

Plot file version 1 created 05-OCT-2021 17:04:31

J0827+5217 GM076.UVDATA.1

Freq = 1.5945 GHz, Bw = 32.000 MH No calibration applied and no bandpass applied

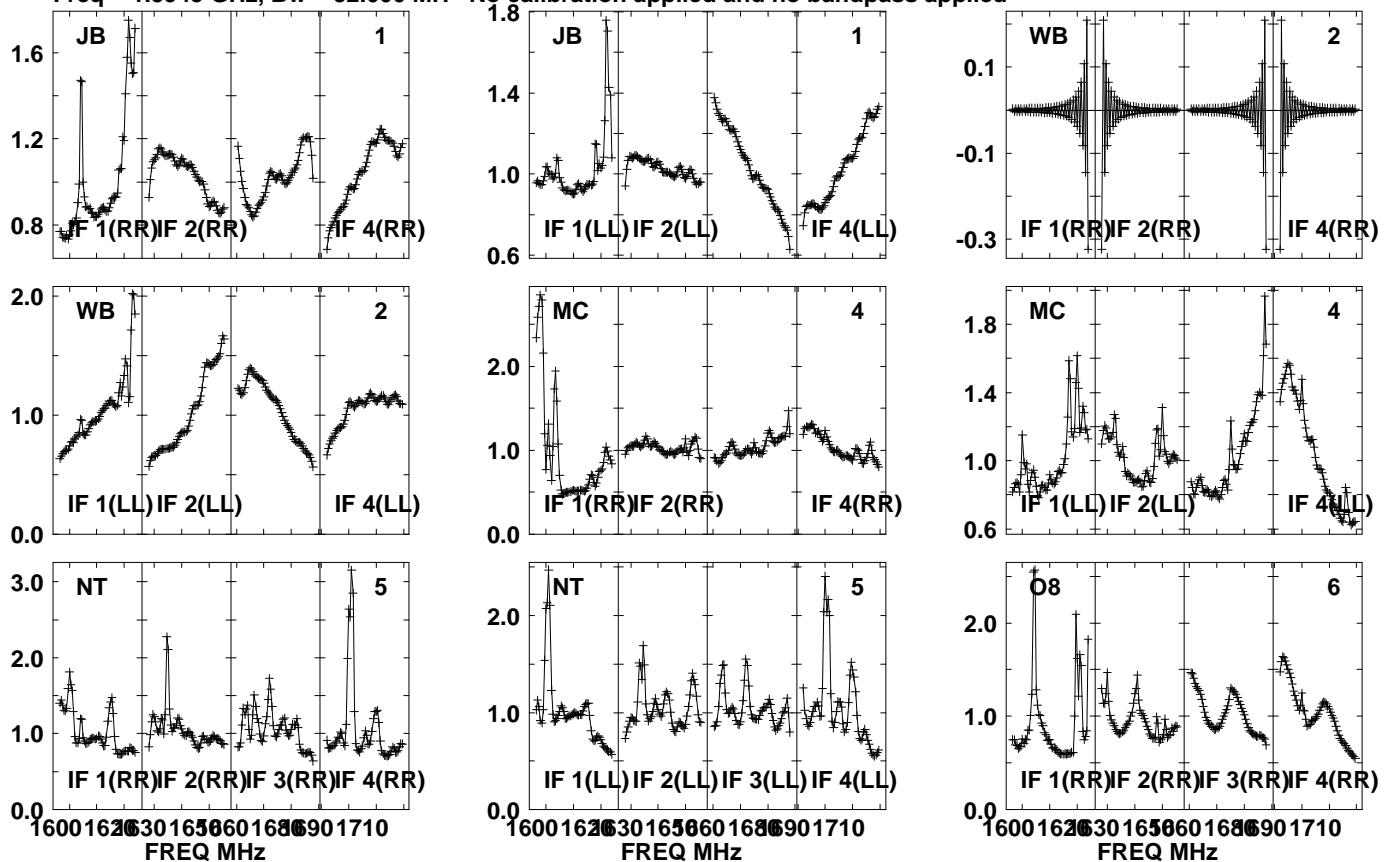

Lower frame: Real Jy  
Auto-corr total-power spectrum Antenna: \*  
Timerange: 00/10:30:01 to 00/10:31:29

Plot file version 2 created 05-OCT-2021 17:04:31

J0827+5217 GM076.UVDATA.1

Freq = 1.5945 GHz, Bw = 32.000 MH No calibration applied and no bandpass applied

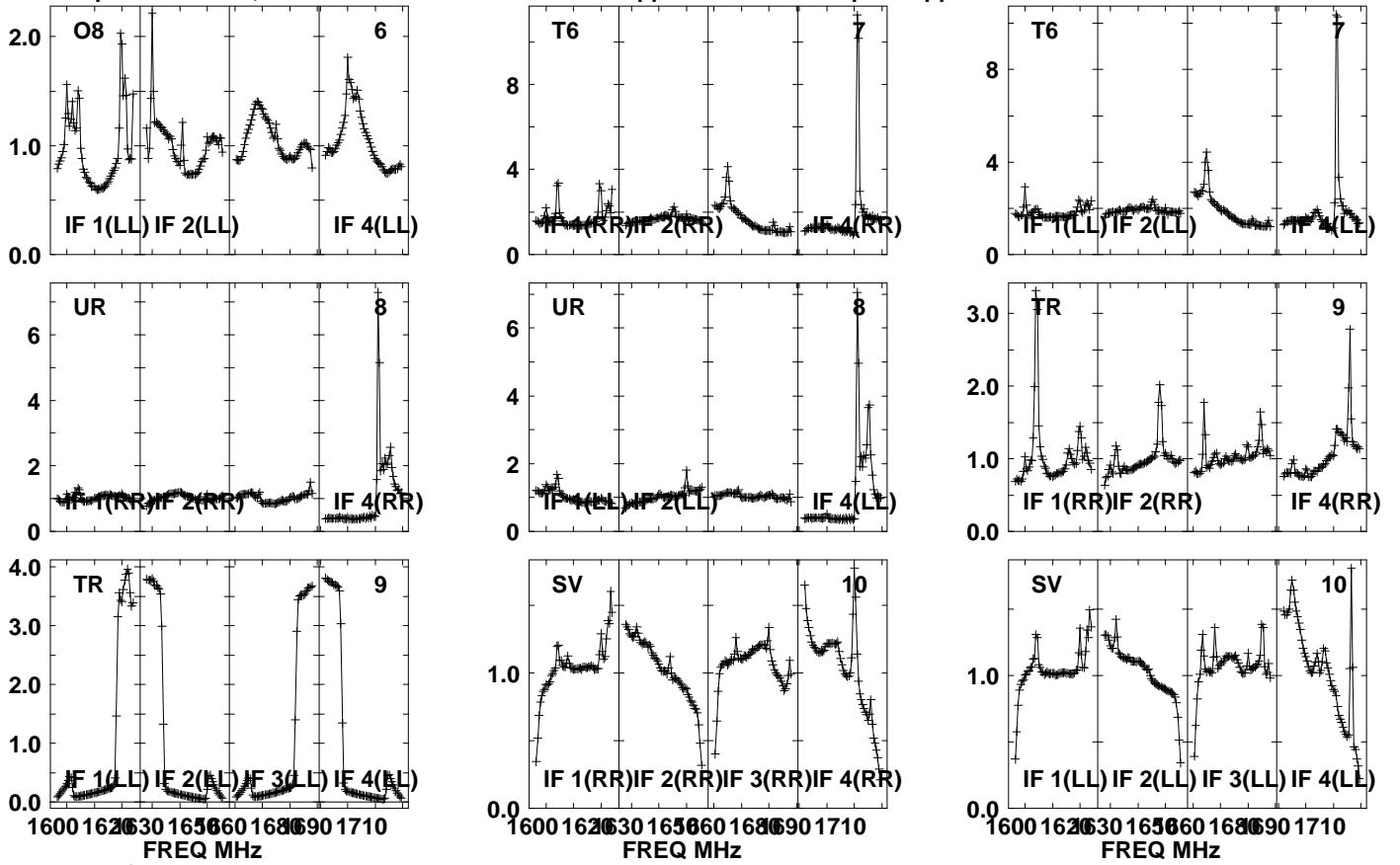

Lower frame: Real Jy

Auto-corr total-power spectrum Antenna: \*

Timerange: 00/10:30:01 to 00/10:31:29



Plot file version 3 created 05-OCT-2021 17:04:31

J0827+5217 GM076.UVDATA.1

Freq = 1.5945 GHz, Bw = 32.000 MH No calibration applied and no bandpass applied

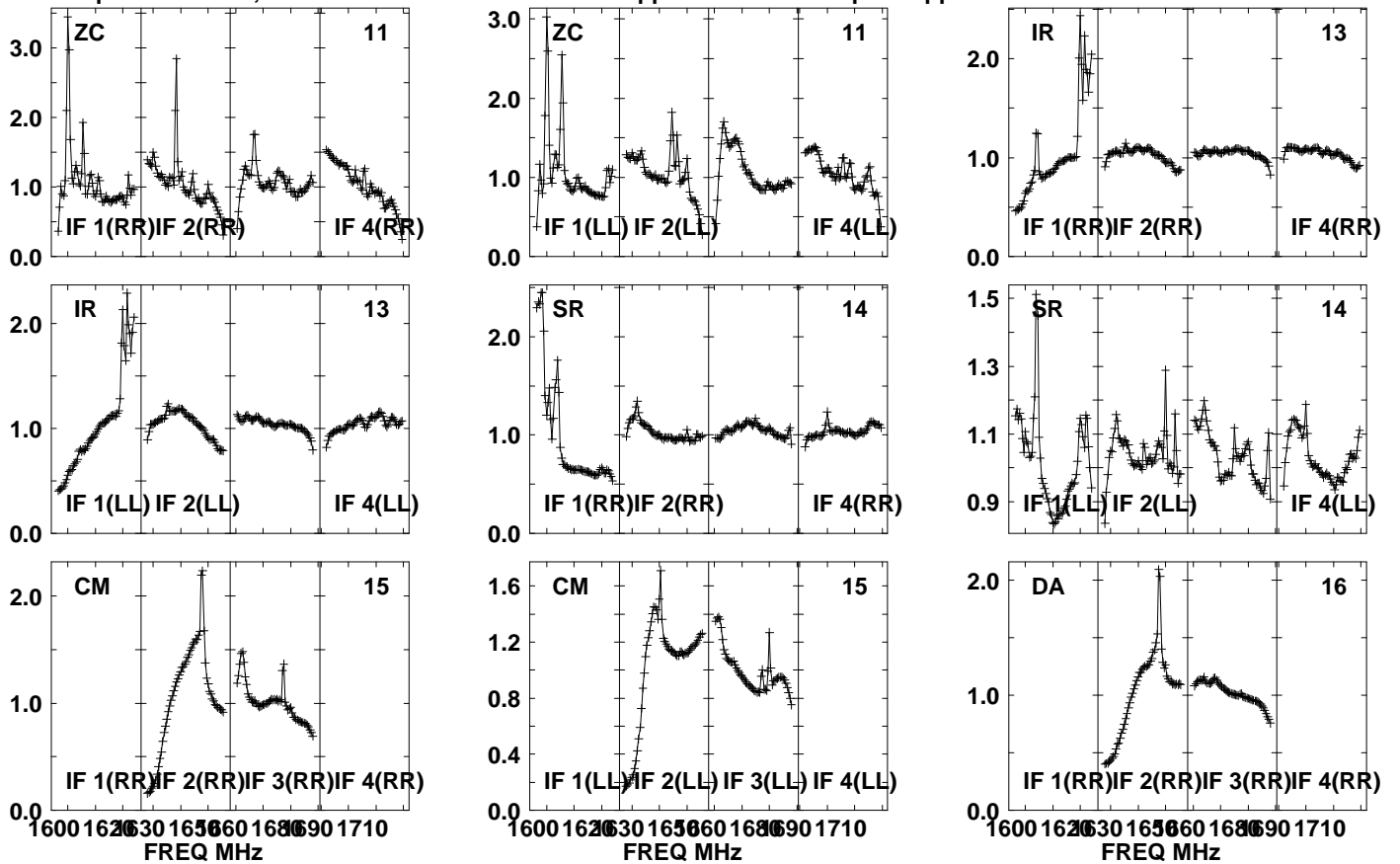

Lower frame: Real Jy

Auto-corr total-power spectrum Antenna: \*

Timerange: 00/10:30:01 to 00/10:31:29

Plot file version 4 created 05-OCT-2021 17:04:32

J0827+5217 GM076.UVDATA.1

Freq = 1.5945 GHz, Bw = 32.000 MH No calibration applied and no bandpass applied

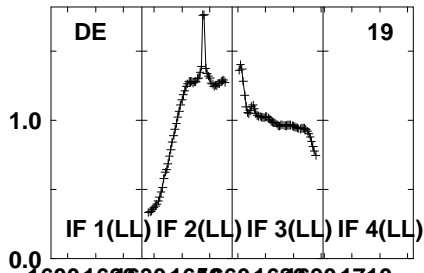
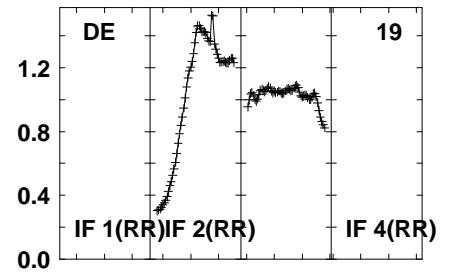
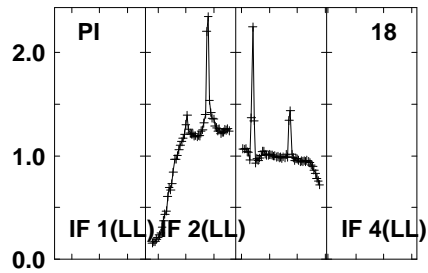
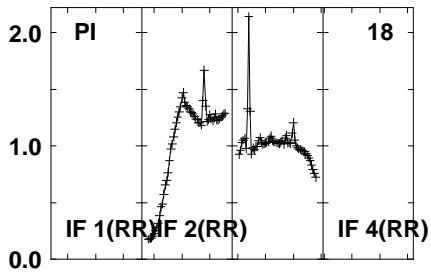
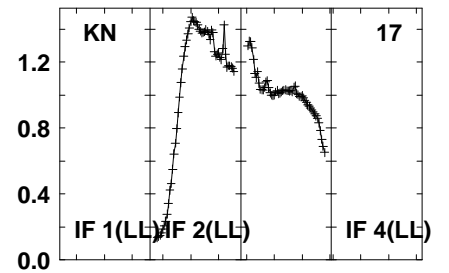
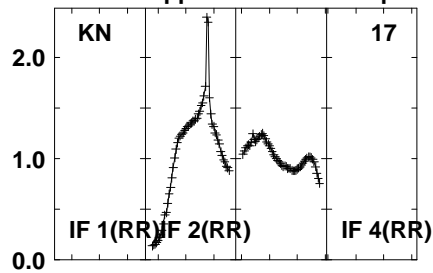
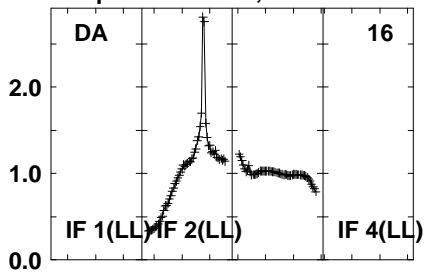

1600 1620 1630 1650 1660 1680 1690 1710  
FREQ MHz

Lower frame: Real Jy

Auto-corr total-power spectrum Antenna: \*

Timerange: 00/10:30:01 to 00/10:31:29

Plot file version 5 created 05-OCT-2021 17:04:32

APM08279+525 GM076.UVDATA.1

Freq = 1.5945 GHz, Bw = 32.000 MH No calibration applied and no bandpass applied

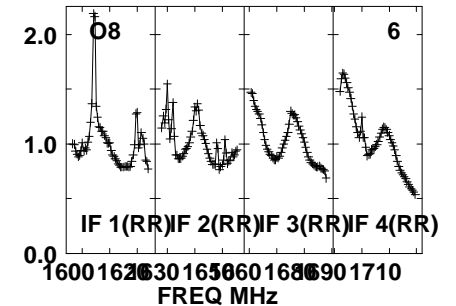
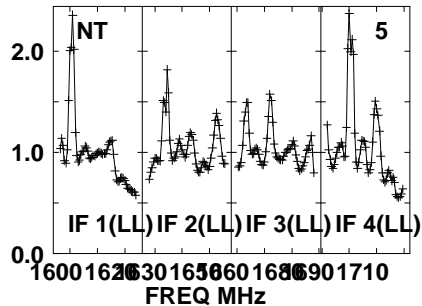
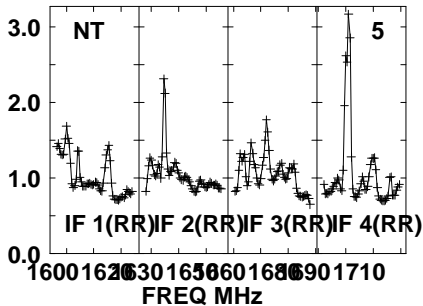
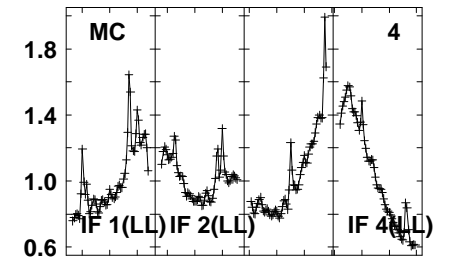
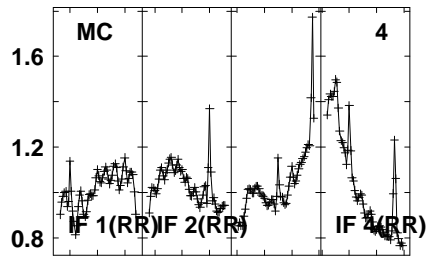
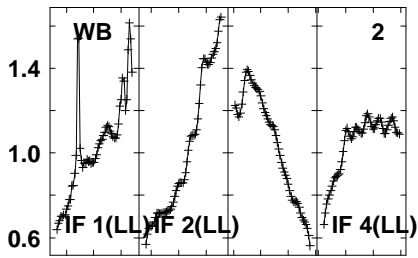
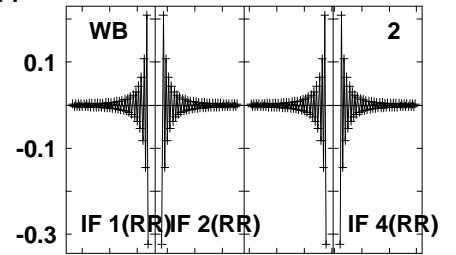
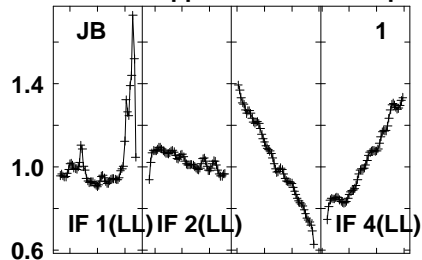
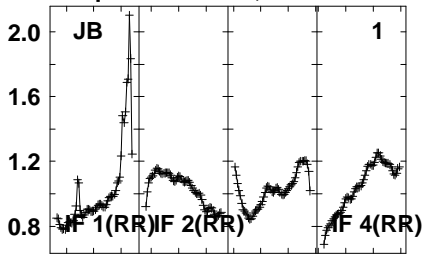

Lower frame: Real Jy  
Auto-corr total-power spectrum Antenna: \*  
Timerange: 00/10:31:31 to 00/10:34:59

Plot file version 6 created 05-OCT-2021 17:04:32

APM08279+525 GM076.UVDATA.1

Freq = 1.5945 GHz, Bw = 32.000 MH No calibration applied and no bandpass applied

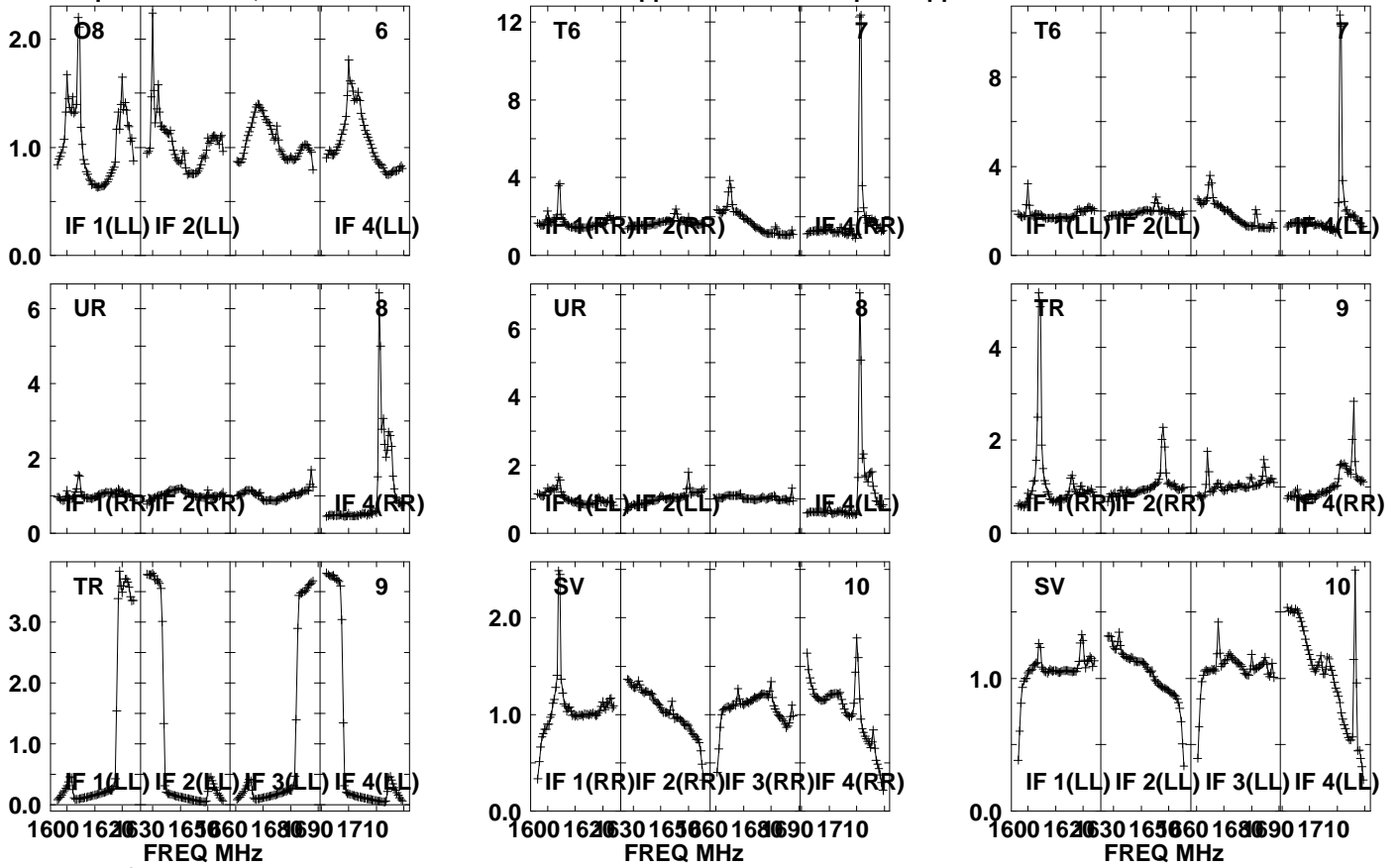

Lower frame: Real Jy

Auto-corr total-power spectrum Antenna: \*

Timerange: 00/10:31:31 to 00/10:34:59

Plot file version 7 created 05-OCT-2021 17:04:32

APM08279+525 GM076.UVDATA.1

Freq = 1.5945 GHz, Bw = 32.000 MH No calibration applied and no bandpass applied

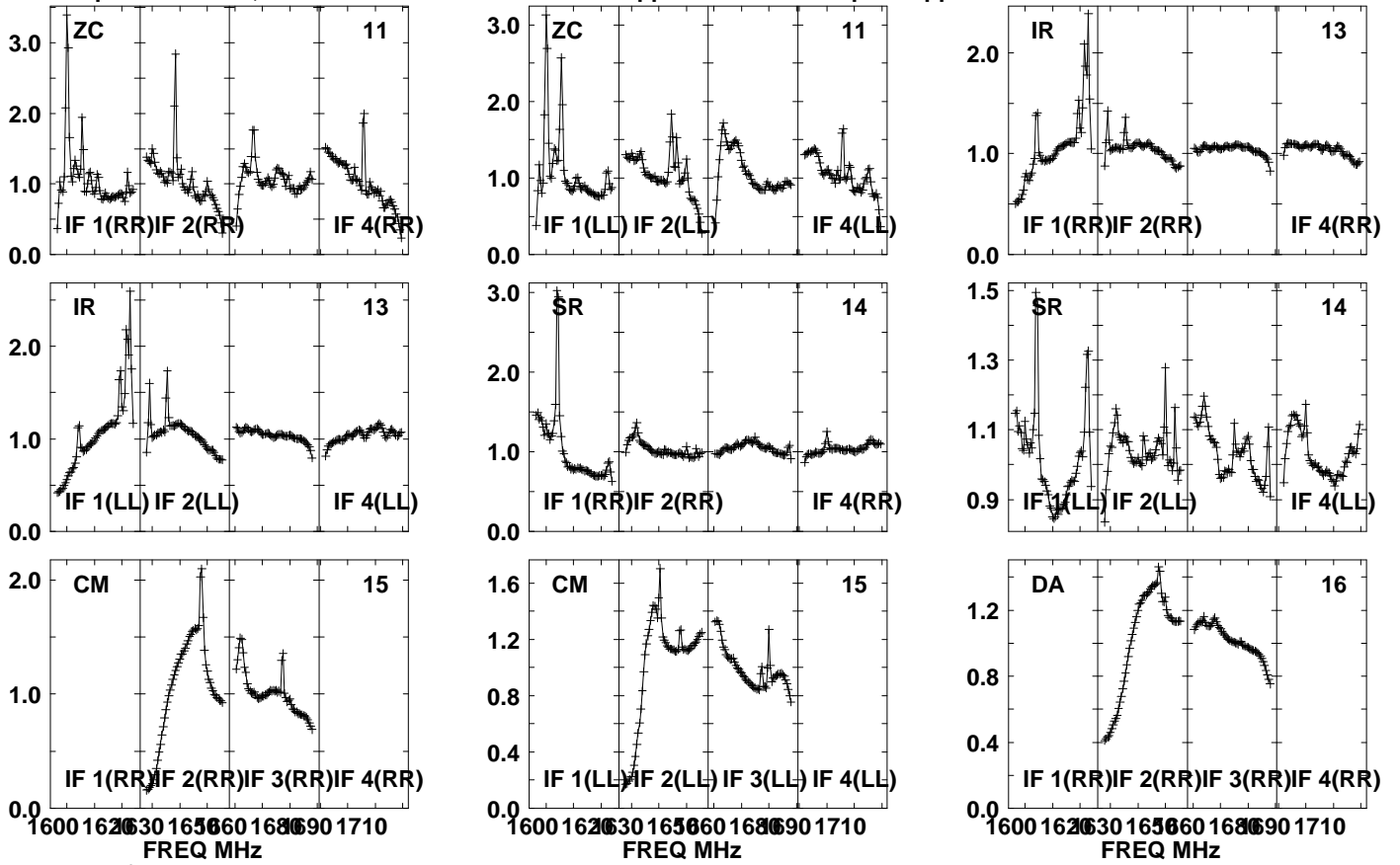

Lower frame: Real Jy

Auto-corr total-power spectrum Antenna: \*

Timerange: 00/10:31:31 to 00/10:34:59

Plot file version 8 created 05-OCT-2021 17:04:33

APM08279+525 GM076.UVDATA.1

Freq = 1.5945 GHz, Bw = 32.000 MH No calibration applied and no bandpass applied

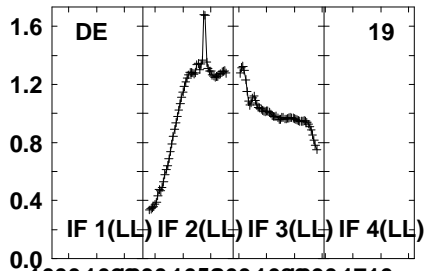
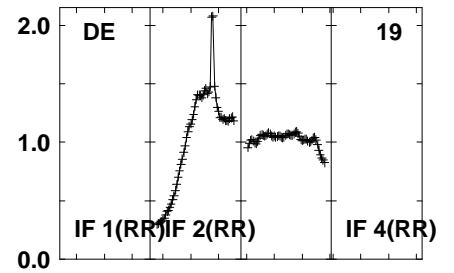
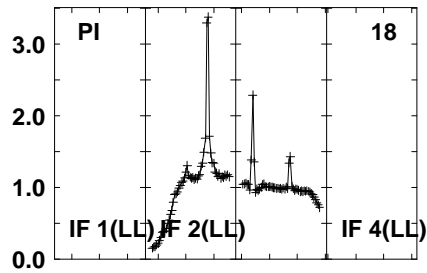
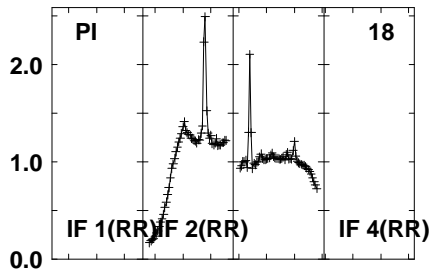
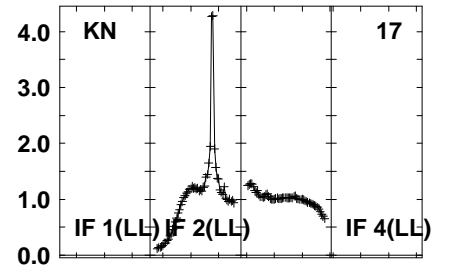
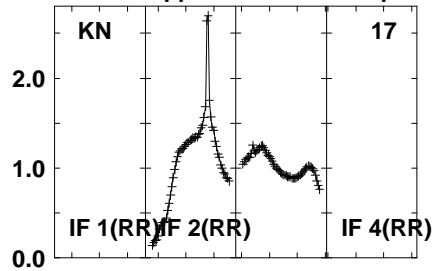
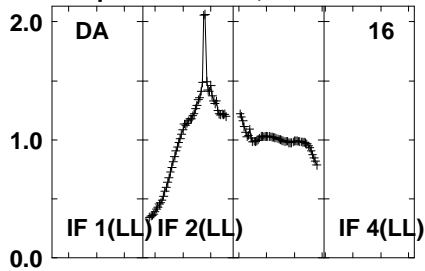

1600 1620 1630 1650 1660 1680 1690 1710  
FREQ MHz

Lower frame: Real Jy

Auto-corr total-power spectrum Antenna: \*

Timerange: 00/10/31:31 to 00/10/34:59

Plot file version 9 created 05-OCT-2021 17:04:33

J0827+5217 GM076.UVDATA.1

Freq = 1.5945 GHz, Bw = 32.000 MH No calibration applied and no bandpass applied

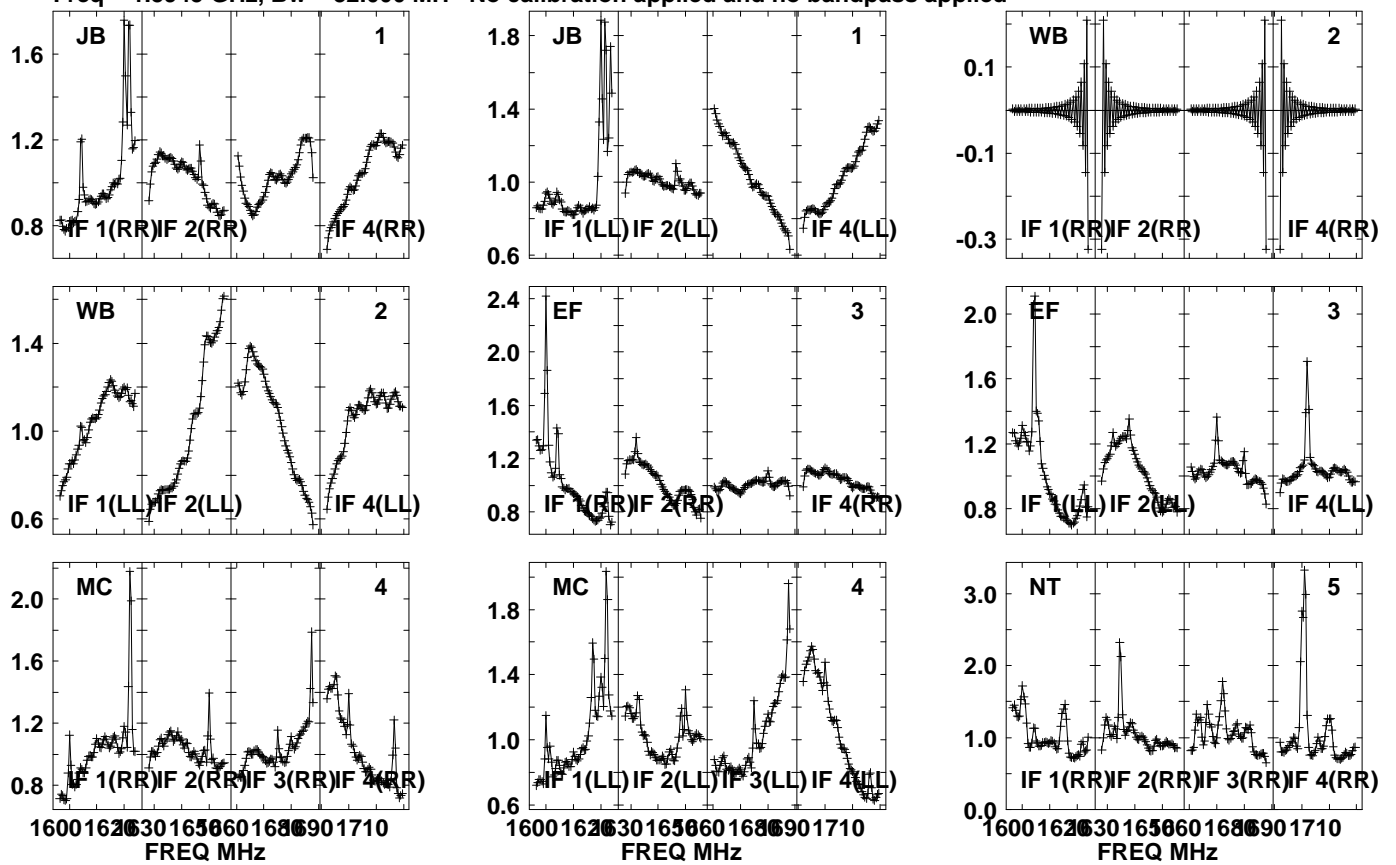

Lower frame: Real Jy  
Auto-corr total-power spectrum Antenna: \*  
Timerange: 00/10:35:31 to 00/10:36:59

Plot file version 10 created 05-OCT-2021 17:04:33

J0827+5217 GM076.UVDATA.1

Freq = 1.5945 GHz, Bw = 32.000 MH No calibration applied and no bandpass applied

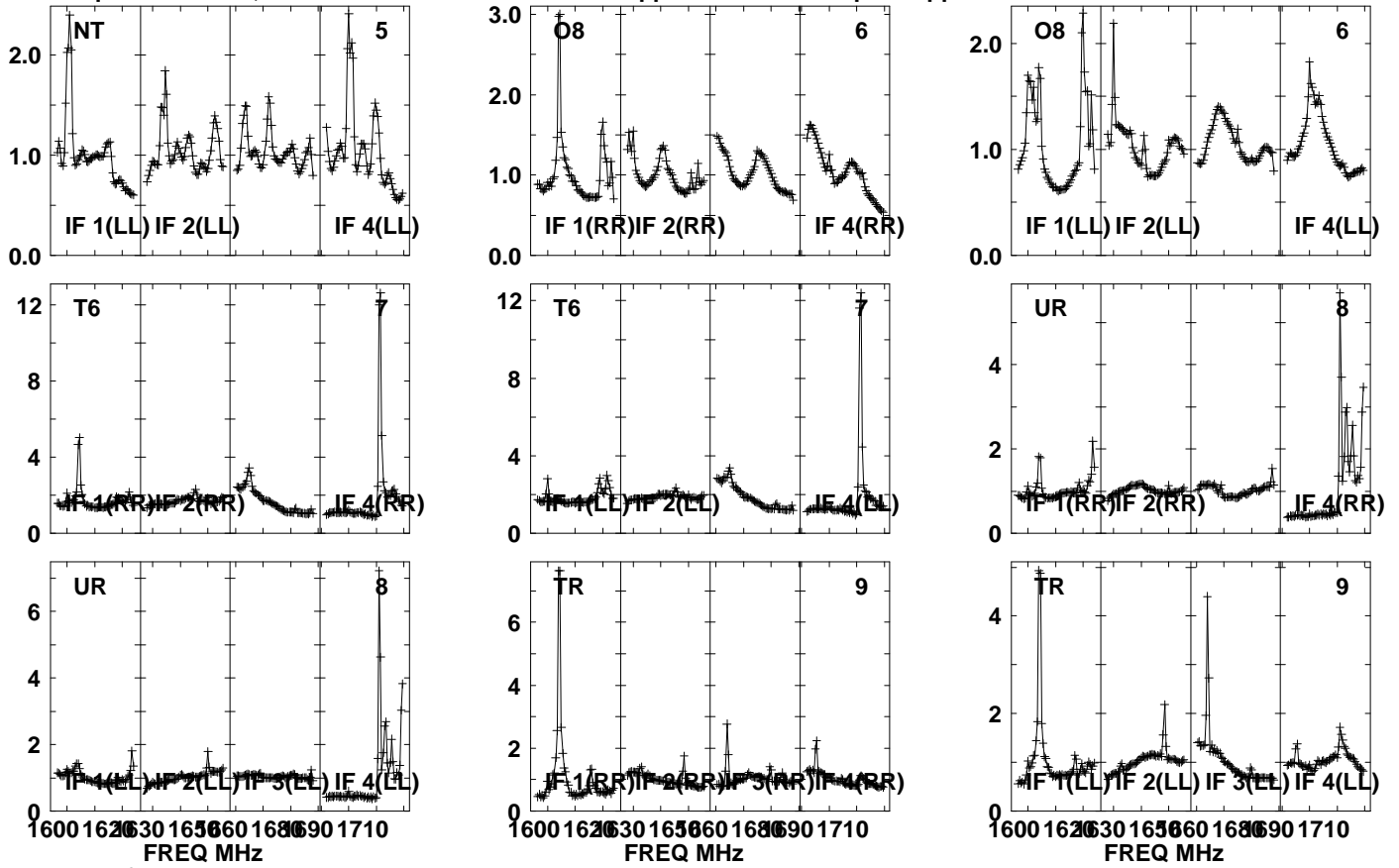

Lower frame: Real Jy  
Auto-corr total-power spectrum Antenna: \*  
Timerange: 00/10:35:31 to 00/10:36:59



Plot file version 11 created 05-OCT-2021 17:04:33

J0827+5217 GM076.UVDATA.1

Freq = 1.5945 GHz, Bw = 32.000 MH No calibration applied and no bandpass applied

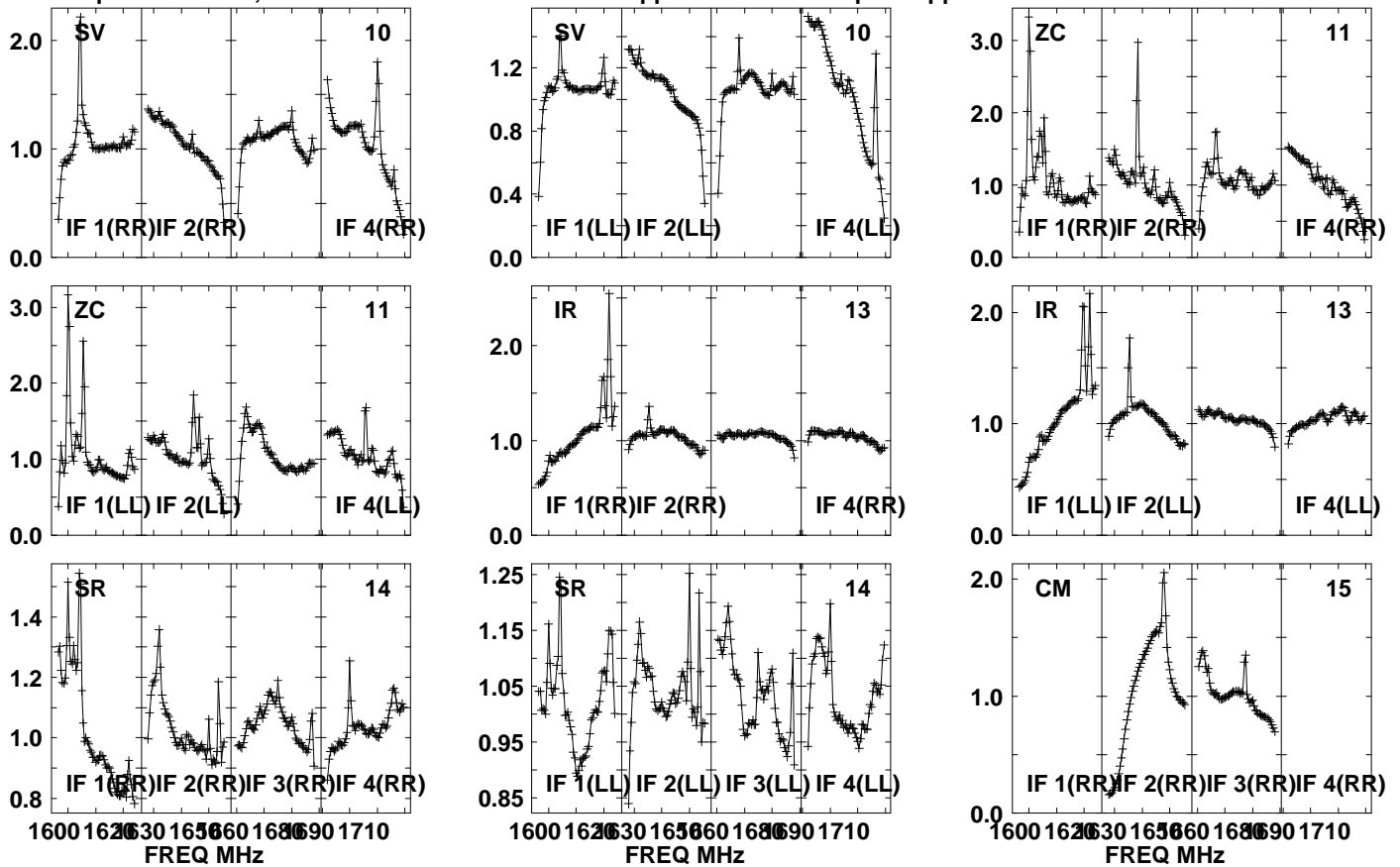

Lower frame: Real Jy  
Auto-corr total-power spectrum Antenna: \*  
Timerange: 00/10:35:31 to 00/10:36:59

Plot file version 12 created 05-OCT-2021 17:04:33

J0827+5217 GM076.UVDATA.1

Freq = 1.5945 GHz, Bw = 32.000 MH No calibration applied and no bandpass applied

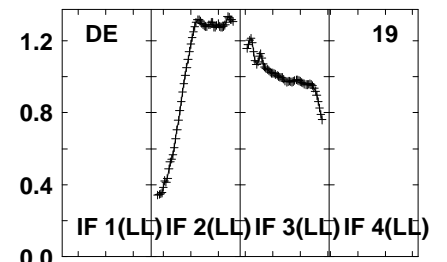
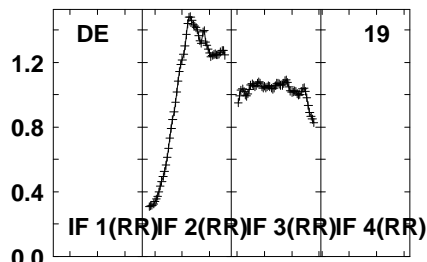
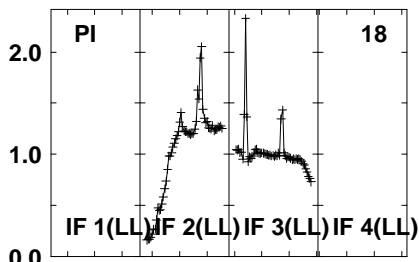
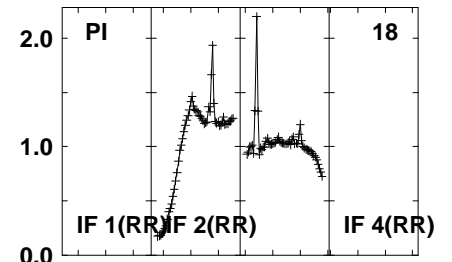
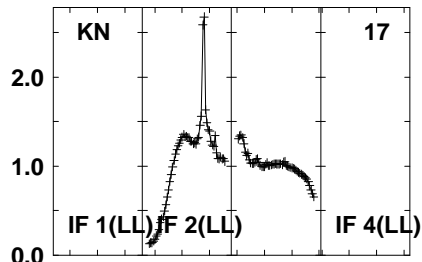
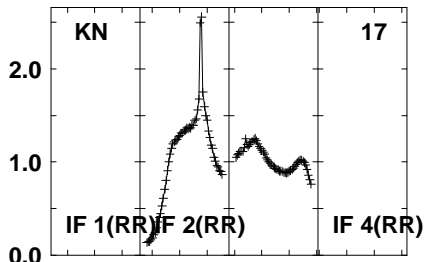
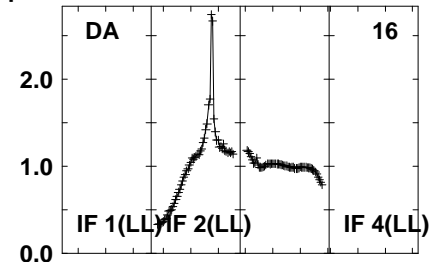
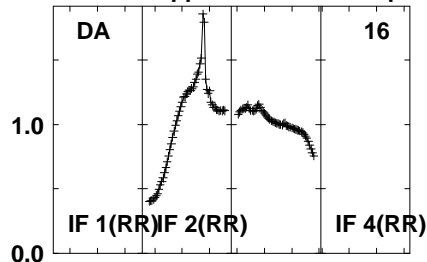
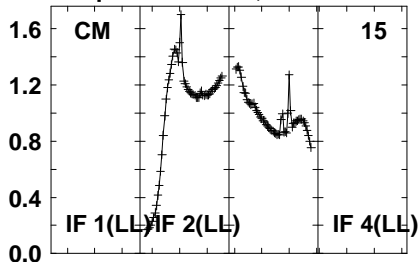

1600 1620 1630 1650 1660 1680 1690 1710  
FREQ MHz

Lower frame: Real Jy  
Auto-corr total-power spectrum Antenna: \*  
Timerange: 00/10:35:31 to 00/10:36:59

Plot file version 13 created 05-OCT-2021 17:04:34

APM08279+525 GM076.UVDATA.1

Freq = 1.5945 GHz, Bw = 32.000 MH No calibration applied and no bandpass applied

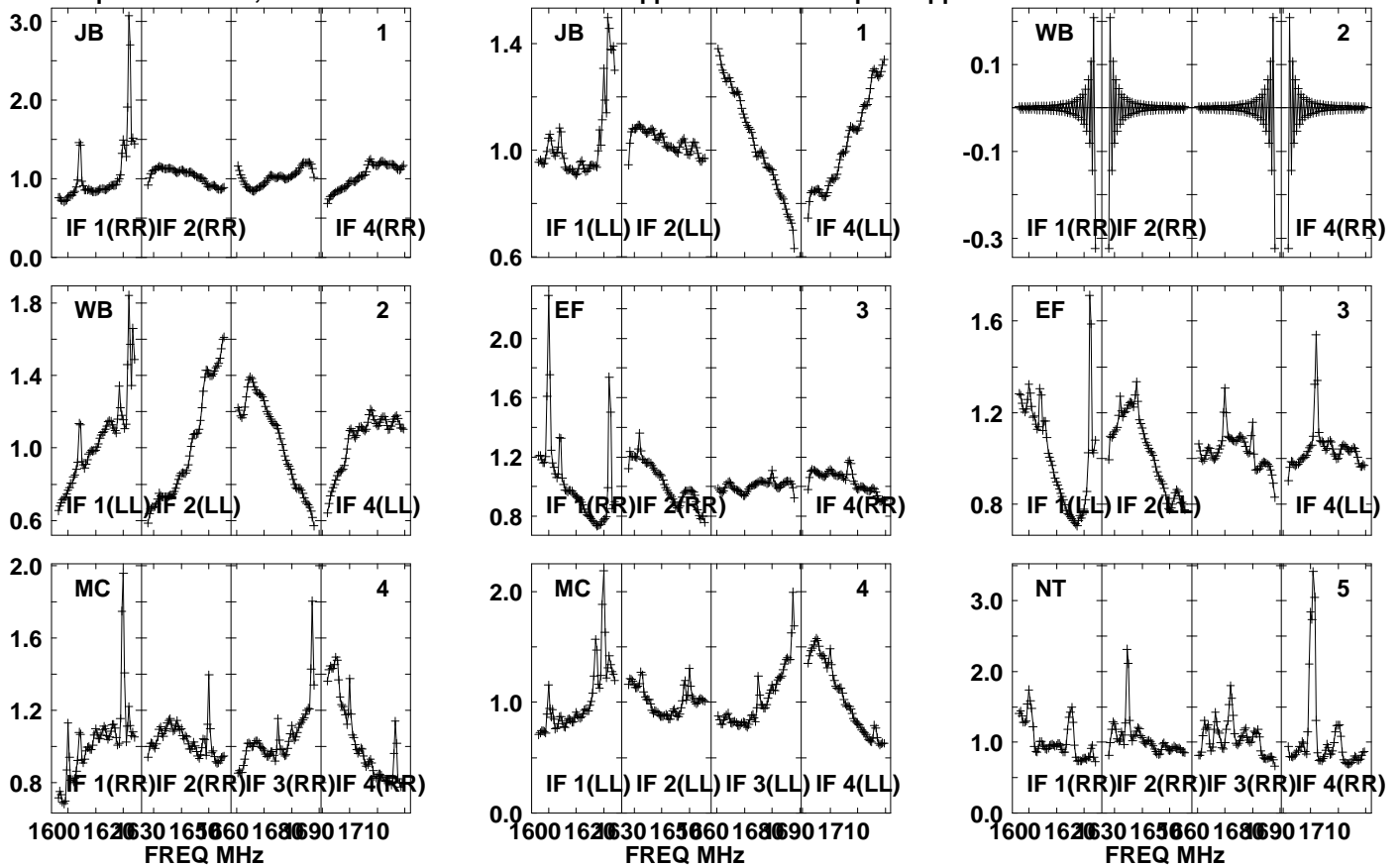

Lower frame: Real Jy

Auto-corr total-power spectrum Antenna: \*

Timerange: 00/10:37:01 to 00/10:40:29

Plot file version 14 created 05-OCT-2021 17:04:34

APM08279+525 GM076.UVDATA.1

Freq = 1.5945 GHz, Bw = 32.000 MH No calibration applied and no bandpass applied

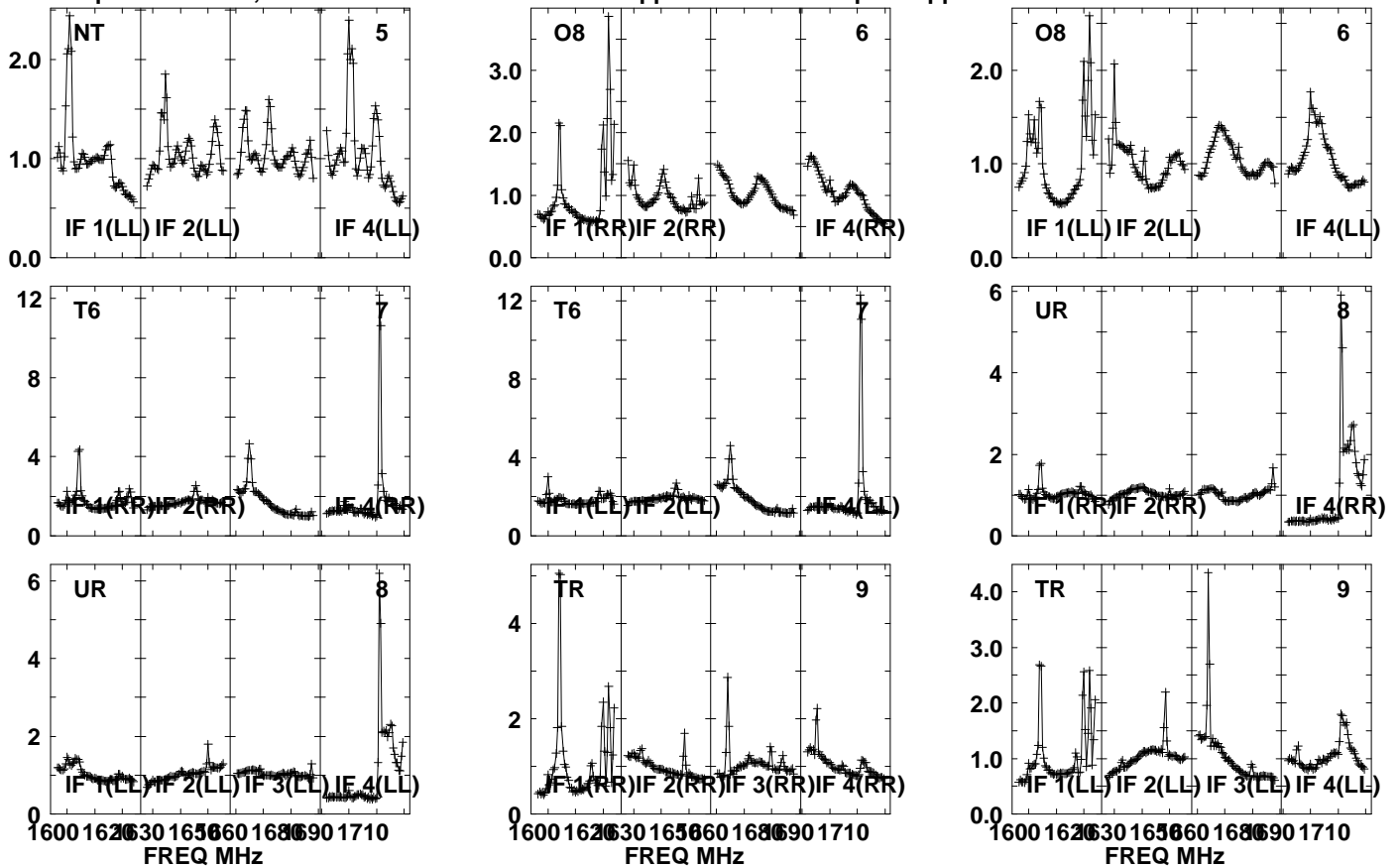

Lower frame: Real Jy

Auto-corr total-power spectrum Antenna: \*

Timerange: 00/10:37:01 to 00/10:40:29

Plot file version 15 created 05-OCT-2021 17:04:34

APM08279+525 GM076.UVDATA.1

Freq = 1.5945 GHz, Bw = 32.000 MH No calibration applied and no bandpass applied

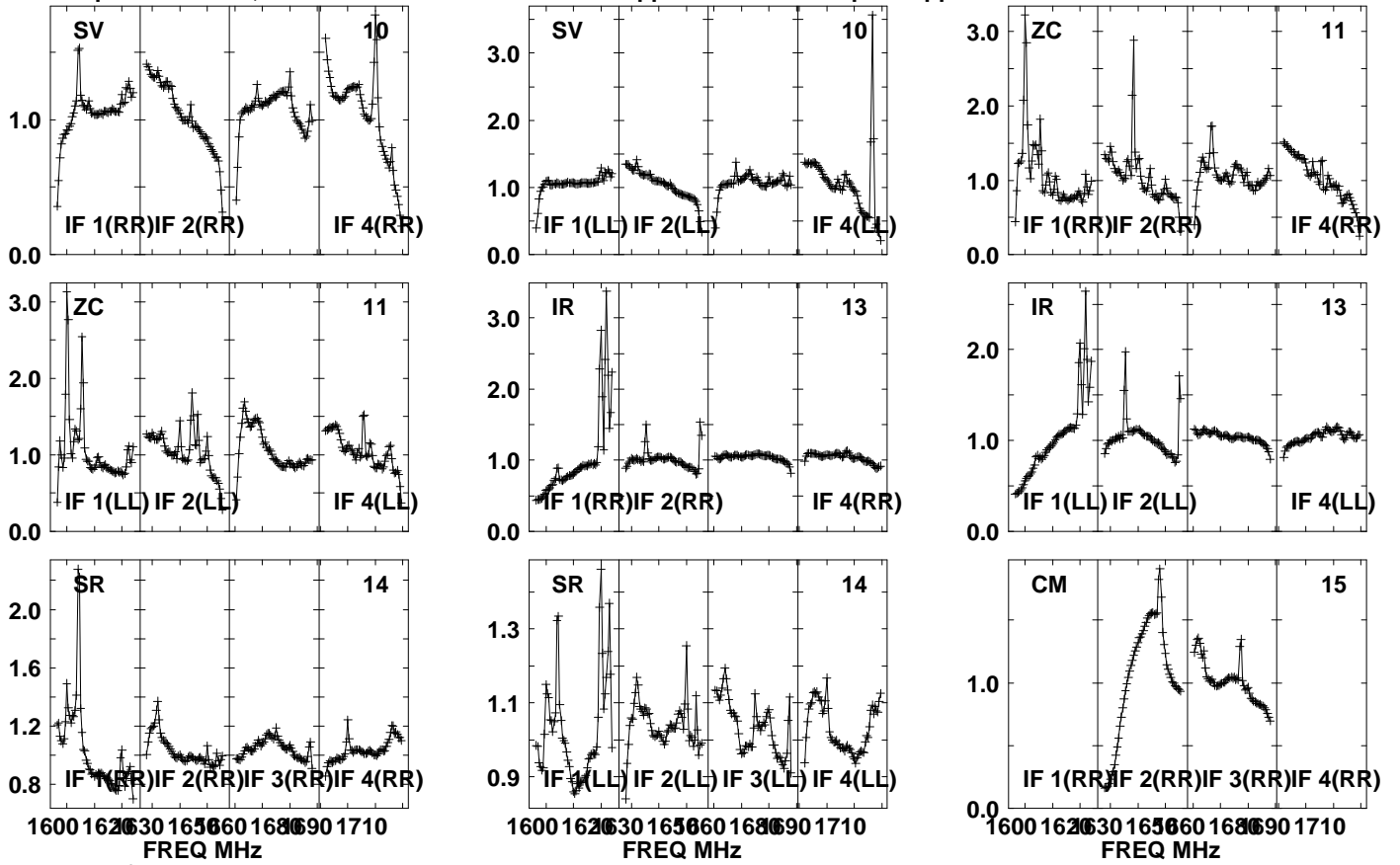

Lower frame: Real Jy  
Auto-corr total-power spectrum Antenna: \*  
Timerange: 00/10:37:01 to 00/10:40:29

Plot file version 16 created 05-OCT-2021 17:04:34

APM08279+525 GM076.UVDATA.1

Freq = 1.5945 GHz, Bw = 32.000 MH No calibration applied and no bandpass applied

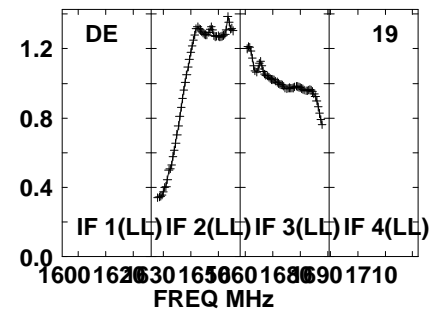
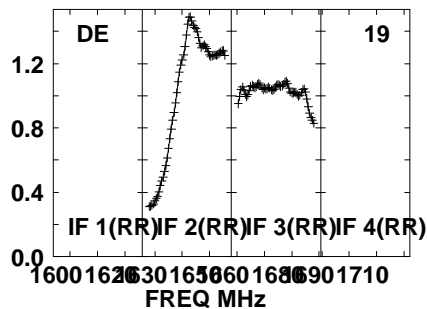
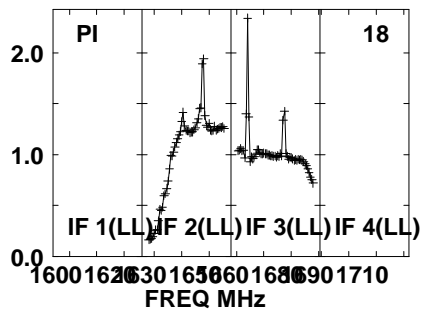
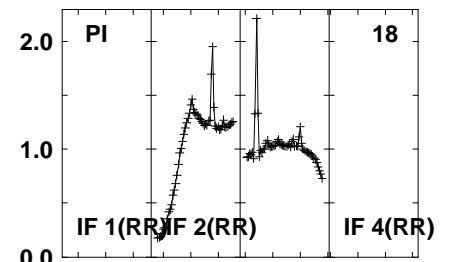
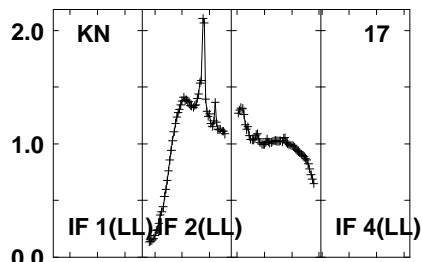
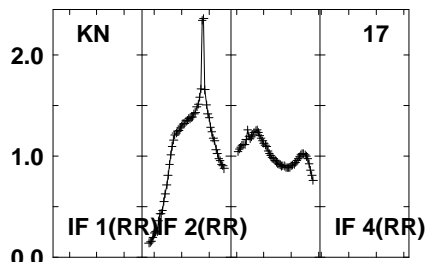
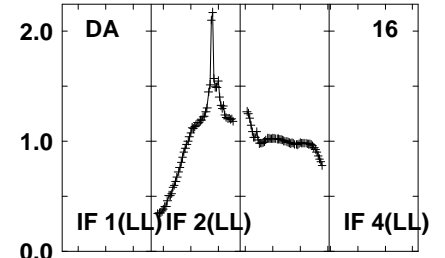
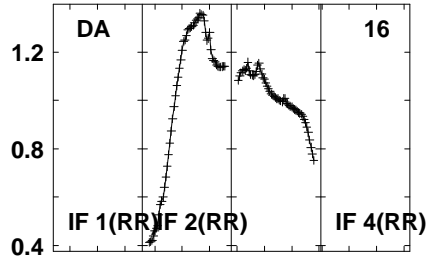
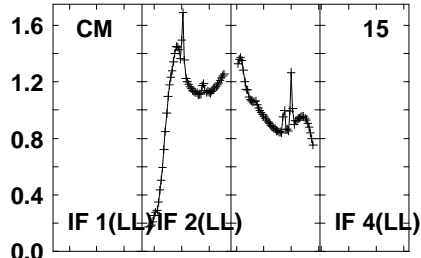

Lower frame: Real Jy  
Auto-corr total-power spectrum Antenna: \*  
Timerange: 00/10:37:01 to 00/10:40:29

Plot file version 17 created 05-OCT-2021 17:04:35

J0827+5217 GM076.UVDATA.1

Freq = 1.5945 GHz, Bw = 32.000 MH No calibration applied and no bandpass applied

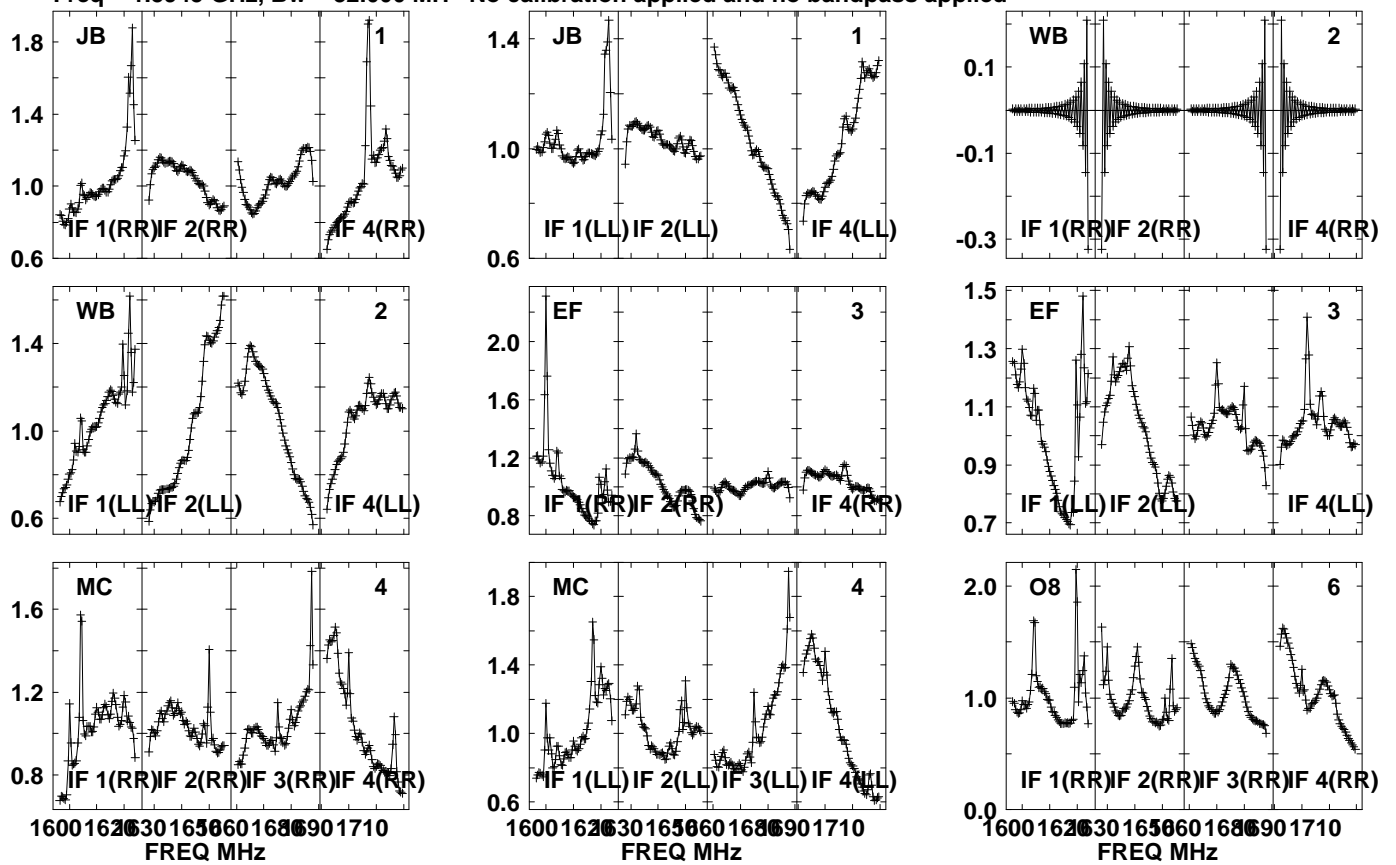

Lower frame: Real Jy  
Auto-corr total-power spectrum Antenna: \*  
Timerange: 00/10:40:31 to 00/10:41:59

Plot file version 18 created 05-OCT-2021 17:04:35

J0827+5217 GM076.UVDATA.1

Freq = 1.5945 GHz, Bw = 32.000 MH No calibration applied and no bandpass applied

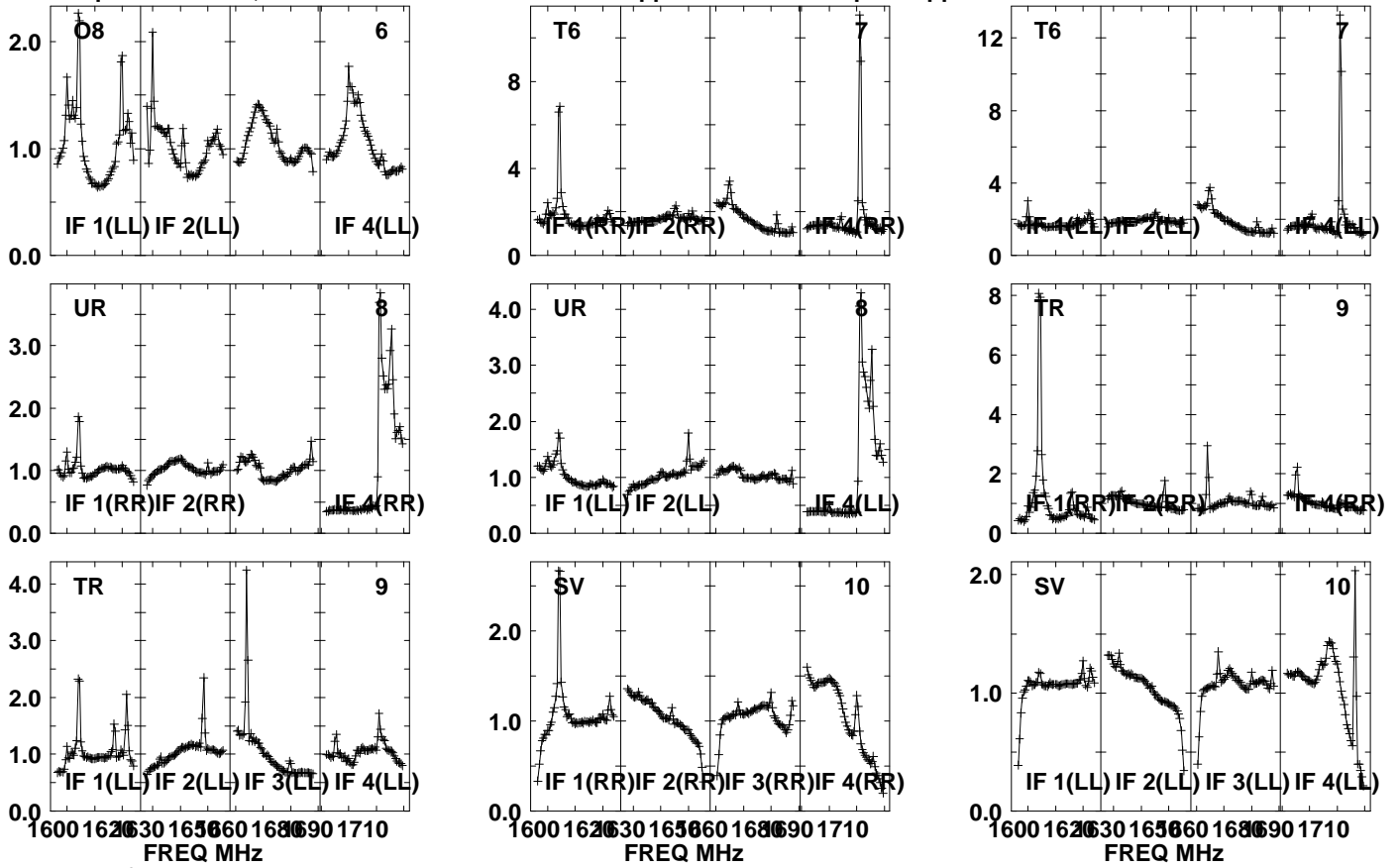

Lower frame: Real Jy  
Auto-corr total-power spectrum Antenna: \*  
Timerange: 00/10:40:31 to 00/10:41:59



Plot file version 19 created 05-OCT-2021 17:04:35

J0827+5217 GM076.UVDATA.1

Freq = 1.5945 GHz, Bw = 32.000 MH No calibration applied and no bandpass applied

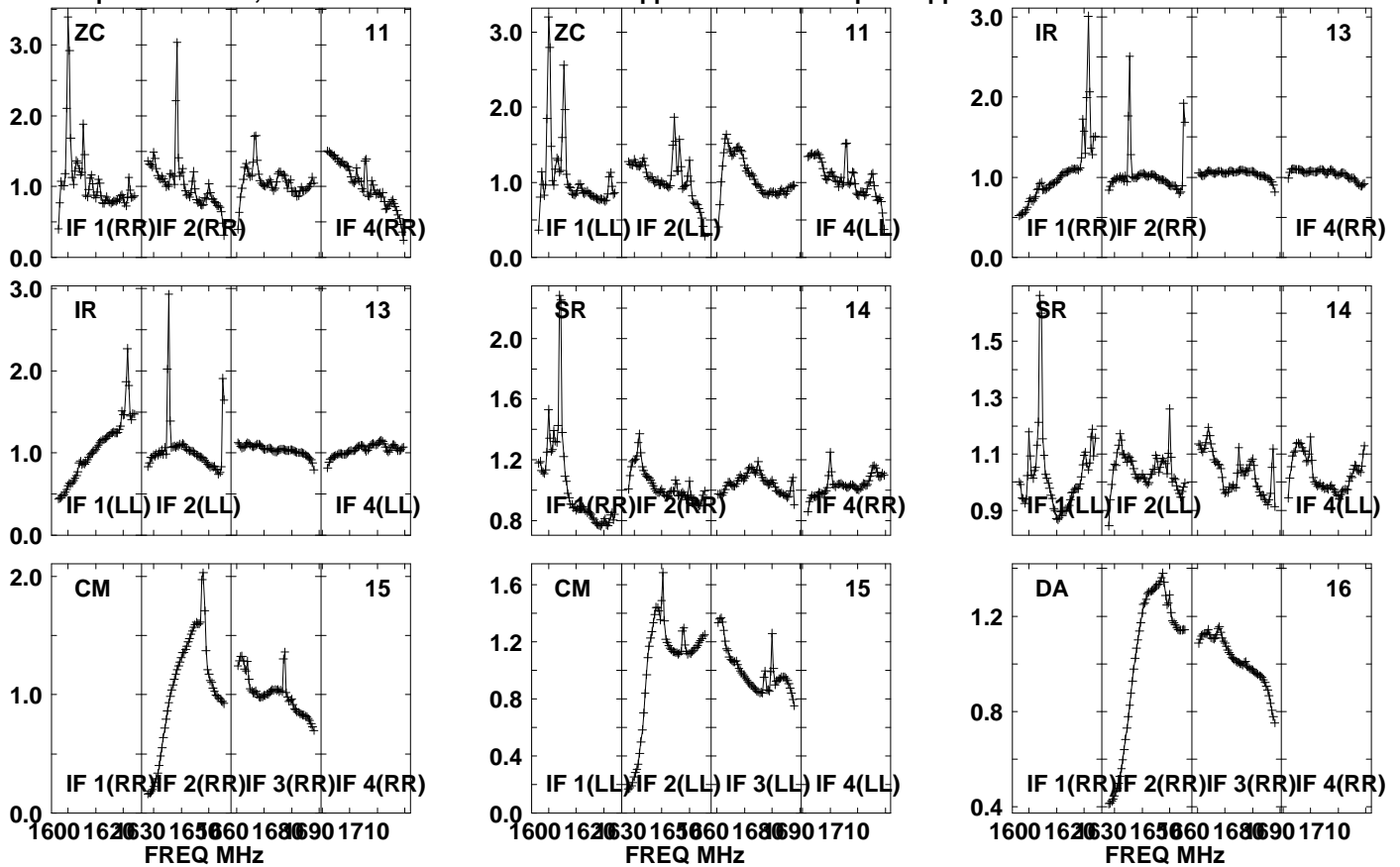

Lower frame: Real Jy

Auto-corr total-power spectrum Antenna: \*

Timerange: 00/10:40:31 to 00/10:41:59

Plot file version 20 created 05-OCT-2021 17:04:35

J0827+5217 GM076.UVDATA.1

Freq = 1.5945 GHz, Bw = 32.000 MH No calibration applied and no bandpass applied

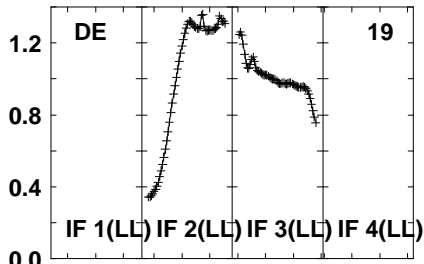
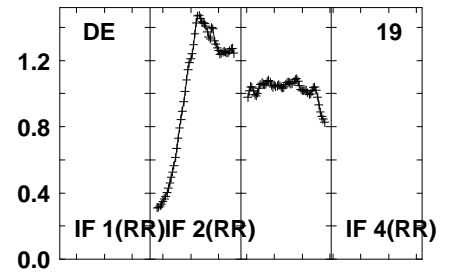
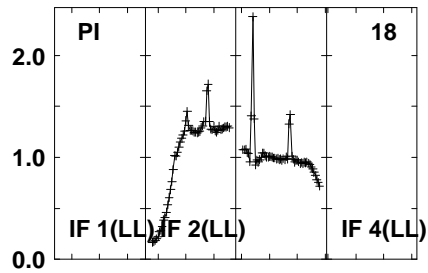
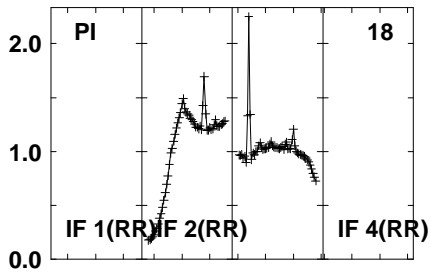
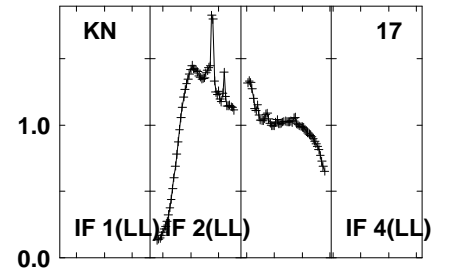
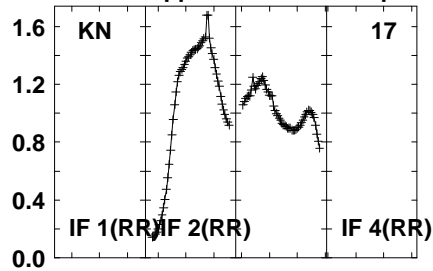
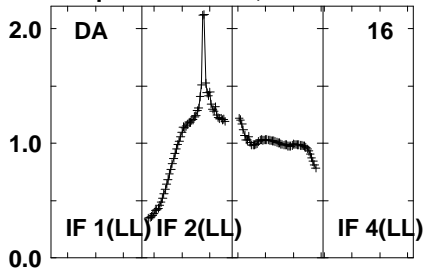

1600 1620 1630 1650 1660 1680 1690 1710  
FREQ MHz

Lower frame: Real Jy

Auto-corr total-power spectrum Antenna: \*

Timerange: 00/10:40:31 to 00/10:41:59

Plot file version 21 created 05-OCT-2021 17:04:36

APM08279+525 GM076.UVDATA.1

Freq = 1.5945 GHz, Bw = 32.000 MH No calibration applied and no bandpass applied

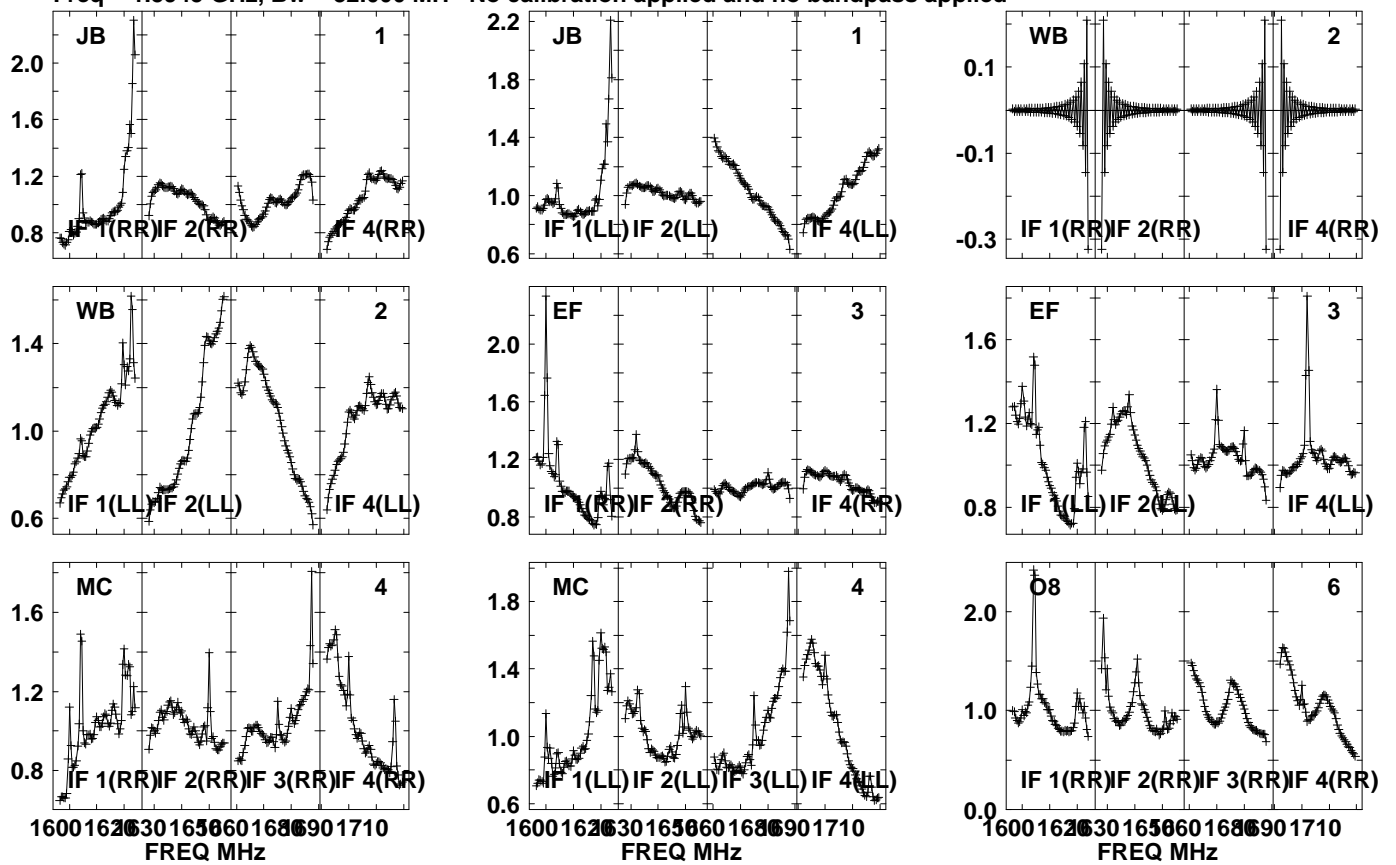

Lower frame: Real Jy  
 Auto-corr total-power spectrum Antenna: \*  
 Timerange: 00/10:42:01 to 00/10:45:29

Plot file version 22 created 05-OCT-2021 17:04:36

APM08279+525 GM076.UVDATA.1

Freq = 1.5945 GHz, Bw = 32.000 MH No calibration applied and no bandpass applied

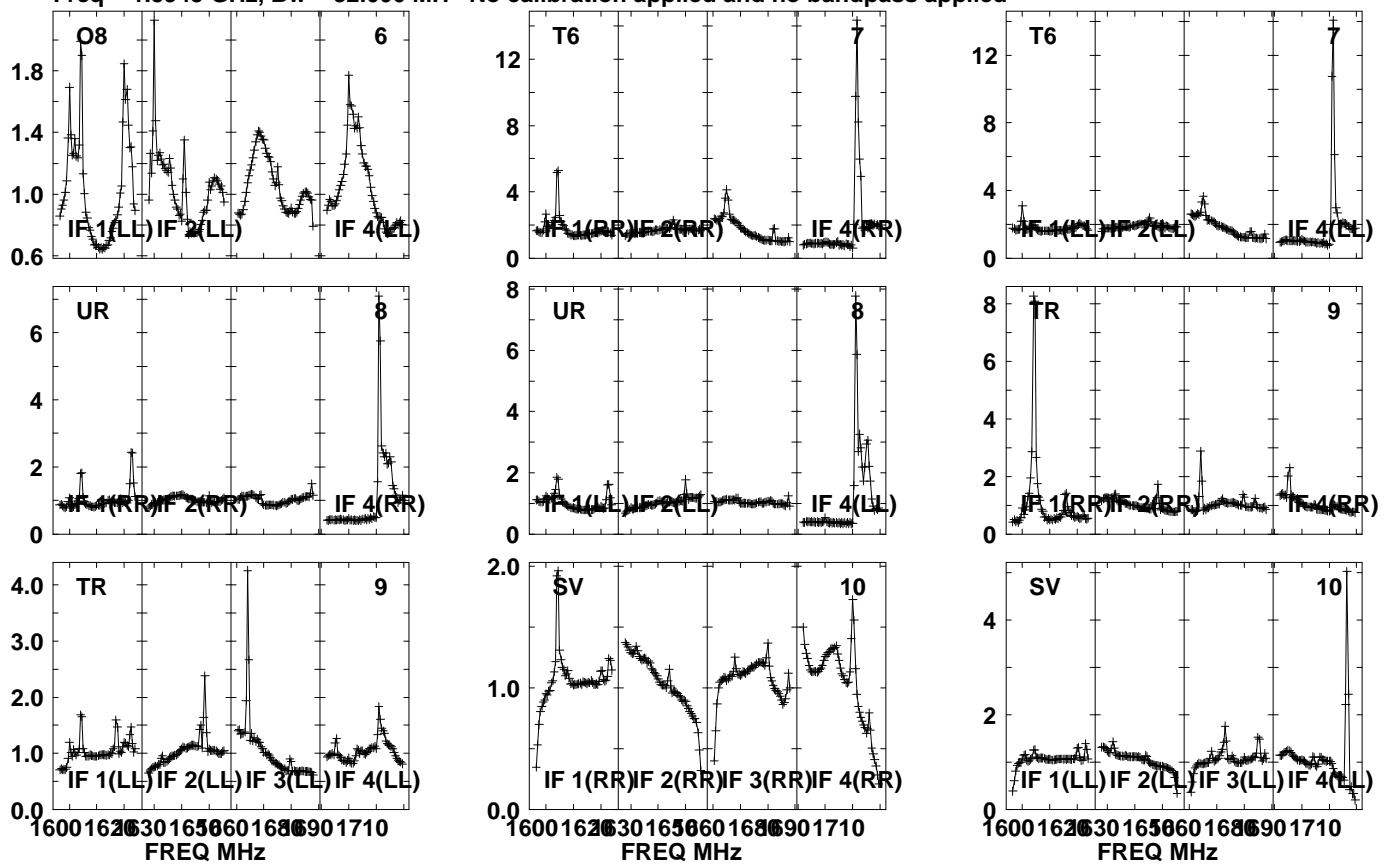

Lower frame: Real Jy  
 Auto-corr total-power spectrum Antenna: \*  
 Timerange: 00/10:42:01 to 00/10:45:29

Plot file version 23 created 05-OCT-2021 17:04:36

APM08279+525 GM076.UVDATA.1

Freq = 1.5945 GHz, Bw = 32.000 MH No calibration applied and no bandpass applied

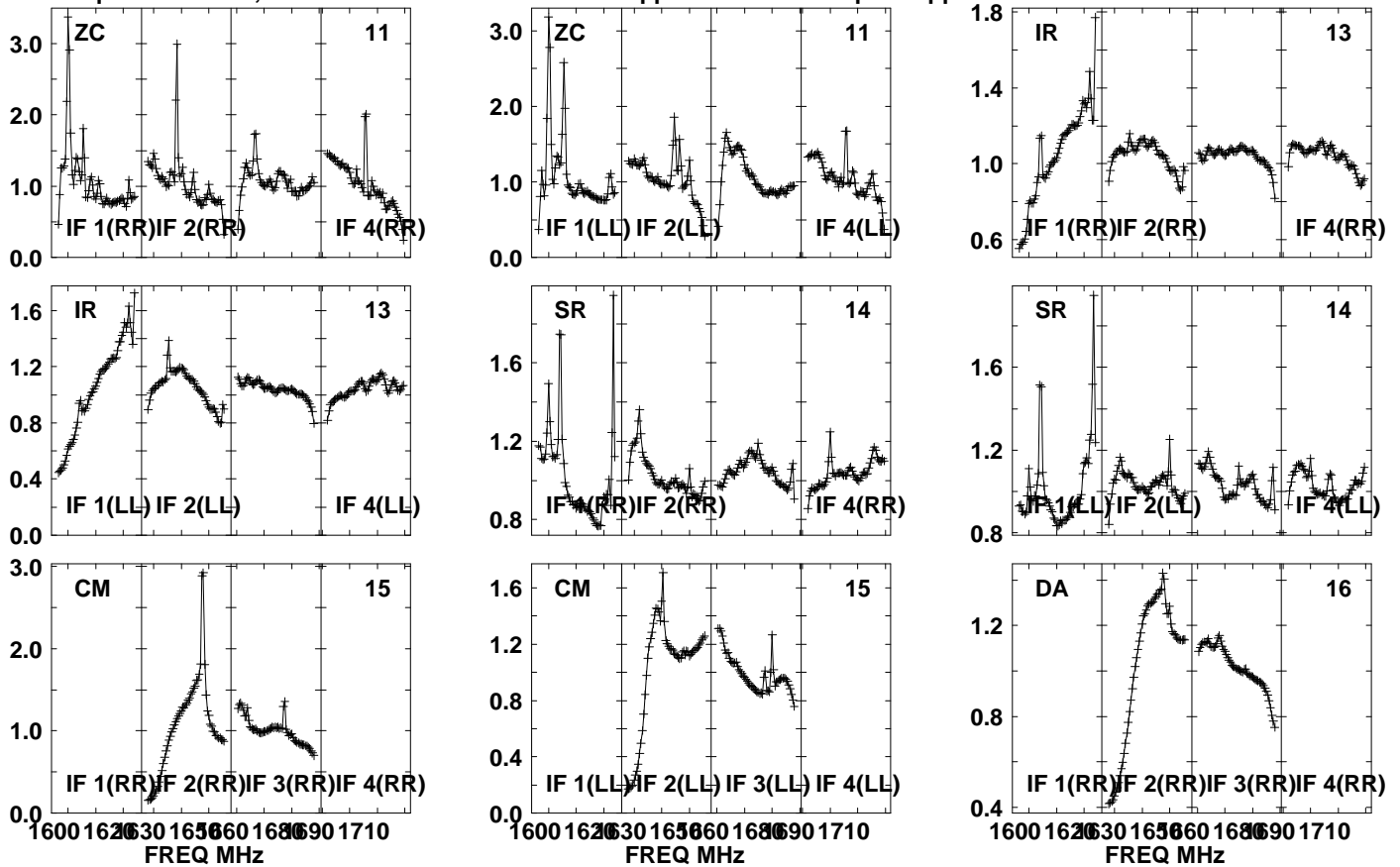

Lower frame: Real Jy

Auto-corr total-power spectrum Antenna: \*

Timerange: 00/10:42:01 to 00/10:45:29

Plot file version 24 created 05-OCT-2021 17:04:36

APM08279+525 GM076.UVDATA.1

Freq = 1.5945 GHz, Bw = 32.000 MH

No calibration applied and no bandpass applied

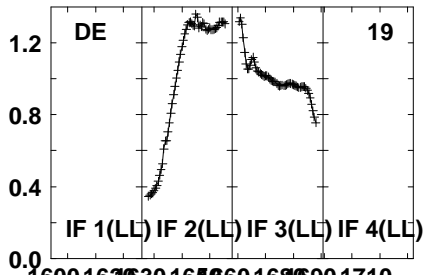
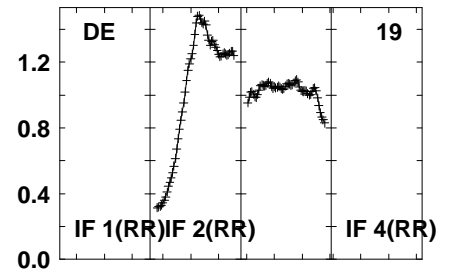
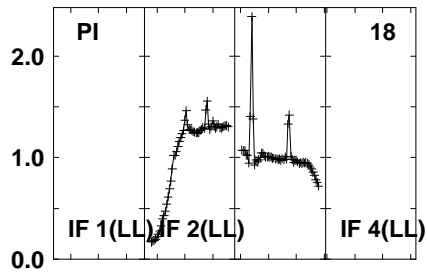
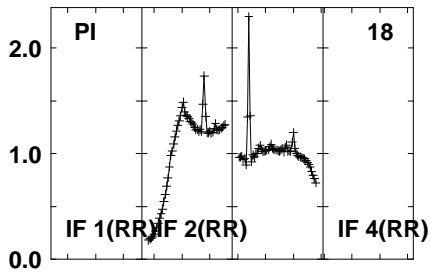
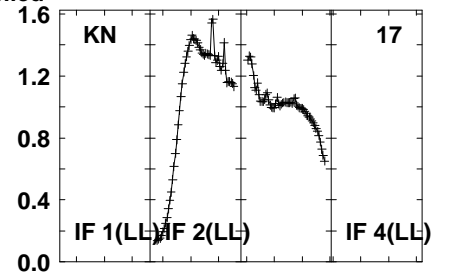
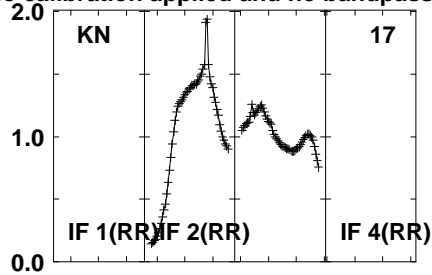
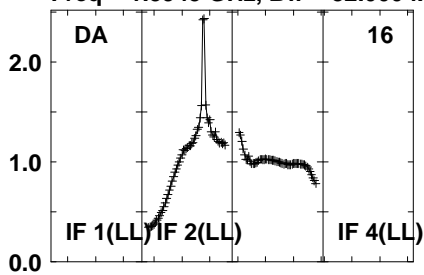

1600 1620 1630 1650 1660 1680 1690 1710  
FREQ MHz

Lower frame: Real Jy

Auto-corr total-power spectrum Antenna: \*

Timerange: 00/10:42:01 to 00/10:45:29

Plot file version 25 created 05-OCT-2021 17:04:37

J0827+5217 GM076.UVDATA.1

Freq = 1.5945 GHz, Bw = 32.000 MH No calibration applied and no bandpass applied

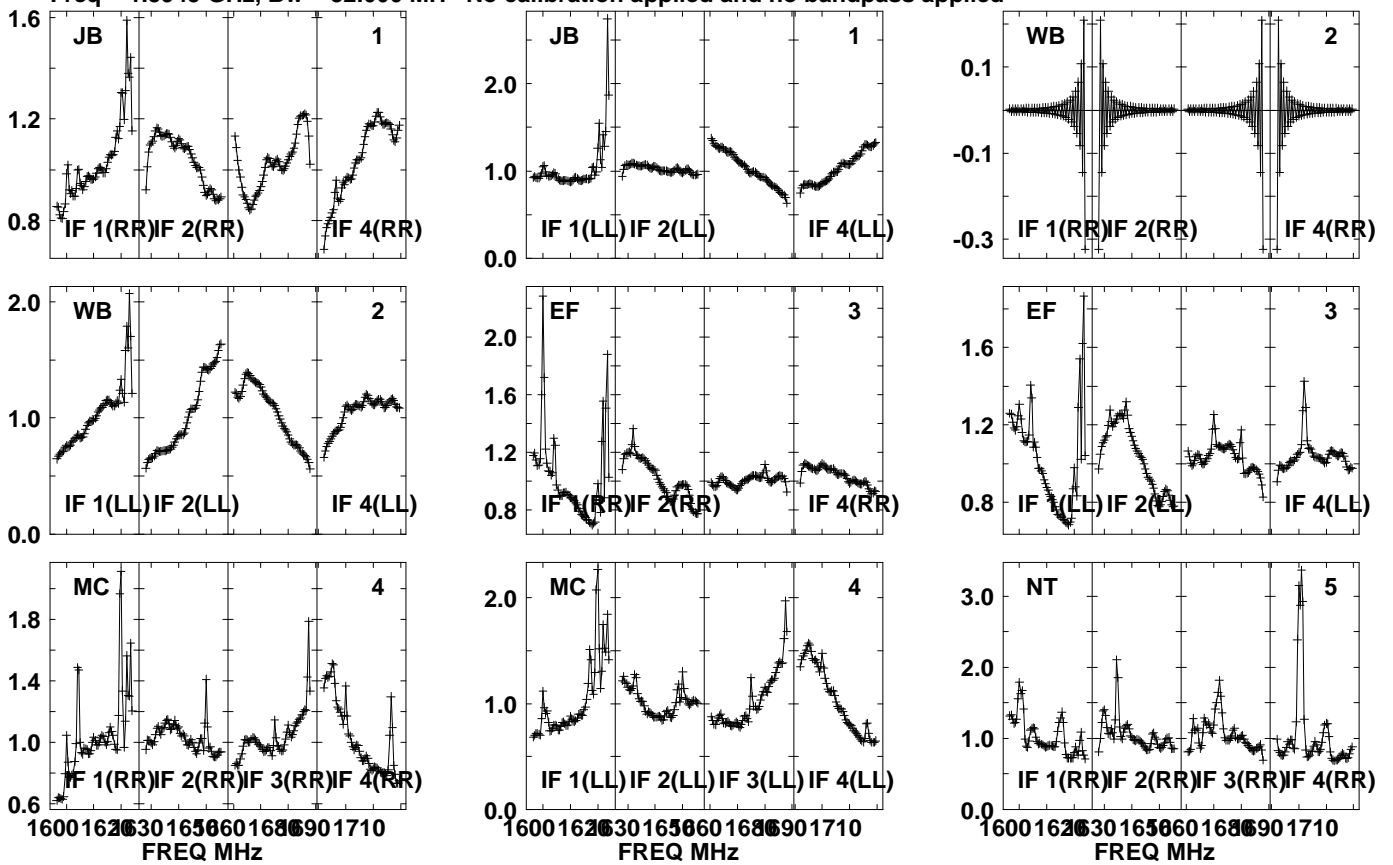

Lower frame: Real Jy  
Auto-corr total-power spectrum Antenna: \*  
Timerange: 00/10:46:01 to 00/10:47:29

Plot file version 26 created 05-OCT-2021 17:04:37

J0827+5217 GM076.UVDATA.1

Freq = 1.5945 GHz, Bw = 32.000 MH No calibration applied and no bandpass applied

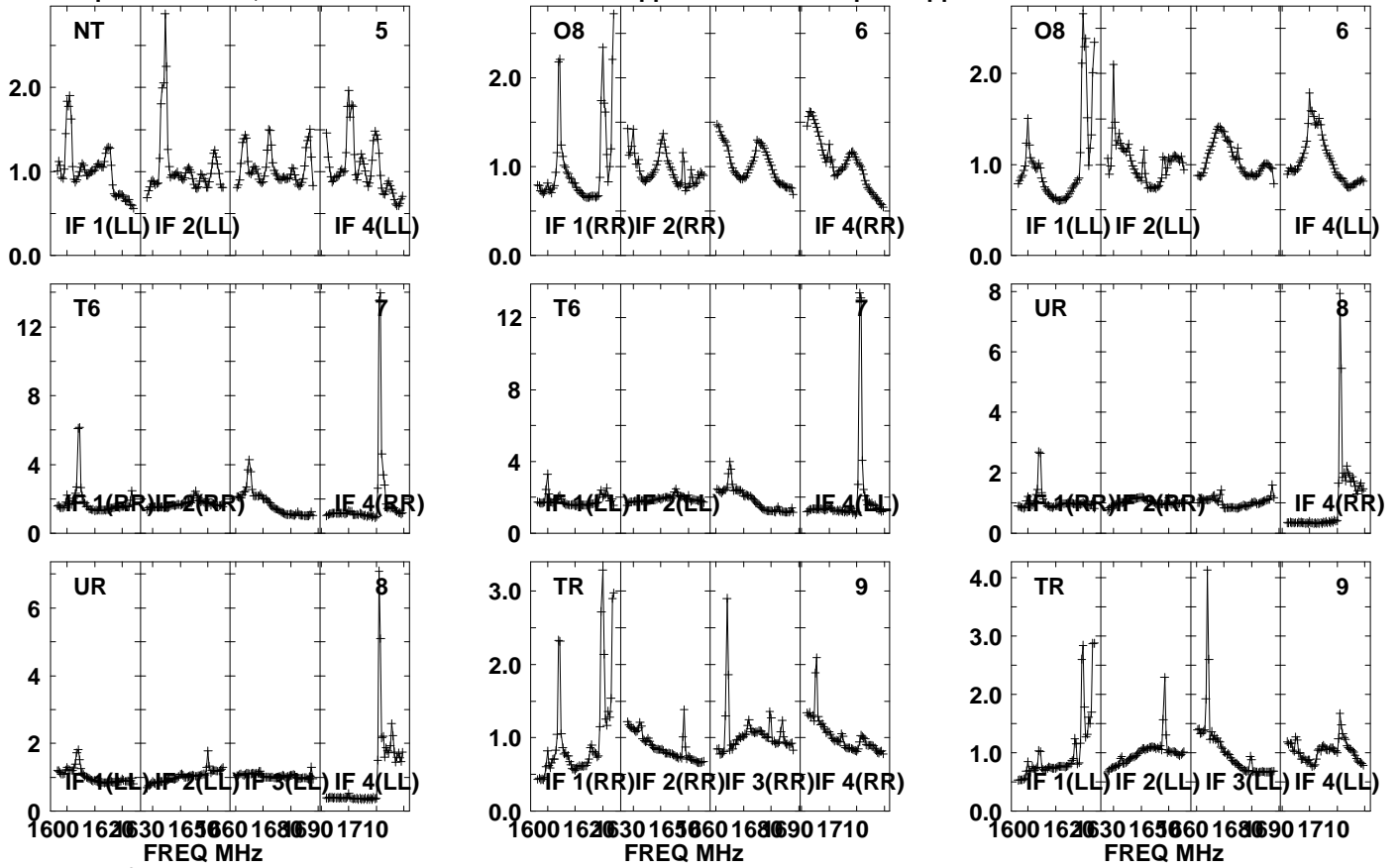

Lower frame: Real Jy

Auto-corr total-power spectrum Antenna: \*

Timerange: 00/10:46:01 to 00/10:47:29



Plot file version 27 created 05-OCT-2021 17:04:37

J0827+5217 GM076.UVDATA.1

Freq = 1.5945 GHz, Bw = 32.000 MH No calibration applied and no bandpass applied

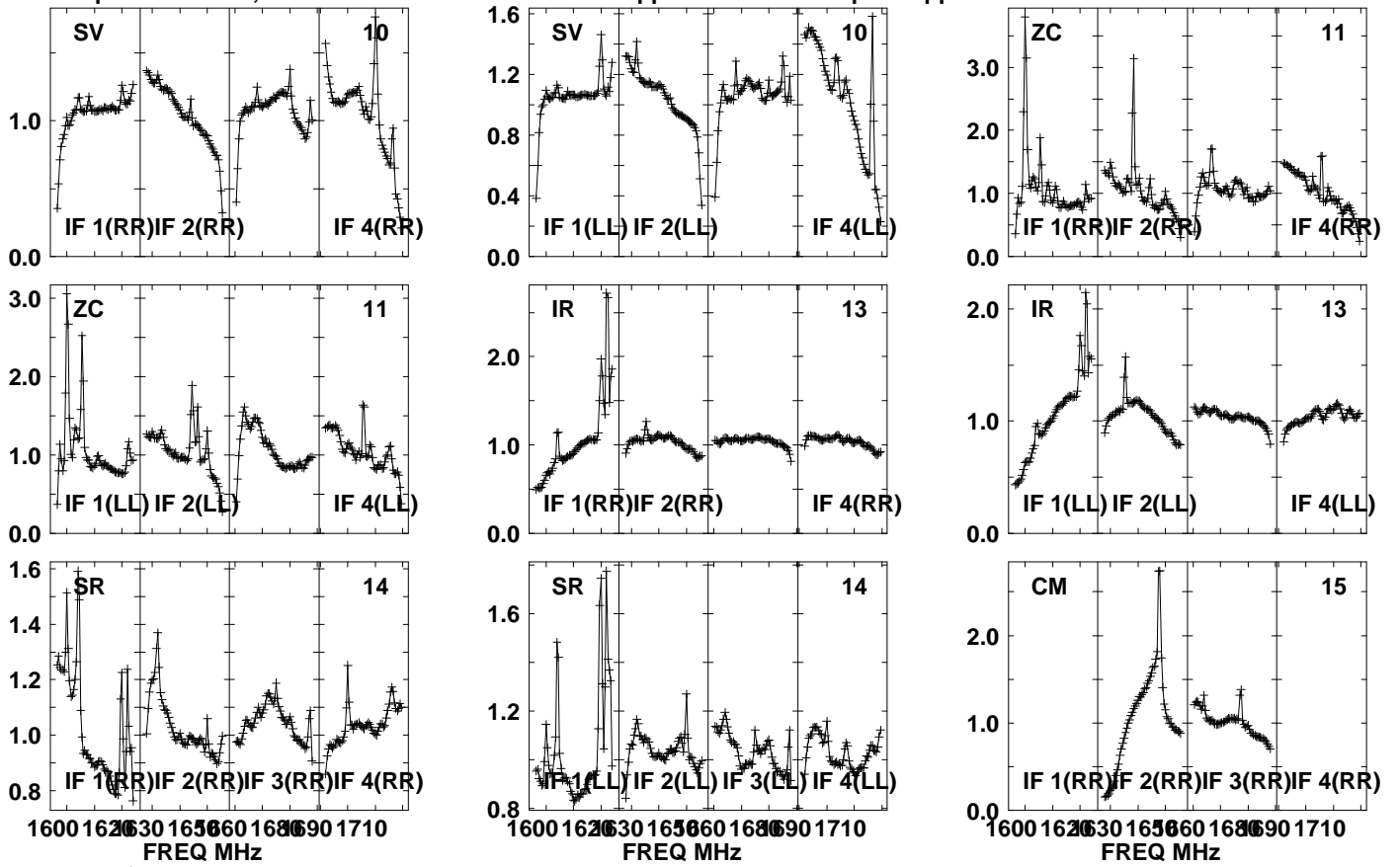

Lower frame: Real Jy  
Auto-corr total-power spectrum Antenna: \*  
Timerange: 00/10:46:01 to 00/10:47:29

Plot file version 28 created 05-OCT-2021 17:04:37

J0827+5217 GM076.UVDATA.1

Freq = 1.5945 GHz, Bw = 32.000 MH No calibration applied and no bandpass applied

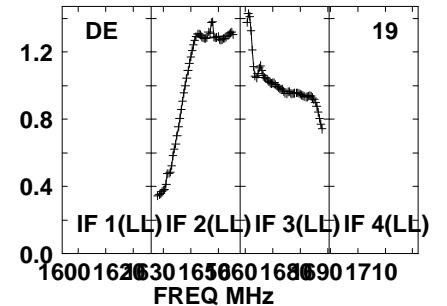
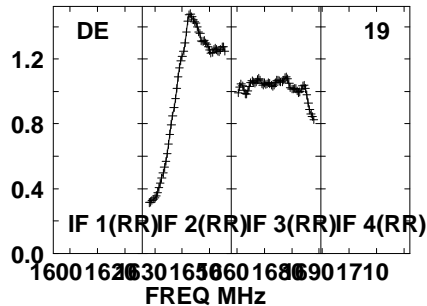
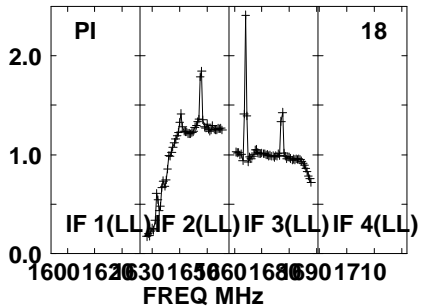
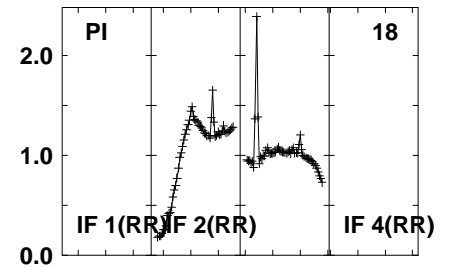
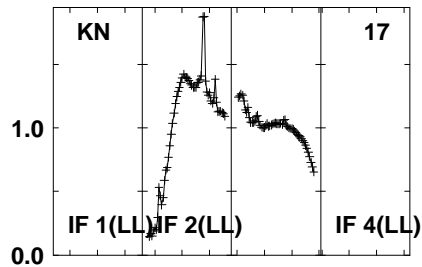
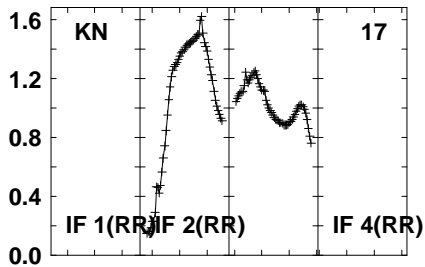
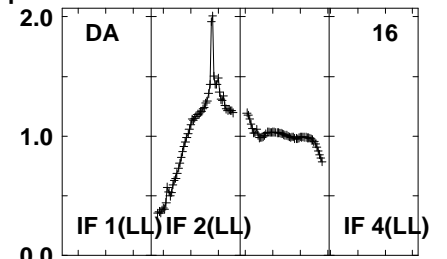
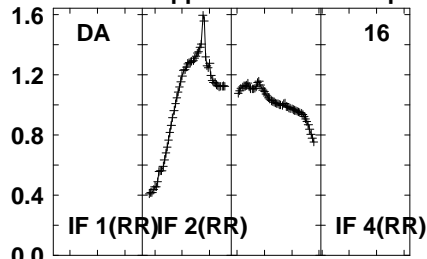
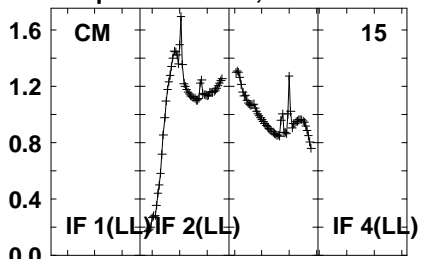

Lower frame: Real Jy  
Auto-corr total-power spectrum Antenna: \*  
Timerange: 00/10:46:01 to 00/10:47:29

Plot file version 29 created 05-OCT-2021 17:04:38

APM08279+525 GM076.UVDATA.1

Freq = 1.5945 GHz, Bw = 32.000 MH No calibration applied and no bandpass applied

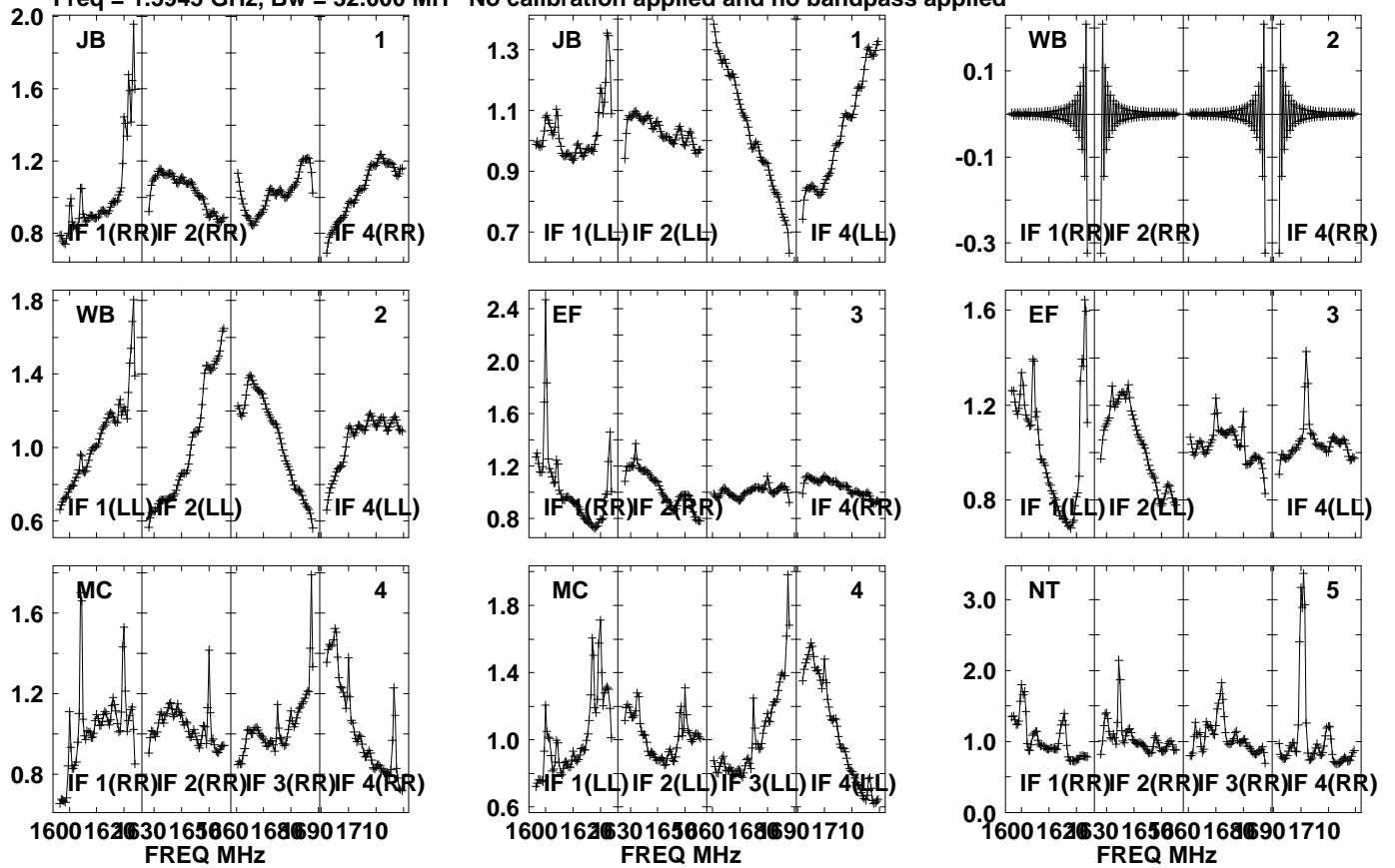

Lower frame: Real Jy  
Auto-corr total-power spectrum Antenna: \*  
Timerange: 00/10:47:31 to 00/10:50:59

Plot file version 30 created 05-OCT-2021 17:04:38

APM08279+525 GM076.UVDATA.1

Freq = 1.5945 GHz, Bw = 32.000 MH

No calibration applied and no bandpass applied

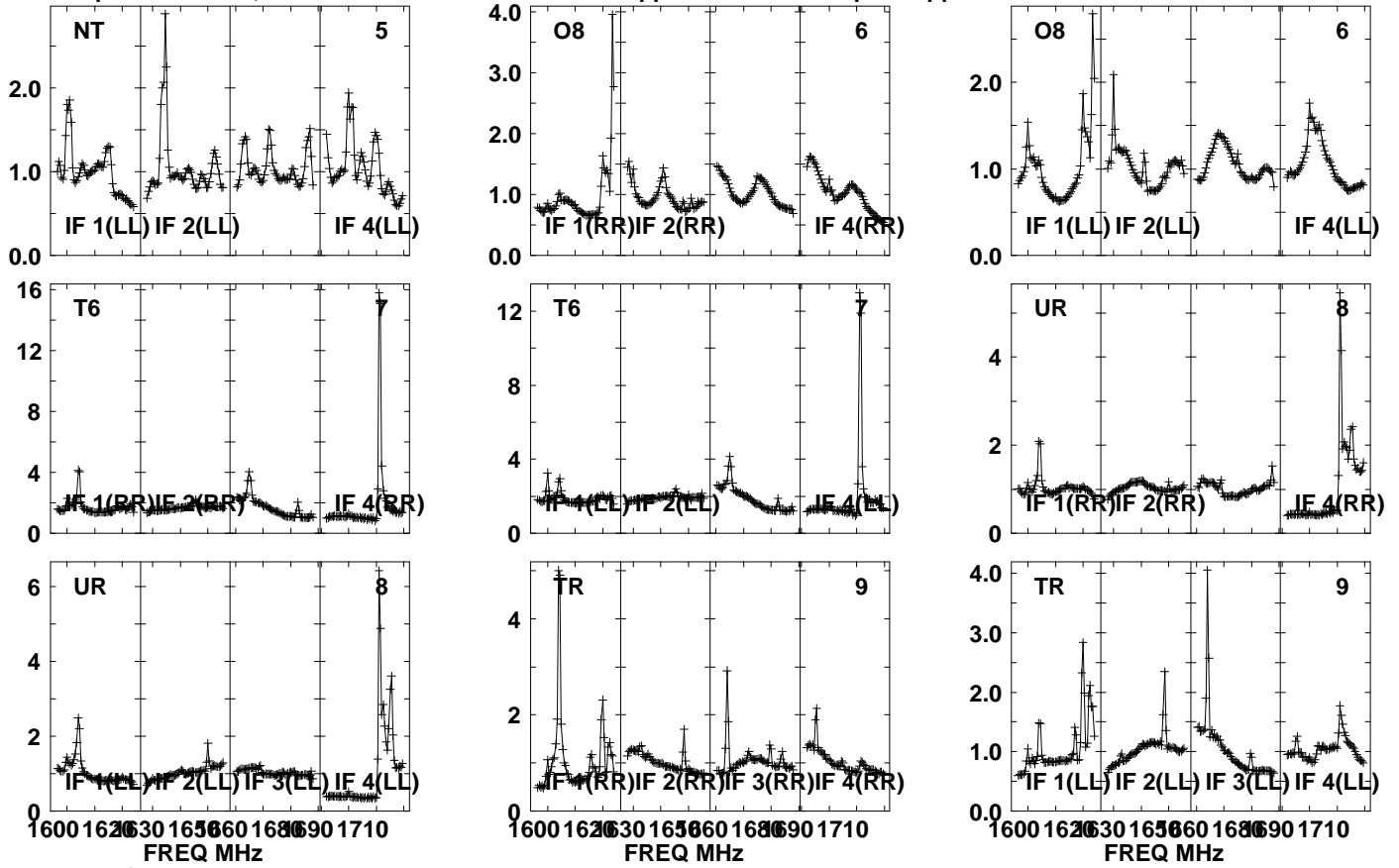

Lower frame: Real Jy

Auto-corr total-power spectrum Antenna: \*

Timerange: 00/10:47:31 to 00/10:50:59

Plot file version 31 created 05-OCT-2021 17:04:38

APM08279+525 GM076.UVDATA.1

Freq = 1.5945 GHz, Bw = 32.000 MH No calibration applied and no bandpass applied

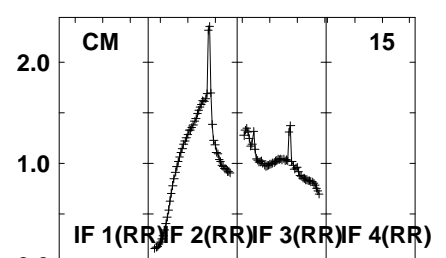
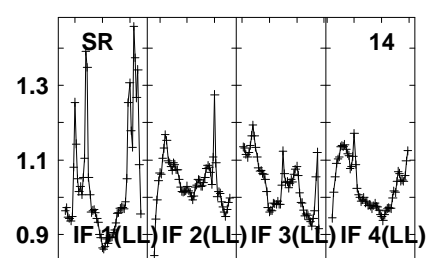
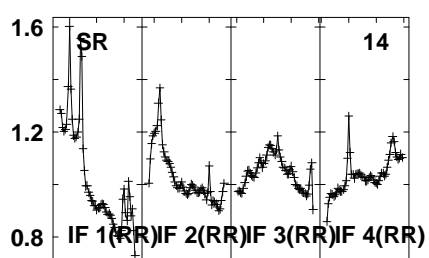
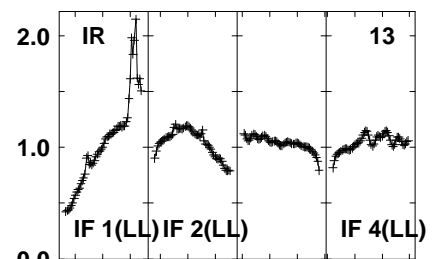
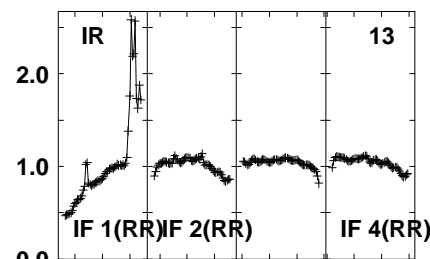
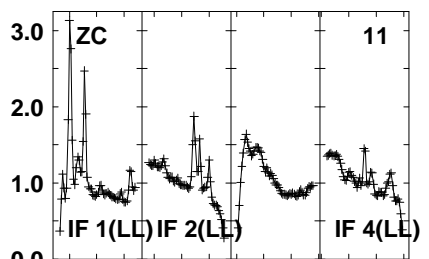
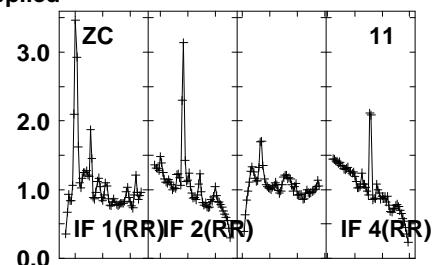
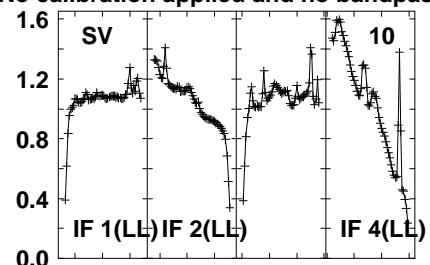
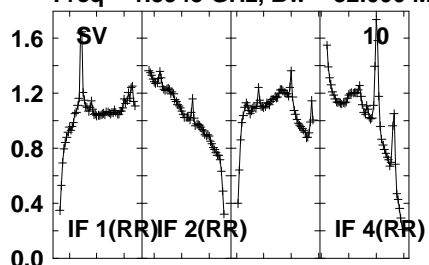

1600 1620 1630 1650 1660 1680 1690 1710  
FREQ MHz

1600 1620 1630 1650 1660 1680 1690 1710  
FREQ MHz

1600 1620 1630 1650 1660 1680 1690 1710  
FREQ MHz

Lower frame: Real Jy  
Auto-corr total-power spectrum Antenna: \*  
Timerange: 00/10:47:31 to 00/10:50:59

Plot file version 32 created 05-OCT-2021 17:04:38

APM08279+525 GM076.UVDATA.1

Freq = 1.5945 GHz, Bw = 32.000 MH No calibration applied and no bandpass applied

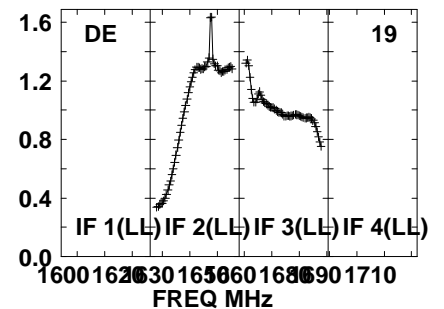
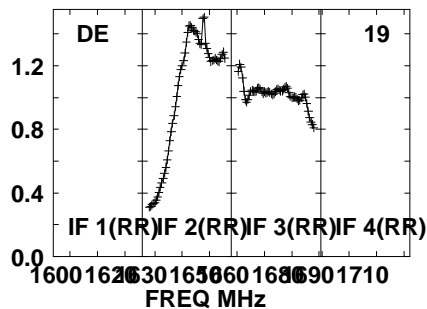
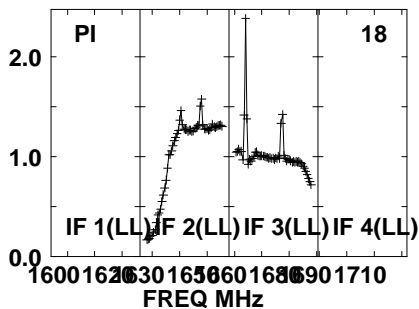
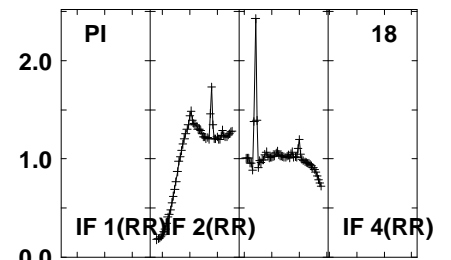
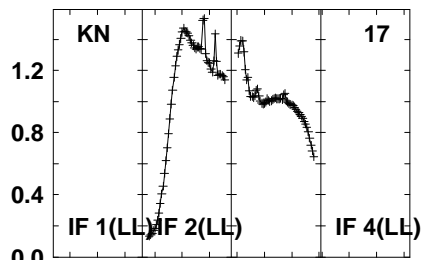
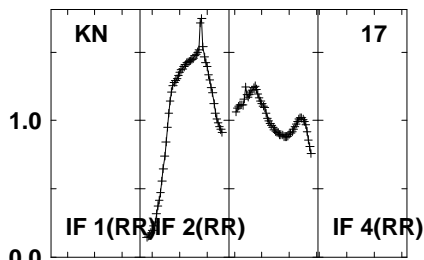
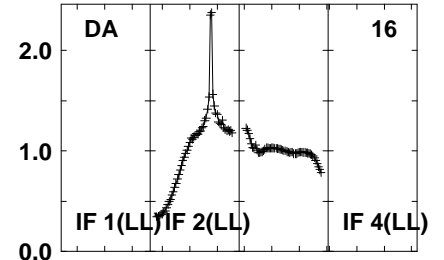
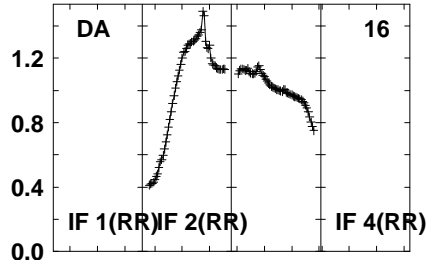
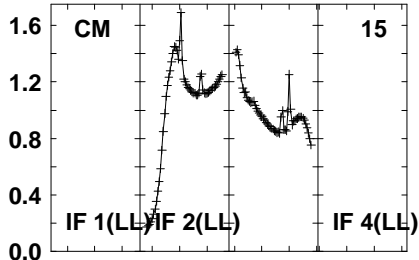

Lower frame: Real Jy  
Auto-corr total-power spectrum Antenna: \*  
Timerange: 00/10:47:31 to 00/10:50:59

Plot file version 33 created 05-OCT-2021 17:04:39

J0827+5217 GM076.UVDATA.1

Freq = 1.5945 GHz, Bw = 32.000 MH No calibration applied and no bandpass applied

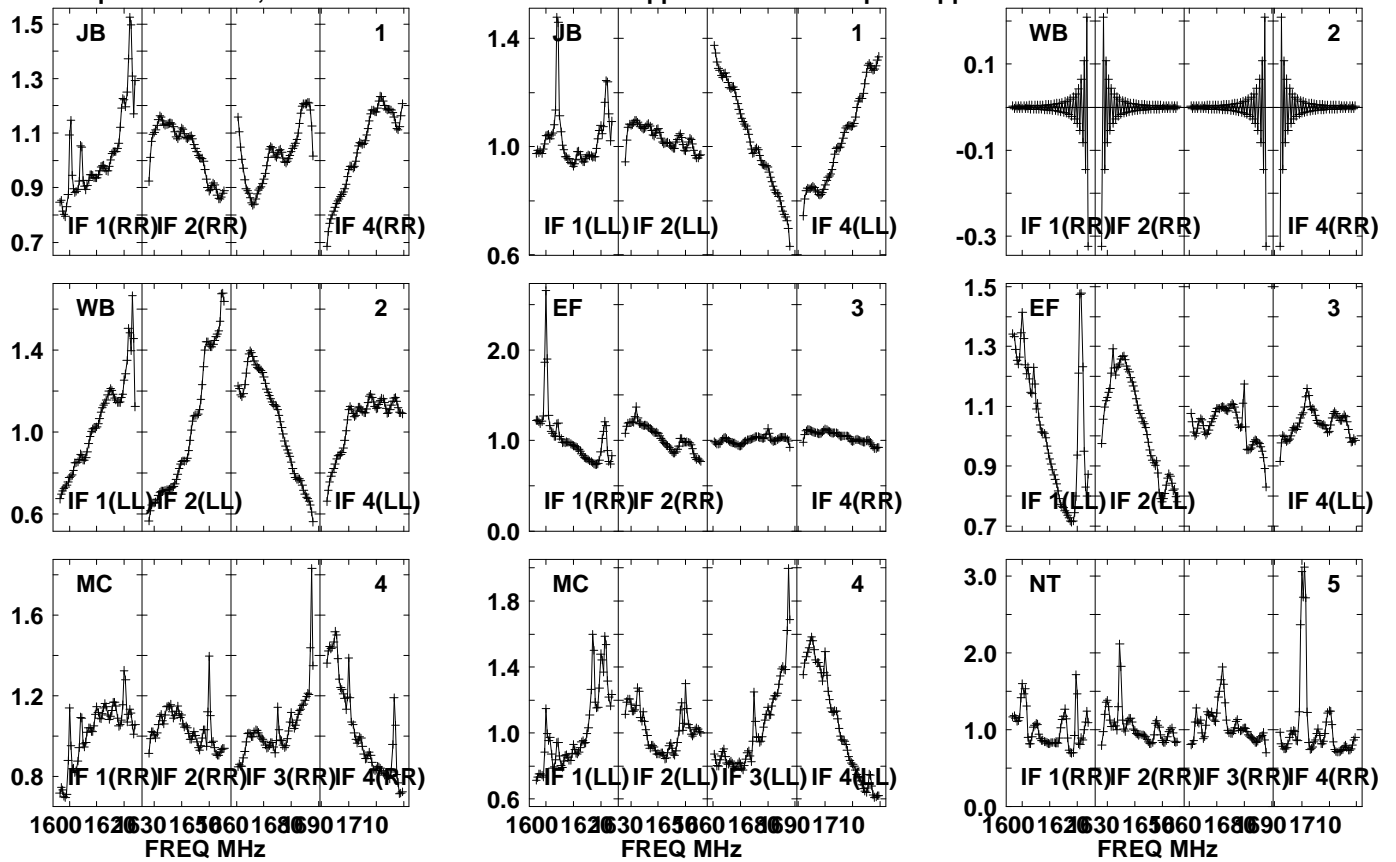

Lower frame: Real Jy  
Auto-corr total-power spectrum Antenna: \*  
Timerange: 00/10:51:01 to 00/10:52:29

Plot file version 34 created 05-OCT-2021 17:04:39

J0827+5217 GM076.UVDATA.1

Freq = 1.5945 GHz, Bw = 32.000 MH No calibration applied and no bandpass applied

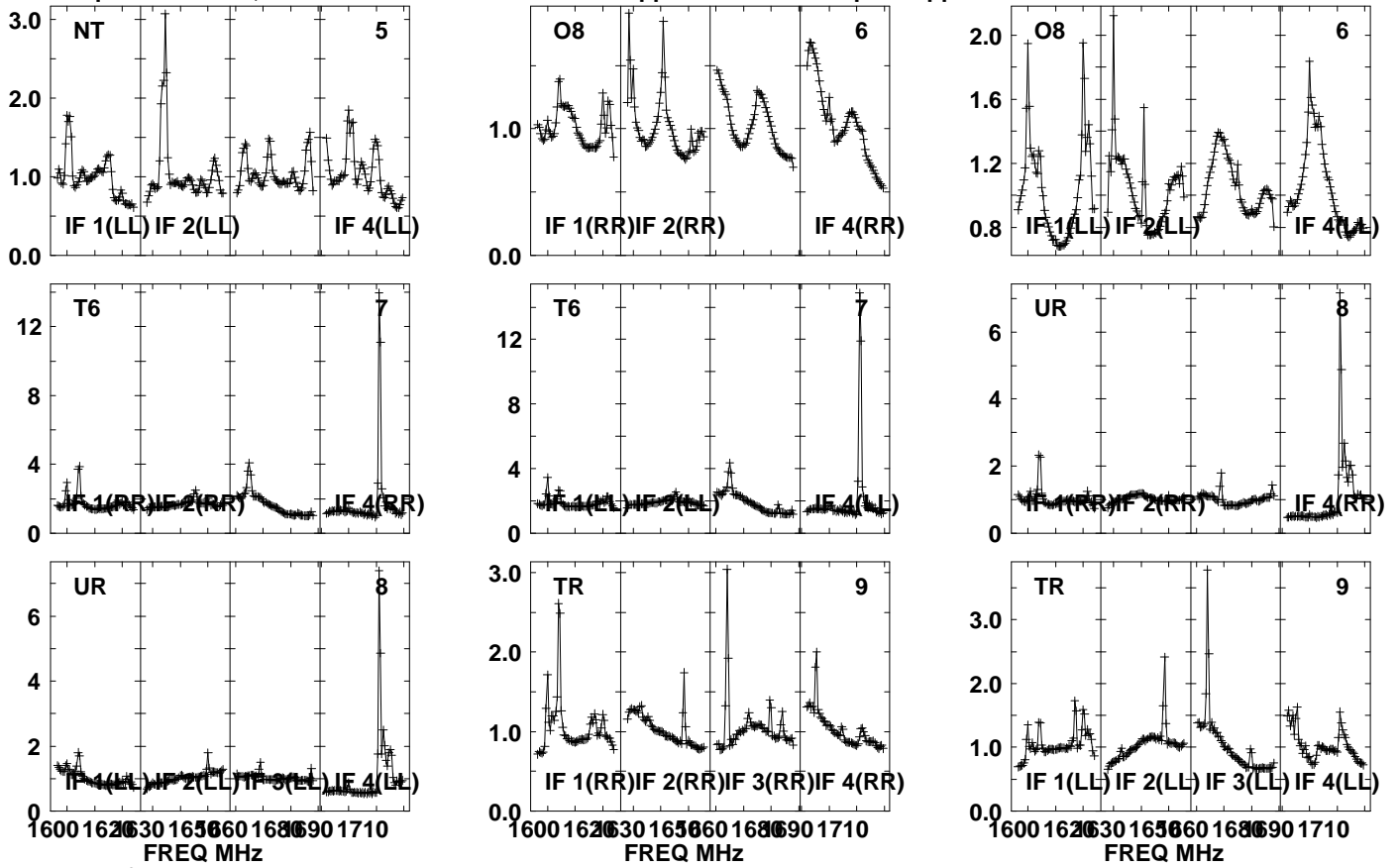

Lower frame: Real Jy

Auto-corr total-power spectrum Antenna: \*

Timerange: 00/10:51:01 to 00/10:52:29



Plot file version 35 created 05-OCT-2021 17:04:39

J0827+5217 GM076.UVDATA.1

Freq = 1.5945 GHz, Bw = 32.000 MH No calibration applied and no bandpass applied

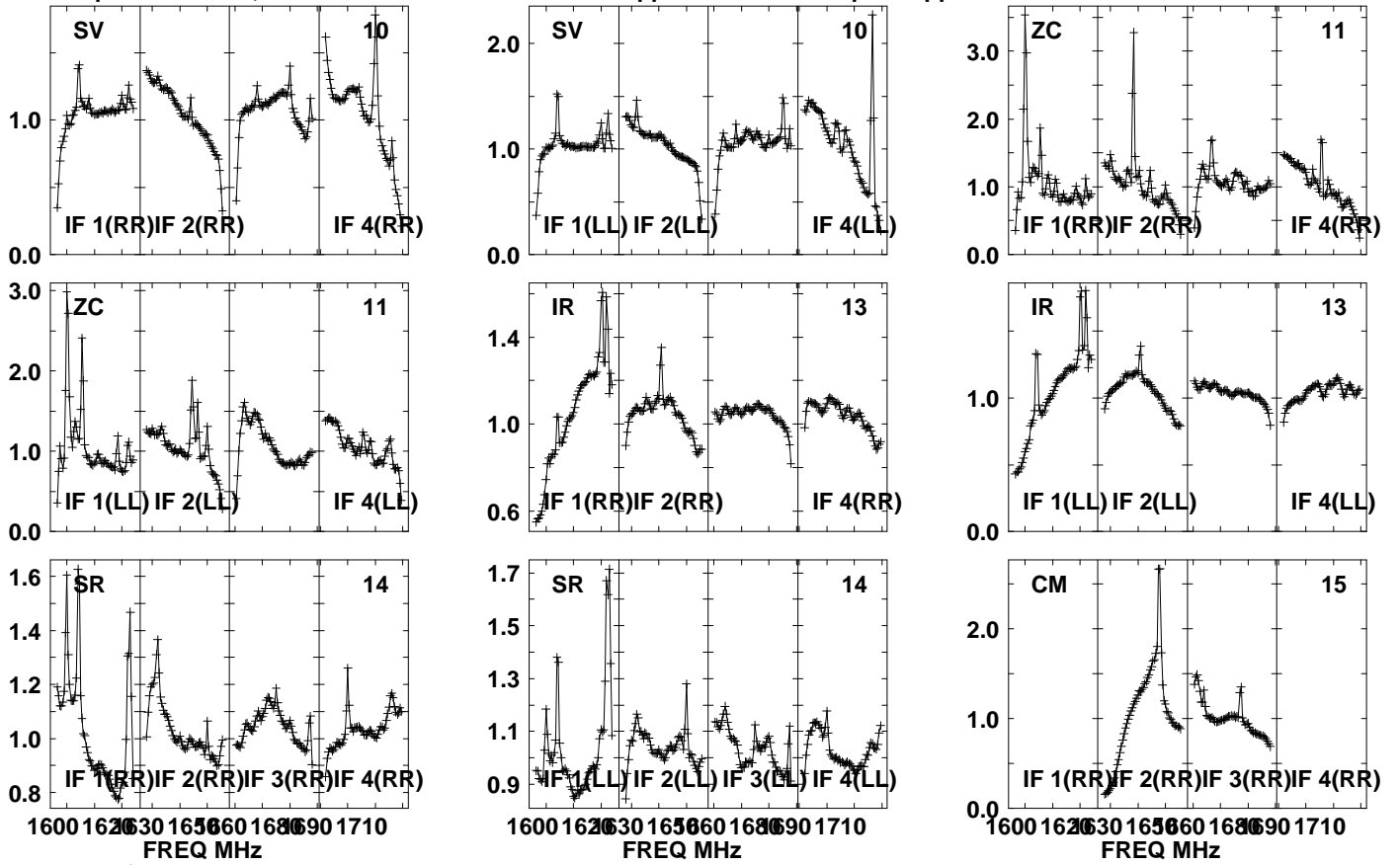

Lower frame: Real Jy

Auto-corr total-power spectrum Antenna: \*

Timerange: 00/10:51:01 to 00/10:52:29

Plot file version 36 created 05-OCT-2021 17:04:39

J0827+5217 GM076.UVDATA.1

Freq = 1.5945 GHz, Bw = 32.000 MH No calibration applied and no bandpass applied

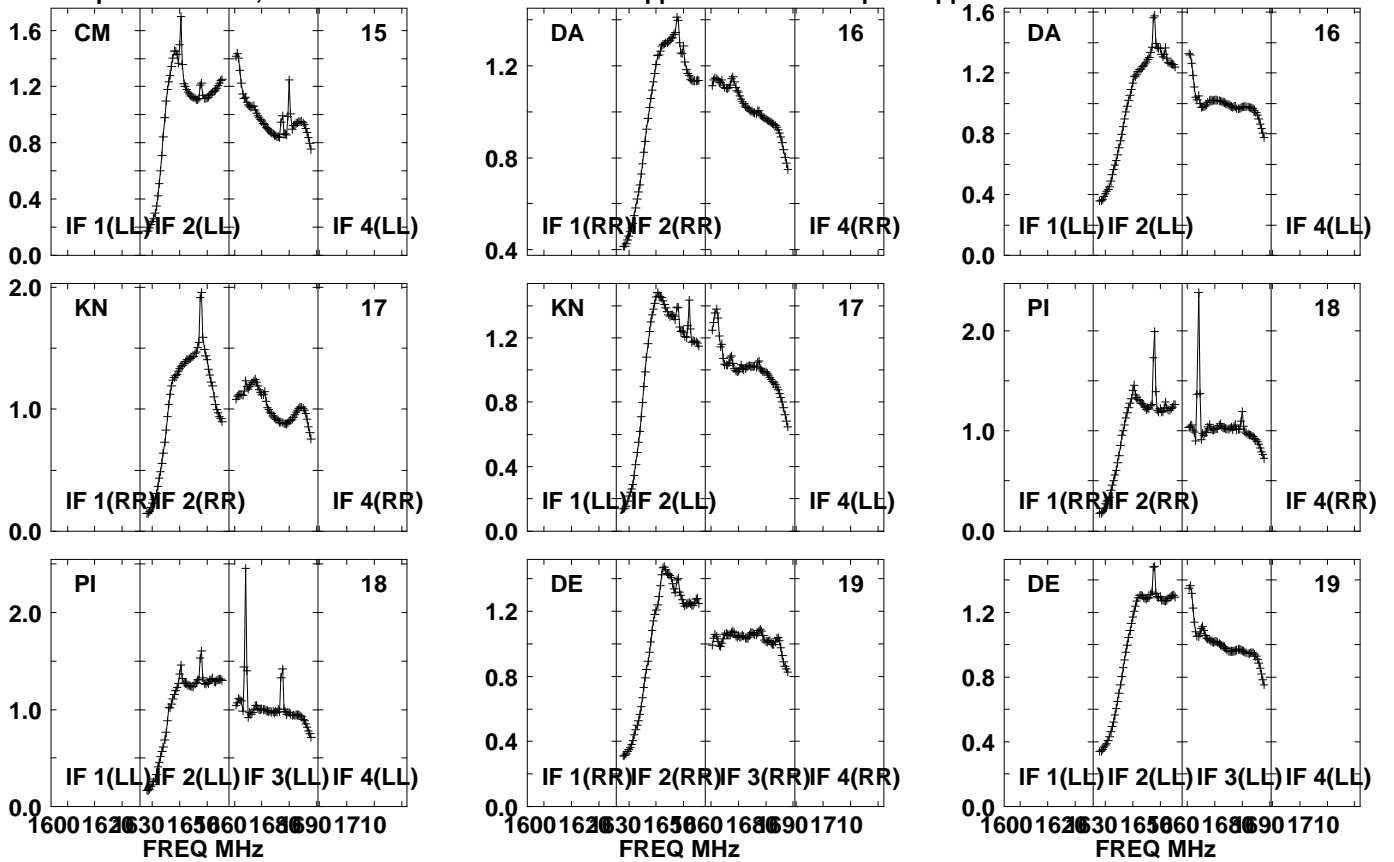

Lower frame: Real Jy  
Auto-corr total-power spectrum Antenna: \*  
Timerange: 00/10:51:01 to 00/10:52:29

Plot file version 37 created 05-OCT-2021 17:04:40

APM08279+525 GM076.UVDATA.1

Freq = 1.5945 GHz, Bw = 32.000 MH No calibration applied and no bandpass applied

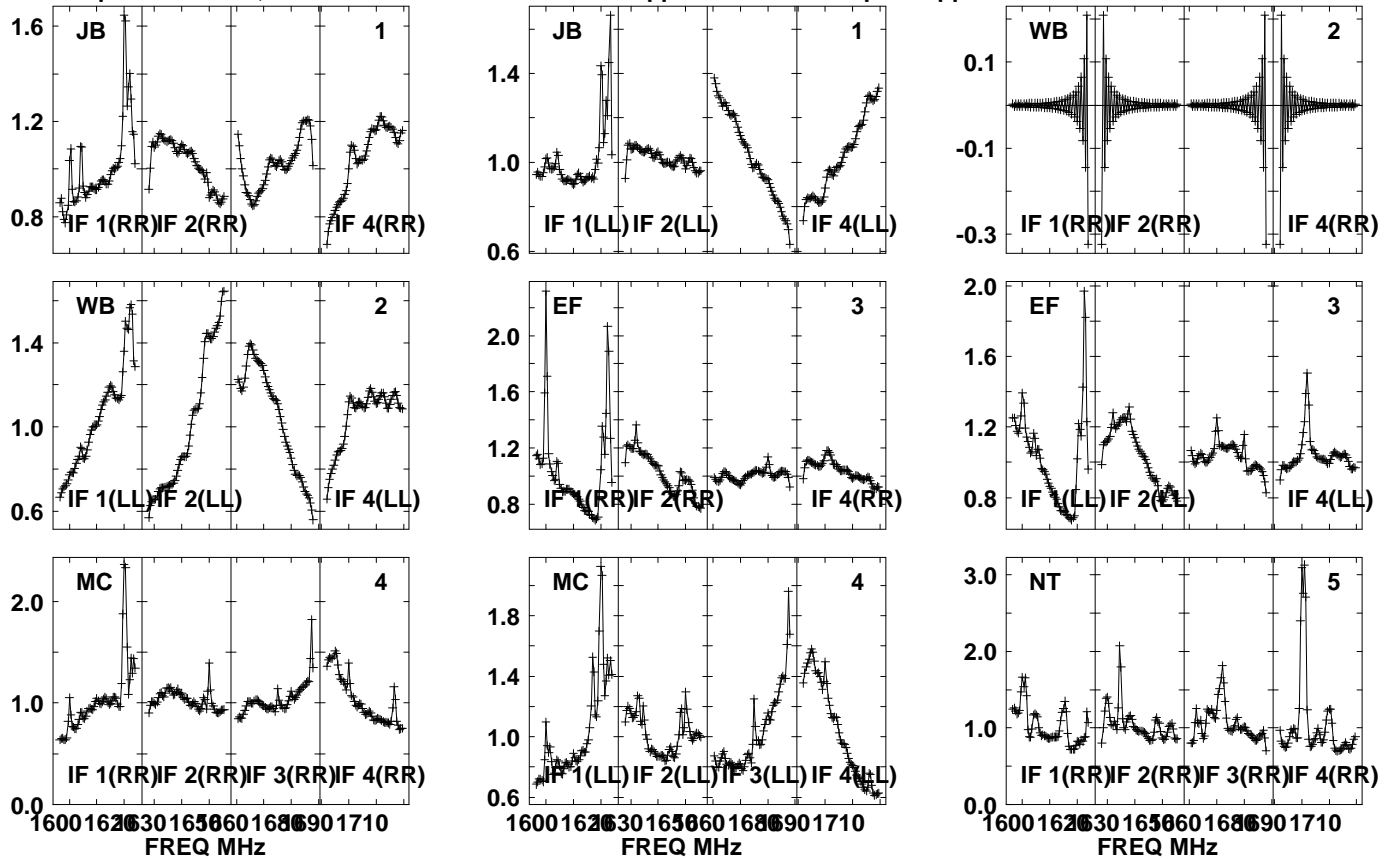

Lower frame: Real Jy  
Auto-corr total-power spectrum Antenna: \*  
Timerange: 00/10:52:31 to 00/10:55:59

Plot file version 38 created 05-OCT-2021 17:04:40

APM08279+525 GM076.UVDATA.1

Freq = 1.5945 GHz, Bw = 32.000 MH

No calibration applied and no bandpass applied

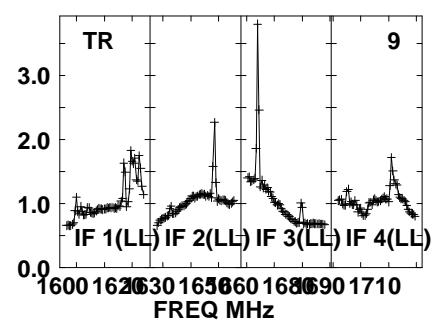
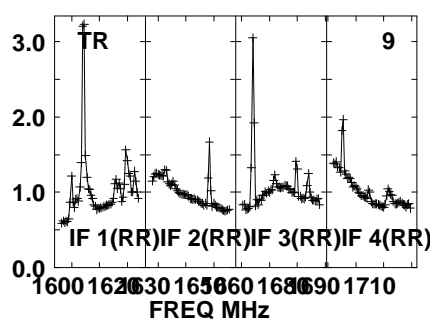
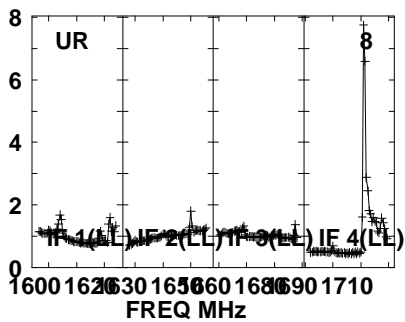
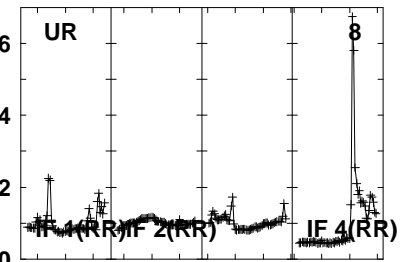
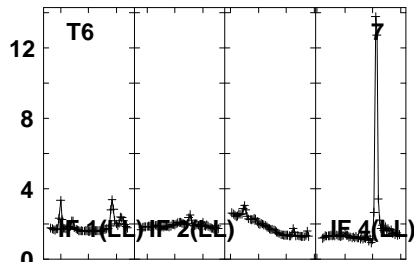
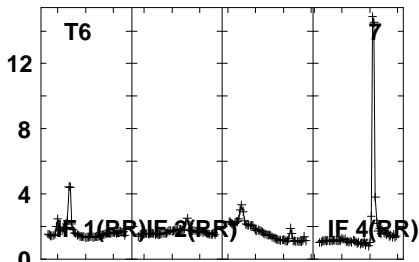
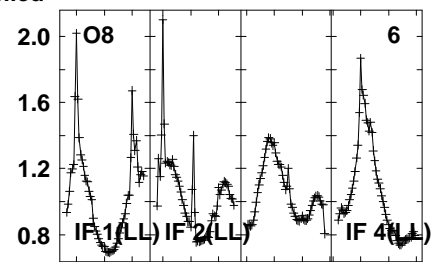
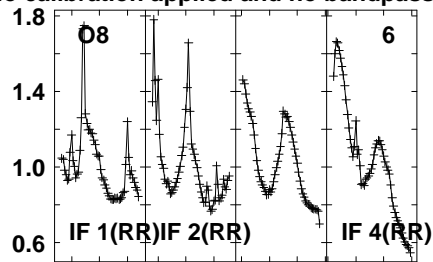
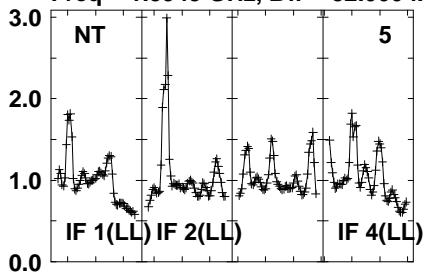

Lower frame: Real Jy

Auto-corr total-power spectrum Antenna: \*

Timerange: 00/10:52:31 to 00/10:55:59

Plot file version 39 created 05-OCT-2021 17:04:40

APM08279+525 GM076.UVDATA.1

Freq = 1.5945 GHz, Bw = 32.000 MH No calibration applied and no bandpass applied

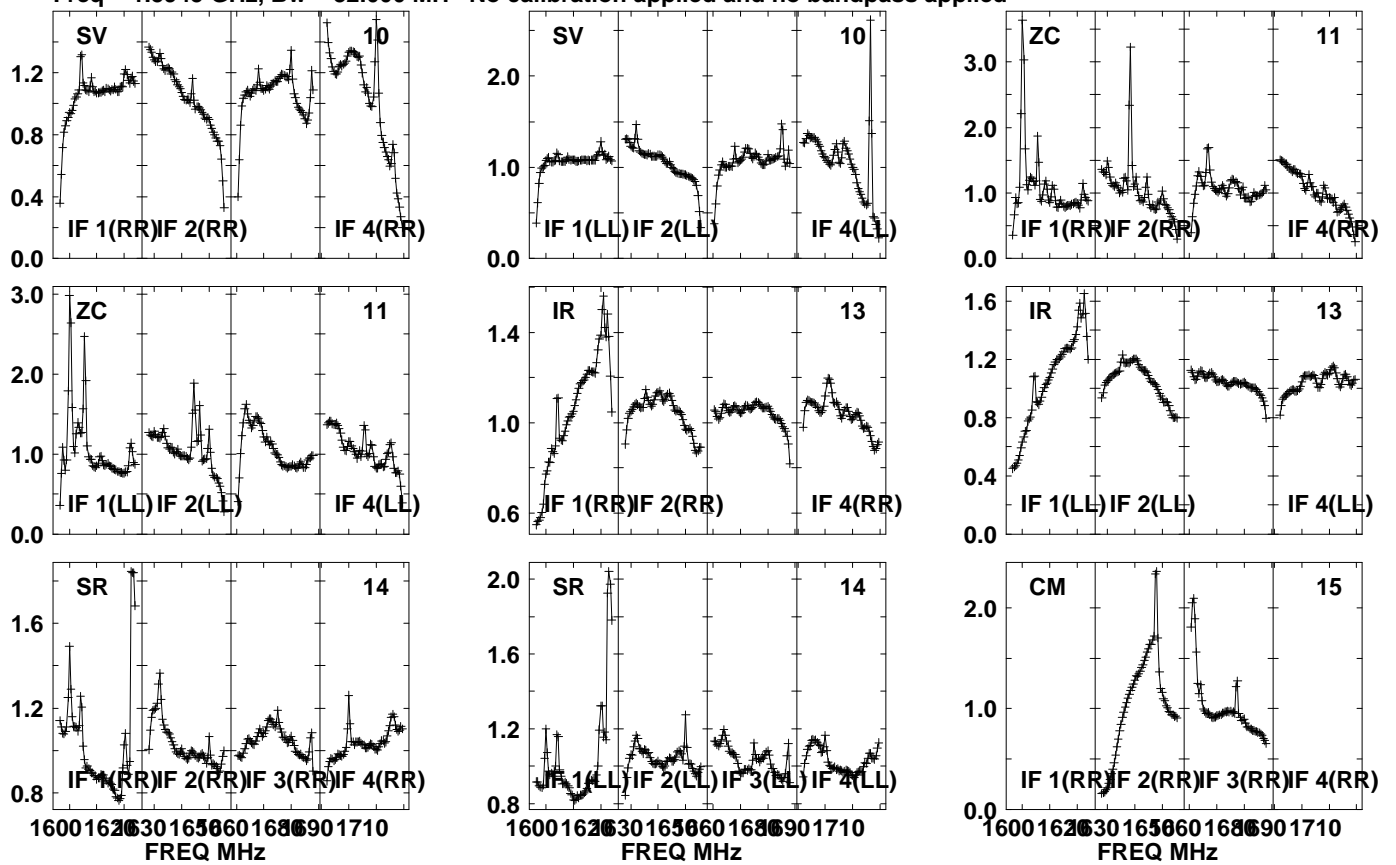

Lower frame: Real Jy  
Auto-corr total-power spectrum Antenna: \*  
Timerange: 00/10:52:31 to 00/10:55:59

Plot file version 40 created 05-OCT-2021 17:04:40

APM08279+525 GM076.UVDATA.1

Freq = 1.5945 GHz, Bw = 32.000 MH No calibration applied and no bandpass applied

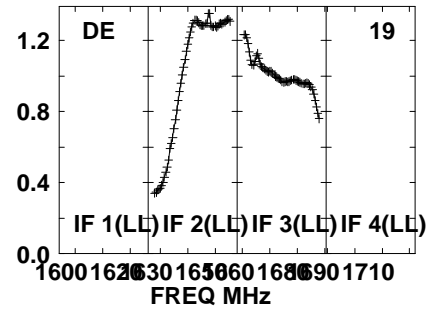
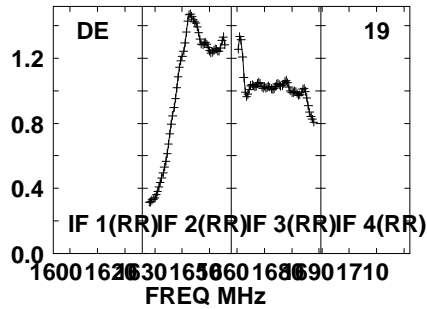
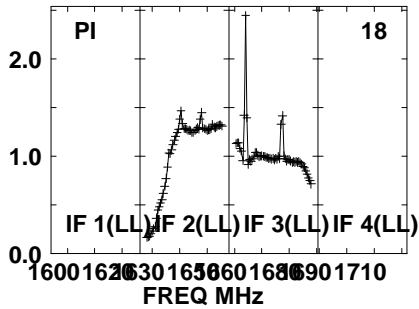
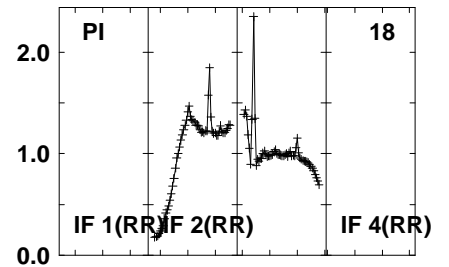
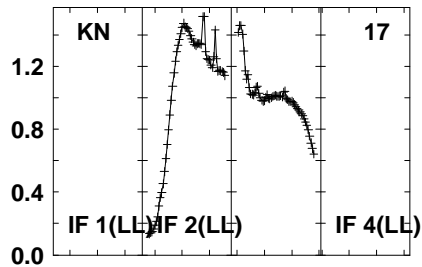
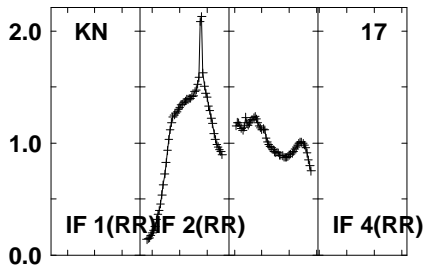
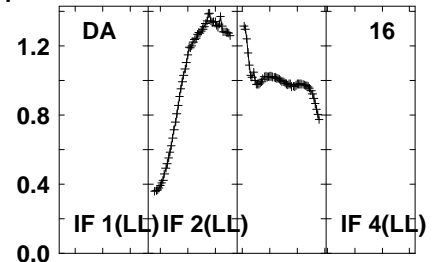
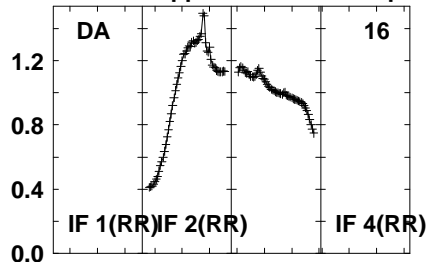
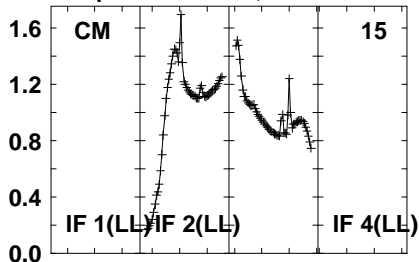

Lower frame: Real Jy  
Auto-corr total-power spectrum Antenna: \*  
Timerange: 00/10:52:31 to 00/10:55:59

Plot file version 41 created 05-OCT-2021 17:04:41

J0827+5217 GM076.UVDATA.1

Freq = 1.5945 GHz, Bw = 32.000 MH No calibration applied and no bandpass applied

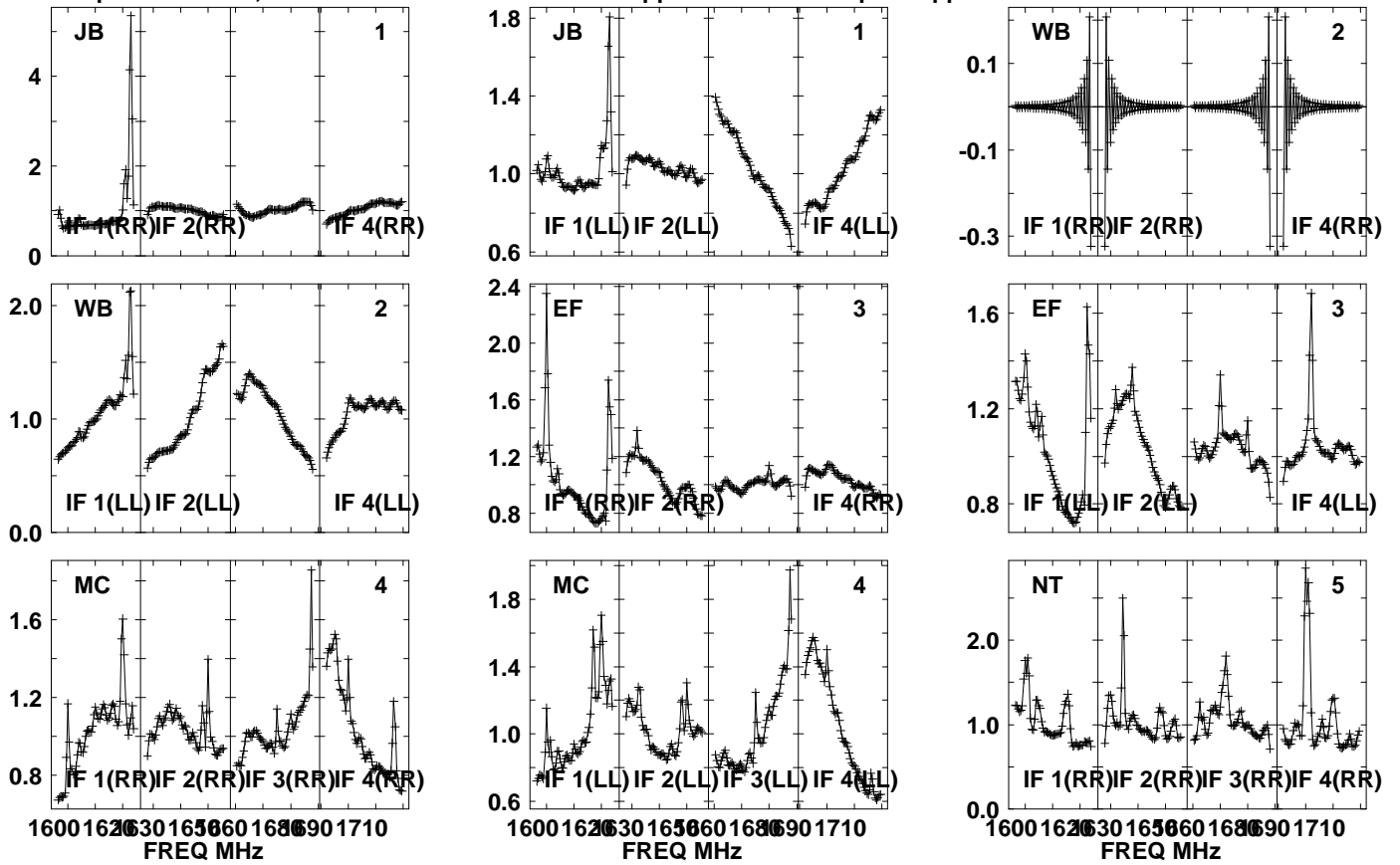

Lower frame: Real Jy

Auto-corr total-power spectrum Antenna: \*

Timerange: 00/10:56:31 to 00/10:57:59

Plot file version 42 created 05-OCT-2021 17:04:41

J0827+5217 GM076.UVDATA.1

Freq = 1.5945 GHz, Bw = 32.000 MH No calibration applied and no bandpass applied

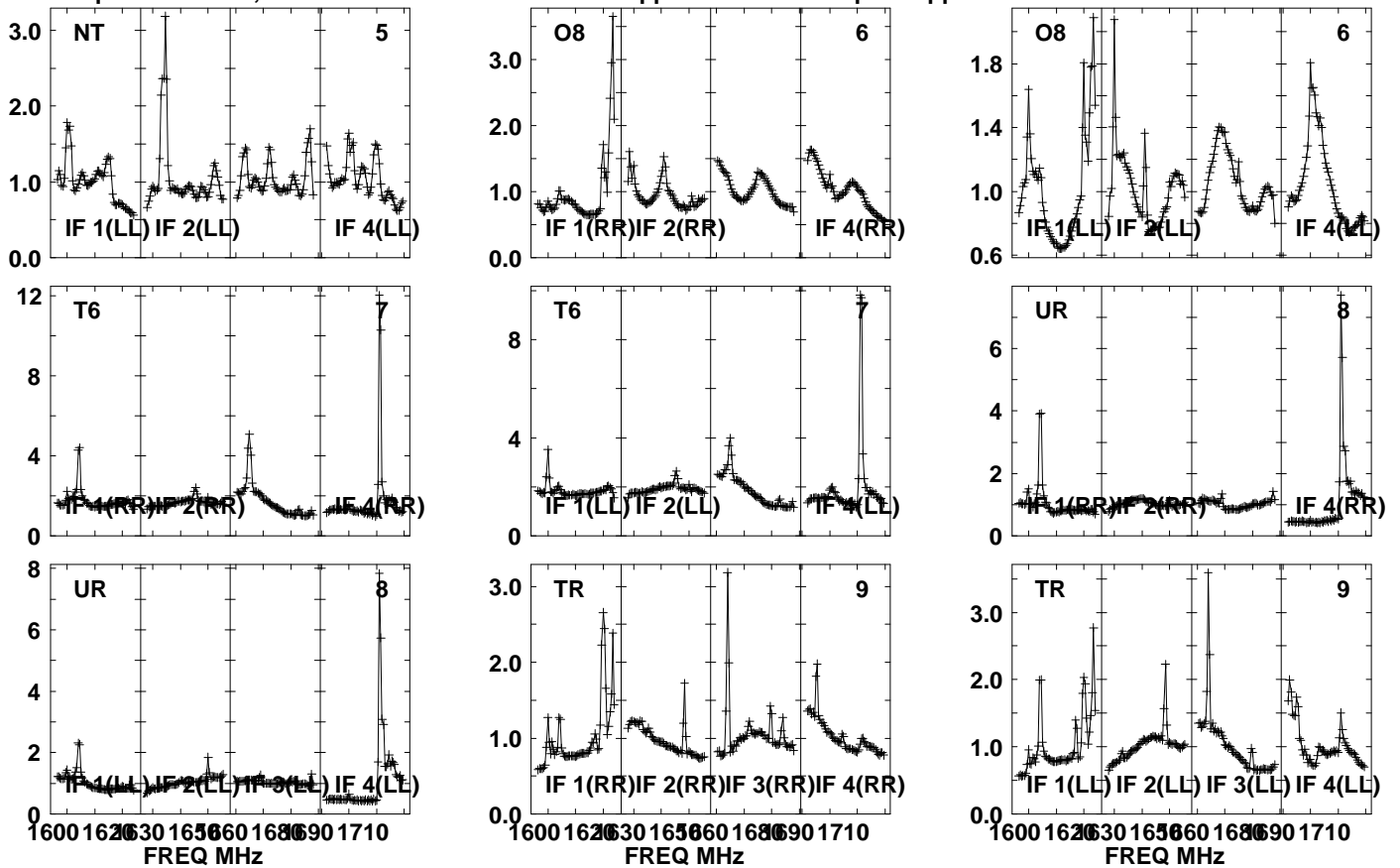

Lower frame: Real Jy

Auto-corr total-power spectrum Antenna: \*

Timerange: 00/10:56:31 to 00/10:57:59



Plot file version 43 created 05-OCT-2021 17:04:41

J0827+5217 GM076.UVDATA.1

Freq = 1.5945 GHz, Bw = 32.000 MH No calibration applied and no bandpass applied

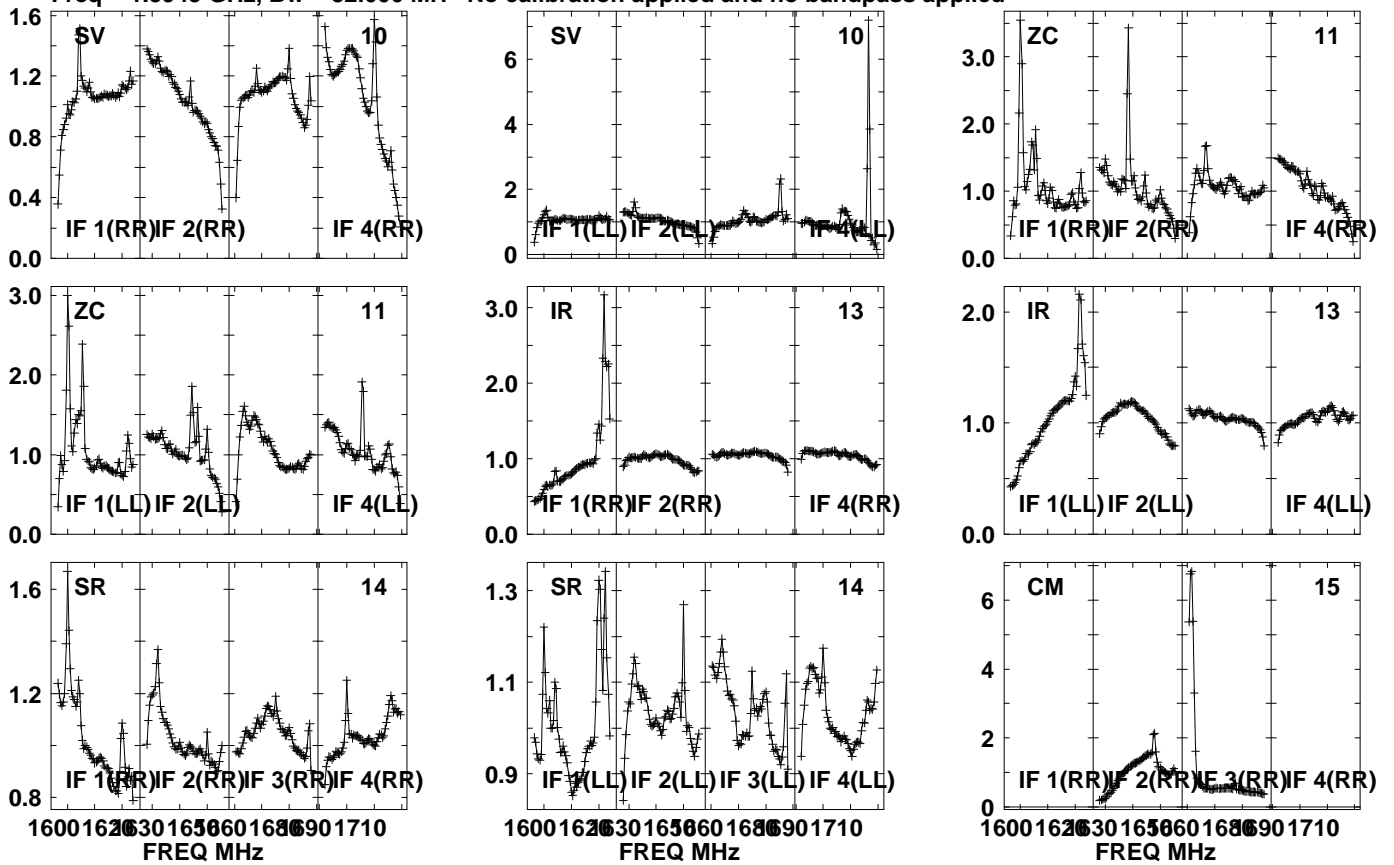

Lower frame: Real Jy  
Auto-corr total-power spectrum Antenna: \*  
Timerange: 00/10:56:31 to 00/10:57:59

Plot file version 44 created 05-OCT-2021 17:04:41

J0827+5217 GM076.UVDATA.1

Freq = 1.5945 GHz, Bw = 32.000 MH No calibration applied and no bandpass applied

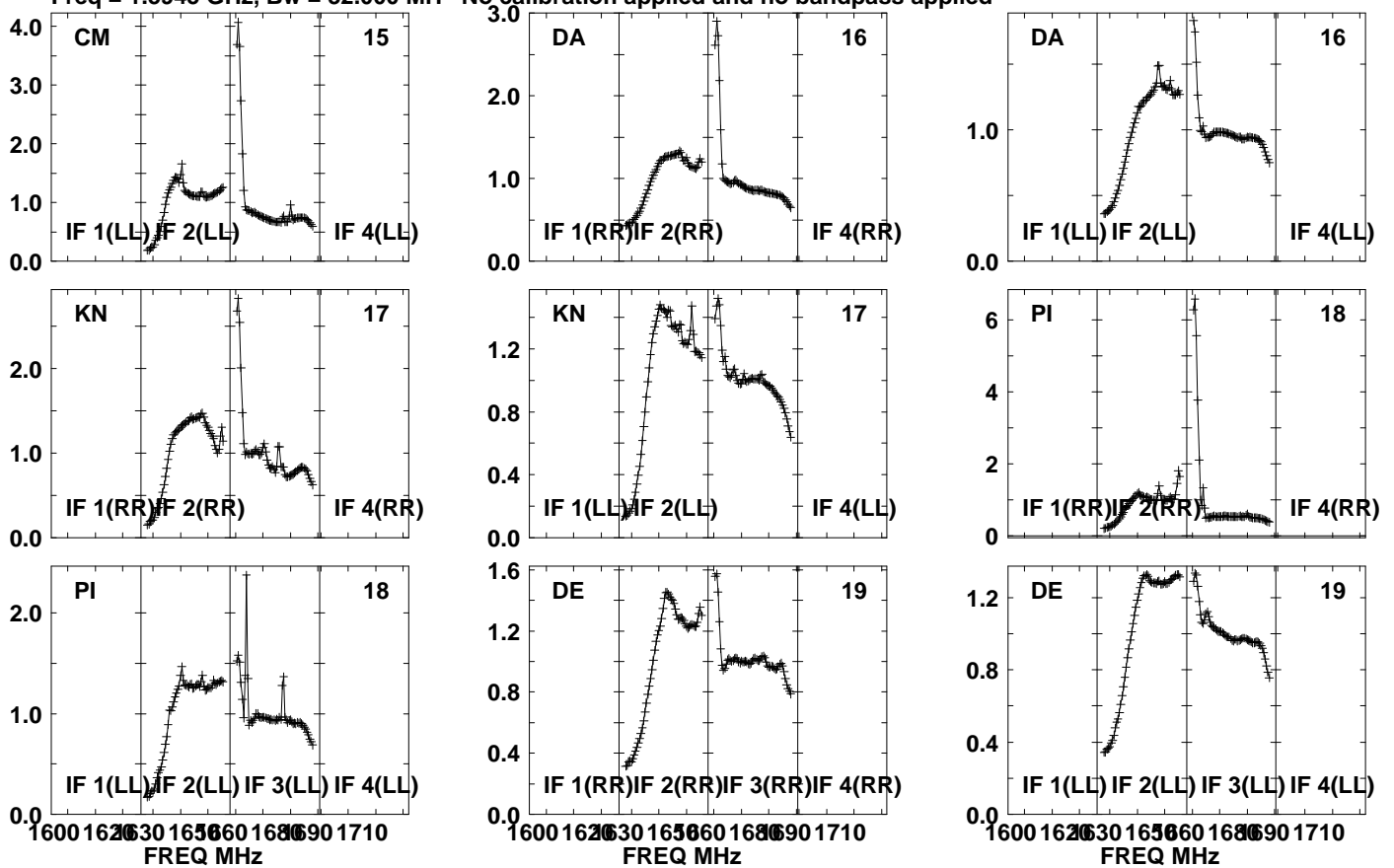

Lower frame: Real Jy

Auto-corr total-power spectrum Antenna: \*

Timerange: 00/10:56:31 to 00/10:57:59

Plot file version 45 created 05-OCT-2021 17:04:42

APM08279+525 GM076.UVDATA.1

Freq = 1.5945 GHz, Bw = 32.000 MH No calibration applied and no bandpass applied

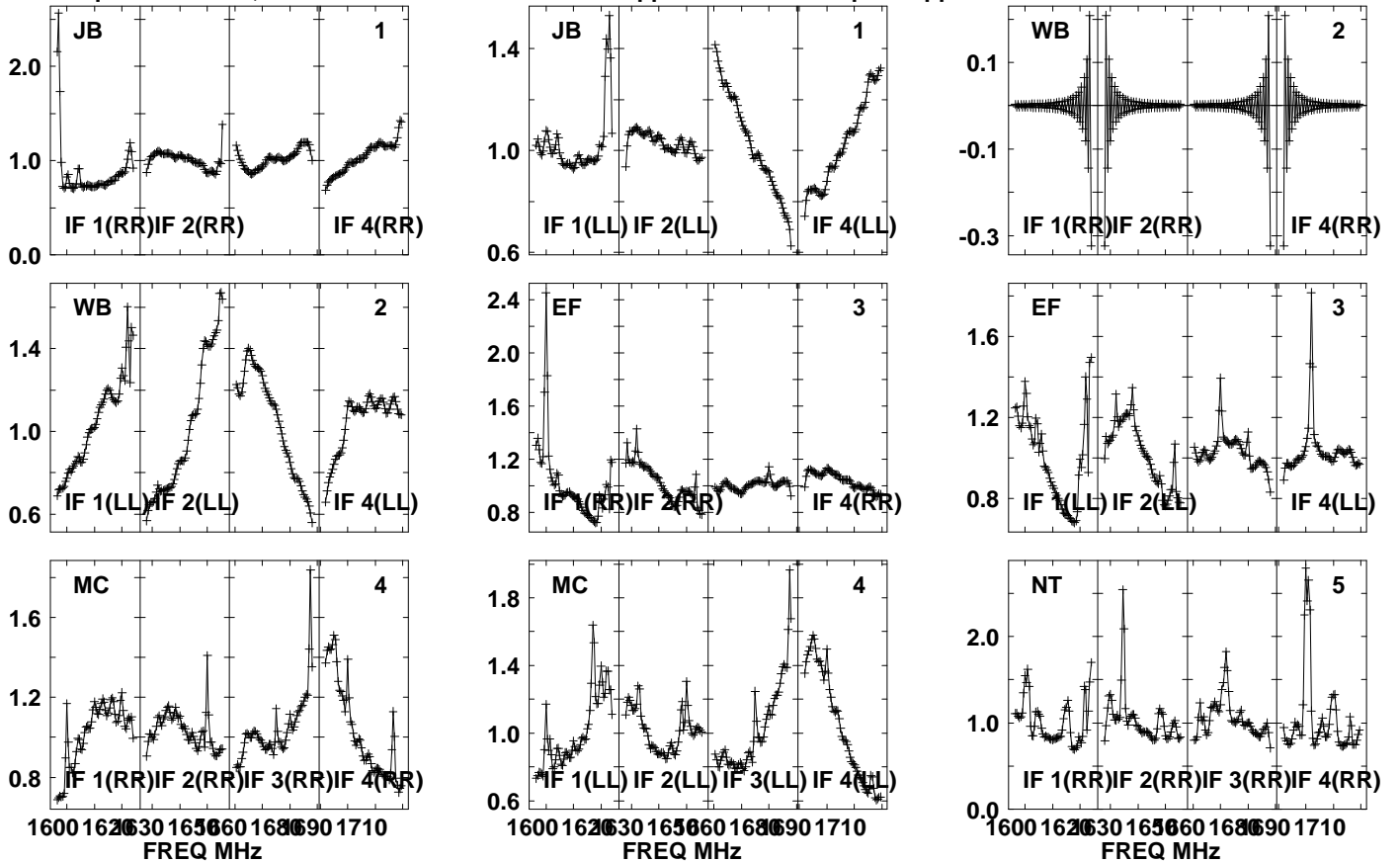

Lower frame: Real Jy

Auto-corr total-power spectrum Antenna: \*

Timerange: 00/10:58:01 to 00/11:01:29

Plot file version 46 created 05-OCT-2021 17:04:42

APM08279+525 GM076.UVDATA.1

Freq = 1.5945 GHz, Bw = 32.000 MH No calibration applied and no bandpass applied

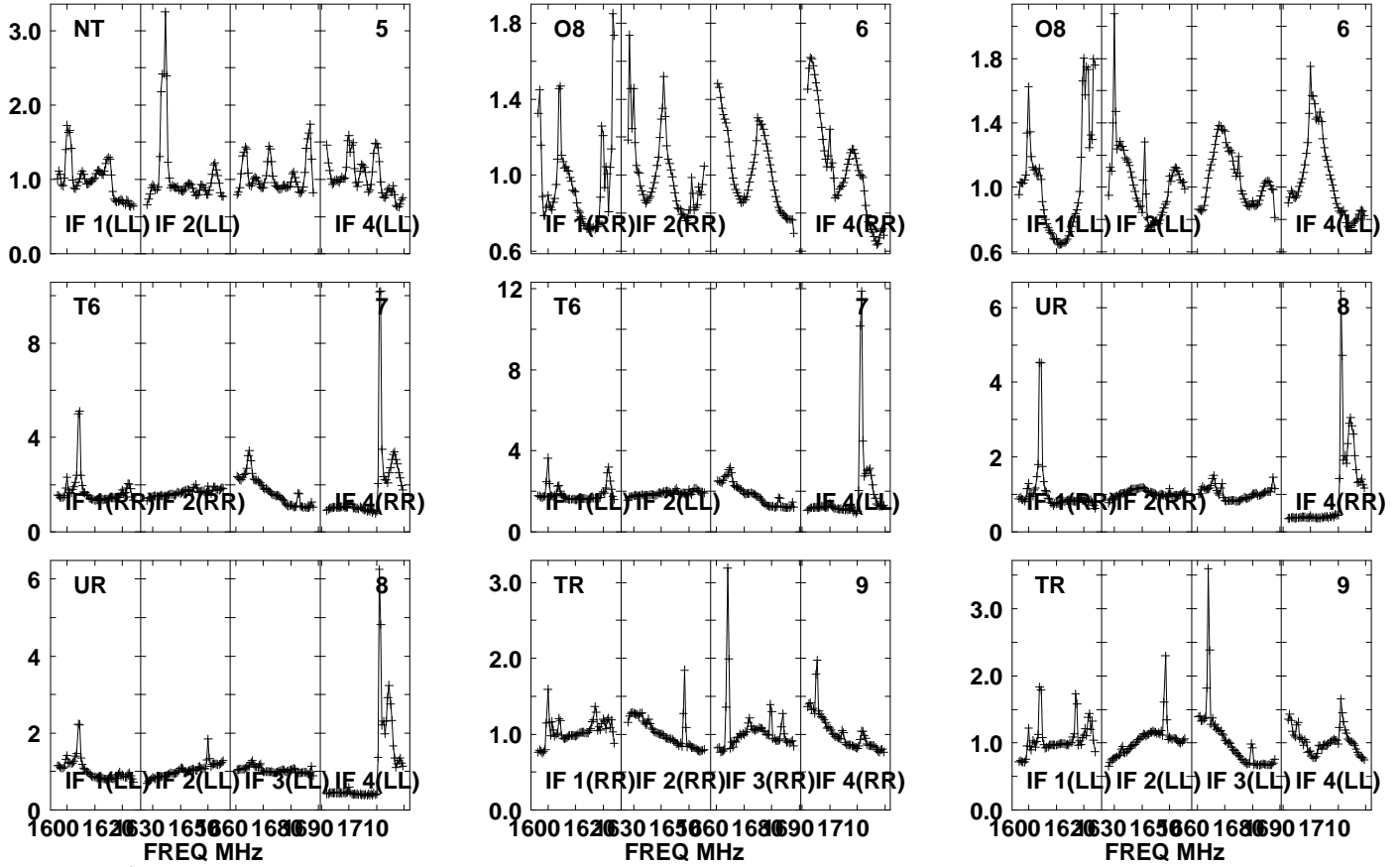

Lower frame: Real Jy

Auto-corr total-power spectrum Antenna: \*

Timerange: 00/10:58:01 to 00/11:01:29

Plot file version 47 created 05-OCT-2021 17:04:42

APM08279+525 GM076.UVDATA.1

Freq = 1.5945 GHz, Bw = 32.000 MH No calibration applied and no bandpass applied

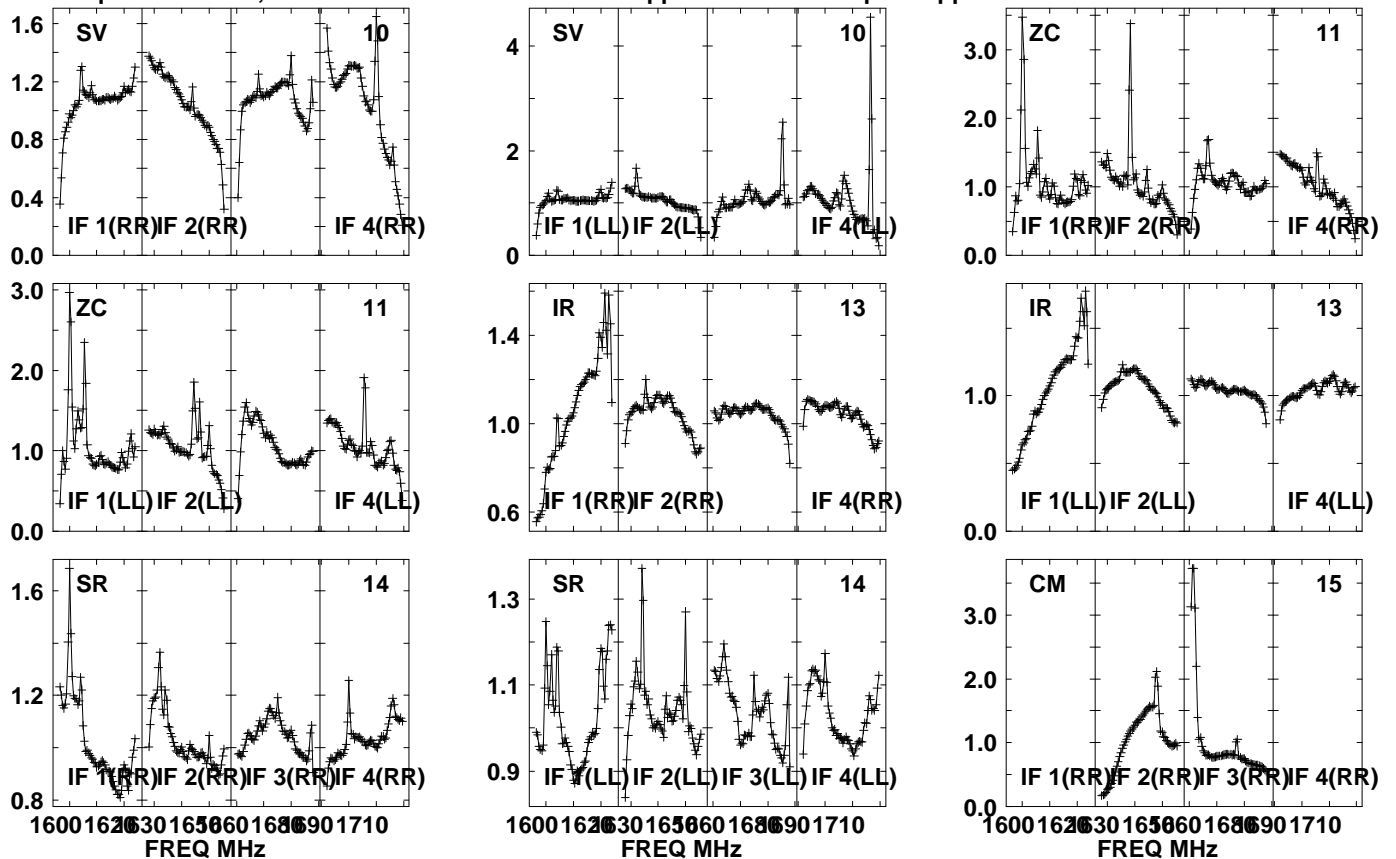

Lower frame: Real Jy  
Auto-corr total-power spectrum Antenna: \*  
Timerange: 00/10:58:01 to 00/11:01:29

Plot file version 48 created 05-OCT-2021 17:04:42

APM08279+525 GM076.UVDATA.1

Freq = 1.5945 GHz, Bw = 32.000 MH

No calibration applied and no bandpass applied

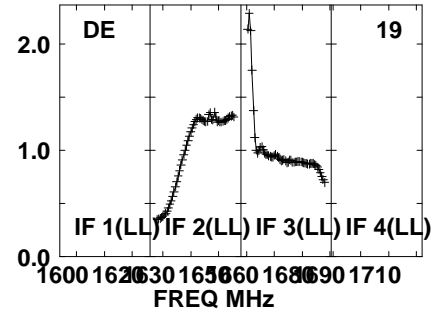
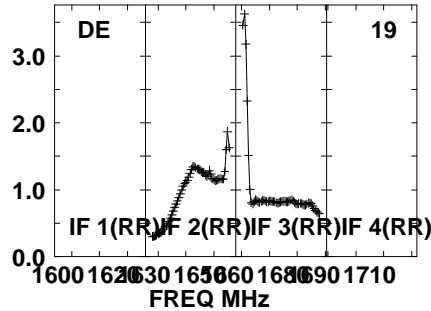
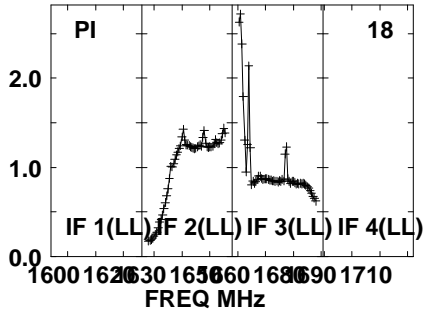
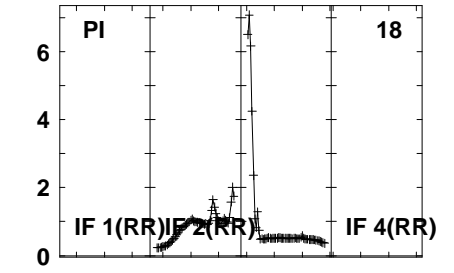
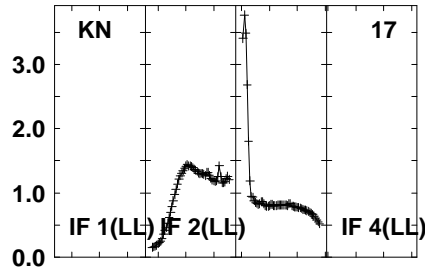
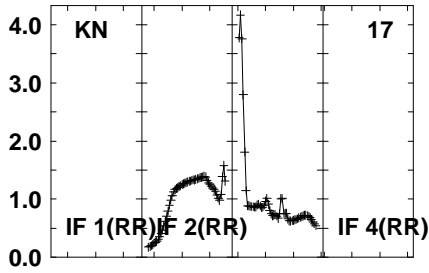
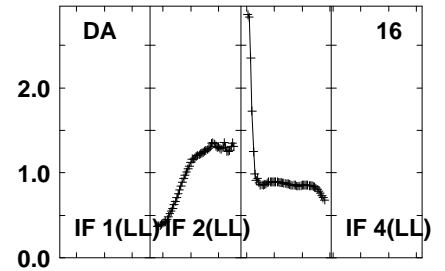
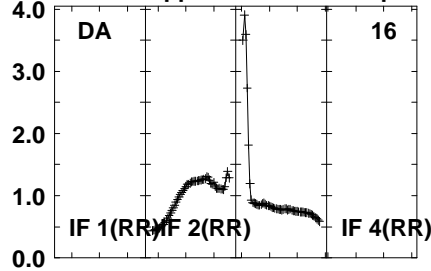
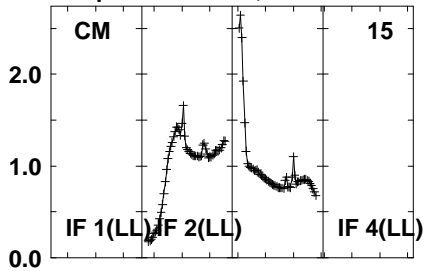

Lower frame: Real Jy

Auto-corr total-power spectrum Antenna: \*

Timerange: 00/10:58:01 to 00/11:01:29

Plot file version 49 created 05-OCT-2021 17:04:43

J0827+5217 GM076.UVDATA.1

Freq = 1.5945 GHz, Bw = 32.000 MH No calibration applied and no bandpass applied

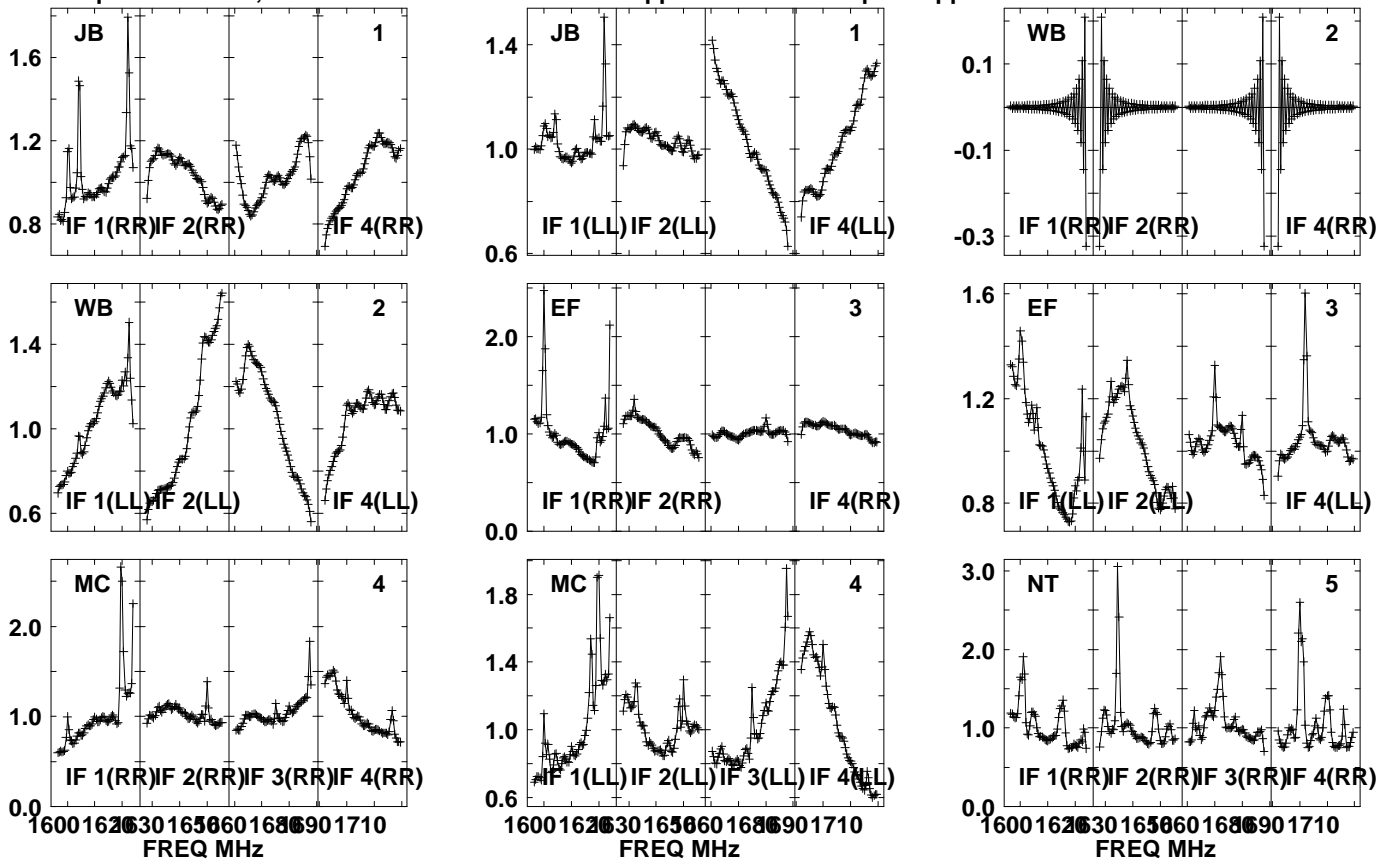

Lower frame: Real Jy  
Auto-corr total-power spectrum Antenna: \*  
Timerange: 00/11:01:31 to 00/11:02:59

Plot file version 50 created 05-OCT-2021 17:04:43

J0827+5217 GM076.UVDATA.1

Freq = 1.5945 GHz, Bw = 32.000 MH No calibration applied and no bandpass applied

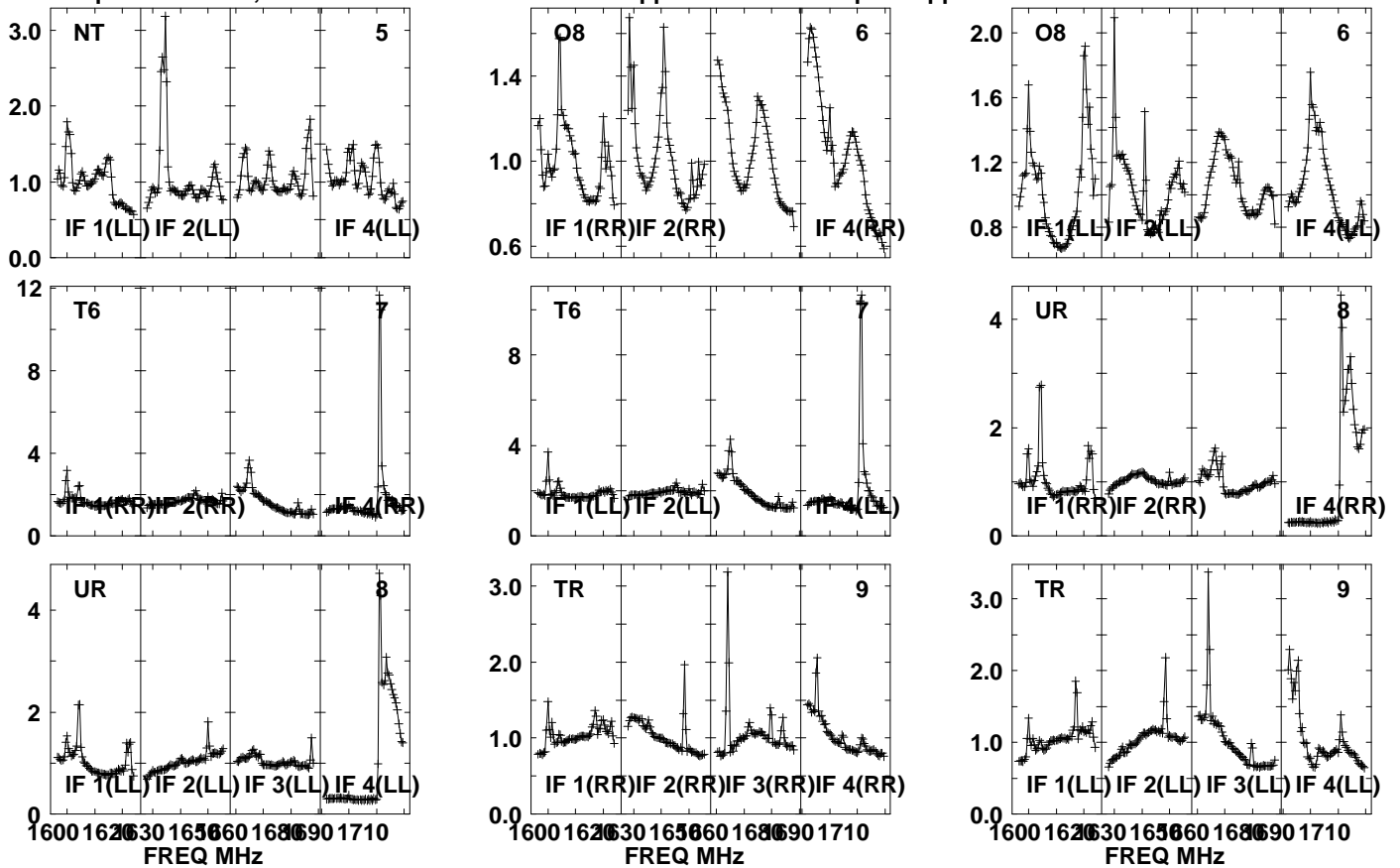

Lower frame: Real Jy

Auto-corr total-power spectrum Antenna: \*

Timerange: 00/11:01:31 to 00/11:02:59



Plot file version 51 created 05-OCT-2021 17:04:43

J0827+5217 GM076.UVDATA.1

Freq = 1.5945 GHz, Bw = 32.000 MH No calibration applied and no bandpass applied

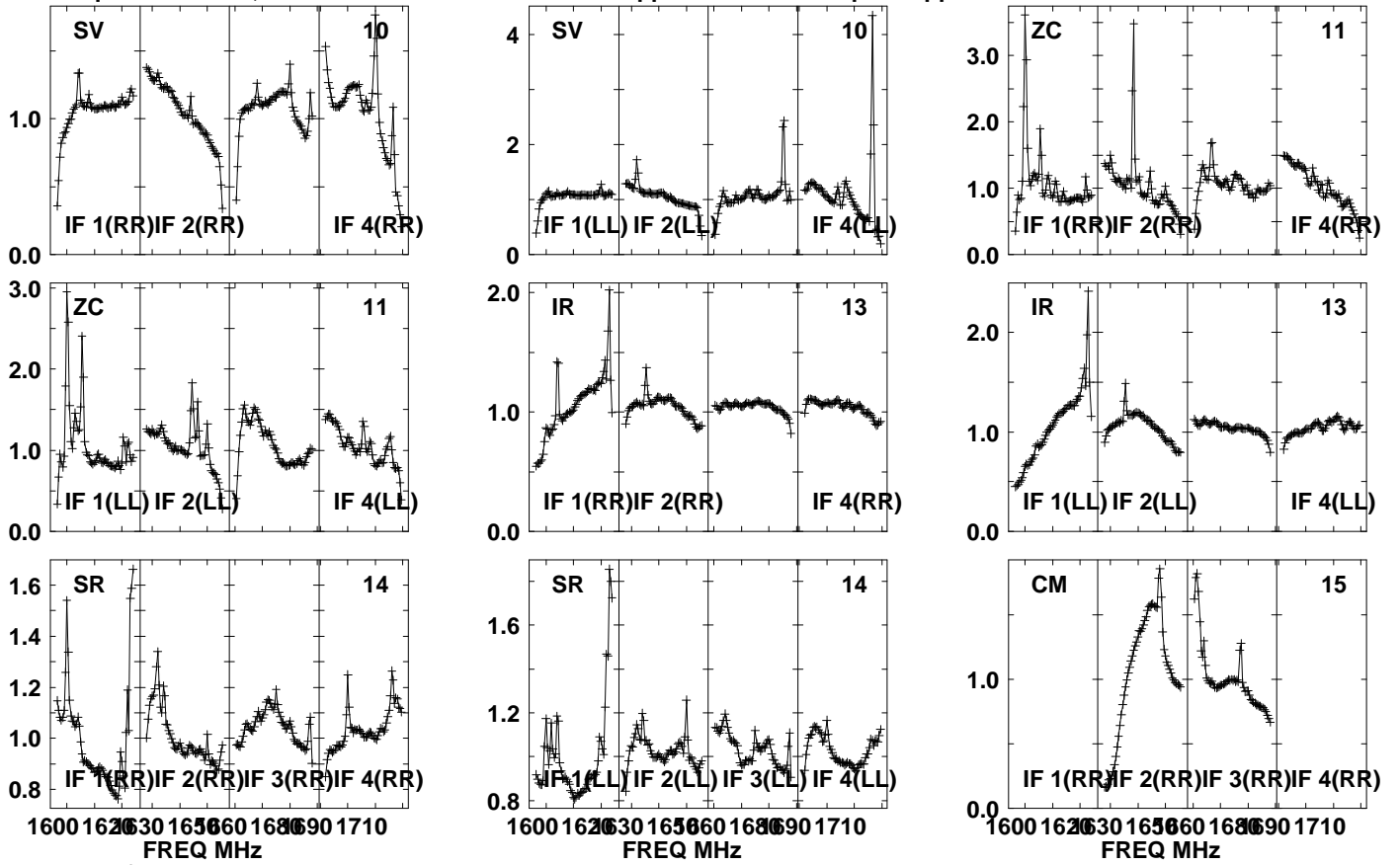

Lower frame: Real Jy  
Auto-corr total-power spectrum Antenna: \*  
Timerange: 00/11:01:31 to 00/11:02:59

Plot file version 52 created 05-OCT-2021 17:04:43

J0827+5217 GM076.UVDATA.1

Freq = 1.5945 GHz, Bw = 32.000 MH No calibration applied and no bandpass applied

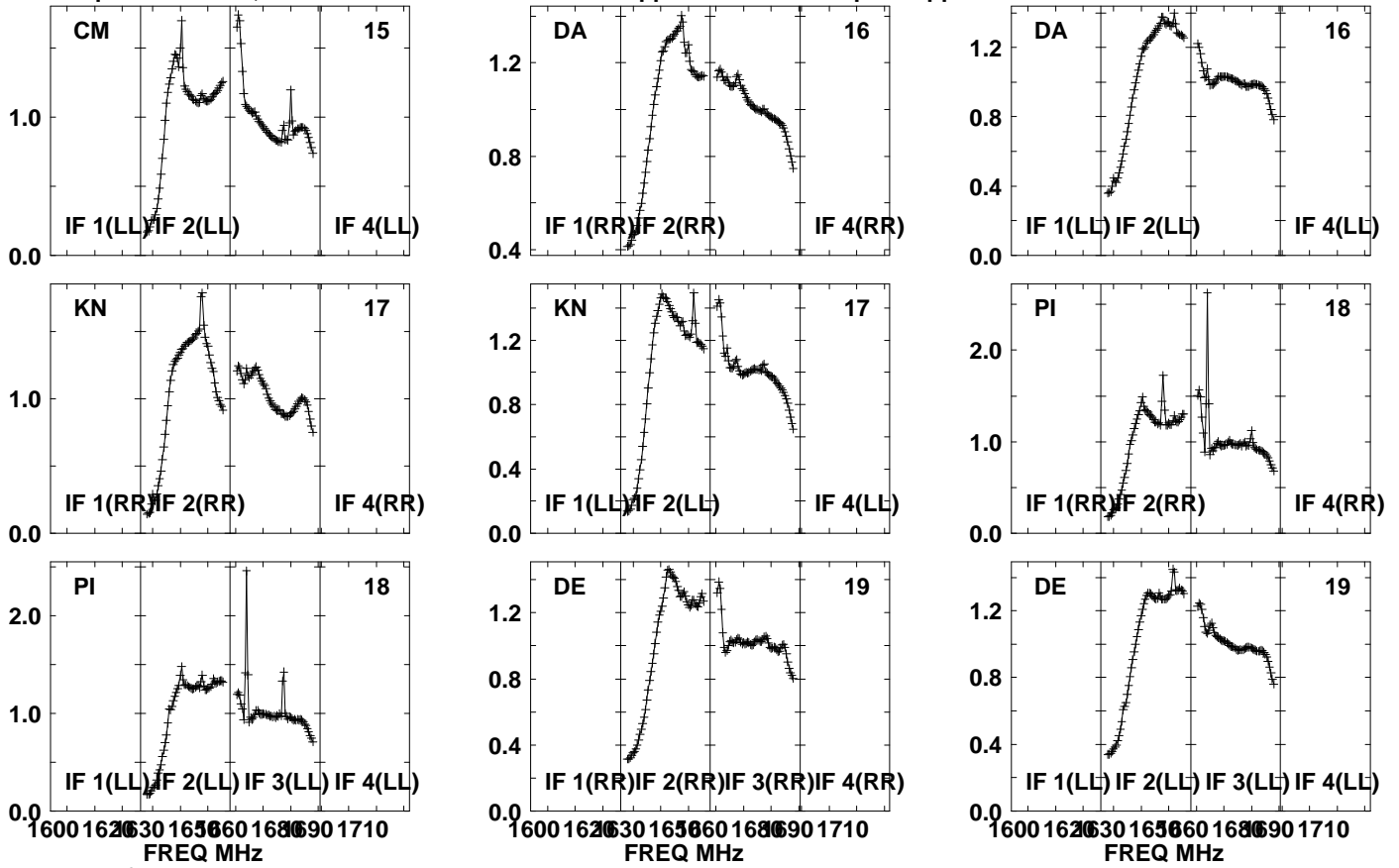

Lower frame: Real Jy  
Auto-corr total-power spectrum Antenna: \*  
Timerange: 00/11:01:31 to 00/11:02:59

Plot file version 53 created 05-OCT-2021 17:04:44

APM08279+525 GM076.UVDATA.1

Freq = 1.5945 GHz, Bw = 32.000 MH No calibration applied and no bandpass applied

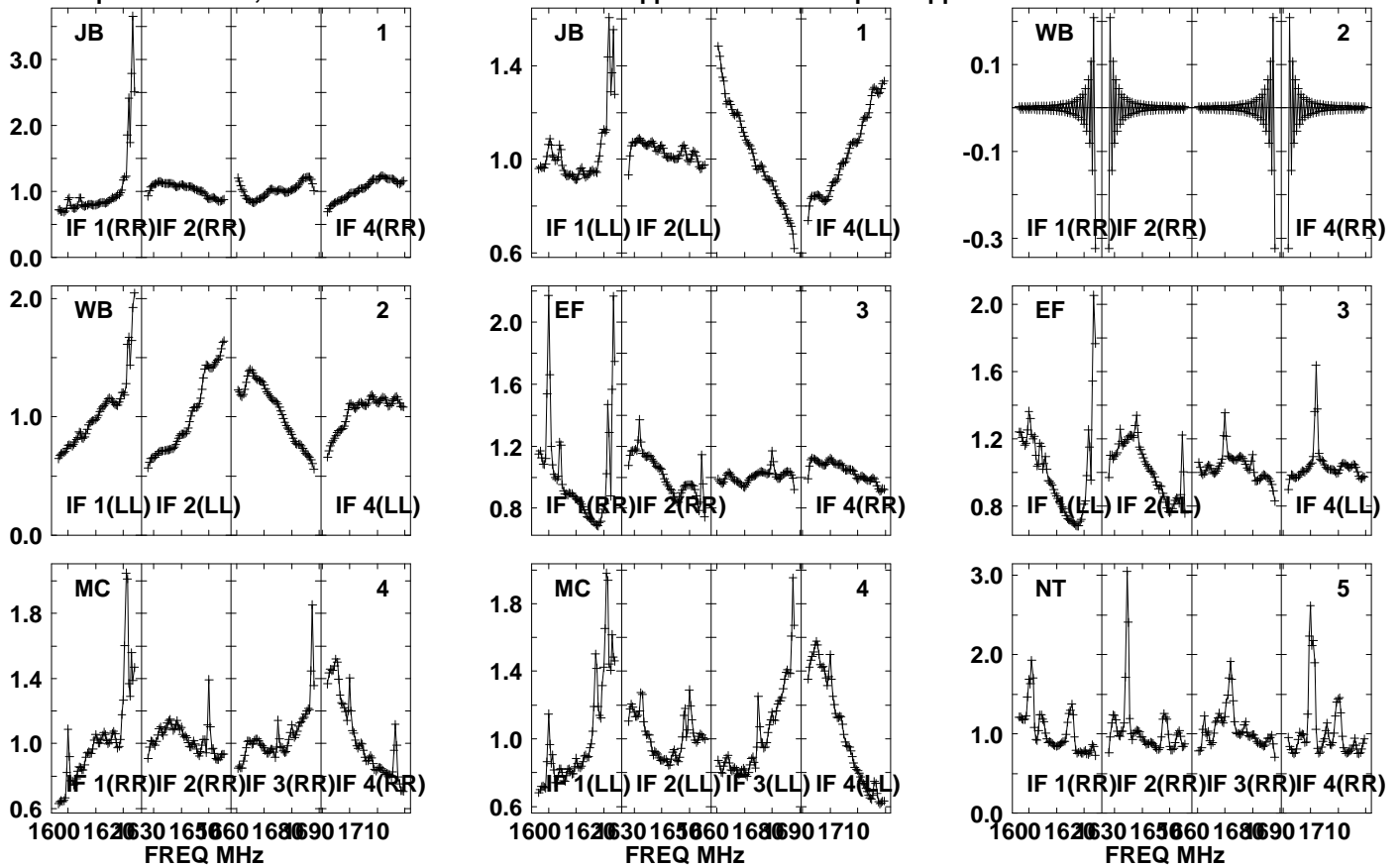

Lower frame: Real Jy

Auto-corr total-power spectrum Antenna: \*

Timerange: 00/11:03:01 to 00/11:06:29

Plot file version 54 created 05-OCT-2021 17:04:44

APM08279+525 GM076.UVDATA.1

Freq = 1.5945 GHz, Bw = 32.000 MH No calibration applied and no bandpass applied

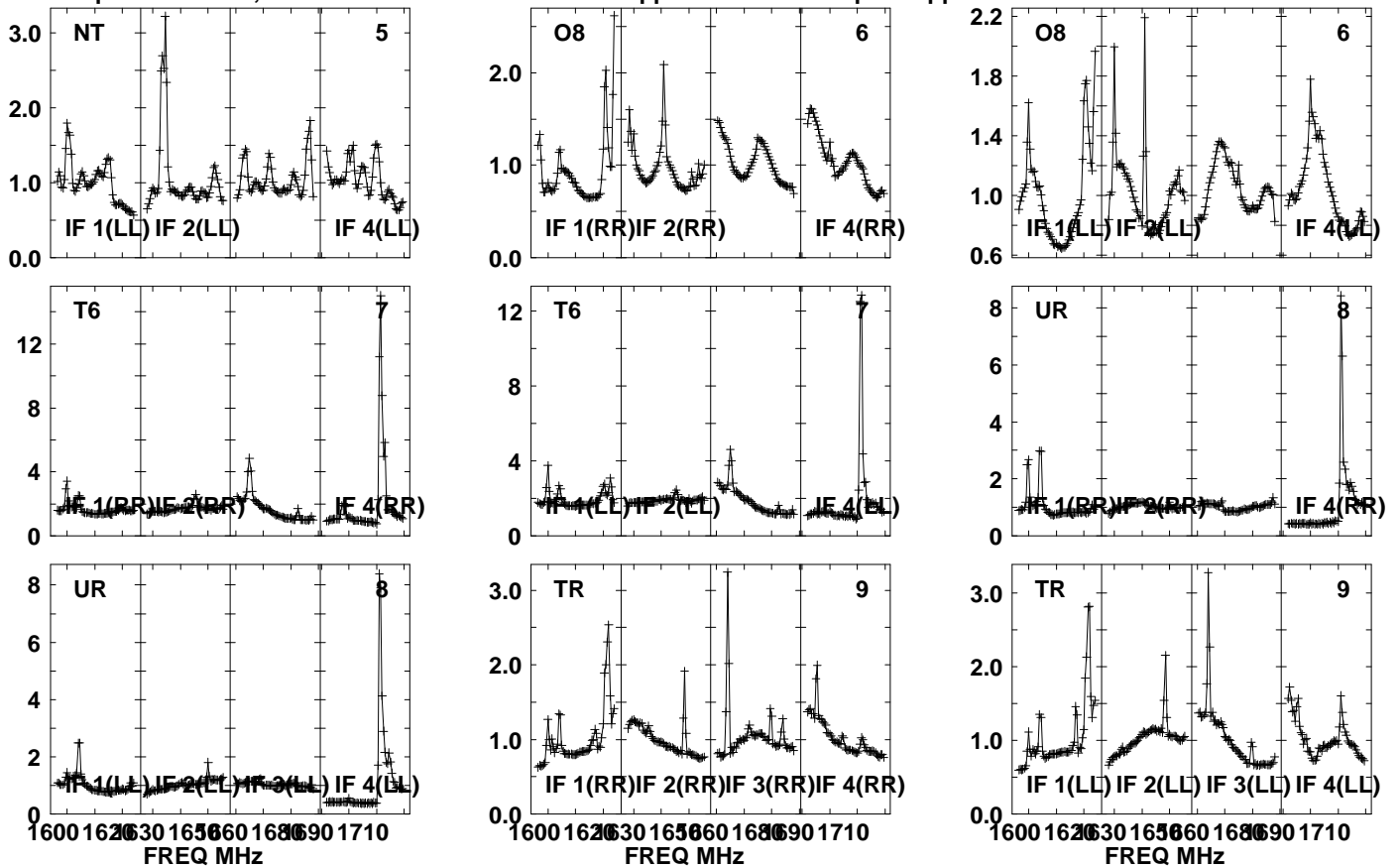

Lower frame: Real Jy

Auto-corr total-power spectrum Antenna: \*

Timerange: 00/11:03:01 to 00/11:06:29

Plot file version 55 created 05-OCT-2021 17:04:44

APM08279+525 GM076.UVDATA.1

Freq = 1.5945 GHz, Bw = 32.000 MH

No calibration applied and no bandpass applied

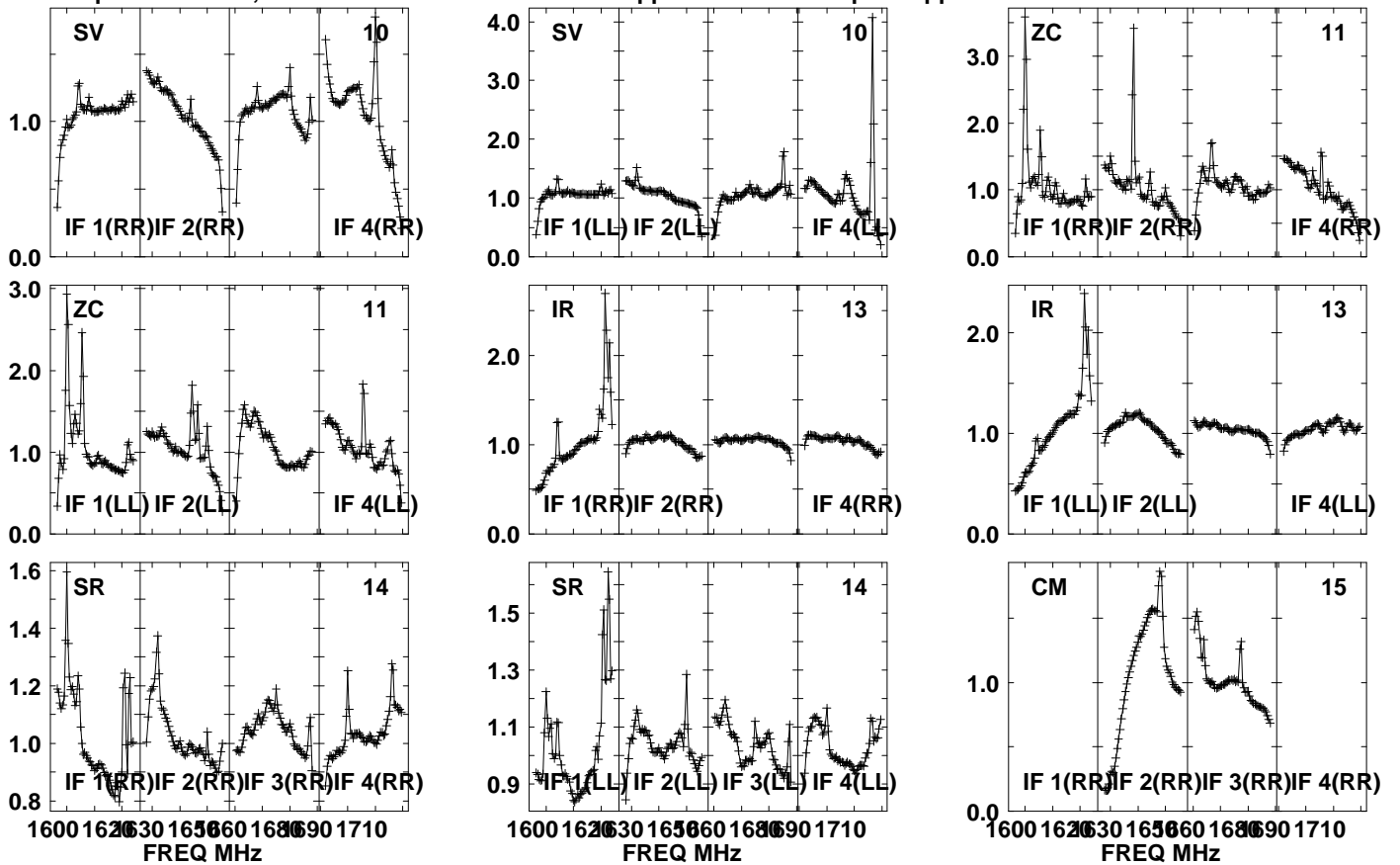

Lower frame: Real Jy

Auto-corr total-power spectrum Antenna: \*

Timerange: 00/11:03:01 to 00/11:06:29

Plot file version 56 created 05-OCT-2021 17:04:44

APM08279+525 GM076.UVDATA.1

Freq = 1.5945 GHz, Bw = 32.000 MH No calibration applied and no bandpass applied

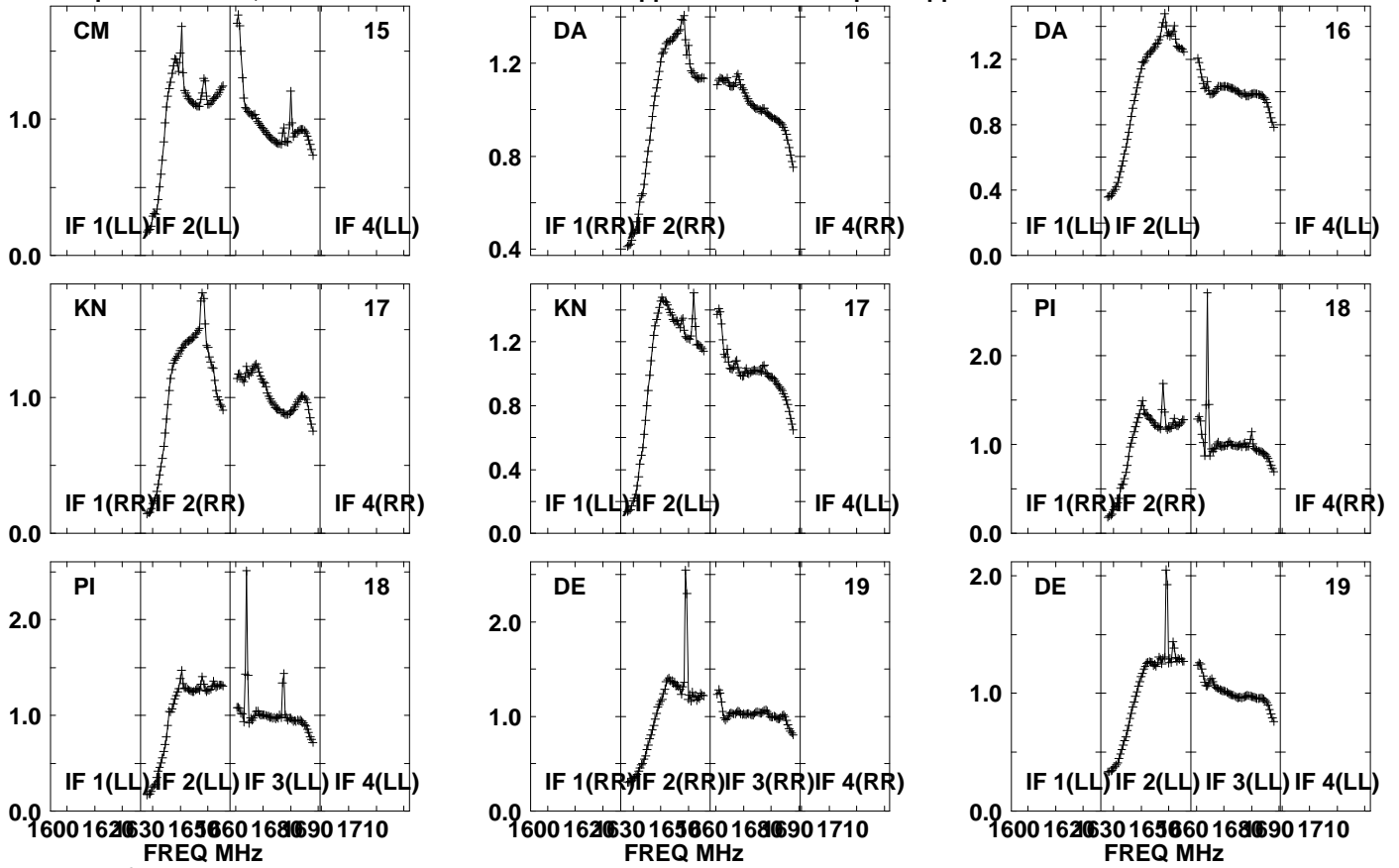

Lower frame: Real Jy  
Auto-corr total-power spectrum Antenna: \*  
Timerange: 00/11:03:01 to 00/11:06:29

Plot file version 57 created 05-OCT-2021 17:04:45

J0827+5217 GM076.UVDATA.1

Freq = 1.5945 GHz, Bw = 32.000 MH No calibration applied and no bandpass applied

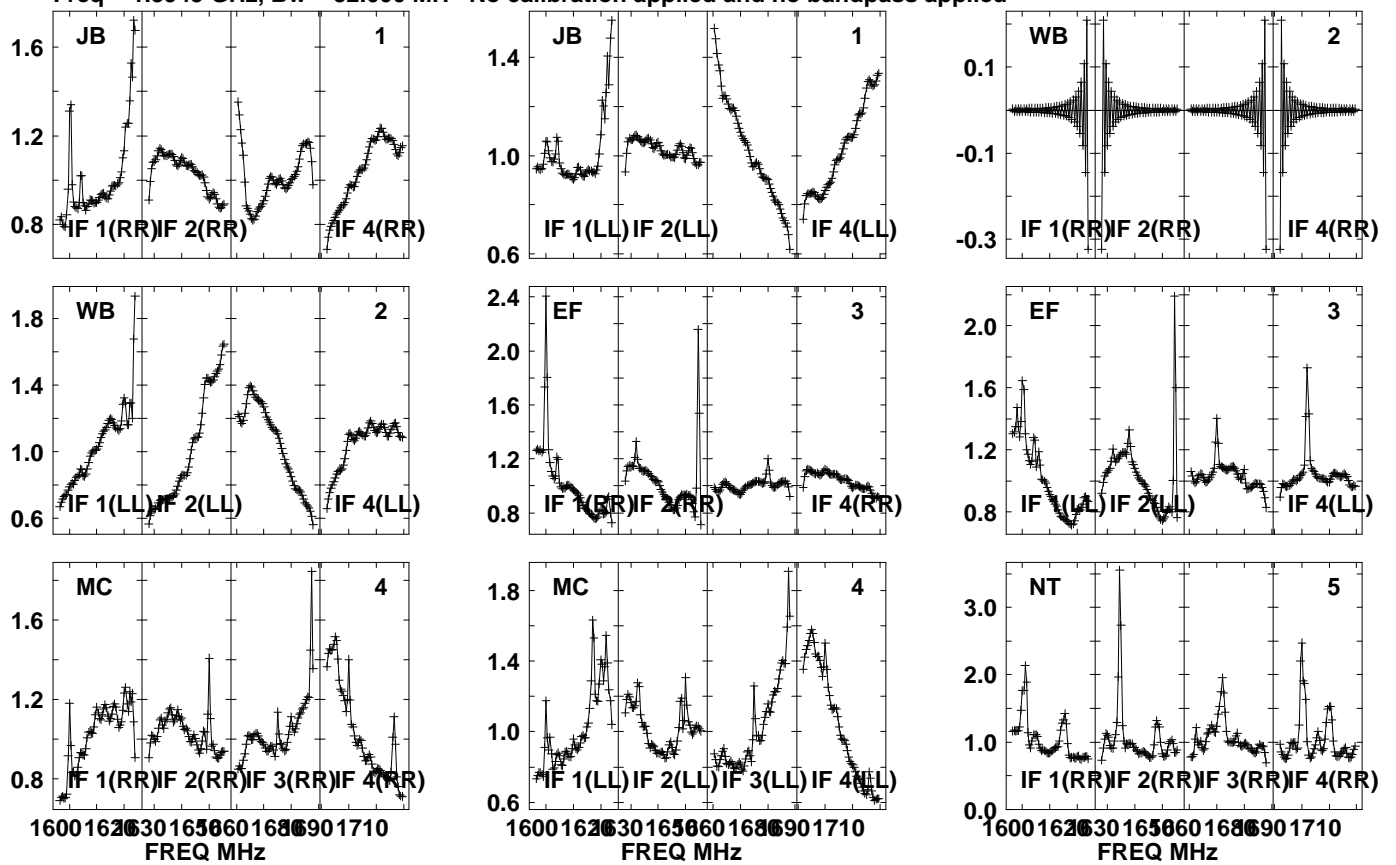

Lower frame: Real Jy  
Auto-corr total-power spectrum Antenna: \*  
Timerange: 00/11:07:01 to 00/11:08:29

Plot file version 58 created 05-OCT-2021 17:04:45

J0827+5217 GM076.UVDATA.1

Freq = 1.5945 GHz, Bw = 32.000 MH No calibration applied and no bandpass applied

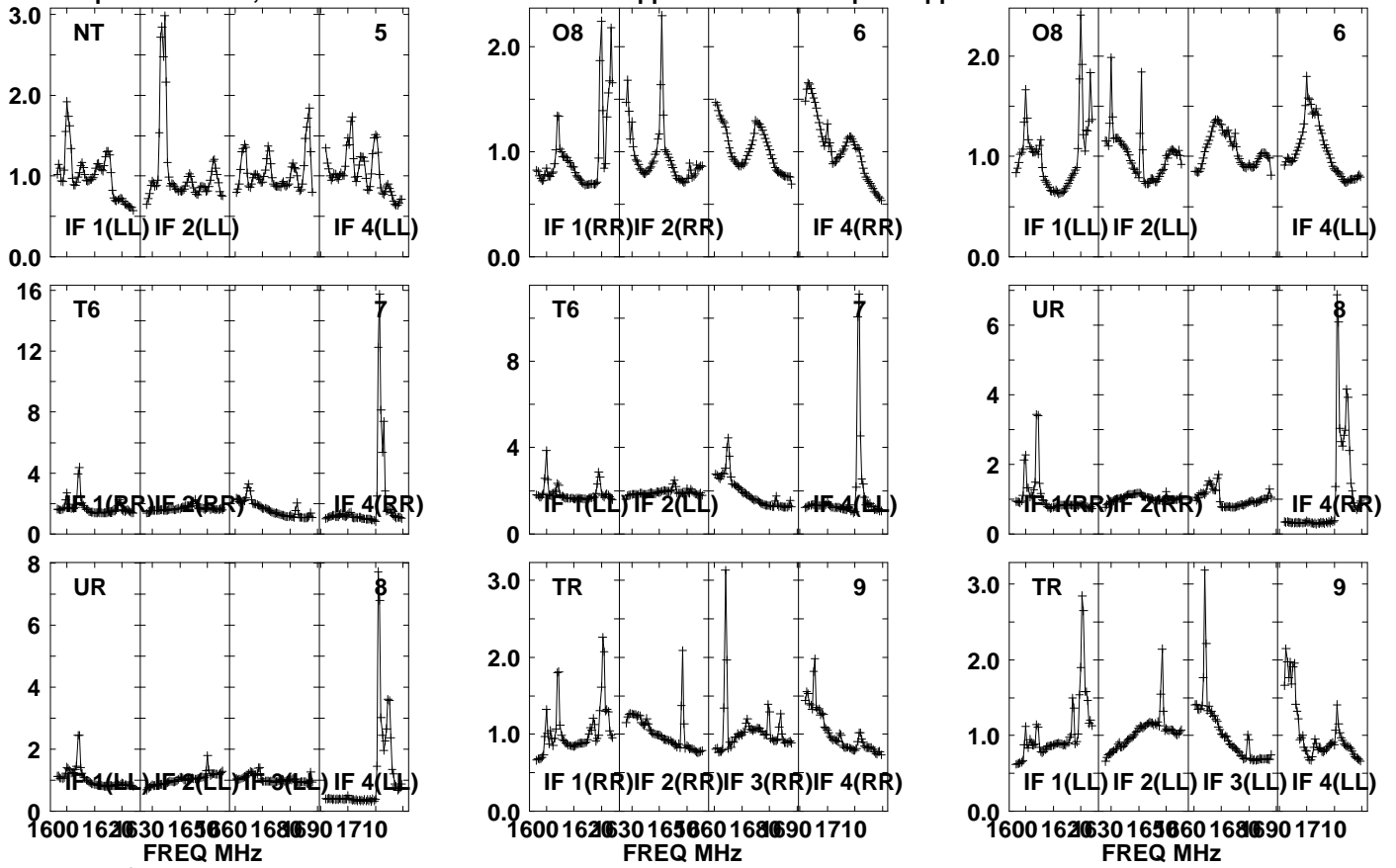

Lower frame: Real Jy

Auto-corr total-power spectrum Antenna: \*

Timerange: 00/11:07:01 to 00/11:08:29



Plot file version 59 created 05-OCT-2021 17:04:45

J0827+5217 GM076.UVDATA.1

Freq = 1.5945 GHz, Bw = 32.000 MH No calibration applied and no bandpass applied

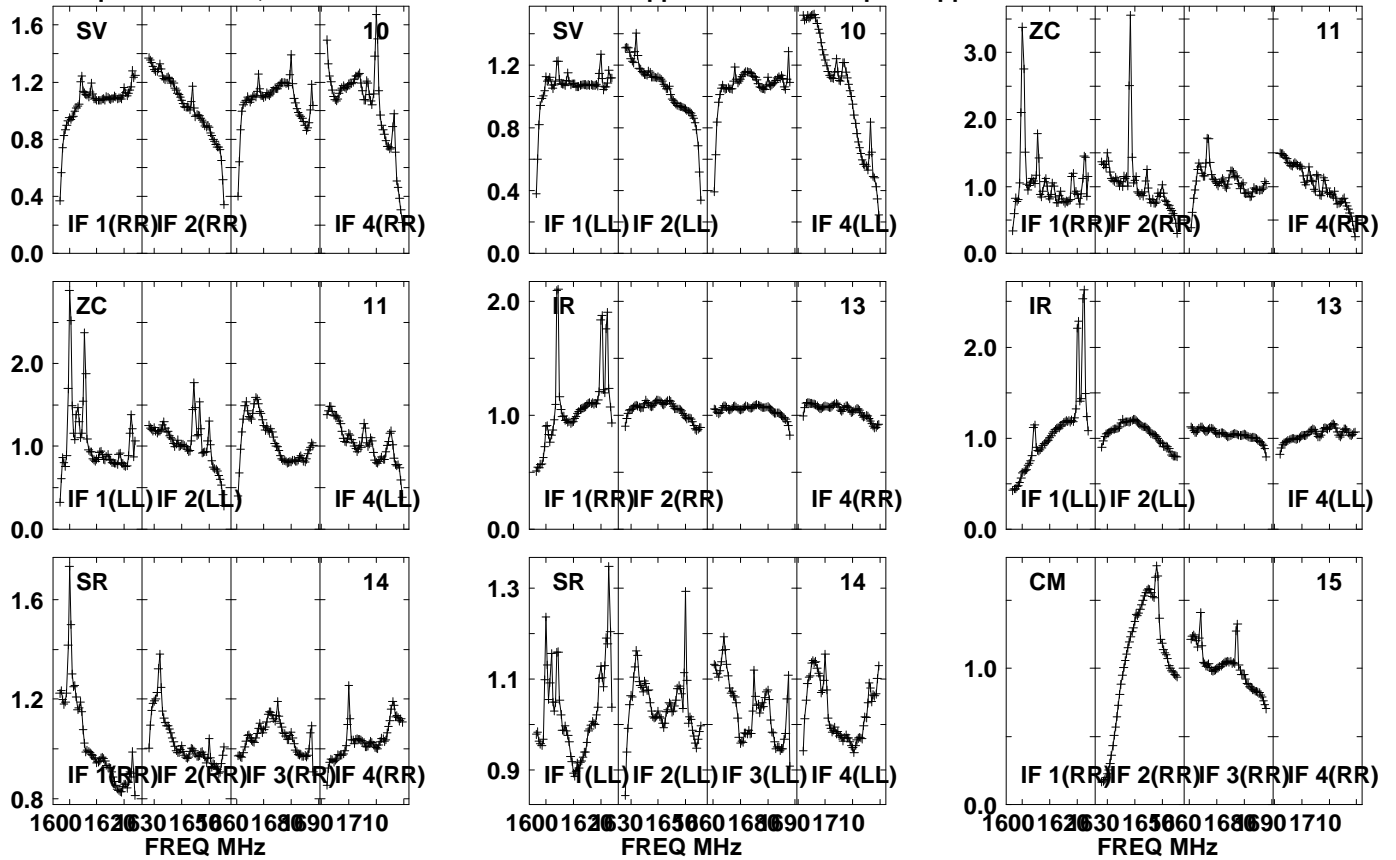

Lower frame: Real Jy  
Auto-corr total-power spectrum Antenna: \*  
Timerange: 00/11:07:01 to 00/11:08:29

Plot file version 60 created 05-OCT-2021 17:04:45

J0827+5217 GM076.UVDATA.1

Freq = 1.5945 GHz, Bw = 32.000 MH No calibration applied and no bandpass applied

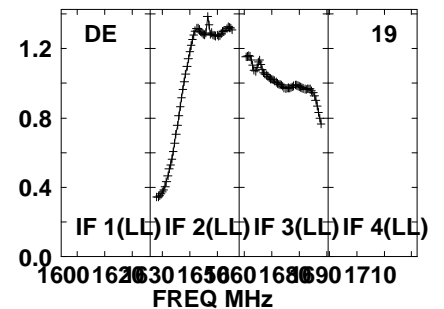
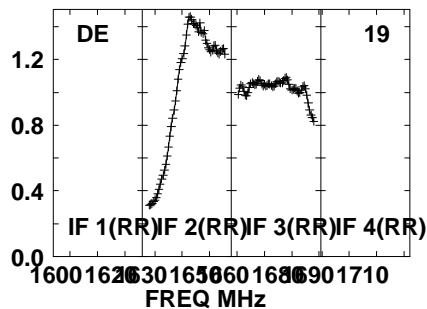
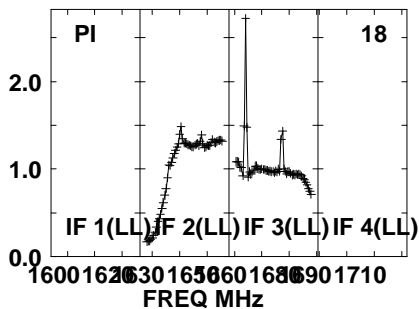
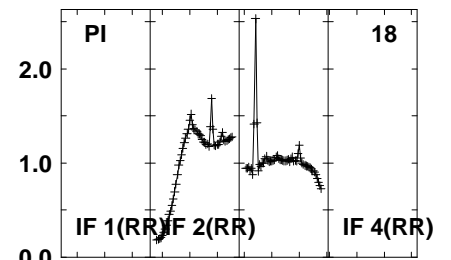
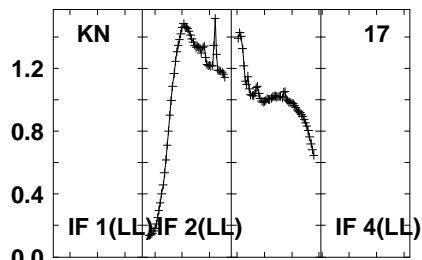
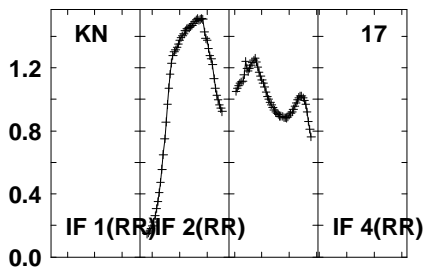
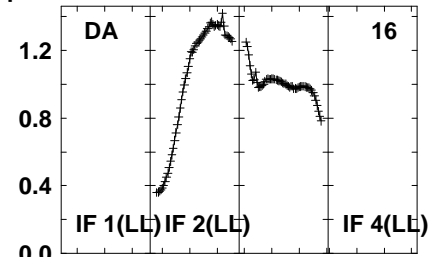
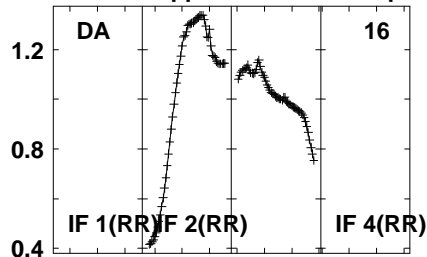
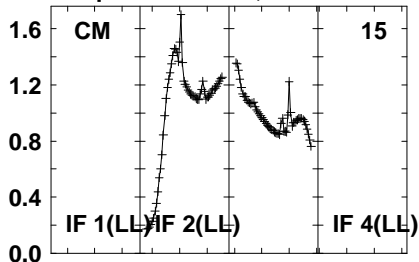

Lower frame: Real Jy  
Auto-corr total-power spectrum Antenna: \*  
Timerange: 00/11:07:01 to 00/11:08:29

Plot file version 61 created 05-OCT-2021 17:04:46

APM08279+525 GM076.UVDATA.1

Freq = 1.5945 GHz, Bw = 32.000 MH No calibration applied and no bandpass applied

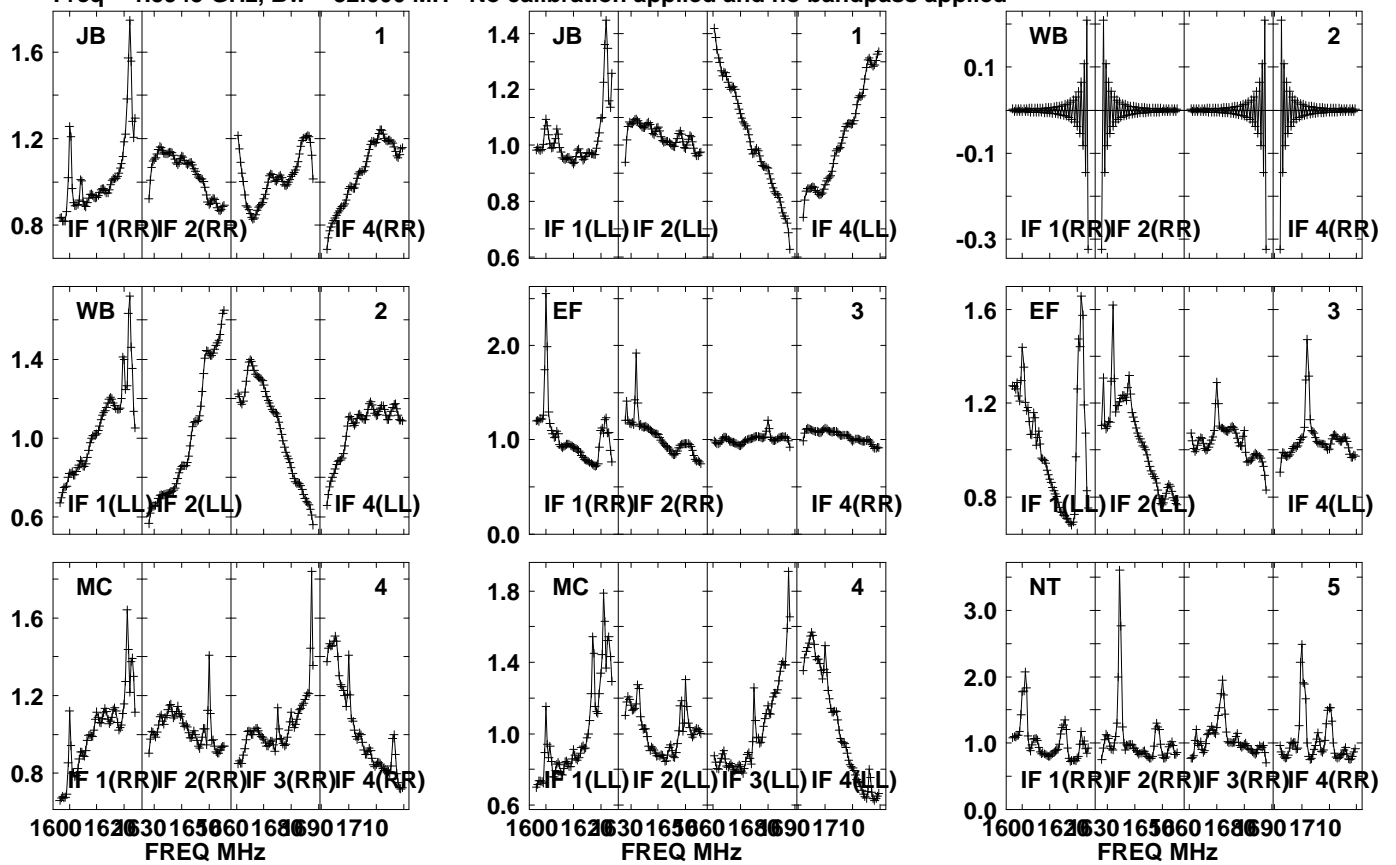

Lower frame: Real Jy  
Auto-corr total-power spectrum Antenna: \*  
Timerange: 00/11:08:31 to 00/11:11:59

Plot file version 62 created 05-OCT-2021 17:04:46

APM08279+525 GM076.UVDATA.1

Freq = 1.5945 GHz, Bw = 32.000 MH No calibration applied and no bandpass applied

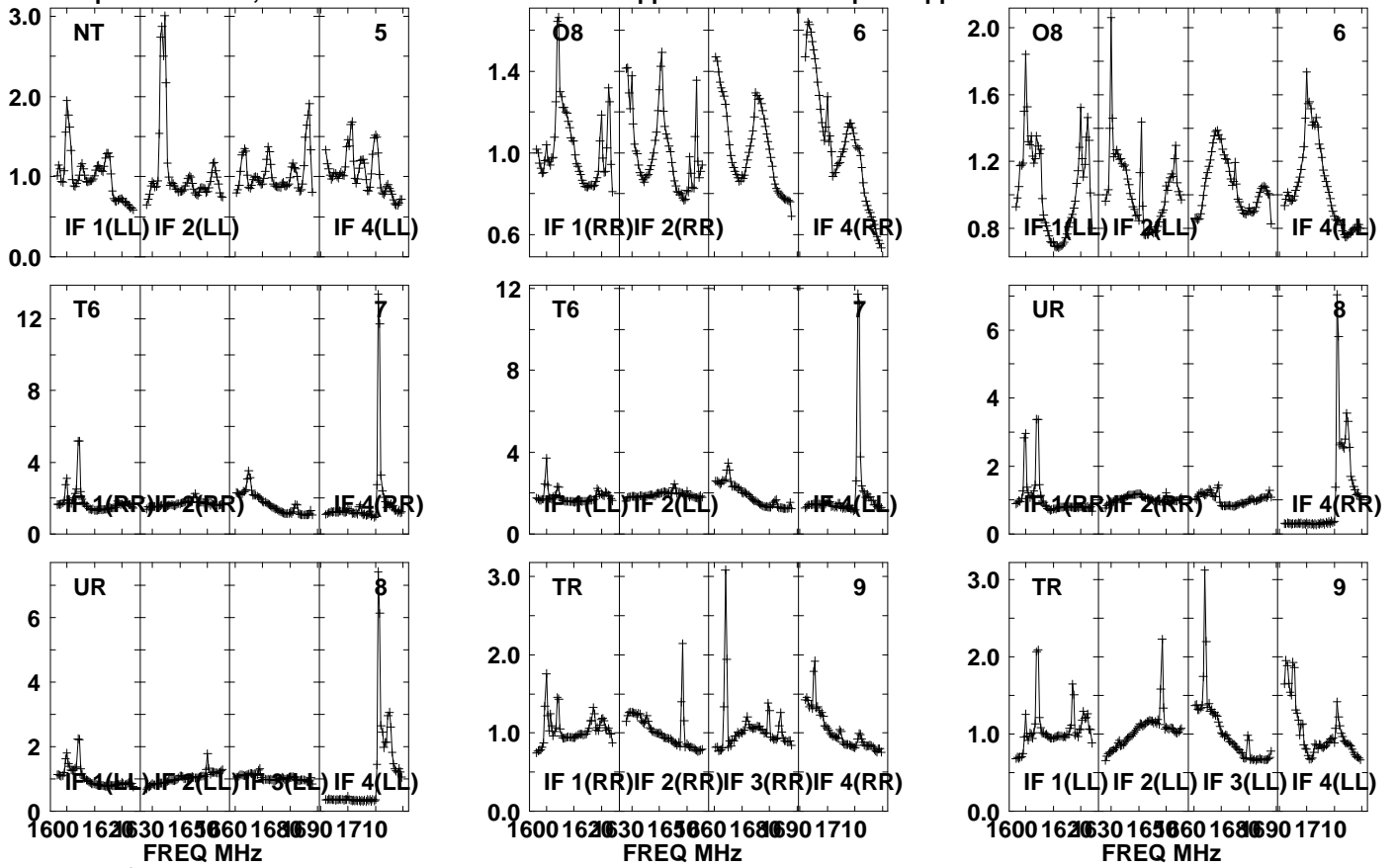

Lower frame: Real Jy  
Auto-corr total-power spectrum Antenna: \*  
Timerange: 00/11:08:31 to 00/11:11:59

Plot file version 63 created 05-OCT-2021 17:04:46

APM08279+525 GM076.UVDATA.1

Freq = 1.5945 GHz, Bw = 32.000 MH No calibration applied and no bandpass applied

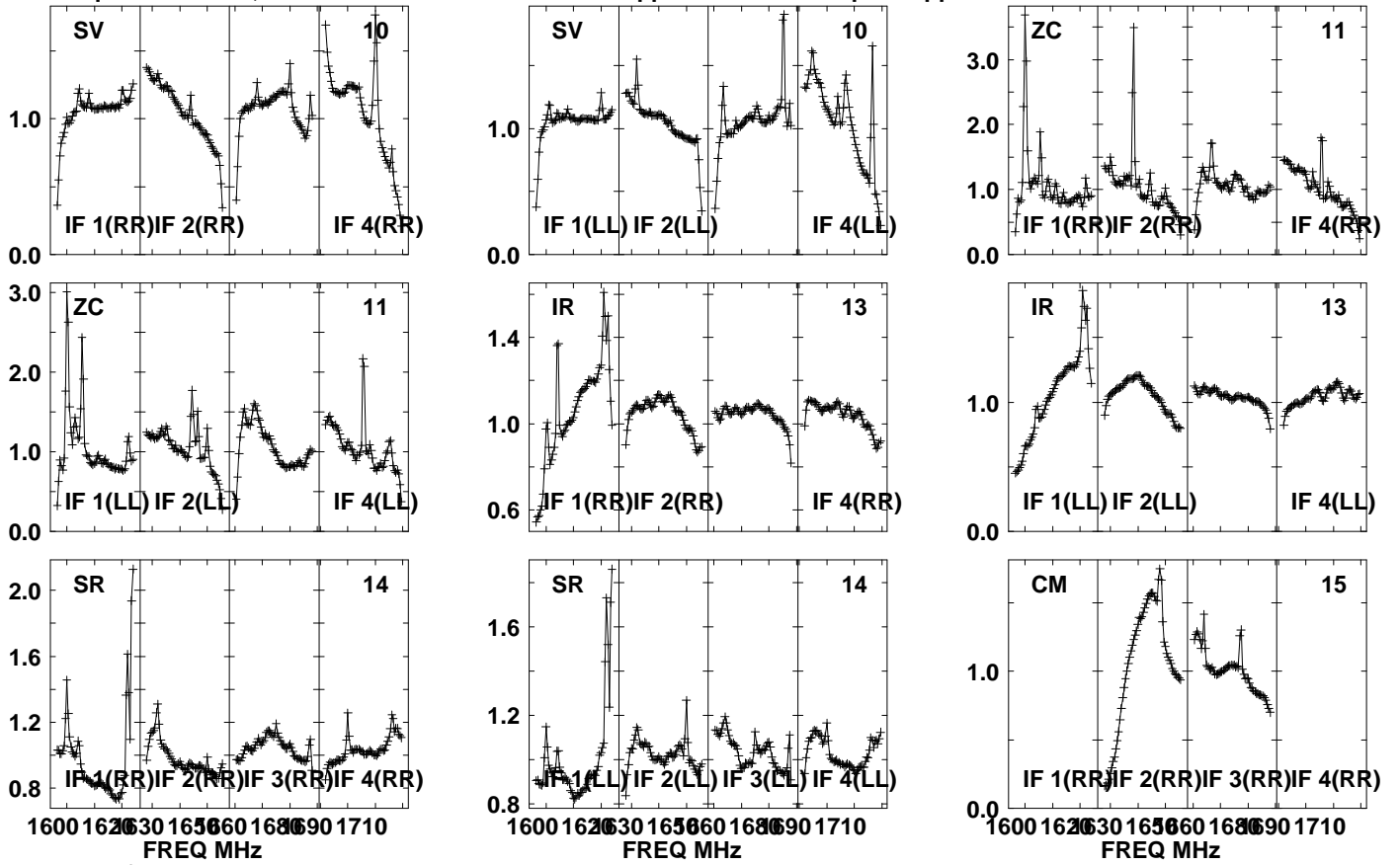

Lower frame: Real Jy

Auto-corr total-power spectrum Antenna: \*

Timerange: 00/11:08:31 to 00/11:11:59

Plot file version 64 created 05-OCT-2021 17:04:46

APM08279+525 GM076.UVDATA.1

Freq = 1.5945 GHz, Bw = 32.000 MH No calibration applied and no bandpass applied

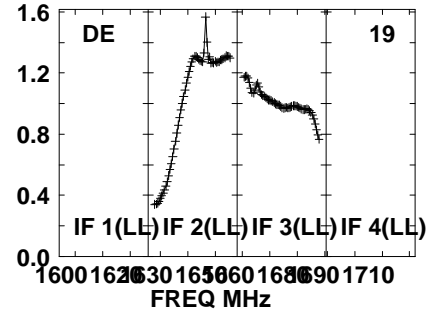
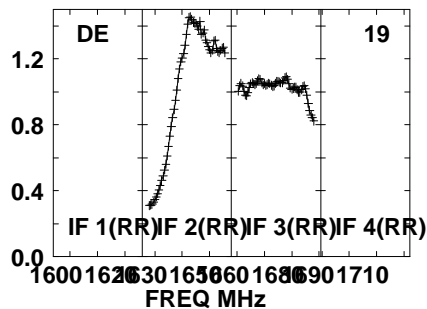
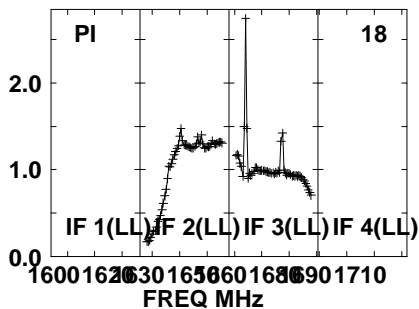
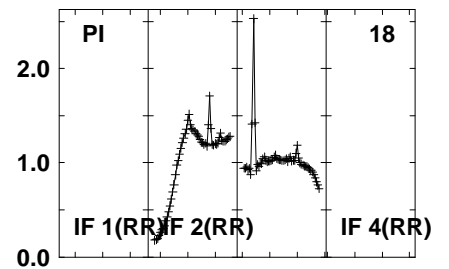
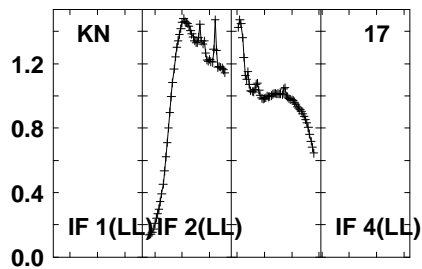
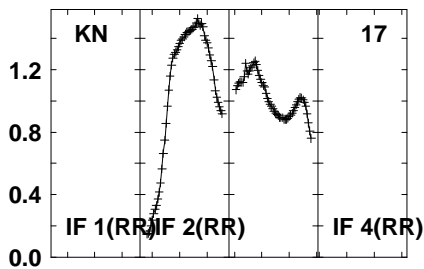
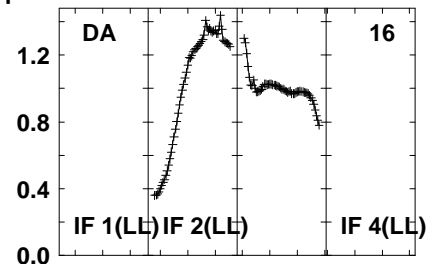
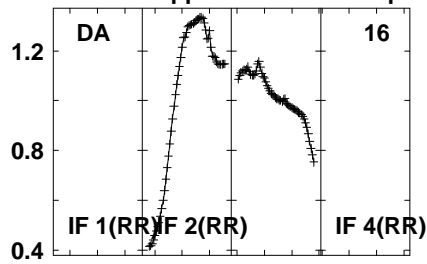
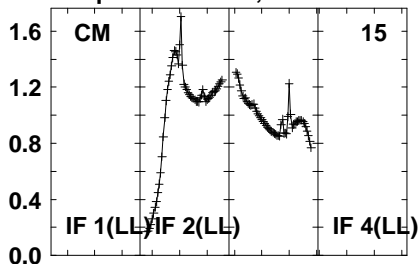

Lower frame: Real Jy  
Auto-corr total-power spectrum Antenna: \*  
Timerange: 00/11:08:31 to 00/11:11:59

Plot file version 65 created 05-OCT-2021 17:04:47

J0827+5217 GM076.UVDATA.1

Freq = 1.5945 GHz, Bw = 32.000 MH No calibration applied and no bandpass applied

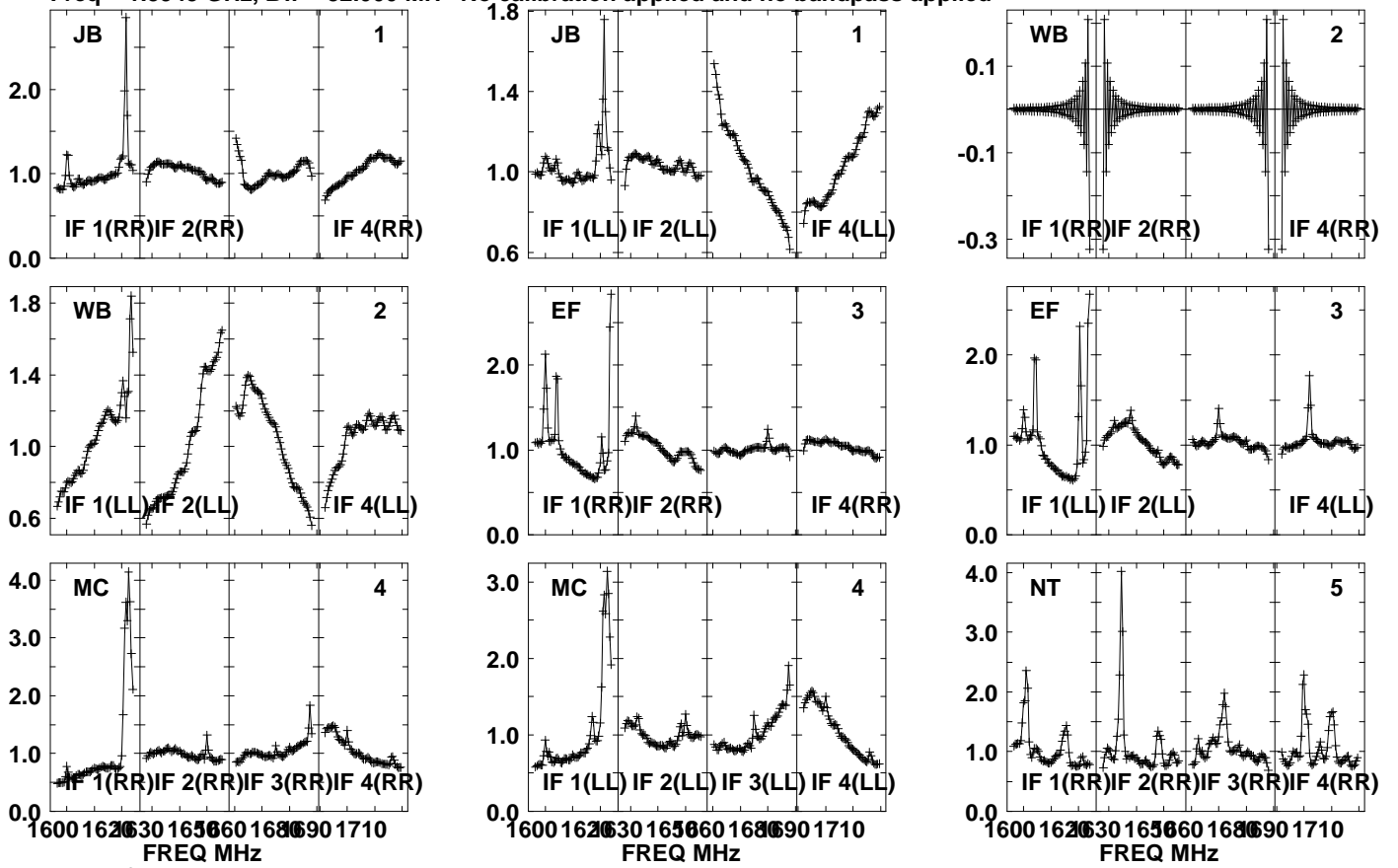

Lower frame: Real Jy  
Auto-corr total-power spectrum Antenna: \*  
Timerange: 00/11:12:01 to 00/11:13:29

Plot file version 66 created 05-OCT-2021 17:04:47

J0827+5217 GM076.UVDATA.1

Freq = 1.5945 GHz, Bw = 32.000 MH No calibration applied and no bandpass applied

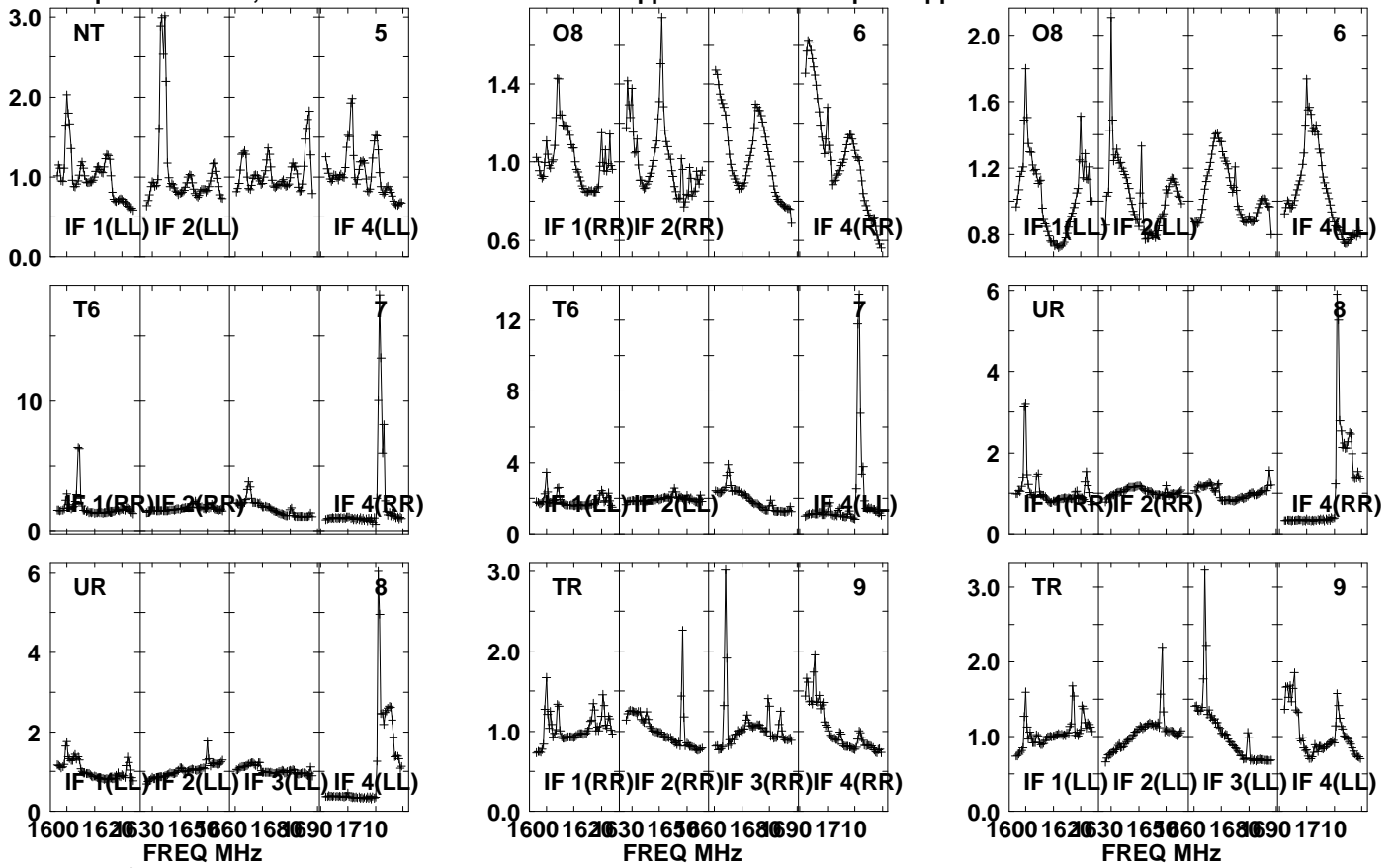

Lower frame: Real Jy  
Auto-corr total-power spectrum Antenna: \*  
Timerange: 00/11:12:01 to 00/11:13:29



Plot file version 67 created 05-OCT-2021 17:04:47

J0827+5217 GM076.UVDATA.1

Freq = 1.5945 GHz, Bw = 32.000 MH No calibration applied and no bandpass applied

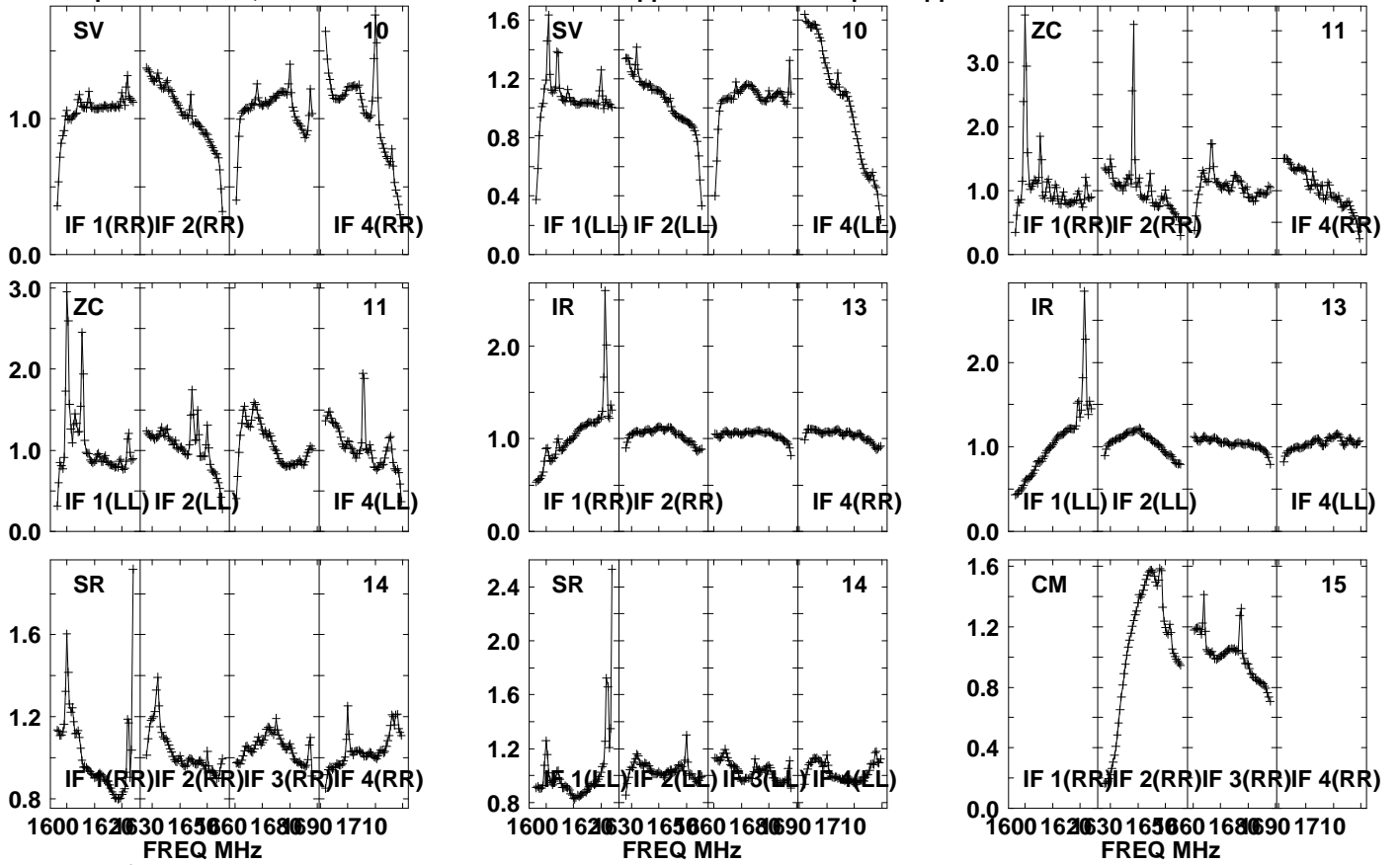

Lower frame: Real Jy  
Auto-corr total-power spectrum Antenna: \*  
Timerange: 00/11:12:01 to 00/11:13:29

Plot file version 68 created 05-OCT-2021 17:04:47

J0827+5217 GM076.UVDATA.1

Freq = 1.5945 GHz, Bw = 32.000 MH No calibration applied and no bandpass applied

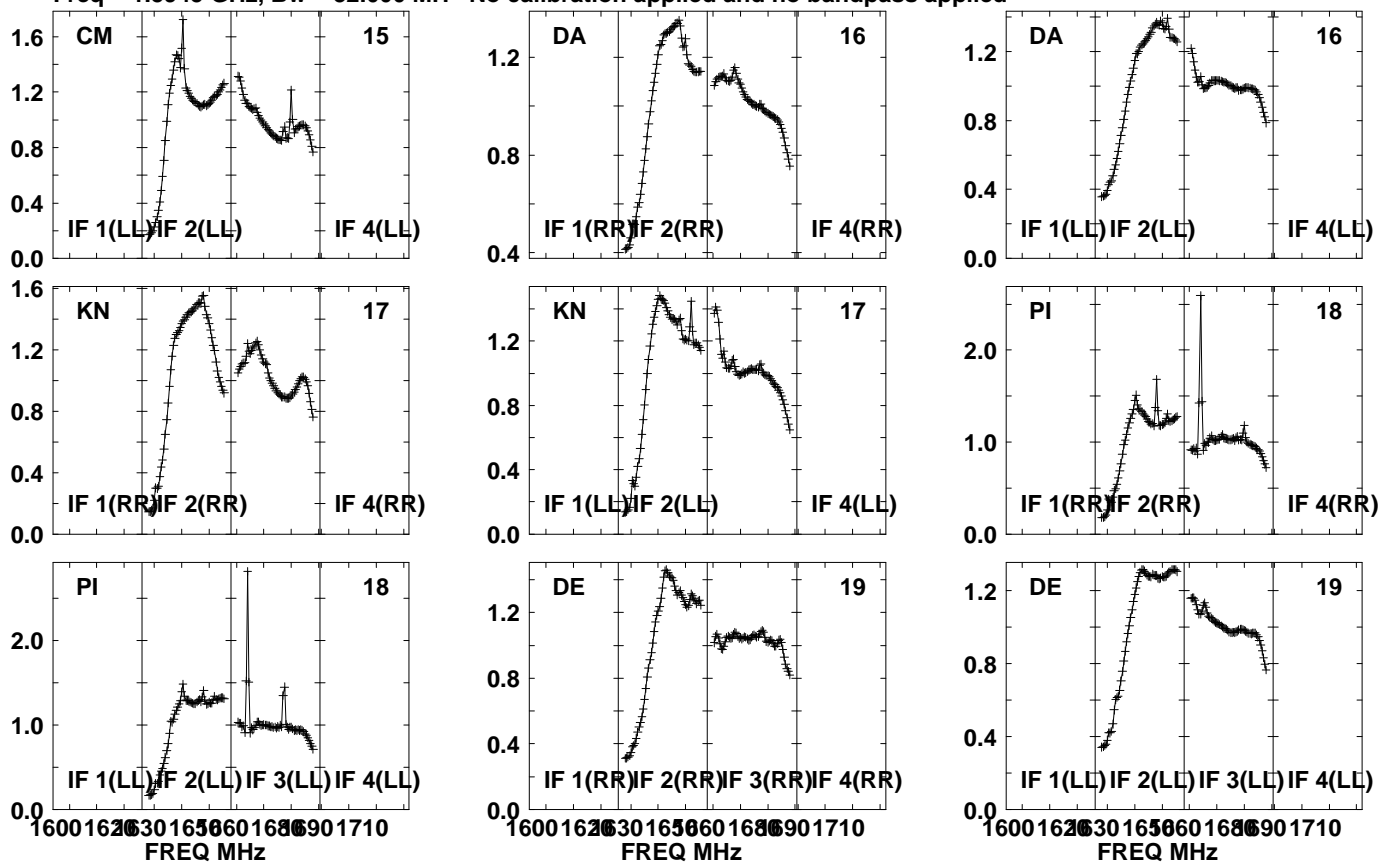

Lower frame: Real Jy  
Auto-corr total-power spectrum Antenna: \*  
Timerange: 00/11:12:01 to 00/11:13:29

Plot file version 69 created 05-OCT-2021 17:04:48

APM08279+525 GM076.UVDATA.1

Freq = 1.5945 GHz, Bw = 32.000 MH

No calibration applied and no bandpass applied

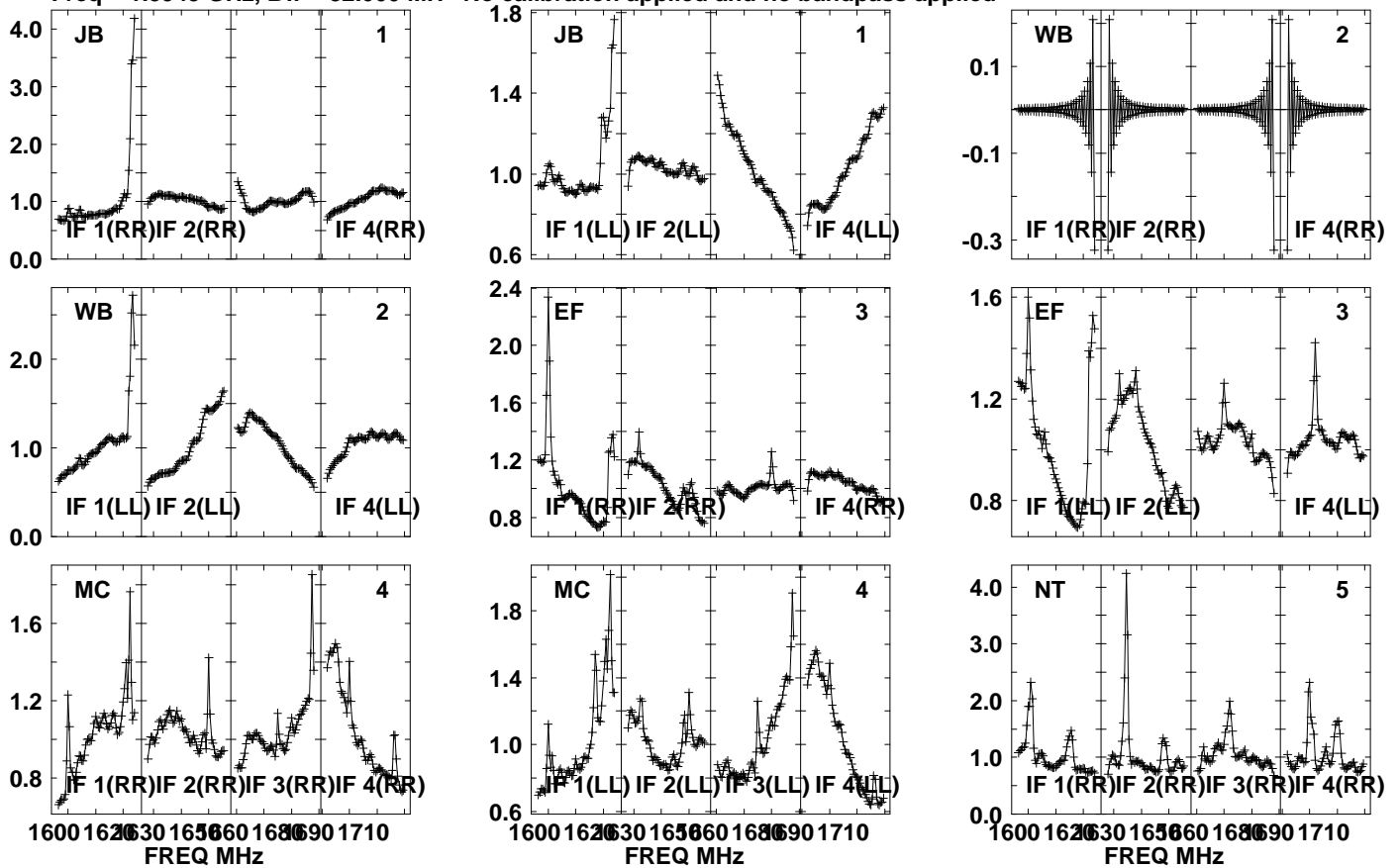

Lower frame: Real Jy

Auto-corr total-power spectrum Antenna: \*

Timerange: 00/11:13:31 to 00/11:16:59

Plot file version 70 created 05-OCT-2021 17:04:48

APM08279+525 GM076.UVDATA.1

Freq = 1.5945 GHz, Bw = 32.000 MH No calibration applied and no bandpass applied

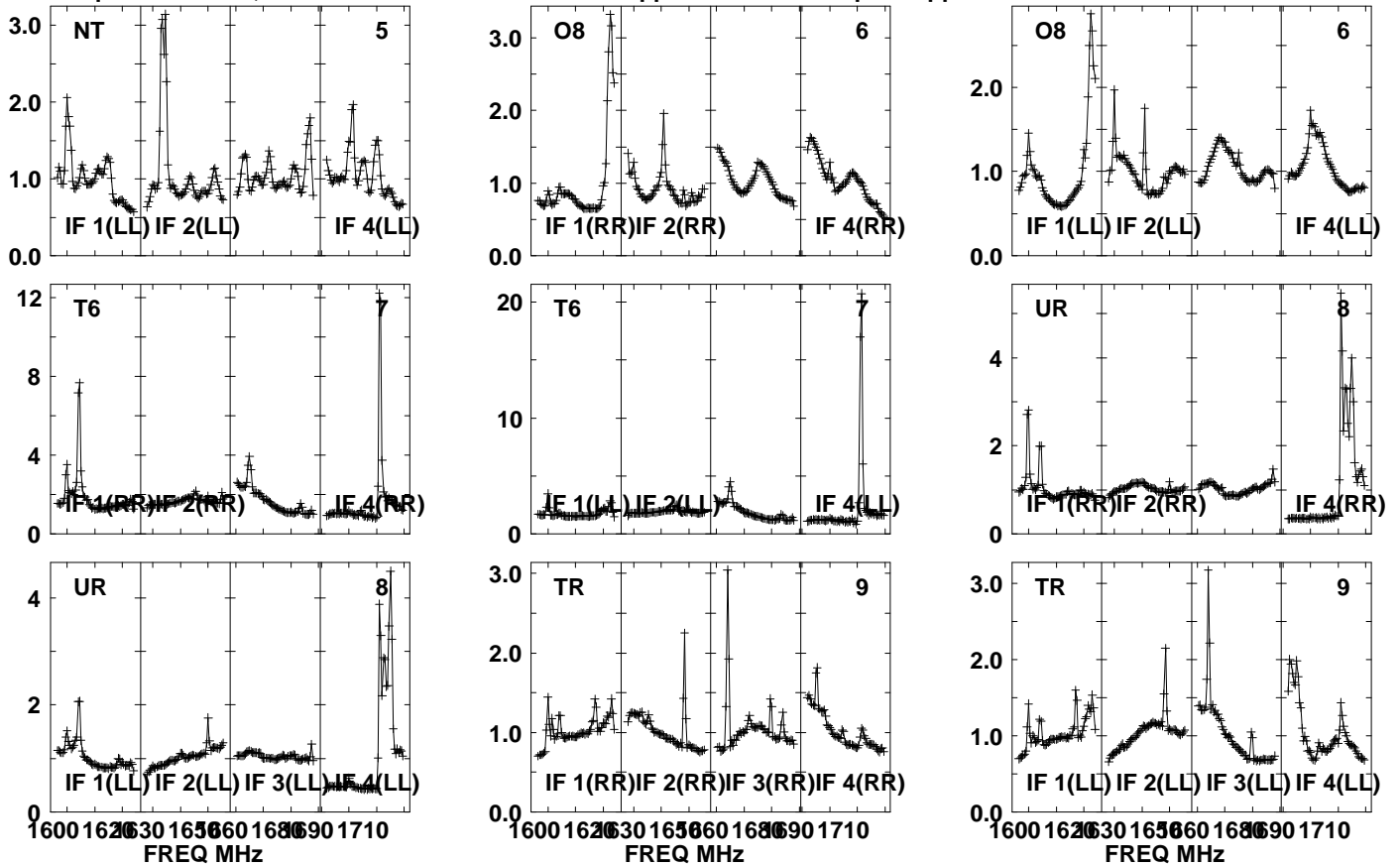

Lower frame: Real Jy

Auto-corr total-power spectrum Antenna: \*

Timerange: 00/11:13:31 to 00/11:16:59

Plot file version 71 created 05-OCT-2021 17:04:48

APM08279+525 GM076.UVDATA.1

Freq = 1.5945 GHz, Bw = 32.000 MH No calibration applied and no bandpass applied

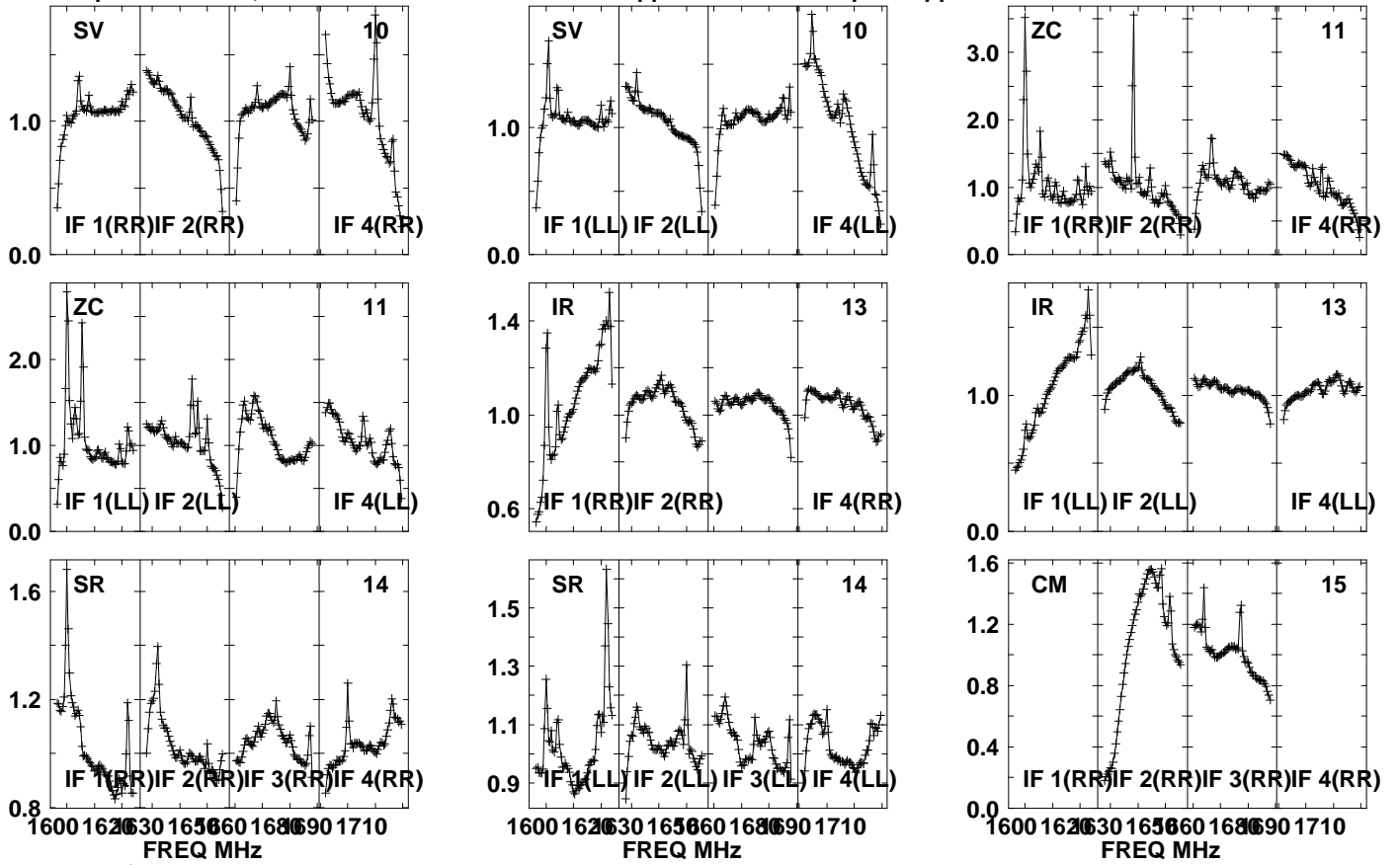

Lower frame: Real Jy

Auto-corr total-power spectrum Antenna: \*

Timerange: 00/11:13:31 to 00/11:16:59

Plot file version 72 created 05-OCT-2021 17:04:48

APM08279+525 GM076.UVDATA.1

Freq = 1.5945 GHz, Bw = 32.000 MH No calibration applied and no bandpass applied

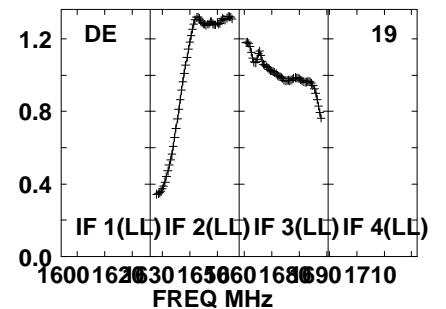
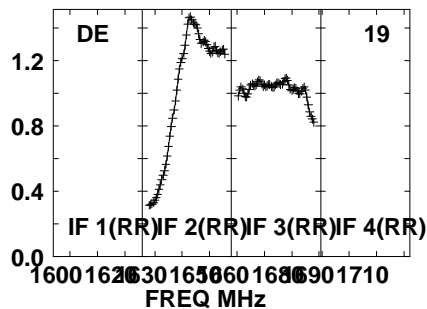
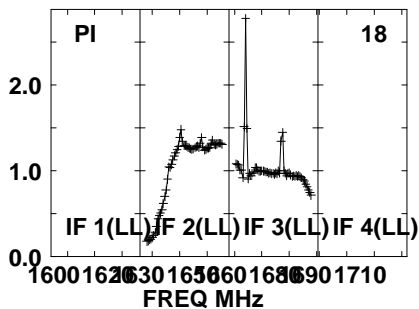
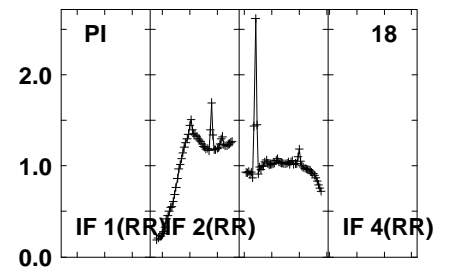
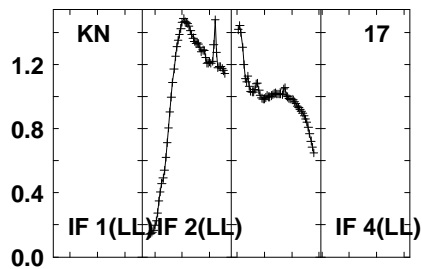
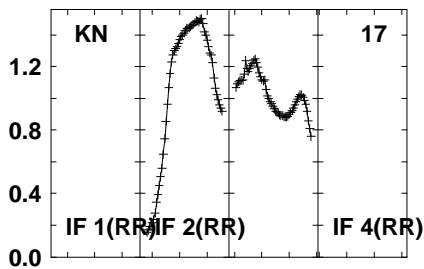
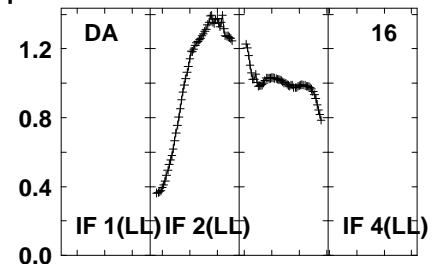
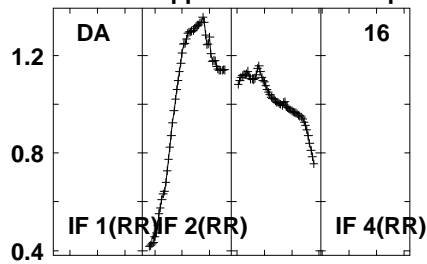
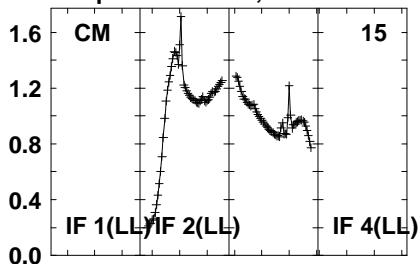

Lower frame: Real Jy  
Auto-corr total-power spectrum Antenna: \*  
Timerange: 00/11:13:31 to 00/11:16:59

Plot file version 73 created 05-OCT-2021 17:04:49

J0827+5217 GM076.UVDATA.1

Freq = 1.5945 GHz, Bw = 32.000 MH No calibration applied and no bandpass applied

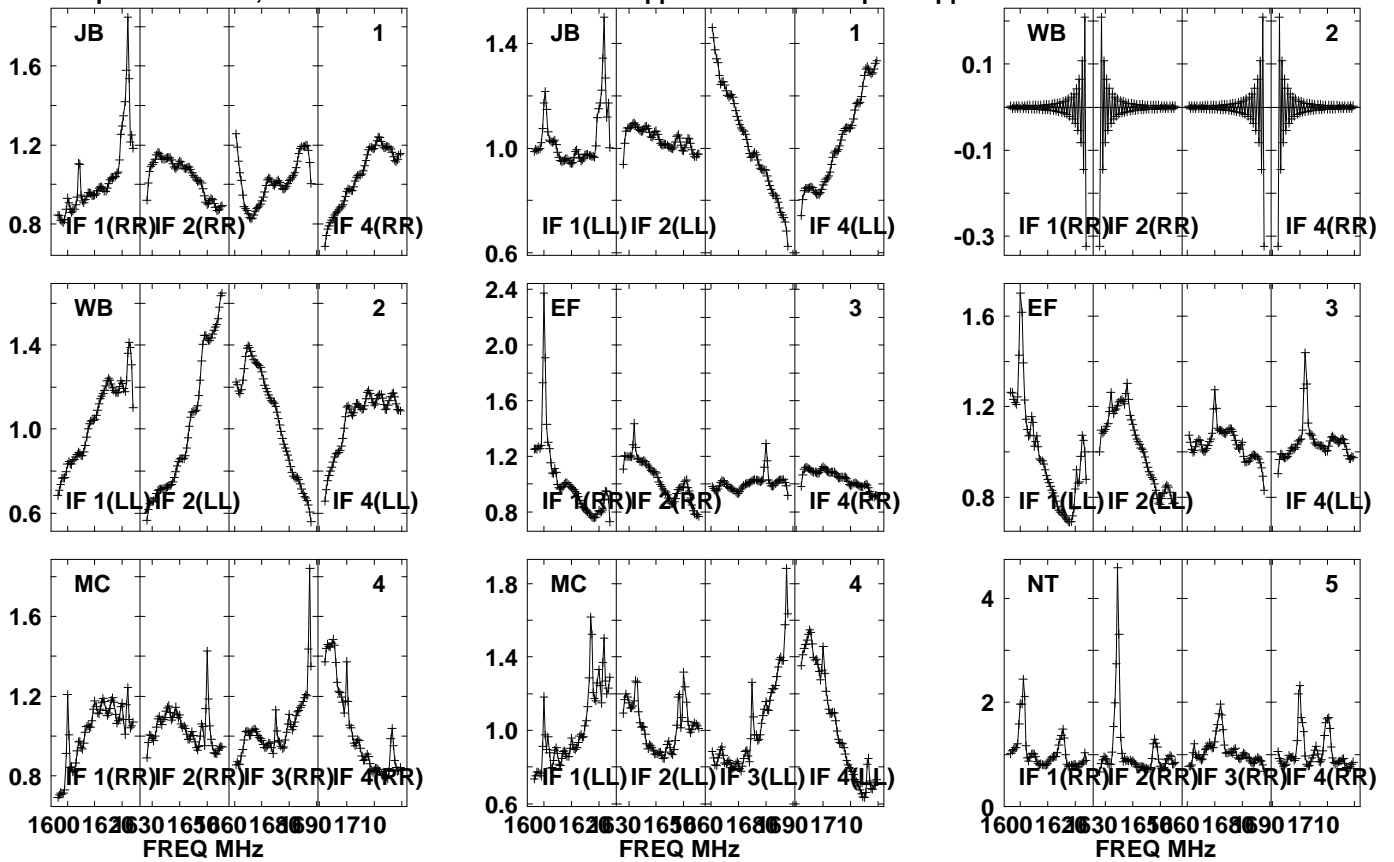

Lower frame: Real Jy  
Auto-corr total-power spectrum Antenna: \*  
Timerange: 00/11:17:31 to 00/11:18:59

Plot file version 74 created 05-OCT-2021 17:04:49

J0827+5217 GM076.UVDATA.1

Freq = 1.5945 GHz, Bw = 32.000 MH No calibration applied and no bandpass applied

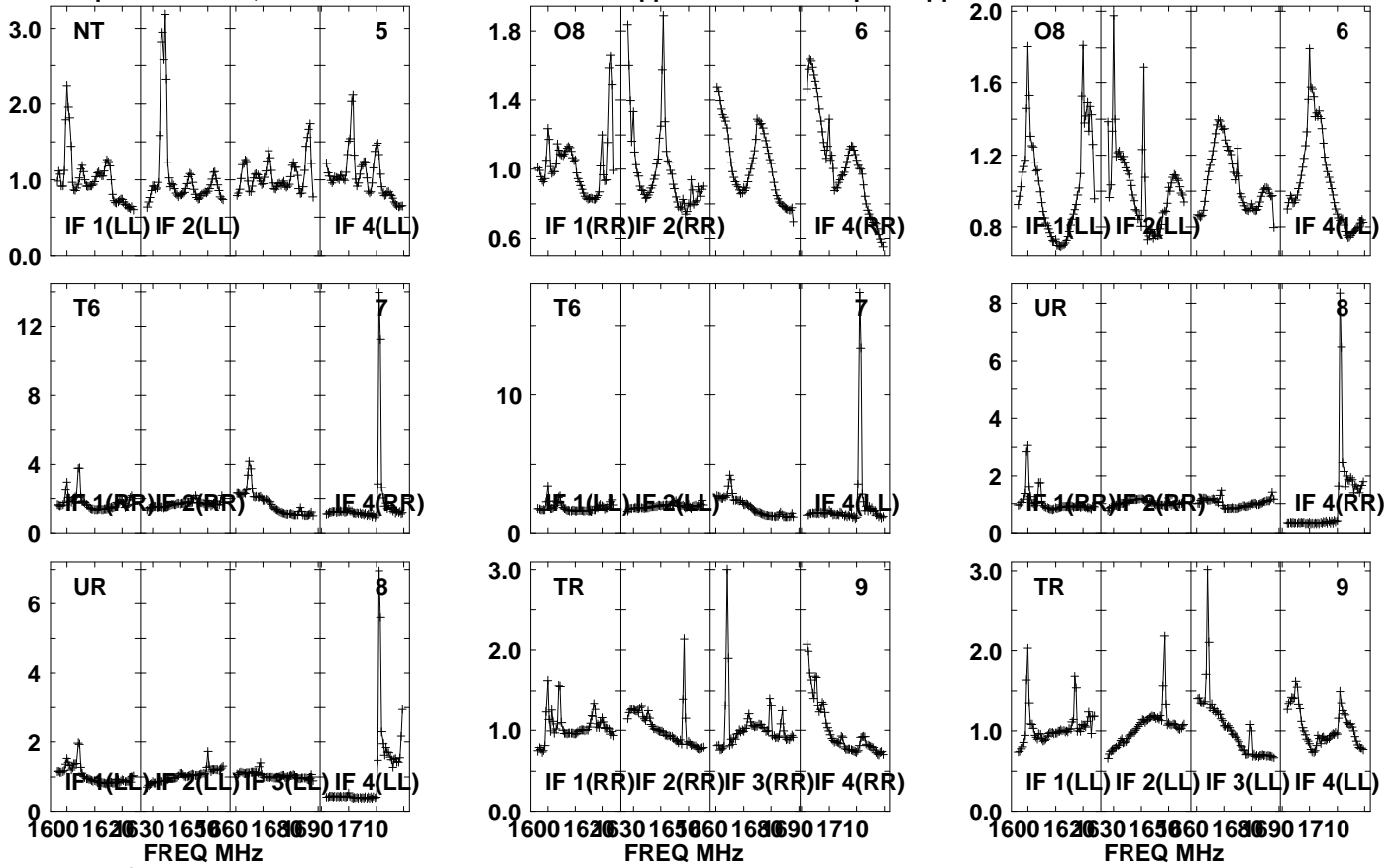

Lower frame: Real Jy  
Auto-corr total-power spectrum Antenna: \*  
Timerange: 00/11:17:31 to 00/11:18:59



Plot file version 75 created 05-OCT-2021 17:04:49

J0827+5217 GM076.UVDATA.1

Freq = 1.5945 GHz, Bw = 32.000 MH No calibration applied and no bandpass applied

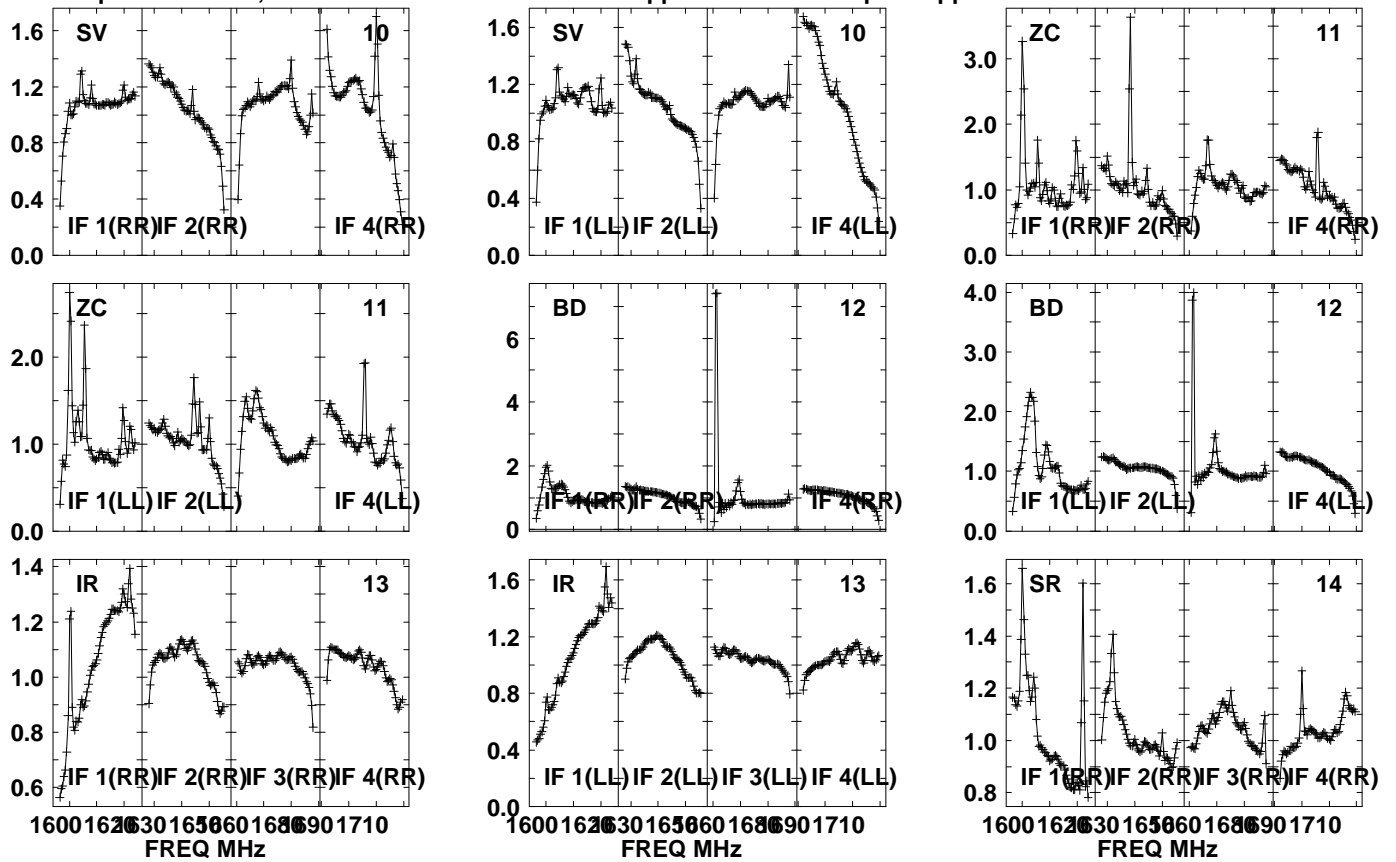

Lower frame: Real Jy  
Auto-corr total-power spectrum Antenna: \*  
Timerange: 00/11:17:31 to 00/11:18:59

Plot file version 76 created 05-OCT-2021 17:04:49

J0827+5217 GM076.UVDATA.1

Freq = 1.5945 GHz, Bw = 32.000 MH No calibration applied and no bandpass applied

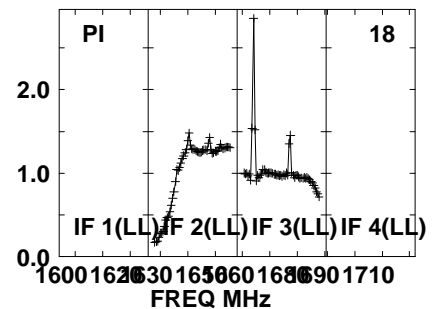
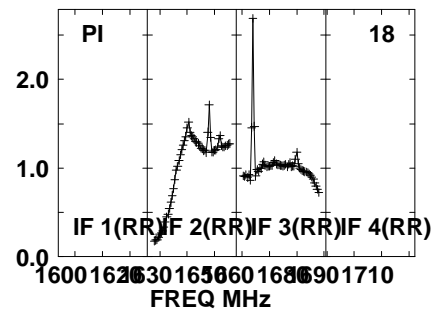
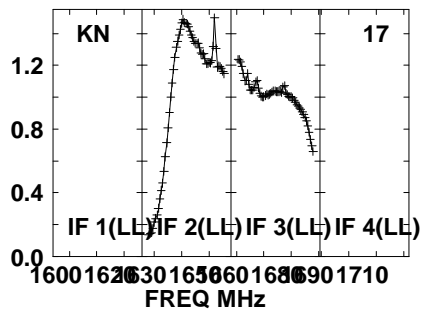
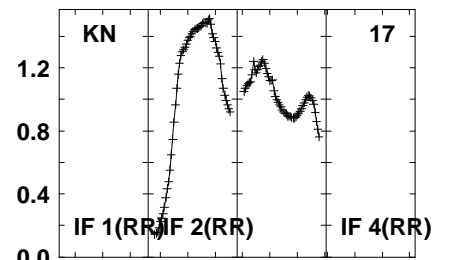
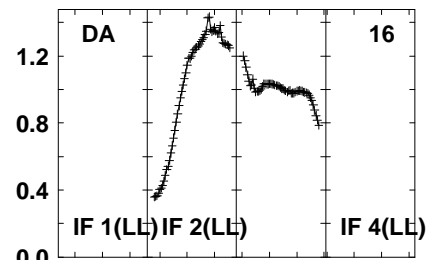
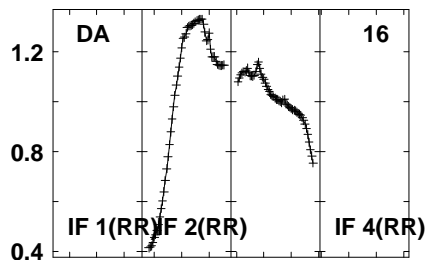
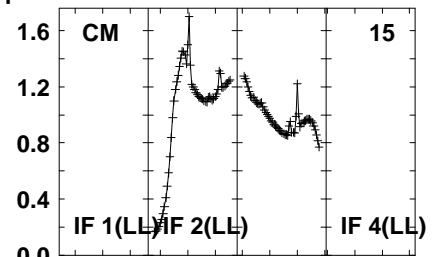
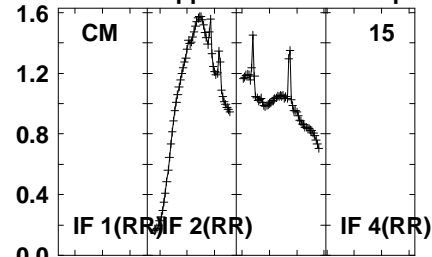
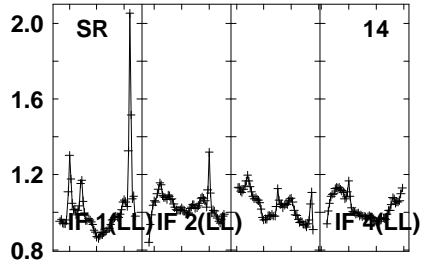

Lower frame: Real Jy  
Auto-corr total-power spectrum Antenna: \*  
Timerange: 00/11:17:31 to 00/11:18:59

Plot file version 77 created 05-OCT-2021 17:04:49

J0827+5217 GM076.UVDATA.1

Freq = 1.5945 GHz, Bw = 32.000 MH No calibration applied and no bandpass applied

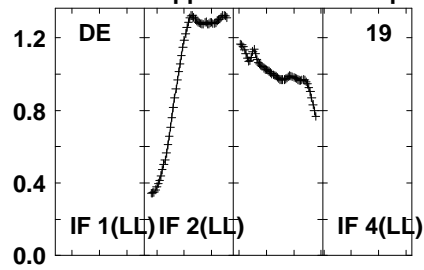
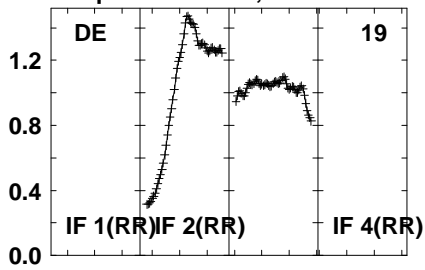

Lower frame: Real Jy  
Auto-corr total-power spectrum Antenna: \*  
Timerange: 00/11:17:31 to 00/11:18:59

Plot file version 78 created 05-OCT-2021 17:04:50

APM08279+525 GM076.UVDATA.1

Freq = 1.5945 GHz, Bw = 32.000 MH No calibration applied and no bandpass applied

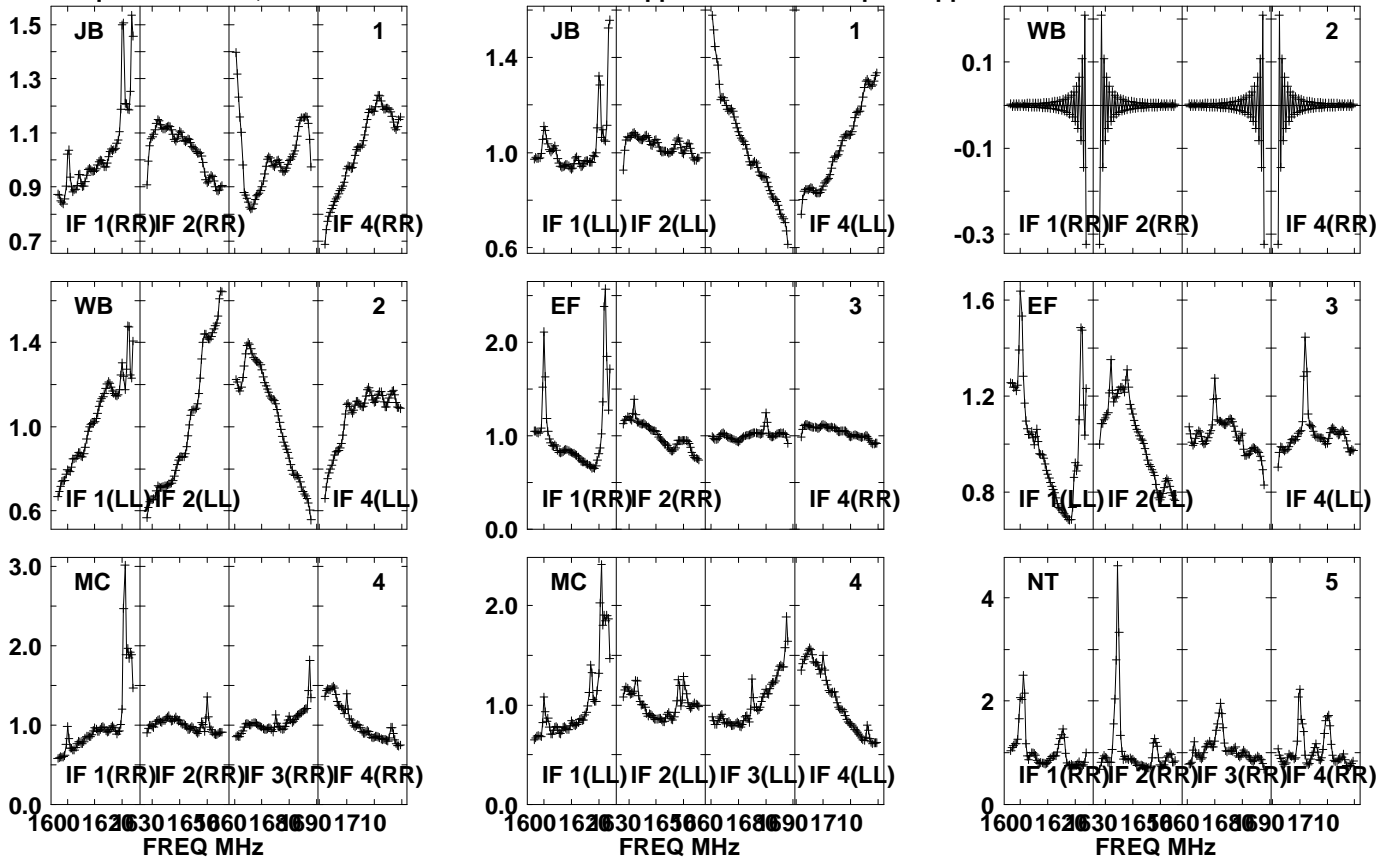

Lower frame: Real Jy  
Auto-corr total-power spectrum Antenna: \*  
Timerange: 00/11:19:01 to 00/11:22:29

Plot file version 79 created 05-OCT-2021 17:04:50

APM08279+525 GM076.UVDATA.1

Freq = 1.5945 GHz, Bw = 32.000 MH No calibration applied and no bandpass applied

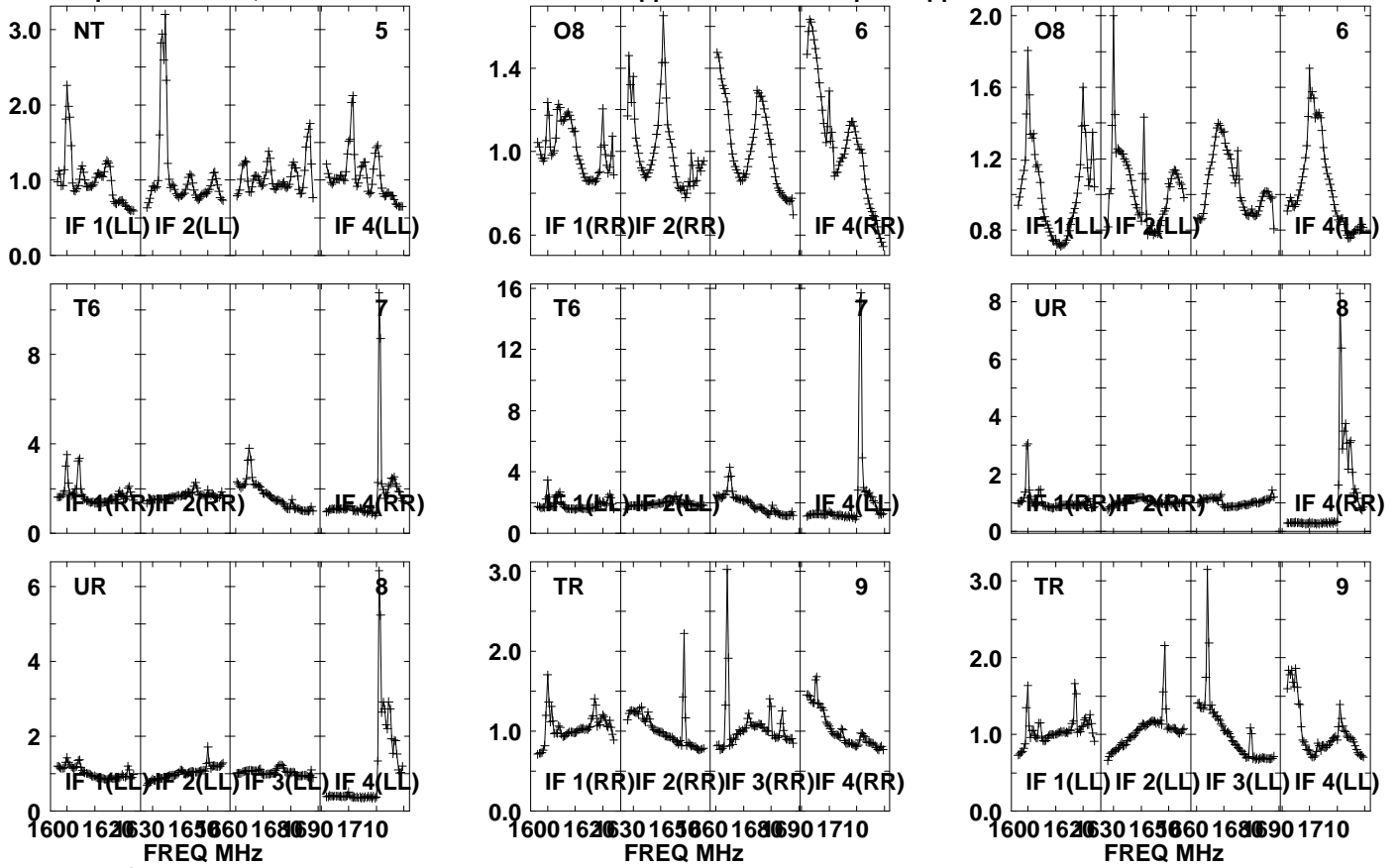

Lower frame: Real Jy

Auto-corr total-power spectrum Antenna: \*

Timerange: 00/11:19:01 to 00/11:22:29

Plot file version 80 created 05-OCT-2021 17:04:50

APM08279+525 GM076.UVDATA.1

Freq = 1.5945 GHz, Bw = 32.000 MH No calibration applied and no bandpass applied

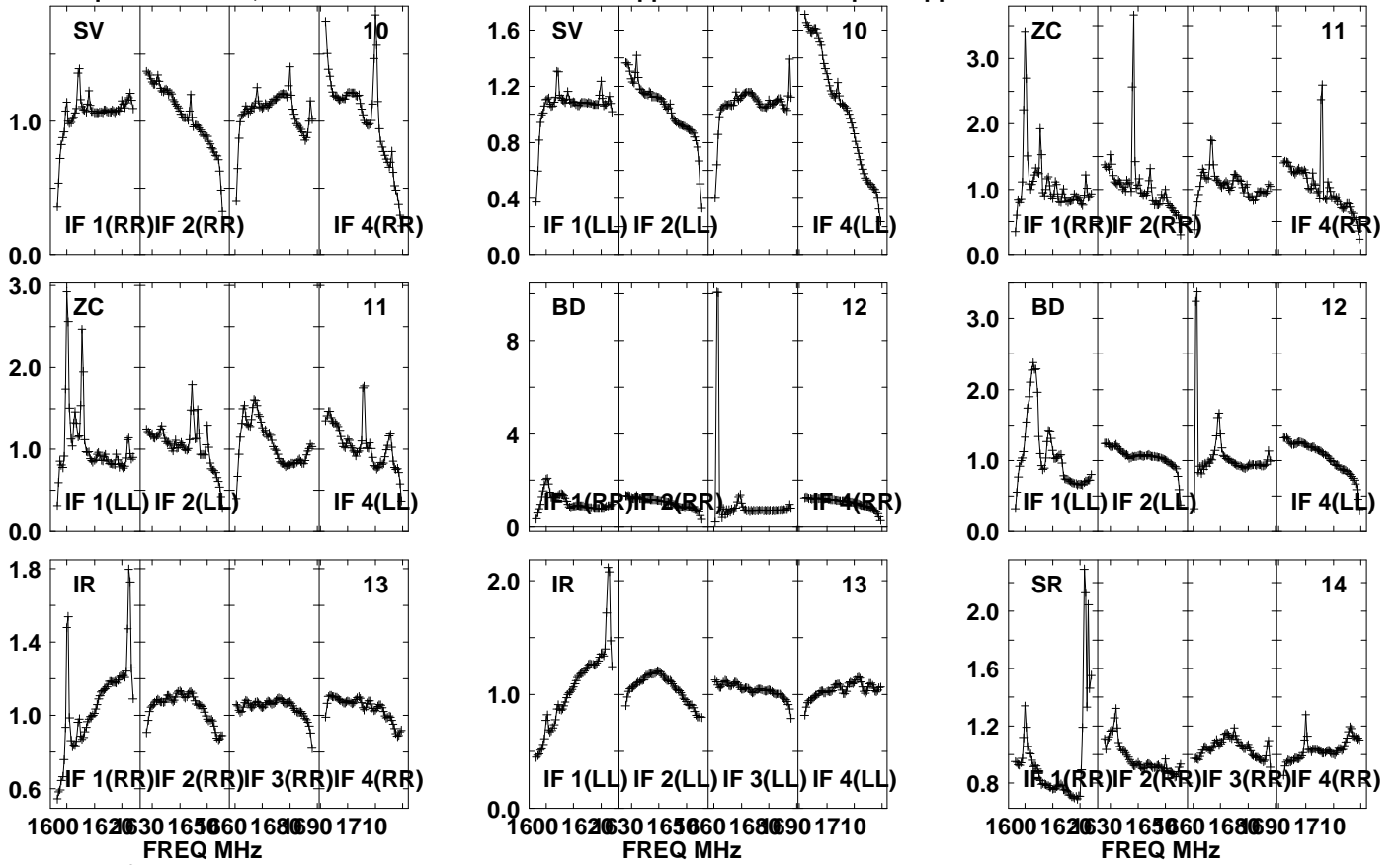

Lower frame: Real Jy  
Auto-corr total-power spectrum Antenna: \*  
Timerange: 00/11:19:01 to 00/11:22:29

Plot file version 81 created 05-OCT-2021 17:04:50

APM08279+525 GM076.UVDATA.1

Freq = 1.5945 GHz, Bw = 32.000 MH

No calibration applied and no bandpass applied

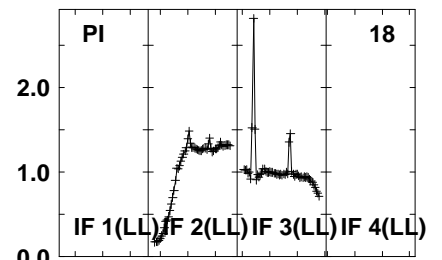
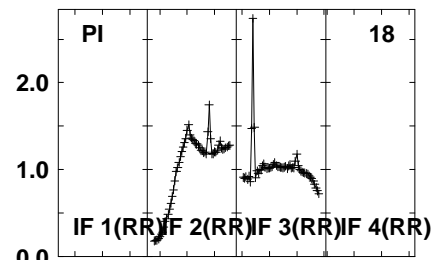
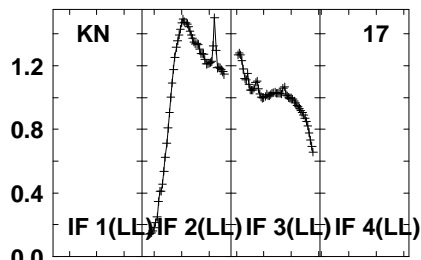
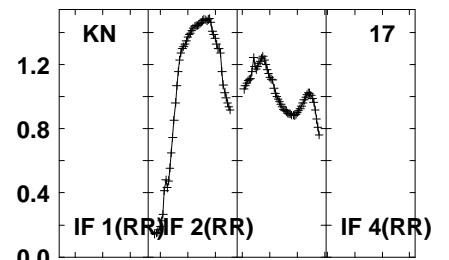
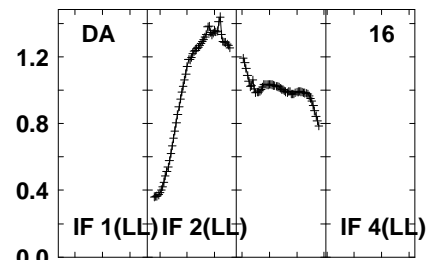
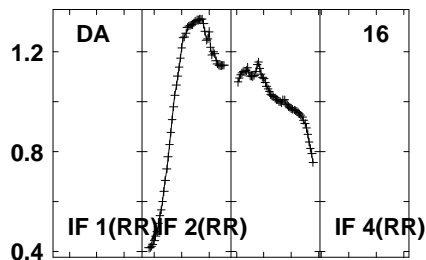
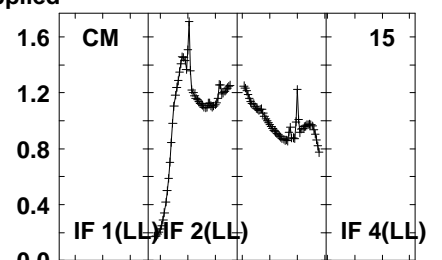
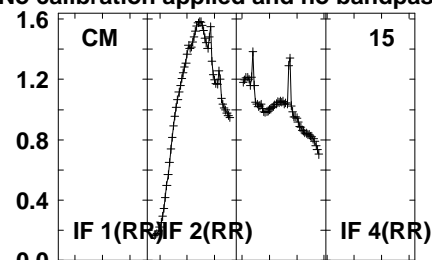
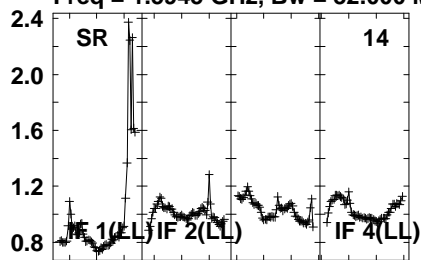

1600 1620 1630 1650 1660 1680 1690 1710  
FREQ MHz

1600 1620 1630 1650 1660 1680 1690 1710  
FREQ MHz

1600 1620 1630 1650 1660 1680 1690 1710  
FREQ MHz

Lower frame: Real Jy  
Auto-corr total-power spectrum Antenna: \*  
Timerange: 00/11:19:01 to 00/11:22:29

Plot file version 82 created 05-OCT-2021 17:04:50

APM08279+525 GM076.UVDATA.1

Freq = 1.5945 GHz, Bw = 32.000 MH No calibration applied and no bandpass applied

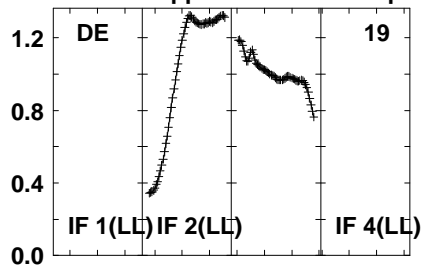
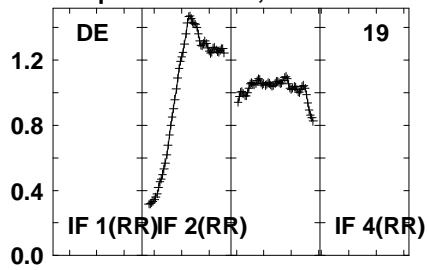

Lower frame: Real Jy  
Auto-corr total-power spectrum Antenna: \*  
Timerange: 00/11:19:01 to 00/11:22:29



Plot file version 83 created 05-OCT-2021 17:04:51

J0827+5217 GM076.UVDATA.1

Freq = 1.5945 GHz, Bw = 32.000 MH No calibration applied and no bandpass applied

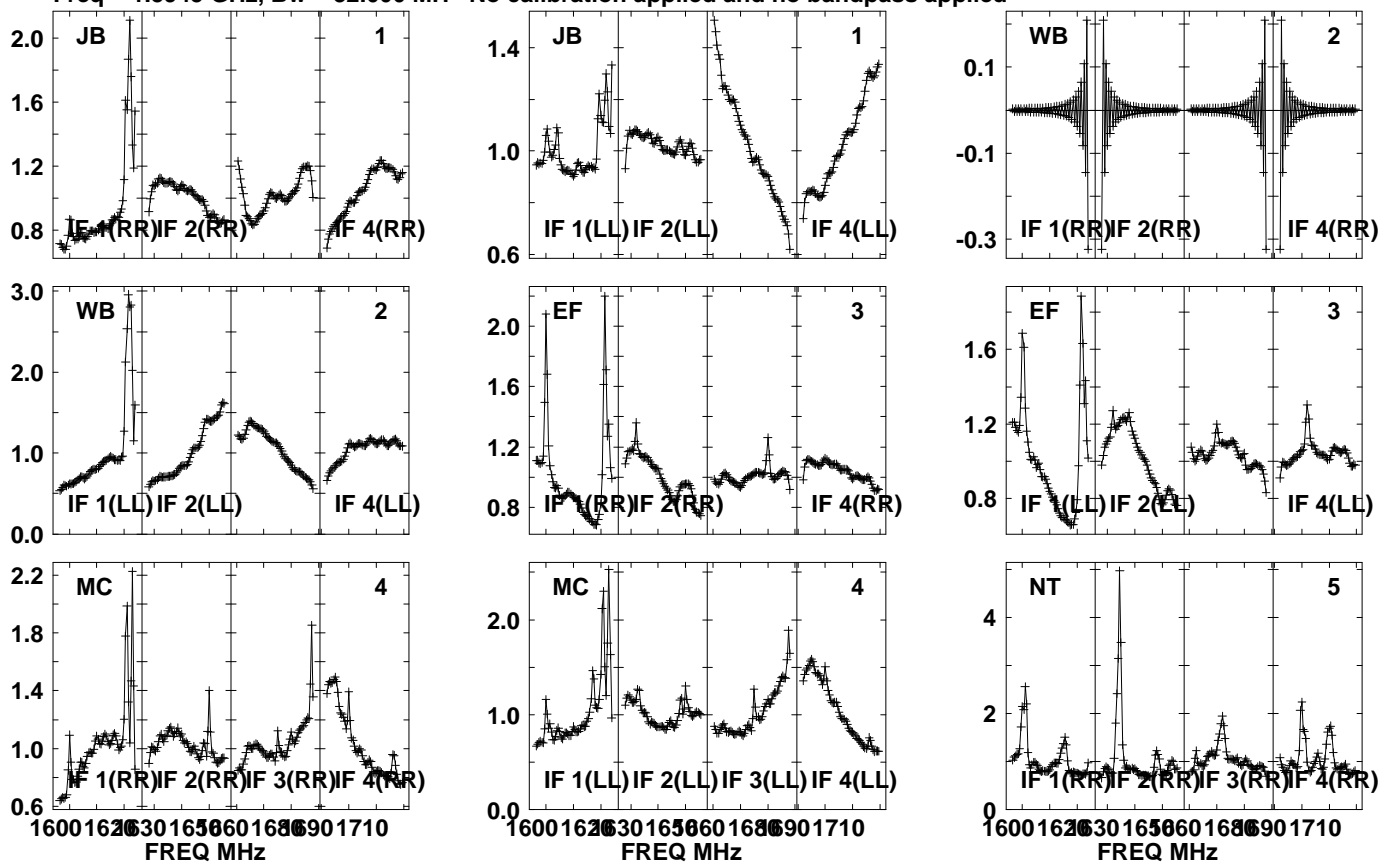

Lower frame: Real Jy  
Auto-corr total-power spectrum Antenna: \*  
Timerange: 00/11:22:31 to 00/11:23:59

Plot file version 84 created 05-OCT-2021 17:04:51

J0827+5217 GM076.UVDATA.1

Freq = 1.5945 GHz, Bw = 32.000 MH No calibration applied and no bandpass applied

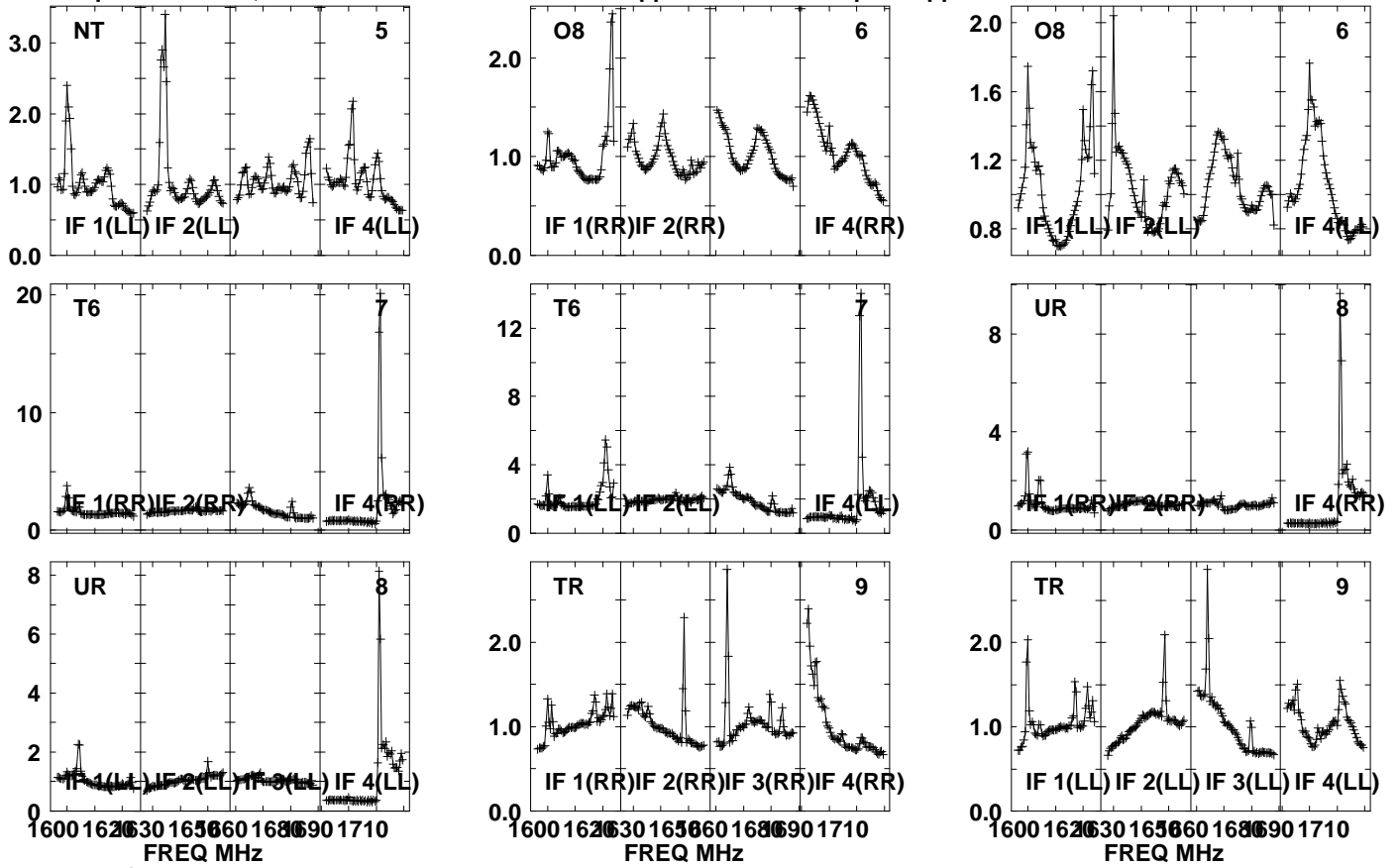

Lower frame: Real Jy

Auto-corr total-power spectrum Antenna: \*

Timerange: 00/11:22:31 to 00/11:23:59

Plot file version 85 created 05-OCT-2021 17:04:51

J0827+5217 GM076.UVDATA.1

Freq = 1.5945 GHz, Bw = 32.000 MH No calibration applied and no bandpass applied

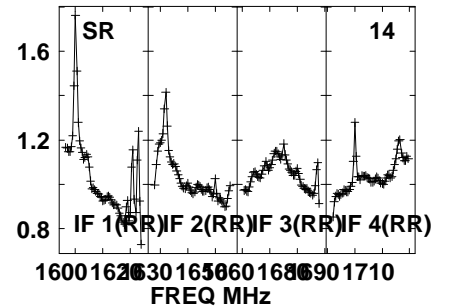
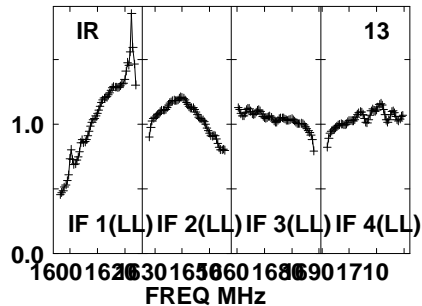
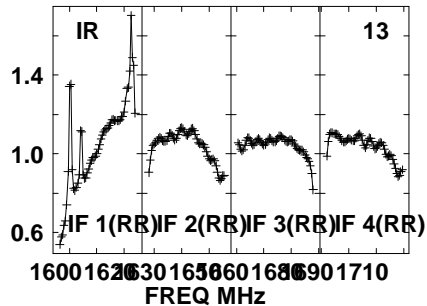
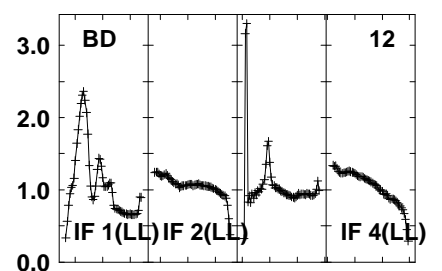
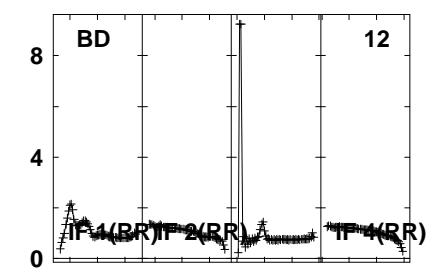
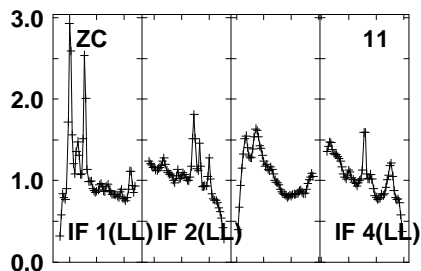
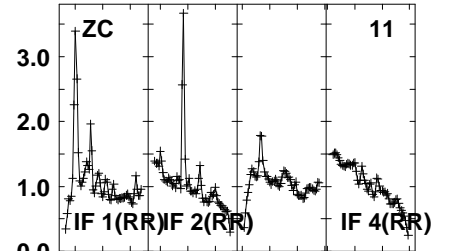
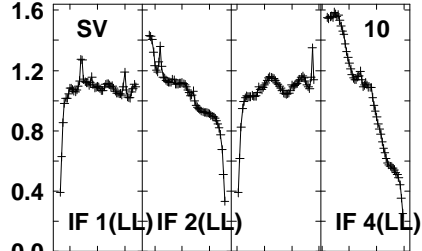
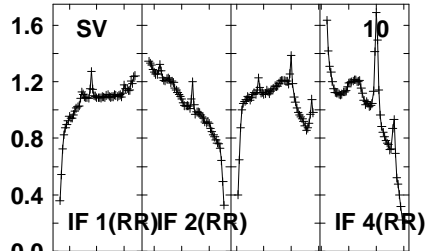

Lower frame: Real Jy  
Auto-corr total-power spectrum Antenna: \*  
Timerange: 00/11:22:31 to 00/11:23:59

Plot file version 86 created 05-OCT-2021 17:04:51

J0827+5217 GM076.UVDATA.1

Freq = 1.5945 GHz, Bw = 32.000 MH No calibration applied and no bandpass applied

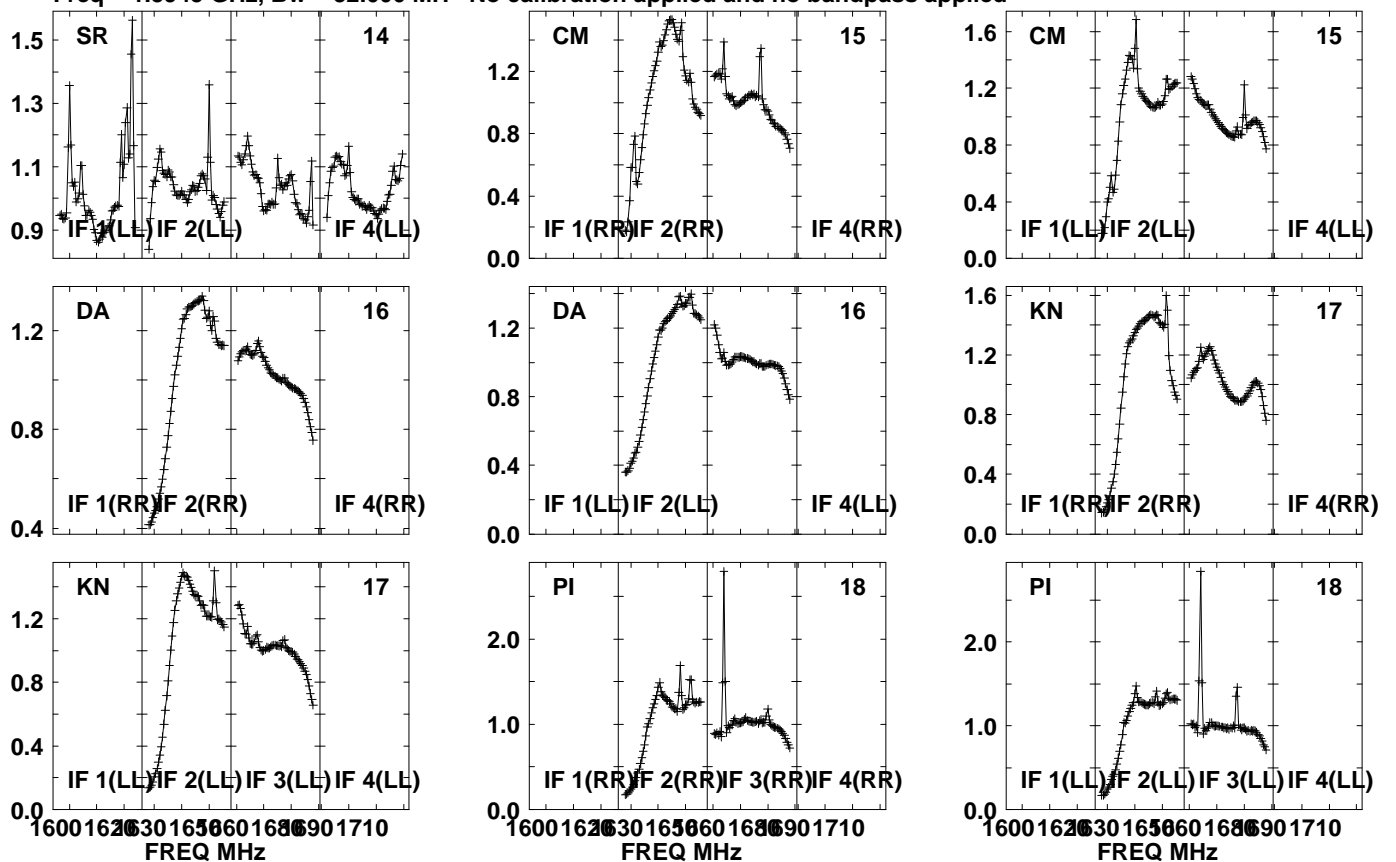

Lower frame: Real Jy  
Auto-corr total-power spectrum Antenna: \*  
Timerange: 00/11:22:31 to 00/11:23:59

Plot file version 87 created 05-OCT-2021 17:04:52

J0827+5217 GM076.UVDATA.1

Freq = 1.5945 GHz, Bw = 32.000 MH No calibration applied and no bandpass applied

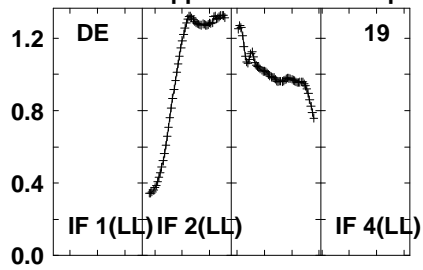
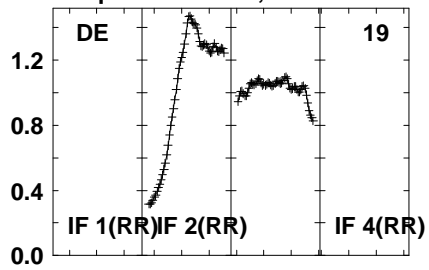

Lower frame: Real Jy  
Auto-corr total-power spectrum Antenna: \*  
Timerange: 00/11:22:31 to 00/11:23:59

Plot file version 88 created 05-OCT-2021 17:04:52

APM08279+525 GM076.UVDATA.1

Freq = 1.5945 GHz, Bw = 32.000 MH No calibration applied and no bandpass applied

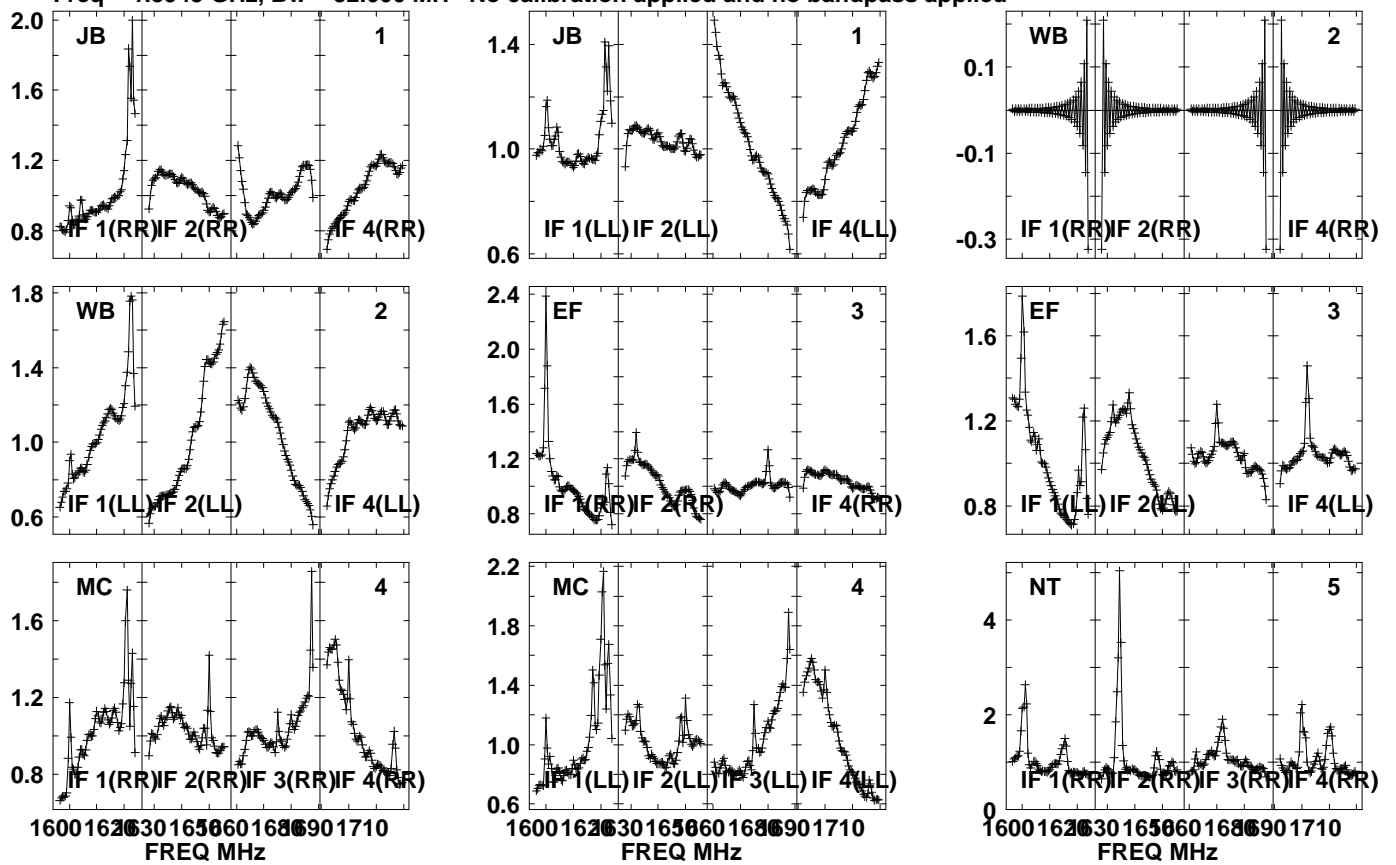

Lower frame: Real Jy  
Auto-corr total-power spectrum Antenna: \*  
Timerange: 00/11:24:01 to 00/11:27:29

Plot file version 89 created 05-OCT-2021 17:04:52

APM08279+525 GM076.UVDATA.1

Freq = 1.5945 GHz, Bw = 32.000 MH No calibration applied and no bandpass applied

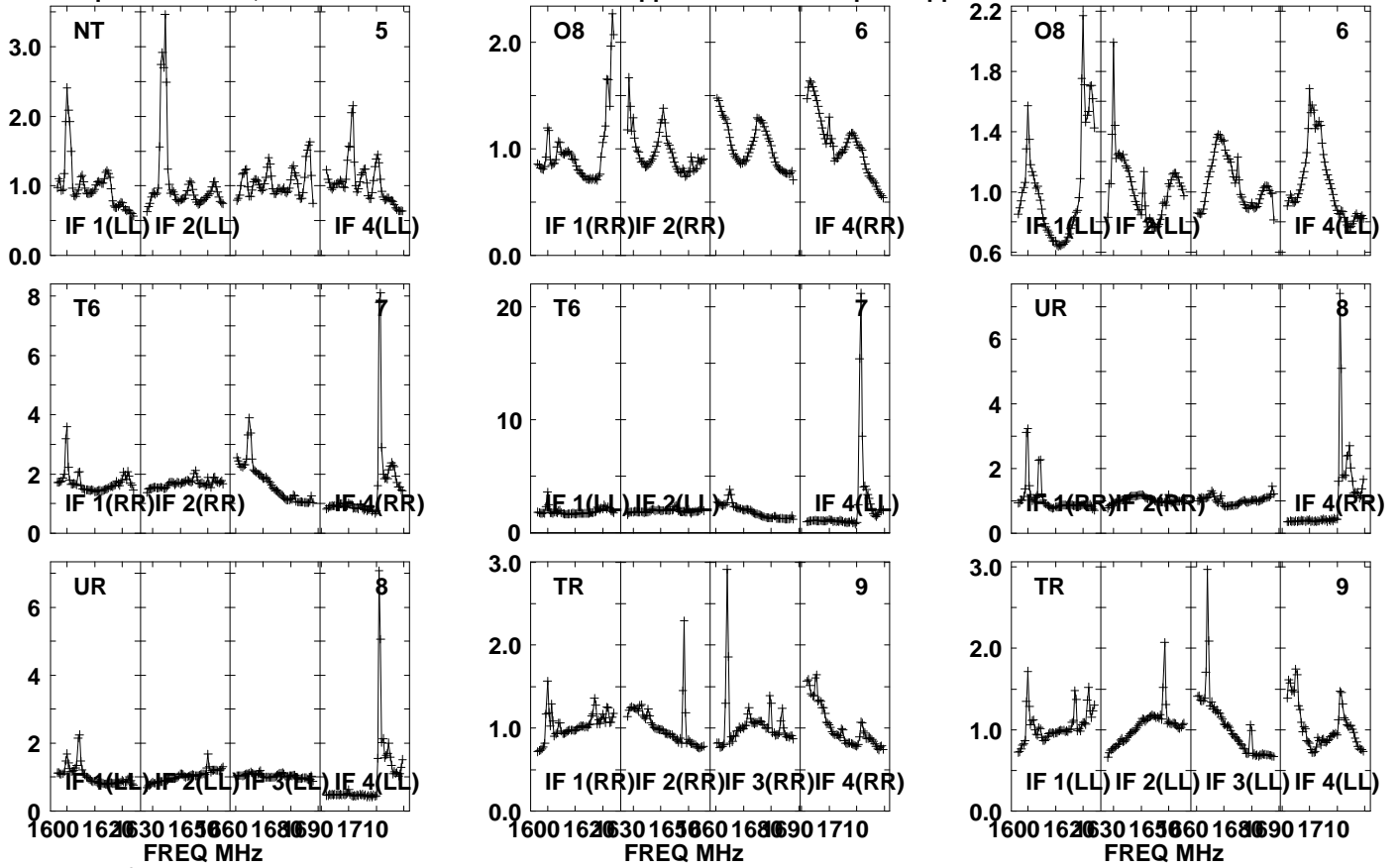

Lower frame: Real Jy

Auto-corr total-power spectrum Antenna: \*

Timerange: 00/11:24:01 to 00/11:27:29

Plot file version 90 created 05-OCT-2021 17:04:52

APM08279+525 GM076.UVDATA.1

Freq = 1.5945 GHz, Bw = 32.000 MH No calibration applied and no bandpass applied

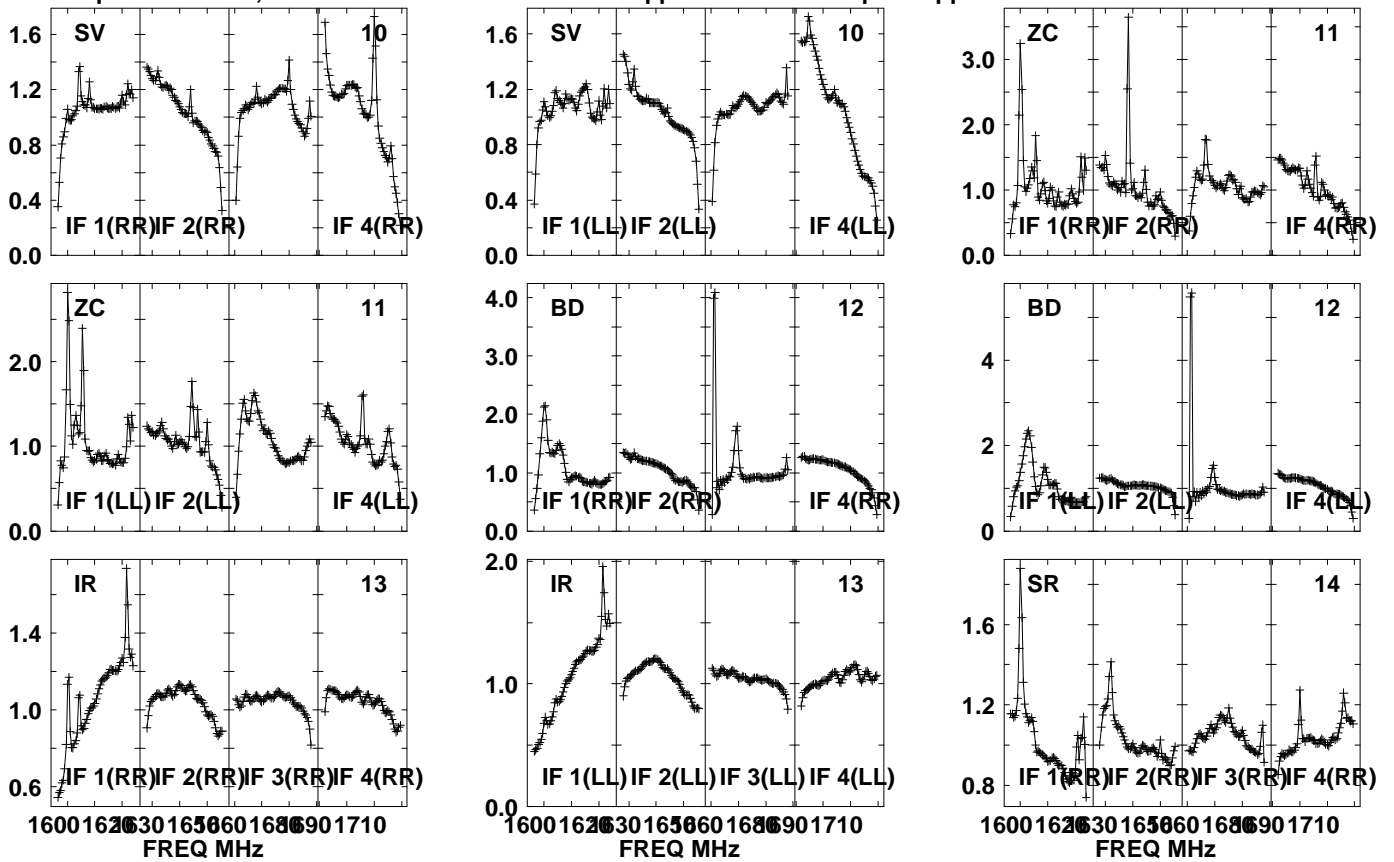

Lower frame: Real Jy  
Auto-corr total-power spectrum Antenna: \*  
Timerange: 00/11:24:01 to 00/11:27:29



Plot file version 91 created 05-OCT-2021 17:04:52

APM08279+525 GM076.UVDATA.1

Freq = 1.5945 GHz, Bw = 32.000 MH No calibration applied and no bandpass applied

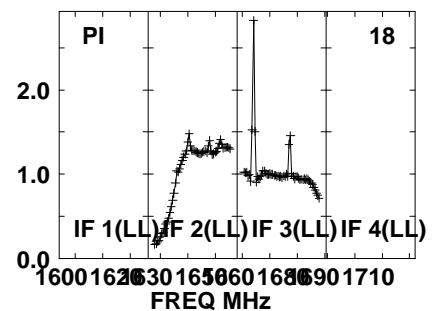
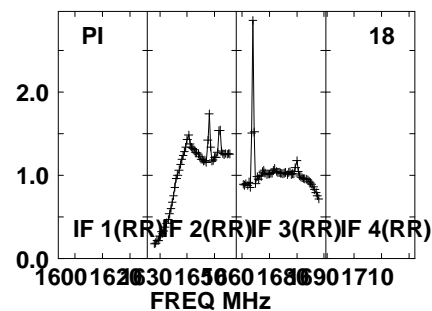
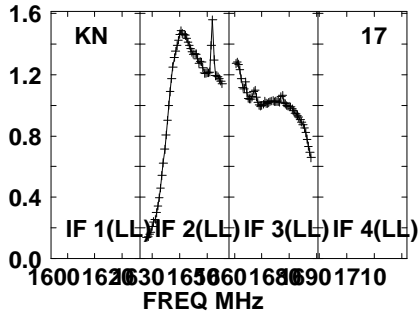
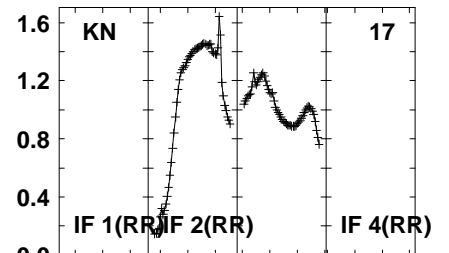
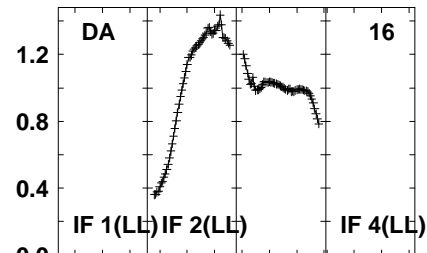
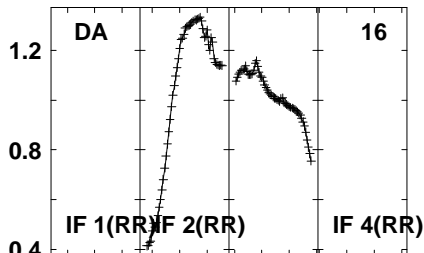
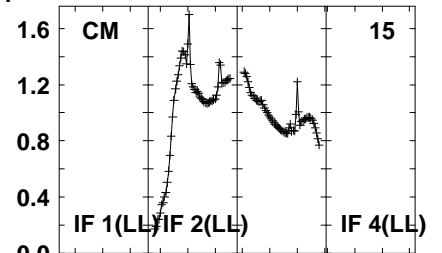
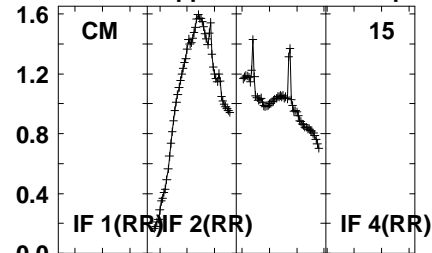
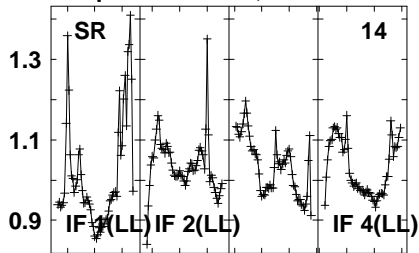

Lower frame: Real Jy  
Auto-corr total-power spectrum Antenna: \*  
Timerange: 00/11:24:01 to 00/11:27:29

Plot file version 92 created 05-OCT-2021 17:04:53

APM08279+525 GM076.UVDATA.1

Freq = 1.5945 GHz, Bw = 32.000 MH No calibration applied and no bandpass applied

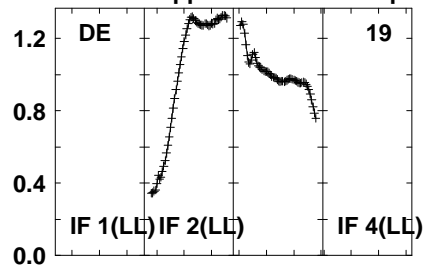
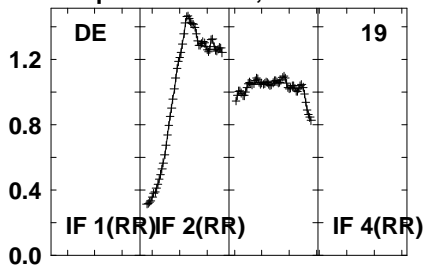

Lower frame: Real Jy  
Auto-corr total-power spectrum Antenna: \*  
Timerange: 00/11:24:01 to 00/11:27:29

Plot file version 93 created 05-OCT-2021 17:04:53

J0827+5217 GM076.UVDATA.1

Freq = 1.5945 GHz, Bw = 32.000 MH No calibration applied and no bandpass applied

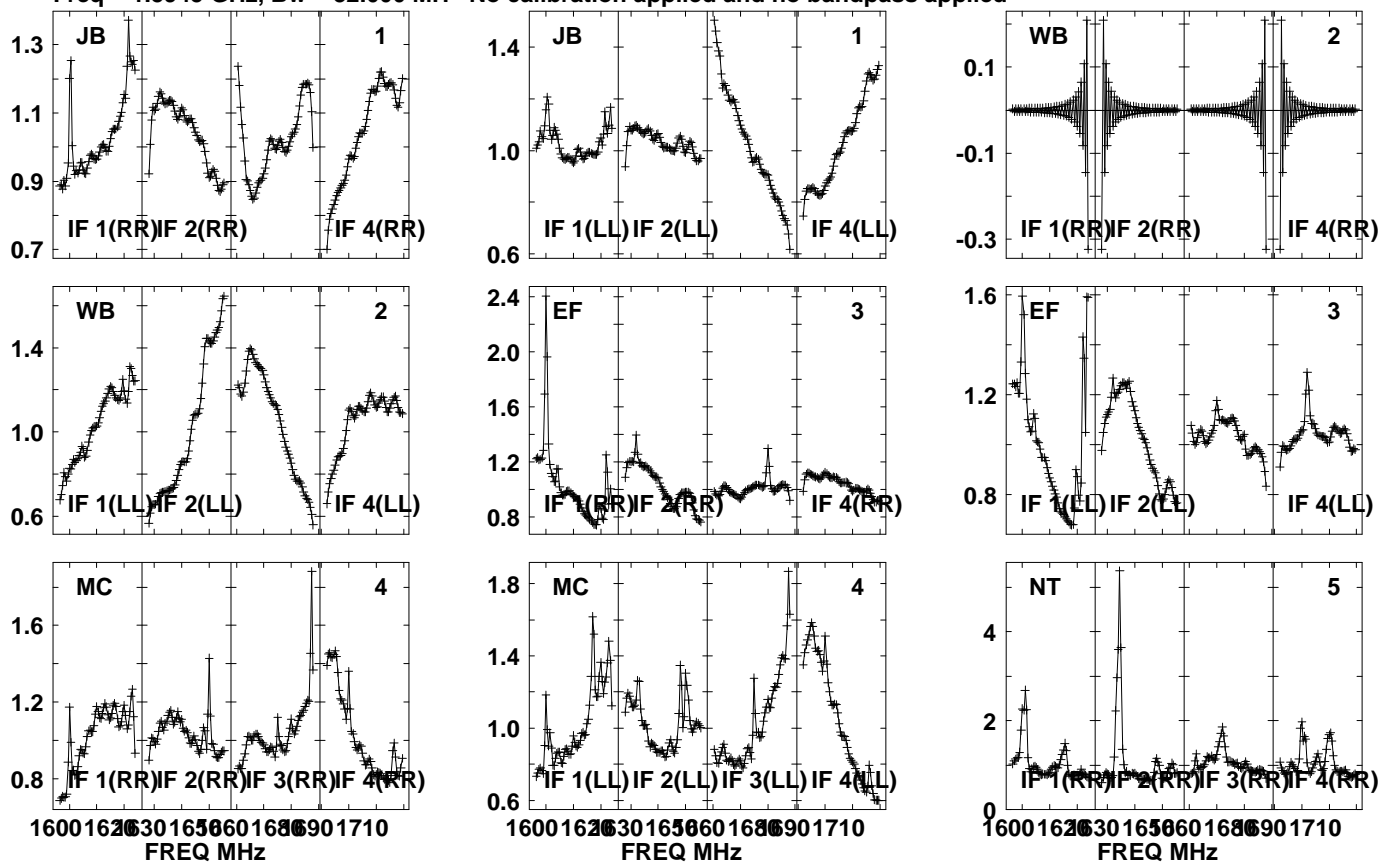

Lower frame: Real Jy  
Auto-corr total-power spectrum Antenna: \*  
Timerange: 00/11:28:01 to 00/11:29:29

Plot file version 94 created 05-OCT-2021 17:04:53

J0827+5217 GM076.UVDATA.1

Freq = 1.5945 GHz, Bw = 32.000 MH No calibration applied and no bandpass applied

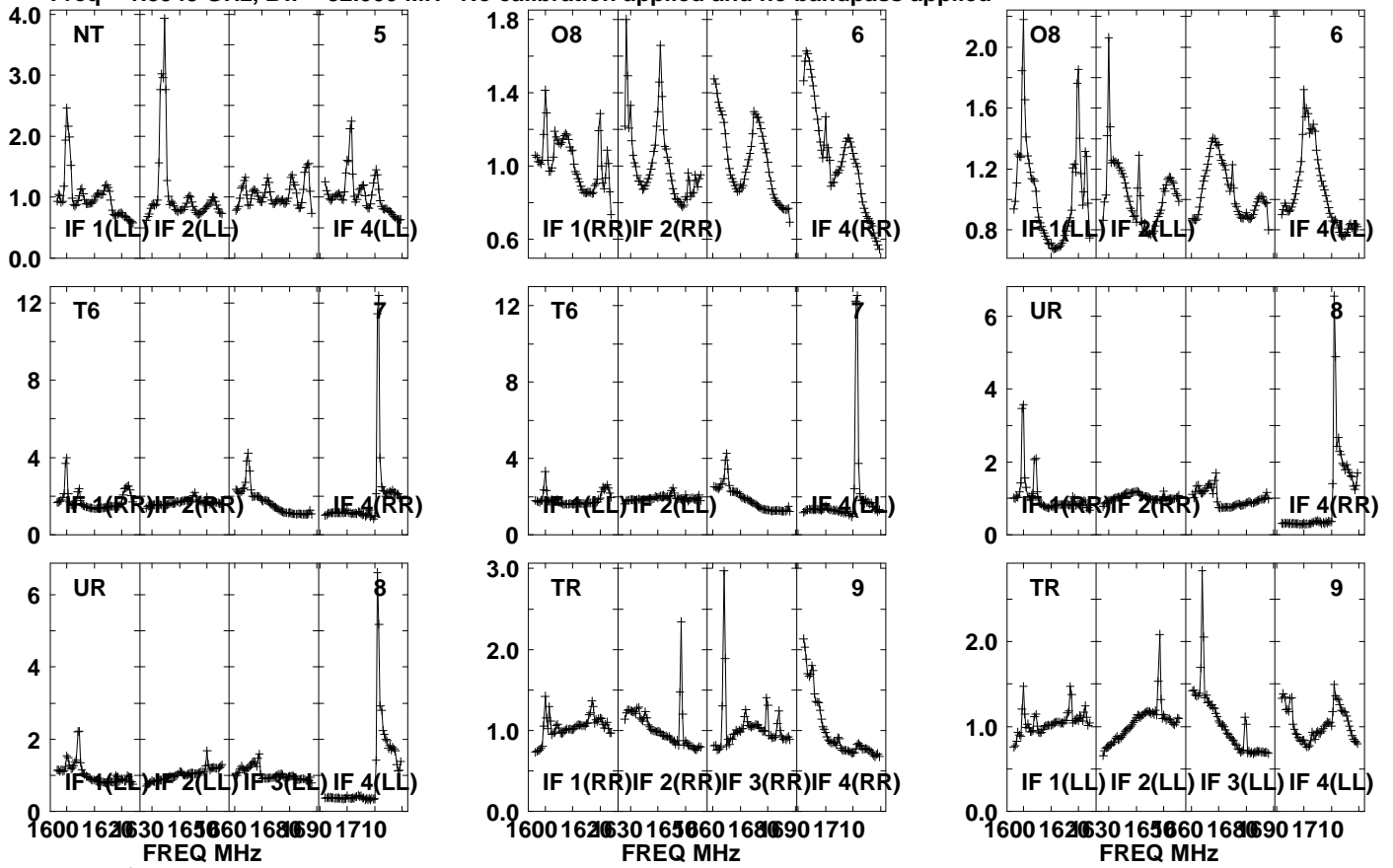

Lower frame: Real Jy  
Auto-corr total-power spectrum Antenna: \*  
Timerange: 00/11:28:01 to 00/11:29:29

Plot file version 95 created 05-OCT-2021 17:04:53

J0827+5217 GM076.UVDATA.1

Freq = 1.5945 GHz, Bw = 32.000 MH No calibration applied and no bandpass applied

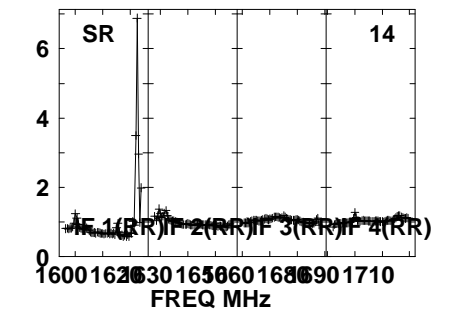
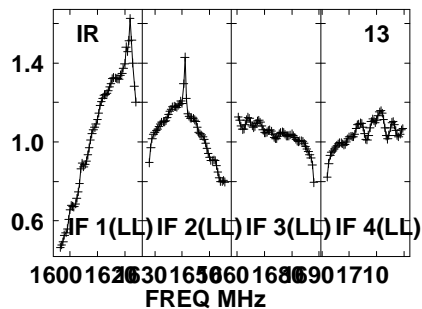
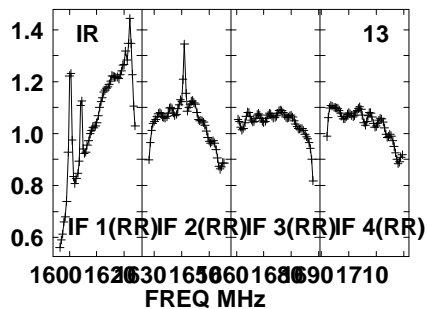
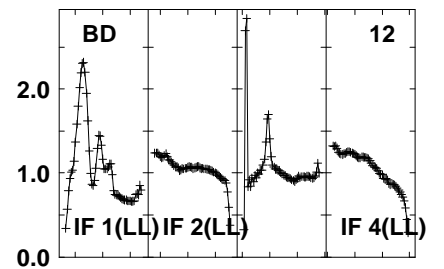
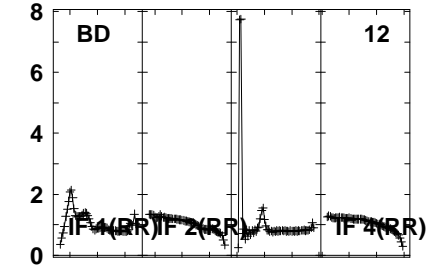
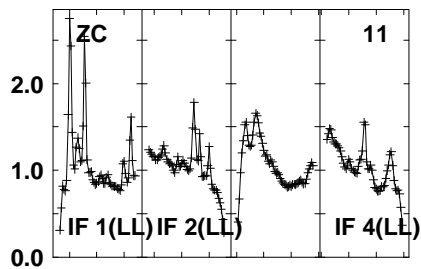
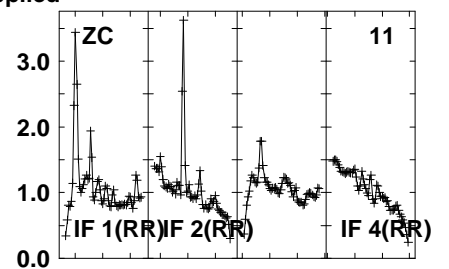
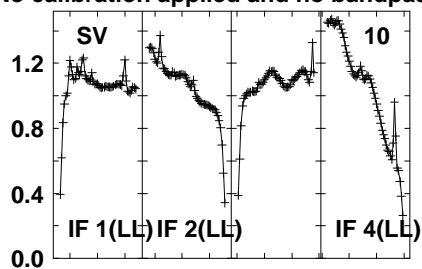
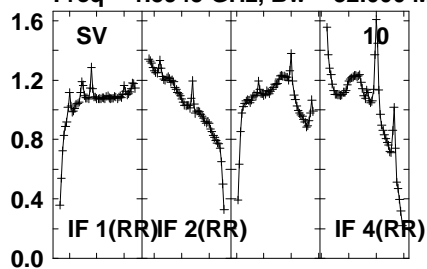

Lower frame: Real Jy  
Auto-corr total-power spectrum Antenna: \*  
Timerange: 00/11:28:01 to 00/11:29:29

Plot file version 96 created 05-OCT-2021 17:04:53

J0827+5217 GM076.UVDATA.1

Freq = 1.5945 GHz, Bw = 32.000 MH No calibration applied and no bandpass applied

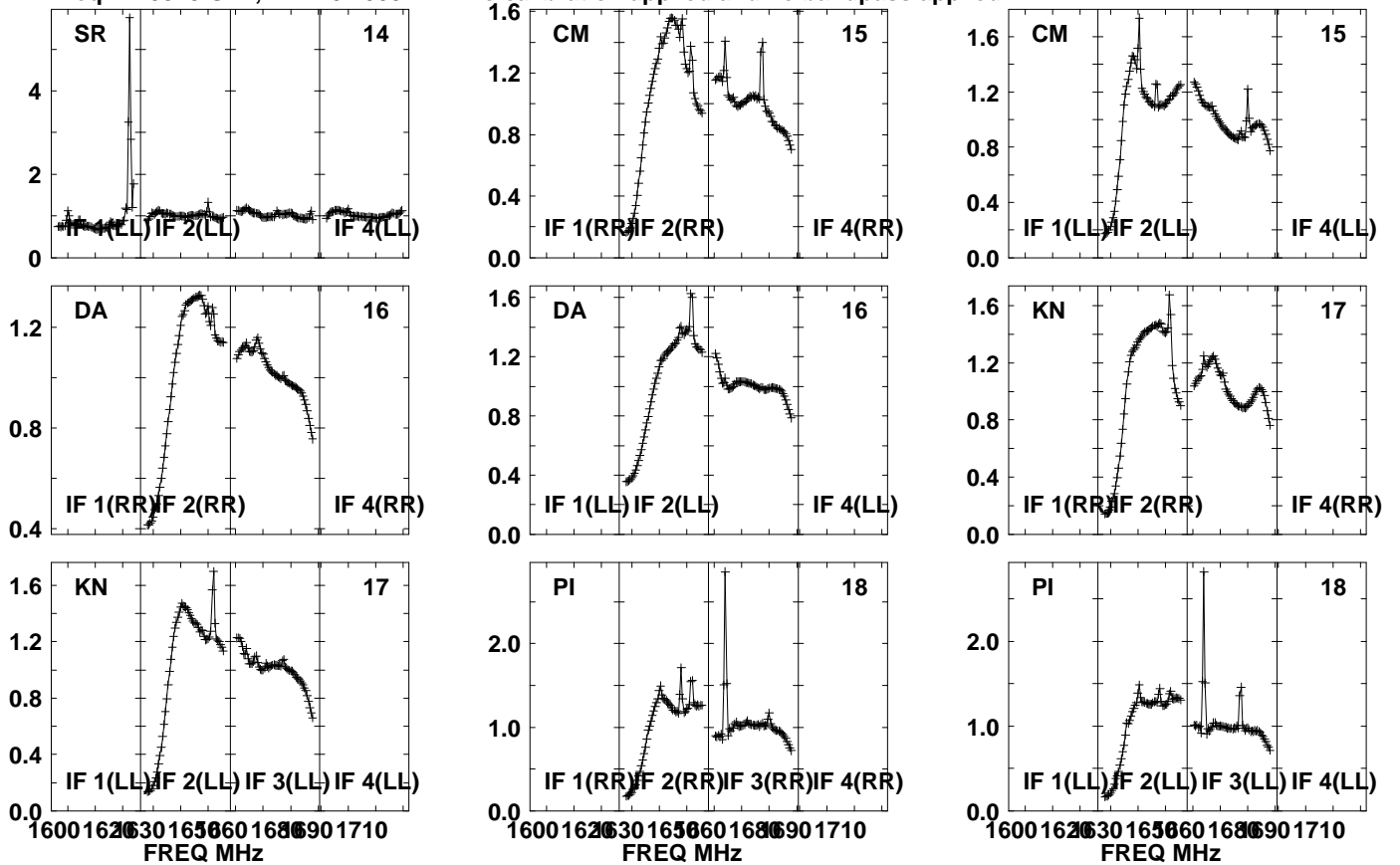

Lower frame: Real Jy  
Auto-corr total-power spectrum Antenna: \*  
Timerange: 00/11:28:01 to 00/11:29:29

Plot file version 97 created 05-OCT-2021 17:04:54

J0827+5217 GM076.UVDATA.1

Freq = 1.5945 GHz, Bw = 32.000 MH No calibration applied and no bandpass applied

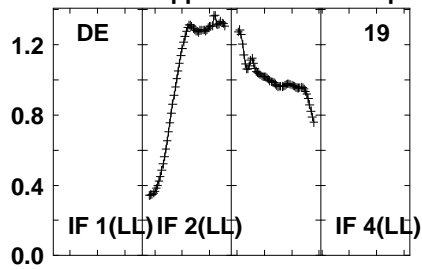
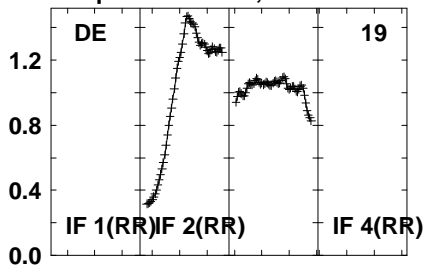

Lower frame: Real Jy  
Auto-corr total-power spectrum Antenna: \*  
Timerange: 00/11:28:01 to 00/11:29:29

Plot file version 98 created 05-OCT-2021 17:04:54

APM08279+525 GM076.UVDATA.1

Freq = 1.5945 GHz, Bw = 32.000 MH No calibration applied and no bandpass applied

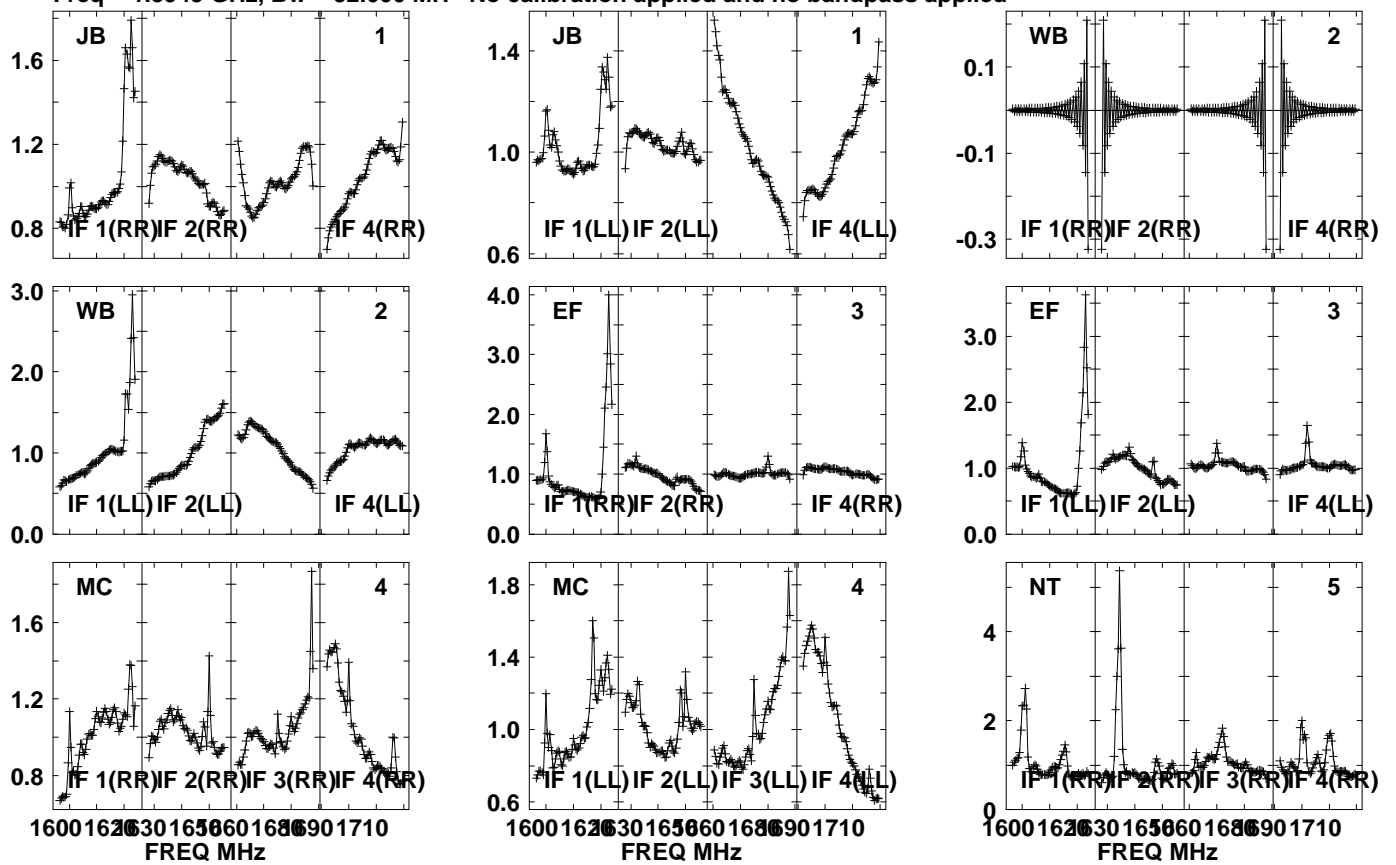

Lower frame: Real Jy  
Auto-corr total-power spectrum Antenna: \*  
Timerange: 00/11:29:31 to 00/11:32:59



Plot file version 99 created 05-OCT-2021 17:04:54

APM08279+525 GM076.UVDATA.1

Freq = 1.5945 GHz, Bw = 32.000 MH No calibration applied and no bandpass applied

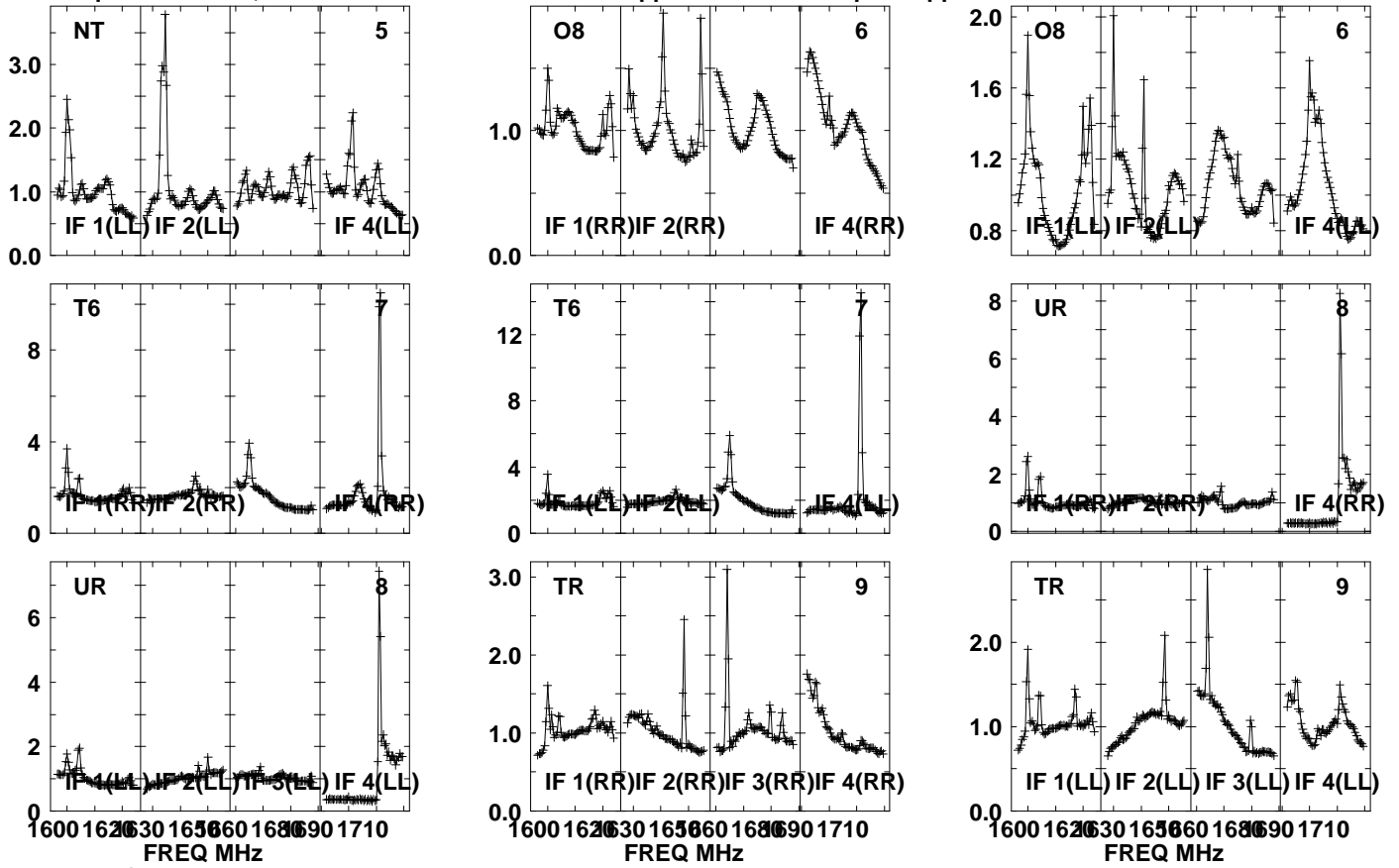

Lower frame: Real Jy

Auto-corr total-power spectrum Antenna: \*

Timerange: 00/11:29:31 to 00/11:32:59

Plot file version 100 created 05-OCT-2021 17:04:54

APM08279+525 GM076.UVDATA.1

Freq = 1.5945 GHz, Bw = 32.000 MH No calibration applied and no bandpass applied

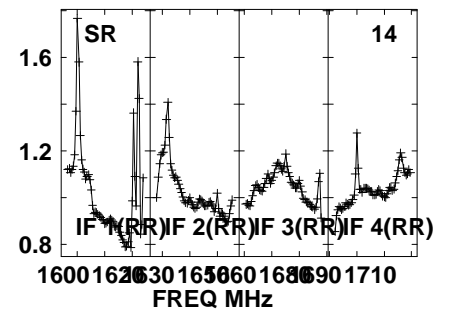
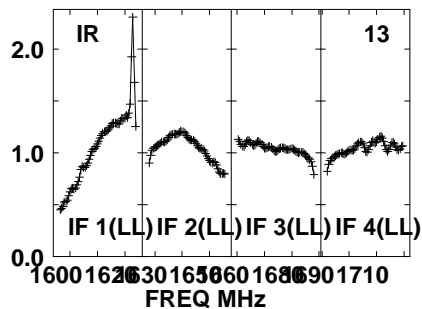
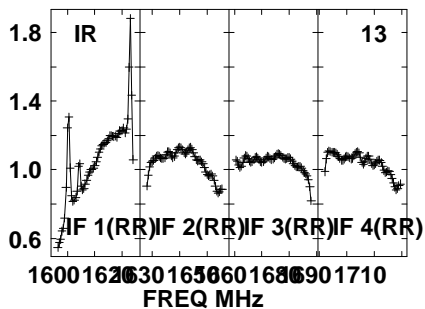
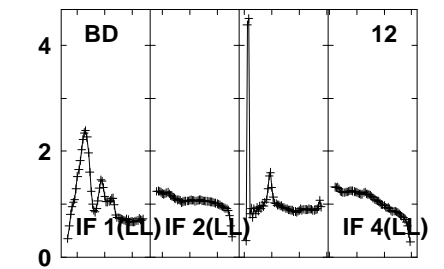
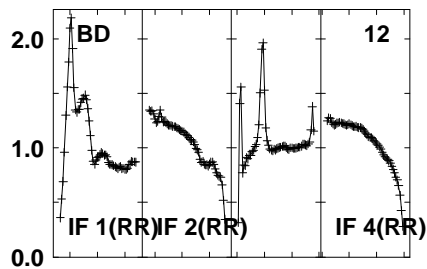
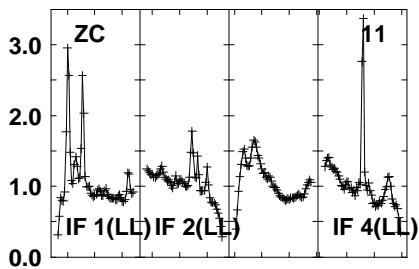
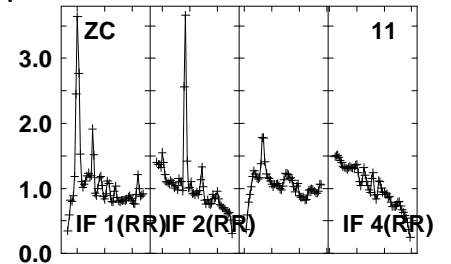
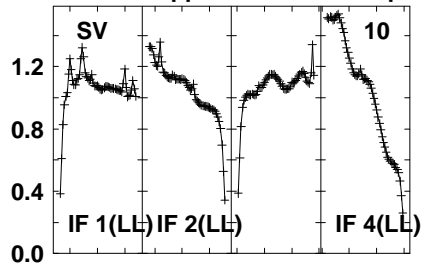
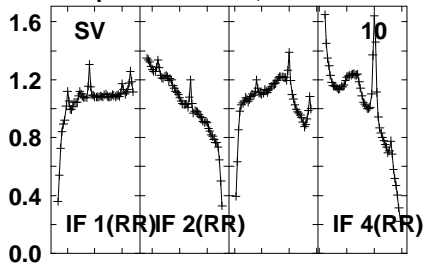

Lower frame: Real Jy  
Auto-corr total-power spectrum Antenna: \*  
Timerange: 00/11:29:31 to 00/11:32:59

Plot file version 101 created 05-OCT-2021 17:04:55

APM08279+525 GM076.UVDATA.1

Freq = 1.5945 GHz, Bw = 32.000 MH No calibration applied and no bandpass applied

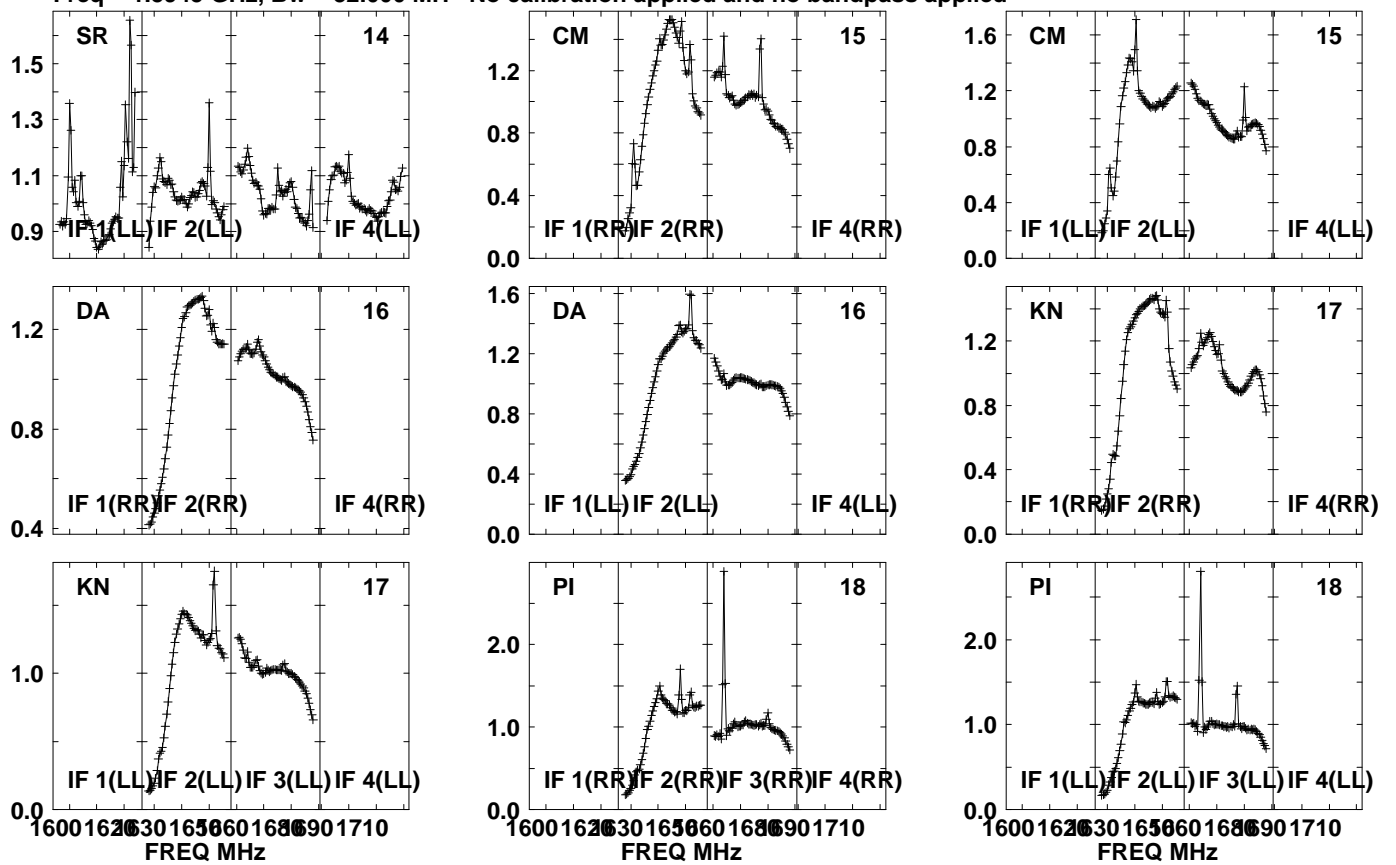

Lower frame: Real Jy  
Auto-corr total-power spectrum Antenna: \*  
Timerange: 00/11:29:31 to 00/11:32:59

Plot file version 102 created 05-OCT-2021 17:04:55

APM08279+525 GM076.UVDATA.1

Freq = 1.5945 GHz, Bw = 32.000 MH No calibration applied and no bandpass applied

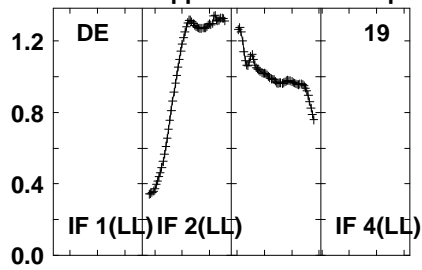
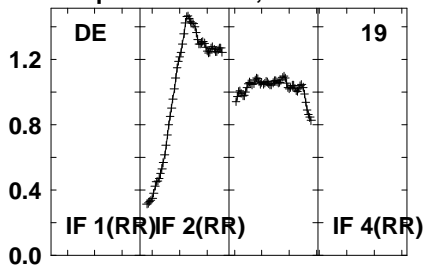

Lower frame: Real Jy  
Auto-corr total-power spectrum Antenna: \*  
Timerange: 00/11:29:31 to 00/11:32:59

Plot file version 103 created 05-OCT-2021 17:04:55

J0827+5217 GM076.UVDATA.1

Freq = 1.5945 GHz, Bw = 32.000 MH No calibration applied and no bandpass applied

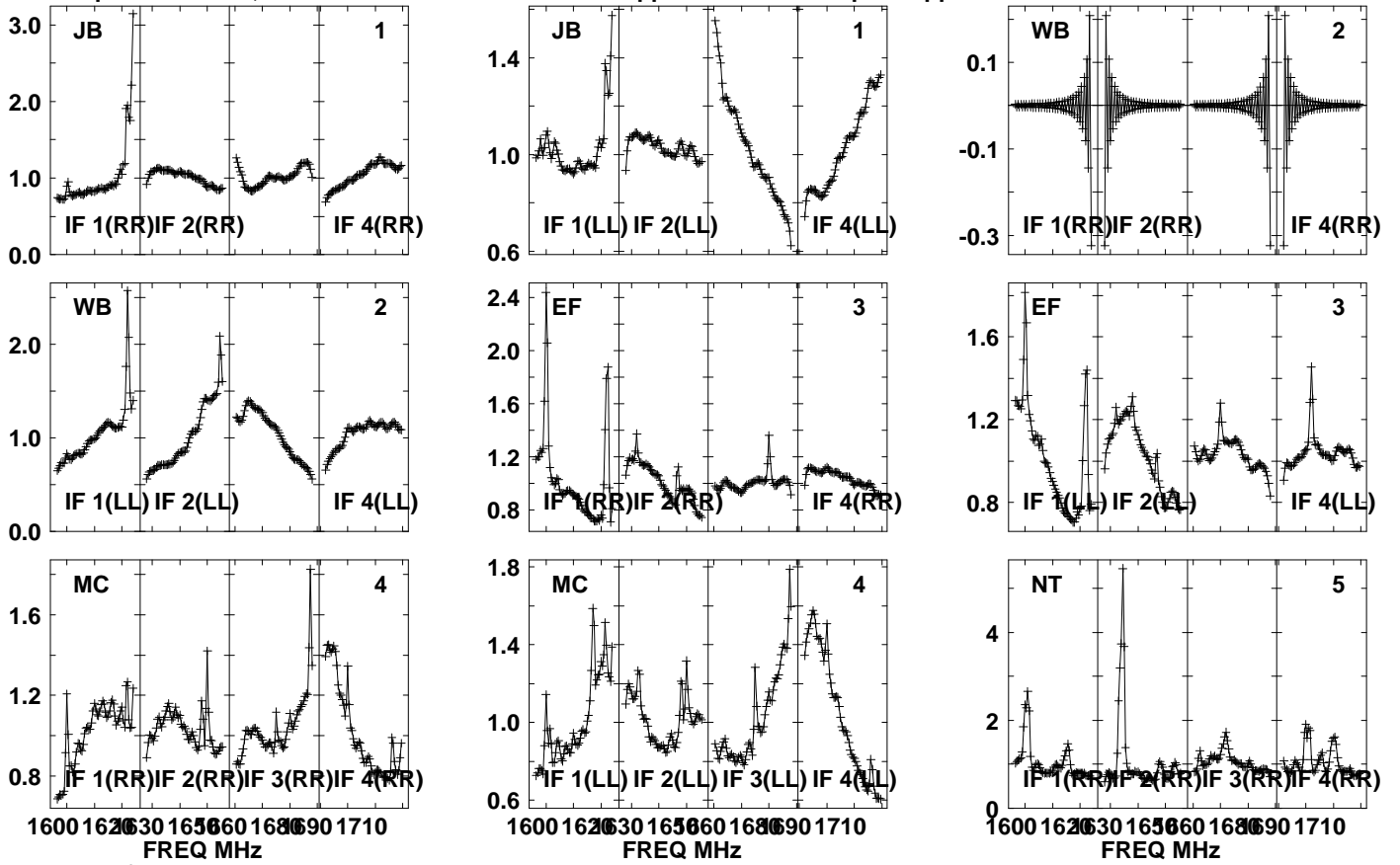

Lower frame: Real Jy

Auto-corr total-power spectrum Antenna: \*

Timerange: 00/11:33:01 to 00/11:34:29

Plot file version 104 created 05-OCT-2021 17:04:55

J0827+5217 GM076.UVDATA.1

Freq = 1.5945 GHz, Bw = 32.000 MH No calibration applied and no bandpass applied

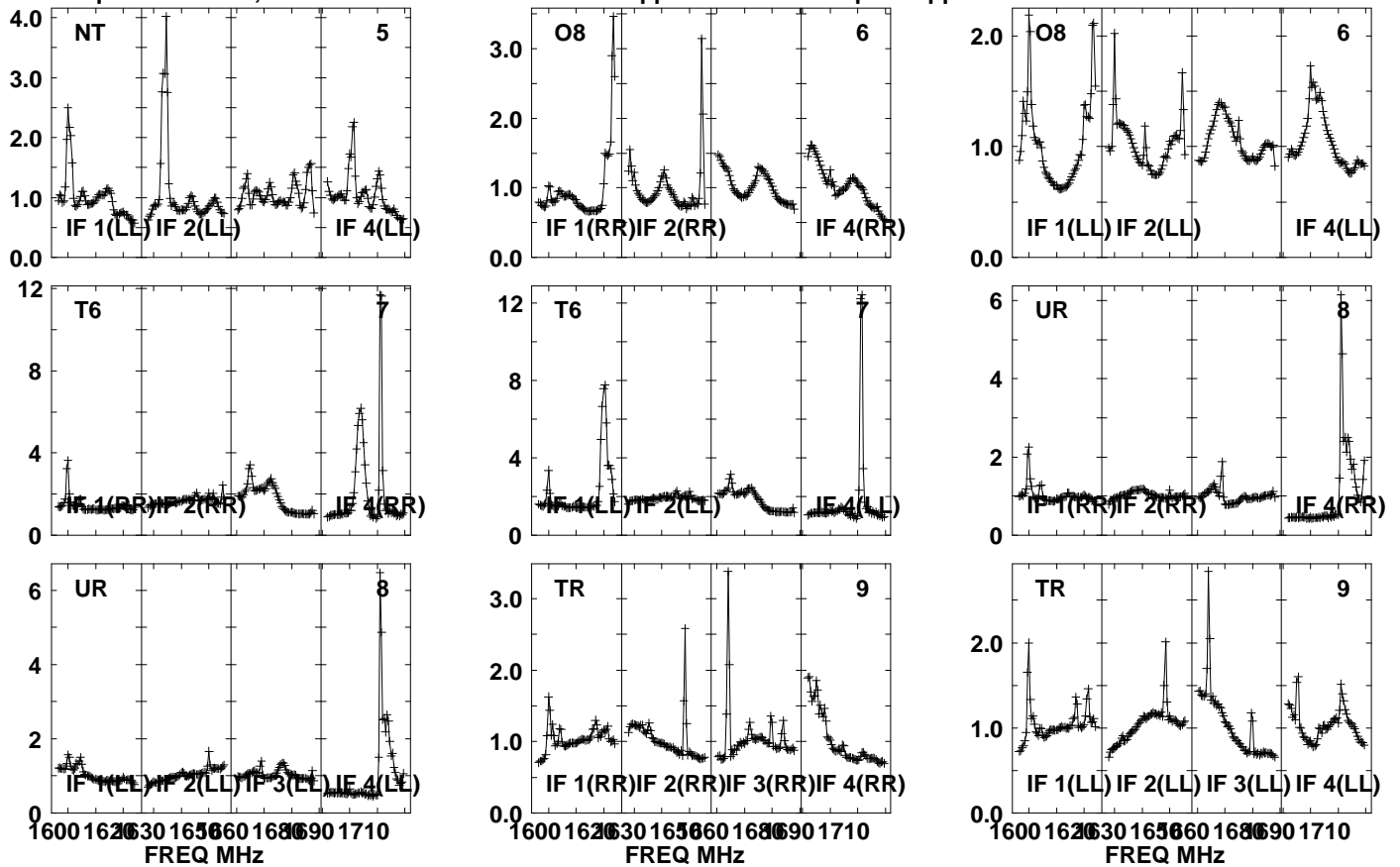

Lower frame: Real Jy

Auto-corr total-power spectrum Antenna: \*

Timerange: 00/11:33:01 to 00/11:34:29

Plot file version 105 created 05-OCT-2021 17:04:55

J0827+5217 GM076.UVDATA.1

Freq = 1.5945 GHz, Bw = 32.000 MH No calibration applied and no bandpass applied

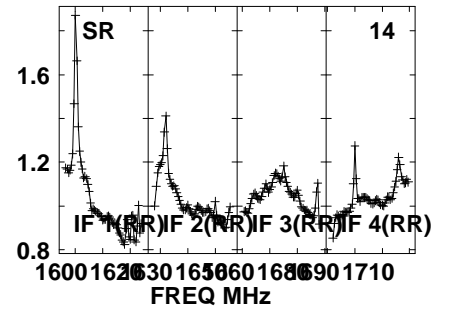
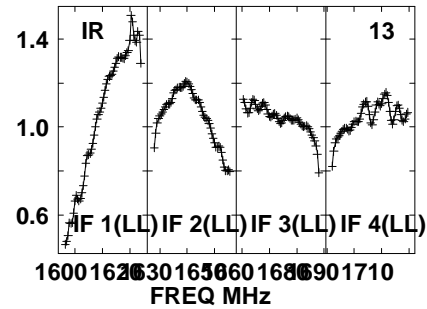
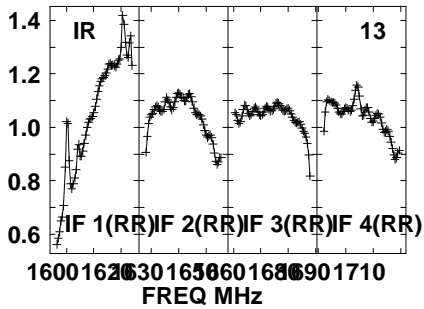
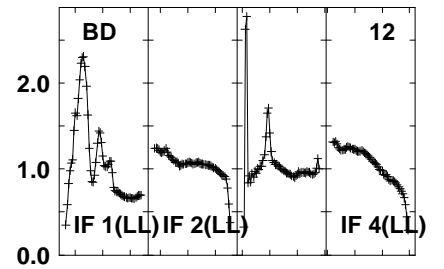
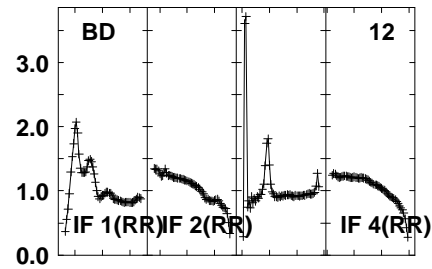
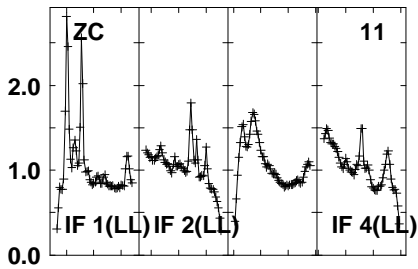
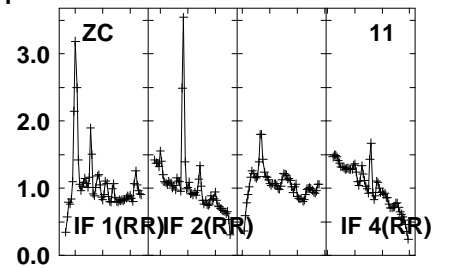
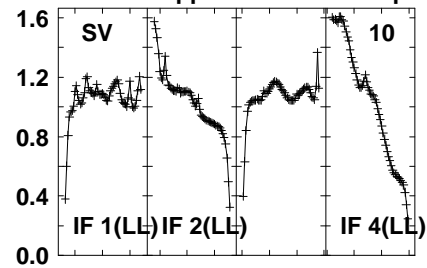
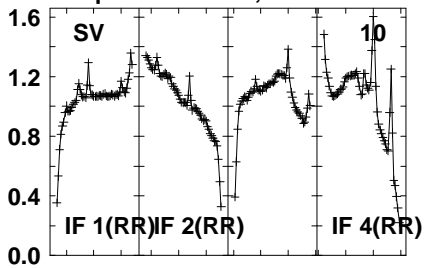

Lower frame: Real Jy  
Auto-corr total-power spectrum Antenna: \*  
Timerange: 00/11:33:01 to 00/11:34:29

Plot file version 106 created 05-OCT-2021 17:04:56

J0827+5217 GM076.UVDATA.1

Freq = 1.5945 GHz, Bw = 32.000 MH No calibration applied and no bandpass applied

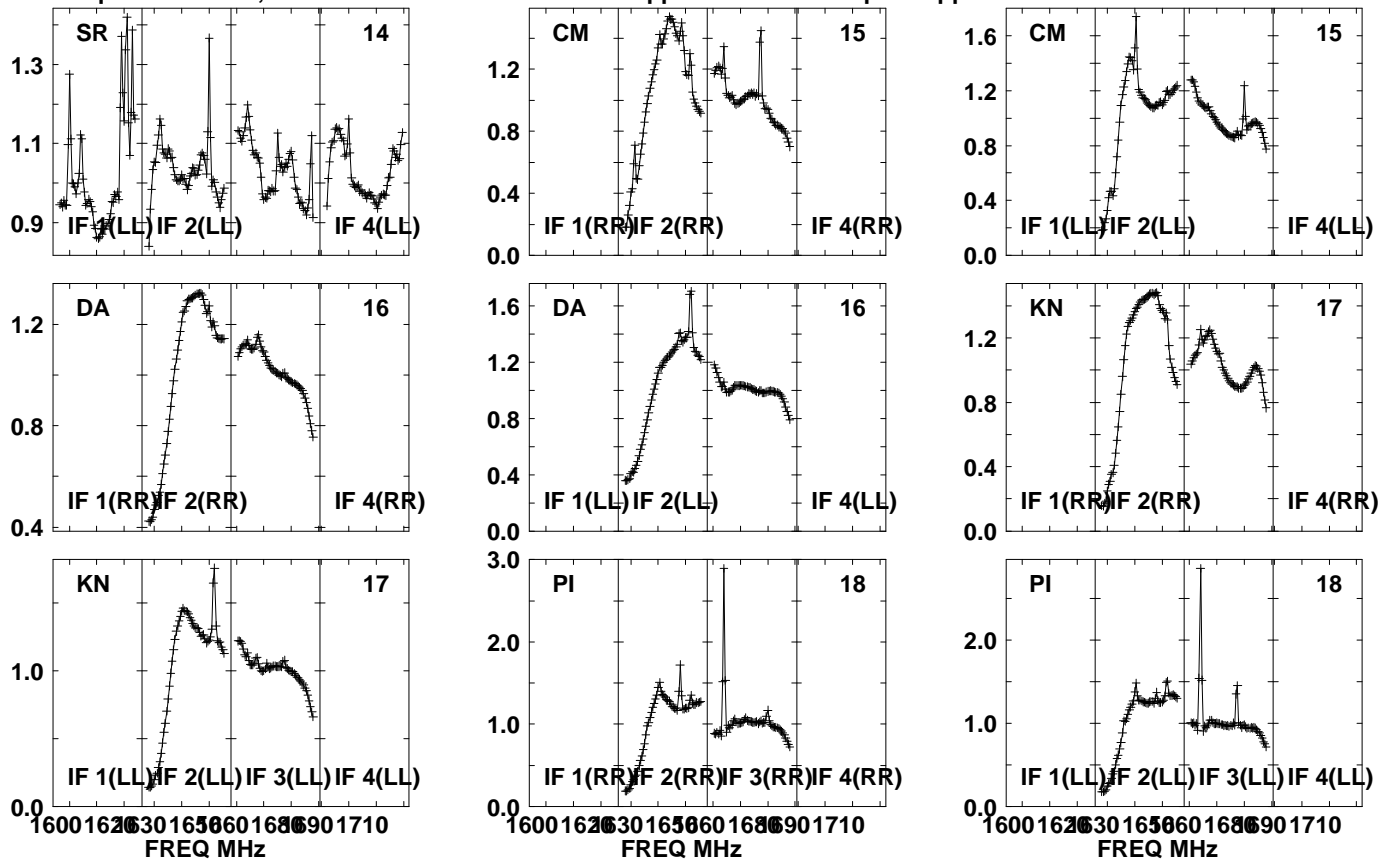

Lower frame: Real Jy  
Auto-corr total-power spectrum Antenna: \*  
Timerange: 00/11:33:01 to 00/11:34:29



Plot file version 107 created 05-OCT-2021 17:04:56

J0827+5217 GM076.UVDATA.1

Freq = 1.5945 GHz, Bw = 32.000 MH No calibration applied and no bandpass applied

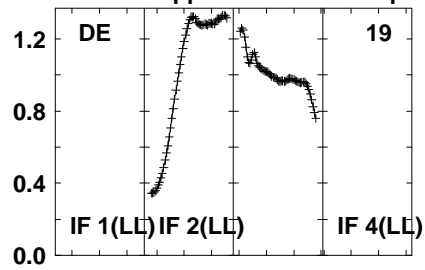
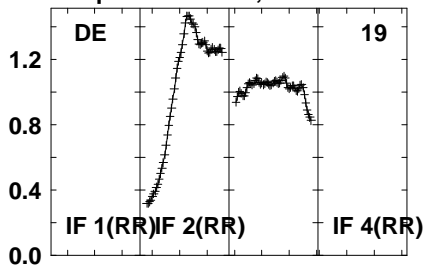

Lower frame: Real Jy  
Auto-corr total-power spectrum Antenna: \*  
Timerange: 00/11:33:01 to 00/11:34:29

Plot file version 108 created 05-OCT-2021 17:04:56

APM08279+525 GM076.UVDATA.1

Freq = 1.5945 GHz, Bw = 32.000 MH No calibration applied and no bandpass applied

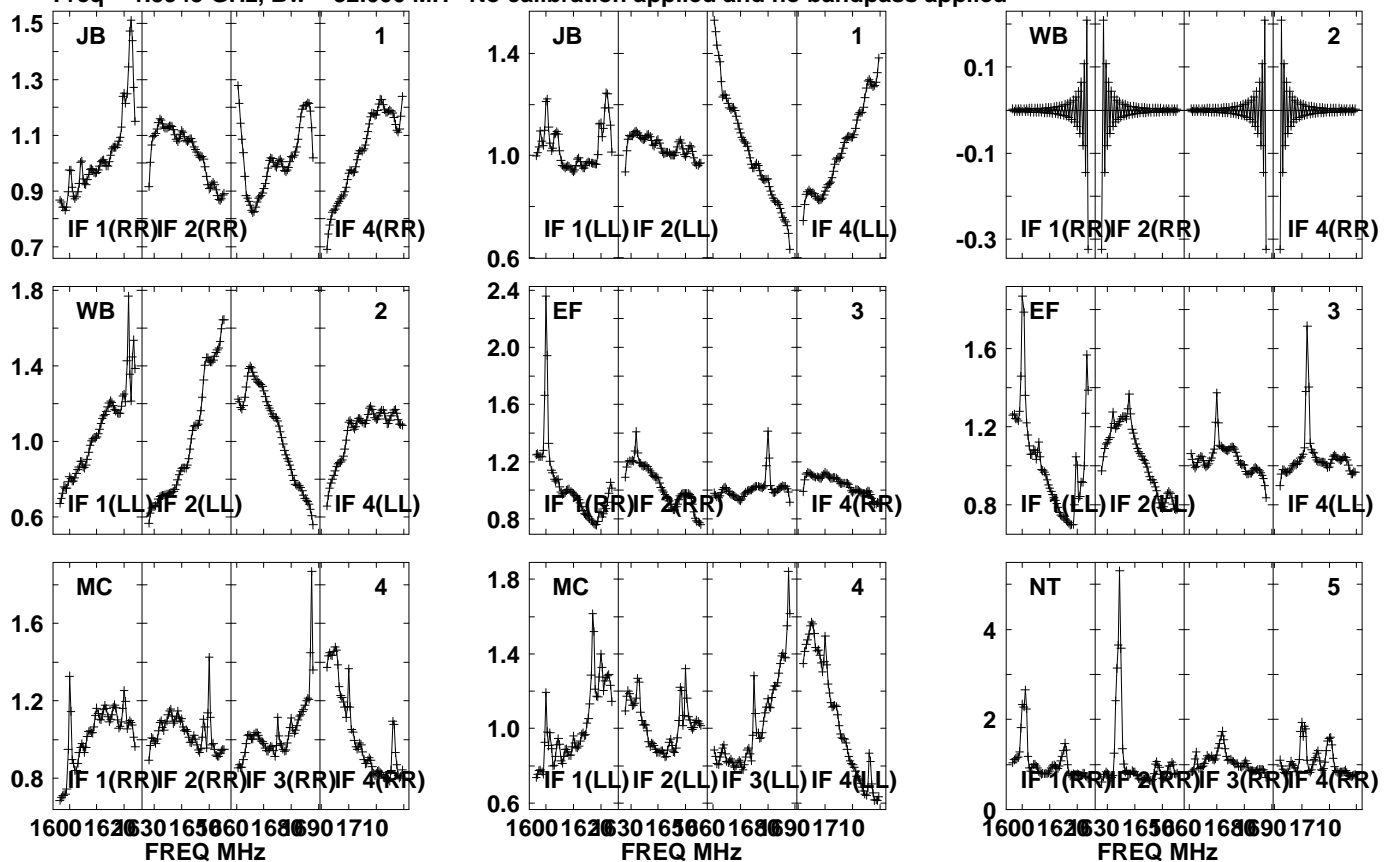

Lower frame: Real Jy  
Auto-corr total-power spectrum Antenna: \*  
Timerange: 00/11:34:31 to 00/11:37:59

Plot file version 109 created 05-OCT-2021 17:04:56

APM08279+525 GM076.UVDATA.1

Freq = 1.5945 GHz, Bw = 32.000 MH No calibration applied and no bandpass applied

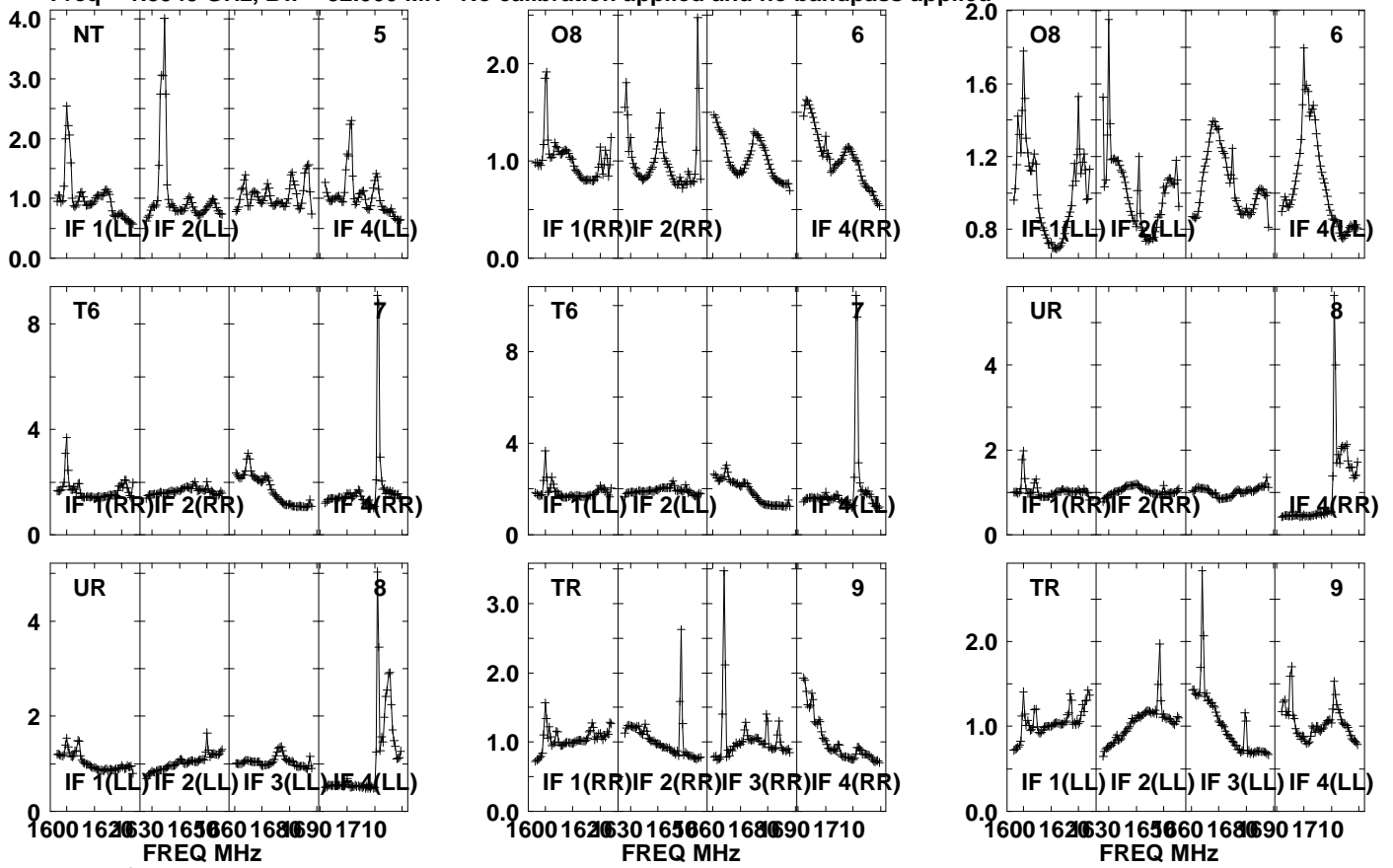

Lower frame: Real Jy

Auto-corr total-power spectrum Antenna: \*

Timerange: 00/11:34:31 to 00/11:37:59

Plot file version 110 created 05-OCT-2021 17:04:56

APM08279+525 GM076.UVDATA.1

Freq = 1.5945 GHz, Bw = 32.000 MH No calibration applied and no bandpass applied

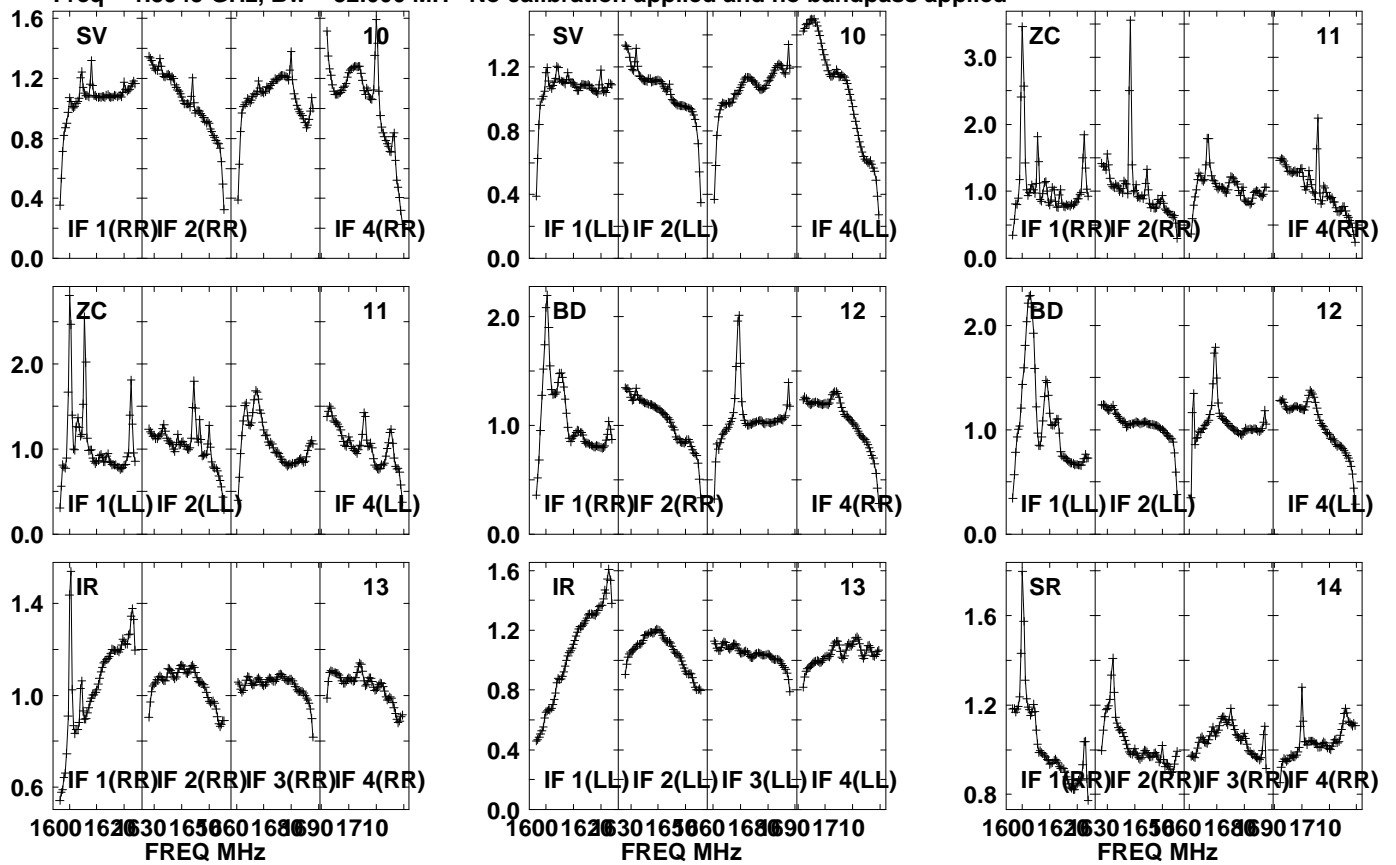

Lower frame: Real Jy  
Auto-corr total-power spectrum Antenna: \*  
Timerange: 00/11:34:31 to 00/11:37:59

Plot file version 111 created 05-OCT-2021 17:04:57

APM08279+525 GM076.UVDATA.1

Freq = 1.5945 GHz, Bw = 32.000 MH

No calibration applied and no bandpass applied

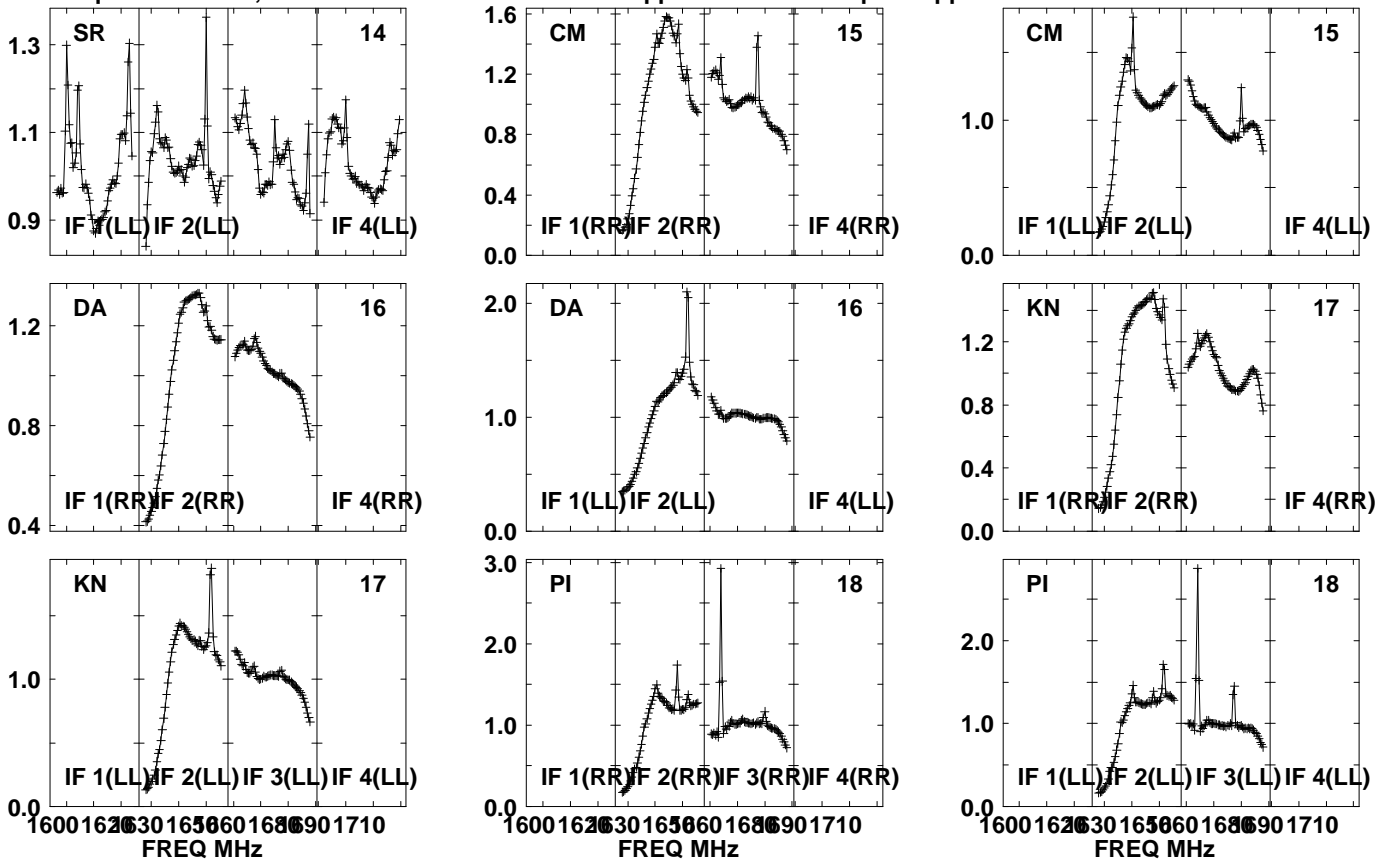

Lower frame: Real Jy  
Auto-corr total-power spectrum Antenna: \*  
Timerange: 00/11:34:31 to 00/11:37:59

Plot file version 112 created 05-OCT-2021 17:04:57

APM08279+525 GM076.UVDATA.1

Freq = 1.5945 GHz, Bw = 32.000 MH No calibration applied and no bandpass applied

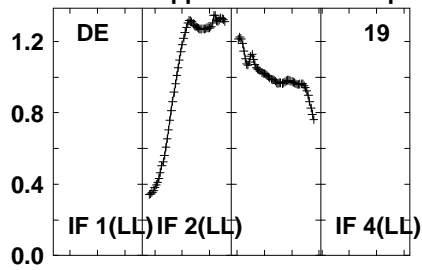
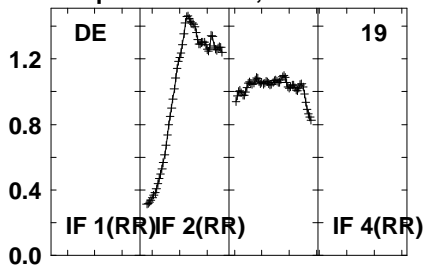

Lower frame: Real Jy  
Auto-corr total-power spectrum Antenna: \*  
Timerange: 00/11:34:31 to 00/11:37:59

Plot file version 113 created 05-OCT-2021 17:04:57

J0827+5217 GM076.UVDATA.1

Freq = 1.5945 GHz, Bw = 32.000 MH No calibration applied and no bandpass applied

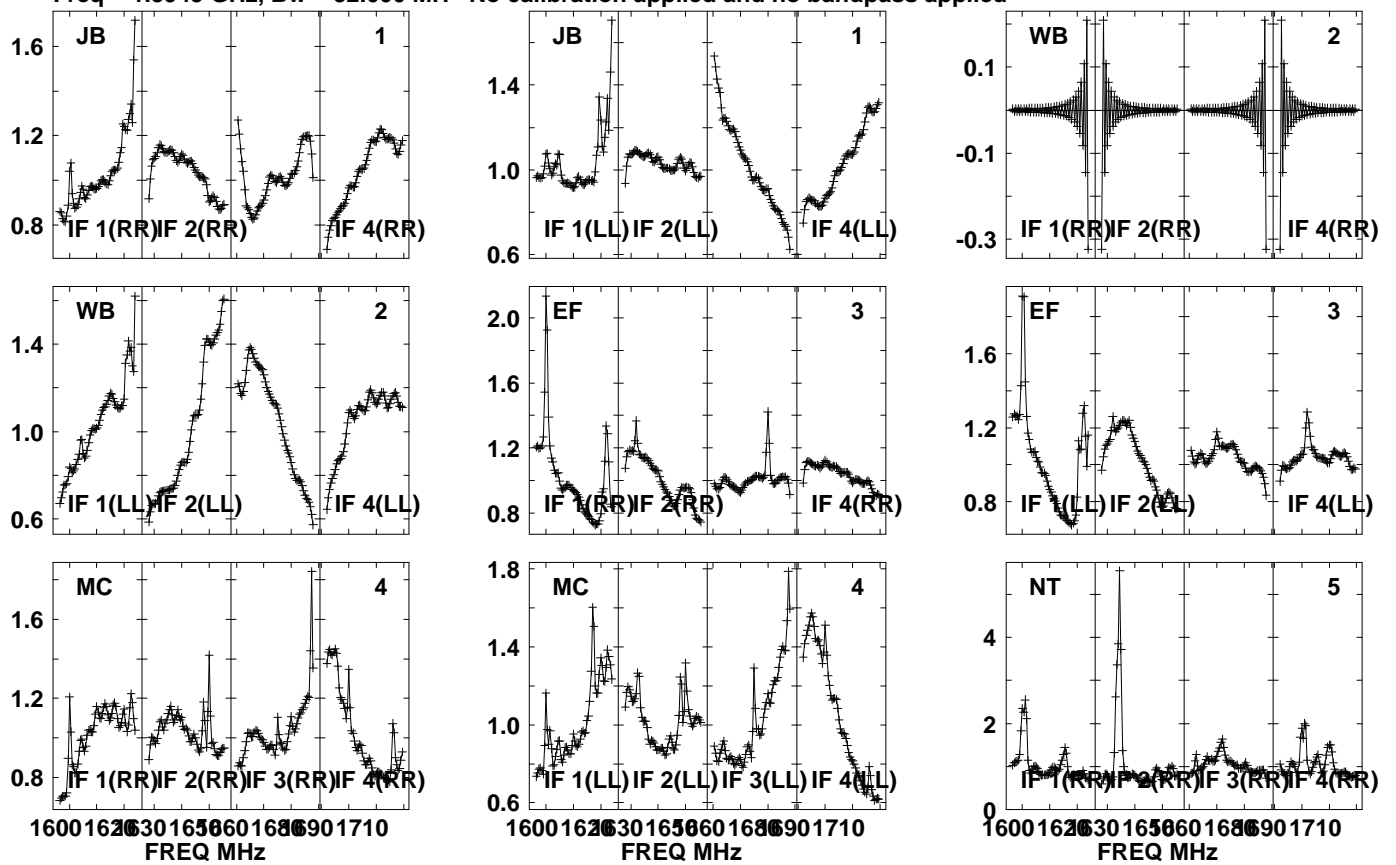

Lower frame: Real Jy

Auto-corr total-power spectrum Antenna: \*

Timerange: 00/11:38:31 to 00/11:39:59

Plot file version 114 created 05-OCT-2021 17:04:57

J0827+5217 GM076.UVDATA.1

Freq = 1.5945 GHz, Bw = 32.000 MH No calibration applied and no bandpass applied

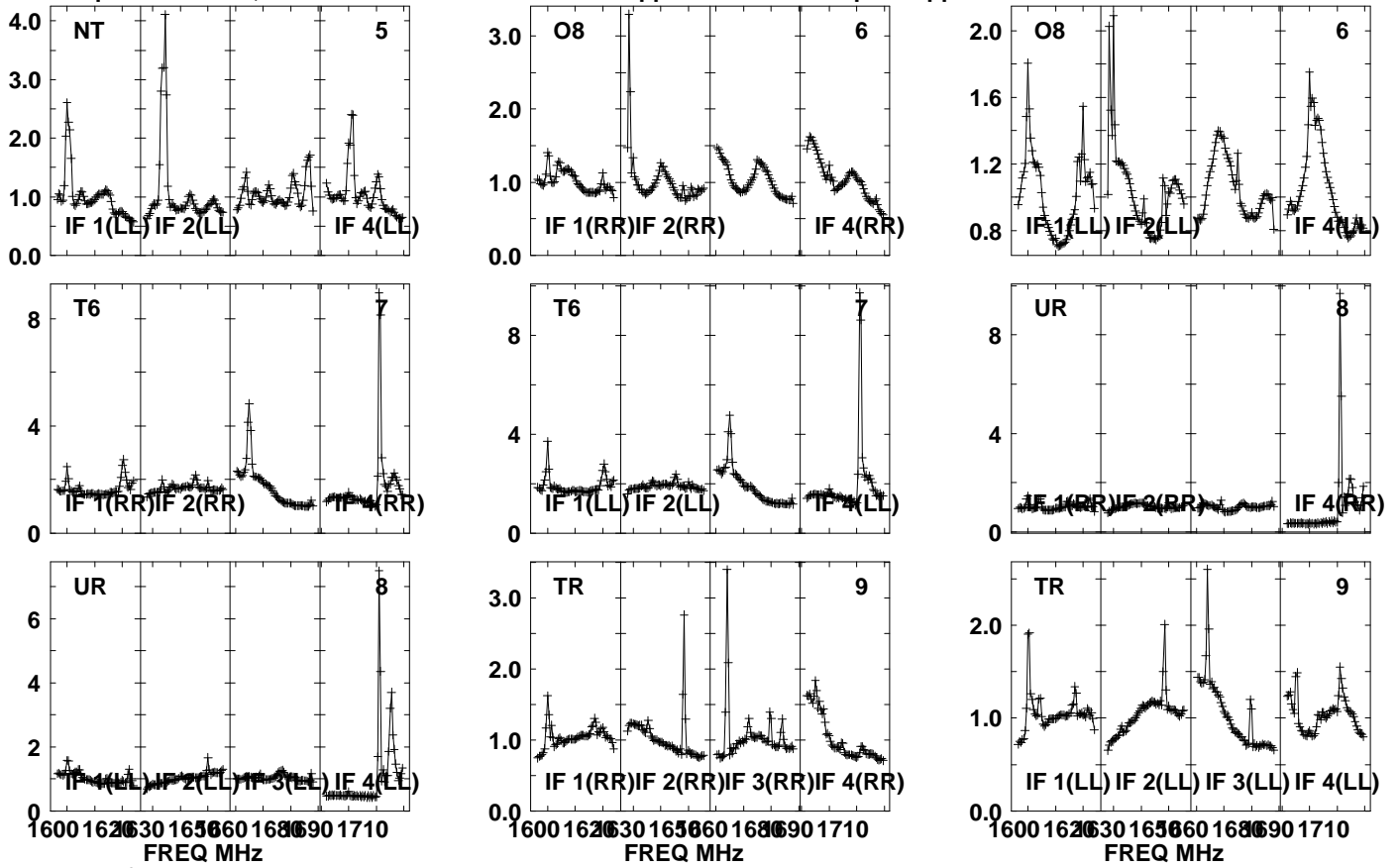

Lower frame: Real Jy  
Auto-corr total-power spectrum Antenna: \*  
Timerange: 00/11:38:31 to 00/11:39:59



Plot file version 115 created 05-OCT-2021 17:04:58

J0827+5217 GM076.UVDATA.1

Freq = 1.5945 GHz, Bw = 32.000 MH No calibration applied and no bandpass applied

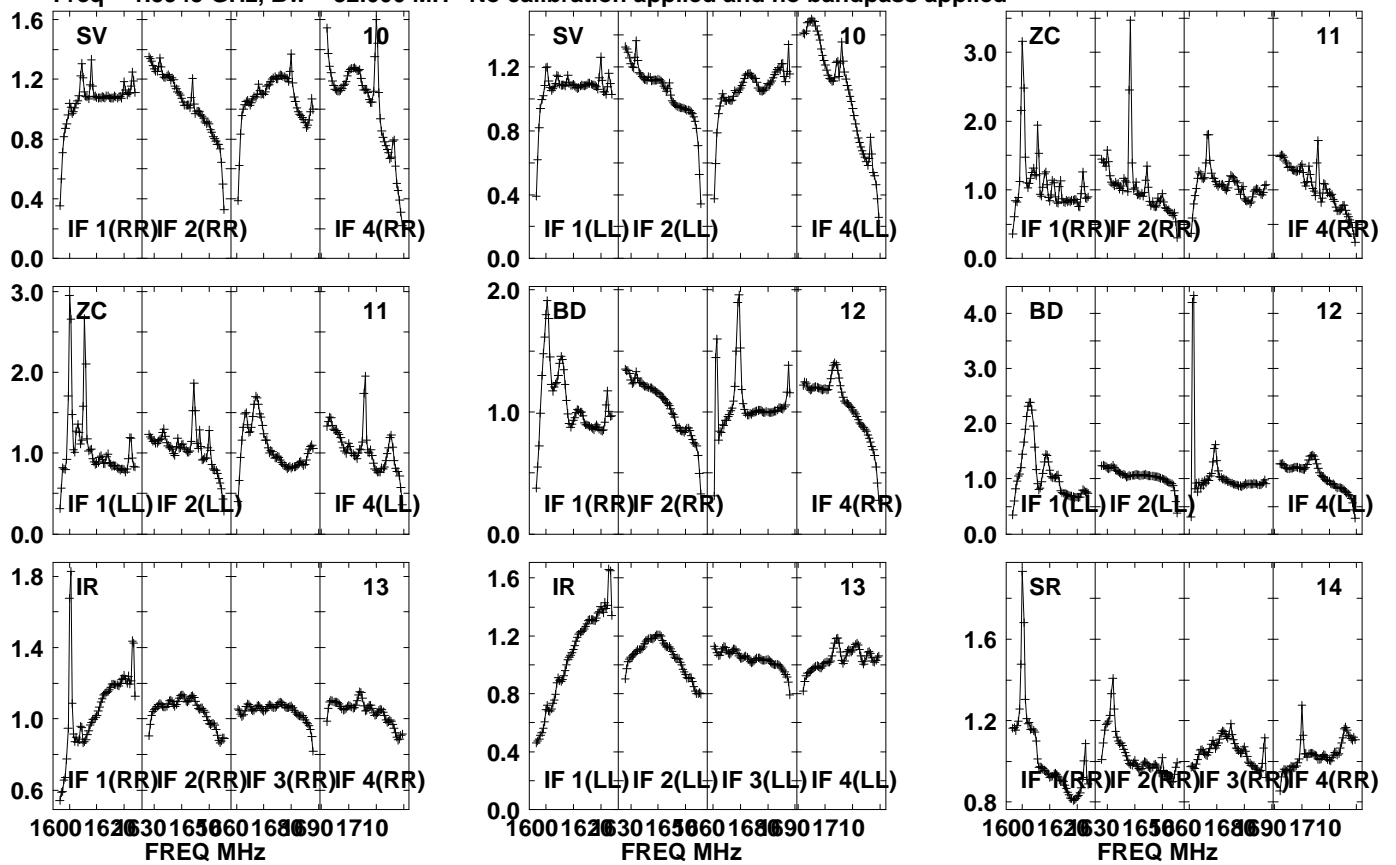

Lower frame: Real Jy  
Auto-corr total-power spectrum Antenna: \*  
Timerange: 00/11:38:31 to 00/11:39:59

Plot file version 116 created 05-OCT-2021 17:04:58

J0827+5217 GM076.UVDATA.1

Freq = 1.5945 GHz, Bw = 32.000 MH No calibration applied and no bandpass applied

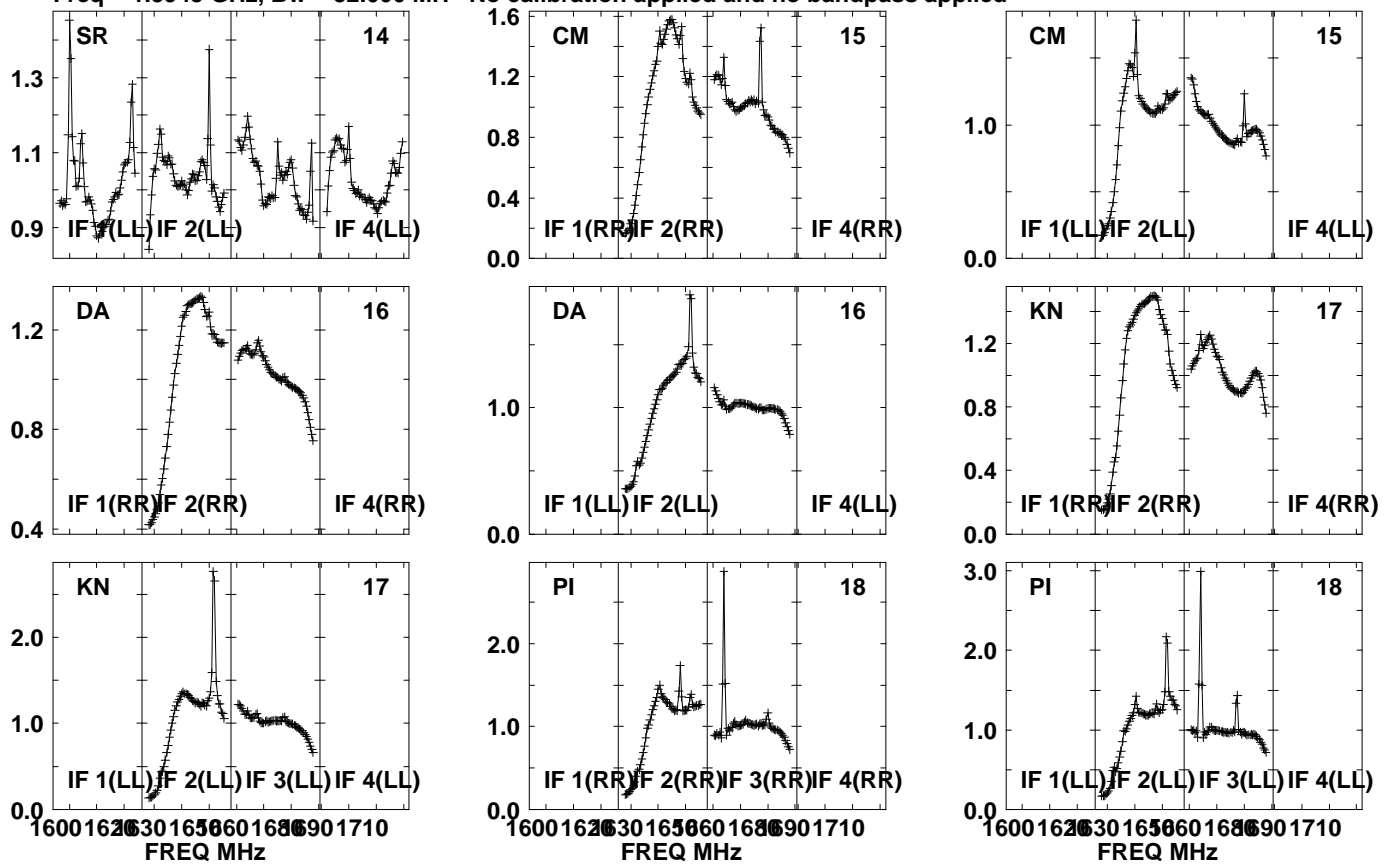

Lower frame: Real Jy  
Auto-corr total-power spectrum Antenna: \*  
Timerange: 00/11:38:31 to 00/11:39:59

Plot file version 117 created 05-OCT-2021 17:04:58

J0827+5217 GM076.UVDATA.1

Freq = 1.5945 GHz, Bw = 32.000 MH No calibration applied and no bandpass applied

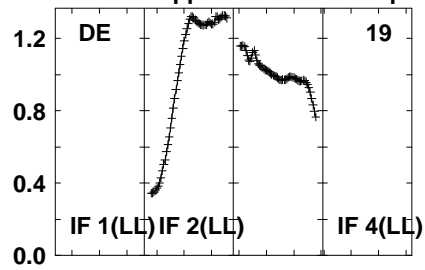
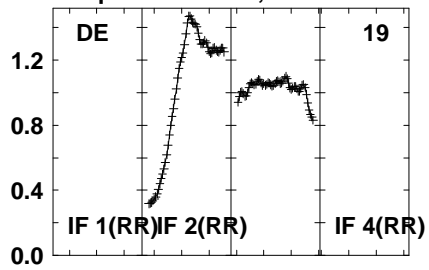

Lower frame: Real Jy  
Auto-corr total-power spectrum Antenna: \*  
Timerange: 00/11:38:31 to 00/11:39:59

Plot file version 118 created 05-OCT-2021 17:04:58

APM08279+525 GM076.UVDATA.1

Freq = 1.5945 GHz, Bw = 32.000 MH No calibration applied and no bandpass applied

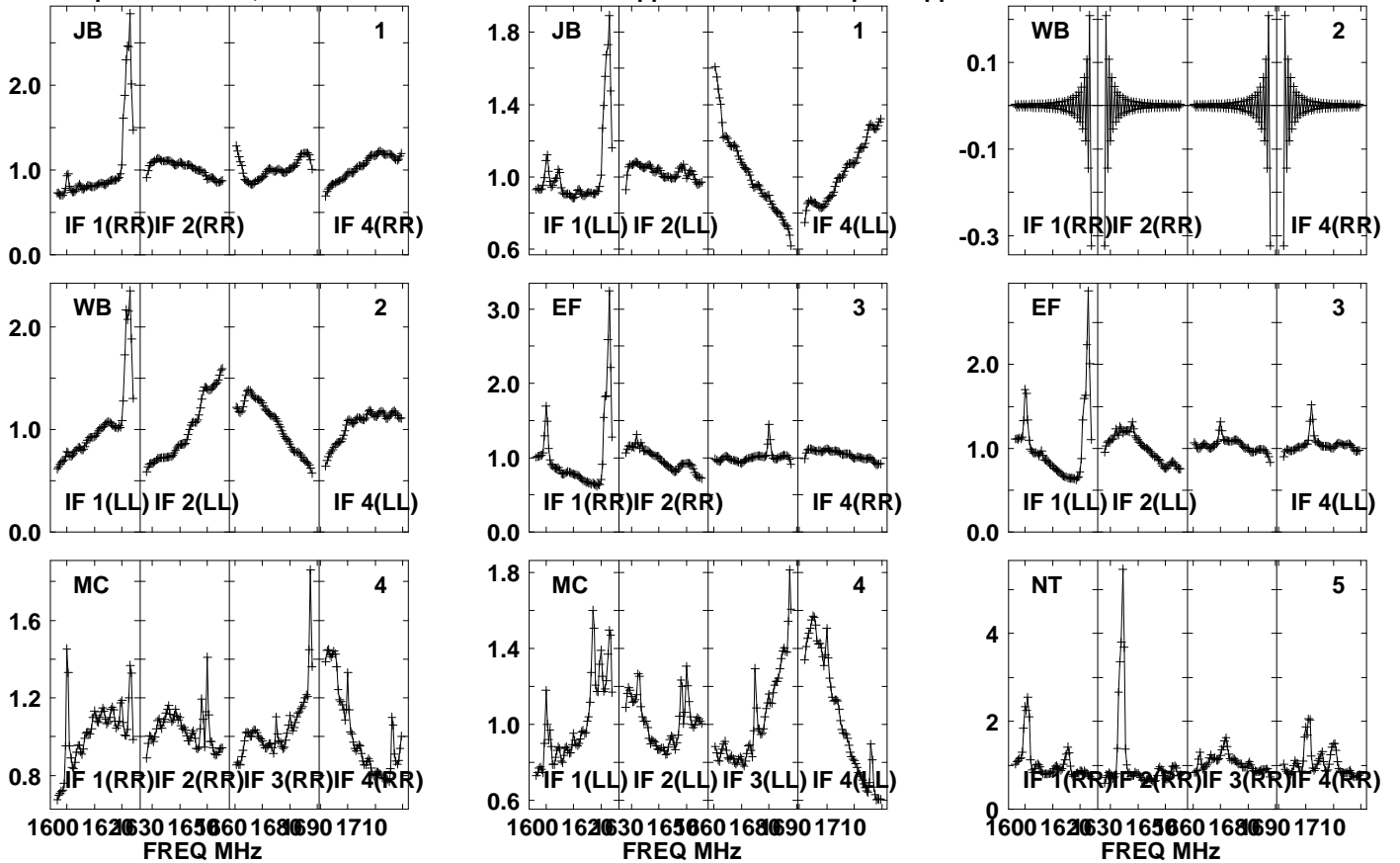

Lower frame: Real Jy  
Auto-corr total-power spectrum Antenna: \*  
Timerange: 00/11:40:01 to 00/11:43:29

Plot file version 119 created 05-OCT-2021 17:04:58

APM08279+525 GM076.UVDATA.1

Freq = 1.5945 GHz, Bw = 32.000 MH No calibration applied and no bandpass applied

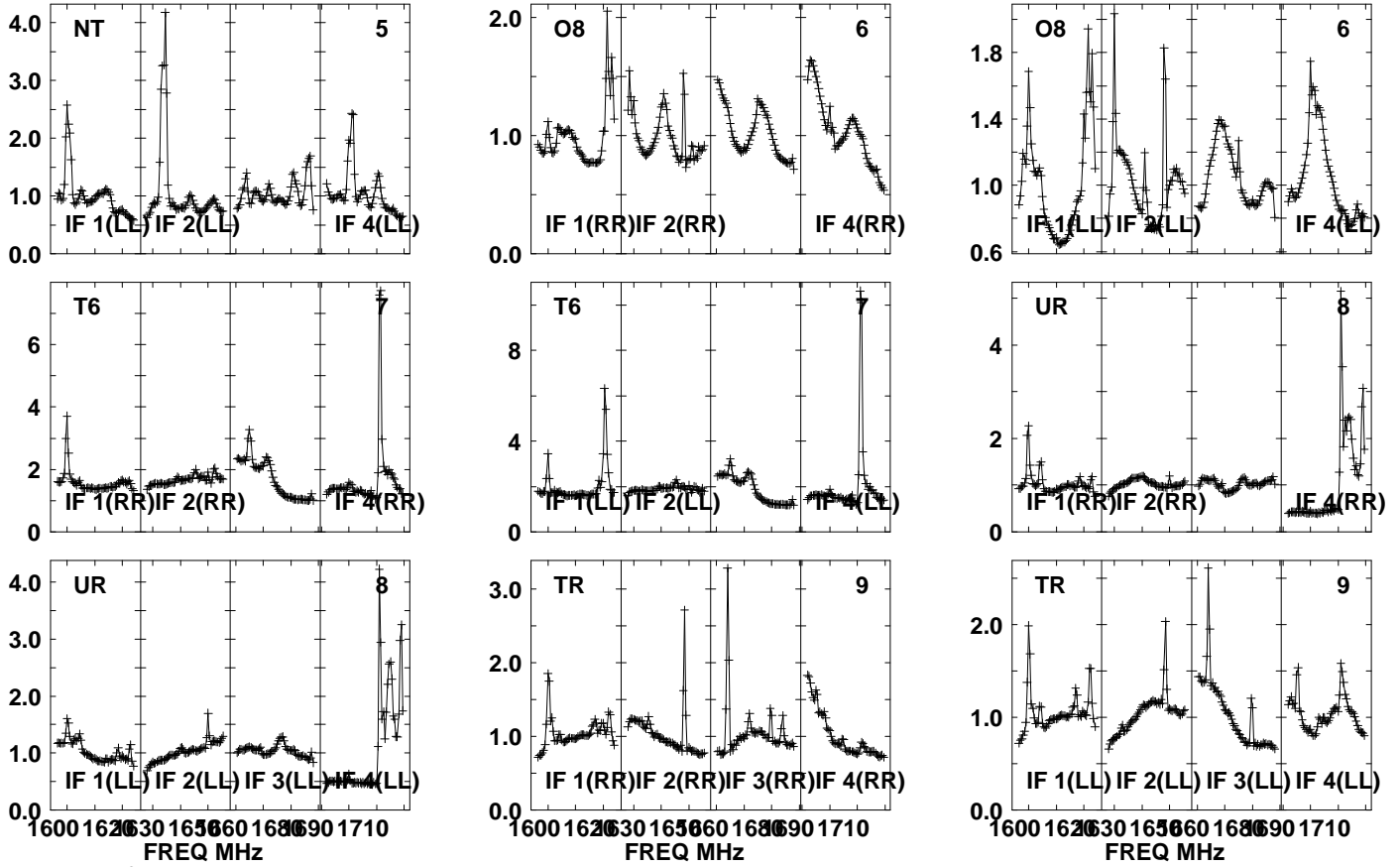

Lower frame: Real Jy  
Auto-corr total-power spectrum Antenna: \*  
Timerange: 00/11:40:01 to 00/11:43:29

Plot file version 120 created 05-OCT-2021 17:04:58

APM08279+525 GM076.UVDATA.1

Freq = 1.5945 GHz, Bw = 32.000 MH No calibration applied and no bandpass applied

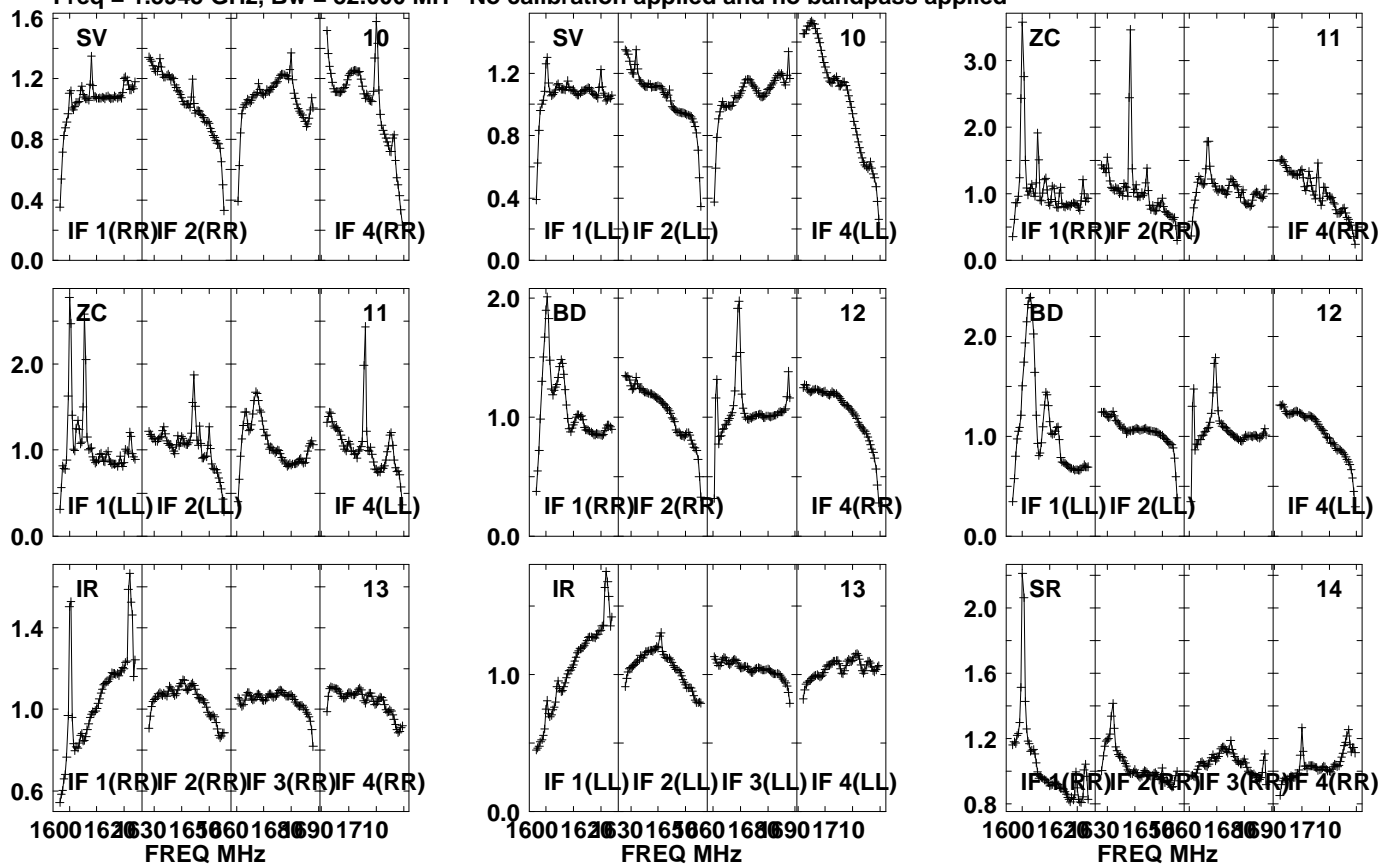

Lower frame: Real Jy  
Auto-corr total-power spectrum Antenna: \*  
Timerange: 00/11:40:01 to 00/11:43:29

Plot file version 121 created 05-OCT-2021 17:04:59

APM08279+525 GM076.UVDATA.1

Freq = 1.5945 GHz, Bw = 32.000 MH No calibration applied and no bandpass applied

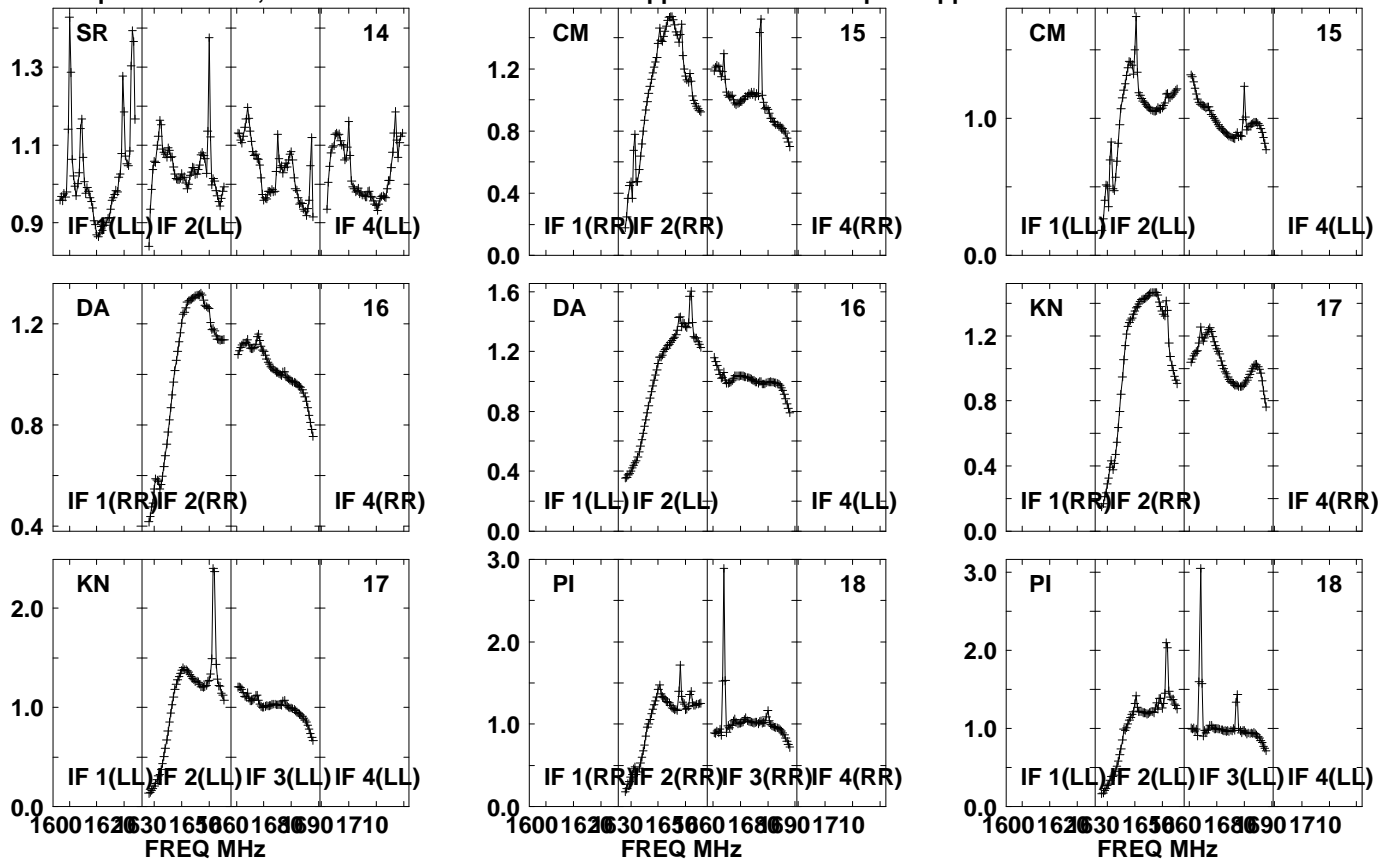

Lower frame: Real Jy  
Auto-corr total-power spectrum Antenna: \*  
Timerange: 00/11:40:01 to 00/11:43:29

Plot file version 122 created 05-OCT-2021 17:04:59

APM08279+525 GM076.UVDATA.1

Freq = 1.5945 GHz, Bw = 32.000 MH No calibration applied and no bandpass applied

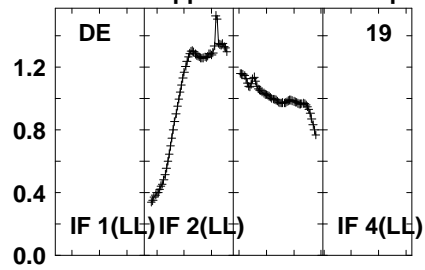
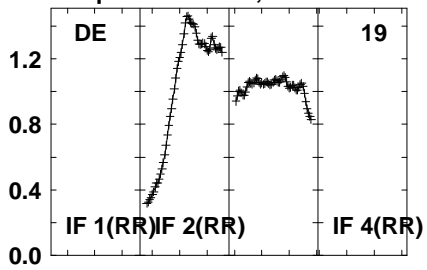

Lower frame: Real Jy  
Auto-corr total-power spectrum Antenna: \*  
Timerange: 00/11:40:01 to 00/11:43:29



Plot file version 123 created 05-OCT-2021 17:04:59

J0827+5217 GM076.UVDATA.1

Freq = 1.5945 GHz, Bw = 32.000 MH No calibration applied and no bandpass applied

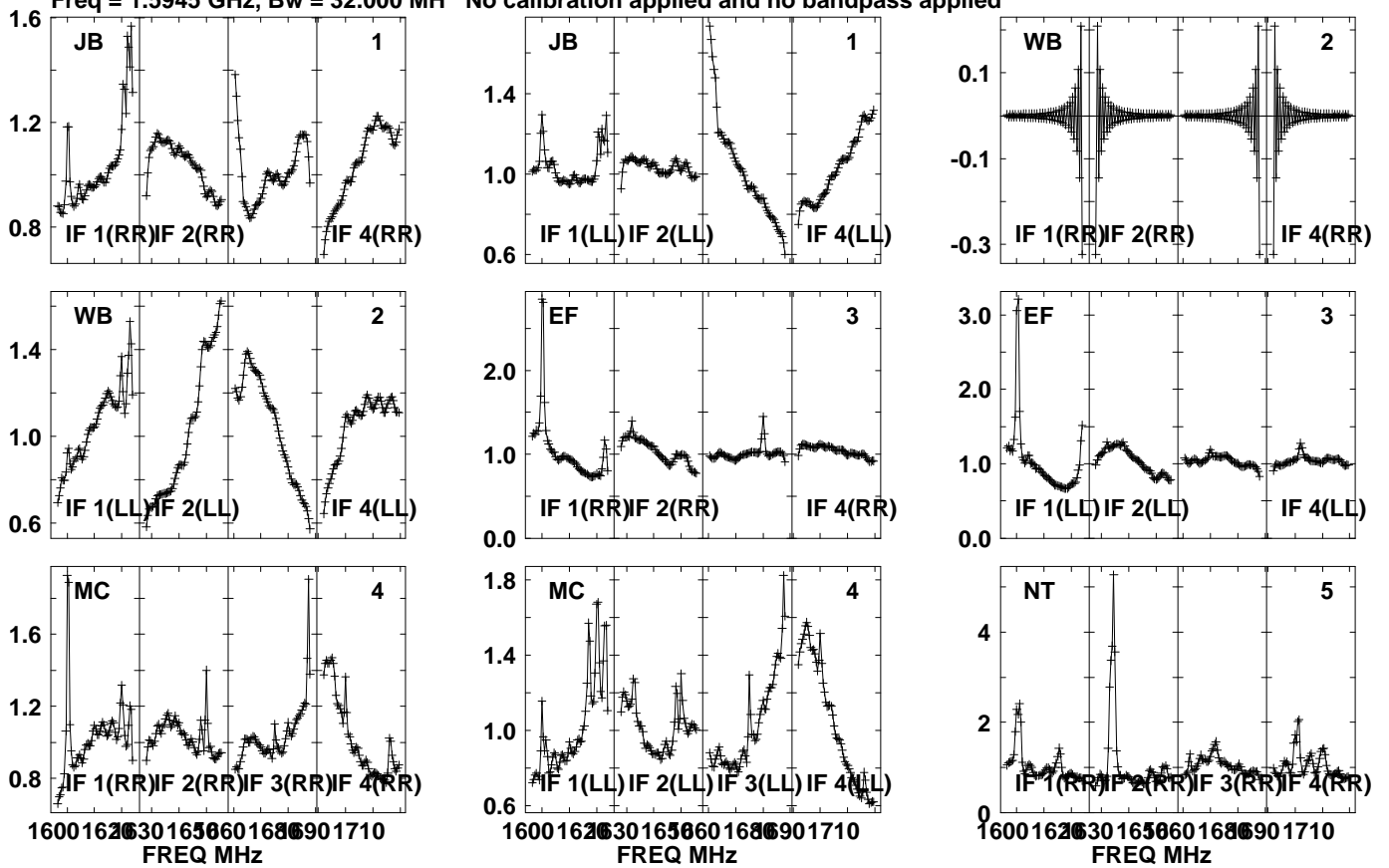

Lower frame: Real Jy  
Auto-corr total-power spectrum Antenna: \*  
Timerange: 00/11:43:31 to 00/11:44:59

Plot file version 124 created 05-OCT-2021 17:04:59

J0827+5217 GM076.UVDATA.1

Freq = 1.5945 GHz, Bw = 32.000 MH No calibration applied and no bandpass applied

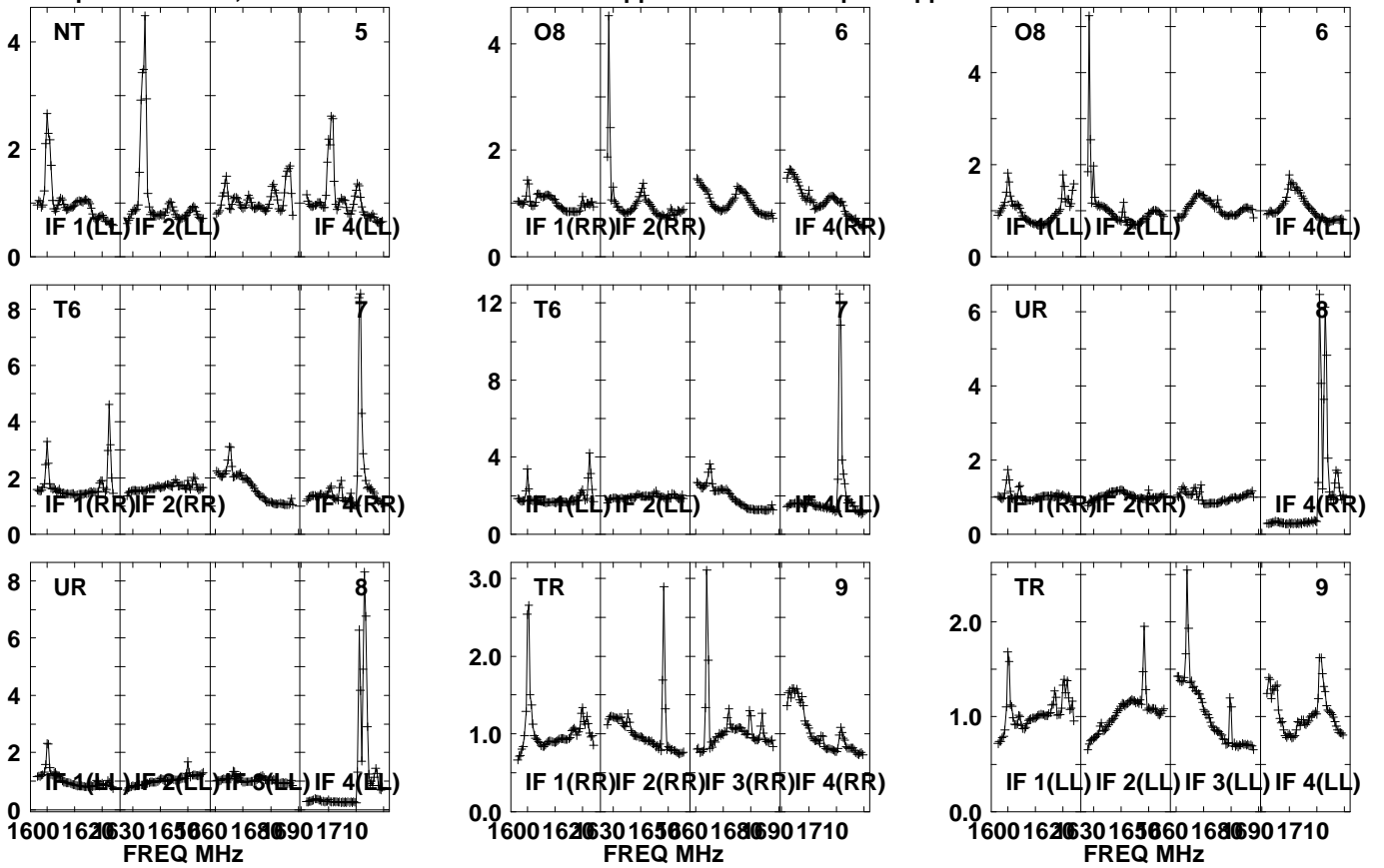

Lower frame: Real Jy  
Auto-corr total-power spectrum Antenna: \*  
Timerange: 00/11:43:31 to 00/11:44:59

Plot file version 125 created 05-OCT-2021 17:05:00

J0827+5217 GM076.UVDATA.1

Freq = 1.5945 GHz, Bw = 32.000 MH No calibration applied and no bandpass applied

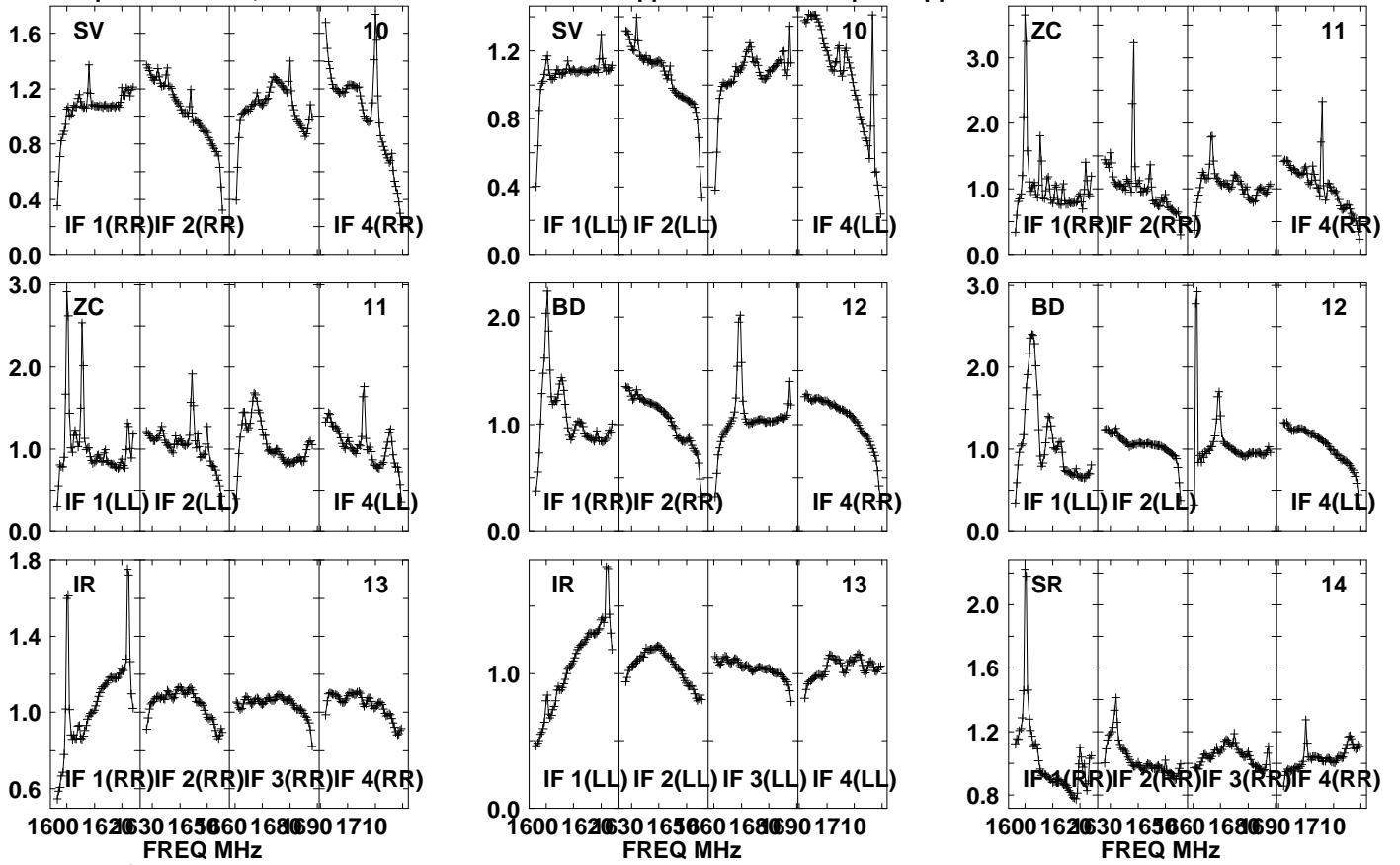

Lower frame: Real Jy

Auto-corr total-power spectrum Antenna: \*

Timerange: 00/11:43:31 to 00/11:44:59

Plot file version 126 created 05-OCT-2021 17:05:00

J0827+5217 GM076.UVDATA.1

Freq = 1.5945 GHz, Bw = 32.000 MH No calibration applied and no bandpass applied

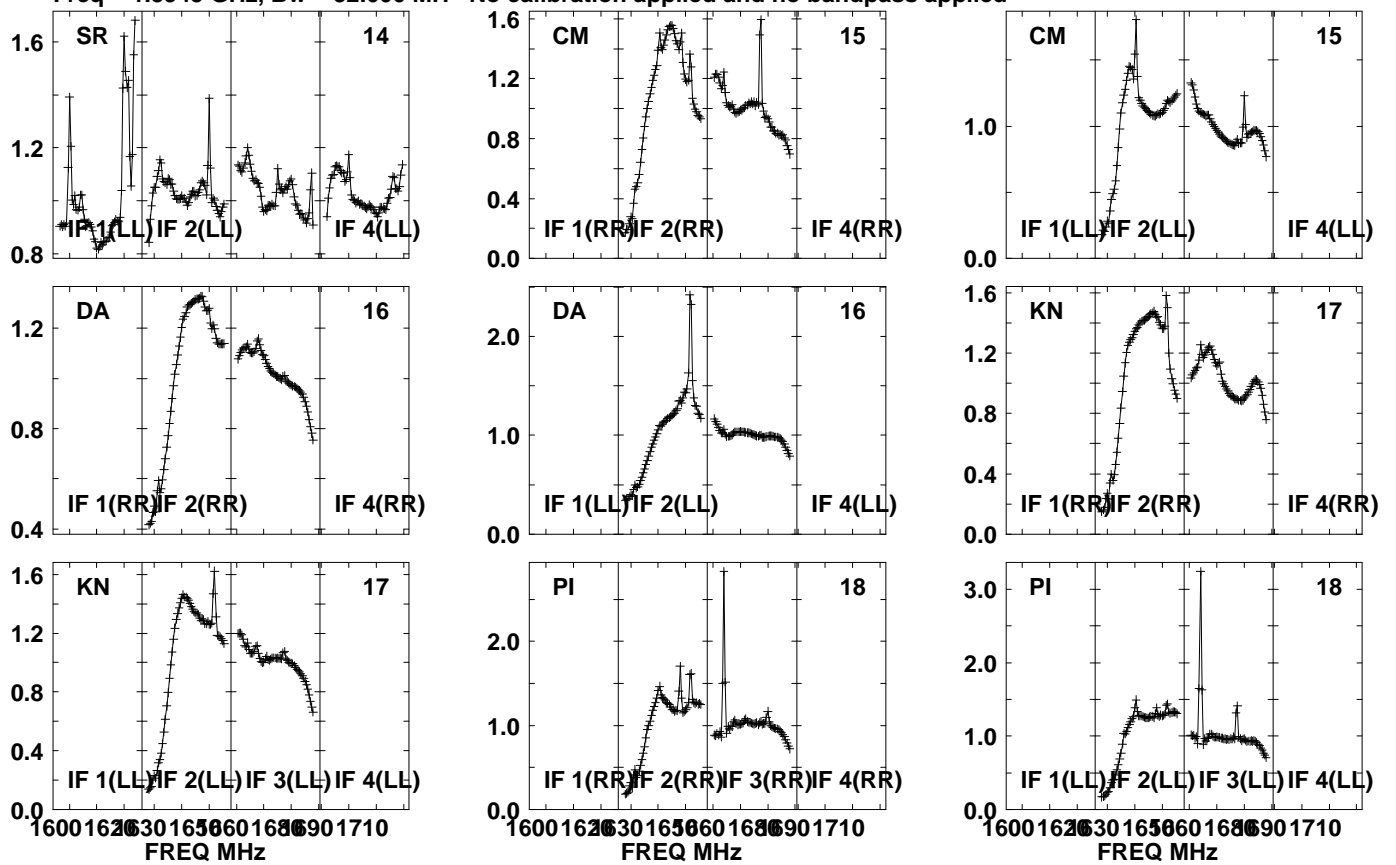

Lower frame: Real Jy  
Auto-corr total-power spectrum Antenna: \*  
Timerange: 00/11:43:31 to 00/11:44:59

Plot file version 127 created 05-OCT-2021 17:05:00

J0827+5217 GM076.UVDATA.1

Freq = 1.5945 GHz, Bw = 32.000 MH No calibration applied and no bandpass applied

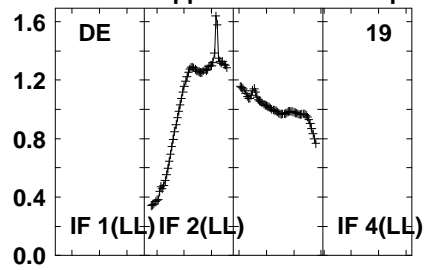
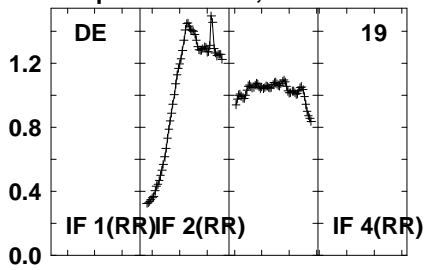

Lower frame: Real Jy  
Auto-corr total-power spectrum Antenna: \*  
Timerange: 00/11:43:31 to 00/11:44:59

Plot file version 128 created 05-OCT-2021 17:05:00

APM08279+525 GM076.UVDATA.1

Freq = 1.5945 GHz, Bw = 32.000 MH No calibration applied and no bandpass applied

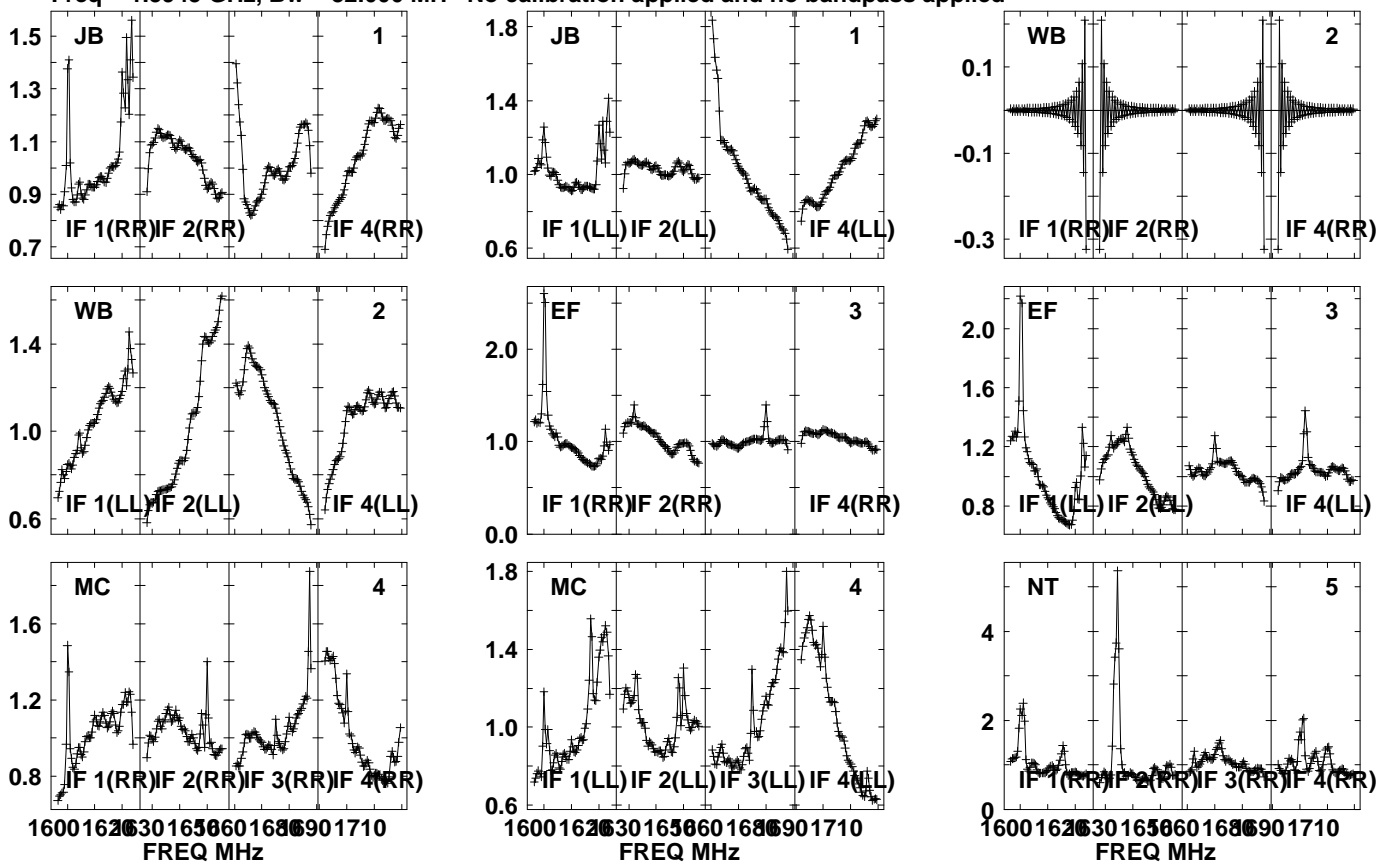

Lower frame: Real Jy  
Auto-corr total-power spectrum Antenna: \*  
Timerange: 00/11:45:01 to 00/11:48:29

Plot file version 129 created 05-OCT-2021 17:05:00

APM08279+525 GM076.UVDATA.1

Freq = 1.5945 GHz, Bw = 32.000 MH No calibration applied and no bandpass applied

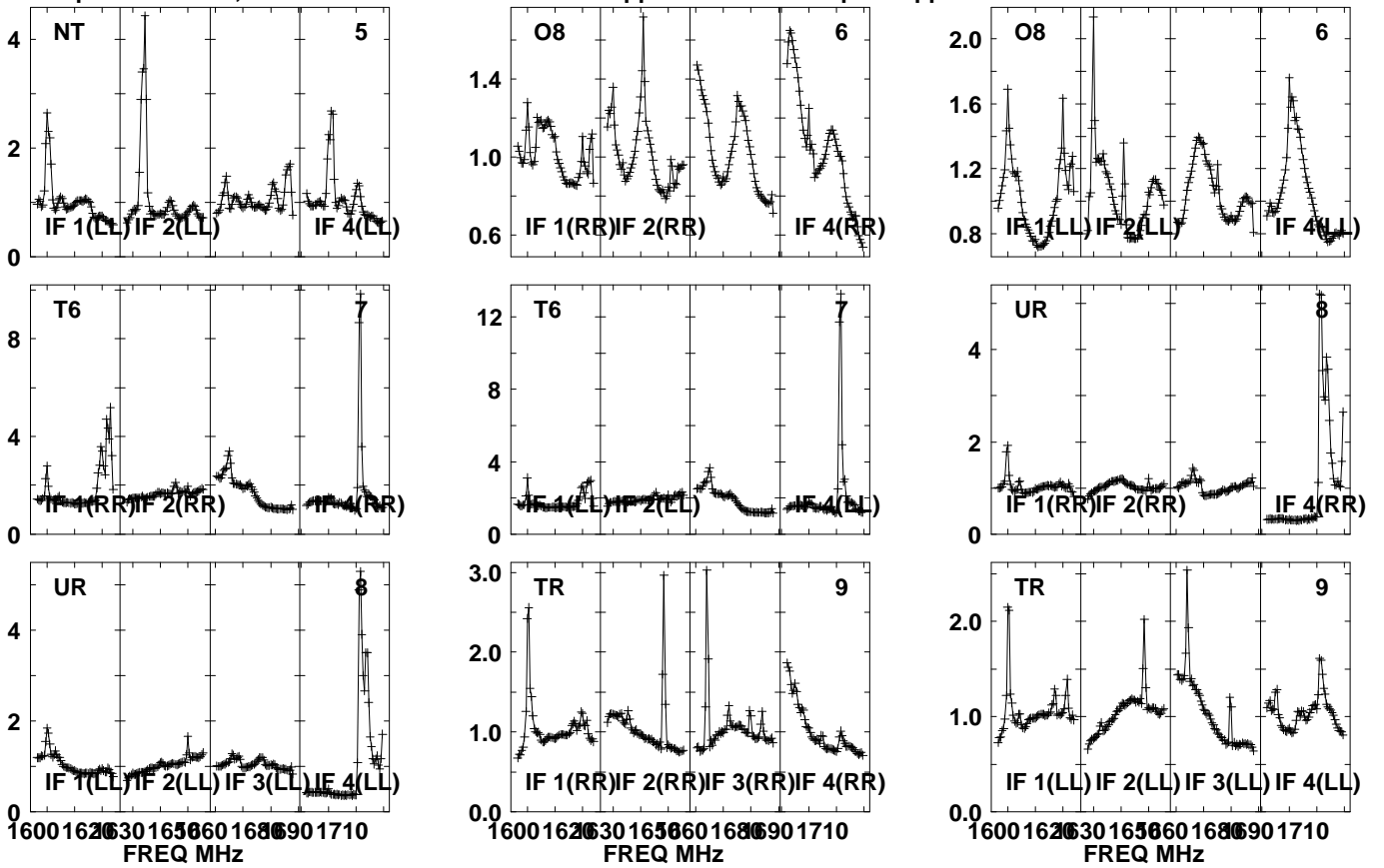

Lower frame: Real Jy

Auto-corr total-power spectrum Antenna: \*

Timerange: 00/11:45:01 to 00/11:48:29

Plot file version 130 created 05-OCT-2021 17:05:01

APM08279+525 GM076.UVDATA.1

Freq = 1.5945 GHz, Bw = 32.000 MH

No calibration applied and no bandpass applied

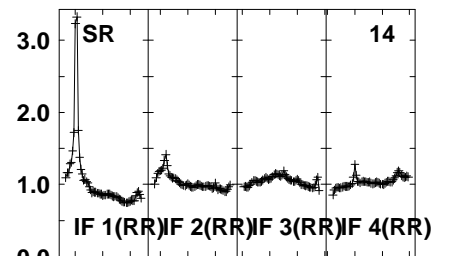
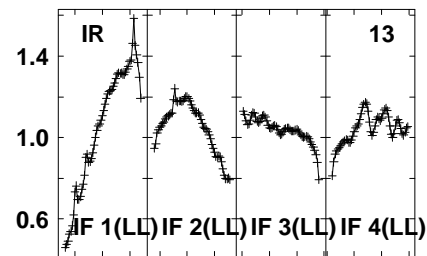
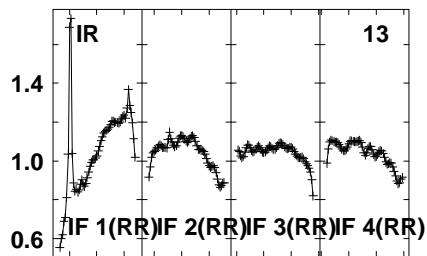
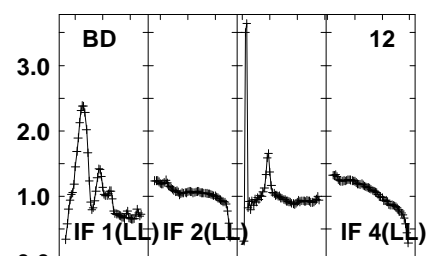
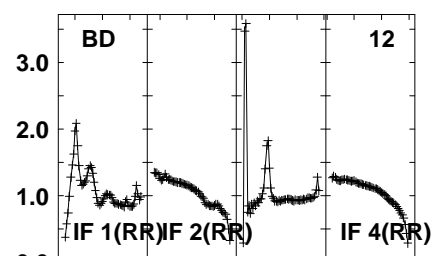
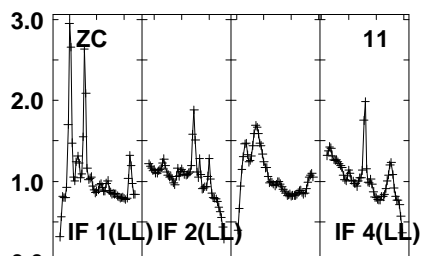
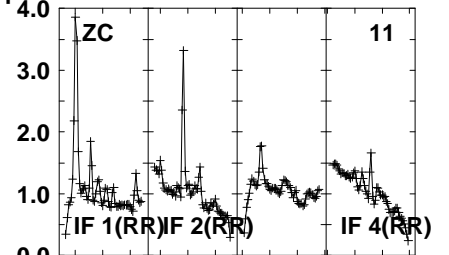
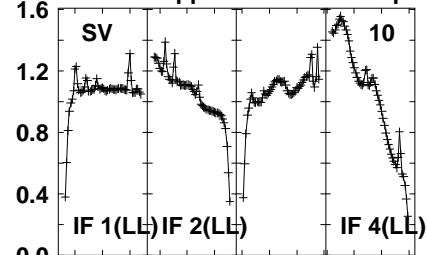
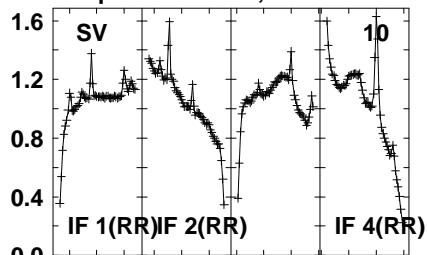

1600 1620 1630 1650 1660 1680 1690 1710  
FREQ MHz

1600 1620 1630 1650 1660 1680 1690 1710  
FREQ MHz

1600 1620 1630 1650 1660 1680 1690 1710  
FREQ MHz

Lower frame: Real Jy  
Auto-corr total-power spectrum Antenna: \*  
Timerange: 00/11:45:01 to 00/11:48:29



Plot file version 131 created 05-OCT-2021 17:05:01

APM08279+525 GM076.UVDATA.1

Freq = 1.5945 GHz, Bw = 32.000 MH

No calibration applied and no bandpass applied

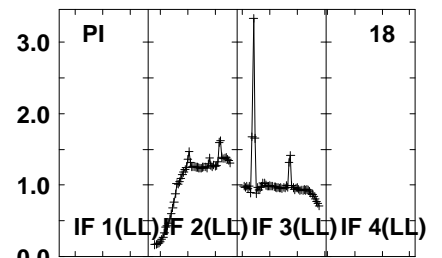
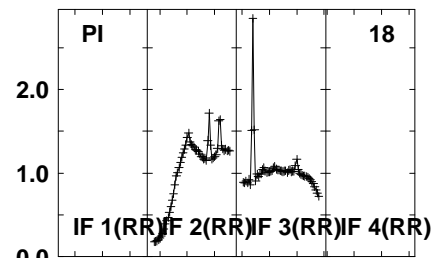
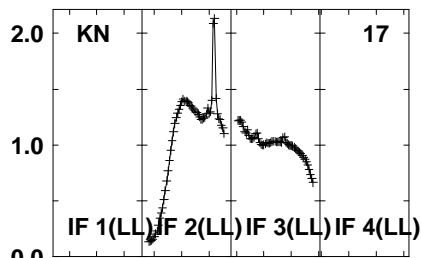
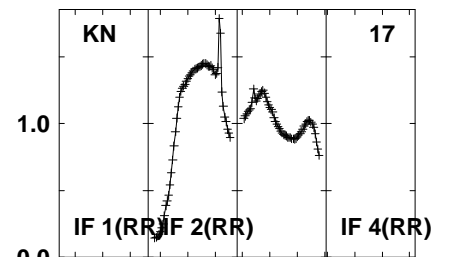
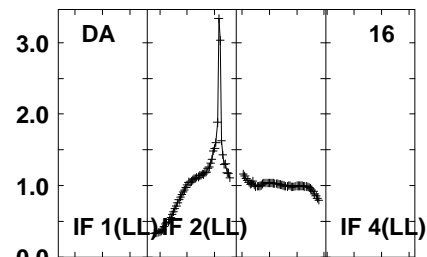
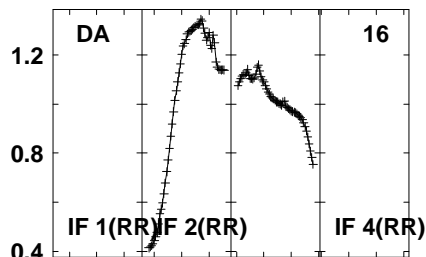
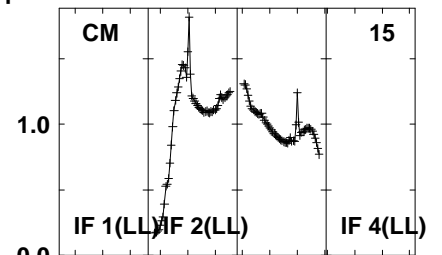
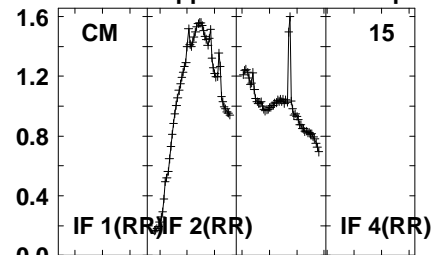
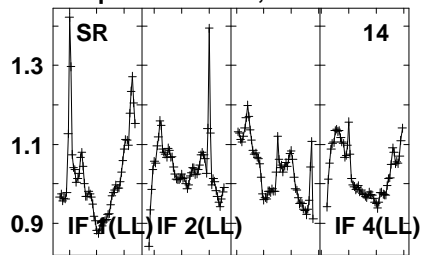

1600 1620 1630 1650 1660 1680 1690 1710  
FREQ MHz

Lower frame: Real Jy  
Auto-corr total-power spectrum Antenna: \*  
Timerange: 00/11:45:01 to 00/11:48:29

Plot file version 132 created 05-OCT-2021 17:05:01

APM08279+525 GM076.UVDATA.1

Freq = 1.5945 GHz, Bw = 32.000 MH No calibration applied and no bandpass applied

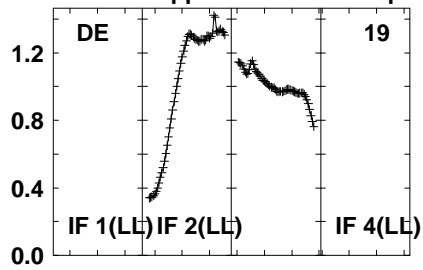
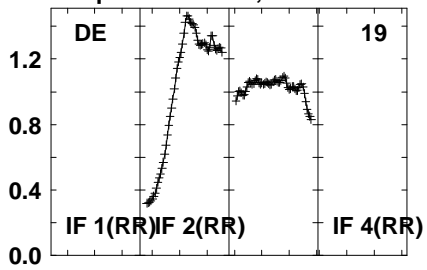

Lower frame: Real Jy  
Auto-corr total-power spectrum Antenna: \*  
Timerange: 00/11:45:01 to 00/11:48:29

Plot file version 133 created 05-OCT-2021 17:05:01

J0827+5217 GM076.UVDATA.1

Freq = 1.5945 GHz, Bw = 32.000 MH No calibration applied and no bandpass applied

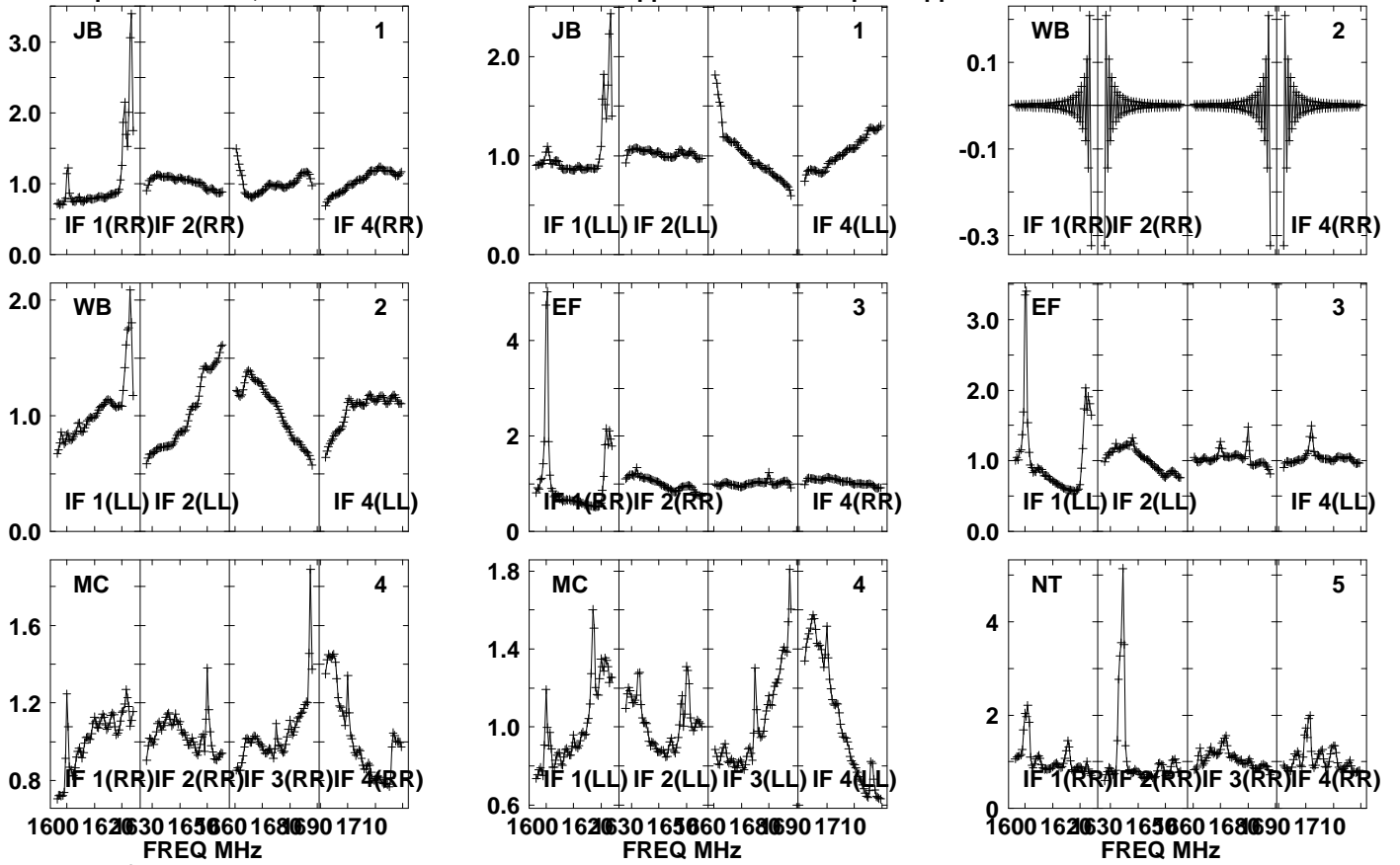

Lower frame: Real Jy

Auto-corr total-power spectrum Antenna: \*

Timerange: 00/11:49:01 to 00/11:50:29

Plot file version 134 created 05-OCT-2021 17:05:01

J0827+5217 GM076.UVDATA.1

Freq = 1.5945 GHz, Bw = 32.000 MH No calibration applied and no bandpass applied

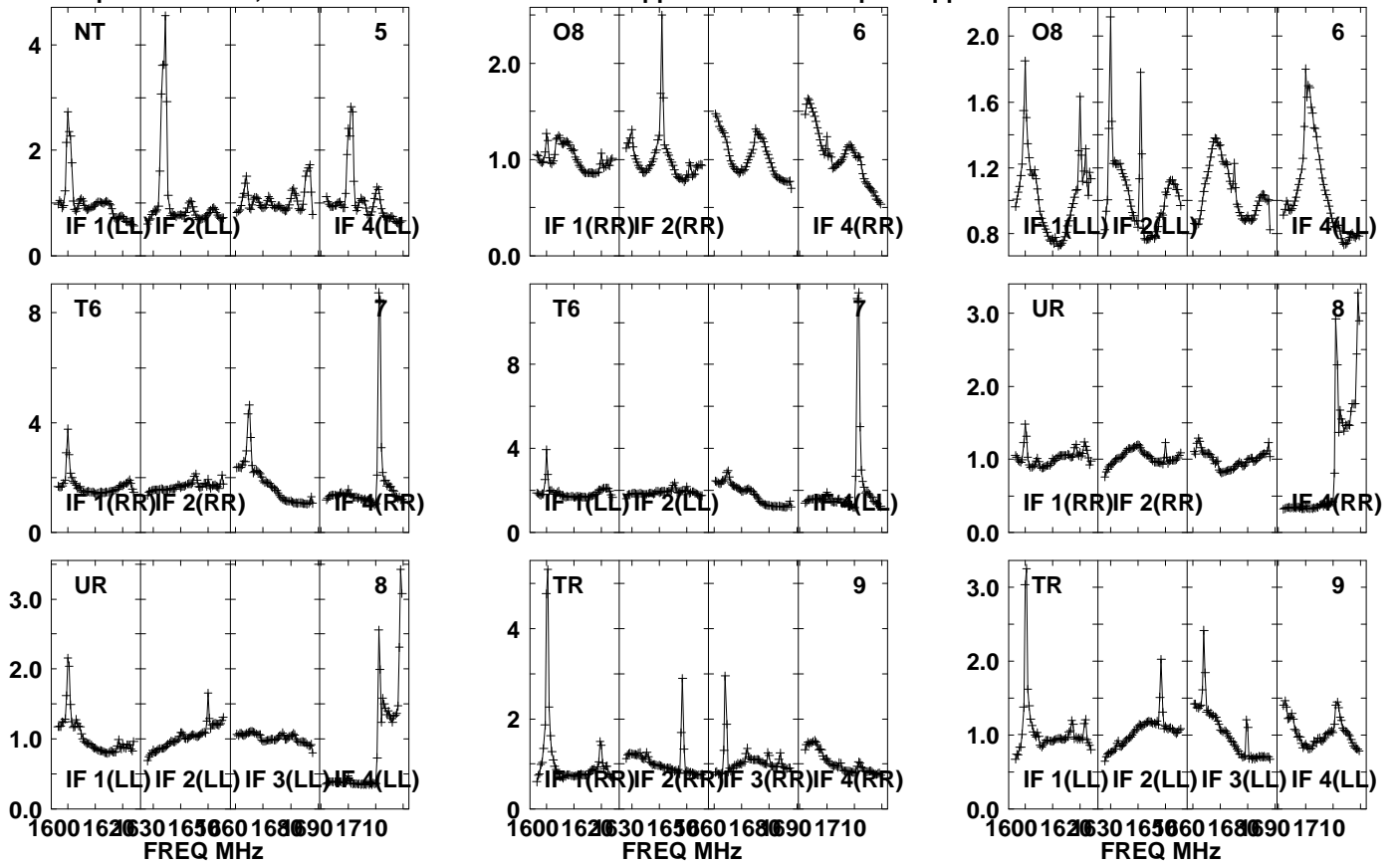

Lower frame: Real Jy  
Auto-corr total-power spectrum Antenna: \*  
Timerange: 00/11:49:01 to 00/11:50:29

Plot file version 135 created 05-OCT-2021 17:05:02

J0827+5217 GM076.UVDATA.1

Freq = 1.5945 GHz, Bw = 32.000 MH No calibration applied and no bandpass applied

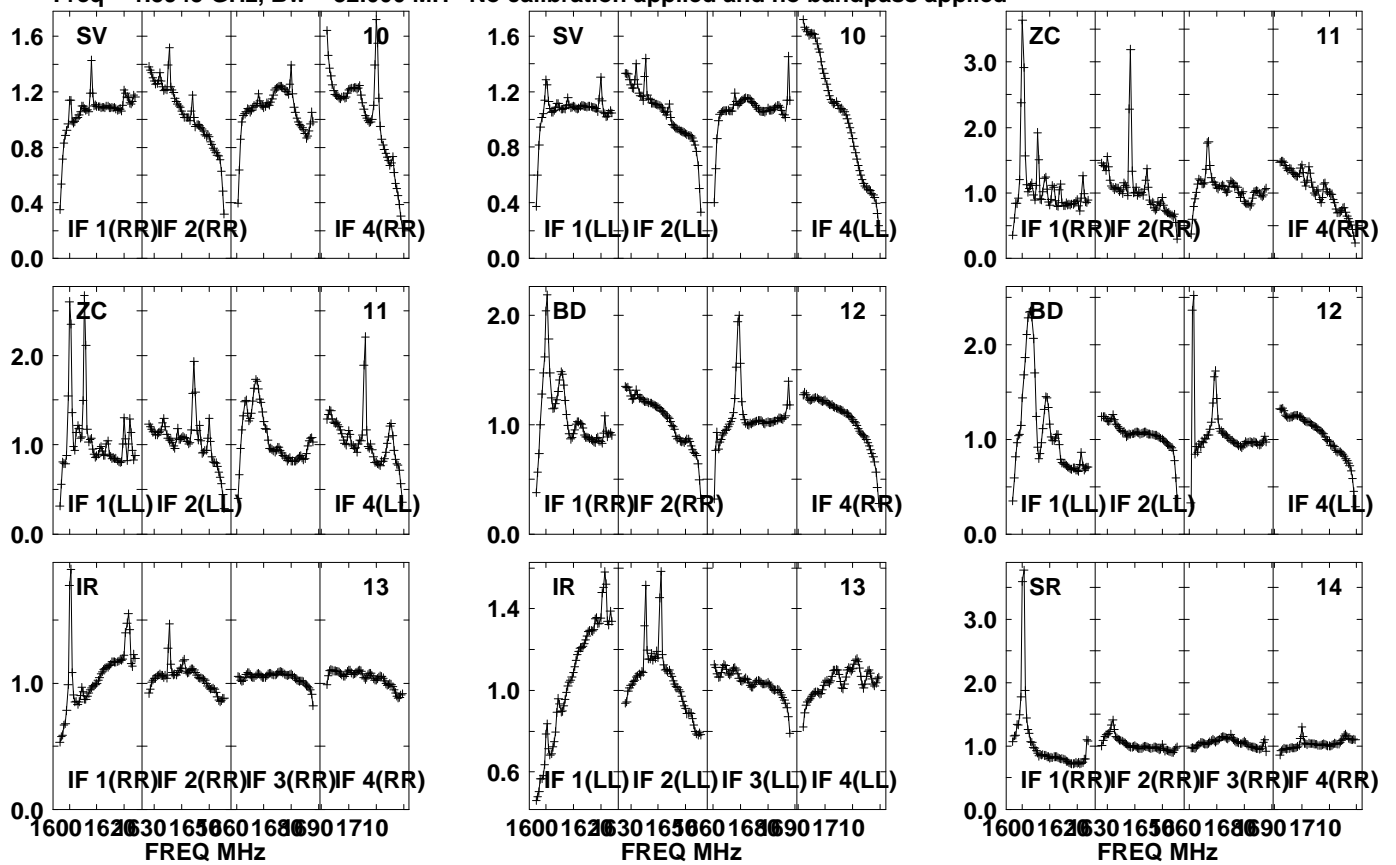

Lower frame: Real Jy  
Auto-corr total-power spectrum Antenna: \*  
Timerange: 00/11:49:01 to 00/11:50:29

Plot file version 136 created 05-OCT-2021 17:05:02

J0827+5217 GM076.UVDATA.1

Freq = 1.5945 GHz, Bw = 32.000 MH No calibration applied and no bandpass applied

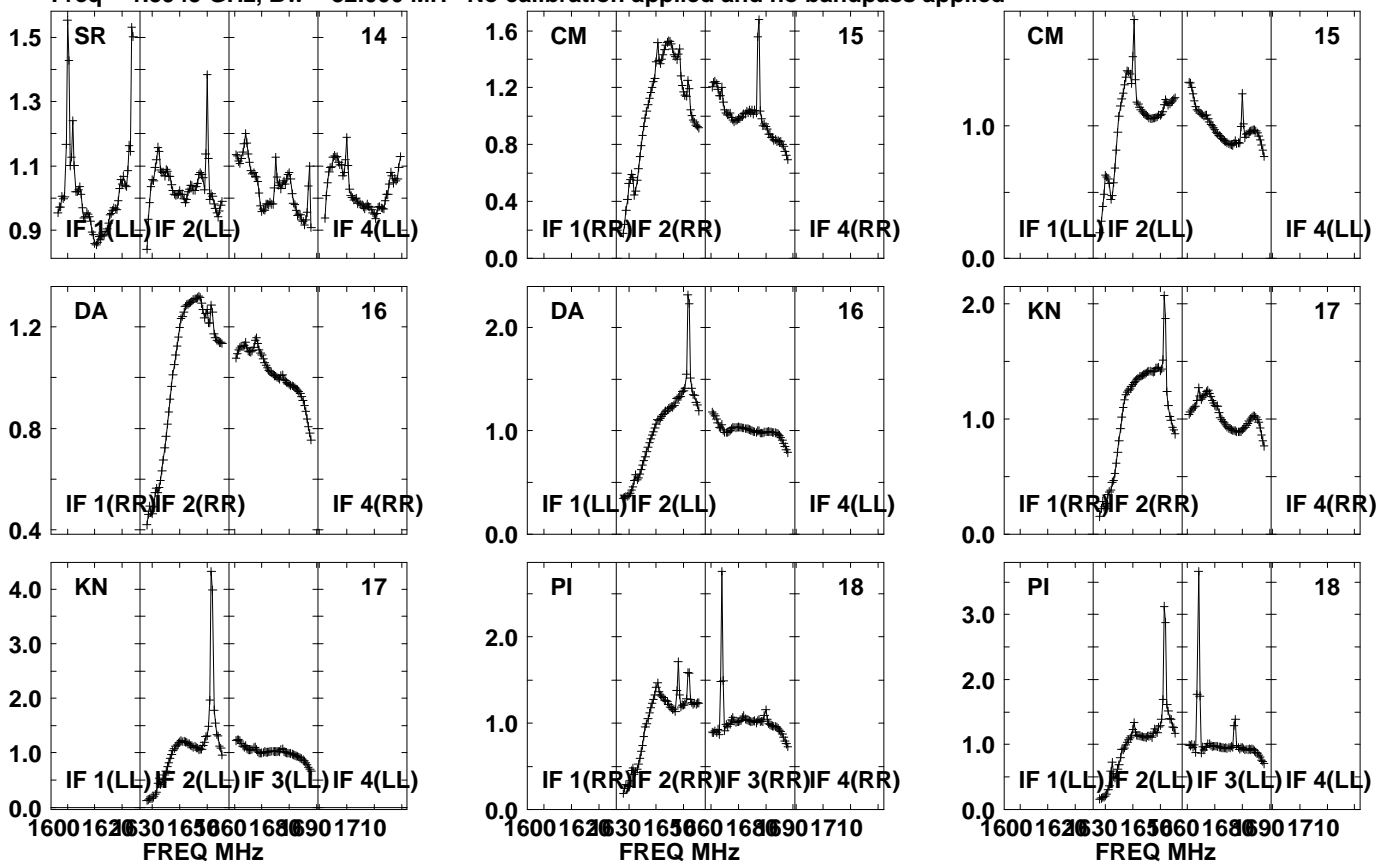

Lower frame: Real Jy  
Auto-corr total-power spectrum Antenna: \*  
Timerange: 00/11:49:01 to 00/11:50:29

Plot file version 137 created 05-OCT-2021 17:05:02  
J0827+5217 GM076.UVDATA.1  
Freq = 1.5945 GHz, Bw = 32.000 MH No calibration applied and no bandpass applied

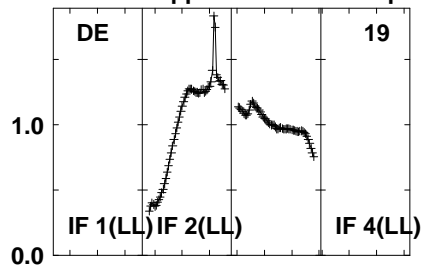
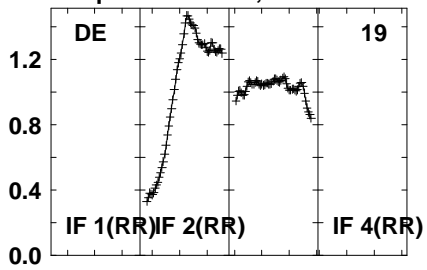

Lower frame: Real Jy  
Auto-corr total-power spectrum Antenna: \*  
Timerange: 00/11:49:01 to 00/11:50:29

Plot file version 138 created 05-OCT-2021 17:05:02

APM08279+525 GM076.UVDATA.1

Freq = 1.5945 GHz, Bw = 32.000 MH No calibration applied and no bandpass applied

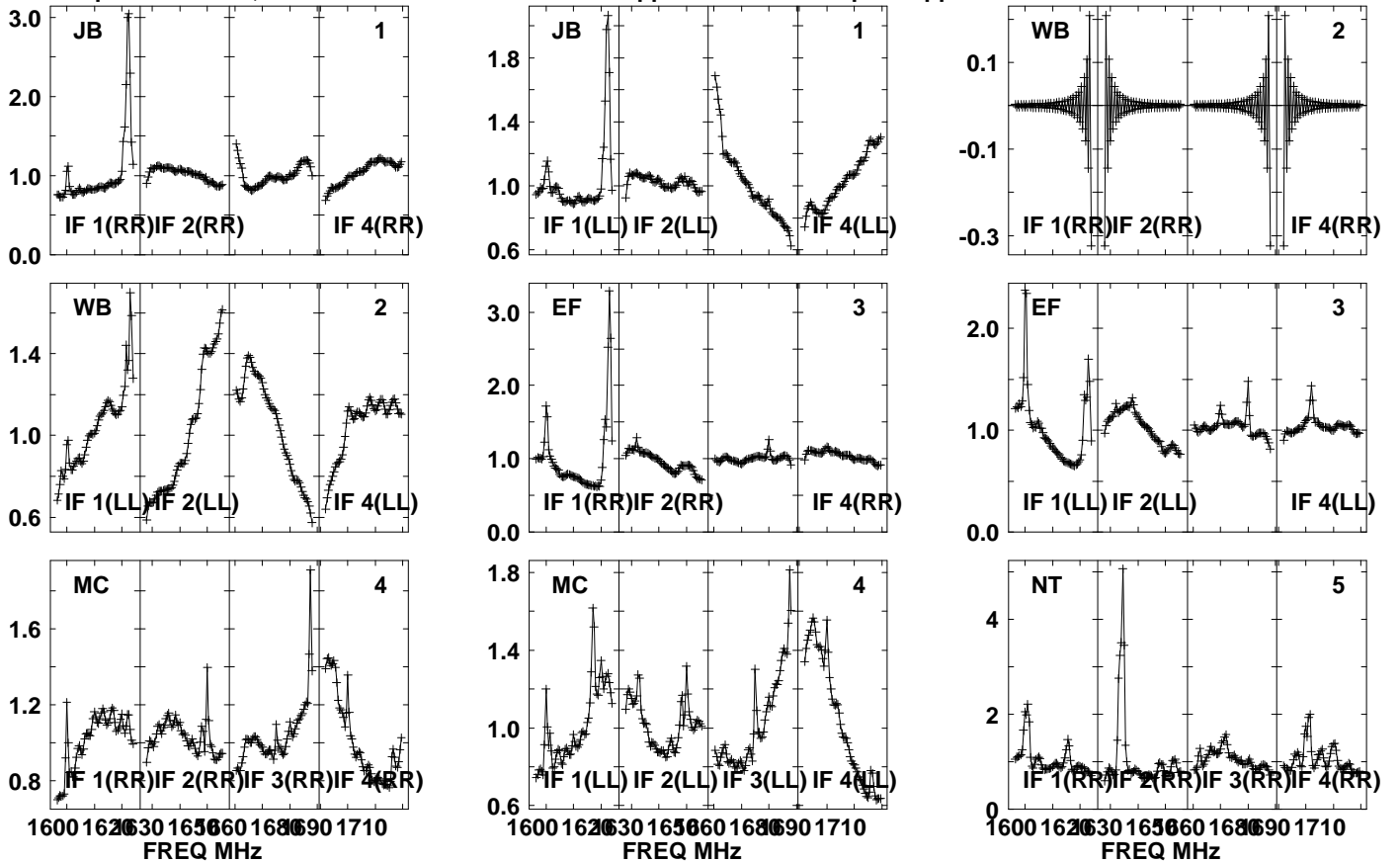

Lower frame: Real Jy

Auto-corr total-power spectrum Antenna: \*

Timerange: 00/11:50:31 to 00/11:53:59



Plot file version 139 created 05-OCT-2021 17:05:02

APM08279+525 GM076.UVDATA.1

Freq = 1.5945 GHz, Bw = 32.000 MH No calibration applied and no bandpass applied

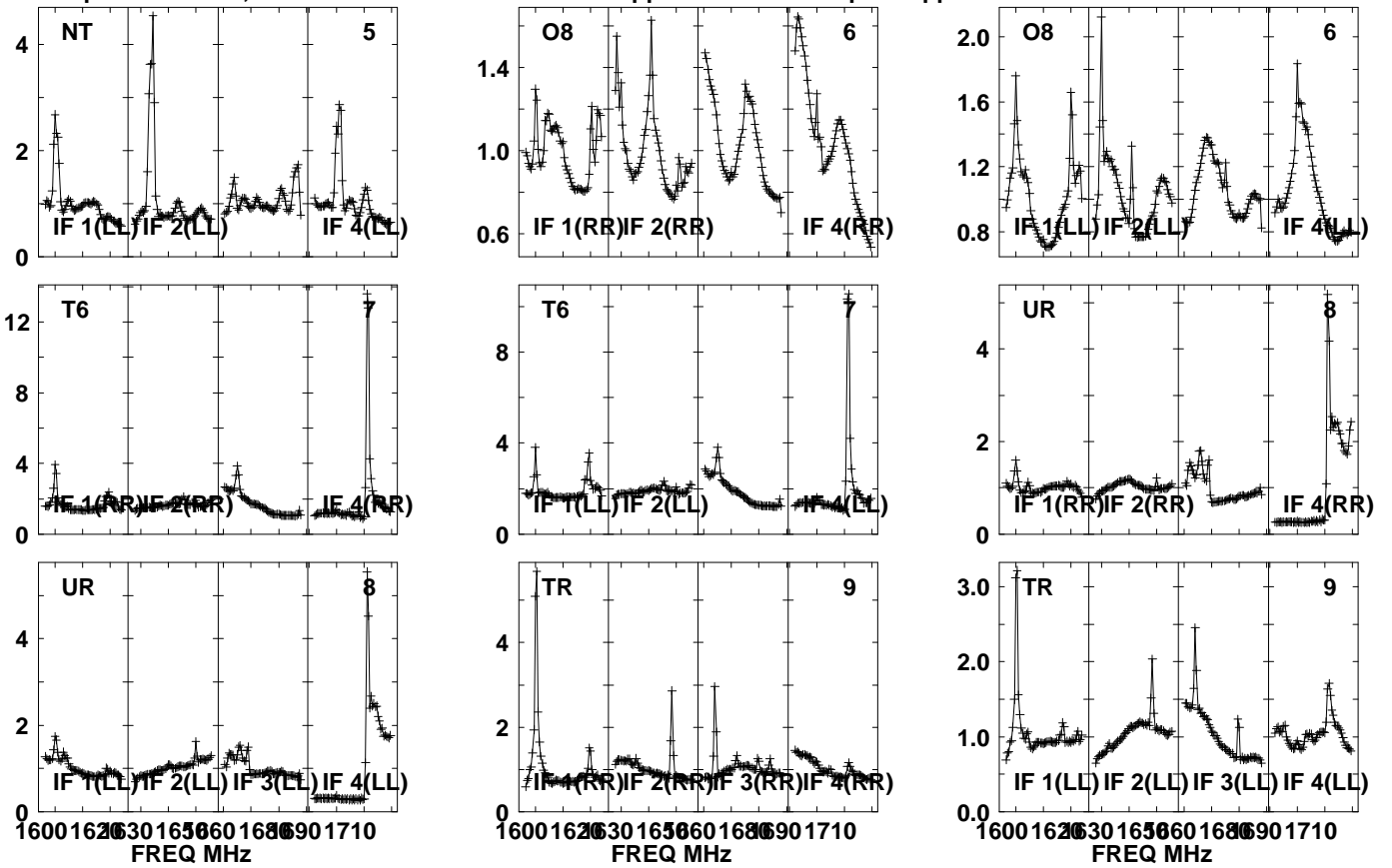

Lower frame: Real Jy

Auto-corr total-power spectrum Antenna: \*

Timerange: 00/11:50:31 to 00/11:53:59

Plot file version 140 created 05-OCT-2021 17:05:03

APM08279+525 GM076.UVDATA.1

Freq = 1.5945 GHz, Bw = 32.000 MH No calibration applied and no bandpass applied

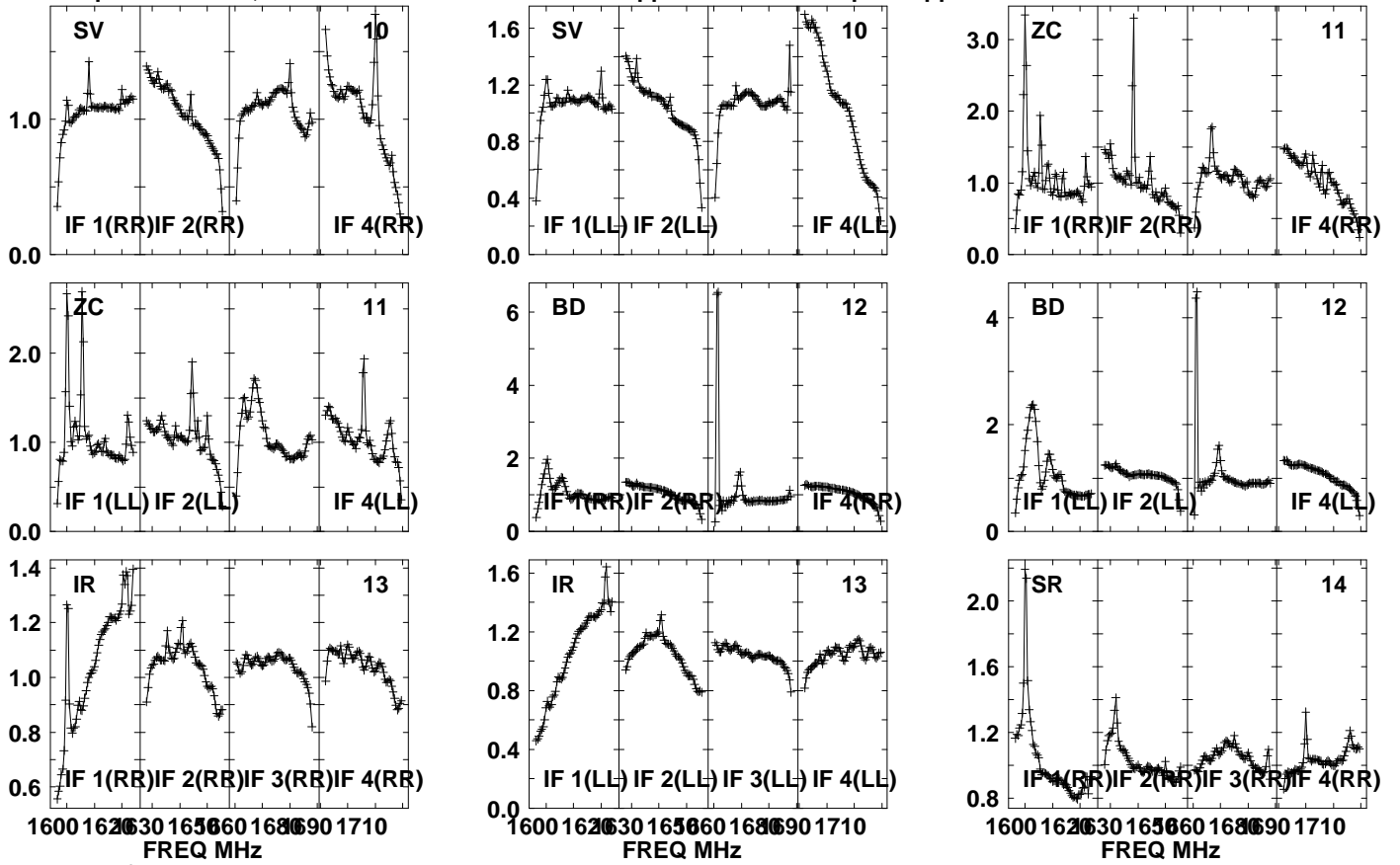

Lower frame: Real Jy

Auto-corr total-power spectrum Antenna: \*

Timerange: 00/11:50:31 to 00/11:53:59

Plot file version 141 created 05-OCT-2021 17:05:03

APM08279+525 GM076.UVDATA.1

Freq = 1.5945 GHz, Bw = 32.000 MH No calibration applied and no bandpass applied

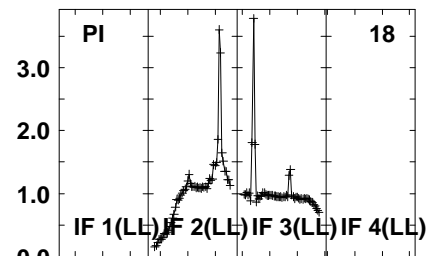
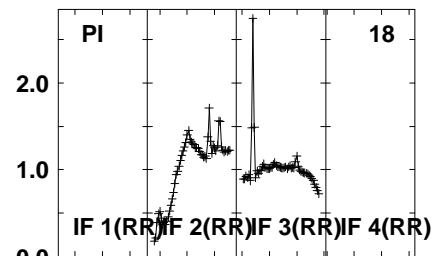
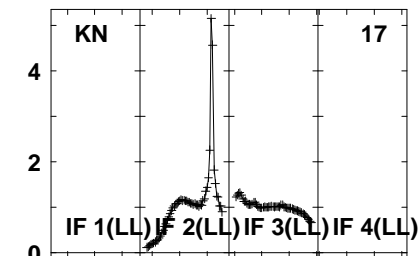
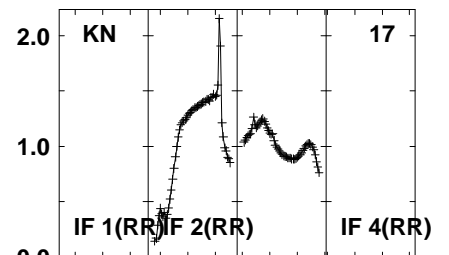
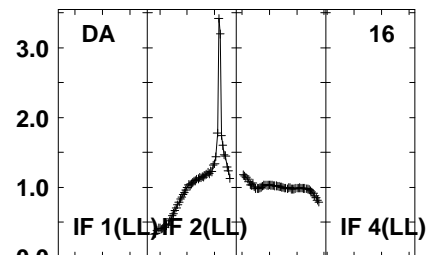
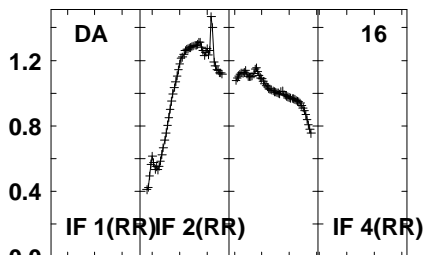
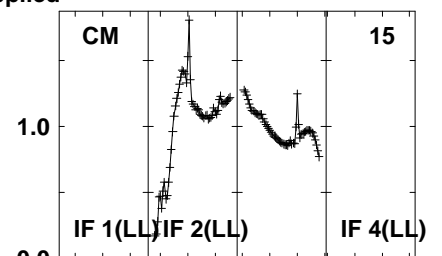
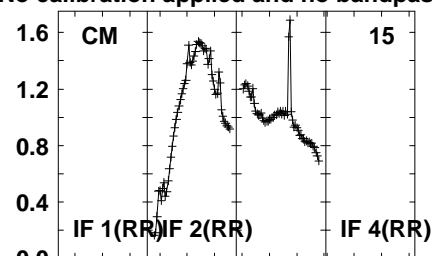
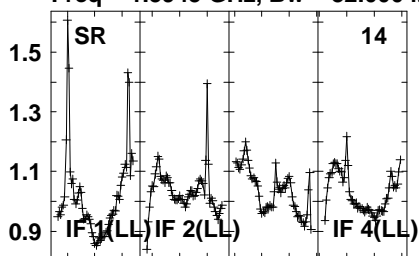

1600 1620 1630 1650 1660 1680 1690 1710  
FREQ MHz

1600 1620 1630 1650 1660 1680 1690 1710  
FREQ MHz

1600 1620 1630 1650 1660 1680 1690 1710  
FREQ MHz

Lower frame: Real Jy  
Auto-corr total-power spectrum Antenna: \*  
Timerange: 00/11:50:31 to 00/11:53:59

Plot file version 142 created 05-OCT-2021 17:05:03

APM08279+525 GM076.UVDATA.1

Freq = 1.5945 GHz, Bw = 32.000 MH No calibration applied and no bandpass applied

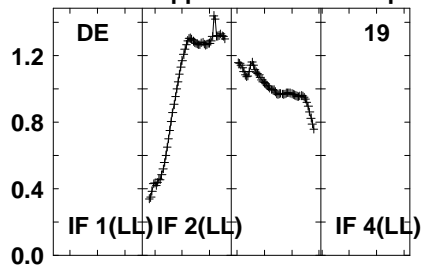
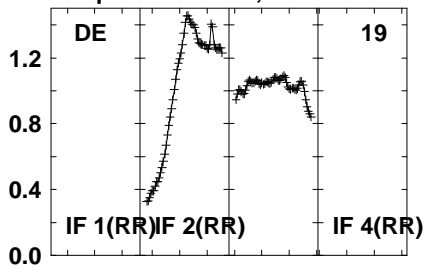

Lower frame: Real Jy  
Auto-corr total-power spectrum Antenna: \*  
Timerange: 00/11:50:31 to 00/11:53:59

Plot file version 143 created 05-OCT-2021 17:05:03

J0827+5217 GM076.UVDATA.1

Freq = 1.5945 GHz, Bw = 32.000 MH No calibration applied and no bandpass applied

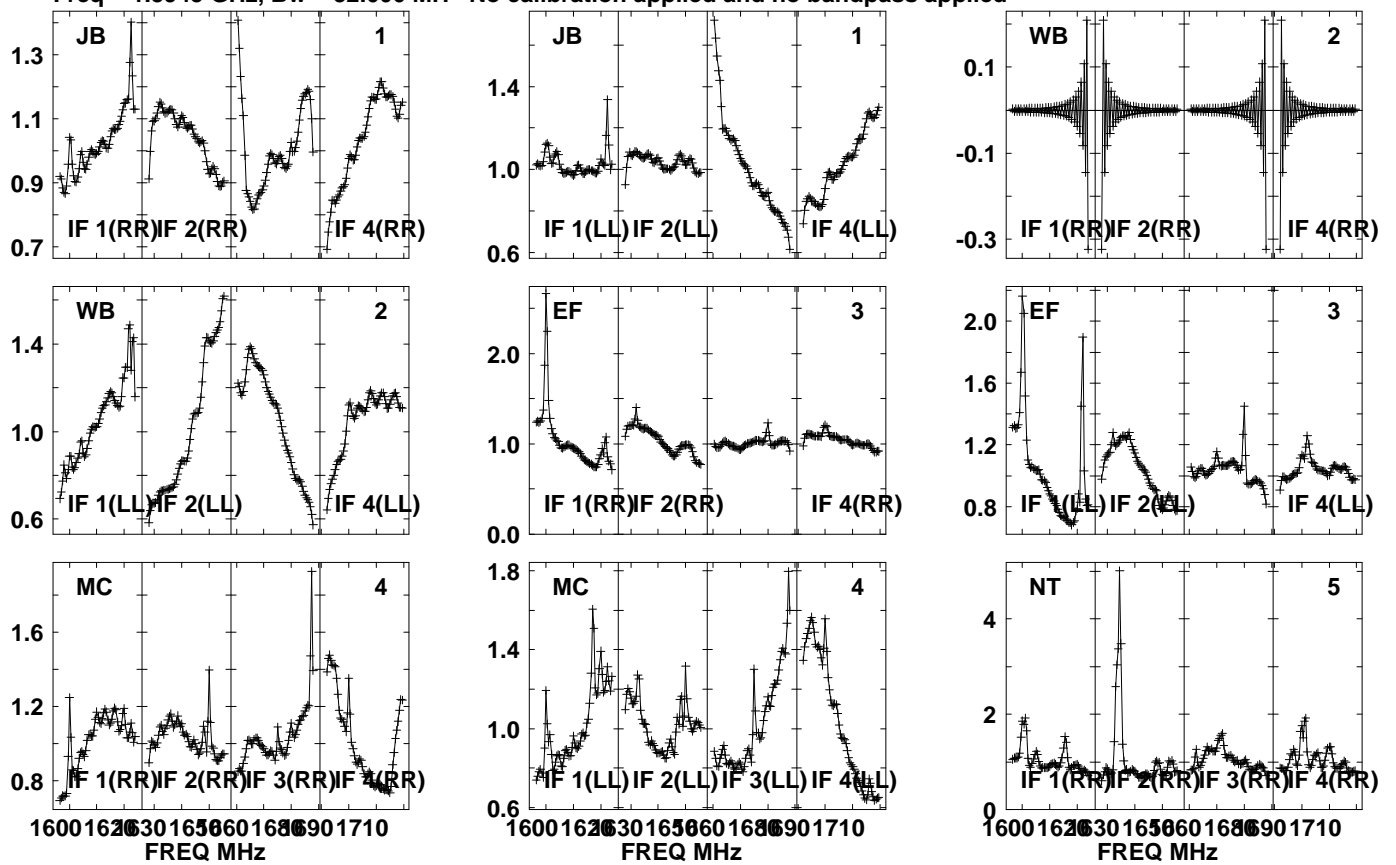

Lower frame: Real Jy  
Auto-corr total-power spectrum Antenna: \*  
Timerange: 00/11:54:01 to 00/11:55:29

Plot file version 144 created 05-OCT-2021 17:05:04

J0827+5217 GM076.UVDATA.1

Freq = 1.5945 GHz, Bw = 32.000 MH No calibration applied and no bandpass applied

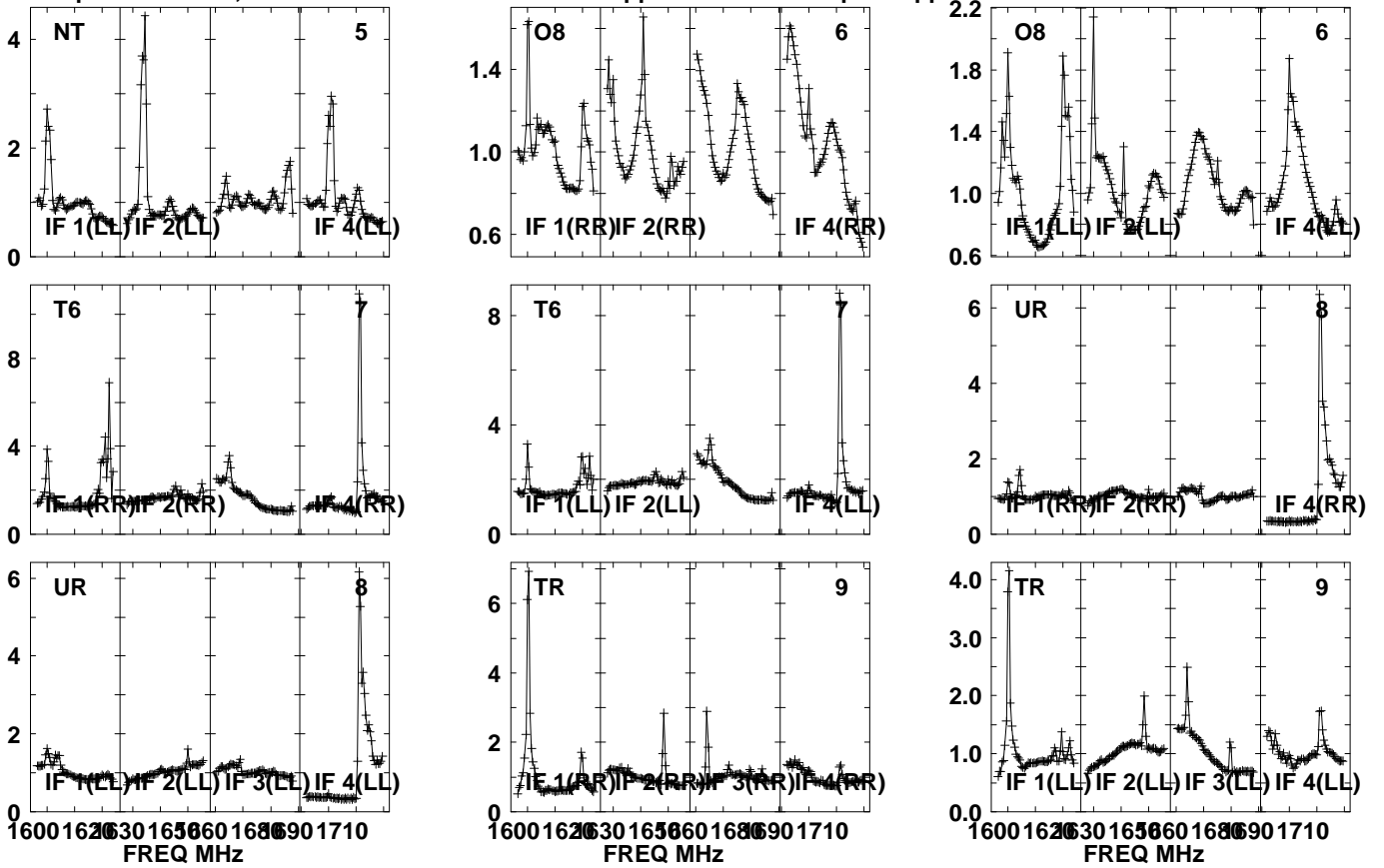

Lower frame: Real Jy  
Auto-corr total-power spectrum Antenna: \*  
Timerange: 00/11:54:01 to 00/11:55:29

Plot file version 145 created 05-OCT-2021 17:05:04

J0827+5217 GM076.UVDATA.1

Freq = 1.5945 GHz, Bw = 32.000 MH No calibration applied and no bandpass applied

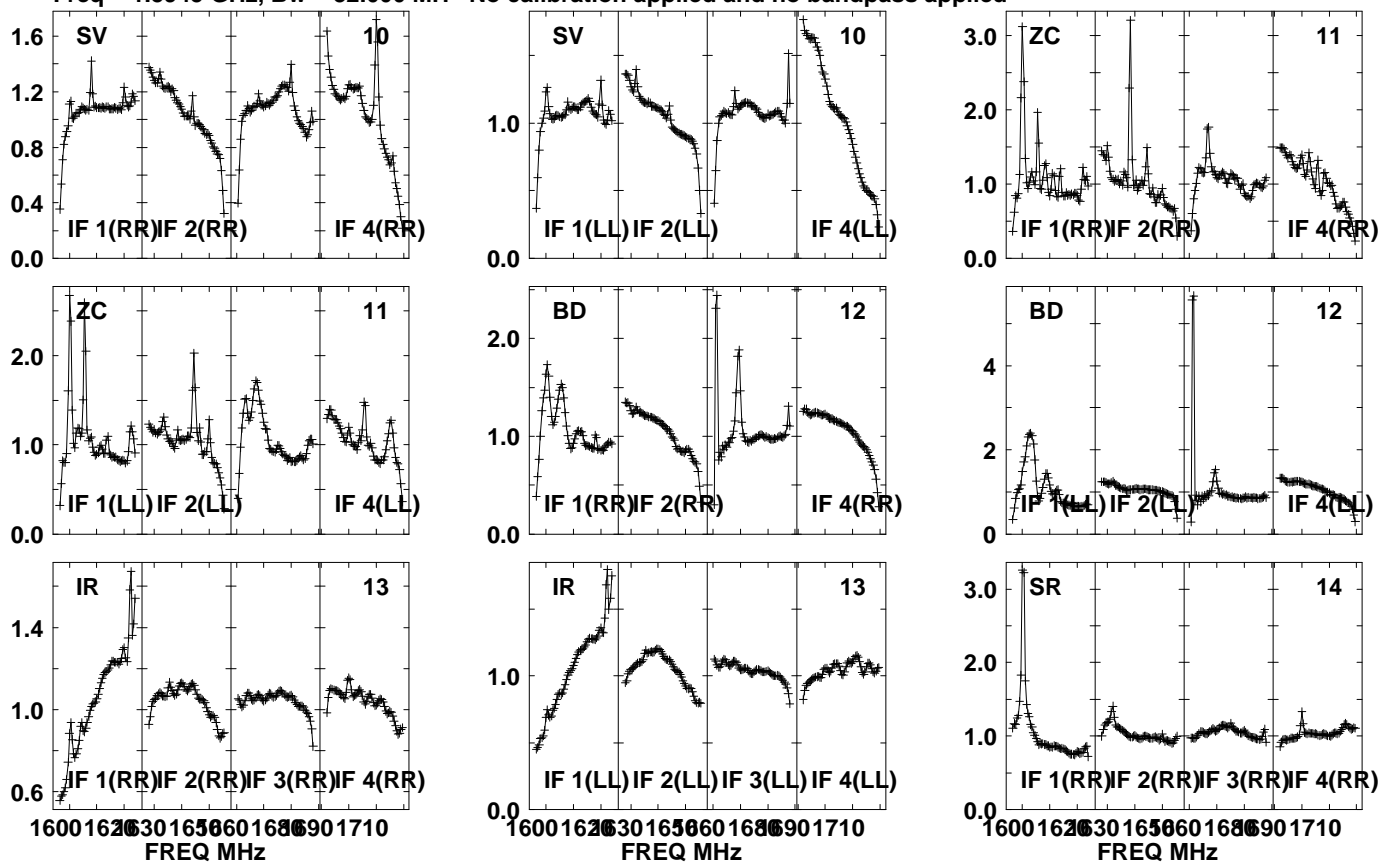

Lower frame: Real Jy  
Auto-corr total-power spectrum Antenna: \*  
Timerange: 00/11:54:01 to 00/11:55:29

Plot file version 146 created 05-OCT-2021 17:05:04

J0827+5217 GM076.UVDATA.1

Freq = 1.5945 GHz, Bw = 32.000 MH No calibration applied and no bandpass applied

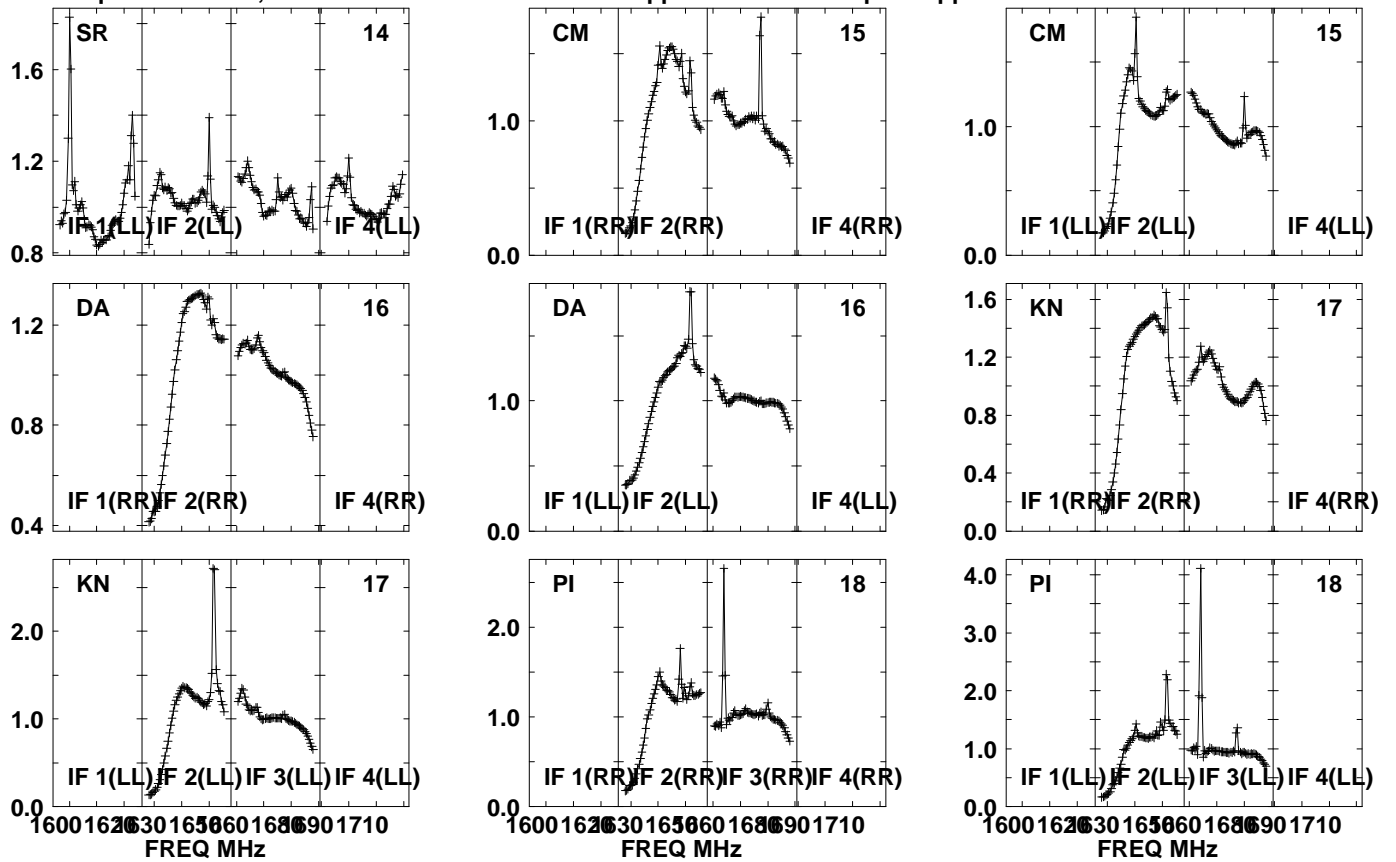

Lower frame: Real Jy  
Auto-corr total-power spectrum Antenna: \*  
Timerange: 00/11:54:01 to 00/11:55:29



Plot file version 147 created 05-OCT-2021 17:05:04

J0827+5217 GM076.UVDATA.1

Freq = 1.5945 GHz, Bw = 32.000 MH No calibration applied and no bandpass applied

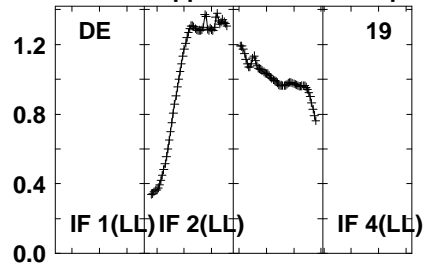
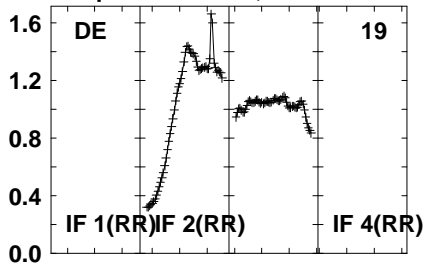

Lower frame: Real Jy  
Auto-corr total-power spectrum Antenna: \*  
Timerange: 00/11:54:01 to 00/11:55:29

Plot file version 148 created 05-OCT-2021 17:05:04

APM08279+525 GM076.UVDATA.1

Freq = 1.5945 GHz, Bw = 32.000 MH No calibration applied and no bandpass applied

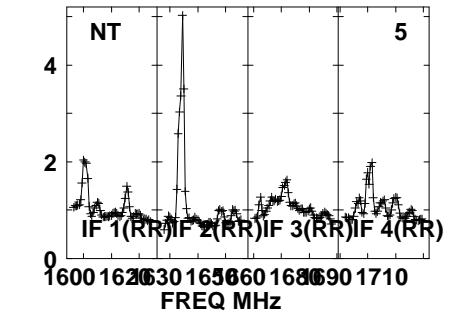
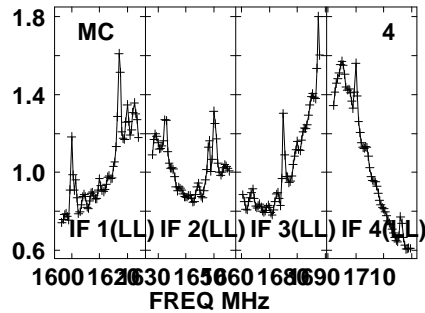
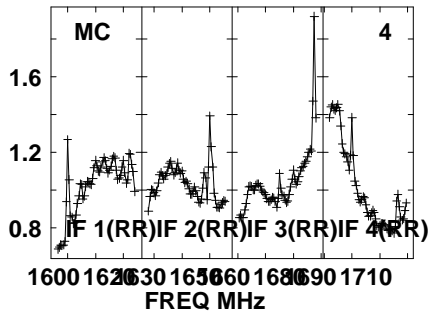
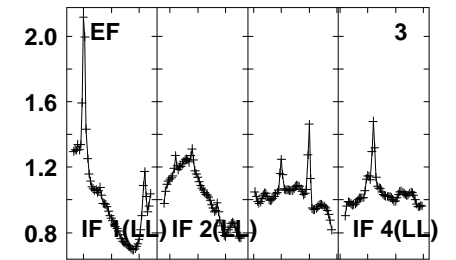
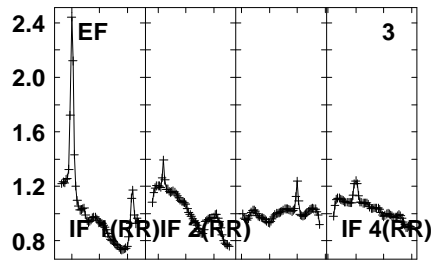
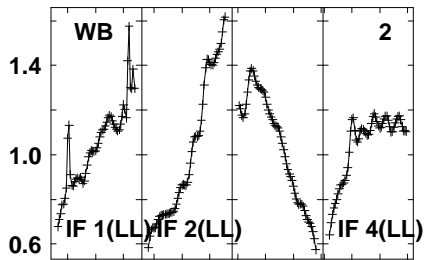
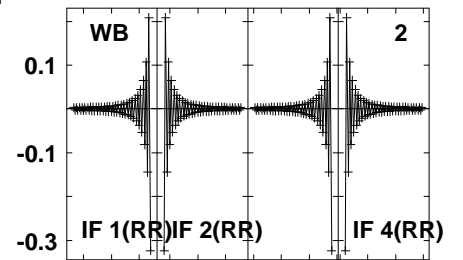
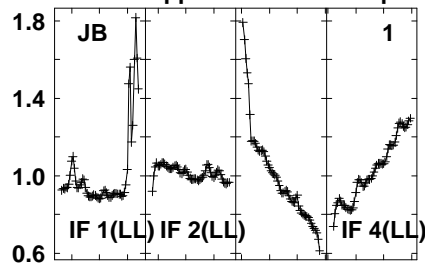
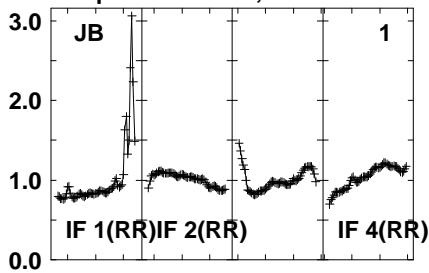

Lower frame: Real Jy

Auto-corr total-power spectrum Antenna: \*

Timerange: 00/11:55:31 to 00/11:58:59

Plot file version 149 created 05-OCT-2021 17:05:04

APM08279+525 GM076.UVDATA.1

Freq = 1.5945 GHz, Bw = 32.000 MH No calibration applied and no bandpass applied

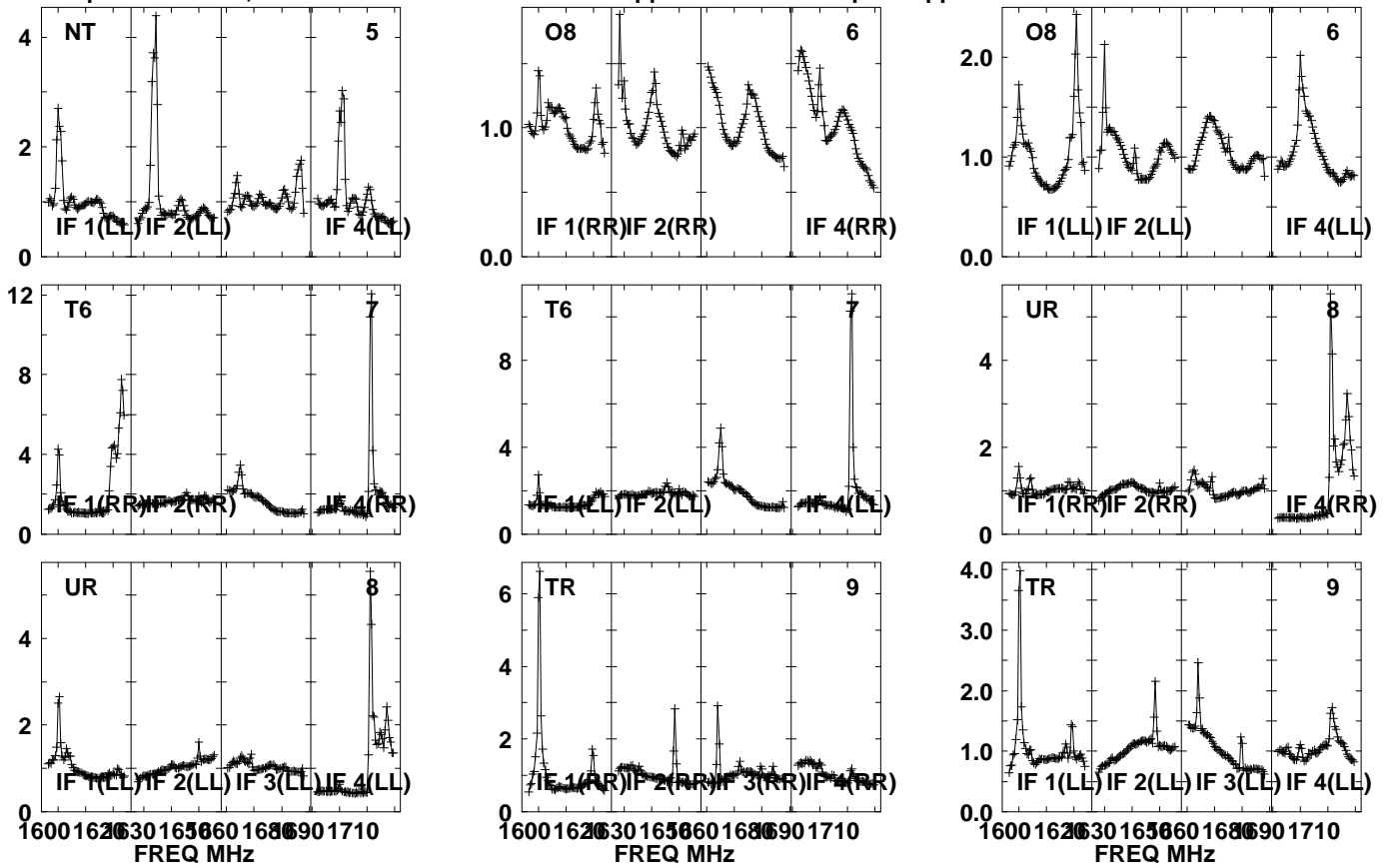

Lower frame: Real Jy  
Auto-corr total-power spectrum Antenna: \*  
Timerange: 00/11:55:31 to 00/11:58:59

Plot file version 150 created 05-OCT-2021 17:05:05

APM08279+525 GM076.UVDATA.1

Freq = 1.5945 GHz, Bw = 32.000 MH No calibration applied and no bandpass applied

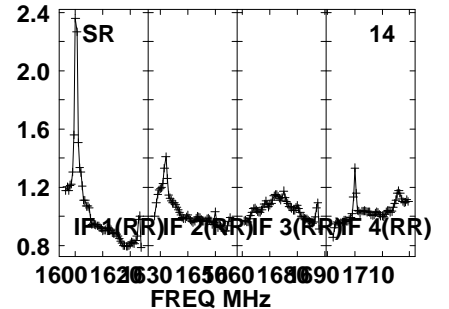
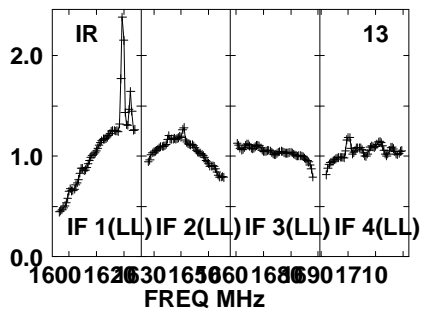
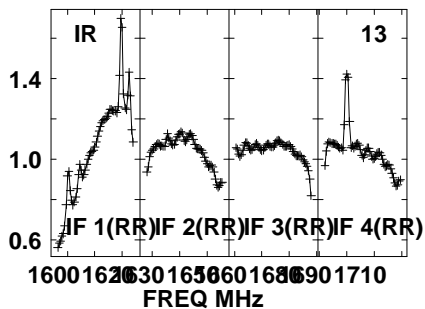
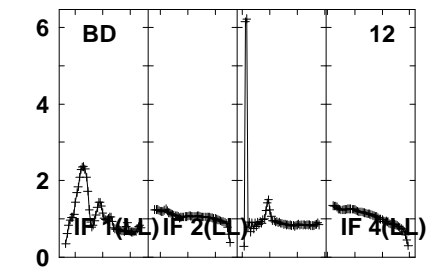
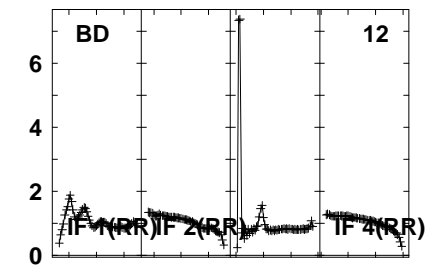
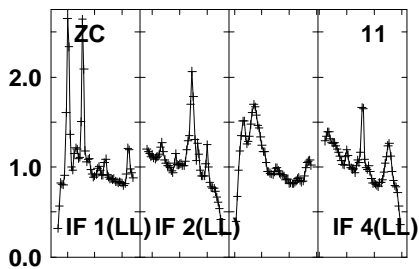
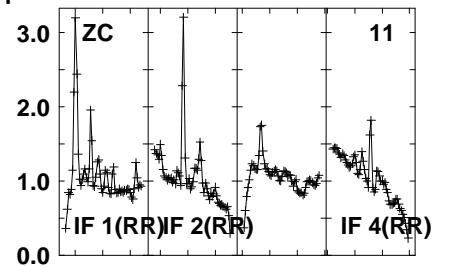
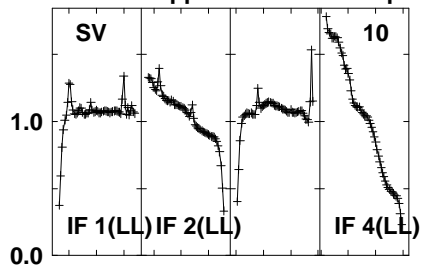
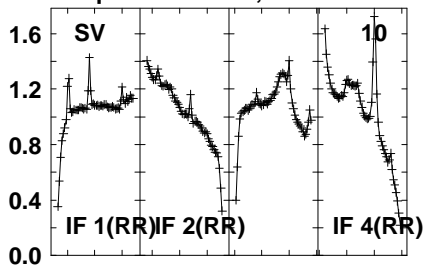

Lower frame: Real Jy  
Auto-corr total-power spectrum Antenna: \*  
Timerange: 00/11:55:31 to 00/11:58:59

Plot file version 151 created 05-OCT-2021 17:05:05

APM08279+525 GM076.UVDATA.1

Freq = 1.5945 GHz, Bw = 32.000 MH No calibration applied and no bandpass applied

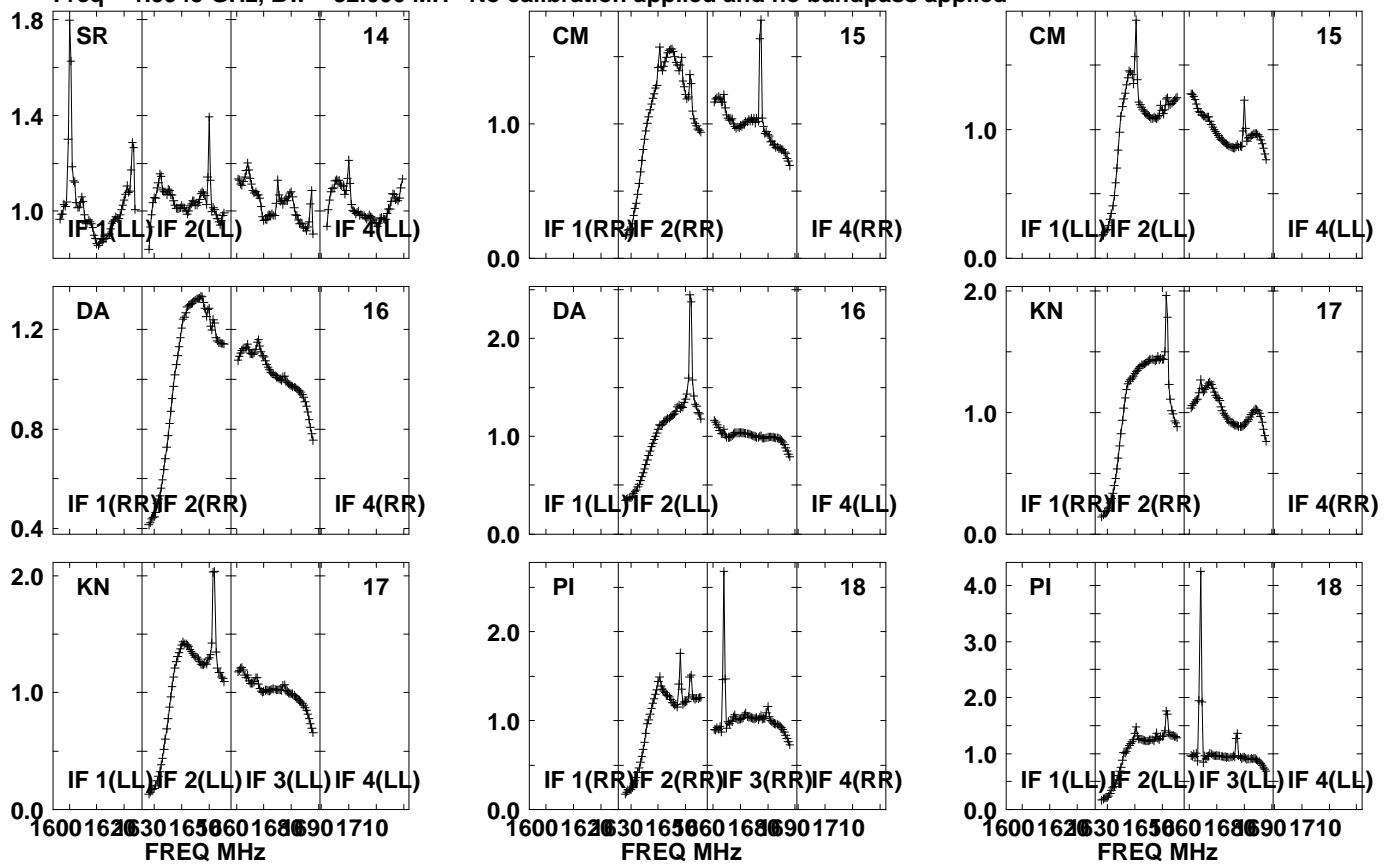

Lower frame: Real Jy  
Auto-corr total-power spectrum Antenna: \*  
Timerange: 00/11:55:31 to 00/11:58:59

Plot file version 152 created 05-OCT-2021 17:05:05

APM08279+525 GM076.UVDATA.1

Freq = 1.5945 GHz, Bw = 32.000 MH No calibration applied and no bandpass applied

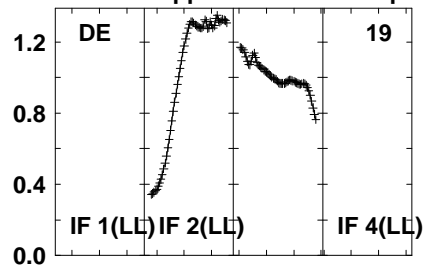
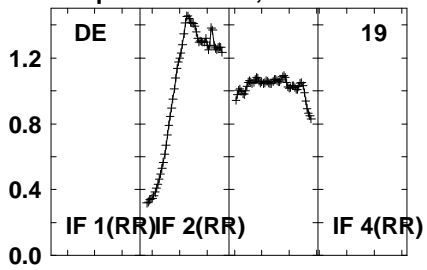

Lower frame: Real Jy  
Auto-corr total-power spectrum Antenna: \*  
Timerange: 00/11:55:31 to 00/11:58:59

Plot file version 153 created 05-OCT-2021 17:05:05

J0827+5217 GM076.UVDATA.1

Freq = 1.5945 GHz, Bw = 32.000 MH No calibration applied and no bandpass applied

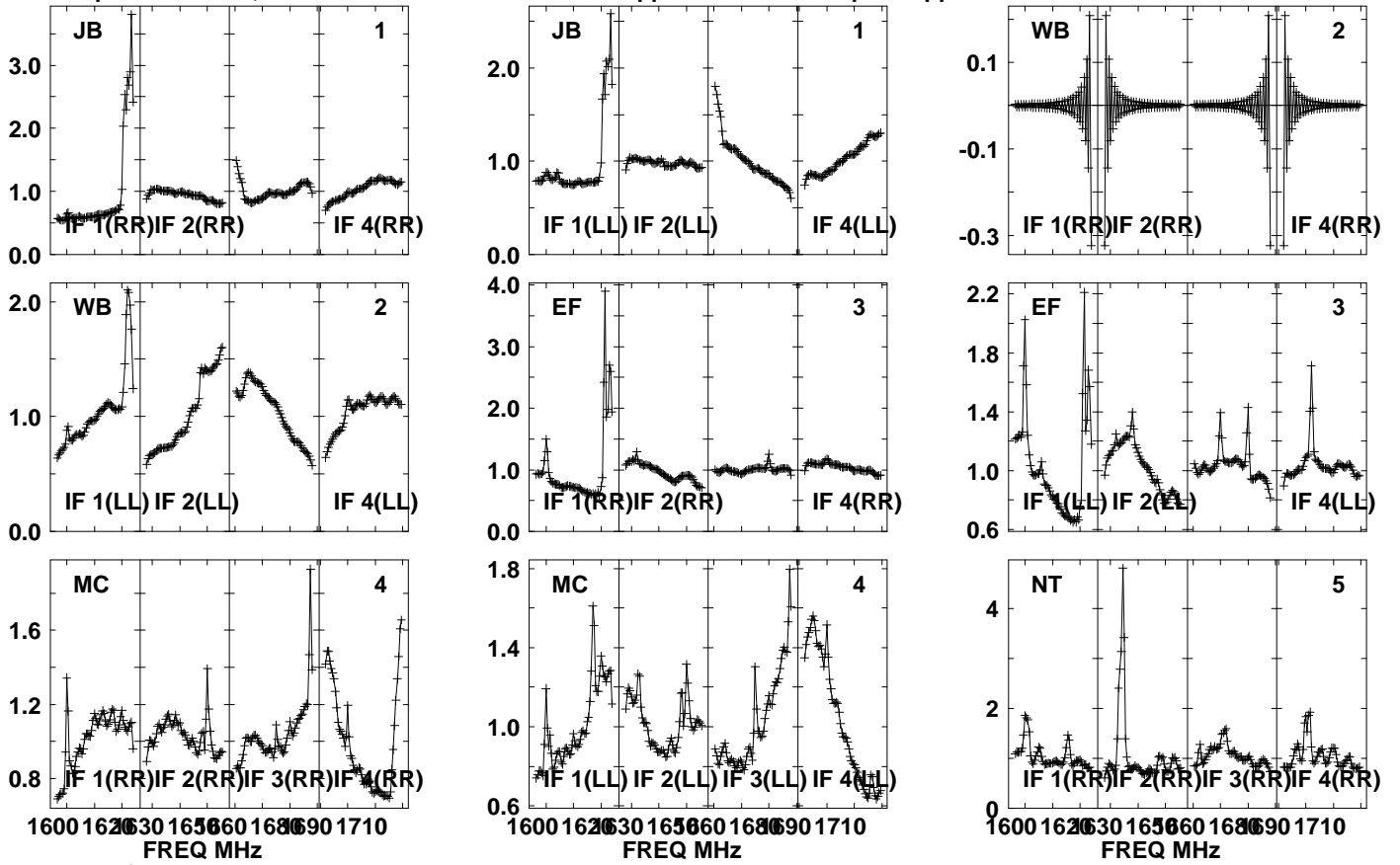

Lower frame: Real Jy  
Auto-corr total-power spectrum Antenna: \*  
Timerange: 00/11:59:31 to 00/12:00:59

Plot file version 154 created 05-OCT-2021 17:05:06

J0827+5217 GM076.UVDATA.1

Freq = 1.5945 GHz, Bw = 32.000 MH No calibration applied and no bandpass applied

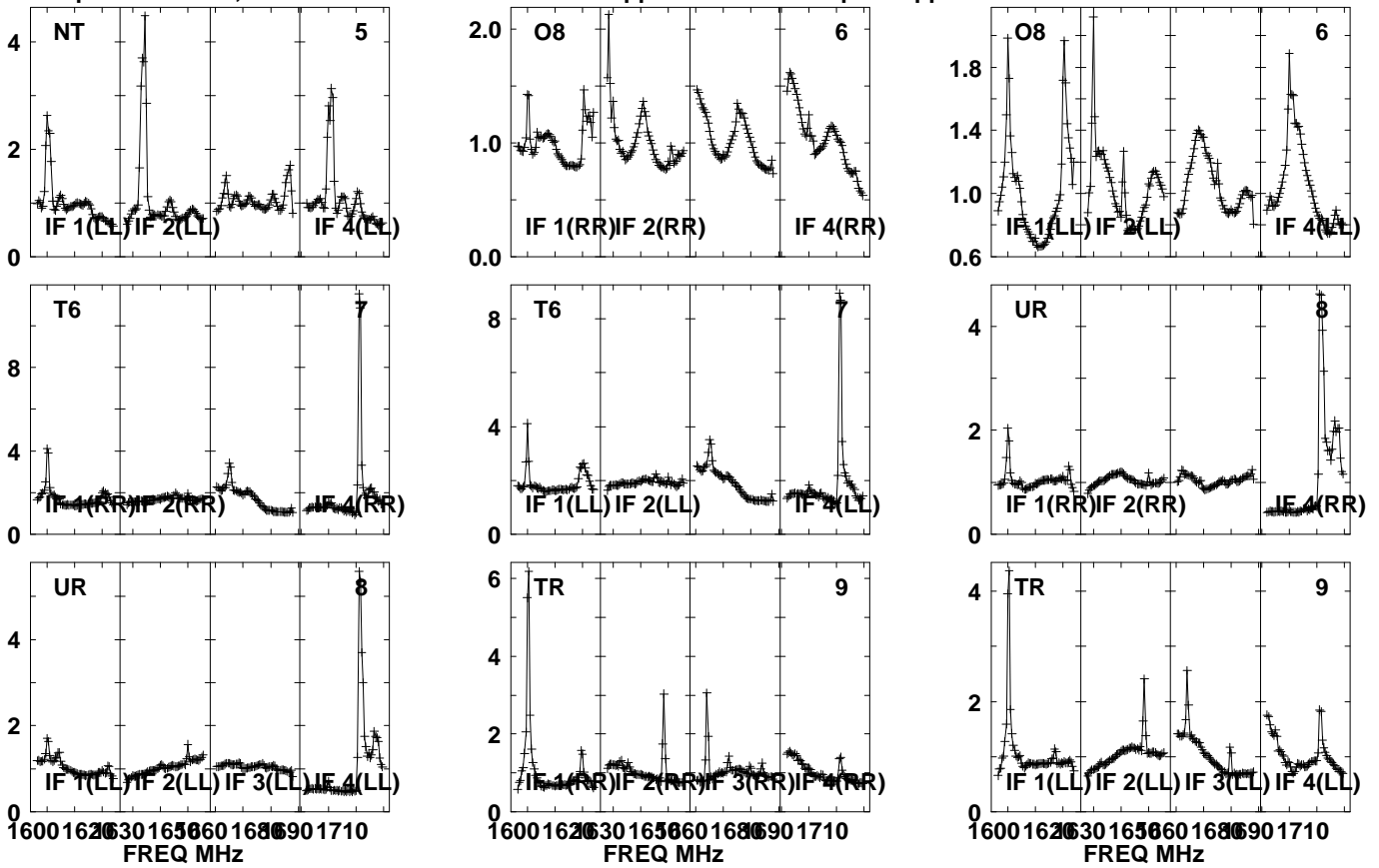

Lower frame: Real Jy  
Auto-corr total-power spectrum Antenna: \*  
Timerange: 00/11:59:31 to 00/12:00:59



Plot file version 155 created 05-OCT-2021 17:05:06

J0827+5217 GM076.UVDATA.1

Freq = 1.5945 GHz, Bw = 32.000 MH No calibration applied and no bandpass applied

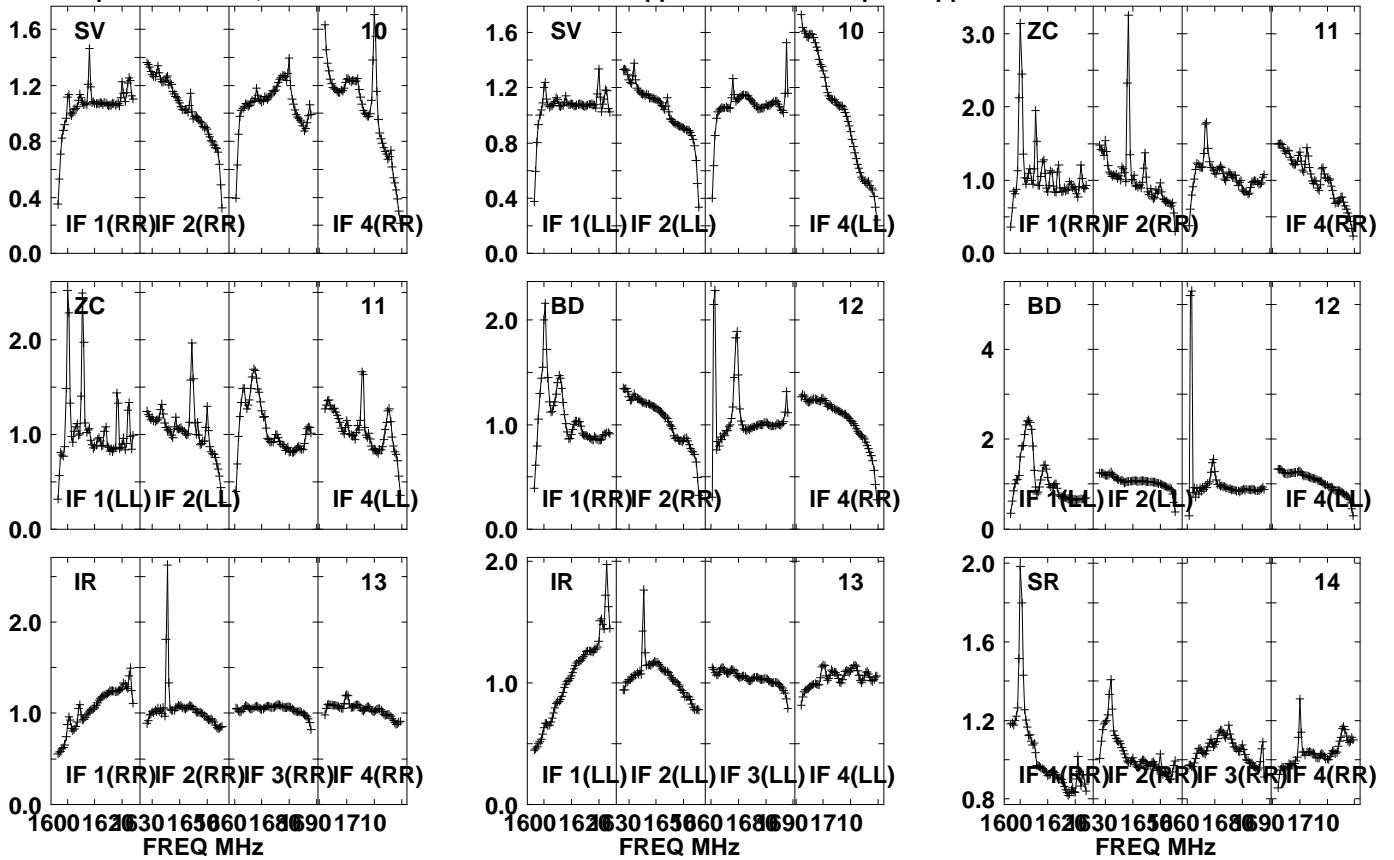

Lower frame: Real Jy  
Auto-corr total-power spectrum Antenna: \*  
Timerange: 00/11:59:31 to 00/12:00:59

Plot file version 156 created 05-OCT-2021 17:05:06

J0827+5217 GM076.UVDATA.1

Freq = 1.5945 GHz, Bw = 32.000 MH No calibration applied and no bandpass applied

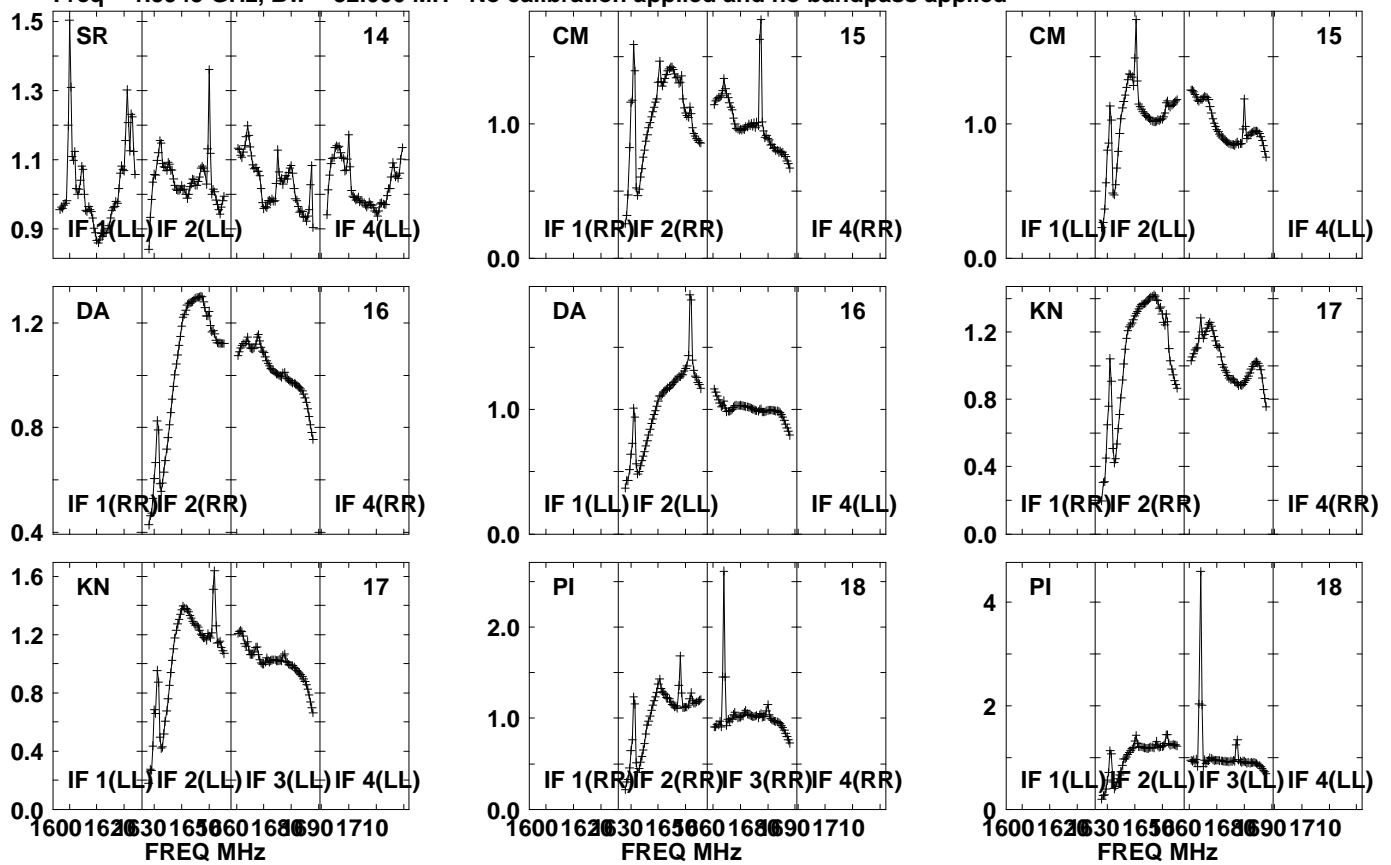

Lower frame: Real Jy  
Auto-corr total-power spectrum Antenna: \*  
Timerange: 00/11:59:31 to 00/12:00:59

Plot file version 157 created 05-OCT-2021 17:05:06

J0827+5217 GM076.UVDATA.1

Freq = 1.5945 GHz, Bw = 32.000 MH No calibration applied and no bandpass applied

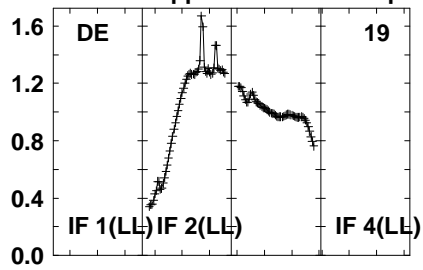
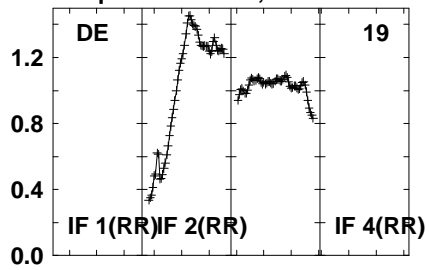

Lower frame: Real Jy  
Auto-corr total-power spectrum Antenna: \*  
Timerange: 00/11:59:31 to 00/12:00:59

Plot file version 158 created 05-OCT-2021 17:05:06

APM08279+525 GM076.UVDATA.1

Freq = 1.5945 GHz, Bw = 32.000 MH No calibration applied and no bandpass applied

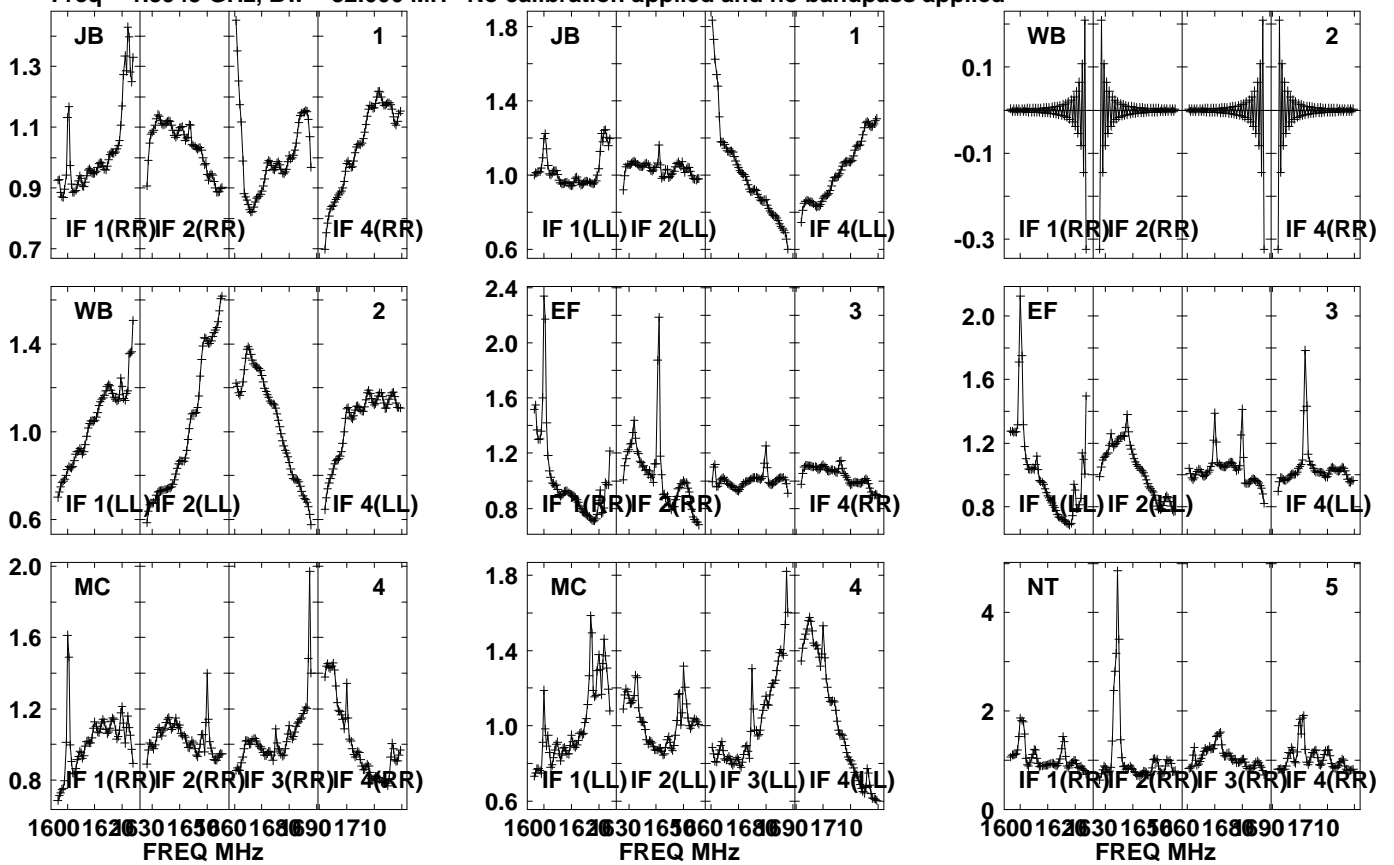

Lower frame: Real Jy  
Auto-corr total-power spectrum Antenna: \*  
Timerange: 00/12:01:01 to 00/12:04:29

Plot file version 159 created 05-OCT-2021 17:05:07

APM08279+525 GM076.UVDATA.1

Freq = 1.5945 GHz, Bw = 32.000 MH No calibration applied and no bandpass applied

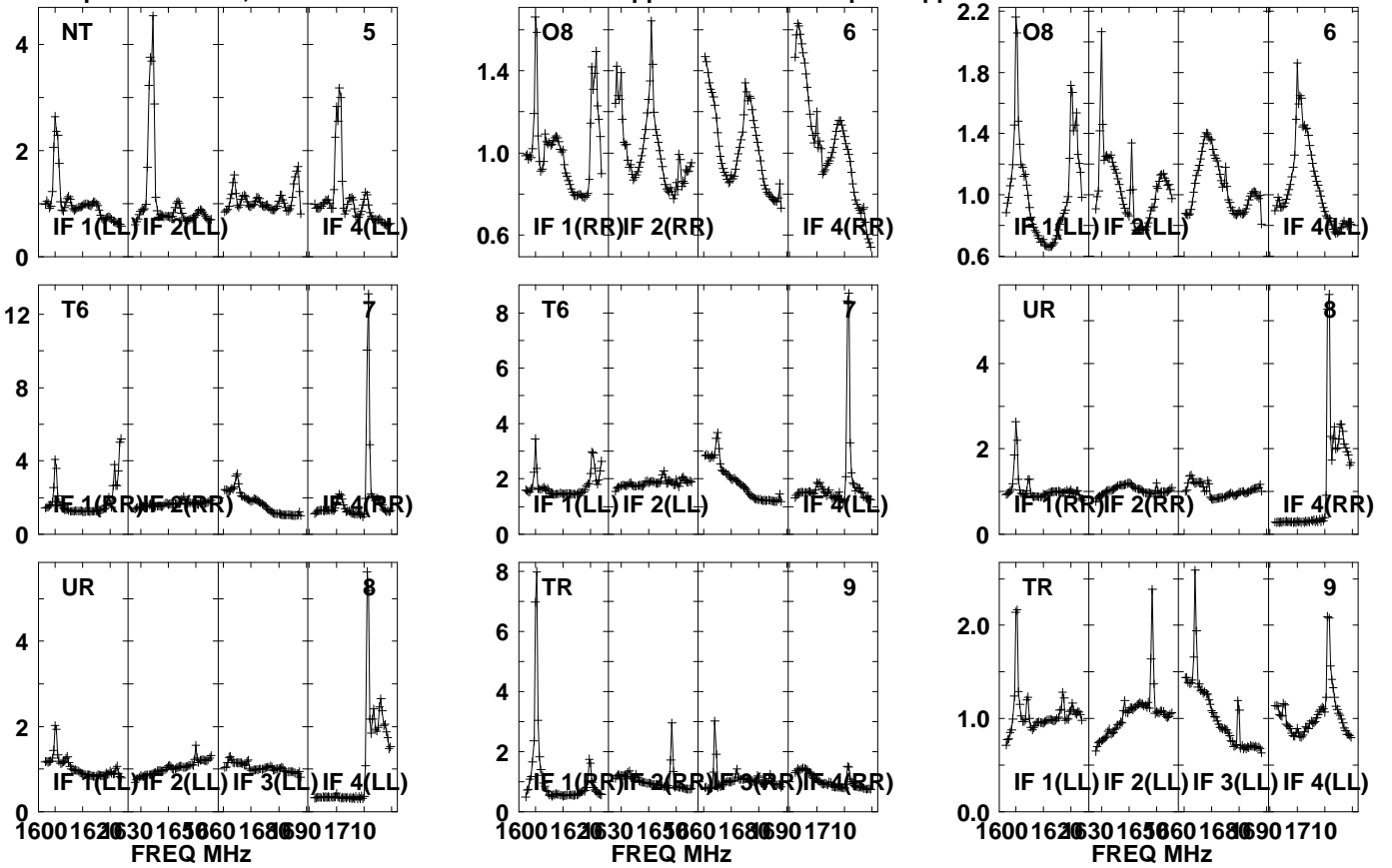

Lower frame: Real Jy  
Auto-corr total-power spectrum Antenna: \*  
Timerange: 00/12:01:01 to 00/12:04:29

Plot file version 160 created 05-OCT-2021 17:05:07

APM08279+525 GM076.UVDATA.1

Freq = 1.5945 GHz, Bw = 32.000 MH No calibration applied and no bandpass applied

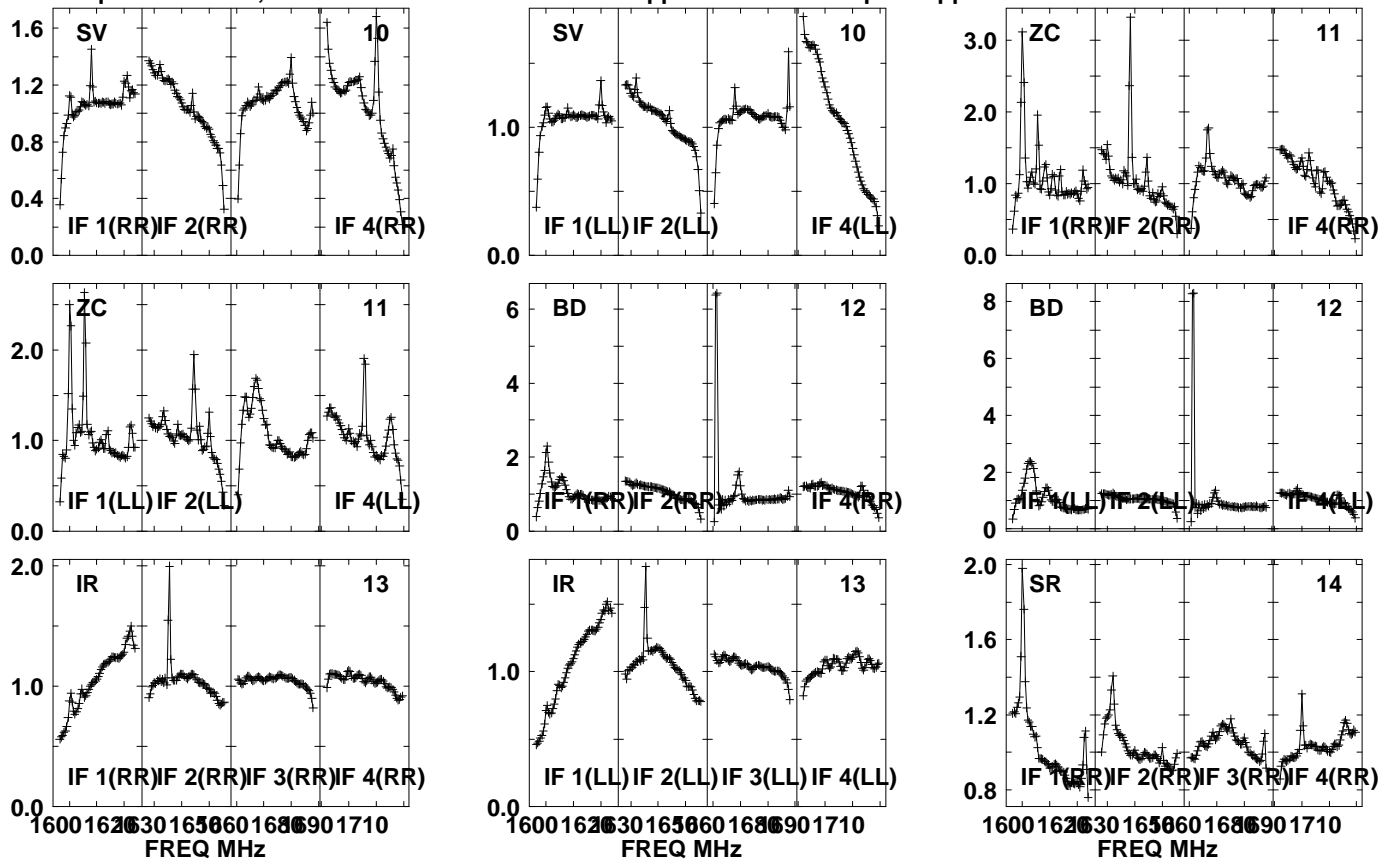

Lower frame: Real Jy  
Auto-corr total-power spectrum Antenna: \*  
Timerange: 00/12:01:01 to 00/12:04:29

Plot file version 161 created 05-OCT-2021 17:05:07

APM08279+525 GM076.UVDATA.1

Freq = 1.5945 GHz, Bw = 32.000 MH No calibration applied and no bandpass applied

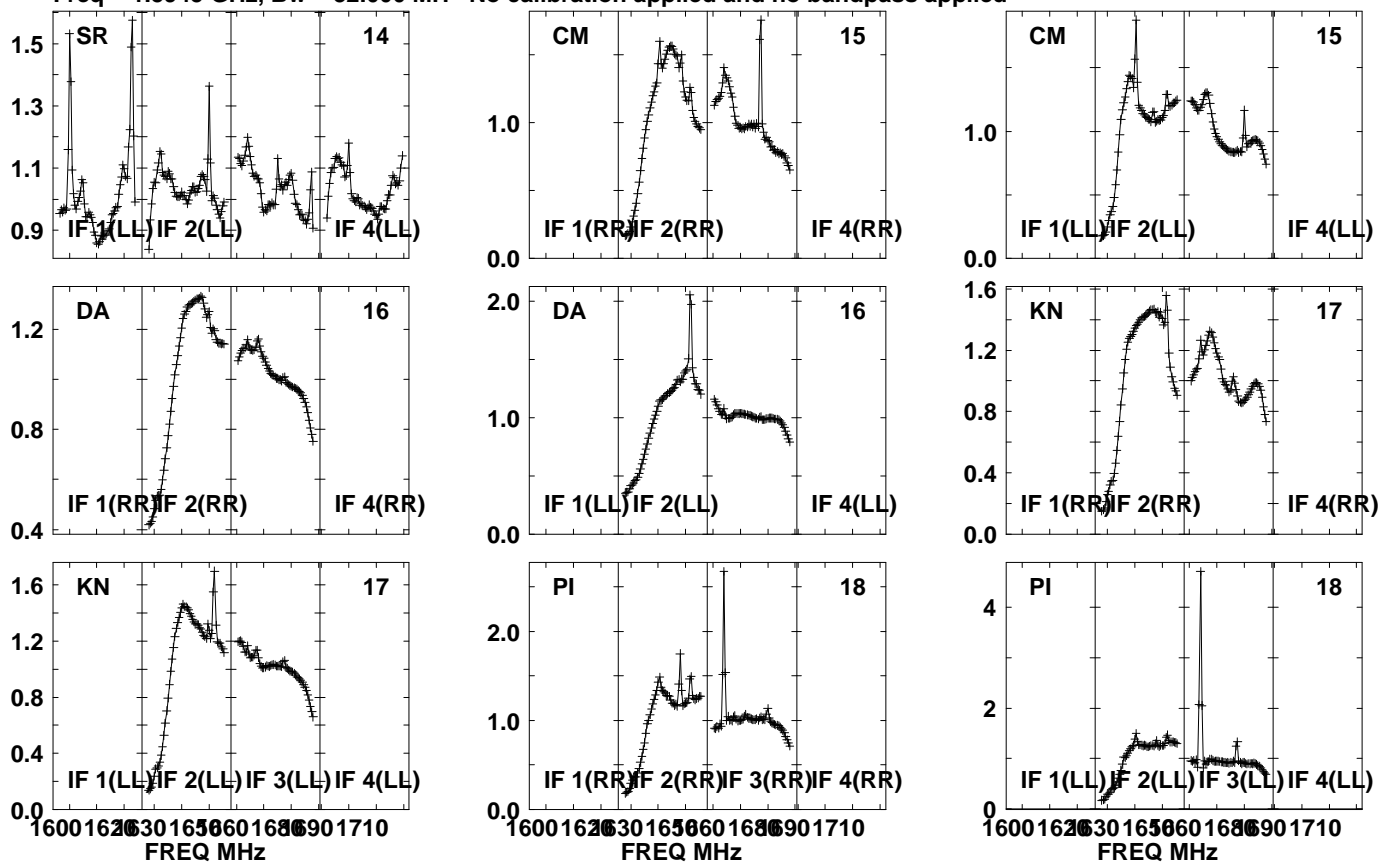

Lower frame: Real Jy  
Auto-corr total-power spectrum Antenna: \*  
Timerange: 00/12:01:01 to 00/12:04:29

Plot file version 162 created 05-OCT-2021 17:05:07

APM08279+525 GM076.UVDATA.1

Freq = 1.5945 GHz, Bw = 32.000 MH No calibration applied and no bandpass applied

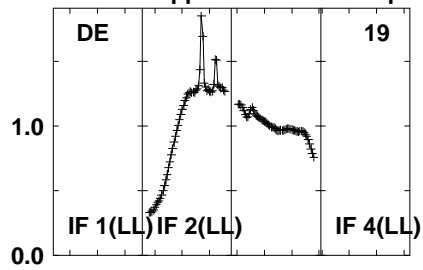
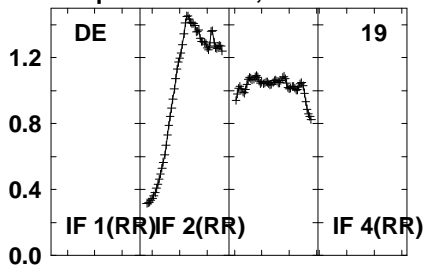

Lower frame: Real Jy  
Auto-corr total-power spectrum Antenna: \*  
Timerange: 00/12:01:01 to 00/12:04:29



Plot file version 163 created 05-OCT-2021 17:05:07

J0827+5217 GM076.UVDATA.1

Freq = 1.5945 GHz, Bw = 32.000 MH No calibration applied and no bandpass applied

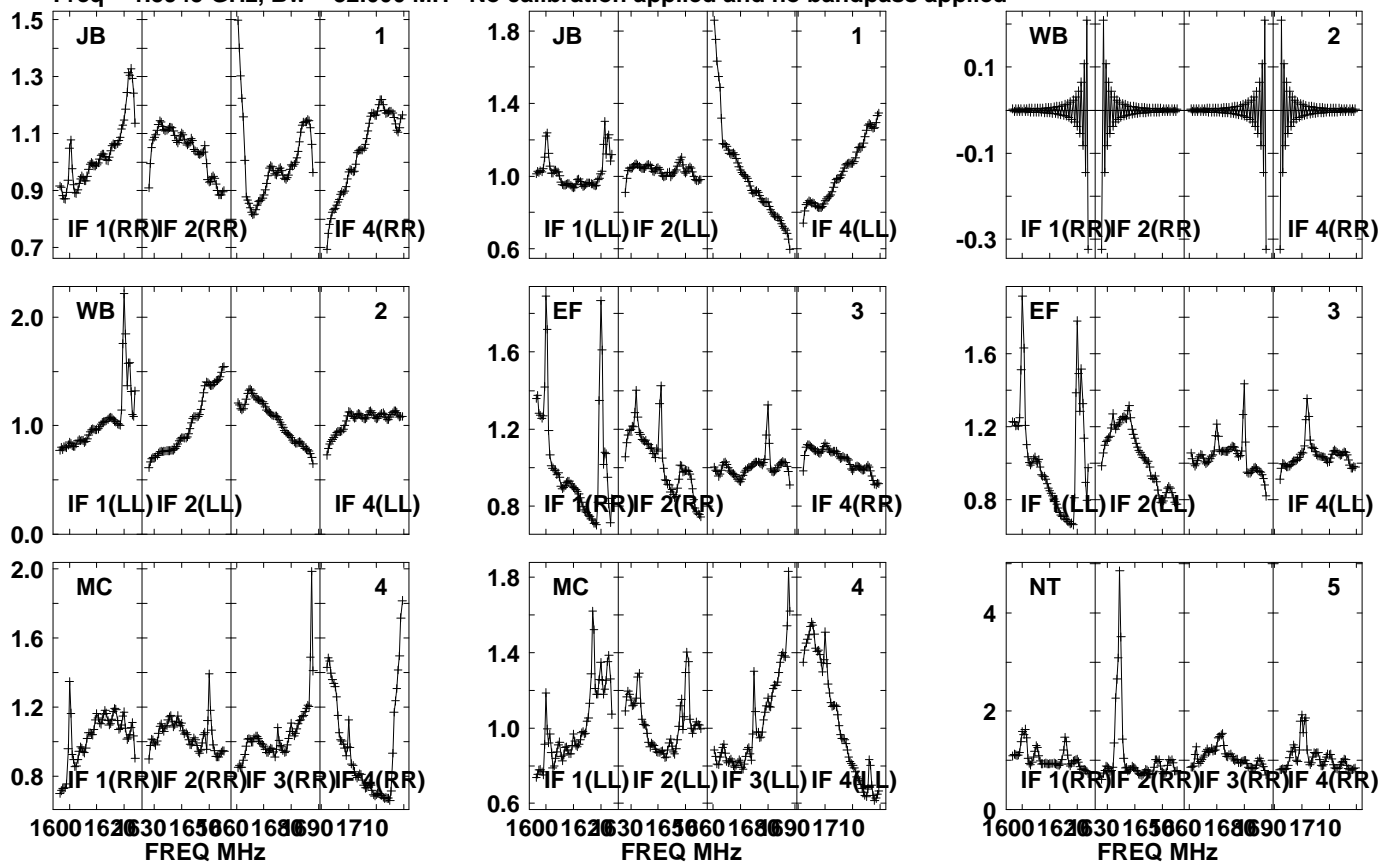

Lower frame: Real Jy  
Auto-corr total-power spectrum Antenna: \*  
Timerange: 00/12:04:31 to 00/12:05:59

Plot file version 164 created 05-OCT-2021 17:05:08

J0827+5217 GM076.UVDATA.1

Freq = 1.5945 GHz, Bw = 32.000 MH No calibration applied and no bandpass applied

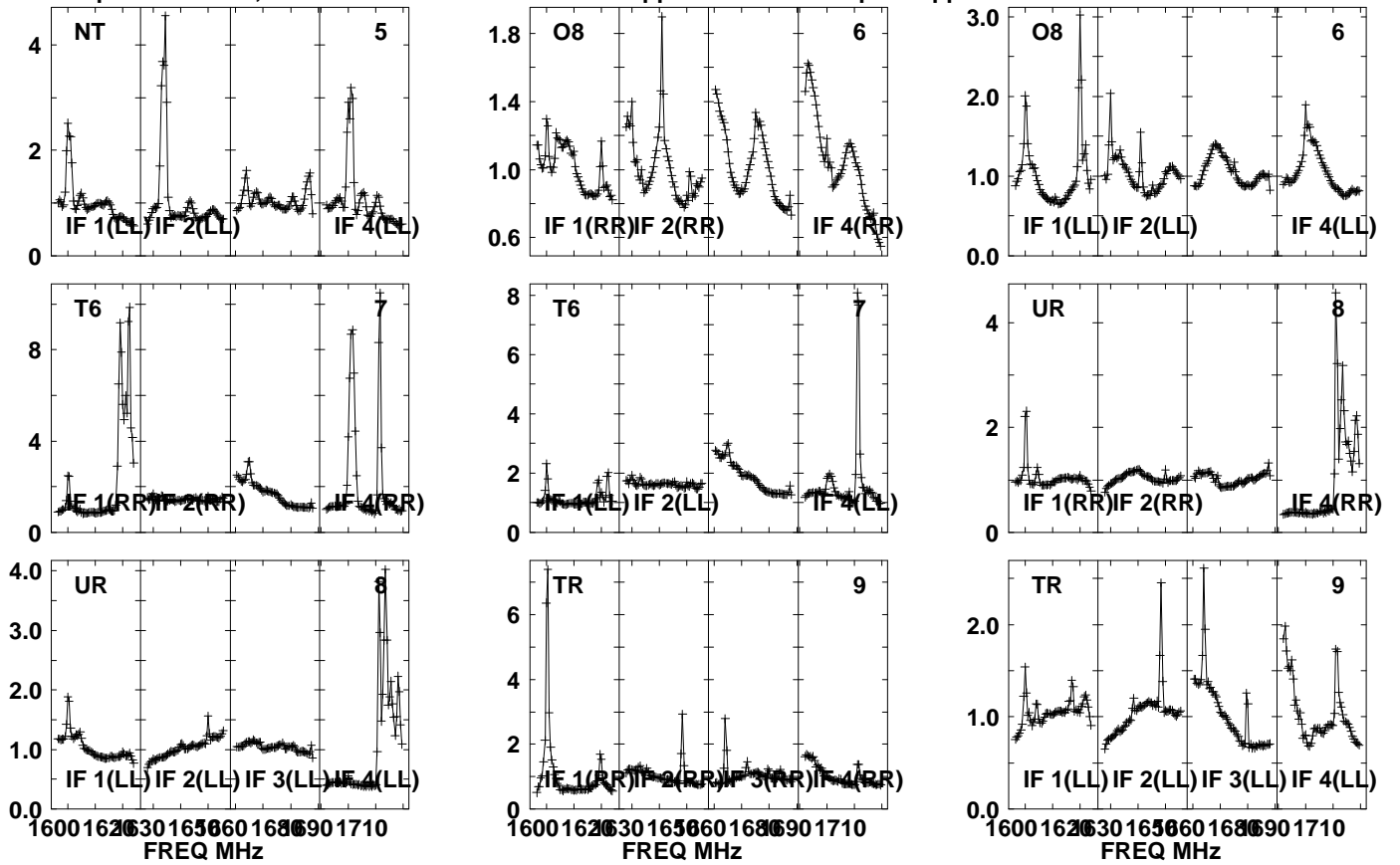

Lower frame: Real Jy  
Auto-corr total-power spectrum Antenna: \*  
Timerange: 00/12:04:31 to 00/12:05:59

Plot file version 165 created 05-OCT-2021 17:05:08

J0827+5217 GM076.UVDATA.1

Freq = 1.5945 GHz, Bw = 32.000 MH No calibration applied and no bandpass applied

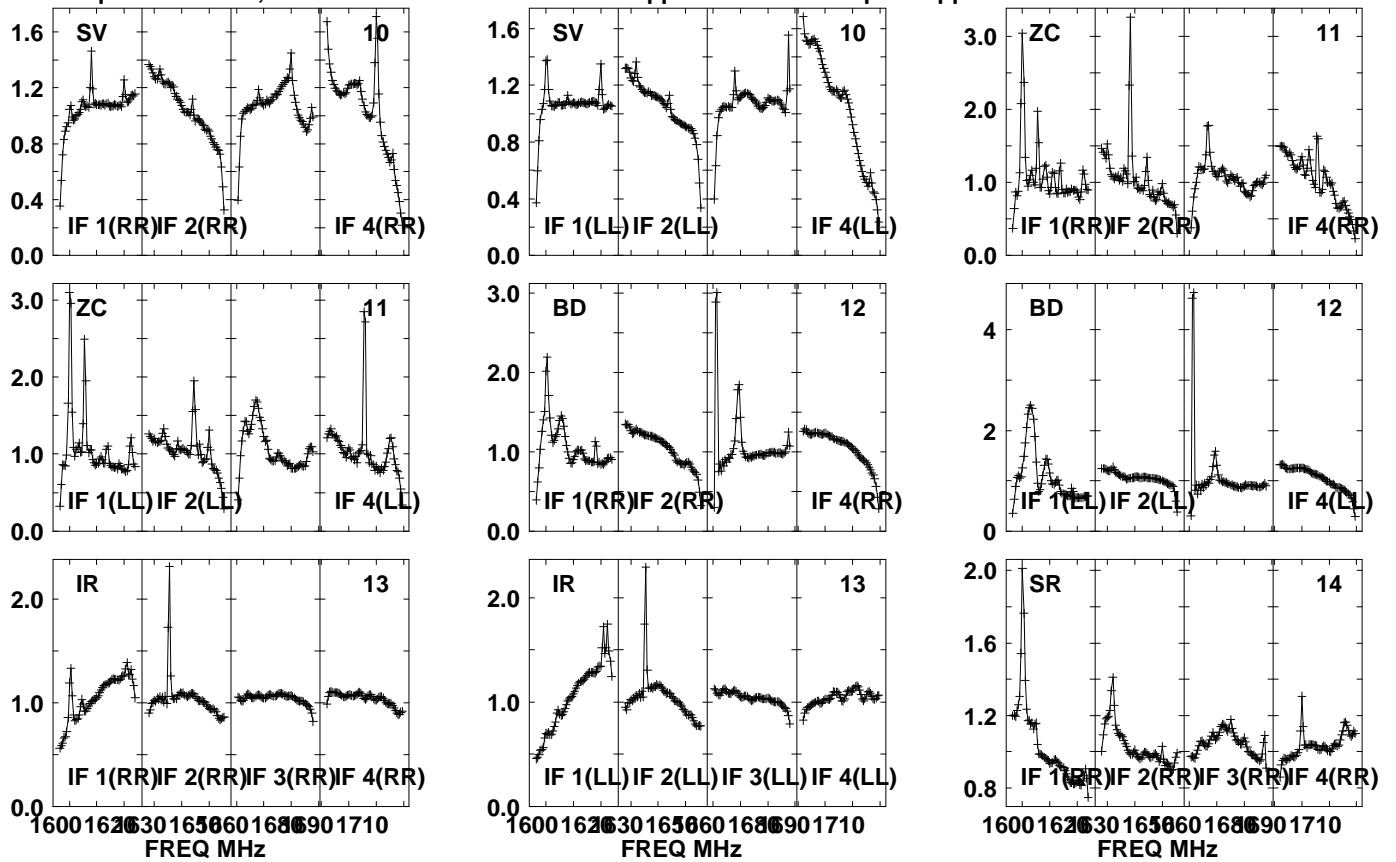

Lower frame: Real Jy  
Auto-corr total-power spectrum Antenna: \*  
Timerange: 00/12:04:31 to 00/12:05:59

Plot file version 166 created 05-OCT-2021 17:05:08

J0827+5217 GM076.UVDATA.1

Freq = 1.5945 GHz, Bw = 32.000 MH No calibration applied and no bandpass applied

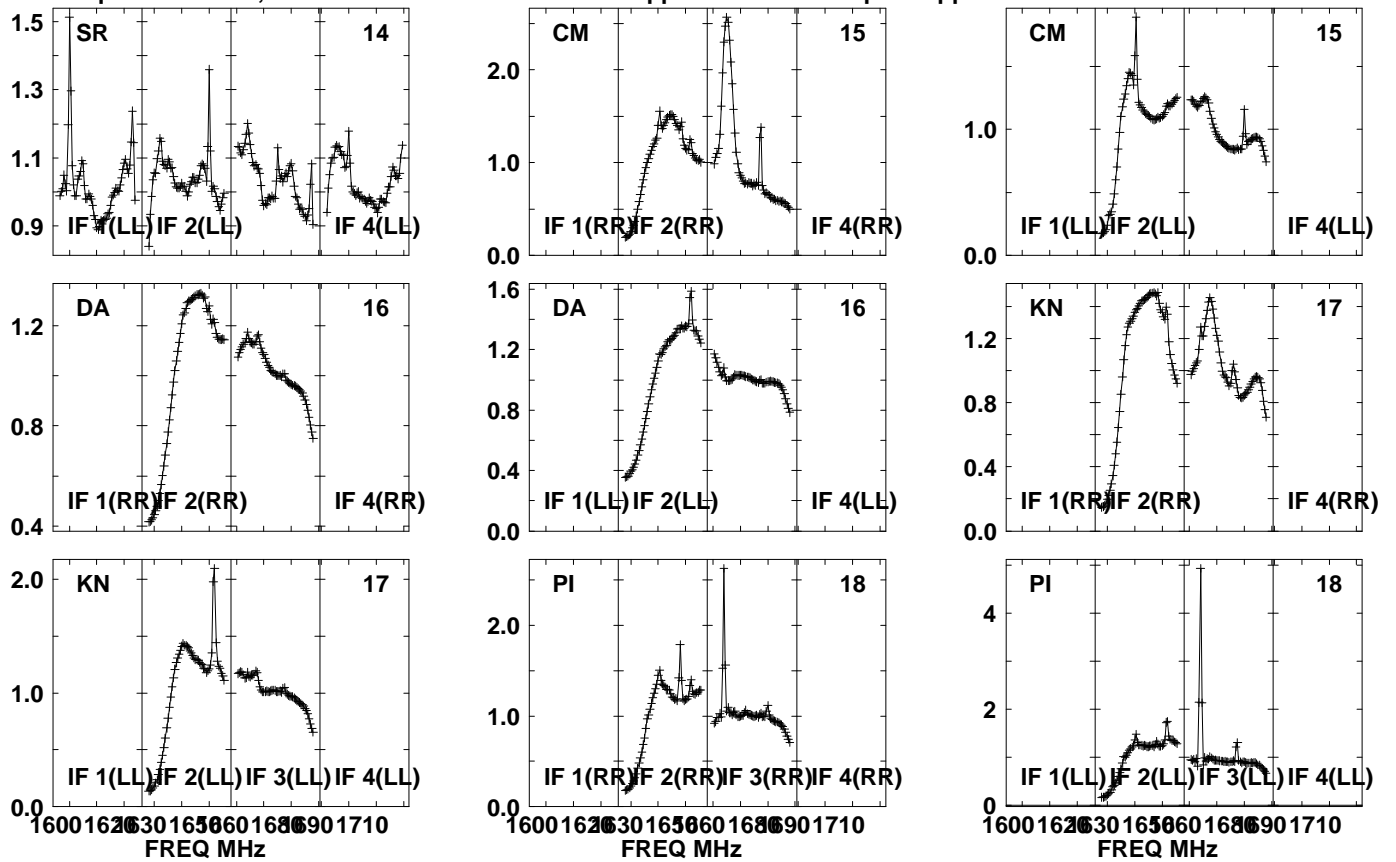

Lower frame: Real Jy  
Auto-corr total-power spectrum Antenna: \*  
Timerange: 00/12:04:31 to 00/12:05:59

Plot file version 167 created 05-OCT-2021 17:05:08

J0827+5217 GM076.UVDATA.1

Freq = 1.5945 GHz, Bw = 32.000 MH No calibration applied and no bandpass applied

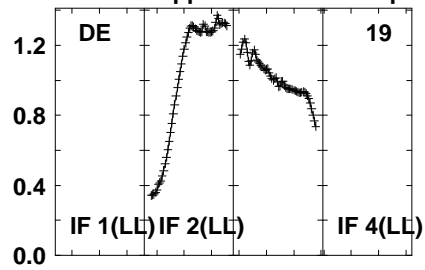
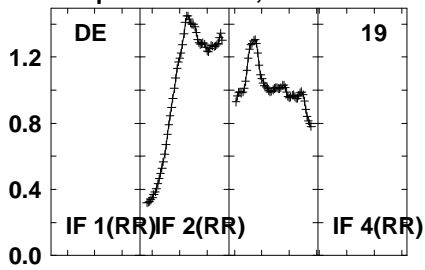

Lower frame: Real Jy  
Auto-corr total-power spectrum Antenna: \*  
Timerange: 00/12:04:31 to 00/12:05:59

Plot file version 168 created 05-OCT-2021 17:05:08

APM08279+525 GM076.UVDATA.1

Freq = 1.5945 GHz, Bw = 32.000 MH No calibration applied and no bandpass applied

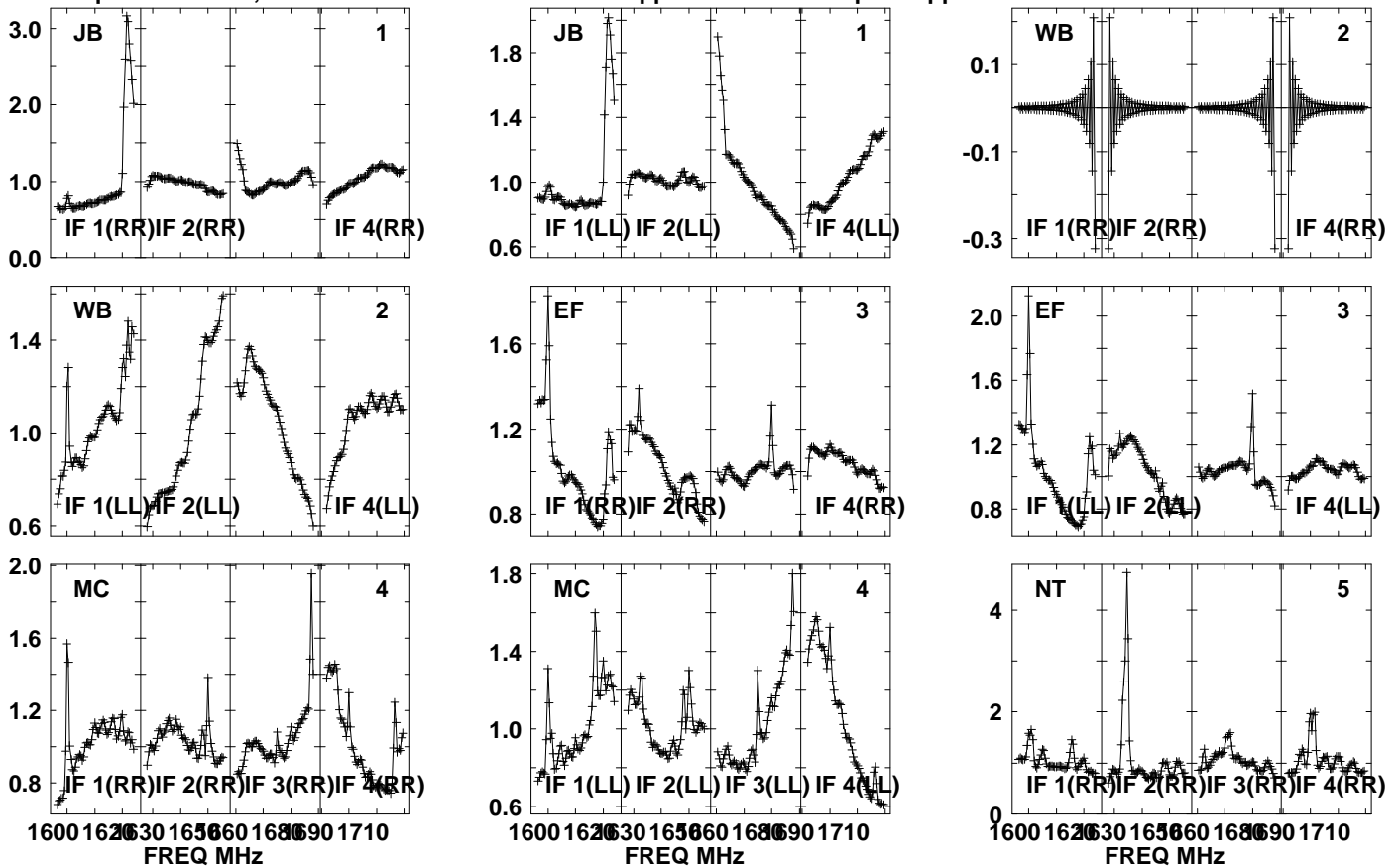

Lower frame: Real Jy

Auto-corr total-power spectrum Antenna: \*

Timerange: 00/12:06:01 to 00/12:09:29

Plot file version 169 created 05-OCT-2021 17:05:09

APM08279+525 GM076.UVDATA.1

Freq = 1.5945 GHz, Bw = 32.000 MH No calibration applied and no bandpass applied

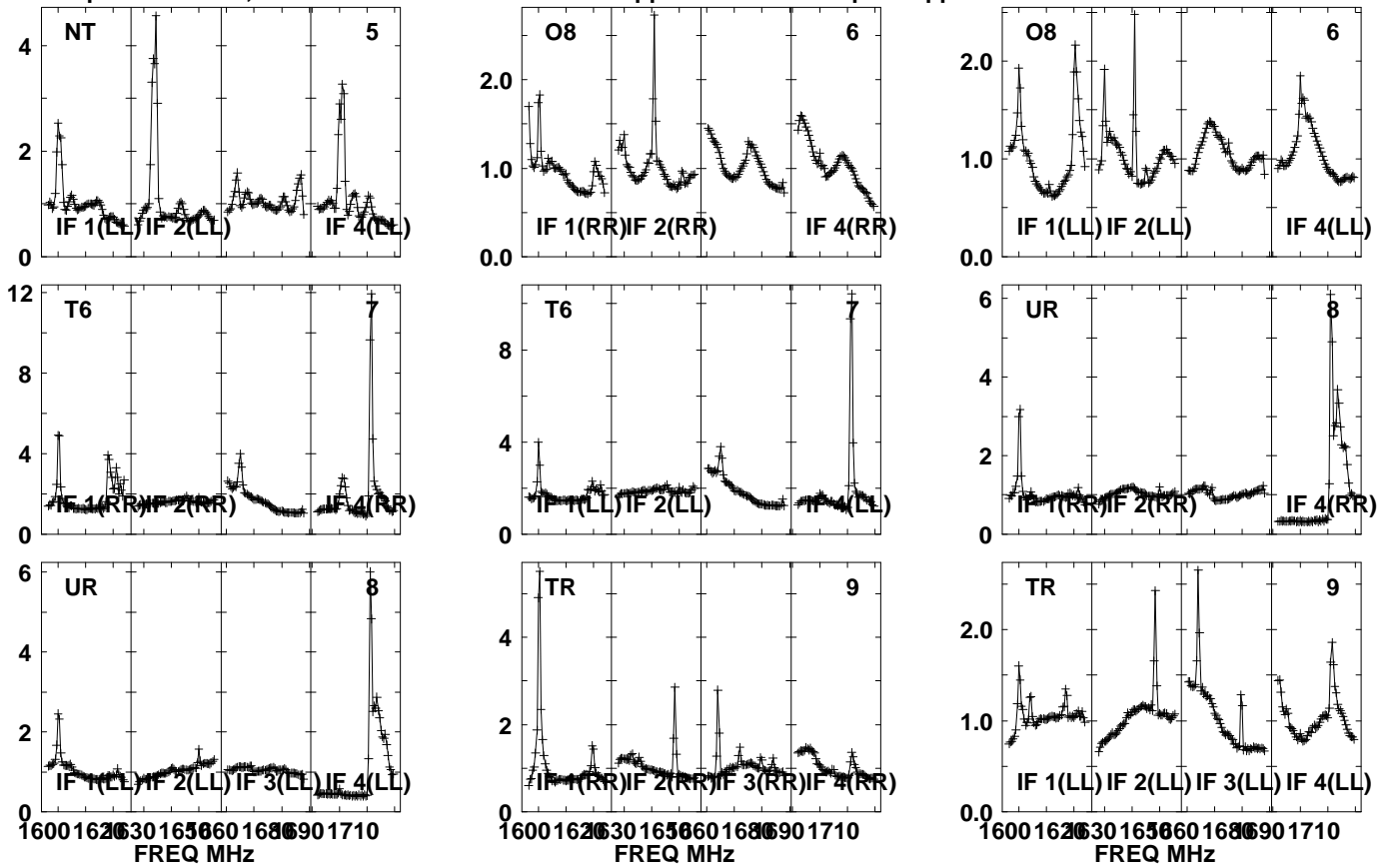

Lower frame: Real Jy  
Auto-corr total-power spectrum Antenna: \*  
Timerange: 00/12:06:01 to 00/12:09:29

Plot file version 170 created 05-OCT-2021 17:05:09

APM08279+525 GM076.UVDATA.1

Freq = 1.5945 GHz, Bw = 32.000 MH No calibration applied and no bandpass applied

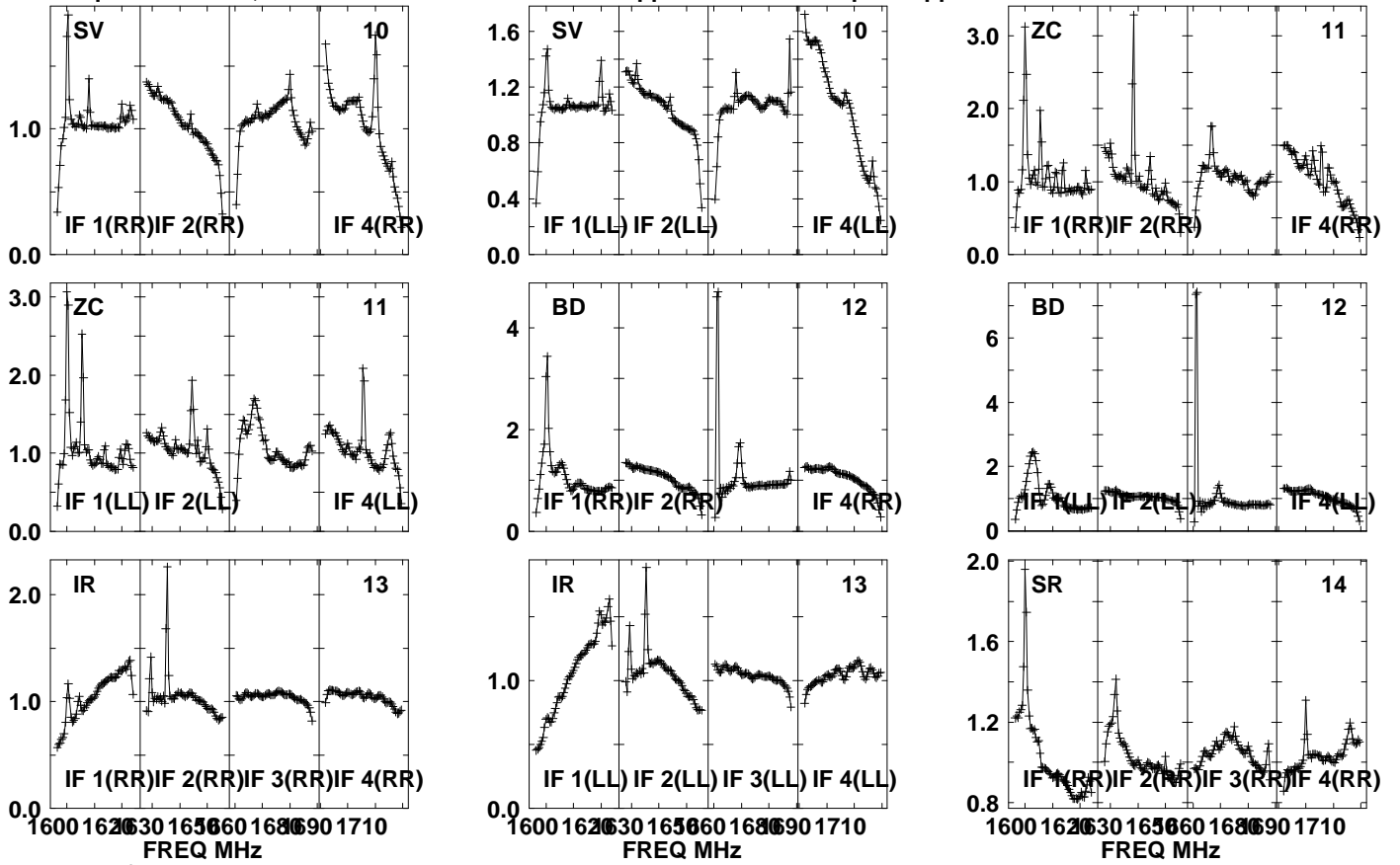

Lower frame: Real Jy

Auto-corr total-power spectrum Antenna: \*

Timerange: 00/12:06:01 to 00/12:09:29



Plot file version 171 created 05-OCT-2021 17:05:09

APM08279+525 GM076.UVDATA.1

Freq = 1.5945 GHz, Bw = 32.000 MH No calibration applied and no bandpass applied

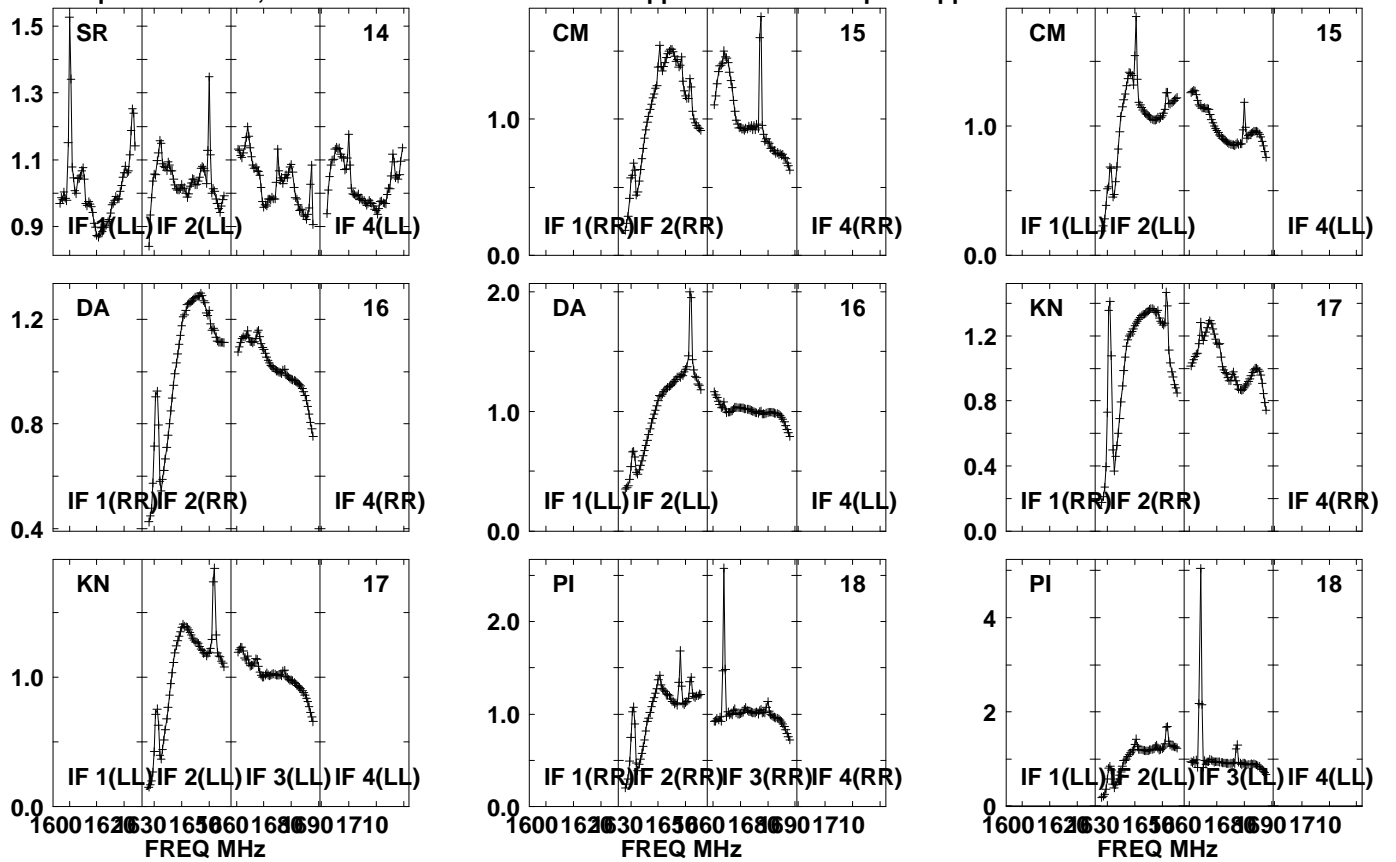

Lower frame: Real Jy  
Auto-corr total-power spectrum Antenna: \*  
Timerange: 00/12:06:01 to 00/12:09:29

Plot file version 172 created 05-OCT-2021 17:05:09

APM08279+525 GM076.UVDATA.1

Freq = 1.5945 GHz, Bw = 32.000 MH No calibration applied and no bandpass applied

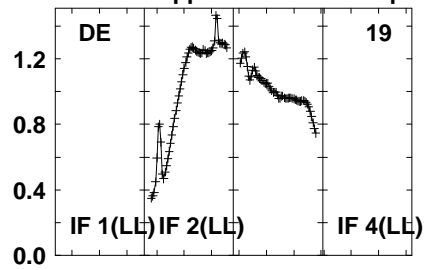
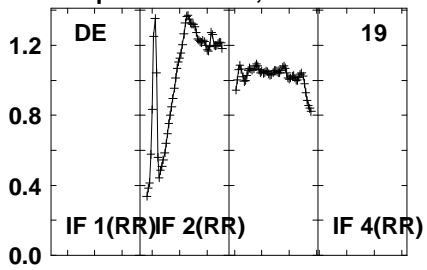

Lower frame: Real Jy  
Auto-corr total-power spectrum Antenna: \*  
Timerange: 00/12:06:01 to 00/12:09:29

Plot file version 173 created 05-OCT-2021 17:05:09

J0827+5217 GM076.UVDATA.1

Freq = 1.5945 GHz, Bw = 32.000 MH No calibration applied and no bandpass applied

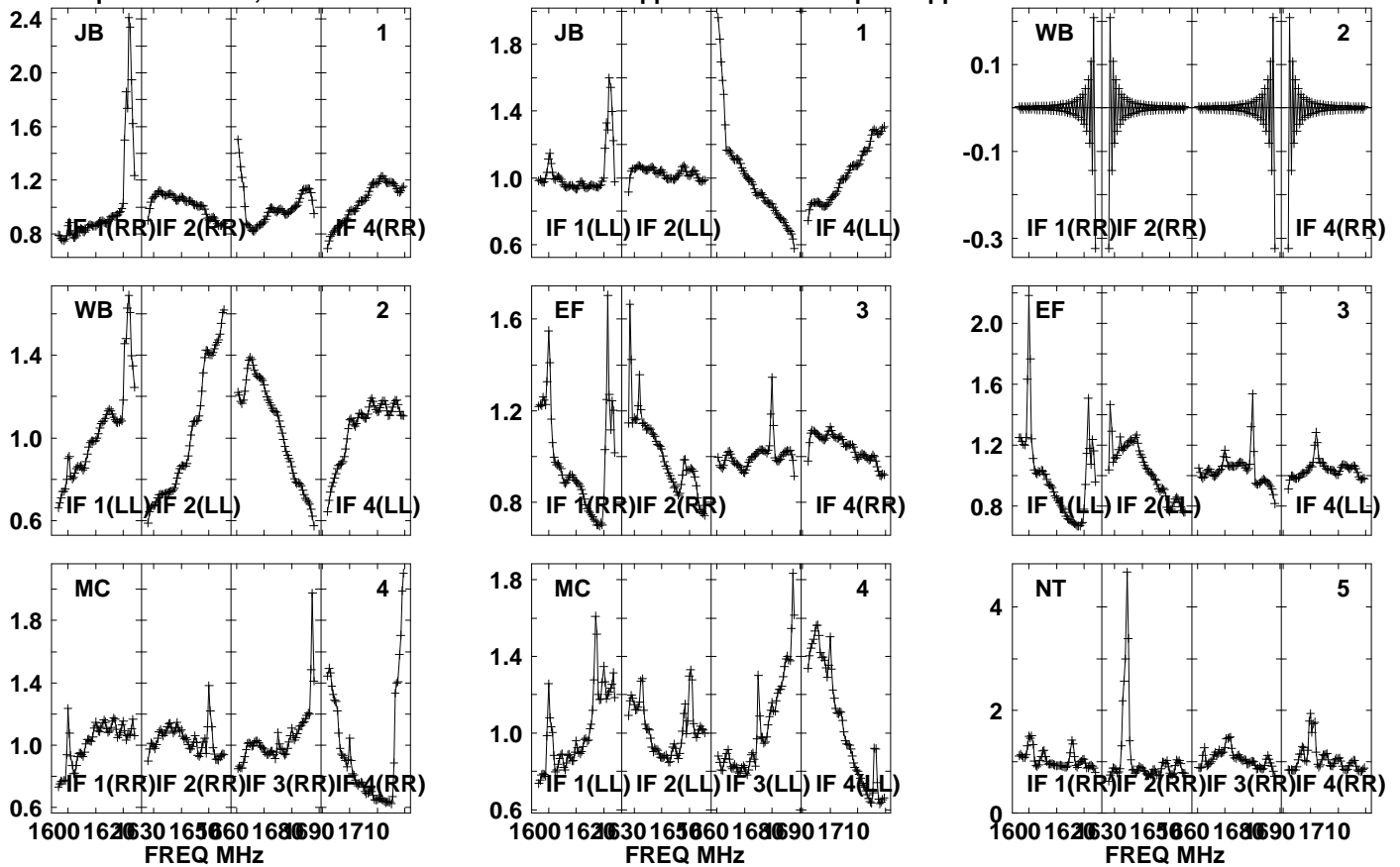

Lower frame: Real Jy  
Auto-corr total-power spectrum Antenna: \*  
Timerange: 00/12:10:01 to 00/12:11:29

Plot file version 174 created 05-OCT-2021 17:05:10

J0827+5217 GM076.UVDATA.1

Freq = 1.5945 GHz, Bw = 32.000 MH No calibration applied and no bandpass applied

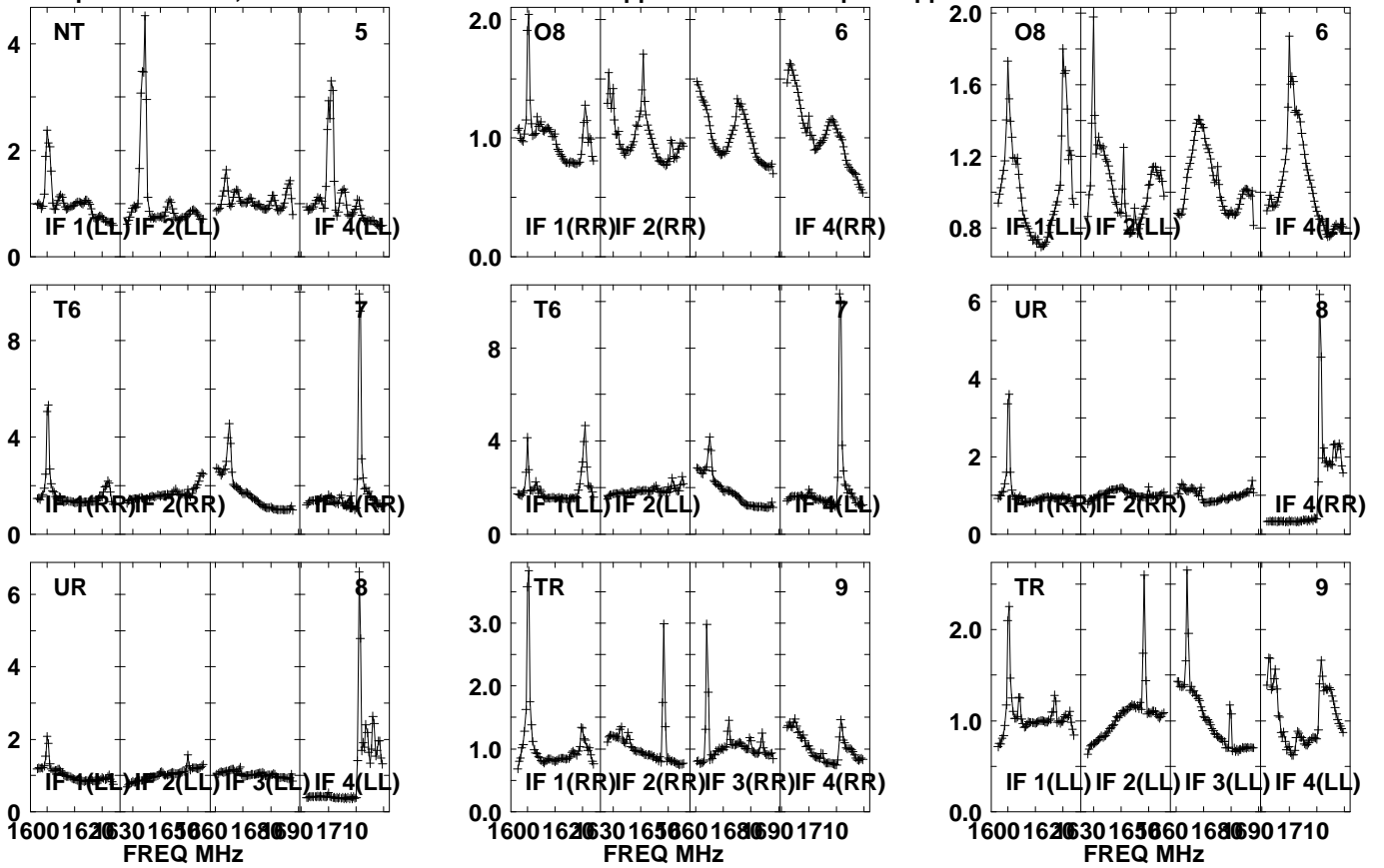

Lower frame: Real Jy  
Auto-corr total-power spectrum Antenna: \*  
Timerange: 00/12:10:01 to 00/12:11:29

Plot file version 175 created 05-OCT-2021 17:05:10

J0827+5217 GM076.UVDATA.1

Freq = 1.5945 GHz, Bw = 32.000 MH No calibration applied and no bandpass applied

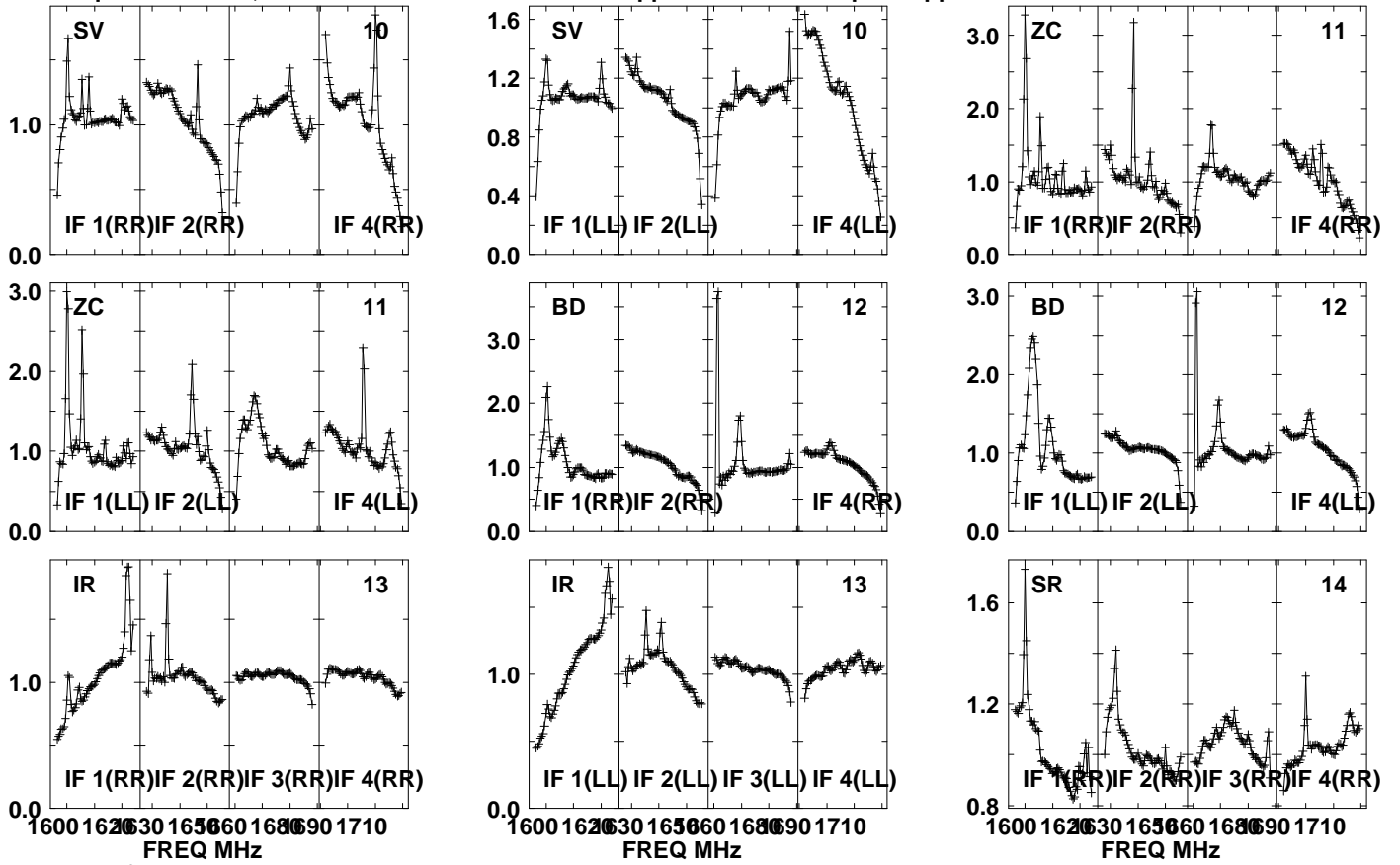

Lower frame: Real Jy  
Auto-corr total-power spectrum Antenna: \*  
Timerange: 00/12:10:01 to 00/12:11:29

Plot file version 176 created 05-OCT-2021 17:05:10

J0827+5217 GM076.UVDATA.1

Freq = 1.5945 GHz, Bw = 32.000 MH No calibration applied and no bandpass applied

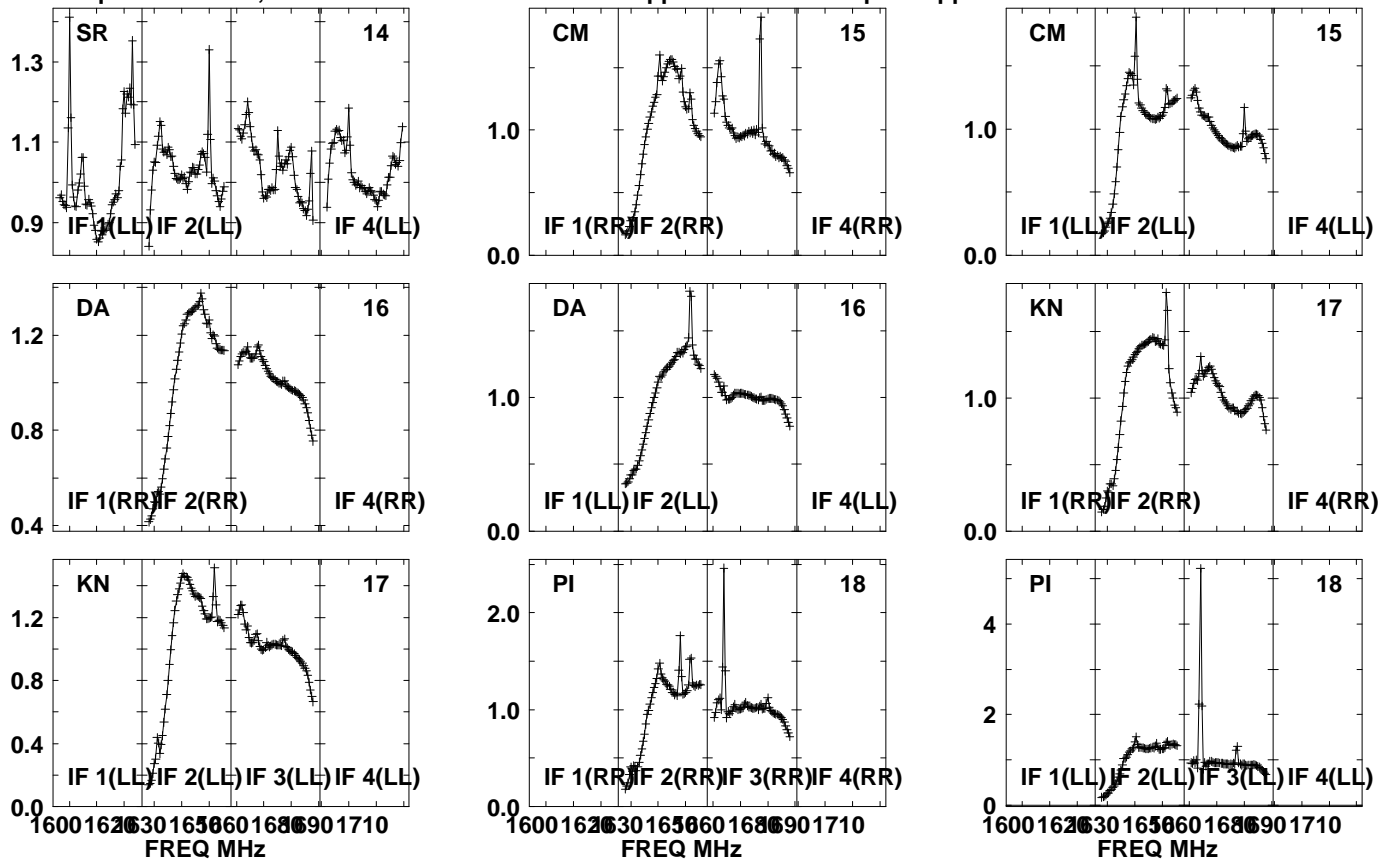

Lower frame: Real Jy  
Auto-corr total-power spectrum Antenna: \*  
Timerange: 00/12:10:01 to 00/12:11:29

Plot file version 177 created 05-OCT-2021 17:05:10

J0827+5217 GM076.UVDATA.1

Freq = 1.5945 GHz, Bw = 32.000 MH No calibration applied and no bandpass applied

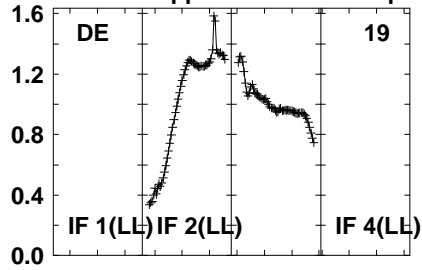
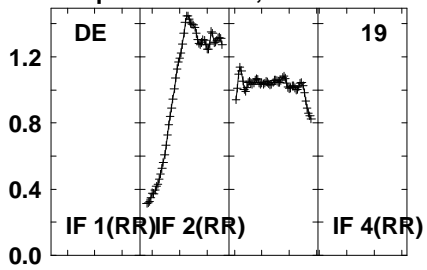

Lower frame: Real Jy  
Auto-corr total-power spectrum Antenna: \*  
Timerange: 00/12:10:01 to 00/12:11:29

Plot file version 178 created 05-OCT-2021 17:05:10

APM08279+525 GM076.UVDATA.1

Freq = 1.5945 GHz, Bw = 32.000 MH No calibration applied and no bandpass applied

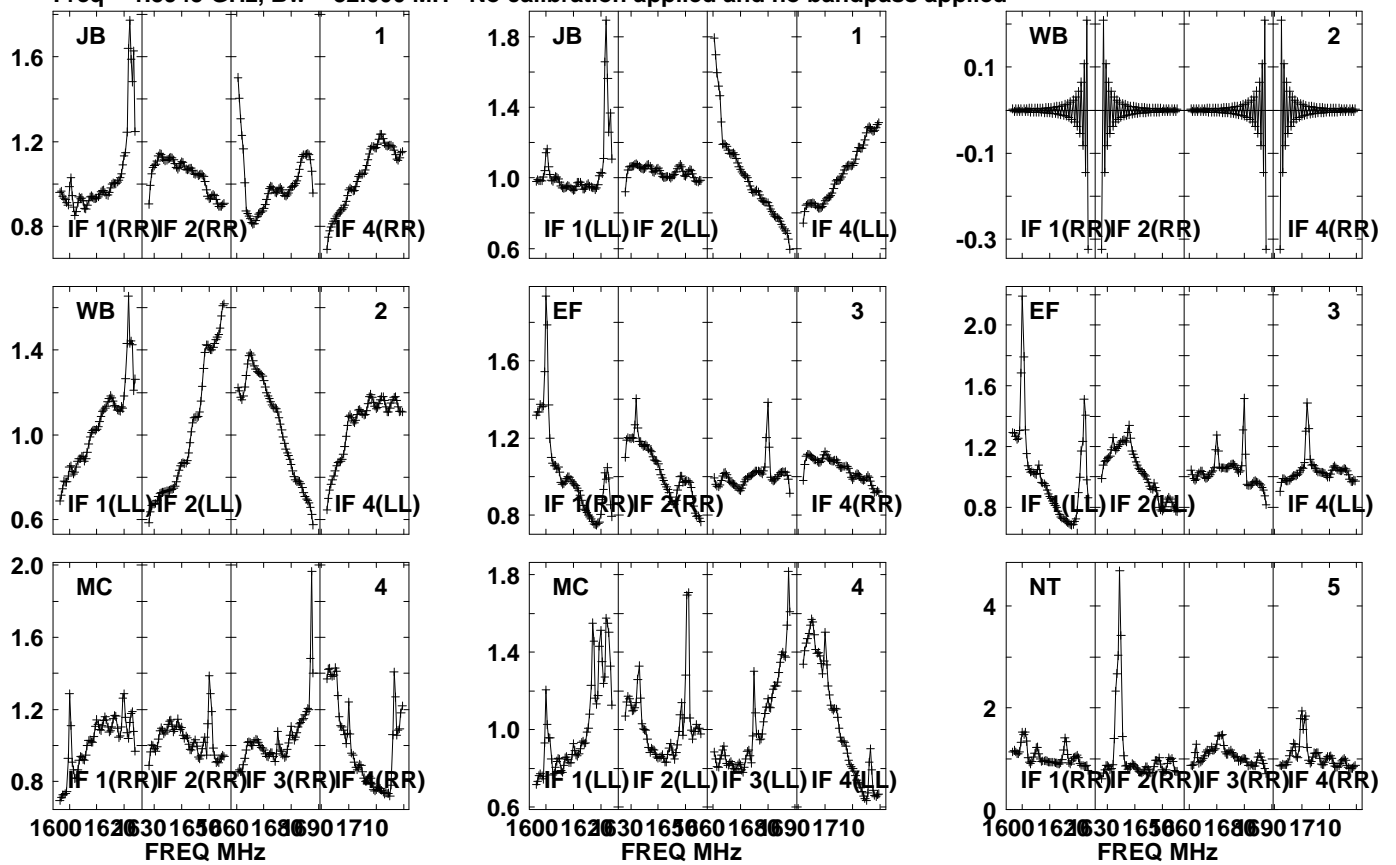

Lower frame: Real Jy  
Auto-corr total-power spectrum Antenna: \*  
Timerange: 00/12:11:31 to 00/12:14:59



Plot file version 179 created 05-OCT-2021 17:05:11

APM08279+525 GM076.UVDATA.1

Freq = 1.5945 GHz, Bw = 32.000 MH No calibration applied and no bandpass applied

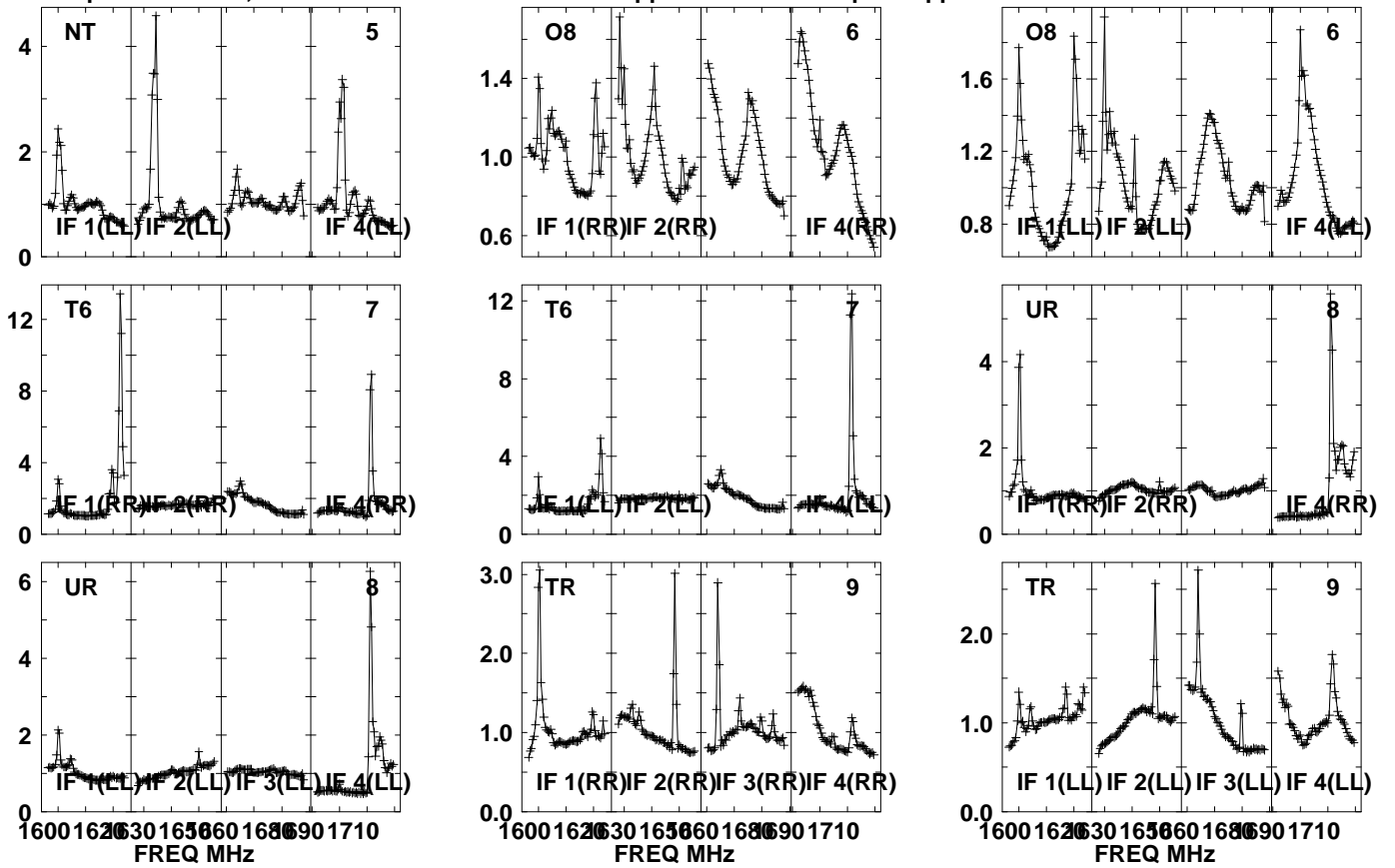

Lower frame: Real Jy  
Auto-corr total-power spectrum Antenna: \*  
Timerange: 00/12:11:31 to 00/12:14:59

Plot file version 180 created 05-OCT-2021 17:05:11

APM08279+525 GM076.UVDATA.1

Freq = 1.5945 GHz, Bw = 32.000 MH No calibration applied and no bandpass applied

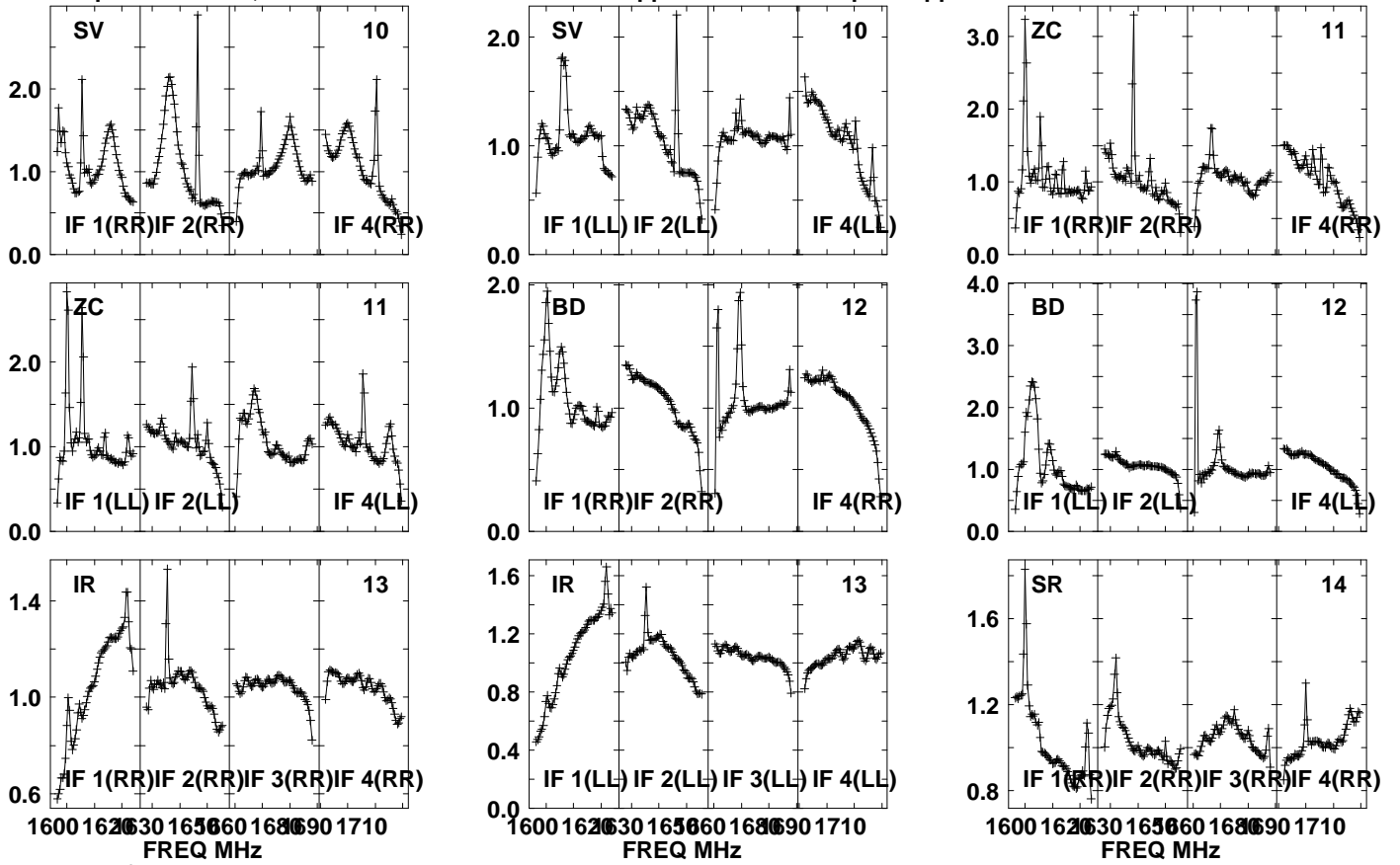

Lower frame: Real Jy

Auto-corr total-power spectrum Antenna: \*

Timerange: 00/12:11:31 to 00/12:14:59

Plot file version 181 created 05-OCT-2021 17:05:11

APM08279+525 GM076.UVDATA.1

Freq = 1.5945 GHz, Bw = 32.000 MH No calibration applied and no bandpass applied

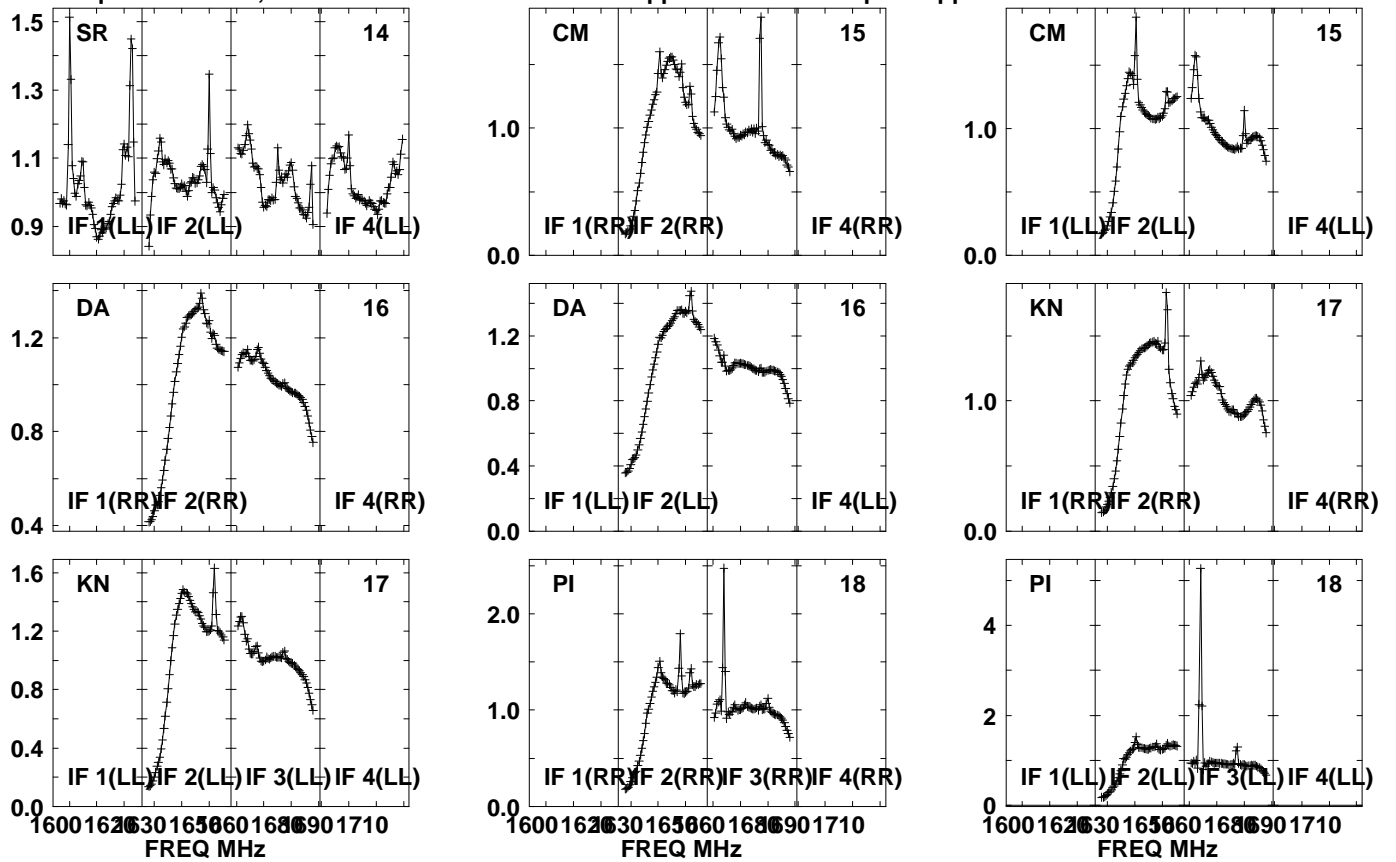

Lower frame: Real Jy  
Auto-corr total-power spectrum Antenna: \*  
Timerange: 00/12:11:31 to 00/12:14:59

Plot file version 182 created 05-OCT-2021 17:05:11

APM08279+525 GM076.UVDATA.1

Freq = 1.5945 GHz, Bw = 32.000 MH No calibration applied and no bandpass applied

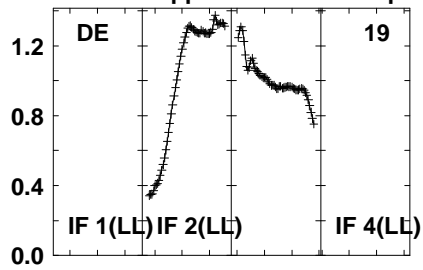
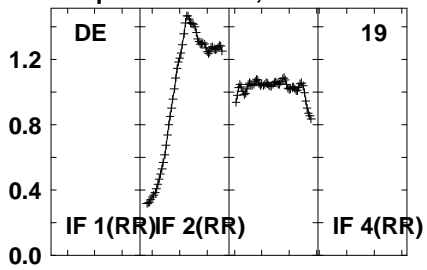

Lower frame: Real Jy  
Auto-corr total-power spectrum Antenna: \*  
Timerange: 00/12:11:31 to 00/12:14:59

Plot file version 183 created 05-OCT-2021 17:05:11

J0827+5217 GM076.UVDATA.1

Freq = 1.5945 GHz, Bw = 32.000 MH No calibration applied and no bandpass applied

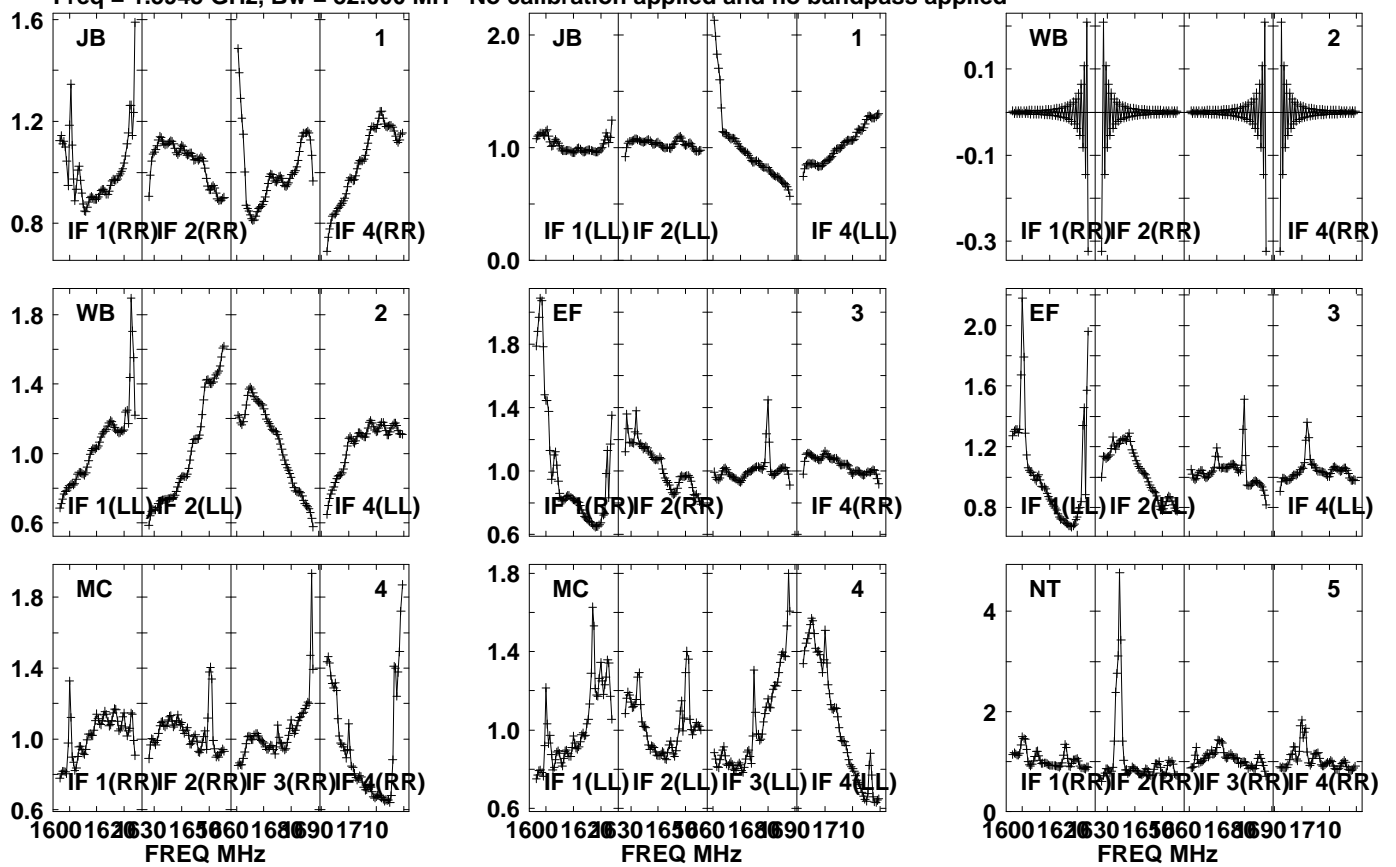

Lower frame: Real Jy  
Auto-corr total-power spectrum Antenna: \*  
Timerange: 00/12:15:01 to 00/12:16:29

Plot file version 184 created 05-OCT-2021 17:05:12

J0827+5217 GM076.UVDATA.1

Freq = 1.5945 GHz, Bw = 32.000 MH No calibration applied and no bandpass applied

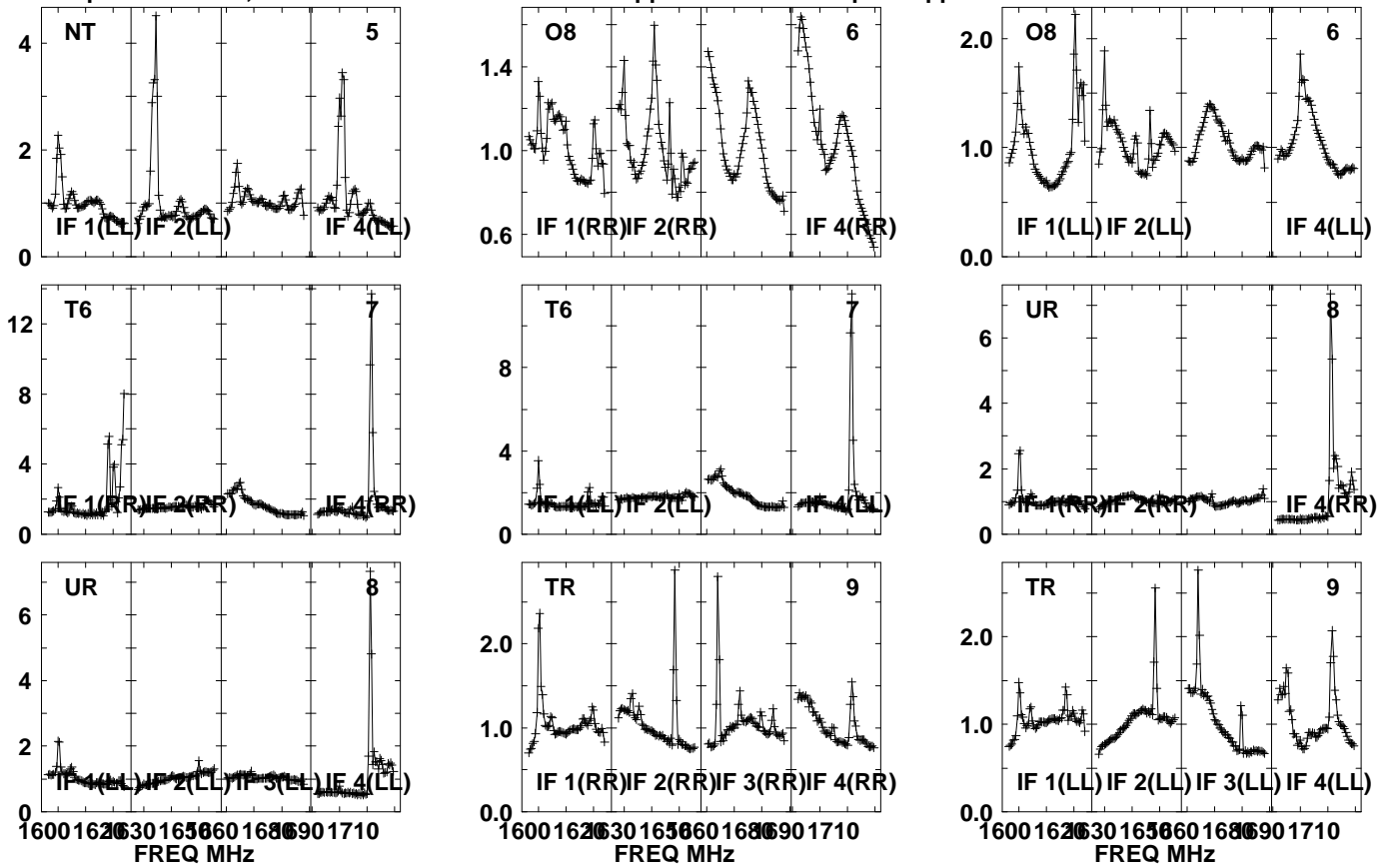

Lower frame: Real Jy  
Auto-corr total-power spectrum Antenna: \*  
Timerange: 00/12:15:01 to 00/12:16:29

Plot file version 185 created 05-OCT-2021 17:05:12

J0827+5217 GM076.UVDATA.1

Freq = 1.5945 GHz, Bw = 32.000 MH No calibration applied and no bandpass applied

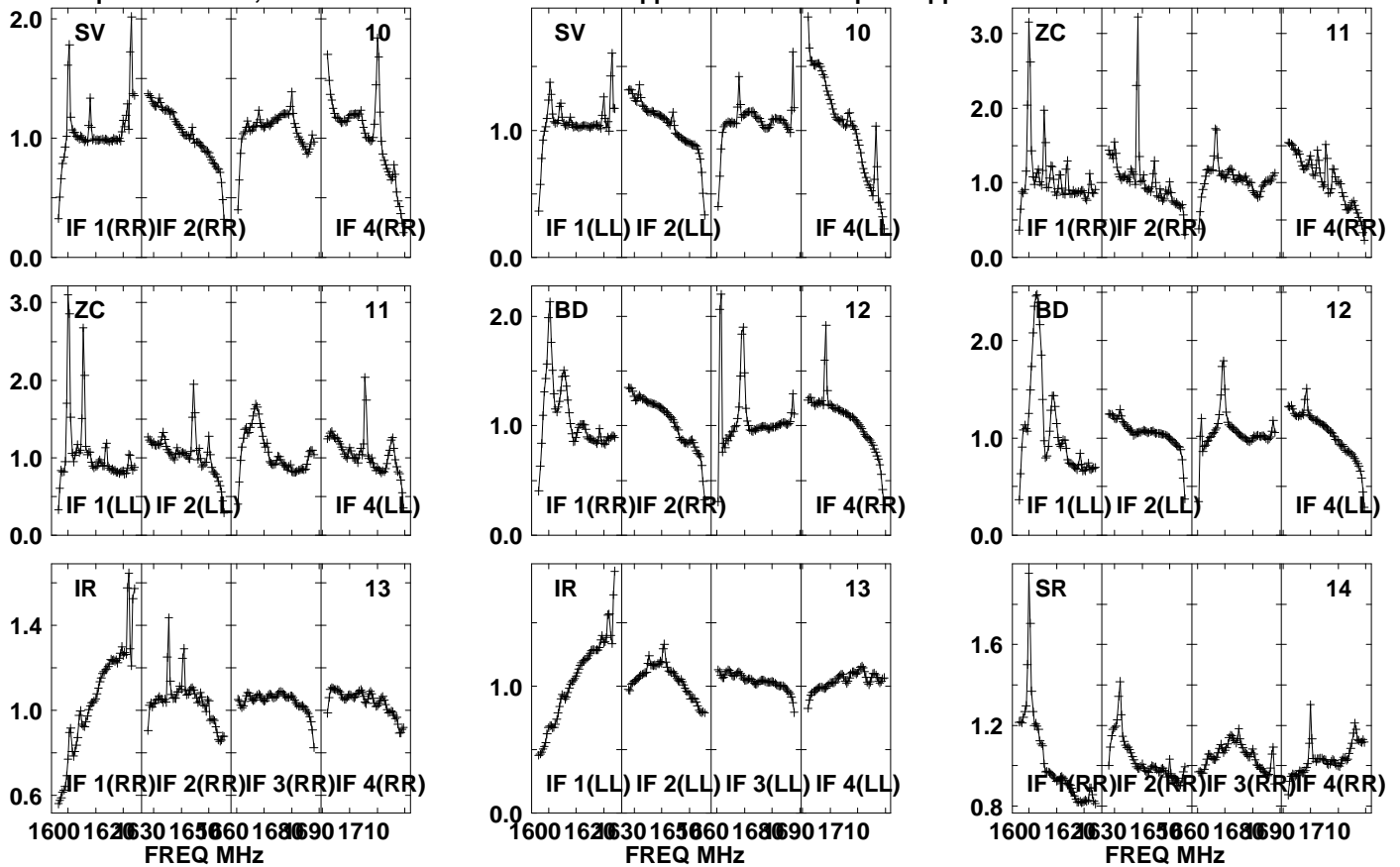

Lower frame: Real Jy

Auto-corr total-power spectrum Antenna: \*

Timerange: 00/12:15:01 to 00/12:16:29

Plot file version 186 created 05-OCT-2021 17:05:12

J0827+5217 GM076.UVDATA.1

Freq = 1.5945 GHz, Bw = 32.000 MH No calibration applied and no bandpass applied

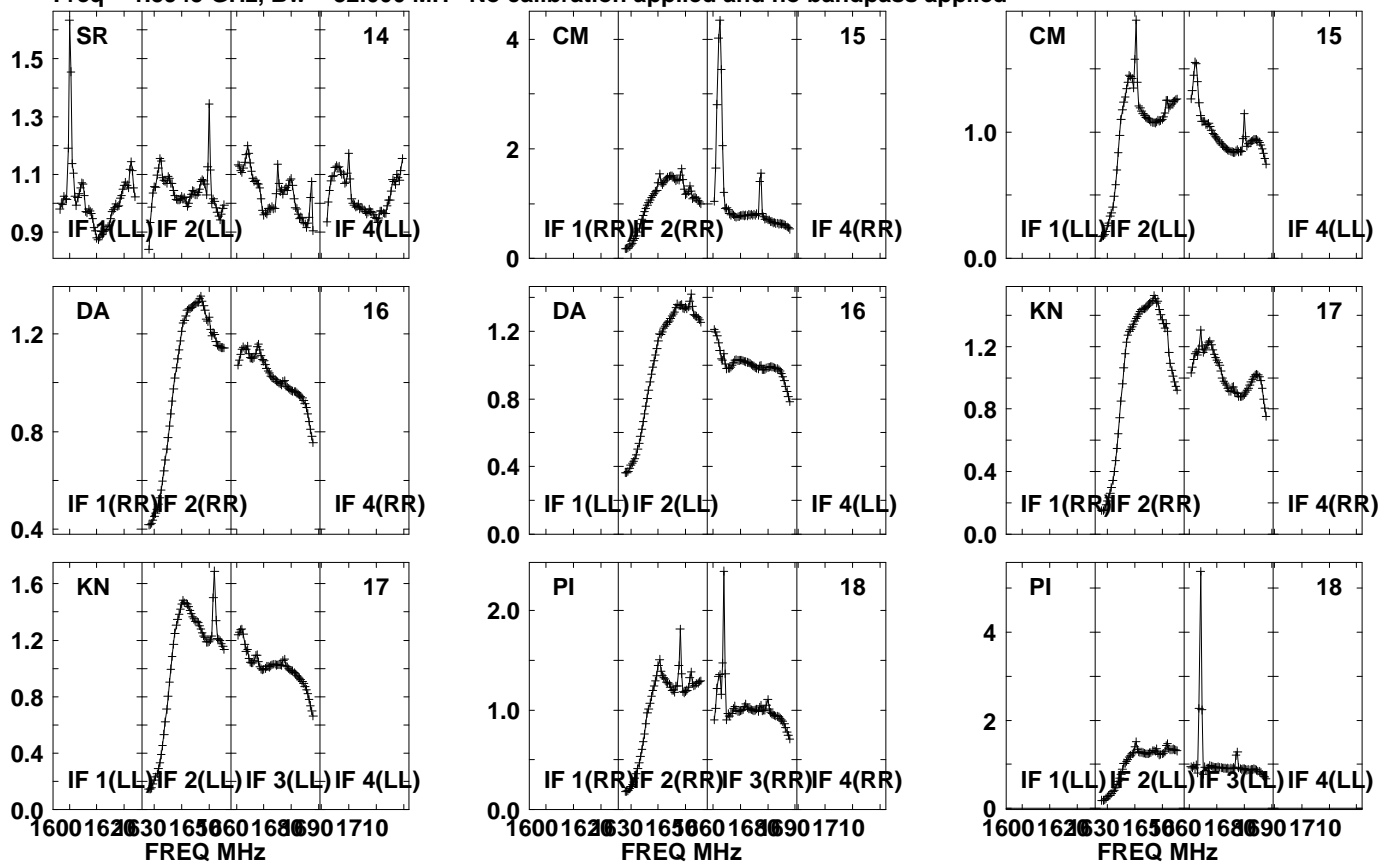

Lower frame: Real Jy  
Auto-corr total-power spectrum Antenna: \*  
Timerange: 00/12:15:01 to 00/12:16:29



Plot file version 187 created 05-OCT-2021 17:05:12

J0827+5217 GM076.UVDATA.1

Freq = 1.5945 GHz, Bw = 32.000 MH No calibration applied and no bandpass applied

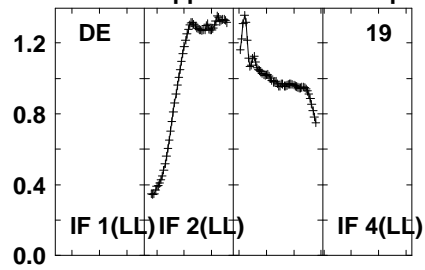
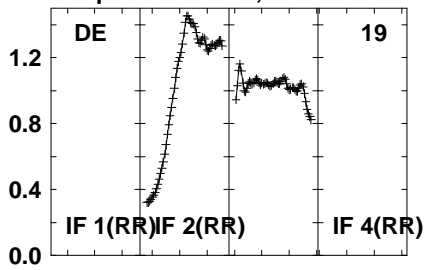

Lower frame: Real Jy  
Auto-corr total-power spectrum Antenna: \*  
Timerange: 00/12:15:01 to 00/12:16:29

Plot file version 188 created 05-OCT-2021 17:05:12

APM08279+525 GM076.UVDATA.1

Freq = 1.5945 GHz, Bw = 32.000 MH No calibration applied and no bandpass applied

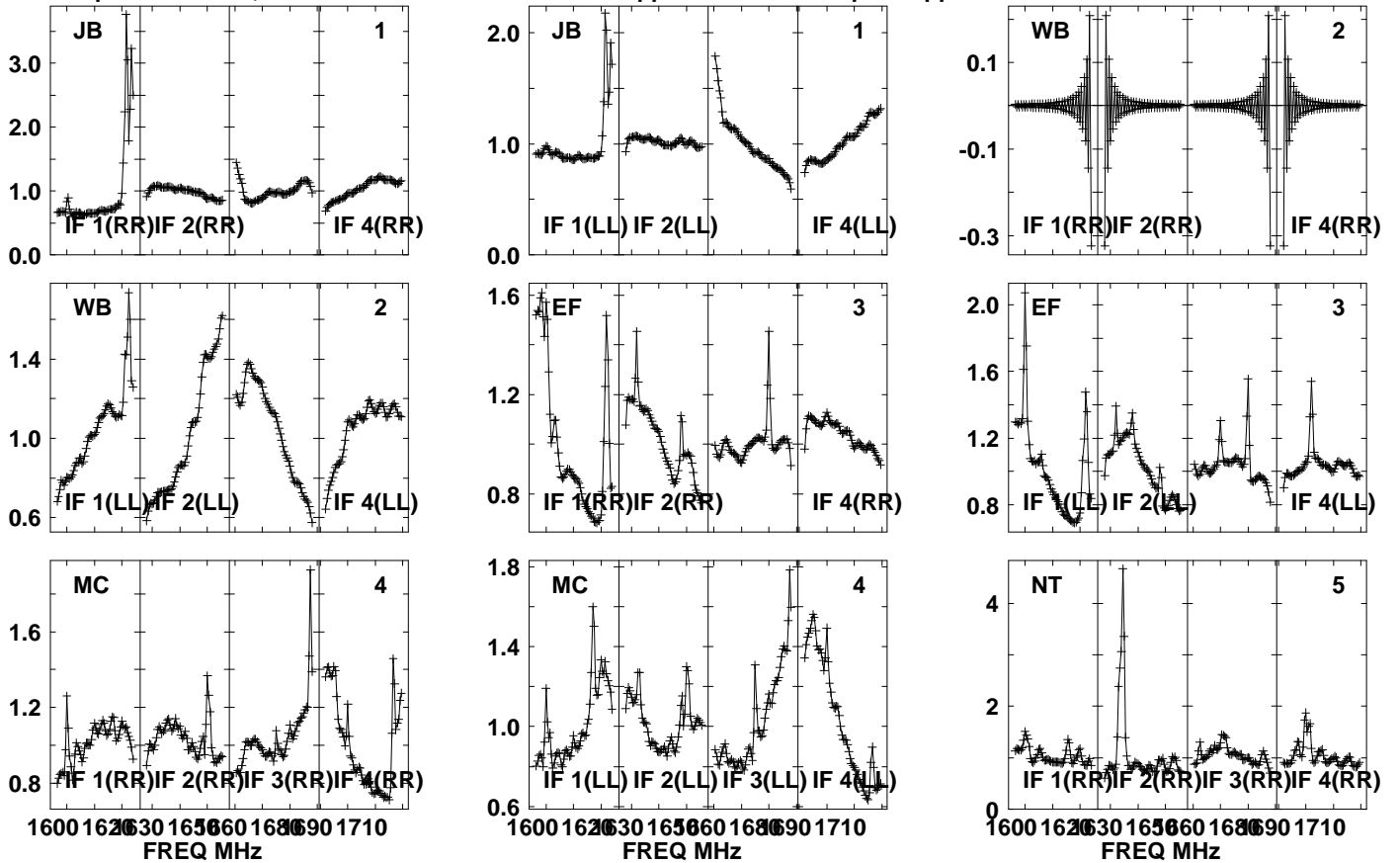

Lower frame: Real Jy  
Auto-corr total-power spectrum Antenna: \*  
Timerange: 00/12:16:31 to 00/12:19:59

Plot file version 189 created 05-OCT-2021 17:05:13

APM08279+525 GM076.UVDATA.1

Freq = 1.5945 GHz, Bw = 32.000 MH No calibration applied and no bandpass applied

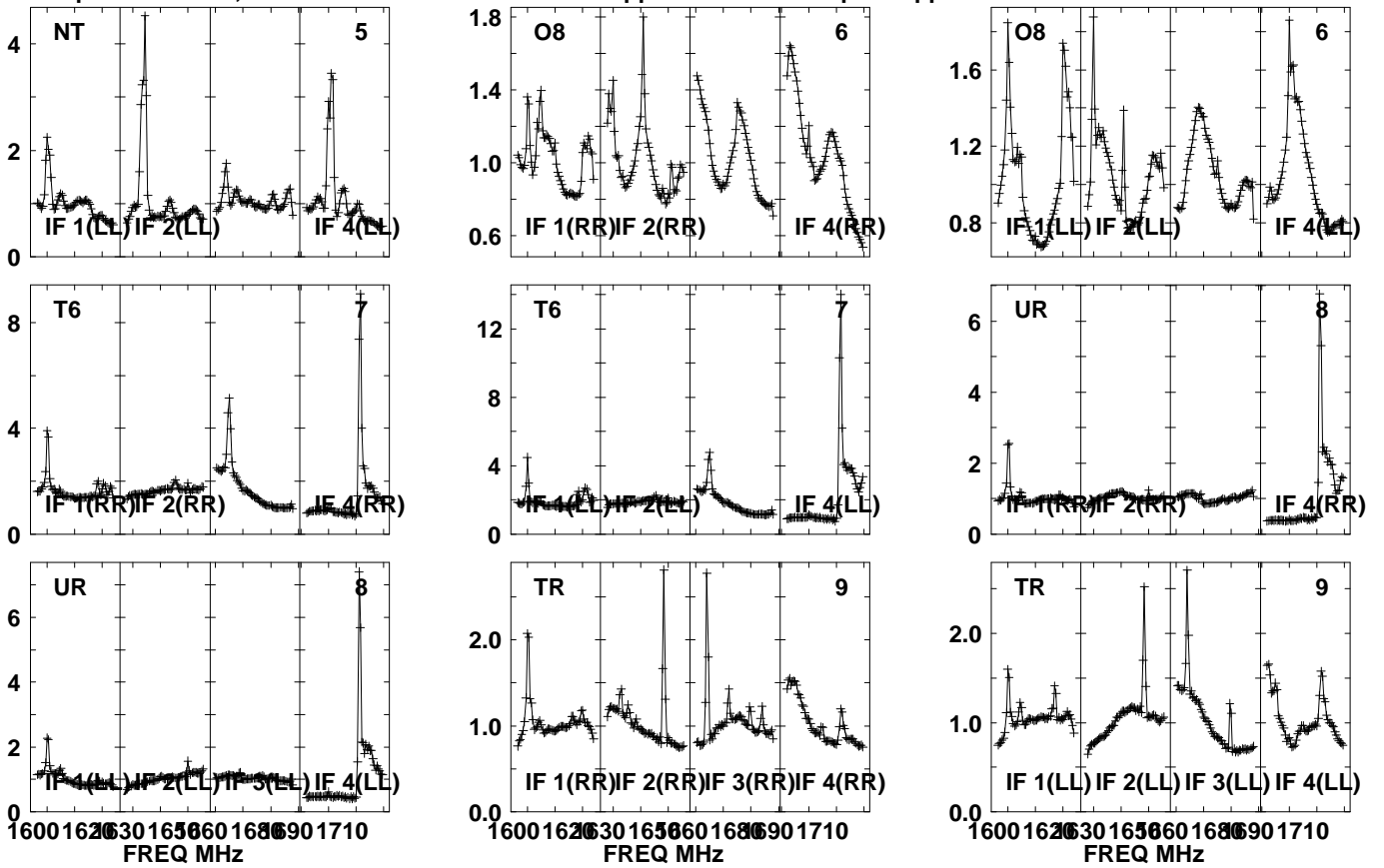

Lower frame: Real Jy  
Auto-corr total-power spectrum Antenna: \*  
Timerange: 00/12:16:31 to 00/12:19:59

Plot file version 190 created 05-OCT-2021 17:05:13

APM08279+525 GM076.UVDATA.1

Freq = 1.5945 GHz, Bw = 32.000 MH No calibration applied and no bandpass applied

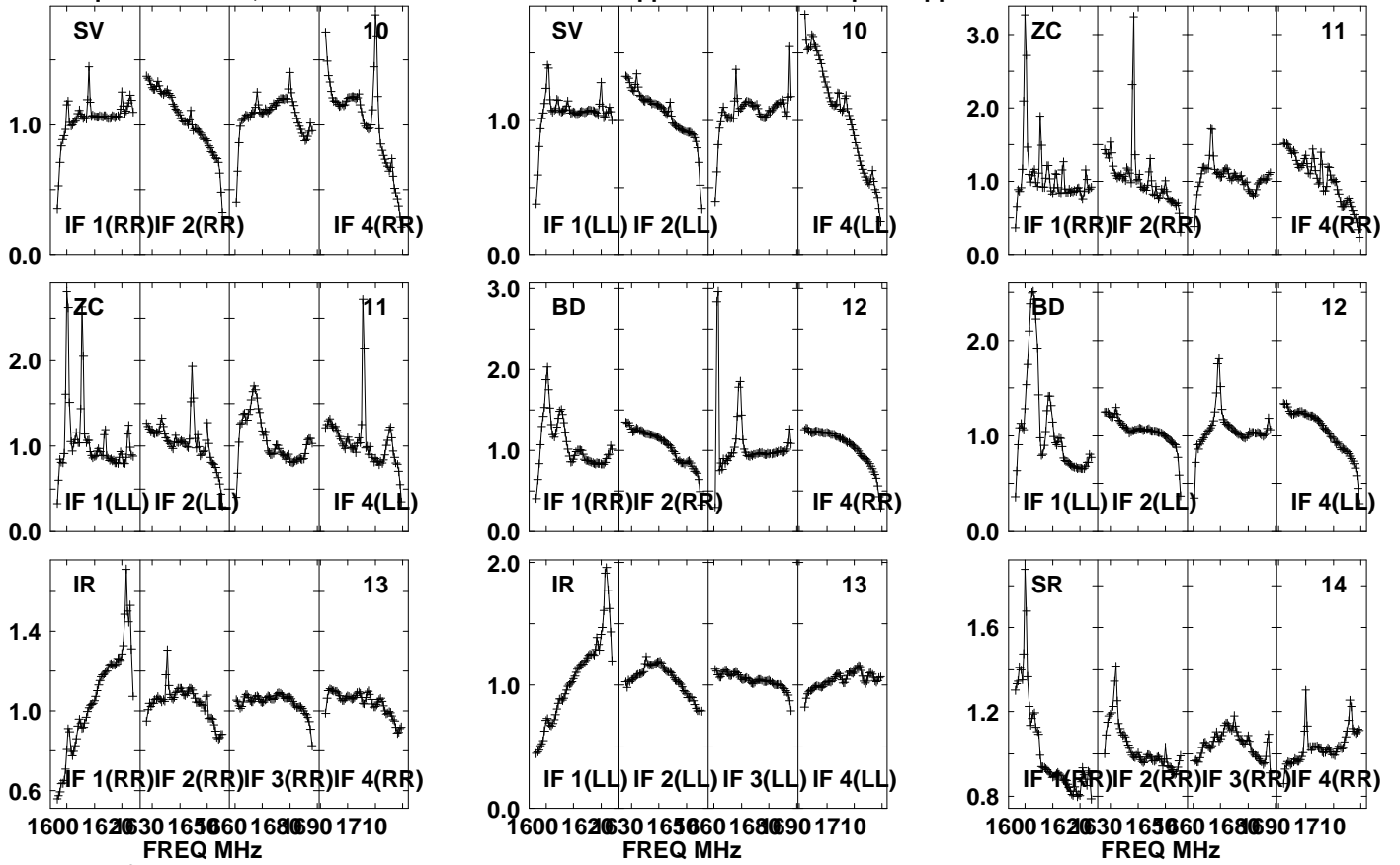

Lower frame: Real Jy

Auto-corr total-power spectrum Antenna: \*

Timerange: 00/12:16:31 to 00/12:19:59

Plot file version 191 created 05-OCT-2021 17:05:13

APM08279+525 GM076.UVDATA.1

Freq = 1.5945 GHz, Bw = 32.000 MH No calibration applied and no bandpass applied

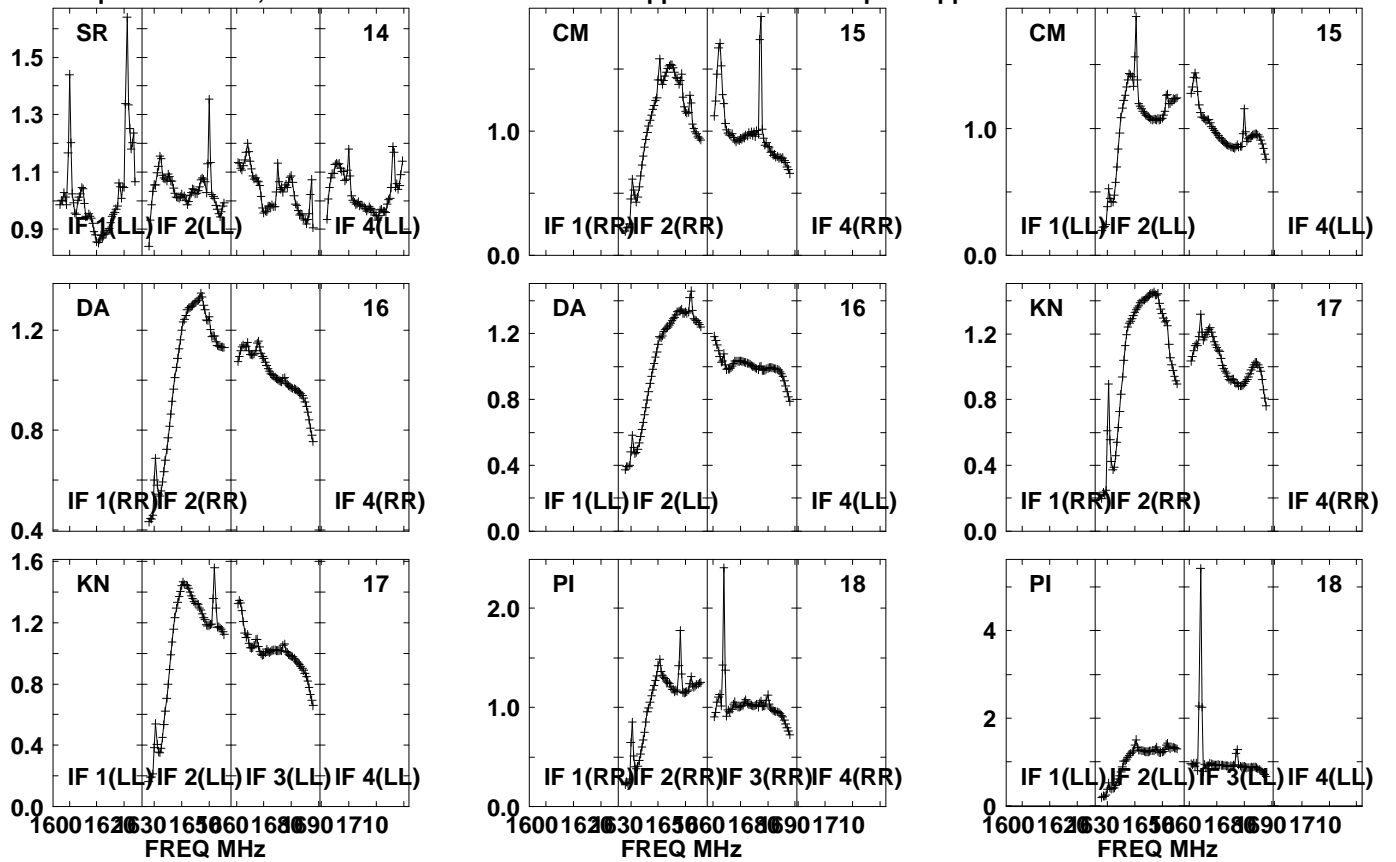

Lower frame: Real Jy  
Auto-corr total-power spectrum Antenna: \*  
Timerange: 00/12:16:31 to 00/12:19:59

Plot file version 192 created 05-OCT-2021 17:05:13

APM08279+525 GM076.UVDATA.1

Freq = 1.5945 GHz, Bw = 32.000 MH No calibration applied and no bandpass applied

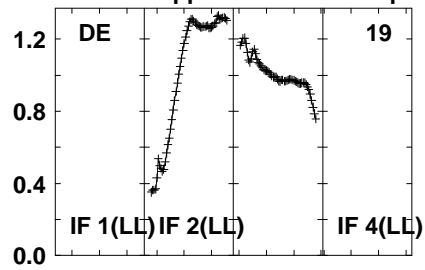
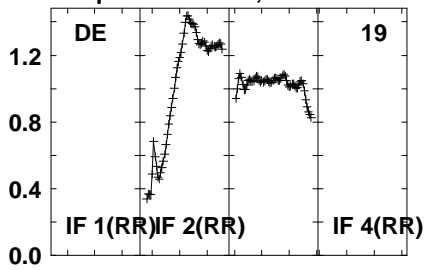

Lower frame: Real Jy  
Auto-corr total-power spectrum Antenna: \*  
Timerange: 00/12:16:31 to 00/12:19:59

Plot file version 193 created 05-OCT-2021 17:05:13

J0827+5217 GM076.UVDATA.1

Freq = 1.5945 GHz, Bw = 32.000 MH No calibration applied and no bandpass applied

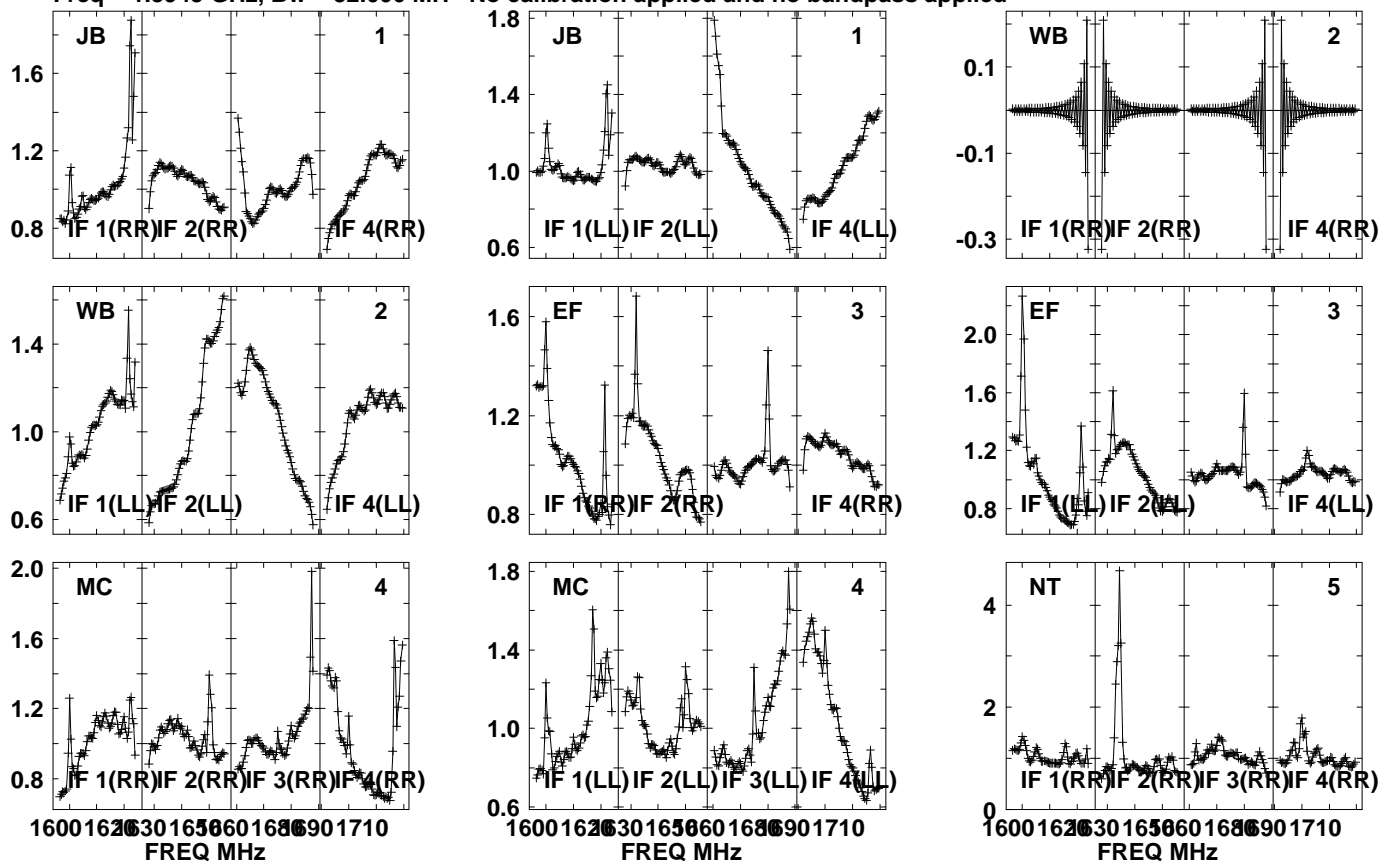

Lower frame: Real Jy  
Auto-corr total-power spectrum Antenna: \*  
Timerange: 00/12:20:31 to 00/12:21:59

Plot file version 194 created 05-OCT-2021 17:05:14

J0827+5217 GM076.UVDATA.1

Freq = 1.5945 GHz, Bw = 32.000 MH No calibration applied and no bandpass applied

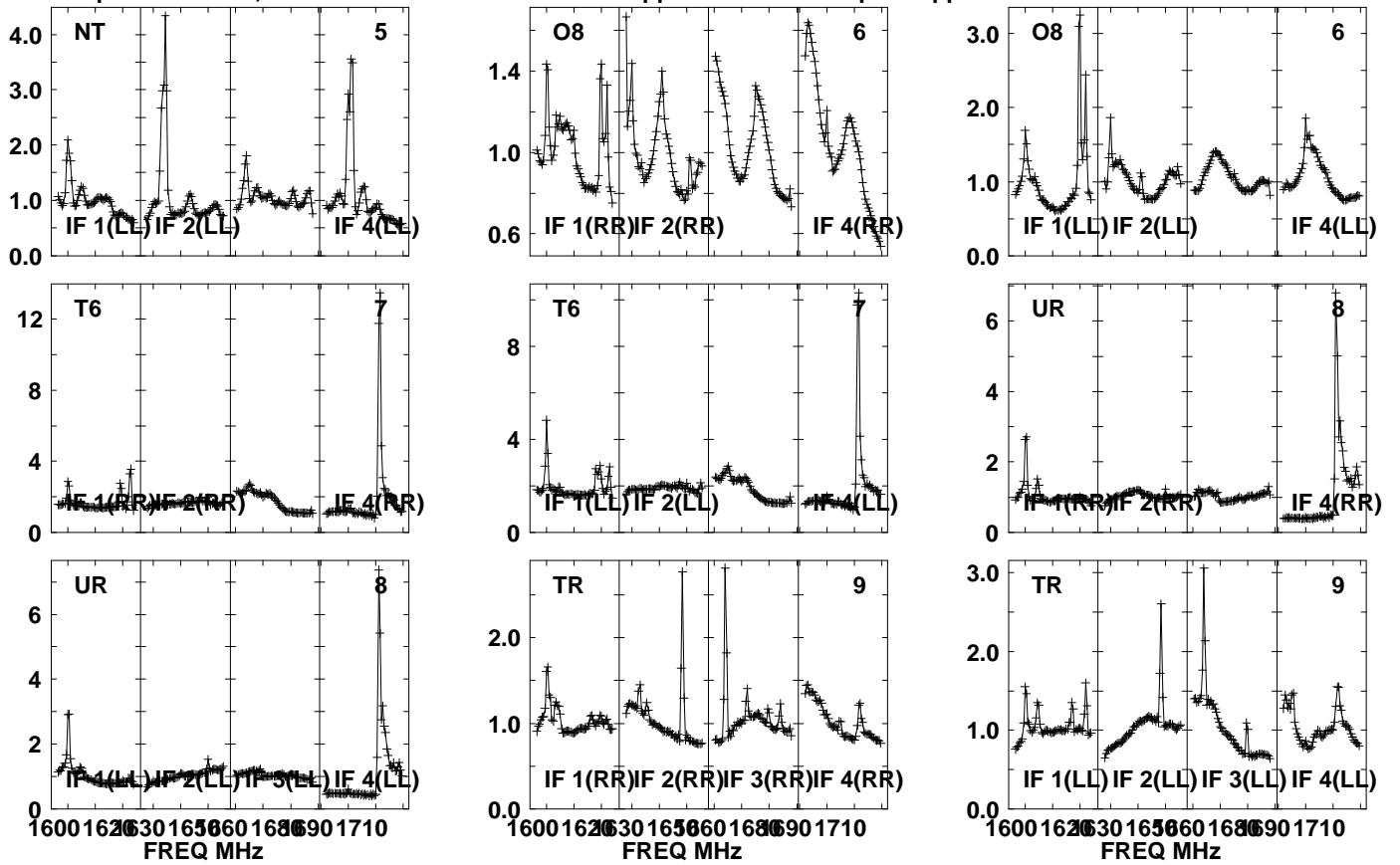

Lower frame: Real Jy

Auto-corr total-power spectrum Antenna: \*

Timerange: 00/12:20:31 to 00/12:21:59



Plot file version 195 created 05-OCT-2021 17:05:14

J0827+5217 GM076.UVDATA.1

Freq = 1.5945 GHz, Bw = 32.000 MH No calibration applied and no bandpass applied

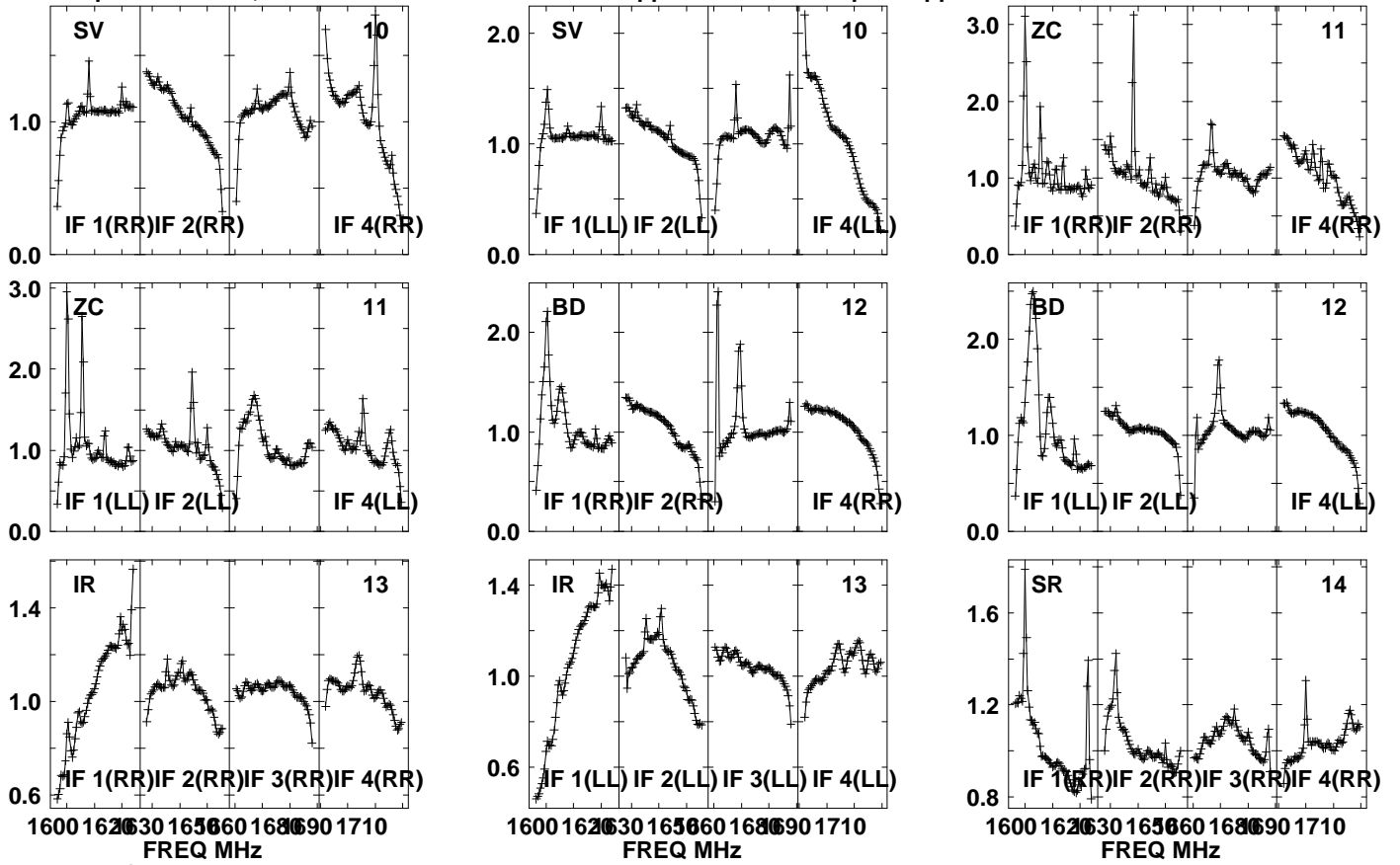

Lower frame: Real Jy  
Auto-corr total-power spectrum Antenna: \*  
Timerange: 00/12:20:31 to 00/12:21:59

Plot file version 196 created 05-OCT-2021 17:05:14

J0827+5217 GM076.UVDATA.1

Freq = 1.5945 GHz, Bw = 32.000 MH No calibration applied and no bandpass applied

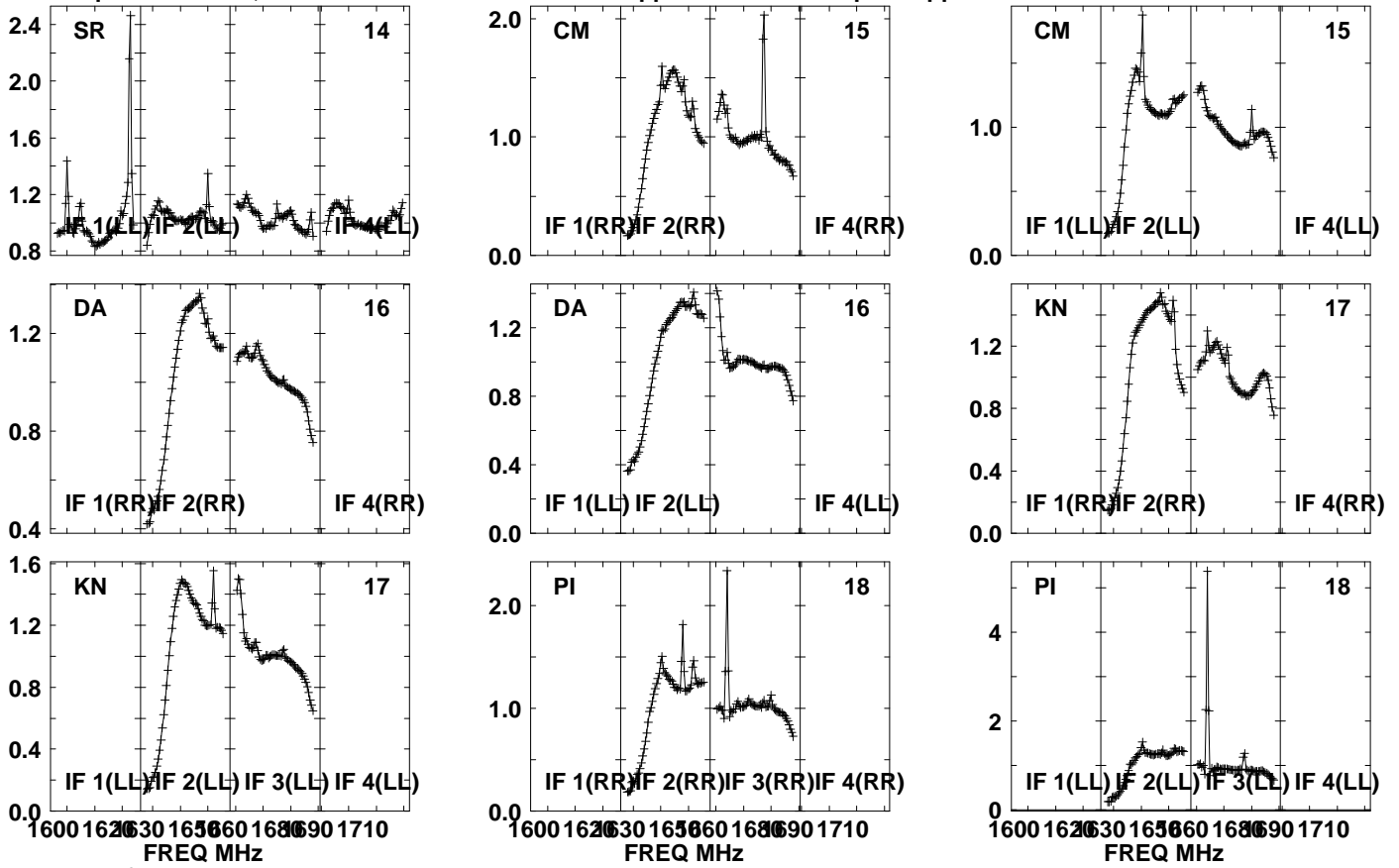

Lower frame: Real Jy

Auto-corr total-power spectrum Antenna: \*

Timerange: 00/12:20:31 to 00/12:21:59

Plot file version 197 created 05-OCT-2021 17:05:14

J0827+5217 GM076.UVDATA.1

Freq = 1.5945 GHz, Bw = 32.000 MH No calibration applied and no bandpass applied

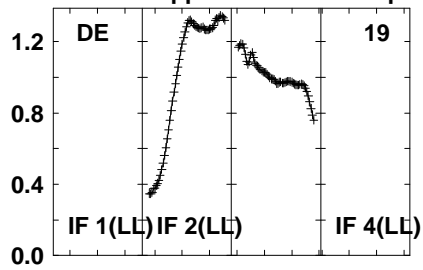
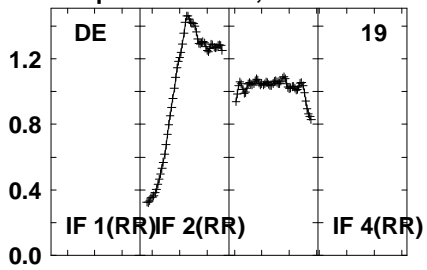

Lower frame: Real Jy  
Auto-corr total-power spectrum Antenna: \*  
Timerange: 00/12:20:31 to 00/12:21:59

Plot file version 198 created 05-OCT-2021 17:05:14

APM08279+525 GM076.UVDATA.1

Freq = 1.5945 GHz, Bw = 32.000 MH No calibration applied and no bandpass applied

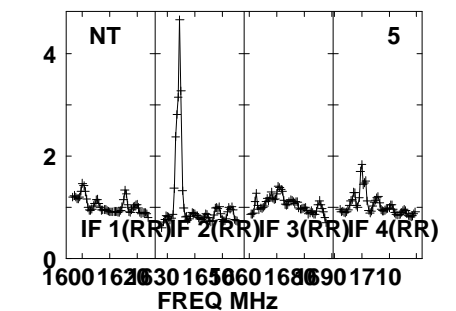
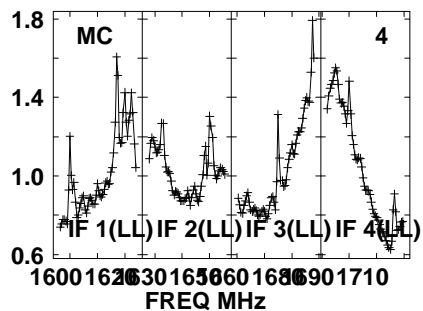
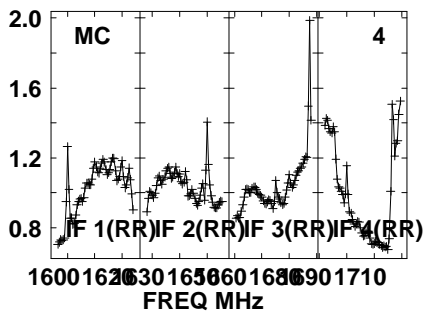
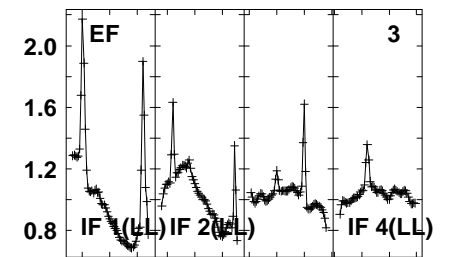
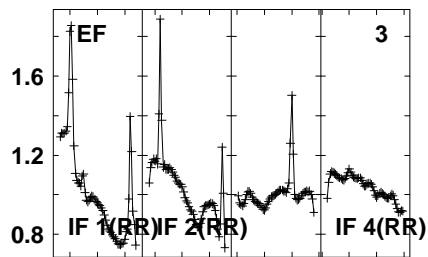
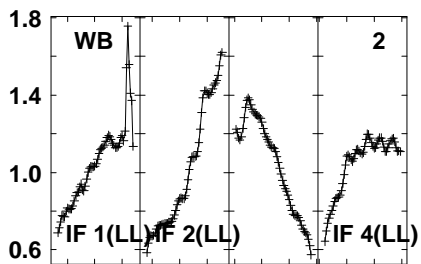
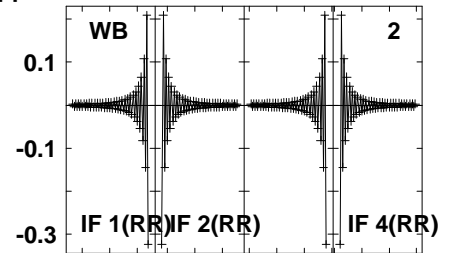
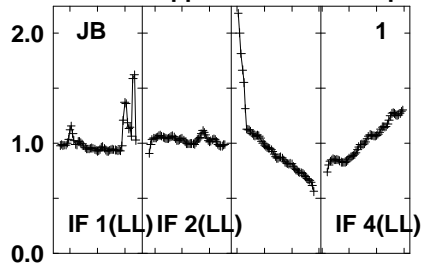
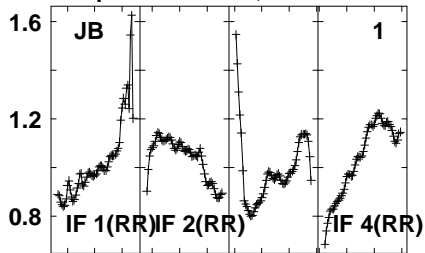

Lower frame: Real Jy  
Auto-corr total-power spectrum Antenna: \*  
Timerange: 00/12:22:01 to 00/12:25:29

Plot file version 199 created 05-OCT-2021 17:05:15

APM08279+525 GM076.UVDATA.1

Freq = 1.5945 GHz, Bw = 32.000 MH No calibration applied and no bandpass applied

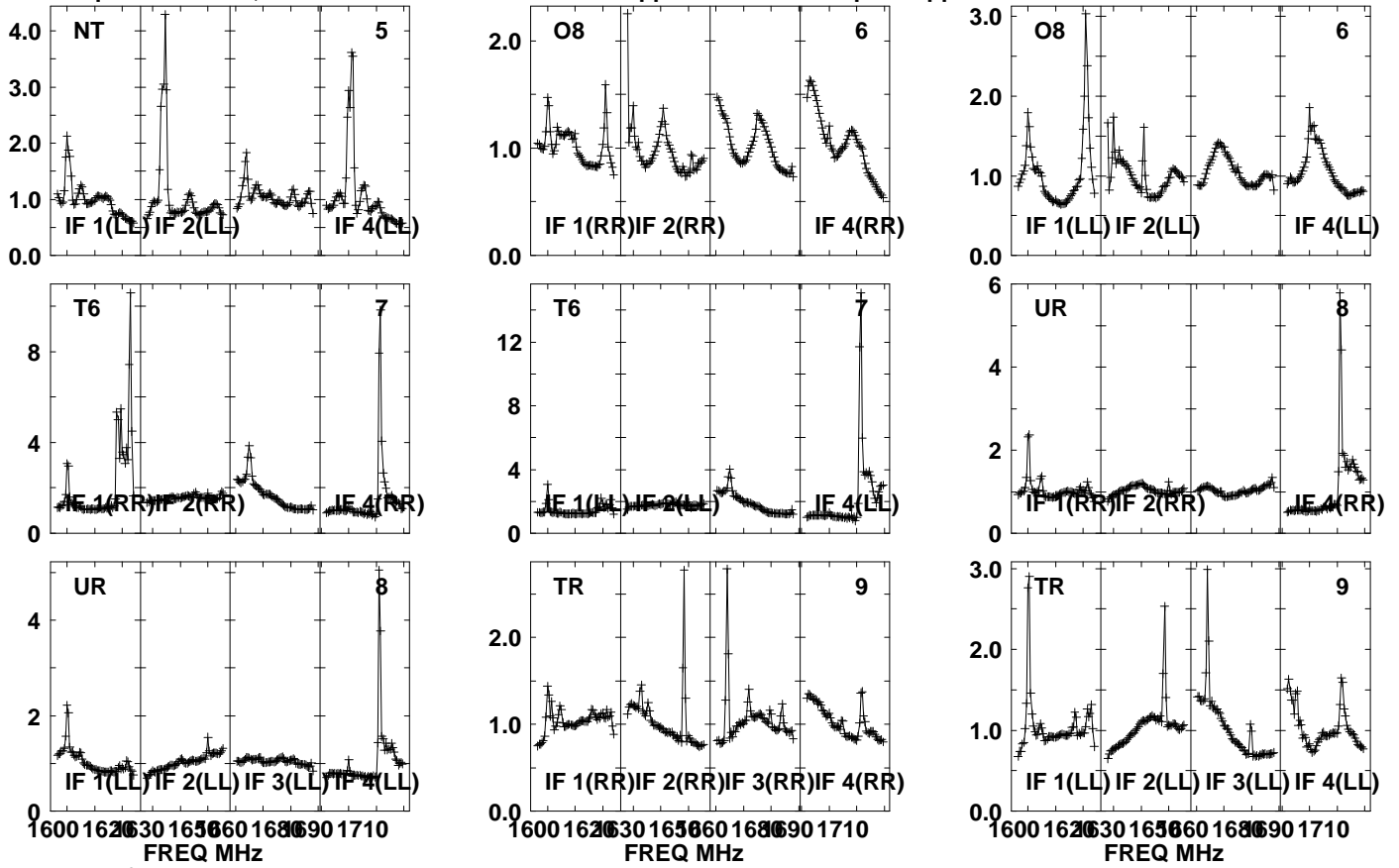

Lower frame: Real Jy  
Auto-corr total-power spectrum Antenna: \*  
Timerange: 00/12:22:01 to 00/12:25:29

Plot file version 200 created 05-OCT-2021 17:05:15

APM08279+525 GM076.UVDATA.1

Freq = 1.5945 GHz, Bw = 32.000 MH No calibration applied and no bandpass applied

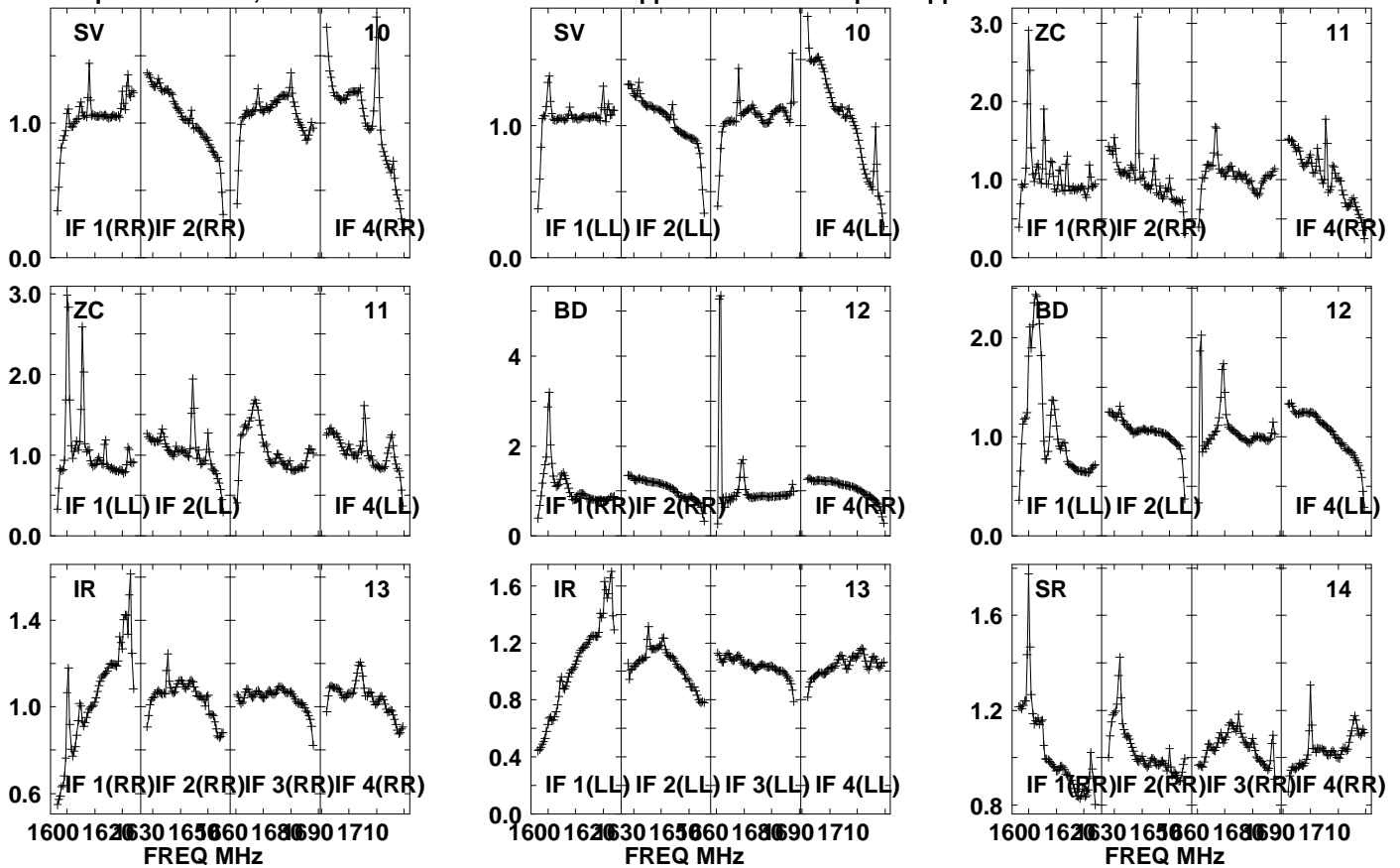

Lower frame: Real Jy

Auto-corr total-power spectrum Antenna: \*

Timerange: 00/12:22:01 to 00/12:25:29

Plot file version 201 created 05-OCT-2021 17:05:15

APM08279+525 GM076.UVDATA.1

Freq = 1.5945 GHz, Bw = 32.000 MH No calibration applied and no bandpass applied

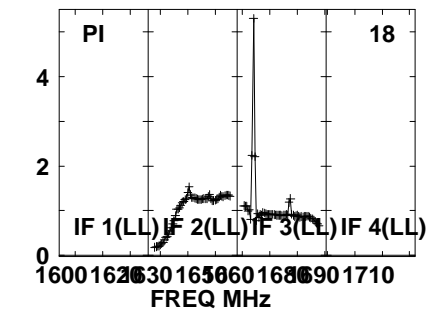
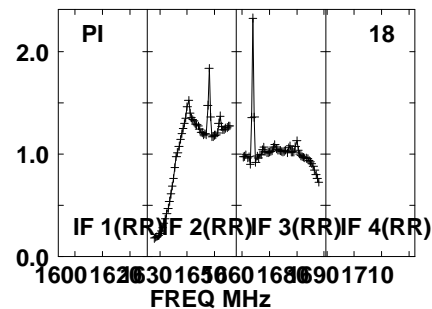
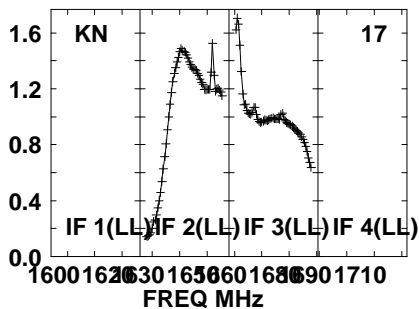
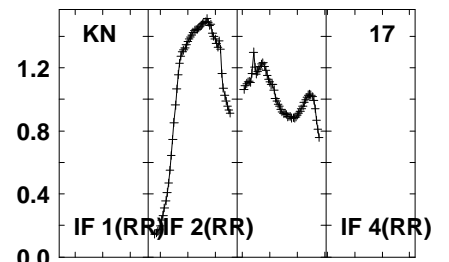
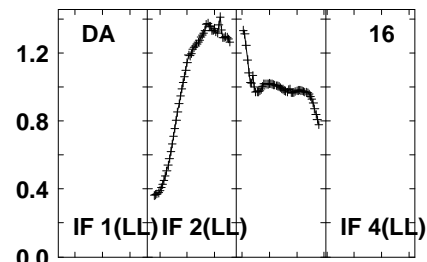
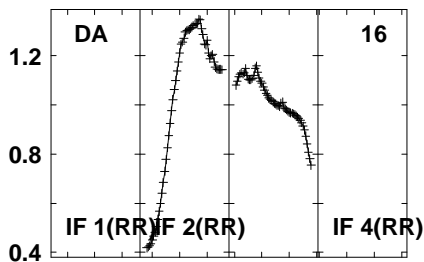
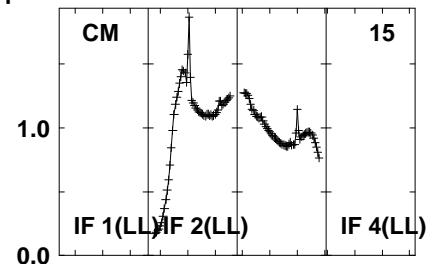
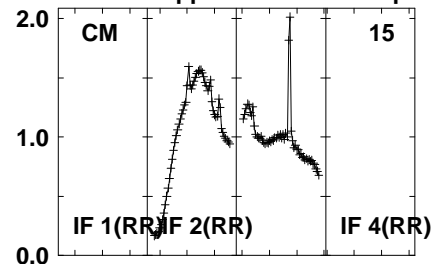
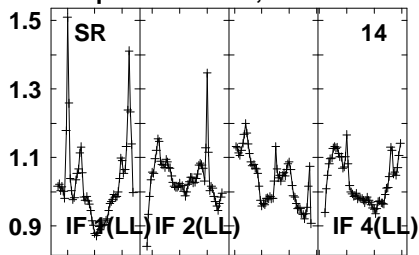

Lower frame: Real Jy  
Auto-corr total-power spectrum Antenna: \*  
Timerange: 00/12:22:01 to 00/12:25:29

Plot file version 202 created 05-OCT-2021 17:05:15

APM08279+525 GM076.UVDATA.1

Freq = 1.5945 GHz, Bw = 32.000 MH No calibration applied and no bandpass applied

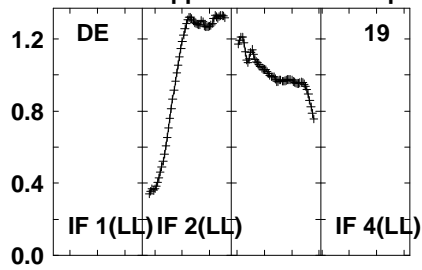
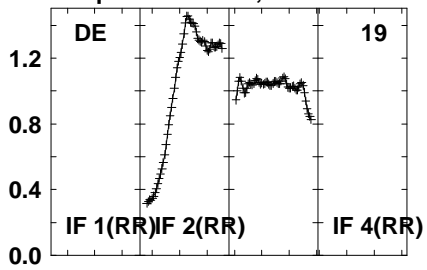

Lower frame: Real Jy  
Auto-corr total-power spectrum Antenna: \*  
Timerange: 00/12:22:01 to 00/12:25:29



Plot file version 203 created 05-OCT-2021 17:05:15

J0827+5217 GM076.UVDATA.1

Freq = 1.5945 GHz, Bw = 32.000 MH No calibration applied and no bandpass applied

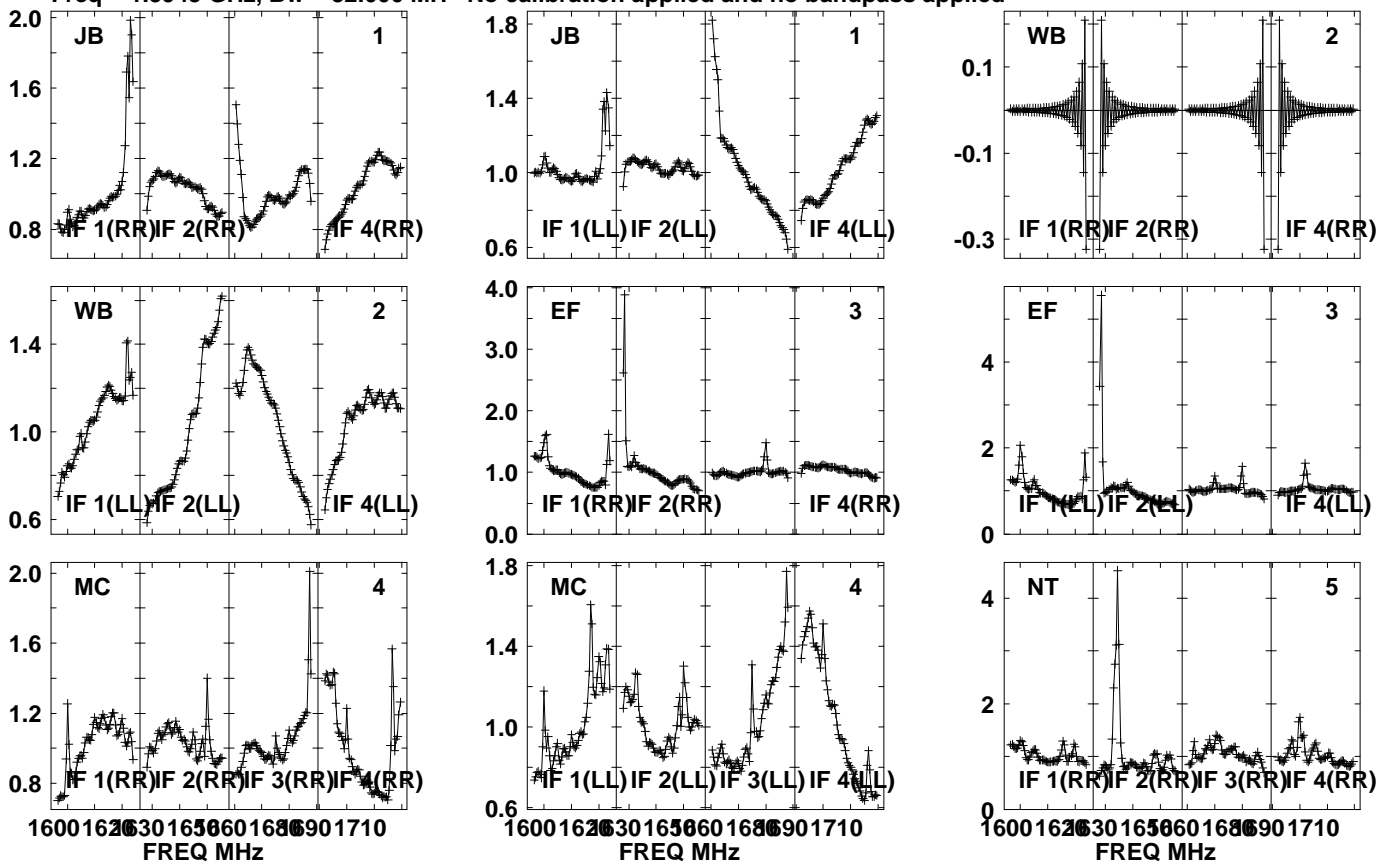

Lower frame: Real Jy  
Auto-corr total-power spectrum Antenna: \*  
Timerange: 00/12:25:31 to 00/12:26:59

Plot file version 204 created 05-OCT-2021 17:05:16

J0827+5217 GM076.UVDATA.1

Freq = 1.5945 GHz, Bw = 32.000 MH No calibration applied and no bandpass applied

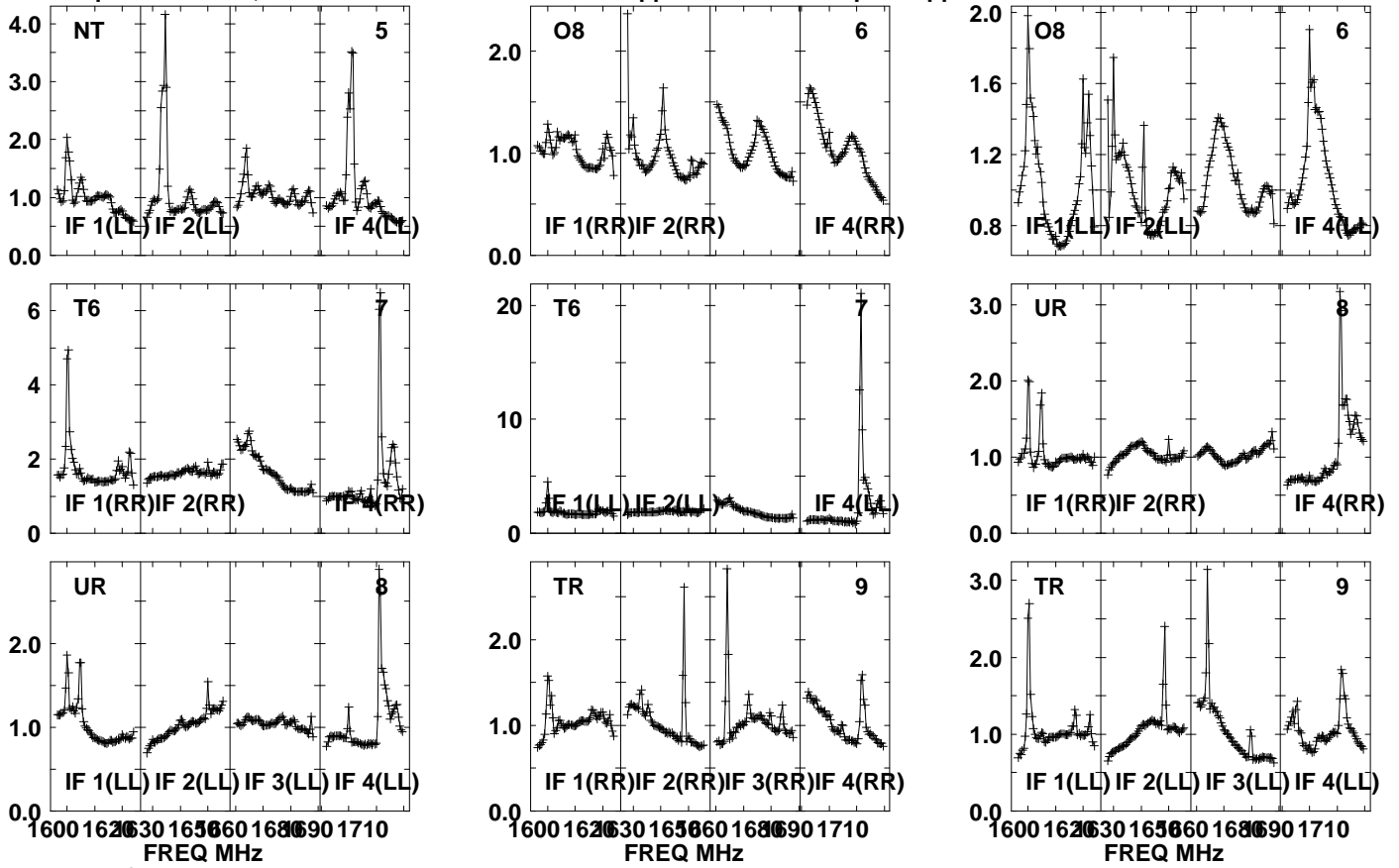

Lower frame: Real Jy  
Auto-corr total-power spectrum Antenna: \*  
Timerange: 00/12:25:31 to 00/12:26:59

Plot file version 205 created 05-OCT-2021 17:05:16

J0827+5217 GM076.UVDATA.1

Freq = 1.5945 GHz, Bw = 32.000 MH No calibration applied and no bandpass applied

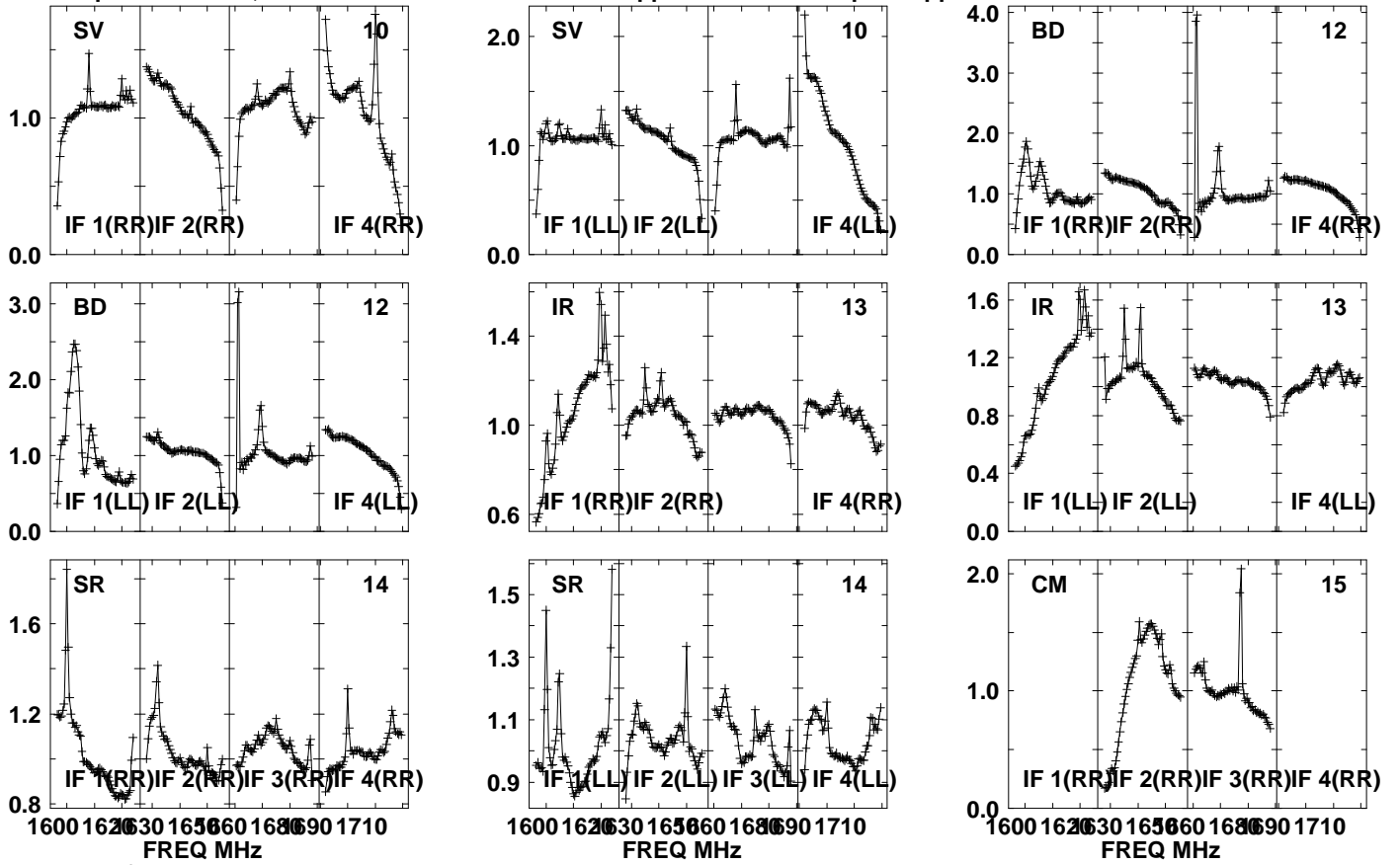

Lower frame: Real Jy  
Auto-corr total-power spectrum Antenna: \*  
Timerange: 00/12:25:31 to 00/12:26:59

Plot file version 206 created 05-OCT-2021 17:05:16

J0827+5217 GM076.UVDATA.1

Freq = 1.5945 GHz, Bw = 32.000 MH No calibration applied and no bandpass applied

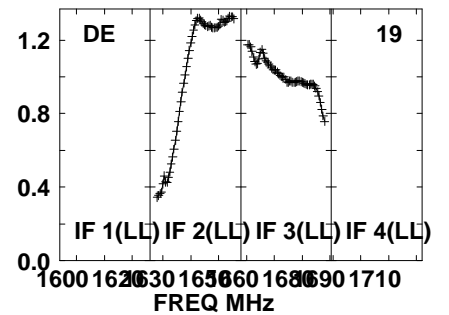
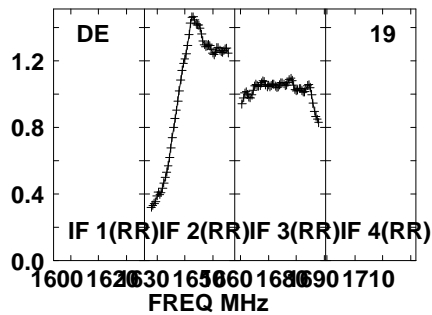
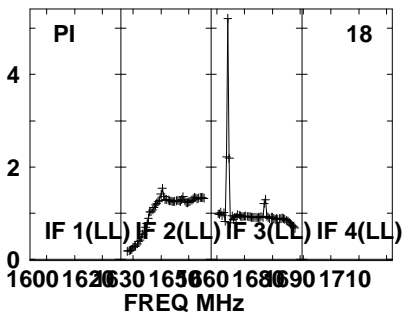
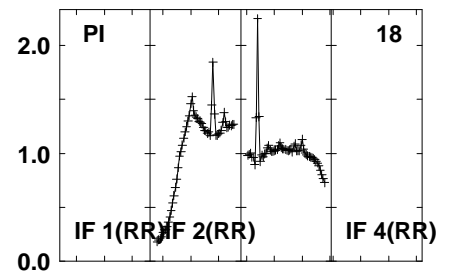
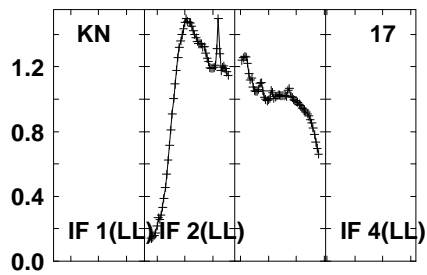
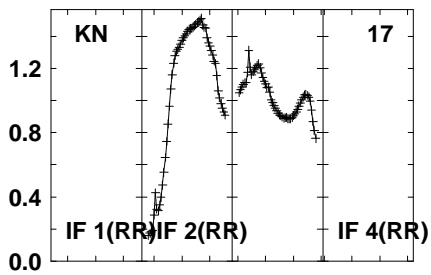
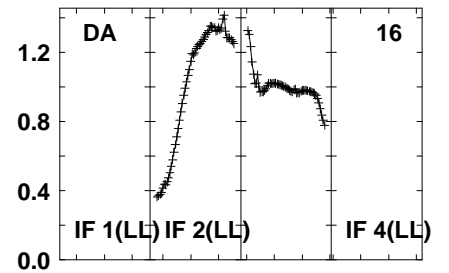
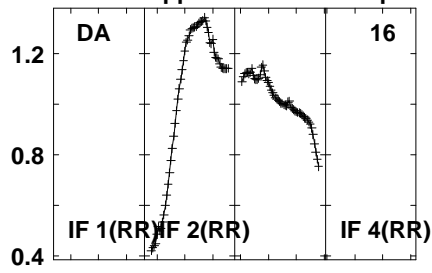
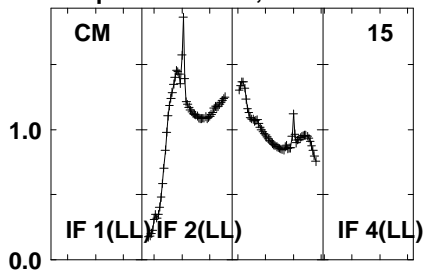

Lower frame: Real Jy

Auto-corr total-power spectrum Antenna: \*

Timerange: 00/12:25:31 to 00/12:26:59

Plot file version 207 created 05-OCT-2021 17:05:16

APM08279+525 GM076.UVDATA.1

Freq = 1.5945 GHz, Bw = 32.000 MH No calibration applied and no bandpass applied

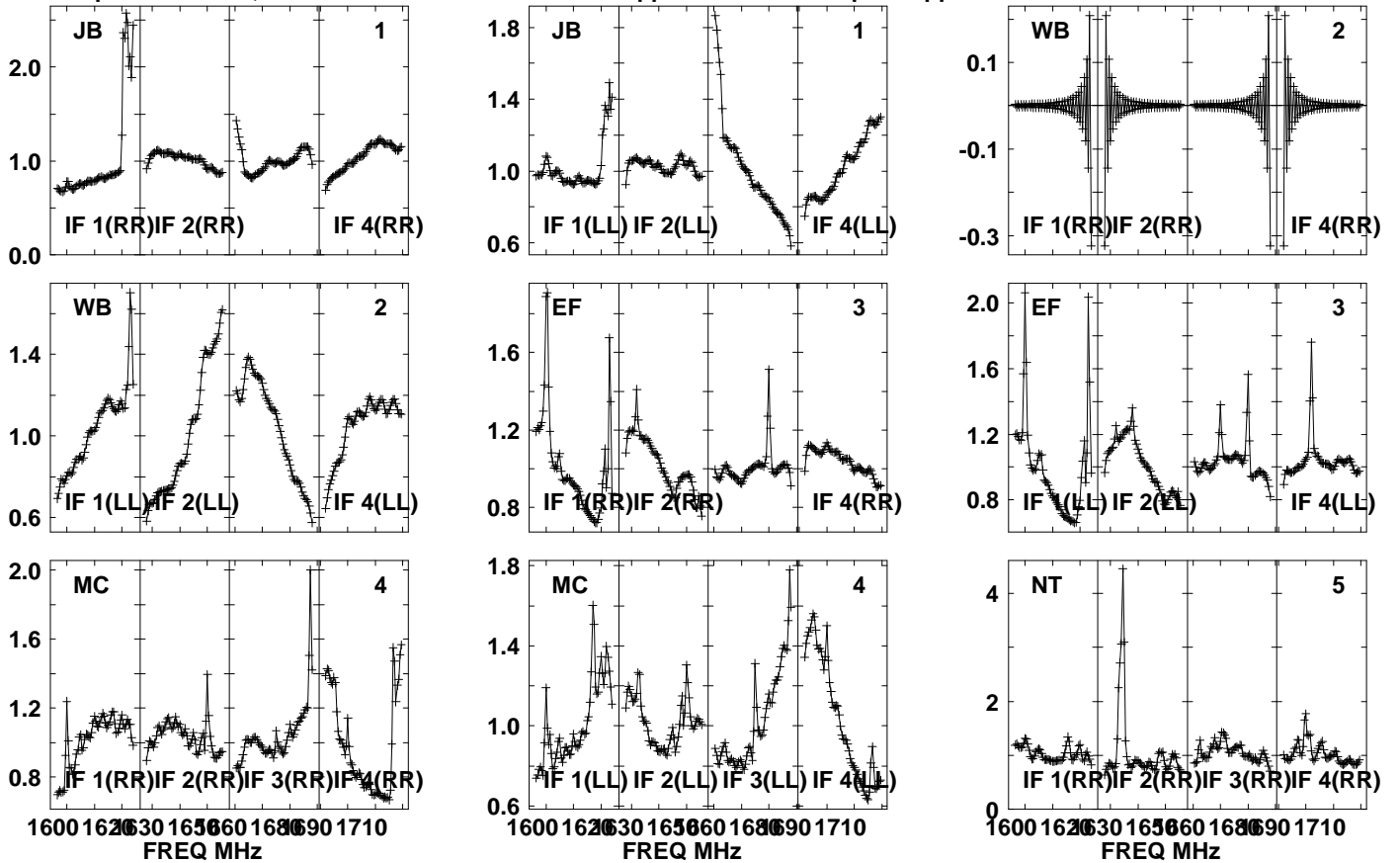

Lower frame: Real Jy

Auto-corr total-power spectrum Antenna: \*

Timerange: 00/12:27:01 to 00/12:30:29

Plot file version 208 created 05-OCT-2021 17:05:17

APM08279+525 GM076.UVDATA.1

Freq = 1.5945 GHz, Bw = 32.000 MH No calibration applied and no bandpass applied

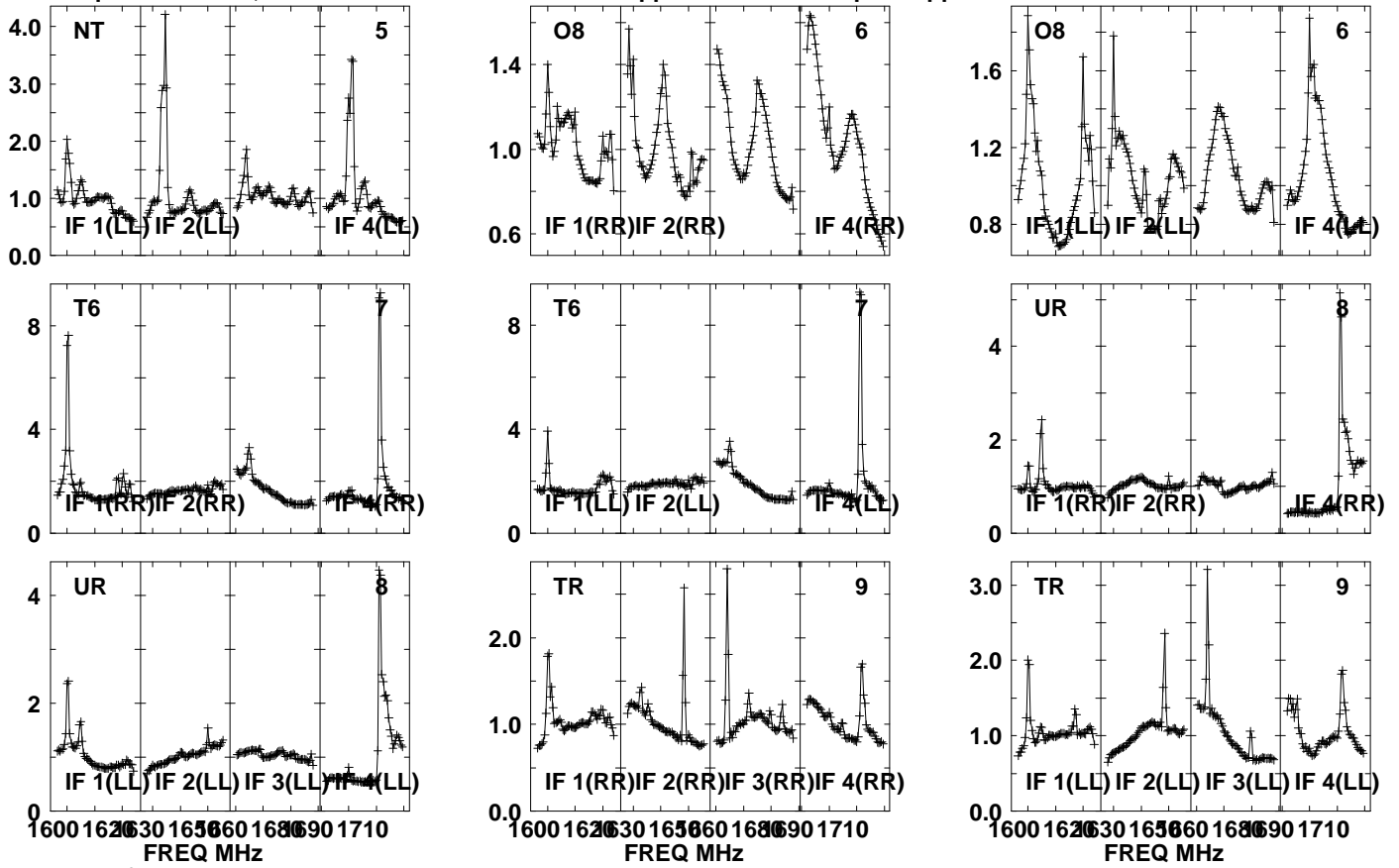

Lower frame: Real Jy

Auto-corr total-power spectrum Antenna: \*

Timerange: 00/12:27:01 to 00/12:30:29

Plot file version 209 created 05-OCT-2021 17:05:17

APM08279+525 GM076.UVDATA.1

Freq = 1.5945 GHz, Bw = 32.000 MH No calibration applied and no bandpass applied

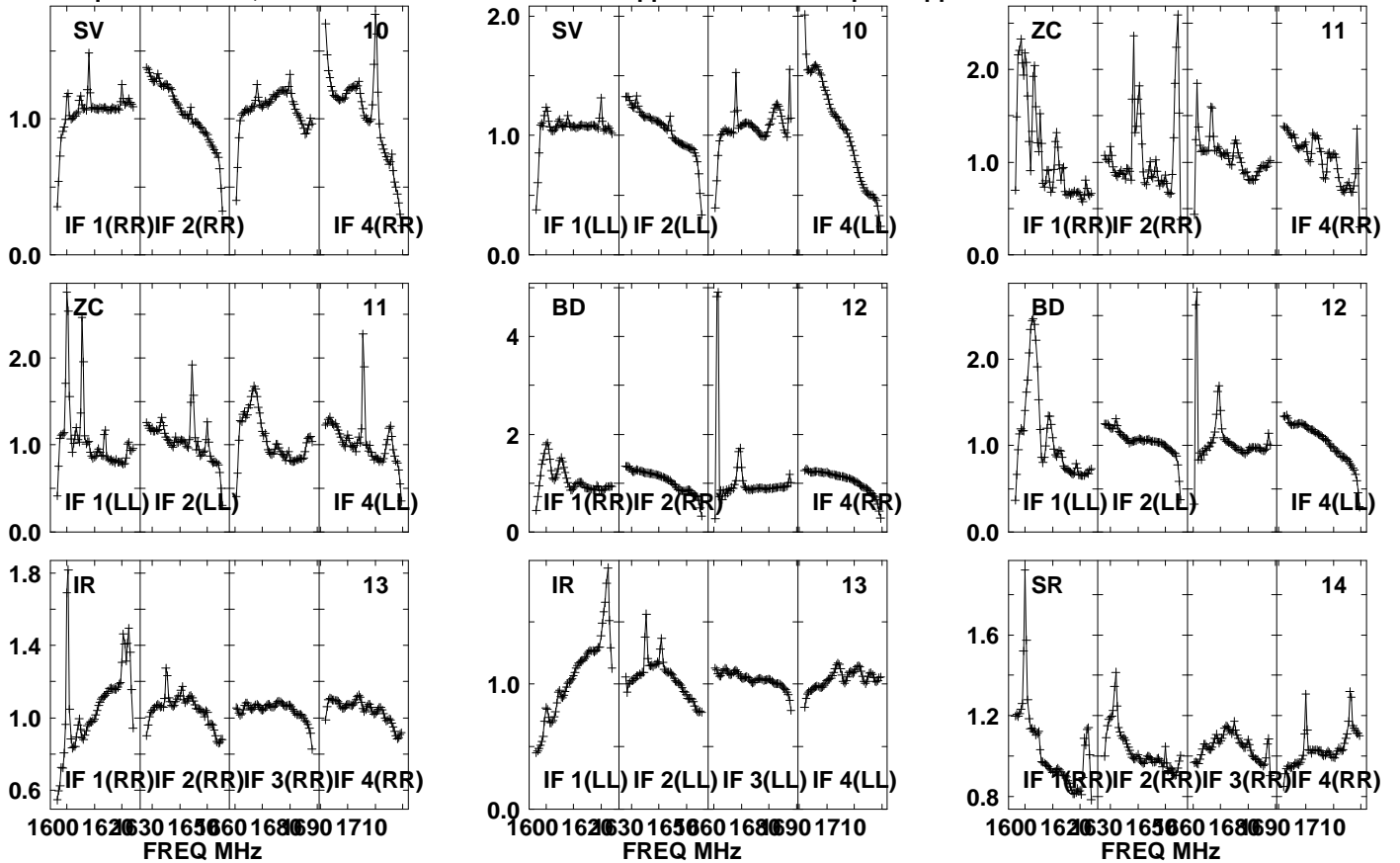

Lower frame: Real Jy  
Auto-corr total-power spectrum Antenna: \*  
Timerange: 00/12:27:01 to 00/12:30:29

Plot file version 210 created 05-OCT-2021 17:05:17

APM08279+525 GM076.UVDATA.1

Freq = 1.5945 GHz, Bw = 32.000 MH No calibration applied and no bandpass applied

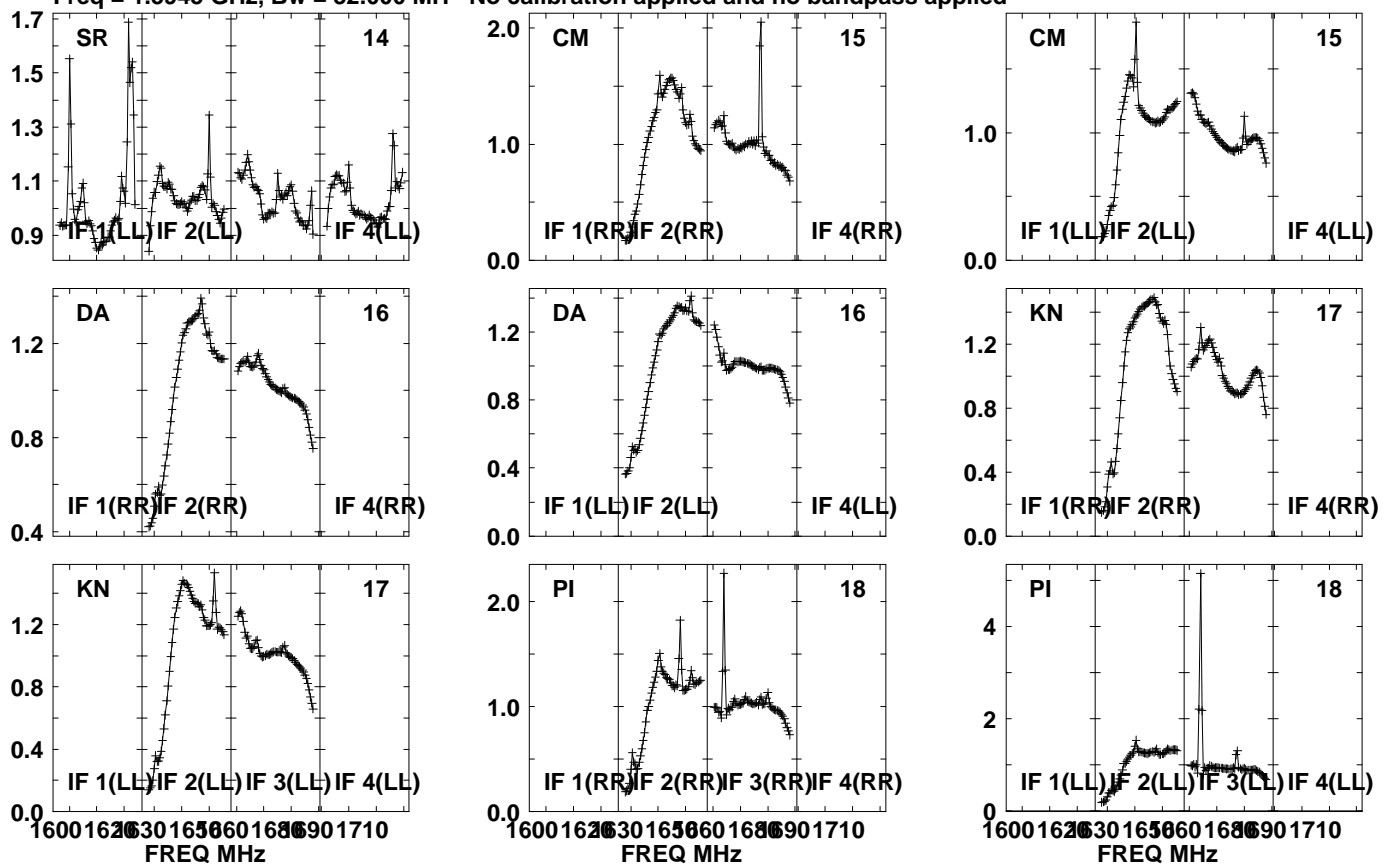

Lower frame: Real Jy  
Auto-corr total-power spectrum Antenna: \*  
Timerange: 00/12:27:01 to 00/12:30:29



Plot file version 211 created 05-OCT-2021 17:05:17

APM08279+525 GM076.UVDATA.1

Freq = 1.5945 GHz, Bw = 32.000 MH No calibration applied and no bandpass applied

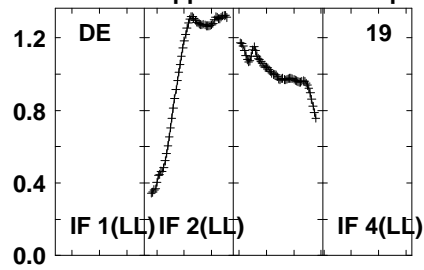
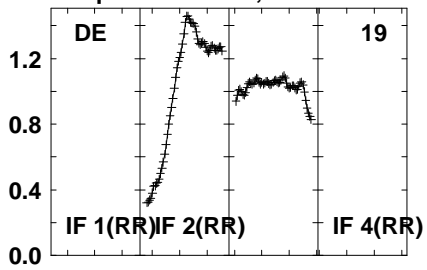

Lower frame: Real Jy  
Auto-corr total-power spectrum Antenna: \*  
Timerange: 00/12:27:01 to 00/12:30:29

Plot file version 212 created 05-OCT-2021 17:05:17

J0827+5217 GM076.UVDATA.1

Freq = 1.5945 GHz, Bw = 32.000 MH No calibration applied and no bandpass applied

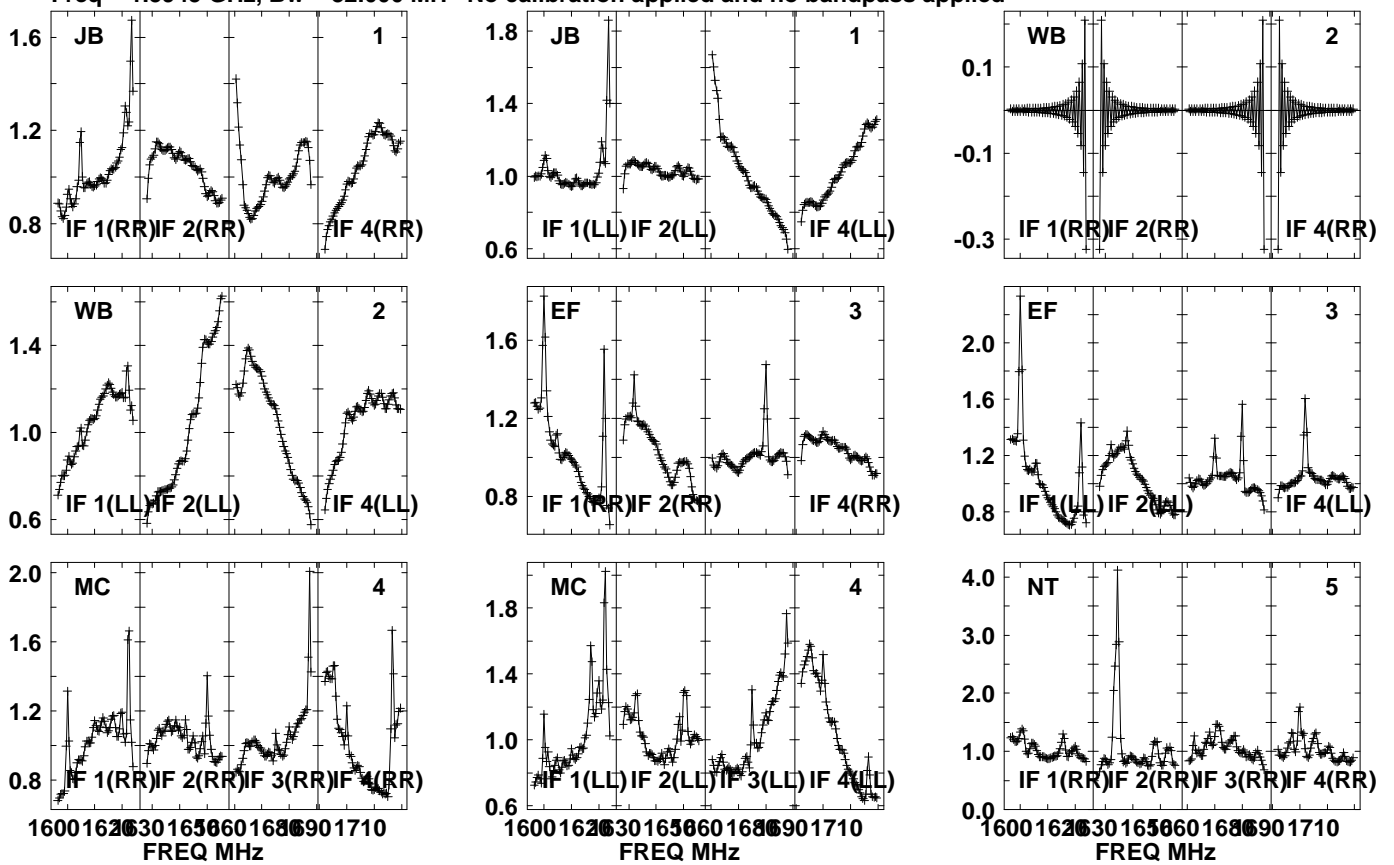

Lower frame: Real Jy  
Auto-corr total-power spectrum Antenna: \*  
Timerange: 00/12:31:01 to 00/12:32:29

Plot file version 213 created 05-OCT-2021 17:05:18

J0827+5217 GM076.UVDATA.1

Freq = 1.5945 GHz, Bw = 32.000 MH No calibration applied and no bandpass applied

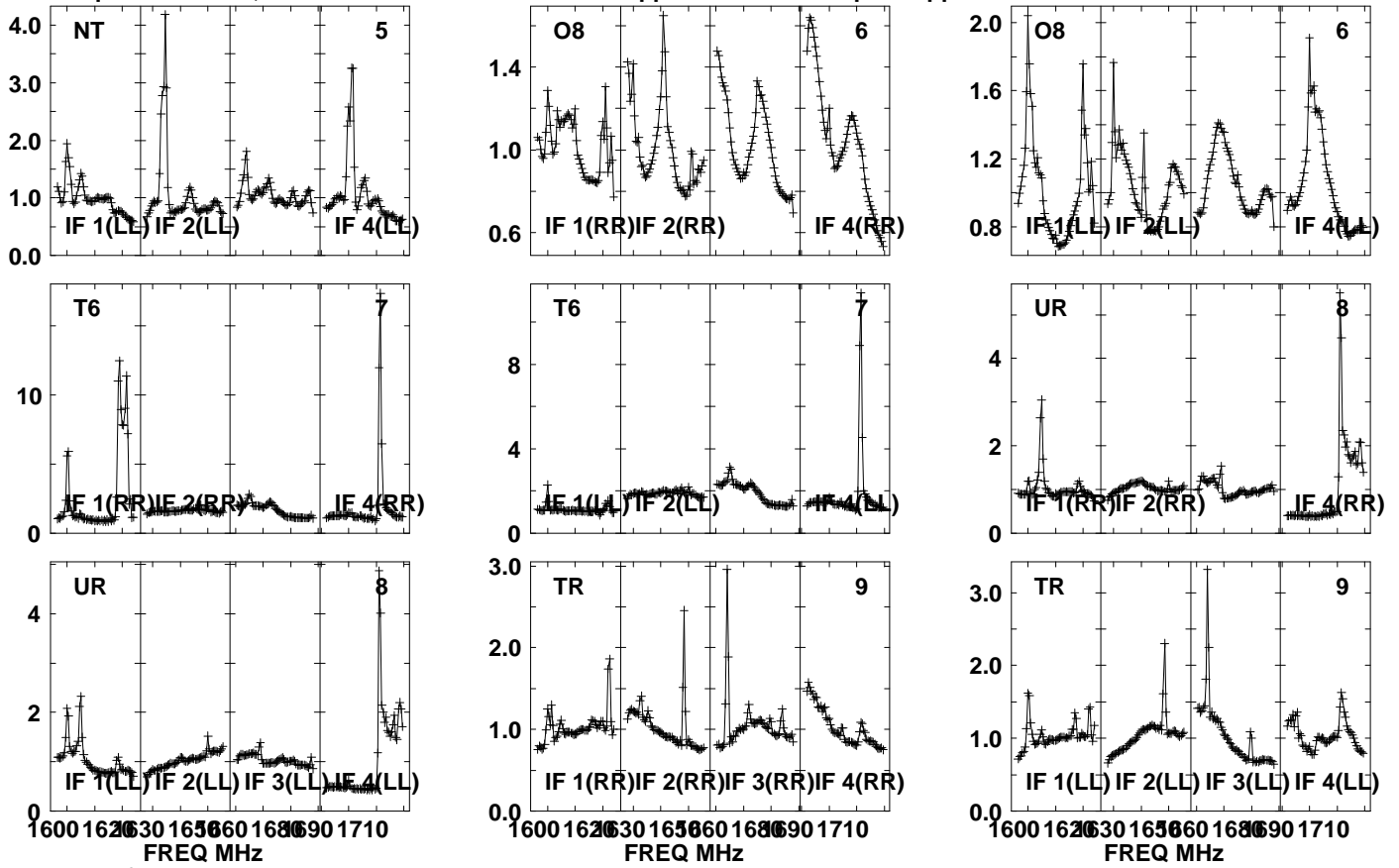

Lower frame: Real Jy  
Auto-corr total-power spectrum Antenna: \*  
Timerange: 00/12:31:01 to 00/12:32:29

Plot file version 214 created 05-OCT-2021 17:05:18

J0827+5217 GM076.UVDATA.1

Freq = 1.5945 GHz, Bw = 32.000 MH No calibration applied and no bandpass applied

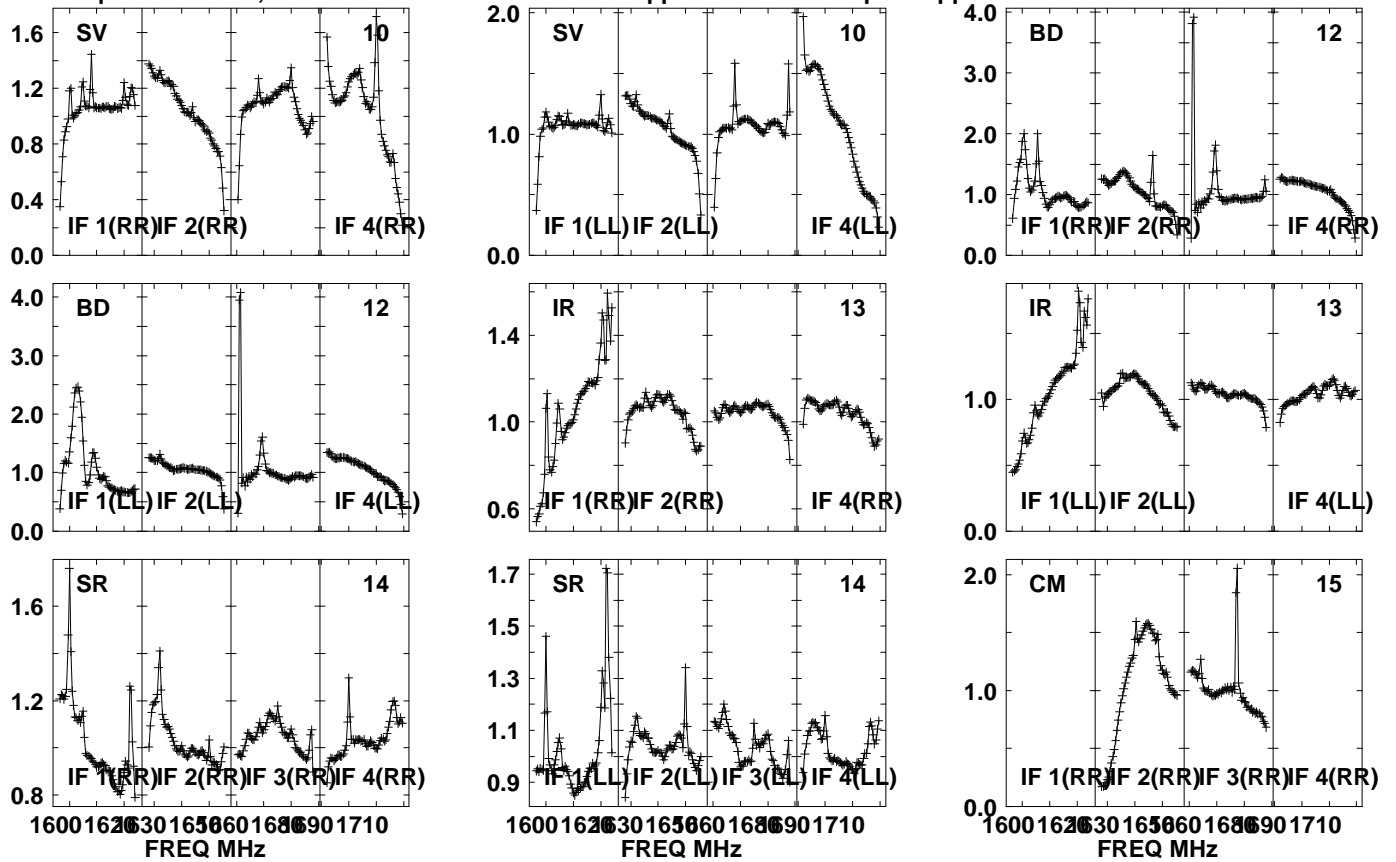

Lower frame: Real Jy  
Auto-corr total-power spectrum Antenna: \*  
Timerange: 00/12:31:01 to 00/12:32:29

Plot file version 215 created 05-OCT-2021 17:05:18

J0827+5217 GM076.UVDATA.1

Freq = 1.5945 GHz, Bw = 32.000 MH No calibration applied and no bandpass applied

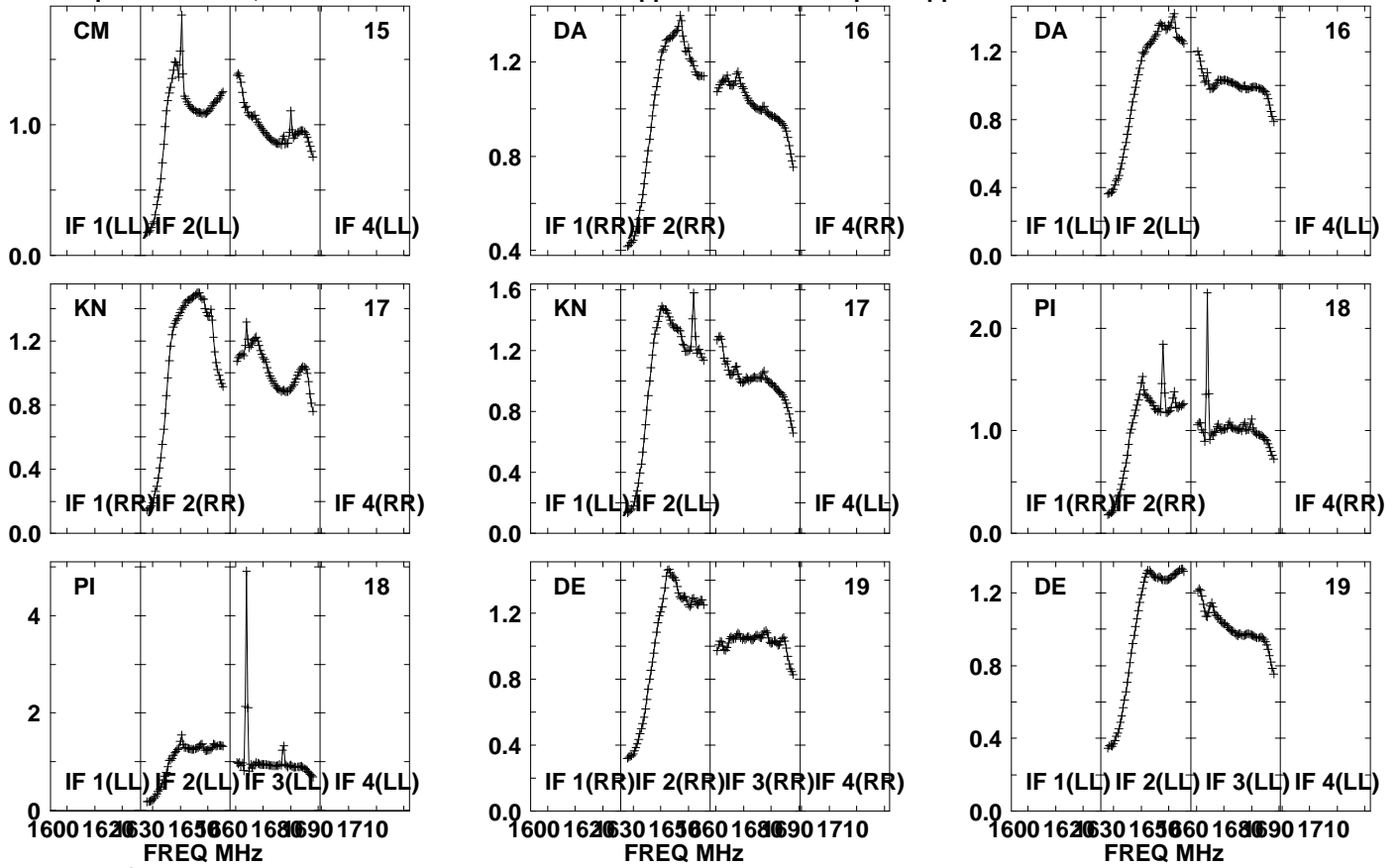

Lower frame: Real Jy  
Auto-corr total-power spectrum Antenna: \*  
Timerange: 00/12:31:01 to 00/12:32:29

Plot file version 216 created 05-OCT-2021 17:05:18

APM08279+525 GM076.UVDATA.1

Freq = 1.5945 GHz, Bw = 32.000 MH No calibration applied and no bandpass applied

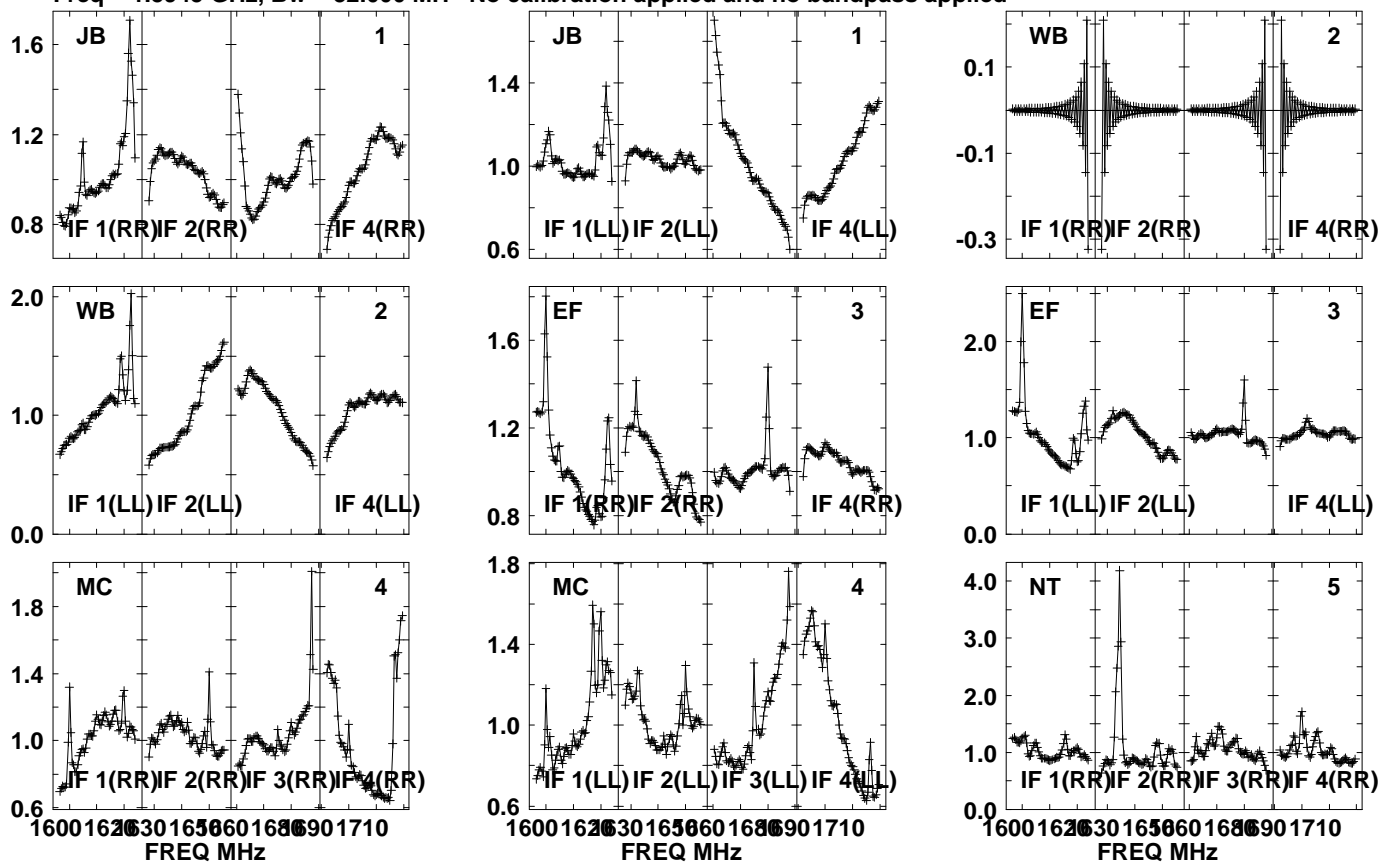

Lower frame: Real Jy  
Auto-corr total-power spectrum Antenna: \*  
Timerange: 00/12:32:31 to 00/12:35:59

Plot file version 217 created 05-OCT-2021 17:05:18

APM08279+525 GM076.UVDATA.1

Freq = 1.5945 GHz, Bw = 32.000 MH No calibration applied and no bandpass applied

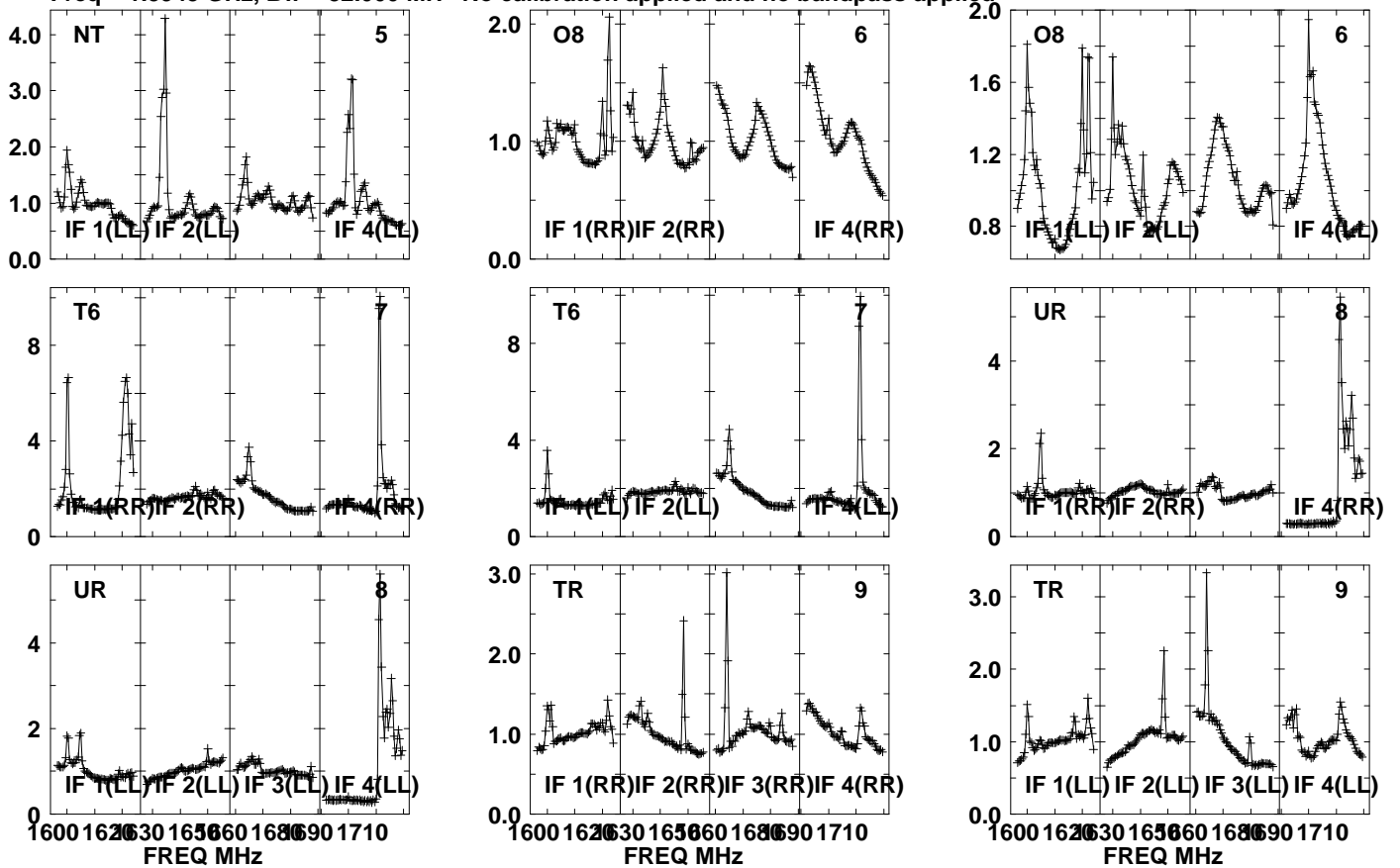

Lower frame: Real Jy  
Auto-corr total-power spectrum Antenna: \*  
Timerange: 00/12:32:31 to 00/12:35:59

Plot file version 218 created 05-OCT-2021 17:05:19

APM08279+525 GM076.UVDATA.1

Freq = 1.5945 GHz, Bw = 32.000 MH No calibration applied and no bandpass applied

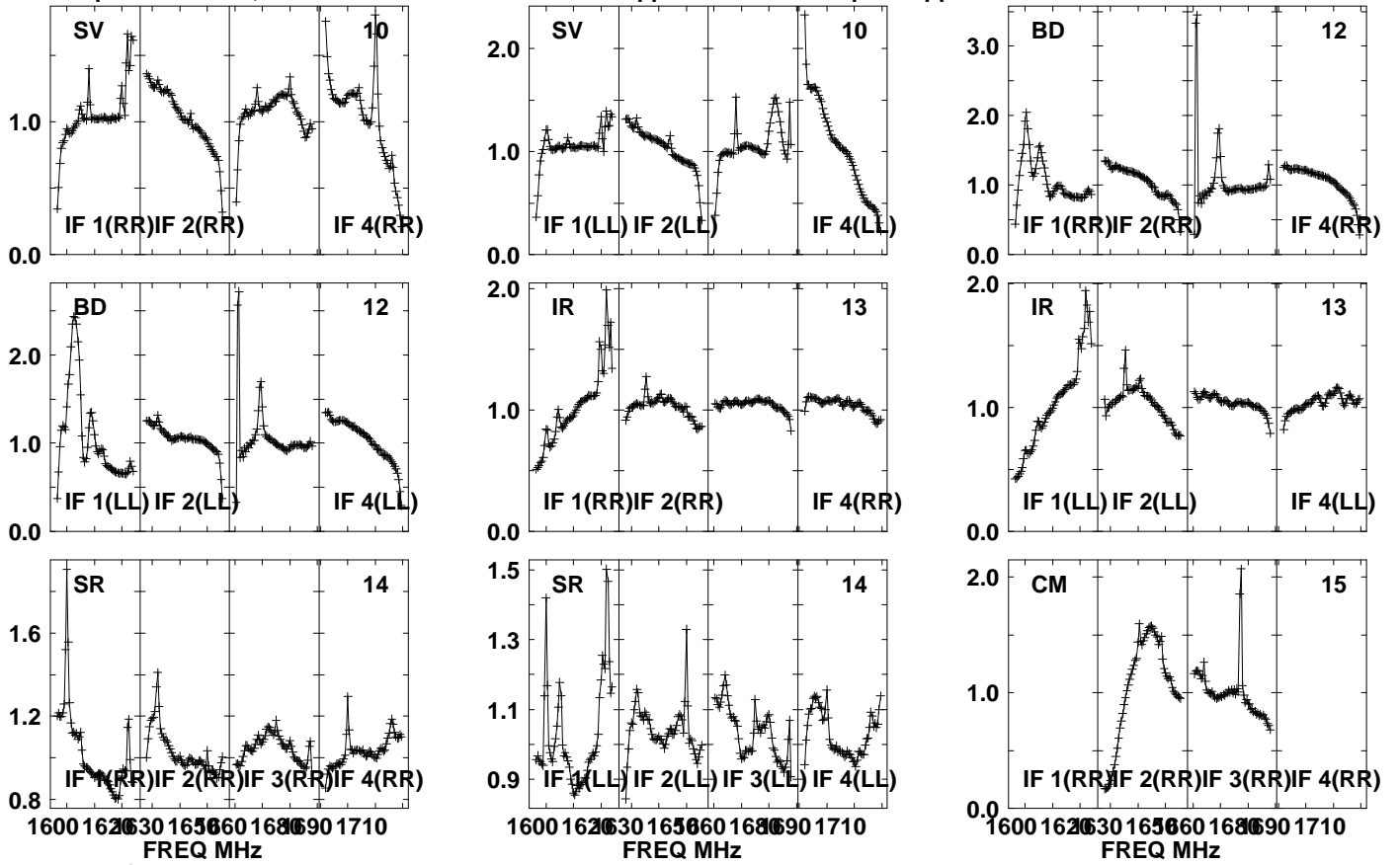

Lower frame: Real Jy  
Auto-corr total-power spectrum Antenna: \*  
Timerange: 00/12:32:31 to 00/12:35:59



Plot file version 219 created 05-OCT-2021 17:05:19

APM08279+525 GM076.UVDATA.1

Freq = 1.5945 GHz, Bw = 32.000 MH No calibration applied and no bandpass applied

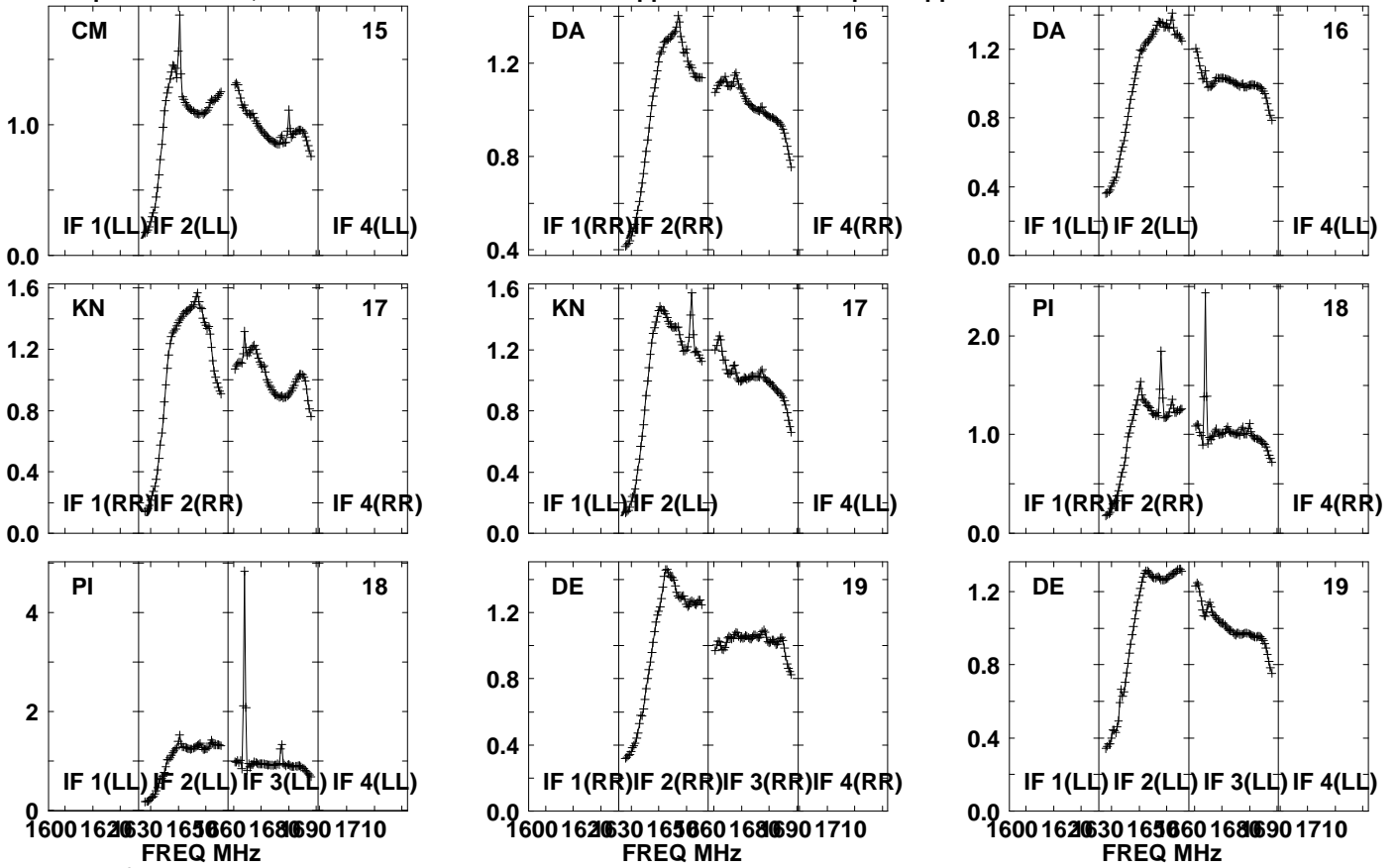

Lower frame: Real Jy  
Auto-corr total-power spectrum Antenna: \*  
Timerange: 00/12:32:31 to 00/12:35:59

Plot file version 220 created 05-OCT-2021 17:05:19

J0827+5217 GM076.UVDATA.1

Freq = 1.5945 GHz, Bw = 32.000 MH No calibration applied and no bandpass applied

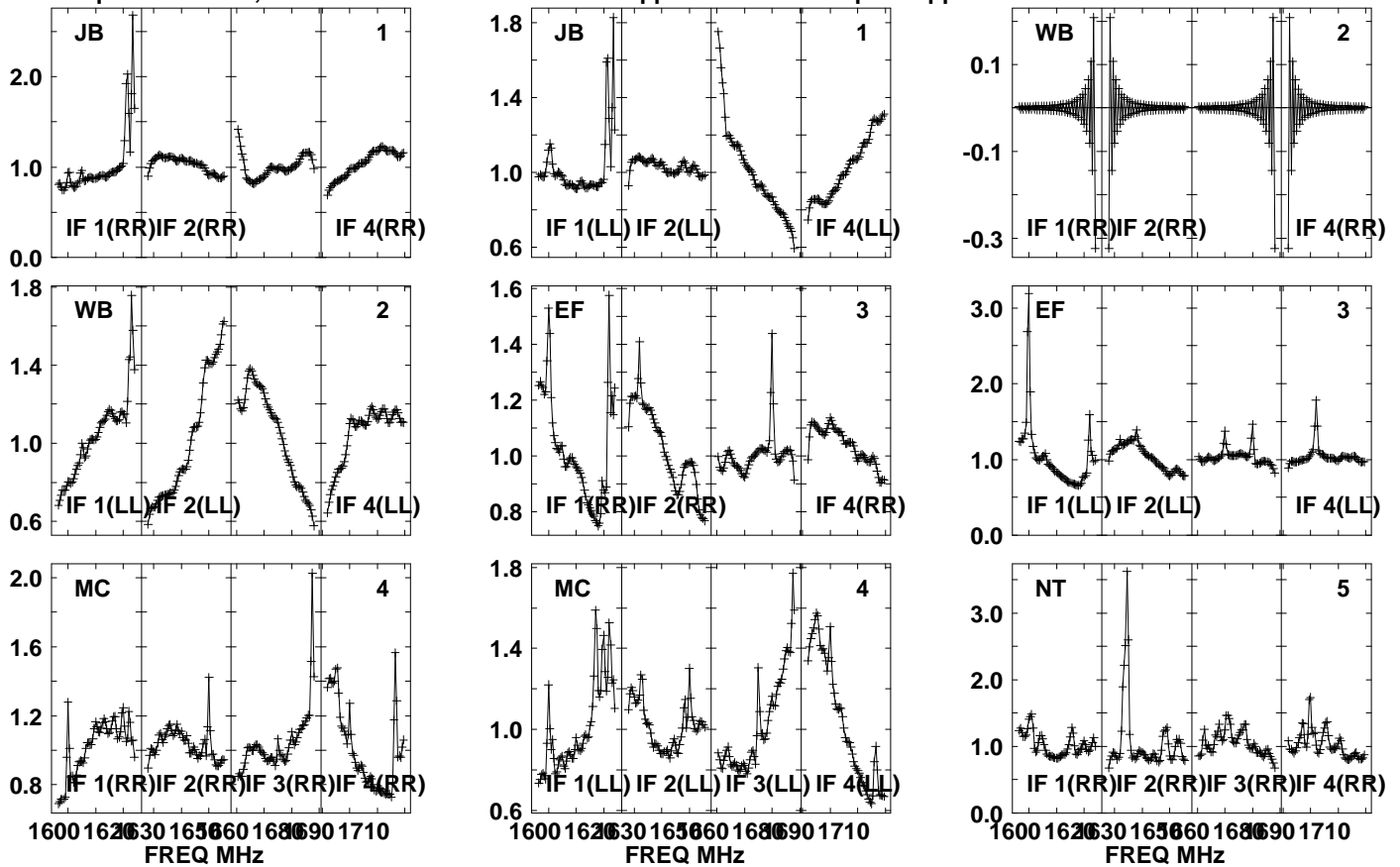

Lower frame: Real Jy  
Auto-corr total-power spectrum Antenna: \*  
Timerange: 00/12:36:01 to 00/12:37:29

Plot file version 221 created 05-OCT-2021 17:05:19

J0827+5217 GM076.UVDATA.1

Freq = 1.5945 GHz, Bw = 32.000 MH No calibration applied and no bandpass applied

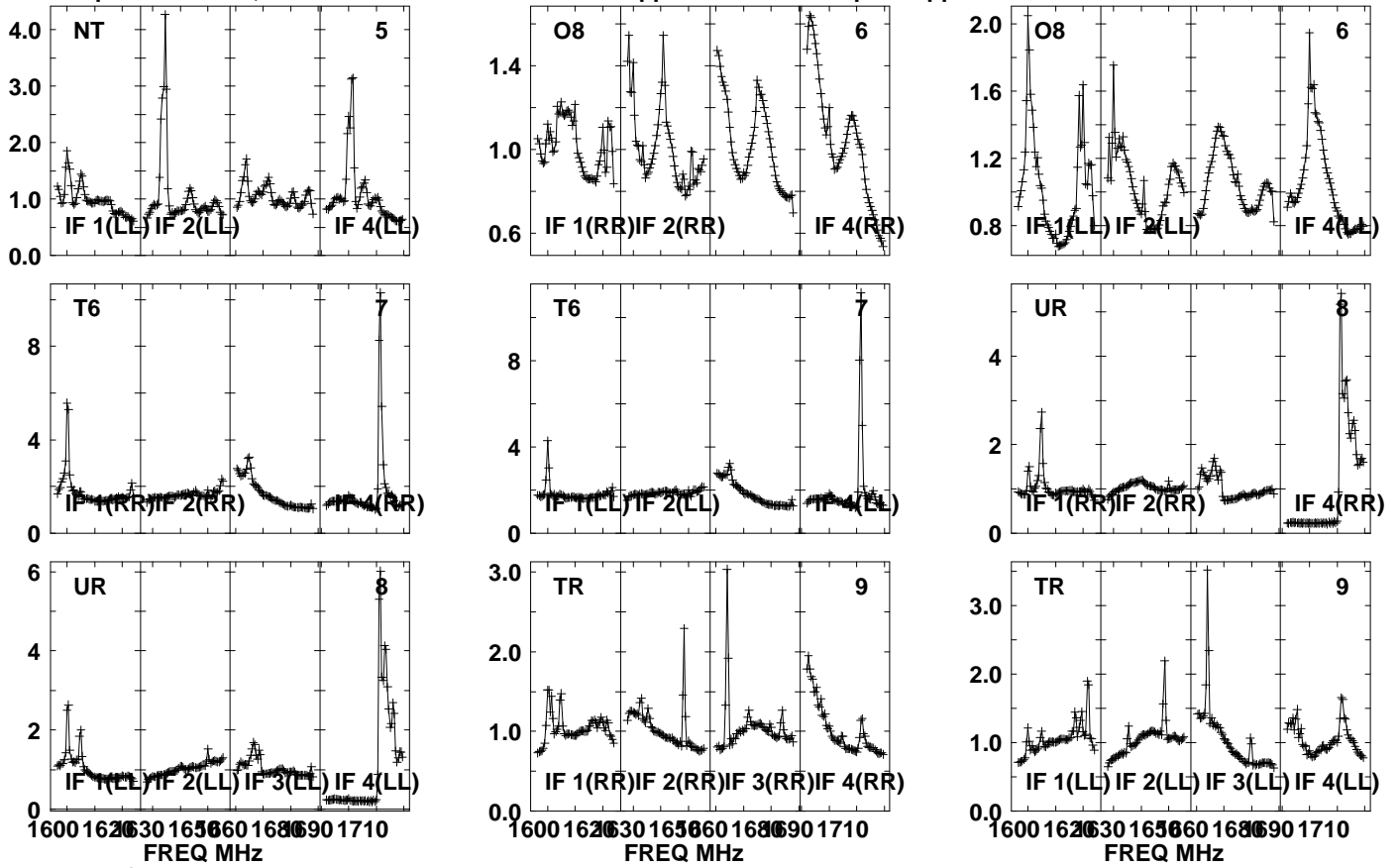

Lower frame: Real Jy  
Auto-corr total-power spectrum Antenna: \*  
Timerange: 00/12:36:01 to 00/12:37:29

Plot file version 222 created 05-OCT-2021 17:05:20

J0827+5217 GM076.UVDATA.1

Freq = 1.5945 GHz, Bw = 32.000 MH No calibration applied and no bandpass applied

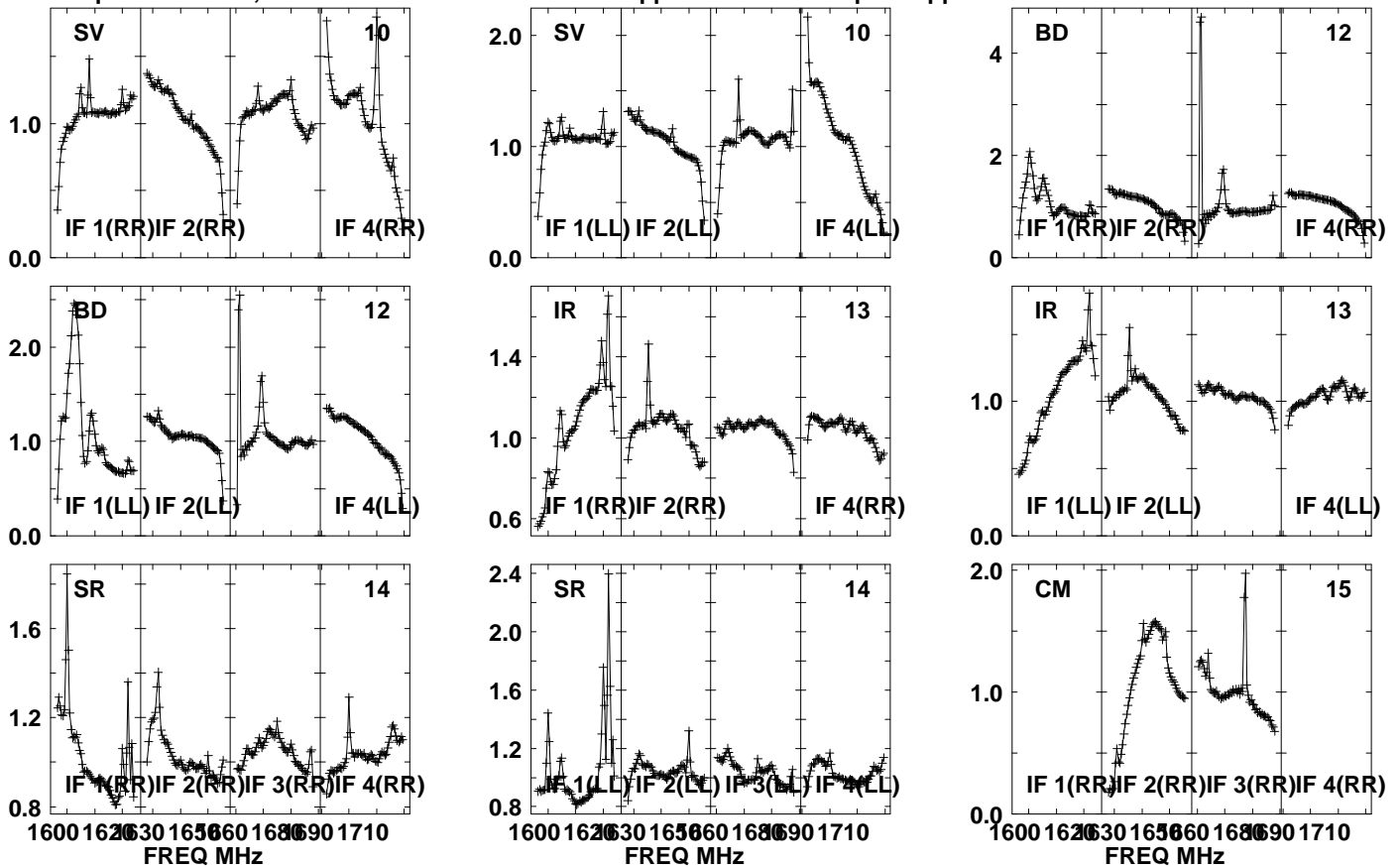

Lower frame: Real Jy

Auto-corr total-power spectrum Antenna: \*

Timerange: 00/12:36:01 to 00/12:37:29

Plot file version 223 created 05-OCT-2021 17:05:20

J0827+5217 GM076.UVDATA.1

Freq = 1.5945 GHz, Bw = 32.000 MH No calibration applied and no bandpass applied

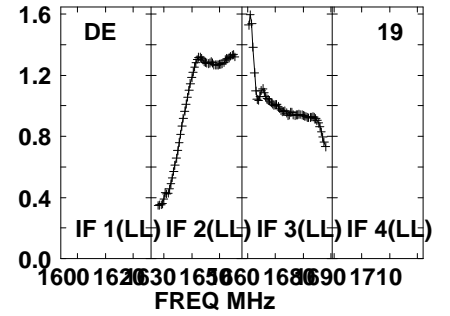
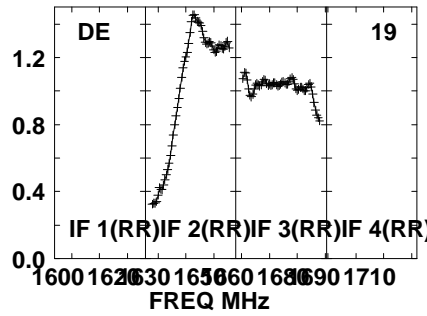
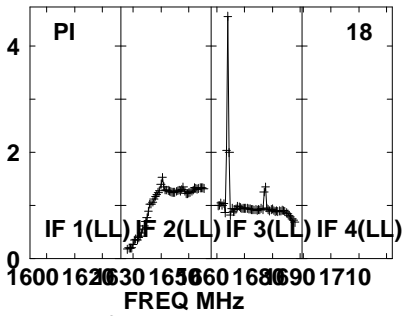
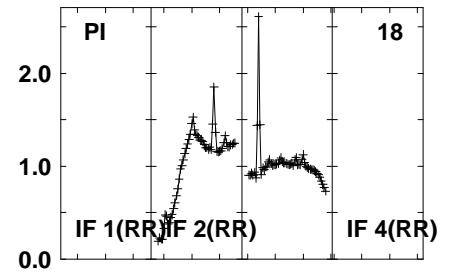
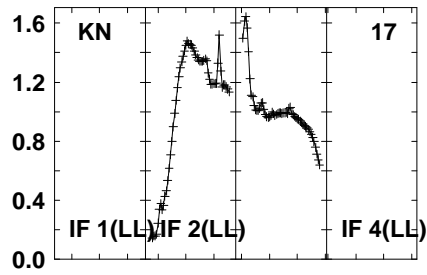
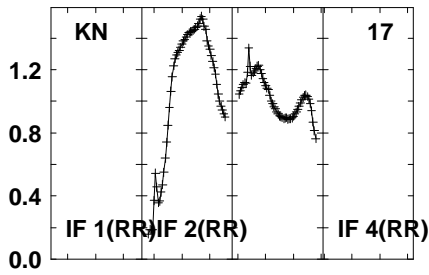
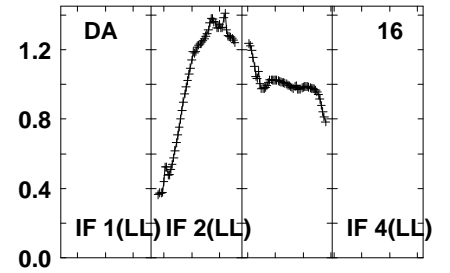
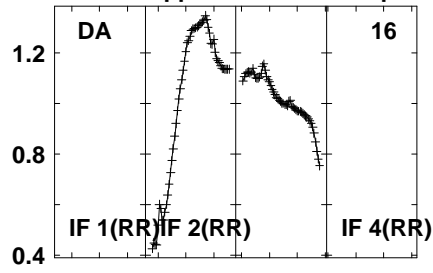
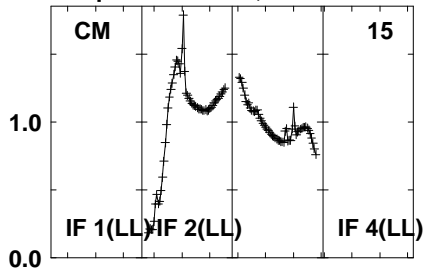

Lower frame: Real Jy

Auto-corr total-power spectrum Antenna: \*

Timerange: 00/12:36:01 to 00/12:37:29

Plot file version 224 created 05-OCT-2021 17:05:20

4C39.25 GM076.UVDATA.1

Freq = 1.5945 GHz, Bw = 32.000 MH No calibration applied and no bandpass applied

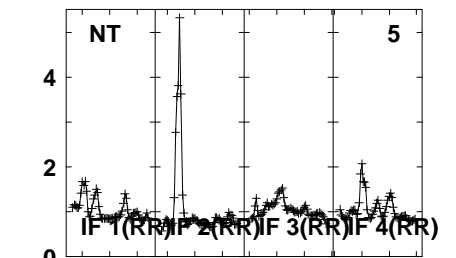
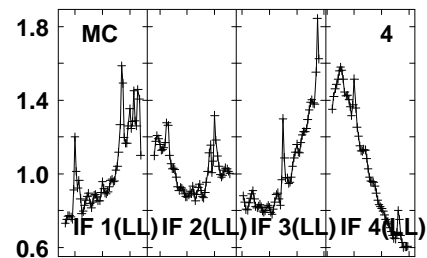
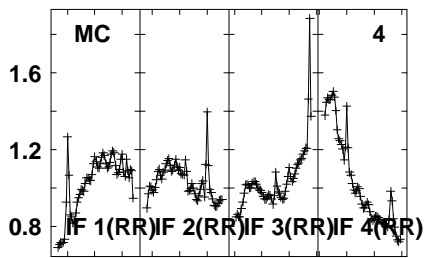
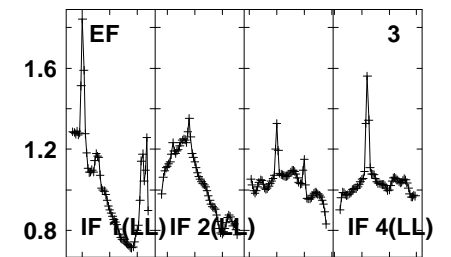
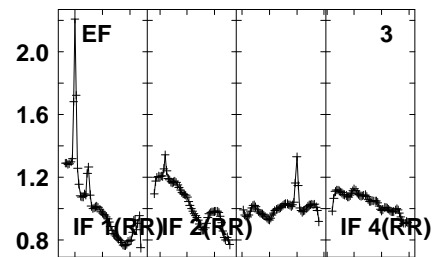
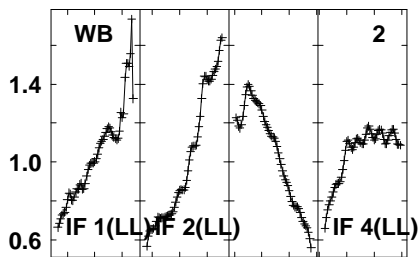
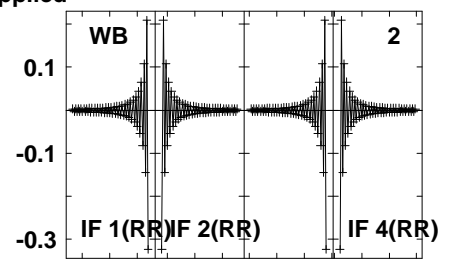
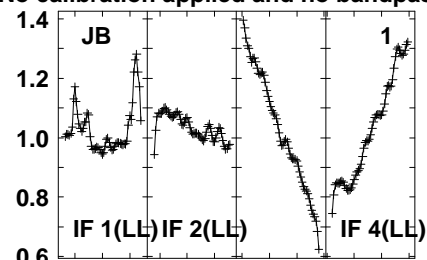
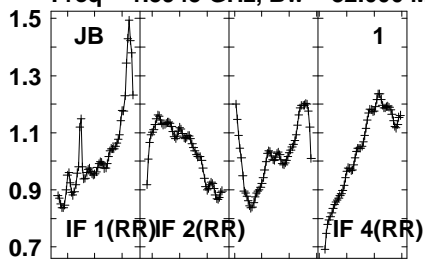

1600 1620 1630 1650 1660 1680 1690 1710  
FREQ MHz

1600 1620 1630 1650 1660 1680 1690 1710  
FREQ MHz

1600 1620 1630 1650 1660 1680 1690 1710  
FREQ MHz

Lower frame: Real Jy  
Auto-corr total-power spectrum Antenna: \*  
Timerange: 00/12:42:31 to 00/12:47:29

Plot file version 225 created 05-OCT-2021 17:05:21

4C39.25 GM076.UVDATA.1

Freq = 1.5945 GHz, Bw = 32.000 MH No calibration applied and no bandpass applied

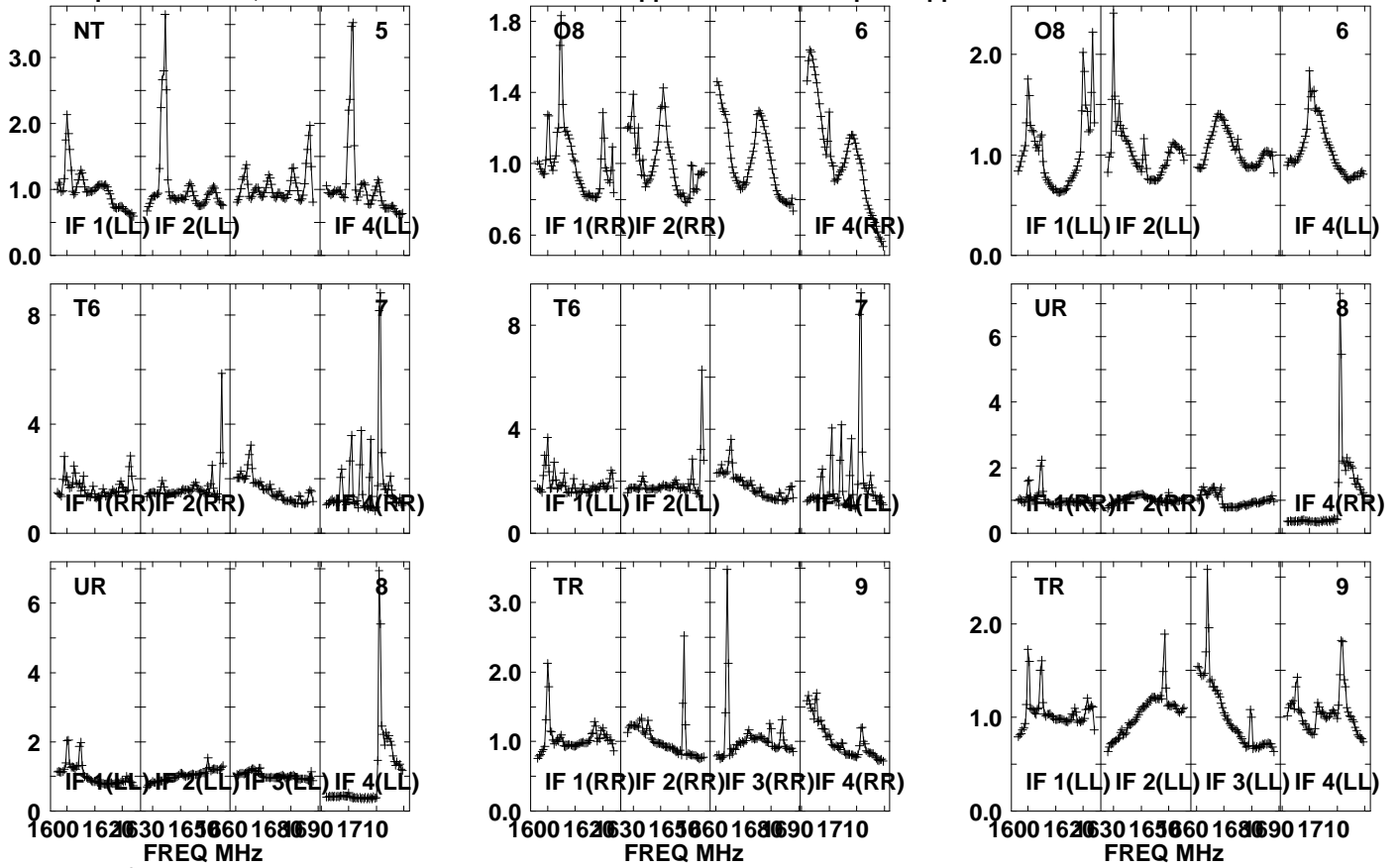

Lower frame: Real Jy

Auto-corr total-power spectrum Antenna: \*

Timerange: 00/12:42:31 to 00/12:47:29

Plot file version 226 created 05-OCT-2021 17:05:21

4C39.25 GM076.UVDATA.1

Freq = 1.5945 GHz, Bw = 32.000 MH No calibration applied and no bandpass applied

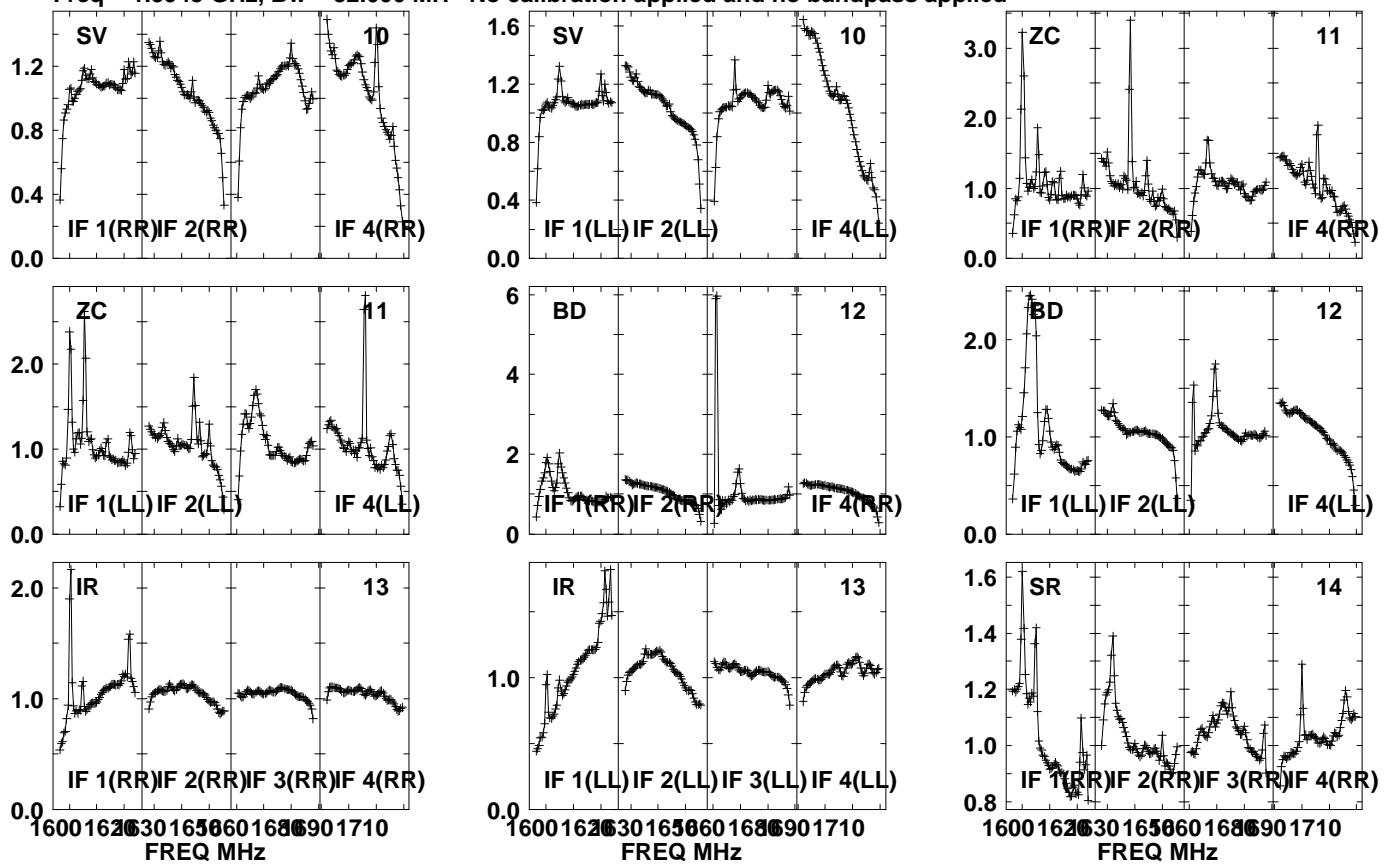

Lower frame: Real Jy  
Auto-corr total-power spectrum Antenna: \*  
Timerange: 00/12:42:31 to 00/12:47:29



Plot file version 227 created 05-OCT-2021 17:05:21

4C39.25 GM076.UVDATA.1

Freq = 1.5945 GHz, Bw = 32.000 MH No calibration applied and no bandpass applied

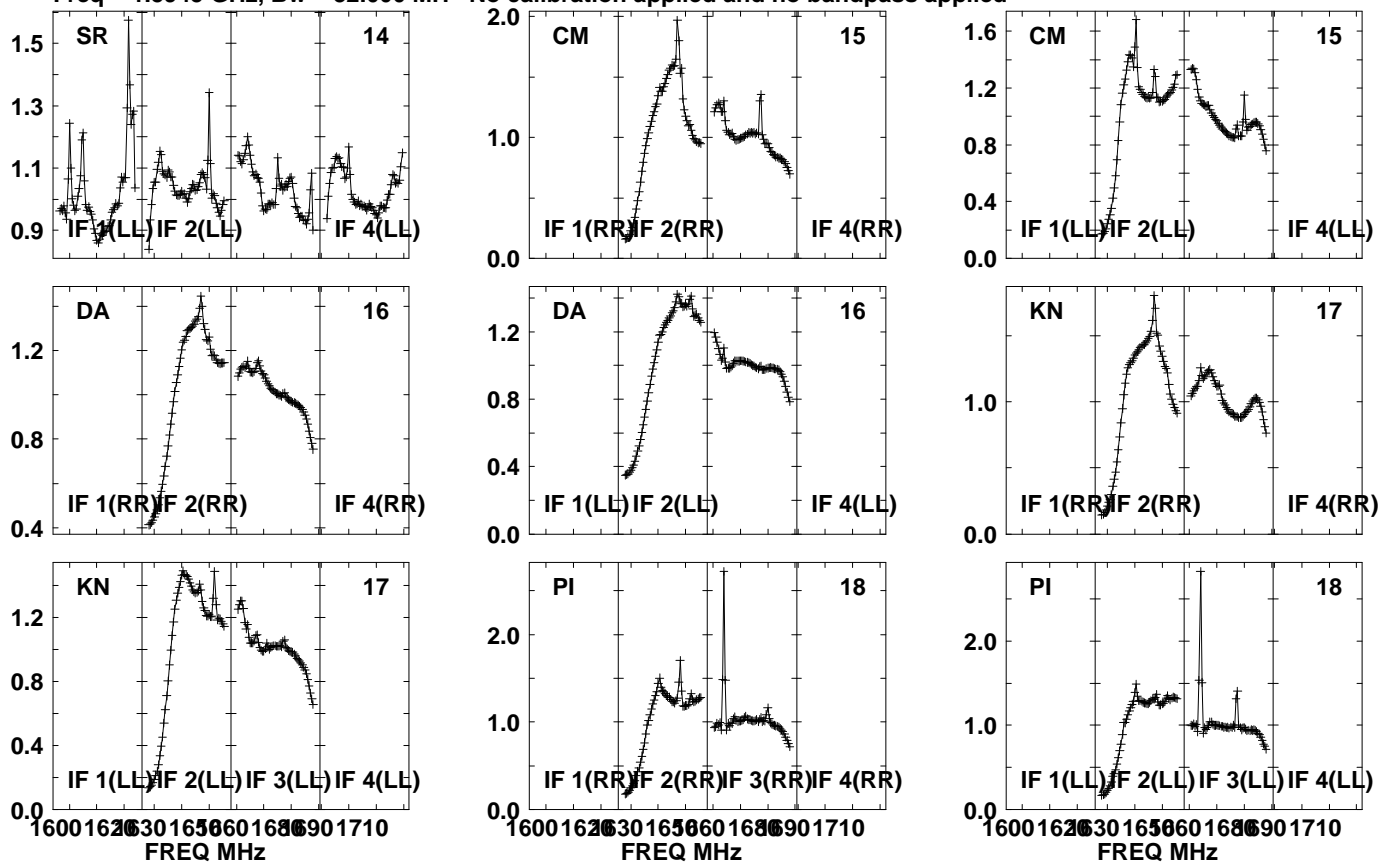

Lower frame: Real Jy  
Auto-corr total-power spectrum Antenna: \*  
Timerange: 00/12:42:31 to 00/12:47:29

Plot file version 228 created 05-OCT-2021 17:05:22

4C39.25 GM076.UVDATA.1

Freq = 1.5945 GHz, Bw = 32.000 MH No calibration applied and no bandpass applied

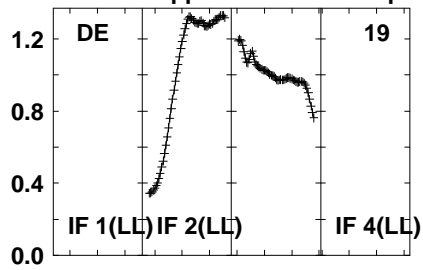
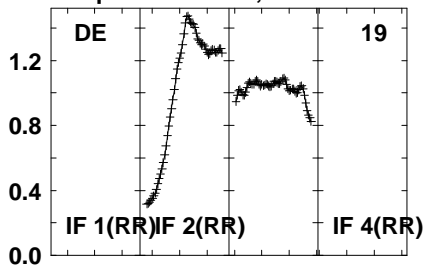

Lower frame: Real Jy  
Auto-corr total-power spectrum Antenna: \*  
Timerange: 00/12:42:31 to 00/12:47:29

Plot file version 229 created 05-OCT-2021 17:05:22

J0827+5217 GM076.UVDATA.1

Freq = 1.5945 GHz, Bw = 32.000 MH No calibration applied and no bandpass applied

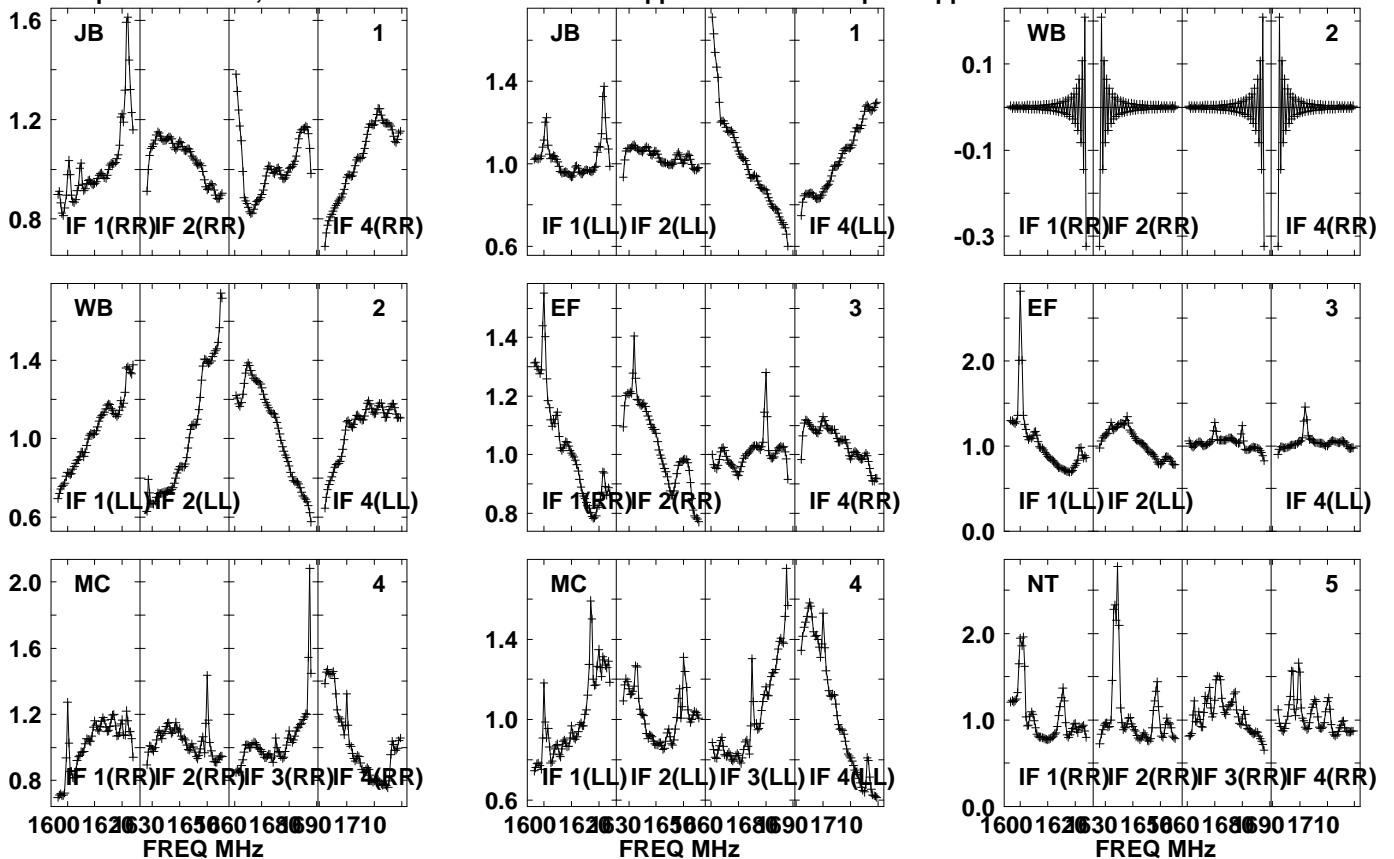

Lower frame: Real Jy  
Auto-corr total-power spectrum Antenna: \*  
Timerange: 00/12:52:31 to 00/12:57:29

Plot file version 230 created 05-OCT-2021 17:05:23

J0827+5217 GM076.UVDATA.1

Freq = 1.5945 GHz, Bw = 32.000 MH No calibration applied and no bandpass applied

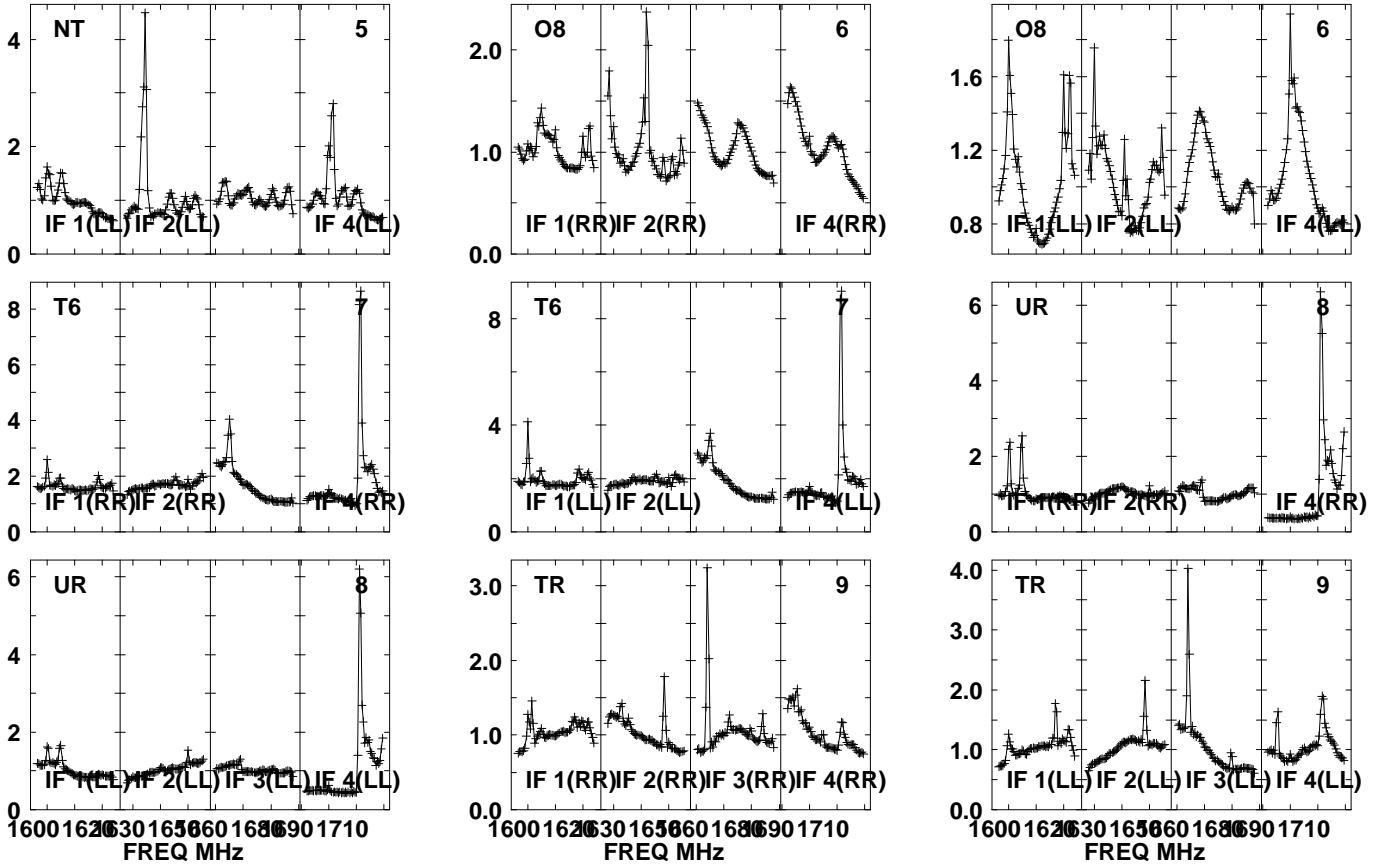

Lower frame: Real Jy

Auto-corr total-power spectrum Antenna: \*

Timerange: 00/12:52:31 to 00/12:57:29

Plot file version 231 created 05-OCT-2021 17:05:23

J0827+5217 GM076.UVDATA.1

Freq = 1.5945 GHz, Bw = 32.000 MH No calibration applied and no bandpass applied

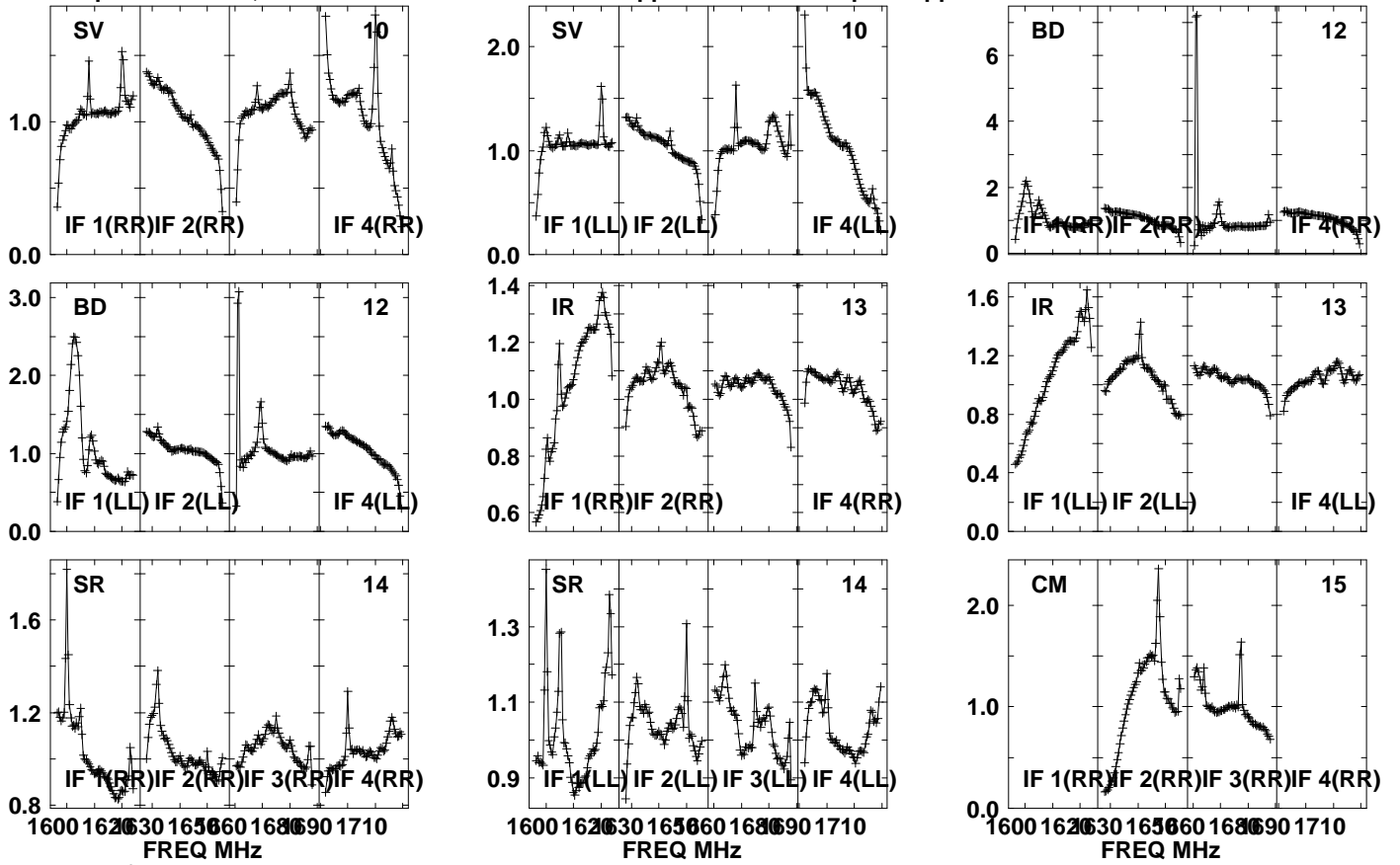

Lower frame: Real Jy

Auto-corr total-power spectrum Antenna: \*

Timerange: 00/12:52:31 to 00/12:57:29

Plot file version 232 created 05-OCT-2021 17:05:23

J0827+5217 GM076.UVDATA.1

Freq = 1.5945 GHz, Bw = 32.000 MH No calibration applied and no bandpass applied

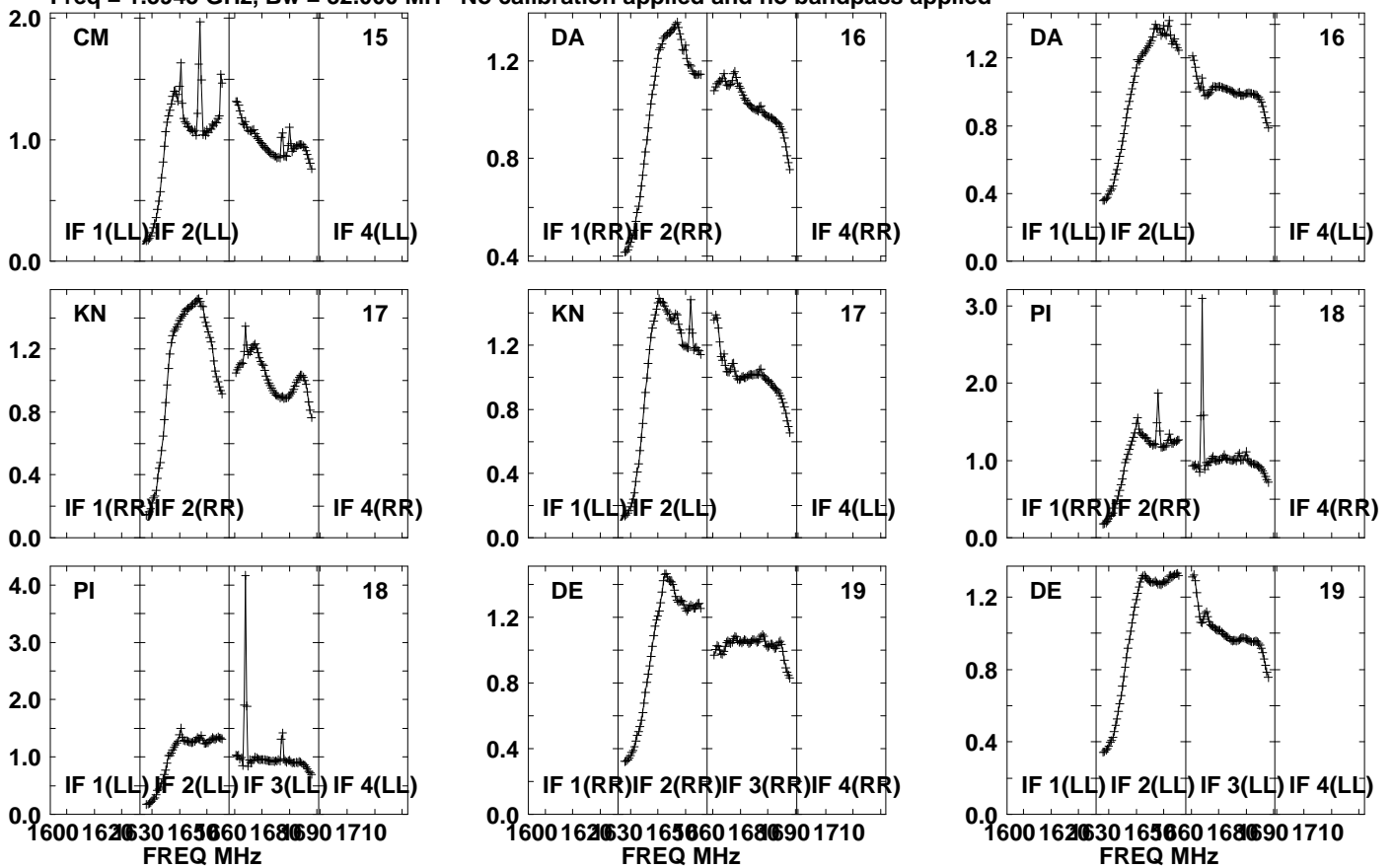

Lower frame: Real Jy  
Auto-corr total-power spectrum Antenna: \*  
Timerange: 00/12:52:31 to 00/12:57:29

Plot file version 233 created 05-OCT-2021 17:05:24

APM08279+525 GM076.UVDATA.1

Freq = 1.5945 GHz, Bw = 32.000 MH No calibration applied and no bandpass applied

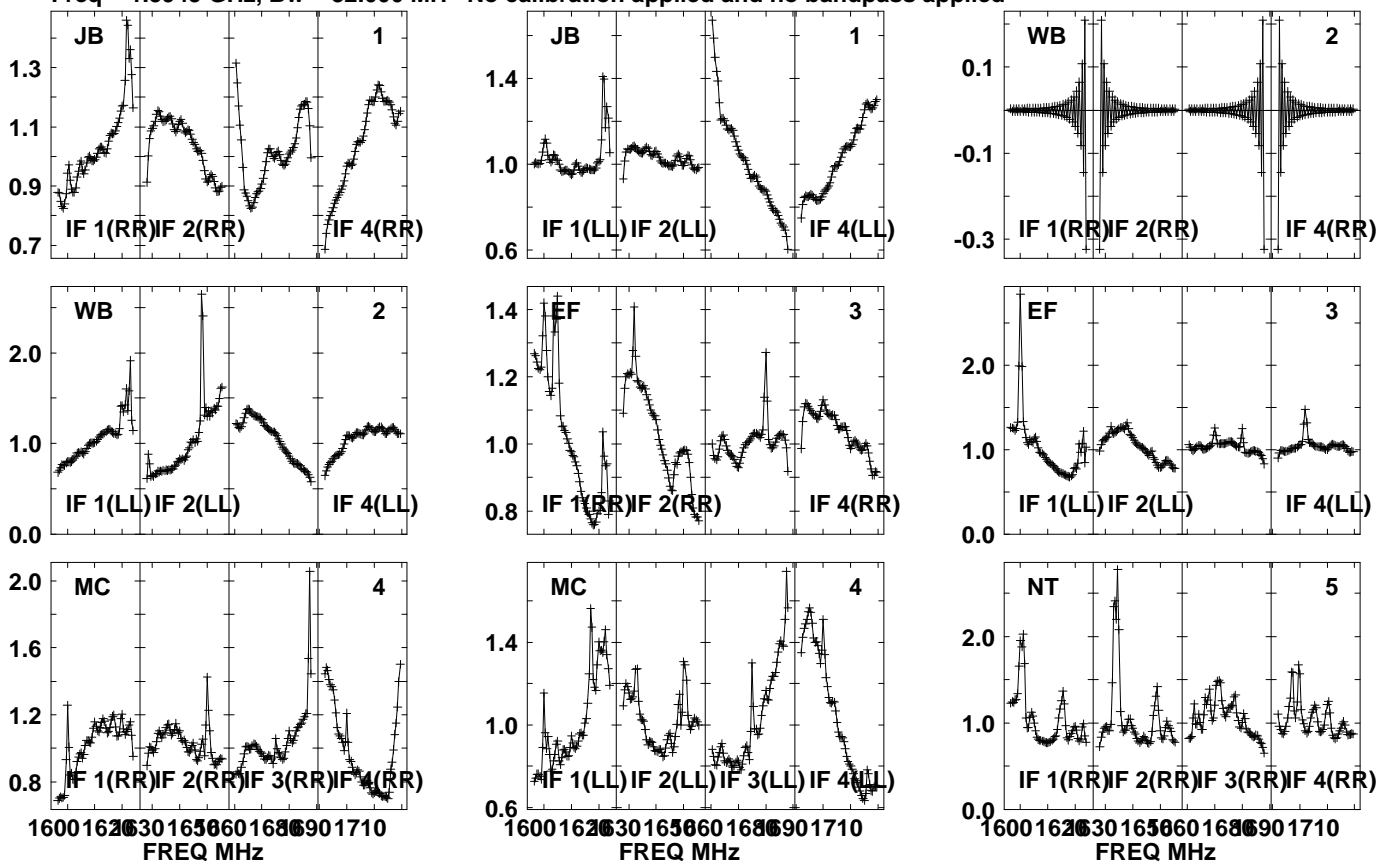

Lower frame: Real Jy  
Auto-corr total-power spectrum Antenna: \*  
Timerange: 00/12:57:31 to 00/13:00:59

Plot file version 234 created 05-OCT-2021 17:05:24

APM08279+525 GM076.UVDATA.1

Freq = 1.5945 GHz, Bw = 32.000 MH No calibration applied and no bandpass applied

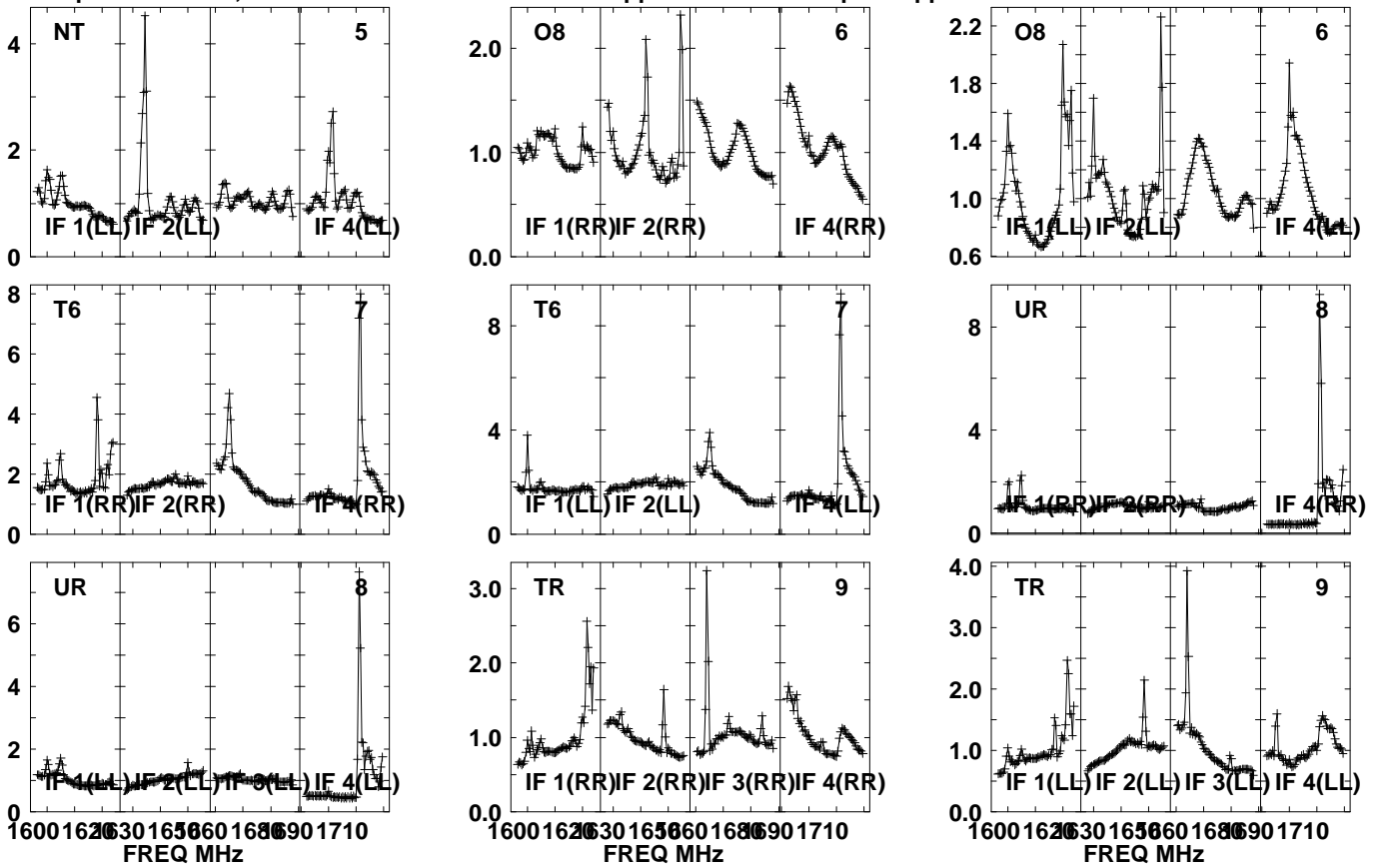

Lower frame: Real Jy  
Auto-corr total-power spectrum Antenna: \*  
Timerange: 00/12:57:31 to 00/13:00:59



Plot file version 235 created 05-OCT-2021 17:05:24

APM08279+525 GM076.UVDATA.1

Freq = 1.5945 GHz, Bw = 32.000 MH No calibration applied and no bandpass applied

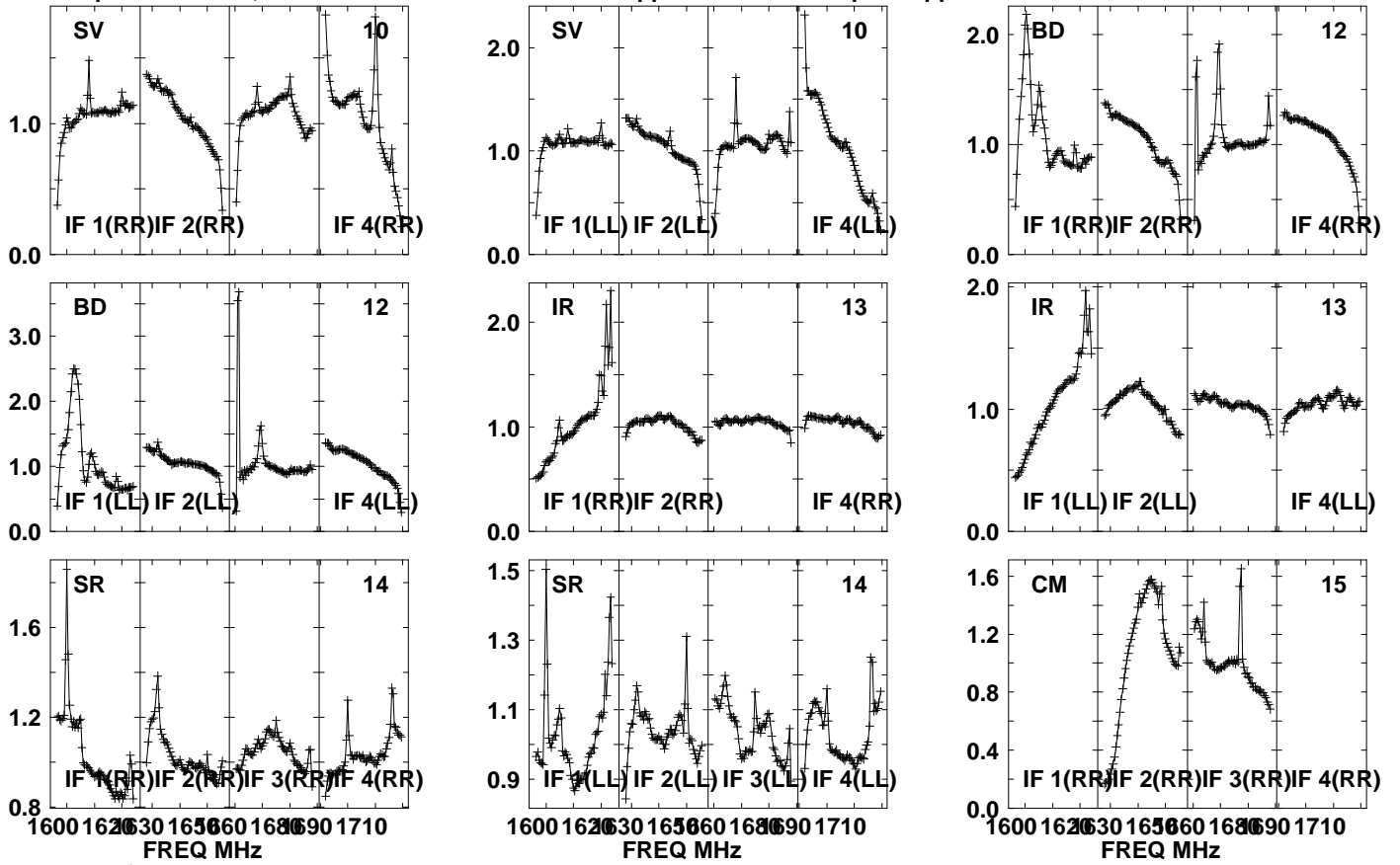

Lower frame: Real Jy

Auto-corr total-power spectrum Antenna: \*

Timerange: 00/12:57:31 to 00/13:00:59

Plot file version 236 created 05-OCT-2021 17:05:24

APM08279+525 GM076.UVDATA.1

Freq = 1.5945 GHz, Bw = 32.000 MH No calibration applied and no bandpass applied

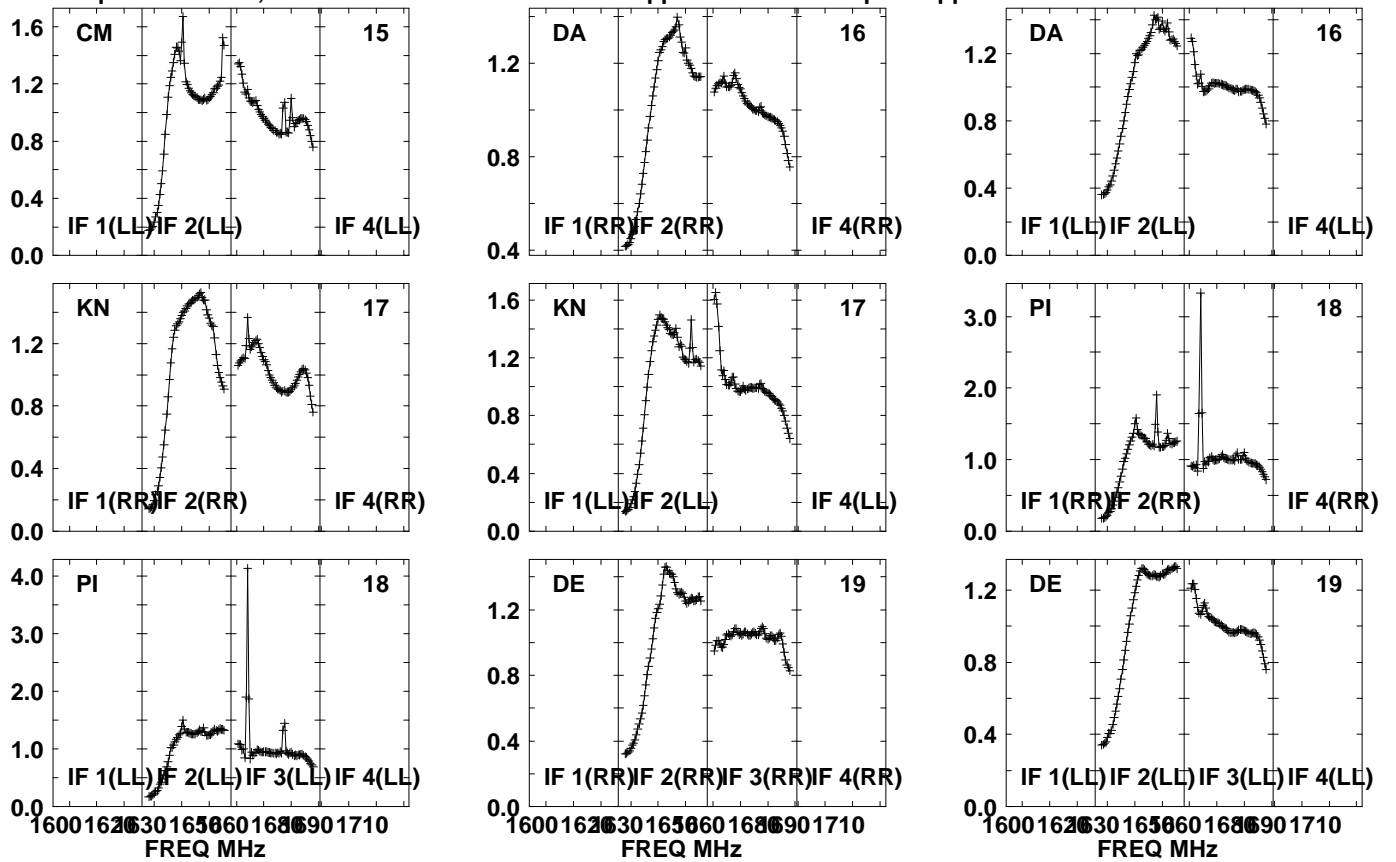

Lower frame: Real Jy  
Auto-corr total-power spectrum Antenna: \*  
Timerange: 00/12:57:31 to 00/13:00:59

Plot file version 237 created 05-OCT-2021 17:05:24

J0827+5217 GM076.UVDATA.1

Freq = 1.5945 GHz, Bw = 32.000 MH No calibration applied and no bandpass applied

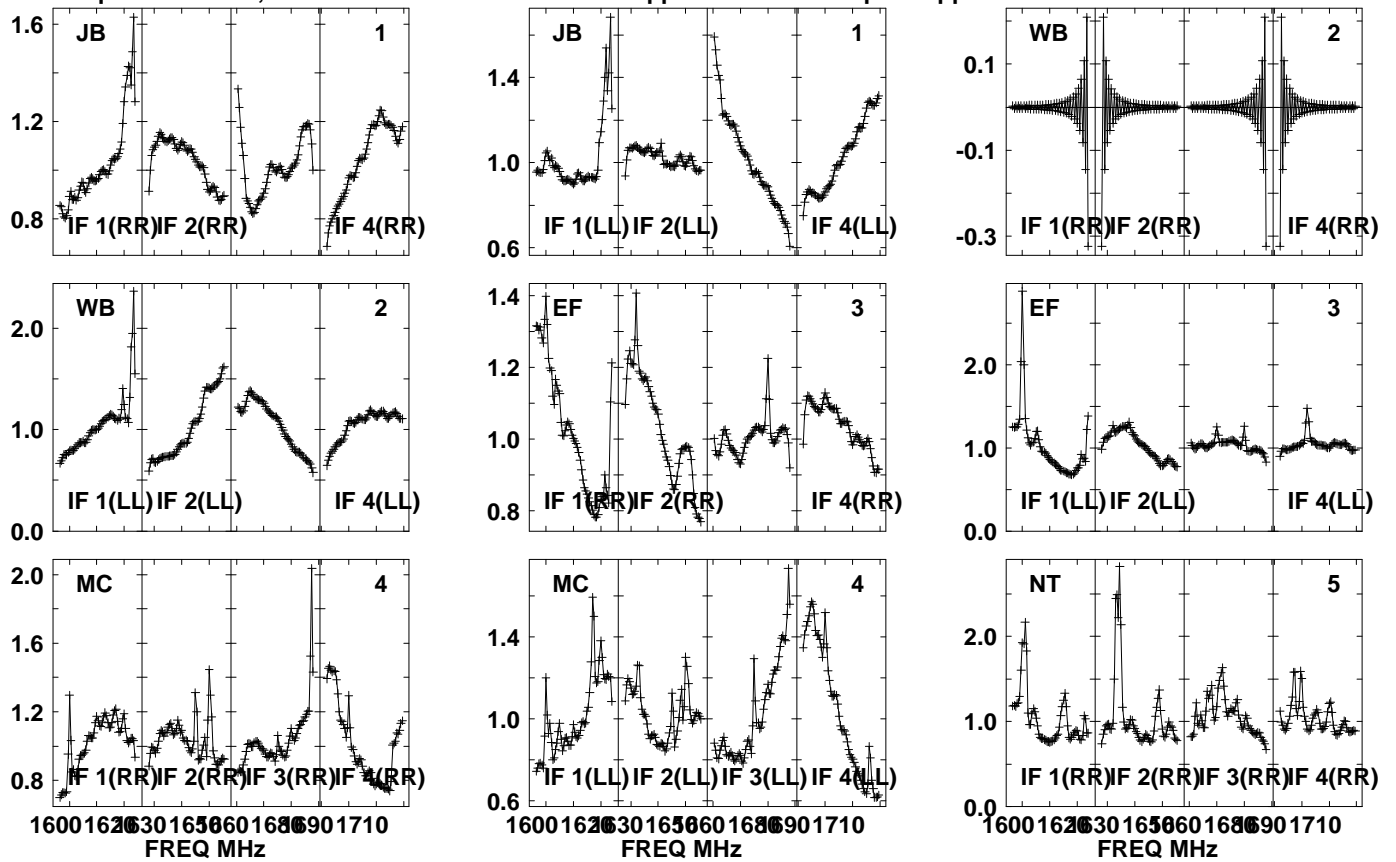

Lower frame: Real Jy  
Auto-corr total-power spectrum Antenna: \*  
Timerange: 00/13:01:31 to 00/13:02:59

Plot file version 238 created 05-OCT-2021 17:05:25

J0827+5217 GM076.UVDATA.1

Freq = 1.5945 GHz, Bw = 32.000 MH No calibration applied and no bandpass applied

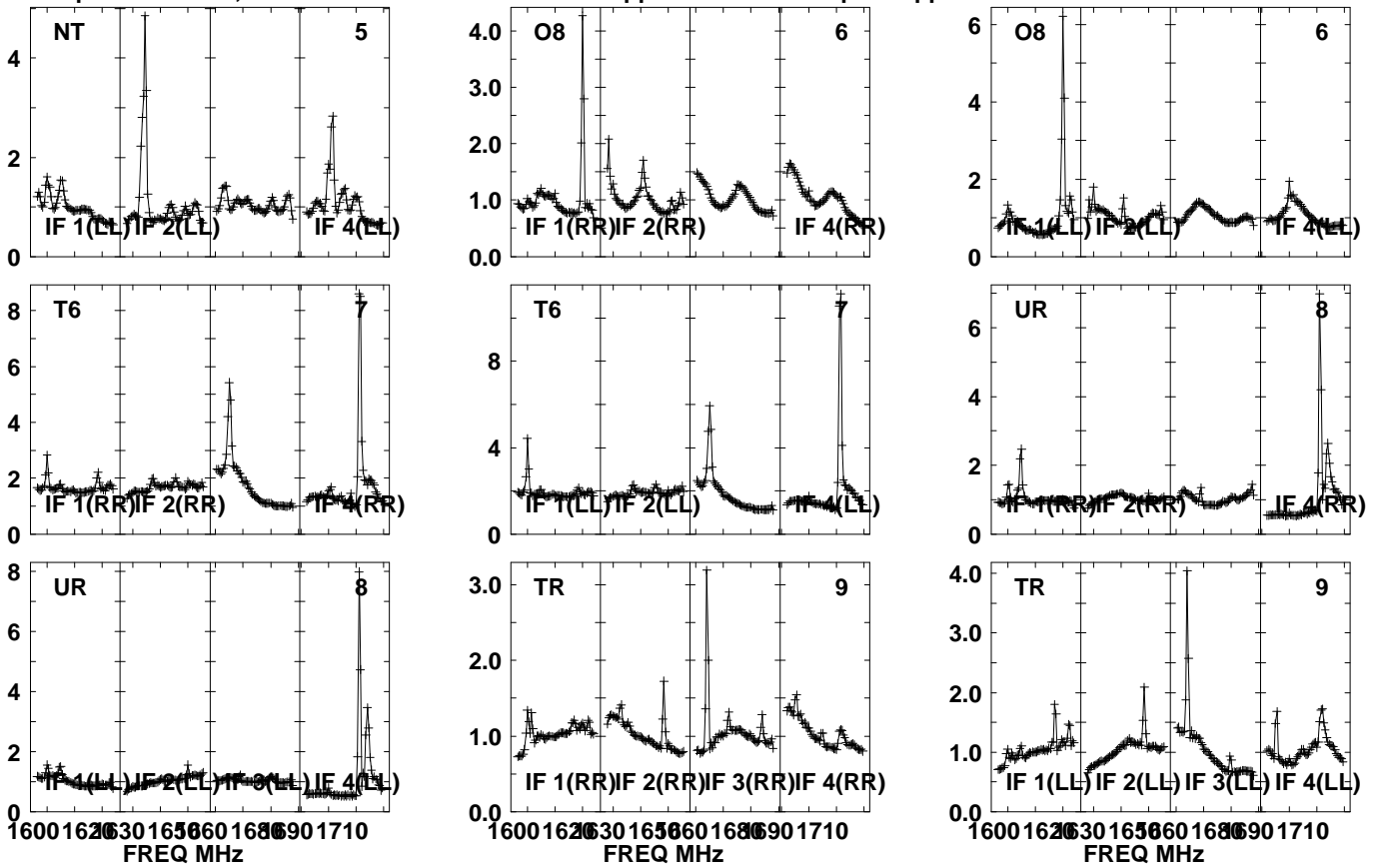

Lower frame: Real Jy  
Auto-corr total-power spectrum Antenna: \*  
Timerange: 00/13:01:31 to 00/13:02:59

Plot file version 239 created 05-OCT-2021 17:05:25

J0827+5217 GM076.UVDATA.1

Freq = 1.5945 GHz, Bw = 32.000 MH No calibration applied and no bandpass applied

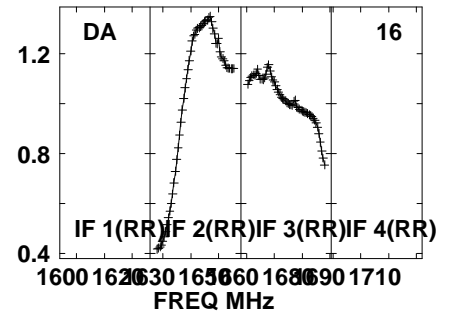
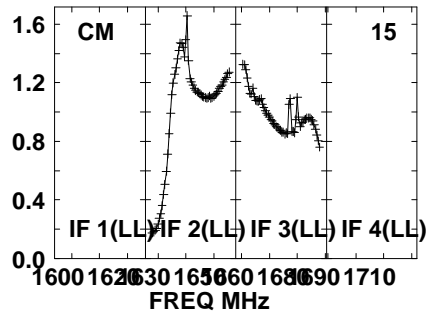
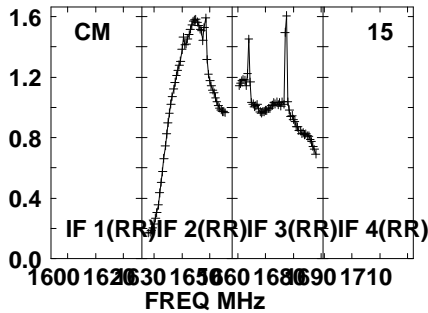
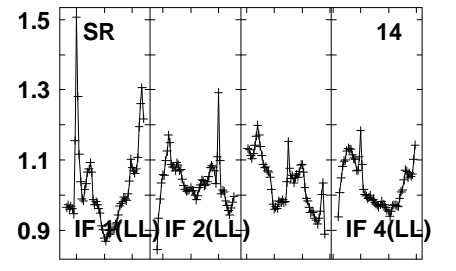
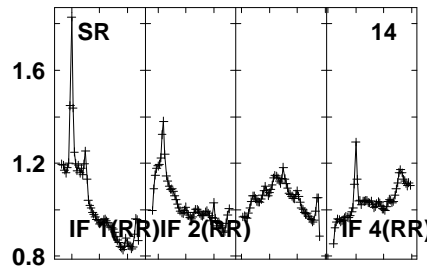
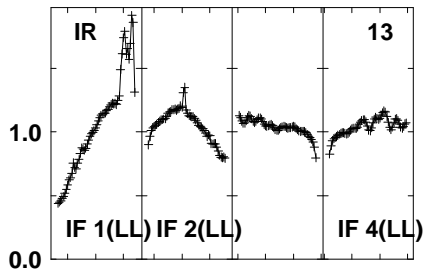
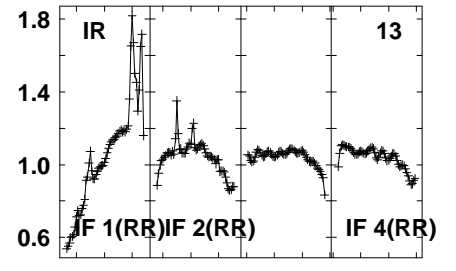
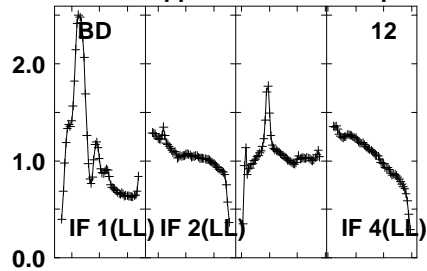
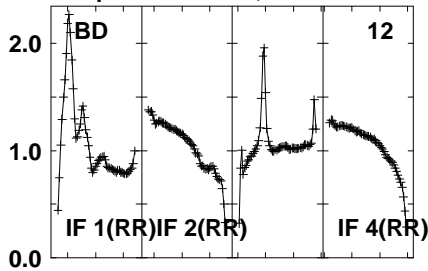

Lower frame: Real Jy  
Auto-corr total-power spectrum Antenna: \*  
Timerange: 00/13:01:31 to 00/13:02:59

Plot file version 240 created 05-OCT-2021 17:05:25

J0827+5217 GM076.UVDATA.1

Freq = 1.5945 GHz, Bw = 32.000 MH No calibration applied and no bandpass applied

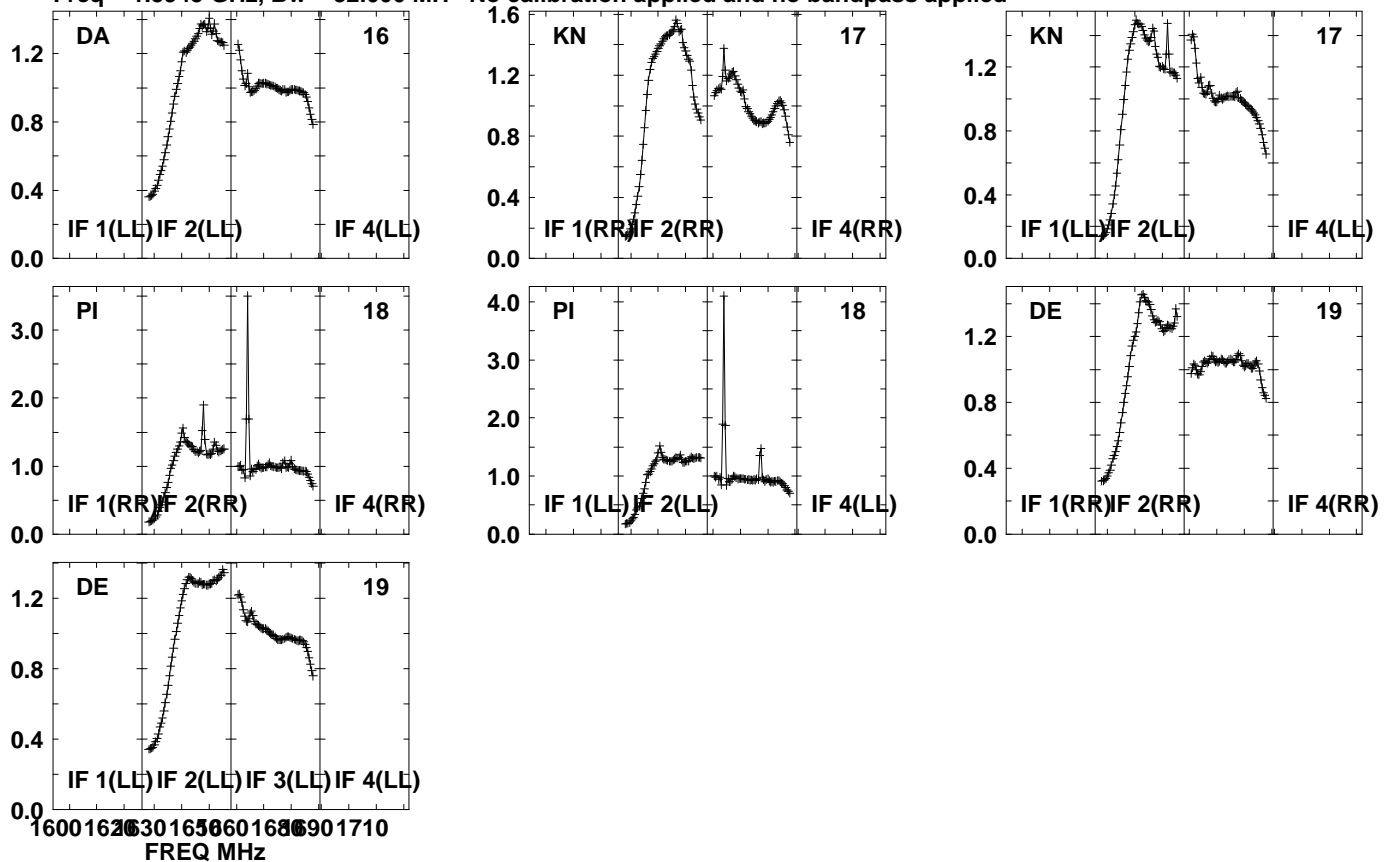

Lower frame: Real Jy  
Auto-corr total-power spectrum Antenna: \*  
Timerange: 00/13:01:31 to 00/13:02:59

Plot file version 241 created 05-OCT-2021 17:05:25

APM08279+525 GM076.UVDATA.1

Freq = 1.5945 GHz, Bw = 32.000 MH No calibration applied and no bandpass applied

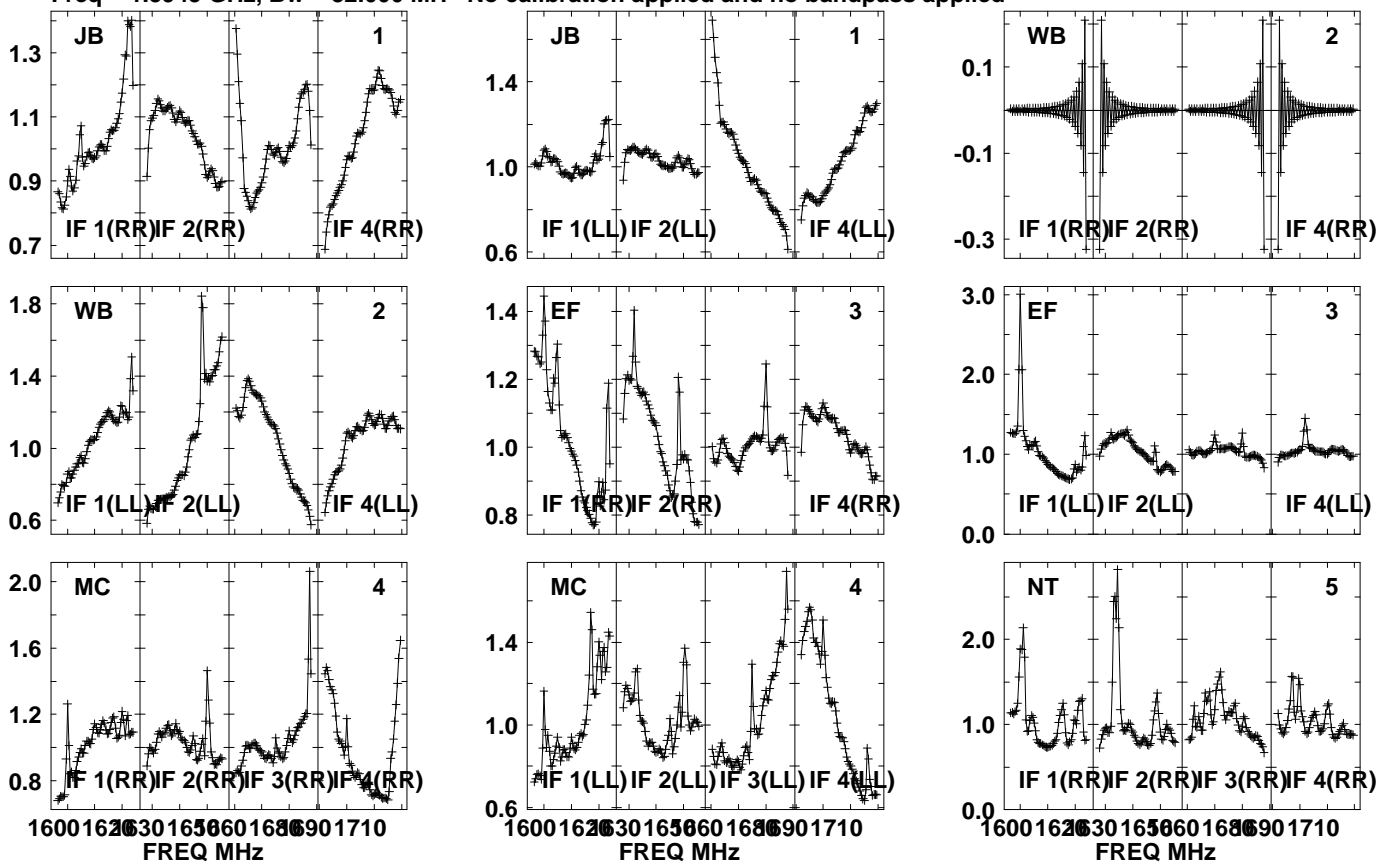

Lower frame: Real Jy  
Auto-corr total-power spectrum Antenna: \*  
Timerange: 00/13:03:01 to 00/13:06:29

Plot file version 242 created 05-OCT-2021 17:05:26

APM08279+525 GM076.UVDATA.1

Freq = 1.5945 GHz, Bw = 32.000 MH No calibration applied and no bandpass applied

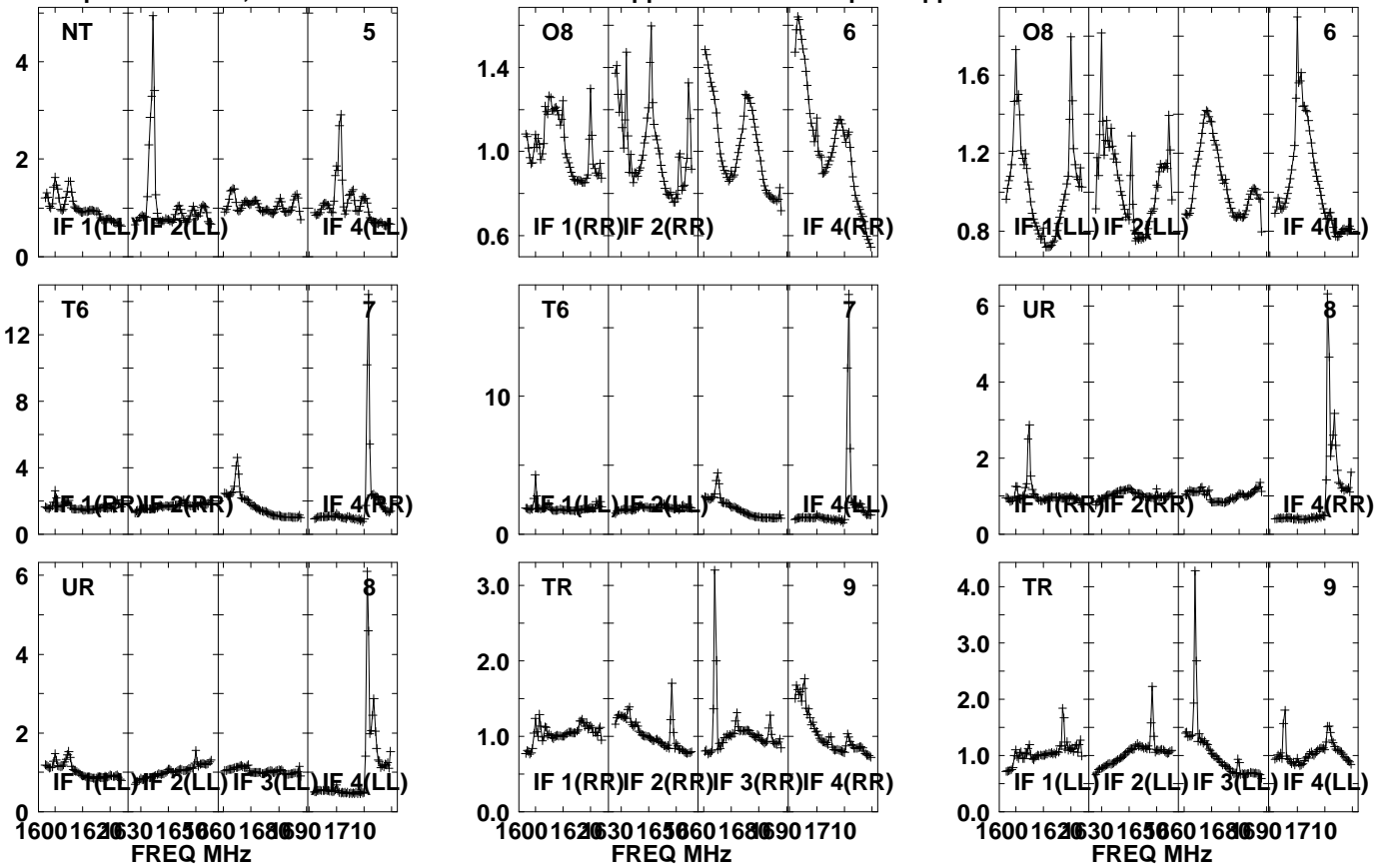

Lower frame: Real Jy  
Auto-corr total-power spectrum Antenna: \*  
Timerange: 00/13:03:01 to 00/13:06:29



Plot file version 243 created 05-OCT-2021 17:05:26

APM08279+525 GM076.UVDATA.1

Freq = 1.5945 GHz, Bw = 32.000 MH No calibration applied and no bandpass applied

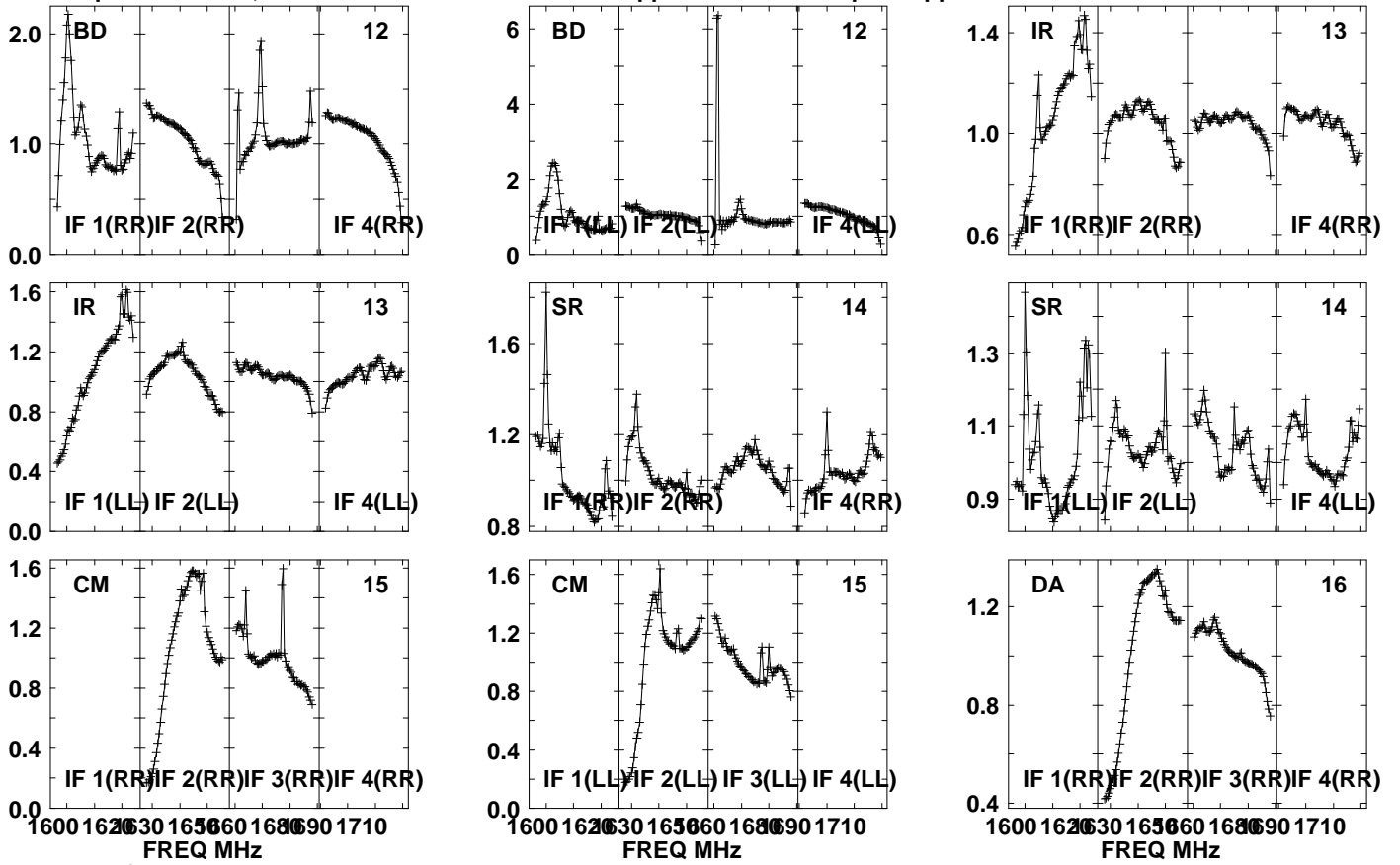

Lower frame: Real Jy

Auto-corr total-power spectrum Antenna: \*

Timerange: 00/13:03:01 to 00/13:06:29

Plot file version 244 created 05-OCT-2021 17:05:26

APM08279+525 GM076.UVDATA.1

Freq = 1.5945 GHz, Bw = 32.000 MH

No calibration applied and no bandpass applied

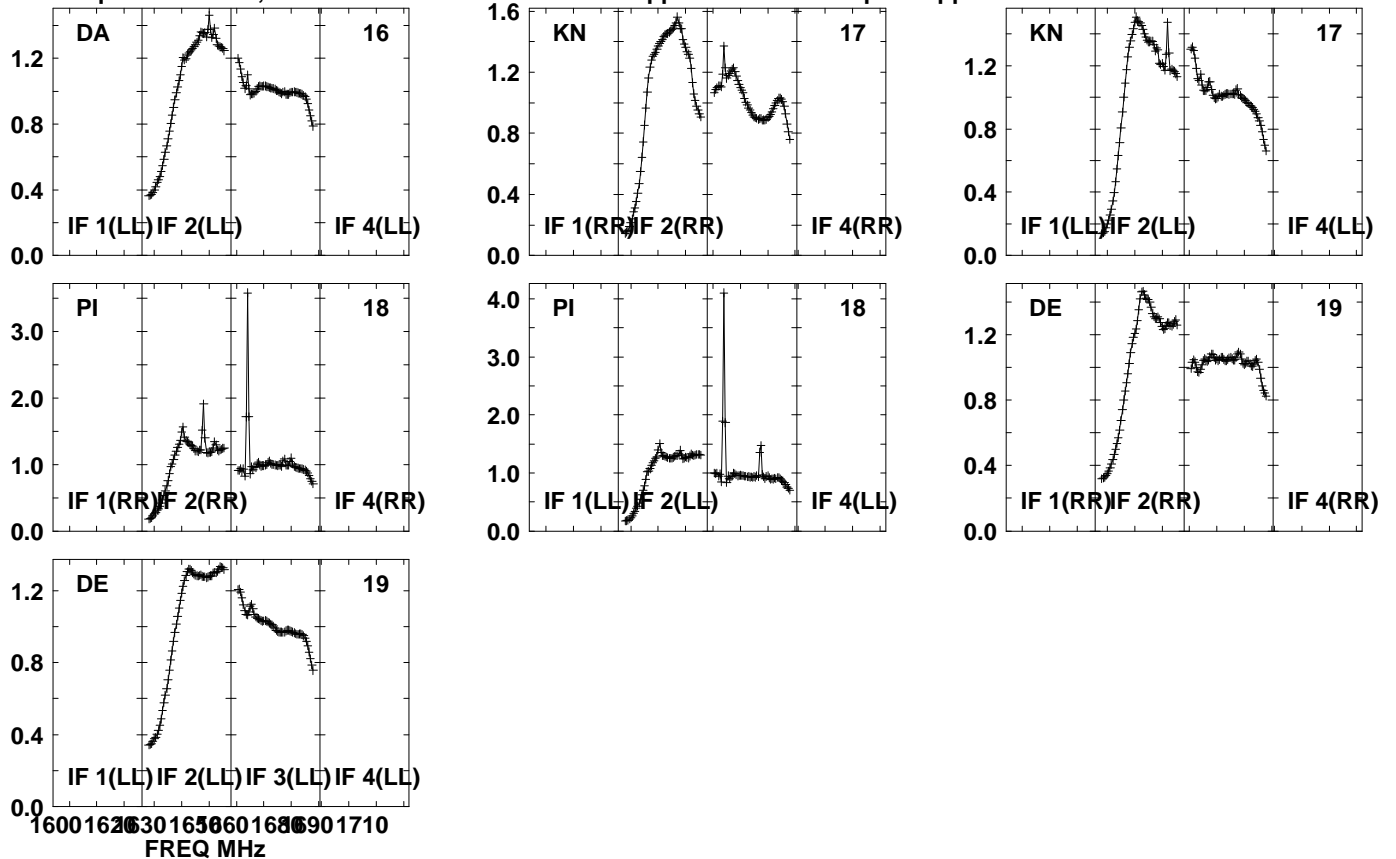

Lower frame: Real Jy  
Auto-corr total-power spectrum Antenna: \*  
Timerange: 00/13:03:01 to 00/13:06:29

Plot file version 245 created 05-OCT-2021 17:05:26

J0827+5217 GM076.UVDATA.1

Freq = 1.5945 GHz, Bw = 32.000 MH No calibration applied and no bandpass applied

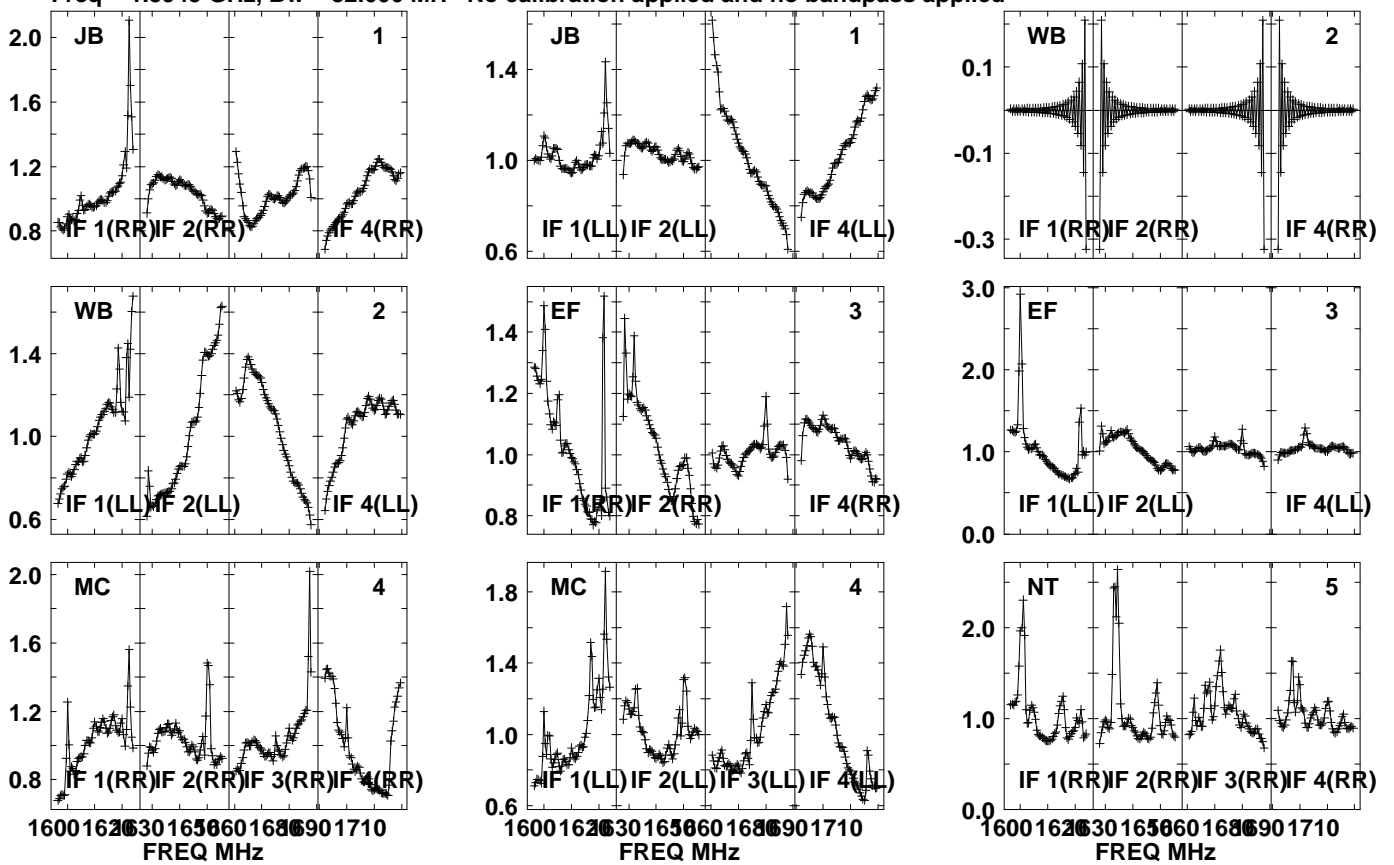

Lower frame: Real Jy  
Auto-corr total-power spectrum Antenna: \*  
Timerange: 00/13:06:31 to 00/13:07:59

Plot file version 246 created 05-OCT-2021 17:05:26

J0827+5217 GM076.UVDATA.1

Freq = 1.5945 GHz, Bw = 32.000 MH No calibration applied and no bandpass applied

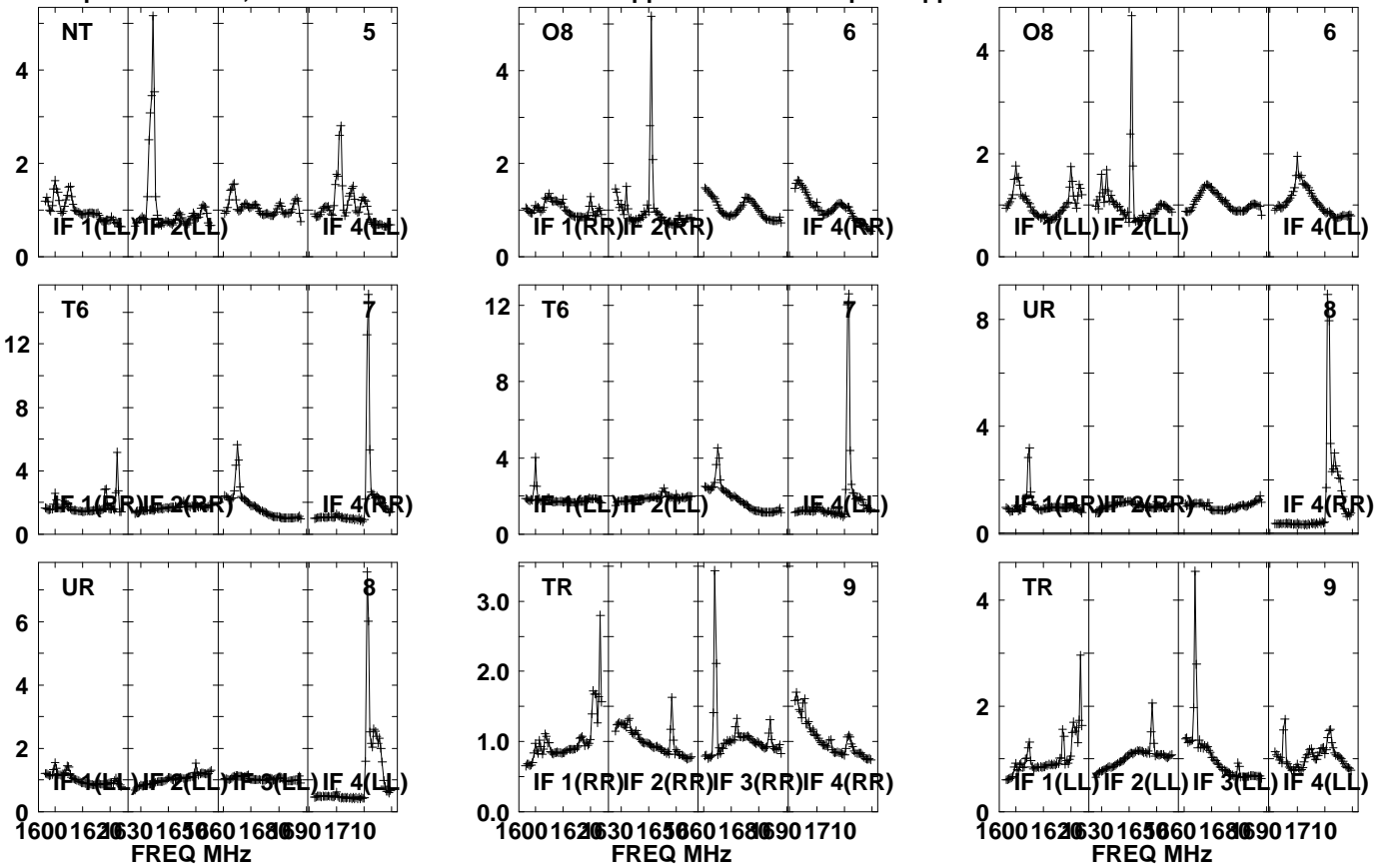

Lower frame: Real Jy

Auto-corr total-power spectrum Antenna: \*

Timerange: 00/13:06:31 to 00/13:07:59

Plot file version 247 created 05-OCT-2021 17:05:27

J0827+5217 GM076.UVDATA.1

Freq = 1.5945 GHz, Bw = 32.000 MH No calibration applied and no bandpass applied

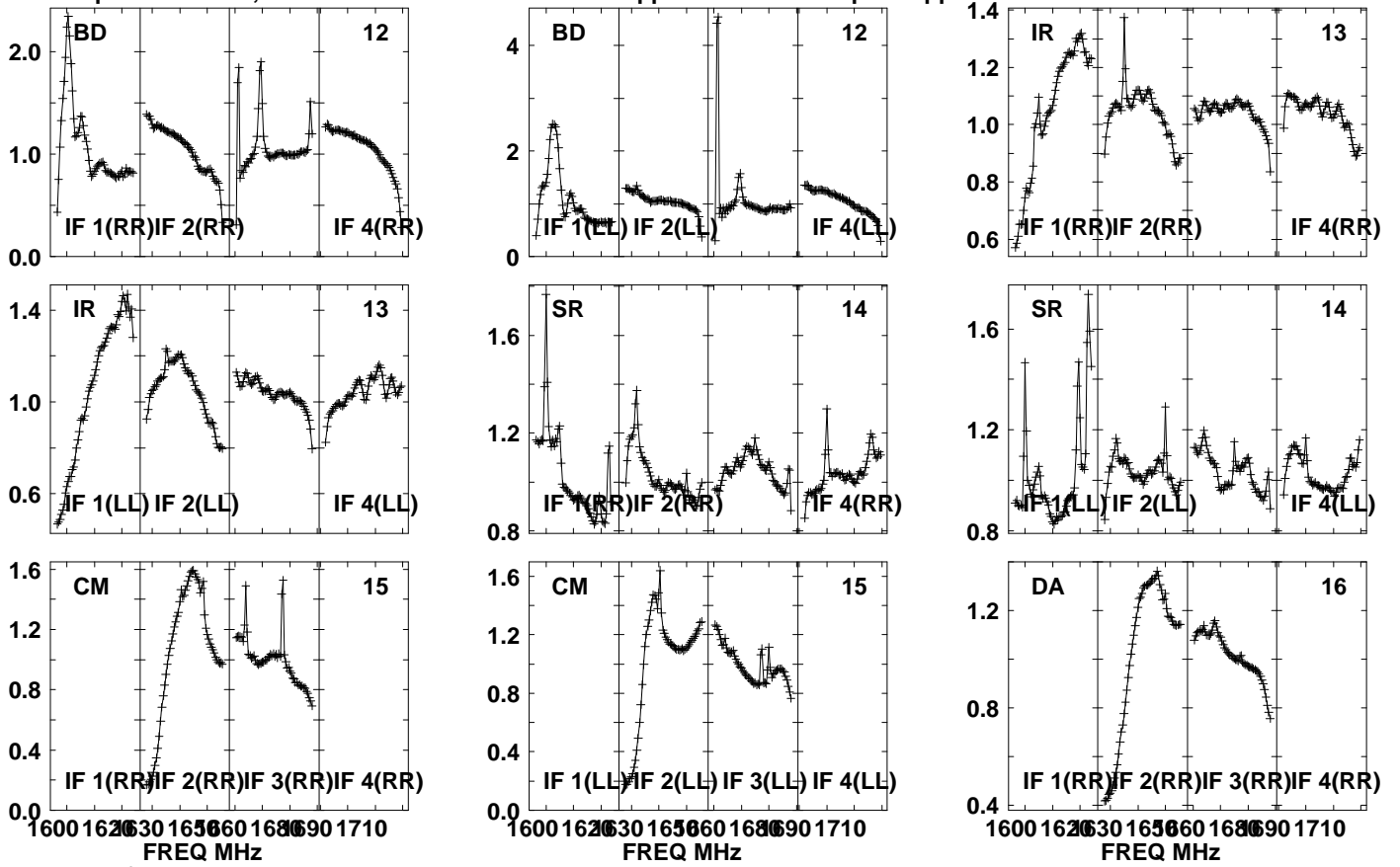

Lower frame: Real Jy

Auto-corr total-power spectrum Antenna: \*

Timerange: 00/13:06:31 to 00/13:07:59

Plot file version 248 created 05-OCT-2021 17:05:27

J0827+5217 GM076.UVDATA.1

Freq = 1.5945 GHz, Bw = 32.000 MH No calibration applied and no bandpass applied

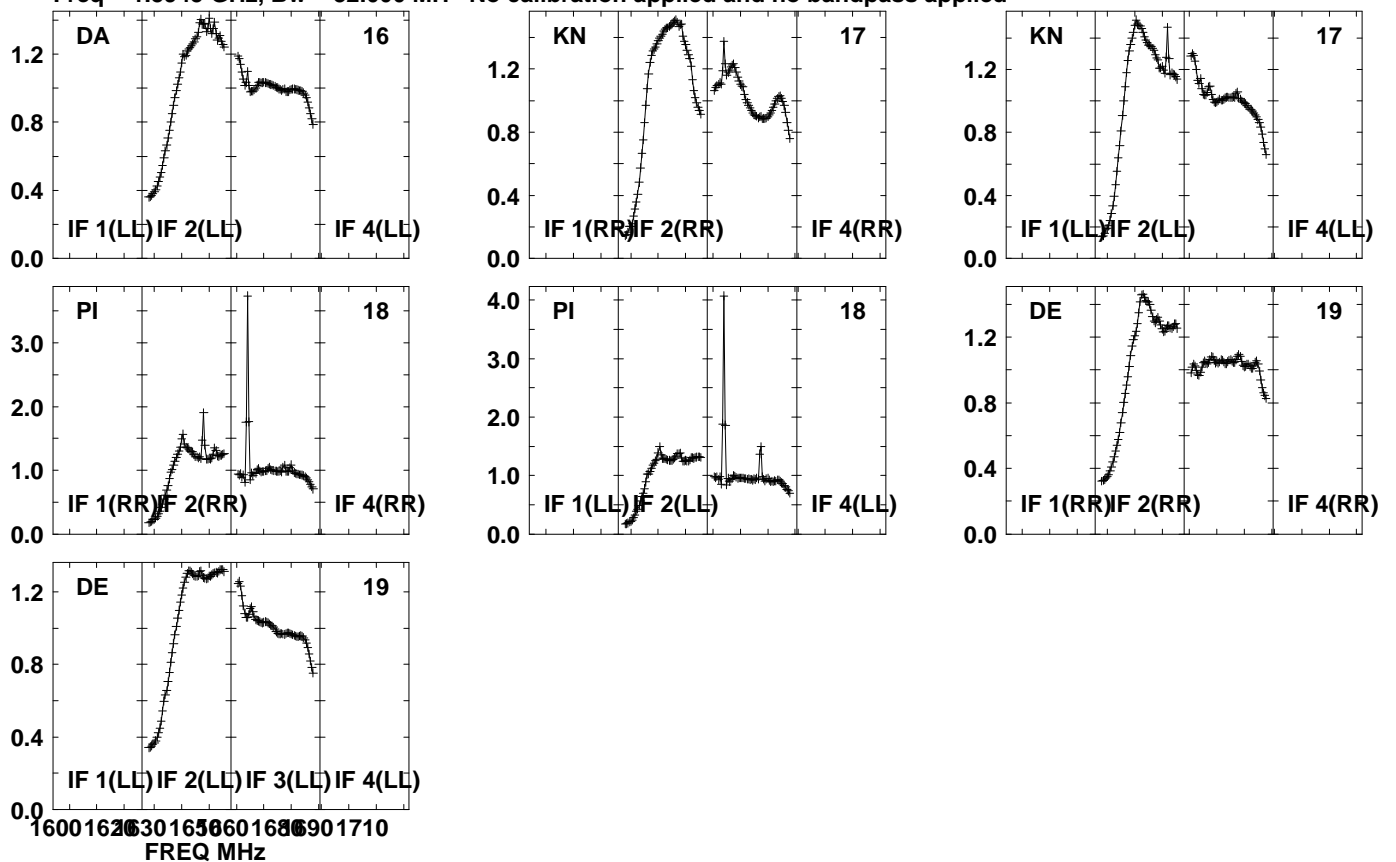

Lower frame: Real Jy  
Auto-corr total-power spectrum Antenna: \*  
Timerange: 00/13:06:31 to 00/13:07:59

Plot file version 249 created 05-OCT-2021 17:05:27

APM08279+525 GM076.UVDATA.1

Freq = 1.5945 GHz, Bw = 32.000 MH No calibration applied and no bandpass applied

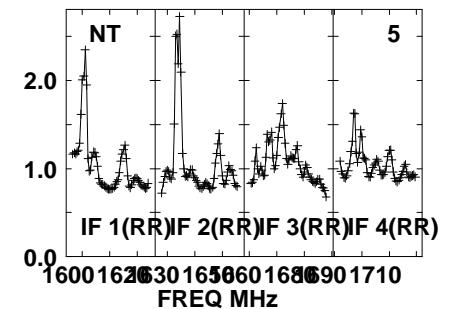
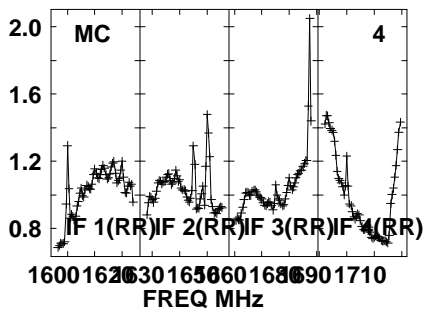
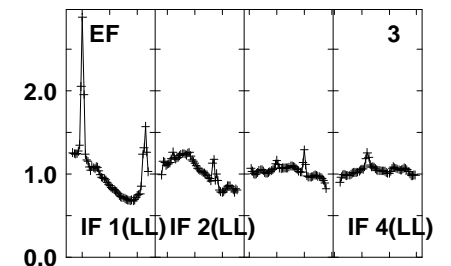
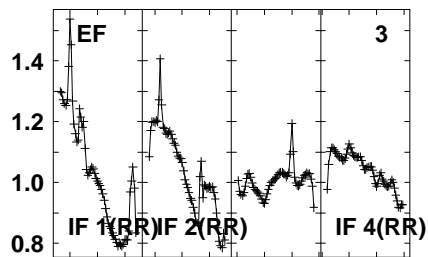
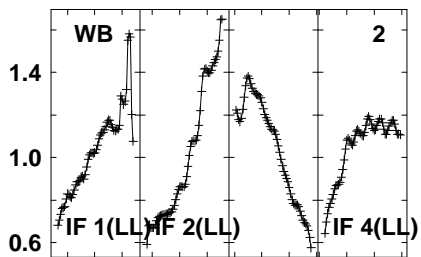
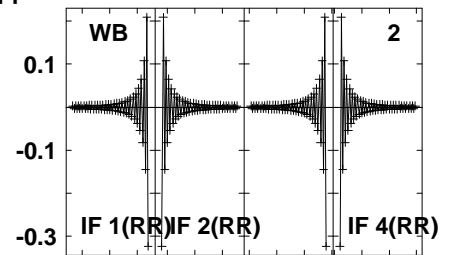
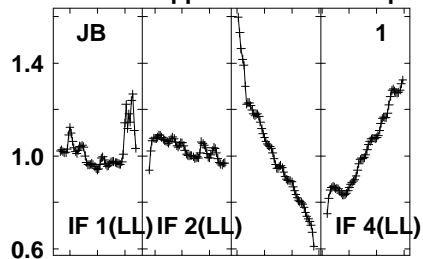
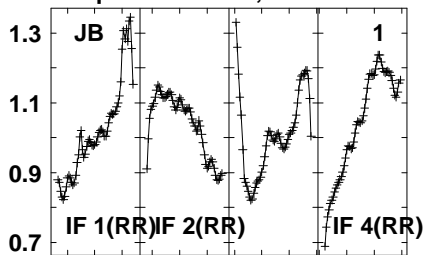

Lower frame: Real Jy  
Auto-corr total-power spectrum Antenna: \*  
Timerange: 00/13:08:01 to 00/13:11:29

Plot file version 250 created 05-OCT-2021 17:05:27

APM08279+525 GM076.UVDATA.1

Freq = 1.5945 GHz, Bw = 32.000 MH No calibration applied and no bandpass applied

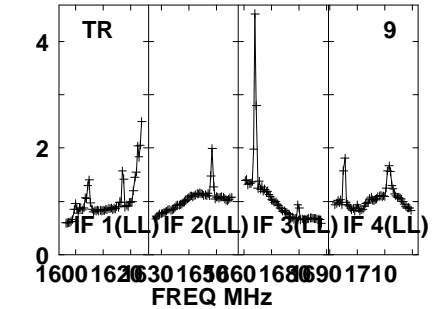
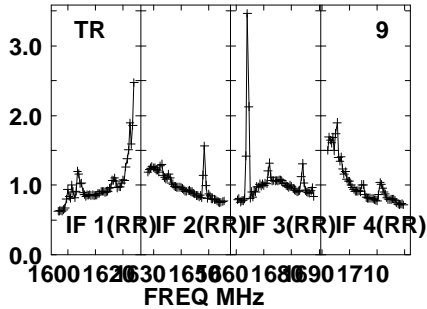
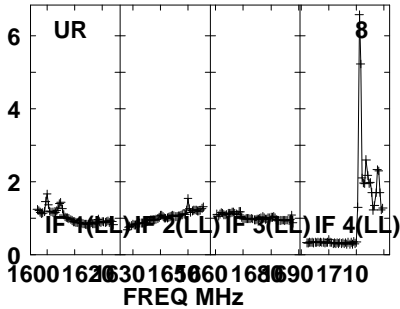
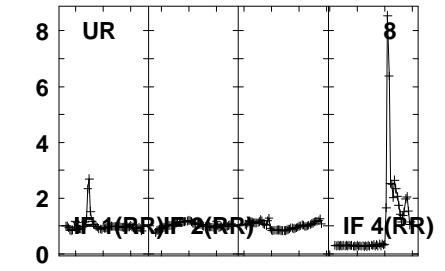
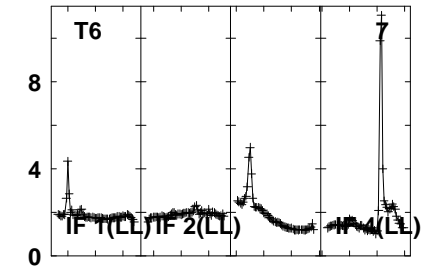
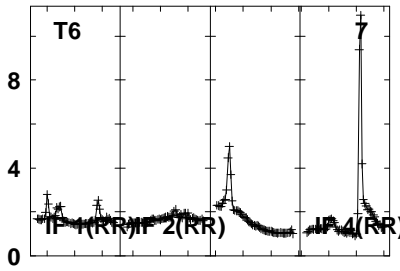
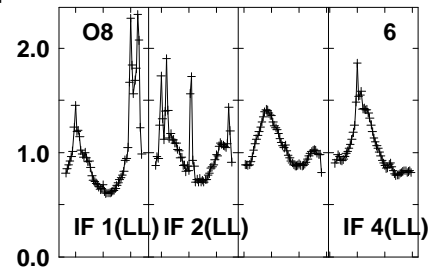
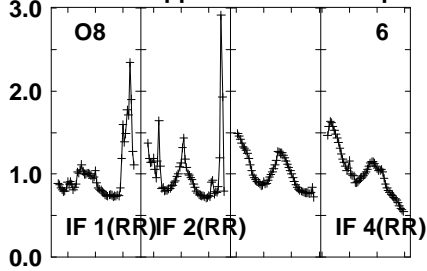
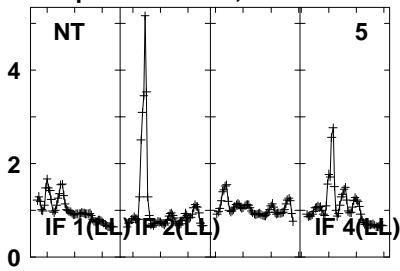

Lower frame: Real Jy  
Auto-corr total-power spectrum Antenna: \*  
Timerange: 00/13:08:01 to 00/13:11:29



Plot file version 251 created 05-OCT-2021 17:05:27

APM08279+525 GM076.UVDATA.1

Freq = 1.5945 GHz, Bw = 32.000 MH No calibration applied and no bandpass applied

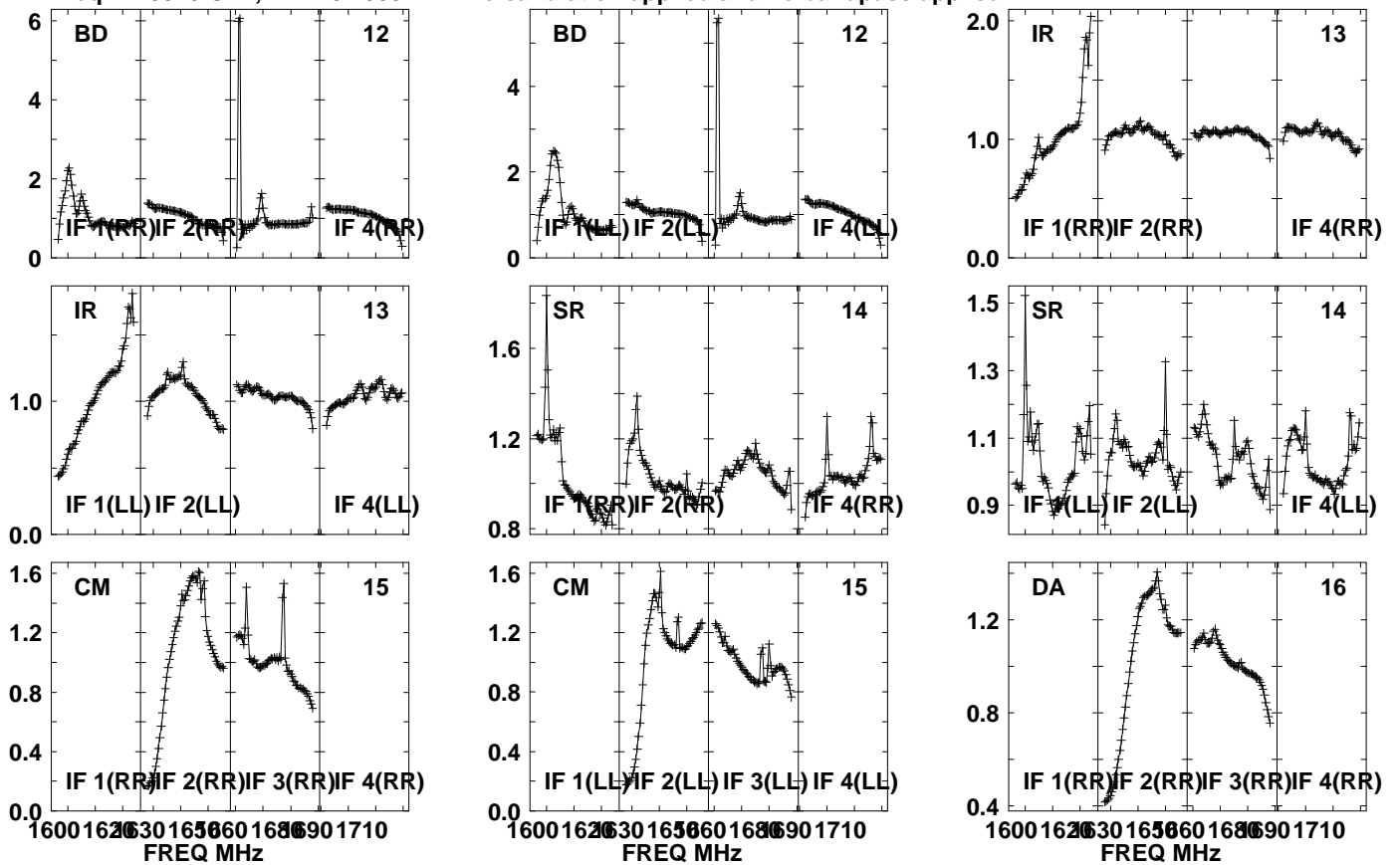

Lower frame: Real Jy

Auto-corr total-power spectrum Antenna: \*

Timerange: 00/13:08:01 to 00/13:11:29

Plot file version 252 created 05-OCT-2021 17:05:28

APM08279+525 GM076.UVDATA.1

Freq = 1.5945 GHz, Bw = 32.000 MH No calibration applied and no bandpass applied

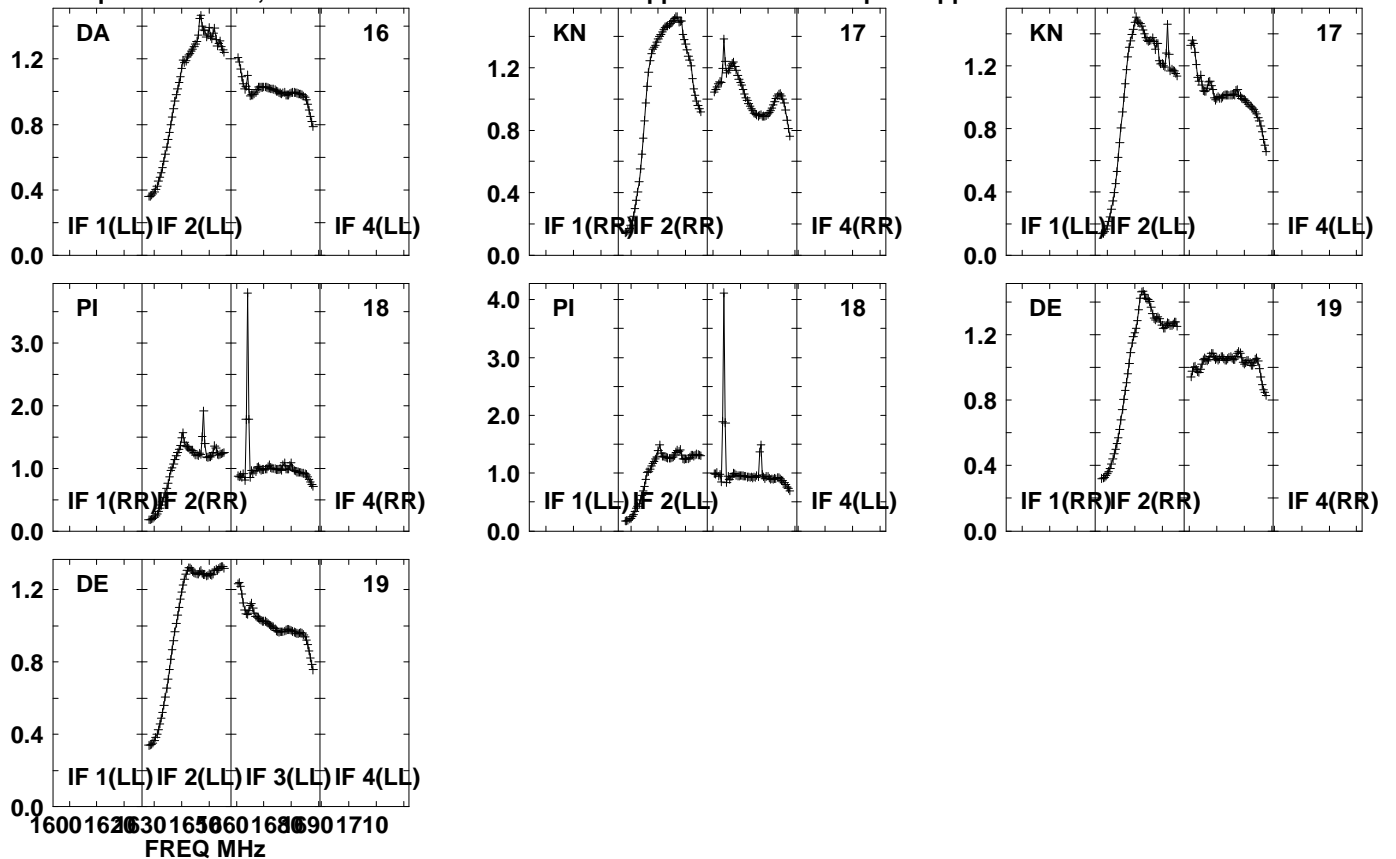

Lower frame: Real Jy  
Auto-corr total-power spectrum Antenna: \*  
Timerange: 00/13:08:01 to 00/13:11:29

Plot file version 253 created 05-OCT-2021 17:05:28

J0827+5217 GM076.UVDATA.1

Freq = 1.5945 GHz, Bw = 32.000 MH No calibration applied and no bandpass applied

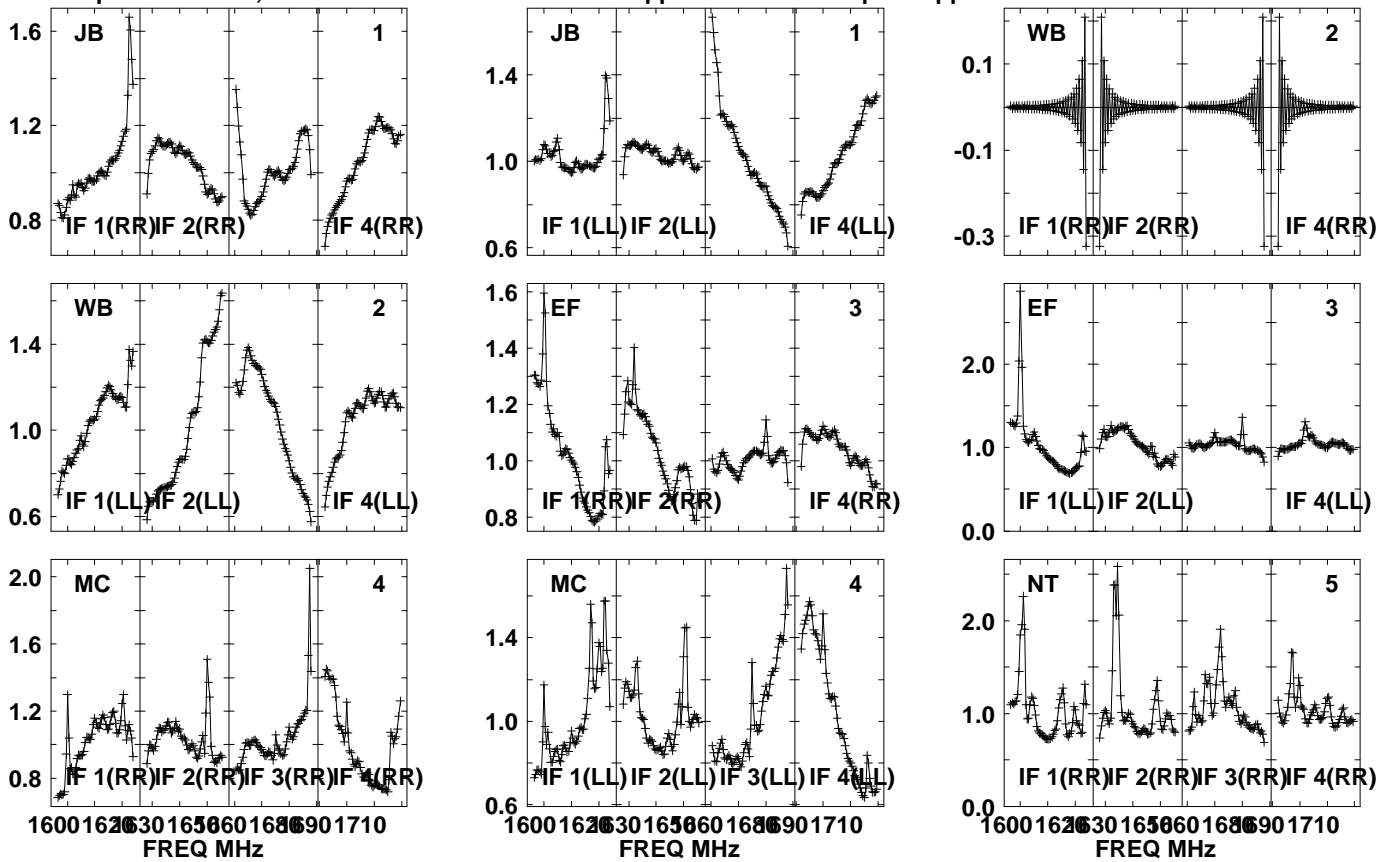

Lower frame: Real Jy  
Auto-corr total-power spectrum Antenna: \*  
Timerange: 00/13:12:01 to 00/13:13:29

Plot file version 254 created 05-OCT-2021 17:05:28

J0827+5217 GM076.UVDATA.1

Freq = 1.5945 GHz, Bw = 32.000 MH No calibration applied and no bandpass applied

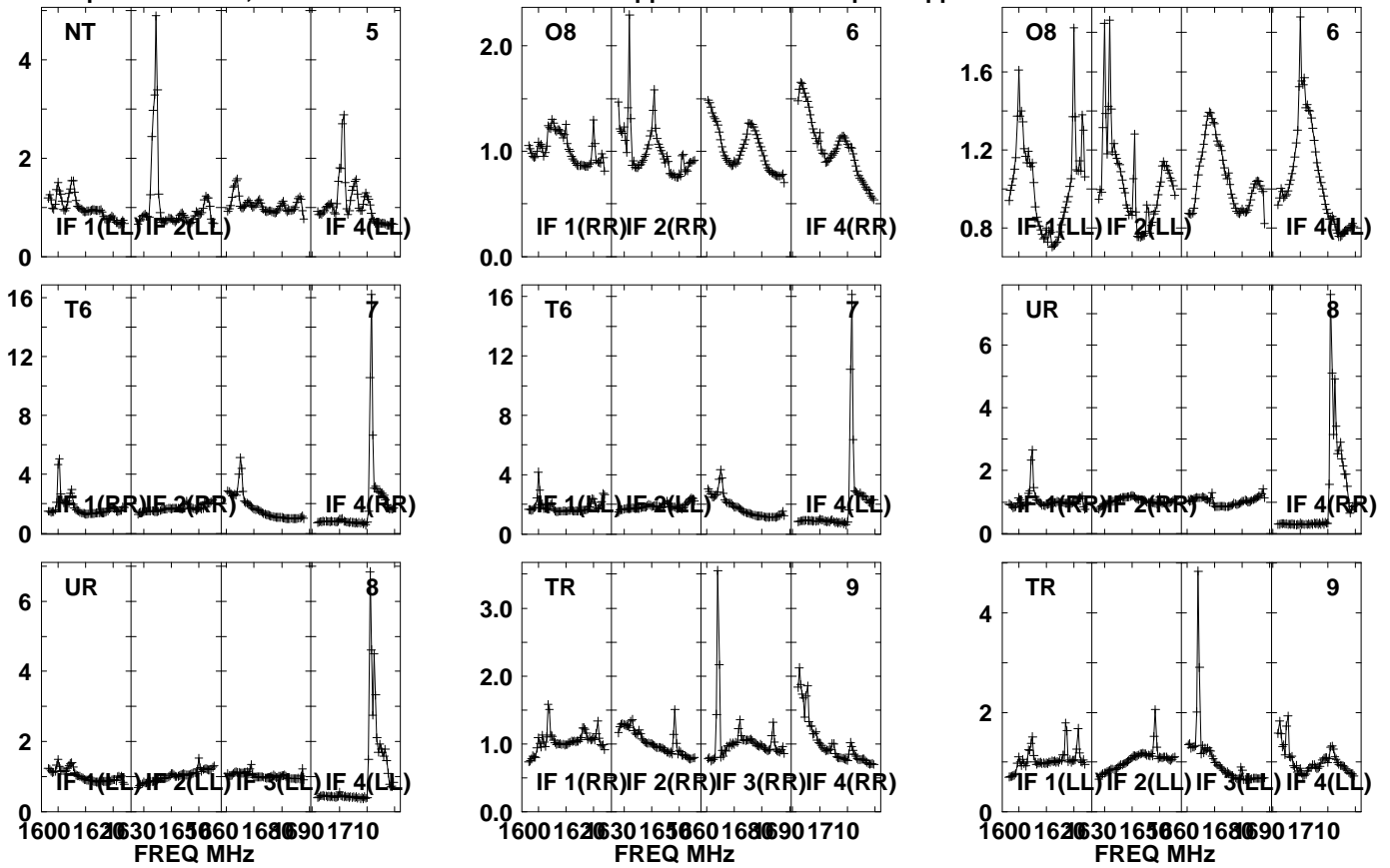

Lower frame: Real Jy  
Auto-corr total-power spectrum Antenna: \*  
Timerange: 00/13:12:01 to 00/13:13:29

Plot file version 255 created 05-OCT-2021 17:05:28

J0827+5217 GM076.UVDATA.1

Freq = 1.5945 GHz, Bw = 32.000 MH No calibration applied and no bandpass applied

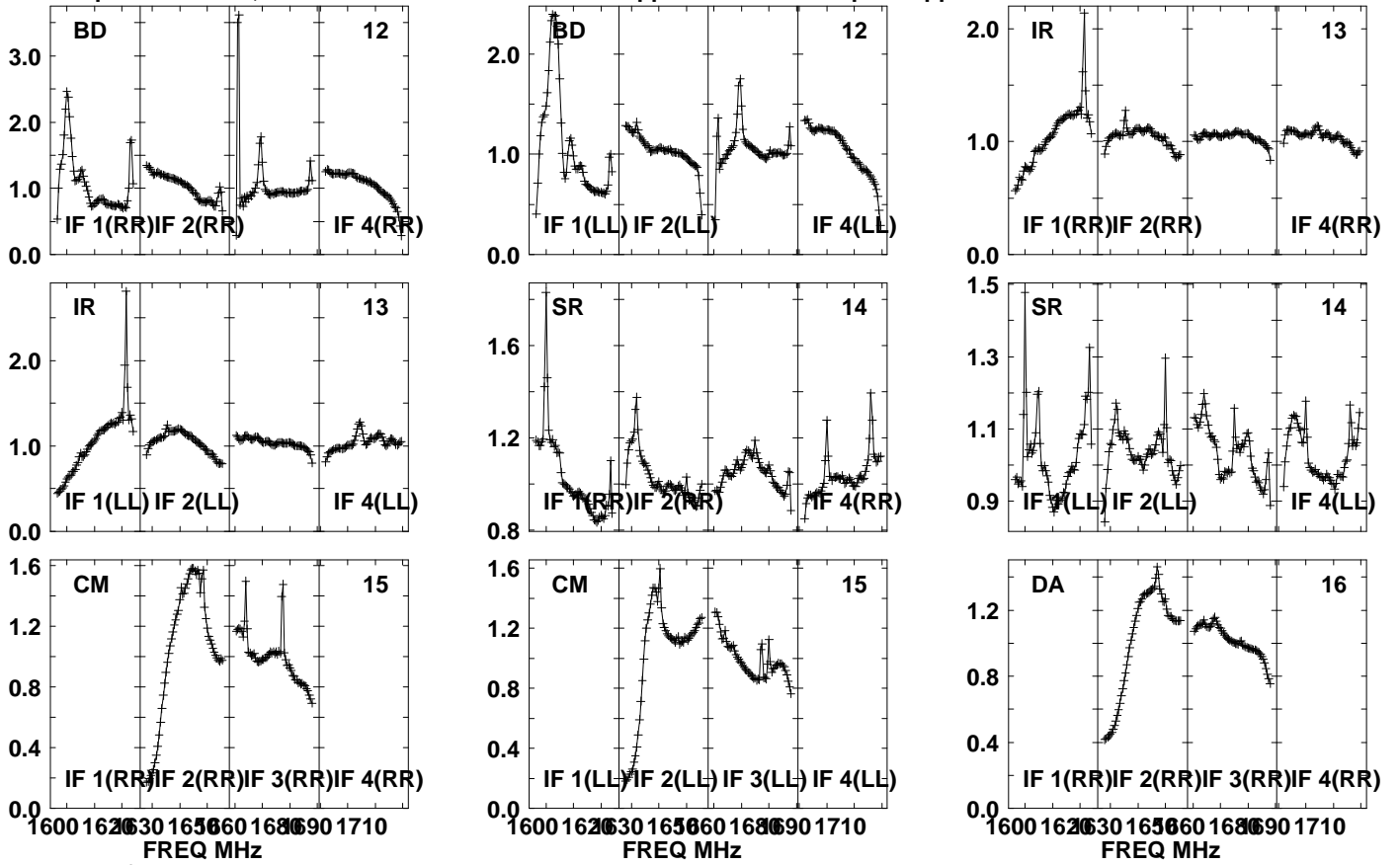

Lower frame: Real Jy

Auto-corr total-power spectrum Antenna: \*

Timerange: 00/13:12:01 to 00/13:13:29

Plot file version 256 created 05-OCT-2021 17:05:28

J0827+5217 GM076.UVDATA.1

Freq = 1.5945 GHz, Bw = 32.000 MH No calibration applied and no bandpass applied

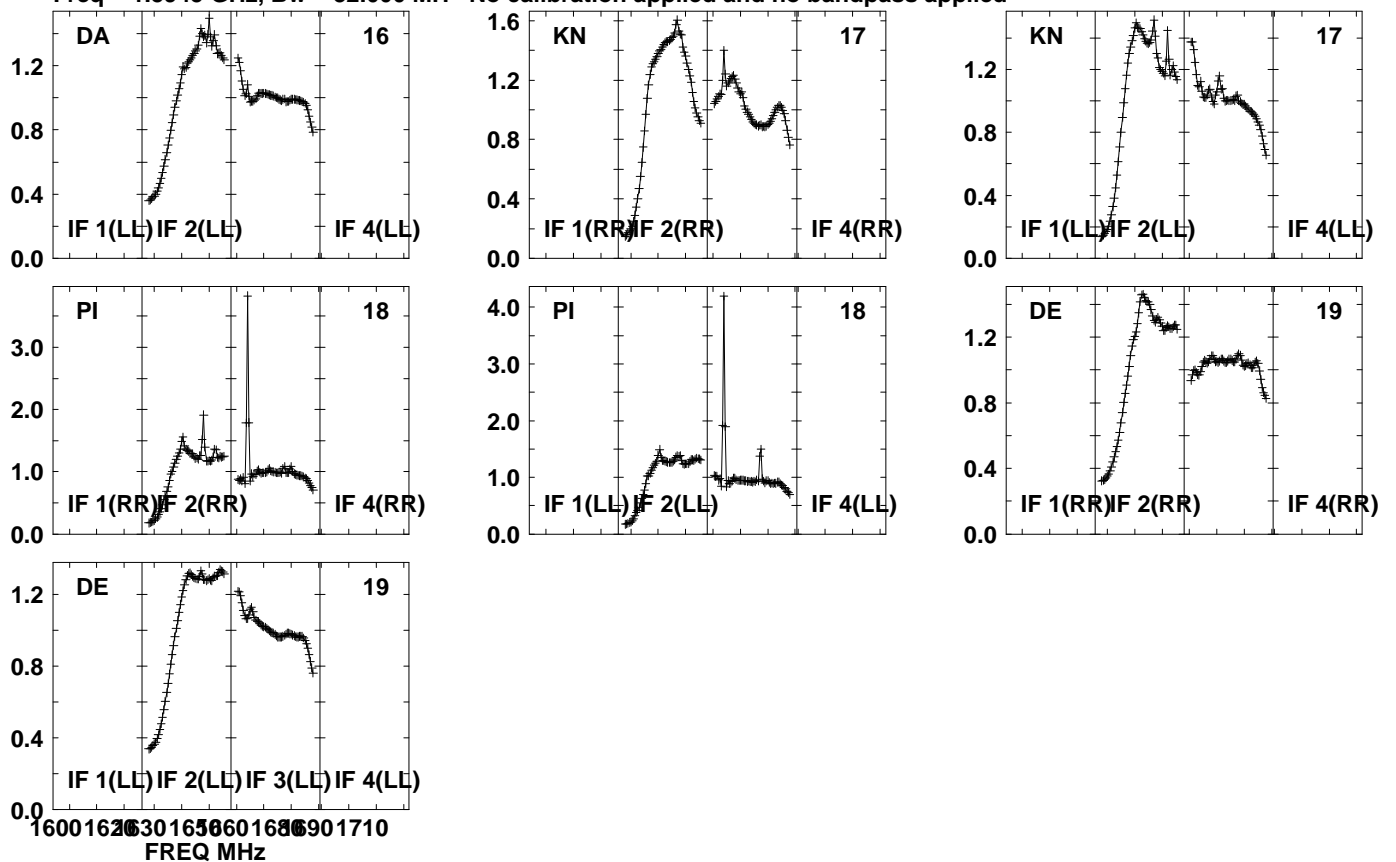

Lower frame: Real Jy  
Auto-corr total-power spectrum Antenna: \*  
Timerange: 00/13:12:01 to 00/13:13:29

Plot file version 257 created 05-OCT-2021 17:05:29

APM08279+525 GM076.UVDATA.1

Freq = 1.5945 GHz, Bw = 32.000 MH No calibration applied and no bandpass applied

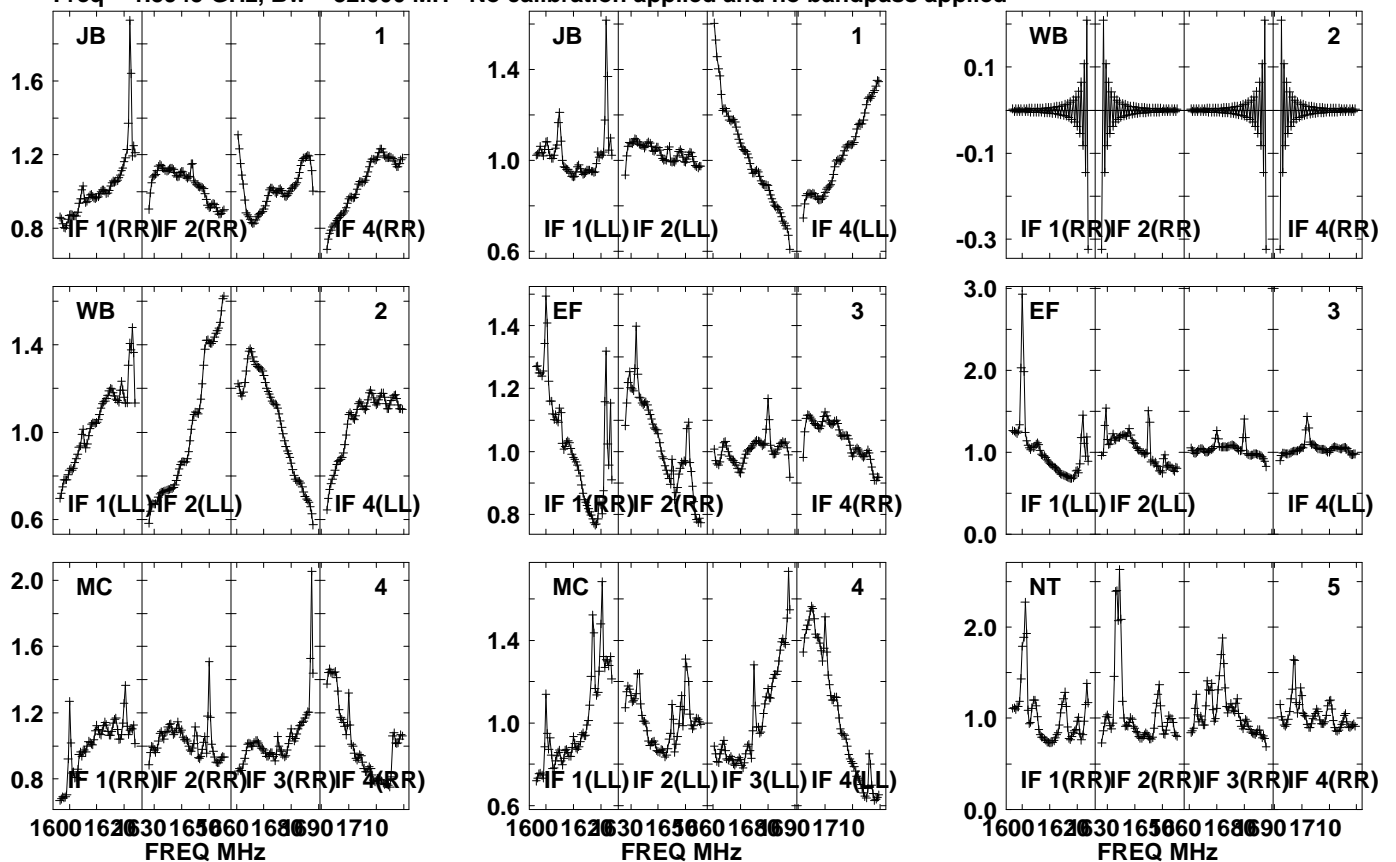

Lower frame: Real Jy  
Auto-corr total-power spectrum Antenna: \*  
Timerange: 00/13:13:31 to 00/13:16:59

Plot file version 258 created 05-OCT-2021 17:05:29

APM08279+525 GM076.UVDATA.1

Freq = 1.5945 GHz, Bw = 32.000 MH No calibration applied and no bandpass applied

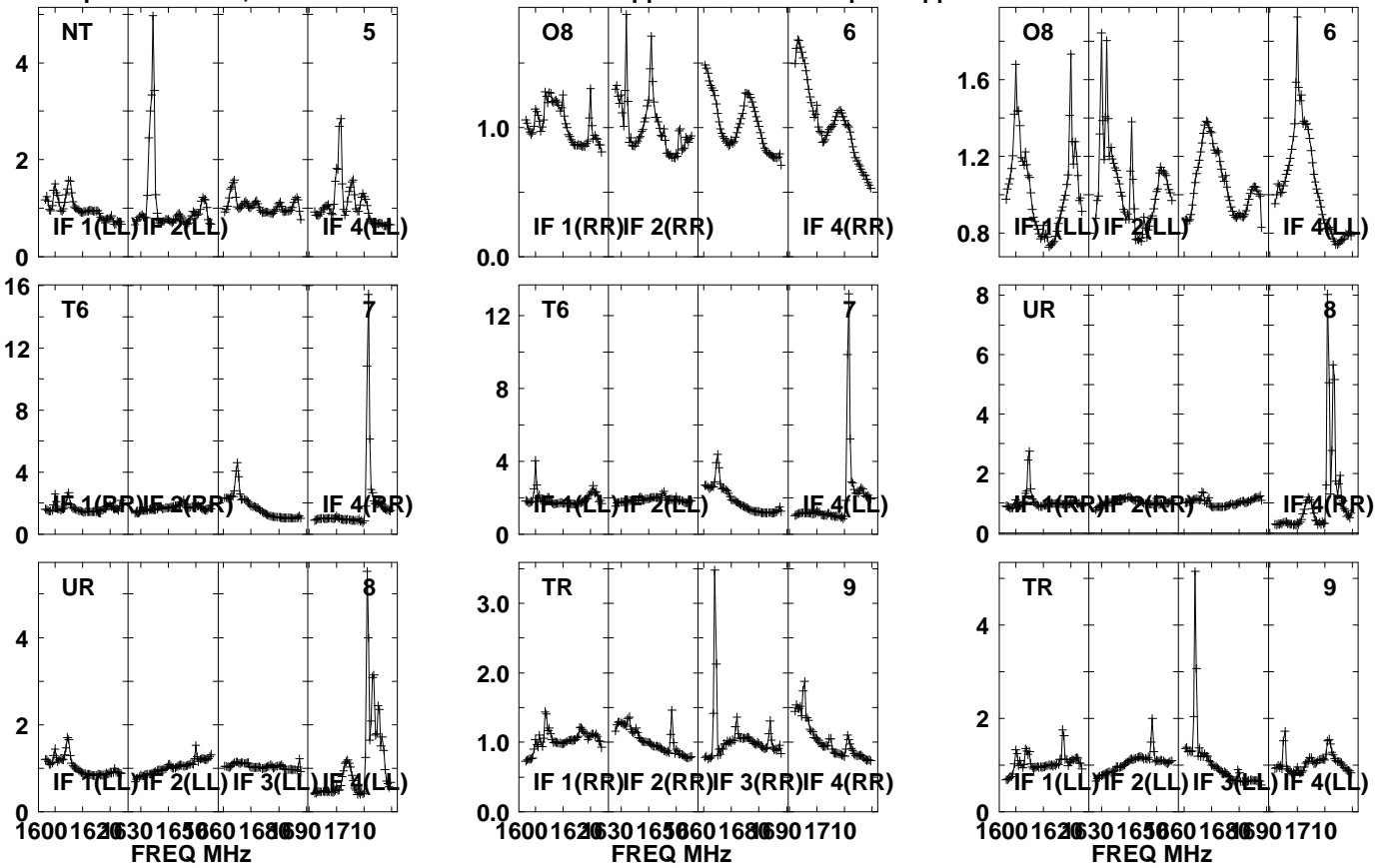

Lower frame: Real Jy  
Auto-corr total-power spectrum Antenna: \*  
Timerange: 00/13:13:31 to 00/13:16:59



Plot file version 259 created 05-OCT-2021 17:05:29

APM08279+525 GM076.UVDATA.1

Freq = 1.5945 GHz, Bw = 32.000 MH No calibration applied and no bandpass applied

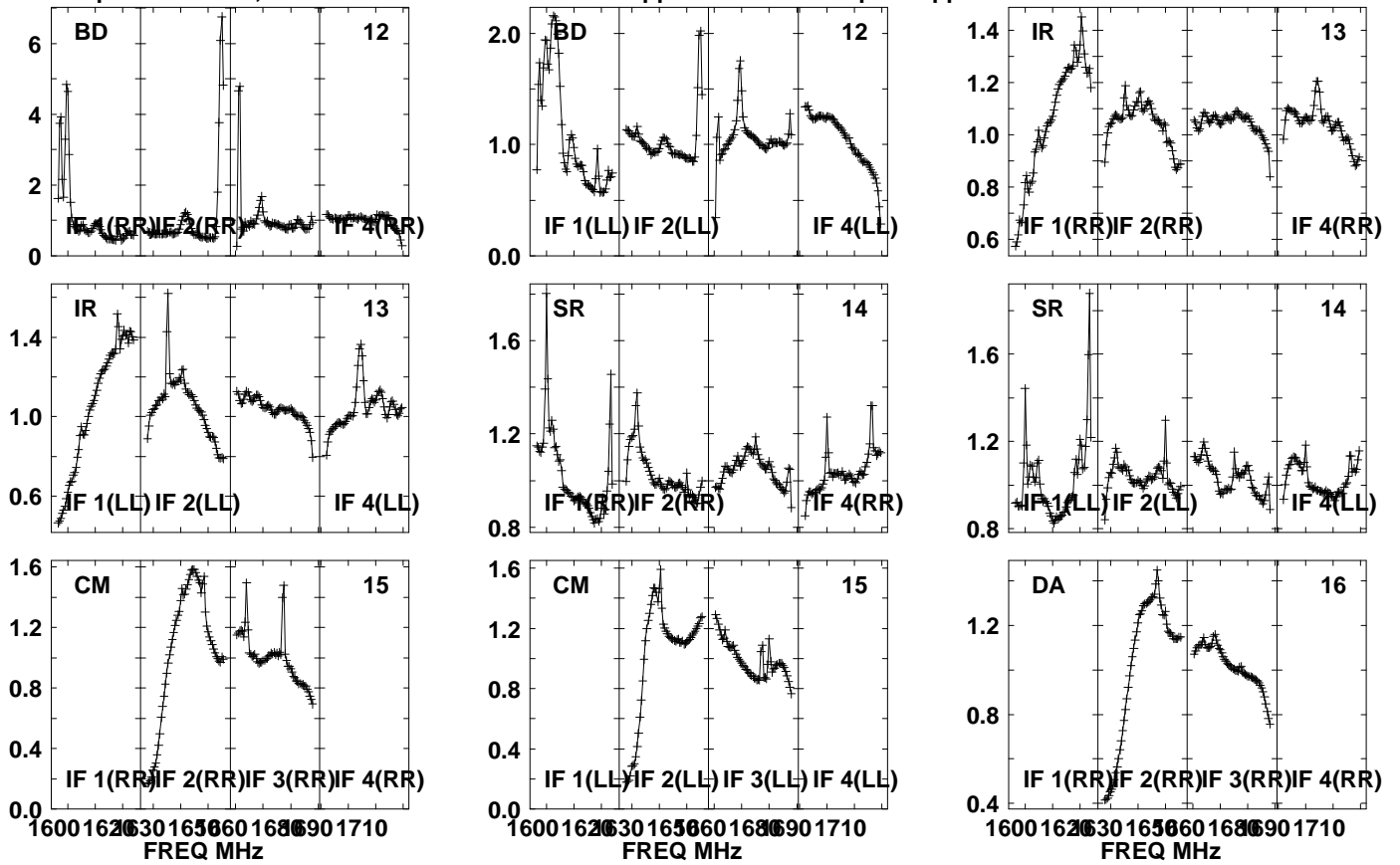

Lower frame: Real Jy

Auto-corr total-power spectrum Antenna: \*

Timerange: 00/13:13:31 to 00/13:16:59

Plot file version 260 created 05-OCT-2021 17:05:29

APM08279+525 GM076.UVDATA.1

Freq = 1.5945 GHz, Bw = 32.000 MH No calibration applied and no bandpass applied

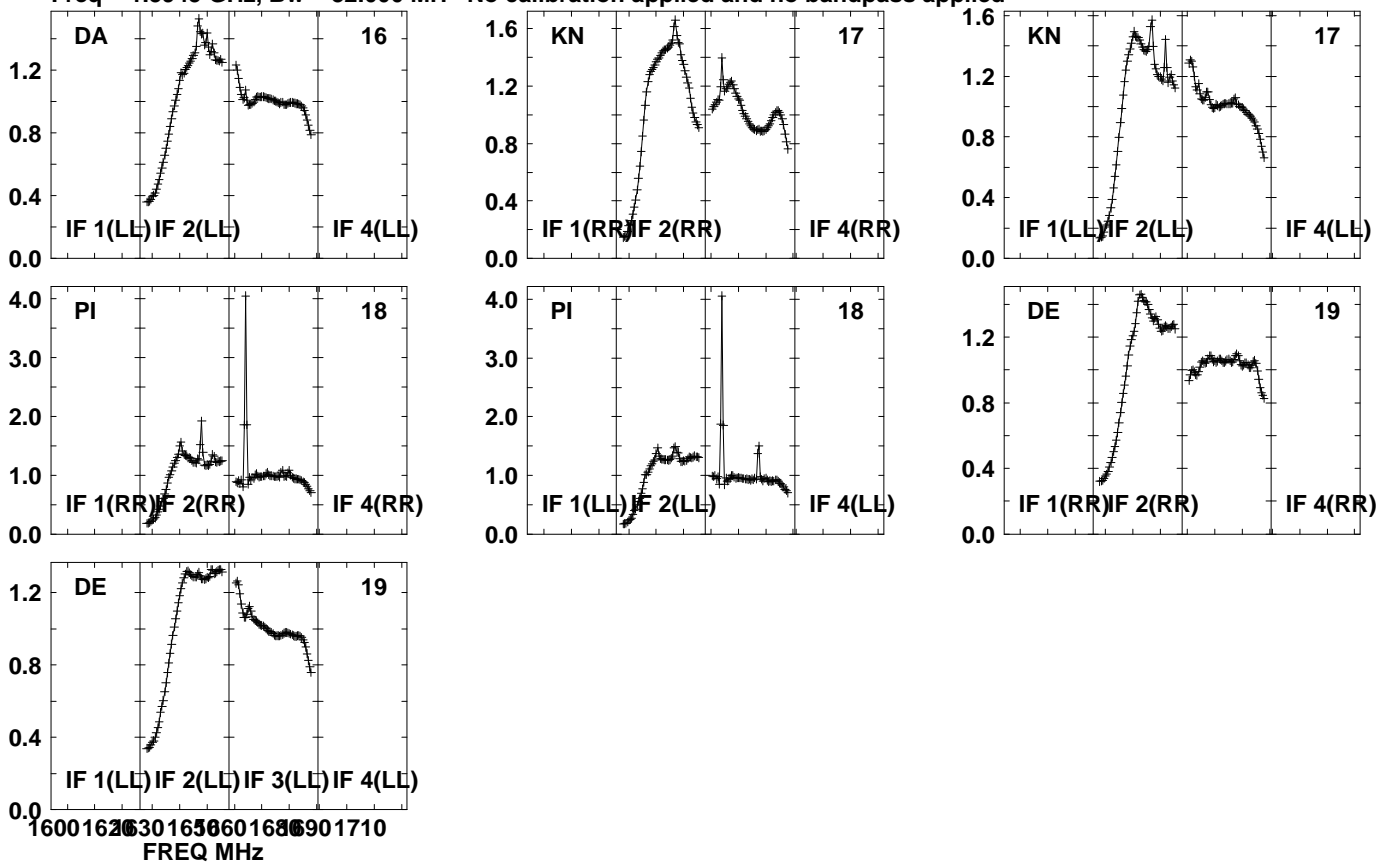

Lower frame: Real Jy

Auto-corr total-power spectrum Antenna: \*

Timerange: 00/13:13:31 to 00/13:16:59

Plot file version 261 created 05-OCT-2021 17:05:30

J0827+5217 GM076.UVDATA.1

Freq = 1.5945 GHz, Bw = 32.000 MH No calibration applied and no bandpass applied

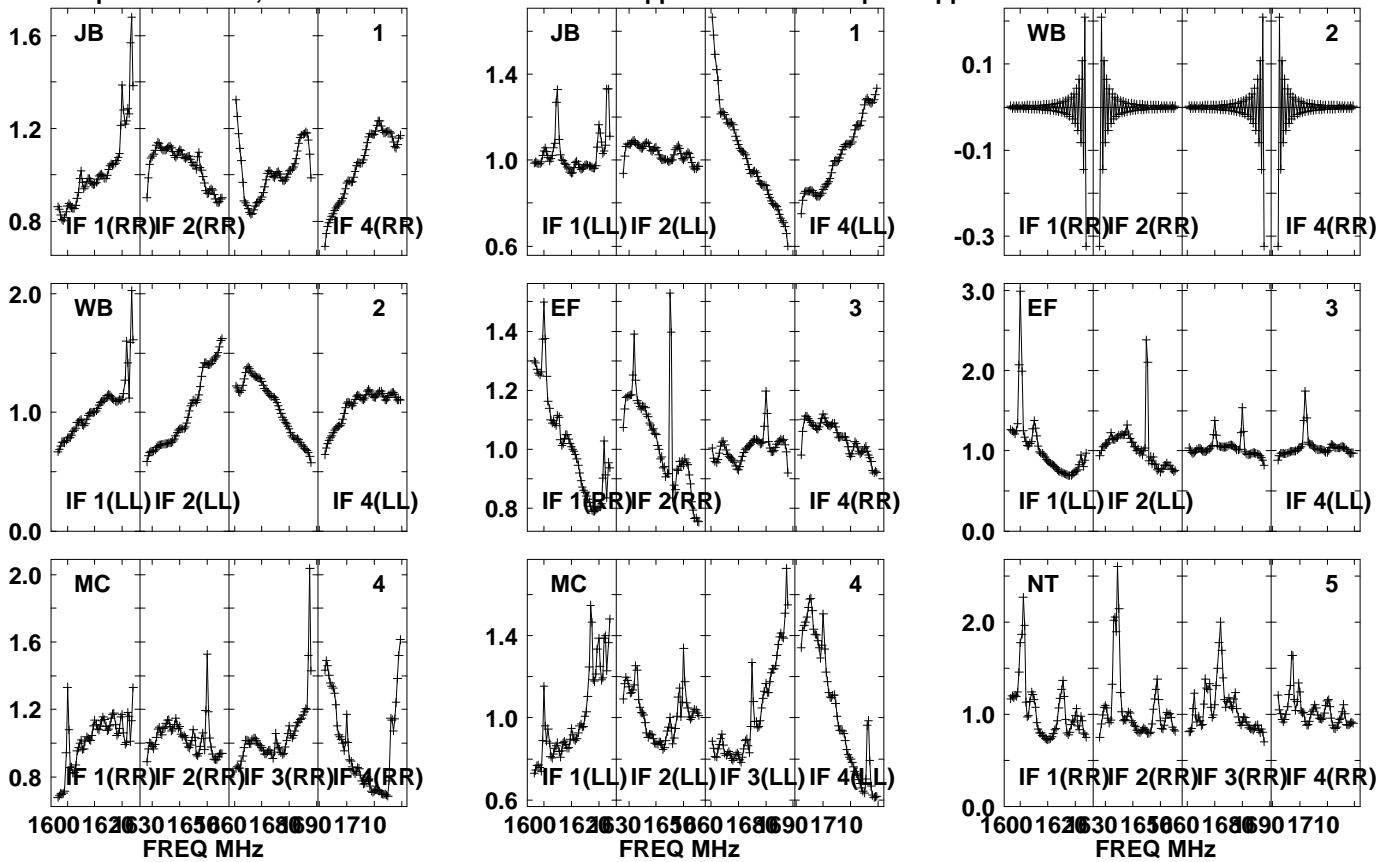

Lower frame: Real Jy

Auto-corr total-power spectrum Antenna: \*

Timerange: 00/13:17:01 to 00/13:18:29

Plot file version 262 created 05-OCT-2021 17:05:30

J0827+5217 GM076.UVDATA.1

Freq = 1.5945 GHz, Bw = 32.000 MH No calibration applied and no bandpass applied

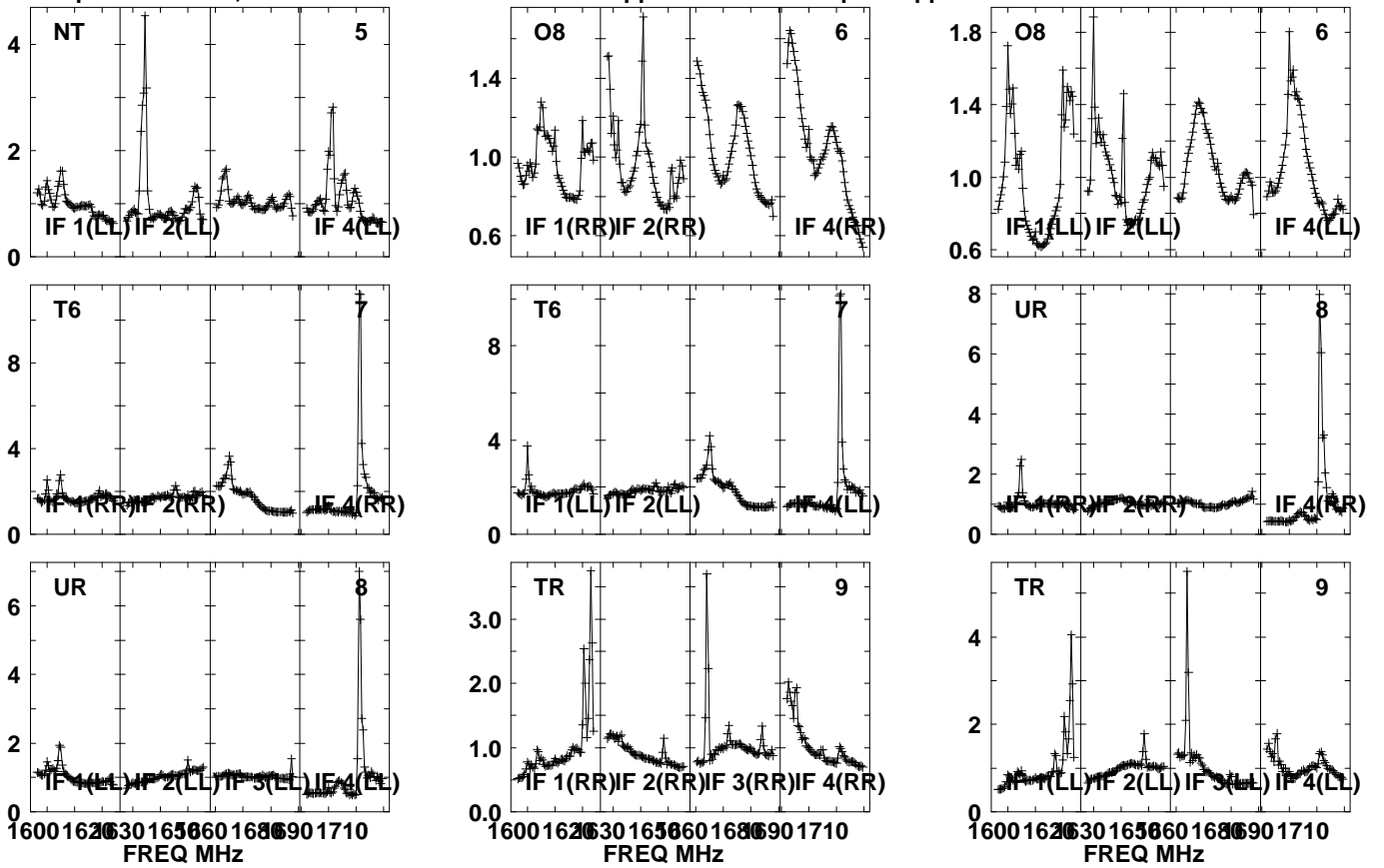

Lower frame: Real Jy  
Auto-corr total-power spectrum Antenna: \*  
Timerange: 00/13:17:01 to 00/13:18:29

Plot file version 263 created 05-OCT-2021 17:05:30

J0827+5217 GM076.UVDATA.1

Freq = 1.5945 GHz, Bw = 32.000 MH No calibration applied and no bandpass applied

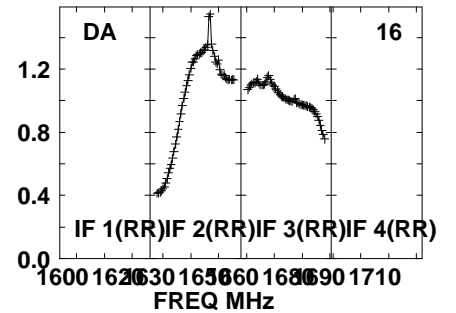
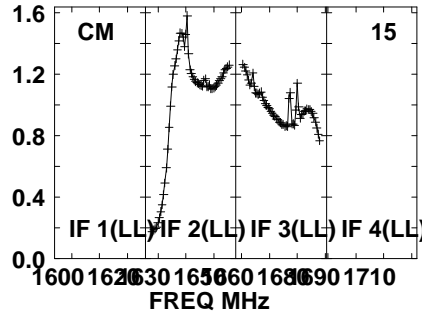
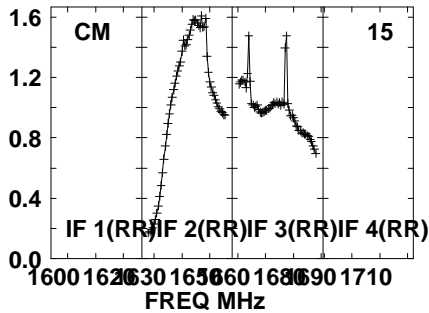
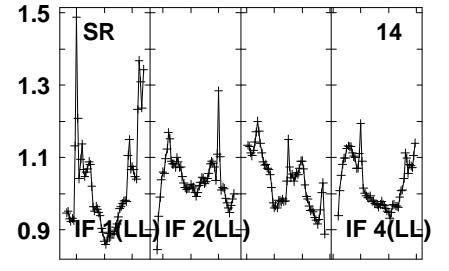
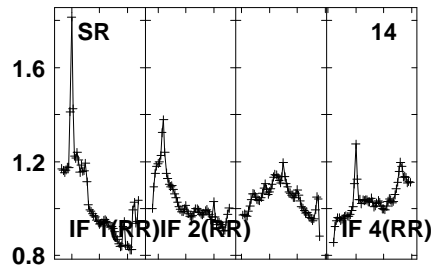
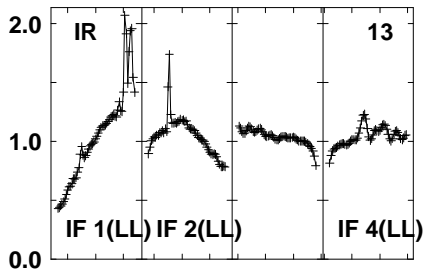
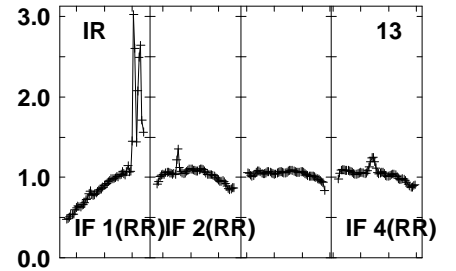
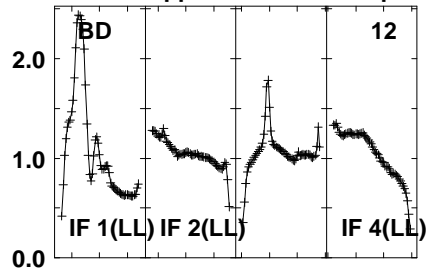
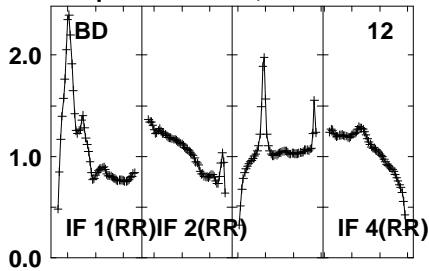

Lower frame: Real Jy

Auto-corr total-power spectrum Antenna: \*

Timerange: 00/13:17:01 to 00/13:18:29

Plot file version 264 created 05-OCT-2021 17:05:30

J0827+5217 GM076.UVDATA.1

Freq = 1.5945 GHz, Bw = 32.000 MH No calibration applied and no bandpass applied

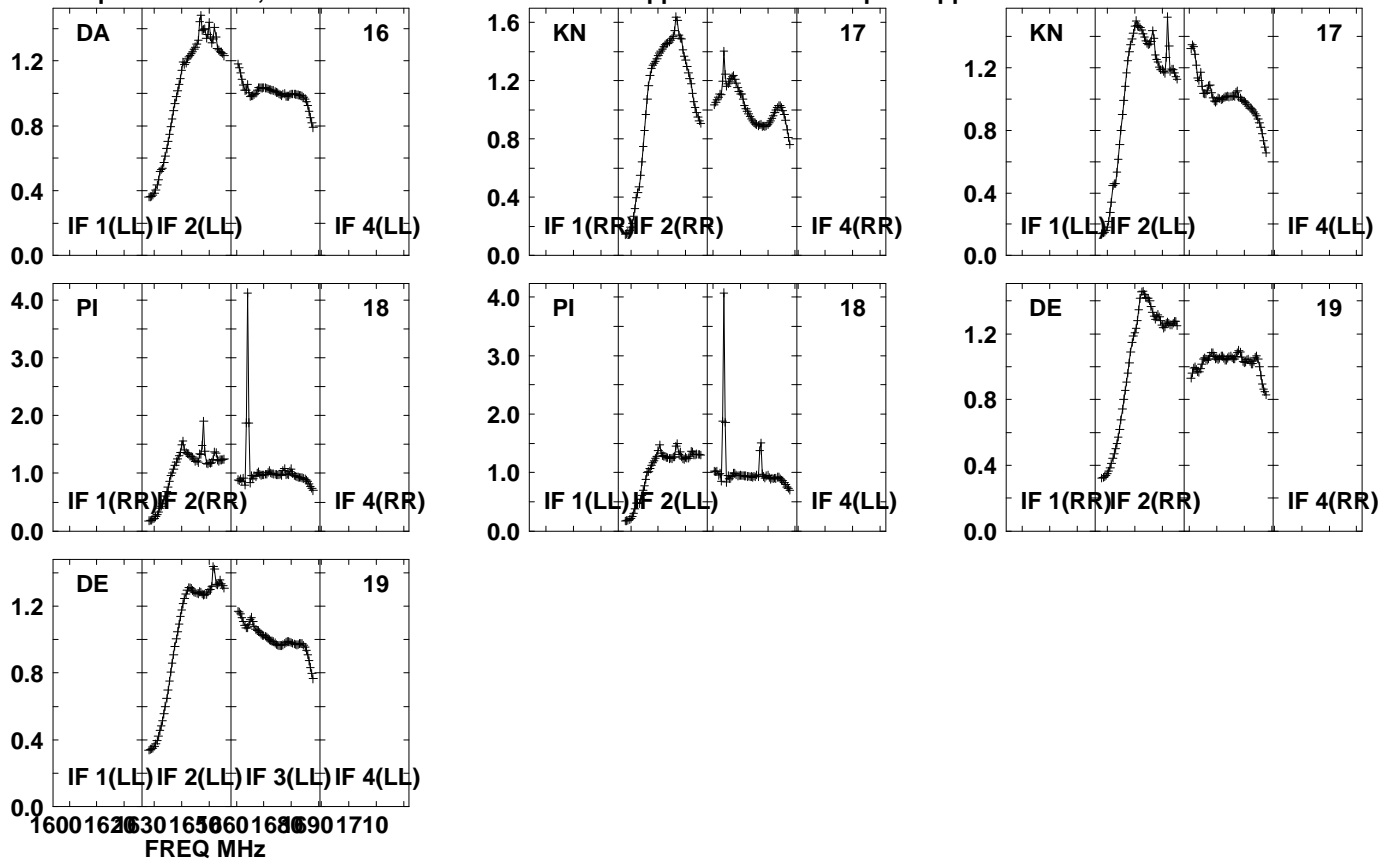

Lower frame: Real Jy  
Auto-corr total-power spectrum Antenna: \*  
Timerange: 00/13:17:01 to 00/13:18:29

Plot file version 265 created 05-OCT-2021 17:05:30

APM08279+525 GM076.UVDATA.1

Freq = 1.5945 GHz, Bw = 32.000 MH No calibration applied and no bandpass applied

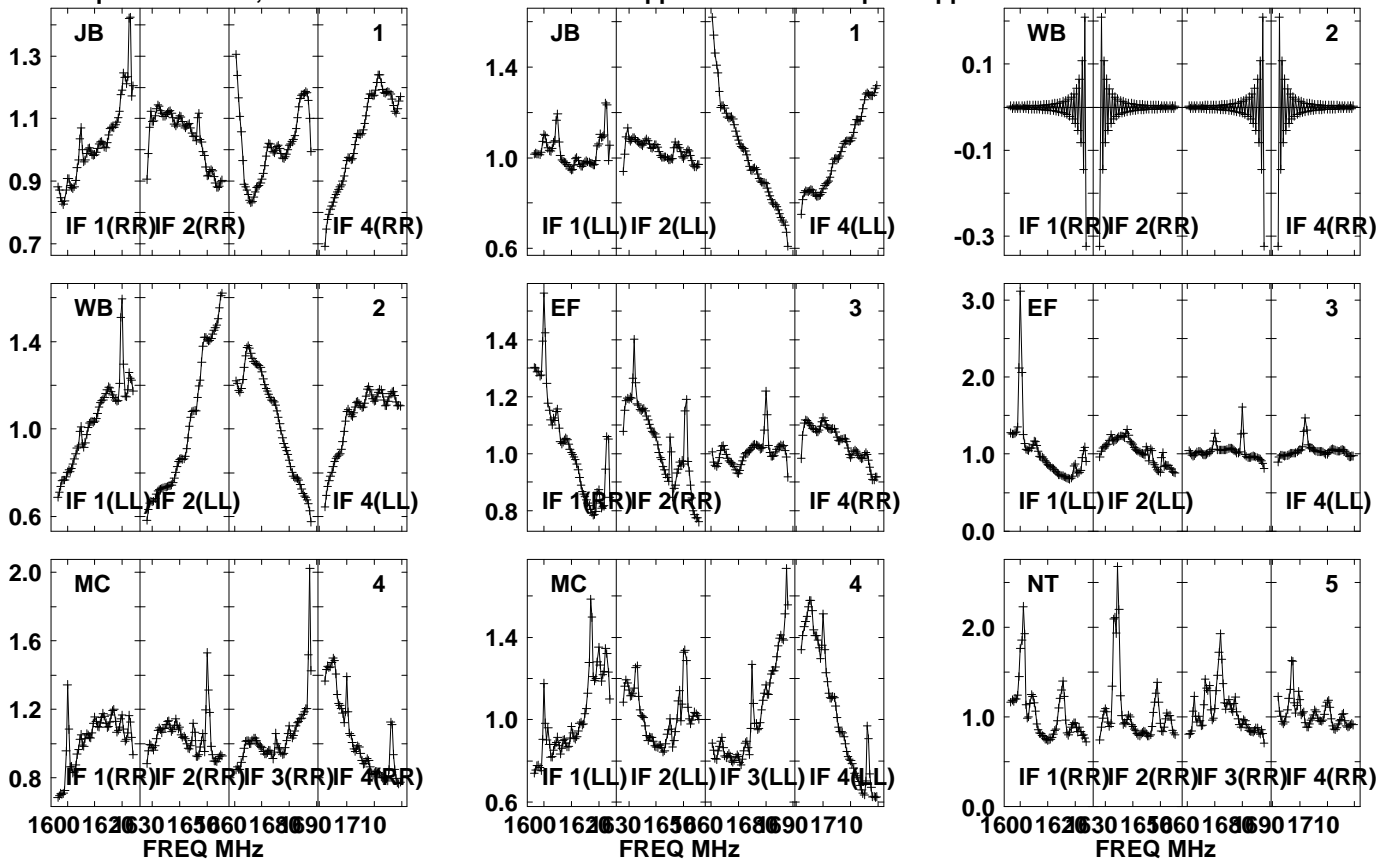

Lower frame: Real Jy  
Auto-corr total-power spectrum Antenna: \*  
Timerange: 00/13:18:31 to 00/13:21:59

Plot file version 266 created 05-OCT-2021 17:05:31

APM08279+525 GM076.UVDATA.1

Freq = 1.5945 GHz, Bw = 32.000 MH No calibration applied and no bandpass applied

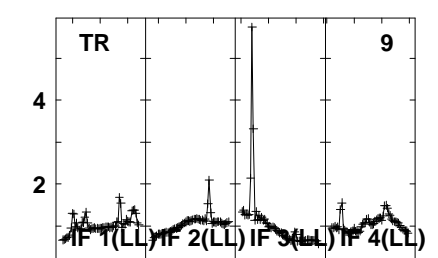
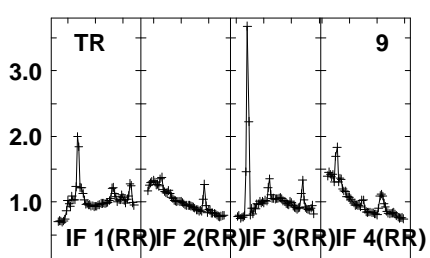
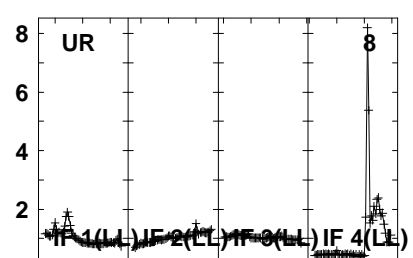
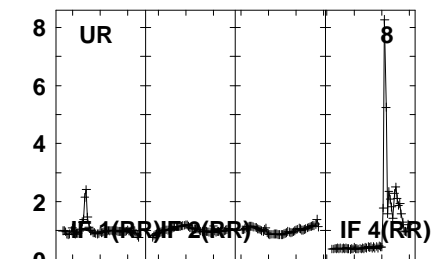
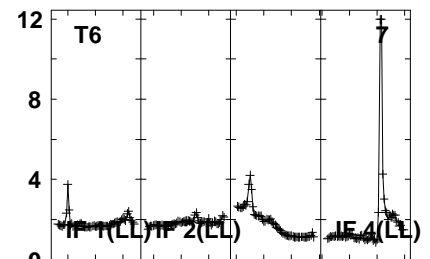
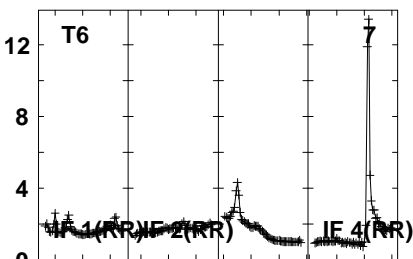
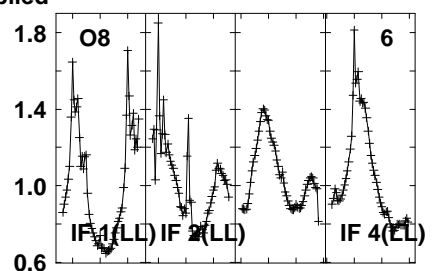
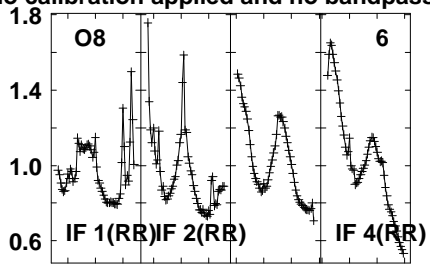
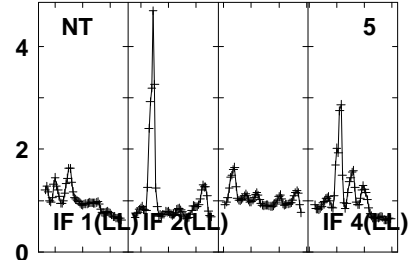

1600 1620 1630 1650 1660 1680 1690 1710  
FREQ MHz

1600 1620 1630 1650 1660 1680 1690 1710  
FREQ MHz

1600 1620 1630 1650 1660 1680 1690 1710  
FREQ MHz

Lower frame: Real Jy  
Auto-corr total-power spectrum Antenna: \*  
Timerange: 00/13:18:31 to 00/13:21:59



Plot file version 267 created 05-OCT-2021 17:05:31

APM08279+525 GM076.UVDATA.1

Freq = 1.5945 GHz, Bw = 32.000 MH No calibration applied and no bandpass applied

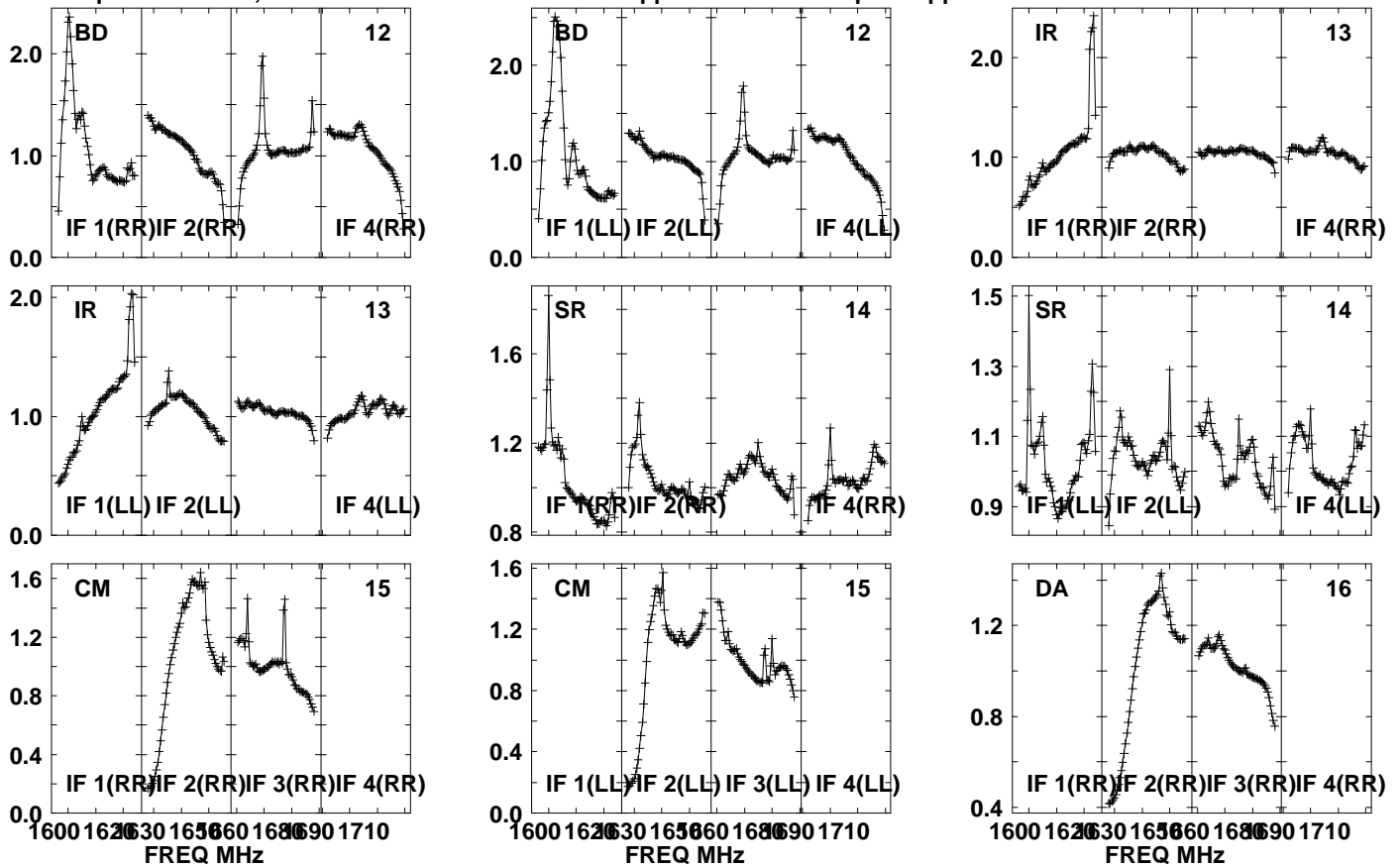

Lower frame: Real Jy

Auto-corr total-power spectrum Antenna: \*

Timerange: 00/13:18:31 to 00/13:21:59

Plot file version 268 created 05-OCT-2021 17:05:31

APM08279+525 GM076.UVDATA.1

Freq = 1.5945 GHz, Bw = 32.000 MH

No calibration applied and no bandpass applied

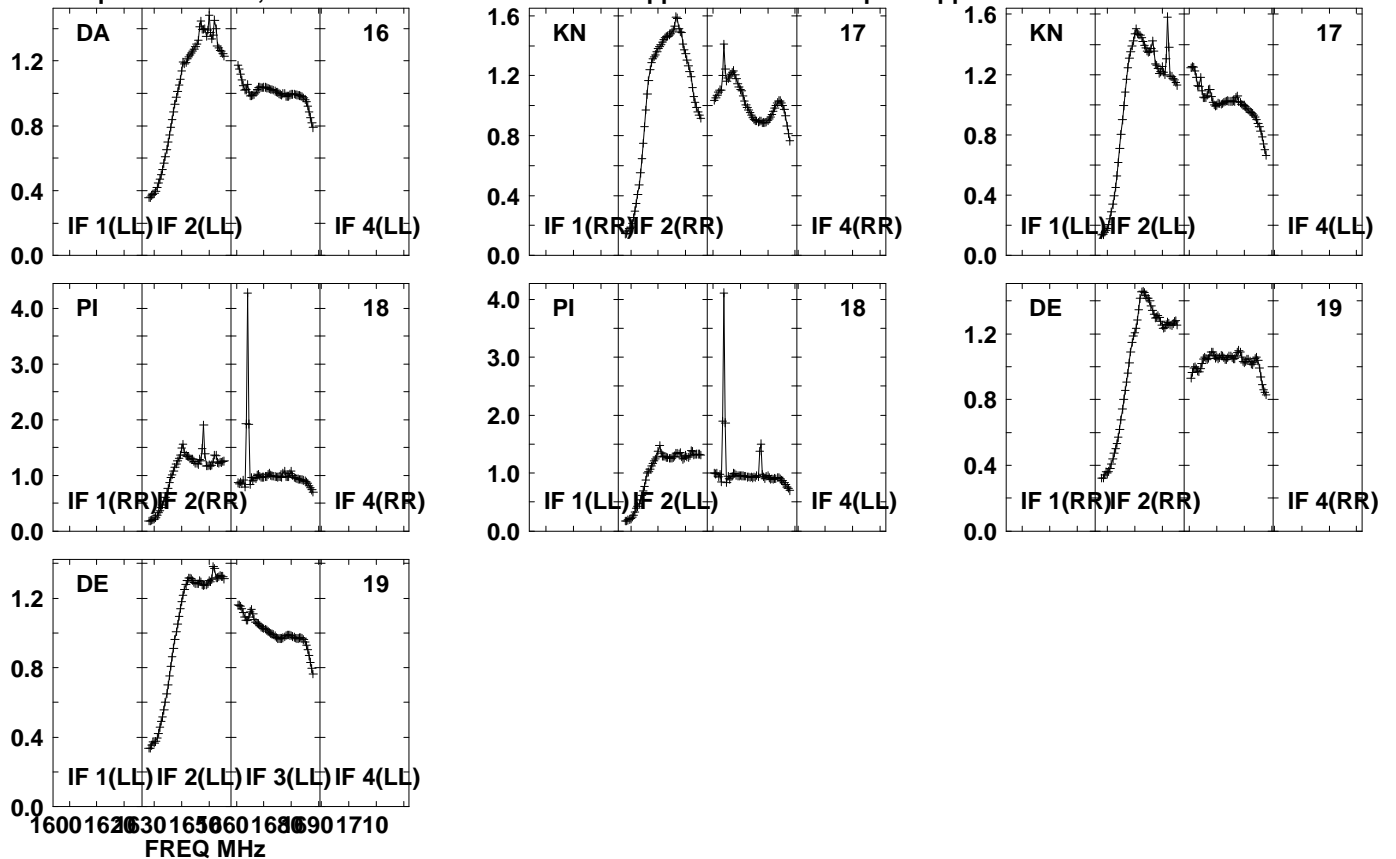

Lower frame: Real Jy  
Auto-corr total-power spectrum Antenna: \*  
Timerange: 00/13:18:31 to 00/13:21:59

Plot file version 269 created 05-OCT-2021 17:05:31

J0827+5217 GM076.UVDATA.1

Freq = 1.5945 GHz, Bw = 32.000 MH No calibration applied and no bandpass applied

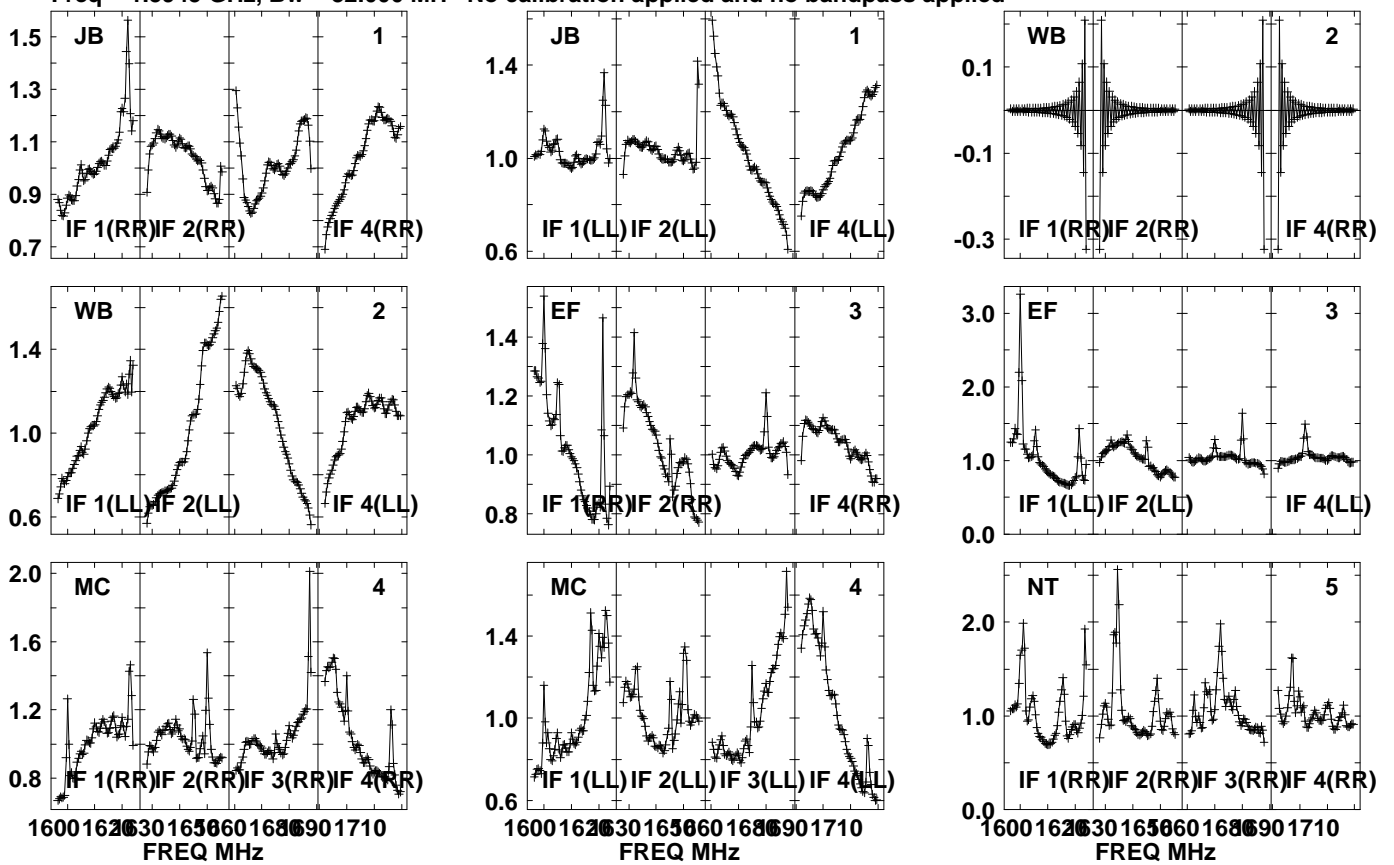

Lower frame: Real Jy  
Auto-corr total-power spectrum Antenna: \*  
Timerange: 00/13:22:31 to 00/13:23:59

Plot file version 270 created 05-OCT-2021 17:05:31

J0827+5217 GM076.UVDATA.1

Freq = 1.5945 GHz, Bw = 32.000 MH No calibration applied and no bandpass applied

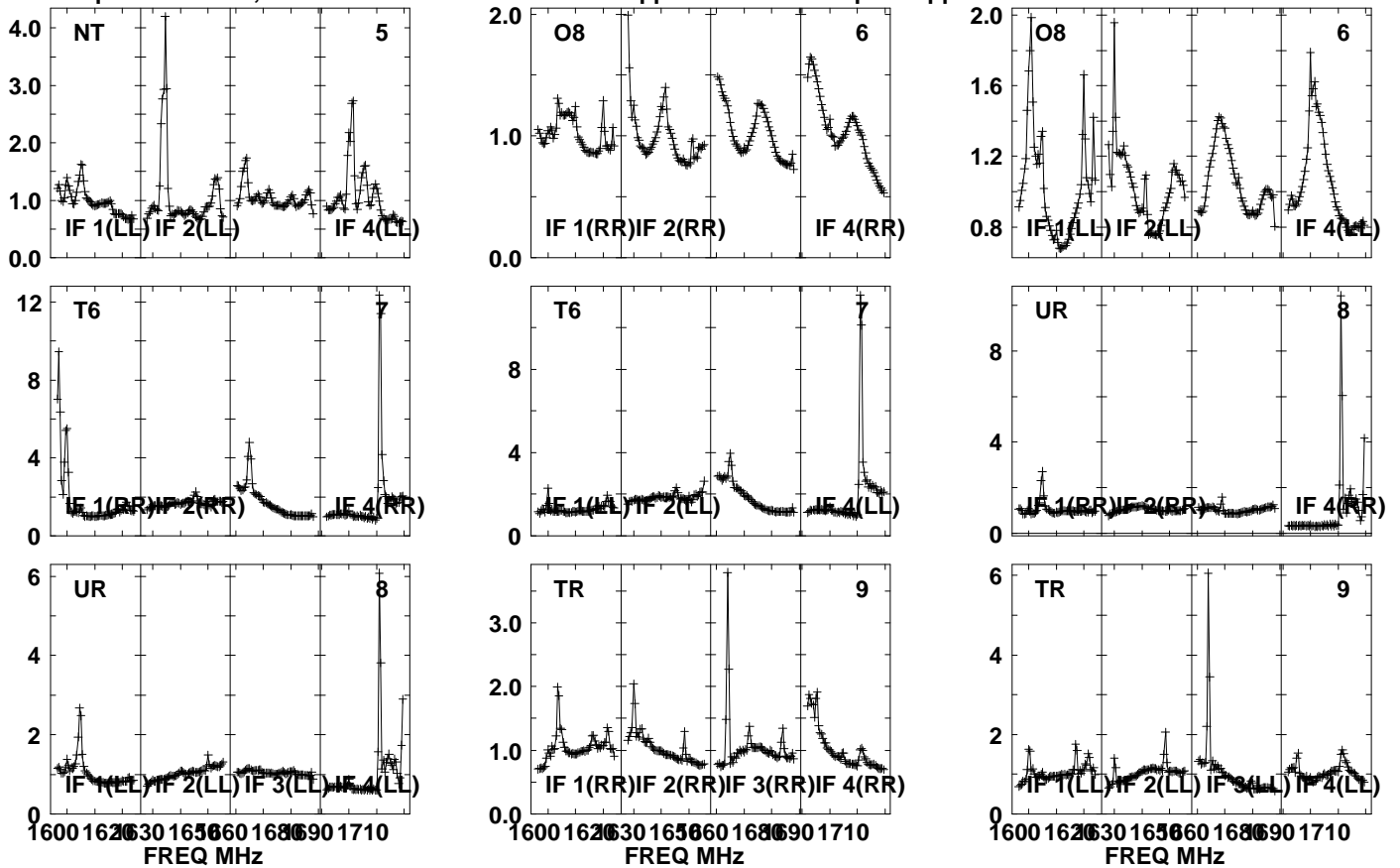

Lower frame: Real Jy

Auto-corr total-power spectrum Antenna: \*

Timerange: 00/13:22:31 to 00/13:23:59

Plot file version 271 created 05-OCT-2021 17:05:32

J0827+5217 GM076.UVDATA.1

Freq = 1.5945 GHz, Bw = 32.000 MH No calibration applied and no bandpass applied

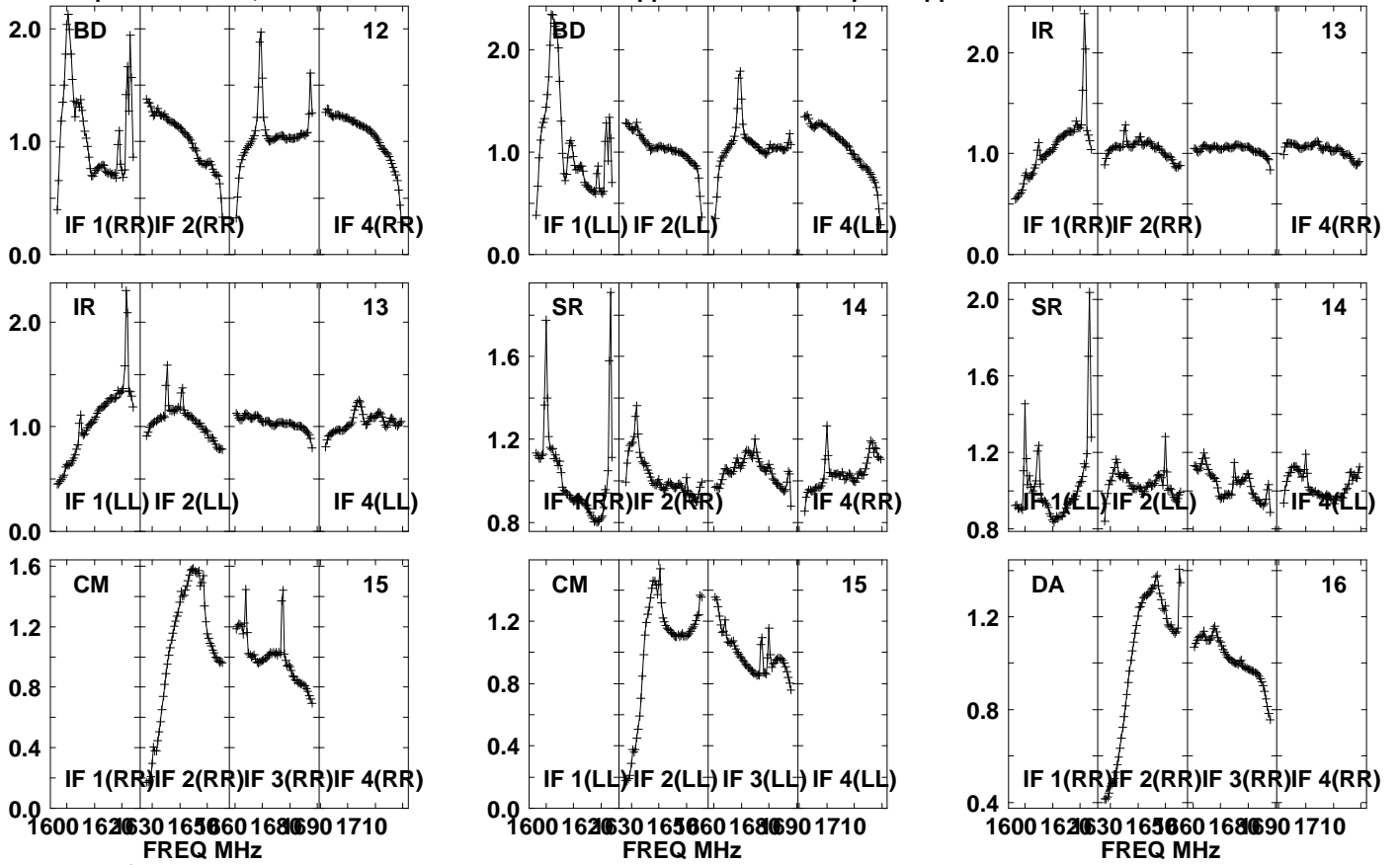

Lower frame: Real Jy  
Auto-corr total-power spectrum Antenna: \*  
Timerange: 00/13:22:31 to 00/13:23:59

Plot file version 272 created 05-OCT-2021 17:05:32

J0827+5217 GM076.UVDATA.1

Freq = 1.5945 GHz, Bw = 32.000 MH No calibration applied and no bandpass applied

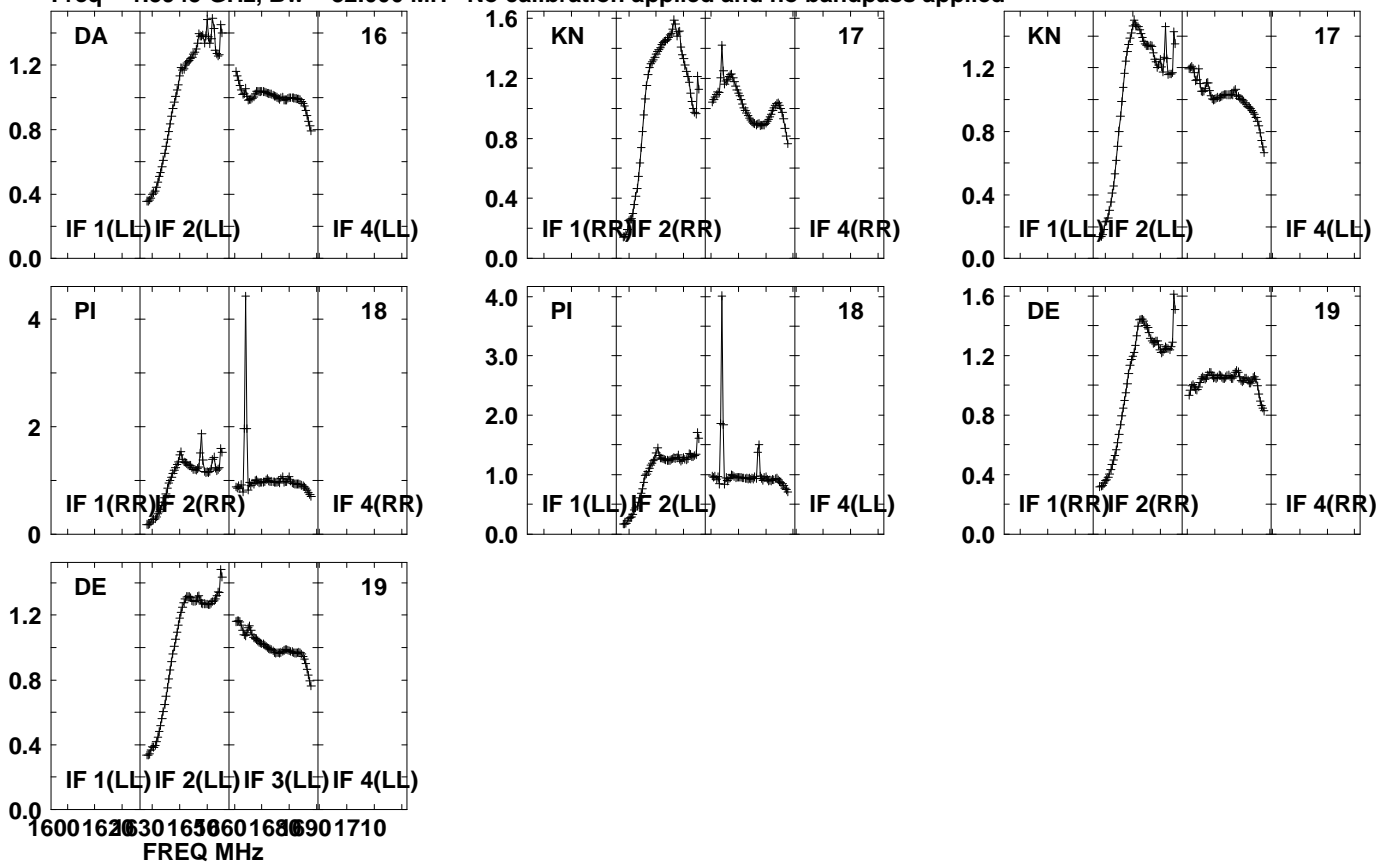

Lower frame: Real Jy  
Auto-corr total-power spectrum Antenna: \*  
Timerange: 00/13:22:31 to 00/13:23:59

Plot file version 273 created 05-OCT-2021 17:05:32

APM08279+525 GM076.UVDATA.1

Freq = 1.5945 GHz, Bw = 32.000 MH No calibration applied and no bandpass applied

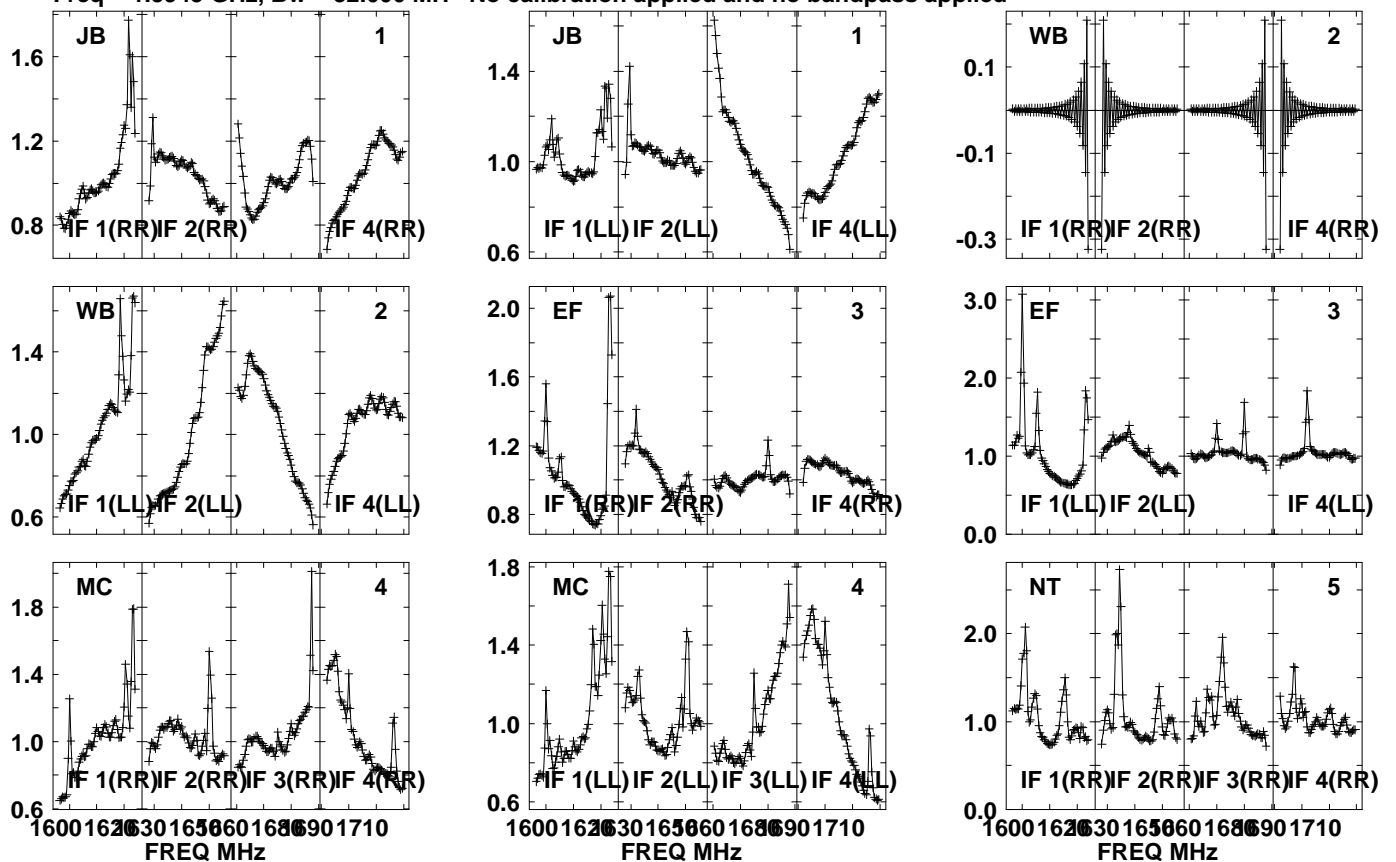

Lower frame: Real Jy  
Auto-corr total-power spectrum Antenna: \*  
Timerange: 00/13:24:01 to 00/13:27:29

Plot file version 274 created 05-OCT-2021 17:05:32

APM08279+525 GM076.UVDATA.1

Freq = 1.5945 GHz, Bw = 32.000 MH No calibration applied and no bandpass applied

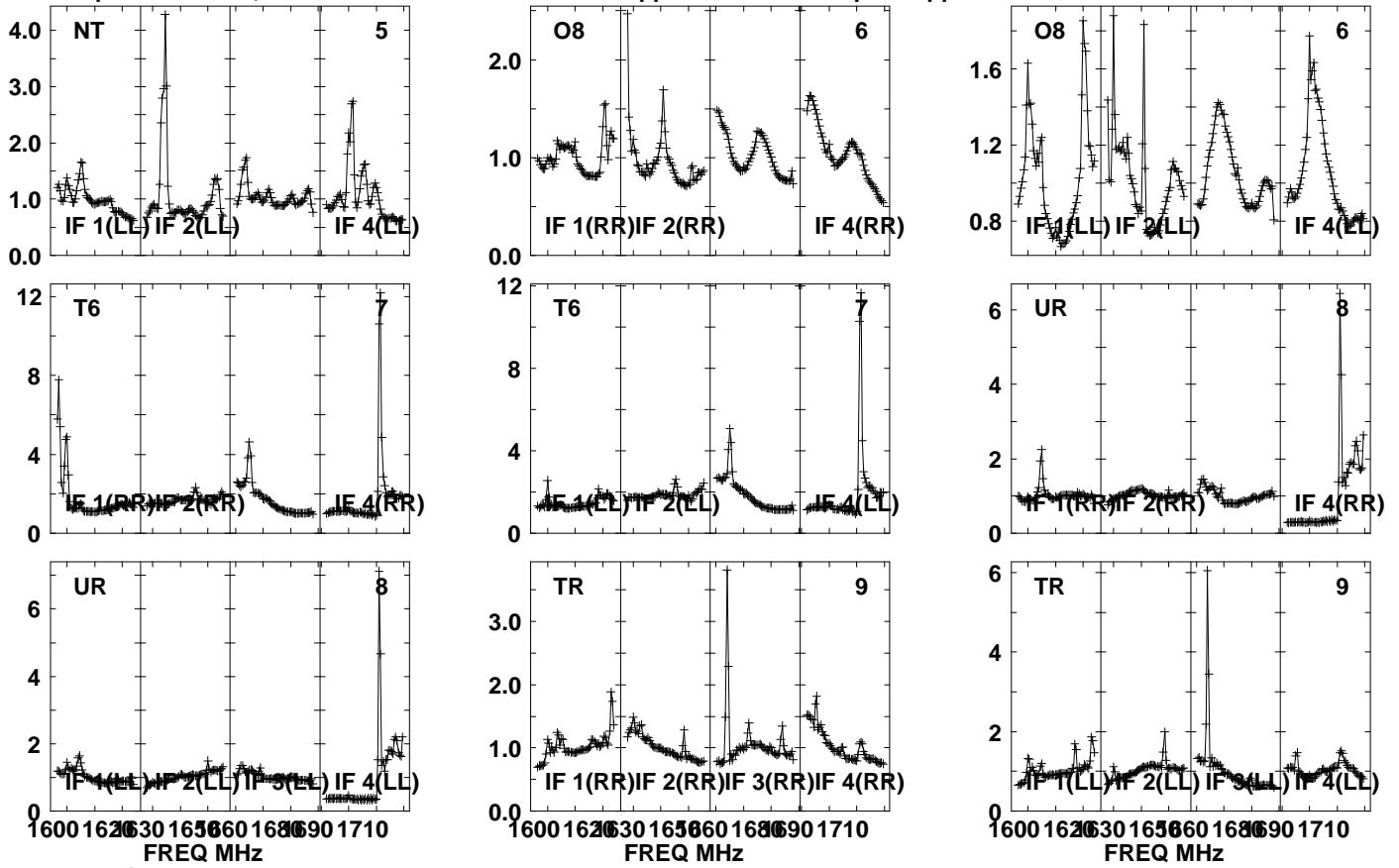

Lower frame: Real Jy

Auto-corr total-power spectrum Antenna: \*

Timerange: 00/13:24:01 to 00/13:27:29



Plot file version 275 created 05-OCT-2021 17:05:33

APM08279+525 GM076.UVDATA.1

Freq = 1.5945 GHz, Bw = 32.000 MH No calibration applied and no bandpass applied

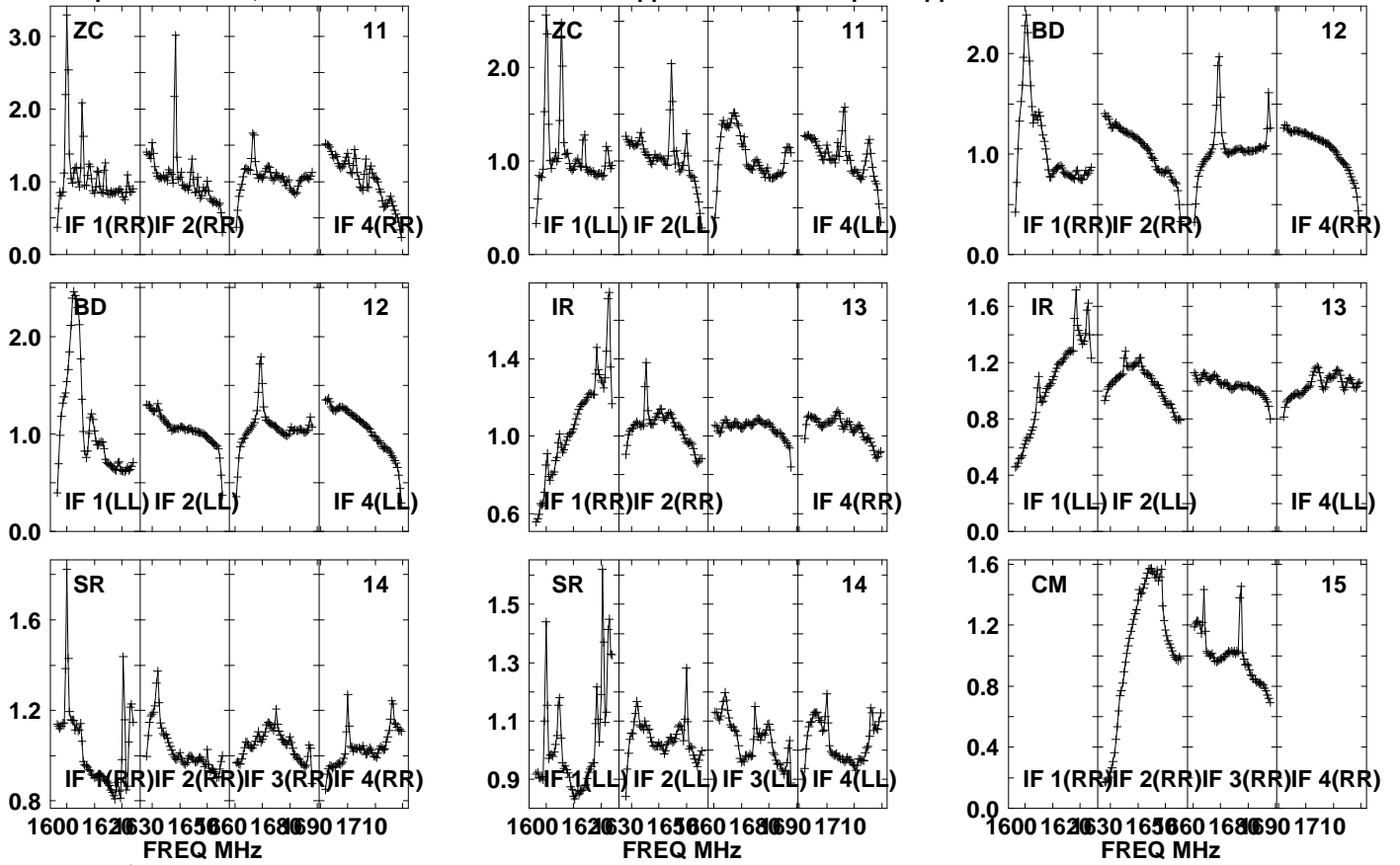

Lower frame: Real Jy  
Auto-corr total-power spectrum Antenna: \*  
Timerange: 00/13:24:01 to 00/13:27:29

Plot file version 276 created 05-OCT-2021 17:05:33

APM08279+525 GM076.UVDATA.1

Freq = 1.5945 GHz, Bw = 32.000 MH No calibration applied and no bandpass applied

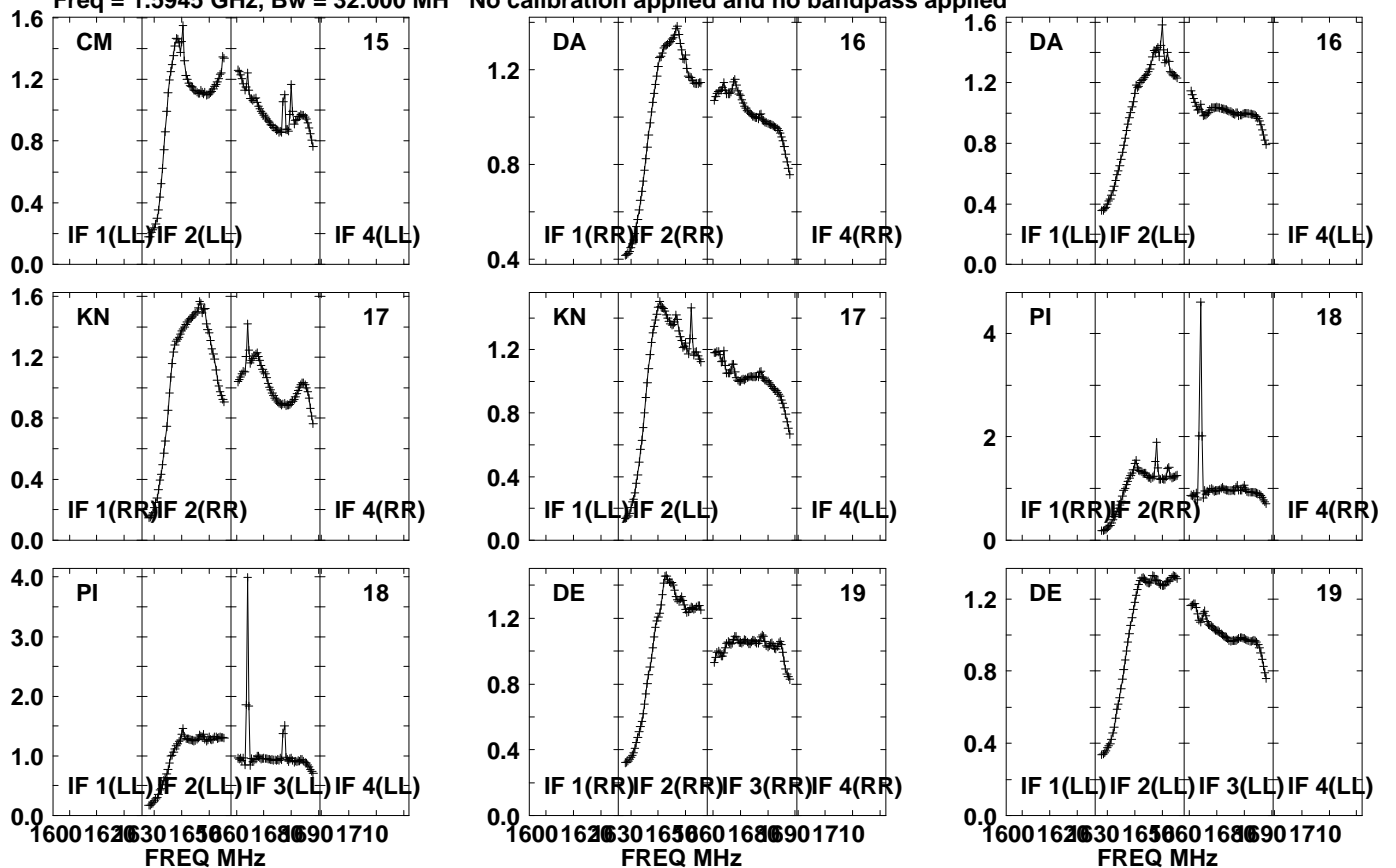

Lower frame: Real Jy  
Auto-corr total-power spectrum Antenna: \*  
Timerange: 00/13:24:01 to 00/13:27:29

Plot file version 277 created 05-OCT-2021 17:05:33

J0827+5217 GM076.UVDATA.1

Freq = 1.5945 GHz, Bw = 32.000 MH No calibration applied and no bandpass applied

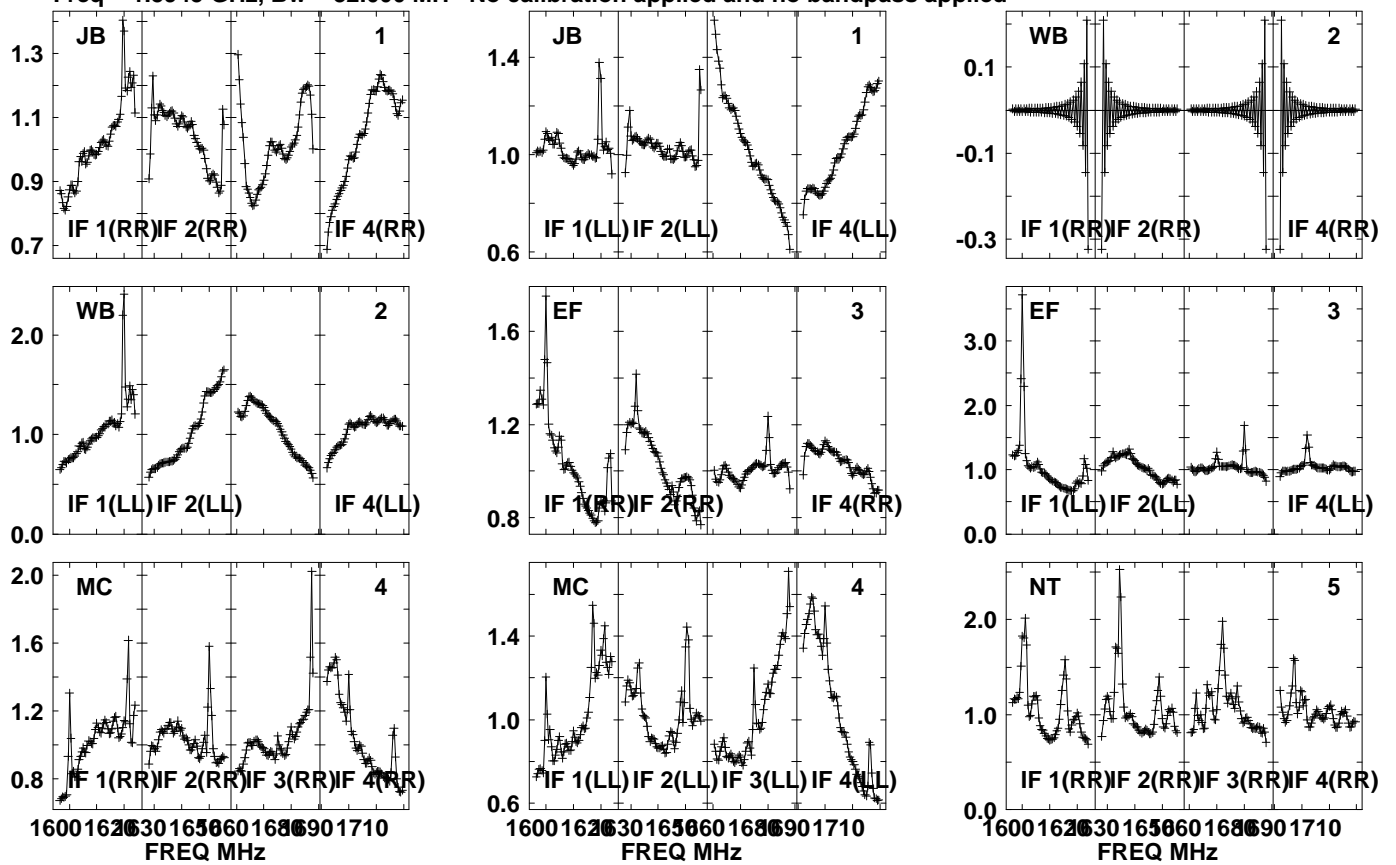

Lower frame: Real Jy  
Auto-corr total-power spectrum Antenna: \*  
Timerange: 00/13:27:31 to 00/13:28:59

Plot file version 278 created 05-OCT-2021 17:05:33

J0827+5217 GM076.UVDATA.1

Freq = 1.5945 GHz, Bw = 32.000 MH No calibration applied and no bandpass applied

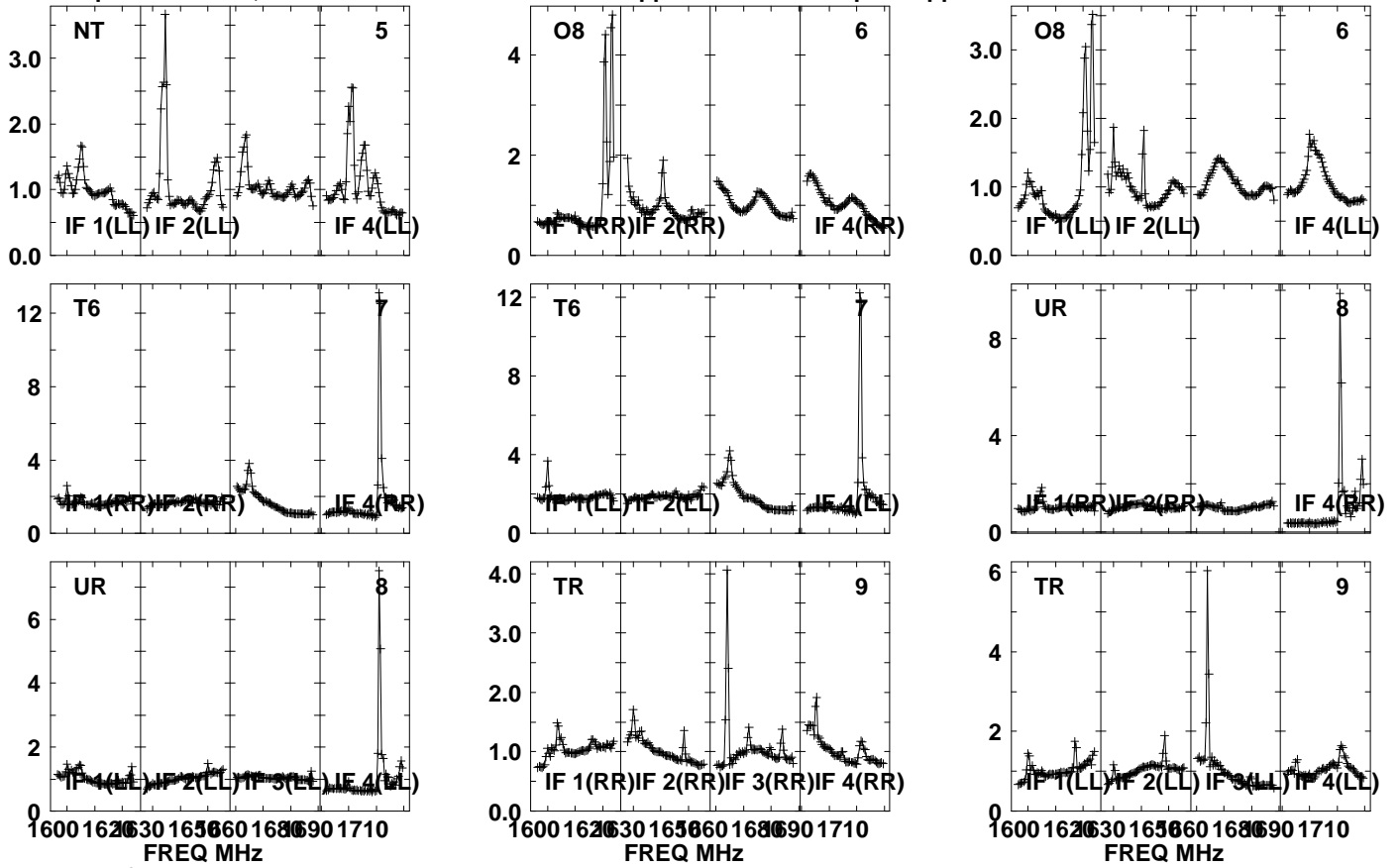

Lower frame: Real Jy

Auto-corr total-power spectrum Antenna: \*

Timerange: 00/13:27:31 to 00/13:28:59

Plot file version 279 created 05-OCT-2021 17:05:34

J0827+5217 GM076.UVDATA.1

Freq = 1.5945 GHz, Bw = 32.000 MH No calibration applied and no bandpass applied

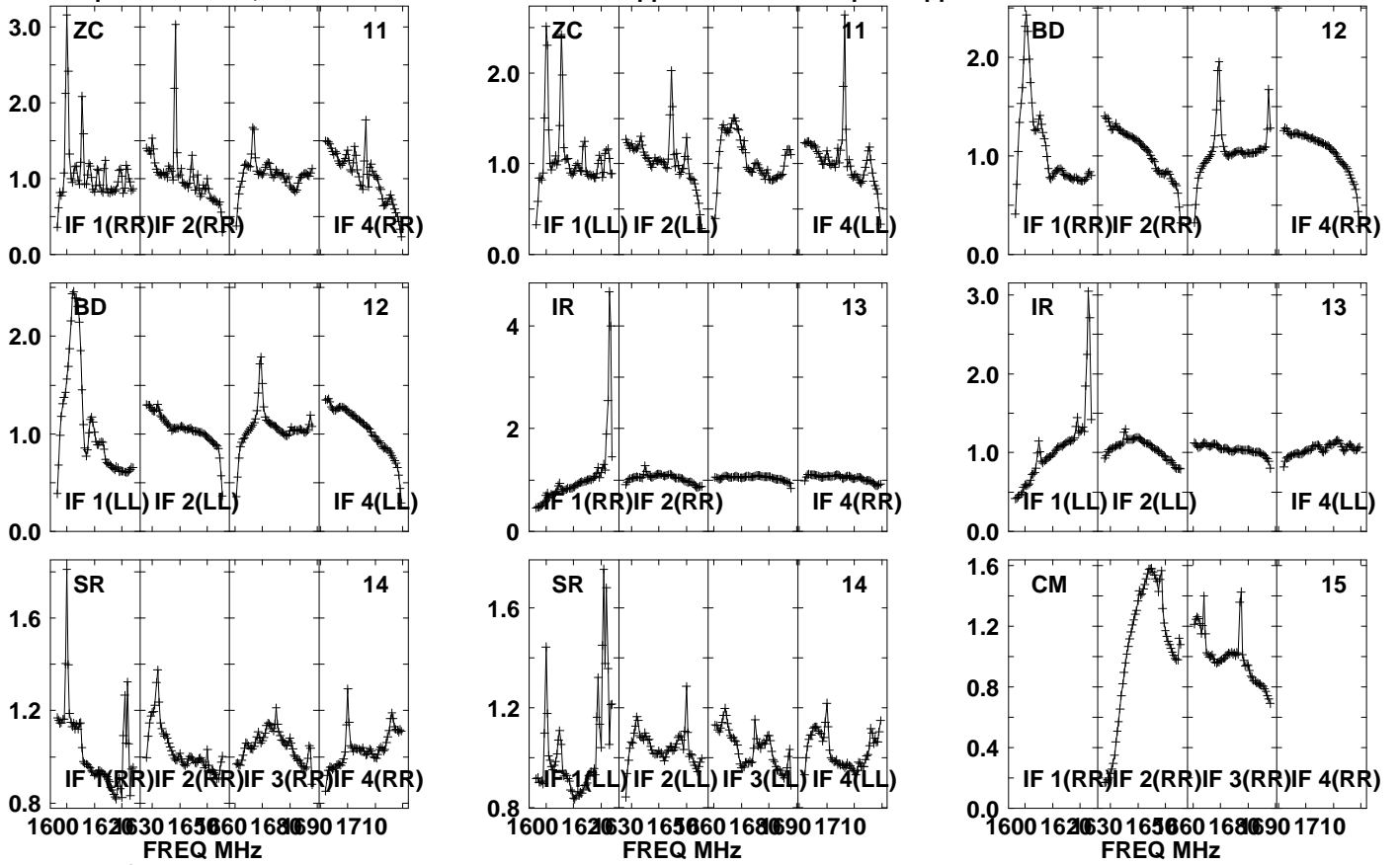

Lower frame: Real Jy

Auto-corr total-power spectrum Antenna: \*

Timerange: 00/13:27:31 to 00/13:28:59

Plot file version 280 created 05-OCT-2021 17:05:34

J0827+5217 GM076.UVDATA.1

Freq = 1.5945 GHz, Bw = 32.000 MH No calibration applied and no bandpass applied

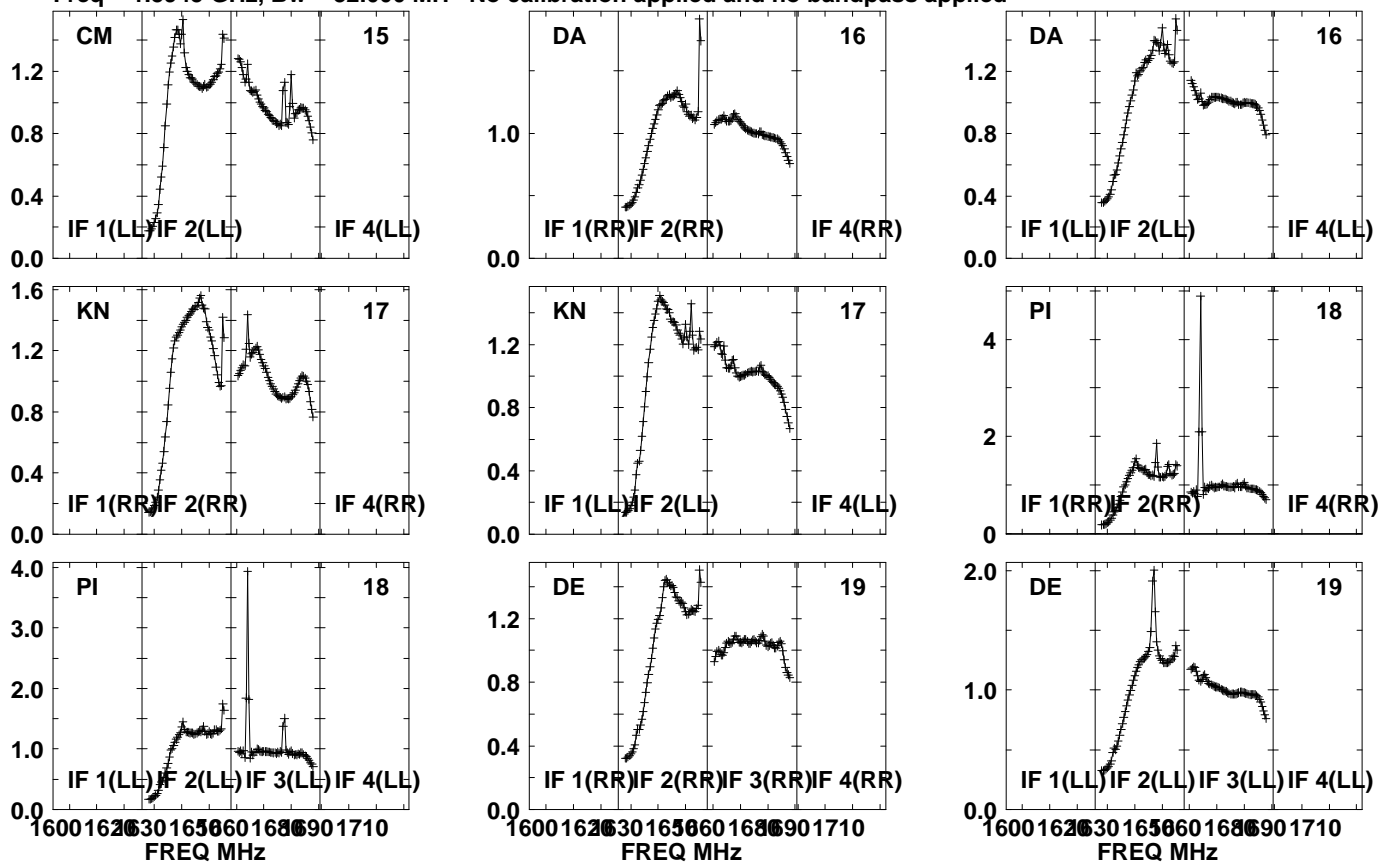

Lower frame: Real Jy  
Auto-corr total-power spectrum Antenna: \*  
Timerange: 00/13:27:31 to 00/13:28:59

Plot file version 281 created 05-OCT-2021 17:05:34

APM08279+525 GM076.UVDATA.1

Freq = 1.5945 GHz, Bw = 32.000 MH No calibration applied and no bandpass applied

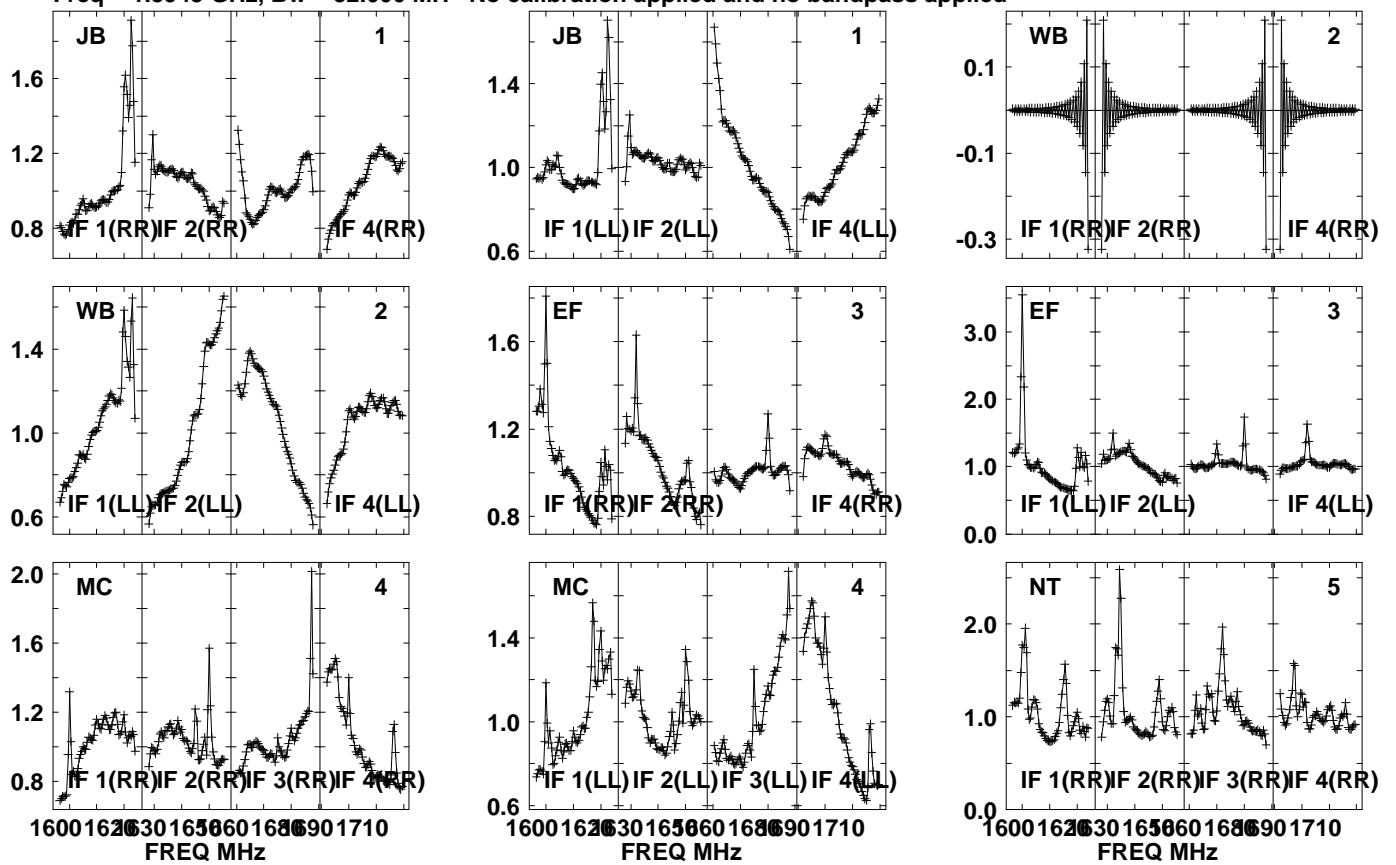

Lower frame: Real Jy  
Auto-corr total-power spectrum Antenna: \*  
Timerange: 00/13:29:01 to 00/13:32:29

Plot file version 282 created 05-OCT-2021 17:05:34

APM08279+525 GM076.UVDATA.1

Freq = 1.5945 GHz, Bw = 32.000 MH No calibration applied and no bandpass applied

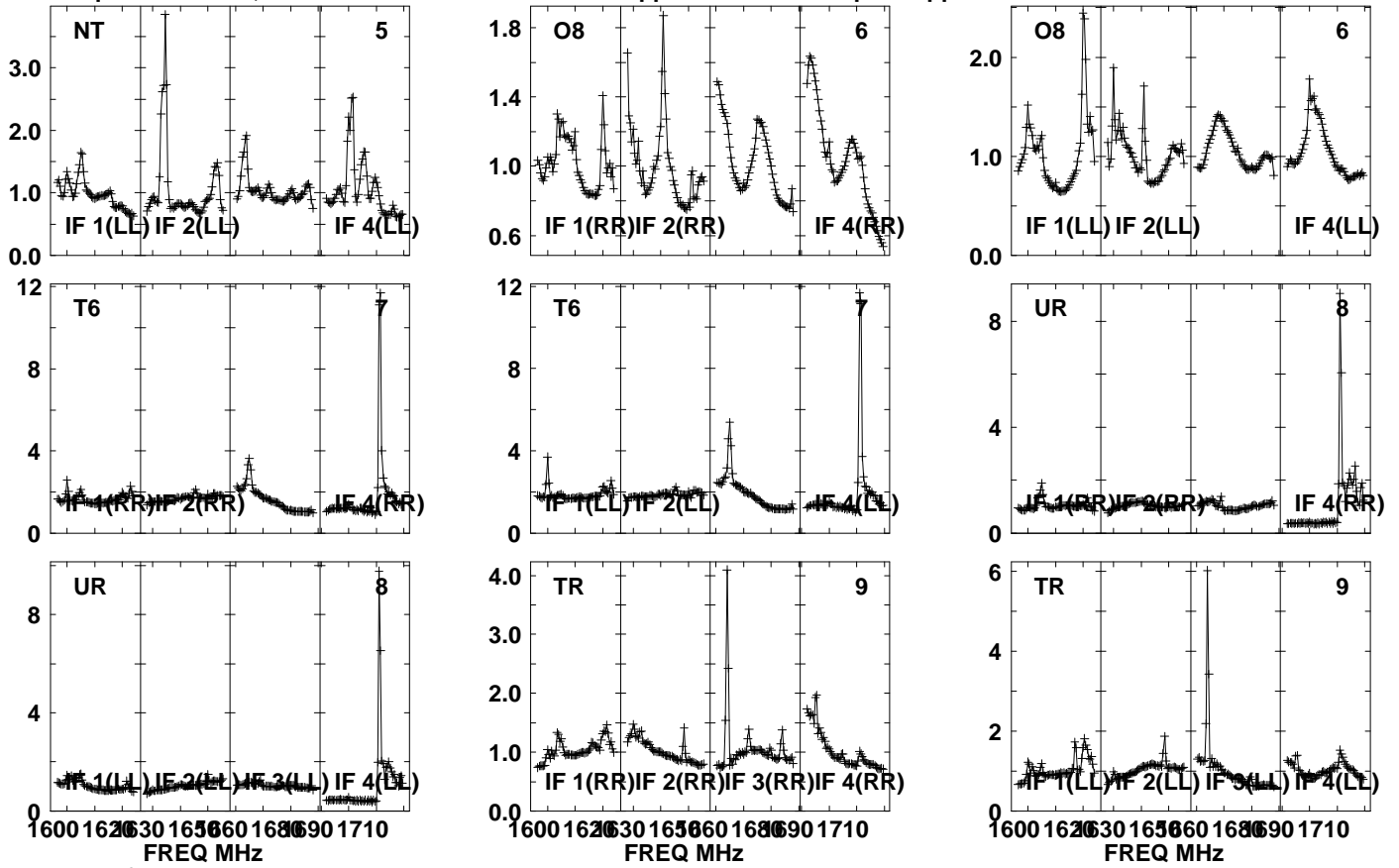

Lower frame: Real Jy  
Auto-corr total-power spectrum Antenna: \*  
Timerange: 00/13:29:01 to 00/13:32:29



Plot file version 283 created 05-OCT-2021 17:05:35

APM08279+525 GM076.UVDATA.1

Freq = 1.5945 GHz, Bw = 32.000 MH No calibration applied and no bandpass applied

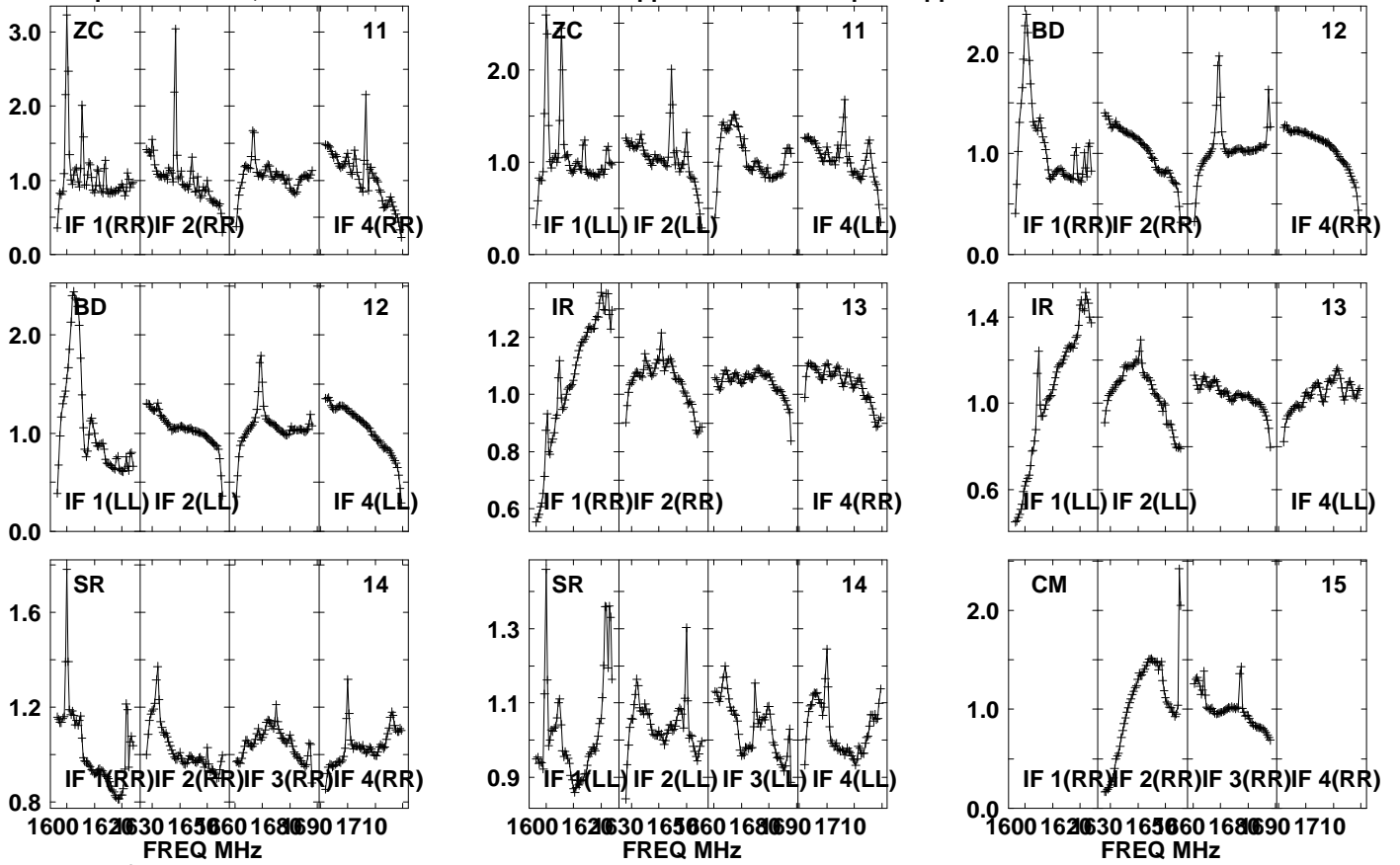

Lower frame: Real Jy  
Auto-corr total-power spectrum Antenna: \*  
Timerange: 00/13:29:01 to 00/13:32:29

Plot file version 284 created 05-OCT-2021 17:05:35

APM08279+525 GM076.UVDATA.1

Freq = 1.5945 GHz, Bw = 32.000 MH No calibration applied and no bandpass applied

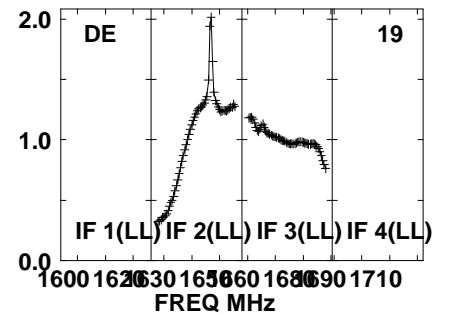
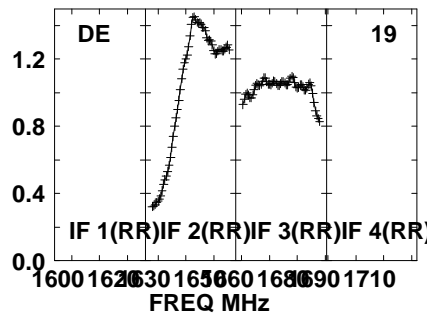
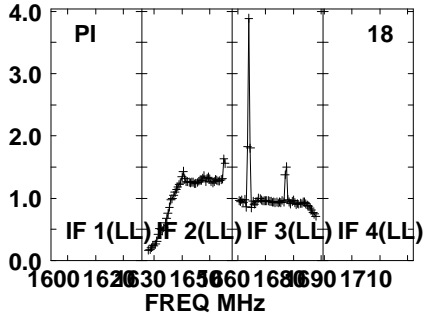
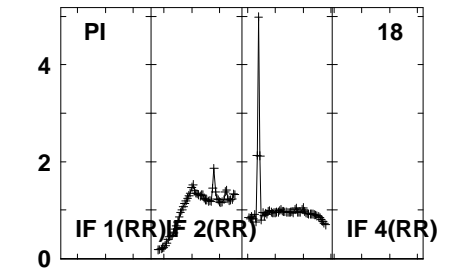
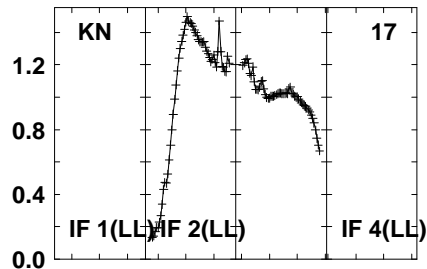
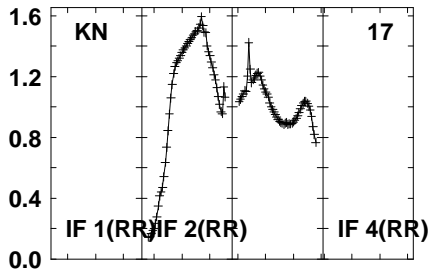
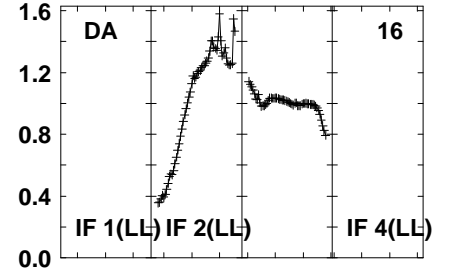
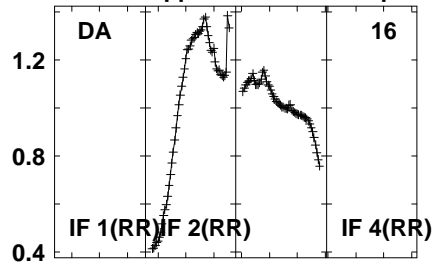
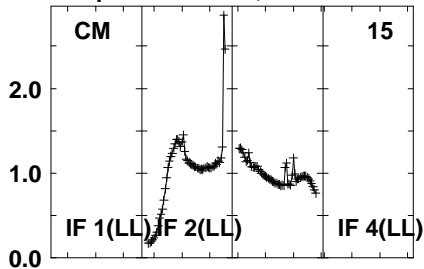

Lower frame: Real Jy

Auto-corr total-power spectrum Antenna: \*

Timerange: 00/13:29:01 to 00/13:32:29

Plot file version 285 created 05-OCT-2021 17:05:35

J0827+5217 GM076.UVDATA.1

Freq = 1.5945 GHz, Bw = 32.000 MH No calibration applied and no bandpass applied

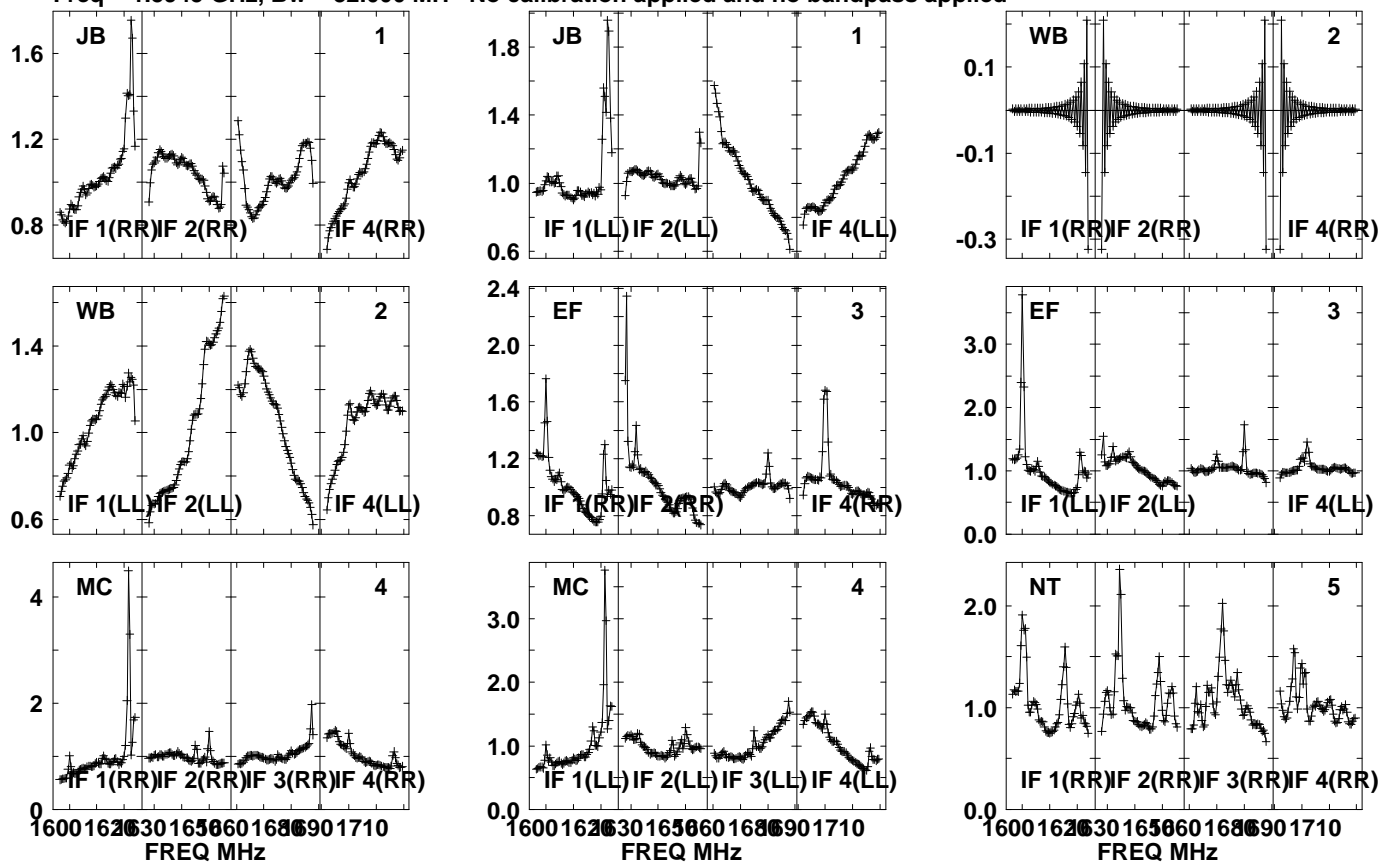

Lower frame: Real Jy  
Auto-corr total-power spectrum Antenna: \*  
Timerange: 00/13:33:01 to 00/13:34:29

Plot file version 286 created 05-OCT-2021 17:05:35

J0827+5217 GM076.UVDATA.1

Freq = 1.5945 GHz, Bw = 32.000 MH No calibration applied and no bandpass applied

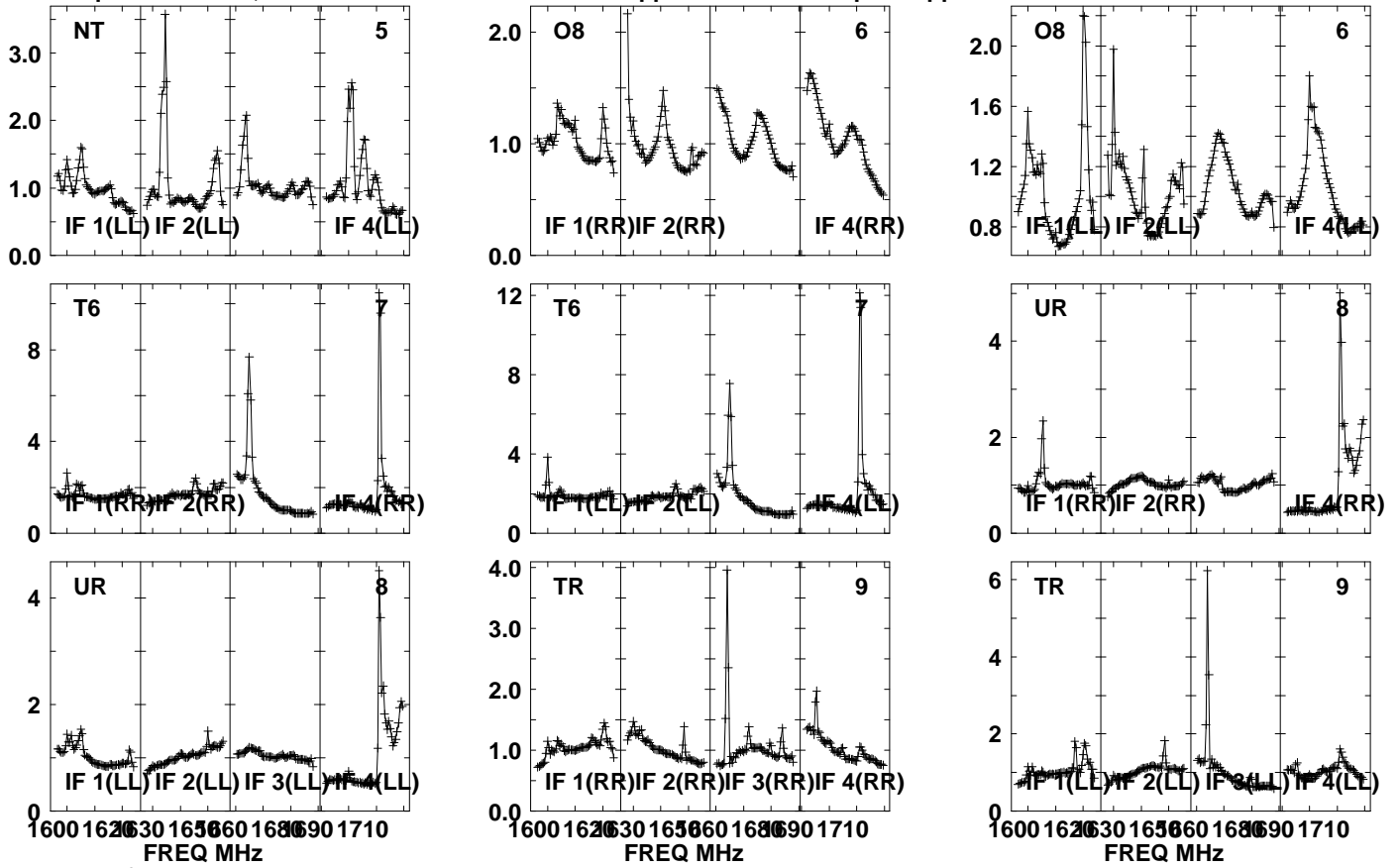

Lower frame: Real Jy

Auto-corr total-power spectrum Antenna: \*

Timerange: 00/13:33:01 to 00/13:34:29

Plot file version 287 created 05-OCT-2021 17:05:36

J0827+5217 GM076.UVDATA.1

Freq = 1.5945 GHz, Bw = 32.000 MH No calibration applied and no bandpass applied

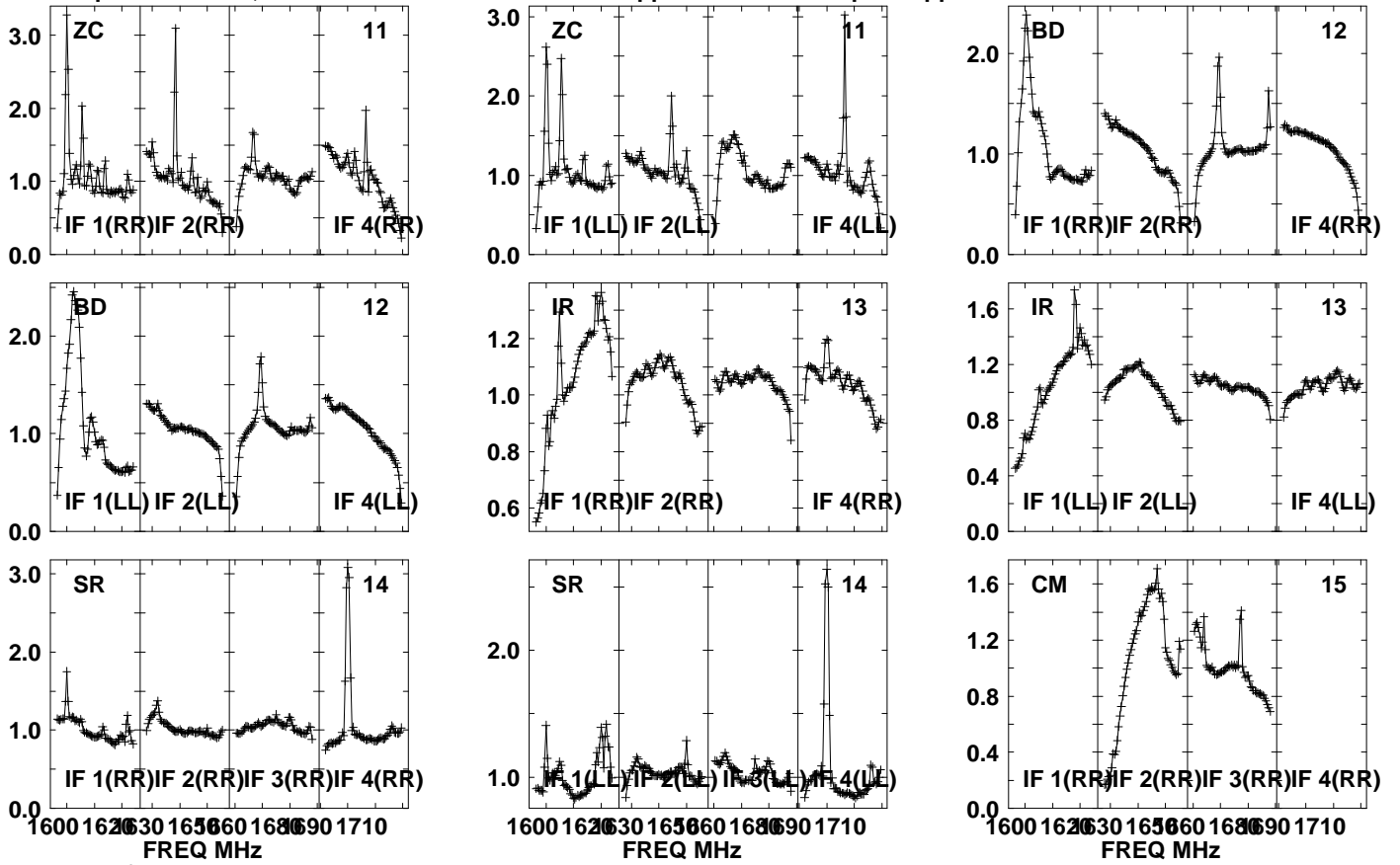

Lower frame: Real Jy

Auto-corr total-power spectrum Antenna: \*

Timerange: 00/13:33:01 to 00/13:34:29

Plot file version 288 created 05-OCT-2021 17:05:36

J0827+5217 GM076.UVDATA.1

Freq = 1.5945 GHz, Bw = 32.000 MH No calibration applied and no bandpass applied

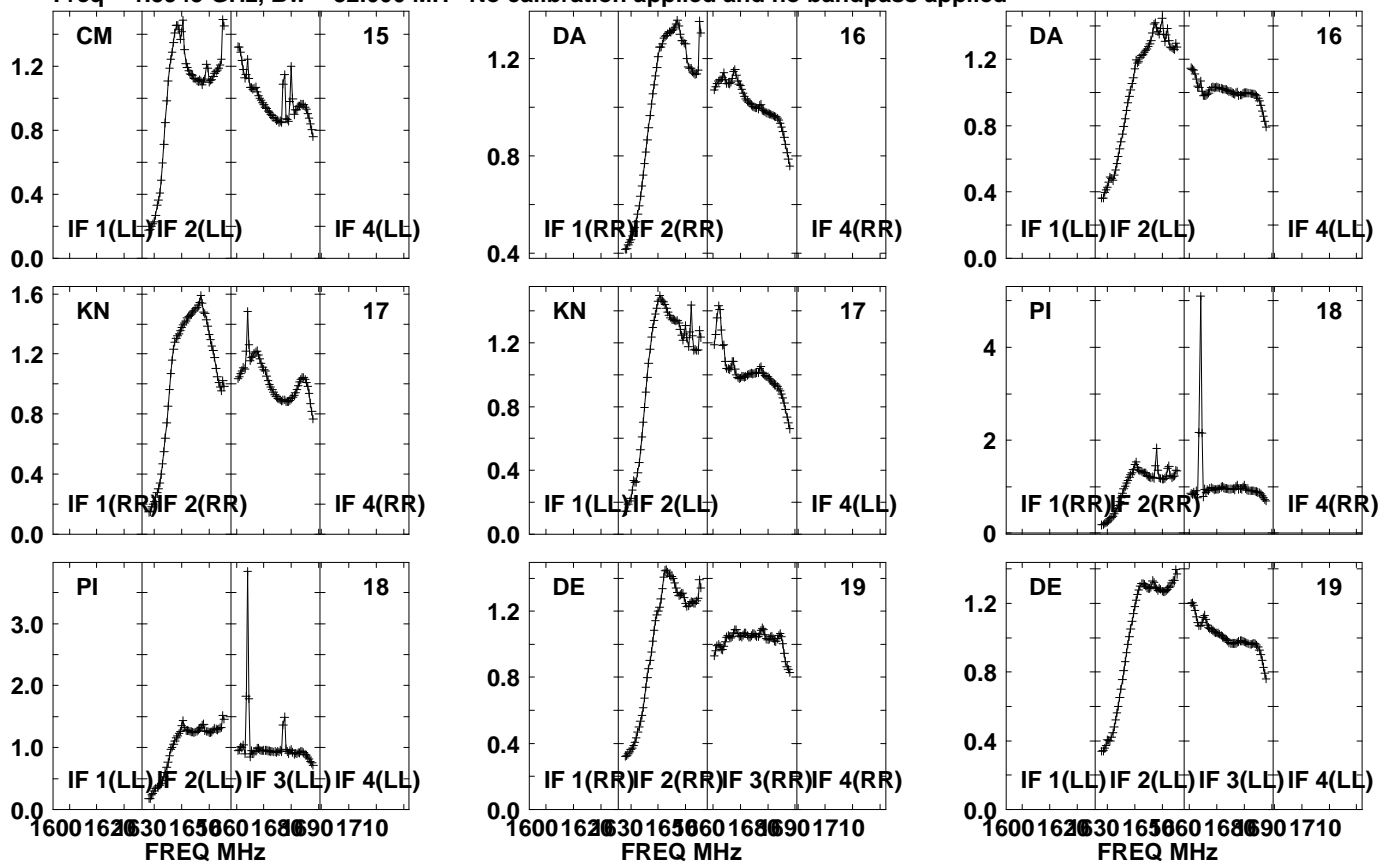

Lower frame: Real Jy  
Auto-corr total-power spectrum Antenna: \*  
Timerange: 00/13:33:01 to 00/13:34:29

Plot file version 289 created 05-OCT-2021 17:05:36

APM08279+525 GM076.UVDATA.1

Freq = 1.5945 GHz, Bw = 32.000 MH No calibration applied and no bandpass applied

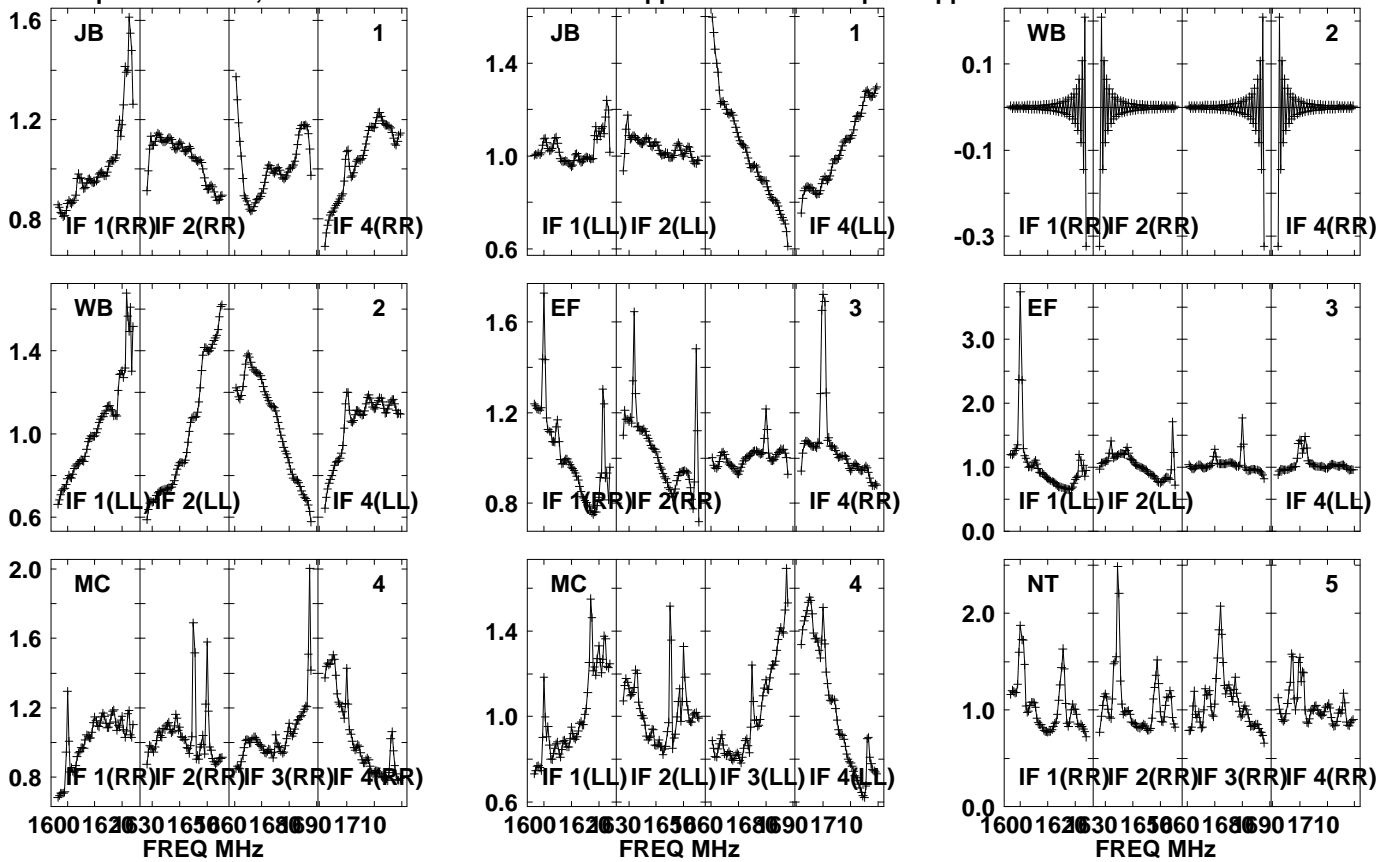

Lower frame: Real Jy  
Auto-corr total-power spectrum Antenna: \*  
Timerange: 00/13:34:31 to 00/13:37:59

Plot file version 290 created 05-OCT-2021 17:05:36

APM08279+525 GM076.UVDATA.1

Freq = 1.5945 GHz, Bw = 32.000 MH

No calibration applied and no bandpass applied

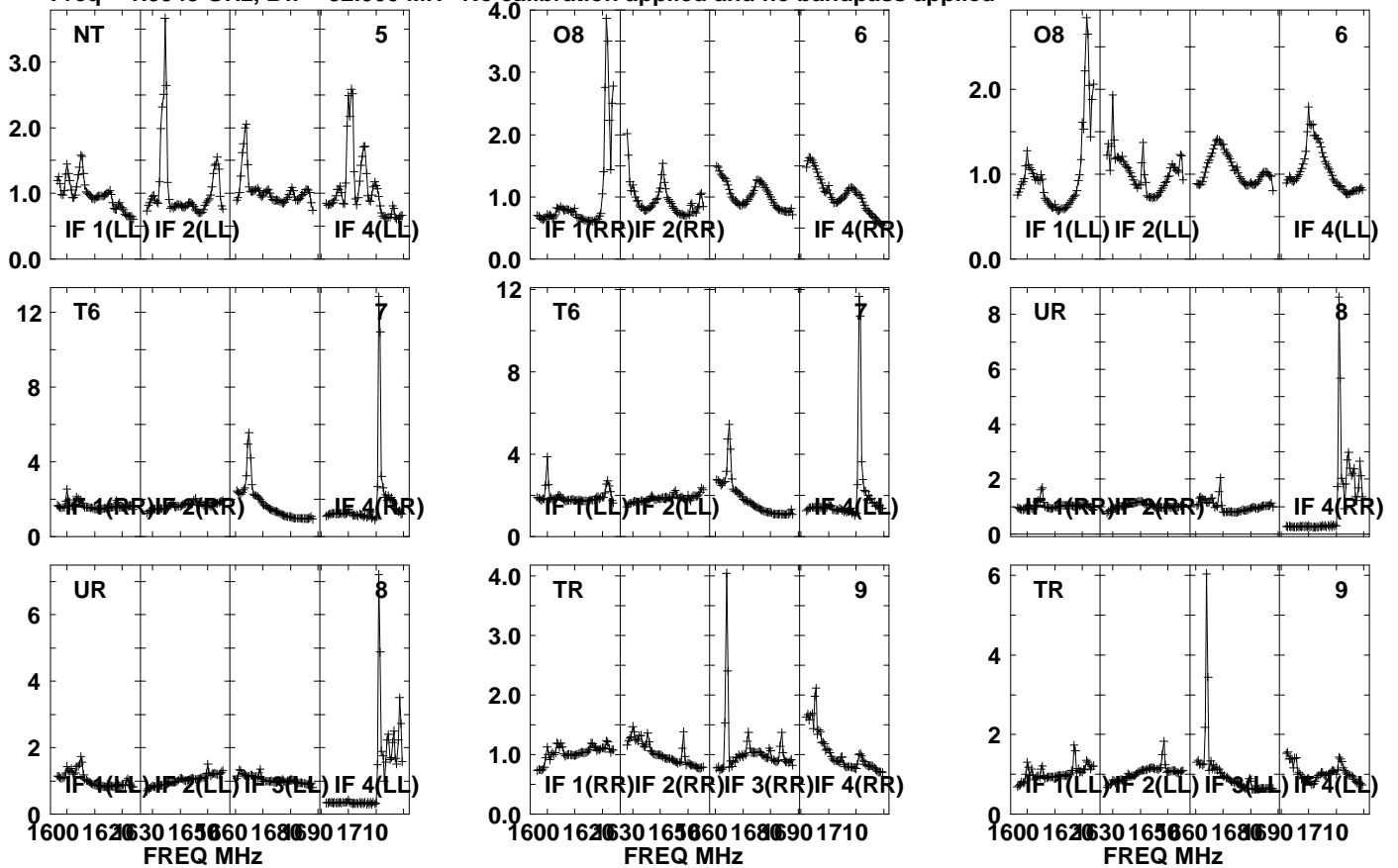

Lower frame: Real Jy

Auto-corr total-power spectrum Antenna: \*

Timerange: 00/13:34:31 to 00/13:37:59



Plot file version 291 created 05-OCT-2021 17:05:37

APM08279+525 GM076.UVDATA.1

Freq = 1.5945 GHz, Bw = 32.000 MH No calibration applied and no bandpass applied

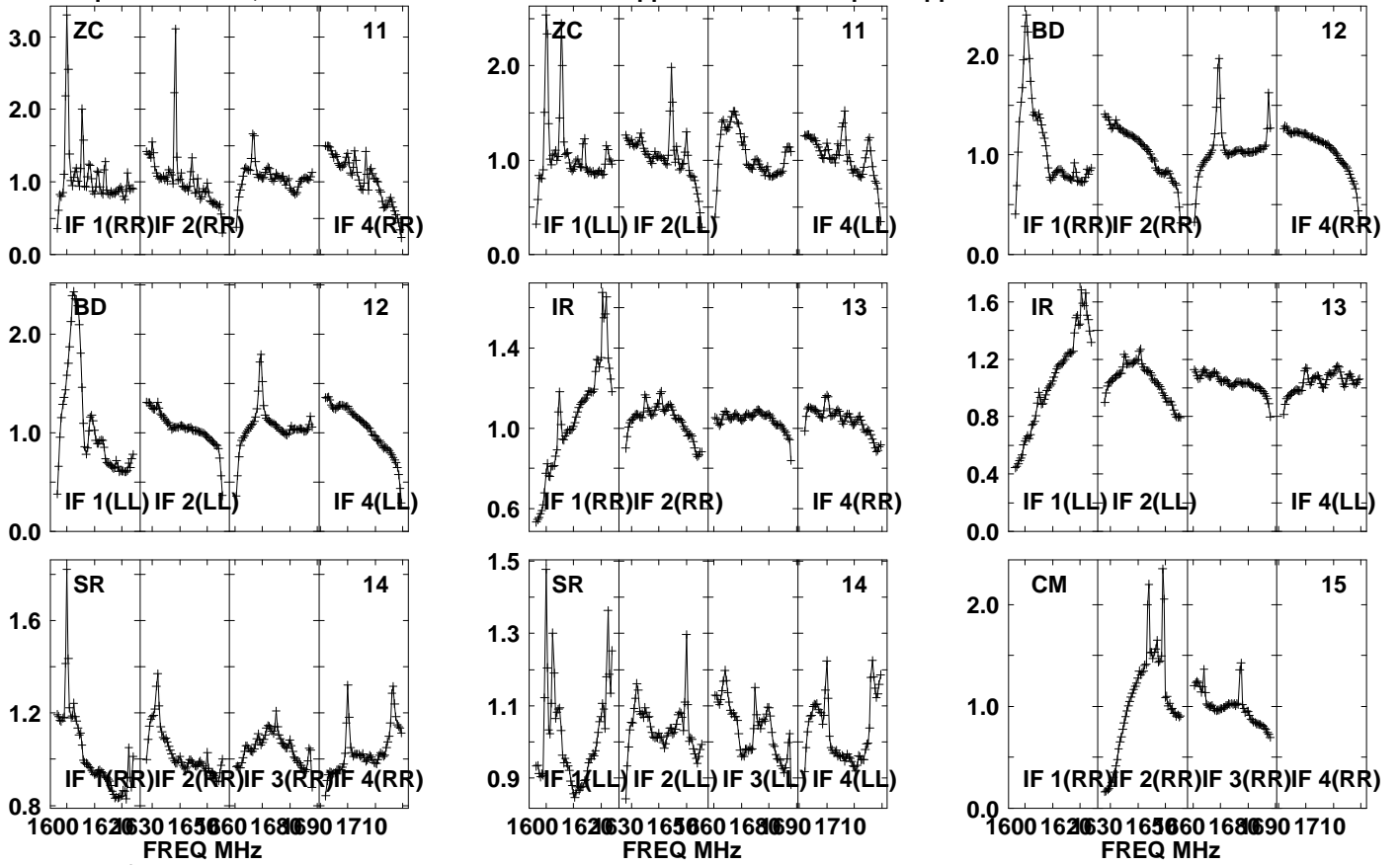

Lower frame: Real Jy  
Auto-corr total-power spectrum Antenna: \*  
Timerange: 00/13:34:31 to 00/13:37:59

Plot file version 292 created 05-OCT-2021 17:05:37

APM08279+525 GM076.UVDATA.1

Freq = 1.5945 GHz, Bw = 32.000 MH No calibration applied and no bandpass applied

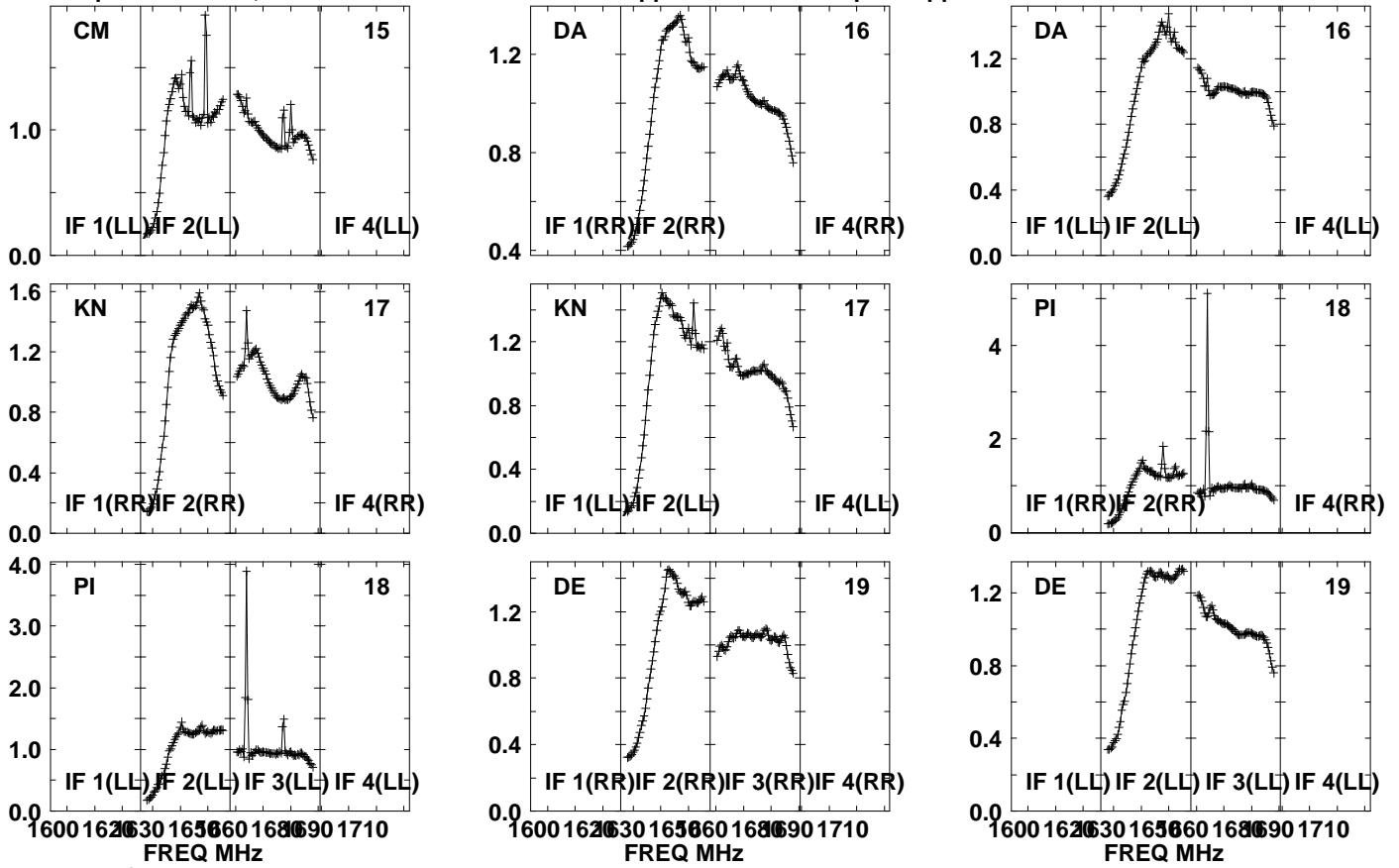

Lower frame: Real Jy  
Auto-corr total-power spectrum Antenna: \*  
Timerange: 00/13:34:31 to 00/13:37:59

Plot file version 293 created 05-OCT-2021 17:05:37

J0827+5217 GM076.UVDATA.1

Freq = 1.5945 GHz, Bw = 32.000 MH No calibration applied and no bandpass applied

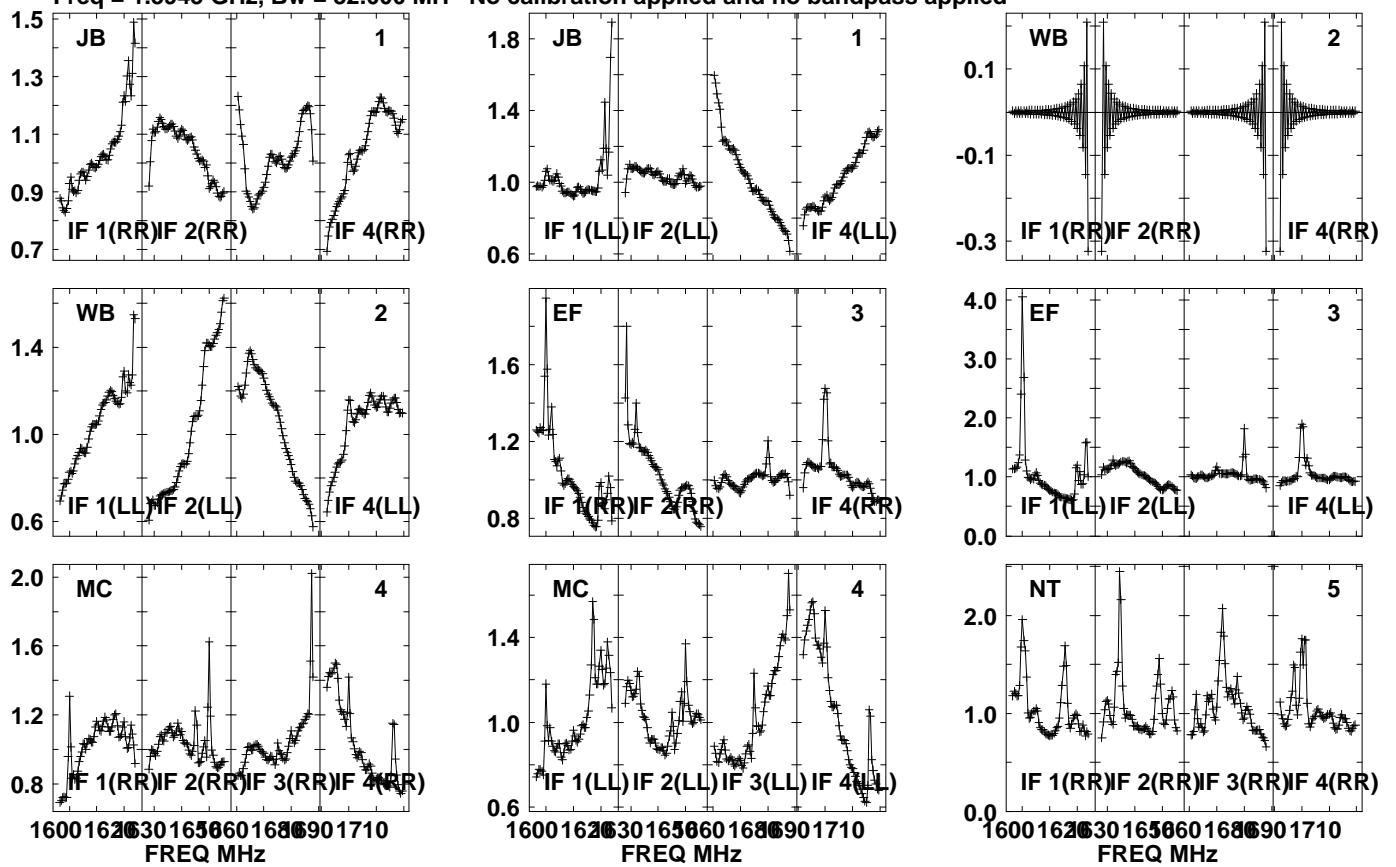

Lower frame: Real Jy  
Auto-corr total-power spectrum Antenna: \*  
Timerange: 00/13:38:01 to 00/13:39:29

Plot file version 294 created 05-OCT-2021 17:05:38

J0827+5217 GM076.UVDATA.1

Freq = 1.5945 GHz, Bw = 32.000 MH No calibration applied and no bandpass applied

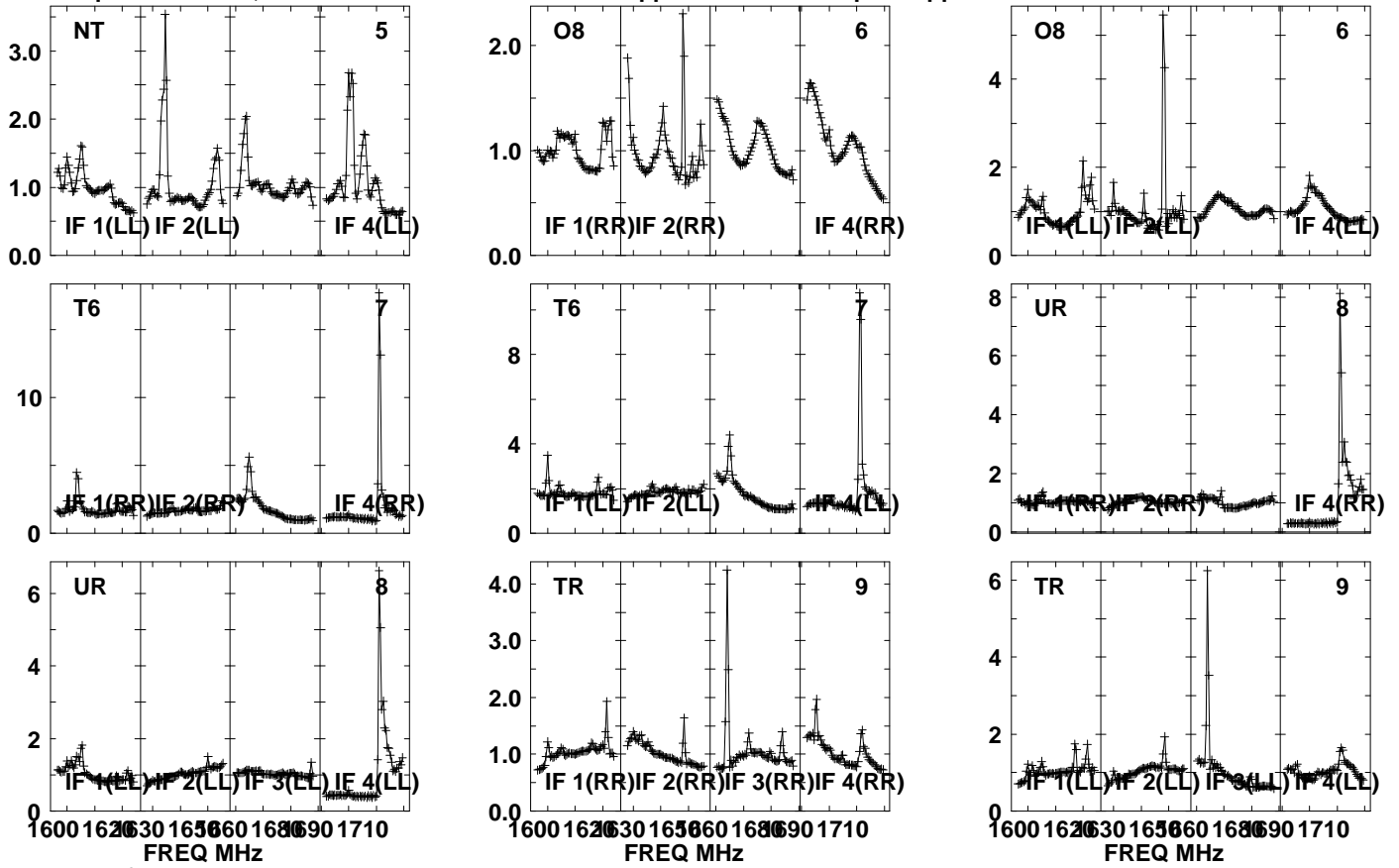

Lower frame: Real Jy

Auto-corr total-power spectrum Antenna: \*

Timerange: 00/13:38:01 to 00/13:39:29

Plot file version 295 created 05-OCT-2021 17:05:38

J0827+5217 GM076.UVDATA.1

Freq = 1.5945 GHz, Bw = 32.000 MH No calibration applied and no bandpass applied

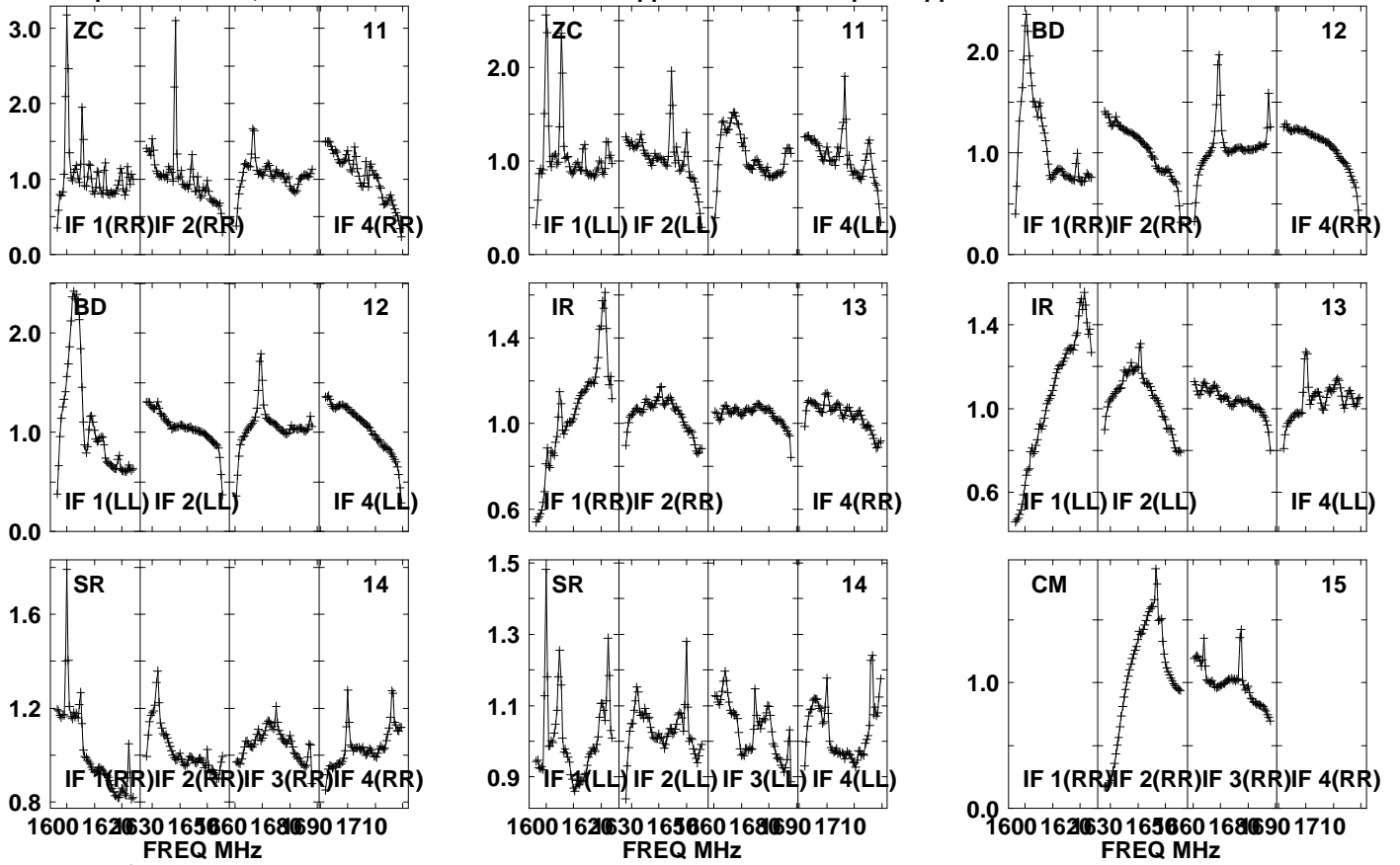

Lower frame: Real Jy

Auto-corr total-power spectrum Antenna: \*

Timerange: 00/13:38:01 to 00/13:39:29

Plot file version 296 created 05-OCT-2021 17:05:38

J0827+5217 GM076.UVDATA.1

Freq = 1.5945 GHz, Bw = 32.000 MH No calibration applied and no bandpass applied

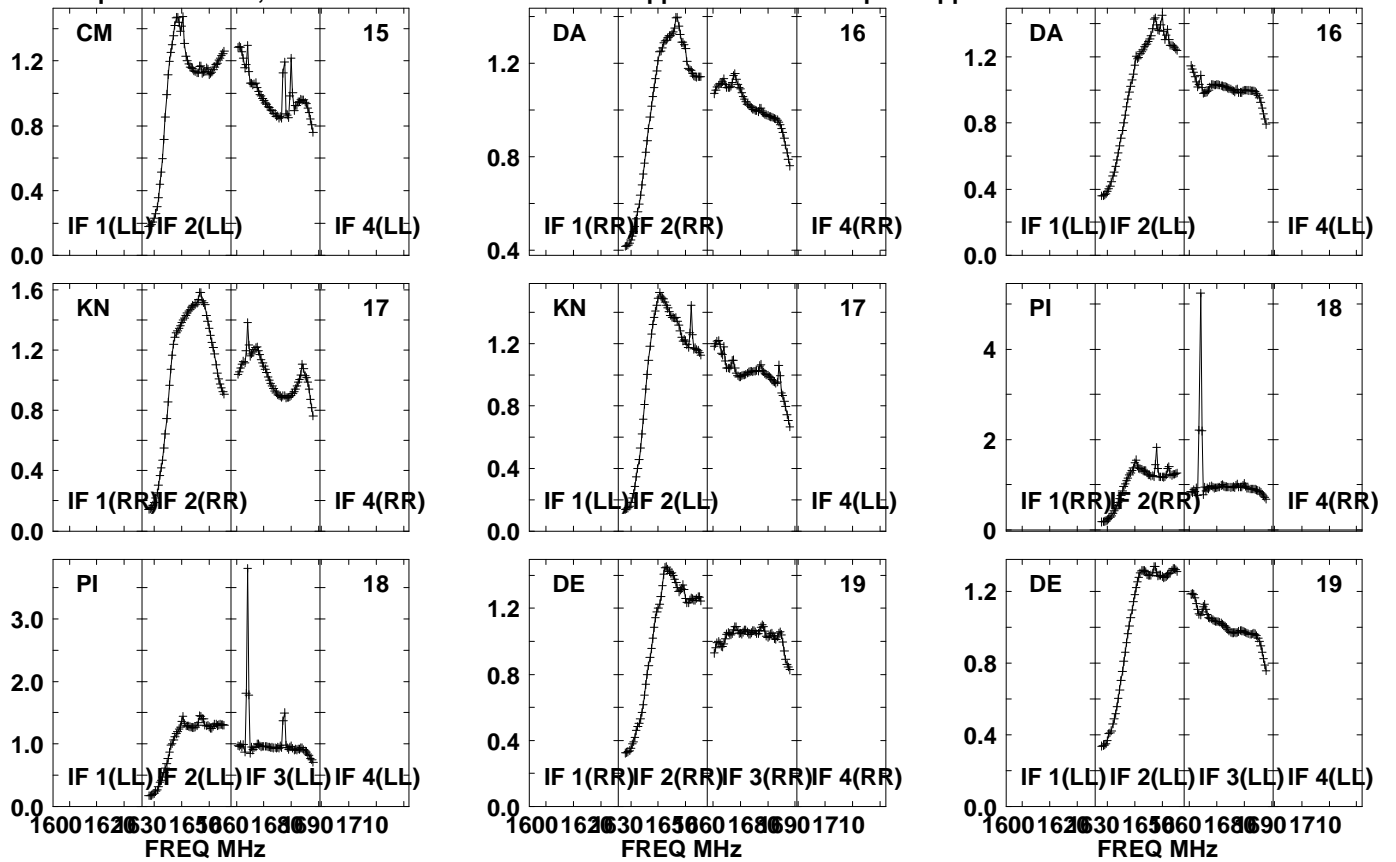

Lower frame: Real Jy  
Auto-corr total-power spectrum Antenna: \*  
Timerange: 00/13:38:01 to 00/13:39:29

Plot file version 297 created 05-OCT-2021 17:05:38

APM08279+525 GM076.UVDATA.1

Freq = 1.5945 GHz, Bw = 32.000 MH No calibration applied and no bandpass applied

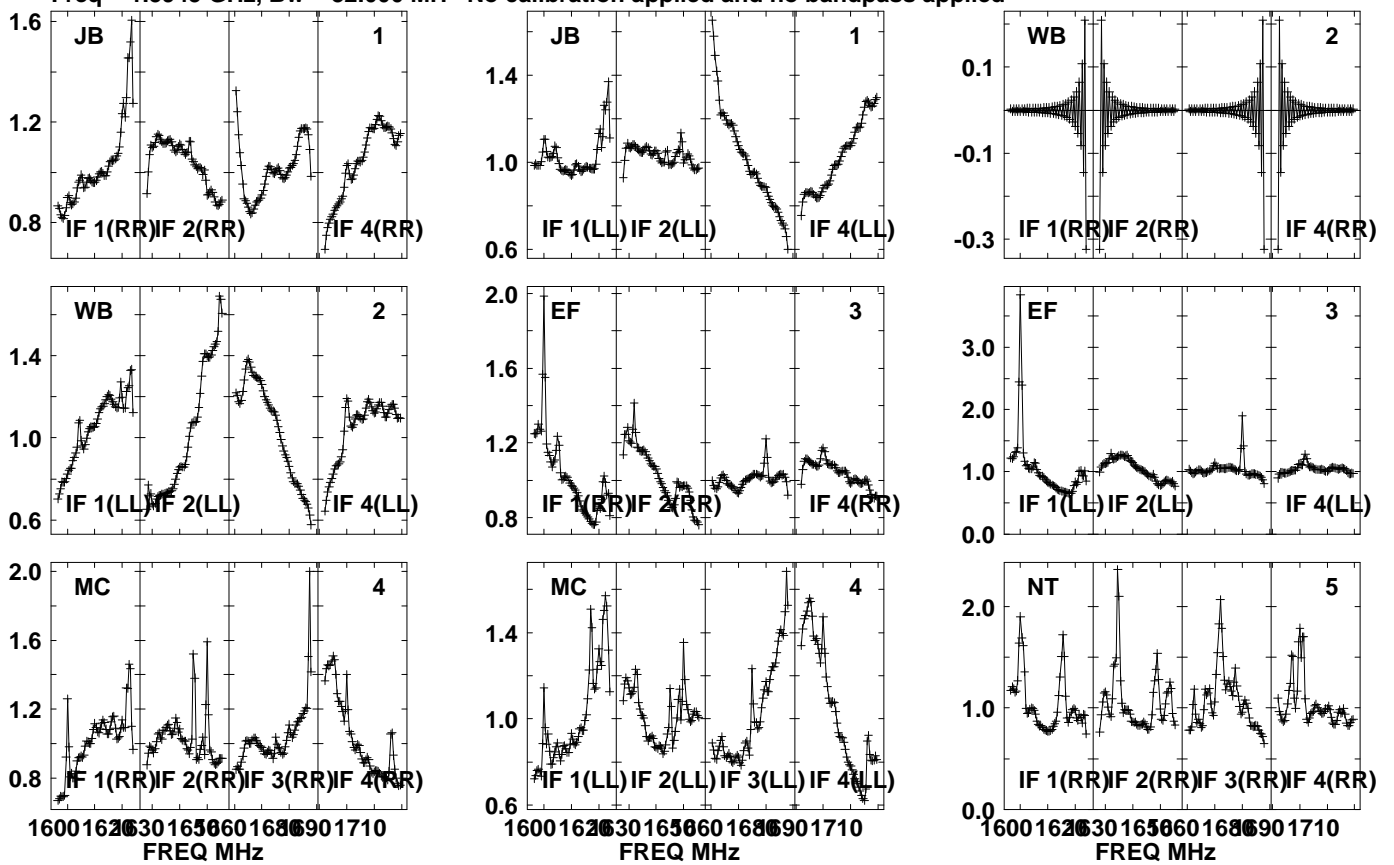

Lower frame: Real Jy  
Auto-corr total-power spectrum Antenna: \*  
Timerange: 00/13:39:31 to 00/13:42:59

Plot file version 298 created 05-OCT-2021 17:05:39

APM08279+525 GM076.UVDATA.1

Freq = 1.5945 GHz, Bw = 32.000 MH No calibration applied and no bandpass applied

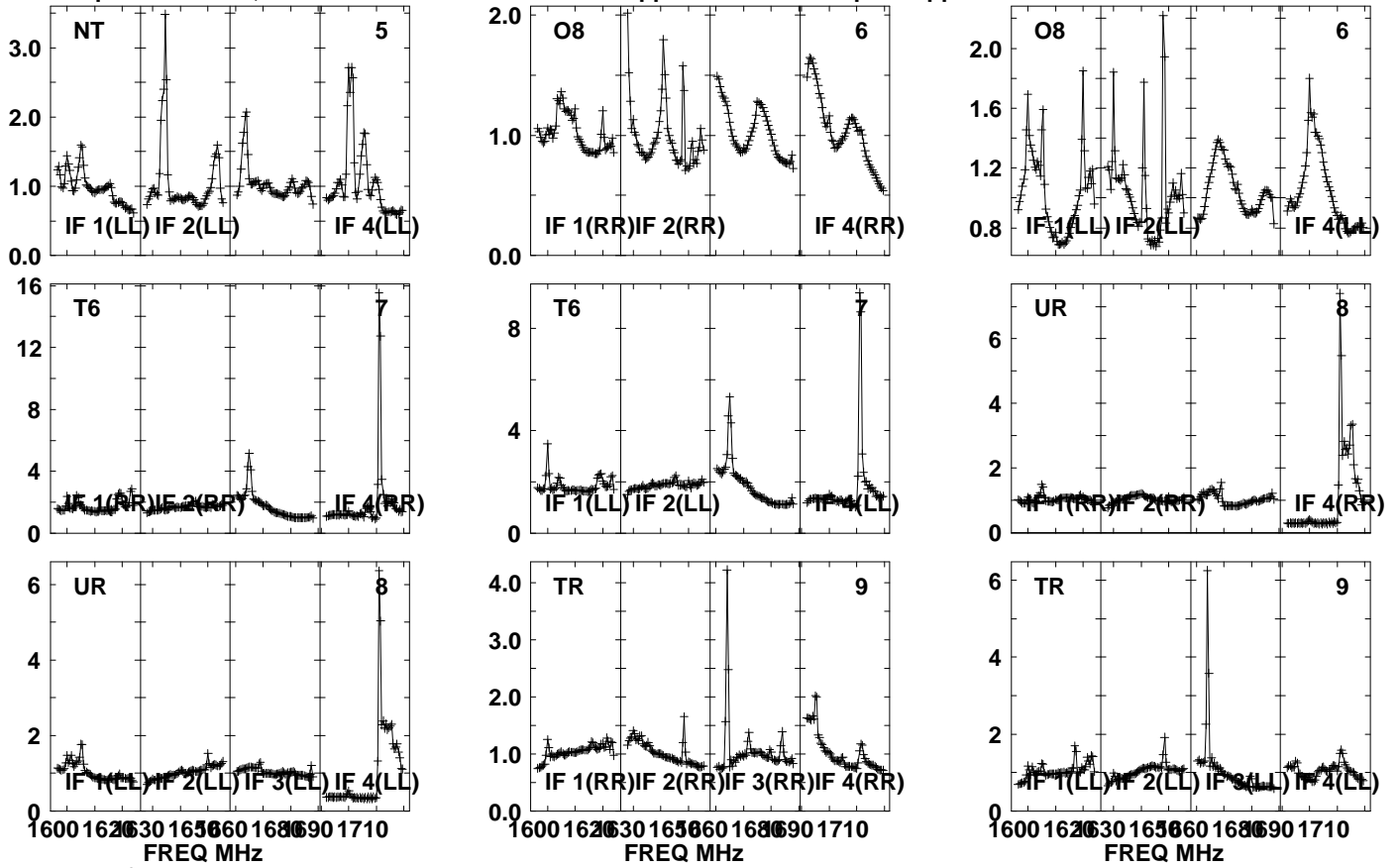

Lower frame: Real Jy

Auto-corr total-power spectrum Antenna: \*

Timerange: 00/13:39:31 to 00/13:42:59



Plot file version 299 created 05-OCT-2021 17:05:39

APM08279+525 GM076.UVDATA.1

Freq = 1.5945 GHz, Bw = 32.000 MH No calibration applied and no bandpass applied

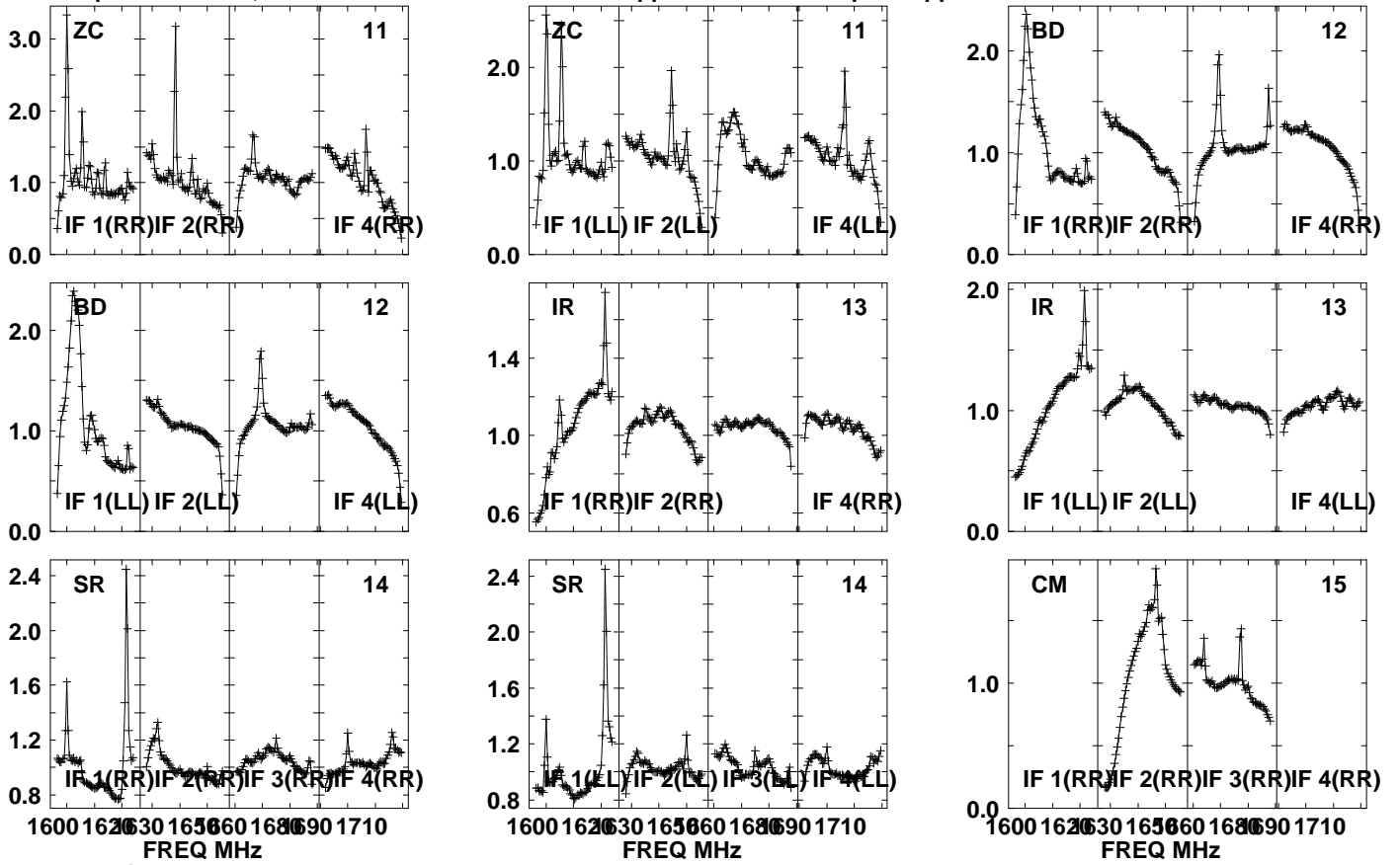

Lower frame: Real Jy  
Auto-corr total-power spectrum Antenna: \*  
Timerange: 00/13:39:31 to 00/13:42:59

Plot file version 300 created 05-OCT-2021 17:05:39

APM08279+525 GM076.UVDATA.1

Freq = 1.5945 GHz, Bw = 32.000 MH No calibration applied and no bandpass applied

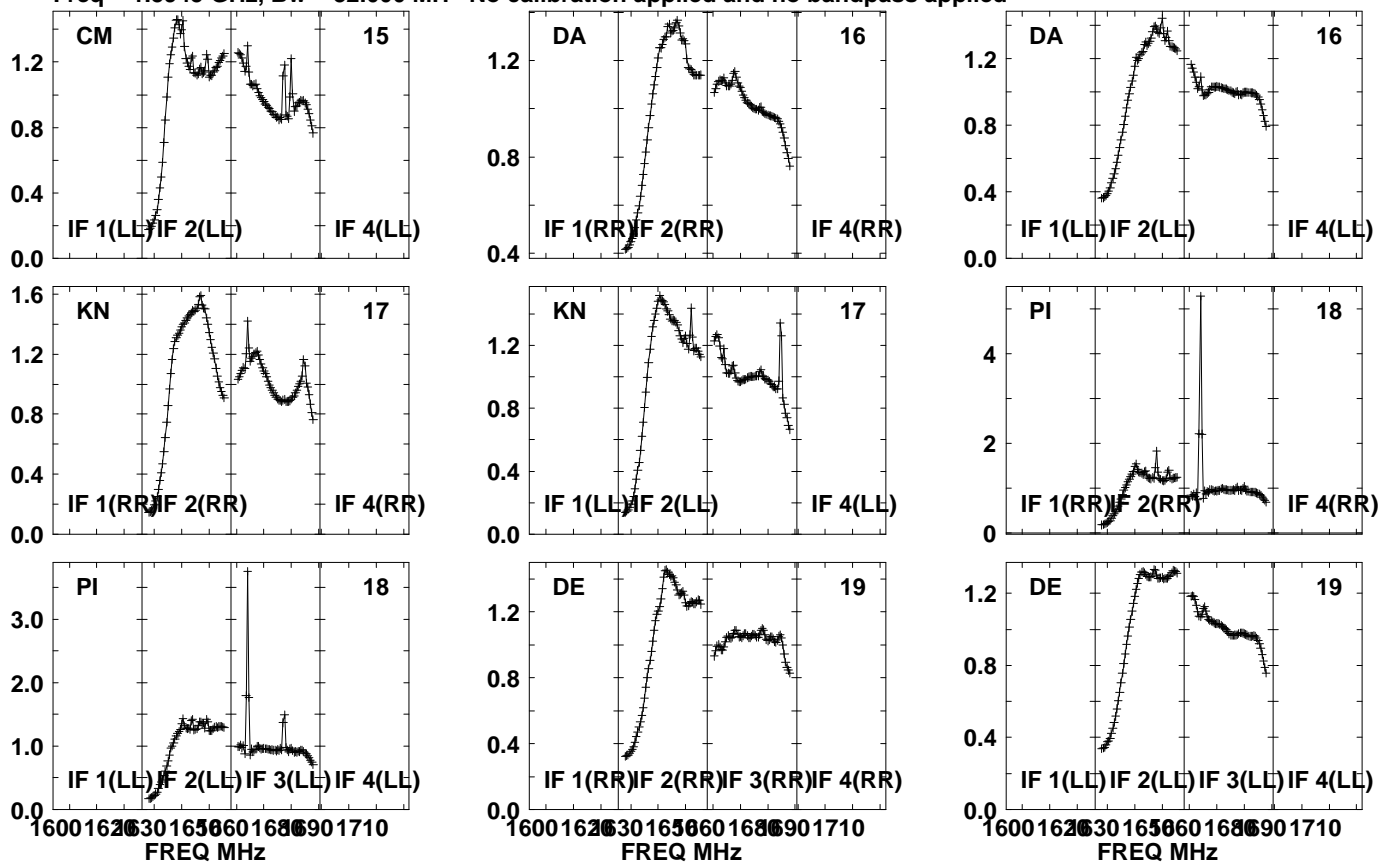

Lower frame: Real Jy  
Auto-corr total-power spectrum Antenna: \*  
Timerange: 00/13:39:31 to 00/13:42:59

Plot file version 301 created 05-OCT-2021 17:05:39

J0827+5217 GM076.UVDATA.1

Freq = 1.5945 GHz, Bw = 32.000 MH No calibration applied and no bandpass applied

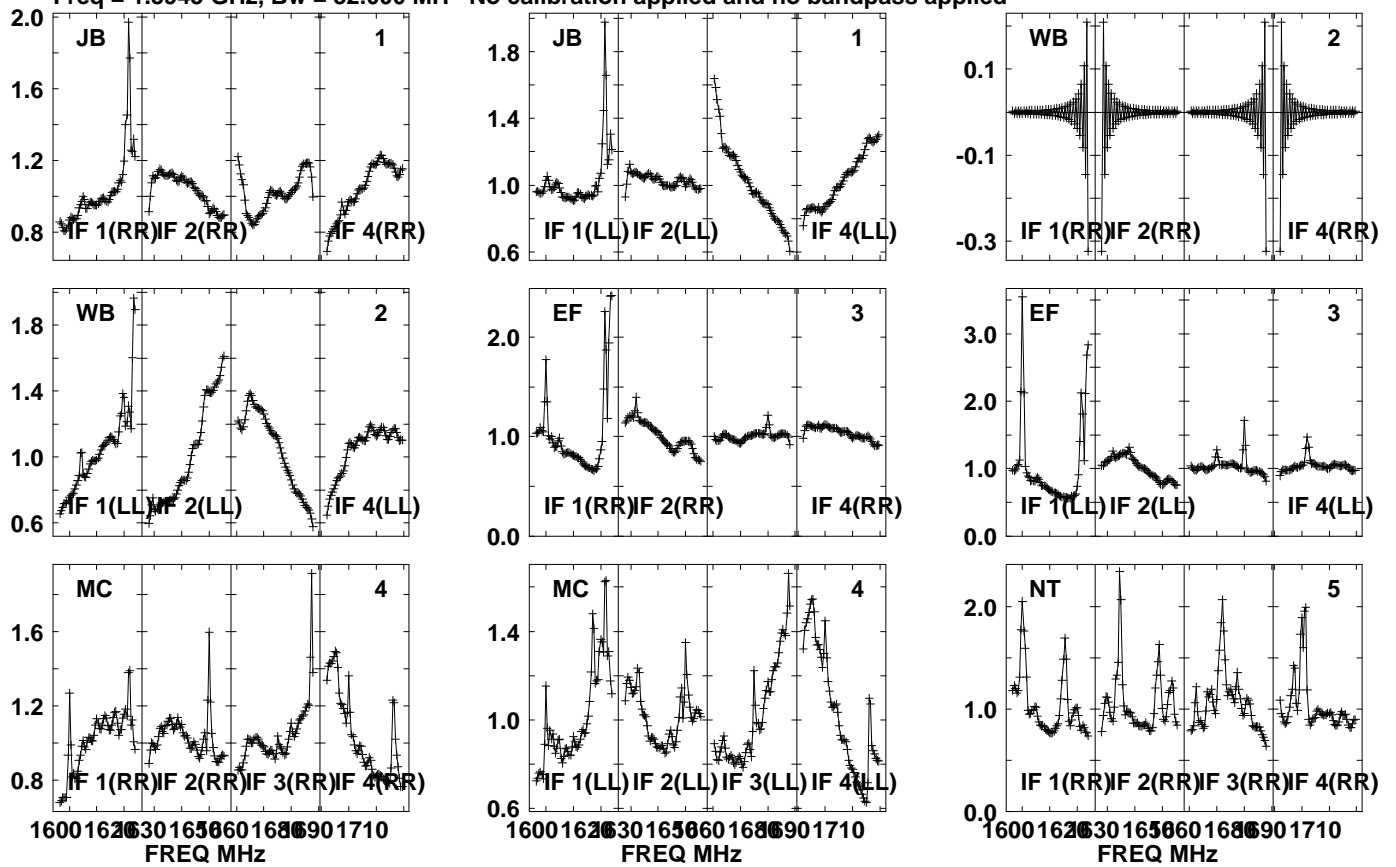

Lower frame: Real Jy  
Auto-corr total-power spectrum Antenna: \*  
Timerange: 00/13:43:31 to 00/13:44:59

Plot file version 302 created 05-OCT-2021 17:05:40

J0827+5217 GM076.UVDATA.1

Freq = 1.5945 GHz, Bw = 32.000 MH No calibration applied and no bandpass applied

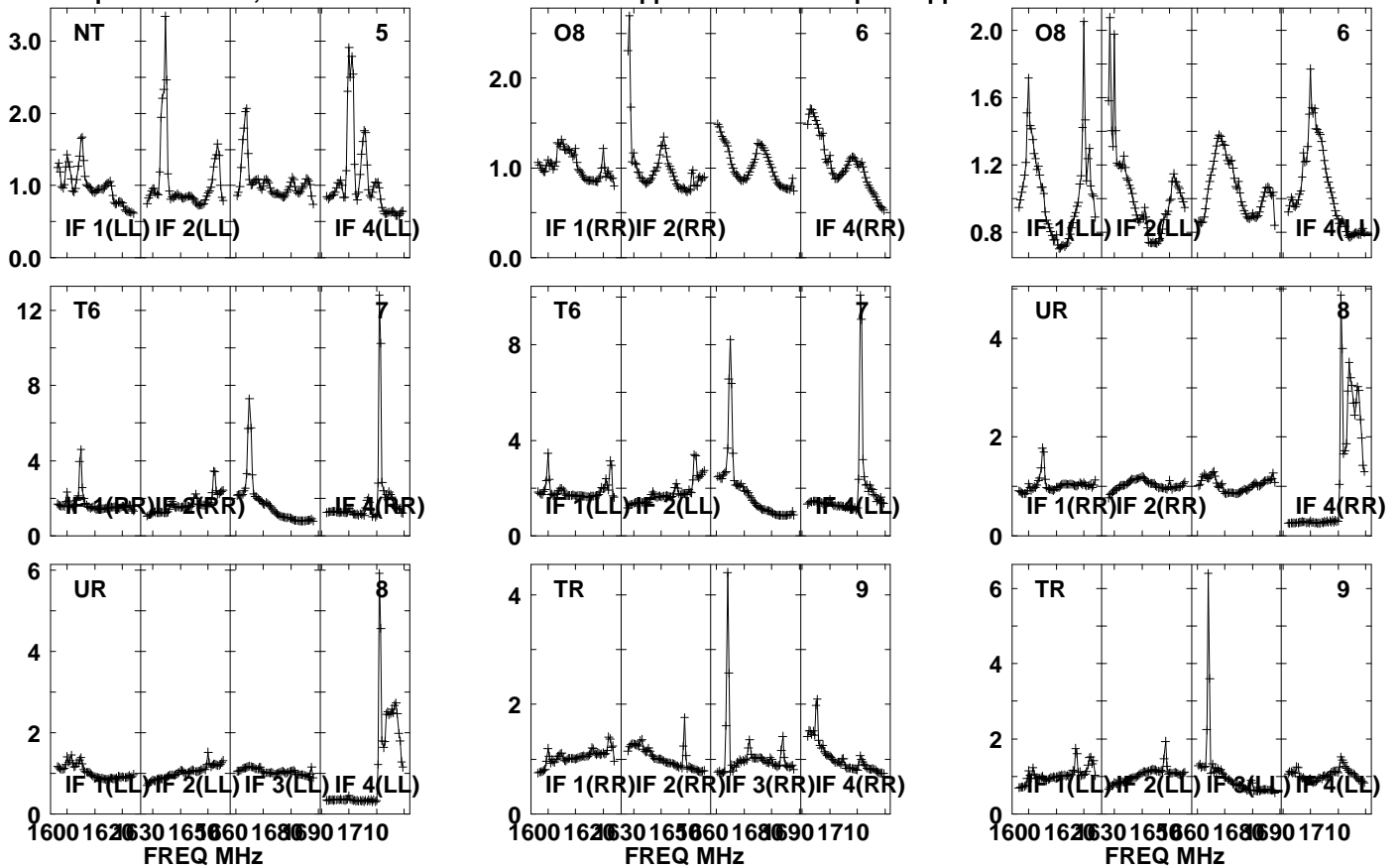

Lower frame: Real Jy

Auto-corr total-power spectrum Antenna: \*

Timerange: 00/13:43:31 to 00/13:44:59

Plot file version 303 created 05-OCT-2021 17:05:40

J0827+5217 GM076.UVDATA.1

Freq = 1.5945 GHz, Bw = 32.000 MH No calibration applied and no bandpass applied

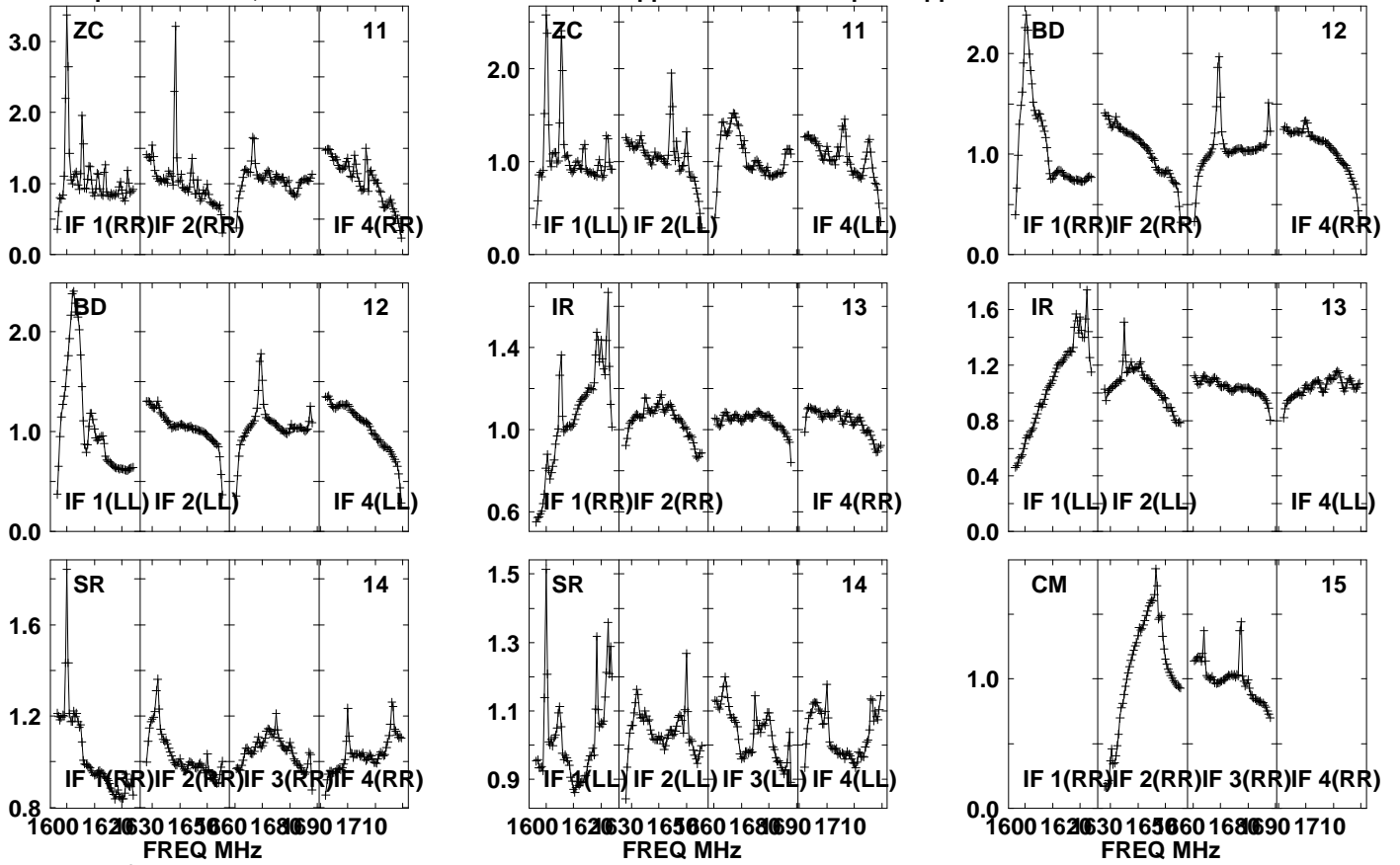

Lower frame: Real Jy  
Auto-corr total-power spectrum Antenna: \*  
Timerange: 00/13:43:31 to 00/13:44:59

Plot file version 304 created 05-OCT-2021 17:05:40

J0827+5217 GM076.UVDATA.1

Freq = 1.5945 GHz, Bw = 32.000 MH No calibration applied and no bandpass applied

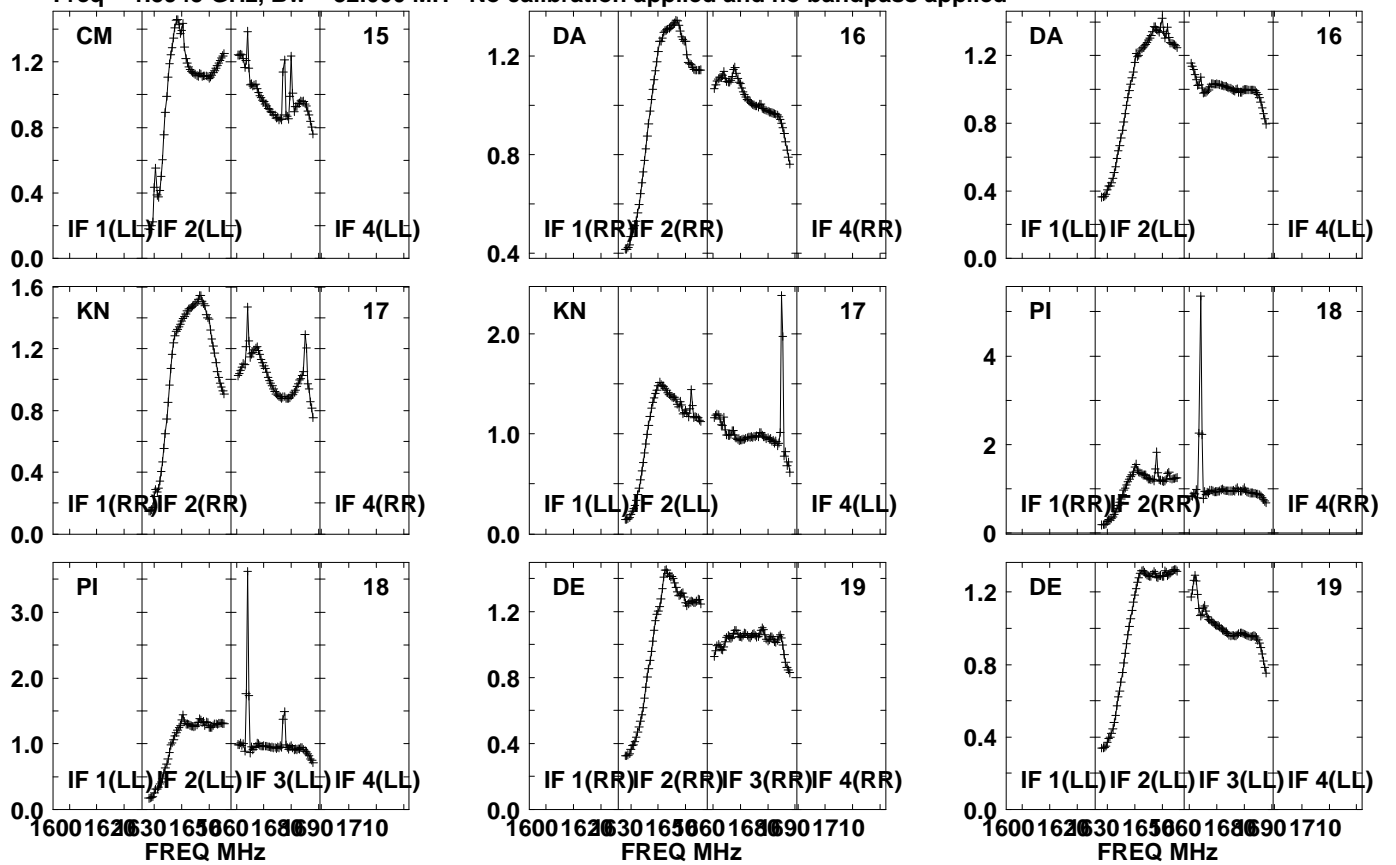

Lower frame: Real Jy  
Auto-corr total-power spectrum Antenna: \*  
Timerange: 00/13:43:31 to 00/13:44:59

Plot file version 305 created 05-OCT-2021 17:05:40

APM08279+525 GM076.UVDATA.1

Freq = 1.5945 GHz, Bw = 32.000 MH No calibration applied and no bandpass applied

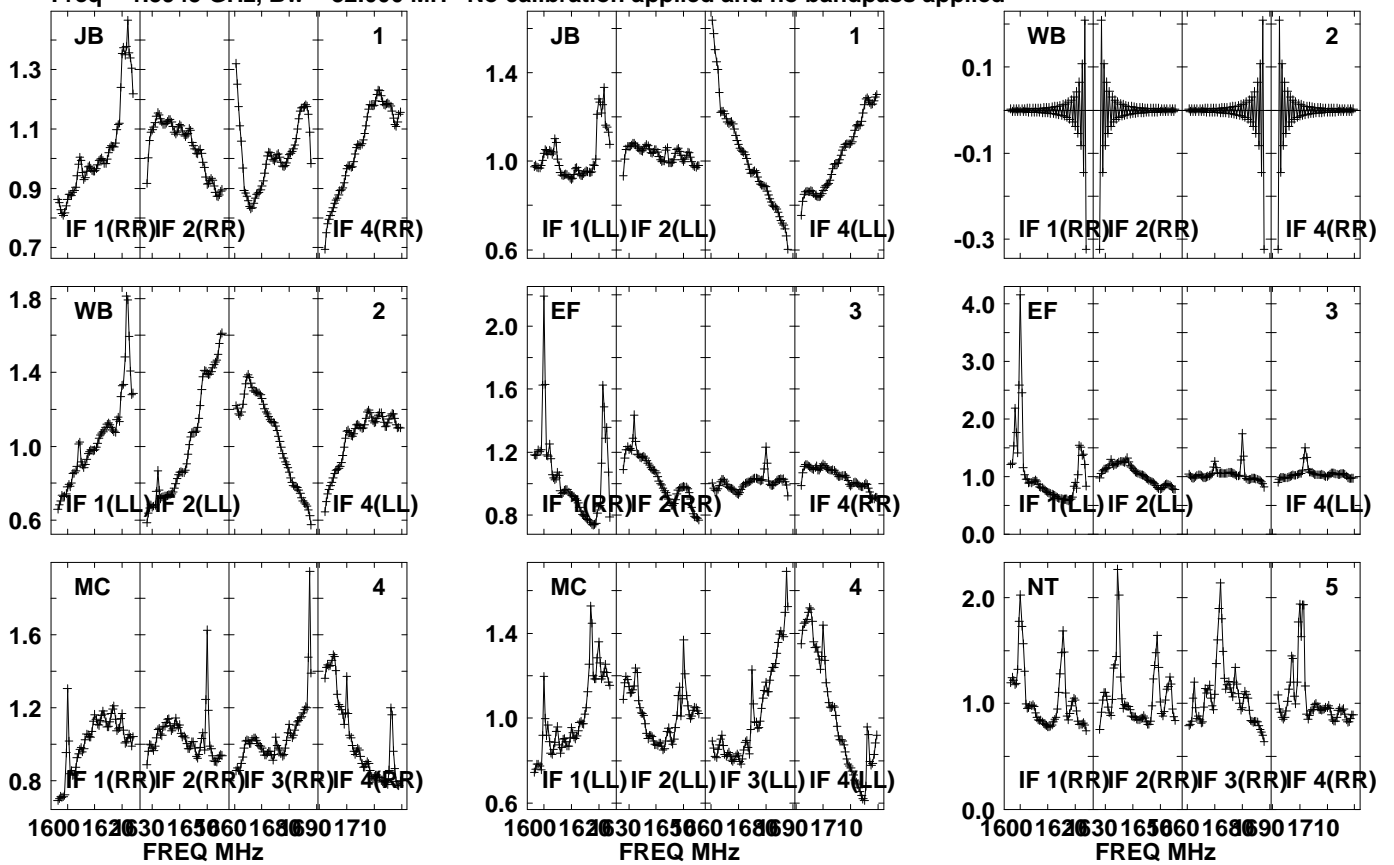

Lower frame: Real Jy  
Auto-corr total-power spectrum Antenna: \*  
Timerange: 00/13:45:01 to 00/13:48:29

Plot file version 306 created 05-OCT-2021 17:05:41

APM08279+525 GM076.UVDATA.1

Freq = 1.5945 GHz, Bw = 32.000 MH No calibration applied and no bandpass applied

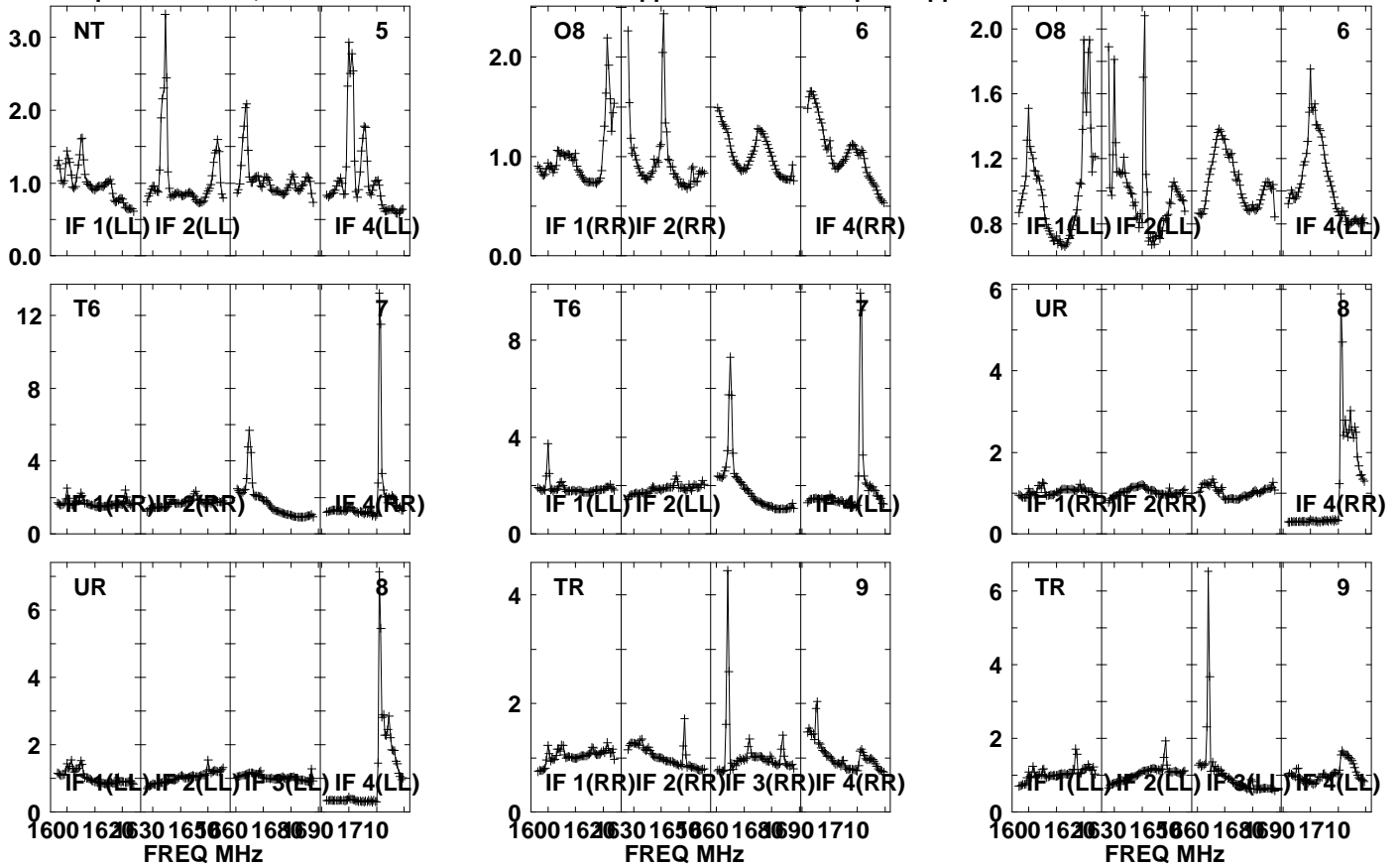

Lower frame: Real Jy

Auto-corr total-power spectrum Antenna: \*

Timerange: 00/13:45:01 to 00/13:48:29



Plot file version 307 created 05-OCT-2021 17:05:41

APM08279+525 GM076.UVDATA.1

Freq = 1.5945 GHz, Bw = 32.000 MH No calibration applied and no bandpass applied

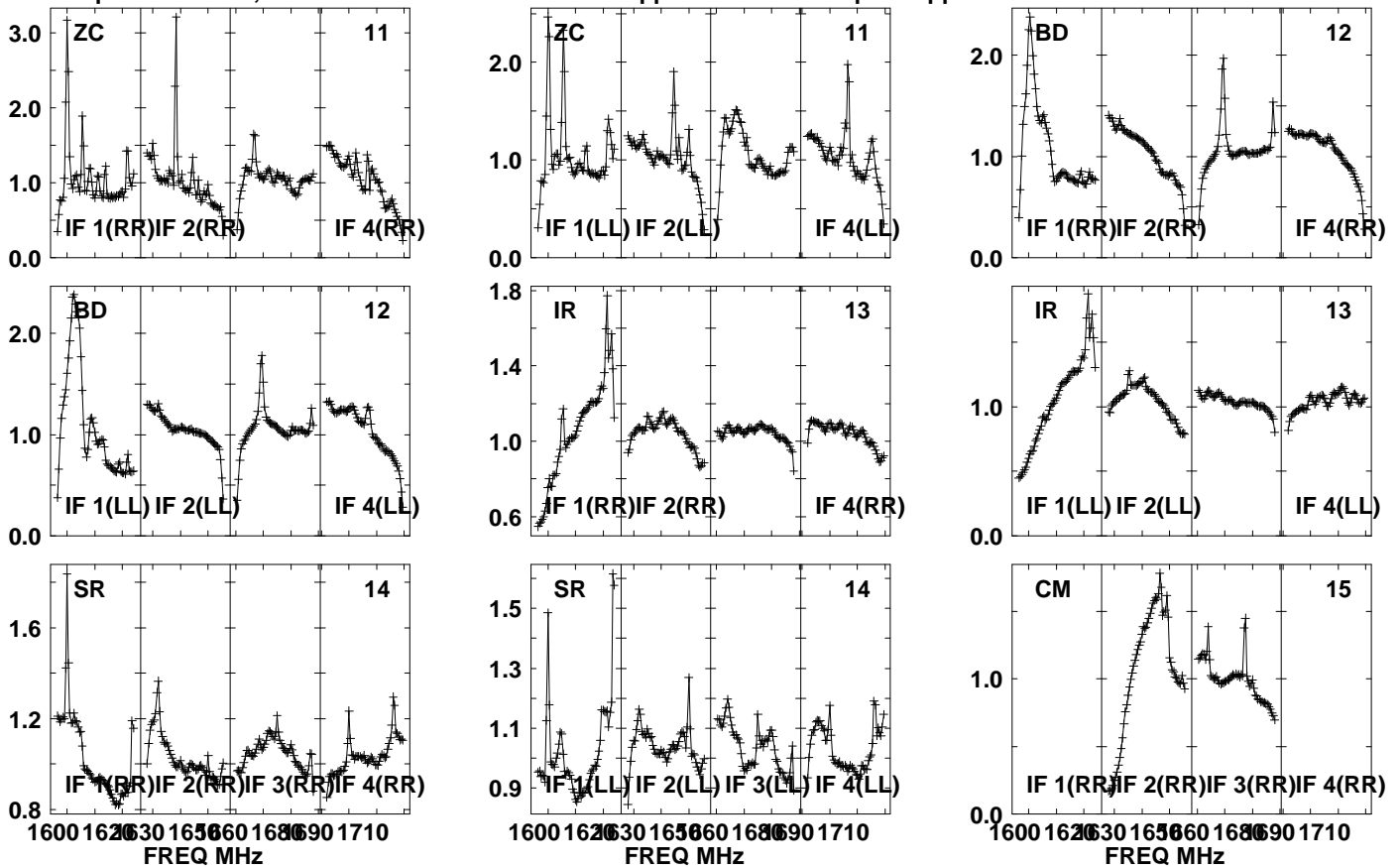

Lower frame: Real Jy

Auto-corr total-power spectrum Antenna: \*

Timerange: 00/13:45:01 to 00/13:48:29

Plot file version 308 created 05-OCT-2021 17:05:41

APM08279+525 GM076.UVDATA.1

Freq = 1.5945 GHz, Bw = 32.000 MH No calibration applied and no bandpass applied

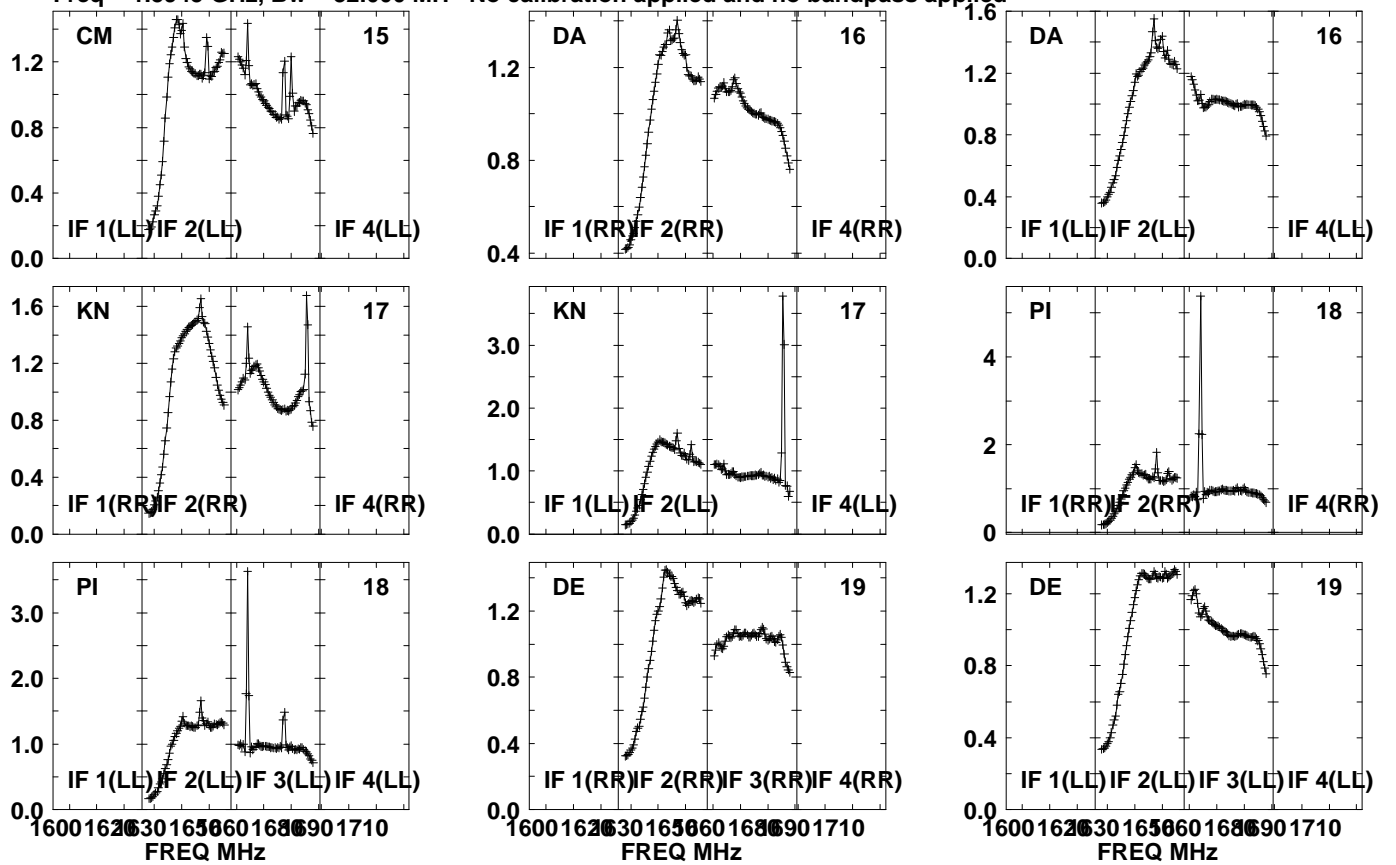

Lower frame: Real Jy  
Auto-corr total-power spectrum Antenna: \*  
Timerange: 00/13:45:01 to 00/13:48:29

Plot file version 309 created 05-OCT-2021 17:05:41

J0827+5217 GM076.UVDATA.1

Freq = 1.5945 GHz, Bw = 32.000 MH No calibration applied and no bandpass applied

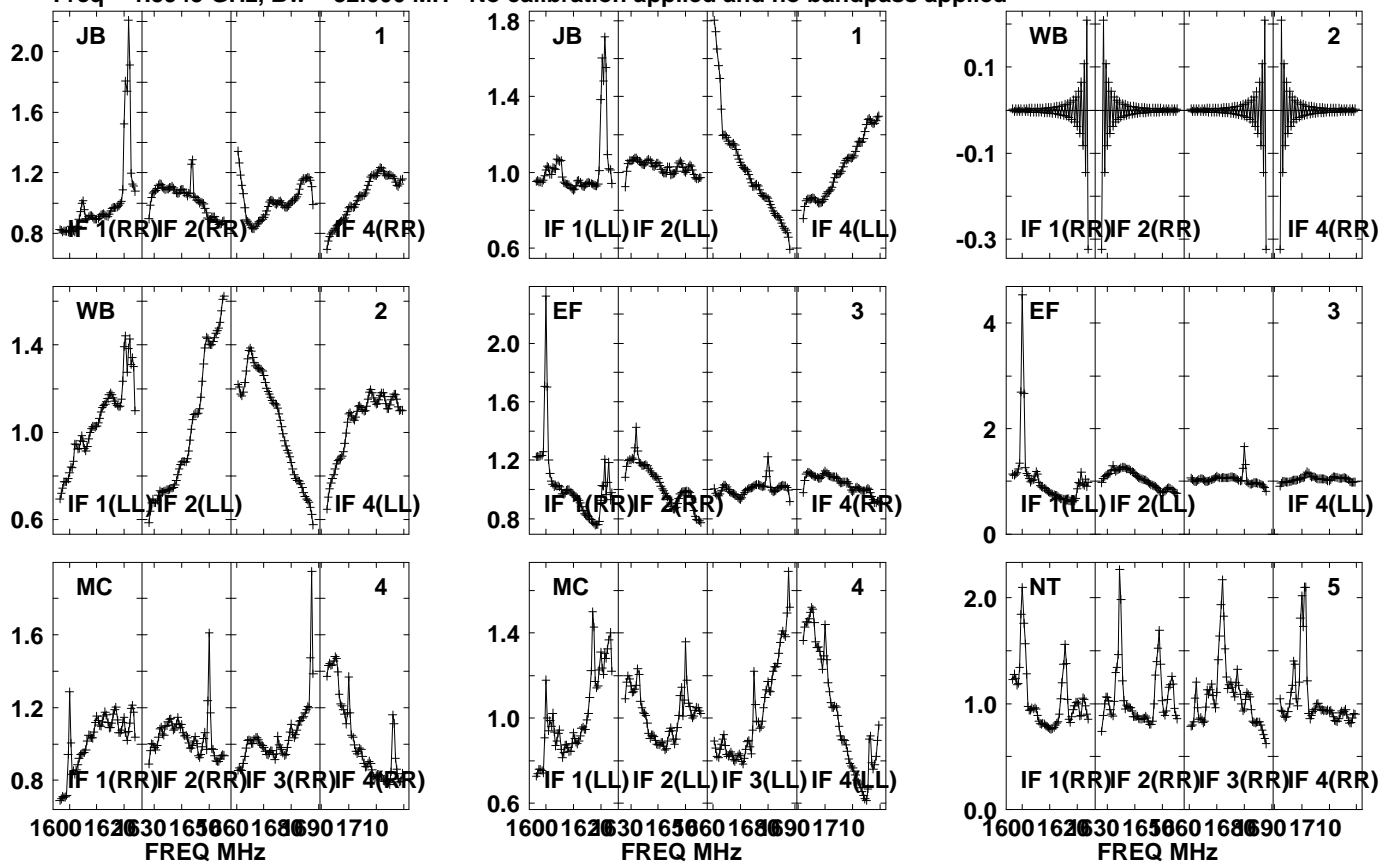

Lower frame: Real Jy  
Auto-corr total-power spectrum Antenna: \*  
Timerange: 00/13:48:31 to 00/13:49:59

Plot file version 310 created 05-OCT-2021 17:05:42

J0827+5217 GM076.UVDATA.1

Freq = 1.5945 GHz, Bw = 32.000 MH No calibration applied and no bandpass applied

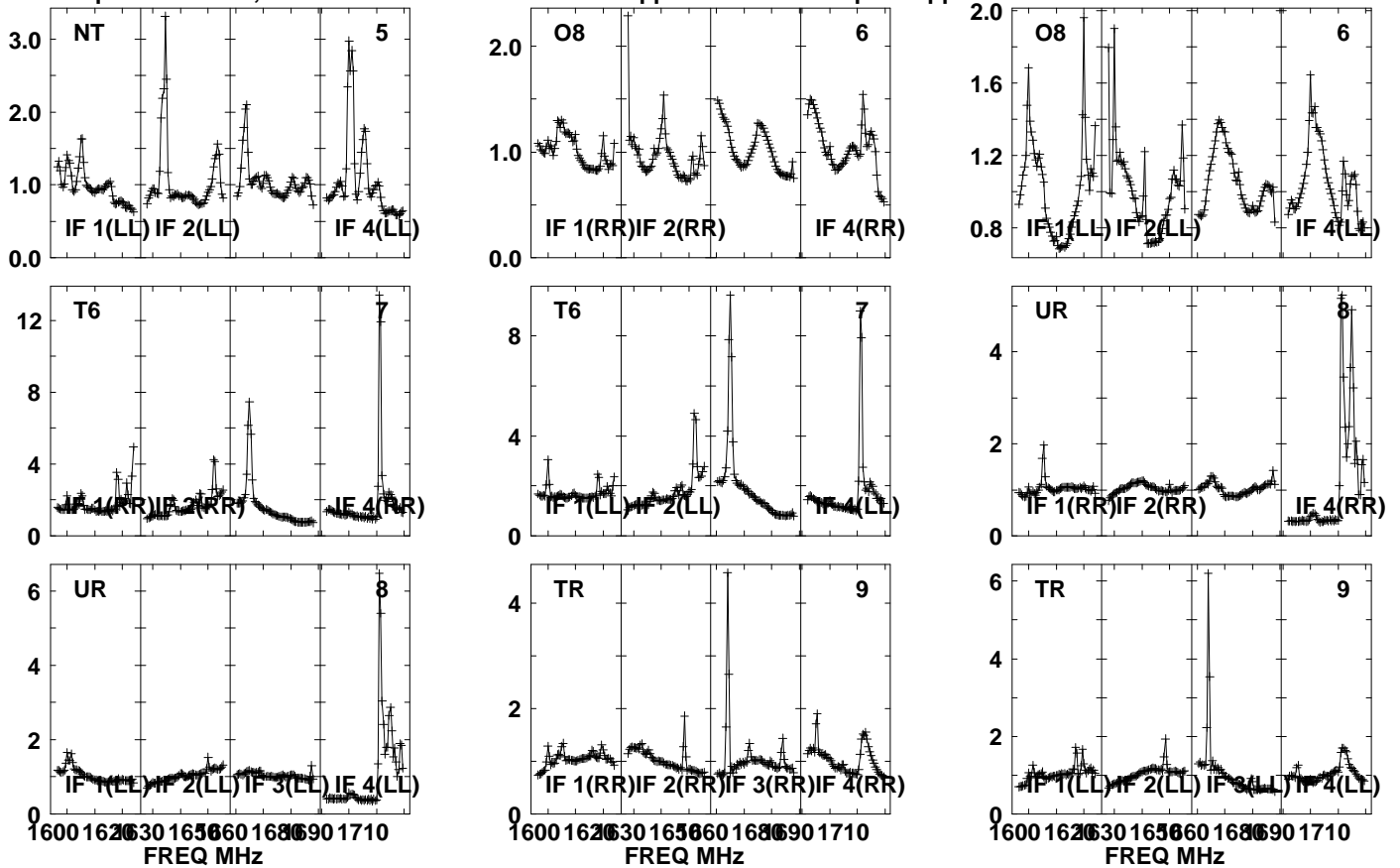

Lower frame: Real Jy

Auto-corr total-power spectrum Antenna: \*

Timerange: 00/13:48:31 to 00/13:49:59

Plot file version 311 created 05-OCT-2021 17:05:42

J0827+5217 GM076.UVDATA.1

Freq = 1.5945 GHz, Bw = 32.000 MH No calibration applied and no bandpass applied

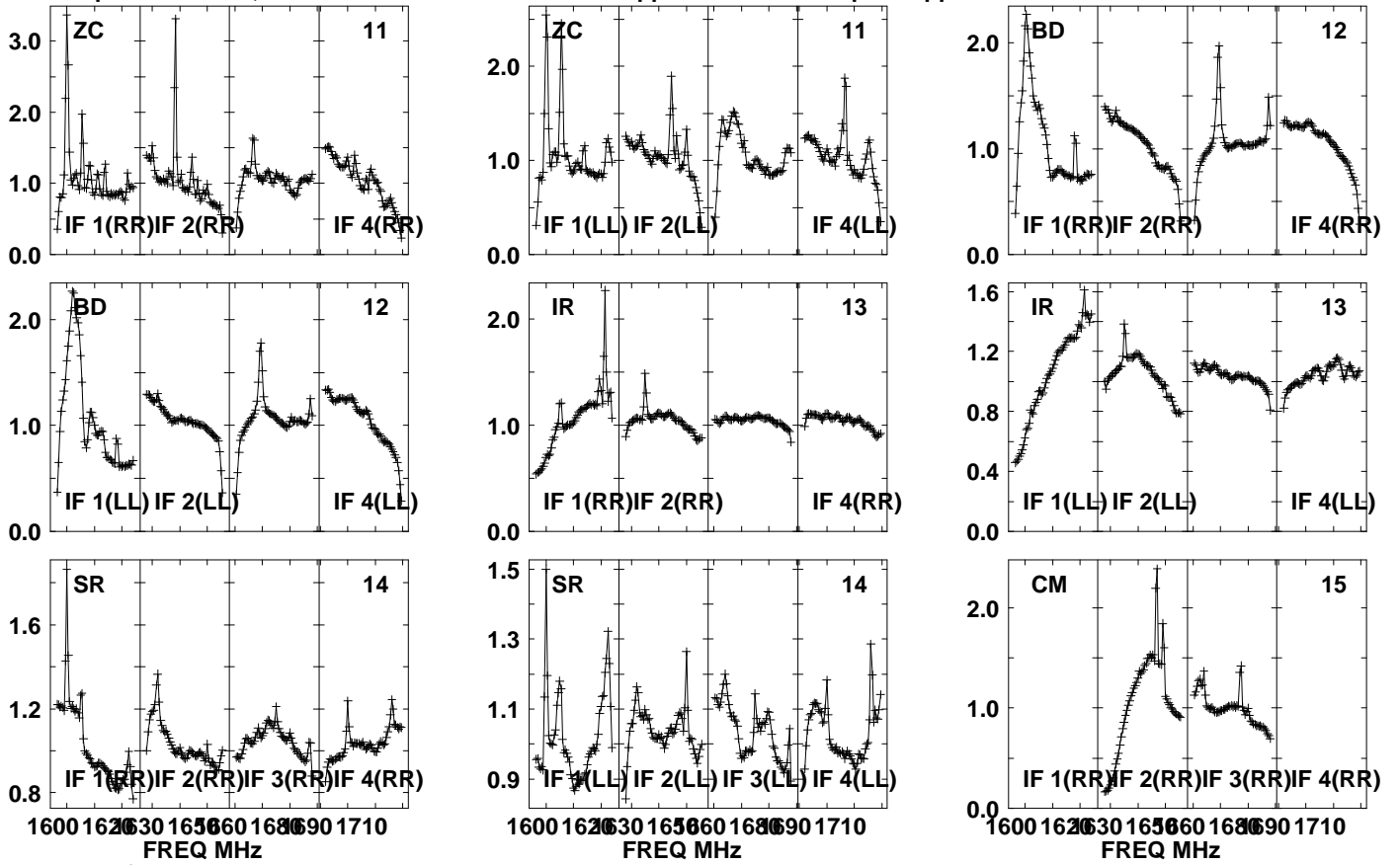

Lower frame: Real Jy

Auto-corr total-power spectrum Antenna: \*

Timerange: 00/13:48:31 to 00/13:49:59

Plot file version 312 created 05-OCT-2021 17:05:42

J0827+5217 GM076.UVDATA.1

Freq = 1.5945 GHz, Bw = 32.000 MH No calibration applied and no bandpass applied

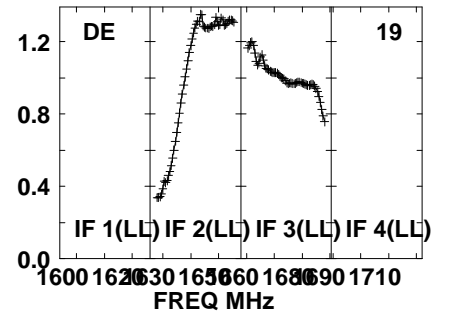
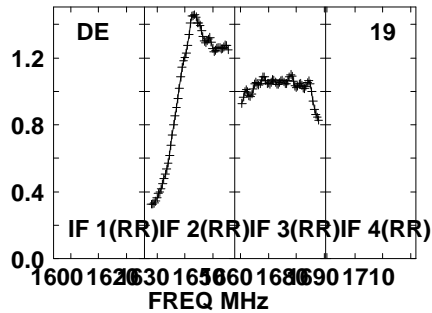
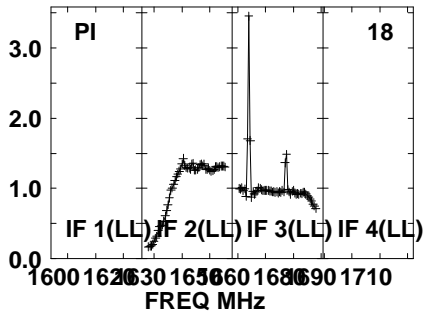
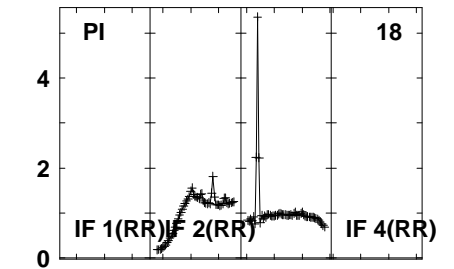
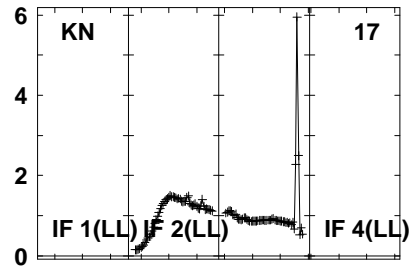
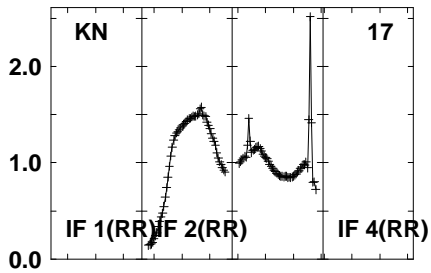
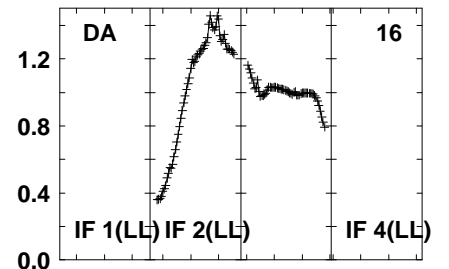
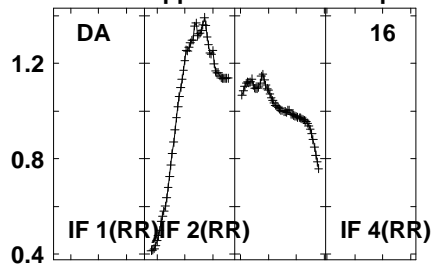
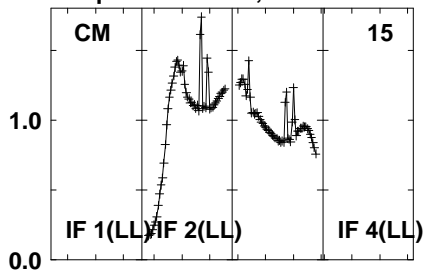

Lower frame: Real Jy

Auto-corr total-power spectrum Antenna: \*

Timerange: 00/13:48:31 to 00/13:49:59

Plot file version 313 created 05-OCT-2021 17:05:42

APM08279+525 GM076.UVDATA.1

Freq = 1.5945 GHz, Bw = 32.000 MH No calibration applied and no bandpass applied

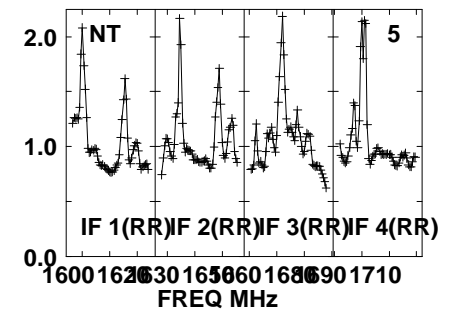
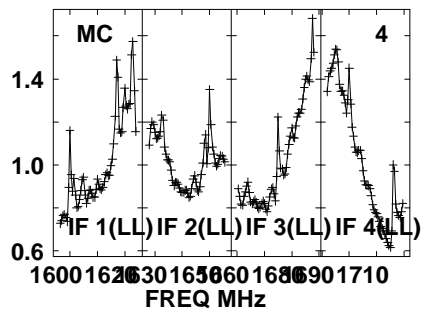
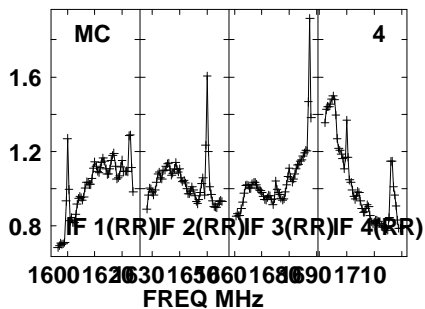
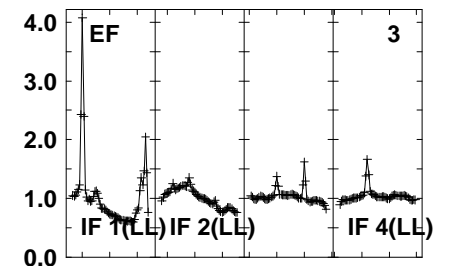
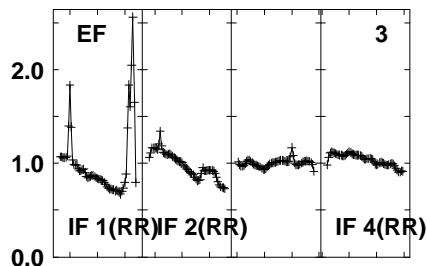
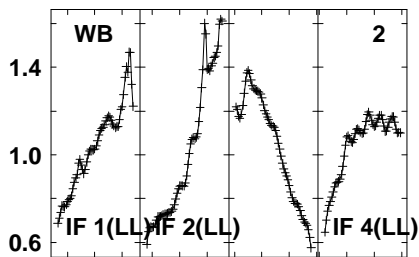
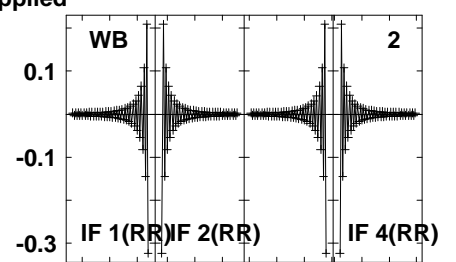
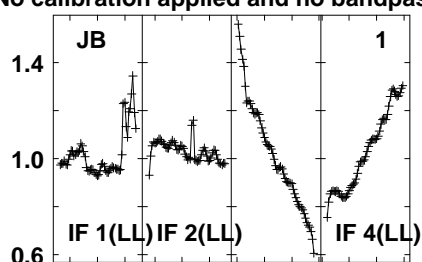
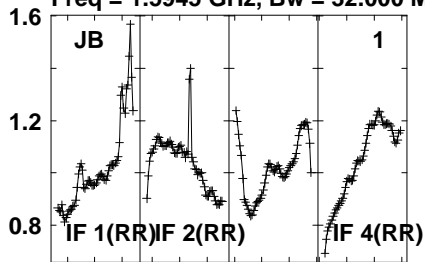

Lower frame: Real Jy  
Auto-corr total-power spectrum Antenna: \*  
Timerange: 00/13:50:01 to 00/13:53:29

Plot file version 314 created 05-OCT-2021 17:05:43

APM08279+525 GM076.UVDATA.1

Freq = 1.5945 GHz, Bw = 32.000 MH No calibration applied and no bandpass applied

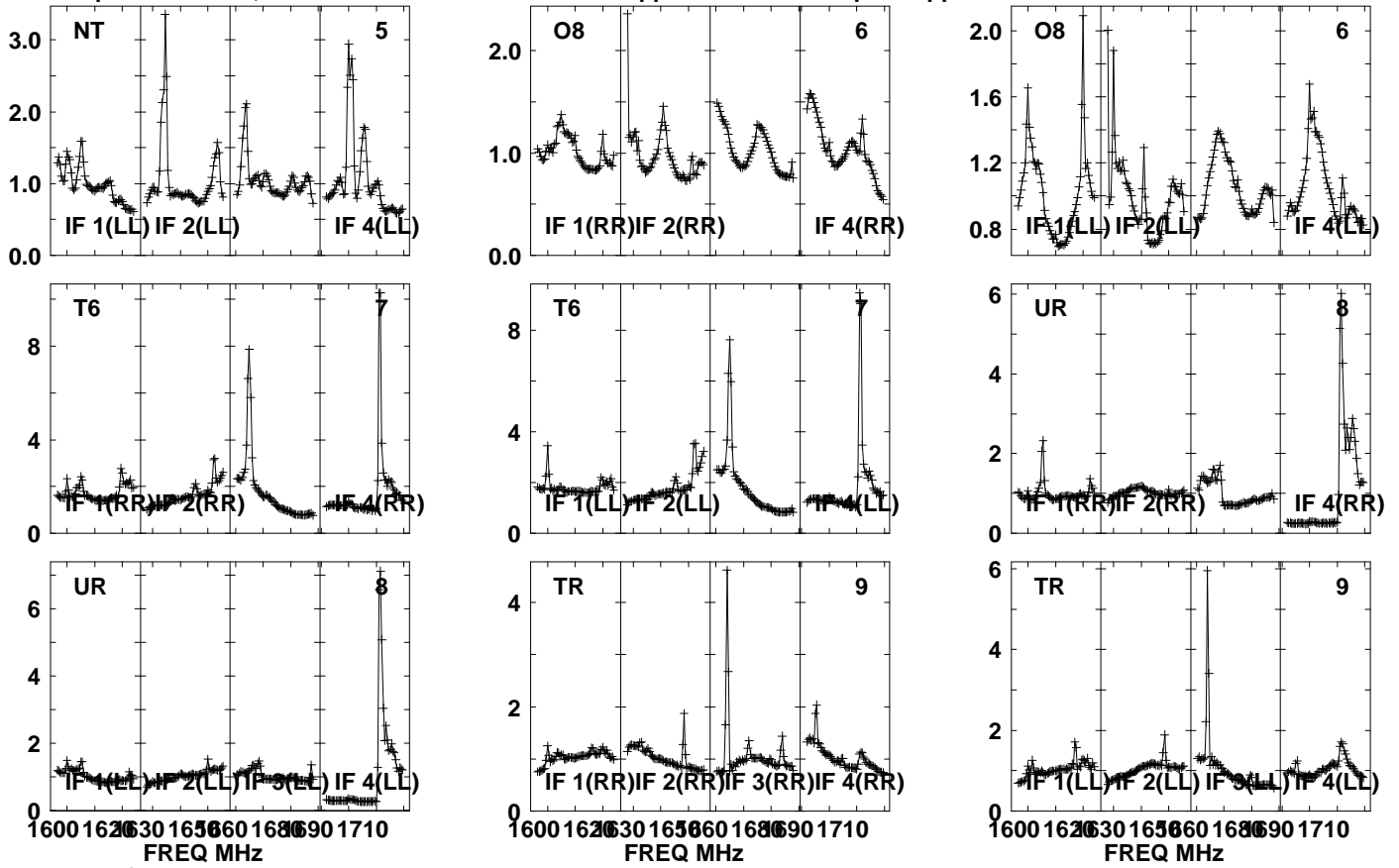

Lower frame: Real Jy

Auto-corr total-power spectrum Antenna: \*

Timerange: 00/13:50:01 to 00/13:53:29



Plot file version 315 created 05-OCT-2021 17:05:43

APM08279+525 GM076.UVDATA.1

Freq = 1.5945 GHz, Bw = 32.000 MH No calibration applied and no bandpass applied

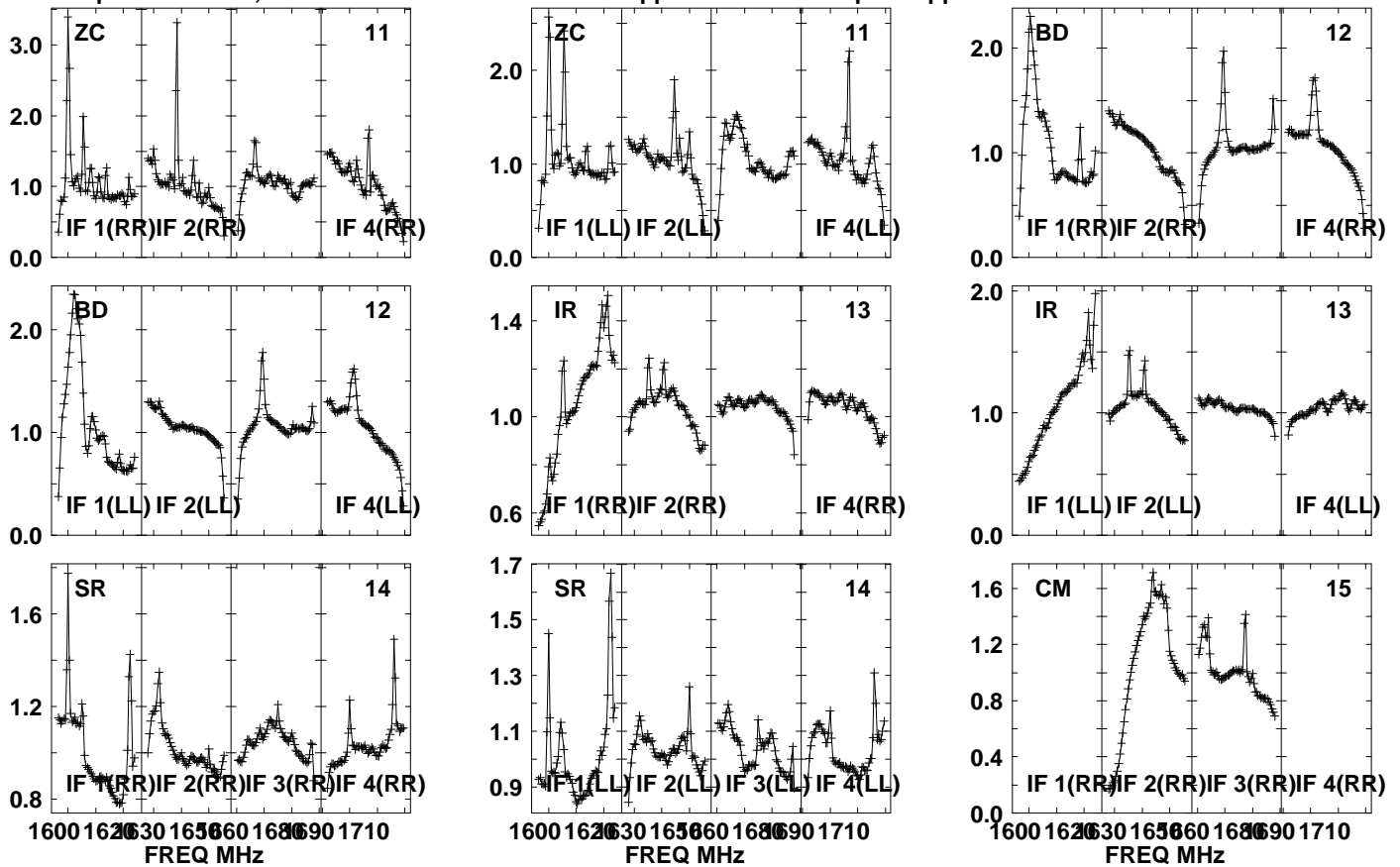

Lower frame: Real Jy

Auto-corr total-power spectrum Antenna: \*

Timerange: 00/13:50:01 to 00/13:53:29

Plot file version 316 created 05-OCT-2021 17:05:43

APM08279+525 GM076.UVDATA.1

Freq = 1.5945 GHz, Bw = 32.000 MH No calibration applied and no bandpass applied

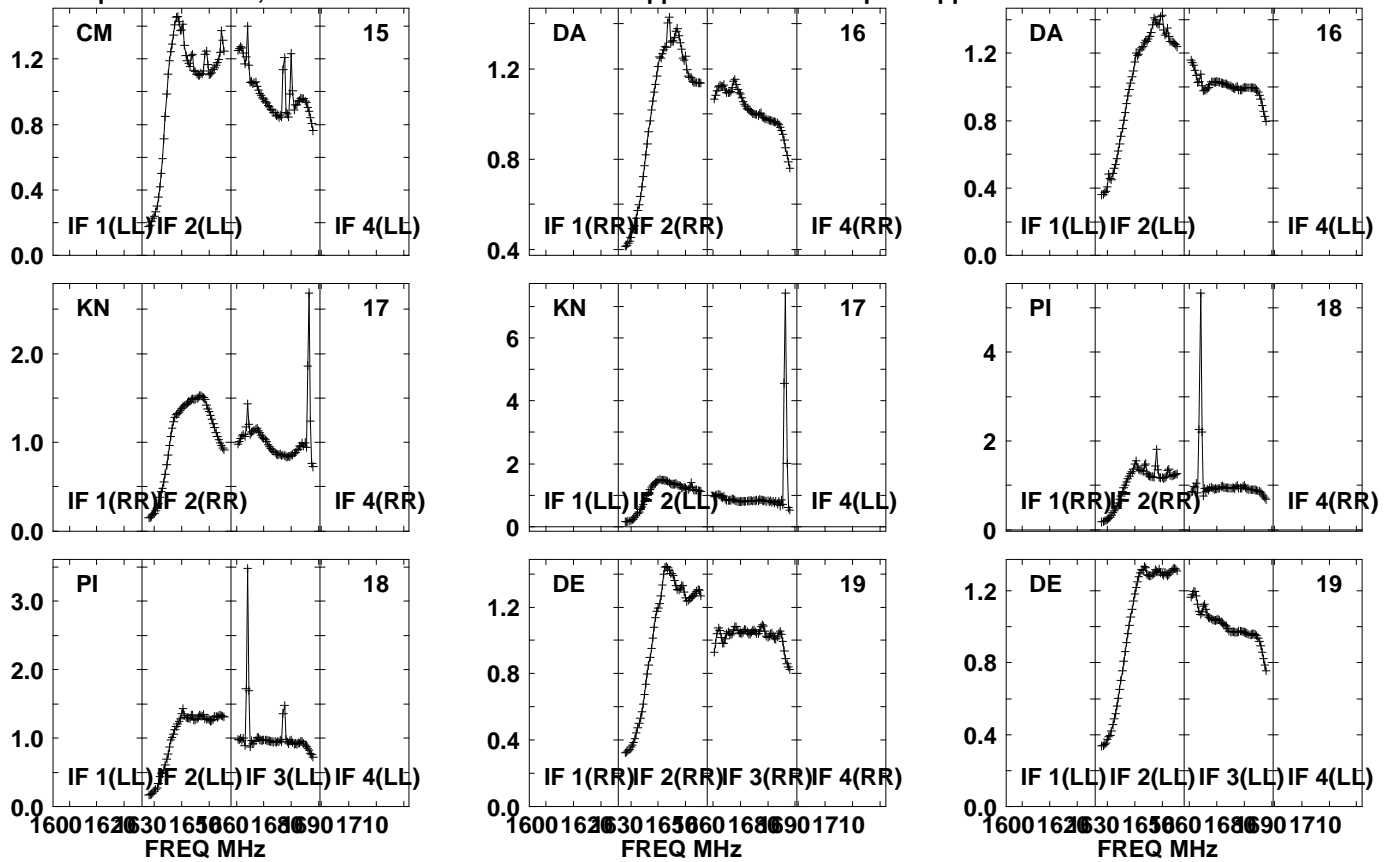

Lower frame: Real Jy  
Auto-corr total-power spectrum Antenna: \*  
Timerange: 00/13:50:01 to 00/13:53:29

Plot file version 317 created 05-OCT-2021 17:05:43

J0827+5217 GM076.UVDATA.1

Freq = 1.5945 GHz, Bw = 32.000 MH No calibration applied and no bandpass applied

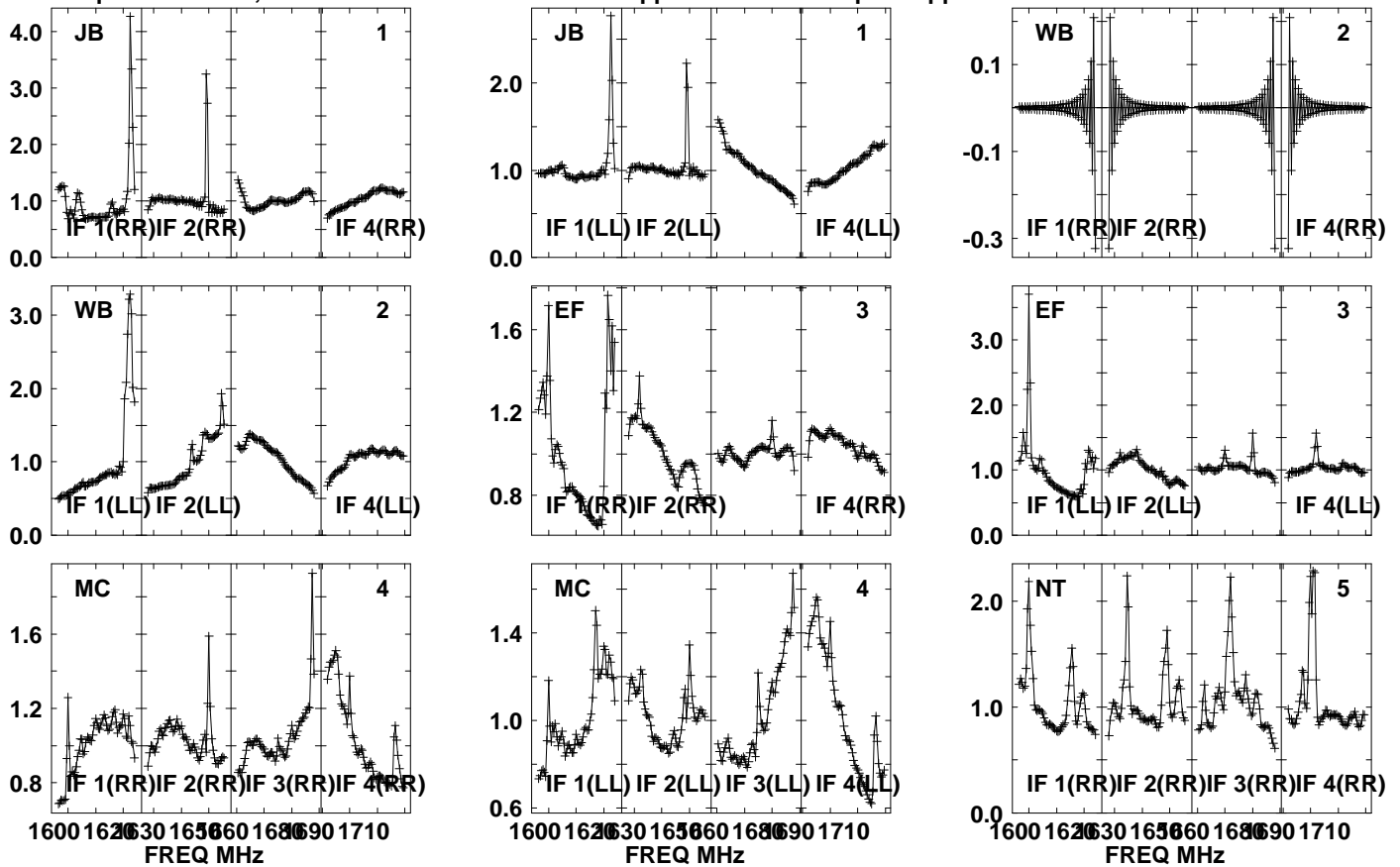

Lower frame: Real Jy

Auto-corr total-power spectrum Antenna: \*

Timerange: 00/13:54:01 to 00/13:55:29

Plot file version 318 created 05-OCT-2021 17:05:44

J0827+5217 GM076.UVDATA.1

Freq = 1.5945 GHz, Bw = 32.000 MH No calibration applied and no bandpass applied

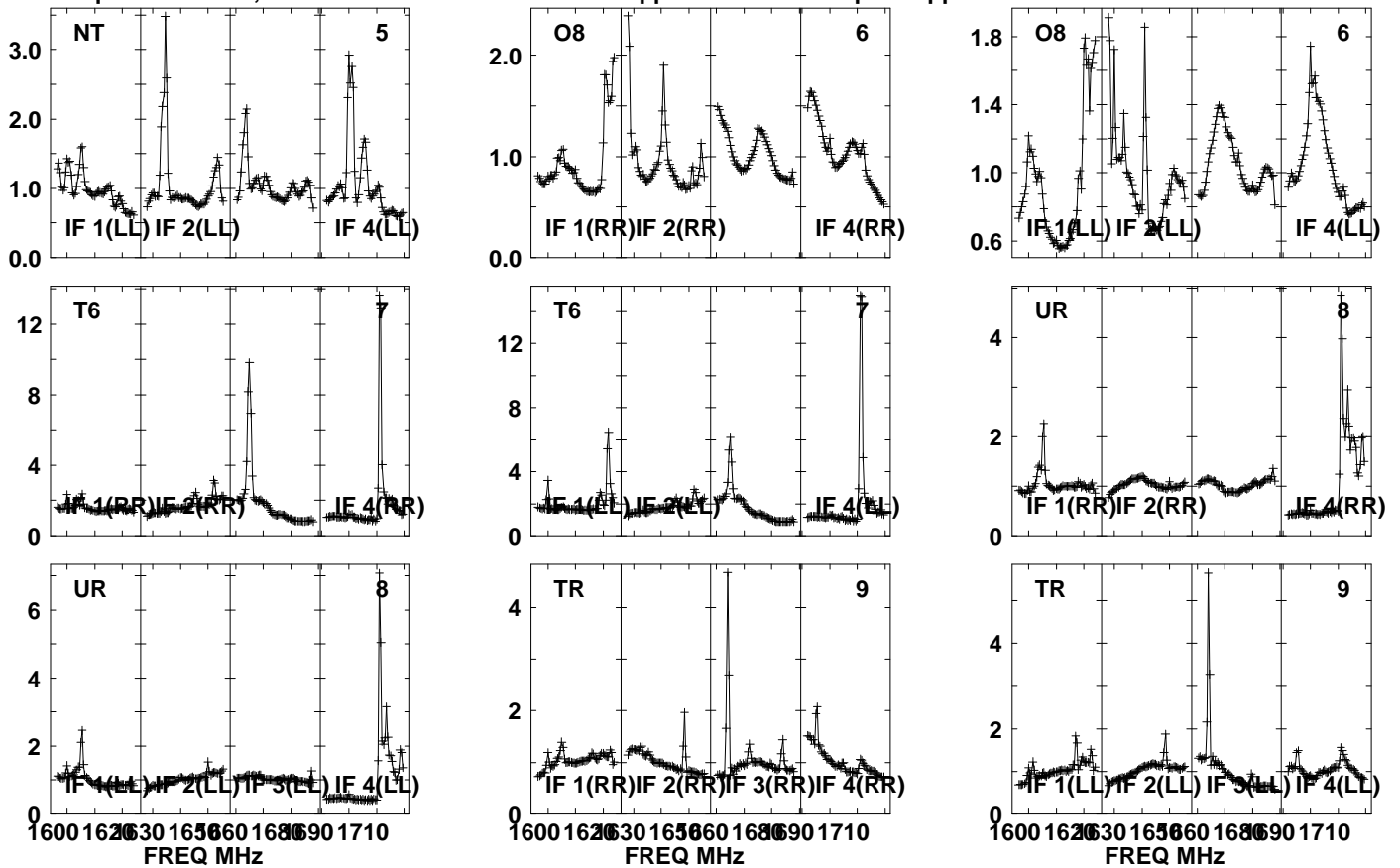

Lower frame: Real Jy

Auto-corr total-power spectrum Antenna: \*

Timerange: 00/13:54:01 to 00/13:55:29

Plot file version 319 created 05-OCT-2021 17:05:44

J0827+5217 GM076.UVDATA.1

Freq = 1.5945 GHz, Bw = 32.000 MH No calibration applied and no bandpass applied

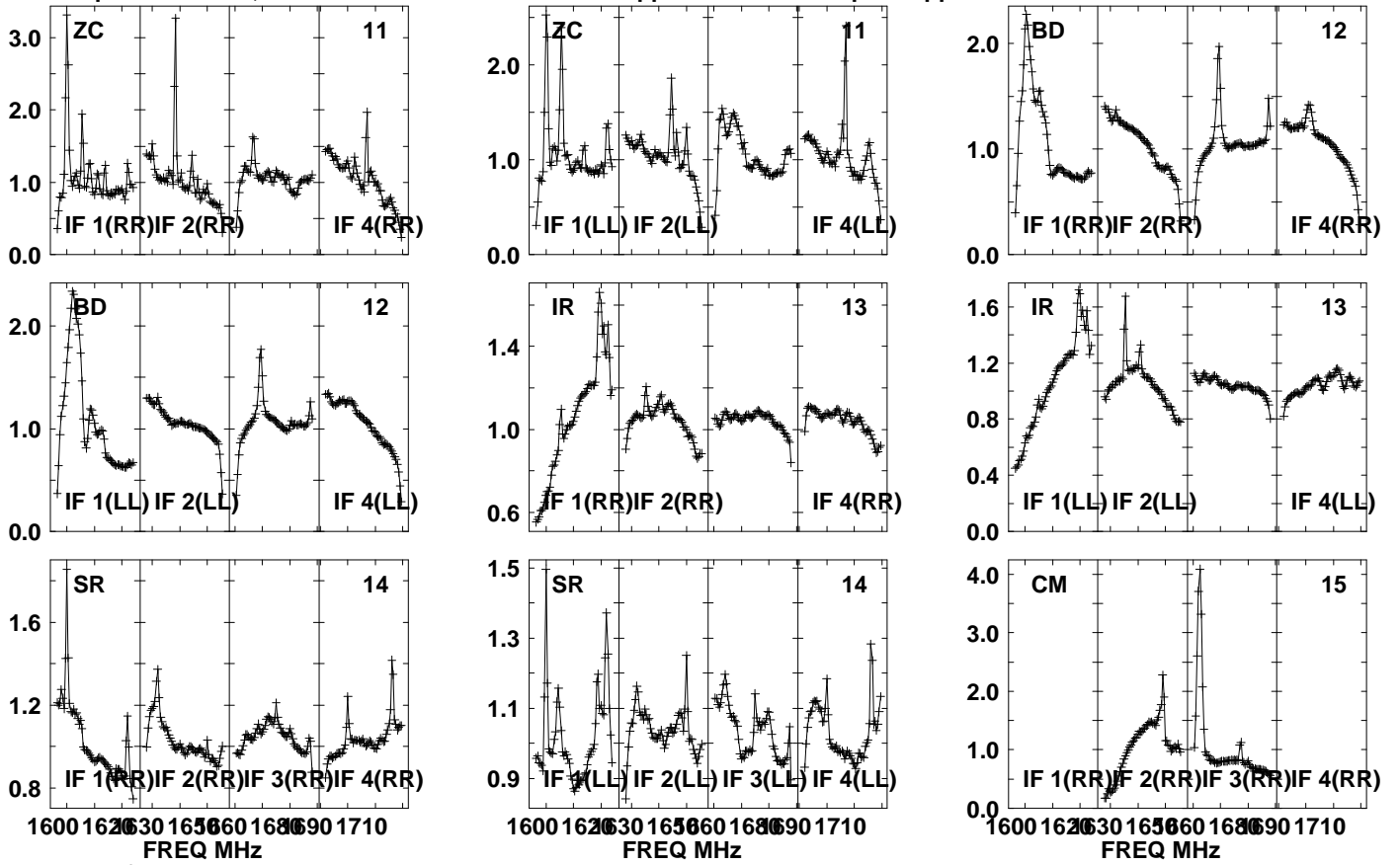

Lower frame: Real Jy

Auto-corr total-power spectrum Antenna: \*

Timerange: 00/13:54:01 to 00/13:55:29

Plot file version 320 created 05-OCT-2021 17:05:44

J0827+5217 GM076.UVDATA.1

Freq = 1.5945 GHz, Bw = 32.000 MH No calibration applied and no bandpass applied

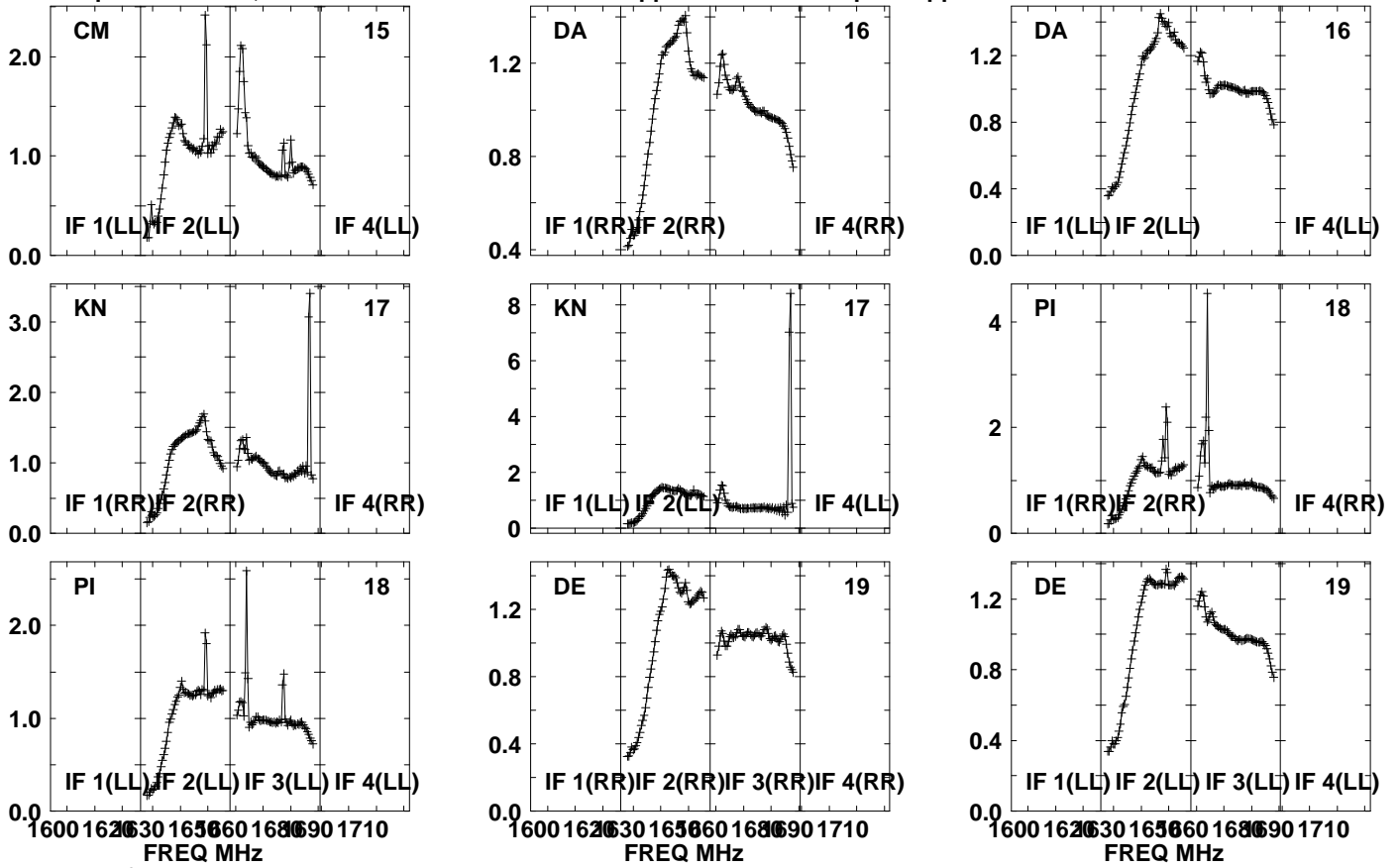

Lower frame: Real Jy  
Auto-corr total-power spectrum Antenna: \*  
Timerange: 00/13:54:01 to 00/13:55:29

Plot file version 321 created 05-OCT-2021 17:05:44

APM08279+525 GM076.UVDATA.1

Freq = 1.5945 GHz, Bw = 32.000 MH No calibration applied and no bandpass applied

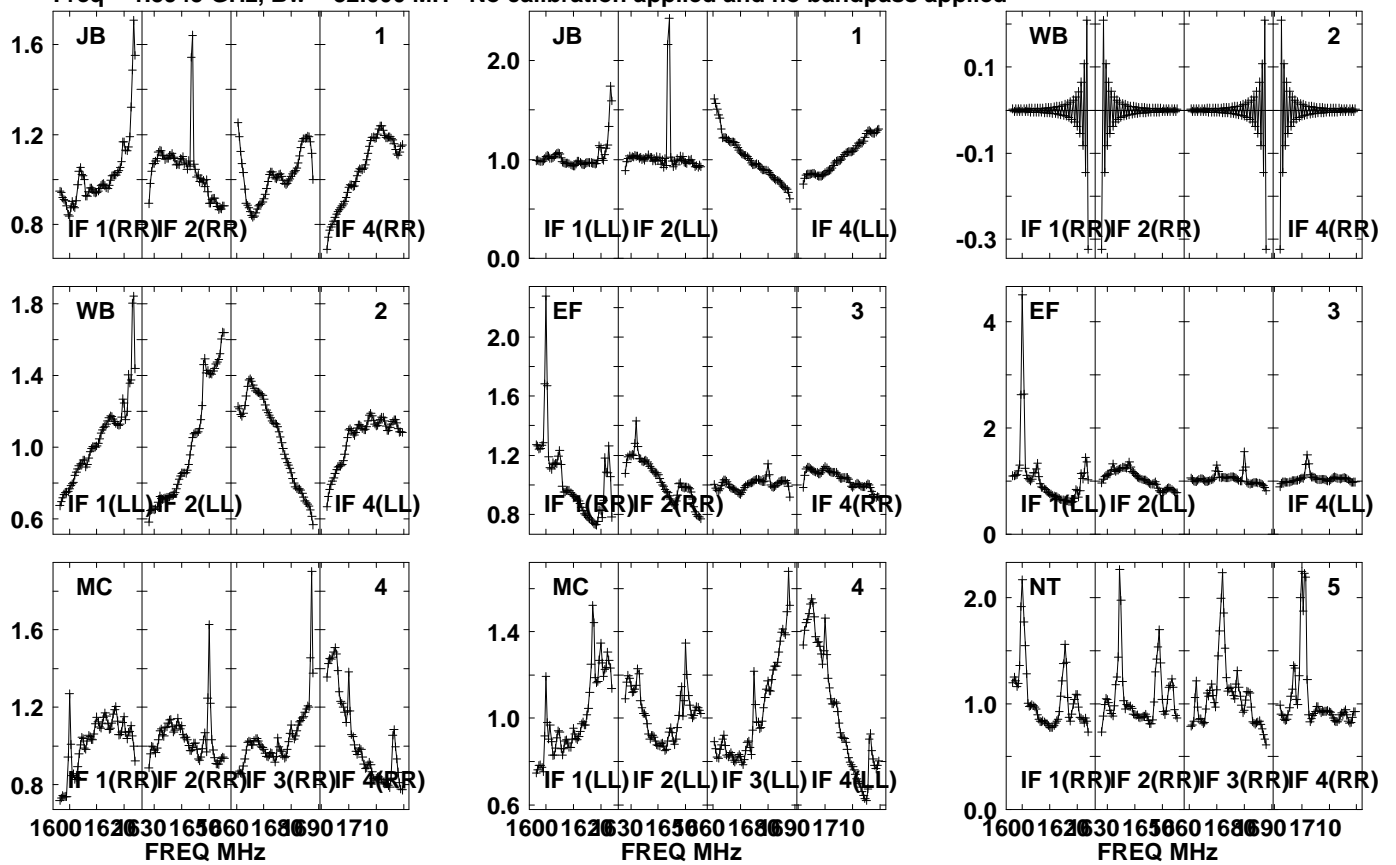

Lower frame: Real Jy  
Auto-corr total-power spectrum Antenna: \*  
Timerange: 00/13:55:31 to 00/13:58:59

Plot file version 322 created 05-OCT-2021 17:05:44

APM08279+525 GM076.UVDATA.1

Freq = 1.5945 GHz, Bw = 32.000 MH No calibration applied and no bandpass applied

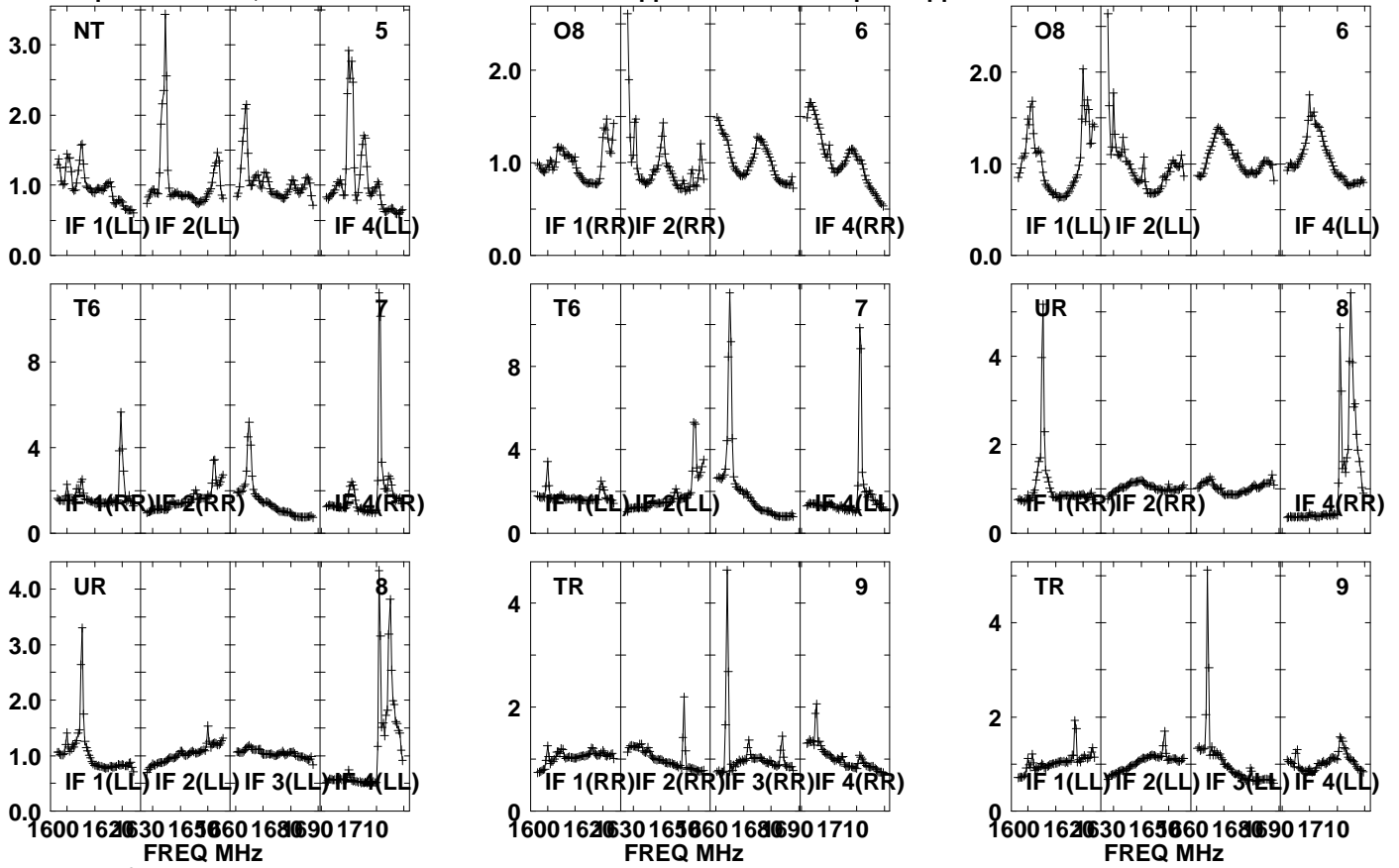

Lower frame: Real Jy  
Auto-corr total-power spectrum Antenna: \*  
Timerange: 00/13:55:31 to 00/13:58:59



Plot file version 323 created 05-OCT-2021 17:05:45

APM08279+525 GM076.UVDATA.1

Freq = 1.5945 GHz, Bw = 32.000 MH No calibration applied and no bandpass applied

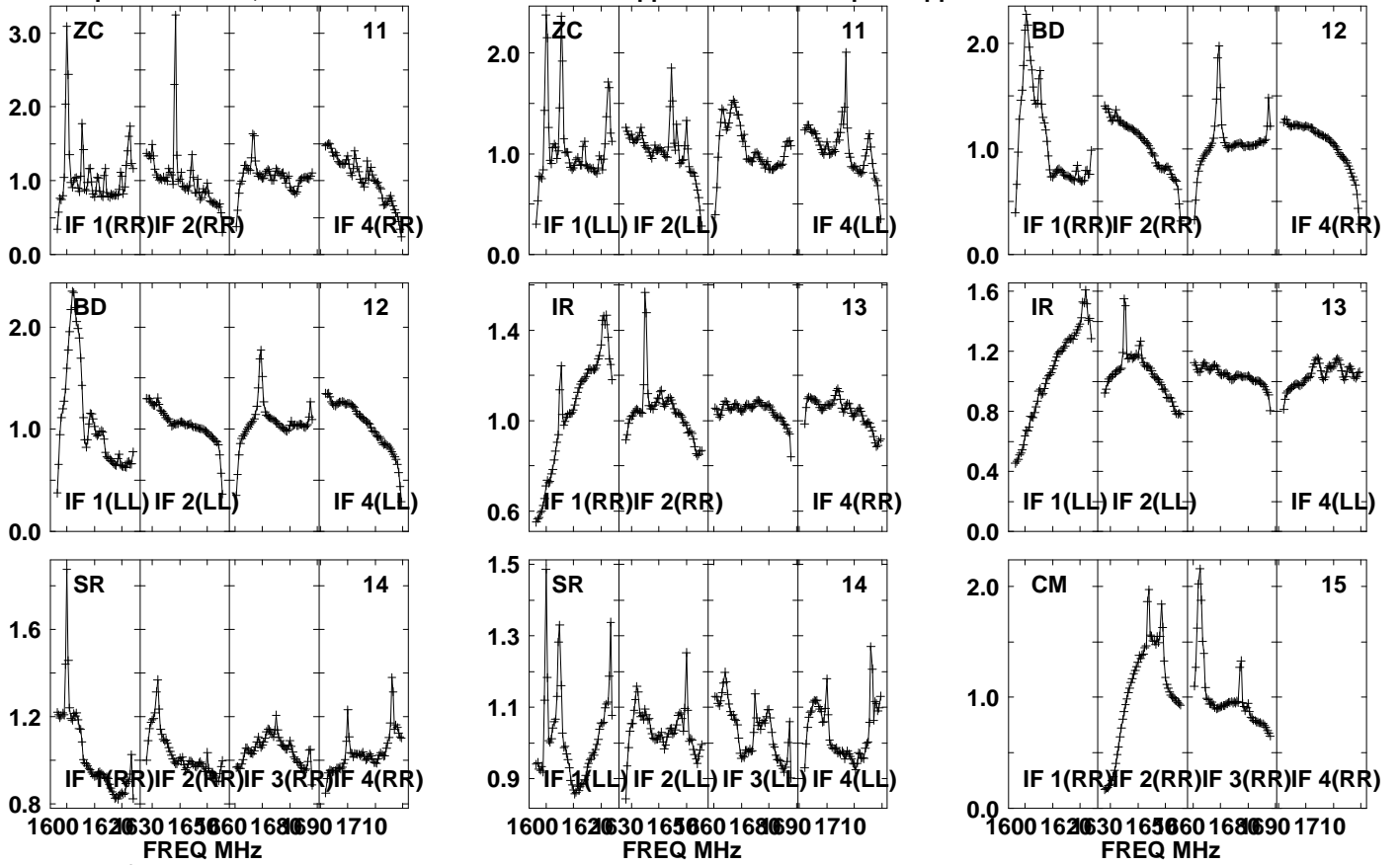

Lower frame: Real Jy

Auto-corr total-power spectrum Antenna: \*

Timerange: 00/13:55:31 to 00/13:58:59

Plot file version 324 created 05-OCT-2021 17:05:45

APM08279+525 GM076.UVDATA.1

Freq = 1.5945 GHz, Bw = 32.000 MH No calibration applied and no bandpass applied

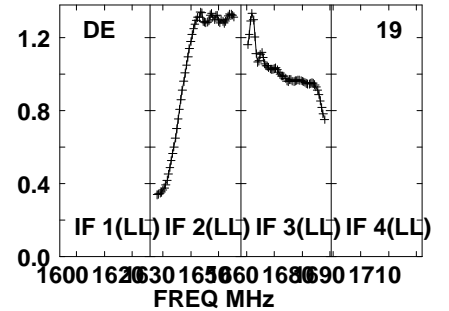
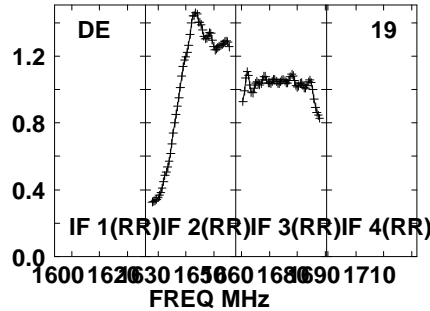
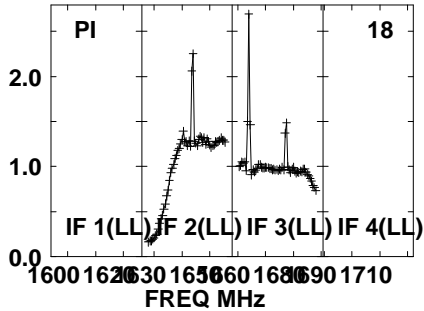
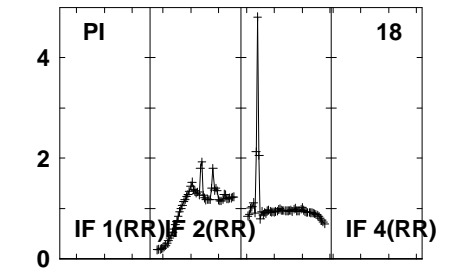
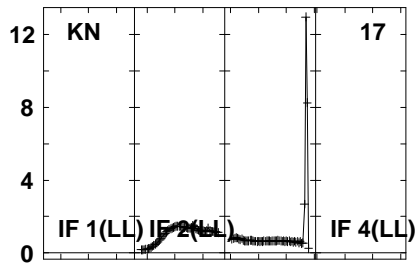
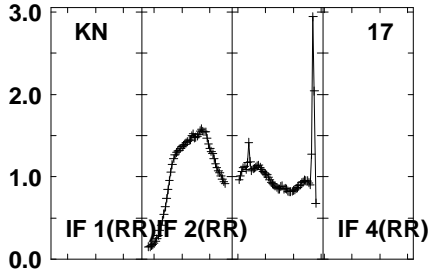
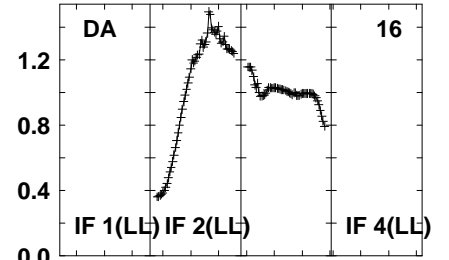
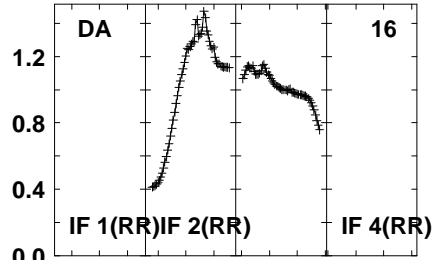
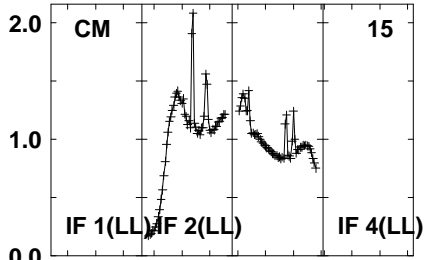

Lower frame: Real Jy

Auto-corr total-power spectrum Antenna: \*

Timerange: 00/13:55:31 to 00/13:58:59

Plot file version 325 created 05-OCT-2021 17:05:45

J0827+5217 GM076.UVDATA.1

Freq = 1.5945 GHz, Bw = 32.000 MH No calibration applied and no bandpass applied

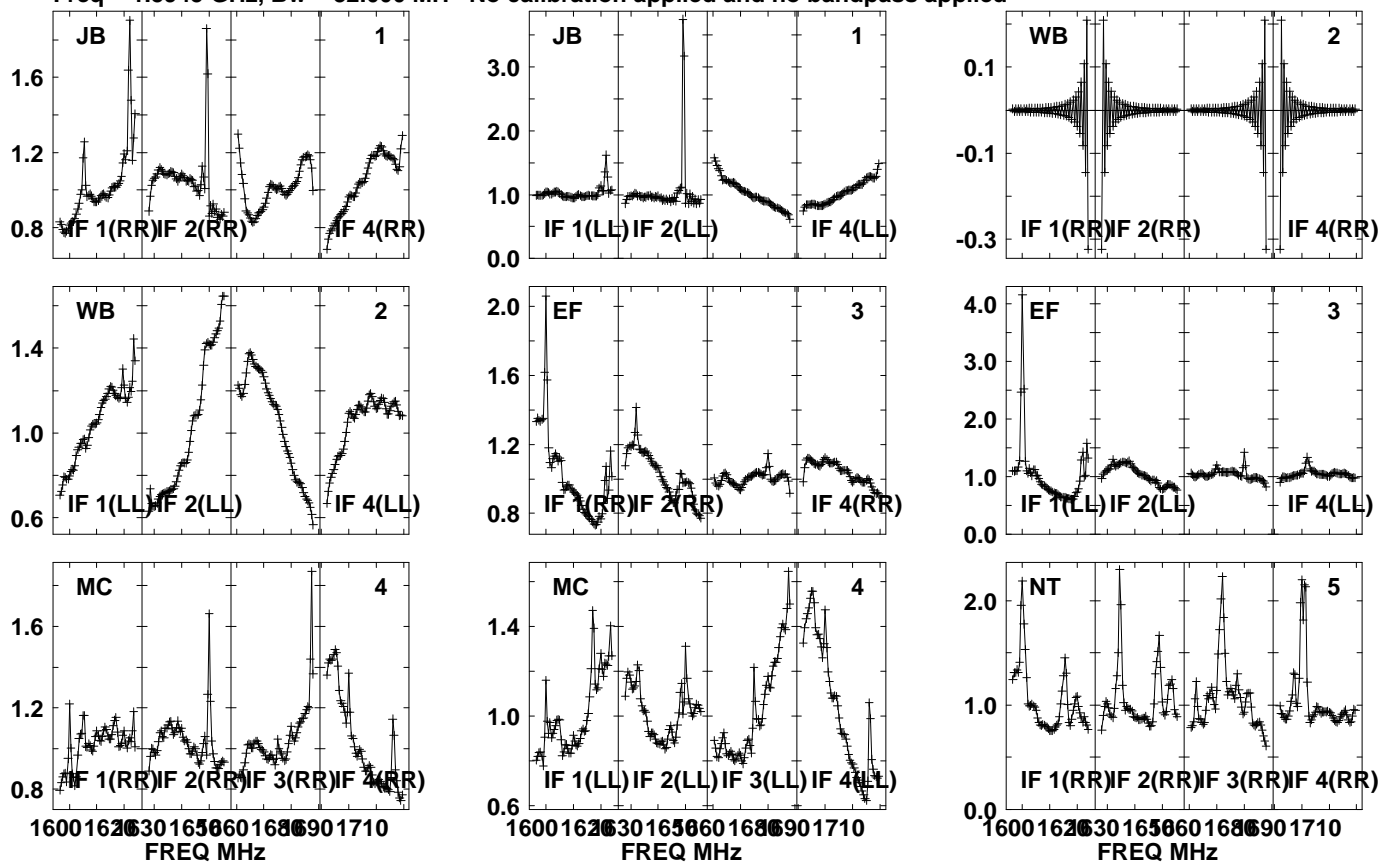

Lower frame: Real Jy  
Auto-corr total-power spectrum Antenna: \*  
Timerange: 00/13:59:01 to 00/14:00:29

Plot file version 326 created 05-OCT-2021 17:05:45

J0827+5217 GM076.UVDATA.1

Freq = 1.5945 GHz, Bw = 32.000 MH No calibration applied and no bandpass applied

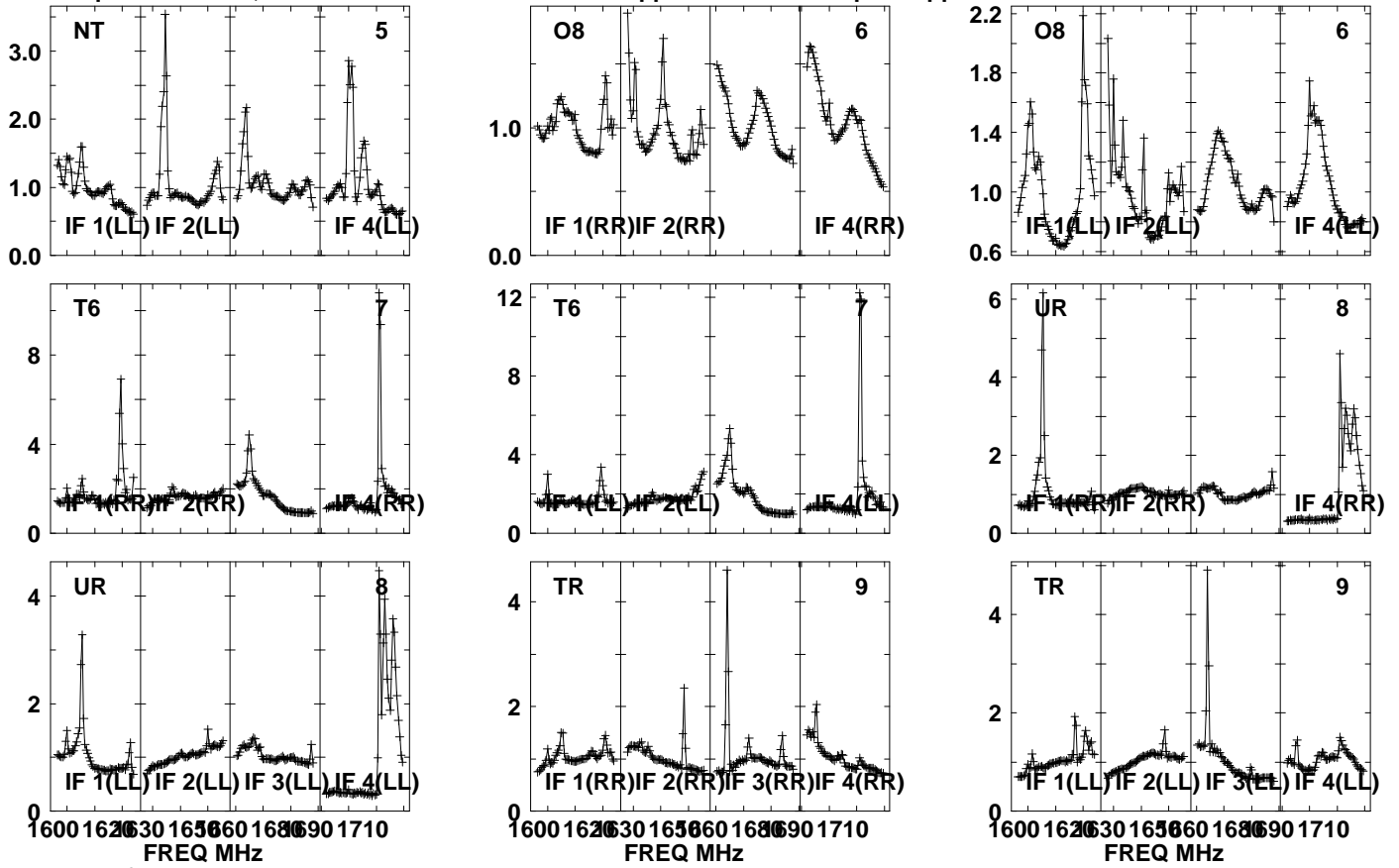

Lower frame: Real Jy  
Auto-corr total-power spectrum Antenna: \*  
Timerange: 00/13:59:01 to 00/14:00:29

Plot file version 327 created 05-OCT-2021 17:05:46

J0827+5217 GM076.UVDATA.1

Freq = 1.5945 GHz, Bw = 32.000 MH No calibration applied and no bandpass applied

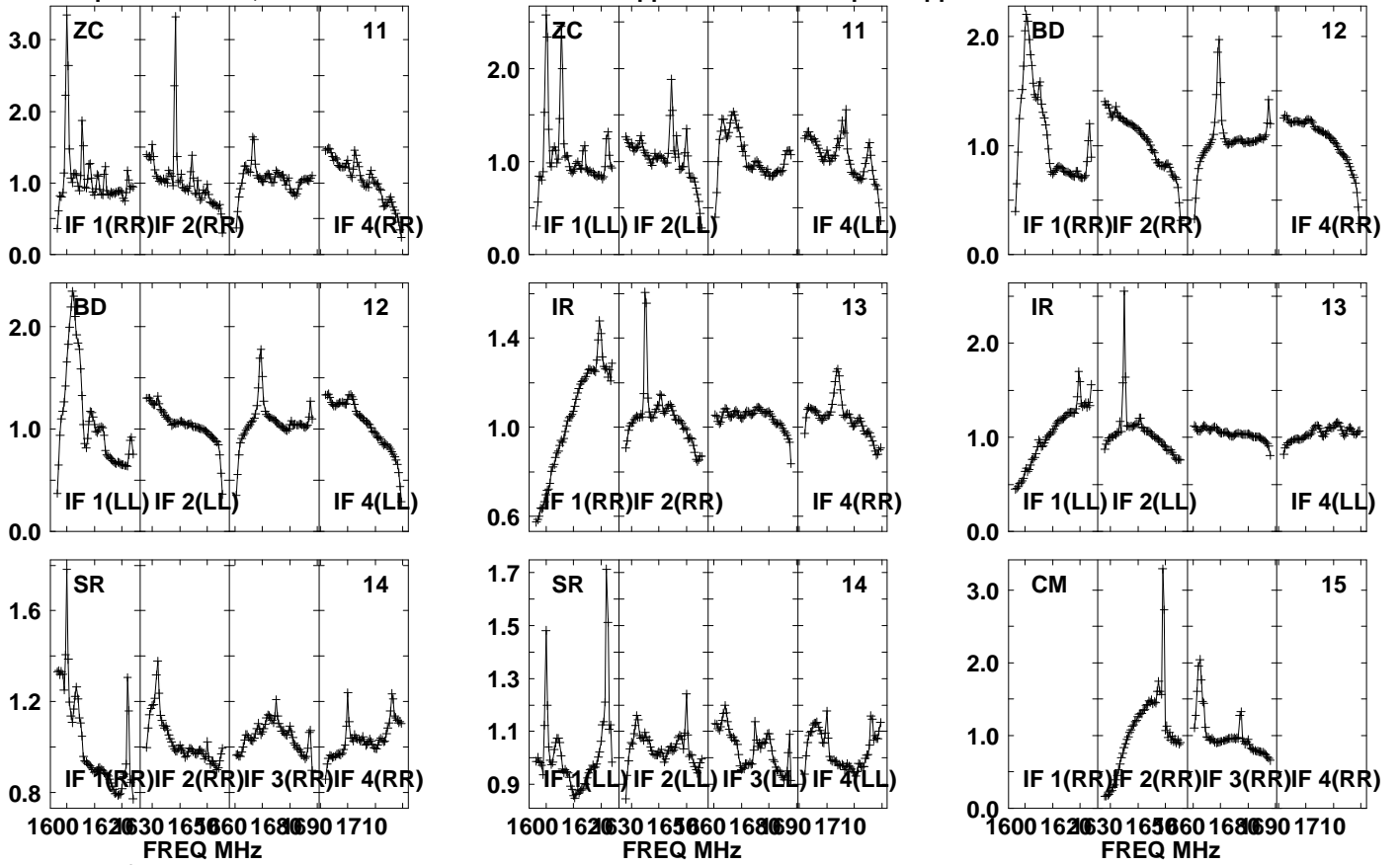

Lower frame: Real Jy  
Auto-corr total-power spectrum Antenna: \*  
Timerange: 00/13:59:01 to 00/14:00:29

Plot file version 328 created 05-OCT-2021 17:05:46

J0827+5217 GM076.UVDATA.1

Freq = 1.5945 GHz, Bw = 32.000 MH No calibration applied and no bandpass applied

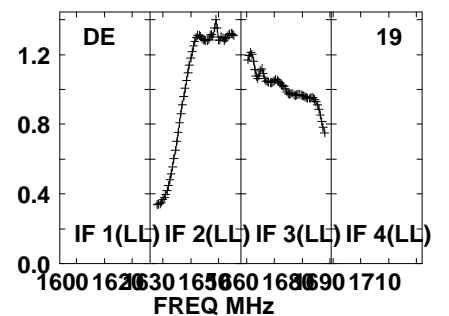
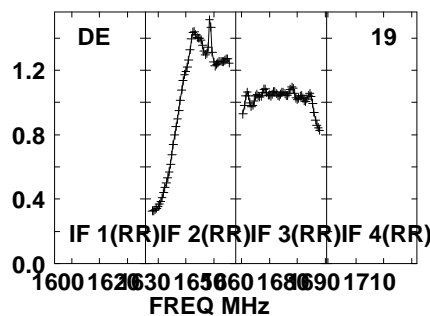
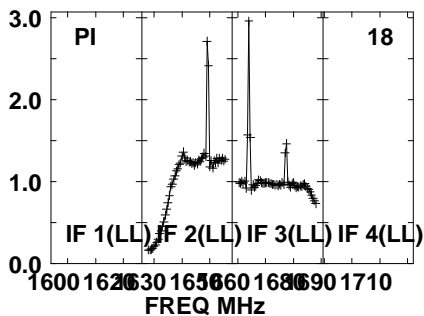
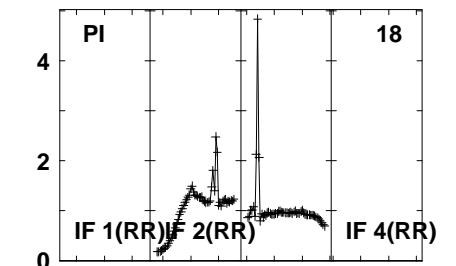
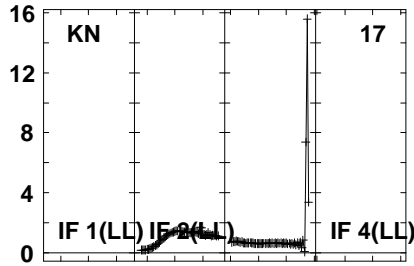
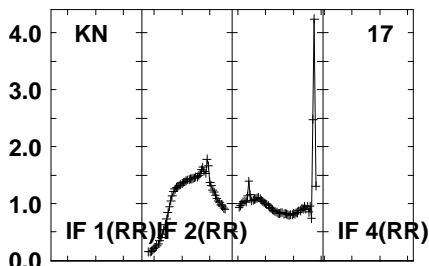
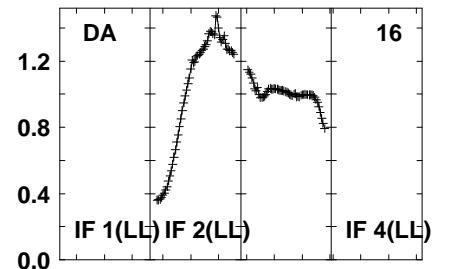
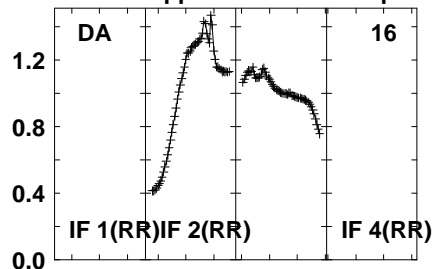
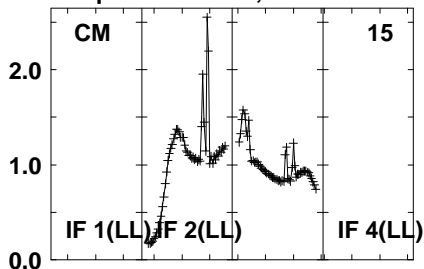

Lower frame: Real Jy

Auto-corr total-power spectrum Antenna: \*

Timerange: 00/13:59:01 to 00/14:00:29

Plot file version 329 created 05-OCT-2021 17:05:46

APM08279+525 GM076.UVDATA.1

Freq = 1.5945 GHz, Bw = 32.000 MH No calibration applied and no bandpass applied

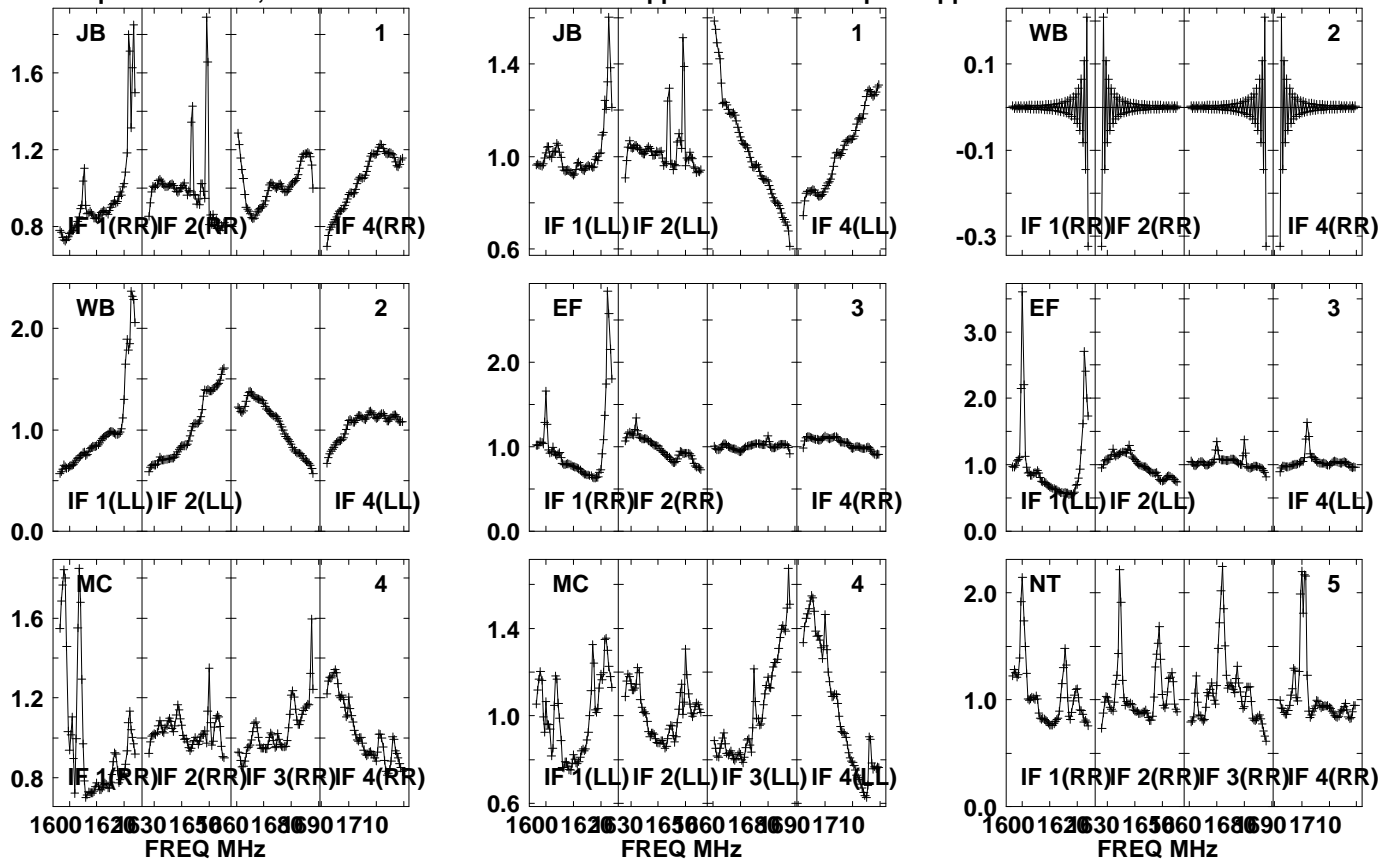

Lower frame: Real Jy  
Auto-corr total-power spectrum Antenna: \*  
Timerange: 00/14:00:31 to 00/14:03:59

Plot file version 330 created 05-OCT-2021 17:05:47

APM08279+525 GM076.UVDATA.1

Freq = 1.5945 GHz, Bw = 32.000 MH No calibration applied and no bandpass applied

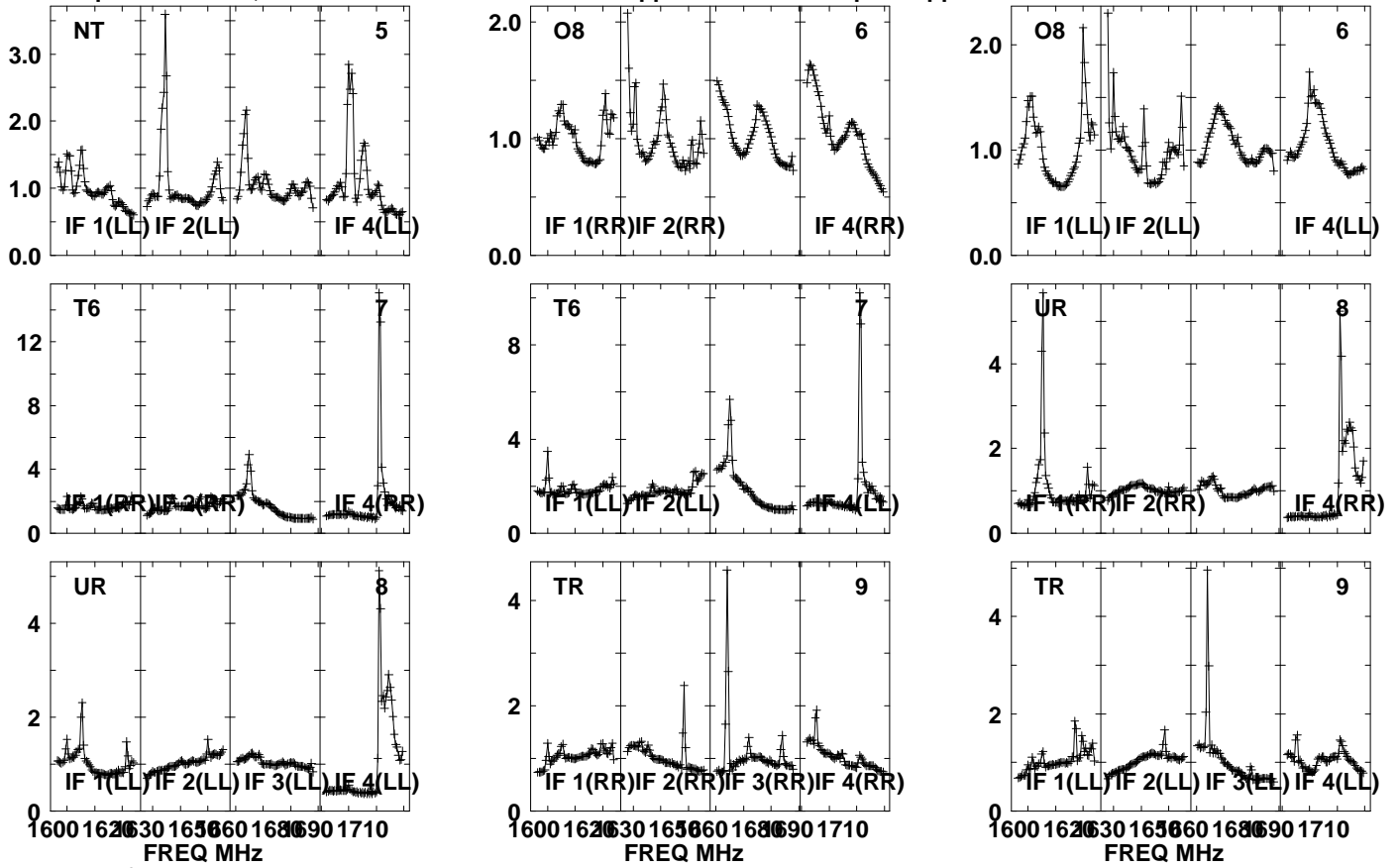

Lower frame: Real Jy

Auto-corr total-power spectrum Antenna: \*

Timerange: 00/14:00:31 to 00/14:03:59



Plot file version 331 created 05-OCT-2021 17:05:47

APM08279+525 GM076.UVDATA.1

Freq = 1.5945 GHz, Bw = 32.000 MH No calibration applied and no bandpass applied

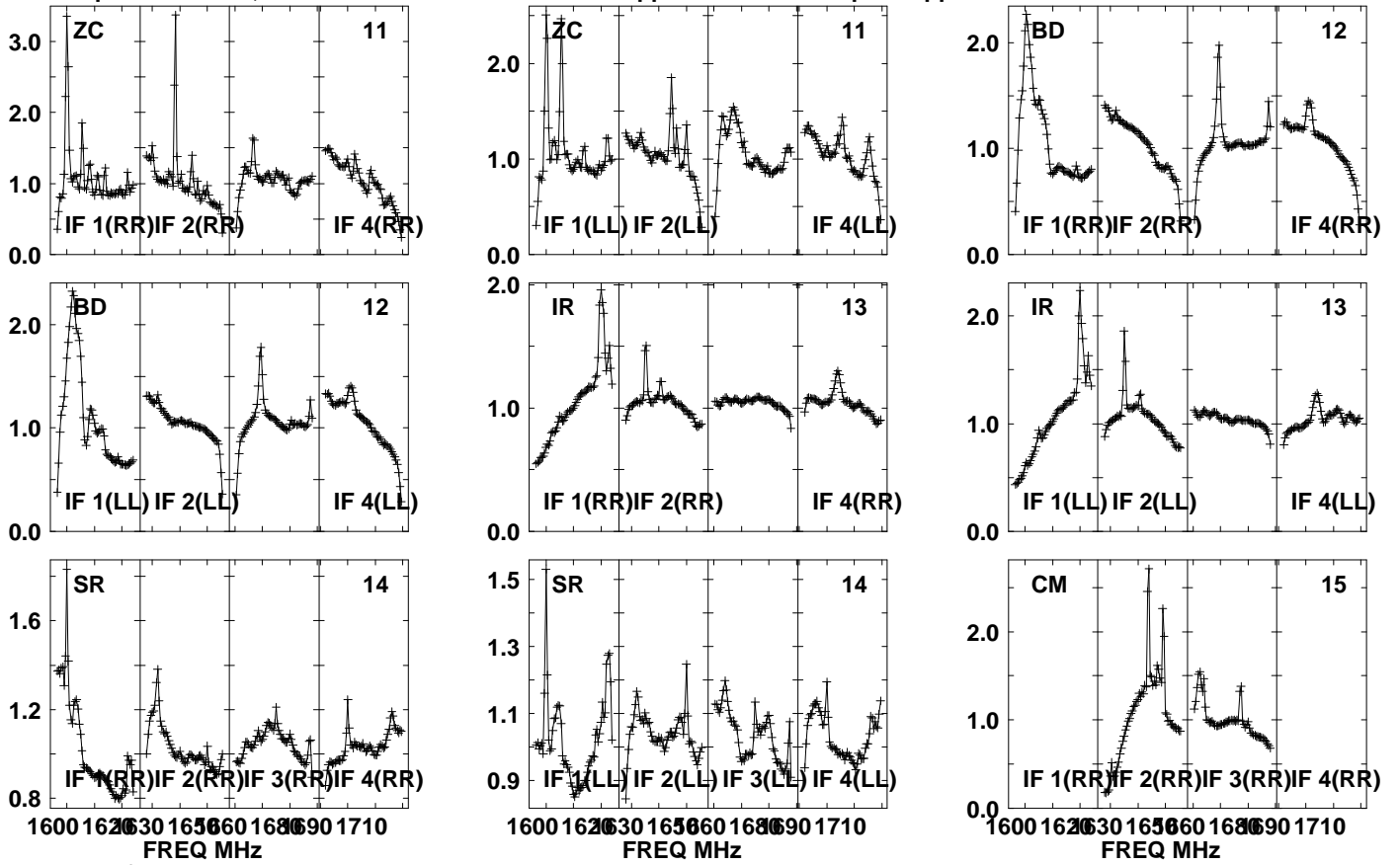

Lower frame: Real Jy

Auto-corr total-power spectrum Antenna: \*

Timerange: 00/14:00:31 to 00/14:03:59

Plot file version 332 created 05-OCT-2021 17:05:47

APM08279+525 GM076.UVDATA.1

Freq = 1.5945 GHz, Bw = 32.000 MH No calibration applied and no bandpass applied

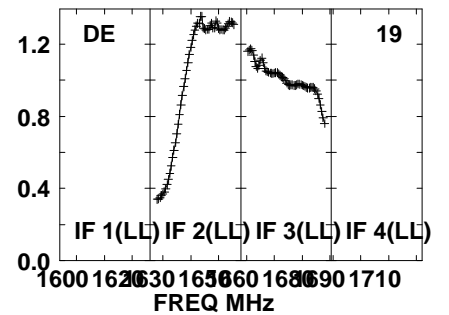
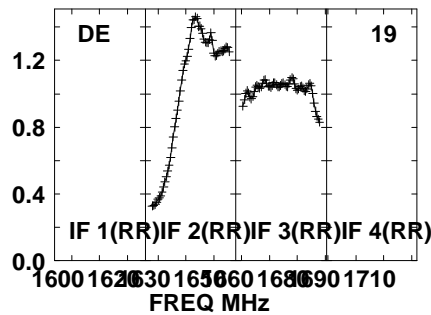
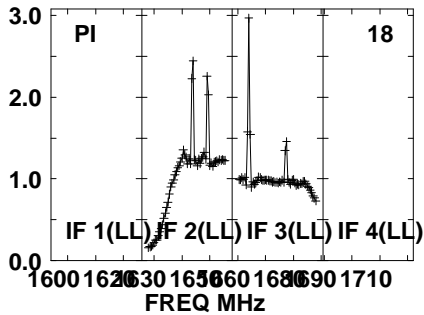
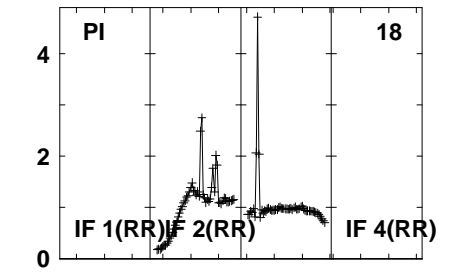
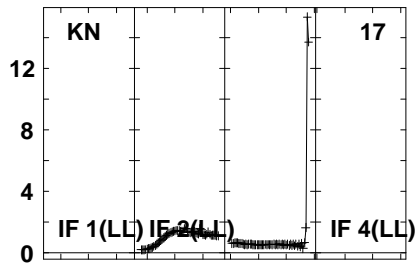
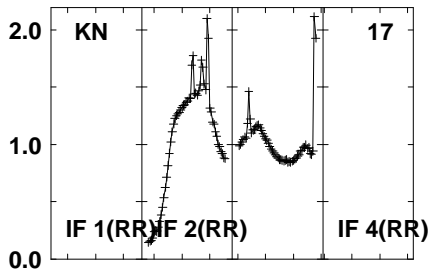
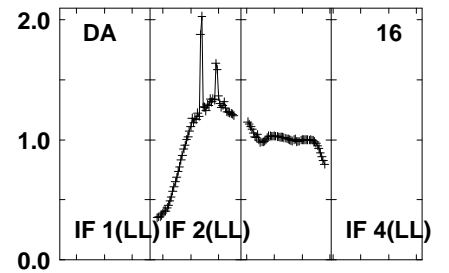
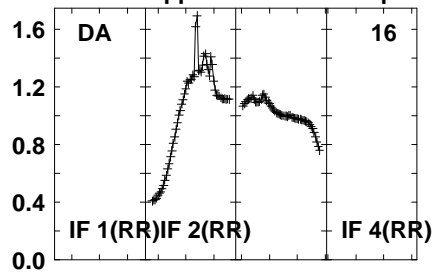
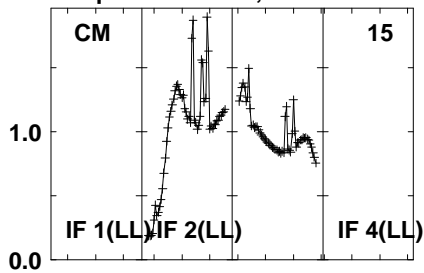

Lower frame: Real Jy

Auto-corr total-power spectrum Antenna: \*

Timerange: 00/14:00:31 to 00/14:03:59

Plot file version 333 created 05-OCT-2021 17:05:48

J0827+5217 GM076.UVDATA.1

Freq = 1.5945 GHz, Bw = 32.000 MH No calibration applied and no bandpass applied

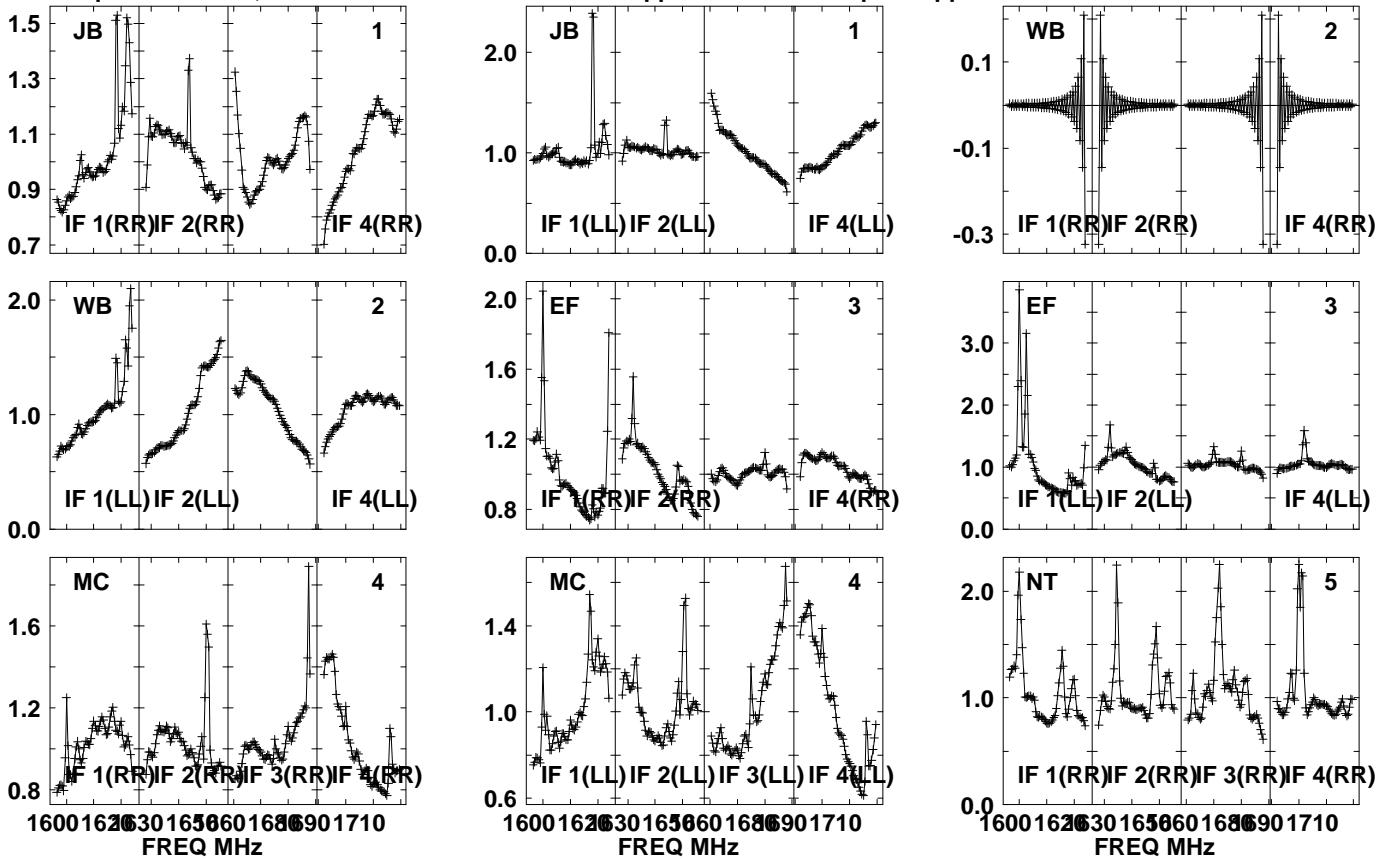

Lower frame: Real Jy  
Auto-corr total-power spectrum Antenna: \*  
Timerange: 00/14:04:31 to 00/14:05:59

Plot file version 334 created 05-OCT-2021 17:05:48

J0827+5217 GM076.UVDATA.1

Freq = 1.5945 GHz, Bw = 32.000 MH No calibration applied and no bandpass applied

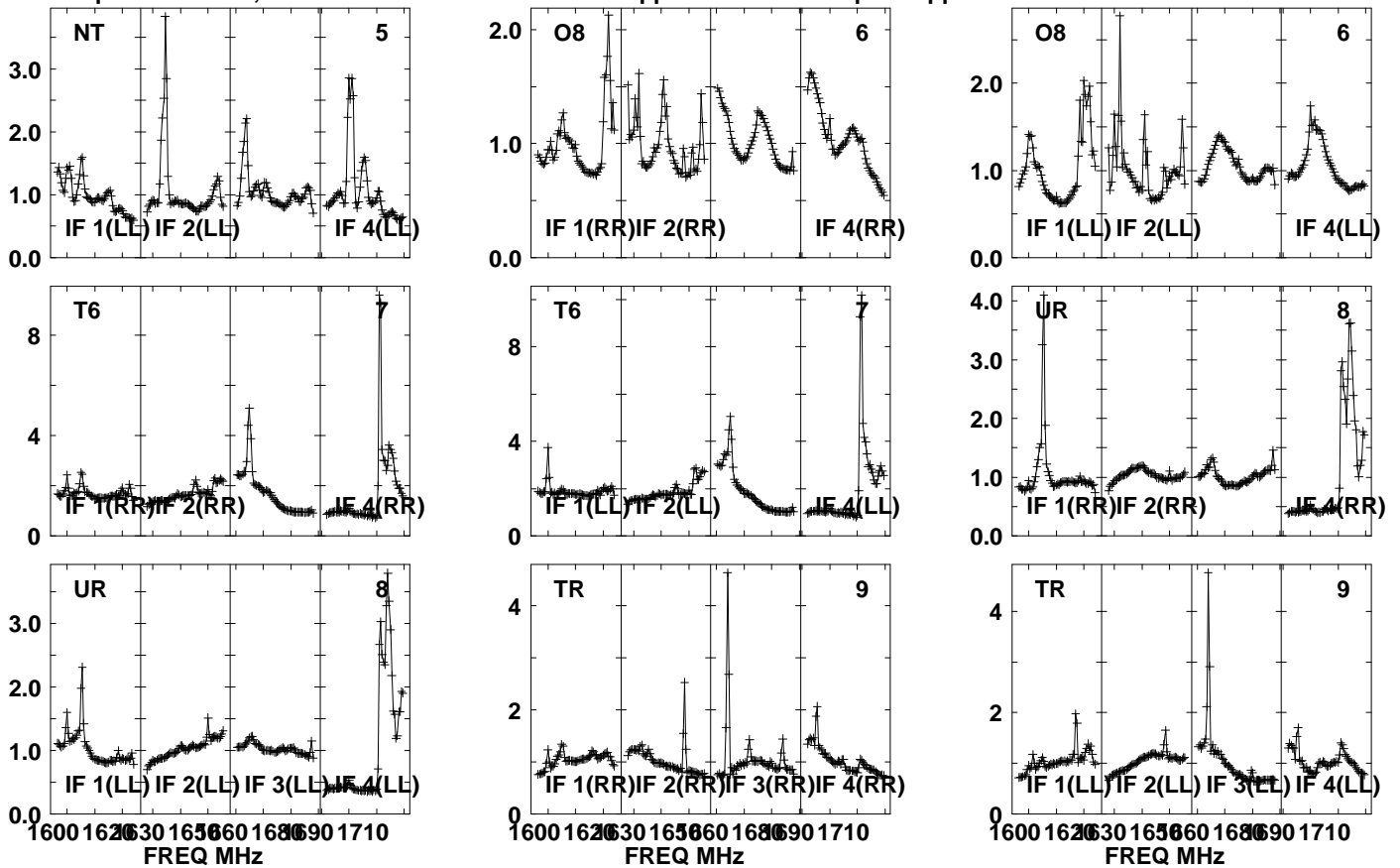

Lower frame: Real Jy

Auto-corr total-power spectrum Antenna: \*

Timerange: 00/14:04:31 to 00/14:05:59

Plot file version 335 created 05-OCT-2021 17:05:48

J0827+5217 GM076.UVDATA.1

Freq = 1.5945 GHz, Bw = 32.000 MH No calibration applied and no bandpass applied

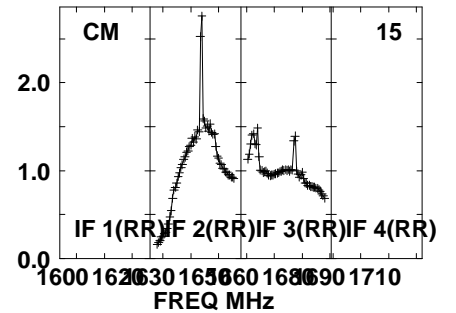
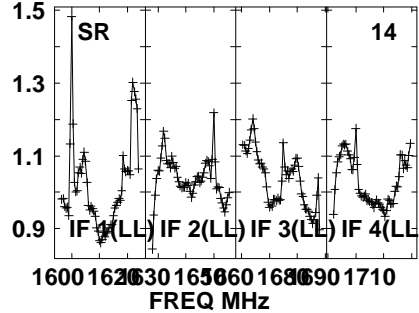
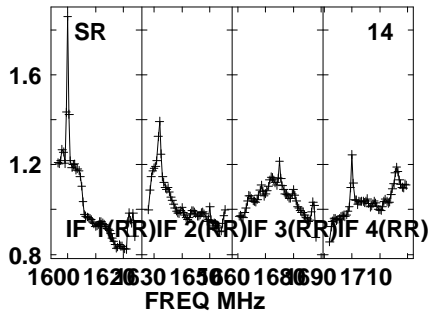
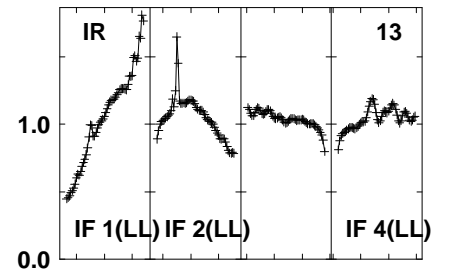
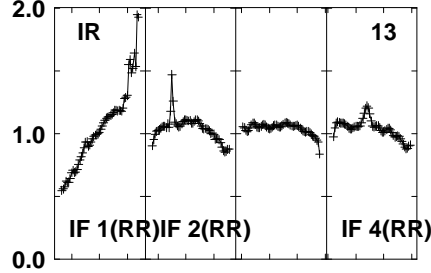
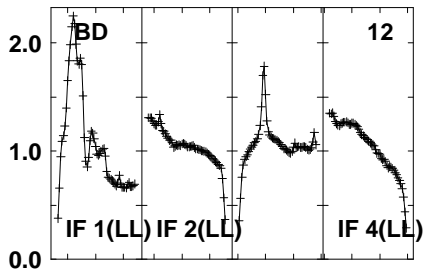
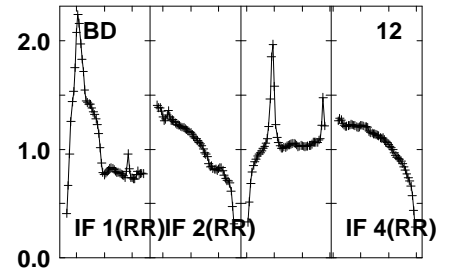
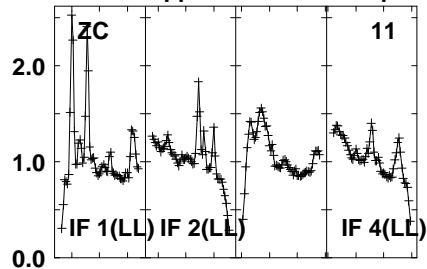
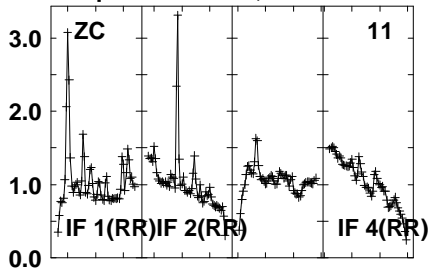

Lower frame: Real Jy

Auto-corr total-power spectrum Antenna: \*

Timerange: 00/14:04:31 to 00/14:05:59

Plot file version 336 created 05-OCT-2021 17:05:48

J0827+5217 GM076.UVDATA.1

Freq = 1.5945 GHz, Bw = 32.000 MH No calibration applied and no bandpass applied

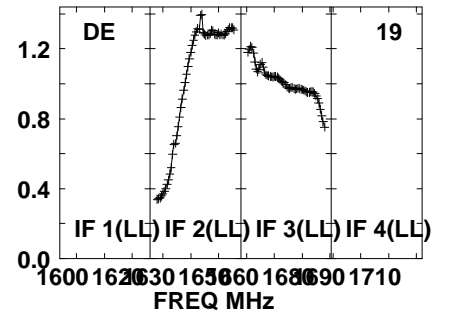
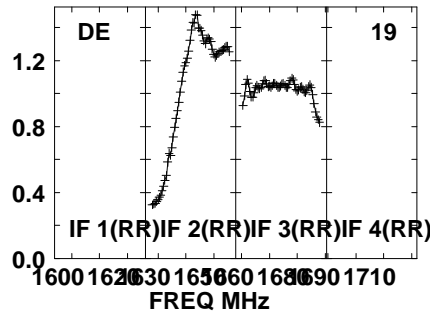
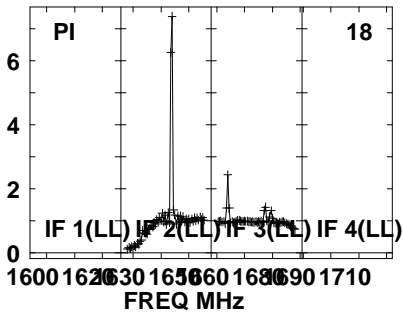
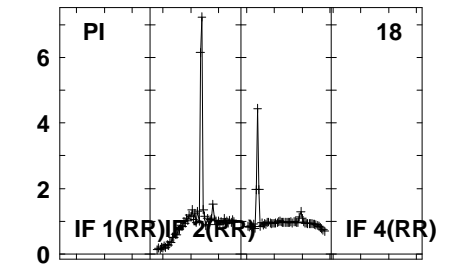
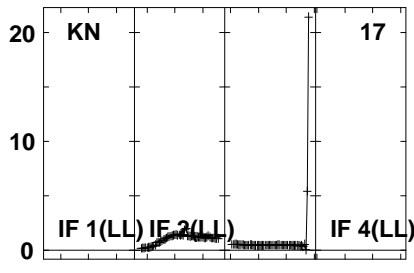
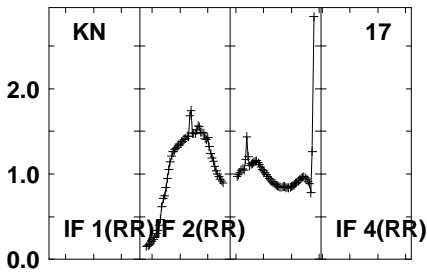
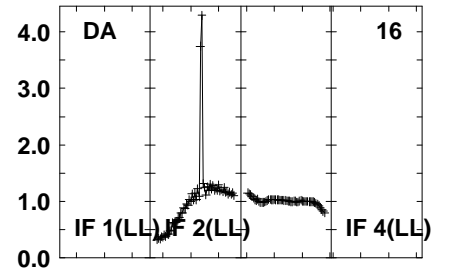
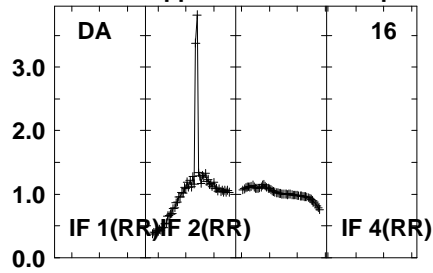
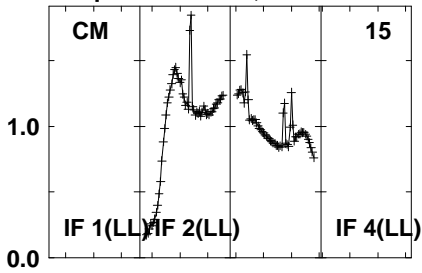

Lower frame: Real Jy  
Auto-corr total-power spectrum Antenna: \*  
Timerange: 00/14:04:31 to 00/14:05:59

Plot file version 337 created 05-OCT-2021 17:05:49

APM08279+525 GM076.UVDATA.1

Freq = 1.5945 GHz, Bw = 32.000 MH No calibration applied and no bandpass applied

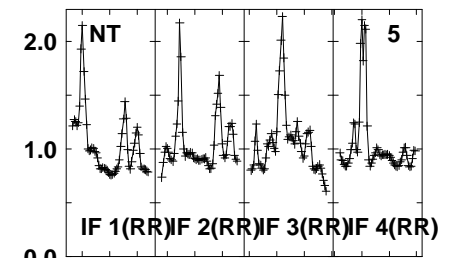
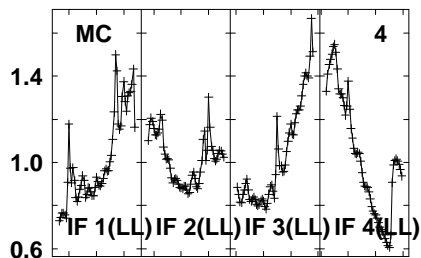
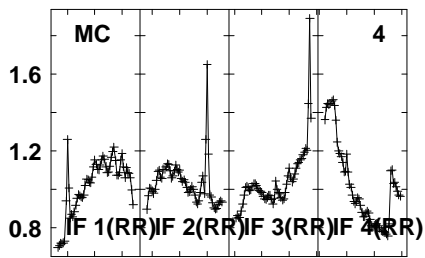
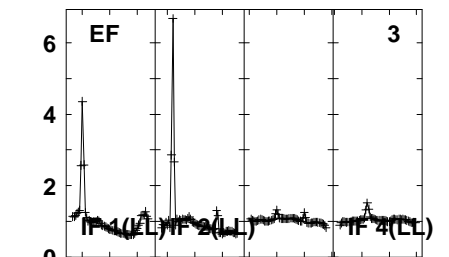
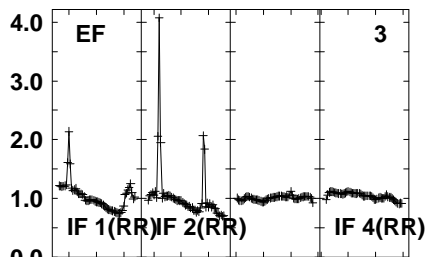
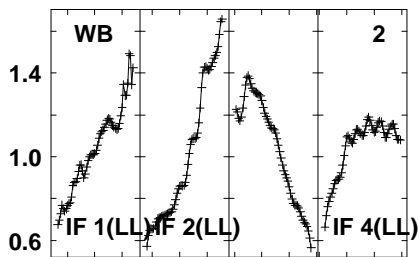
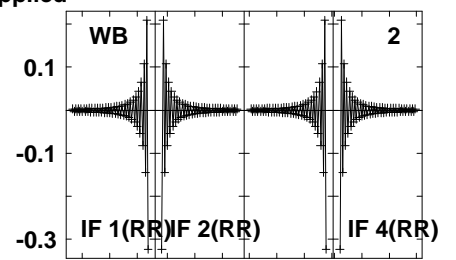
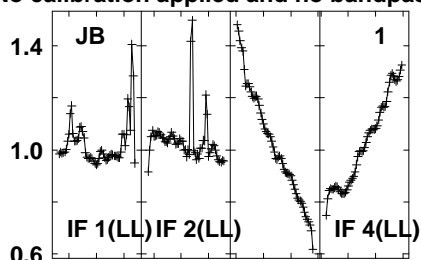
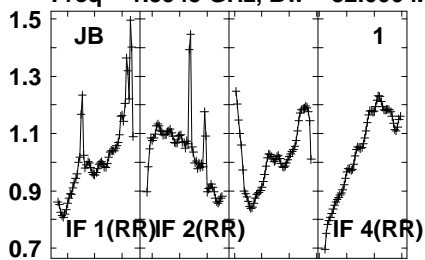

1600 1620 1630 1650 1660 1680 1690 1710  
FREQ MHz

1600 1620 1630 1650 1660 1680 1690 1710  
FREQ MHz

1600 1620 1630 1650 1660 1680 1690 1710  
FREQ MHz

Lower frame: Real Jy  
Auto-corr total-power spectrum Antenna: \*  
Timerange: 00/14:06:01 to 00/14:09:29

Plot file version 338 created 05-OCT-2021 17:05:49

APM08279+525 GM076.UVDATA.1

Freq = 1.5945 GHz, Bw = 32.000 MH No calibration applied and no bandpass applied

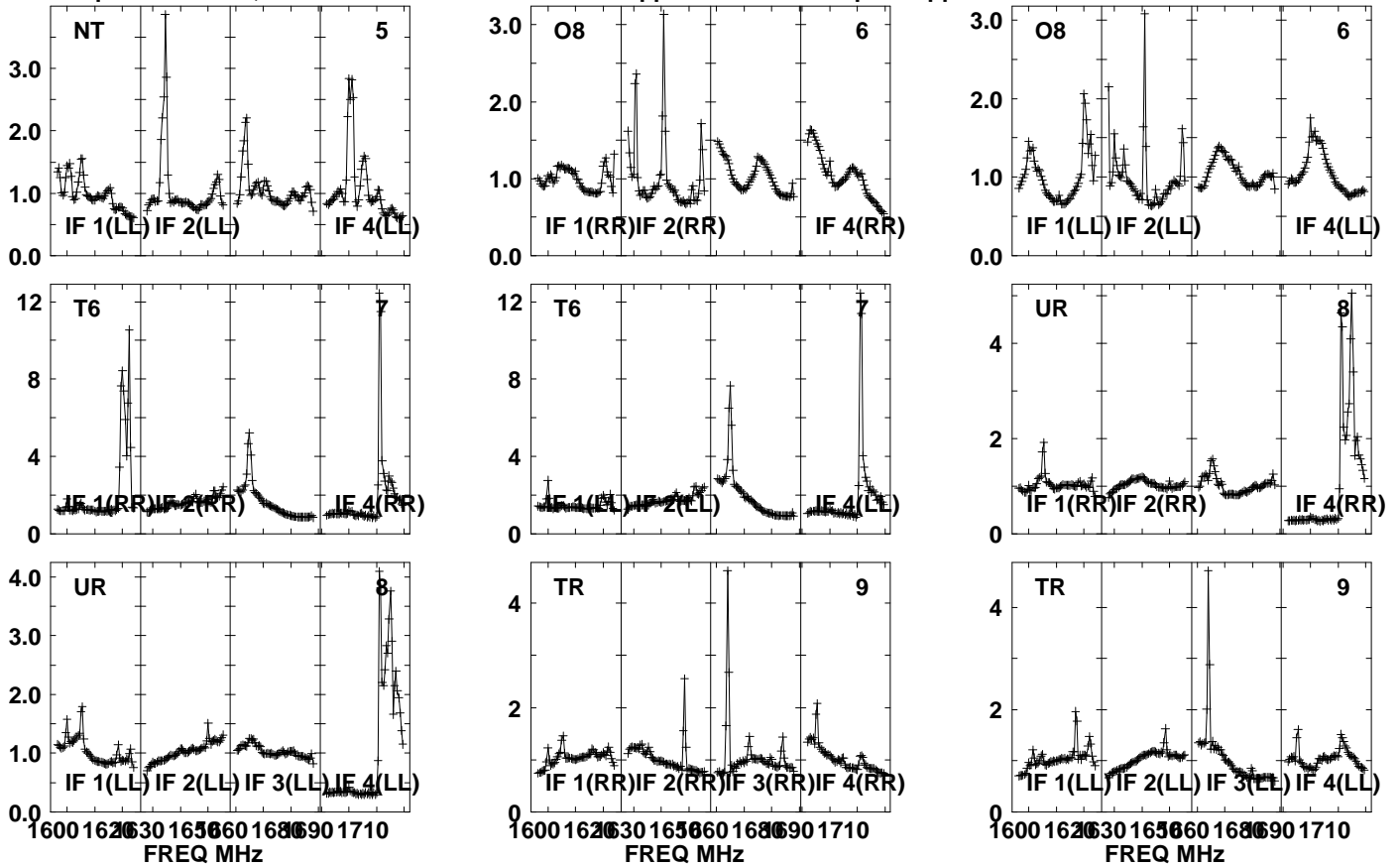

Lower frame: Real Jy  
Auto-corr total-power spectrum Antenna: \*  
Timerange: 00/14:06:01 to 00/14:09:29



Plot file version 339 created 05-OCT-2021 17:05:49

APM08279+525 GM076.UVDATA.1

Freq = 1.5945 GHz, Bw = 32.000 MH No calibration applied and no bandpass applied

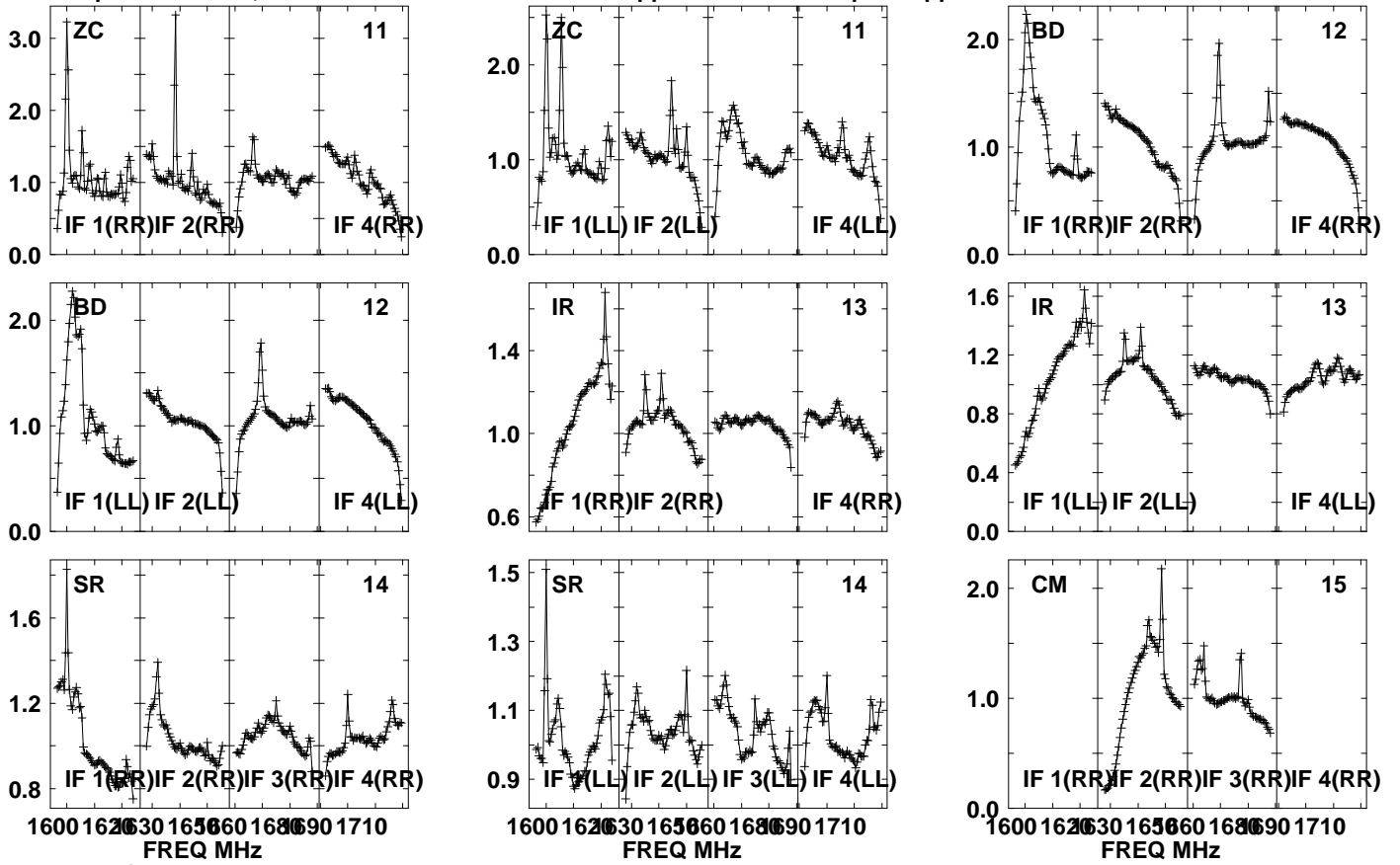

Lower frame: Real Jy  
Auto-corr total-power spectrum Antenna: \*  
Timerange: 00/14:06:01 to 00/14:09:29

Plot file version 340 created 05-OCT-2021 17:05:49

APM08279+525 GM076.UVDATA.1

Freq = 1.5945 GHz, Bw = 32.000 MH No calibration applied and no bandpass applied

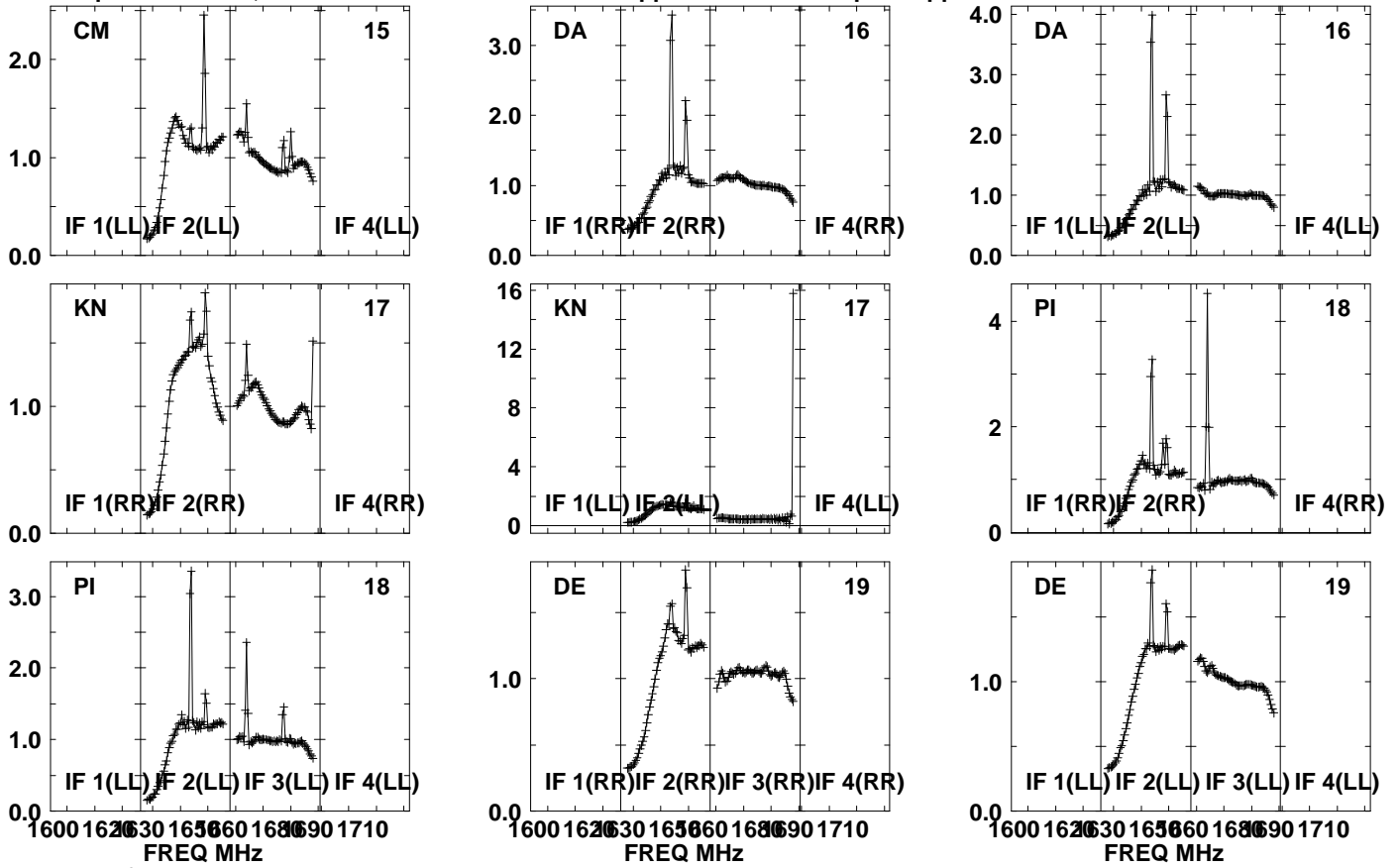

Lower frame: Real Jy

Auto-corr total-power spectrum Antenna: \*

Timerange: 00/14:06:01 to 00/14:09:29

Plot file version 341 created 05-OCT-2021 17:05:50

J0827+5217 GM076.UVDATA.1

Freq = 1.5945 GHz, Bw = 32.000 MH No calibration applied and no bandpass applied

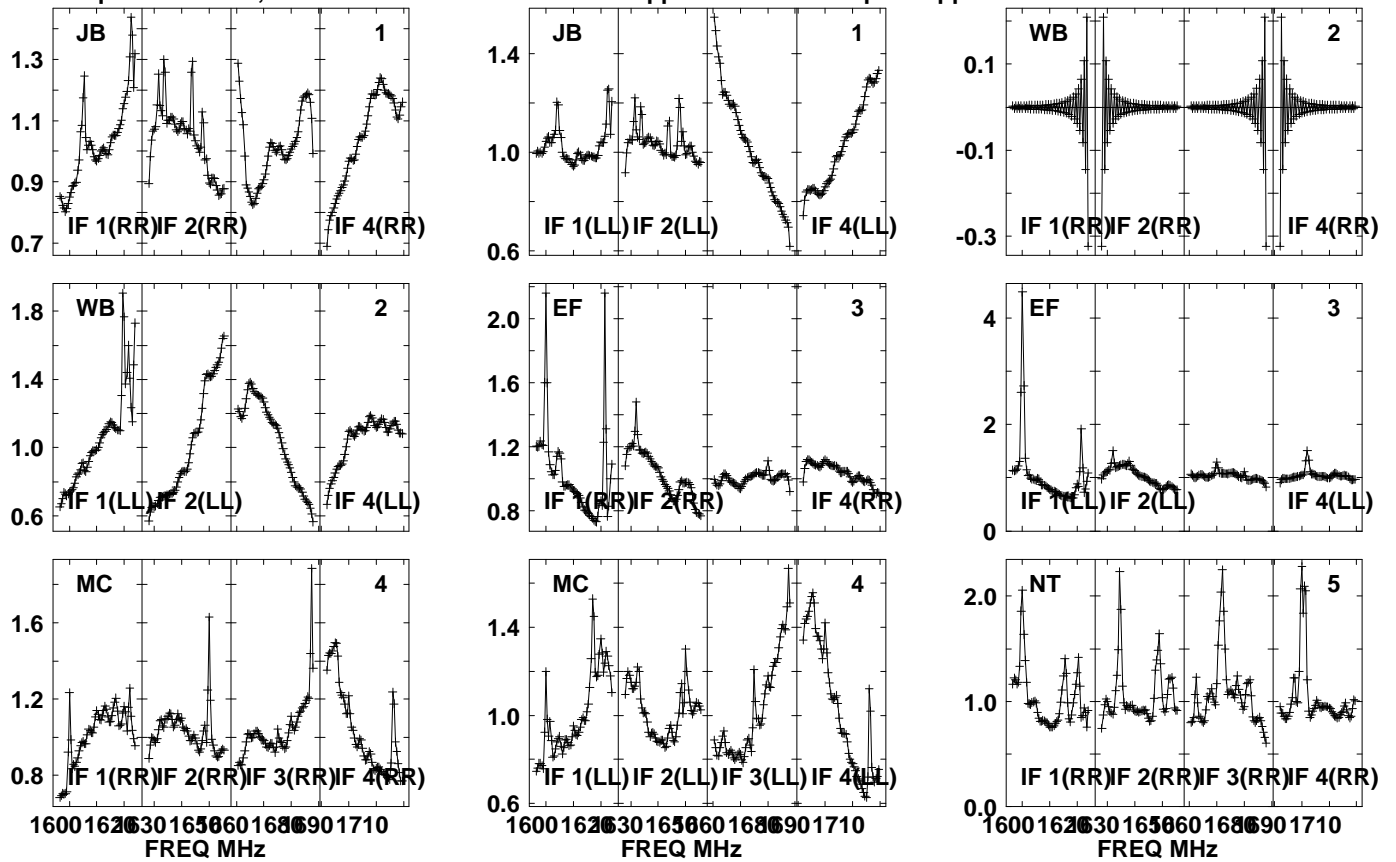

Lower frame: Real Jy  
Auto-corr total-power spectrum Antenna: \*  
Timerange: 00/14:09:31 to 00/14:10:59

Plot file version 342 created 05-OCT-2021 17:05:50

J0827+5217 GM076.UVDATA.1

Freq = 1.5945 GHz, Bw = 32.000 MH No calibration applied and no bandpass applied

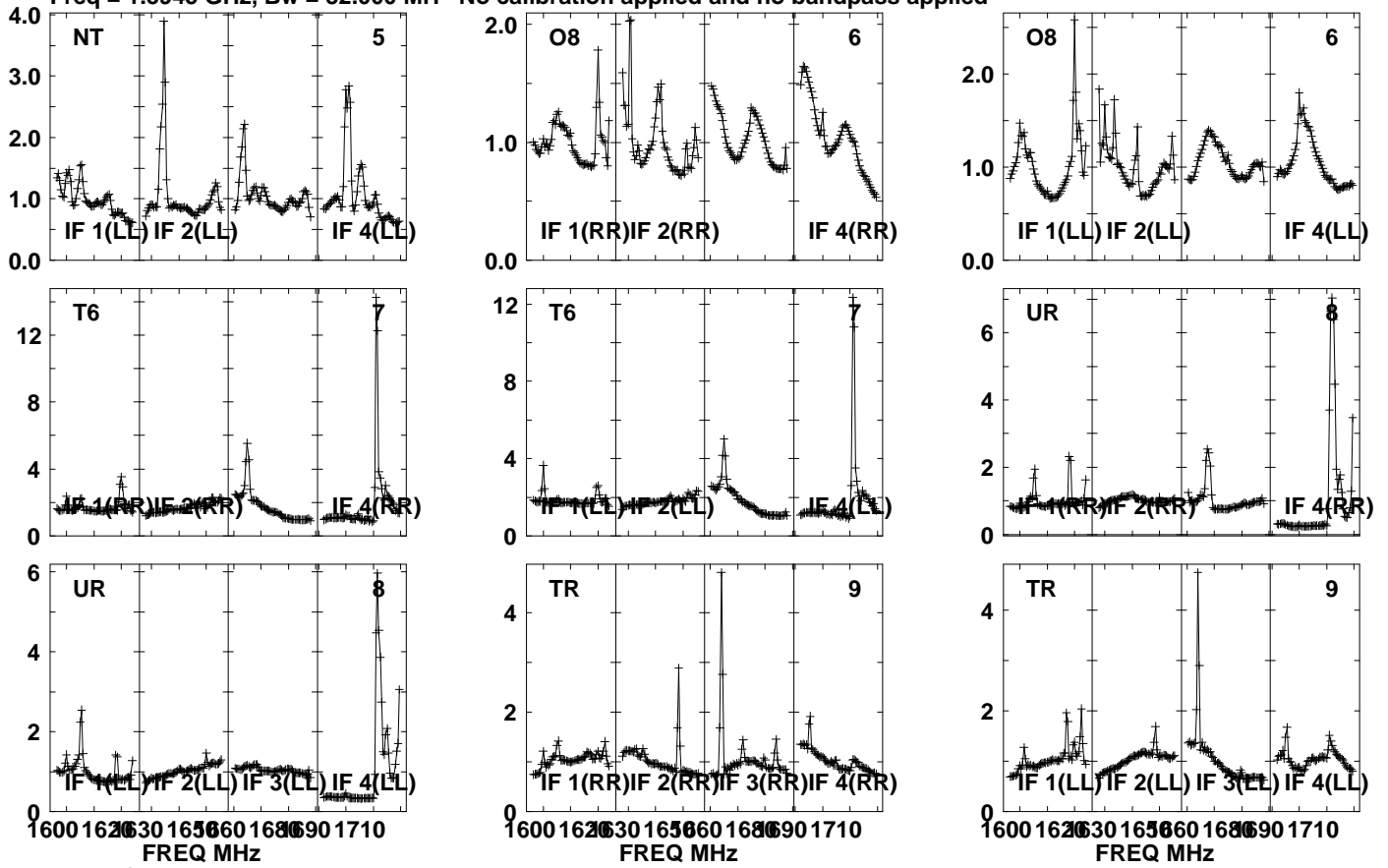

Lower frame: Real Jy  
Auto-corr total-power spectrum Antenna: \*  
Timerange: 00/14:09:31 to 00/14:10:59

Plot file version 343 created 05-OCT-2021 17:05:50

J0827+5217 GM076.UVDATA.1

Freq = 1.5945 GHz, Bw = 32.000 MH No calibration applied and no bandpass applied

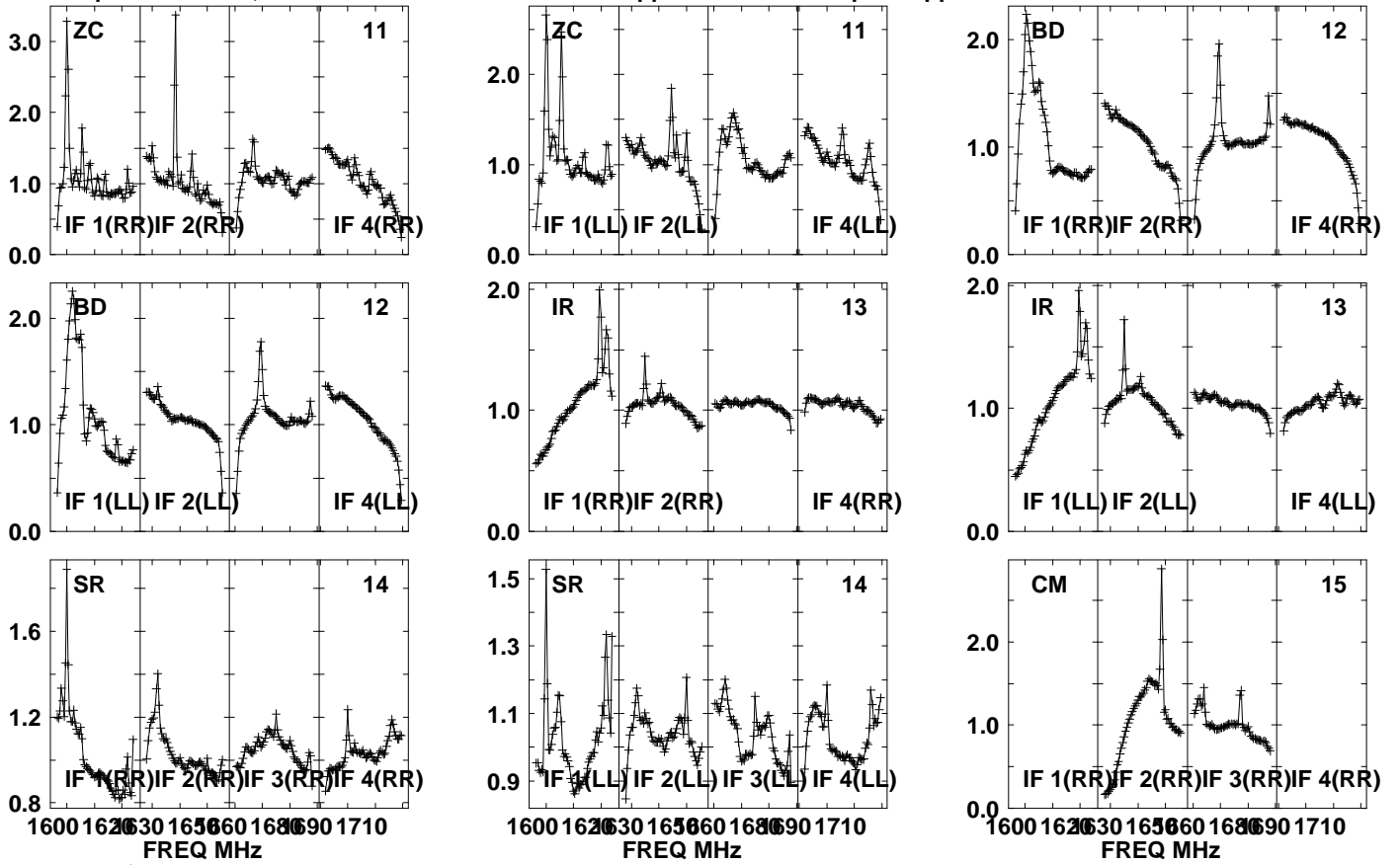

Lower frame: Real Jy

Auto-corr total-power spectrum Antenna: \*

Timerange: 00/14:09:31 to 00/14:10:59

Plot file version 344 created 05-OCT-2021 17:05:50

J0827+5217 GM076.UVDATA.1

Freq = 1.5945 GHz, Bw = 32.000 MH No calibration applied and no bandpass applied

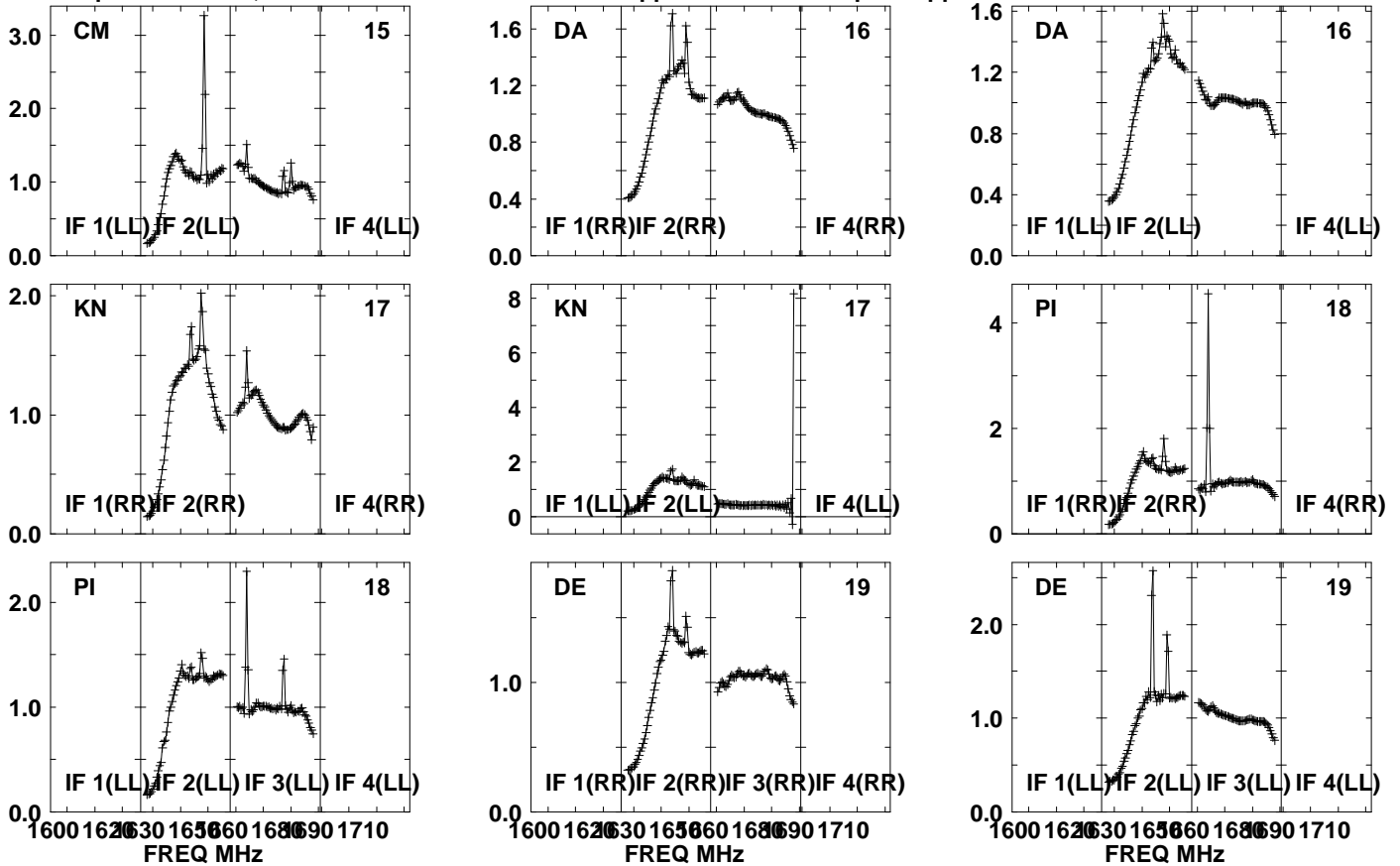

Lower frame: Real Jy

Auto-corr total-power spectrum Antenna: \*

Timerange: 00/14:09:31 to 00/14:10:59

Plot file version 345 created 05-OCT-2021 17:05:51

APM08279+525 GM076.UVDATA.1

Freq = 1.5945 GHz, Bw = 32.000 MH No calibration applied and no bandpass applied

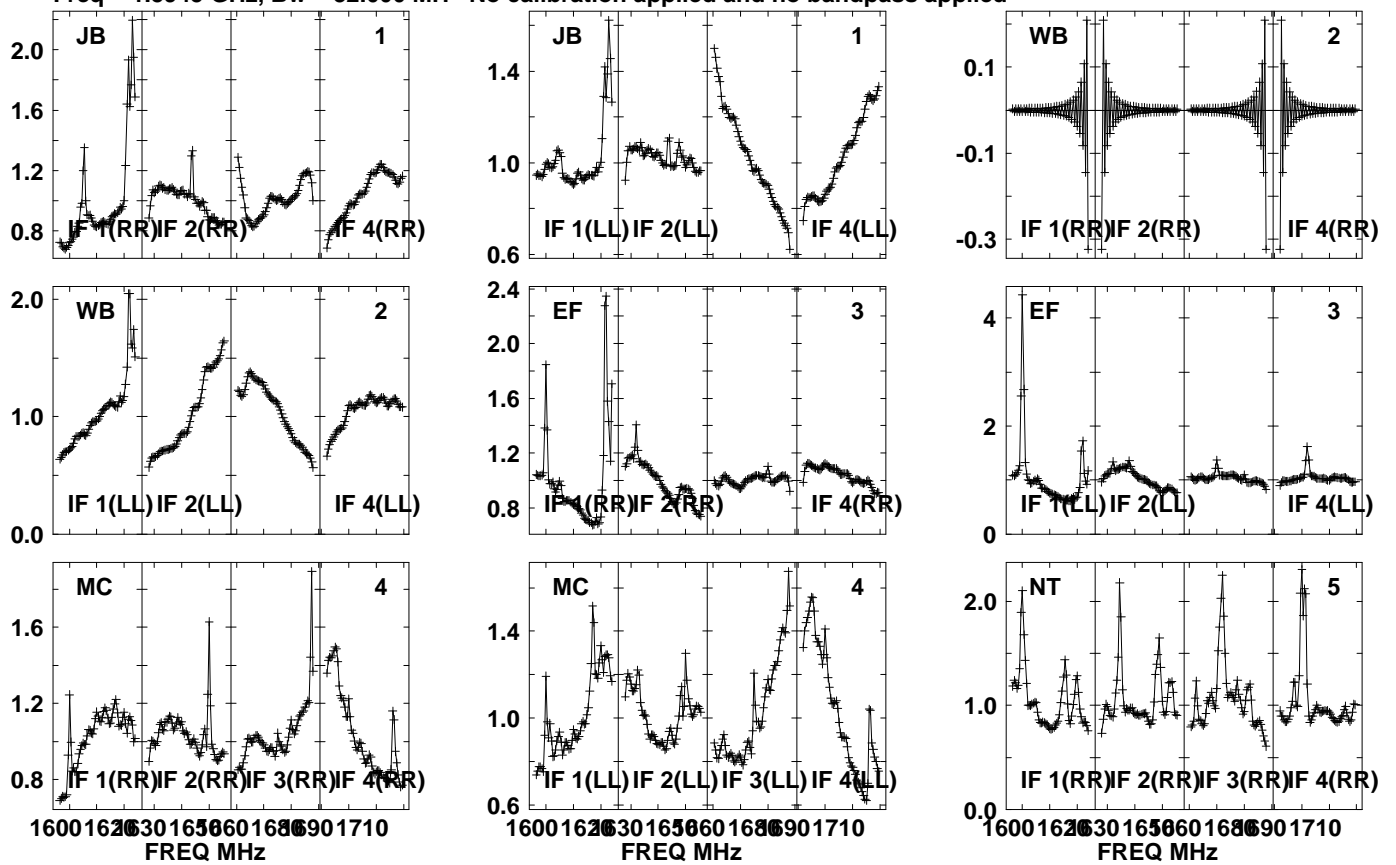

Lower frame: Real Jy  
Auto-corr total-power spectrum Antenna: \*  
Timerange: 00/14:11:01 to 00/14:14:29

Plot file version 346 created 05-OCT-2021 17:05:51

APM08279+525 GM076.UVDATA.1

Freq = 1.5945 GHz, Bw = 32.000 MH No calibration applied and no bandpass applied

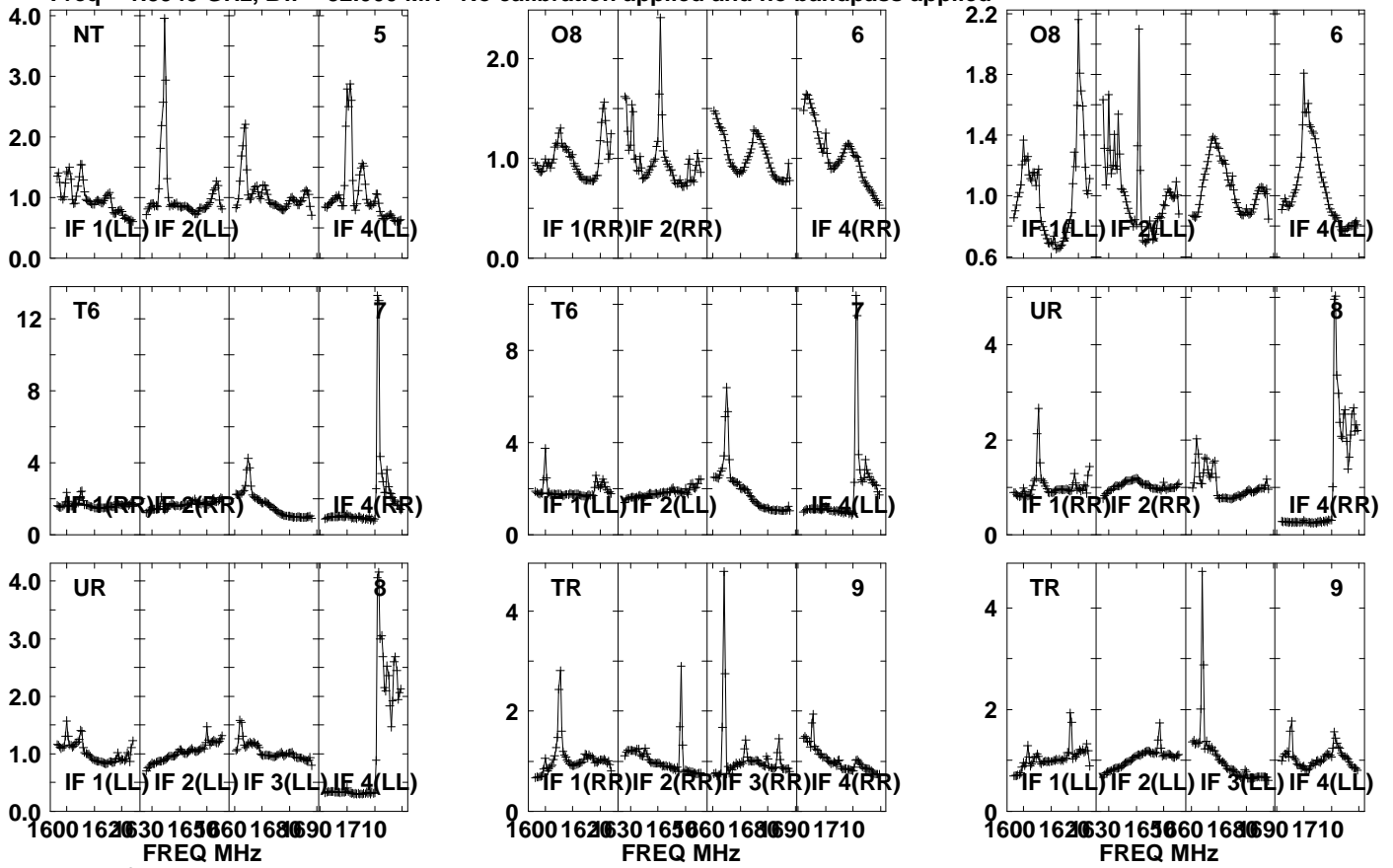

Lower frame: Real Jy

Auto-corr total-power spectrum Antenna: \*

Timerange: 00/14:11:01 to 00/14:14:29



Plot file version 347 created 05-OCT-2021 17:05:51

APM08279+525 GM076.UVDATA.1

Freq = 1.5945 GHz, Bw = 32.000 MH No calibration applied and no bandpass applied

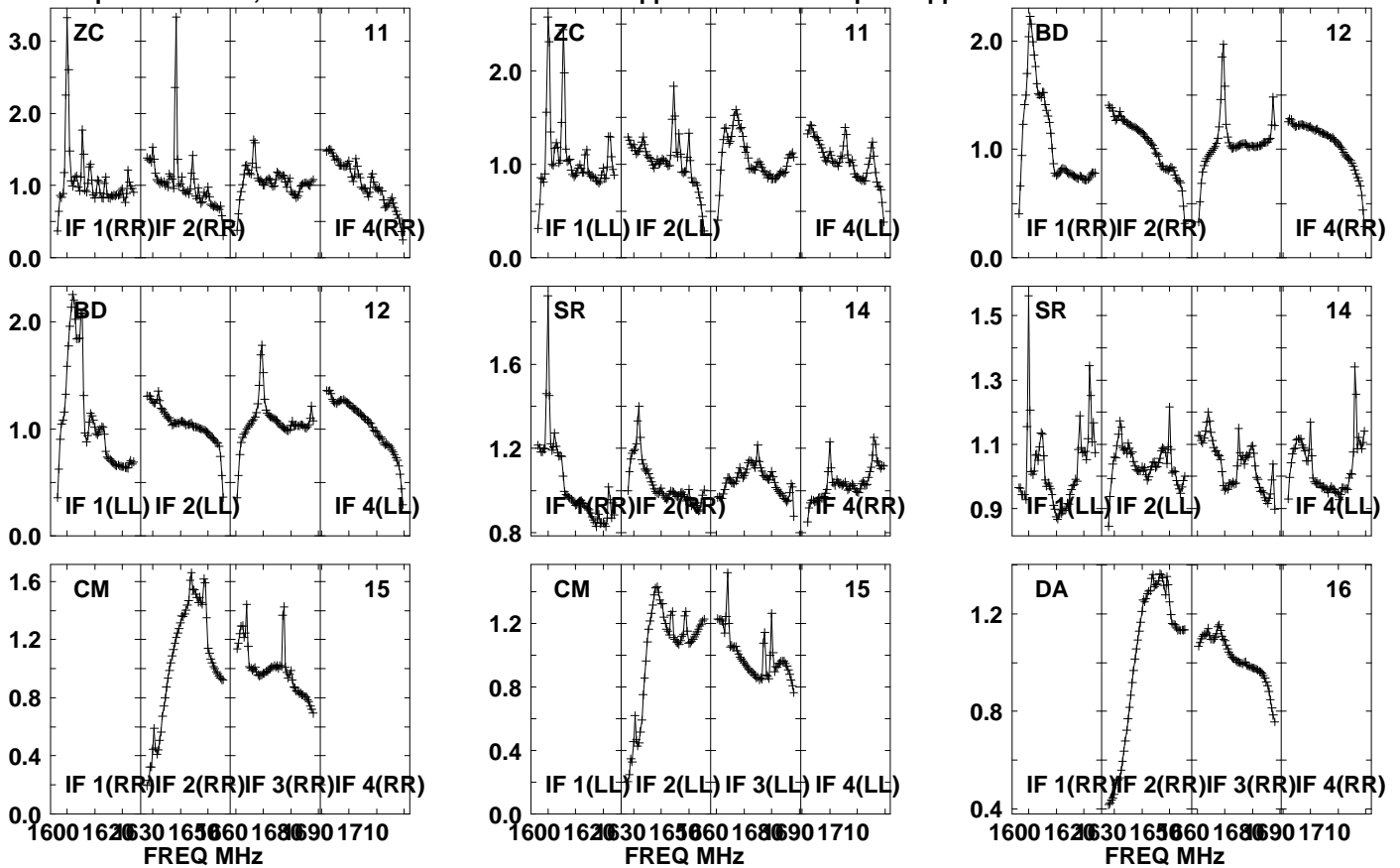

Lower frame: Real Jy

Auto-corr total-power spectrum Antenna: \*

Timerange: 00/14:11:01 to 00/14:14:29

Plot file version 348 created 05-OCT-2021 17:05:52

APM08279+525 GM076.UVDATA.1

Freq = 1.5945 GHz, Bw = 32.000 MH No calibration applied and no bandpass applied

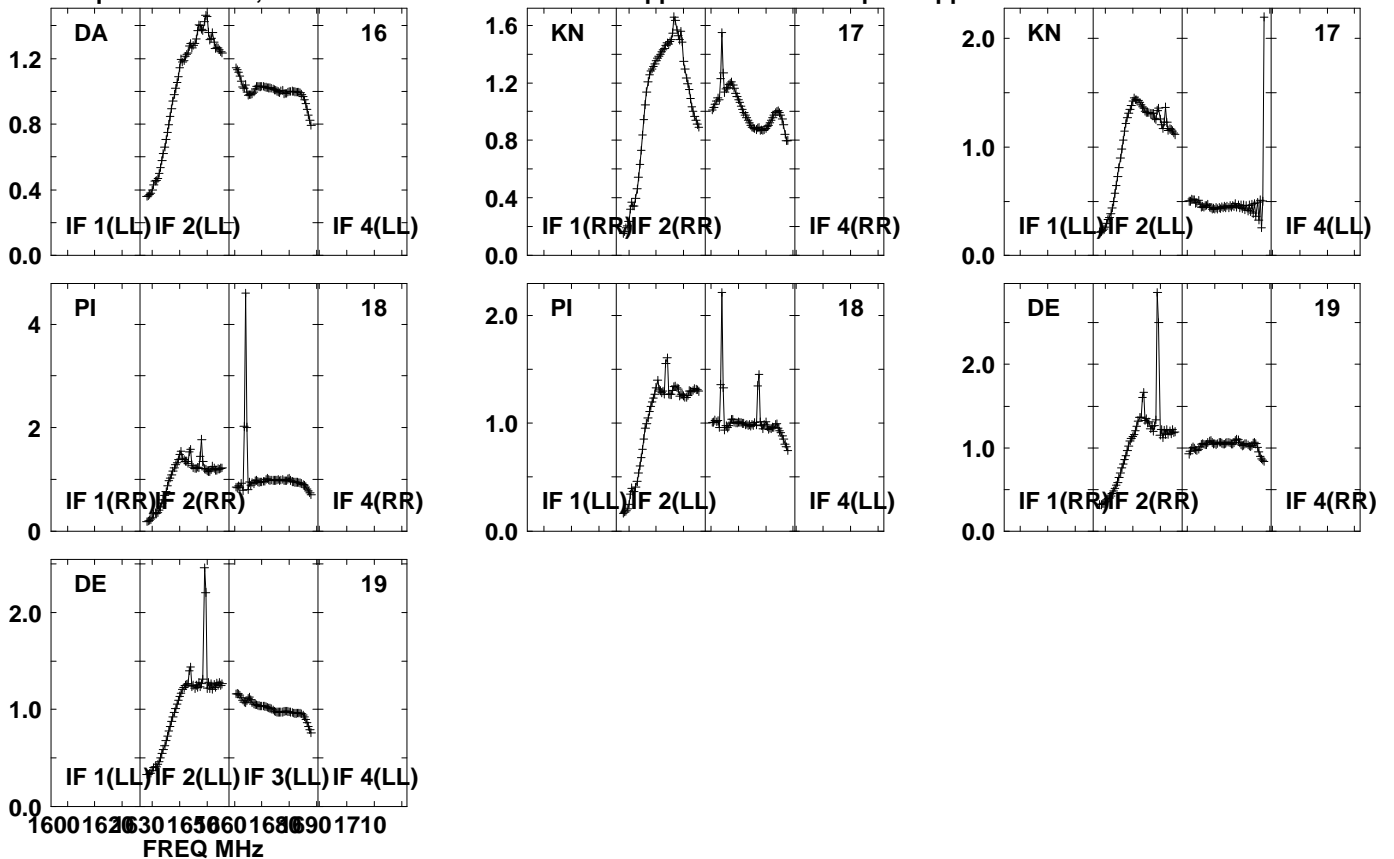

Lower frame: Real Jy  
Auto-corr total-power spectrum Antenna: \*  
Timerange: 00/14:11:01 to 00/14:14:29

Plot file version 349 created 05-OCT-2021 17:05:52

J0827+5217 GM076.UVDATA.1

Freq = 1.5945 GHz, Bw = 32.000 MH No calibration applied and no bandpass applied

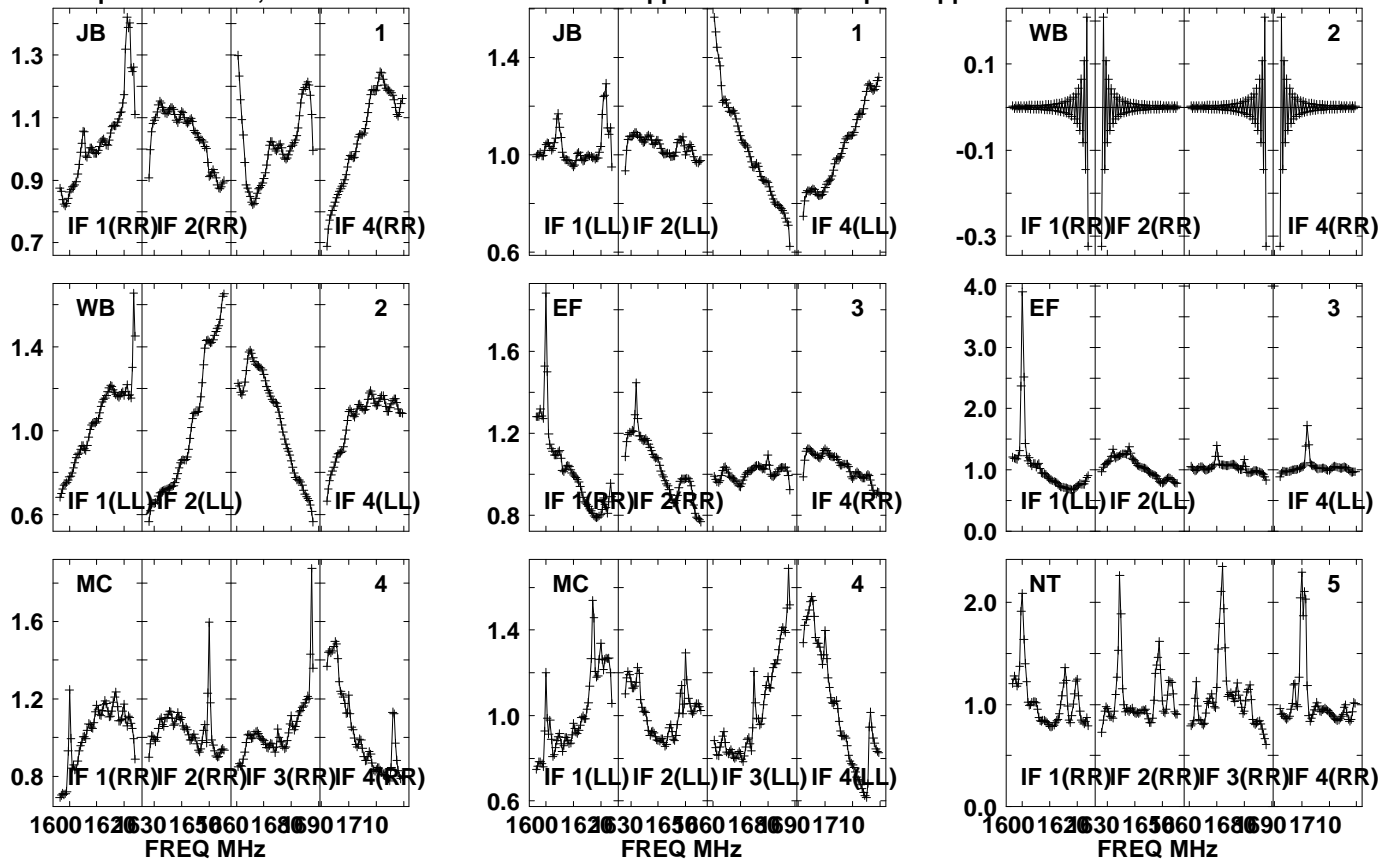

Lower frame: Real Jy  
Auto-corr total-power spectrum Antenna: \*  
Timerange: 00/14:15:01 to 00/14:16:29

Plot file version 350 created 05-OCT-2021 17:05:52

J0827+5217 GM076.UVDATA.1

Freq = 1.5945 GHz, Bw = 32.000 MH No calibration applied and no bandpass applied

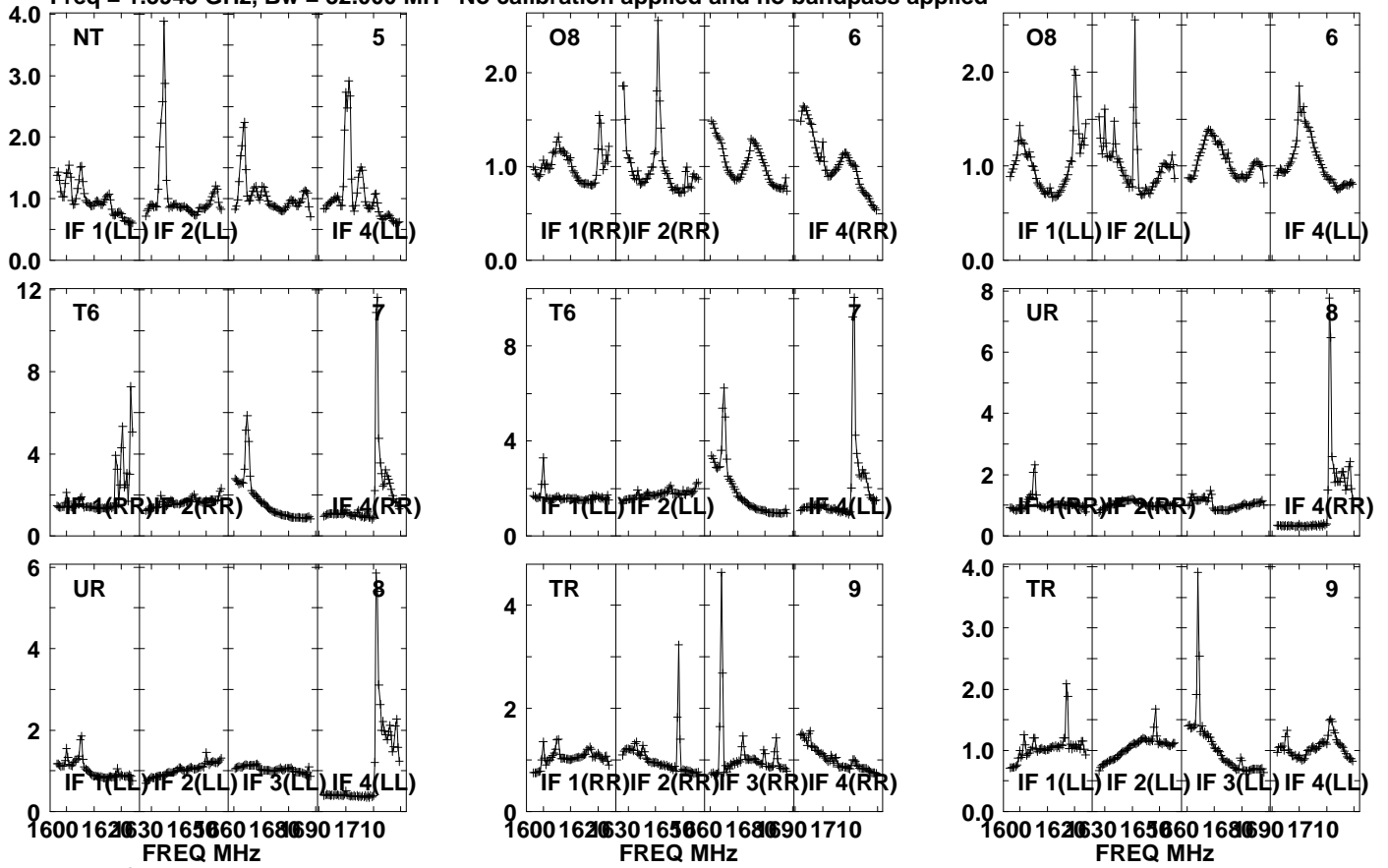

Lower frame: Real Jy

Auto-corr total-power spectrum Antenna: \*

Timerange: 00/14:15:01 to 00/14:16:29

Plot file version 351 created 05-OCT-2021 17:05:52

J0827+5217 GM076.UVDATA.1

Freq = 1.5945 GHz, Bw = 32.000 MH No calibration applied and no bandpass applied

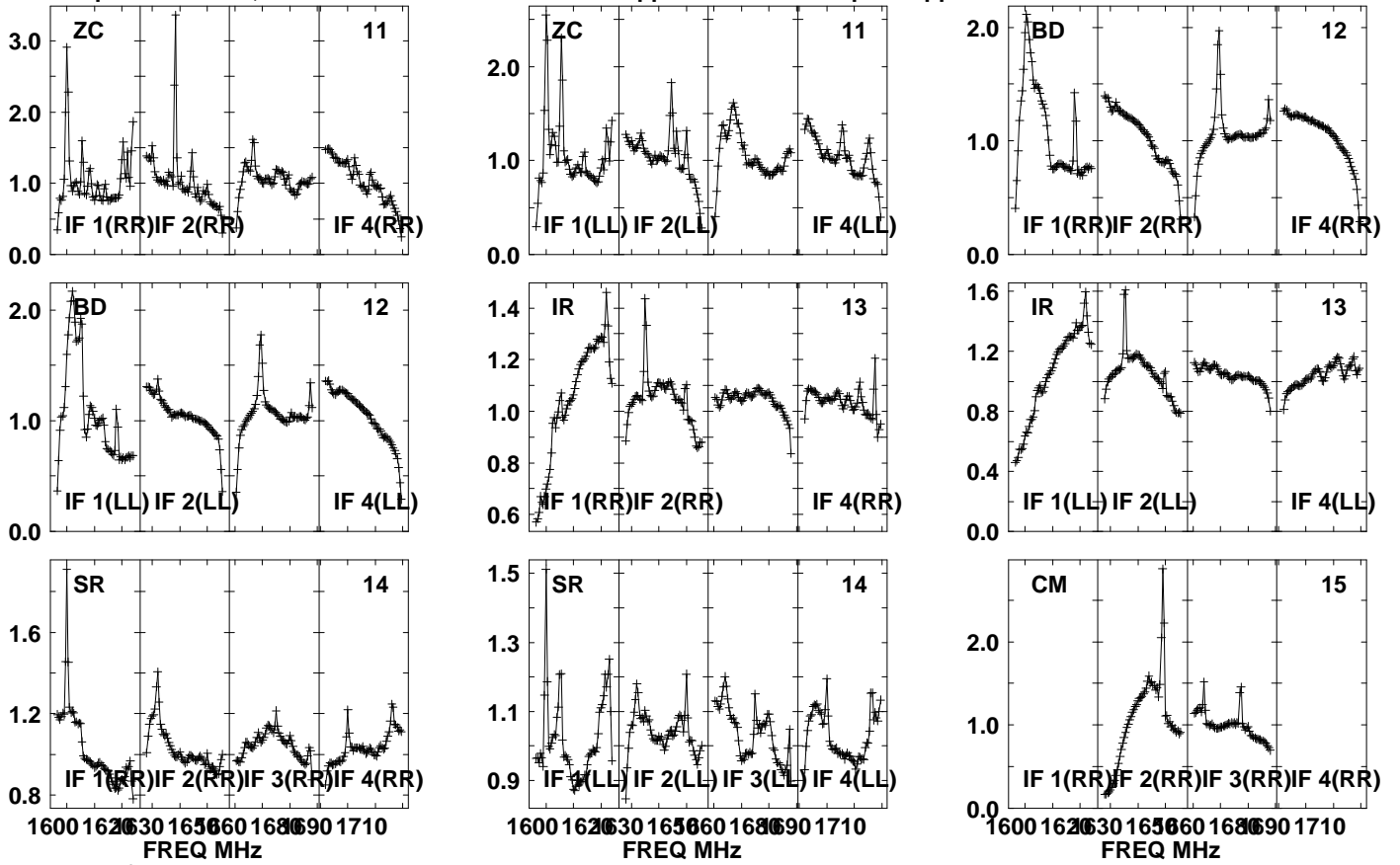

Lower frame: Real Jy

Auto-corr total-power spectrum Antenna: \*

Timerange: 00/14:15:01 to 00/14:16:29

Plot file version 352 created 05-OCT-2021 17:05:53

J0827+5217 GM076.UVDATA.1

Freq = 1.5945 GHz, Bw = 32.000 MH No calibration applied and no bandpass applied

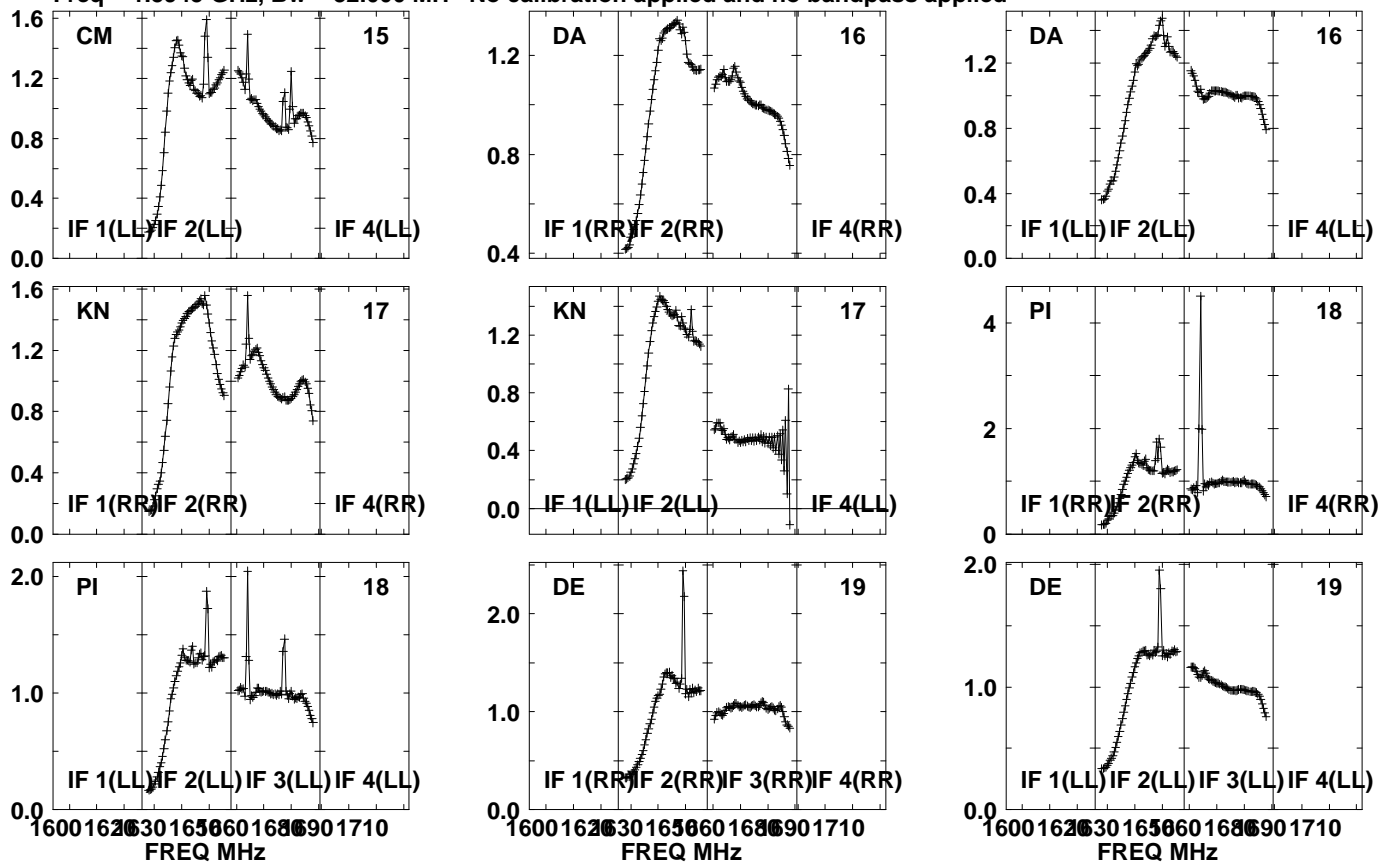

Lower frame: Real Jy  
Auto-corr total-power spectrum Antenna: \*  
Timerange: 00/14:15:01 to 00/14:16:29

Plot file version 353 created 05-OCT-2021 17:05:53

APM08279+525 GM076.UVDATA.1

Freq = 1.5945 GHz, Bw = 32.000 MH No calibration applied and no bandpass applied

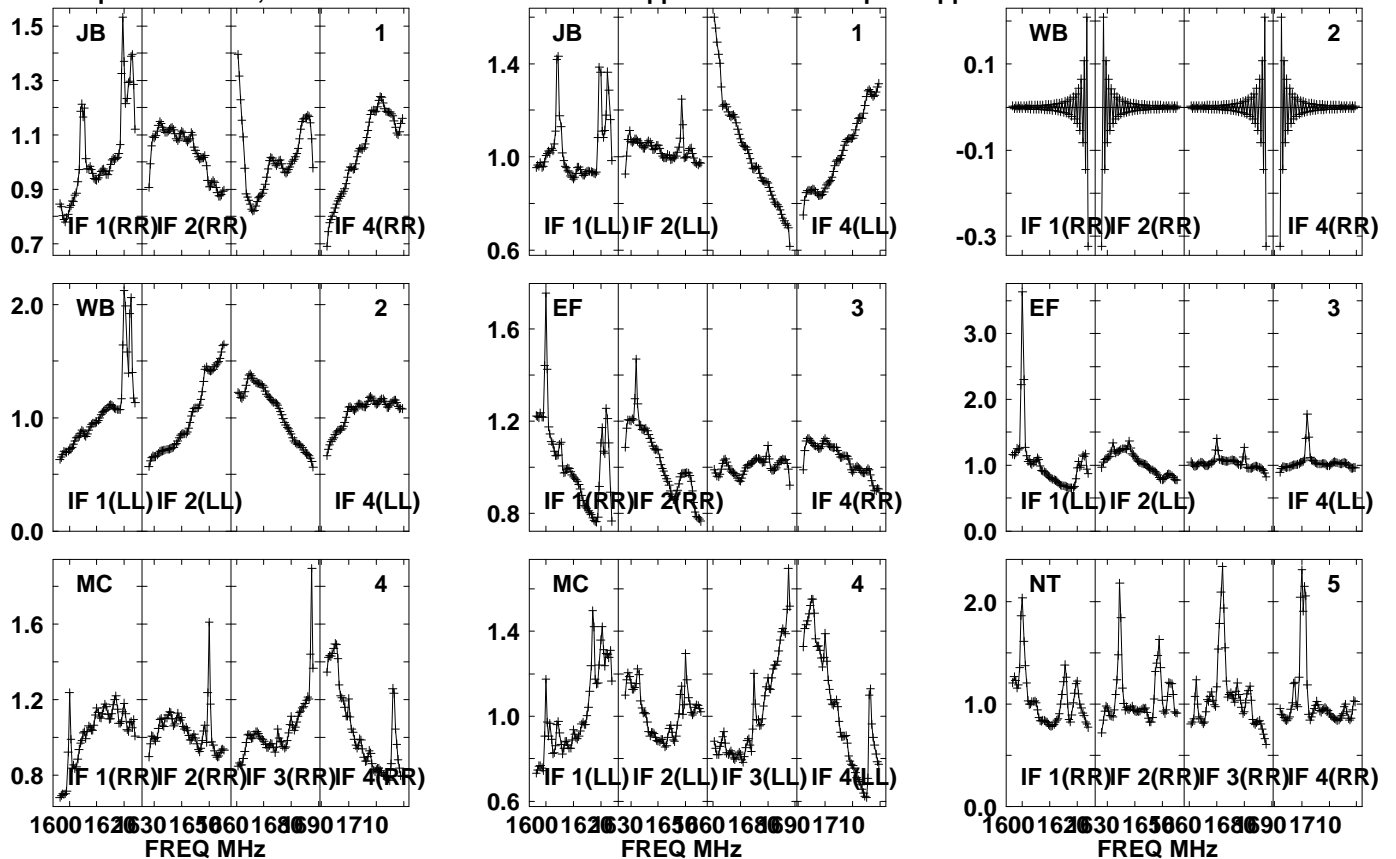

Lower frame: Real Jy  
Auto-corr total-power spectrum Antenna: \*  
Timerange: 00/14:16:31 to 00/14:19:59

Plot file version 354 created 05-OCT-2021 17:05:53

APM08279+525 GM076.UVDATA.1

Freq = 1.5945 GHz, Bw = 32.000 MH No calibration applied and no bandpass applied

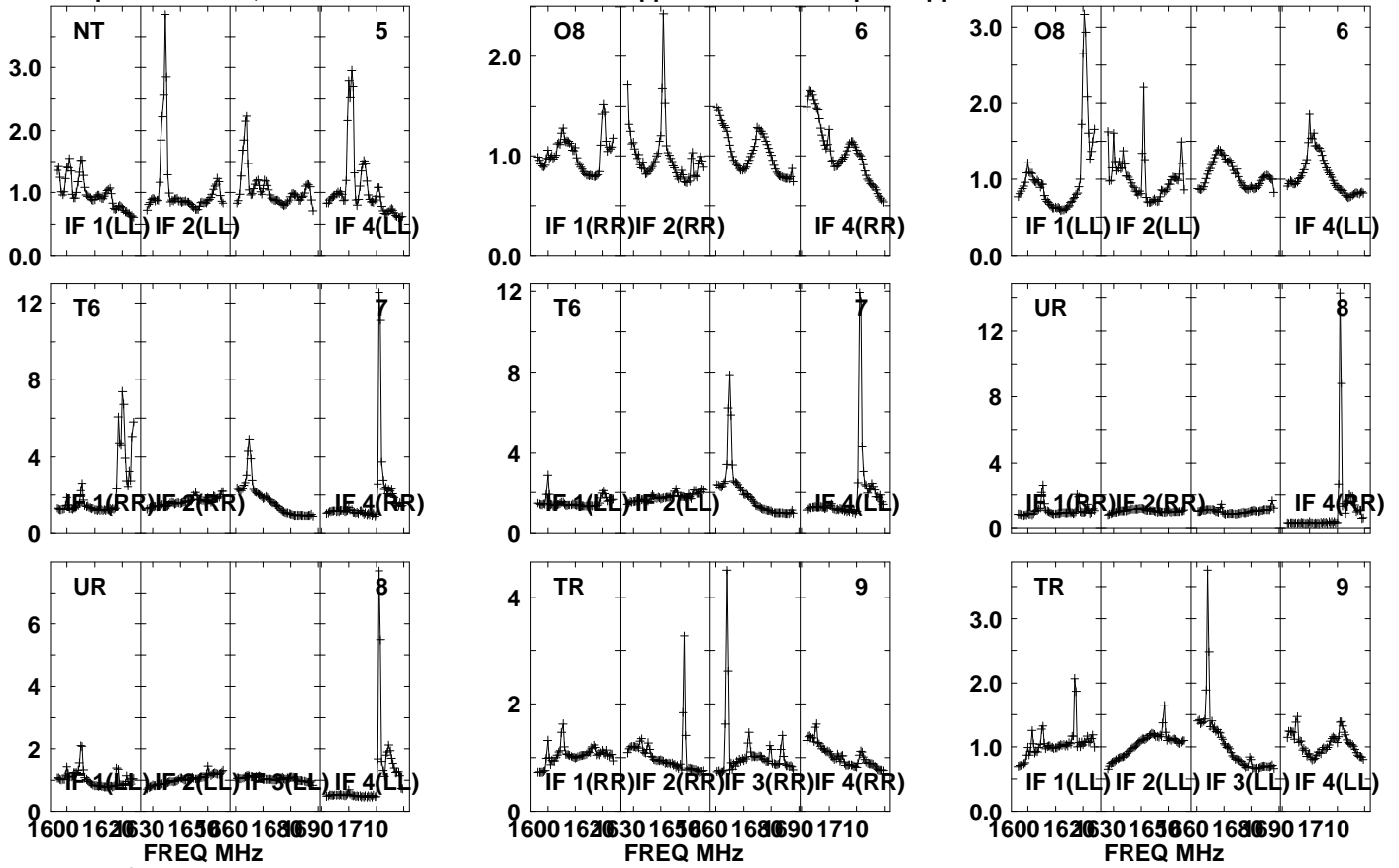

Lower frame: Real Jy

Auto-corr total-power spectrum Antenna: \*

Timerange: 00/14:16:31 to 00/14:19:59



Plot file version 355 created 05-OCT-2021 17:05:53

APM08279+525 GM076.UVDATA.1

Freq = 1.5945 GHz, Bw = 32.000 MH No calibration applied and no bandpass applied

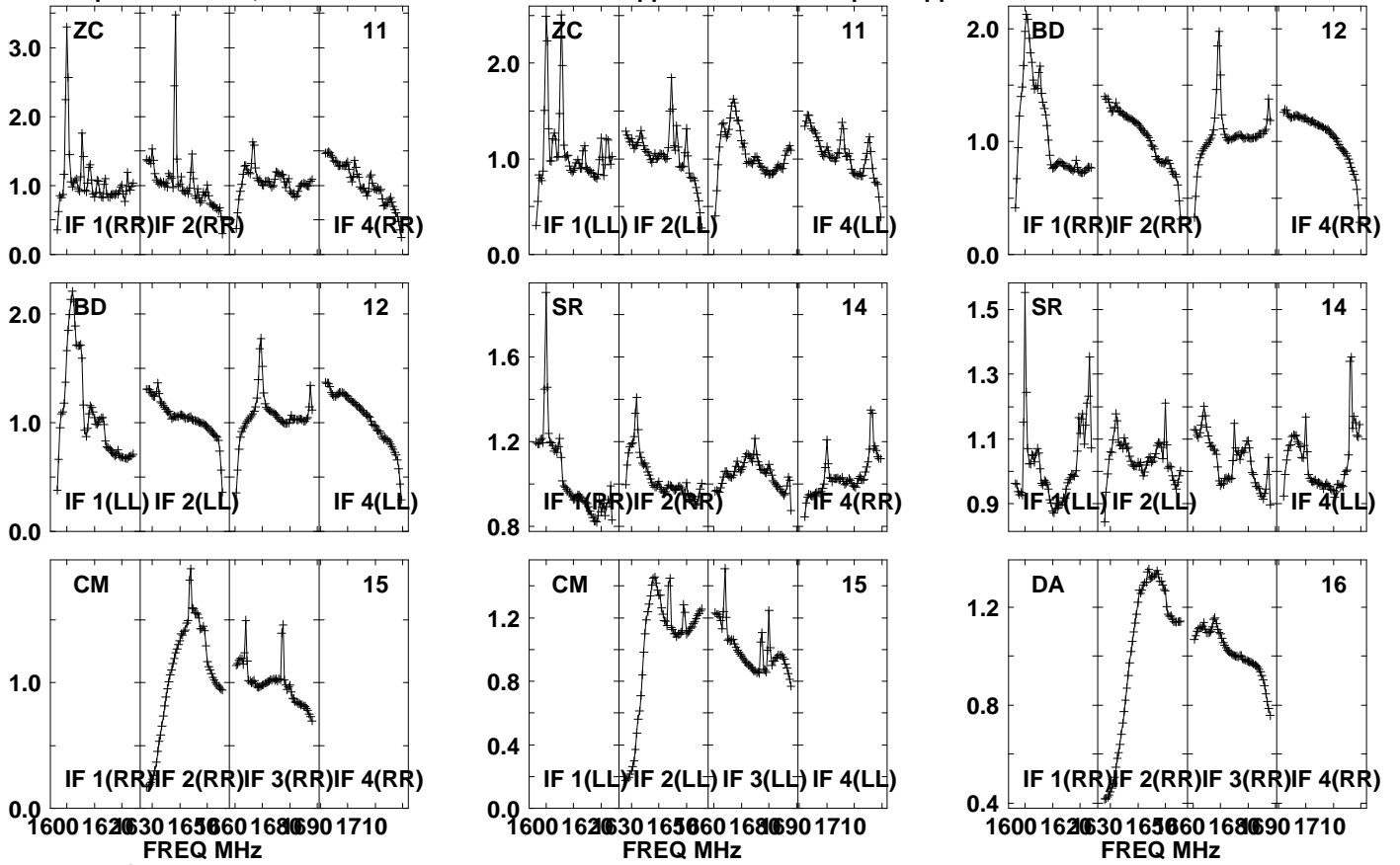

Lower frame: Real Jy  
Auto-corr total-power spectrum Antenna: \*  
Timerange: 00/14:16:31 to 00/14:19:59

Plot file version 356 created 05-OCT-2021 17:05:54

APM08279+525 GM076.UVDATA.1

Freq = 1.5945 GHz, Bw = 32.000 MH No calibration applied and no bandpass applied

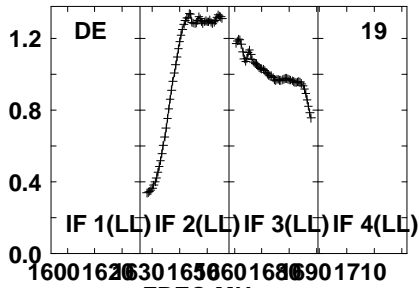
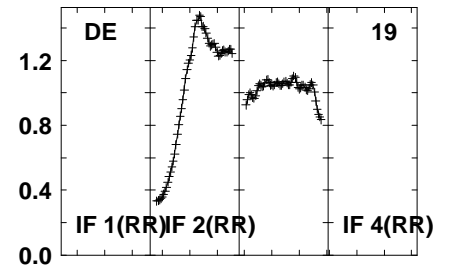
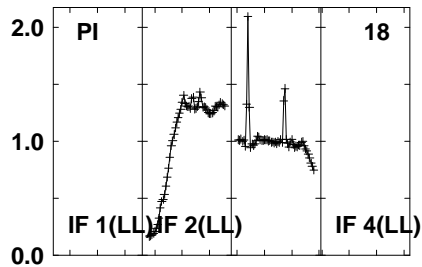
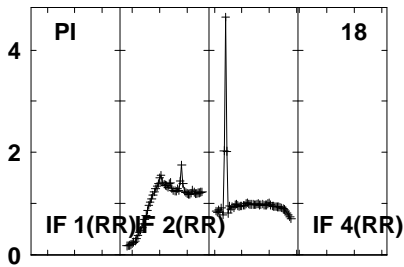
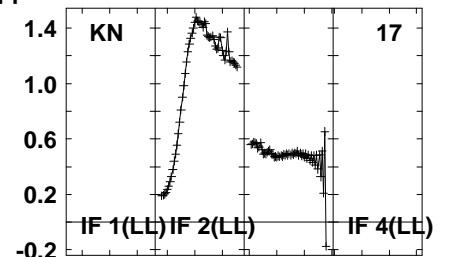
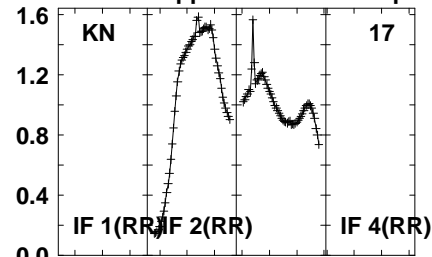
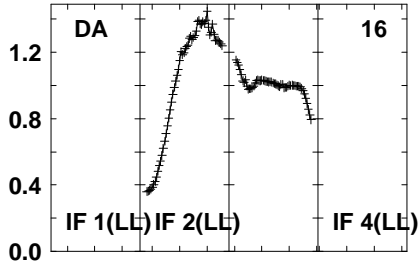

1600 1620 1630 1650 1660 1680 1690 1710  
FREQ MHz

Lower frame: Real Jy  
Auto-corr total-power spectrum Antenna: \*  
Timerange: 00/14:16:31 to 00/14:19:59

Plot file version 357 created 05-OCT-2021 17:05:54

J0827+5217 GM076.UVDATA.1

Freq = 1.5945 GHz, Bw = 32.000 MH No calibration applied and no bandpass applied

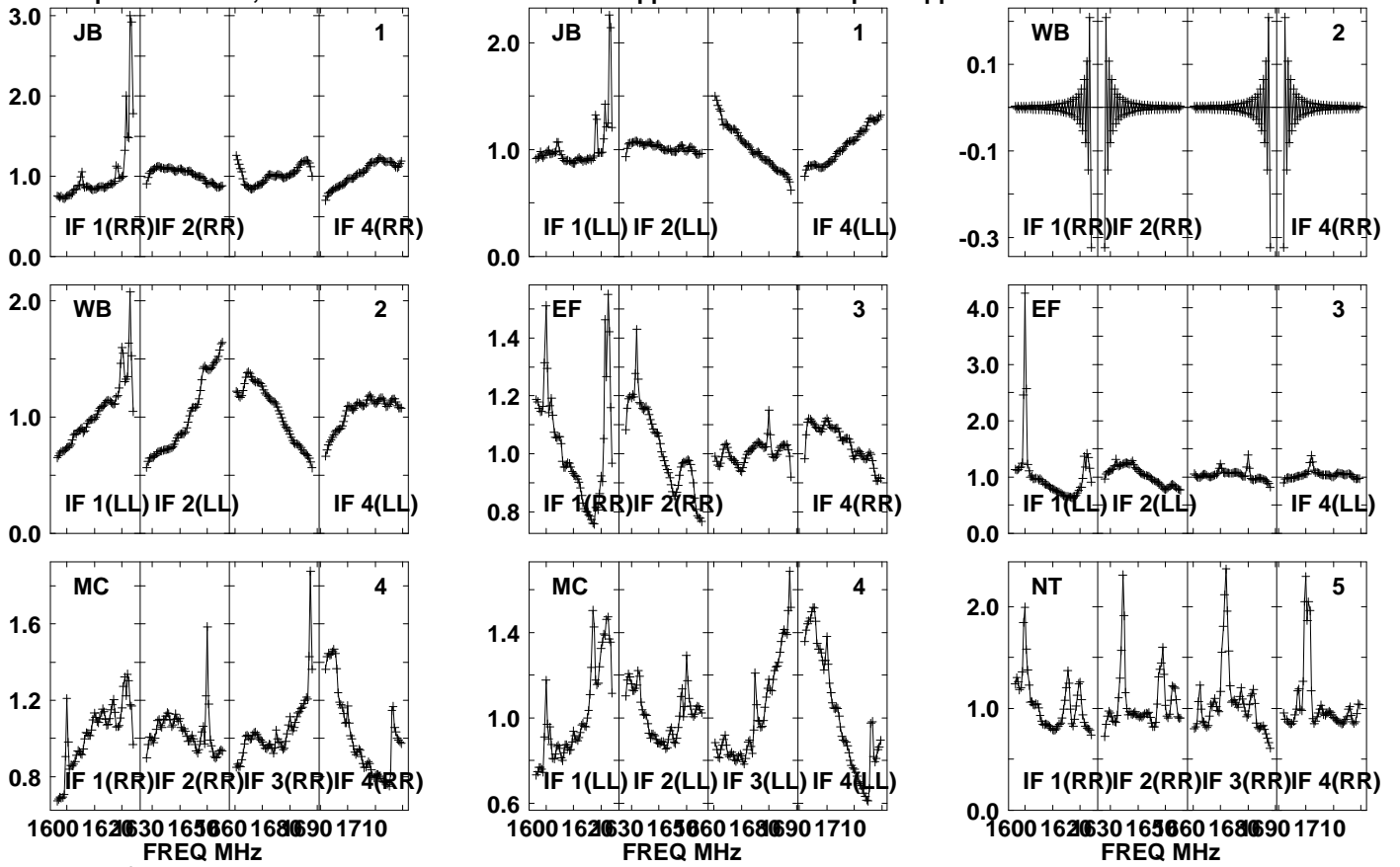

Lower frame: Real Jy

Auto-corr total-power spectrum Antenna: \*

Timerange: 00/14:20:01 to 00/14:21:29

Plot file version 358 created 05-OCT-2021 17:05:54

J0827+5217 GM076.UVDATA.1

Freq = 1.5945 GHz, Bw = 32.000 MH No calibration applied and no bandpass applied

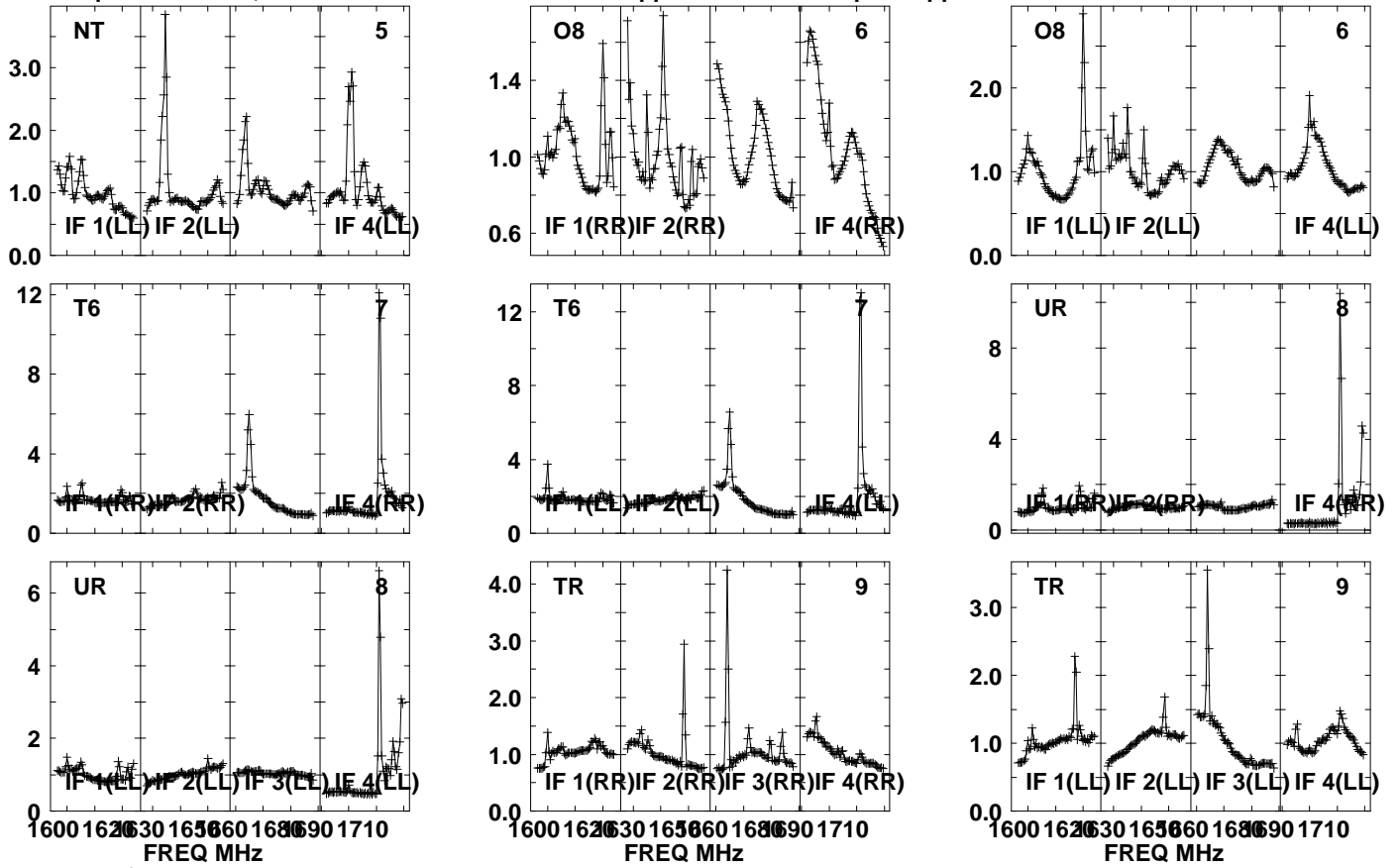

Lower frame: Real Jy

Auto-corr total-power spectrum Antenna: \*

Timerange: 00/14:20:01 to 00/14:21:29

Plot file version 359 created 05-OCT-2021 17:05:54

J0827+5217 GM076.UVDATA.1

Freq = 1.5945 GHz, Bw = 32.000 MH No calibration applied and no bandpass applied

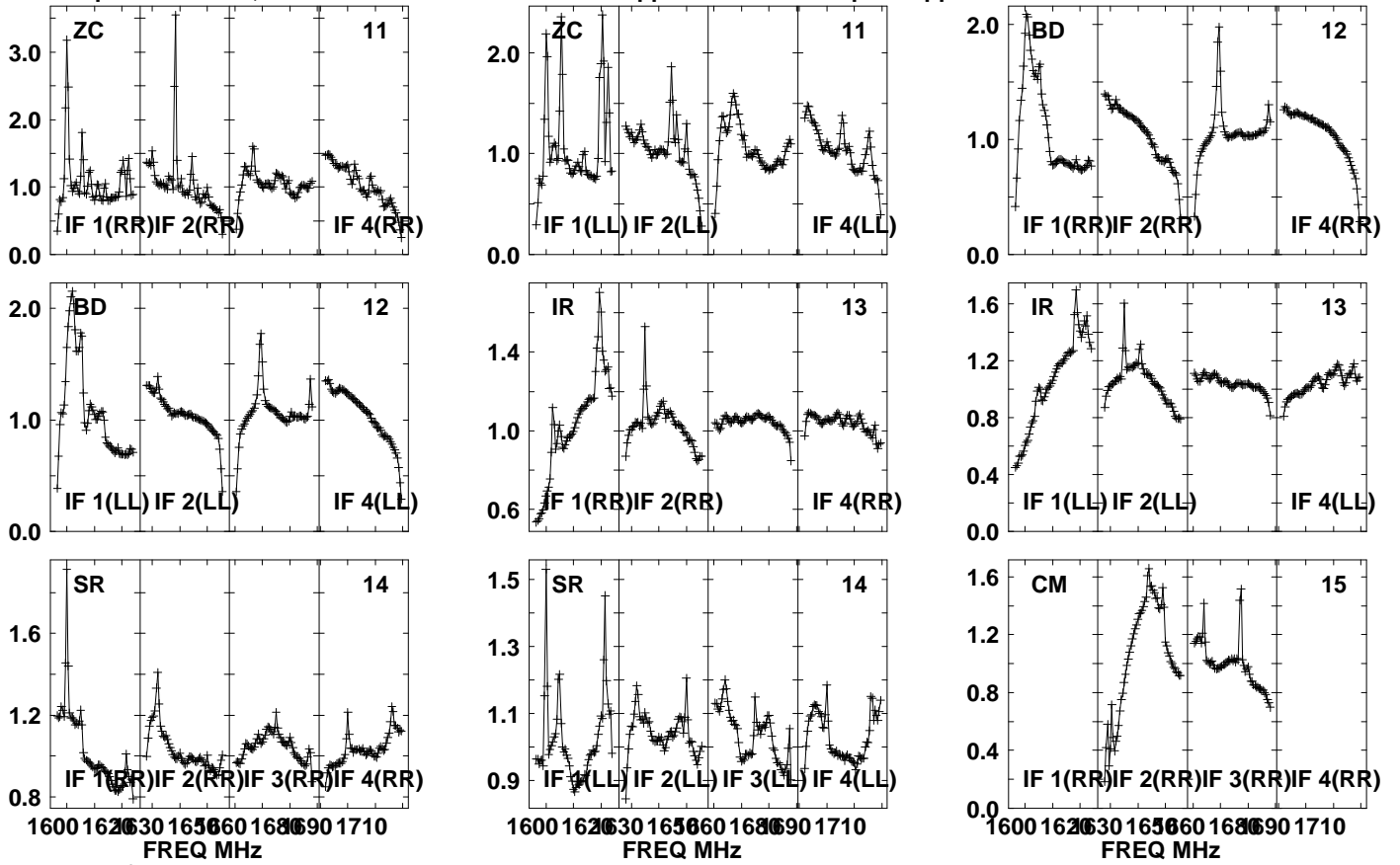

Lower frame: Real Jy

Auto-corr total-power spectrum Antenna: \*

Timerange: 00/14:20:01 to 00/14:21:29

Plot file version 360 created 05-OCT-2021 17:05:55

J0827+5217 GM076.UVDATA.1

Freq = 1.5945 GHz, Bw = 32.000 MH No calibration applied and no bandpass applied

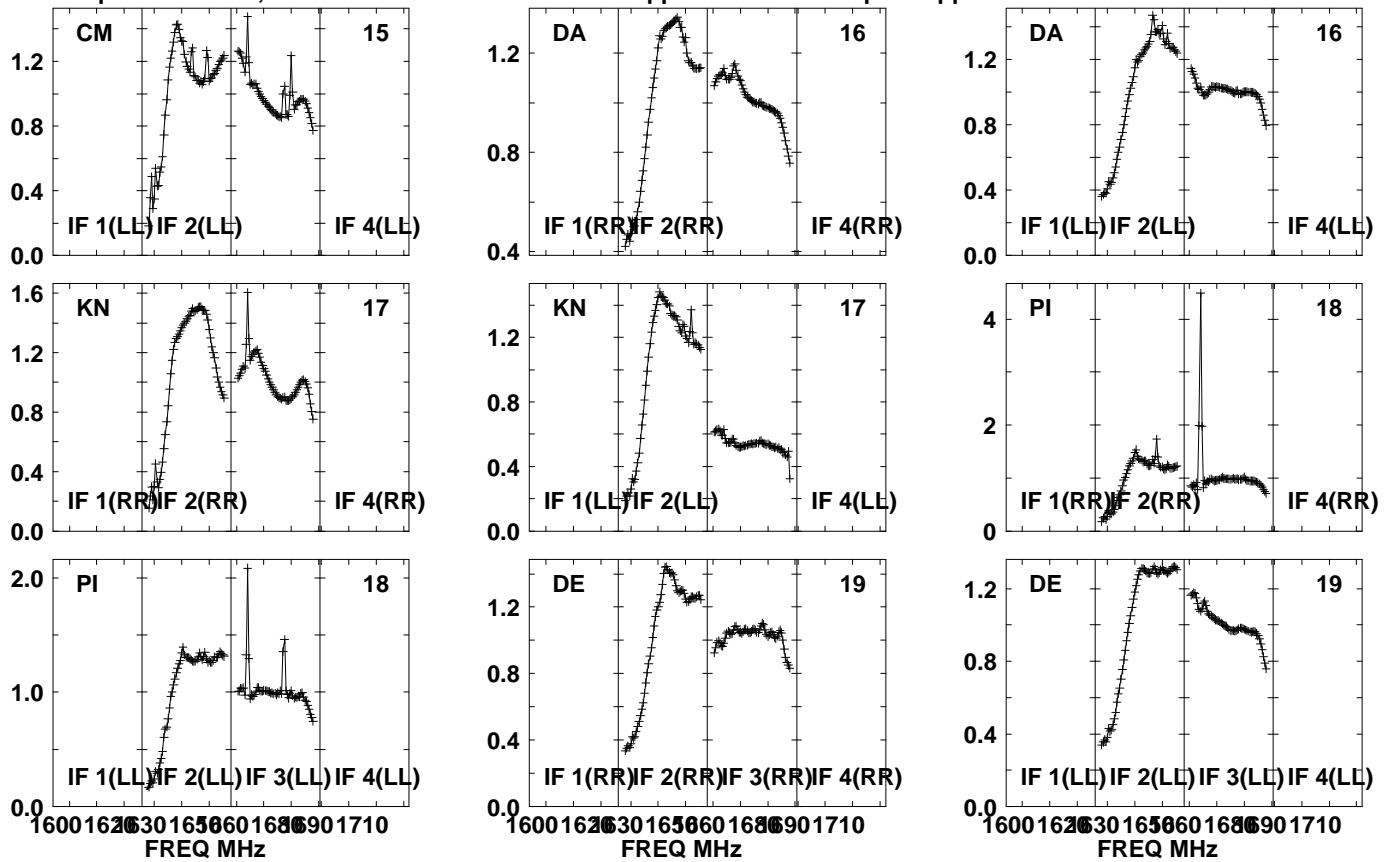

Lower frame: Real Jy  
Auto-corr total-power spectrum Antenna: \*  
Timerange: 00/14:20:01 to 00/14:21:29

Plot file version 361 created 05-OCT-2021 17:05:55

APM08279+525 GM076.UVDATA.1

Freq = 1.5945 GHz, Bw = 32.000 MH No calibration applied and no bandpass applied

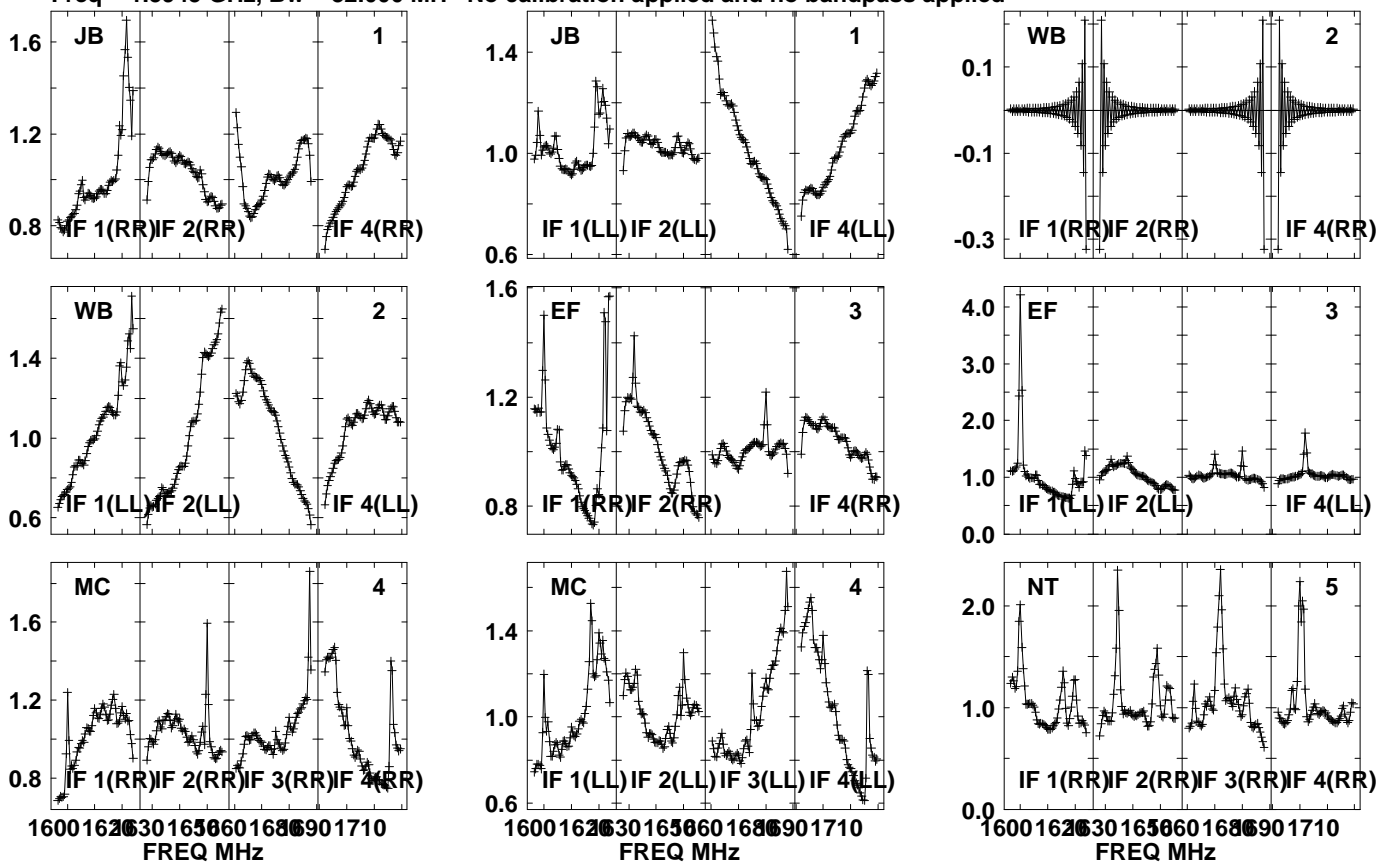

Lower frame: Real Jy  
Auto-corr total-power spectrum Antenna: \*  
Timerange: 00/14:21:31 to 00/14:24:59

Plot file version 362 created 05-OCT-2021 17:05:55

APM08279+525 GM076.UVDATA.1

Freq = 1.5945 GHz, Bw = 32.000 MH No calibration applied and no bandpass applied

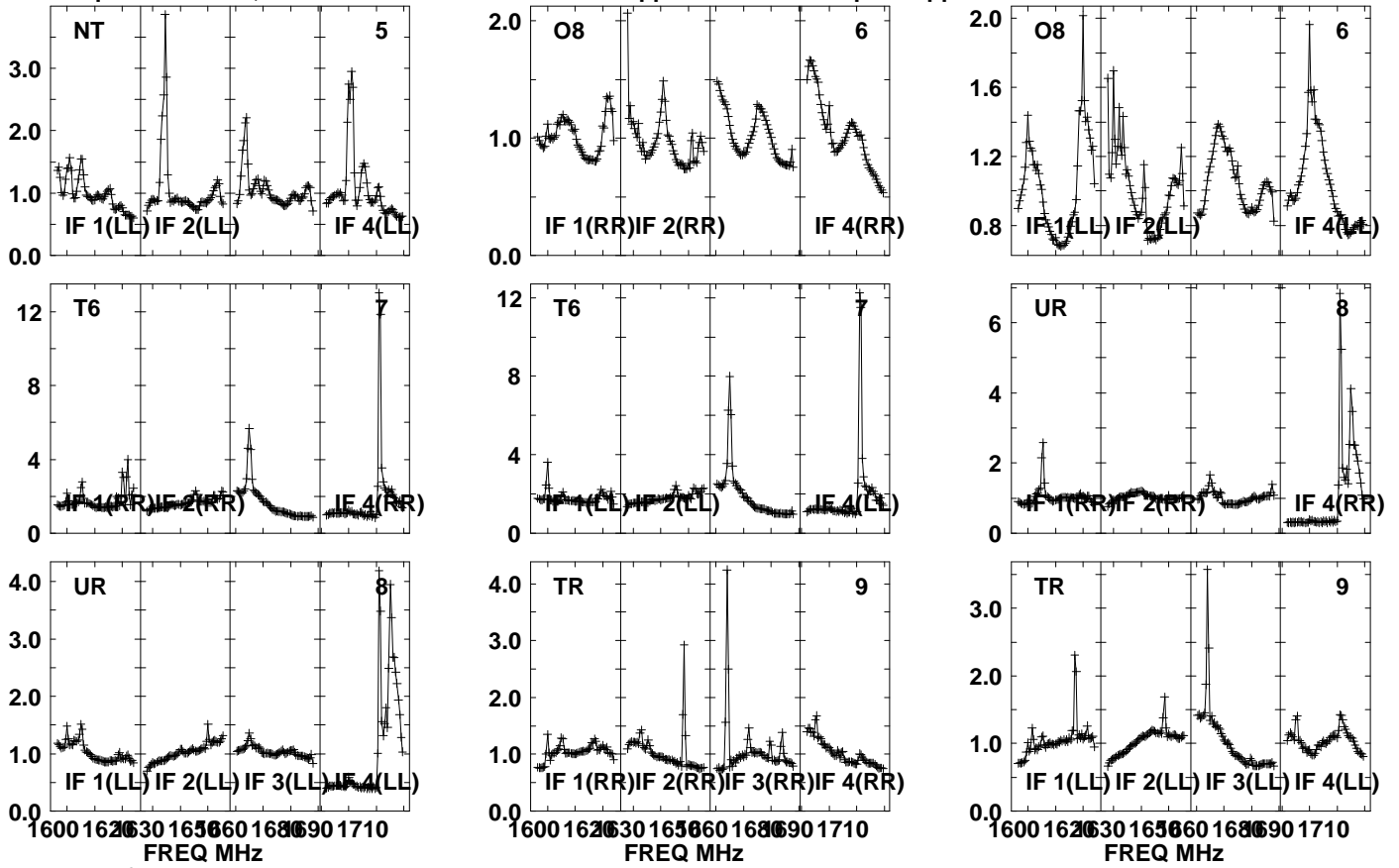

Lower frame: Real Jy

Auto-corr total-power spectrum Antenna: \*

Timerange: 00/14:21:31 to 00/14:24:59



Plot file version 363 created 05-OCT-2021 17:05:56

APM08279+525 GM076.UVDATA.1

Freq = 1.5945 GHz, Bw = 32.000 MH No calibration applied and no bandpass applied

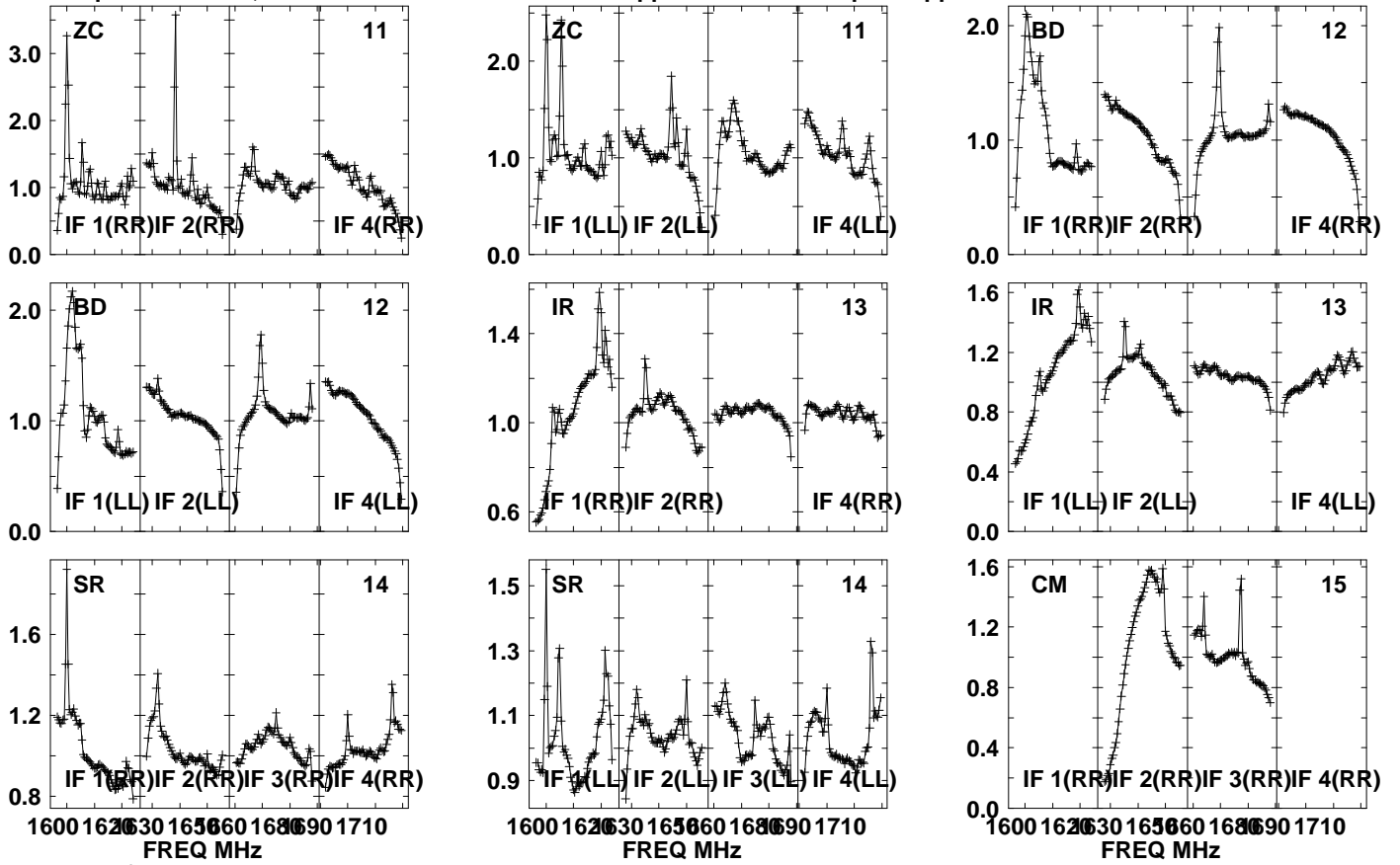

Lower frame: Real Jy

Auto-corr total-power spectrum Antenna: \*

Timerange: 00/14:21:31 to 00/14:24:59

Plot file version 364 created 05-OCT-2021 17:05:56

APM08279+525 GM076.UVDATA.1

Freq = 1.5945 GHz, Bw = 32.000 MH No calibration applied and no bandpass applied

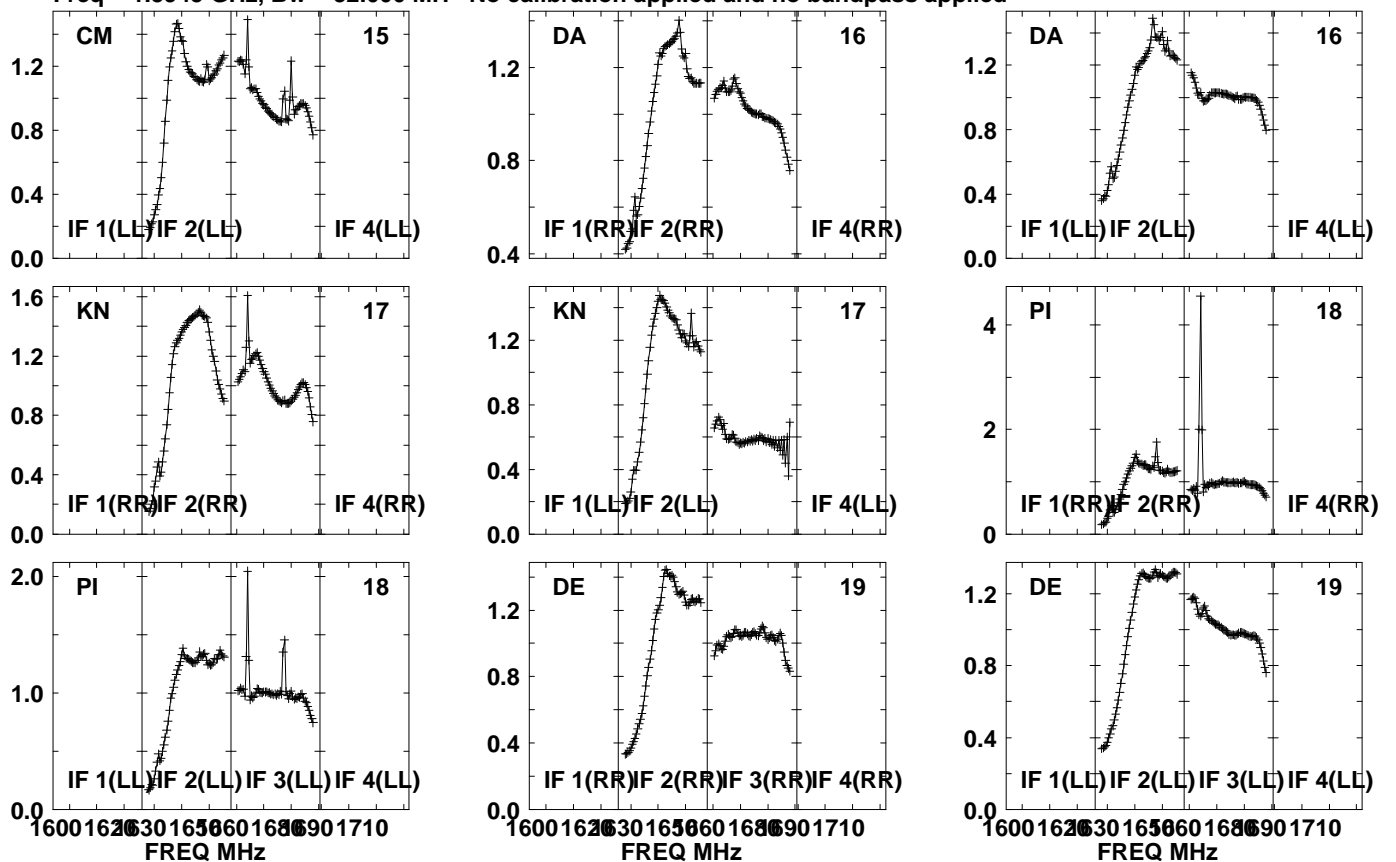

Lower frame: Real Jy  
Auto-corr total-power spectrum Antenna: \*  
Timerange: 00/14:21:31 to 00/14:24:59

Plot file version 365 created 05-OCT-2021 17:05:56

J0827+5217 GM076.UVDATA.1

Freq = 1.5945 GHz, Bw = 32.000 MH No calibration applied and no bandpass applied

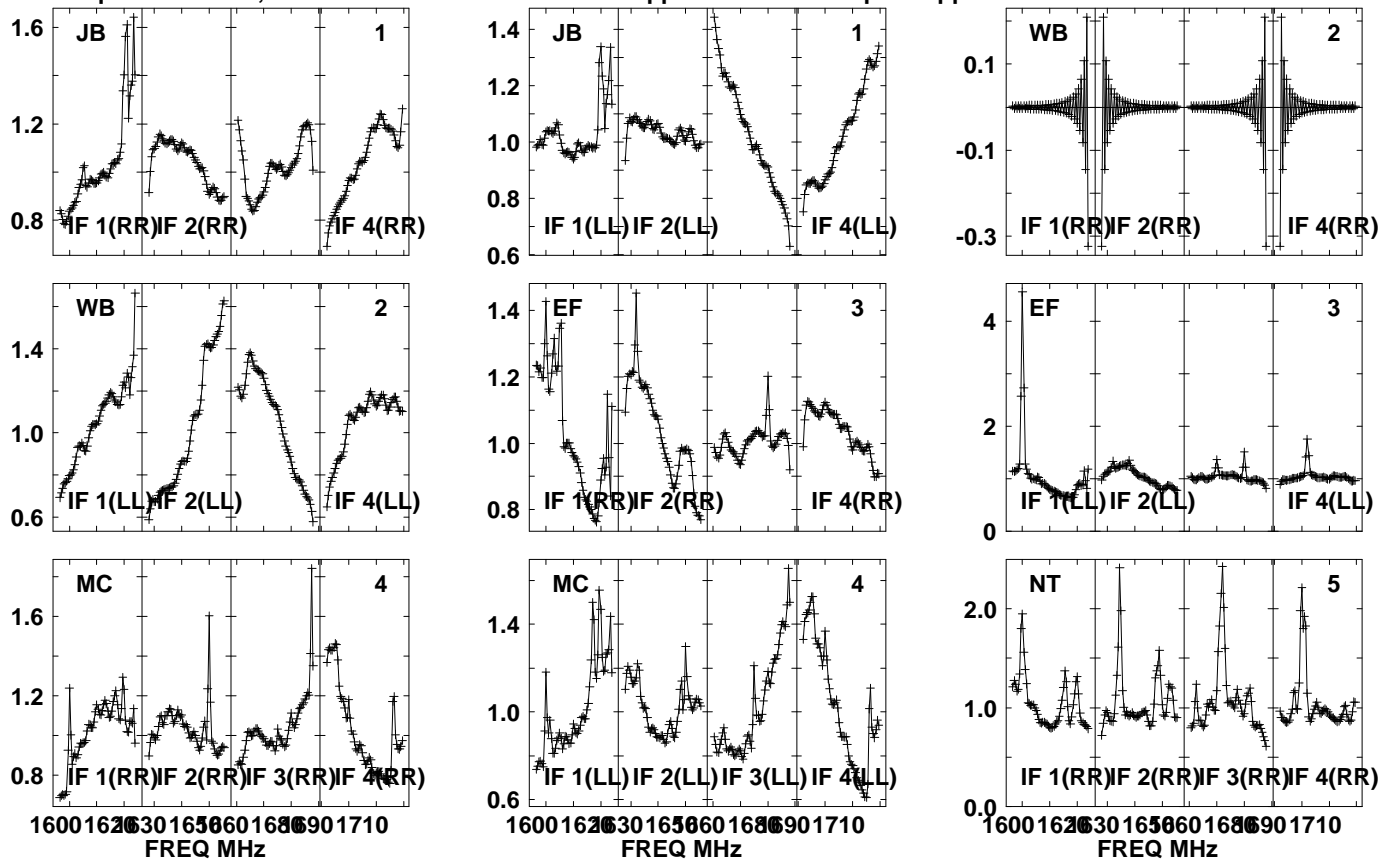

Lower frame: Real Jy  
Auto-corr total-power spectrum Antenna: \*  
Timerange: 00/14:25:31 to 00/14:26:59

Plot file version 366 created 05-OCT-2021 17:05:56

J0827+5217 GM076.UVDATA.1

Freq = 1.5945 GHz, Bw = 32.000 MH No calibration applied and no bandpass applied

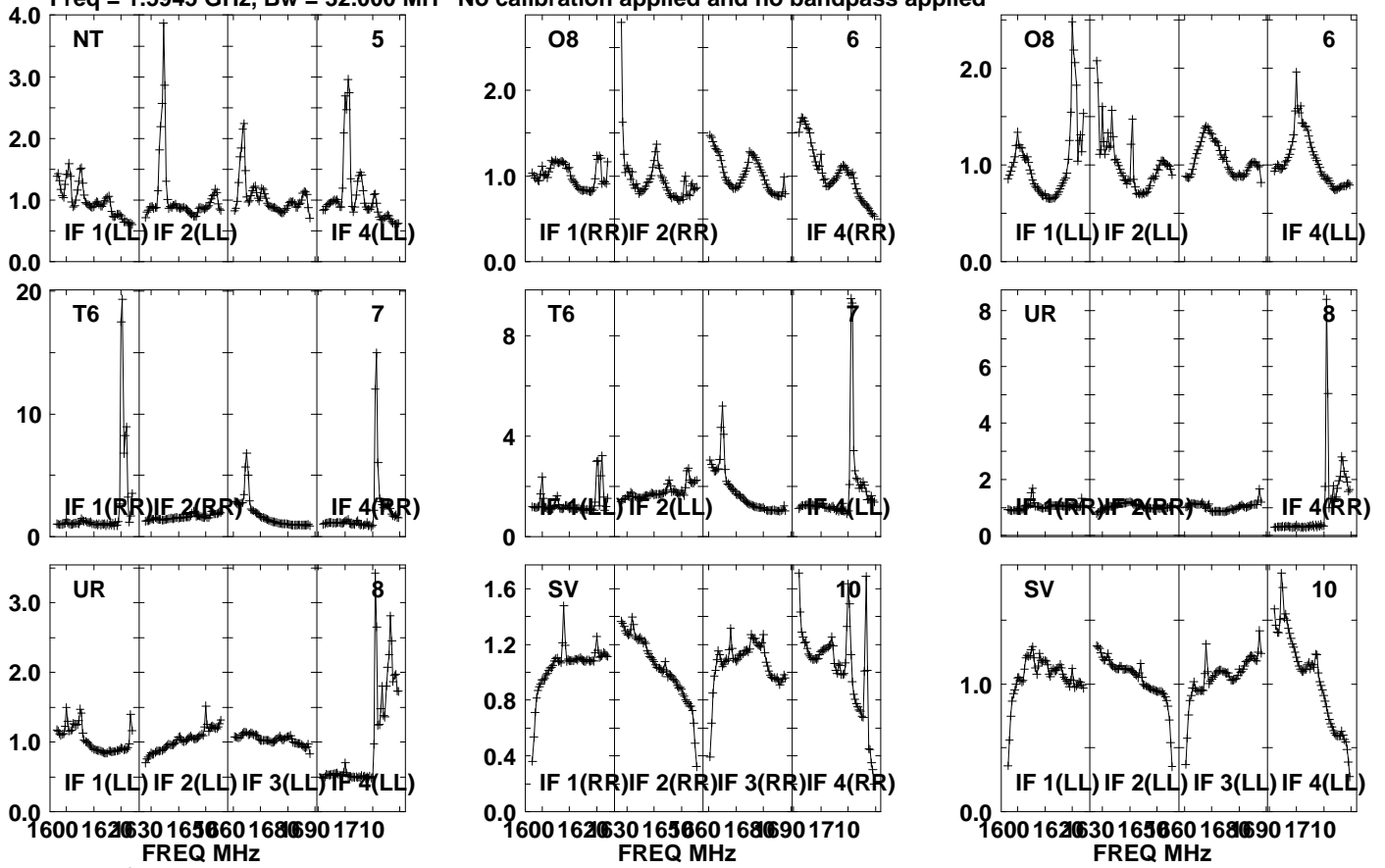

Lower frame: Real Jy  
Auto-corr total-power spectrum Antenna: \*  
Timerange: 00/14:25:31 to 00/14:26:59

Plot file version 367 created 05-OCT-2021 17:05:56

J0827+5217 GM076.UVDATA.1

Freq = 1.5945 GHz, Bw = 32.000 MH No calibration applied and no bandpass applied

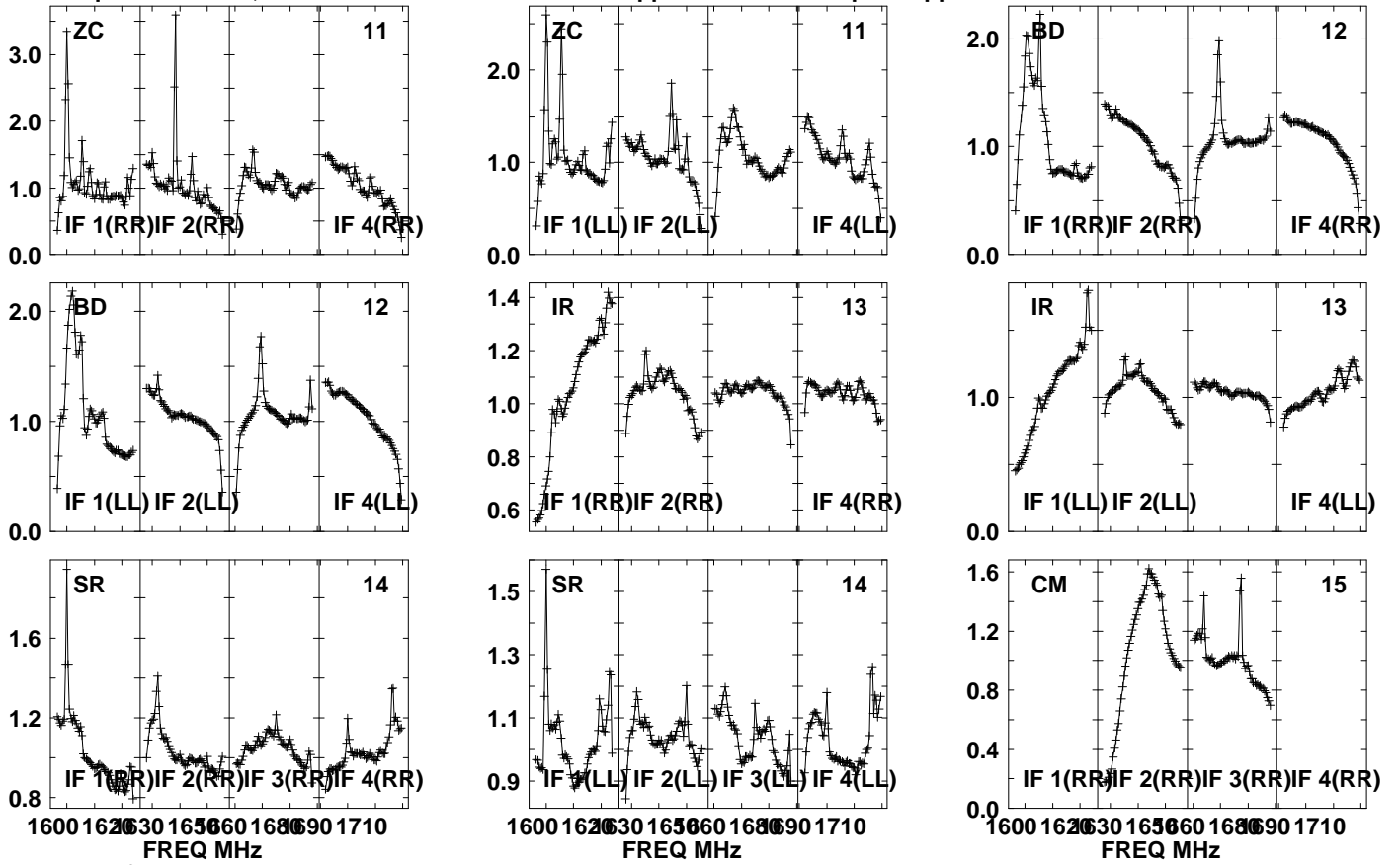

Lower frame: Real Jy

Auto-corr total-power spectrum Antenna: \*

Timerange: 00/14:25:31 to 00/14:26:59

Plot file version 368 created 05-OCT-2021 17:05:57

J0827+5217 GM076.UVDATA.1

Freq = 1.5945 GHz, Bw = 32.000 MH No calibration applied and no bandpass applied

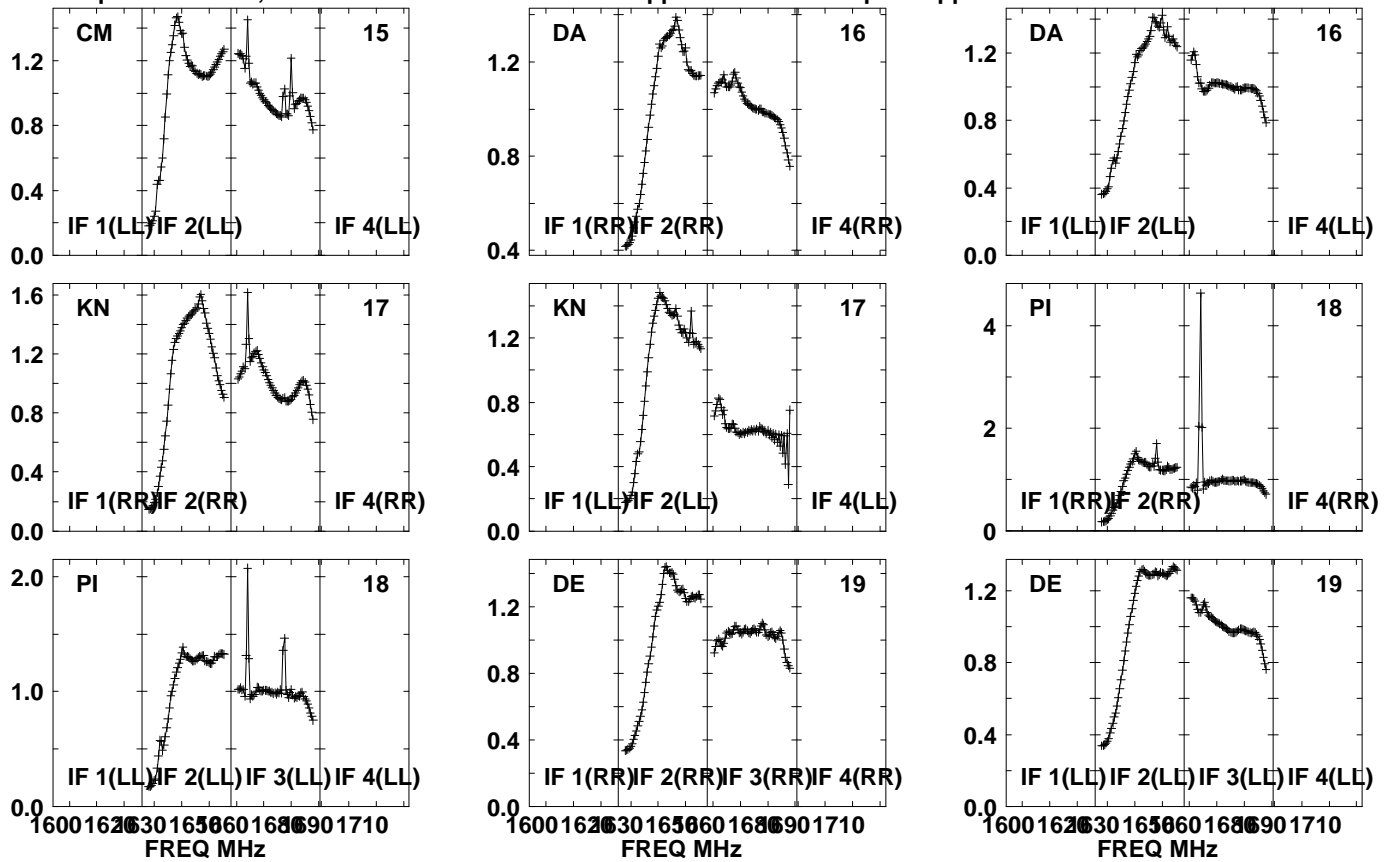

Lower frame: Real Jy  
Auto-corr total-power spectrum Antenna: \*  
Timerange: 00/14:25:31 to 00/14:26:59

Plot file version 369 created 05-OCT-2021 17:05:57

APM08279+525 GM076.UVDATA.1

Freq = 1.5945 GHz, Bw = 32.000 MH No calibration applied and no bandpass applied

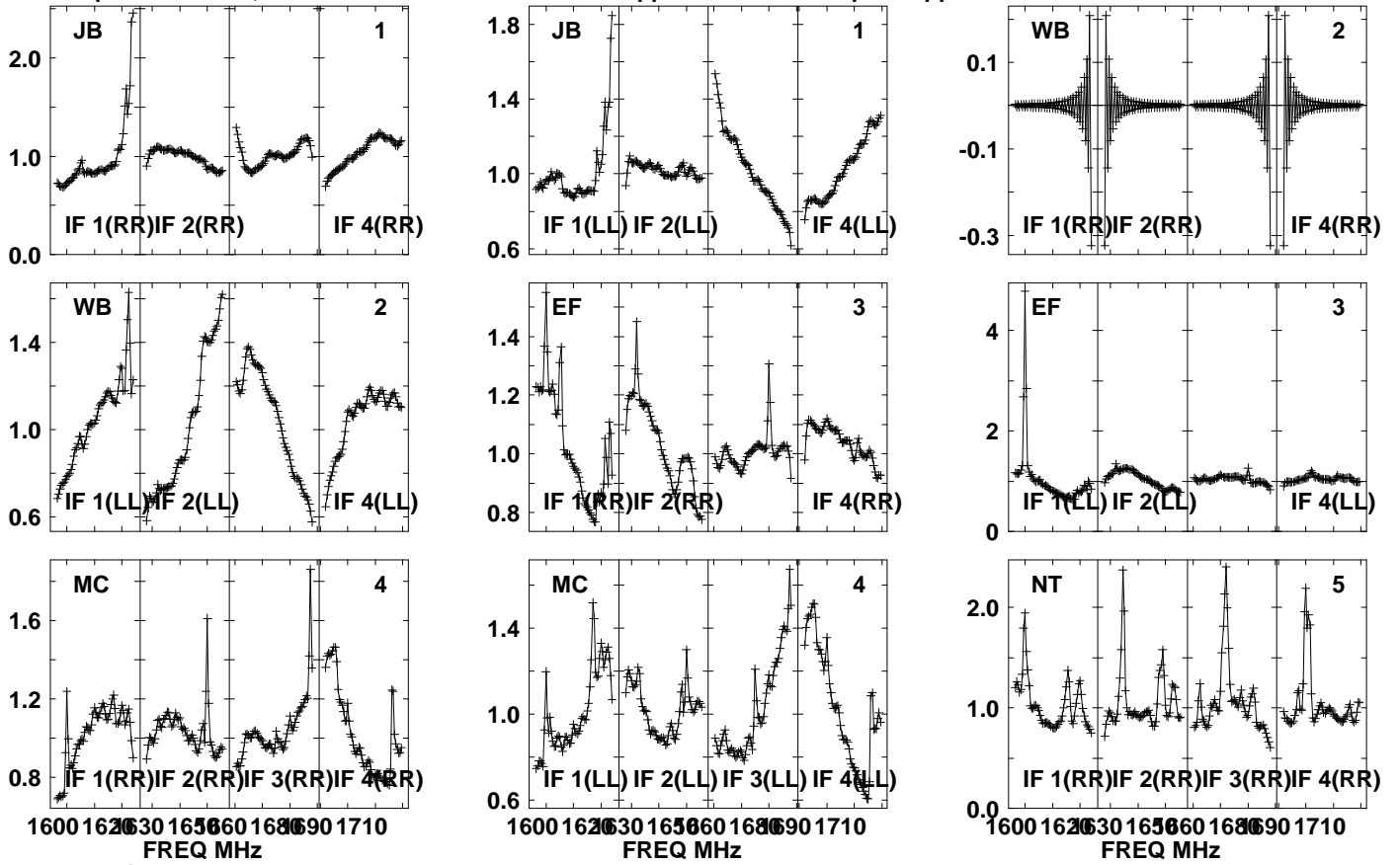

Lower frame: Real Jy

Auto-corr total-power spectrum Antenna: \*

Timerange: 00/14:27:01 to 00/14:29:59

Plot file version 370 created 05-OCT-2021 17:05:57

APM08279+525 GM076.UVDATA.1

Freq = 1.5945 GHz, Bw = 32.000 MH No calibration applied and no bandpass applied

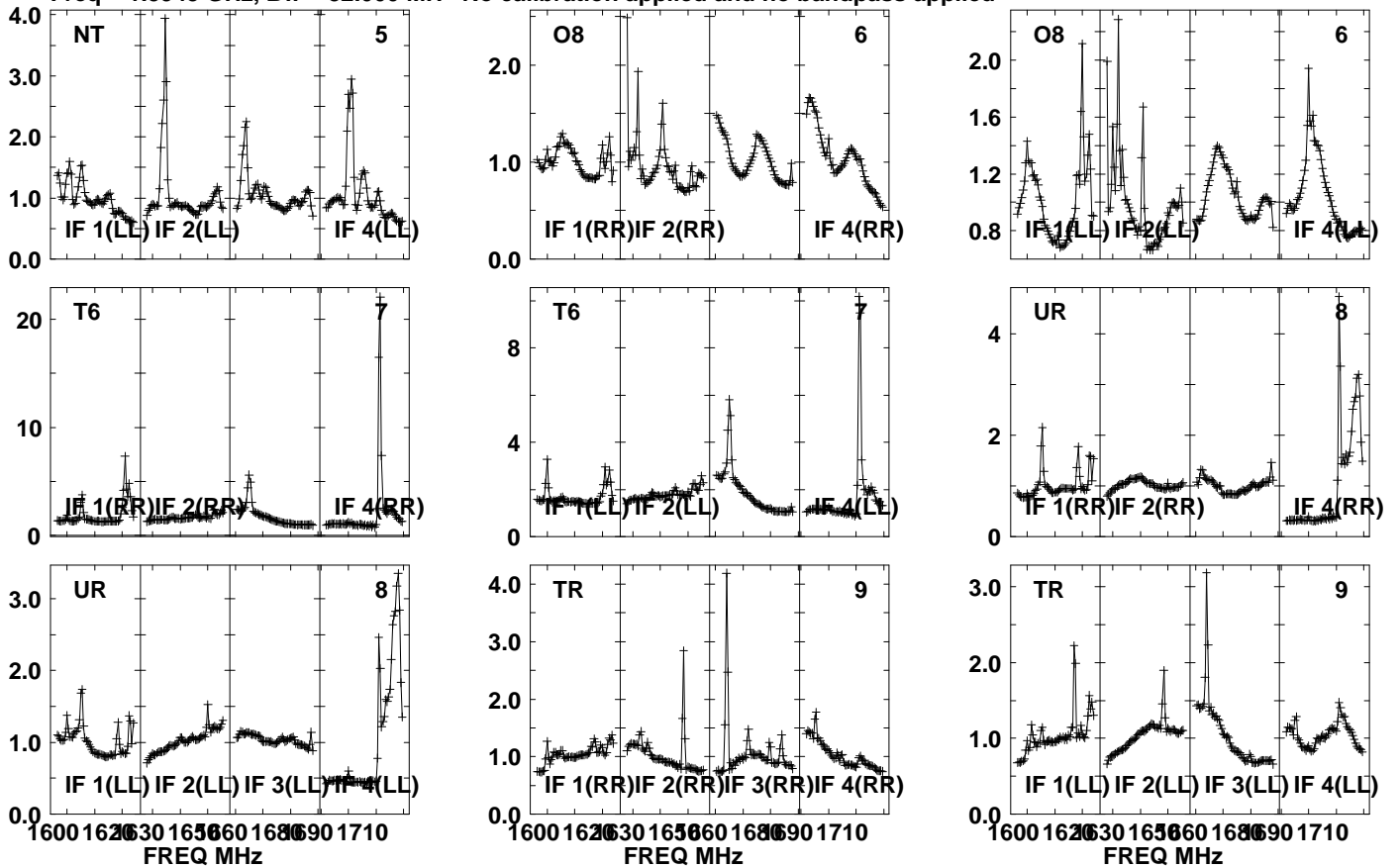

Lower frame: Real Jy  
Auto-corr total-power spectrum Antenna: \*  
Timerange: 00/14:27:01 to 00/14:29:59



Plot file version 371 created 05-OCT-2021 17:05:57

APM08279+525 GM076.UVDATA.1

Freq = 1.5945 GHz, Bw = 32.000 MH No calibration applied and no bandpass applied

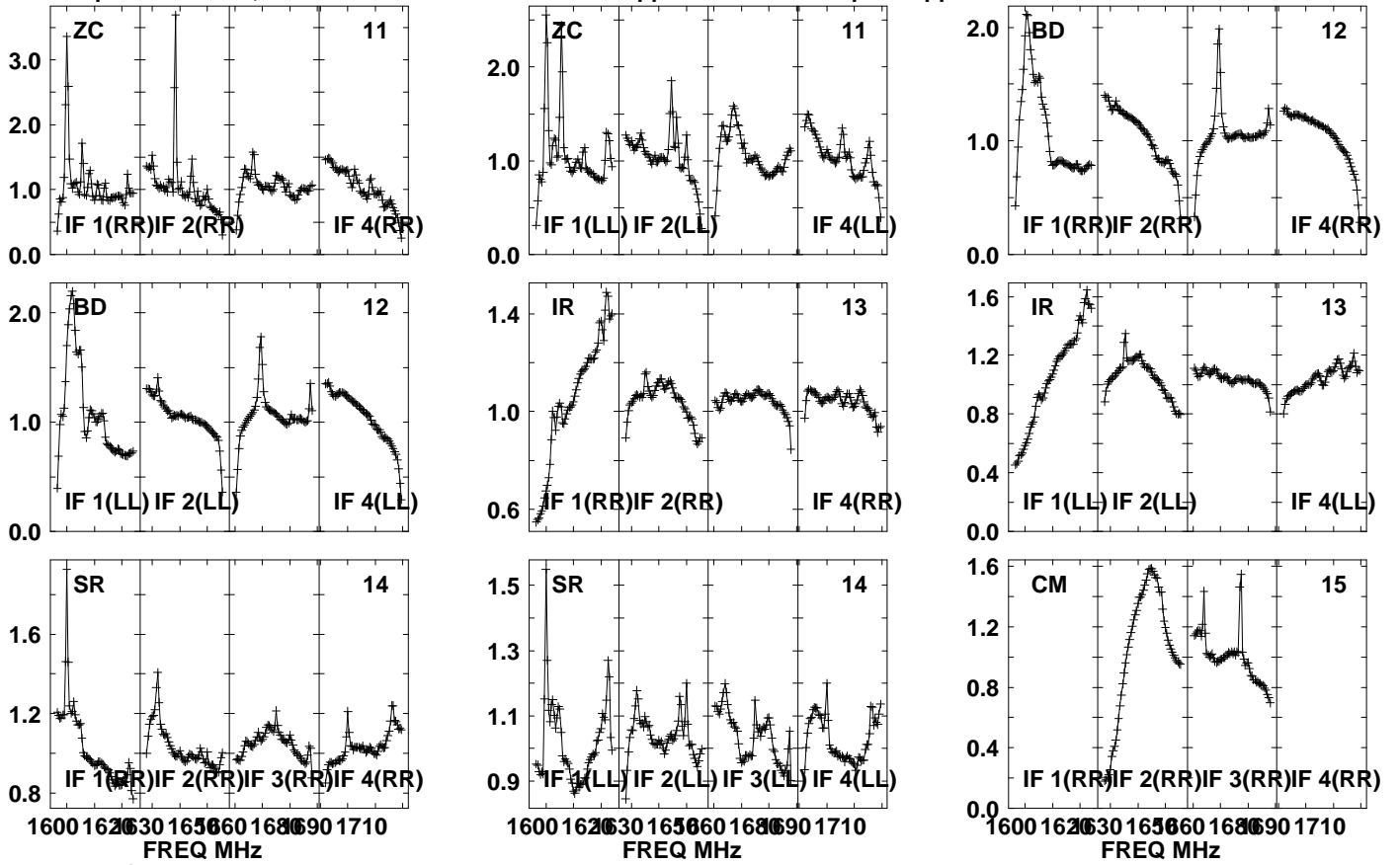

Lower frame: Real Jy  
Auto-corr total-power spectrum Antenna: \*  
Timerange: 00/14:27:01 to 00/14:29:59

Plot file version 372 created 05-OCT-2021 17:05:57

APM08279+525 GM076.UVDATA.1

Freq = 1.5945 GHz, Bw = 32.000 MH No calibration applied and no bandpass applied

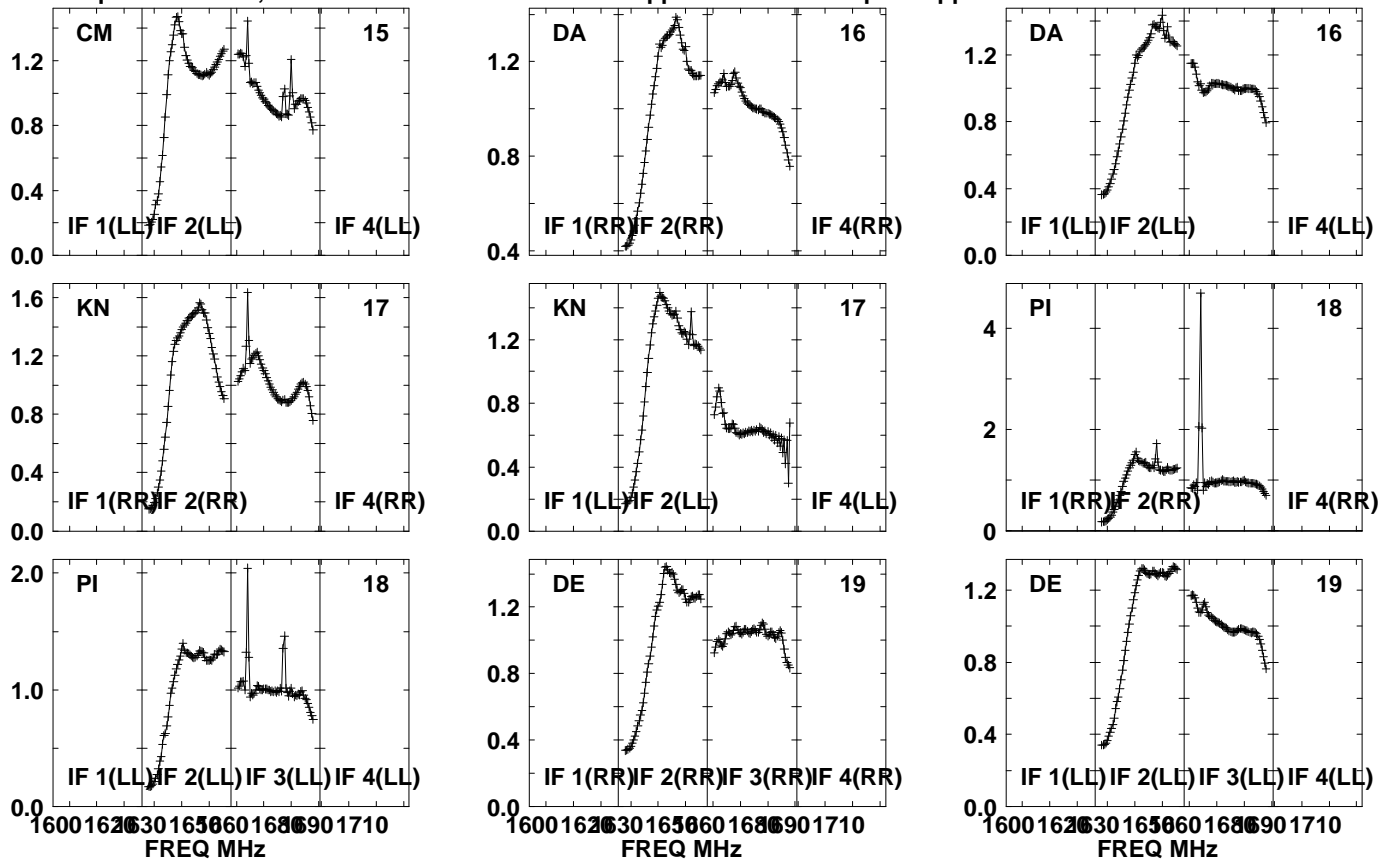

Lower frame: Real Jy  
Auto-corr total-power spectrum Antenna: \*  
Timerange: 00/14:27:01 to 00/14:29:59

Plot file version 373 created 05-OCT-2021 17:05:58

J0827+5217 GM076.UVDATA.1

Freq = 1.5945 GHz, Bw = 32.000 MH No calibration applied and no bandpass applied

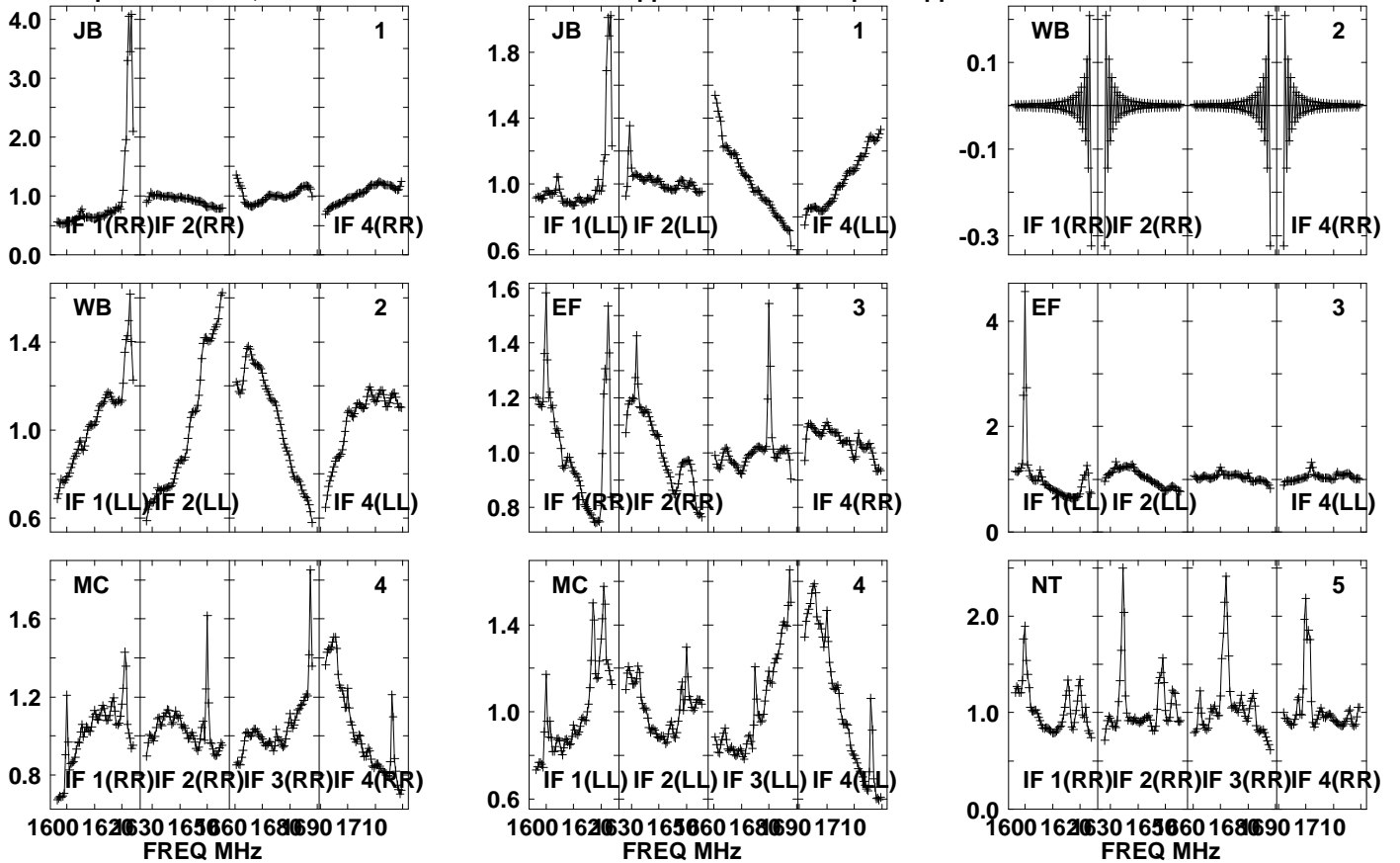

Lower frame: Real Jy

Auto-corr total-power spectrum Antenna: \*

Timerange: 00/14:30:31 to 00/14:31:59

Plot file version 374 created 05-OCT-2021 17:05:58

J0827+5217 GM076.UVDATA.1

Freq = 1.5945 GHz, Bw = 32.000 MH No calibration applied and no bandpass applied

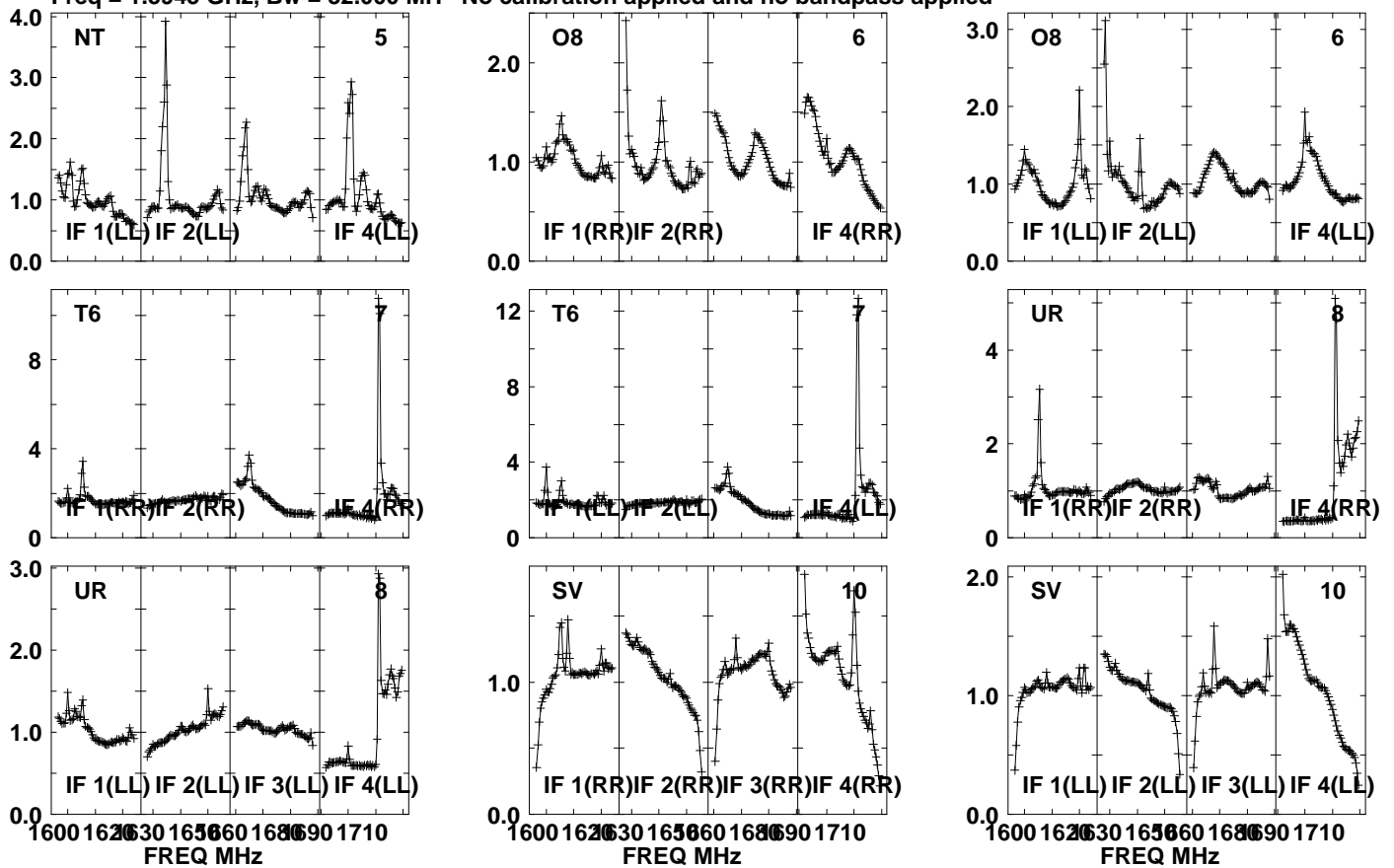

Lower frame: Real Jy

Auto-corr total-power spectrum Antenna: \*

Timerange: 00/14:30:31 to 00/14:31:59

Plot file version 375 created 05-OCT-2021 17:05:59

J0827+5217 GM076.UVDATA.1

Freq = 1.5945 GHz, Bw = 32.000 MH No calibration applied and no bandpass applied

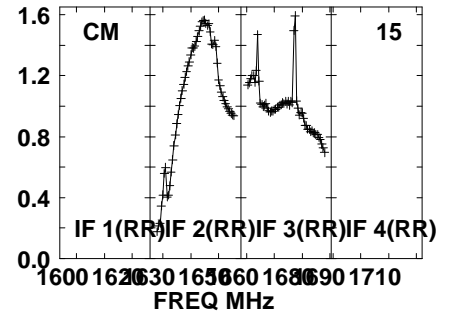
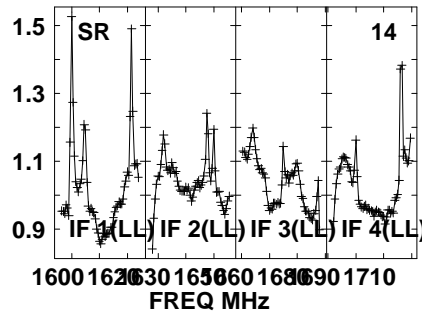
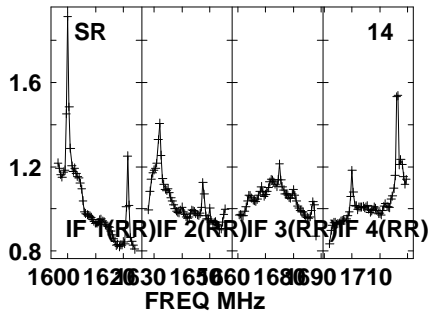
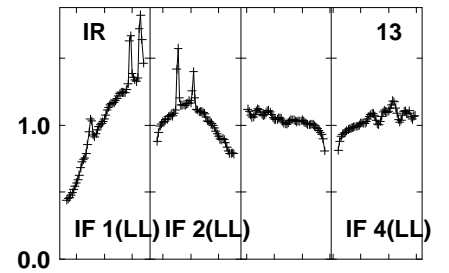
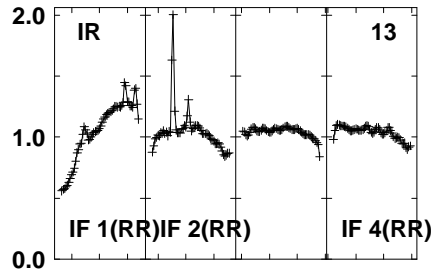
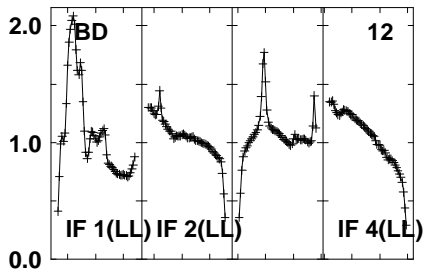
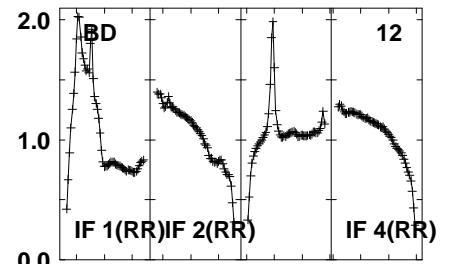
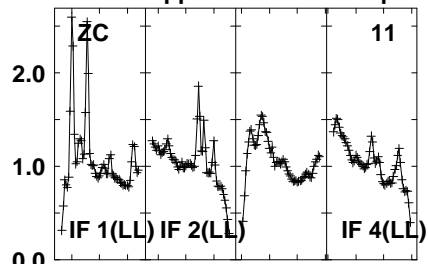
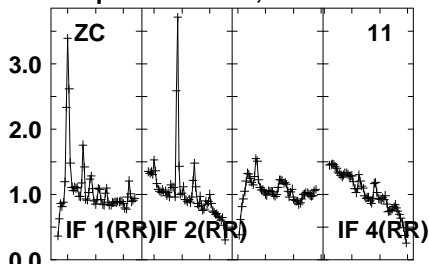

Lower frame: Real Jy

Auto-corr total-power spectrum Antenna: \*

Timerange: 00/14:30:31 to 00/14:31:59

Plot file version 376 created 05-OCT-2021 17:05:59

J0827+5217 GM076.UVDATA.1

Freq = 1.5945 GHz, Bw = 32.000 MH No calibration applied and no bandpass applied

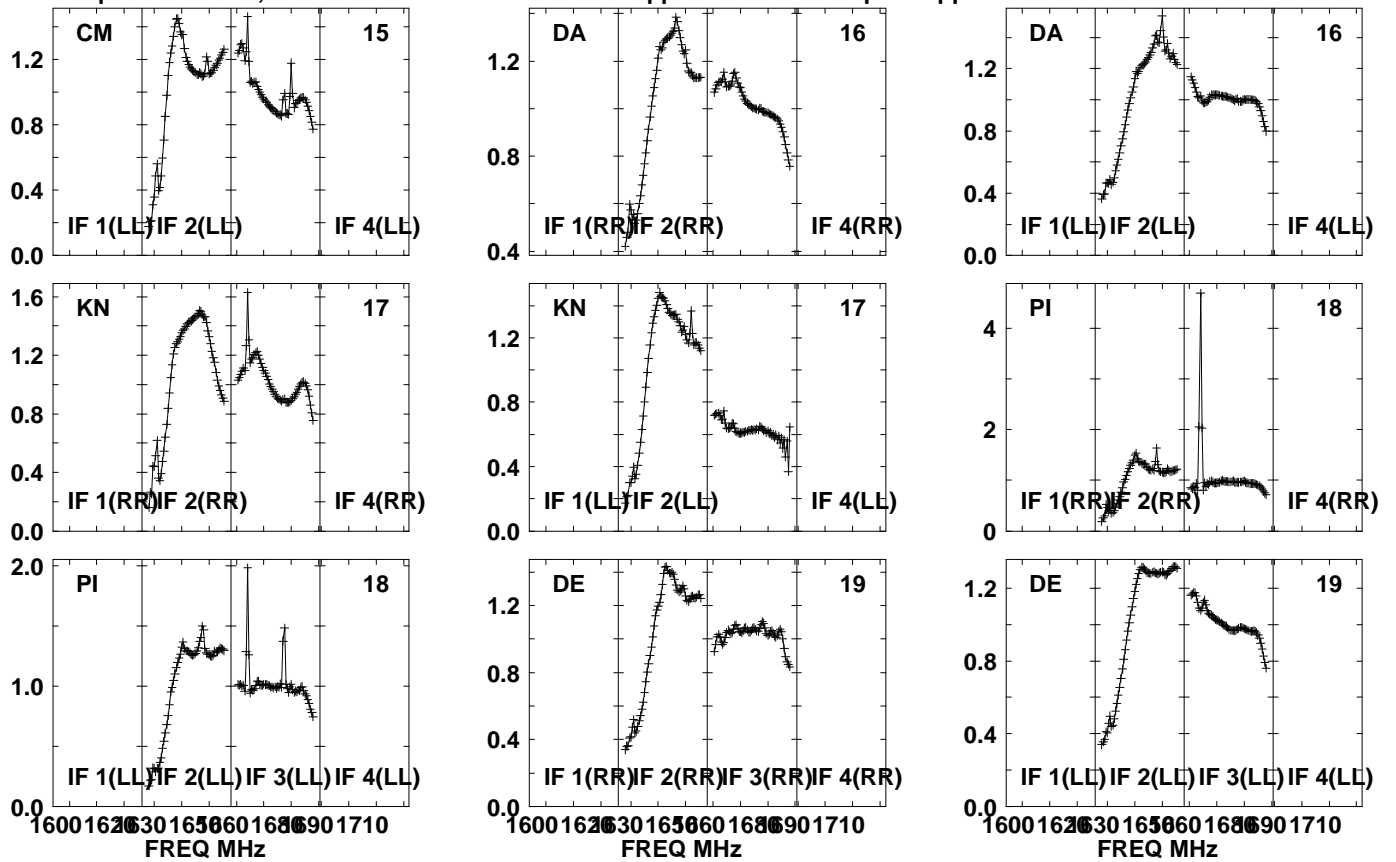

Lower frame: Real Jy  
Auto-corr total-power spectrum Antenna: \*  
Timerange: 00/14:30:31 to 00/14:31:59

Plot file version 377 created 05-OCT-2021 17:06:00

APM08279+525 GM076.UVDATA.1

Freq = 1.5945 GHz, Bw = 32.000 MH No calibration applied and no bandpass applied

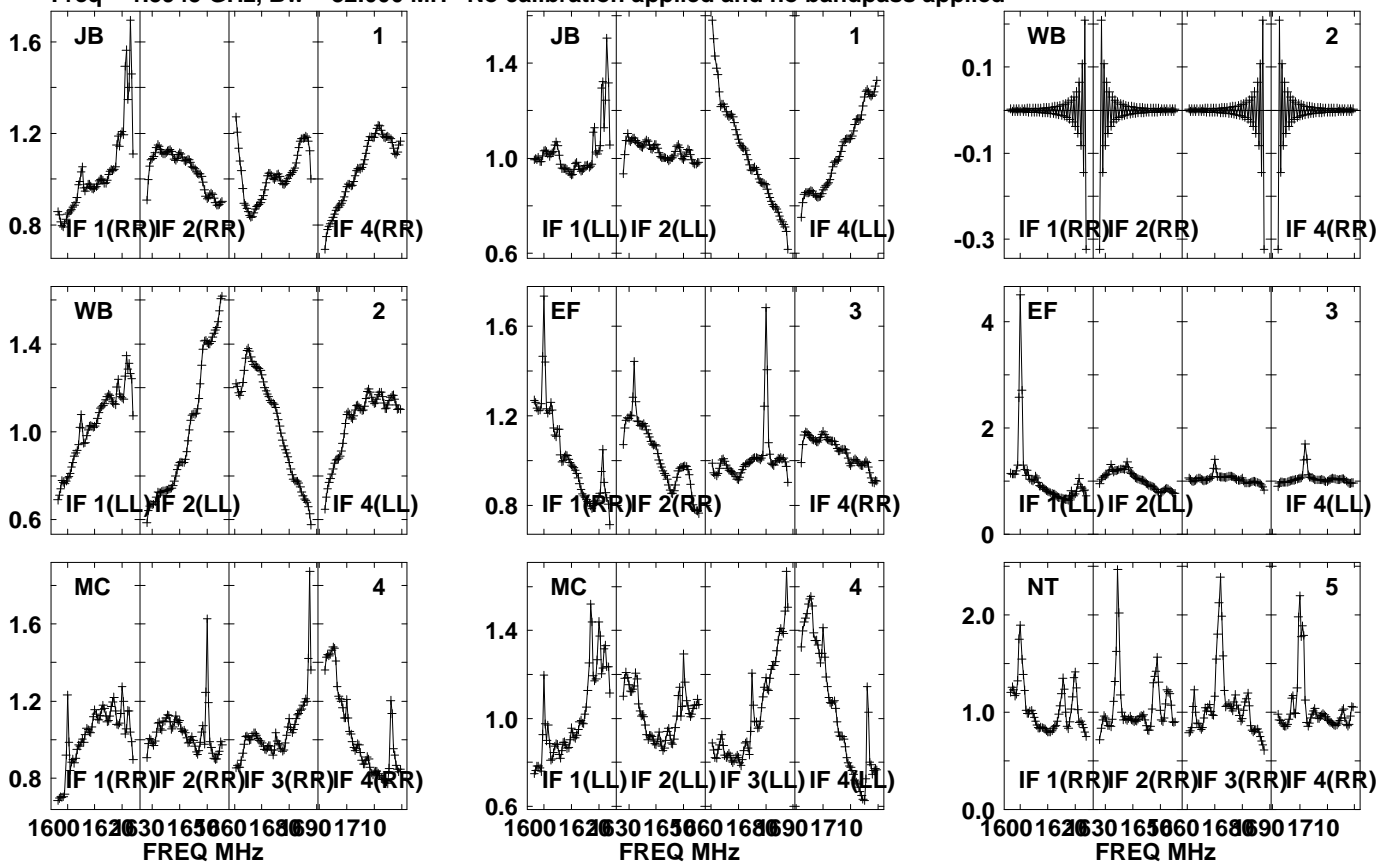

Lower frame: Real Jy  
Auto-corr total-power spectrum Antenna: \*  
Timerange: 00/14:32:01 to 00/14:35:29

Plot file version 378 created 05-OCT-2021 17:06:00

APM08279+525 GM076.UVDATA.1

Freq = 1.5945 GHz, Bw = 32.000 MH No calibration applied and no bandpass applied

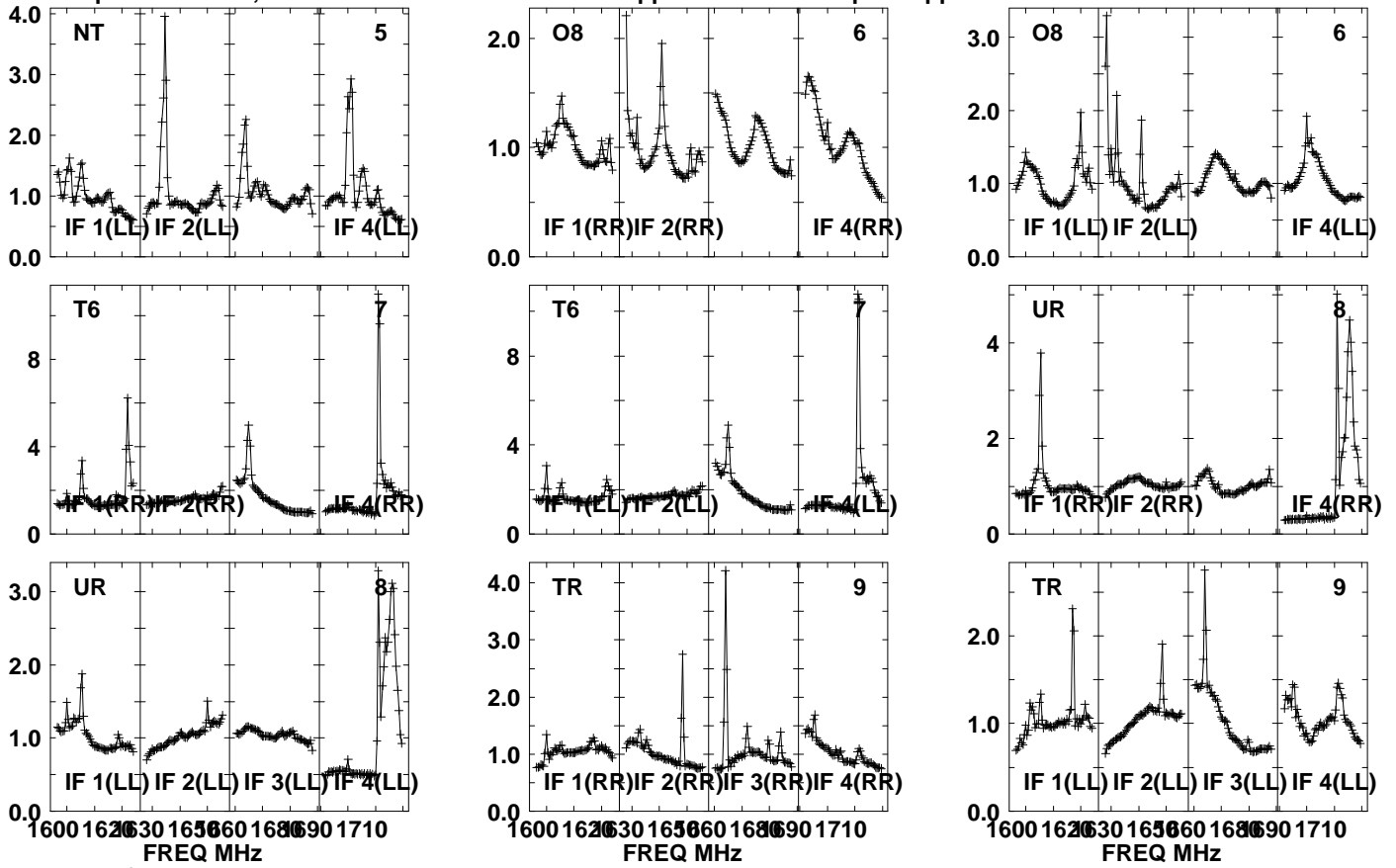

Lower frame: Real Jy

Auto-corr total-power spectrum Antenna: \*

Timerange: 00/14:32:01 to 00/14:35:29



Plot file version 379 created 05-OCT-2021 17:06:00

APM08279+525 GM076.UVDATA.1

Freq = 1.5945 GHz, Bw = 32.000 MH No calibration applied and no bandpass applied

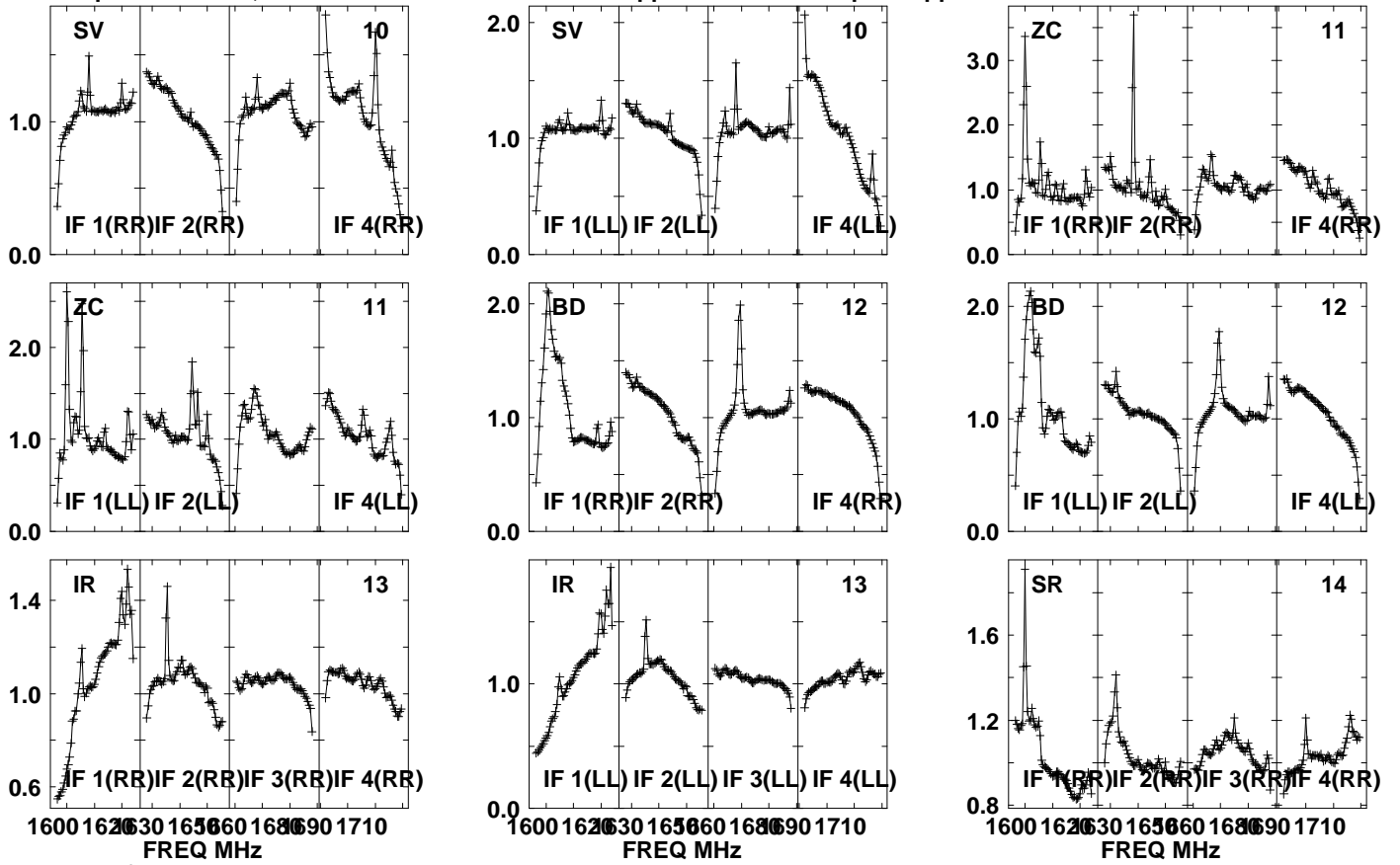

Lower frame: Real Jy

Auto-corr total-power spectrum Antenna: \*

Timerange: 00/14:32:01 to 00/14:35:29

Plot file version 380 created 05-OCT-2021 17:06:01

APM08279+525 GM076.UVDATA.1

Freq = 1.5945 GHz, Bw = 32.000 MH No calibration applied and no bandpass applied

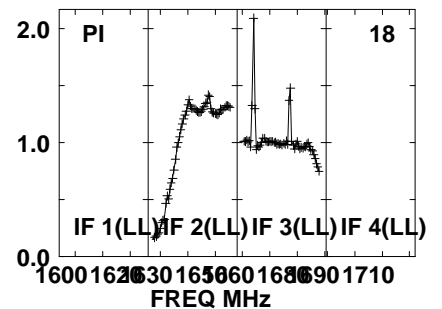
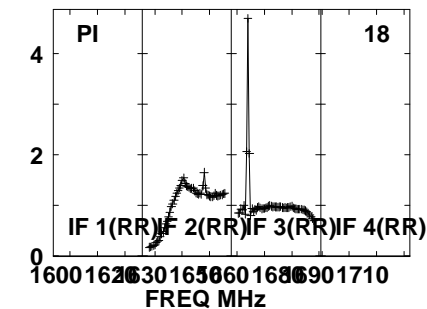
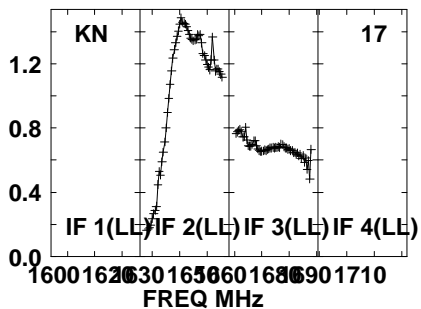
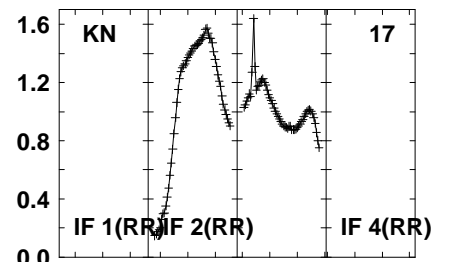
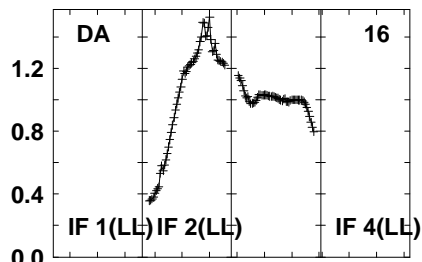
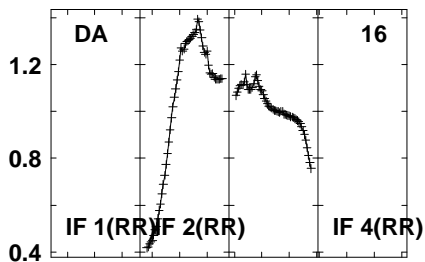
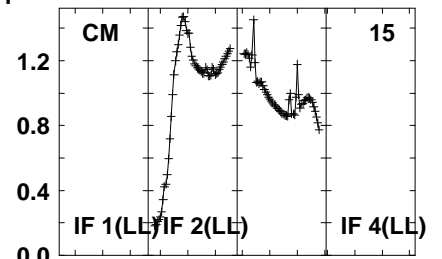
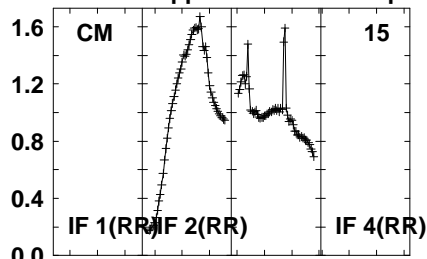
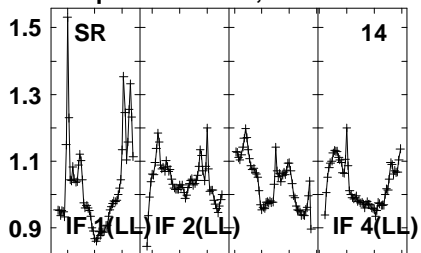

Lower frame: Real Jy  
Auto-corr total-power spectrum Antenna: \*  
Timerange: 00/14:32:01 to 00/14:35:29

Plot file version 381 created 05-OCT-2021 17:06:01

APM08279+525 GM076.UVDATA.1

Freq = 1.5945 GHz, Bw = 32.000 MH No calibration applied and no bandpass applied

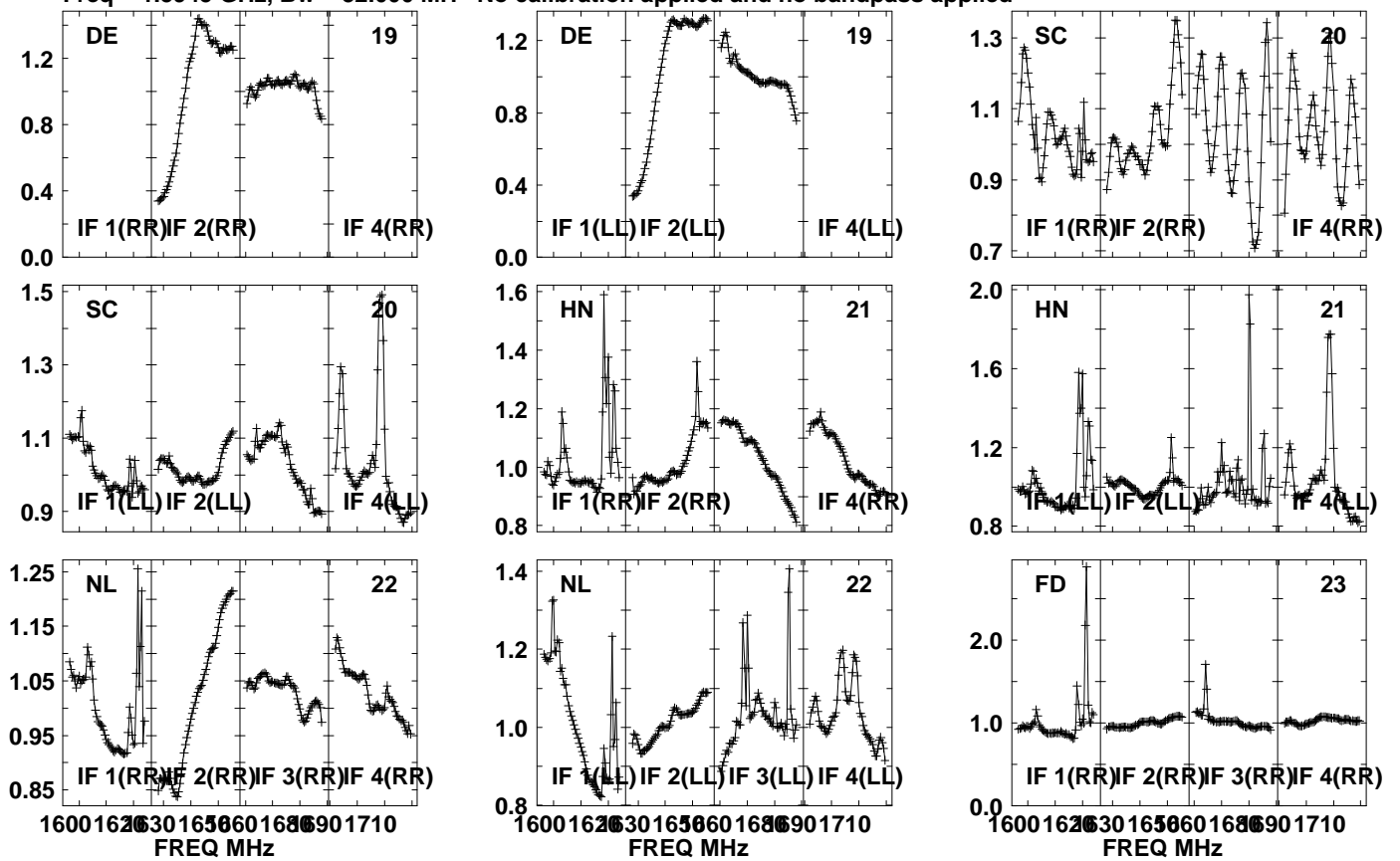

Lower frame: Real Jy  
Auto-corr total-power spectrum Antenna: \*  
Timerange: 00/14:32:01 to 00/14:35:29

Plot file version 382 created 05-OCT-2021 17:06:02

APM08279+525 GM076.UVDATA.1

Freq = 1.5945 GHz, Bw = 32.000 MH No calibration applied and no bandpass applied

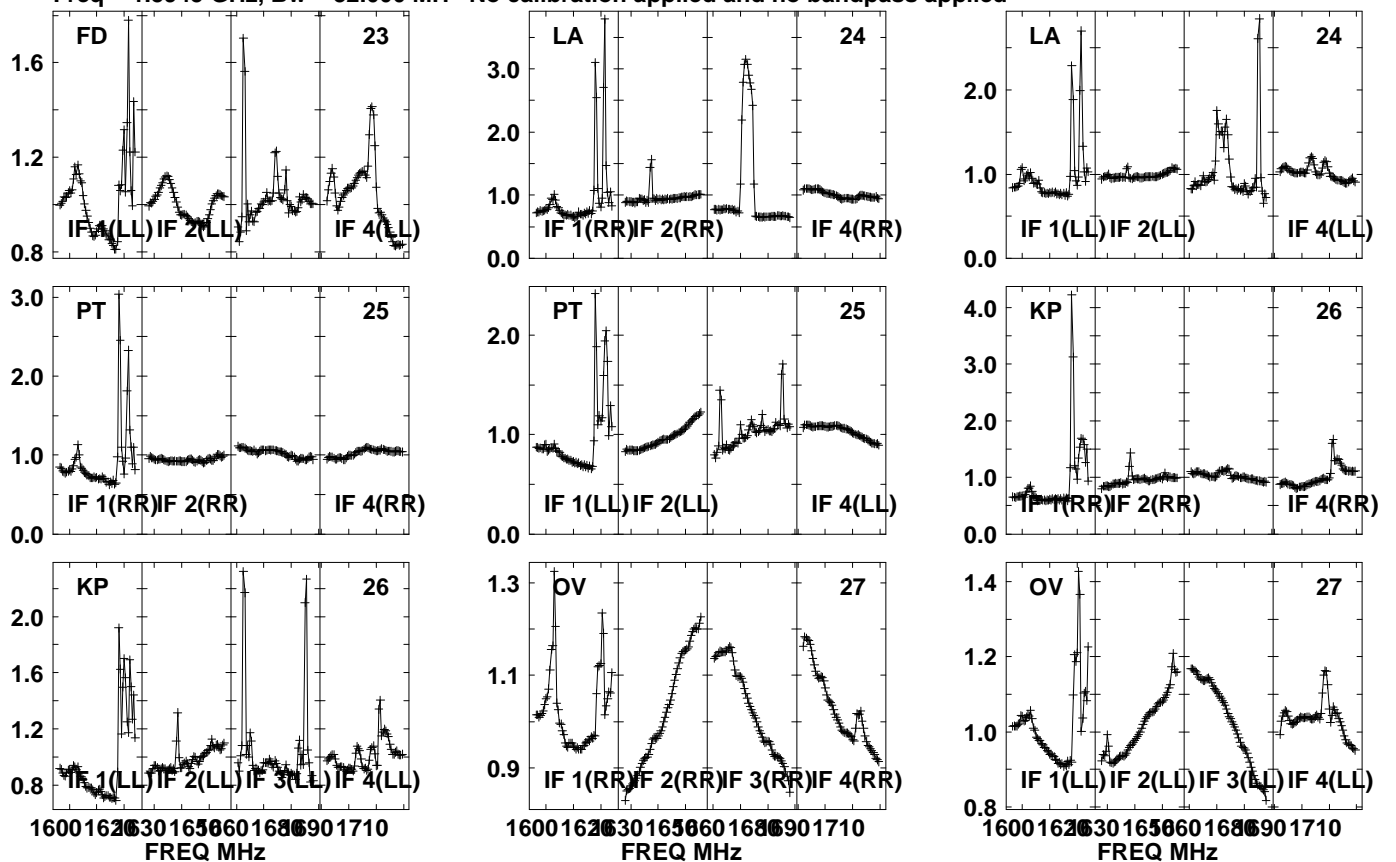

Lower frame: Real Jy  
Auto-corr total-power spectrum Antenna: \*  
Timerange: 00/14:32:01 to 00/14:35:29

Plot file version 383 created 05-OCT-2021 17:06:02

APM08279+525 GM076.UVDATA.1

Freq = 1.5945 GHz, Bw = 32.000 MH

No calibration applied and no bandpass applied

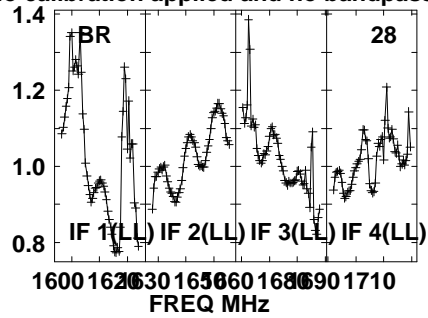
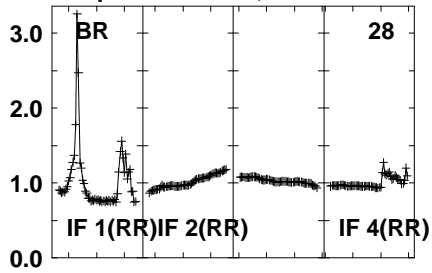

Lower frame: Real Jy

Auto-corr total-power spectrum Antenna: \*

Timerange: 00/14:32:01 to 00/14:35:29

Plot file version 384 created 05-OCT-2021 17:06:02

J0827+5217 GM076.UVDATA.1

Freq = 1.5945 GHz, Bw = 32.000 MH No calibration applied and no bandpass applied

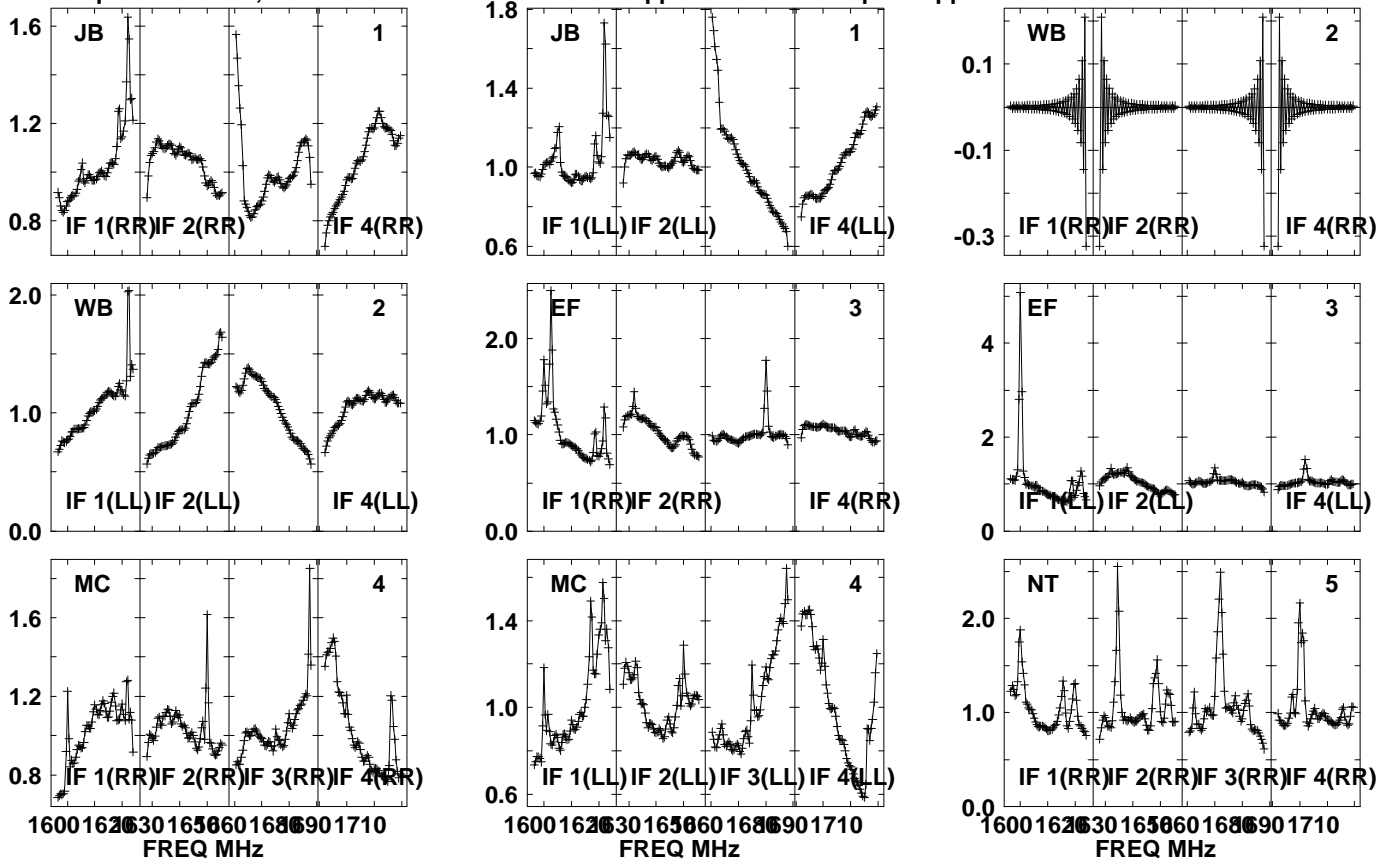

Lower frame: Real Jy  
Auto-corr total-power spectrum Antenna: \*  
Timerange: 00/14:36:01 to 00/14:37:29

Plot file version 385 created 05-OCT-2021 17:06:03

J0827+5217 GM076.UVDATA.1

Freq = 1.5945 GHz, Bw = 32.000 MH No calibration applied and no bandpass applied

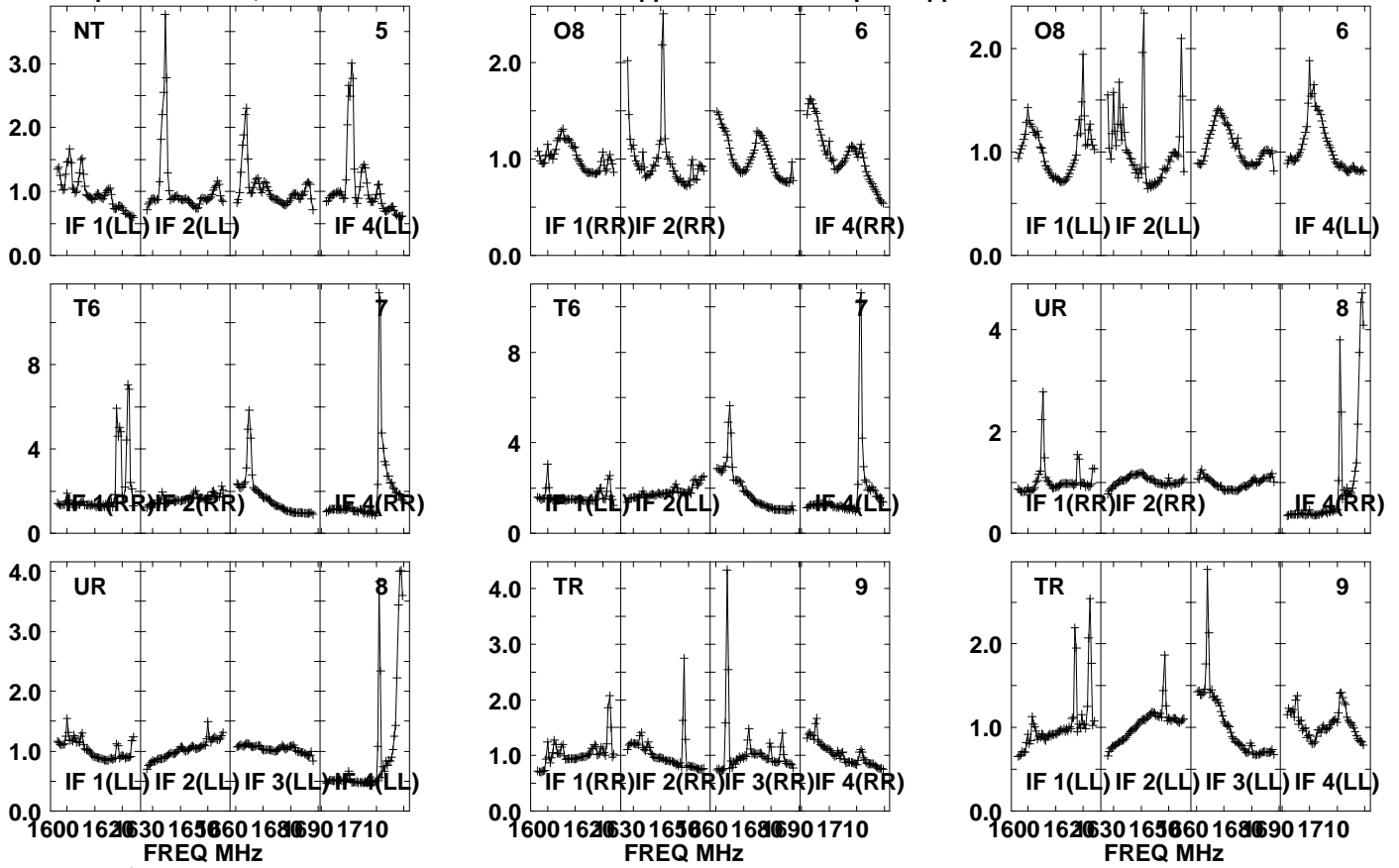

Lower frame: Real Jy  
Auto-corr total-power spectrum Antenna: \*  
Timerange: 00/14:36:01 to 00/14:37:29

Plot file version 386 created 05-OCT-2021 17:06:03

J0827+5217 GM076.UVDATA.1

Freq = 1.5945 GHz, Bw = 32.000 MH No calibration applied and no bandpass applied

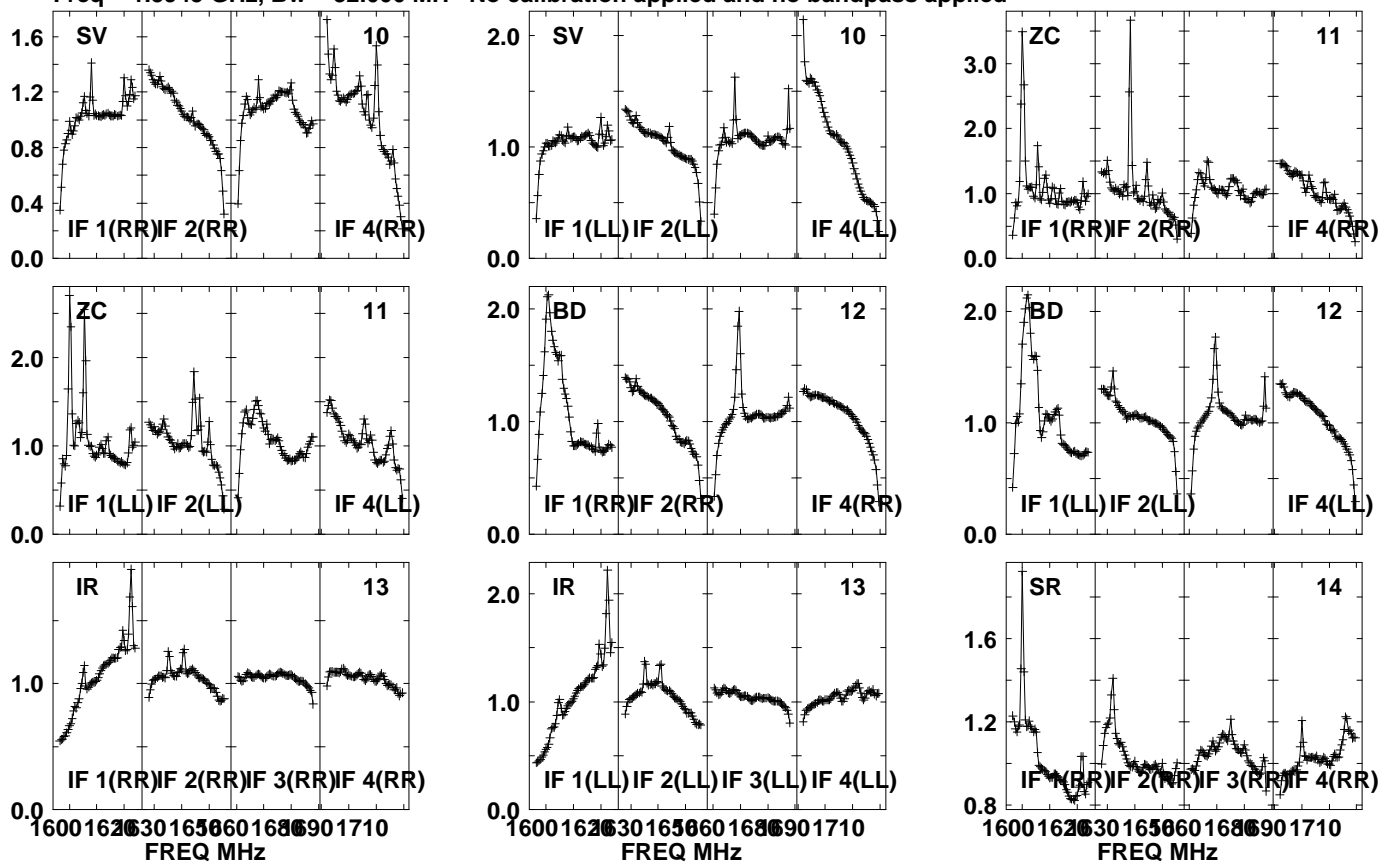

Lower frame: Real Jy  
Auto-corr total-power spectrum Antenna: \*  
Timerange: 00/14:36:01 to 00/14:37:29



Plot file version 387 created 05-OCT-2021 17:06:03

J0827+5217 GM076.UVDATA.1

Freq = 1.5945 GHz, Bw = 32.000 MH No calibration applied and no bandpass applied

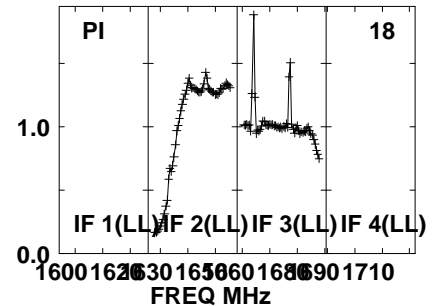
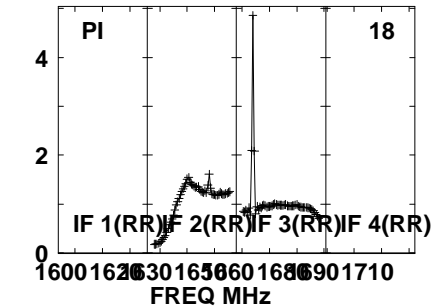
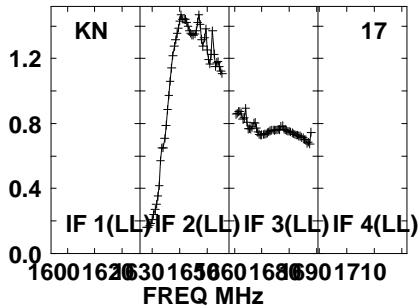
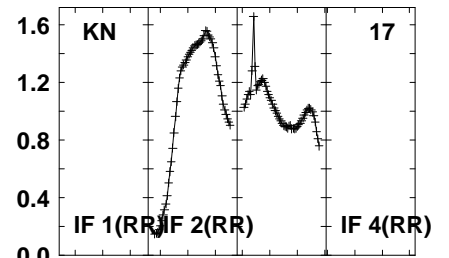
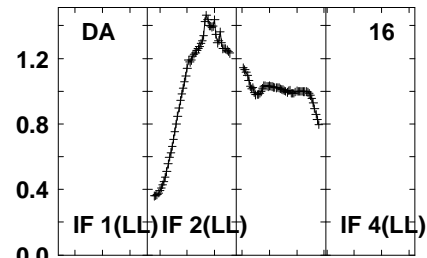
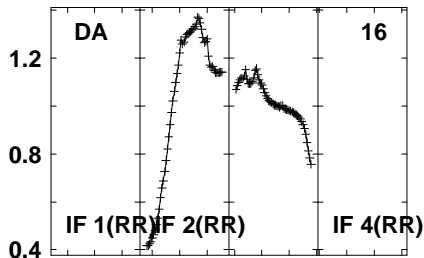
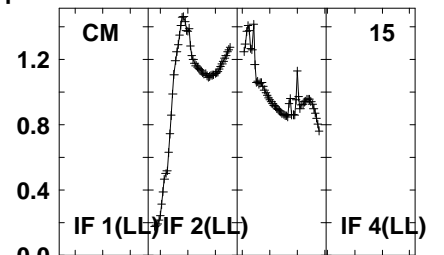
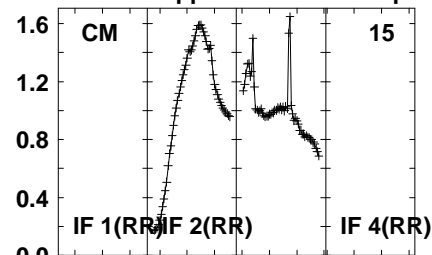
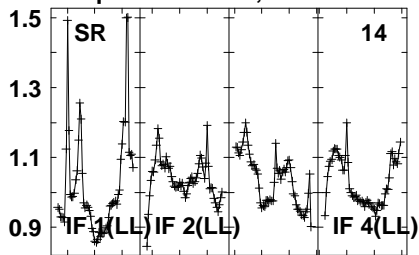

Lower frame: Real Jy  
Auto-corr total-power spectrum Antenna: \*  
Timerange: 00/14:36:01 to 00/14:37:29

Plot file version 388 created 05-OCT-2021 17:06:04

J0827+5217 GM076.UVDATA.1

Freq = 1.5945 GHz, Bw = 32.000 MH No calibration applied and no bandpass applied

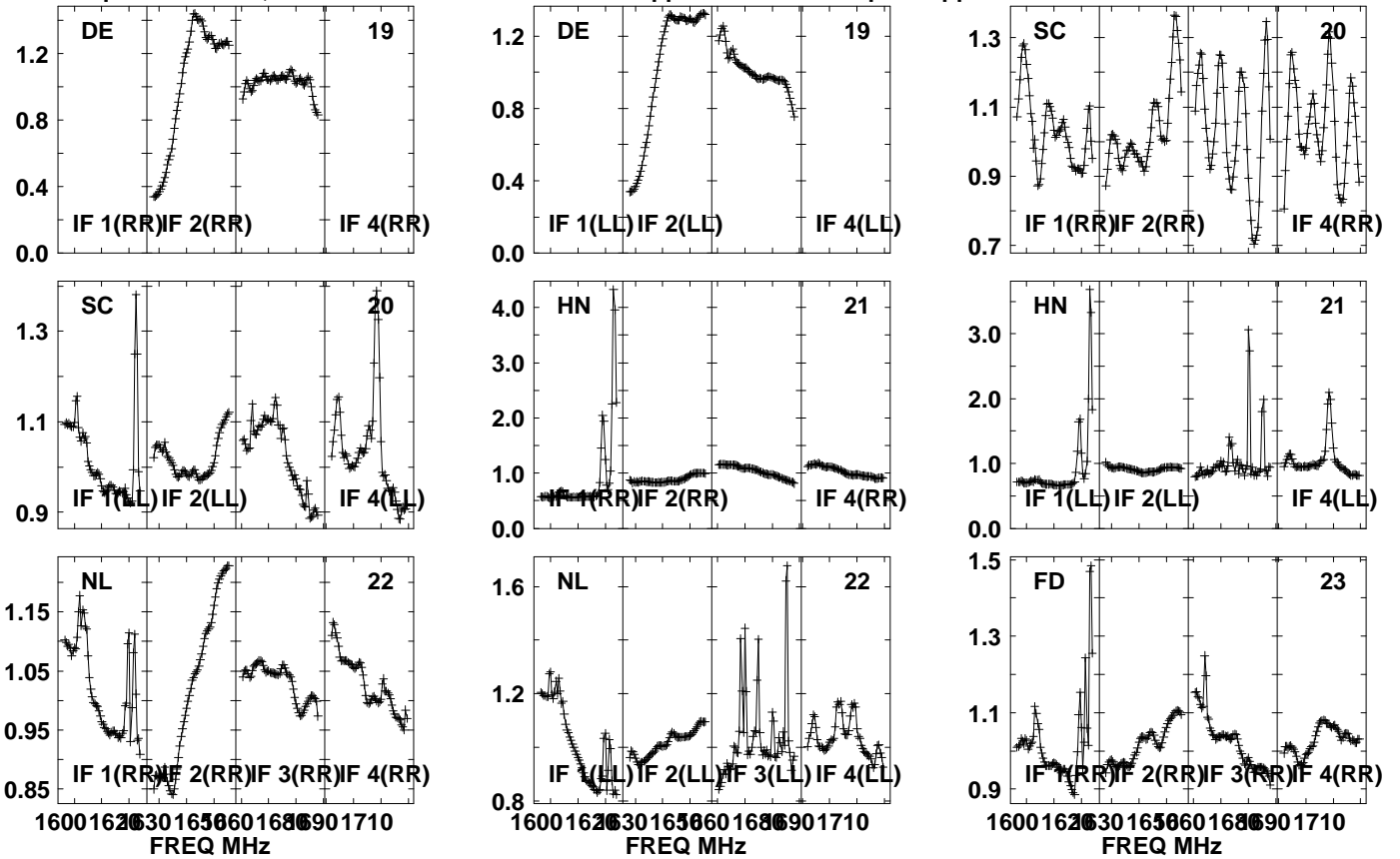

Lower frame: Real Jy  
Auto-corr total-power spectrum Antenna: \*  
Timerange: 00/14:36:01 to 00/14:37:29

Plot file version 389 created 05-OCT-2021 17:06:04

J0827+5217 GM076.UVDATA.1

Freq = 1.5945 GHz, Bw = 32.000 MH No calibration applied and no bandpass applied

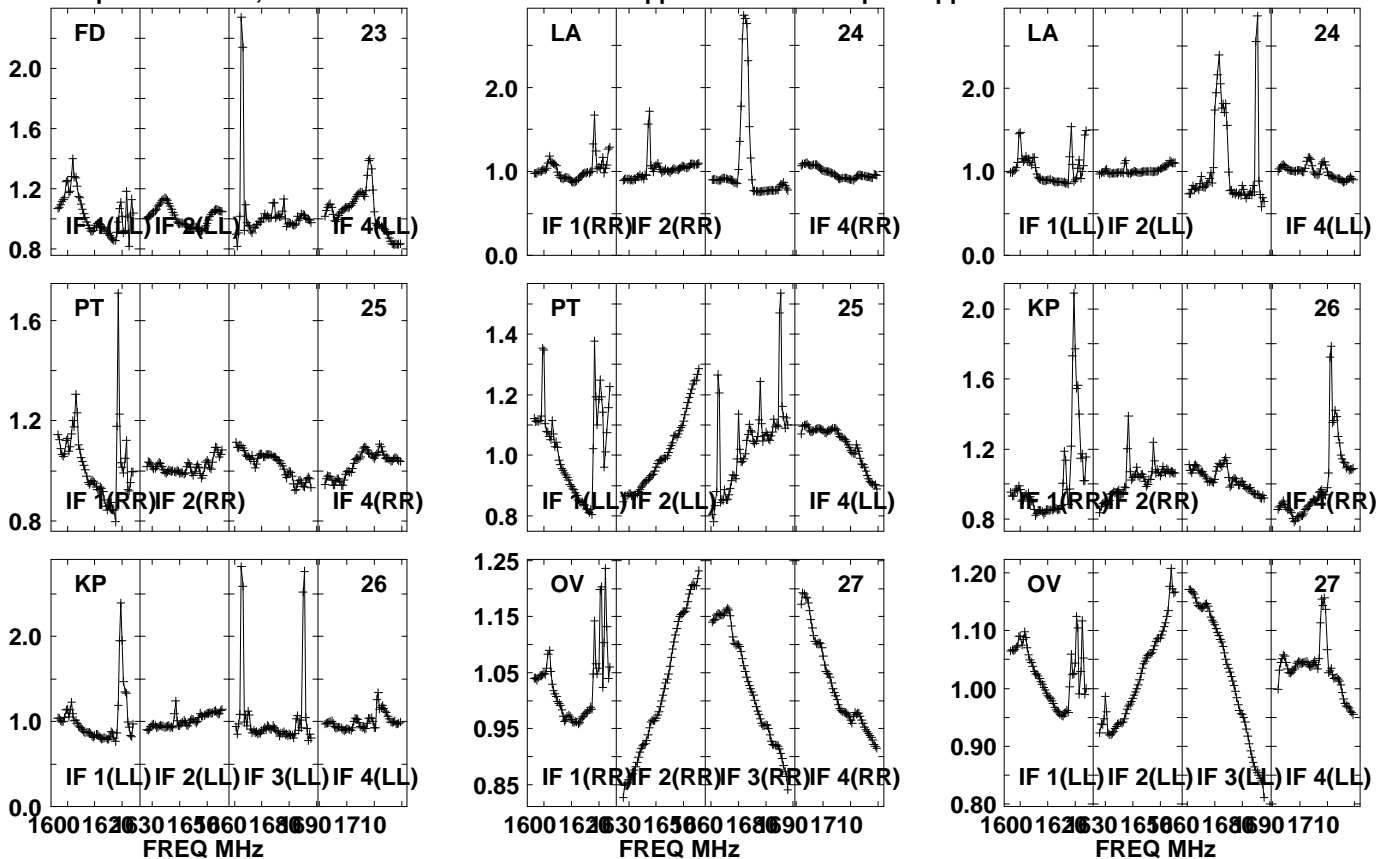

Lower frame: Real Jy  
Auto-corr total-power spectrum Antenna: \*  
Timerange: 00/14:36:01 to 00/14:37:29

Plot file version 390 created 05-OCT-2021 17:06:05

J0827+5217 GM076.UVDATA.1

Freq = 1.5945 GHz, Bw = 32.000 MH No calibration applied and no bandpass applied

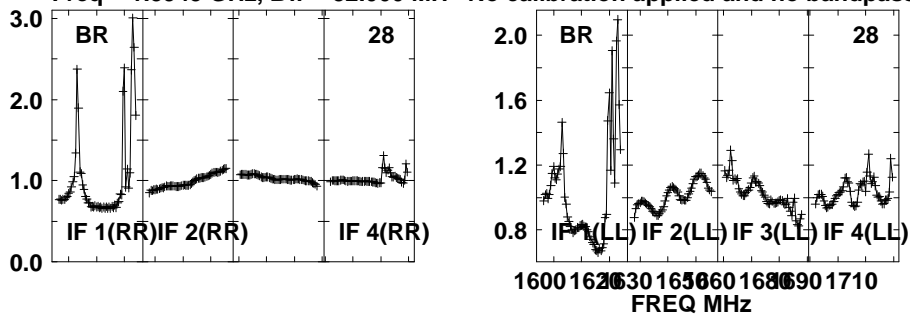

Lower frame: Real Jy

Auto-corr total-power spectrum Antenna: \*

Timerange: 00/14:36:01 to 00/14:37:29

Plot file version 391 created 05-OCT-2021 17:06:05

APM08279+525 GM076.UVDATA.1

Freq = 1.5945 GHz, Bw = 32.000 MH No calibration applied and no bandpass applied

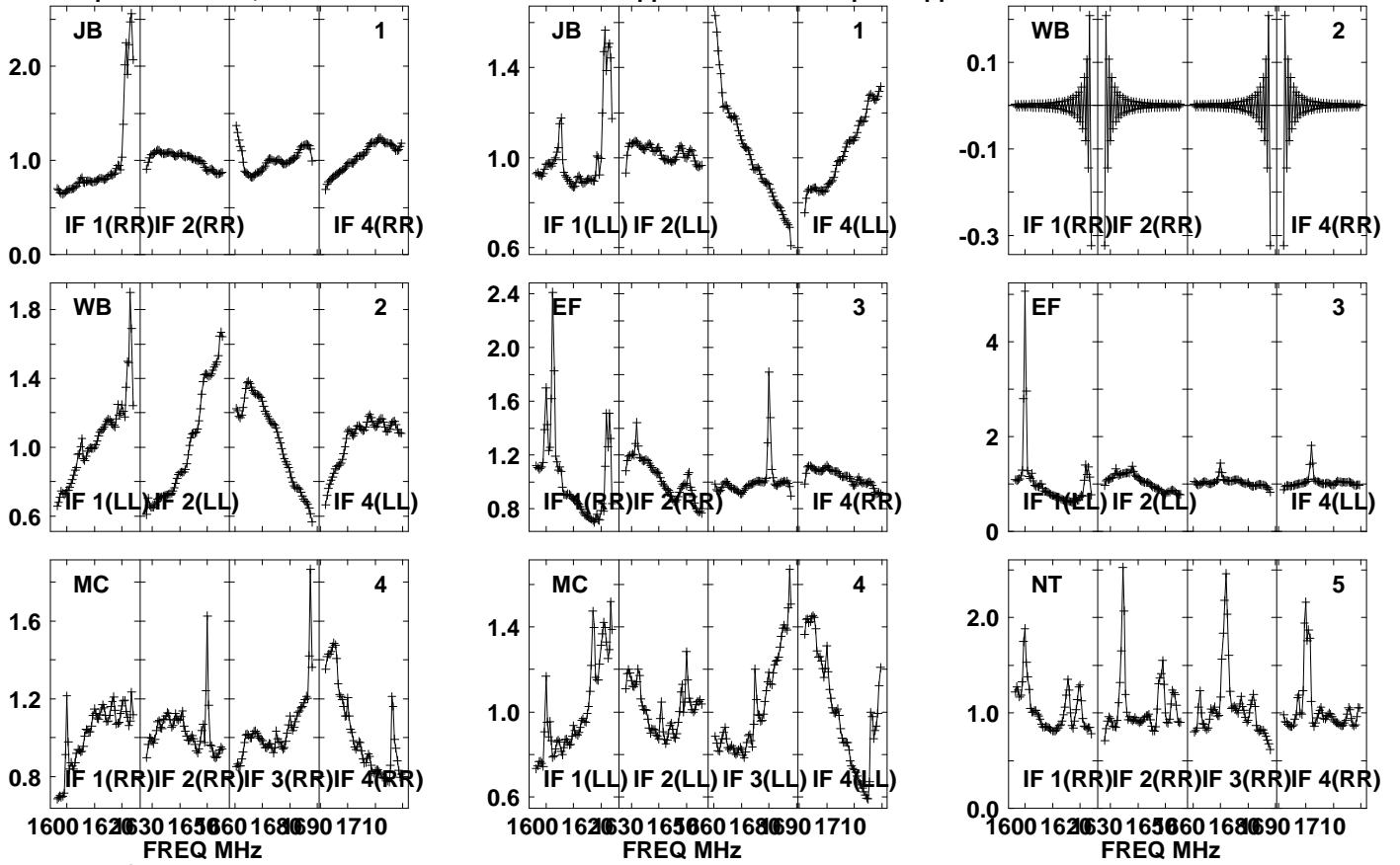

Lower frame: Real Jy

Auto-corr total-power spectrum Antenna: \*

Timerange: 00/14:37:31 to 00/14:40:59

Plot file version 392 created 05-OCT-2021 17:06:05

APM08279+525 GM076.UVDATA.1

Freq = 1.5945 GHz, Bw = 32.000 MH No calibration applied and no bandpass applied

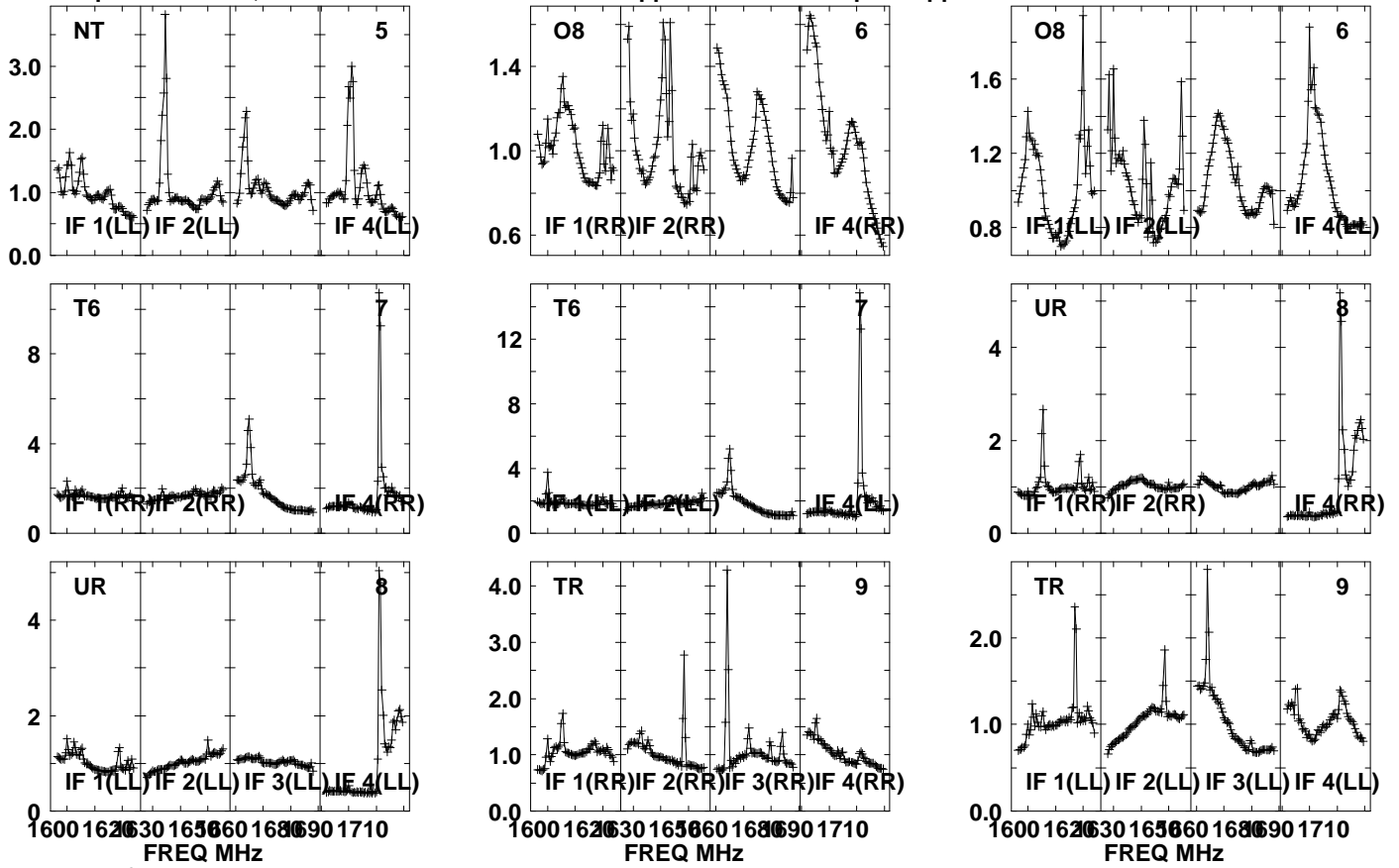

Lower frame: Real Jy

Auto-corr total-power spectrum Antenna: \*

Timerange: 00/14:37:31 to 00/14:40:59

Plot file version 393 created 05-OCT-2021 17:06:05

APM08279+525 GM076.UVDATA.1

Freq = 1.5945 GHz, Bw = 32.000 MH No calibration applied and no bandpass applied

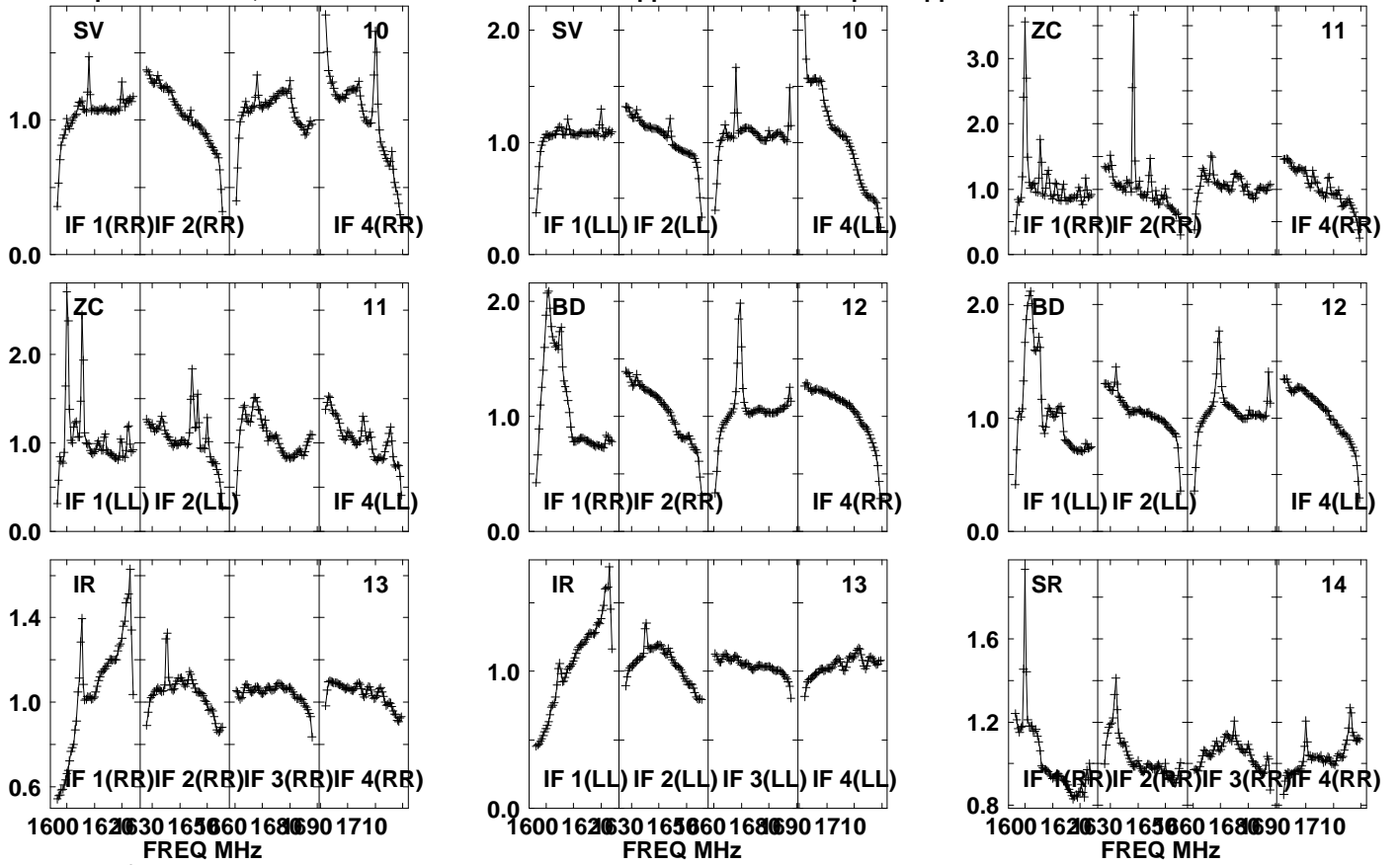

Lower frame: Real Jy  
Auto-corr total-power spectrum Antenna: \*  
Timerange: 00/14:37:31 to 00/14:40:59

Plot file version 394 created 05-OCT-2021 17:06:06

APM08279+525 GM076.UVDATA.1

Freq = 1.5945 GHz, Bw = 32.000 MH No calibration applied and no bandpass applied

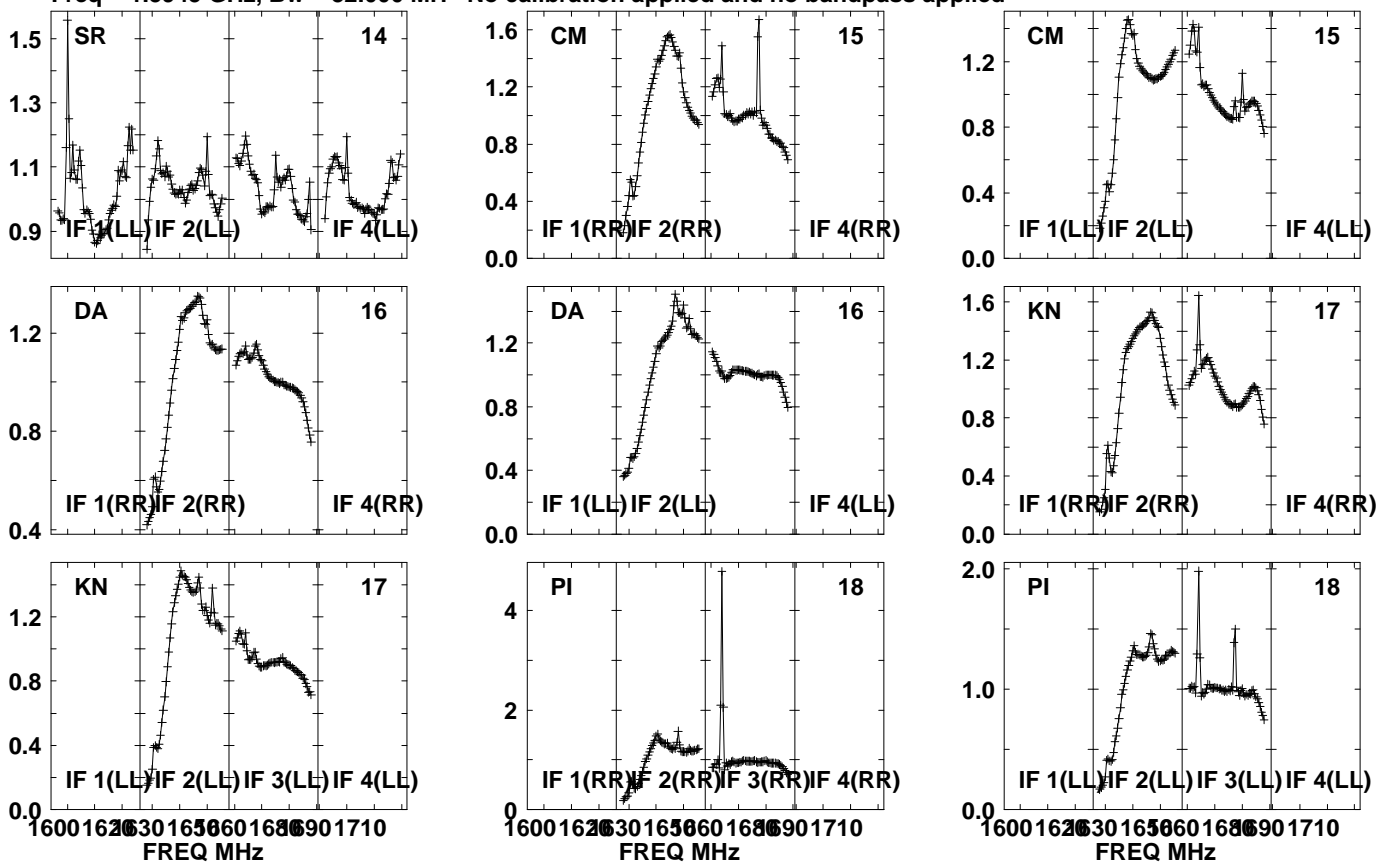

Lower frame: Real Jy  
Auto-corr total-power spectrum Antenna: \*  
Timerange: 00/14:37:31 to 00/14:40:59



Plot file version 395 created 05-OCT-2021 17:06:06

APM08279+525 GM076.UVDATA.1

Freq = 1.5945 GHz, Bw = 32.000 MH No calibration applied and no bandpass applied

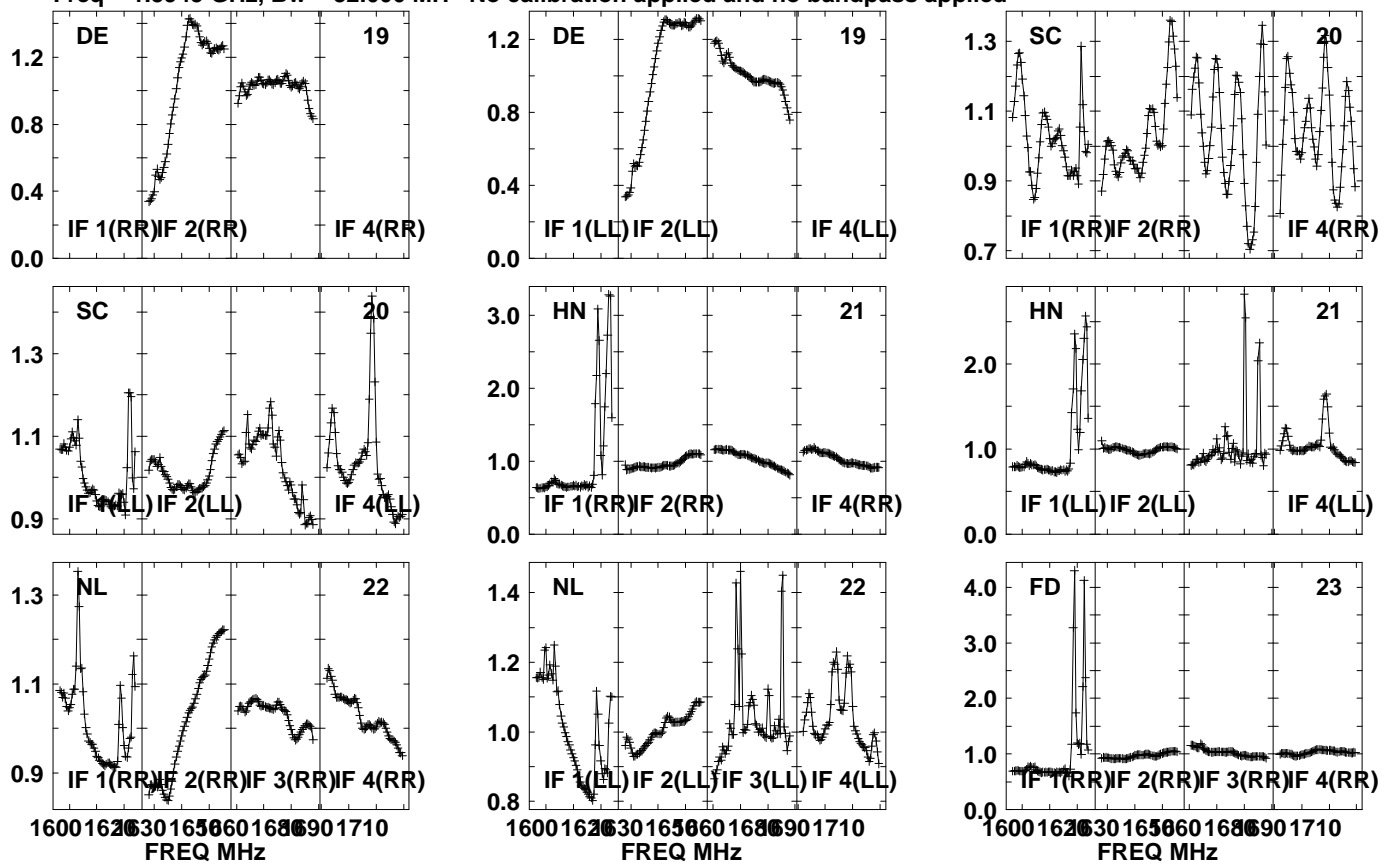

Lower frame: Real Jy  
Auto-corr total-power spectrum Antenna: \*  
Timerange: 00/14:37:31 to 00/14:40:59

Plot file version 396 created 05-OCT-2021 17:06:06

APM08279+525 GM076.UVDATA.1

Freq = 1.5945 GHz, Bw = 32.000 MH No calibration applied and no bandpass applied

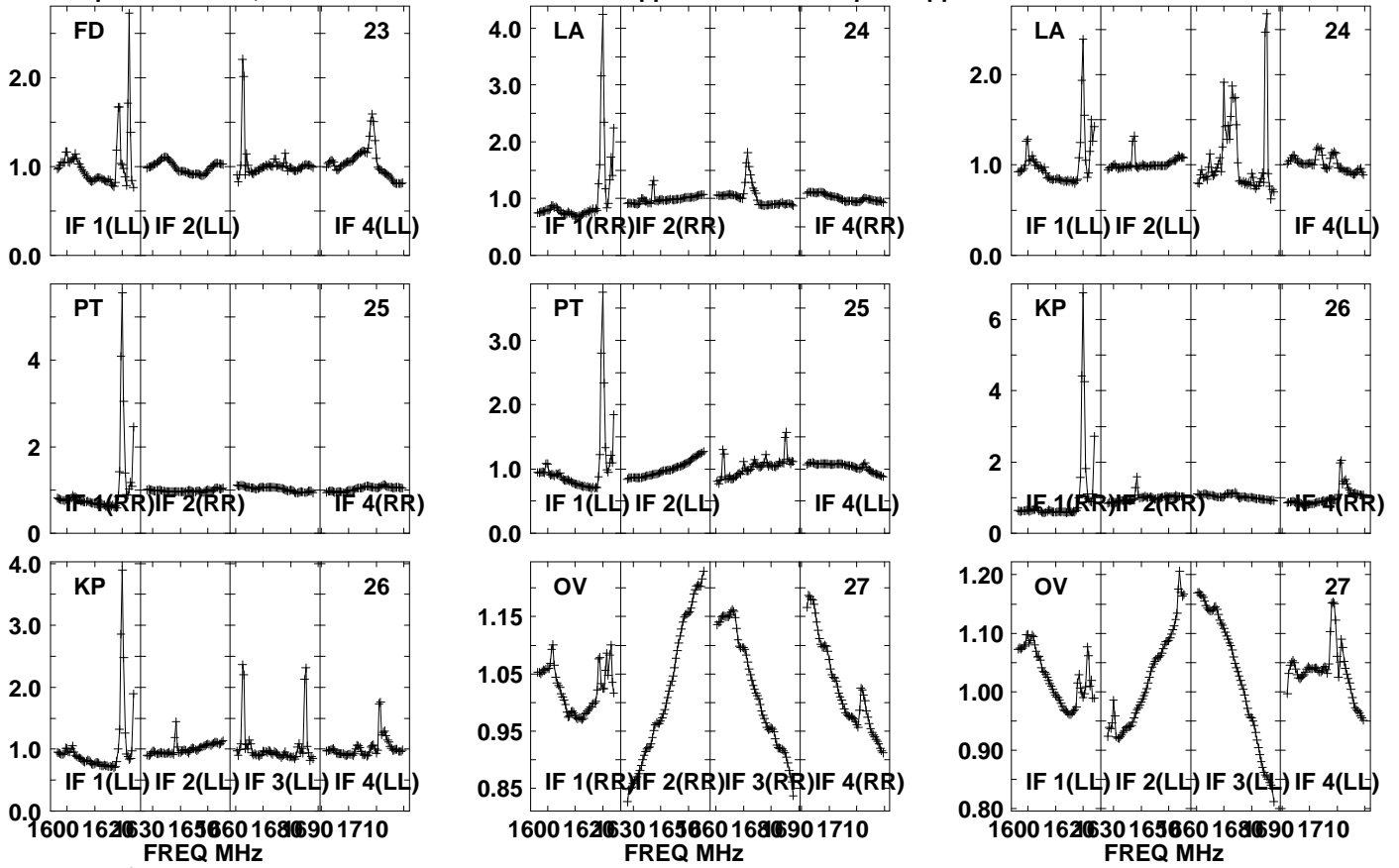

Lower frame: Real Jy  
Auto-corr total-power spectrum Antenna: \*  
Timerange: 00/14:37:31 to 00/14:40:59

Plot file version 397 created 05-OCT-2021 17:06:07

APM08279+525 GM076.UVDATA.1

Freq = 1.5945 GHz, Bw = 32.000 MH No calibration applied and no bandpass applied

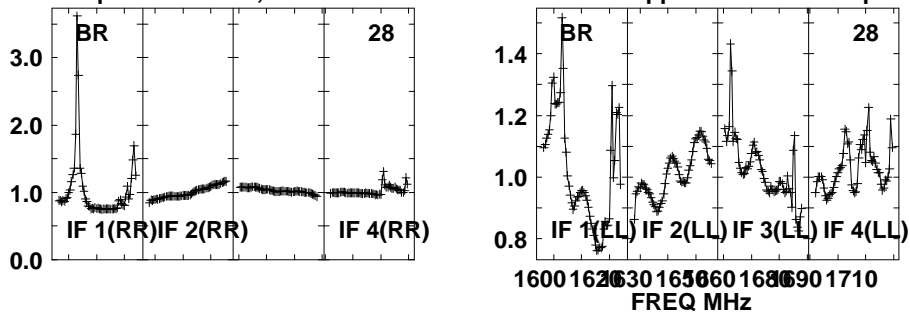

Lower frame: Real Jy

Auto-corr total-power spectrum Antenna: \*

Timerange: 00/14:37:31 to 00/14:40:59

Plot file version 398 created 05-OCT-2021 17:06:07

J0827+5217 GM076.UVDATA.1

Freq = 1.5945 GHz, Bw = 32.000 MH No calibration applied and no bandpass applied

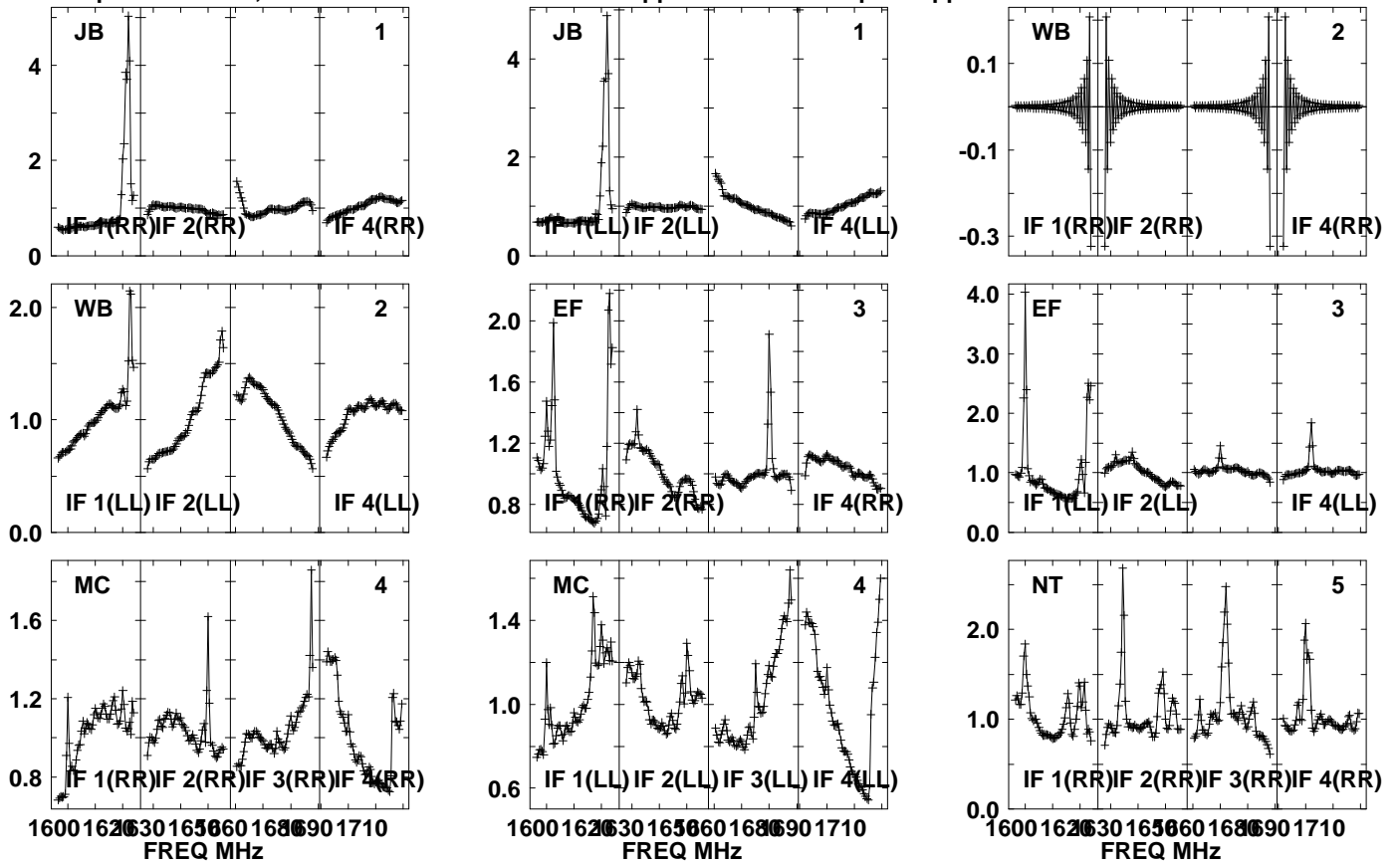

Lower frame: Real Jy  
Auto-corr total-power spectrum Antenna: \*  
Timerange: 00/14:41:01 to 00/14:42:29

Plot file version 399 created 05-OCT-2021 17:06:07

J0827+5217 GM076.UVDATA.1

Freq = 1.5945 GHz, Bw = 32.000 MH No calibration applied and no bandpass applied

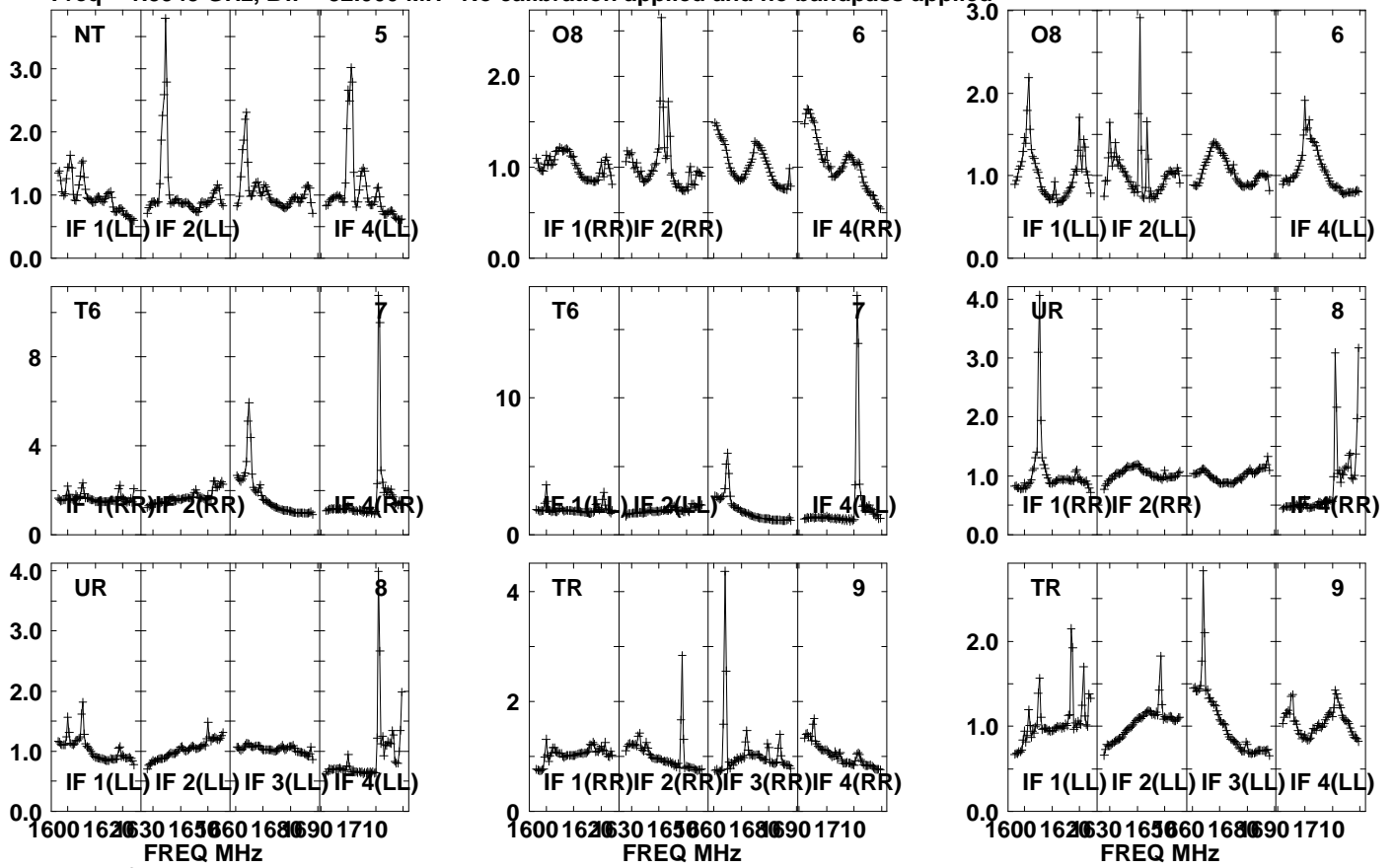

Lower frame: Real Jy  
Auto-corr total-power spectrum Antenna: \*  
Timerange: 00/14:41:01 to 00/14:42:29

Plot file version 400 created 05-OCT-2021 17:06:08

J0827+5217 GM076.UVDATA.1

Freq = 1.5945 GHz, Bw = 32.000 MH No calibration applied and no bandpass applied

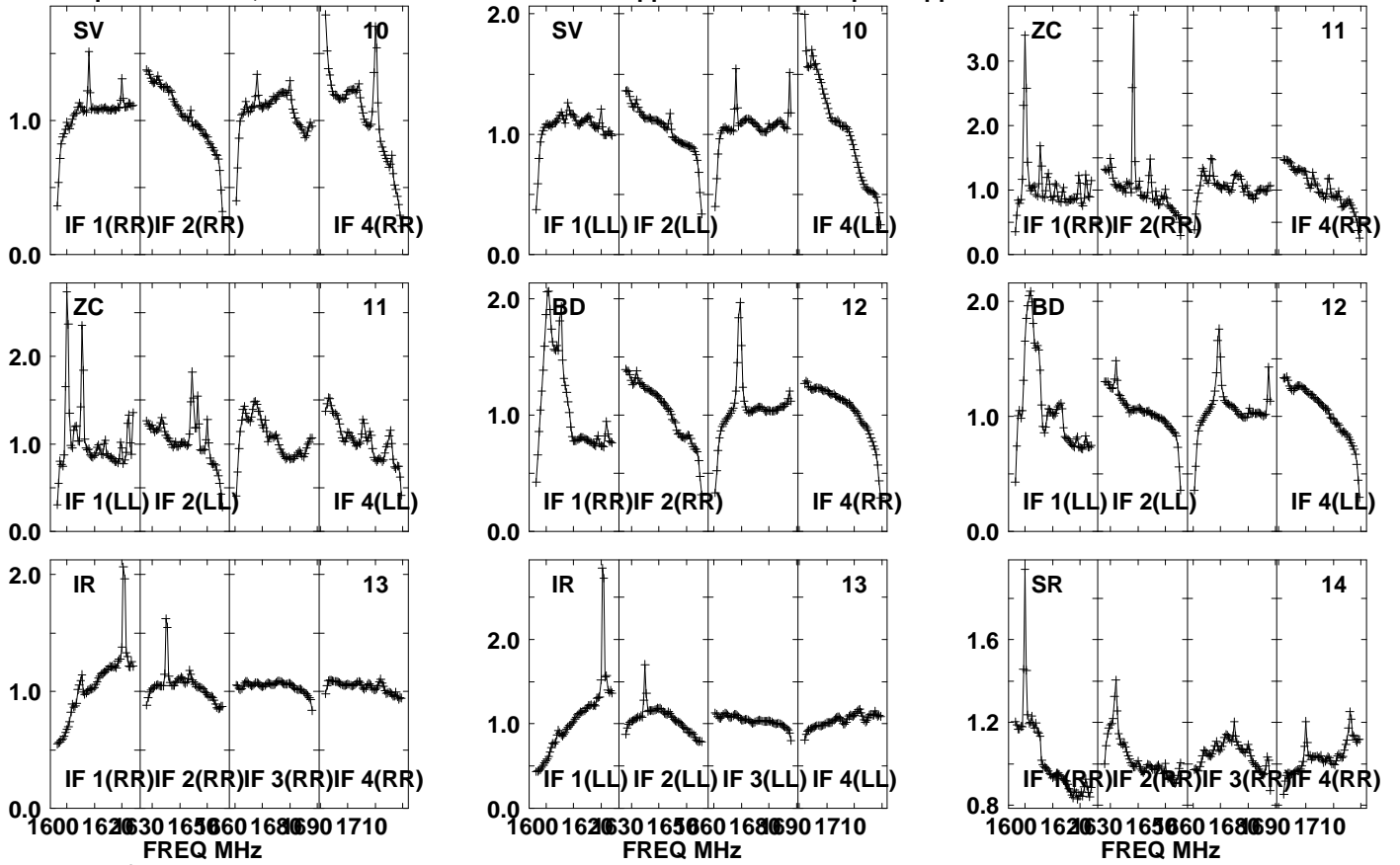

Lower frame: Real Jy  
Auto-corr total-power spectrum Antenna: \*  
Timerange: 00/14:41:01 to 00/14:42:29

Plot file version 401 created 05-OCT-2021 17:06:08

J0827+5217 GM076.UVDATA.1

Freq = 1.5945 GHz, Bw = 32.000 MH No calibration applied and no bandpass applied

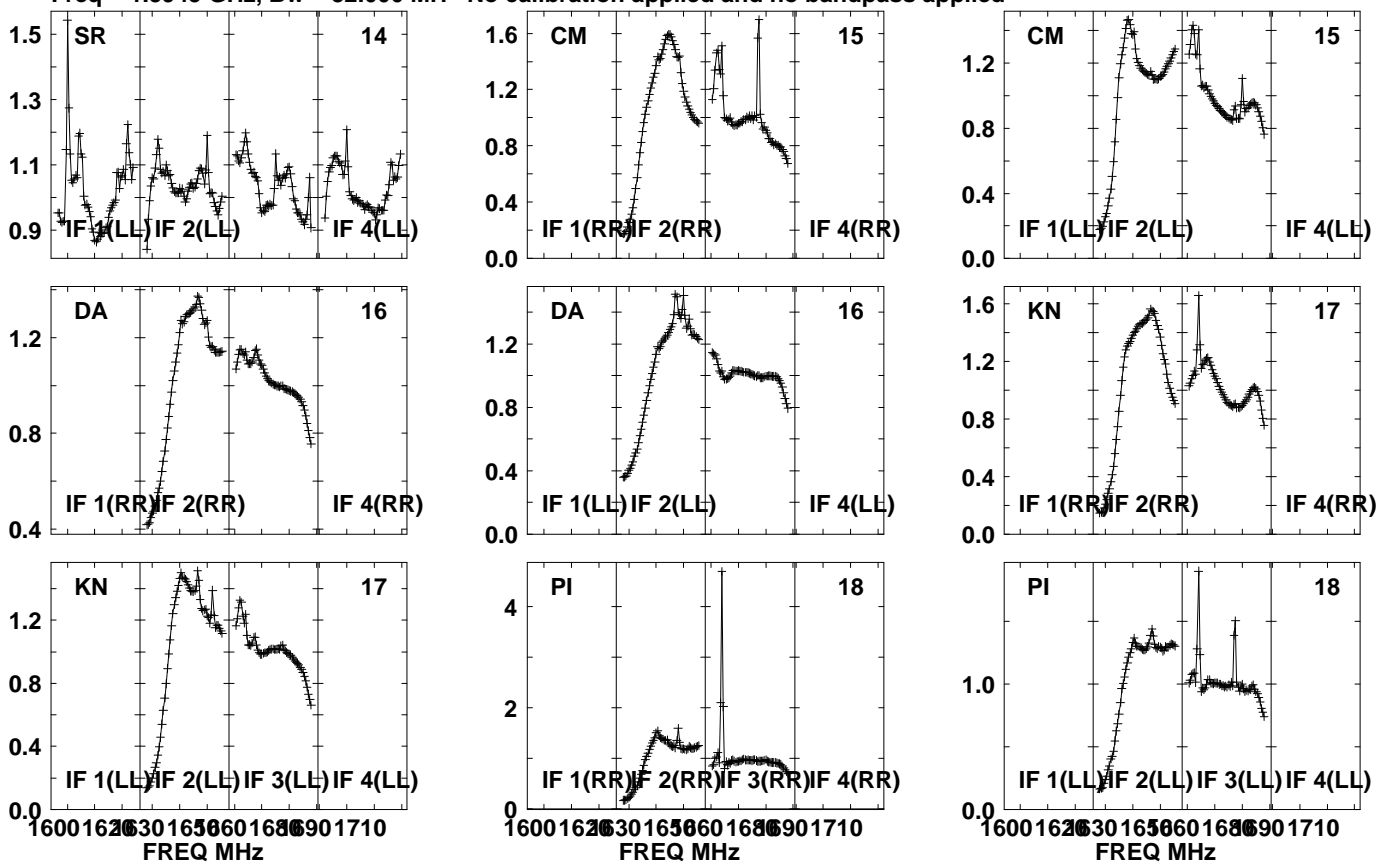

Lower frame: Real Jy  
Auto-corr total-power spectrum Antenna: \*  
Timerange: 00/14:41:01 to 00/14:42:29

Plot file version 402 created 05-OCT-2021 17:06:09

J0827+5217 GM076.UVDATA.1

Freq = 1.5945 GHz, Bw = 32.000 MH No calibration applied and no bandpass applied

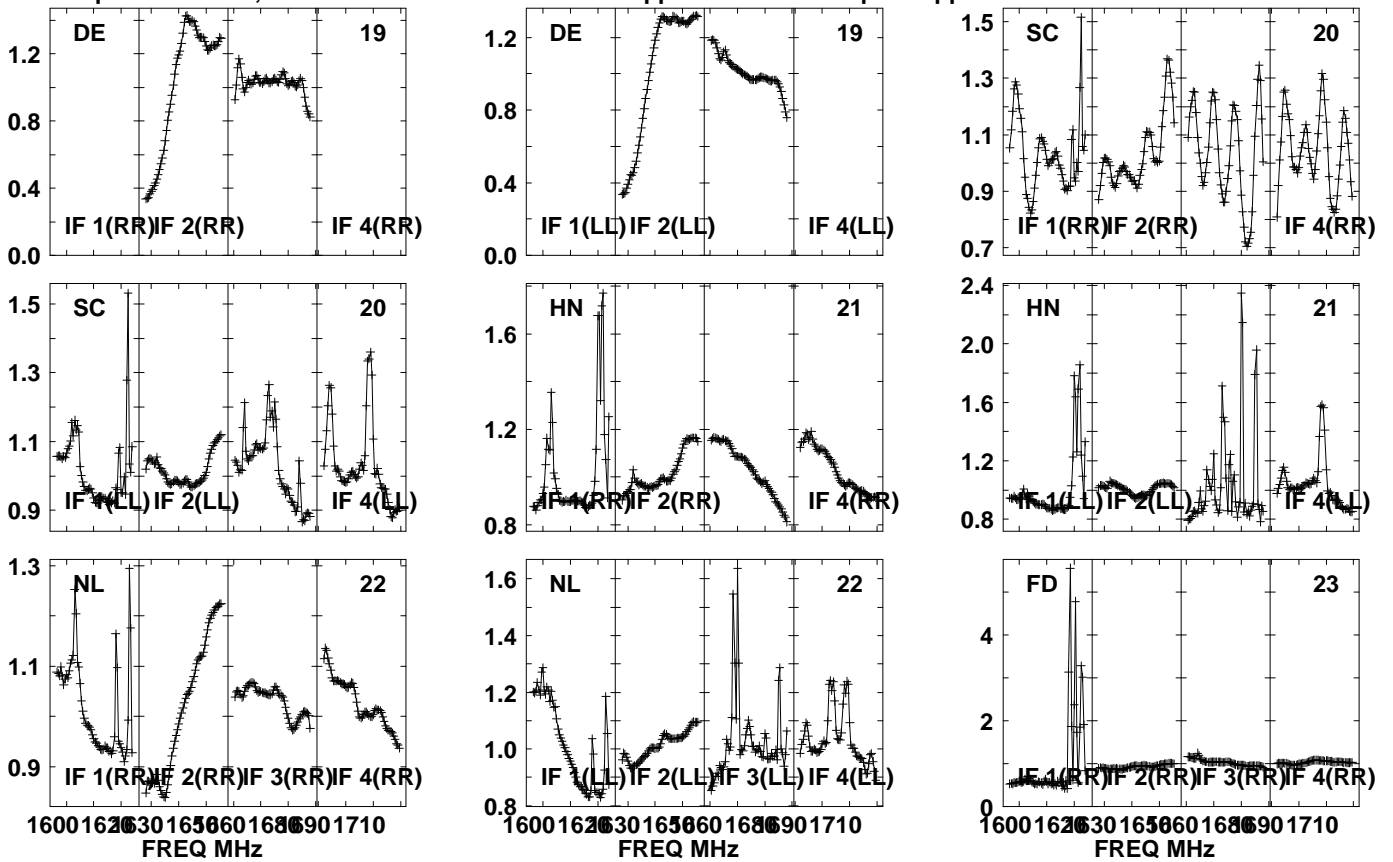

Lower frame: Real Jy  
Auto-corr total-power spectrum Antenna: \*  
Timerange: 00/14:41:01 to 00/14:42:29



Plot file version 403 created 05-OCT-2021 17:06:09

J0827+5217 GM076.UVDATA.1

Freq = 1.5945 GHz, Bw = 32.000 MH No calibration applied and no bandpass applied

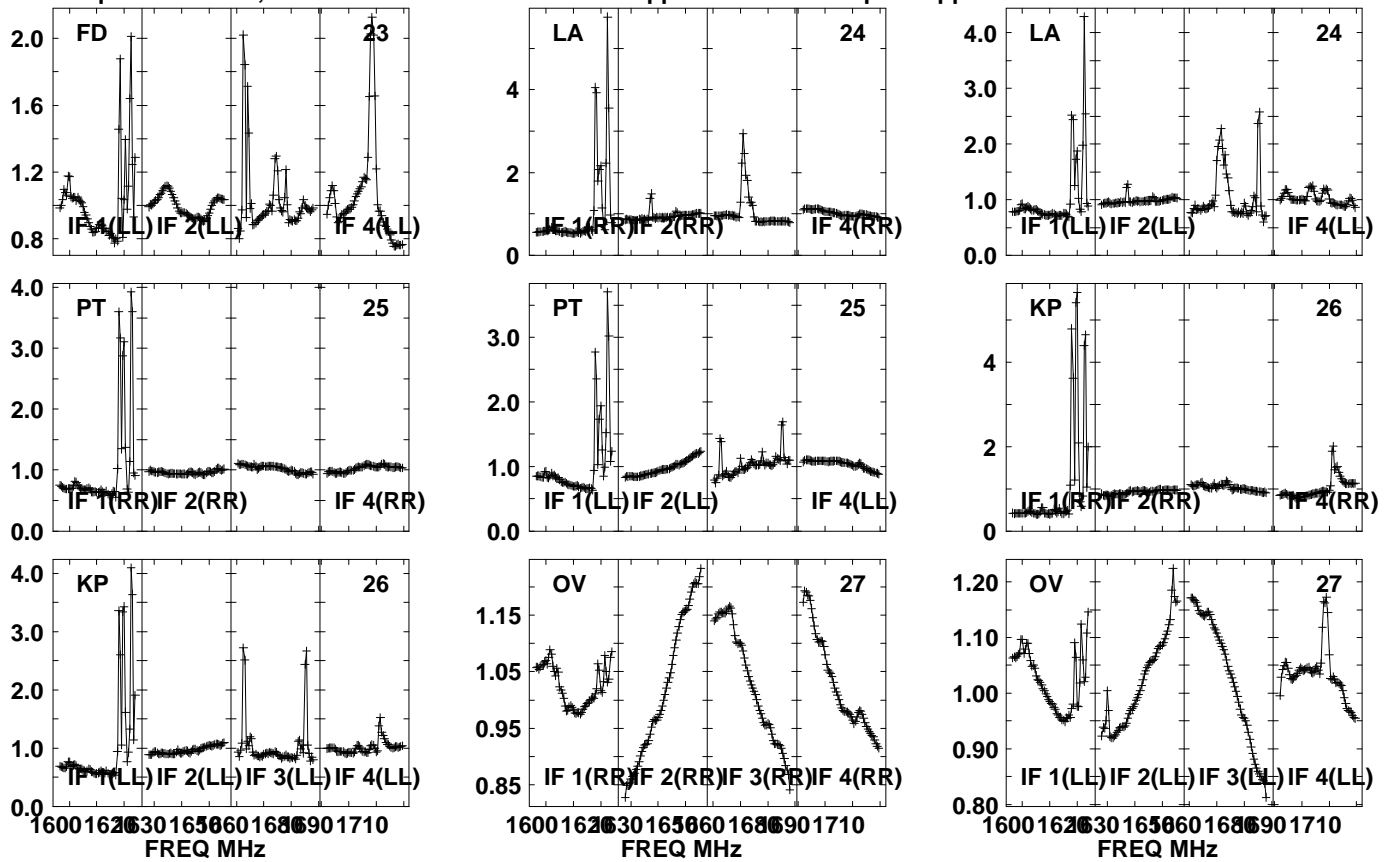

Lower frame: Real Jy  
Auto-corr total-power spectrum Antenna: \*  
Timerange: 00/14:41:01 to 00/14:42:29

Plot file version 404 created 05-OCT-2021 17:06:09

J0827+5217 GM076.UVDATA.1

Freq = 1.5945 GHz, Bw = 32.000 MH

No calibration applied and no bandpass applied

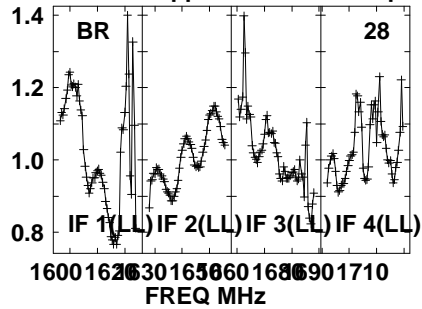
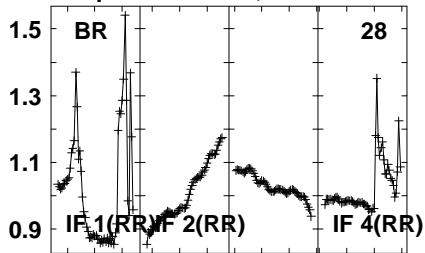

Lower frame: Real Jy  
Auto-corr total-power spectrum Antenna: \*  
Timerange: 00/14:41:01 to 00/14:42:29

Plot file version 405 created 05-OCT-2021 17:06:09

APM08279+525 GM076.UVDATA.1

Freq = 1.5945 GHz, Bw = 32.000 MH No calibration applied and no bandpass applied

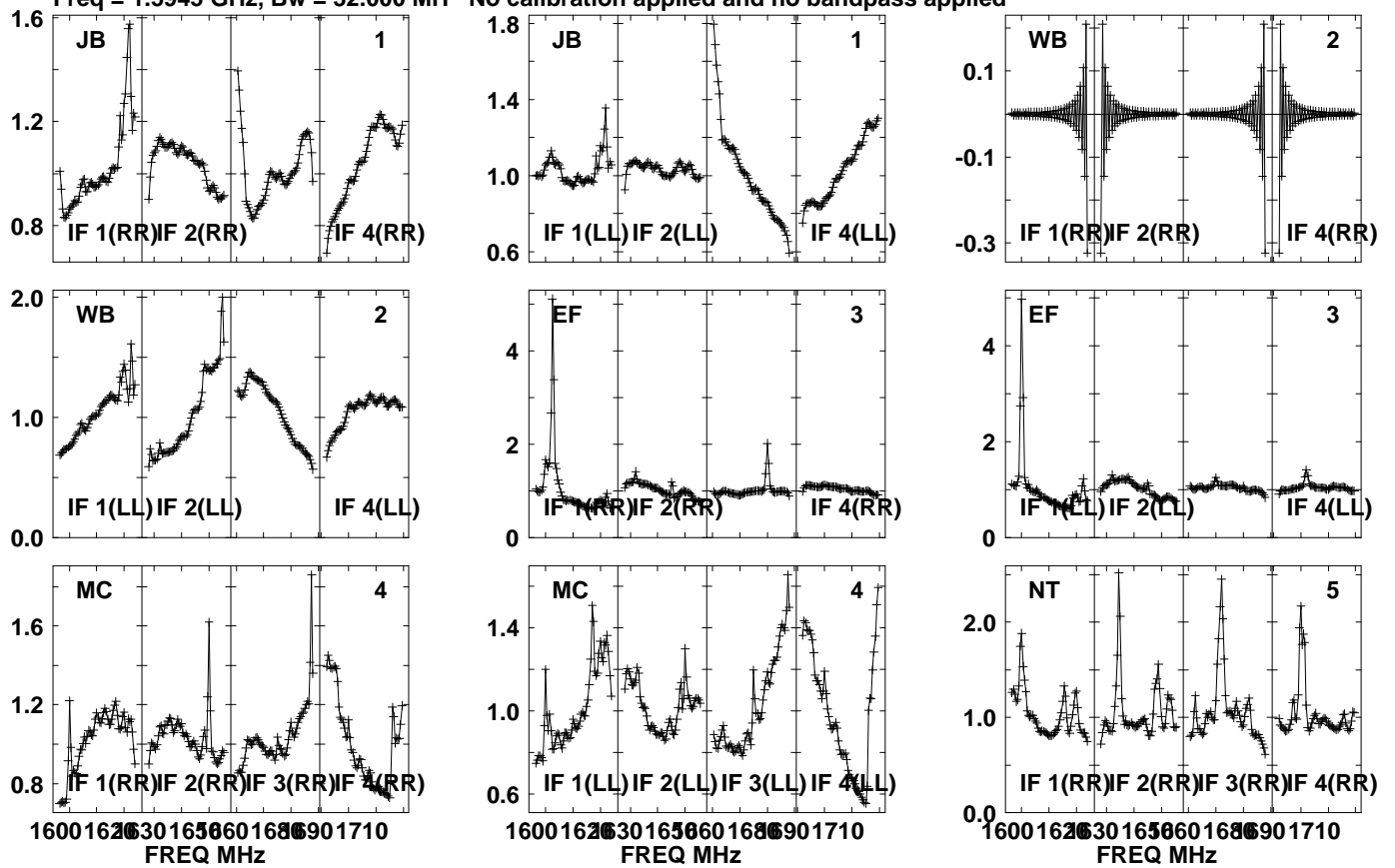

Lower frame: Real Jy  
Auto-corr total-power spectrum Antenna: \*  
Timerange: 00/14:42:31 to 00/14:45:59

Plot file version 406 created 05-OCT-2021 17:06:10

APM08279+525 GM076.UVDATA.1

Freq = 1.5945 GHz, Bw = 32.000 MH No calibration applied and no bandpass applied

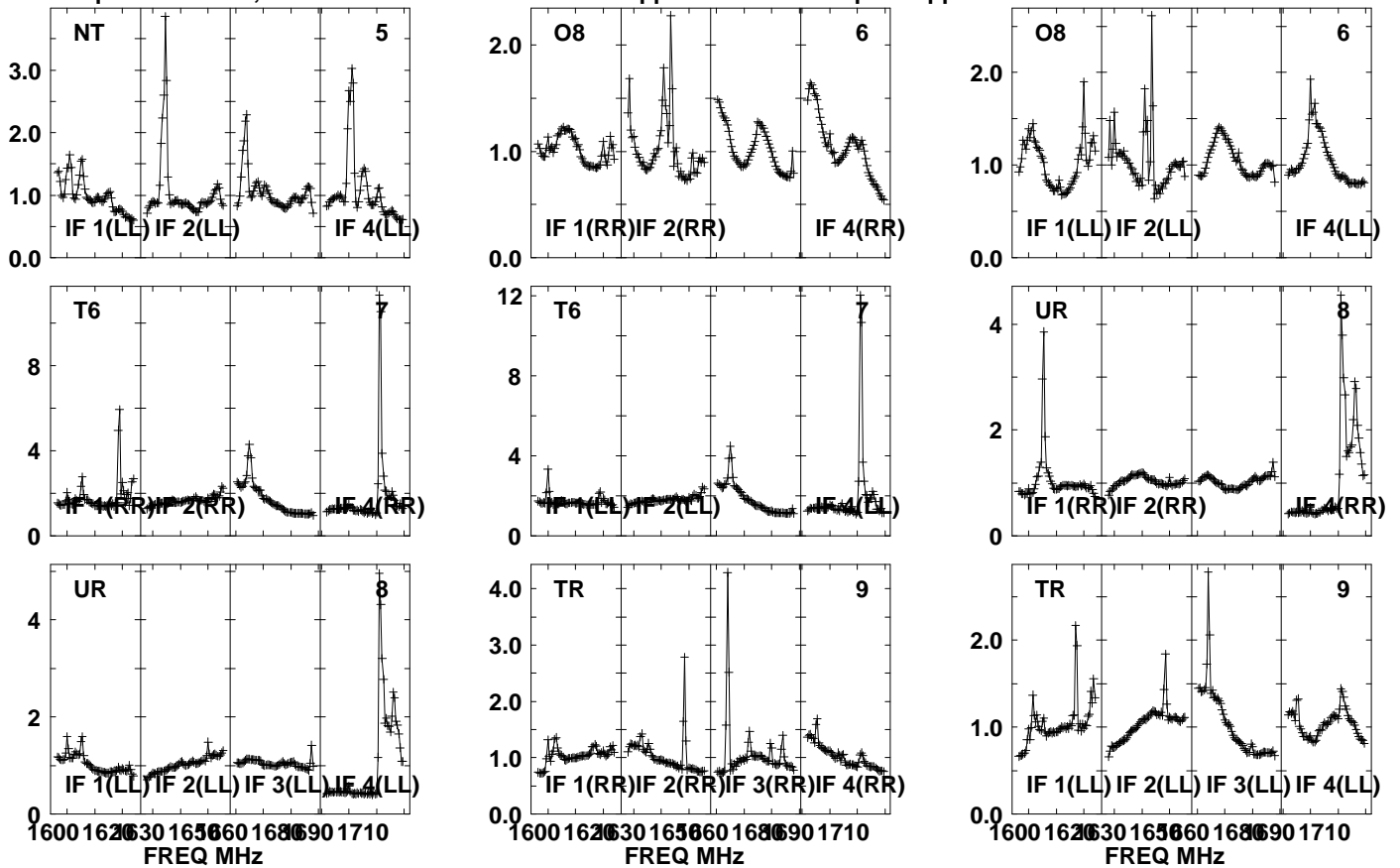

Lower frame: Real Jy

Auto-corr total-power spectrum Antenna: \*

Timerange: 00/14:42:31 to 00/14:45:59

Plot file version 407 created 05-OCT-2021 17:06:10

APM08279+525 GM076.UVDATA.1

Freq = 1.5945 GHz, Bw = 32.000 MH No calibration applied and no bandpass applied

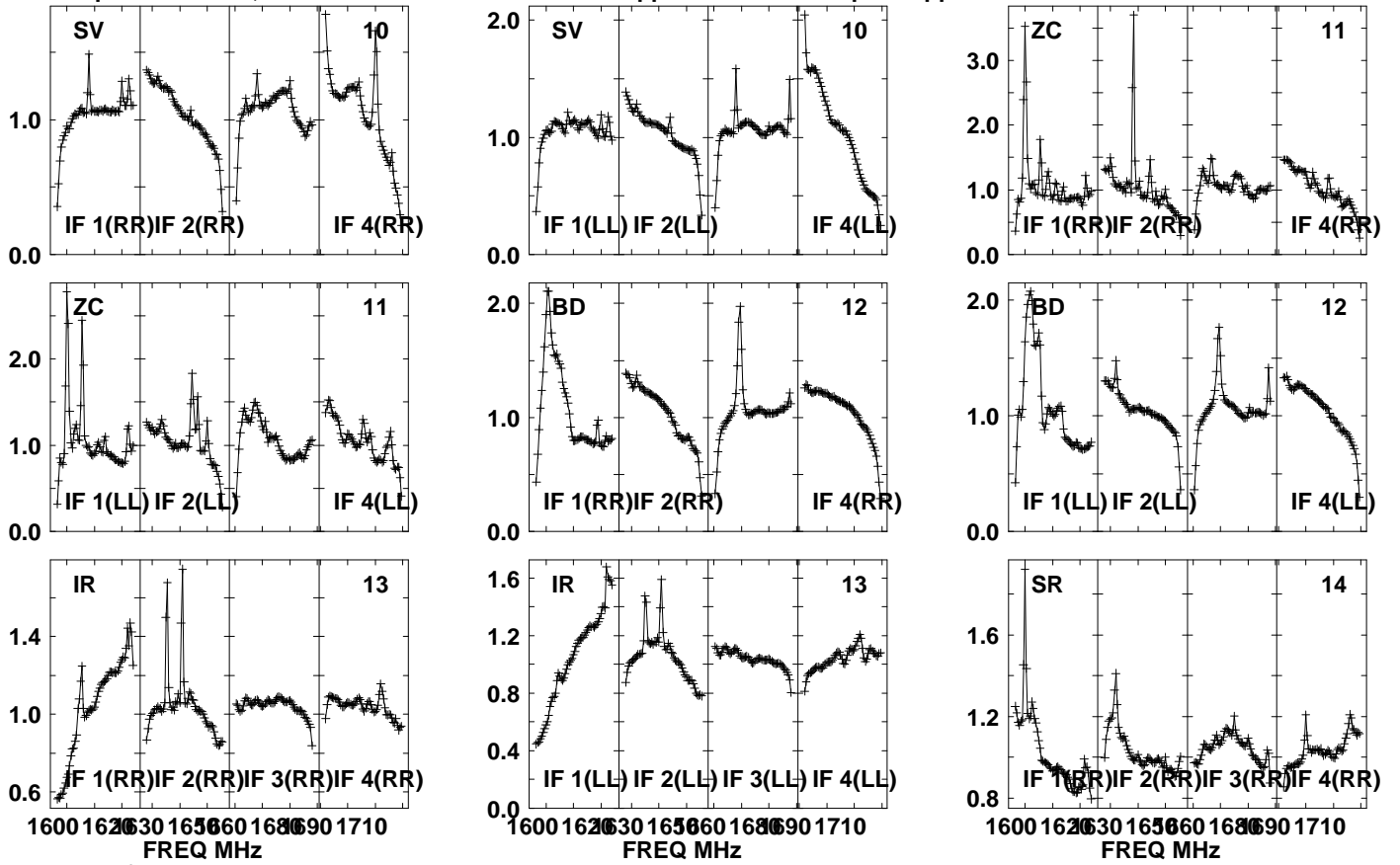

Lower frame: Real Jy  
Auto-corr total-power spectrum Antenna: \*  
Timerange: 00/14:42:31 to 00/14:45:59

Plot file version 408 created 05-OCT-2021 17:06:10

APM08279+525 GM076.UVDATA.1

Freq = 1.5945 GHz, Bw = 32.000 MH No calibration applied and no bandpass applied

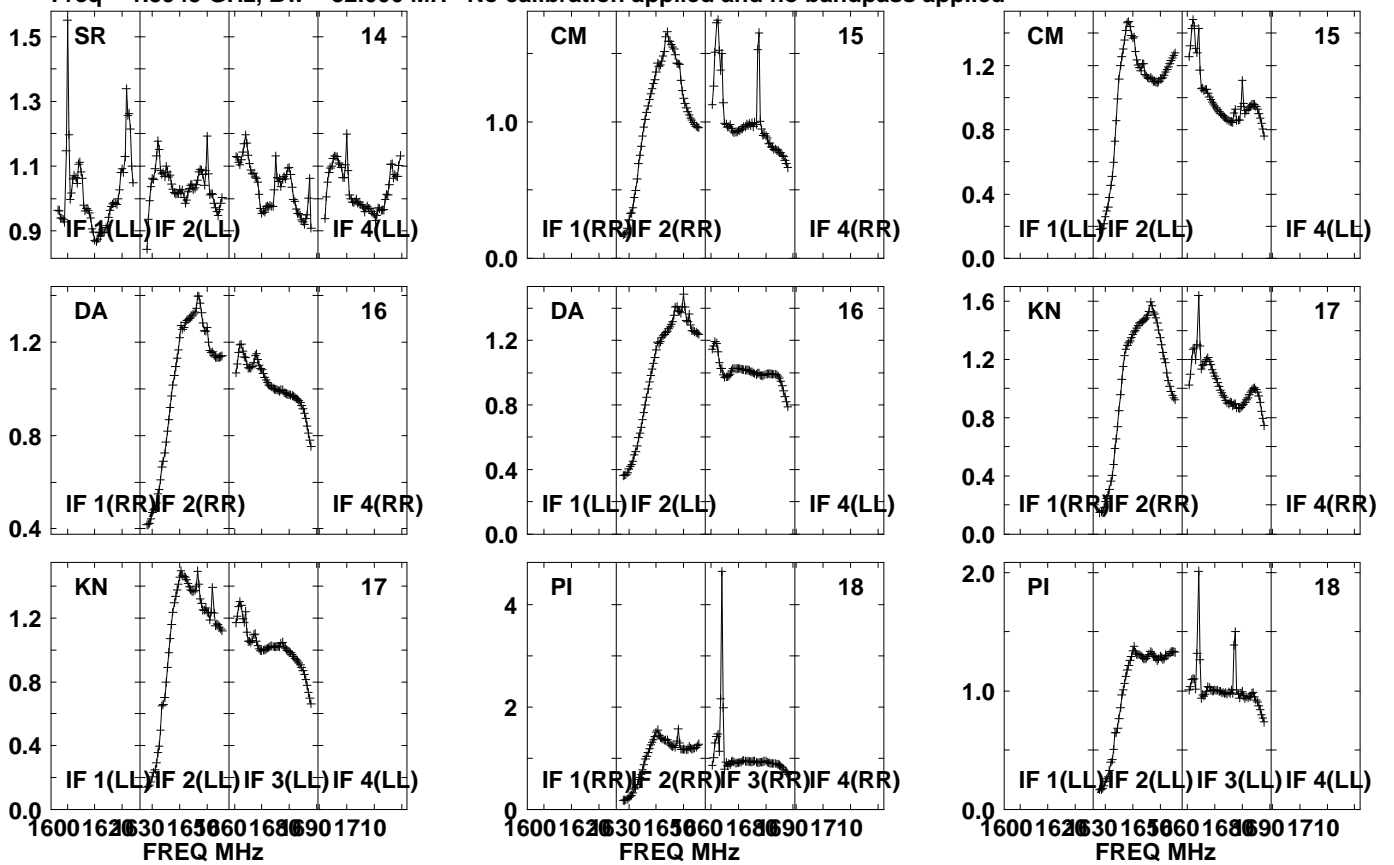

Lower frame: Real Jy  
Auto-corr total-power spectrum Antenna: \*  
Timerange: 00/14:42:31 to 00/14:45:59

Plot file version 409 created 05-OCT-2021 17:06:11

APM08279+525 GM076.UVDATA.1

Freq = 1.5945 GHz, Bw = 32.000 MH No calibration applied and no bandpass applied

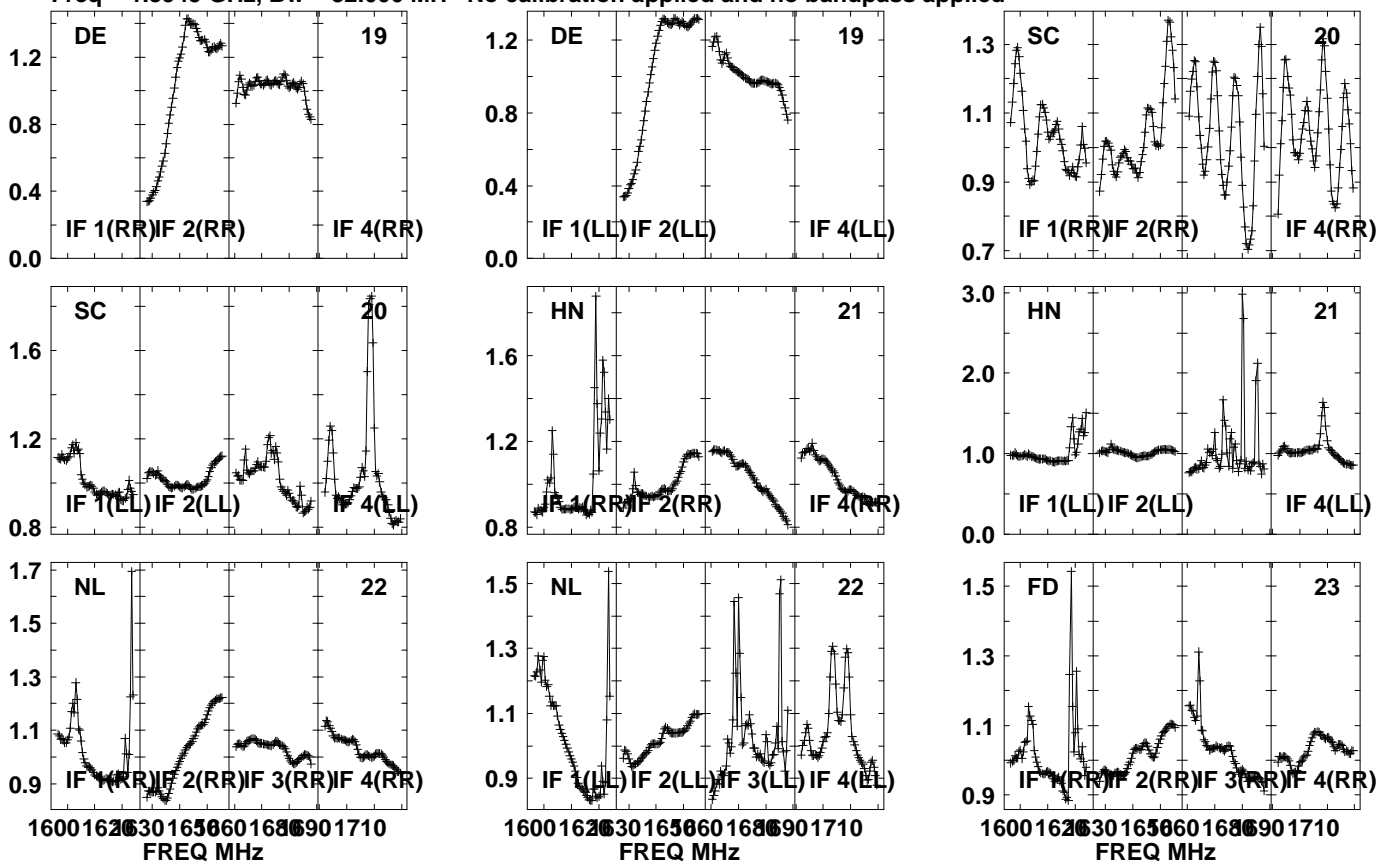

Lower frame: Real Jy  
Auto-corr total-power spectrum Antenna: \*  
Timerange: 00/14:42:31 to 00/14:45:59

Plot file version 410 created 05-OCT-2021 17:06:11

APM08279+525 GM076.UVDATA.1

Freq = 1.5945 GHz, Bw = 32.000 MH No calibration applied and no bandpass applied

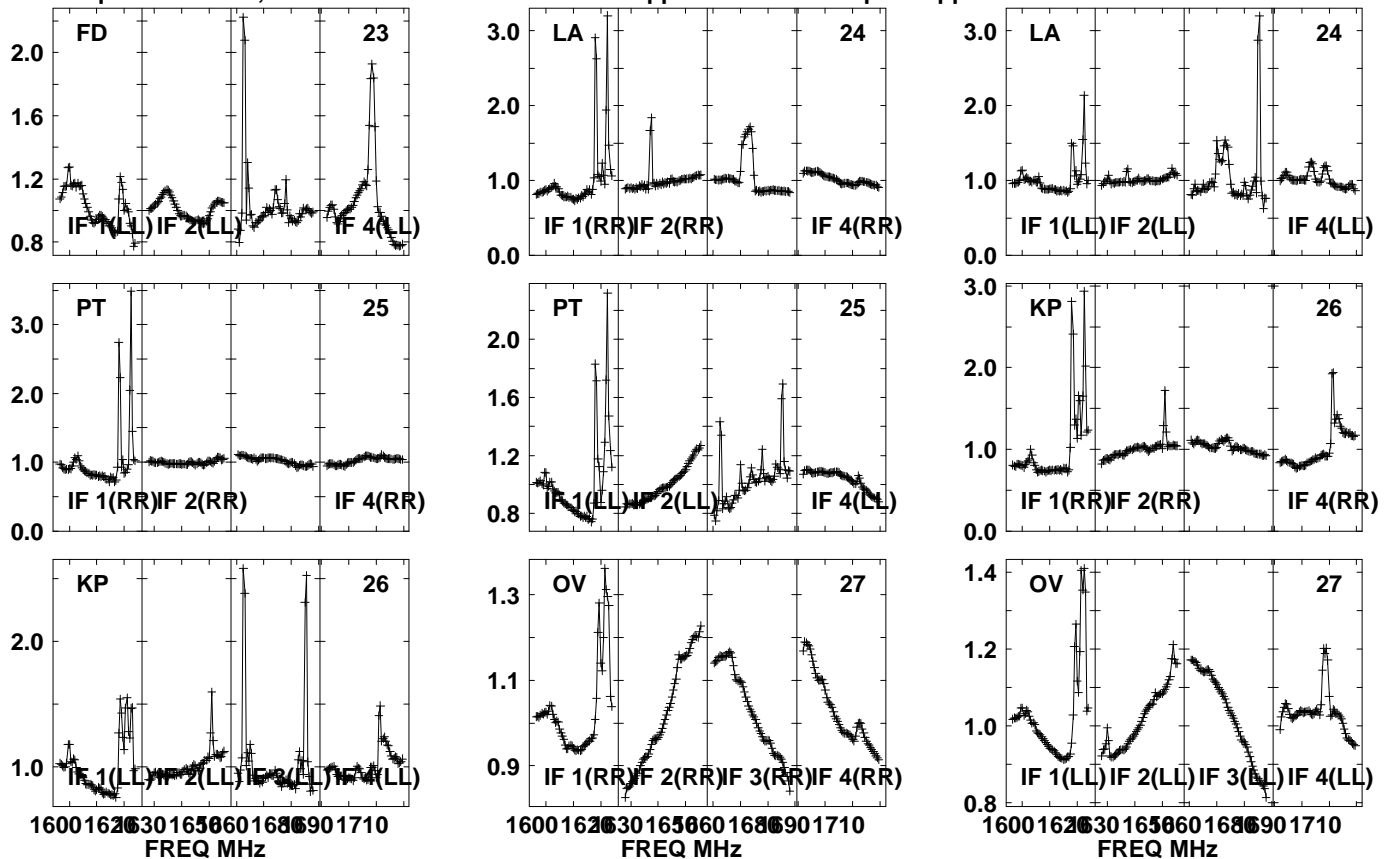

Lower frame: Real Jy  
Auto-corr total-power spectrum Antenna: \*  
Timerange: 00/14:42:31 to 00/14:45:59



Plot file version 411 created 05-OCT-2021 17:06:12

APM08279+525 GM076.UVDATA.1

Freq = 1.5945 GHz, Bw = 32.000 MH No calibration applied and no bandpass applied

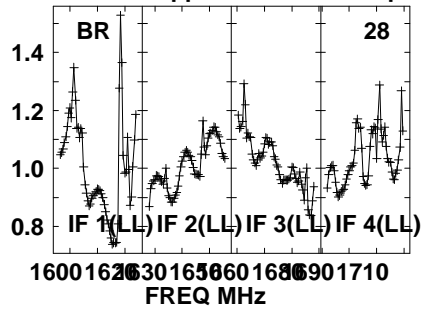
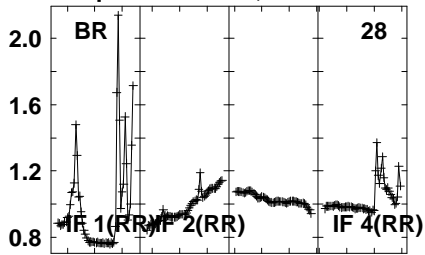

Lower frame: Real Jy  
Auto-corr total-power spectrum Antenna: \*  
Timerange: 00/14:42:31 to 00/14:45:59

Plot file version 412 created 05-OCT-2021 17:06:12

J0827+5217 GM076.UVDATA.1

Freq = 1.5945 GHz, Bw = 32.000 MH No calibration applied and no bandpass applied

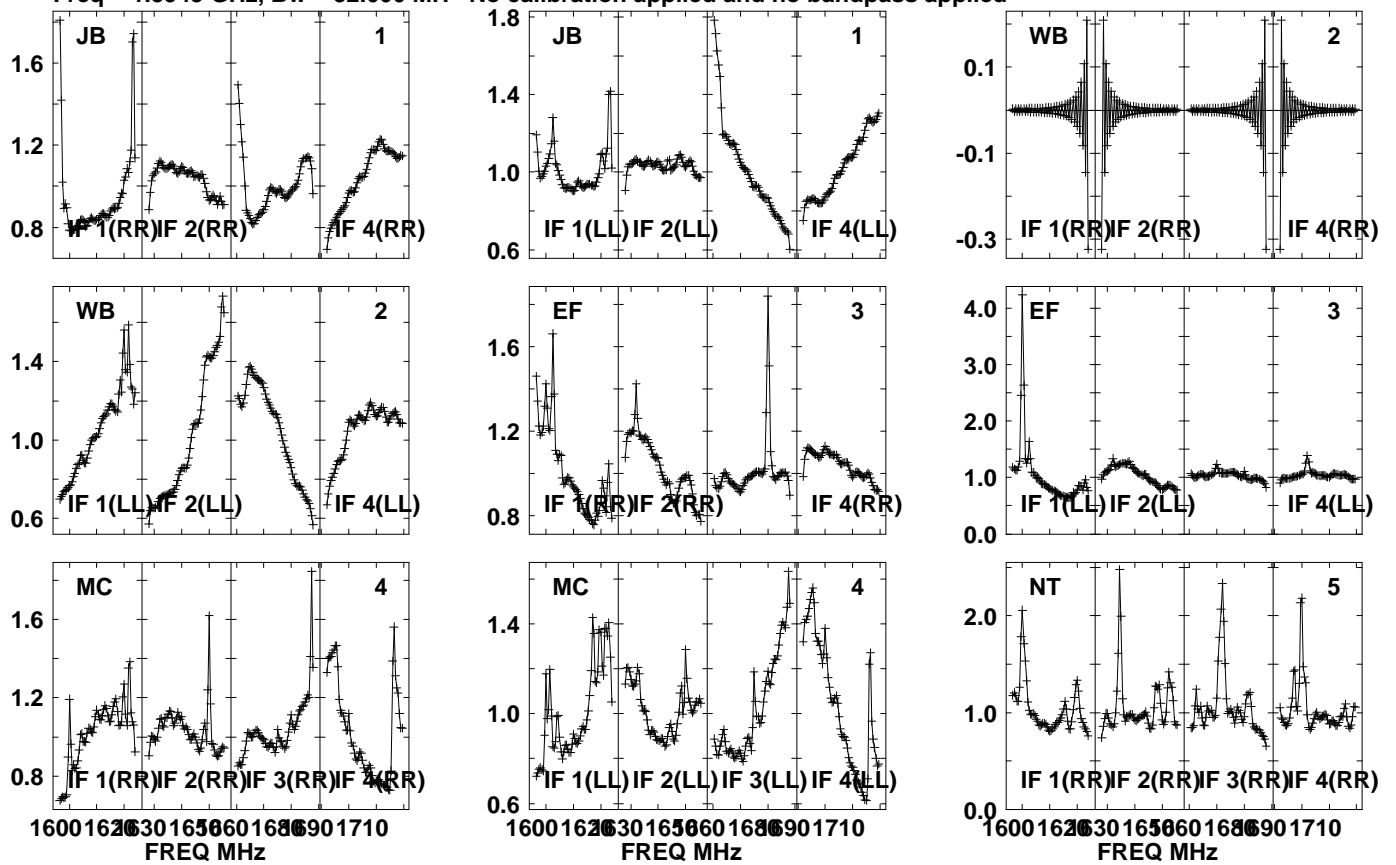

Lower frame: Real Jy  
Auto-corr total-power spectrum Antenna: \*  
Timerange: 00/14:46:31 to 00/14:47:59

Plot file version 413 created 05-OCT-2021 17:06:12

J0827+5217 GM076.UVDATA.1

Freq = 1.5945 GHz, Bw = 32.000 MH No calibration applied and no bandpass applied

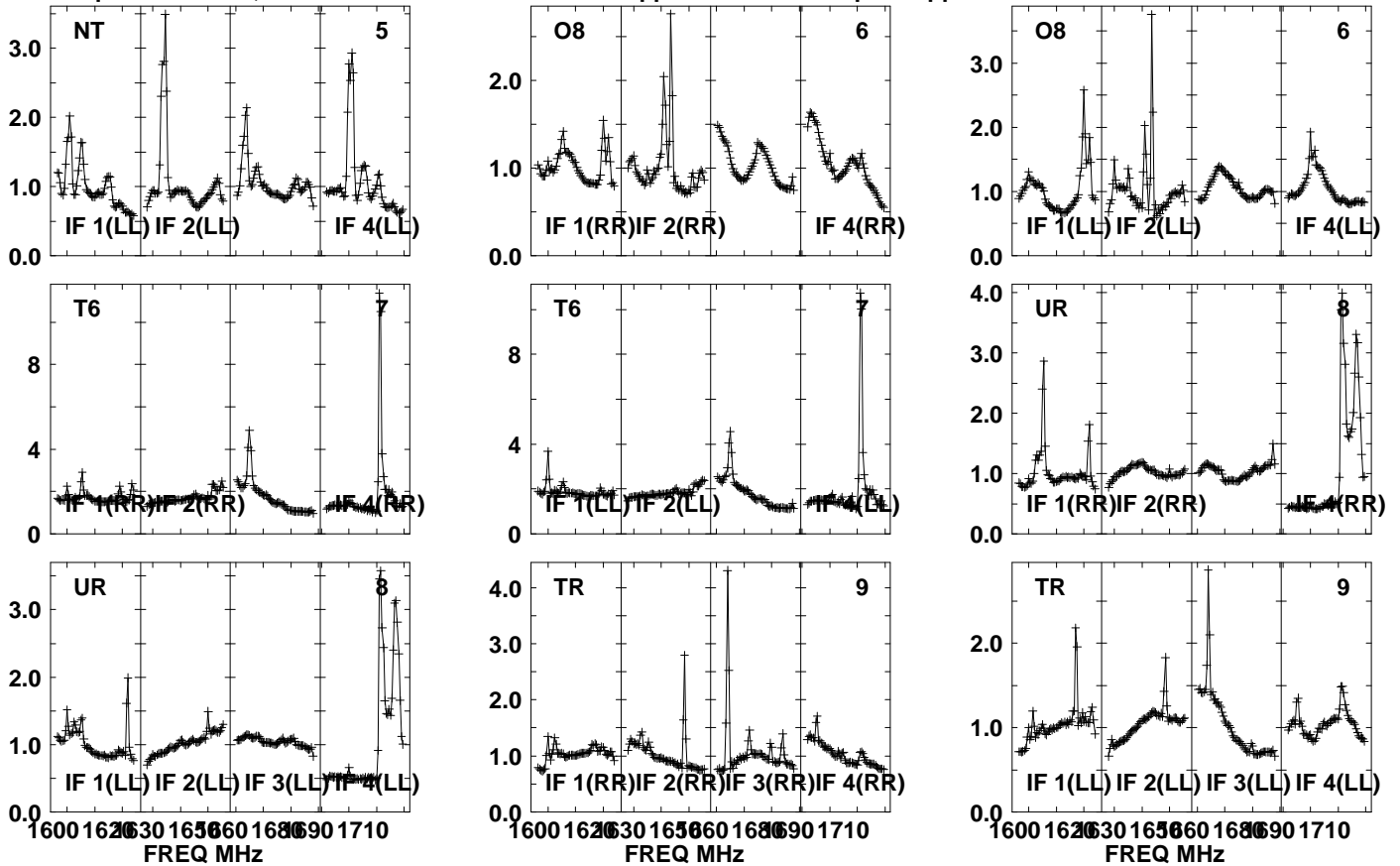

Lower frame: Real Jy

Auto-corr total-power spectrum Antenna: \*

Timerange: 00/14:46:31 to 00/14:47:59

Plot file version 414 created 05-OCT-2021 17:06:12

J0827+5217 GM076.UVDATA.1

Freq = 1.5945 GHz, Bw = 32.000 MH No calibration applied and no bandpass applied

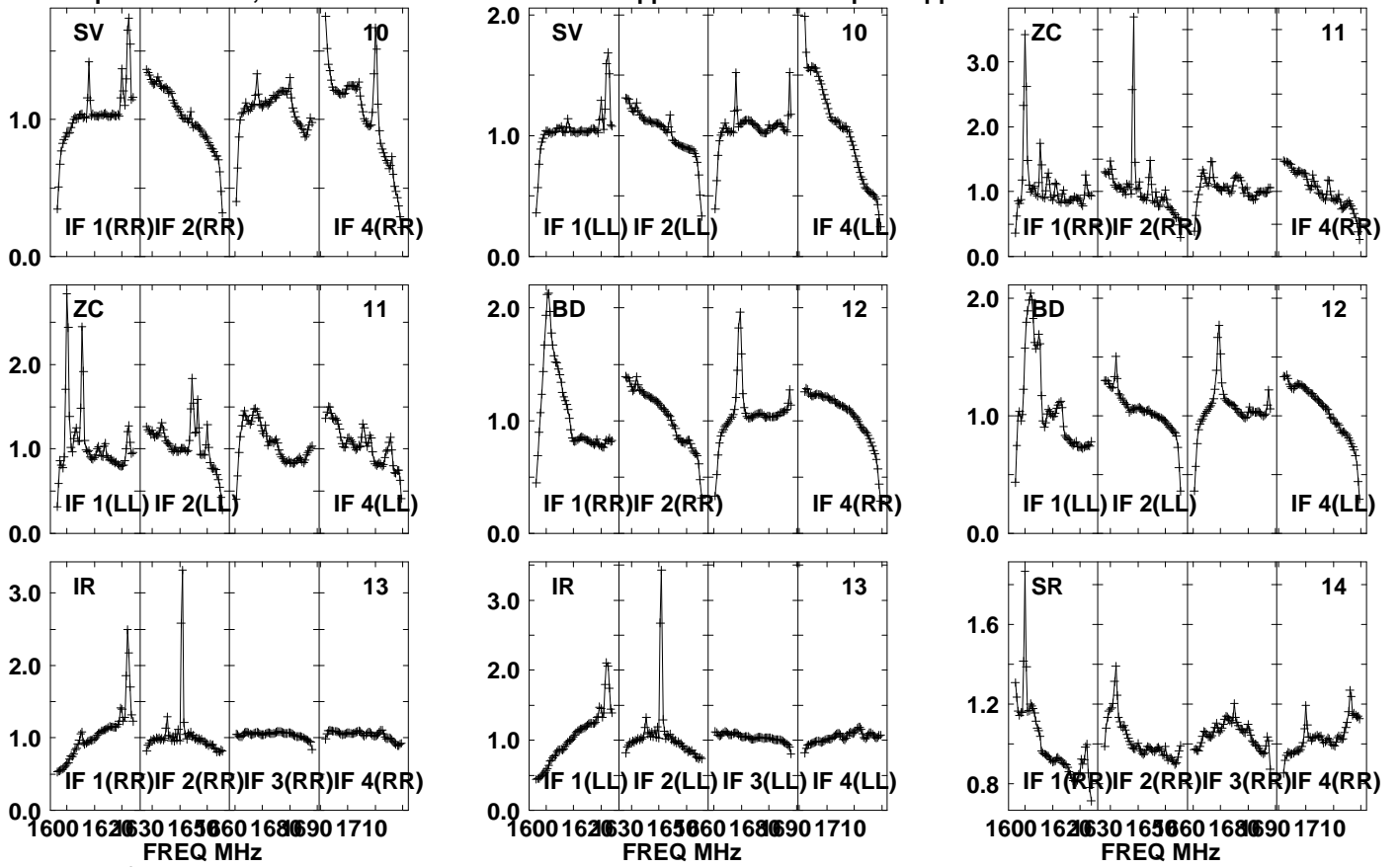

Lower frame: Real Jy

Auto-corr total-power spectrum Antenna: \*

Timerange: 00/14:46:31 to 00/14:47:59

Plot file version 415 created 05-OCT-2021 17:06:13

J0827+5217 GM076.UVDATA.1

Freq = 1.5945 GHz, Bw = 32.000 MH No calibration applied and no bandpass applied

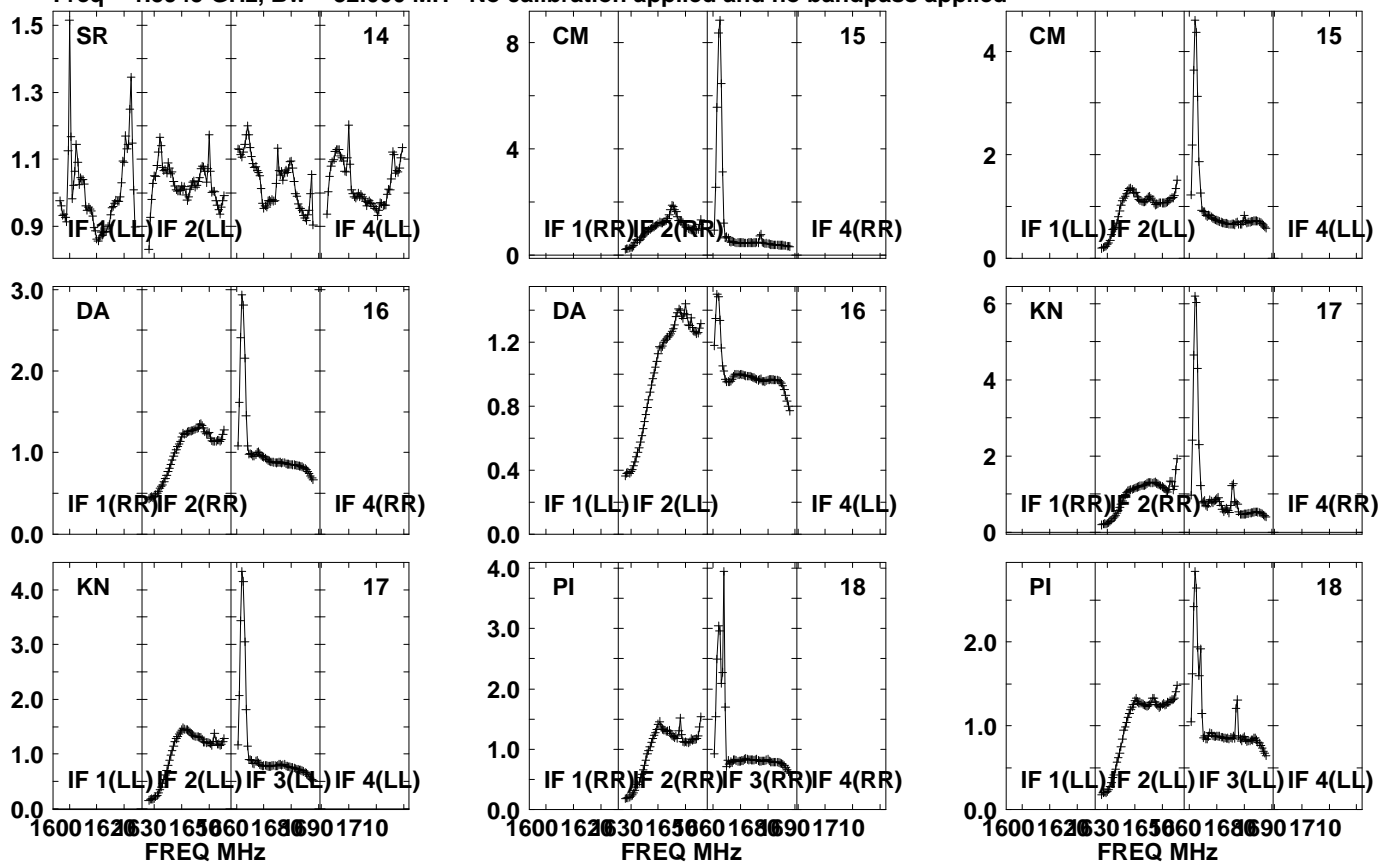

Lower frame: Real Jy  
Auto-corr total-power spectrum Antenna: \*  
Timerange: 00/14:46:31 to 00/14:47:59

Plot file version 416 created 05-OCT-2021 17:06:13

J0827+5217 GM076.UVDATA.1

Freq = 1.5945 GHz, Bw = 32.000 MH No calibration applied and no bandpass applied

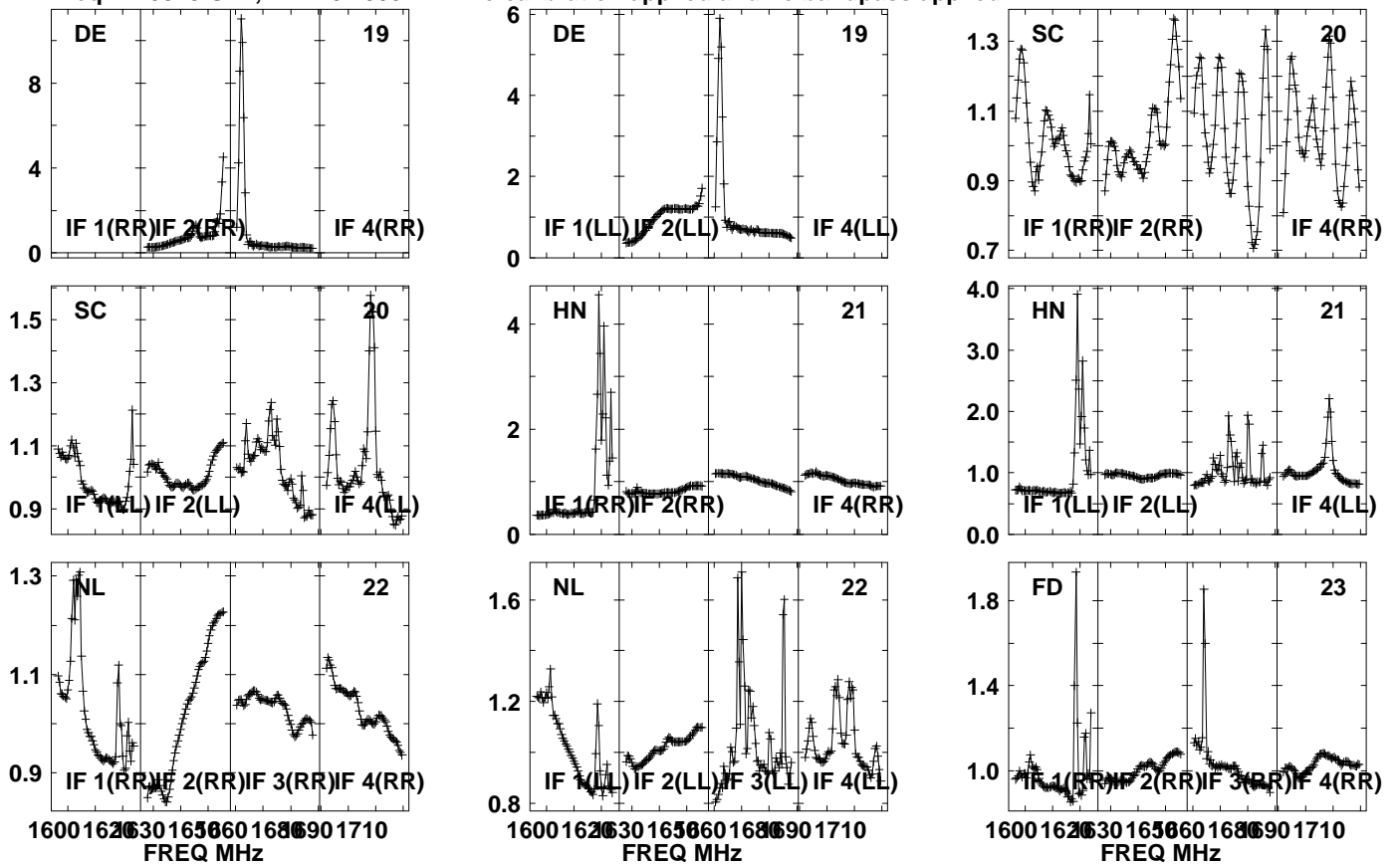

Lower frame: Real Jy  
Auto-corr total-power spectrum Antenna: \*  
Timerange: 00/14:46:31 to 00/14:47:59

Plot file version 417 created 05-OCT-2021 17:06:13

J0827+5217 GM076.UVDATA.1

Freq = 1.5945 GHz, Bw = 32.000 MH No calibration applied and no bandpass applied

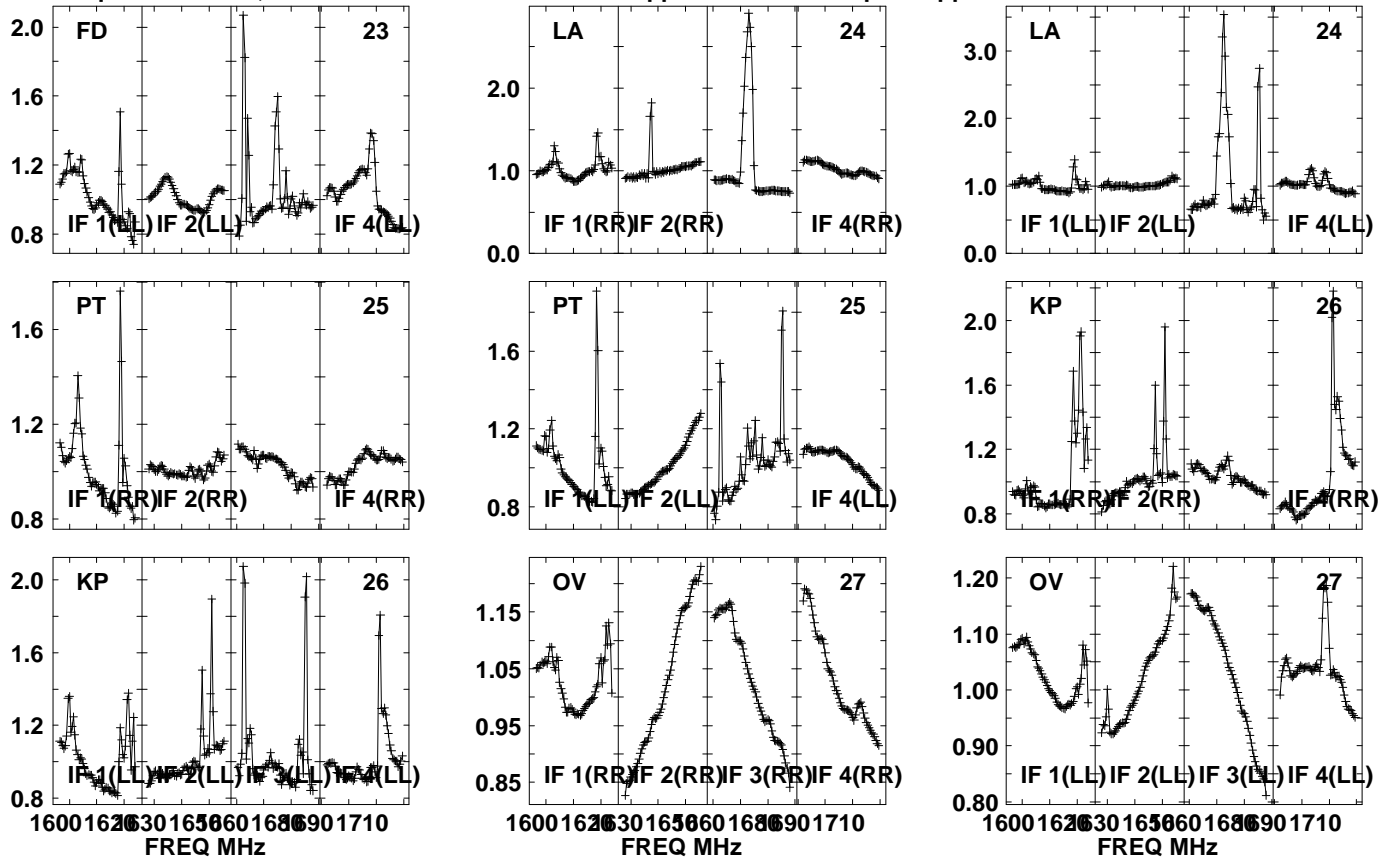

Lower frame: Real Jy  
Auto-corr total-power spectrum Antenna: \*  
Timerange: 00/14:46:31 to 00/14:47:59

Plot file version 418 created 05-OCT-2021 17:06:14

J0827+5217 GM076.UVDATA.1

Freq = 1.5945 GHz, Bw = 32.000 MH No calibration applied and no bandpass applied

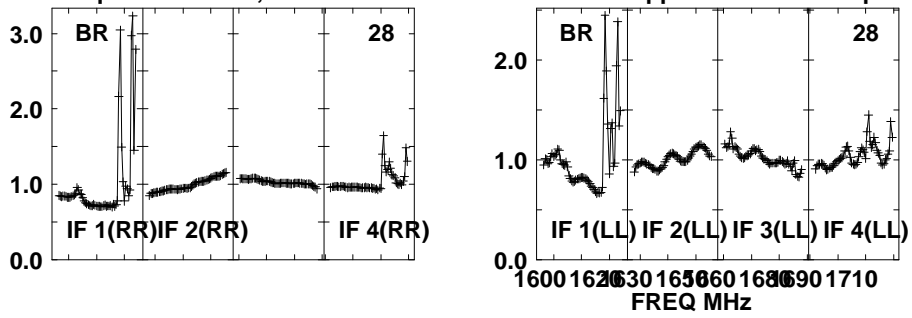

Lower frame: Real Jy

Auto-corr total-power spectrum Antenna: \*

Timerange: 00/14:46:31 to 00/14:47:59



Plot file version 419 created 05-OCT-2021 17:06:14

APM08279+525 GM076.UVDATA.1

Freq = 1.5945 GHz, Bw = 32.000 MH No calibration applied and no bandpass applied

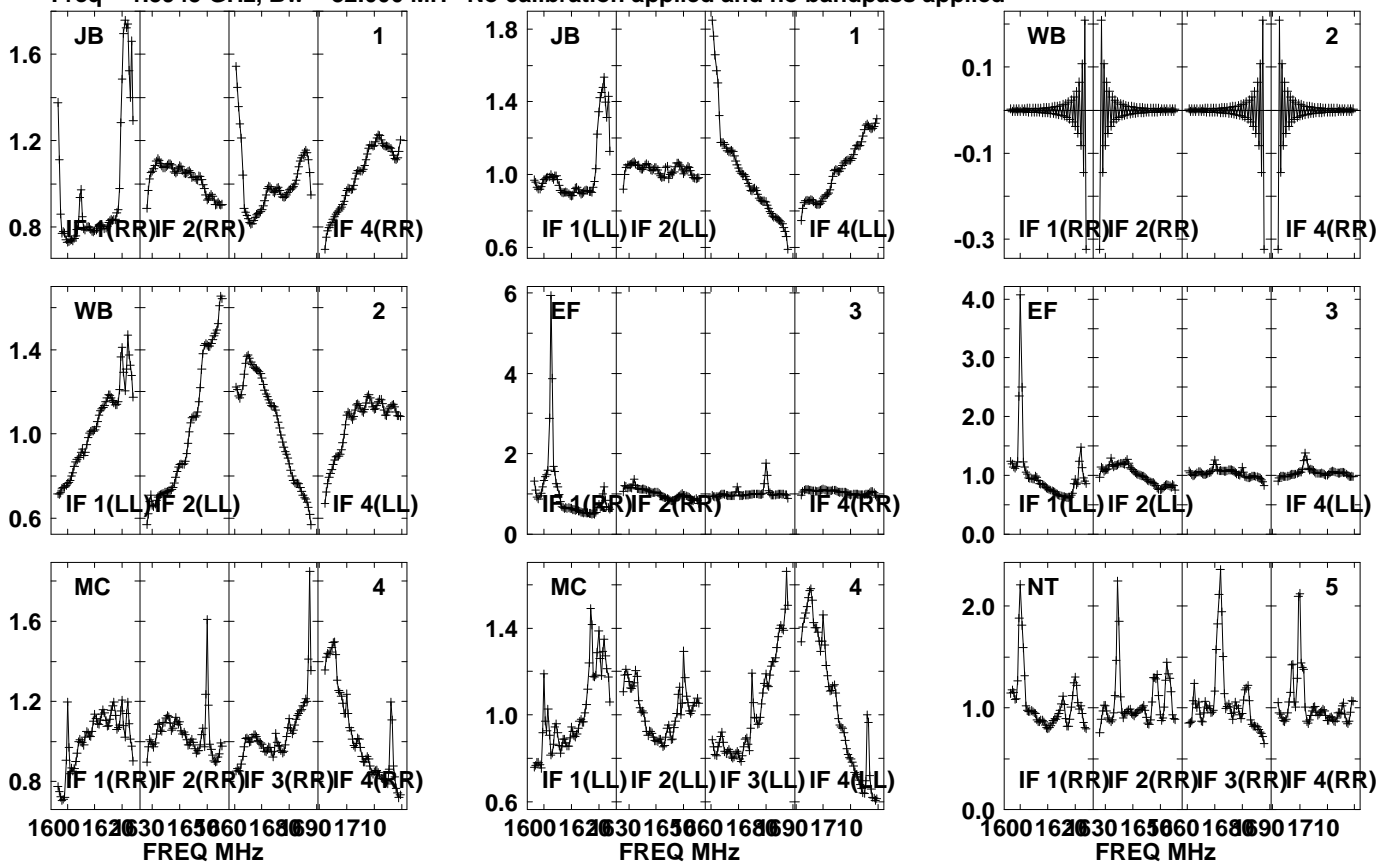

Lower frame: Real Jy  
Auto-corr total-power spectrum Antenna: \*  
Timerange: 00/14:48:01 to 00/14:51:29

Plot file version 420 created 05-OCT-2021 17:06:14

APM08279+525 GM076.UVDATA.1

Freq = 1.5945 GHz, Bw = 32.000 MH No calibration applied and no bandpass applied

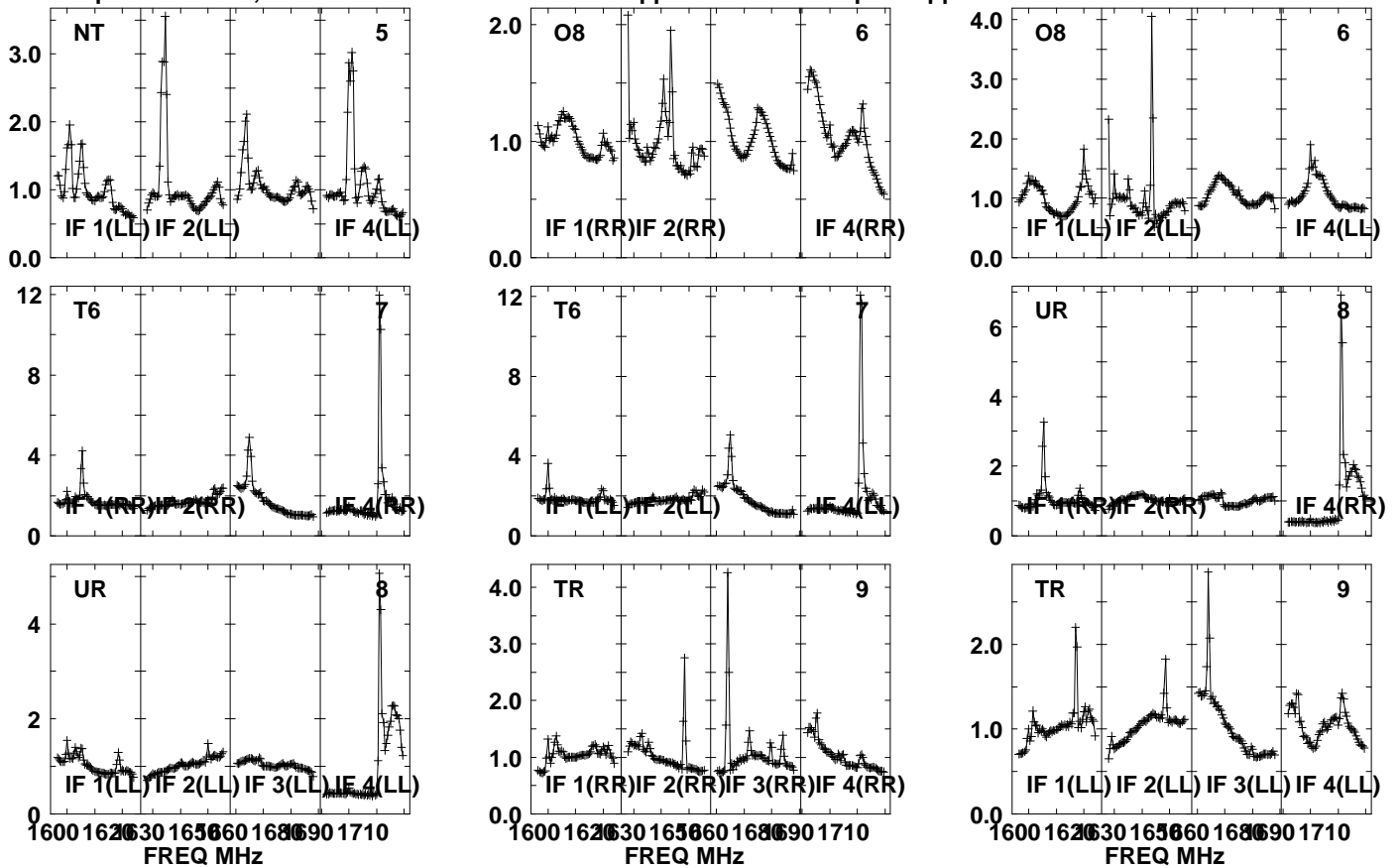

Lower frame: Real Jy

Auto-corr total-power spectrum Antenna: \*

Timerange: 00/14:48:01 to 00/14:51:29

Plot file version 421 created 05-OCT-2021 17:06:14

APM08279+525 GM076.UVDATA.1

Freq = 1.5945 GHz, Bw = 32.000 MH

No calibration applied and no bandpass applied

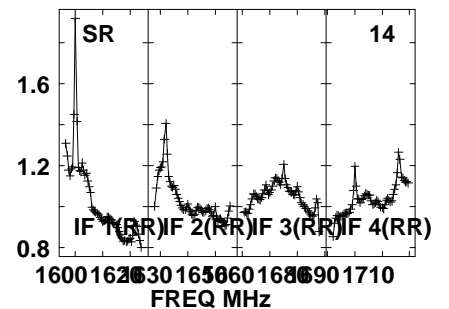
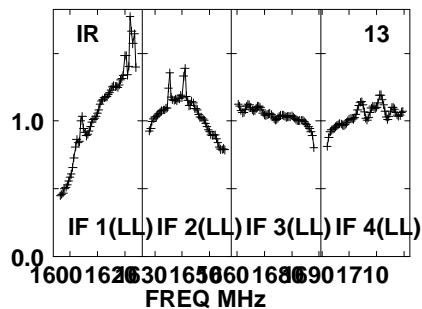
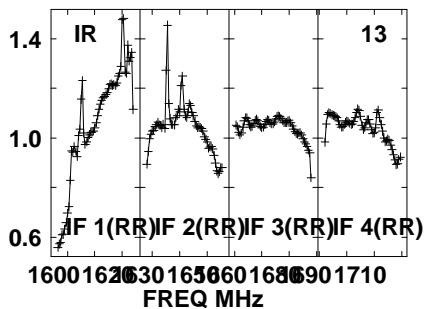
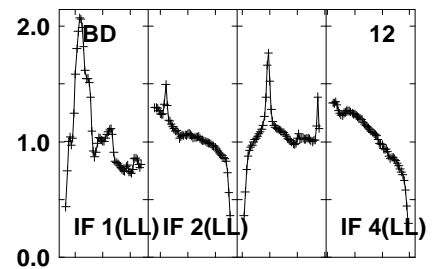
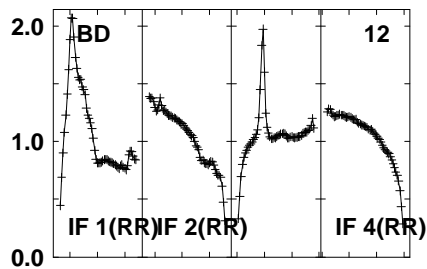
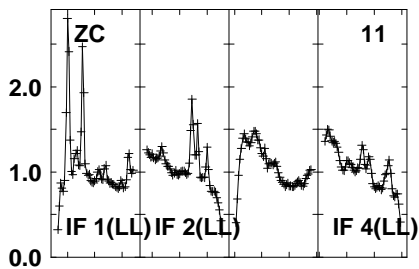
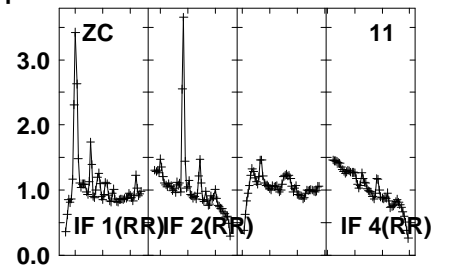
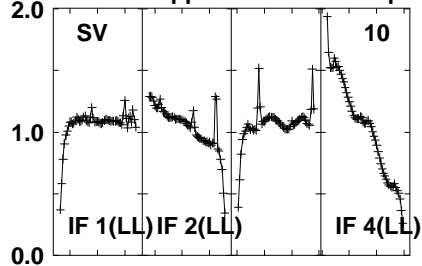
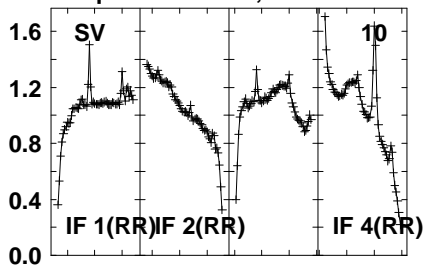

Lower frame: Real Jy  
Auto-corr total-power spectrum Antenna: \*  
Timerange: 00/14:48:01 to 00/14:51:29

Plot file version 422 created 05-OCT-2021 17:06:15

APM08279+525 GM076.UVDATA.1

Freq = 1.5945 GHz, Bw = 32.000 MH No calibration applied and no bandpass applied

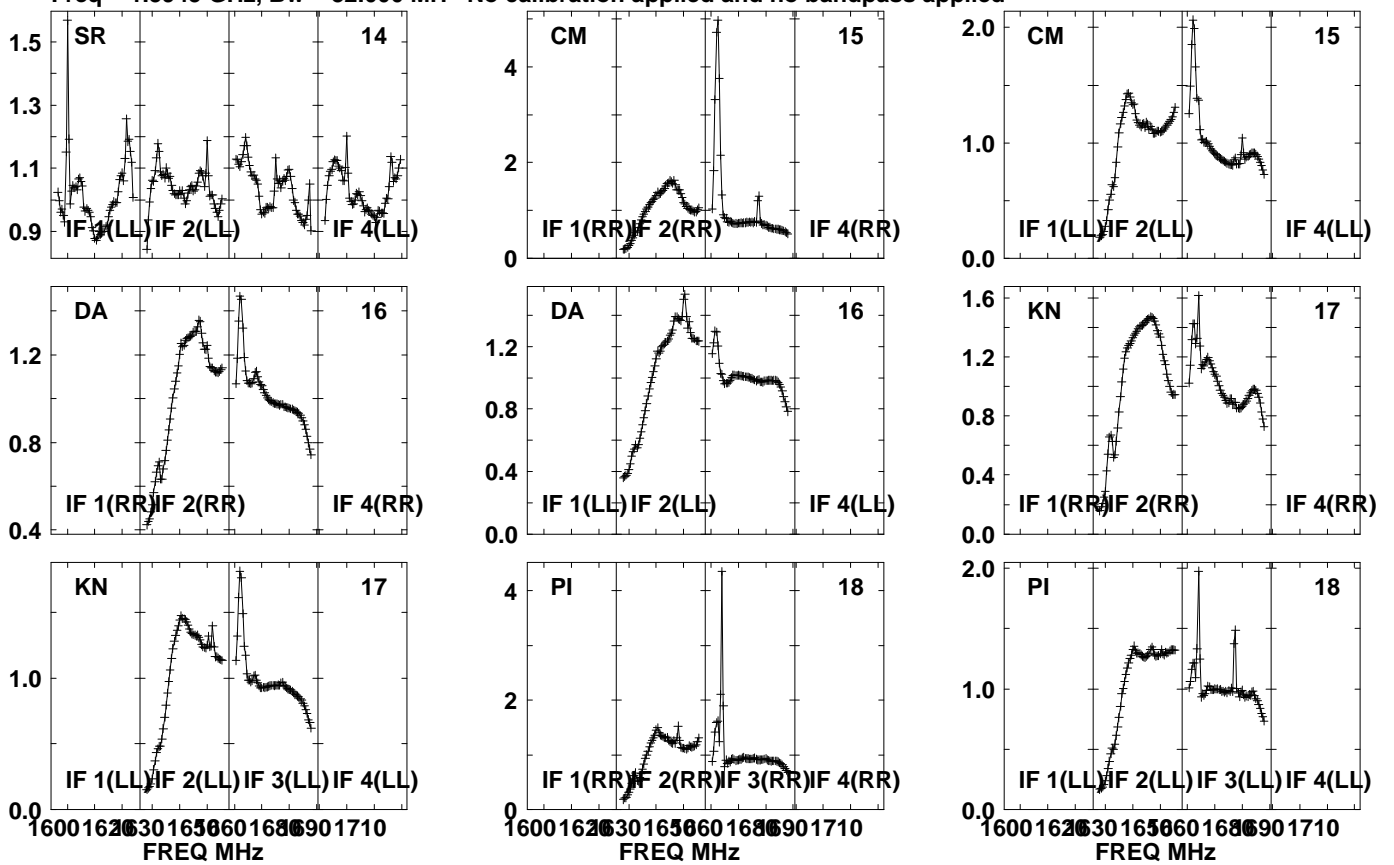

Lower frame: Real Jy  
Auto-corr total-power spectrum Antenna: \*  
Timerange: 00/14:48:01 to 00/14:51:29

Plot file version 423 created 05-OCT-2021 17:06:15

APM08279+525 GM076.UVDATA.1

Freq = 1.5945 GHz, Bw = 32.000 MH No calibration applied and no bandpass applied

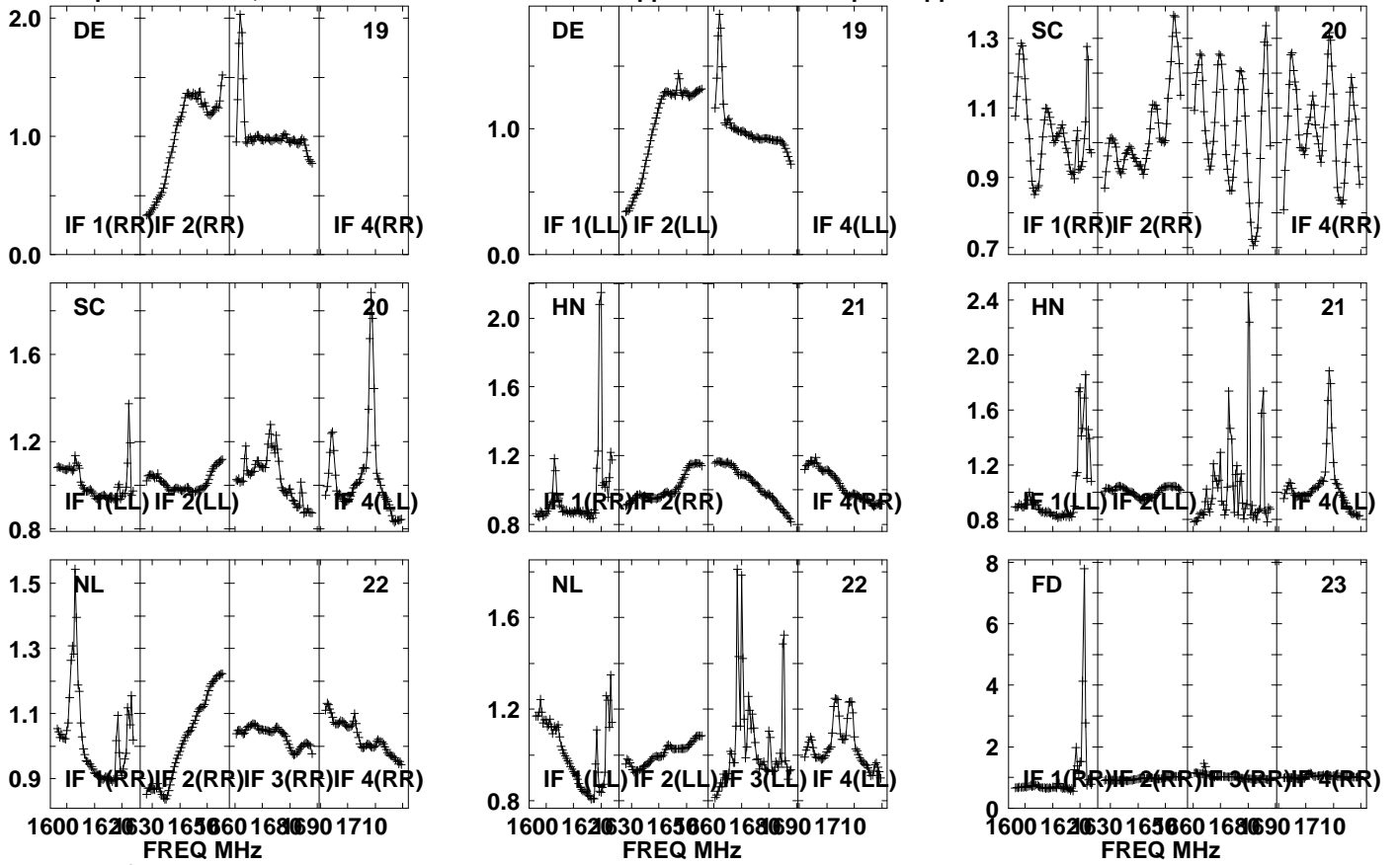

Lower frame: Real Jy

Auto-corr total-power spectrum Antenna: \*

Timerange: 00/14:48:01 to 00/14:51:29

Plot file version 424 created 05-OCT-2021 17:06:15

APM08279+525 GM076.UVDATA.1

Freq = 1.5945 GHz, Bw = 32.000 MH No calibration applied and no bandpass applied

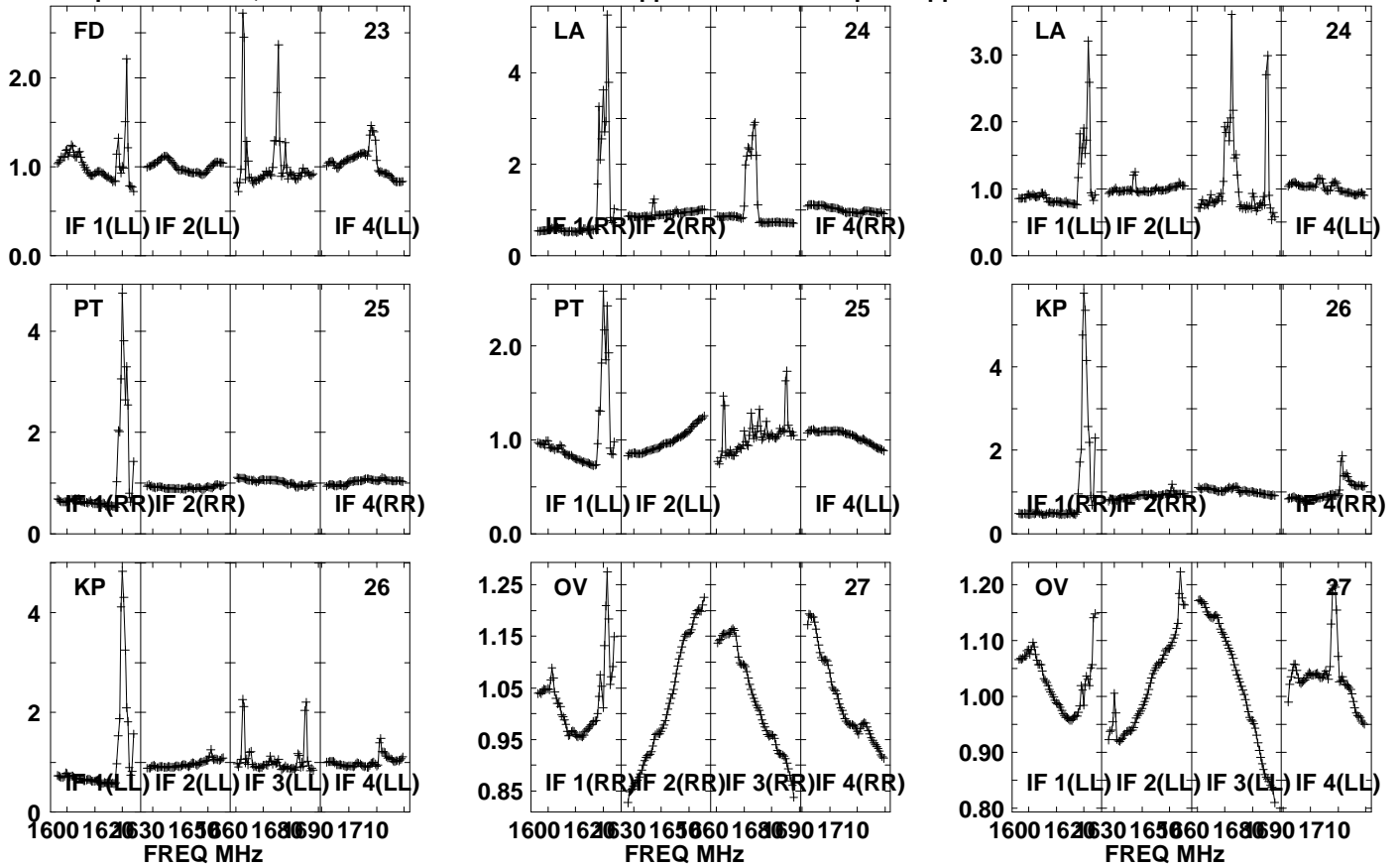

Lower frame: Real Jy  
Auto-corr total-power spectrum Antenna: \*  
Timerange: 00/14:48:01 to 00/14:51:29

Plot file version 425 created 05-OCT-2021 17:06:16

APM08279+525 GM076.UVDATA.1

Freq = 1.5945 GHz, Bw = 32.000 MH No calibration applied and no bandpass applied

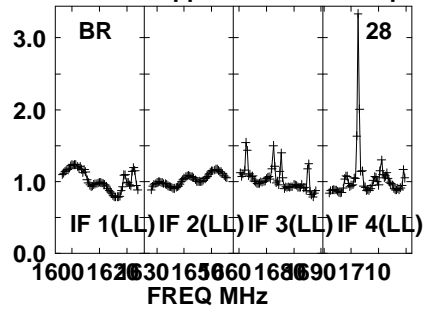
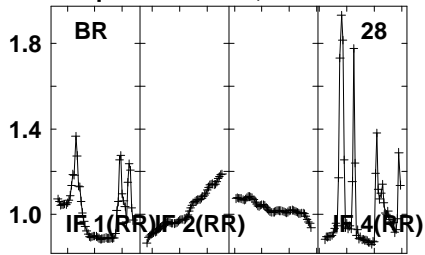

Lower frame: Real Jy  
Auto-corr total-power spectrum Antenna: \*  
Timerange: 00/14:48:01 to 00/14:51:29

Plot file version 426 created 05-OCT-2021 17:06:16

J0827+5217 GM076.UVDATA.1

Freq = 1.5945 GHz, Bw = 32.000 MH No calibration applied and no bandpass applied

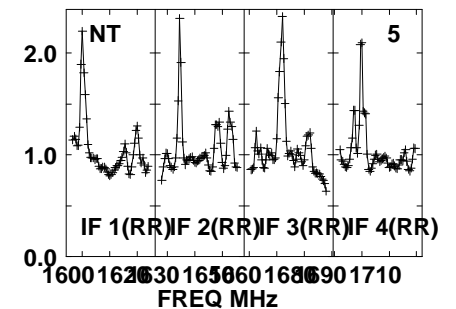
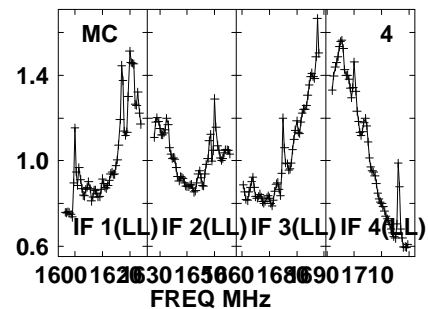
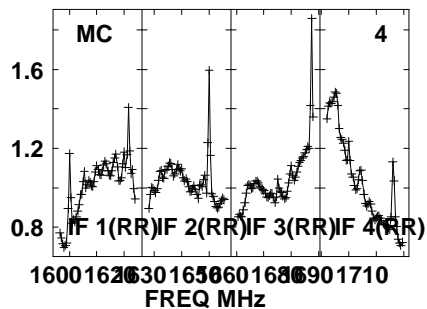
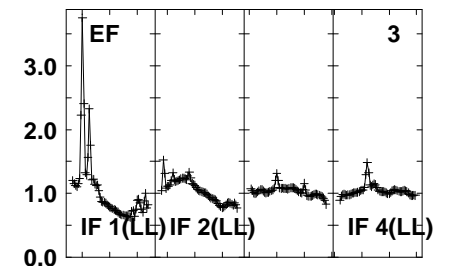
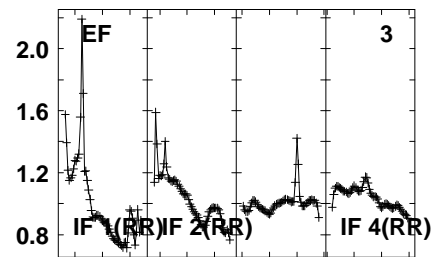
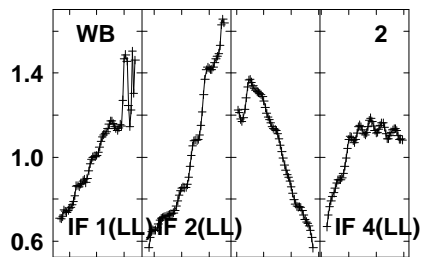
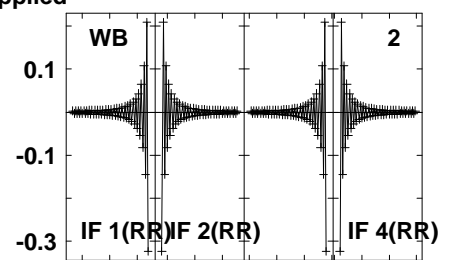
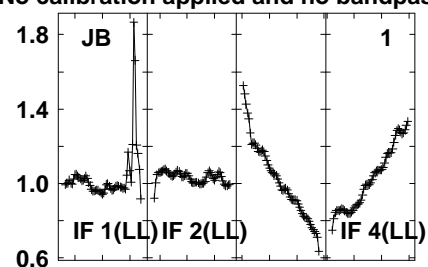
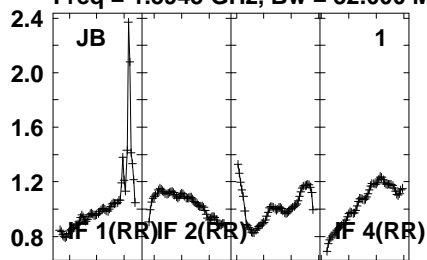

Lower frame: Real Jy  
Auto-corr total-power spectrum Antenna: \*  
Timerange: 00/14:51:31 to 00/14:52:59



Plot file version 427 created 05-OCT-2021 17:06:16

J0827+5217 GM076.UVDATA.1

Freq = 1.5945 GHz, Bw = 32.000 MH No calibration applied and no bandpass applied

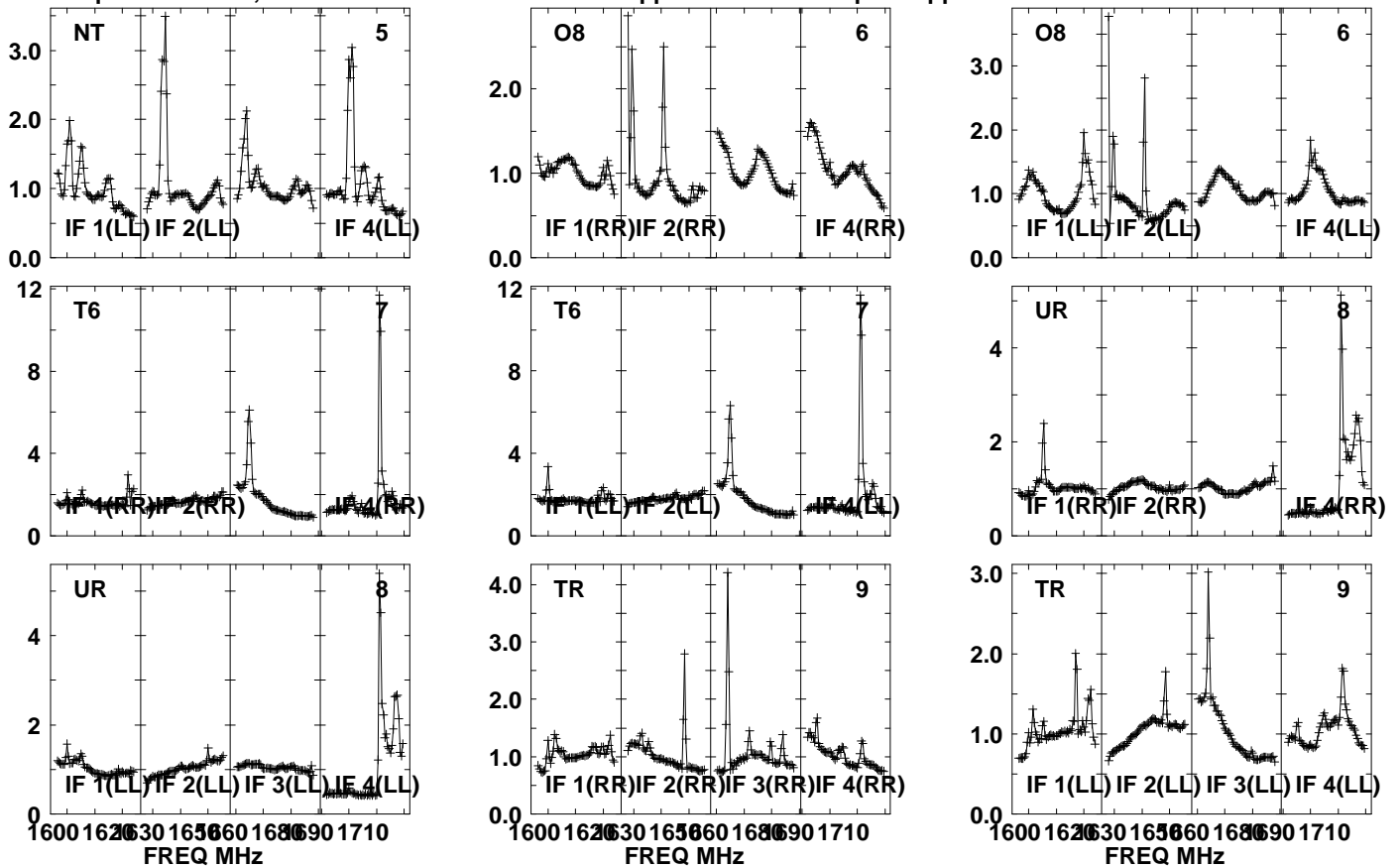

Lower frame: Real Jy

Auto-corr total-power spectrum Antenna: \*

Timerange: 00/14:51:31 to 00/14:52:59

Plot file version 428 created 05-OCT-2021 17:06:17

J0827+5217 GM076.UVDATA.1

Freq = 1.5945 GHz, Bw = 32.000 MH No calibration applied and no bandpass applied

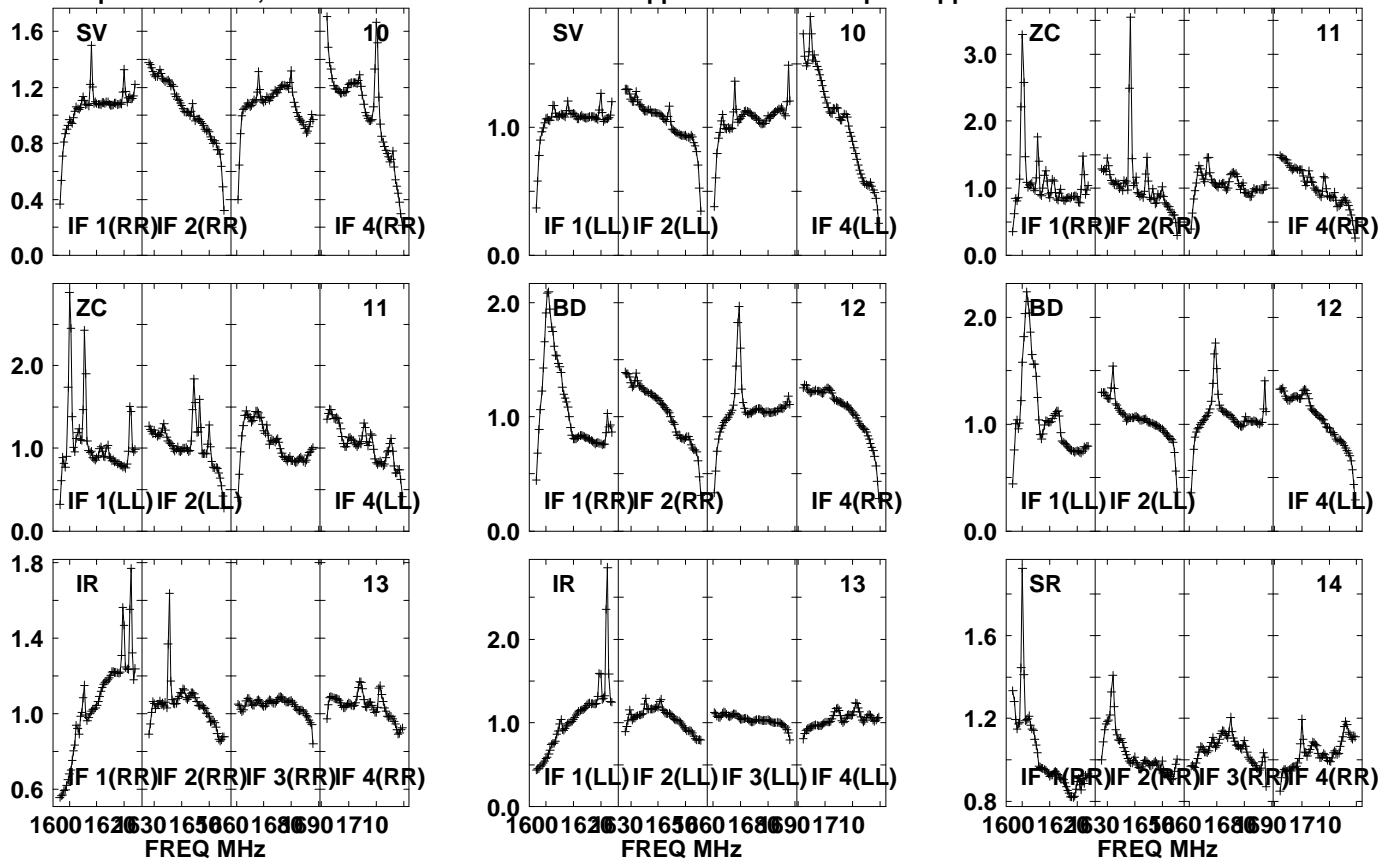

Lower frame: Real Jy  
Auto-corr total-power spectrum Antenna: \*  
Timerange: 00/14:51:31 to 00/14:52:59

Plot file version 429 created 05-OCT-2021 17:06:17

J0827+5217 GM076.UVDATA.1

Freq = 1.5945 GHz, Bw = 32.000 MH No calibration applied and no bandpass applied

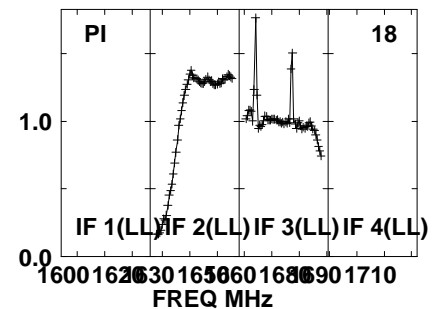
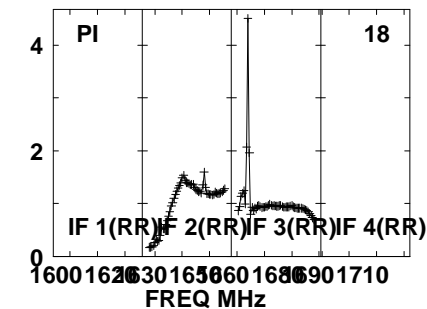
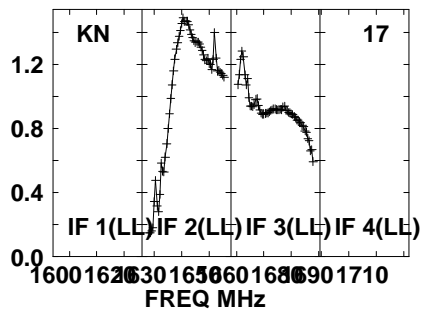
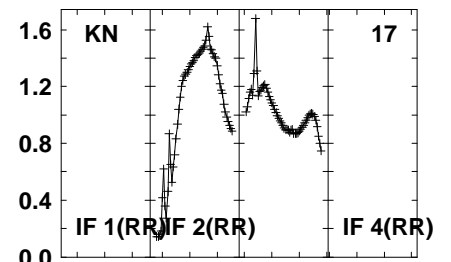
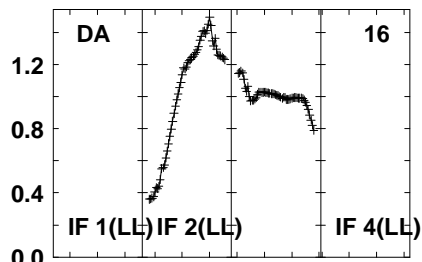
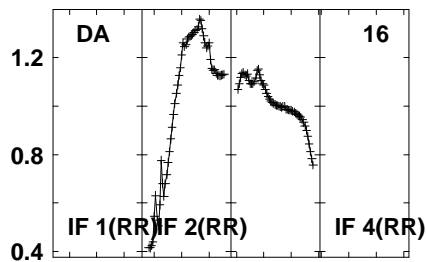
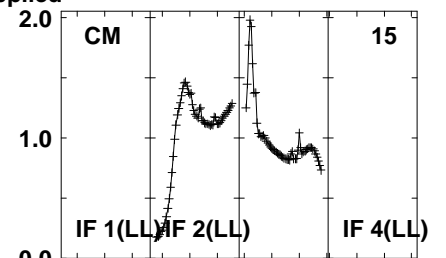
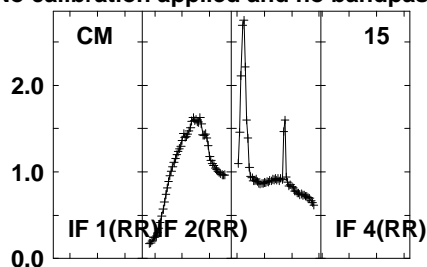
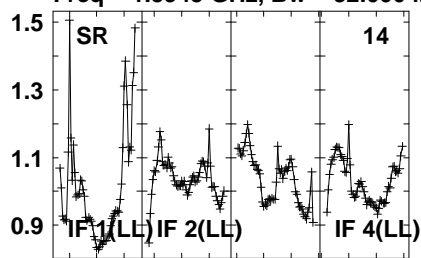

Lower frame: Real Jy  
Auto-corr total-power spectrum Antenna: \*  
Timerange: 00/14:51:31 to 00/14:52:59

Plot file version 430 created 05-OCT-2021 17:06:17

J0827+5217 GM076.UVDATA.1

Freq = 1.5945 GHz, Bw = 32.000 MH No calibration applied and no bandpass applied

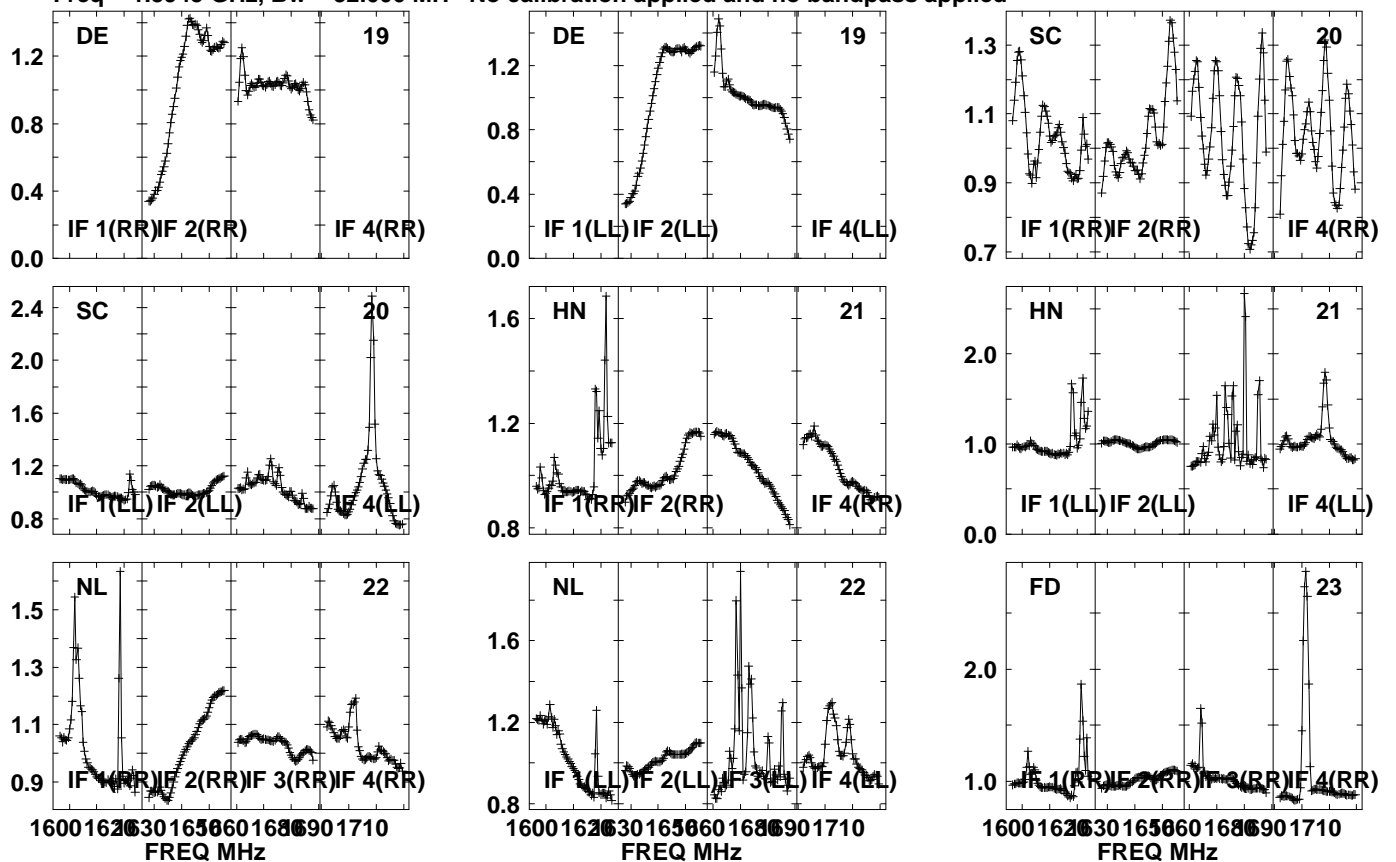

Lower frame: Real Jy  
Auto-corr total-power spectrum Antenna: \*  
Timerange: 00/14:51:31 to 00/14:52:59

Plot file version 431 created 05-OCT-2021 17:06:18

J0827+5217 GM076.UVDATA.1

Freq = 1.5945 GHz, Bw = 32.000 MH No calibration applied and no bandpass applied

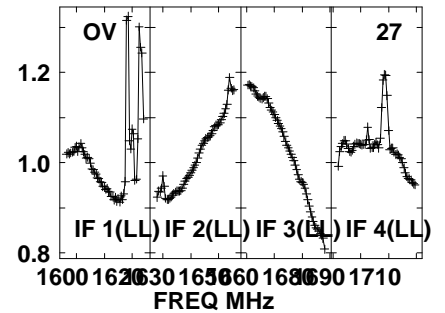
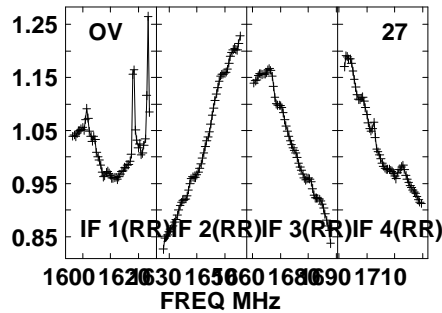
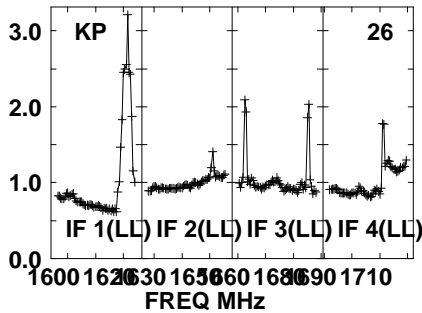
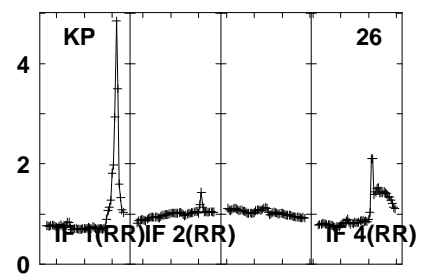
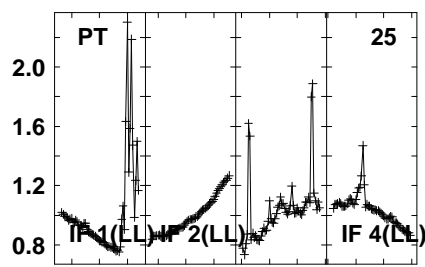
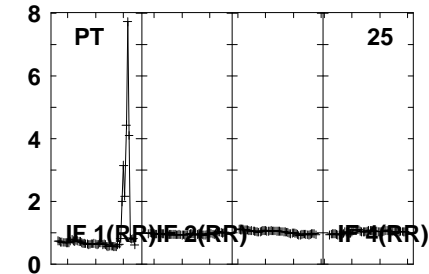
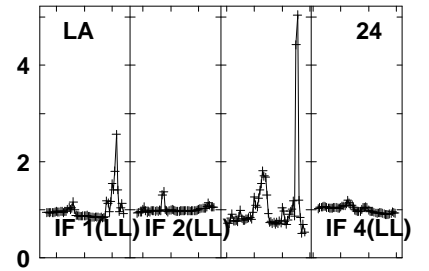
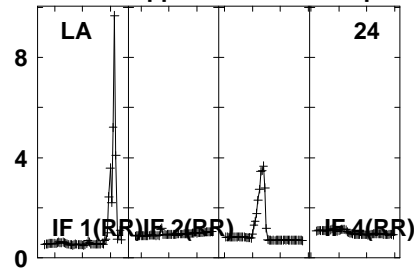
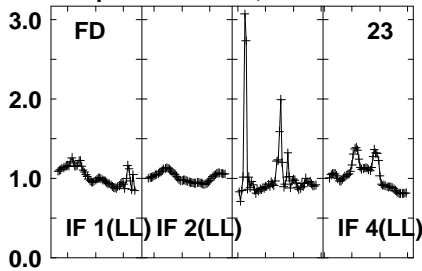

Lower frame: Real Jy

Auto-corr total-power spectrum Antenna: \*

Timerange: 00/14:51:31 to 00/14:52:59

Plot file version 432 created 05-OCT-2021 17:06:18

J0827+5217 GM076.UVDATA.1

Freq = 1.5945 GHz, Bw = 32.000 MH No calibration applied and no bandpass applied

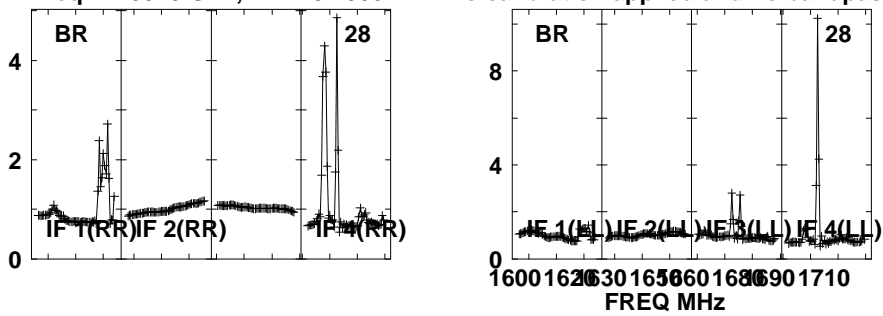

Lower frame: Real Jy  
Auto-corr total-power spectrum Antenna: \*  
Timerange: 00/14:51:31 to 00/14:52:59

Plot file version 433 created 05-OCT-2021 17:06:18

APM08279+525 GM076.UVDATA.1

Freq = 1.5945 GHz, Bw = 32.000 MH No calibration applied and no bandpass applied

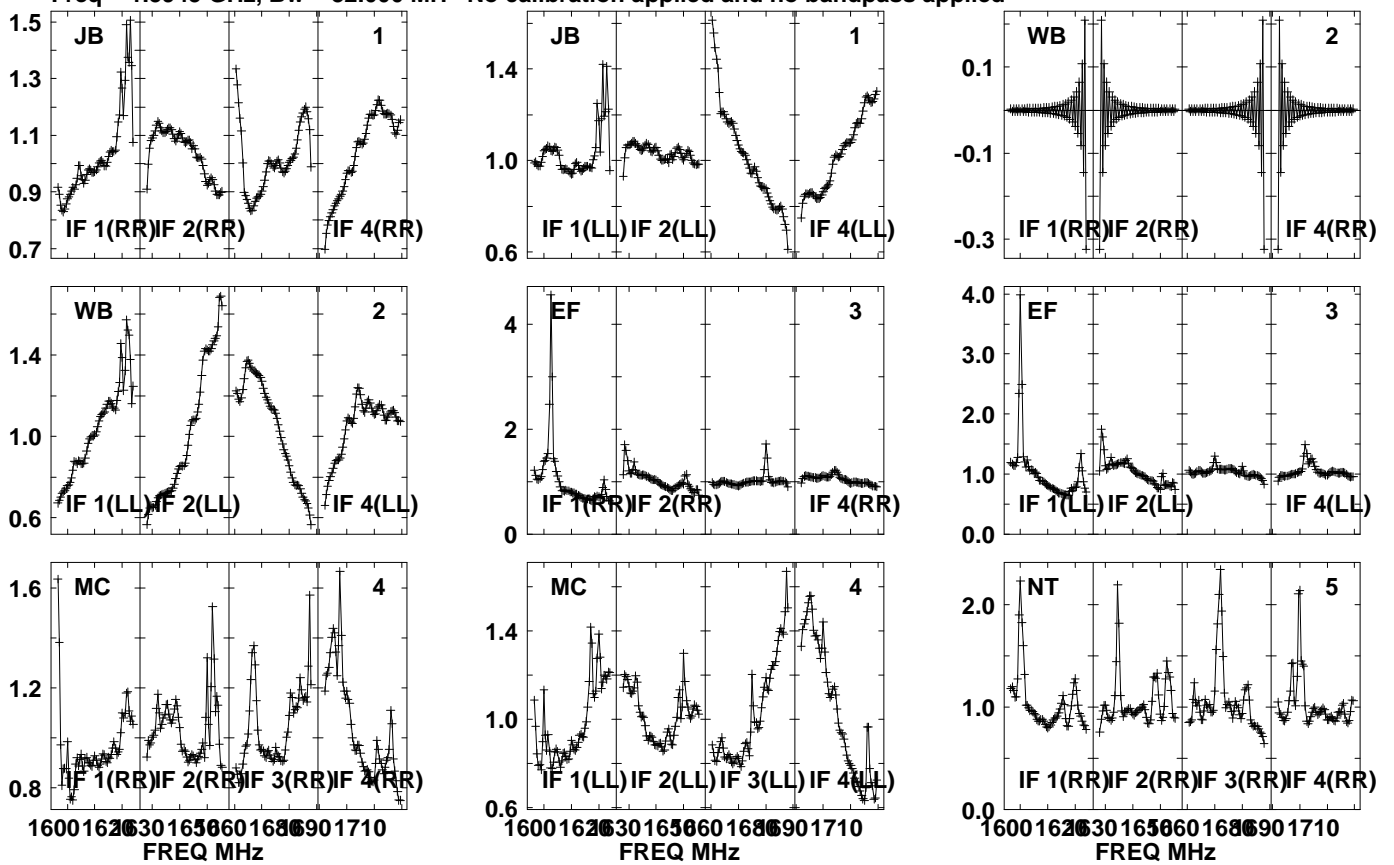

Lower frame: Real Jy  
Auto-corr total-power spectrum Antenna: \*  
Timerange: 00/14:53:01 to 00/14:56:29

Plot file version 434 created 05-OCT-2021 17:06:18

APM08279+525 GM076.UVDATA.1

Freq = 1.5945 GHz, Bw = 32.000 MH No calibration applied and no bandpass applied

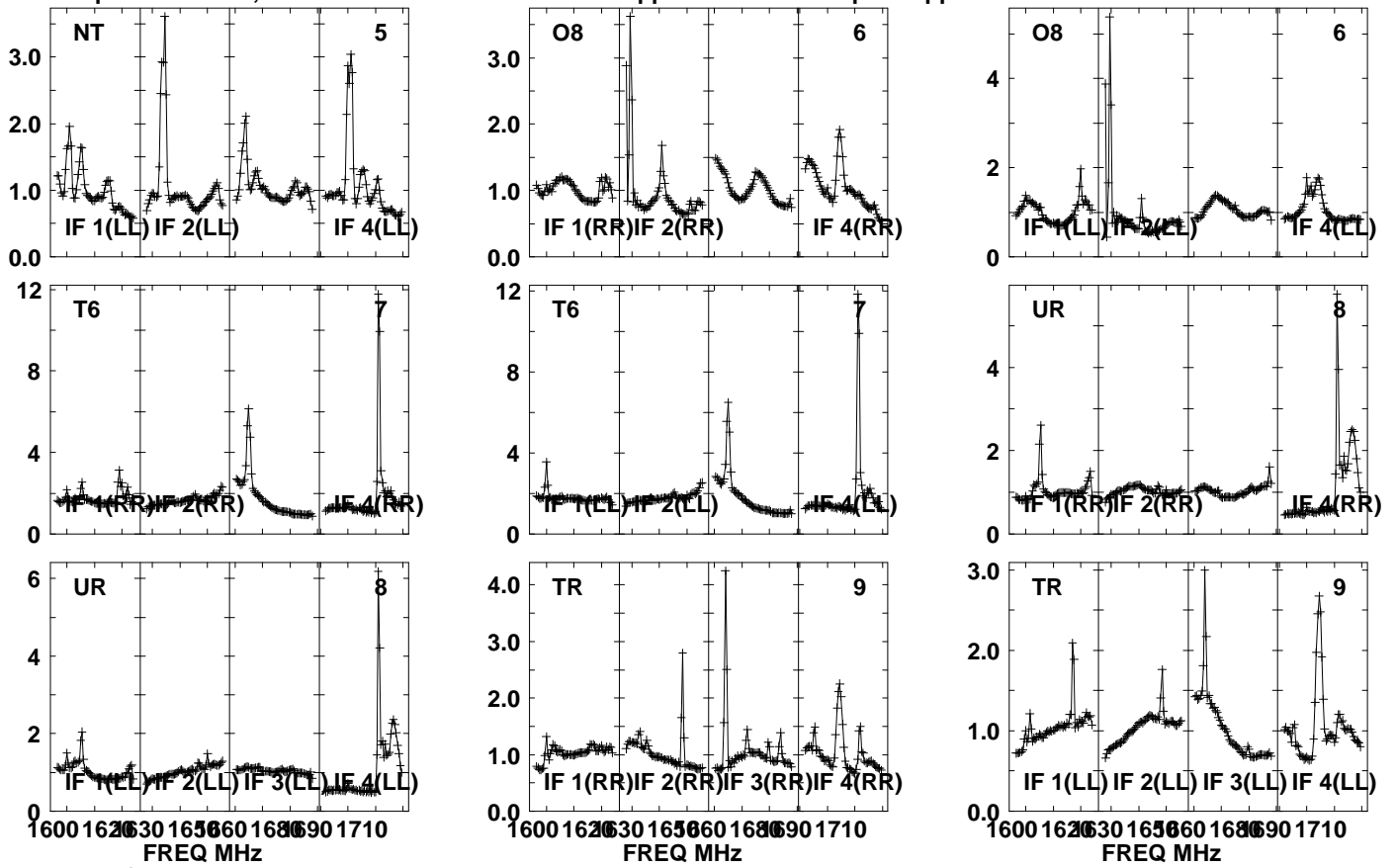

Lower frame: Real Jy

Auto-corr total-power spectrum Antenna: \*

Timerange: 00/14:53:01 to 00/14:56:29



Plot file version 435 created 05-OCT-2021 17:06:19

APM08279+525 GM076.UVDATA.1

Freq = 1.5945 GHz, Bw = 32.000 MH No calibration applied and no bandpass applied

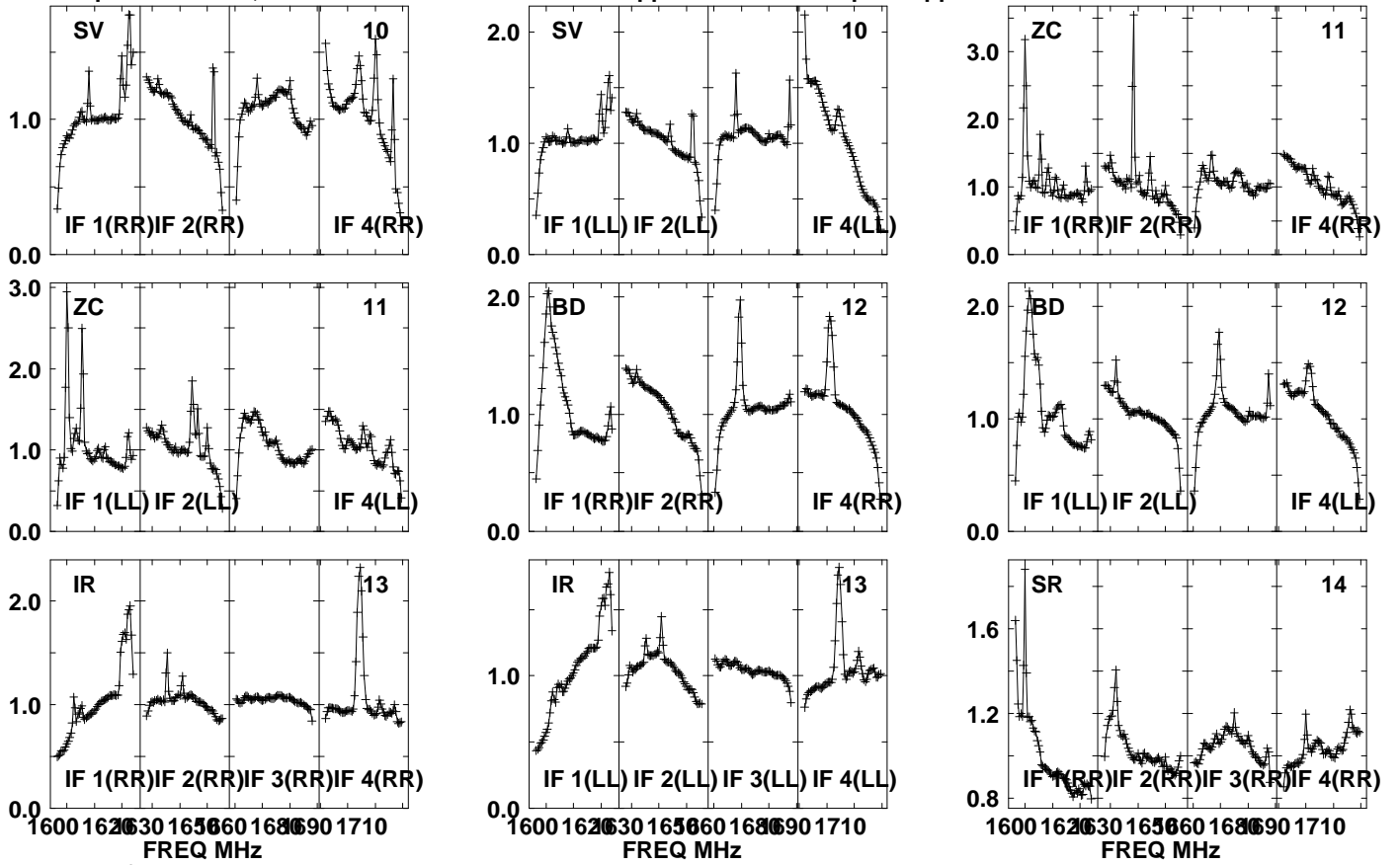

Lower frame: Real Jy  
Auto-corr total-power spectrum Antenna: \*  
Timerange: 00/14:53:01 to 00/14:56:29

Plot file version 436 created 05-OCT-2021 17:06:19

APM08279+525 GM076.UVDATA.1

Freq = 1.5945 GHz, Bw = 32.000 MH No calibration applied and no bandpass applied

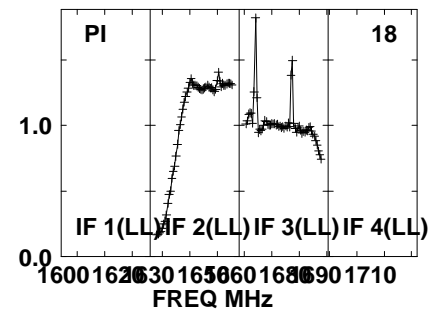
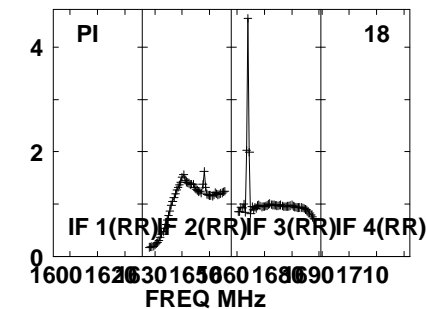
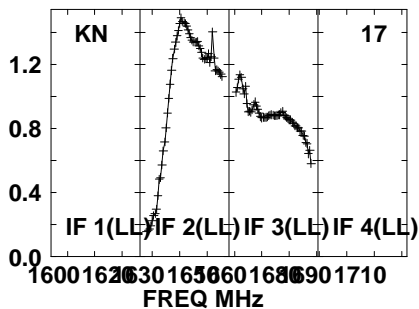
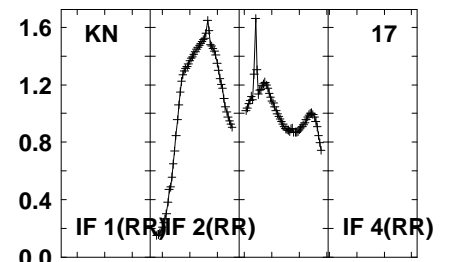
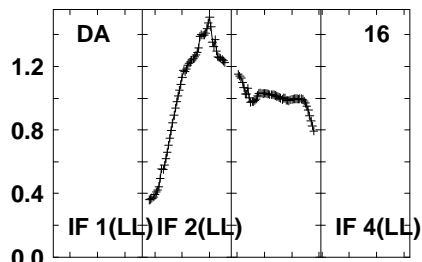
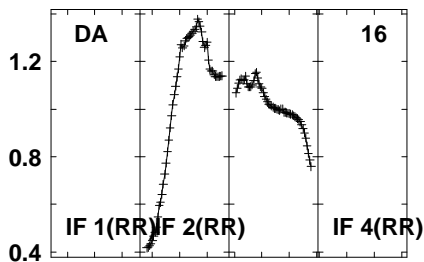
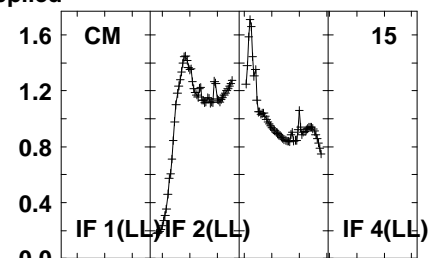
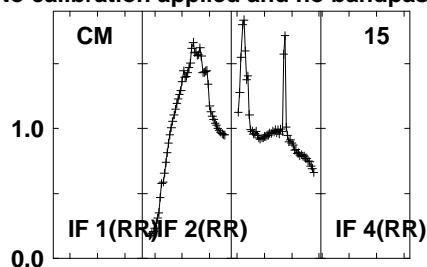
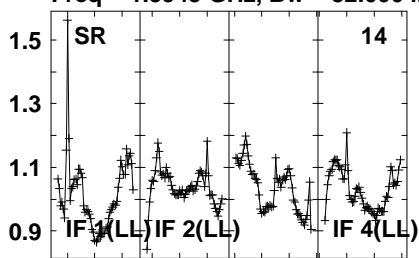

Lower frame: Real Jy  
Auto-corr total-power spectrum Antenna: \*  
Timerange: 00/14:53:01 to 00/14:56:29

Plot file version 437 created 05-OCT-2021 17:06:19

APM08279+525 GM076.UVDATA.1

Freq = 1.5945 GHz, Bw = 32.000 MH No calibration applied and no bandpass applied

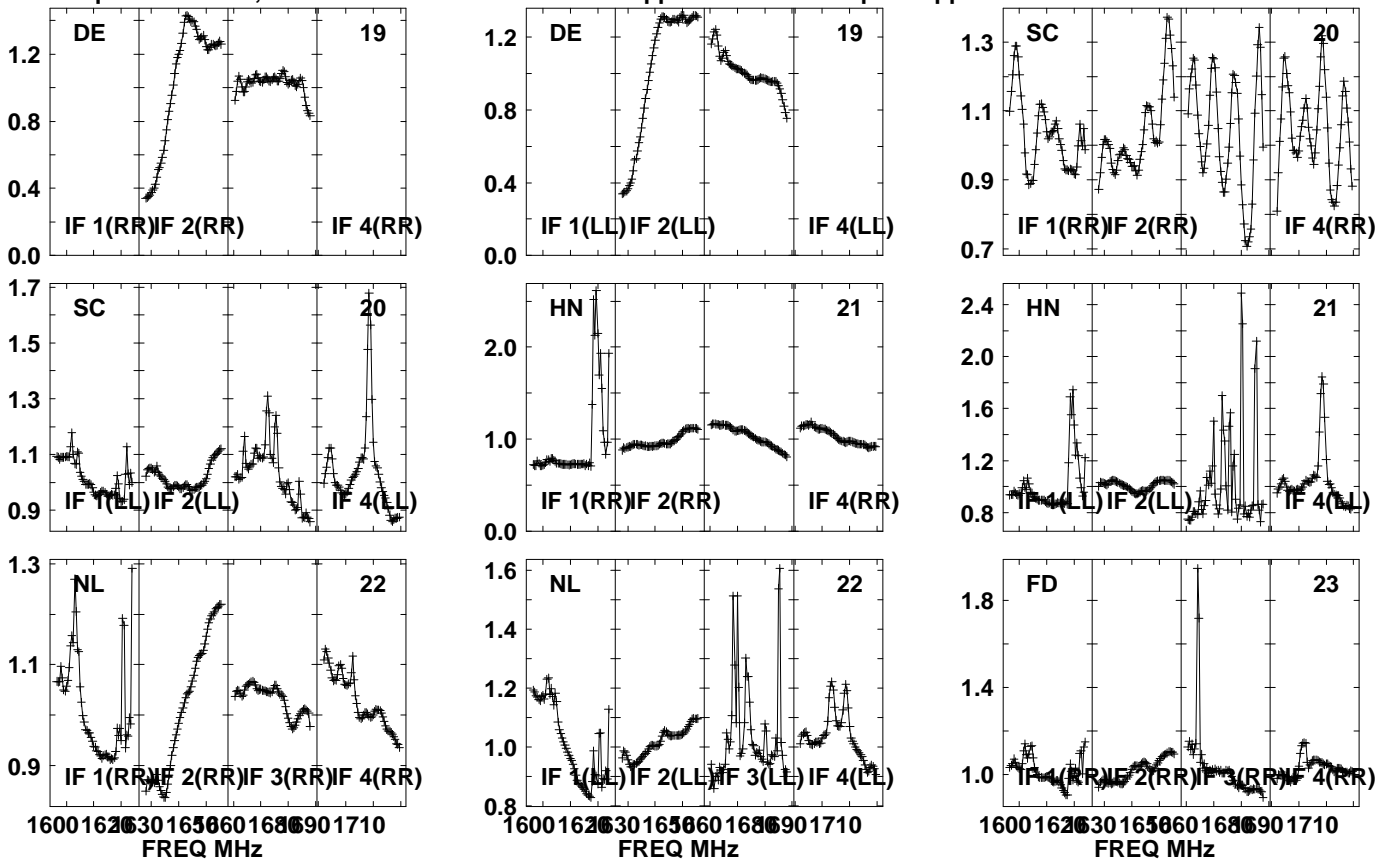

Lower frame: Real Jy  
Auto-corr total-power spectrum Antenna: \*  
Timerange: 00/14:53:01 to 00/14:56:29

Plot file version 438 created 05-OCT-2021 17:06:20

APM08279+525 GM076.UVDATA.1

Freq = 1.5945 GHz, Bw = 32.000 MH No calibration applied and no bandpass applied

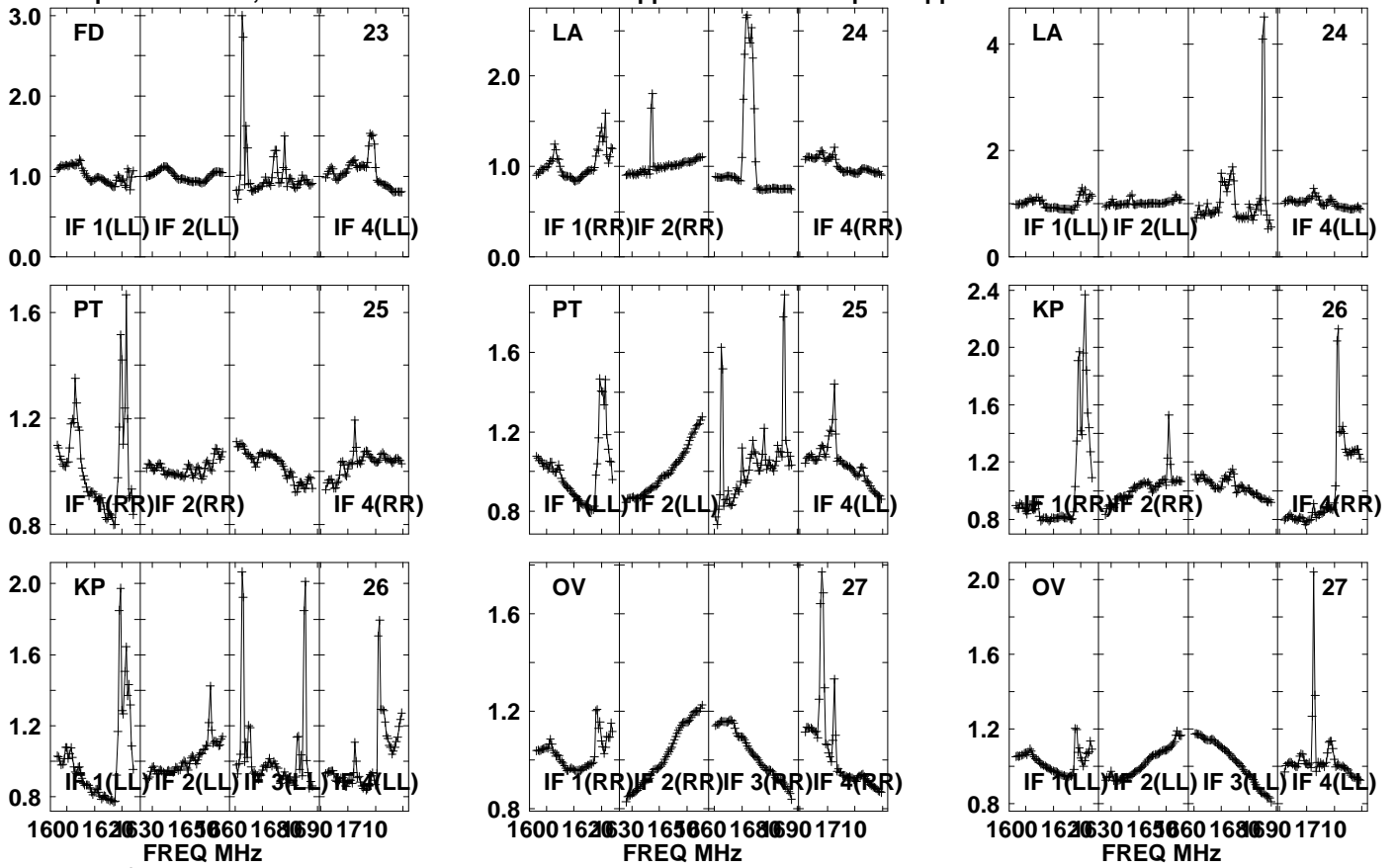

Lower frame: Real Jy

Auto-corr total-power spectrum Antenna: \*

Timerange: 00/14:53:01 to 00/14:56:29

Plot file version 439 created 05-OCT-2021 17:06:20

APM08279+525 GM076.UVDATA.1

Freq = 1.5945 GHz, Bw = 32.000 MH

No calibration applied and no bandpass applied

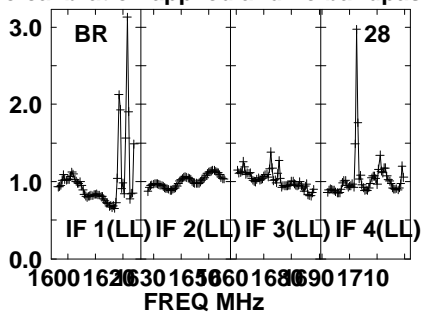
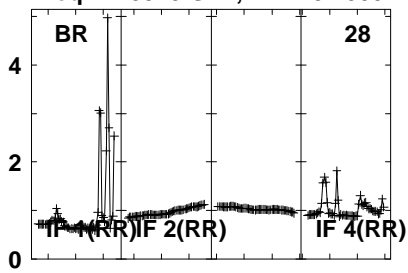

Lower frame: Real Jy

Auto-corr total-power spectrum Antenna: \*

Timerange: 00/14:53:01 to 00/14:56:29

Plot file version 440 created 05-OCT-2021 17:06:20

J0827+5217 GM076.UVDATA.1

Freq = 1.5945 GHz, Bw = 32.000 MH No calibration applied and no bandpass applied

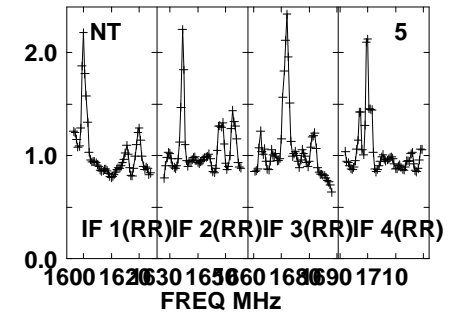
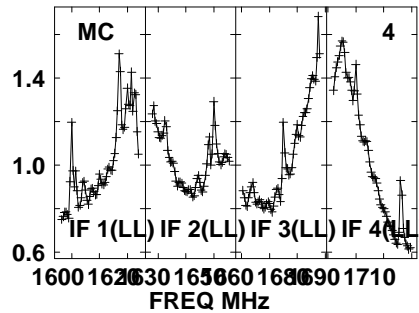
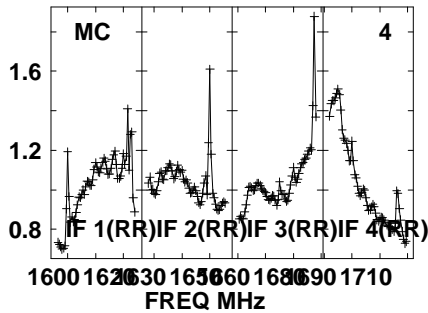
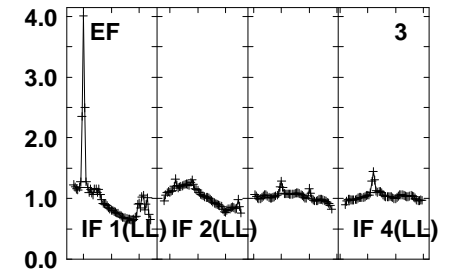
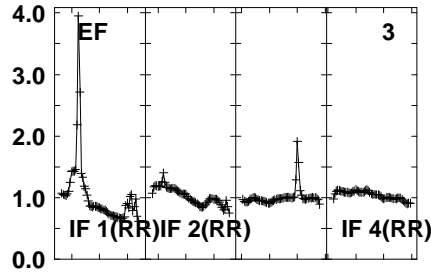
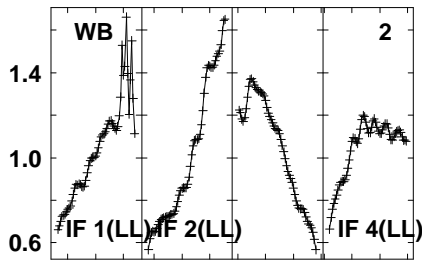
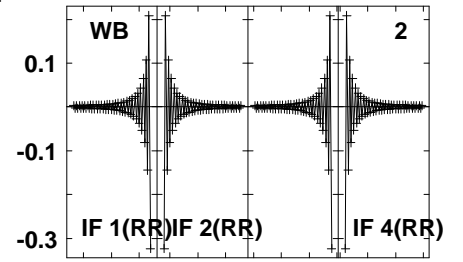
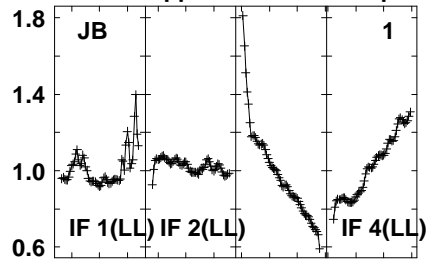
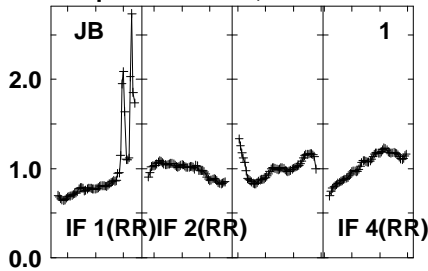

Lower frame: Real Jy

Auto-corr total-power spectrum Antenna: \*

Timerange: 00/14:57:01 to 00/14:58:29

Plot file version 441 created 05-OCT-2021 17:06:21

J0827+5217 GM076.UVDATA.1

Freq = 1.5945 GHz, Bw = 32.000 MH No calibration applied and no bandpass applied

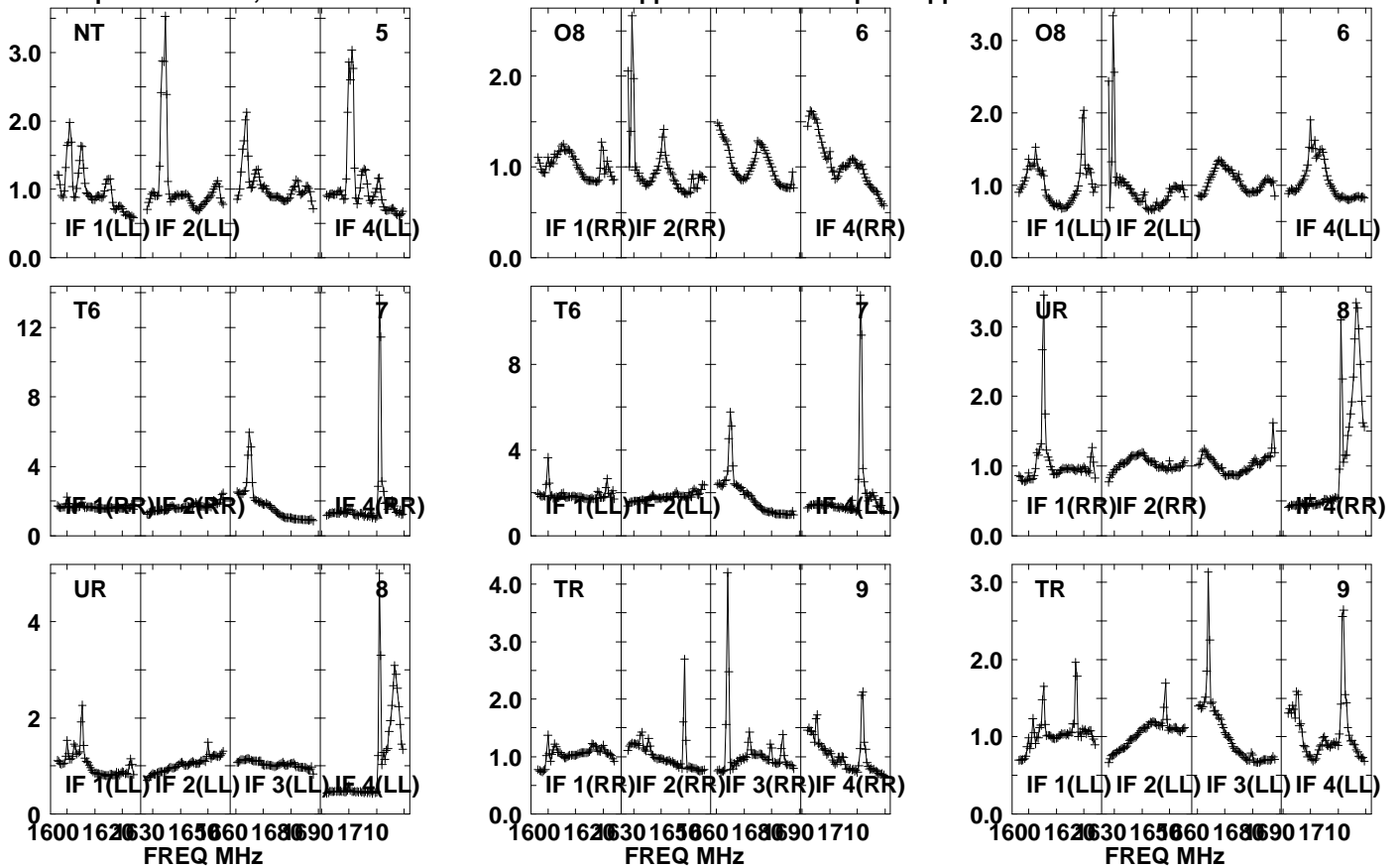

Lower frame: Real Jy

Auto-corr total-power spectrum Antenna: \*

Timerange: 00/14:57:01 to 00/14:58:29

Plot file version 442 created 05-OCT-2021 17:06:21

J0827+5217 GM076.UVDATA.1

Freq = 1.5945 GHz, Bw = 32.000 MH No calibration applied and no bandpass applied

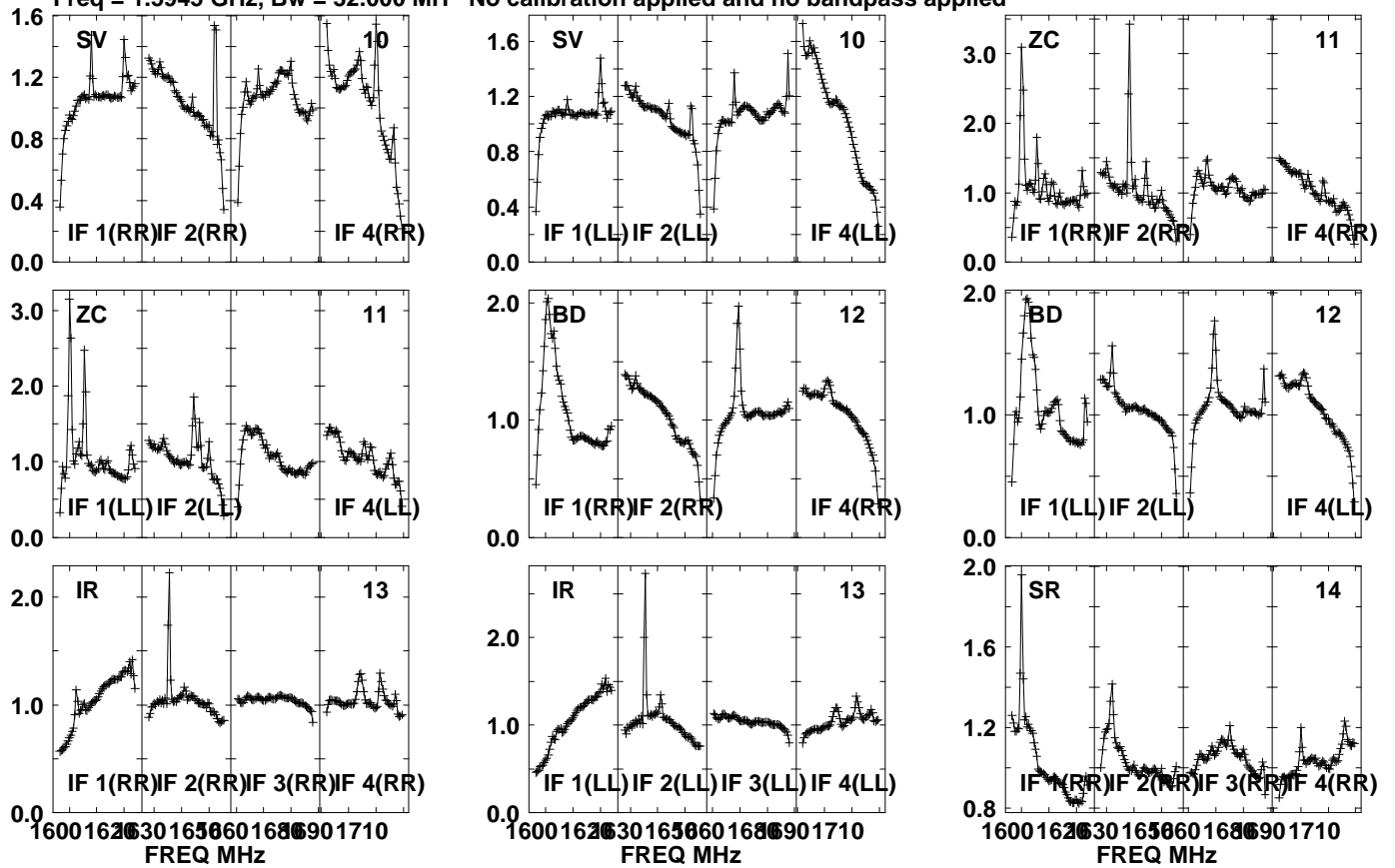

Lower frame: Real Jy  
Auto-corr total-power spectrum Antenna: \*  
Timerange: 00/14:57:01 to 00/14:58:29



Plot file version 443 created 05-OCT-2021 17:06:21

J0827+5217 GM076.UVDATA.1

Freq = 1.5945 GHz, Bw = 32.000 MH No calibration applied and no bandpass applied

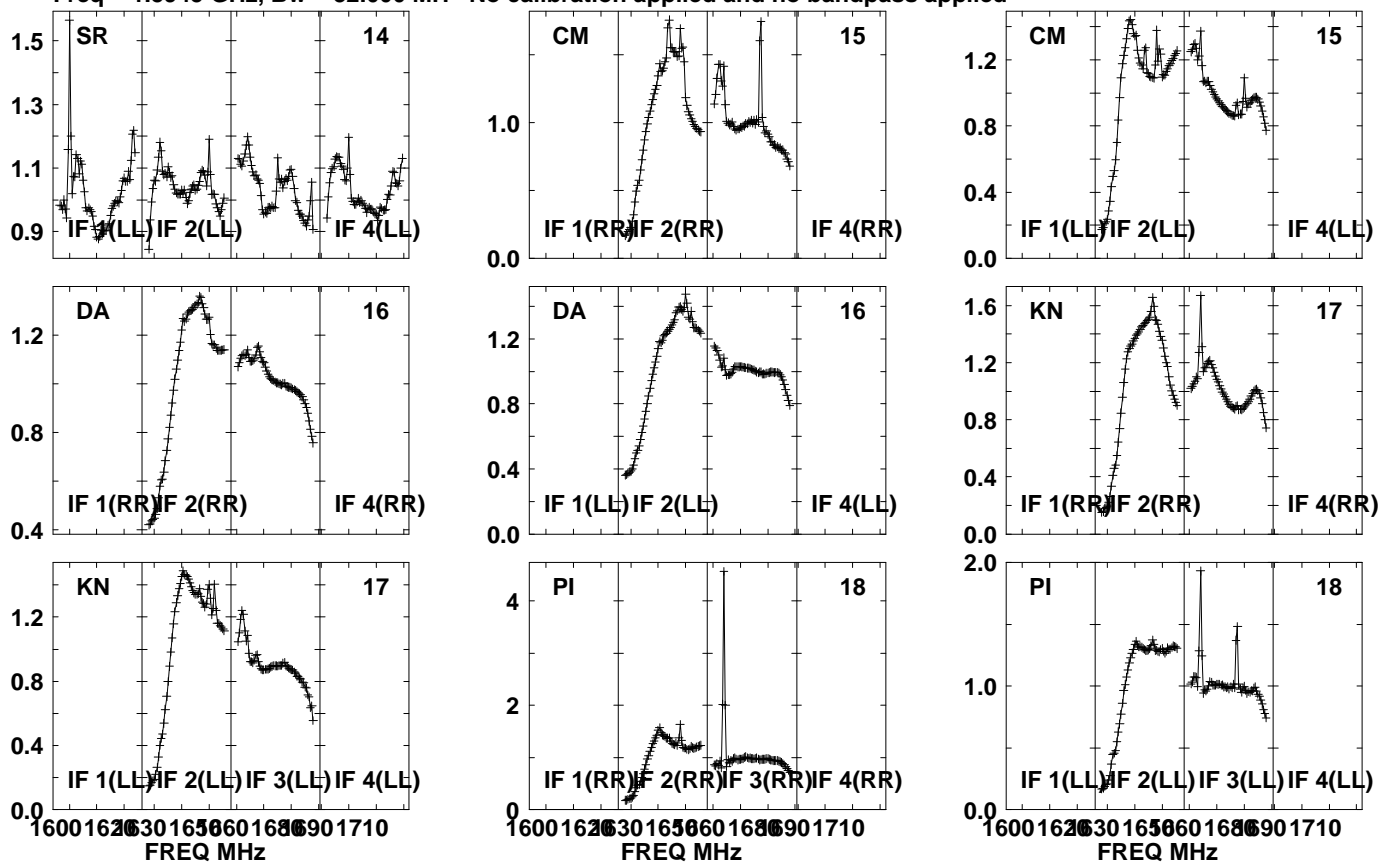

Lower frame: Real Jy  
Auto-corr total-power spectrum Antenna: \*  
Timerange: 00/14:57:01 to 00/14:58:29

Plot file version 444 created 05-OCT-2021 17:06:22

J0827+5217 GM076.UVDATA.1

Freq = 1.5945 GHz, Bw = 32.000 MH No calibration applied and no bandpass applied

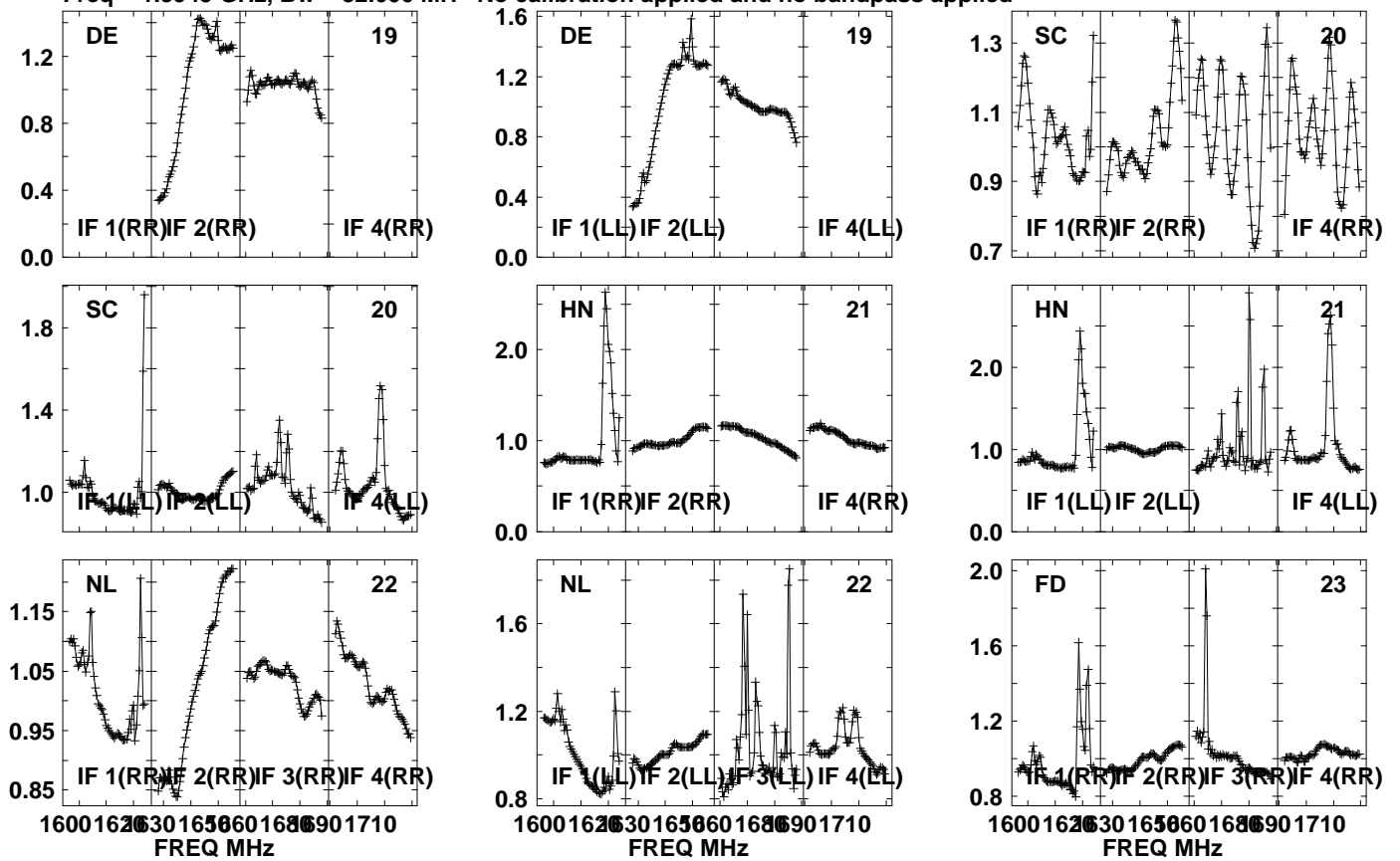

Lower frame: Real Jy  
Auto-corr total-power spectrum Antenna: \*  
Timerange: 00/14:57:01 to 00/14:58:29

Plot file version 445 created 05-OCT-2021 17:06:22

J0827+5217 GM076.UVDATA.1

Freq = 1.5945 GHz, Bw = 32.000 MH No calibration applied and no bandpass applied

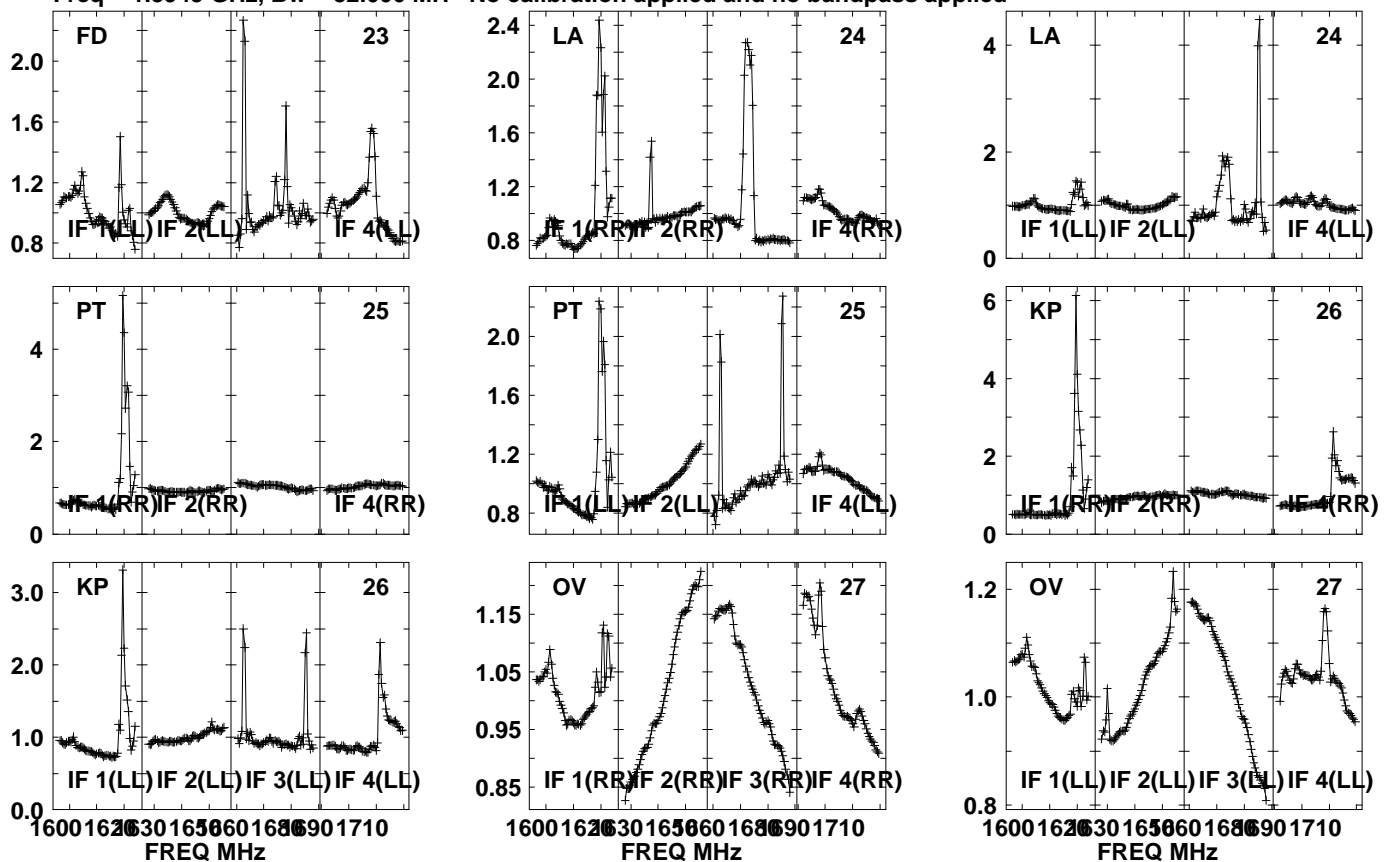

Lower frame: Real Jy  
Auto-corr total-power spectrum Antenna: \*  
Timerange: 00/14:57:01 to 00/14:58:29

Plot file version 446 created 05-OCT-2021 17:06:22

J0827+5217 GM076.UVDATA.1

Freq = 1.5945 GHz, Bw = 32.000 MH No calibration applied and no bandpass applied

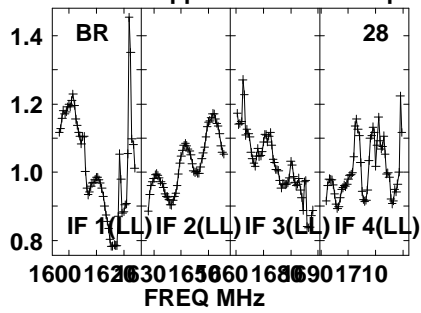
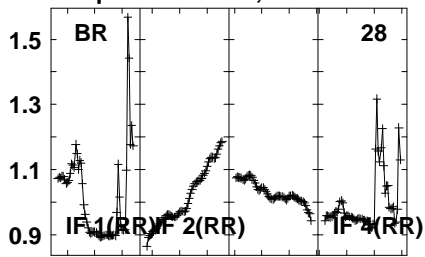

Lower frame: Real Jy  
Auto-corr total-power spectrum Antenna: \*  
Timerange: 00/14:57:01 to 00/14:58:29

Plot file version 447 created 05-OCT-2021 17:06:23

APM08279+525 GM076.UVDATA.1

Freq = 1.5945 GHz, Bw = 32.000 MH No calibration applied and no bandpass applied

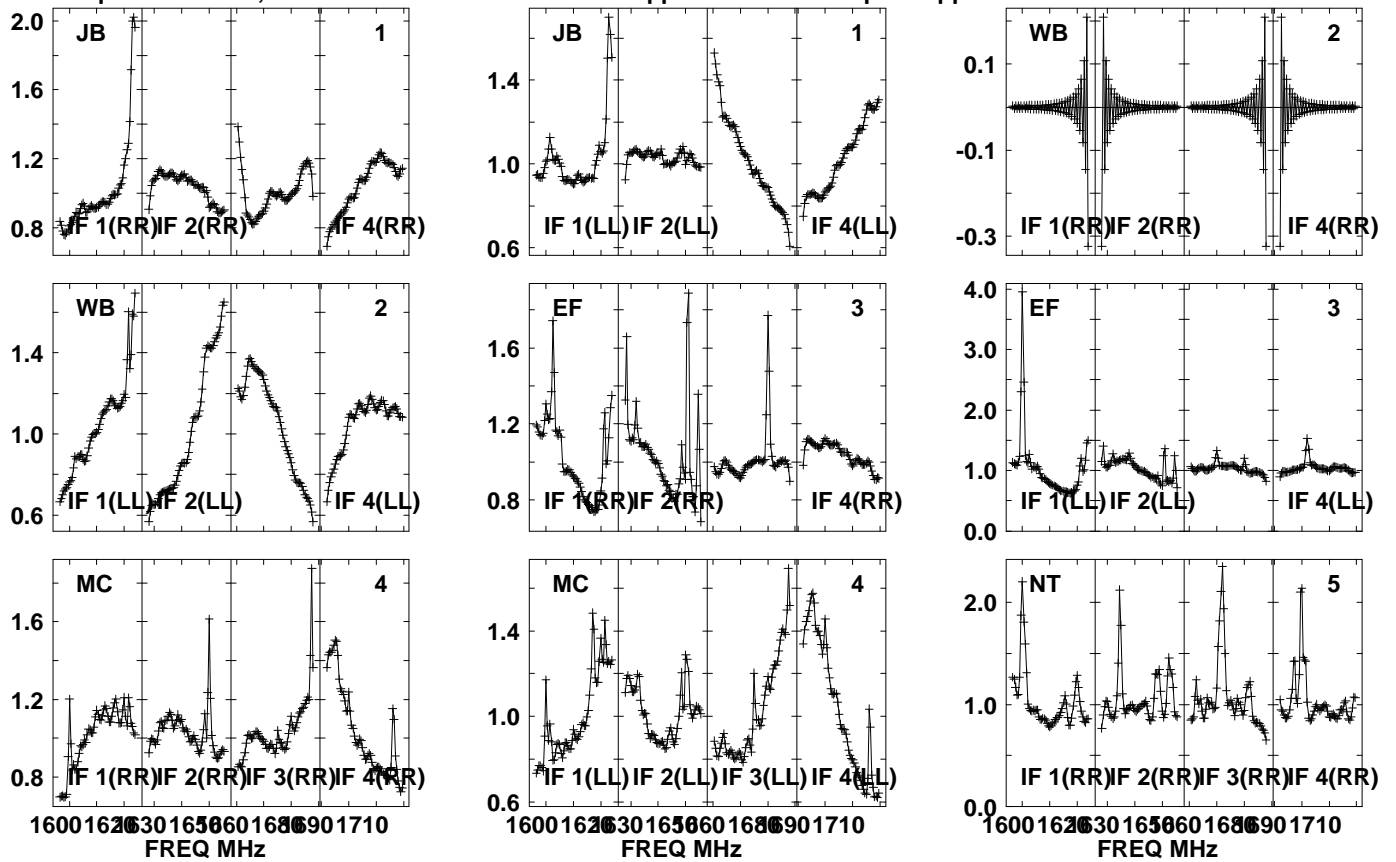

Lower frame: Real Jy  
Auto-corr total-power spectrum Antenna: \*  
Timerange: 00/14:58:31 to 00/15:01:59

Plot file version 448 created 05-OCT-2021 17:06:23

APM08279+525 GM076.UVDATA.1

Freq = 1.5945 GHz, Bw = 32.000 MH No calibration applied and no bandpass applied

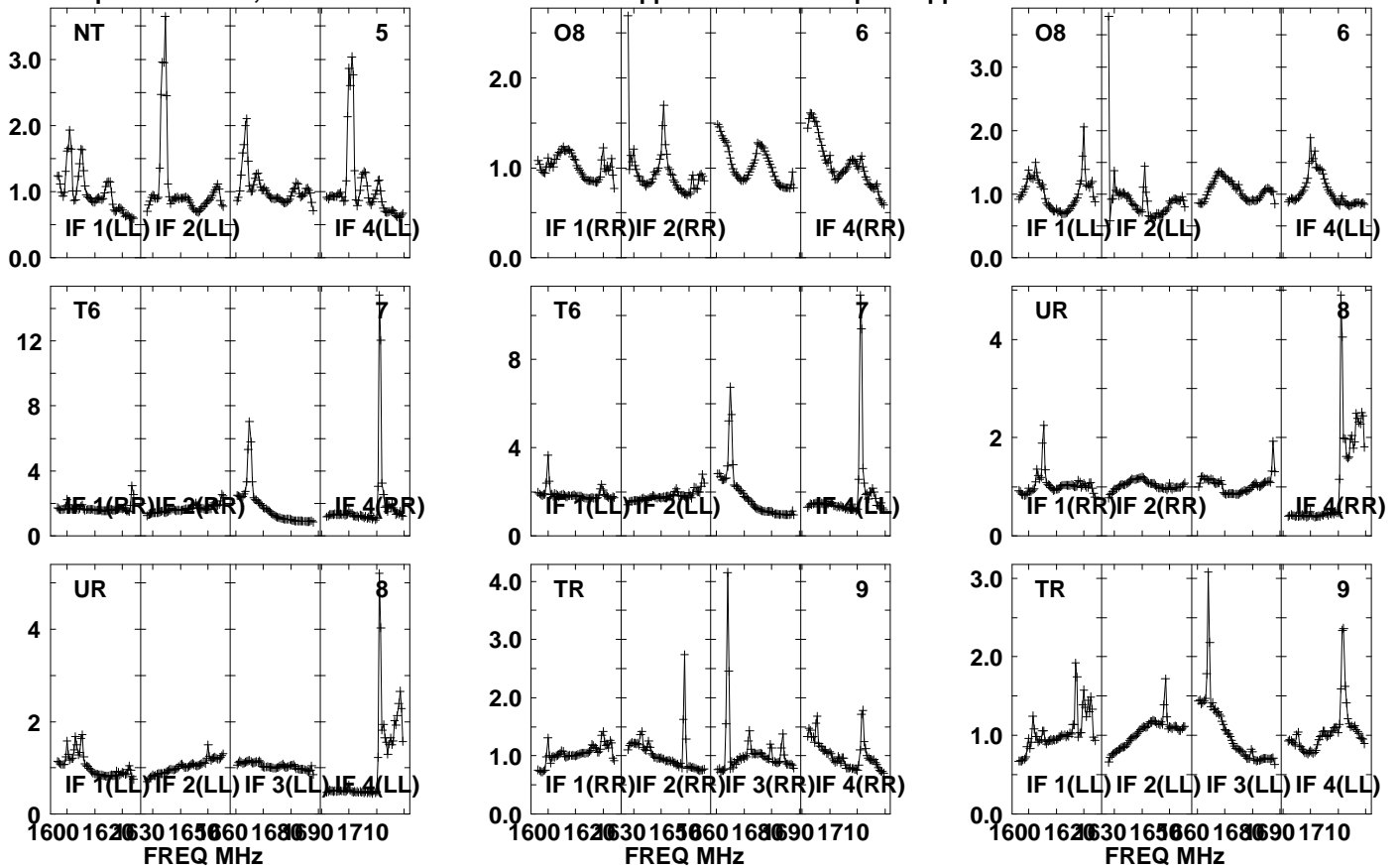

Lower frame: Real Jy

Auto-corr total-power spectrum Antenna: \*

Timerange: 00/14:58:31 to 00/15:01:59

Plot file version 449 created 05-OCT-2021 17:06:23

APM08279+525 GM076.UVDATA.1

Freq = 1.5945 GHz, Bw = 32.000 MH No calibration applied and no bandpass applied

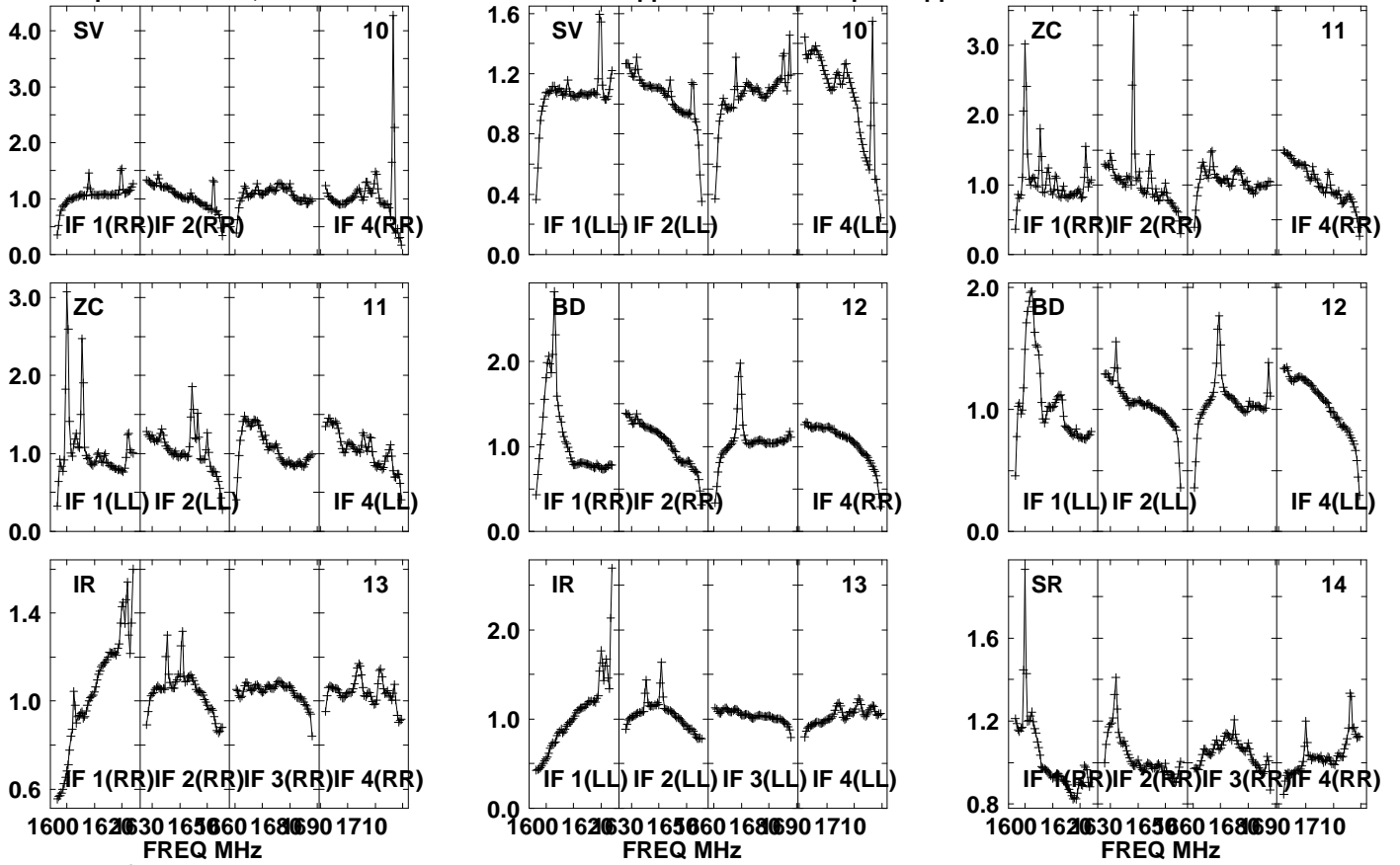

Lower frame: Real Jy  
Auto-corr total-power spectrum Antenna: \*  
Timerange: 00/14:58:31 to 00/15:01:59

Plot file version 450 created 05-OCT-2021 17:06:24

APM08279+525 GM076.UVDATA.1

Freq = 1.5945 GHz, Bw = 32.000 MH No calibration applied and no bandpass applied

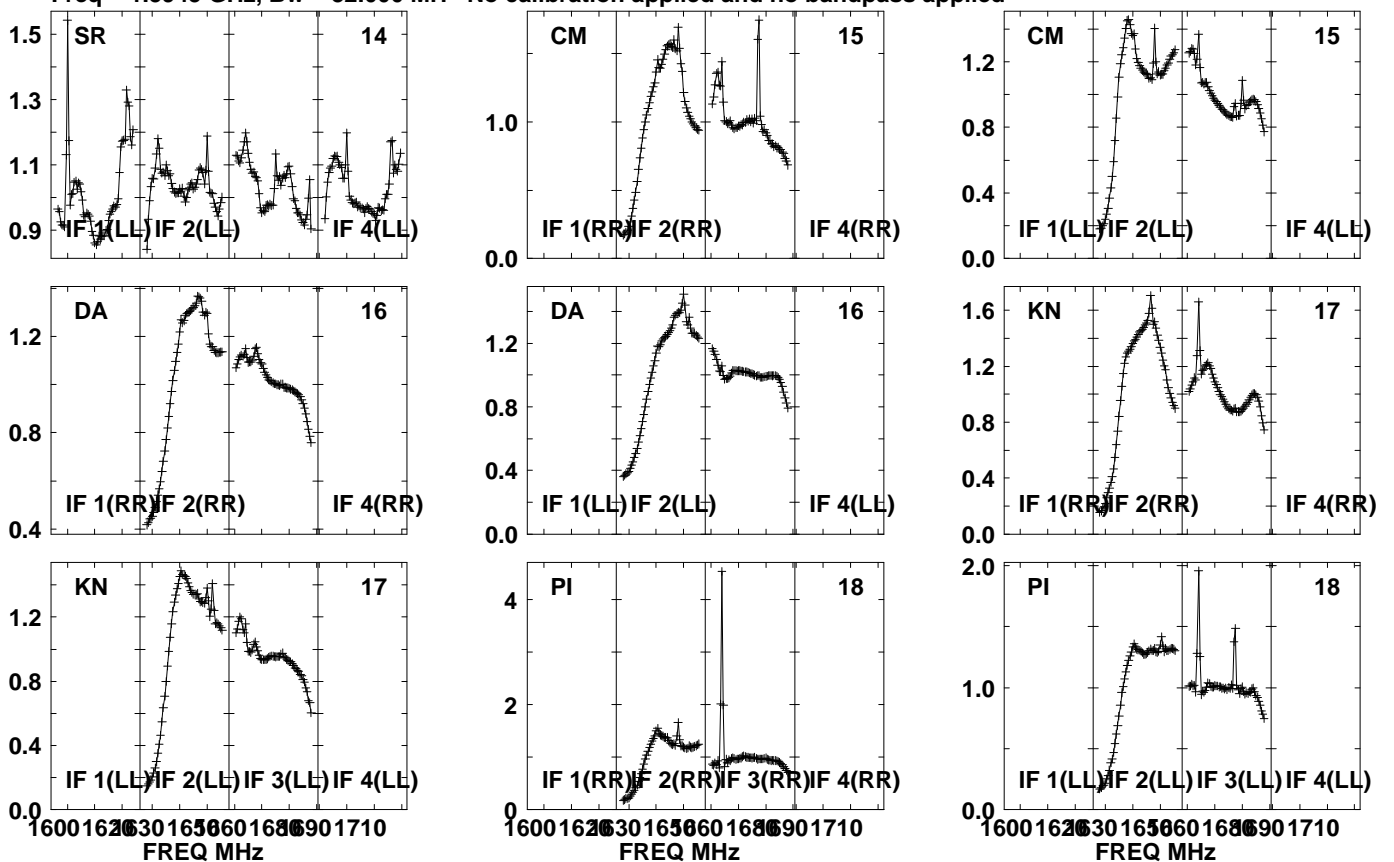

Lower frame: Real Jy  
Auto-corr total-power spectrum Antenna: \*  
Timerange: 00/14:58:31 to 00/15:01:59



Plot file version 451 created 05-OCT-2021 17:06:24

APM08279+525 GM076.UVDATA.1

Freq = 1.5945 GHz, Bw = 32.000 MH No calibration applied and no bandpass applied

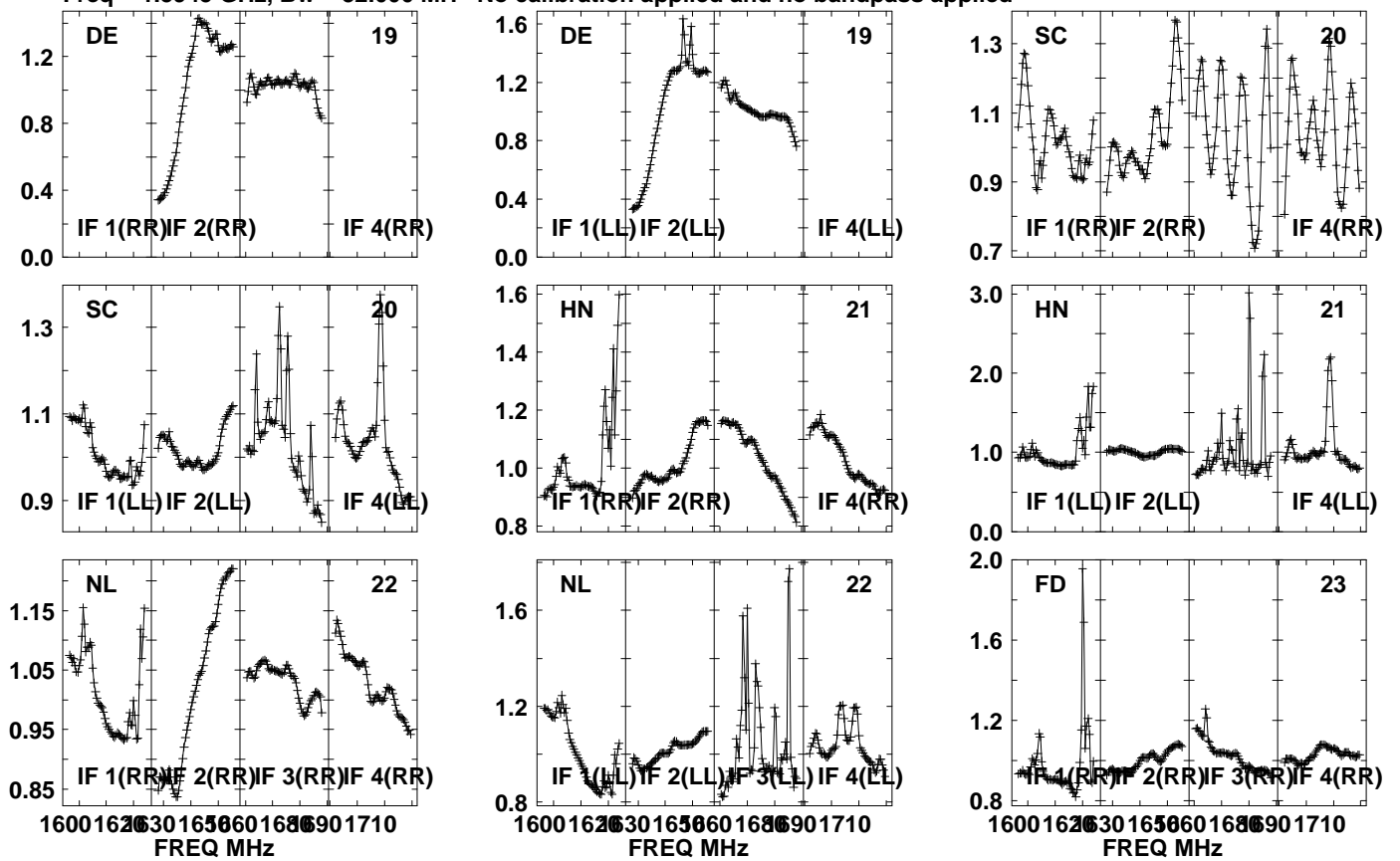

Lower frame: Real Jy  
Auto-corr total-power spectrum Antenna: \*  
Timerange: 00/14:58:31 to 00/15:01:59

Plot file version 452 created 05-OCT-2021 17:06:24

APM08279+525 GM076.UVDATA.1

Freq = 1.5945 GHz, Bw = 32.000 MH No calibration applied and no bandpass applied

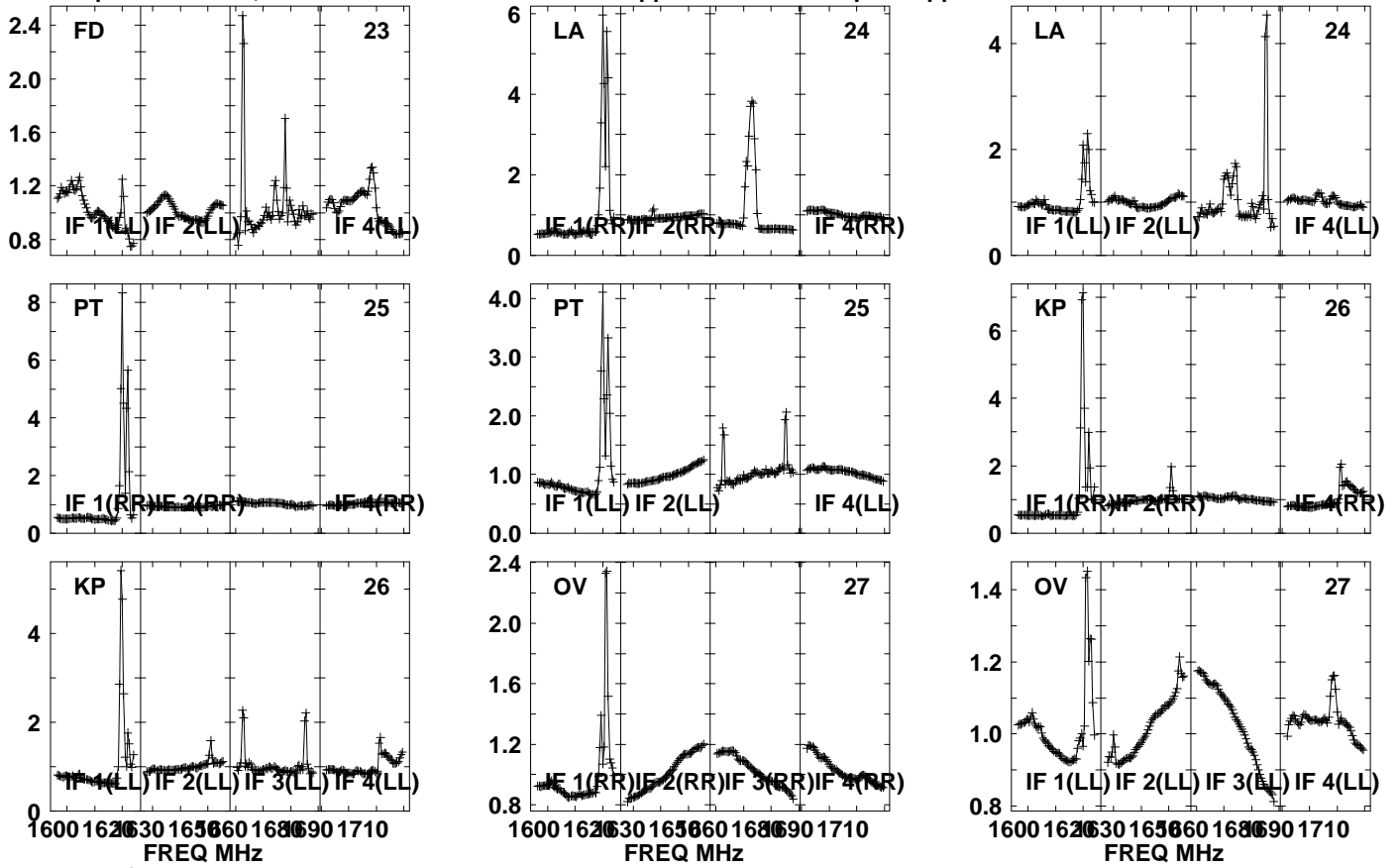

Lower frame: Real Jy

Auto-corr total-power spectrum Antenna: \*

Timerange: 00/14:58:31 to 00/15:01:59

Plot file version 453 created 05-OCT-2021 17:06:25

APM08279+525 GM076.UVDATA.1

Freq = 1.5945 GHz, Bw = 32.000 MH No calibration applied and no bandpass applied

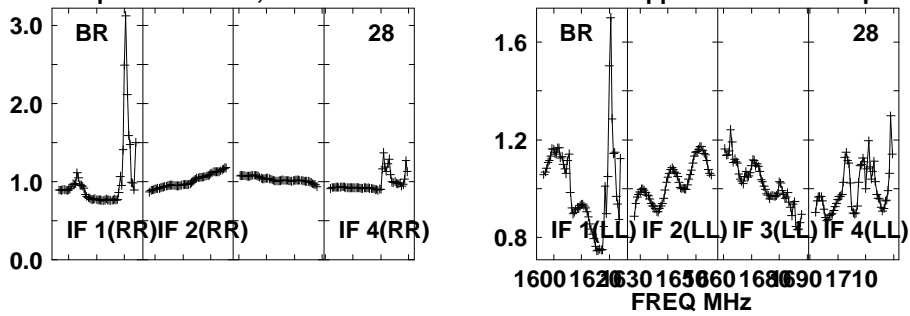

Lower frame: Real Jy

Auto-corr total-power spectrum Antenna: \*

Timerange: 00/14:58:31 to 00/15:01:59

Plot file version 454 created 05-OCT-2021 17:06:25

J0827+5217 GM076.UVDATA.1

Freq = 1.5945 GHz, Bw = 32.000 MH No calibration applied and no bandpass applied

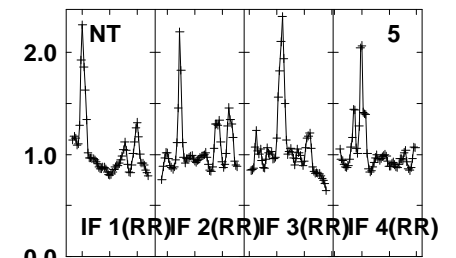
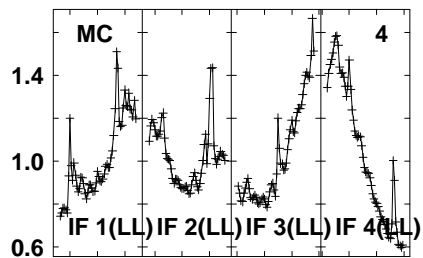
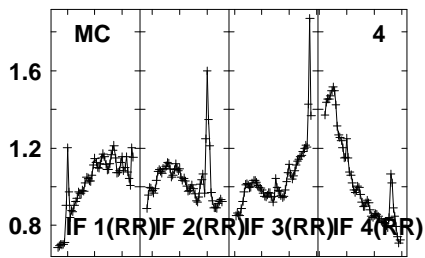
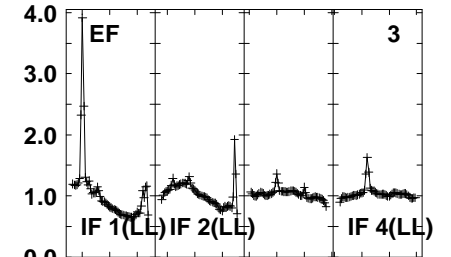
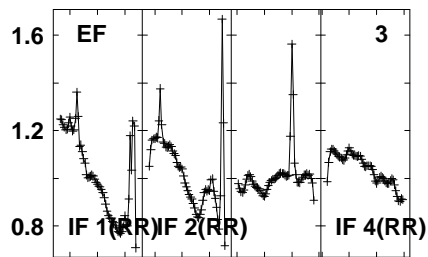
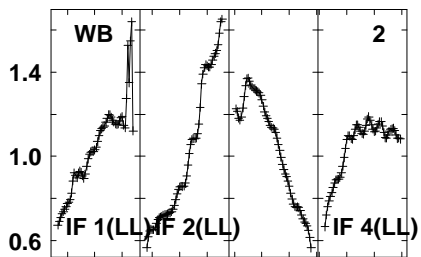
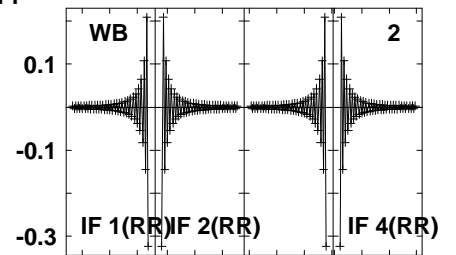
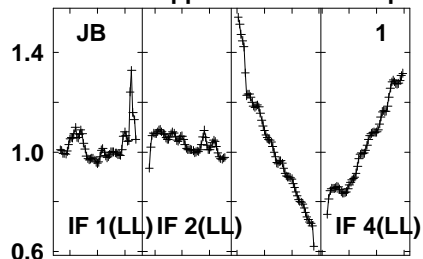
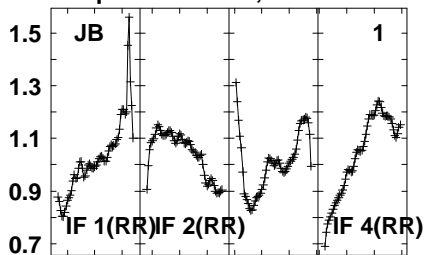

1600 1620 1630 1650 1660 1680 1690 1710  
FREQ MHz

1600 1620 1630 1650 1660 1680 1690 1710  
FREQ MHz

1600 1620 1630 1650 1660 1680 1690 1710  
FREQ MHz

Lower frame: Real Jy  
Auto-corr total-power spectrum Antenna: \*  
Timerange: 00/15:02:01 to 00/15:03:29

Plot file version 455 created 05-OCT-2021 17:06:25

J0827+5217 GM076.UVDATA.1

Freq = 1.5945 GHz, Bw = 32.000 MH No calibration applied and no bandpass applied

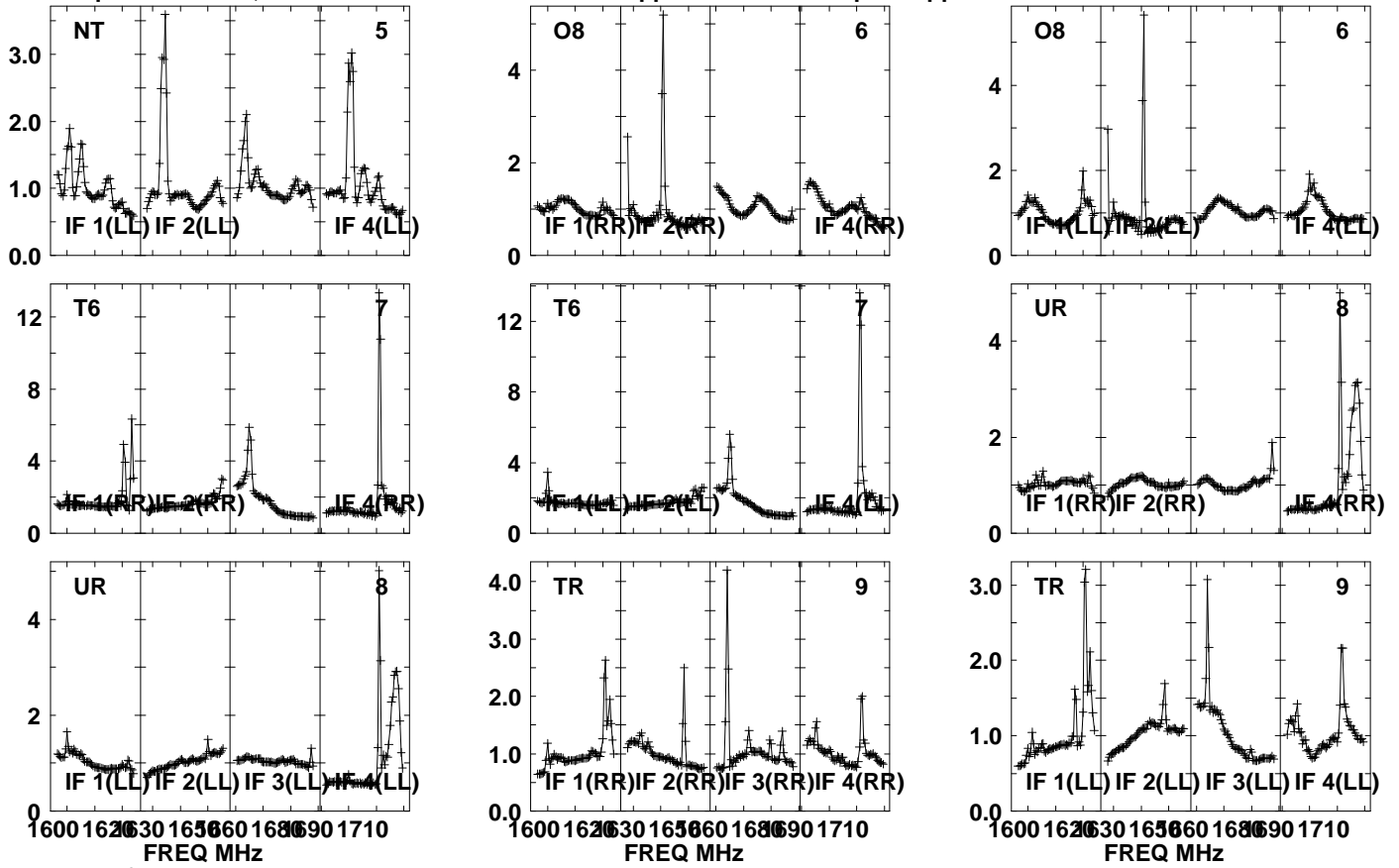

Lower frame: Real Jy  
Auto-corr total-power spectrum Antenna: \*  
Timerange: 00/15:02:01 to 00/15:03:29

Plot file version 456 created 05-OCT-2021 17:06:25

J0827+5217 GM076.UVDATA.1

Freq = 1.5945 GHz, Bw = 32.000 MH No calibration applied and no bandpass applied

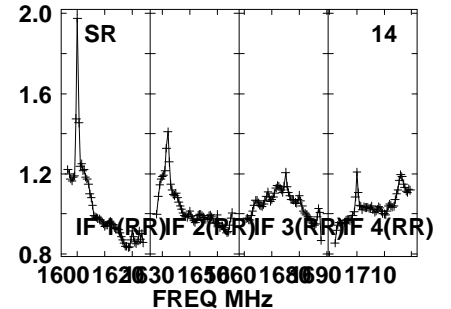
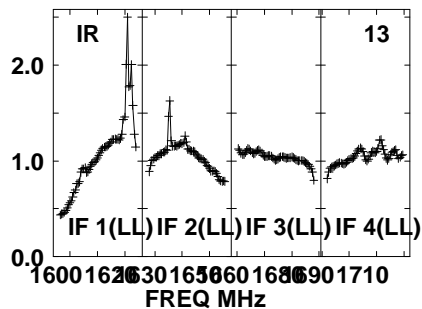
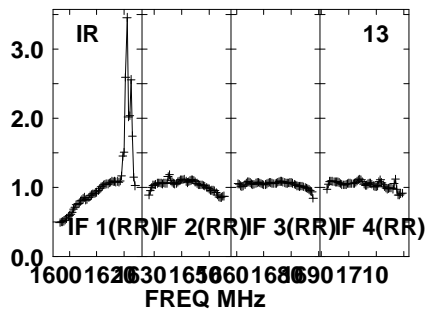
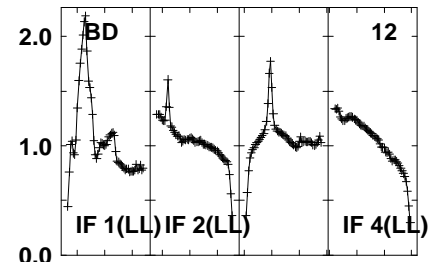
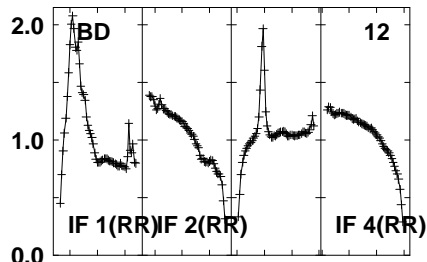
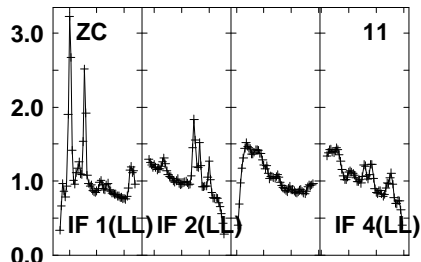
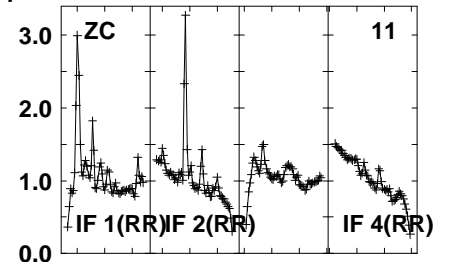
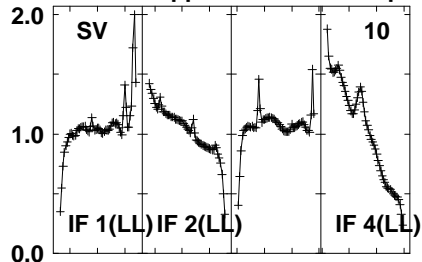
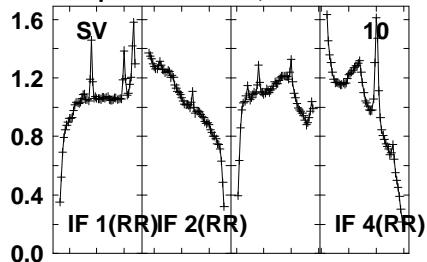

Lower frame: Real Jy  
Auto-corr total-power spectrum Antenna: \*  
Timerange: 00/15:02:01 to 00/15:03:29

Plot file version 457 created 05-OCT-2021 17:06:26

J0827+5217 GM076.UVDATA.1

Freq = 1.5945 GHz, Bw = 32.000 MH No calibration applied and no bandpass applied

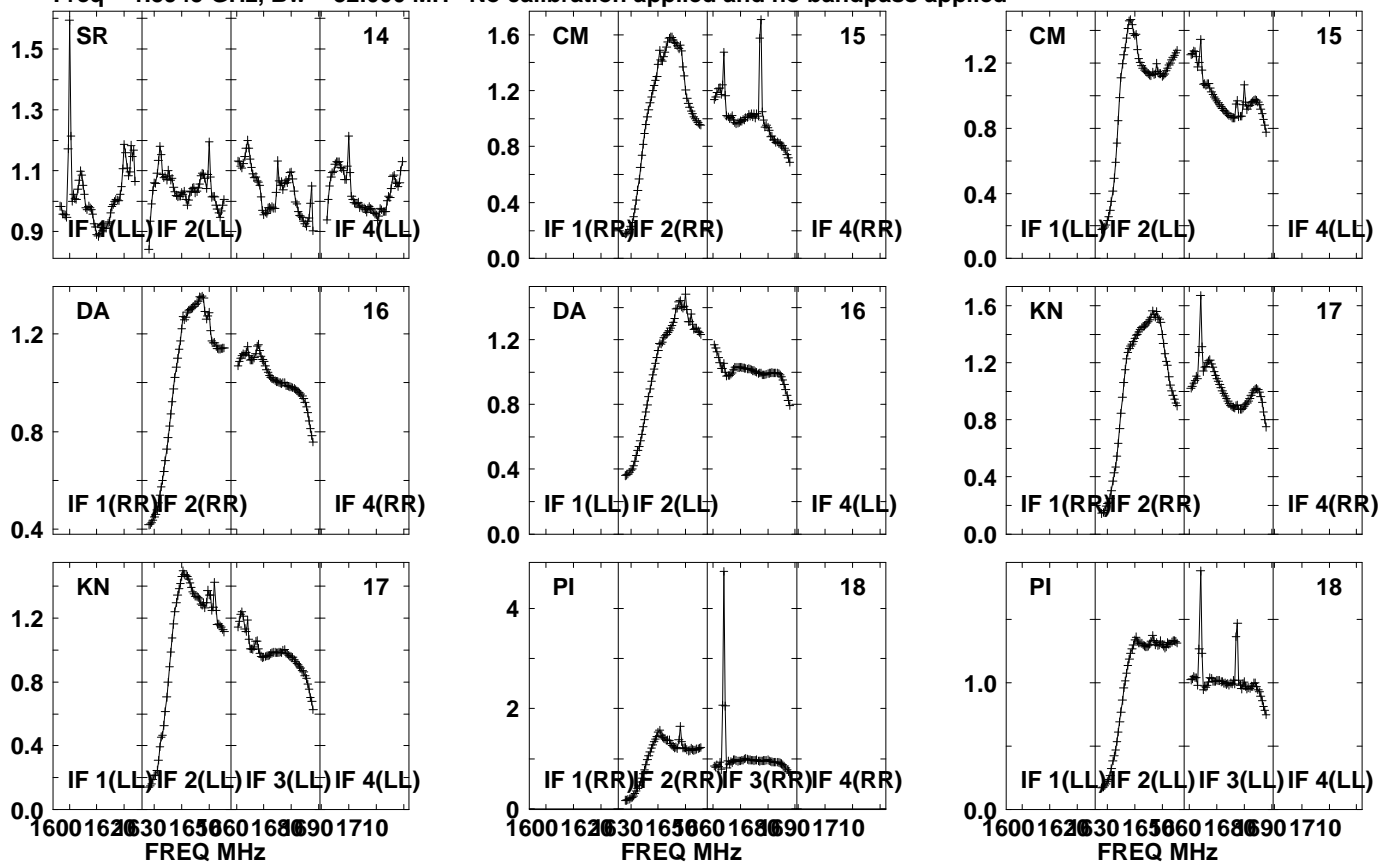

Lower frame: Real Jy  
Auto-corr total-power spectrum Antenna: \*  
Timerange: 00/15:02:01 to 00/15:03:29

Plot file version 458 created 05-OCT-2021 17:06:26

J0827+5217 GM076.UVDATA.1

Freq = 1.5945 GHz, Bw = 32.000 MH No calibration applied and no bandpass applied

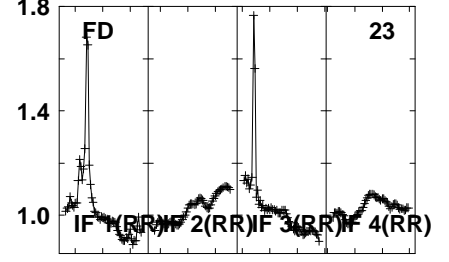
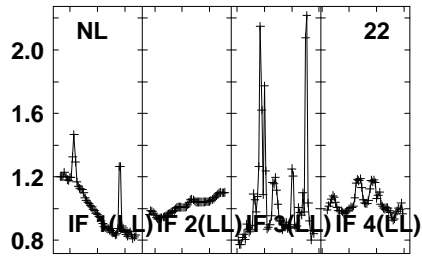
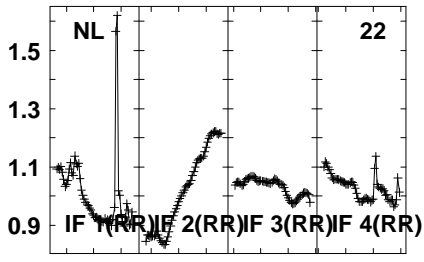
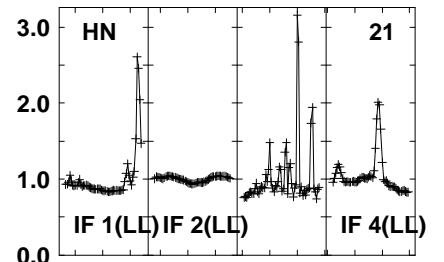
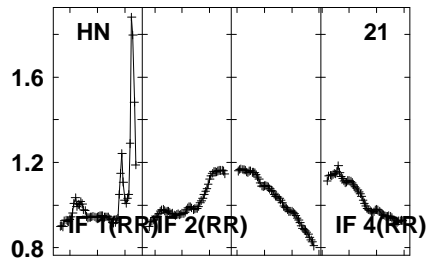
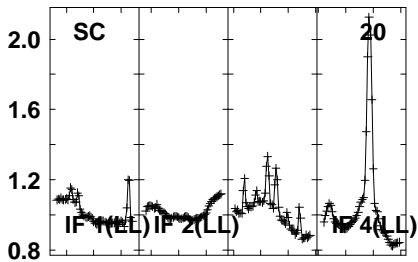
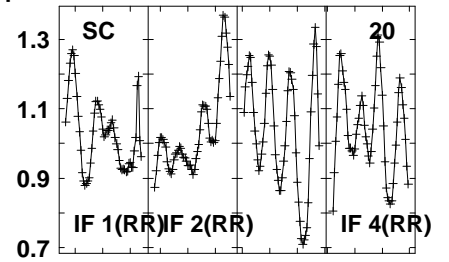
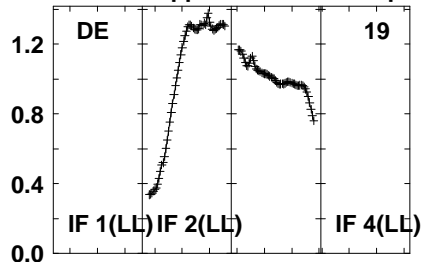
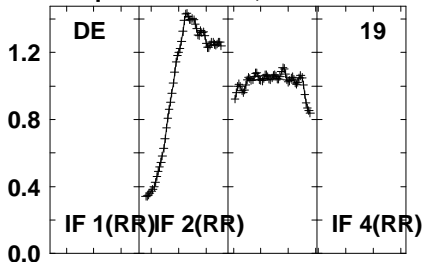

Lower frame: Real Jy  
Auto-corr total-power spectrum Antenna: \*  
Timerange: 00/15:02:01 to 00/15:03:29



Plot file version 459 created 05-OCT-2021 17:06:26

J0827+5217 GM076.UVDATA.1

Freq = 1.5945 GHz, Bw = 32.000 MH No calibration applied and no bandpass applied

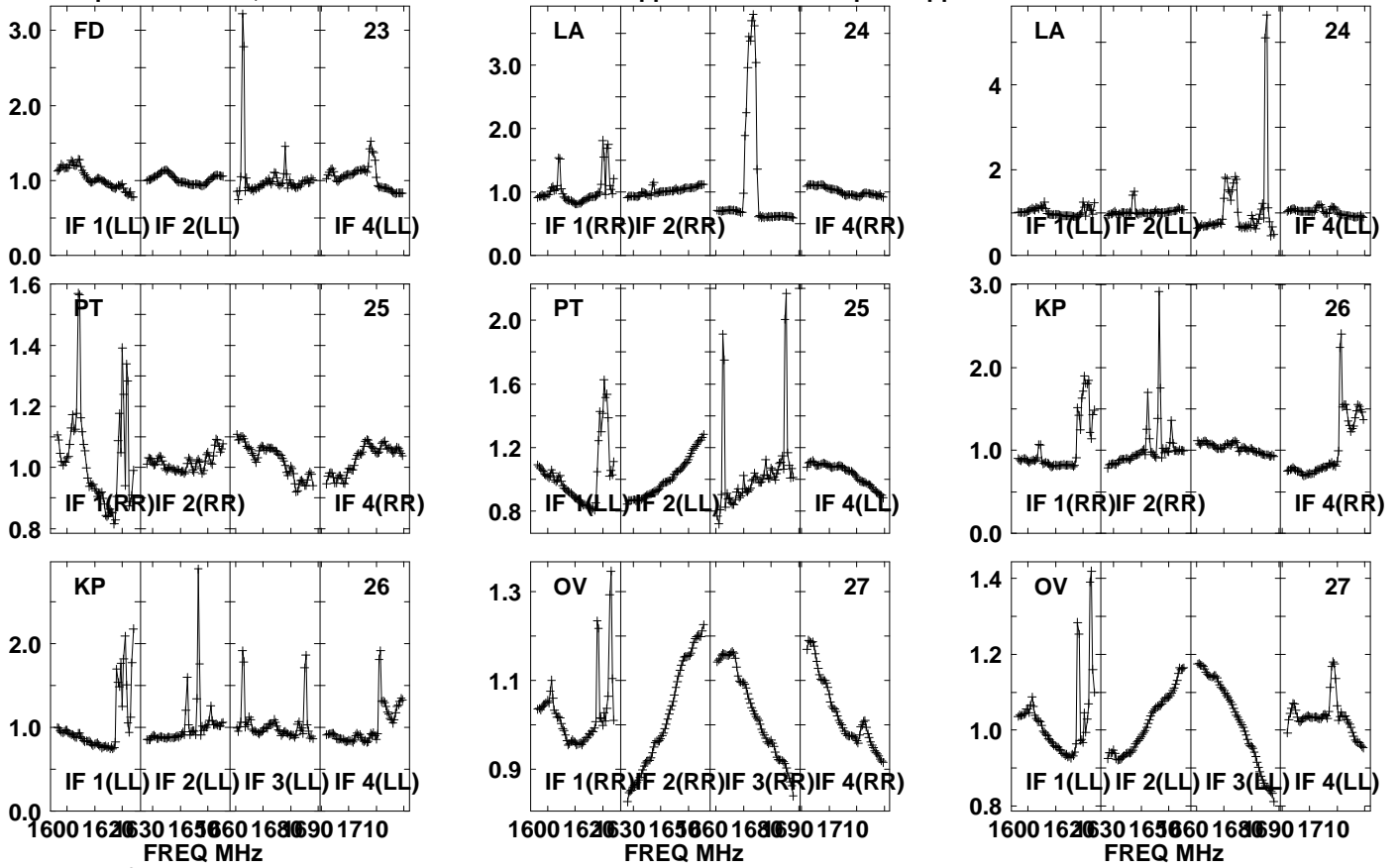

Lower frame: Real Jy  
Auto-corr total-power spectrum Antenna: \*  
Timerange: 00/15:02:01 to 00/15:03:29

Plot file version 460 created 05-OCT-2021 17:06:27

J0827+5217 GM076.UVDATA.1

Freq = 1.5945 GHz, Bw = 32.000 MH

No calibration applied and no bandpass applied

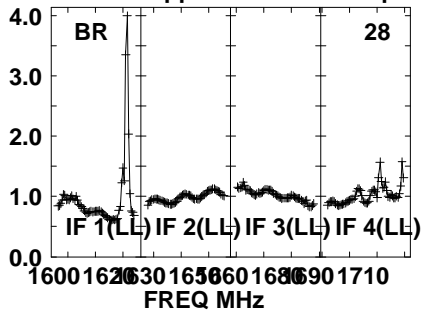
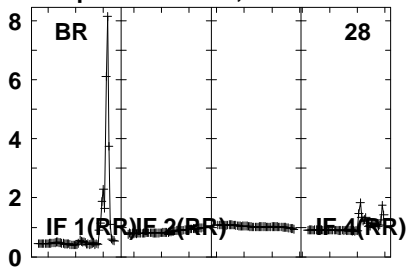

Lower frame: Real Jy  
Auto-corr total-power spectrum Antenna: \*  
Timerange: 00/15:02:01 to 00/15:03:29

Plot file version 461 created 05-OCT-2021 17:06:27

APM08279+525 GM076.UVDATA.1

Freq = 1.5945 GHz, Bw = 32.000 MH No calibration applied and no bandpass applied

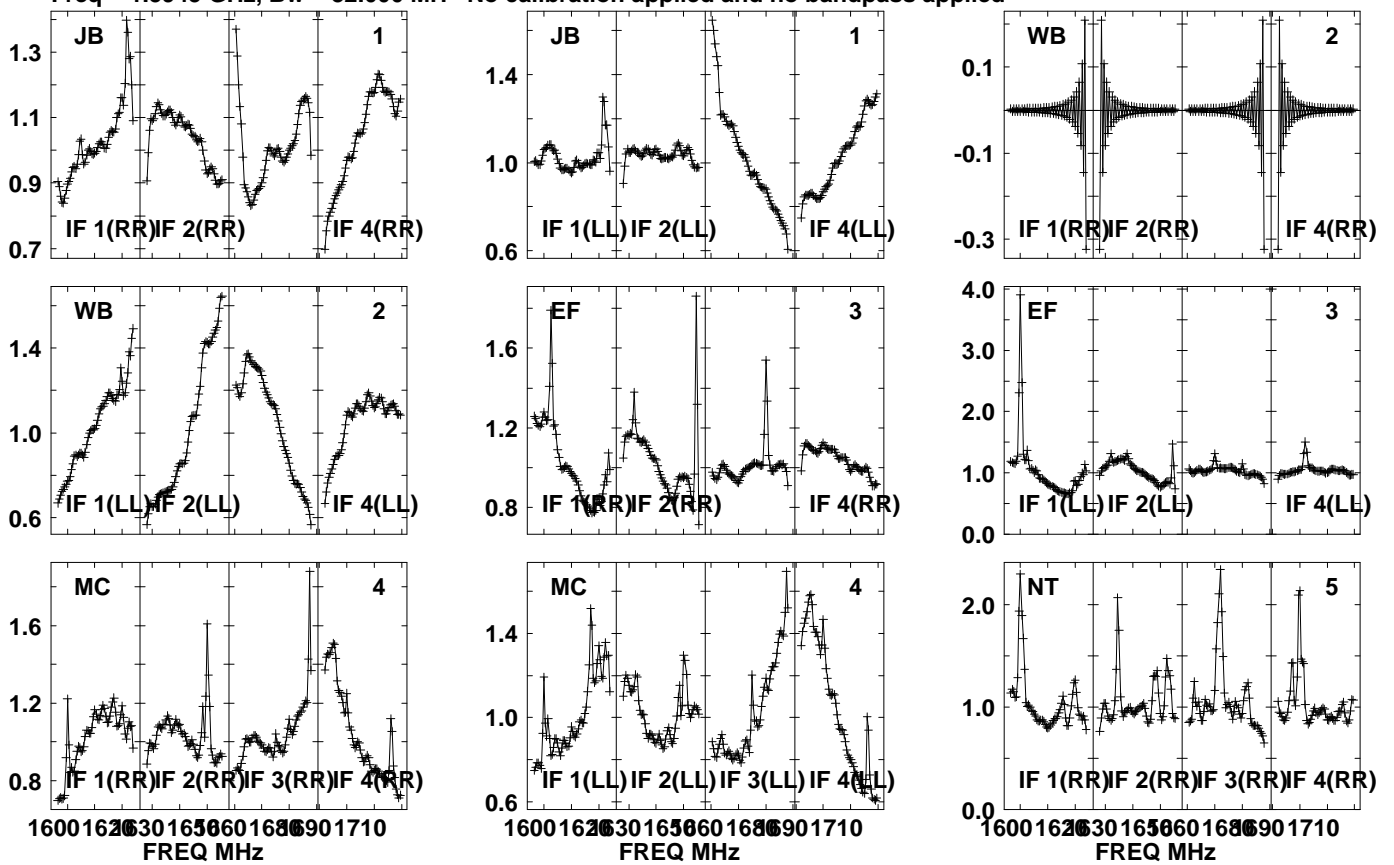

Lower frame: Real Jy  
Auto-corr total-power spectrum Antenna: \*  
Timerange: 00/15:03:31 to 00/15:06:59

Plot file version 462 created 05-OCT-2021 17:06:27

APM08279+525 GM076.UVDATA.1

Freq = 1.5945 GHz, Bw = 32.000 MH No calibration applied and no bandpass applied

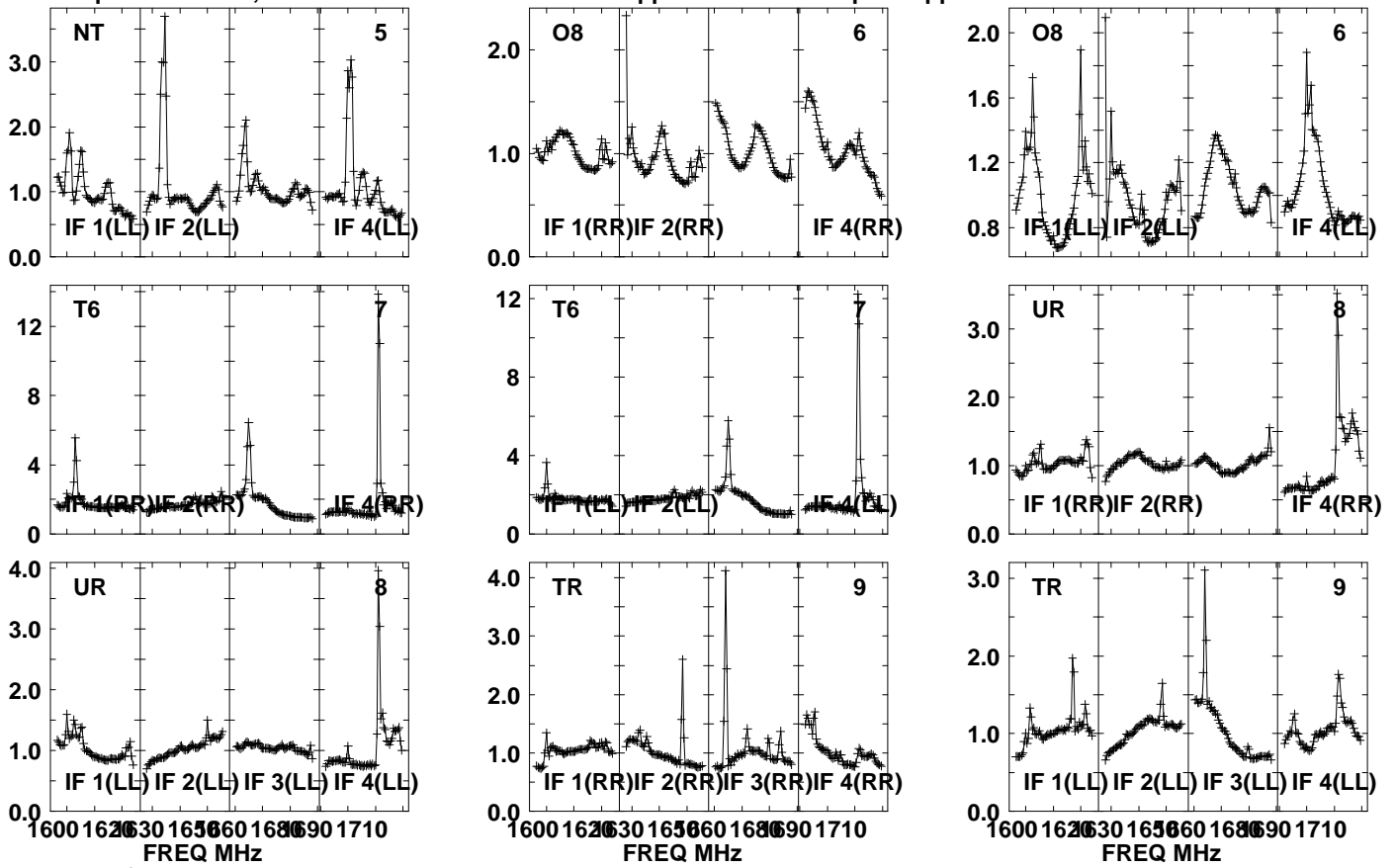

Lower frame: Real Jy

Auto-corr total-power spectrum Antenna: \*

Timerange: 00/15:03:31 to 00/15:06:59

Plot file version 463 created 05-OCT-2021 17:06:28

APM08279+525 GM076.UVDATA.1

Freq = 1.5945 GHz, Bw = 32.000 MH No calibration applied and no bandpass applied

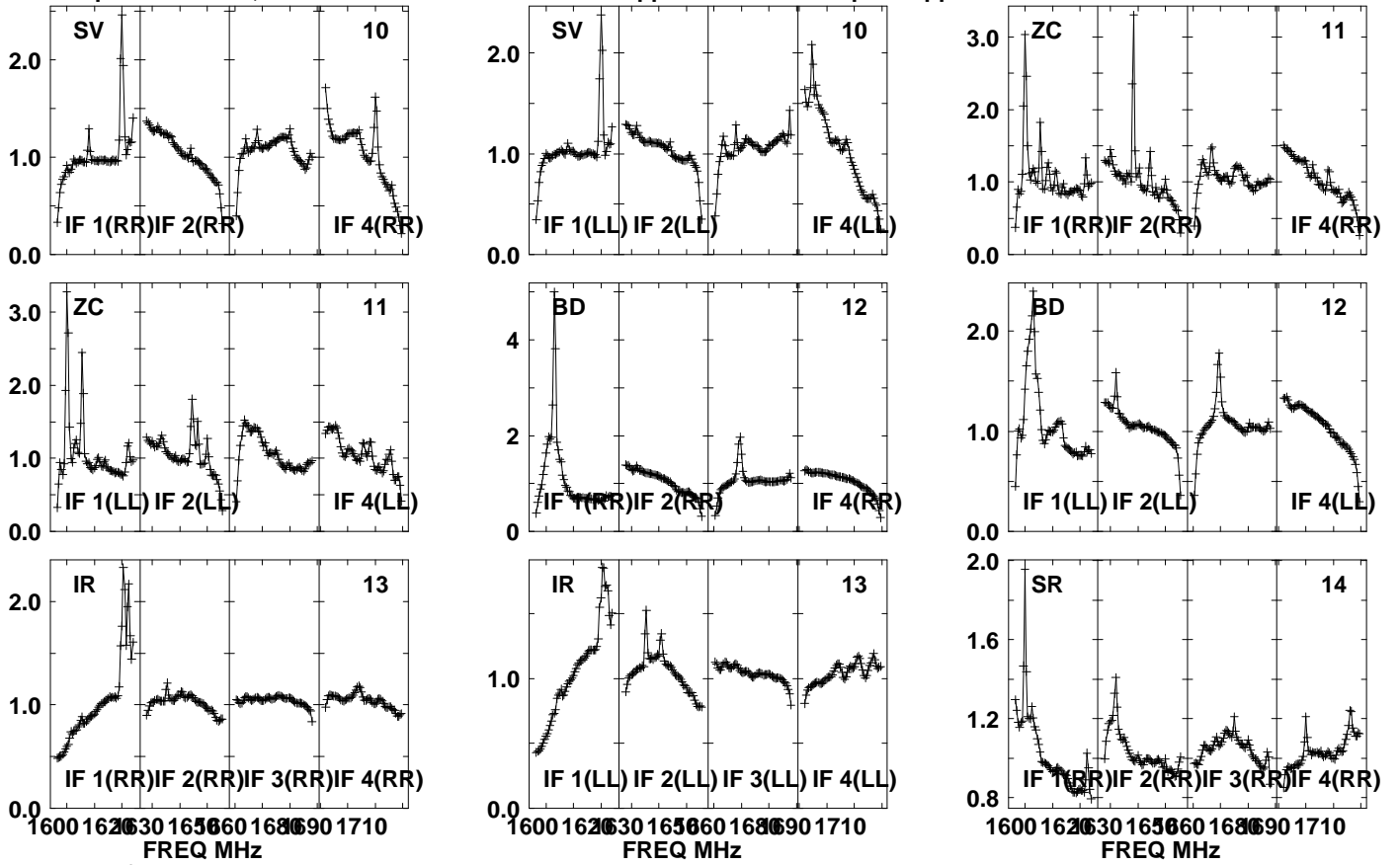

Lower frame: Real Jy

Auto-corr total-power spectrum Antenna: \*

Timerange: 00/15:03:31 to 00/15:06:59

Plot file version 464 created 05-OCT-2021 17:06:28

APM08279+525 GM076.UVDATA.1

Freq = 1.5945 GHz, Bw = 32.000 MH No calibration applied and no bandpass applied

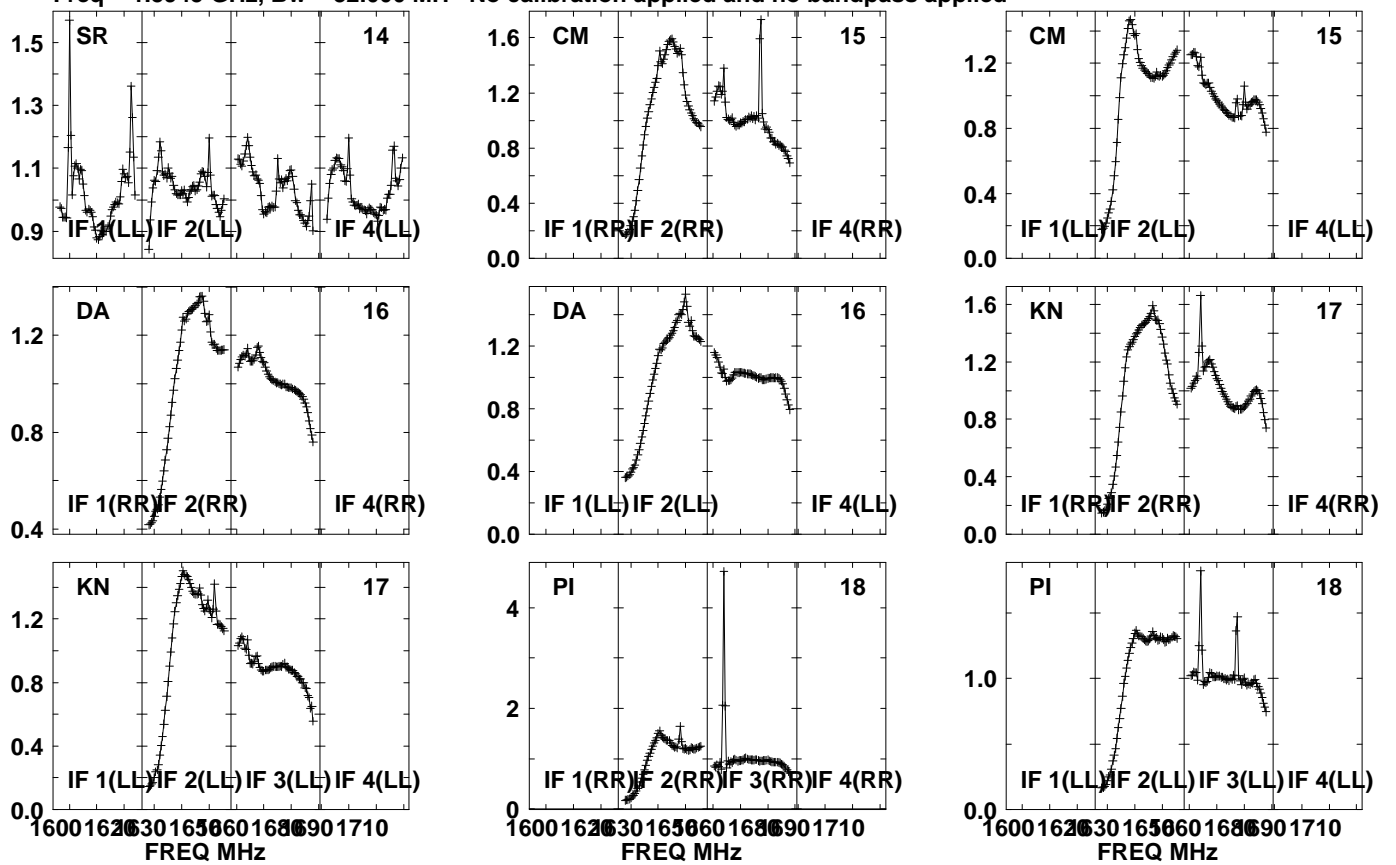

Lower frame: Real Jy  
Auto-corr total-power spectrum Antenna: \*  
Timerange: 00/15:03:31 to 00/15:06:59

Plot file version 465 created 05-OCT-2021 17:06:28

APM08279+525 GM076.UVDATA.1

Freq = 1.5945 GHz, Bw = 32.000 MH No calibration applied and no bandpass applied

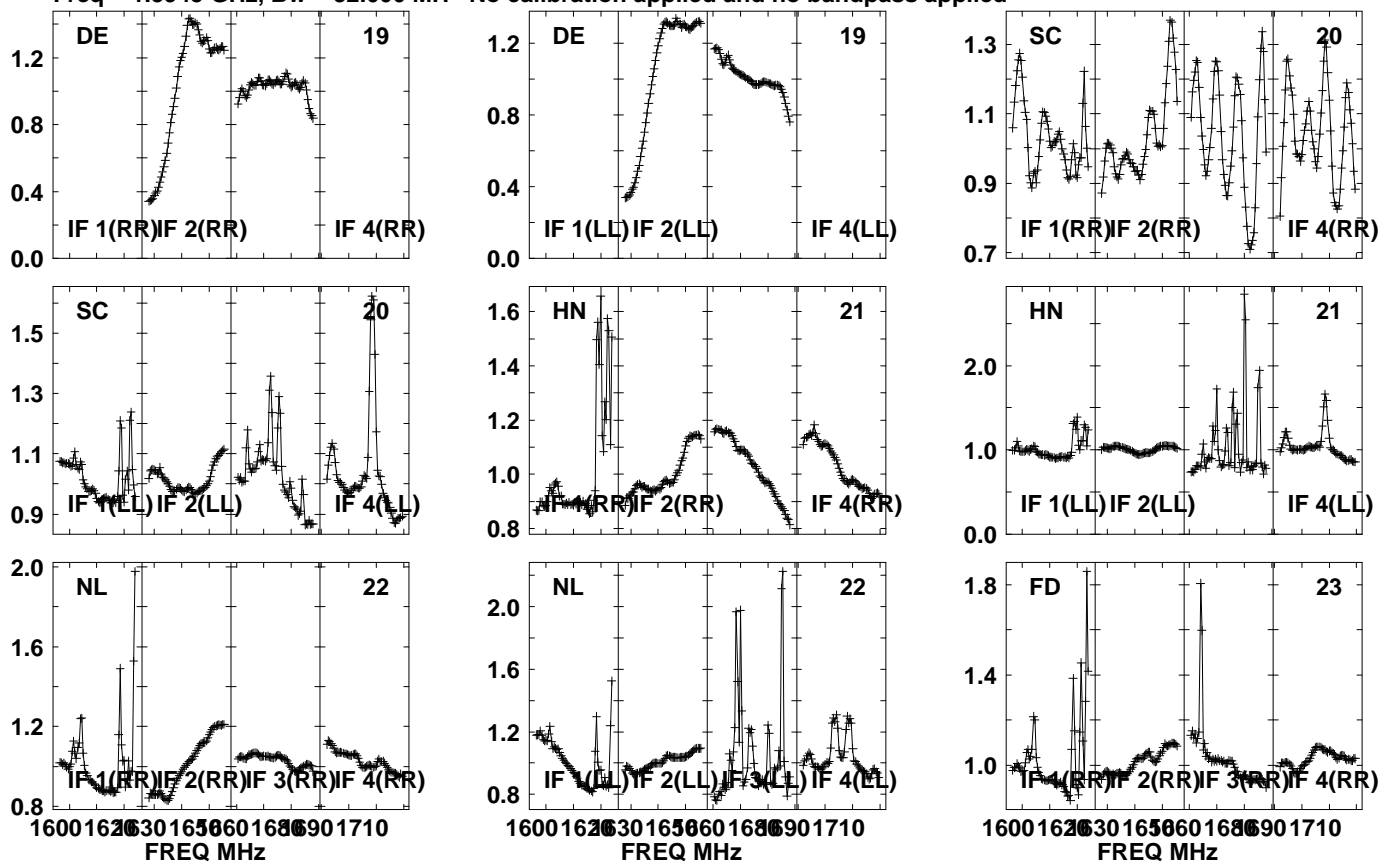

Lower frame: Real Jy  
Auto-corr total-power spectrum Antenna: \*  
Timerange: 00/15:03:31 to 00/15:06:59

Plot file version 466 created 05-OCT-2021 17:06:29

APM08279+525 GM076.UVDATA.1

Freq = 1.5945 GHz, Bw = 32.000 MH No calibration applied and no bandpass applied

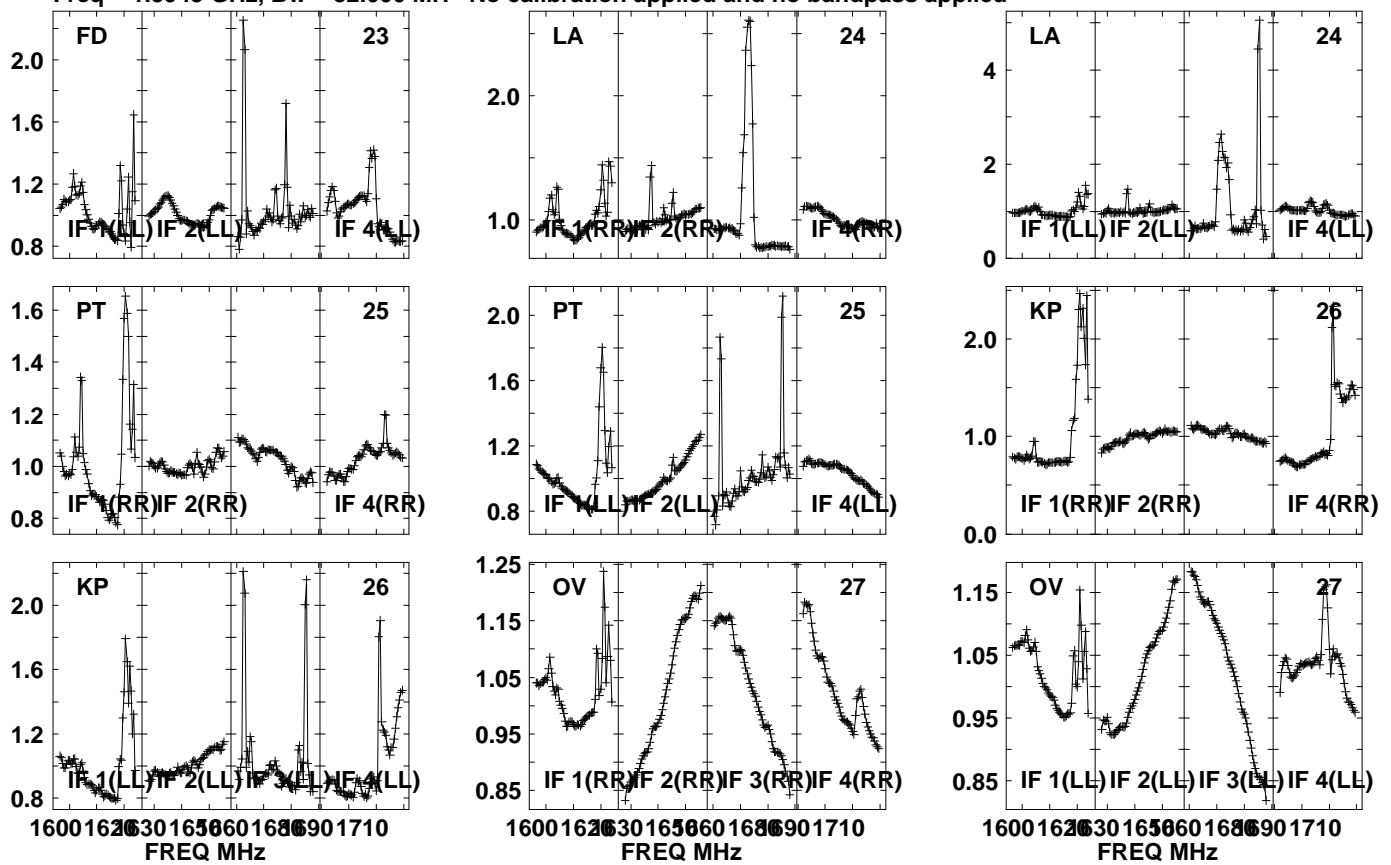

Lower frame: Real Jy  
Auto-corr total-power spectrum Antenna: \*  
Timerange: 00/15:03:31 to 00/15:06:59



Plot file version 467 created 05-OCT-2021 17:06:29

APM08279+525 GM076.UVDATA.1

Freq = 1.5945 GHz, Bw = 32.000 MH No calibration applied and no bandpass applied

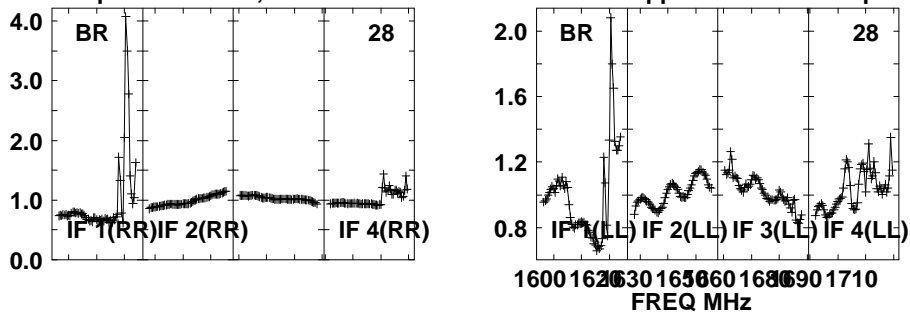

Lower frame: Real Jy

Auto-corr total-power spectrum Antenna: \*

Timerange: 00/15:03:31 to 00/15:06:59

Plot file version 468 created 05-OCT-2021 17:06:29

J0827+5217 GM076.UVDATA.1

Freq = 1.5945 GHz, Bw = 32.000 MH No calibration applied and no bandpass applied

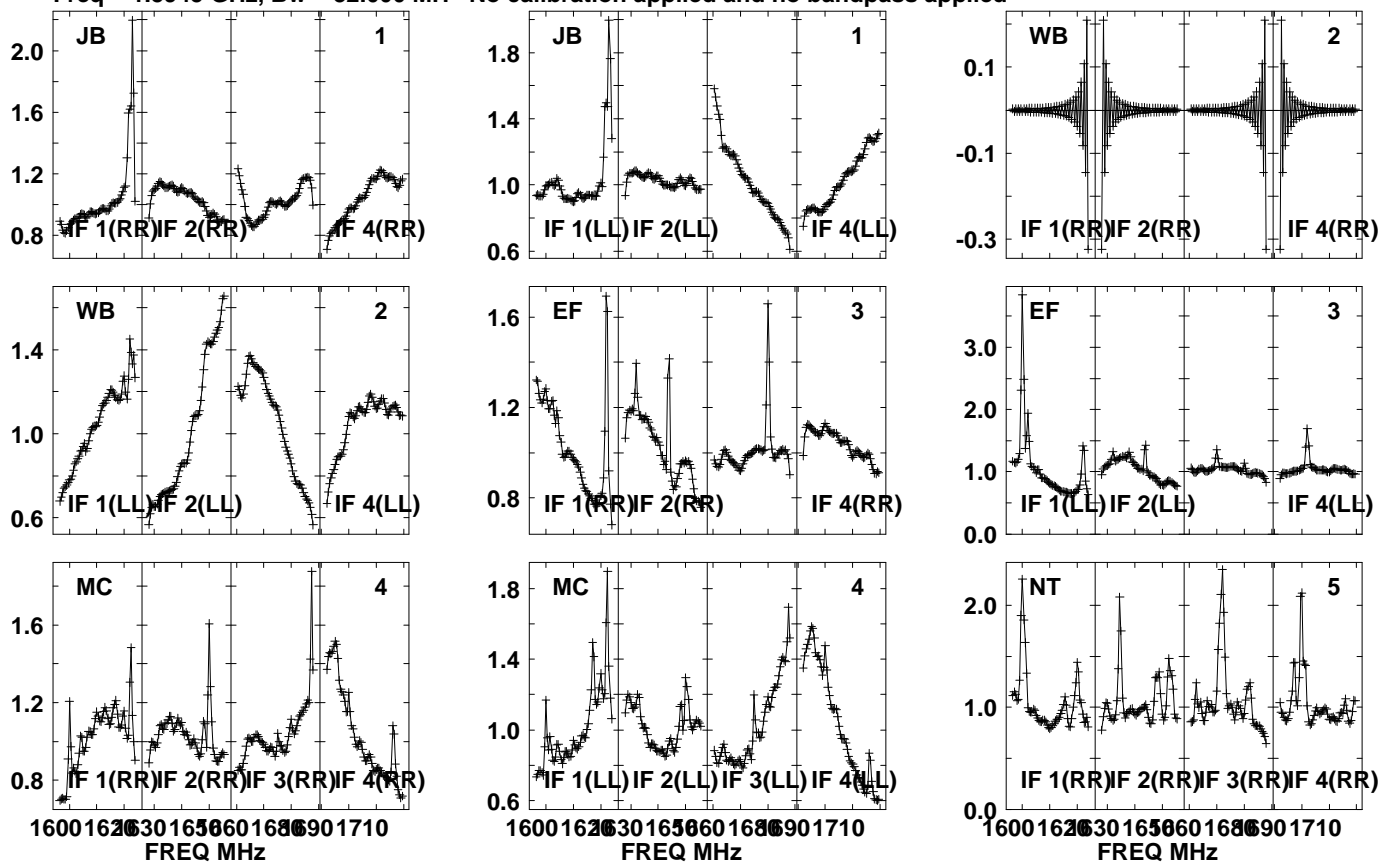

Lower frame: Real Jy  
Auto-corr total-power spectrum Antenna: \*  
Timerange: 00/15:07:31 to 00/15:08:59

Plot file version 469 created 05-OCT-2021 17:06:29

J0827+5217 GM076.UVDATA.1

Freq = 1.5945 GHz, Bw = 32.000 MH No calibration applied and no bandpass applied

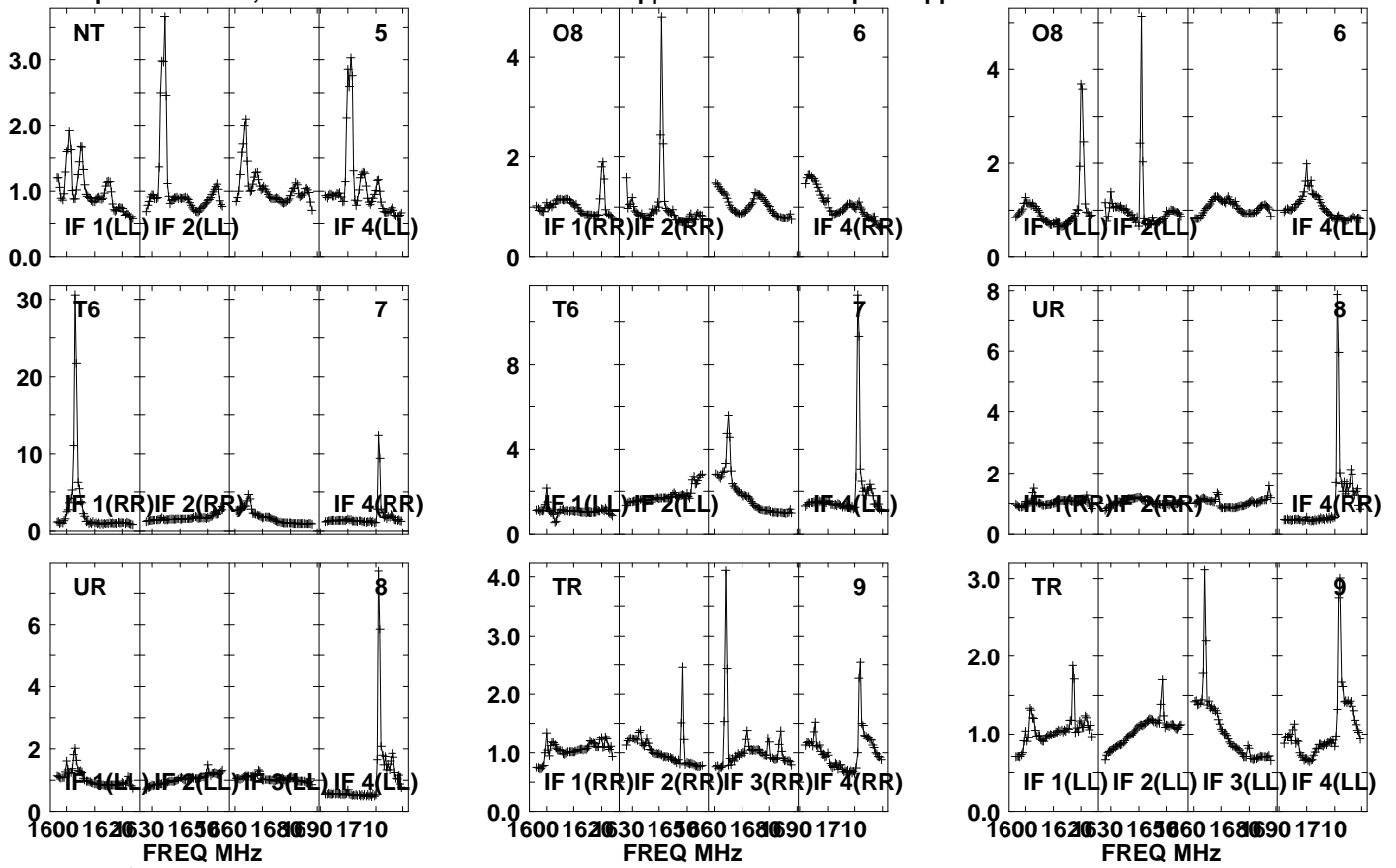

Lower frame: Real Jy  
Auto-corr total-power spectrum Antenna: \*  
Timerange: 00/15:07:31 to 00/15:08:59

Plot file version 470 created 05-OCT-2021 17:06:30

J0827+5217 GM076.UVDATA.1

Freq = 1.5945 GHz, Bw = 32.000 MH No calibration applied and no bandpass applied

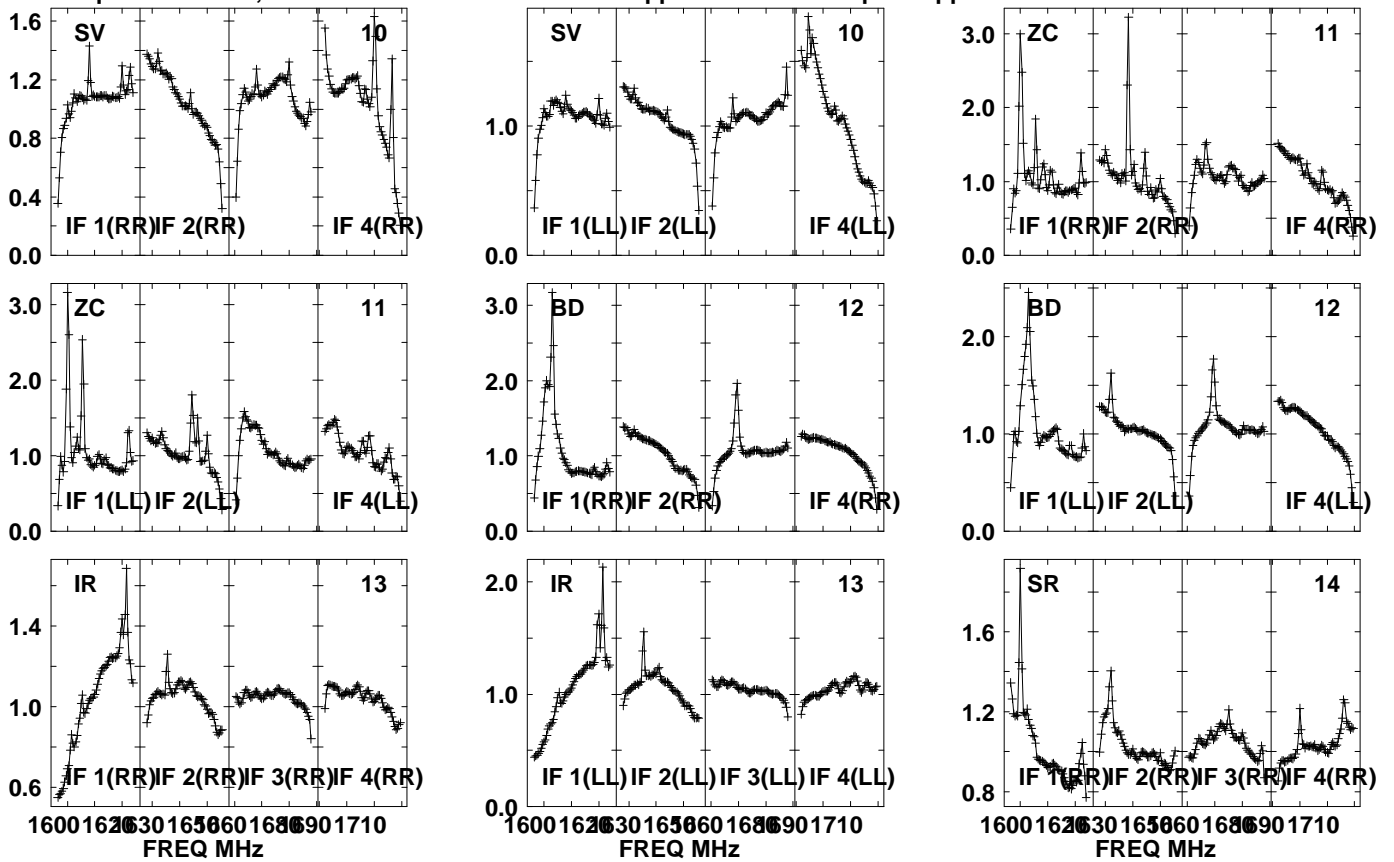

Lower frame: Real Jy  
Auto-corr total-power spectrum Antenna: \*  
Timerange: 00/15:07:31 to 00/15:08:59

Plot file version 471 created 05-OCT-2021 17:06:30

J0827+5217 GM076.UVDATA.1

Freq = 1.5945 GHz, Bw = 32.000 MH No calibration applied and no bandpass applied

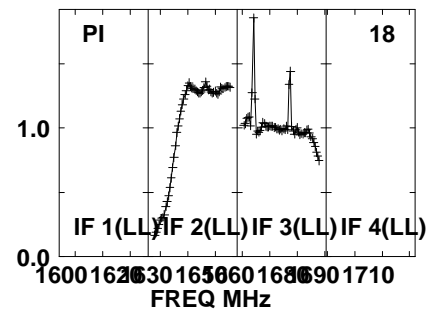
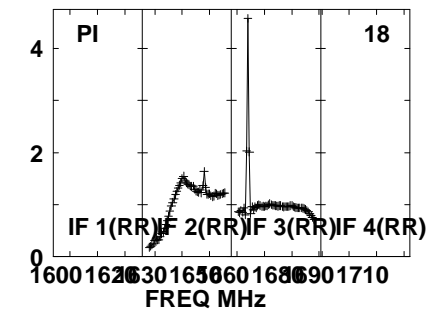
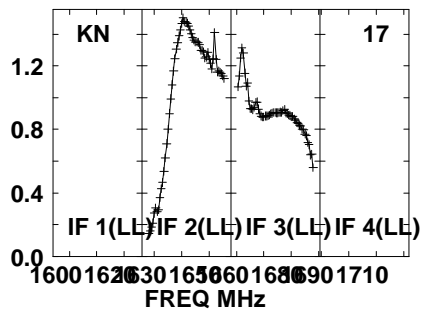
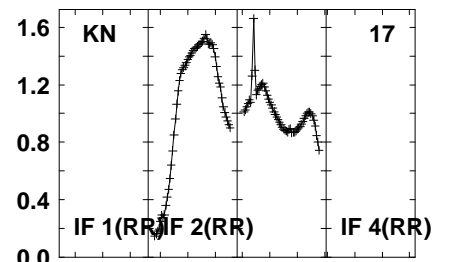
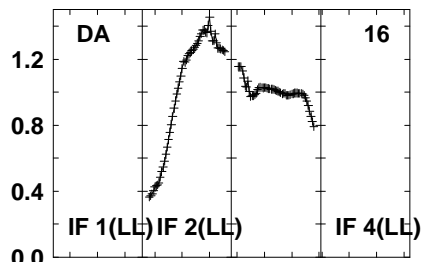
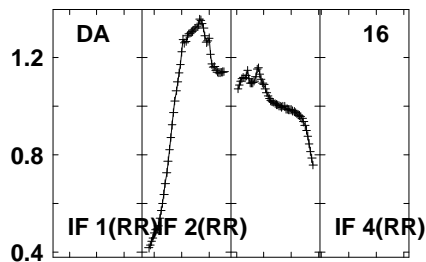
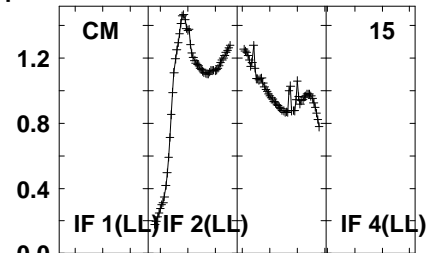
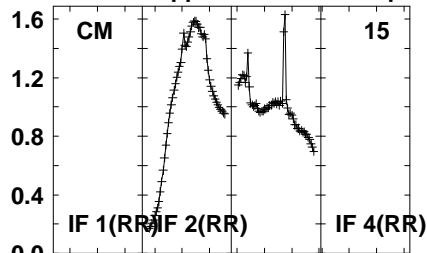
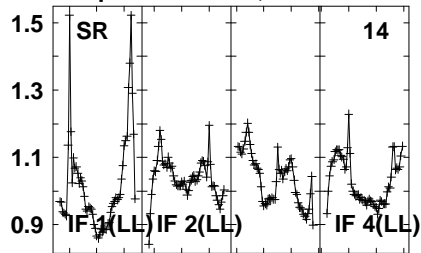

Lower frame: Real Jy  
Auto-corr total-power spectrum Antenna: \*  
Timerange: 00/15:07:31 to 00/15:08:59

Plot file version 472 created 05-OCT-2021 17:06:30

J0827+5217 GM076.UVDATA.1

Freq = 1.5945 GHz, Bw = 32.000 MH No calibration applied and no bandpass applied

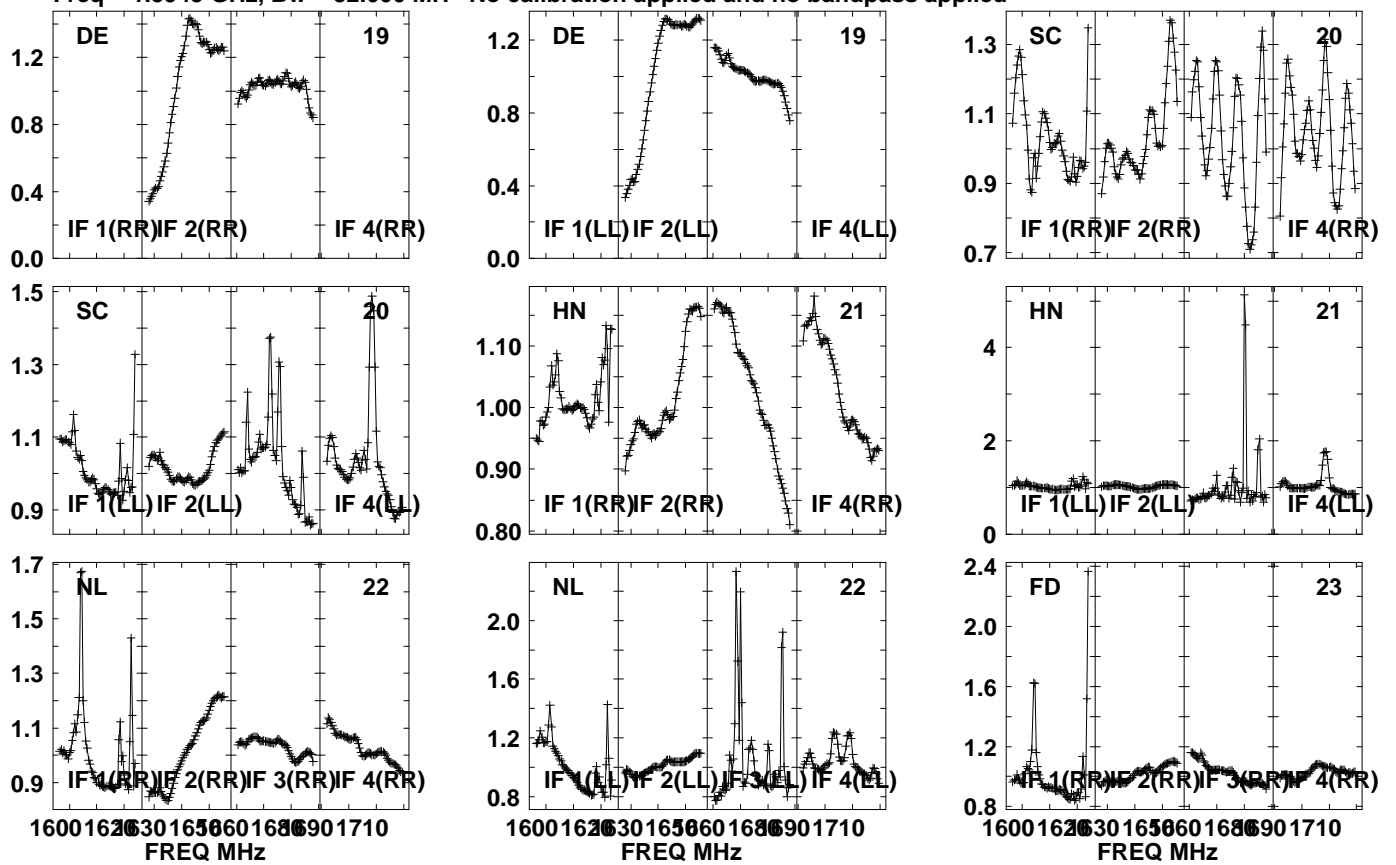

Lower frame: Real Jy  
Auto-corr total-power spectrum Antenna: \*  
Timerange: 00/15:07:31 to 00/15:08:59

Plot file version 473 created 05-OCT-2021 17:06:31

J0827+5217 GM076.UVDATA.1

Freq = 1.5945 GHz, Bw = 32.000 MH No calibration applied and no bandpass applied

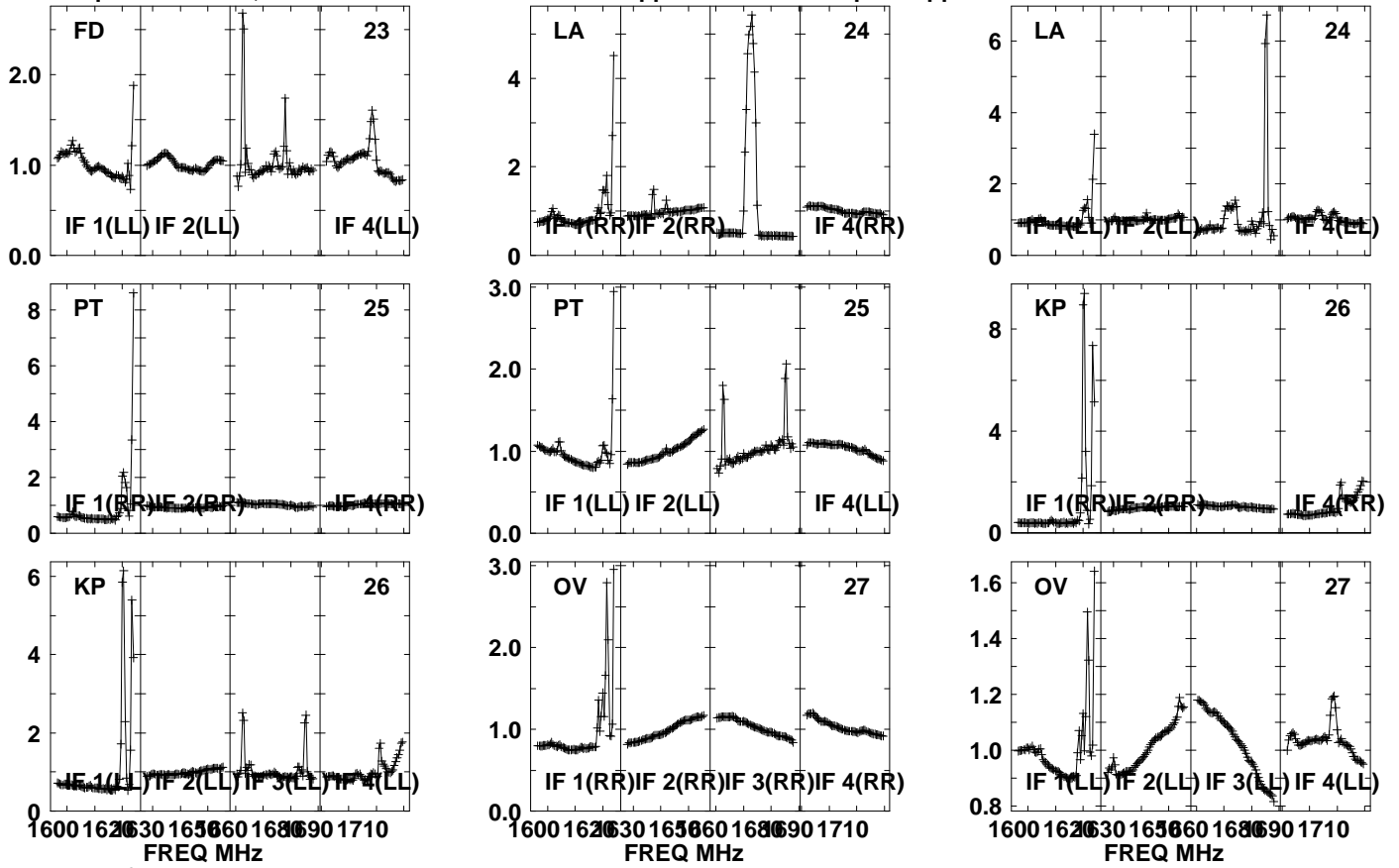

Lower frame: Real Jy

Auto-corr total-power spectrum Antenna: \*

Timerange: 00/15:07:31 to 00/15:08:59

Plot file version 474 created 05-OCT-2021 17:06:31

J0827+5217 GM076.UVDATA.1

Freq = 1.5945 GHz, Bw = 32.000 MH No calibration applied and no bandpass applied

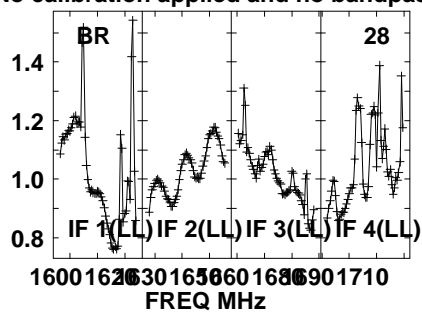
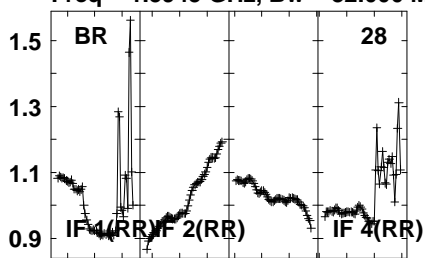

Lower frame: Real Jy  
Auto-corr total-power spectrum Antenna: \*  
Timerange: 00/15:07:31 to 00/15:08:59



Plot file version 475 created 05-OCT-2021 17:06:31

APM08279+525 GM076.UVDATA.1

Freq = 1.5945 GHz, Bw = 32.000 MH No calibration applied and no bandpass applied

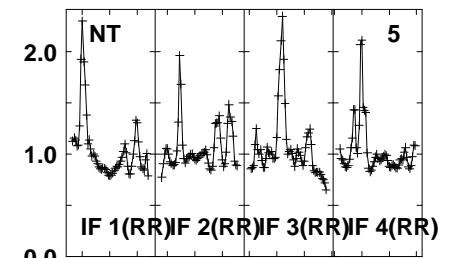
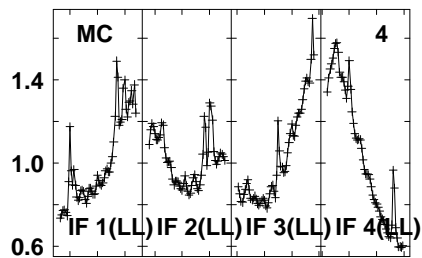
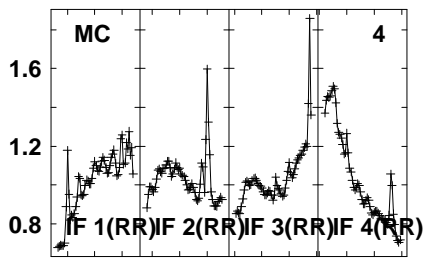
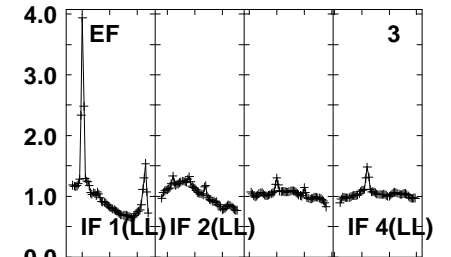
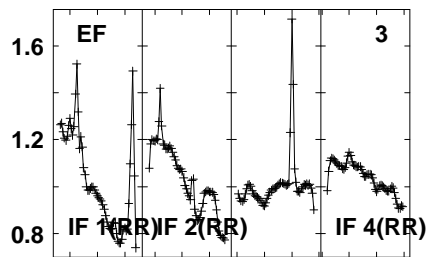
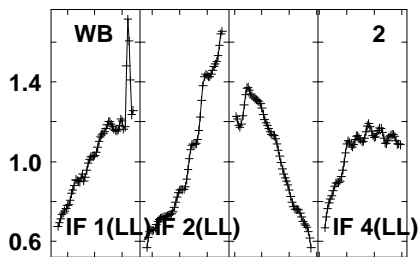
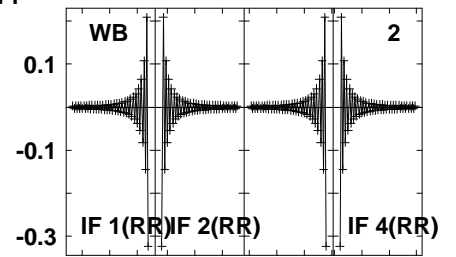
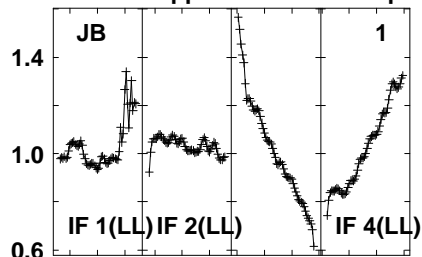
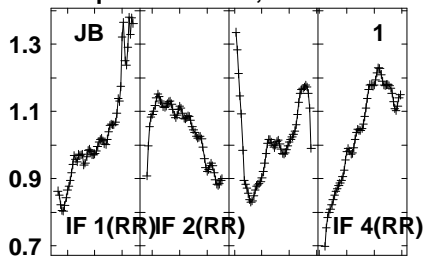

1600 1620 1630 1650 1660 1680 1690 1710  
FREQ MHz

1600 1620 1630 1650 1660 1680 1690 1710  
FREQ MHz

1600 1620 1630 1650 1660 1680 1690 1710  
FREQ MHz

Lower frame: Real Jy  
Auto-corr total-power spectrum Antenna: \*  
Timerange: 00/15:09:01 to 00/15:12:29

Plot file version 476 created 05-OCT-2021 17:06:32

APM08279+525 GM076.UVDATA.1

Freq = 1.5945 GHz, Bw = 32.000 MH No calibration applied and no bandpass applied

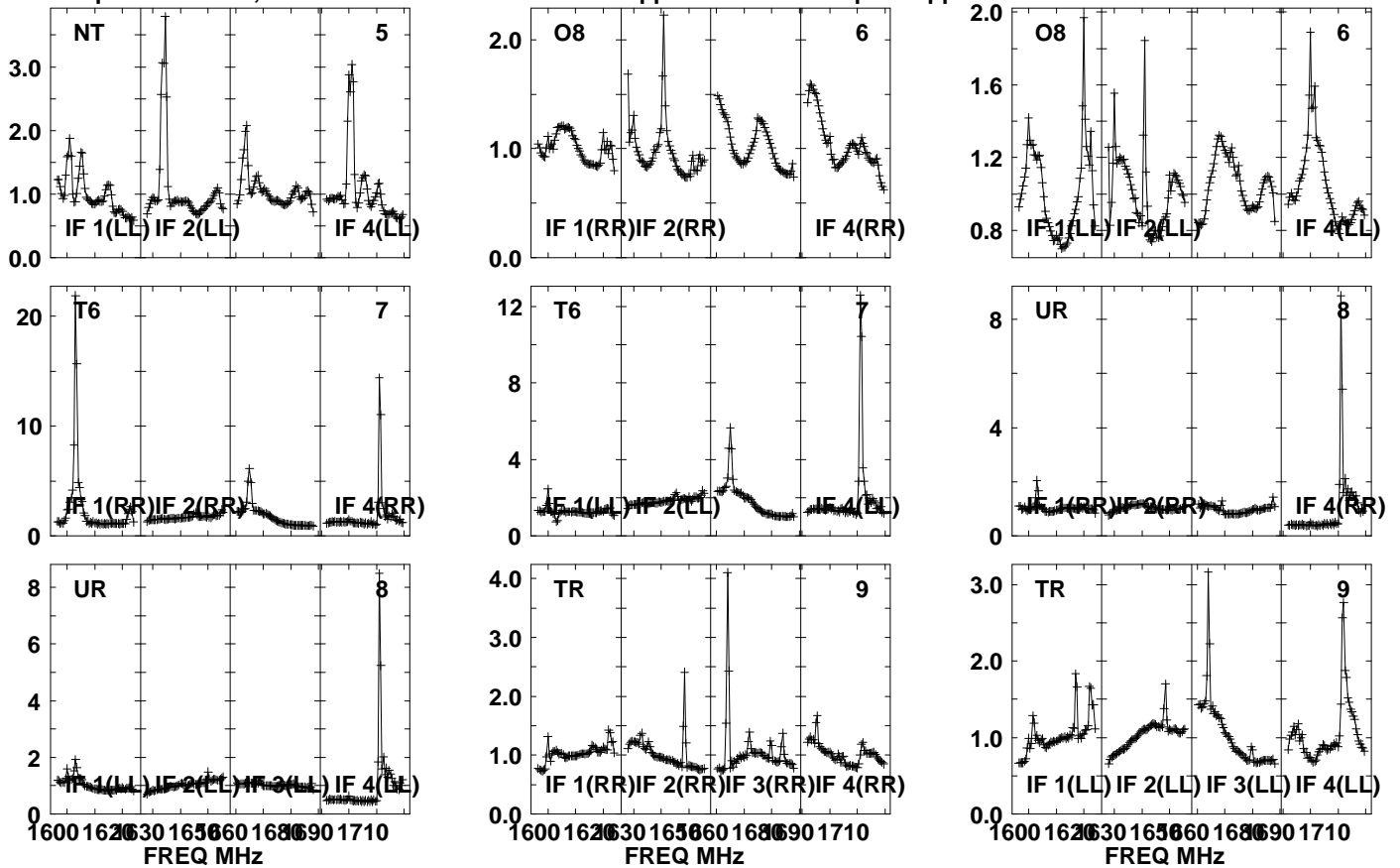

Lower frame: Real Jy

Auto-corr total-power spectrum Antenna: \*

Timerange: 00/15:09:01 to 00/15:12:29

Plot file version 477 created 05-OCT-2021 17:06:32

APM08279+525 GM076.UVDATA.1

Freq = 1.5945 GHz, Bw = 32.000 MH No calibration applied and no bandpass applied

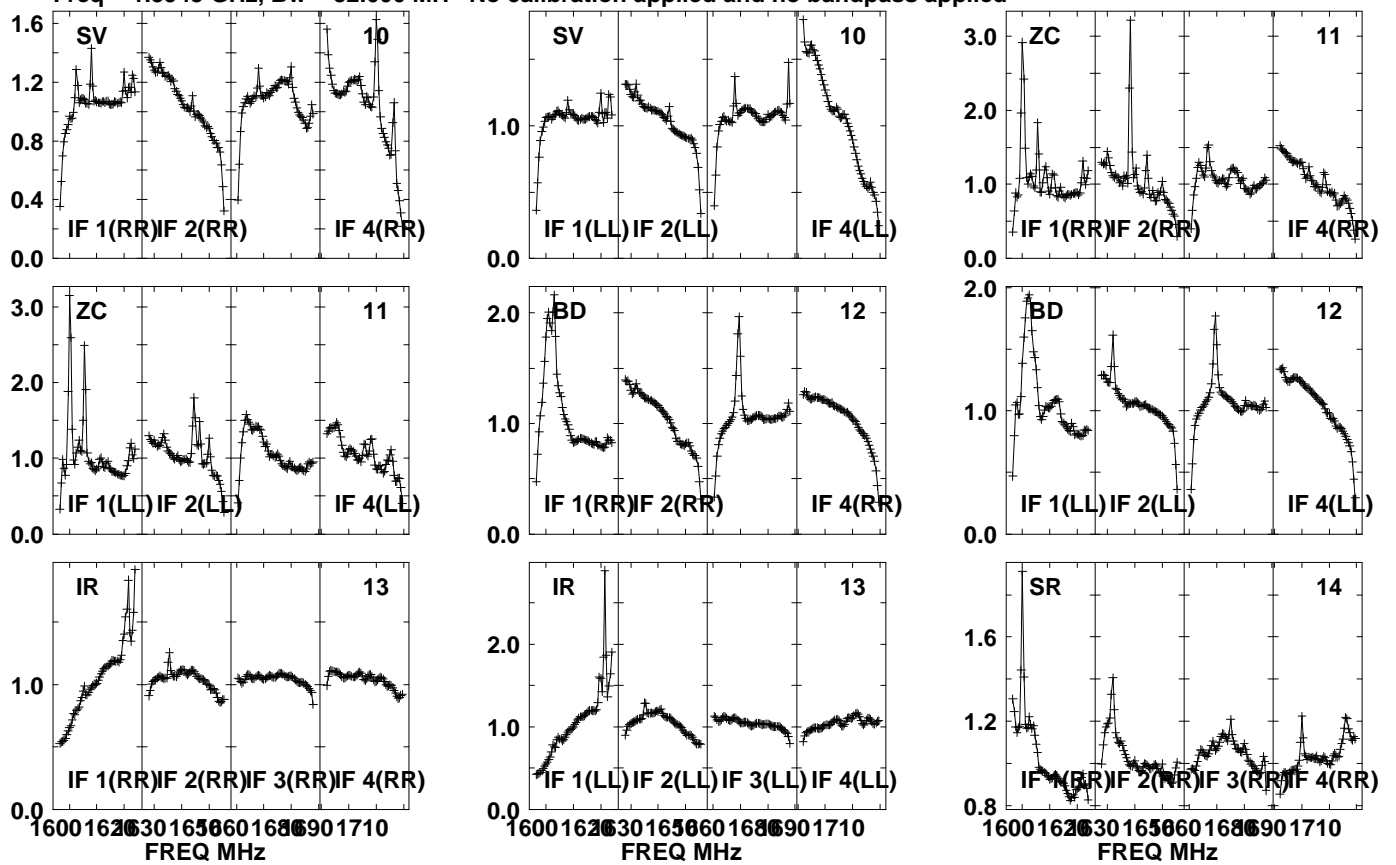

Lower frame: Real Jy  
Auto-corr total-power spectrum Antenna: \*  
Timerange: 00/15:09:01 to 00/15:12:29

Plot file version 478 created 05-OCT-2021 17:06:32

APM08279+525 GM076.UVDATA.1

Freq = 1.5945 GHz, Bw = 32.000 MH No calibration applied and no bandpass applied

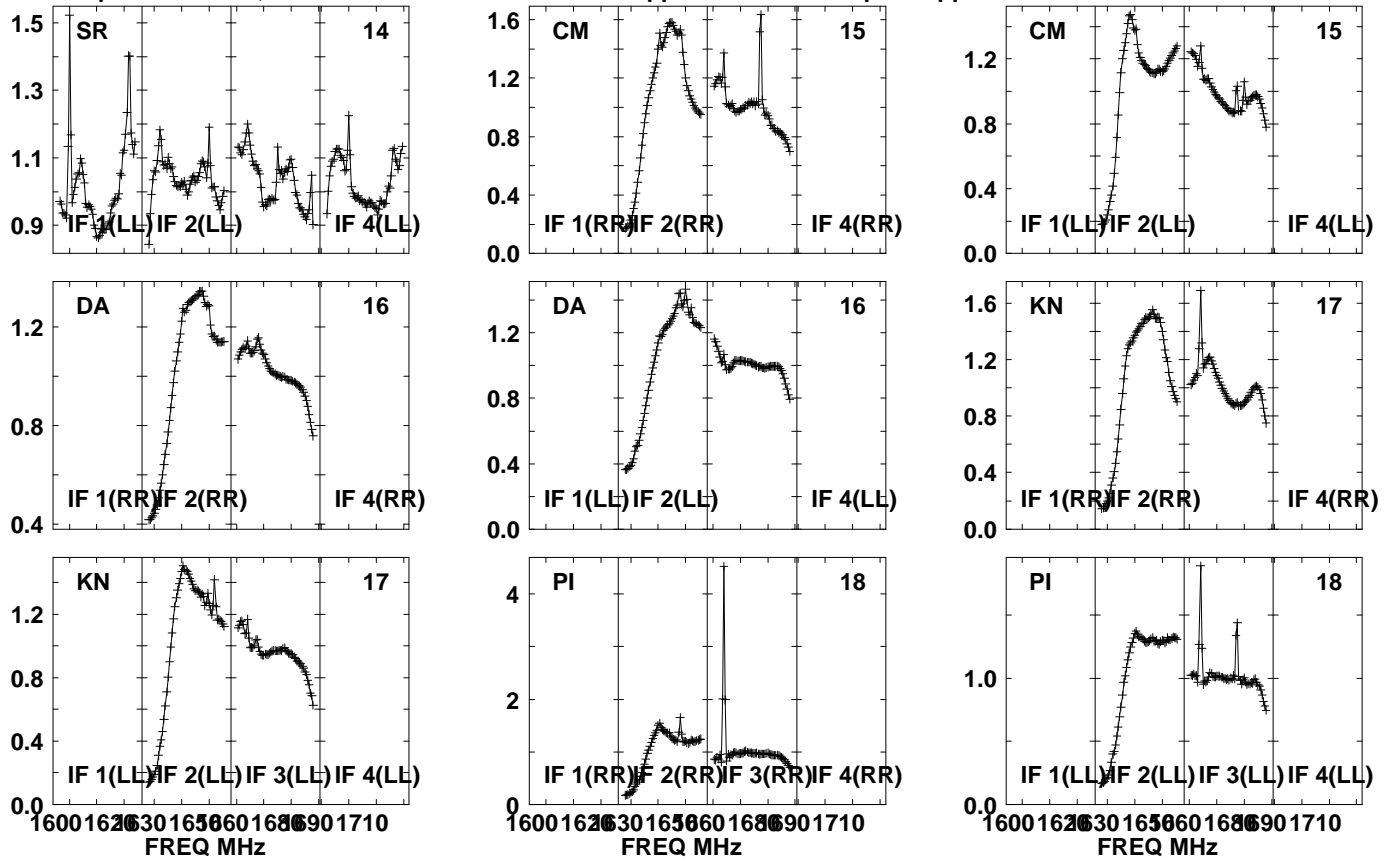

Lower frame: Real Jy  
Auto-corr total-power spectrum Antenna: \*  
Timerange: 00/15:09:01 to 00/15:12:29

Plot file version 479 created 05-OCT-2021 17:06:33

APM08279+525 GM076.UVDATA.1

Freq = 1.5945 GHz, Bw = 32.000 MH No calibration applied and no bandpass applied

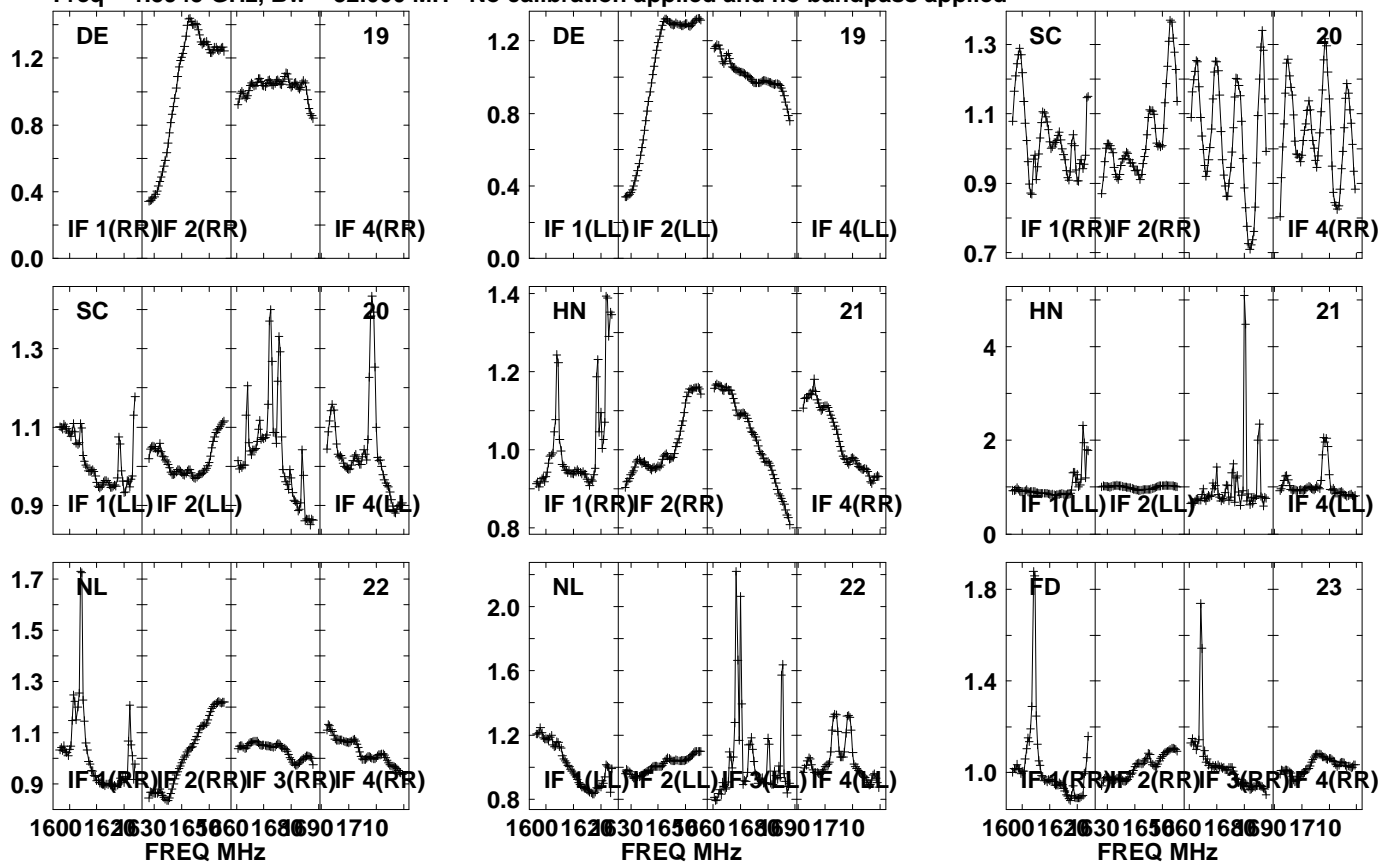

Lower frame: Real Jy  
Auto-corr total-power spectrum Antenna: \*  
Timerange: 00/15:09:01 to 00/15:12:29

Plot file version 480 created 05-OCT-2021 17:06:33

APM08279+525 GM076.UVDATA.1

Freq = 1.5945 GHz, Bw = 32.000 MH No calibration applied and no bandpass applied

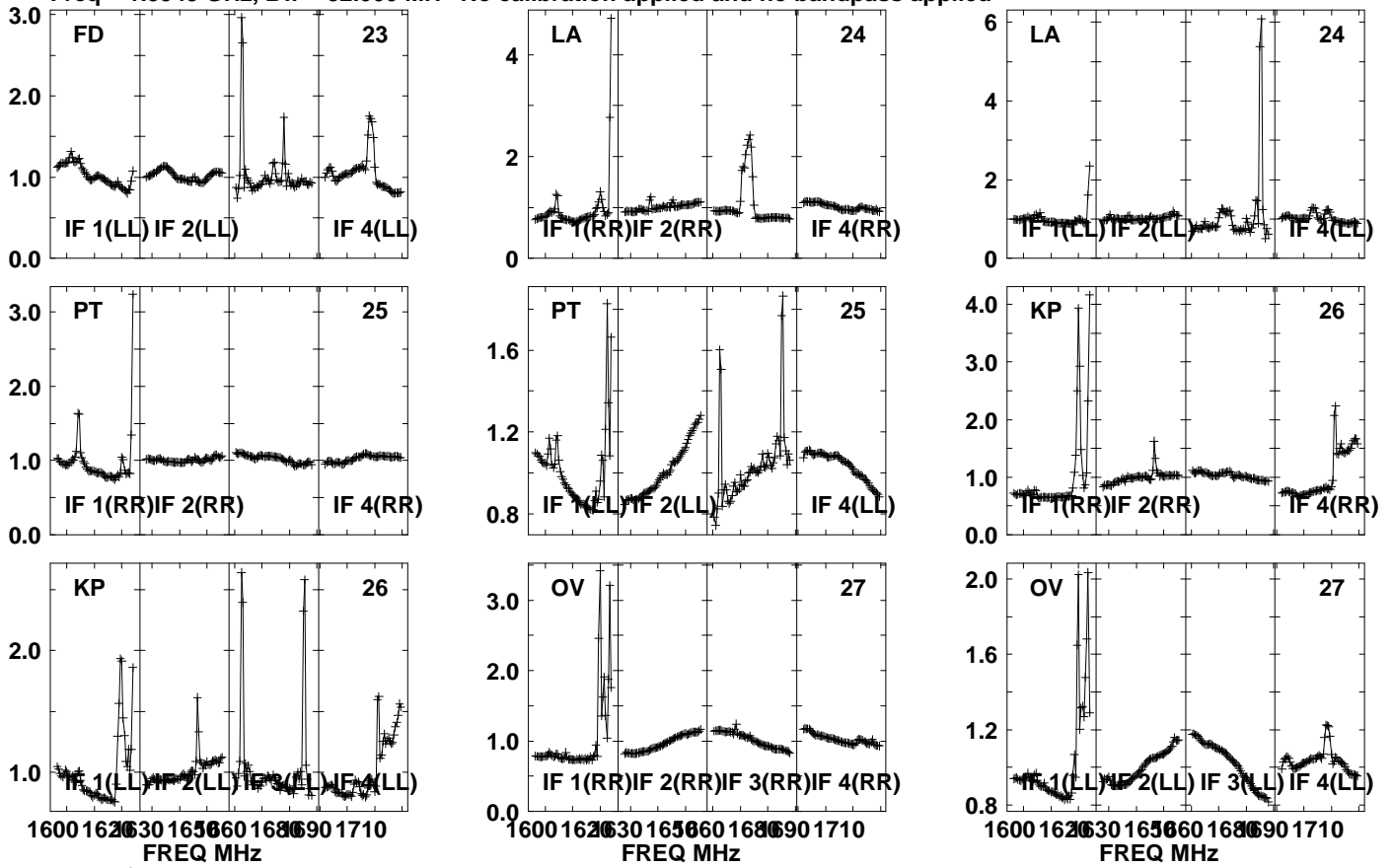

Lower frame: Real Jy

Auto-corr total-power spectrum Antenna: \*

Timerange: 00/15:09:01 to 00/15:12:29

Plot file version 481 created 05-OCT-2021 17:06:33

APM08279+525 GM076.UVDATA.1

Freq = 1.5945 GHz, Bw = 32.000 MH No calibration applied and no bandpass applied

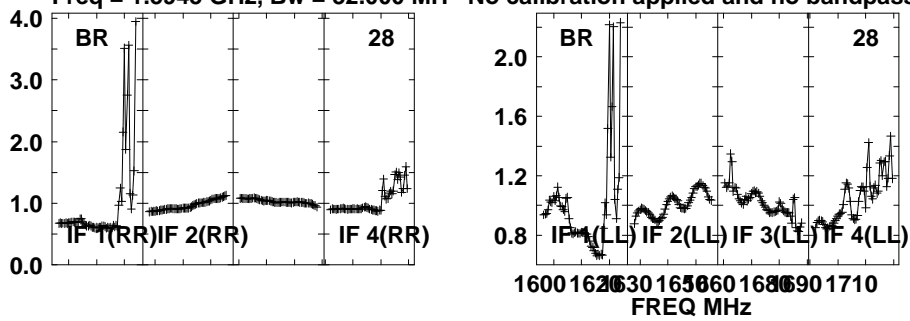

Lower frame: Real Jy

Auto-corr total-power spectrum Antenna: \*

Timerange: 00/15:09:01 to 00/15:12:29

Plot file version 482 created 05-OCT-2021 17:06:34

J0827+5217 GM076.UVDATA.1

Freq = 1.5945 GHz, Bw = 32.000 MH No calibration applied and no bandpass applied

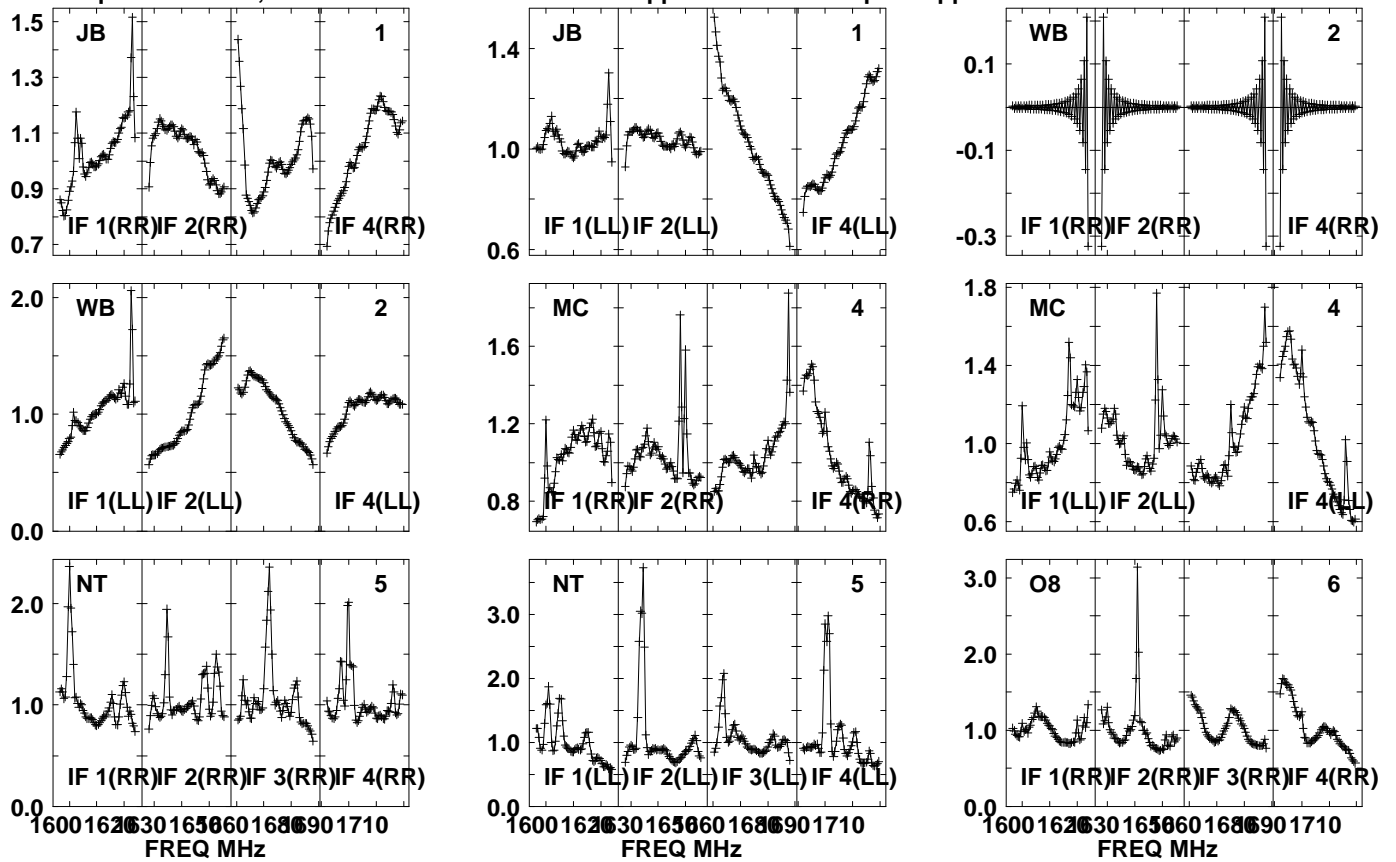

Lower frame: Real Jy  
Auto-corr total-power spectrum Antenna: \*  
Timerange: 00/15:12:31 to 00/15:13:59



Plot file version 483 created 05-OCT-2021 17:06:34

J0827+5217 GM076.UVDATA.1

Freq = 1.5945 GHz, Bw = 32.000 MH No calibration applied and no bandpass applied

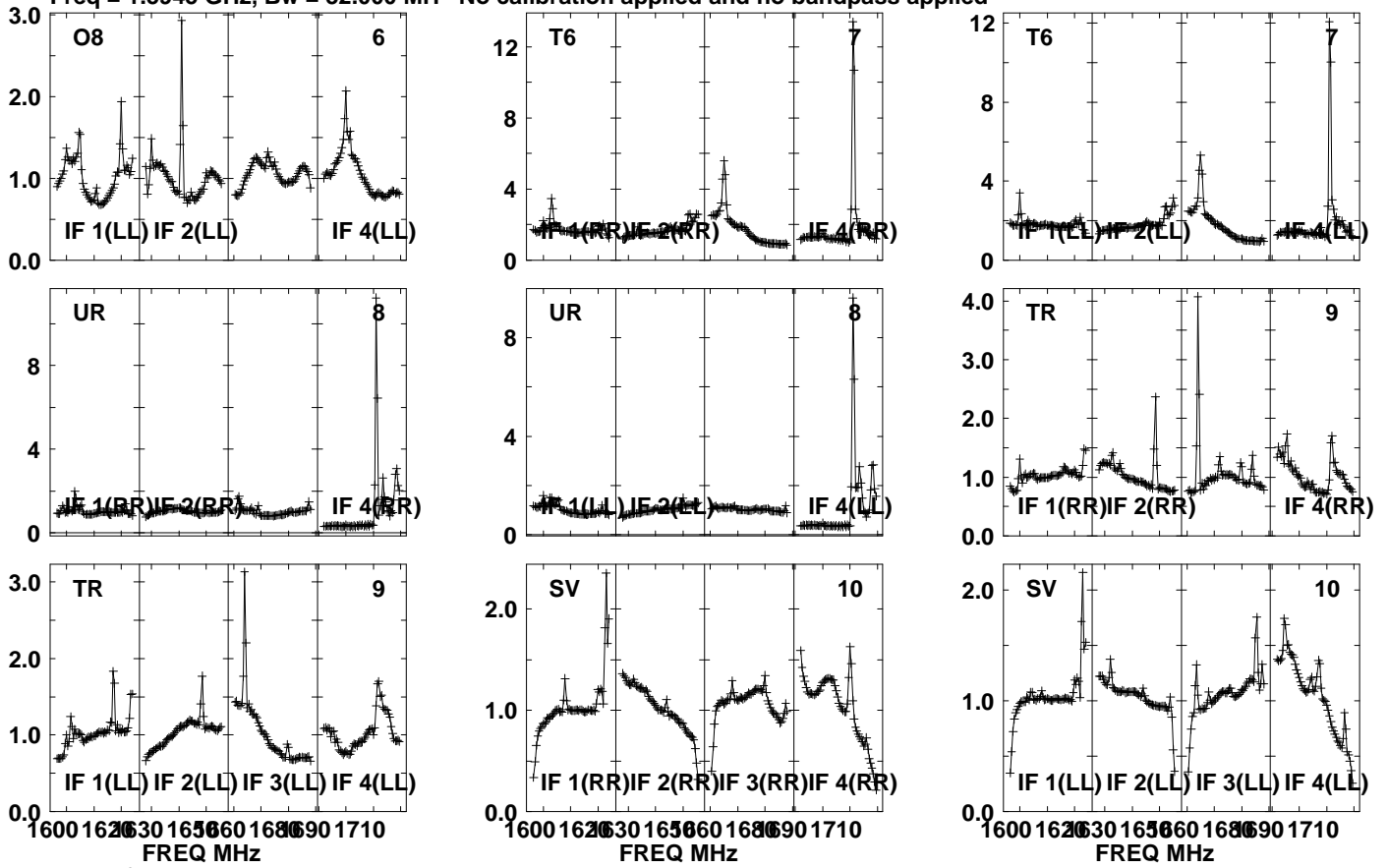

Lower frame: Real Jy  
Auto-corr total-power spectrum Antenna: \*  
Timerange: 00/15:12:31 to 00/15:13:59

Plot file version 484 created 05-OCT-2021 17:06:34

J0827+5217 GM076.UVDATA.1

Freq = 1.5945 GHz, Bw = 32.000 MH No calibration applied and no bandpass applied

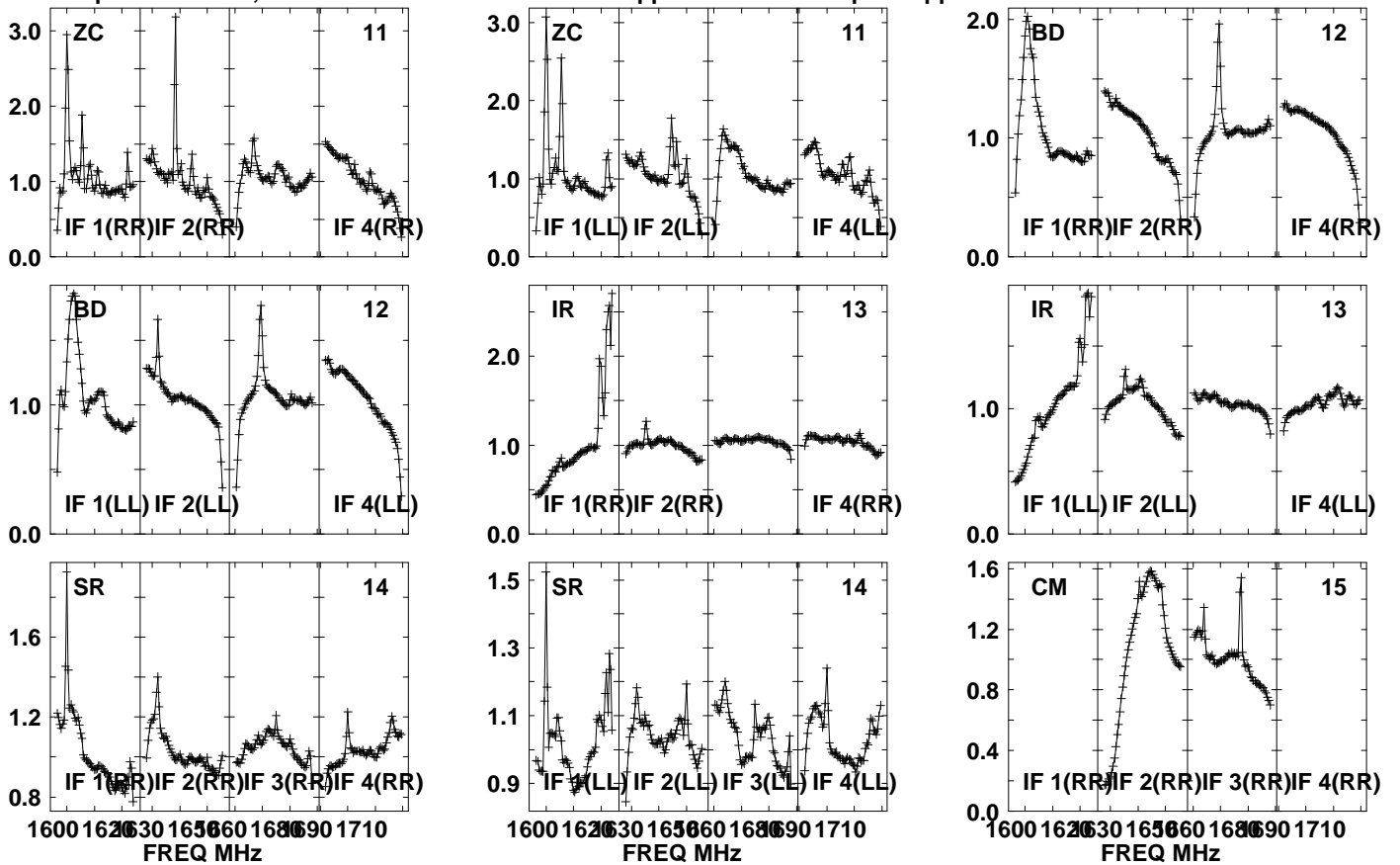

Lower frame: Real Jy  
Auto-corr total-power spectrum Antenna: \*  
Timerange: 00/15:12:31 to 00/15:13:59

Plot file version 485 created 05-OCT-2021 17:06:35

J0827+5217 GM076.UVDATA.1

Freq = 1.5945 GHz, Bw = 32.000 MH No calibration applied and no bandpass applied

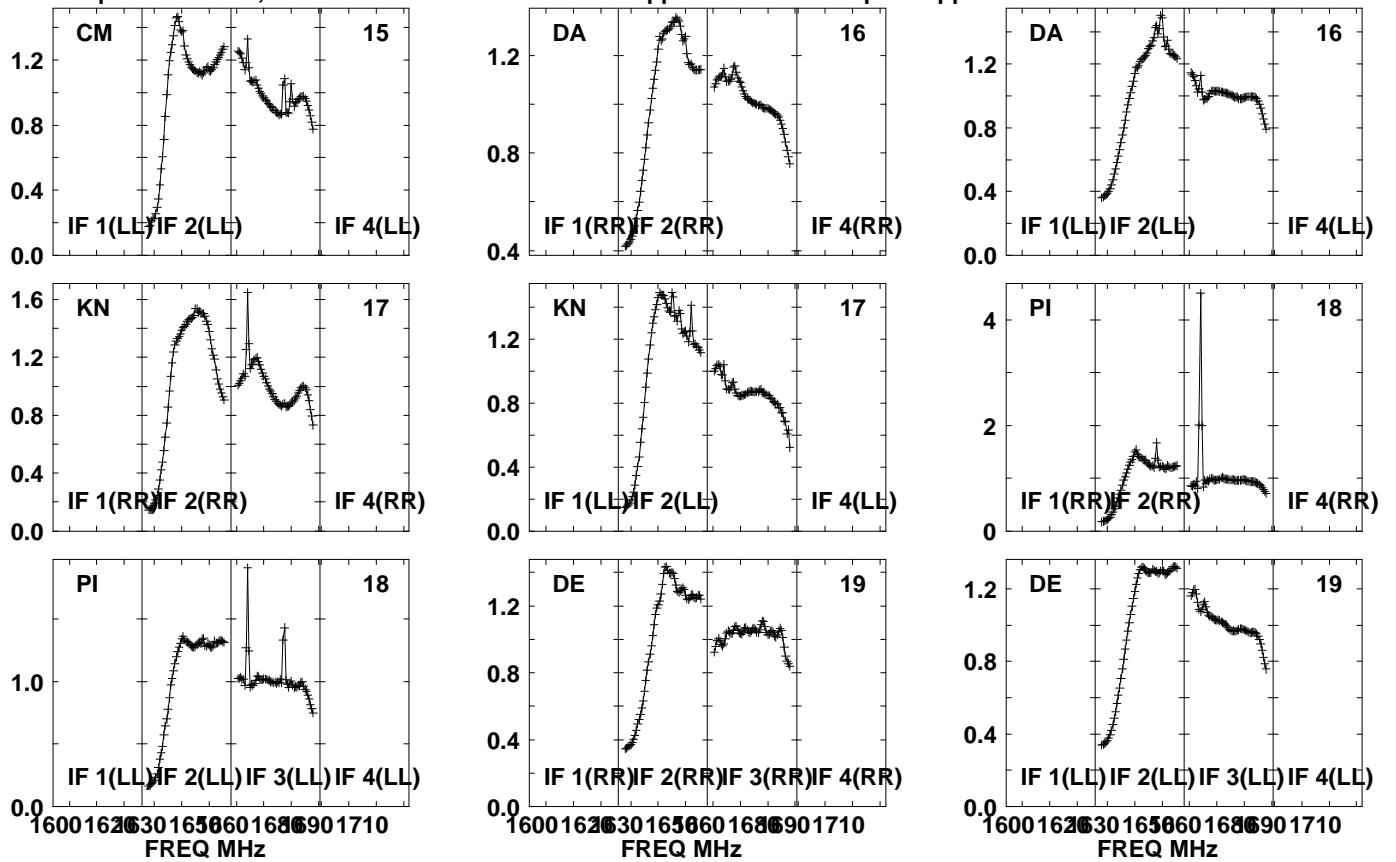

Lower frame: Real Jy  
Auto-corr total-power spectrum Antenna: \*  
Timerange: 00/15:12:31 to 00/15:13:59

Plot file version 486 created 05-OCT-2021 17:06:35

J0827+5217 GM076.UVDATA.1

Freq = 1.5945 GHz, Bw = 32.000 MH No calibration applied and no bandpass applied

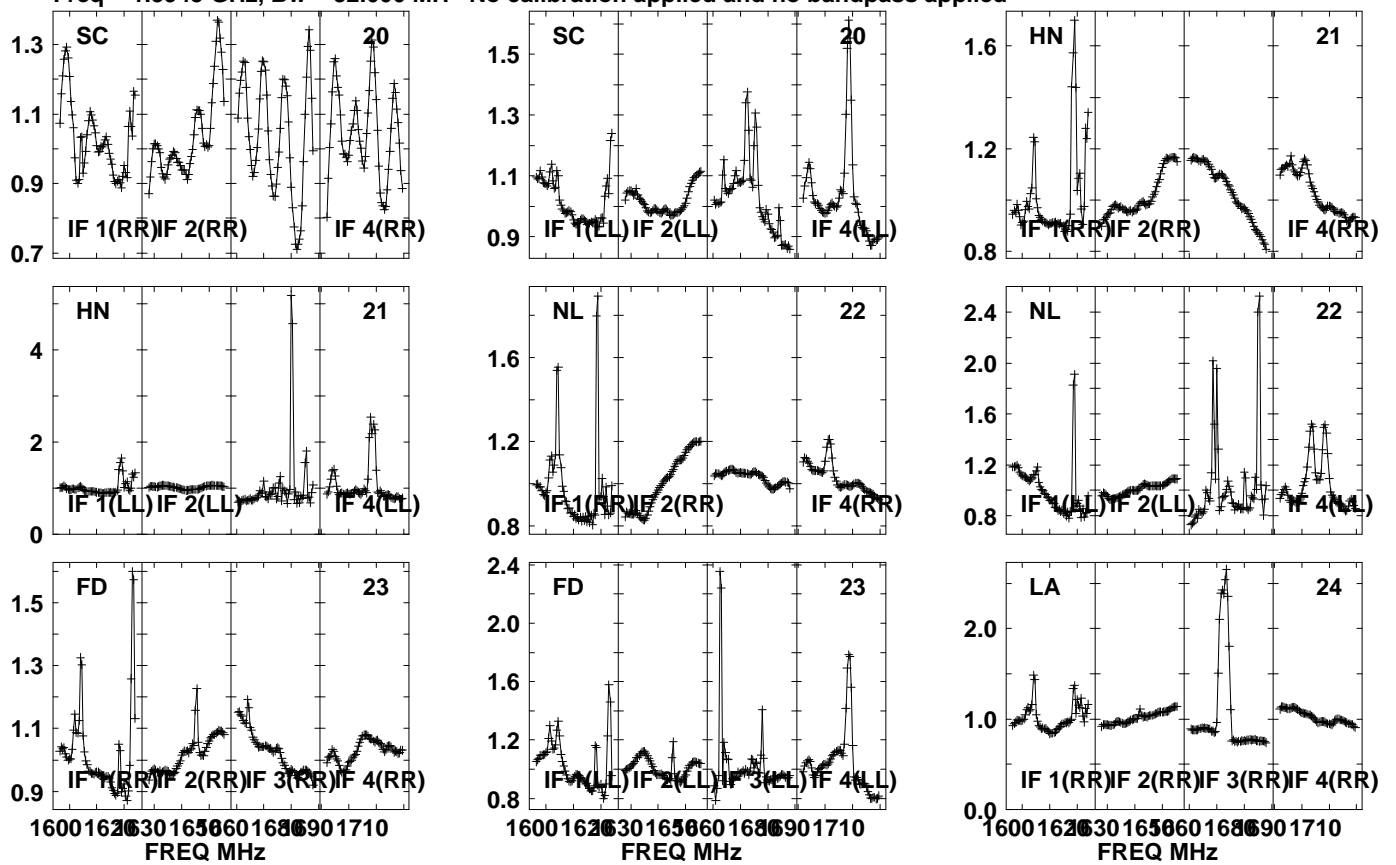

Lower frame: Real Jy  
Auto-corr total-power spectrum Antenna: \*  
Timerange: 00/15:12:31 to 00/15:13:59

Plot file version 487 created 05-OCT-2021 17:06:35

J0827+5217 GM076.UVDATA.1

Freq = 1.5945 GHz, Bw = 32.000 MH No calibration applied and no bandpass applied

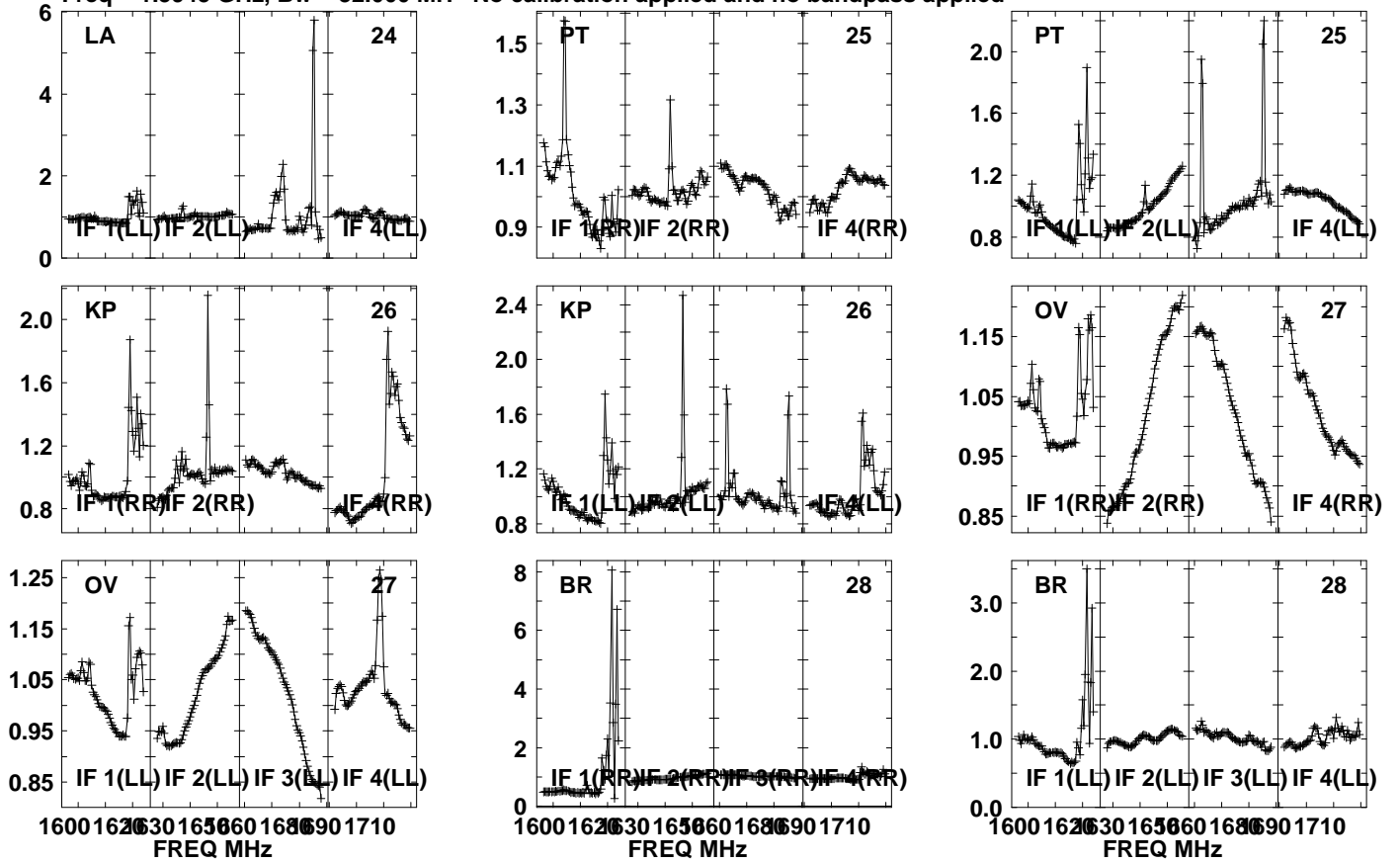

Lower frame: Real Jy

Auto-corr total-power spectrum Antenna: \*

Timerange: 00/15:12:31 to 00/15:13:59

Plot file version 488 created 05-OCT-2021 17:06:36

APM08279+525 GM076.UVDATA.1

Freq = 1.5945 GHz, Bw = 32.000 MH No calibration applied and no bandpass applied

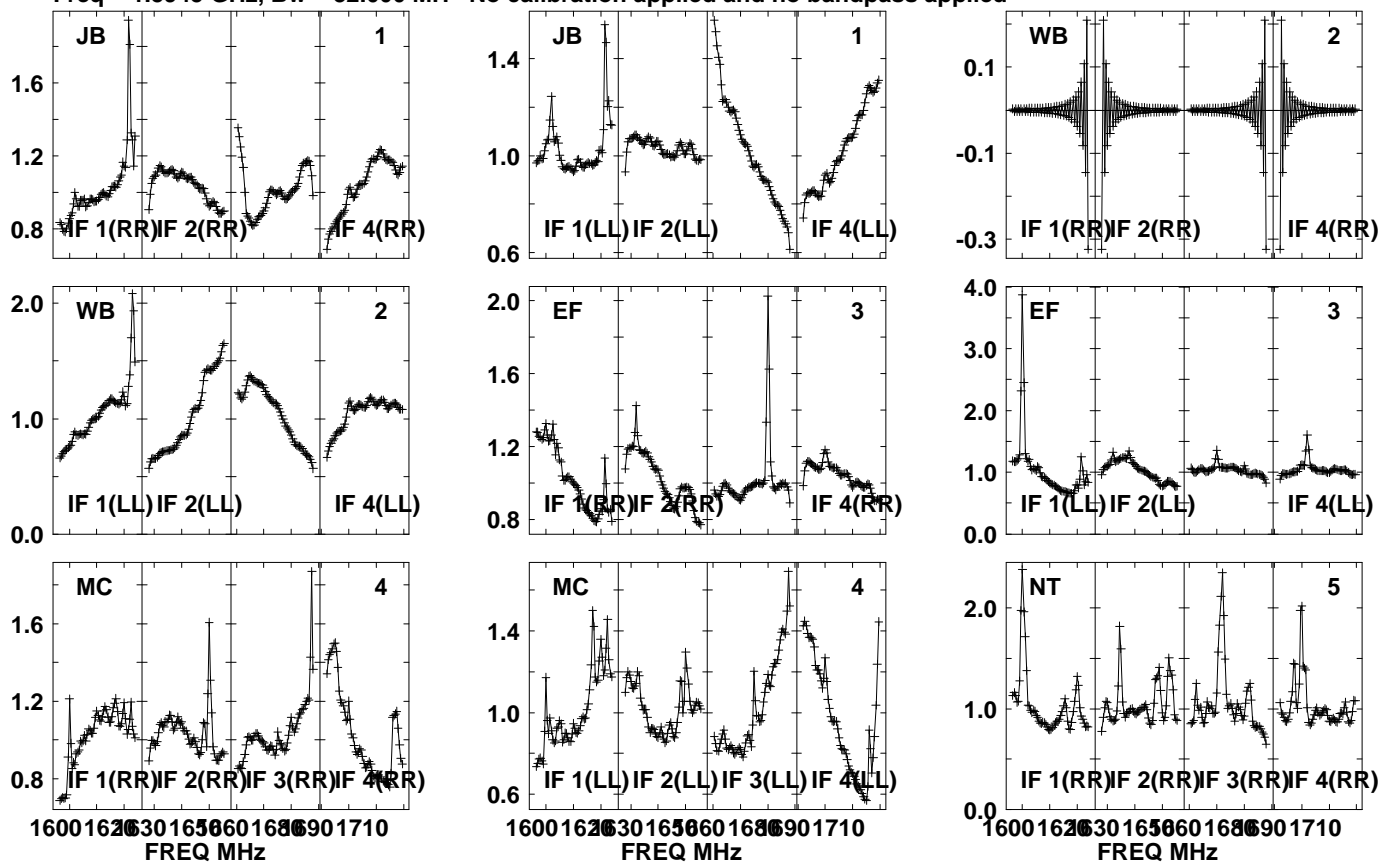

Lower frame: Real Jy  
Auto-corr total-power spectrum Antenna: \*  
Timerange: 00/15:14:01 to 00/15:17:29

Plot file version 489 created 05-OCT-2021 17:06:36

APM08279+525 GM076.UVDATA.1

Freq = 1.5945 GHz, Bw = 32.000 MH No calibration applied and no bandpass applied

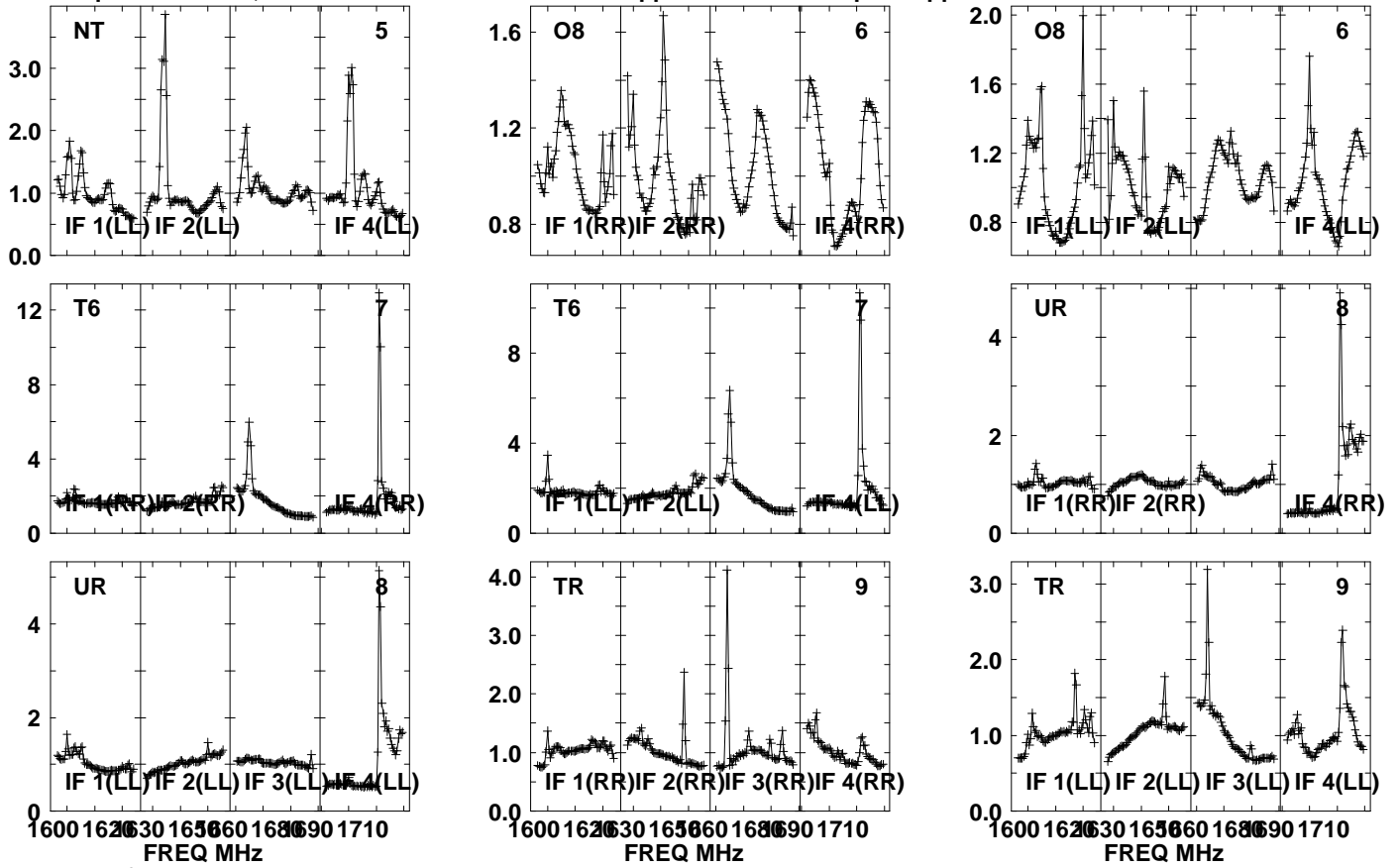

Lower frame: Real Jy  
Auto-corr total-power spectrum Antenna: \*  
Timerange: 00/15:14:01 to 00/15:17:29

Plot file version 490 created 05-OCT-2021 17:06:37

APM08279+525 GM076.UVDATA.1

Freq = 1.5945 GHz, Bw = 32.000 MH

No calibration applied and no bandpass applied

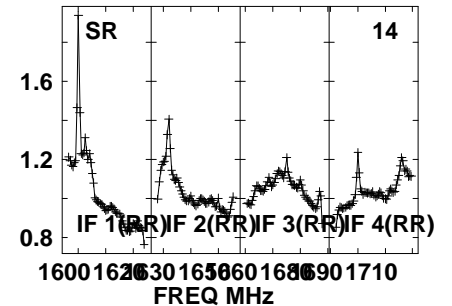
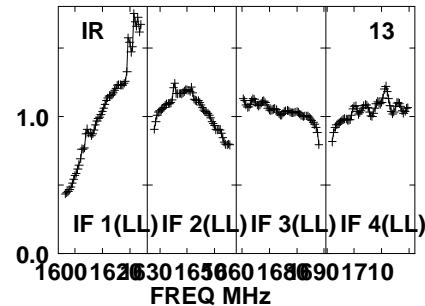
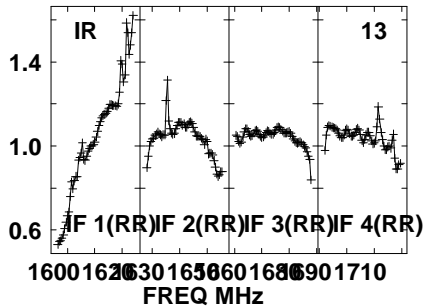
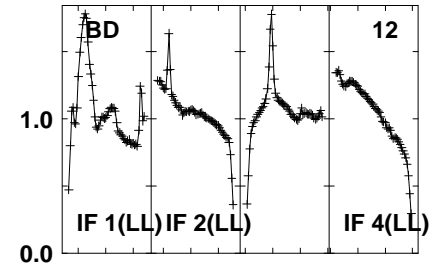
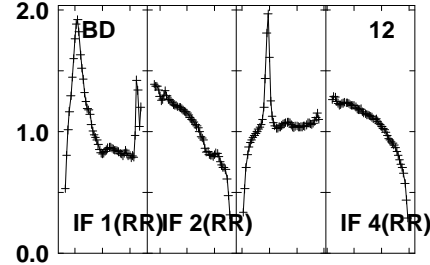
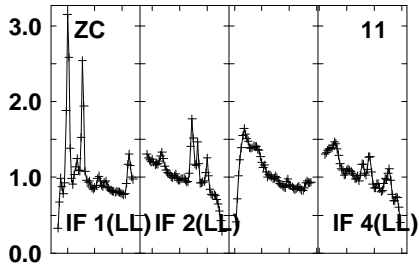
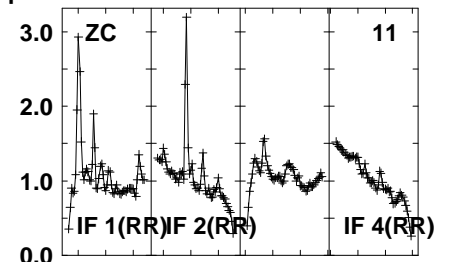
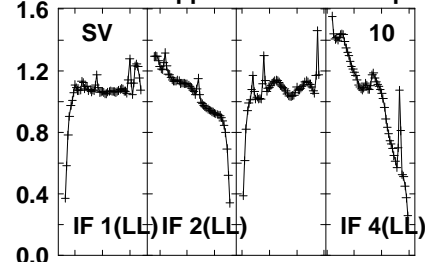
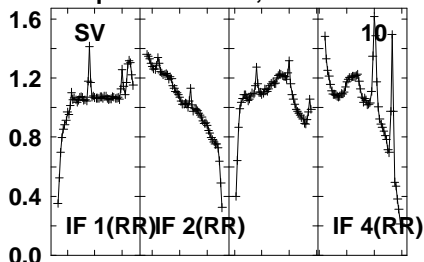

Lower frame: Real Jy

Auto-corr total-power spectrum Antenna: \*

Timerange: 00/15:14:01 to 00/15:17:29



Plot file version 491 created 05-OCT-2021 17:06:37

APM08279+525 GM076.UVDATA.1

Freq = 1.5945 GHz, Bw = 32.000 MH

No calibration applied and no bandpass applied

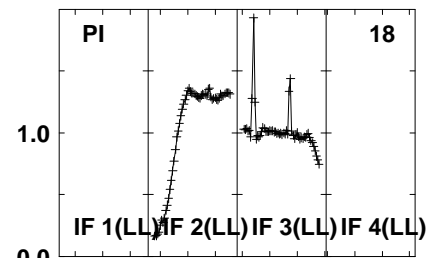
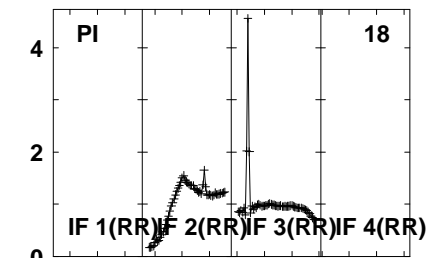
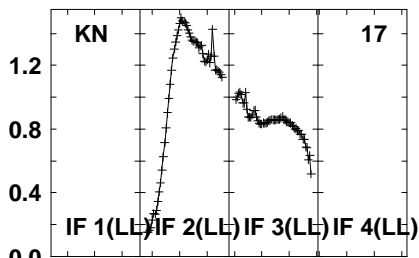
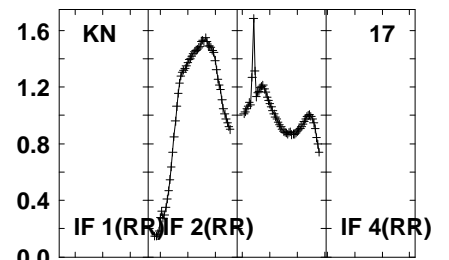
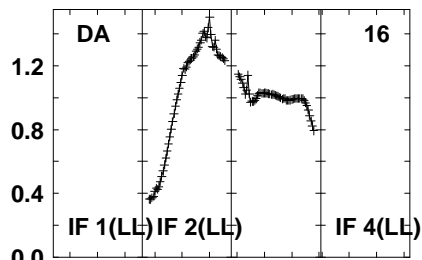
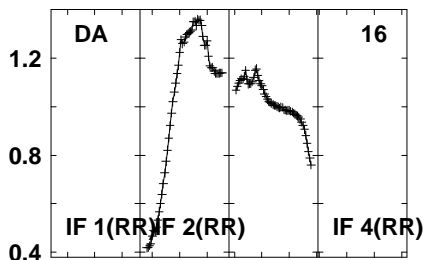
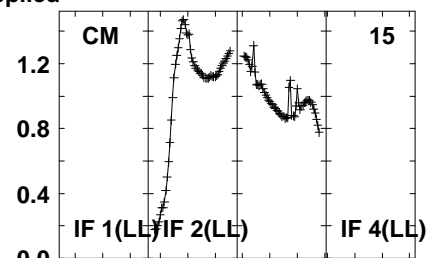
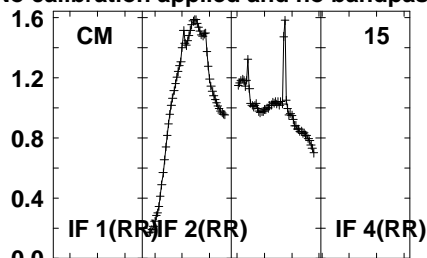
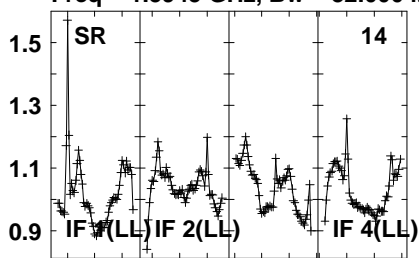

1600 1620 1630 1650 1660 1680 1690 1710  
FREQ MHz

Lower frame: Real Jy  
Auto-corr total-power spectrum Antenna: \*  
Timerange: 00/15:14:01 to 00/15:17:29

Plot file version 492 created 05-OCT-2021 17:06:37

APM08279+525 GM076.UVDATA.1

Freq = 1.5945 GHz, Bw = 32.000 MH No calibration applied and no bandpass applied

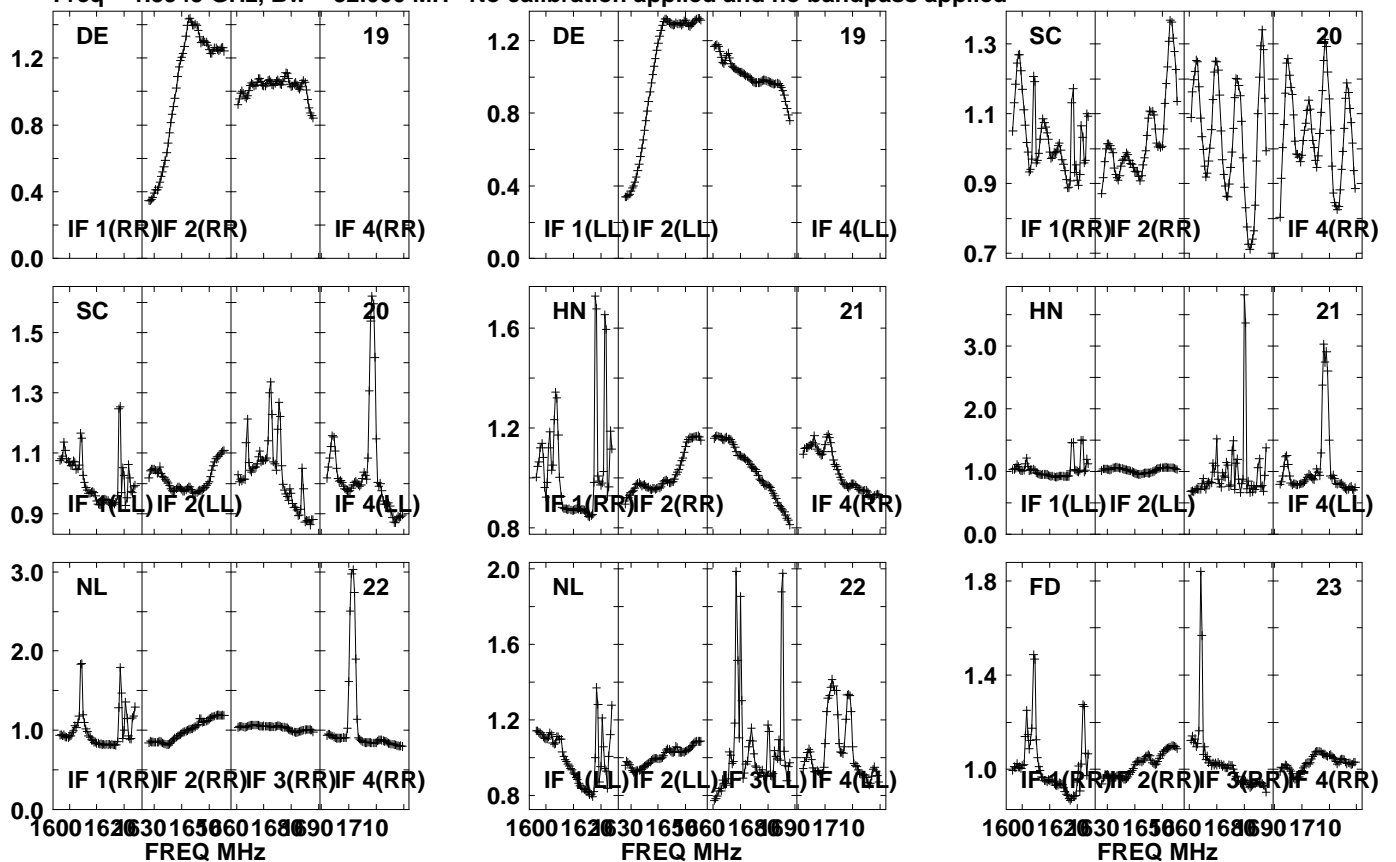

Lower frame: Real Jy  
Auto-corr total-power spectrum Antenna: \*  
Timerange: 00/15:14:01 to 00/15:17:29

Plot file version 493 created 05-OCT-2021 17:06:38

APM08279+525 GM076.UVDATA.1

Freq = 1.5945 GHz, Bw = 32.000 MH No calibration applied and no bandpass applied

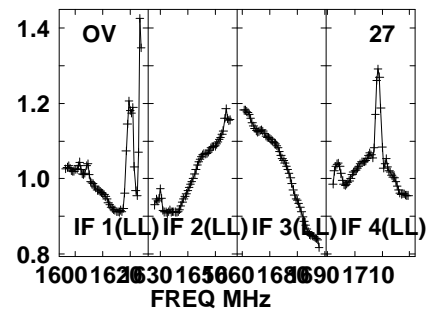
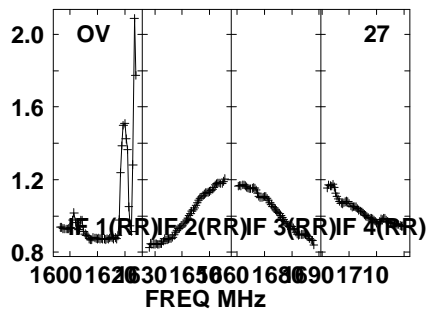
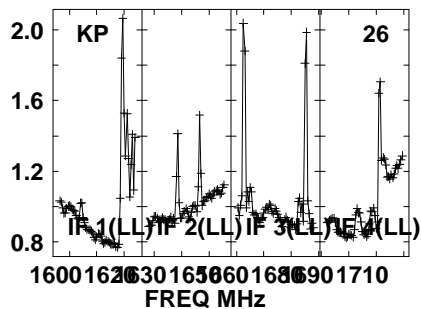
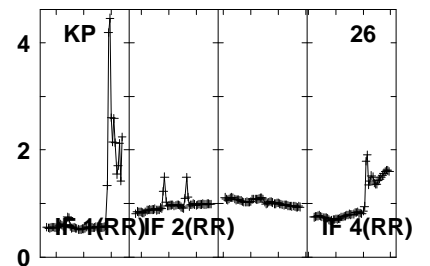
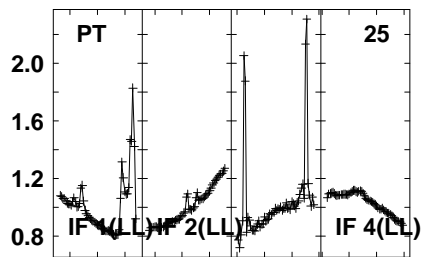
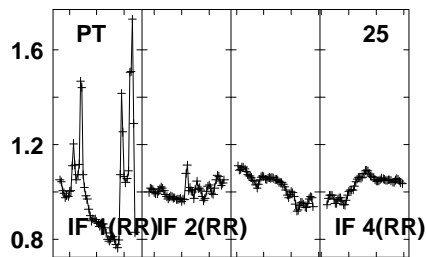
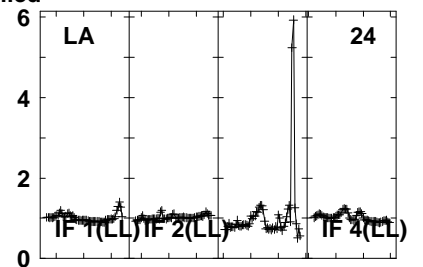
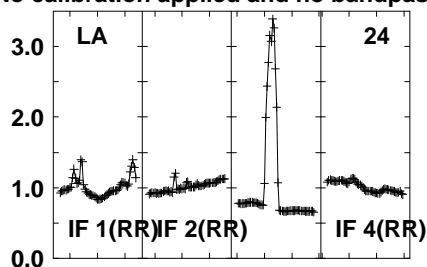
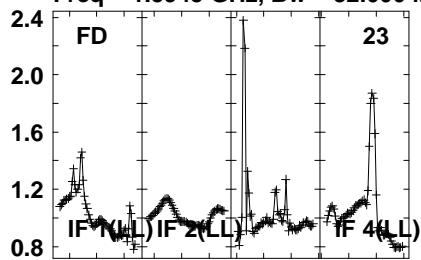

Lower frame: Real Jy  
Auto-corr total-power spectrum Antenna: \*  
Timerange: 00/15:14:01 to 00/15:17:29

Plot file version 494 created 05-OCT-2021 17:06:38

APM08279+525 GM076.UVDATA.1

Freq = 1.5945 GHz, Bw = 32.000 MH No calibration applied and no bandpass applied

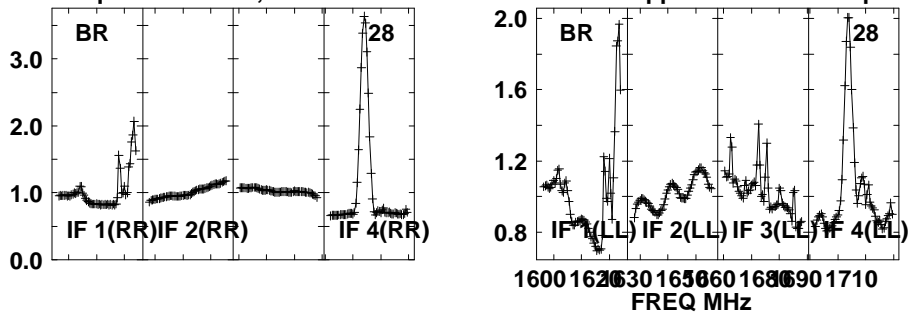

Lower frame: Real Jy

Auto-corr total-power spectrum Antenna: \*

Timerange: 00/15:14:01 to 00/15:17:29

Plot file version 495 created 05-OCT-2021 17:06:38

J0827+5217 GM076.UVDATA.1

Freq = 1.5945 GHz, Bw = 32.000 MH No calibration applied and no bandpass applied

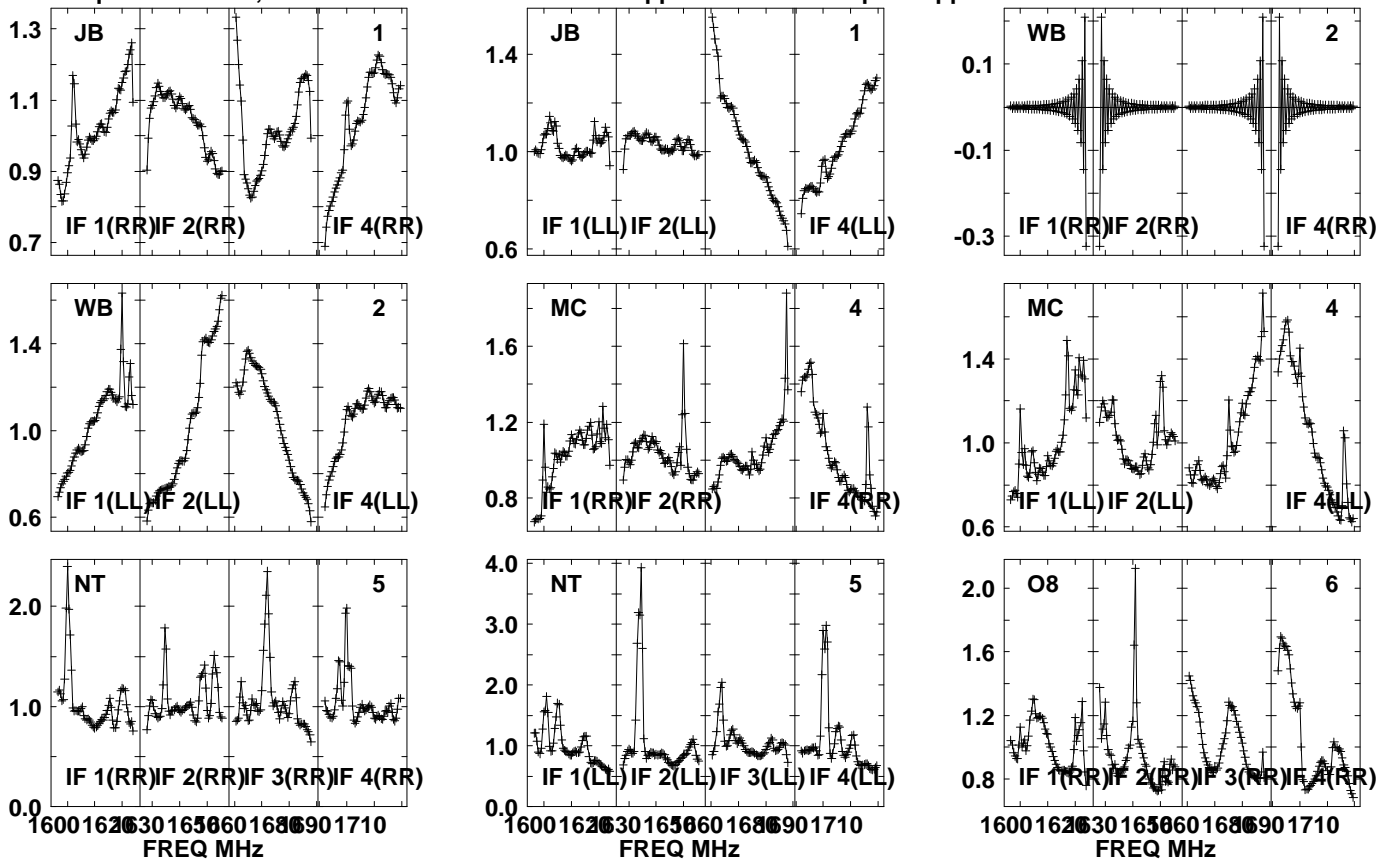

Lower frame: Real Jy  
Auto-corr total-power spectrum Antenna: \*  
Timerange: 00/15:18:01 to 00/15:19:29

Plot file version 496 created 05-OCT-2021 17:06:39

J0827+5217 GM076.UVDATA.1

Freq = 1.5945 GHz, Bw = 32.000 MH No calibration applied and no bandpass applied

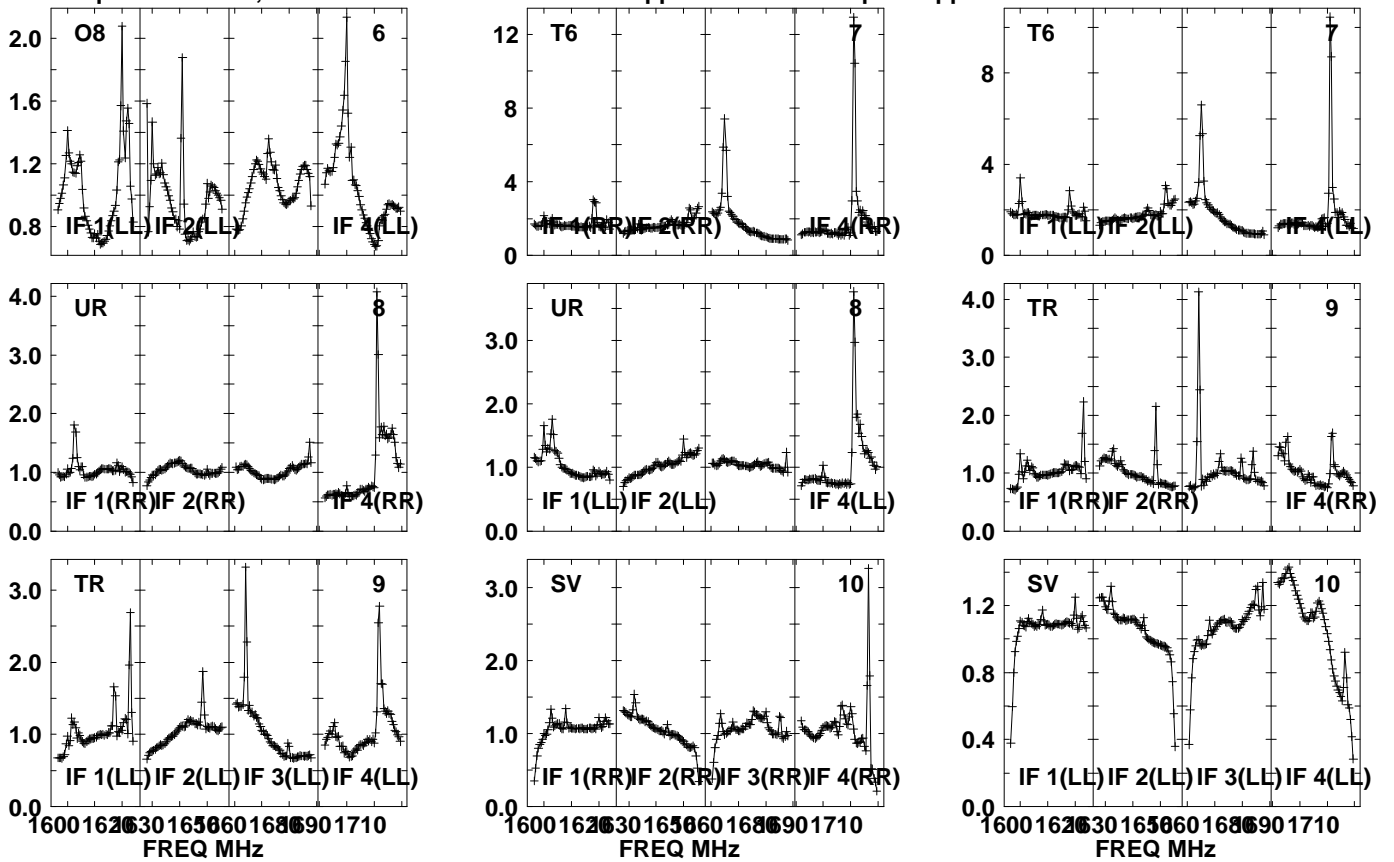

Lower frame: Real Jy  
Auto-corr total-power spectrum Antenna: \*  
Timerange: 00/15:18:01 to 00/15:19:29

Plot file version 497 created 05-OCT-2021 17:06:39

J0827+5217 GM076.UVDATA.1

Freq = 1.5945 GHz, Bw = 32.000 MH No calibration applied and no bandpass applied

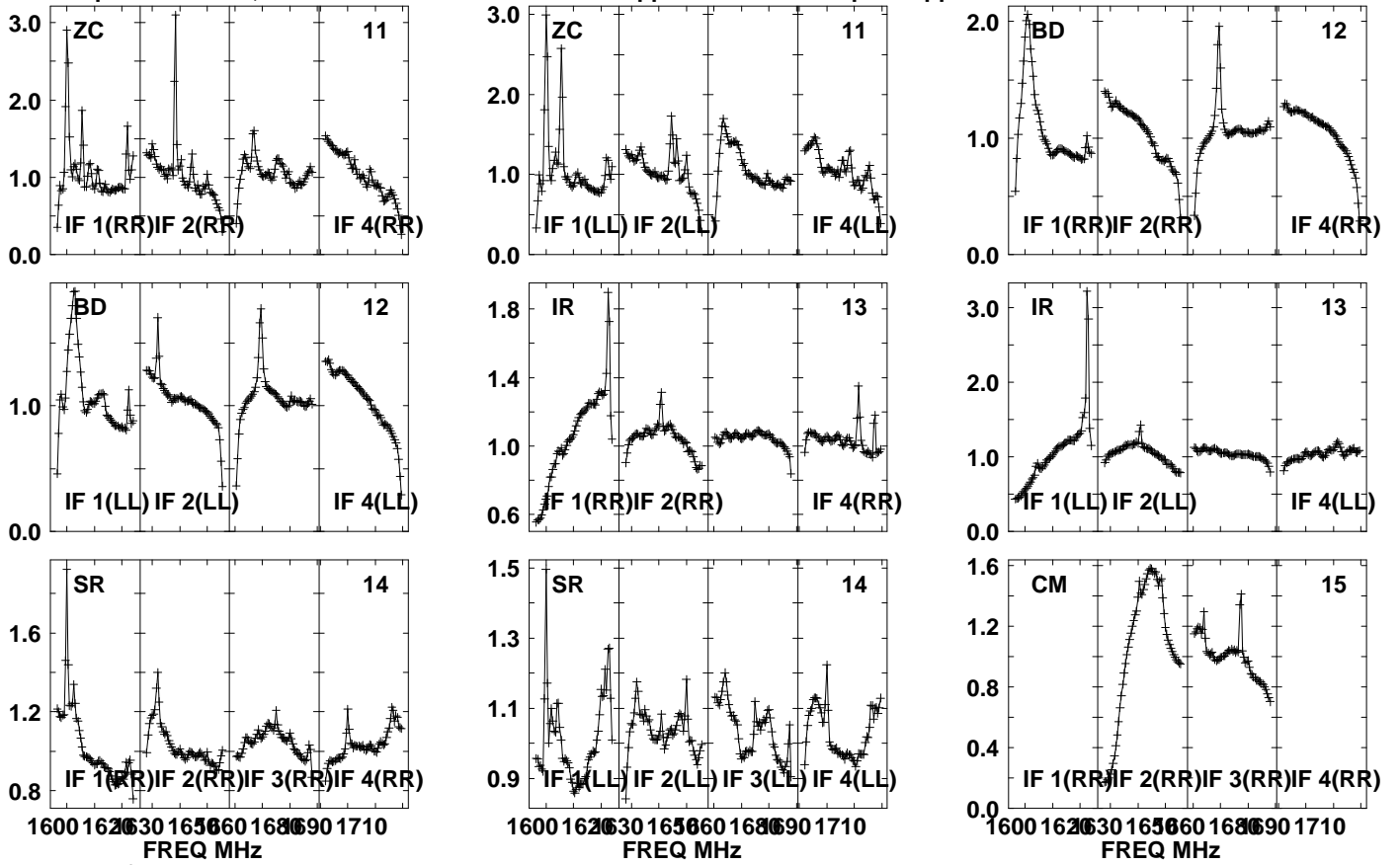

Lower frame: Real Jy

Auto-corr total-power spectrum Antenna: \*

Timerange: 00/15:18:01 to 00/15:19:29

Plot file version 498 created 05-OCT-2021 17:06:39

J0827+5217 GM076.UVDATA.1

Freq = 1.5945 GHz, Bw = 32.000 MH No calibration applied and no bandpass applied

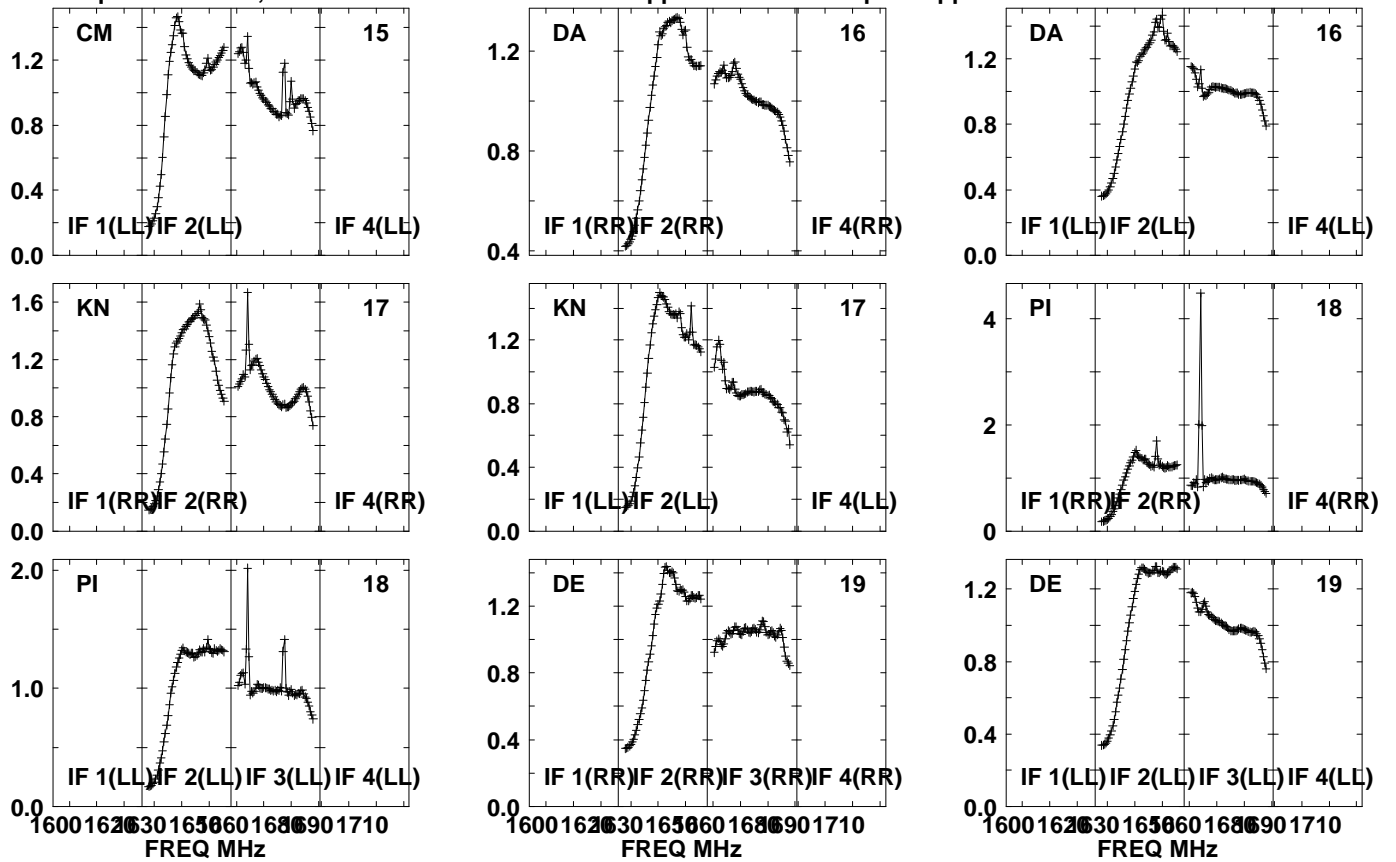

Lower frame: Real Jy  
Auto-corr total-power spectrum Antenna: \*  
Timerange: 00/15:18:01 to 00/15:19:29



Plot file version 499 created 05-OCT-2021 17:06:40

J0827+5217 GM076.UVDATA.1

Freq = 1.5945 GHz, Bw = 32.000 MH No calibration applied and no bandpass applied

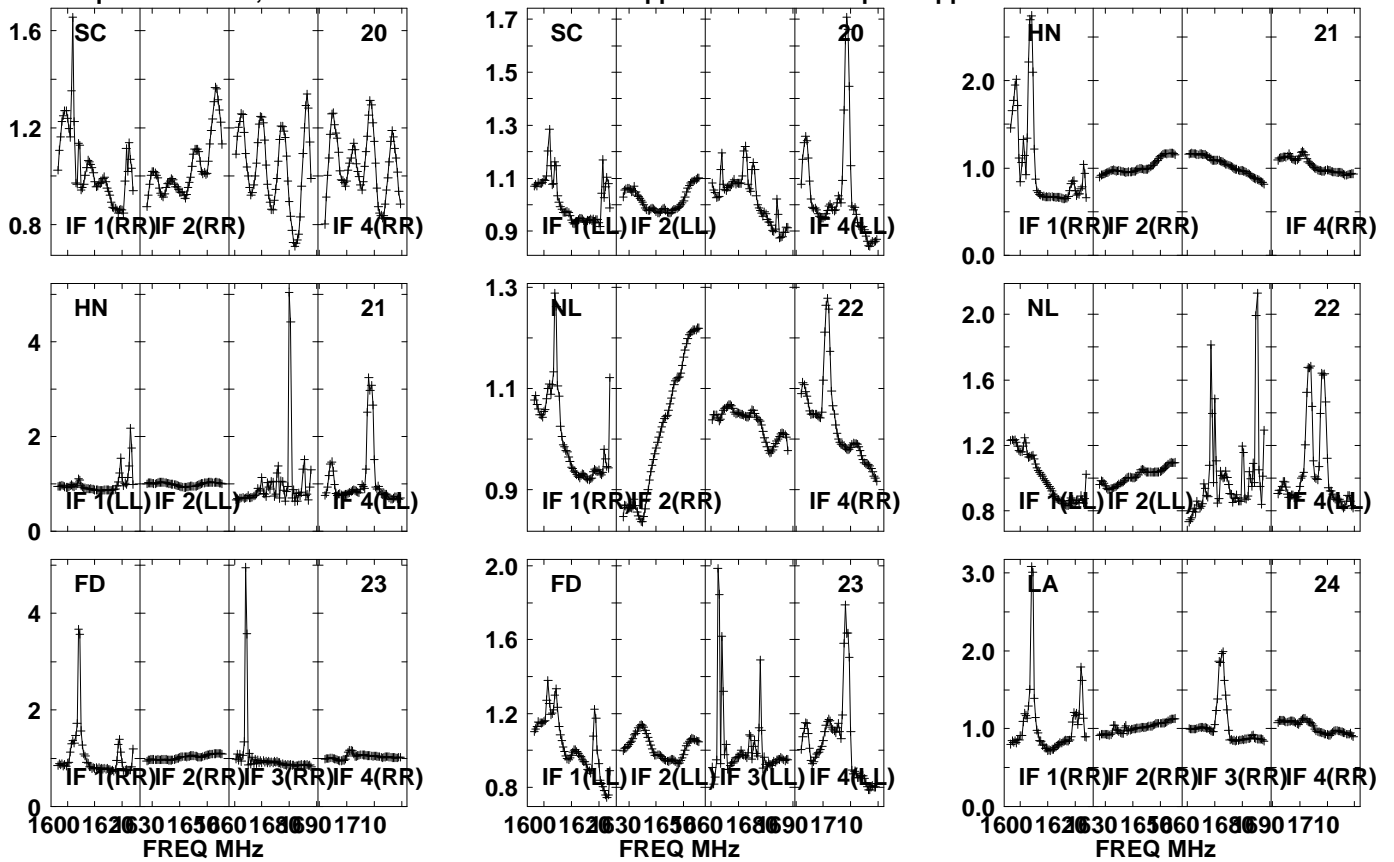

Lower frame: Real Jy  
Auto-corr total-power spectrum Antenna: \*  
Timerange: 00/15:18:01 to 00/15:19:29

Plot file version 500 created 05-OCT-2021 17:06:40

J0827+5217 GM076.UVDATA.1

Freq = 1.5945 GHz, Bw = 32.000 MH No calibration applied and no bandpass applied

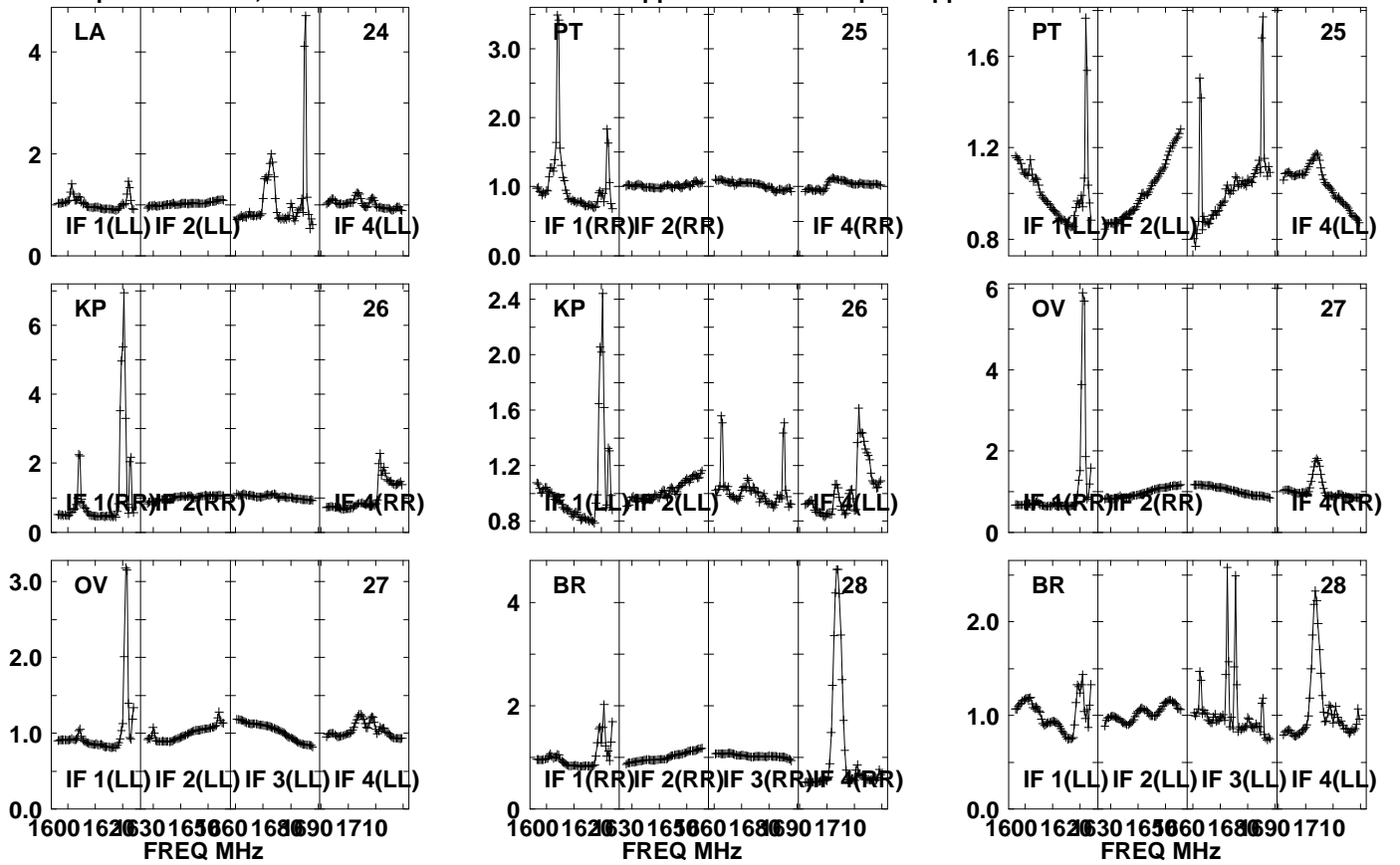

Lower frame: Real Jy  
Auto-corr total-power spectrum Antenna: \*  
Timerange: 00/15:18:01 to 00/15:19:29

Plot file version 501 created 05-OCT-2021 17:06:41

APM08279+525 GM076.UVDATA.1

Freq = 1.5945 GHz, Bw = 32.000 MH No calibration applied and no bandpass applied

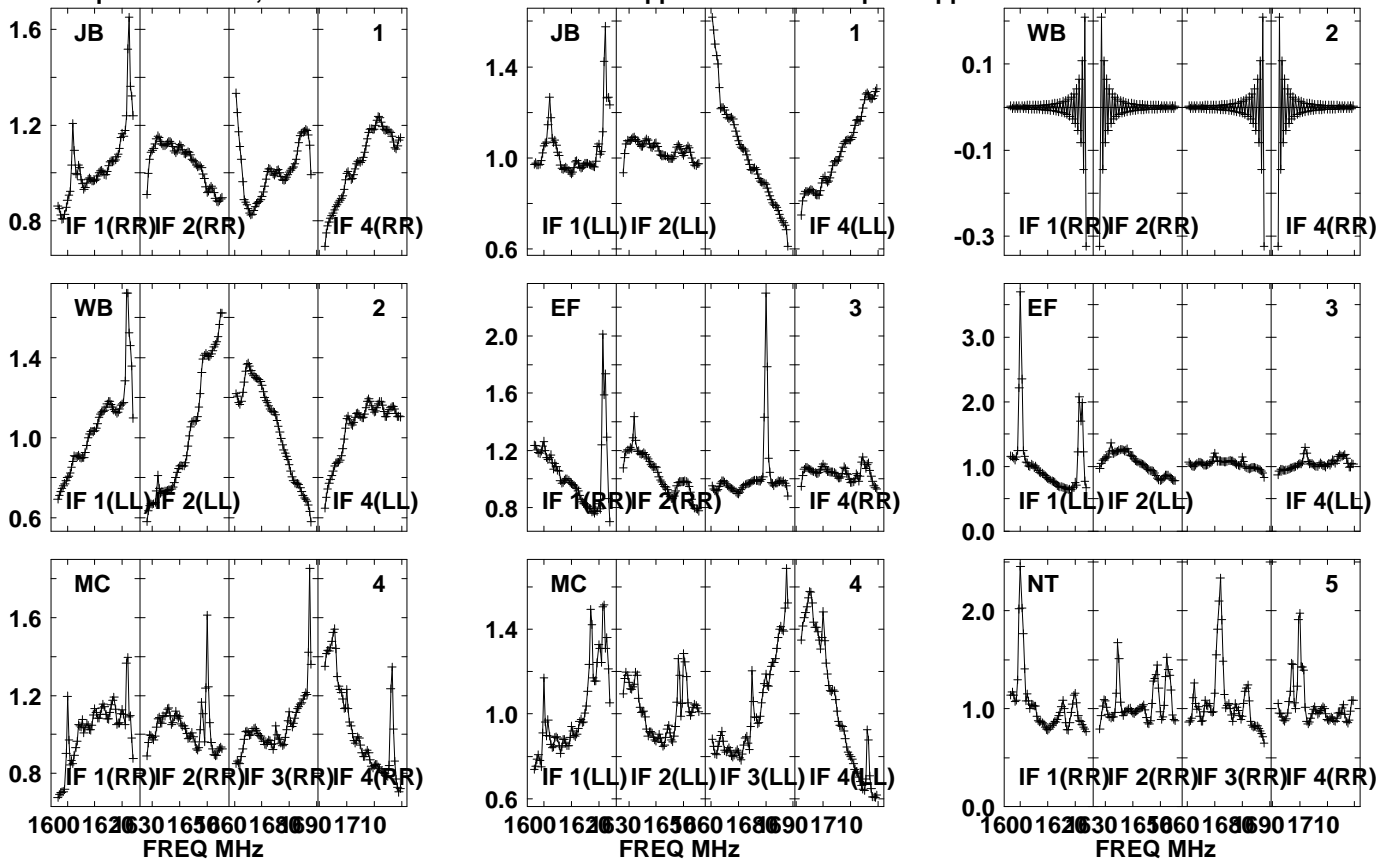

Lower frame: Real Jy  
Auto-corr total-power spectrum Antenna: \*  
Timerange: 00/15:19:31 to 00/15:22:59

Plot file version 502 created 05-OCT-2021 17:06:41

APM08279+525 GM076.UVDATA.1

Freq = 1.5945 GHz, Bw = 32.000 MH No calibration applied and no bandpass applied

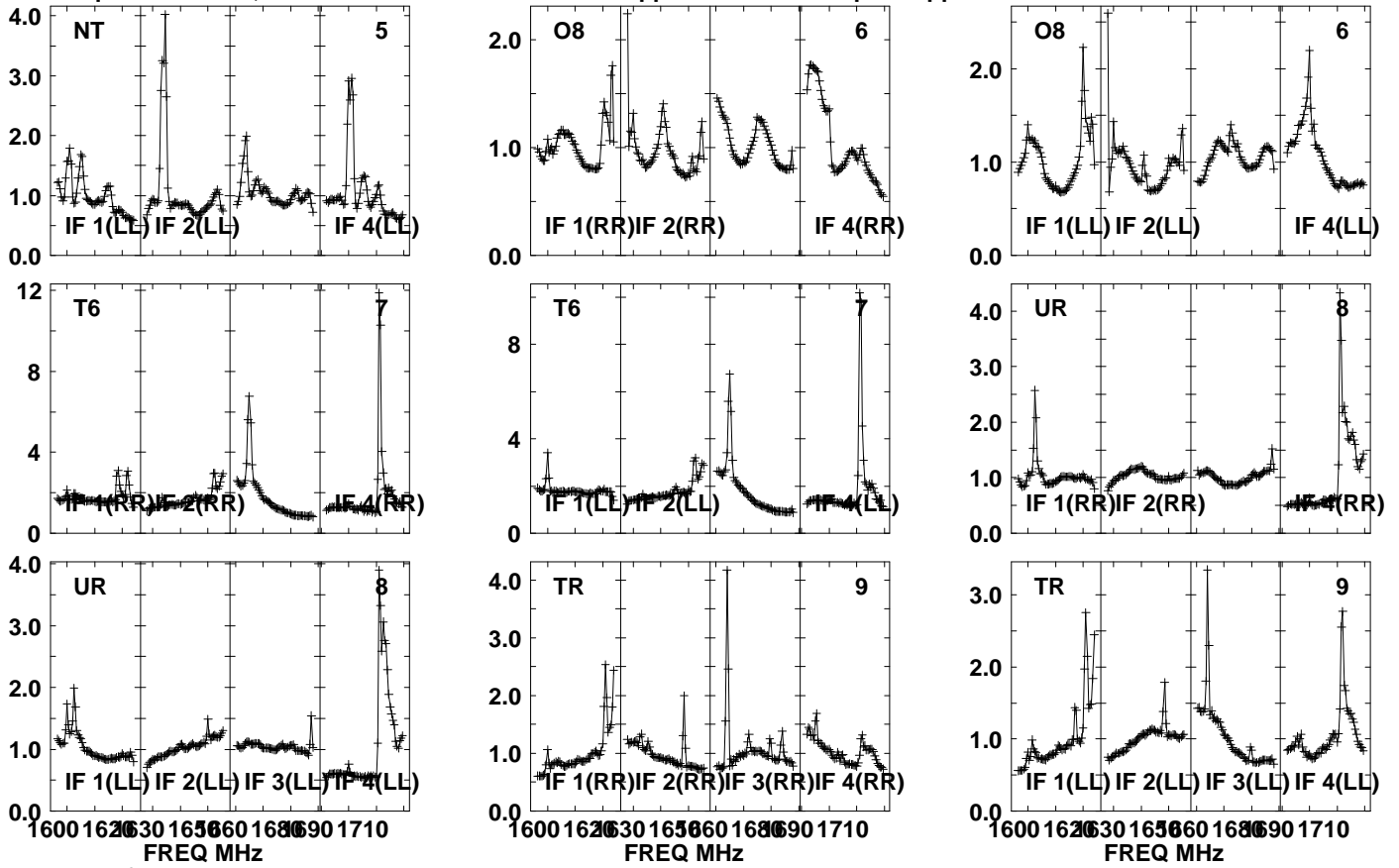

Lower frame: Real Jy  
Auto-corr total-power spectrum Antenna: \*  
Timerange: 00/15:19:31 to 00/15:22:59

Plot file version 503 created 05-OCT-2021 17:06:41

APM08279+525 GM076.UVDATA.1

Freq = 1.5945 GHz, Bw = 32.000 MH No calibration applied and no bandpass applied

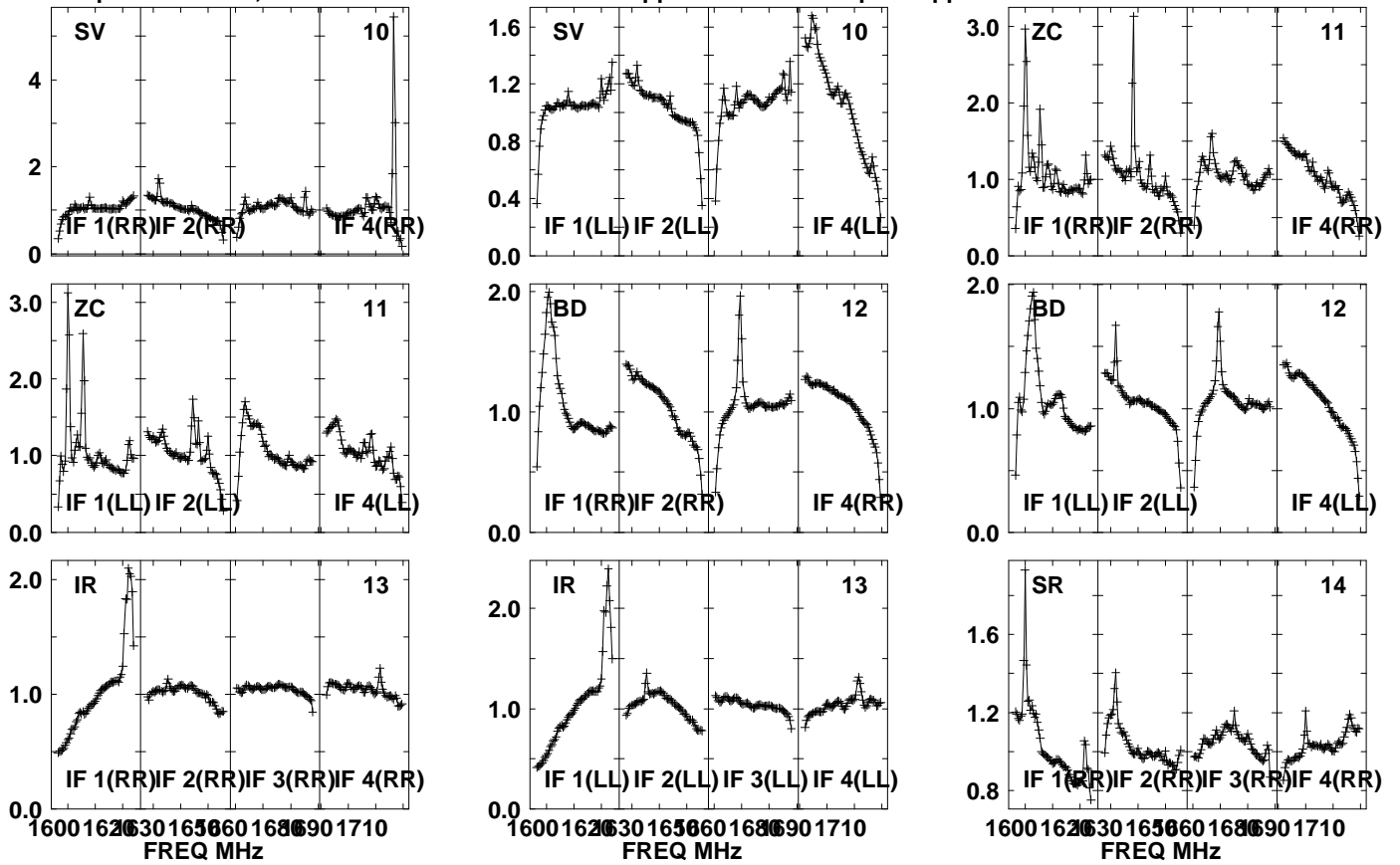

Lower frame: Real Jy  
Auto-corr total-power spectrum Antenna: \*  
Timerange: 00/15:19:31 to 00/15:22:59

Plot file version 504 created 05-OCT-2021 17:06:42

APM08279+525 GM076.UVDATA.1

Freq = 1.5945 GHz, Bw = 32.000 MH

No calibration applied and no bandpass applied

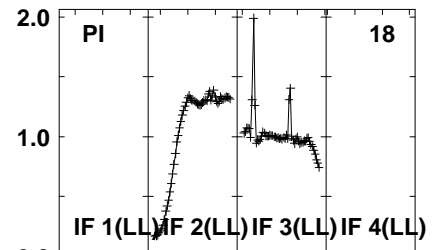
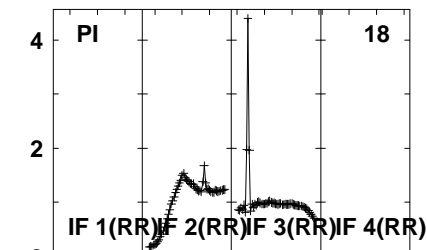
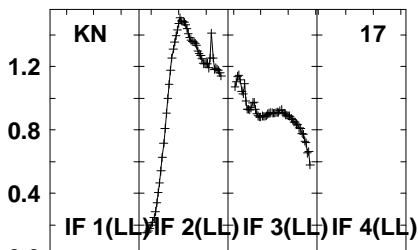
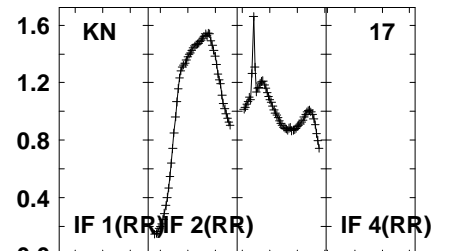
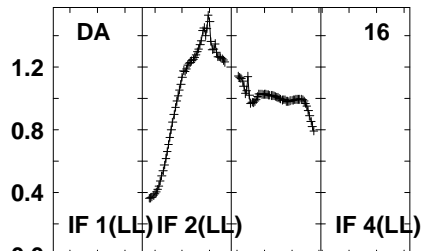
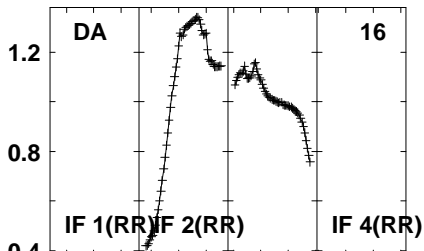
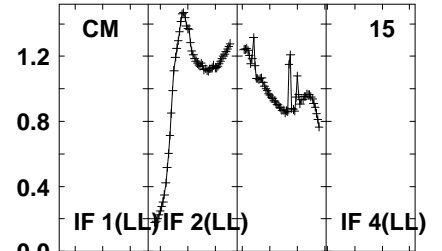
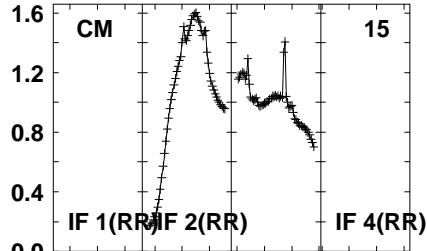
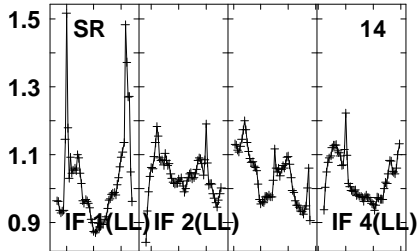

1600 1620 1630 1650 1660 1680 1690 1710  
FREQ MHz

1600 1620 1630 1650 1660 1680 1690 1710  
FREQ MHz

1600 1620 1630 1650 1660 1680 1690 1710  
FREQ MHz

Lower frame: Real Jy  
Auto-corr total-power spectrum Antenna: \*  
Timerange: 00/15:19:31 to 00/15:22:59

Plot file version 505 created 05-OCT-2021 17:06:42

APM08279+525 GM076.UVDATA.1

Freq = 1.5945 GHz, Bw = 32.000 MH No calibration applied and no bandpass applied

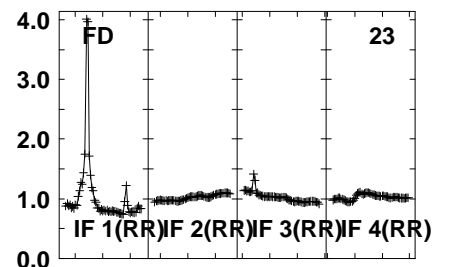
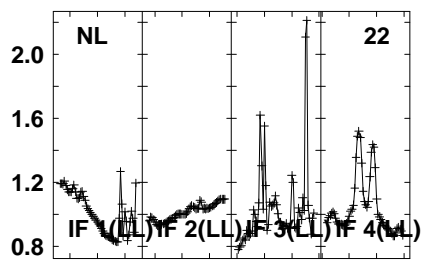
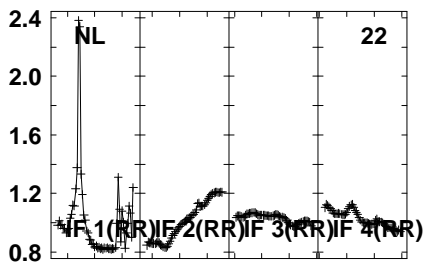
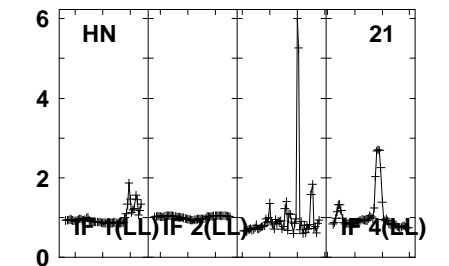
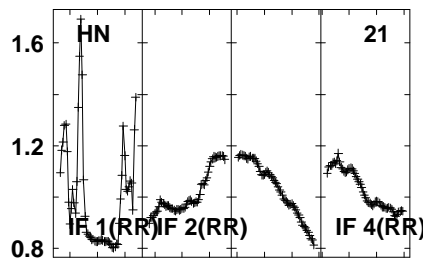
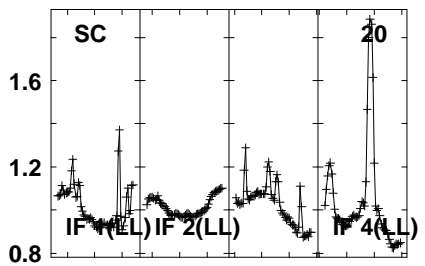
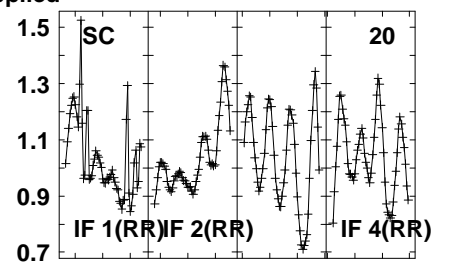
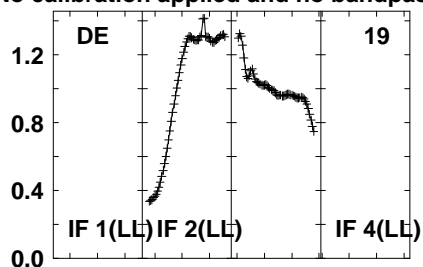
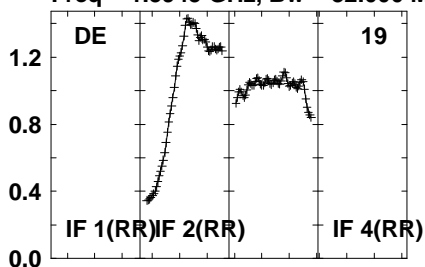

1600 1620 1630 1650 1660 1680 1690 1710  
FREQ MHz

1600 1620 1630 1650 1660 1680 1690 1710  
FREQ MHz

1600 1620 1630 1650 1660 1680 1690 1710  
FREQ MHz

Lower frame: Real Jy  
Auto-corr total-power spectrum Antenna: \*  
Timerange: 00/15:19:31 to 00/15:22:59

Plot file version 506 created 05-OCT-2021 17:06:42

APM08279+525 GM076.UVDATA.1

Freq = 1.5945 GHz, Bw = 32.000 MH No calibration applied and no bandpass applied

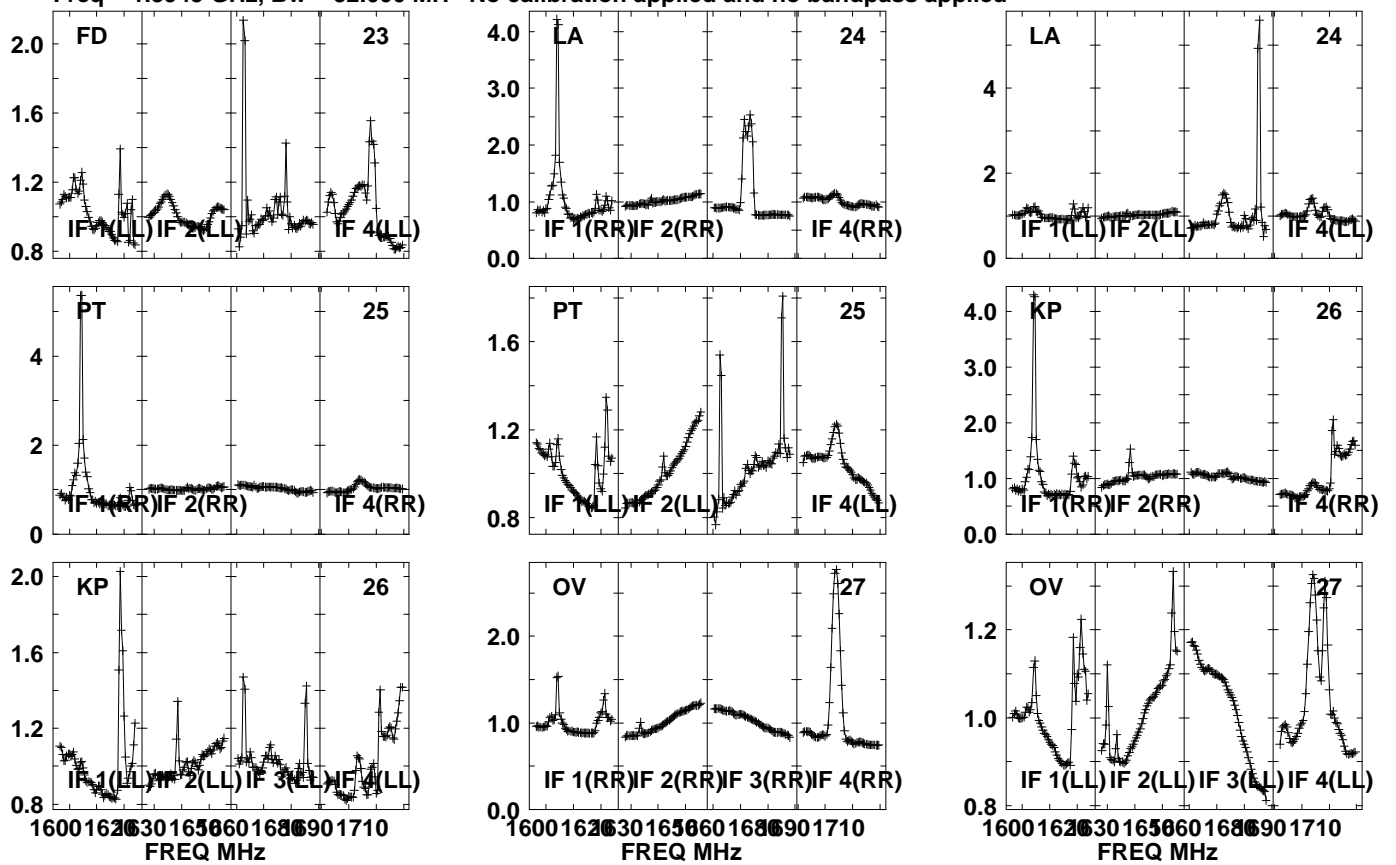

Lower frame: Real Jy  
Auto-corr total-power spectrum Antenna: \*  
Timerange: 00/15:19:31 to 00/15:22:59



Plot file version 507 created 05-OCT-2021 17:06:43

APM08279+525 GM076.UVDATA.1

Freq = 1.5945 GHz, Bw = 32.000 MH No calibration applied and no bandpass applied

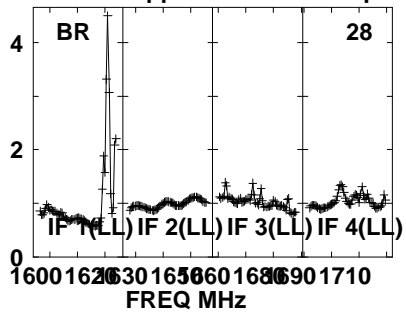
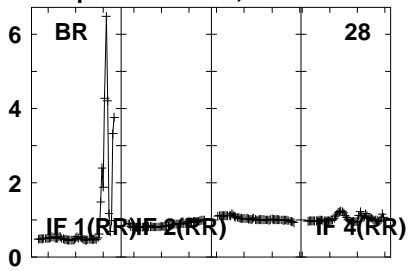

Lower frame: Real Jy  
Auto-corr total-power spectrum Antenna: \*  
Timerange: 00/15:19:31 to 00/15:22:59

Plot file version 508 created 05-OCT-2021 17:06:43

J0827+5217 GM076.UVDATA.1

Freq = 1.5945 GHz, Bw = 32.000 MH No calibration applied and no bandpass applied

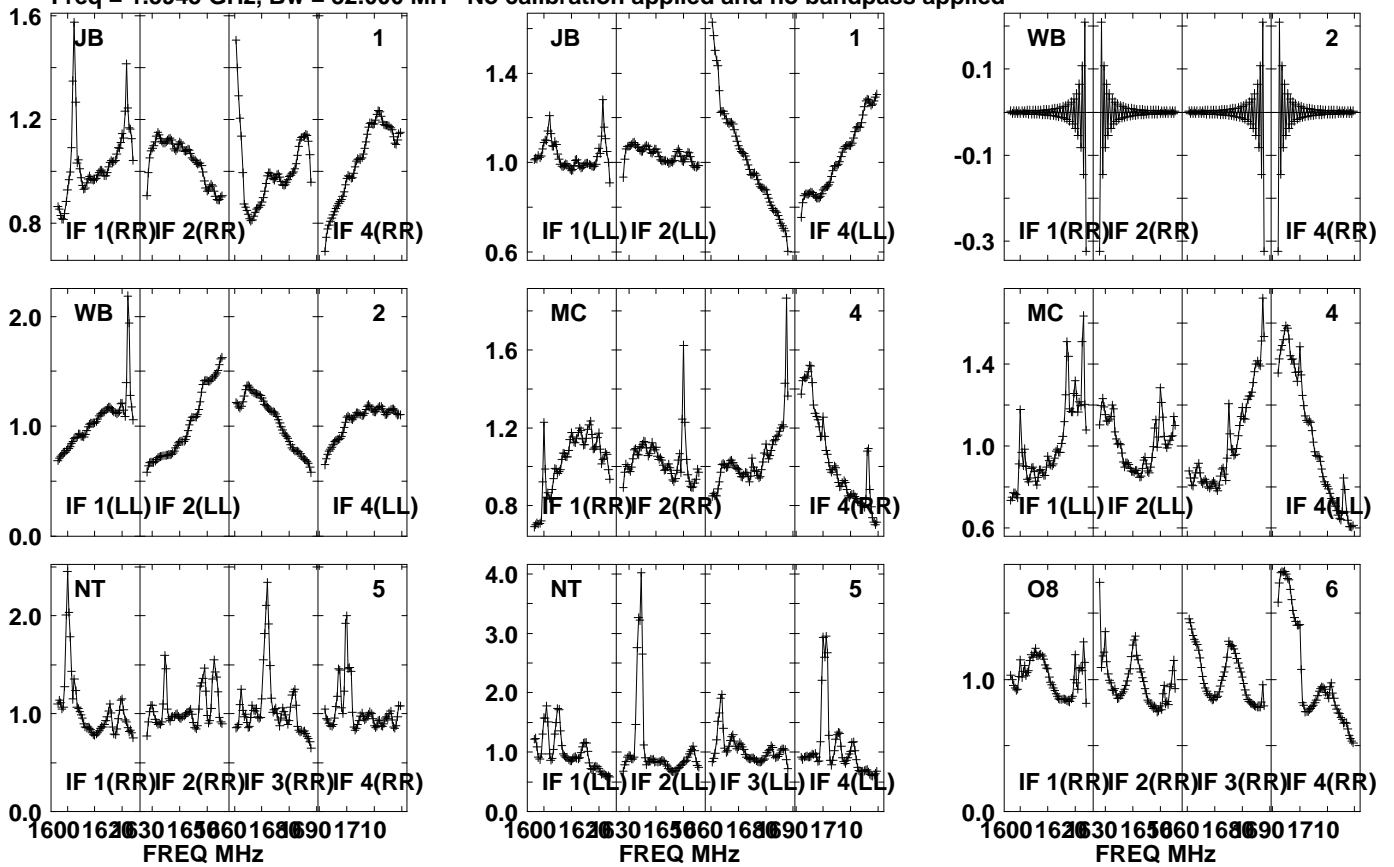

Lower frame: Real Jy

Auto-corr total-power spectrum Antenna: \*

Timerange: 00/15:23:01 to 00/15:24:29

Plot file version 509 created 05-OCT-2021 17:06:43

J0827+5217 GM076.UVDATA.1

Freq = 1.5945 GHz, Bw = 32.000 MH No calibration applied and no bandpass applied

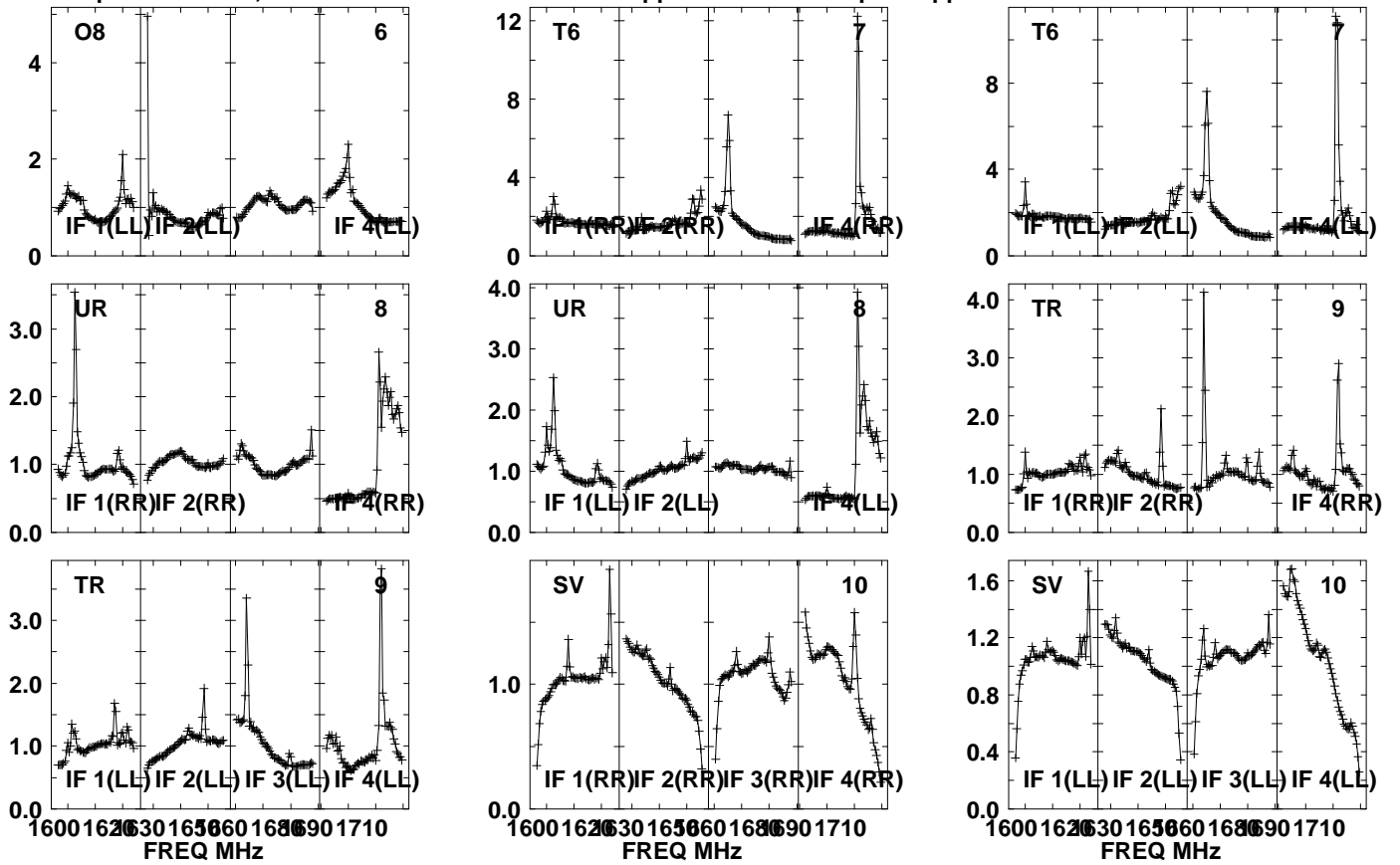

Lower frame: Real Jy  
Auto-corr total-power spectrum Antenna: \*  
Timerange: 00/15:23:01 to 00/15:24:29

Plot file version 510 created 05-OCT-2021 17:06:44

J0827+5217 GM076.UVDATA.1

Freq = 1.5945 GHz, Bw = 32.000 MH No calibration applied and no bandpass applied

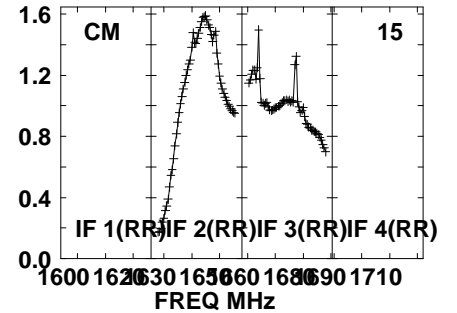
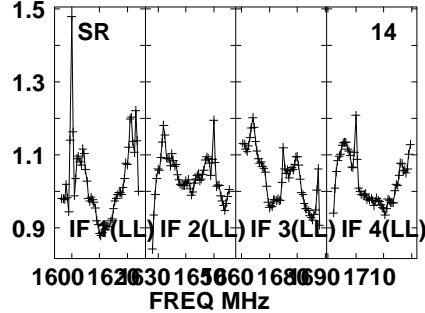
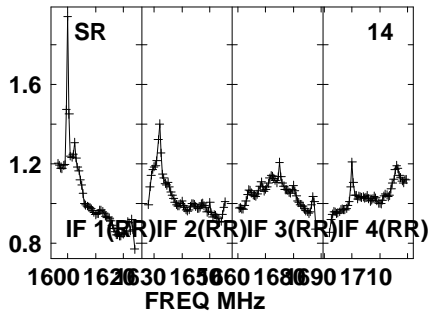
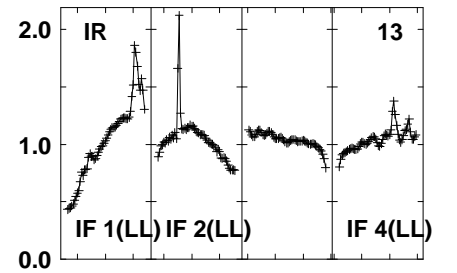
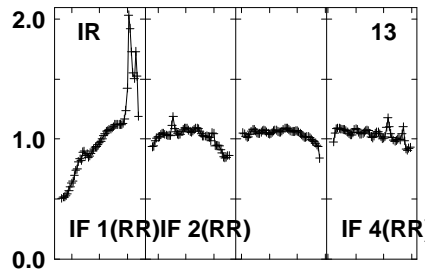
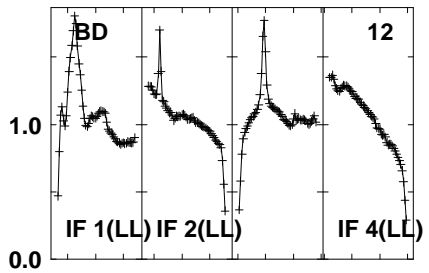
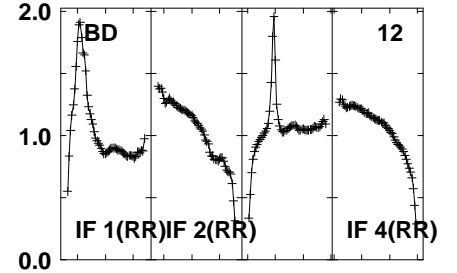
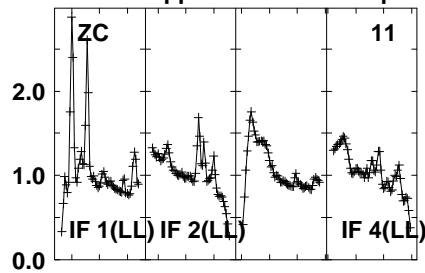
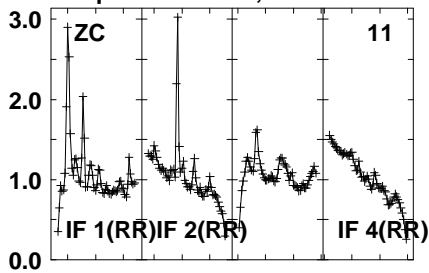

Lower frame: Real Jy

Auto-corr total-power spectrum Antenna: \*

Timerange: 00/15:23:01 to 00/15:24:29

Plot file version 511 created 05-OCT-2021 17:06:44

J0827+5217 GM076.UVDATA.1

Freq = 1.5945 GHz, Bw = 32.000 MH No calibration applied and no bandpass applied

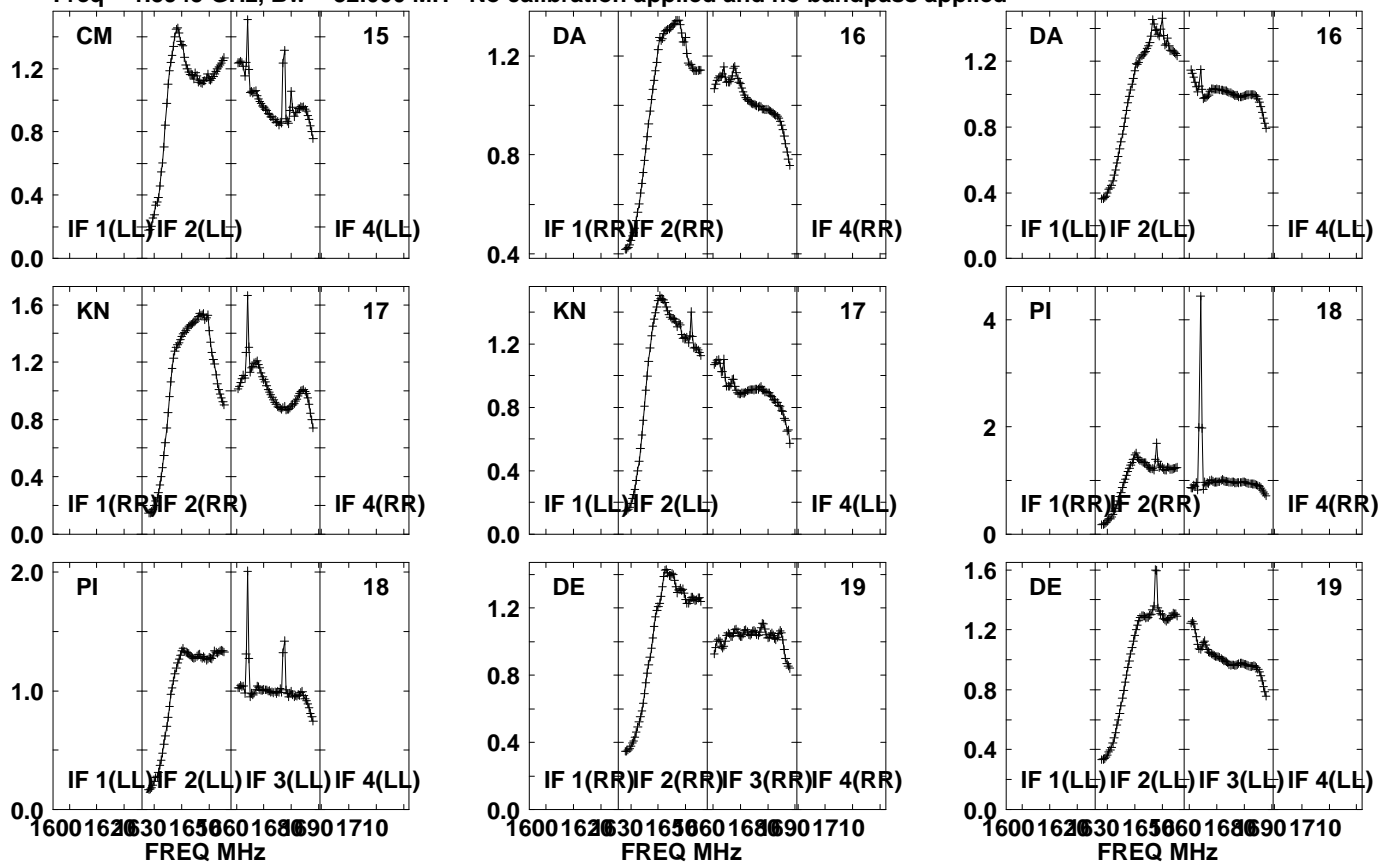

Lower frame: Real Jy  
Auto-corr total-power spectrum Antenna: \*  
Timerange: 00/15:23:01 to 00/15:24:29

Plot file version 512 created 05-OCT-2021 17:06:44

J0827+5217 GM076.UVDATA.1

Freq = 1.5945 GHz, Bw = 32.000 MH No calibration applied and no bandpass applied

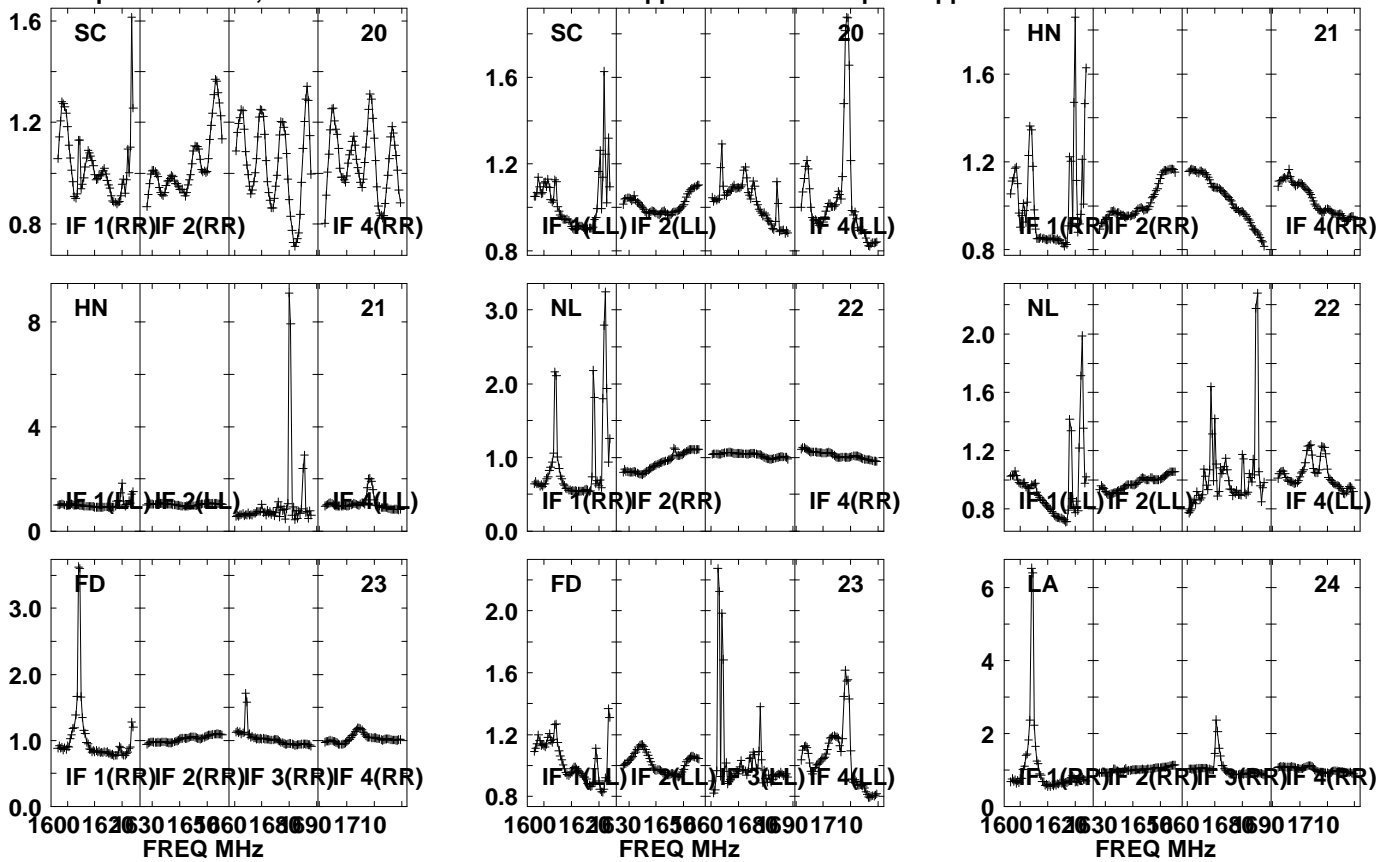

Lower frame: Real Jy  
Auto-corr total-power spectrum Antenna: \*  
Timerange: 00/15:23:01 to 00/15:24:29

Plot file version 513 created 05-OCT-2021 17:06:45

J0827+5217 GM076.UVDATA.1

Freq = 1.5945 GHz, Bw = 32.000 MH No calibration applied and no bandpass applied

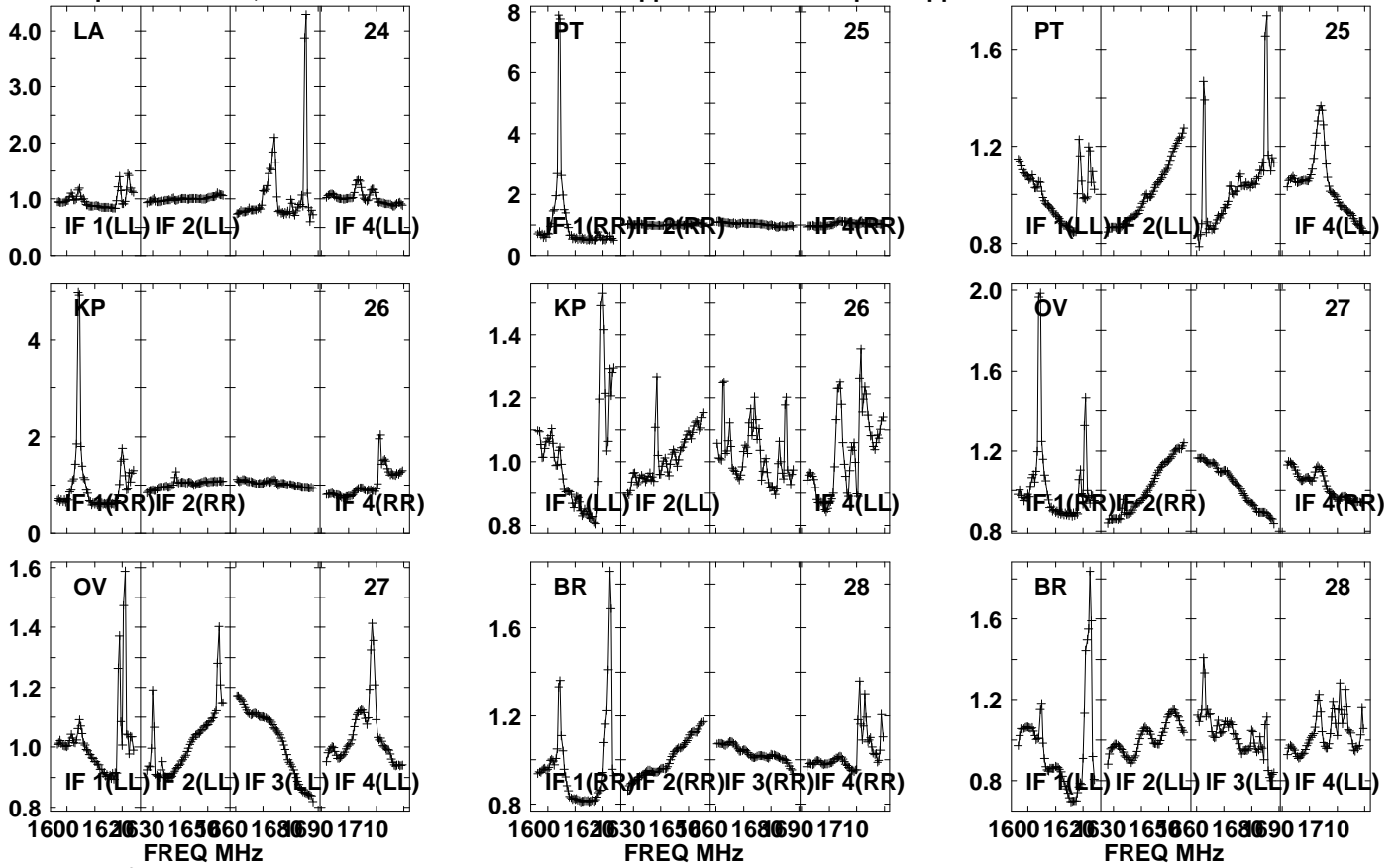

Lower frame: Real Jy  
Auto-corr total-power spectrum Antenna: \*  
Timerange: 00/15:23:01 to 00/15:24:29

Plot file version 514 created 05-OCT-2021 17:06:45

APM08279+525 GM076.UVDATA.1

Freq = 1.5945 GHz, Bw = 32.000 MH No calibration applied and no bandpass applied

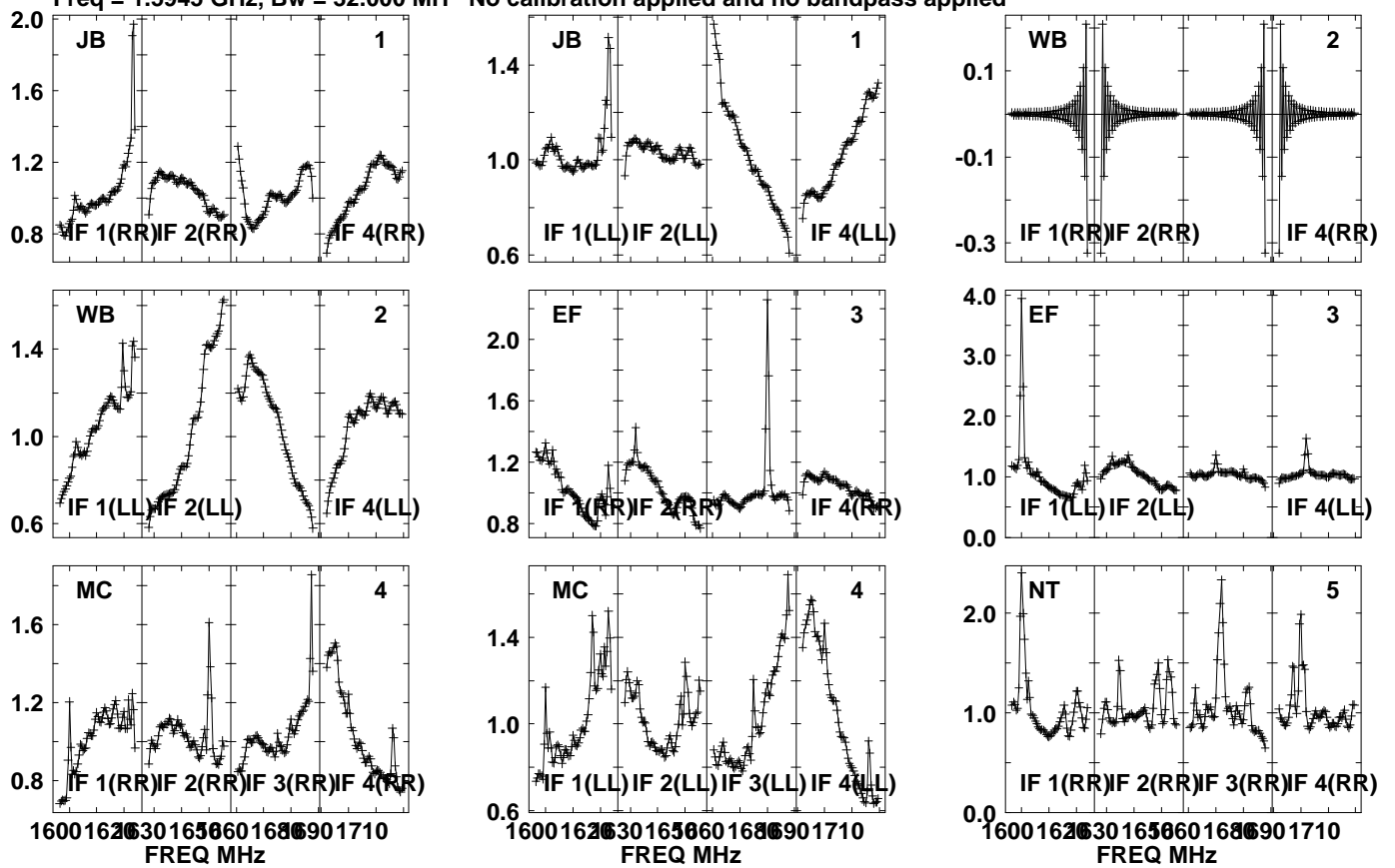

Lower frame: Real Jy  
Auto-corr total-power spectrum Antenna: \*  
Timerange: 00/15:24:31 to 00/15:27:59



Plot file version 515 created 05-OCT-2021 17:06:45

APM08279+525 GM076.UVDATA.1

Freq = 1.5945 GHz, Bw = 32.000 MH No calibration applied and no bandpass applied

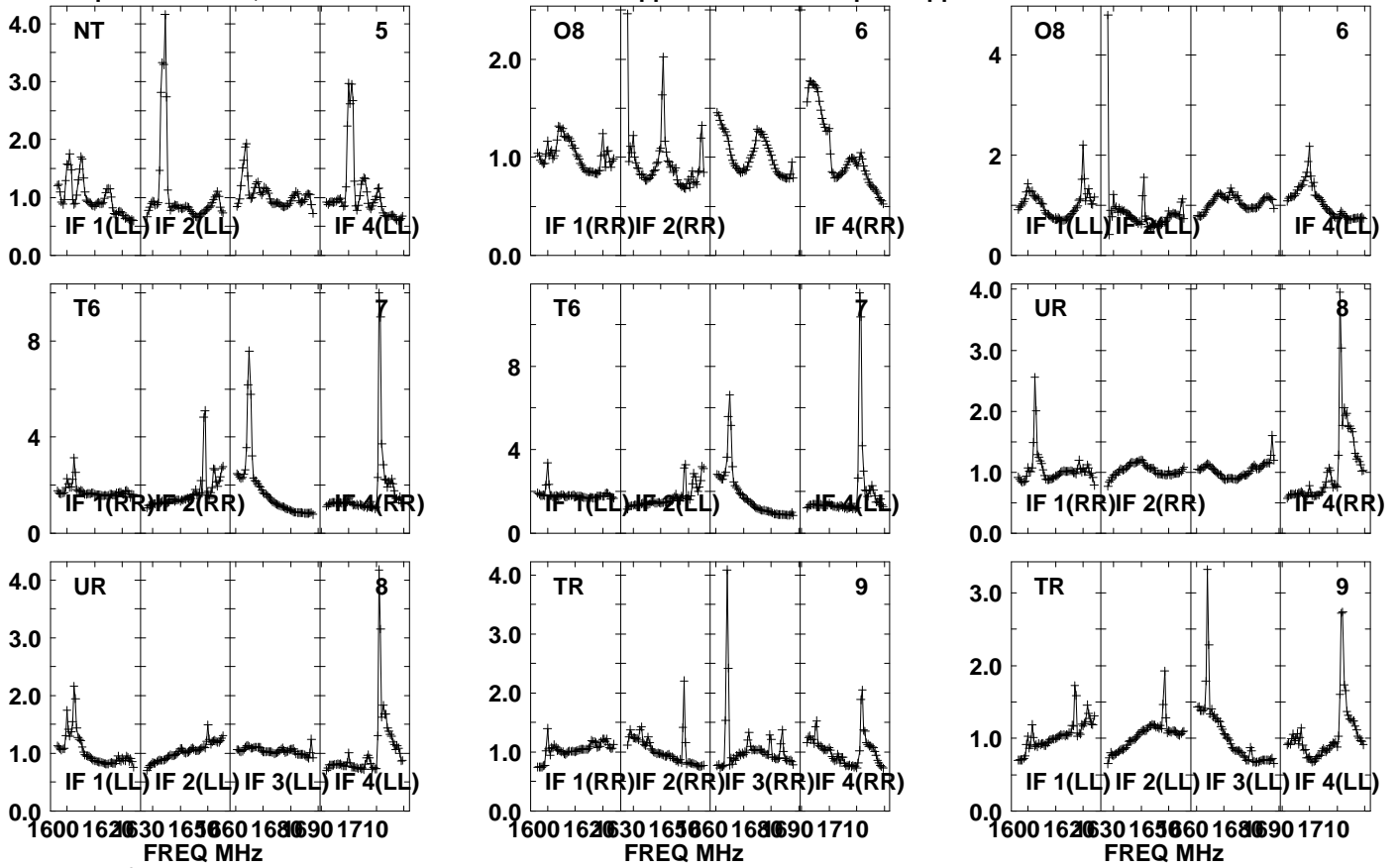

Lower frame: Real Jy

Auto-corr total-power spectrum Antenna: \*

Timerange: 00/15:24:31 to 00/15:27:59

Plot file version 516 created 05-OCT-2021 17:06:46

APM08279+525 GM076.UVDATA.1

Freq = 1.5945 GHz, Bw = 32.000 MH No calibration applied and no bandpass applied

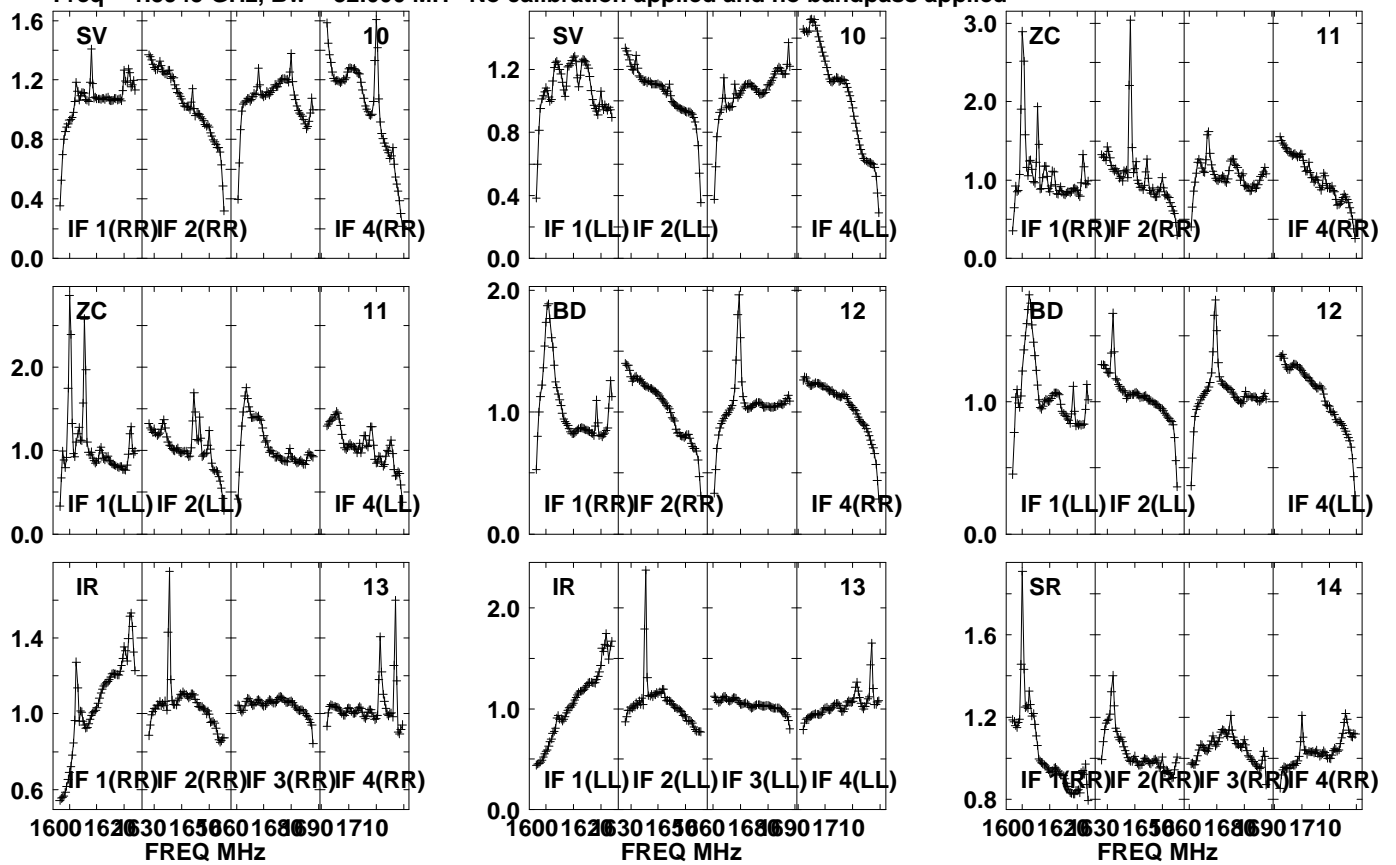

Lower frame: Real Jy  
Auto-corr total-power spectrum Antenna: \*  
Timerange: 00/15:24:31 to 00/15:27:59

Plot file version 517 created 05-OCT-2021 17:06:46

APM08279+525 GM076.UVDATA.1

Freq = 1.5945 GHz, Bw = 32.000 MH

No calibration applied and no bandpass applied

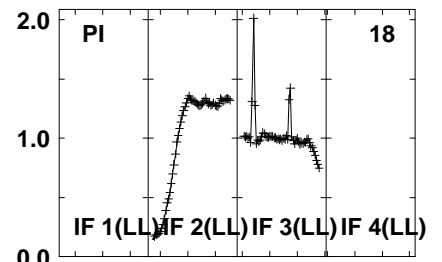
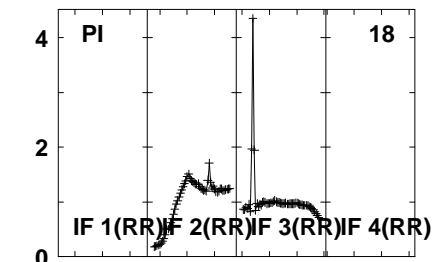
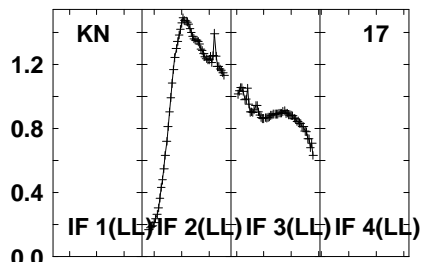
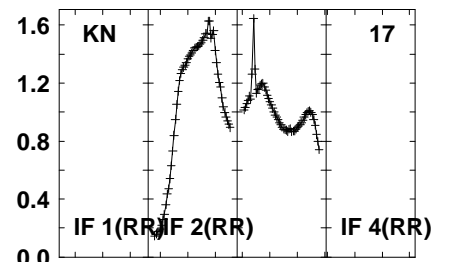
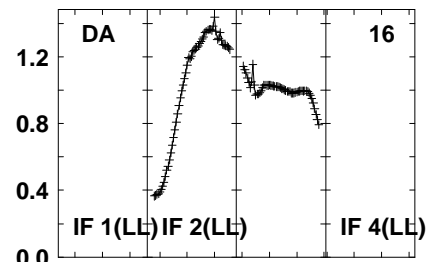
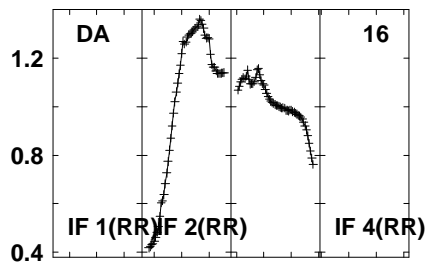
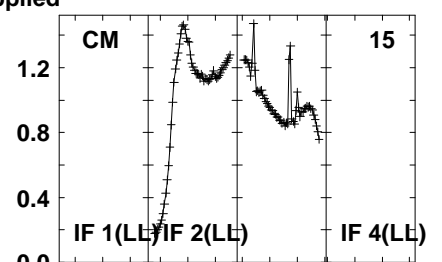
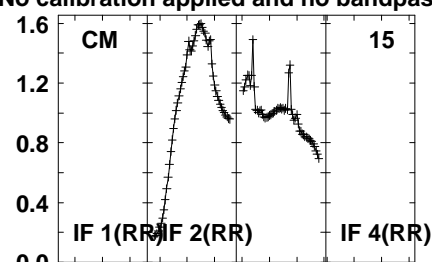
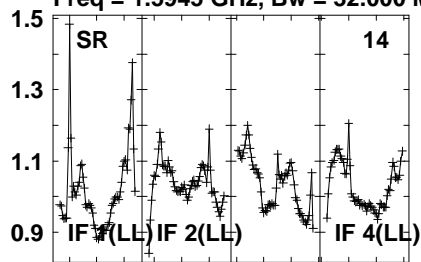

1600 1620 1630 1650 1660 1680 1690 1710  
FREQ MHz

Lower frame: Real Jy  
Auto-corr total-power spectrum Antenna: \*  
Timerange: 00/15:24:31 to 00/15:27:59

Plot file version 518 created 05-OCT-2021 17:06:46

APM08279+525 GM076.UVDATA.1

Freq = 1.5945 GHz, Bw = 32.000 MH No calibration applied and no bandpass applied

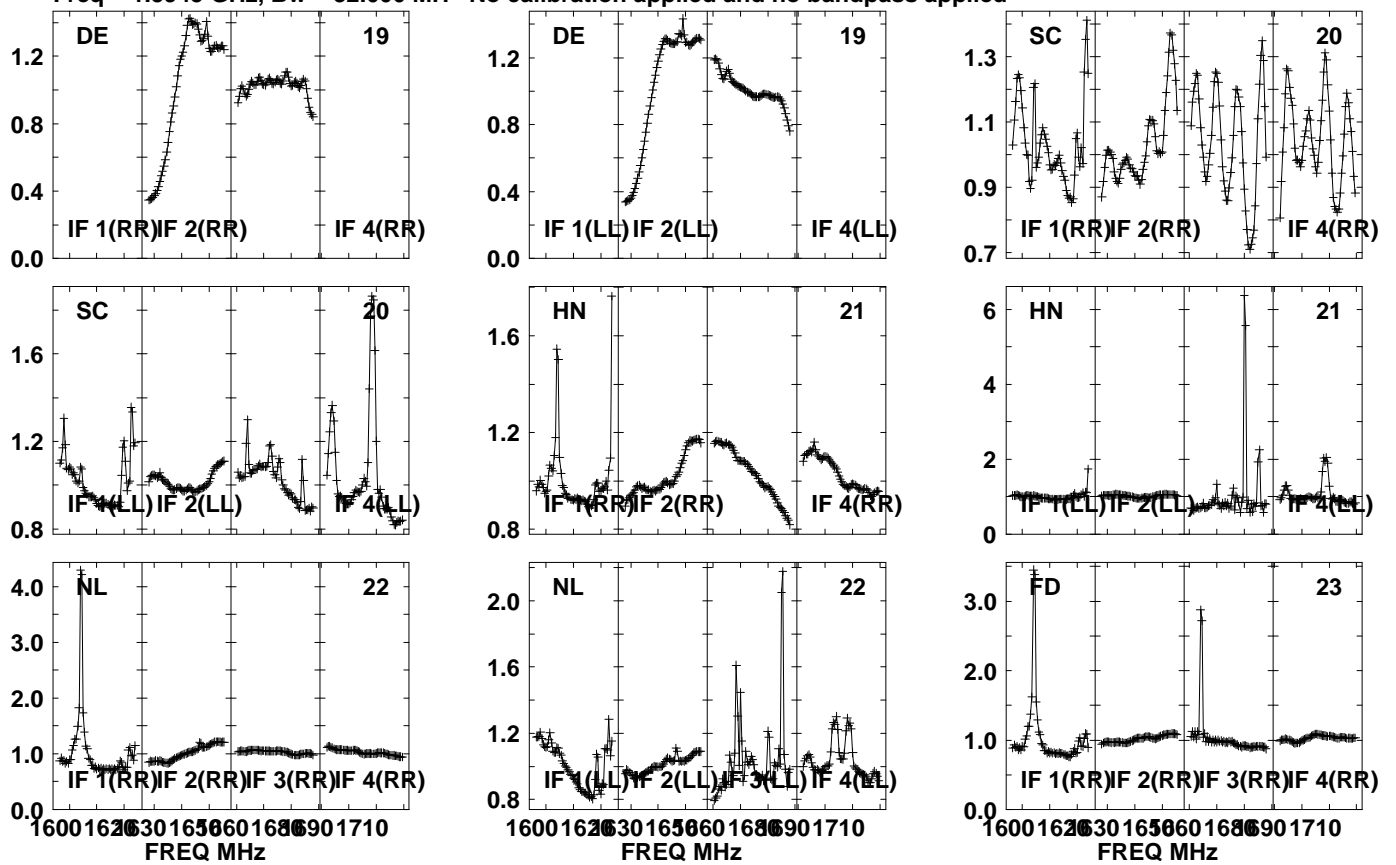

Lower frame: Real Jy  
Auto-corr total-power spectrum Antenna: \*  
Timerange: 00/15:24:31 to 00/15:27:59

Plot file version 519 created 05-OCT-2021 17:06:47

APM08279+525 GM076.UVDATA.1

Freq = 1.5945 GHz, Bw = 32.000 MH No calibration applied and no bandpass applied

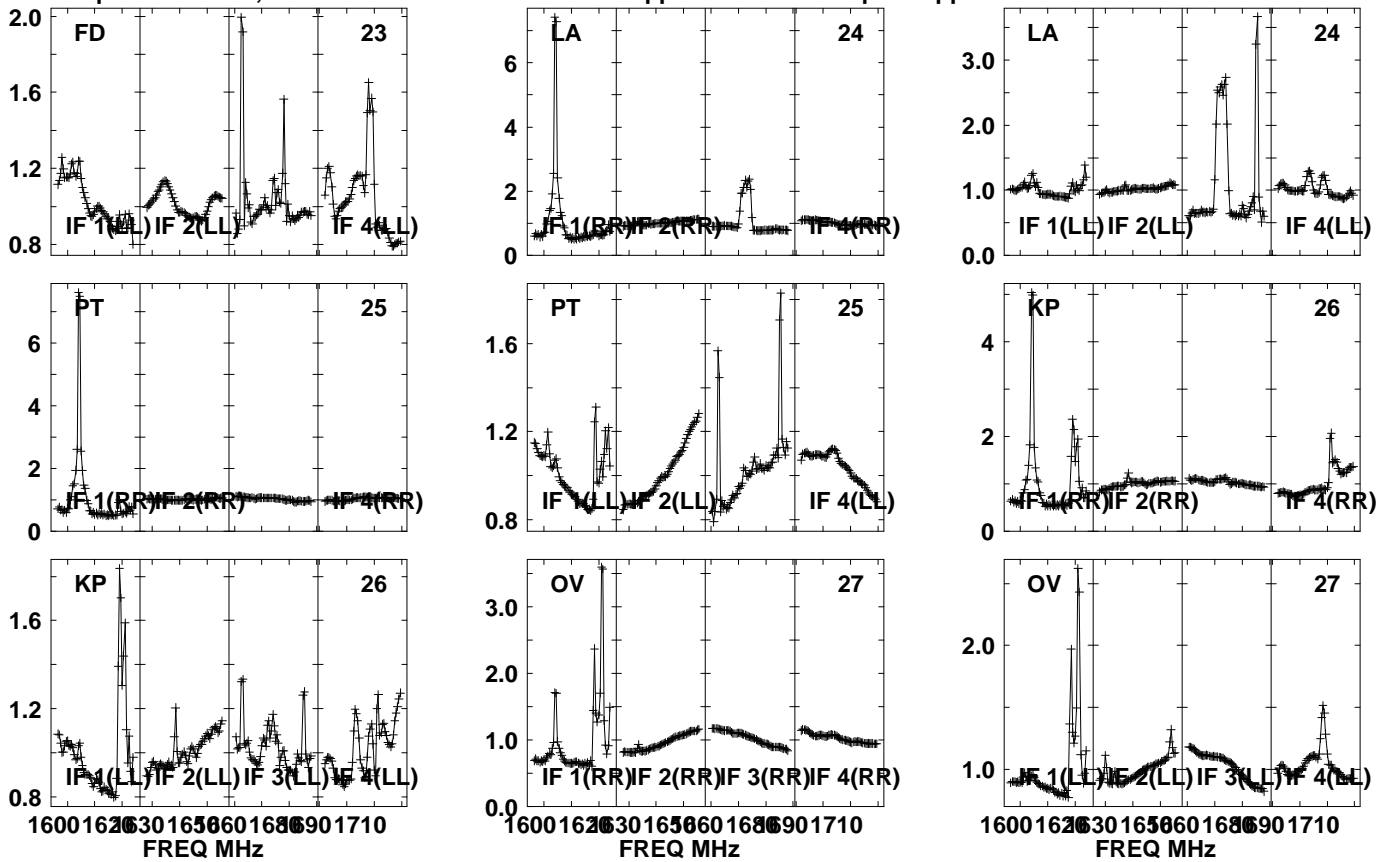

Lower frame: Real Jy  
Auto-corr total-power spectrum Antenna: \*  
Timerange: 00/15:24:31 to 00/15:27:59

Plot file version 520 created 05-OCT-2021 17:06:47

APM08279+525 GM076.UVDATA.1

Freq = 1.5945 GHz, Bw = 32.000 MH No calibration applied and no bandpass applied

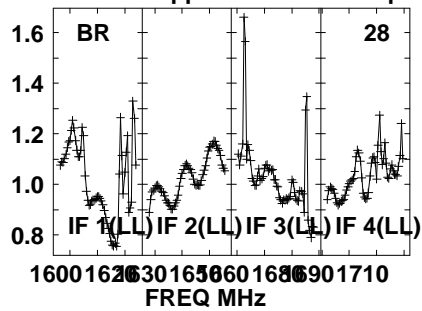
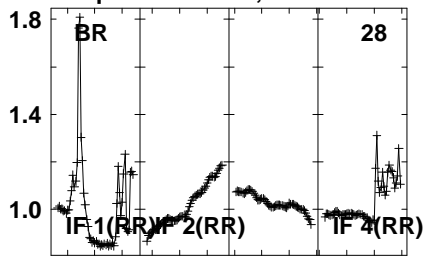

Lower frame: Real Jy  
Auto-corr total-power spectrum Antenna: \*  
Timerange: 00/15:24:31 to 00/15:27:59

Plot file version 521 created 05-OCT-2021 17:06:47

J0827+5217 GM076.UVDATA.1

Freq = 1.5945 GHz, Bw = 32.000 MH No calibration applied and no bandpass applied

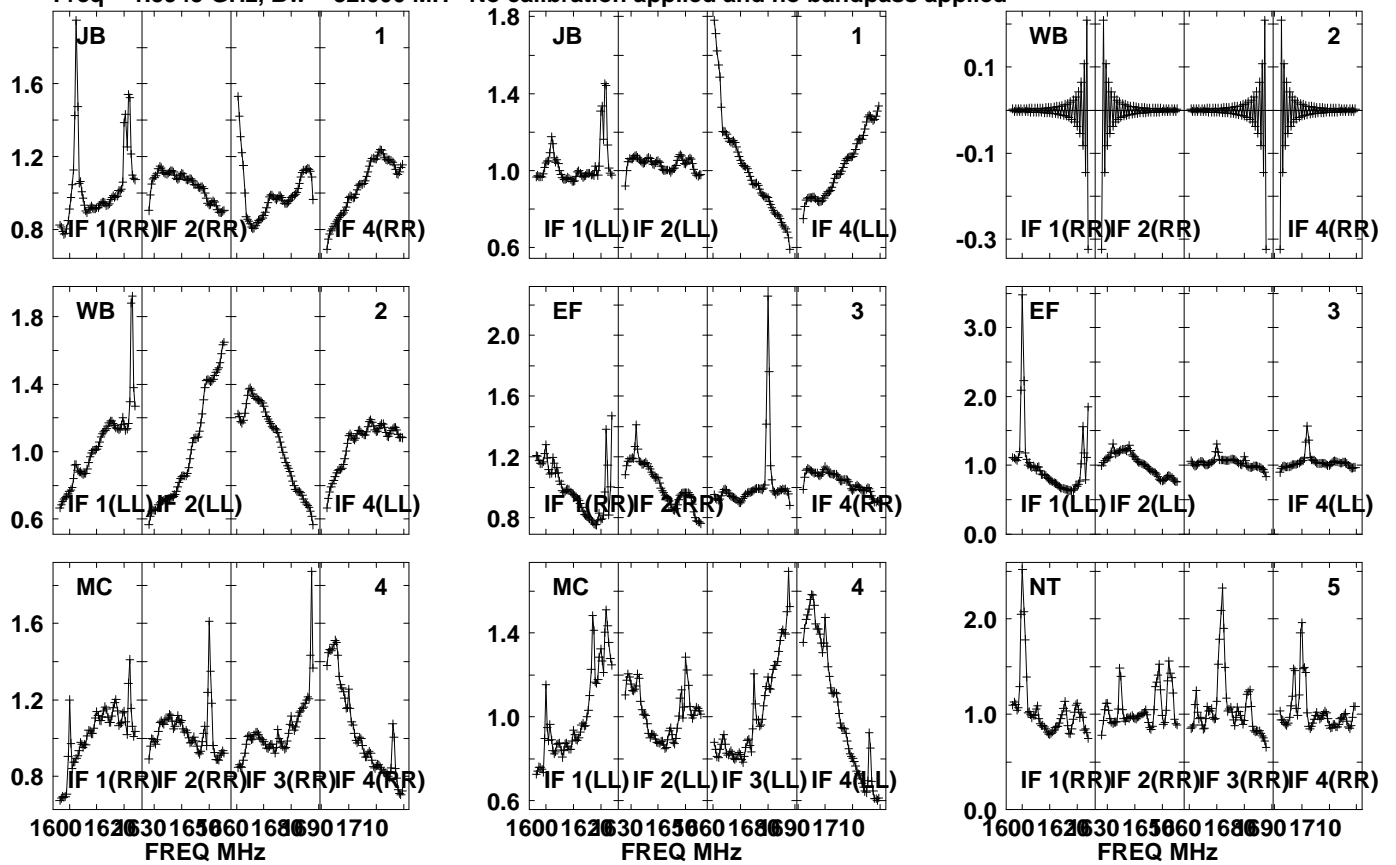

Lower frame: Real Jy  
Auto-corr total-power spectrum Antenna: \*  
Timerange: 00/15:28:31 to 00/15:29:59

Plot file version 522 created 05-OCT-2021 17:06:48

J0827+5217 GM076.UVDATA.1

Freq = 1.5945 GHz, Bw = 32.000 MH No calibration applied and no bandpass applied

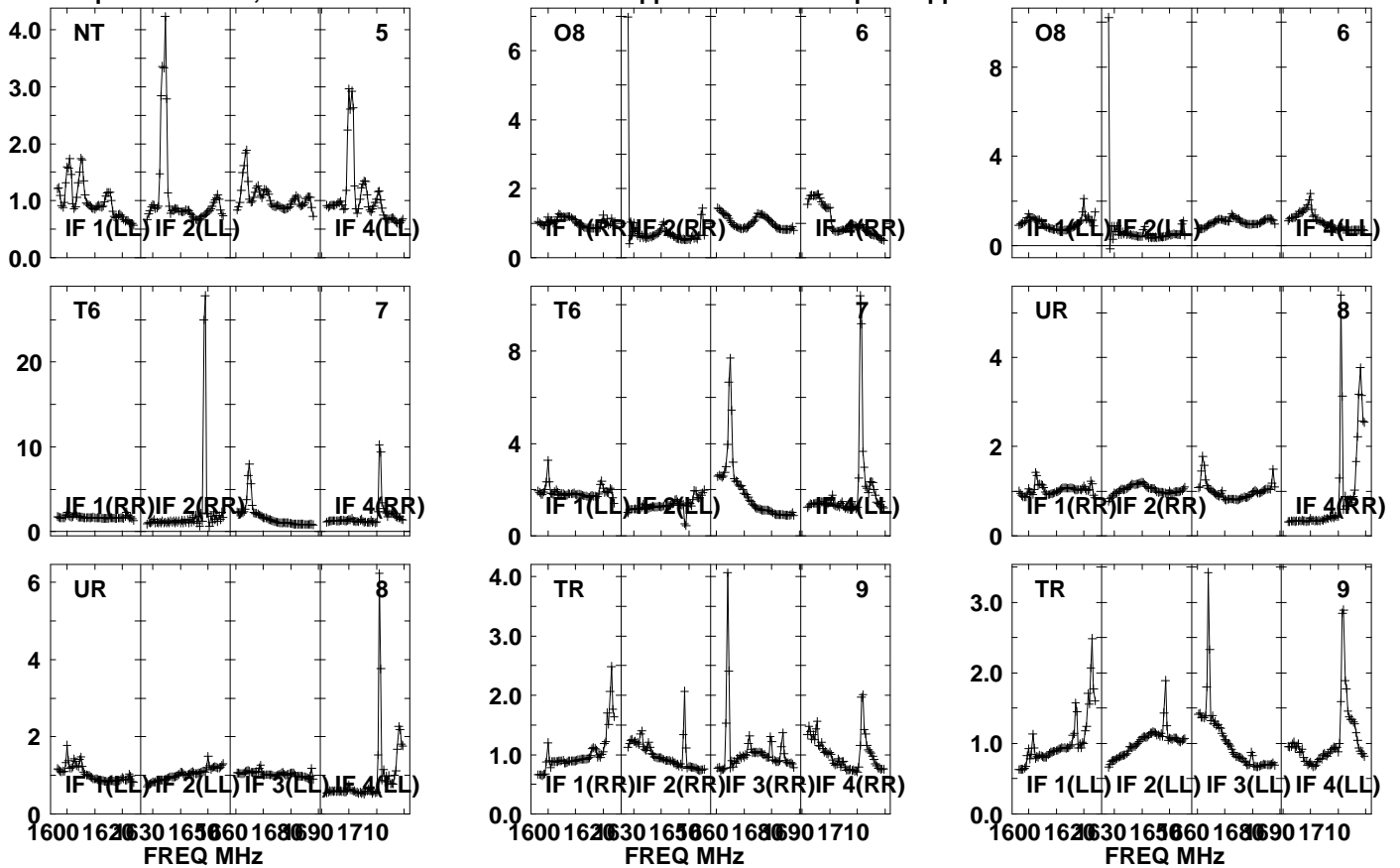

Lower frame: Real Jy

Auto-corr total-power spectrum Antenna: \*

Timerange: 00/15:28:31 to 00/15:29:59



Plot file version 523 created 05-OCT-2021 17:06:48

J0827+5217 GM076.UVDATA.1

Freq = 1.5945 GHz, Bw = 32.000 MH No calibration applied and no bandpass applied

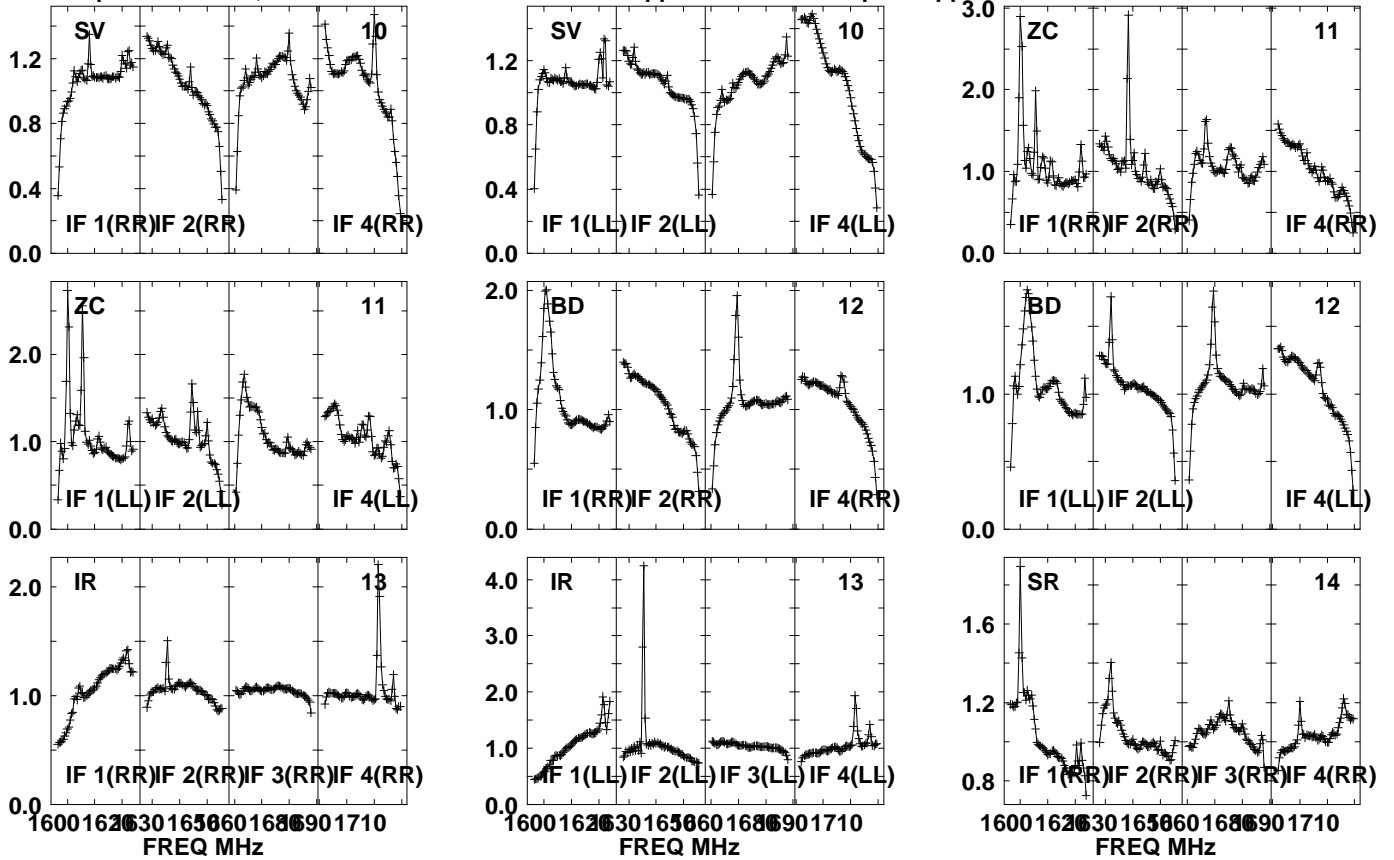

Lower frame: Real Jy  
Auto-corr total-power spectrum Antenna: \*  
Timerange: 00/15:28:31 to 00/15:29:59

Plot file version 524 created 05-OCT-2021 17:06:48

J0827+5217 GM076.UVDATA.1

Freq = 1.5945 GHz, Bw = 32.000 MH No calibration applied and no bandpass applied

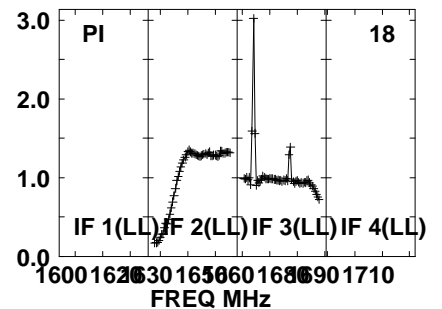
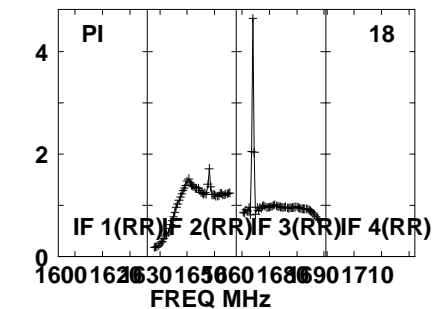
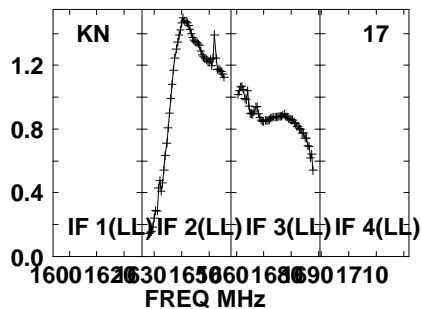
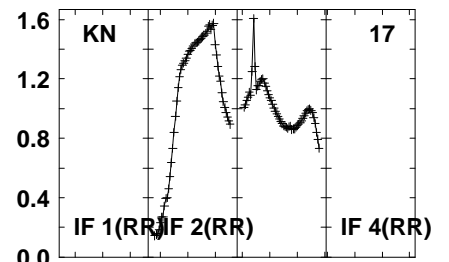
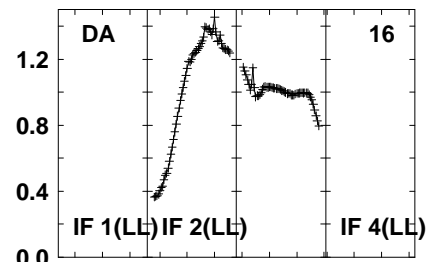
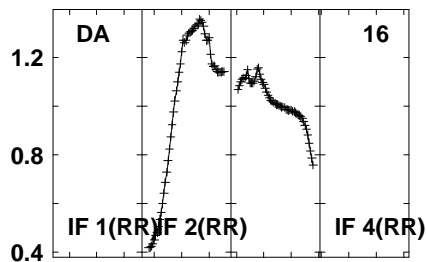
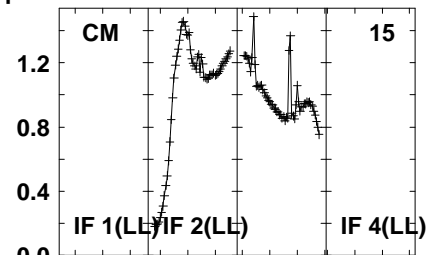
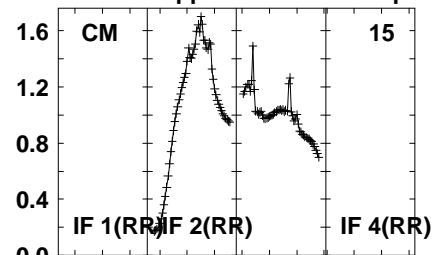
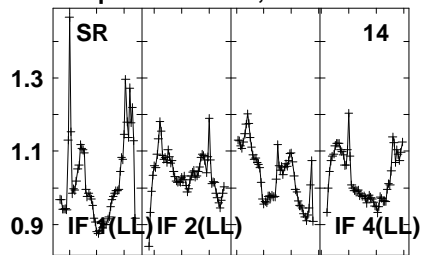

Lower frame: Real Jy  
Auto-corr total-power spectrum Antenna: \*  
Timerange: 00/15:28:31 to 00/15:29:59

Plot file version 525 created 05-OCT-2021 17:06:49

J0827+5217 GM076.UVDATA.1

Freq = 1.5945 GHz, Bw = 32.000 MH No calibration applied and no bandpass applied

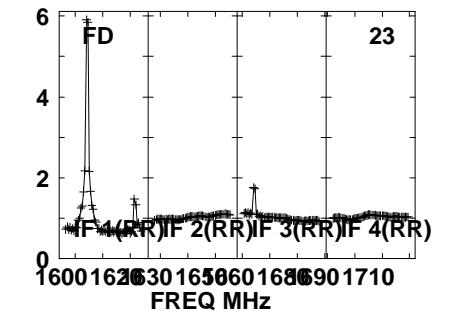
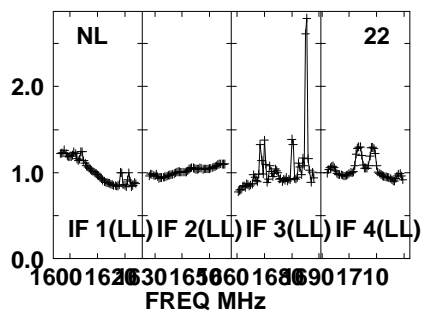
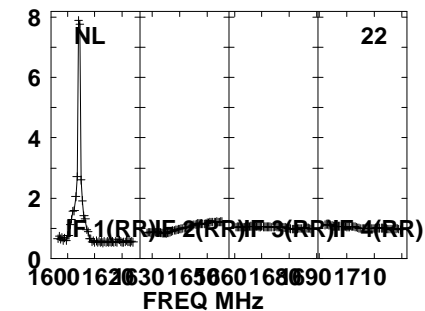
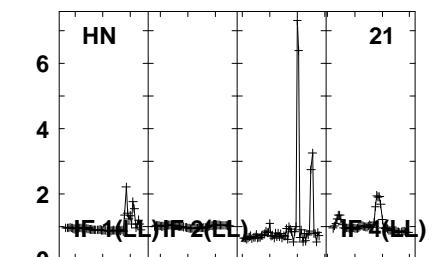
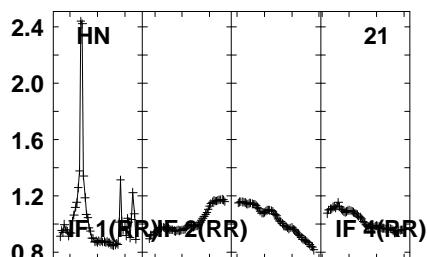
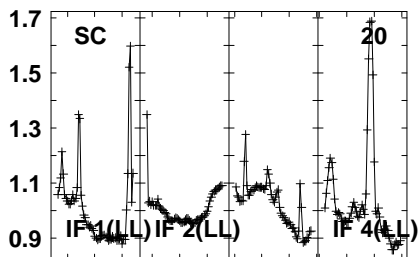
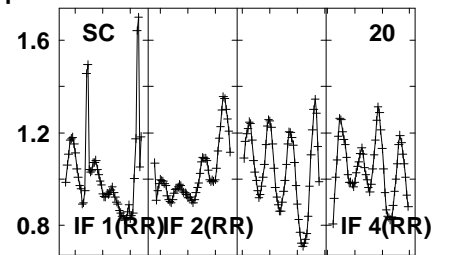
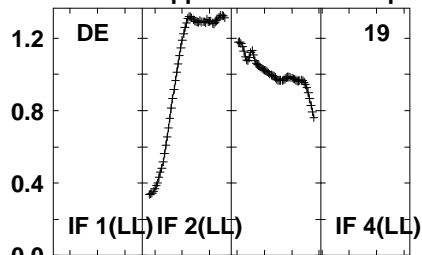
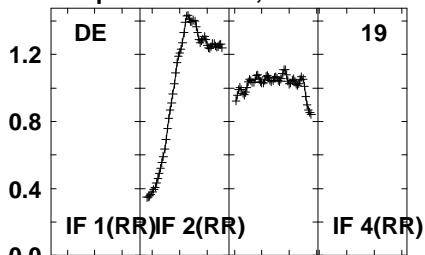

Lower frame: Real Jy  
Auto-corr total-power spectrum Antenna: \*  
Timerange: 00/15:28:31 to 00/15:29:59

Plot file version 526 created 05-OCT-2021 17:06:49

J0827+5217 GM076.UVDATA.1

Freq = 1.5945 GHz, Bw = 32.000 MH No calibration applied and no bandpass applied

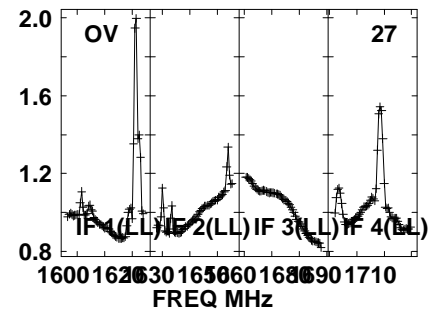
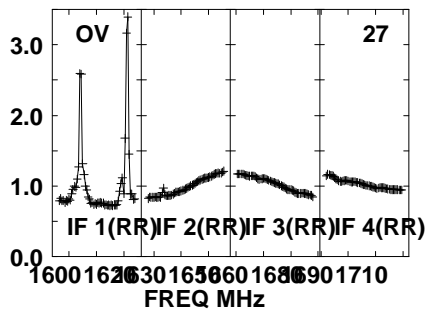
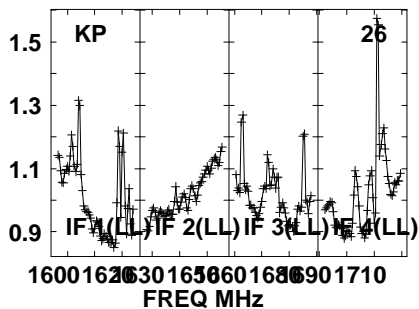
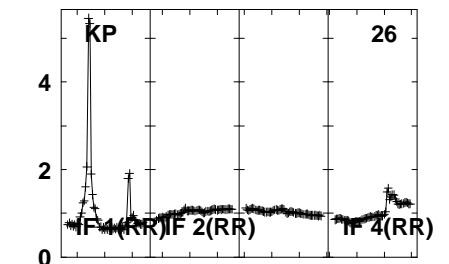
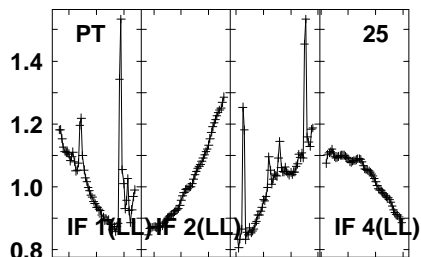
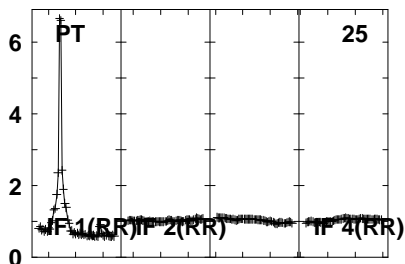
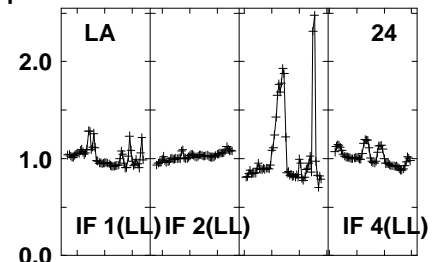
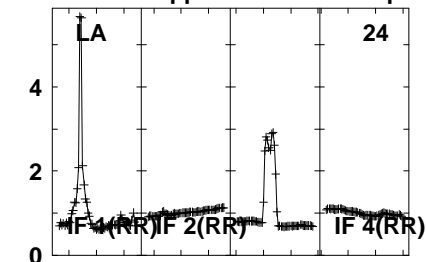
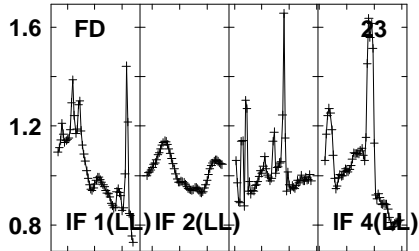

Lower frame: Real Jy  
Auto-corr total-power spectrum Antenna: \*  
Timerange: 00/15:28:31 to 00/15:29:59

Plot file version 527 created 05-OCT-2021 17:06:49

J0827+5217 GM076.UVDATA.1

Freq = 1.5945 GHz, Bw = 32.000 MH

No calibration applied and no bandpass applied

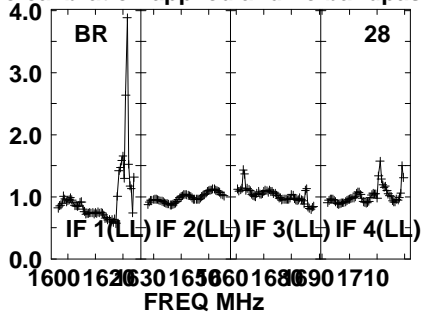
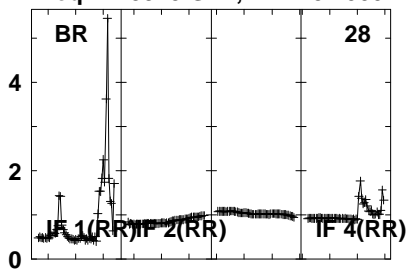

Lower frame: Real Jy

Auto-corr total-power spectrum Antenna: \*

Timerange: 00/15:28:31 to 00/15:29:59

Plot file version 528 created 05-OCT-2021 17:06:49

APM08279+525 GM076.UVDATA.1

Freq = 1.5945 GHz, Bw = 32.000 MH No calibration applied and no bandpass applied

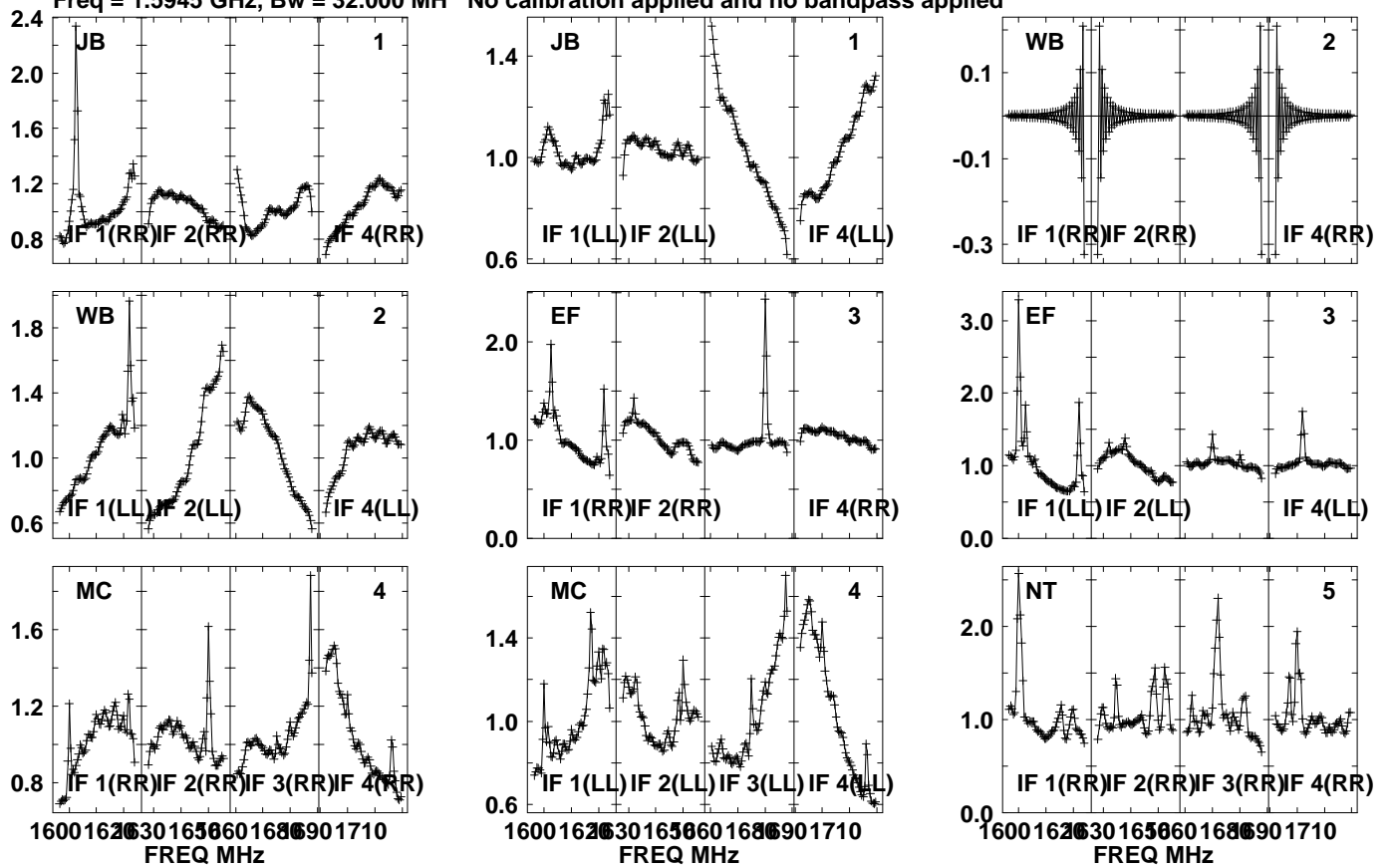

Lower frame: Real Jy  
Auto-corr total-power spectrum Antenna: \*  
Timerange: 00/15:30:01 to 00/15:33:29

Plot file version 529 created 05-OCT-2021 17:06:50

APM08279+525 GM076.UVDATA.1

Freq = 1.5945 GHz, Bw = 32.000 MH No calibration applied and no bandpass applied

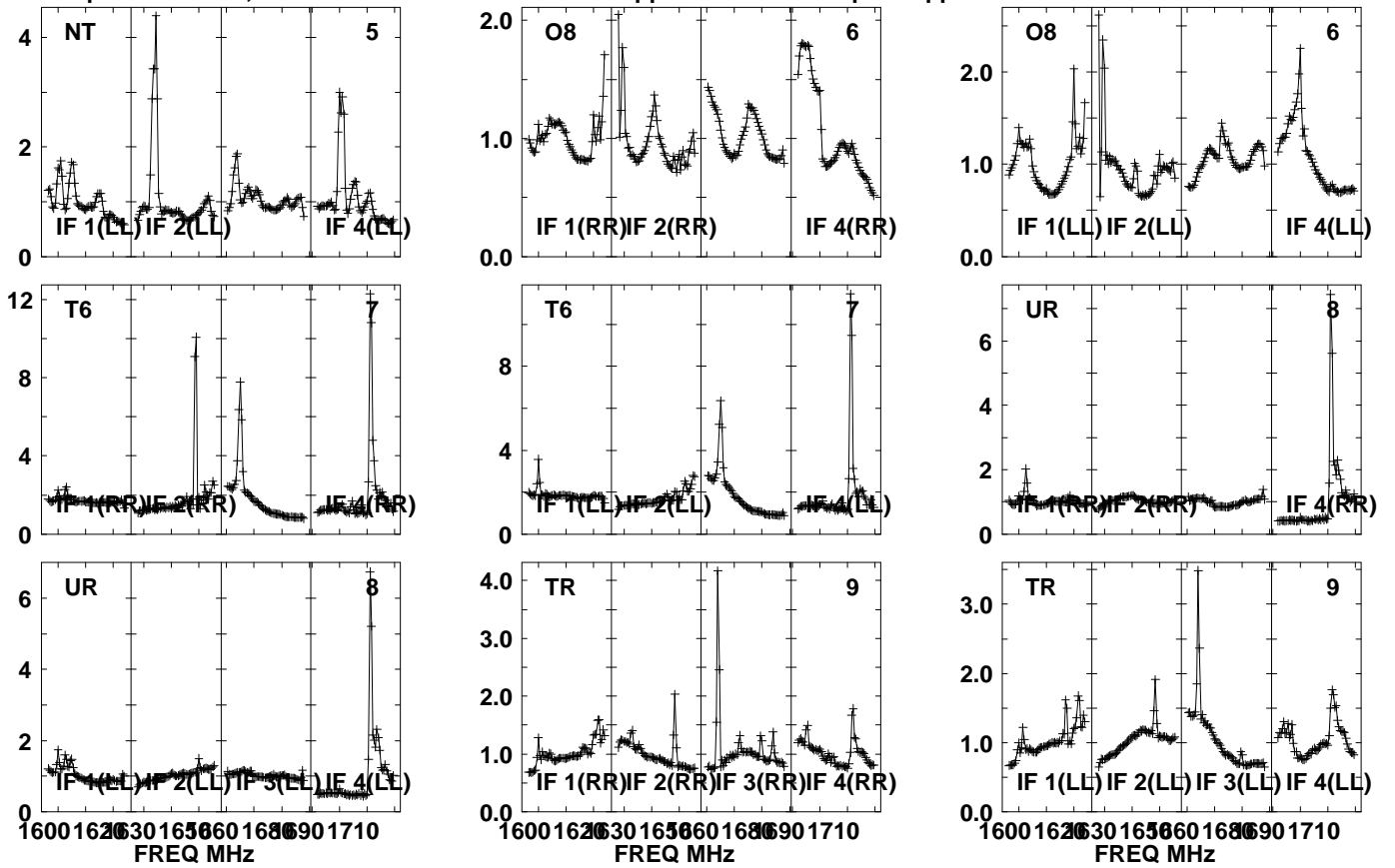

Lower frame: Real Jy

Auto-corr total-power spectrum Antenna: \*

Timerange: 00/15:30:01 to 00/15:33:29

Plot file version 530 created 05-OCT-2021 17:06:50

APM08279+525 GM076.UVDATA.1

Freq = 1.5945 GHz, Bw = 32.000 MH

No calibration applied and no bandpass applied

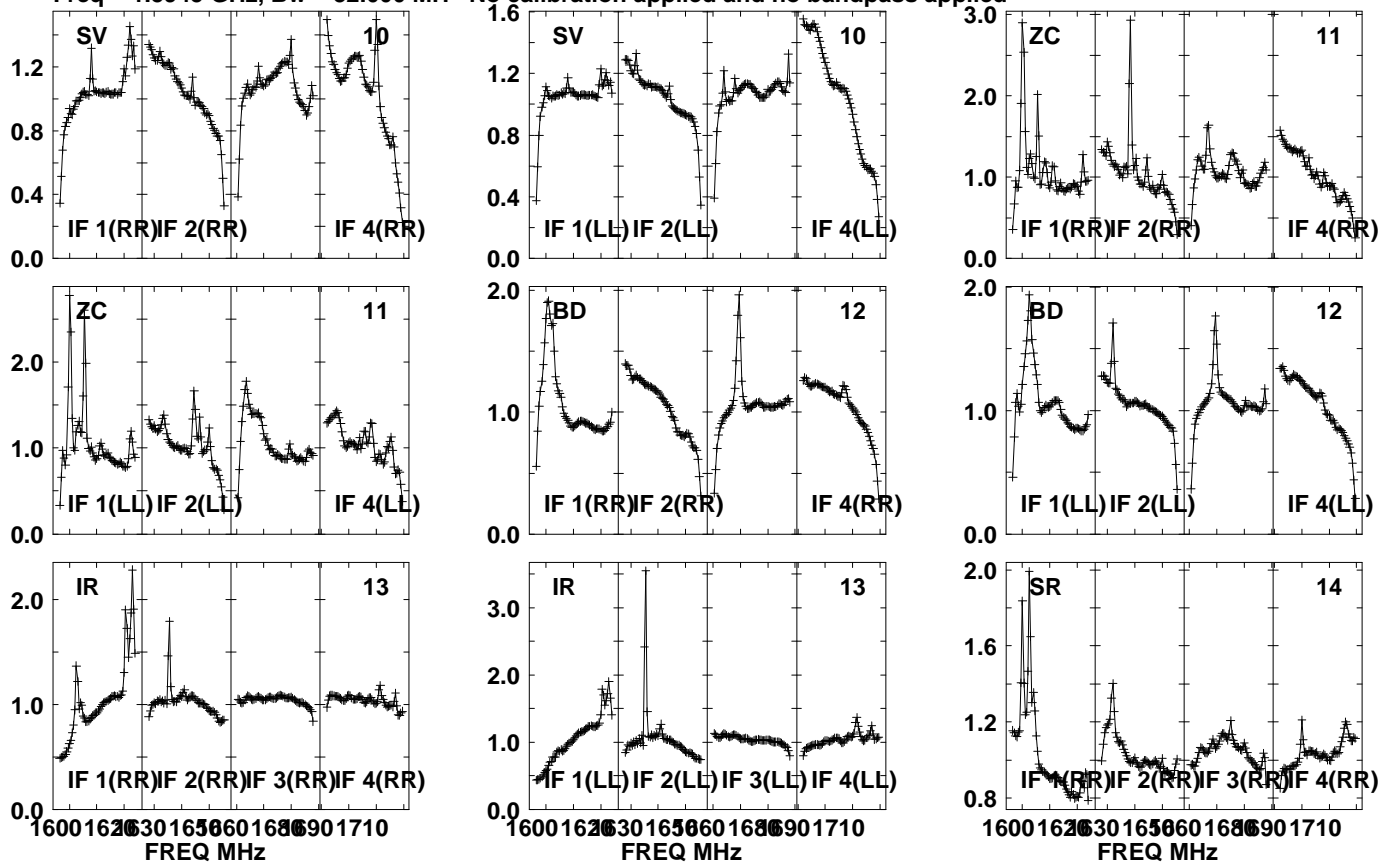

Lower frame: Real Jy  
Auto-corr total-power spectrum Antenna: \*  
Timerange: 00/15:30:01 to 00/15:33:29



Plot file version 531 created 05-OCT-2021 17:06:50

APM08279+525 GM076.UVDATA.1

Freq = 1.5945 GHz, Bw = 32.000 MH No calibration applied and no bandpass applied

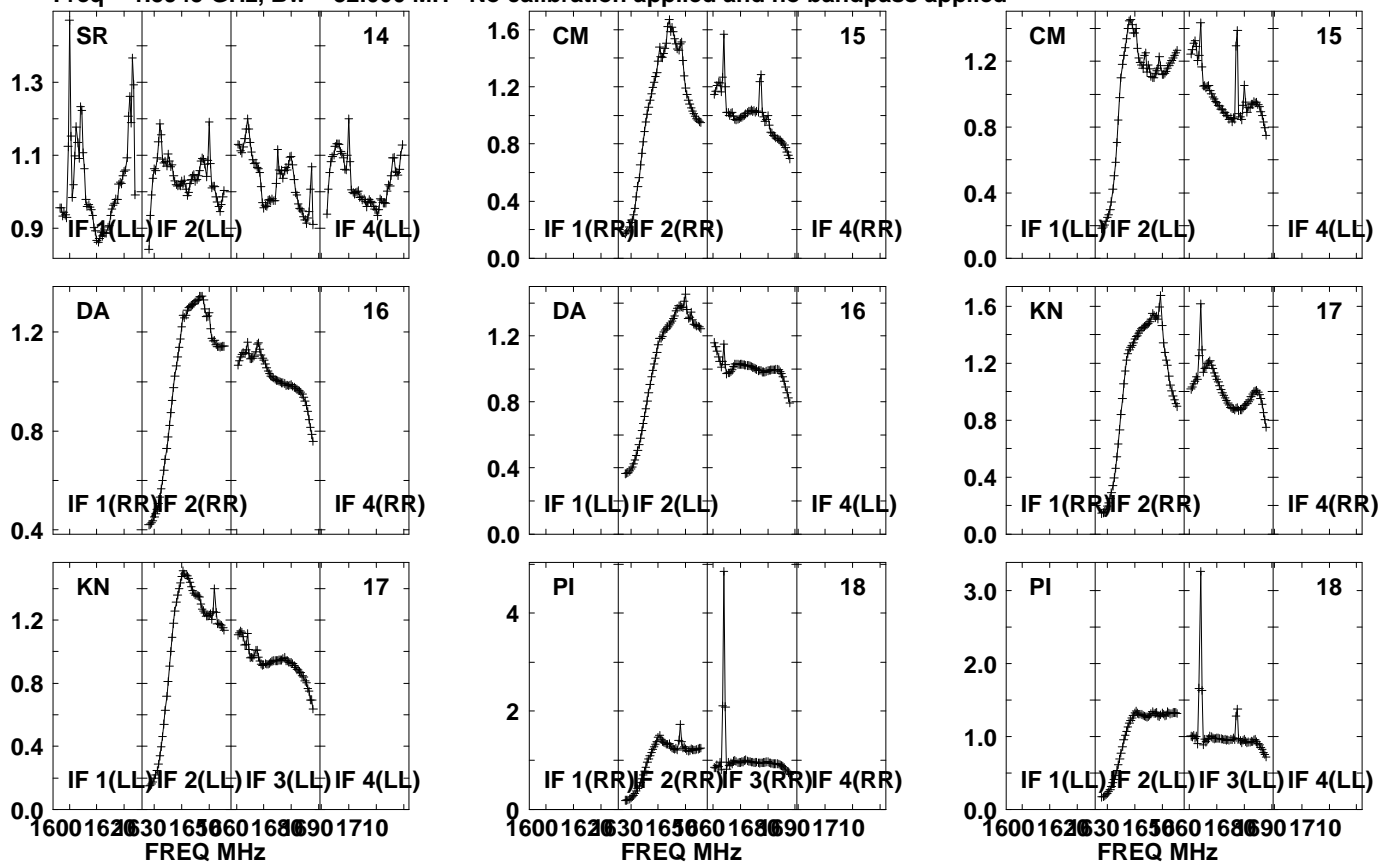

Lower frame: Real Jy  
Auto-corr total-power spectrum Antenna: \*  
Timerange: 00/15:30:01 to 00/15:33:29

Plot file version 532 created 05-OCT-2021 17:06:51

APM08279+525 GM076.UVDATA.1

Freq = 1.5945 GHz, Bw = 32.000 MH No calibration applied and no bandpass applied

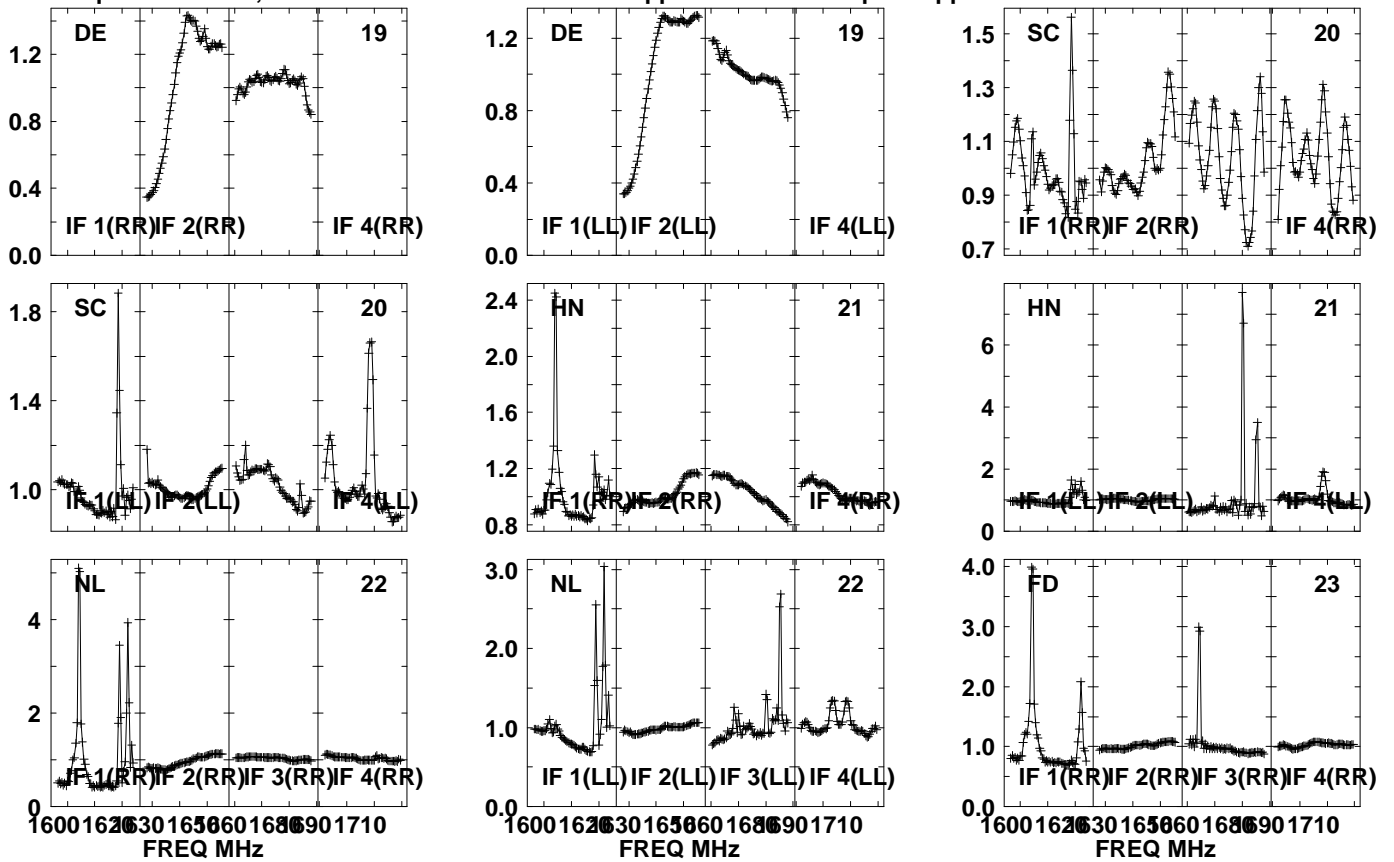

Lower frame: Real Jy  
Auto-corr total-power spectrum Antenna: \*  
Timerange: 00/15:30:01 to 00/15:33:29

Plot file version 533 created 05-OCT-2021 17:06:51

APM08279+525 GM076.UVDATA.1

Freq = 1.5945 GHz, Bw = 32.000 MH No calibration applied and no bandpass applied

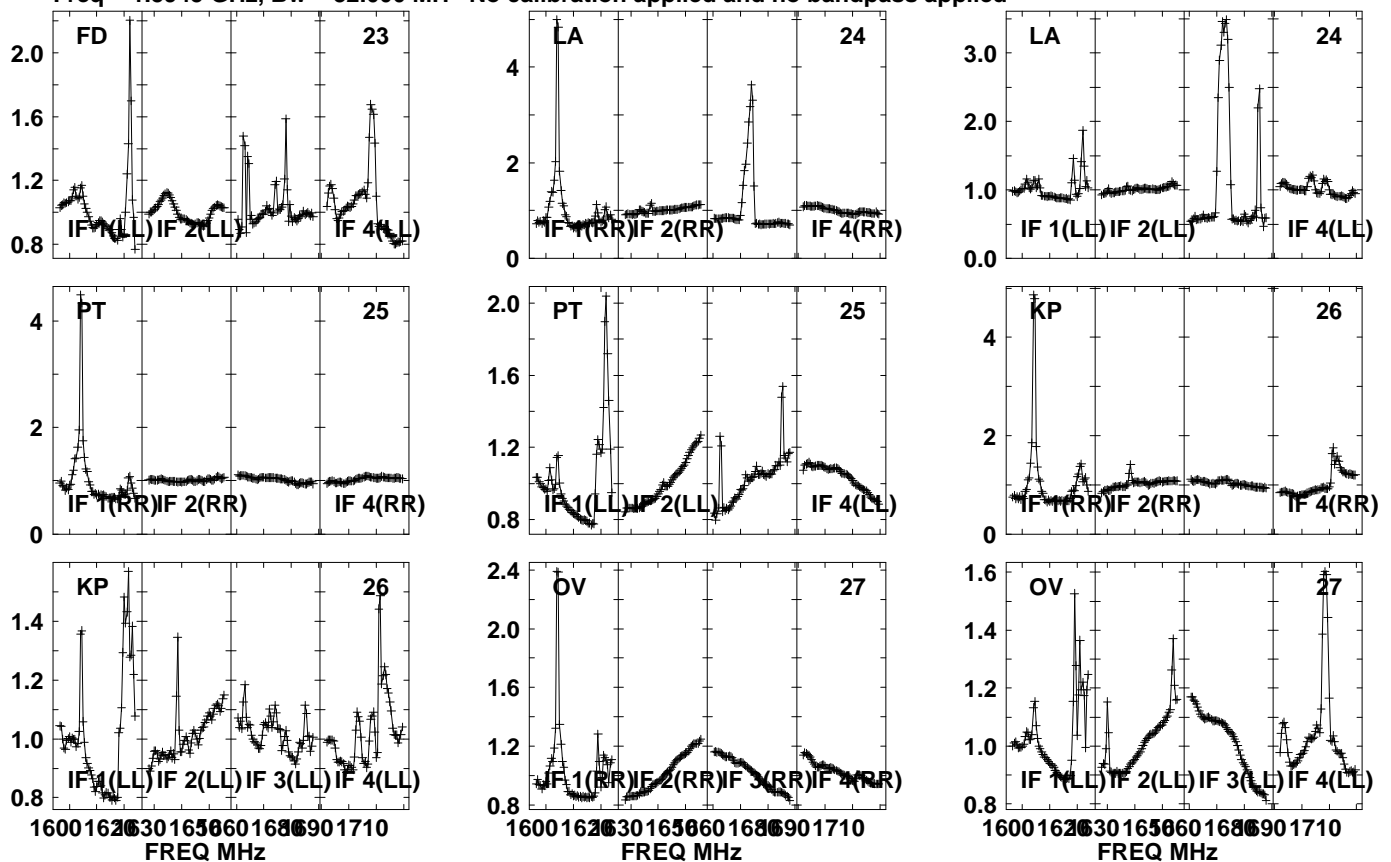

Lower frame: Real Jy  
Auto-corr total-power spectrum Antenna: \*  
Timerange: 00/15:30:01 to 00/15:33:29

Plot file version 534 created 05-OCT-2021 17:06:51

APM08279+525 GM076.UVDATA.1

Freq = 1.5945 GHz, Bw = 32.000 MH No calibration applied and no bandpass applied

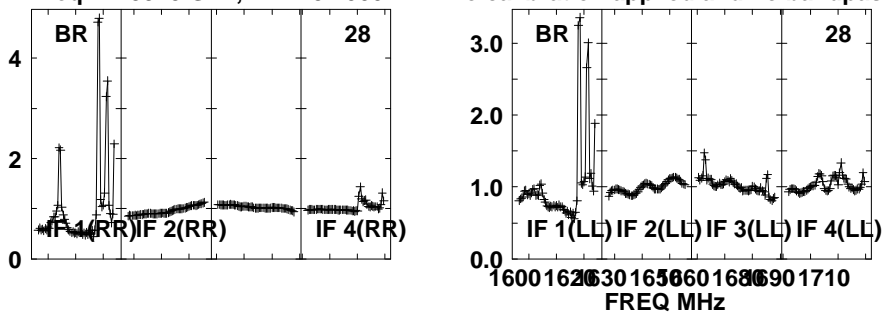

Lower frame: Real Jy

Auto-corr total-power spectrum Antenna: \*

Timerange: 00/15:30:01 to 00/15:33:29

Plot file version 535 created 05-OCT-2021 17:06:52

J0827+5217 GM076.UVDATA.1

Freq = 1.5945 GHz, Bw = 32.000 MH No calibration applied and no bandpass applied

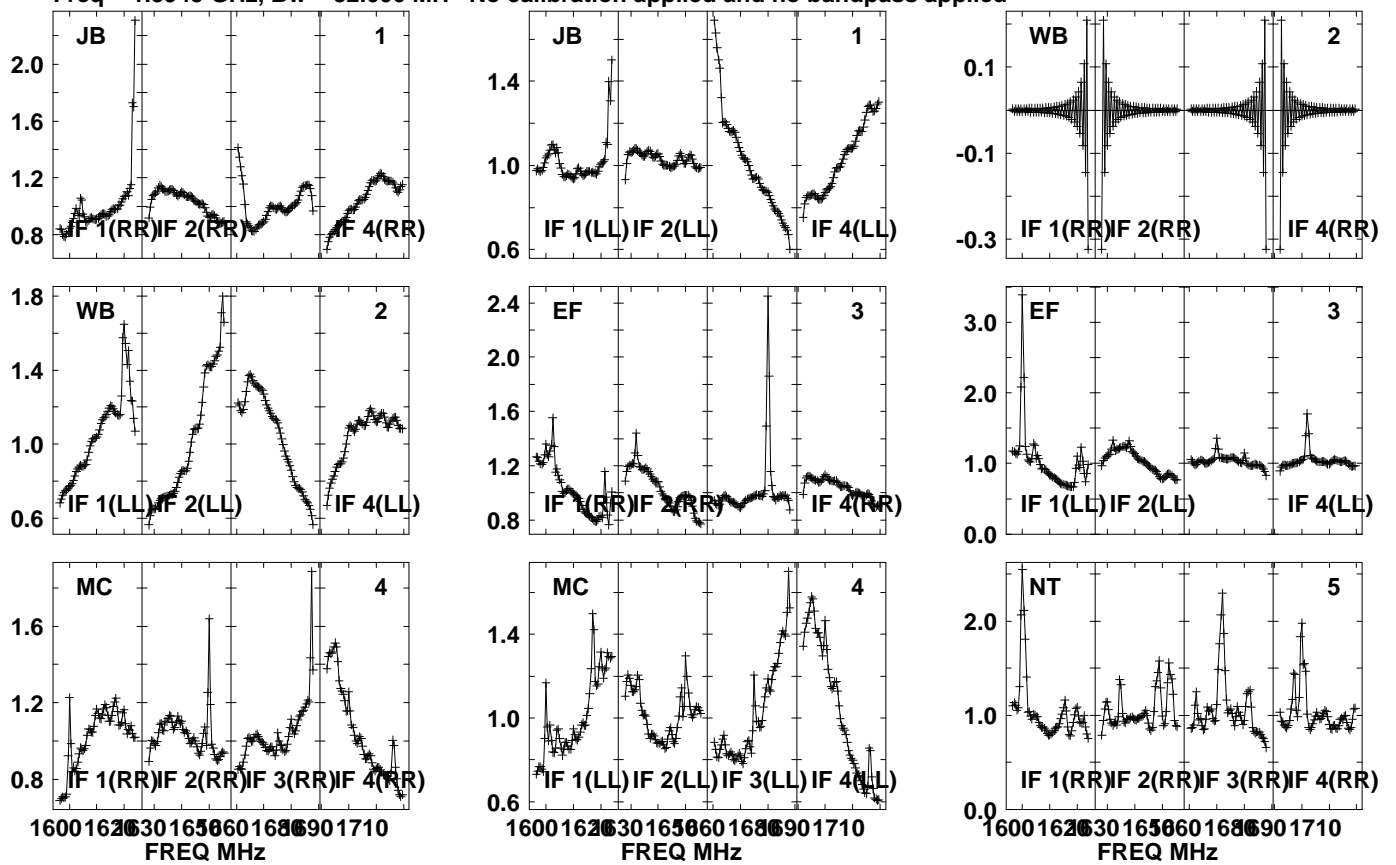

Lower frame: Real Jy  
Auto-corr total-power spectrum Antenna: \*  
Timerange: 00/15:33:31 to 00/15:34:59

Plot file version 536 created 05-OCT-2021 17:06:52

J0827+5217 GM076.UVDATA.1

Freq = 1.5945 GHz, Bw = 32.000 MH No calibration applied and no bandpass applied

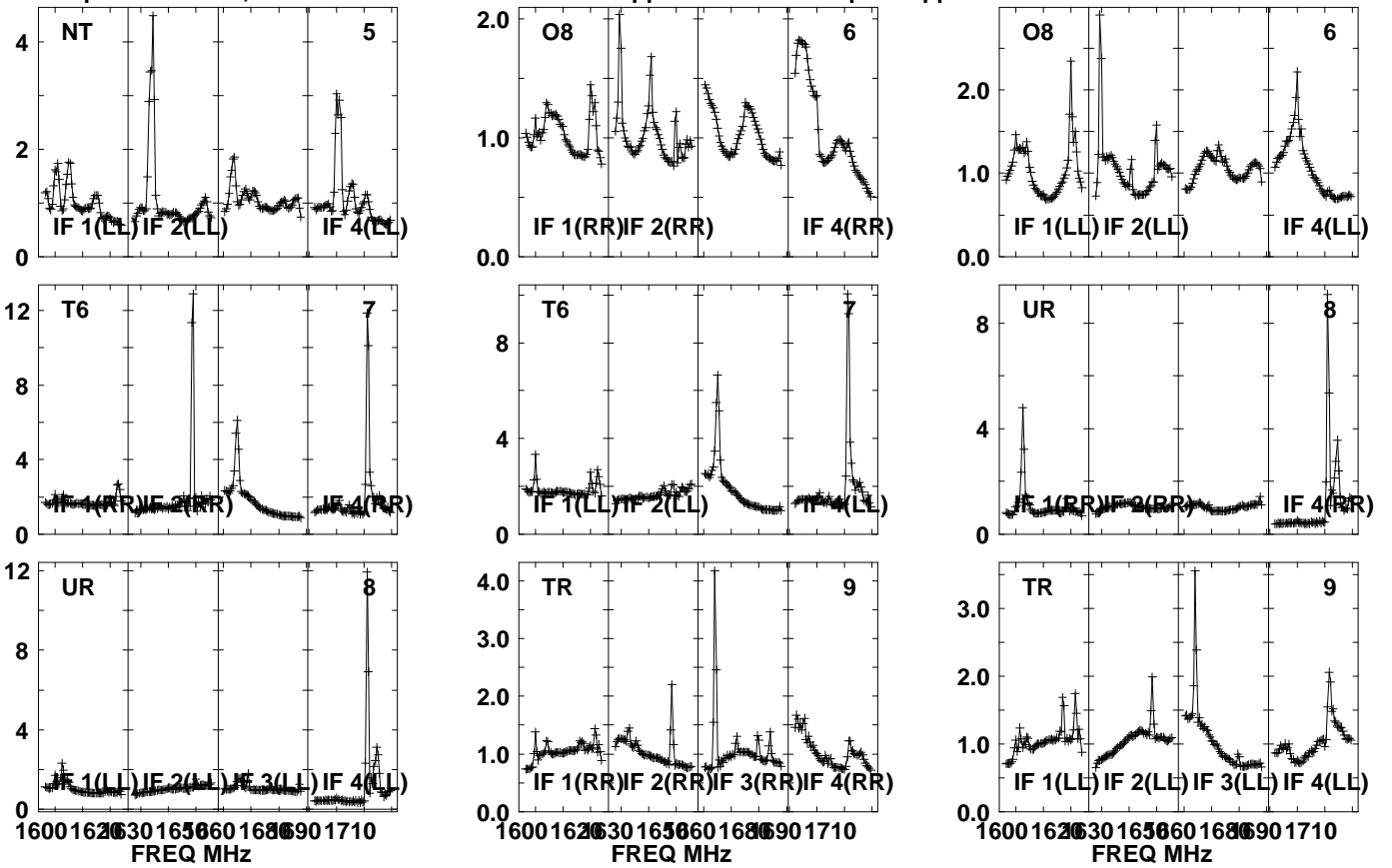

Lower frame: Real Jy  
Auto-corr total-power spectrum Antenna: \*  
Timerange: 00/15:33:31 to 00/15:34:59

Plot file version 537 created 05-OCT-2021 17:06:52

J0827+5217 GM076.UVDATA.1

Freq = 1.5945 GHz, Bw = 32.000 MH No calibration applied and no bandpass applied

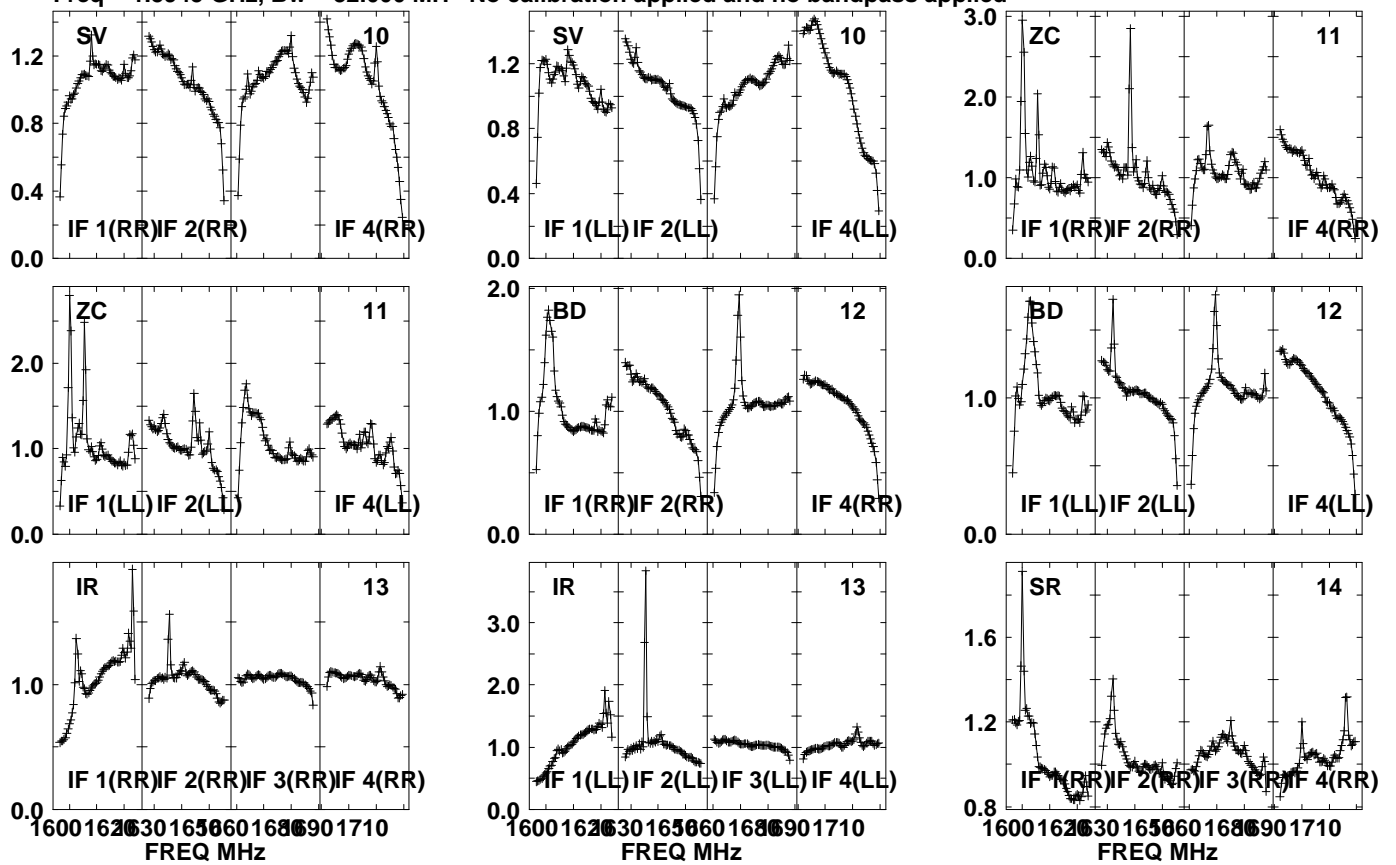

Lower frame: Real Jy  
Auto-corr total-power spectrum Antenna: \*  
Timerange: 00/15:33:31 to 00/15:34:59

Plot file version 538 created 05-OCT-2021 17:06:53

J0827+5217 GM076.UVDATA.1

Freq = 1.5945 GHz, Bw = 32.000 MH No calibration applied and no bandpass applied

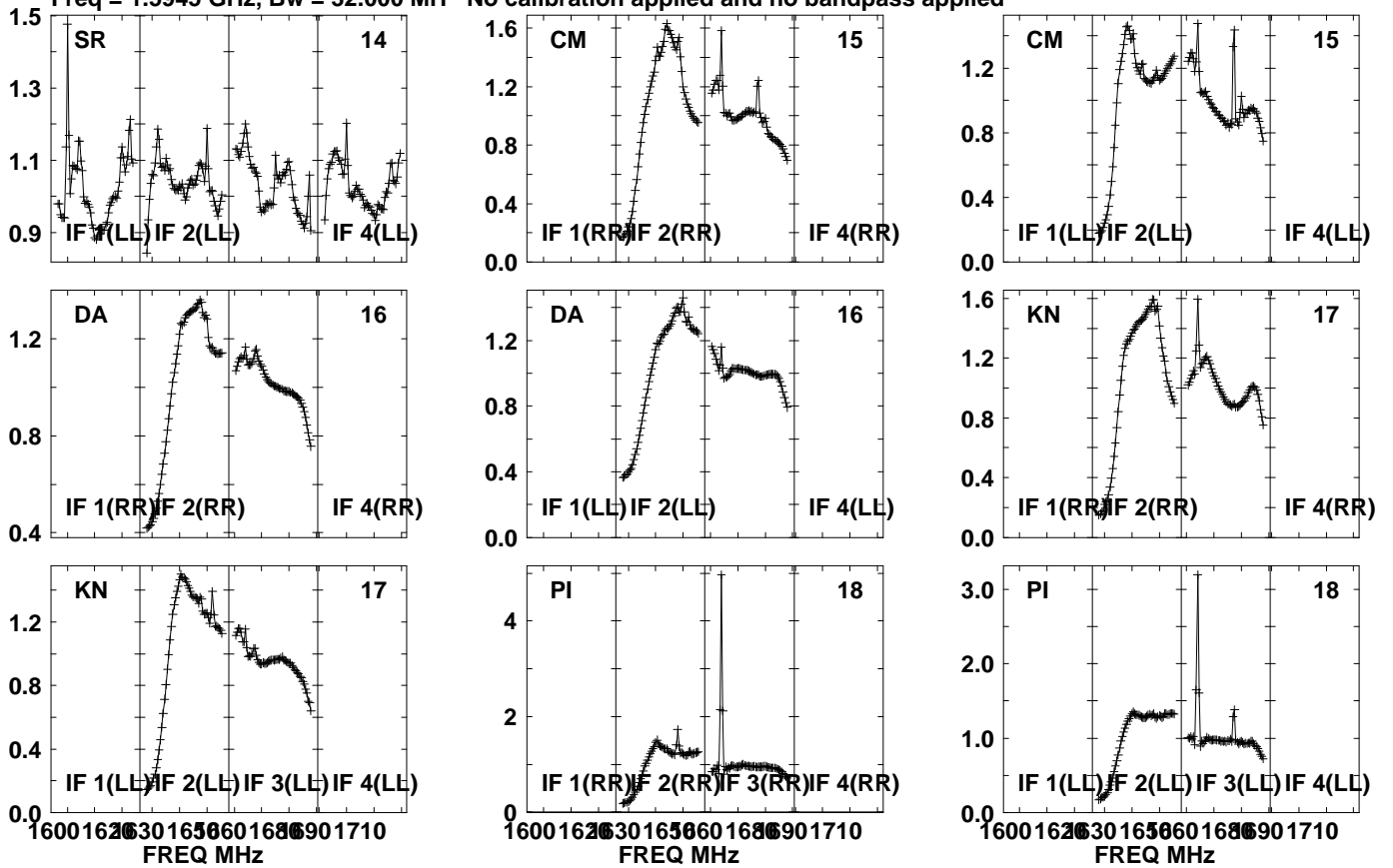

Lower frame: Real Jy  
Auto-corr total-power spectrum Antenna: \*  
Timerange: 00/15:33:31 to 00/15:34:59



Plot file version 539 created 05-OCT-2021 17:06:53

J0827+5217 GM076.UVDATA.1

Freq = 1.5945 GHz, Bw = 32.000 MH No calibration applied and no bandpass applied

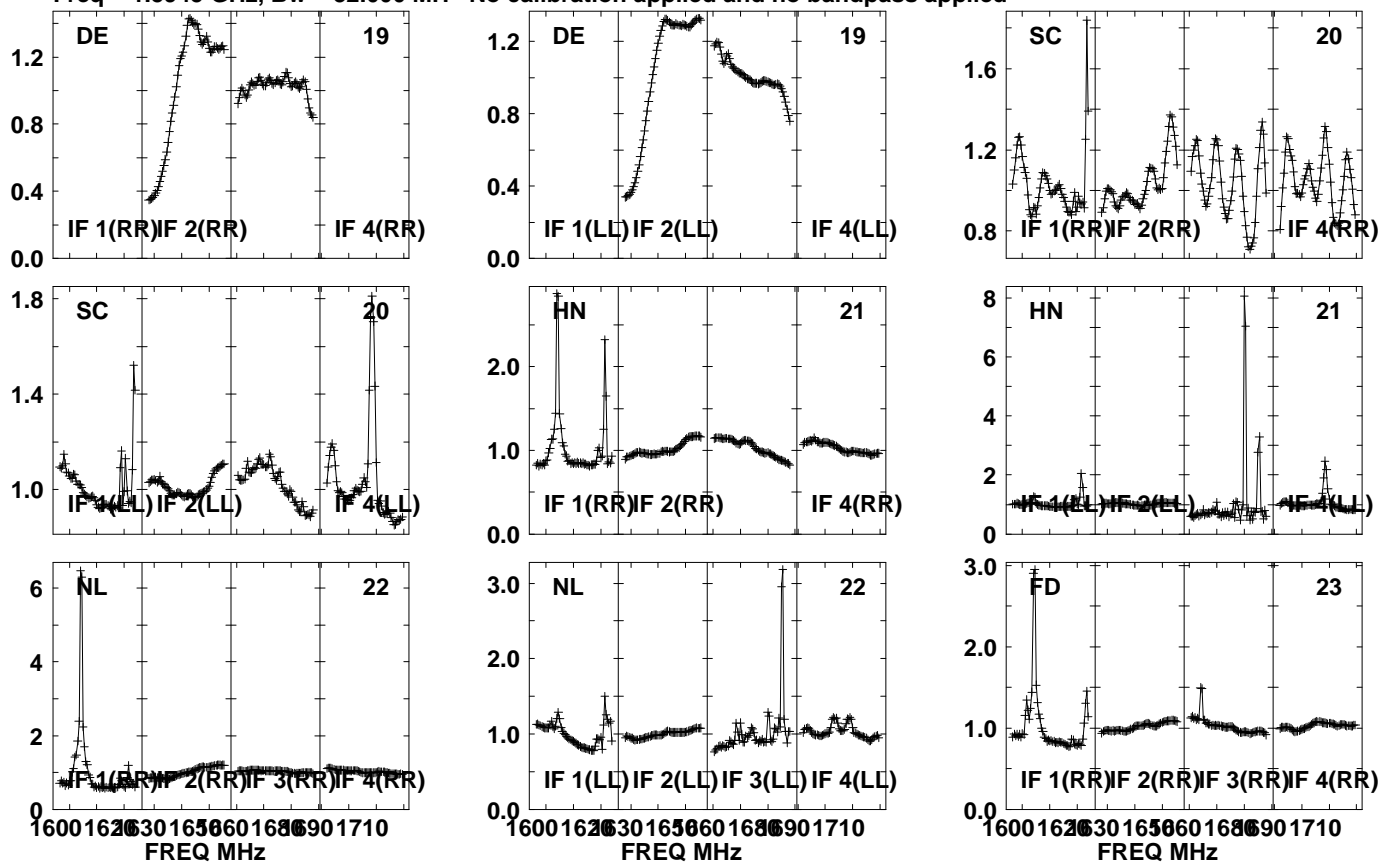

Lower frame: Real Jy  
Auto-corr total-power spectrum Antenna: \*  
Timerange: 00/15:33:31 to 00/15:34:59

Plot file version 540 created 05-OCT-2021 17:06:53

J0827+5217 GM076.UVDATA.1

Freq = 1.5945 GHz, Bw = 32.000 MH No calibration applied and no bandpass applied

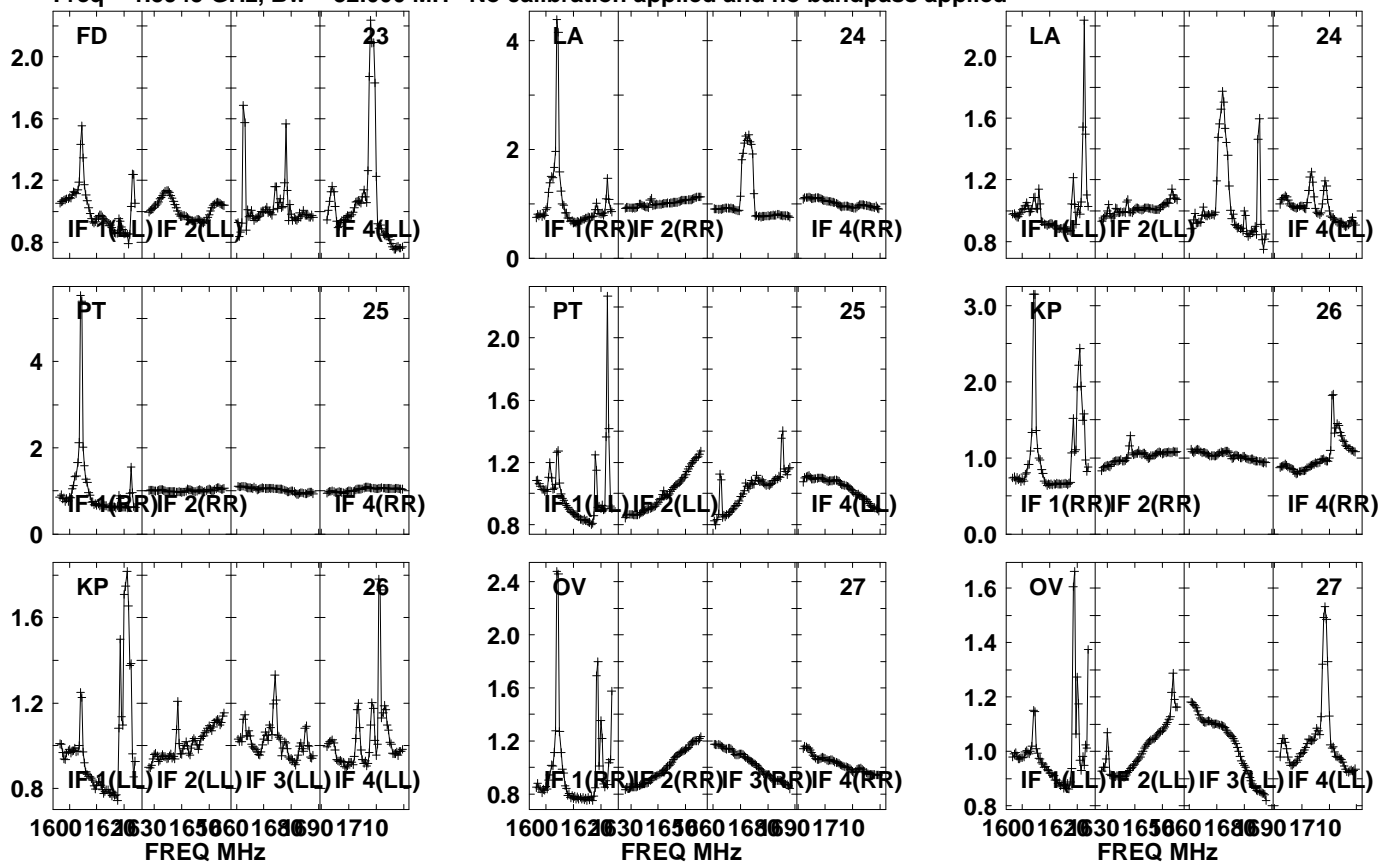

Lower frame: Real Jy  
Auto-corr total-power spectrum Antenna: \*  
Timerange: 00/15:33:31 to 00/15:34:59

Plot file version 541 created 05-OCT-2021 17:06:54

J0827+5217 GM076.UVDATA.1

Freq = 1.5945 GHz, Bw = 32.000 MH

No calibration applied and no bandpass applied

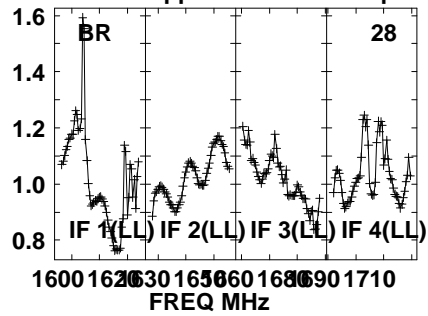
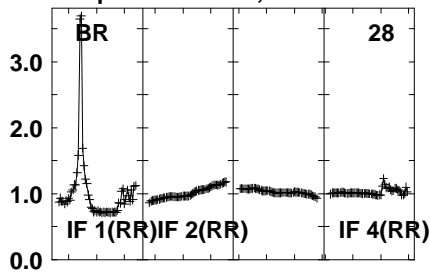

Lower frame: Real Jy

Auto-corr total-power spectrum Antenna: \*

Timerange: 00/15:33:31 to 00/15:34:59

Plot file version 542 created 05-OCT-2021 17:06:54

APM08279+525 GM076.UVDATA.1

Freq = 1.5945 GHz, Bw = 32.000 MH No calibration applied and no bandpass applied

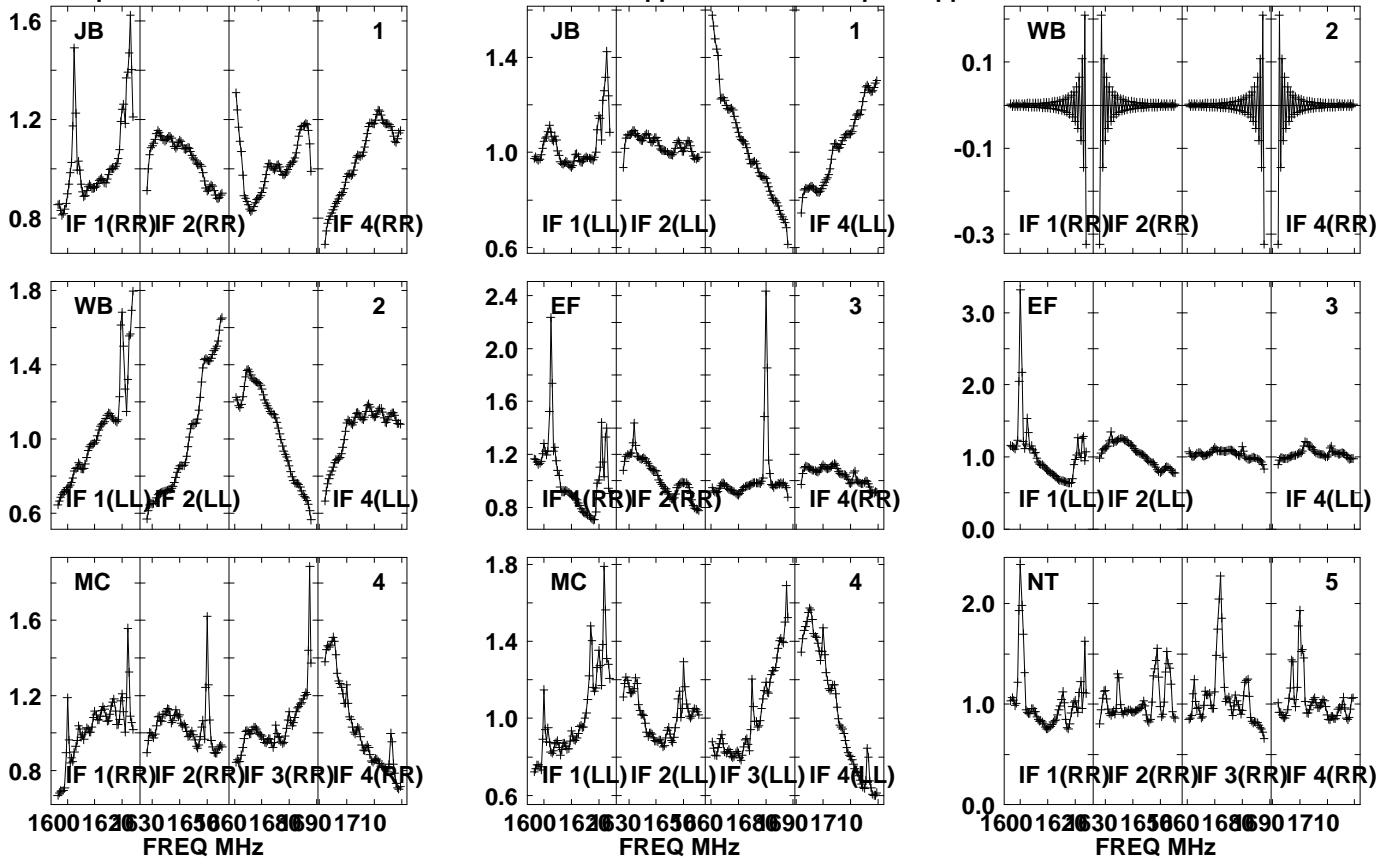

Lower frame: Real Jy  
Auto-corr total-power spectrum Antenna: \*  
Timerange: 00/15:35:01 to 00/15:38:29

Plot file version 543 created 05-OCT-2021 17:06:54

APM08279+525 GM076.UVDATA.1

Freq = 1.5945 GHz, Bw = 32.000 MH No calibration applied and no bandpass applied

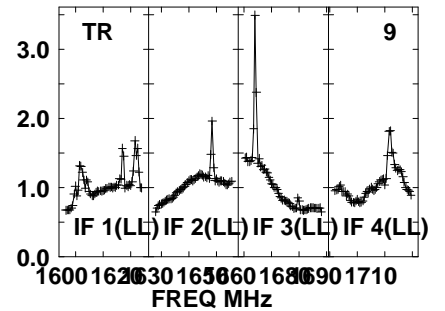
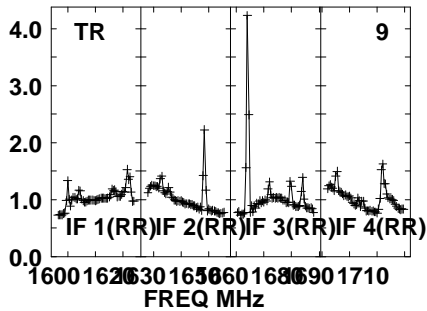
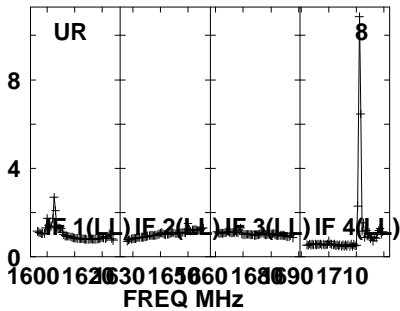
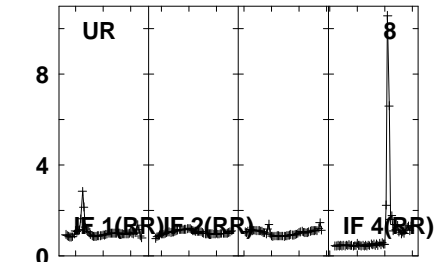
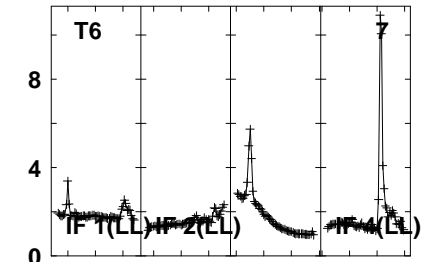
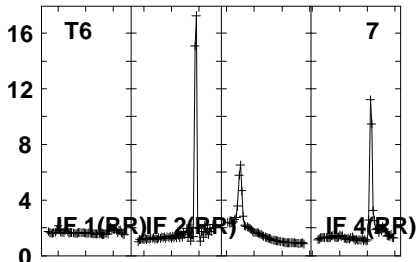
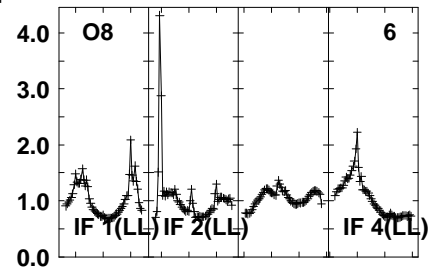
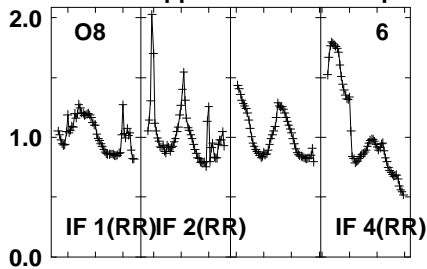
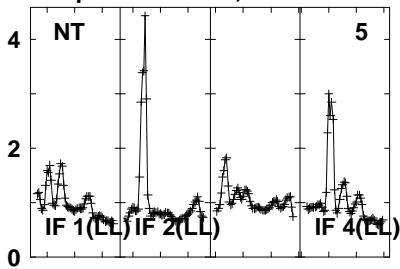

Lower frame: Real Jy

Auto-corr total-power spectrum Antenna: \*

Timerange: 00/15:35:01 to 00/15:38:29

Plot file version 544 created 05-OCT-2021 17:06:54

APM08279+525 GM076.UVDATA.1

Freq = 1.5945 GHz, Bw = 32.000 MH No calibration applied and no bandpass applied

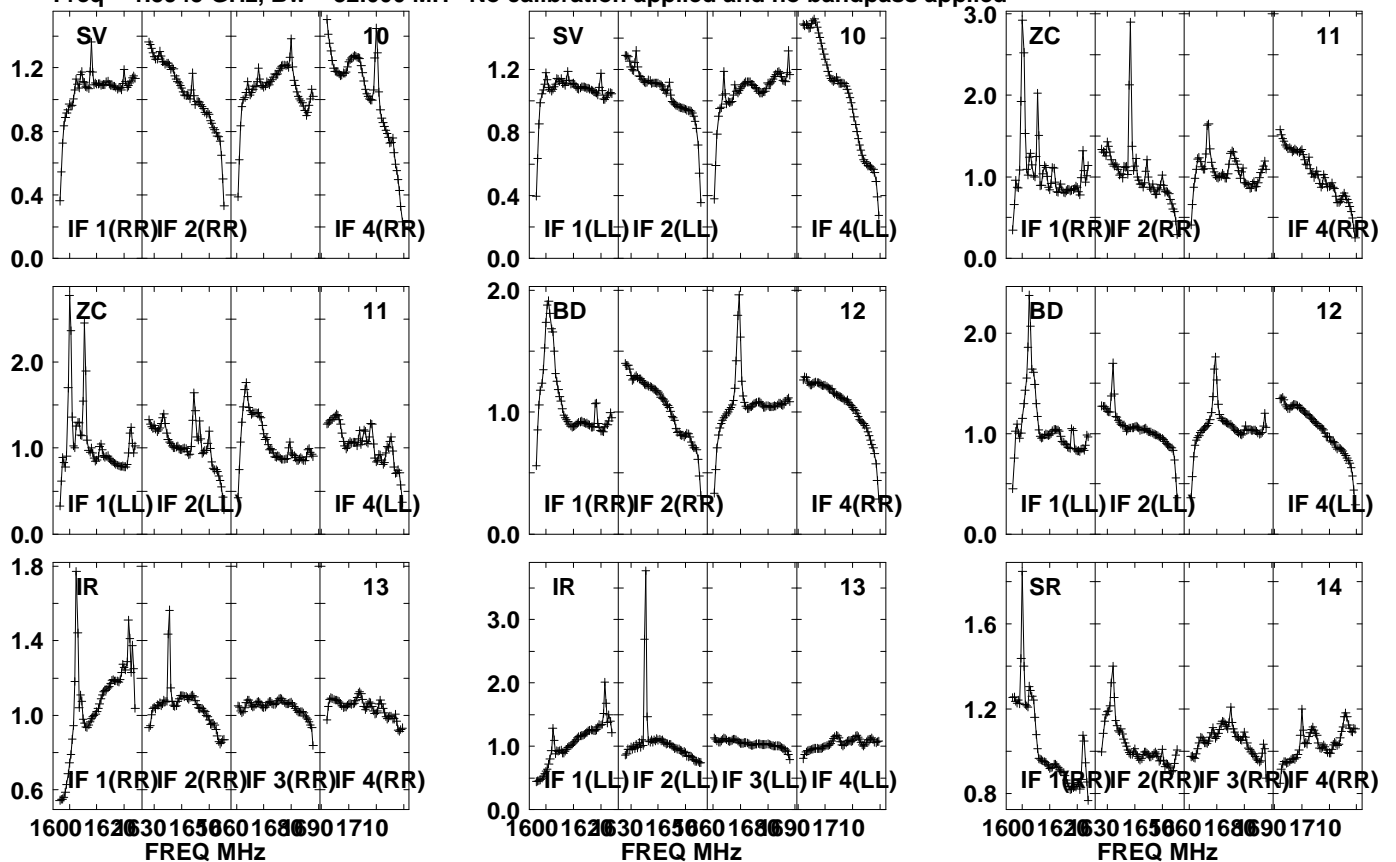

Lower frame: Real Jy  
Auto-corr total-power spectrum Antenna: \*  
Timerange: 00/15:35:01 to 00/15:38:29

Plot file version 545 created 05-OCT-2021 17:06:54

APM08279+525 GM076.UVDATA.1

Freq = 1.5945 GHz, Bw = 32.000 MH No calibration applied and no bandpass applied

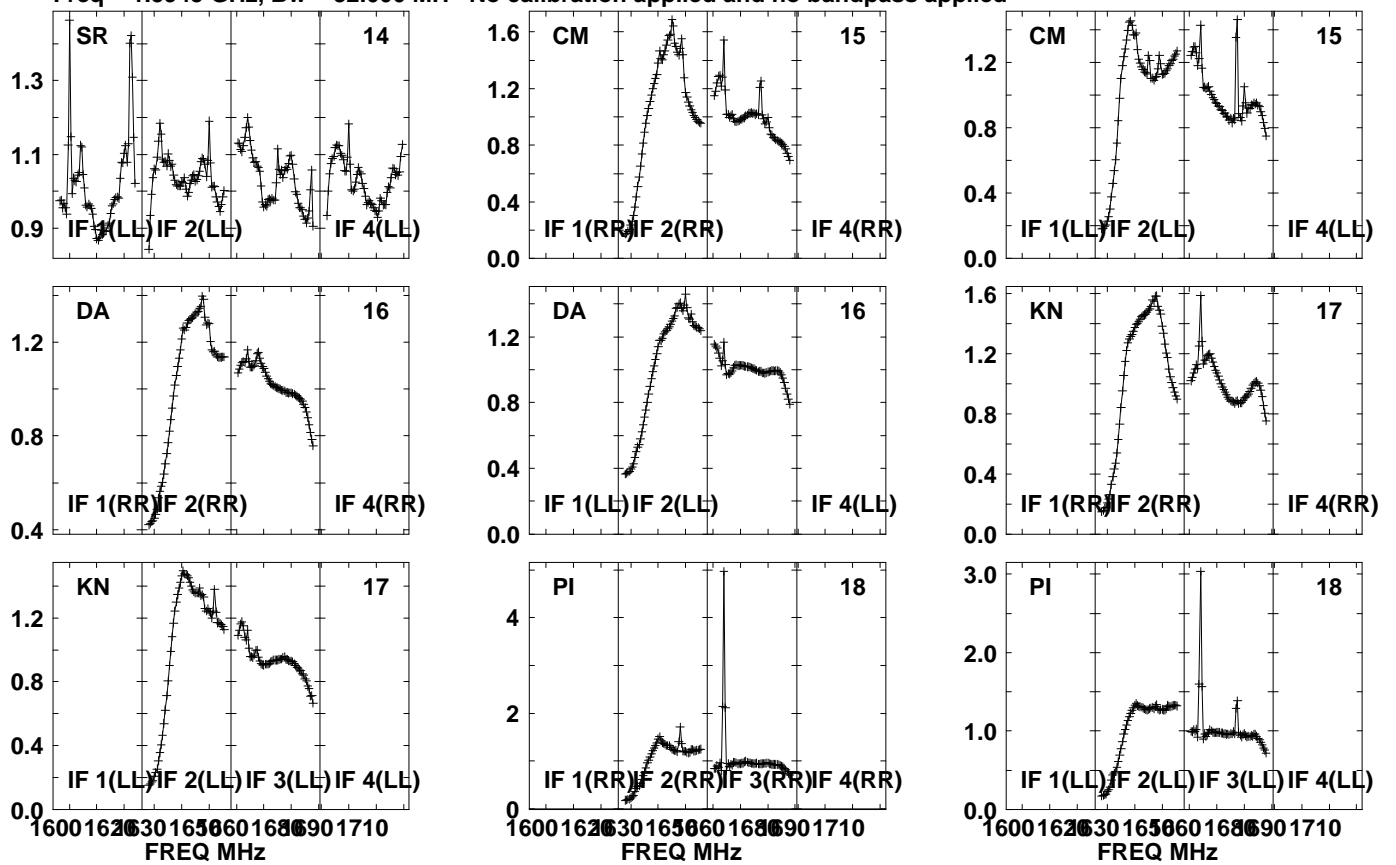

Lower frame: Real Jy  
Auto-corr total-power spectrum Antenna: \*  
Timerange: 00/15:35:01 to 00/15:38:29

Plot file version 546 created 05-OCT-2021 17:06:55

APM08279+525 GM076.UVDATA.1

Freq = 1.5945 GHz, Bw = 32.000 MH No calibration applied and no bandpass applied

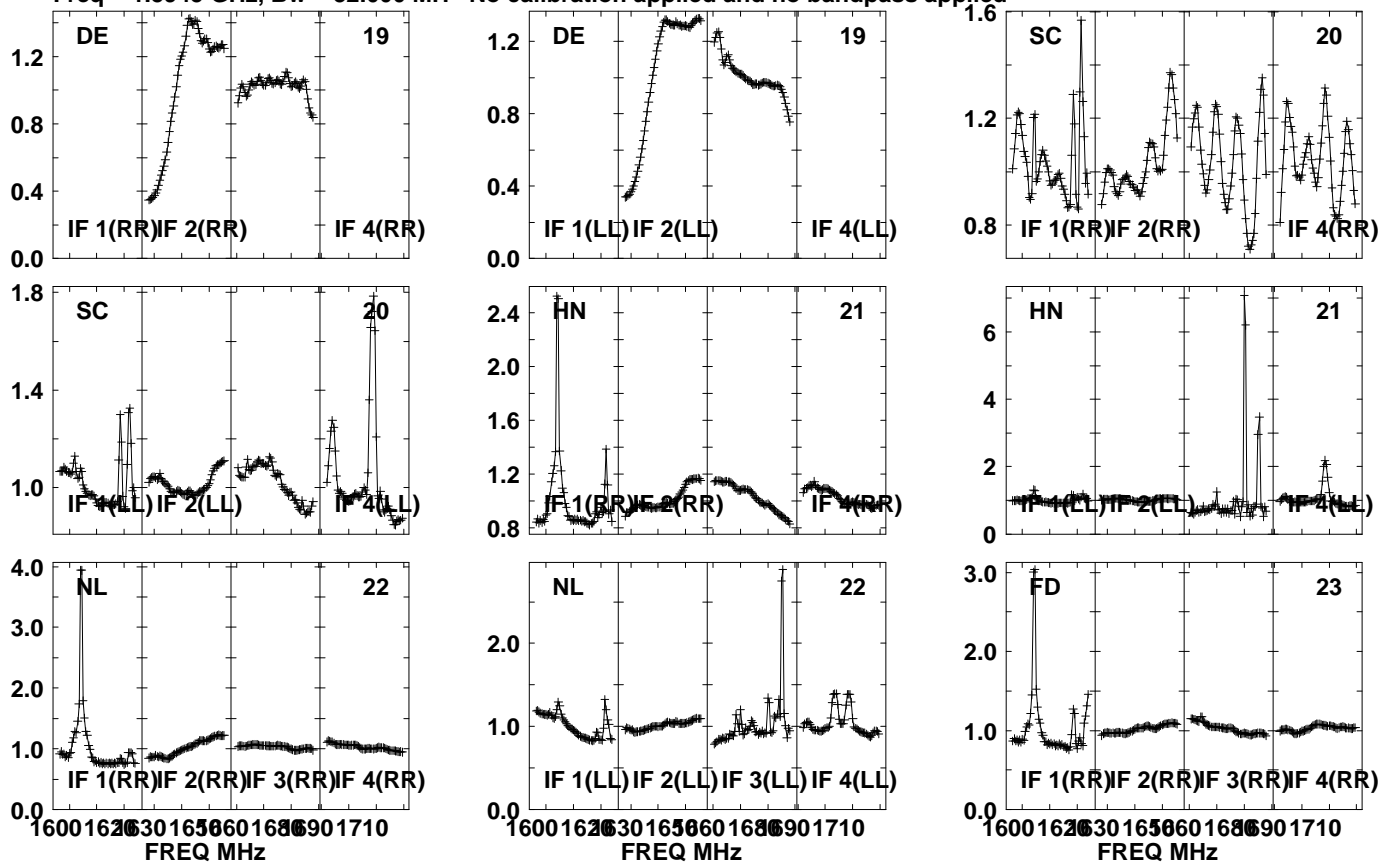

Lower frame: Real Jy  
Auto-corr total-power spectrum Antenna: \*  
Timerange: 00/15:35:01 to 00/15:38:29



Plot file version 547 created 05-OCT-2021 17:06:55

APM08279+525 GM076.UVDATA.1

Freq = 1.5945 GHz, Bw = 32.000 MH No calibration applied and no bandpass applied

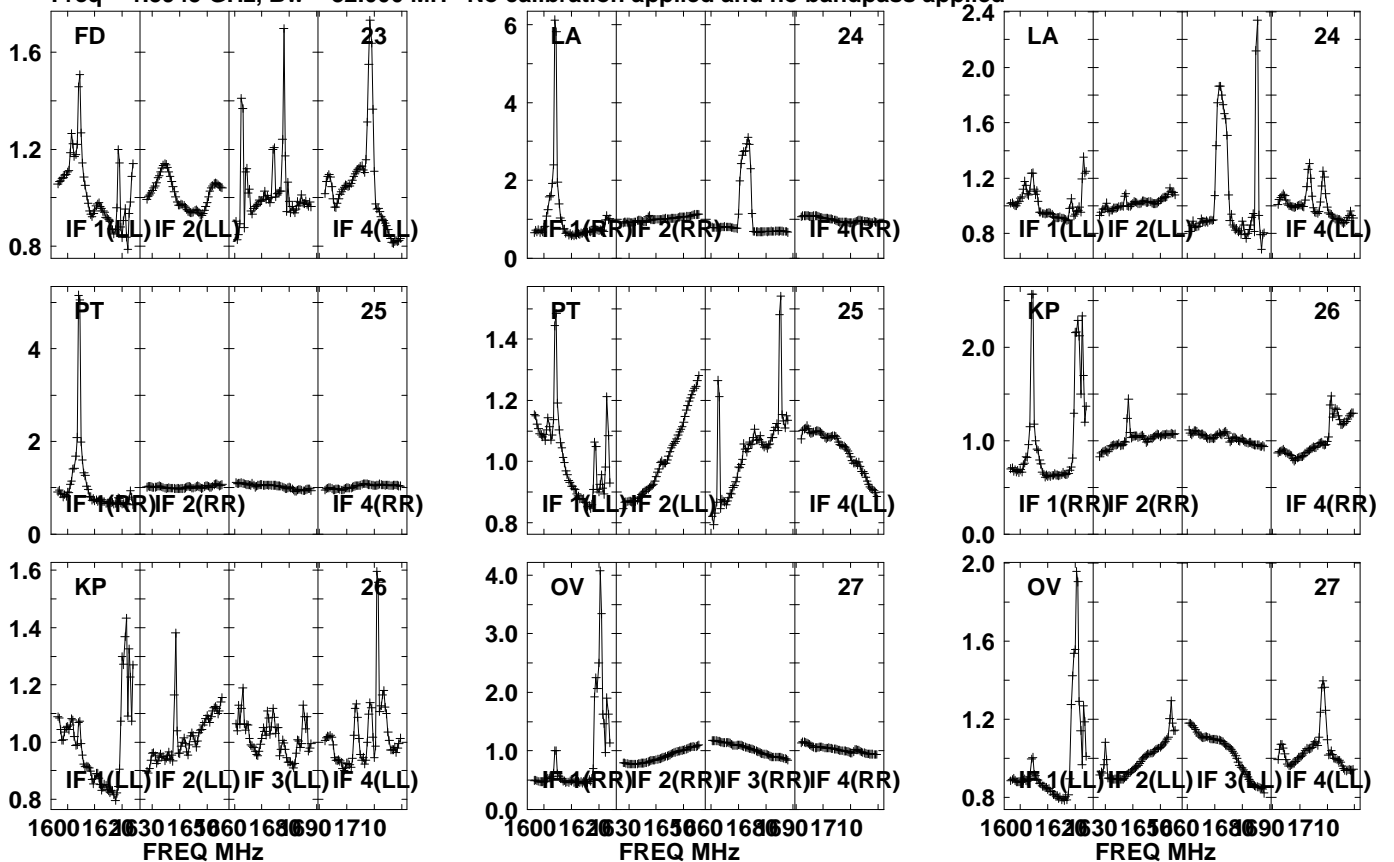

Lower frame: Real Jy  
Auto-corr total-power spectrum Antenna: \*  
Timerange: 00/15:35:01 to 00/15:38:29

Plot file version 548 created 05-OCT-2021 17:06:55

APM08279+525 GM076.UVDATA.1

Freq = 1.5945 GHz, Bw = 32.000 MH No calibration applied and no bandpass applied

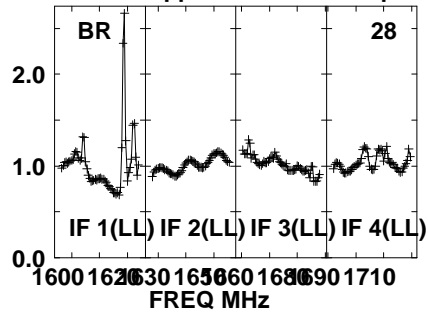
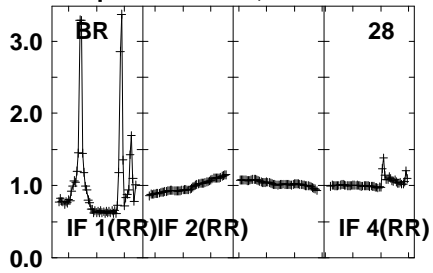

Lower frame: Real Jy

Auto-corr total-power spectrum Antenna: \*

Timerange: 00/15:35:01 to 00/15:38:29

Plot file version 549 created 05-OCT-2021 17:06:55

J0827+5217 GM076.UVDATA.1

Freq = 1.5945 GHz, Bw = 32.000 MH No calibration applied and no bandpass applied

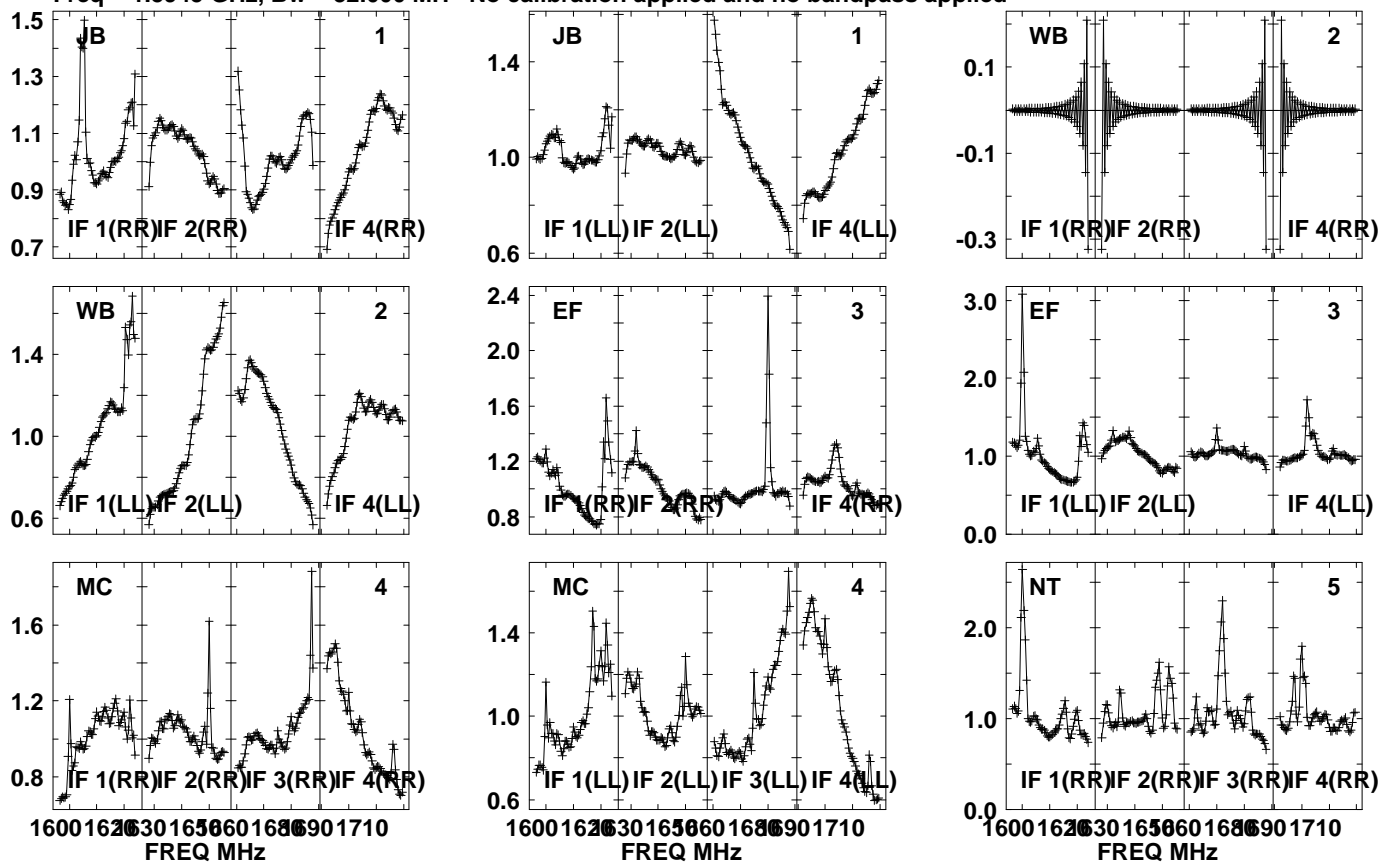

Lower frame: Real Jy  
Auto-corr total-power spectrum Antenna: \*  
Timerange: 00/15:39:01 to 00/15:40:29

Plot file version 550 created 05-OCT-2021 17:06:56

J0827+5217 GM076.UVDATA.1

Freq = 1.5945 GHz, Bw = 32.000 MH No calibration applied and no bandpass applied

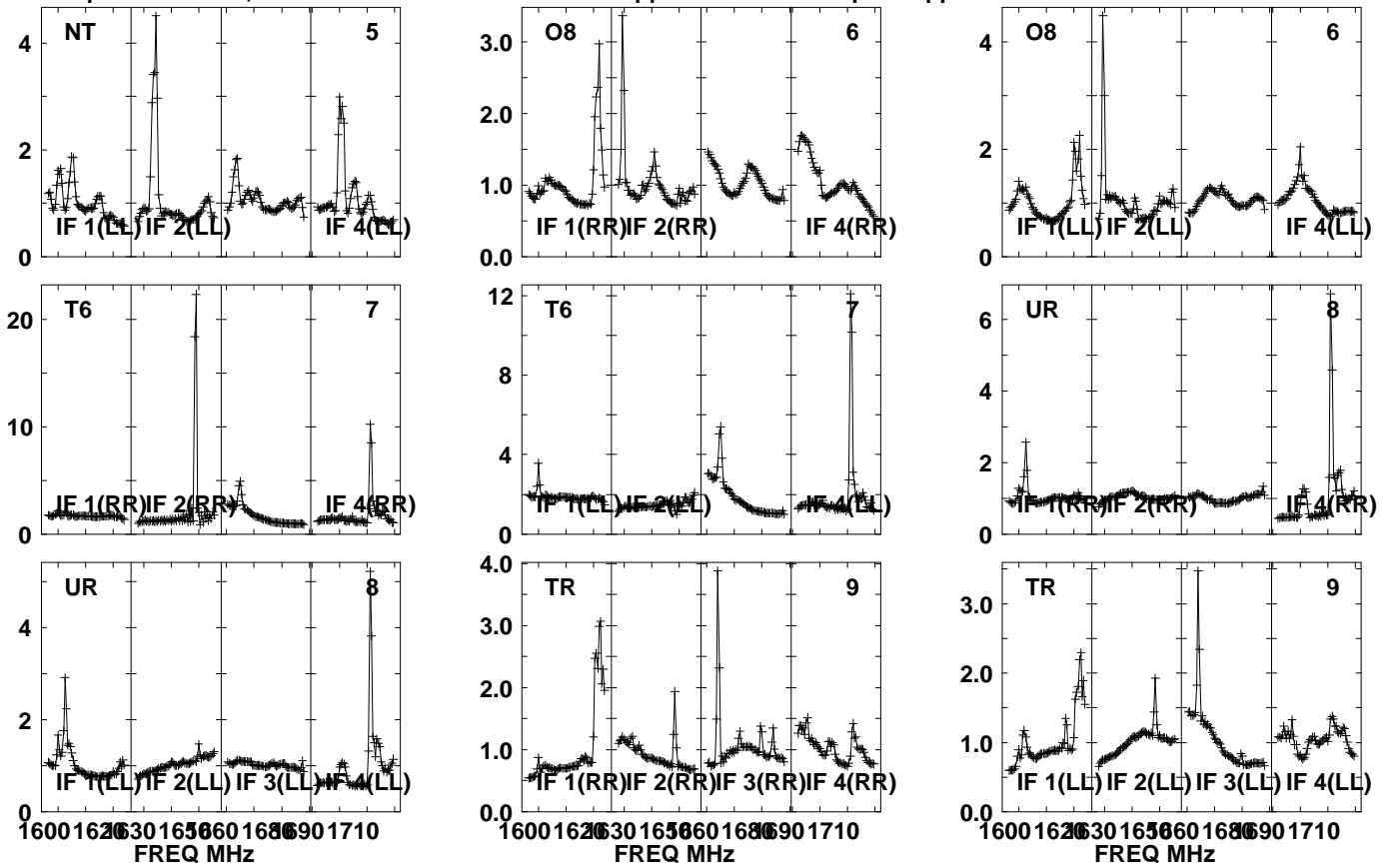

Lower frame: Real Jy

Auto-corr total-power spectrum Antenna: \*

Timerange: 00/15:39:01 to 00/15:40:29

Plot file version 551 created 05-OCT-2021 17:06:56

J0827+5217 GM076.UVDATA.1

Freq = 1.5945 GHz, Bw = 32.000 MH No calibration applied and no bandpass applied

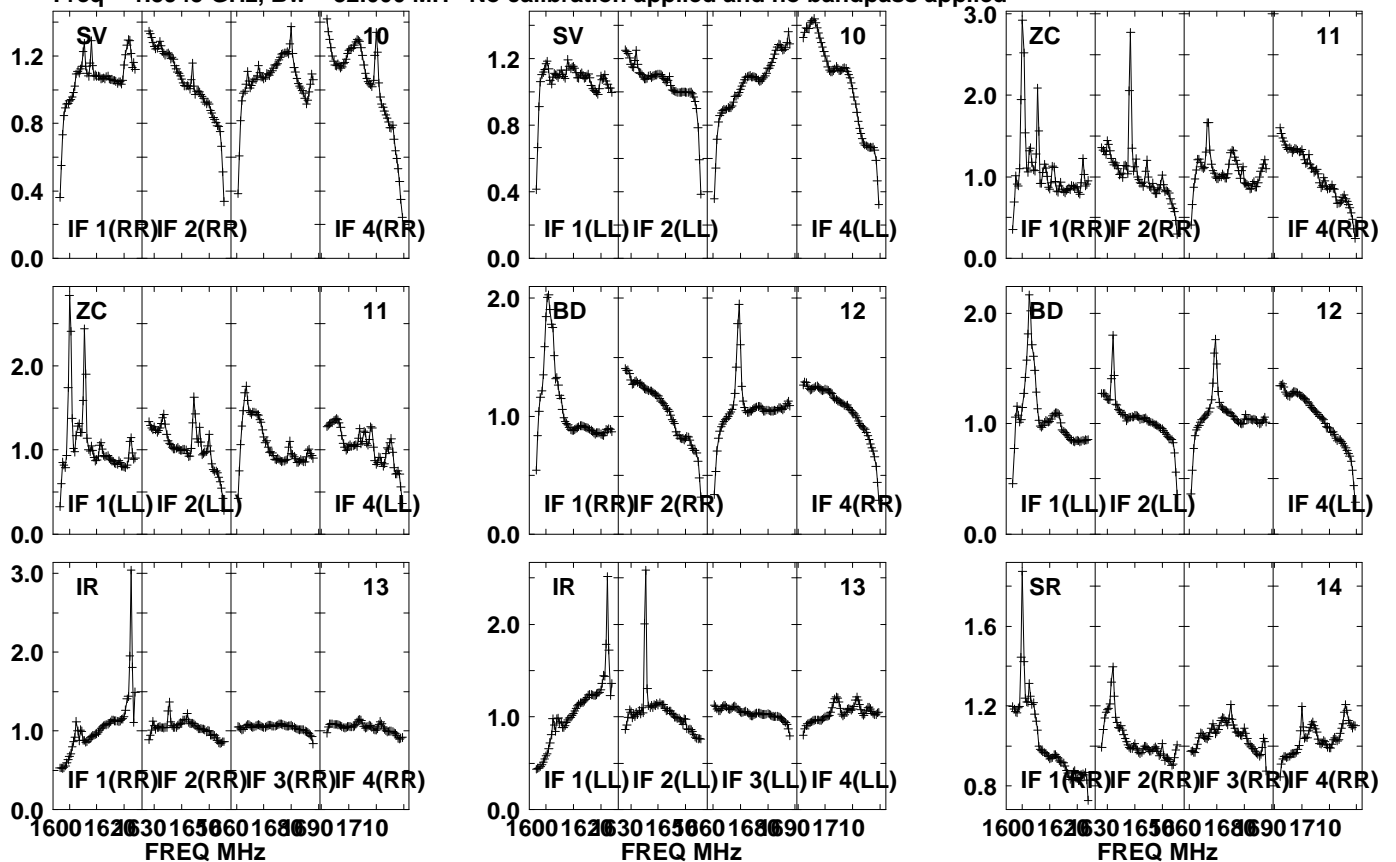

Lower frame: Real Jy

Auto-corr total-power spectrum Antenna: \*

Timerange: 00/15:39:01 to 00/15:40:29

Plot file version 552 created 05-OCT-2021 17:06:56

J0827+5217 GM076.UVDATA.1

Freq = 1.5945 GHz, Bw = 32.000 MH No calibration applied and no bandpass applied

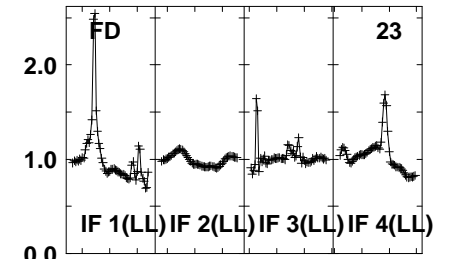
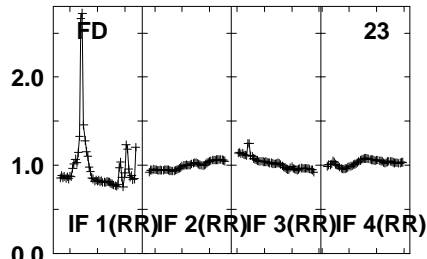
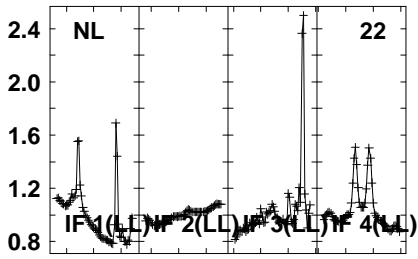
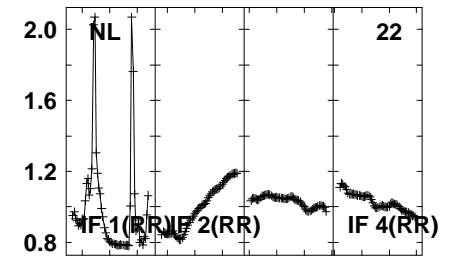
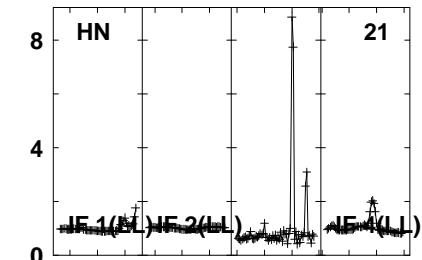
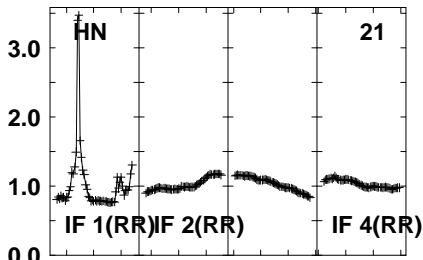
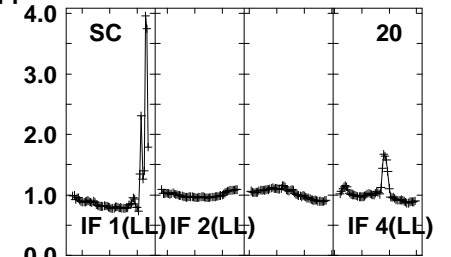
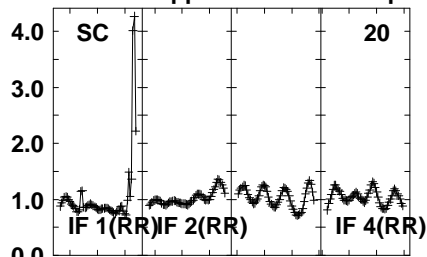
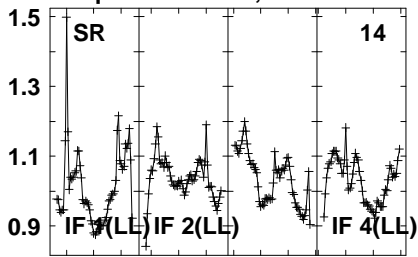

1600 1620 1630 1650 1660 1680 1690 1710  
FREQ MHz

1600 1620 1630 1650 1660 1680 1690 1710  
FREQ MHz

1600 1620 1630 1650 1660 1680 1690 1710  
FREQ MHz

Lower frame: Real Jy  
Auto-corr total-power spectrum Antenna: \*  
Timerange: 00/15:39:01 to 00/15:40:29

Plot file version 553 created 05-OCT-2021 17:06:56

J0827+5217 GM076.UVDATA.1

Freq = 1.5945 GHz, Bw = 32.000 MH No calibration applied and no bandpass applied

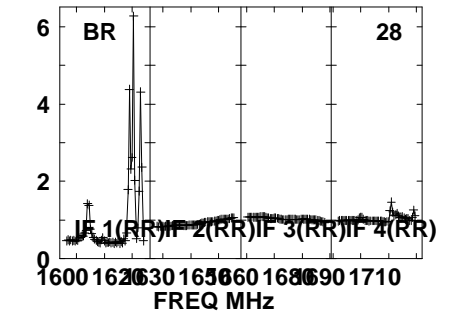
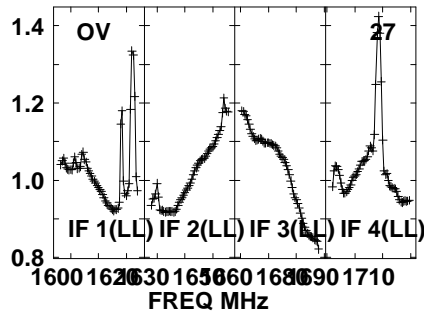
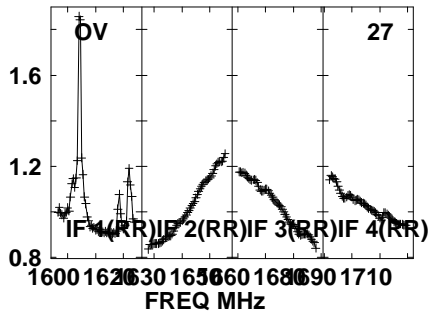
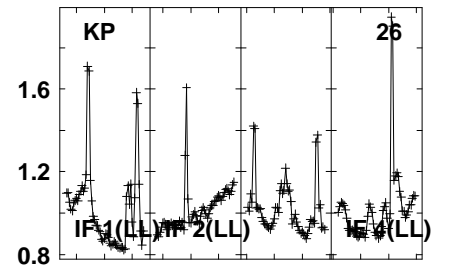
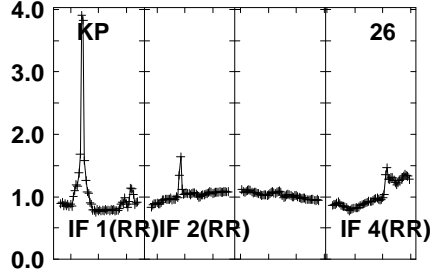
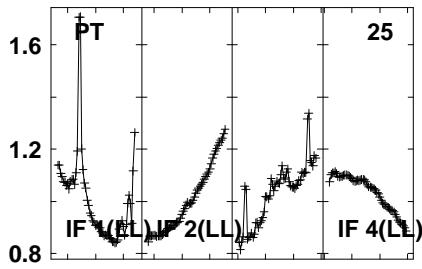
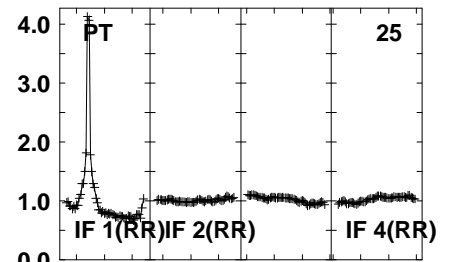
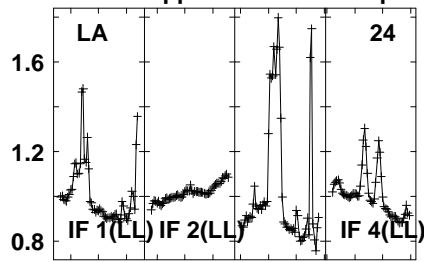
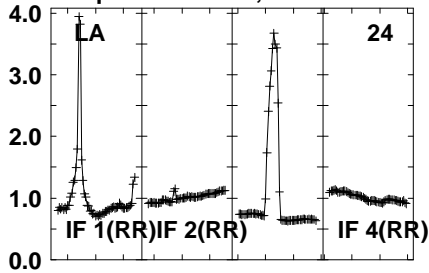

Lower frame: Real Jy

Auto-corr total-power spectrum Antenna: \*

Timerange: 00/15:39:01 to 00/15:40:29

Plot file version 554 created 05-OCT-2021 17:06:57

J0827+5217 GM076.UVDATA.1

Freq = 1.5945 GHz, Bw = 32.000 MH No calibration applied and no bandpass applied

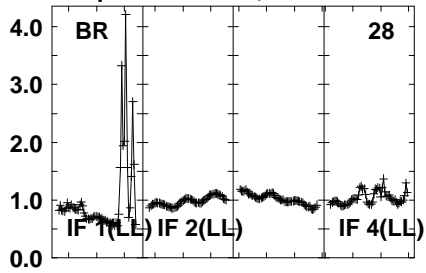

Lower frame: Real Jy

Auto-corr total-power spectrum Antenna: \*

Timerange: 00/15:39:01 to 00/15:40:29



Plot file version 555 created 05-OCT-2021 17:06:57

APM08279+525 GM076.UVDATA.1

Freq = 1.5945 GHz, Bw = 32.000 MH No calibration applied and no bandpass applied

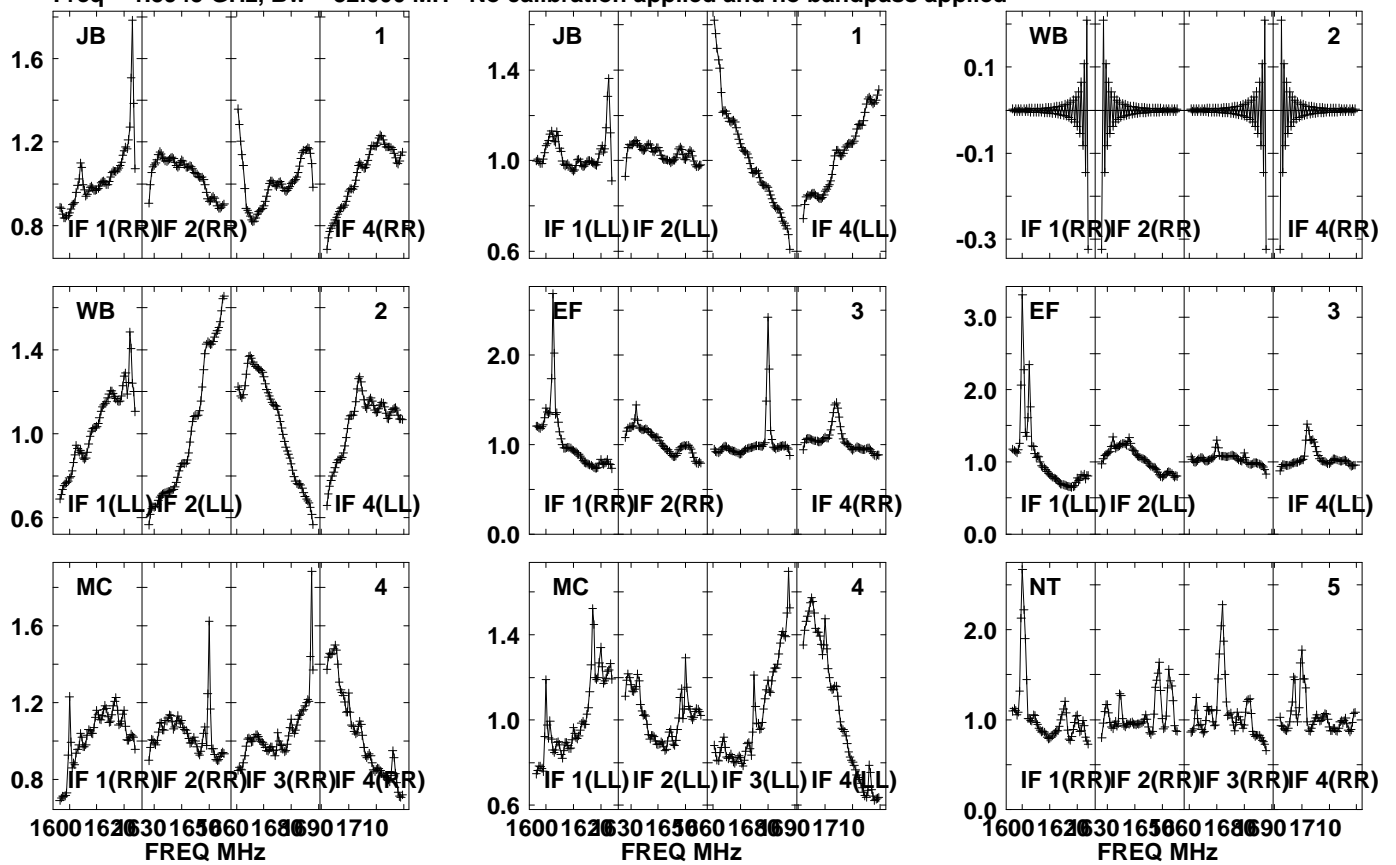

Lower frame: Real Jy  
Auto-corr total-power spectrum Antenna: \*  
Timerange: 00/15:40:31 to 00/15:43:59

Plot file version 556 created 05-OCT-2021 17:06:57

APM08279+525 GM076.UVDATA.1

Freq = 1.5945 GHz, Bw = 32.000 MH No calibration applied and no bandpass applied

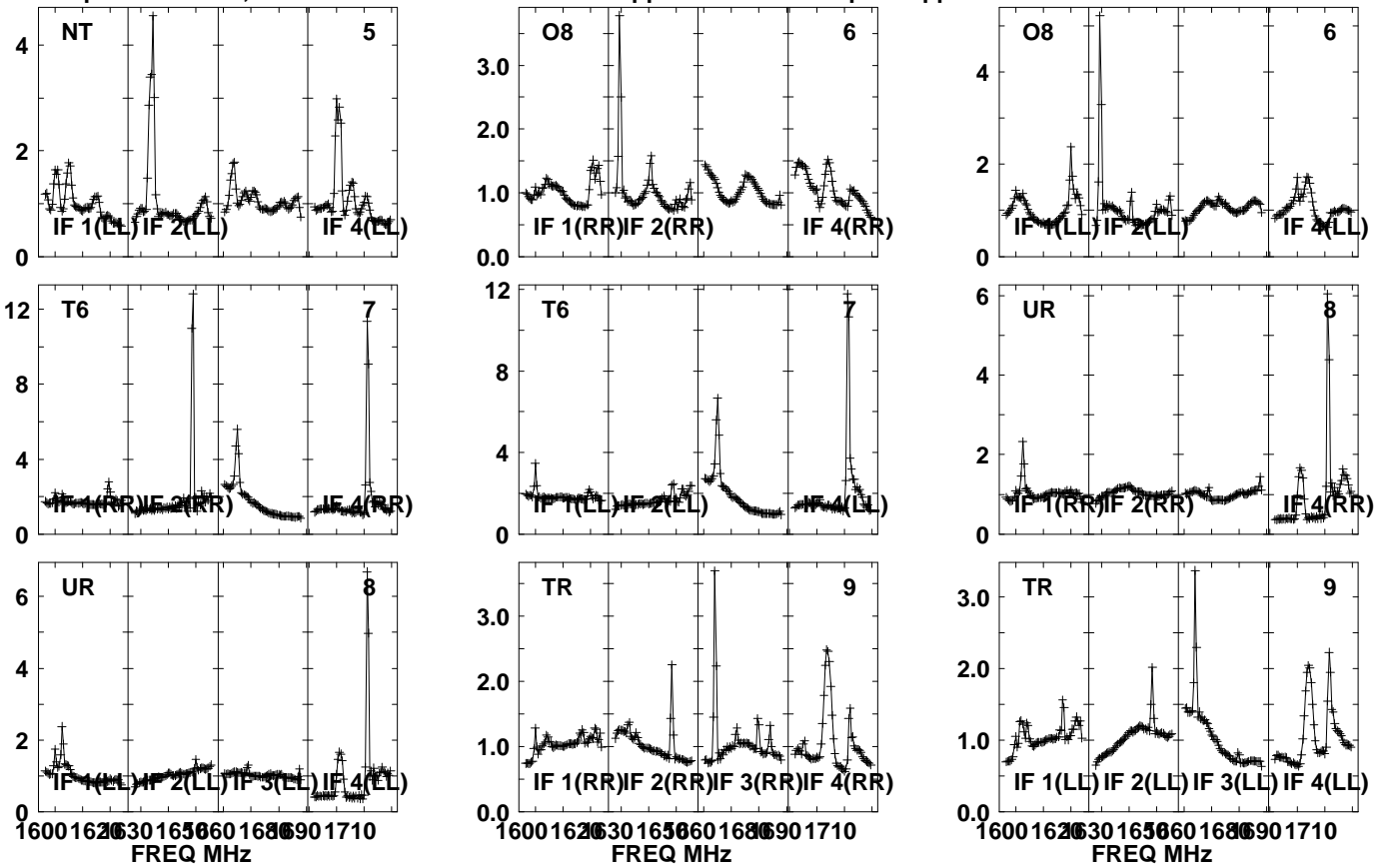

Lower frame: Real Jy

Auto-corr total-power spectrum Antenna: \*

Timerange: 00/15:40:31 to 00/15:43:59

Plot file version 557 created 05-OCT-2021 17:06:57

APM08279+525 GM076.UVDATA.1

Freq = 1.5945 GHz, Bw = 32.000 MH No calibration applied and no bandpass applied

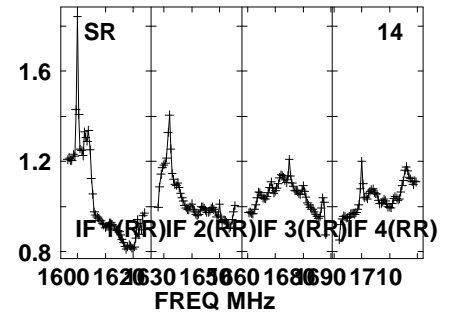
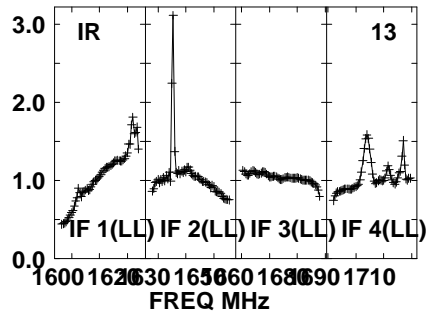
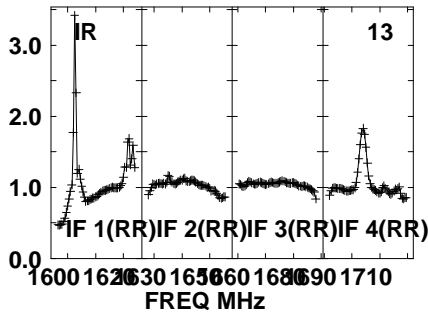
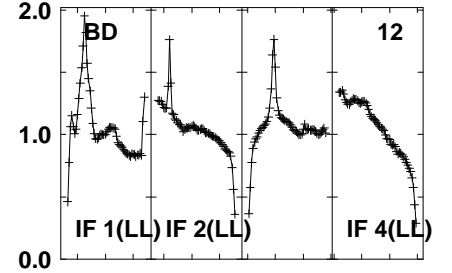
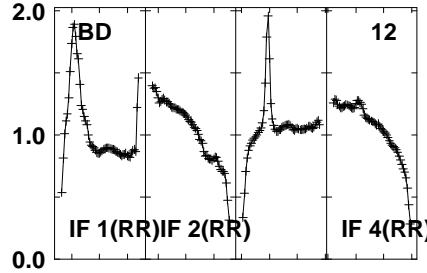
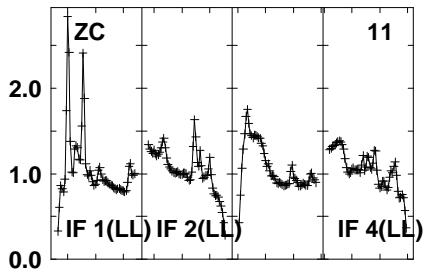
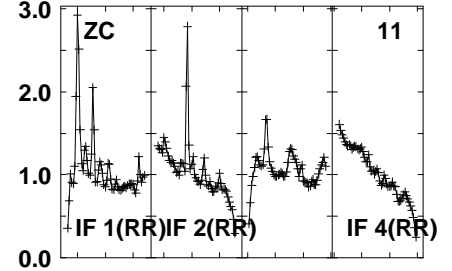
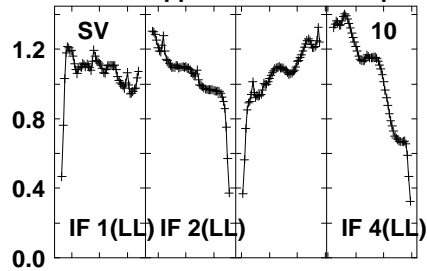
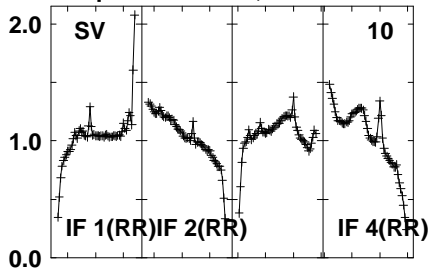

Lower frame: Real Jy

Auto-corr total-power spectrum Antenna: \*

Timerange: 00/15:40:31 to 00/15:43:59

Plot file version 558 created 05-OCT-2021 17:06:57

APM08279+525 GM076.UVDATA.1

Freq = 1.5945 GHz, Bw = 32.000 MH No calibration applied and no bandpass applied

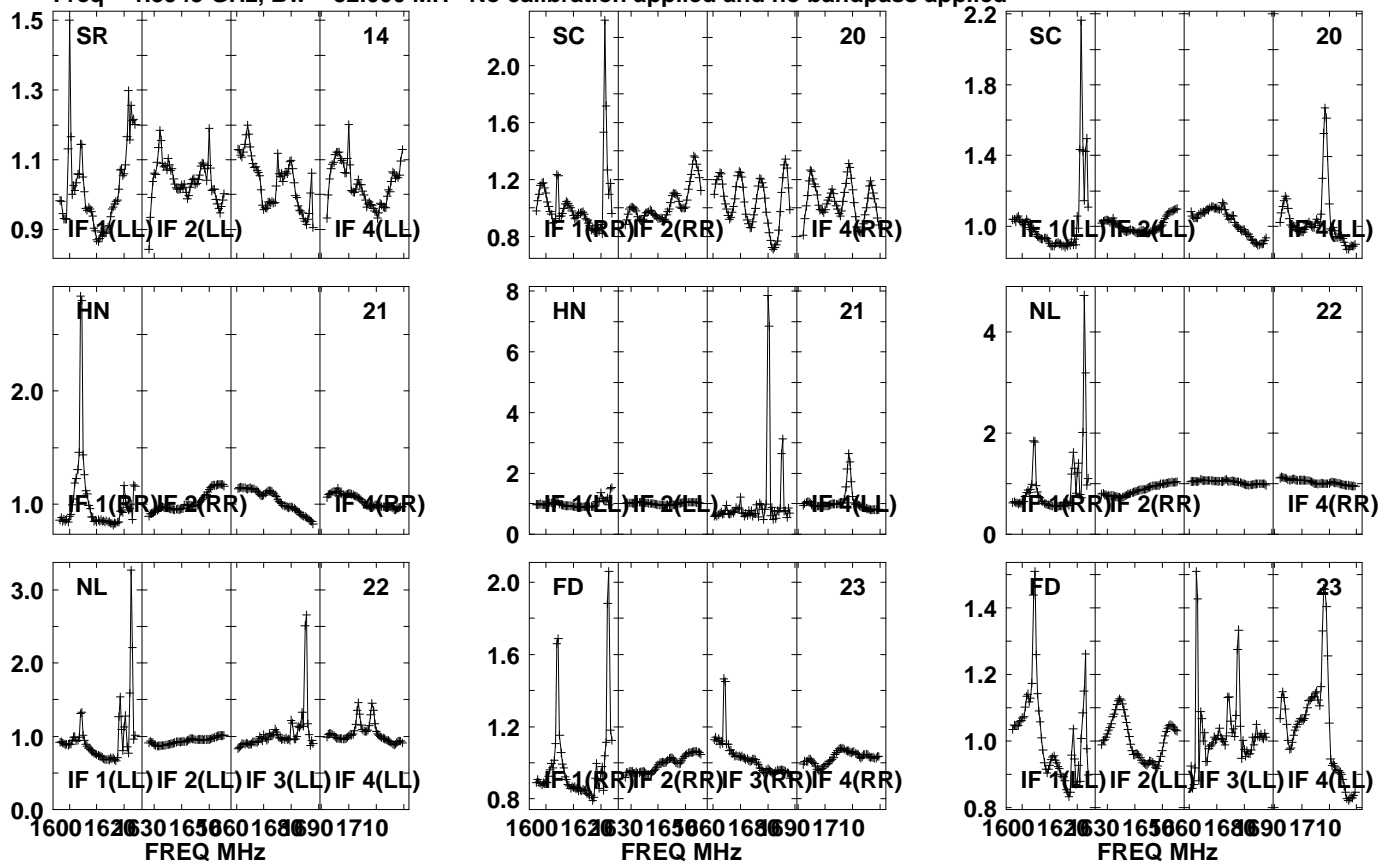

Lower frame: Real Jy  
Auto-corr total-power spectrum Antenna: \*  
Timerange: 00/15:40:31 to 00/15:43:59

Plot file version 559 created 05-OCT-2021 17:06:58

APM08279+525 GM076.UVDATA.1

Freq = 1.5945 GHz, Bw = 32.000 MH No calibration applied and no bandpass applied

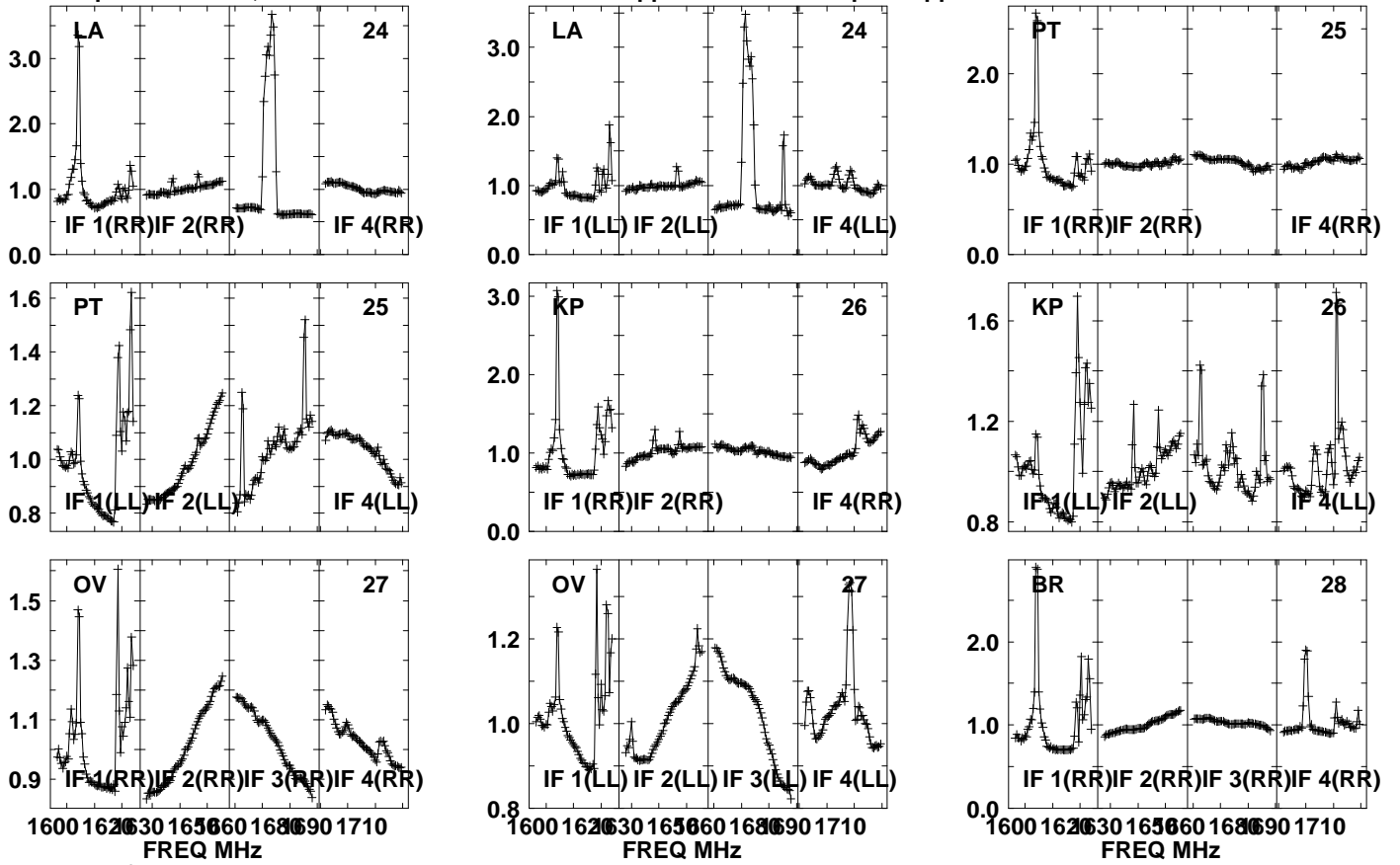

Lower frame: Real Jy  
Auto-corr total-power spectrum Antenna: \*  
Timerange: 00/15:40:31 to 00/15:43:59

Plot file version 560 created 05-OCT-2021 17:06:58

APM08279+525 GM076.UVDATA.1

Freq = 1.5945 GHz, Bw = 32.000 MH No calibration applied and no bandpass applied

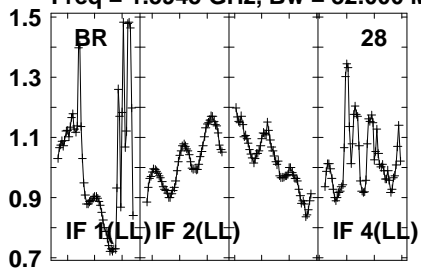

Lower frame: Real Jy

Auto-corr total-power spectrum Antenna: \*

Timerange: 00/15:40:31 to 00/15:43:59

Plot file version 561 created 05-OCT-2021 17:06:58

J0827+5217 GM076.UVDATA.1

Freq = 1.5945 GHz, Bw = 32.000 MH No calibration applied and no bandpass applied

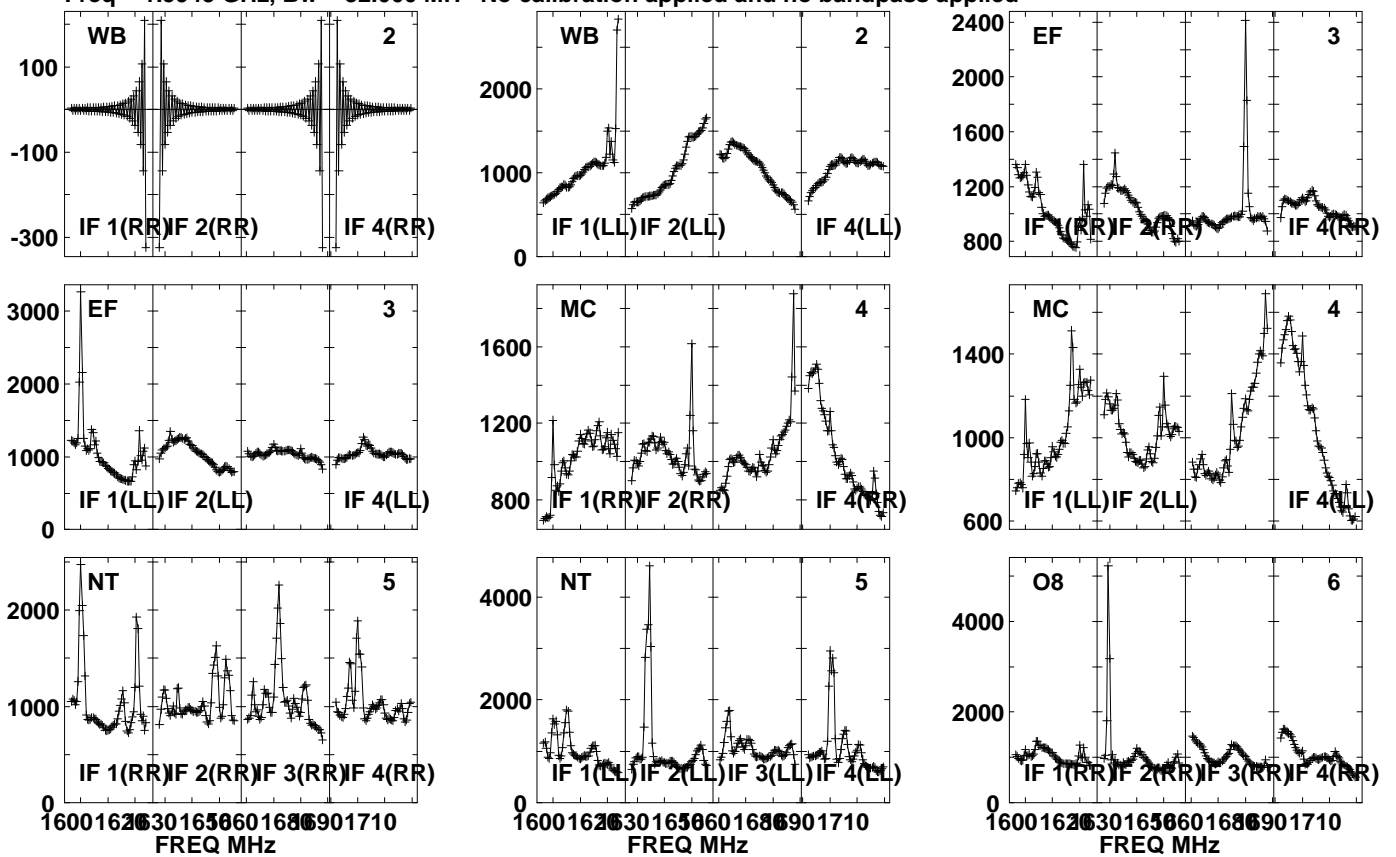

Lower frame: Milli Real Jy  
Auto-corr total-power spectrum Antenna: \*  
Timerange: 00/15:44:01 to 00/15:45:29

Plot file version 562 created 05-OCT-2021 17:06:58

J0827+5217 GM076.UVDATA.1

Freq = 1.5945 GHz, Bw = 32.000 MH No calibration applied and no bandpass applied

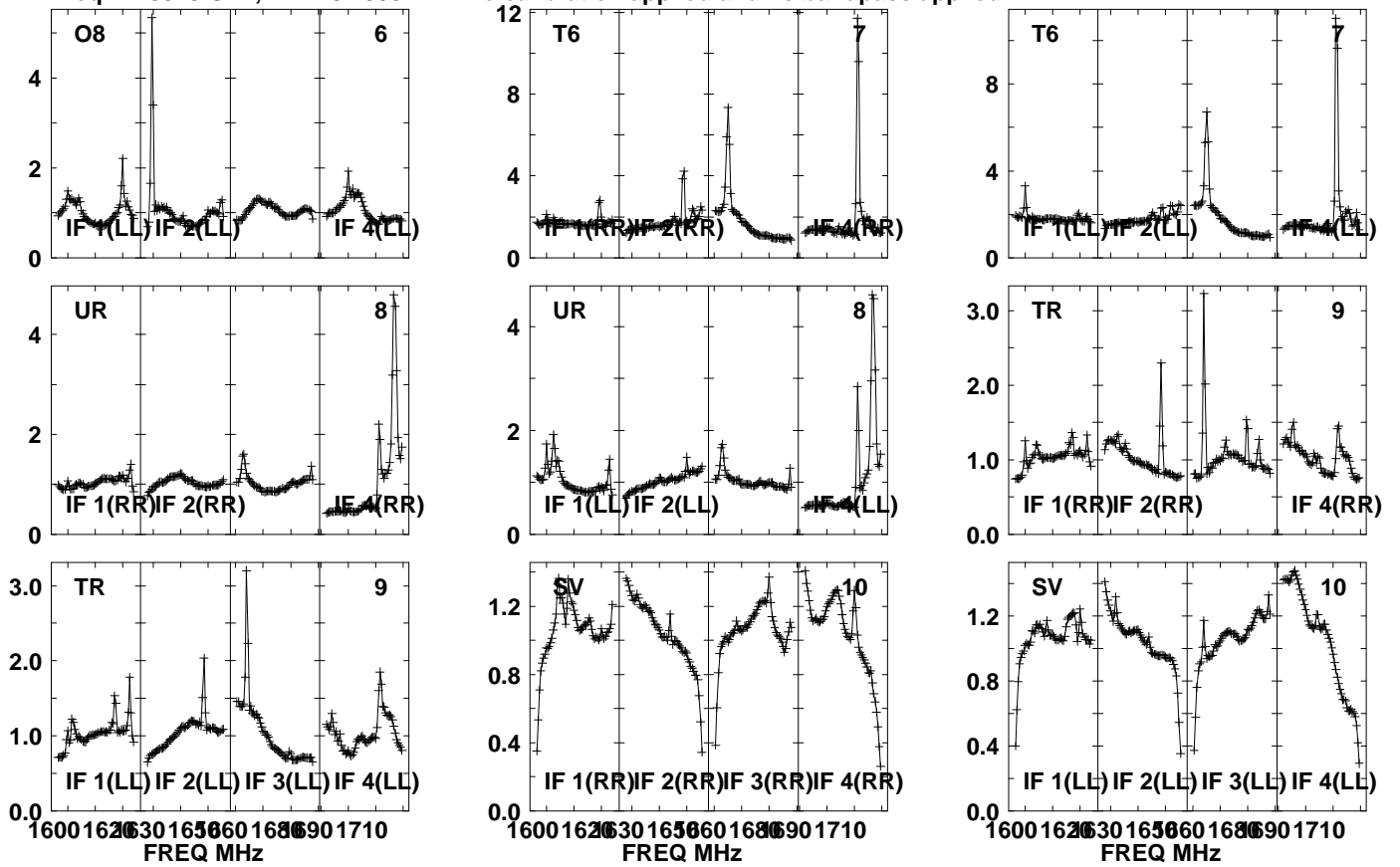

Lower frame: Real Jy  
Auto-corr total-power spectrum Antenna: \*  
Timerange: 00/15:44:01 to 00/15:45:29



Plot file version 563 created 05-OCT-2021 17:06:59

J0827+5217 GM076.UVDATA.1

Freq = 1.5945 GHz, Bw = 32.000 MH No calibration applied and no bandpass applied

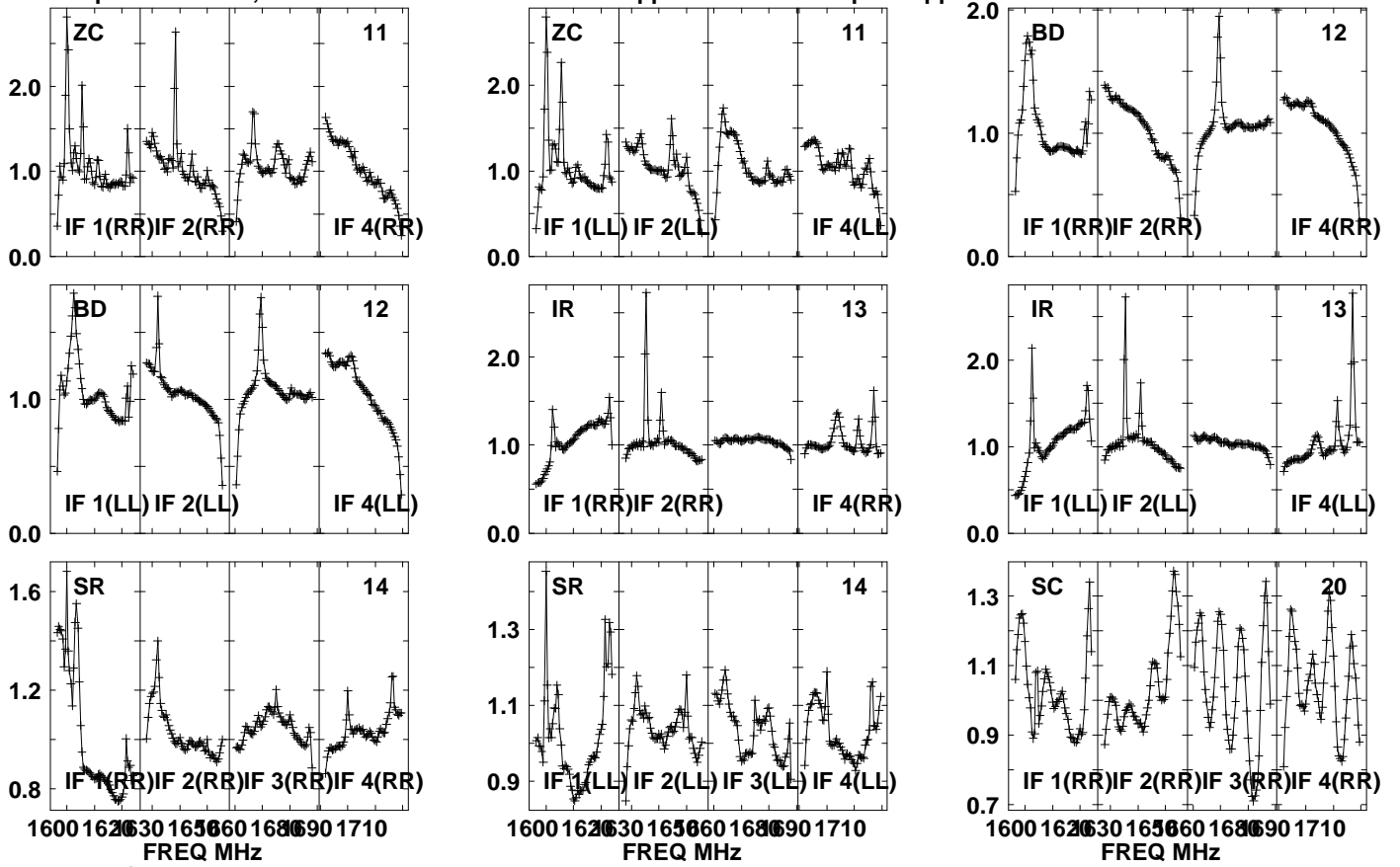

Lower frame: Real Jy  
Auto-corr total-power spectrum Antenna: \*  
Timerange: 00/15:44:01 to 00/15:45:29

Plot file version 564 created 05-OCT-2021 17:06:59

J0827+5217 GM076.UVDATA.1

Freq = 1.5945 GHz, Bw = 32.000 MH No calibration applied and no bandpass applied

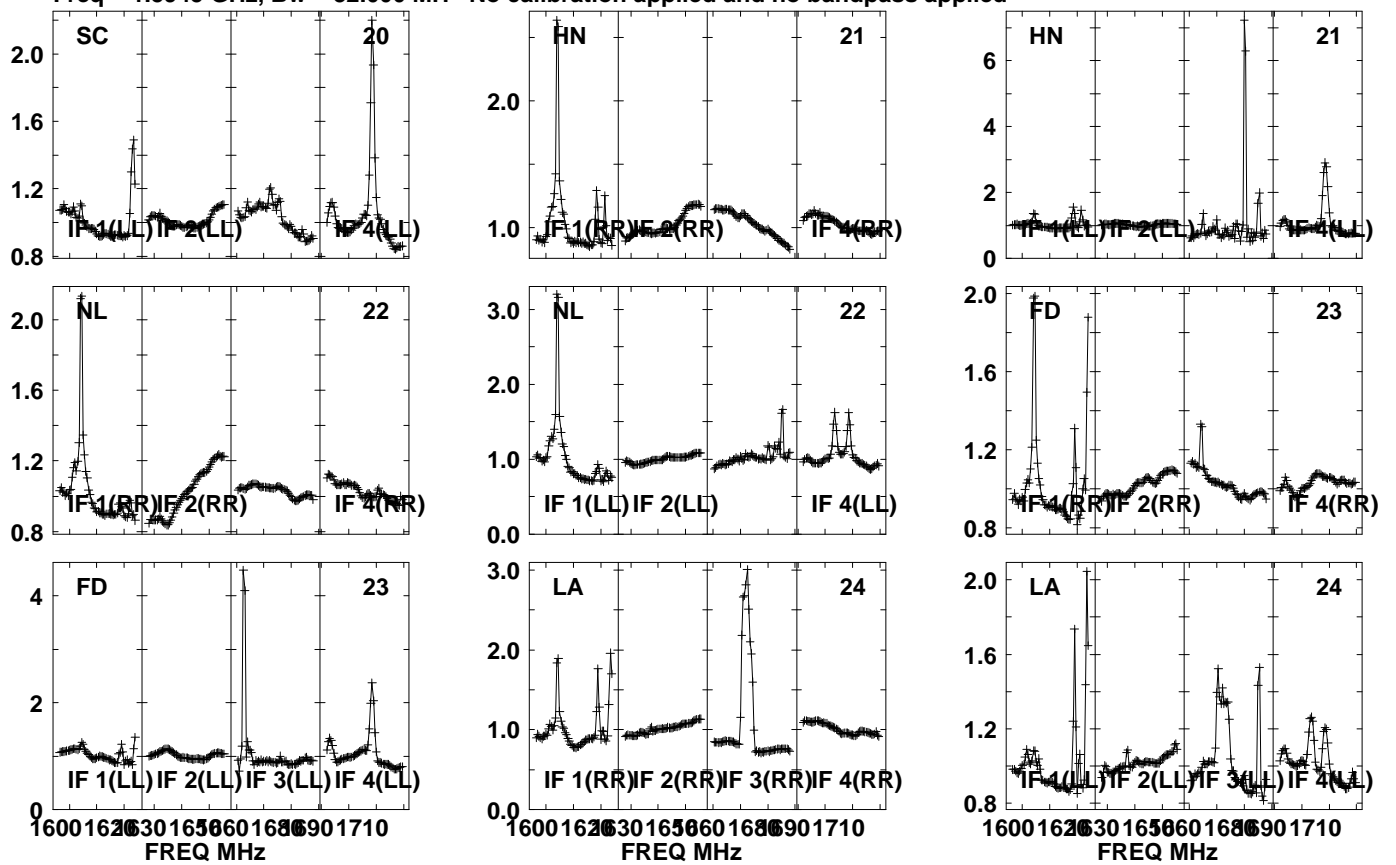

Lower frame: Real Jy  
Auto-corr total-power spectrum Antenna: \*  
Timerange: 00/15:44:01 to 00/15:45:29

Plot file version 565 created 05-OCT-2021 17:06:59

J0827+5217 GM076.UVDATA.1

Freq = 1.5945 GHz, Bw = 32.000 MH No calibration applied and no bandpass applied

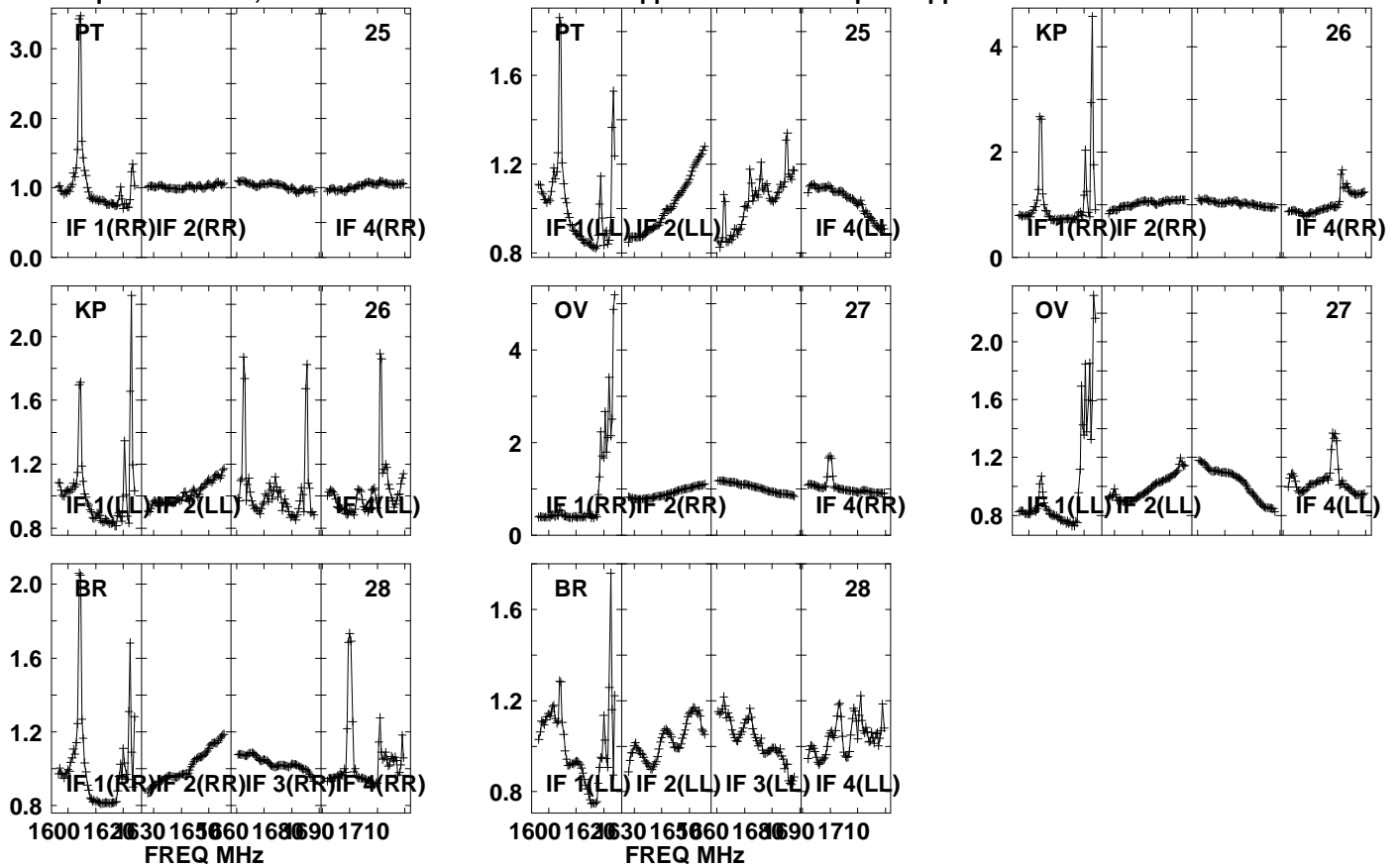

Lower frame: Real Jy

Auto-corr total-power spectrum Antenna: \*

Timerange: 00/15:44:01 to 00/15:45:29

Plot file version 566 created 05-OCT-2021 17:07:00

APM08279+525 GM076.UVDATA.1

Freq = 1.5945 GHz, Bw = 32.000 MH No calibration applied and no bandpass applied

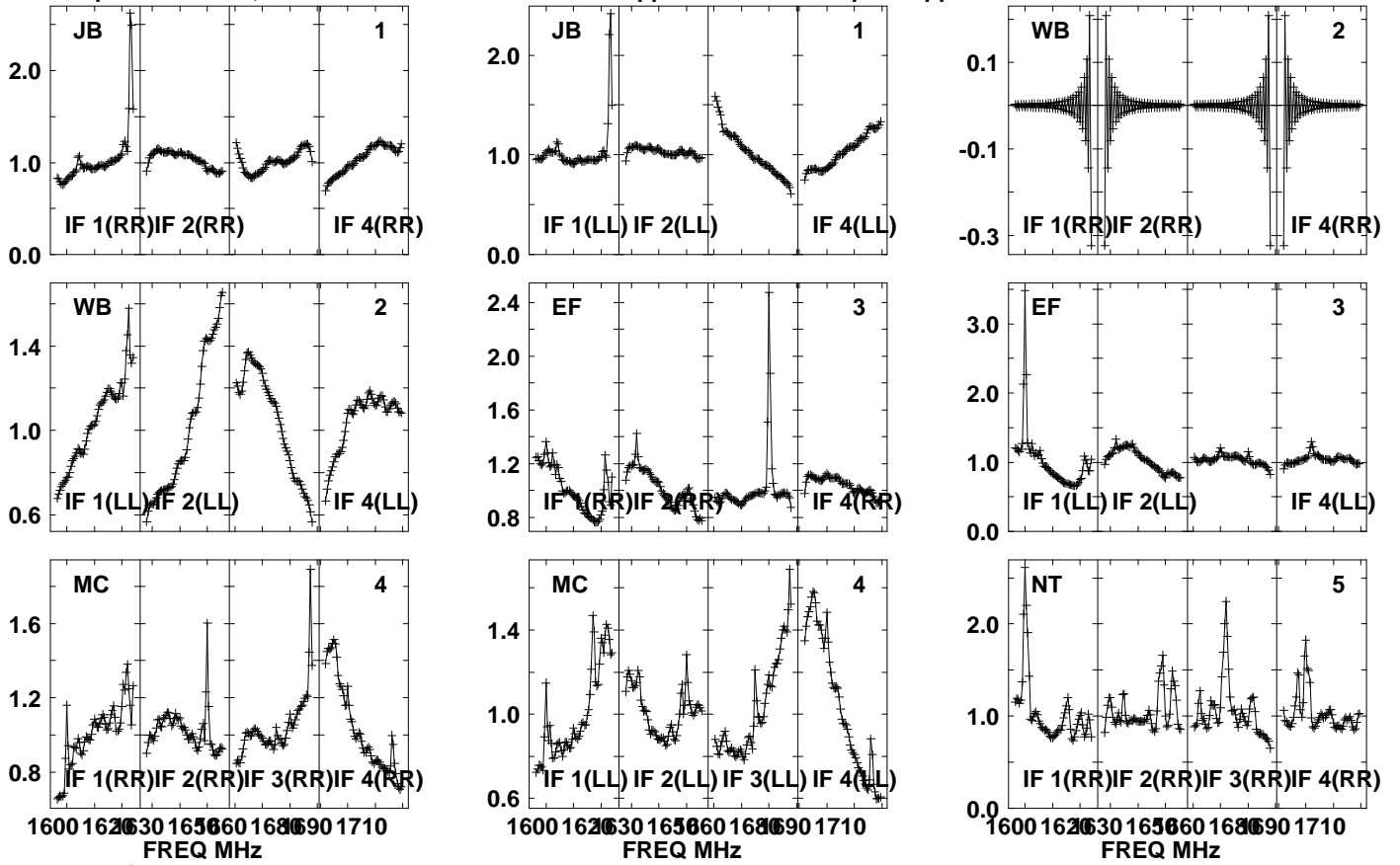

Lower frame: Real Jy

Auto-corr total-power spectrum Antenna: \*

Timerange: 00/15:45:31 to 00/15:48:59

Plot file version 567 created 05-OCT-2021 17:07:00

APM08279+525 GM076.UVDATA.1

Freq = 1.5945 GHz, Bw = 32.000 MH No calibration applied and no bandpass applied

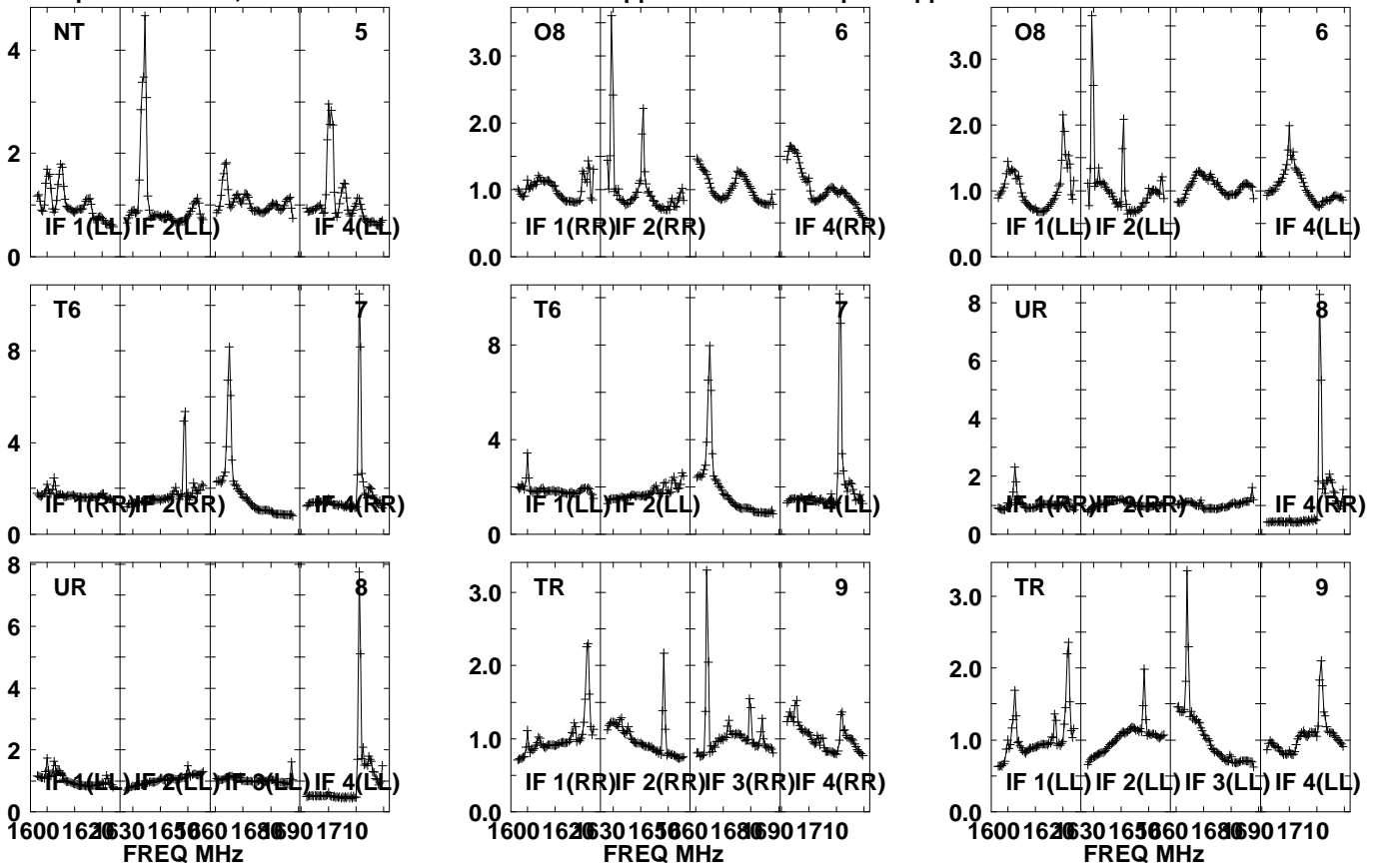

Lower frame: Real Jy

Auto-corr total-power spectrum Antenna: \*

Timerange: 00/15:45:31 to 00/15:48:59

Plot file version 568 created 05-OCT-2021 17:07:00

APM08279+525 GM076.UVDATA.1

Freq = 1.5945 GHz, Bw = 32.000 MH No calibration applied and no bandpass applied

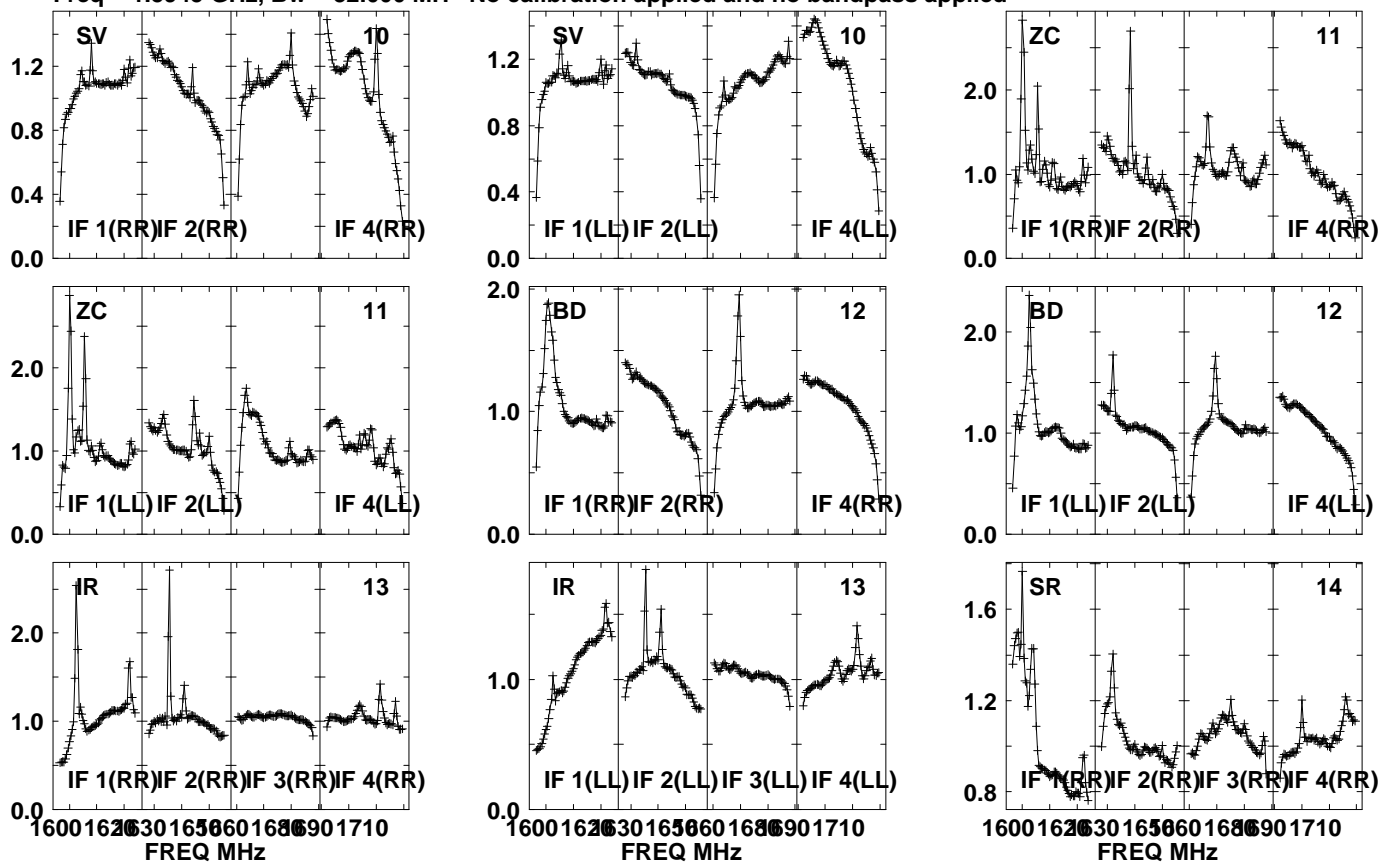

Lower frame: Real Jy  
Auto-corr total-power spectrum Antenna: \*  
Timerange: 00/15:45:31 to 00/15:48:59

Plot file version 569 created 05-OCT-2021 17:07:00

APM08279+525 GM076.UVDATA.1

Freq = 1.5945 GHz, Bw = 32.000 MH No calibration applied and no bandpass applied

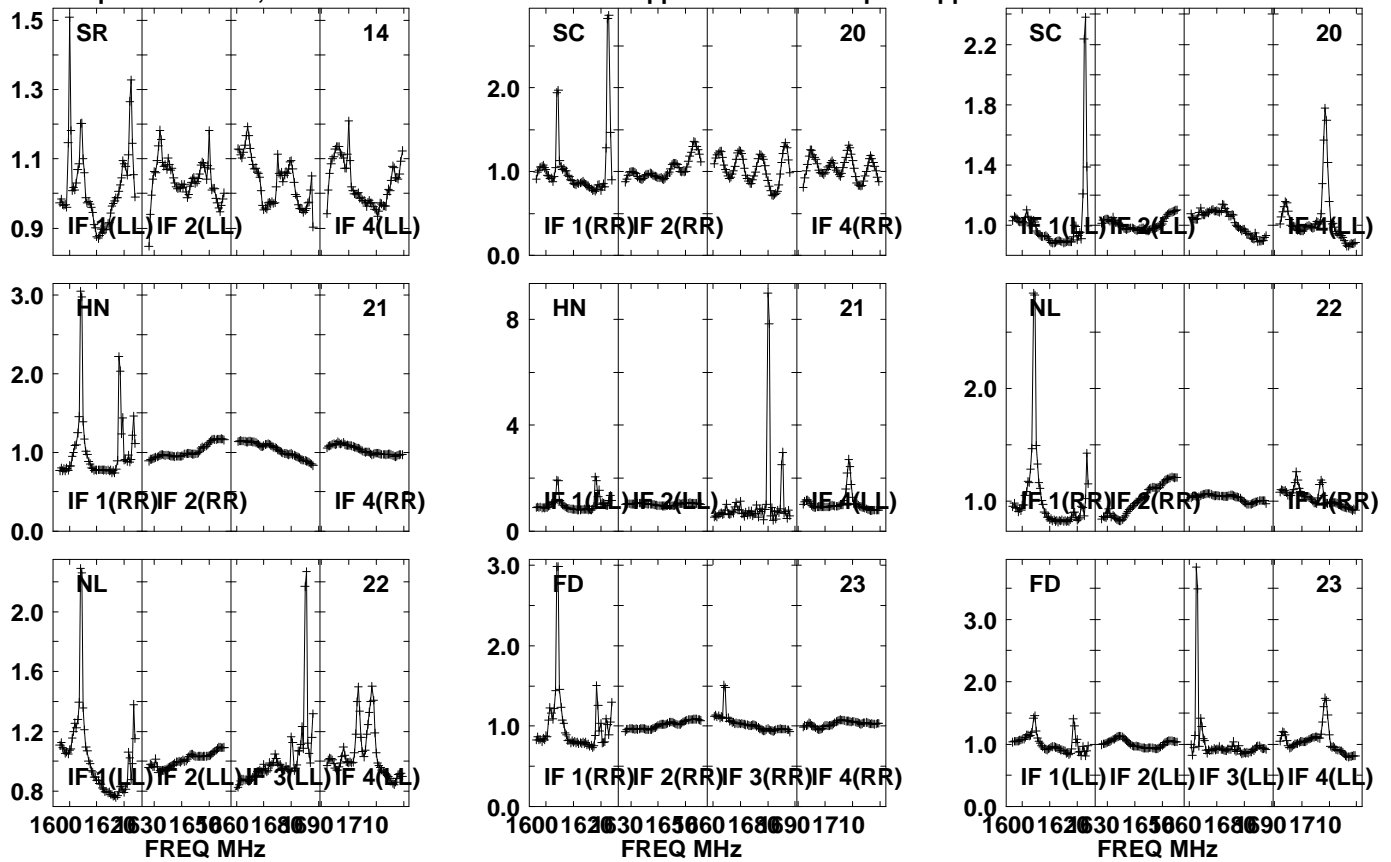

Lower frame: Real Jy  
Auto-corr total-power spectrum Antenna: \*  
Timerange: 00/15:45:31 to 00/15:48:59

Plot file version 570 created 05-OCT-2021 17:07:01

APM08279+525 GM076.UVDATA.1

Freq = 1.5945 GHz, Bw = 32.000 MH No calibration applied and no bandpass applied

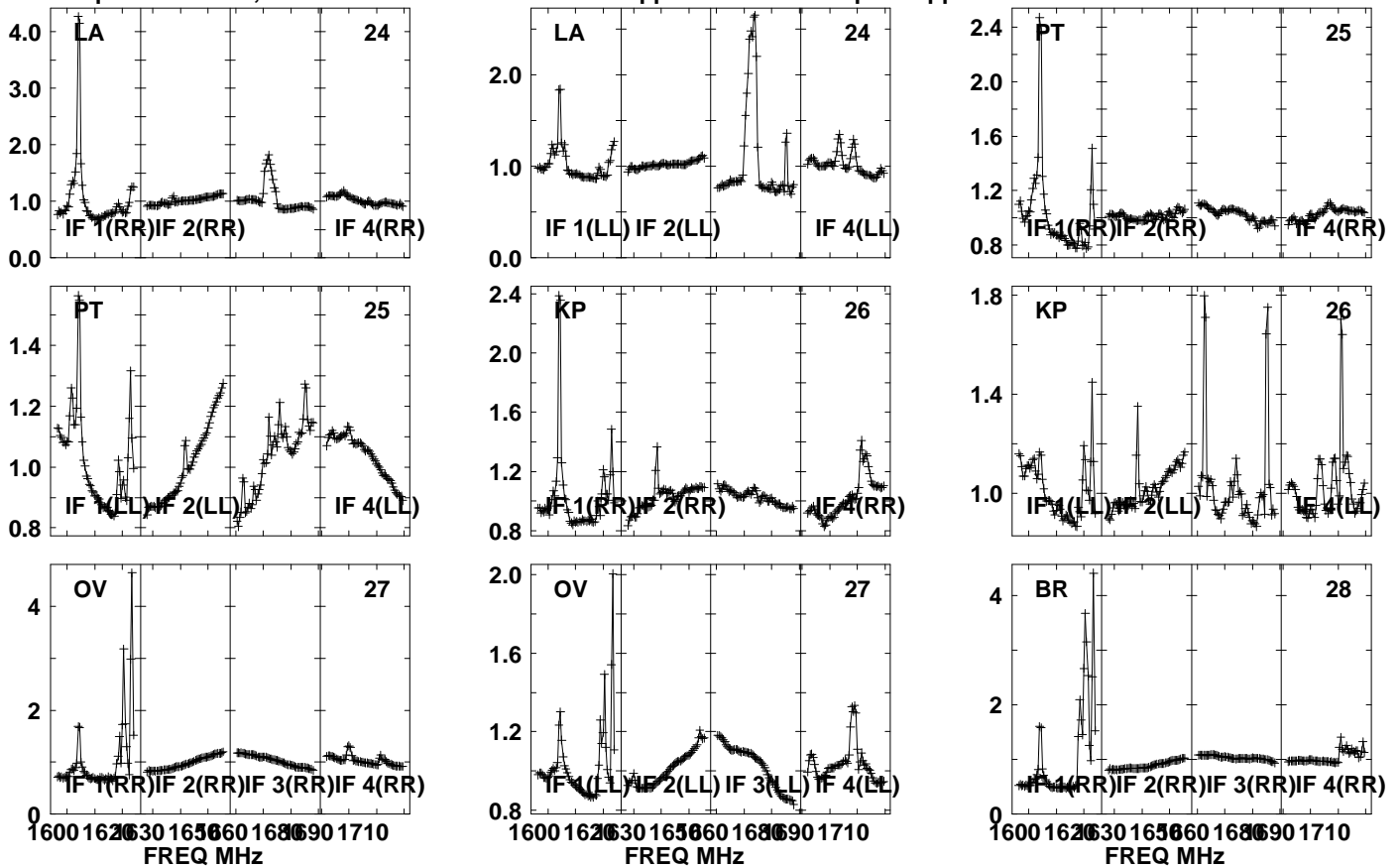

Lower frame: Real Jy

Auto-corr total-power spectrum Antenna: \*

Timerange: 00/15:45:31 to 00/15:48:59



Plot file version 571 created 05-OCT-2021 17:07:01

APM08279+525 GM076.UVDATA.1

Freq = 1.5945 GHz, Bw = 32.000 MH No calibration applied and no bandpass applied

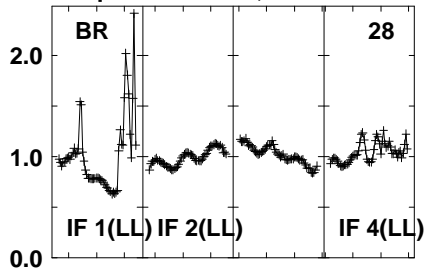

Lower frame: Real Jy

Auto-corr total-power spectrum Antenna: \*

Timerange: 00/15:45:31 to 00/15:48:59

Plot file version 572 created 05-OCT-2021 17:07:01

J0827+5217 GM076.UVDATA.1

Freq = 1.5945 GHz, Bw = 32.000 MH No calibration applied and no bandpass applied

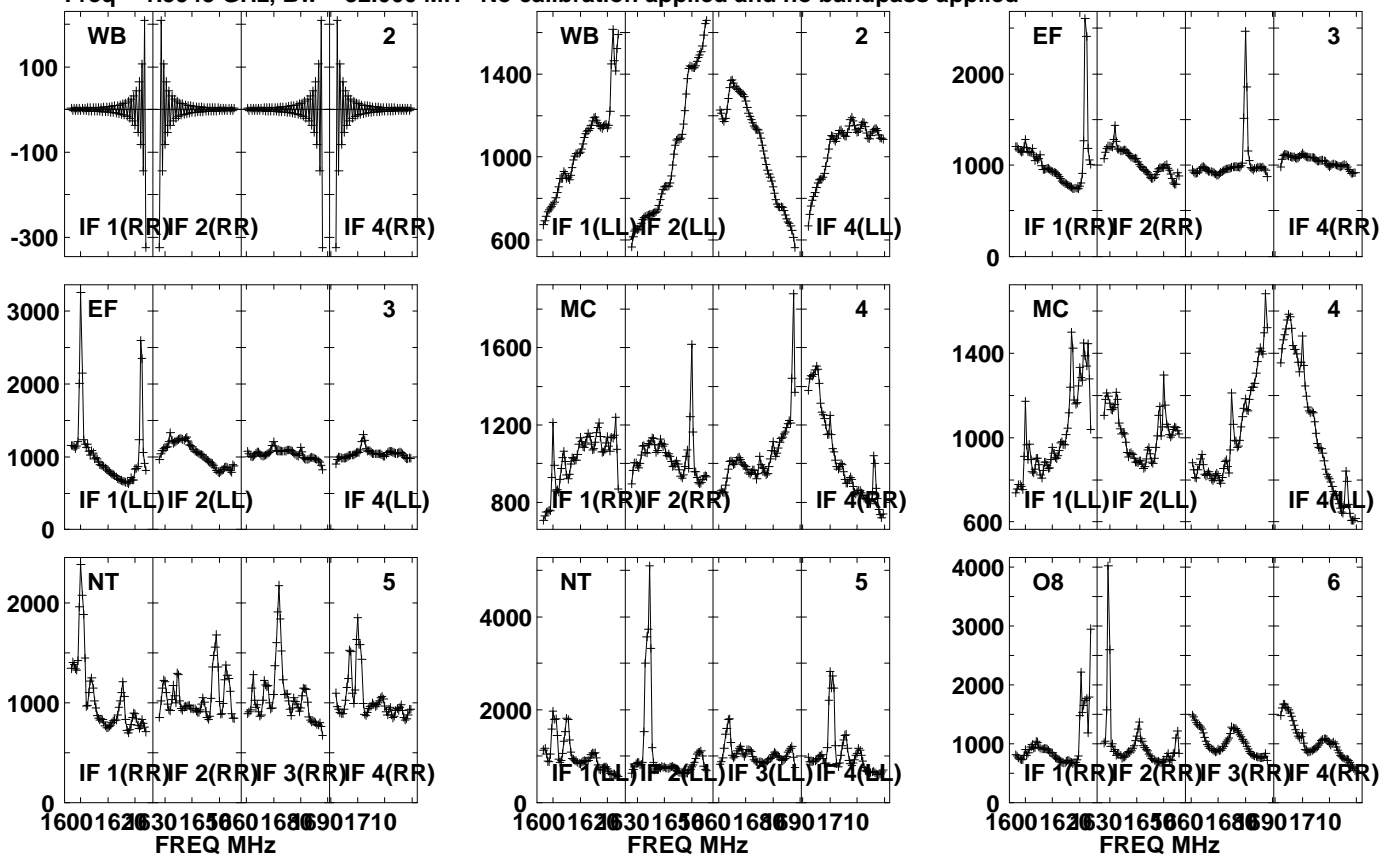

Lower frame: Milli Real Jy  
Auto-corr total-power spectrum Antenna: \*  
Timerange: 00/15:49:31 to 00/15:50:59

Plot file version 573 created 05-OCT-2021 17:07:01

J0827+5217 GM076.UVDATA.1

Freq = 1.5945 GHz, Bw = 32.000 MH No calibration applied and no bandpass applied

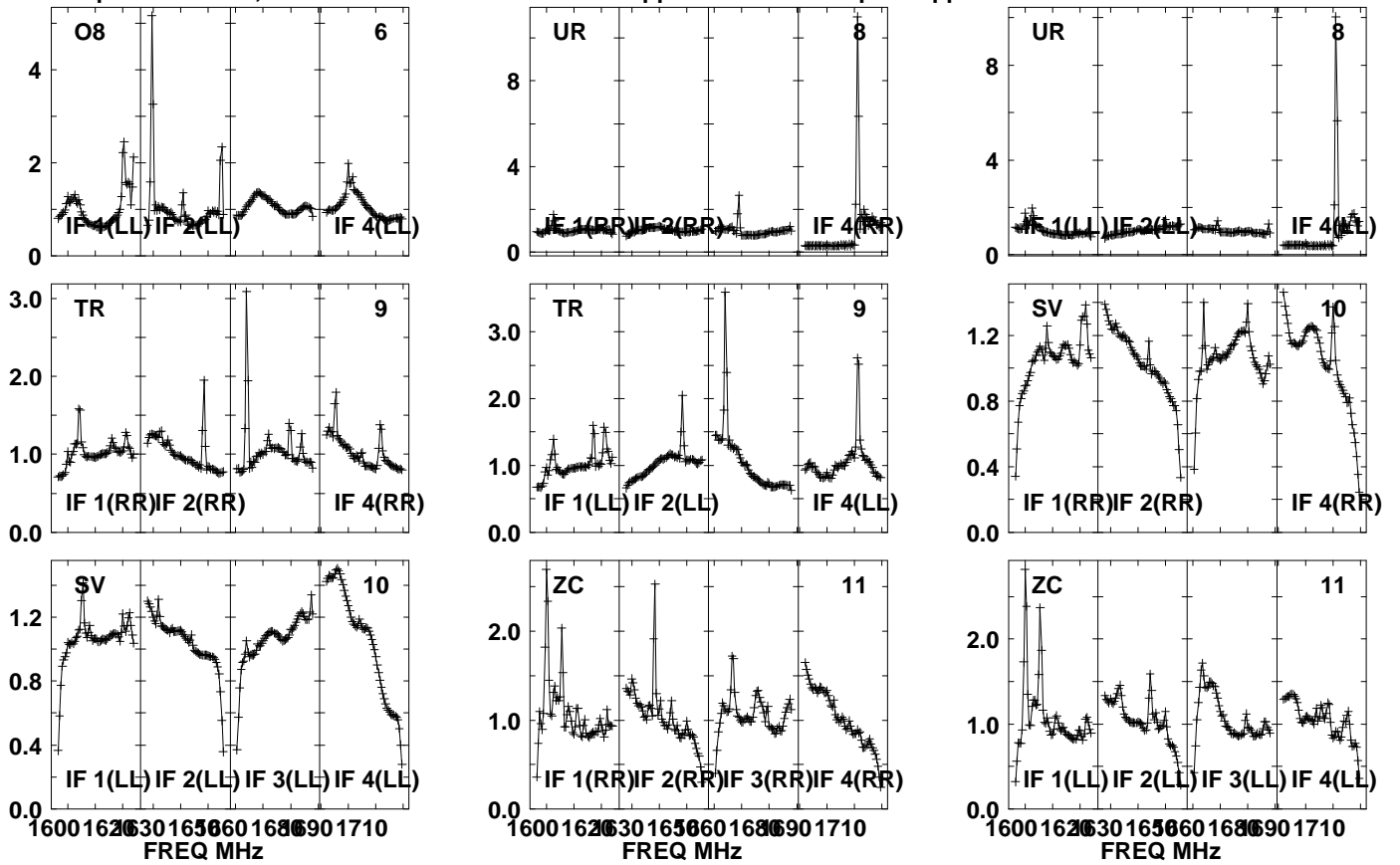

Lower frame: Real Jy

Auto-corr total-power spectrum Antenna: \*

Timerange: 00/15:49:31 to 00/15:50:59

Plot file version 574 created 05-OCT-2021 17:07:02

J0827+5217 GM076.UVDATA.1

Freq = 1.5945 GHz, Bw = 32.000 MH No calibration applied and no bandpass applied

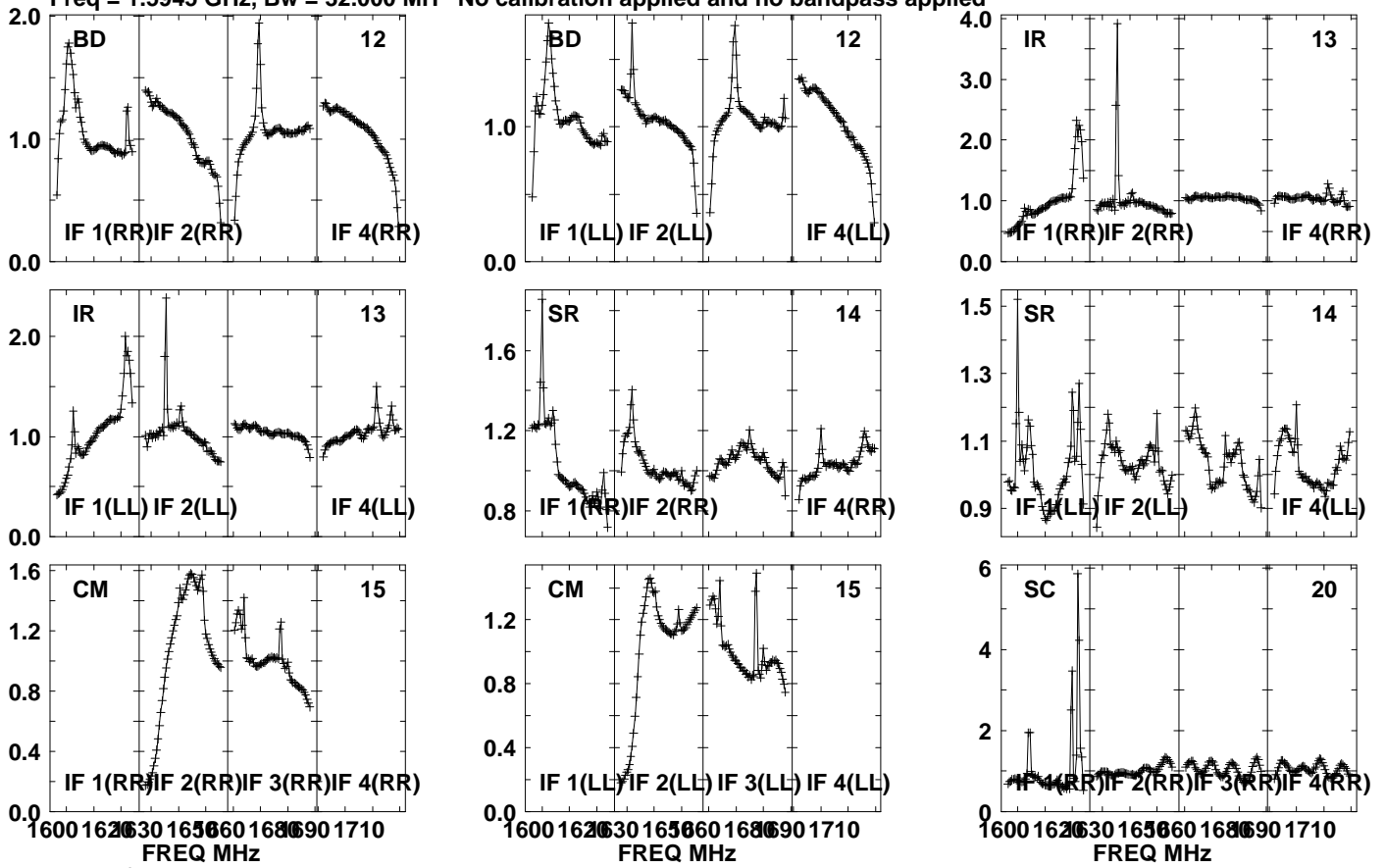

Lower frame: Real Jy

Auto-corr total-power spectrum Antenna: \*

Timerange: 00/15:49:31 to 00/15:50:59

Plot file version 575 created 05-OCT-2021 17:07:02

J0827+5217 GM076.UVDATA.1

Freq = 1.5945 GHz, Bw = 32.000 MH No calibration applied and no bandpass applied

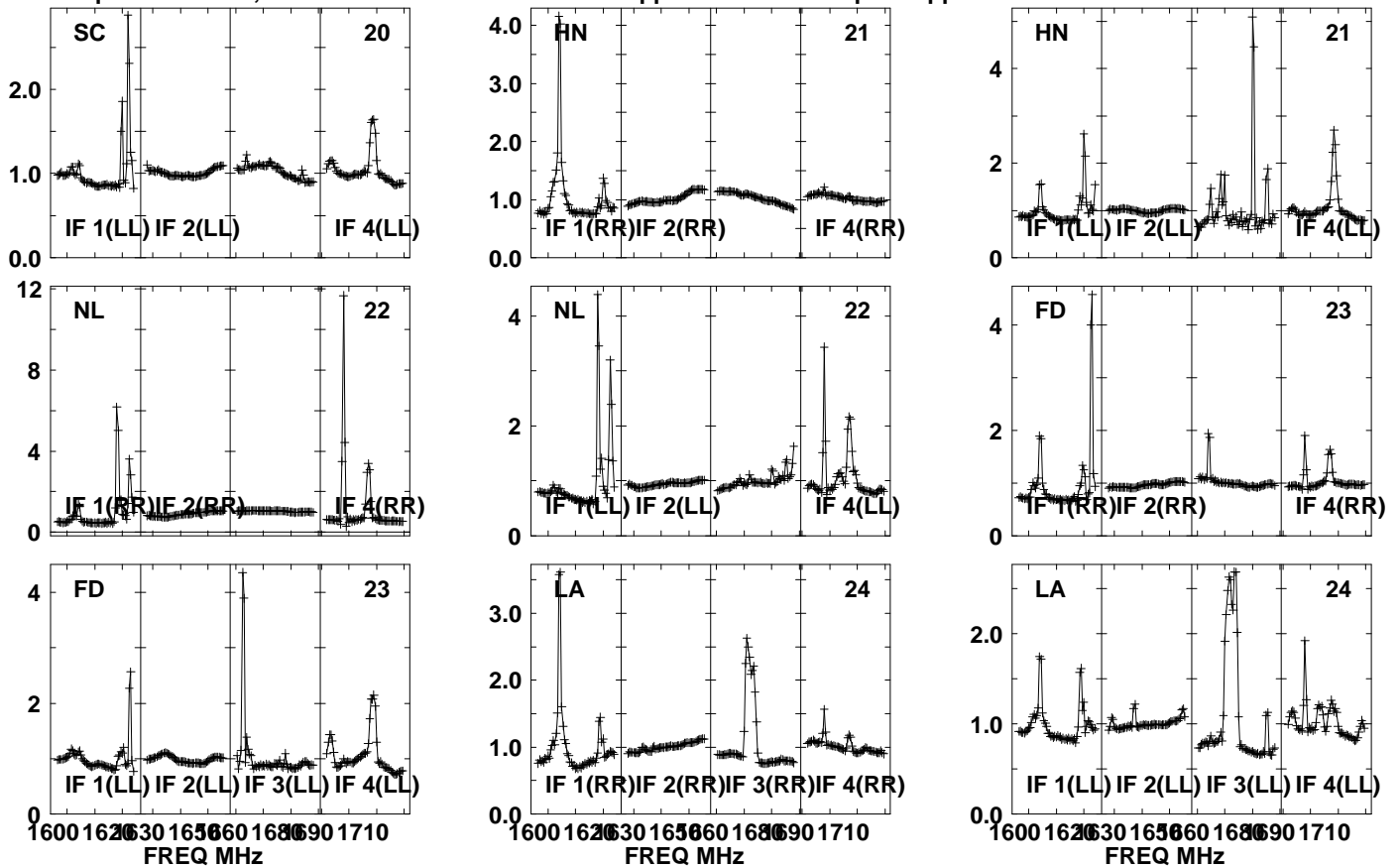

Lower frame: Real Jy  
Auto-corr total-power spectrum Antenna: \*  
Timerange: 00/15:49:31 to 00/15:50:59

Plot file version 576 created 05-OCT-2021 17:07:03

J0827+5217 GM076.UVDATA.1

Freq = 1.5945 GHz, Bw = 32.000 MH No calibration applied and no bandpass applied

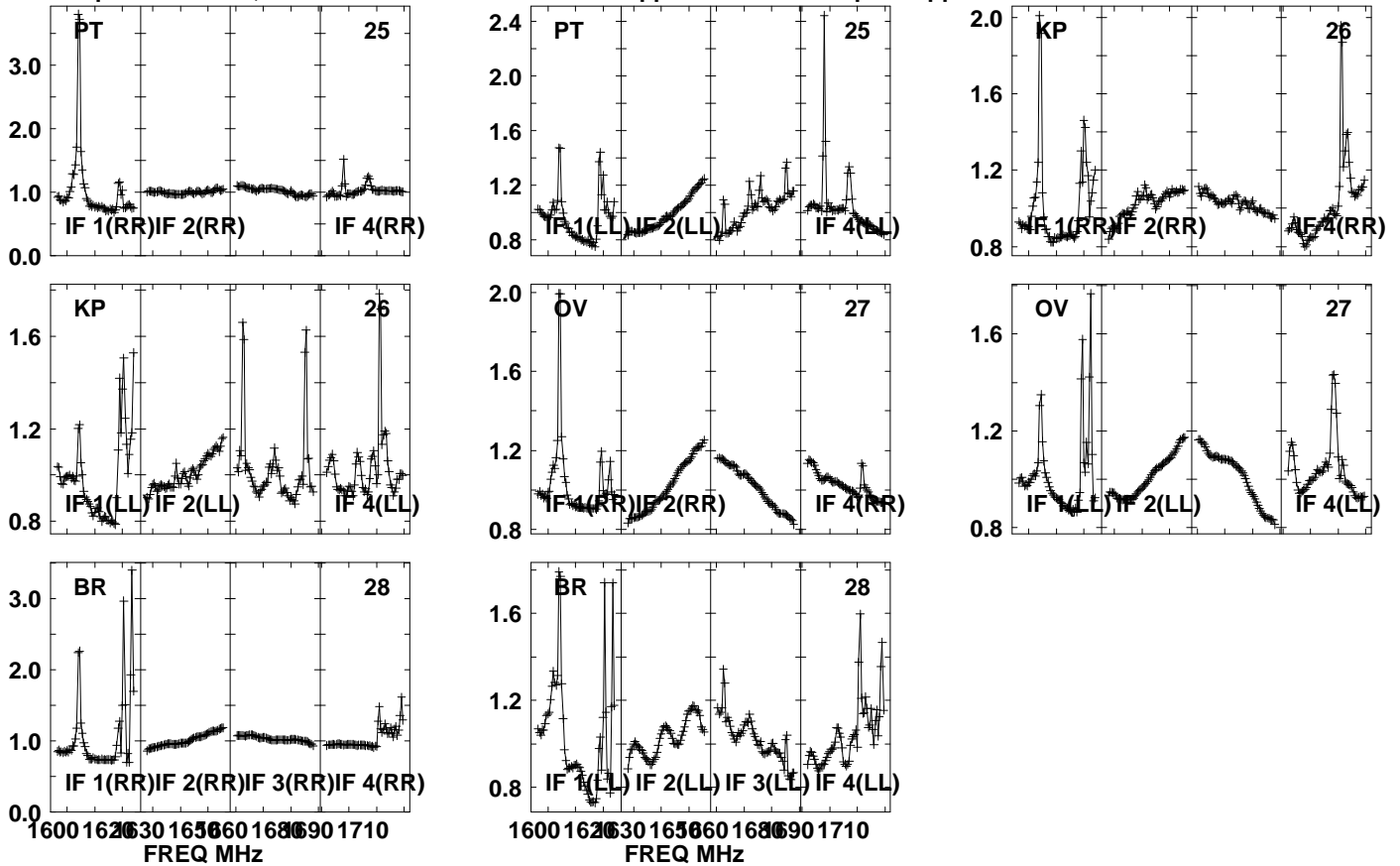

Lower frame: Real Jy

Auto-corr total-power spectrum Antenna: \*

Timerange: 00/15:49:31 to 00/15:50:59

Plot file version 577 created 05-OCT-2021 17:07:03

APM08279+525 GM076.UVDATA.1

Freq = 1.5945 GHz, Bw = 32.000 MH No calibration applied and no bandpass applied

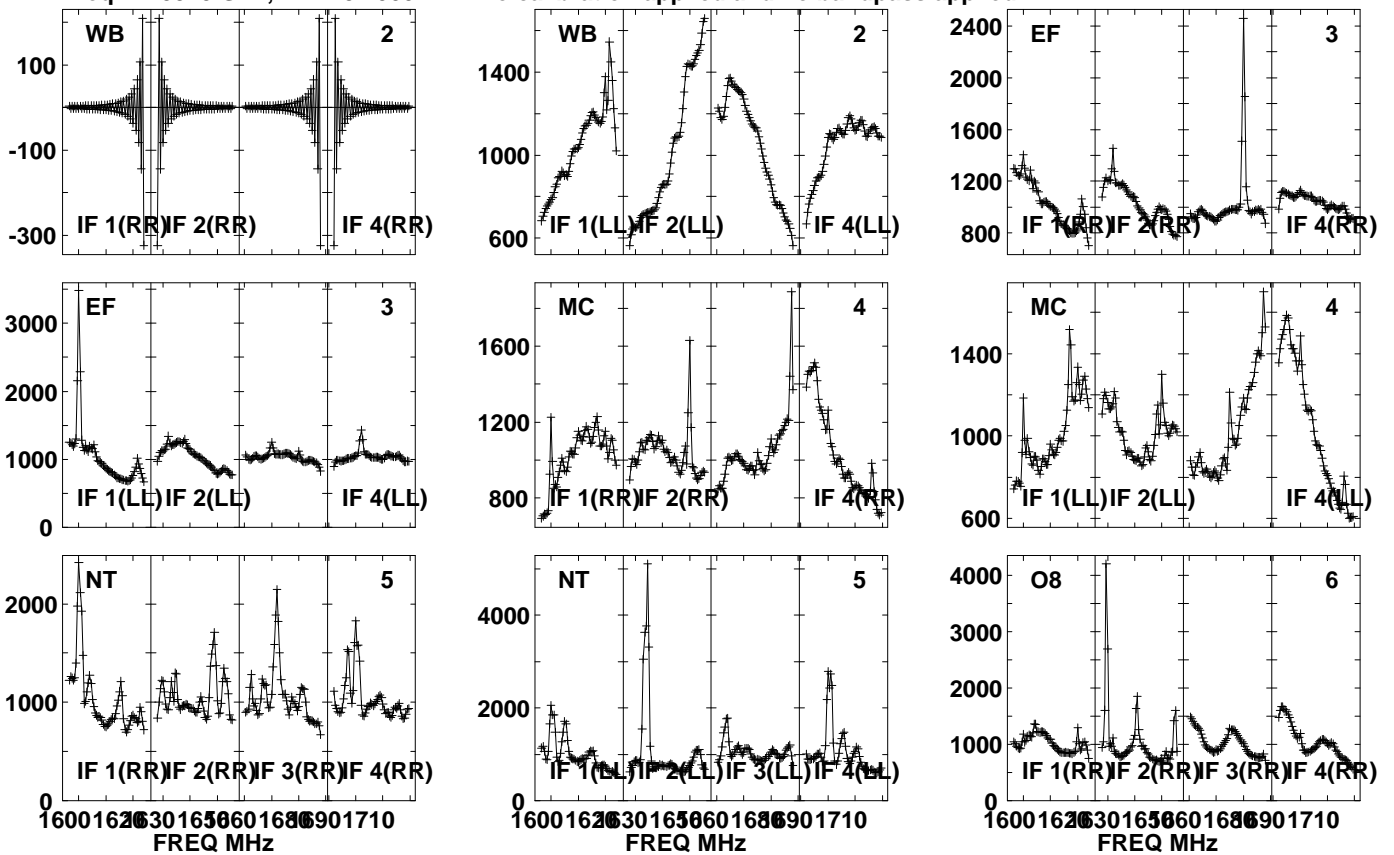

Lower frame: Milli Real Jy  
Auto-corr total-power spectrum Antenna: \*  
Timerange: 00/15:51:01 to 00/15:54:29

Plot file version 578 created 05-OCT-2021 17:07:03

APM08279+525 GM076.UVDATA.1

Freq = 1.5945 GHz, Bw = 32.000 MH No calibration applied and no bandpass applied

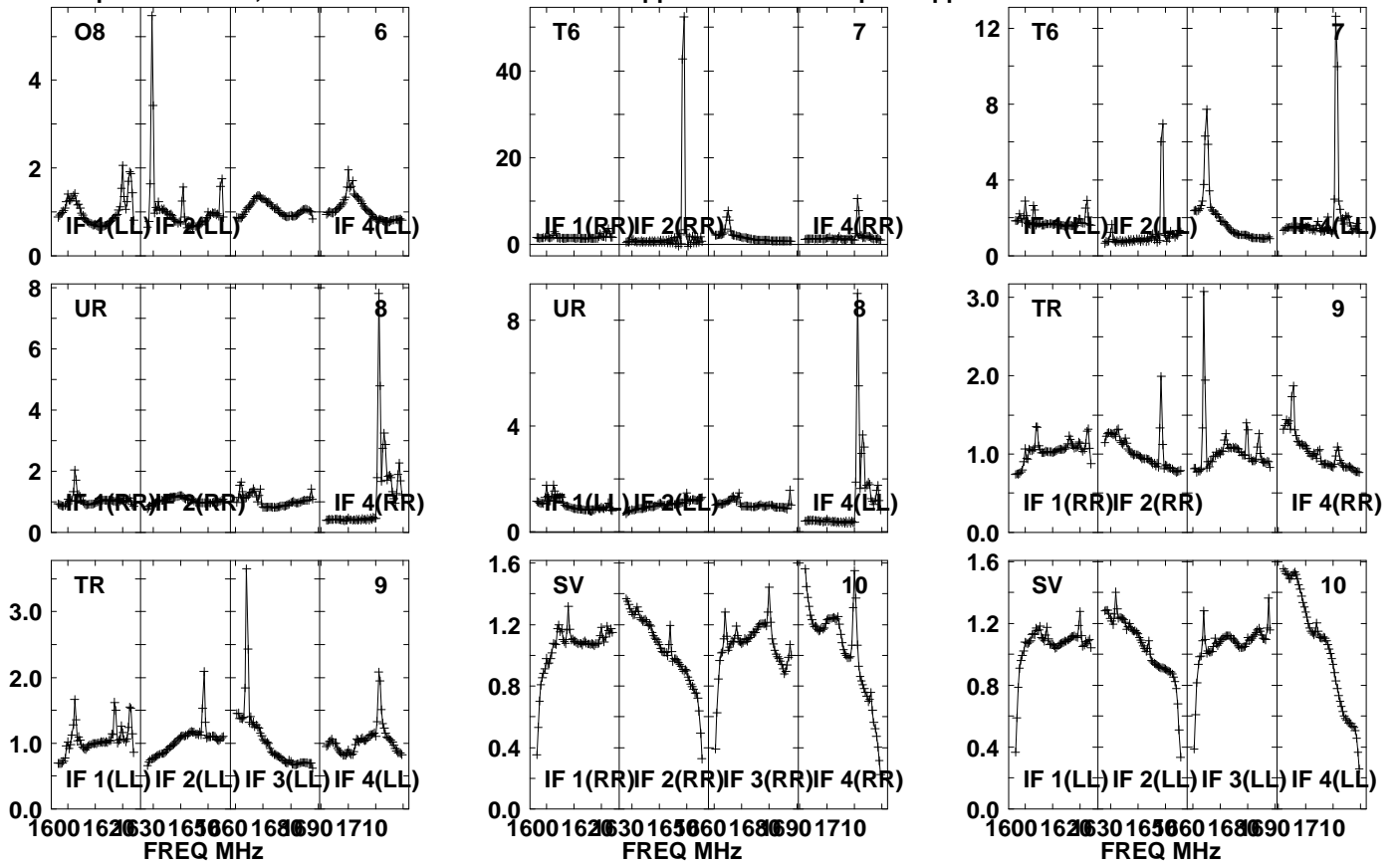

Lower frame: Real Jy  
Auto-corr total-power spectrum Antenna: \*  
Timerange: 00/15:51:01 to 00/15:54:29



Plot file version 579 created 05-OCT-2021 17:07:04

APM08279+525 GM076.UVDATA.1

Freq = 1.5945 GHz, Bw = 32.000 MH No calibration applied and no bandpass applied

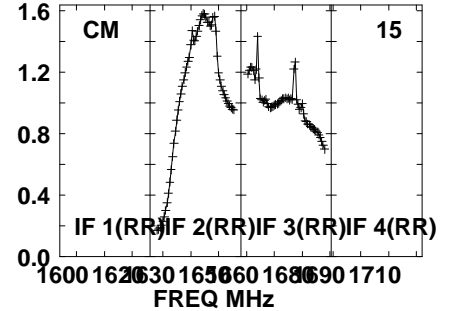
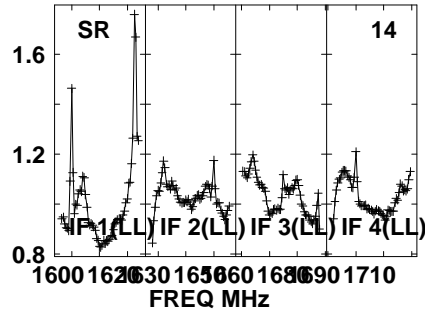
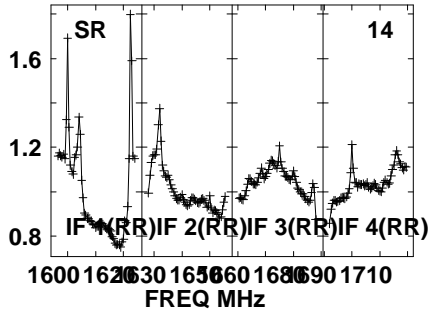
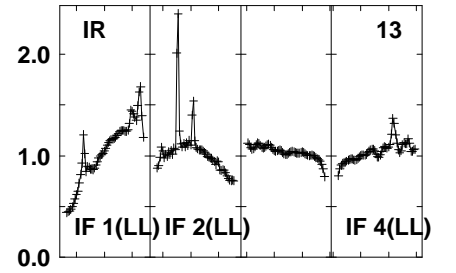
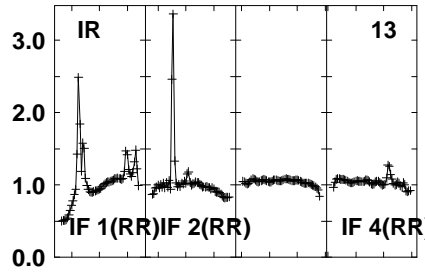
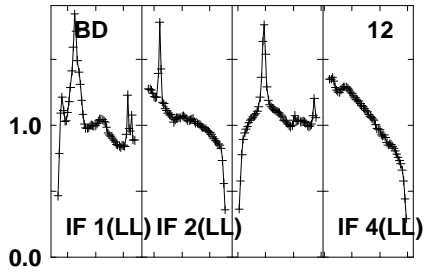
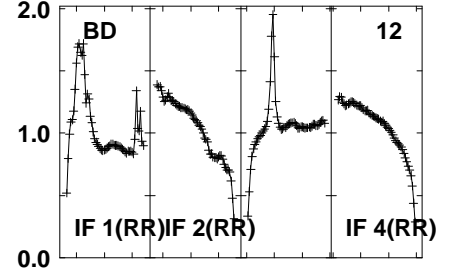
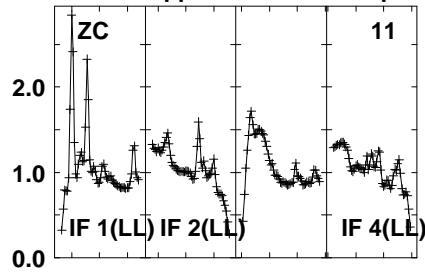
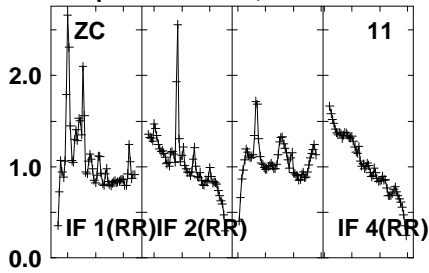

Lower frame: Real Jy  
Auto-corr total-power spectrum Antenna: \*  
Timerange: 00/15:51:01 to 00/15:54:29

Plot file version 580 created 05-OCT-2021 17:07:04

APM08279+525 GM076.UVDATA.1

Freq = 1.5945 GHz, Bw = 32.000 MH No calibration applied and no bandpass applied

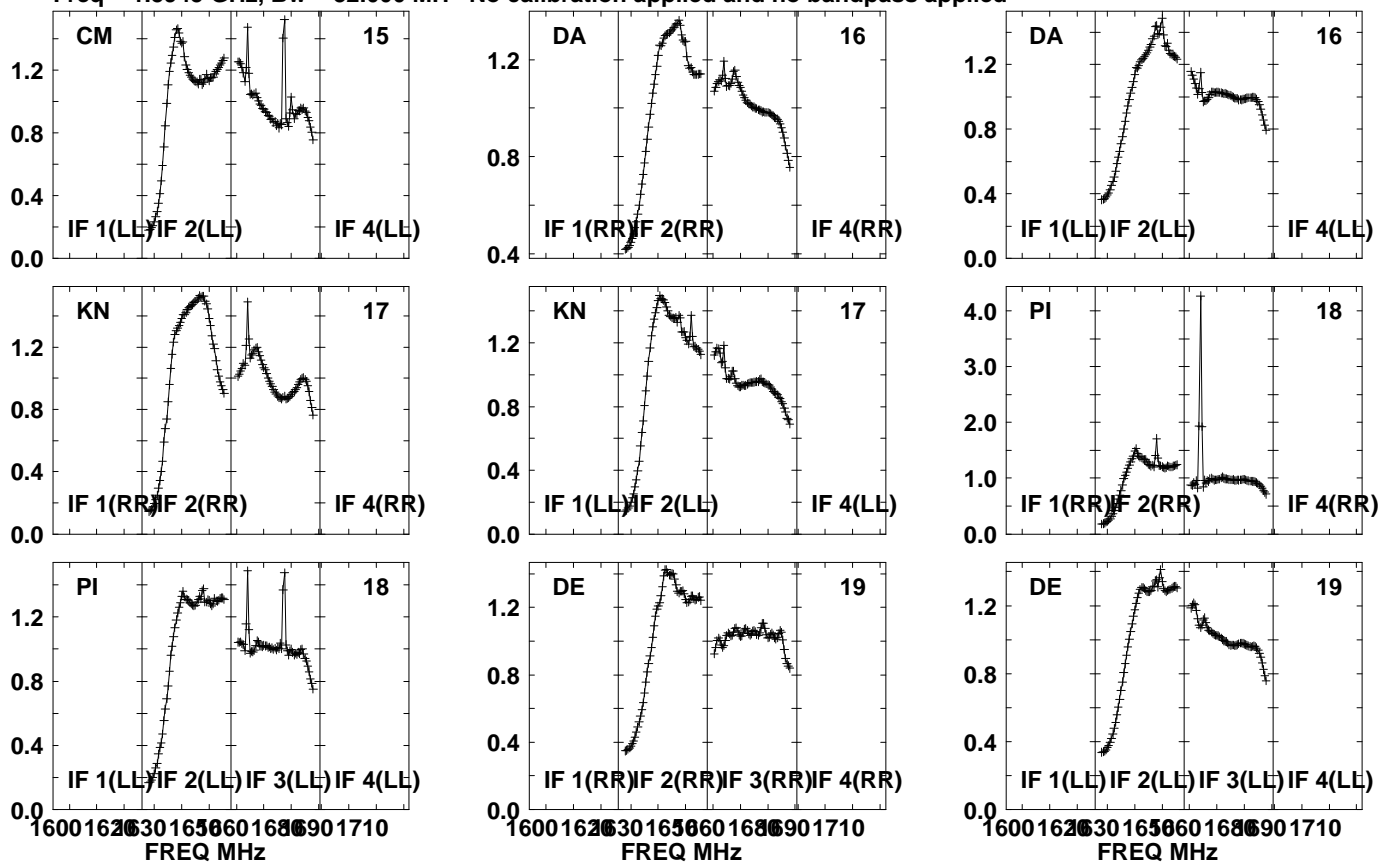

Lower frame: Real Jy  
Auto-corr total-power spectrum Antenna: \*  
Timerange: 00/15:51:01 to 00/15:54:29

Plot file version 581 created 05-OCT-2021 17:07:04

APM08279+525 GM076.UVDATA.1

Freq = 1.5945 GHz, Bw = 32.000 MH No calibration applied and no bandpass applied

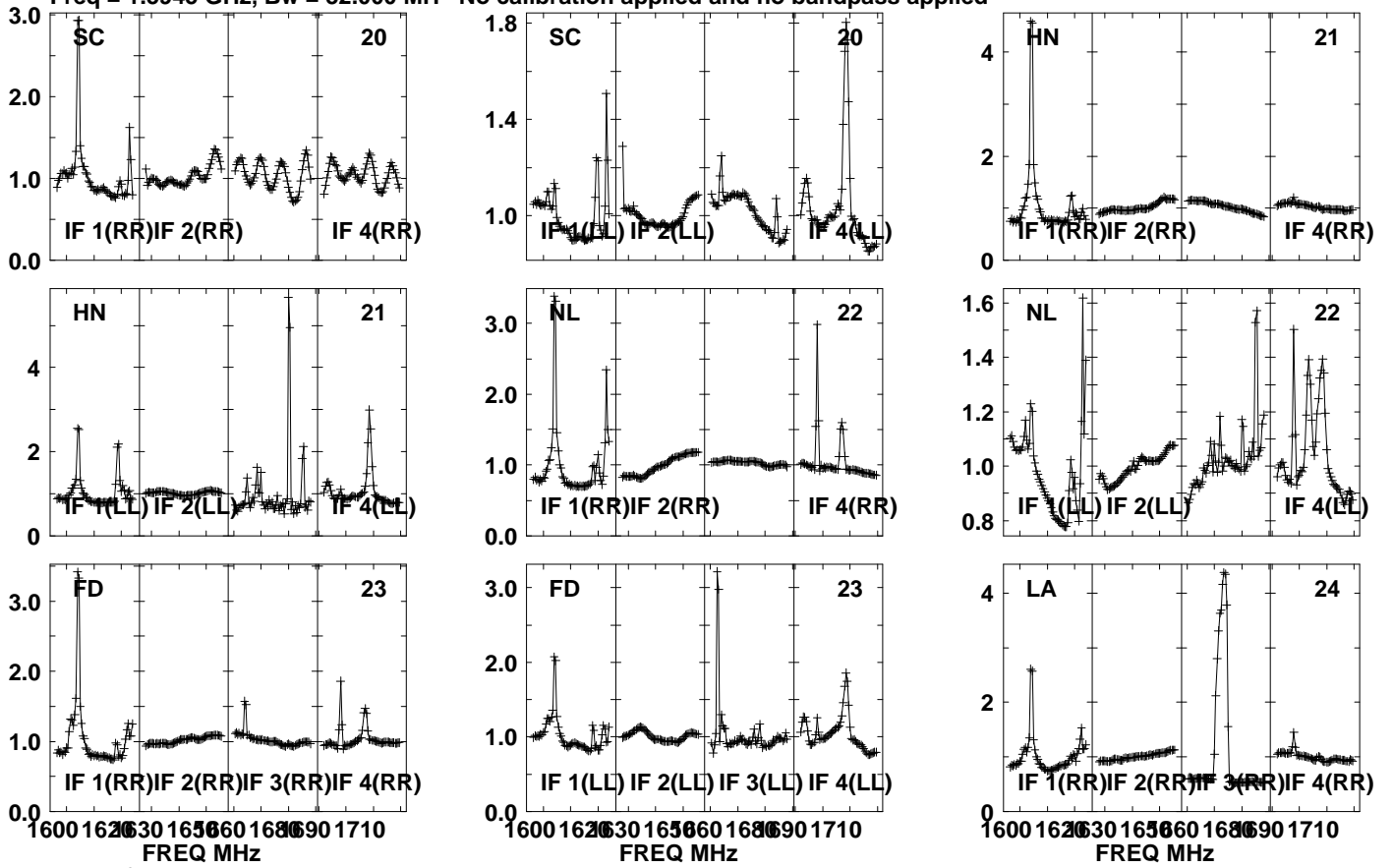

Lower frame: Real Jy  
Auto-corr total-power spectrum Antenna: \*  
Timerange: 00/15:51:01 to 00/15:54:29

Plot file version 582 created 05-OCT-2021 17:07:05

APM08279+525 GM076.UVDATA.1

Freq = 1.5945 GHz, Bw = 32.000 MH No calibration applied and no bandpass applied

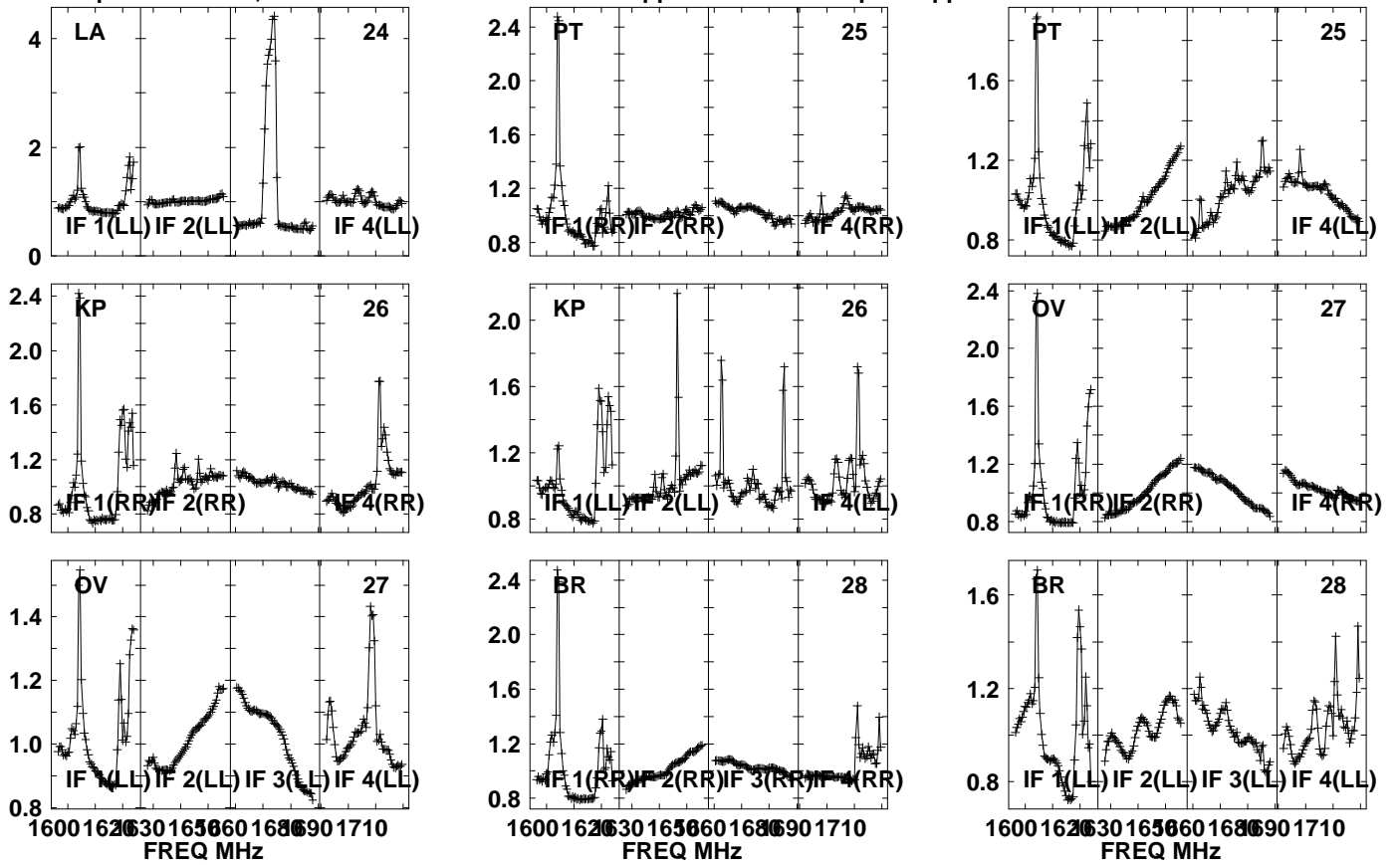

Lower frame: Real Jy  
Auto-corr total-power spectrum Antenna: \*  
Timerange: 00/15:51:01 to 00/15:54:29

Plot file version 583 created 05-OCT-2021 17:07:05

J0827+5217 GM076.UVDATA.1

Freq = 1.5945 GHz, Bw = 32.000 MH No calibration applied and no bandpass applied

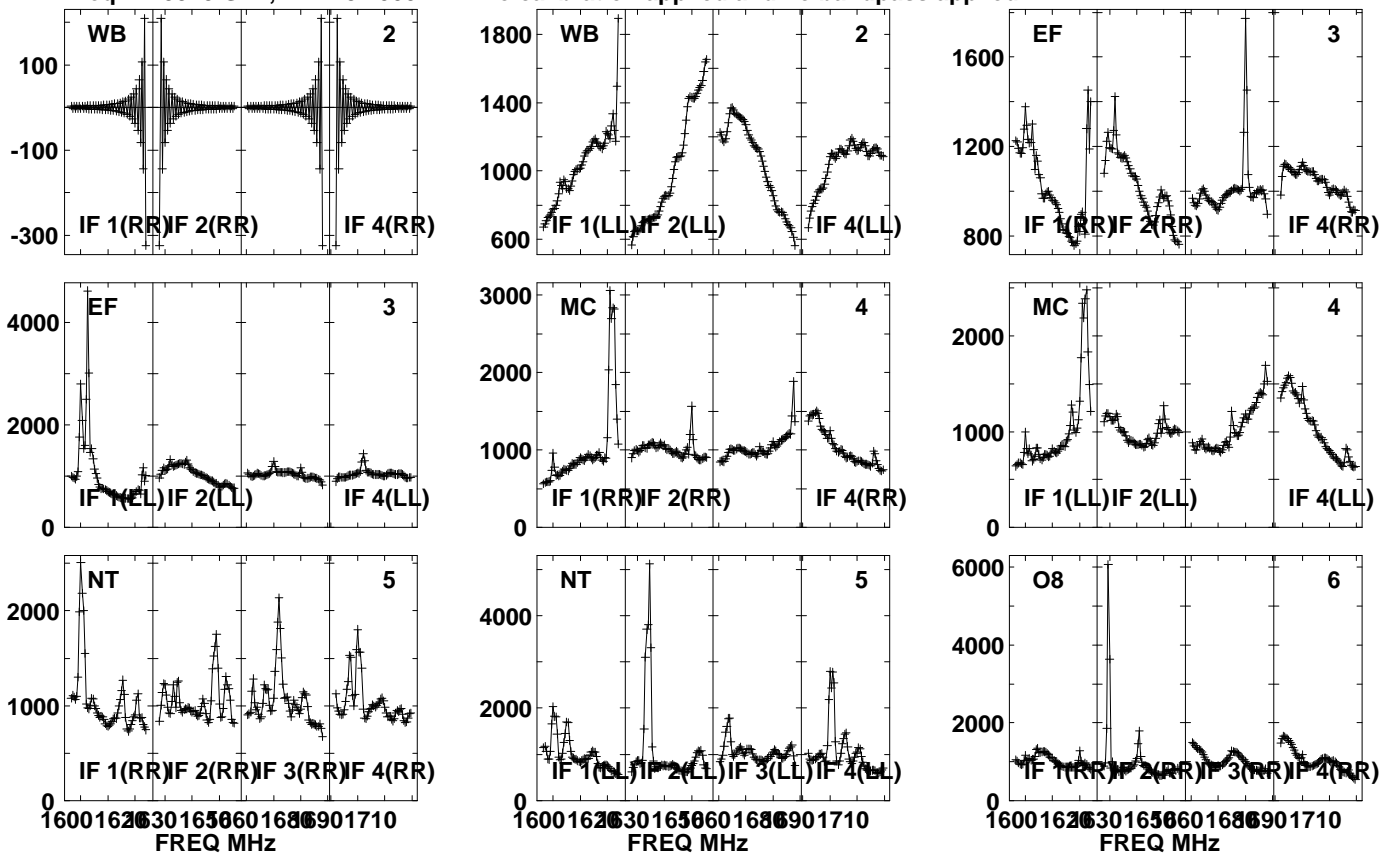

Lower frame: Milli Real Jy  
Auto-corr total-power spectrum Antenna: \*  
Timerange: 00/15:54:31 to 00/15:55:59

Plot file version 584 created 05-OCT-2021 17:07:05

J0827+5217 GM076.UVDATA.1

Freq = 1.5945 GHz, Bw = 32.000 MH No calibration applied and no bandpass applied

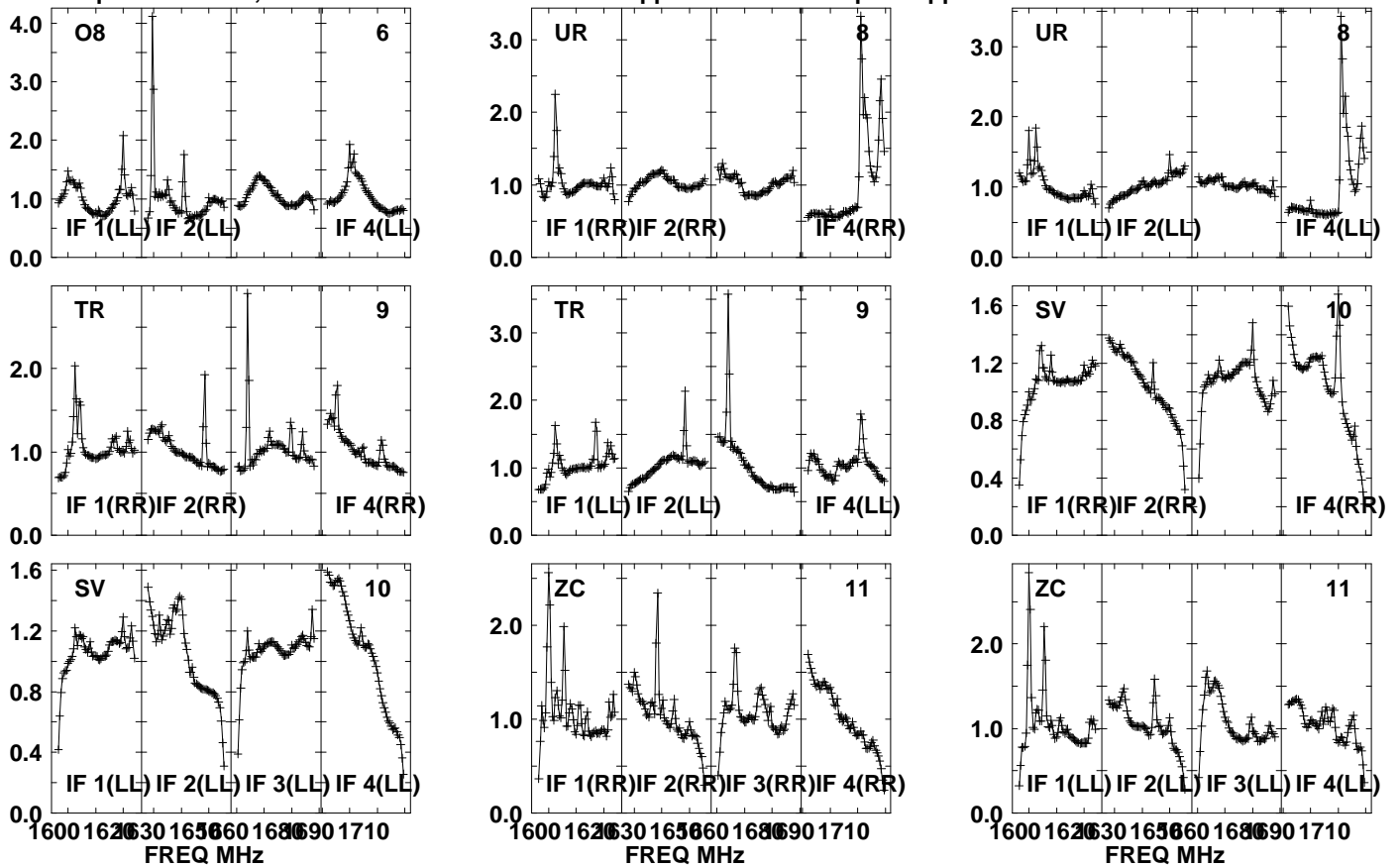

Lower frame: Real Jy

Auto-corr total-power spectrum Antenna: \*

Timerange: 00/15:54:31 to 00/15:55:59

Plot file version 585 created 05-OCT-2021 17:07:06

J0827+5217 GM076.UVDATA.1

Freq = 1.5945 GHz, Bw = 32.000 MH No calibration applied and no bandpass applied

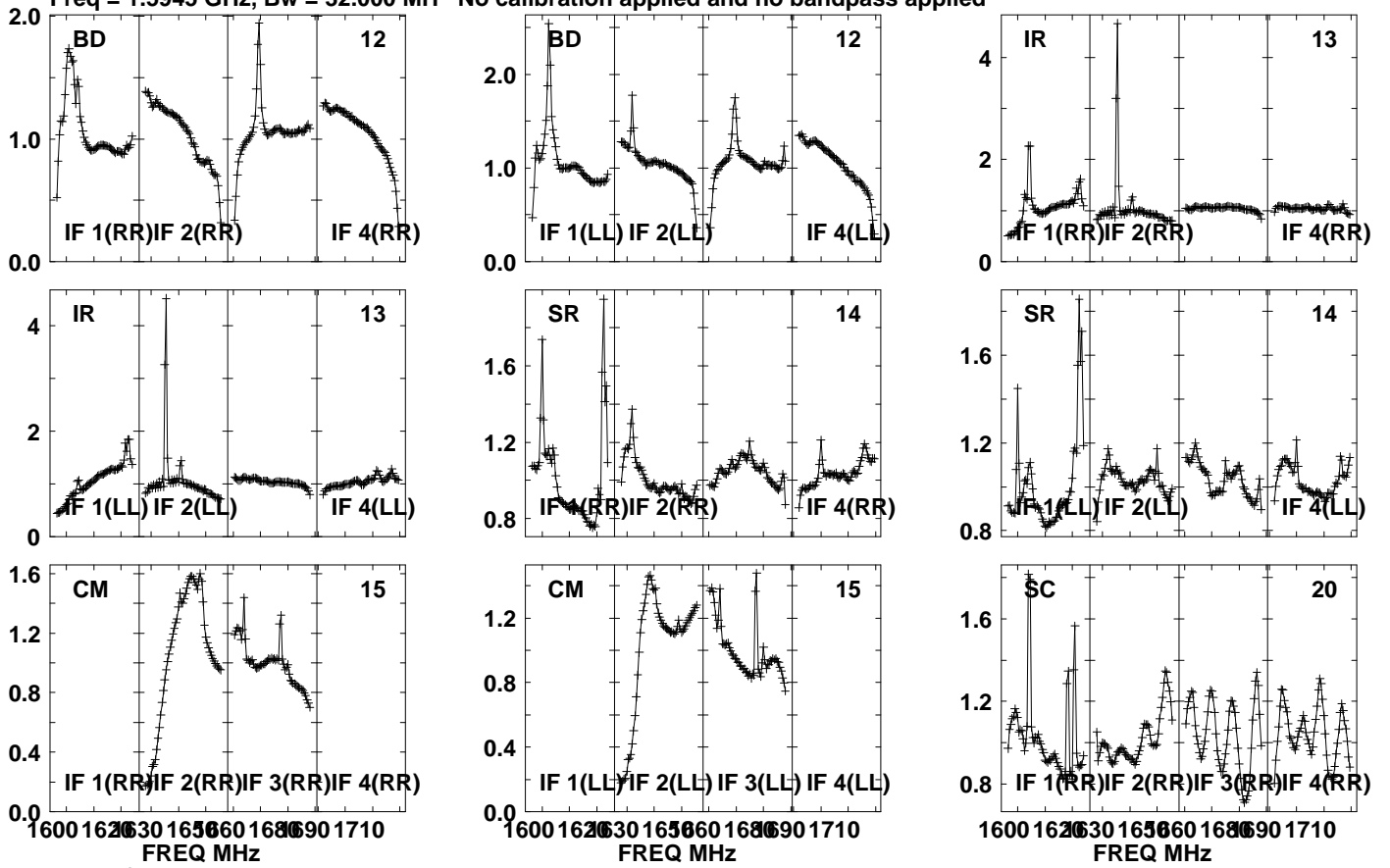

Lower frame: Real Jy  
Auto-corr total-power spectrum Antenna: \*  
Timerange: 00/15:54:31 to 00/15:55:59

Plot file version 586 created 05-OCT-2021 17:07:06

J0827+5217 GM076.UVDATA.1

Freq = 1.5945 GHz, Bw = 32.000 MH No calibration applied and no bandpass applied

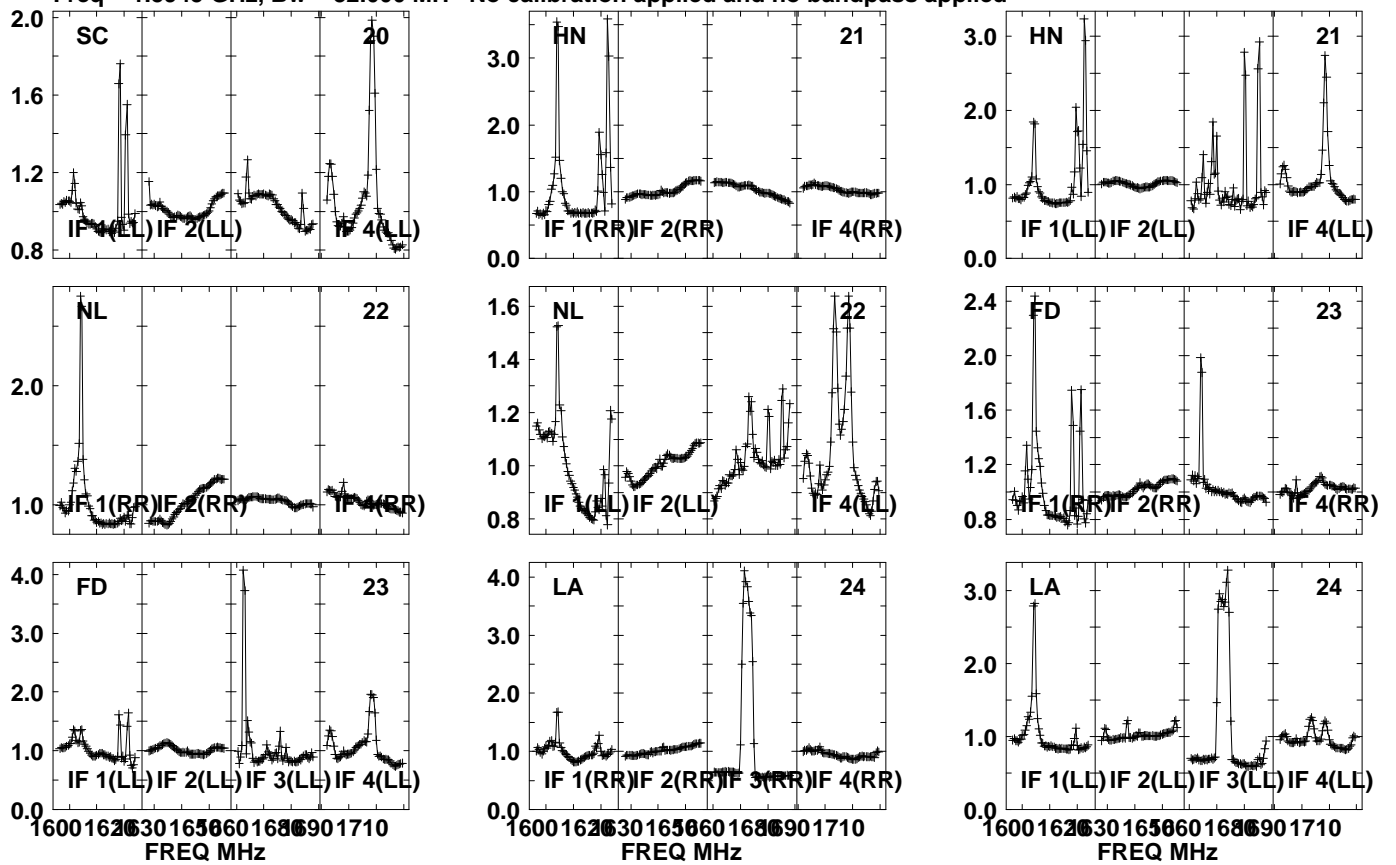

Lower frame: Real Jy  
Auto-corr total-power spectrum Antenna: \*  
Timerange: 00/15:54:31 to 00/15:55:59



Plot file version 587 created 05-OCT-2021 17:07:06

J0827+5217 GM076.UVDATA.1

Freq = 1.5945 GHz, Bw = 32.000 MH No calibration applied and no bandpass applied

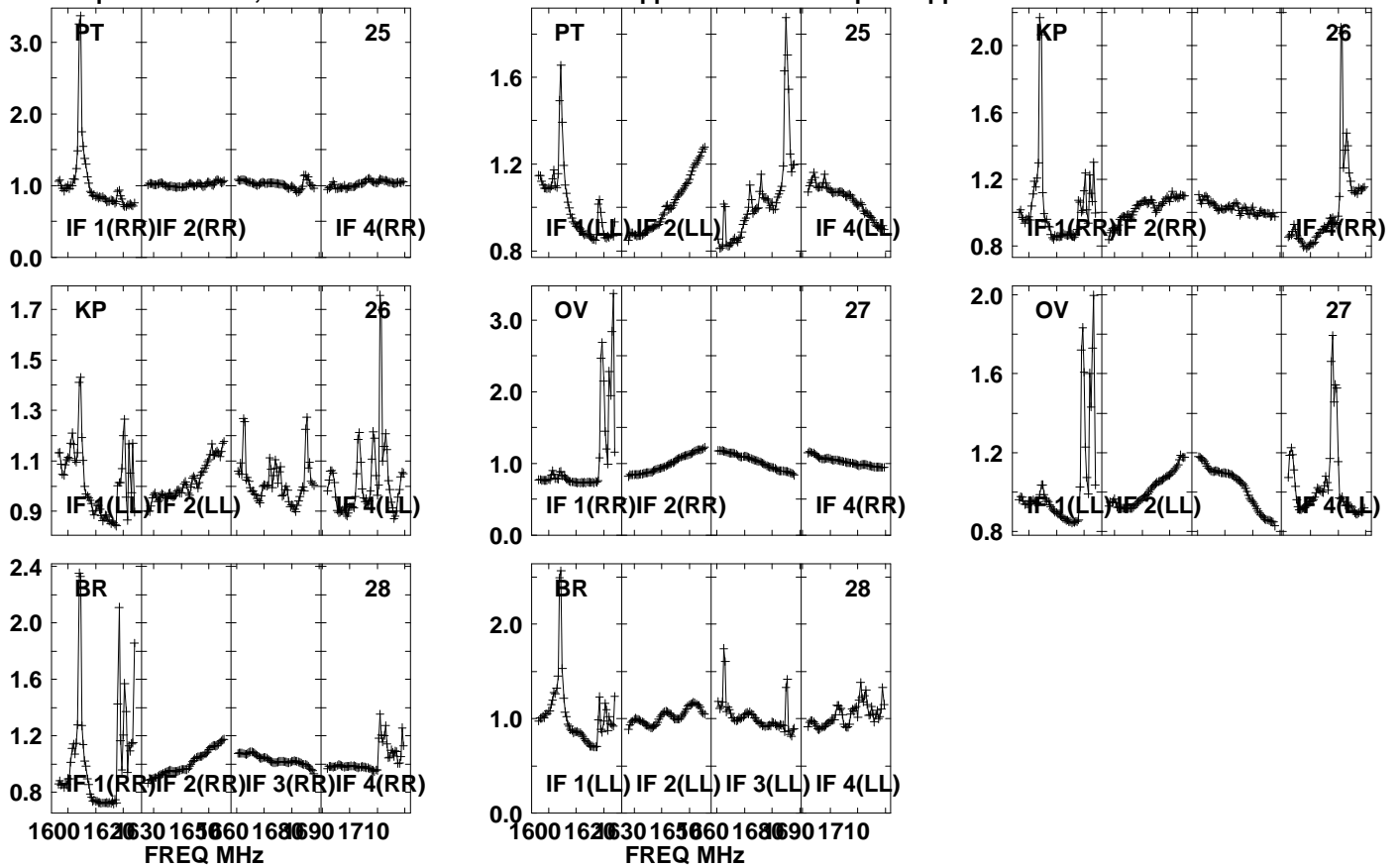

Lower frame: Real Jy

Auto-corr total-power spectrum Antenna: \*

Timerange: 00/15:54:31 to 00/15:55:59

Plot file version 588 created 05-OCT-2021 17:07:07

APM08279+525 GM076.UVDATA.1

Freq = 1.5945 GHz, Bw = 32.000 MH No calibration applied and no bandpass applied

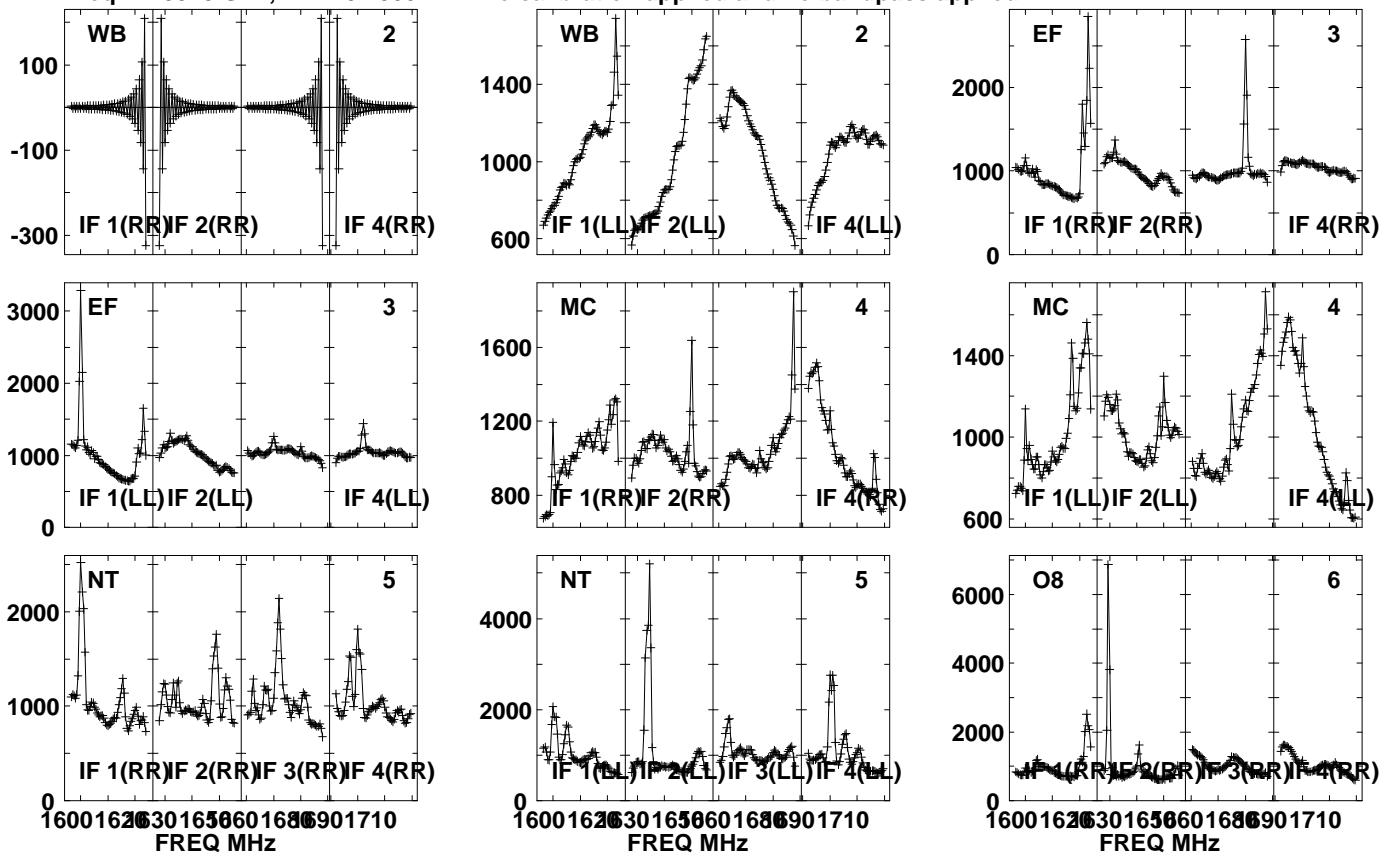

Lower frame: Milli Real Jy  
Auto-corr total-power spectrum Antenna: \*  
Timerange: 00/15:56:01 to 00/15:59:29

Plot file version 589 created 05-OCT-2021 17:07:07

APM08279+525 GM076.UVDATA.1

Freq = 1.5945 GHz, Bw = 32.000 MH No calibration applied and no bandpass applied

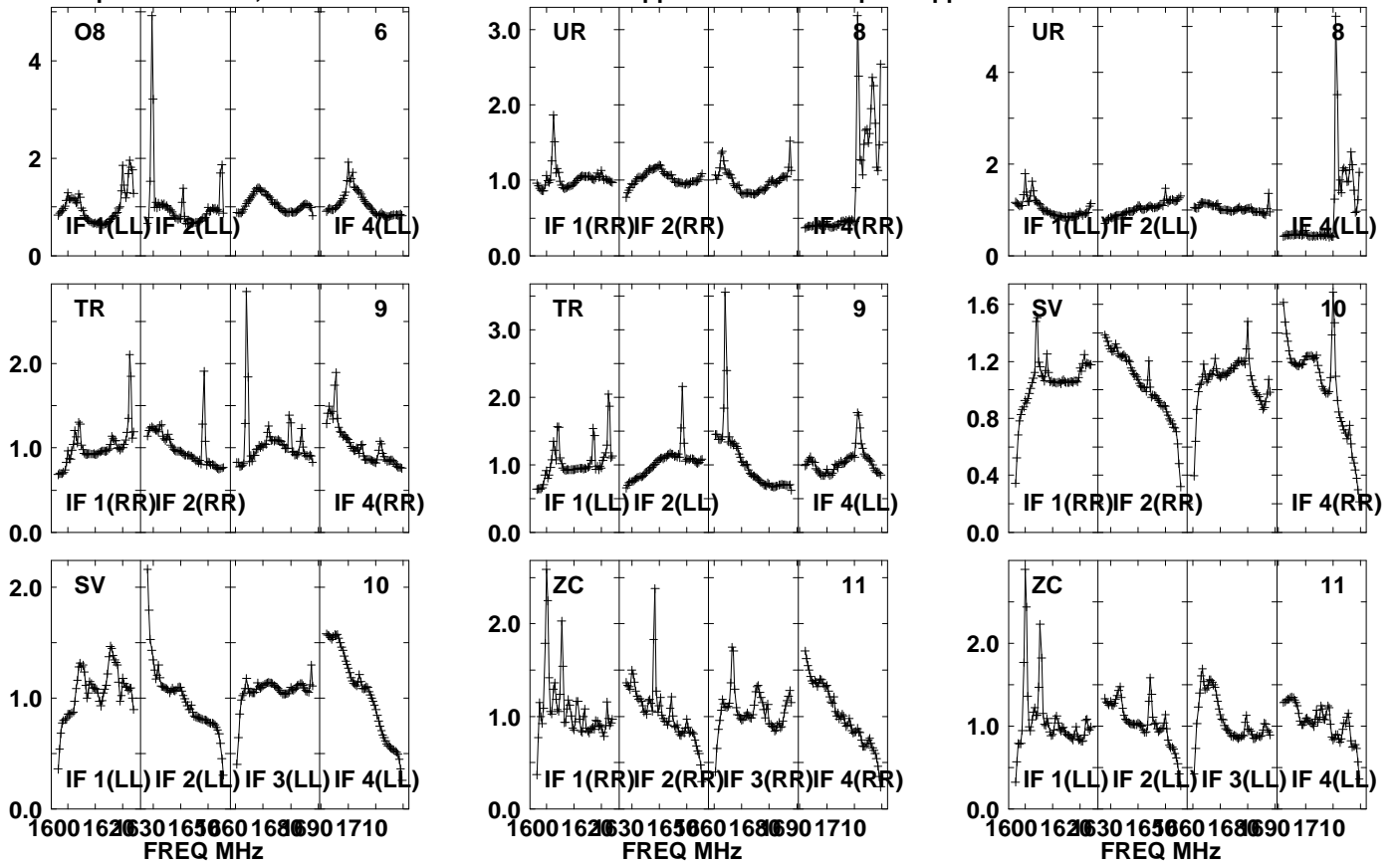

Lower frame: Real Jy  
Auto-corr total-power spectrum Antenna: \*  
Timerange: 00/15:56:01 to 00/15:59:29

Plot file version 590 created 05-OCT-2021 17:07:07

APM08279+525 GM076.UVDATA.1

Freq = 1.5945 GHz, Bw = 32.000 MH No calibration applied and no bandpass applied

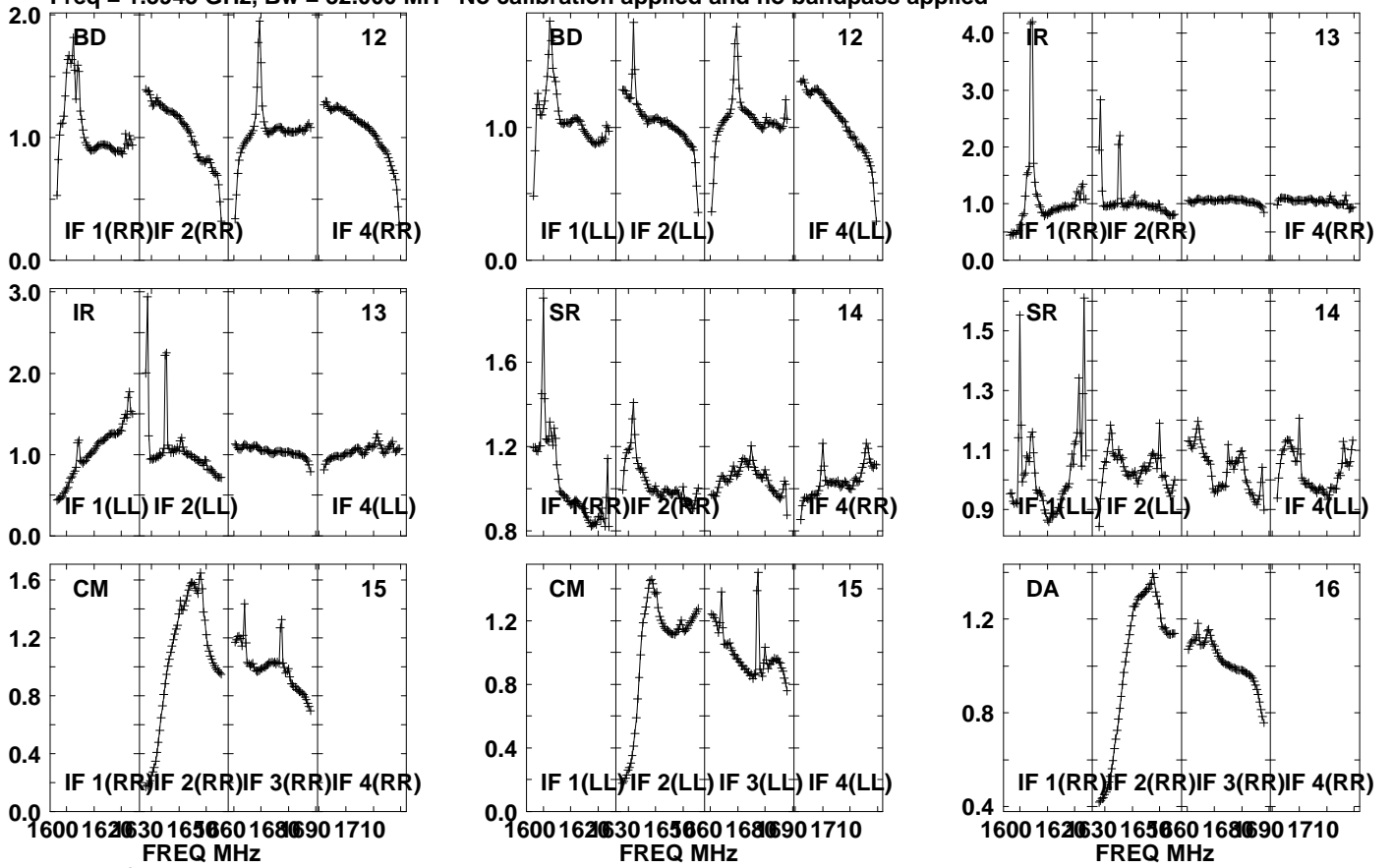

Lower frame: Real Jy

Auto-corr total-power spectrum Antenna: \*

Timerange: 00/15:56:01 to 00/15:59:29

Plot file version 591 created 05-OCT-2021 17:07:08

APM08279+525 GM076.UVDATA.1

Freq = 1.5945 GHz, Bw = 32.000 MH No calibration applied and no bandpass applied

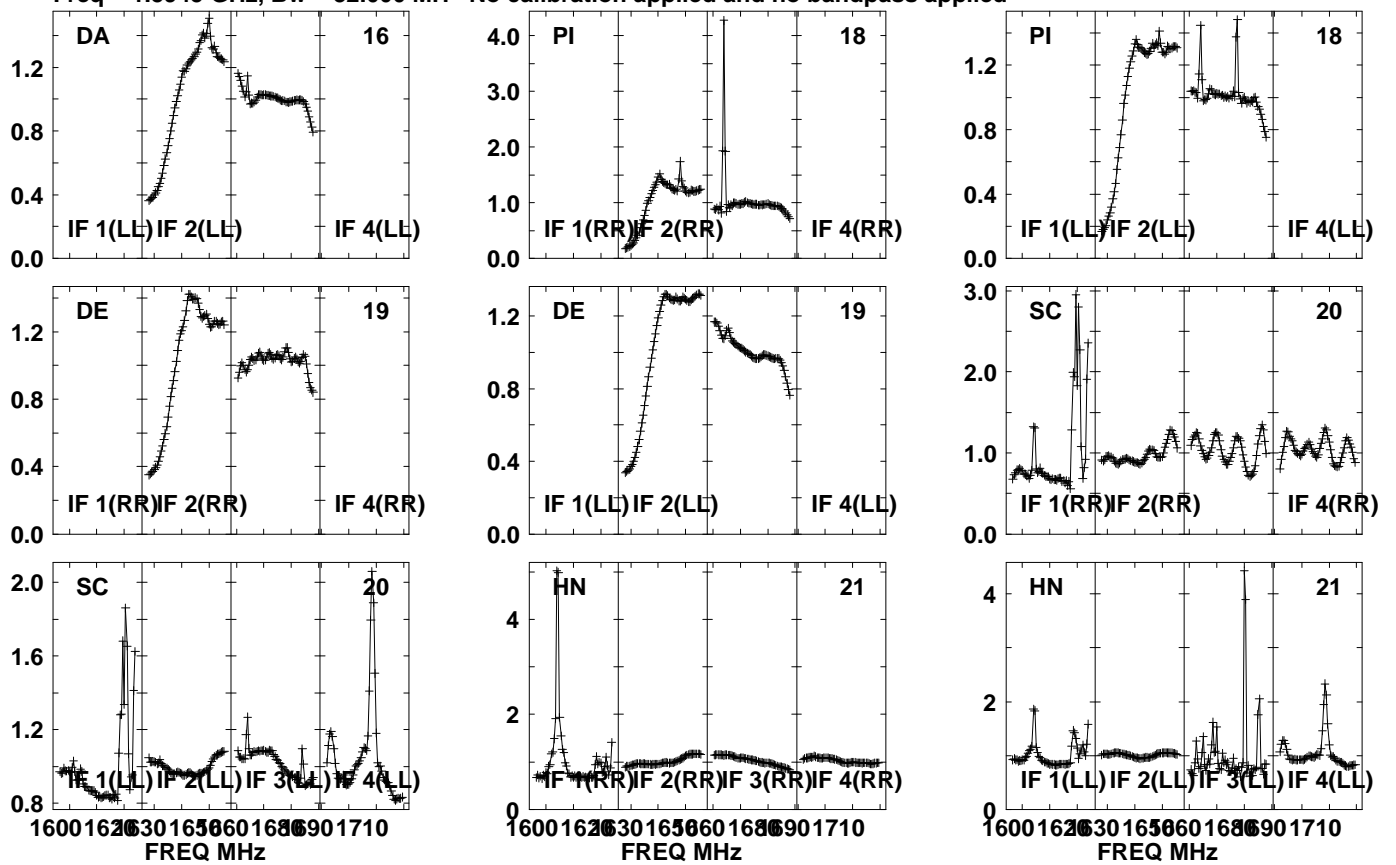

Lower frame: Real Jy  
Auto-corr total-power spectrum Antenna: \*  
Timerange: 00/15:56:01 to 00/15:59:29

Plot file version 592 created 05-OCT-2021 17:07:08

APM08279+525 GM076.UVDATA.1

Freq = 1.5945 GHz, Bw = 32.000 MH No calibration applied and no bandpass applied

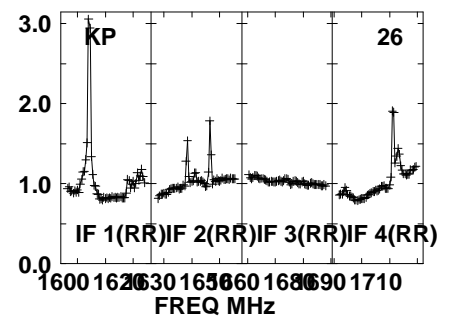
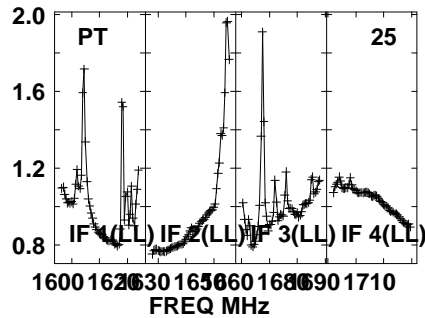
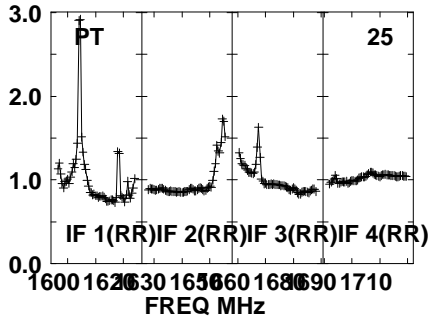
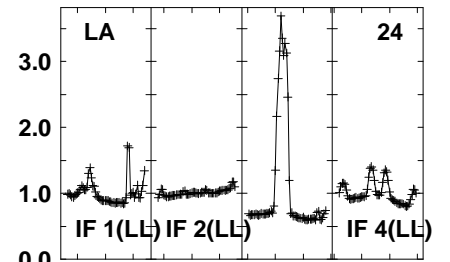
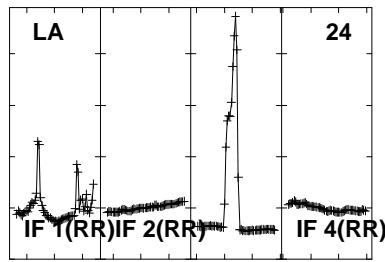
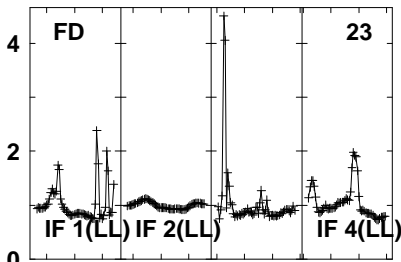
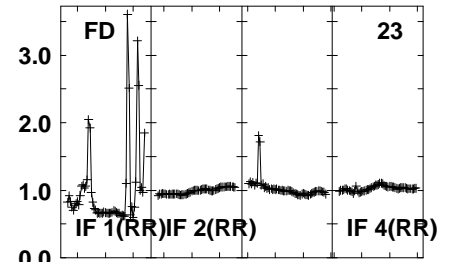
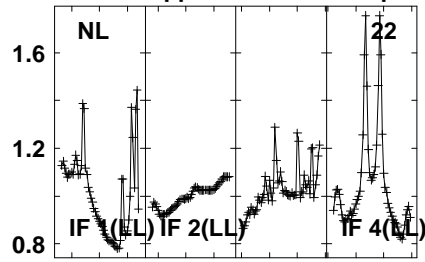
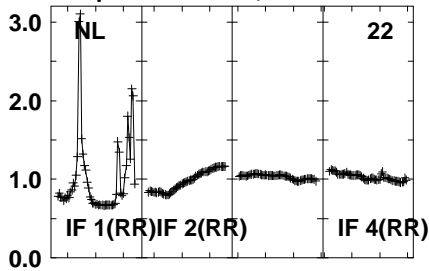

Lower frame: Real Jy

Auto-corr total-power spectrum Antenna: \*

Timerange: 00/15:56:01 to 00/15:59:29

Plot file version 593 created 05-OCT-2021 17:07:08

APM08279+525 GM076.UVDATA.1

Freq = 1.5945 GHz, Bw = 32.000 MH No calibration applied and no bandpass applied

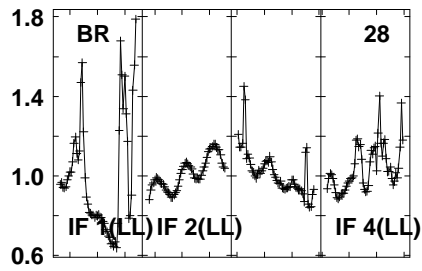
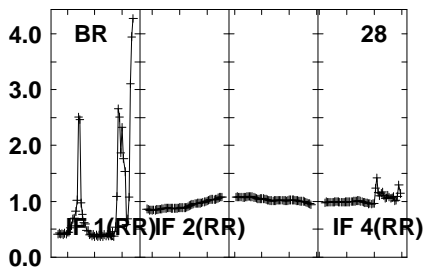
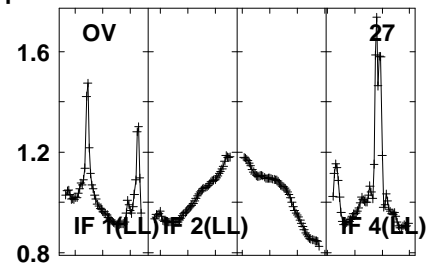
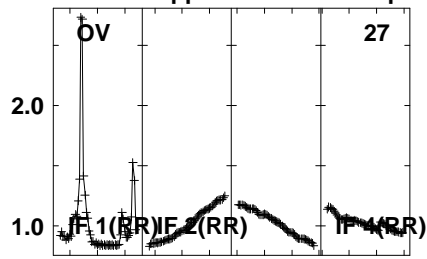
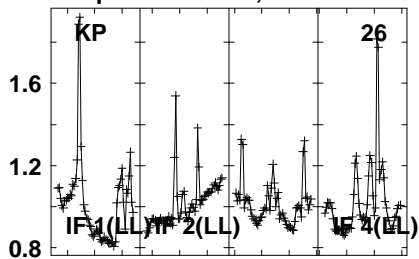

Lower frame: Real Jy  
Auto-corr total-power spectrum Antenna: \*  
Timerange: 00/15:56:01 to 00/15:59:29

Plot file version 594 created 05-OCT-2021 17:07:09

J0827+5217 GM076.UVDATA.1

Freq = 1.5945 GHz, Bw = 32.000 MH No calibration applied and no bandpass applied

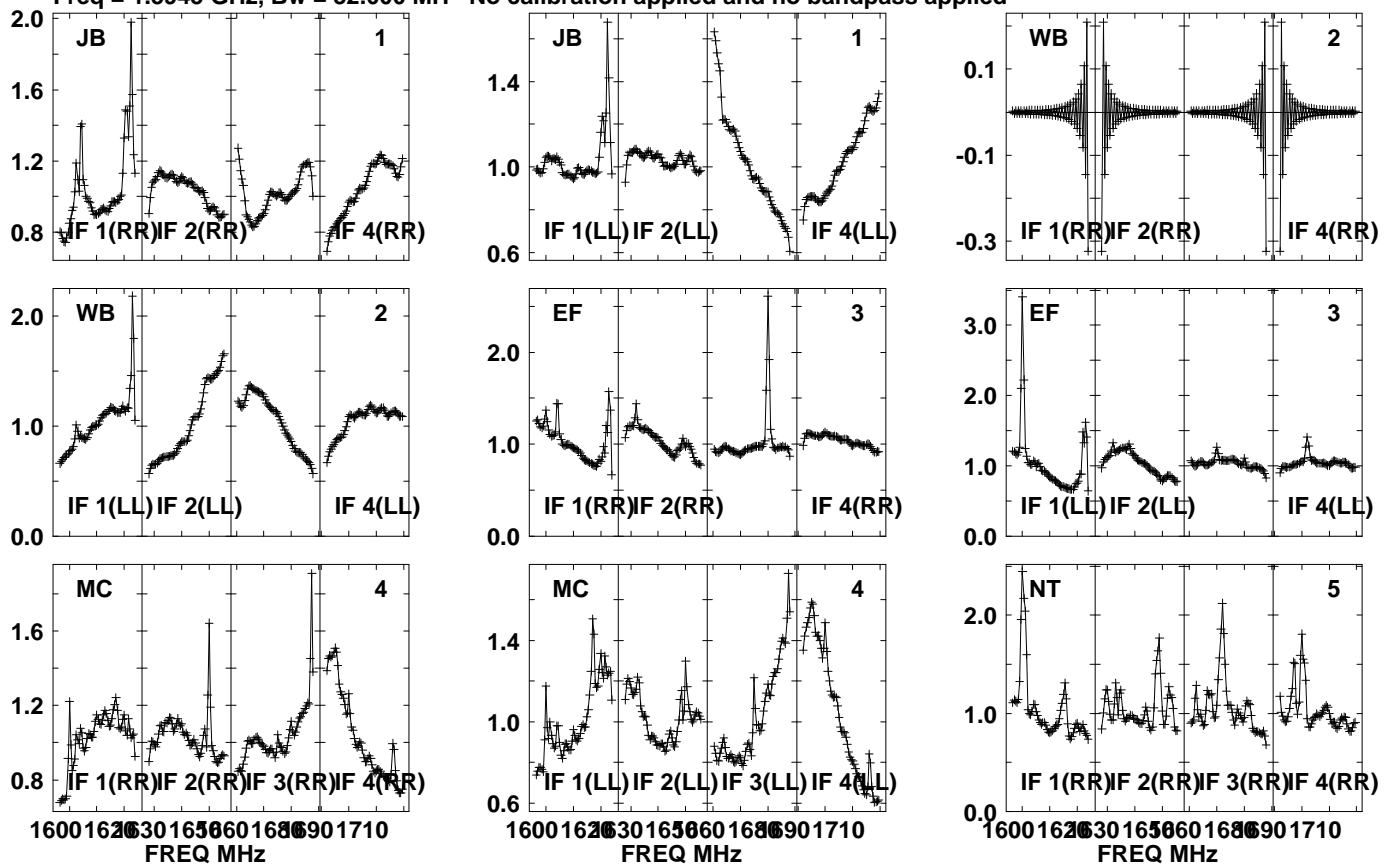

Lower frame: Real Jy  
Auto-corr total-power spectrum Antenna: \*  
Timerange: 00/16:00:01 to 00/16:01:29



Plot file version 595 created 05-OCT-2021 17:07:09

J0827+5217 GM076.UVDATA.1

Freq = 1.5945 GHz, Bw = 32.000 MH No calibration applied and no bandpass applied

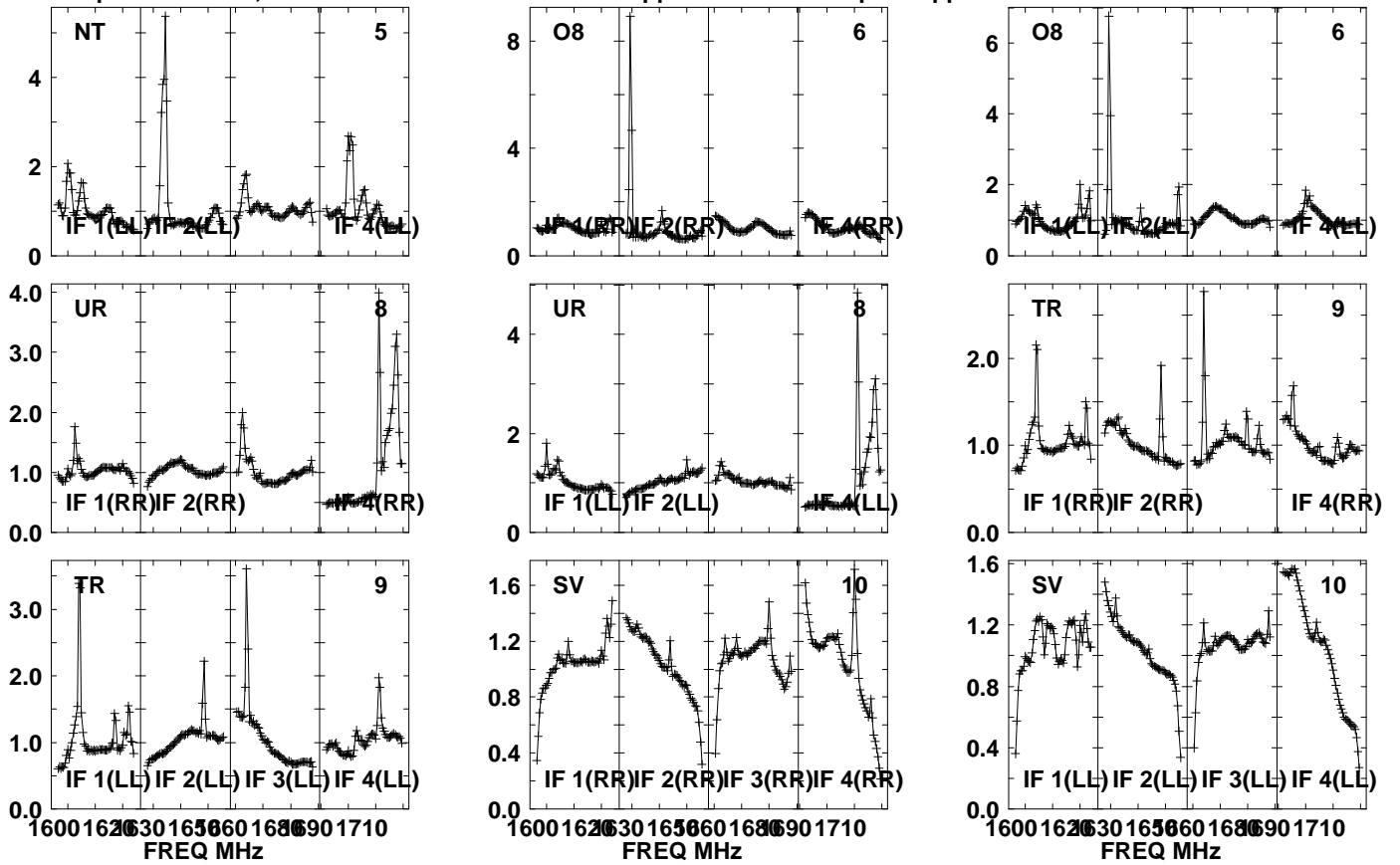

Lower frame: Real Jy

Auto-corr total-power spectrum Antenna: \*

Timerange: 00/16:00:01 to 00/16:01:29

Plot file version 596 created 05-OCT-2021 17:07:09

J0827+5217 GM076.UVDATA.1

Freq = 1.5945 GHz, Bw = 32.000 MH No calibration applied and no bandpass applied

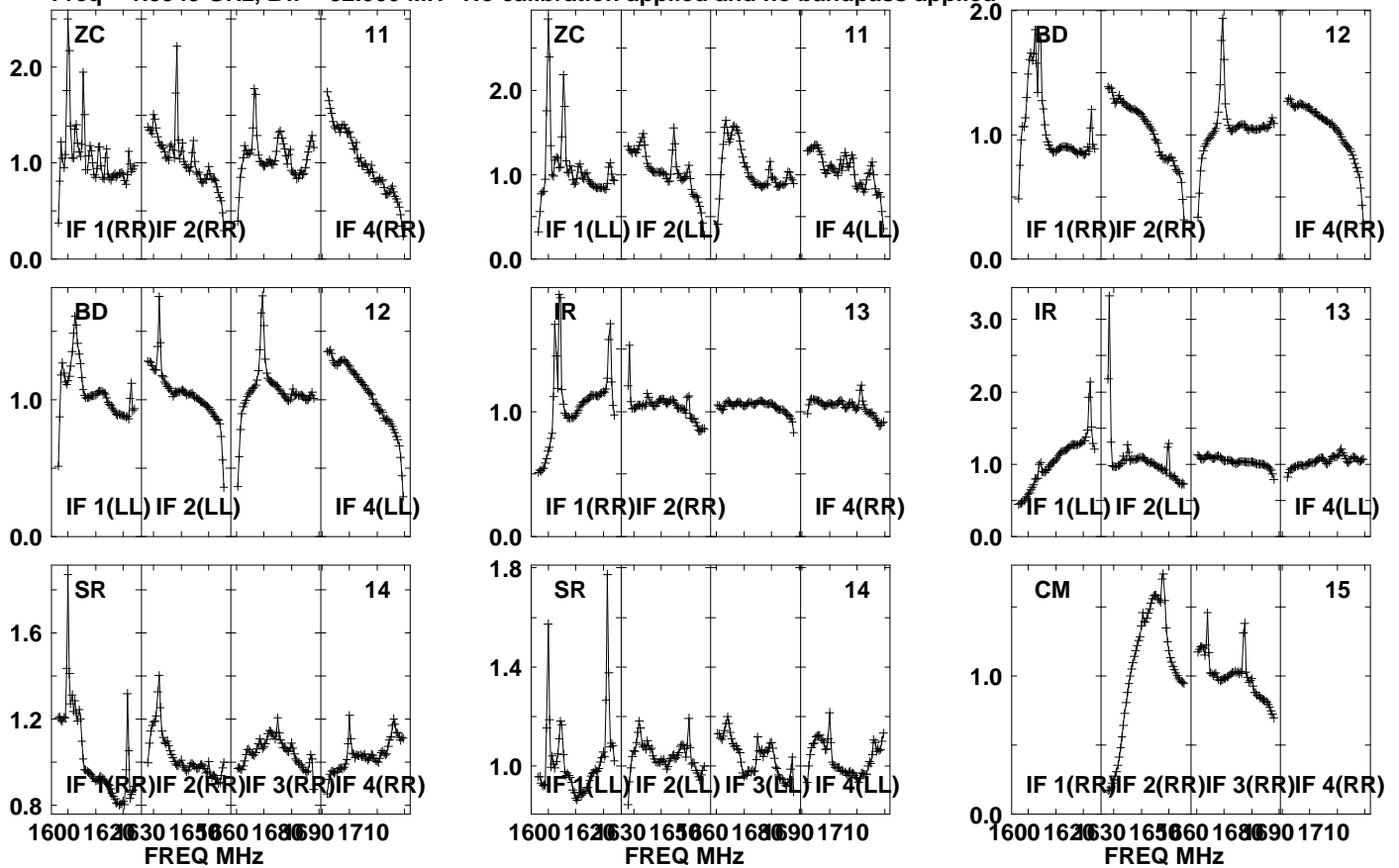

Lower frame: Real Jy

Auto-corr total-power spectrum Antenna: \*

Timerange: 00/16:00:01 to 00/16:01:29

Plot file version 597 created 05-OCT-2021 17:07:10

J0827+5217 GM076.UVDATA.1

Freq = 1.5945 GHz, Bw = 32.000 MH No calibration applied and no bandpass applied

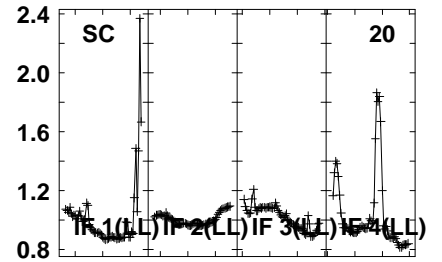
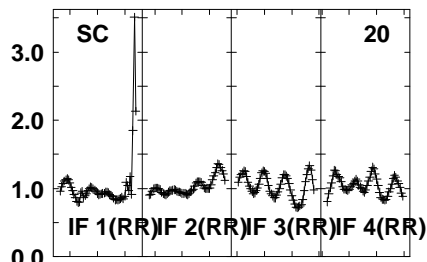
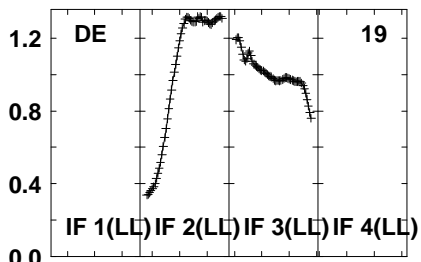
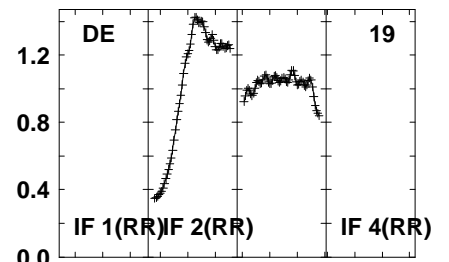
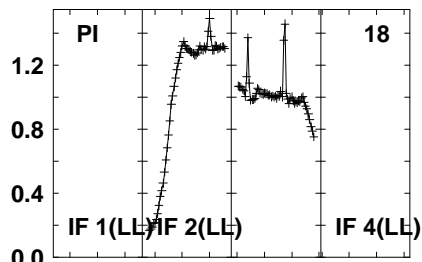
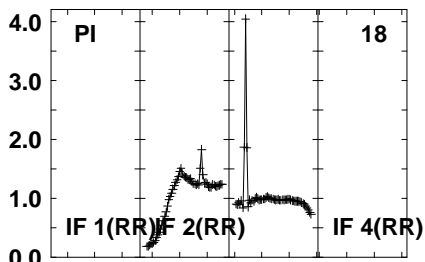
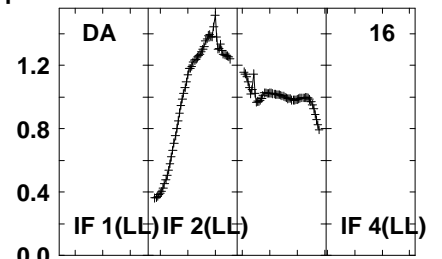
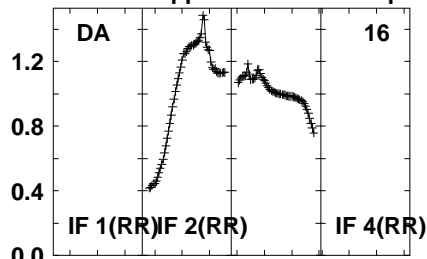
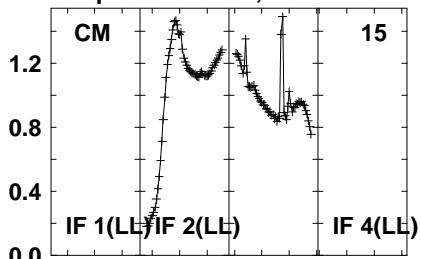

1600 1625 1650 1675 1700 1710  
FREQ MHz

1600 1625 1650 1675 1700 1710  
FREQ MHz

1600 1625 1650 1675 1700 1710  
FREQ MHz

Lower frame: Real Jy  
Auto-corr total-power spectrum Antenna: \*  
Timerange: 00/16:00:01 to 00/16:01:29

Plot file version 598 created 05-OCT-2021 17:07:10

J0827+5217 GM076.UVDATA.1

Freq = 1.5945 GHz, Bw = 32.000 MH No calibration applied and no bandpass applied

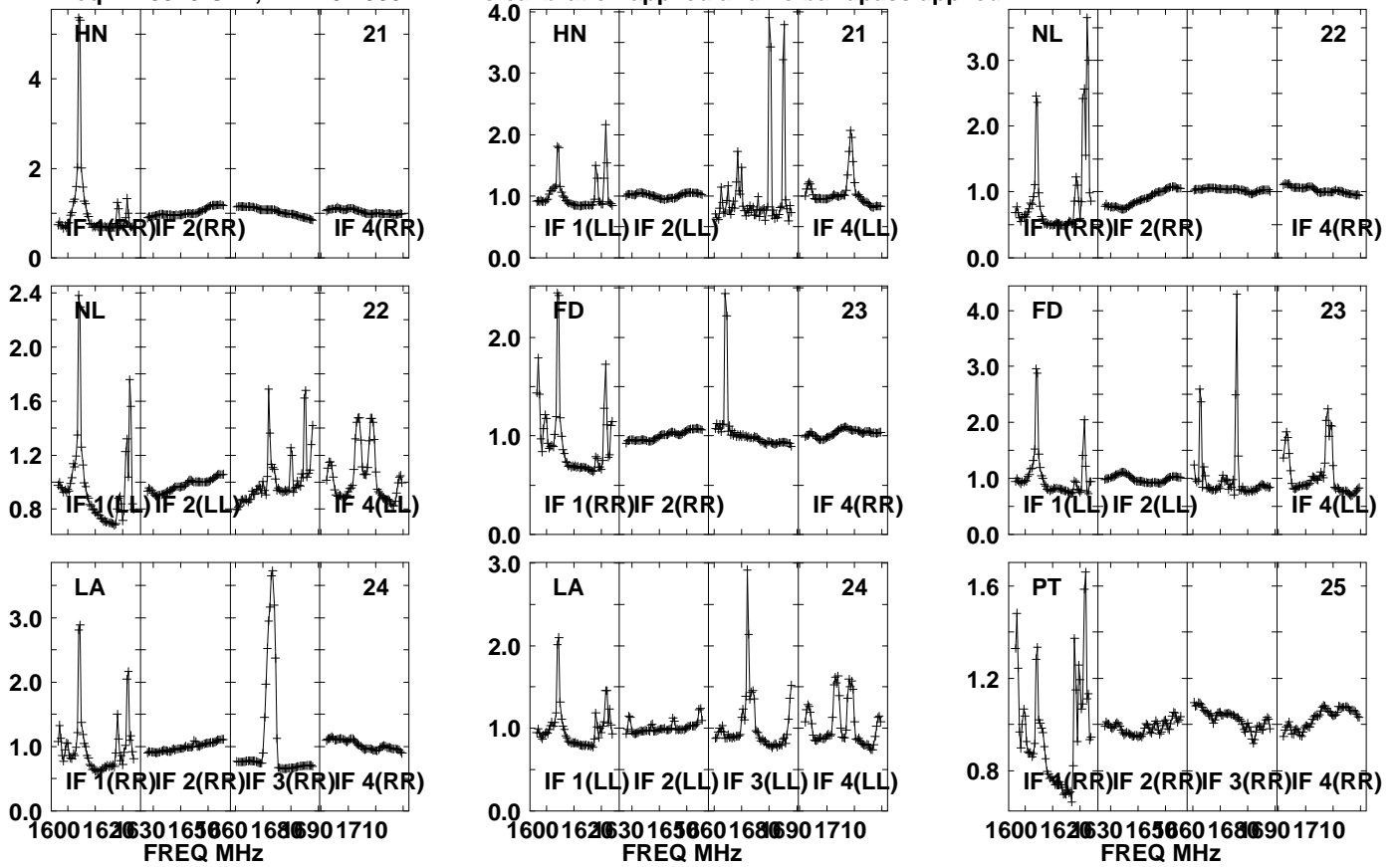

Lower frame: Real Jy  
Auto-corr total-power spectrum Antenna: \*  
Timerange: 00/16:00:01 to 00/16:01:29

Plot file version 599 created 05-OCT-2021 17:07:10

J0827+5217 GM076.UVDATA.1

Freq = 1.5945 GHz, Bw = 32.000 MH No calibration applied and no bandpass applied

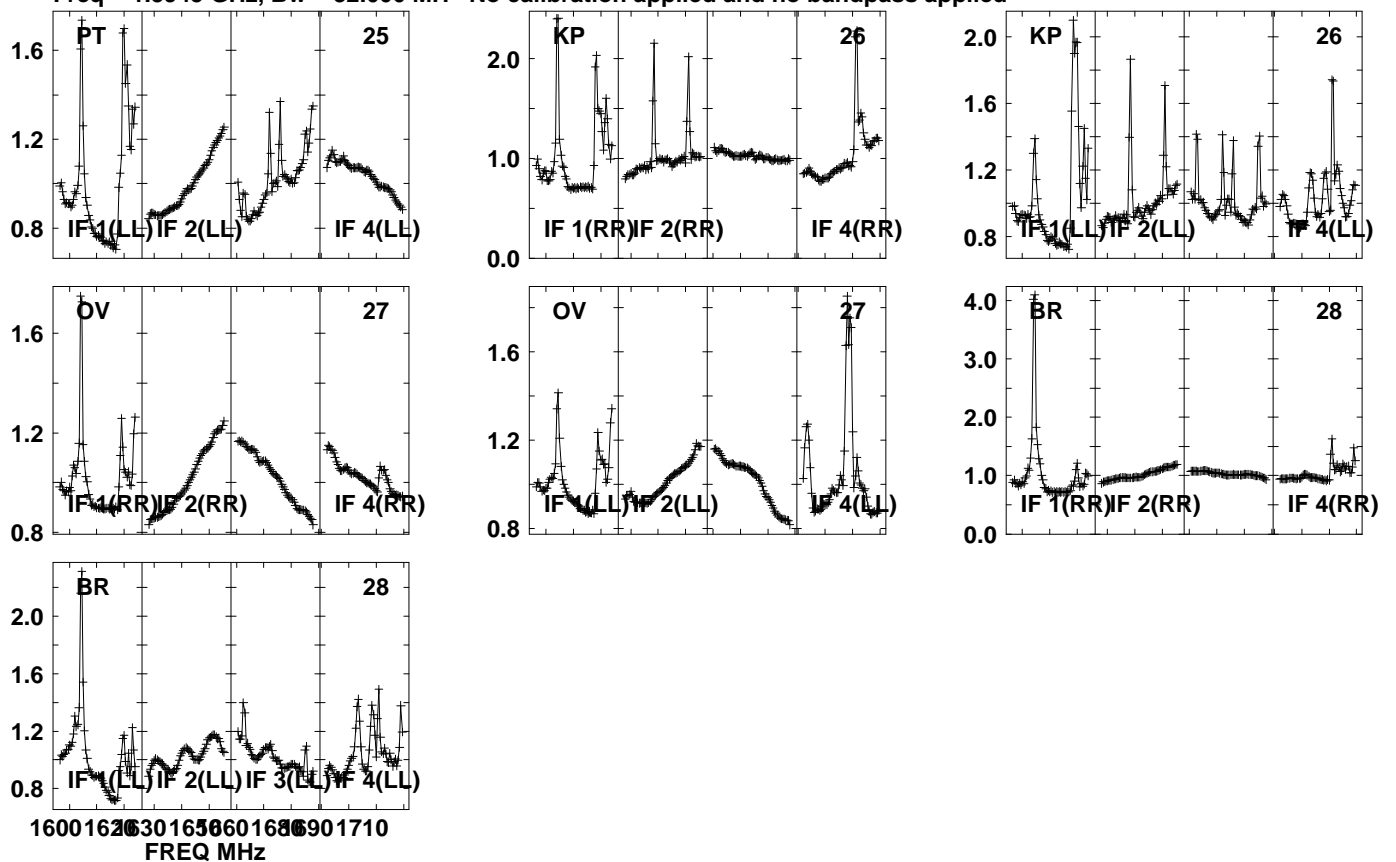

Lower frame: Real Jy  
Auto-corr total-power spectrum Antenna: \*  
Timerange: 00/16:00:01 to 00/16:01:29

Plot file version 600 created 05-OCT-2021 17:07:11

APM08279+525 GM076.UVDATA.1

Freq = 1.5945 GHz, Bw = 32.000 MH No calibration applied and no bandpass applied

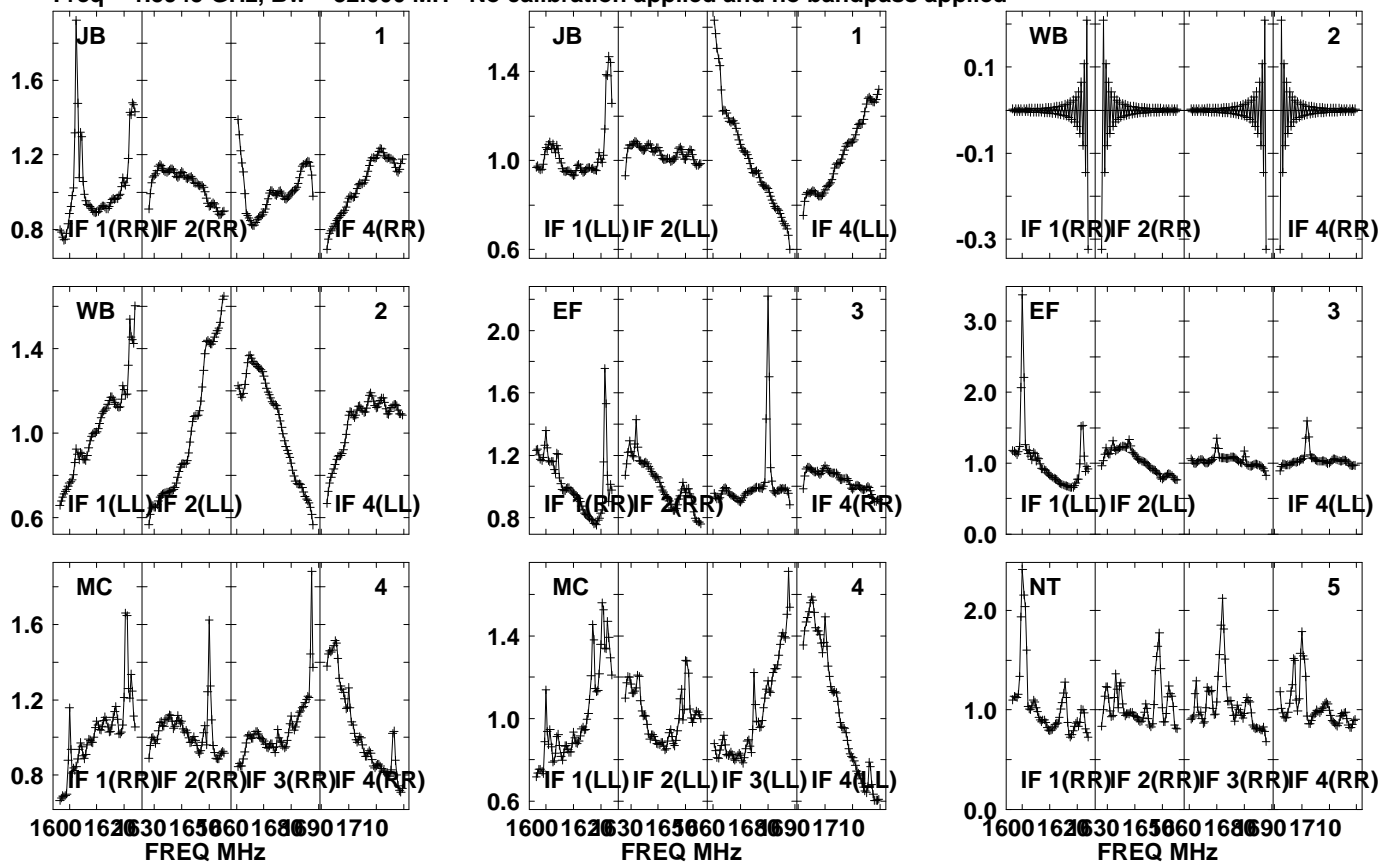

Lower frame: Real Jy  
Auto-corr total-power spectrum Antenna: \*  
Timerange: 00/16:01:31 to 00/16:04:59

Plot file version 601 created 05-OCT-2021 17:07:11

APM08279+525 GM076.UVDATA.1

Freq = 1.5945 GHz, Bw = 32.000 MH No calibration applied and no bandpass applied

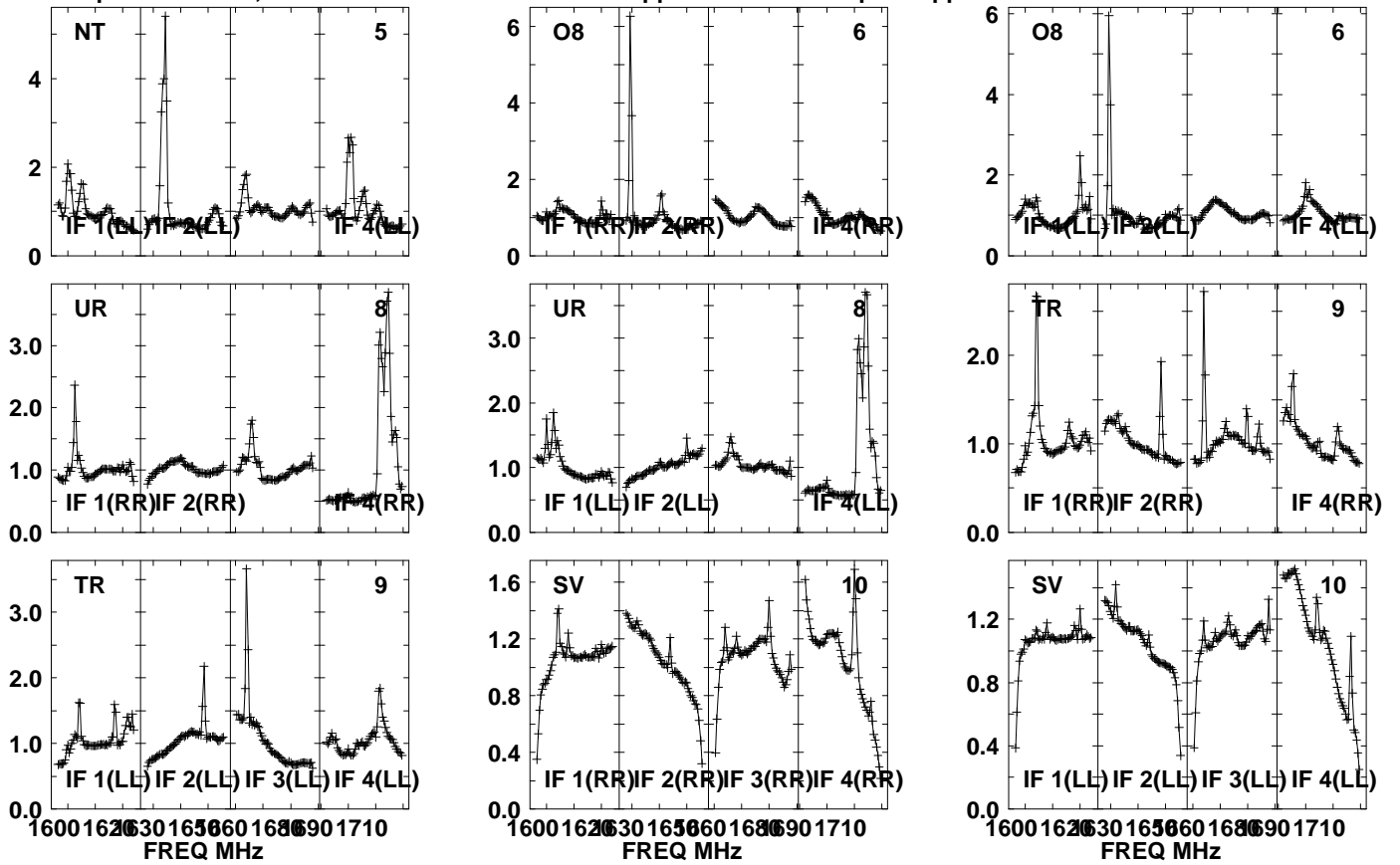

Lower frame: Real Jy

Auto-corr total-power spectrum Antenna: \*

Timerange: 00/16:01:31 to 00/16:04:59

Plot file version 602 created 05-OCT-2021 17:07:11

APM08279+525 GM076.UVDATA.1

Freq = 1.5945 GHz, Bw = 32.000 MH No calibration applied and no bandpass applied

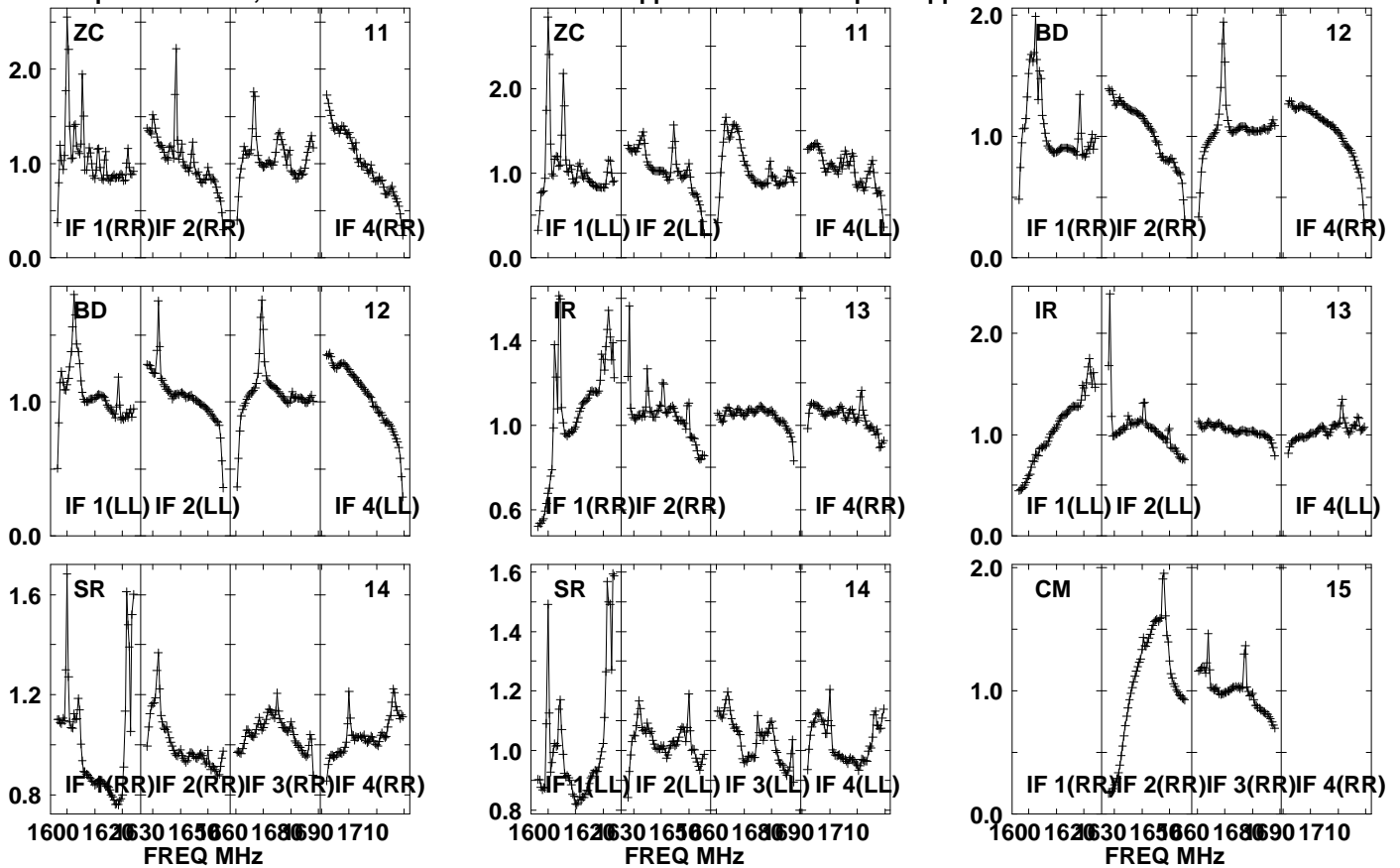

Lower frame: Real Jy

Auto-corr total-power spectrum Antenna: \*

Timerange: 00/16:01:31 to 00/16:04:59



Plot file version 603 created 05-OCT-2021 17:07:12

APM08279+525 GM076.UVDATA.1

Freq = 1.5945 GHz, Bw = 32.000 MH No calibration applied and no bandpass applied

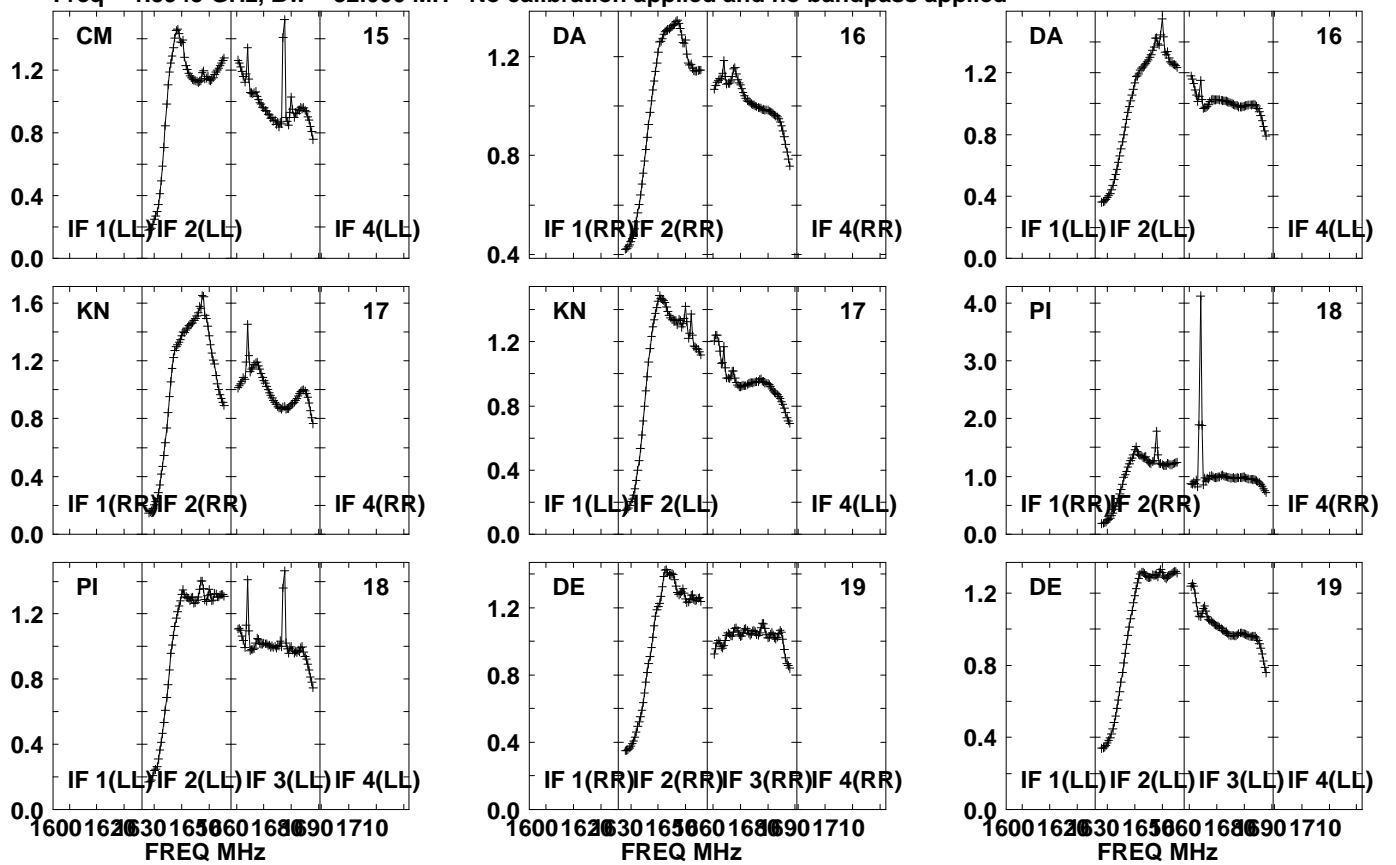

Lower frame: Real Jy  
Auto-corr total-power spectrum Antenna: \*  
Timerange: 00/16:01:31 to 00/16:04:59

Plot file version 604 created 05-OCT-2021 17:07:12

APM08279+525 GM076.UVDATA.1

Freq = 1.5945 GHz, Bw = 32.000 MH No calibration applied and no bandpass applied

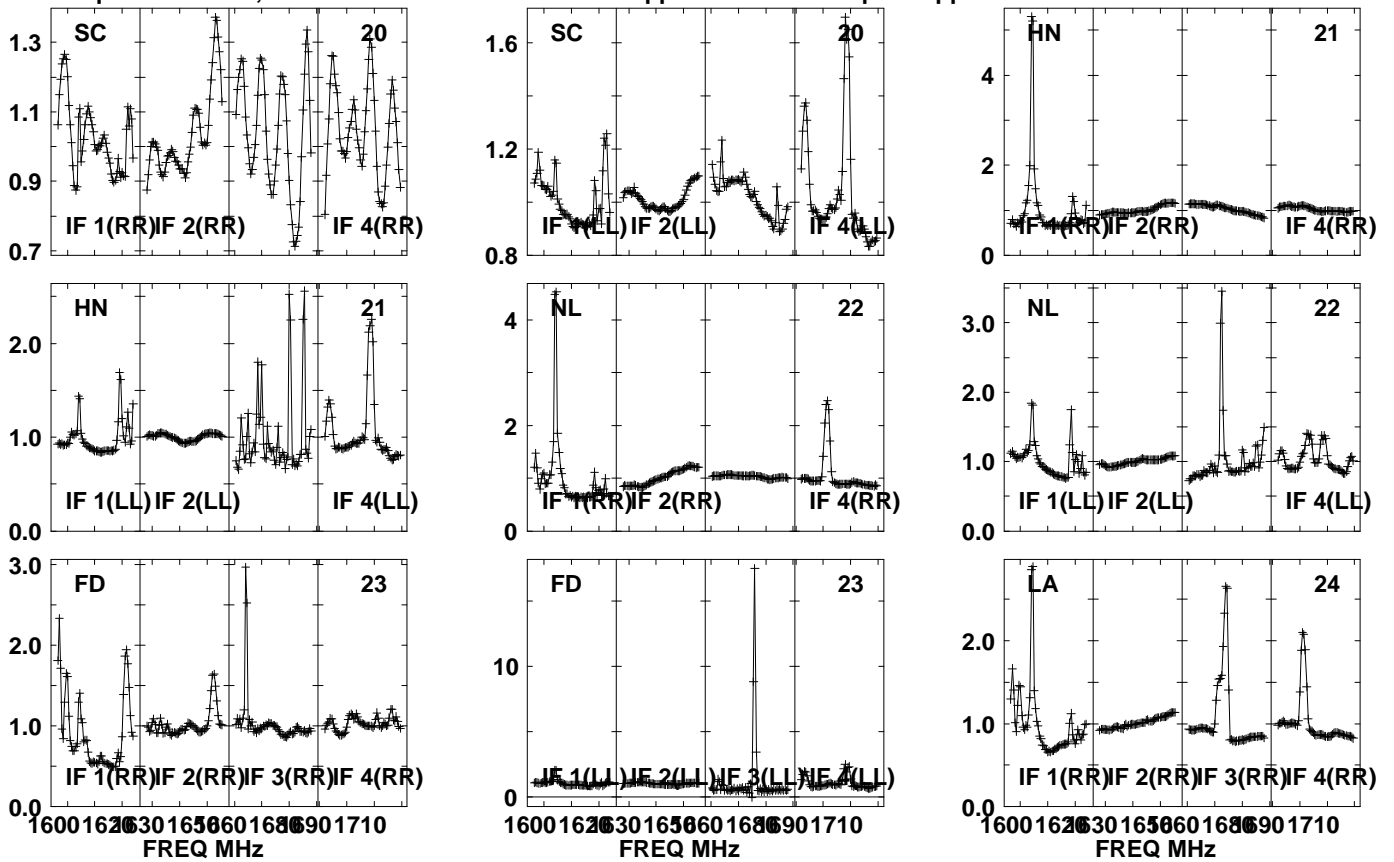

Lower frame: Real Jy  
Auto-corr total-power spectrum Antenna: \*  
Timerange: 00/16:01:31 to 00/16:04:59

Plot file version 605 created 05-OCT-2021 17:07:12

APM08279+525 GM076.UVDATA.1

Freq = 1.5945 GHz, Bw = 32.000 MH No calibration applied and no bandpass applied

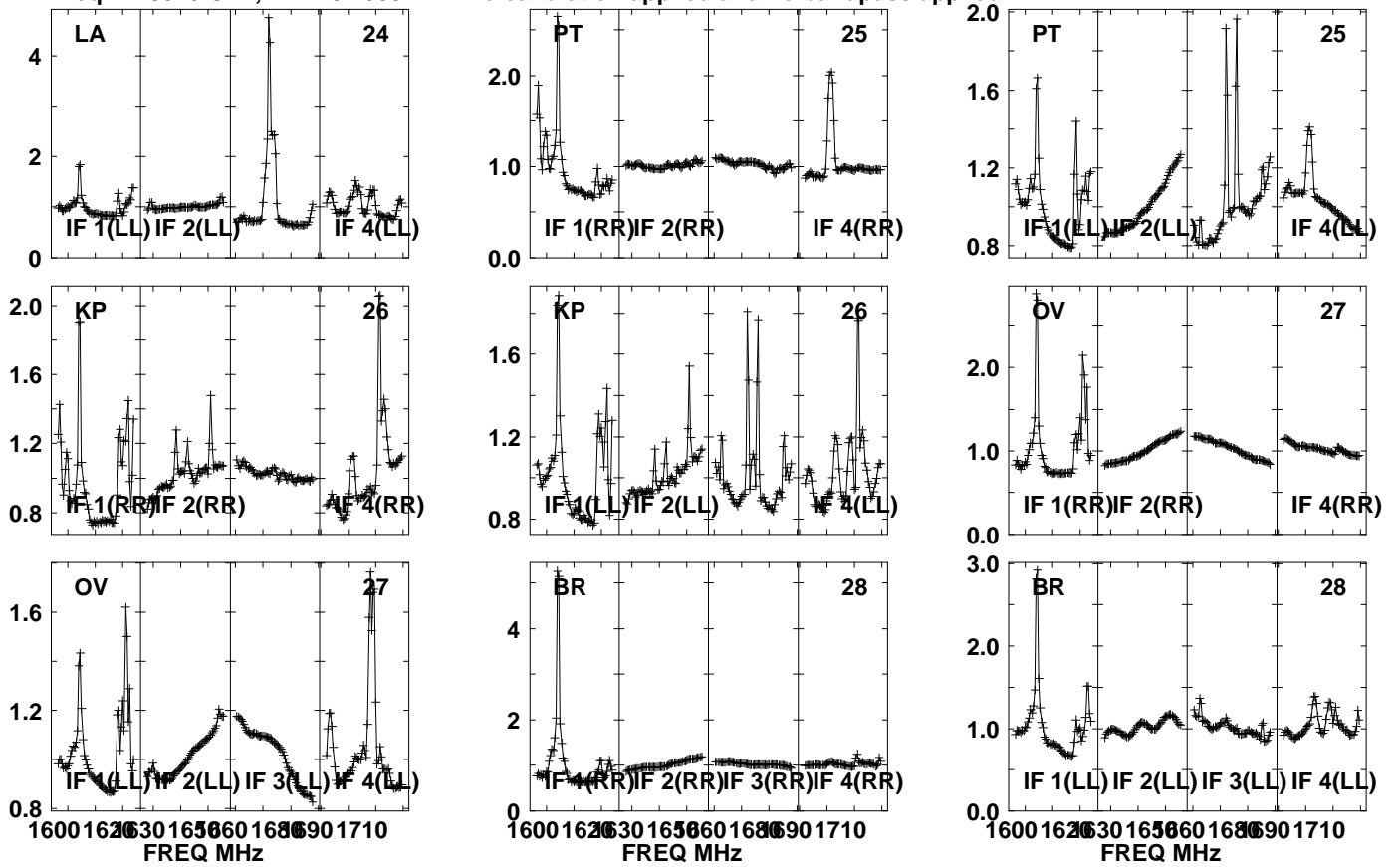

Lower frame: Real Jy  
Auto-corr total-power spectrum Antenna: \*  
Timerange: 00/16:01:31 to 00/16:04:59

Plot file version 606 created 05-OCT-2021 17:07:13

J0827+5217 GM076.UVDATA.1

Freq = 1.5945 GHz, Bw = 32.000 MH No calibration applied and no bandpass applied

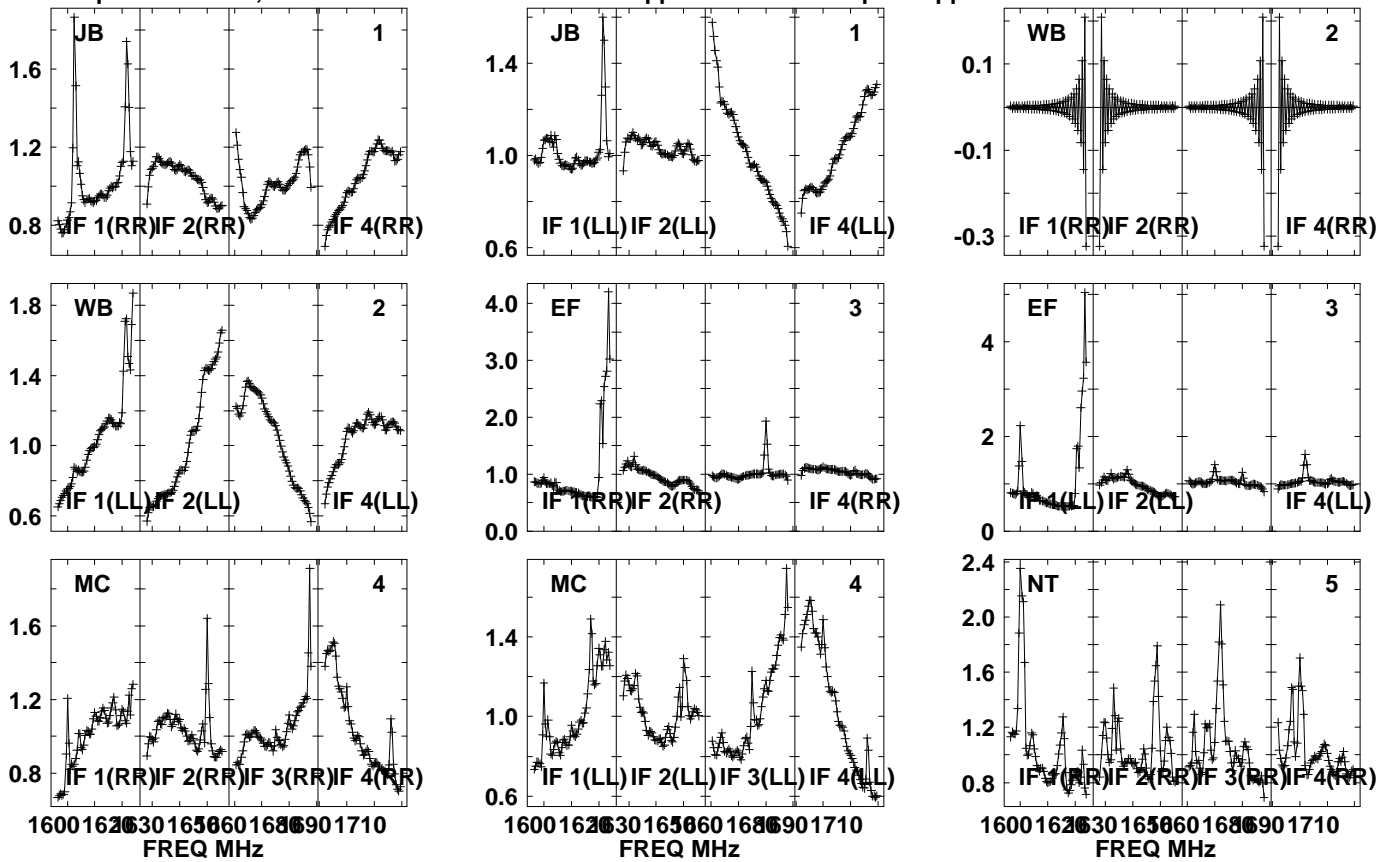

Lower frame: Real Jy  
Auto-corr total-power spectrum Antenna: \*  
Timerange: 00/16:05:01 to 00/16:06:29

Plot file version 607 created 05-OCT-2021 17:07:13

J0827+5217 GM076.UVDATA.1

Freq = 1.5945 GHz, Bw = 32.000 MH No calibration applied and no bandpass applied

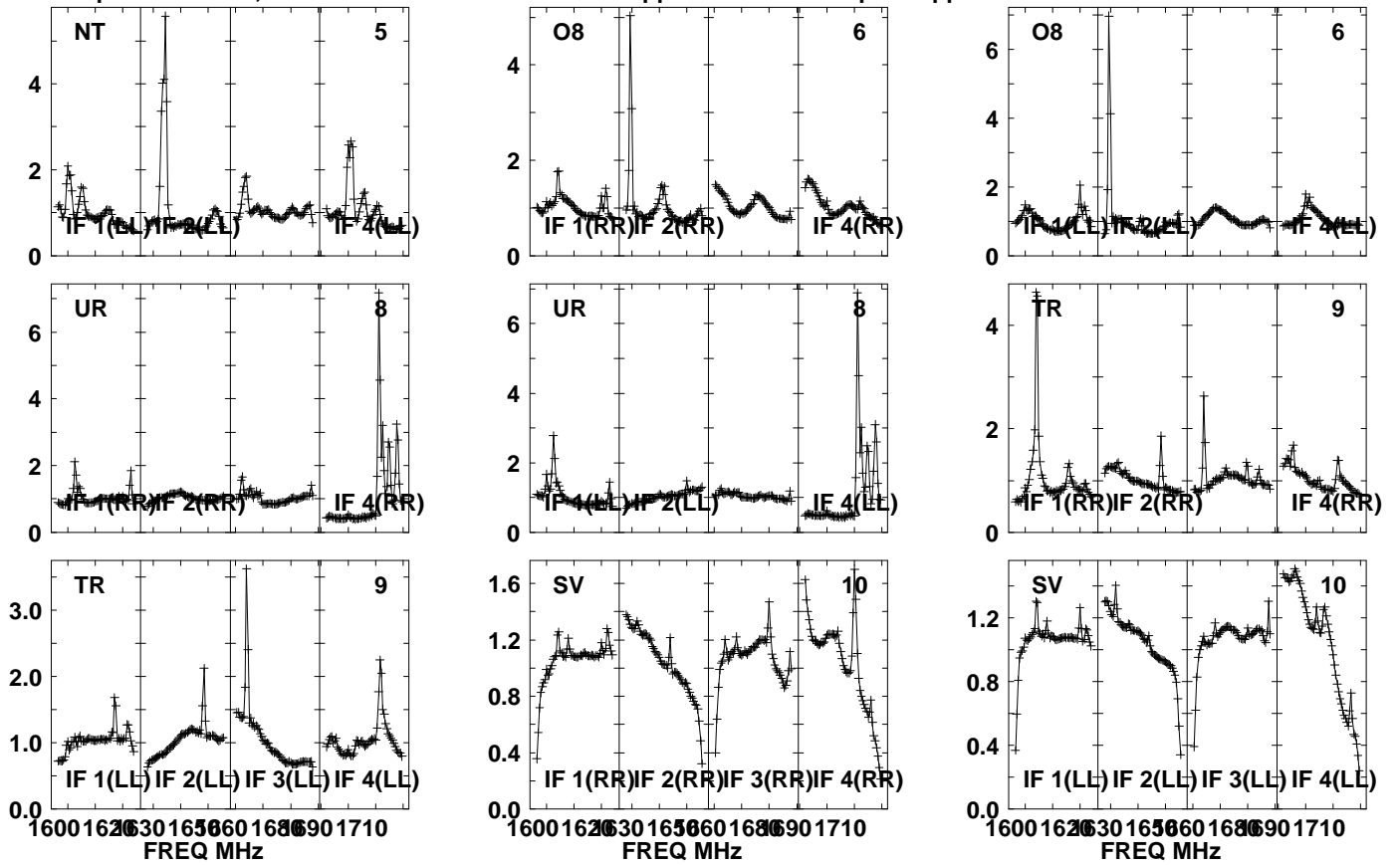

Lower frame: Real Jy  
Auto-corr total-power spectrum Antenna: \*  
Timerange: 00/16:05:01 to 00/16:06:29

Plot file version 608 created 05-OCT-2021 17:07:13

J0827+5217 GM076.UVDATA.1

Freq = 1.5945 GHz, Bw = 32.000 MH No calibration applied and no bandpass applied

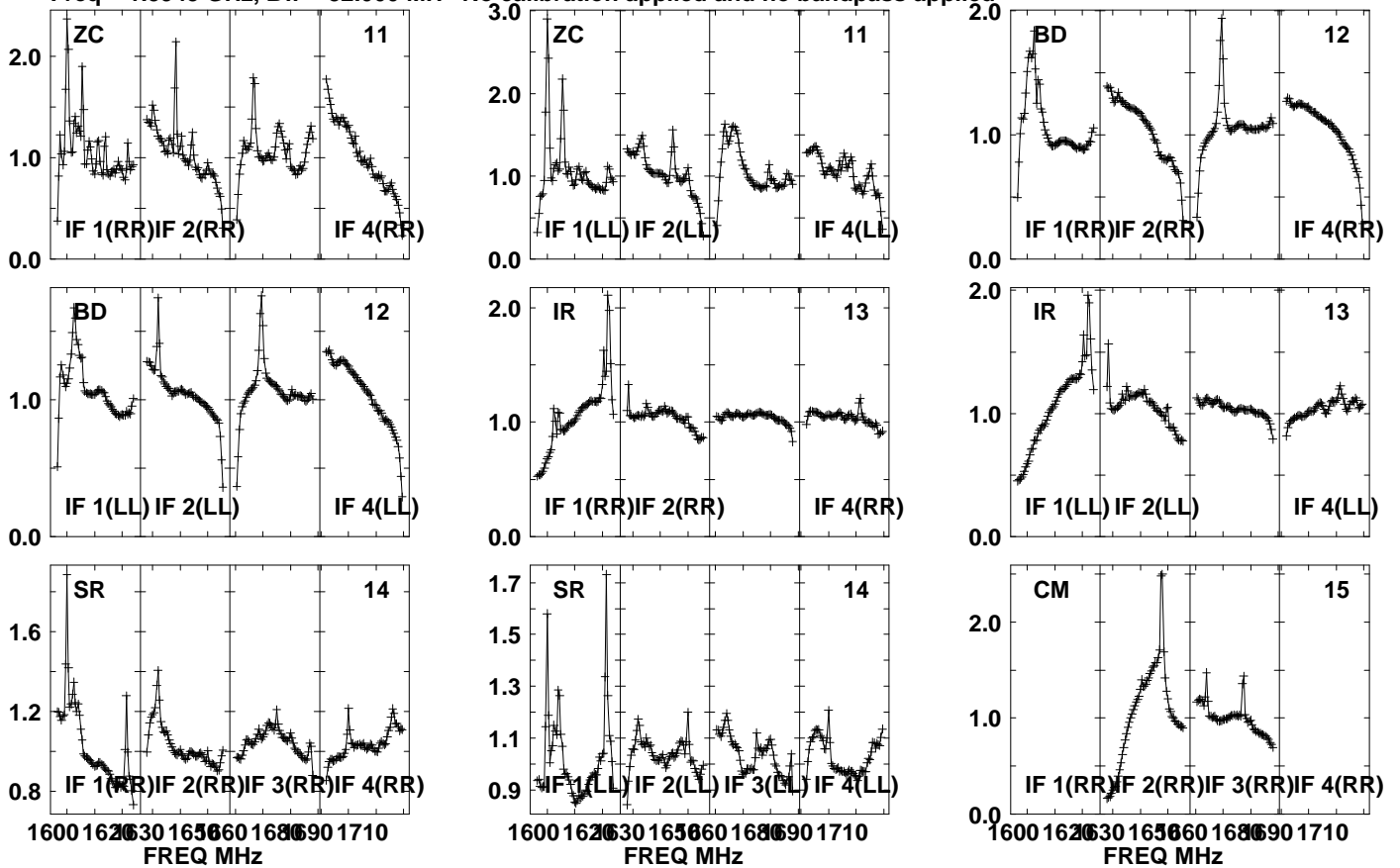

Lower frame: Real Jy  
Auto-corr total-power spectrum Antenna: \*  
Timerange: 00/16:05:01 to 00/16:06:29

Plot file version 609 created 05-OCT-2021 17:07:14

J0827+5217 GM076.UVDATA.1

Freq = 1.5945 GHz, Bw = 32.000 MH No calibration applied and no bandpass applied

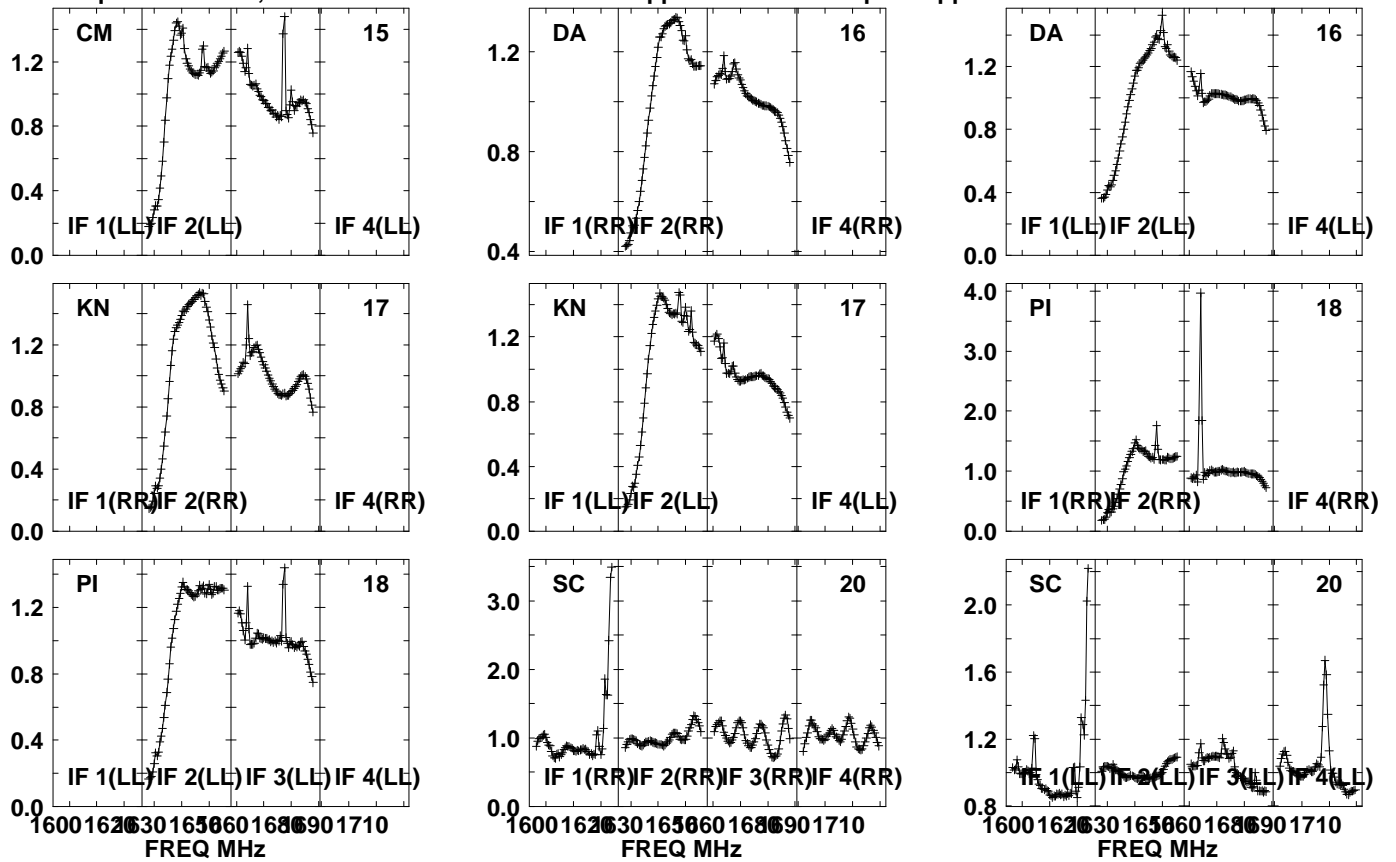

Lower frame: Real Jy  
Auto-corr total-power spectrum Antenna: \*  
Timerange: 00/16:05:01 to 00/16:06:29

Plot file version 610 created 05-OCT-2021 17:07:14

J0827+5217 GM076.UVDATA.1

Freq = 1.5945 GHz, Bw = 32.000 MH No calibration applied and no bandpass applied

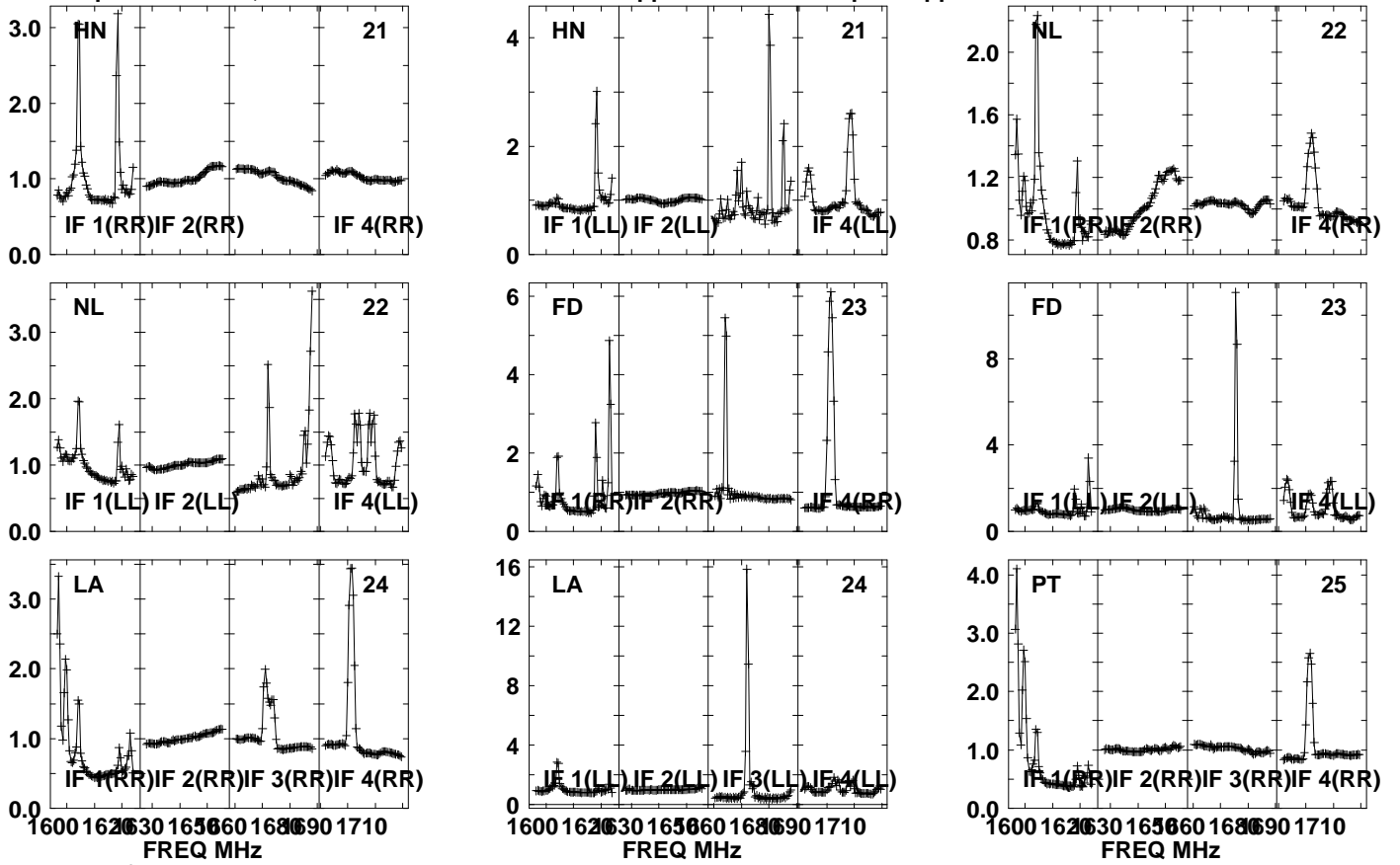

Lower frame: Real Jy

Auto-corr total-power spectrum Antenna: \*

Timerange: 00/16:05:01 to 00/16:06:29



Plot file version 611 created 05-OCT-2021 17:07:14

J0827+5217 GM076.UVDATA.1

Freq = 1.5945 GHz, Bw = 32.000 MH No calibration applied and no bandpass applied

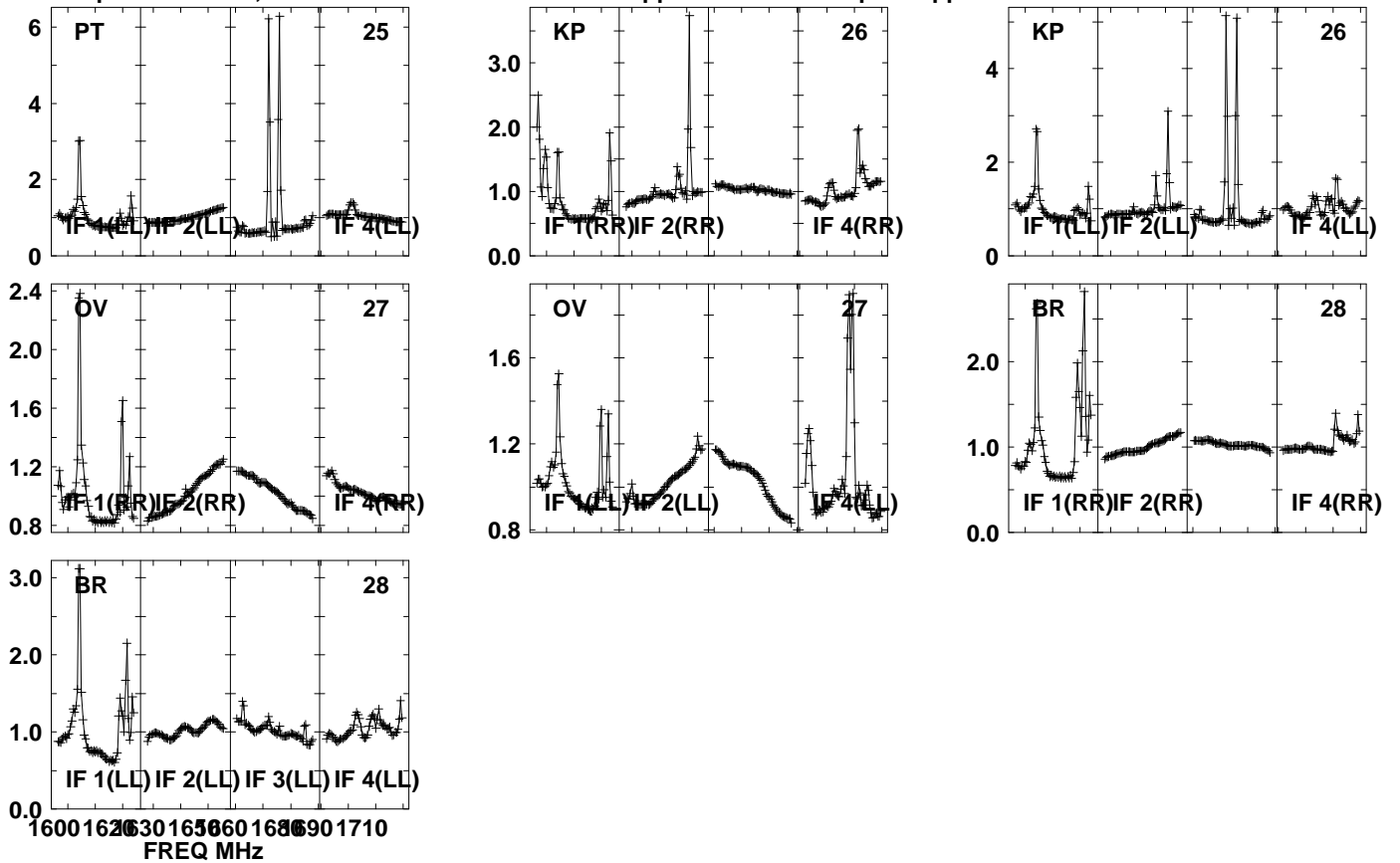

Lower frame: Real Jy

Auto-corr total-power spectrum Antenna: \*

Timerange: 00/16:05:01 to 00/16:06:29

Plot file version 612 created 05-OCT-2021 17:07:15

APM08279+525 GM076.UVDATA.1

Freq = 1.5945 GHz, Bw = 32.000 MH No calibration applied and no bandpass applied

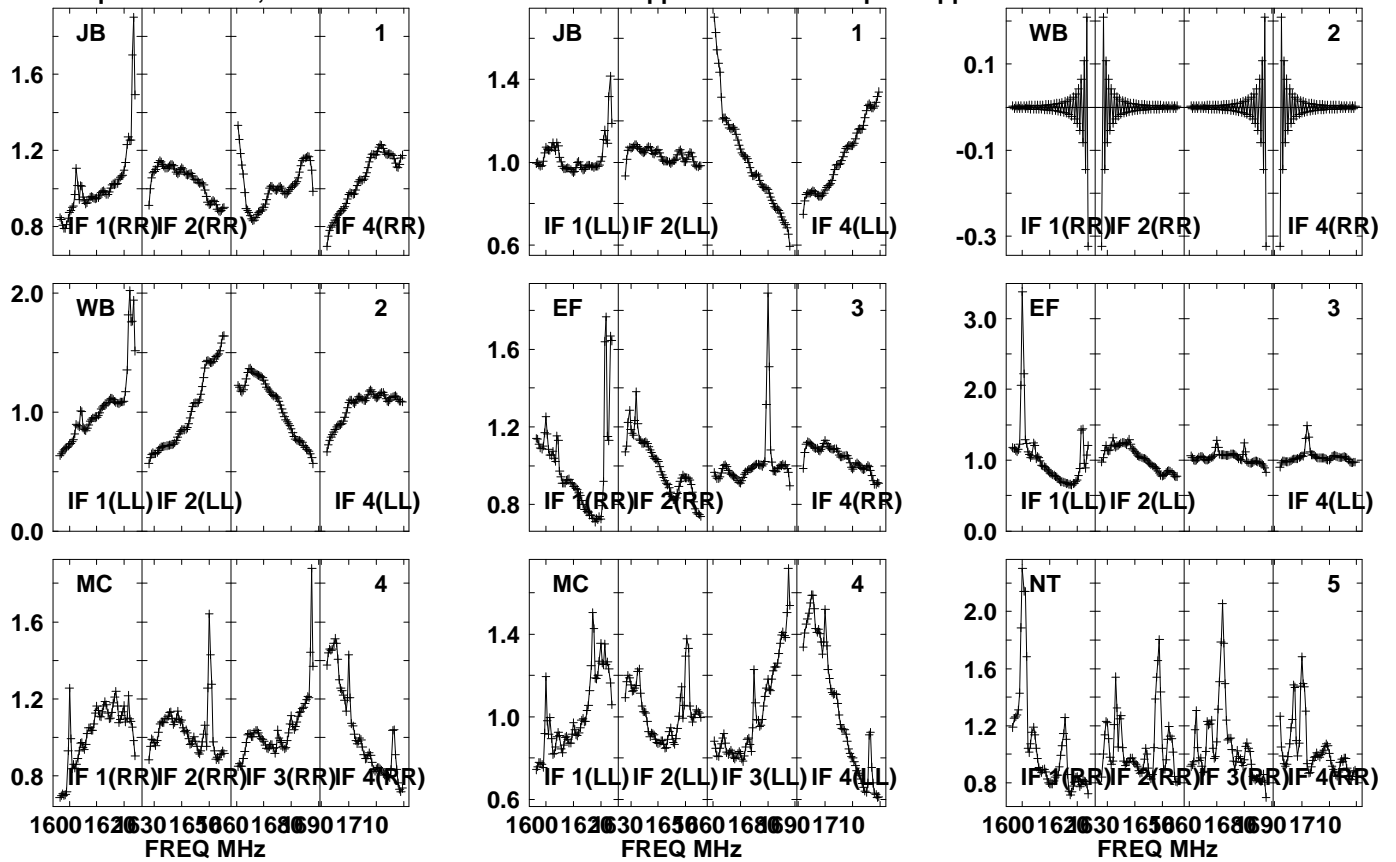

Lower frame: Real Jy  
Auto-corr total-power spectrum Antenna: \*  
Timerange: 00/16:06:31 to 00/16:09:59

Plot file version 613 created 05-OCT-2021 17:07:15

APM08279+525 GM076.UVDATA.1

Freq = 1.5945 GHz, Bw = 32.000 MH No calibration applied and no bandpass applied

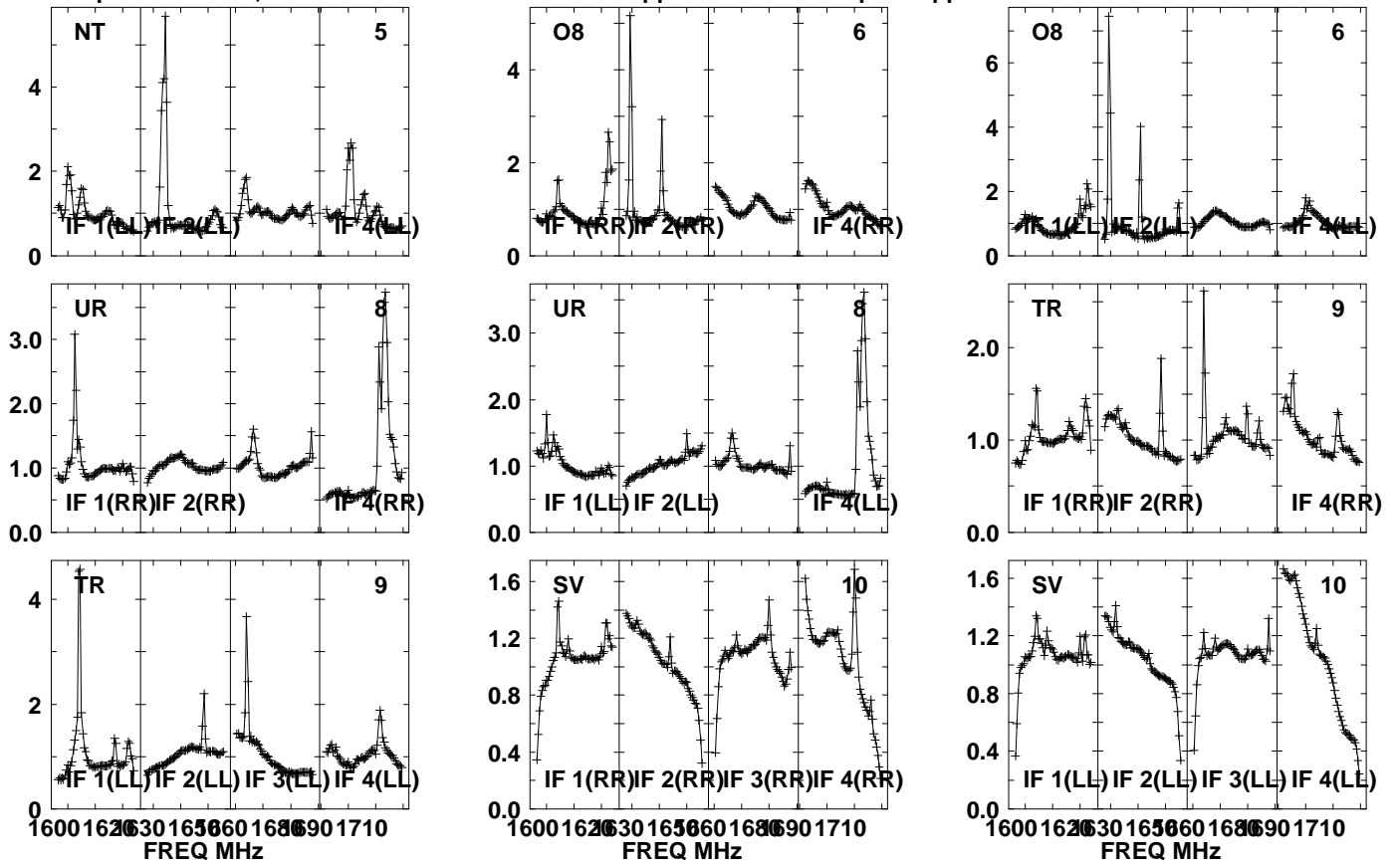

Lower frame: Real Jy

Auto-corr total-power spectrum Antenna: \*

Timerange: 00/16:06:31 to 00/16:09:59

Plot file version 614 created 05-OCT-2021 17:07:15

APM08279+525 GM076.UVDATA.1

Freq = 1.5945 GHz, Bw = 32.000 MH No calibration applied and no bandpass applied

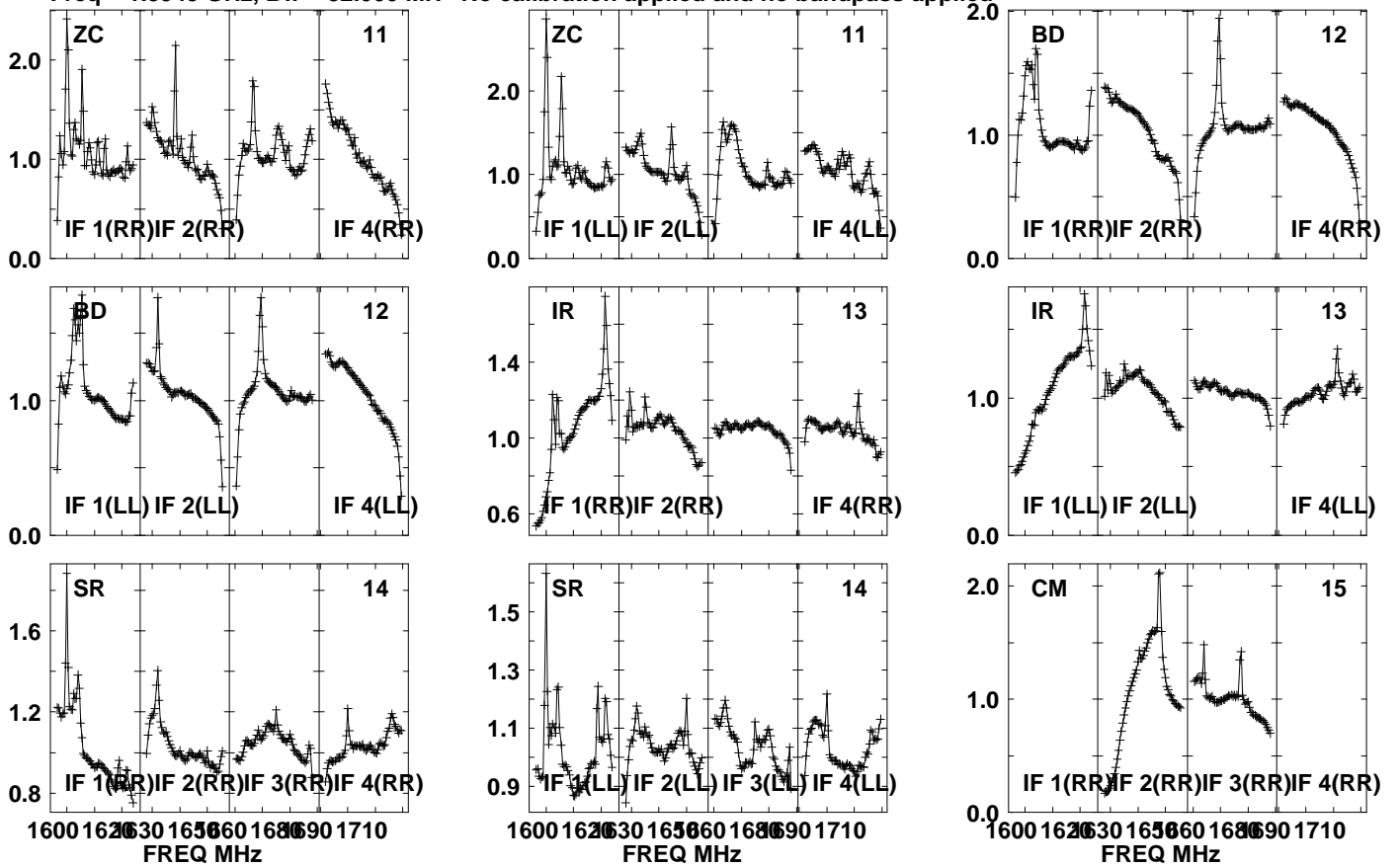

Lower frame: Real Jy

Auto-corr total-power spectrum Antenna: \*

Timerange: 00/16:06:31 to 00/16:09:59

Plot file version 615 created 05-OCT-2021 17:07:16

APM08279+525 GM076.UVDATA.1

Freq = 1.5945 GHz, Bw = 32.000 MH No calibration applied and no bandpass applied

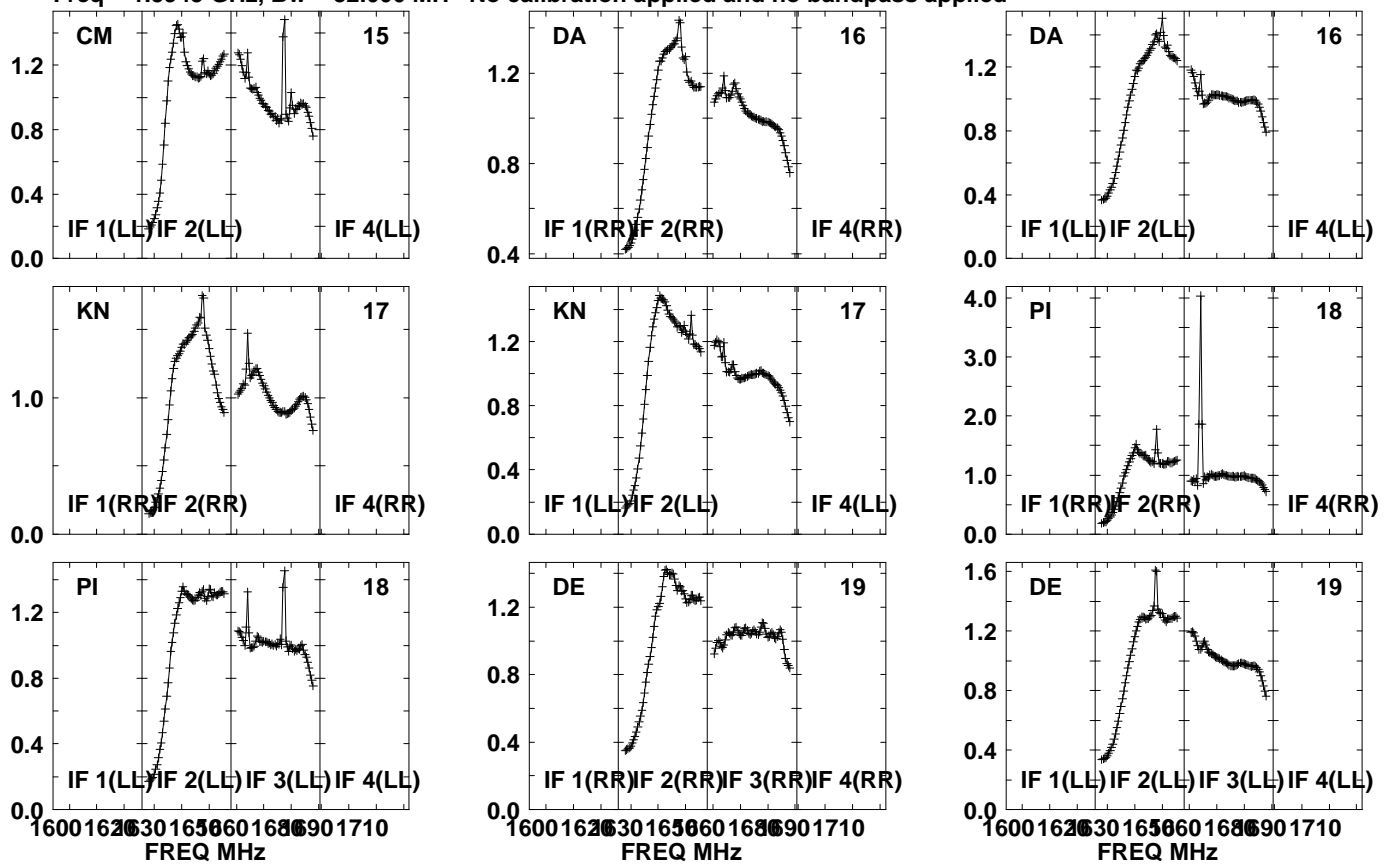

Lower frame: Real Jy  
Auto-corr total-power spectrum Antenna: \*  
Timerange: 00/16:06:31 to 00/16:09:59

Plot file version 616 created 05-OCT-2021 17:07:16

APM08279+525 GM076.UVDATA.1

Freq = 1.5945 GHz, Bw = 32.000 MH No calibration applied and no bandpass applied

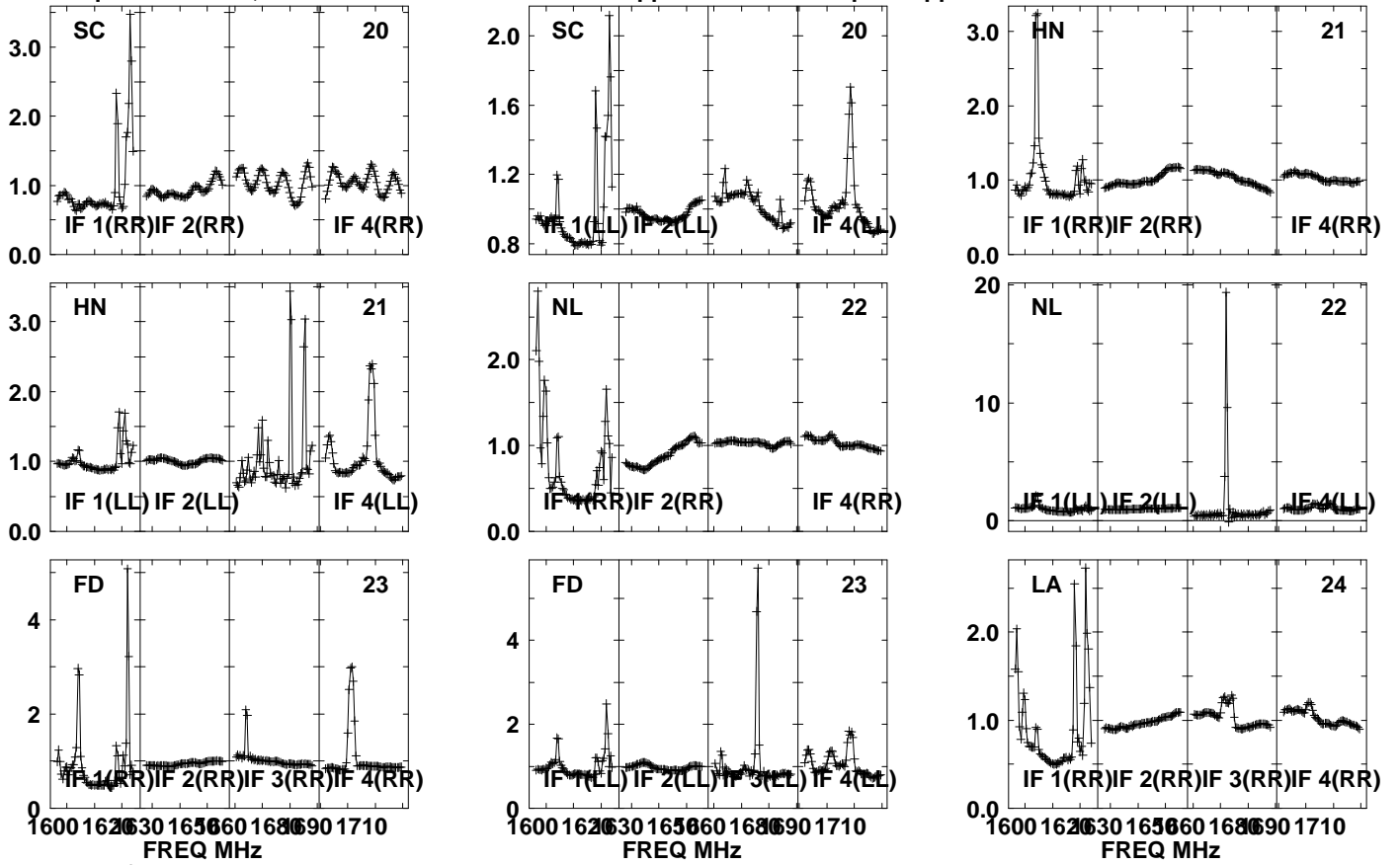

Lower frame: Real Jy  
Auto-corr total-power spectrum Antenna: \*  
Timerange: 00/16:06:31 to 00/16:09:59

Plot file version 617 created 05-OCT-2021 17:07:16

APM08279+525 GM076.UVDATA.1

Freq = 1.5945 GHz, Bw = 32.000 MH No calibration applied and no bandpass applied

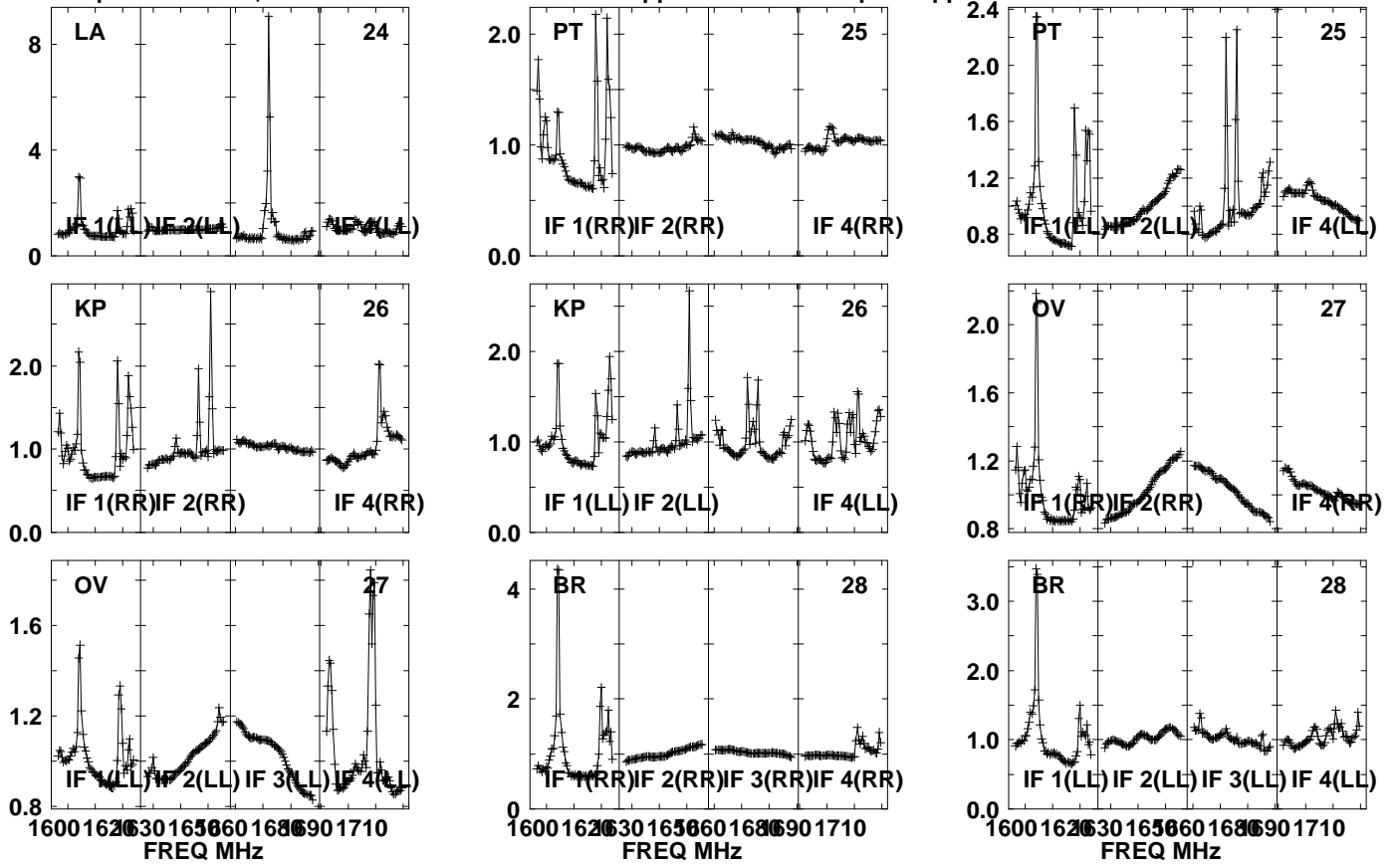

Lower frame: Real Jy  
Auto-corr total-power spectrum Antenna: \*  
Timerange: 00/16:06:31 to 00/16:09:59

Plot file version 618 created 05-OCT-2021 17:07:17

J0827+5217 GM076.UVDATA.1

Freq = 1.5945 GHz, Bw = 32.000 MH No calibration applied and no bandpass applied

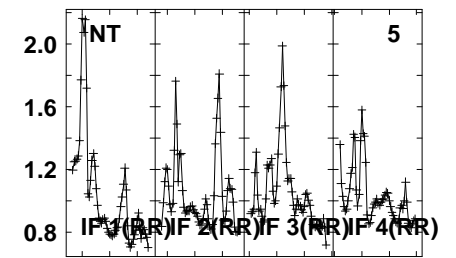
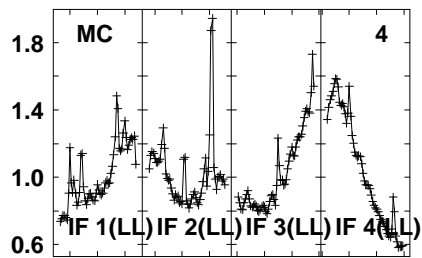
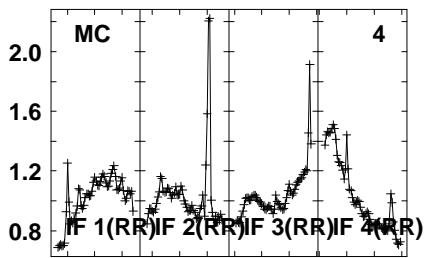
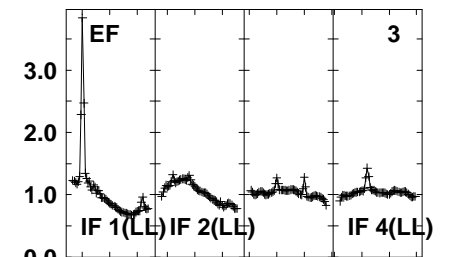
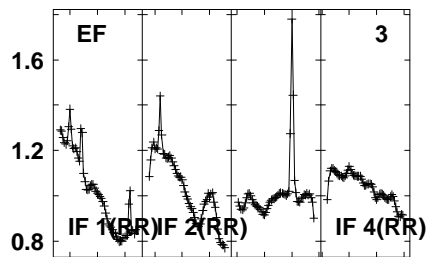
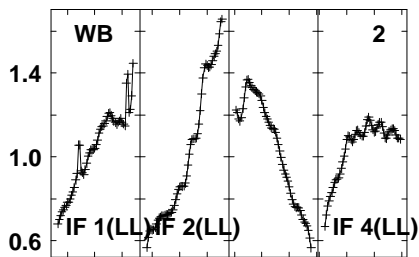
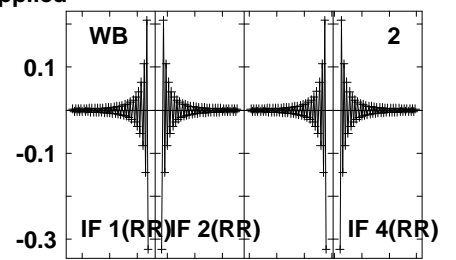
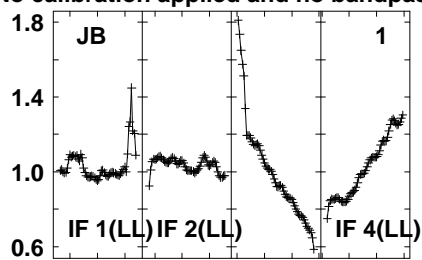
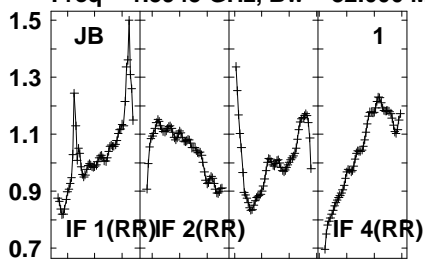

1600 1620 1630 1650 1660 1680 1690 1710  
FREQ MHz

1600 1620 1630 1650 1660 1680 1690 1710  
FREQ MHz

1600 1620 1630 1650 1660 1680 1690 1710  
FREQ MHz

Lower frame: Real Jy  
Auto-corr total-power spectrum Antenna: \*  
Timerange: 00/16:10:31 to 00/16:11:59



Plot file version 619 created 05-OCT-2021 17:07:17

J0827+5217 GM076.UVDATA.1

Freq = 1.5945 GHz, Bw = 32.000 MH No calibration applied and no bandpass applied

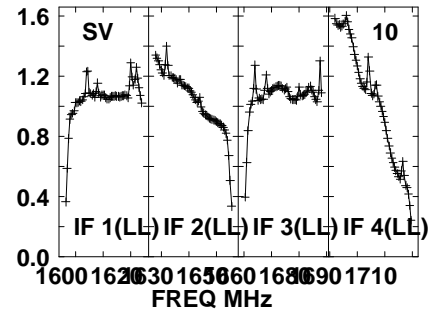
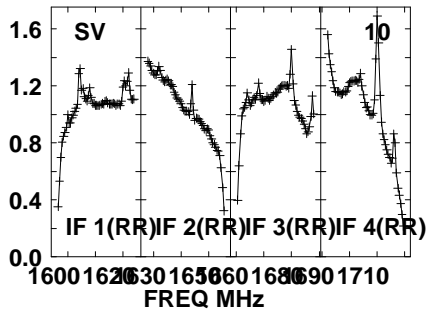
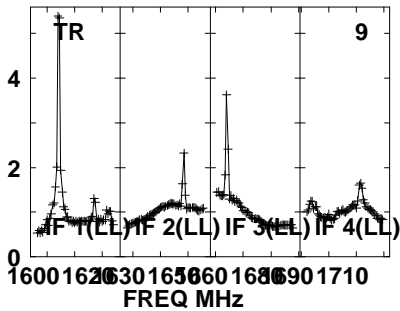
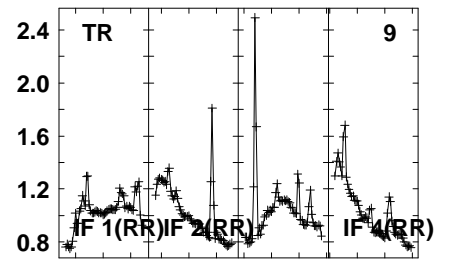
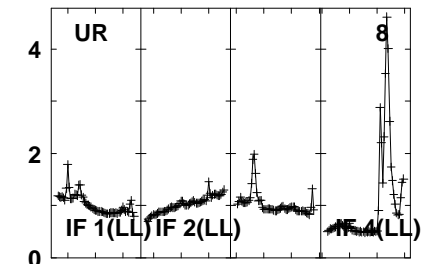
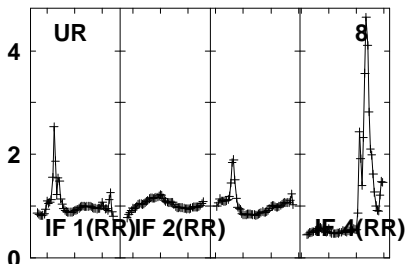
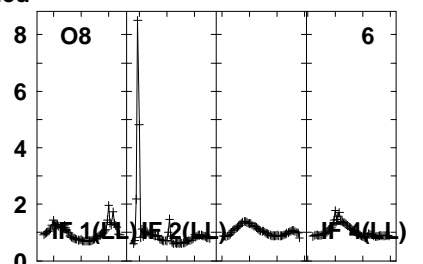
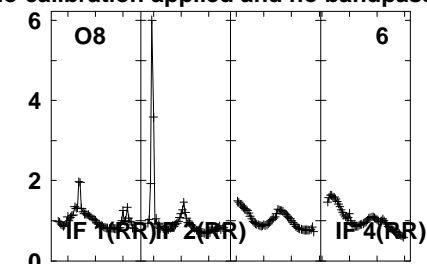
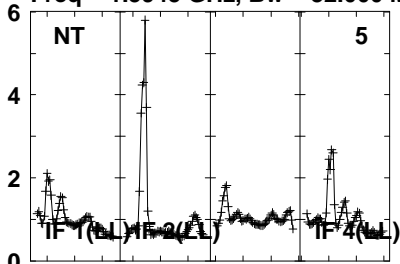

Lower frame: Real Jy

Auto-corr total-power spectrum Antenna: \*

Timerange: 00/16:10:31 to 00/16:11:59

Plot file version 620 created 05-OCT-2021 17:07:17

J0827+5217 GM076.UVDATA.1

Freq = 1.5945 GHz, Bw = 32.000 MH No calibration applied and no bandpass applied

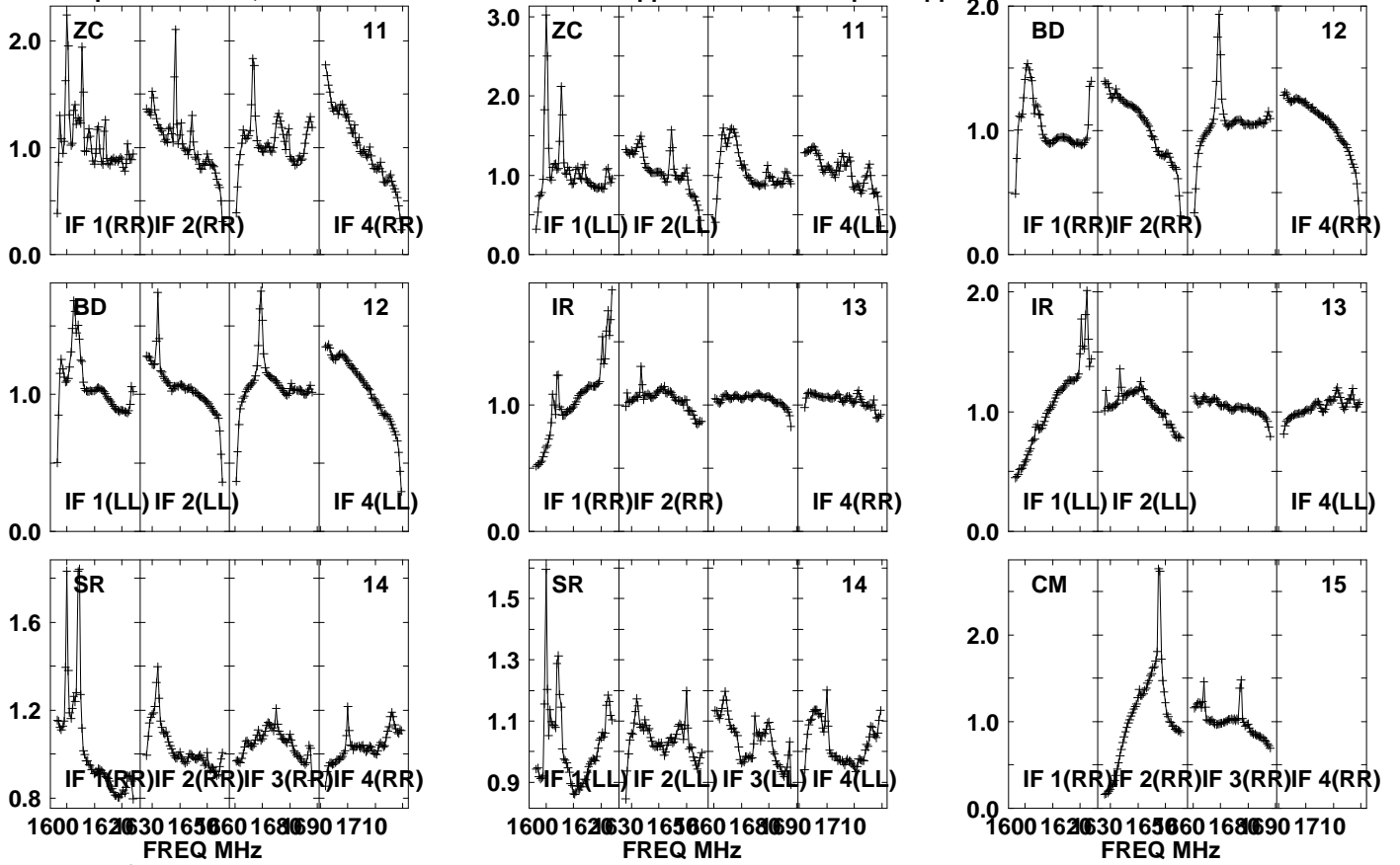

Lower frame: Real Jy  
Auto-corr total-power spectrum Antenna: \*  
Timerange: 00/16:10:31 to 00/16:11:59

Plot file version 621 created 05-OCT-2021 17:07:18

J0827+5217 GM076.UVDATA.1

Freq = 1.5945 GHz, Bw = 32.000 MH No calibration applied and no bandpass applied

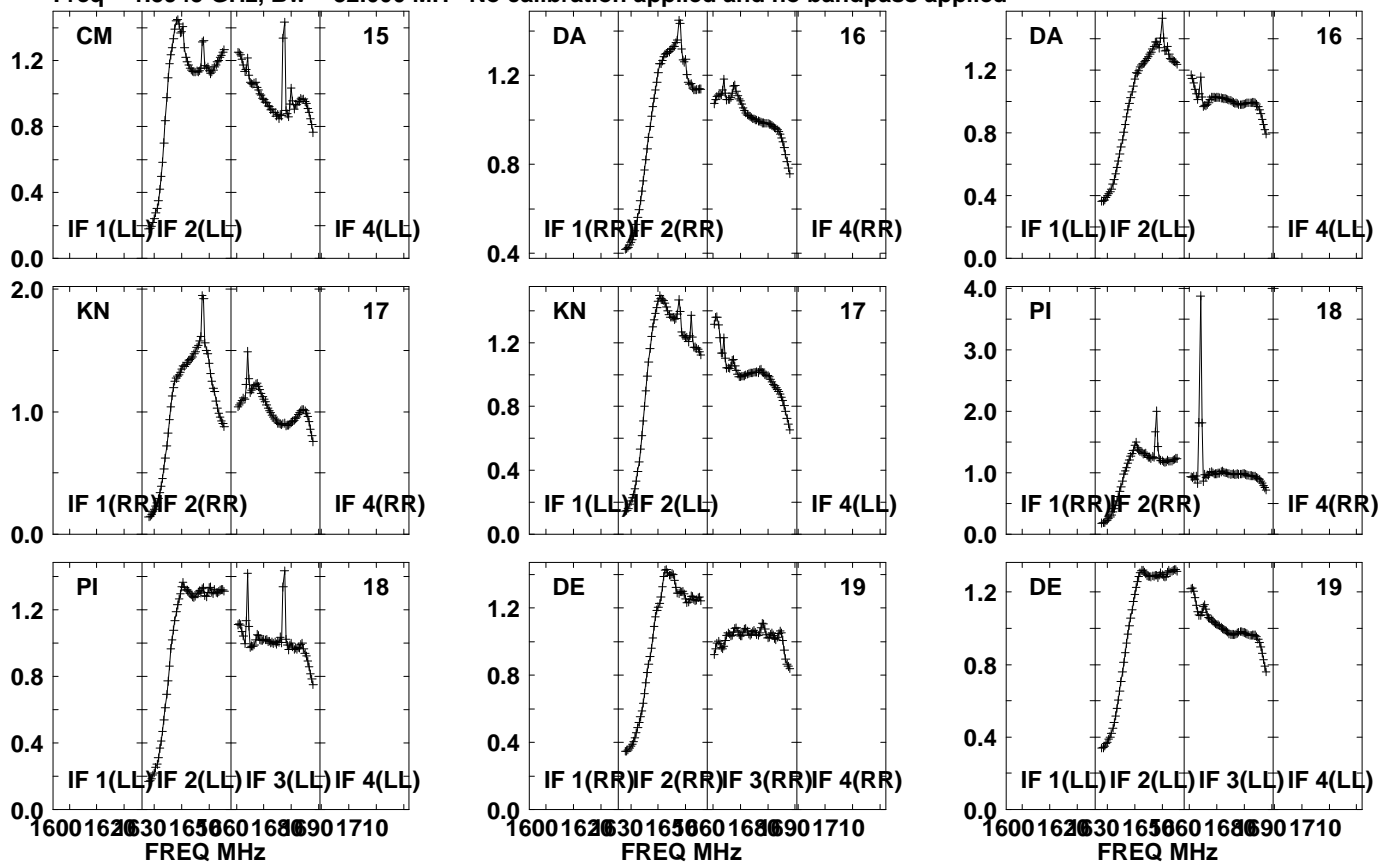

Lower frame: Real Jy  
Auto-corr total-power spectrum Antenna: \*  
Timerange: 00/16:10:31 to 00/16:11:59

Plot file version 622 created 05-OCT-2021 17:07:18

J0827+5217 GM076.UVDATA.1

Freq = 1.5945 GHz, Bw = 32.000 MH No calibration applied and no bandpass applied

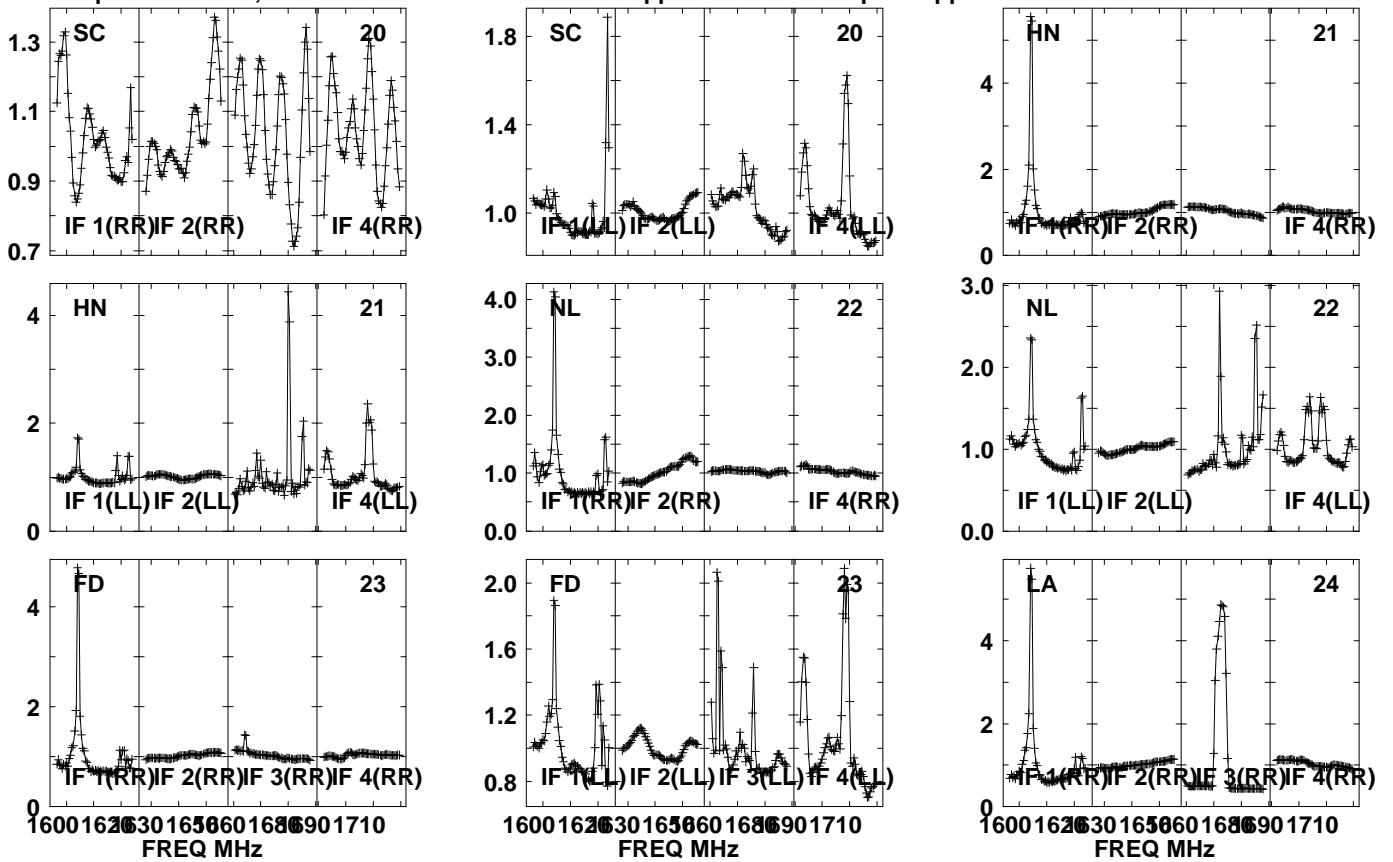

Lower frame: Real Jy  
Auto-corr total-power spectrum Antenna: \*  
Timerange: 00/16:10:31 to 00/16:11:59

Plot file version 623 created 05-OCT-2021 17:07:18

J0827+5217 GM076.UVDATA.1

Freq = 1.5945 GHz, Bw = 32.000 MH No calibration applied and no bandpass applied

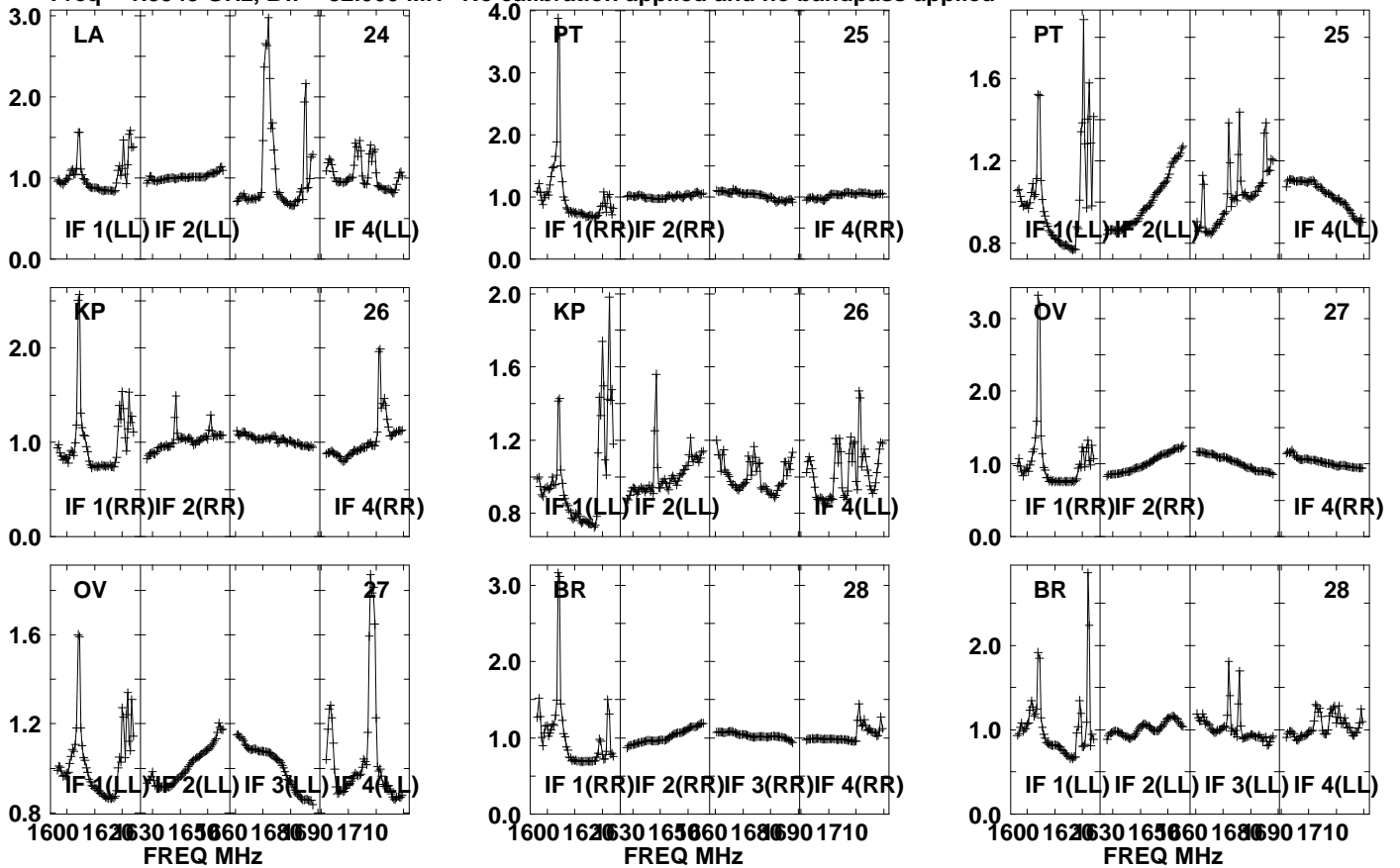

Lower frame: Real Jy  
Auto-corr total-power spectrum Antenna: \*  
Timerange: 00/16:10:31 to 00/16:11:59

Plot file version 624 created 05-OCT-2021 17:07:19

APM08279+525 GM076.UVDATA.1

Freq = 1.5945 GHz, Bw = 32.000 MH No calibration applied and no bandpass applied

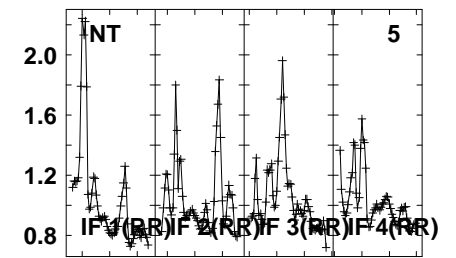
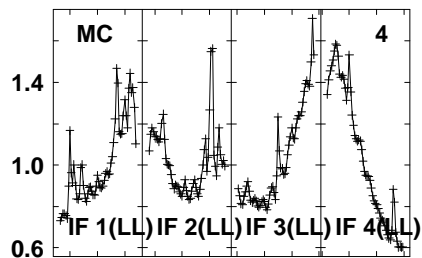
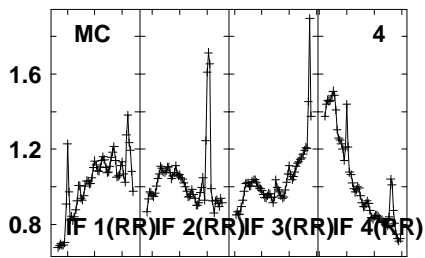
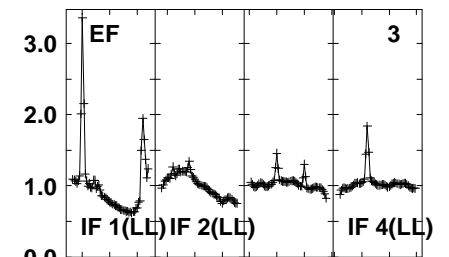
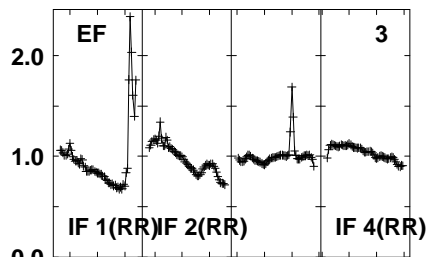
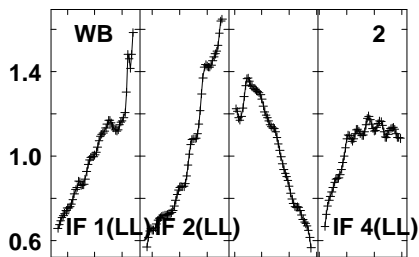
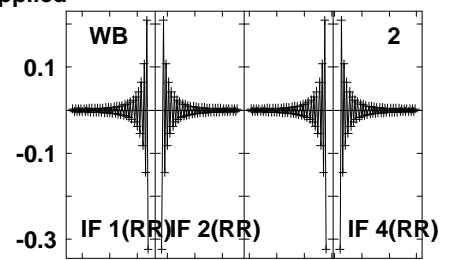
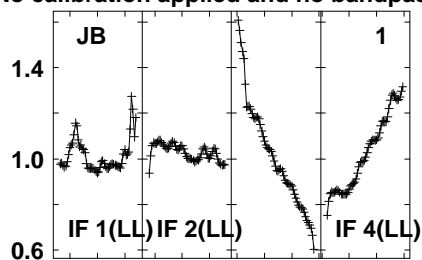
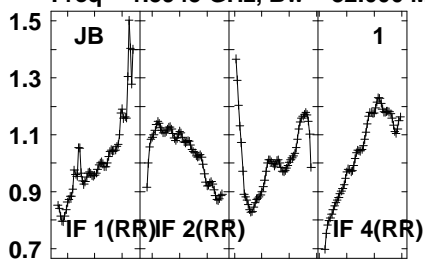

1600 1620 1630 1650 1660 1680 1690 1710  
FREQ MHz

1600 1620 1630 1650 1660 1680 1690 1710  
FREQ MHz

1600 1620 1630 1650 1660 1680 1690 1710  
FREQ MHz

Lower frame: Real Jy  
Auto-corr total-power spectrum Antenna: \*  
Timerange: 00/16:12:01 to 00/16:15:29

Plot file version 625 created 05-OCT-2021 17:07:19

APM08279+525 GM076.UVDATA.1

Freq = 1.5945 GHz, Bw = 32.000 MH No calibration applied and no bandpass applied

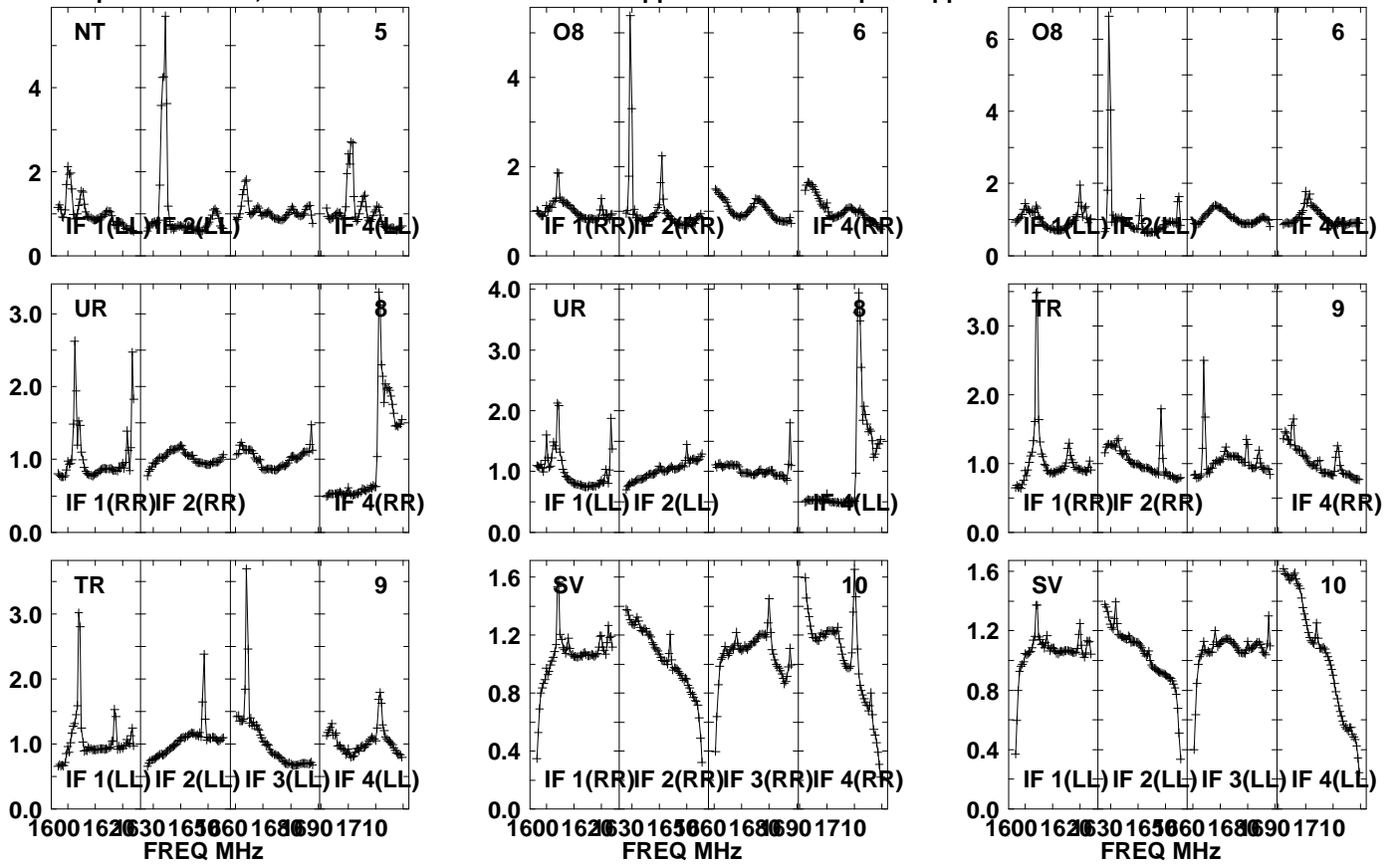

Lower frame: Real Jy  
Auto-corr total-power spectrum Antenna: \*  
Timerange: 00/16:12:01 to 00/16:15:29

Plot file version 626 created 05-OCT-2021 17:07:19

APM08279+525 GM076.UVDATA.1

Freq = 1.5945 GHz, Bw = 32.000 MH

No calibration applied and no bandpass applied

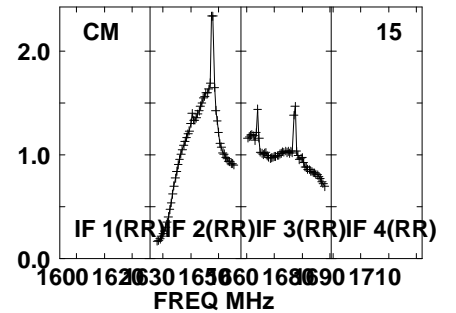
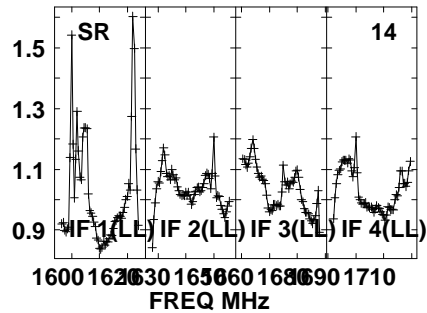
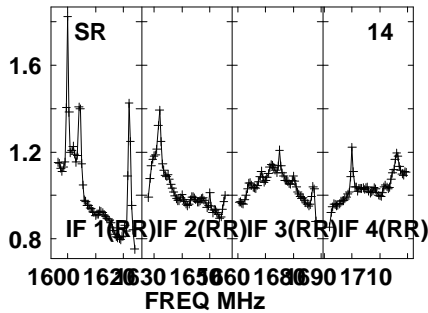
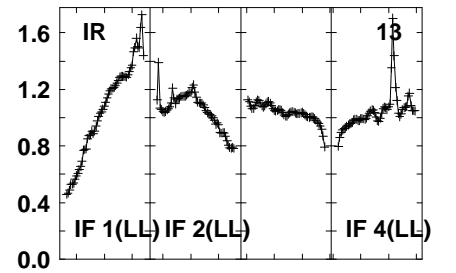
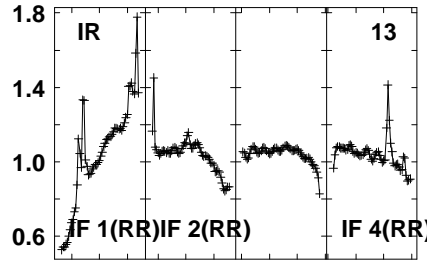
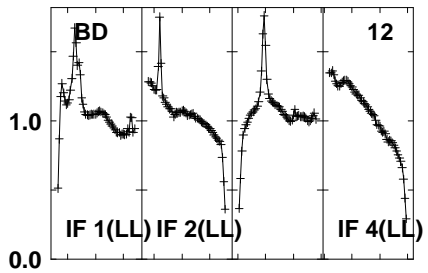
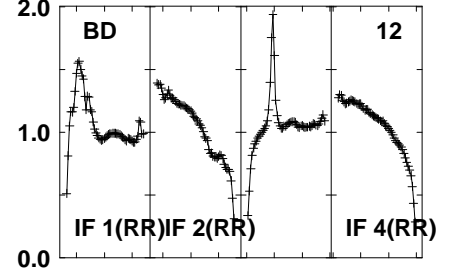
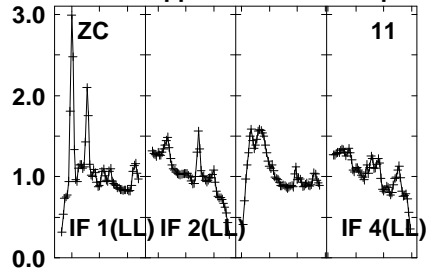
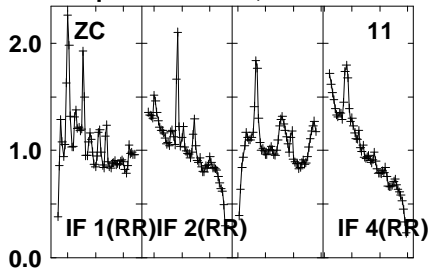

Lower frame: Real Jy

Auto-corr total-power spectrum Antenna: \*

Timerange: 00/16:12:01 to 00/16:15:29



Plot file version 627 created 05-OCT-2021 17:07:20

APM08279+525 GM076.UVDATA.1

Freq = 1.5945 GHz, Bw = 32.000 MH No calibration applied and no bandpass applied

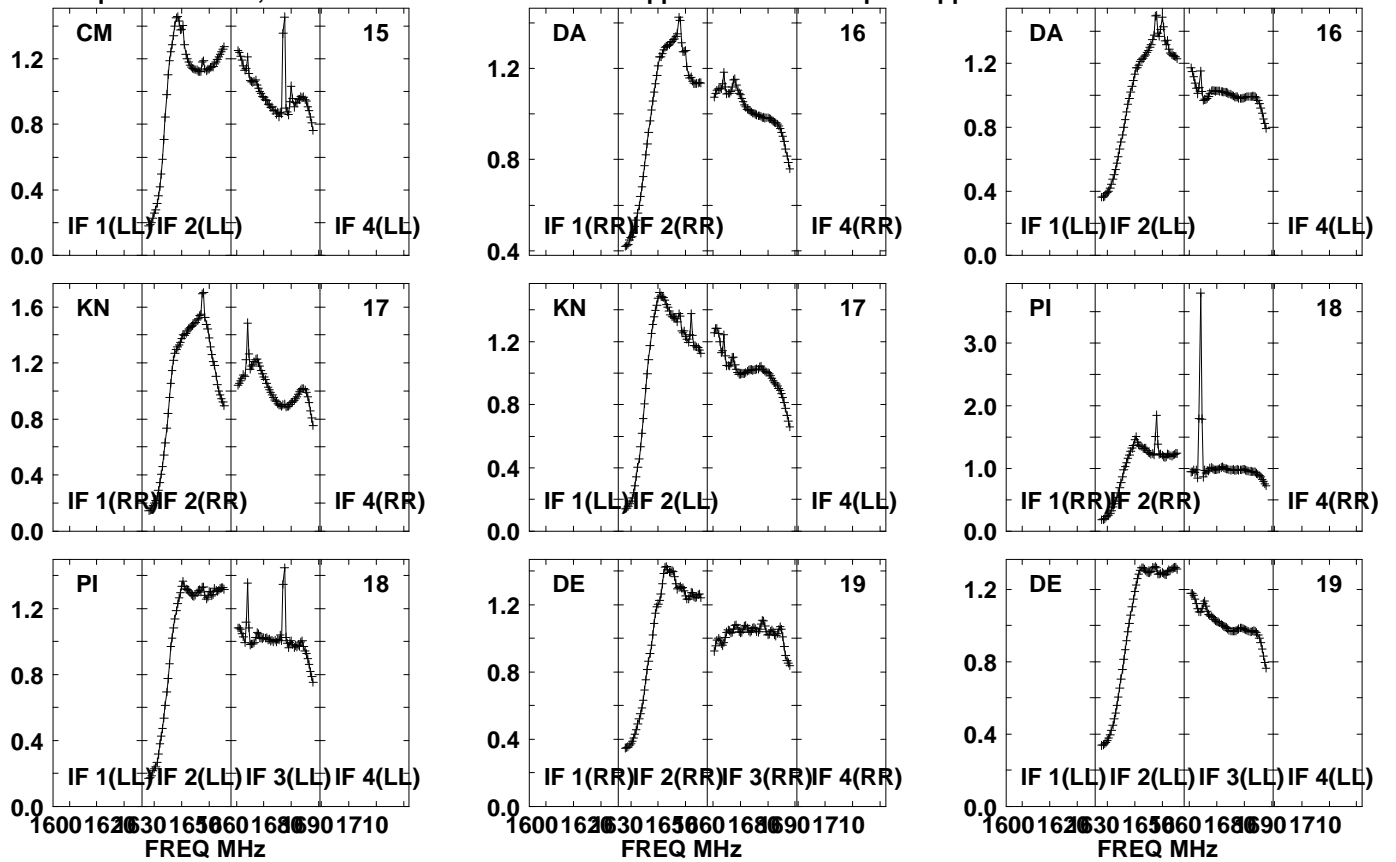

Lower frame: Real Jy  
Auto-corr total-power spectrum Antenna: \*  
Timerange: 00/16:12:01 to 00/16:15:29

Plot file version 628 created 05-OCT-2021 17:07:20

APM08279+525 GM076.UVDATA.1

Freq = 1.5945 GHz, Bw = 32.000 MH No calibration applied and no bandpass applied

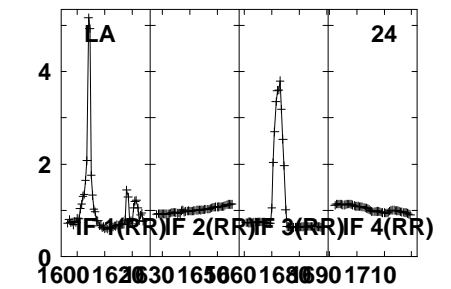
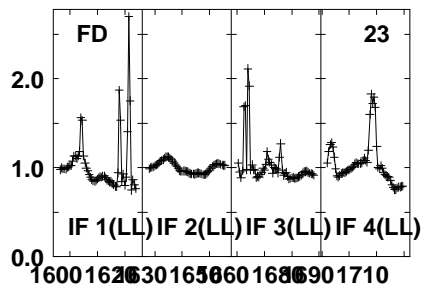
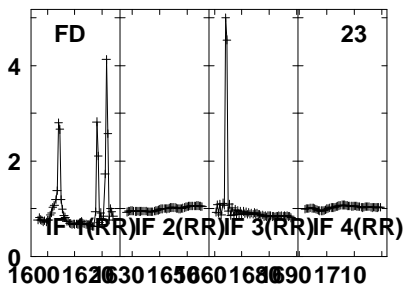
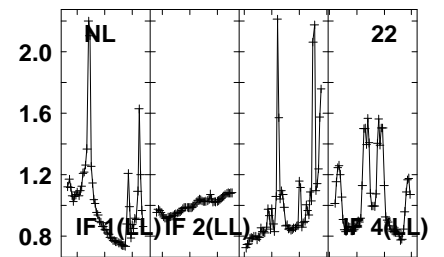
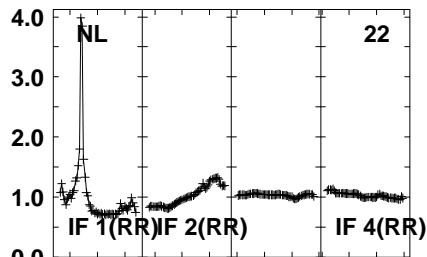
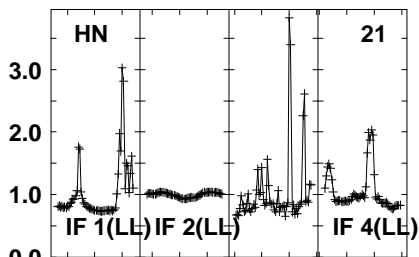
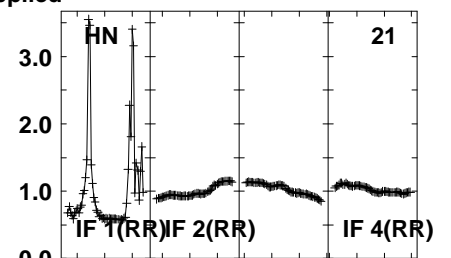
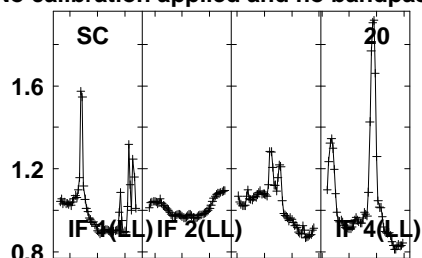
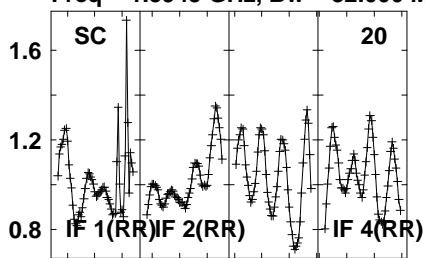

Lower frame: Real Jy  
Auto-corr total-power spectrum Antenna: \*  
Timerange: 00/16:12:01 to 00/16:15:29

Plot file version 629 created 05-OCT-2021 17:07:20

APM08279+525 GM076.UVDATA.1

Freq = 1.5945 GHz, Bw = 32.000 MH No calibration applied and no bandpass applied

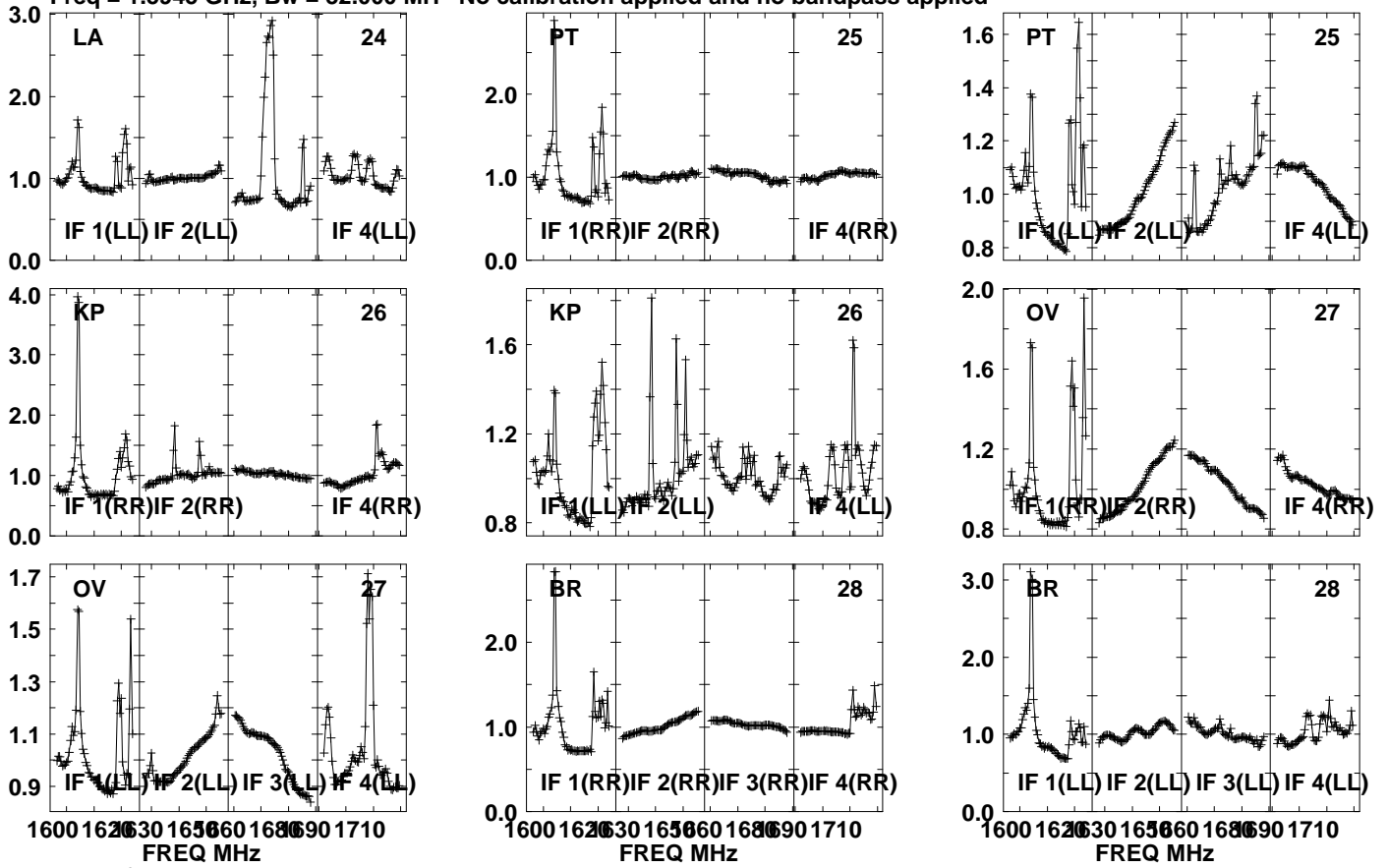

Plot file version 630 created 05-OCT-2021 17:07:21

J0827+5217 GM076.UVDATA.1

Freq = 1.5945 GHz, Bw = 32.000 MH No calibration applied and no bandpass applied

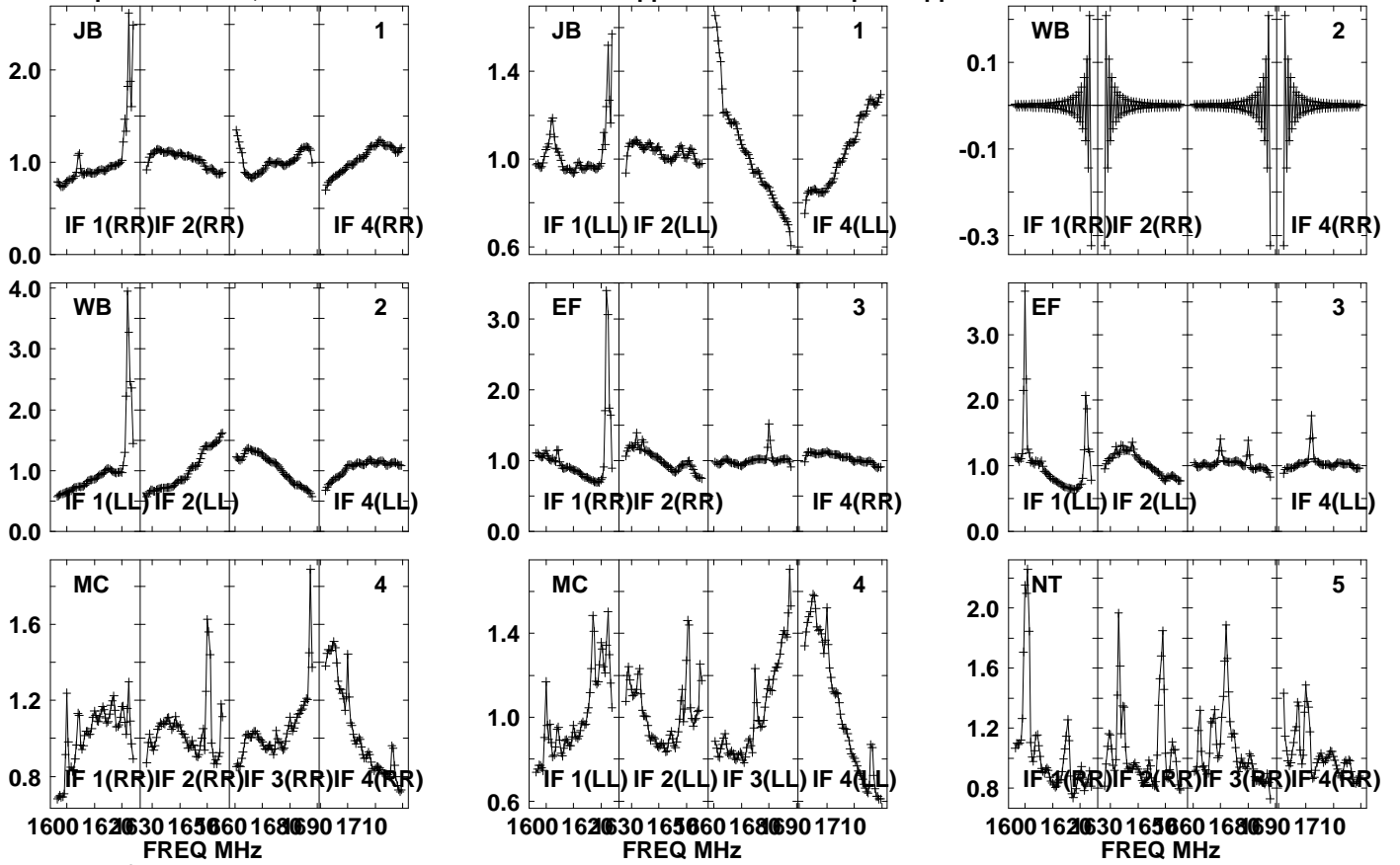

Lower frame: Real Jy

Auto-corr total-power spectrum Antenna: \*

Timerange: 00/16:15:31 to 00/16:16:59

Plot file version 631 created 05-OCT-2021 17:07:21

J0827+5217 GM076.UVDATA.1

Freq = 1.5945 GHz, Bw = 32.000 MH No calibration applied and no bandpass applied

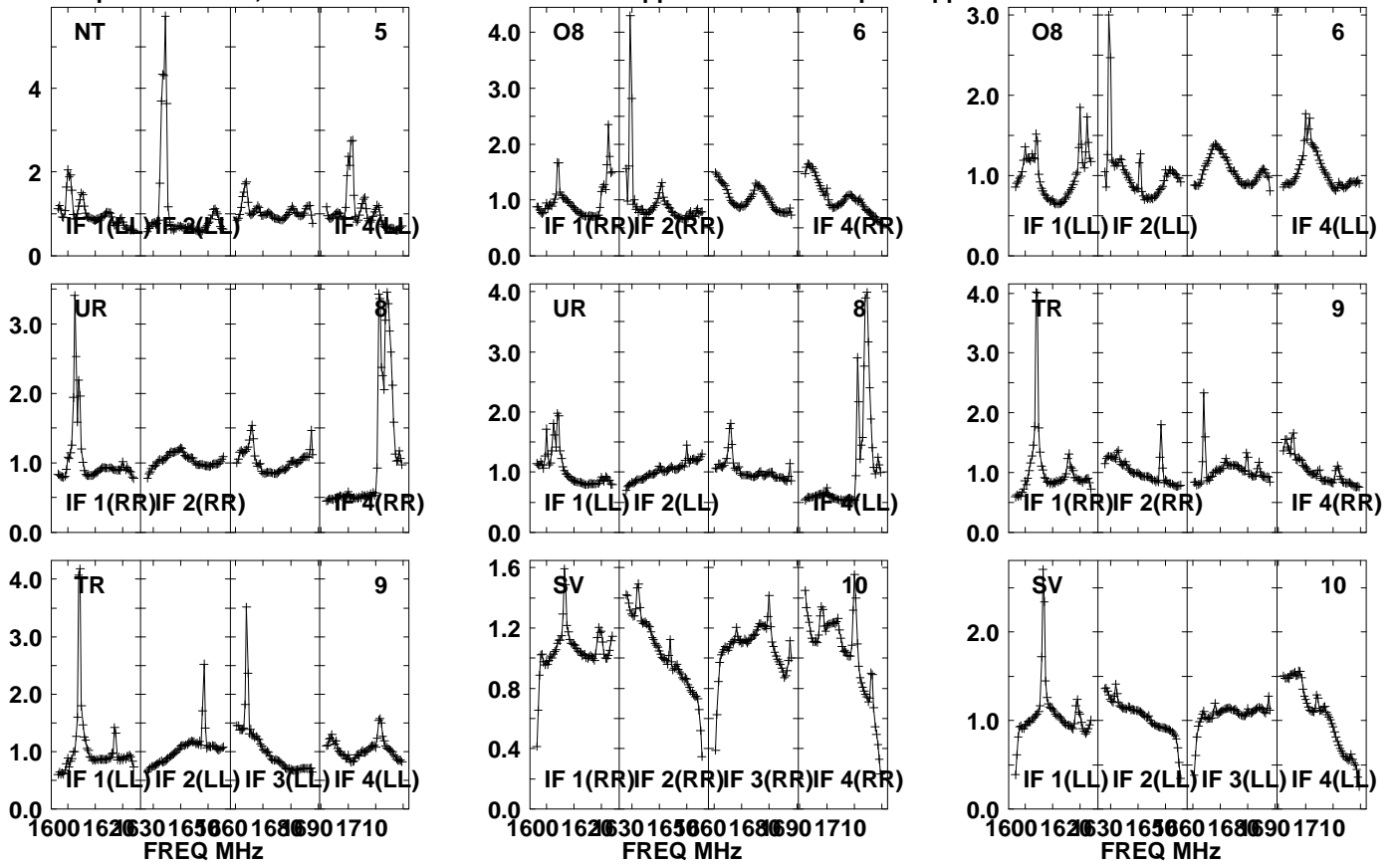

Lower frame: Real Jy

Auto-corr total-power spectrum Antenna: \*

Timerange: 00/16:15:31 to 00/16:16:59

Plot file version 632 created 05-OCT-2021 17:07:21

J0827+5217 GM076.UVDATA.1

Freq = 1.5945 GHz, Bw = 32.000 MH No calibration applied and no bandpass applied

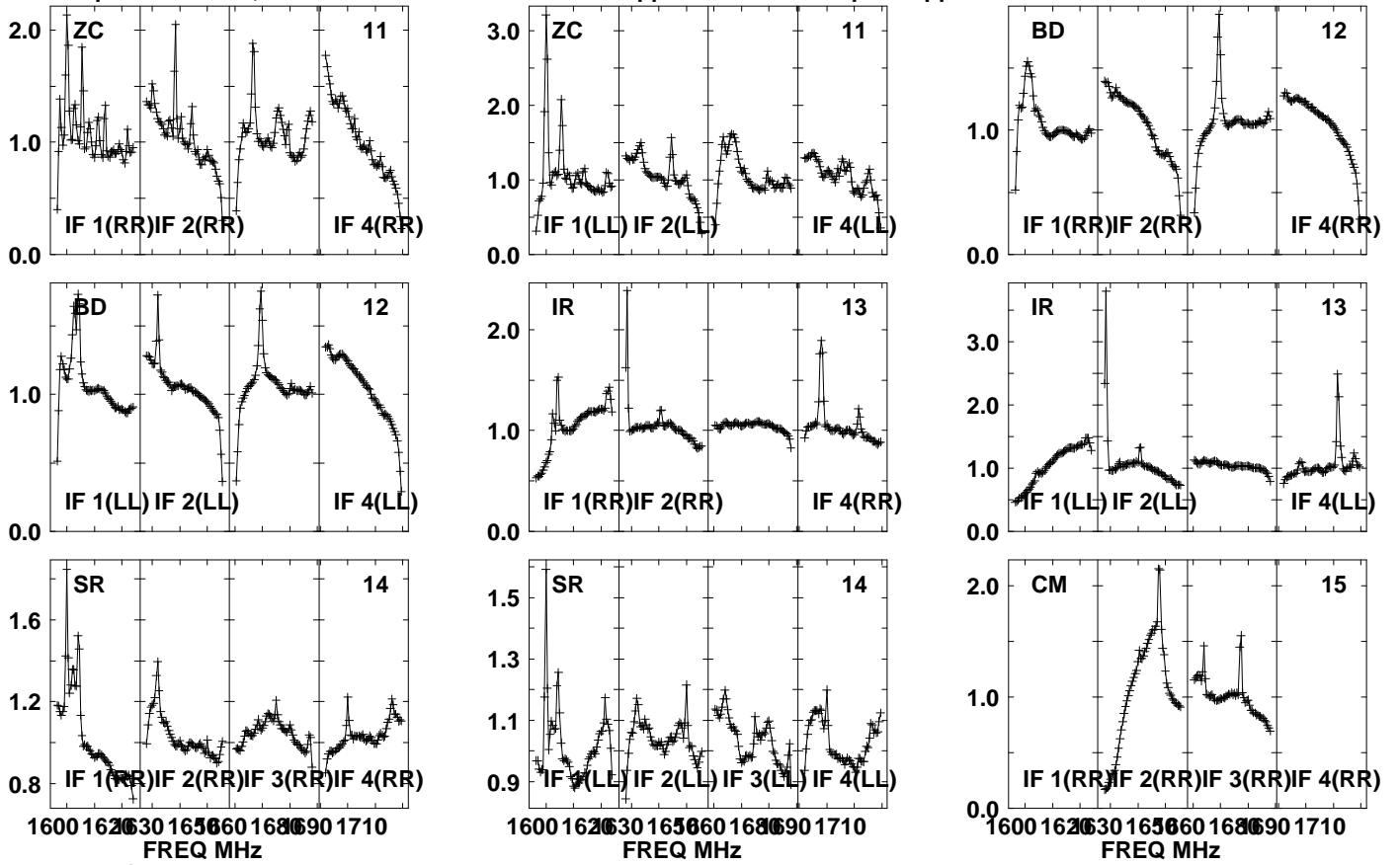

Lower frame: Real Jy  
Auto-corr total-power spectrum Antenna: \*  
Timerange: 00/16:15:31 to 00/16:16:59

Plot file version 633 created 05-OCT-2021 17:07:22

J0827+5217 GM076.UVDATA.1

Freq = 1.5945 GHz, Bw = 32.000 MH No calibration applied and no bandpass applied

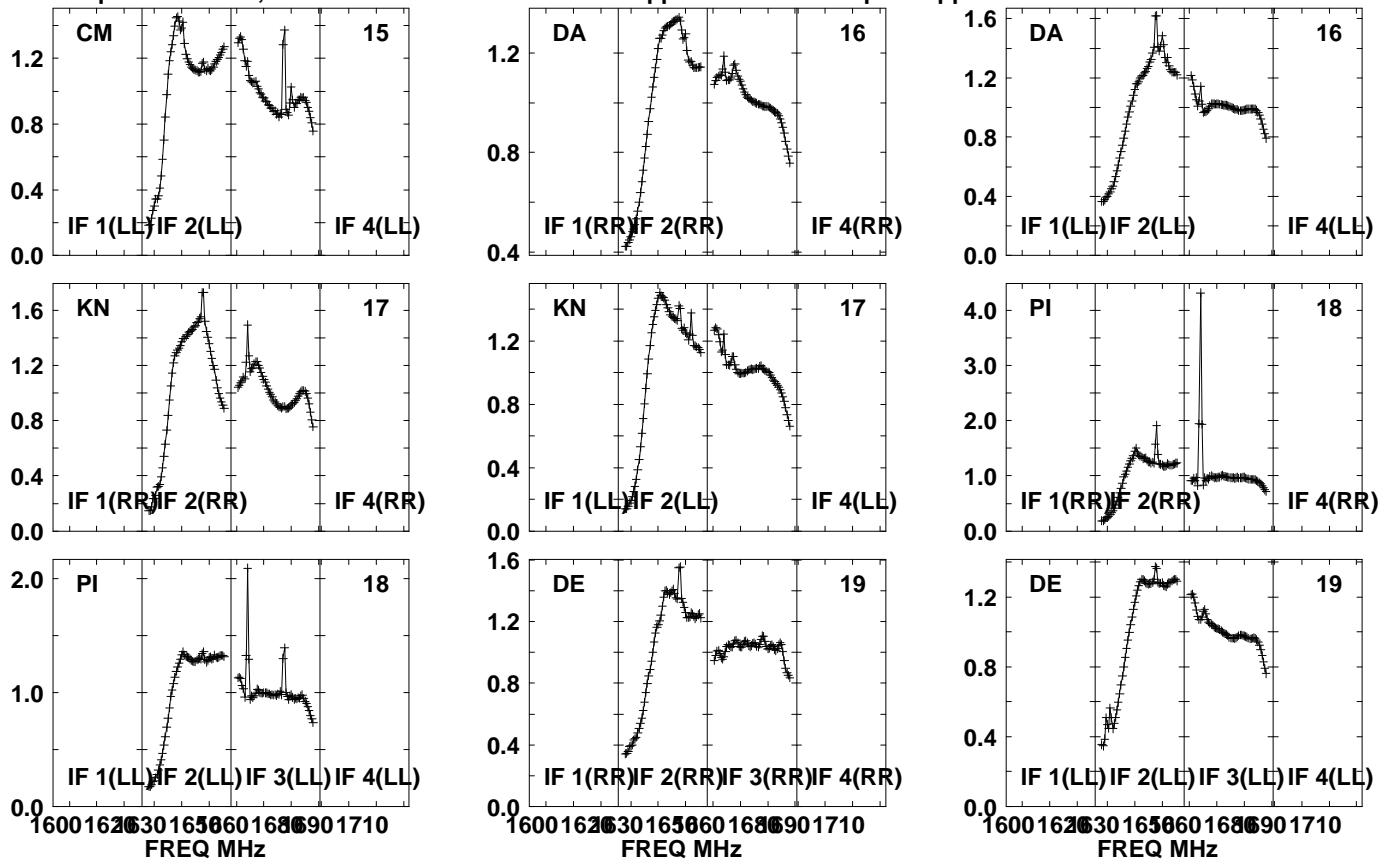

Lower frame: Real Jy  
Auto-corr total-power spectrum Antenna: \*  
Timerange: 00/16:15:31 to 00/16:16:59

Plot file version 634 created 05-OCT-2021 17:07:22

J0827+5217 GM076.UVDATA.1

Freq = 1.5945 GHz, Bw = 32.000 MH No calibration applied and no bandpass applied

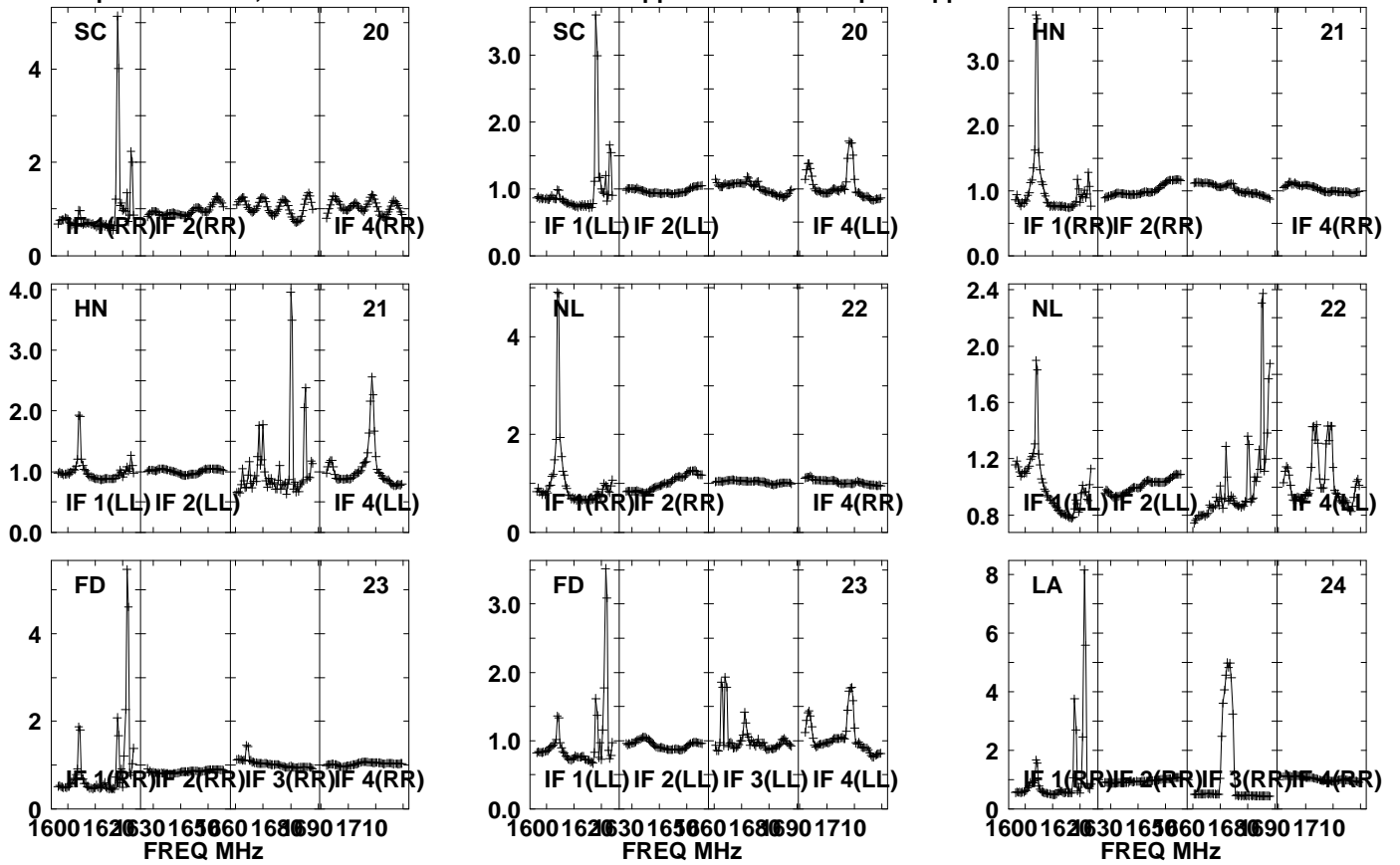

Lower frame: Real Jy  
Auto-corr total-power spectrum Antenna: \*  
Timerange: 00/16:15:31 to 00/16:16:59



Plot file version 635 created 05-OCT-2021 17:07:22

J0827+5217 GM076.UVDATA.1

Freq = 1.5945 GHz, Bw = 32.000 MH No calibration applied and no bandpass applied

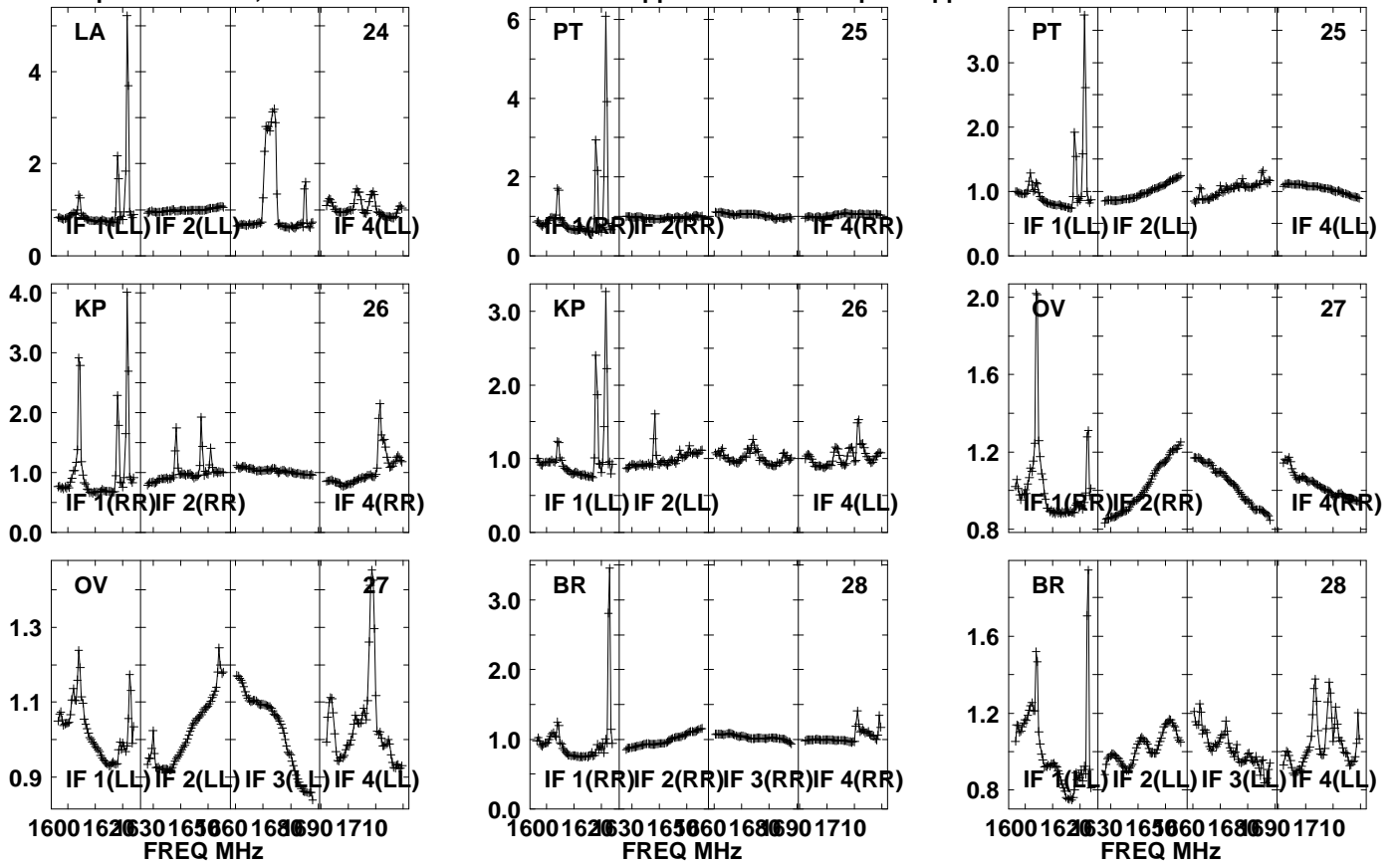

Lower frame: Real Jy  
Auto-corr total-power spectrum Antenna: \*  
Timerange: 00/16:15:31 to 00/16:16:59

Plot file version 636 created 05-OCT-2021 17:07:23

APM08279+525 GM076.UVDATA.1

Freq = 1.5945 GHz, Bw = 32.000 MH No calibration applied and no bandpass applied

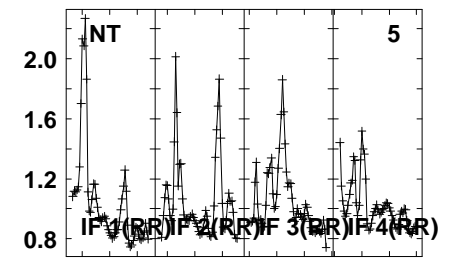
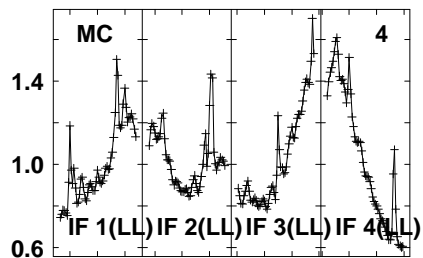
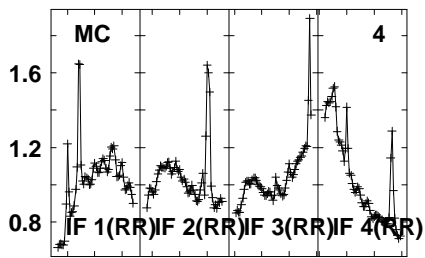
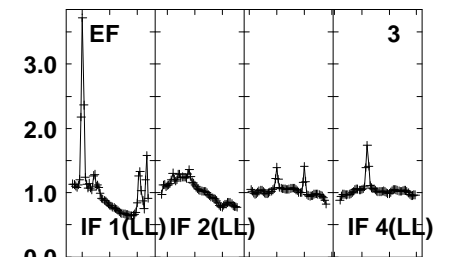
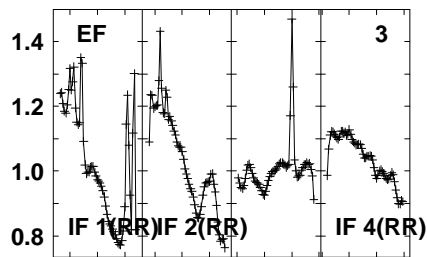
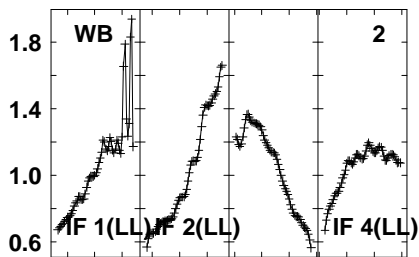
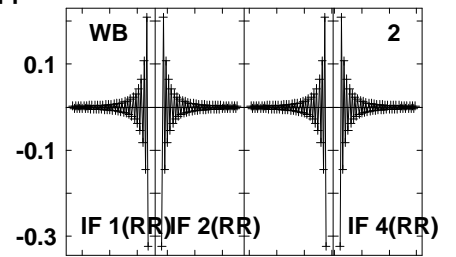
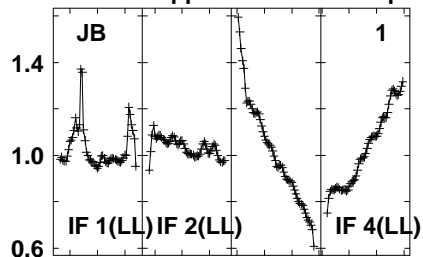
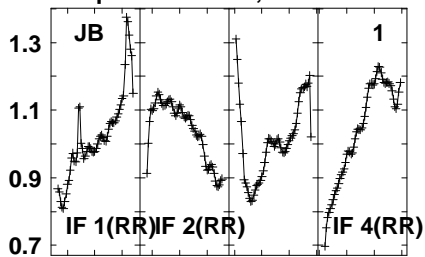

1600 1620 1630 1650 1660 1680 1690 1710  
FREQ MHz

1600 1620 1630 1650 1660 1680 1690 1710  
FREQ MHz

1600 1620 1630 1650 1660 1680 1690 1710  
FREQ MHz

Lower frame: Real Jy  
Auto-corr total-power spectrum Antenna: \*  
Timerange: 00/16:17:01 to 00/16:20:29

Plot file version 637 created 05-OCT-2021 17:07:23

APM08279+525 GM076.UVDATA.1

Freq = 1.5945 GHz, Bw = 32.000 MH No calibration applied and no bandpass applied

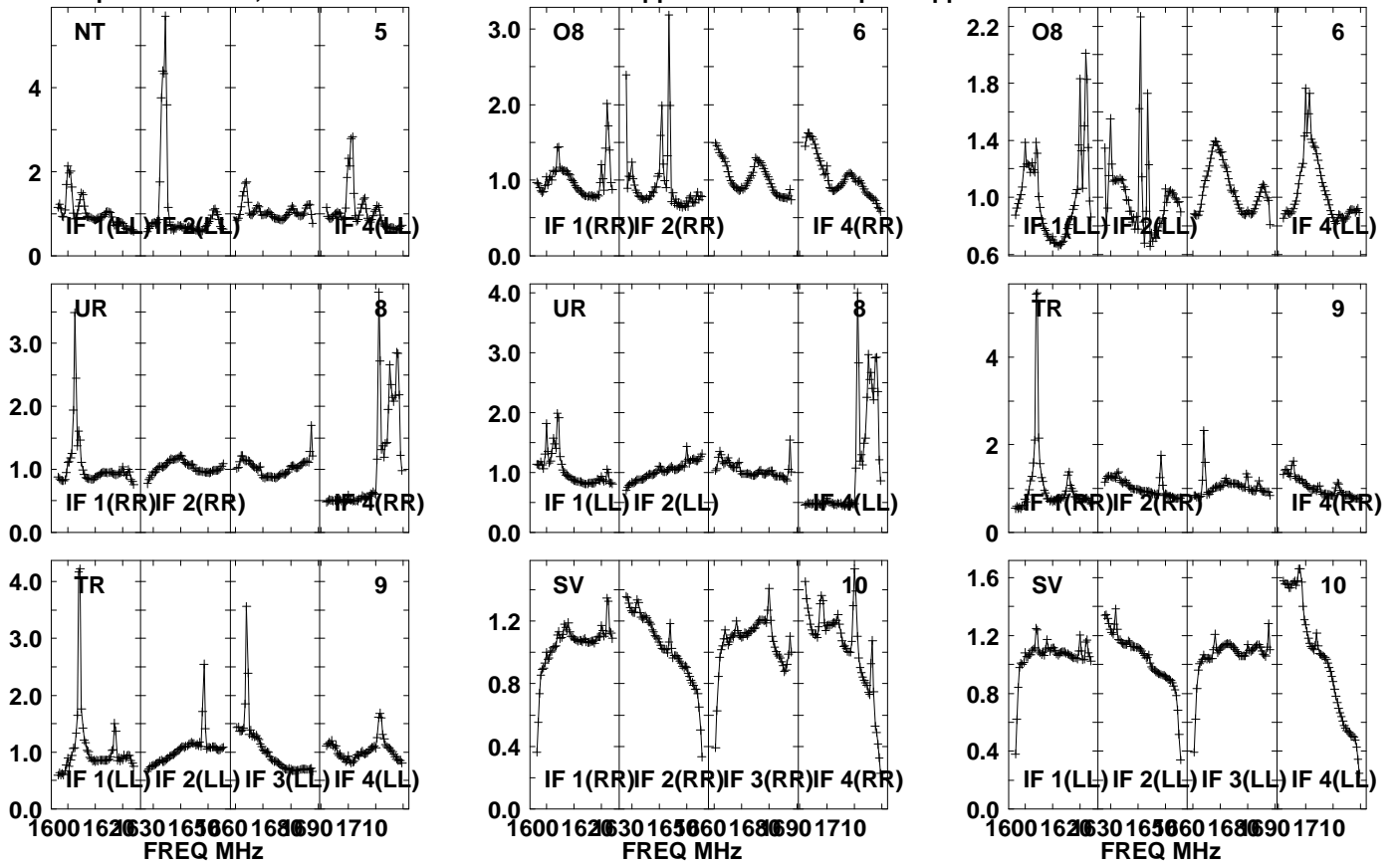

Lower frame: Real Jy  
Auto-corr total-power spectrum Antenna: \*  
Timerange: 00/16:17:01 to 00/16:20:29

Plot file version 638 created 05-OCT-2021 17:07:24

APM08279+525 GM076.UVDATA.1

Freq = 1.5945 GHz, Bw = 32.000 MH No calibration applied and no bandpass applied

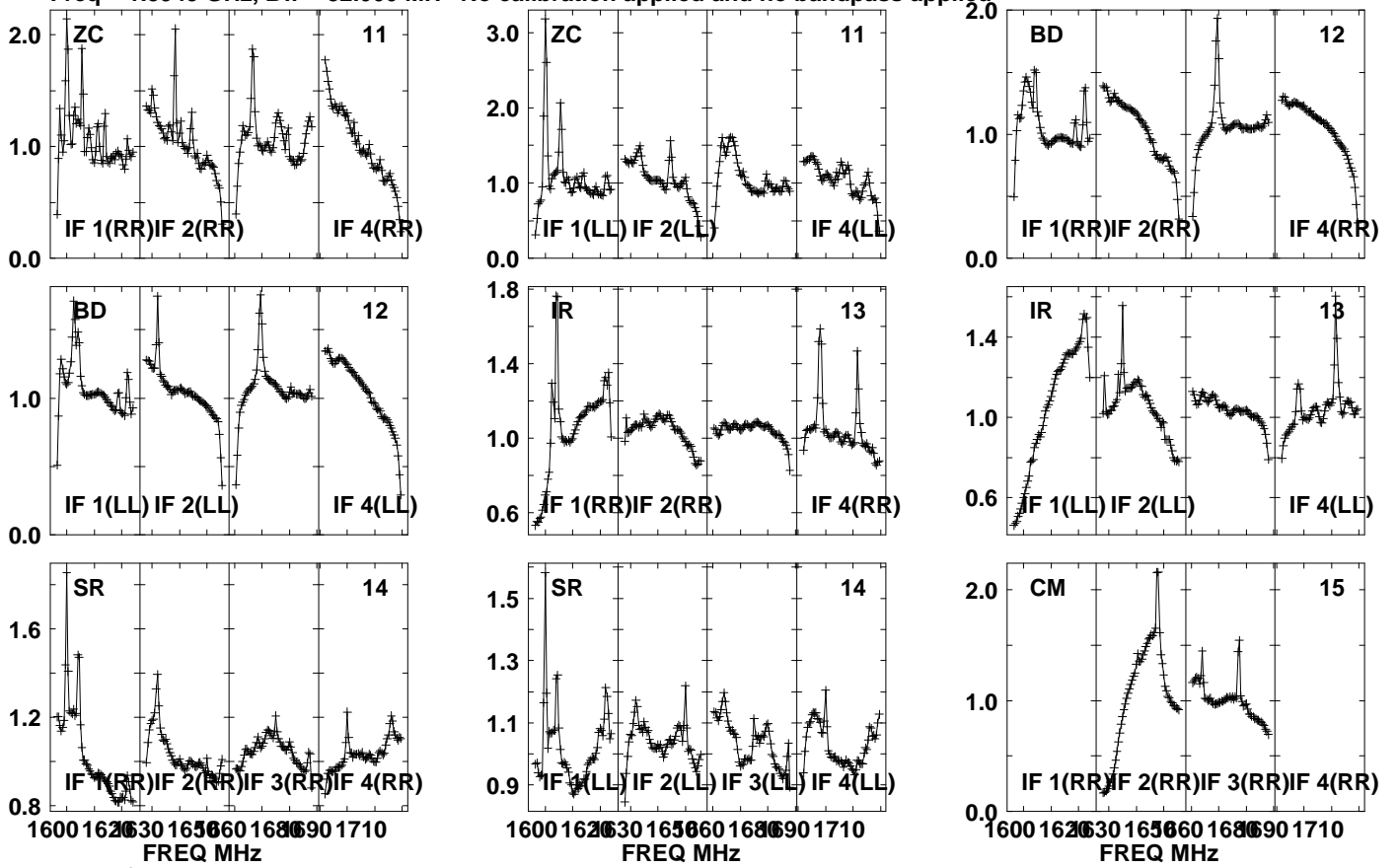

Lower frame: Real Jy

Auto-corr total-power spectrum Antenna: \*

Timerange: 00/16:17:01 to 00/16:20:29

Plot file version 639 created 05-OCT-2021 17:07:24

APM08279+525 GM076.UVDATA.1

Freq = 1.5945 GHz, Bw = 32.000 MH No calibration applied and no bandpass applied

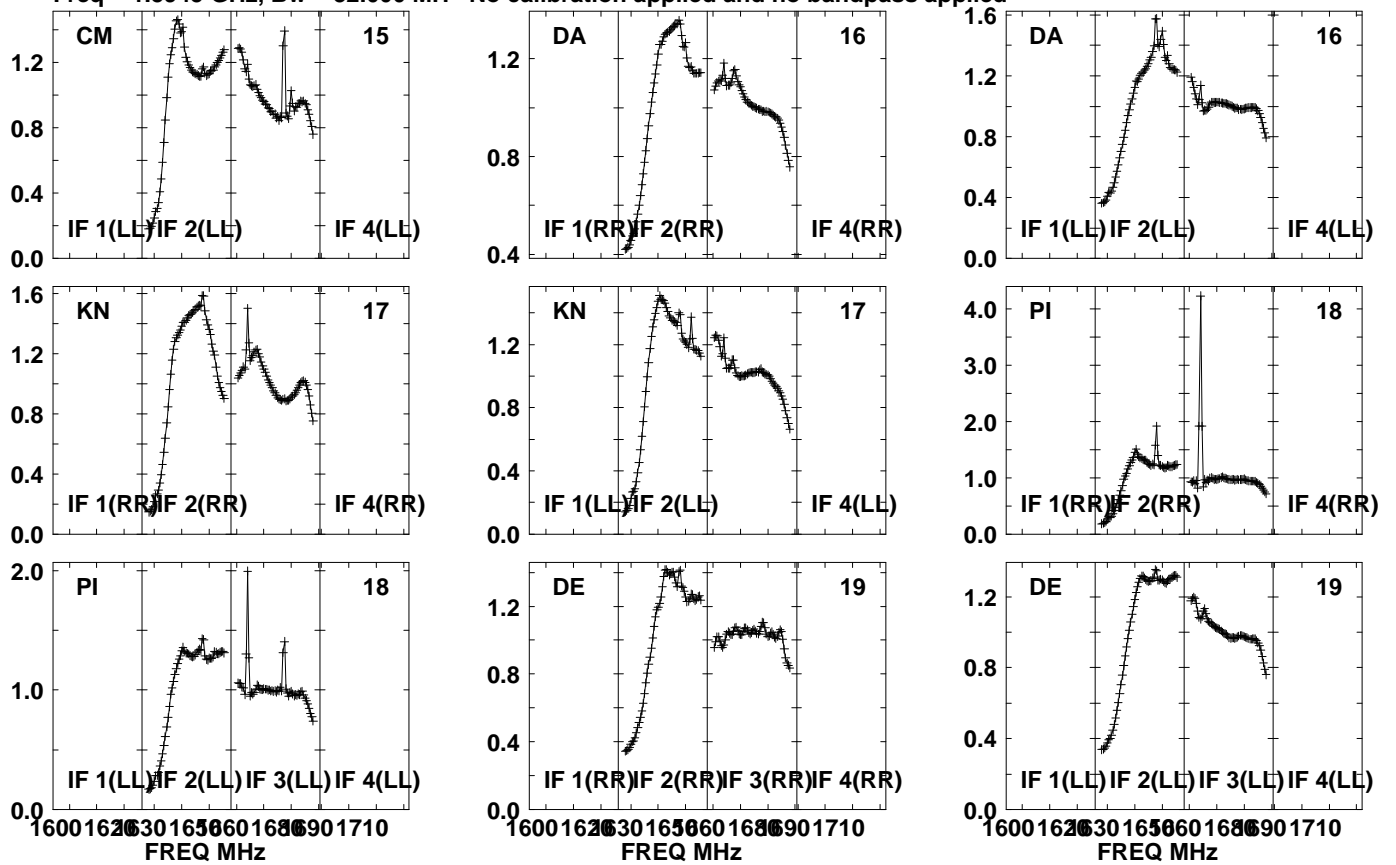

Lower frame: Real Jy  
Auto-corr total-power spectrum Antenna: \*  
Timerange: 00/16:17:01 to 00/16:20:29

Plot file version 640 created 05-OCT-2021 17:07:24

APM08279+525 GM076.UVDATA.1

Freq = 1.5945 GHz, Bw = 32.000 MH No calibration applied and no bandpass applied

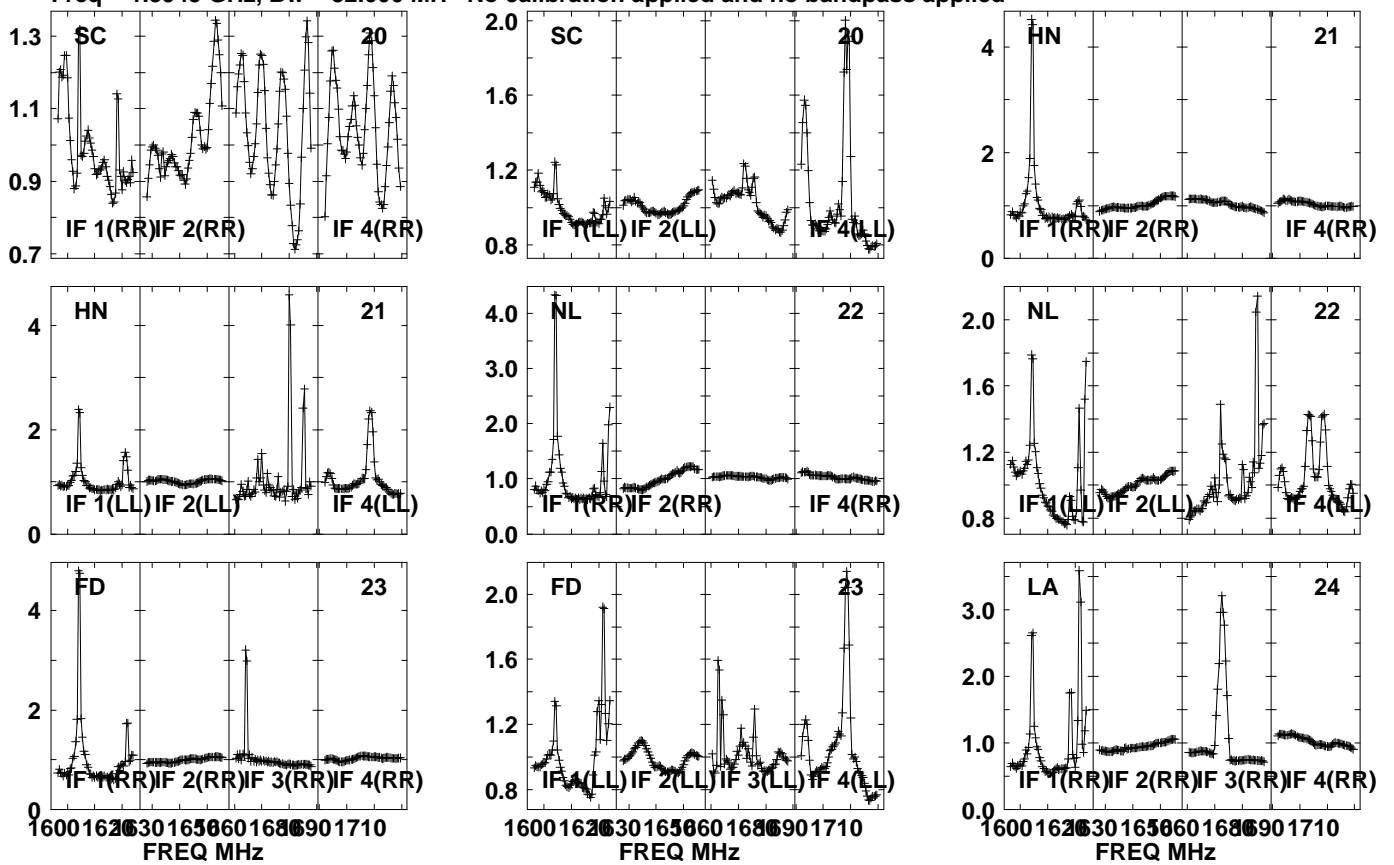

Lower frame: Real Jy  
Auto-corr total-power spectrum Antenna: \*  
Timerange: 00/16:17:01 to 00/16:20:29

Plot file version 641 created 05-OCT-2021 17:07:24

APM08279+525 GM076.UVDATA.1

Freq = 1.5945 GHz, Bw = 32.000 MH No calibration applied and no bandpass applied

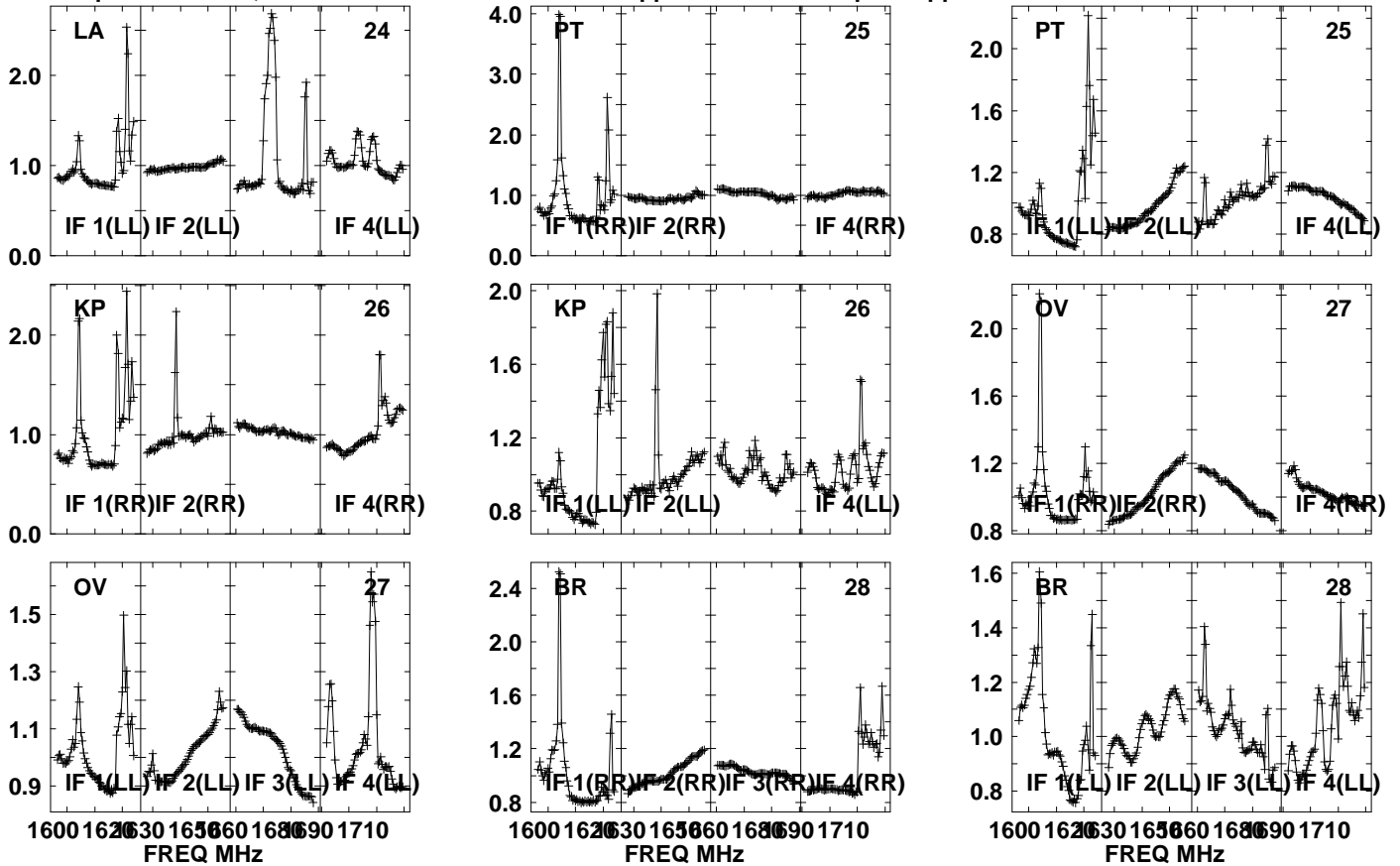

Lower frame: Real Jy  
Auto-corr total-power spectrum Antenna: \*  
Timerange: 00/16:17:01 to 00/16:20:29

Plot file version 642 created 05-OCT-2021 17:07:25

J0827+5217 GM076.UVDATA.1

Freq = 1.5945 GHz, Bw = 32.000 MH No calibration applied and no bandpass applied

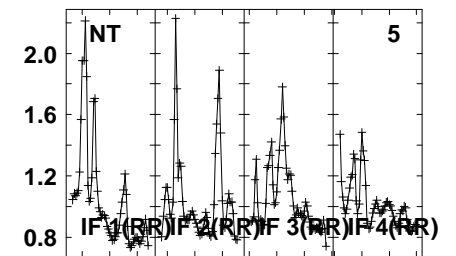
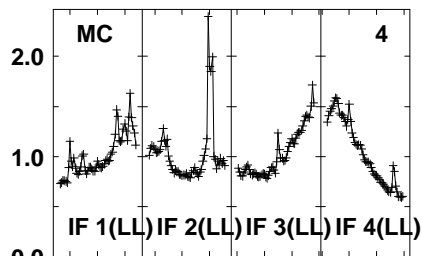
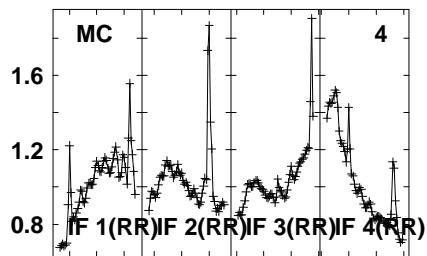
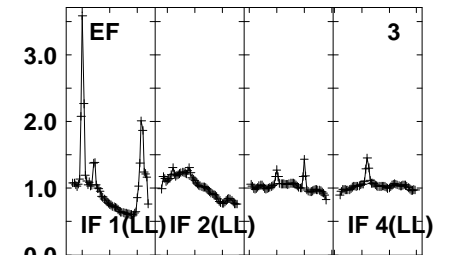
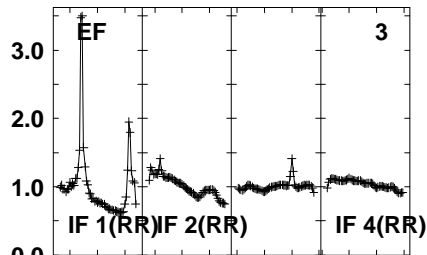
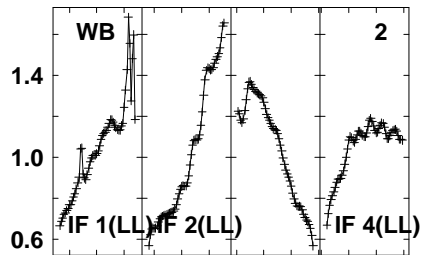
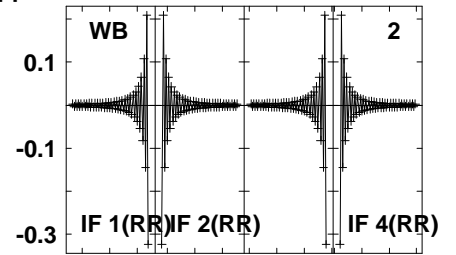
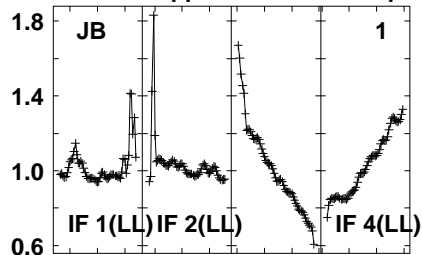
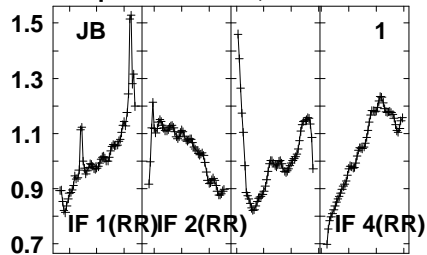

1600 1620 1630 1650 1660 1680 1690 1710  
FREQ MHz

1600 1620 1630 1650 1660 1680 1690 1710  
FREQ MHz

1600 1620 1630 1650 1660 1680 1690 1710  
FREQ MHz

Lower frame: Real Jy  
Auto-corr total-power spectrum Antenna: \*  
Timerange: 00/16:21:01 to 00/16:22:29



Plot file version 643 created 05-OCT-2021 17:07:25

J0827+5217 GM076.UVDATA.1

Freq = 1.5945 GHz, Bw = 32.000 MH No calibration applied and no bandpass applied

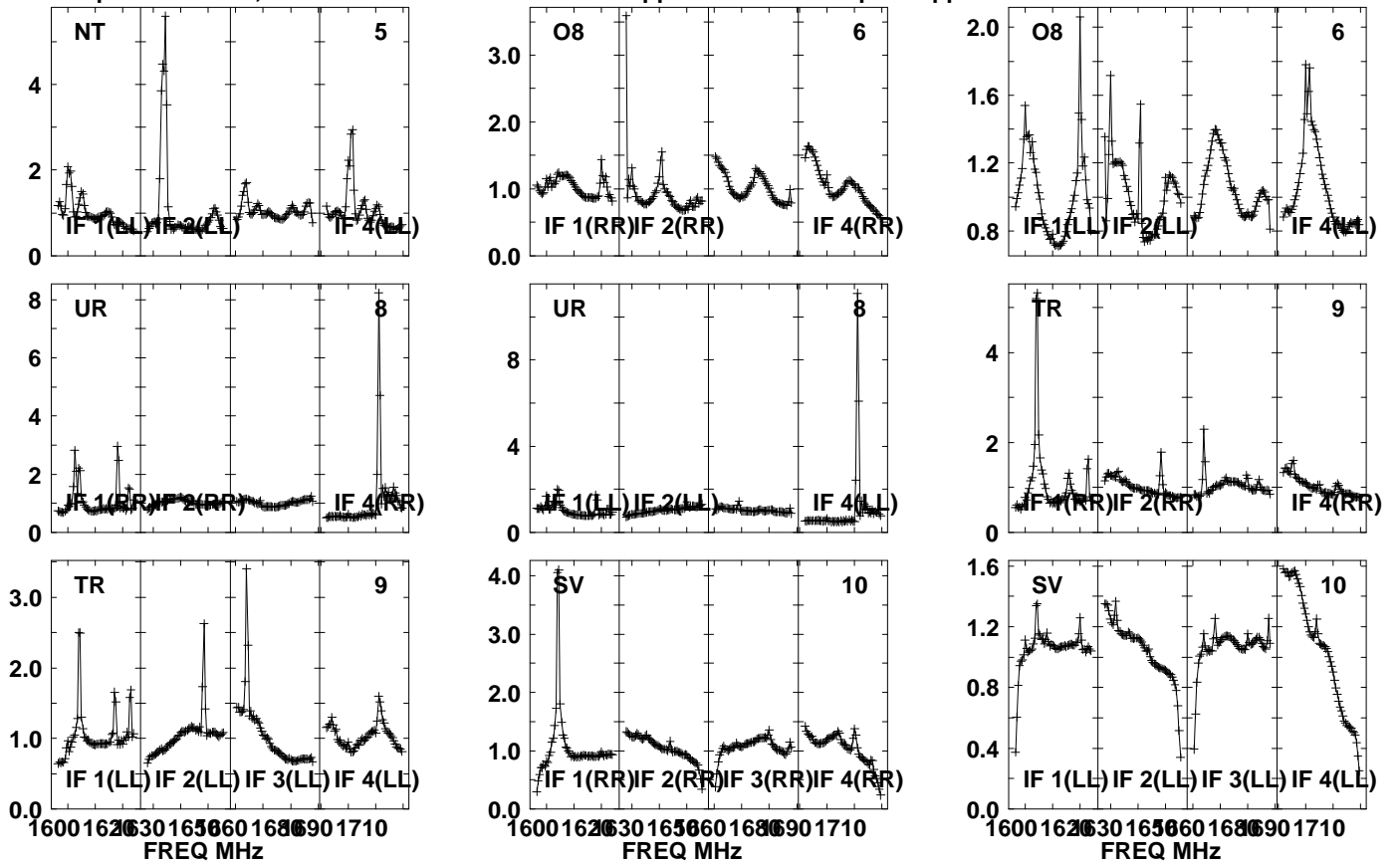

Lower frame: Real Jy

Auto-corr total-power spectrum Antenna: \*

Timerange: 00/16:21:01 to 00/16:22:29

Plot file version 644 created 05-OCT-2021 17:07:26

J0827+5217 GM076.UVDATA.1

Freq = 1.5945 GHz, Bw = 32.000 MH No calibration applied and no bandpass applied

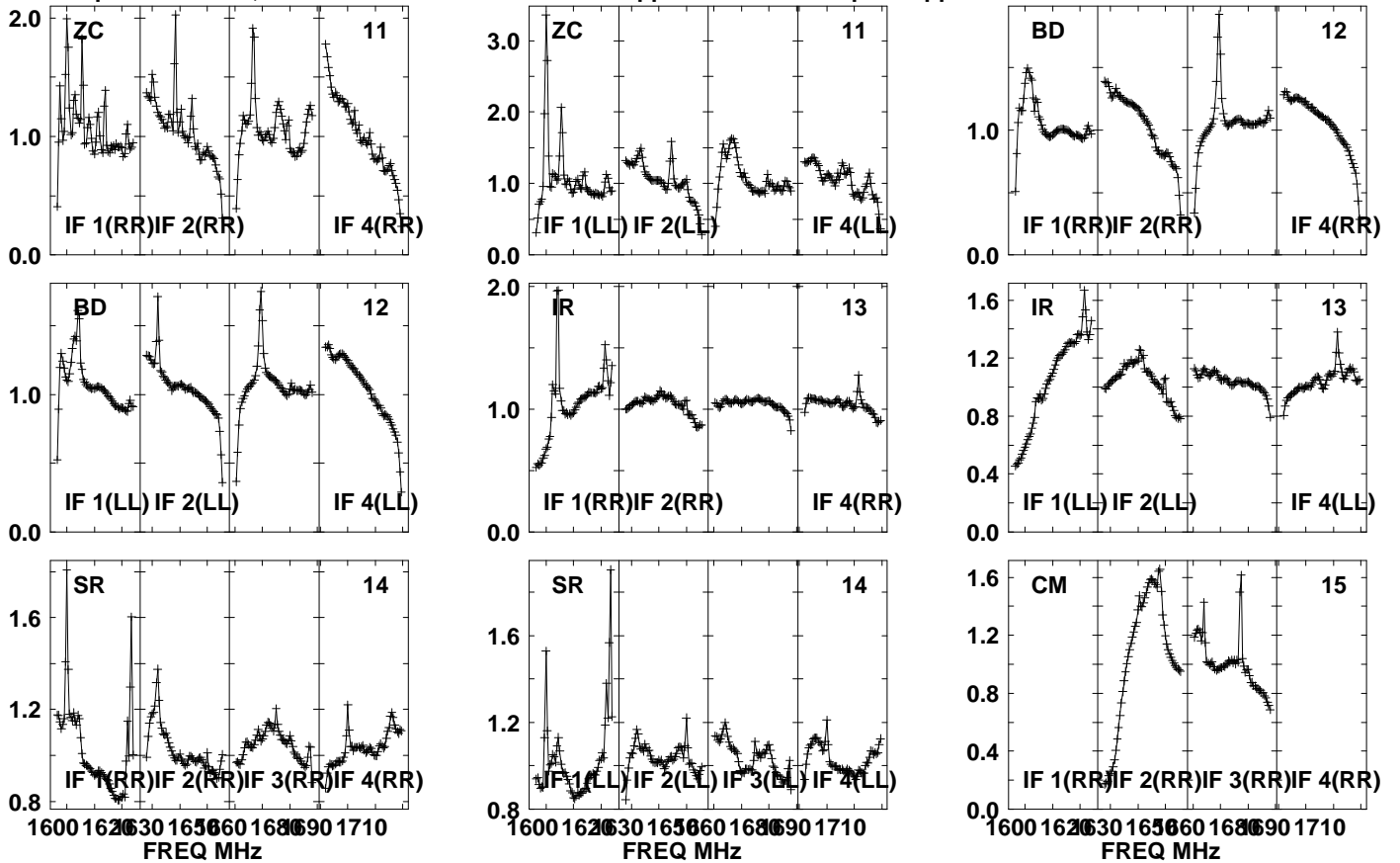

Lower frame: Real Jy

Auto-corr total-power spectrum Antenna: \*

Timerange: 00/16:21:01 to 00/16:22:29

Plot file version 645 created 05-OCT-2021 17:07:26

J0827+5217 GM076.UVDATA.1

Freq = 1.5945 GHz, Bw = 32.000 MH No calibration applied and no bandpass applied

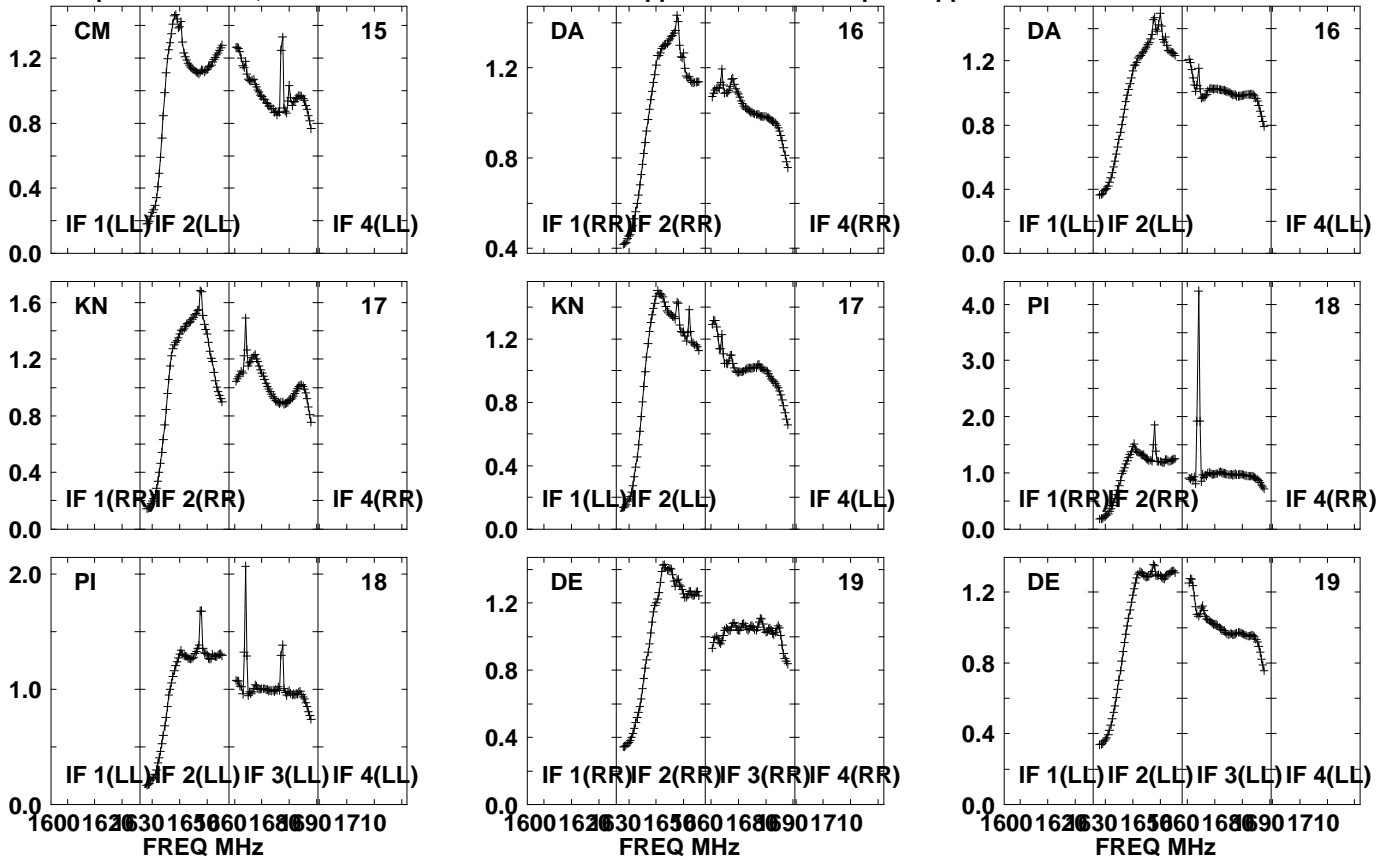

Lower frame: Real Jy  
Auto-corr total-power spectrum Antenna: \*  
Timerange: 00/16:21:01 to 00/16:22:29

Plot file version 646 created 05-OCT-2021 17:07:26

J0827+5217 GM076.UVDATA.1

Freq = 1.5945 GHz, Bw = 32.000 MH No calibration applied and no bandpass applied

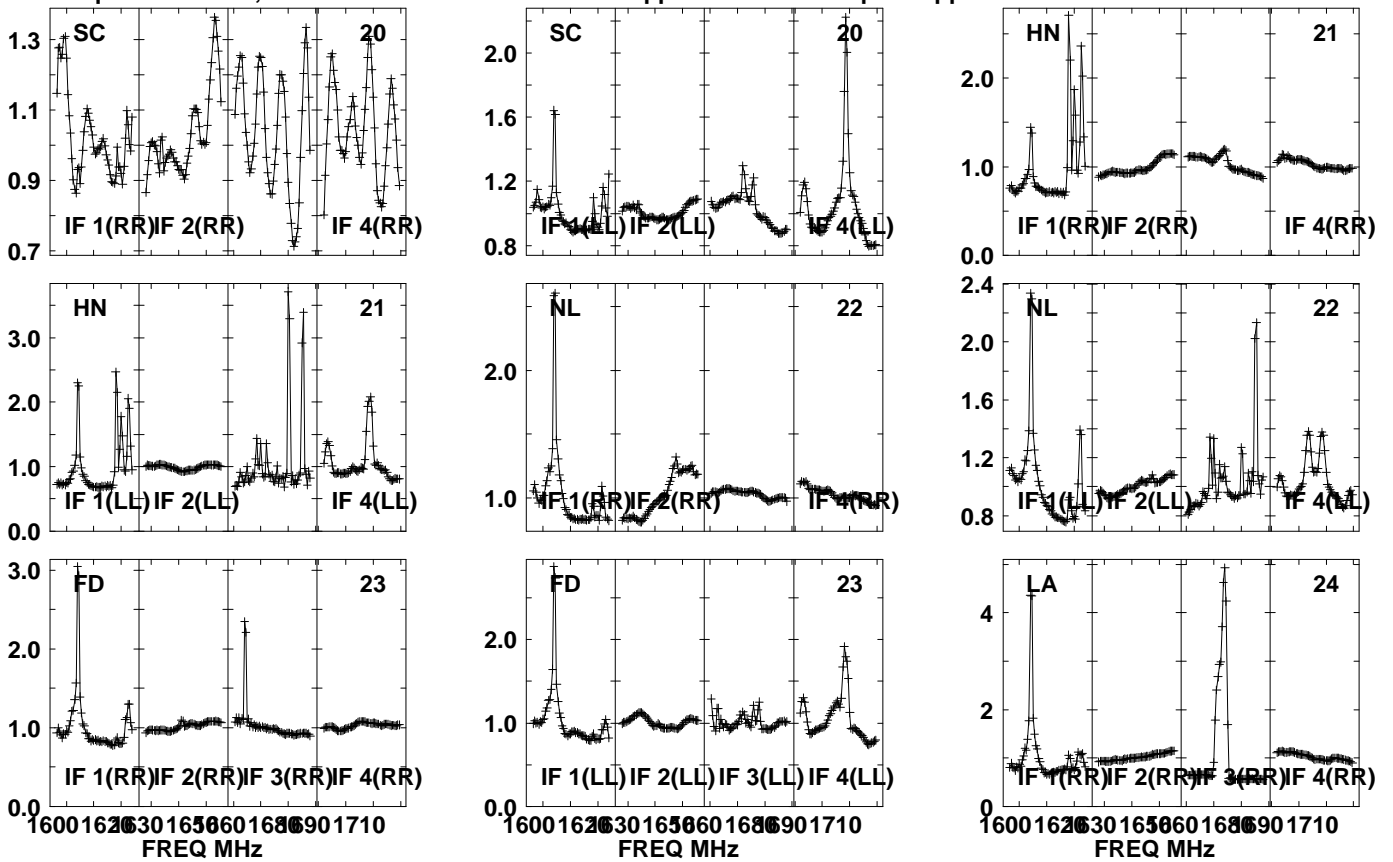

Lower frame: Real Jy  
Auto-corr total-power spectrum Antenna: \*  
Timerange: 00/16:21:01 to 00/16:22:29

Plot file version 647 created 05-OCT-2021 17:07:26

J0827+5217 GM076.UVDATA.1

Freq = 1.5945 GHz, Bw = 32.000 MH No calibration applied and no bandpass applied

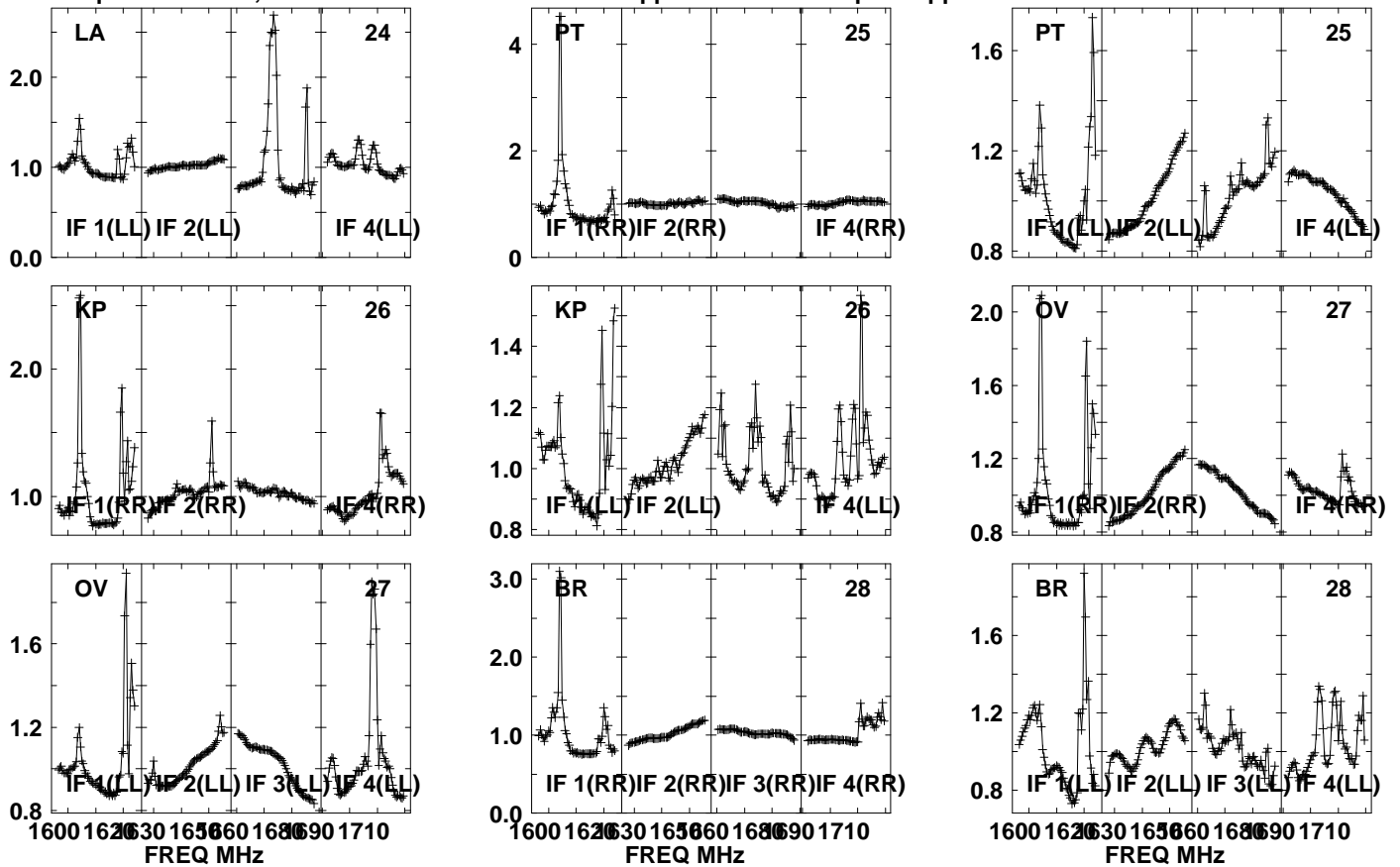

Lower frame: Real Jy

Auto-corr total-power spectrum Antenna: \*

Timerange: 00/16:21:01 to 00/16:22:29

Plot file version 648 created 05-OCT-2021 17:07:27

APM08279+525 GM076.UVDATA.1

Freq = 1.5945 GHz, Bw = 32.000 MH No calibration applied and no bandpass applied

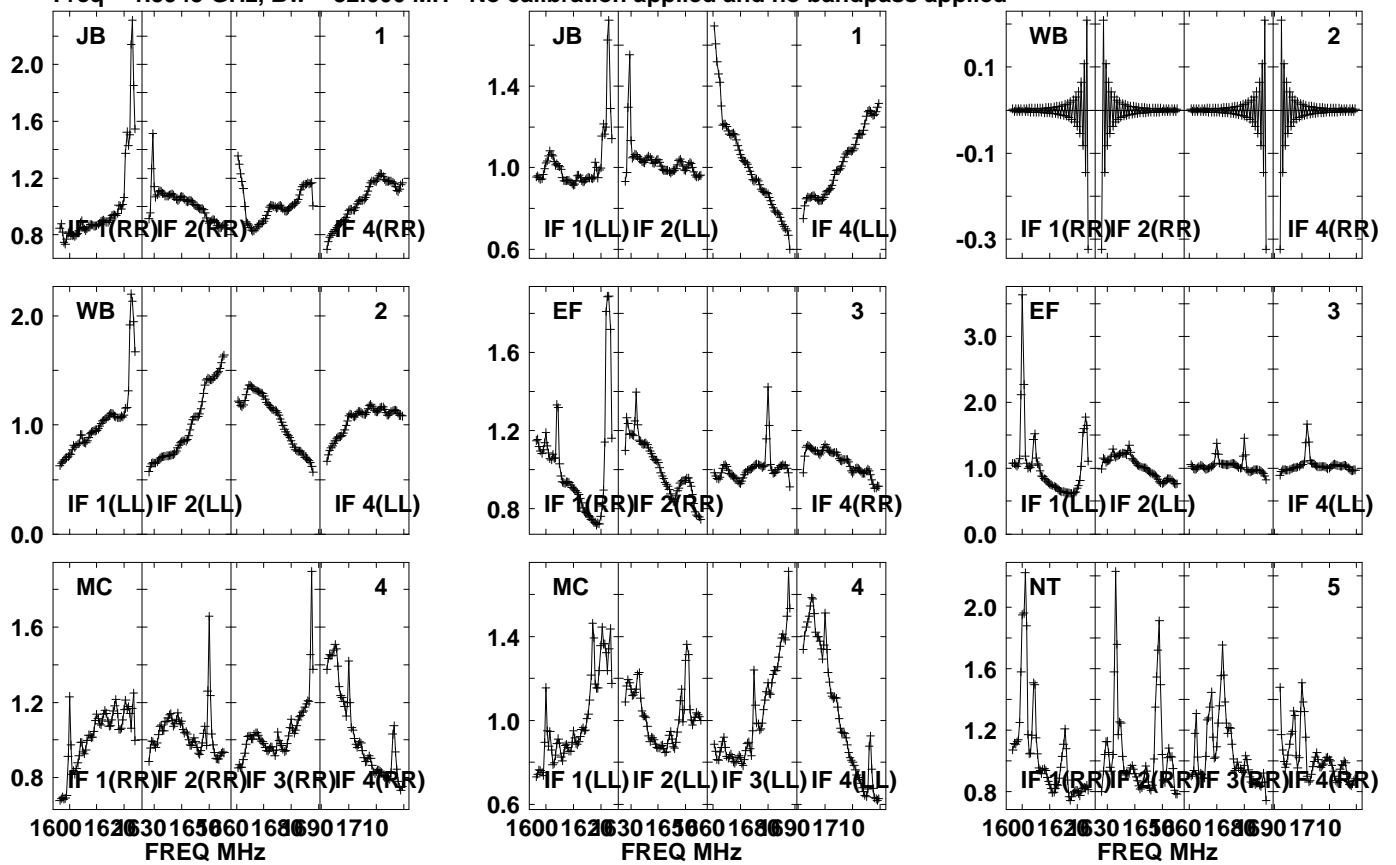

Lower frame: Real Jy  
Auto-corr total-power spectrum Antenna: \*  
Timerange: 00/16:22:31 to 00/16:25:59

Plot file version 649 created 05-OCT-2021 17:07:27

APM08279+525 GM076.UVDATA.1

Freq = 1.5945 GHz, Bw = 32.000 MH No calibration applied and no bandpass applied

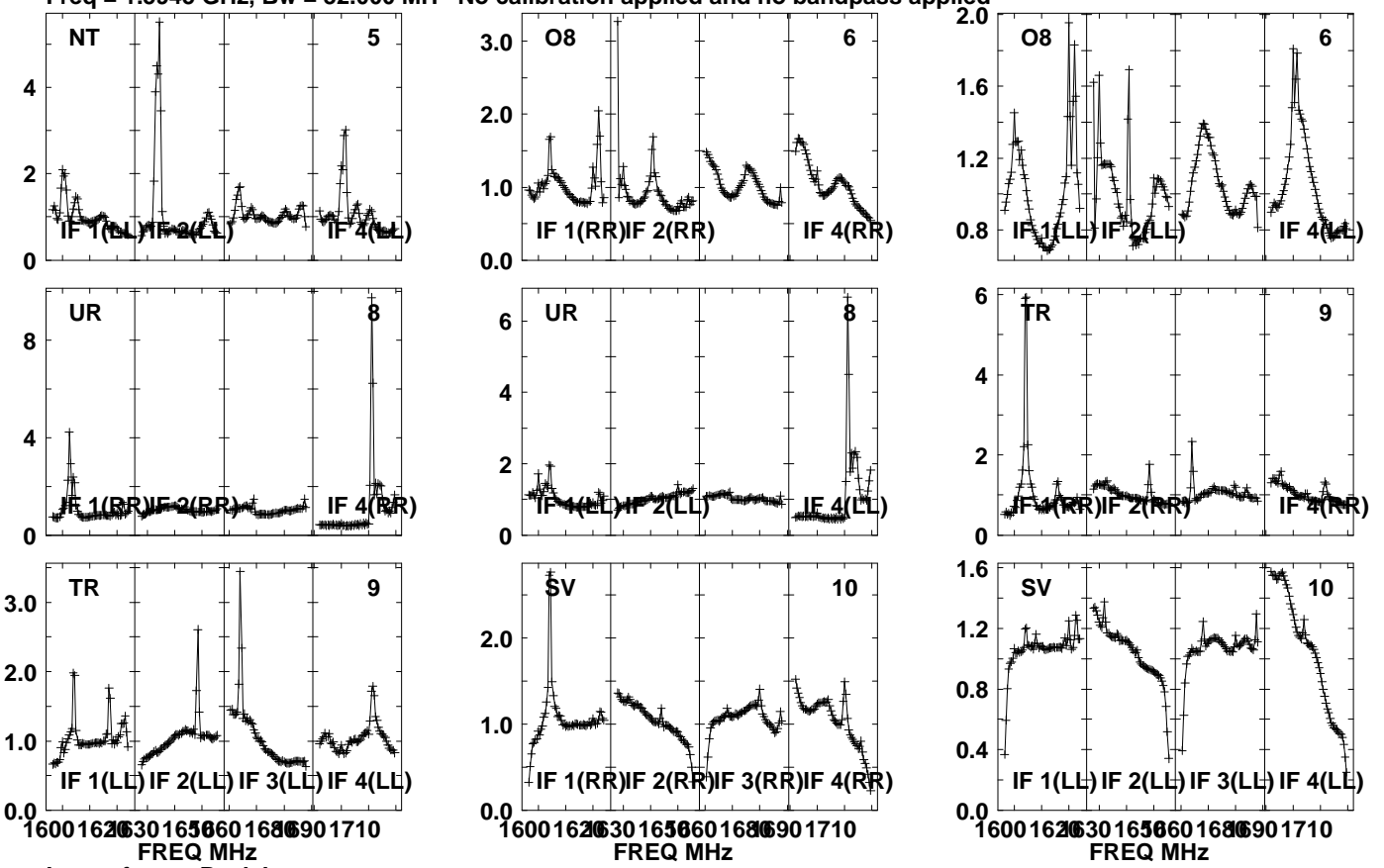

Lower frame: Real Jy  
Auto-corr total-power spectrum Antenna: \*  
Timerange: 00/16:22:31 to 00/16:25:59

Plot file version 650 created 05-OCT-2021 17:07:28

APM08279+525 GM076.UVDATA.1

Freq = 1.5945 GHz, Bw = 32.000 MH No calibration applied and no bandpass applied

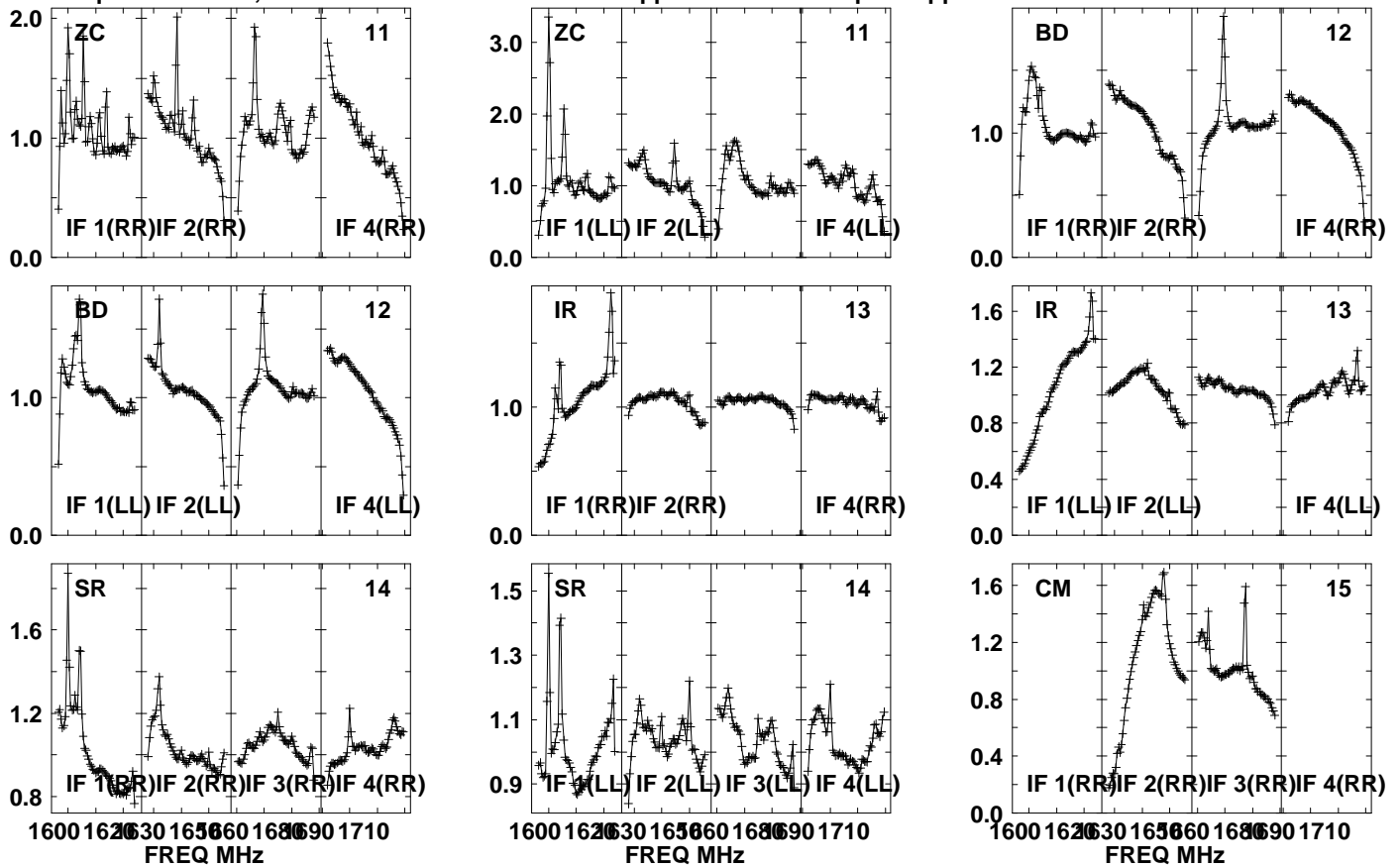

Lower frame: Real Jy

Auto-corr total-power spectrum Antenna: \*

Timerange: 00/16:22:31 to 00/16:25:59



Plot file version 651 created 05-OCT-2021 17:07:28

APM08279+525 GM076.UVDATA.1

Freq = 1.5945 GHz, Bw = 32.000 MH No calibration applied and no bandpass applied

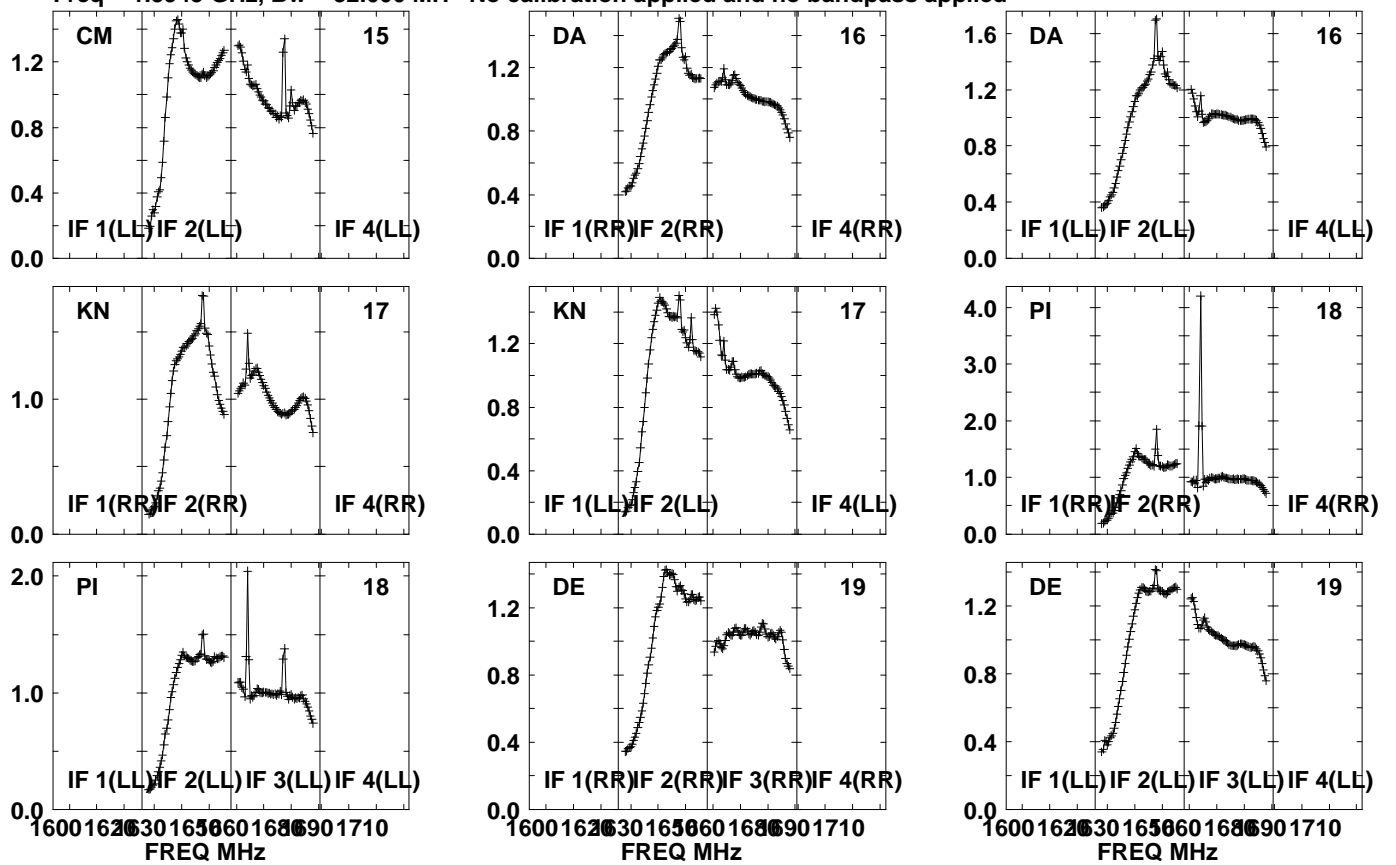

Lower frame: Real Jy  
Auto-corr total-power spectrum Antenna: \*  
Timerange: 00/16:22:31 to 00/16:25:59

Plot file version 652 created 05-OCT-2021 17:07:28

APM08279+525 GM076.UVDATA.1

Freq = 1.5945 GHz, Bw = 32.000 MH No calibration applied and no bandpass applied

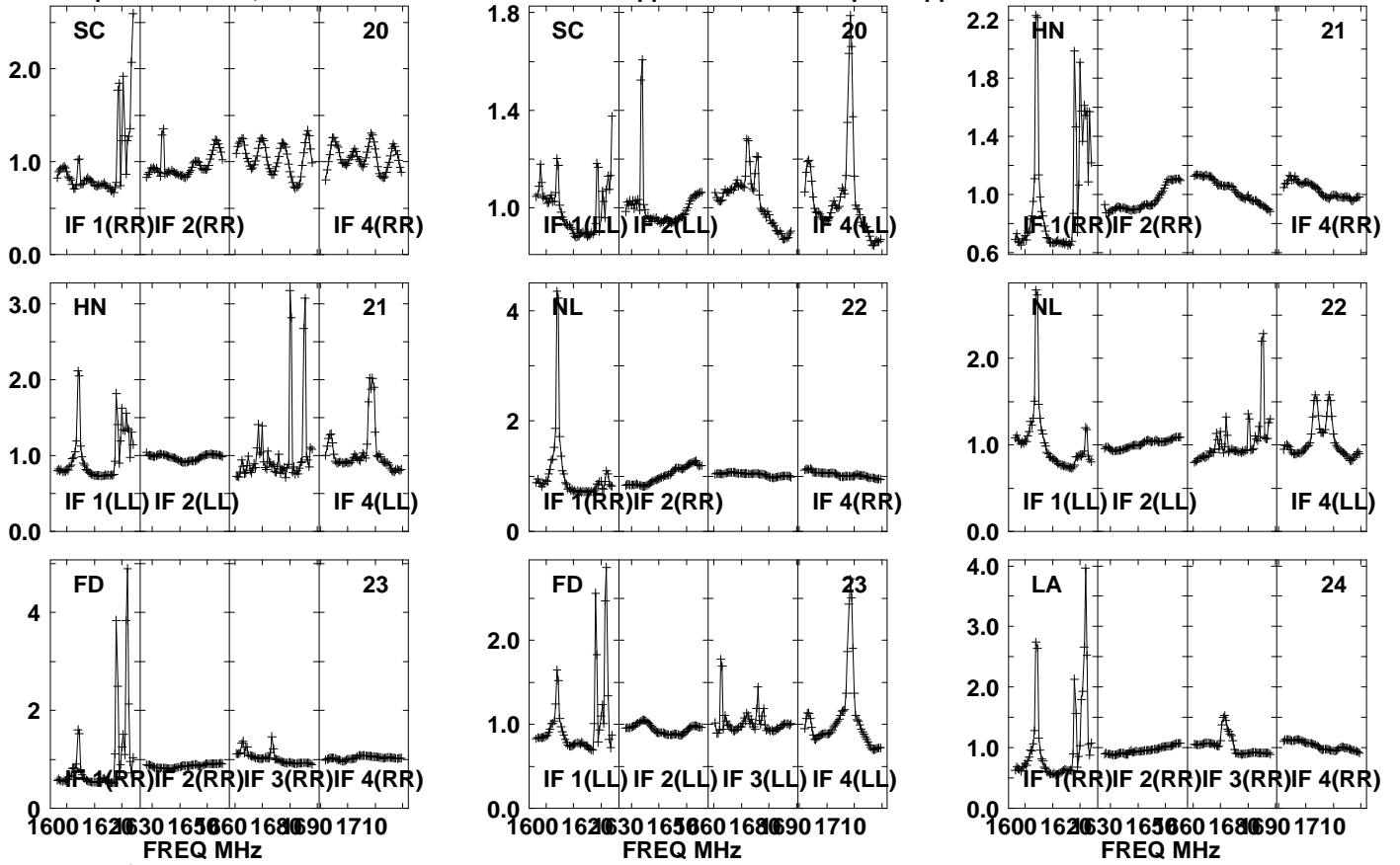

Lower frame: Real Jy

Auto-corr total-power spectrum Antenna: \*

Timerange: 00/16:22:31 to 00/16:25:59

Plot file version 653 created 05-OCT-2021 17:07:29

APM08279+525 GM076.UVDATA.1

Freq = 1.5945 GHz, Bw = 32.000 MH No calibration applied and no bandpass applied

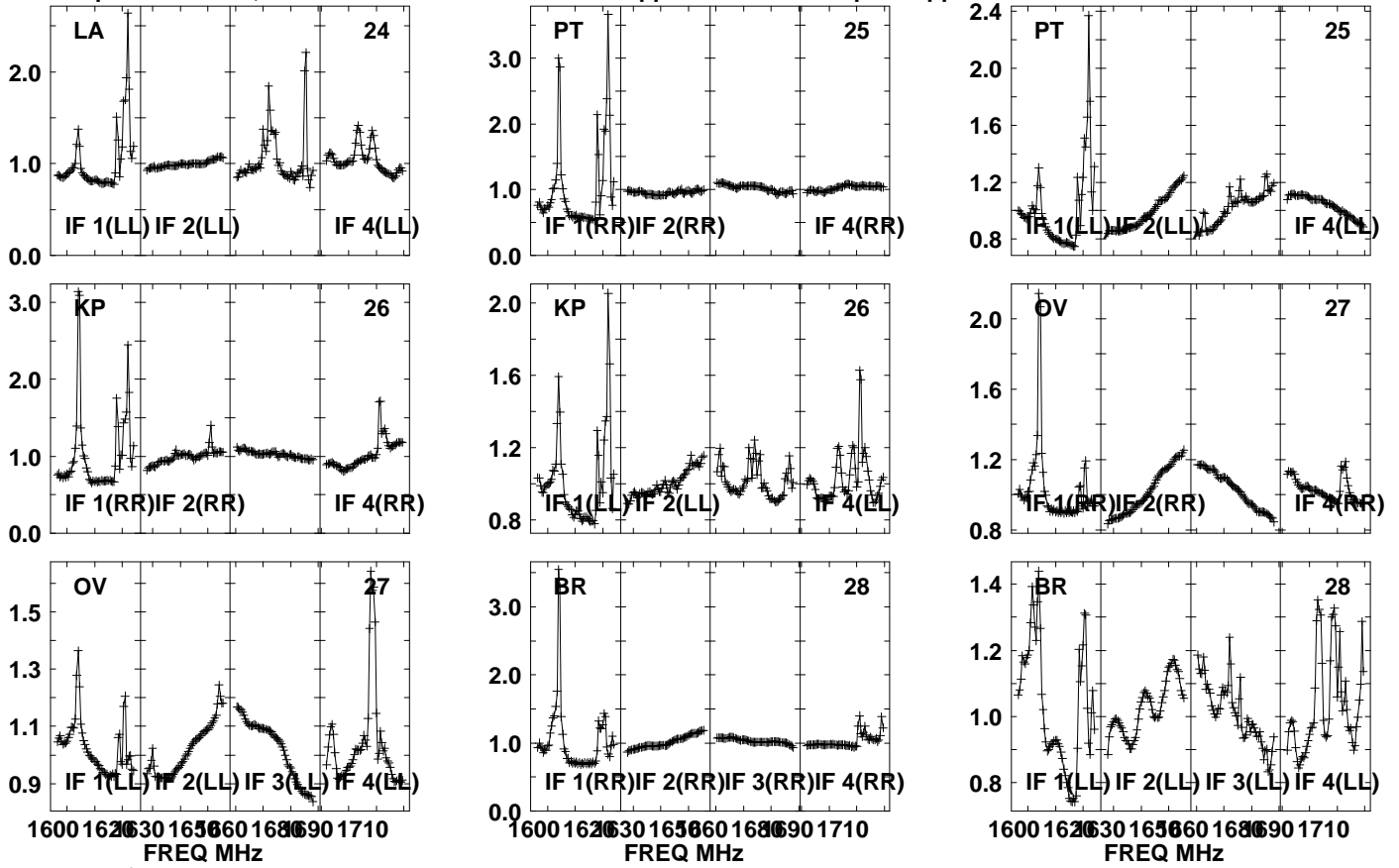

Lower frame: Real Jy  
Auto-corr total-power spectrum Antenna: \*  
Timerange: 00/16:22:31 to 00/16:25:59

Plot file version 654 created 05-OCT-2021 17:07:29

J0827+5217 GM076.UVDATA.1

Freq = 1.5945 GHz, Bw = 32.000 MH No calibration applied and no bandpass applied

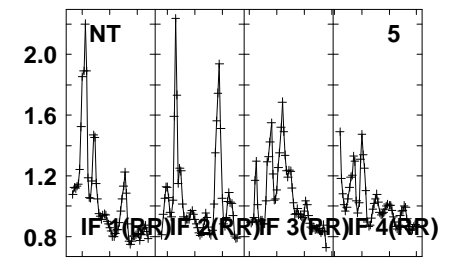
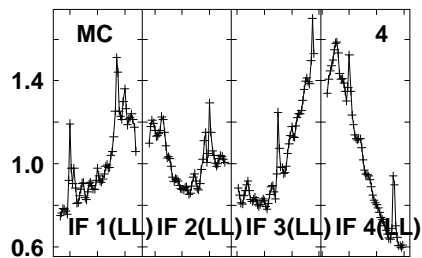
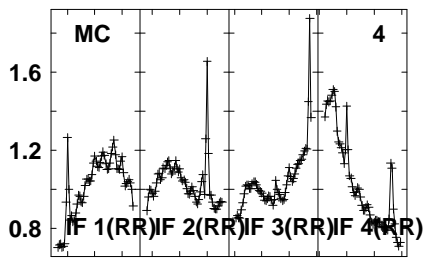
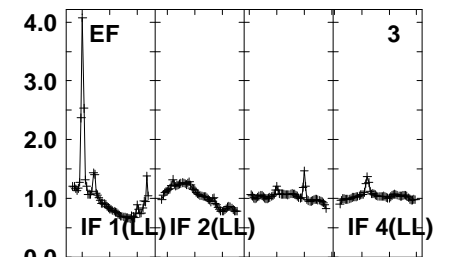
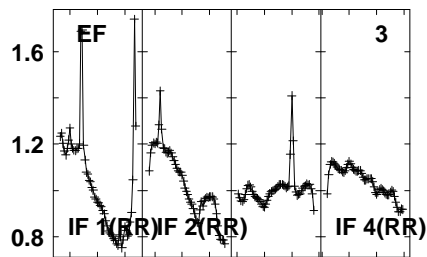
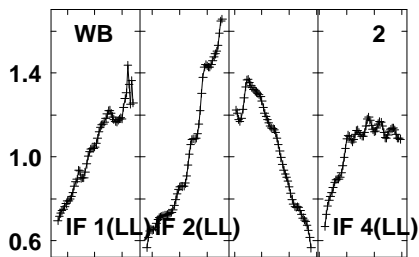
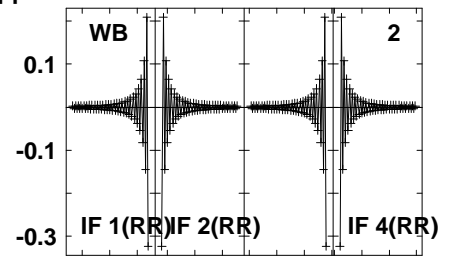
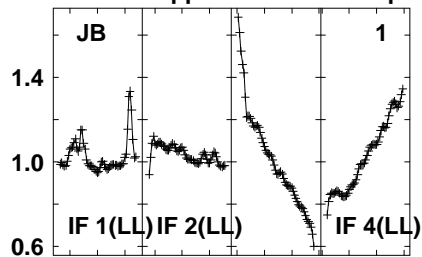
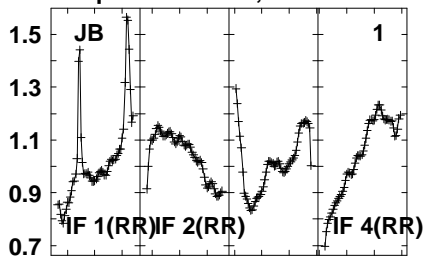

1600 1620 1630 1650 1660 1680 1690 1710  
FREQ MHz

1600 1620 1630 1650 1660 1680 1690 1710  
FREQ MHz

1600 1620 1630 1650 1660 1680 1690 1710  
FREQ MHz

Lower frame: Real Jy  
Auto-corr total-power spectrum Antenna: \*  
Timerange: 00/16:26:01 to 00/16:27:29

Plot file version 655 created 05-OCT-2021 17:07:29

J0827+5217 GM076.UVDATA.1

Freq = 1.5945 GHz, Bw = 32.000 MH No calibration applied and no bandpass applied

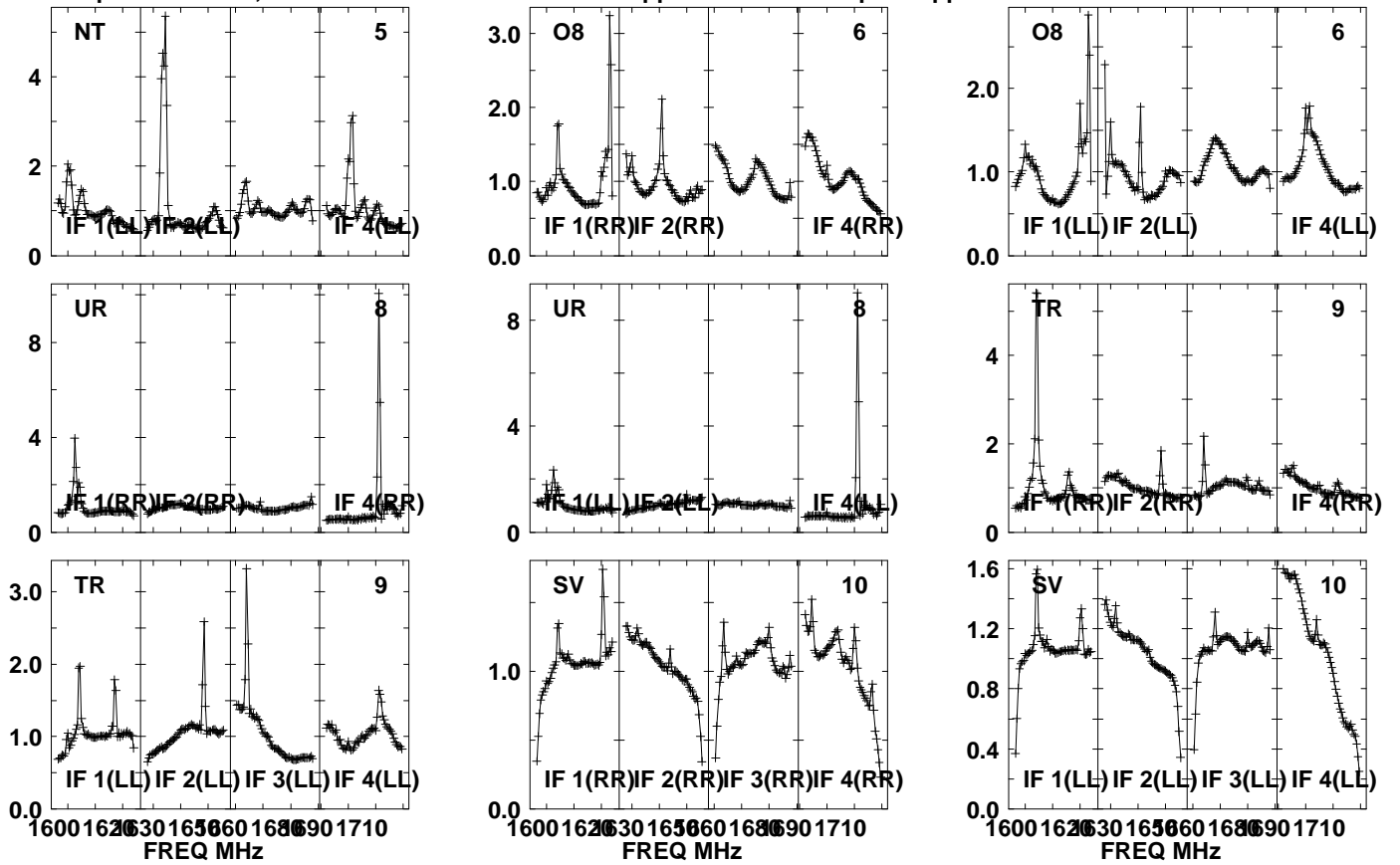

Lower frame: Real Jy  
Auto-corr total-power spectrum Antenna: \*  
Timerange: 00/16:26:01 to 00/16:27:29

Plot file version 656 created 05-OCT-2021 17:07:30

J0827+5217 GM076.UVDATA.1

Freq = 1.5945 GHz, Bw = 32.000 MH No calibration applied and no bandpass applied

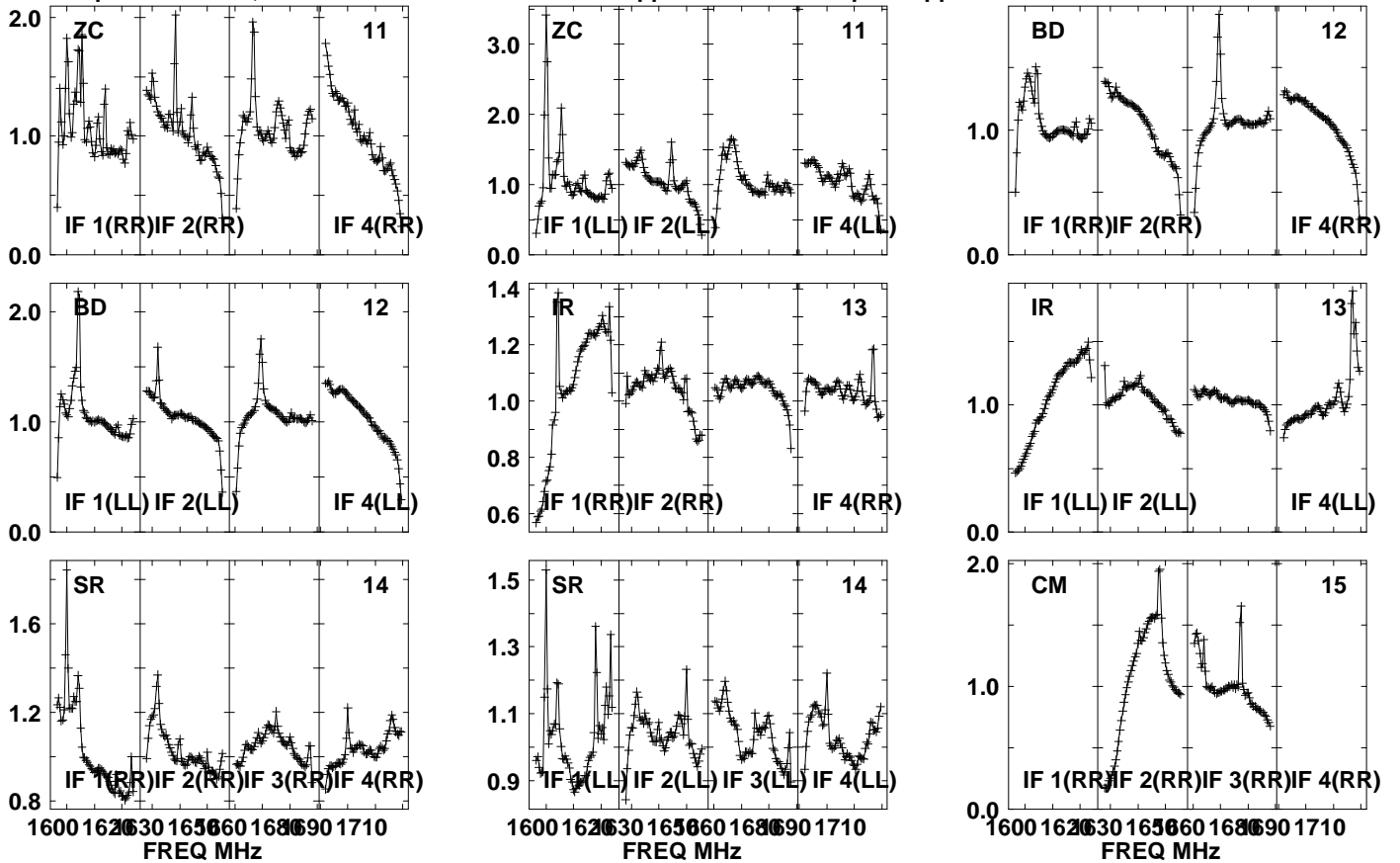

Lower frame: Real Jy

Auto-corr total-power spectrum Antenna: \*

Timerange: 00/16:26:01 to 00/16:27:29

Plot file version 657 created 05-OCT-2021 17:07:30

J0827+5217 GM076.UVDATA.1

Freq = 1.5945 GHz, Bw = 32.000 MH No calibration applied and no bandpass applied

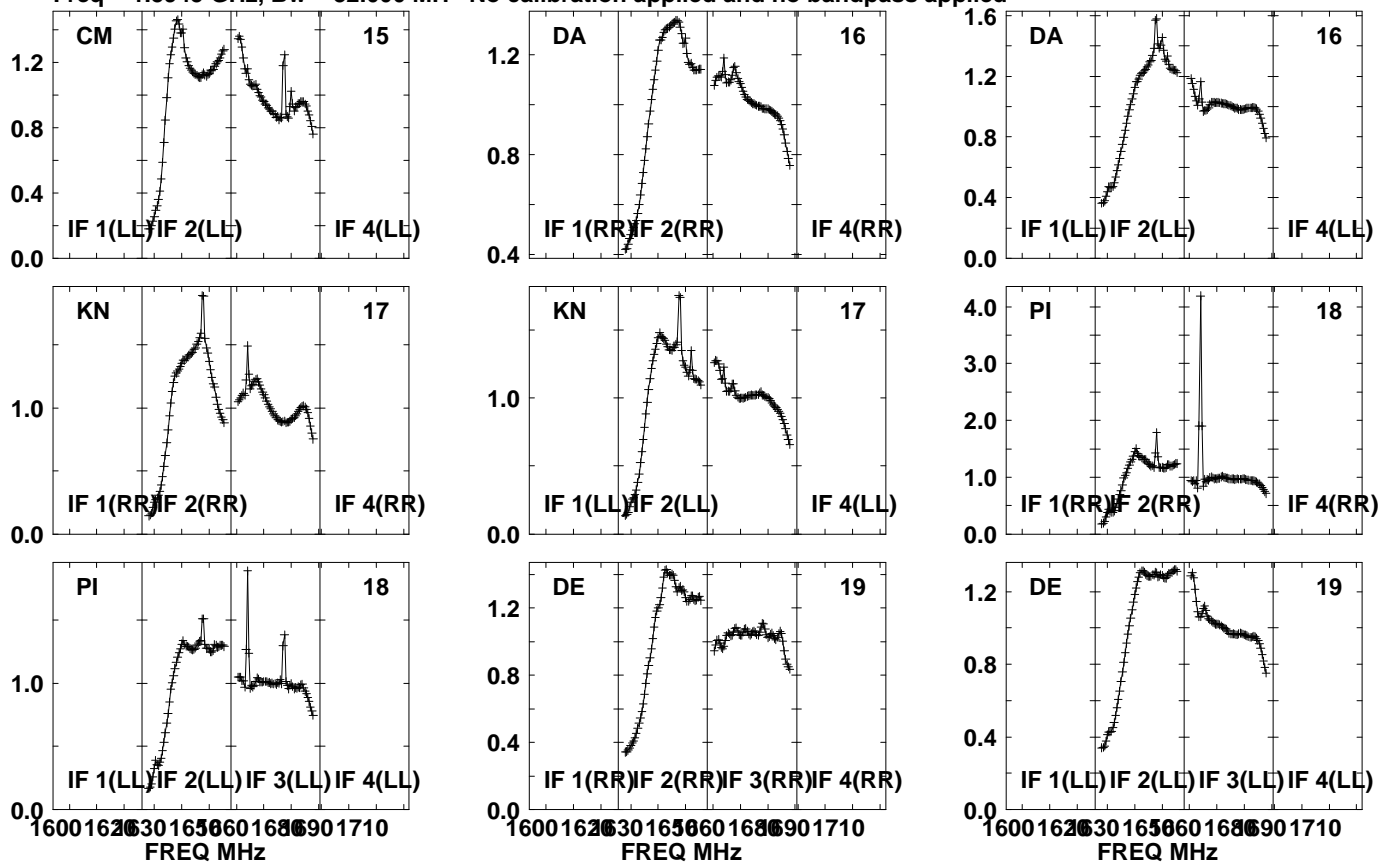

Lower frame: Real Jy  
Auto-corr total-power spectrum Antenna: \*  
Timerange: 00/16:26:01 to 00/16:27:29

Plot file version 658 created 05-OCT-2021 17:07:31

J0827+5217 GM076.UVDATA.1

Freq = 1.5945 GHz, Bw = 32.000 MH No calibration applied and no bandpass applied

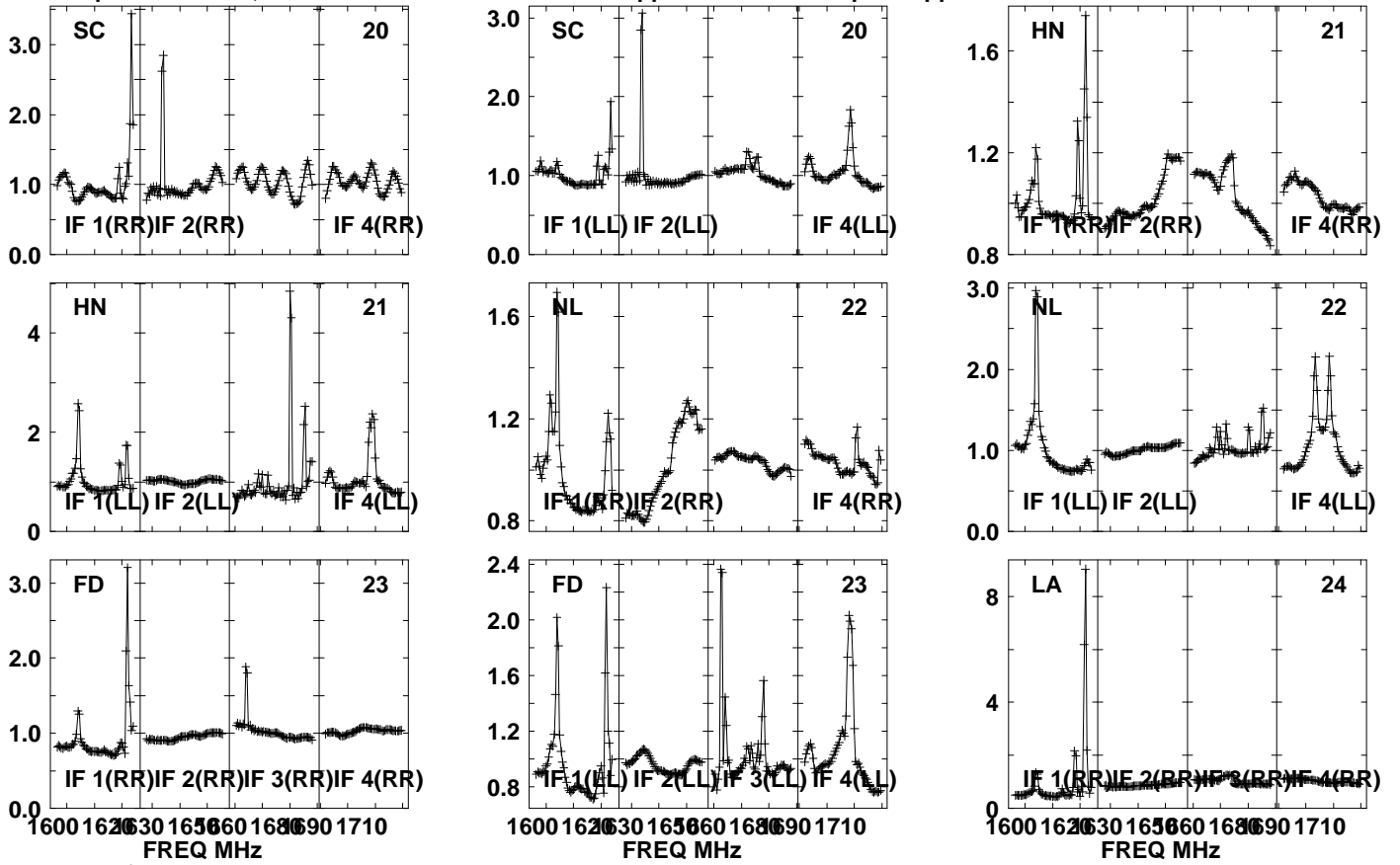

Lower frame: Real Jy  
Auto-corr total-power spectrum Antenna: \*  
Timerange: 00/16:26:01 to 00/16:27:29



Plot file version 659 created 05-OCT-2021 17:07:31

J0827+5217 GM076.UVDATA.1

Freq = 1.5945 GHz, Bw = 32.000 MH No calibration applied and no bandpass applied

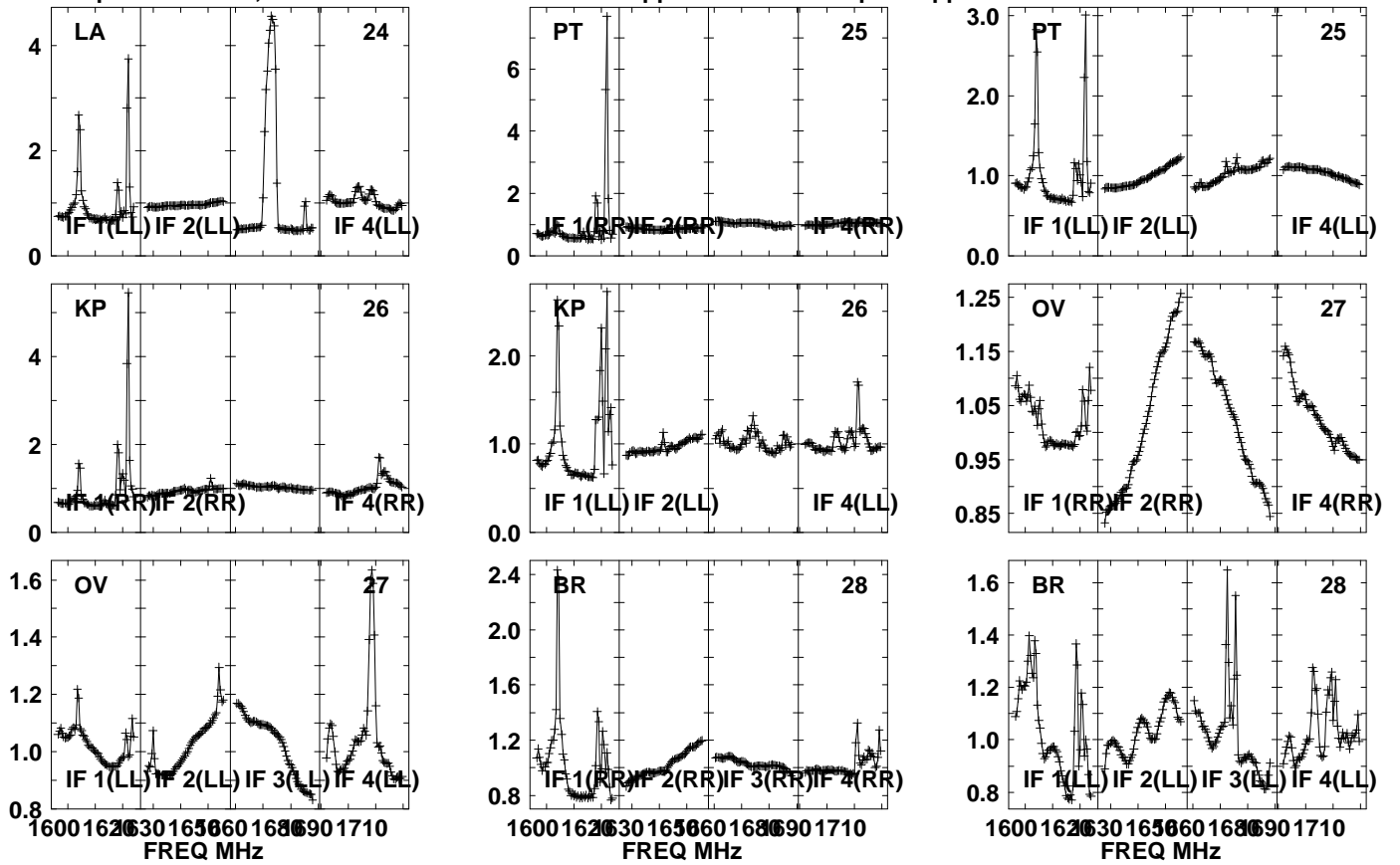

Lower frame: Real Jy  
Auto-corr total-power spectrum Antenna: \*  
Timerange: 00/16:26:01 to 00/16:27:29

Plot file version 660 created 05-OCT-2021 17:07:32

4C39.25 GM076.UVDATA.1

Freq = 1.5945 GHz, Bw = 32.000 MH No calibration applied and no bandpass applied

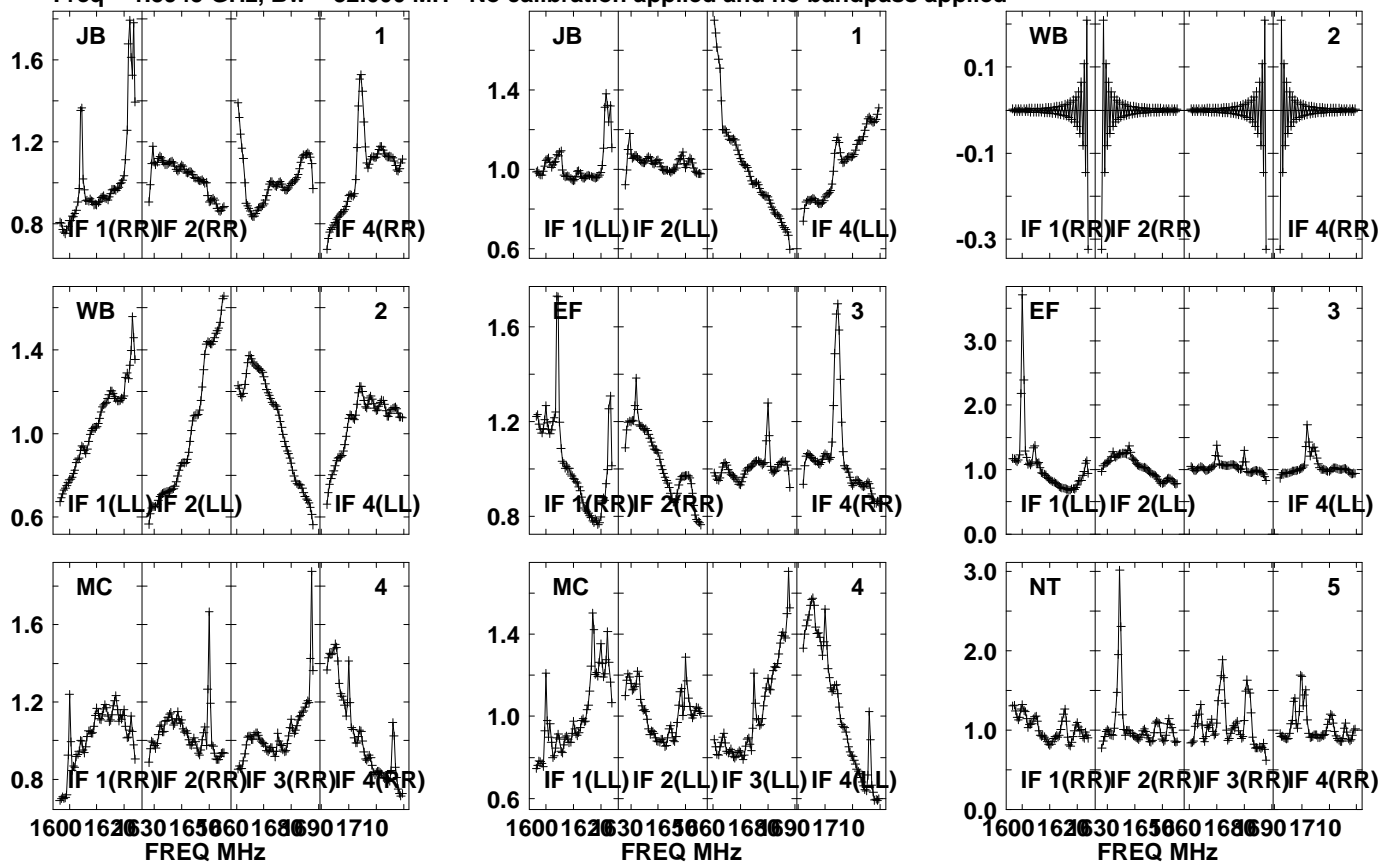

Lower frame: Real Jy  
Auto-corr total-power spectrum Antenna: \*  
Timerange: 00/16:32:31 to 00/16:37:29

Plot file version 661 created 05-OCT-2021 17:07:32

4C39.25 GM076.UVDATA.1

Freq = 1.5945 GHz, Bw = 32.000 MH No calibration applied and no bandpass applied

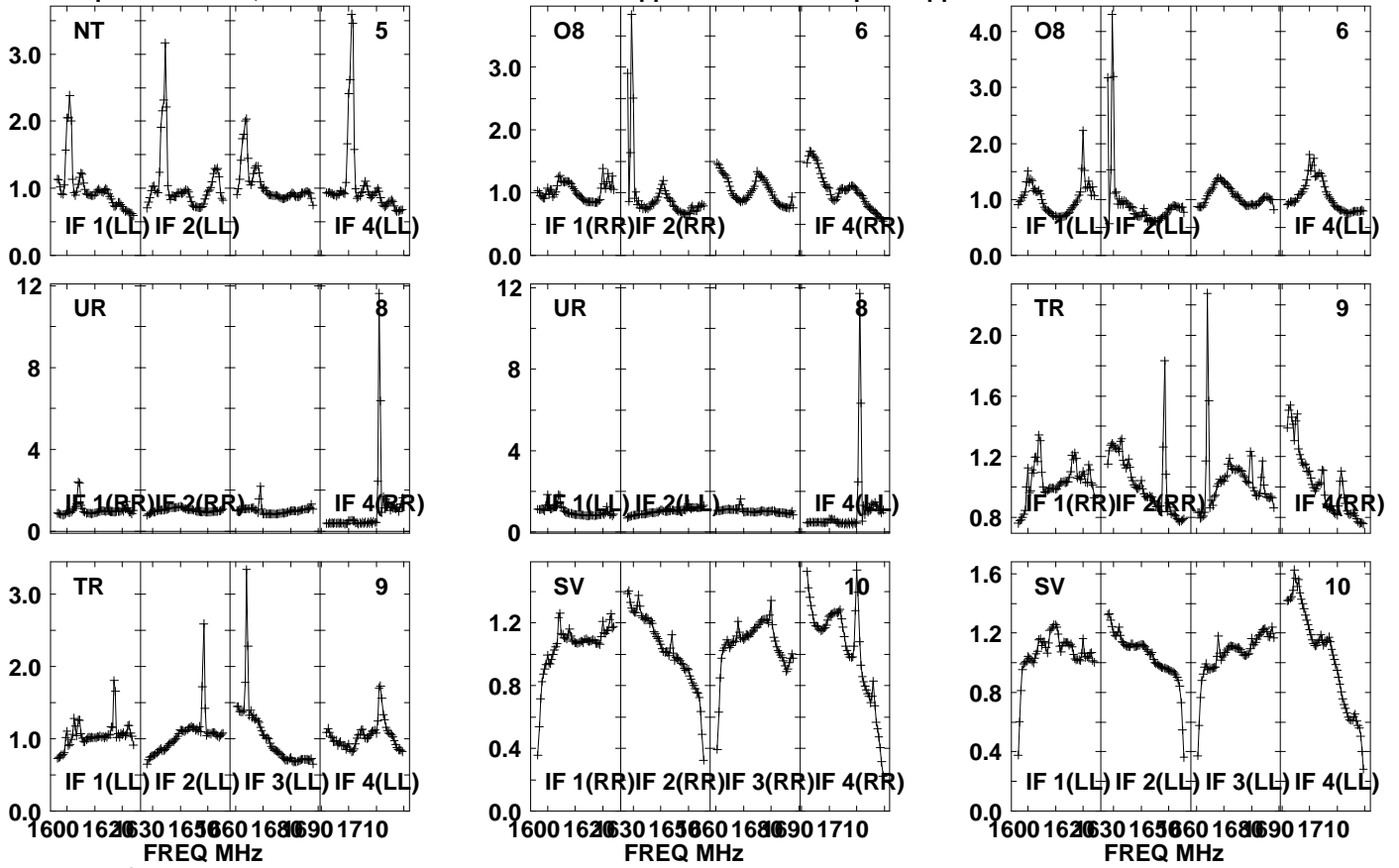

Lower frame: Real Jy  
Auto-corr total-power spectrum Antenna: \*  
Timerange: 00/16:32:31 to 00/16:37:29

Plot file version 662 created 05-OCT-2021 17:07:33

4C39.25 GM076.UVDATA.1

Freq = 1.5945 GHz, Bw = 32.000 MH No calibration applied and no bandpass applied

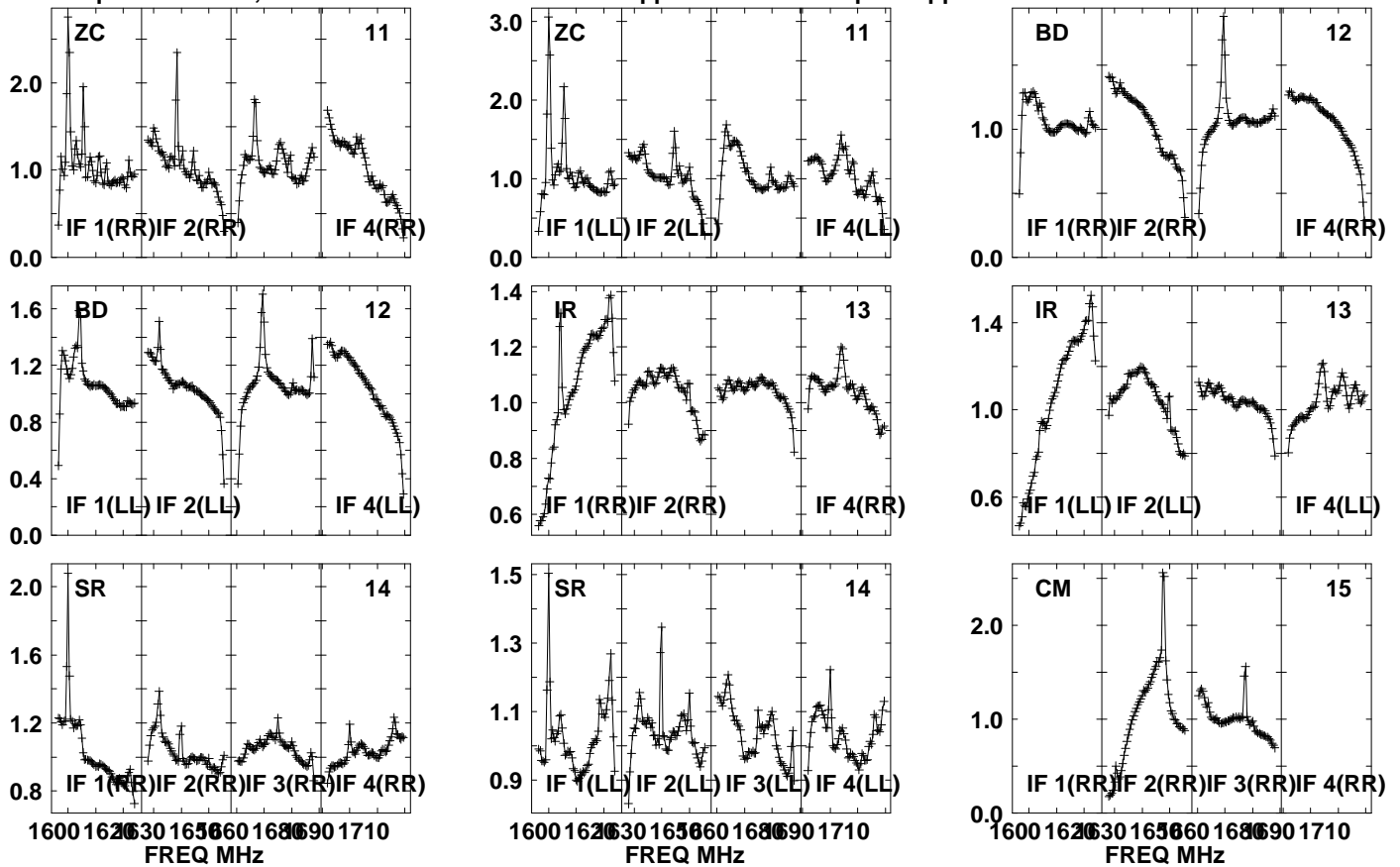

Lower frame: Real Jy

Auto-corr total-power spectrum Antenna: \*

Timerange: 00/16:32:31 to 00/16:37:29

Plot file version 663 created 05-OCT-2021 17:07:33

4C39.25 GM076.UVDATA.1

Freq = 1.5945 GHz, Bw = 32.000 MH No calibration applied and no bandpass applied

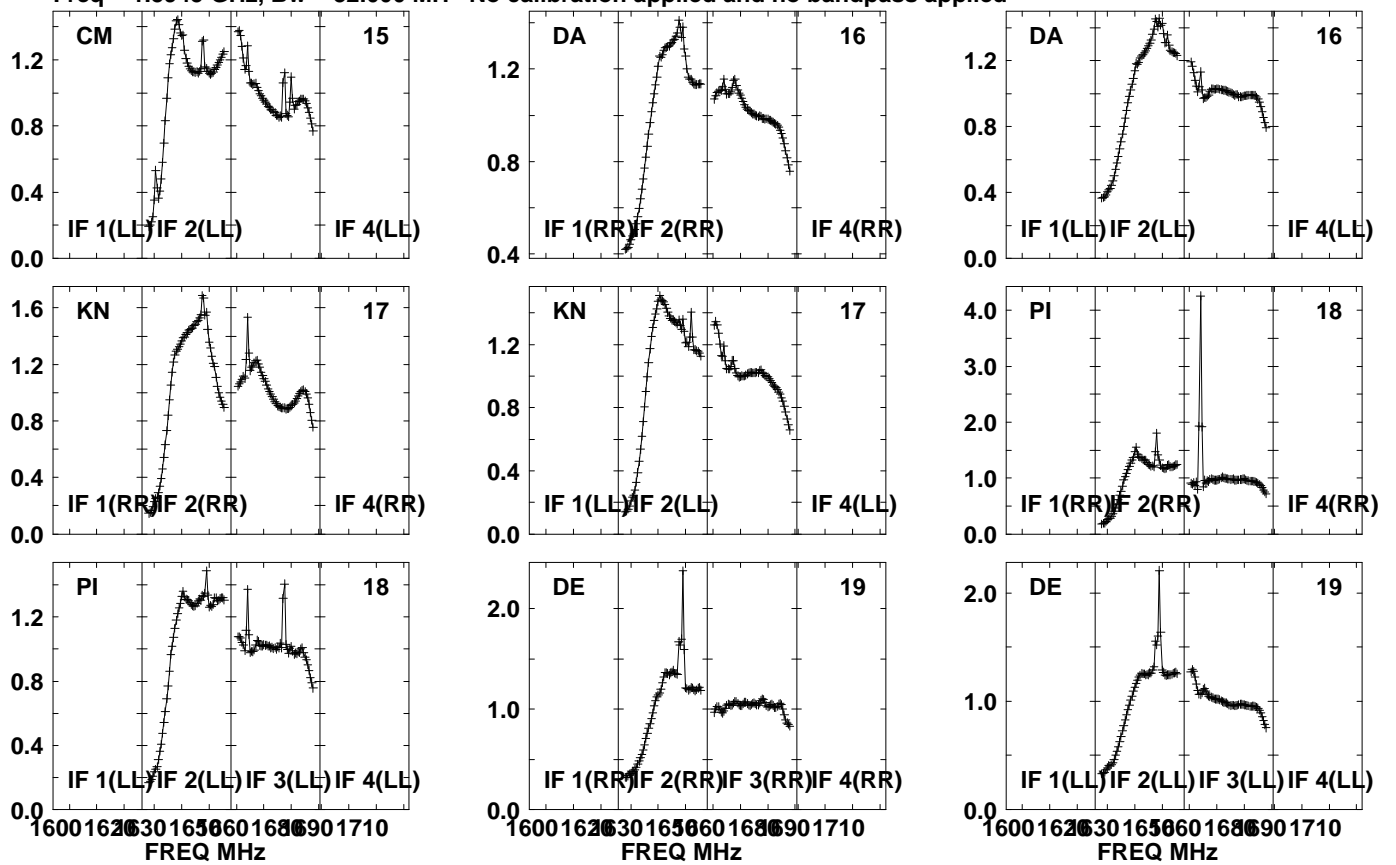

Lower frame: Real Jy  
Auto-corr total-power spectrum Antenna: \*  
Timerange: 00/16:32:31 to 00/16:37:29

Plot file version 664 created 05-OCT-2021 17:07:33

4C39.25 GM076.UVDATA.1

Freq = 1.5945 GHz, Bw = 32.000 MH No calibration applied and no bandpass applied

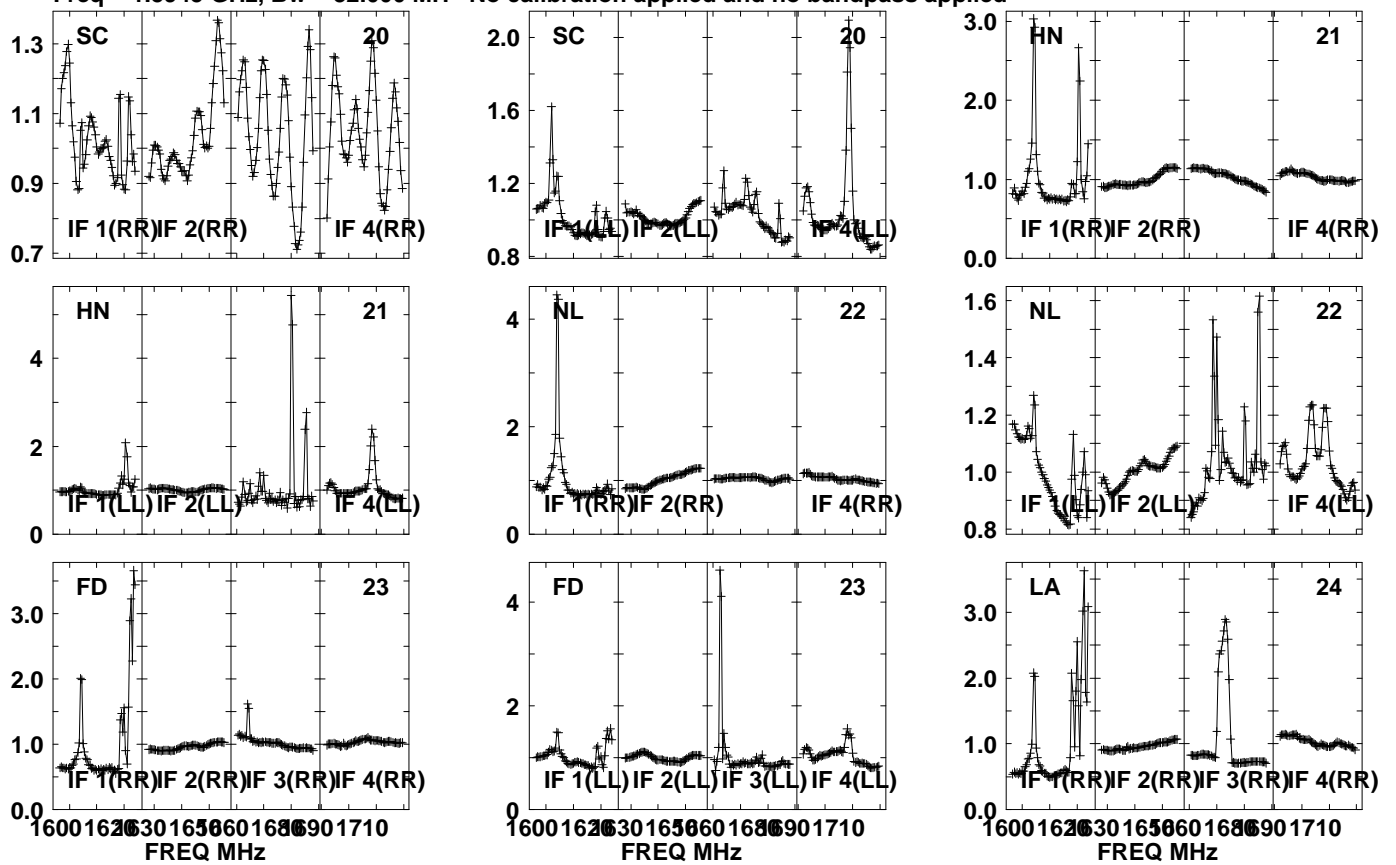

Lower frame: Real Jy  
Auto-corr total-power spectrum Antenna: \*  
Timerange: 00/16:32:31 to 00/16:37:29

Plot file version 665 created 05-OCT-2021 17:07:34

4C39.25 GM076.UVDATA.1

Freq = 1.5945 GHz, Bw = 32.000 MH No calibration applied and no bandpass applied

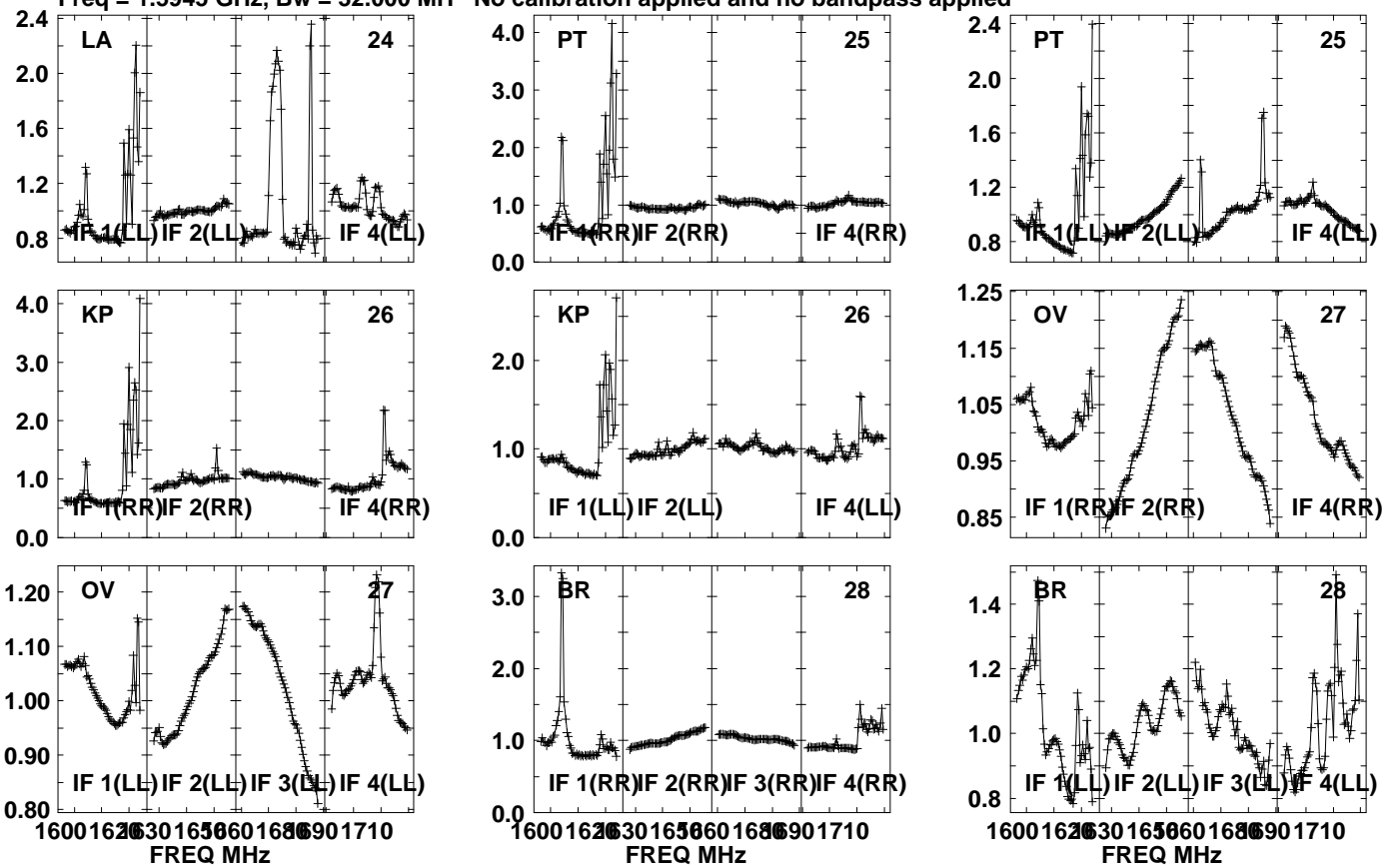

Lower frame: Real Jy  
Auto-corr total-power spectrum Antenna: \*  
Timerange: 00/16:32:31 to 00/16:37:29

Plot file version 666 created 05-OCT-2021 17:07:34

J0827+5217 GM076.UVDATA.1

Freq = 1.5945 GHz, Bw = 32.000 MH No calibration applied and no bandpass applied

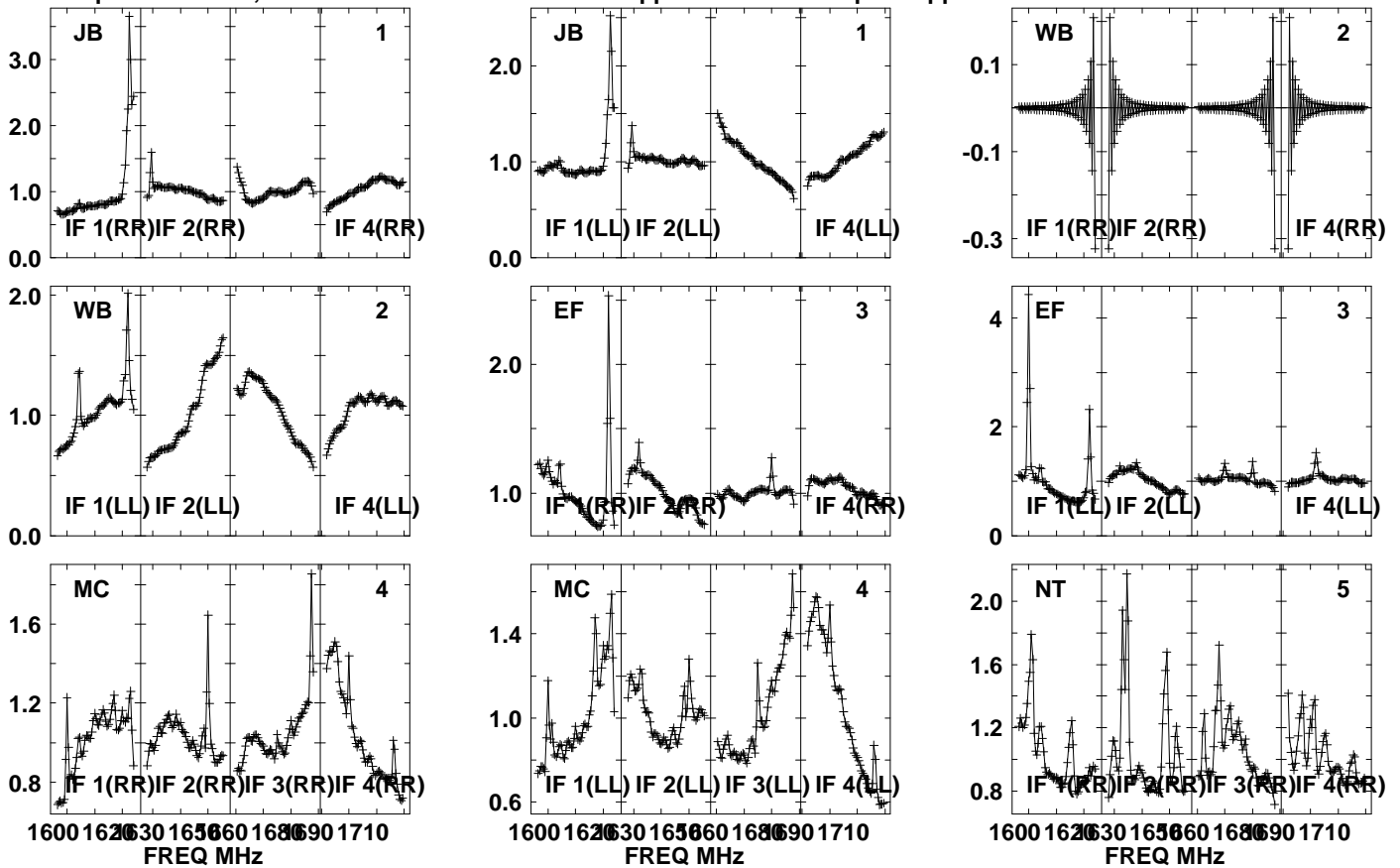

Lower frame: Real Jy

Auto-corr total-power spectrum Antenna: \*

Timerange: 00/16:42:31 to 00/16:44:29



Plot file version 667 created 05-OCT-2021 17:07:35

J0827+5217 GM076.UVDATA.1

Freq = 1.5945 GHz, Bw = 32.000 MH No calibration applied and no bandpass applied

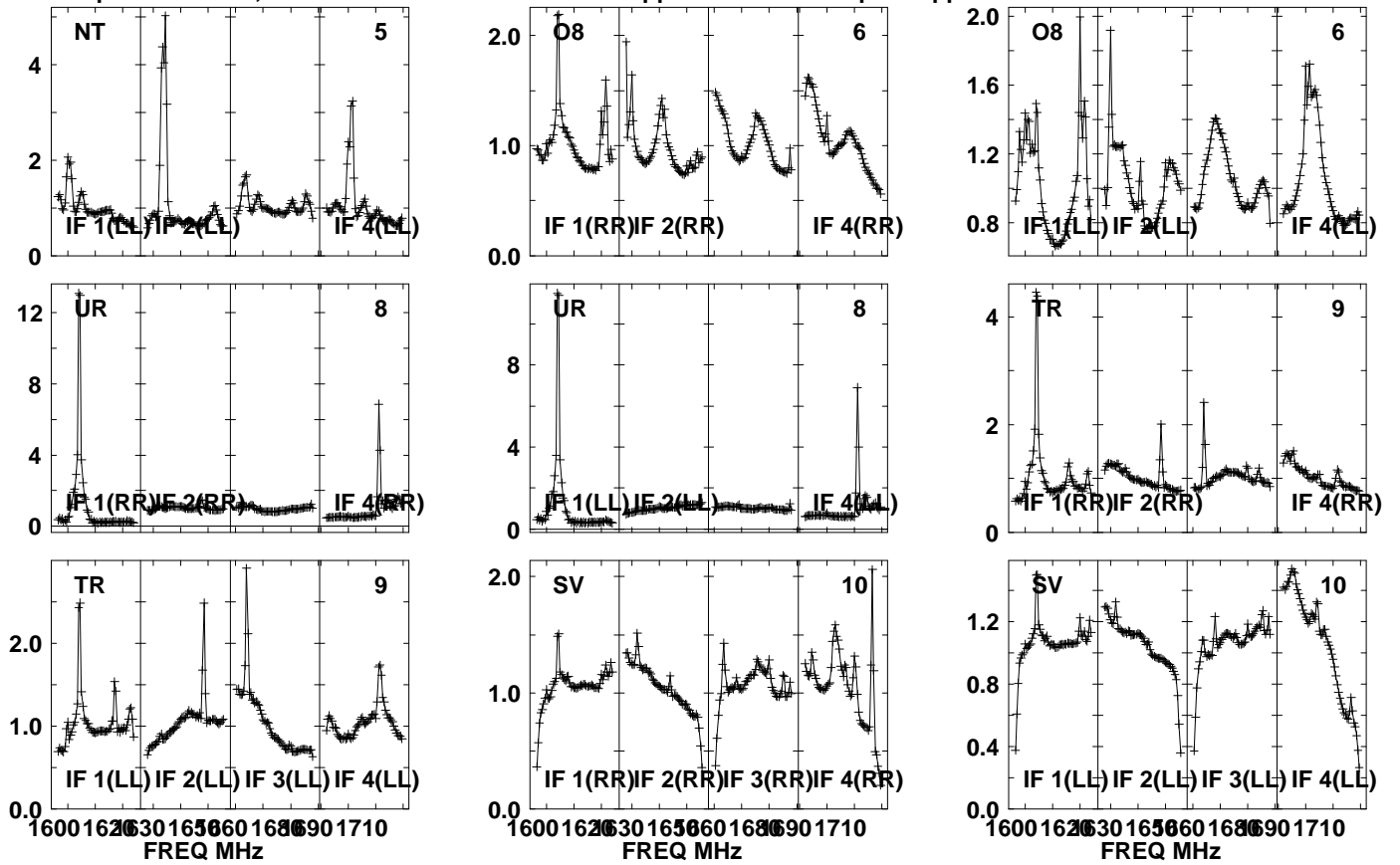

Lower frame: Real Jy  
Auto-corr total-power spectrum Antenna: \*  
Timerange: 00/16:42:31 to 00/16:44:29

Plot file version 668 created 05-OCT-2021 17:07:35

J0827+5217 GM076.UVDATA.1

Freq = 1.5945 GHz, Bw = 32.000 MH No calibration applied and no bandpass applied

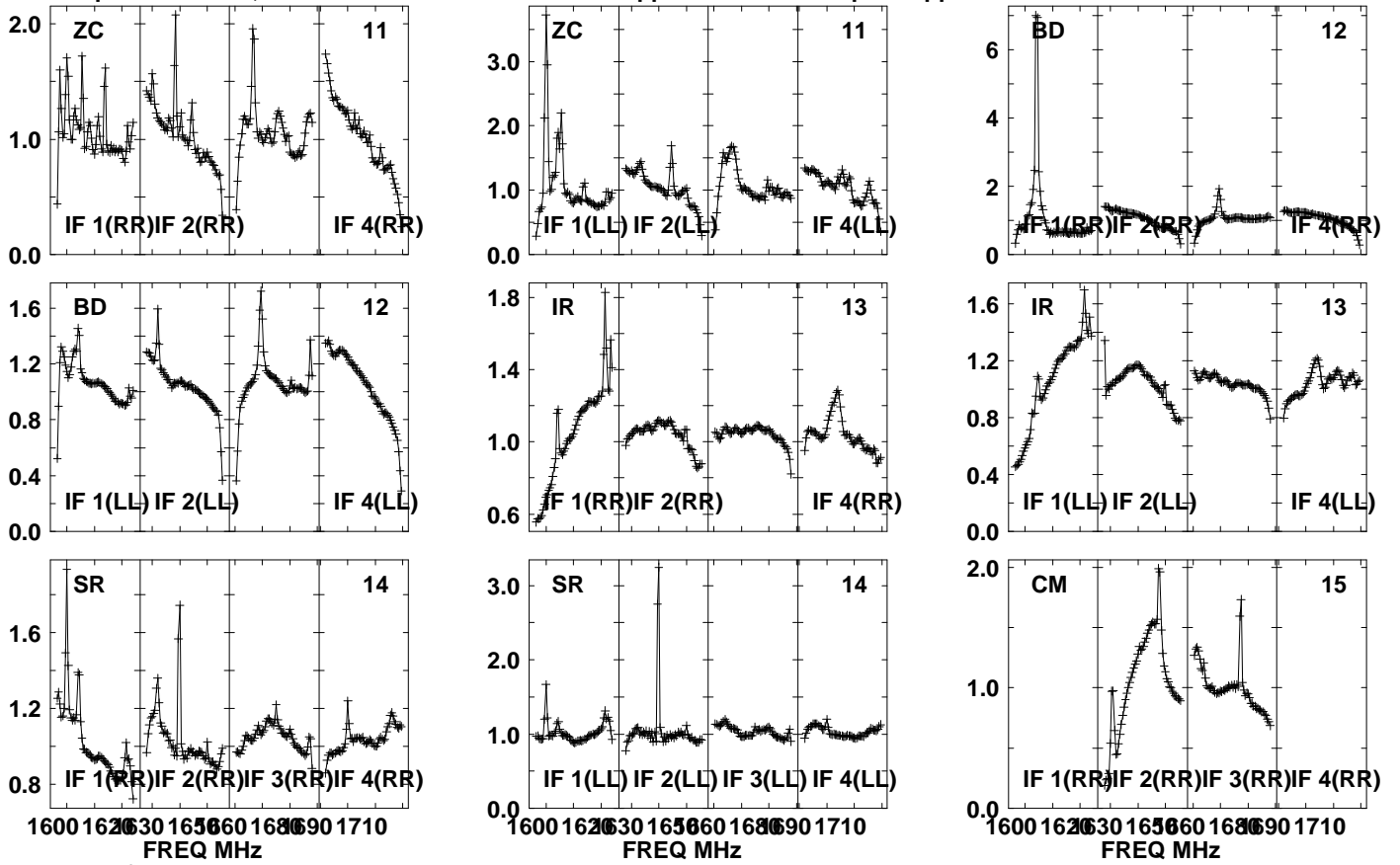

Lower frame: Real Jy  
Auto-corr total-power spectrum Antenna: \*  
Timerange: 00/16:42:31 to 00/16:44:29

Plot file version 669 created 05-OCT-2021 17:07:35

J0827+5217 GM076.UVDATA.1

Freq = 1.5945 GHz, Bw = 32.000 MH No calibration applied and no bandpass applied

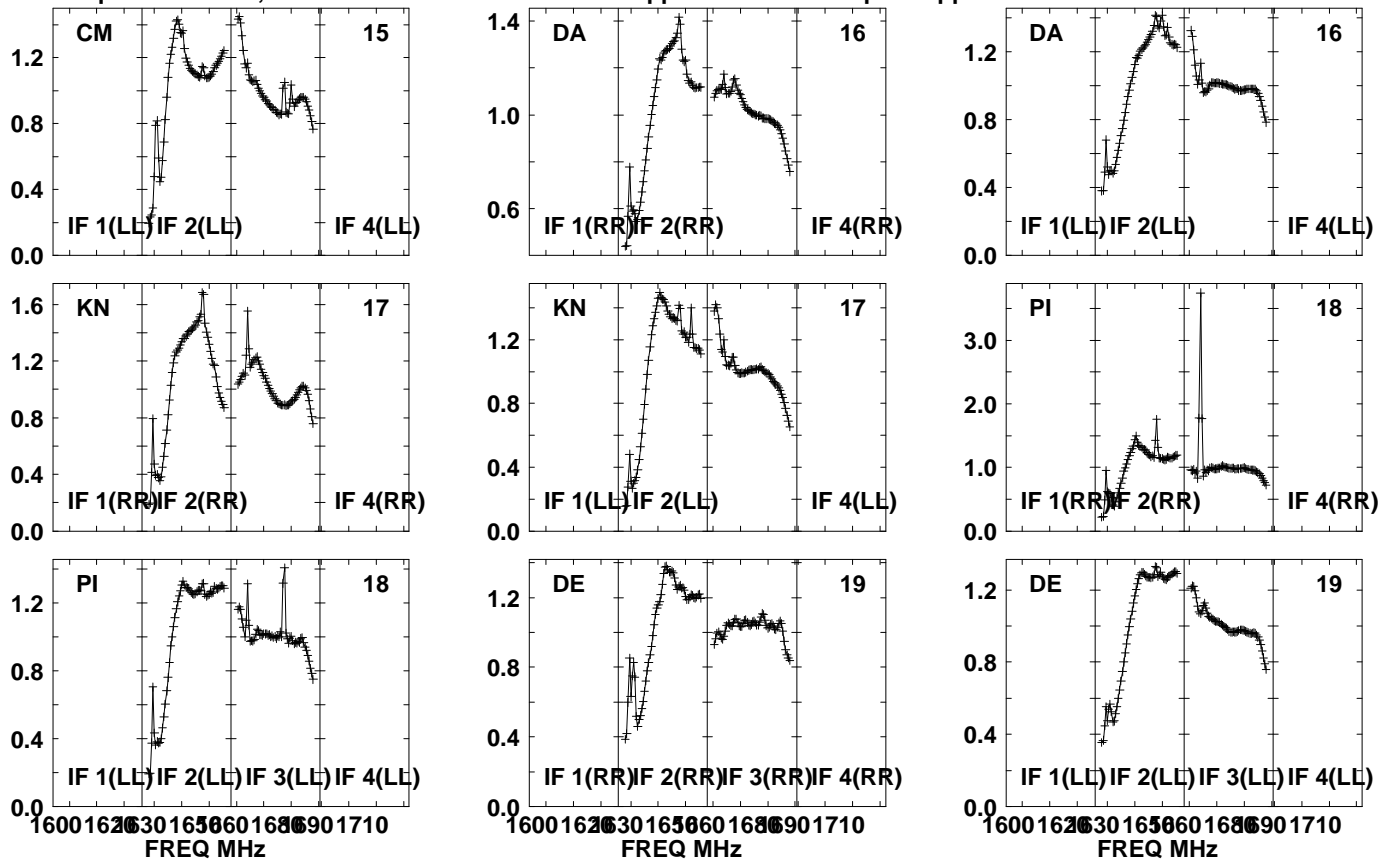

Lower frame: Real Jy  
Auto-corr total-power spectrum Antenna: \*  
Timerange: 00/16:42:31 to 00/16:44:29

Plot file version 670 created 05-OCT-2021 17:07:36

J0827+5217 GM076.UVDATA.1

Freq = 1.5945 GHz, Bw = 32.000 MH No calibration applied and no bandpass applied

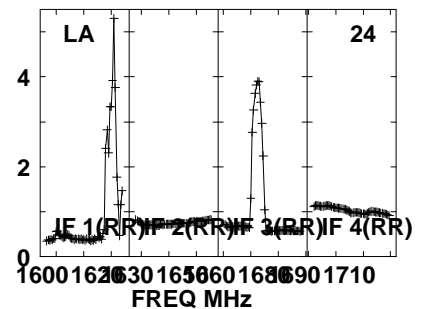
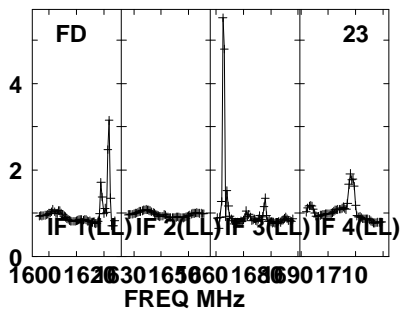
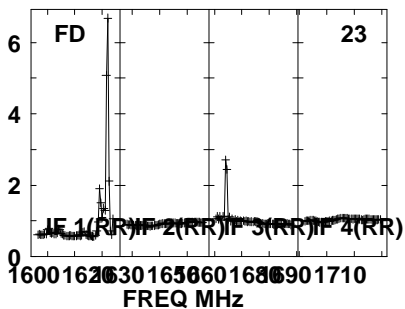
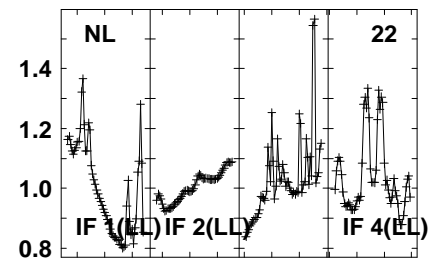
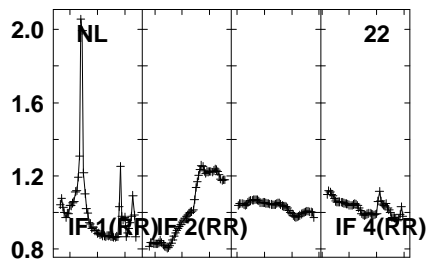
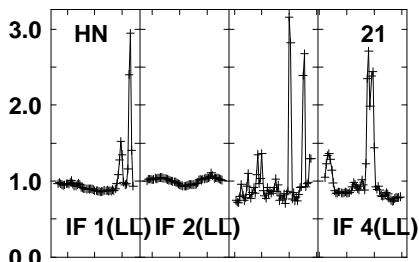
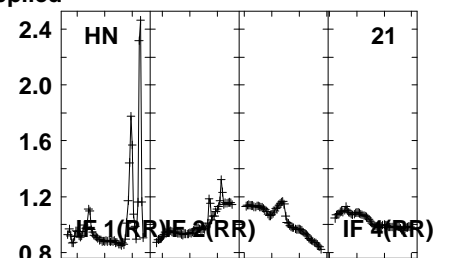
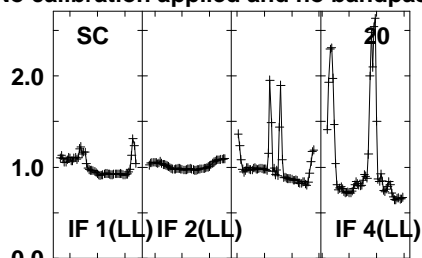
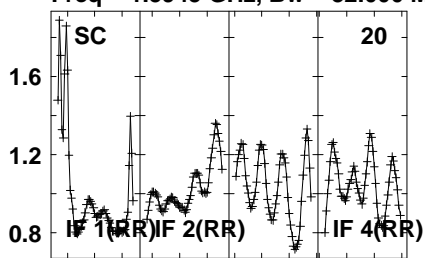

Lower frame: Real Jy  
Auto-corr total-power spectrum Antenna: \*  
Timerange: 00/16:42:31 to 00/16:44:29

Plot file version 671 created 05-OCT-2021 17:07:36

J0827+5217 GM076.UVDATA.1

Freq = 1.5945 GHz, Bw = 32.000 MH No calibration applied and no bandpass applied

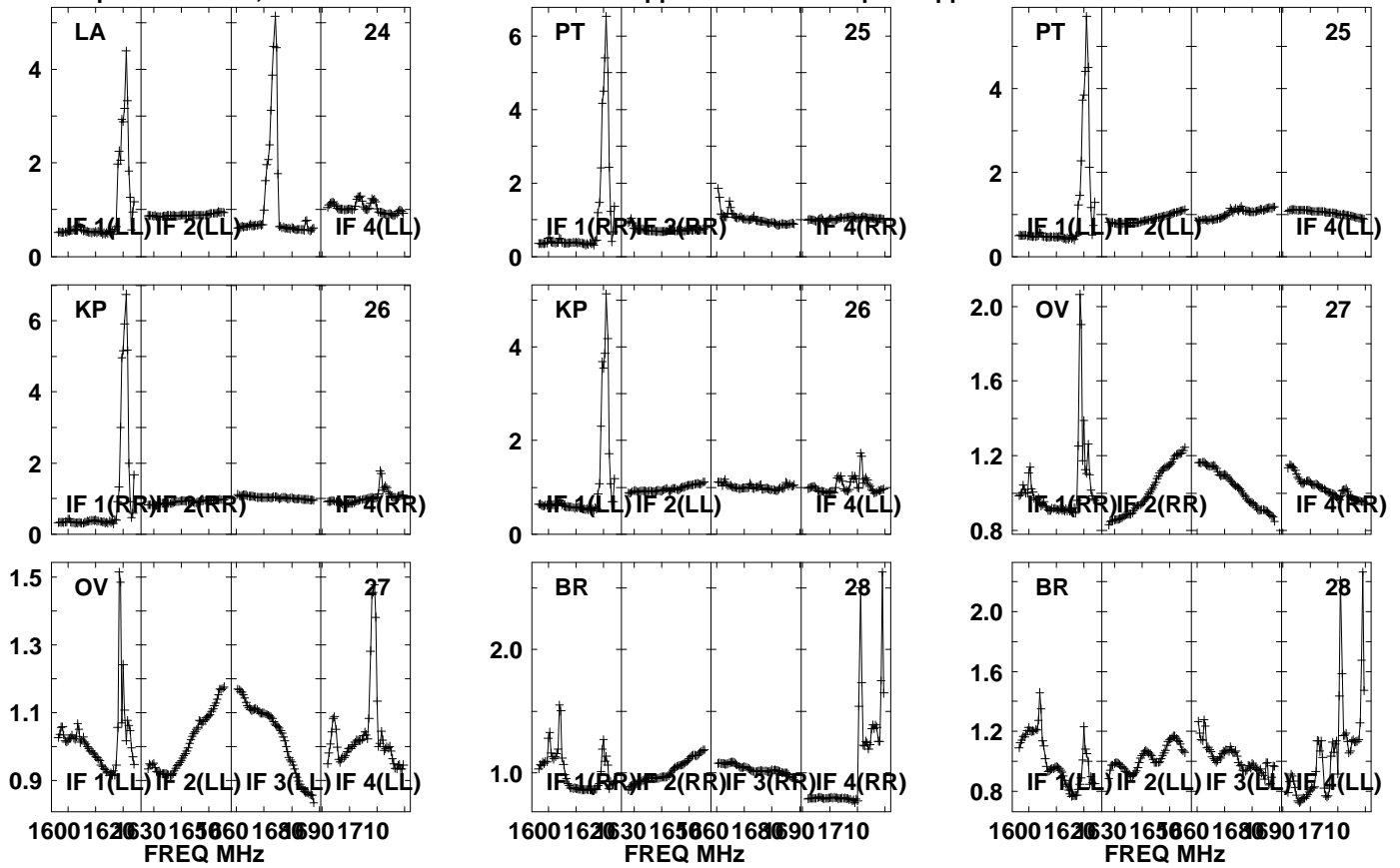

Lower frame: Real Jy

Auto-corr total-power spectrum Antenna: \*

Timerange: 00/16:42:31 to 00/16:44:29

Plot file version 672 created 05-OCT-2021 17:07:37

APM08279+525 GM076.UVDATA.1

Freq = 1.5945 GHz, Bw = 32.000 MH No calibration applied and no bandpass applied

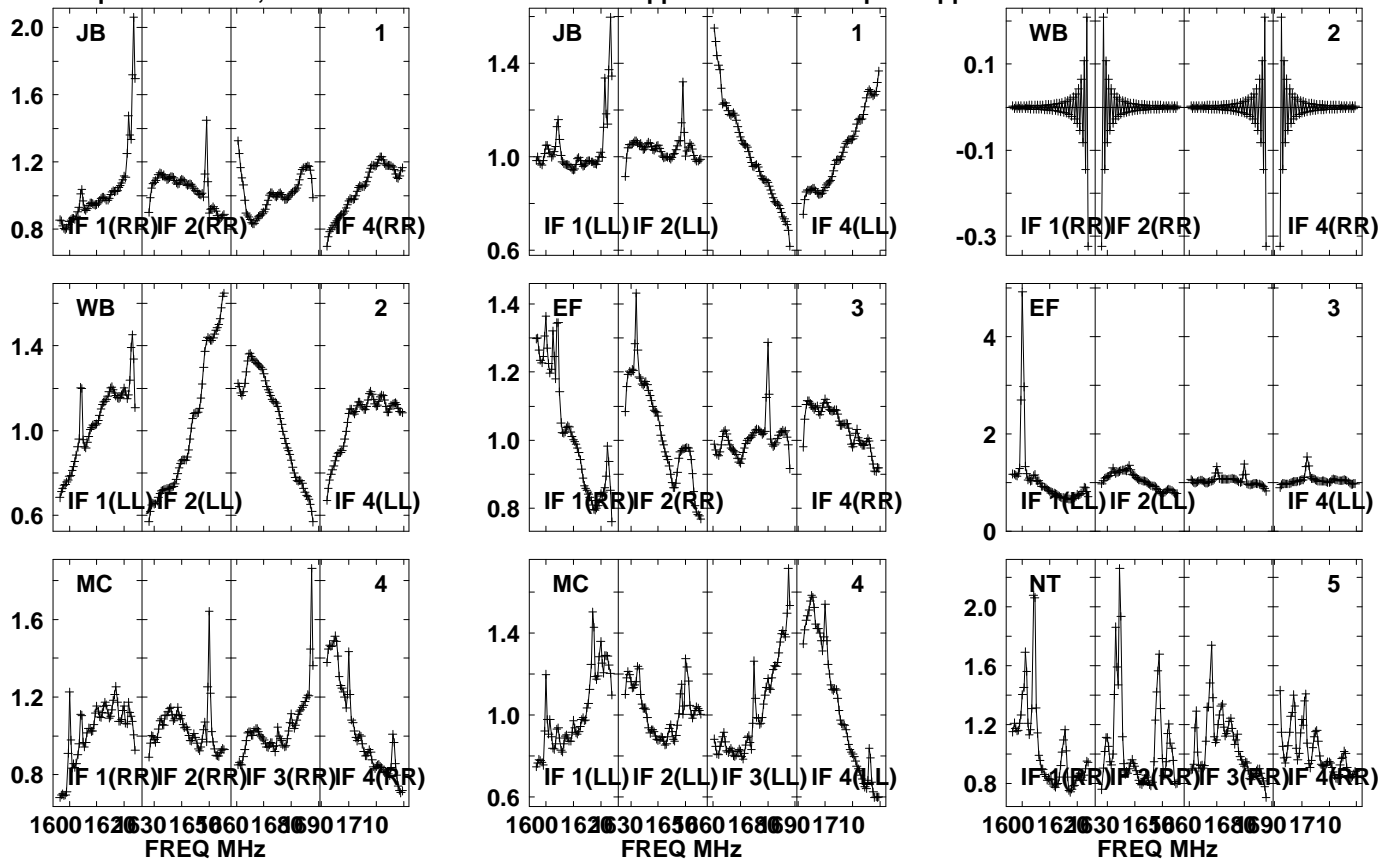

Lower frame: Real Jy  
Auto-corr total-power spectrum Antenna: \*  
Timerange: 00/16:44:31 to 00/16:47:59

Plot file version 673 created 05-OCT-2021 17:07:37

APM08279+525 GM076.UVDATA.1

Freq = 1.5945 GHz, Bw = 32.000 MH No calibration applied and no bandpass applied

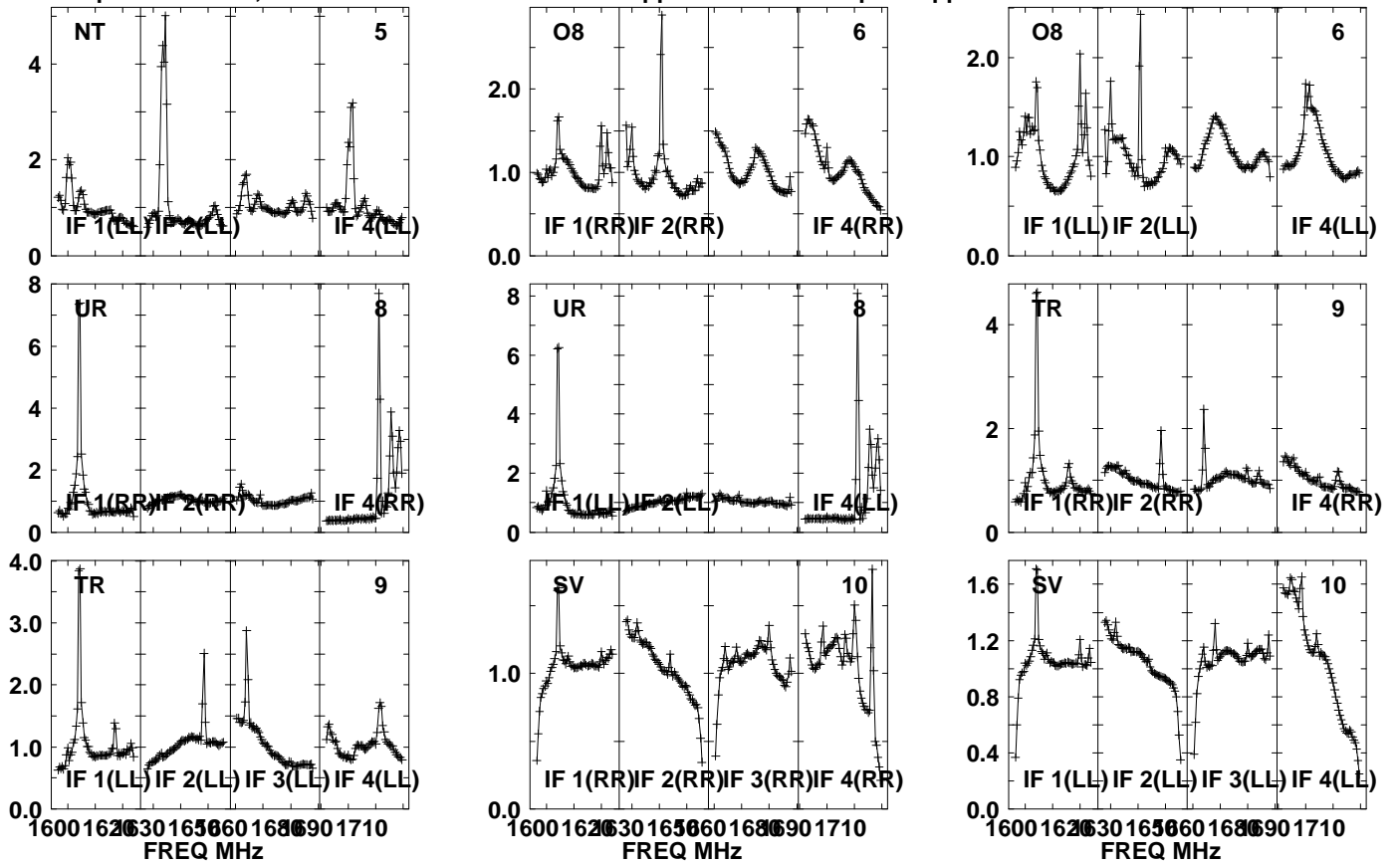

Lower frame: Real Jy  
Auto-corr total-power spectrum Antenna: \*  
Timerange: 00/16:44:31 to 00/16:47:59

Plot file version 674 created 05-OCT-2021 17:07:37

APM08279+525 GM076.UVDATA.1

Freq = 1.5945 GHz, Bw = 32.000 MH No calibration applied and no bandpass applied

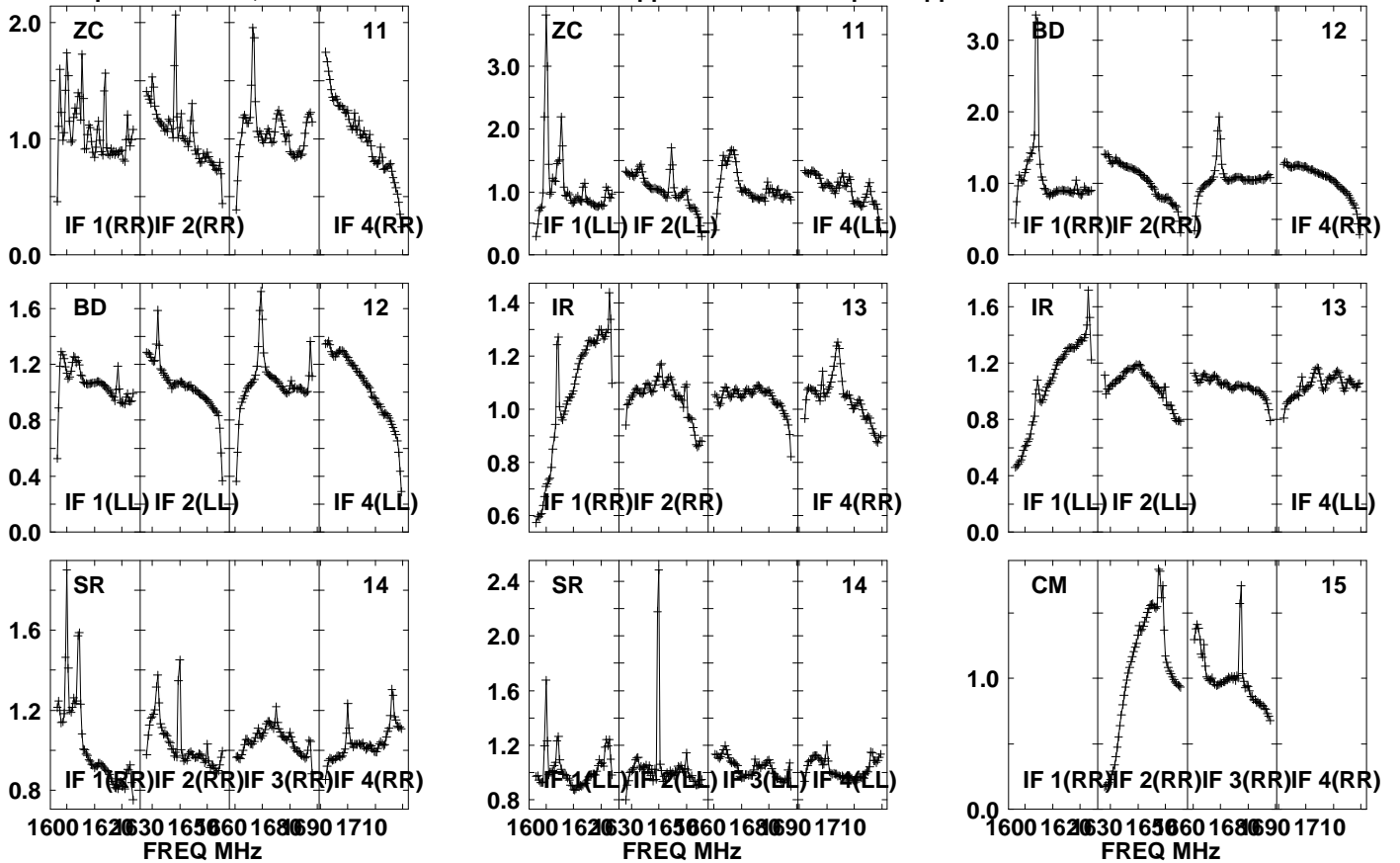

Lower frame: Real Jy  
Auto-corr total-power spectrum Antenna: \*  
Timerange: 00/16:44:31 to 00/16:47:59



Plot file version 675 created 05-OCT-2021 17:07:38

APM08279+525 GM076.UVDATA.1

Freq = 1.5945 GHz, Bw = 32.000 MH No calibration applied and no bandpass applied

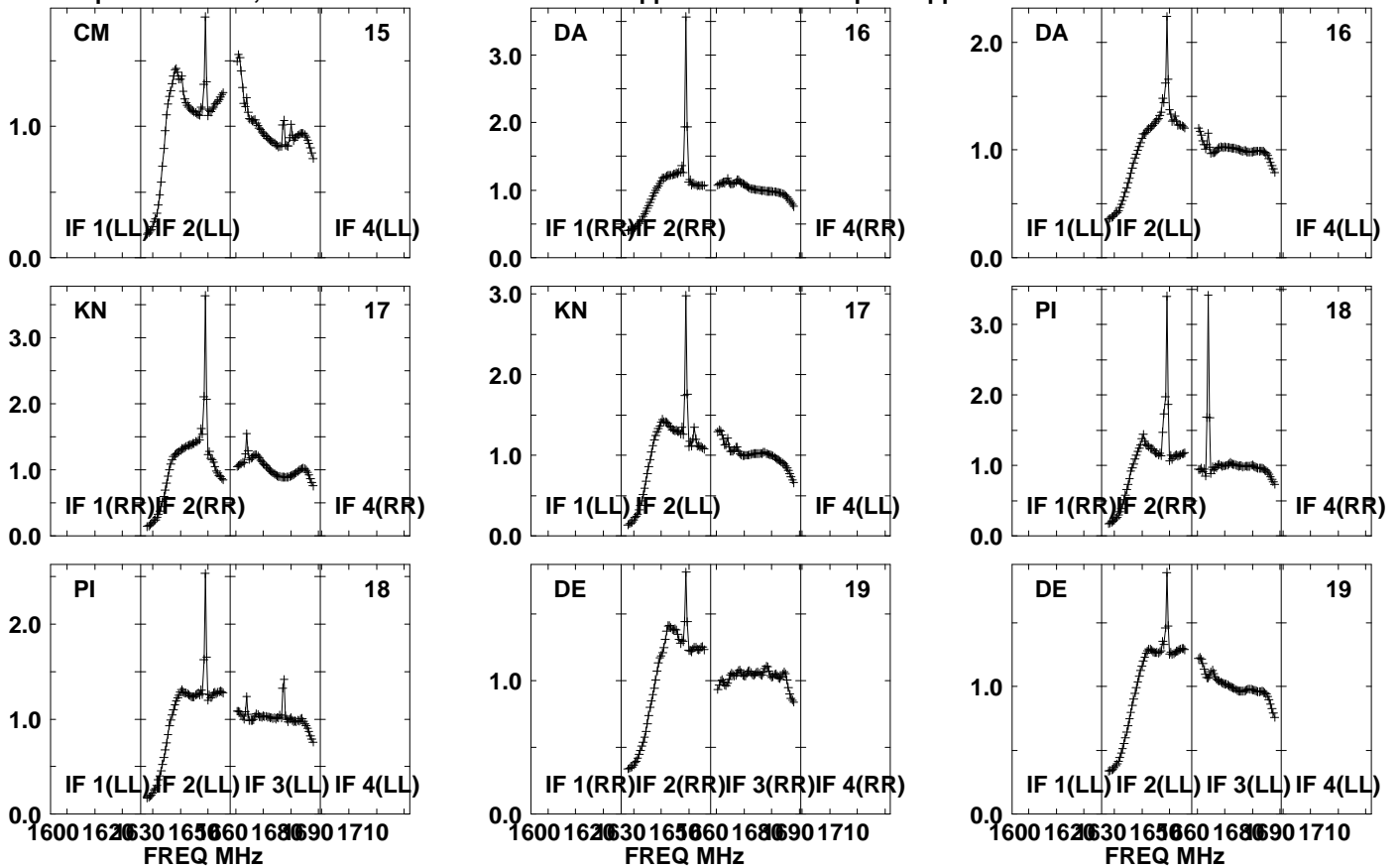

Lower frame: Real Jy

Auto-corr total-power spectrum Antenna: \*

Timerange: 00/16:44:31 to 00/16:47:59

Plot file version 676 created 05-OCT-2021 17:07:38

APM08279+525 GM076.UVDATA.1

Freq = 1.5945 GHz, Bw = 32.000 MH No calibration applied and no bandpass applied

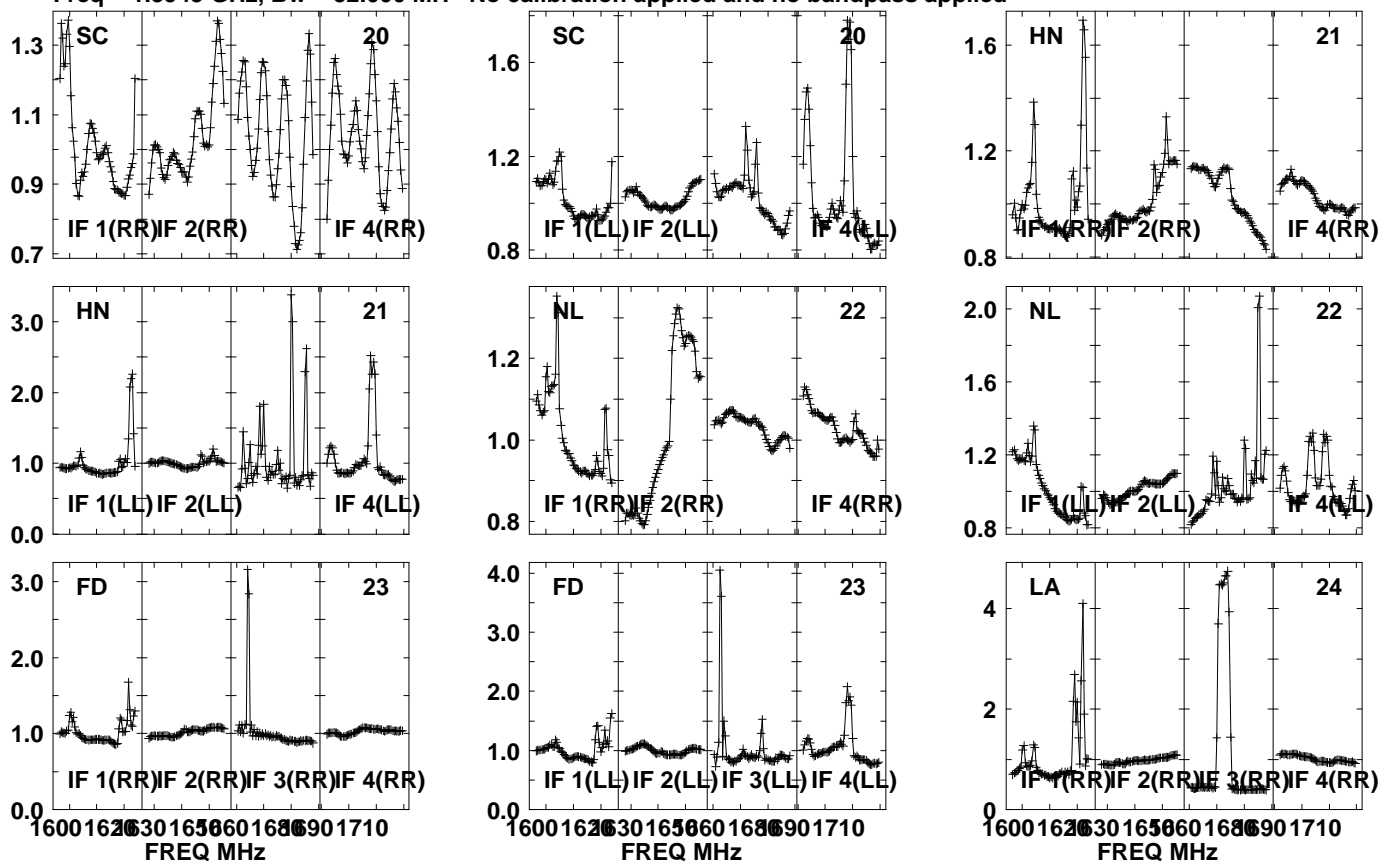

Lower frame: Real Jy  
Auto-corr total-power spectrum Antenna: \*  
Timerange: 00/16:44:31 to 00/16:47:59

Plot file version 677 created 05-OCT-2021 17:07:38

APM08279+525 GM076.UVDATA.1

Freq = 1.5945 GHz, Bw = 32.000 MH No calibration applied and no bandpass applied

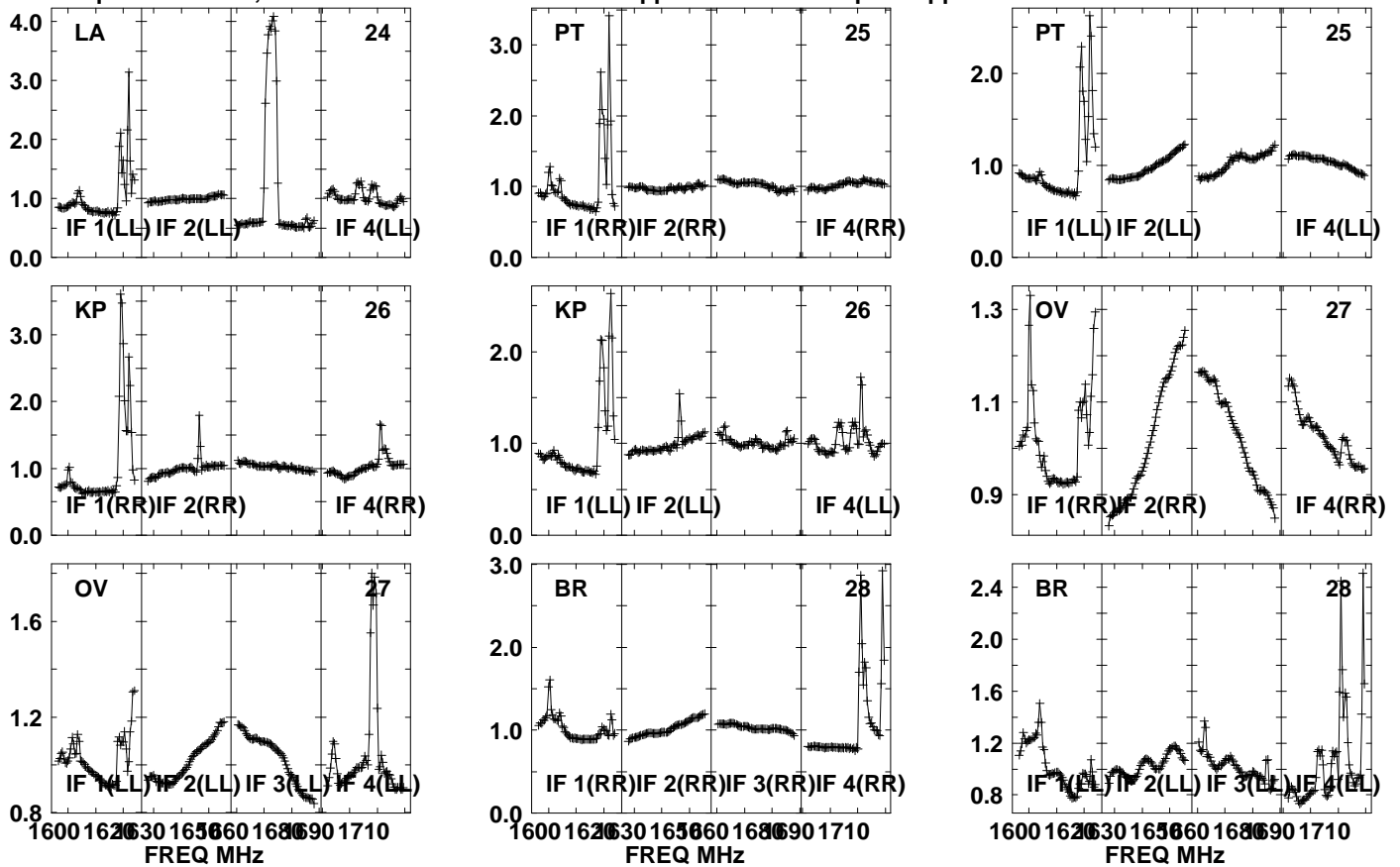

Lower frame: Real Jy

Auto-corr total-power spectrum Antenna: \*

Timerange: 00/16:44:31 to 00/16:47:59

Plot file version 678 created 05-OCT-2021 17:07:39

J0827+5217 GM076.UVDATA.1

Freq = 1.5945 GHz, Bw = 32.000 MH No calibration applied and no bandpass applied

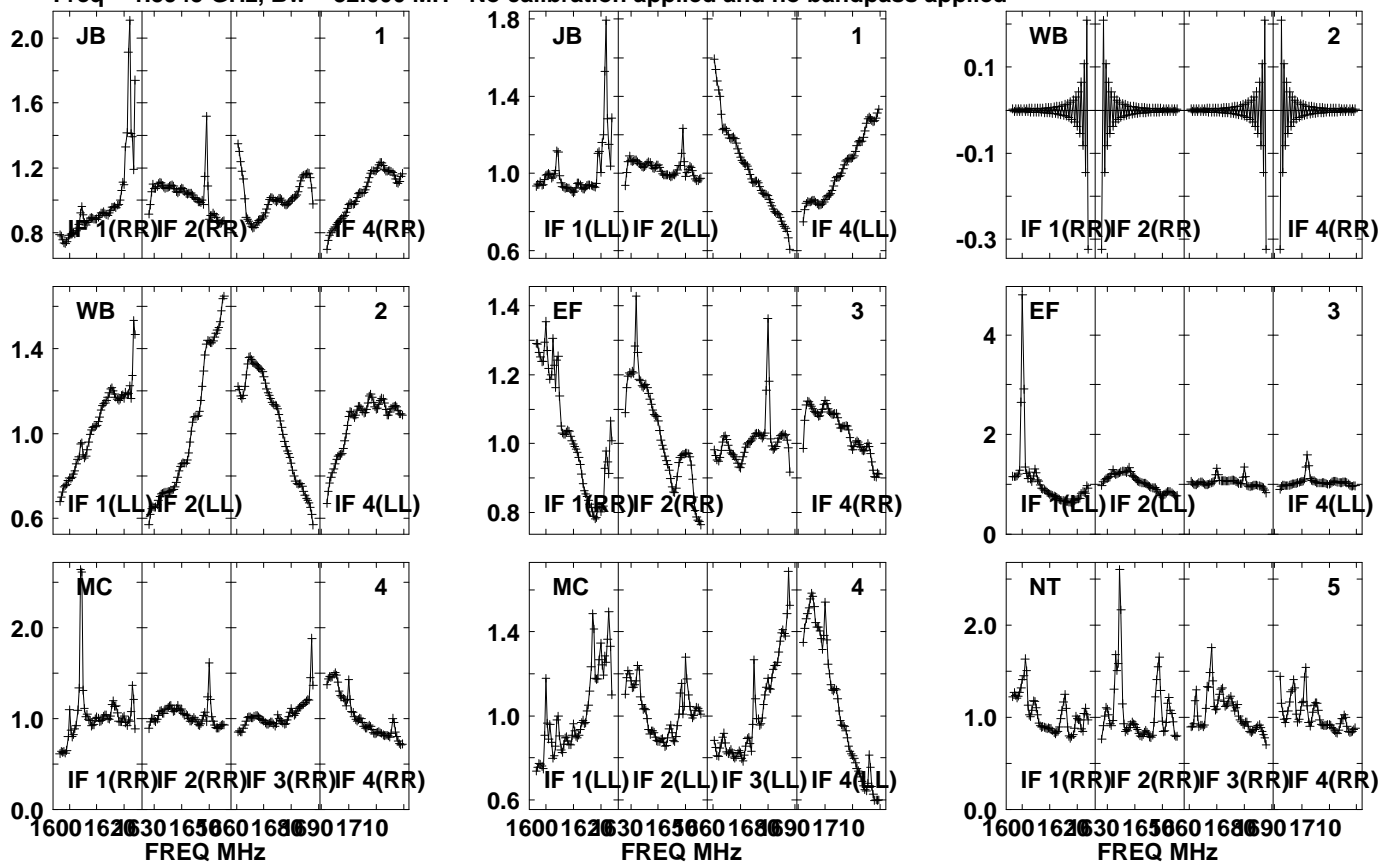

Lower frame: Real Jy  
Auto-corr total-power spectrum Antenna: \*  
Timerange: 00/16:48:31 to 00/16:49:59

Plot file version 679 created 05-OCT-2021 17:07:39

J0827+5217 GM076.UVDATA.1

Freq = 1.5945 GHz, Bw = 32.000 MH No calibration applied and no bandpass applied

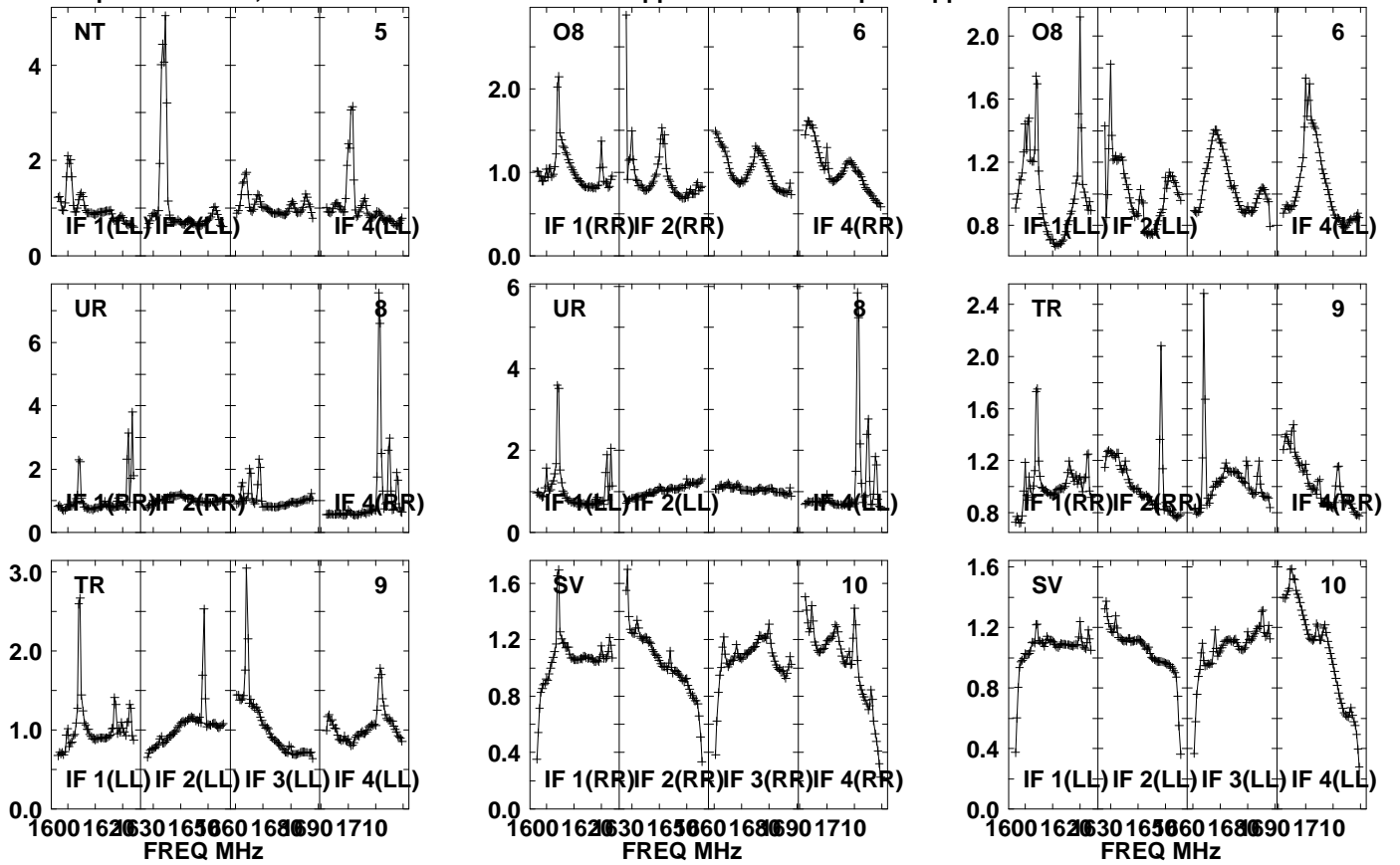

Lower frame: Real Jy

Auto-corr total-power spectrum Antenna: \*

Timerange: 00/16:48:31 to 00/16:49:59

Plot file version 680 created 05-OCT-2021 17:07:40

J0827+5217 GM076.UVDATA.1

Freq = 1.5945 GHz, Bw = 32.000 MH No calibration applied and no bandpass applied

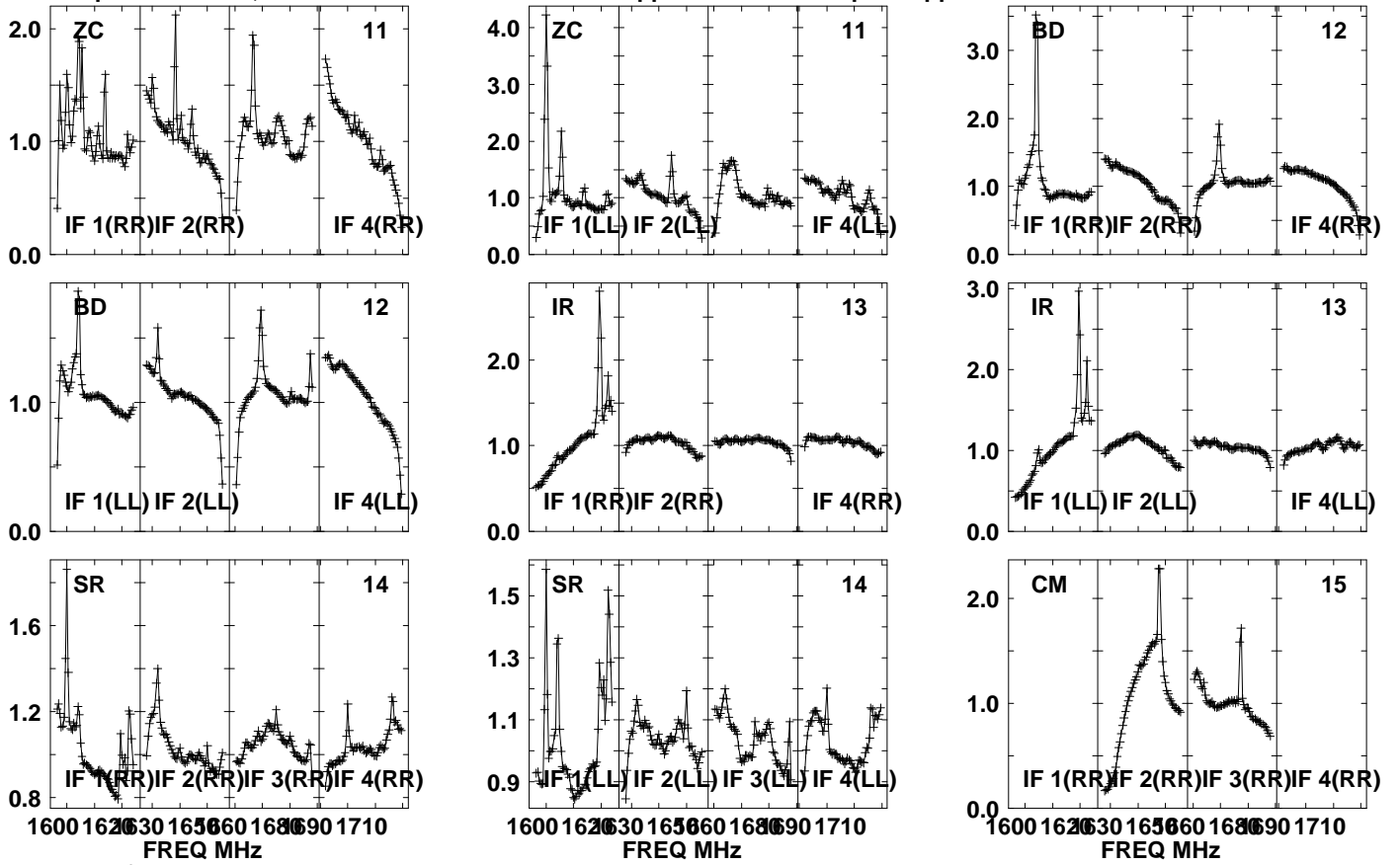

Lower frame: Real Jy

Auto-corr total-power spectrum Antenna: \*

Timerange: 00/16:48:31 to 00/16:49:59

Plot file version 681 created 05-OCT-2021 17:07:40

J0827+5217 GM076.UVDATA.1

Freq = 1.5945 GHz, Bw = 32.000 MH No calibration applied and no bandpass applied

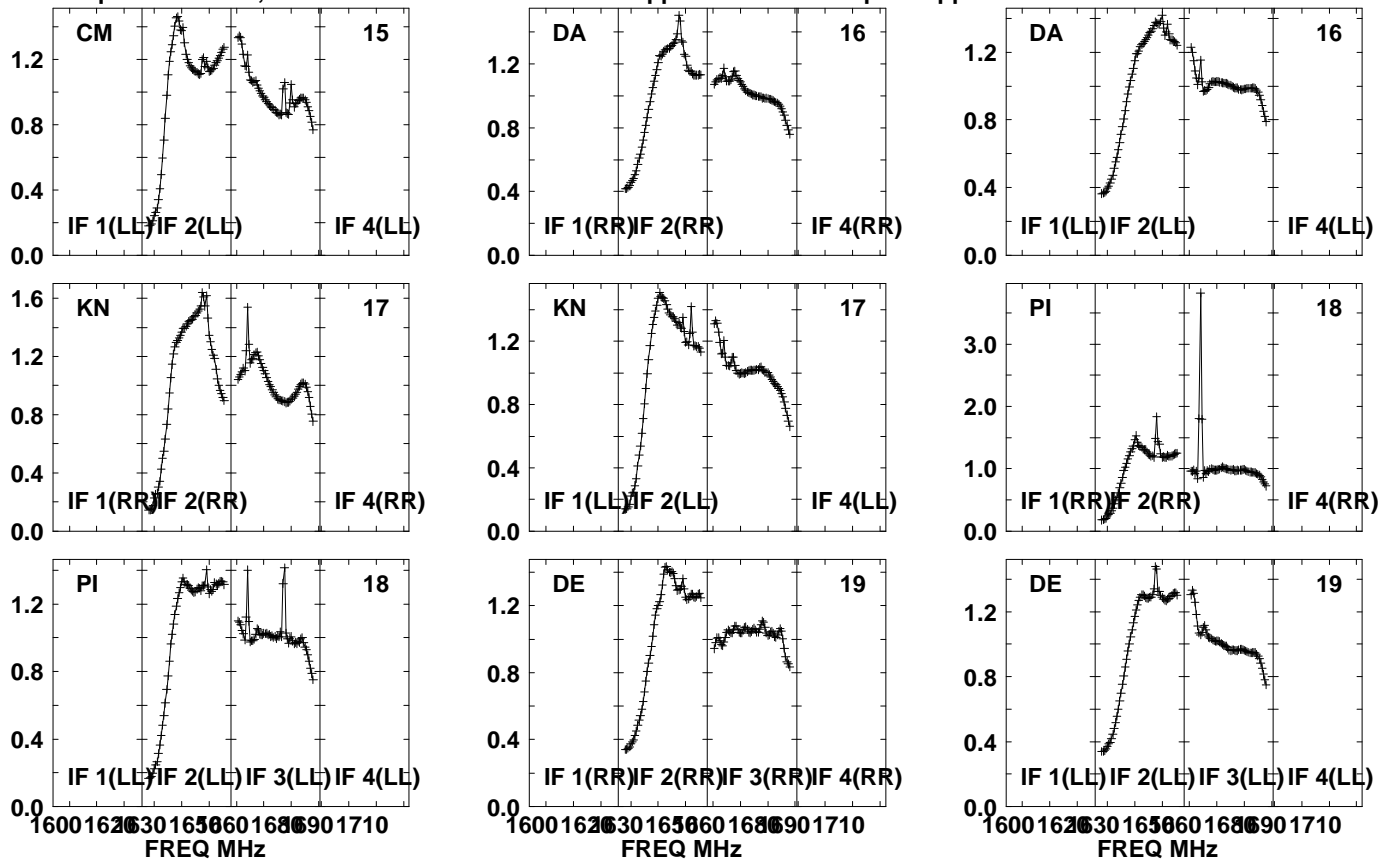

Lower frame: Real Jy  
Auto-corr total-power spectrum Antenna: \*  
Timerange: 00/16:48:31 to 00/16:49:59

Plot file version 682 created 05-OCT-2021 17:07:40

J0827+5217 GM076.UVDATA.1

Freq = 1.5945 GHz, Bw = 32.000 MH No calibration applied and no bandpass applied

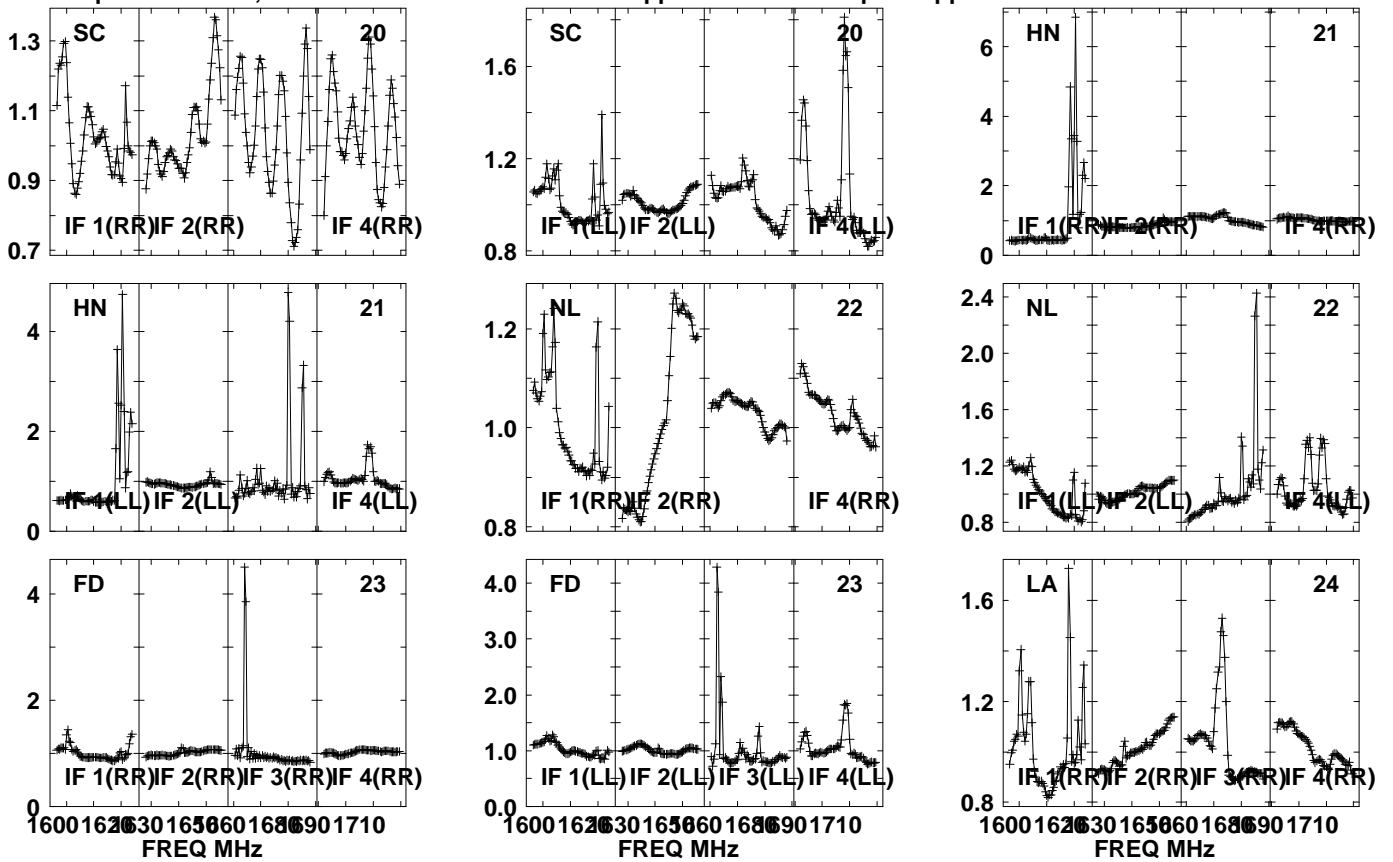

Lower frame: Real Jy  
Auto-corr total-power spectrum Antenna: \*  
Timerange: 00/16:48:31 to 00/16:49:59



Plot file version 683 created 05-OCT-2021 17:07:40

J0827+5217 GM076.UVDATA.1

Freq = 1.5945 GHz, Bw = 32.000 MH No calibration applied and no bandpass applied

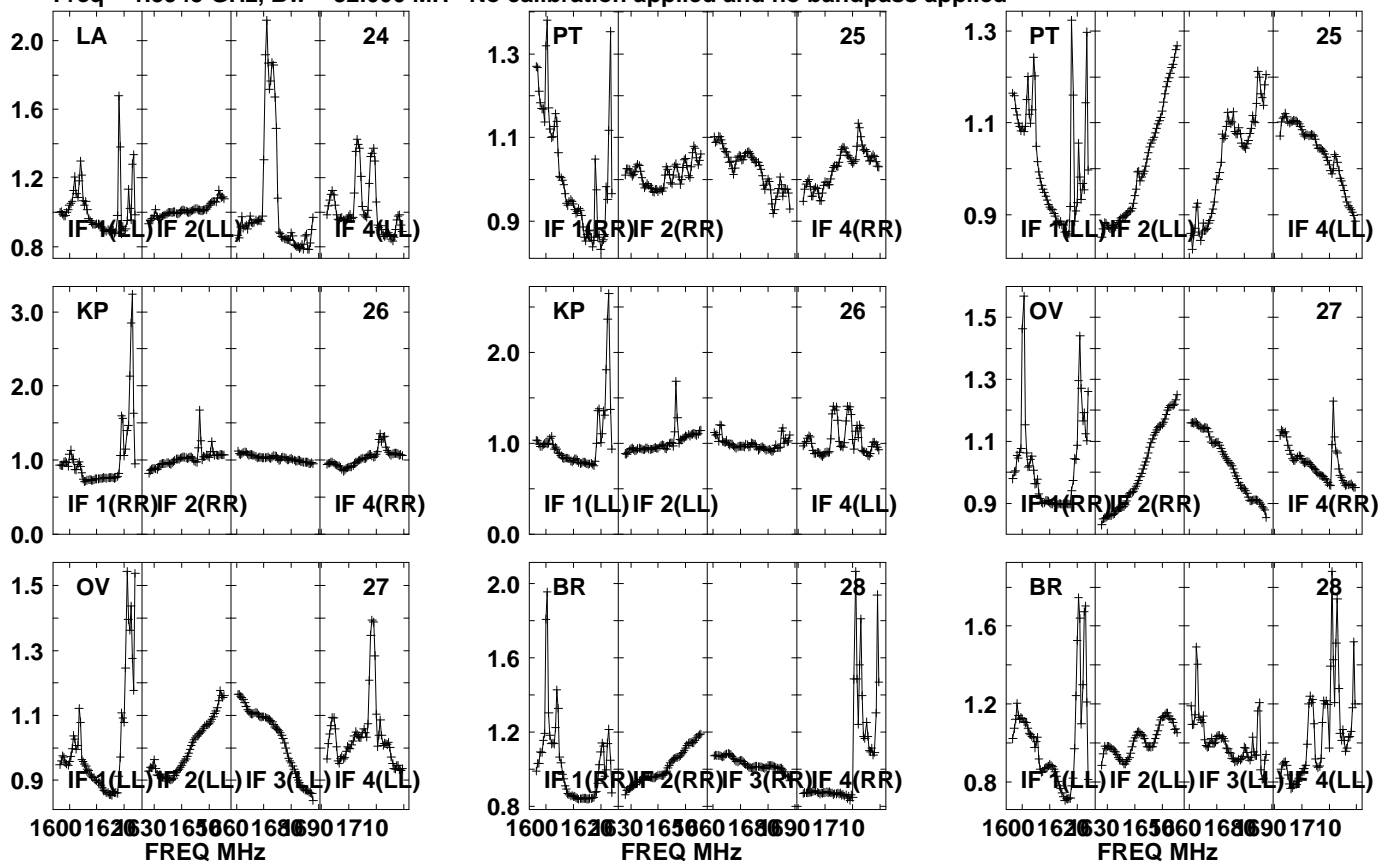

Lower frame: Real Jy  
Auto-corr total-power spectrum Antenna: \*  
Timerange: 00/16:48:31 to 00/16:49:59

Plot file version 684 created 05-OCT-2021 17:07:41

APM08279+525 GM076.UVDATA.1

Freq = 1.5945 GHz, Bw = 32.000 MH No calibration applied and no bandpass applied

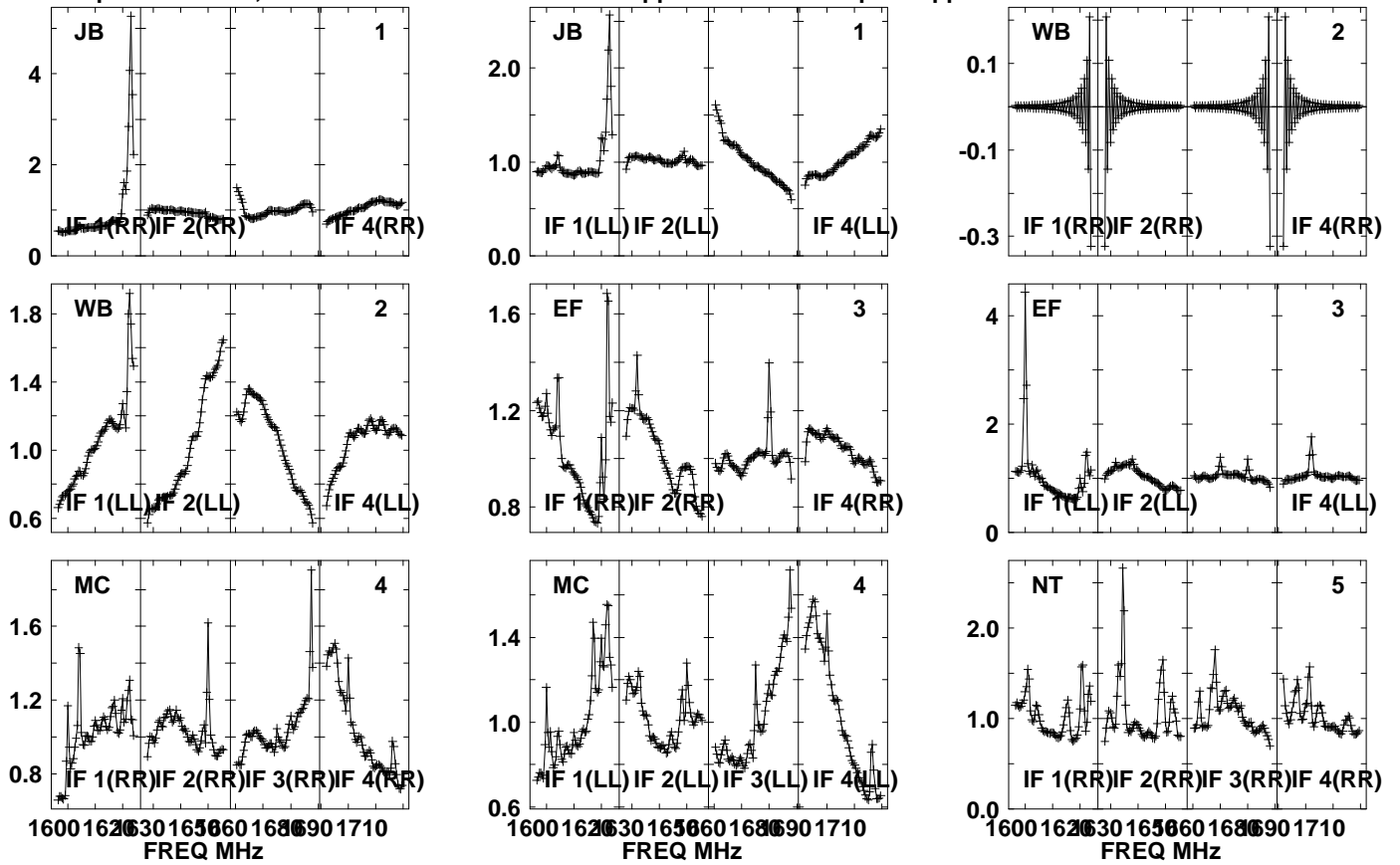

Lower frame: Real Jy

Auto-corr total-power spectrum Antenna: \*

Timerange: 00/16:50:01 to 00/16:53:29

Plot file version 685 created 05-OCT-2021 17:07:41

APM08279+525 GM076.UVDATA.1

Freq = 1.5945 GHz, Bw = 32.000 MH No calibration applied and no bandpass applied

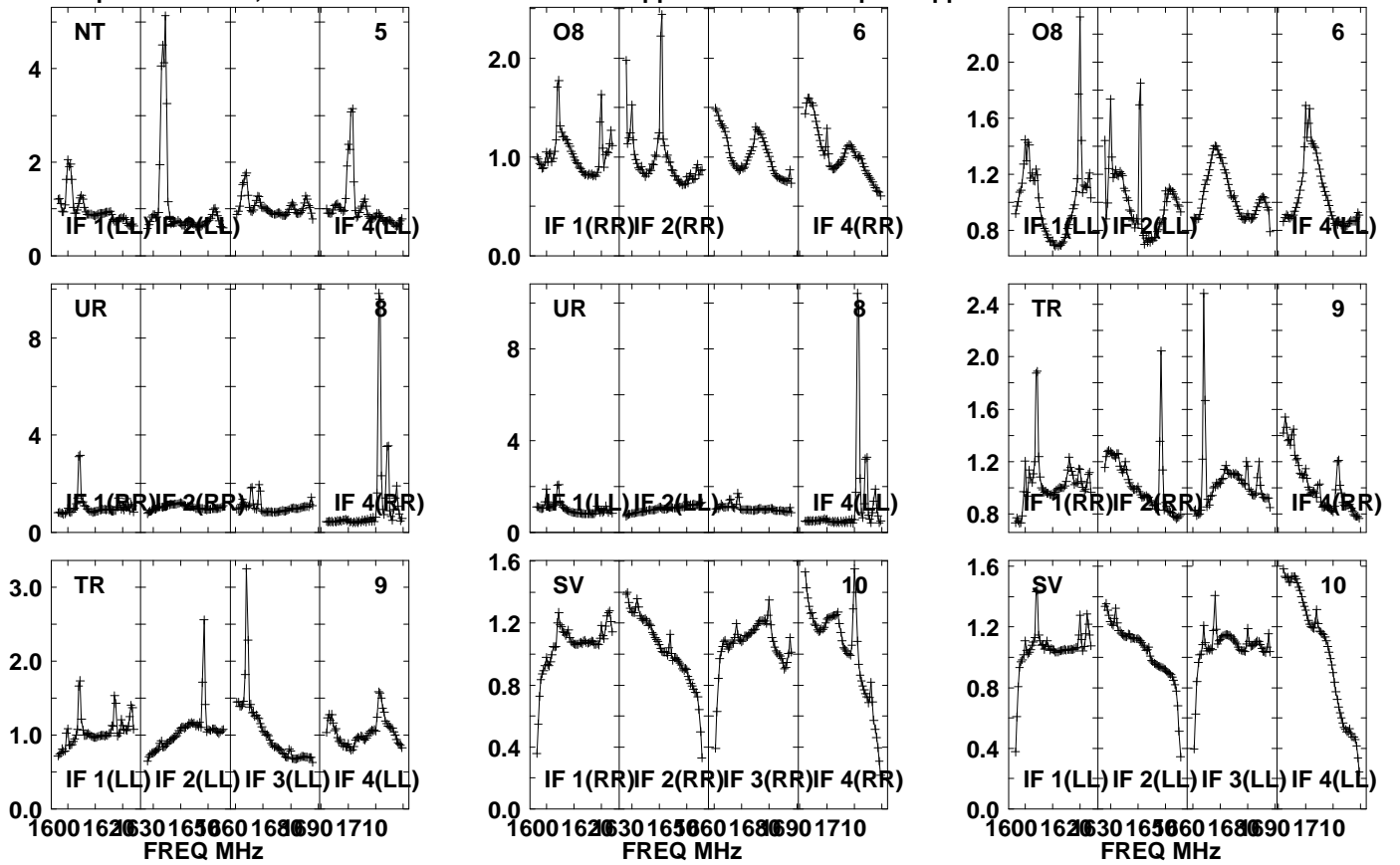

Lower frame: Real Jy

Auto-corr total-power spectrum Antenna: \*

Timerange: 00/16:50:01 to 00/16:53:29

Plot file version 686 created 05-OCT-2021 17:07:42

APM08279+525 GM076.UVDATA.1

Freq = 1.5945 GHz, Bw = 32.000 MH No calibration applied and no bandpass applied

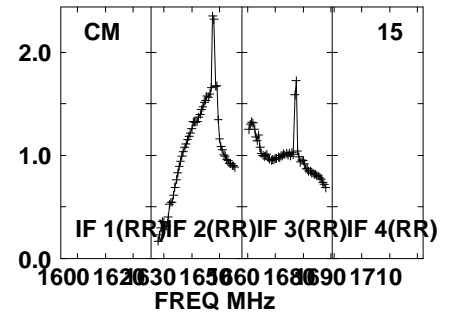
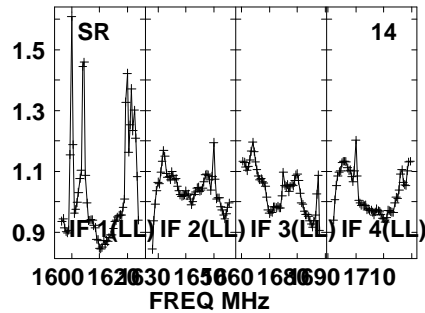
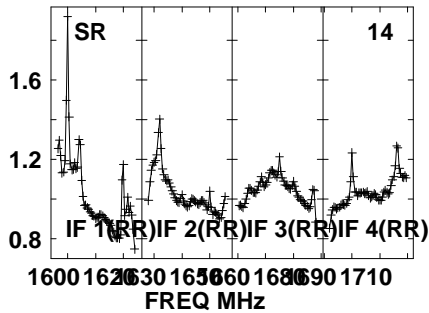
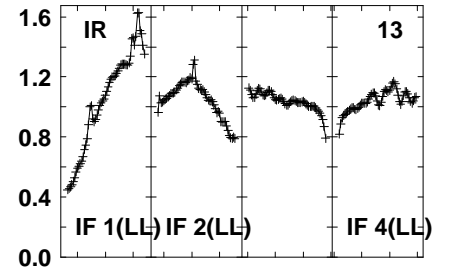
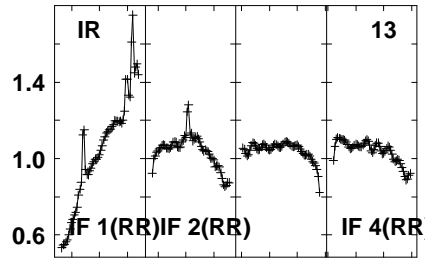
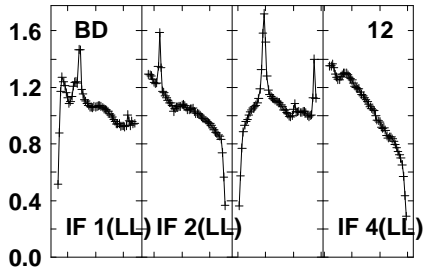
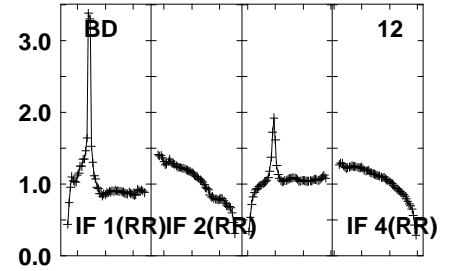
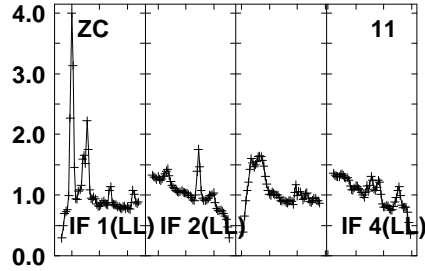
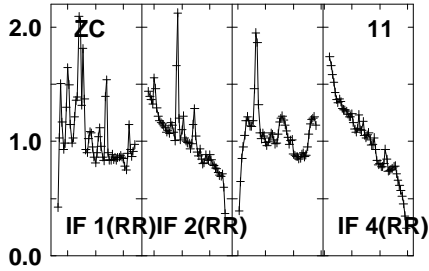

Lower frame: Real Jy  
Auto-corr total-power spectrum Antenna: \*  
Timerange: 00/16:50:01 to 00/16:53:29

Plot file version 687 created 05-OCT-2021 17:07:42

APM08279+525 GM076.UVDATA.1

Freq = 1.5945 GHz, Bw = 32.000 MH No calibration applied and no bandpass applied

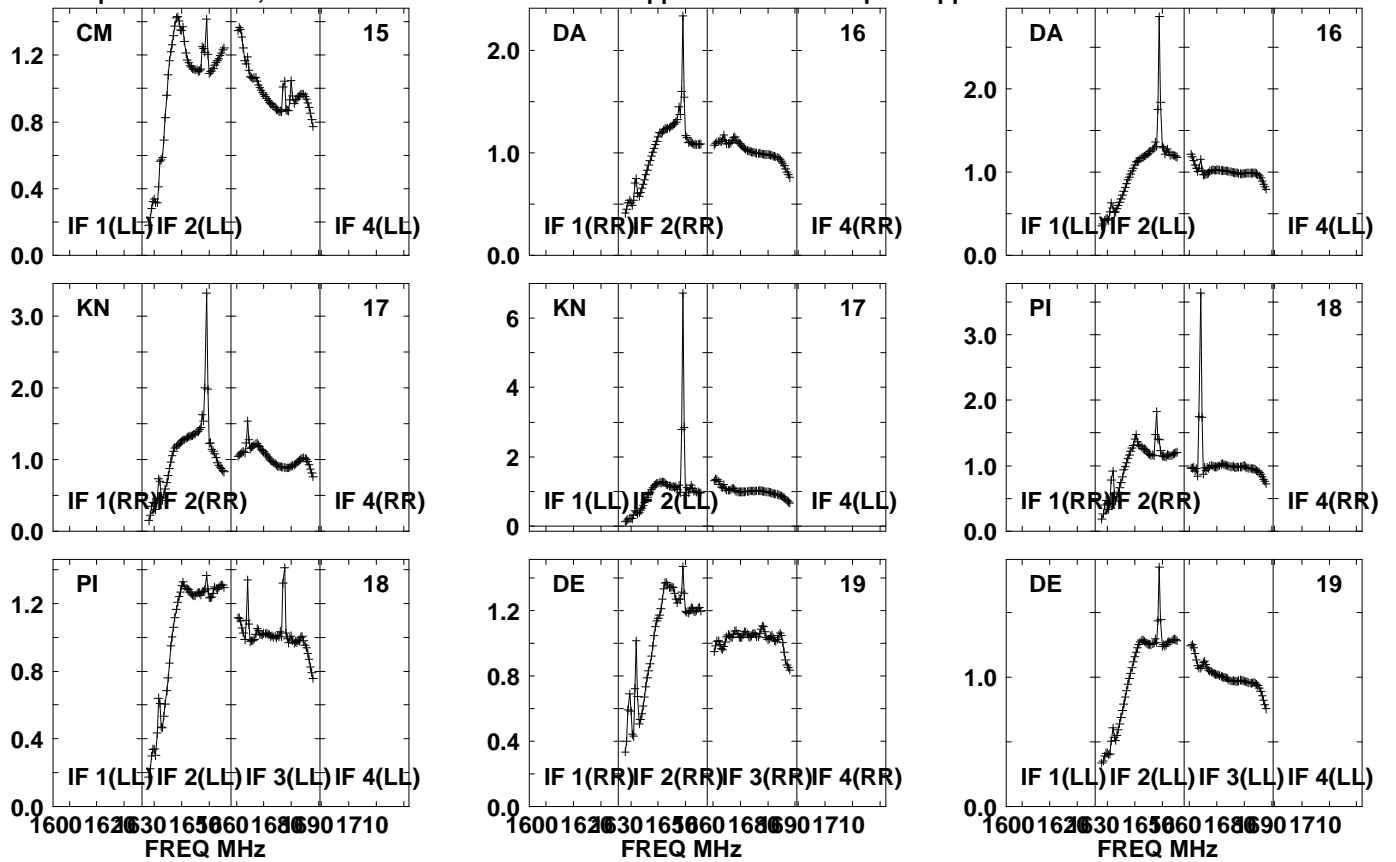

Lower frame: Real Jy  
Auto-corr total-power spectrum Antenna: \*  
Timerange: 00/16:50:01 to 00/16:53:29

Plot file version 688 created 05-OCT-2021 17:07:42

APM08279+525 GM076.UVDATA.1

Freq = 1.5945 GHz, Bw = 32.000 MH No calibration applied and no bandpass applied

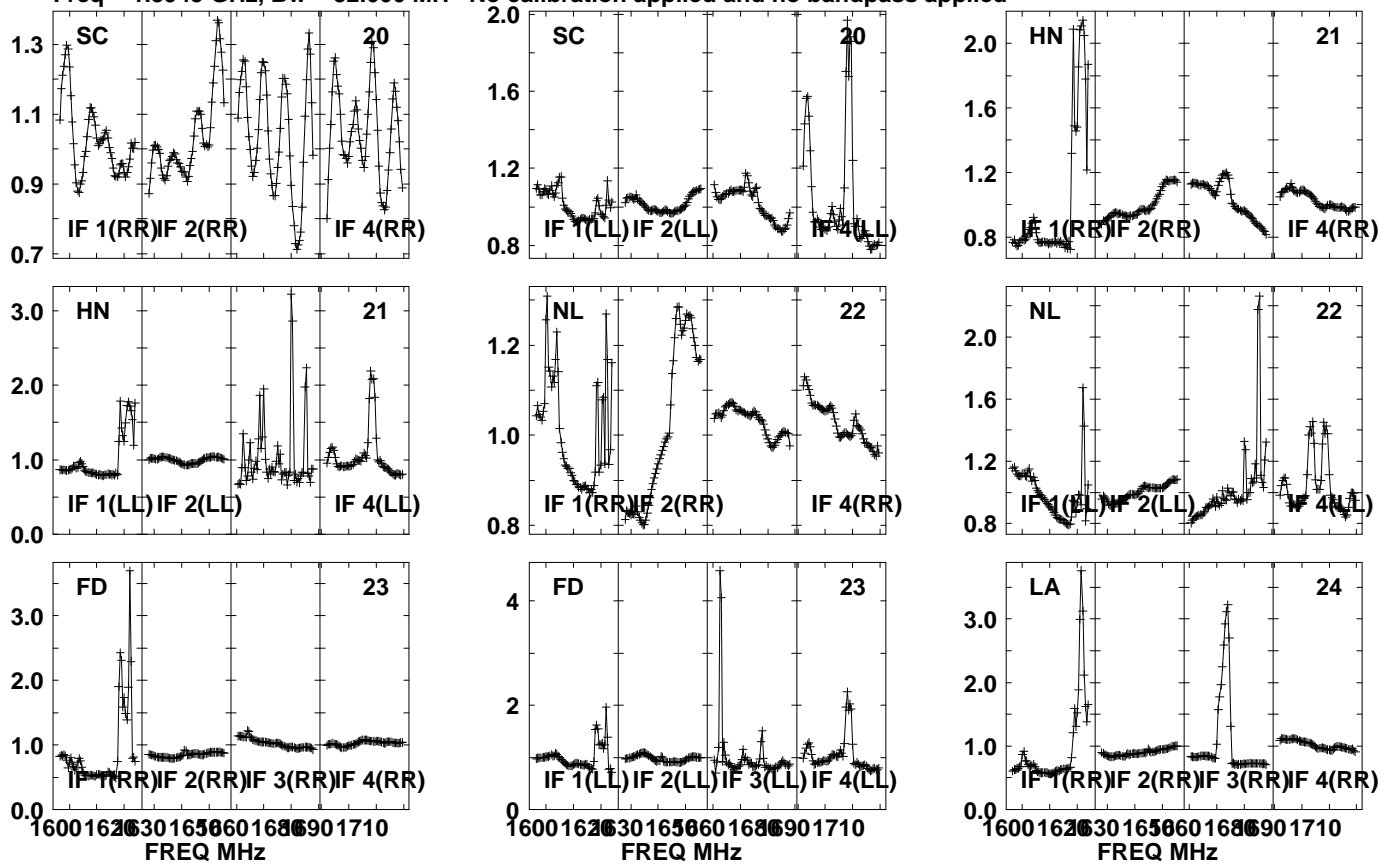

Lower frame: Real Jy  
Auto-corr total-power spectrum Antenna: \*  
Timerange: 00/16:50:01 to 00/16:53:29

Plot file version 689 created 05-OCT-2021 17:07:43

APM08279+525 GM076.UVDATA.1

Freq = 1.5945 GHz, Bw = 32.000 MH No calibration applied and no bandpass applied

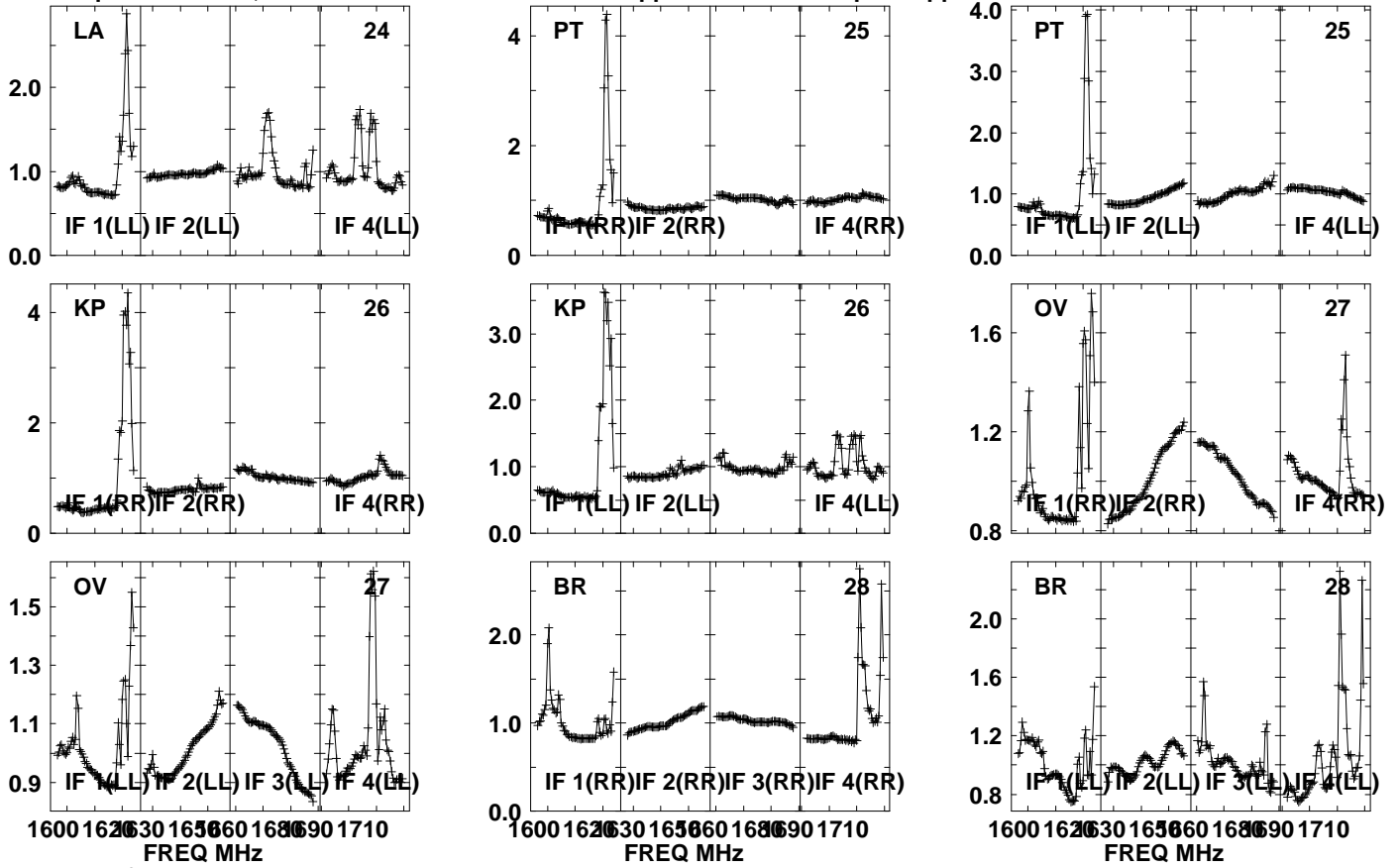

Lower frame: Real Jy

Auto-corr total-power spectrum Antenna: \*

Timerange: 00/16:50:01 to 00/16:53:29

Plot file version 690 created 05-OCT-2021 17:07:43

J0827+5217 GM076.UVDATA.1

Freq = 1.5945 GHz, Bw = 32.000 MH No calibration applied and no bandpass applied

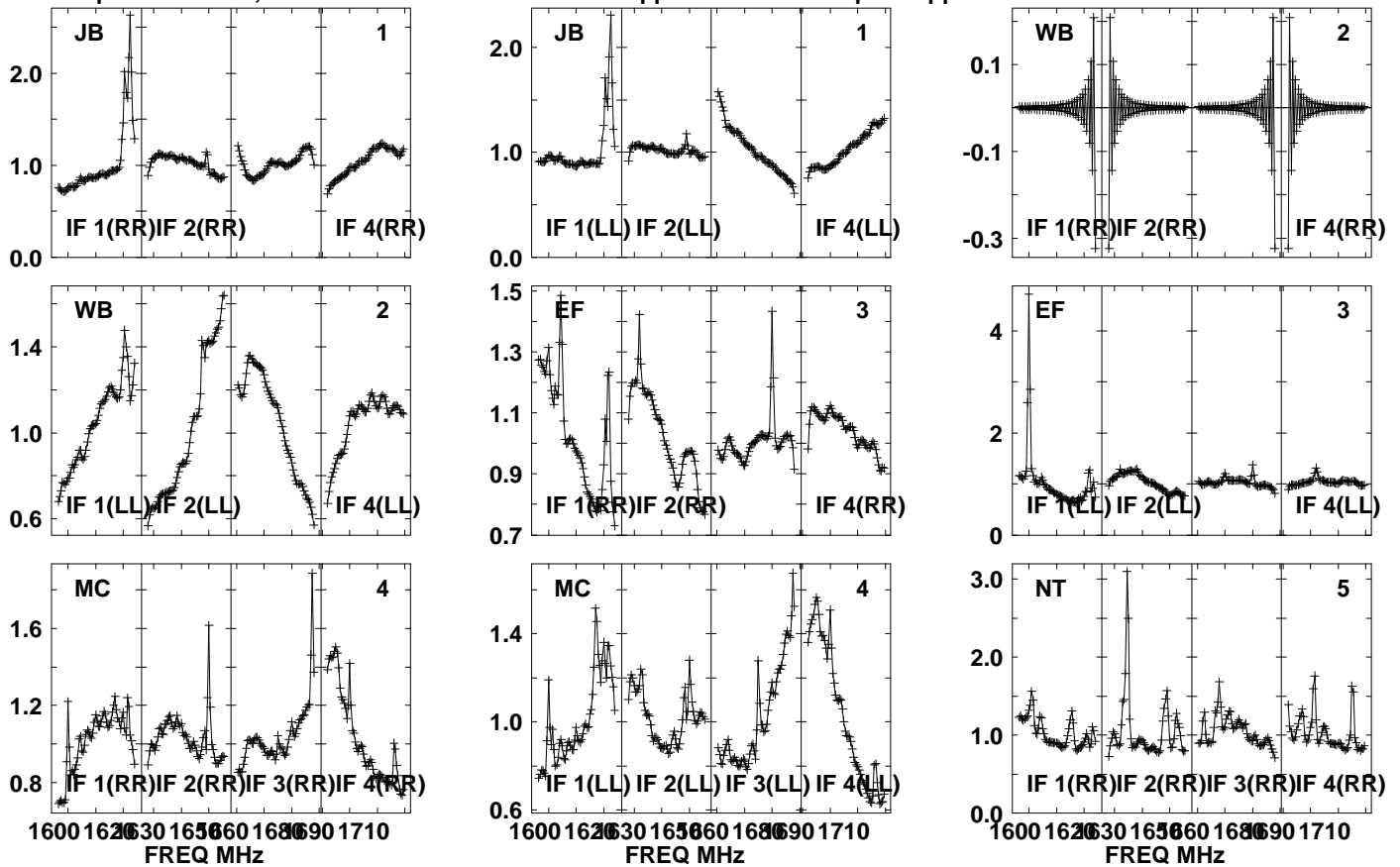

Lower frame: Real Jy

Auto-corr total-power spectrum Antenna: \*

Timerange: 00/16:53:31 to 00/16:54:59



Plot file version 691 created 05-OCT-2021 17:07:43

J0827+5217 GM076.UVDATA.1

Freq = 1.5945 GHz, Bw = 32.000 MH No calibration applied and no bandpass applied

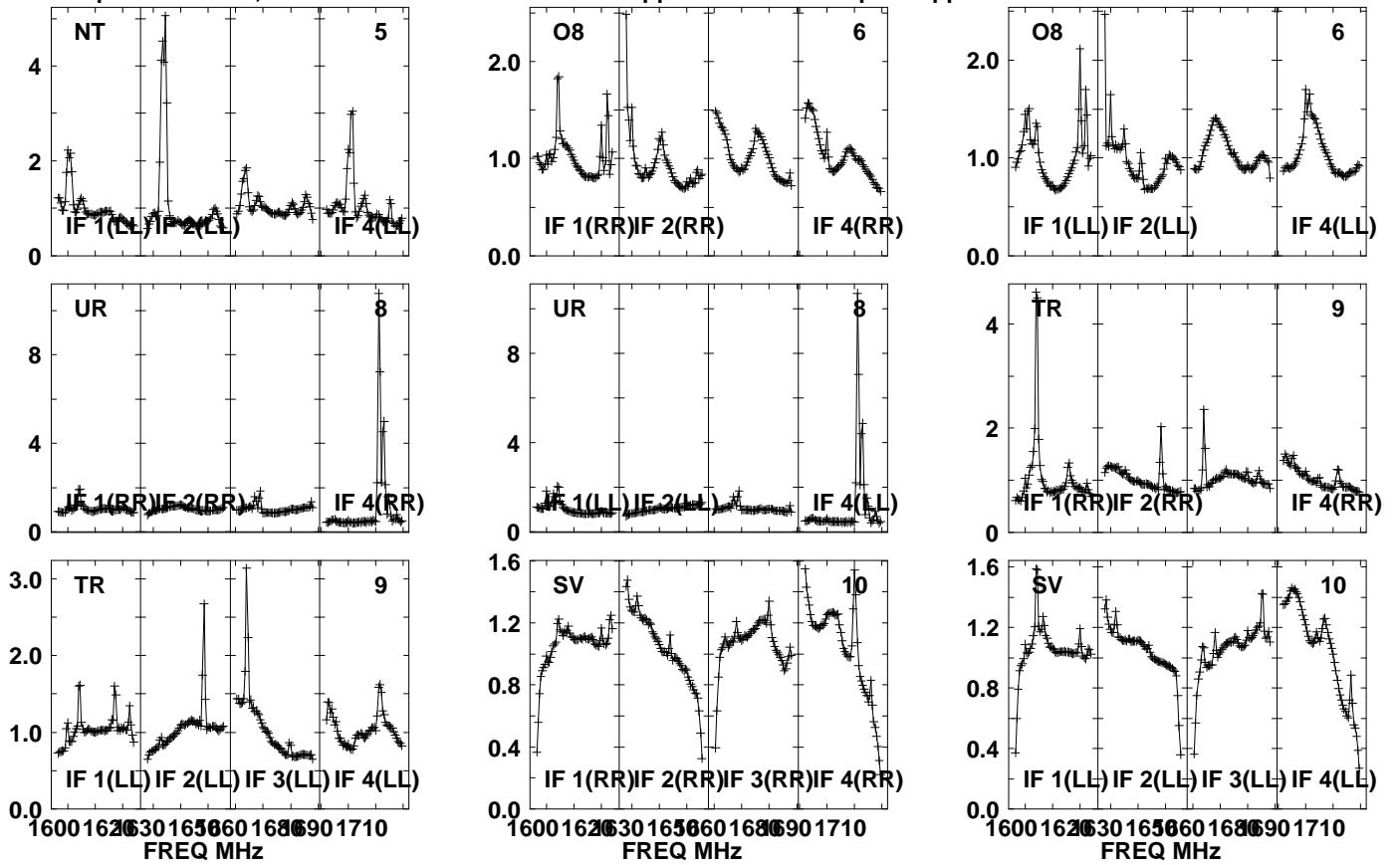

Lower frame: Real Jy  
Auto-corr total-power spectrum Antenna: \*  
Timerange: 00/16:53:31 to 00/16:54:59

Plot file version 692 created 05-OCT-2021 17:07:44

J0827+5217 GM076.UVDATA.1

Freq = 1.5945 GHz, Bw = 32.000 MH No calibration applied and no bandpass applied

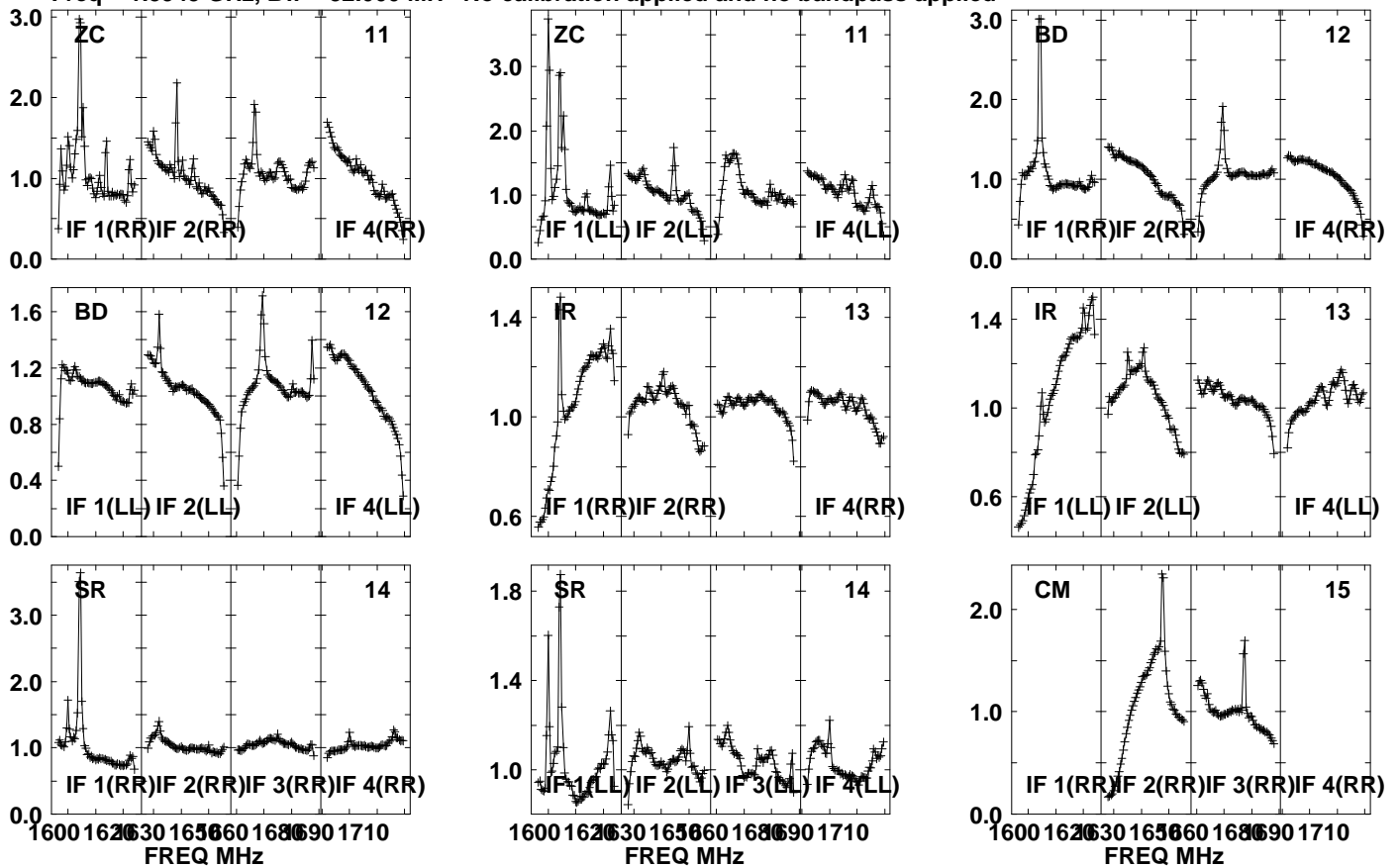

Lower frame: Real Jy

Auto-corr total-power spectrum Antenna: \*

Timerange: 00/16:53:31 to 00/16:54:59

Plot file version 693 created 05-OCT-2021 17:07:44

J0827+5217 GM076.UVDATA.1

Freq = 1.5945 GHz, Bw = 32.000 MH No calibration applied and no bandpass applied

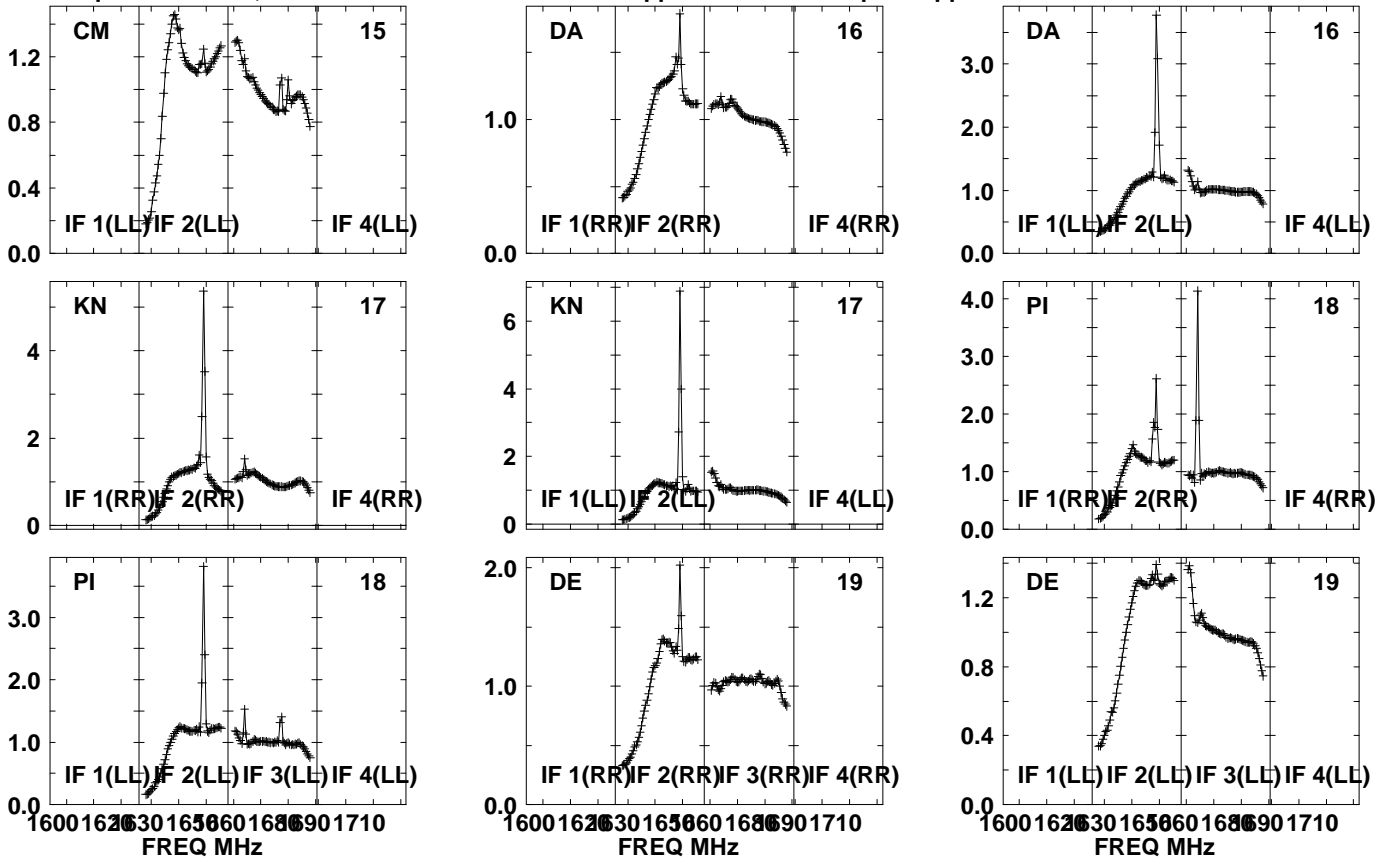

Lower frame: Real Jy  
Auto-corr total-power spectrum Antenna: \*  
Timerange: 00/16:53:31 to 00/16:54:59

Plot file version 694 created 05-OCT-2021 17:07:44

J0827+5217 GM076.UVDATA.1

Freq = 1.5945 GHz, Bw = 32.000 MH No calibration applied and no bandpass applied

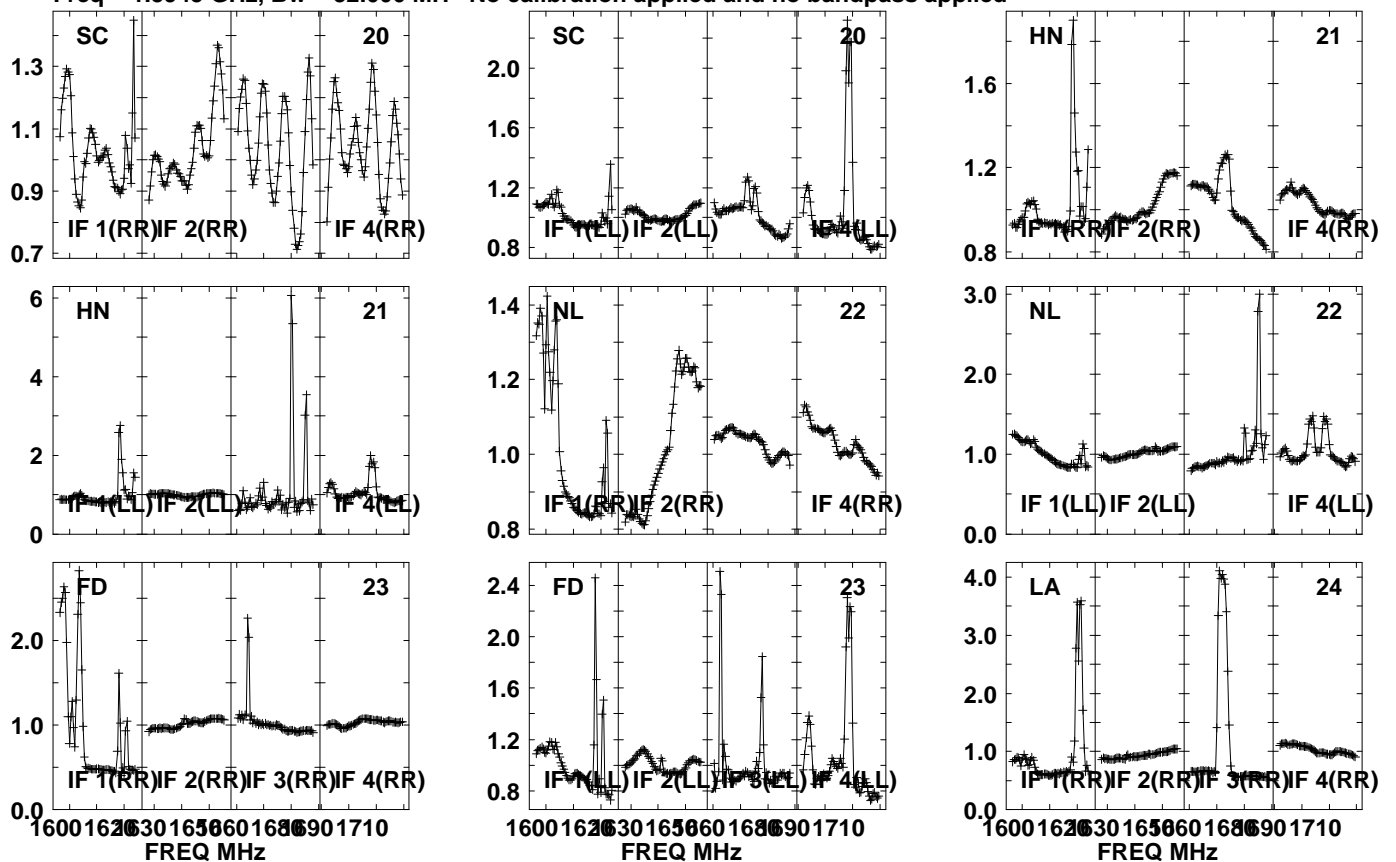

Lower frame: Real Jy  
Auto-corr total-power spectrum Antenna: \*  
Timerange: 00/16:53:31 to 00/16:54:59

Plot file version 695 created 05-OCT-2021 17:07:45

J0827+5217 GM076.UVDATA.1

Freq = 1.5945 GHz, Bw = 32.000 MH No calibration applied and no bandpass applied

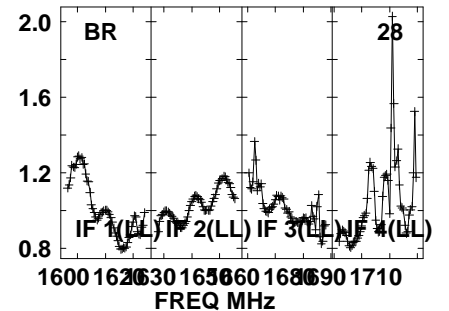
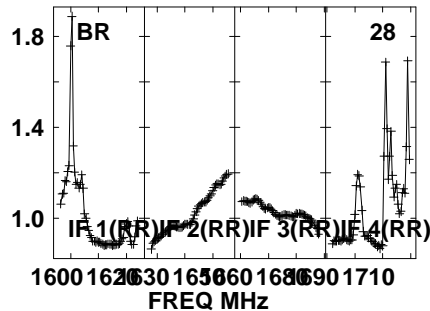
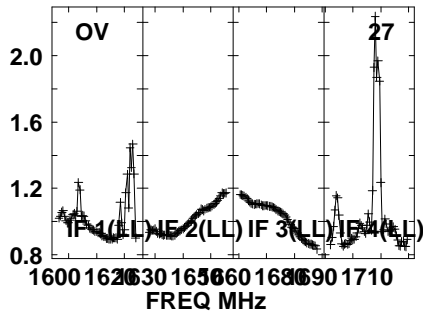
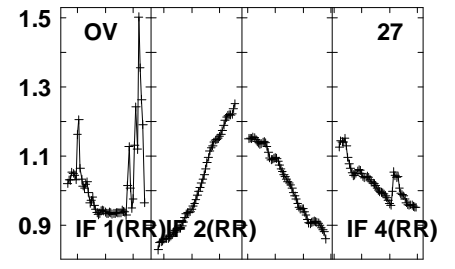
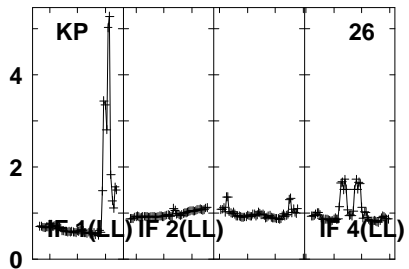
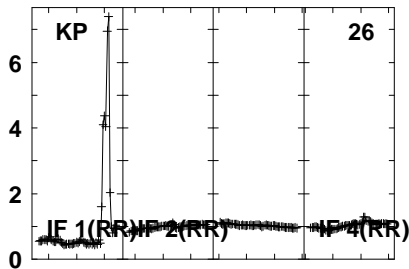
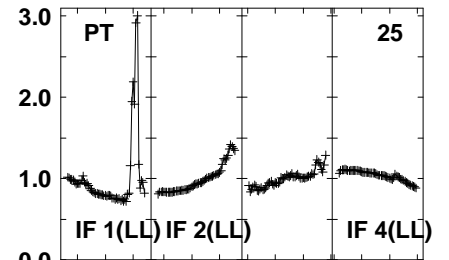
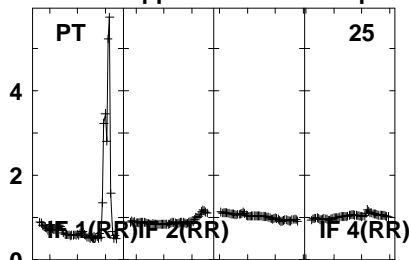
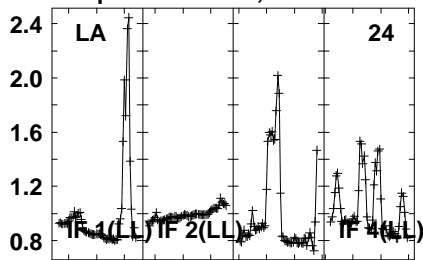

Lower frame: Real Jy

Auto-corr total-power spectrum Antenna: \*

Timerange: 00/16:53:31 to 00/16:54:59

Plot file version 696 created 05-OCT-2021 17:07:45

APM08279+525 GM076.UVDATA.1

Freq = 1.5945 GHz, Bw = 32.000 MH No calibration applied and no bandpass applied

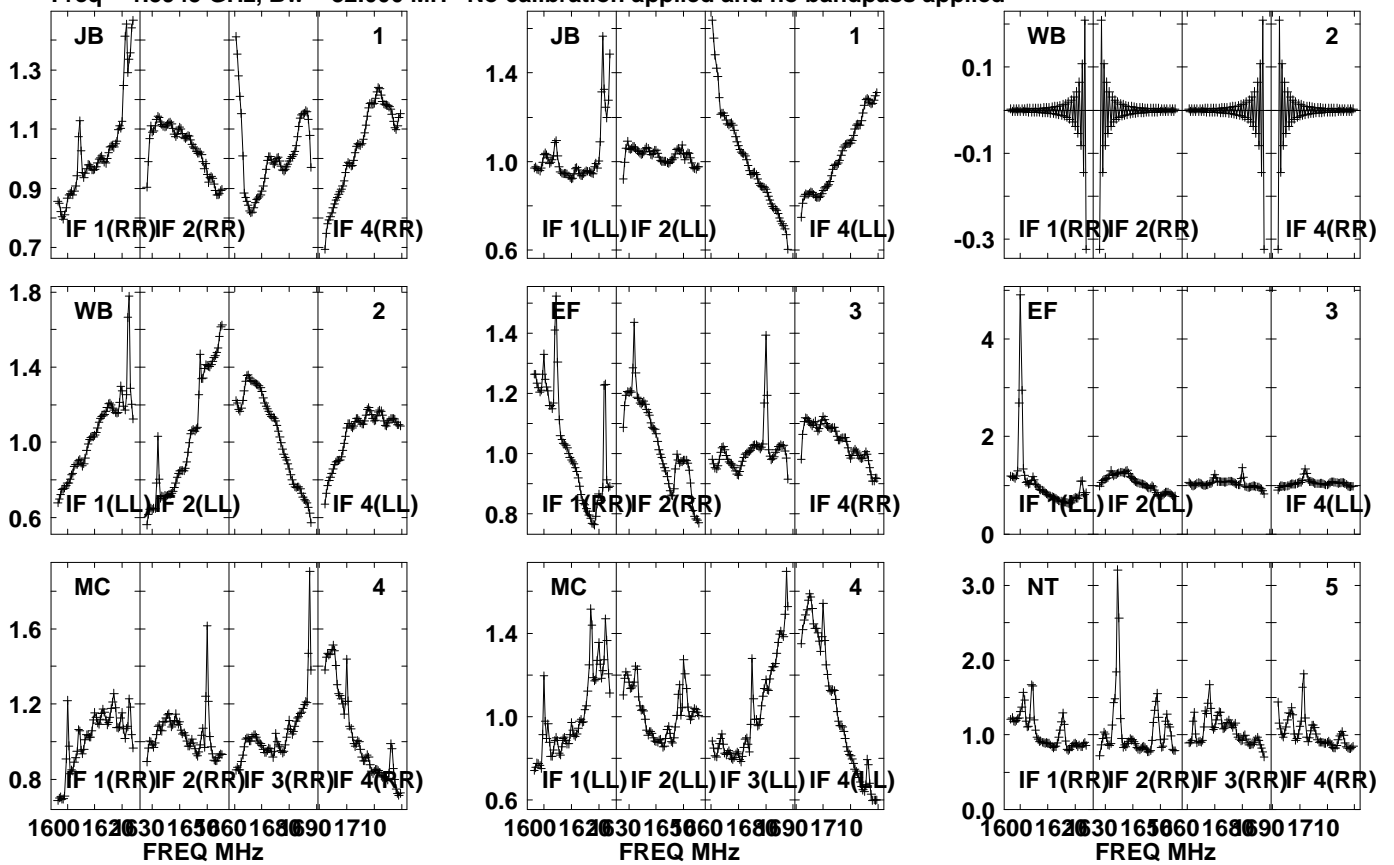

Lower frame: Real Jy  
Auto-corr total-power spectrum Antenna: \*  
Timerange: 00/16:55:01 to 00/16:58:29

Plot file version 697 created 05-OCT-2021 17:07:45

APM08279+525 GM076.UVDATA.1

Freq = 1.5945 GHz, Bw = 32.000 MH No calibration applied and no bandpass applied

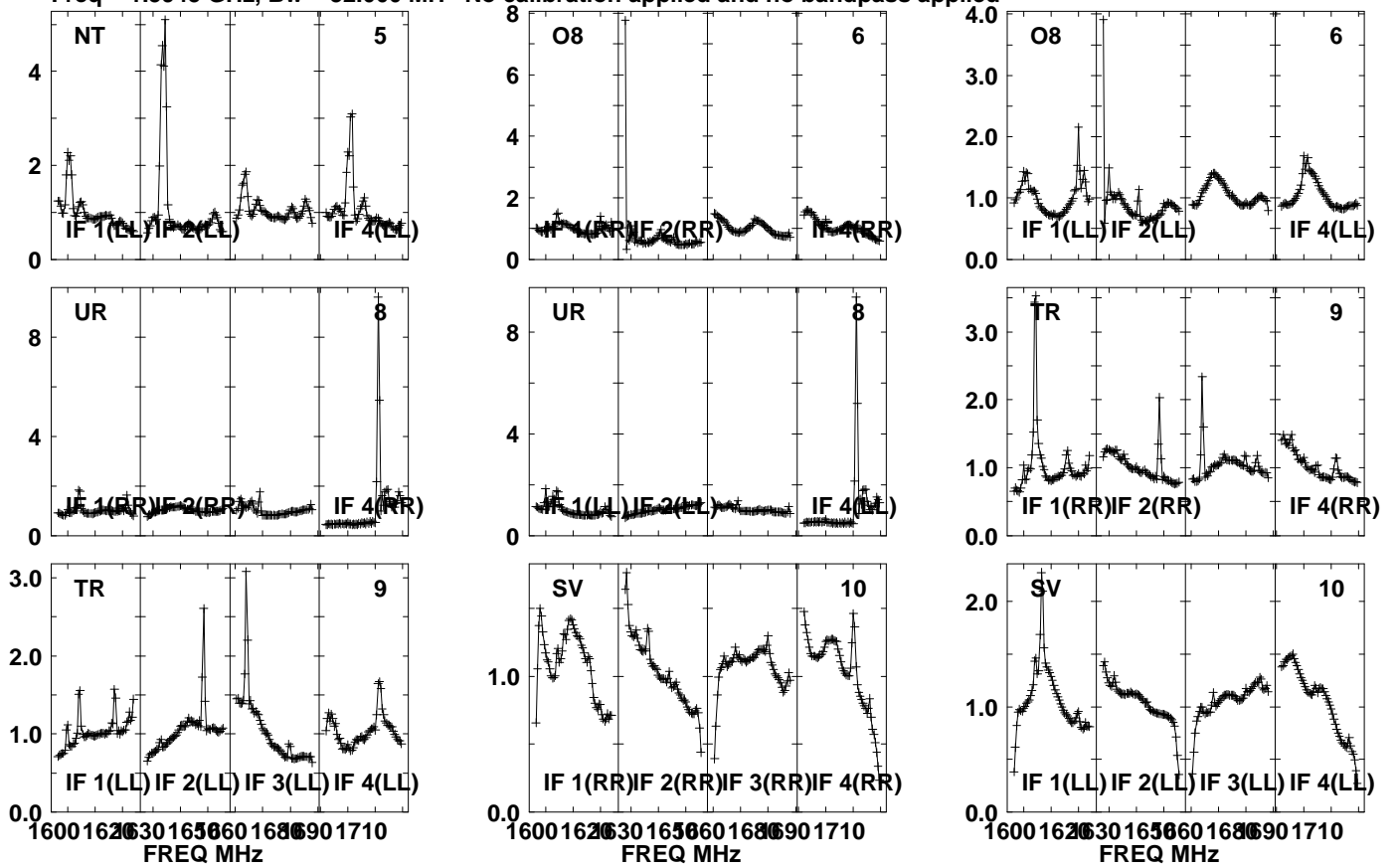

Lower frame: Real Jy

Auto-corr total-power spectrum Antenna: \*

Timerange: 00/16:55:01 to 00/16:58:29

Plot file version 698 created 05-OCT-2021 17:07:46

APM08279+525 GM076.UVDATA.1

Freq = 1.5945 GHz, Bw = 32.000 MH No calibration applied and no bandpass applied

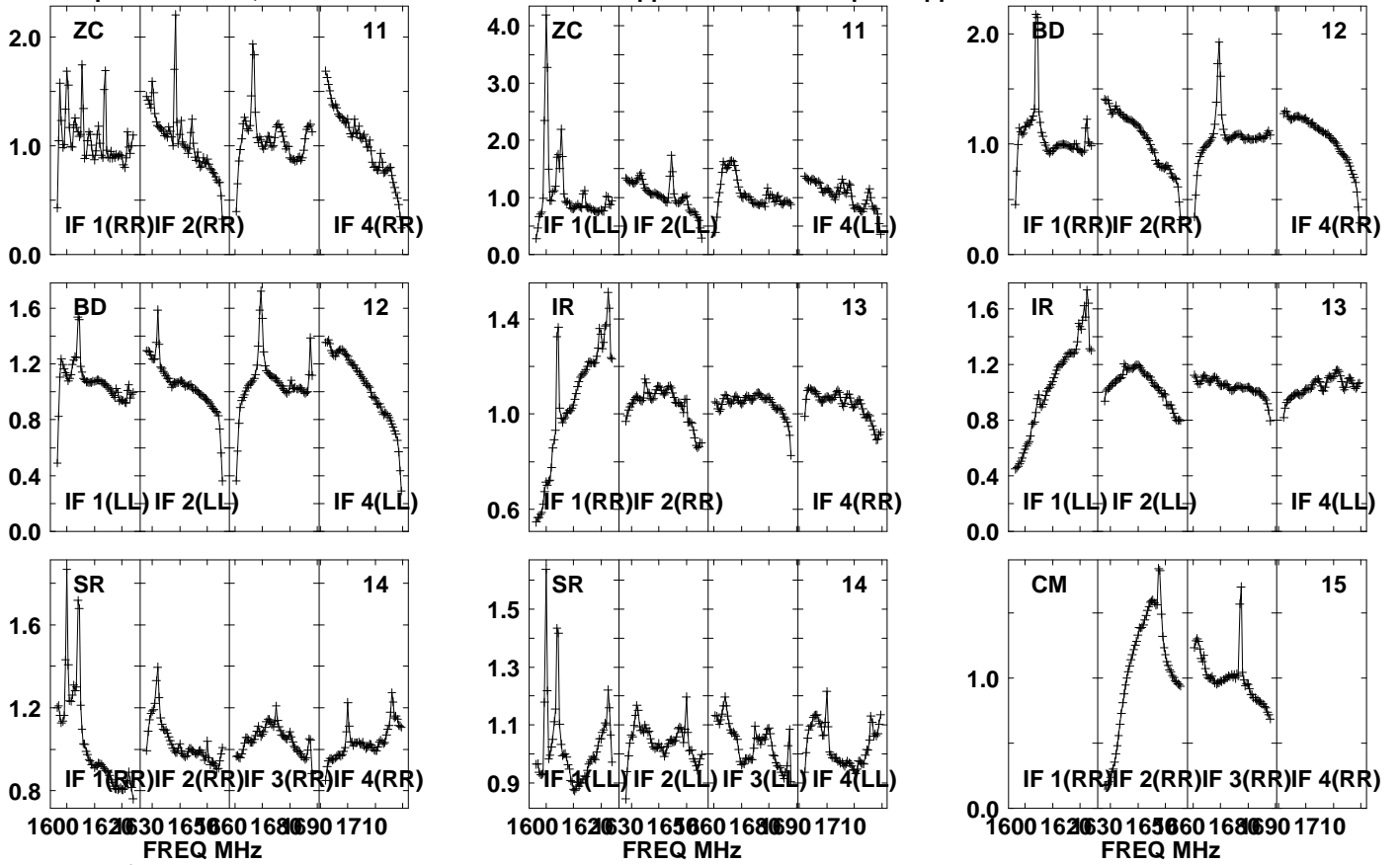

Lower frame: Real Jy

Auto-corr total-power spectrum Antenna: \*

Timerange: 00/16:55:01 to 00/16:58:29



Plot file version 699 created 05-OCT-2021 17:07:46

APM08279+525 GM076.UVDATA.1

Freq = 1.5945 GHz, Bw = 32.000 MH

No calibration applied and no bandpass applied

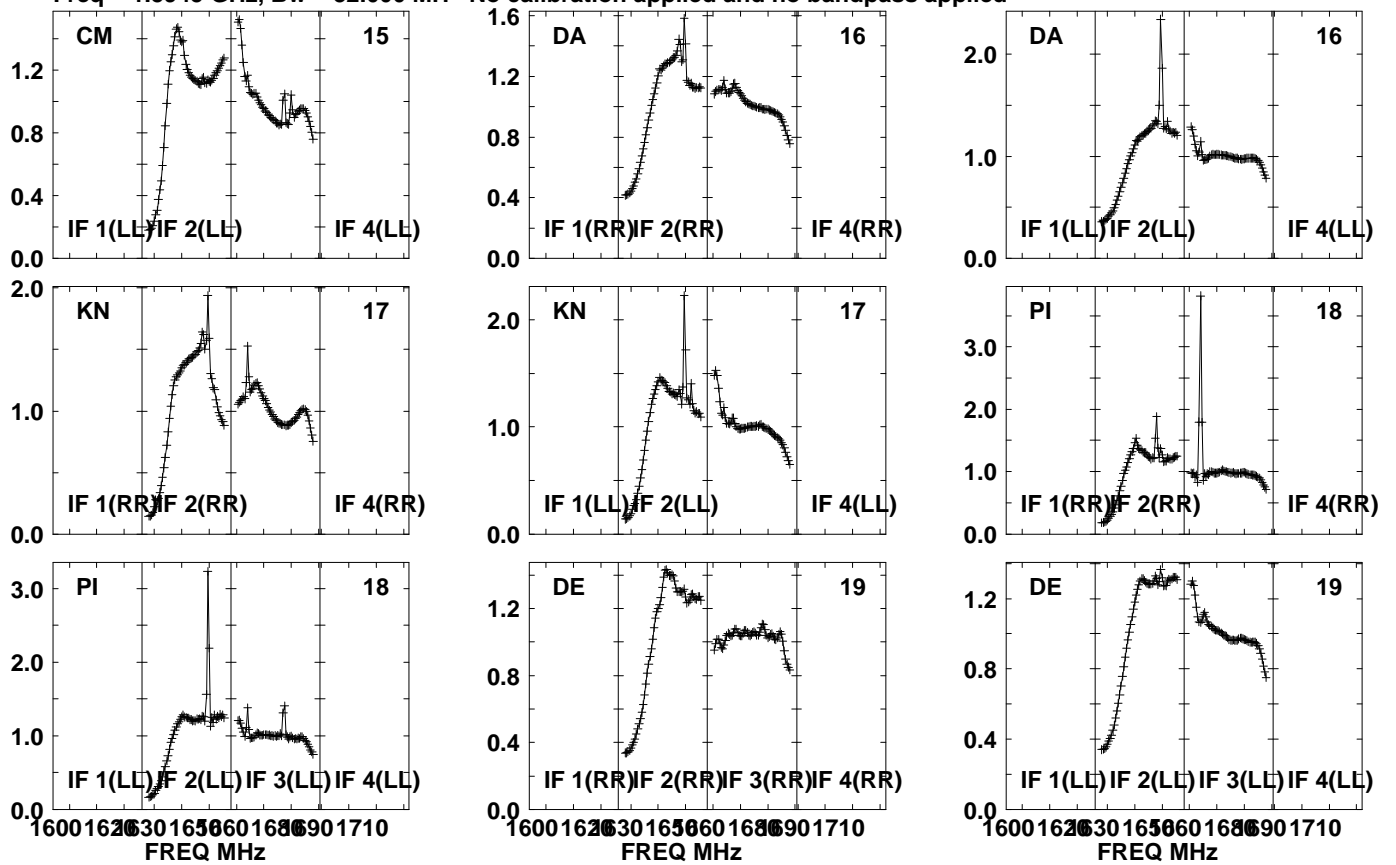

Lower frame: Real Jy  
Auto-corr total-power spectrum Antenna: \*  
Timerange: 00/16:55:01 to 00/16:58:29

Plot file version 700 created 05-OCT-2021 17:07:46

APM08279+525 GM076.UVDATA.1

Freq = 1.5945 GHz, Bw = 32.000 MH No calibration applied and no bandpass applied

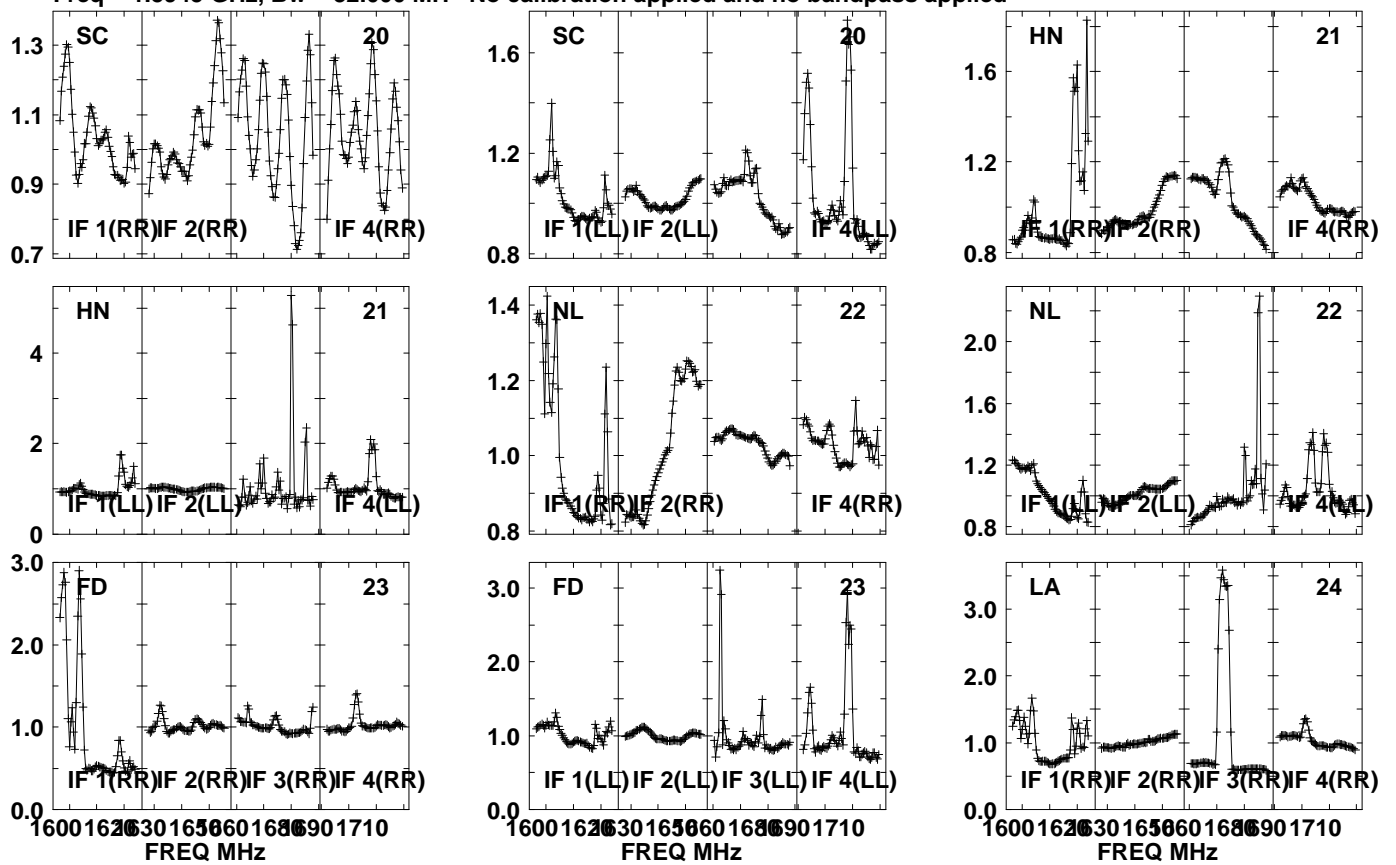

Lower frame: Real Jy  
Auto-corr total-power spectrum Antenna: \*  
Timerange: 00/16:55:01 to 00/16:58:29

Plot file version 701 created 05-OCT-2021 17:07:47

APM08279+525 GM076.UVDATA.1

Freq = 1.5945 GHz, Bw = 32.000 MH No calibration applied and no bandpass applied

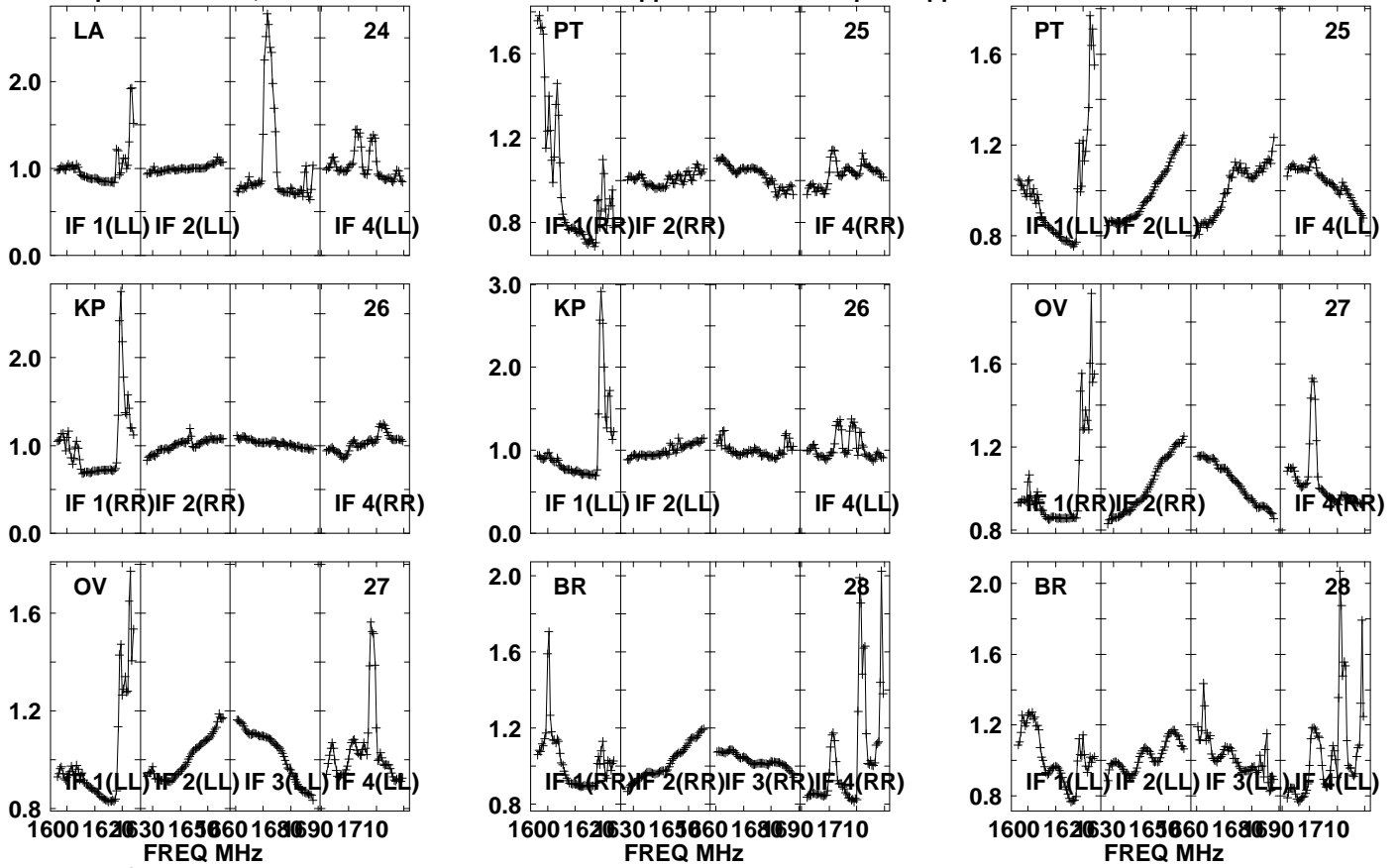

Lower frame: Real Jy

Auto-corr total-power spectrum Antenna: \*

Timerange: 00/16:55:01 to 00/16:58:29

Plot file version 702 created 05-OCT-2021 17:07:47

J0827+5217 GM076.UVDATA.1

Freq = 1.5945 GHz, Bw = 32.000 MH No calibration applied and no bandpass applied

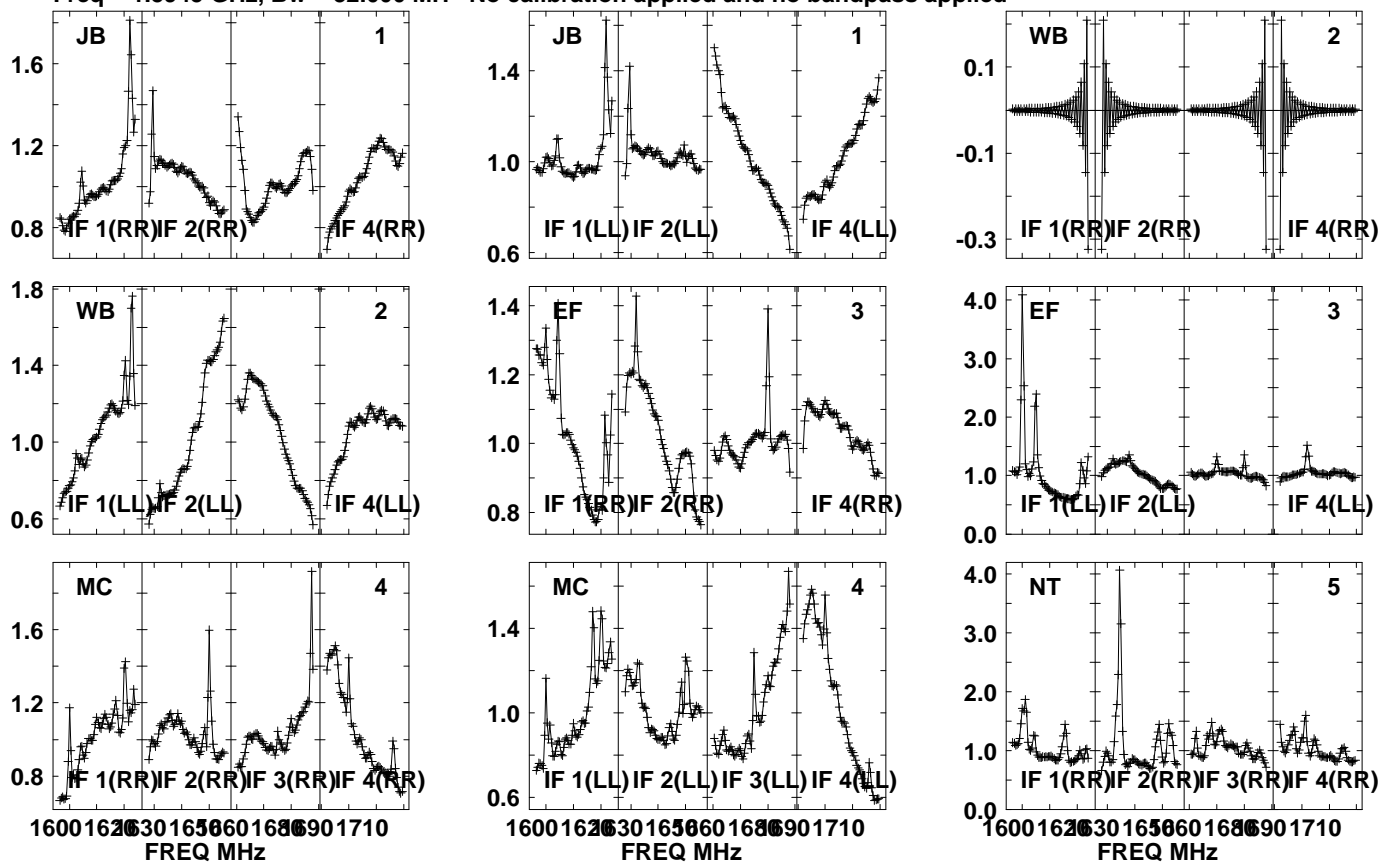

Lower frame: Real Jy  
Auto-corr total-power spectrum Antenna: \*  
Timerange: 00/16:59:01 to 00/17:00:29

Plot file version 703 created 05-OCT-2021 17:07:47

J0827+5217 GM076.UVDATA.1

Freq = 1.5945 GHz, Bw = 32.000 MH No calibration applied and no bandpass applied

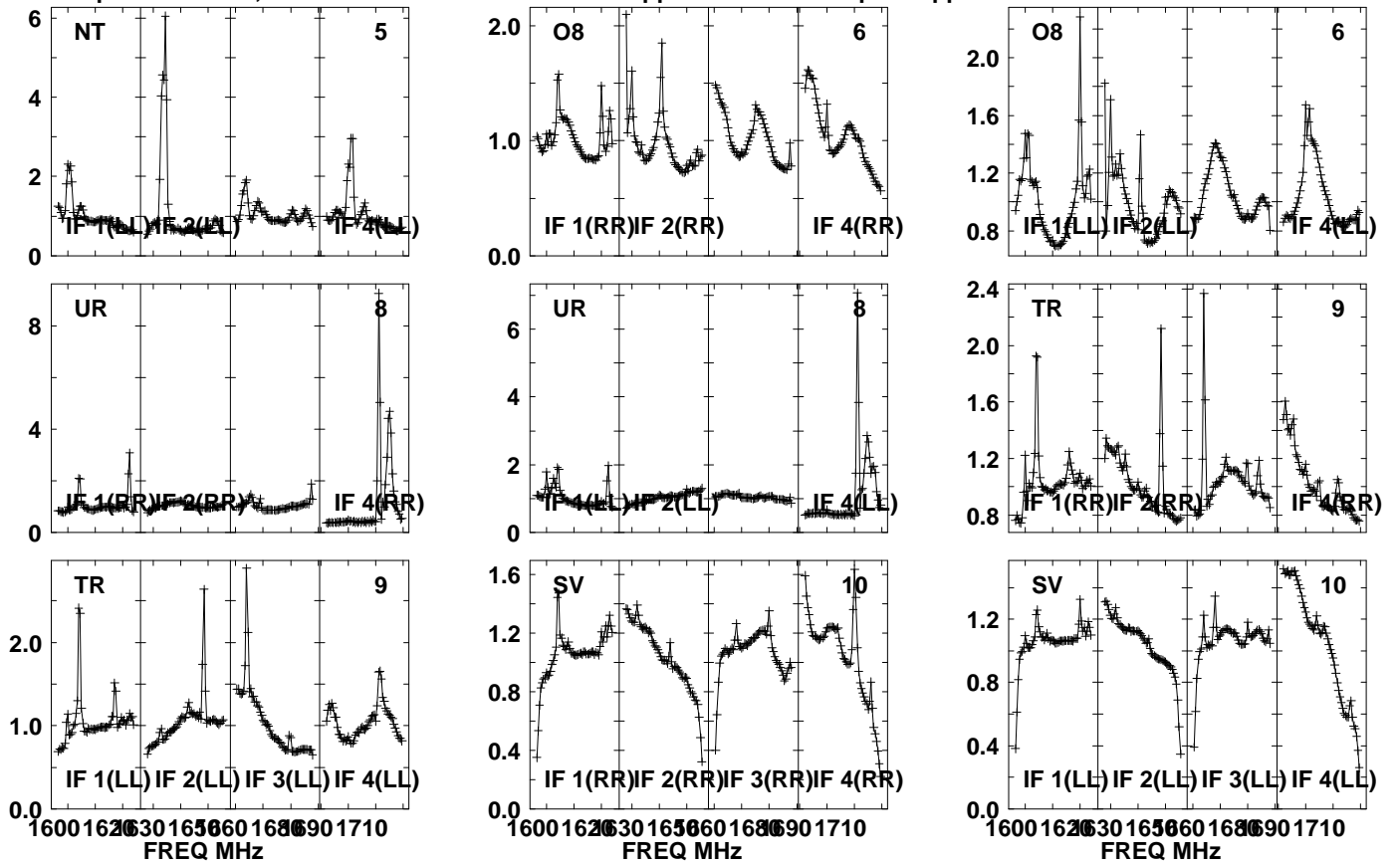

Lower frame: Real Jy  
Auto-corr total-power spectrum Antenna: \*  
Timerange: 00/16:59:01 to 00/17:00:29

Plot file version 704 created 05-OCT-2021 17:07:48

J0827+5217 GM076.UVDATA.1

Freq = 1.5945 GHz, Bw = 32.000 MH No calibration applied and no bandpass applied

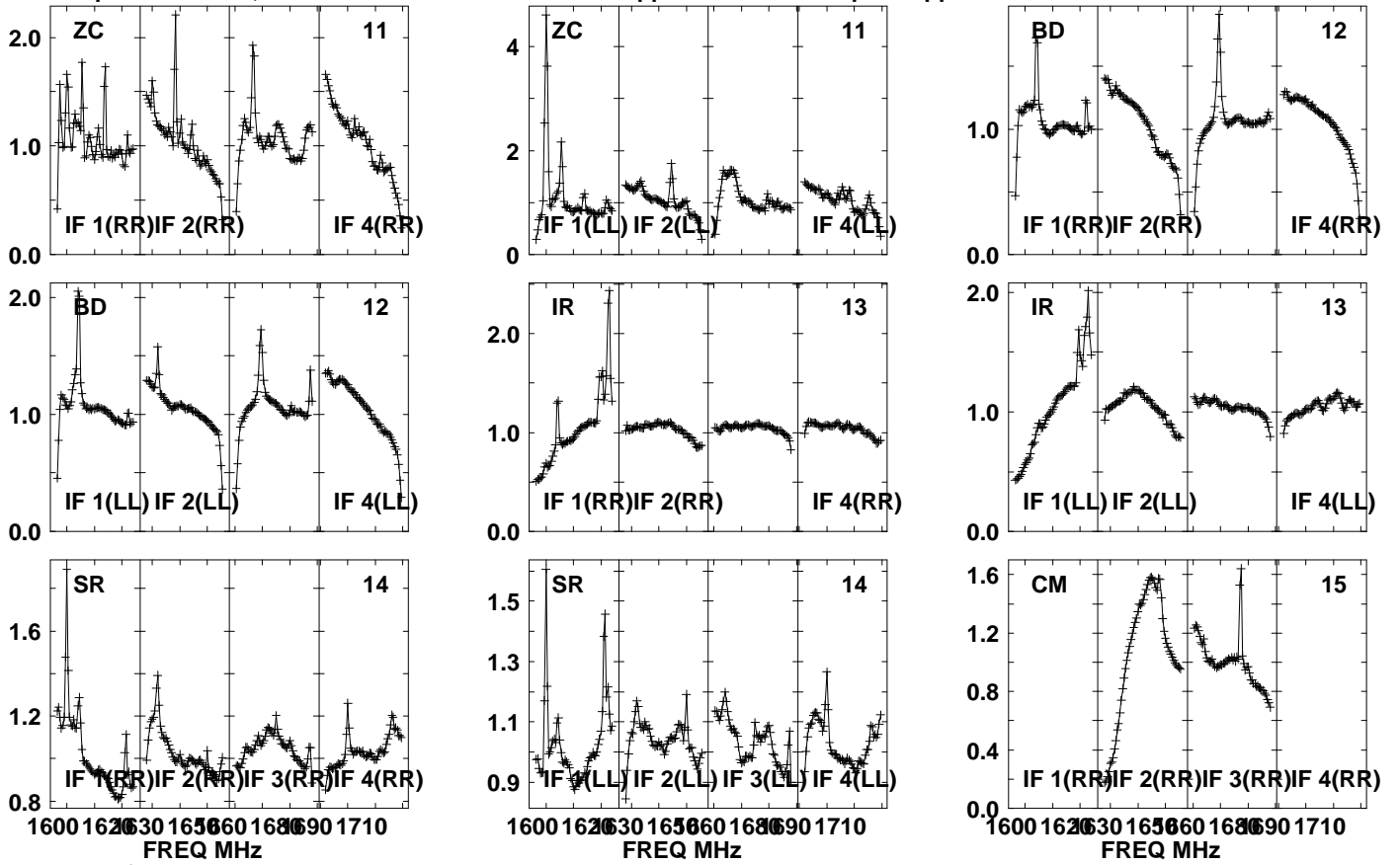

Lower frame: Real Jy  
Auto-corr total-power spectrum Antenna: \*  
Timerange: 00/16:59:01 to 00/17:00:29

Plot file version 705 created 05-OCT-2021 17:07:48

J0827+5217 GM076.UVDATA.1

Freq = 1.5945 GHz, Bw = 32.000 MH No calibration applied and no bandpass applied

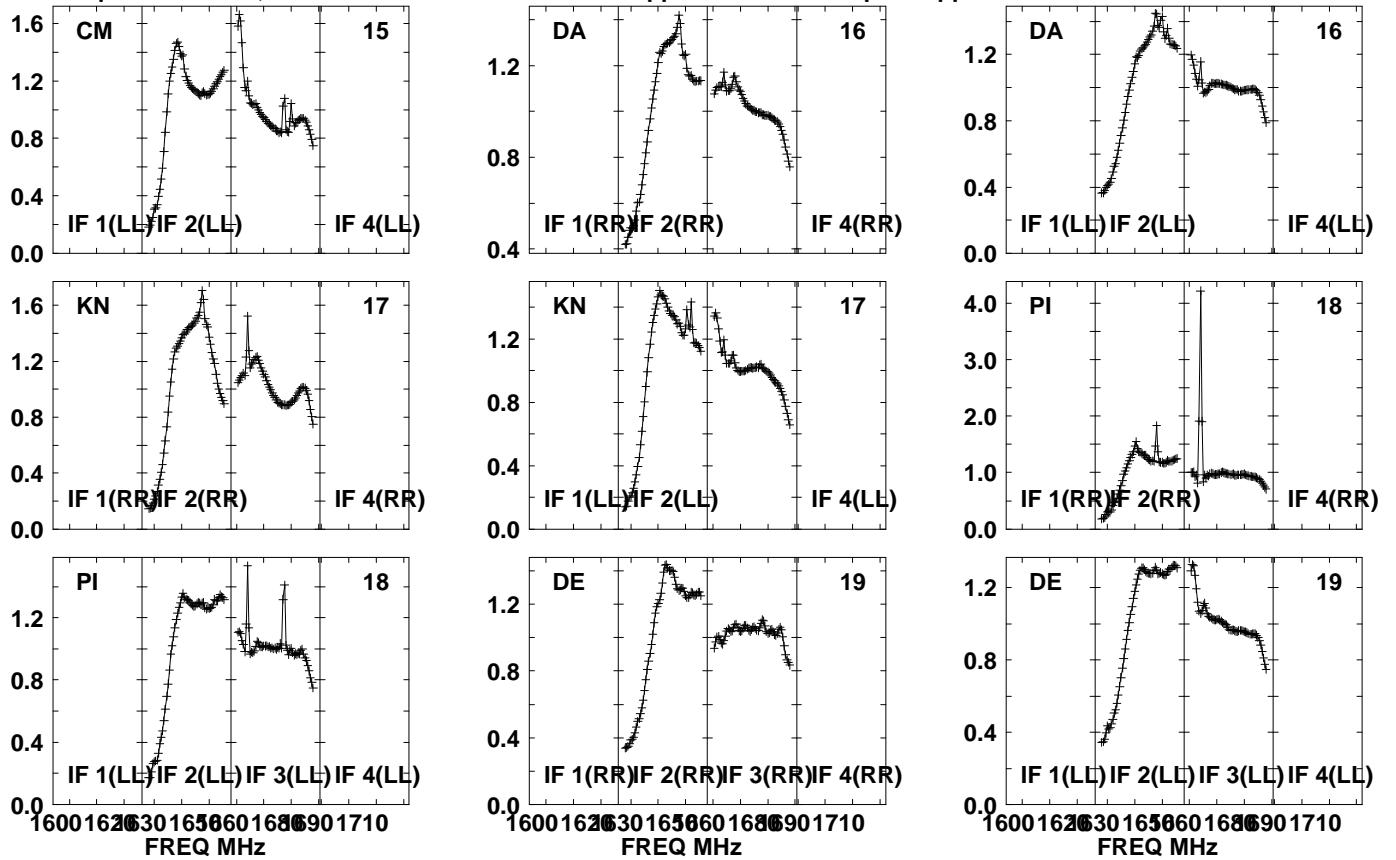

Lower frame: Real Jy  
Auto-corr total-power spectrum Antenna: \*  
Timerange: 00/16:59:01 to 00/17:00:29

Plot file version 706 created 05-OCT-2021 17:07:48

J0827+5217 GM076.UVDATA.1

Freq = 1.5945 GHz, Bw = 32.000 MH No calibration applied and no bandpass applied

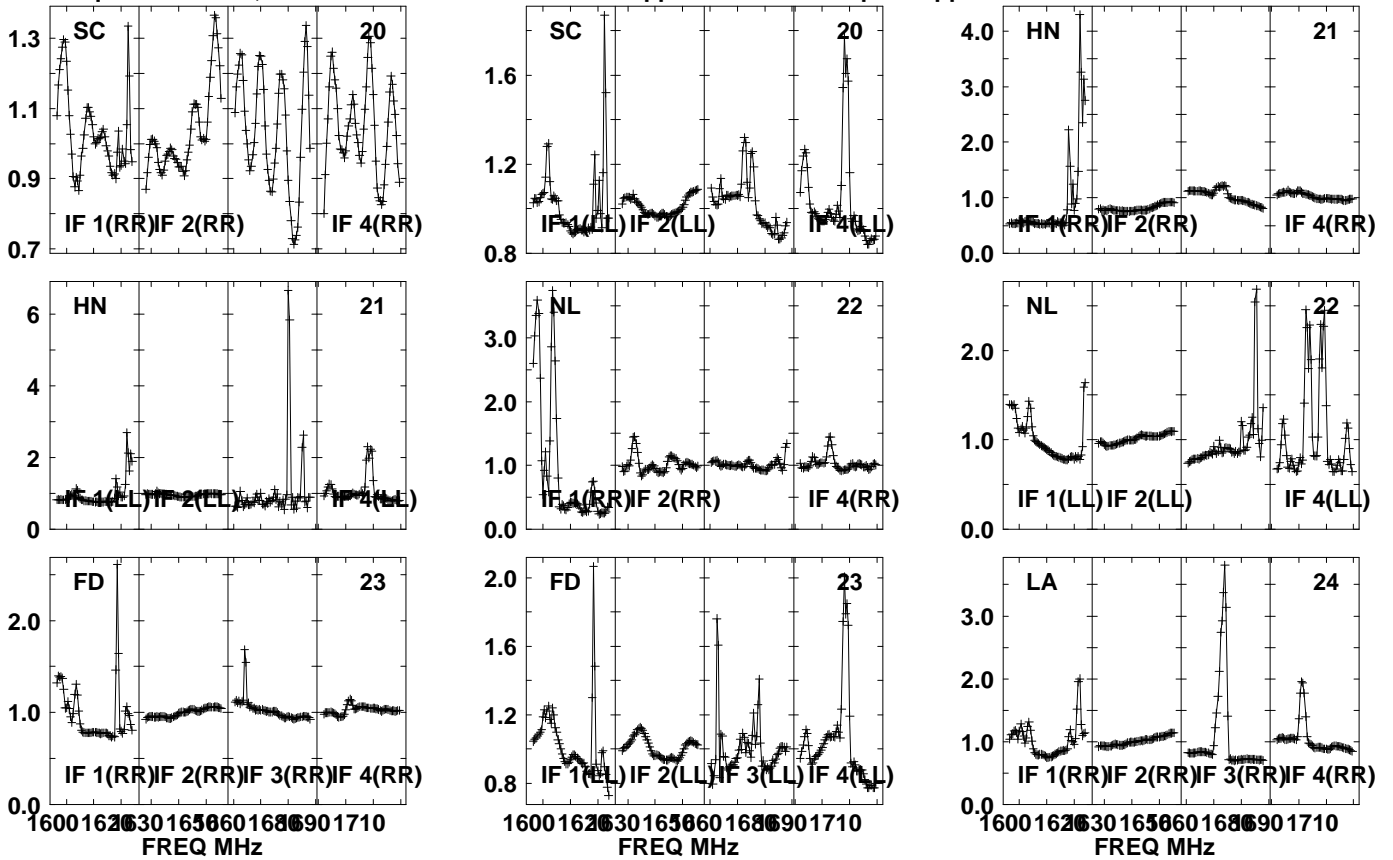

Lower frame: Real Jy  
Auto-corr total-power spectrum Antenna: \*  
Timerange: 00/16:59:01 to 00/17:00:29



Plot file version 707 created 05-OCT-2021 17:07:49

J0827+5217 GM076.UVDATA.1

Freq = 1.5945 GHz, Bw = 32.000 MH No calibration applied and no bandpass applied

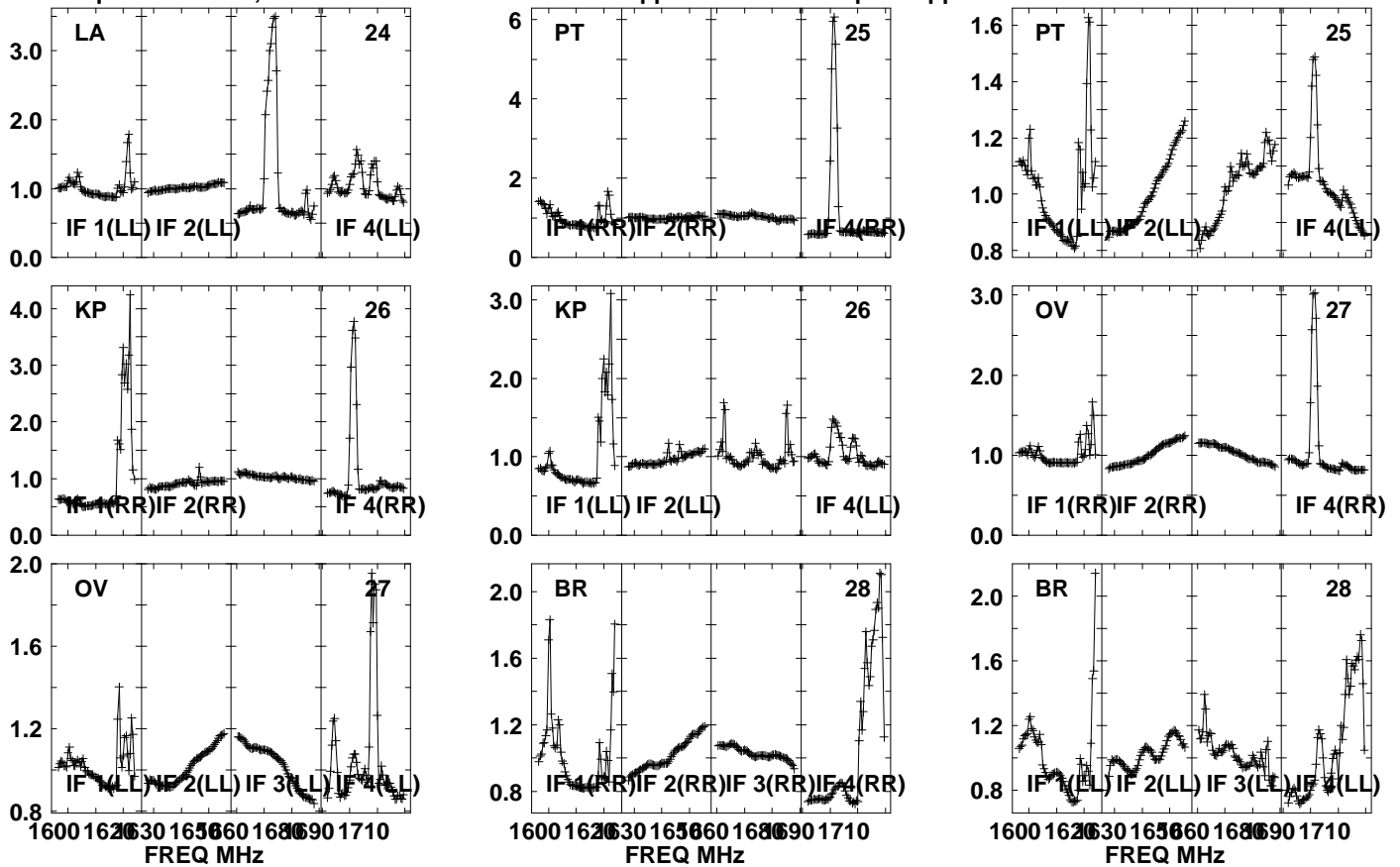

Lower frame: Real Jy

Auto-corr total-power spectrum Antenna: \*

Timerange: 00/16:59:01 to 00/17:00:29

Plot file version 708 created 05-OCT-2021 17:07:49

APM08279+525 GM076.UVDATA.1

Freq = 1.5945 GHz, Bw = 32.000 MH No calibration applied and no bandpass applied

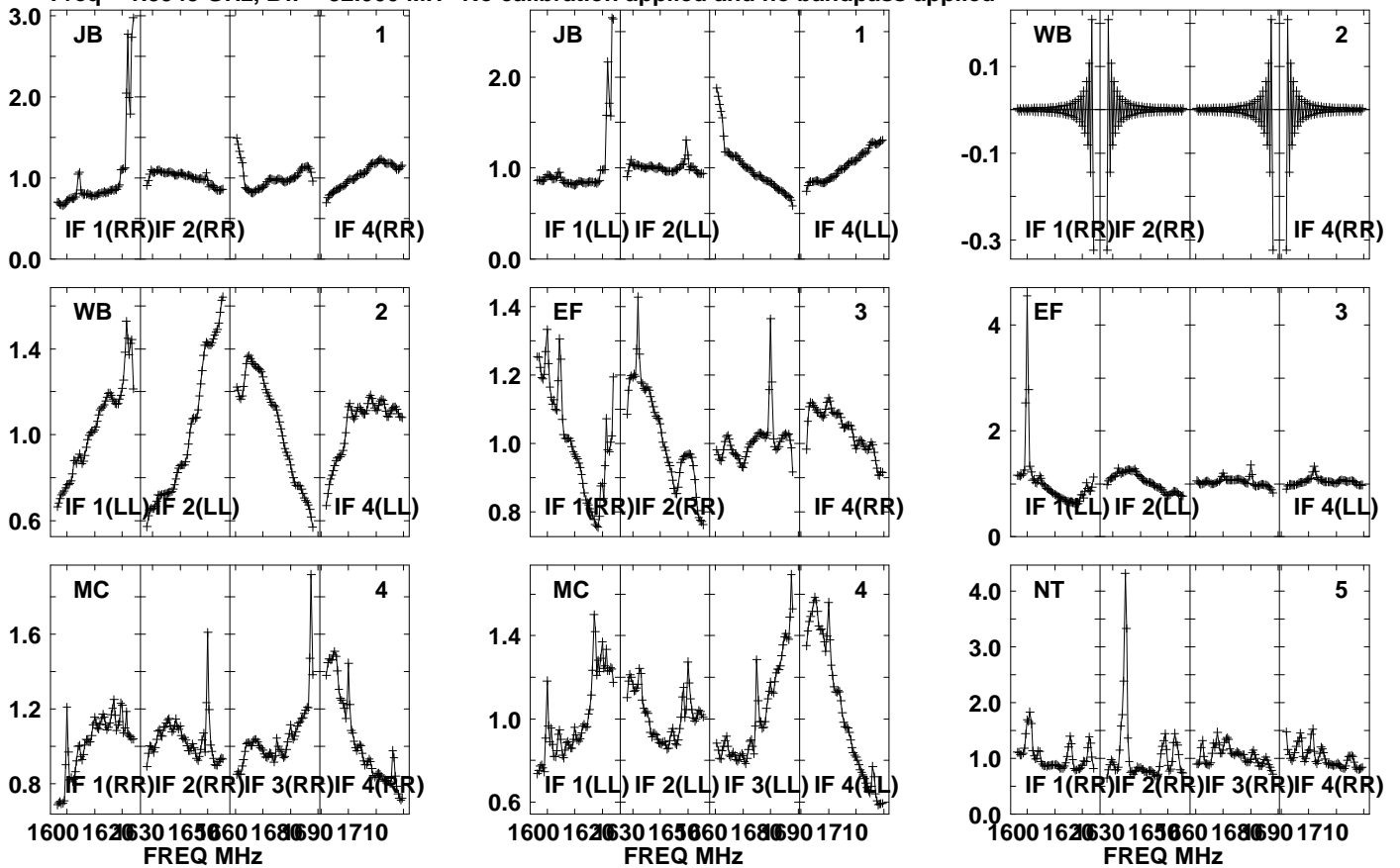

Lower frame: Real Jy  
Auto-corr total-power spectrum Antenna: \*  
Timerange: 00/17:00:31 to 00/17:03:59

Plot file version 709 created 05-OCT-2021 17:07:49

APM08279+525 GM076.UVDATA.1

Freq = 1.5945 GHz, Bw = 32.000 MH No calibration applied and no bandpass applied

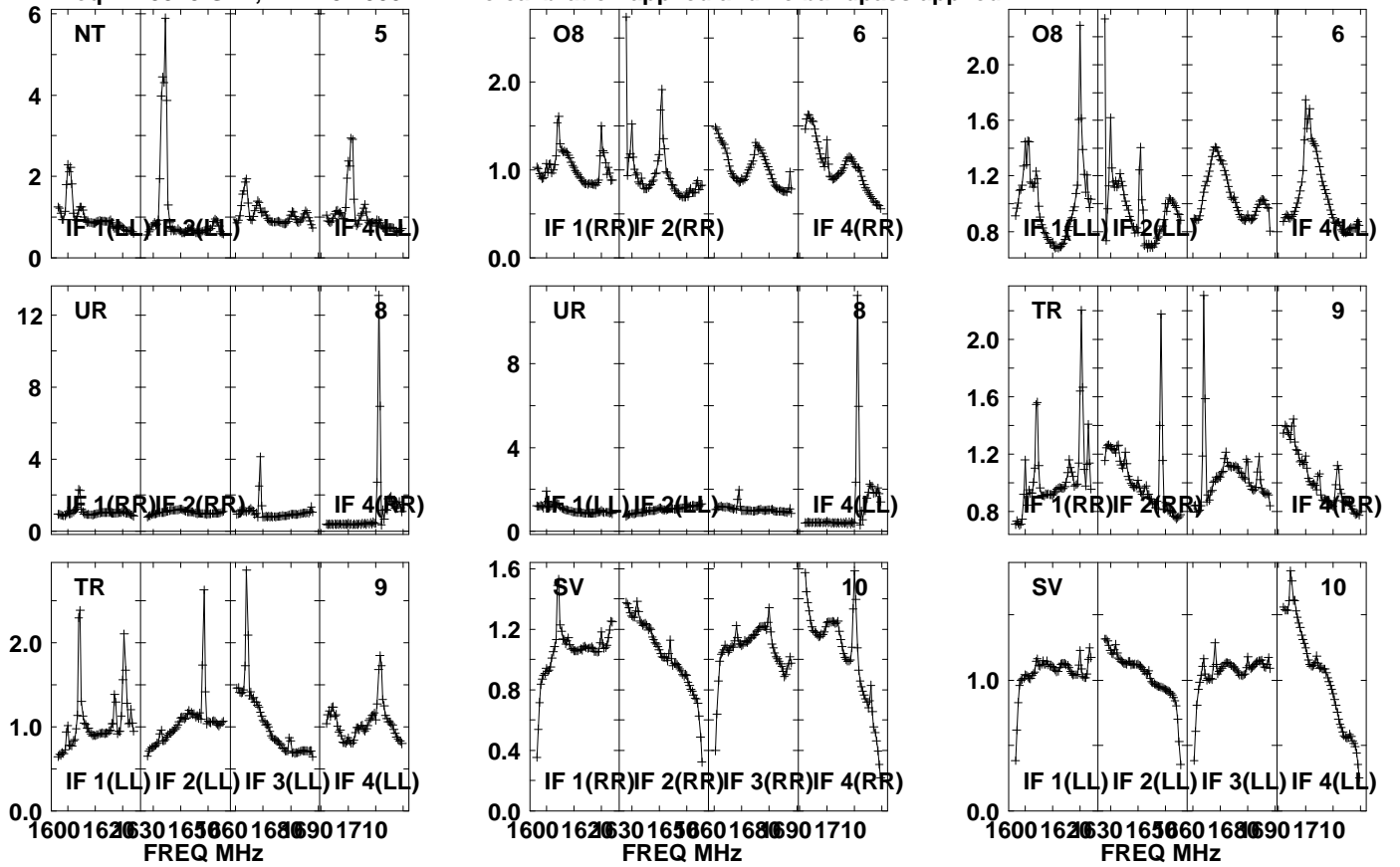

Lower frame: Real Jy

Auto-corr total-power spectrum Antenna: \*

Timerange: 00/17:00:31 to 00/17:03:59

Plot file version 710 created 05-OCT-2021 17:07:50

APM08279+525 GM076.UVDATA.1

Freq = 1.5945 GHz, Bw = 32.000 MH No calibration applied and no bandpass applied

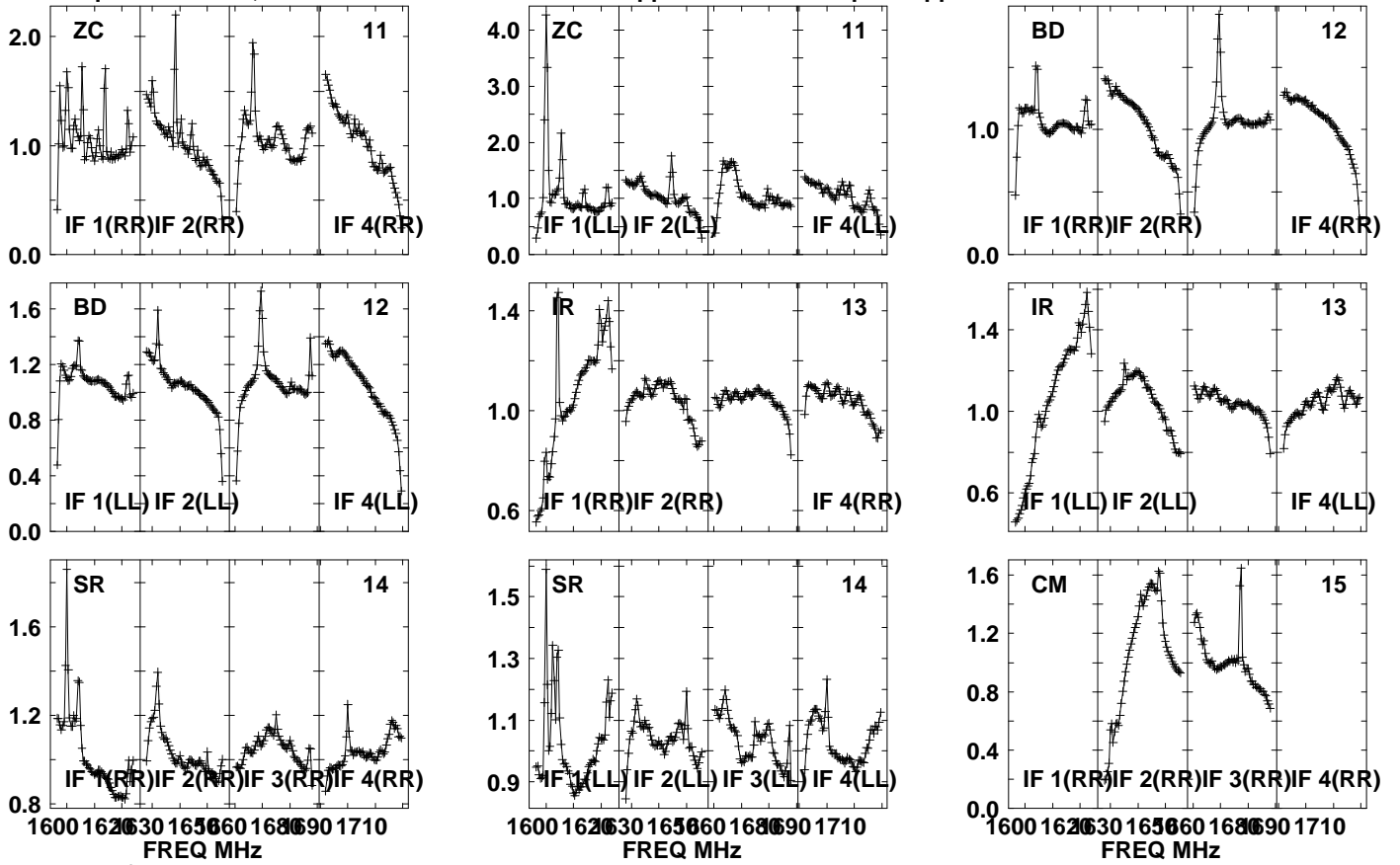

Lower frame: Real Jy  
Auto-corr total-power spectrum Antenna: \*  
Timerange: 00/17:00:31 to 00/17:03:59

Plot file version 711 created 05-OCT-2021 17:07:50

APM08279+525 GM076.UVDATA.1

Freq = 1.5945 GHz, Bw = 32.000 MH No calibration applied and no bandpass applied

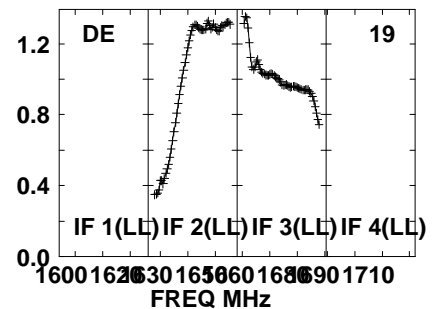
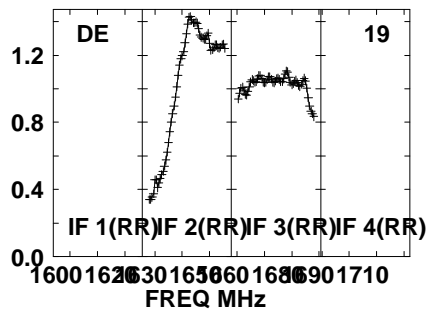
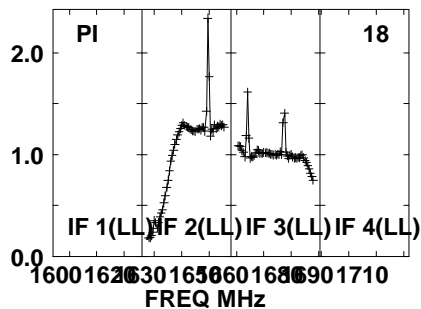
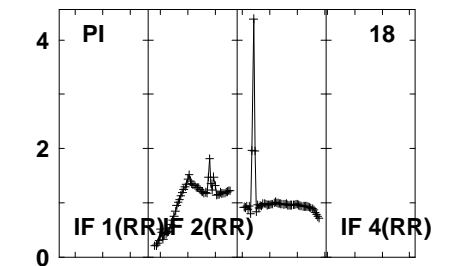
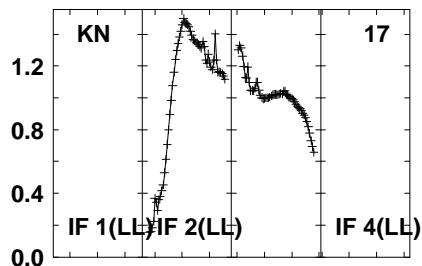
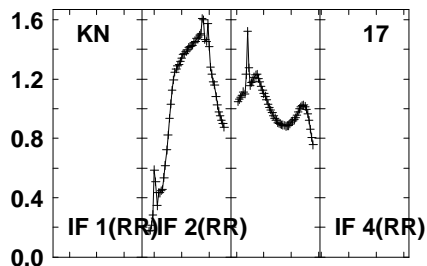
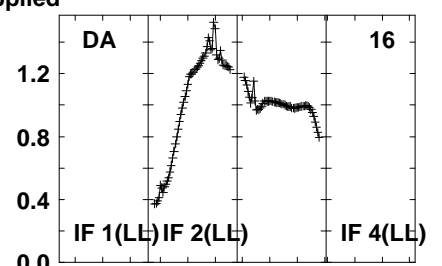
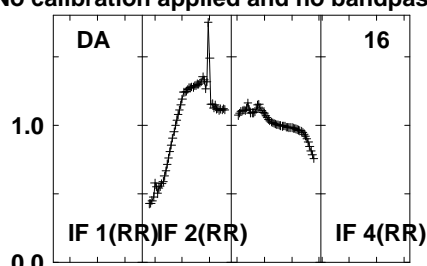
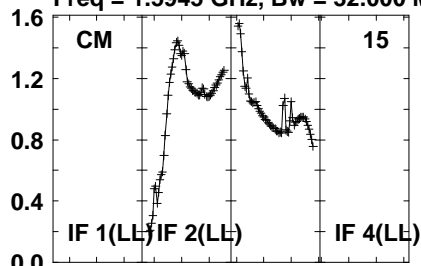

Lower frame: Real Jy  
Auto-corr total-power spectrum Antenna: \*  
Timerange: 00/17:00:31 to 00/17:03:59

Plot file version 712 created 05-OCT-2021 17:07:50

APM08279+525 GM076.UVDATA.1

Freq = 1.5945 GHz, Bw = 32.000 MH No calibration applied and no bandpass applied

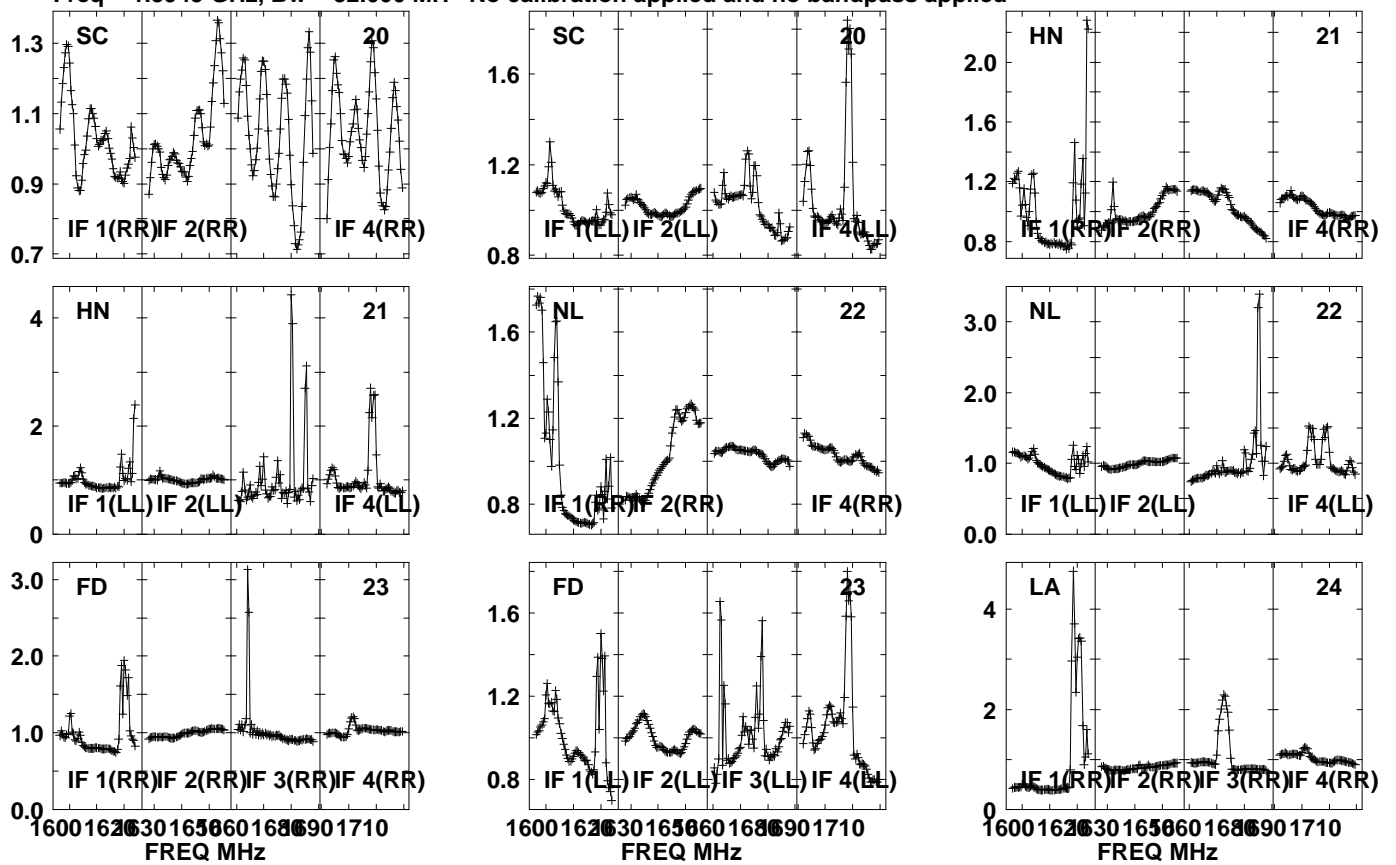

Lower frame: Real Jy  
Auto-corr total-power spectrum Antenna: \*  
Timerange: 00/17:00:31 to 00/17:03:59

Plot file version 713 created 05-OCT-2021 17:07:51

APM08279+525 GM076.UVDATA.1

Freq = 1.5945 GHz, Bw = 32.000 MH No calibration applied and no bandpass applied

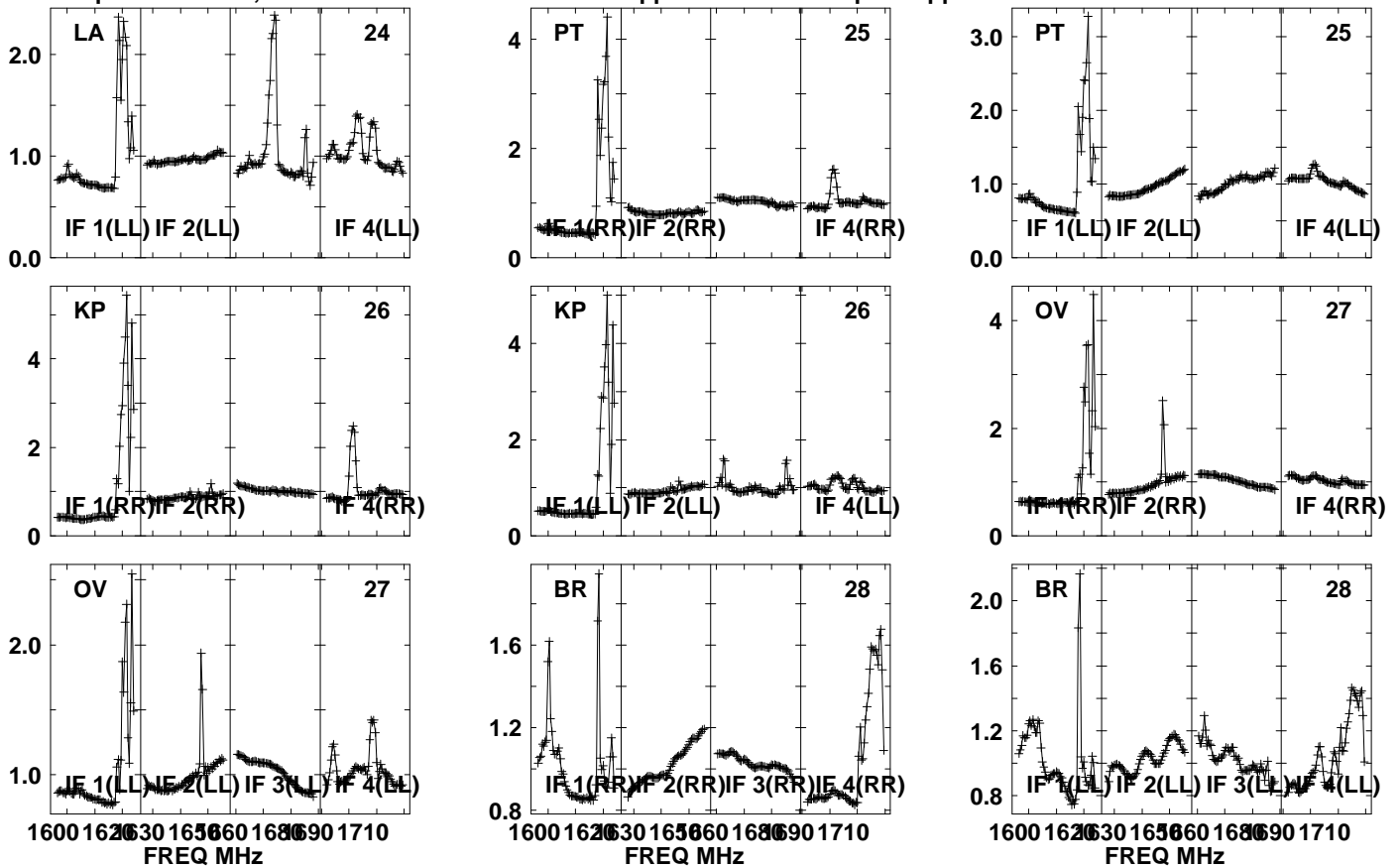

Lower frame: Real Jy

Auto-corr total-power spectrum Antenna: \*

Timerange: 00/17:00:31 to 00/17:03:59

Plot file version 714 created 05-OCT-2021 17:07:51

J0827+5217 GM076.UVDATA.1

Freq = 1.5945 GHz, Bw = 32.000 MH No calibration applied and no bandpass applied

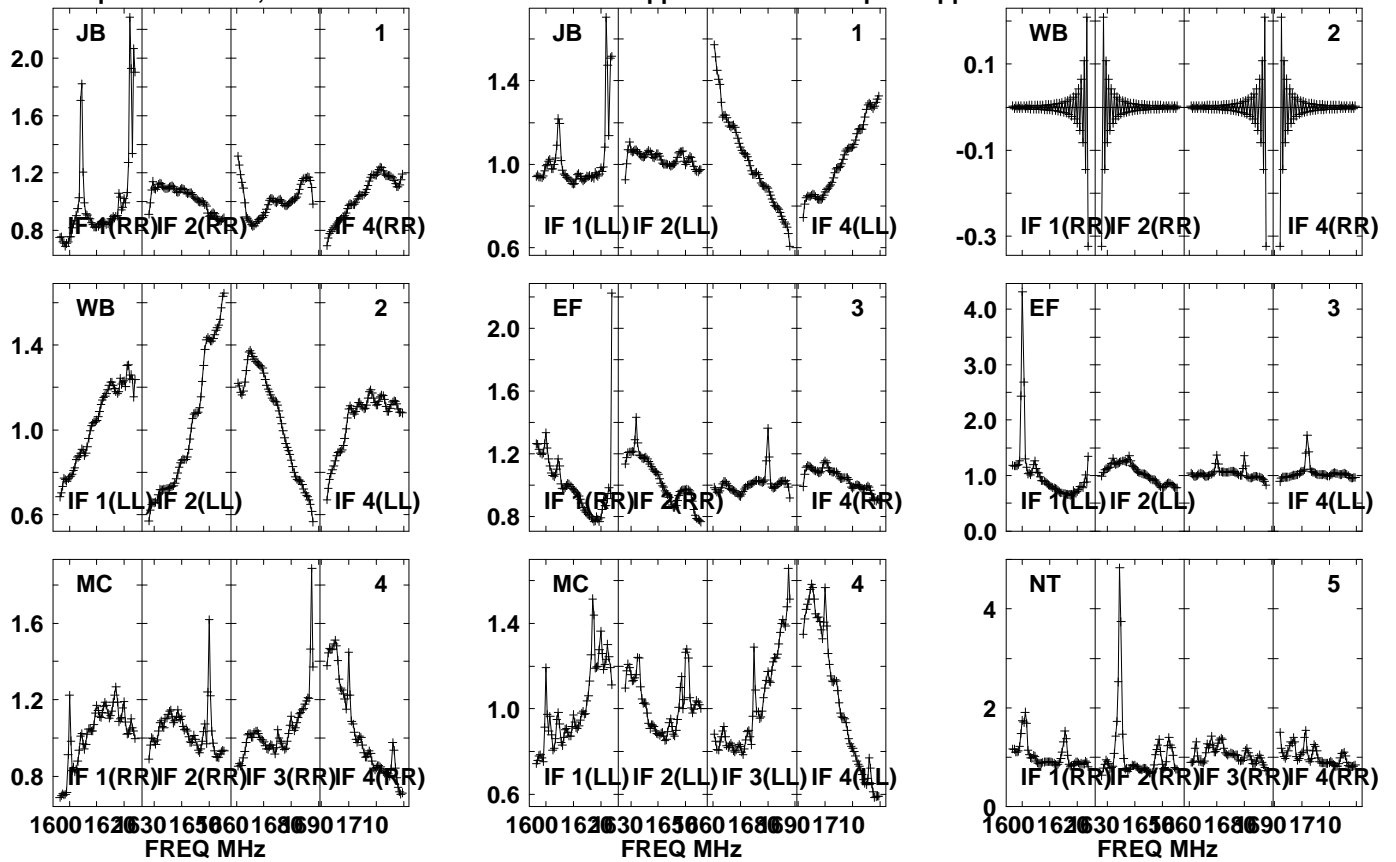

Lower frame: Real Jy  
Auto-corr total-power spectrum Antenna: \*  
Timerange: 00/17:04:01 to 00/17:05:29



Plot file version 715 created 05-OCT-2021 17:07:51

J0827+5217 GM076.UVDATA.1

Freq = 1.5945 GHz, Bw = 32.000 MH No calibration applied and no bandpass applied

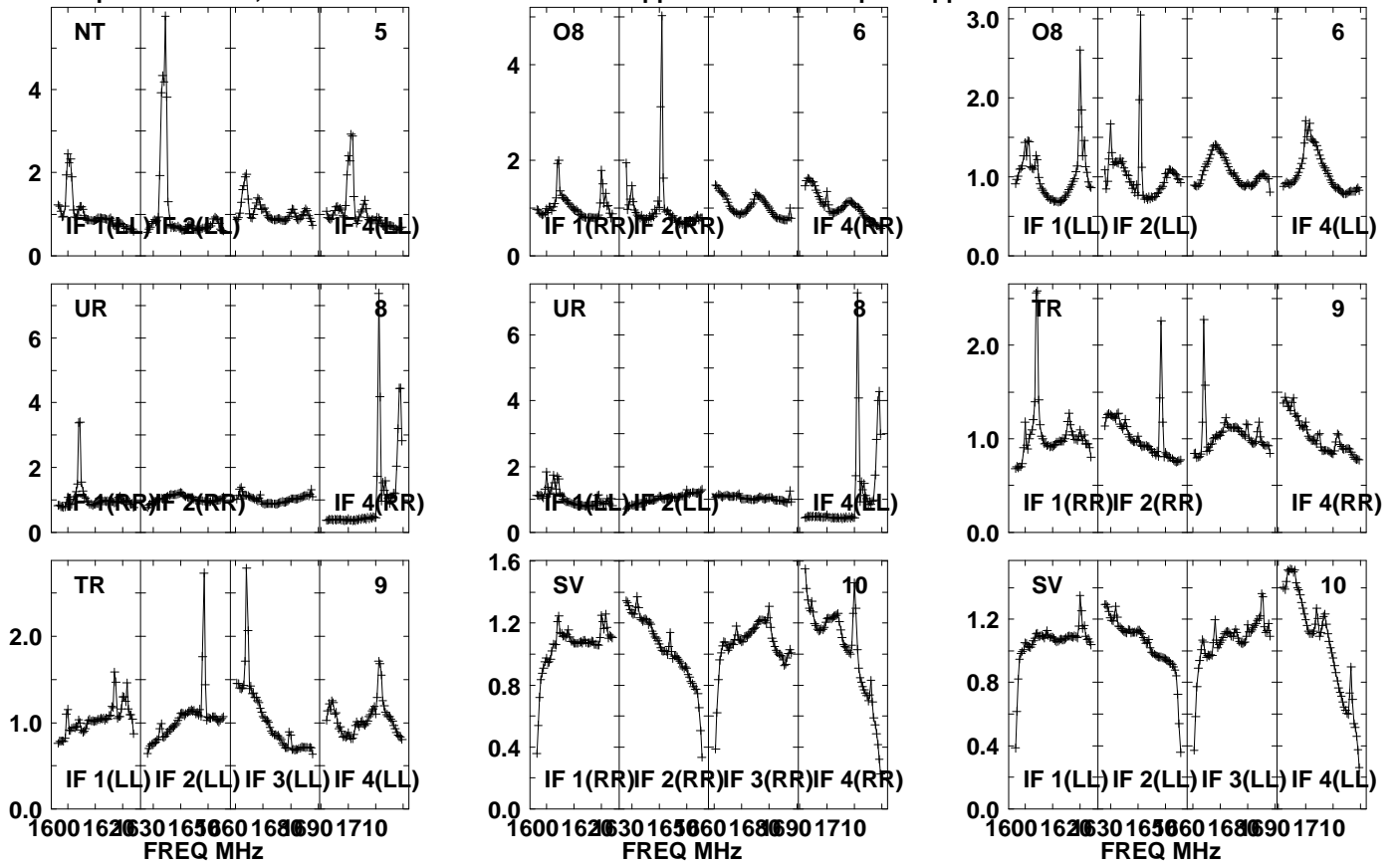

Lower frame: Real Jy  
Auto-corr total-power spectrum Antenna: \*  
Timerange: 00/17:04:01 to 00/17:05:29

Plot file version 716 created 05-OCT-2021 17:07:52

J0827+5217 GM076.UVDATA.1

Freq = 1.5945 GHz, Bw = 32.000 MH No calibration applied and no bandpass applied

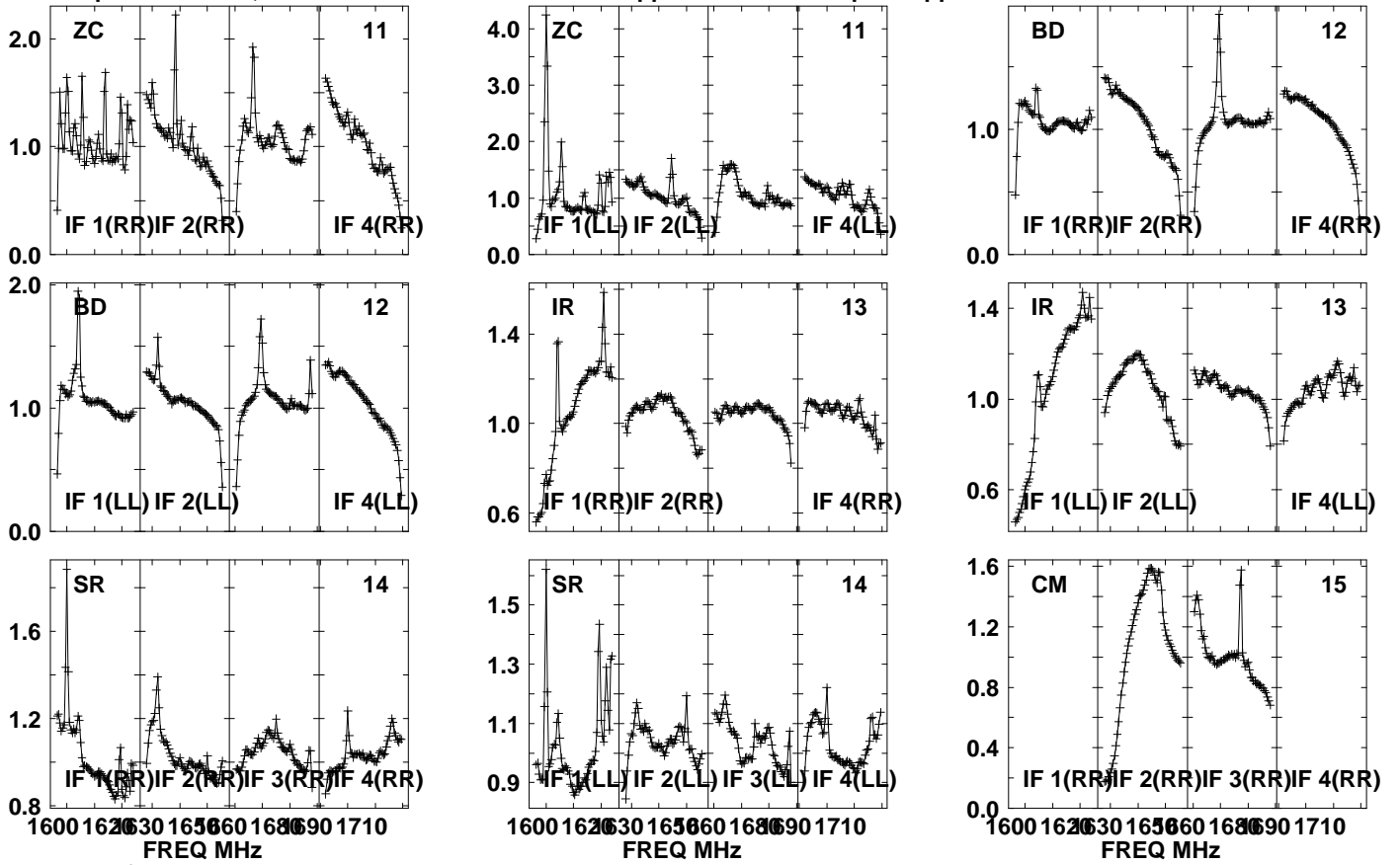

Lower frame: Real Jy

Auto-corr total-power spectrum Antenna: \*

Timerange: 00/17:04:01 to 00/17:05:29

Plot file version 717 created 05-OCT-2021 17:07:52

J0827+5217 GM076.UVDATA.1

Freq = 1.5945 GHz, Bw = 32.000 MH No calibration applied and no bandpass applied

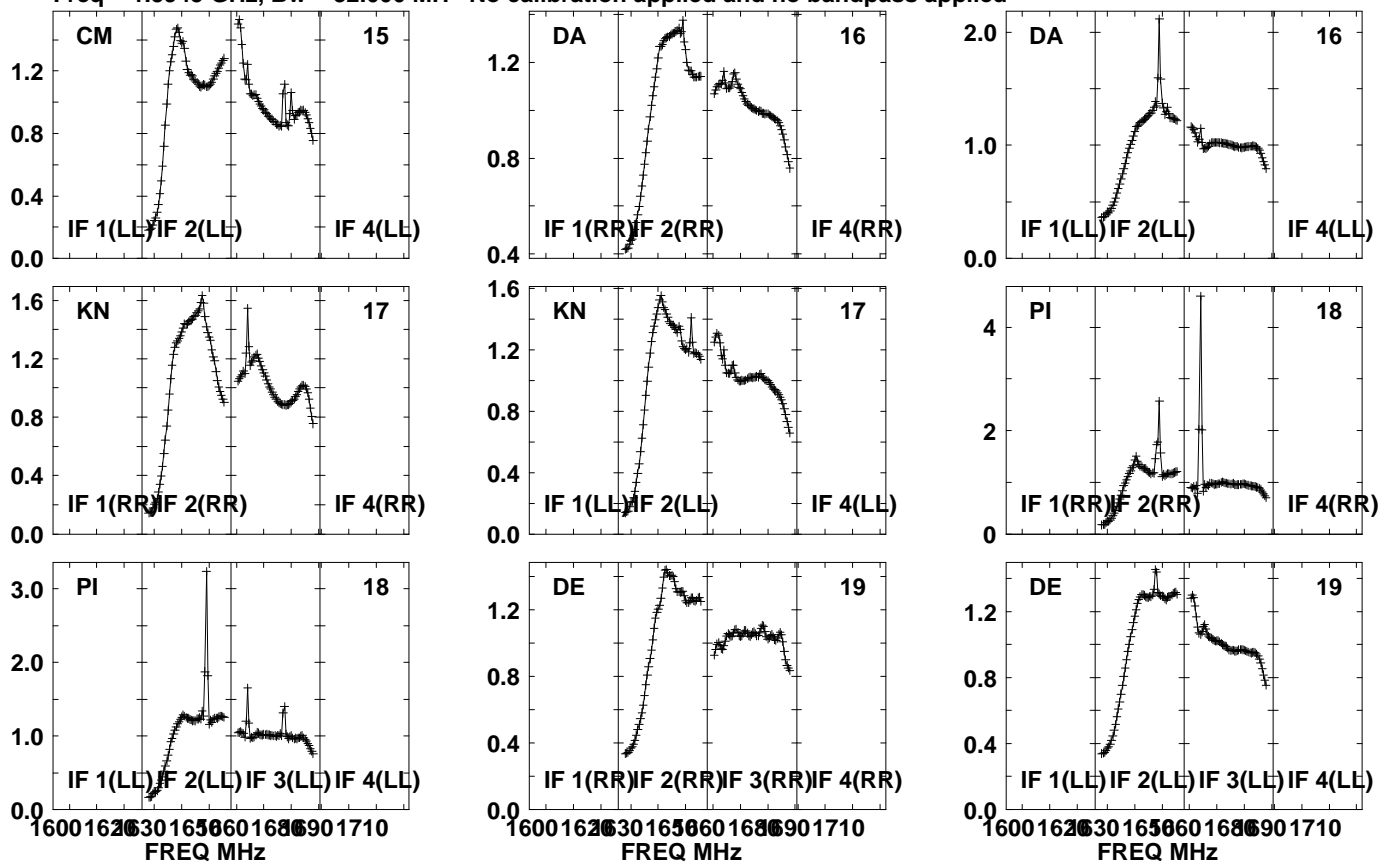

Lower frame: Real Jy  
Auto-corr total-power spectrum Antenna: \*  
Timerange: 00/17:04:01 to 00/17:05:29

Plot file version 718 created 05-OCT-2021 17:07:52

J0827+5217 GM076.UVDATA.1

Freq = 1.5945 GHz, Bw = 32.000 MH No calibration applied and no bandpass applied

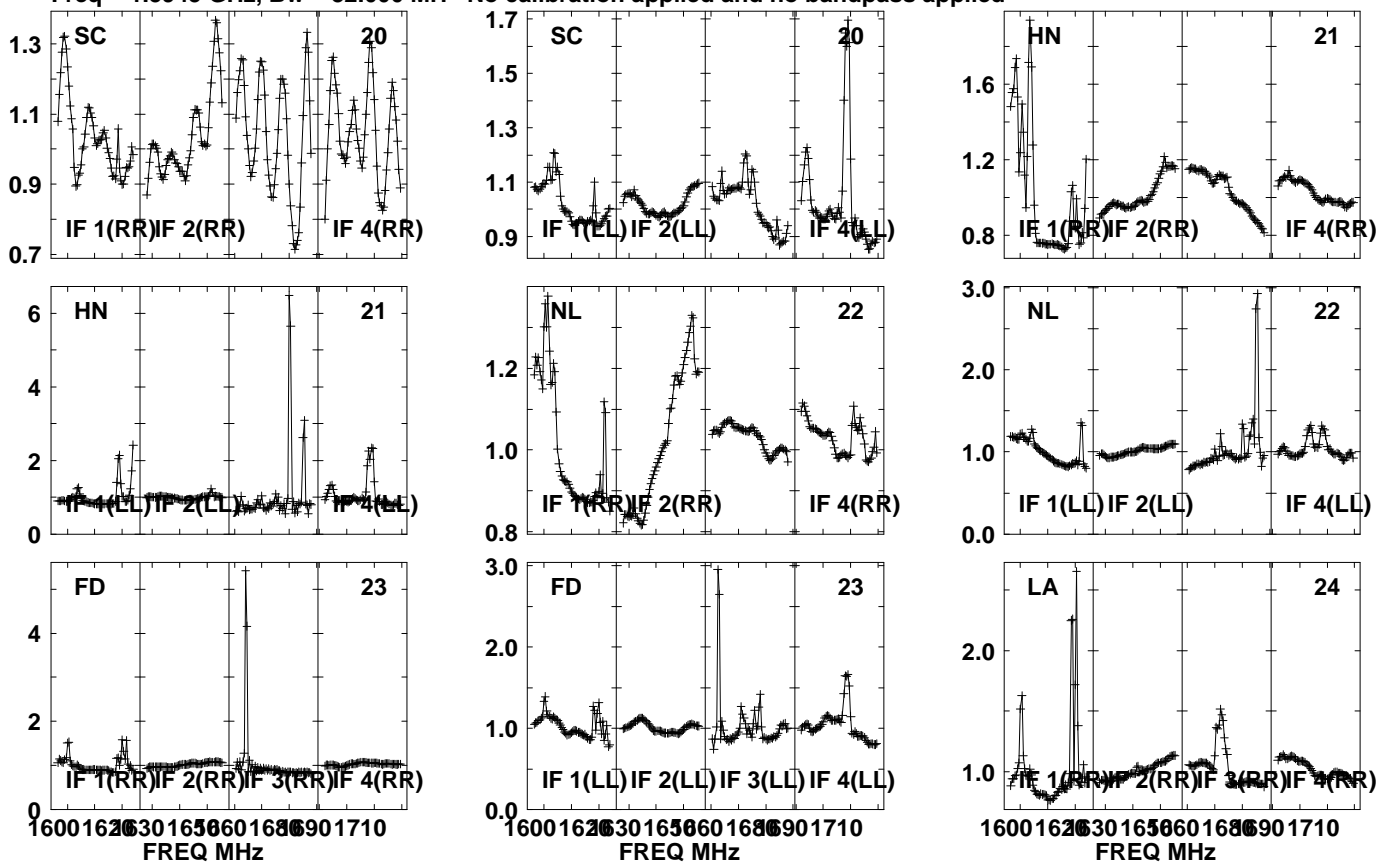

Lower frame: Real Jy  
Auto-corr total-power spectrum Antenna: \*  
Timerange: 00/17:04:01 to 00/17:05:29

Plot file version 719 created 05-OCT-2021 17:07:53

J0827+5217 GM076.UVDATA.1

Freq = 1.5945 GHz, Bw = 32.000 MH No calibration applied and no bandpass applied

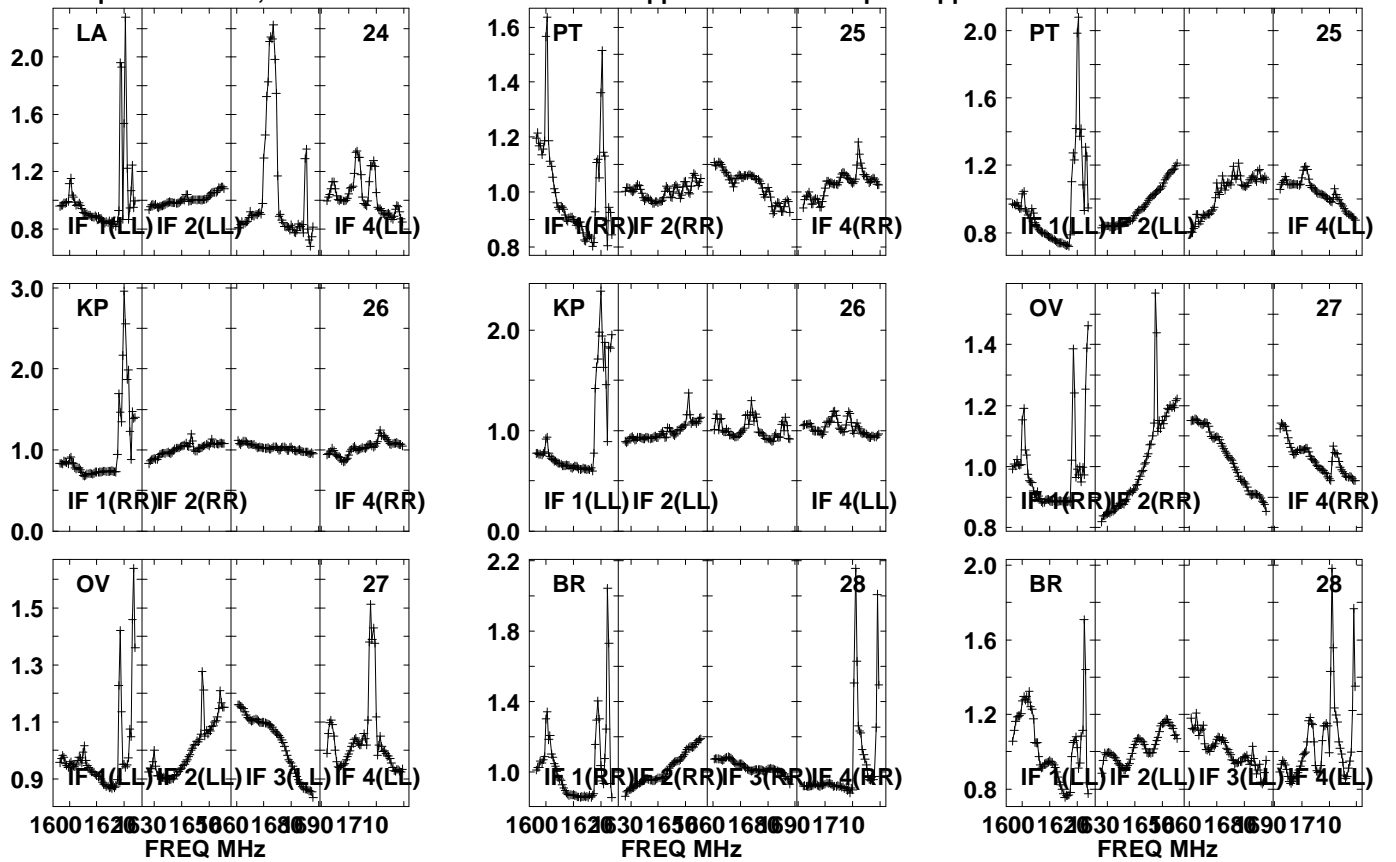

Lower frame: Real Jy  
Auto-corr total-power spectrum Antenna: \*  
Timerange: 00/17:04:01 to 00/17:05:29

Plot file version 720 created 05-OCT-2021 17:07:53

APM08279+525 GM076.UVDATA.1

Freq = 1.5945 GHz, Bw = 32.000 MH No calibration applied and no bandpass applied

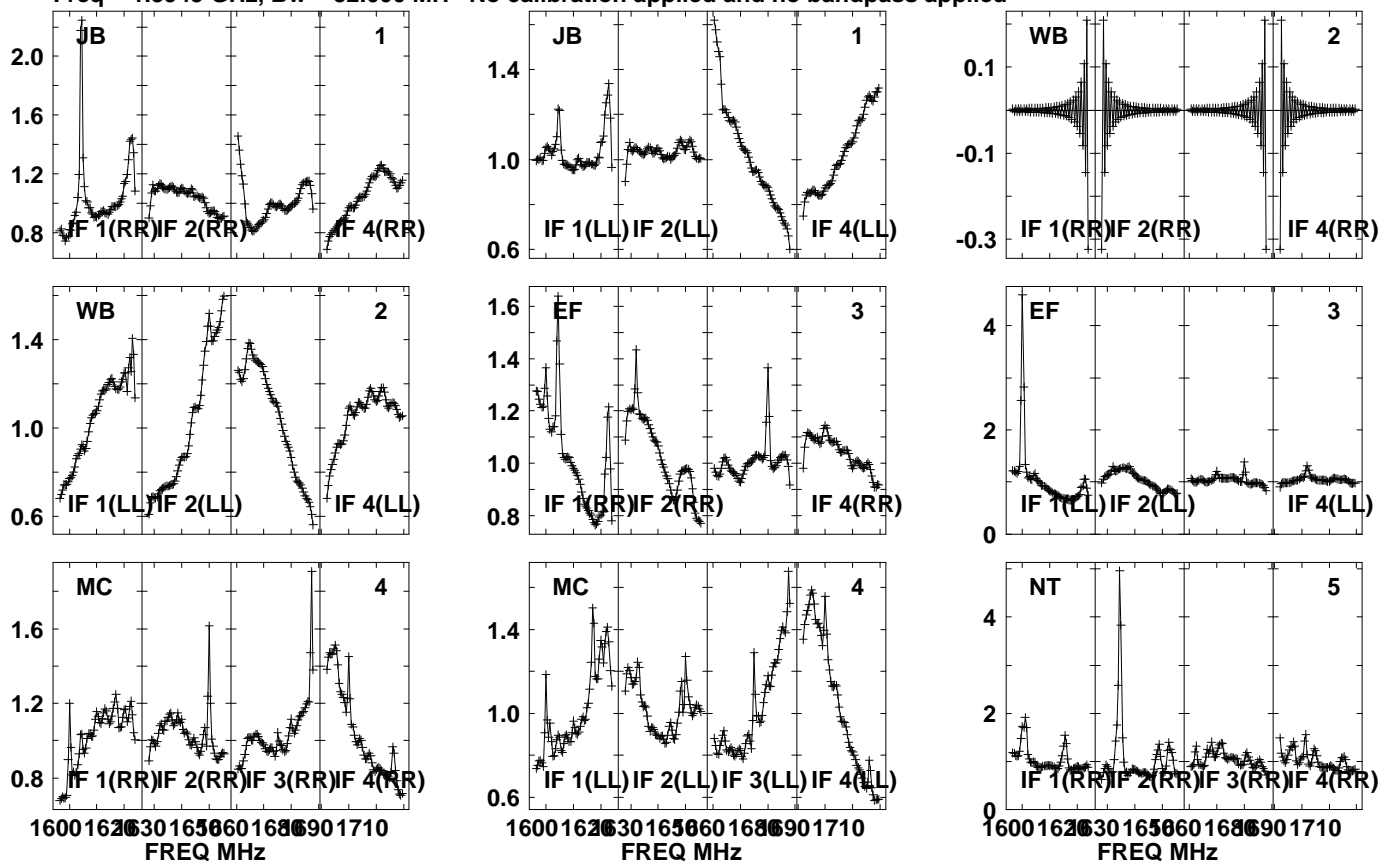

Lower frame: Real Jy  
Auto-corr total-power spectrum Antenna: \*  
Timerange: 00/17:05:31 to 00/17:08:59

Plot file version 721 created 05-OCT-2021 17:07:53

APM08279+525 GM076.UVDATA.1

Freq = 1.5945 GHz, Bw = 32.000 MH No calibration applied and no bandpass applied

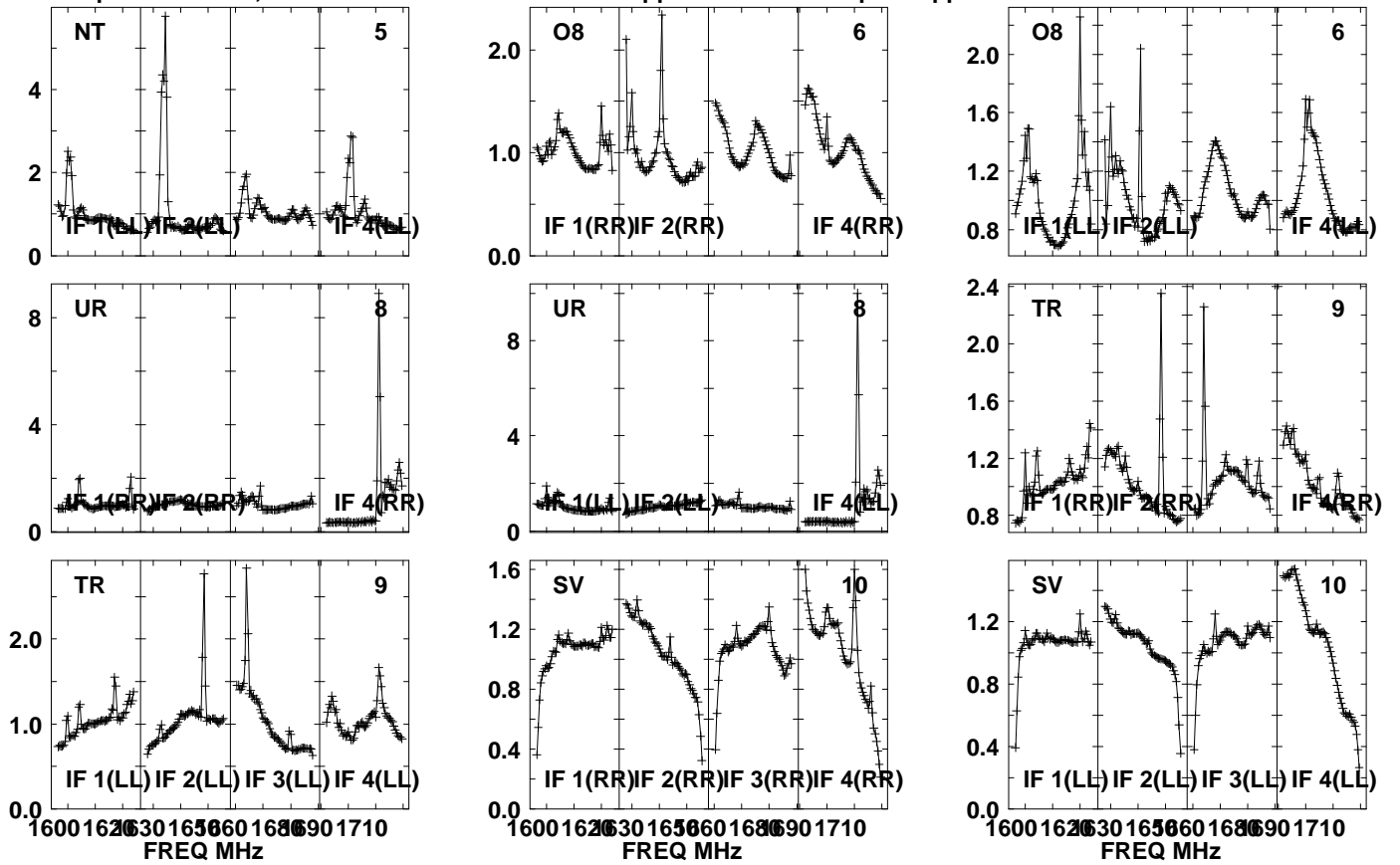

Lower frame: Real Jy  
Auto-corr total-power spectrum Antenna: \*  
Timerange: 00/17:05:31 to 00/17:08:59

Plot file version 722 created 05-OCT-2021 17:07:54

APM08279+525 GM076.UVDATA.1

Freq = 1.5945 GHz, Bw = 32.000 MH No calibration applied and no bandpass applied

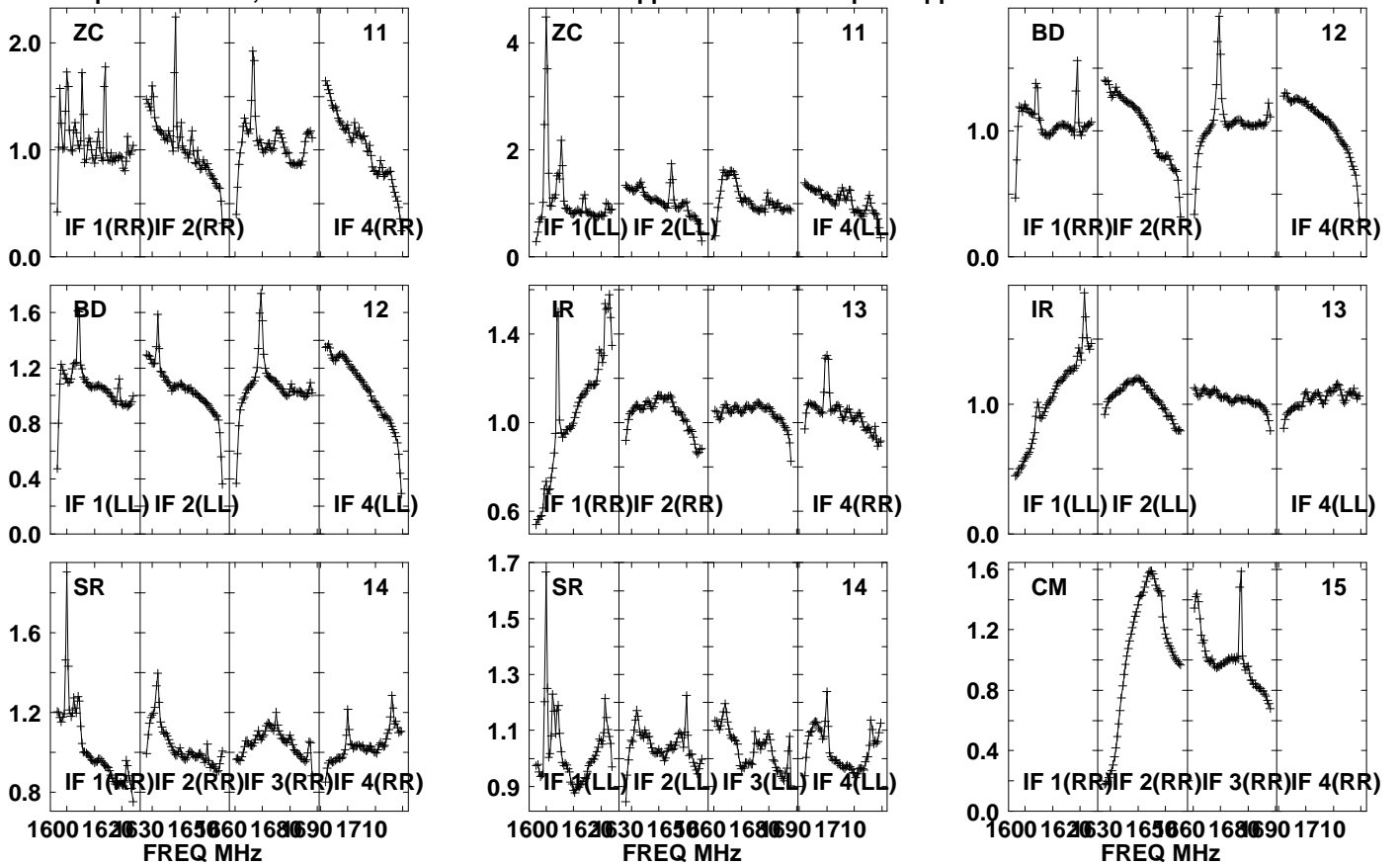

Lower frame: Real Jy

Auto-corr total-power spectrum Antenna: \*

Timerange: 00/17:05:31 to 00/17:08:59



Plot file version 723 created 05-OCT-2021 17:07:54

APM08279+525 GM076.UVDATA.1

Freq = 1.5945 GHz, Bw = 32.000 MH No calibration applied and no bandpass applied

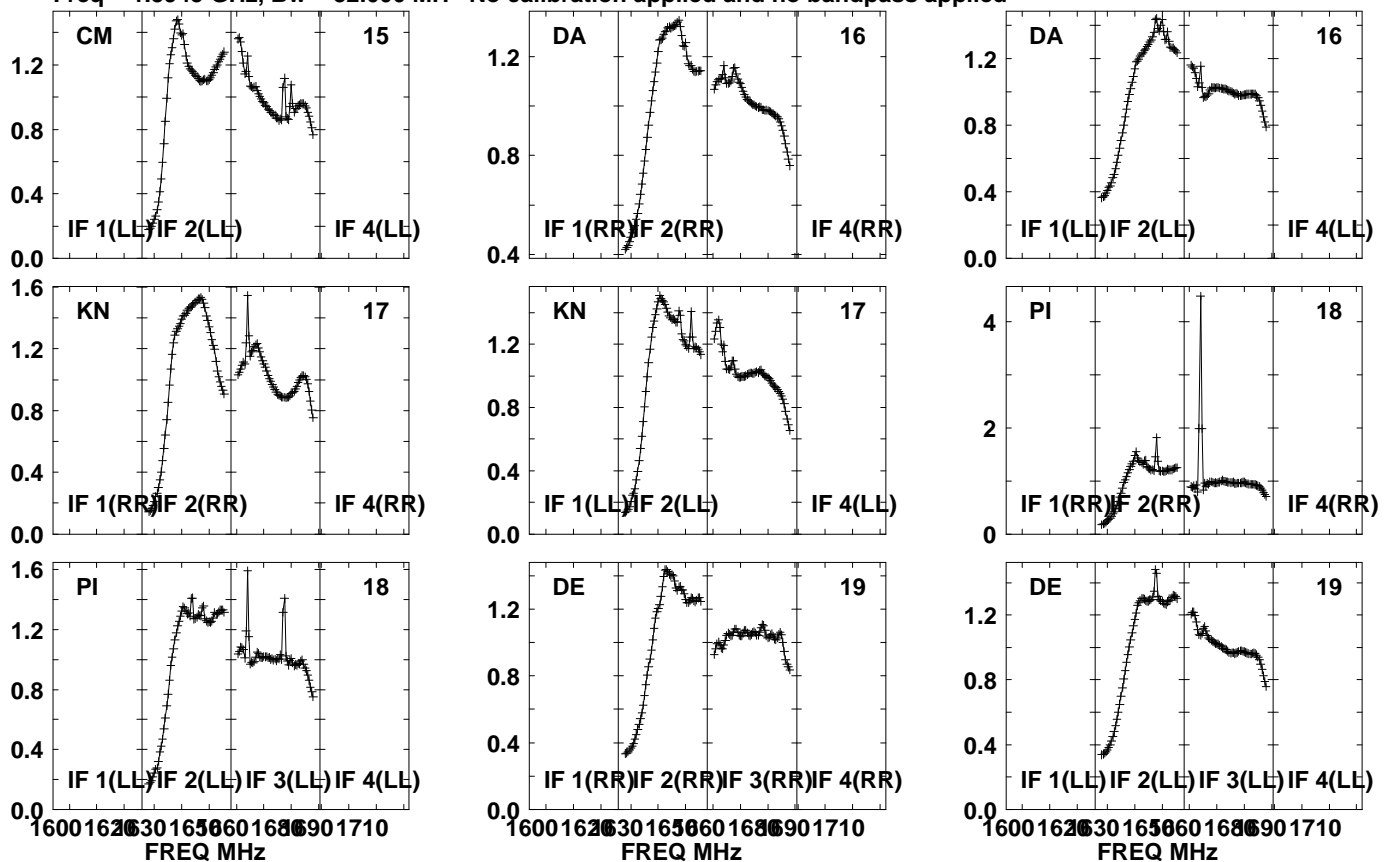

Lower frame: Real Jy  
Auto-corr total-power spectrum Antenna: \*  
Timerange: 00/17:05:31 to 00/17:08:59

Plot file version 724 created 05-OCT-2021 17:07:54

APM08279+525 GM076.UVDATA.1

Freq = 1.5945 GHz, Bw = 32.000 MH No calibration applied and no bandpass applied

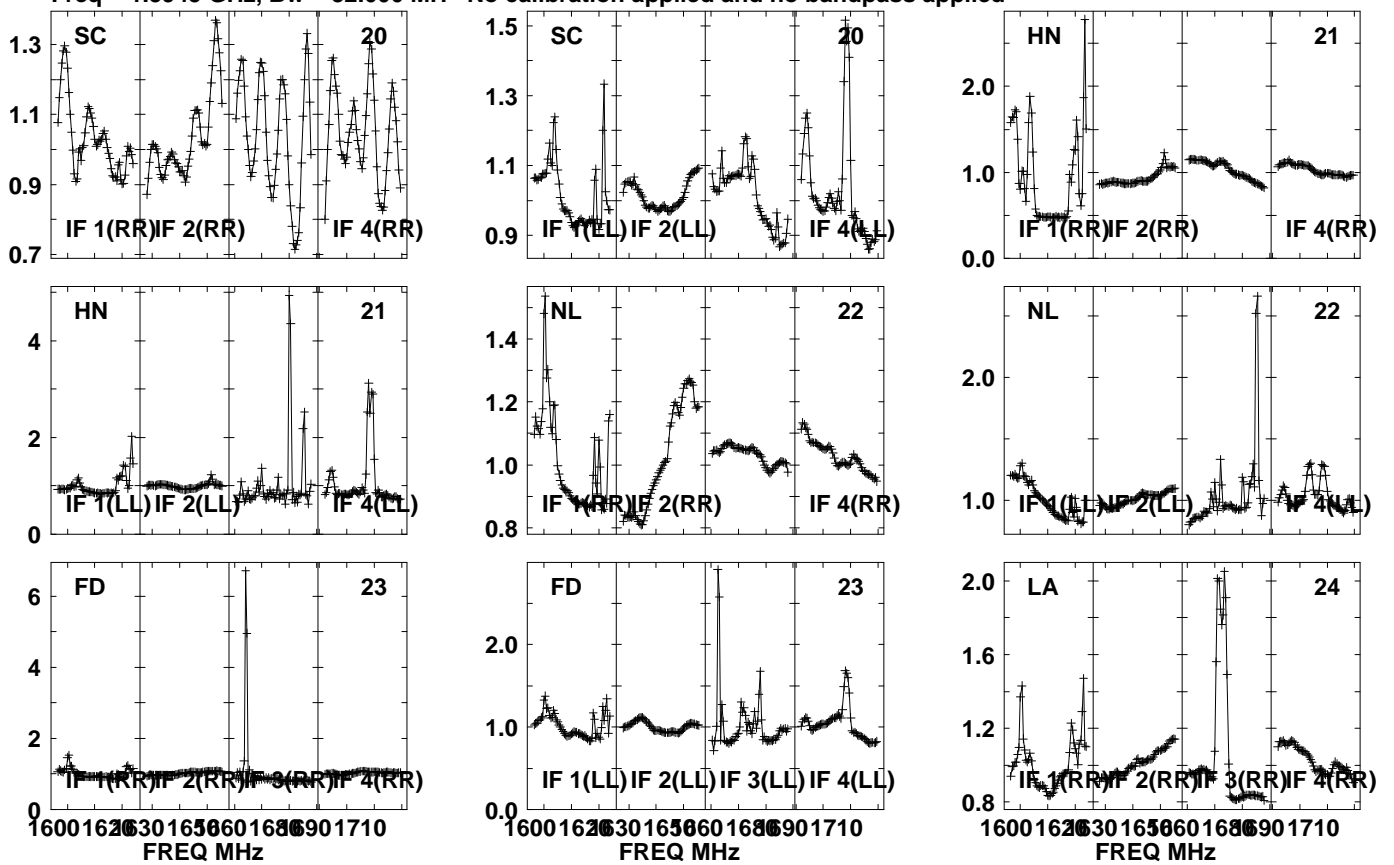

Lower frame: Real Jy  
Auto-corr total-power spectrum Antenna: \*  
Timerange: 00/17:05:31 to 00/17:08:59

Plot file version 725 created 05-OCT-2021 17:07:55

APM08279+525 GM076.UVDATA.1

Freq = 1.5945 GHz, Bw = 32.000 MH No calibration applied and no bandpass applied

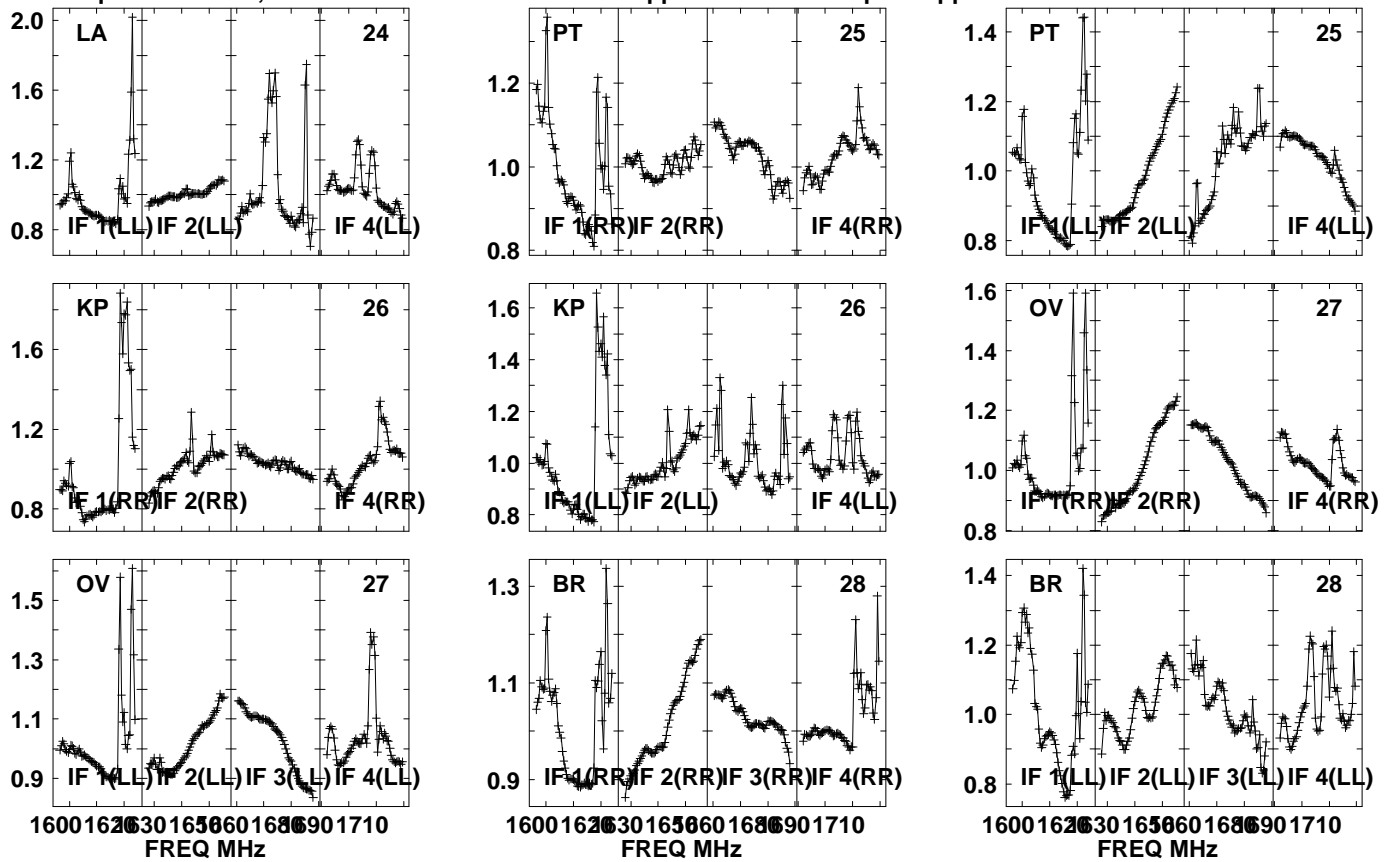

Lower frame: Real Jy  
Auto-corr total-power spectrum Antenna: \*  
Timerange: 00/17:05:31 to 00/17:08:59

Plot file version 726 created 05-OCT-2021 17:07:55

J0827+5217 GM076.UVDATA.1

Freq = 1.5945 GHz, Bw = 32.000 MH No calibration applied and no bandpass applied

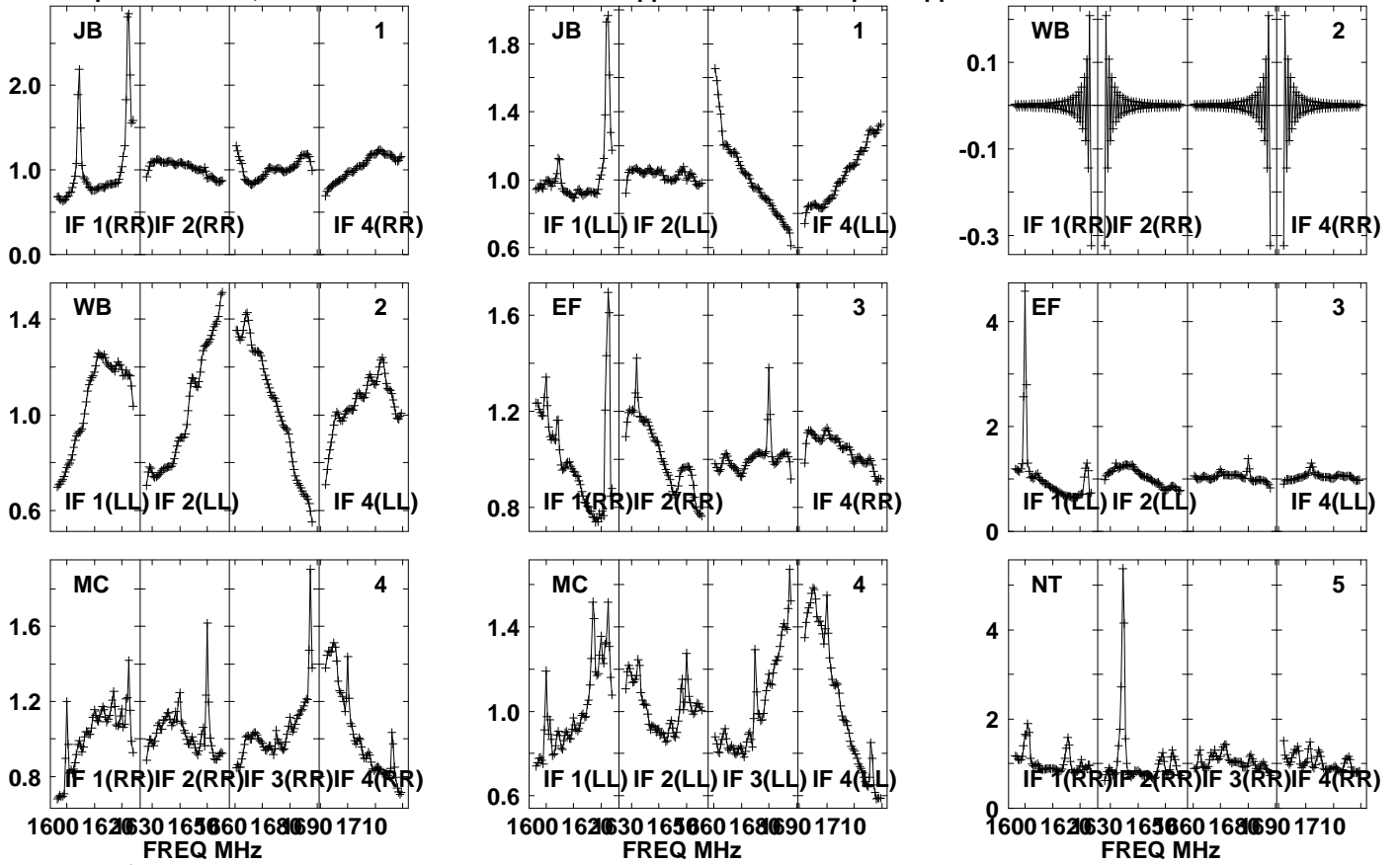

Lower frame: Real Jy  
Auto-corr total-power spectrum Antenna: \*  
Timerange: 00/17:09:31 to 00/17:10:59

Plot file version 727 created 05-OCT-2021 17:07:55

J0827+5217 GM076.UVDATA.1

Freq = 1.5945 GHz, Bw = 32.000 MH No calibration applied and no bandpass applied

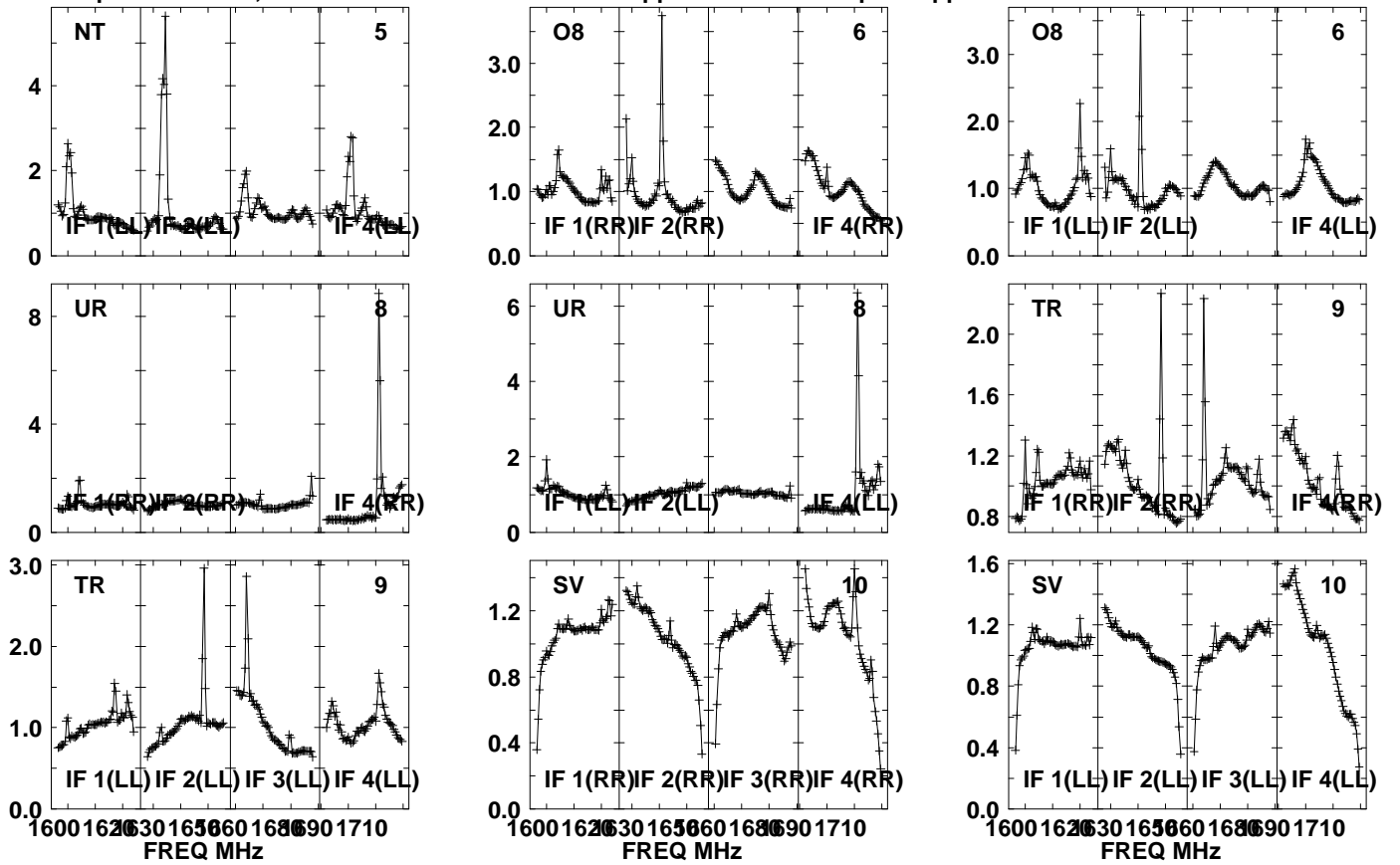

Lower frame: Real Jy  
Auto-corr total-power spectrum Antenna: \*  
Timerange: 00/17:09:31 to 00/17:10:59

Plot file version 728 created 05-OCT-2021 17:07:56

J0827+5217 GM076.UVDATA.1

Freq = 1.5945 GHz, Bw = 32.000 MH No calibration applied and no bandpass applied

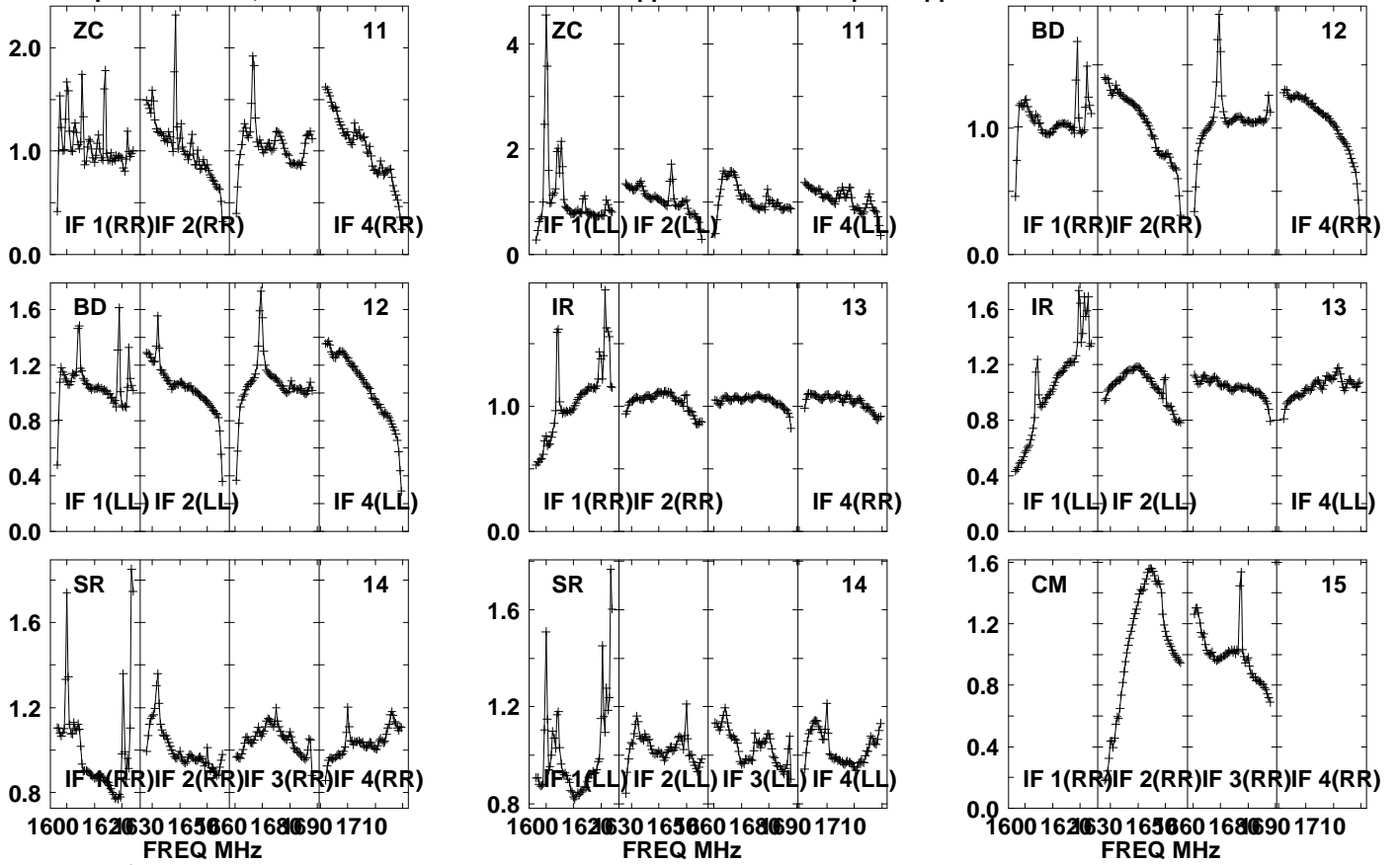

Lower frame: Real Jy  
Auto-corr total-power spectrum Antenna: \*  
Timerange: 00/17:09:31 to 00/17:10:59

Plot file version 729 created 05-OCT-2021 17:07:56

J0827+5217 GM076.UVDATA.1

Freq = 1.5945 GHz, Bw = 32.000 MH No calibration applied and no bandpass applied

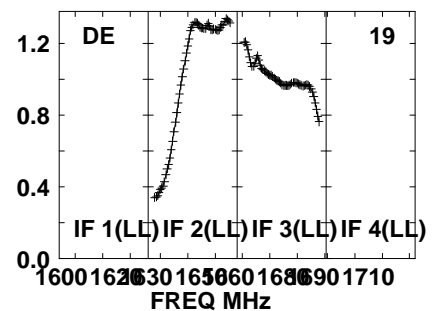
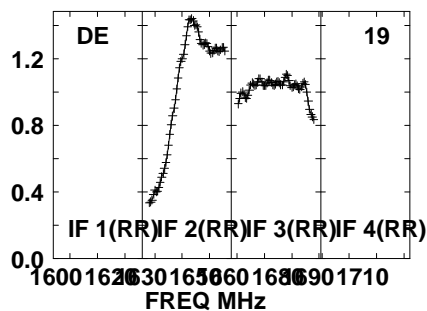
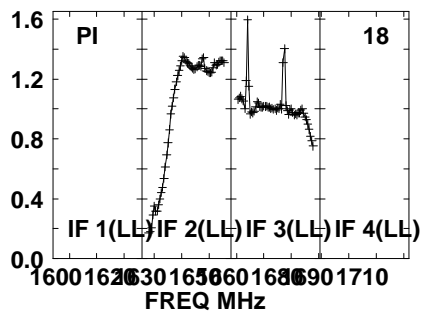
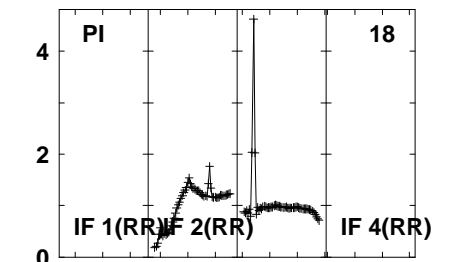
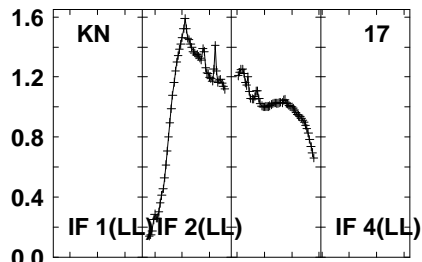
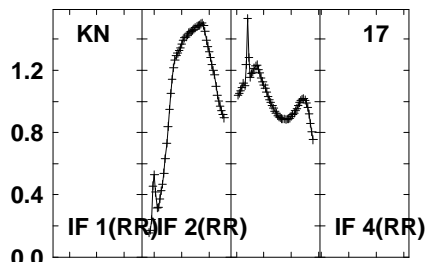
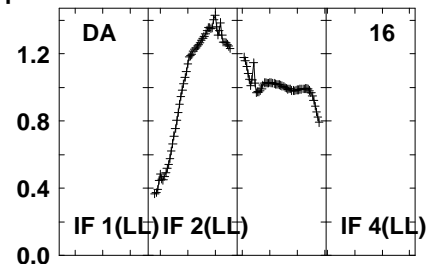
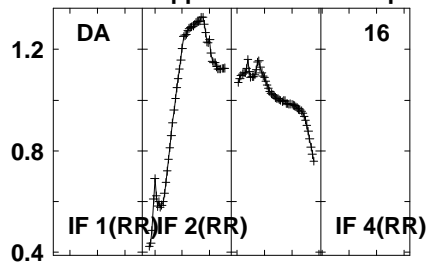
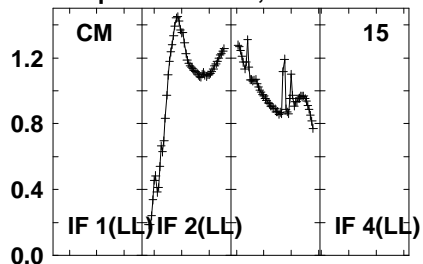

Lower frame: Real Jy  
Auto-corr total-power spectrum Antenna: \*  
Timerange: 00/17:09:31 to 00/17:10:59

Plot file version 730 created 05-OCT-2021 17:07:56

J0827+5217 GM076.UVDATA.1

Freq = 1.5945 GHz, Bw = 32.000 MH No calibration applied and no bandpass applied

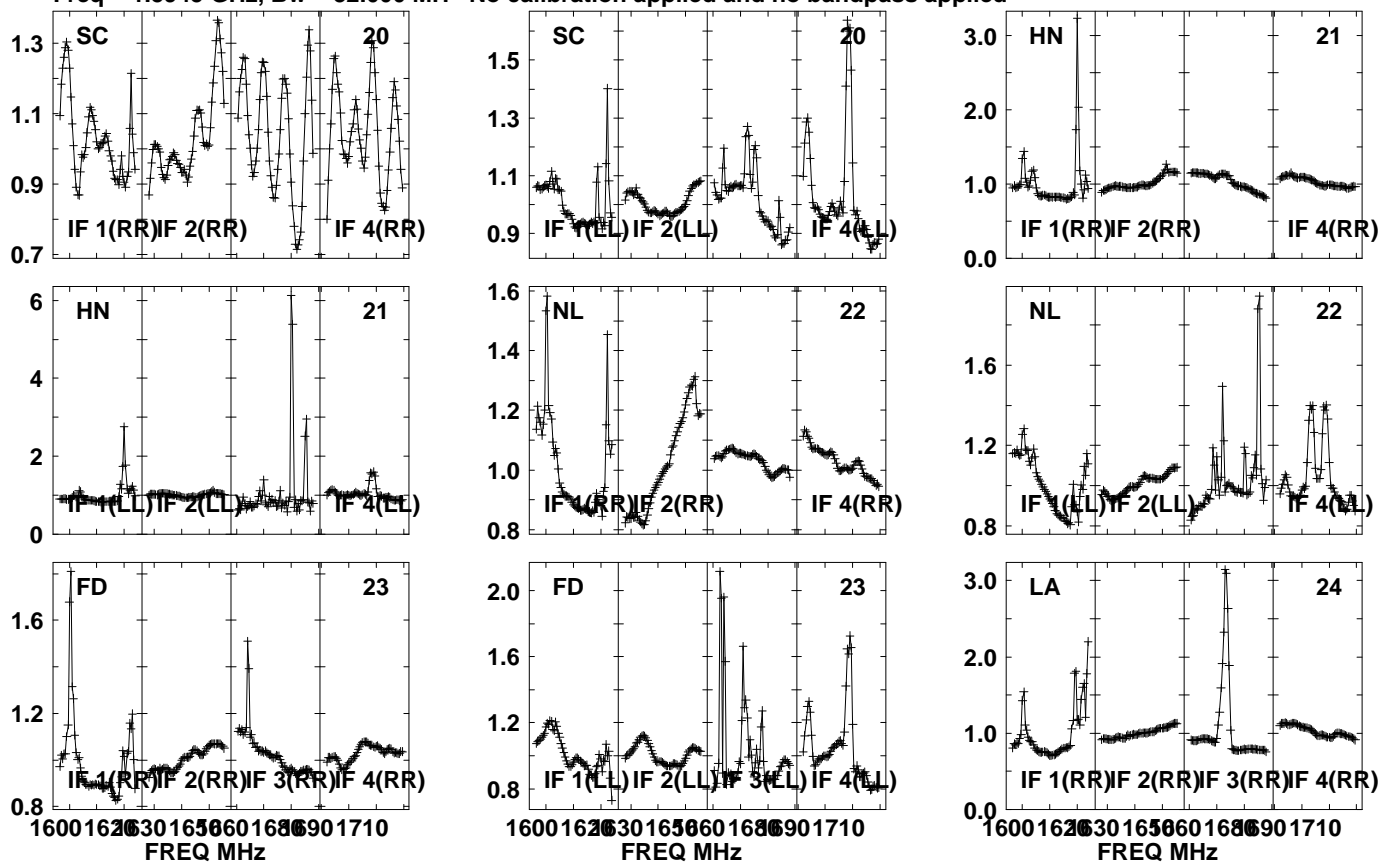

Lower frame: Real Jy  
Auto-corr total-power spectrum Antenna: \*  
Timerange: 00/17:09:31 to 00/17:10:59



Plot file version 731 created 05-OCT-2021 17:07:57

J0827+5217 GM076.UVDATA.1

Freq = 1.5945 GHz, Bw = 32.000 MH No calibration applied and no bandpass applied

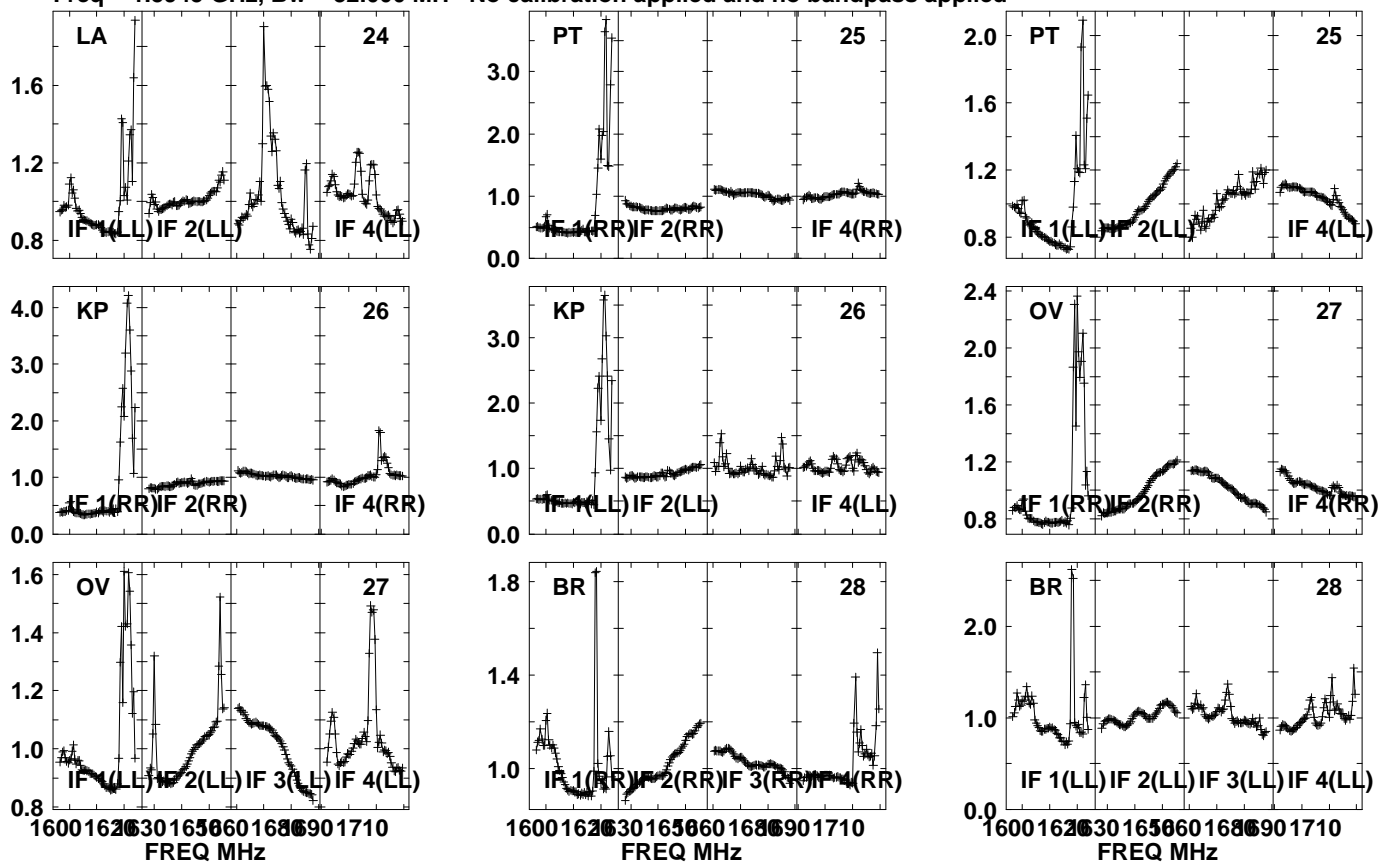

Lower frame: Real Jy  
Auto-corr total-power spectrum Antenna: \*  
Timerange: 00/17:09:31 to 00/17:10:59

Plot file version 732 created 05-OCT-2021 17:07:57

APM08279+525 GM076.UVDATA.1

Freq = 1.5945 GHz, Bw = 32.000 MH No calibration applied and no bandpass applied

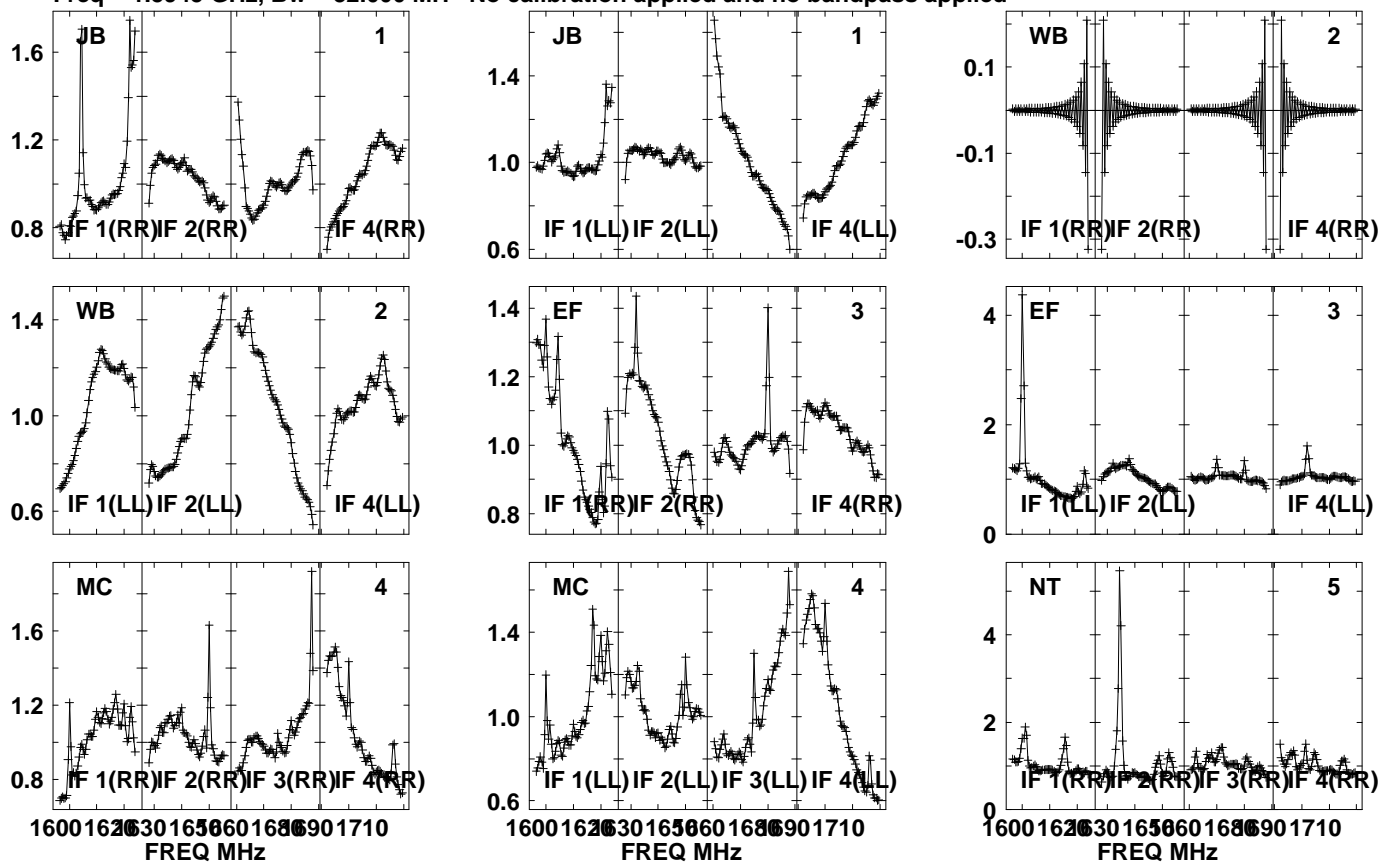

Lower frame: Real Jy  
Auto-corr total-power spectrum Antenna: \*  
Timerange: 00/17:11:01 to 00/17:14:29

Plot file version 733 created 05-OCT-2021 17:07:57

APM08279+525 GM076.UVDATA.1

Freq = 1.5945 GHz, Bw = 32.000 MH No calibration applied and no bandpass applied

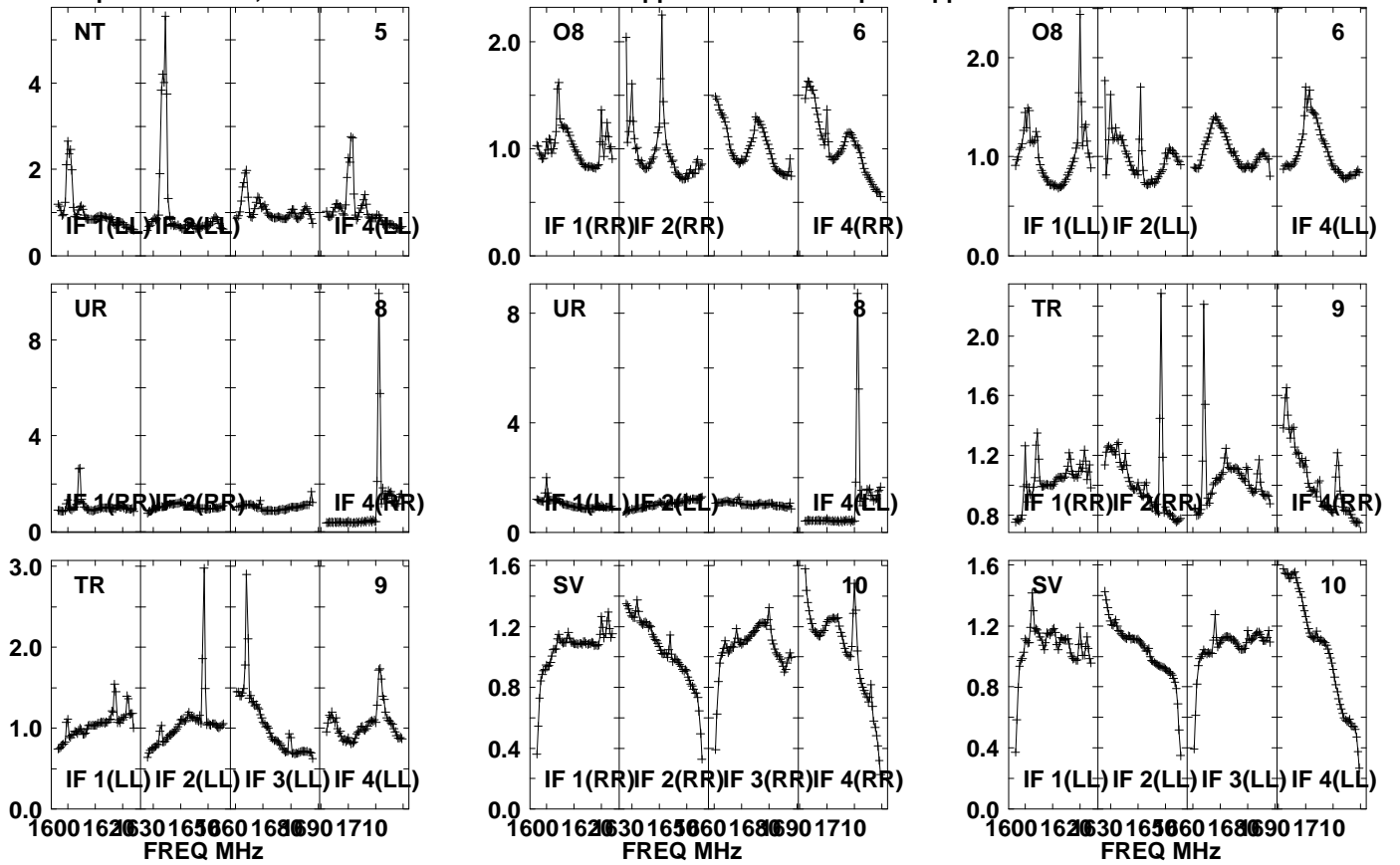

Lower frame: Real Jy

Auto-corr total-power spectrum Antenna: \*

Timerange: 00/17:11:01 to 00/17:14:29

Plot file version 734 created 05-OCT-2021 17:07:58

APM08279+525 GM076.UVDATA.1

Freq = 1.5945 GHz, Bw = 32.000 MH No calibration applied and no bandpass applied

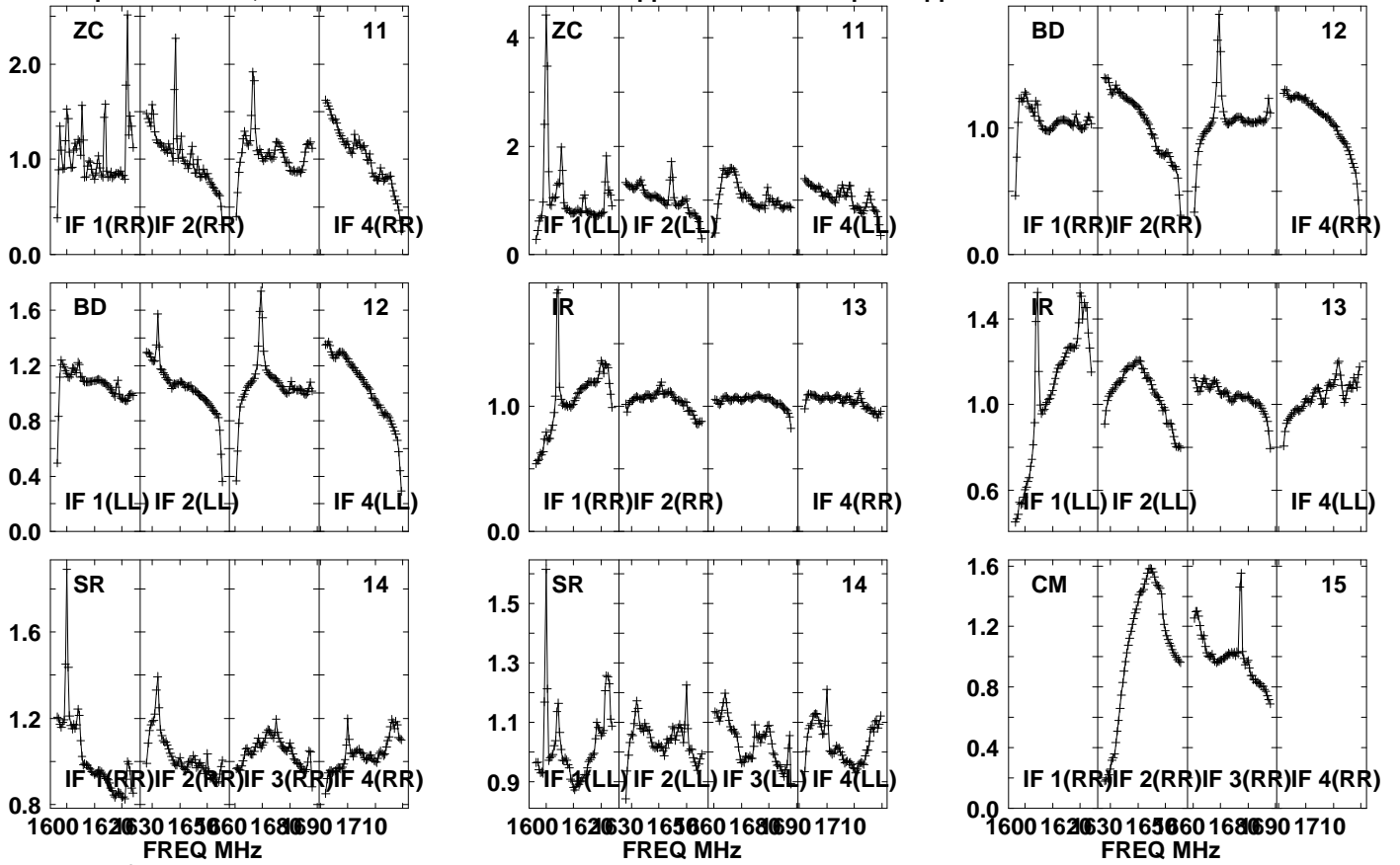

Lower frame: Real Jy  
Auto-corr total-power spectrum Antenna: \*  
Timerange: 00/17:11:01 to 00/17:14:29

Plot file version 735 created 05-OCT-2021 17:07:58

APM08279+525 GM076.UVDATA.1

Freq = 1.5945 GHz, Bw = 32.000 MH No calibration applied and no bandpass applied

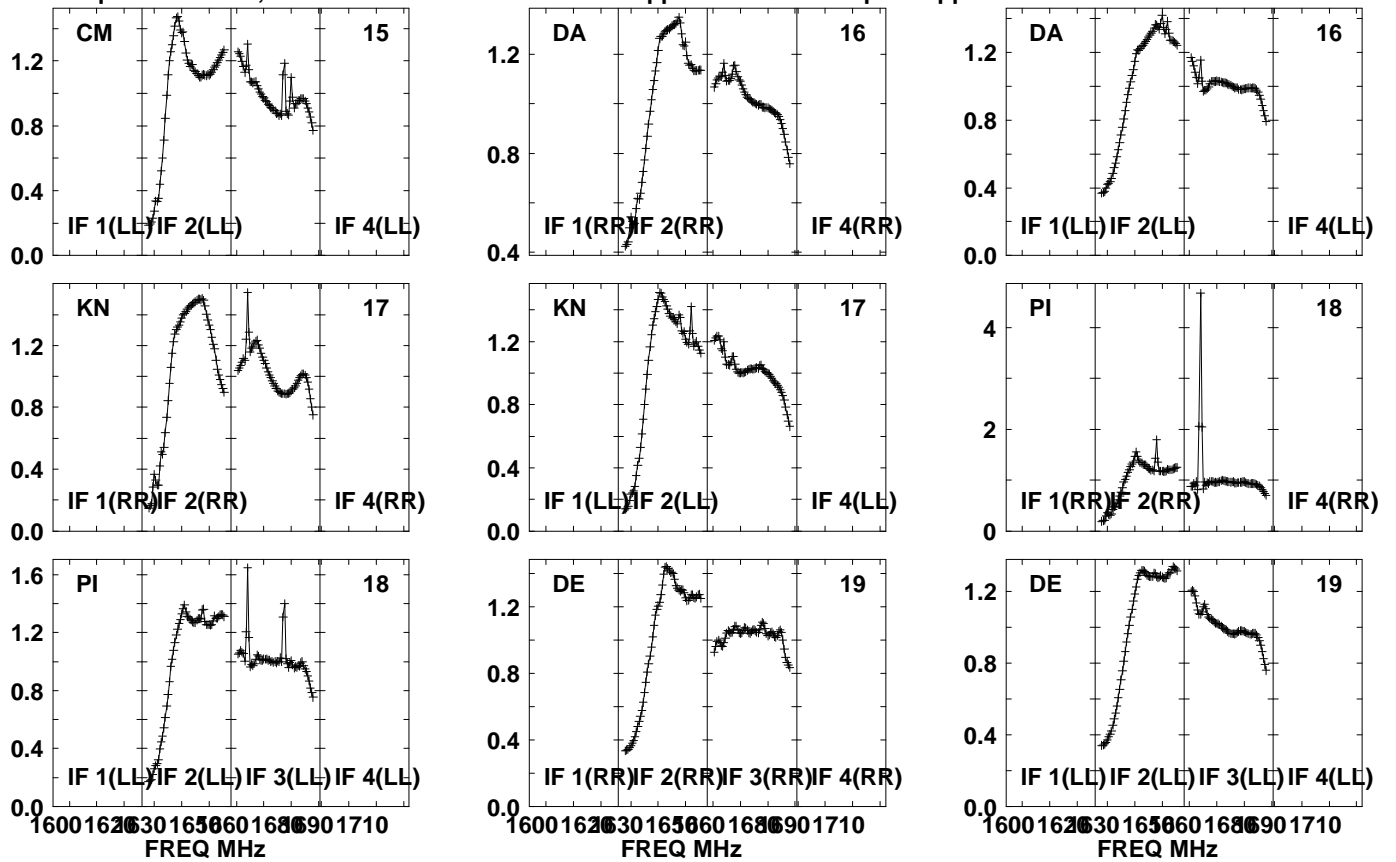

Lower frame: Real Jy  
Auto-corr total-power spectrum Antenna: \*  
Timerange: 00/17:11:01 to 00/17:14:29

Plot file version 736 created 05-OCT-2021 17:07:58

APM08279+525 GM076.UVDATA.1

Freq = 1.5945 GHz, Bw = 32.000 MH No calibration applied and no bandpass applied

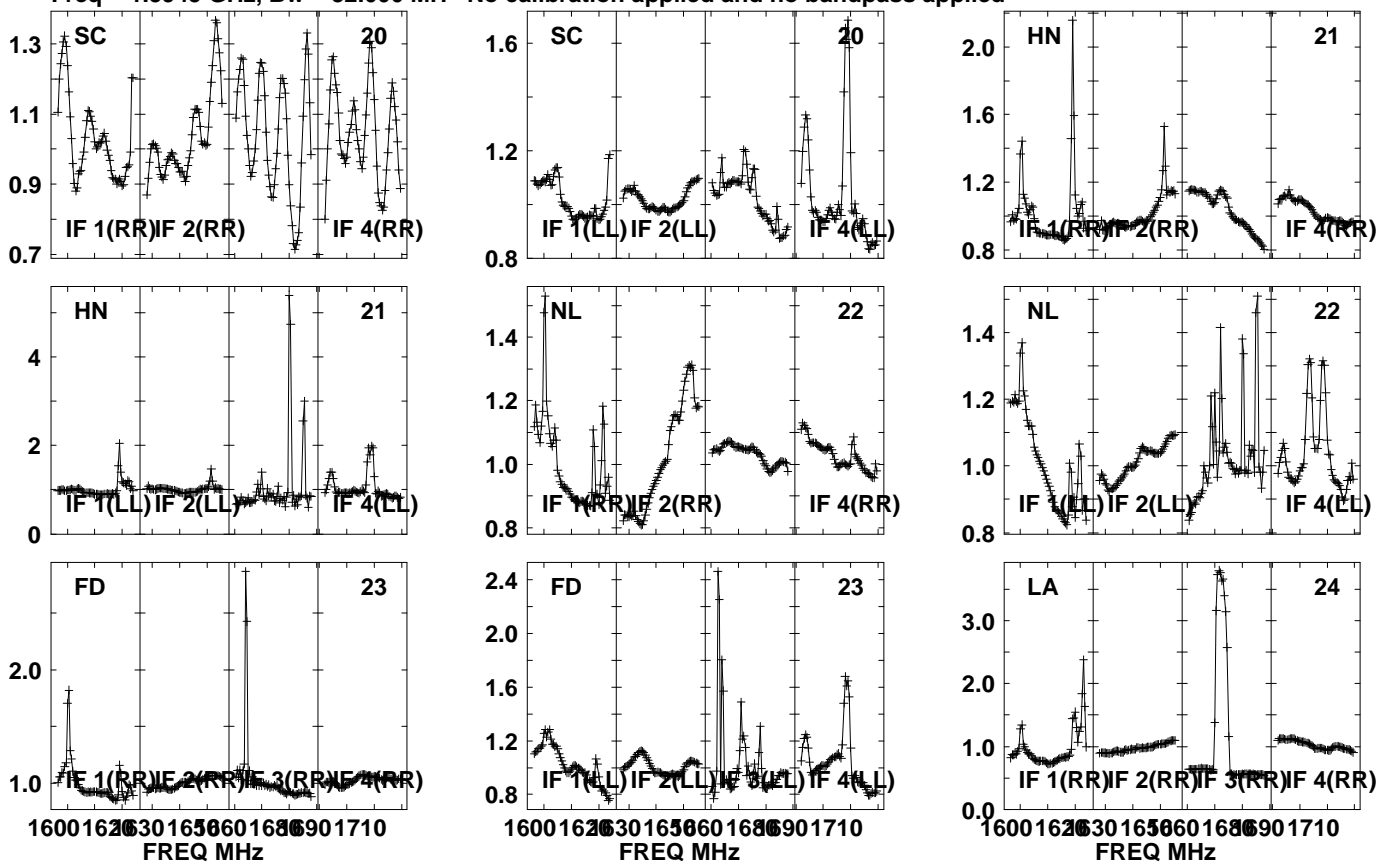

Lower frame: Real Jy  
Auto-corr total-power spectrum Antenna: \*  
Timerange: 00/17:11:01 to 00/17:14:29

Plot file version 737 created 05-OCT-2021 17:07:58

APM08279+525 GM076.UVDATA.1

Freq = 1.5945 GHz, Bw = 32.000 MH No calibration applied and no bandpass applied

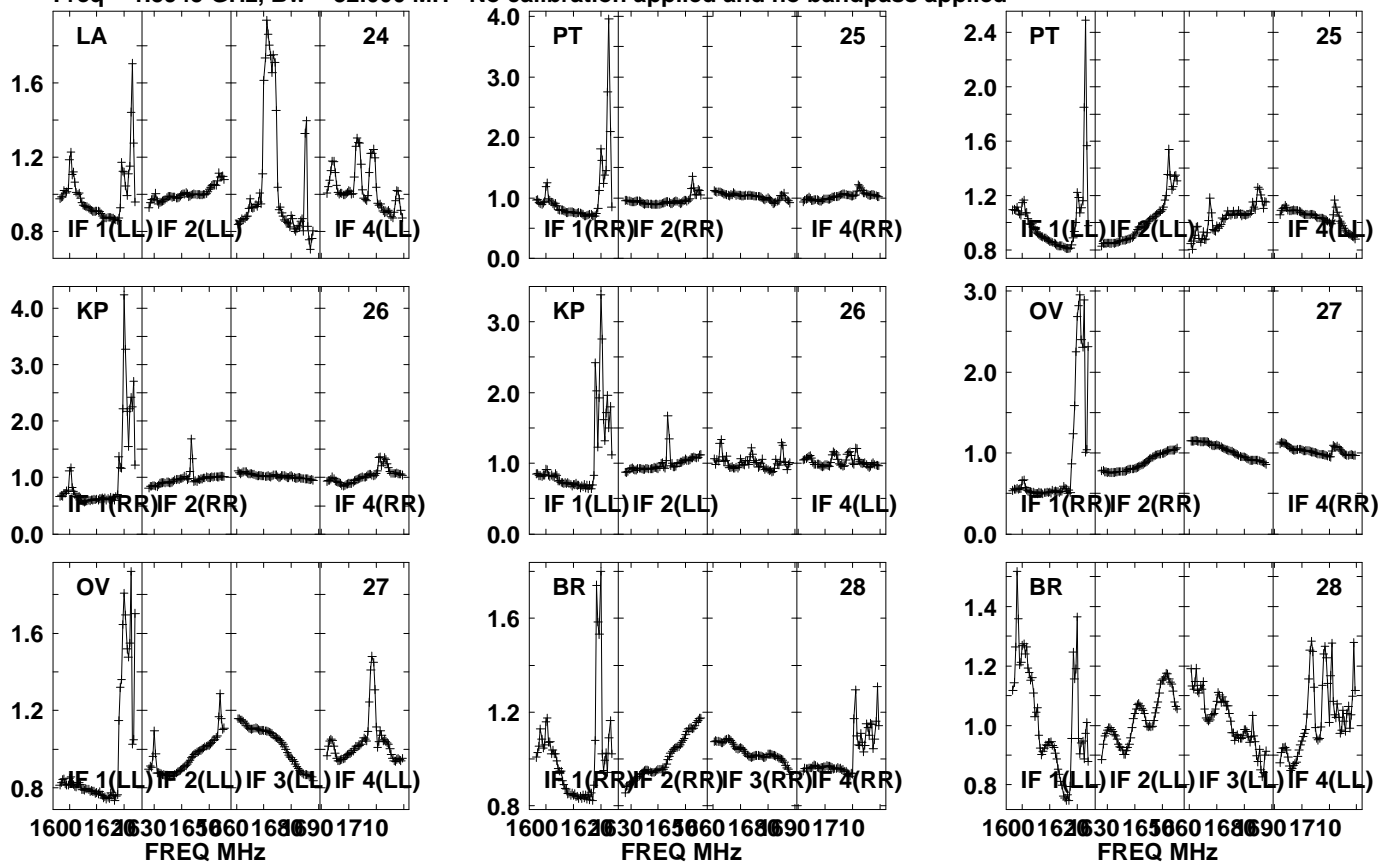

Lower frame: Real Jy  
Auto-corr total-power spectrum Antenna: \*  
Timerange: 00/17:11:01 to 00/17:14:29

Plot file version 738 created 05-OCT-2021 17:07:59

J0827+5217 GM076.UVDATA.1

Freq = 1.5945 GHz, Bw = 32.000 MH No calibration applied and no bandpass applied

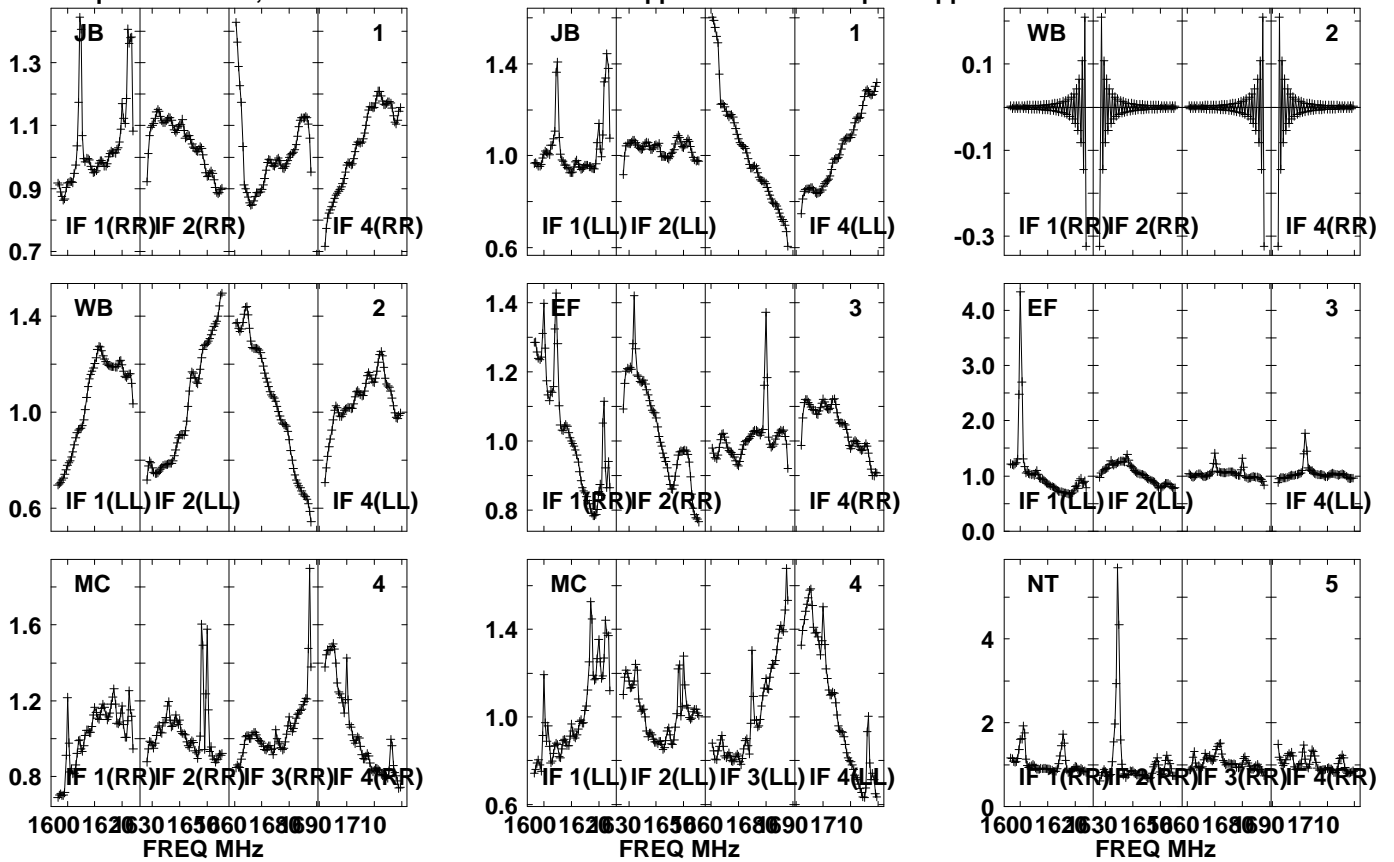

Lower frame: Real Jy  
Auto-corr total-power spectrum Antenna: \*  
Timerange: 00/17:14:31 to 00/17:15:59



Plot file version 739 created 05-OCT-2021 17:07:59

J0827+5217 GM076.UVDATA.1

Freq = 1.5945 GHz, Bw = 32.000 MH No calibration applied and no bandpass applied

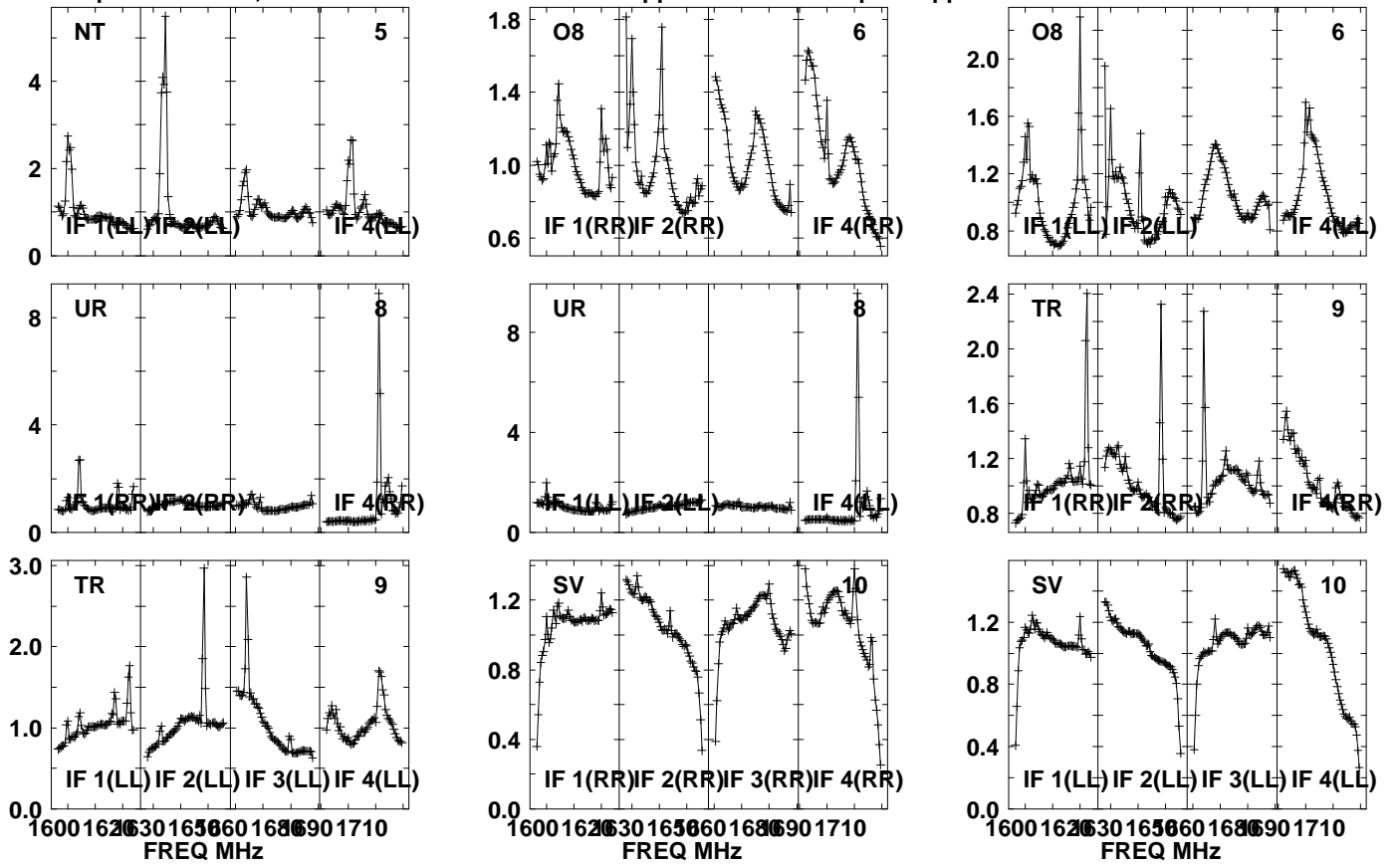

Lower frame: Real Jy  
Auto-corr total-power spectrum Antenna: \*  
Timerange: 00/17:14:31 to 00/17:15:59

Plot file version 740 created 05-OCT-2021 17:08:00

J0827+5217 GM076.UVDATA.1

Freq = 1.5945 GHz, Bw = 32.000 MH No calibration applied and no bandpass applied

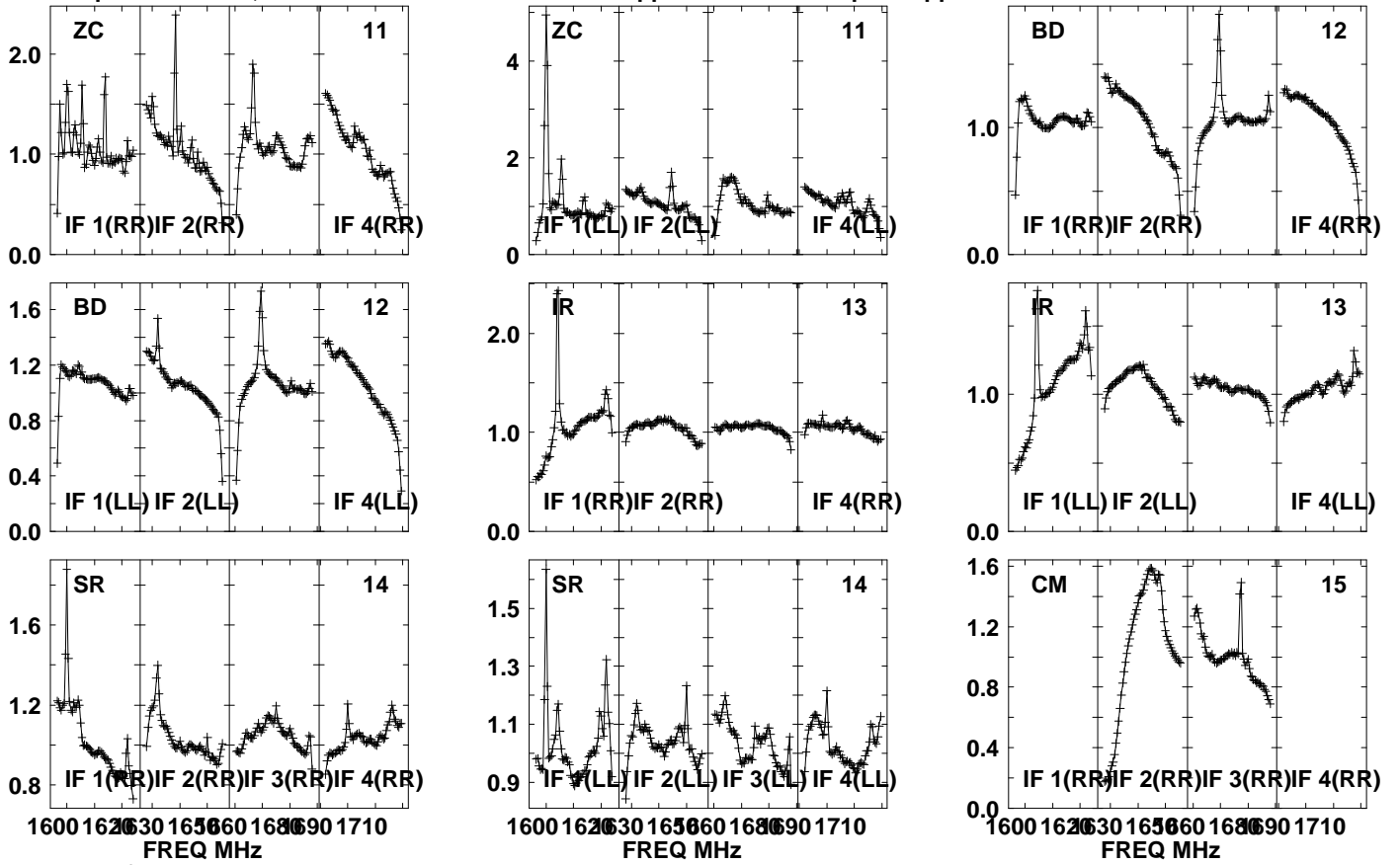

Lower frame: Real Jy  
Auto-corr total-power spectrum Antenna: \*  
Timerange: 00/17:14:31 to 00/17:15:59

Plot file version 741 created 05-OCT-2021 17:08:00

J0827+5217 GM076.UVDATA.1

Freq = 1.5945 GHz, Bw = 32.000 MH No calibration applied and no bandpass applied

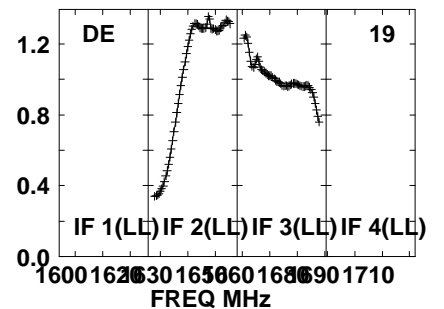
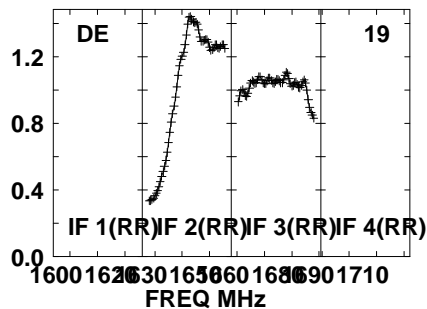
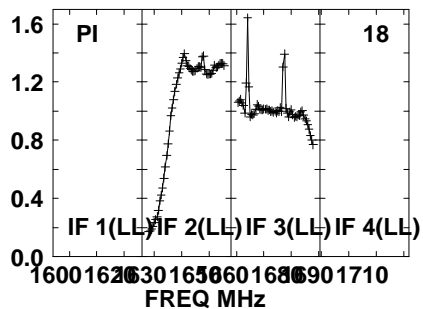
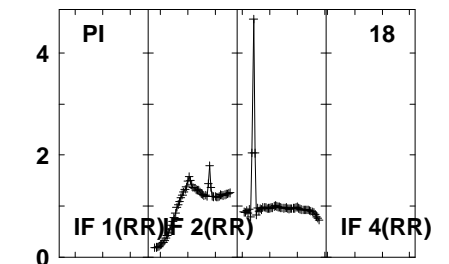
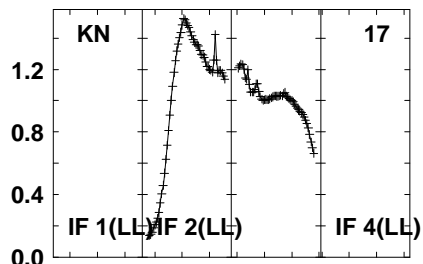
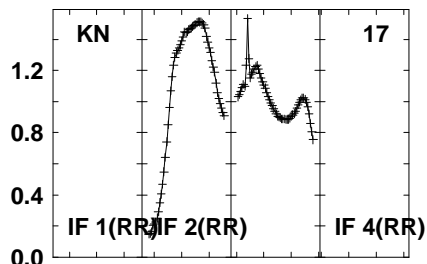
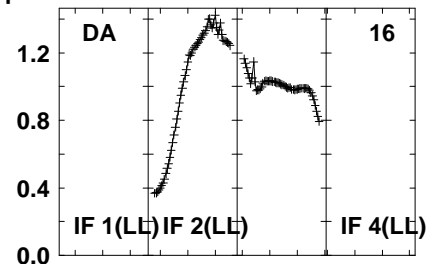
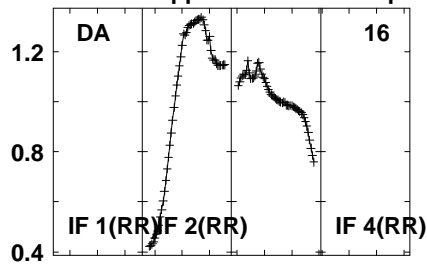
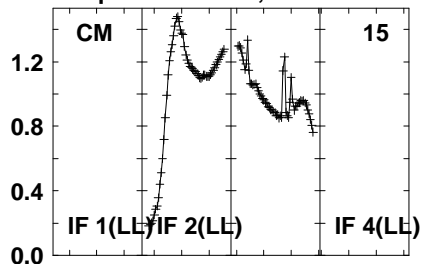

Lower frame: Real Jy  
Auto-corr total-power spectrum Antenna: \*  
Timerange: 00/17:14:31 to 00/17:15:59

Plot file version 742 created 05-OCT-2021 17:08:00

J0827+5217 GM076.UVDATA.1

Freq = 1.5945 GHz, Bw = 32.000 MH No calibration applied and no bandpass applied

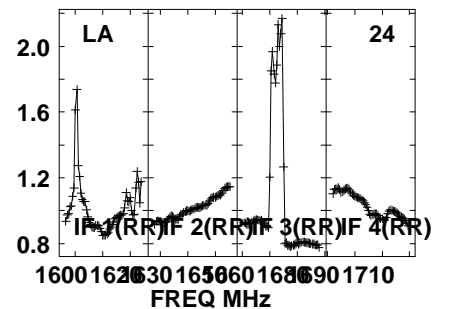
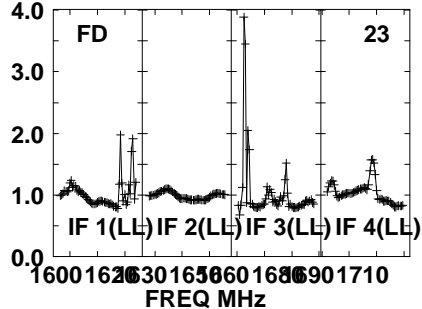
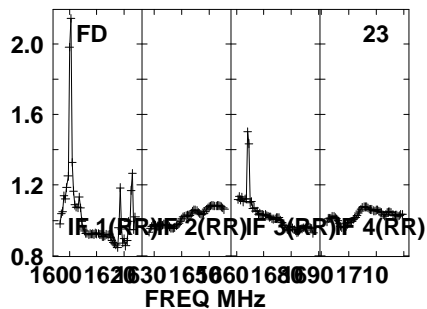
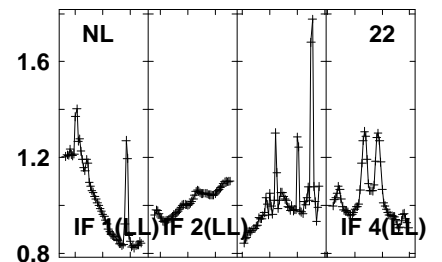
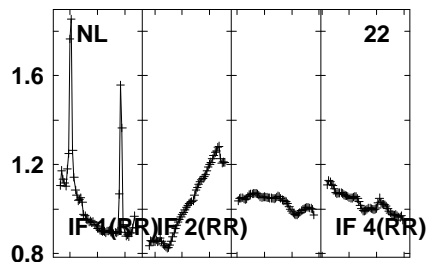
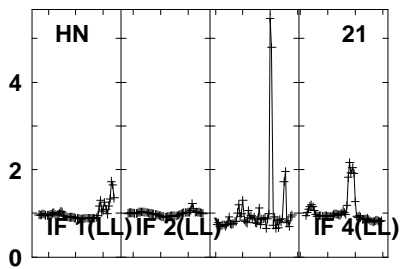
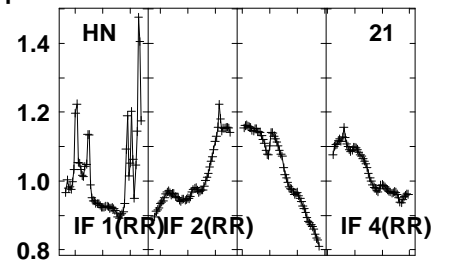
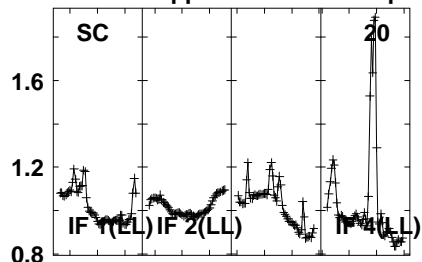
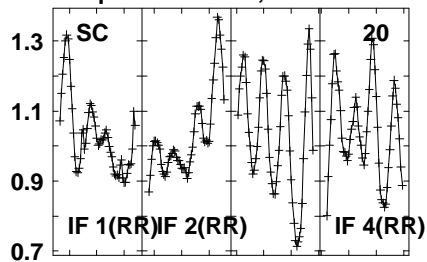

Lower frame: Real Jy  
Auto-corr total-power spectrum Antenna: \*  
Timerange: 00/17:14:31 to 00/17:15:59

Plot file version 743 created 05-OCT-2021 17:08:00

J0827+5217 GM076.UVDATA.1

Freq = 1.5945 GHz, Bw = 32.000 MH No calibration applied and no bandpass applied

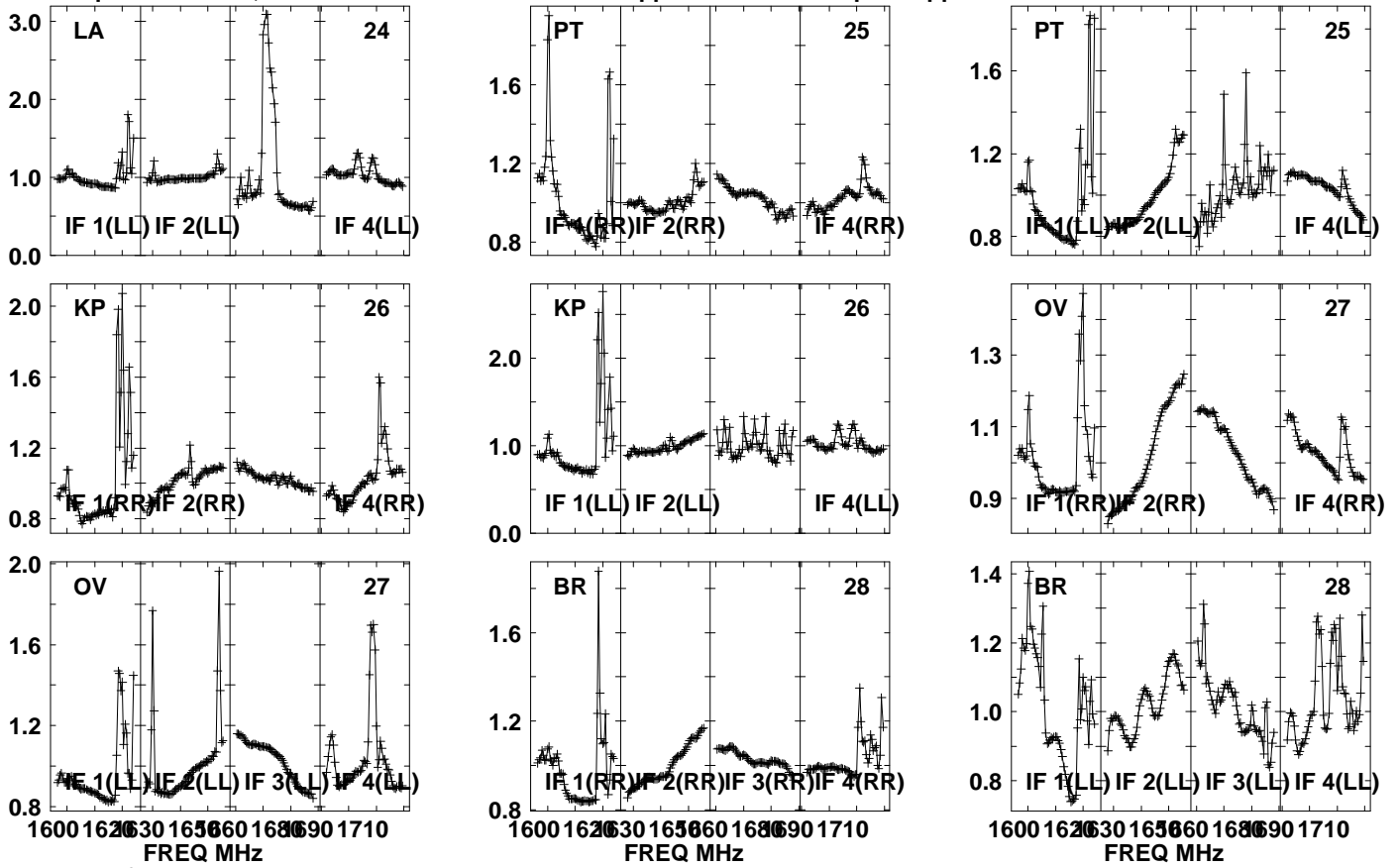

Lower frame: Real Jy

Auto-corr total-power spectrum Antenna: \*

Timerange: 00/17:14:31 to 00/17:15:59

Plot file version 744 created 05-OCT-2021 17:08:01

APM08279+525 GM076.UVDATA.1

Freq = 1.5945 GHz, Bw = 32.000 MH No calibration applied and no bandpass applied

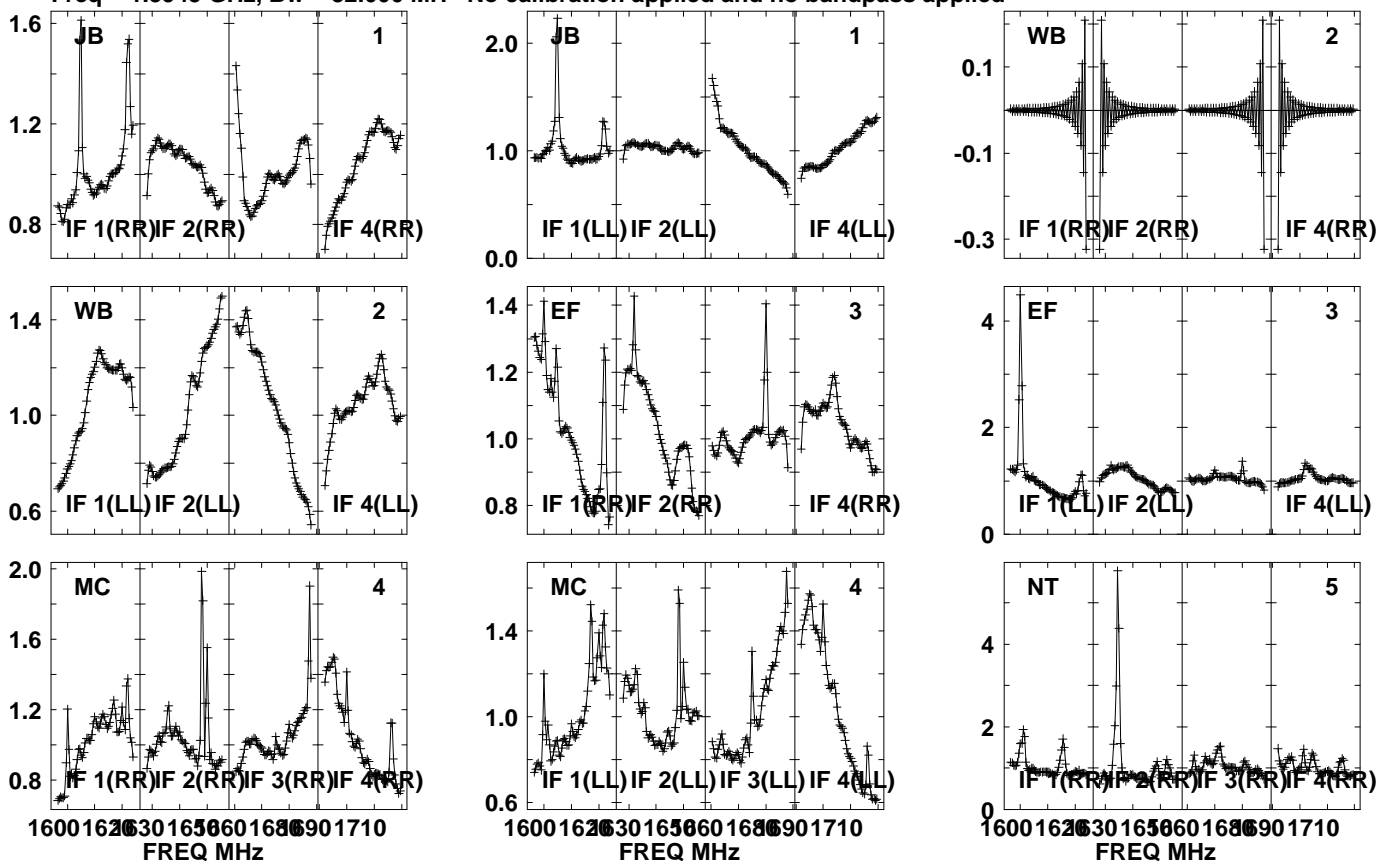

Lower frame: Real Jy  
Auto-corr total-power spectrum Antenna: \*  
Timerange: 00/17:16:01 to 00/17:19:29

Plot file version 745 created 05-OCT-2021 17:08:01

APM08279+525 GM076.UVDATA.1

Freq = 1.5945 GHz, Bw = 32.000 MH No calibration applied and no bandpass applied

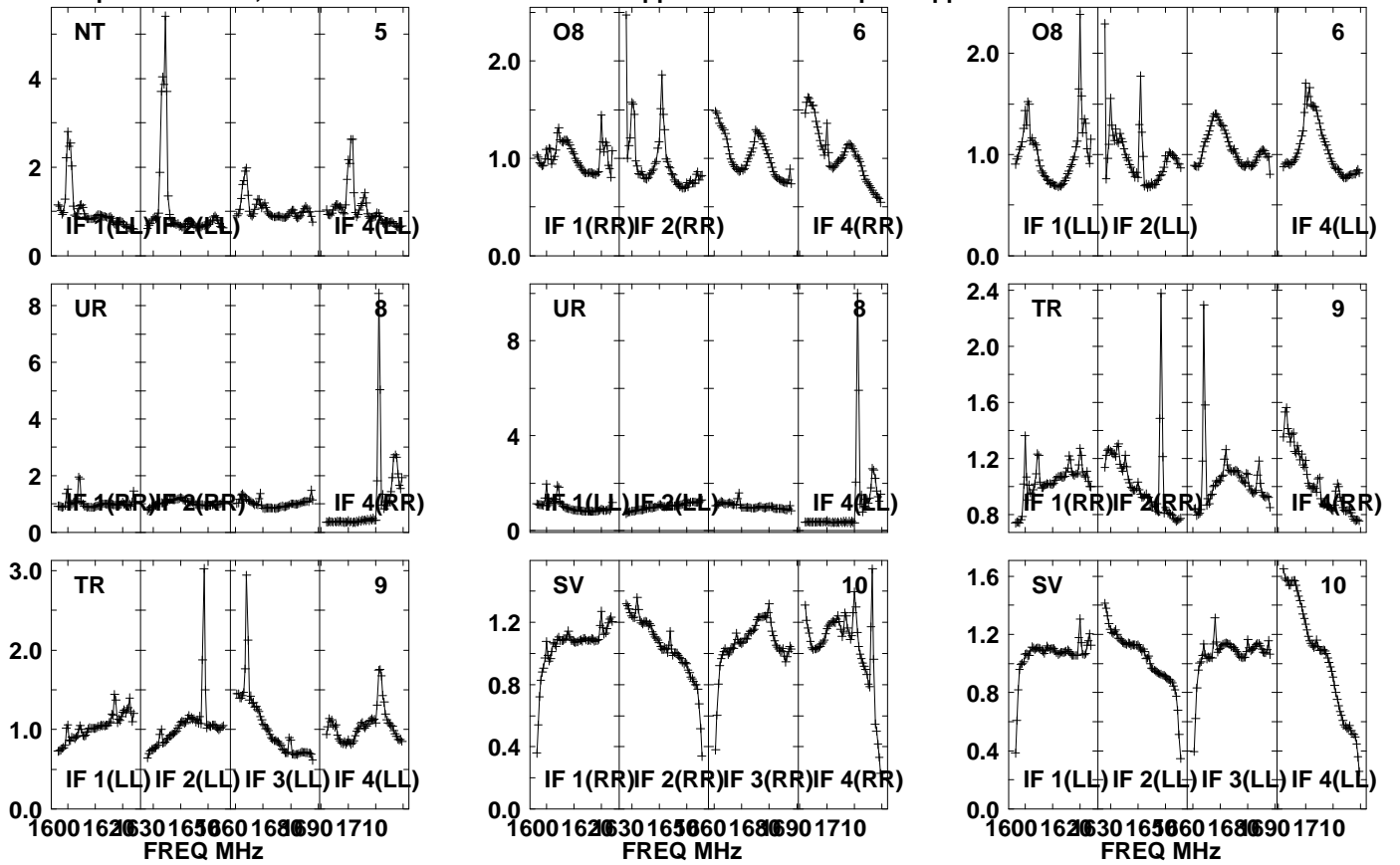

Lower frame: Real Jy

Auto-corr total-power spectrum Antenna: \*

Timerange: 00/17:16:01 to 00/17:19:29

Plot file version 746 created 05-OCT-2021 17:08:01

APM08279+525 GM076.UVDATA.1

Freq = 1.5945 GHz, Bw = 32.000 MH No calibration applied and no bandpass applied

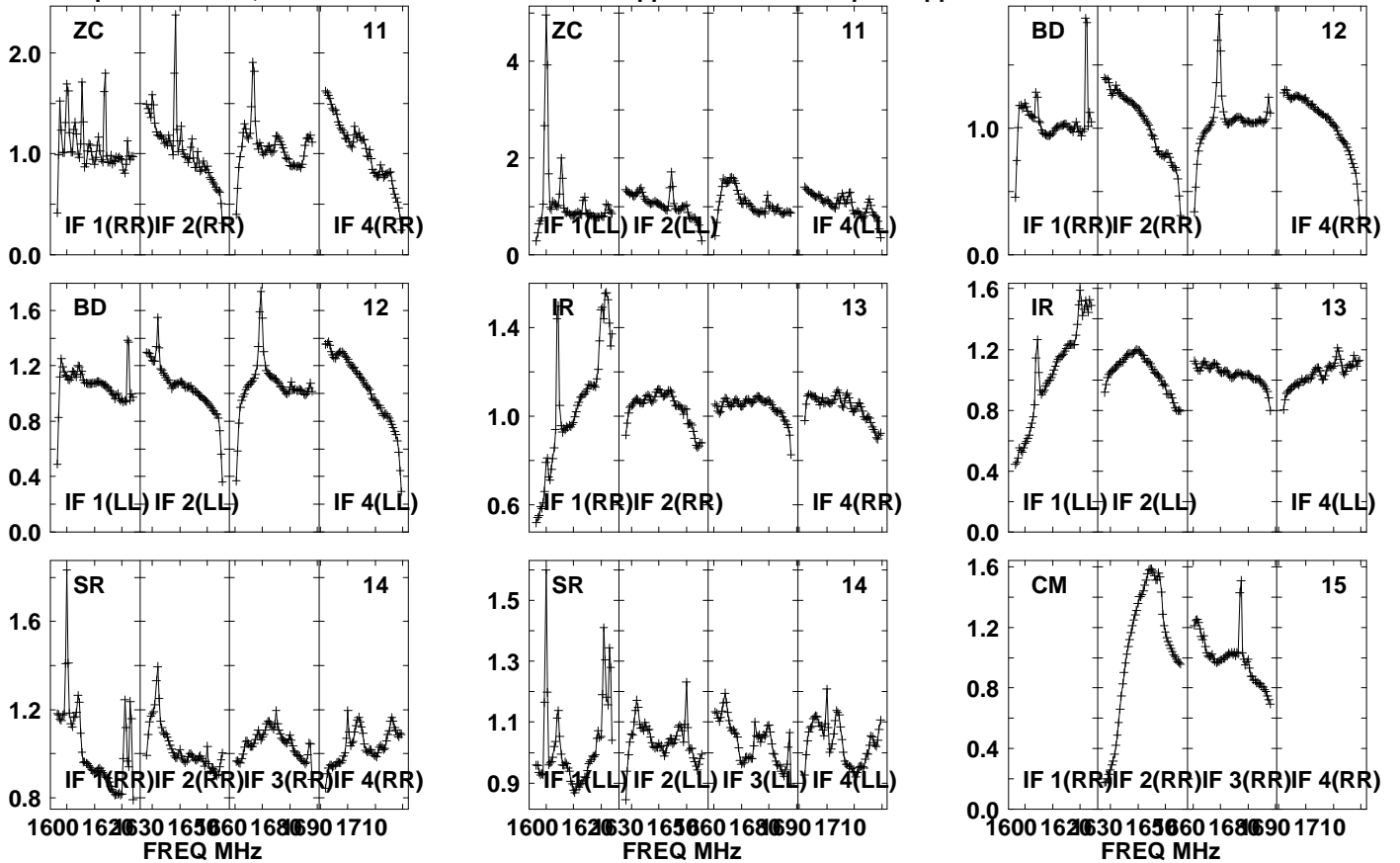

Lower frame: Real Jy  
Auto-corr total-power spectrum Antenna: \*  
Timerange: 00/17:16:01 to 00/17:19:29



Plot file version 747 created 05-OCT-2021 17:08:02

APM08279+525 GM076.UVDATA.1

Freq = 1.5945 GHz, Bw = 32.000 MH No calibration applied and no bandpass applied

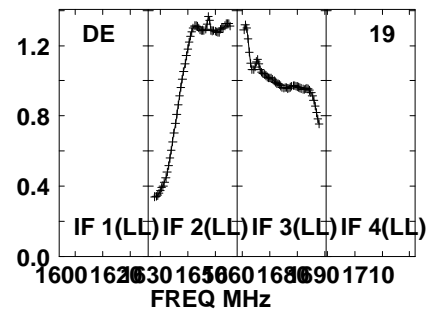
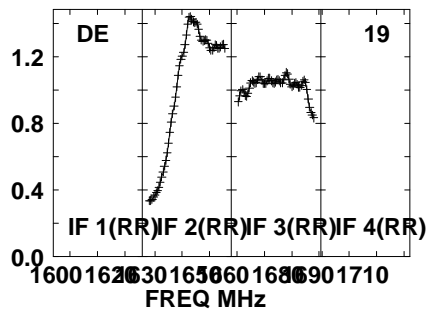
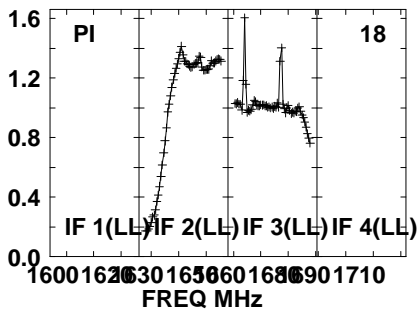
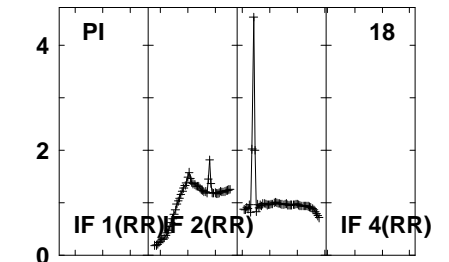
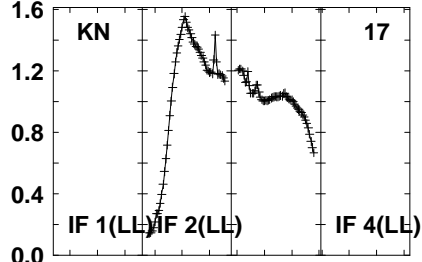
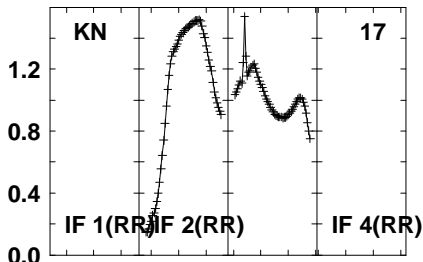
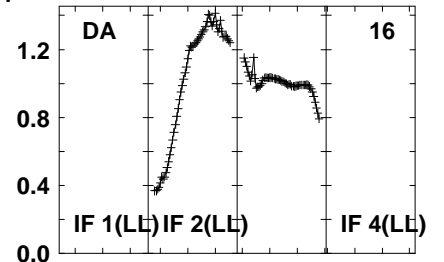
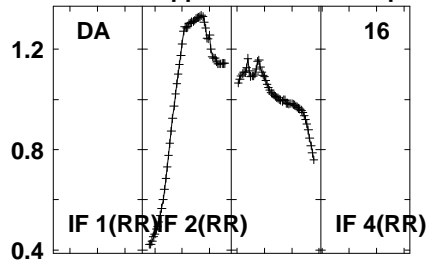
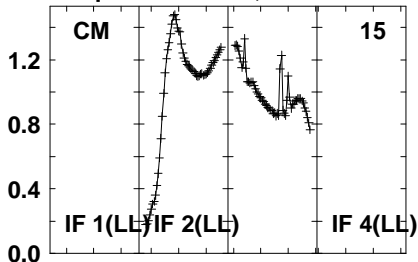

Lower frame: Real Jy  
Auto-corr total-power spectrum Antenna: \*  
Timerange: 00/17:16:01 to 00/17:19:29

Plot file version 748 created 05-OCT-2021 17:08:02

APM08279+525 GM076.UVDATA.1

Freq = 1.5945 GHz, Bw = 32.000 MH No calibration applied and no bandpass applied

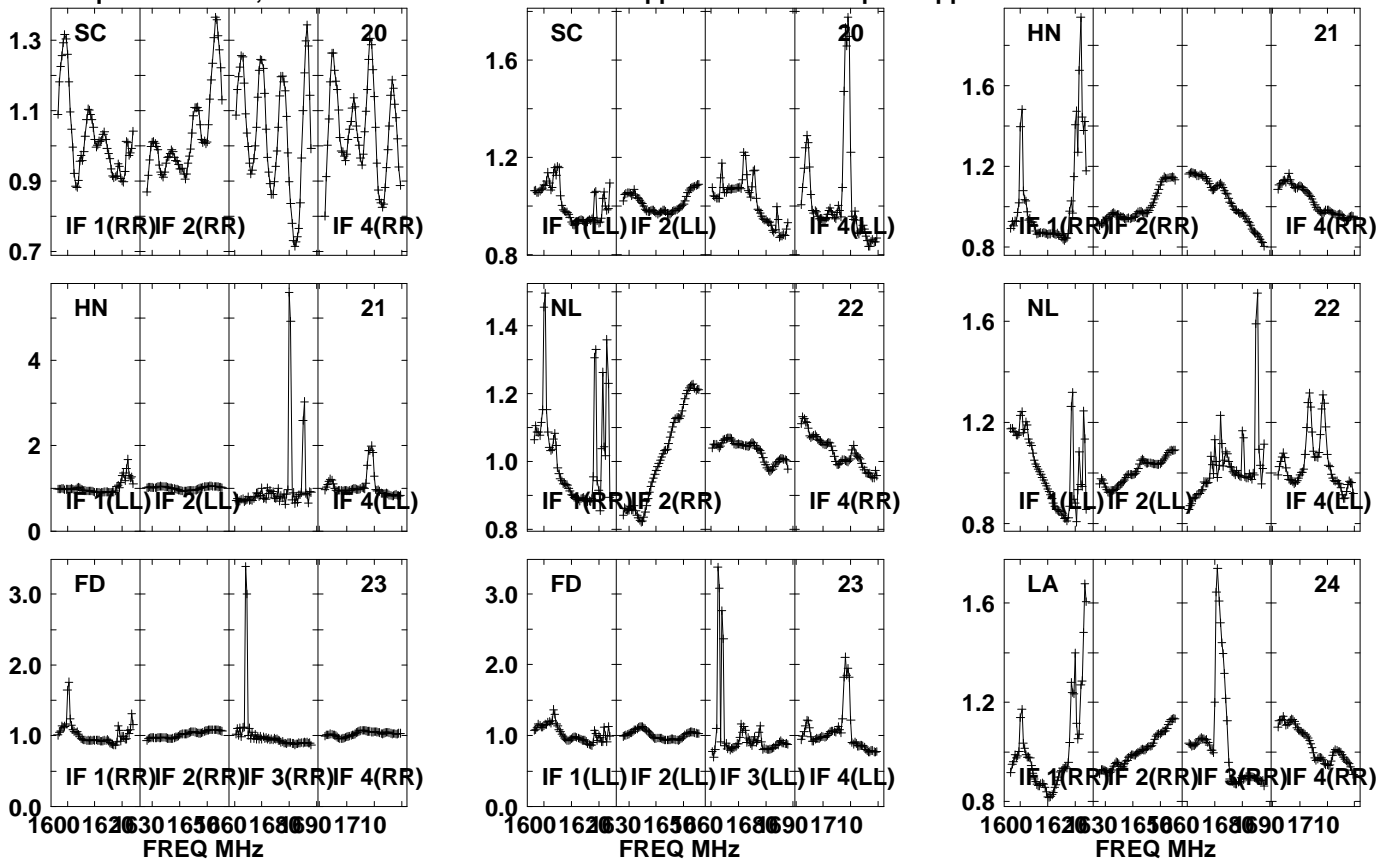

Lower frame: Real Jy  
Auto-corr total-power spectrum Antenna: \*  
Timerange: 00/17:16:01 to 00/17:19:29

Plot file version 749 created 05-OCT-2021 17:08:02

APM08279+525 GM076.UVDATA.1

Freq = 1.5945 GHz, Bw = 32.000 MH No calibration applied and no bandpass applied

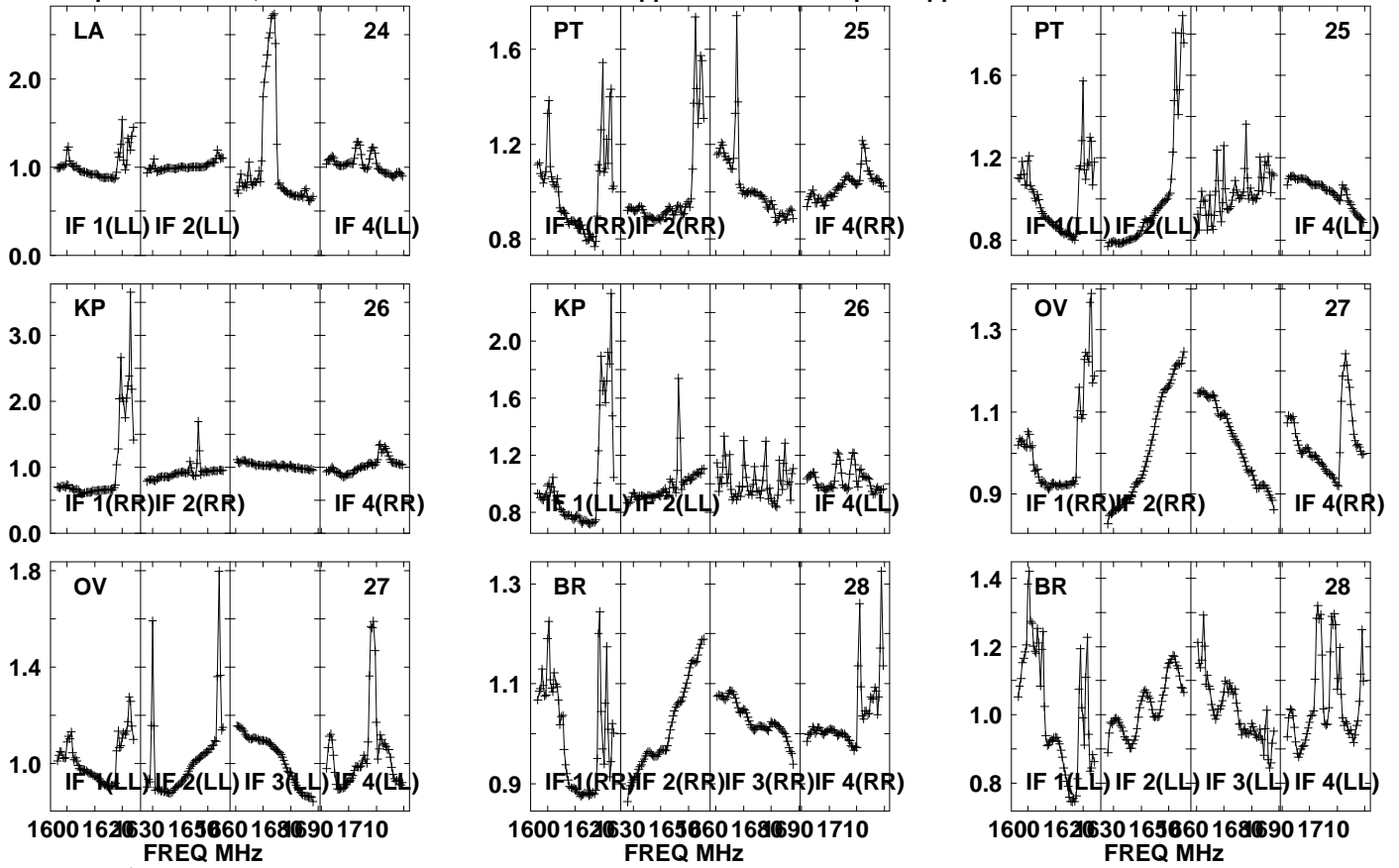

Lower frame: Real Jy

Auto-corr total-power spectrum Antenna: \*

Timerange: 00/17:16:01 to 00/17:19:29

Plot file version 750 created 05-OCT-2021 17:08:03

J0827+5217 GM076.UVDATA.1

Freq = 1.5945 GHz, Bw = 32.000 MH No calibration applied and no bandpass applied

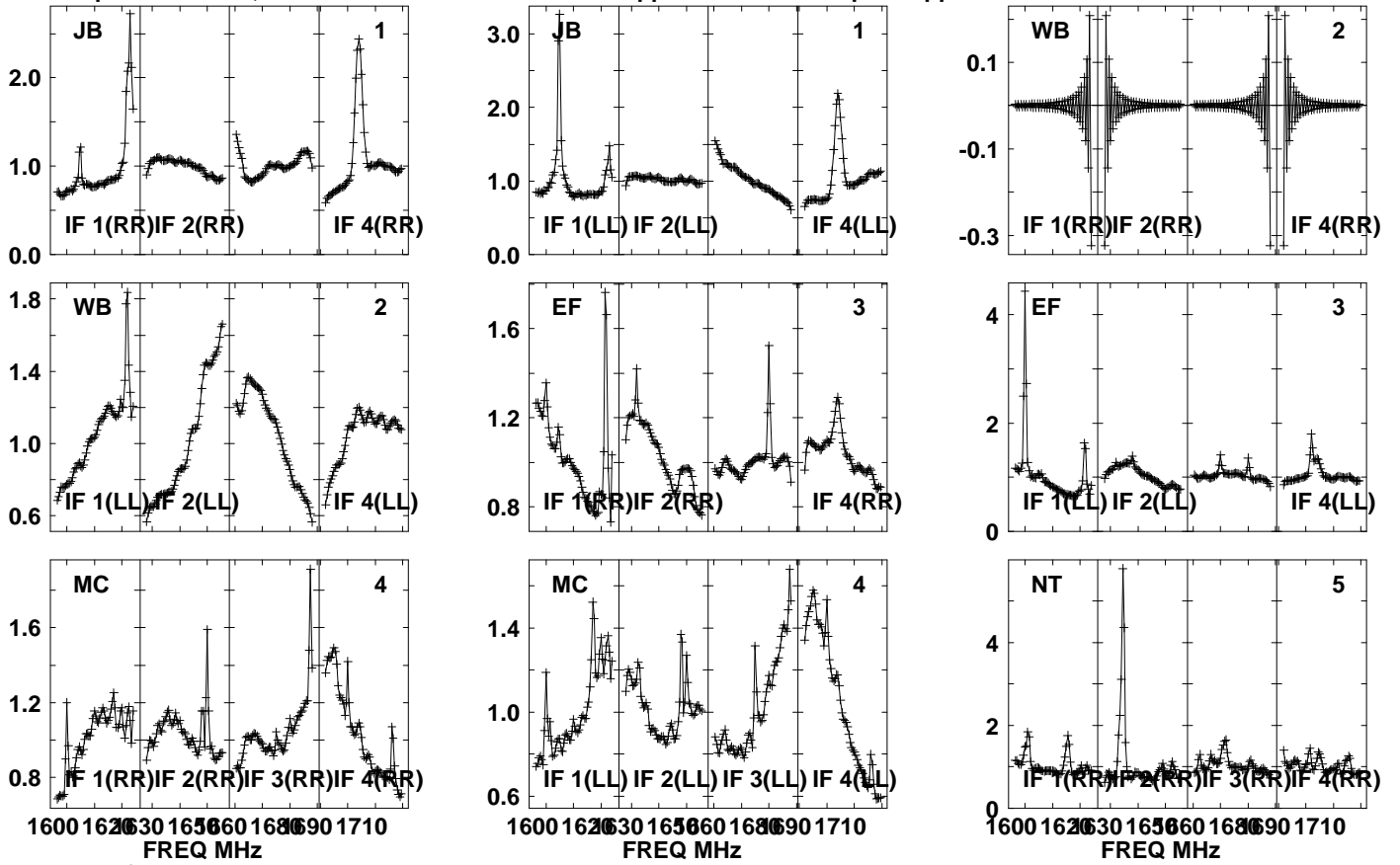

Lower frame: Real Jy  
Auto-corr total-power spectrum Antenna: \*  
Timerange: 00/17:20:01 to 00/17:21:29

Plot file version 751 created 05-OCT-2021 17:08:03

J0827+5217 GM076.UVDATA.1

Freq = 1.5945 GHz, Bw = 32.000 MH No calibration applied and no bandpass applied

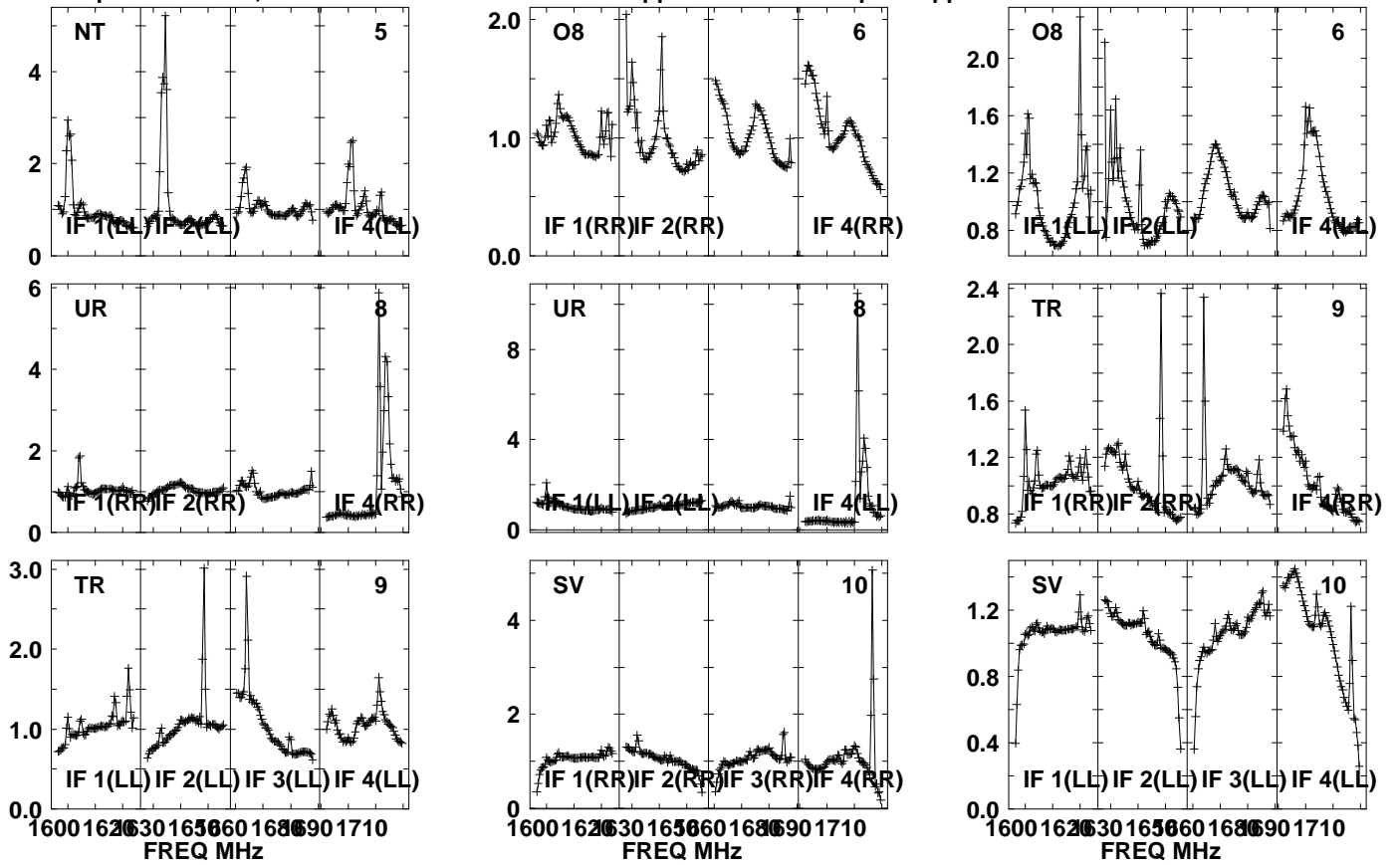

Lower frame: Real Jy  
Auto-corr total-power spectrum Antenna: \*  
Timerange: 00/17:20:01 to 00/17:21:29

Plot file version 752 created 05-OCT-2021 17:08:03

J0827+5217 GM076.UVDATA.1

Freq = 1.5945 GHz, Bw = 32.000 MH No calibration applied and no bandpass applied

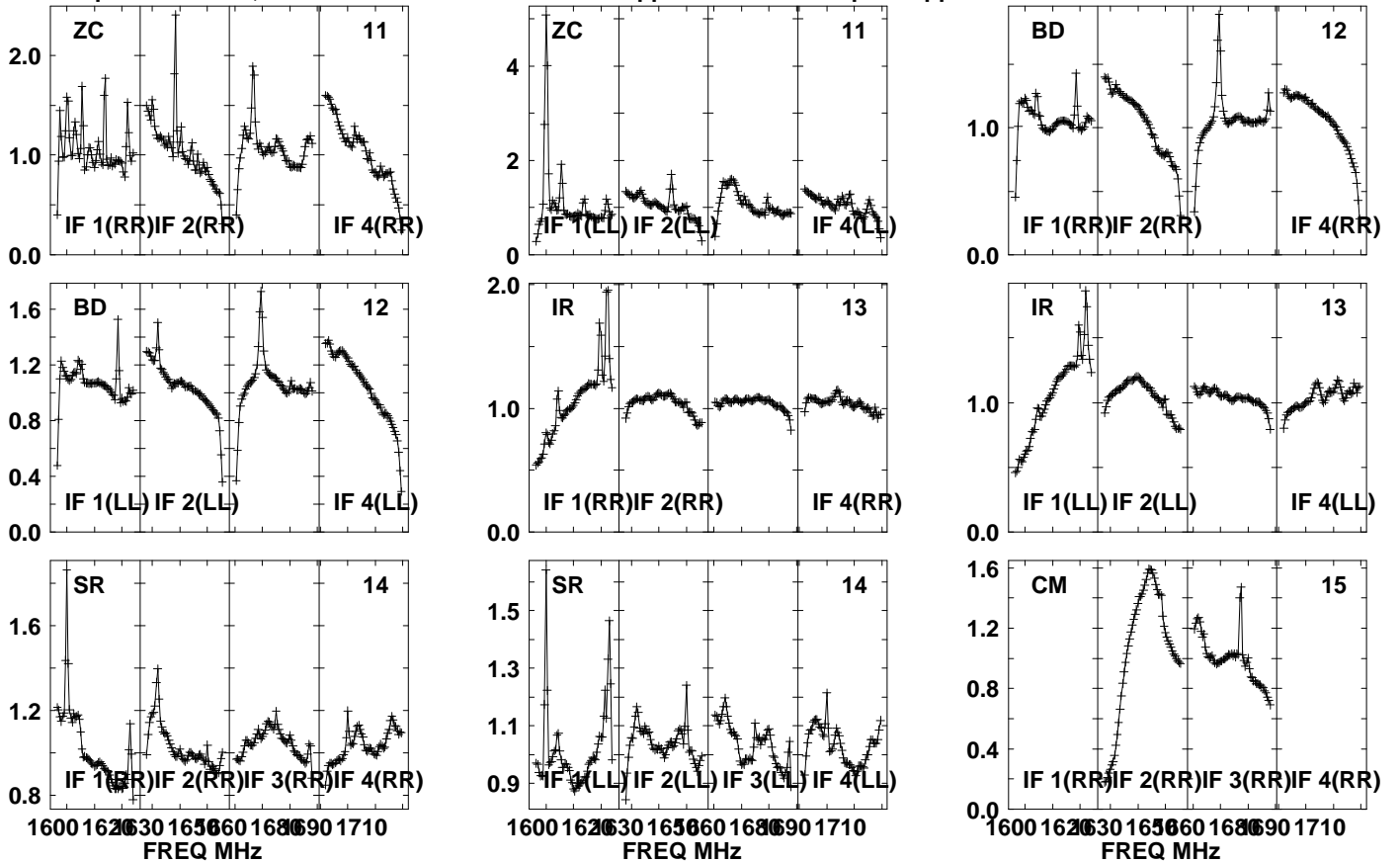

Lower frame: Real Jy  
Auto-corr total-power spectrum Antenna: \*  
Timerange: 00/17:20:01 to 00/17:21:29

Plot file version 753 created 05-OCT-2021 17:08:04

J0827+5217 GM076.UVDATA.1

Freq = 1.5945 GHz, Bw = 32.000 MH No calibration applied and no bandpass applied

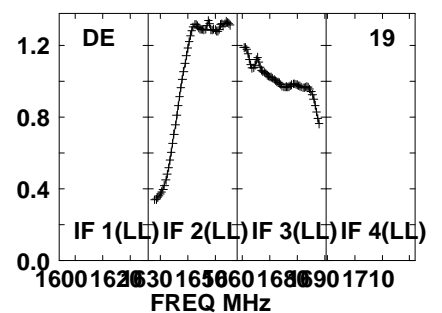
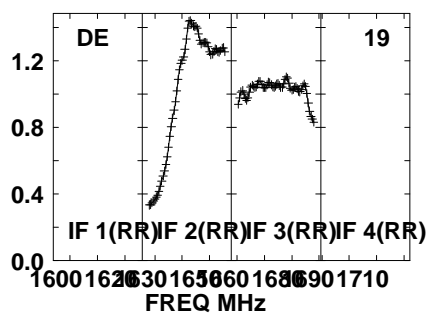
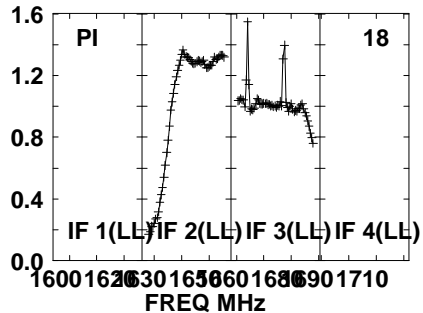
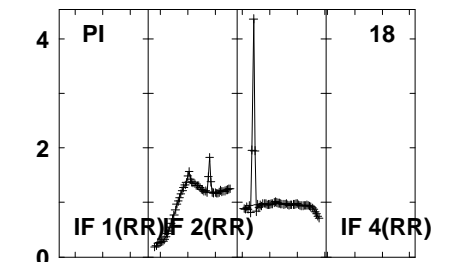
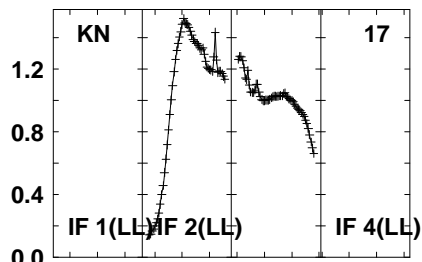
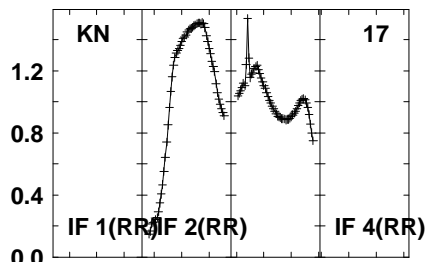
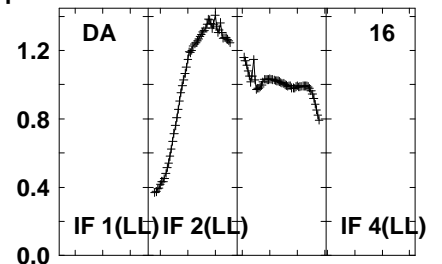
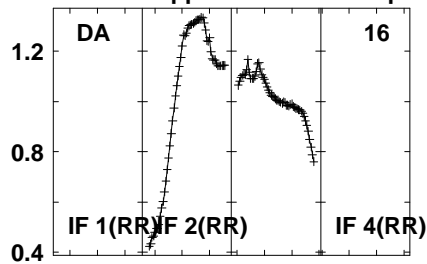
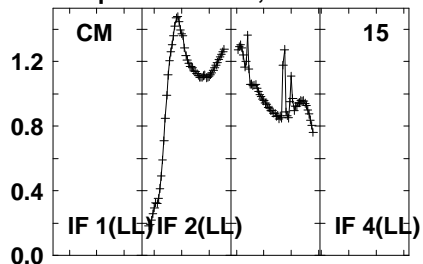

Lower frame: Real Jy  
Auto-corr total-power spectrum Antenna: \*  
Timerange: 00/17:20:01 to 00/17:21:29

Plot file version 754 created 05-OCT-2021 17:08:04

J0827+5217 GM076.UVDATA.1

Freq = 1.5945 GHz, Bw = 32.000 MH No calibration applied and no bandpass applied

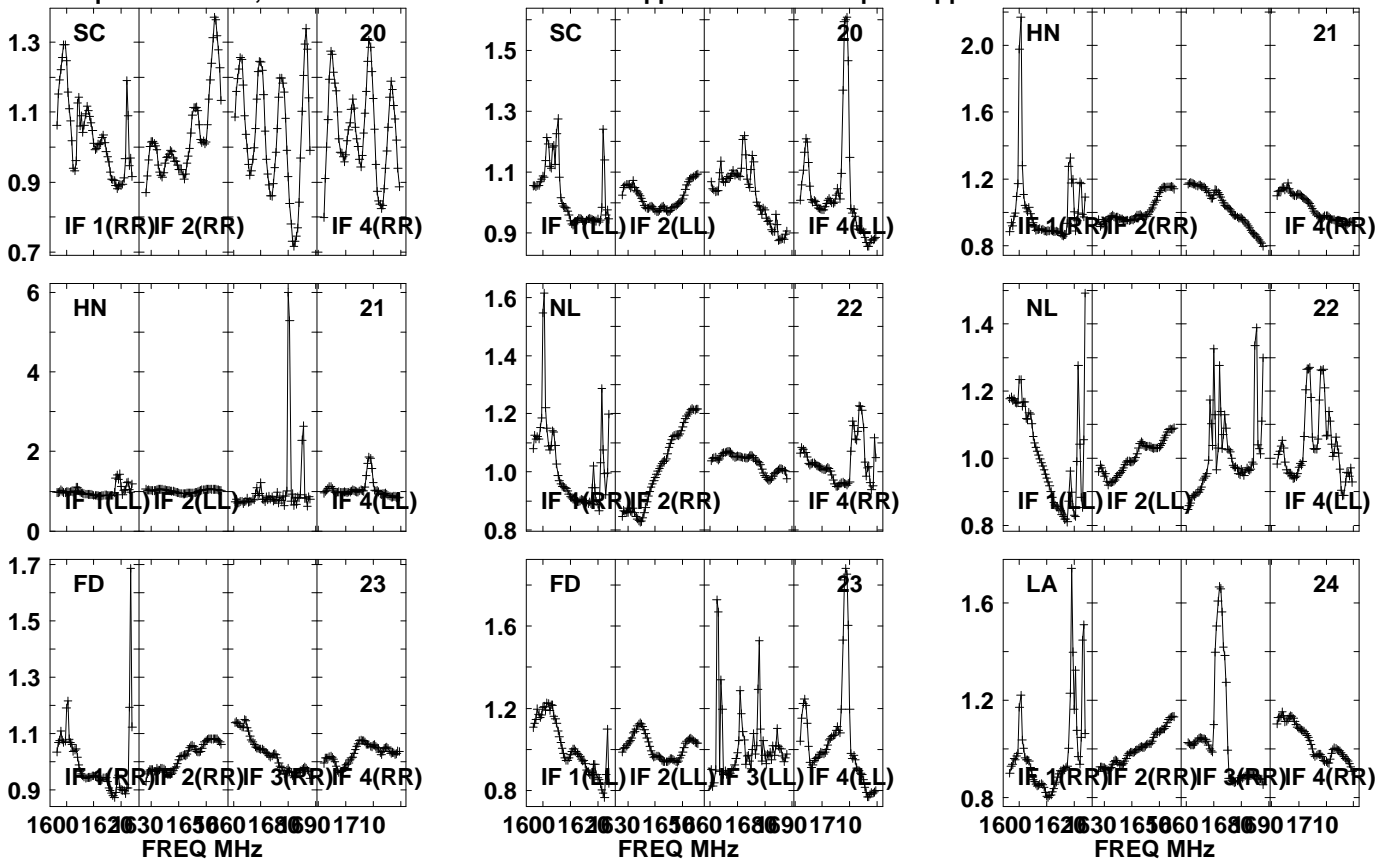

Lower frame: Real Jy  
Auto-corr total-power spectrum Antenna: \*  
Timerange: 00/17:20:01 to 00/17:21:29



Plot file version 755 created 05-OCT-2021 17:08:04

J0827+5217 GM076.UVDATA.1

Freq = 1.5945 GHz, Bw = 32.000 MH No calibration applied and no bandpass applied

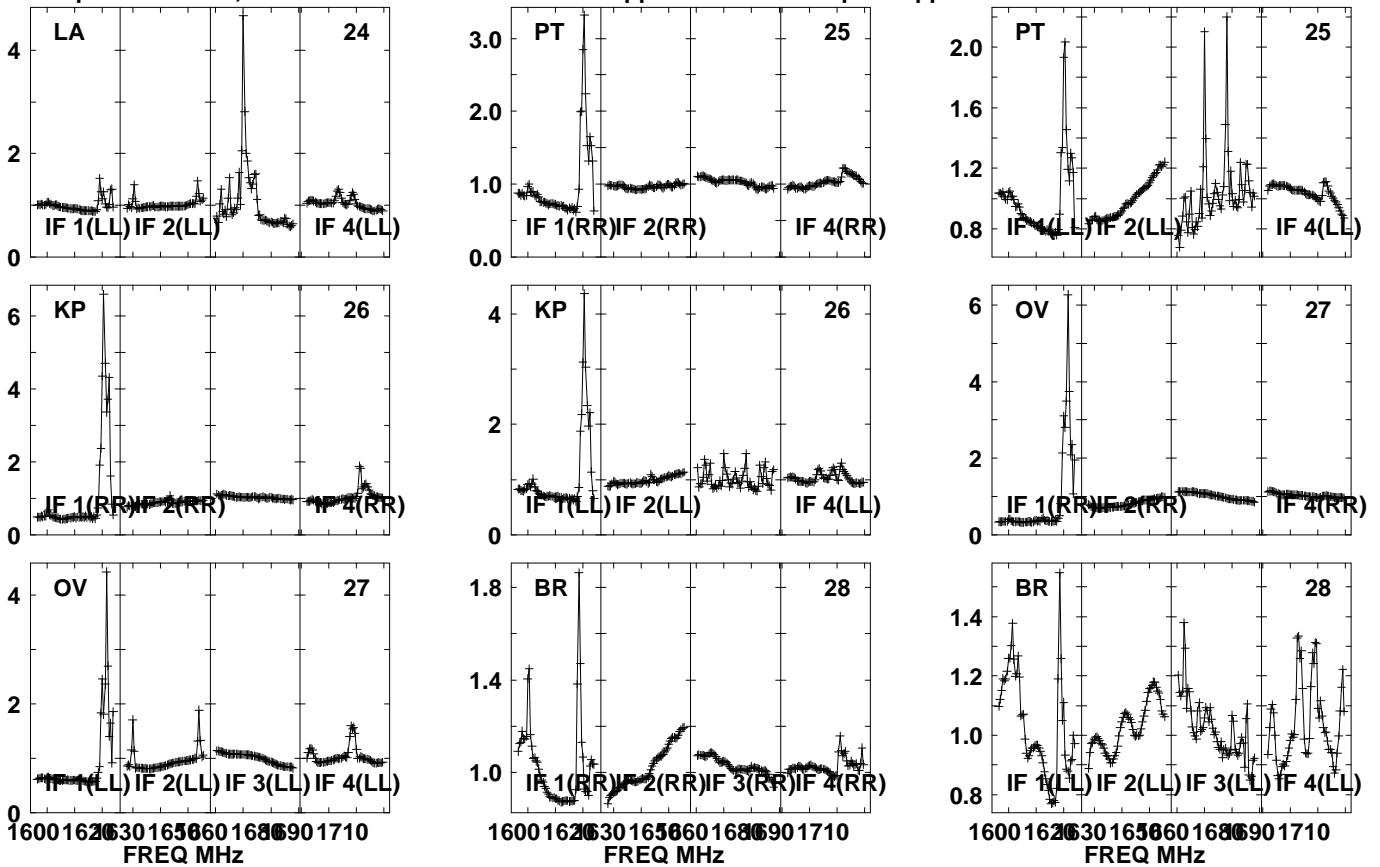

Lower frame: Real Jy

Auto-corr total-power spectrum Antenna: \*

Timerange: 00/17:20:01 to 00/17:21:29

Plot file version 756 created 05-OCT-2021 17:08:05

APM08279+525 GM076.UVDATA.1

Freq = 1.5945 GHz, Bw = 32.000 MH

No calibration applied and no bandpass applied

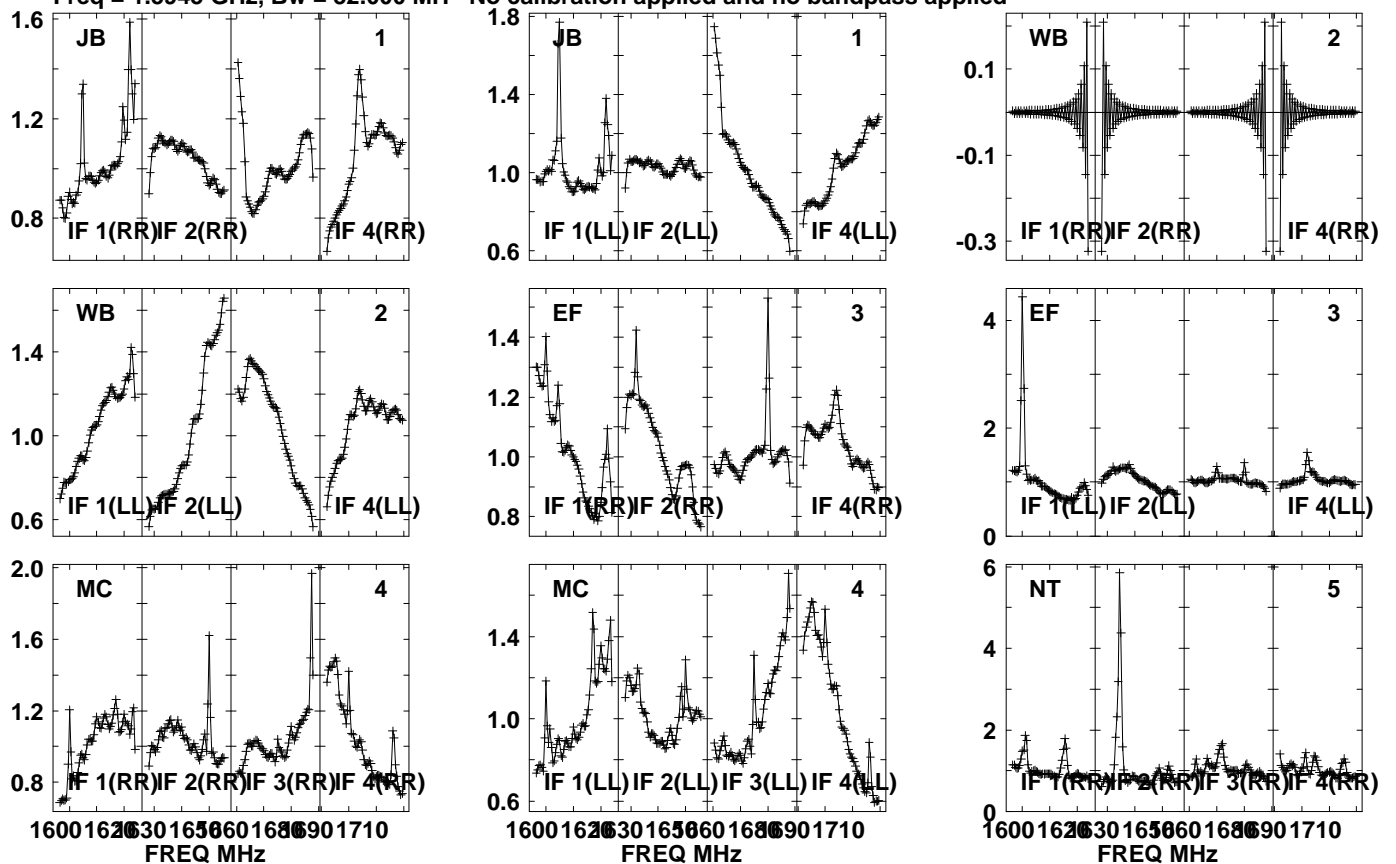

Lower frame: Real Jy  
Auto-corr total-power spectrum Antenna: \*  
Timerange: 00/17:21:31 to 00/17:24:59

Plot file version 757 created 05-OCT-2021 17:08:05

APM08279+525 GM076.UVDATA.1

Freq = 1.5945 GHz, Bw = 32.000 MH No calibration applied and no bandpass applied

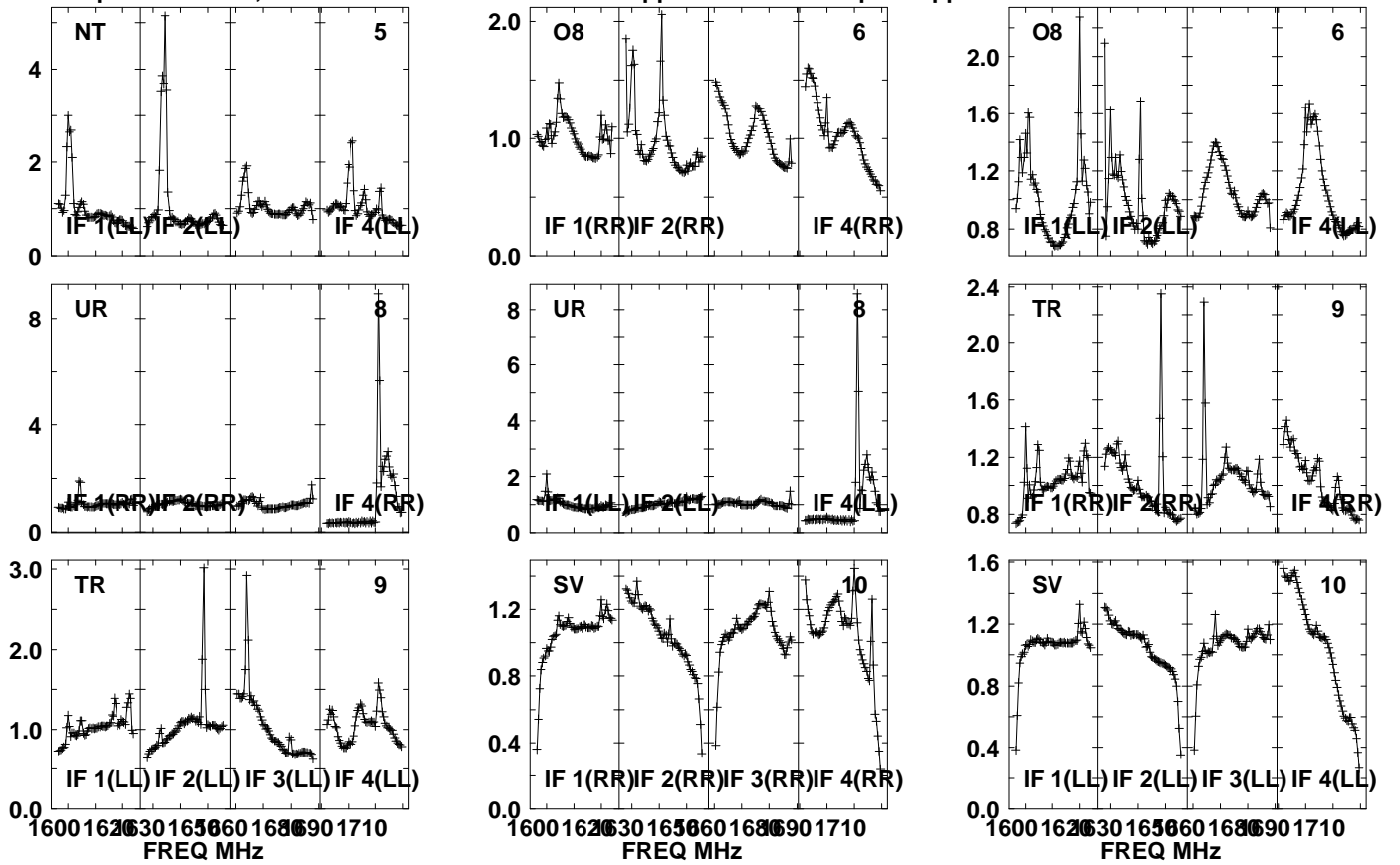

Lower frame: Real Jy

Auto-corr total-power spectrum Antenna: \*

Timerange: 00/17:21:31 to 00/17:24:59

Plot file version 758 created 05-OCT-2021 17:08:05

APM08279+525 GM076.UVDATA.1

Freq = 1.5945 GHz, Bw = 32.000 MH No calibration applied and no bandpass applied

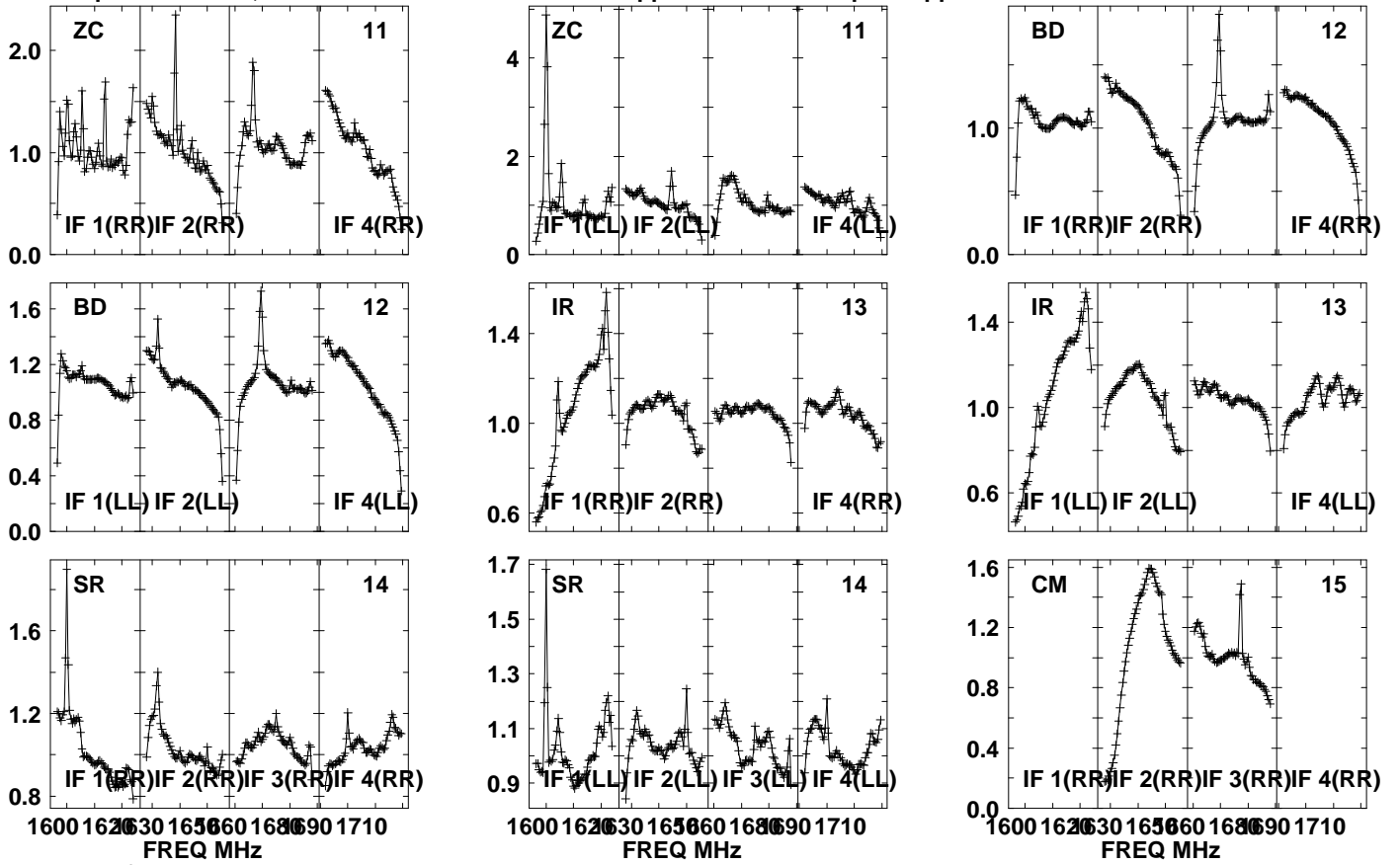

Lower frame: Real Jy  
Auto-corr total-power spectrum Antenna: \*  
Timerange: 00/17:21:31 to 00/17:24:59

Plot file version 759 created 05-OCT-2021 17:08:06

APM08279+525 GM076.UVDATA.1

Freq = 1.5945 GHz, Bw = 32.000 MH No calibration applied and no bandpass applied

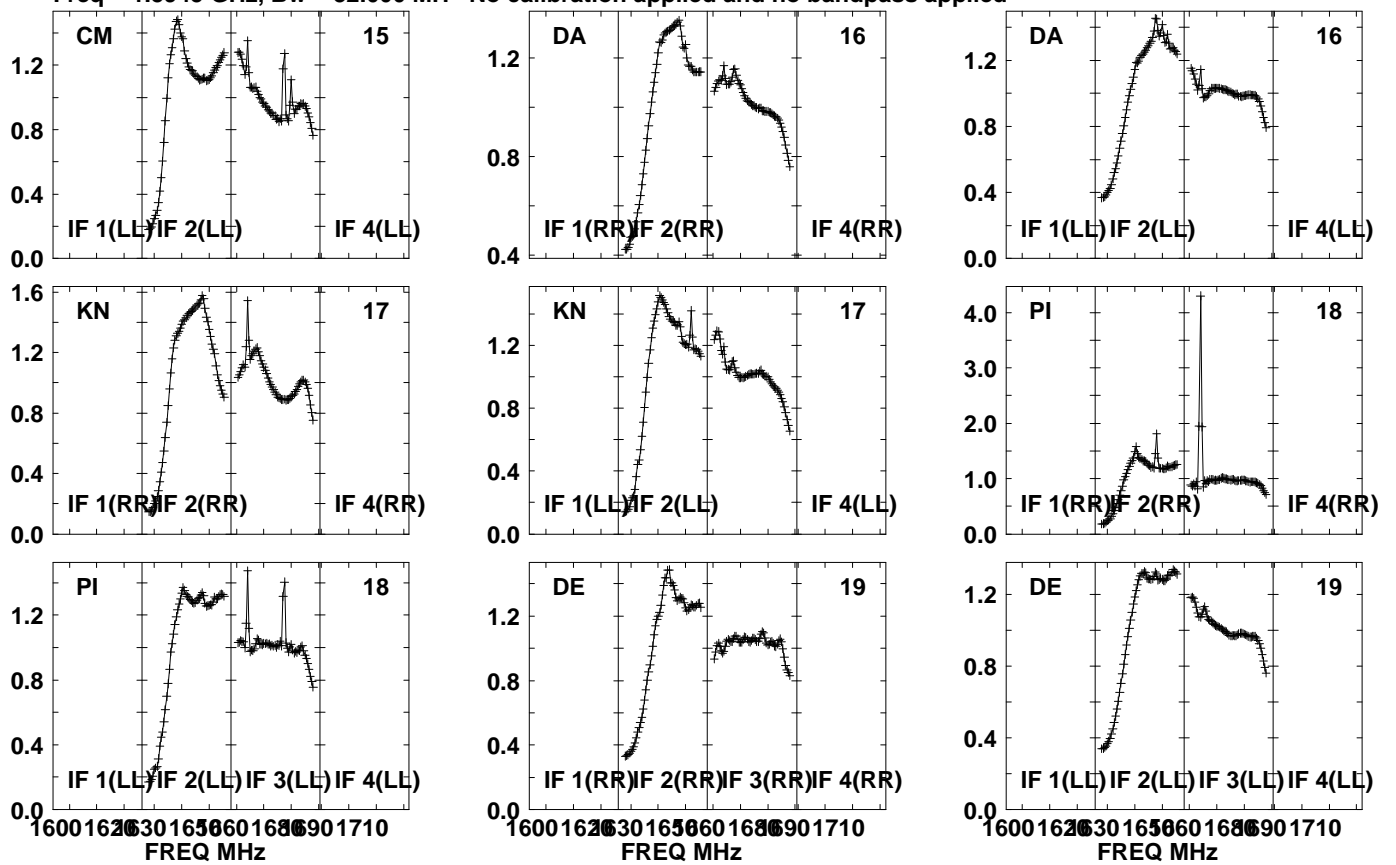

Lower frame: Real Jy  
Auto-corr total-power spectrum Antenna: \*  
Timerange: 00/17:21:31 to 00/17:24:59

Plot file version 760 created 05-OCT-2021 17:08:06

APM08279+525 GM076.UVDATA.1

Freq = 1.5945 GHz, Bw = 32.000 MH No calibration applied and no bandpass applied

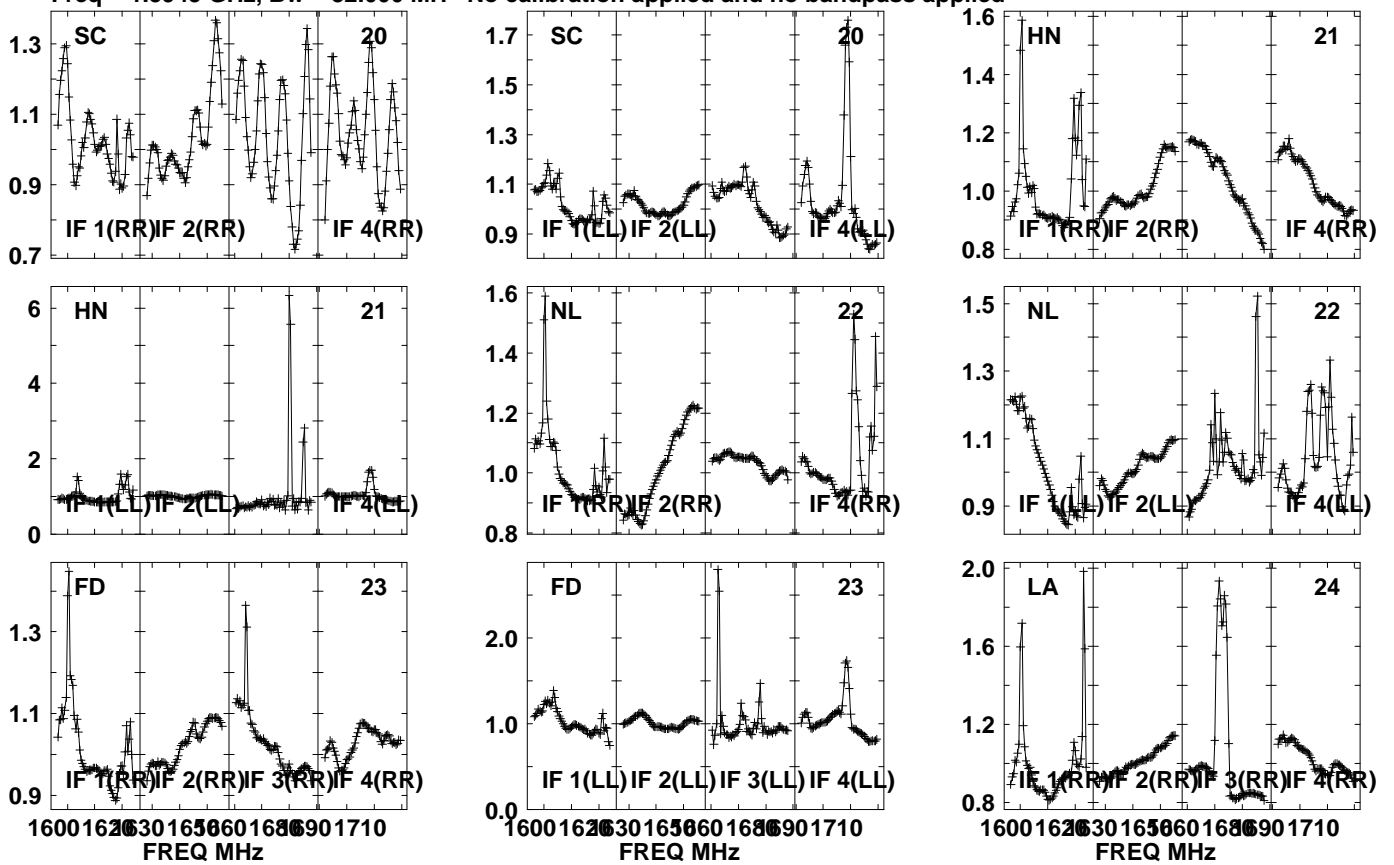

Lower frame: Real Jy  
Auto-corr total-power spectrum Antenna: \*  
Timerange: 00/17:21:31 to 00/17:24:59

Plot file version 761 created 05-OCT-2021 17:08:06

APM08279+525 GM076.UVDATA.1

Freq = 1.5945 GHz, Bw = 32.000 MH

No calibration applied and no bandpass applied

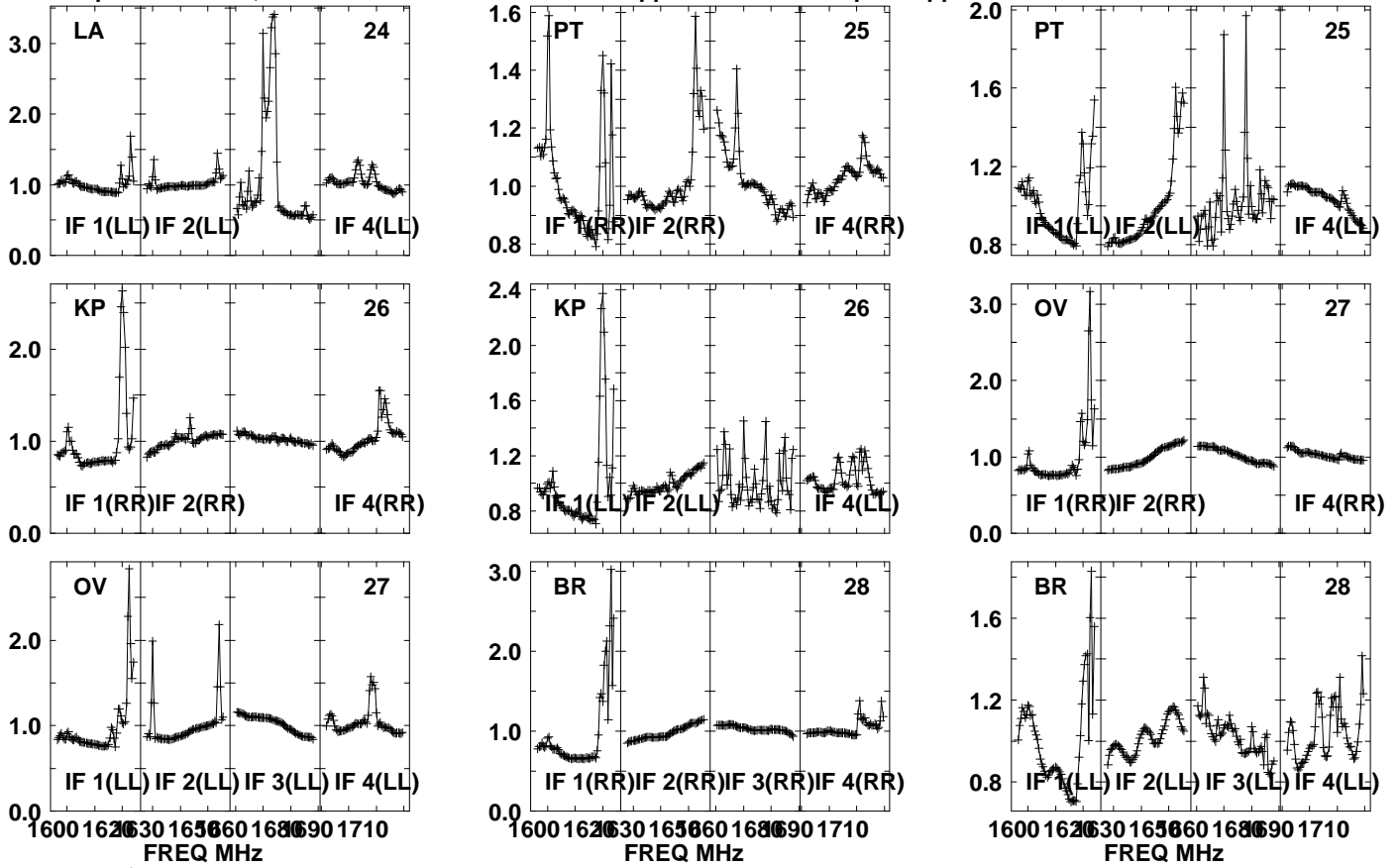

Lower frame: Real Jy

Auto-corr total-power spectrum Antenna: \*

Timerange: 00/17:21:31 to 00/17:24:59

Plot file version 762 created 05-OCT-2021 17:08:07

J0827+5217 GM076.UVDATA.1

Freq = 1.5945 GHz, Bw = 32.000 MH No calibration applied and no bandpass applied

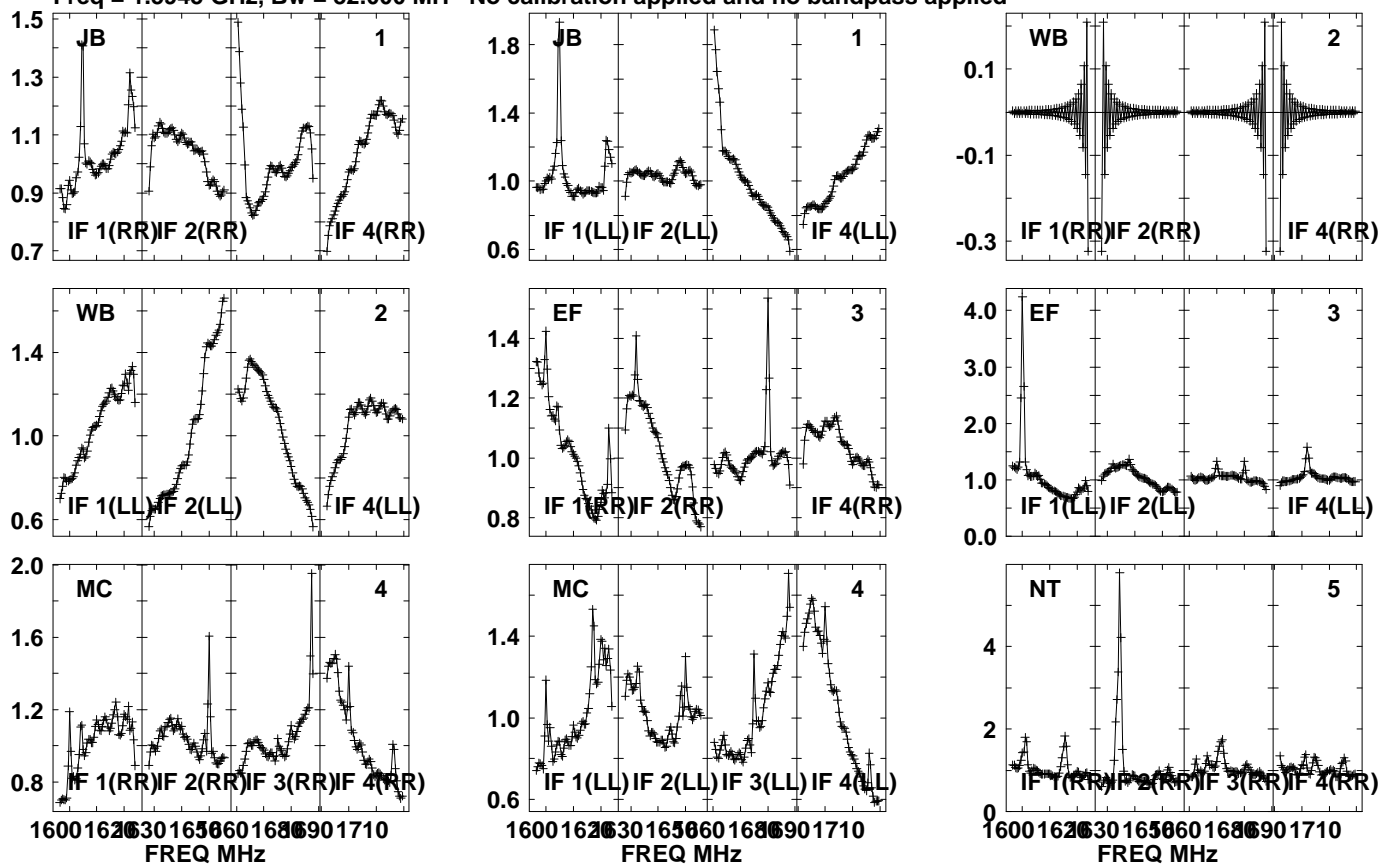

Lower frame: Real Jy  
Auto-corr total-power spectrum Antenna: \*  
Timerange: 00/17:25:01 to 00/17:26:29



Plot file version 763 created 05-OCT-2021 17:08:07

J0827+5217 GM076.UVDATA.1

Freq = 1.5945 GHz, Bw = 32.000 MH No calibration applied and no bandpass applied

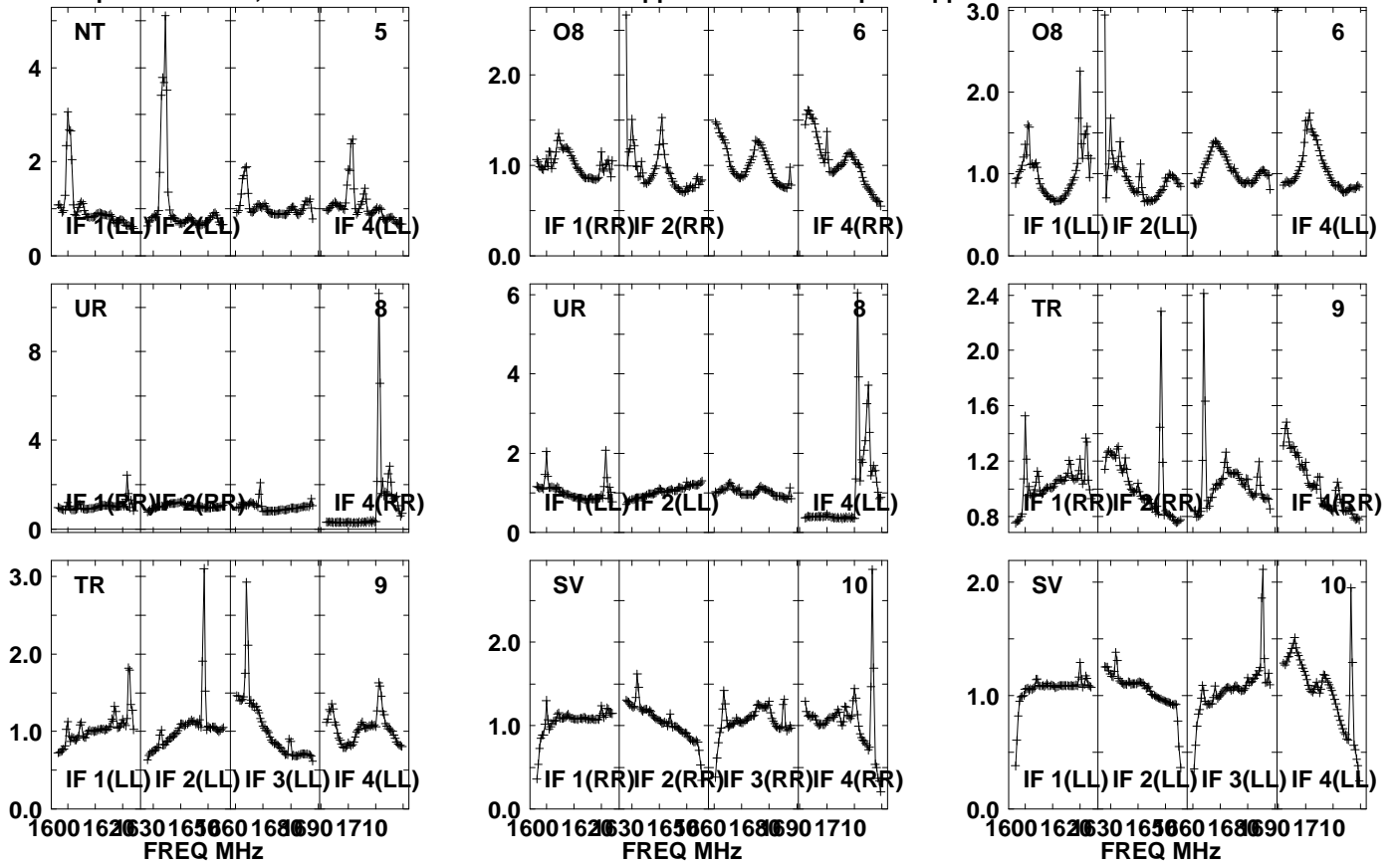

Lower frame: Real Jy  
Auto-corr total-power spectrum Antenna: \*  
Timerange: 00/17:25:01 to 00/17:26:29

Plot file version 764 created 05-OCT-2021 17:08:07

J0827+5217 GM076.UVDATA.1

Freq = 1.5945 GHz, Bw = 32.000 MH No calibration applied and no bandpass applied

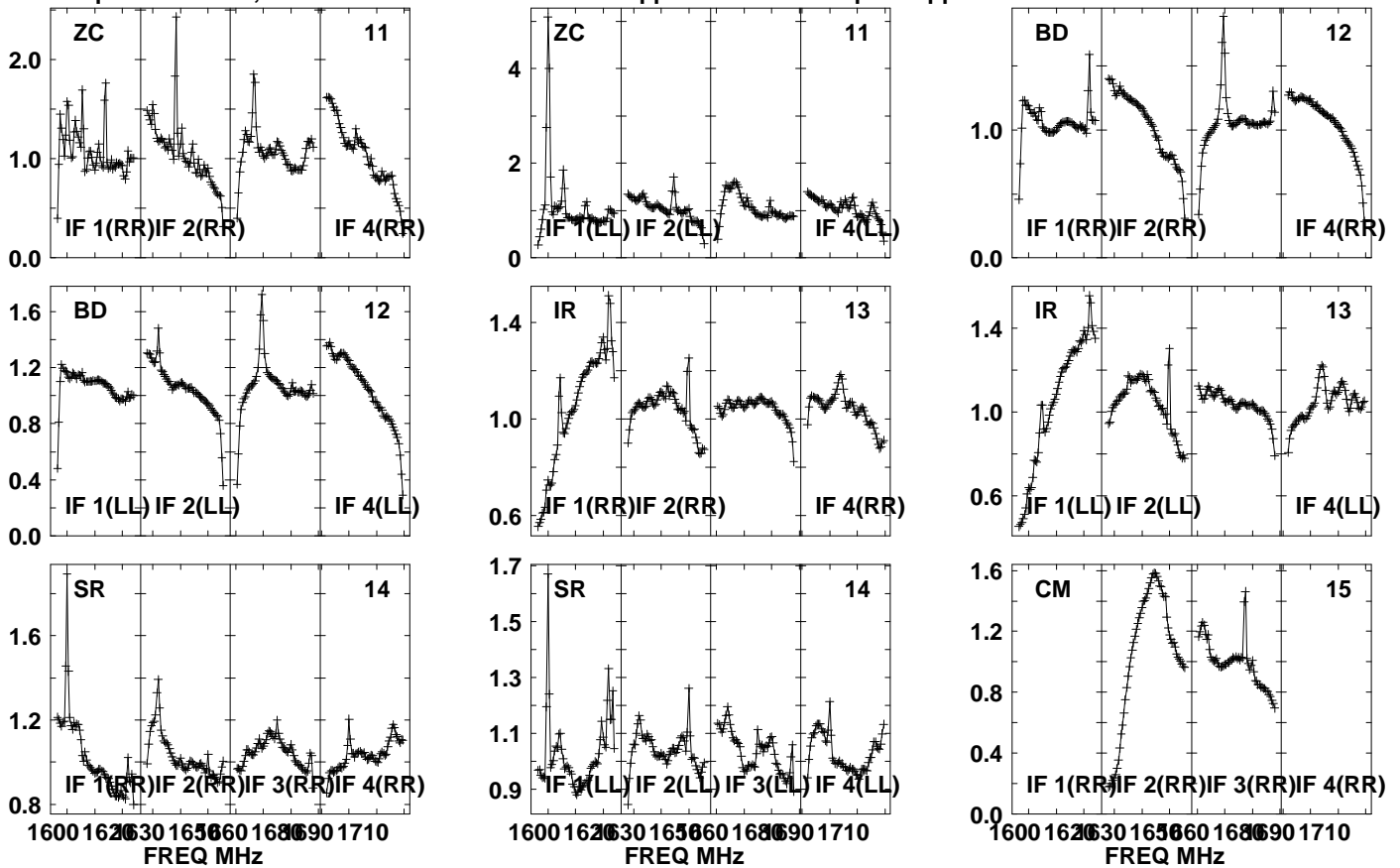

Lower frame: Real Jy

Auto-corr total-power spectrum Antenna: \*

Timerange: 00/17:25:01 to 00/17:26:29

Plot file version 765 created 05-OCT-2021 17:08:08

J0827+5217 GM076.UVDATA.1

Freq = 1.5945 GHz, Bw = 32.000 MH No calibration applied and no bandpass applied

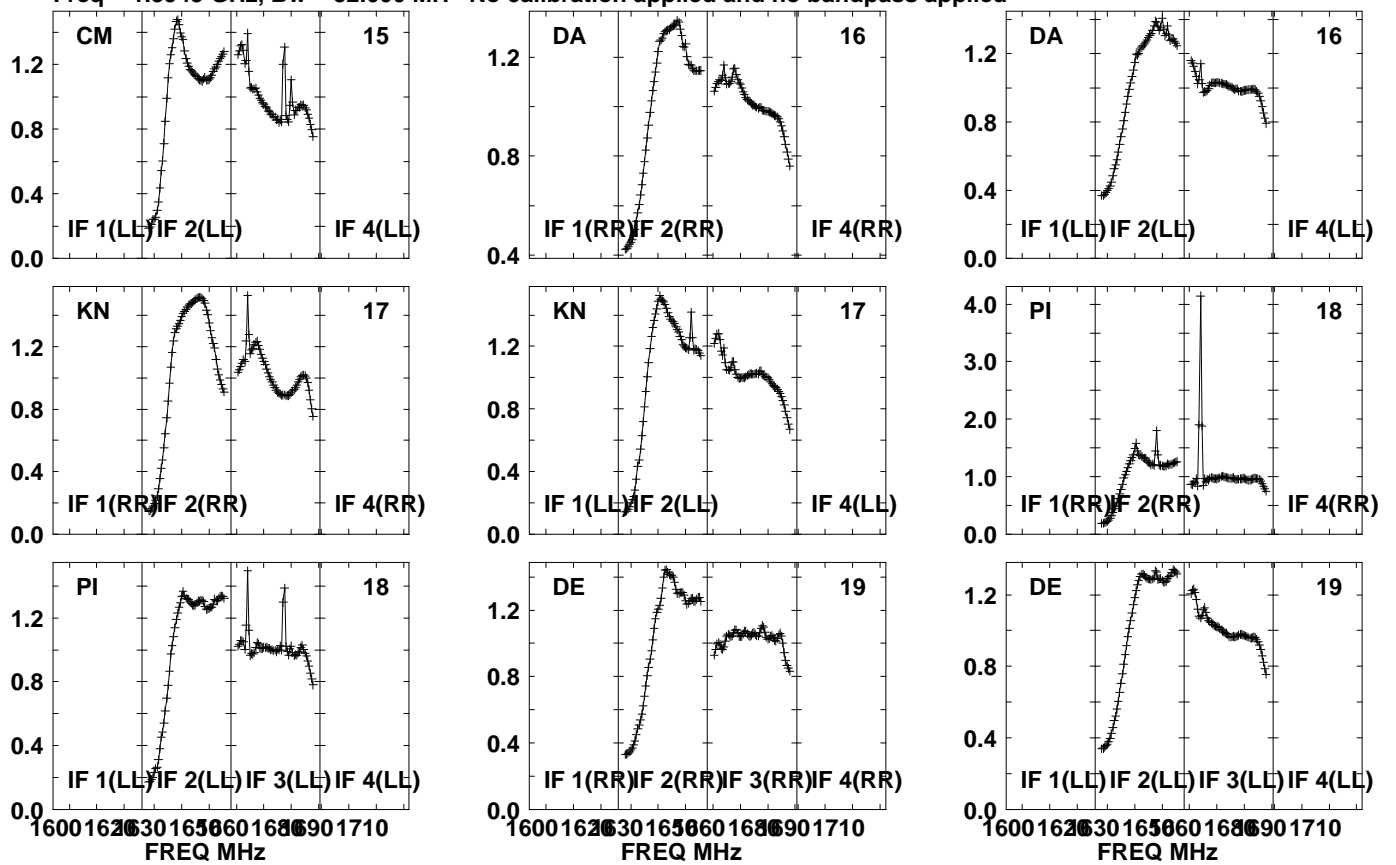

Lower frame: Real Jy  
Auto-corr total-power spectrum Antenna: \*  
Timerange: 00/17:25:01 to 00/17:26:29

Plot file version 766 created 05-OCT-2021 17:08:08

J0827+5217 GM076.UVDATA.1

Freq = 1.5945 GHz, Bw = 32.000 MH No calibration applied and no bandpass applied

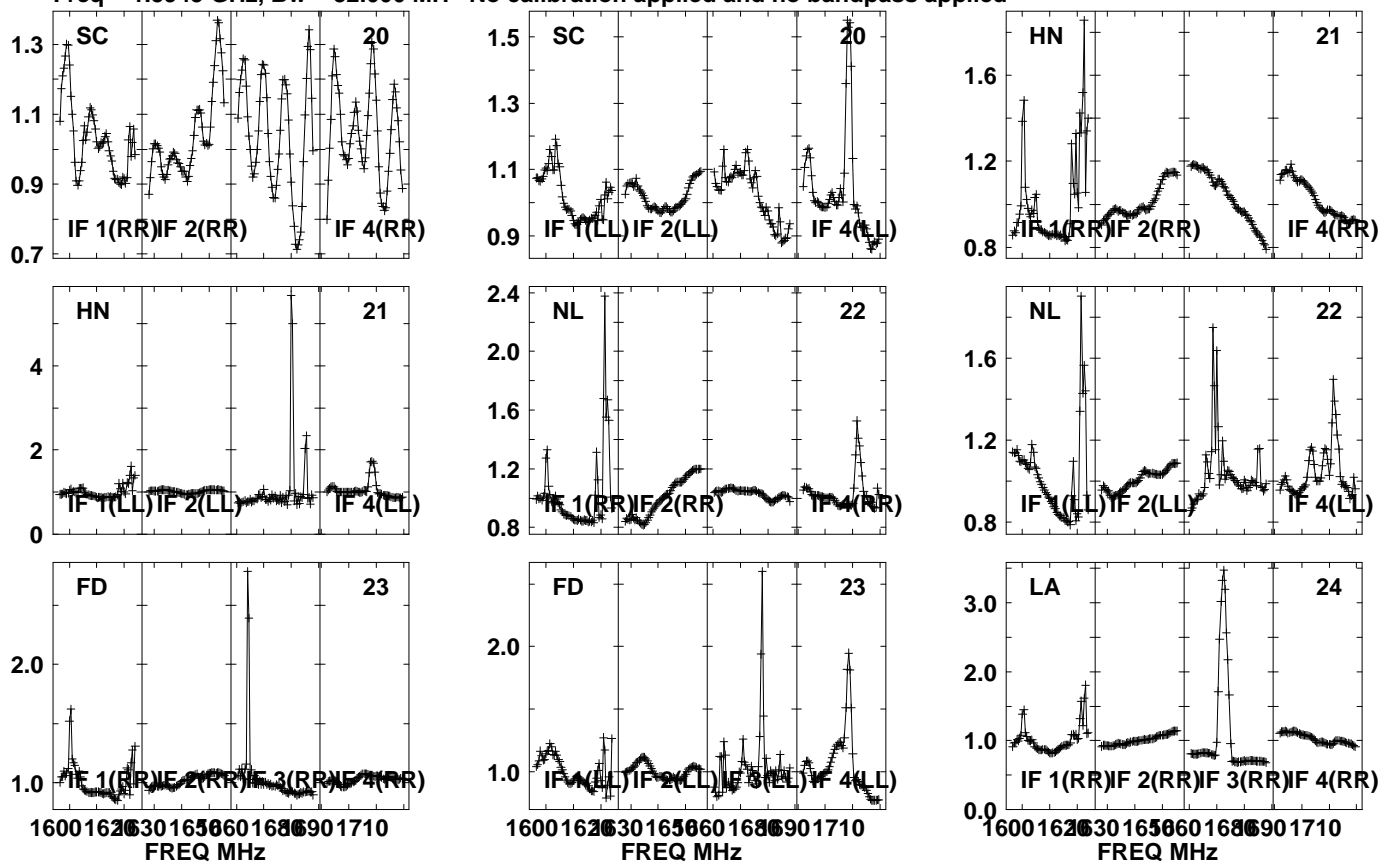

Lower frame: Real Jy  
Auto-corr total-power spectrum Antenna: \*  
Timerange: 00/17:25:01 to 00/17:26:29

Plot file version 767 created 05-OCT-2021 17:08:08

J0827+5217 GM076.UVDATA.1

Freq = 1.5945 GHz, Bw = 32.000 MH No calibration applied and no bandpass applied

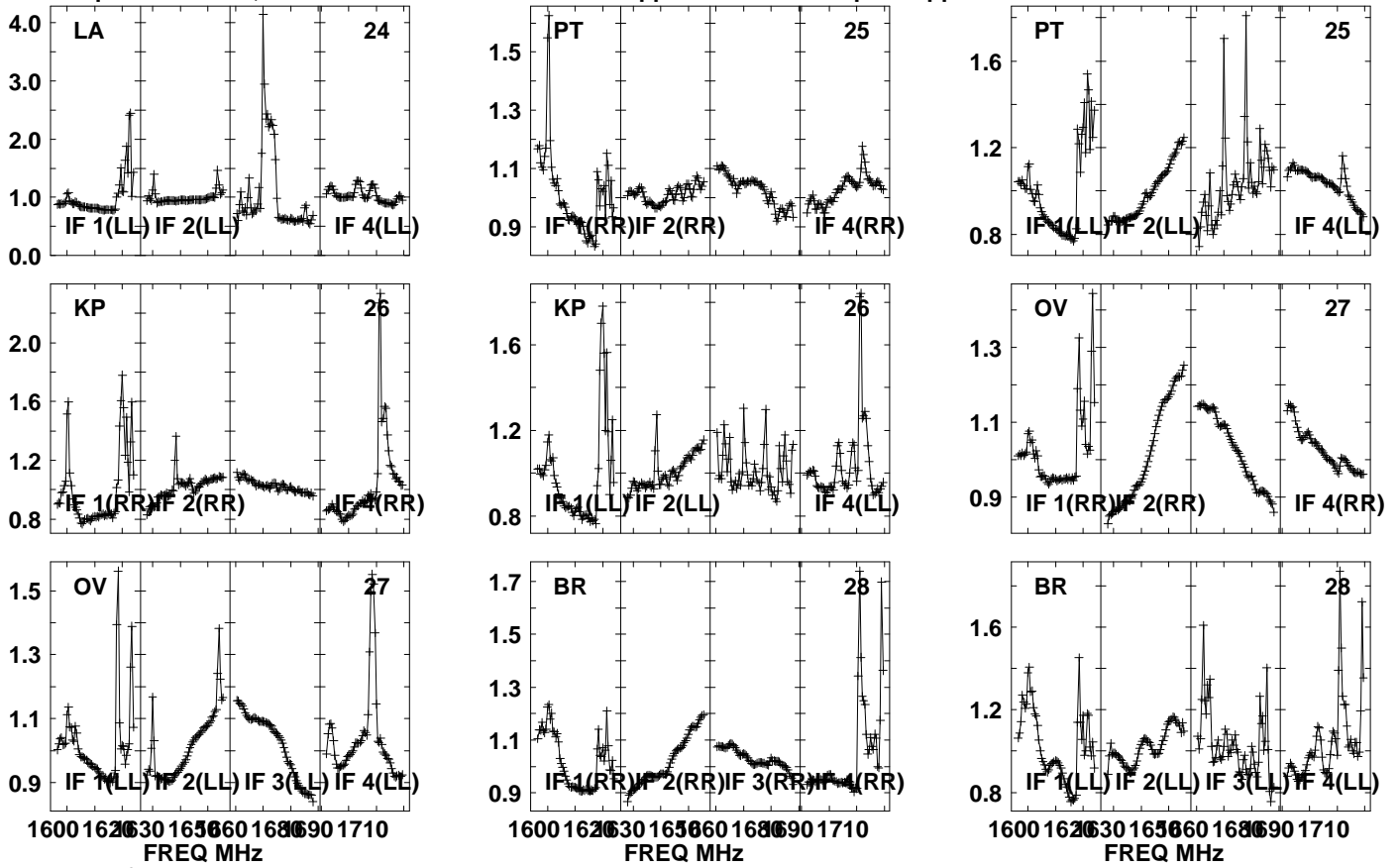

Lower frame: Real Jy  
Auto-corr total-power spectrum Antenna: \*  
Timerange: 00/17:25:01 to 00/17:26:29

Plot file version 768 created 05-OCT-2021 17:08:09

APM08279+525 GM076.UVDATA.1

Freq = 1.5945 GHz, Bw = 32.000 MH No calibration applied and no bandpass applied

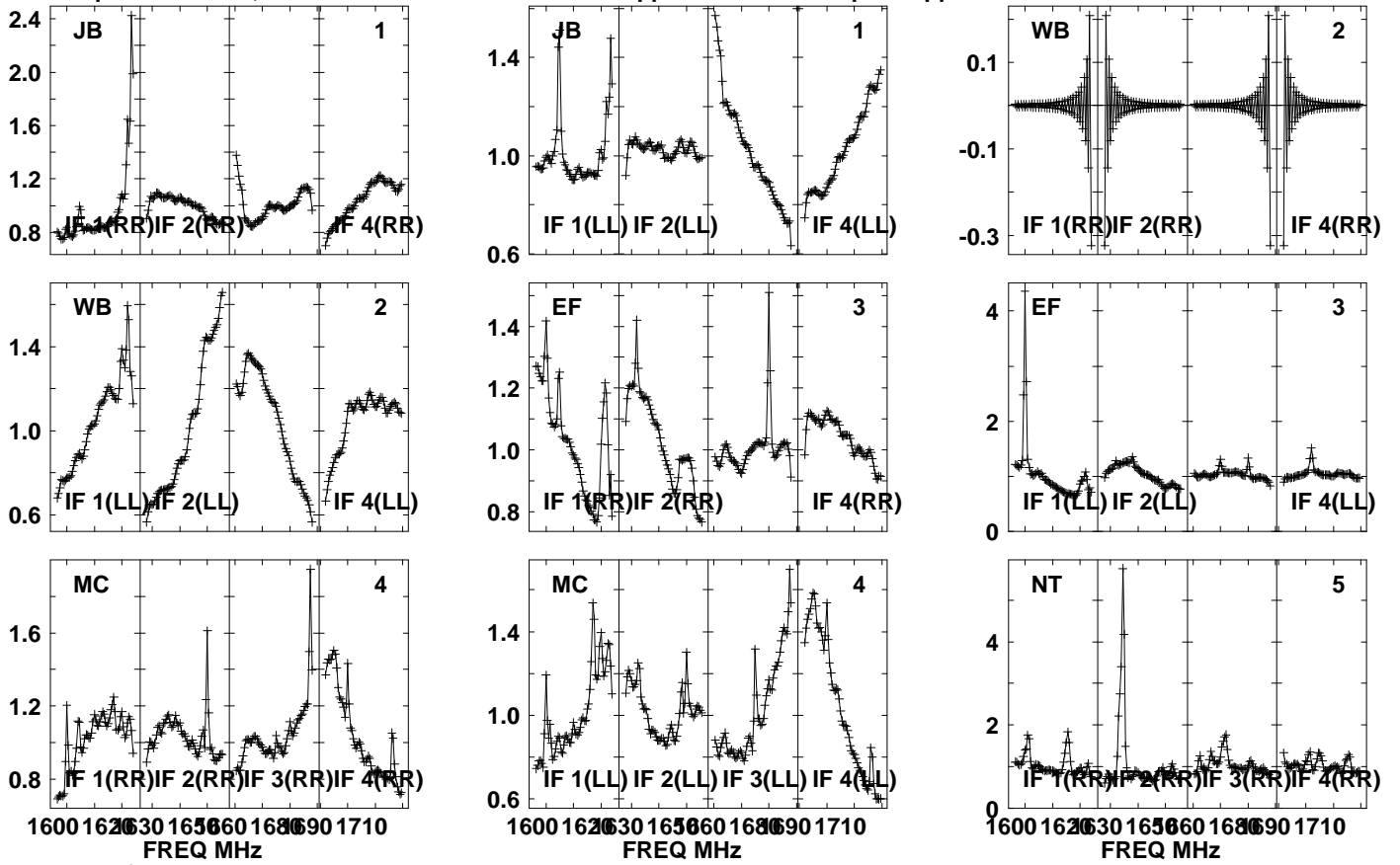

Lower frame: Real Jy

Auto-corr total-power spectrum Antenna: \*

Timerange: 00/17:26:31 to 00/17:29:59

Plot file version 769 created 05-OCT-2021 17:08:09

APM08279+525 GM076.UVDATA.1

Freq = 1.5945 GHz, Bw = 32.000 MH No calibration applied and no bandpass applied

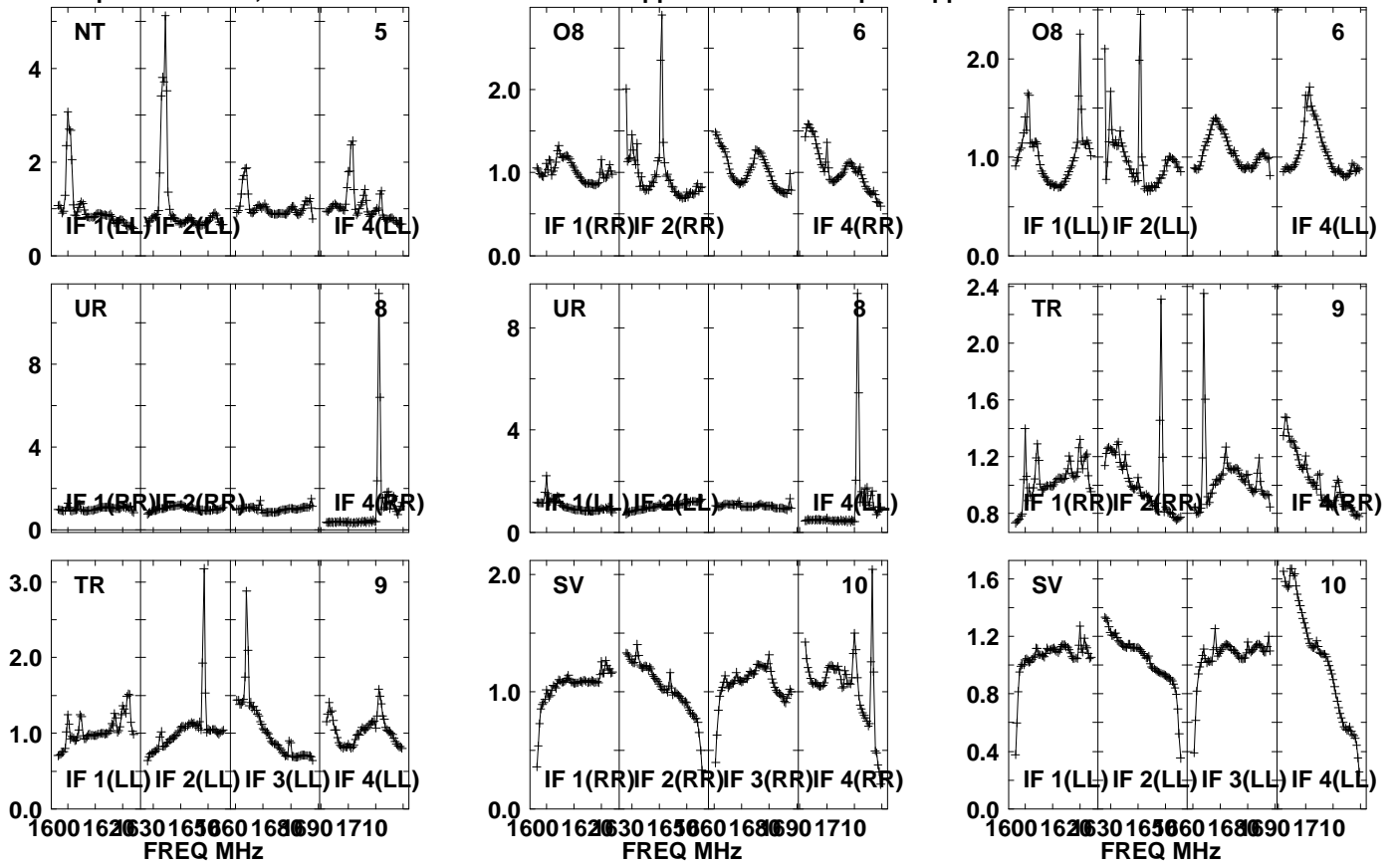

Lower frame: Real Jy

Auto-corr total-power spectrum Antenna: \*

Timerange: 00/17:26:31 to 00/17:29:59

Plot file version 770 created 05-OCT-2021 17:08:09

APM08279+525 GM076.UVDATA.1

Freq = 1.5945 GHz, Bw = 32.000 MH No calibration applied and no bandpass applied

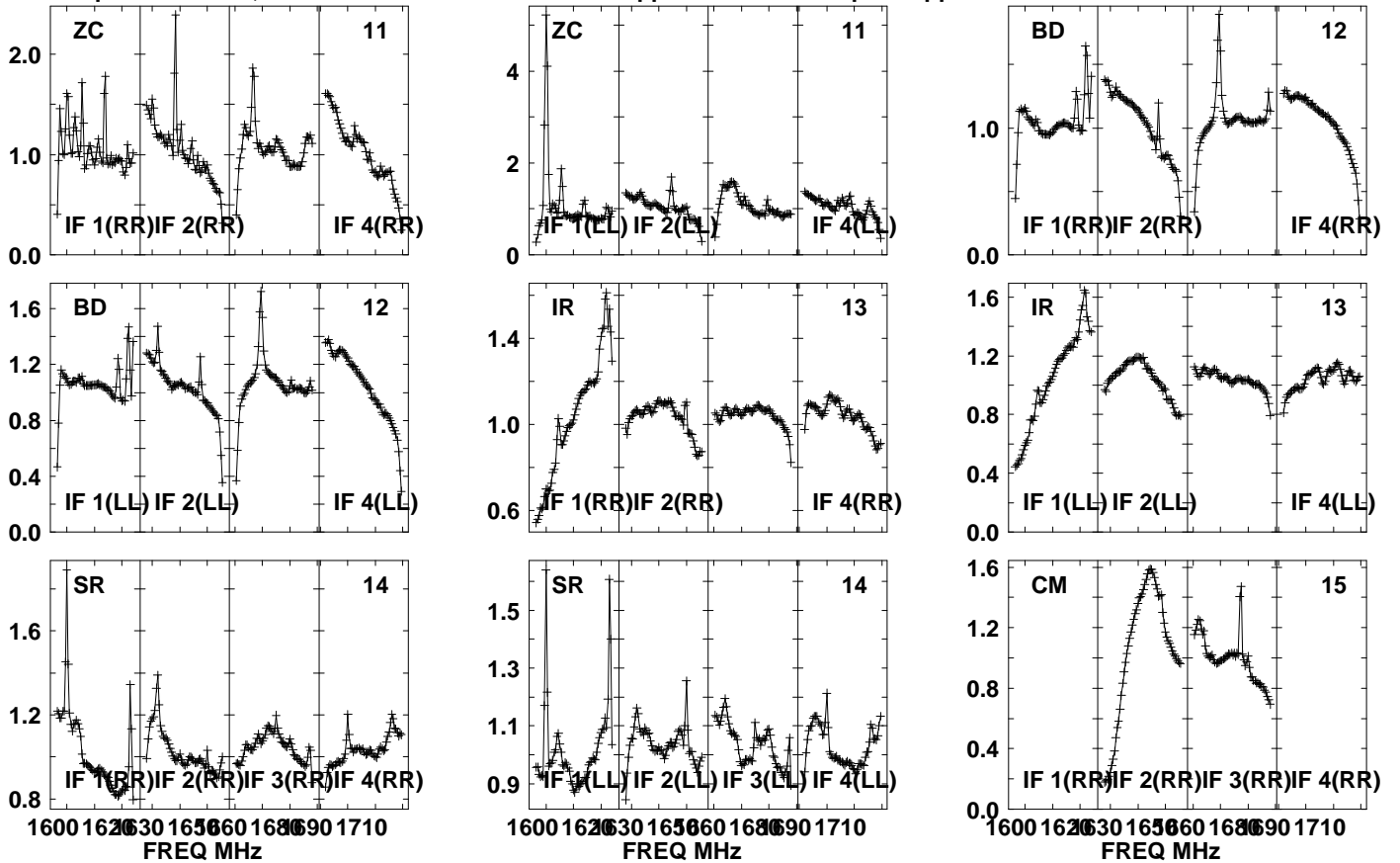

Lower frame: Real Jy

Auto-corr total-power spectrum Antenna: \*

Timerange: 00/17:26:31 to 00/17:29:59



Plot file version 771 created 05-OCT-2021 17:08:10

APM08279+525 GM076.UVDATA.1

Freq = 1.5945 GHz, Bw = 32.000 MH No calibration applied and no bandpass applied

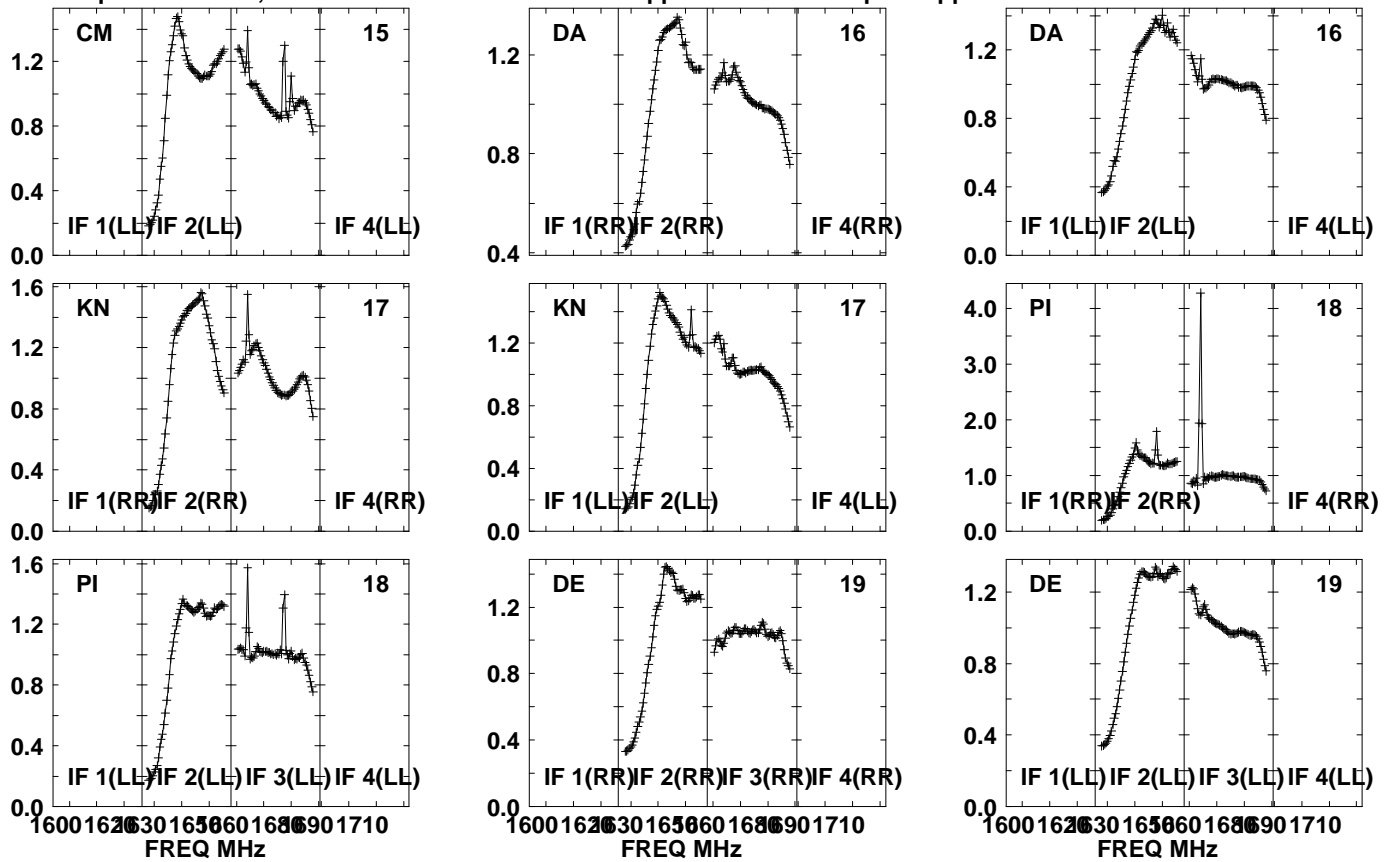

Lower frame: Real Jy  
Auto-corr total-power spectrum Antenna: \*  
Timerange: 00/17:26:31 to 00/17:29:59

Plot file version 772 created 05-OCT-2021 17:08:10

APM08279+525 GM076.UVDATA.1

Freq = 1.5945 GHz, Bw = 32.000 MH No calibration applied and no bandpass applied

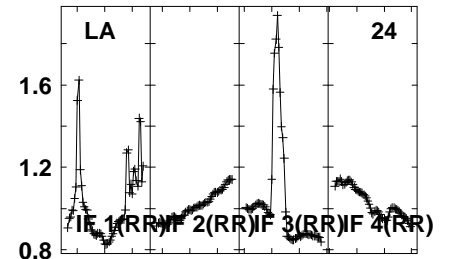
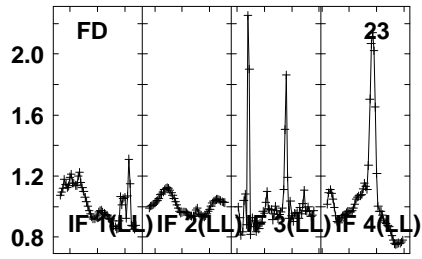
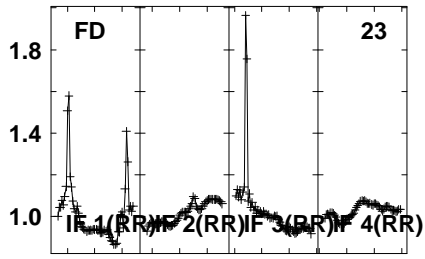
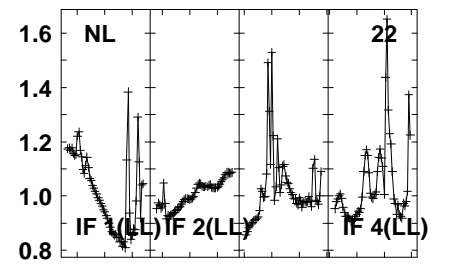
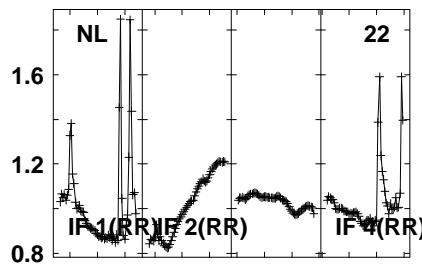
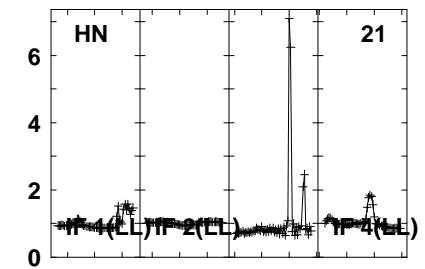
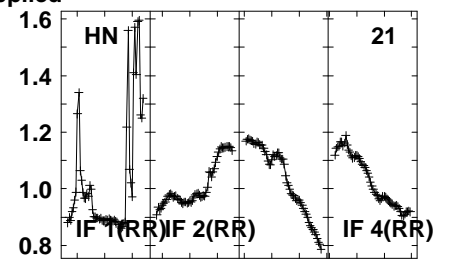
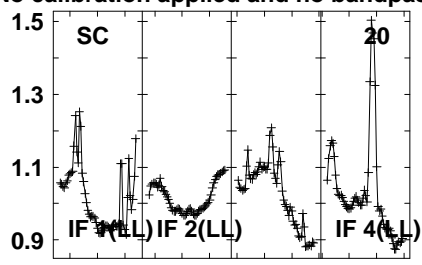
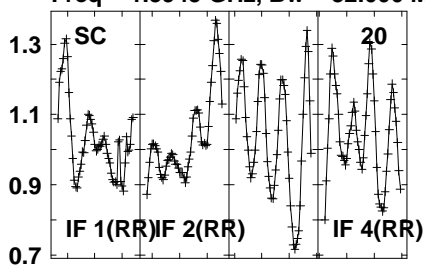

1600 1620 1630 1650 1660 1680 1690 1710  
FREQ MHz

1600 1620 1630 1650 1660 1680 1690 1710  
FREQ MHz

1600 1620 1630 1650 1660 1680 1690 1710  
FREQ MHz

Lower frame: Real Jy  
Auto-corr total-power spectrum Antenna: \*  
Timerange: 00/17:26:31 to 00/17:29:59

Plot file version 773 created 05-OCT-2021 17:08:10

APM08279+525 GM076.UVDATA.1

Freq = 1.5945 GHz, Bw = 32.000 MH No calibration applied and no bandpass applied

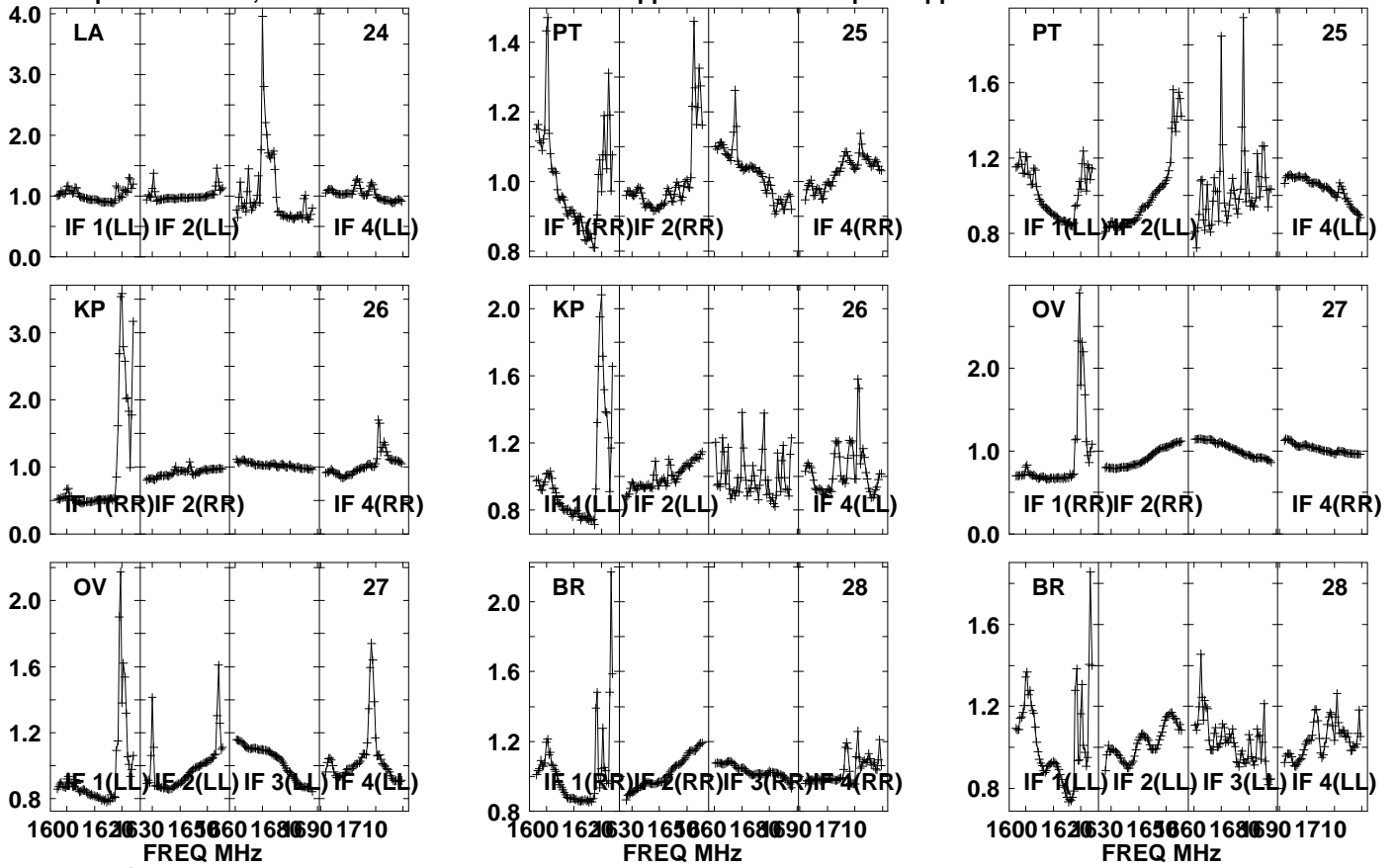

Lower frame: Real Jy  
Auto-corr total-power spectrum Antenna: \*  
Timerange: 00/17:26:31 to 00/17:29:59

Plot file version 774 created 05-OCT-2021 17:08:11

J0827+5217 GM076.UVDATA.1

Freq = 1.5945 GHz, Bw = 32.000 MH No calibration applied and no bandpass applied

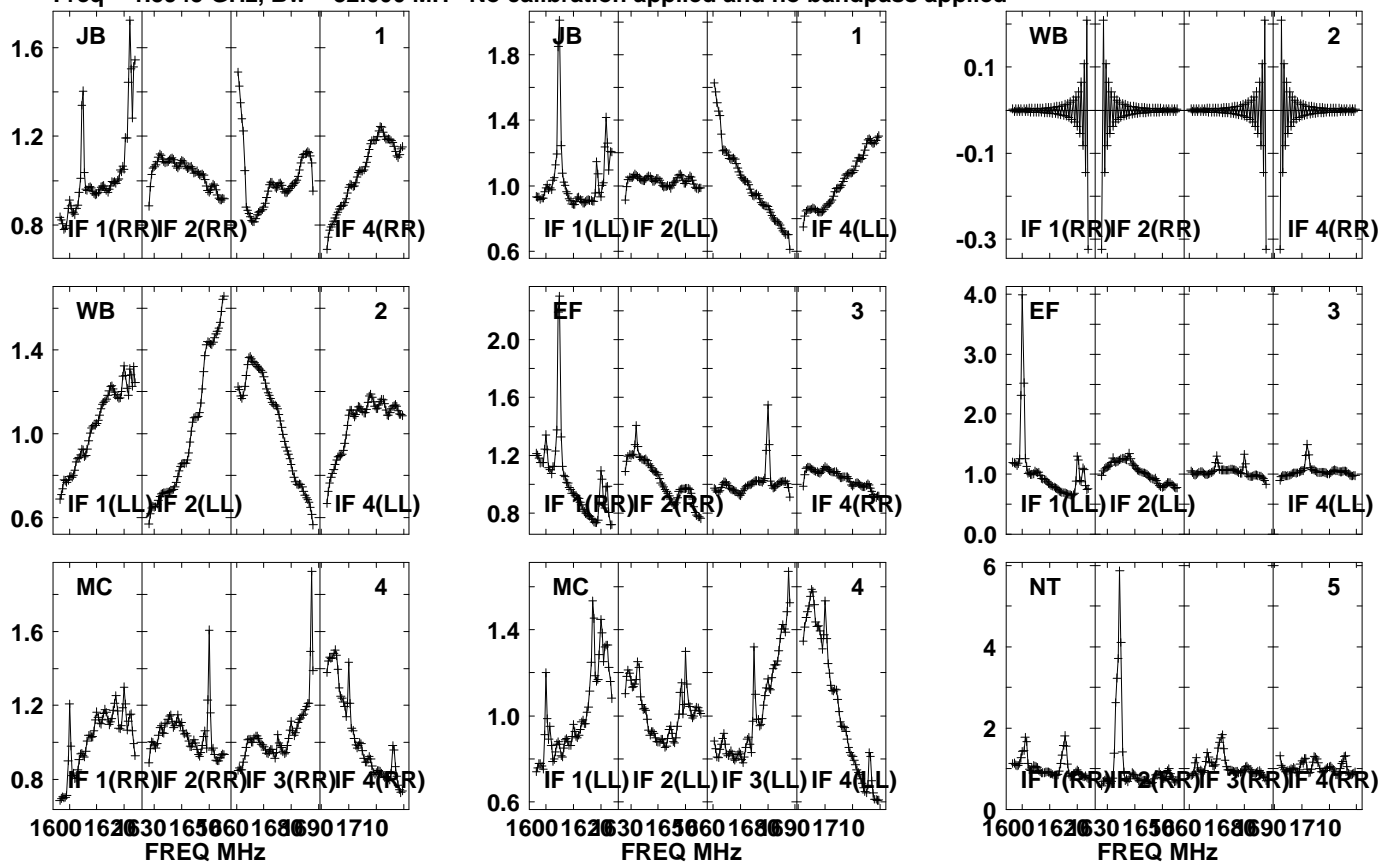

Lower frame: Real Jy  
Auto-corr total-power spectrum Antenna: \*  
Timerange: 00/17:30:31 to 00/17:31:59

Plot file version 775 created 05-OCT-2021 17:08:11

J0827+5217 GM076.UVDATA.1

Freq = 1.5945 GHz, Bw = 32.000 MH No calibration applied and no bandpass applied

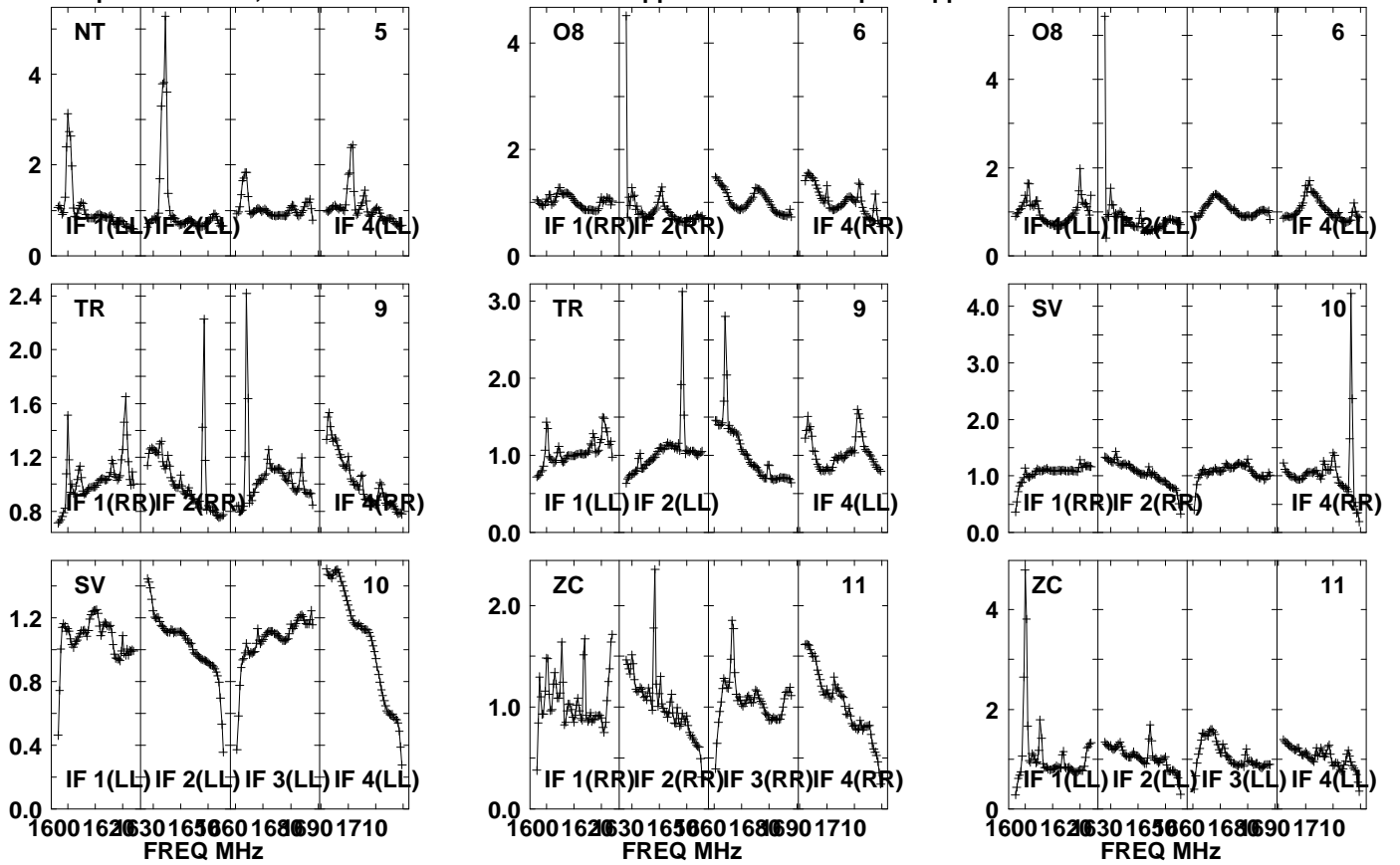

Lower frame: Real Jy

Auto-corr total-power spectrum Antenna: \*

Timerange: 00/17:30:31 to 00/17:31:59

Plot file version 776 created 05-OCT-2021 17:08:11

J0827+5217 GM076.UVDATA.1

Freq = 1.5945 GHz, Bw = 32.000 MH No calibration applied and no bandpass applied

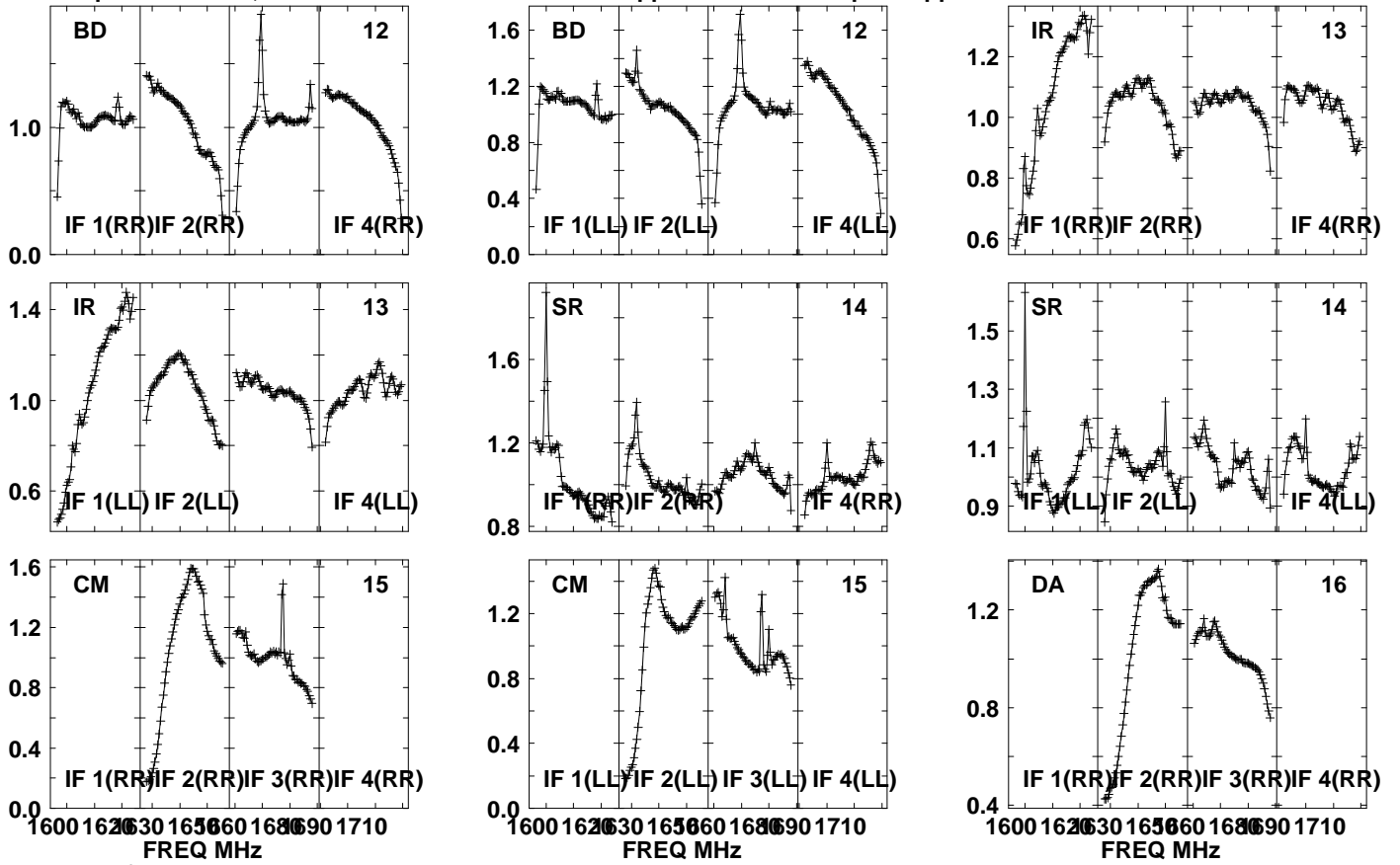

Lower frame: Real Jy  
Auto-corr total-power spectrum Antenna: \*  
Timerange: 00/17:30:31 to 00/17:31:59

Plot file version 777 created 05-OCT-2021 17:08:12

J0827+5217 GM076.UVDATA.1

Freq = 1.5945 GHz, Bw = 32.000 MH No calibration applied and no bandpass applied

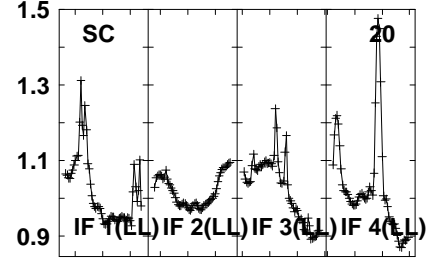
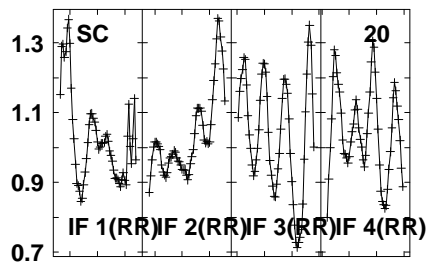
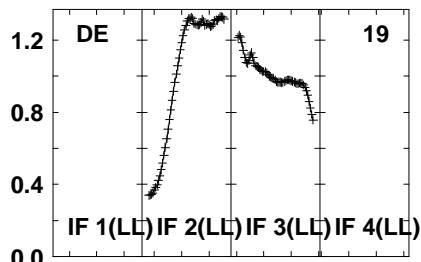
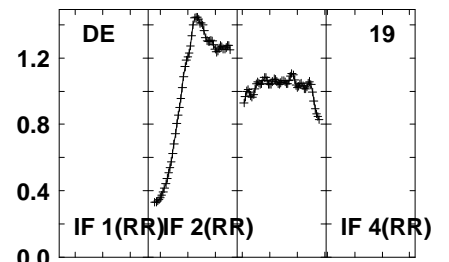
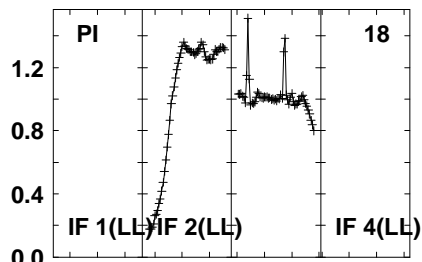
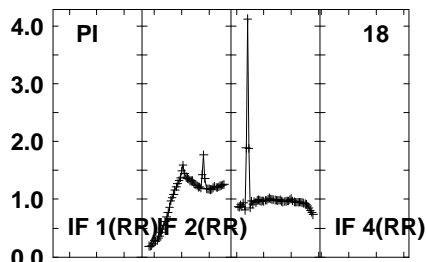
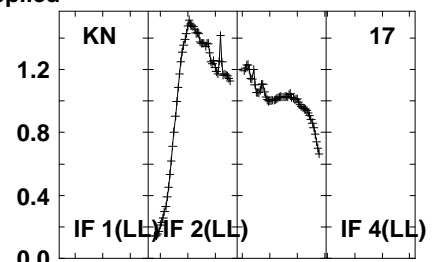
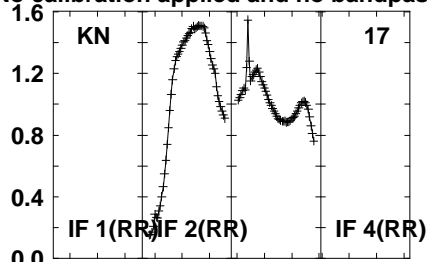
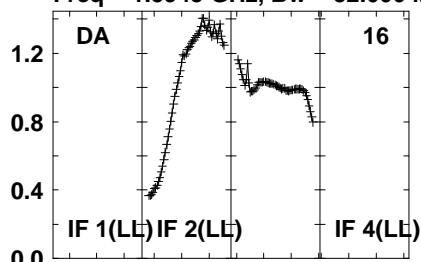

1600 1620 1630 1650 1660 1680 1690 1710  
FREQ MHz

1600 1620 1630 1650 1660 1680 1690 1710  
FREQ MHz

1600 1620 1630 1650 1660 1680 1690 1710  
FREQ MHz

Lower frame: Real Jy  
Auto-corr total-power spectrum Antenna: \*  
Timerange: 00/17:30:31 to 00/17:31:59

Plot file version 778 created 05-OCT-2021 17:08:12

J0827+5217 GM076.UVDATA.1

Freq = 1.5945 GHz, Bw = 32.000 MH No calibration applied and no bandpass applied

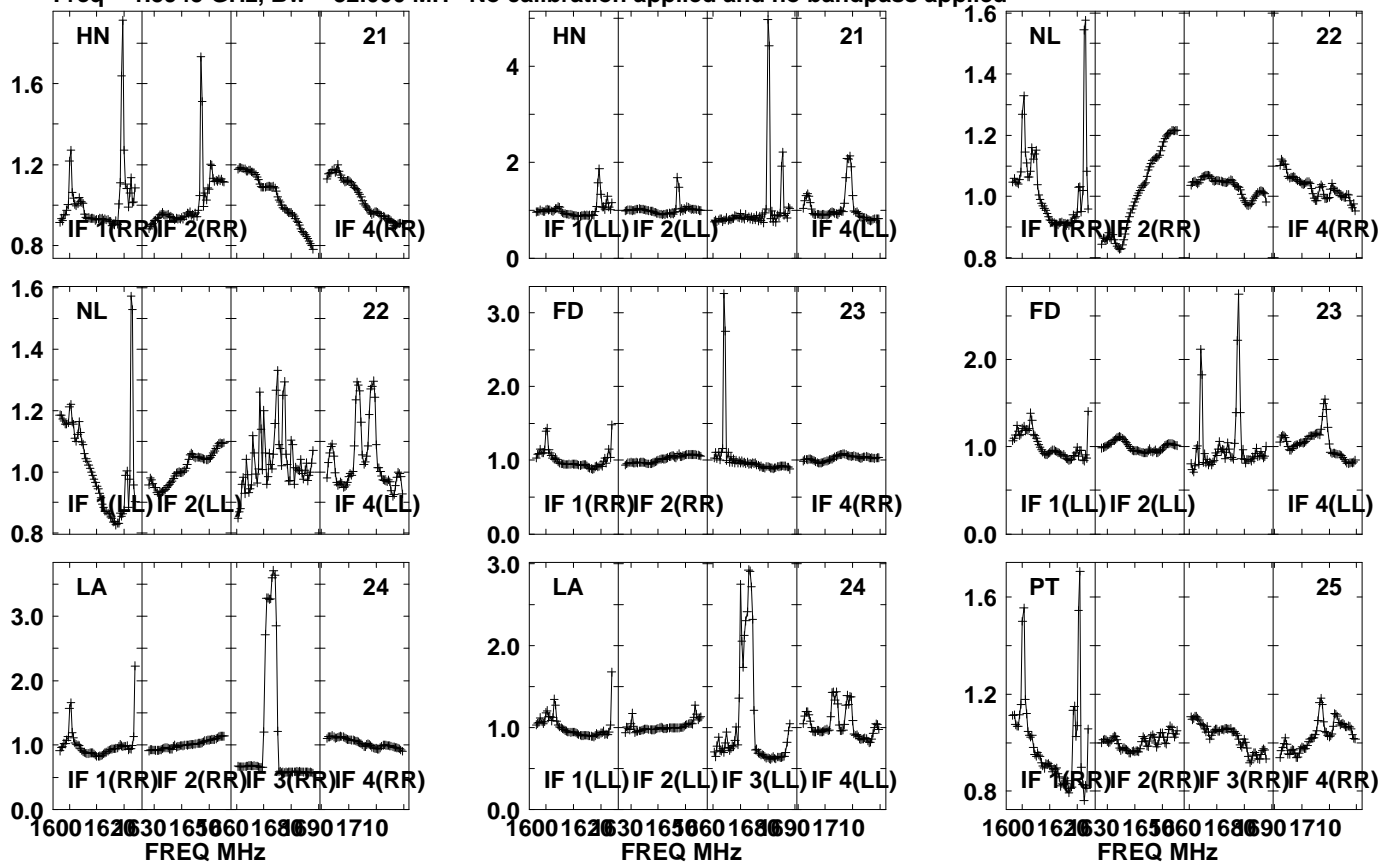

Lower frame: Real Jy  
Auto-corr total-power spectrum Antenna: \*  
Timerange: 00/17:30:31 to 00/17:31:59



Plot file version 779 created 05-OCT-2021 17:08:12

J0827+5217 GM076.UVDATA.1

Freq = 1.5945 GHz, Bw = 32.000 MH No calibration applied and no bandpass applied

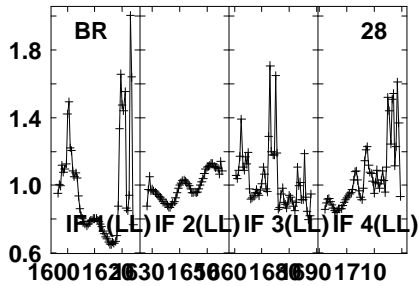
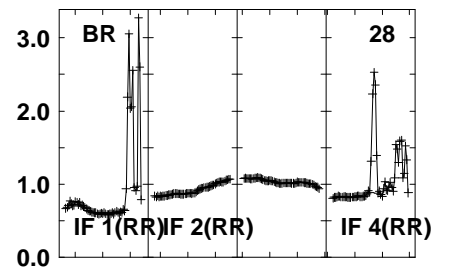
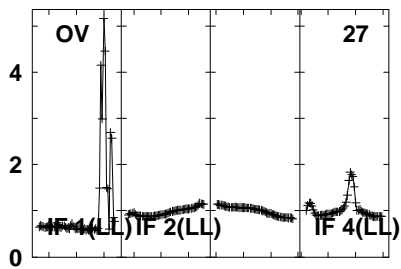
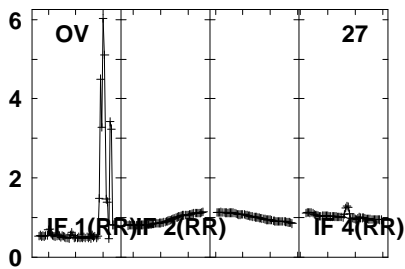
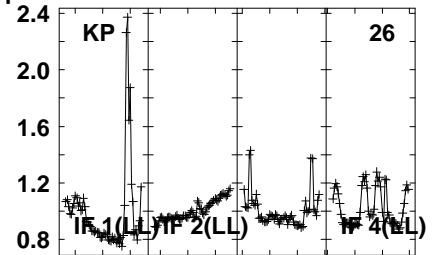
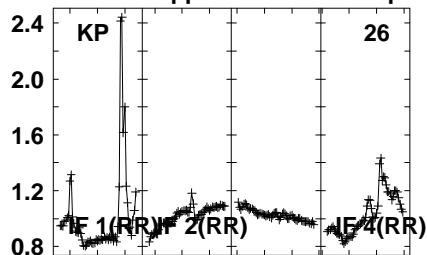
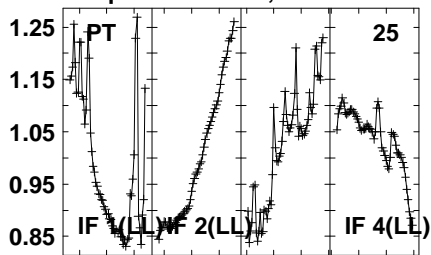

1600 1620 1630 1650 1660 1680 1690 1710  
FREQ MHz

Lower frame: Real Jy  
Auto-corr total-power spectrum Antenna: \*  
Timerange: 00/17:30:31 to 00/17:31:59

Plot file version 780 created 05-OCT-2021 17:08:13

APM08279+525 GM076.UVDATA.1

Freq = 1.5945 GHz, Bw = 32.000 MH No calibration applied and no bandpass applied

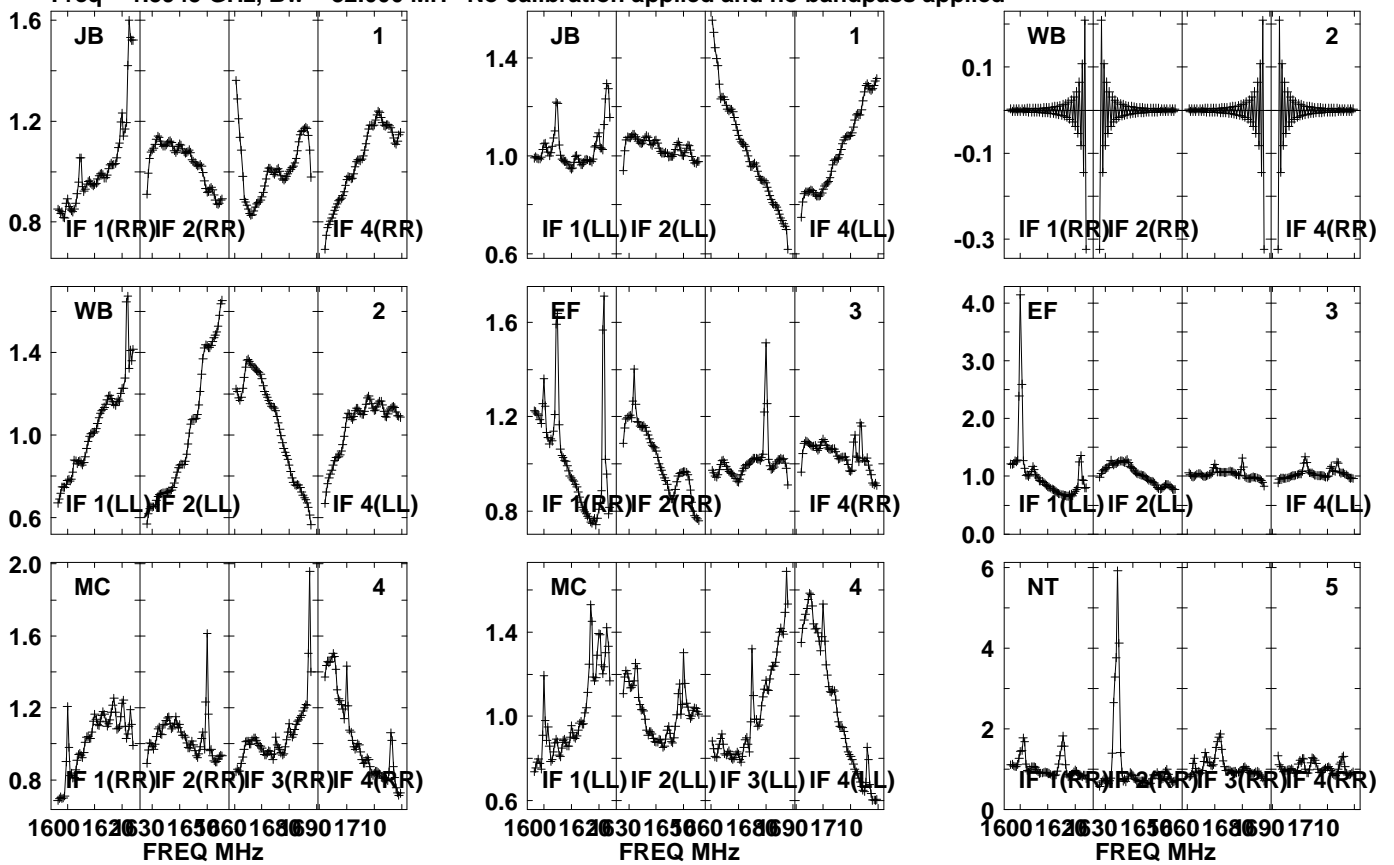

Lower frame: Real Jy  
Auto-corr total-power spectrum Antenna: \*  
Timerange: 00/17:32:01 to 00/17:35:29

Plot file version 781 created 05-OCT-2021 17:08:13

APM08279+525 GM076.UVDATA.1

Freq = 1.5945 GHz, Bw = 32.000 MH No calibration applied and no bandpass applied

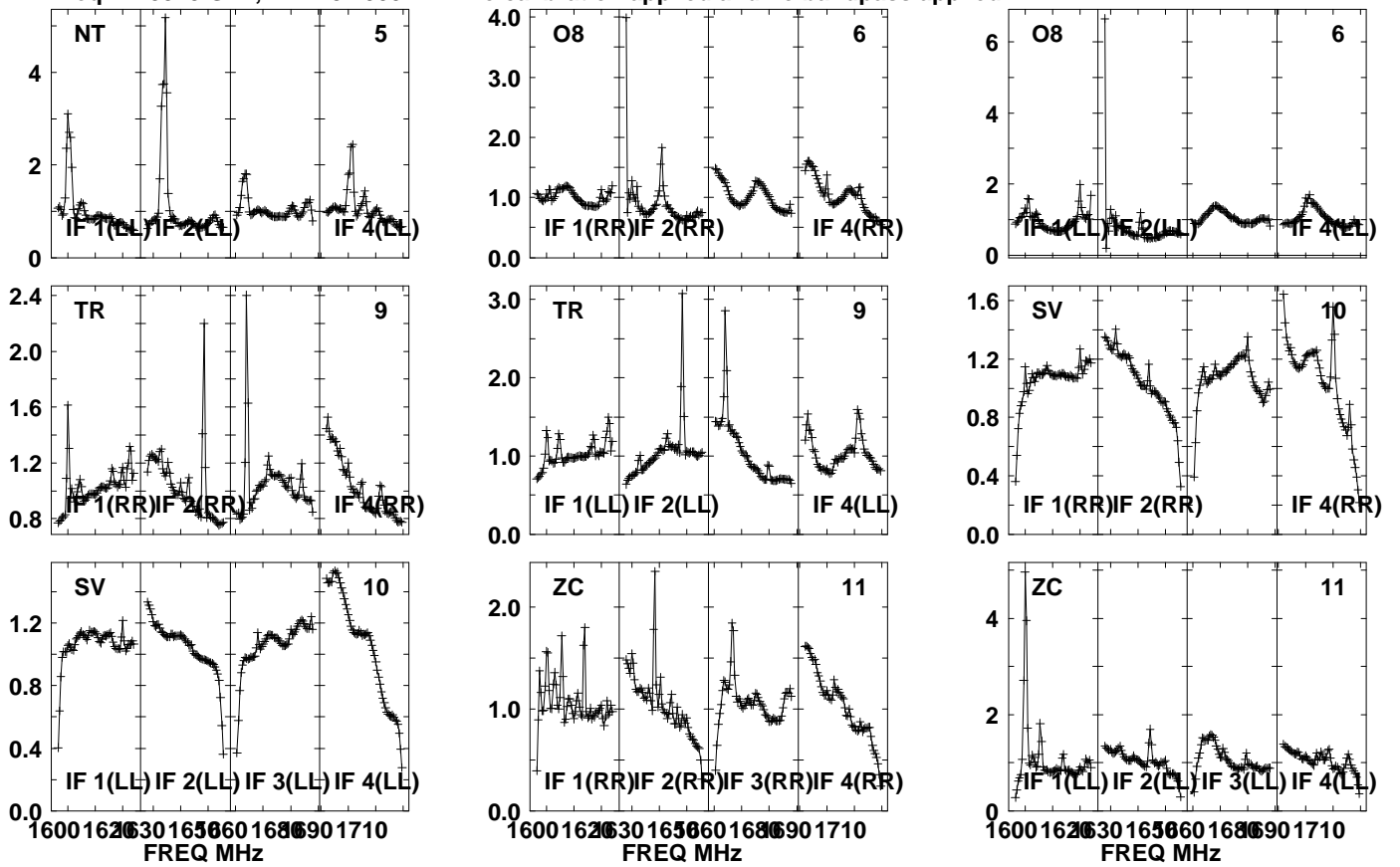

Lower frame: Real Jy  
 Auto-corr total-power spectrum Antenna: \*  
 Timerange: 00/17:32:01 to 00/17:35:29

Plot file version 782 created 05-OCT-2021 17:08:13

APM08279+525 GM076.UVDATA.1

Freq = 1.5945 GHz, Bw = 32.000 MH No calibration applied and no bandpass applied

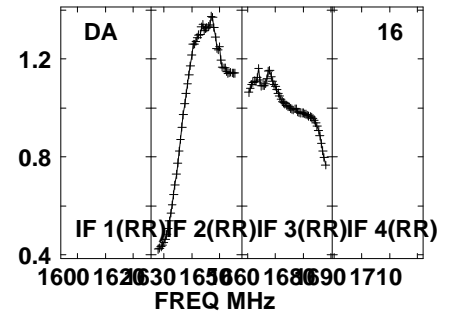
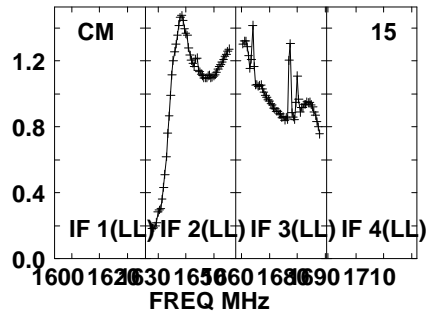
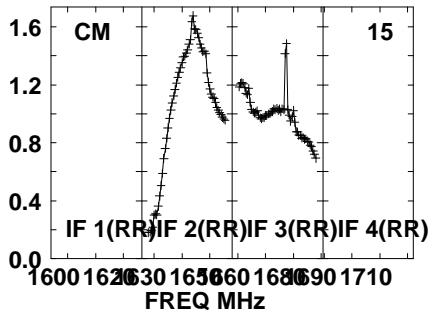
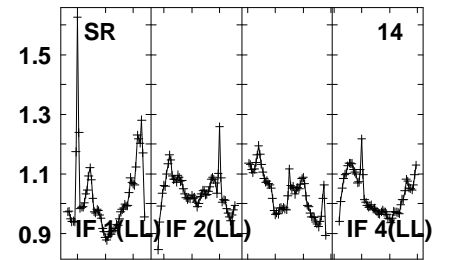
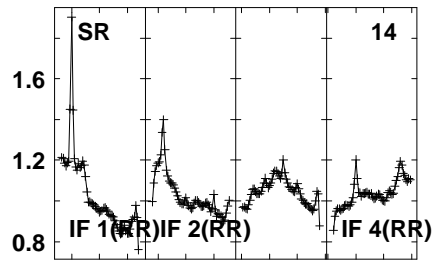
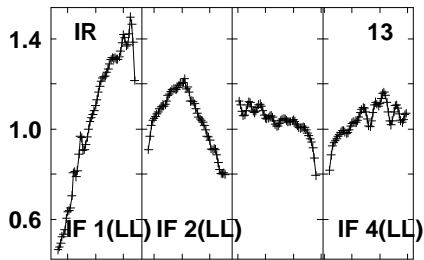
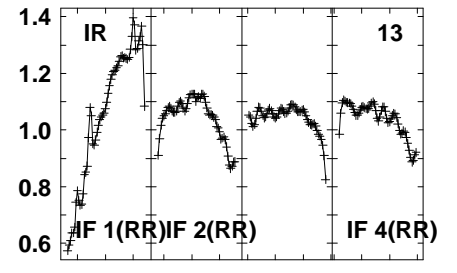
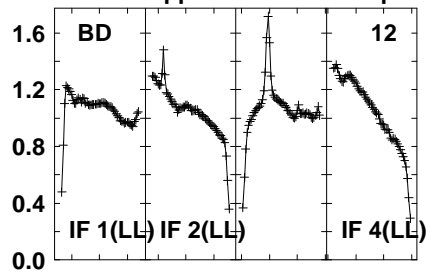
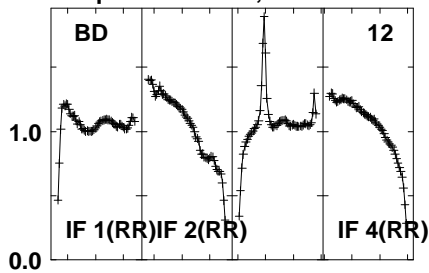

Lower frame: Real Jy

Auto-corr total-power spectrum Antenna: \*

Timerange: 00/17:32:01 to 00/17:35:29

Plot file version 783 created 05-OCT-2021 17:08:14

APM08279+525 GM076.UVDATA.1

Freq = 1.5945 GHz, Bw = 32.000 MH No calibration applied and no bandpass applied

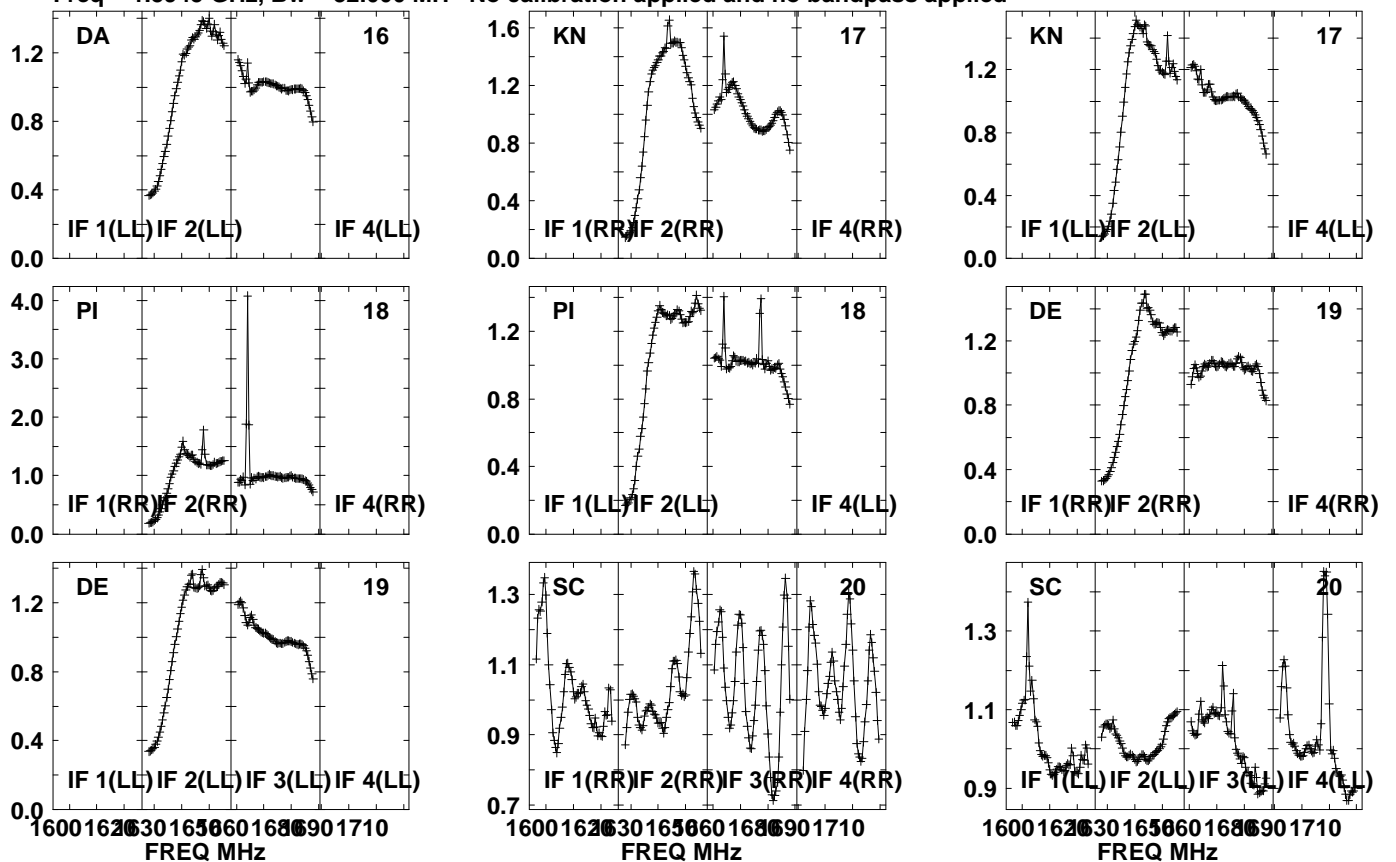

Lower frame: Real Jy  
Auto-corr total-power spectrum Antenna: \*  
Timerange: 00/17:32:01 to 00/17:35:29

Plot file version 784 created 05-OCT-2021 17:08:14

APM08279+525 GM076.UVDATA.1

Freq = 1.5945 GHz, Bw = 32.000 MH No calibration applied and no bandpass applied

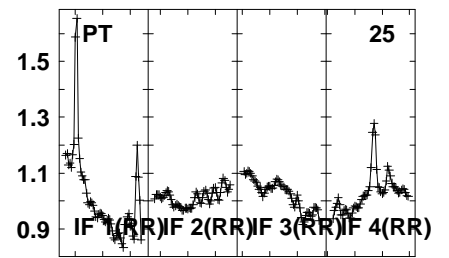
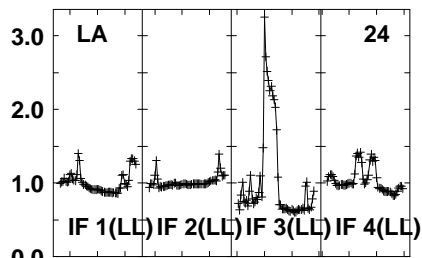
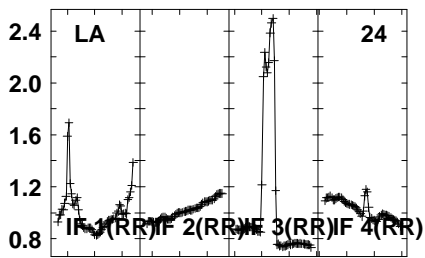
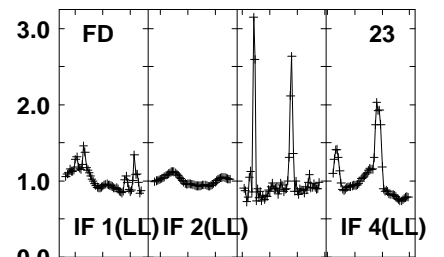
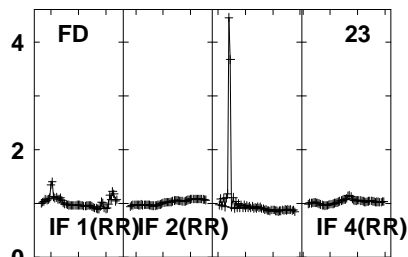
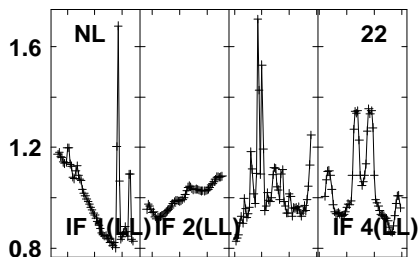
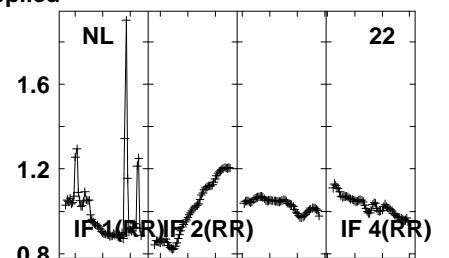
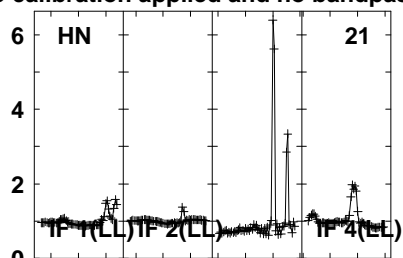
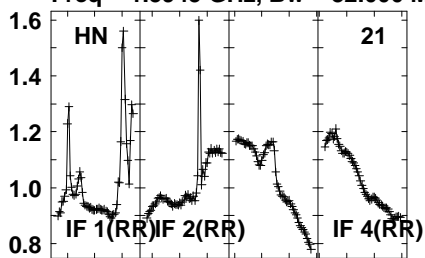

1600 1625 1650 1675 1700 1710  
FREQ MHz

1600 1625 1650 1675 1700 1710  
FREQ MHz

1600 1625 1650 1675 1700 1710  
FREQ MHz

Lower frame: Real Jy  
Auto-corr total-power spectrum Antenna: \*  
Timerange: 00/17:32:01 to 00/17:35:29

Plot file version 785 created 05-OCT-2021 17:08:14

APM08279+525 GM076.UVDATA.1

Freq = 1.5945 GHz, Bw = 32.000 MH No calibration applied and no bandpass applied

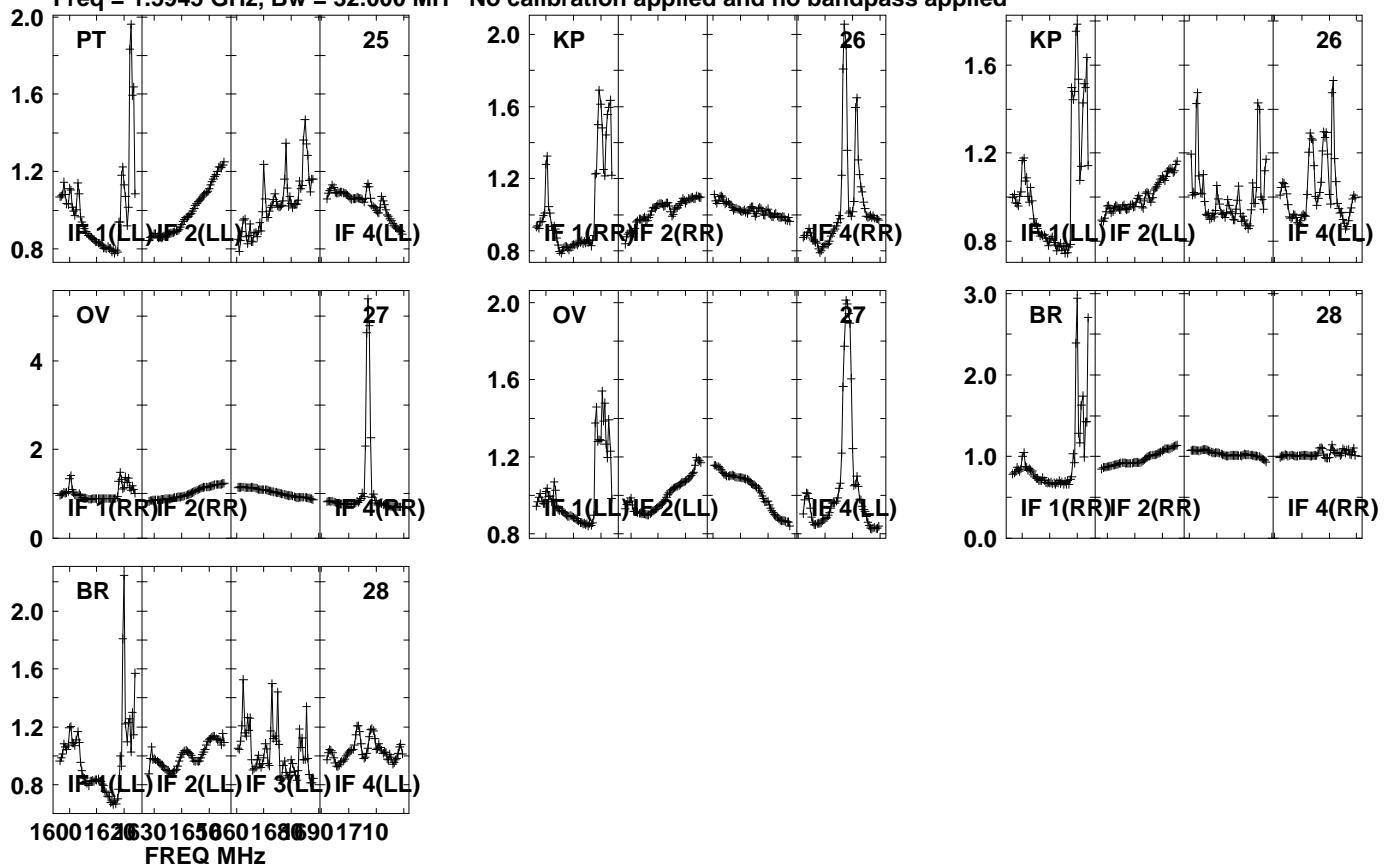

Lower frame: Real Jy

Auto-corr total-power spectrum Antenna: \*

Timerange: 00/17:32:01 to 00/17:35:29

Plot file version 786 created 05-OCT-2021 17:08:15

J0827+5217 GM076.UVDATA.1

Freq = 1.5945 GHz, Bw = 32.000 MH No calibration applied and no bandpass applied

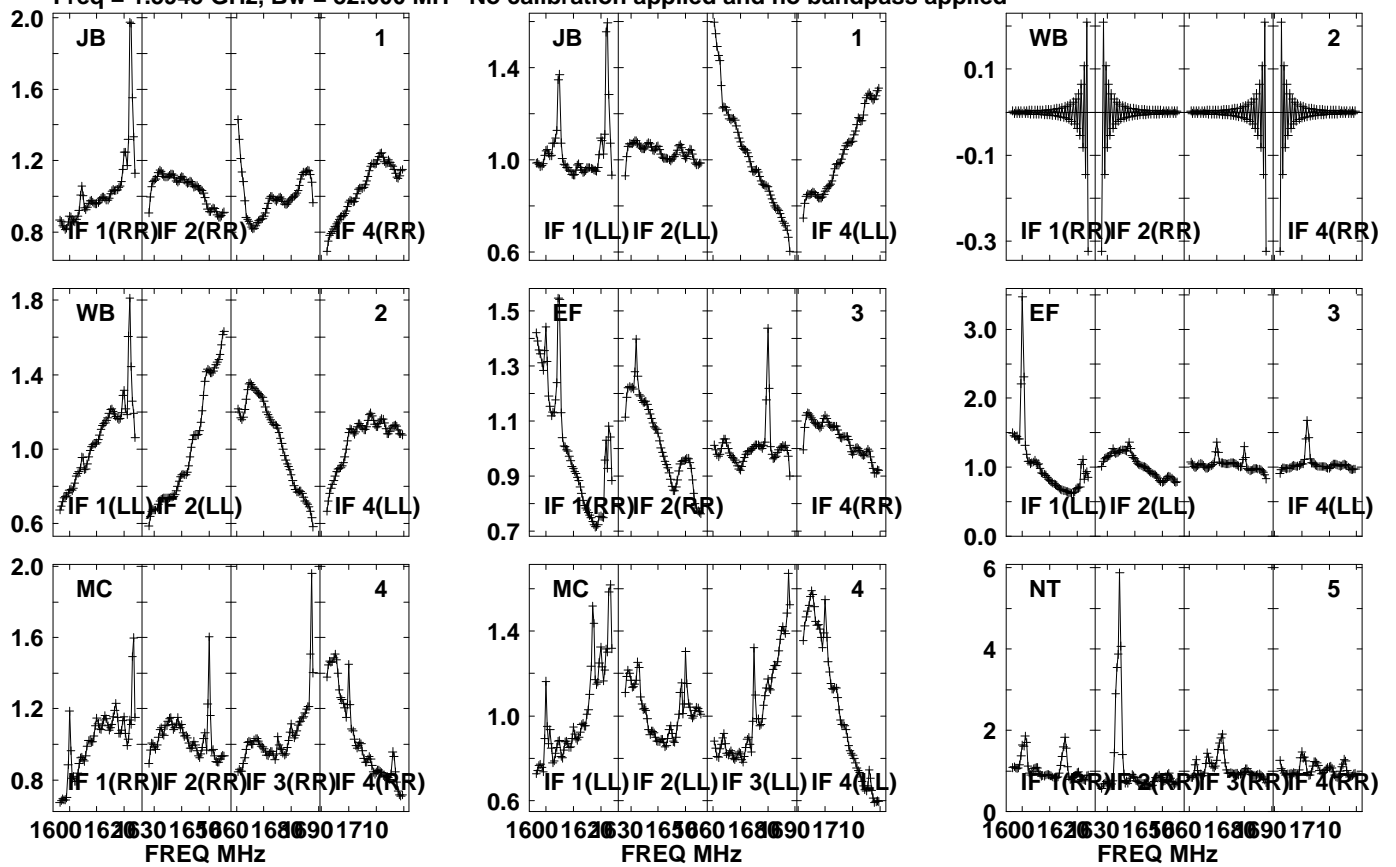

Lower frame: Real Jy  
Auto-corr total-power spectrum Antenna: \*  
Timerange: 00/17:35:31 to 00/17:36:59



Plot file version 787 created 05-OCT-2021 17:08:15

J0827+5217 GM076.UVDATA.1

Freq = 1.5945 GHz, Bw = 32.000 MH No calibration applied and no bandpass applied

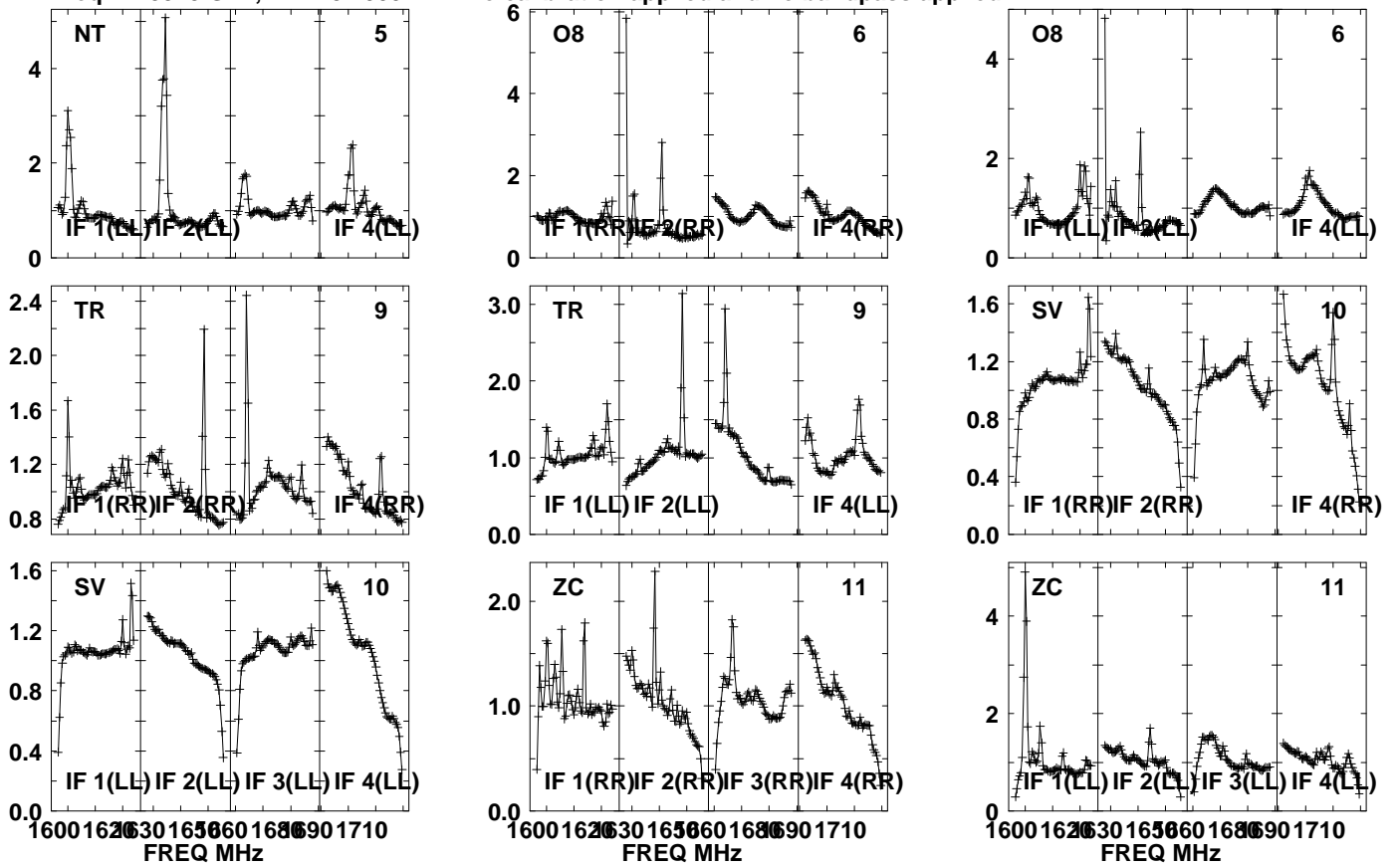

Lower frame: Real Jy  
Auto-corr total-power spectrum Antenna: \*  
Timerange: 00/17:35:31 to 00/17:36:59

Plot file version 788 created 05-OCT-2021 17:08:15

J0827+5217 GM076.UVDATA.1

Freq = 1.5945 GHz, Bw = 32.000 MH No calibration applied and no bandpass applied

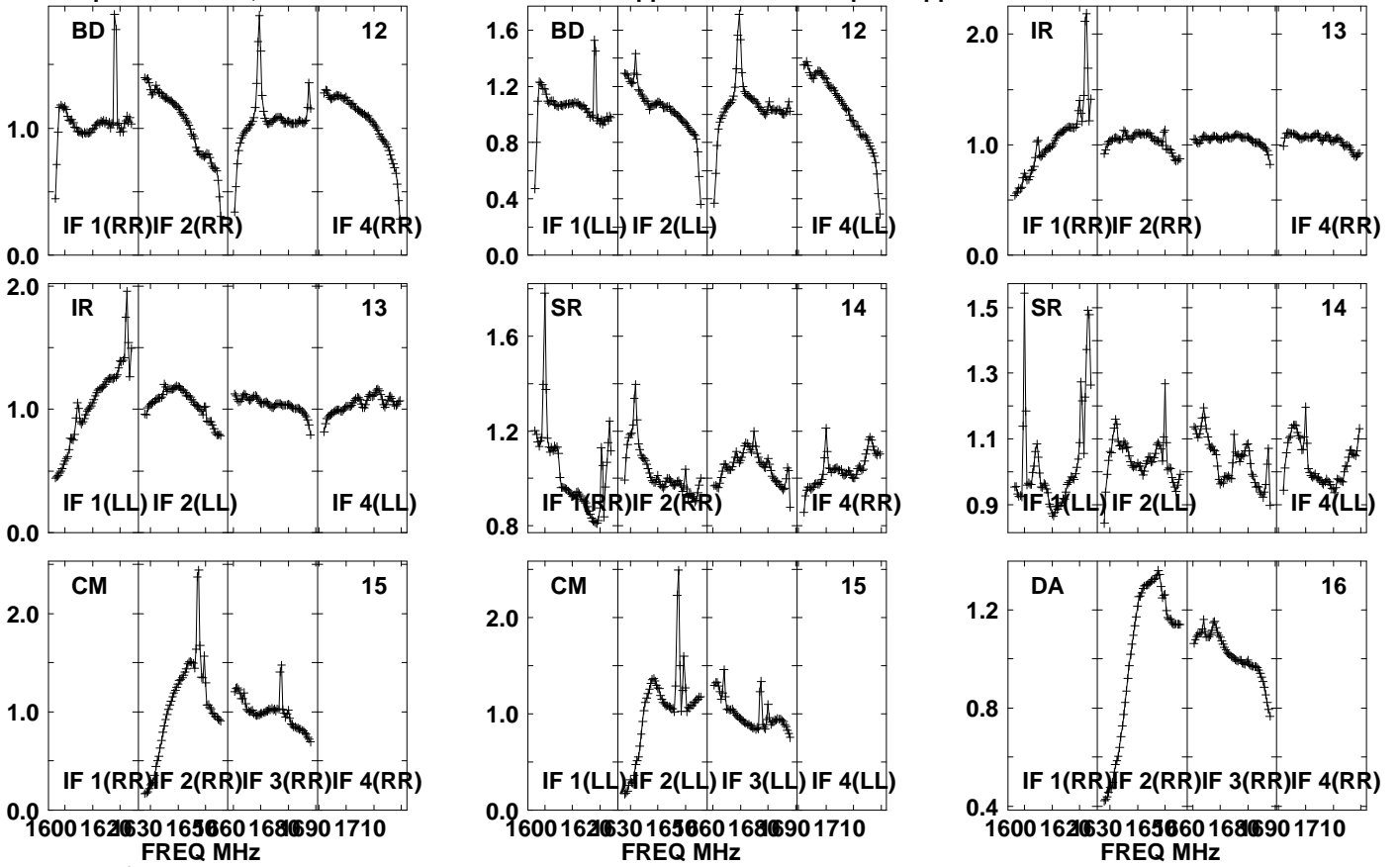

Lower frame: Real Jy

Auto-corr total-power spectrum Antenna: \*

Timerange: 00/17:35:31 to 00/17:36:59

Plot file version 789 created 05-OCT-2021 17:08:16

J0827+5217 GM076.UVDATA.1

Freq = 1.5945 GHz, Bw = 32.000 MH No calibration applied and no bandpass applied

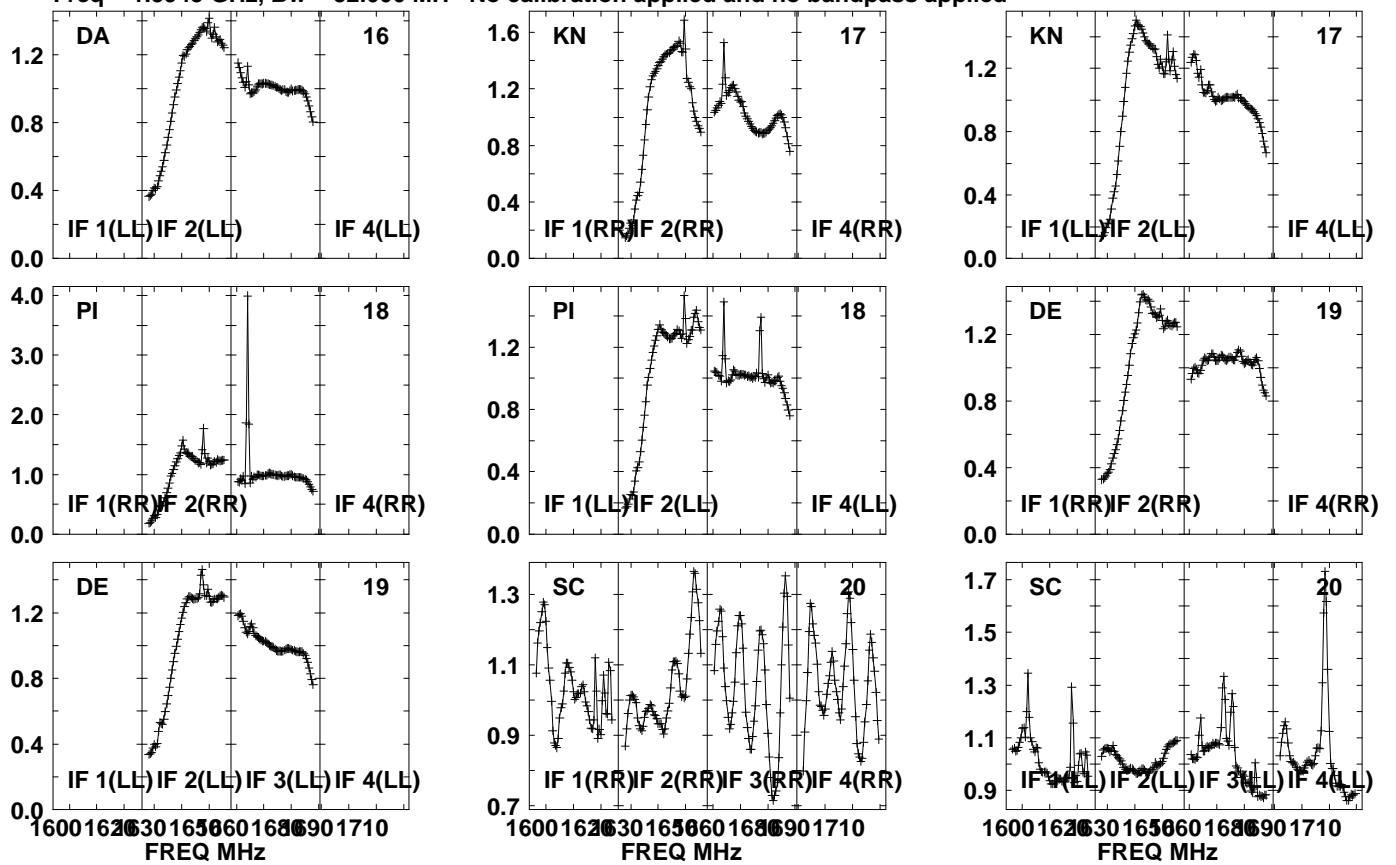

Lower frame: Real Jy  
Auto-corr total-power spectrum Antenna: \*  
Timerange: 00/17:35:31 to 00/17:36:59

Plot file version 790 created 05-OCT-2021 17:08:16

J0827+5217 GM076.UVDATA.1

Freq = 1.5945 GHz, Bw = 32.000 MH No calibration applied and no bandpass applied

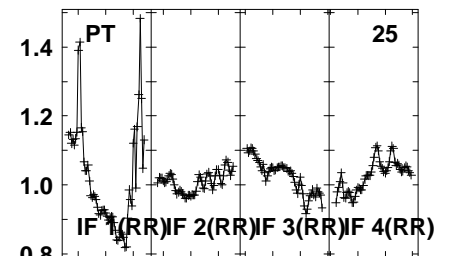
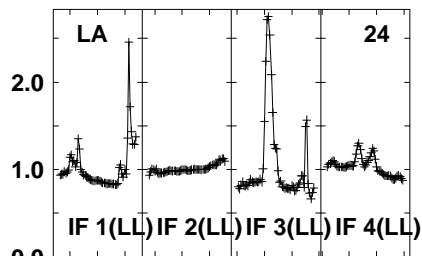
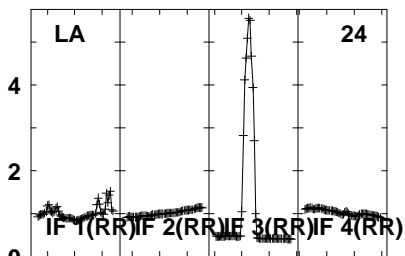
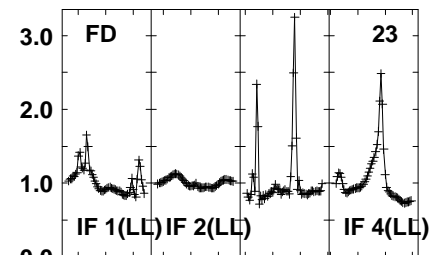
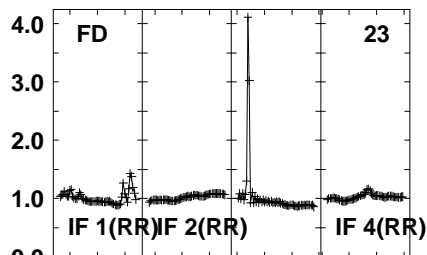
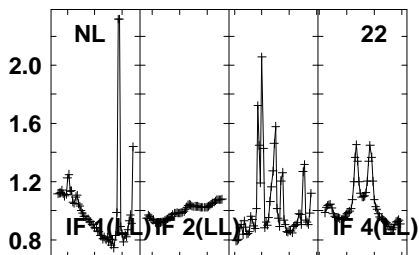
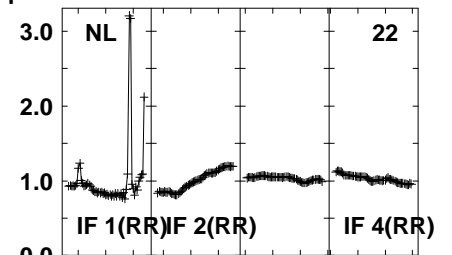
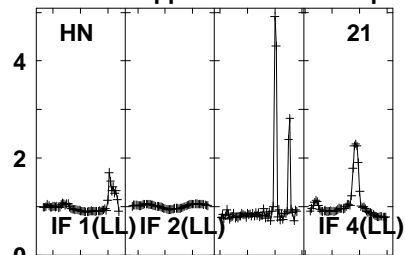
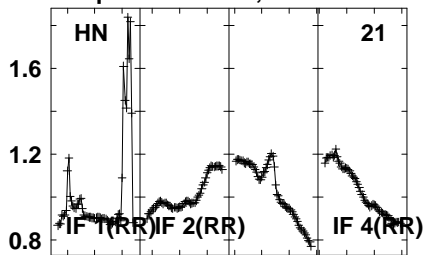

1600 1625 1650 1675 1700  
FREQ MHz

1600 1625 1650 1675 1700  
FREQ MHz

1600 1625 1650 1675 1700  
FREQ MHz

Lower frame: Real Jy  
Auto-corr total-power spectrum Antenna: \*  
Timerange: 00/17:35:31 to 00/17:36:59

Plot file version 791 created 05-OCT-2021 17:08:16

J0827+5217 GM076.UVDATA.1

Freq = 1.5945 GHz, Bw = 32.000 MH No calibration applied and no bandpass applied

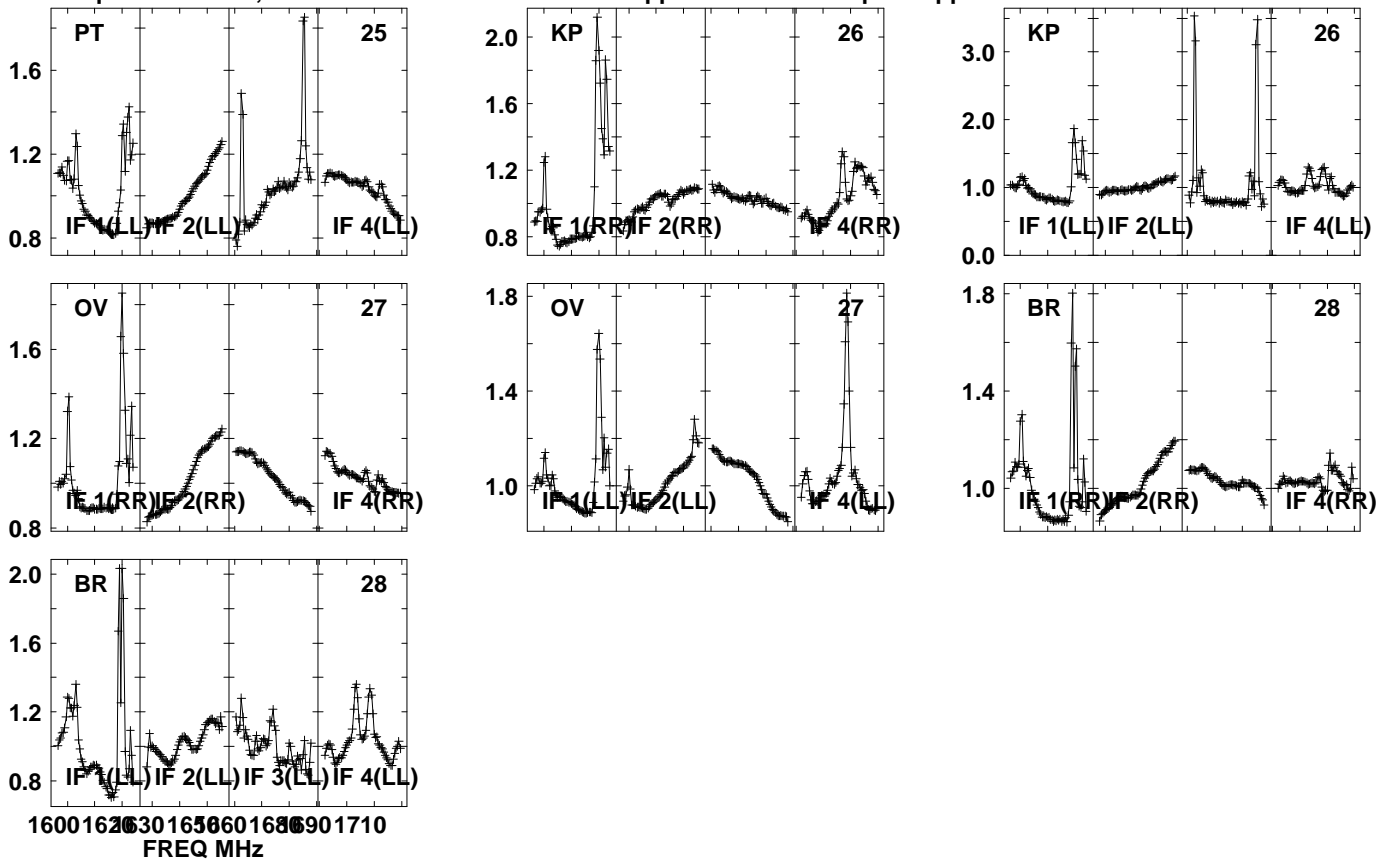

1600 1620 1630 1650 1660 1680 1690 1710  
FREQ MHz  
Lower frame: Real Jy  
Auto-corr total-power spectrum Antenna: \*  
Timerange: 00/17:35:31 to 00/17:36:59

Plot file version 792 created 05-OCT-2021 17:08:17

APM08279+525 GM076.UVDATA.1

Freq = 1.5945 GHz, Bw = 32.000 MH No calibration applied and no bandpass applied

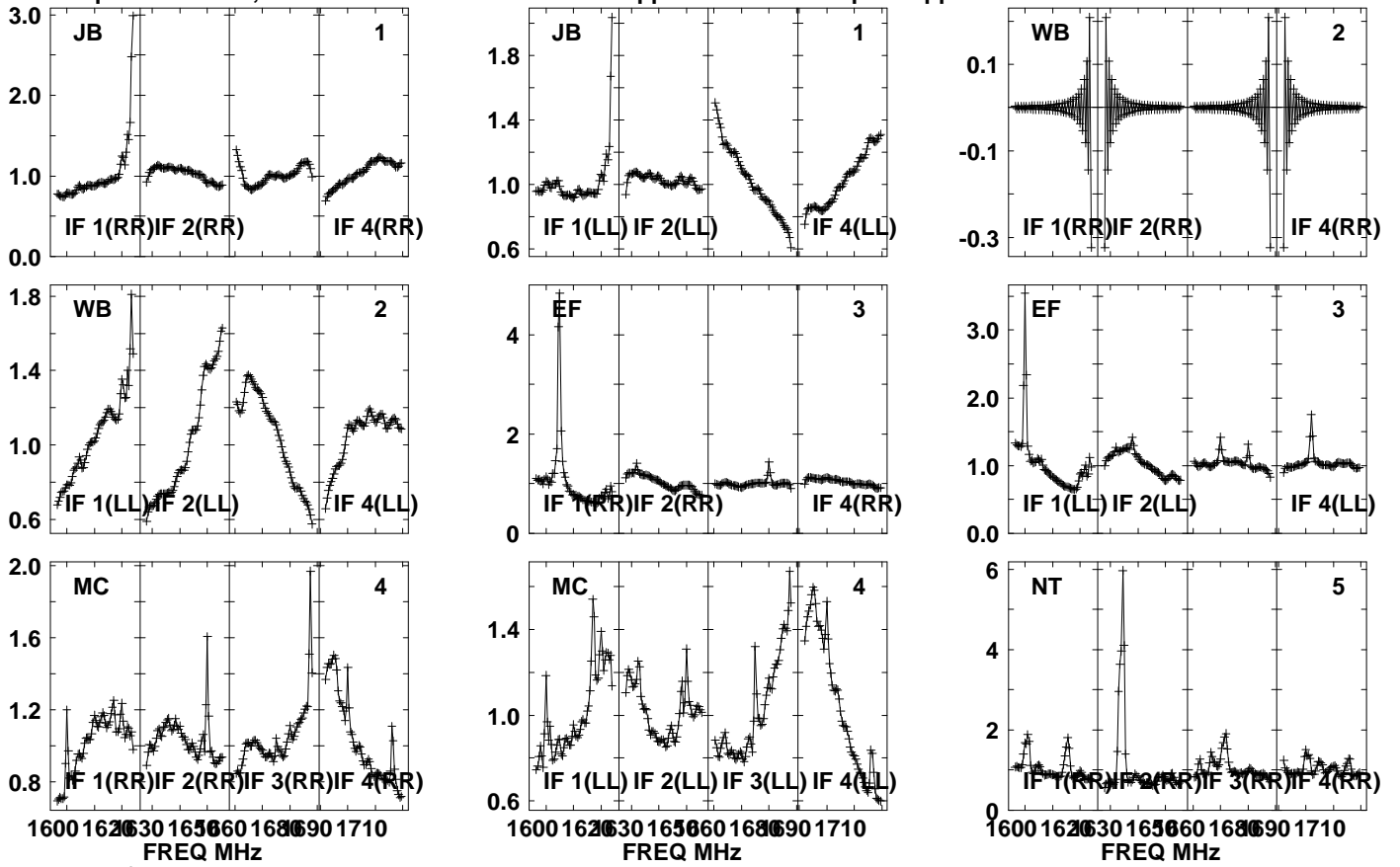

Lower frame: Real Jy  
Auto-corr total-power spectrum Antenna: \*  
Timerange: 00/17:37:01 to 00/17:40:29

Plot file version 793 created 05-OCT-2021 17:08:17

APM08279+525 GM076.UVDATA.1

Freq = 1.5945 GHz, Bw = 32.000 MH No calibration applied and no bandpass applied

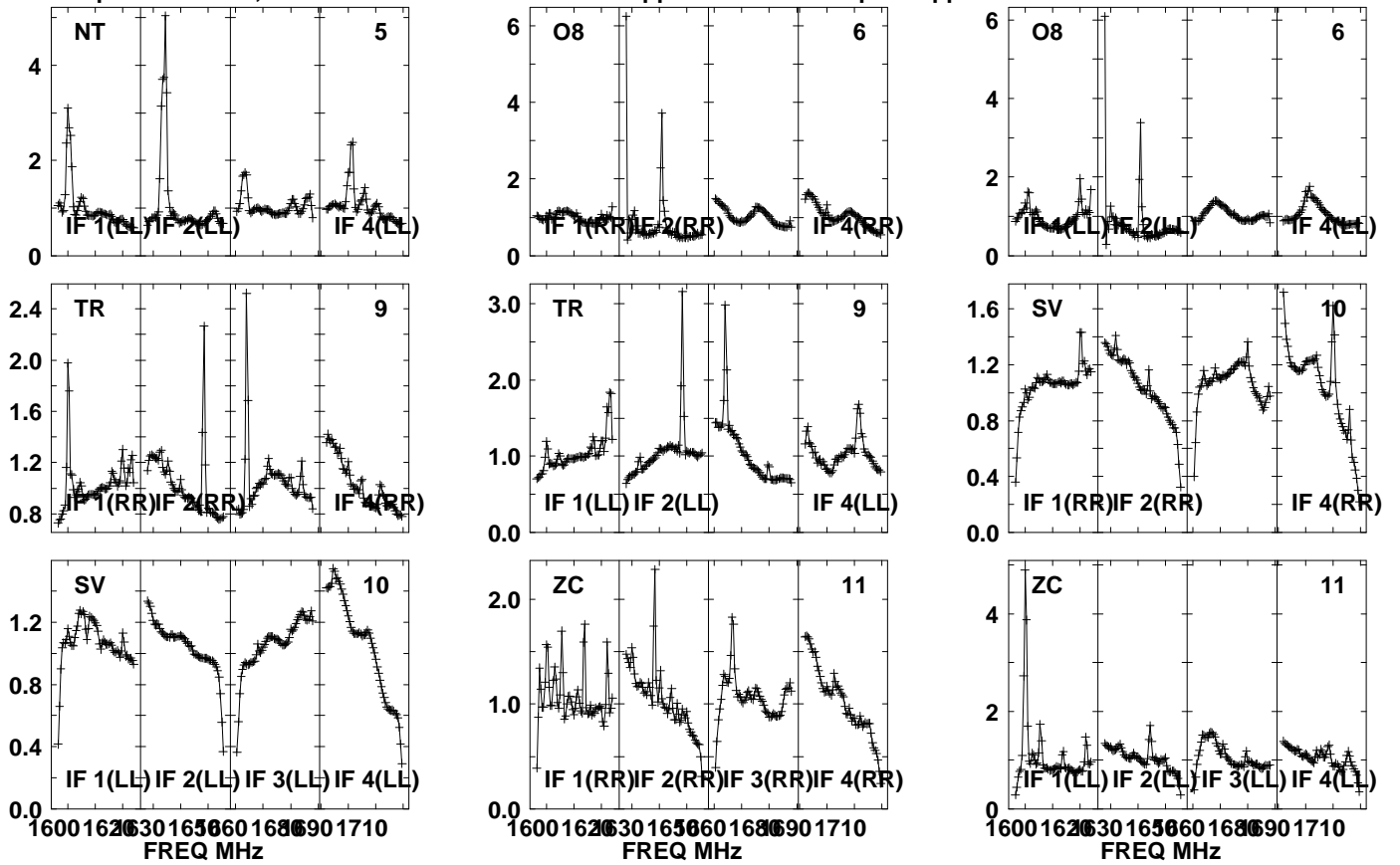

Lower frame: Real Jy  
Auto-corr total-power spectrum Antenna: \*  
Timerange: 00/17:37:01 to 00/17:40:29

Plot file version 794 created 05-OCT-2021 17:08:17

APM08279+525 GM076.UVDATA.1

Freq = 1.5945 GHz, Bw = 32.000 MH No calibration applied and no bandpass applied

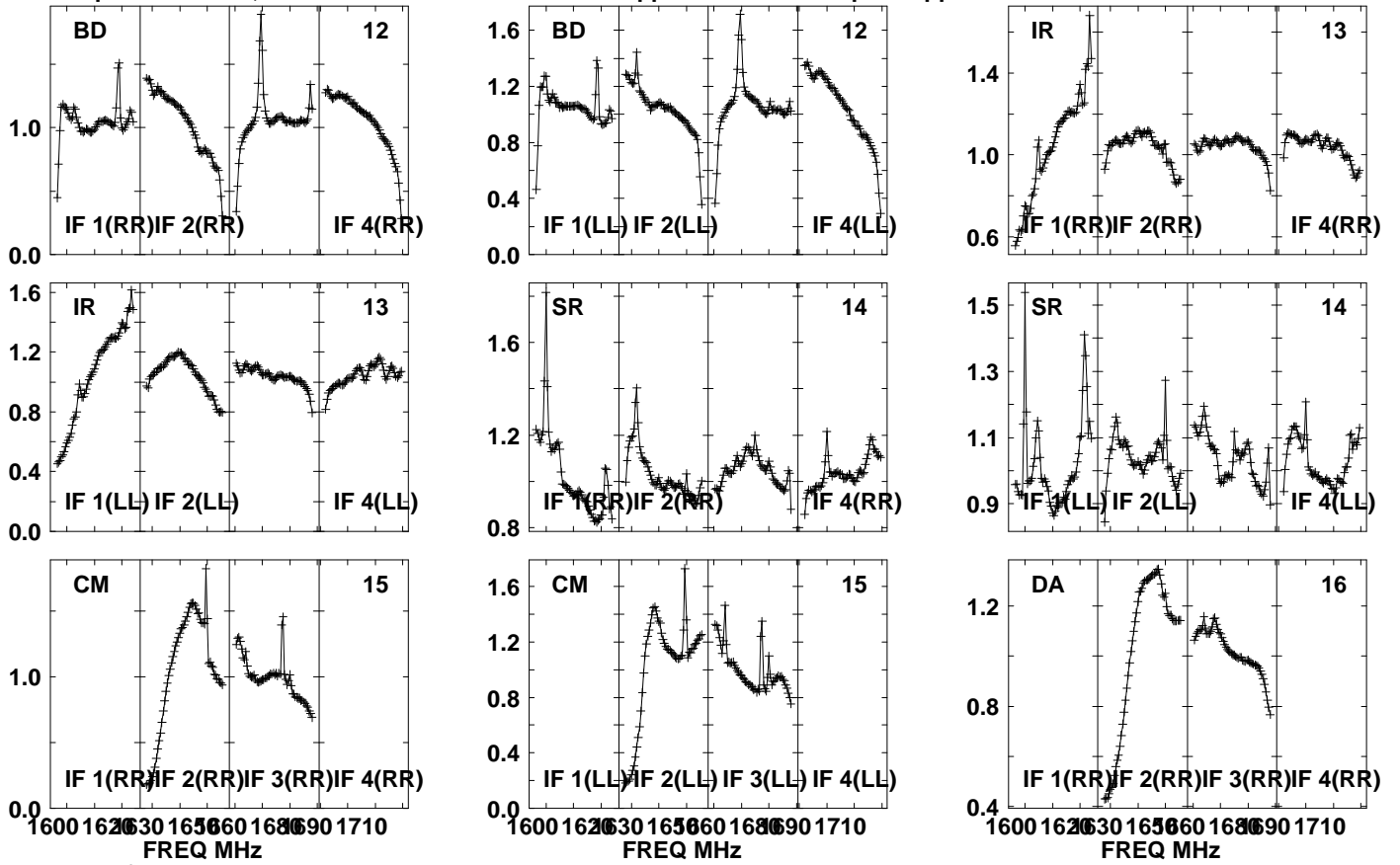

Lower frame: Real Jy

Auto-corr total-power spectrum Antenna: \*

Timerange: 00/17:37:01 to 00/17:40:29



Plot file version 795 created 05-OCT-2021 17:08:18

APM08279+525 GM076.UVDATA.1

Freq = 1.5945 GHz, Bw = 32.000 MH No calibration applied and no bandpass applied

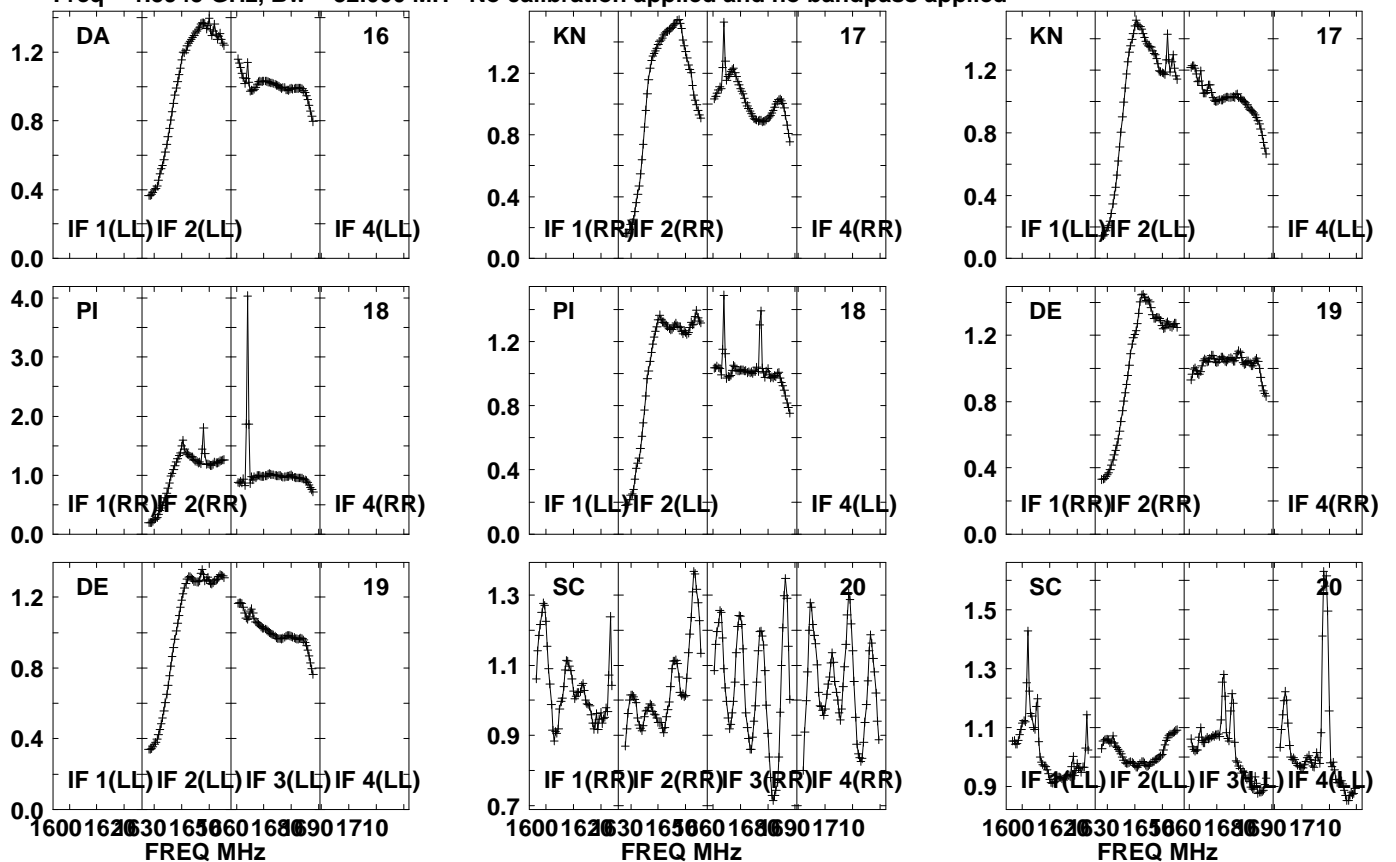

Lower frame: Real Jy  
Auto-corr total-power spectrum Antenna: \*  
Timerange: 00/17:37:01 to 00/17:40:29

Plot file version 796 created 05-OCT-2021 17:08:18

APM08279+525 GM076.UVDATA.1

Freq = 1.5945 GHz, Bw = 32.000 MH No calibration applied and no bandpass applied

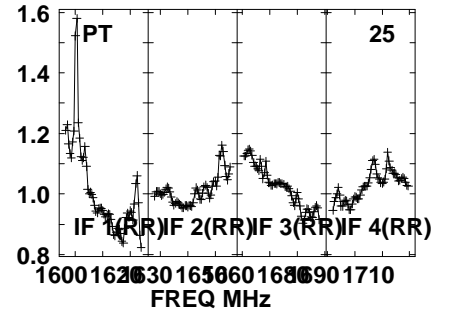
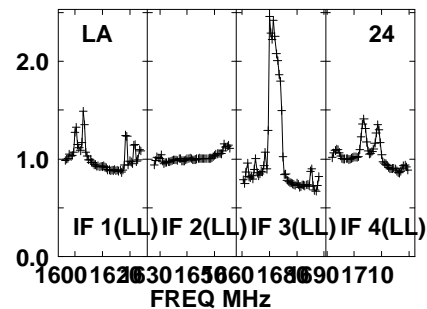
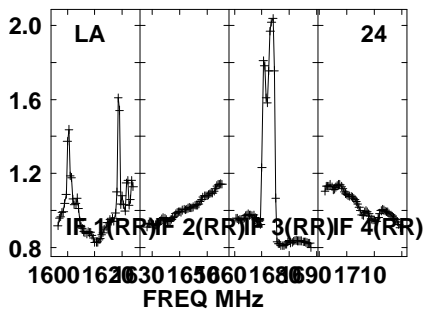
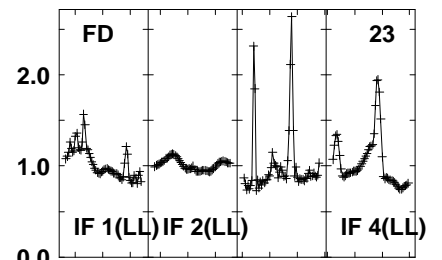
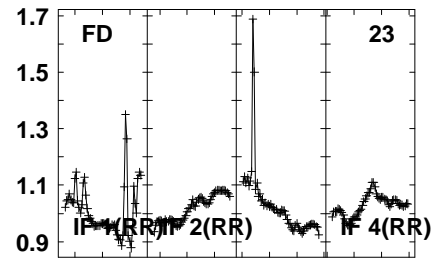
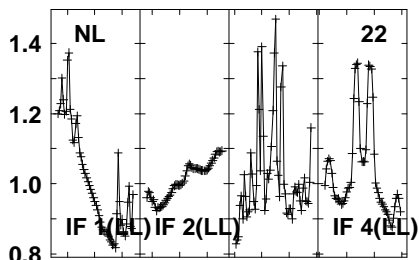
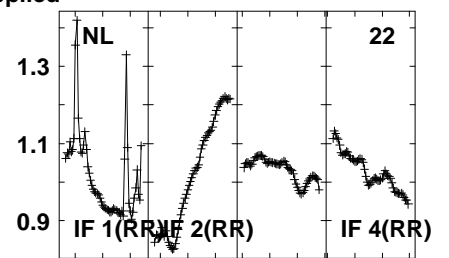
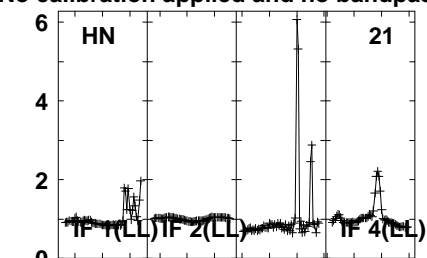
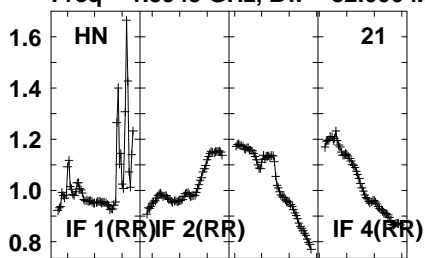

Lower frame: Real Jy  
Auto-corr total-power spectrum Antenna: \*  
Timerange: 00/17:37:01 to 00/17:40:29

Plot file version 797 created 05-OCT-2021 17:08:18

APM08279+525 GM076.UVDATA.1

Freq = 1.5945 GHz, Bw = 32.000 MH

No calibration applied and no bandpass applied

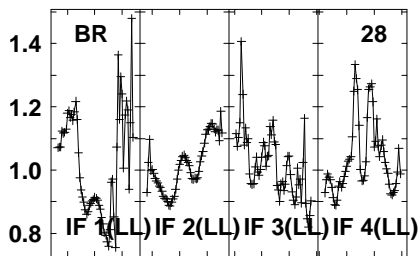
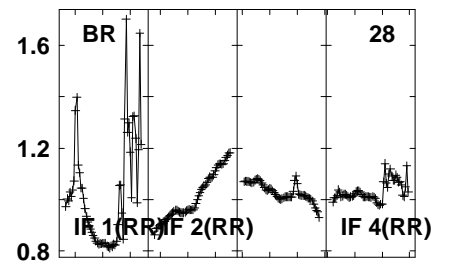
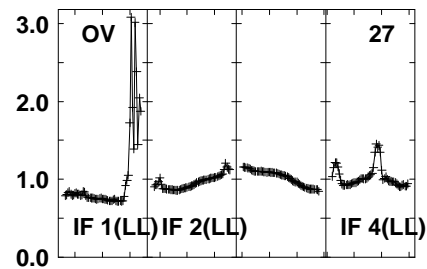
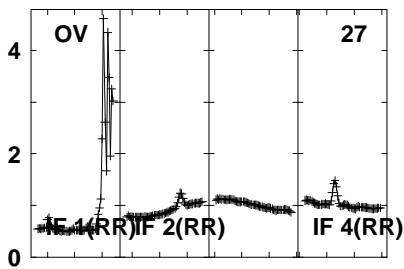
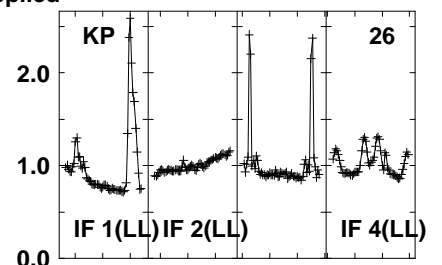
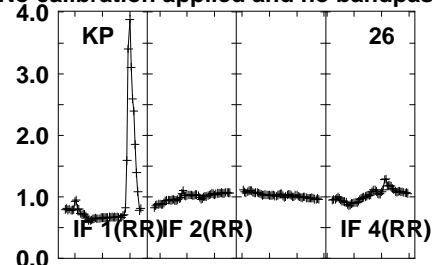
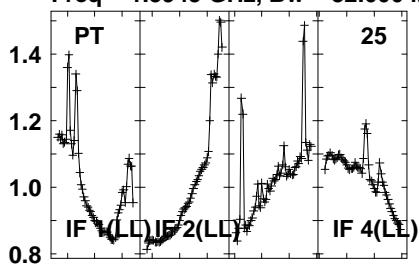

1600 1620 1630 1650 1660 1680 1690 1710  
FREQ MHz

Lower frame: Real Jy

Auto-corr total-power spectrum Antenna: \*

Timerange: 00/17:37:01 to 00/17:40:29

Plot file version 798 created 05-OCT-2021 17:08:19

J0827+5217 GM076.UVDATA.1

Freq = 1.5945 GHz, Bw = 32.000 MH No calibration applied and no bandpass applied

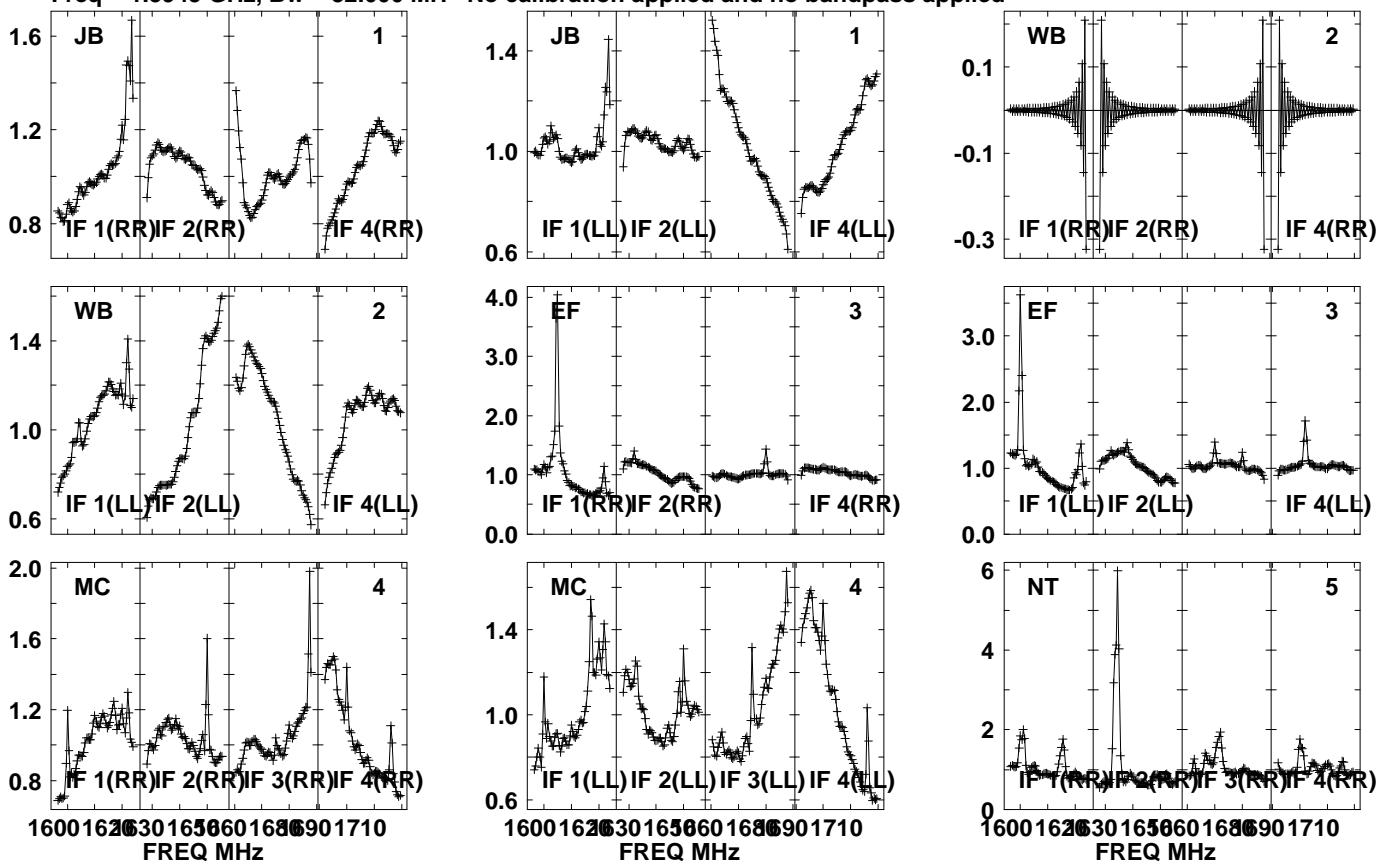

Lower frame: Real Jy  
Auto-corr total-power spectrum Antenna: \*  
Timerange: 00/17:41:01 to 00/17:42:29

Plot file version 799 created 05-OCT-2021 17:08:19

J0827+5217 GM076.UVDATA.1

Freq = 1.5945 GHz, Bw = 32.000 MH No calibration applied and no bandpass applied

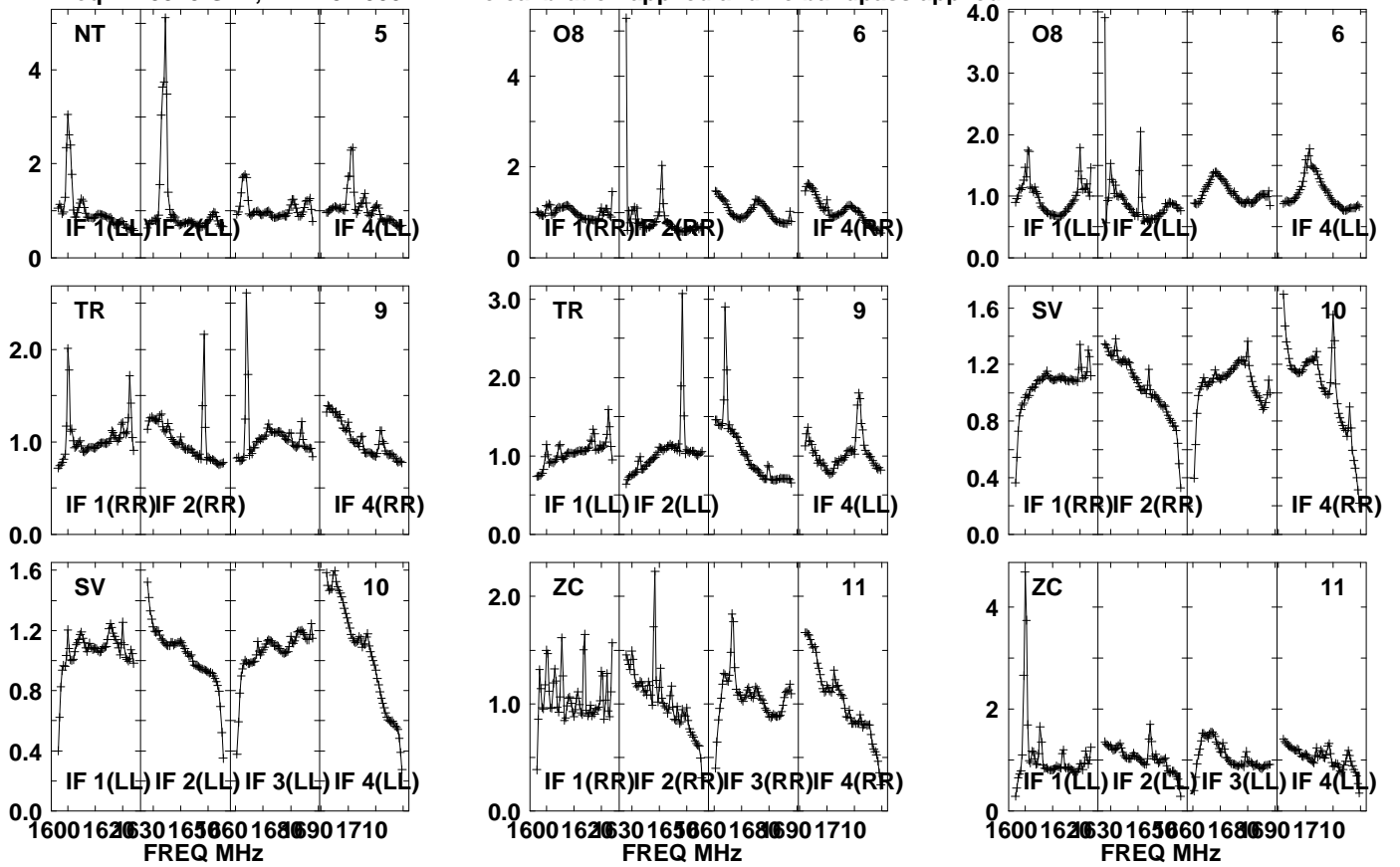

Lower frame: Real Jy  
Auto-corr total-power spectrum Antenna: \*  
Timerange: 00/17:41:01 to 00/17:42:29

Plot file version 800 created 05-OCT-2021 17:08:19

J0827+5217 GM076.UVDATA.1

Freq = 1.5945 GHz, Bw = 32.000 MH No calibration applied and no bandpass applied

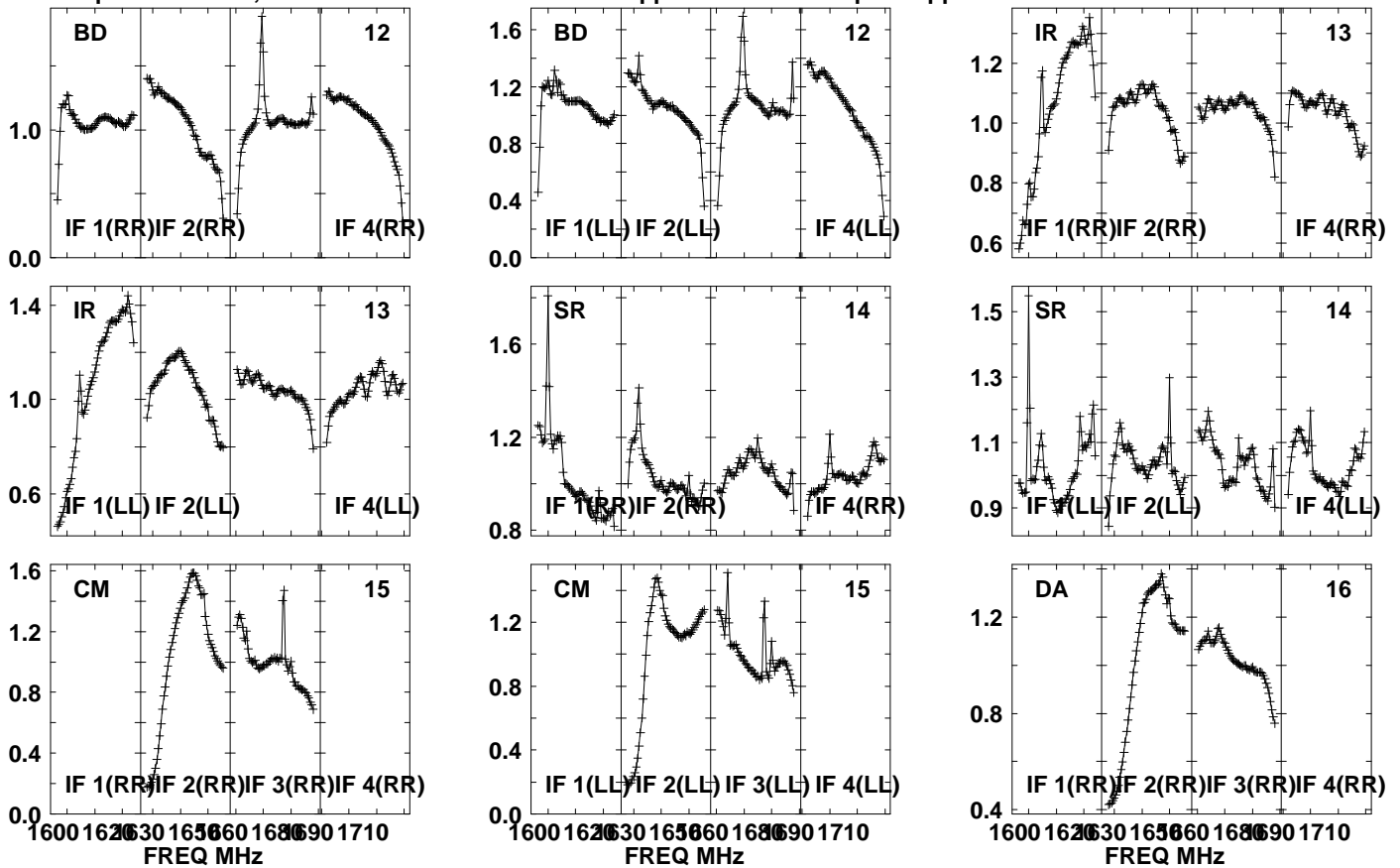

Lower frame: Real Jy

Auto-corr total-power spectrum Antenna: \*

Timerange: 00/17:41:01 to 00/17:42:29

Plot file version 801 created 05-OCT-2021 17:08:20

J0827+5217 GM076.UVDATA.1

Freq = 1.5945 GHz, Bw = 32.000 MH No calibration applied and no bandpass applied

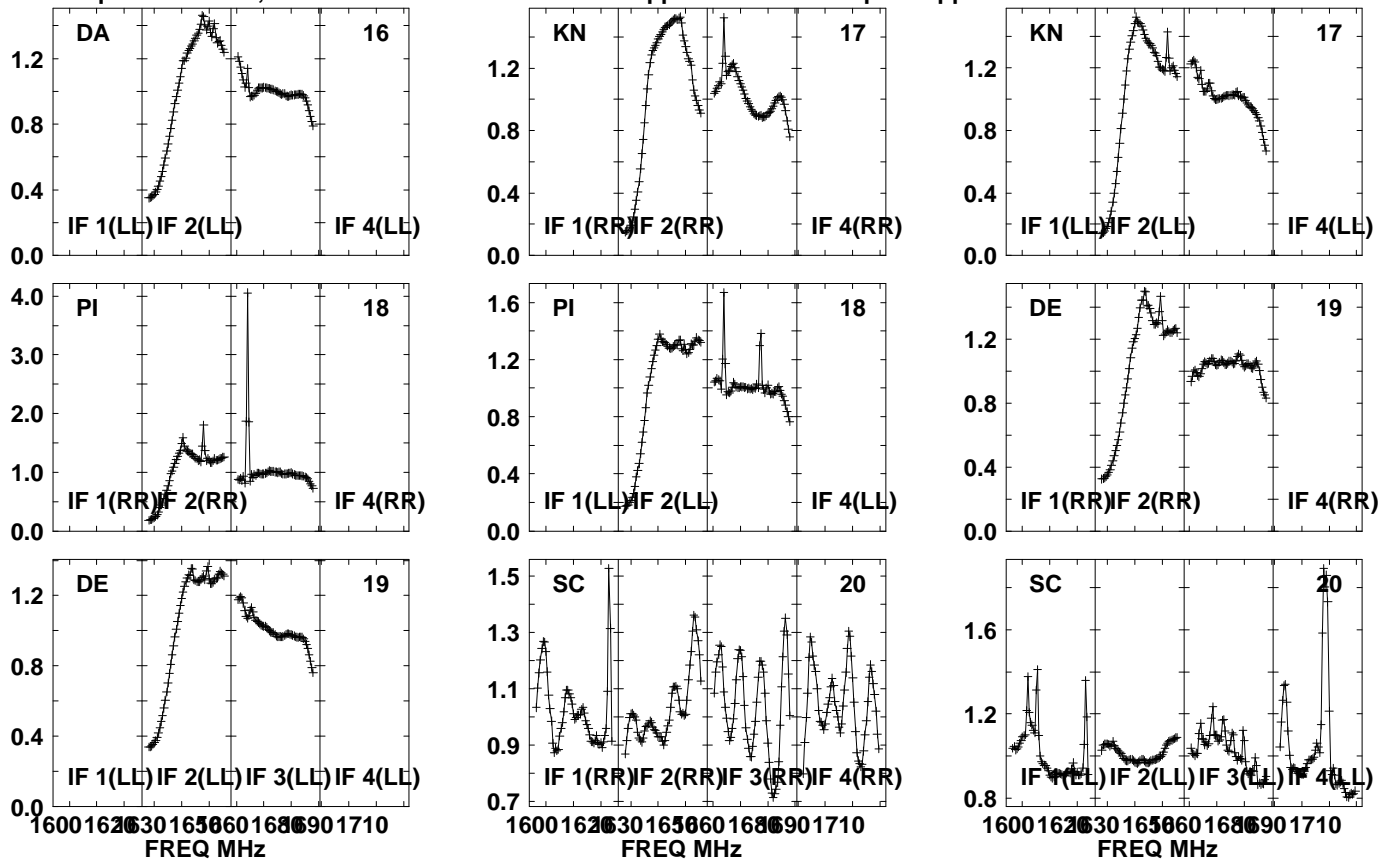

Lower frame: Real Jy  
Auto-corr total-power spectrum Antenna: \*  
Timerange: 00/17:41:01 to 00/17:42:29

Plot file version 802 created 05-OCT-2021 17:08:20

J0827+5217 GM076.UVDATA.1

Freq = 1.5945 GHz, Bw = 32.000 MH No calibration applied and no bandpass applied

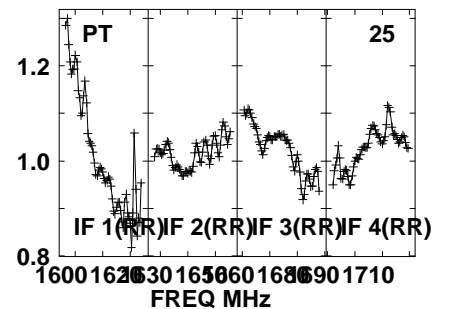
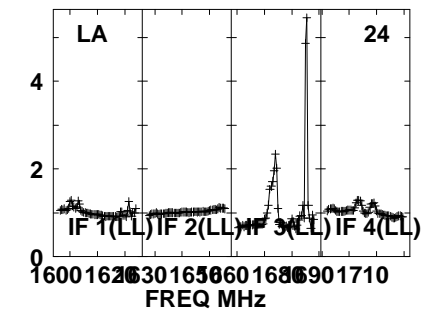
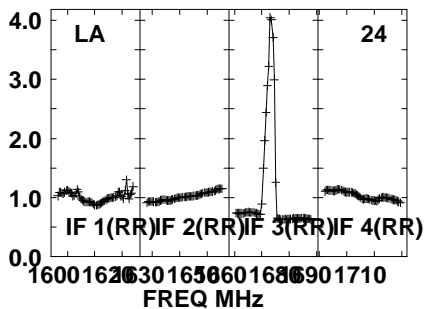
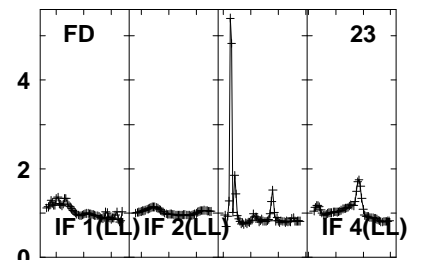
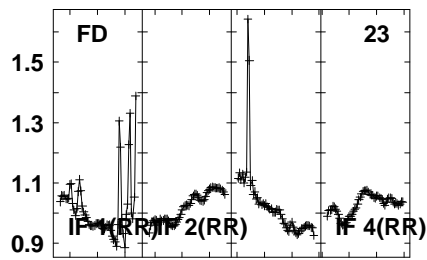
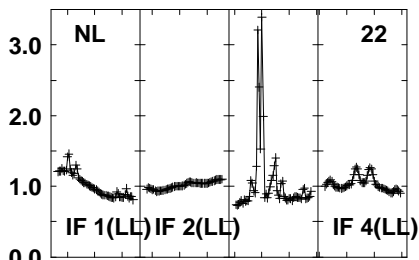
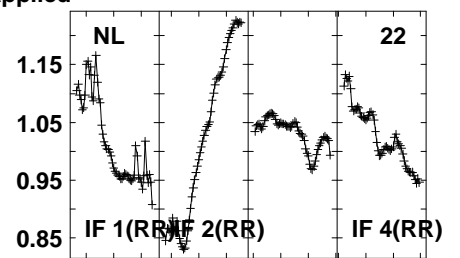
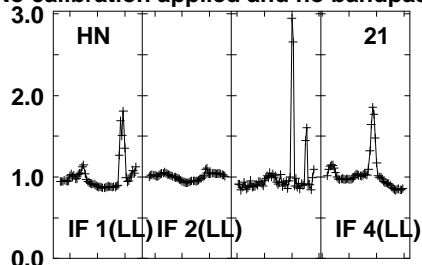
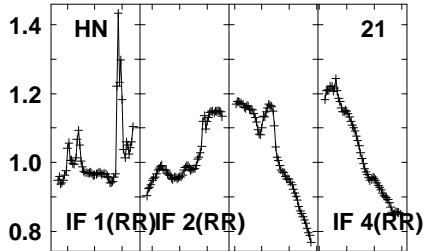

Lower frame: Real Jy  
Auto-corr total-power spectrum Antenna: \*  
Timerange: 00/17:41:01 to 00/17:42:29



Plot file version 803 created 05-OCT-2021 17:08:20

J0827+5217 GM076.UVDATA.1

Freq = 1.5945 GHz, Bw = 32.000 MH No calibration applied and no bandpass applied

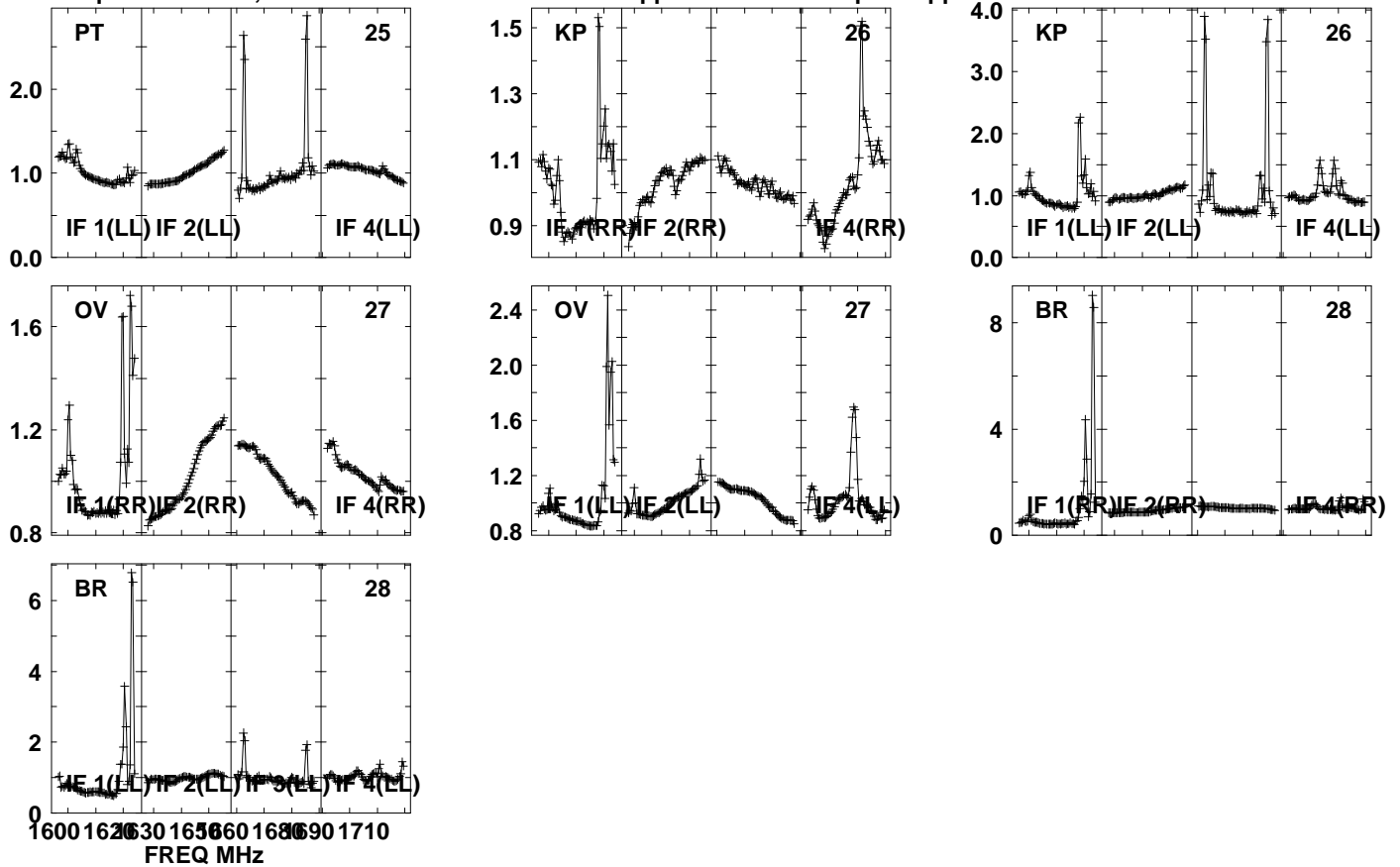

Lower frame: Real Jy

Auto-corr total-power spectrum Antenna: \*

Timerange: 00/17:41:01 to 00/17:42:29

Plot file version 804 created 05-OCT-2021 17:08:21

APM08279+525 GM076.UVDATA.1

Freq = 1.5945 GHz, Bw = 32.000 MH No calibration applied and no bandpass applied

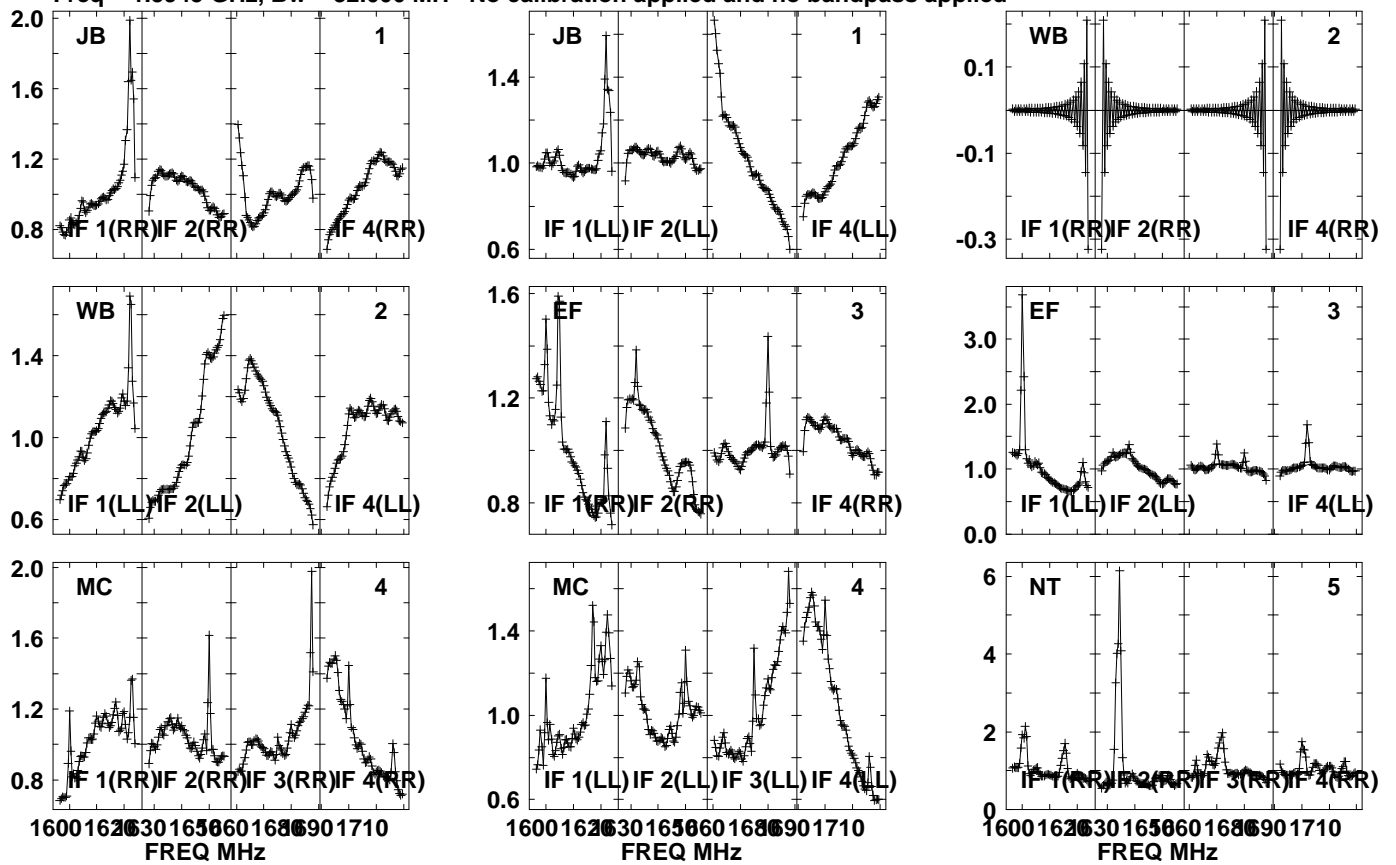

Lower frame: Real Jy  
Auto-corr total-power spectrum Antenna: \*  
Timerange: 00/17:42:31 to 00/17:45:59

Plot file version 805 created 05-OCT-2021 17:08:21

APM08279+525 GM076.UVDATA.1

Freq = 1.5945 GHz, Bw = 32.000 MH No calibration applied and no bandpass applied

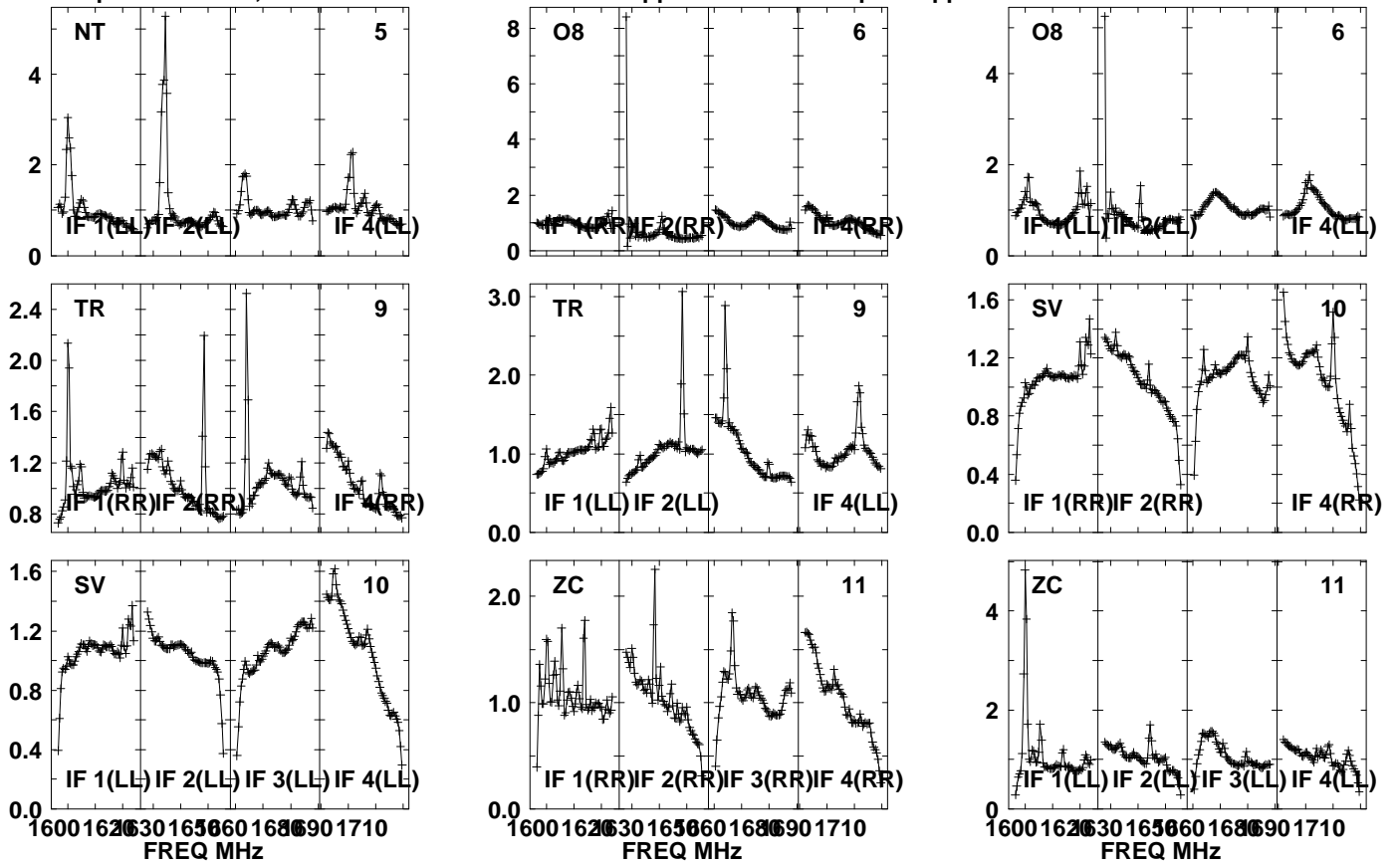

Lower frame: Real Jy  
Auto-corr total-power spectrum Antenna: \*  
Timerange: 00/17:42:31 to 00/17:45:59

Plot file version 806 created 05-OCT-2021 17:08:21

APM08279+525 GM076.UVDATA.1

Freq = 1.5945 GHz, Bw = 32.000 MH No calibration applied and no bandpass applied

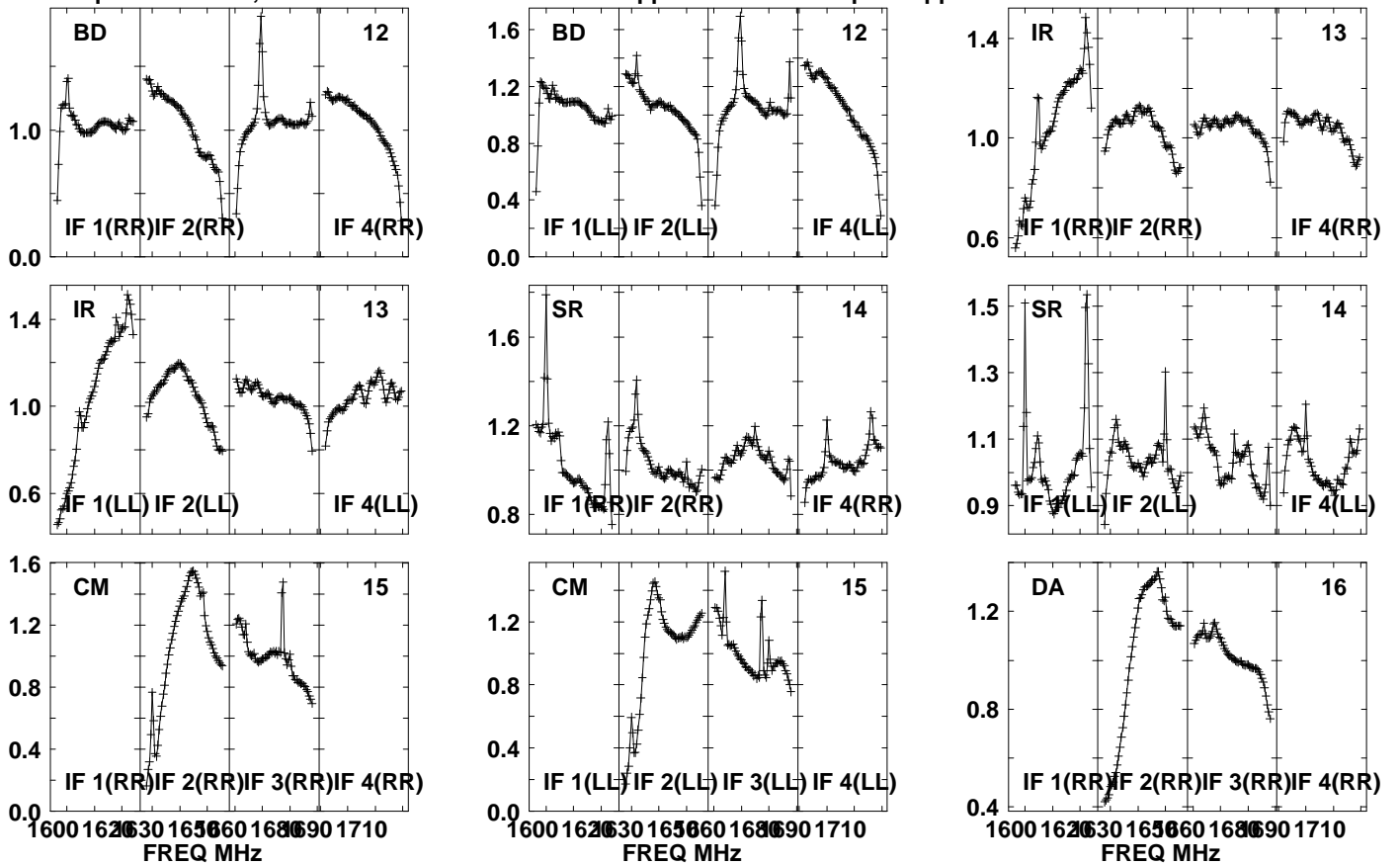

Lower frame: Real Jy

Auto-corr total-power spectrum Antenna: \*

Timerange: 00/17:42:31 to 00/17:45:59

Plot file version 807 created 05-OCT-2021 17:08:22

APM08279+525 GM076.UVDATA.1

Freq = 1.5945 GHz, Bw = 32.000 MH No calibration applied and no bandpass applied

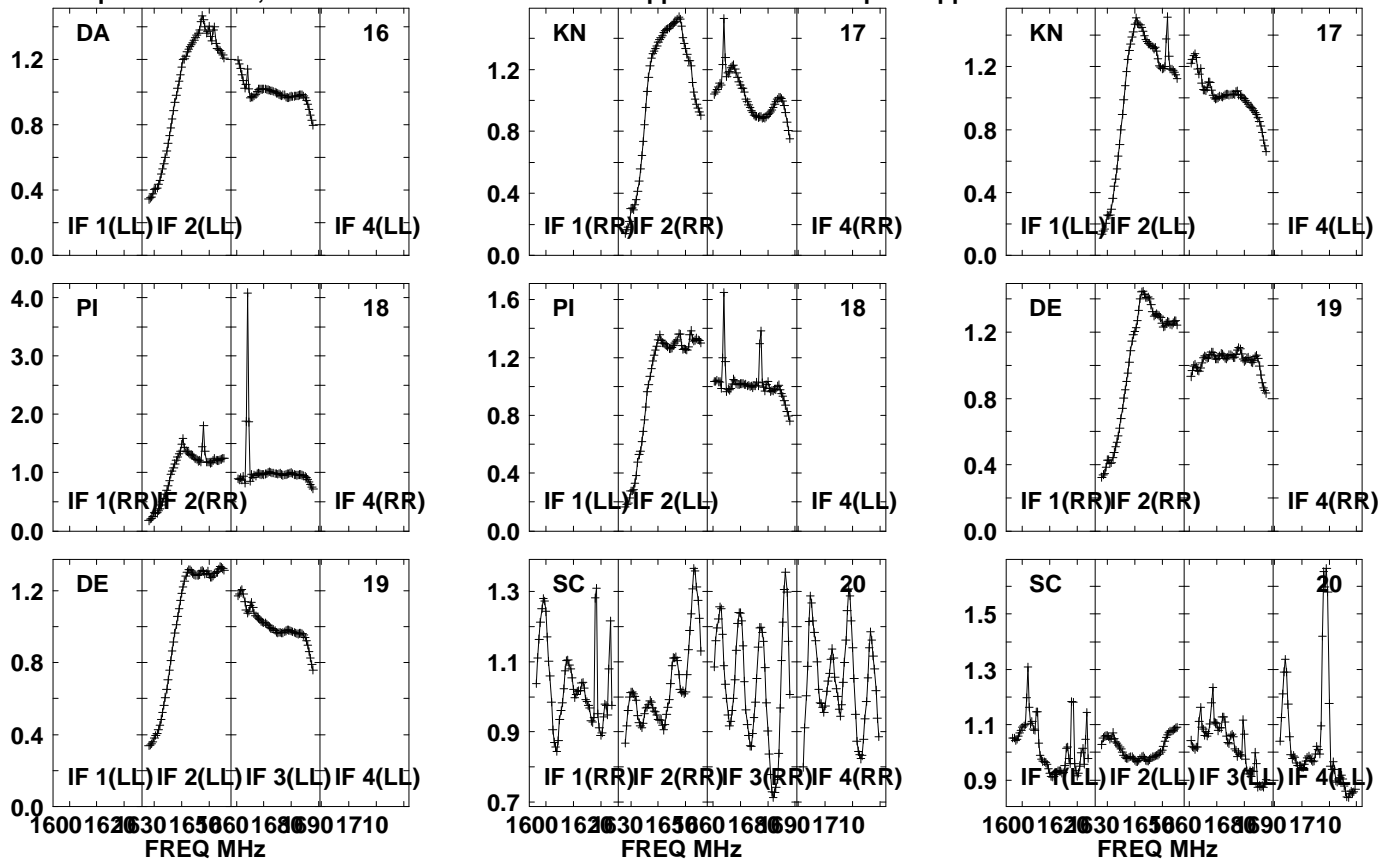

Lower frame: Real Jy  
Auto-corr total-power spectrum Antenna: \*  
Timerange: 00/17:42:31 to 00/17:45:59

Plot file version 808 created 05-OCT-2021 17:08:22

APM08279+525 GM076.UVDATA.1

Freq = 1.5945 GHz, Bw = 32.000 MH No calibration applied and no bandpass applied

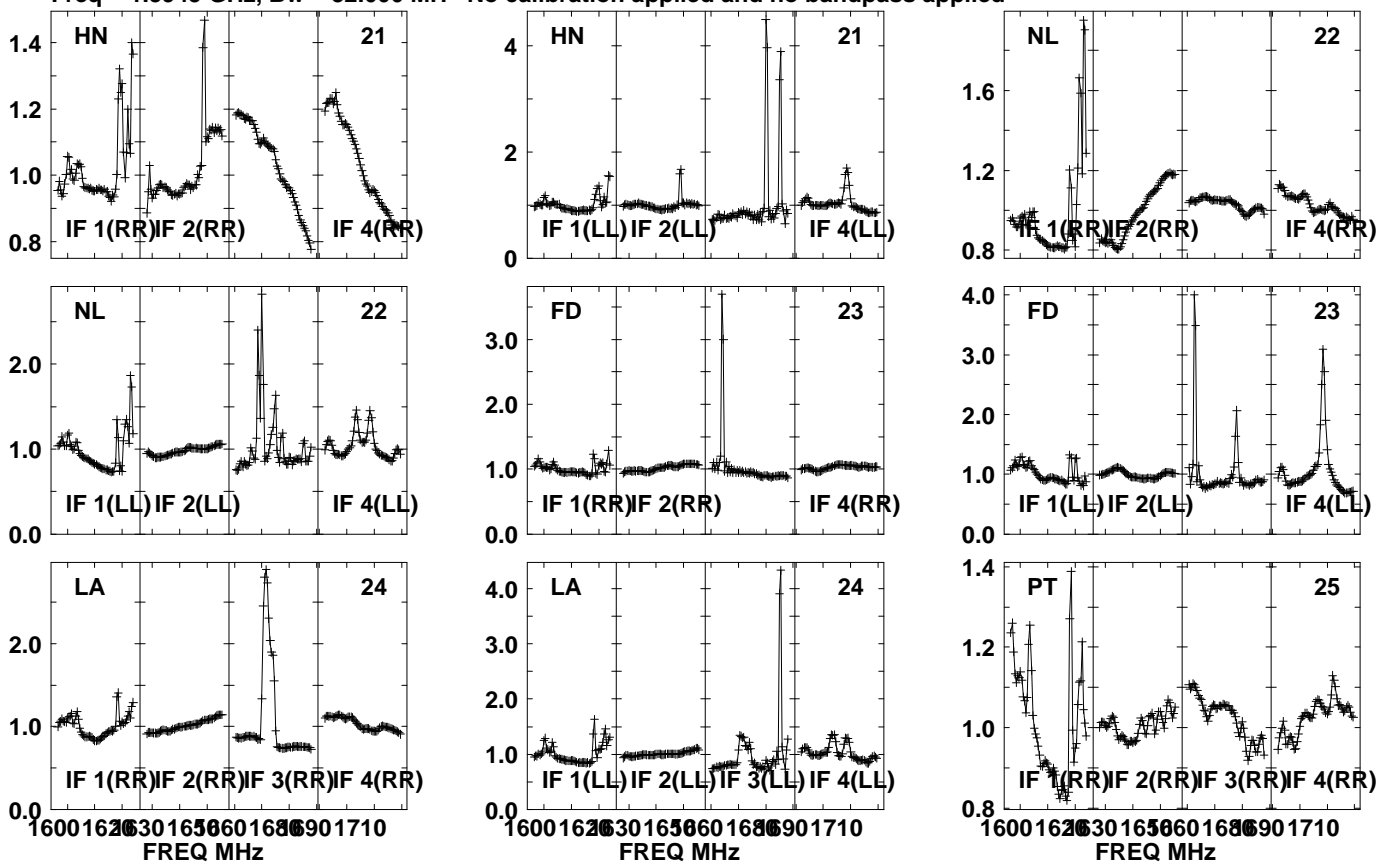

Lower frame: Real Jy  
Auto-corr total-power spectrum Antenna: \*  
Timerange: 00/17:42:31 to 00/17:45:59

Plot file version 809 created 05-OCT-2021 17:08:22

APM08279+525 GM076.UVDATA.1

Freq = 1.5945 GHz, Bw = 32.000 MH No calibration applied and no bandpass applied

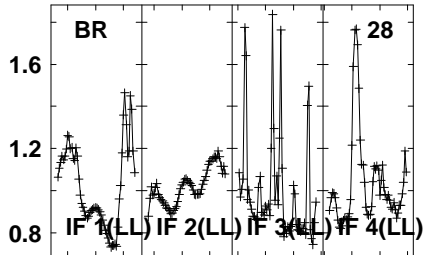
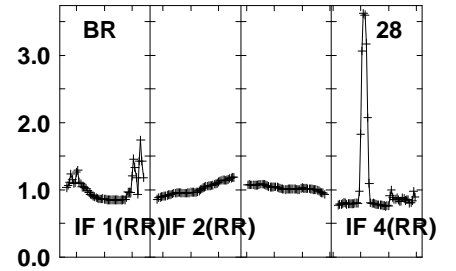
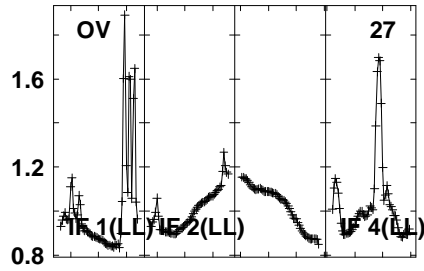
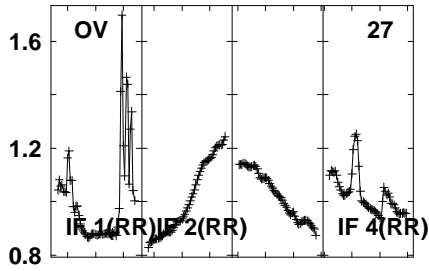
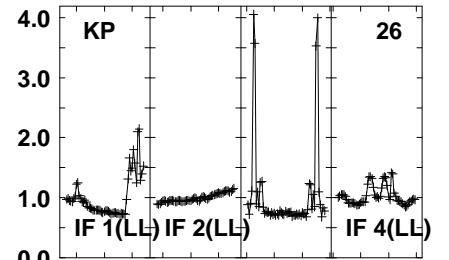
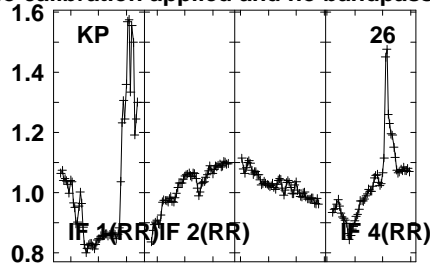
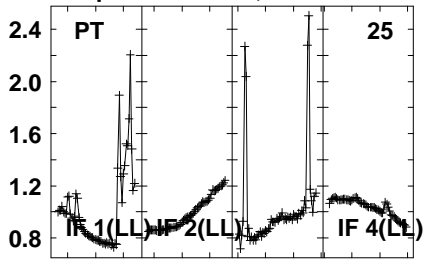

1600 1620 1630 1650 1660 1680 1690 1710  
FREQ MHz

Lower frame: Real Jy

Auto-corr total-power spectrum Antenna: \*

Timerange: 00/17:42:31 to 00/17:45:59

Plot file version 810 created 05-OCT-2021 17:08:23

J0827+5217 GM076.UVDATA.1

Freq = 1.5945 GHz, Bw = 32.000 MH No calibration applied and no bandpass applied

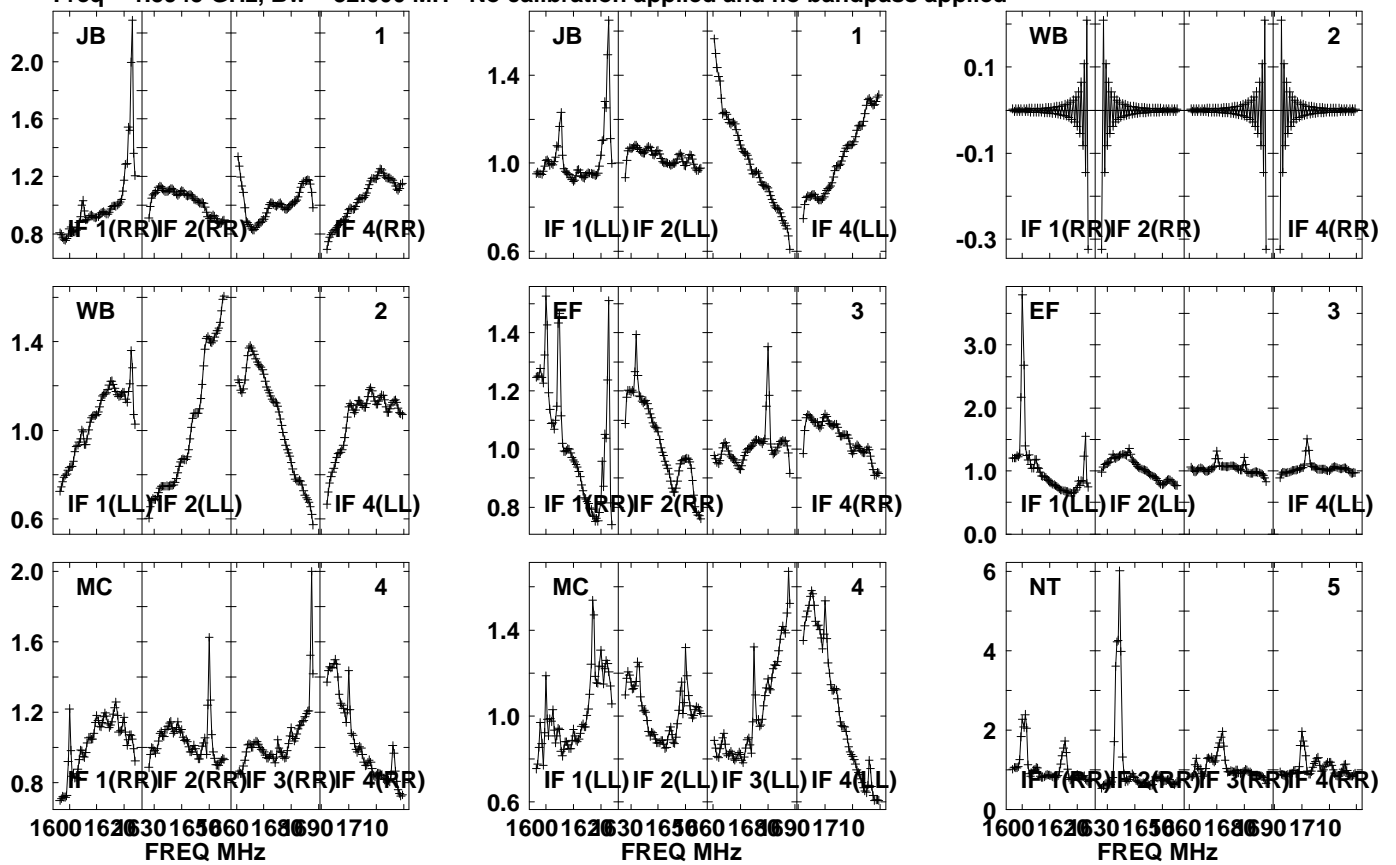

Lower frame: Real Jy  
Auto-corr total-power spectrum Antenna: \*  
Timerange: 00/17:46:01 to 00/17:47:29



Plot file version 811 created 05-OCT-2021 17:08:23

J0827+5217 GM076.UVDATA.1

Freq = 1.5945 GHz, Bw = 32.000 MH No calibration applied and no bandpass applied

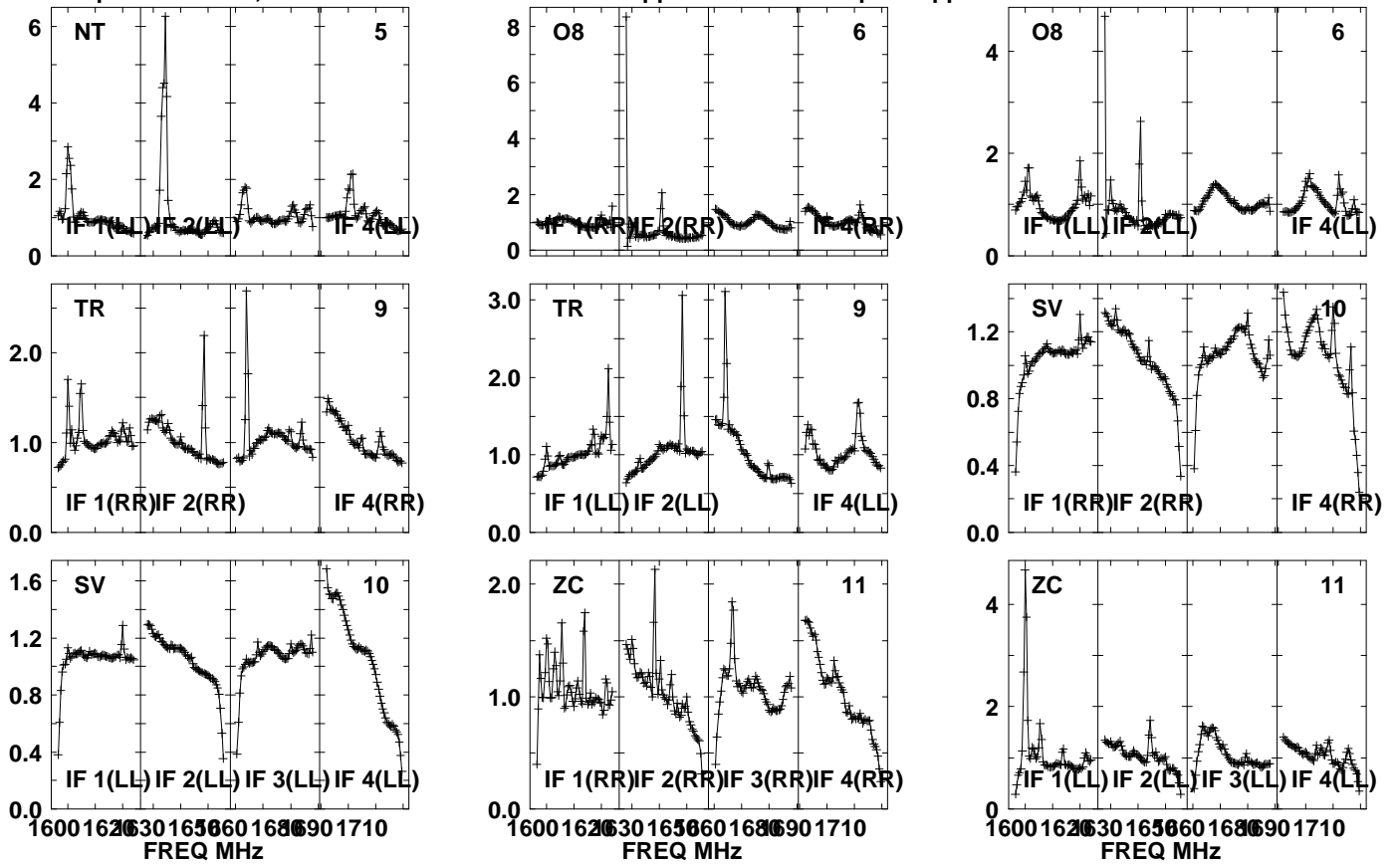

Lower frame: Real Jy  
Auto-corr total-power spectrum Antenna: \*  
Timerange: 00/17:46:01 to 00/17:47:29

Plot file version 812 created 05-OCT-2021 17:08:23

J0827+5217 GM076.UVDATA.1

Freq = 1.5945 GHz, Bw = 32.000 MH No calibration applied and no bandpass applied

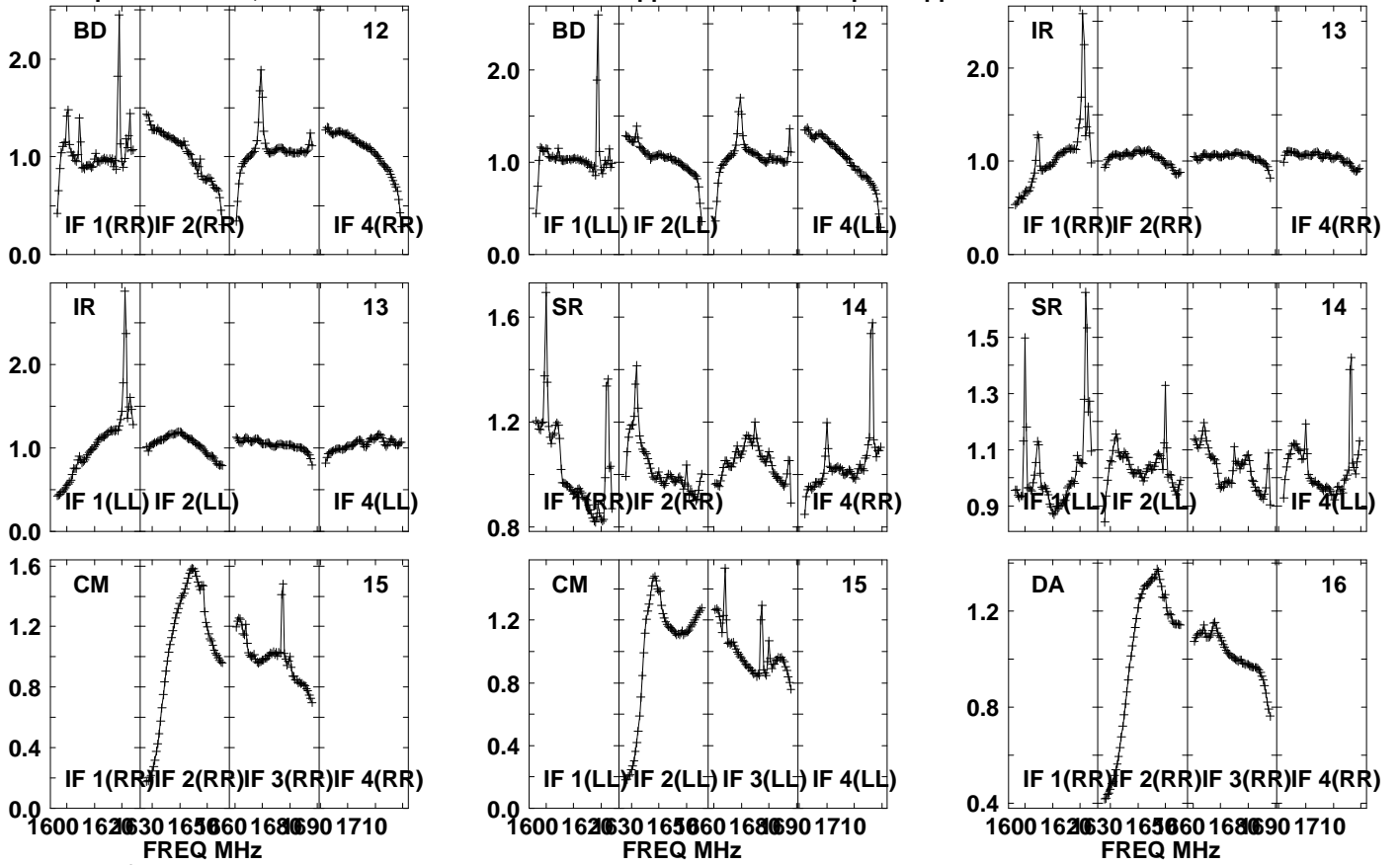

Lower frame: Real Jy  
Auto-corr total-power spectrum Antenna: \*  
Timerange: 00/17:46:01 to 00/17:47:29

Plot file version 813 created 05-OCT-2021 17:08:24

J0827+5217 GM076.UVDATA.1

Freq = 1.5945 GHz, Bw = 32.000 MH No calibration applied and no bandpass applied

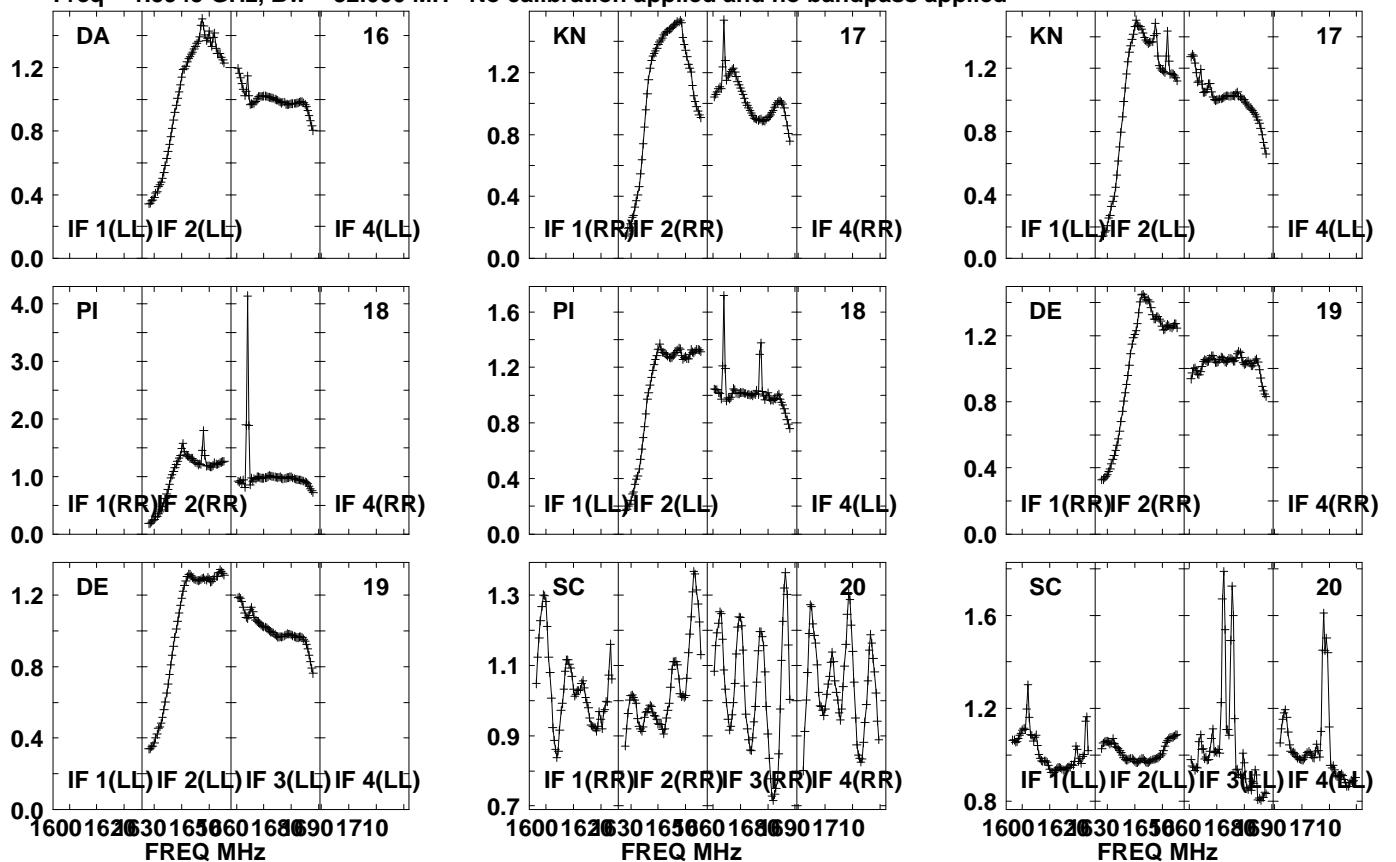

Lower frame: Real Jy  
Auto-corr total-power spectrum Antenna: \*  
Timerange: 00/17:46:01 to 00/17:47:29

Plot file version 814 created 05-OCT-2021 17:08:24

J0827+5217 GM076.UVDATA.1

Freq = 1.5945 GHz, Bw = 32.000 MH No calibration applied and no bandpass applied

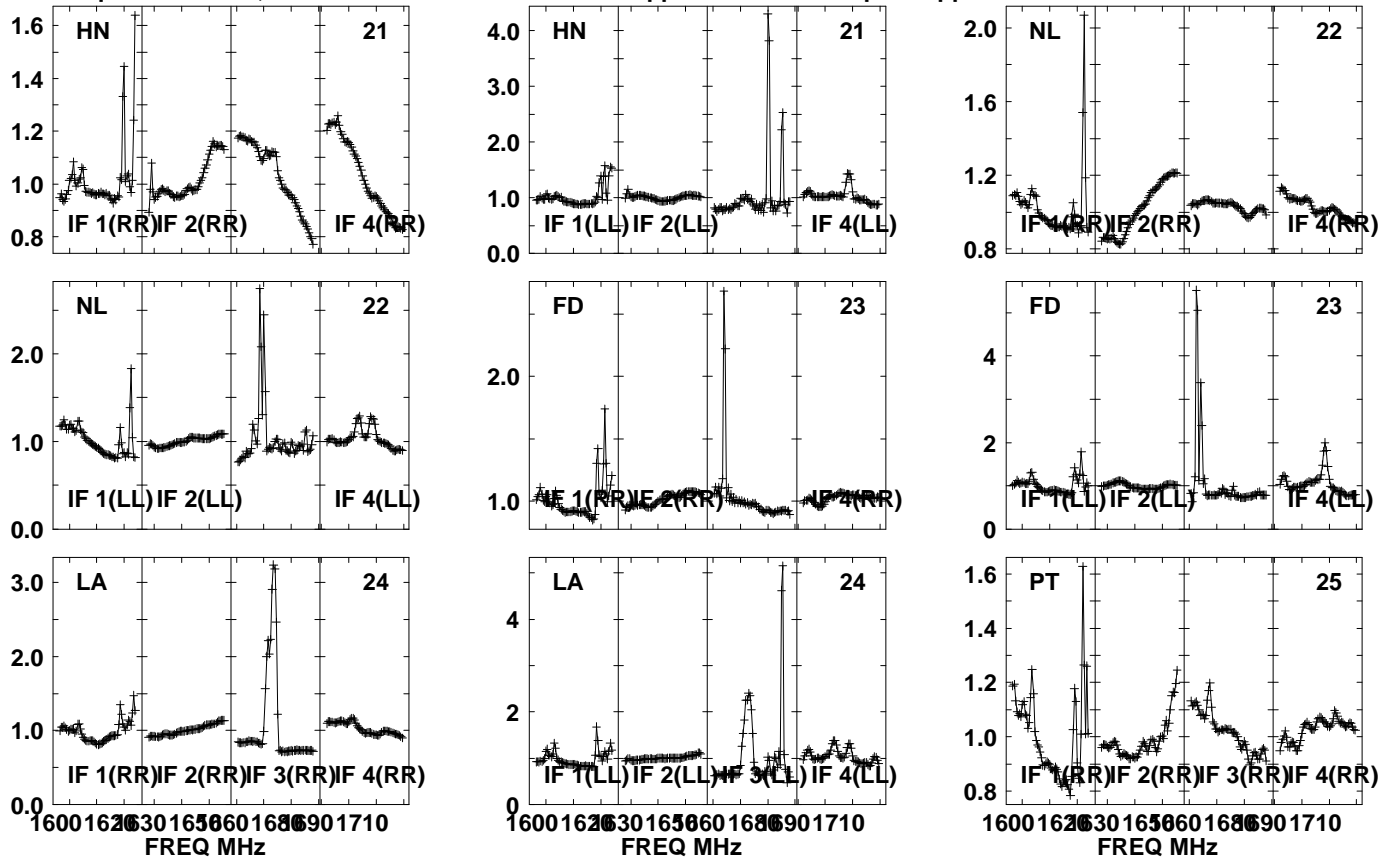

Lower frame: Real Jy  
Auto-corr total-power spectrum Antenna: \*  
Timerange: 00/17:46:01 to 00/17:47:29

Plot file version 815 created 05-OCT-2021 17:08:24

J0827+5217 GM076.UVDATA.1

Freq = 1.5945 GHz, Bw = 32.000 MH No calibration applied and no bandpass applied

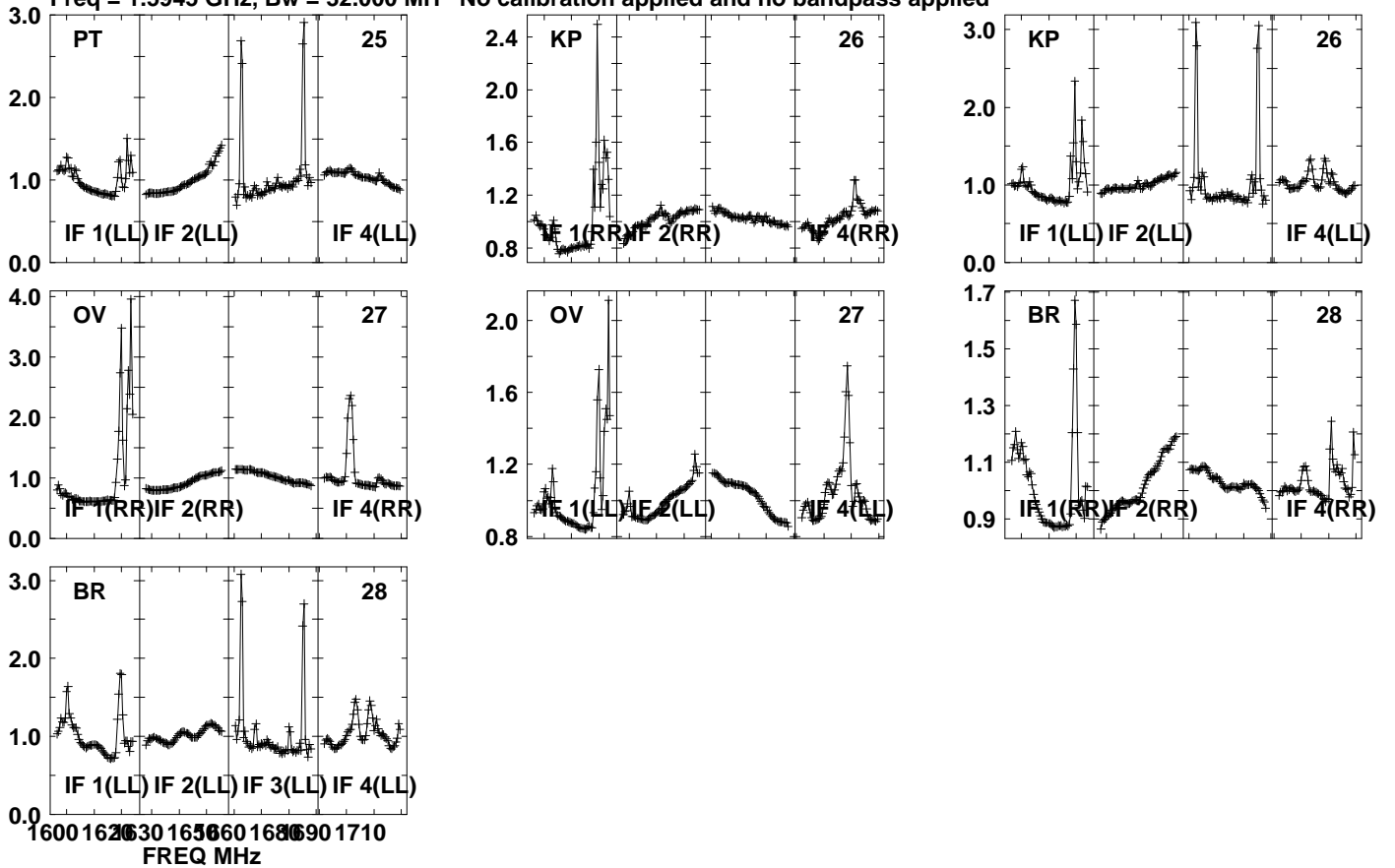

Lower frame: Real Jy  
Auto-corr total-power spectrum Antenna: \*  
Timerange: 00/17:46:01 to 00/17:47:29

Plot file version 816 created 05-OCT-2021 17:08:25

APM08279+525 GM076.UVDATA.1

Freq = 1.5945 GHz, Bw = 32.000 MH No calibration applied and no bandpass applied

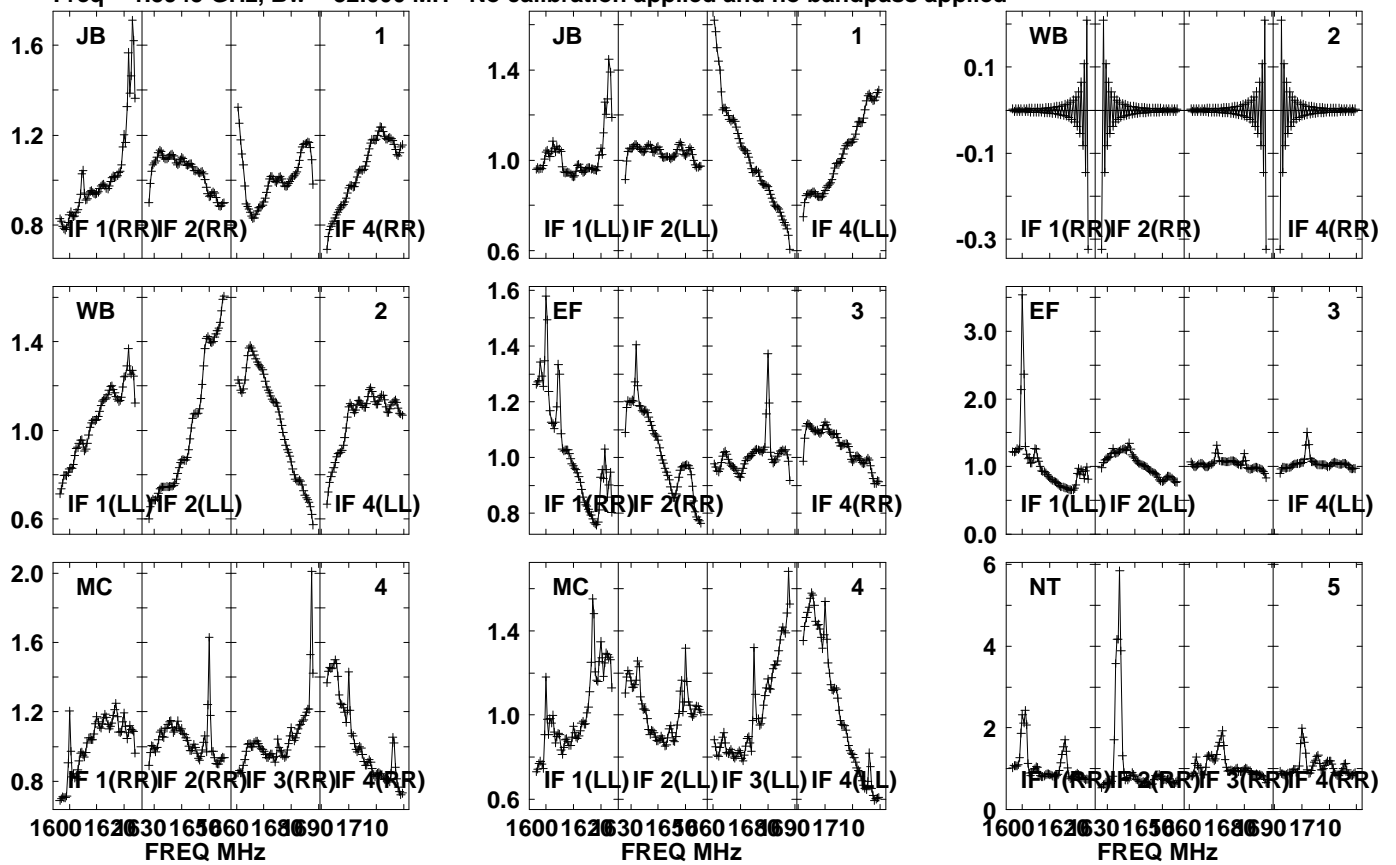

Lower frame: Real Jy  
Auto-corr total-power spectrum Antenna: \*  
Timerange: 00/17:47:31 to 00/17:50:59

Plot file version 817 created 05-OCT-2021 17:08:25

APM08279+525 GM076.UVDATA.1

Freq = 1.5945 GHz, Bw = 32.000 MH No calibration applied and no bandpass applied

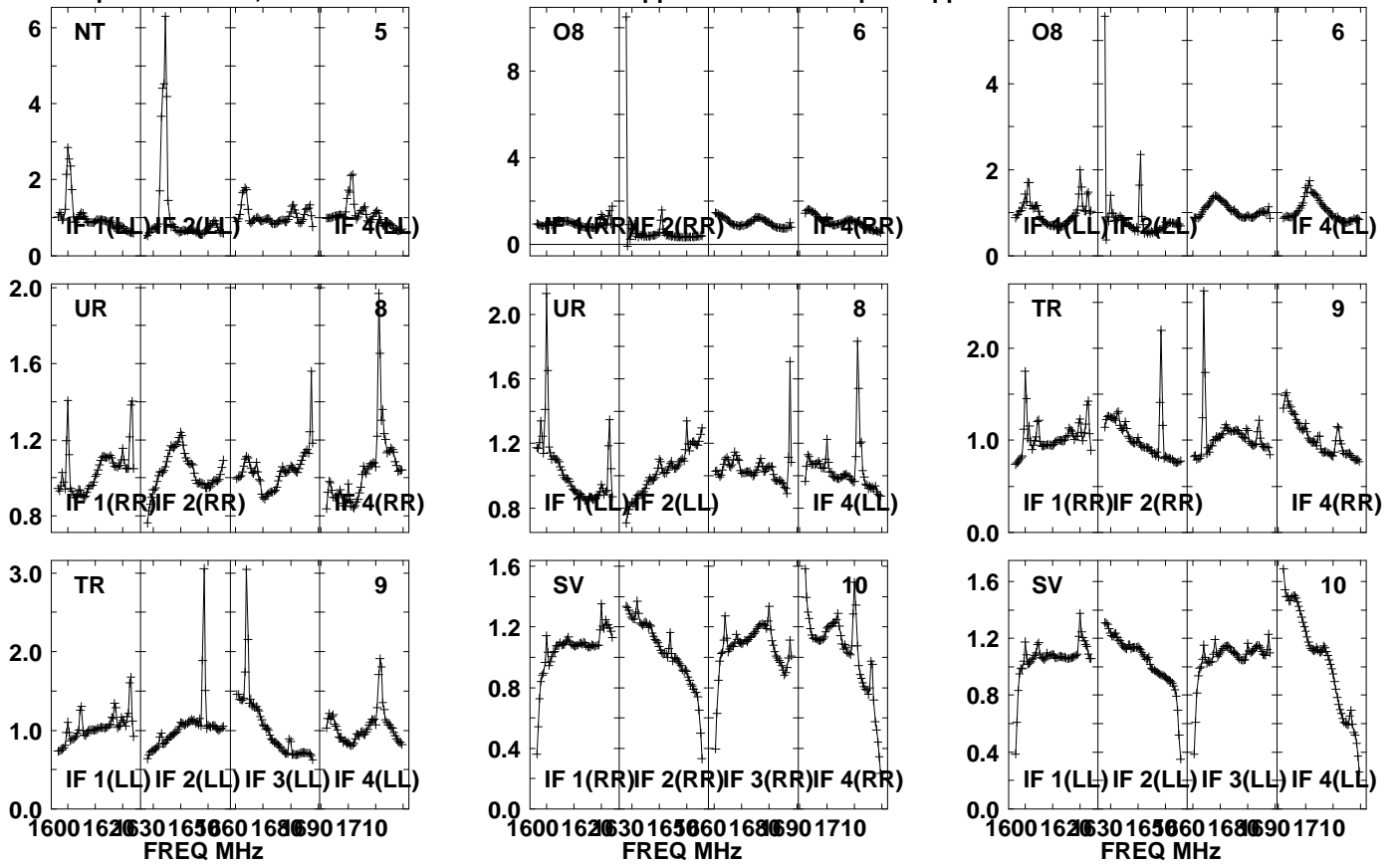

Lower frame: Real Jy  
Auto-corr total-power spectrum Antenna: \*  
Timerange: 00/17:47:31 to 00/17:50:59

Plot file version 818 created 05-OCT-2021 17:08:25

APM08279+525 GM076.UVDATA.1

Freq = 1.5945 GHz, Bw = 32.000 MH No calibration applied and no bandpass applied

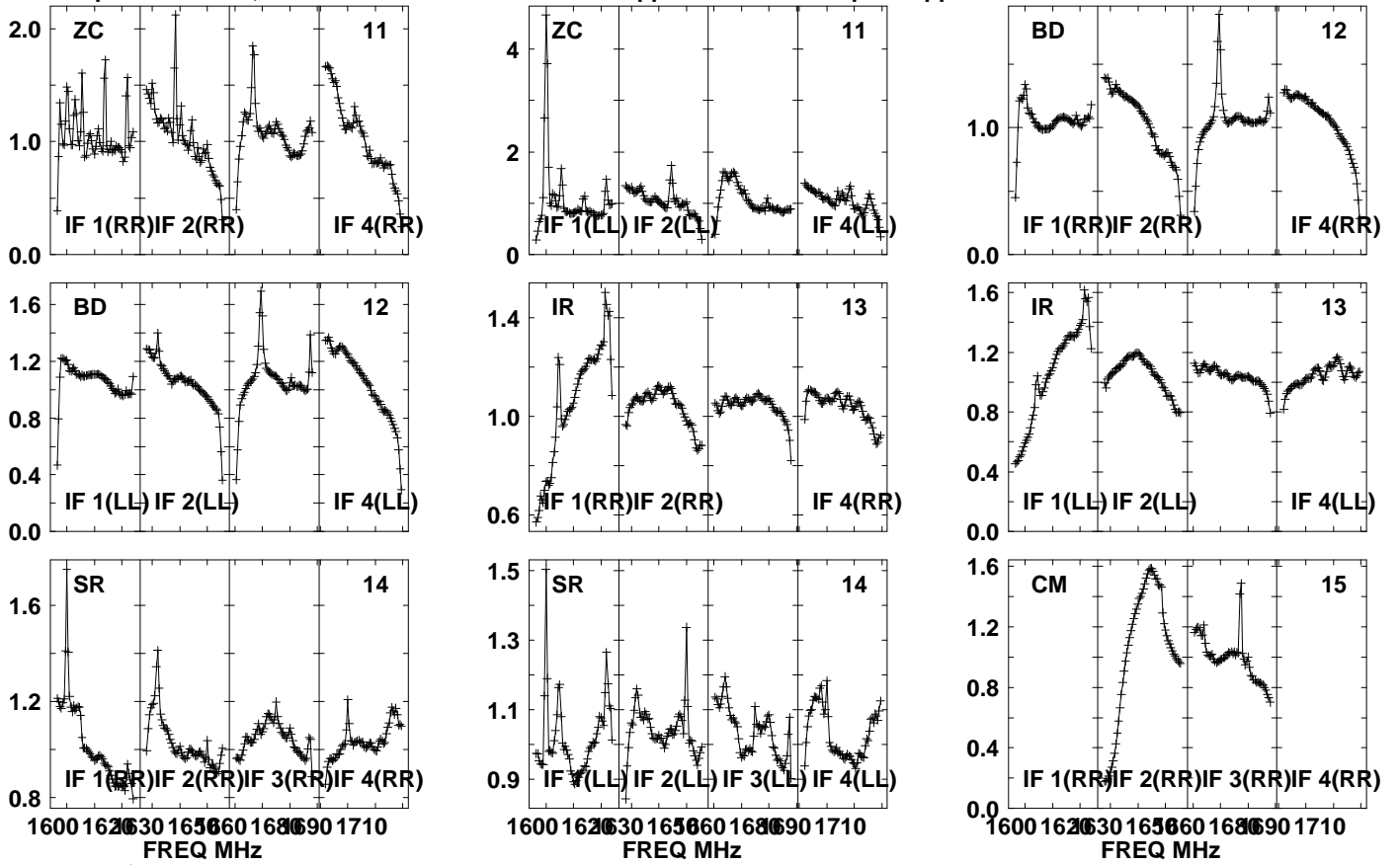

Lower frame: Real Jy  
Auto-corr total-power spectrum Antenna: \*  
Timerange: 00/17:47:31 to 00/17:50:59



Plot file version 819 created 05-OCT-2021 17:08:25

APM08279+525 GM076.UVDATA.1

Freq = 1.5945 GHz, Bw = 32.000 MH No calibration applied and no bandpass applied

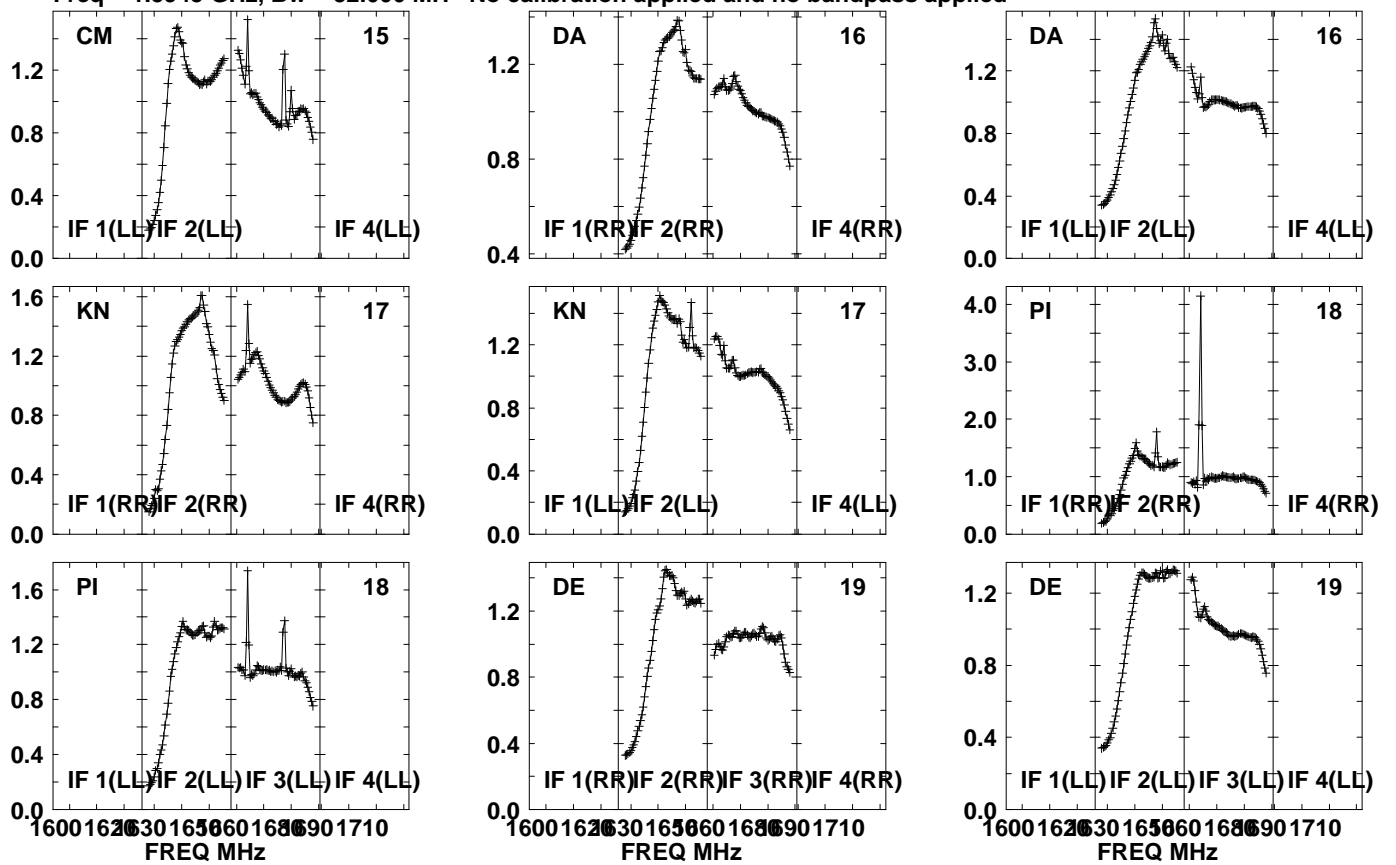

Lower frame: Real Jy  
Auto-corr total-power spectrum Antenna: \*  
Timerange: 00/17:47:31 to 00/17:50:59

Plot file version 820 created 05-OCT-2021 17:08:26

APM08279+525 GM076.UVDATA.1

Freq = 1.5945 GHz, Bw = 32.000 MH No calibration applied and no bandpass applied

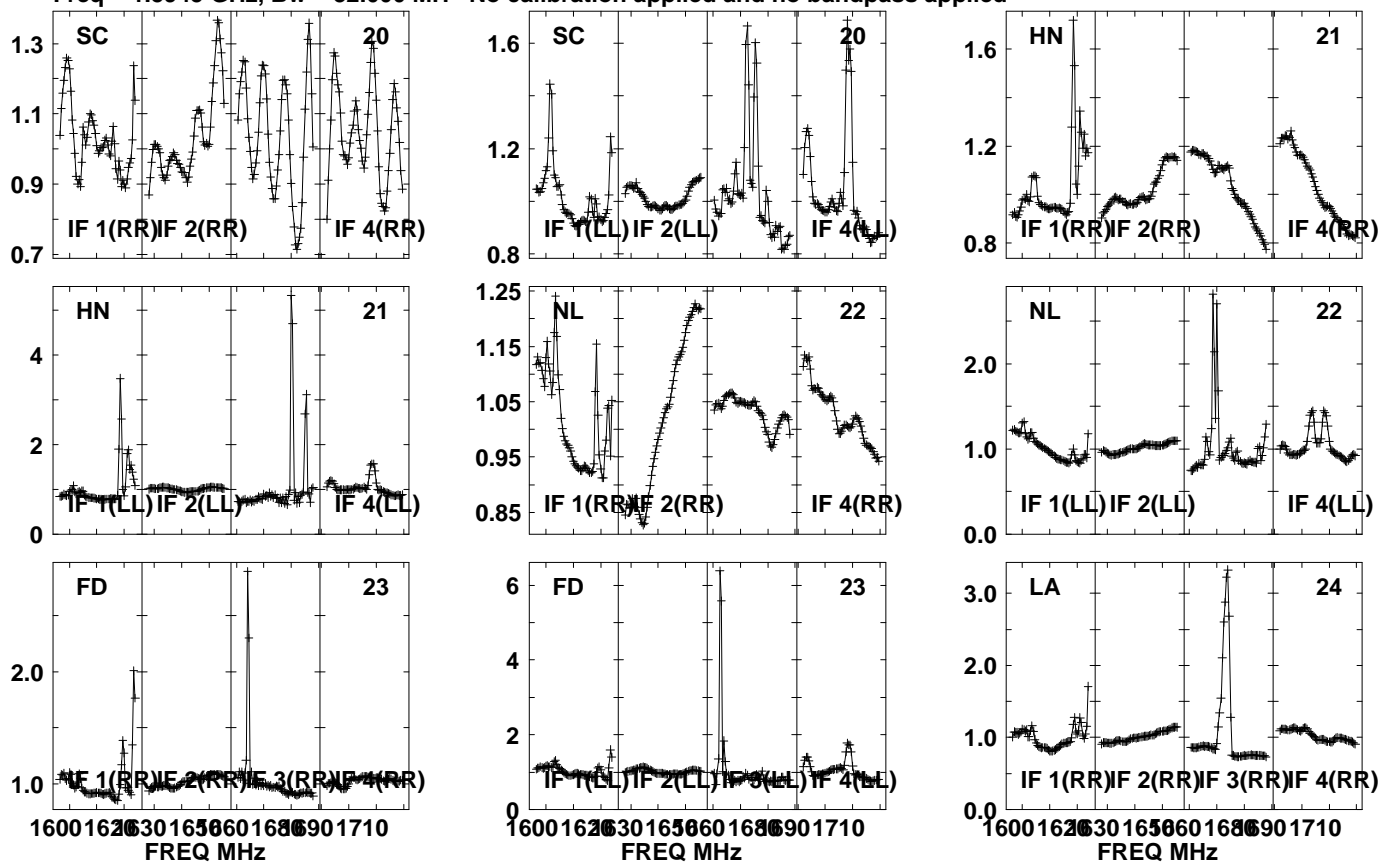

Lower frame: Real Jy  
Auto-corr total-power spectrum Antenna: \*  
Timerange: 00/17:47:31 to 00/17:50:59

Plot file version 821 created 05-OCT-2021 17:08:26

APM08279+525 GM076.UVDATA.1

Freq = 1.5945 GHz, Bw = 32.000 MH No calibration applied and no bandpass applied

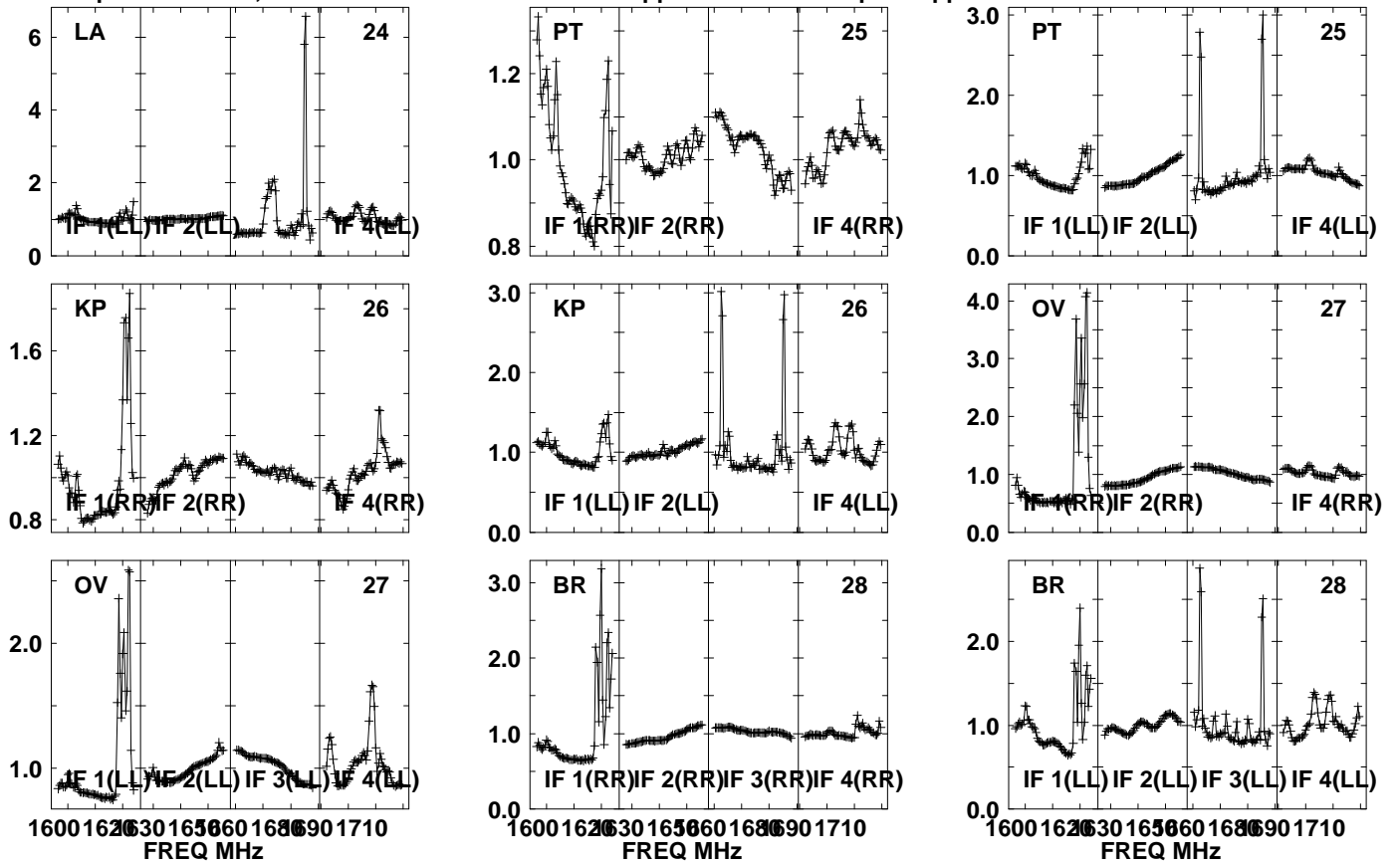

Lower frame: Real Jy  
Auto-corr total-power spectrum Antenna: \*  
Timerange: 00/17:47:31 to 00/17:50:59

Plot file version 822 created 05-OCT-2021 17:08:27

J0827+5217 GM076.UVDATA.1

Freq = 1.5945 GHz, Bw = 32.000 MH No calibration applied and no bandpass applied

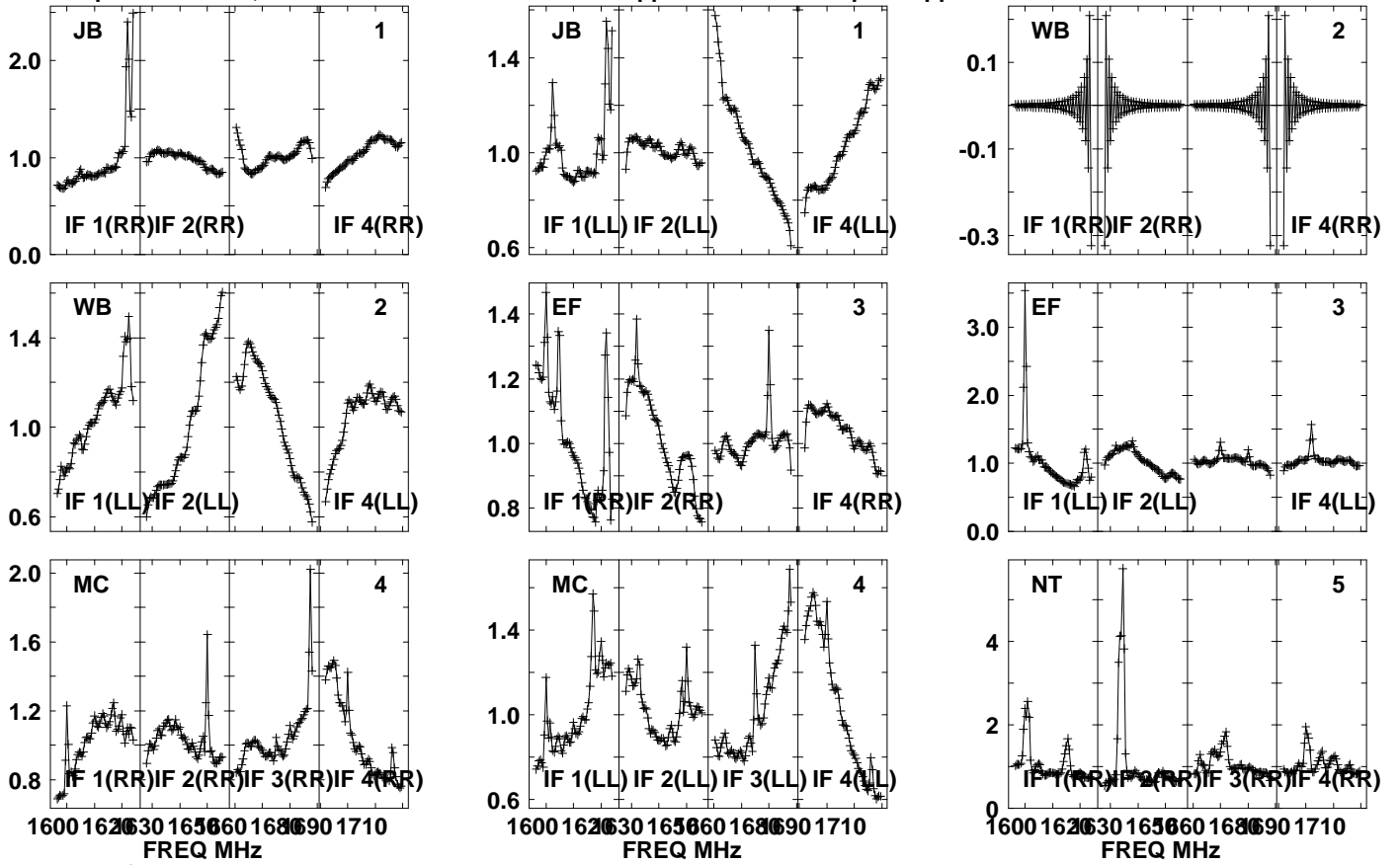

Lower frame: Real Jy  
Auto-corr total-power spectrum Antenna: \*  
Timerange: 00/17:51:31 to 00/17:52:59

Plot file version 823 created 05-OCT-2021 17:08:27

J0827+5217 GM076.UVDATA.1

Freq = 1.5945 GHz, Bw = 32.000 MH No calibration applied and no bandpass applied

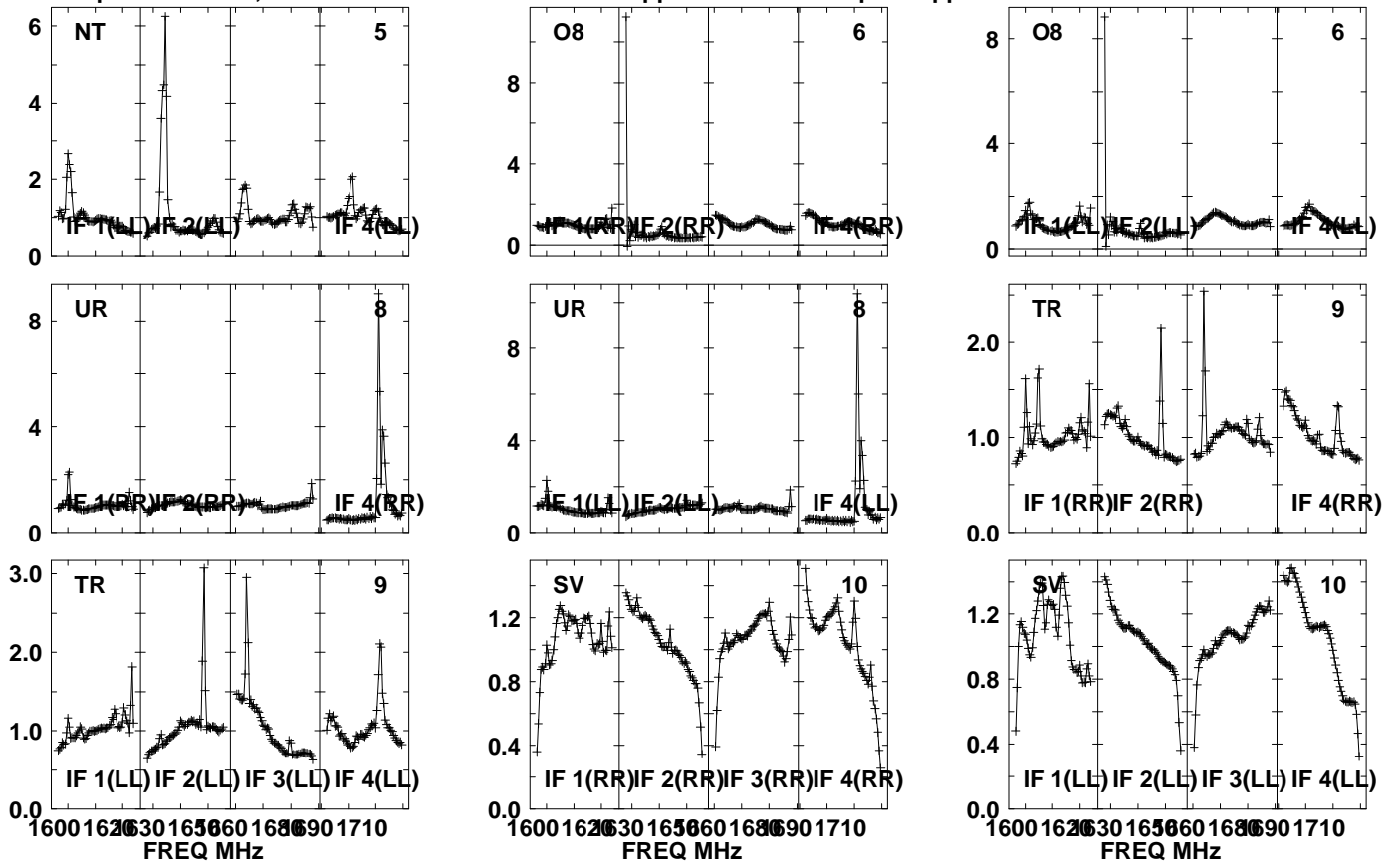

Lower frame: Real Jy

Auto-corr total-power spectrum Antenna: \*

Timerange: 00/17:51:31 to 00/17:52:59

Plot file version 824 created 05-OCT-2021 17:08:27

J0827+5217 GM076.UVDATA.1

Freq = 1.5945 GHz, Bw = 32.000 MH No calibration applied and no bandpass applied

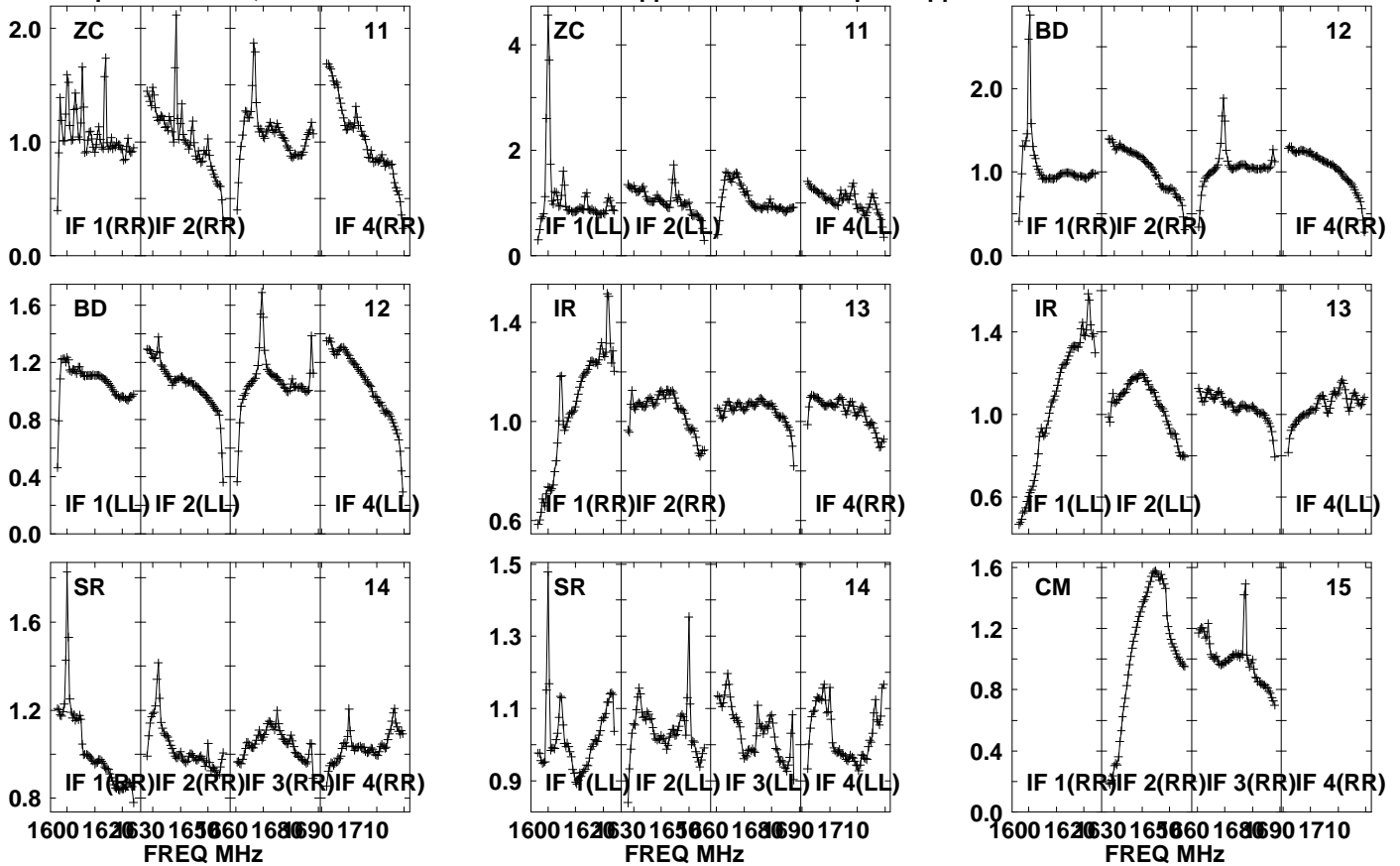

Lower frame: Real Jy  
Auto-corr total-power spectrum Antenna: \*  
Timerange: 00/17:51:31 to 00/17:52:59

Plot file version 825 created 05-OCT-2021 17:08:27

J0827+5217 GM076.UVDATA.1

Freq = 1.5945 GHz, Bw = 32.000 MH No calibration applied and no bandpass applied

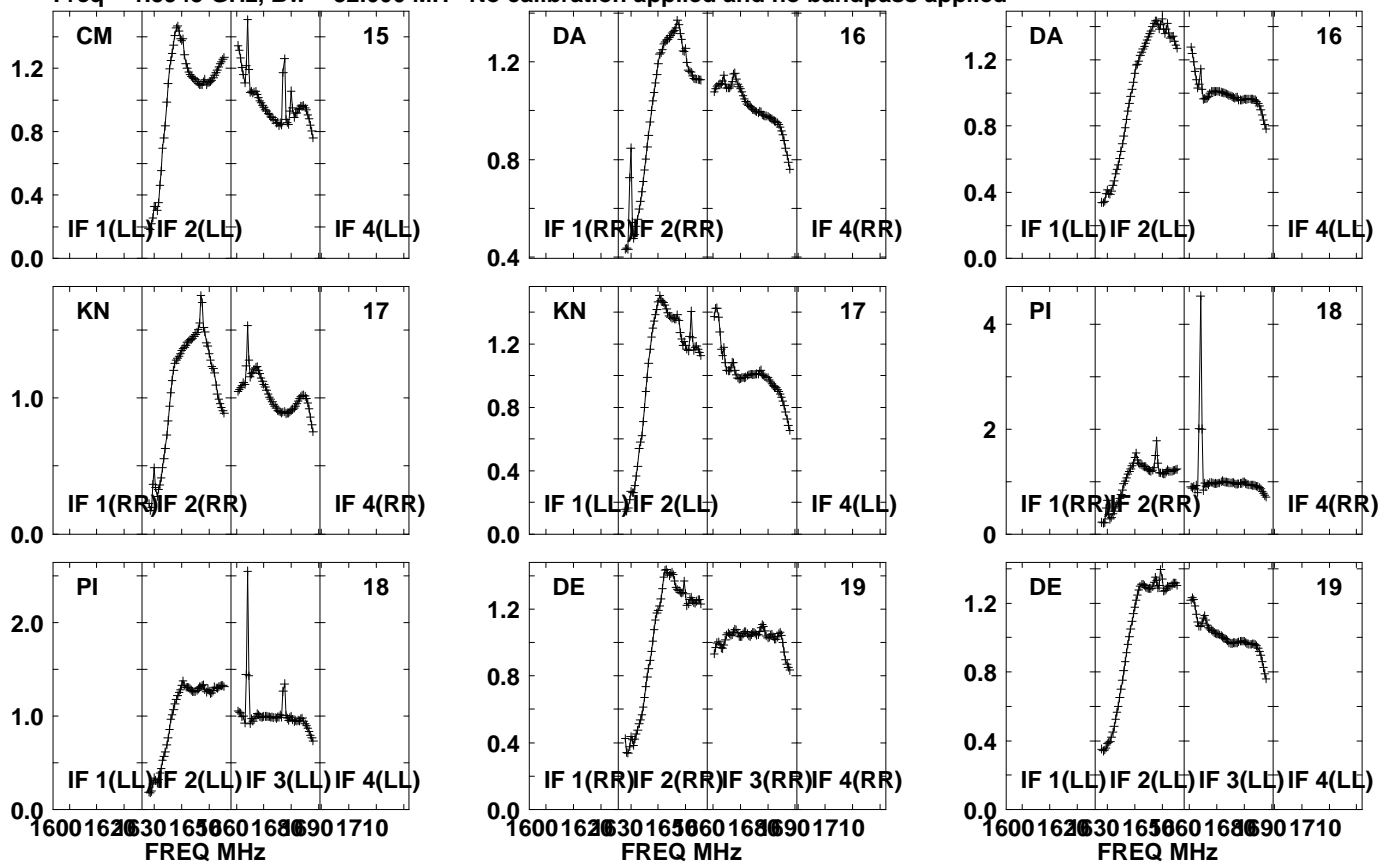

Lower frame: Real Jy  
Auto-corr total-power spectrum Antenna: \*  
Timerange: 00/17:51:31 to 00/17:52:59

Plot file version 826 created 05-OCT-2021 17:08:28

J0827+5217 GM076.UVDATA.1

Freq = 1.5945 GHz, Bw = 32.000 MH No calibration applied and no bandpass applied

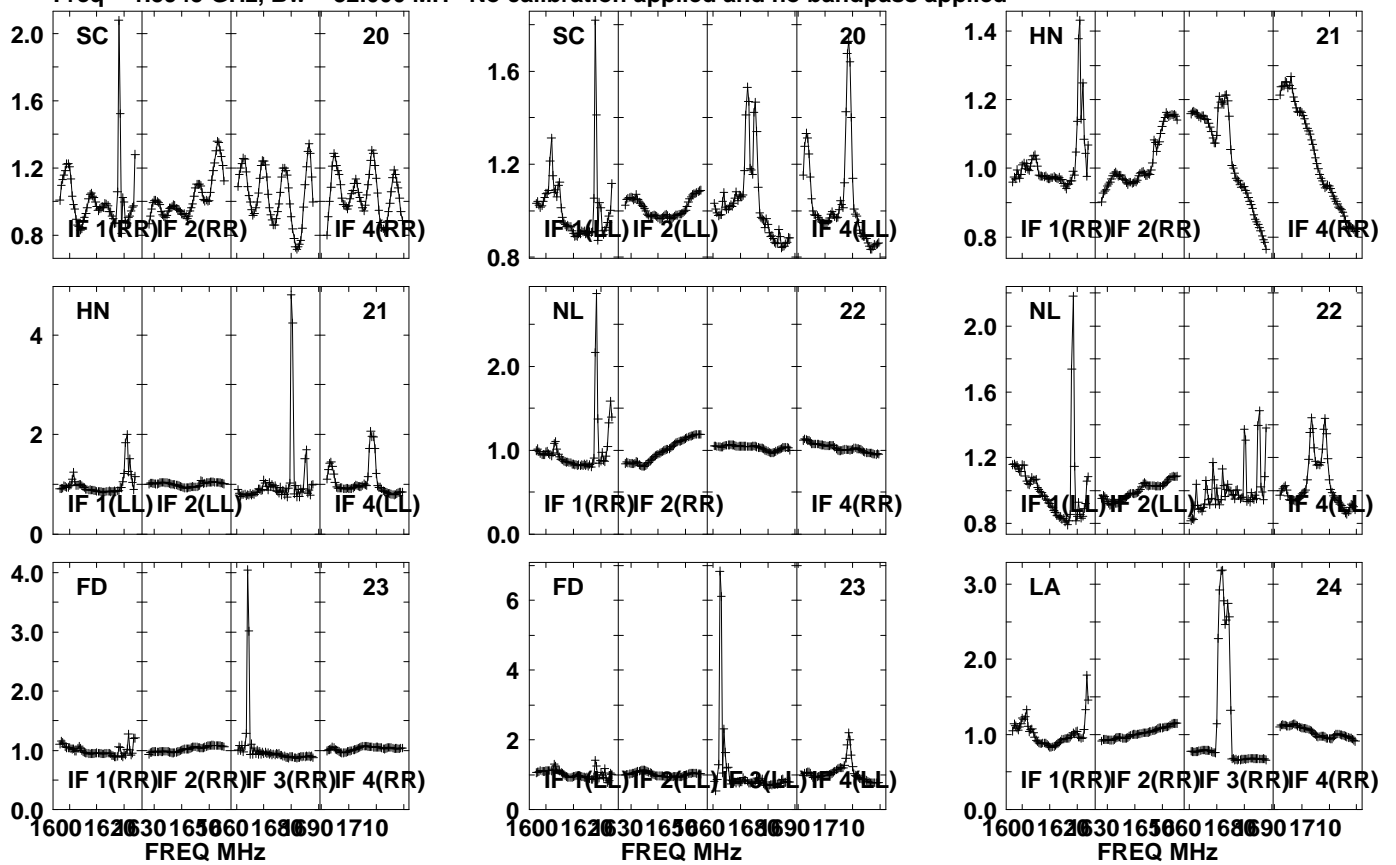

Lower frame: Real Jy  
Auto-corr total-power spectrum Antenna: \*  
Timerange: 00/17:51:31 to 00/17:52:59



Plot file version 827 created 05-OCT-2021 17:08:28

J0827+5217 GM076.UVDATA.1

Freq = 1.5945 GHz, Bw = 32.000 MH No calibration applied and no bandpass applied

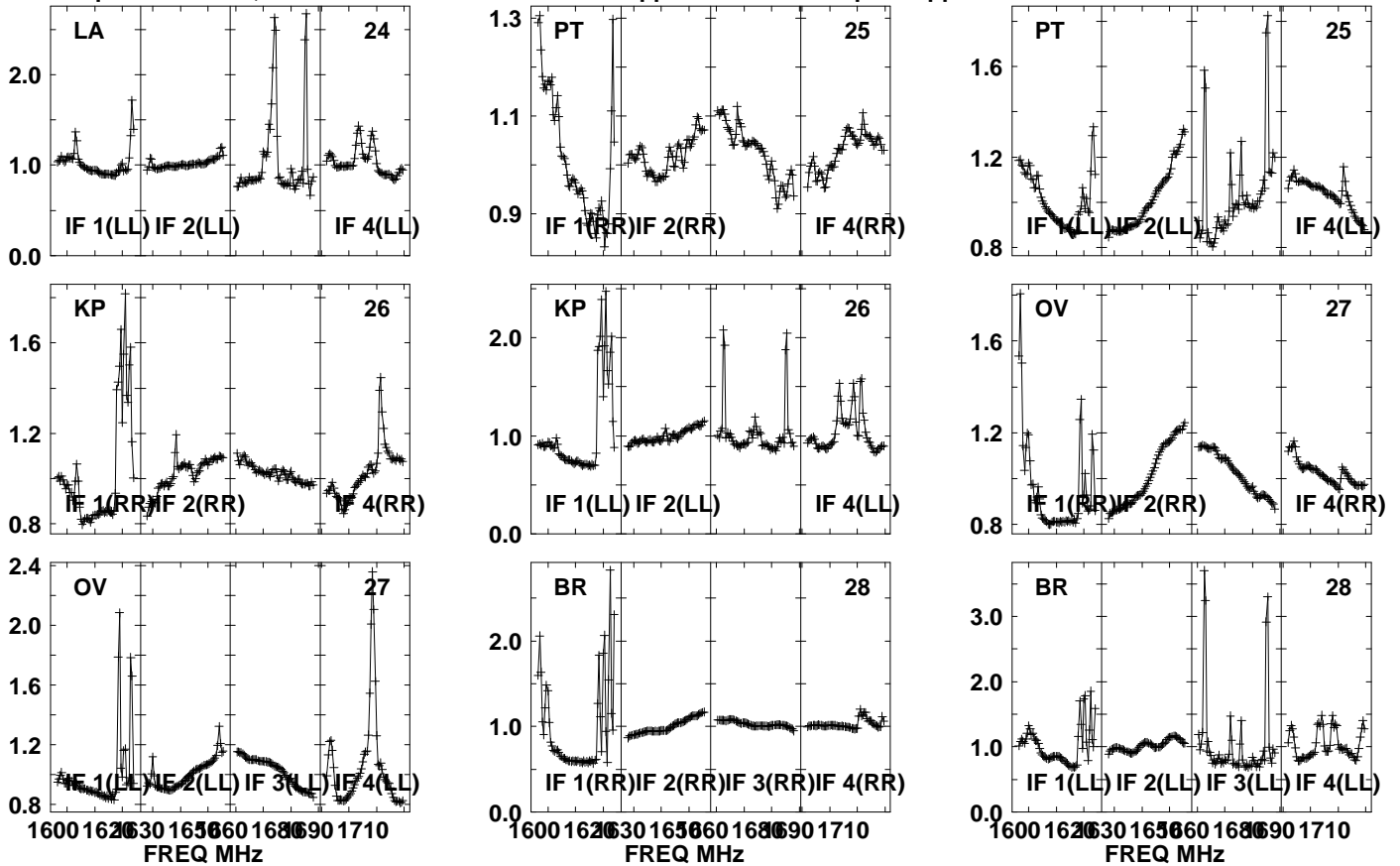

Lower frame: Real Jy

Auto-corr total-power spectrum Antenna: \*

Timerange: 00/17:51:31 to 00/17:52:59

Plot file version 828 created 05-OCT-2021 17:08:28

APM08279+525 GM076.UVDATA.1

Freq = 1.5945 GHz, Bw = 32.000 MH No calibration applied and no bandpass applied

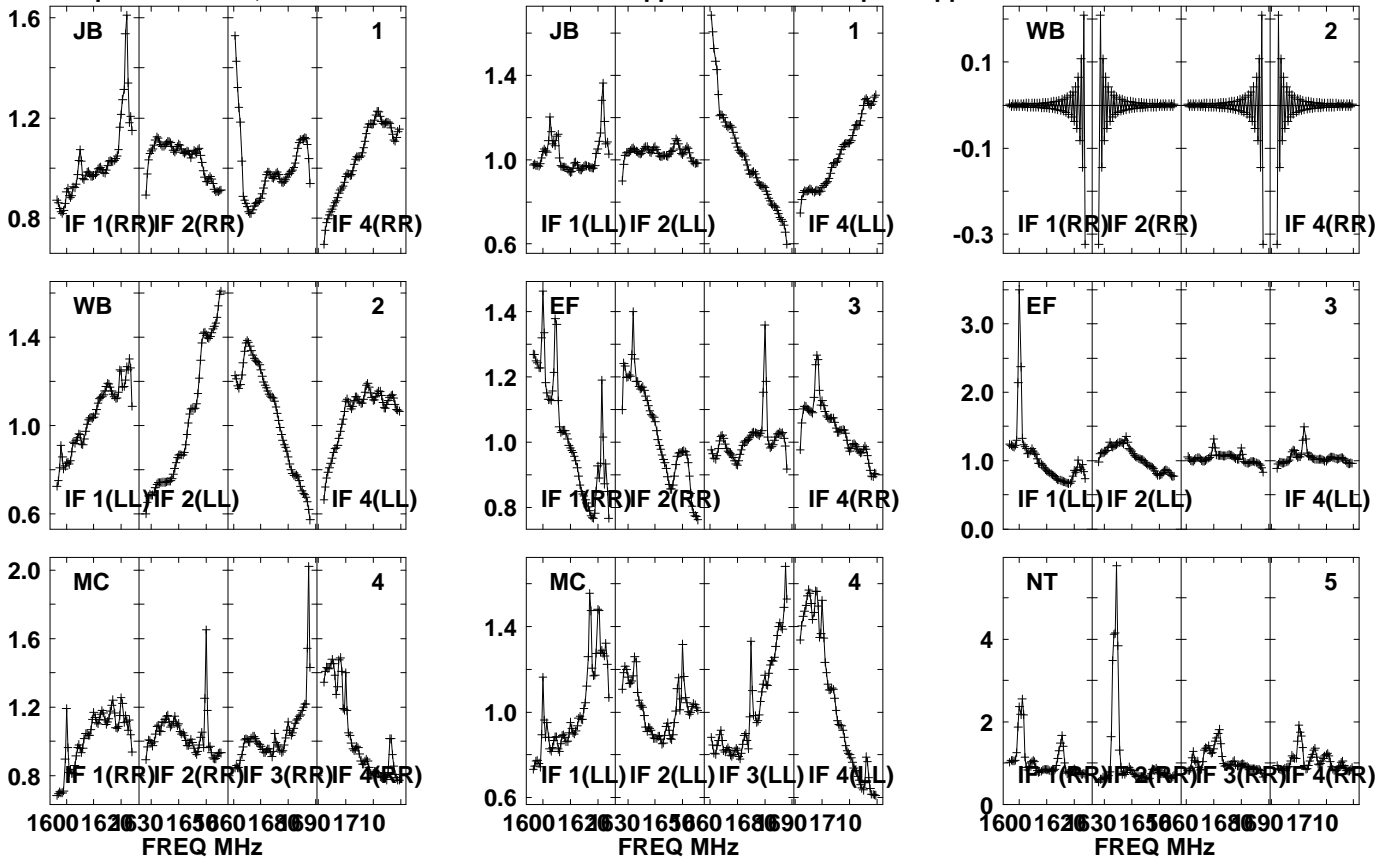

Lower frame: Real Jy  
Auto-corr total-power spectrum Antenna: \*  
Timerange: 00/17:53:01 to 00/17:56:29

Plot file version 829 created 05-OCT-2021 17:08:29

APM08279+525 GM076.UVDATA.1

Freq = 1.5945 GHz, Bw = 32.000 MH No calibration applied and no bandpass applied

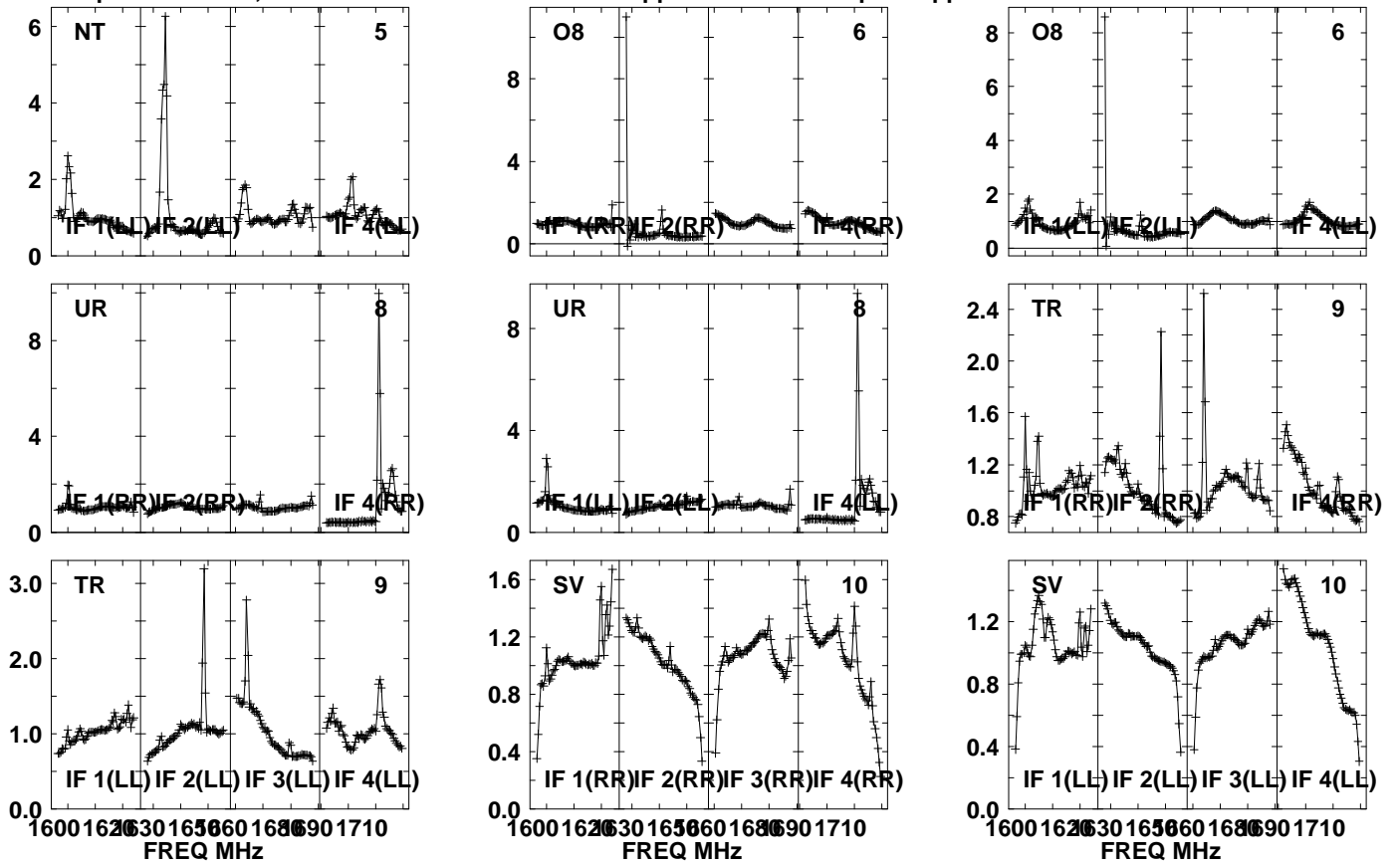

Lower frame: Real Jy

Auto-corr total-power spectrum Antenna: \*

Timerange: 00/17:53:01 to 00/17:56:29

Plot file version 830 created 05-OCT-2021 17:08:29

APM08279+525 GM076.UVDATA.1

Freq = 1.5945 GHz, Bw = 32.000 MH No calibration applied and no bandpass applied

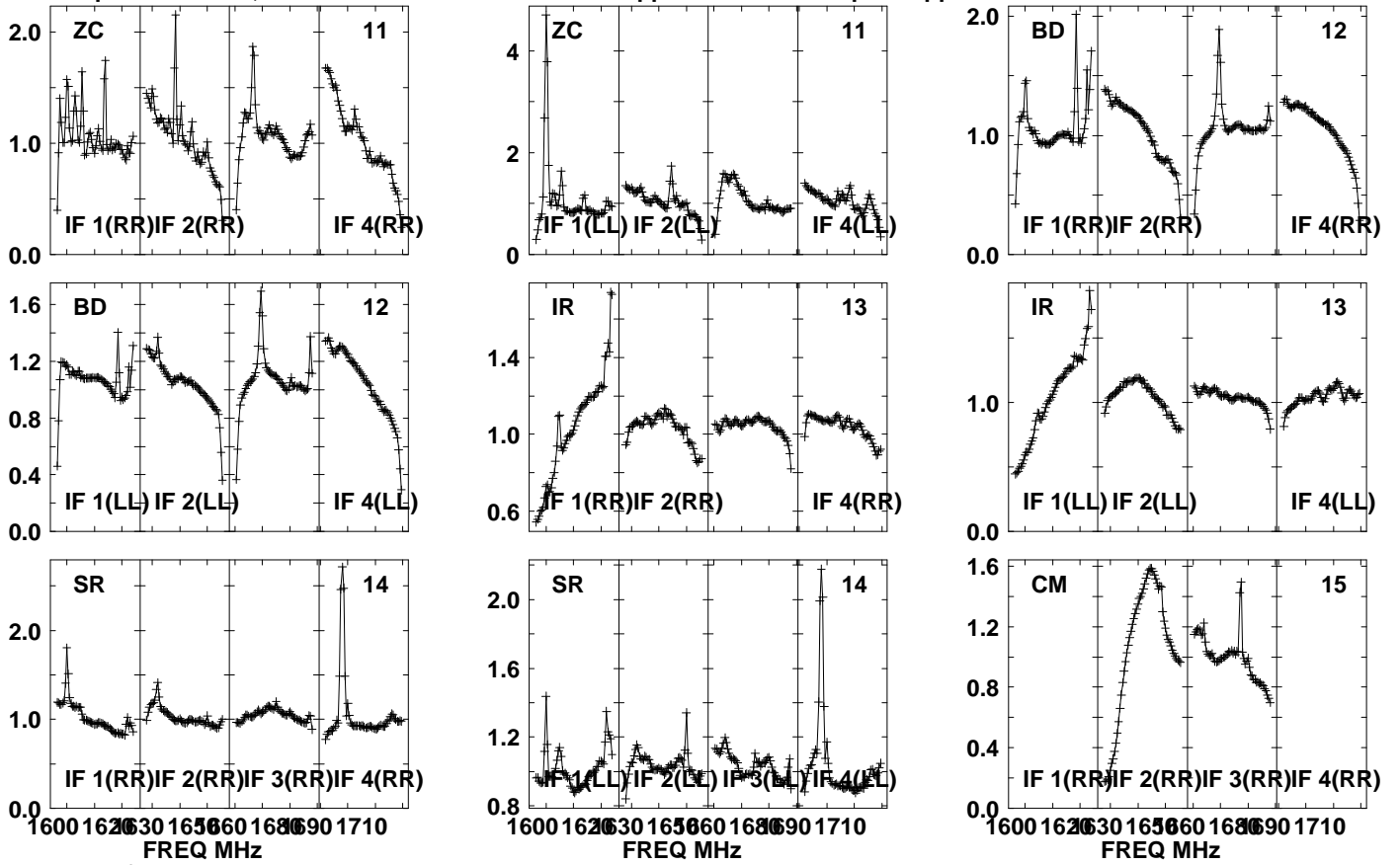

Lower frame: Real Jy

Auto-corr total-power spectrum Antenna: \*

Timerange: 00/17:53:01 to 00/17:56:29

Plot file version 831 created 05-OCT-2021 17:08:29

APM08279+525 GM076.UVDATA.1

Freq = 1.5945 GHz, Bw = 32.000 MH No calibration applied and no bandpass applied

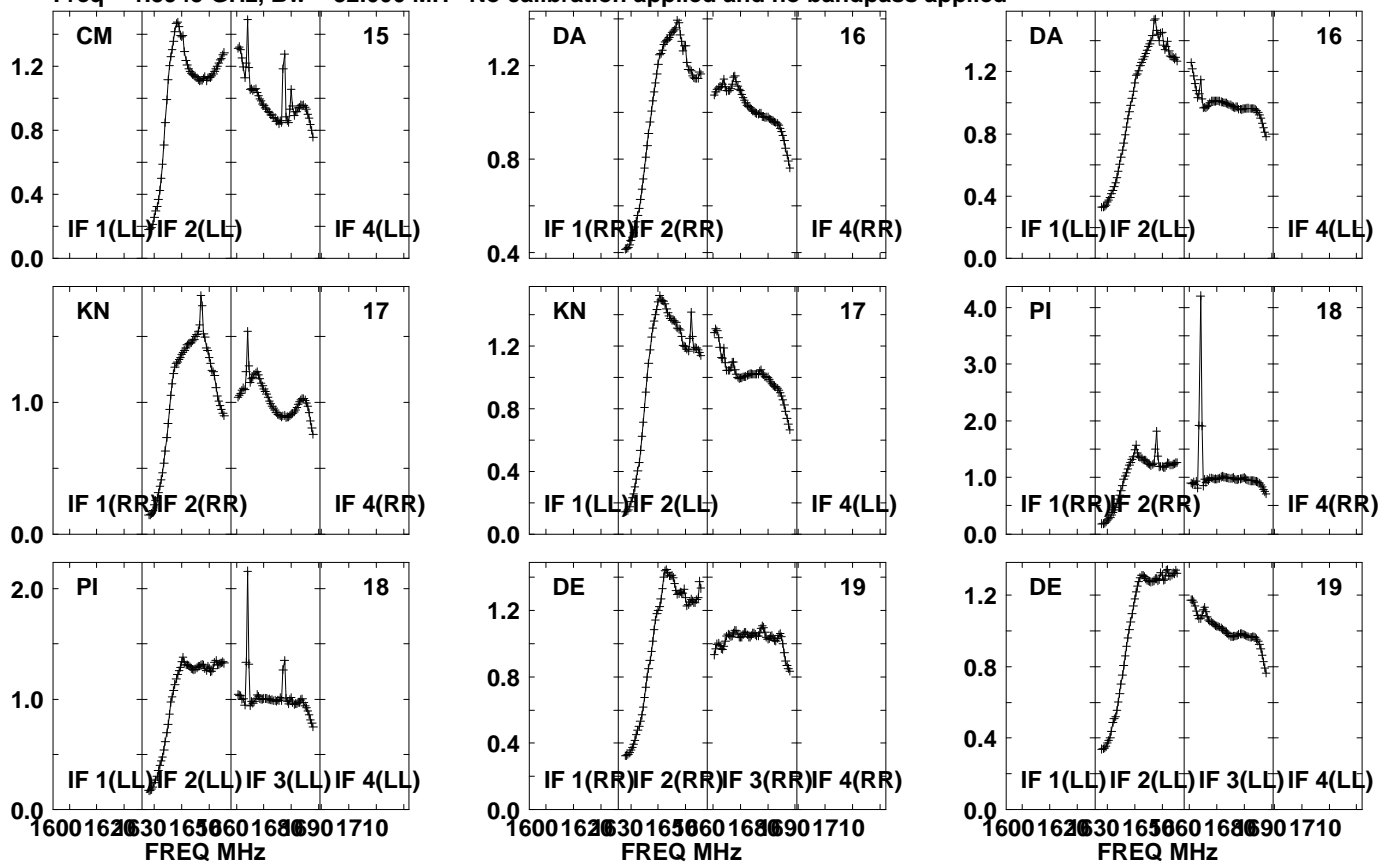

Lower frame: Real Jy  
Auto-corr total-power spectrum Antenna: \*  
Timerange: 00/17:53:01 to 00/17:56:29

Plot file version 832 created 05-OCT-2021 17:08:30

APM08279+525 GM076.UVDATA.1

Freq = 1.5945 GHz, Bw = 32.000 MH No calibration applied and no bandpass applied

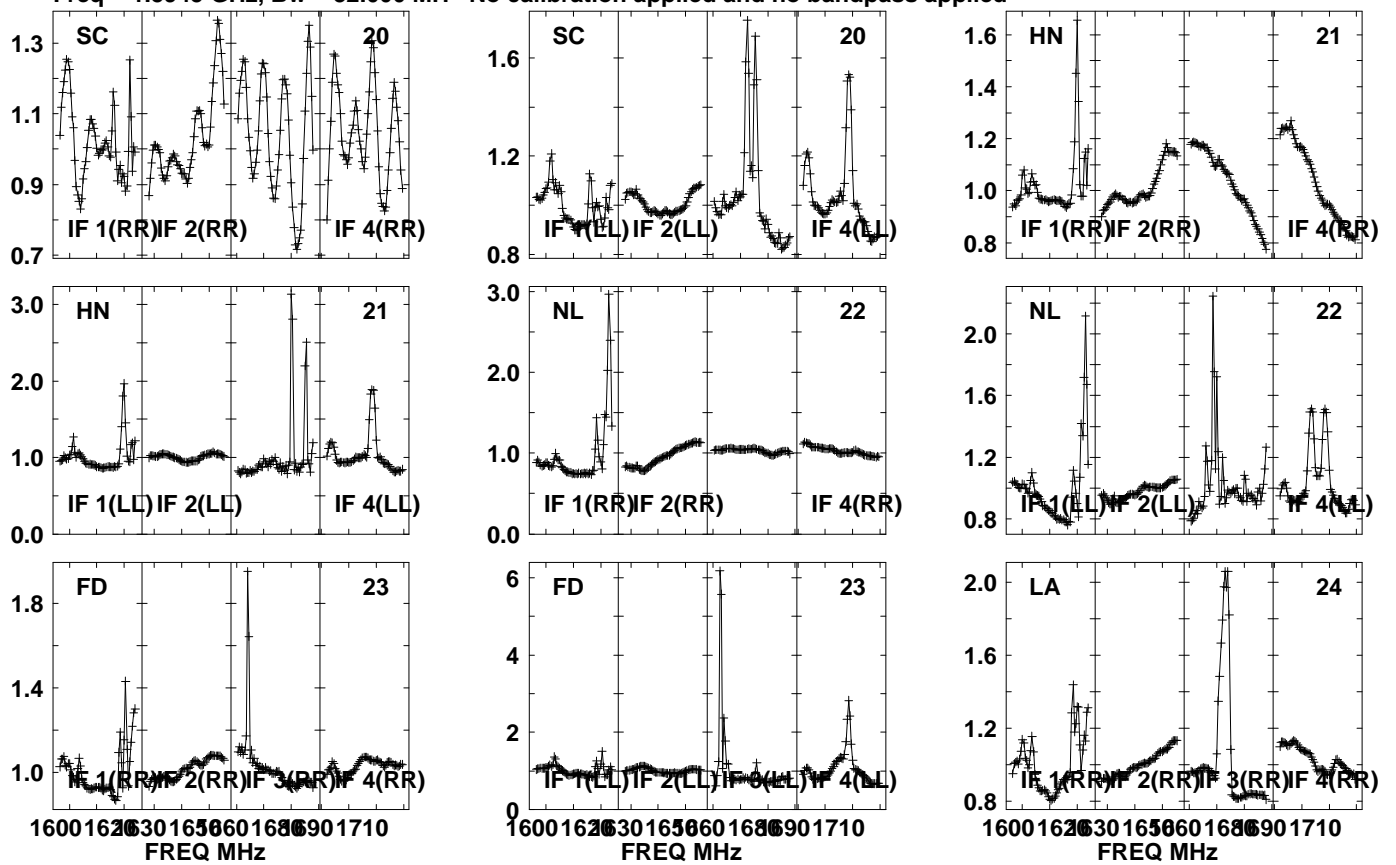

Lower frame: Real Jy  
Auto-corr total-power spectrum Antenna: \*  
Timerange: 00/17:53:01 to 00/17:56:29

Plot file version 833 created 05-OCT-2021 17:08:30

APM08279+525 GM076.UVDATA.1

Freq = 1.5945 GHz, Bw = 32.000 MH No calibration applied and no bandpass applied

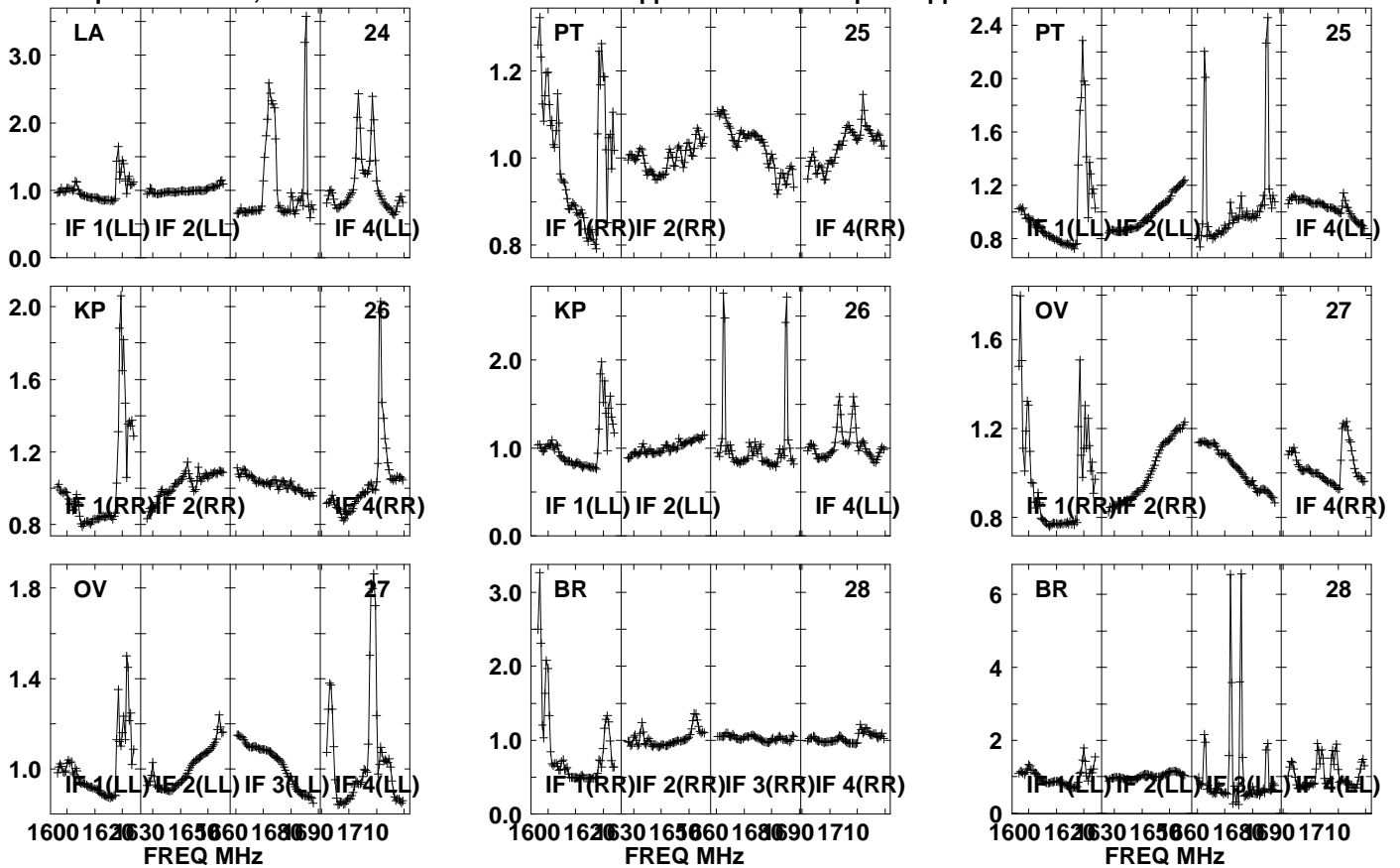

Lower frame: Real Jy

Auto-corr total-power spectrum Antenna: \*

Timerange: 00/17:53:01 to 00/17:56:29

Plot file version 834 created 05-OCT-2021 17:08:30

J0827+5217 GM076.UVDATA.1

Freq = 1.5945 GHz, Bw = 32.000 MH No calibration applied and no bandpass applied

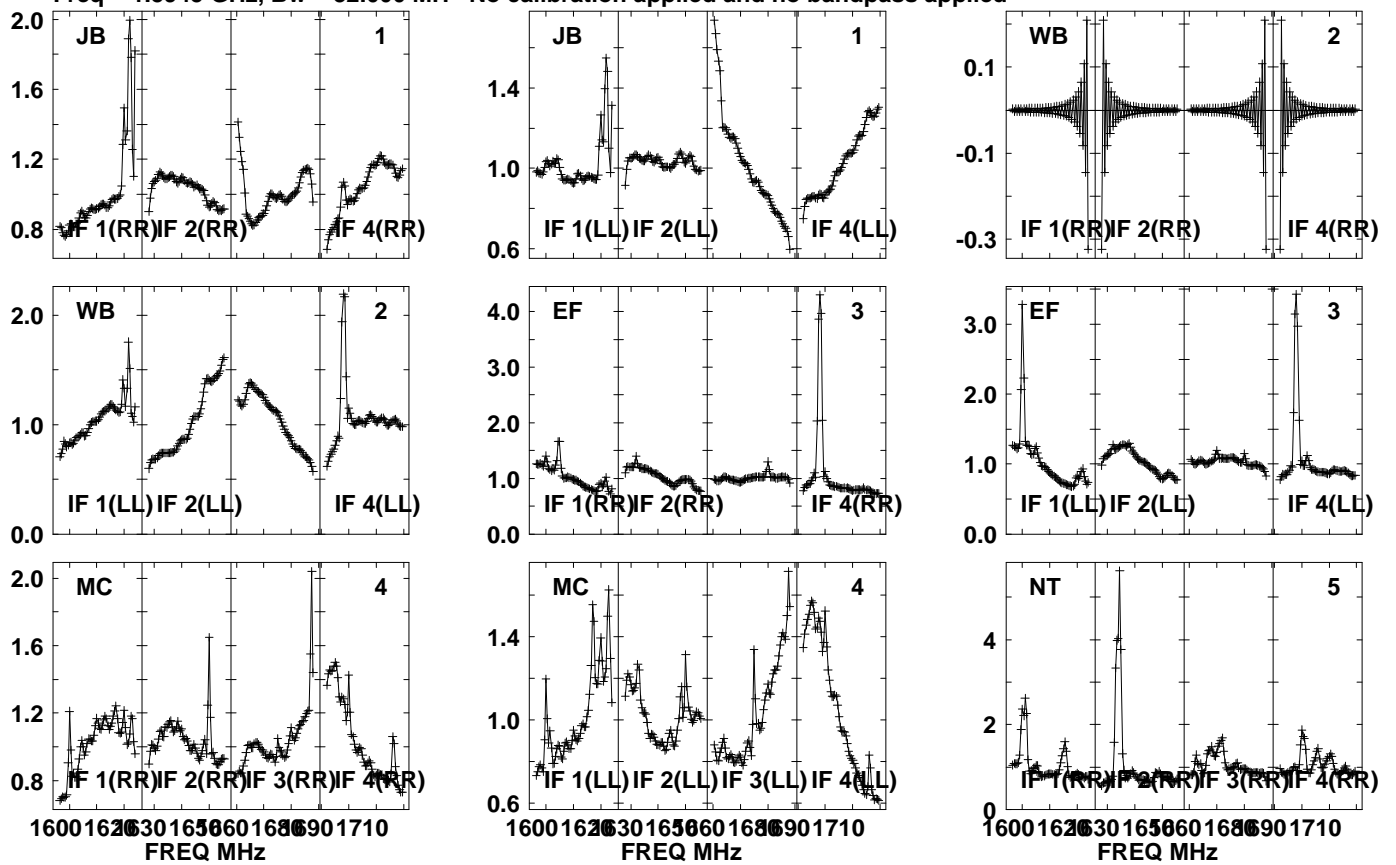

Lower frame: Real Jy  
Auto-corr total-power spectrum Antenna: \*  
Timerange: 00/17:56:31 to 00/17:57:59



Plot file version 835 created 05-OCT-2021 17:08:31

J0827+5217 GM076.UVDATA.1

Freq = 1.5945 GHz, Bw = 32.000 MH No calibration applied and no bandpass applied

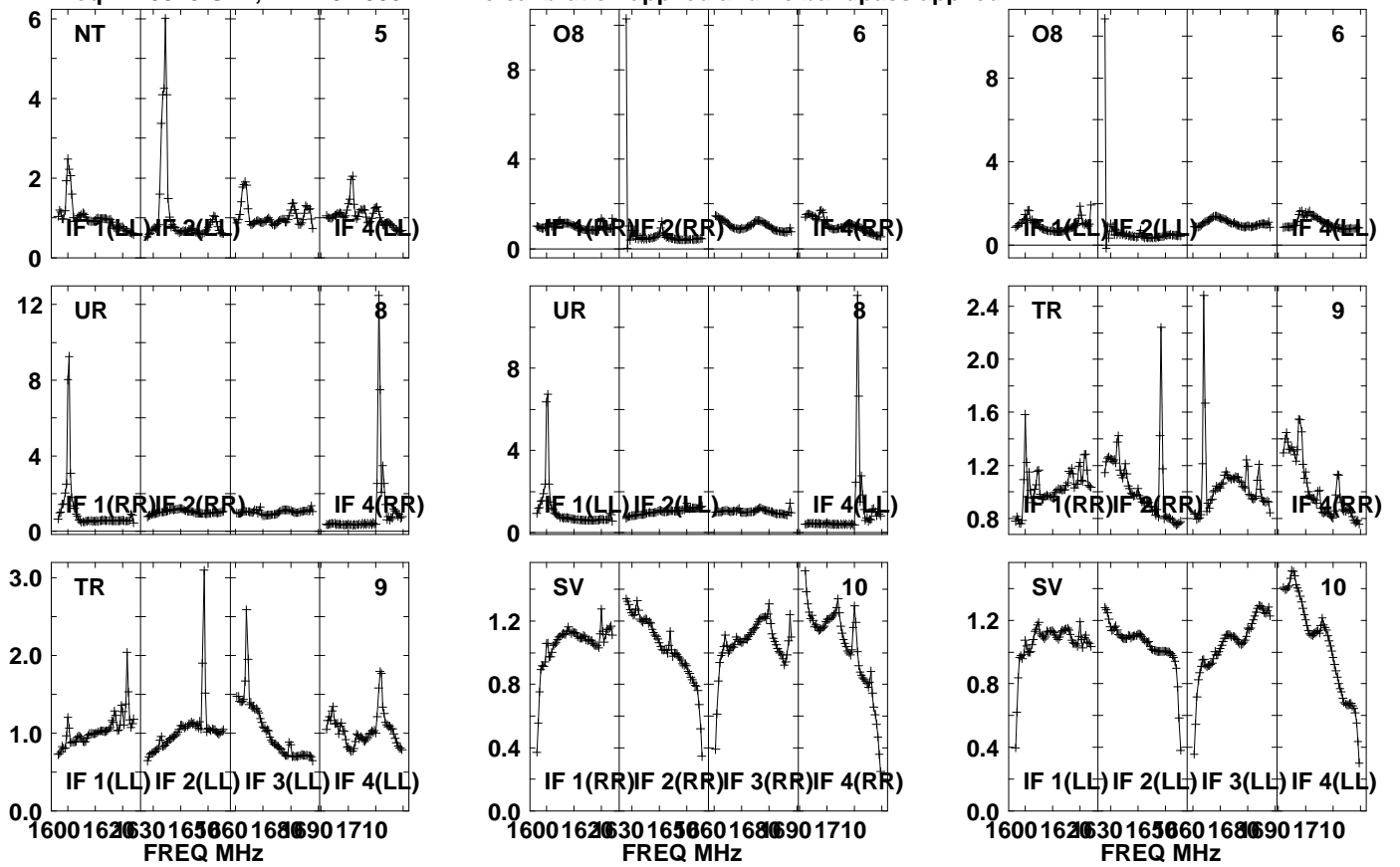

Lower frame: Real Jy  
Auto-corr total-power spectrum Antenna: \*  
Timerange: 00/17:56:31 to 00/17:57:59

Plot file version 836 created 05-OCT-2021 17:08:31

J0827+5217 GM076.UVDATA.1

Freq = 1.5945 GHz, Bw = 32.000 MH No calibration applied and no bandpass applied

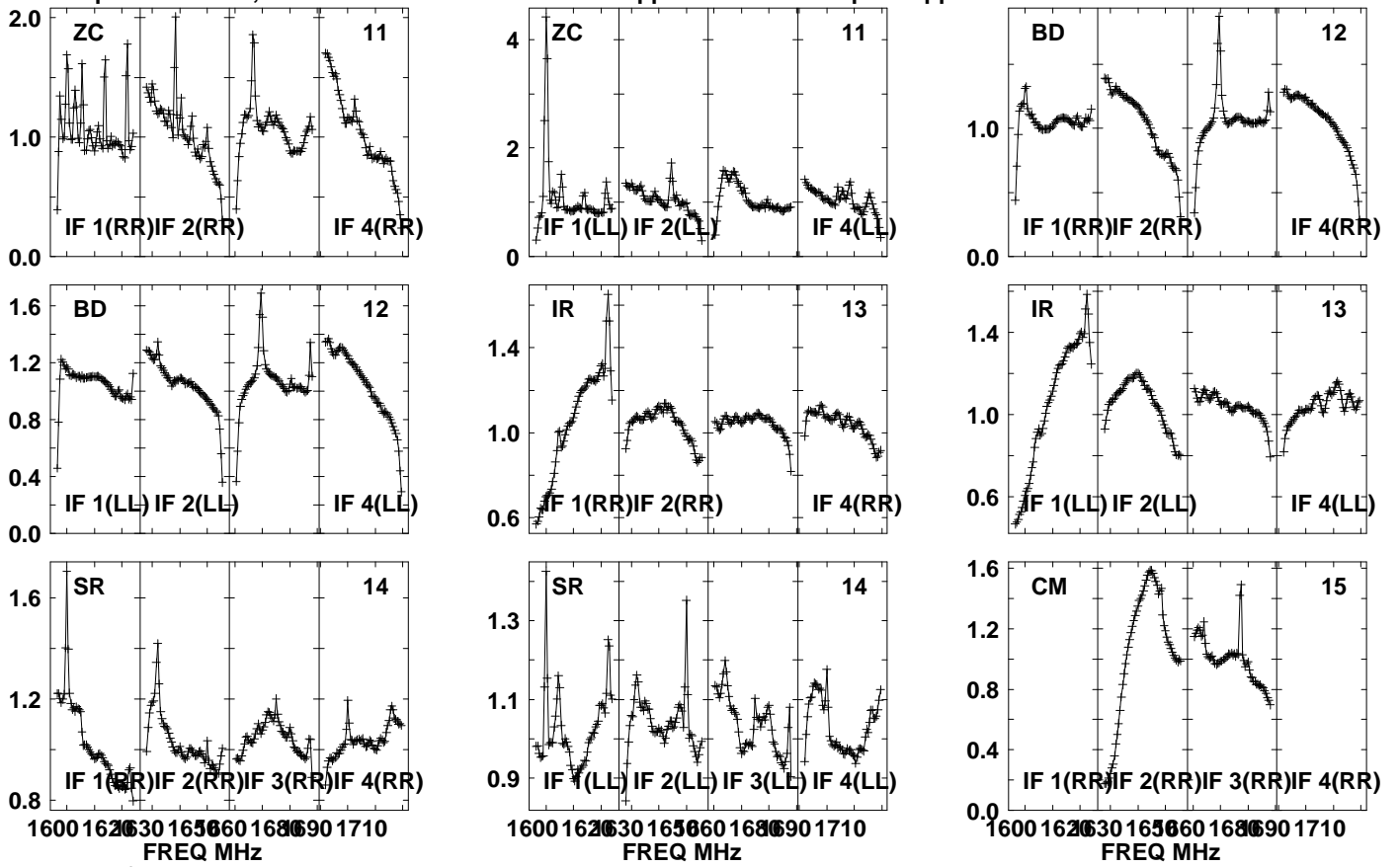

Lower frame: Real Jy  
Auto-corr total-power spectrum Antenna: \*  
Timerange: 00/17:56:31 to 00/17:57:59

Plot file version 837 created 05-OCT-2021 17:08:31

J0827+5217 GM076.UVDATA.1

Freq = 1.5945 GHz, Bw = 32.000 MH No calibration applied and no bandpass applied

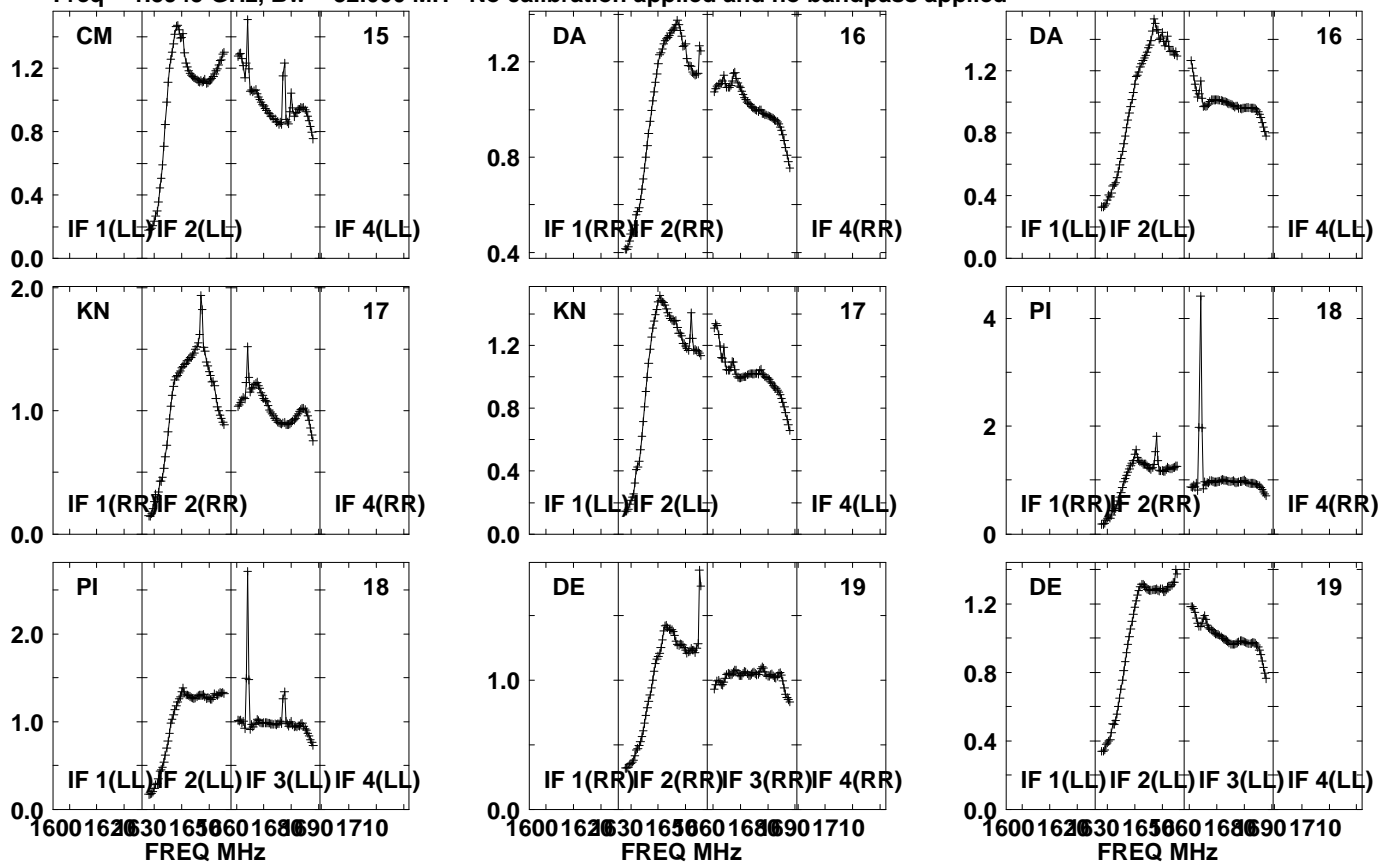

Lower frame: Real Jy  
Auto-corr total-power spectrum Antenna: \*  
Timerange: 00/17:56:31 to 00/17:57:59

Plot file version 838 created 05-OCT-2021 17:08:32

J0827+5217 GM076.UVDATA.1

Freq = 1.5945 GHz, Bw = 32.000 MH No calibration applied and no bandpass applied

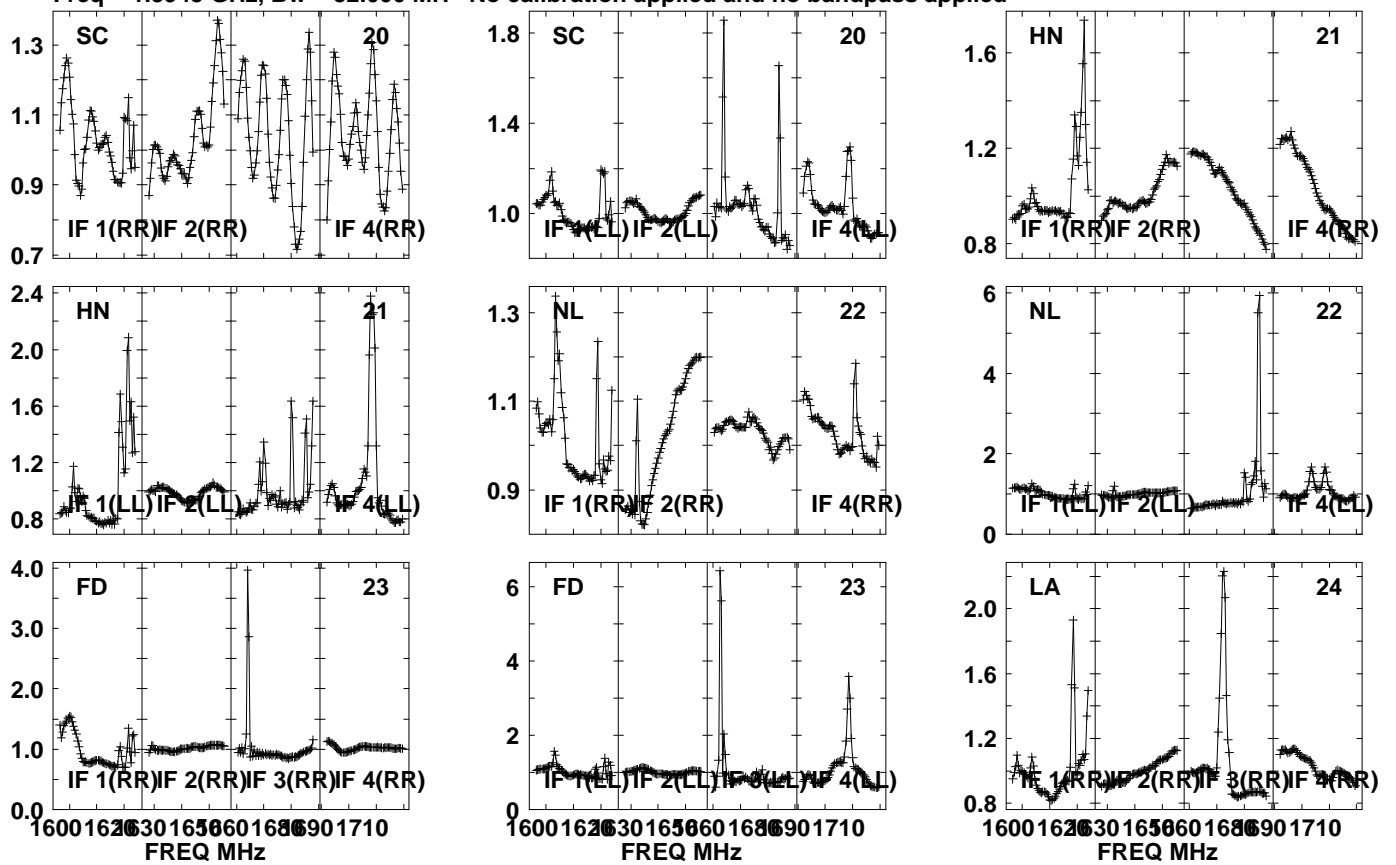

Lower frame: Real Jy  
Auto-corr total-power spectrum Antenna: \*  
Timerange: 00/17:56:31 to 00/17:57:59

Plot file version 839 created 05-OCT-2021 17:08:32

J0827+5217 GM076.UVDATA.1

Freq = 1.5945 GHz, Bw = 32.000 MH No calibration applied and no bandpass applied

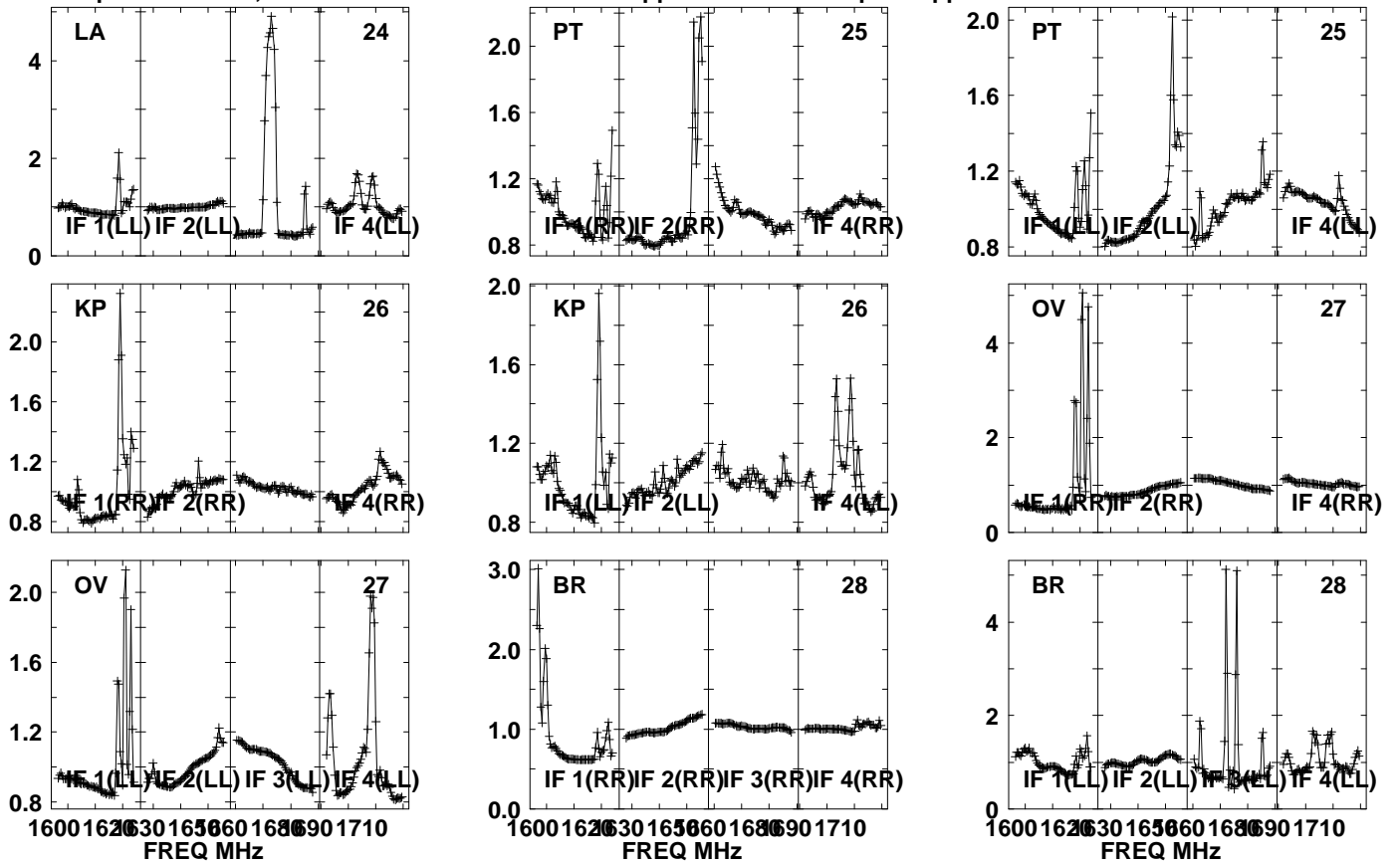

Lower frame: Real Jy  
Auto-corr total-power spectrum Antenna: \*  
Timerange: 00/17:56:31 to 00/17:57:59

Plot file version 840 created 05-OCT-2021 17:08:32

APM08279+525 GM076.UVDATA.1

Freq = 1.5945 GHz, Bw = 32.000 MH No calibration applied and no bandpass applied

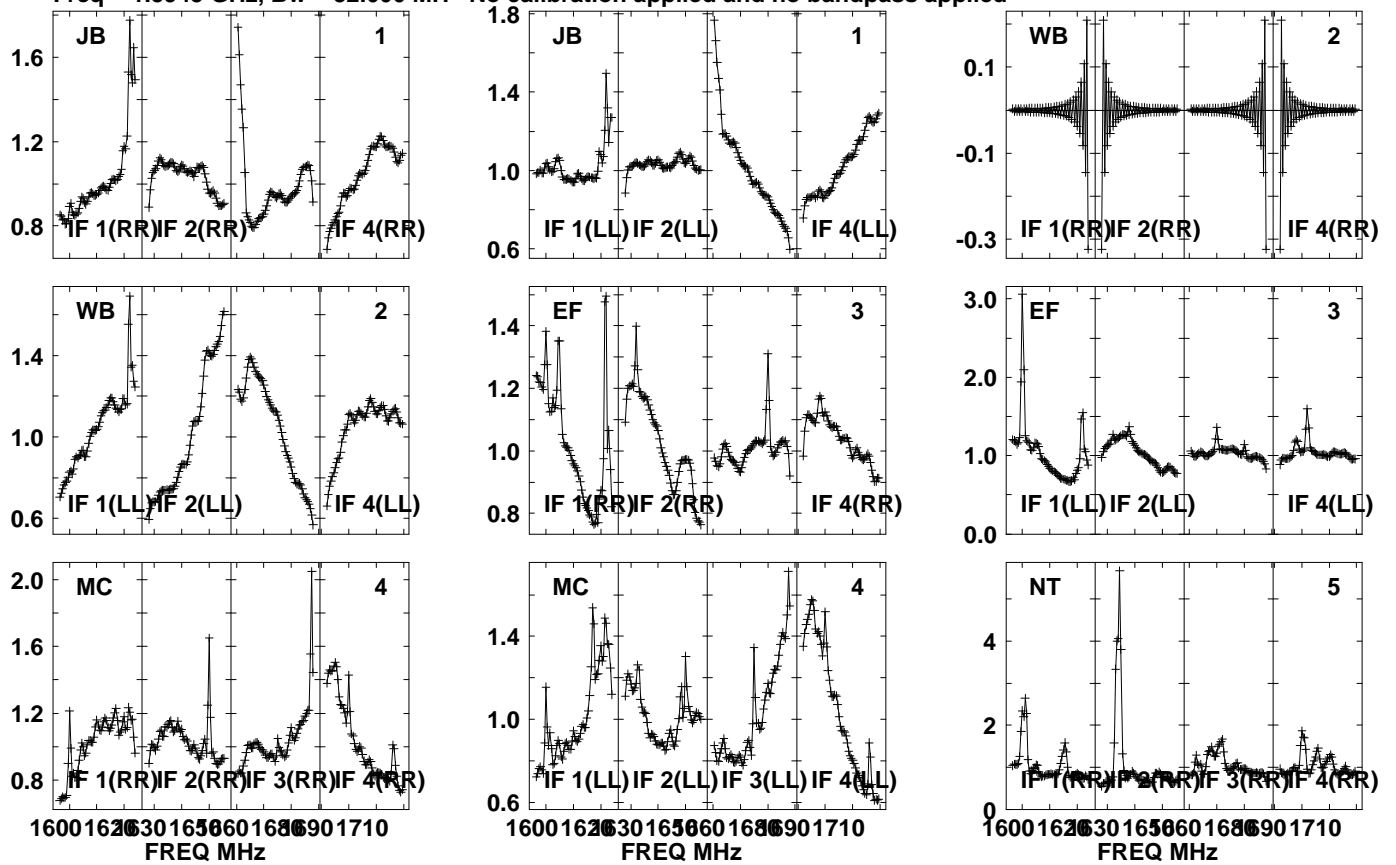

Lower frame: Real Jy  
Auto-corr total-power spectrum Antenna: \*  
Timerange: 00/17:58:01 to 00/18:01:29

Plot file version 841 created 05-OCT-2021 17:08:33

APM08279+525 GM076.UVDATA.1

Freq = 1.5945 GHz, Bw = 32.000 MH No calibration applied and no bandpass applied

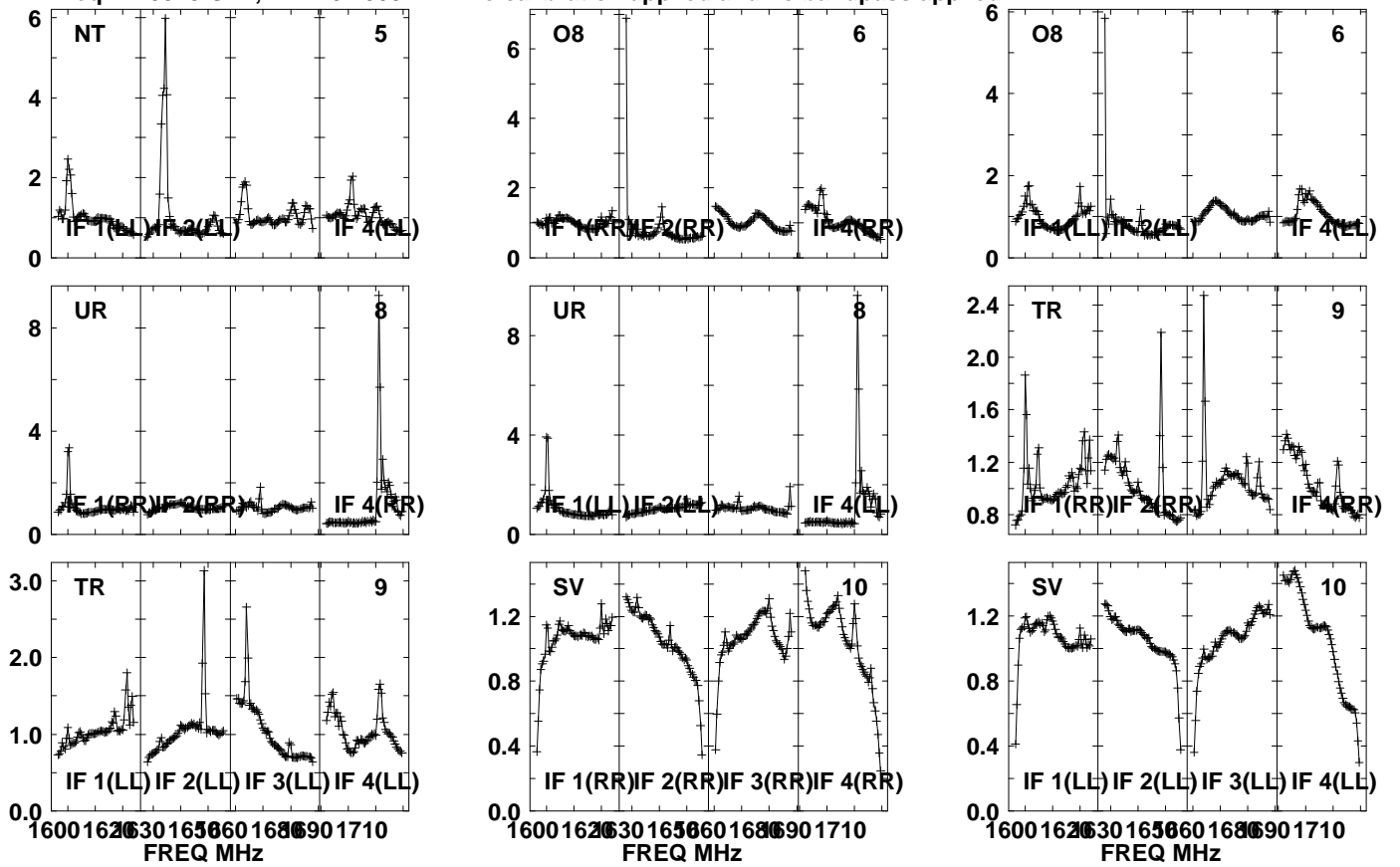

Lower frame: Real Jy

Auto-corr total-power spectrum Antenna: \*

Timerange: 00/17:58:01 to 00/18:01:29

Plot file version 842 created 05-OCT-2021 17:08:33

APM08279+525 GM076.UVDATA.1

Freq = 1.5945 GHz, Bw = 32.000 MH No calibration applied and no bandpass applied

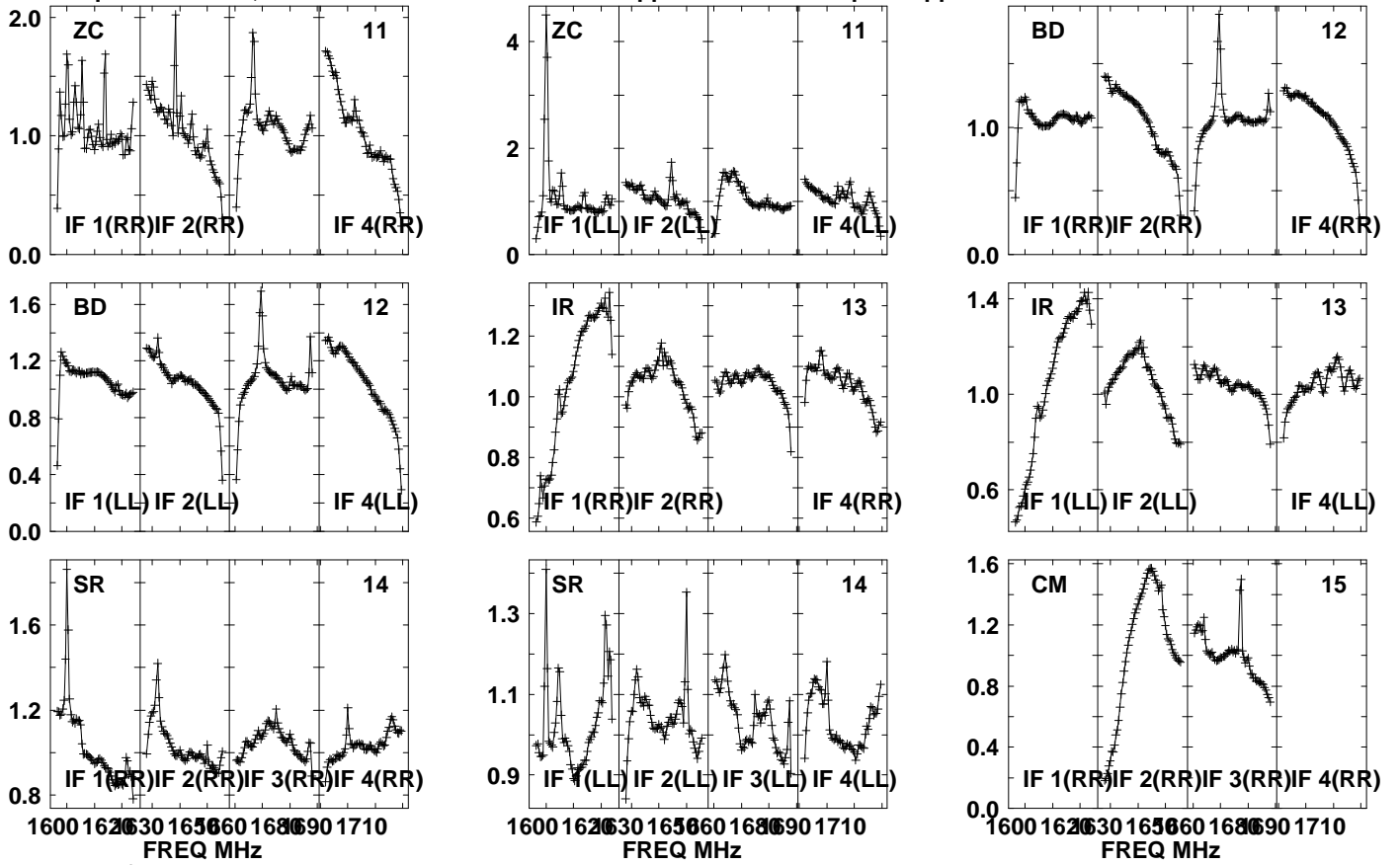

Lower frame: Real Jy  
Auto-corr total-power spectrum Antenna: \*  
Timerange: 00/17:58:01 to 00/18:01:29



Plot file version 843 created 05-OCT-2021 17:08:33

APM08279+525 GM076.UVDATA.1

Freq = 1.5945 GHz, Bw = 32.000 MH No calibration applied and no bandpass applied

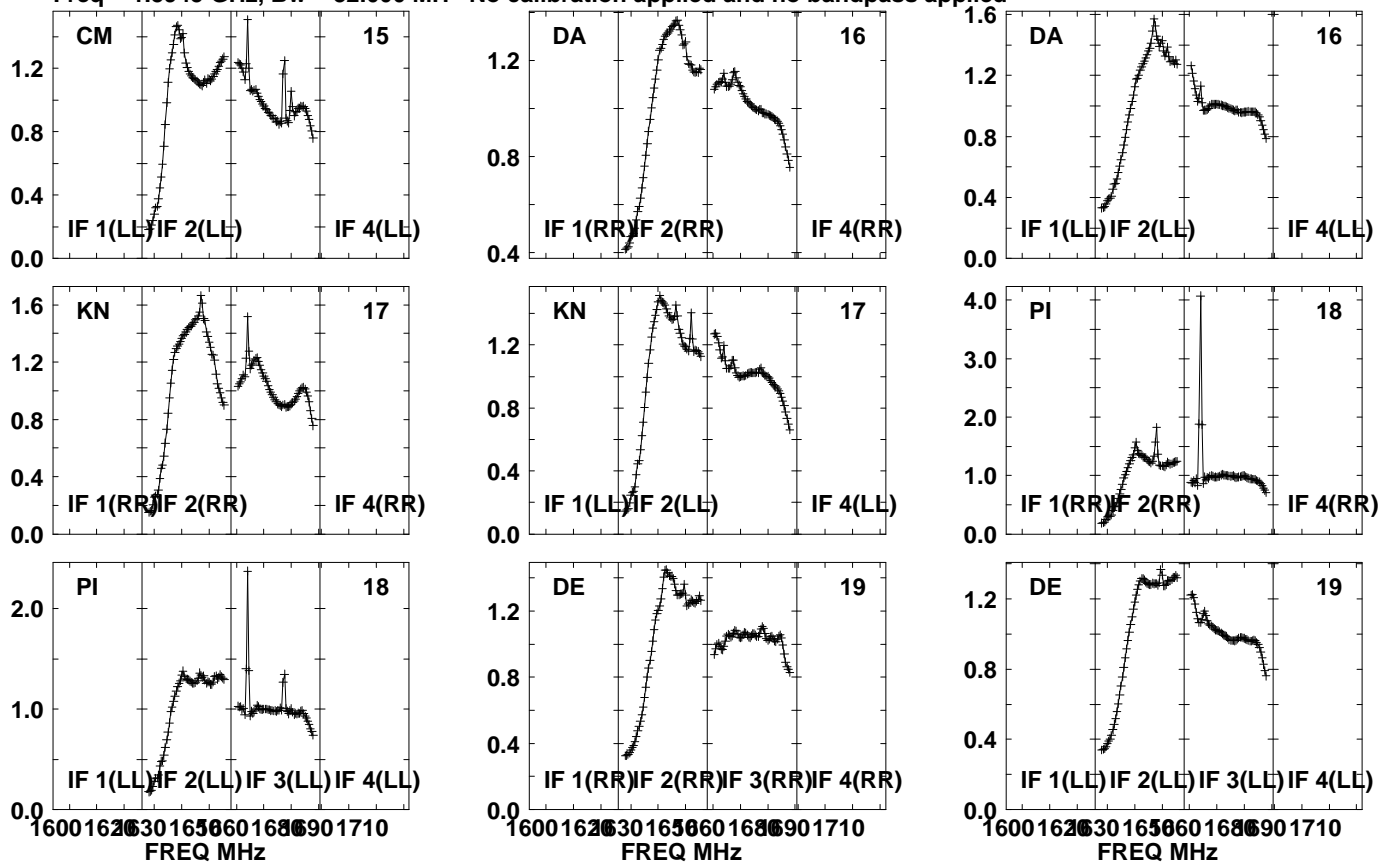

Lower frame: Real Jy  
Auto-corr total-power spectrum Antenna: \*  
Timerange: 00/17:58:01 to 00/18:01:29

Plot file version 844 created 05-OCT-2021 17:08:34

APM08279+525 GM076.UVDATA.1

Freq = 1.5945 GHz, Bw = 32.000 MH No calibration applied and no bandpass applied

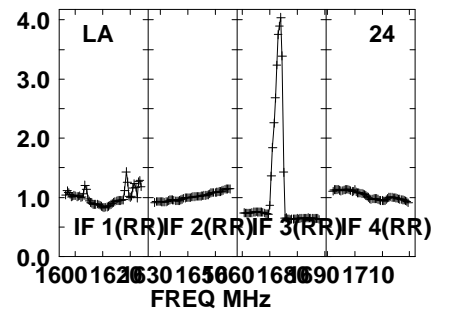
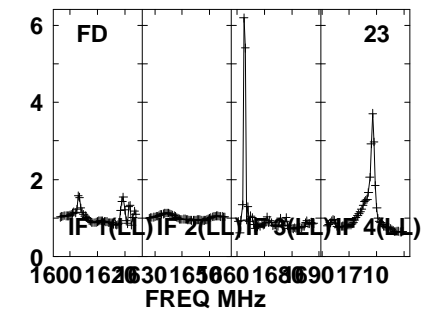
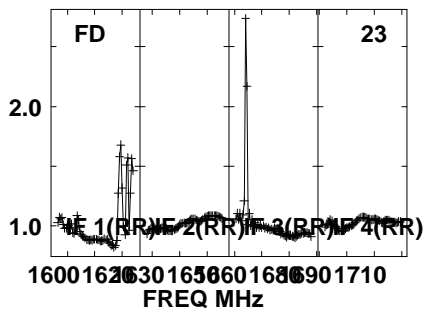
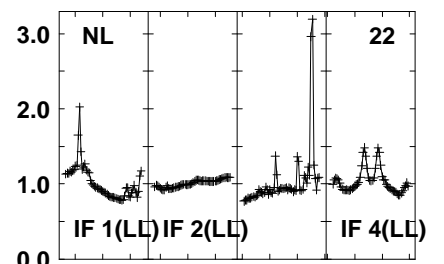
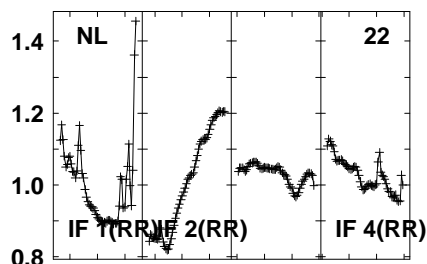
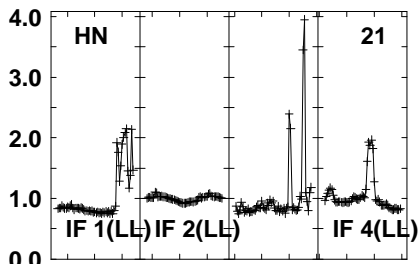
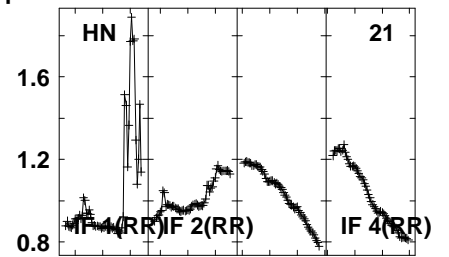
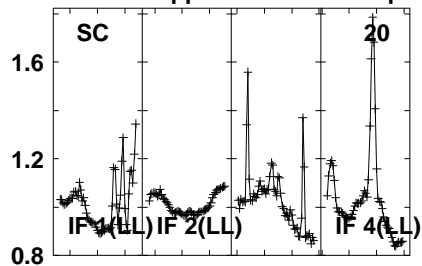
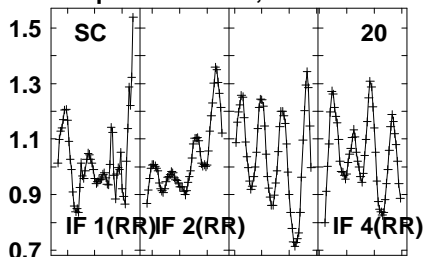

Lower frame: Real Jy  
Auto-corr total-power spectrum Antenna: \*  
Timerange: 00/17:58:01 to 00/18:01:29

Plot file version 845 created 05-OCT-2021 17:08:34

APM08279+525 GM076.UVDATA.1

Freq = 1.5945 GHz, Bw = 32.000 MH No calibration applied and no bandpass applied

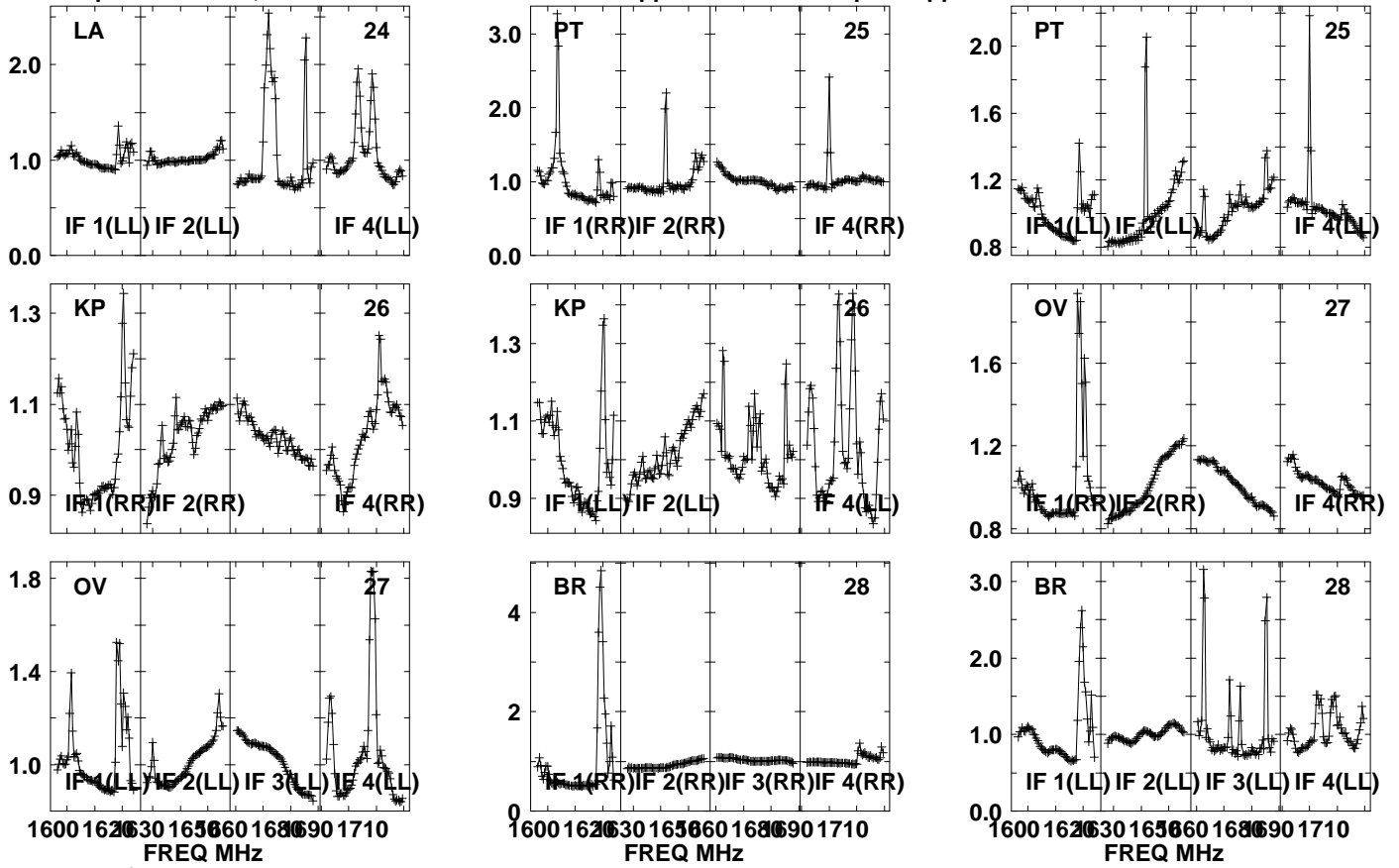

Lower frame: Real Jy

Auto-corr total-power spectrum Antenna: \*

Timerange: 00:17:58:01 to 00:18:01:29

Plot file version 846 created 05-OCT-2021 17:08:34

J0827+5217 GM076.UVDATA.1

Freq = 1.5945 GHz, Bw = 32.000 MH No calibration applied and no bandpass applied

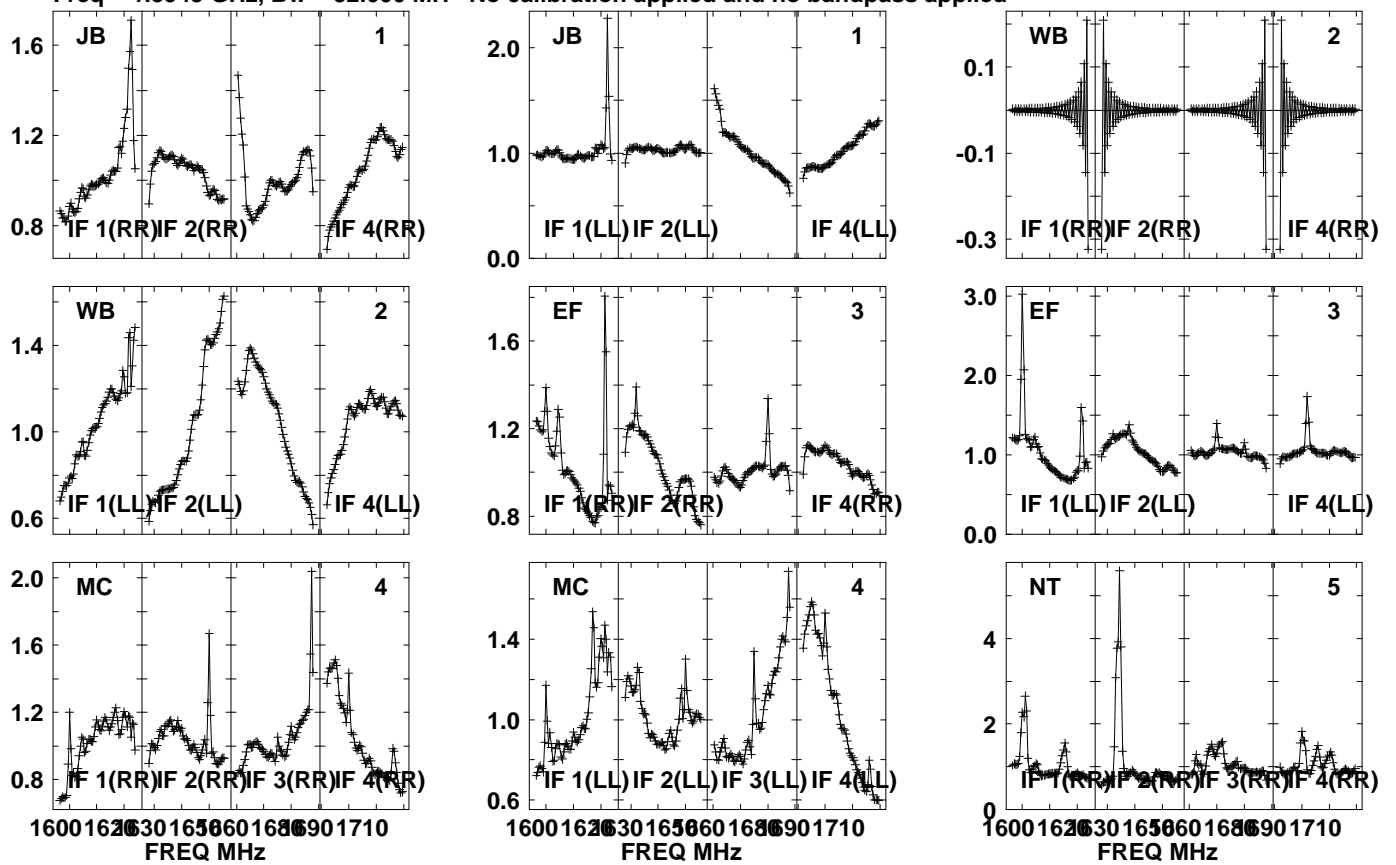

Lower frame: Real Jy  
Auto-corr total-power spectrum Antenna: \*  
Timerange: 00/18:02:01 to 00/18:03:29

Plot file version 847 created 05-OCT-2021 17:08:35

J0827+5217 GM076.UVDATA.1

Freq = 1.5945 GHz, Bw = 32.000 MH No calibration applied and no bandpass applied

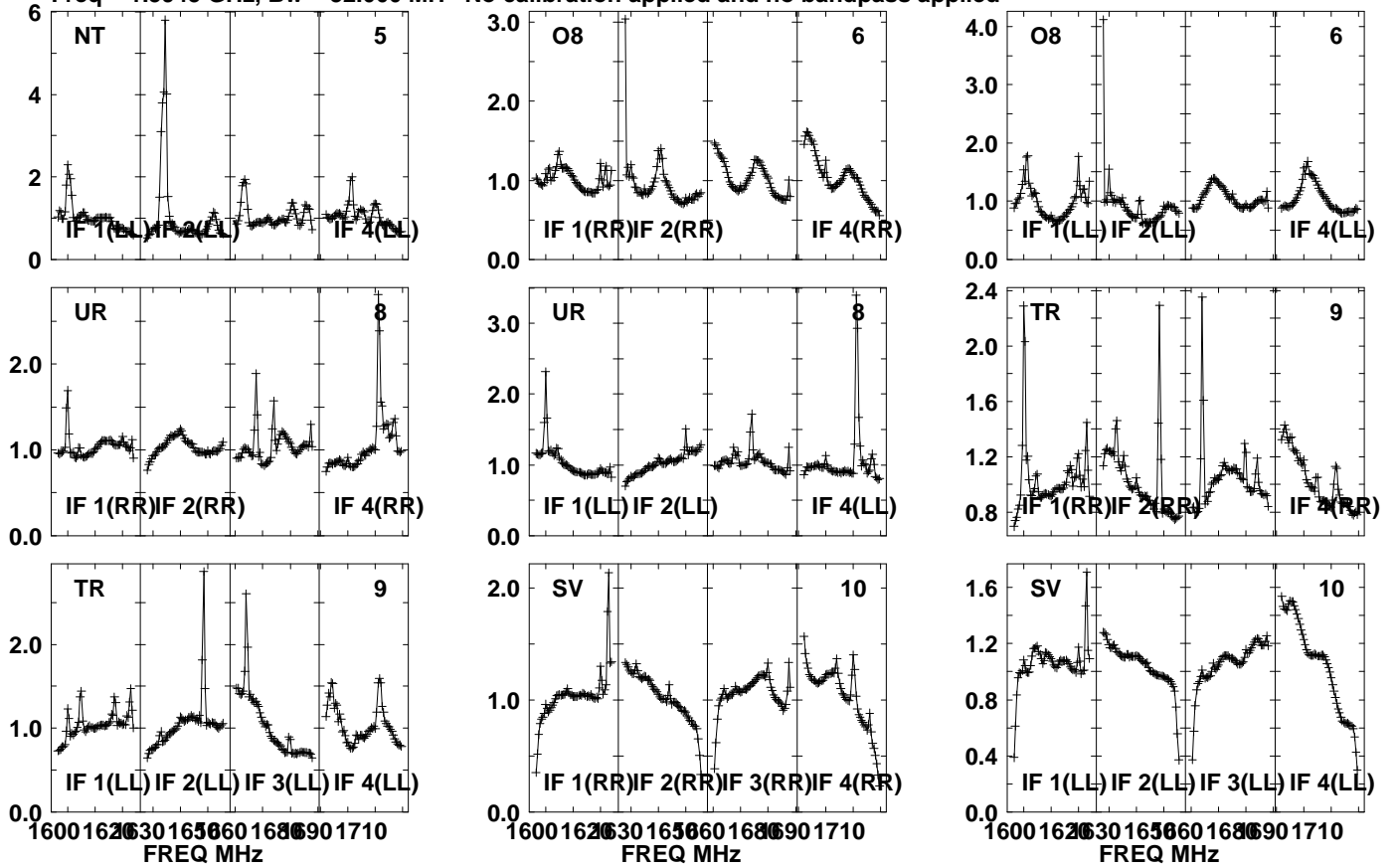

Lower frame: Real Jy  
Auto-corr total-power spectrum Antenna: \*  
Timerange: 00/18:02:01 to 00/18:03:29

Plot file version 848 created 05-OCT-2021 17:08:35

J0827+5217 GM076.UVDATA.1

Freq = 1.5945 GHz, Bw = 32.000 MH No calibration applied and no bandpass applied

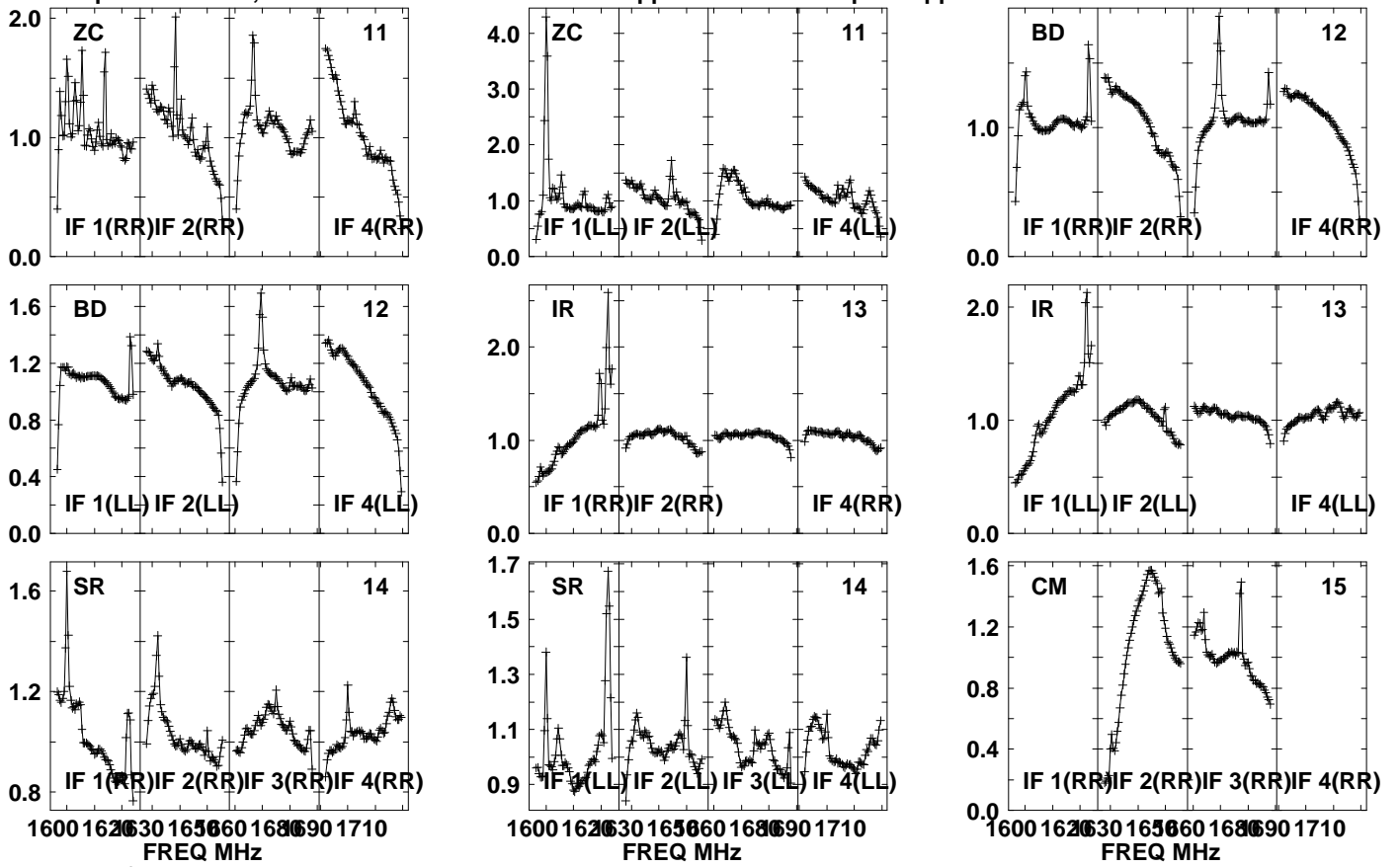

Lower frame: Real Jy  
Auto-corr total-power spectrum Antenna: \*  
Timerange: 00/18:02:01 to 00/18:03:29

Plot file version 849 created 05-OCT-2021 17:08:35

J0827+5217 GM076.UVDATA.1

Freq = 1.5945 GHz, Bw = 32.000 MH No calibration applied and no bandpass applied

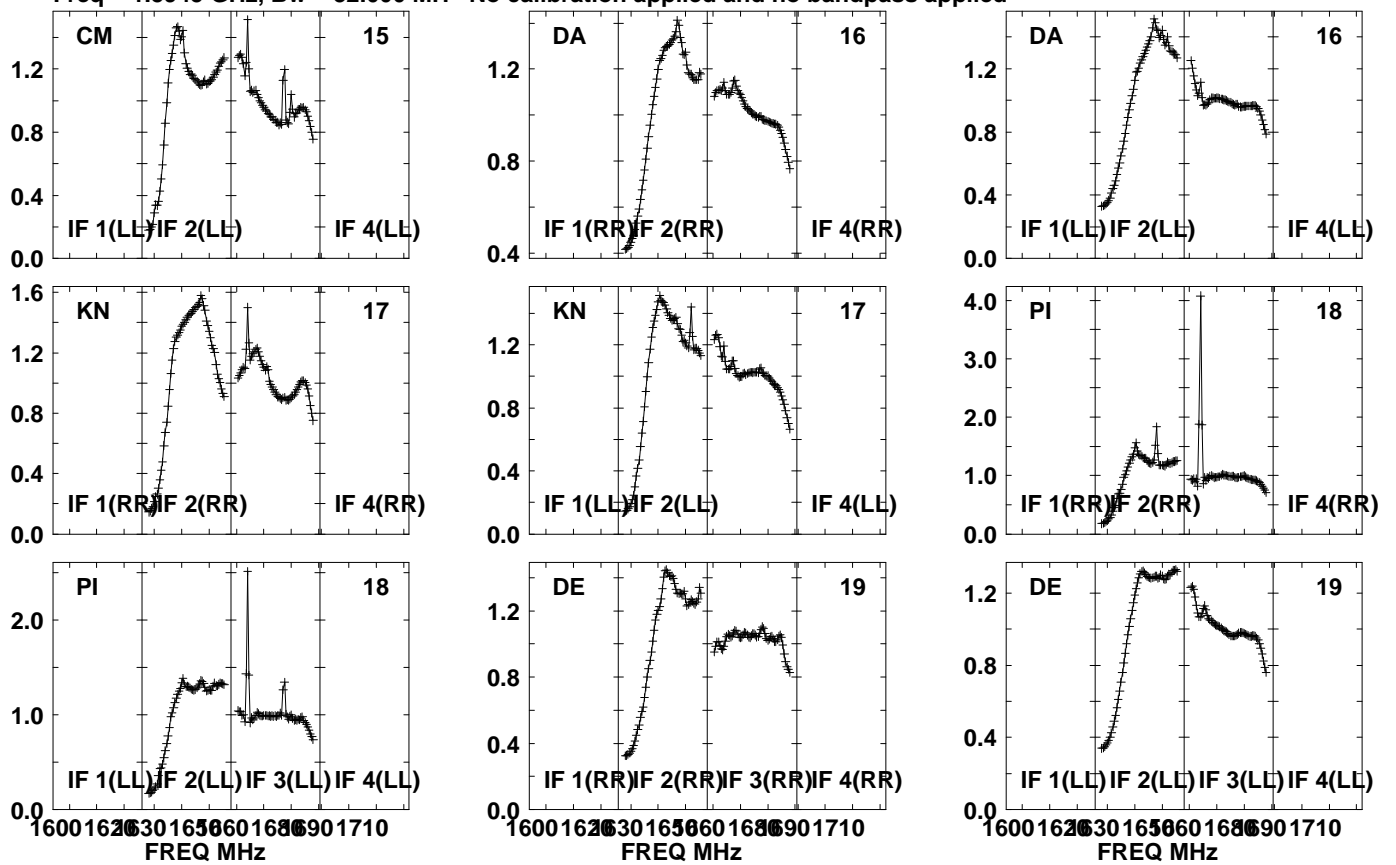

Lower frame: Real Jy  
Auto-corr total-power spectrum Antenna: \*  
Timerange: 00/18:02:01 to 00/18:03:29

Plot file version 850 created 05-OCT-2021 17:08:36

J0827+5217 GM076.UVDATA.1

Freq = 1.5945 GHz, Bw = 32.000 MH No calibration applied and no bandpass applied

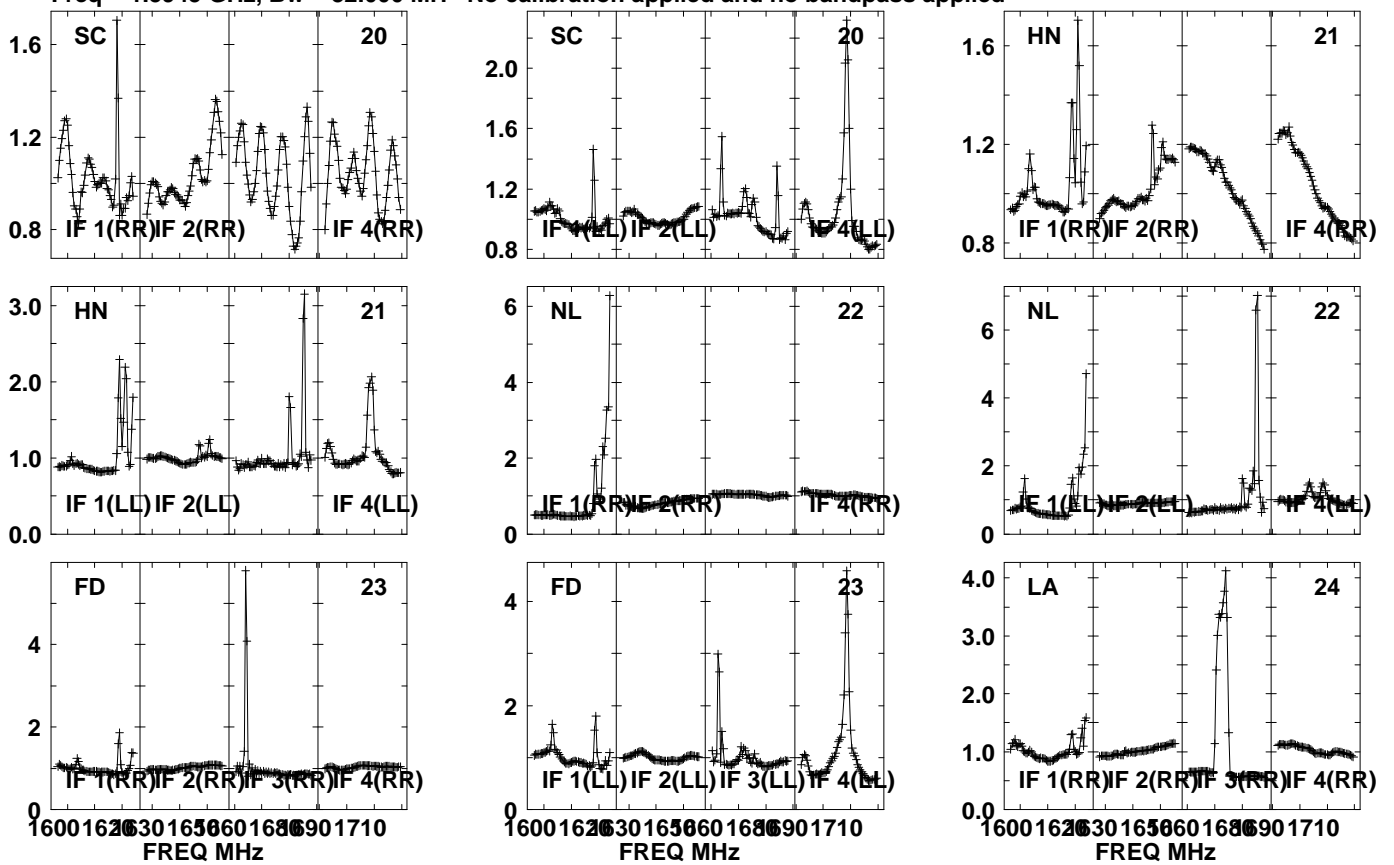

Lower frame: Real Jy  
Auto-corr total-power spectrum Antenna: \*  
Timerange: 00/18:02:01 to 00/18:03:29



Plot file version 851 created 05-OCT-2021 17:08:36

J0827+5217 GM076.UVDATA.1

Freq = 1.5945 GHz, Bw = 32.000 MH No calibration applied and no bandpass applied

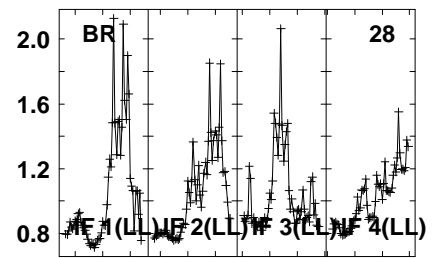
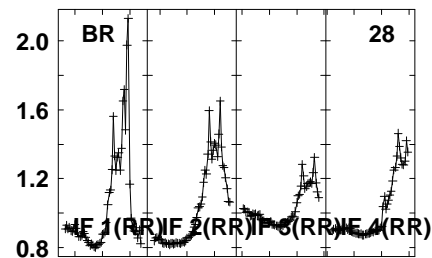
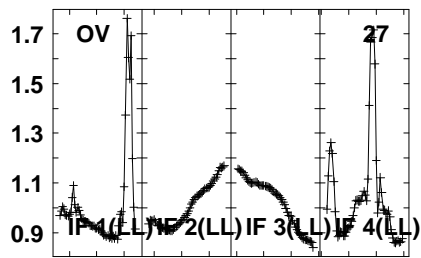
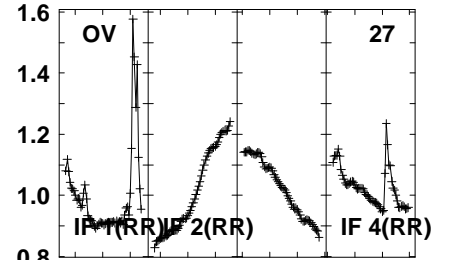
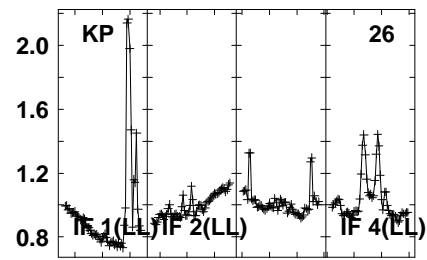
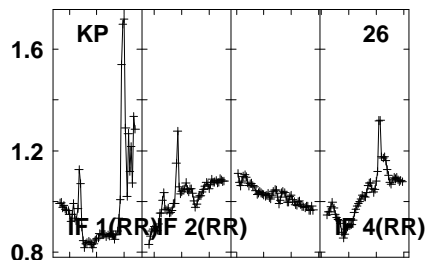
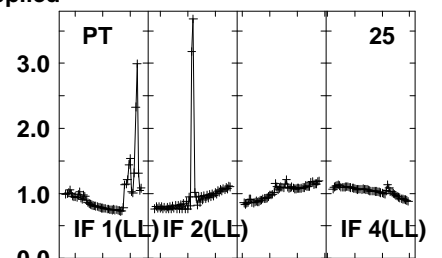
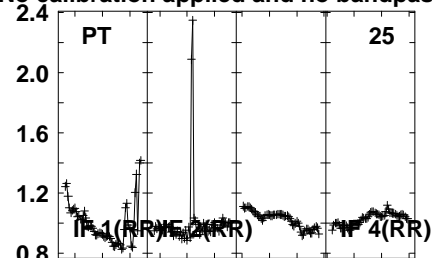
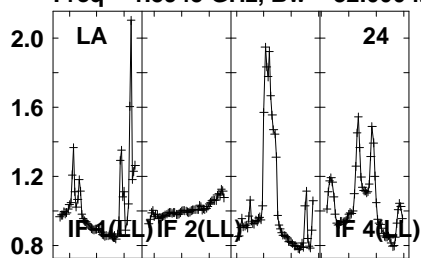

1600 1620 1630 1650 1660 1680 1690 1710  
FREQ MHz

1600 1620 1630 1650 1660 1680 1690 1710  
FREQ MHz

1600 1620 1630 1650 1660 1680 1690 1710  
FREQ MHz

Lower frame: Real Jy  
Auto-corr total-power spectrum Antenna: \*  
Timerange: 00/18:02:01 to 00/18:03:29

Plot file version 852 created 05-OCT-2021 17:08:36

APM08279+525 GM076.UVDATA.1

Freq = 1.5945 GHz, Bw = 32.000 MH No calibration applied and no bandpass applied

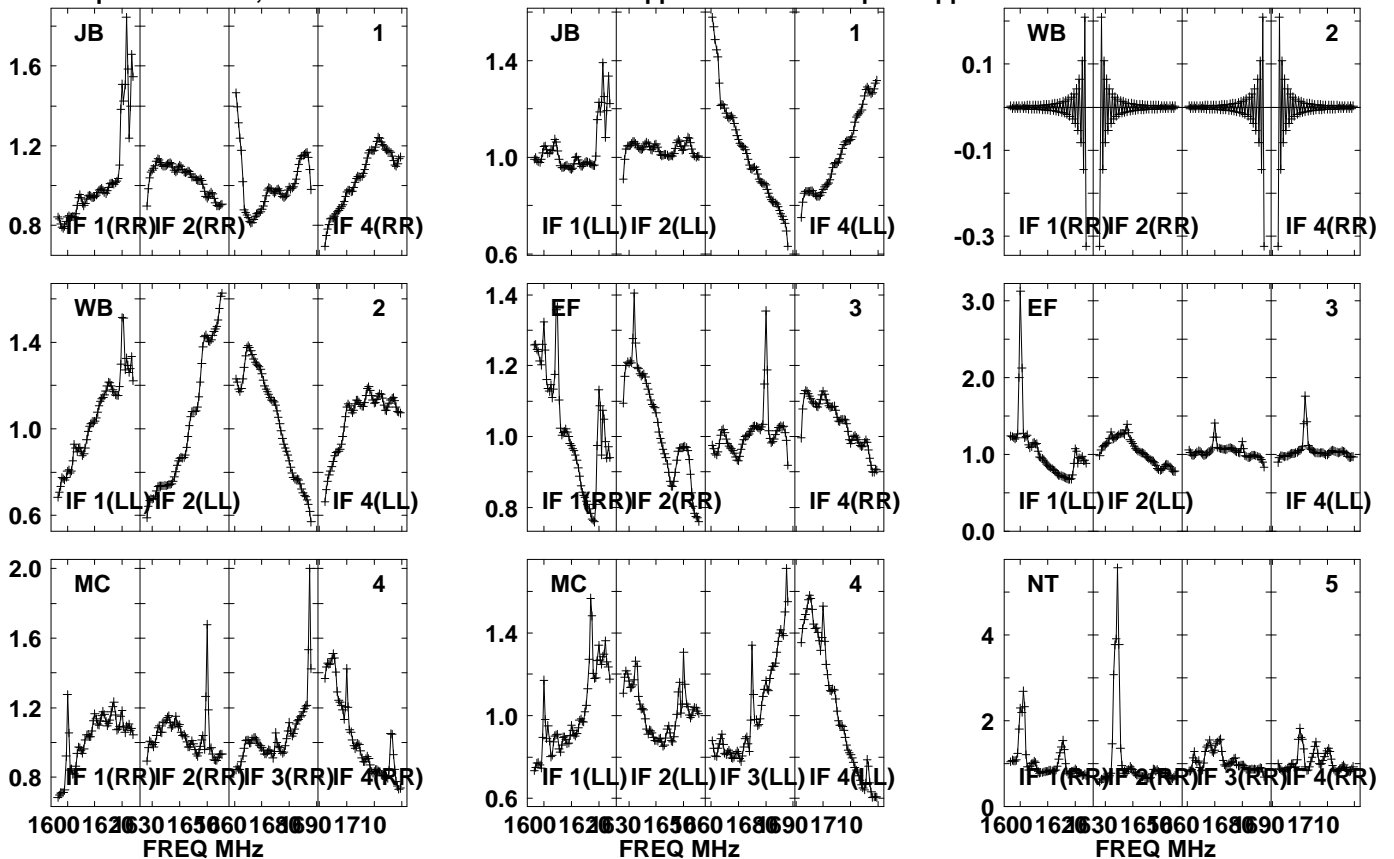

Lower frame: Real Jy  
Auto-corr total-power spectrum Antenna: \*  
Timerange: 00/18:03:31 to 00/18:06:59

Plot file version 853 created 05-OCT-2021 17:08:37

APM08279+525 GM076.UVDATA.1

Freq = 1.5945 GHz, Bw = 32.000 MH No calibration applied and no bandpass applied

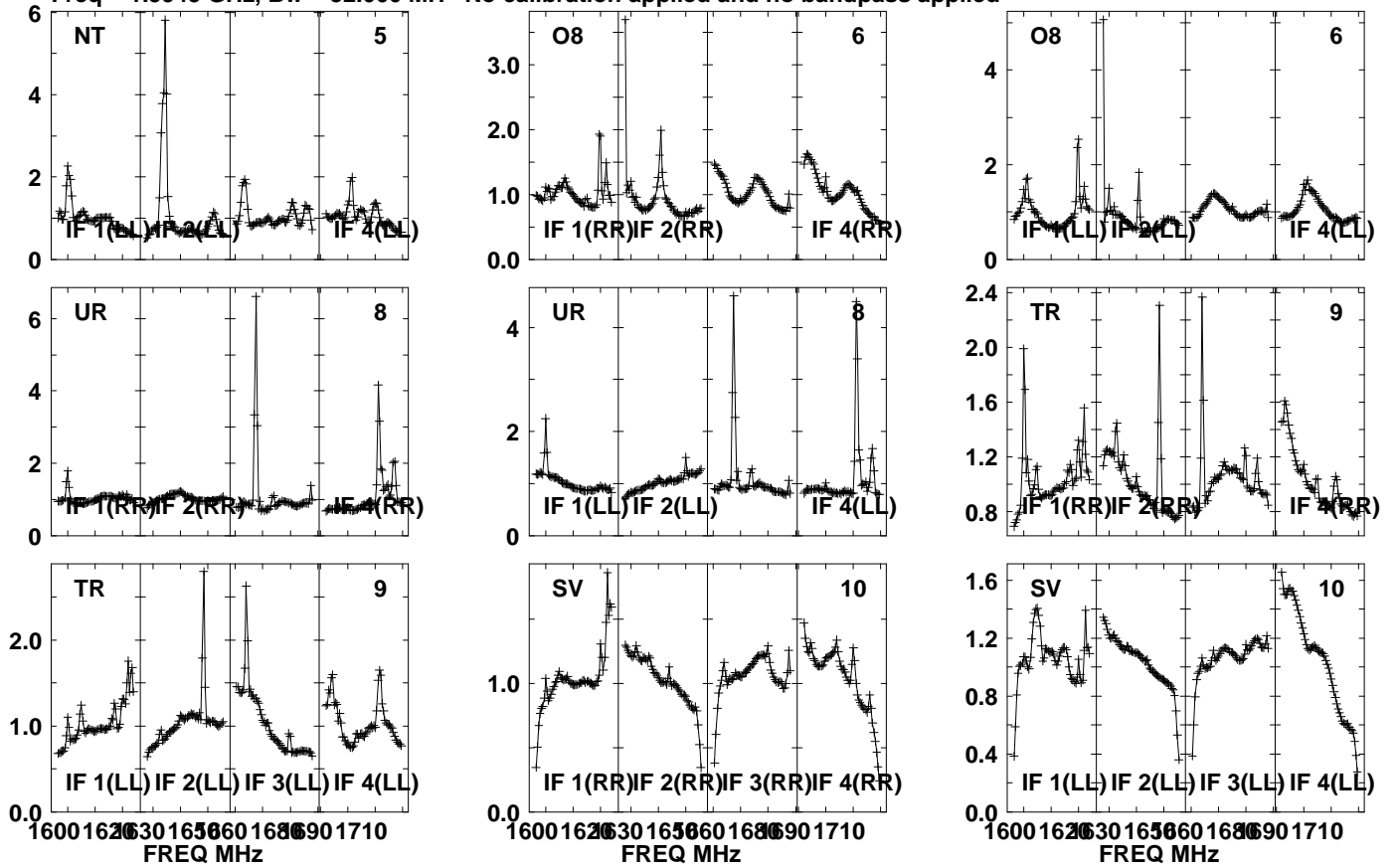

Lower frame: Real Jy

Auto-corr total-power spectrum Antenna: \*

Timerange: 00/18:03:31 to 00/18:06:59

Plot file version 854 created 05-OCT-2021 17:08:37

APM08279+525 GM076.UVDATA.1

Freq = 1.5945 GHz, Bw = 32.000 MH No calibration applied and no bandpass applied

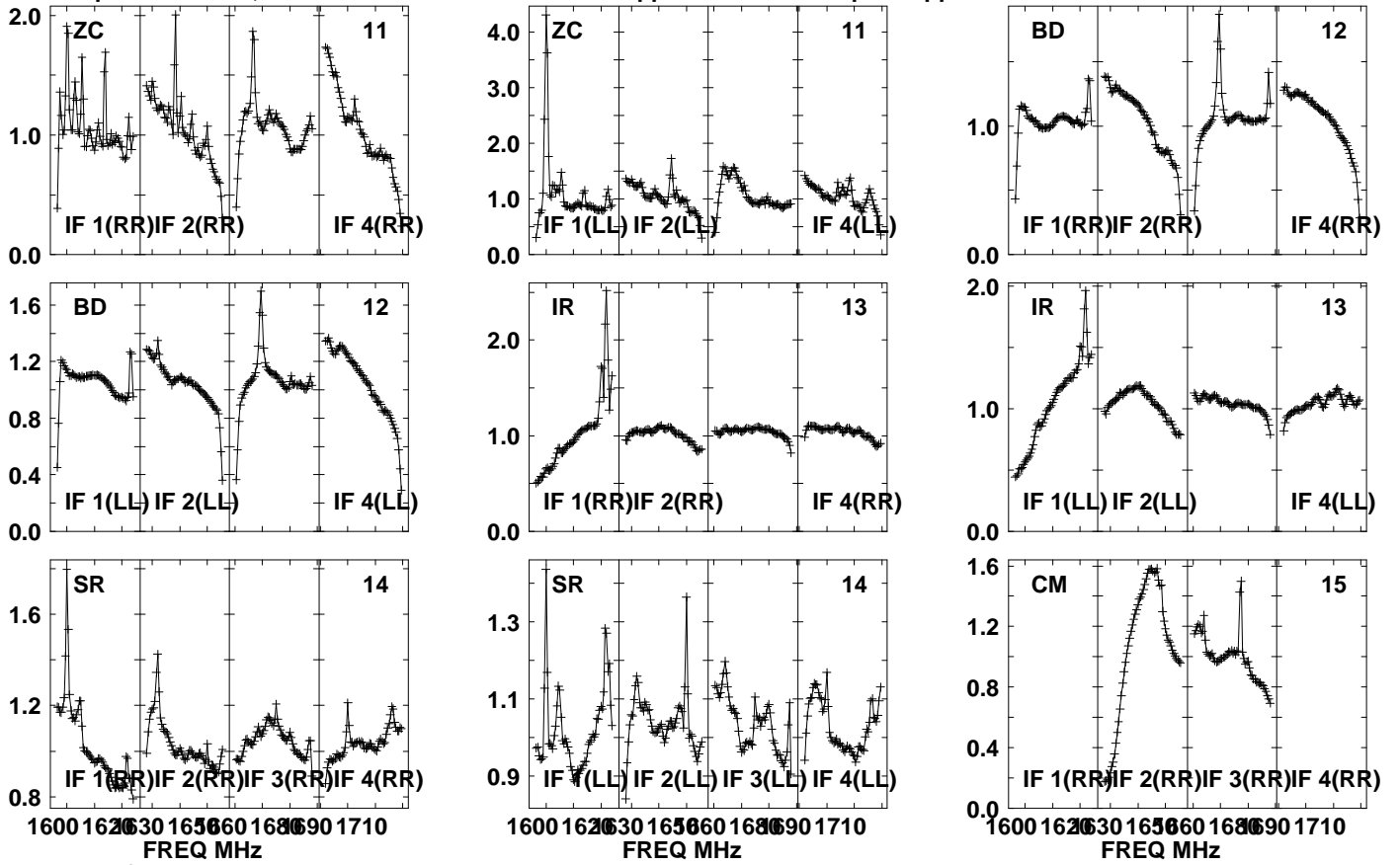

Lower frame: Real Jy  
Auto-corr total-power spectrum Antenna: \*  
Timerange: 00/18:03:31 to 00/18:06:59

Plot file version 855 created 05-OCT-2021 17:08:37

APM08279+525 GM076.UVDATA.1

Freq = 1.5945 GHz, Bw = 32.000 MH No calibration applied and no bandpass applied

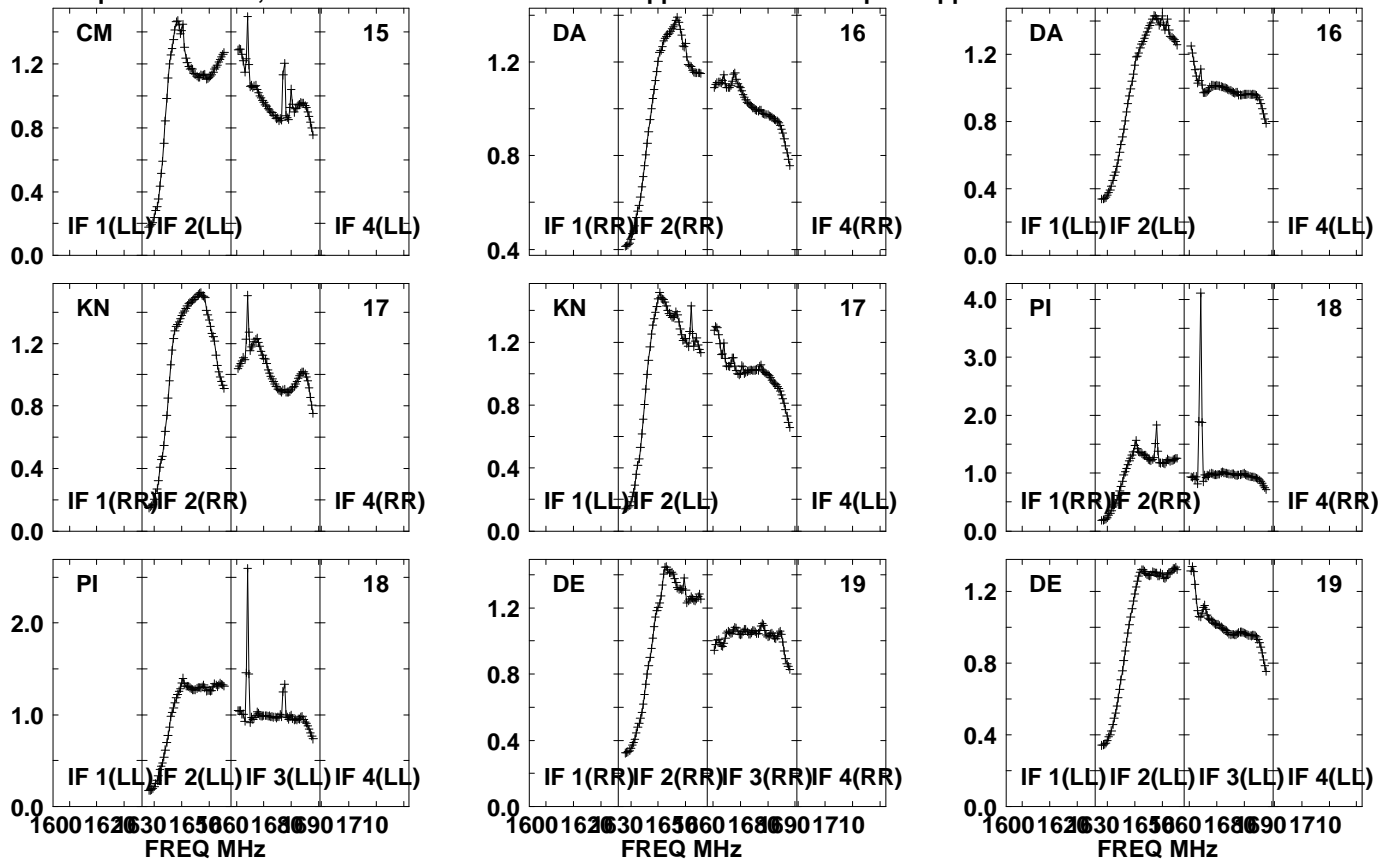

Lower frame: Real Jy  
Auto-corr total-power spectrum Antenna: \*  
Timerange: 00/18:03:31 to 00/18:06:59

Plot file version 856 created 05-OCT-2021 17:08:38

APM08279+525 GM076.UVDATA.1

Freq = 1.5945 GHz, Bw = 32.000 MH No calibration applied and no bandpass applied

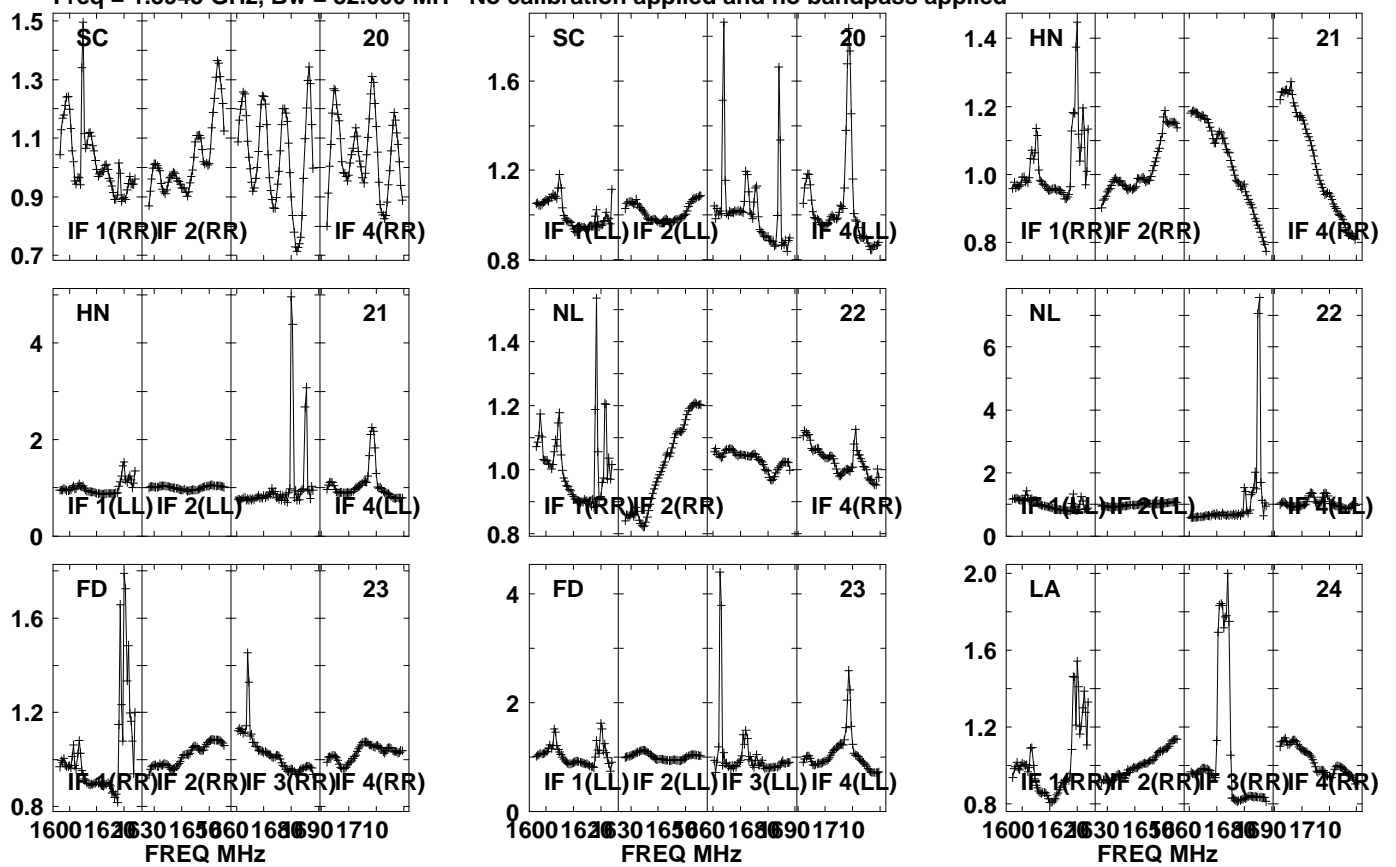

Lower frame: Real Jy  
Auto-corr total-power spectrum Antenna: \*  
Timerange: 00/18:03:31 to 00/18:06:59

Plot file version 857 created 05-OCT-2021 17:08:38

APM08279+525 GM076.UVDATA.1

Freq = 1.5945 GHz, Bw = 32.000 MH No calibration applied and no bandpass applied

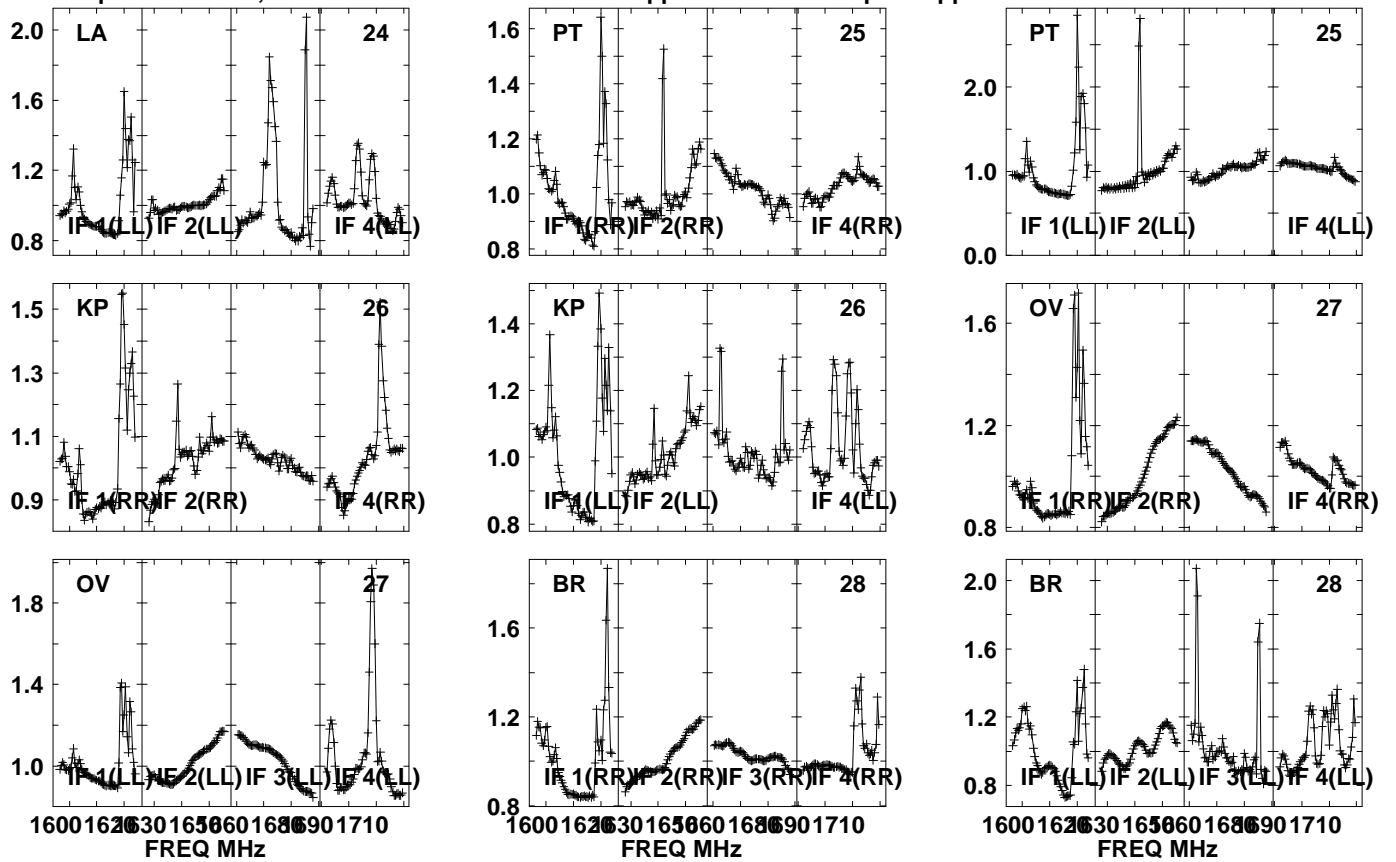

Lower frame: Real Jy  
Auto-corr total-power spectrum Antenna: \*  
Timerange: 00/18:03:31 to 00/18:06:59

Plot file version 858 created 05-OCT-2021 17:08:38

J0827+5217 GM076.UVDATA.1

Freq = 1.5945 GHz, Bw = 32.000 MH No calibration applied and no bandpass applied

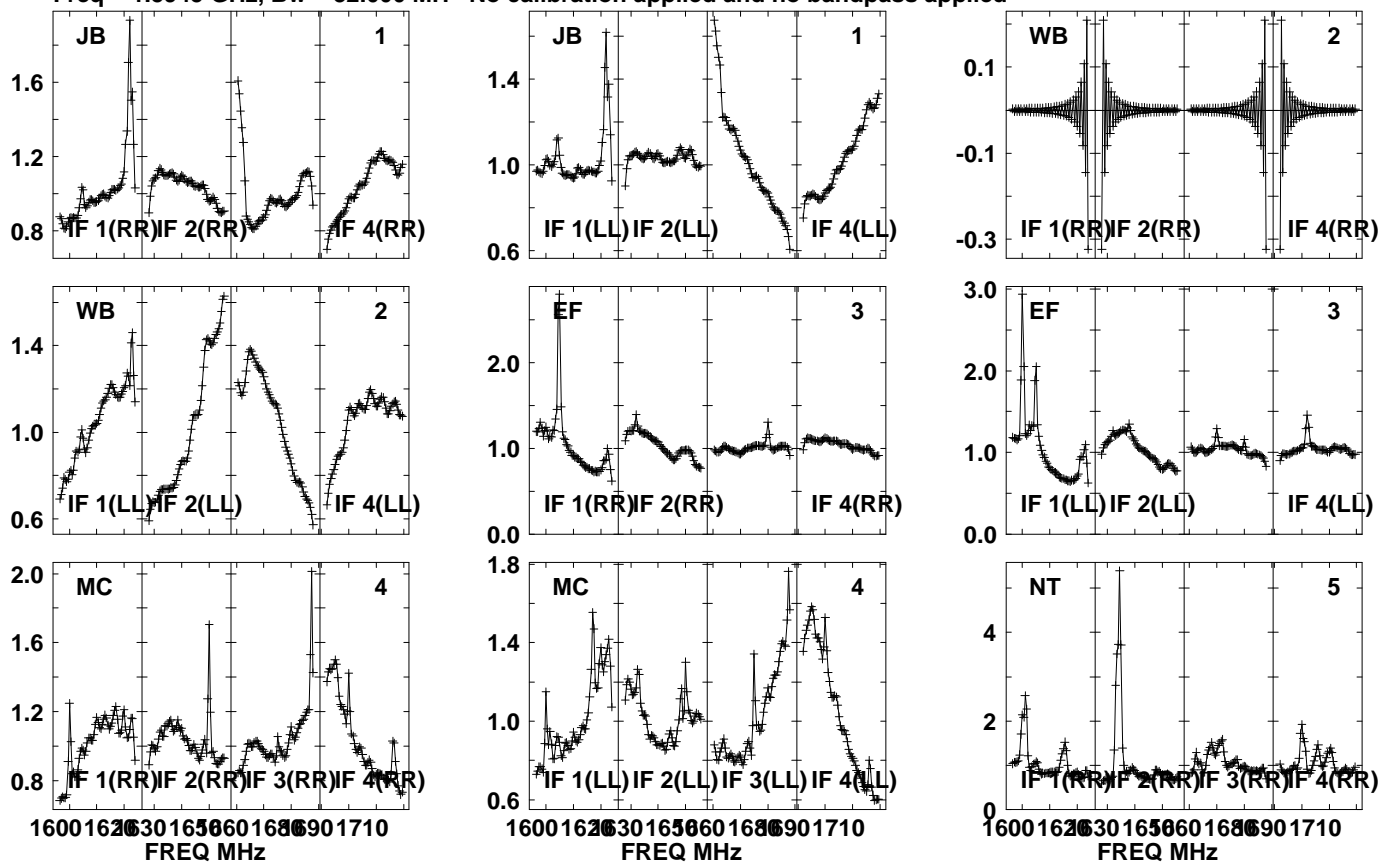

Lower frame: Real Jy  
Auto-corr total-power spectrum Antenna: \*  
Timerange: 00/18:07:01 to 00/18:08:29



Plot file version 859 created 05-OCT-2021 17:08:39

J0827+5217 GM076.UVDATA.1

Freq = 1.5945 GHz, Bw = 32.000 MH No calibration applied and no bandpass applied

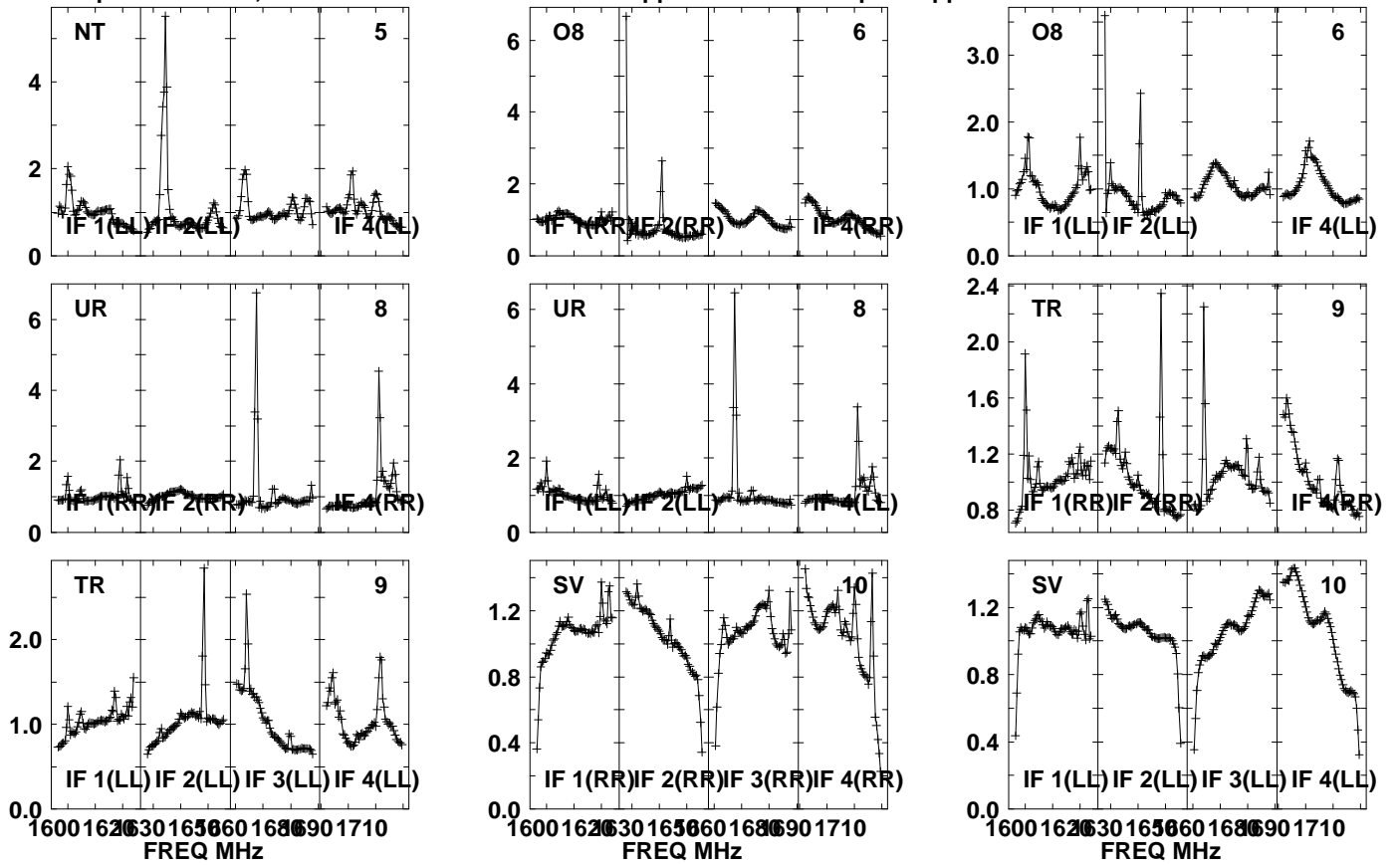

Lower frame: Real Jy  
Auto-corr total-power spectrum Antenna: \*  
Timerange: 00/18:07:01 to 00/18:08:29

Plot file version 860 created 05-OCT-2021 17:08:39

J0827+5217 GM076.UVDATA.1

Freq = 1.5945 GHz, Bw = 32.000 MH No calibration applied and no bandpass applied

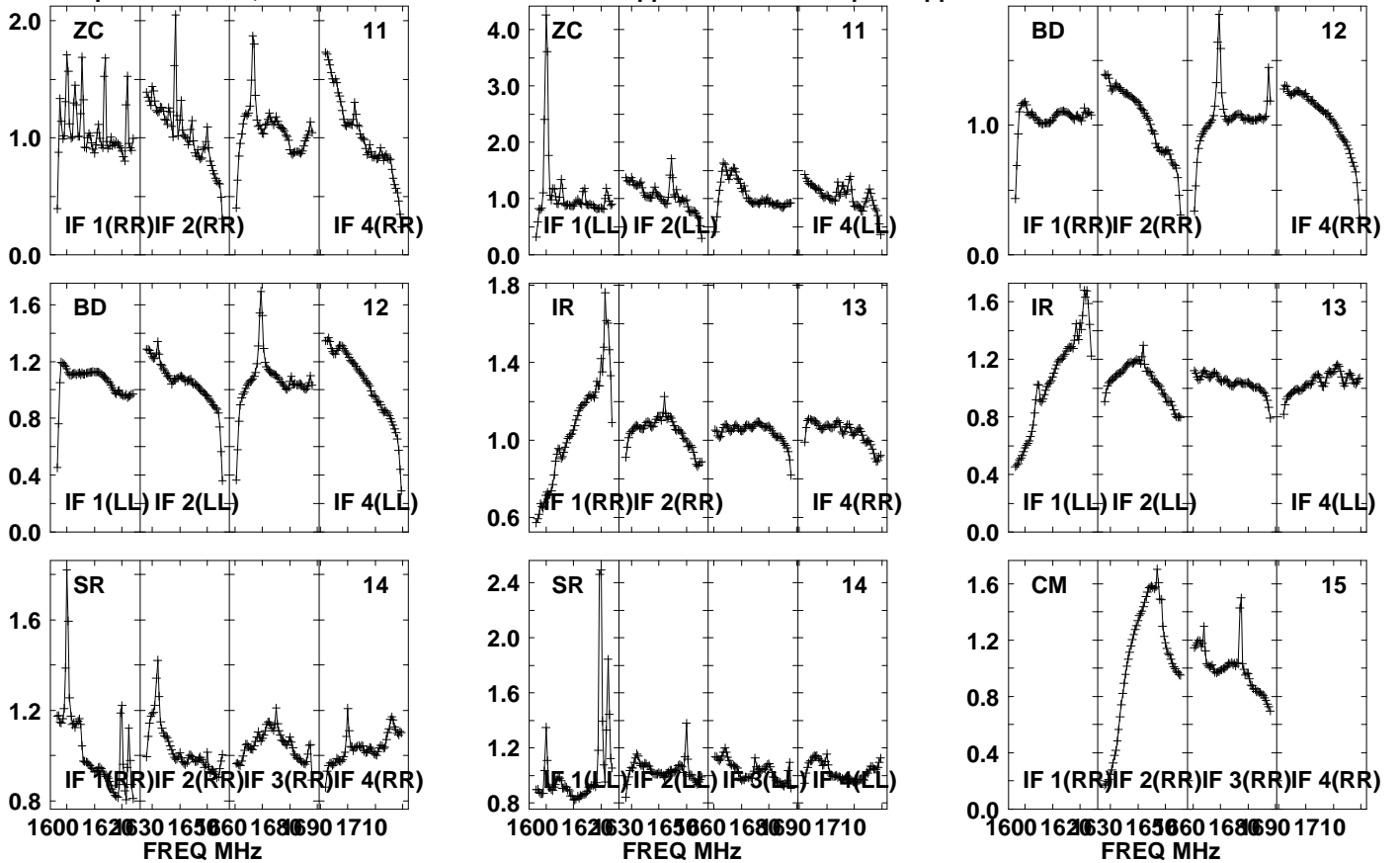

Lower frame: Real Jy  
Auto-corr total-power spectrum Antenna: \*  
Timerange: 00/18:07:01 to 00/18:08:29

Plot file version 861 created 05-OCT-2021 17:08:39

J0827+5217 GM076.UVDATA.1

Freq = 1.5945 GHz, Bw = 32.000 MH No calibration applied and no bandpass applied

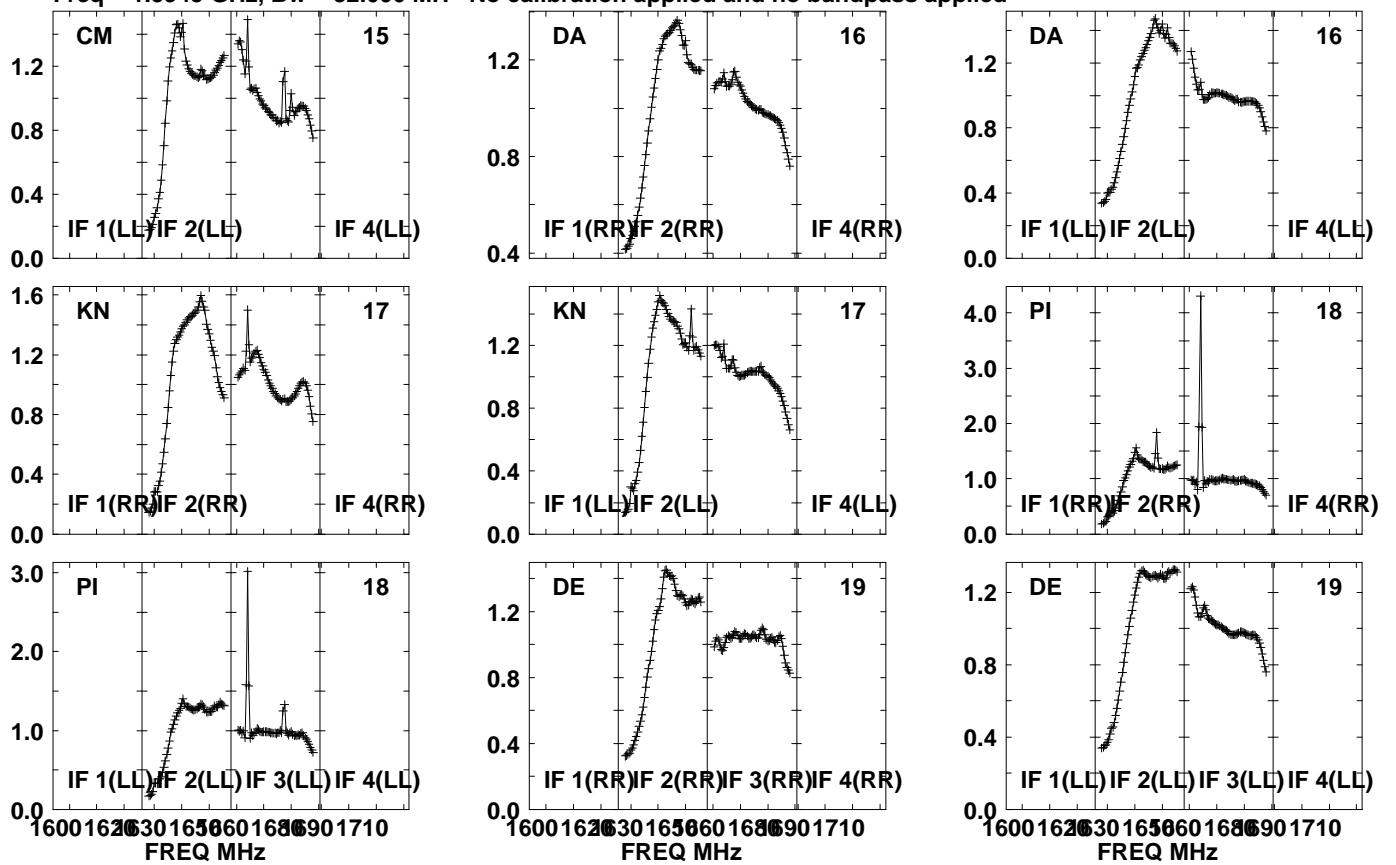

Lower frame: Real Jy  
Auto-corr total-power spectrum Antenna: \*  
Timerange: 00/18:07:01 to 00/18:08:29

Plot file version 862 created 05-OCT-2021 17:08:39

J0827+5217 GM076.UVDATA.1

Freq = 1.5945 GHz, Bw = 32.000 MH No calibration applied and no bandpass applied

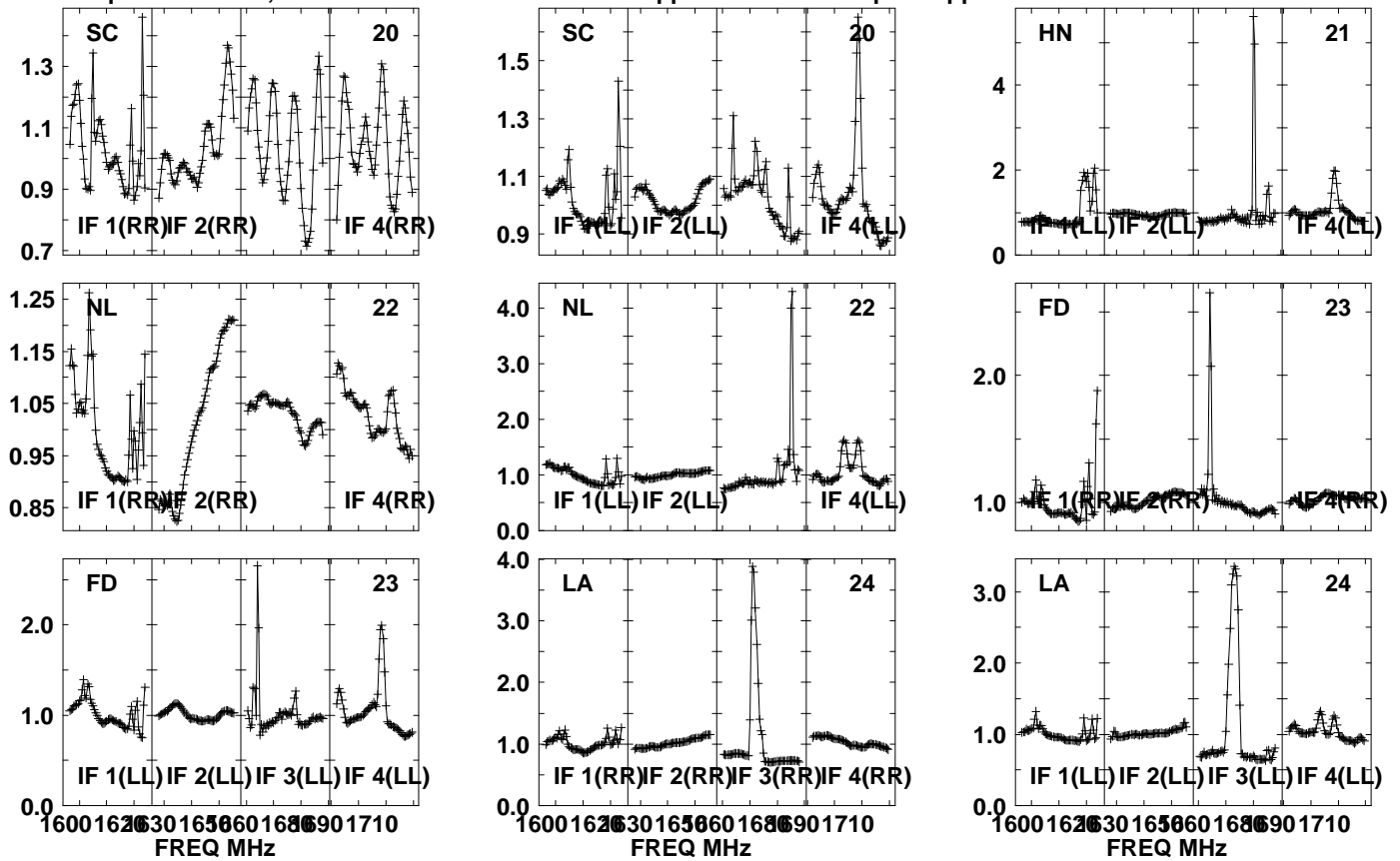

Lower frame: Real Jy  
Auto-corr total-power spectrum Antenna: \*  
Timerange: 00/18:07:01 to 00/18:08:29

Plot file version 863 created 05-OCT-2021 17:08:40

J0827+5217 GM076.UVDATA.1

Freq = 1.5945 GHz, Bw = 32.000 MH No calibration applied and no bandpass applied

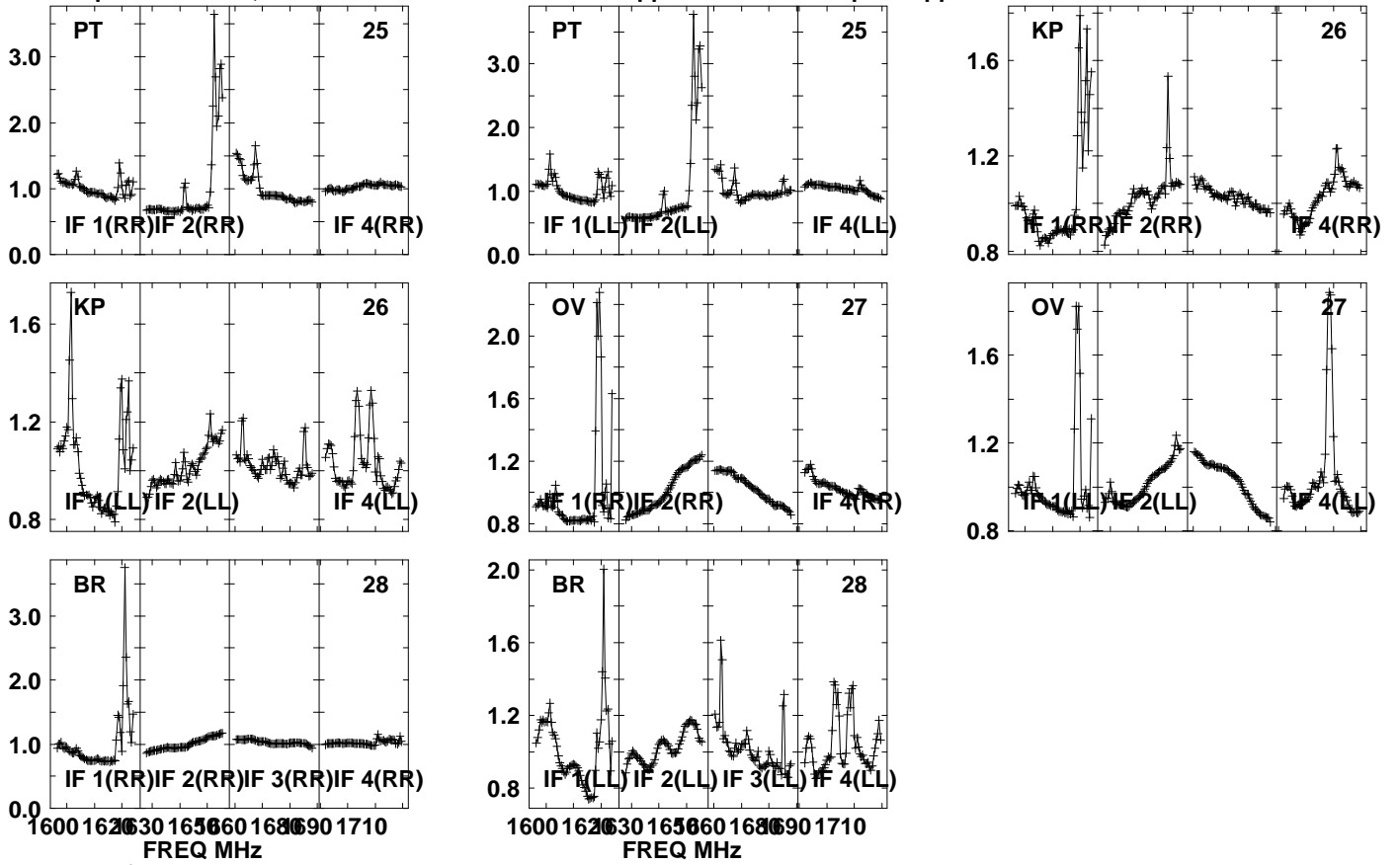

Lower frame: Real Jy  
Auto-corr total-power spectrum Antenna: \*  
Timerange: 00/18:07:01 to 00/18:08:29

Plot file version 864 created 05-OCT-2021 17:08:40

APM08279+525 GM076.UVDATA.1

Freq = 1.5945 GHz, Bw = 32.000 MH No calibration applied and no bandpass applied

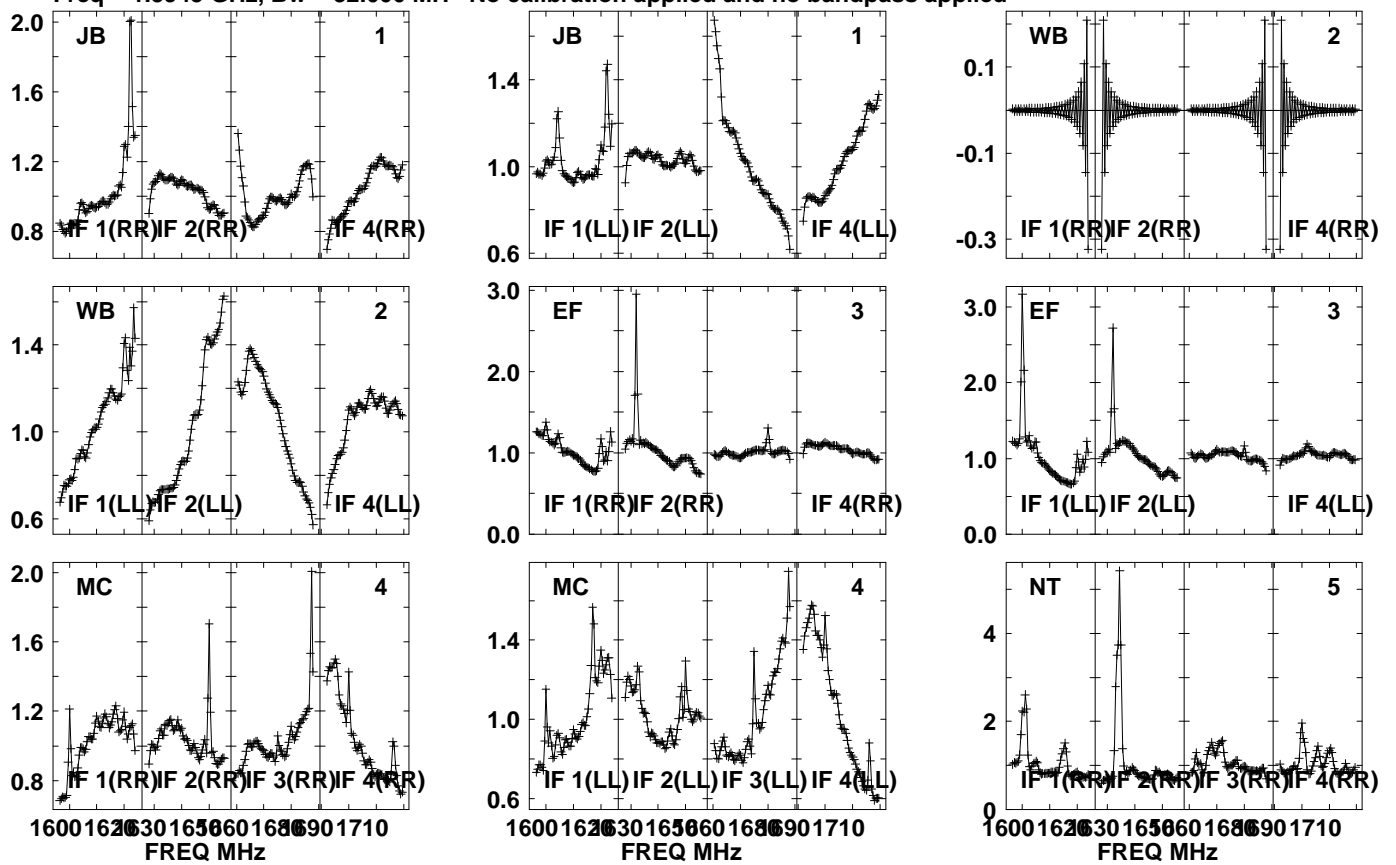

Lower frame: Real Jy  
Auto-corr total-power spectrum Antenna: \*  
Timerange: 00/18:08:31 to 00/18:11:59

Plot file version 865 created 05-OCT-2021 17:08:40

APM08279+525 GM076.UVDATA.1

Freq = 1.5945 GHz, Bw = 32.000 MH No calibration applied and no bandpass applied

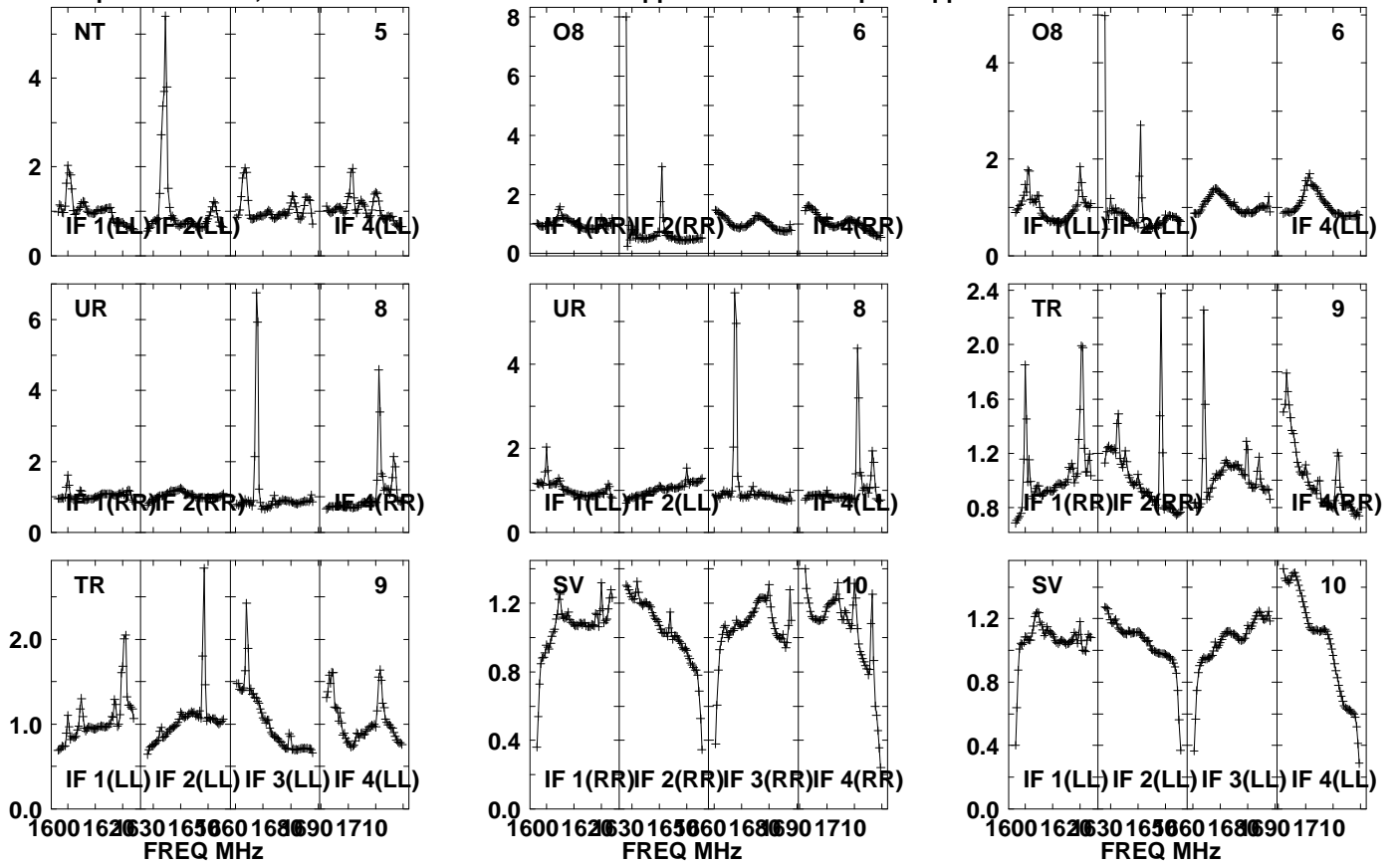

Lower frame: Real Jy

Auto-corr total-power spectrum Antenna: \*

Timerange: 00/18:08:31 to 00/18:11:59

Plot file version 866 created 05-OCT-2021 17:08:41

APM08279+525 GM076.UVDATA.1

Freq = 1.5945 GHz, Bw = 32.000 MH No calibration applied and no bandpass applied

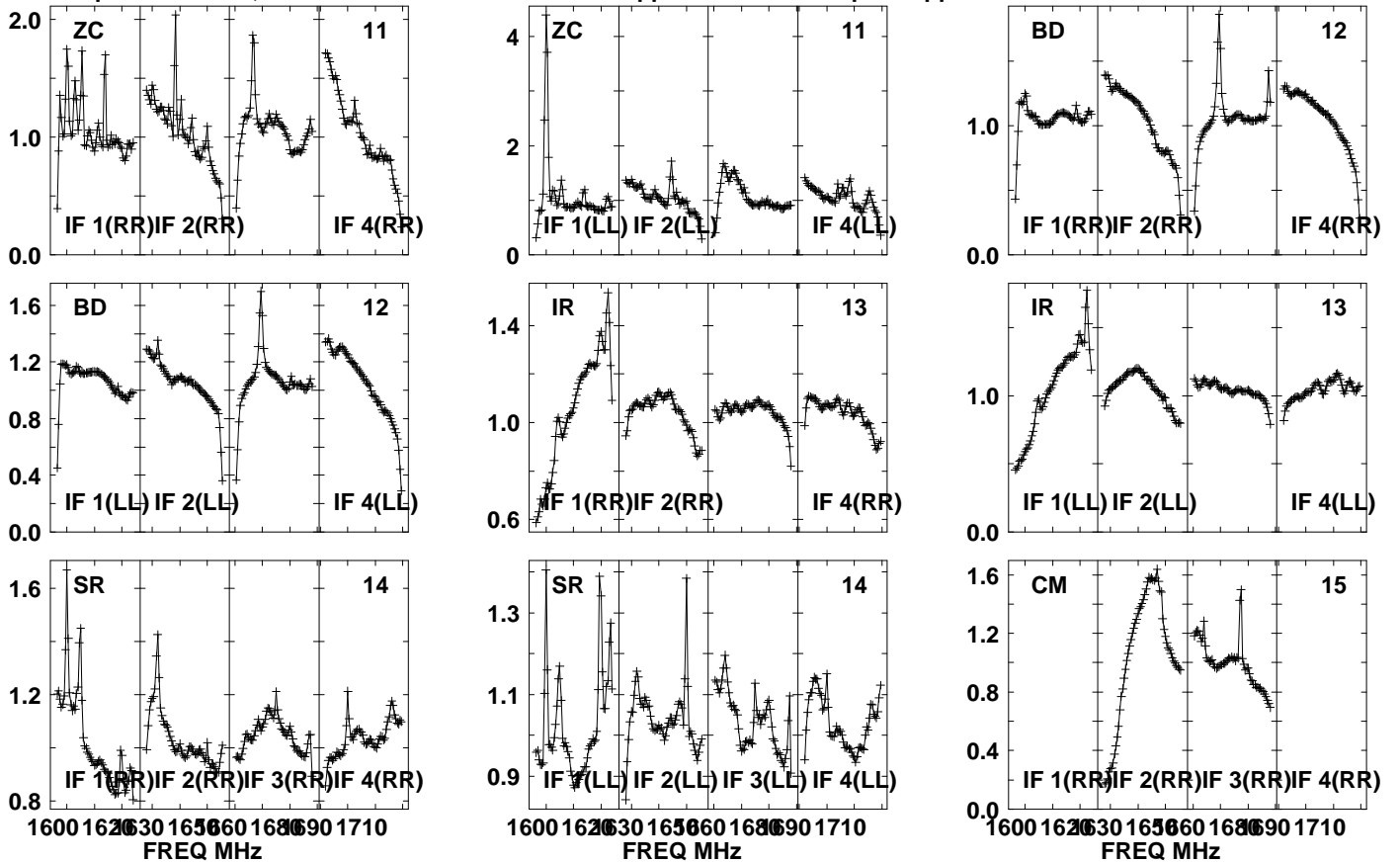

Lower frame: Real Jy

Auto-corr total-power spectrum Antenna: \*

Timerange: 00/18:08:31 to 00/18:11:59



Plot file version 867 created 05-OCT-2021 17:08:41

APM08279+525 GM076.UVDATA.1

Freq = 1.5945 GHz, Bw = 32.000 MH No calibration applied and no bandpass applied

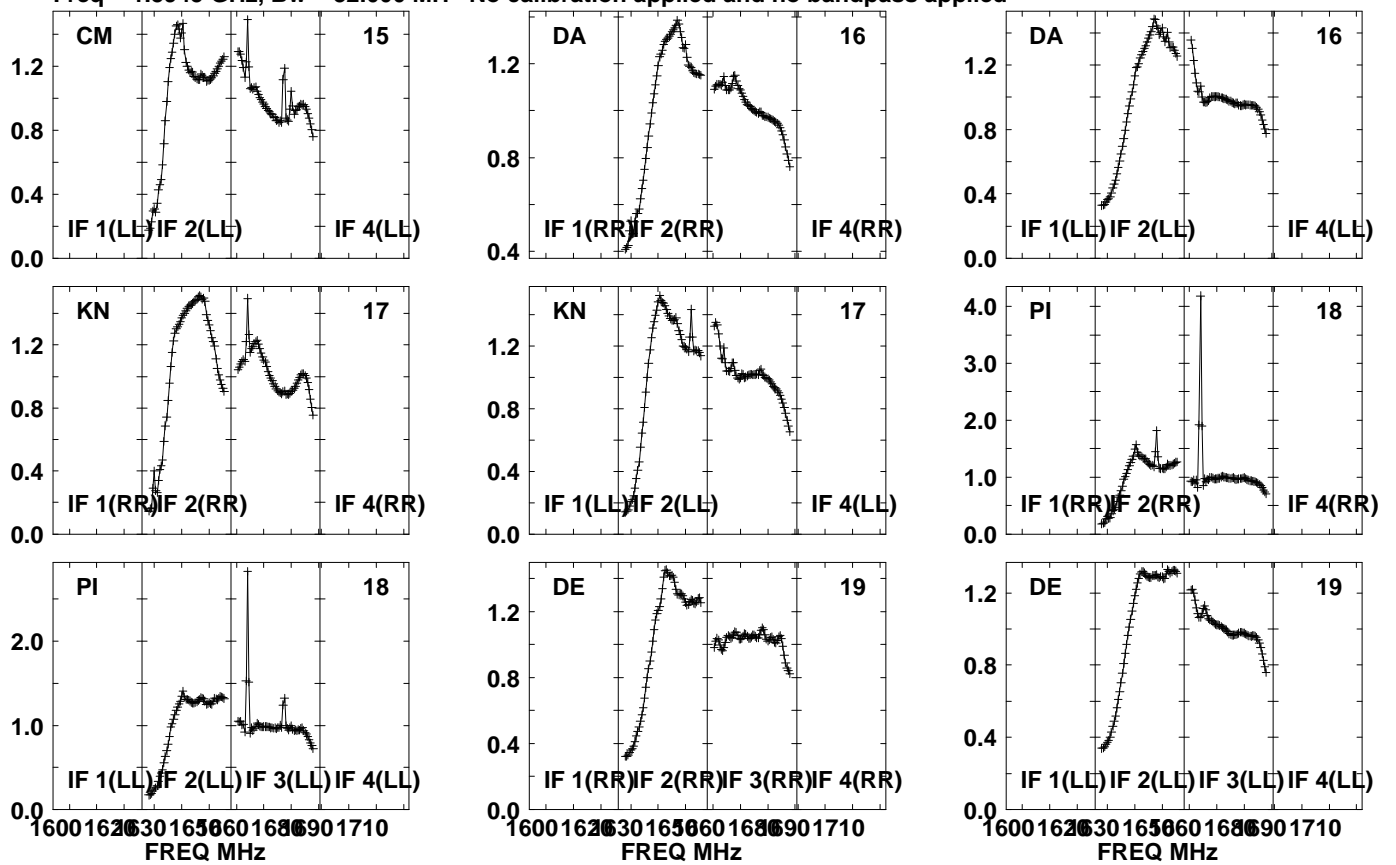

Lower frame: Real Jy  
Auto-corr total-power spectrum Antenna: \*  
Timerange: 00/18:08:31 to 00/18:11:59

Plot file version 868 created 05-OCT-2021 17:08:41

APM08279+525 GM076.UVDATA.1

Freq = 1.5945 GHz, Bw = 32.000 MH No calibration applied and no bandpass applied

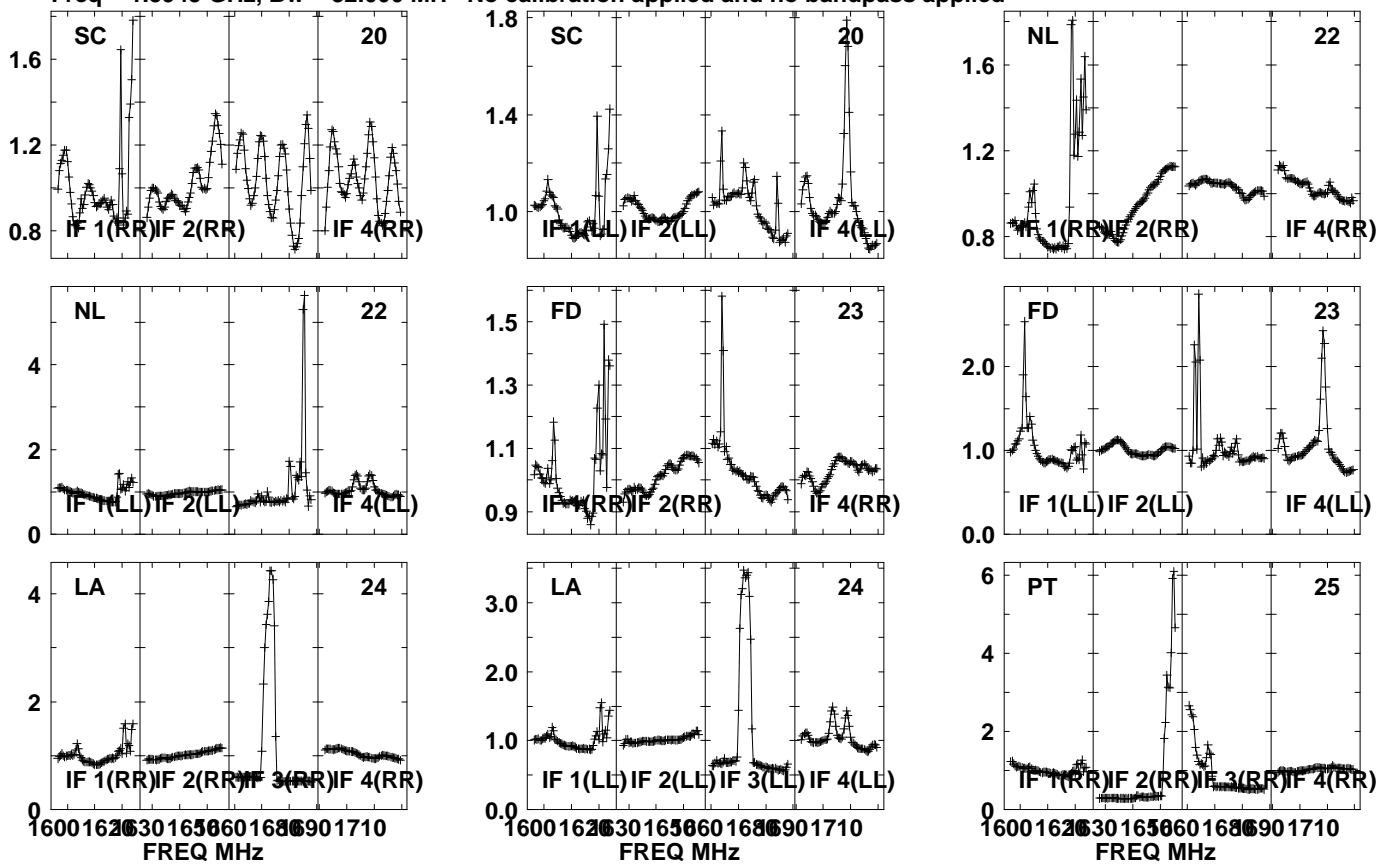

Lower frame: Real Jy  
Auto-corr total-power spectrum Antenna: \*  
Timerange: 00/18:08:31 to 00/18:11:59

Plot file version 869 created 05-OCT-2021 17:08:42

APM08279+525 GM076.UVDATA.1

Freq = 1.5945 GHz, Bw = 32.000 MH No calibration applied and no bandpass applied

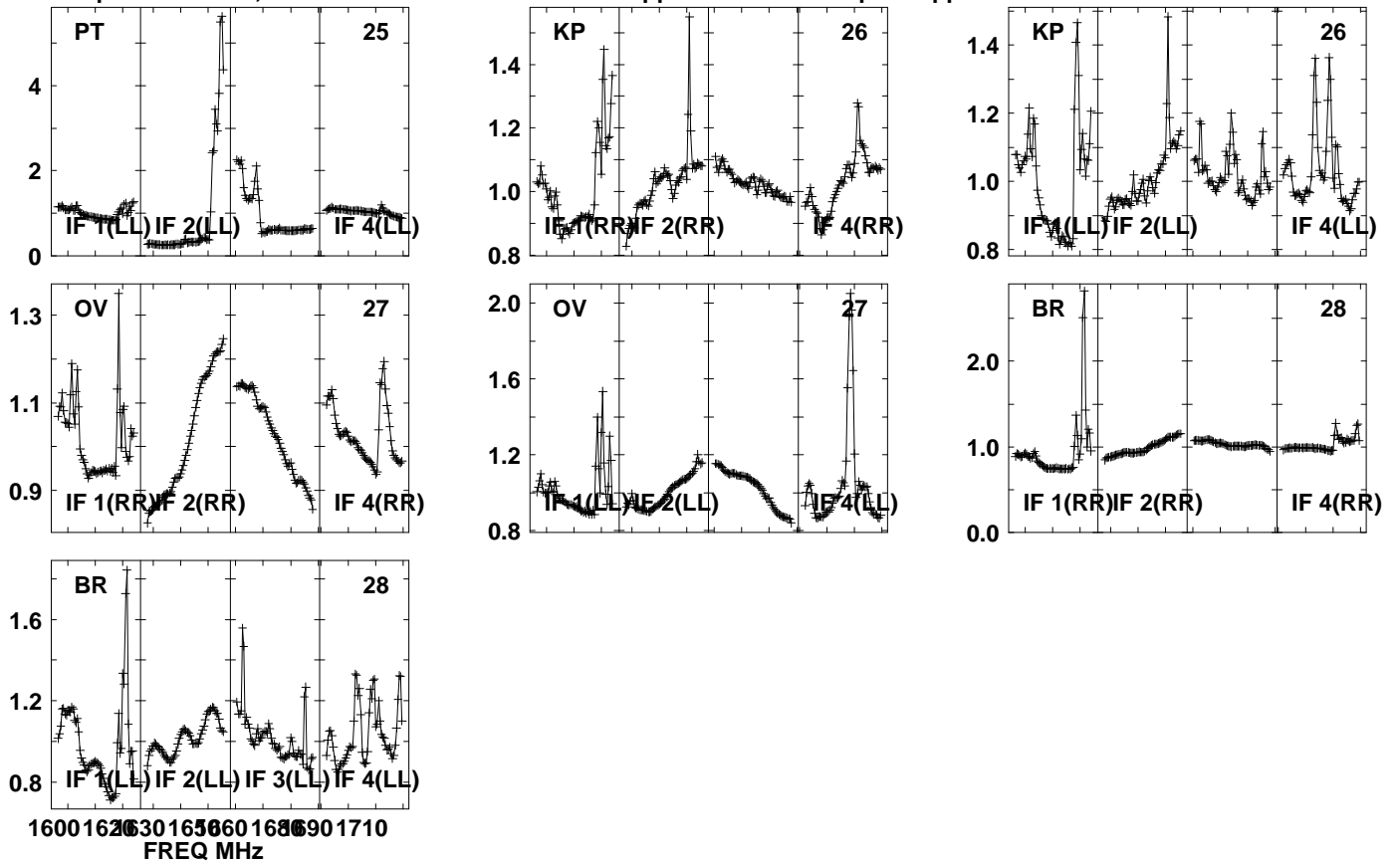

Lower frame: Real Jy

Auto-corr total-power spectrum Antenna: \*

Timerange: 00/18:08:31 to 00/18:11:59

Plot file version 870 created 05-OCT-2021 17:08:42

J0827+5217 GM076.UVDATA.1

Freq = 1.5945 GHz, Bw = 32.000 MH No calibration applied and no bandpass applied

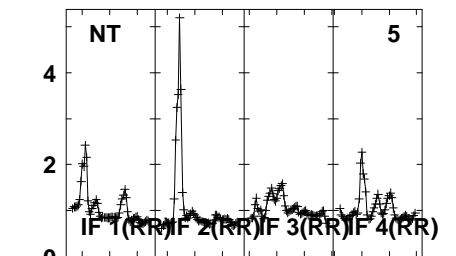
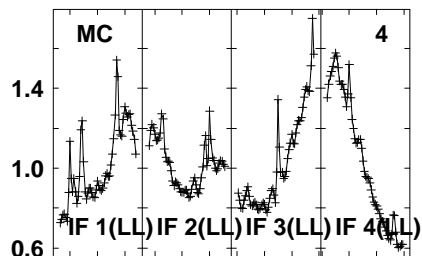
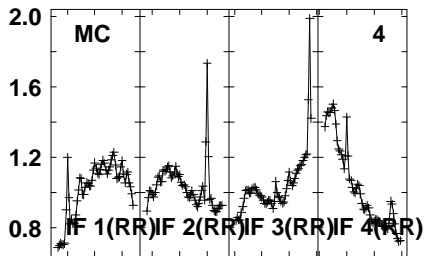
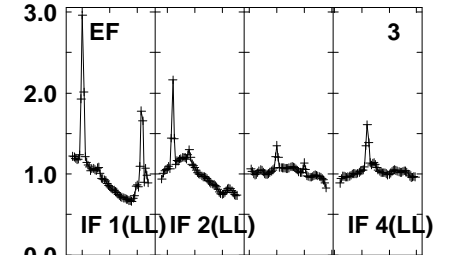
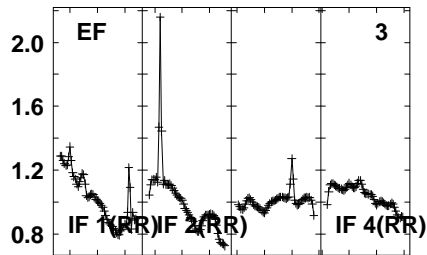
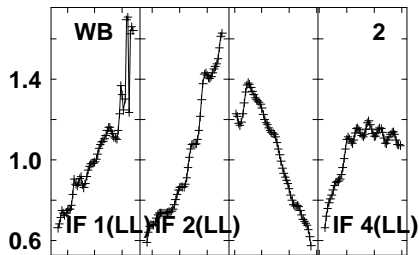
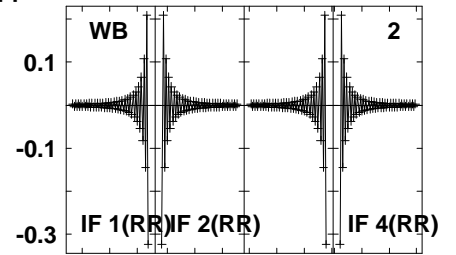
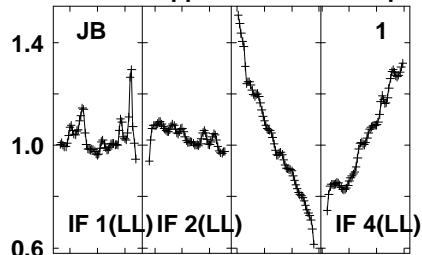
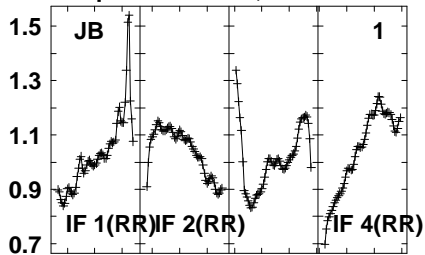

1600 1620 1630 1650 1660 1680 1690 1710  
FREQ MHz

1600 1620 1630 1650 1660 1680 1690 1710  
FREQ MHz

1600 1620 1630 1650 1660 1680 1690 1710  
FREQ MHz

Lower frame: Real Jy  
Auto-corr total-power spectrum Antenna: \*  
Timerange: 00/18:12:31 to 00/18:13:59

Plot file version 871 created 05-OCT-2021 17:08:42

J0827+5217 GM076.UVDATA.1

Freq = 1.5945 GHz, Bw = 32.000 MH No calibration applied and no bandpass applied

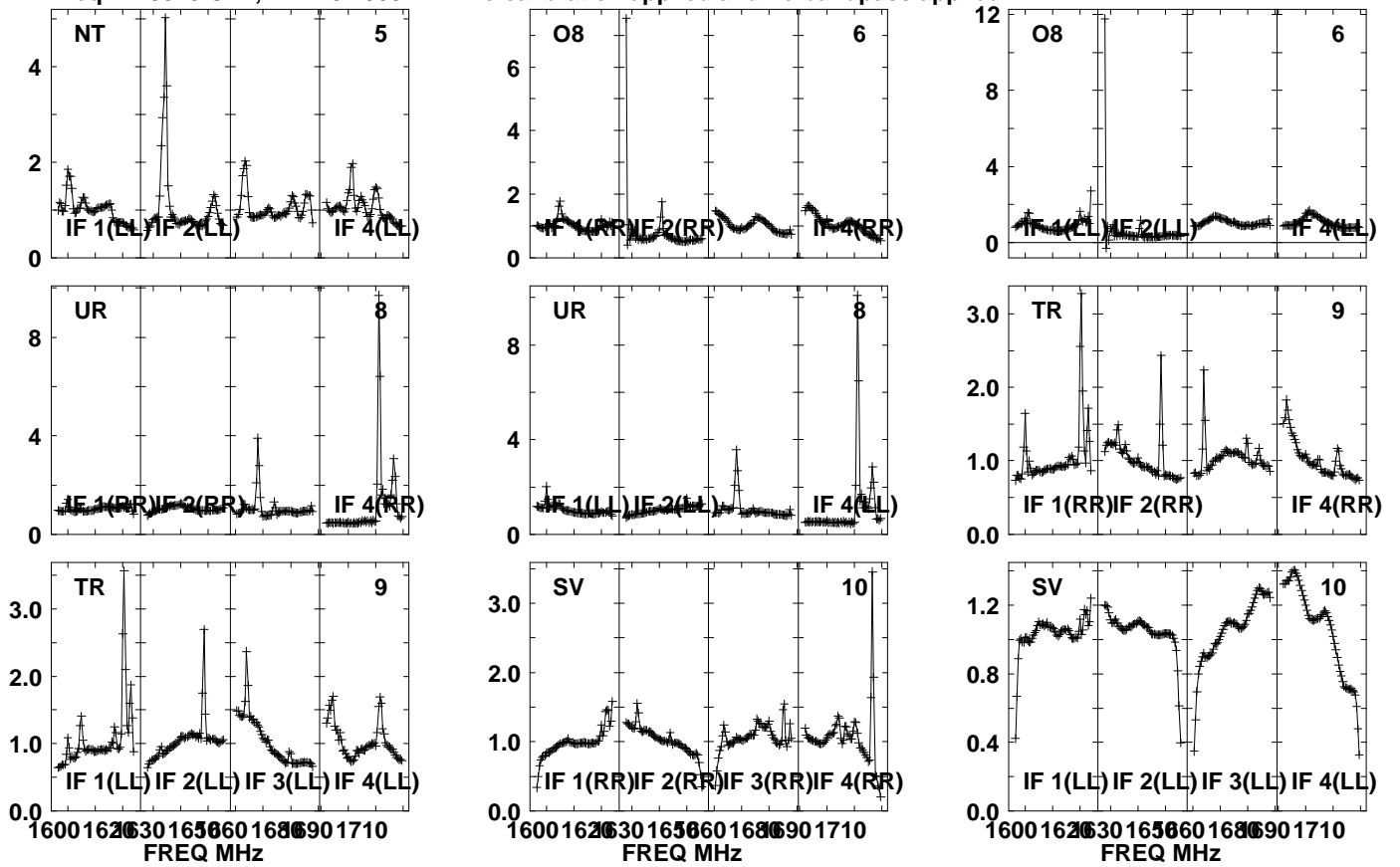

Lower frame: Real Jy

Auto-corr total-power spectrum Antenna: \*

Timerange: 00/18:12:31 to 00/18:13:59

Plot file version 872 created 05-OCT-2021 17:08:43

J0827+5217 GM076.UVDATA.1

Freq = 1.5945 GHz, Bw = 32.000 MH No calibration applied and no bandpass applied

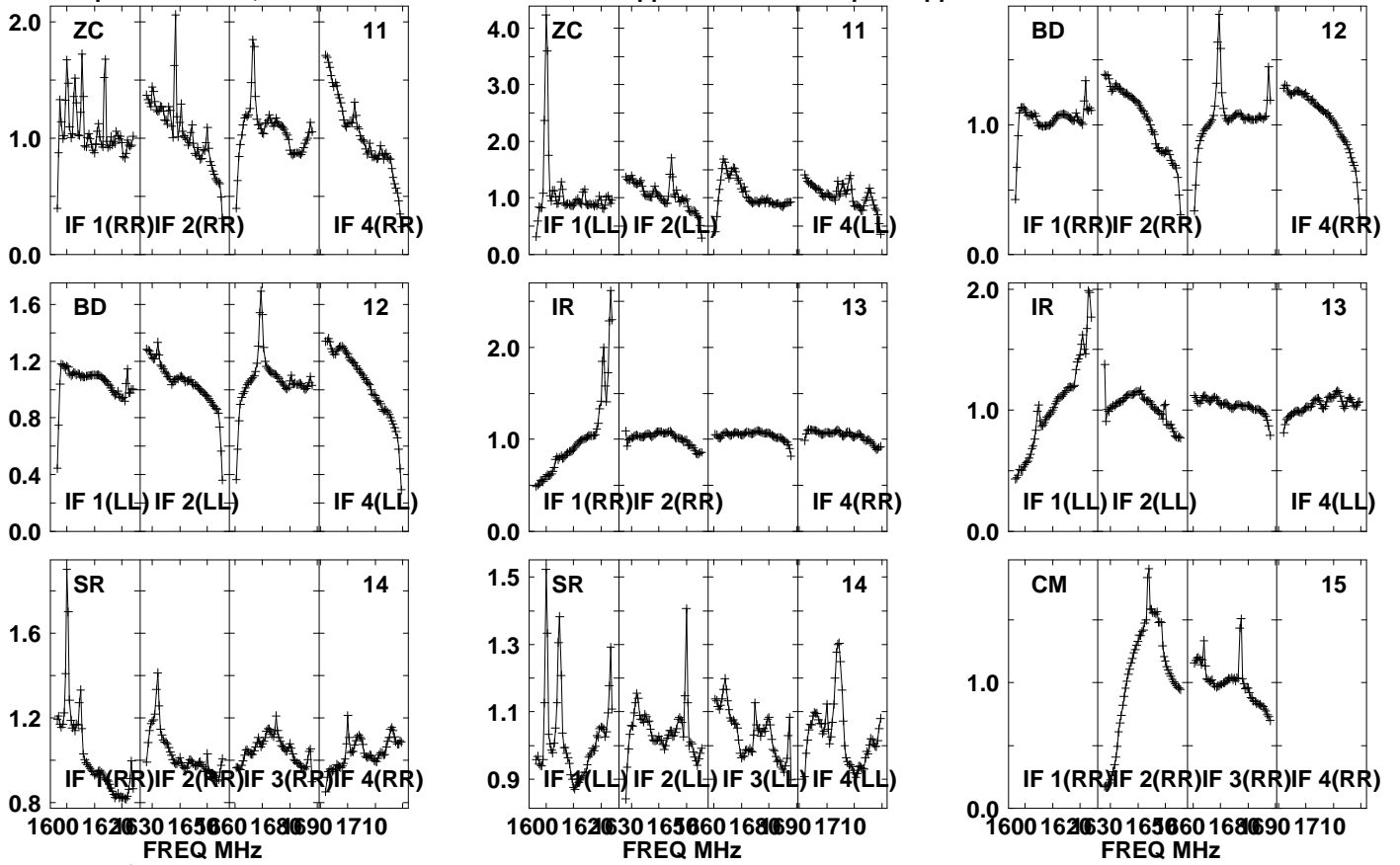

Lower frame: Real Jy  
Auto-corr total-power spectrum Antenna: \*  
Timerange: 00/18:12:31 to 00/18:13:59

Plot file version 873 created 05-OCT-2021 17:08:43

J0827+5217 GM076.UVDATA.1

Freq = 1.5945 GHz, Bw = 32.000 MH No calibration applied and no bandpass applied

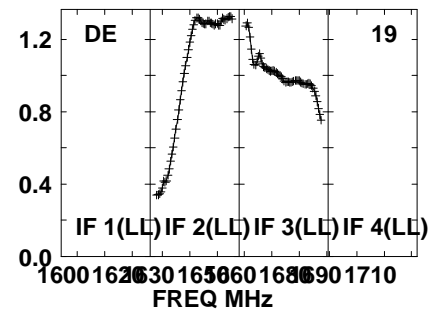
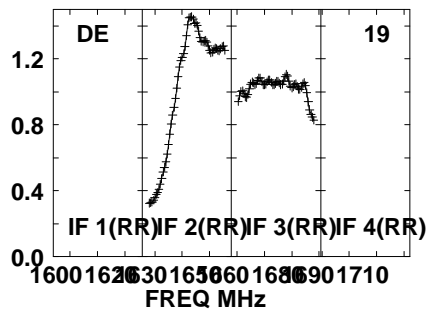
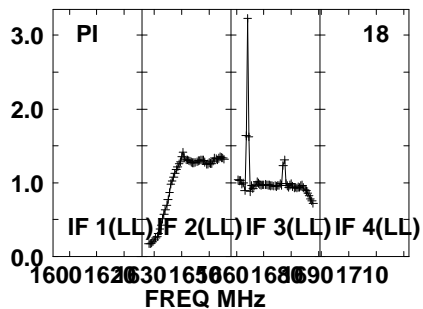
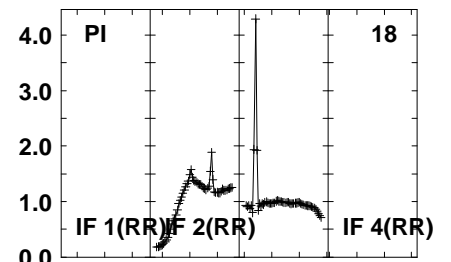
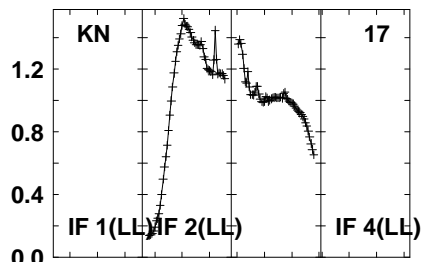
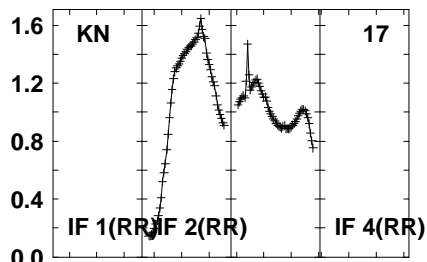
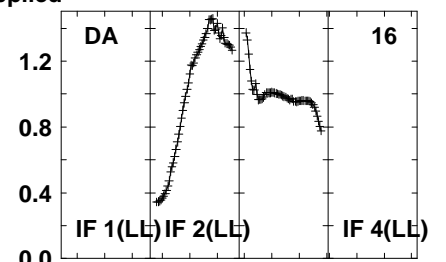
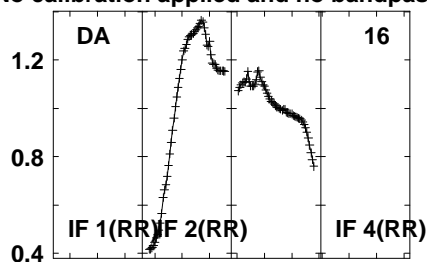
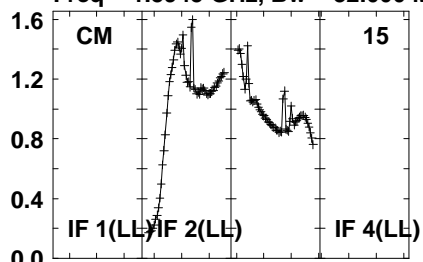

Lower frame: Real Jy  
Auto-corr total-power spectrum Antenna: \*  
Timerange: 00/18:12:31 to 00/18:13:59

Plot file version 874 created 05-OCT-2021 17:08:43

J0827+5217 GM076.UVDATA.1

Freq = 1.5945 GHz, Bw = 32.000 MH No calibration applied and no bandpass applied

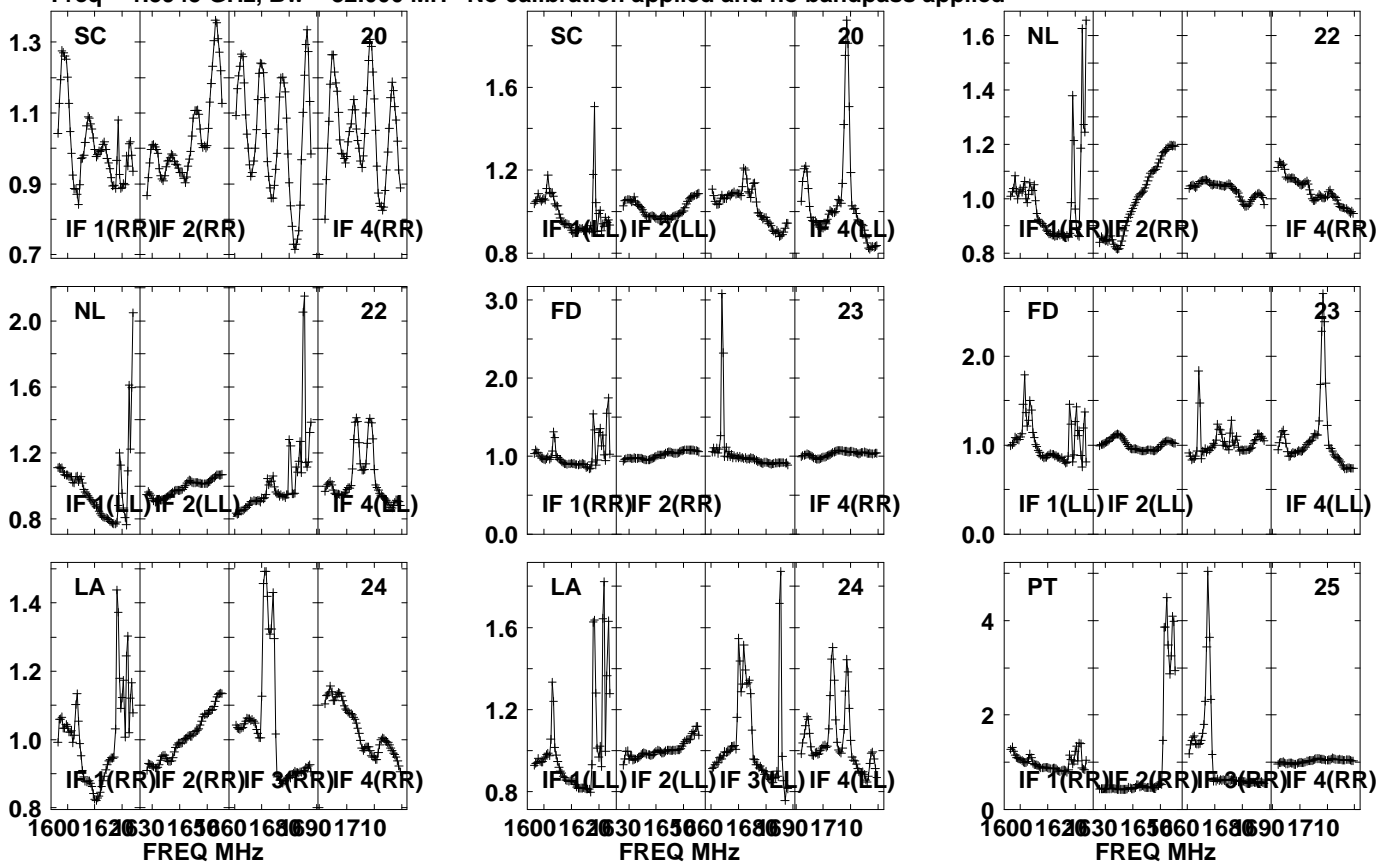

Lower frame: Real Jy  
Auto-corr total-power spectrum Antenna: \*  
Timerange: 00/18:12:31 to 00/18:13:59



Plot file version 875 created 05-OCT-2021 17:08:44

J0827+5217 GM076.UVDATA.1

Freq = 1.5945 GHz, Bw = 32.000 MH No calibration applied and no bandpass applied

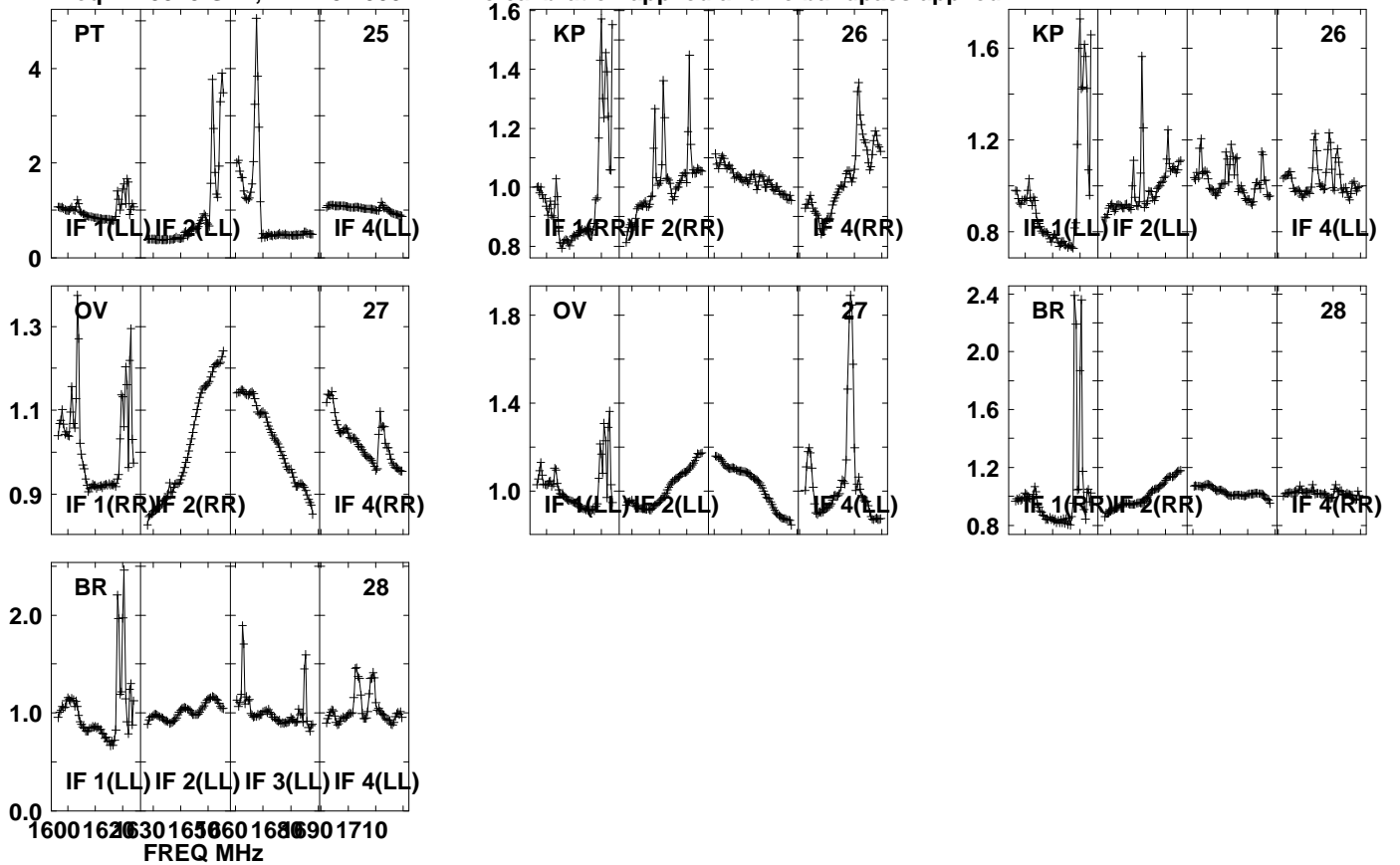

Lower frame: Real Jy  
Auto-corr total-power spectrum Antenna: \*  
Timerange: 00/18:12:31 to 00/18:13:59

Plot file version 876 created 05-OCT-2021 17:08:44

APM08279+525 GM076.UVDATA.1

Freq = 1.5945 GHz, Bw = 32.000 MH No calibration applied and no bandpass applied

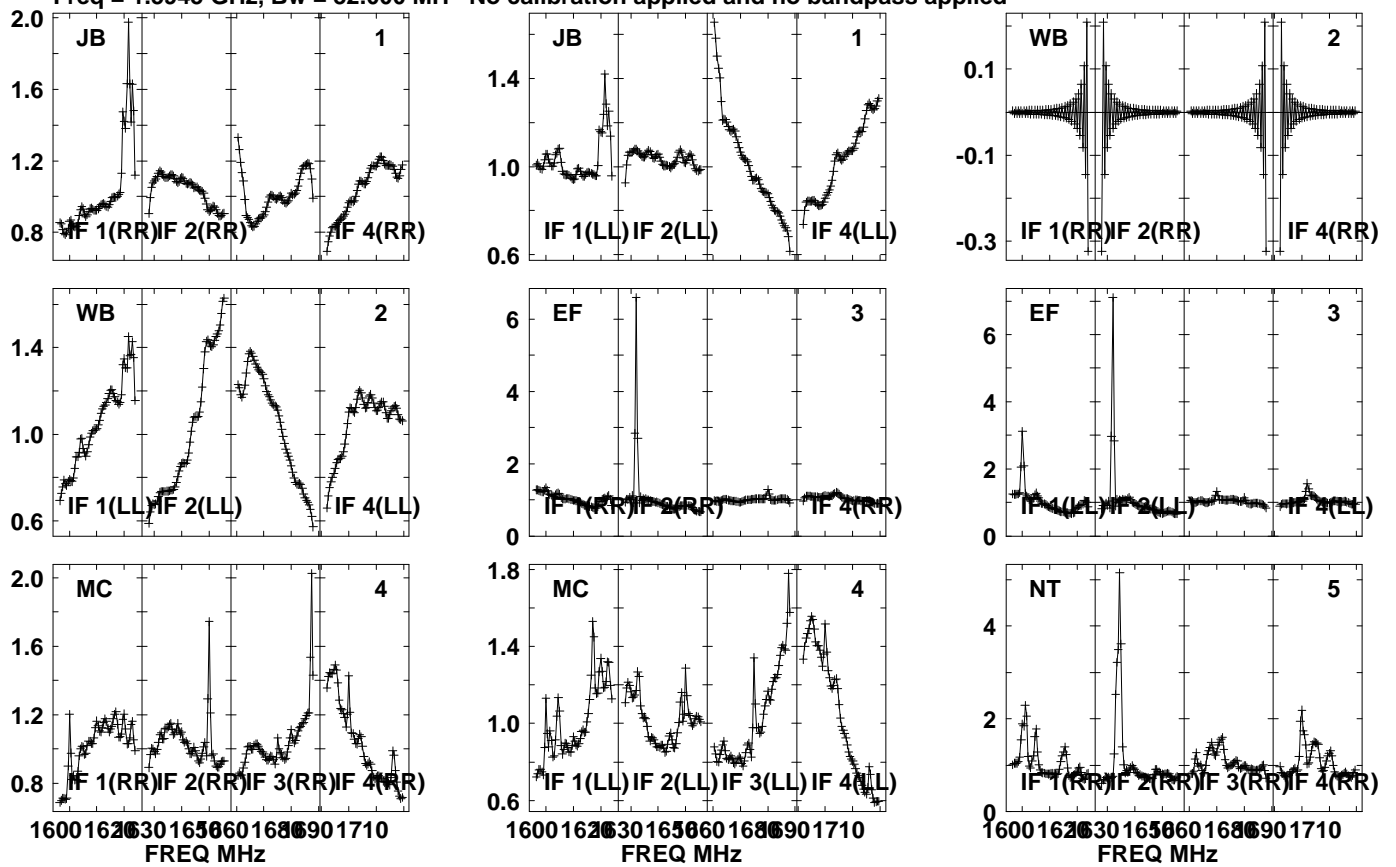

Lower frame: Real Jy  
Auto-corr total-power spectrum Antenna: \*  
Timerange: 00/18:14:01 to 00/18:17:29

Plot file version 877 created 05-OCT-2021 17:08:44

APM08279+525 GM076.UVDATA.1

Freq = 1.5945 GHz, Bw = 32.000 MH No calibration applied and no bandpass applied

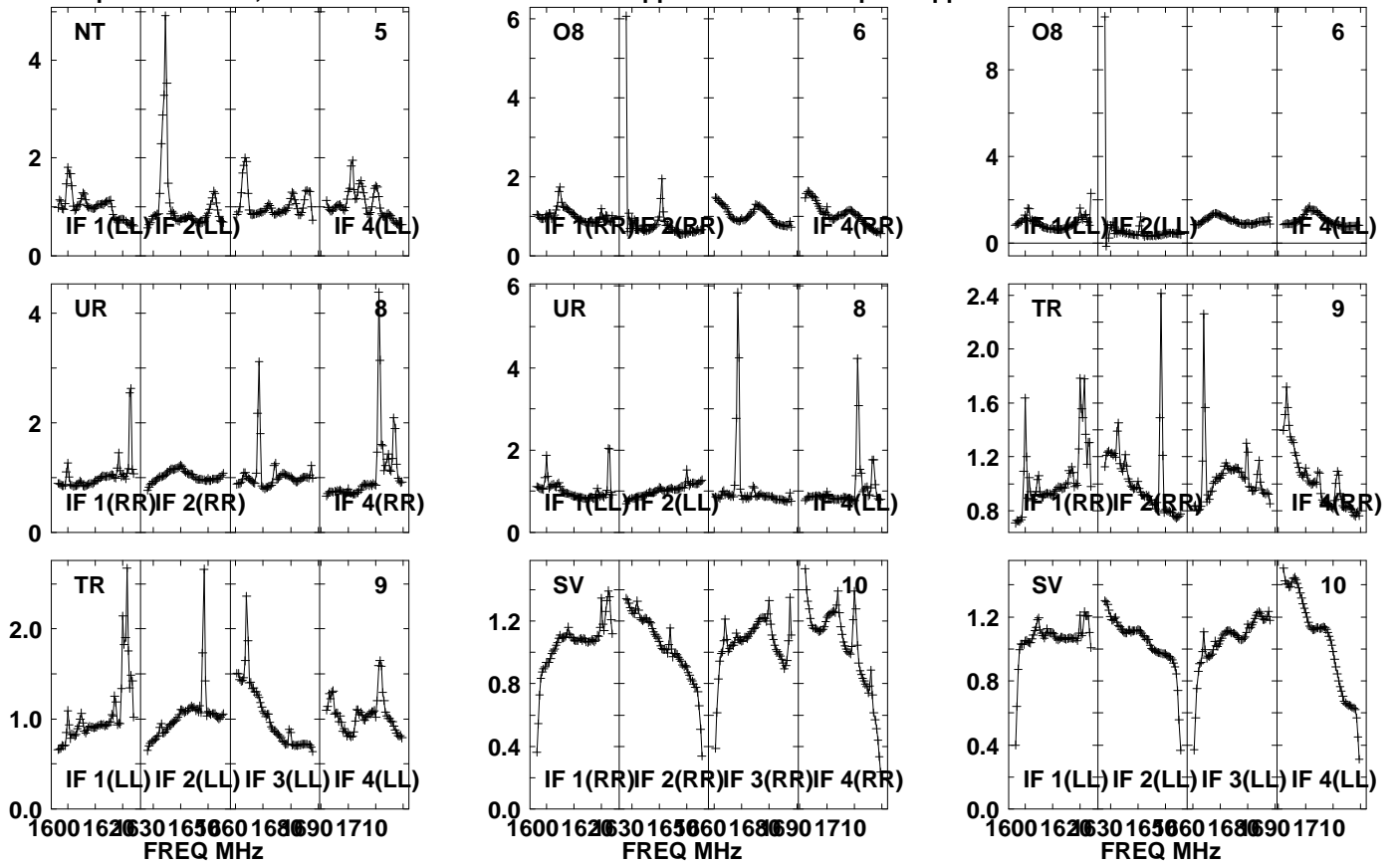

Lower frame: Real Jy  
Auto-corr total-power spectrum Antenna: \*  
Timerange: 00/18:14:01 to 00/18:17:29

Plot file version 878 created 05-OCT-2021 17:08:45

APM08279+525 GM076.UVDATA.1

Freq = 1.5945 GHz, Bw = 32.000 MH No calibration applied and no bandpass applied

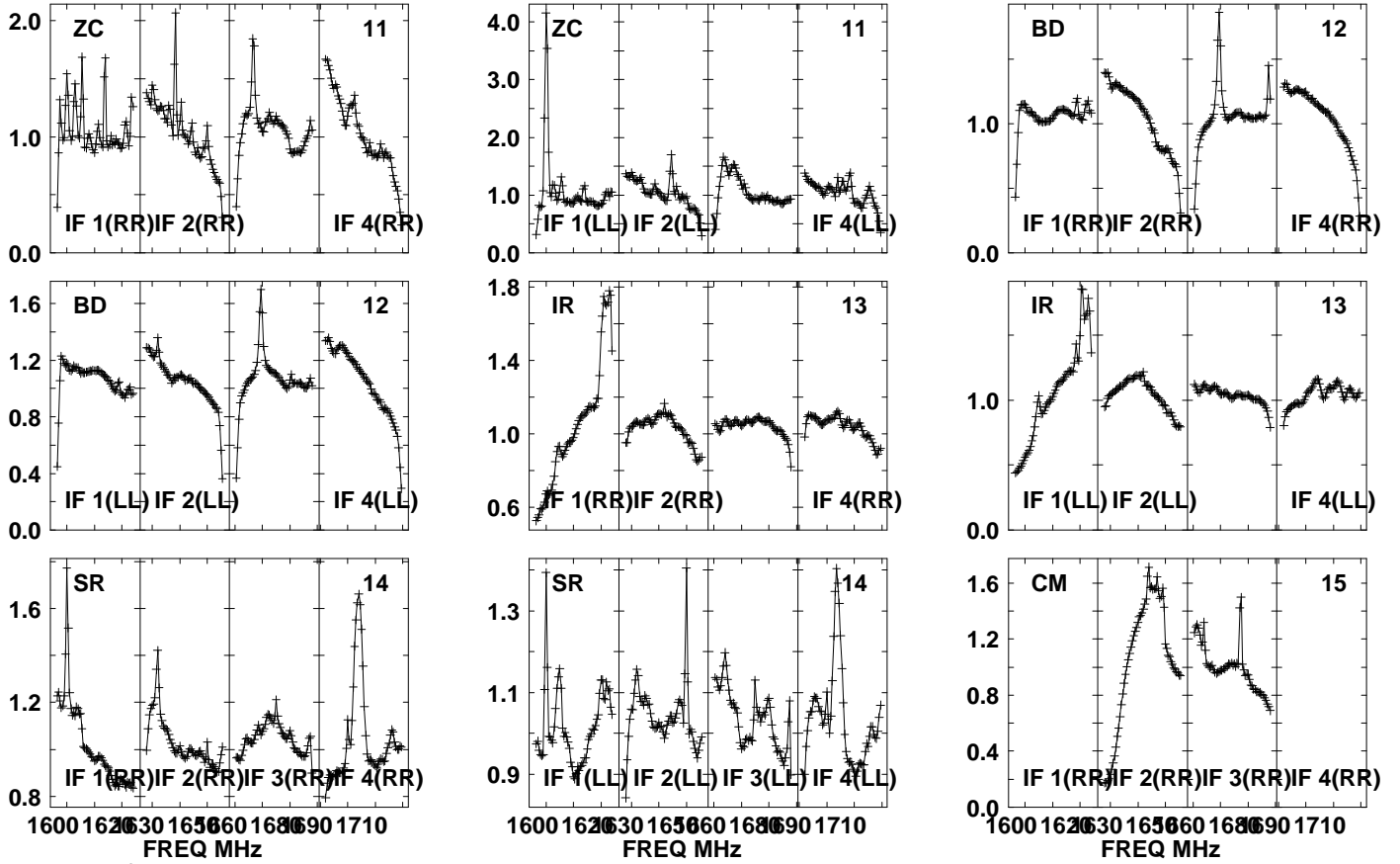

Lower frame: Real Jy  
Auto-corr total-power spectrum Antenna: \*  
Timerange: 00/18:14:01 to 00/18:17:29

Plot file version 879 created 05-OCT-2021 17:08:45

APM08279+525 GM076.UVDATA.1

Freq = 1.5945 GHz, Bw = 32.000 MH No calibration applied and no bandpass applied

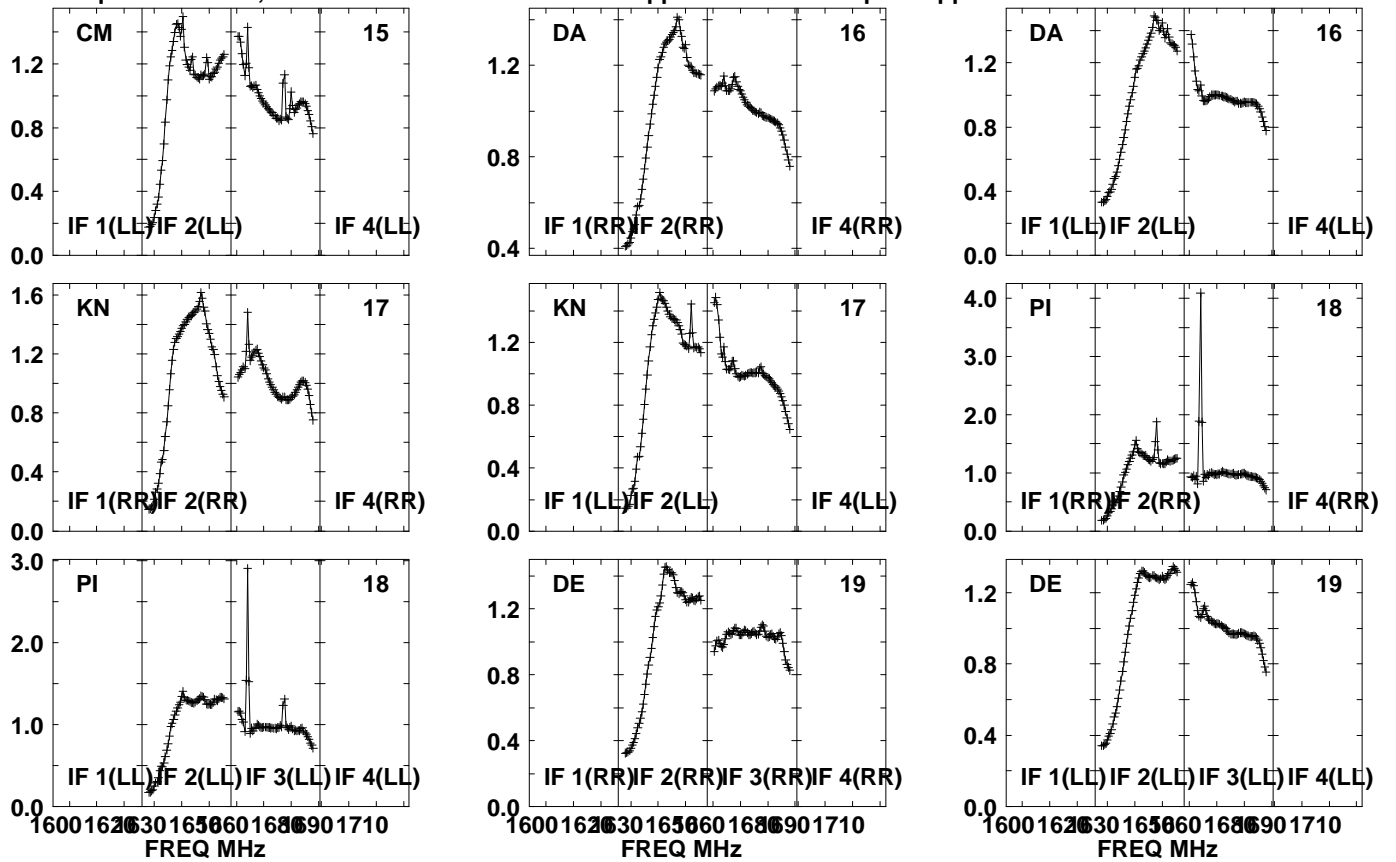

Lower frame: Real Jy  
Auto-corr total-power spectrum Antenna: \*  
Timerange: 00/18:14:01 to 00/18:17:29

Plot file version 880 created 05-OCT-2021 17:08:45

APM08279+525 GM076.UVDATA.1

Freq = 1.5945 GHz, Bw = 32.000 MH No calibration applied and no bandpass applied

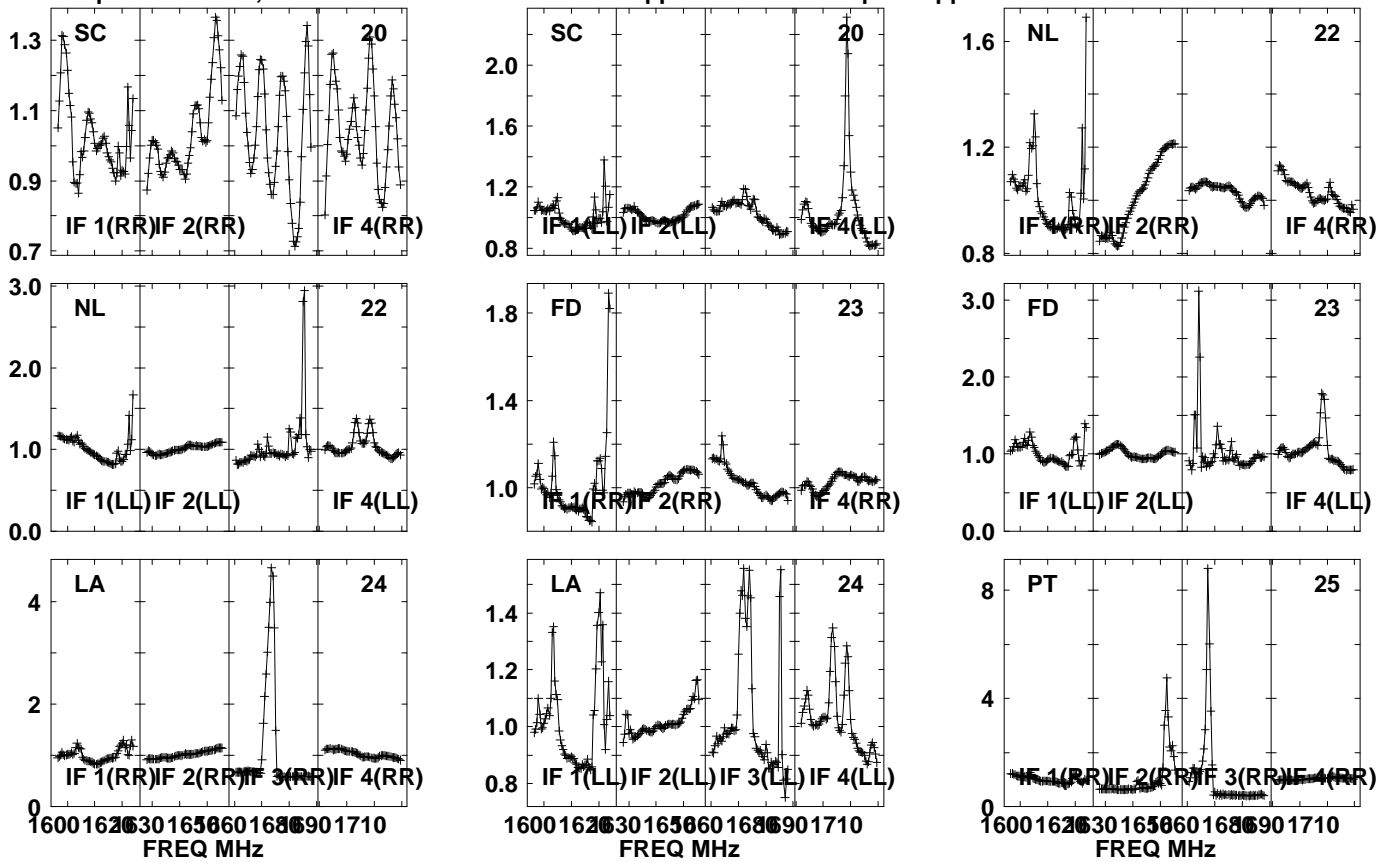

Lower frame: Real Jy  
Auto-corr total-power spectrum Antenna: \*  
Timerange: 00/18:14:01 to 00/18:17:29

Plot file version 881 created 05-OCT-2021 17:08:46

APM08279+525 GM076.UVDATA.1

Freq = 1.5945 GHz, Bw = 32.000 MH No calibration applied and no bandpass applied

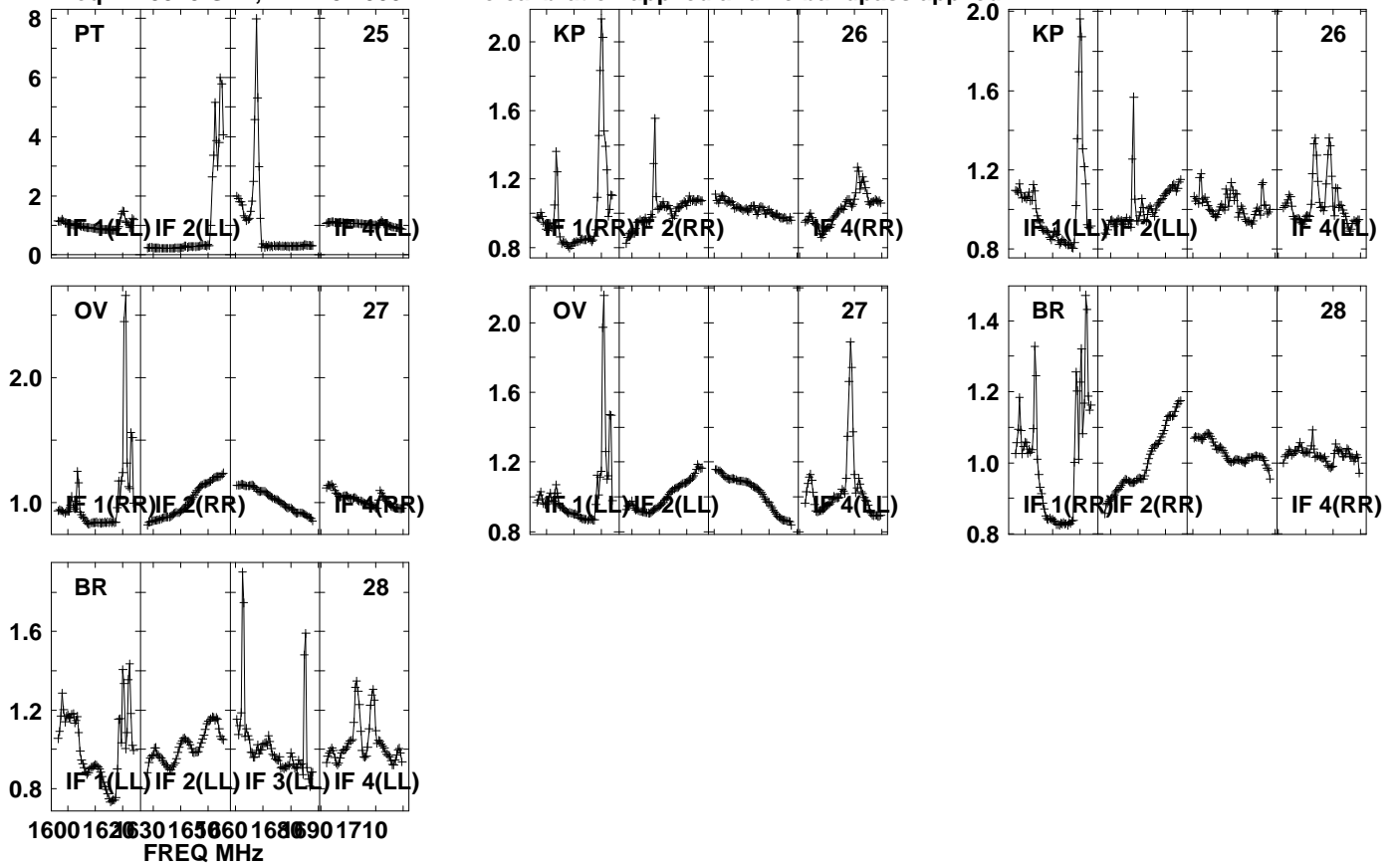

Lower frame: Real Jy

Auto-corr total-power spectrum Antenna: \*

Timerange: 00/18:14:01 to 00/18:17:29

Plot file version 882 created 05-OCT-2021 17:08:46

J0827+5217 GM076.UVDATA.1

Freq = 1.5945 GHz, Bw = 32.000 MH No calibration applied and no bandpass applied

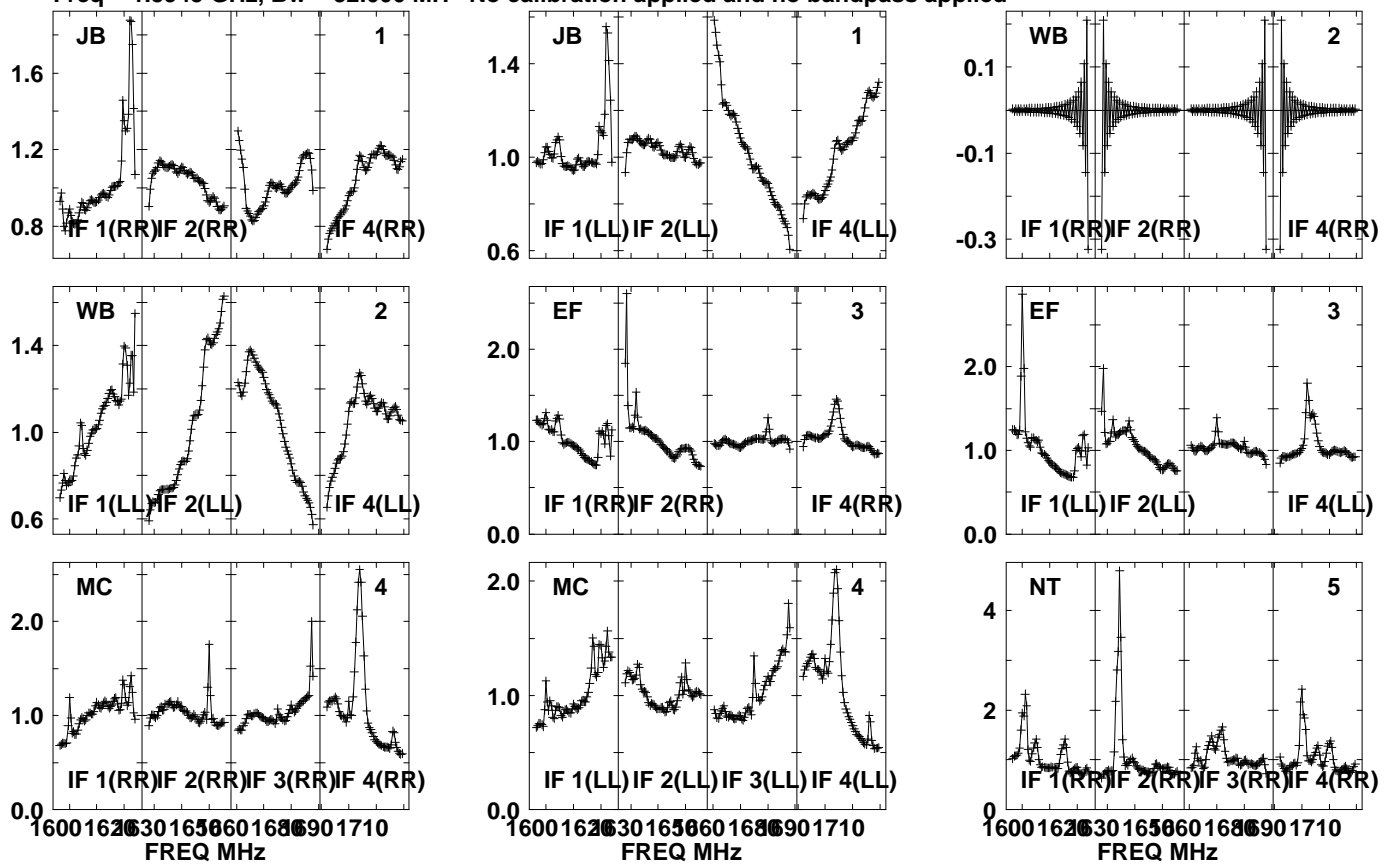

Lower frame: Real Jy

Auto-corr total-power spectrum Antenna: \*

Timerange: 00/18:17:31 to 00/18:18:59



Plot file version 883 created 05-OCT-2021 17:08:46

J0827+5217 GM076.UVDATA.1

Freq = 1.5945 GHz, Bw = 32.000 MH No calibration applied and no bandpass applied

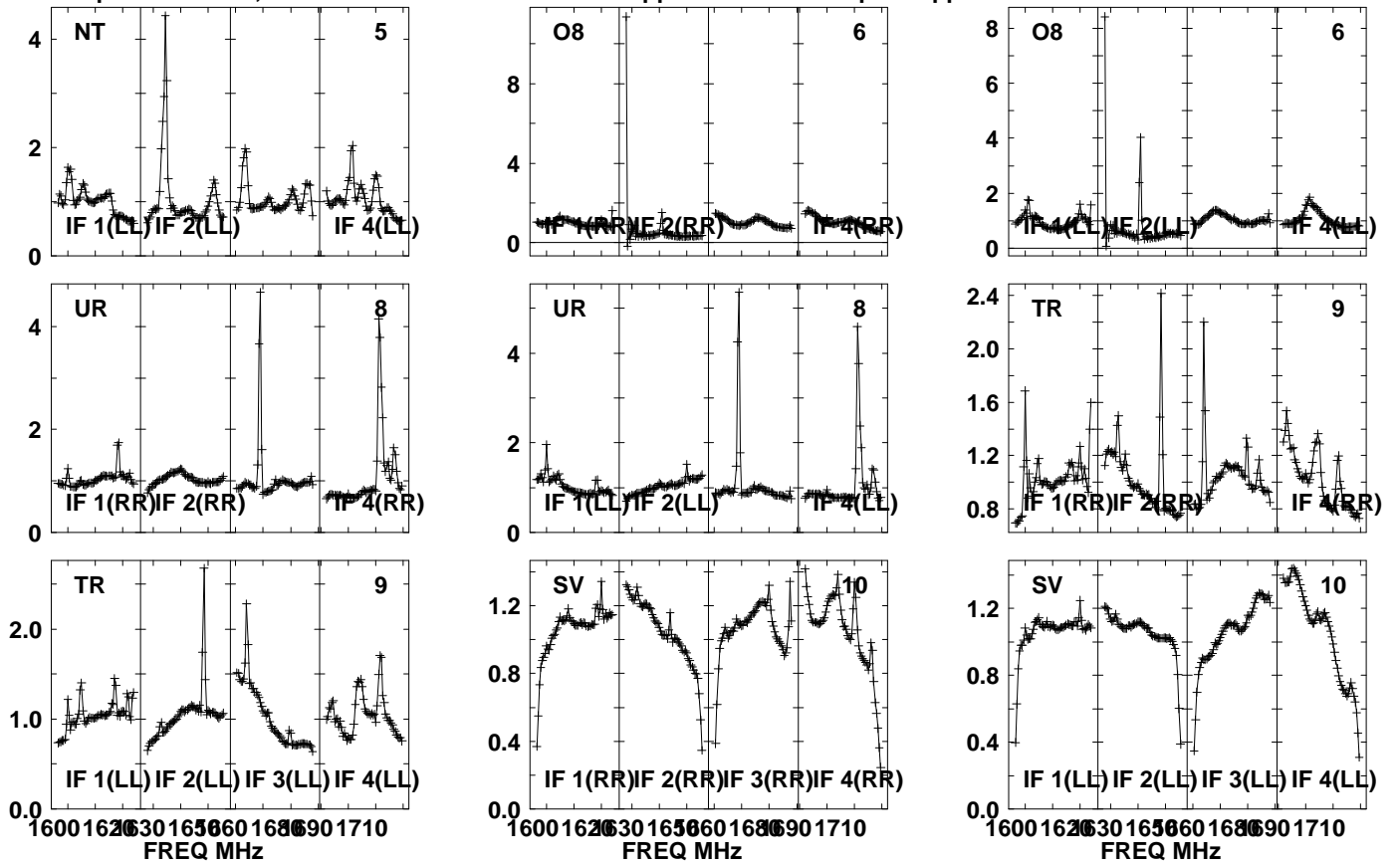

Lower frame: Real Jy  
Auto-corr total-power spectrum Antenna: \*  
Timerange: 00/18:17:31 to 00/18:18:59

Plot file version 884 created 05-OCT-2021 17:08:47

J0827+5217 GM076.UVDATA.1

Freq = 1.5945 GHz, Bw = 32.000 MH No calibration applied and no bandpass applied

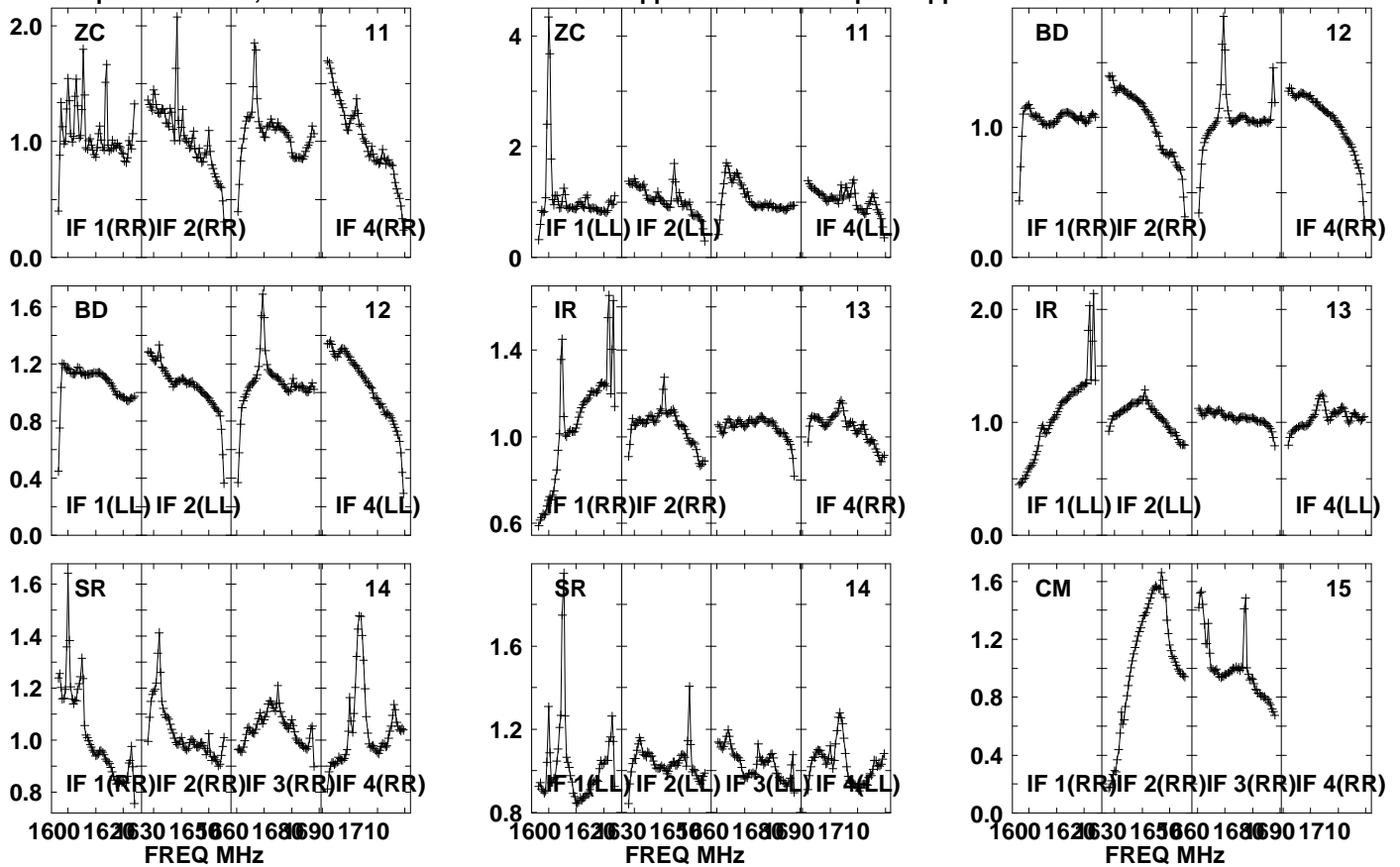

Lower frame: Real Jy

Auto-corr total-power spectrum Antenna: \*

Timerange: 00/18:17:31 to 00/18:18:59

Plot file version 885 created 05-OCT-2021 17:08:47

J0827+5217 GM076.UVDATA.1

Freq = 1.5945 GHz, Bw = 32.000 MH No calibration applied and no bandpass applied

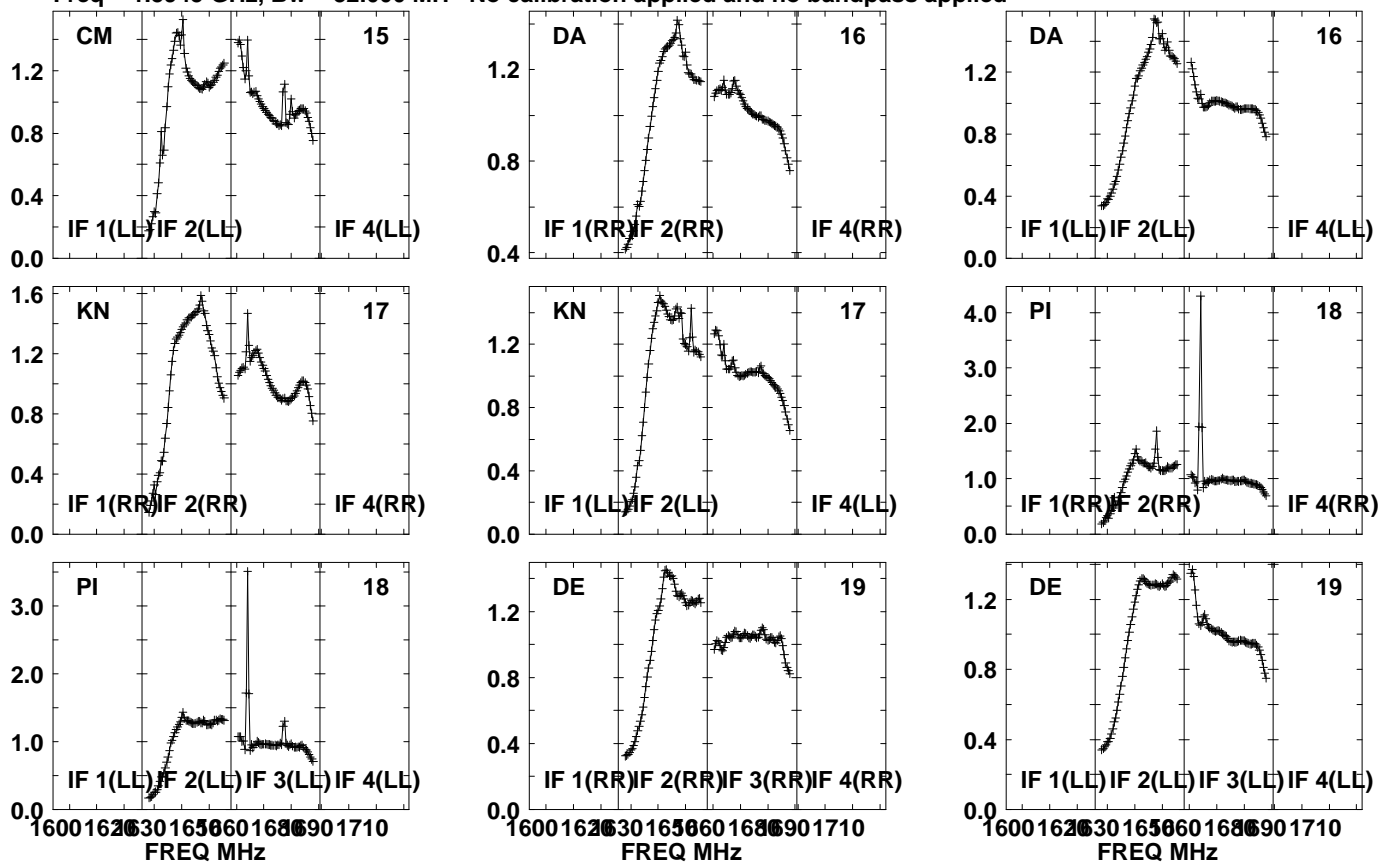

Lower frame: Real Jy  
Auto-corr total-power spectrum Antenna: \*  
Timerange: 00/18:17:31 to 00/18:18:59

Plot file version 886 created 05-OCT-2021 17:08:47

J0827+5217 GM076.UVDATA.1

Freq = 1.5945 GHz, Bw = 32.000 MH No calibration applied and no bandpass applied

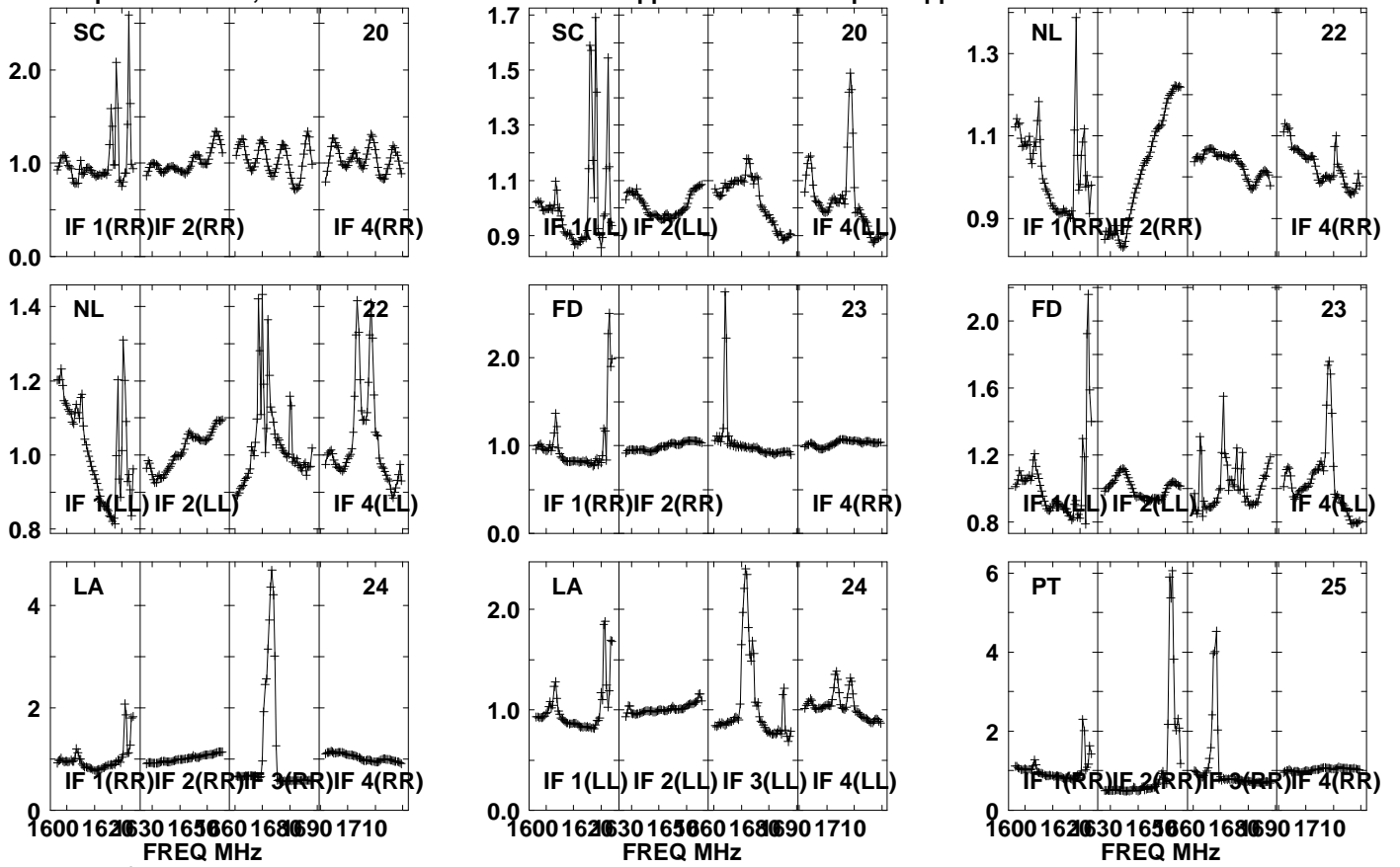

Lower frame: Real Jy  
Auto-corr total-power spectrum Antenna: \*  
Timerange: 00/18:17:31 to 00/18:18:59

Plot file version 887 created 05-OCT-2021 17:08:47

J0827+5217 GM076.UVDATA.1

Freq = 1.5945 GHz, Bw = 32.000 MH No calibration applied and no bandpass applied

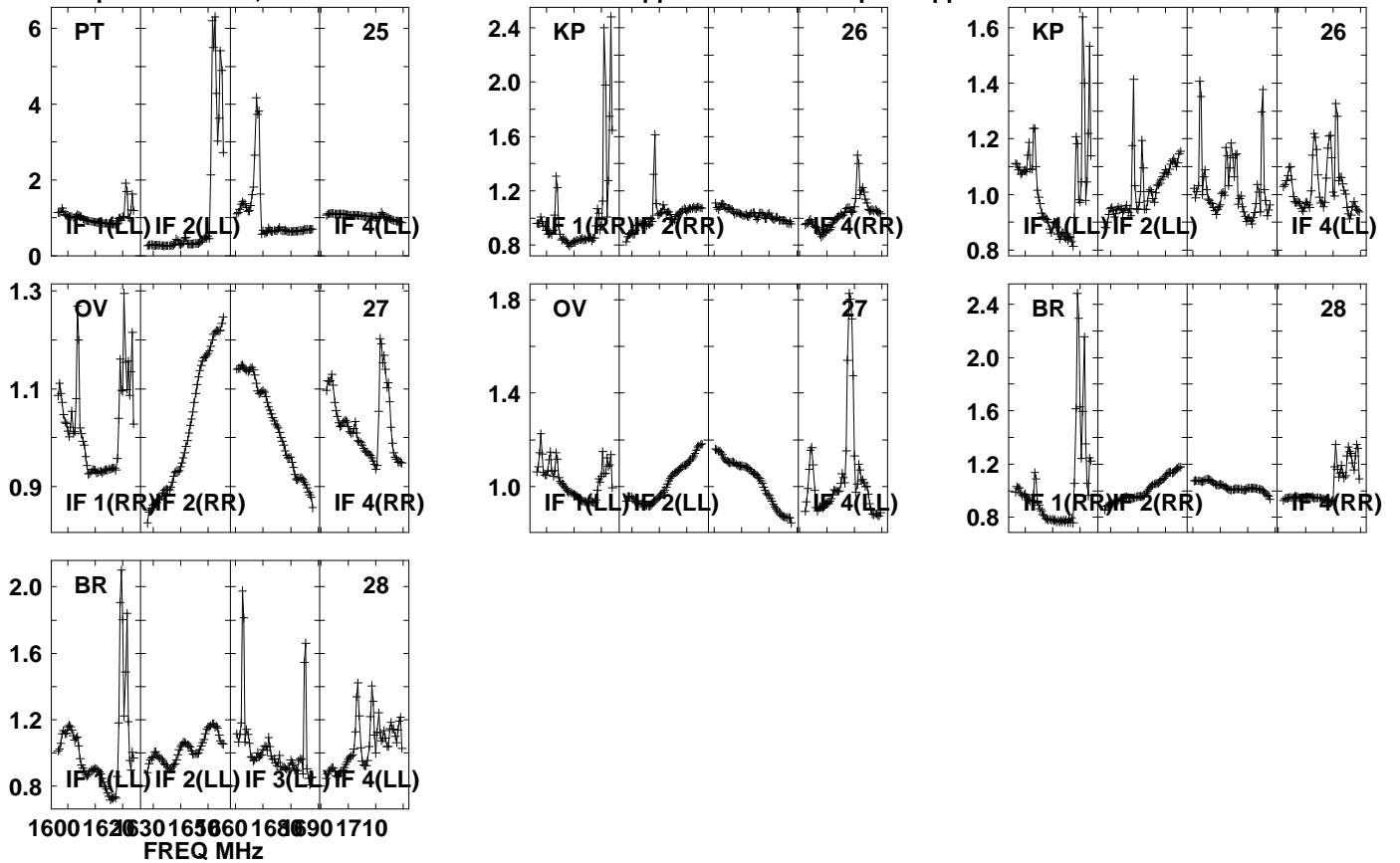

Lower frame: Real Jy

Auto-corr total-power spectrum Antenna: \*

Timerange: 00/18:17:31 to 00/18:18:59

Plot file version 888 created 05-OCT-2021 17:08:48

APM08279+525 GM076.UVDATA.1

Freq = 1.5945 GHz, Bw = 32.000 MH No calibration applied and no bandpass applied

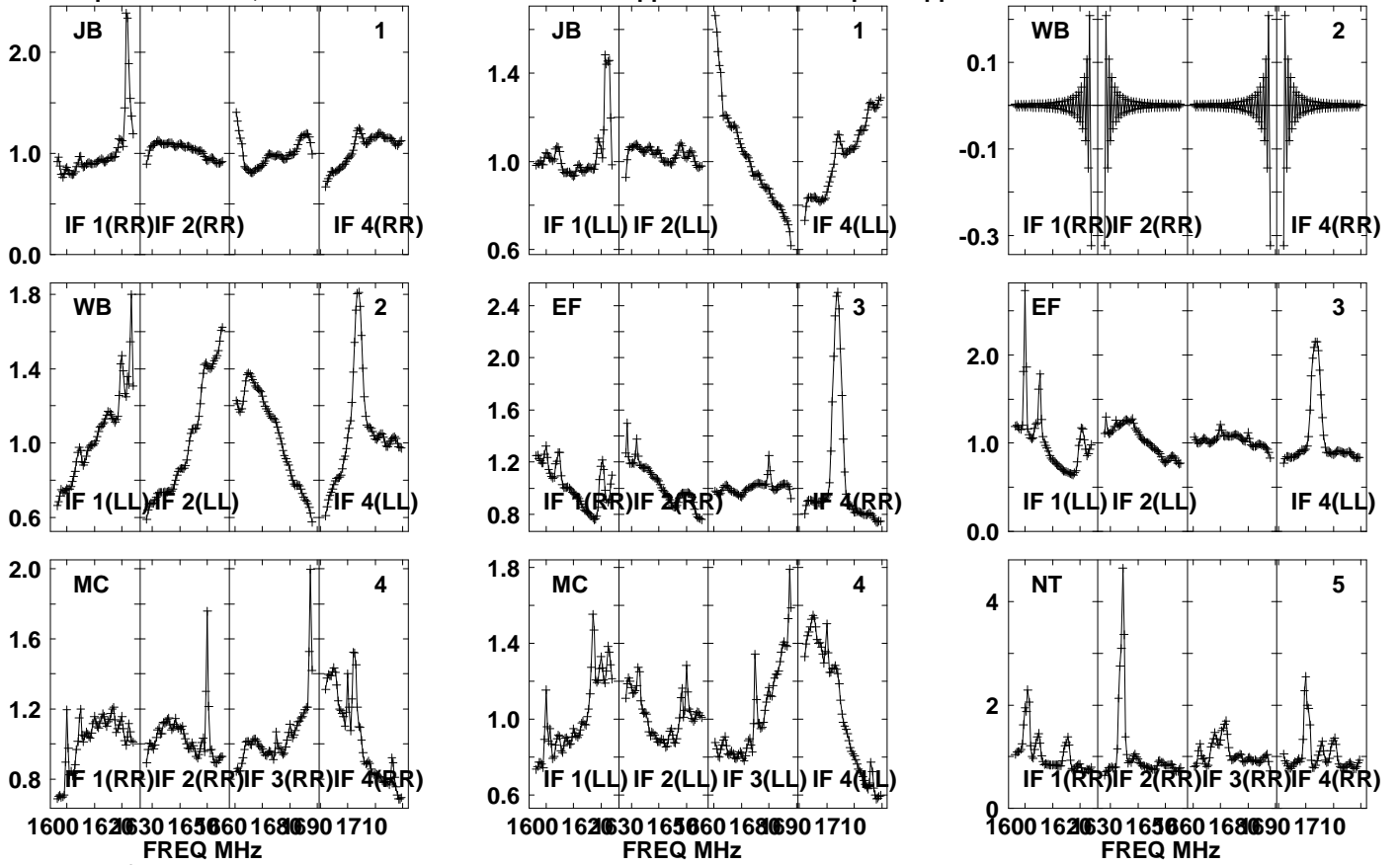

Lower frame: Real Jy  
Auto-corr total-power spectrum Antenna: \*  
Timerange: 00/18:19:01 to 00/18:22:29

Plot file version 889 created 05-OCT-2021 17:08:48

APM08279+525 GM076.UVDATA.1

Freq = 1.5945 GHz, Bw = 32.000 MH No calibration applied and no bandpass applied

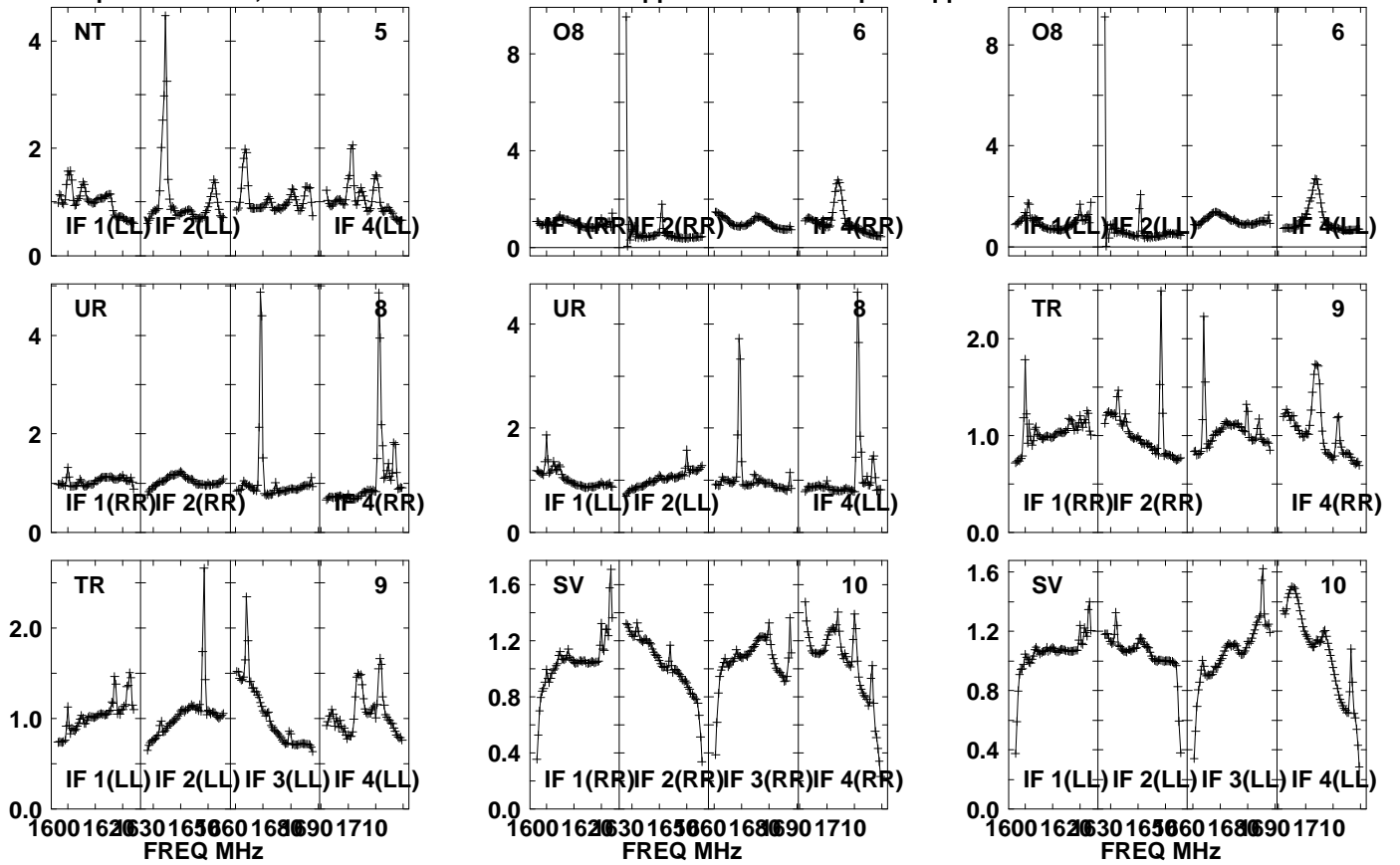

Lower frame: Real Jy  
Auto-corr total-power spectrum Antenna: \*  
Timerange: 00/18:19:01 to 00/18:22:29

Plot file version 890 created 05-OCT-2021 17:08:48

APM08279+525 GM076.UVDATA.1

Freq = 1.5945 GHz, Bw = 32.000 MH No calibration applied and no bandpass applied

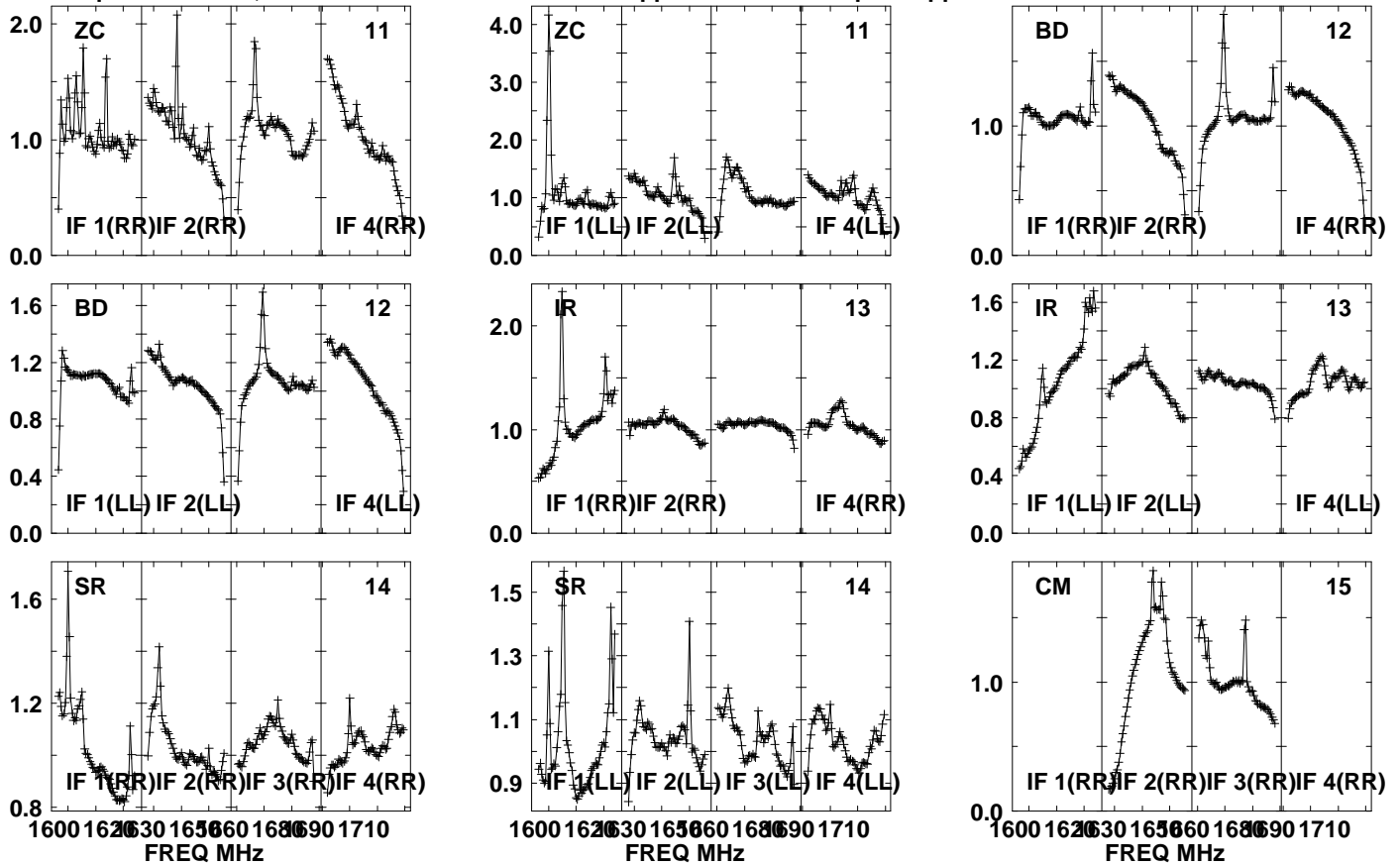

Lower frame: Real Jy

Auto-corr total-power spectrum Antenna: \*

Timerange: 00/18:19:01 to 00/18:22:29



Plot file version 891 created 05-OCT-2021 17:08:49

APM08279+525 GM076.UVDATA.1

Freq = 1.5945 GHz, Bw = 32.000 MH No calibration applied and no bandpass applied

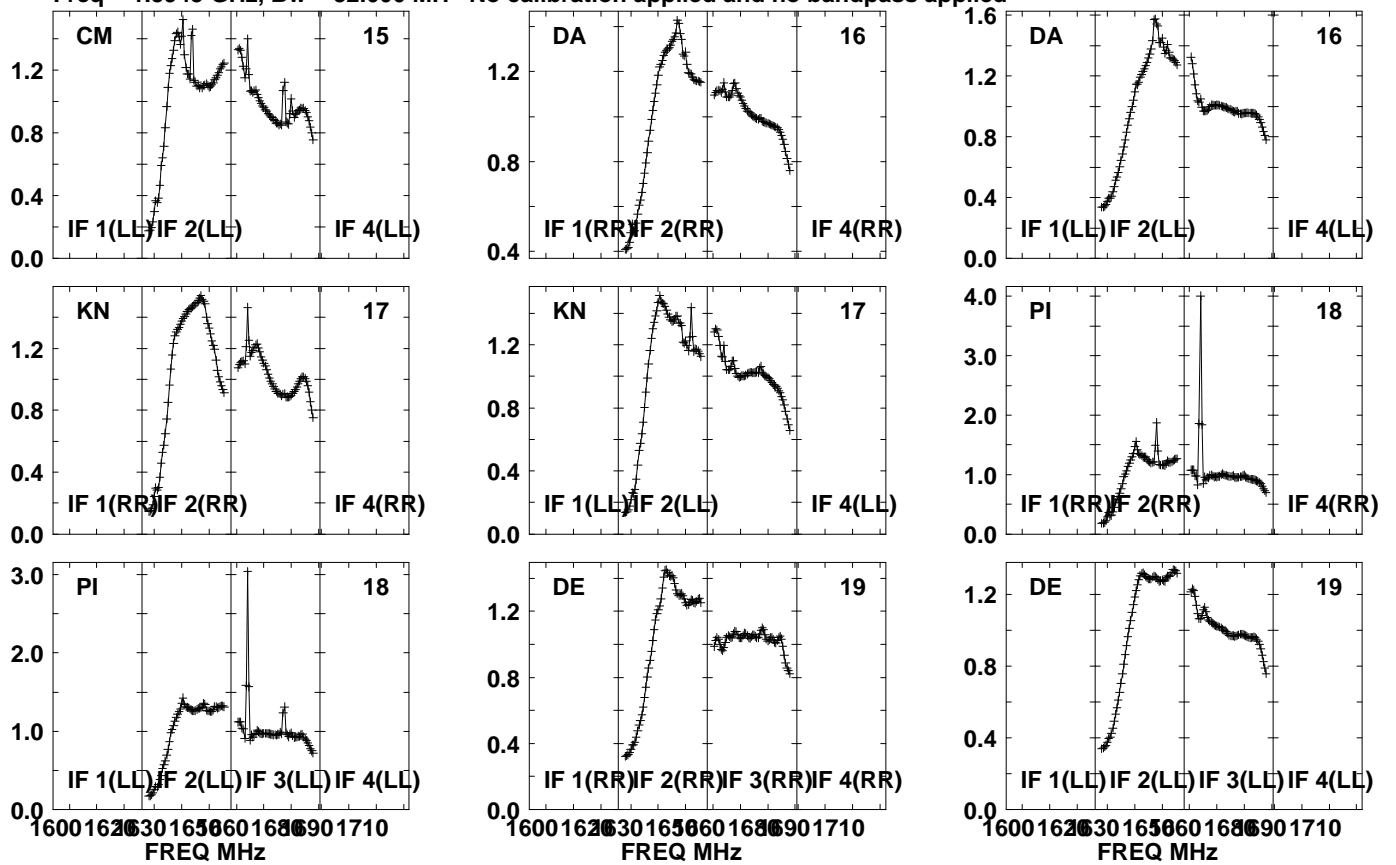

Lower frame: Real Jy  
Auto-corr total-power spectrum Antenna: \*  
Timerange: 00/18:19:01 to 00/18:22:29

Plot file version 892 created 05-OCT-2021 17:08:49

APM08279+525 GM076.UVDATA.1

Freq = 1.5945 GHz, Bw = 32.000 MH No calibration applied and no bandpass applied

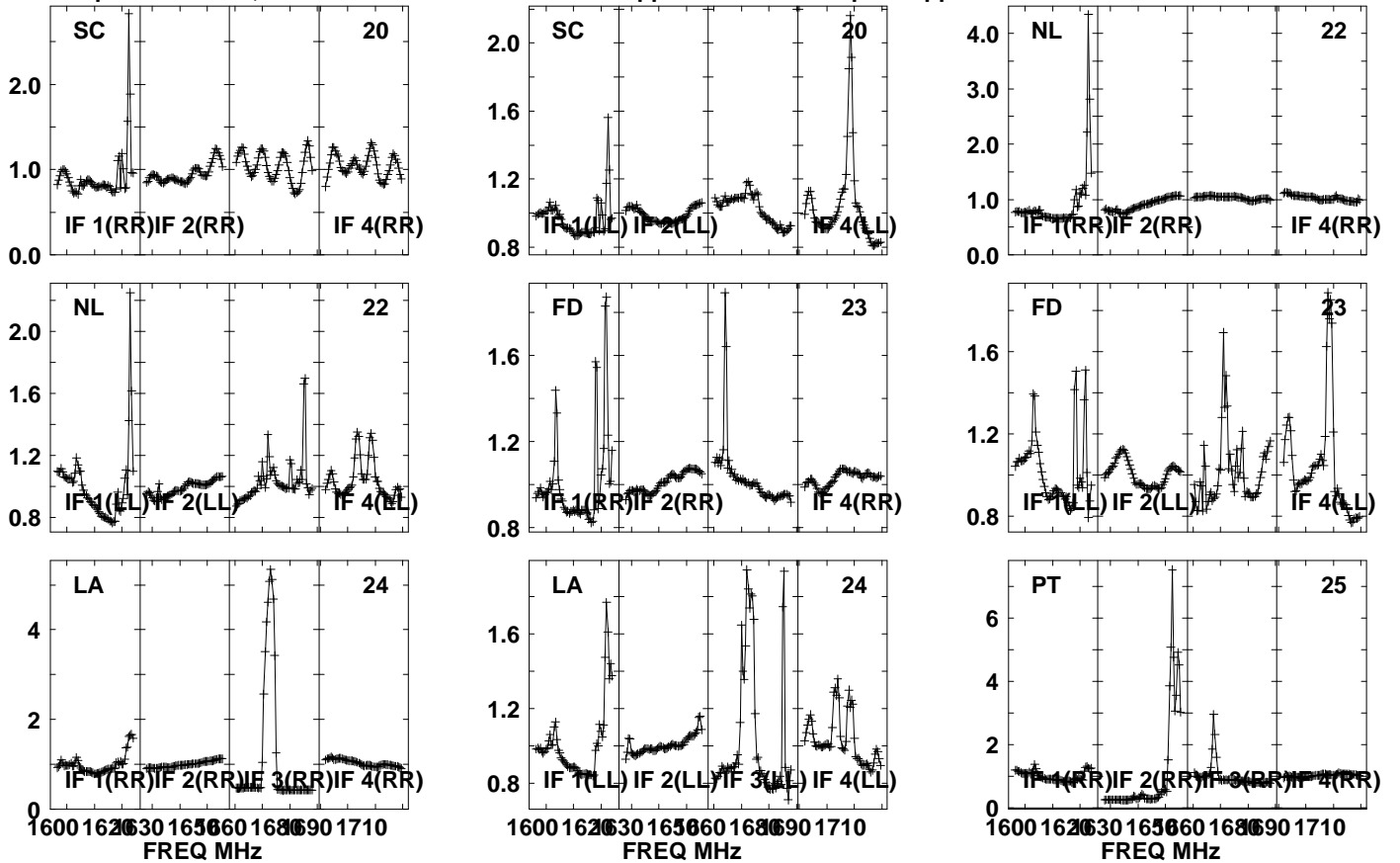

Lower frame: Real Jy

Auto-corr total-power spectrum Antenna: \*

Timerange: 00/18:19:01 to 00/18:22:29

Plot file version 893 created 05-OCT-2021 17:08:49

APM08279+525 GM076.UVDATA.1

Freq = 1.5945 GHz, Bw = 32.000 MH No calibration applied and no bandpass applied

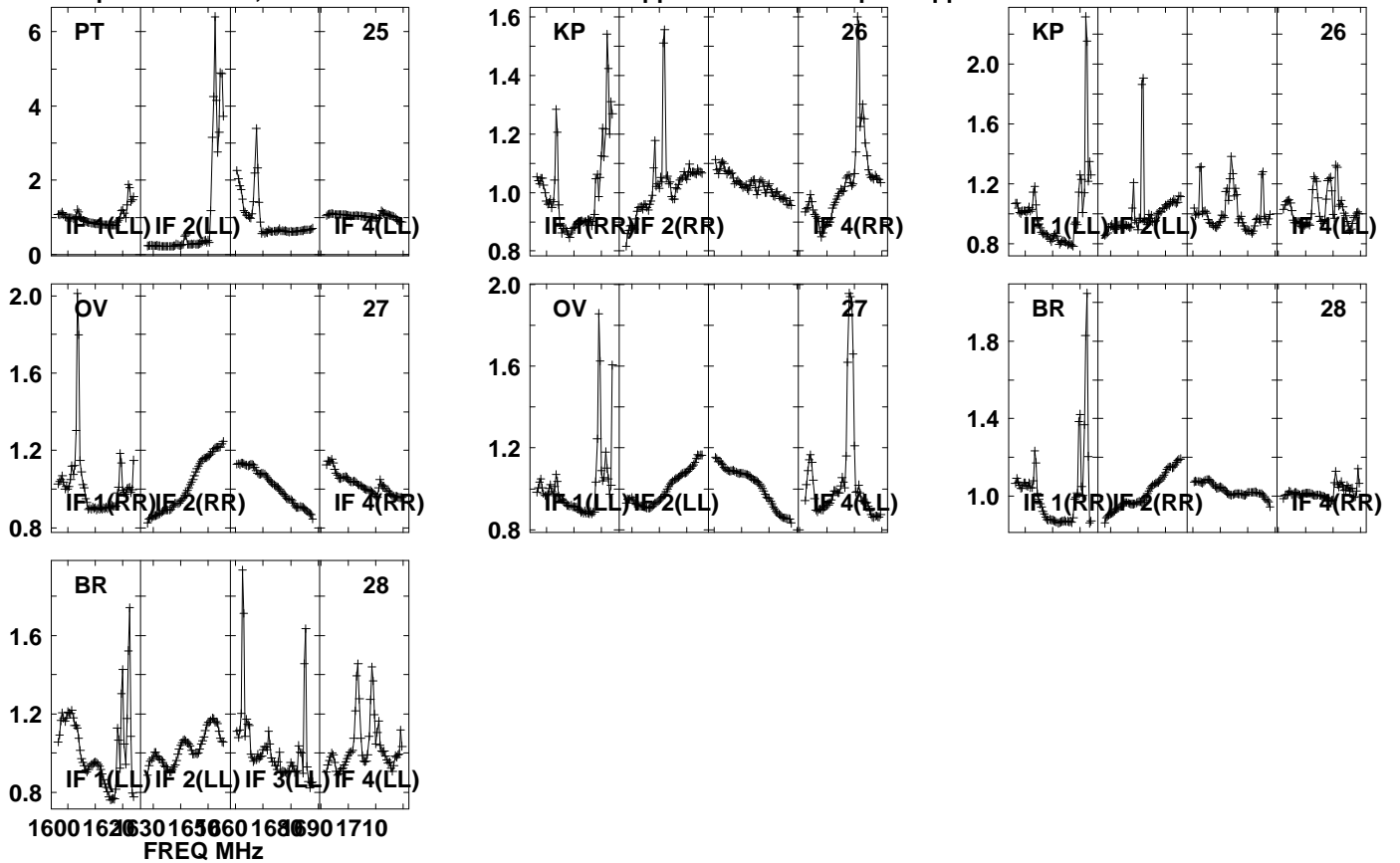

Lower frame: Real Jy

Auto-corr total-power spectrum Antenna: \*

Timerange: 00/18:19:01 to 00/18:22:29

Plot file version 894 created 05-OCT-2021 17:08:50

J0827+5217 GM076.UVDATA.1

Freq = 1.5945 GHz, Bw = 32.000 MH No calibration applied and no bandpass applied

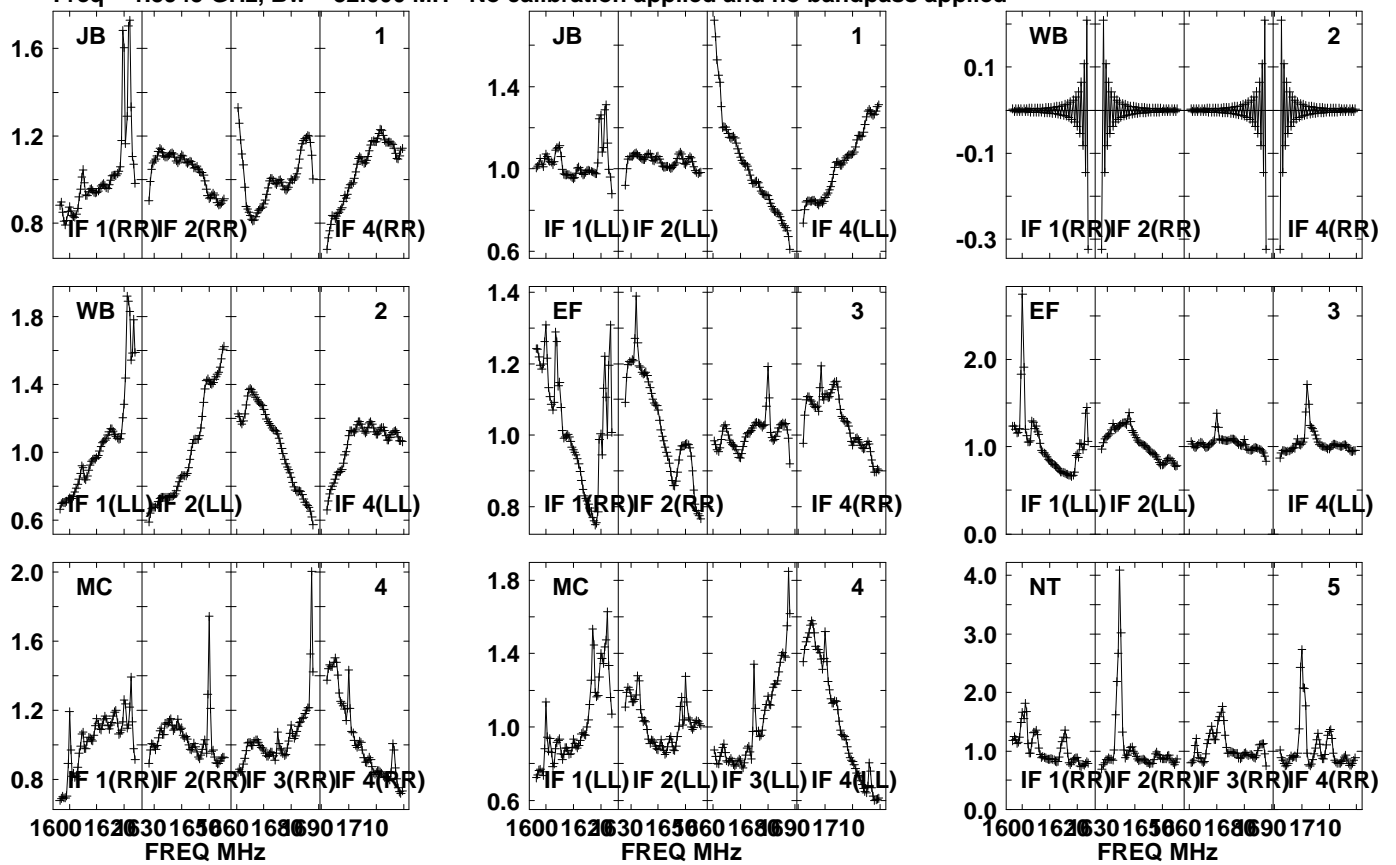

Lower frame: Real Jy  
Auto-corr total-power spectrum Antenna: \*  
Timerange: 00/18:23:01 to 00/18:24:29

Plot file version 895 created 05-OCT-2021 17:08:50

J0827+5217 GM076.UVDATA.1

Freq = 1.5945 GHz, Bw = 32.000 MH No calibration applied and no bandpass applied

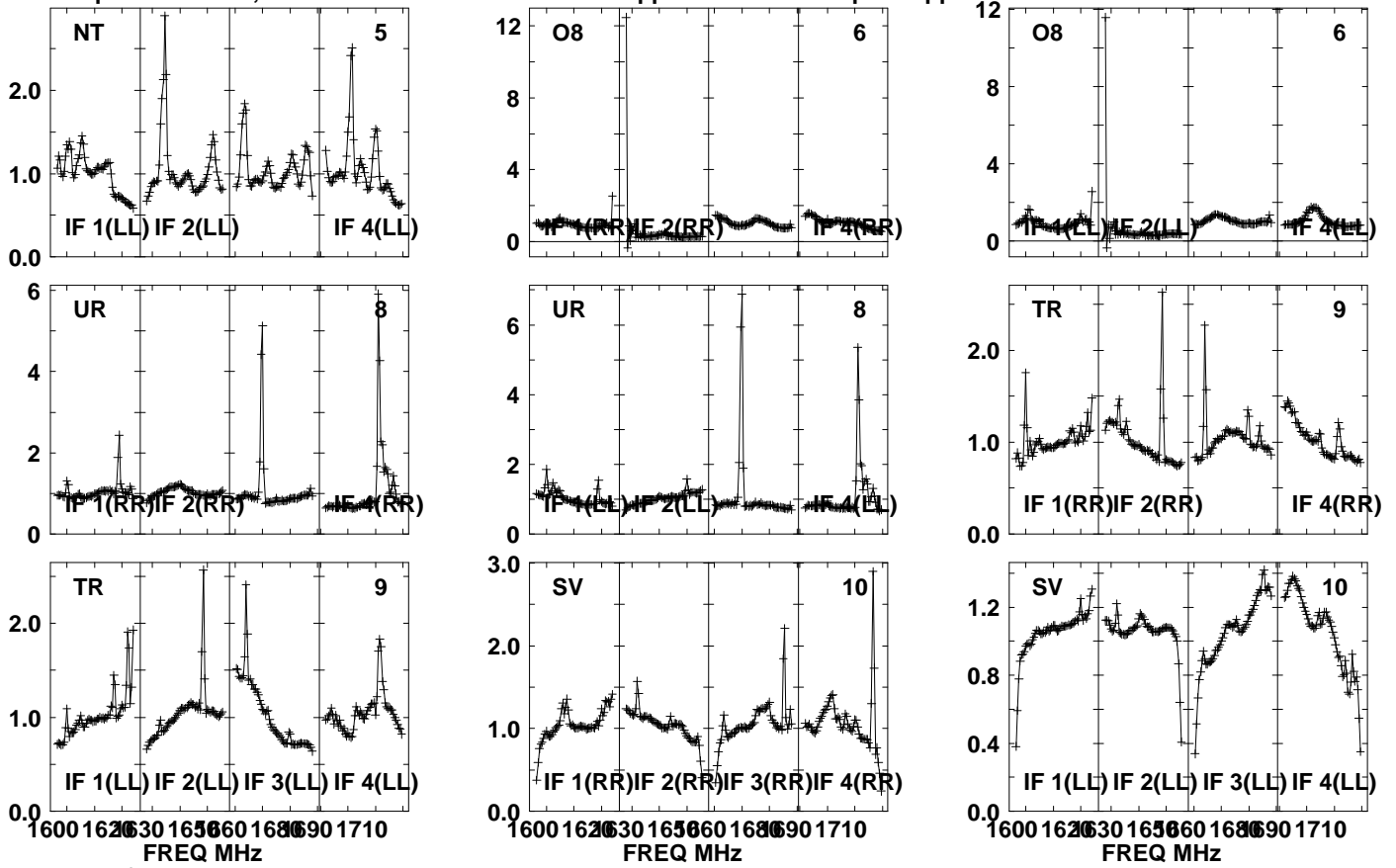

Lower frame: Real Jy

Auto-corr total-power spectrum Antenna: \*

Timerange: 00/18:23:01 to 00/18:24:29

Plot file version 896 created 05-OCT-2021 17:08:50

J0827+5217 GM076.UVDATA.1

Freq = 1.5945 GHz, Bw = 32.000 MH No calibration applied and no bandpass applied

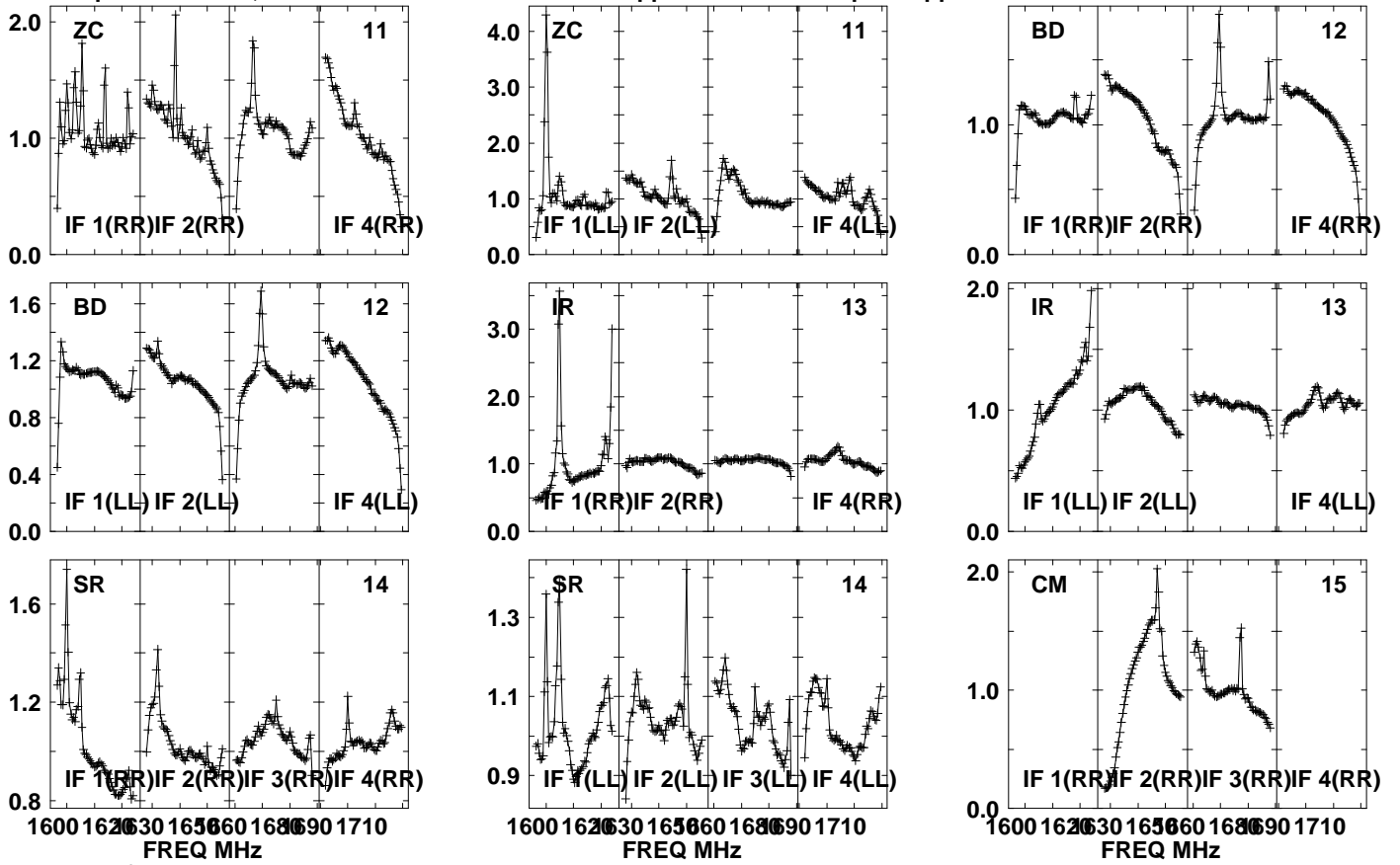

Lower frame: Real Jy  
Auto-corr total-power spectrum Antenna: \*  
Timerange: 00/18:23:01 to 00/18:24:29

Plot file version 897 created 05-OCT-2021 17:08:51

J0827+5217 GM076.UVDATA.1

Freq = 1.5945 GHz, Bw = 32.000 MH No calibration applied and no bandpass applied

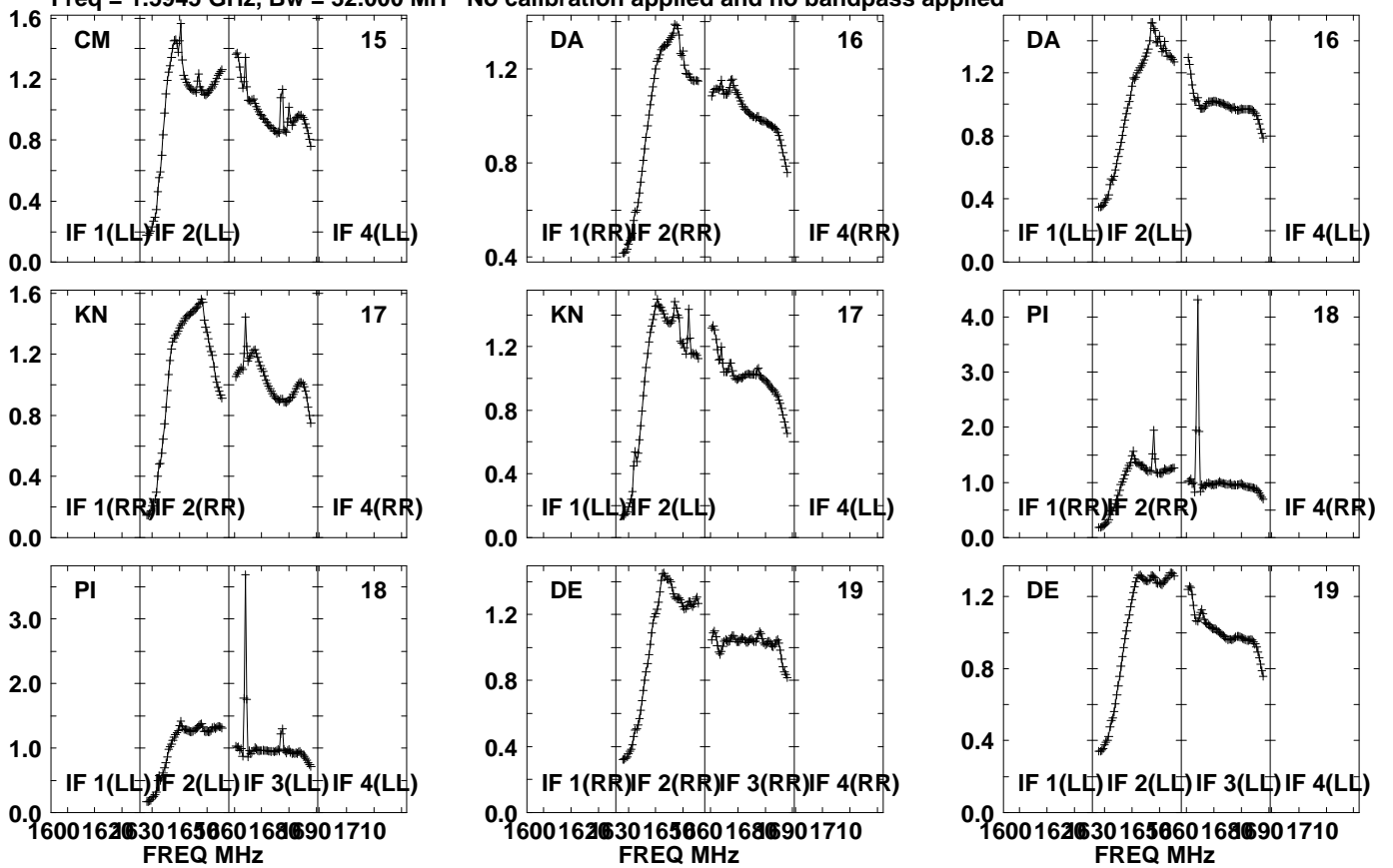

Lower frame: Real Jy  
Auto-corr total-power spectrum Antenna: \*  
Timerange: 00/18:23:01 to 00/18:24:29

Plot file version 898 created 05-OCT-2021 17:08:51

J0827+5217 GM076.UVDATA.1

Freq = 1.5945 GHz, Bw = 32.000 MH No calibration applied and no bandpass applied

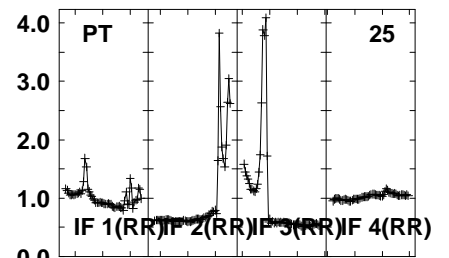
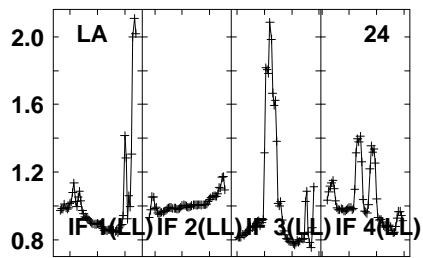
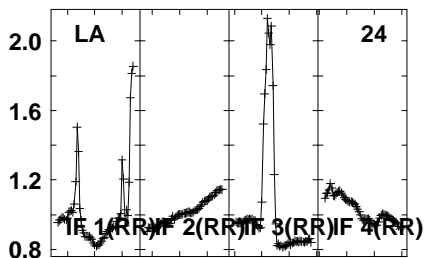
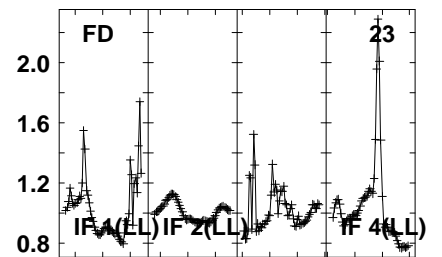
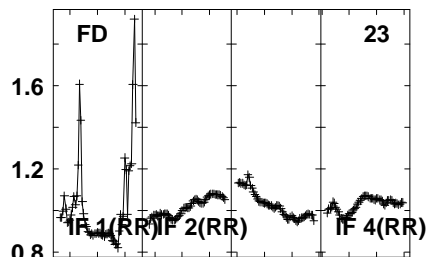
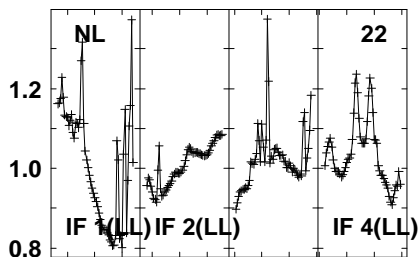
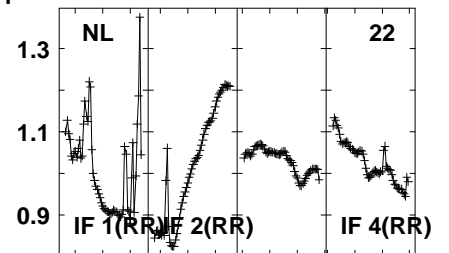
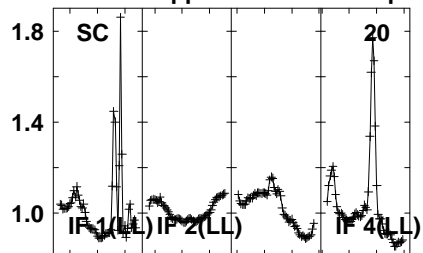
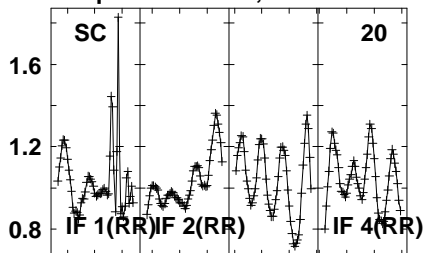

1600 1620 1630 1650 1660 1680 1690 1710  
FREQ MHz

1600 1620 1630 1650 1660 1680 1690 1710  
FREQ MHz

1600 1620 1630 1650 1660 1680 1690 1710  
FREQ MHz

Lower frame: Real Jy  
Auto-corr total-power spectrum Antenna: \*  
Timerange: 00/18:23:01 to 00/18:24:29



Plot file version 899 created 05-OCT-2021 17:08:51

J0827+5217 GM076.UVDATA.1

Freq = 1.5945 GHz, Bw = 32.000 MH No calibration applied and no bandpass applied

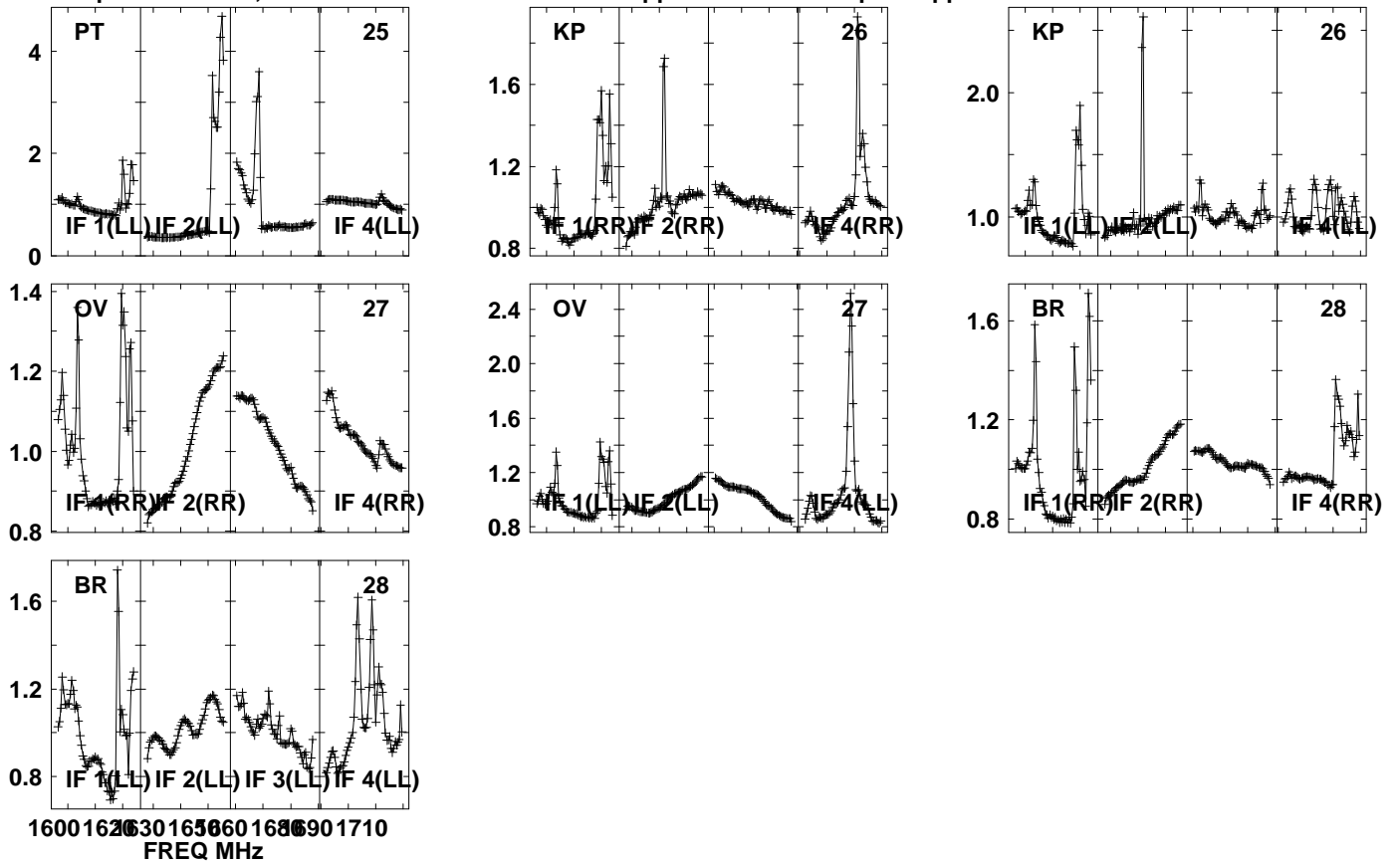

Lower frame: Real Jy  
Auto-corr total-power spectrum Antenna: \*  
Timerange: 00/18:23:01 to 00/18:24:29

Plot file version 900 created 05-OCT-2021 17:08:52

APM08279+525 GM076.UVDATA.1

Freq = 1.5945 GHz, Bw = 32.000 MH No calibration applied and no bandpass applied

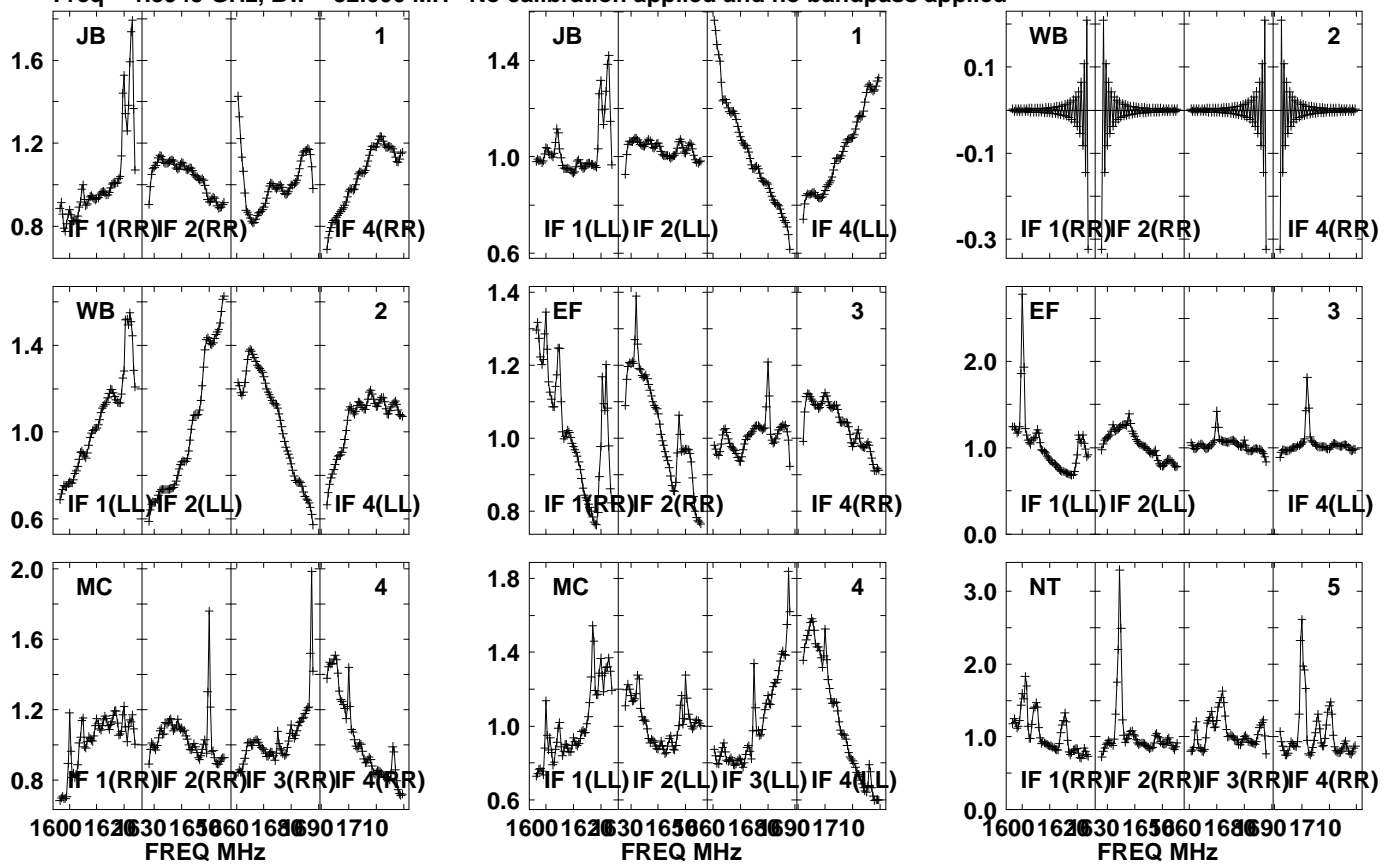

Lower frame: Real Jy  
Auto-corr total-power spectrum Antenna: \*  
Timerange: 00/18:24:31 to 00/18:27:59

Plot file version 901 created 05-OCT-2021 17:08:52

APM08279+525 GM076.UVDATA.1

Freq = 1.5945 GHz, Bw = 32.000 MH No calibration applied and no bandpass applied

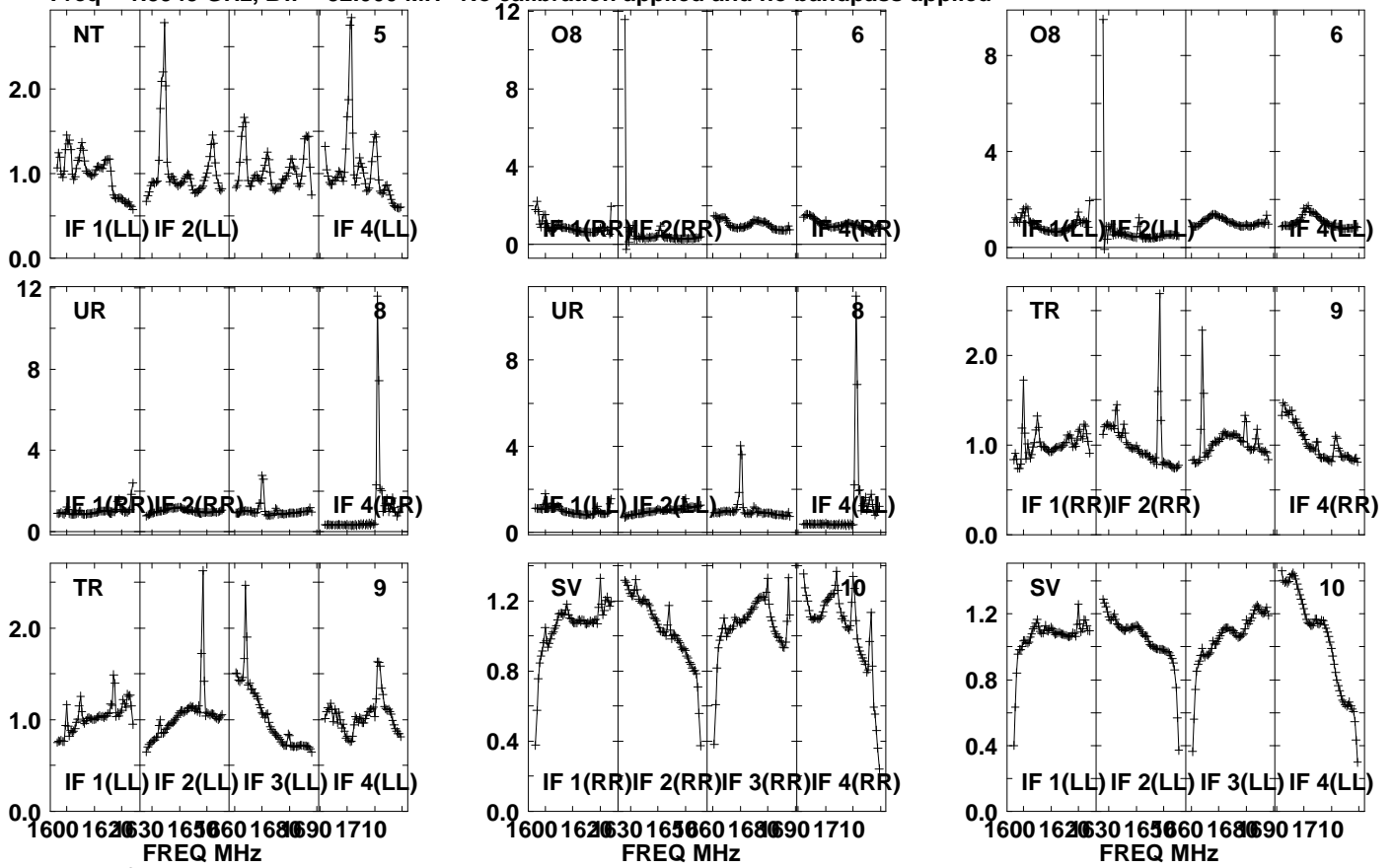

Lower frame: Real Jy

Auto-corr total-power spectrum Antenna: \*

Timerange: 00/18:24:31 to 00/18:27:59

Plot file version 902 created 05-OCT-2021 17:08:52

APM08279+525 GM076.UVDATA.1

Freq = 1.5945 GHz, Bw = 32.000 MH No calibration applied and no bandpass applied

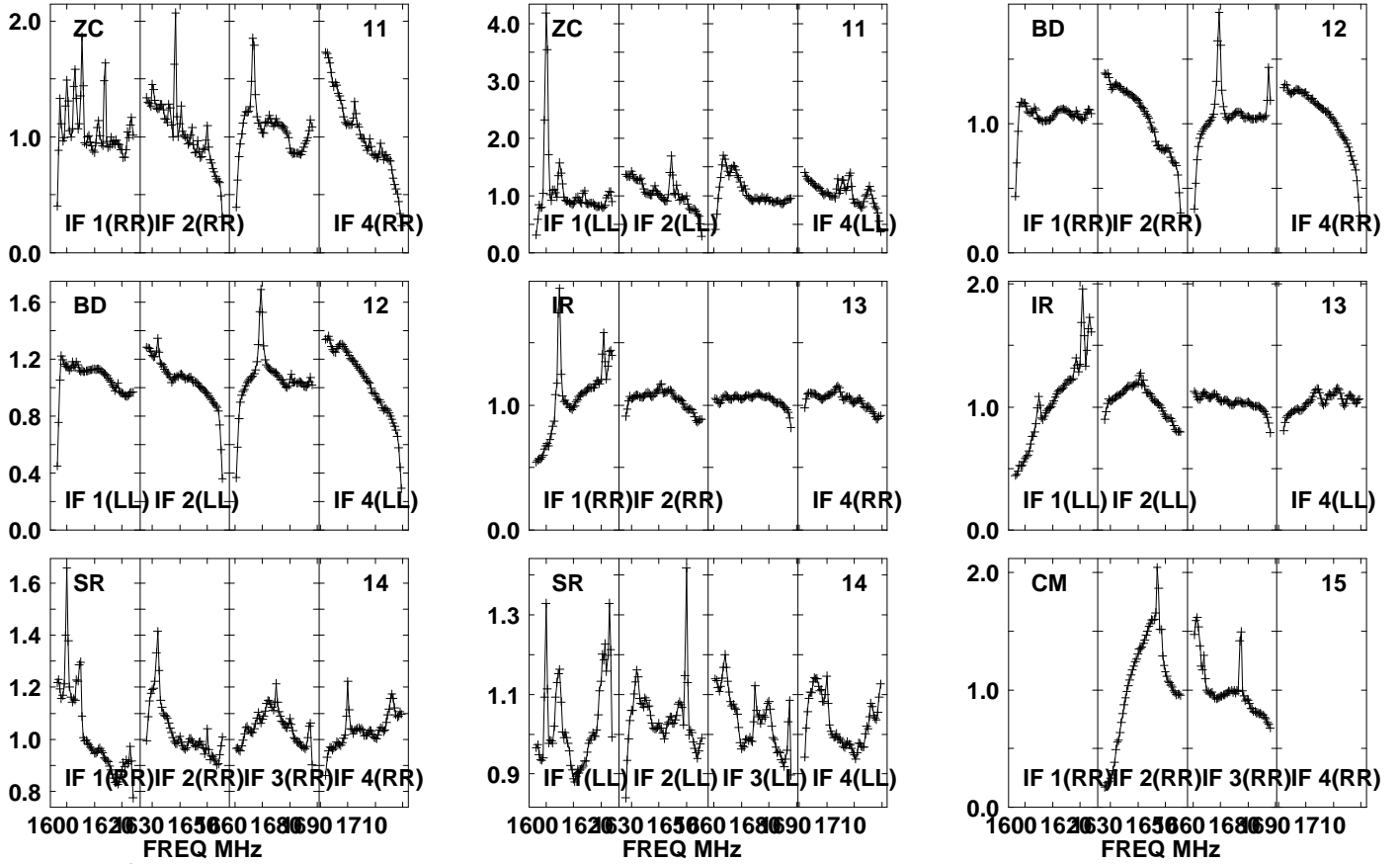

Lower frame: Real Jy  
Auto-corr total-power spectrum Antenna: \*  
Timerange: 00/18:24:31 to 00/18:27:59

Plot file version 903 created 05-OCT-2021 17:08:52

APM08279+525 GM076.UVDATA.1

Freq = 1.5945 GHz, Bw = 32.000 MH No calibration applied and no bandpass applied

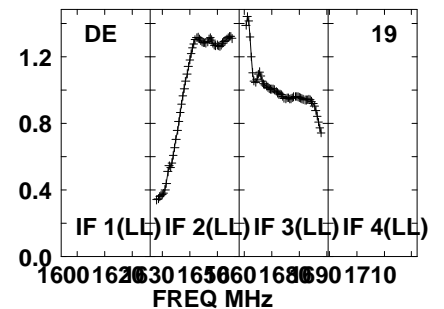
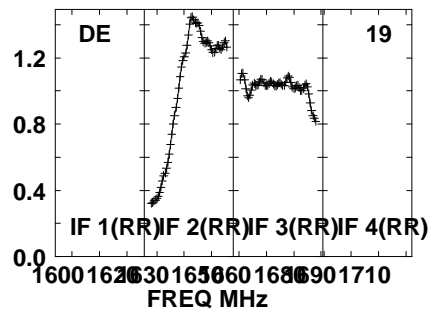
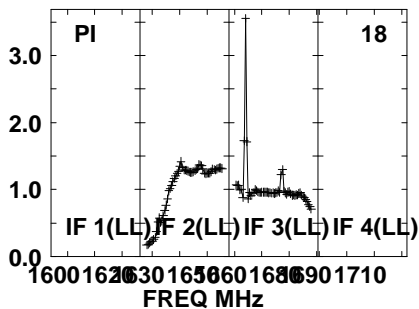
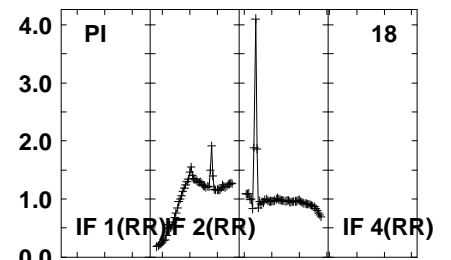
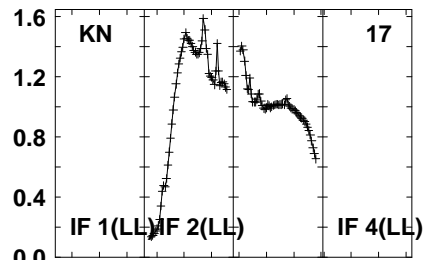
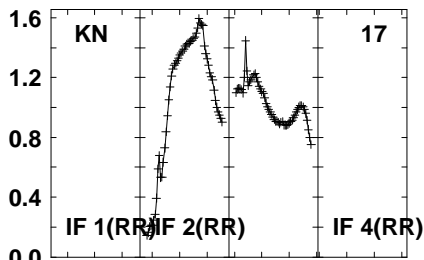
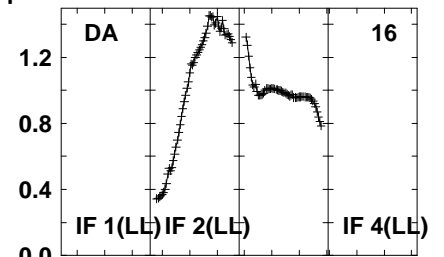
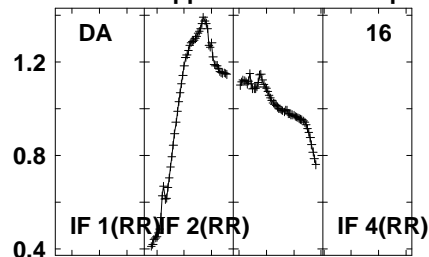
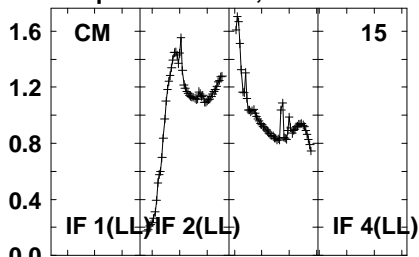

Lower frame: Real Jy  
Auto-corr total-power spectrum Antenna: \*  
Timerange: 00/18:24:31 to 00/18:27:59

Plot file version 904 created 05-OCT-2021 17:08:53

APM08279+525 GM076.UVDATA.1

Freq = 1.5945 GHz, Bw = 32.000 MH No calibration applied and no bandpass applied

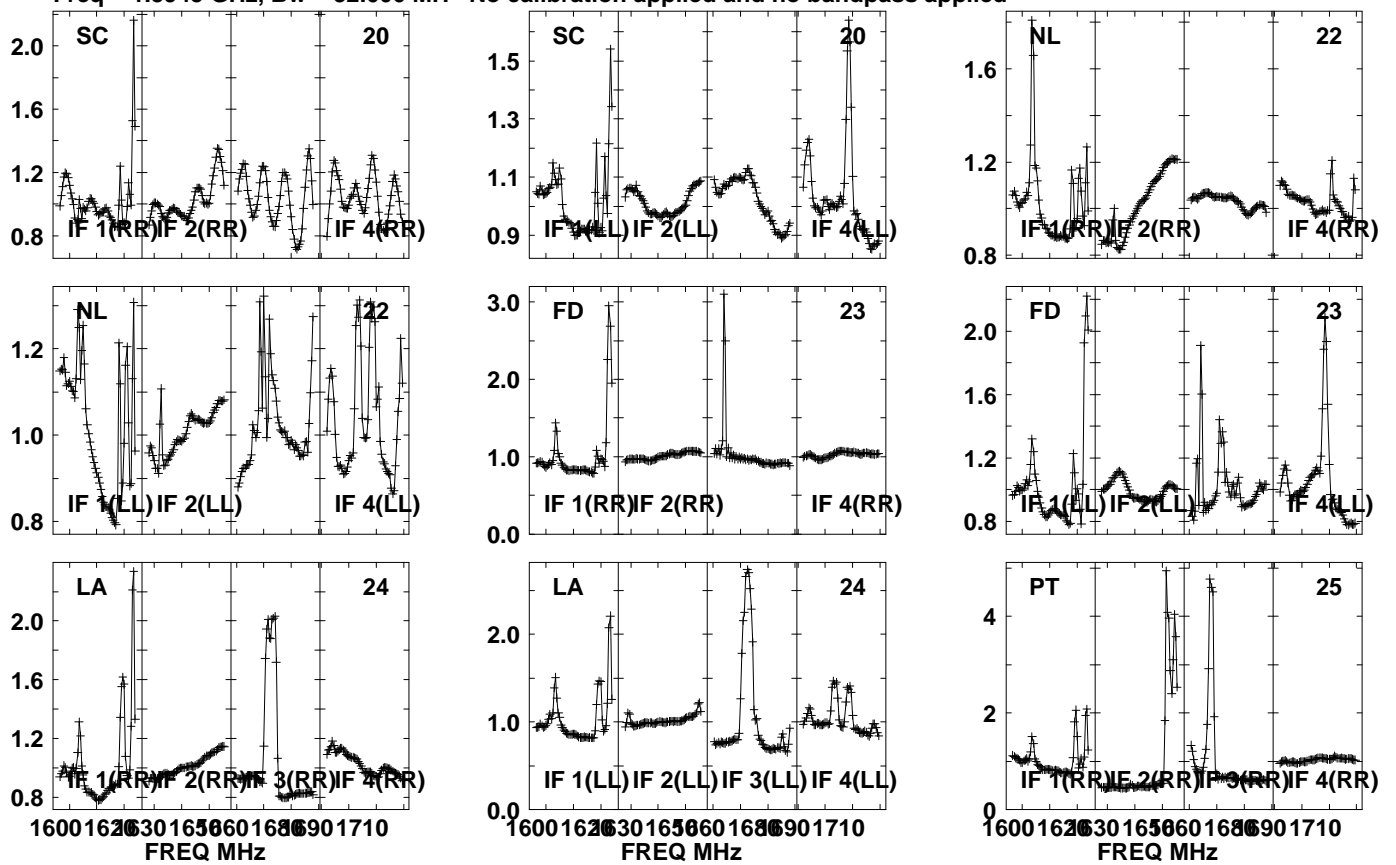

Lower frame: Real Jy  
Auto-corr total-power spectrum Antenna: \*  
Timerange: 00/18:24:31 to 00/18:27:59

Plot file version 905 created 05-OCT-2021 17:08:53

APM08279+525 GM076.UVDATA.1

Freq = 1.5945 GHz, Bw = 32.000 MH No calibration applied and no bandpass applied

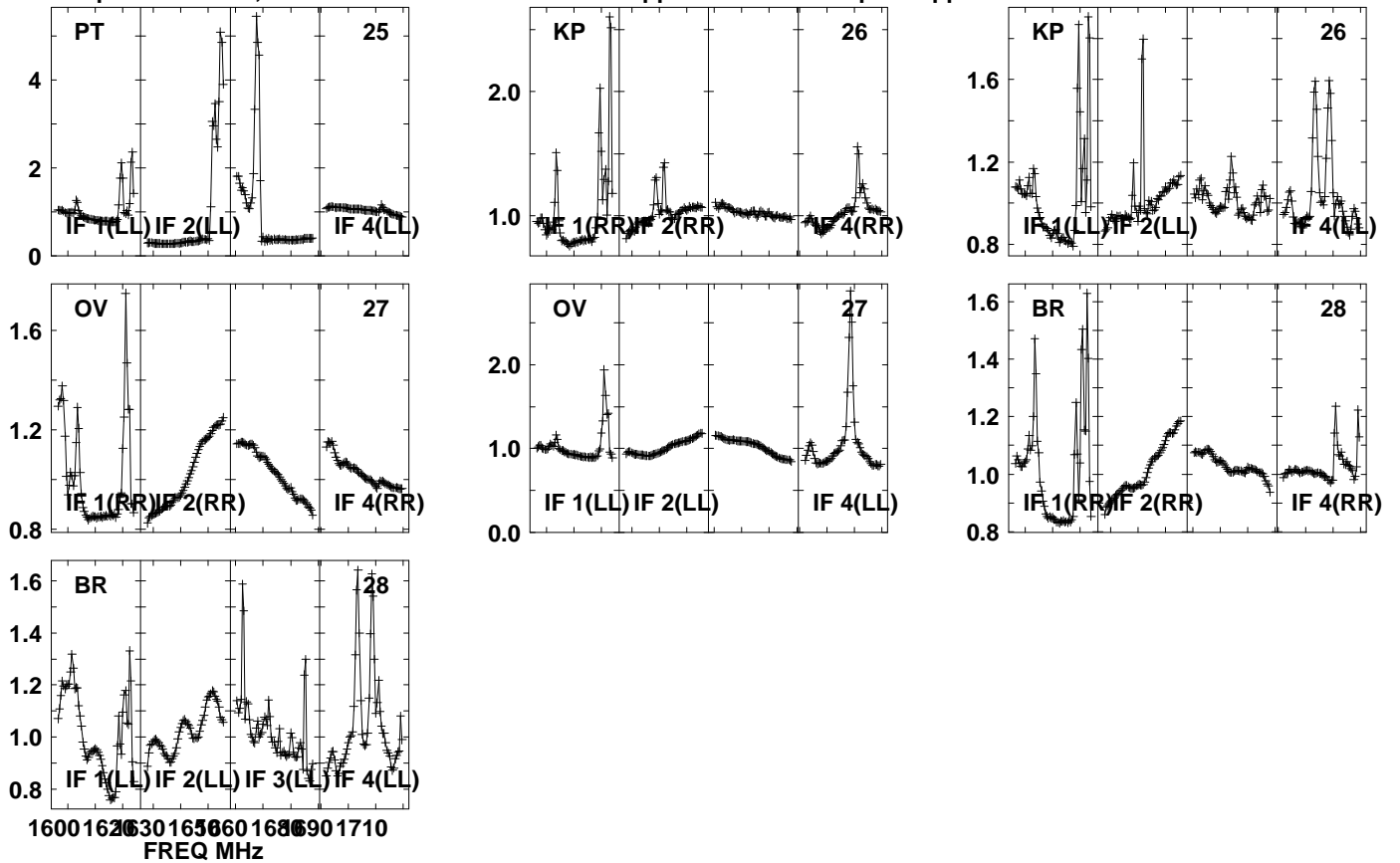

Lower frame: Real Jy

Auto-corr total-power spectrum Antenna: \*

Timerange: 00/18:24:31 to 00/18:27:59

Plot file version 906 created 05-OCT-2021 17:08:53

J0827+5217 GM076.UVDATA.1

Freq = 1.5945 GHz, Bw = 32.000 MH No calibration applied and no bandpass applied

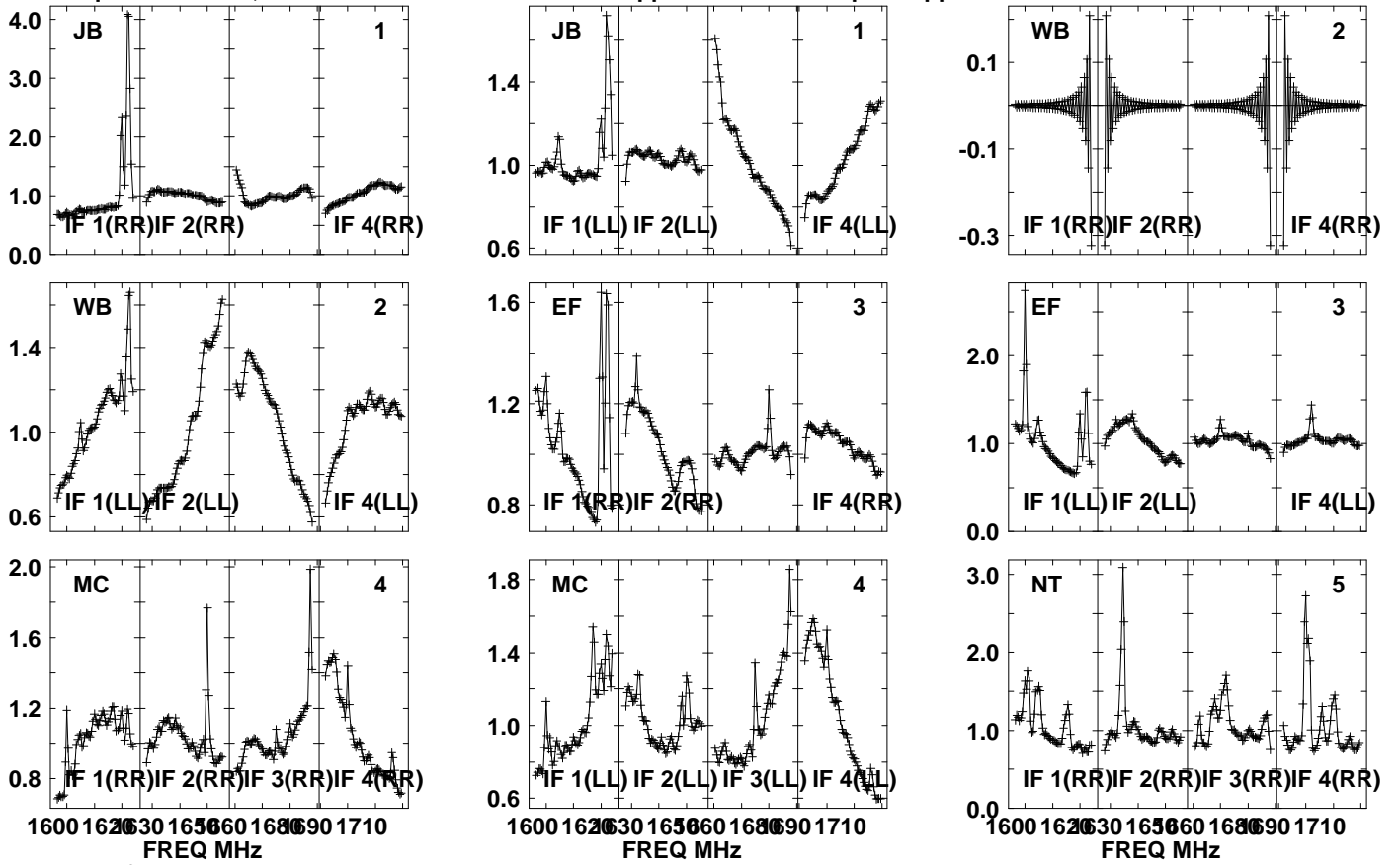

Lower frame: Real Jy  
Auto-corr total-power spectrum Antenna: \*  
Timerange: 00/18:28:01 to 00/18:29:29



Plot file version 907 created 05-OCT-2021 17:08:54

J0827+5217 GM076.UVDATA.1

Freq = 1.5945 GHz, Bw = 32.000 MH No calibration applied and no bandpass applied

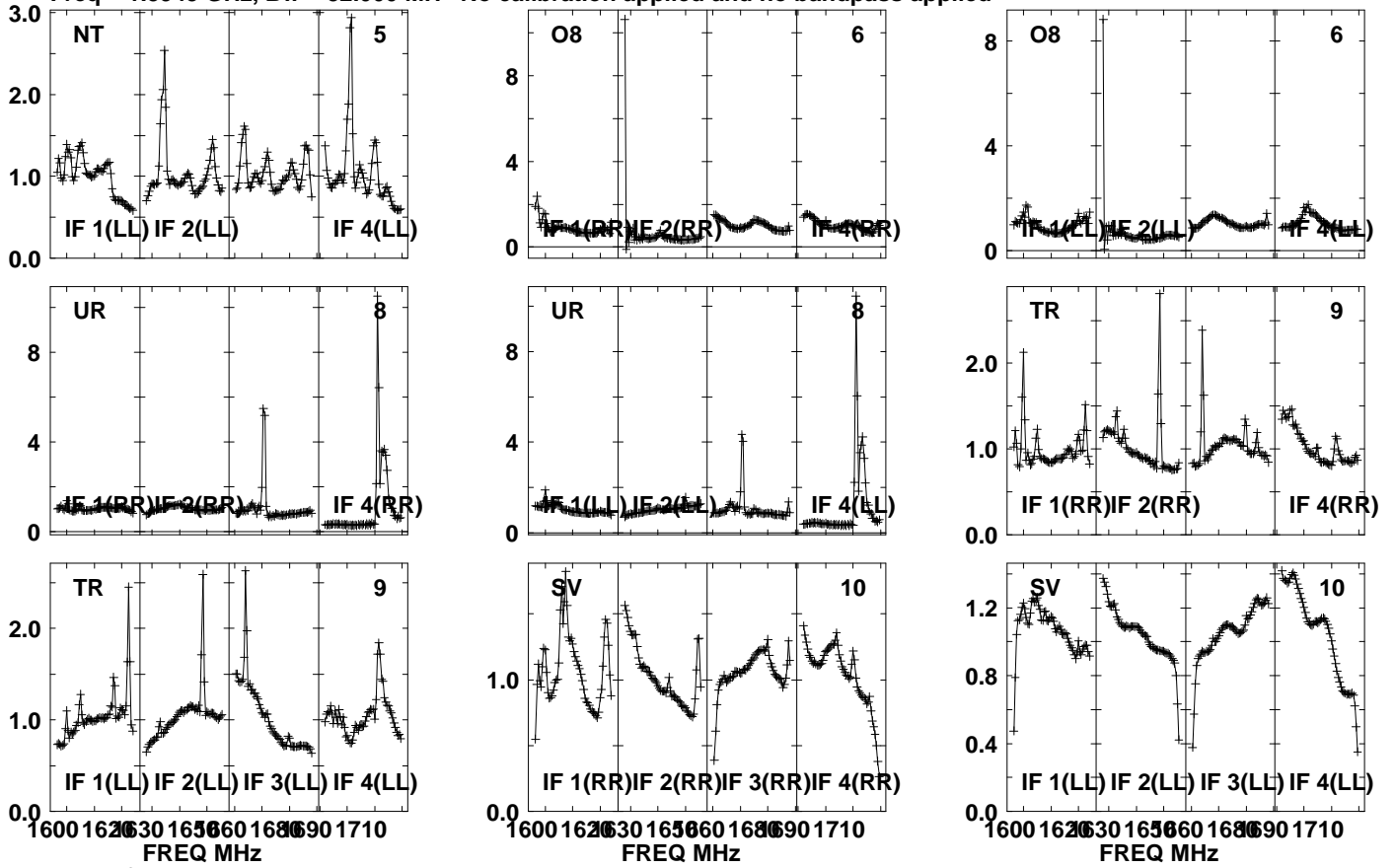

Lower frame: Real Jy  
Auto-corr total-power spectrum Antenna: \*  
Timerange: 00/18:28:01 to 00/18:29:29

Plot file version 908 created 05-OCT-2021 17:08:54

J0827+5217 GM076.UVDATA.1

Freq = 1.5945 GHz, Bw = 32.000 MH No calibration applied and no bandpass applied

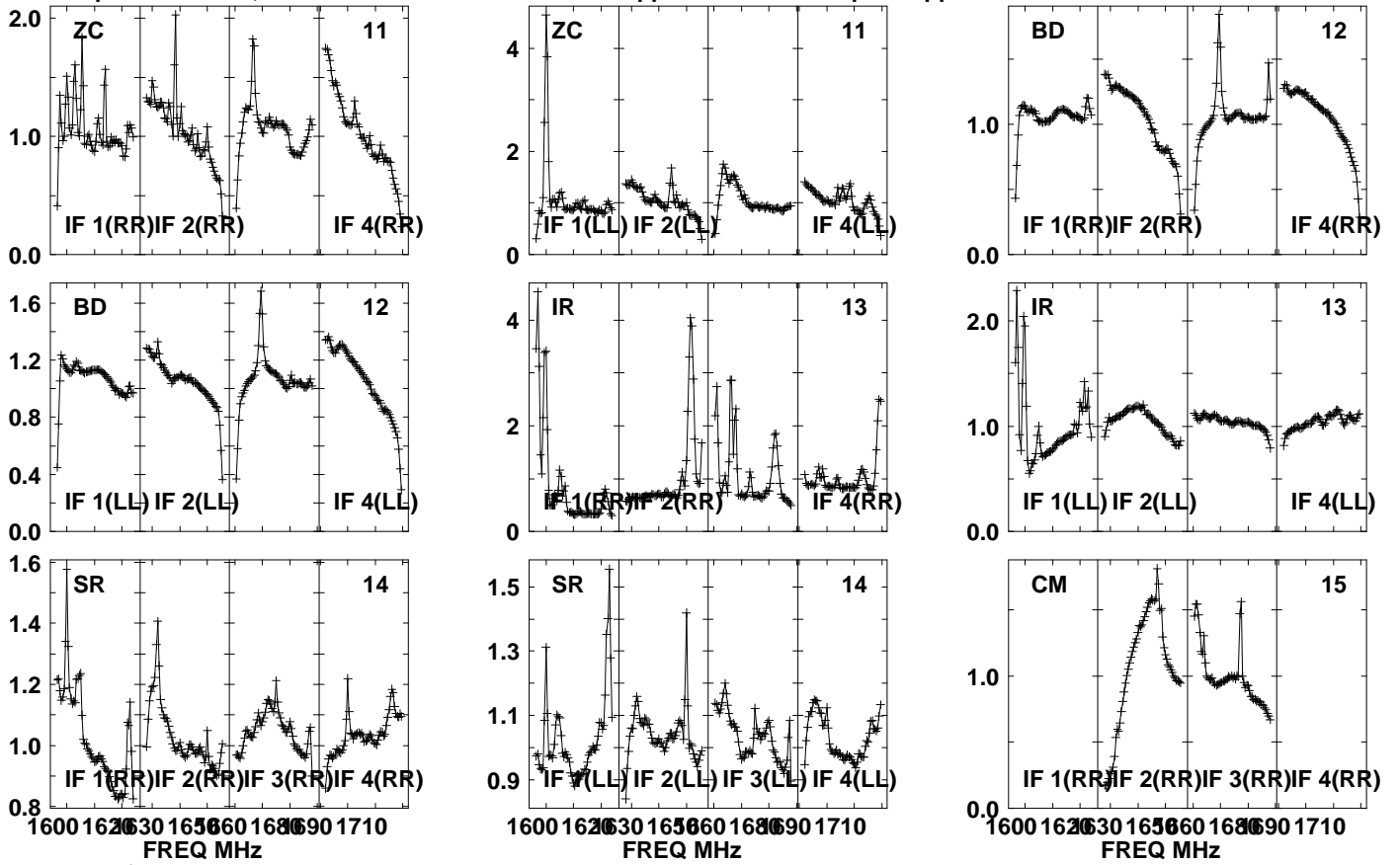

Lower frame: Real Jy

Auto-corr total-power spectrum Antenna: \*

Timerange: 00/18:28:01 to 00/18:29:29

Plot file version 909 created 05-OCT-2021 17:08:54

J0827+5217 GM076.UVDATA.1

Freq = 1.5945 GHz, Bw = 32.000 MH No calibration applied and no bandpass applied

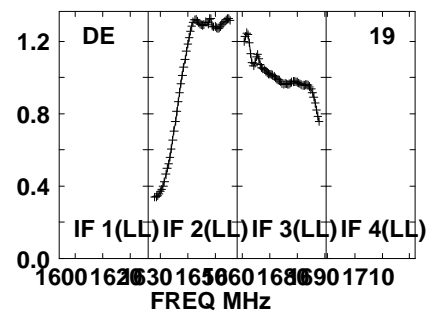
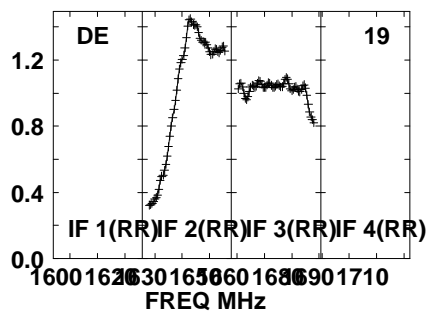
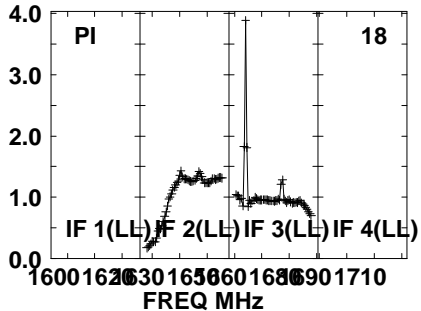
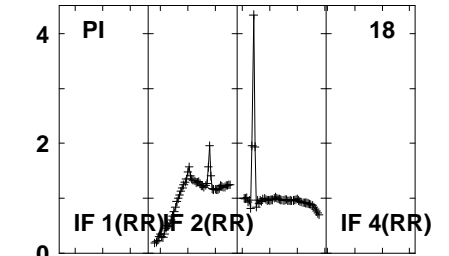
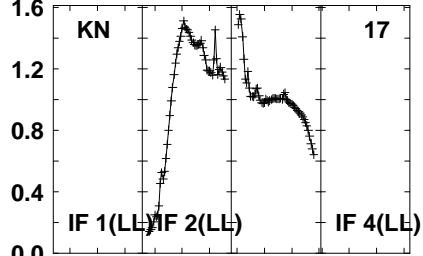
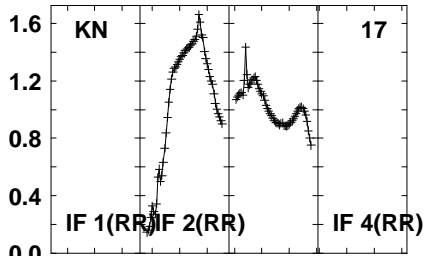
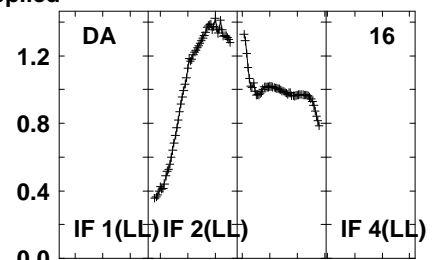
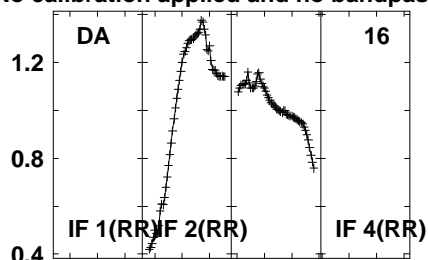
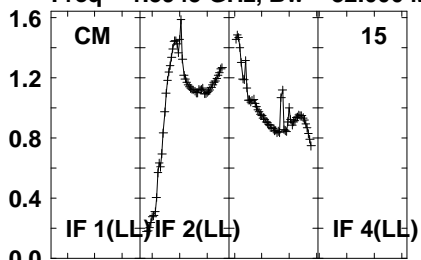

Lower frame: Real Jy  
Auto-corr total-power spectrum Antenna: \*  
Timerange: 00/18:28:01 to 00/18:29:29

Plot file version 910 created 05-OCT-2021 17:08:55

J0827+5217 GM076.UVDATA.1

Freq = 1.5945 GHz, Bw = 32.000 MH No calibration applied and no bandpass applied

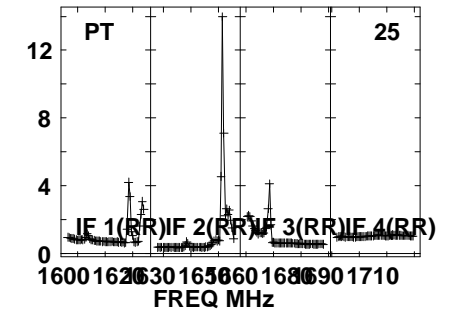
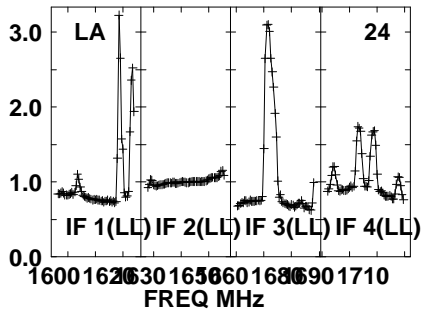
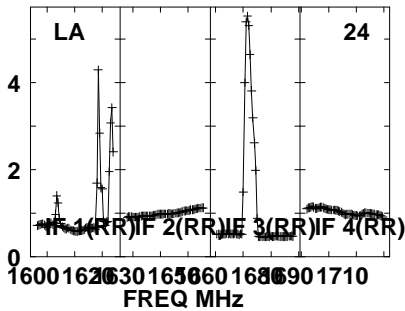
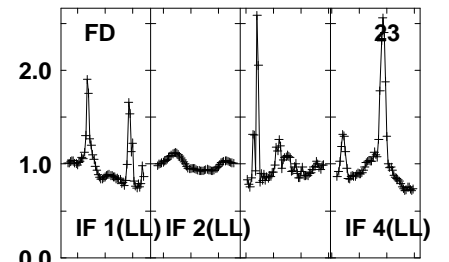
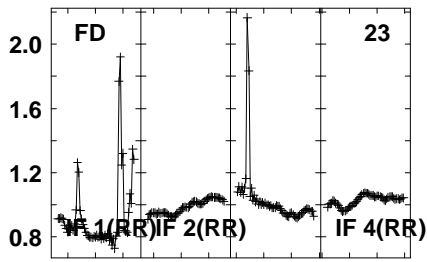
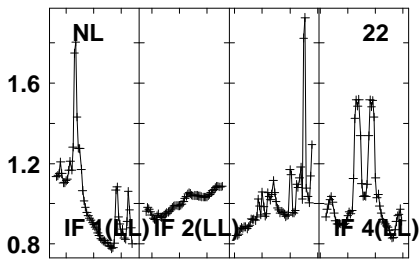
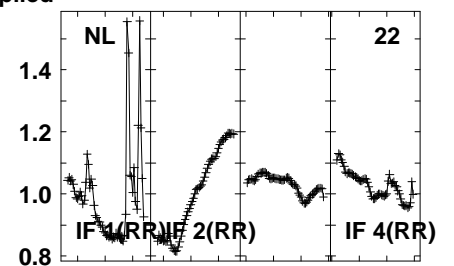
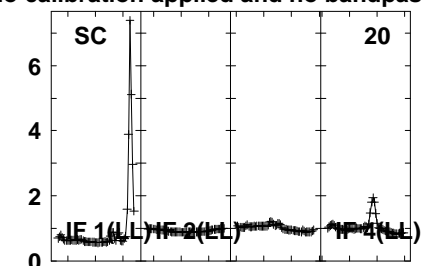
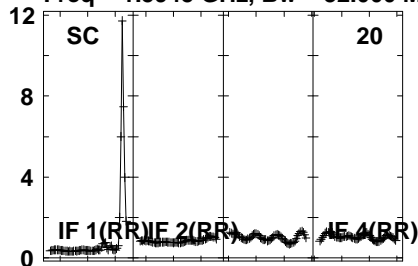

Lower frame: Real Jy

Auto-corr total-power spectrum Antenna: \*

Timerange: 00/18:28:01 to 00/18:29:29

Plot file version 911 created 05-OCT-2021 17:08:55

J0827+5217 GM076.UVDATA.1

Freq = 1.5945 GHz, Bw = 32.000 MH No calibration applied and no bandpass applied

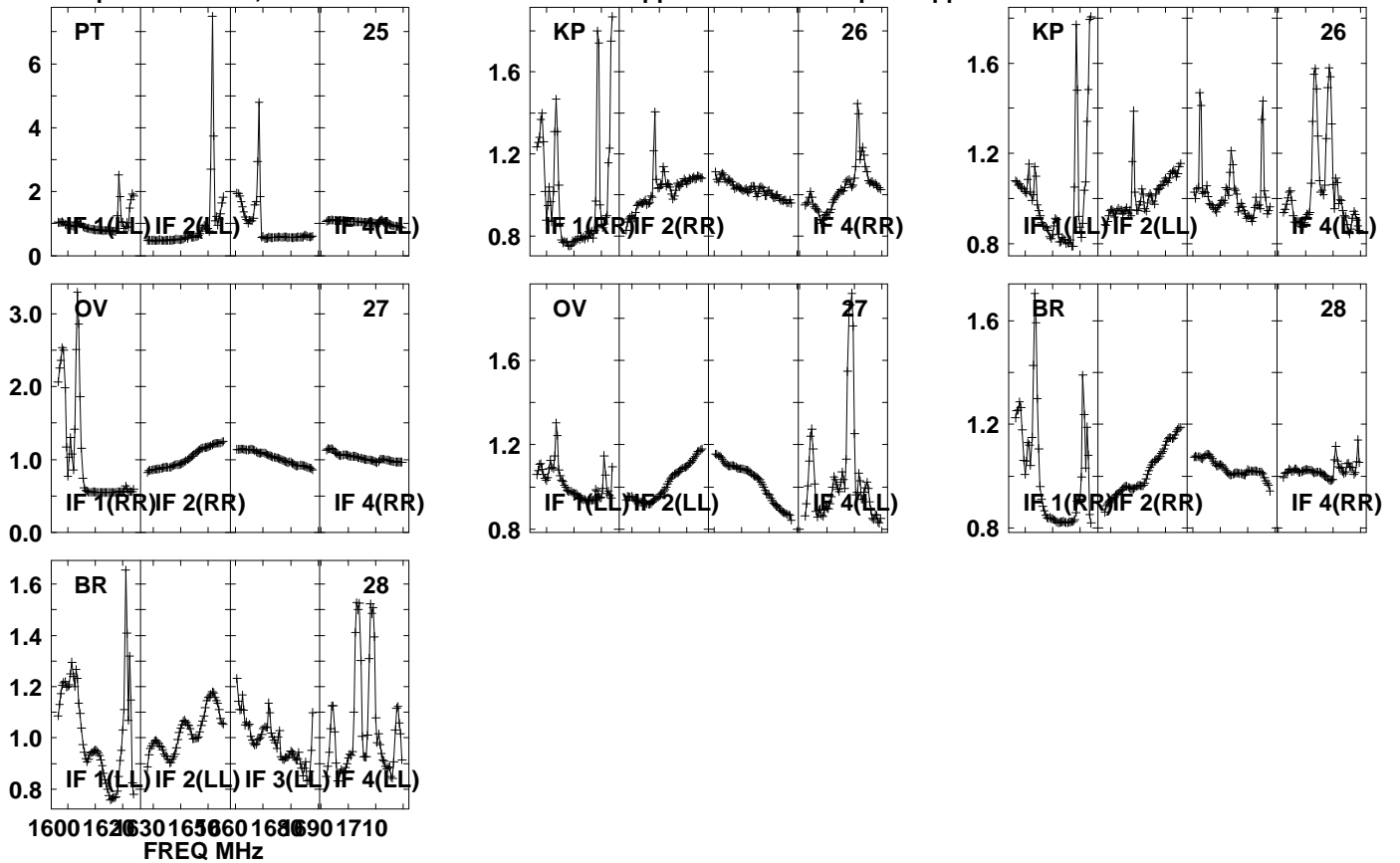

Lower frame: Real Jy

Auto-corr total-power spectrum Antenna: \*

Timerange: 00/18:28:01 to 00/18:29:29

Plot file version 912 created 05-OCT-2021 17:08:55

APM08279+525 GM076.UVDATA.1

Freq = 1.5945 GHz, Bw = 32.000 MH No calibration applied and no bandpass applied

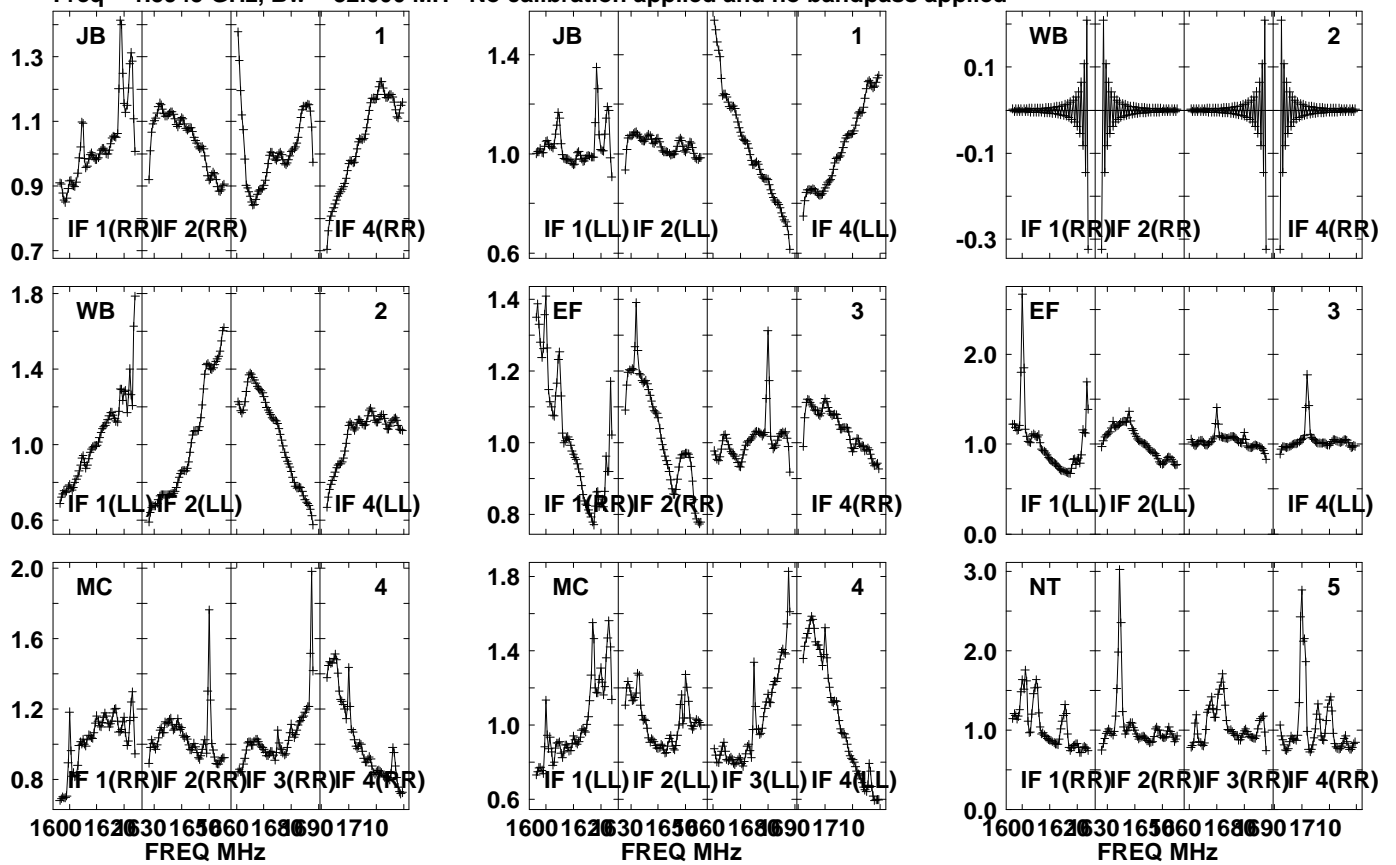

Lower frame: Real Jy  
Auto-corr total-power spectrum Antenna: \*  
Timerange: 00/18:29:31 to 00/18:32:59

Plot file version 913 created 05-OCT-2021 17:08:56

APM08279+525 GM076.UVDATA.1

Freq = 1.5945 GHz, Bw = 32.000 MH No calibration applied and no bandpass applied

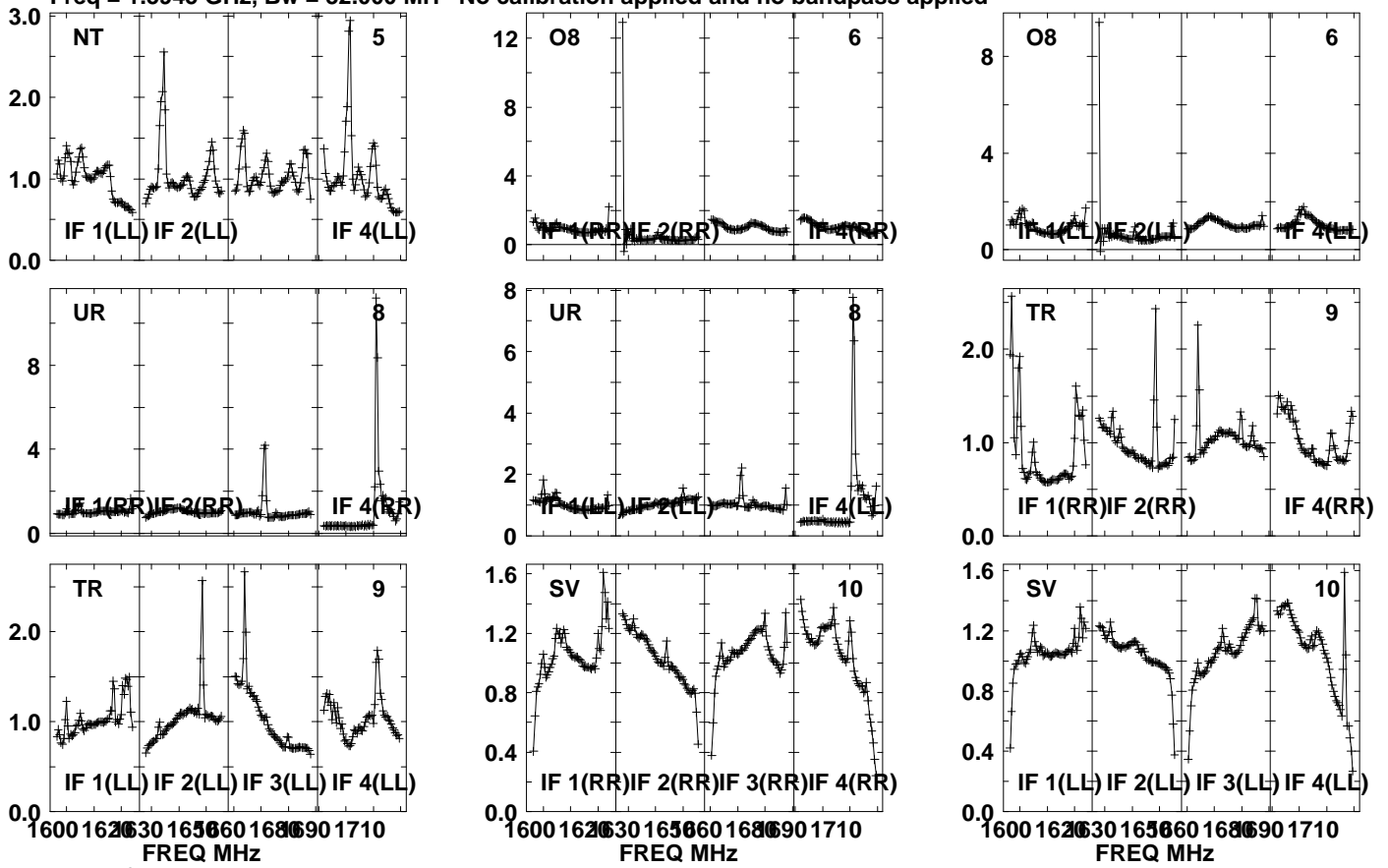

Lower frame: Real Jy  
Auto-corr total-power spectrum Antenna: \*  
Timerange: 00/18:29:31 to 00/18:32:59

Plot file version 914 created 05-OCT-2021 17:08:56

APM08279+525 GM076.UVDATA.1

Freq = 1.5945 GHz, Bw = 32.000 MH No calibration applied and no bandpass applied

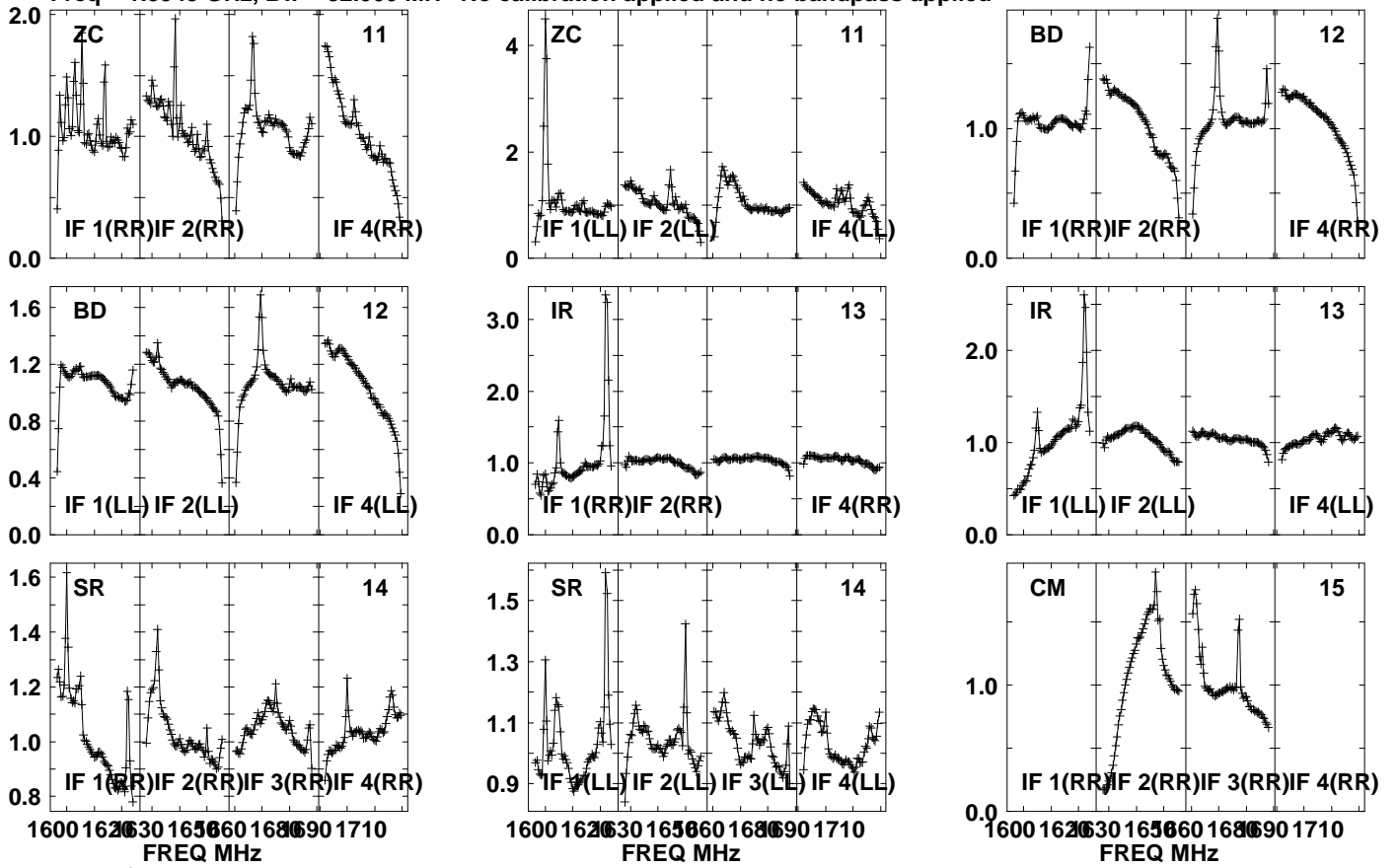

Lower frame: Real Jy

Auto-corr total-power spectrum Antenna: \*

Timerange: 00/18:29:31 to 00/18:32:59



Plot file version 915 created 05-OCT-2021 17:08:56

APM08279+525 GM076.UVDATA.1

Freq = 1.5945 GHz, Bw = 32.000 MH No calibration applied and no bandpass applied

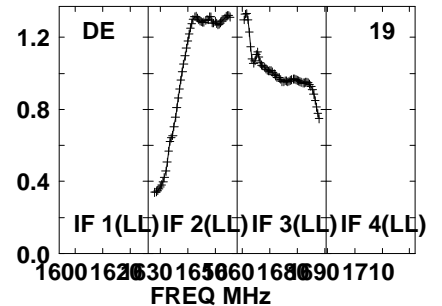
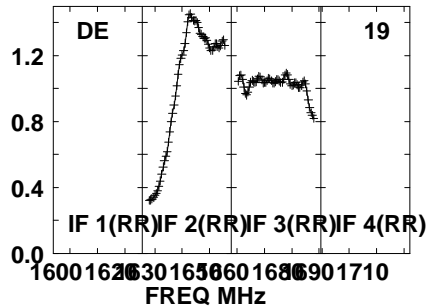
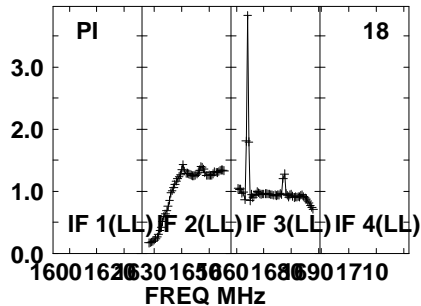
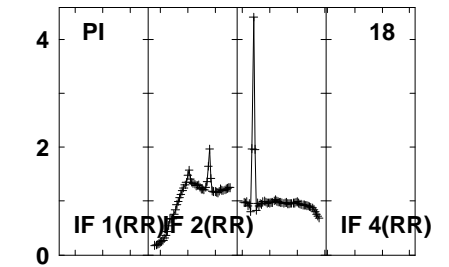
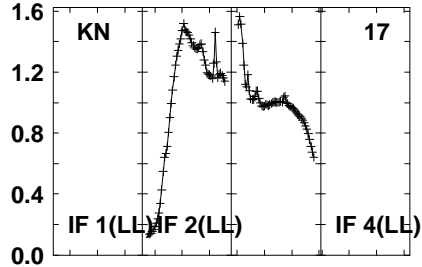
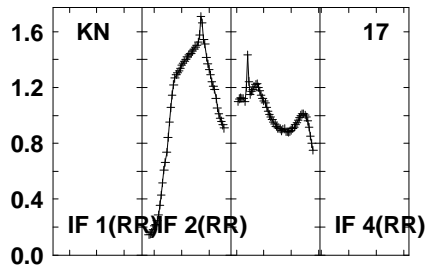
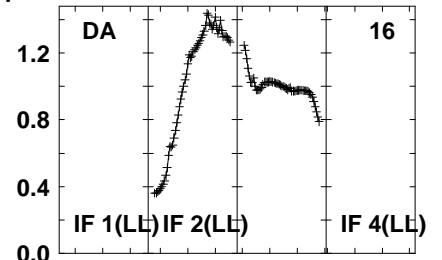
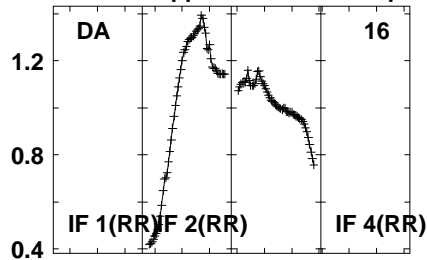
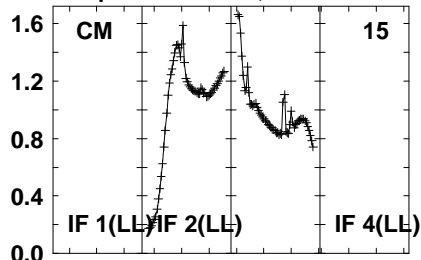

Lower frame: Real Jy  
Auto-corr total-power spectrum Antenna: \*  
Timerange: 00/18:29:31 to 00/18:32:59

Plot file version 916 created 05-OCT-2021 17:08:57

APM08279+525 GM076.UVDATA.1

Freq = 1.5945 GHz, Bw = 32.000 MH No calibration applied and no bandpass applied

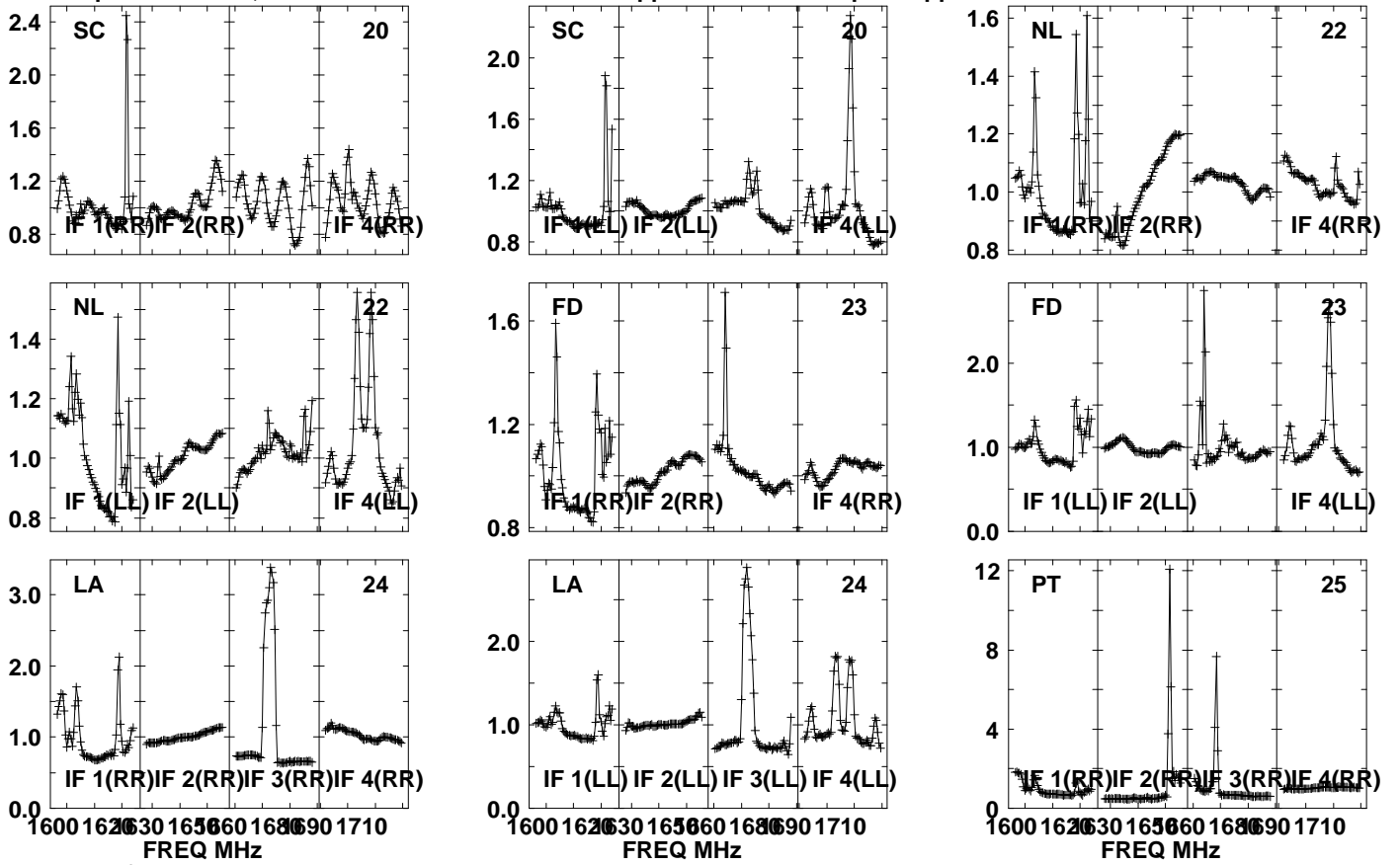

Lower frame: Real Jy  
Auto-corr total-power spectrum Antenna: \*  
Timerange: 00/18:29:31 to 00/18:32:59

Plot file version 917 created 05-OCT-2021 17:08:57

APM08279+525 GM076.UVDATA.1

Freq = 1.5945 GHz, Bw = 32.000 MH No calibration applied and no bandpass applied

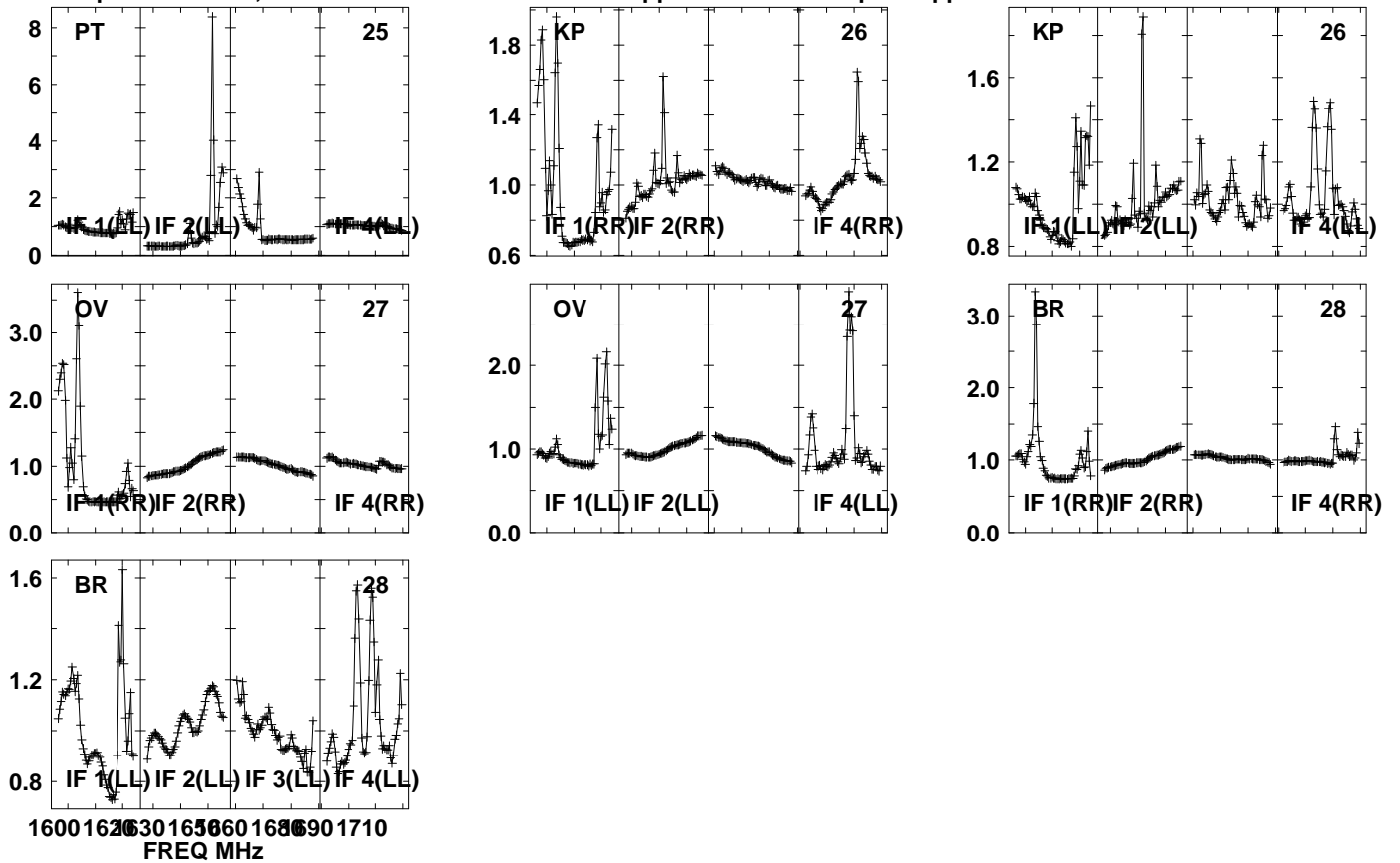

Lower frame: Real Jy

Auto-corr total-power spectrum Antenna: \*

Timerange: 00/18:29:31 to 00/18:32:59

Plot file version 918 created 05-OCT-2021 17:08:57

J0827+5217 GM076.UVDATA.1

Freq = 1.5945 GHz, Bw = 32.000 MH No calibration applied and no bandpass applied

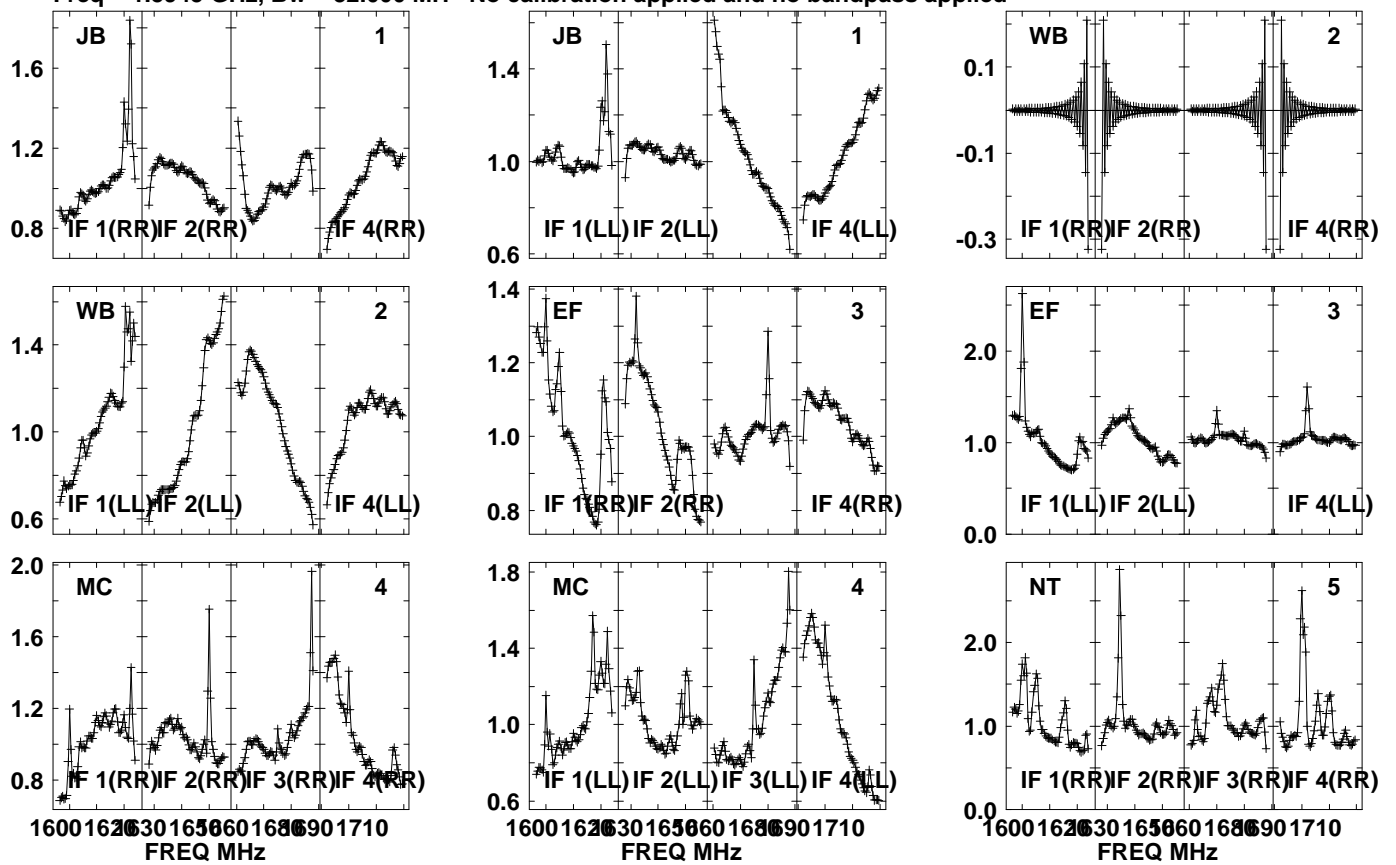

Lower frame: Real Jy  
Auto-corr total-power spectrum Antenna: \*  
Timerange: 00/18:33:31 to 00/18:34:59

Plot file version 919 created 05-OCT-2021 17:08:57

J0827+5217 GM076.UVDATA.1

Freq = 1.5945 GHz, Bw = 32.000 MH No calibration applied and no bandpass applied

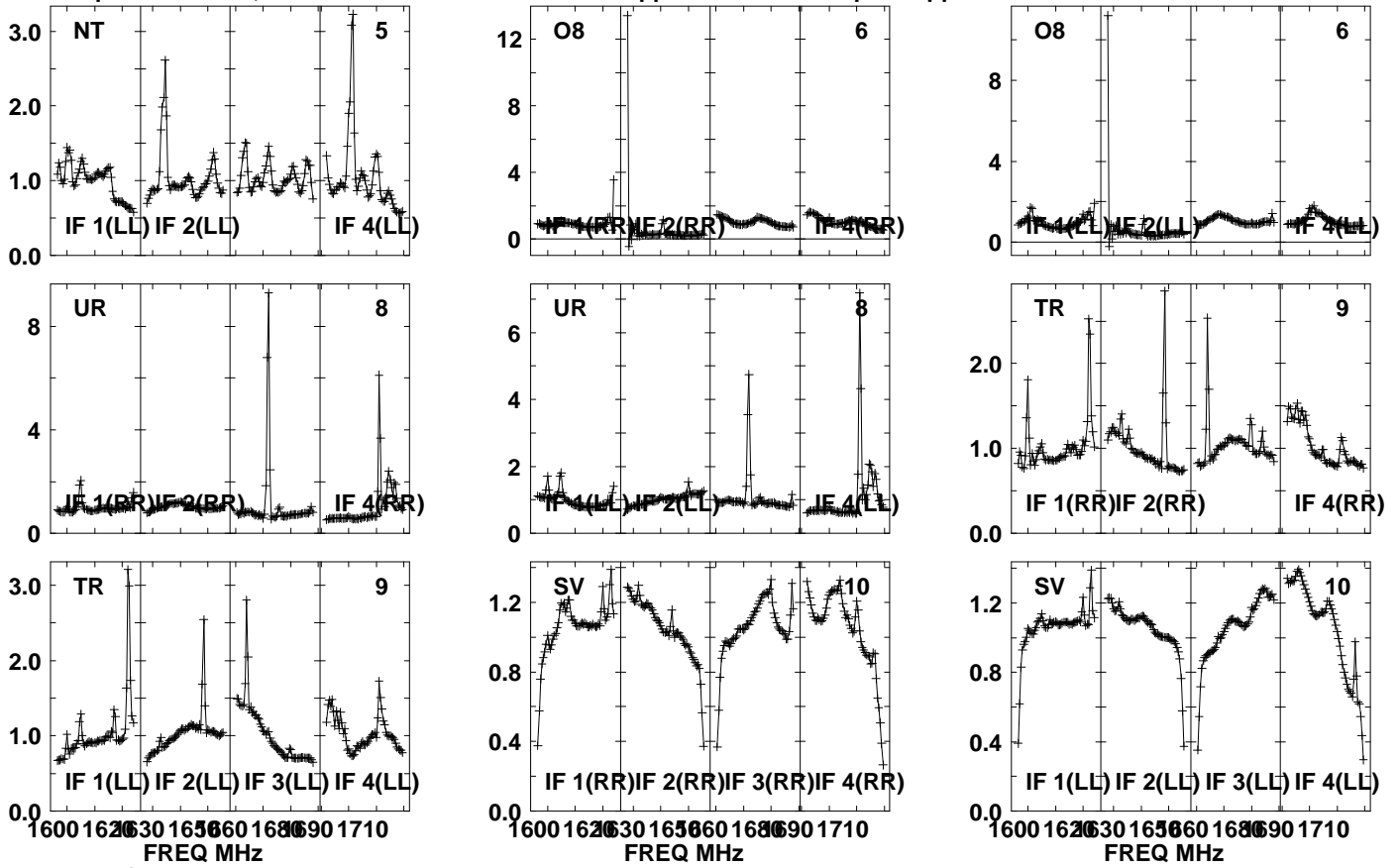

Lower frame: Real Jy  
Auto-corr total-power spectrum Antenna: \*  
Timerange: 00/18:33:31 to 00/18:34:59

Plot file version 920 created 05-OCT-2021 17:08:58

J0827+5217 GM076.UVDATA.1

Freq = 1.5945 GHz, Bw = 32.000 MH No calibration applied and no bandpass applied

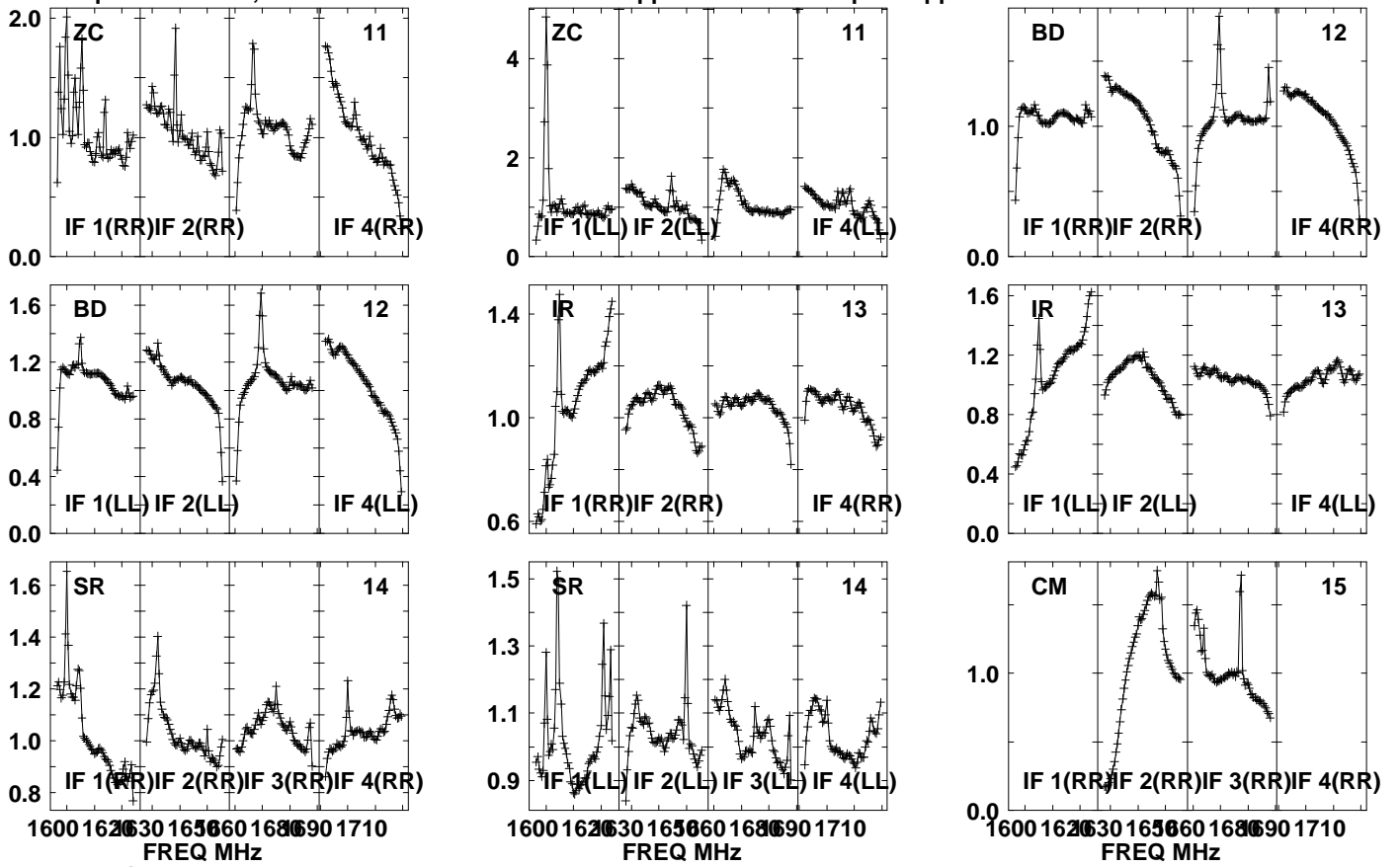

Lower frame: Real Jy

Auto-corr total-power spectrum Antenna: \*

Timerange: 00/18:33:31 to 00/18:34:59

Plot file version 921 created 05-OCT-2021 17:08:58

J0827+5217 GM076.UVDATA.1

Freq = 1.5945 GHz, Bw = 32.000 MH No calibration applied and no bandpass applied

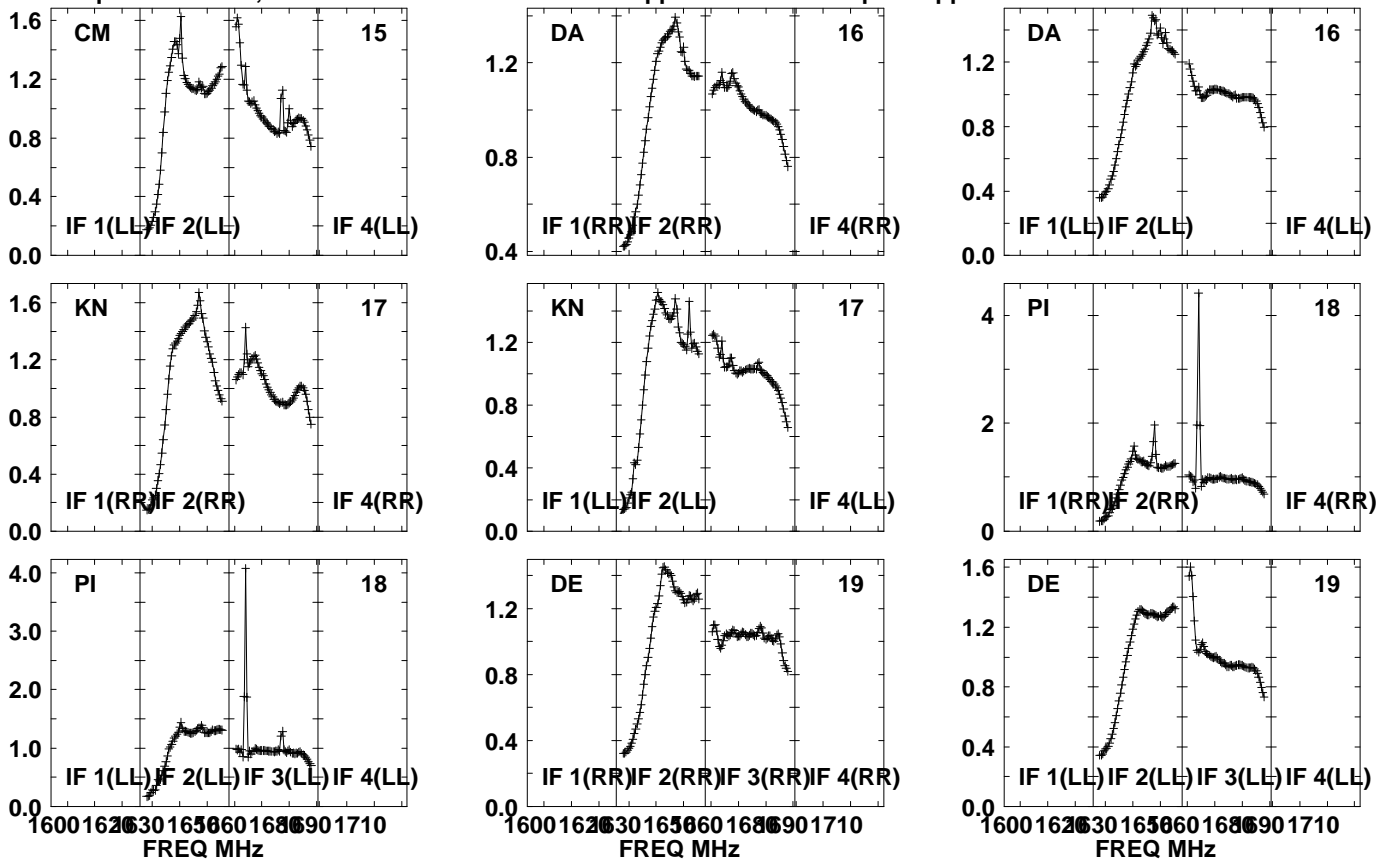

Lower frame: Real Jy  
Auto-corr total-power spectrum Antenna: \*  
Timerange: 00/18:33:31 to 00/18:34:59

Plot file version 922 created 05-OCT-2021 17:08:58

J0827+5217 GM076.UVDATA.1

Freq = 1.5945 GHz, Bw = 32.000 MH No calibration applied and no bandpass applied

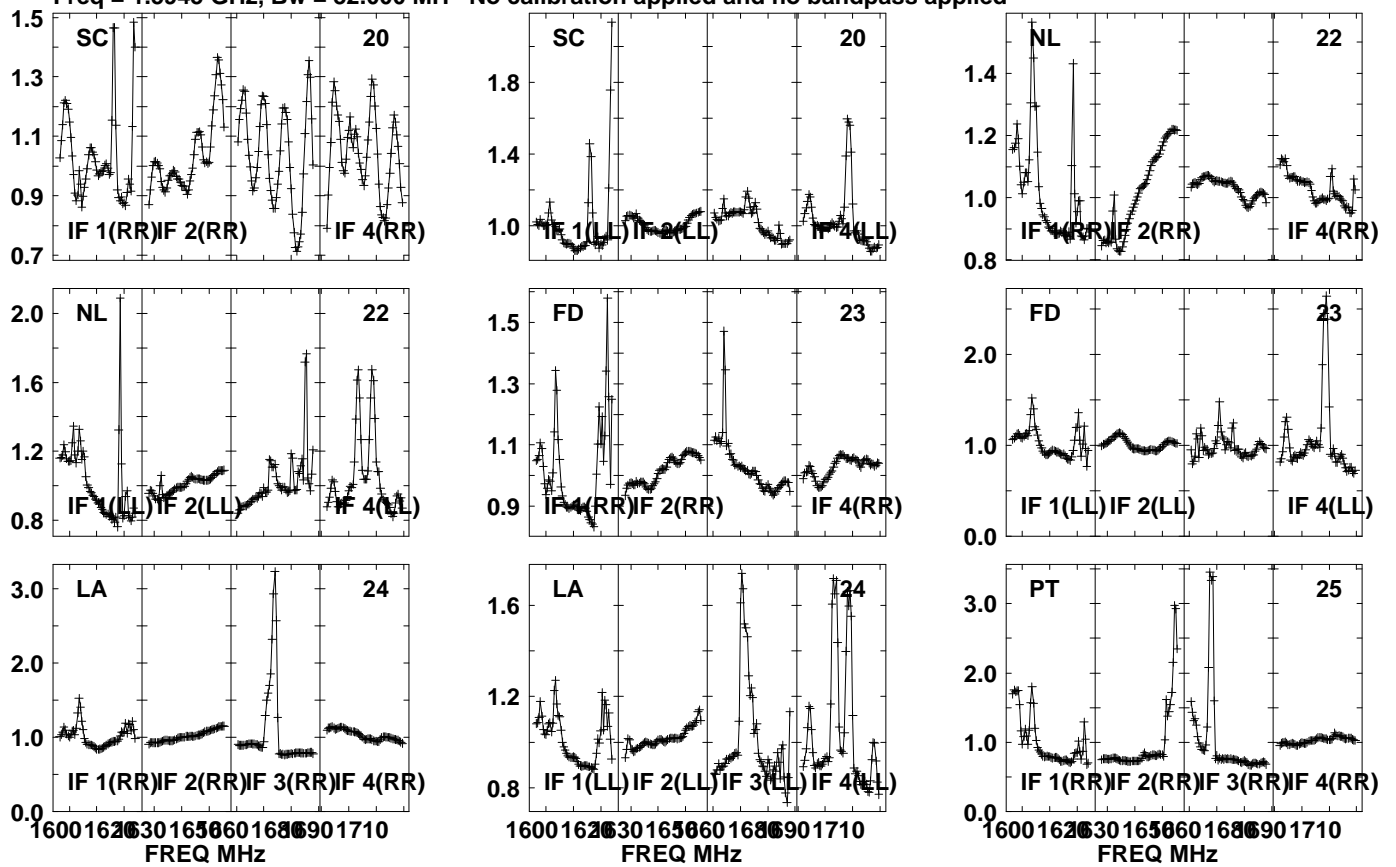

Lower frame: Real Jy  
Auto-corr total-power spectrum Antenna: \*  
Timerange: 00/18:33:31 to 00/18:34:59



Plot file version 923 created 05-OCT-2021 17:08:59

J0827+5217 GM076.UVDATA.1

Freq = 1.5945 GHz, Bw = 32.000 MH No calibration applied and no bandpass applied

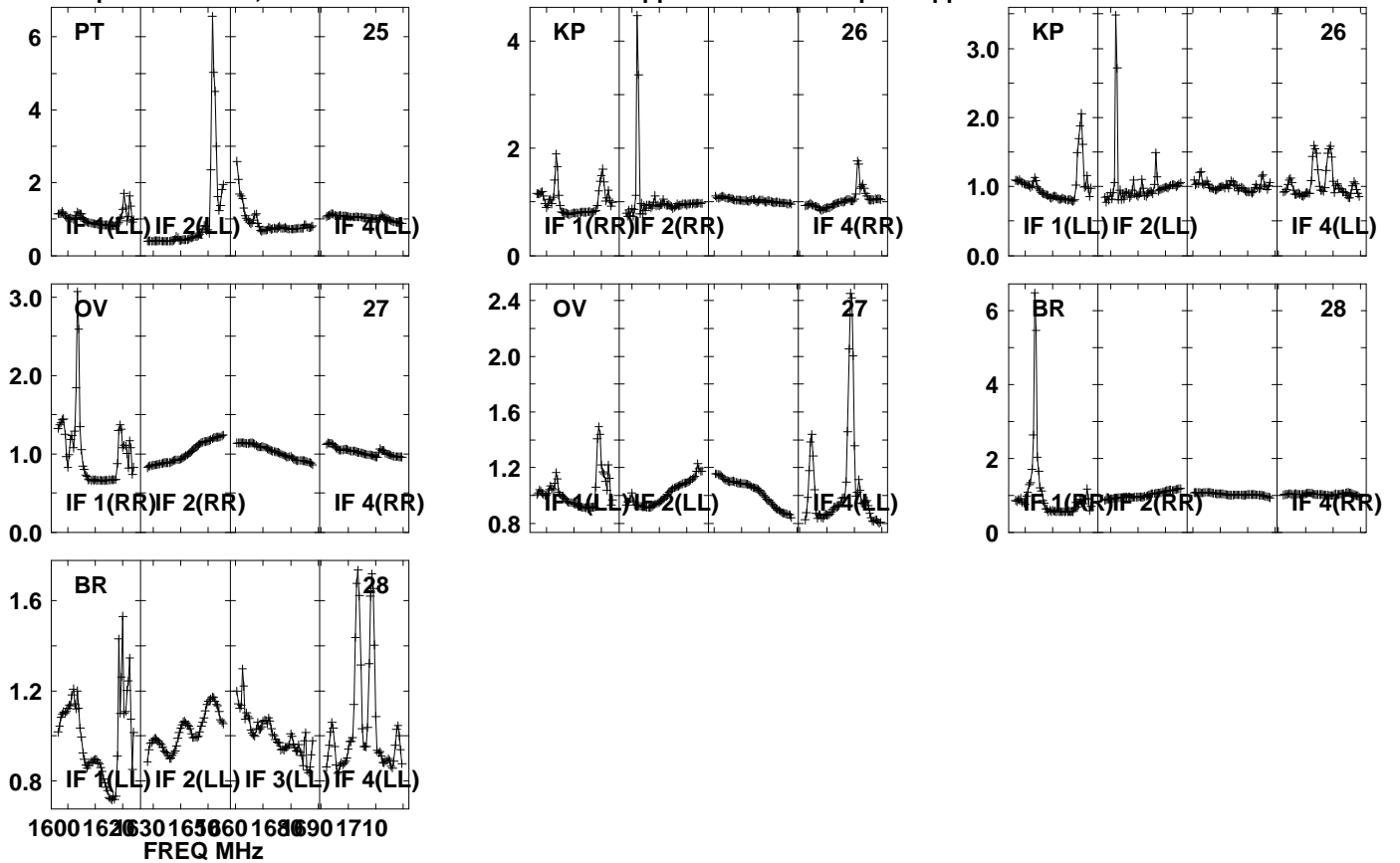

Lower frame: Real Jy

Auto-corr total-power spectrum Antenna: \*

Timerange: 00/18:33:31 to 00/18:34:59

Plot file version 924 created 05-OCT-2021 17:08:59

APM08279+525 GM076.UVDATA.1

Freq = 1.5945 GHz, Bw = 32.000 MH No calibration applied and no bandpass applied

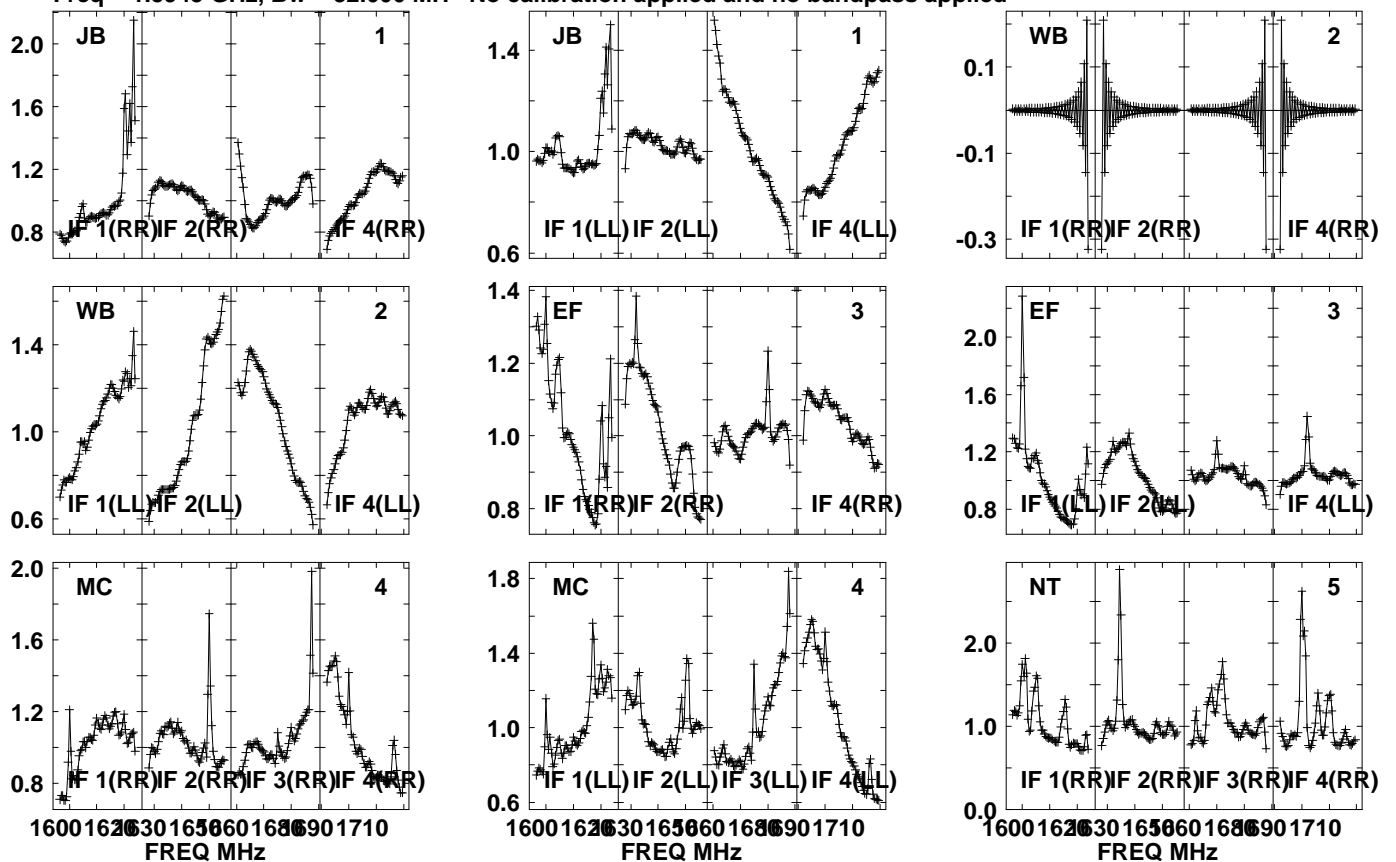

Lower frame: Real Jy  
Auto-corr total-power spectrum Antenna: \*  
Timerange: 00/18:35:01 to 00/18:38:29

Plot file version 925 created 05-OCT-2021 17:08:59

APM08279+525 GM076.UVDATA.1

Freq = 1.5945 GHz, Bw = 32.000 MH No calibration applied and no bandpass applied

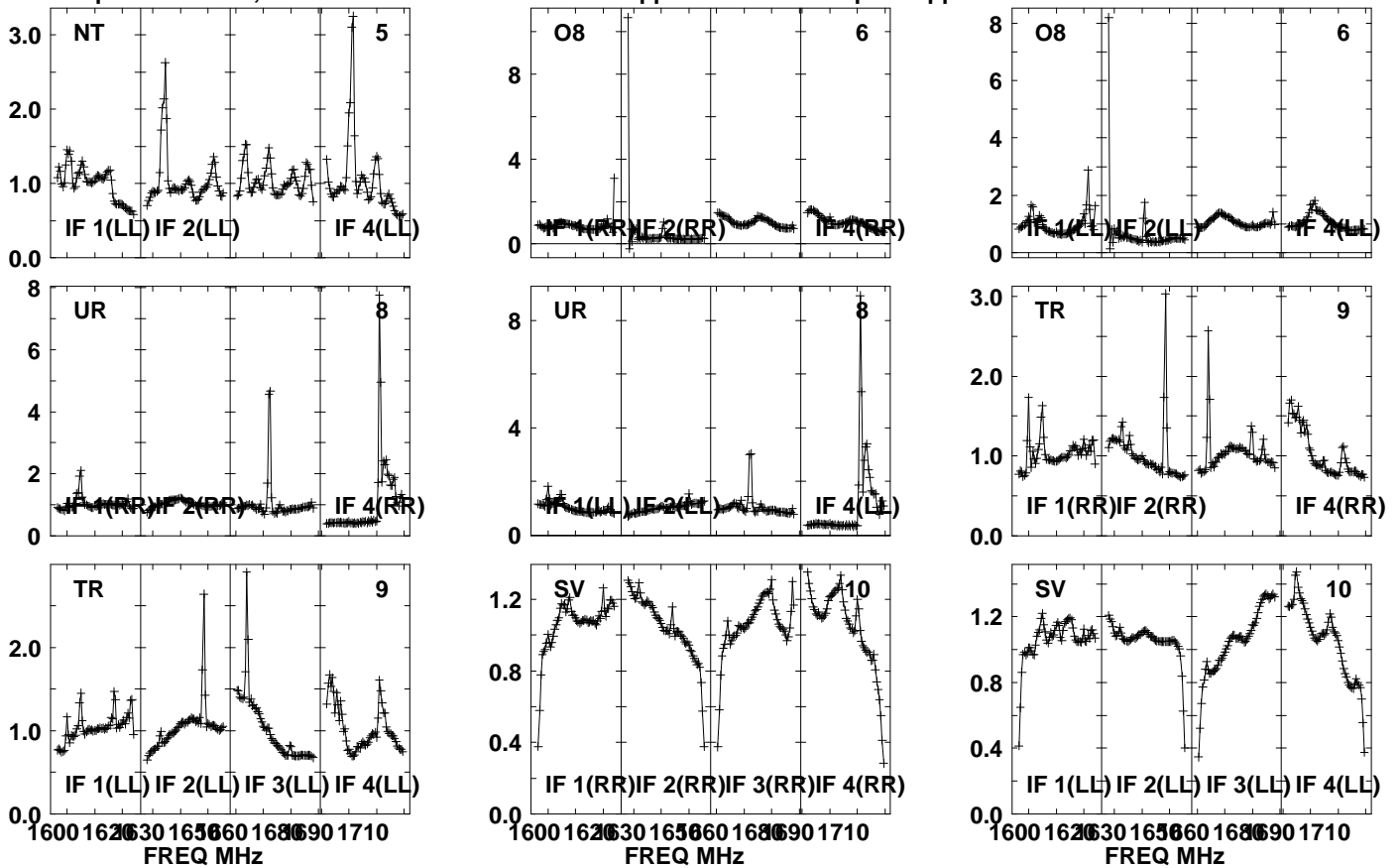

Lower frame: Real Jy

Auto-corr total-power spectrum Antenna: \*

Timerange: 00/18:35:01 to 00/18:38:29

Plot file version 926 created 05-OCT-2021 17:09:00

APM08279+525 GM076.UVDATA.1

Freq = 1.5945 GHz, Bw = 32.000 MH No calibration applied and no bandpass applied

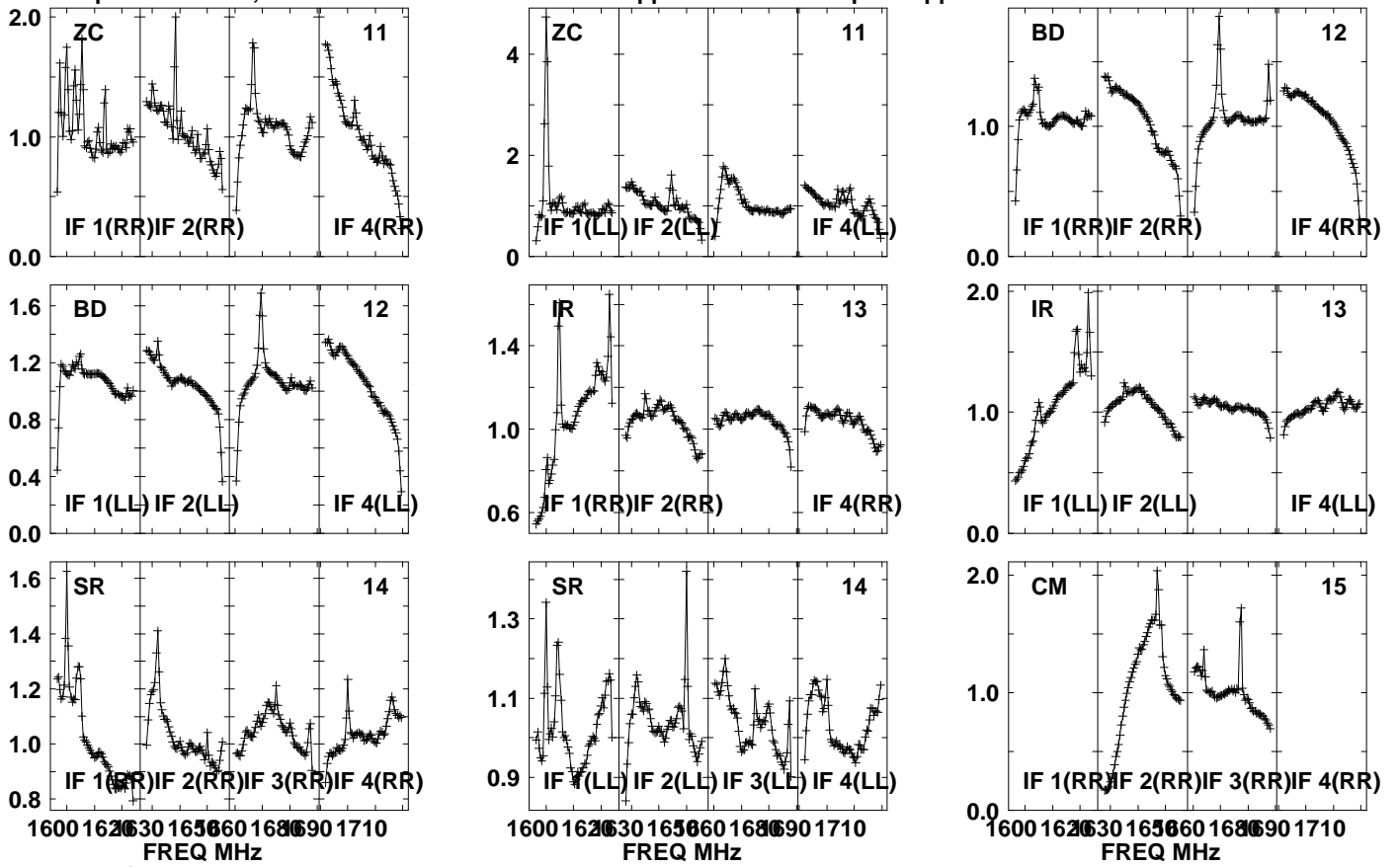

Lower frame: Real Jy

Auto-corr total-power spectrum Antenna: \*

Timerange: 00/18:35:01 to 00/18:38:29

Plot file version 927 created 05-OCT-2021 17:09:00

APM08279+525 GM076.UVDATA.1

Freq = 1.5945 GHz, Bw = 32.000 MH No calibration applied and no bandpass applied

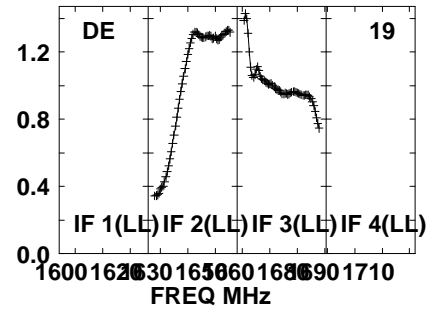
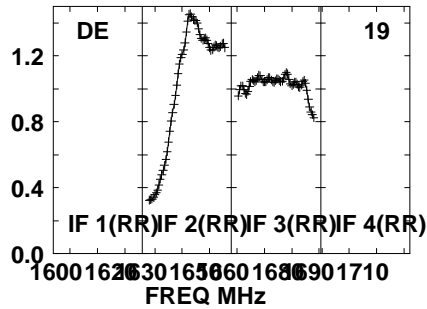
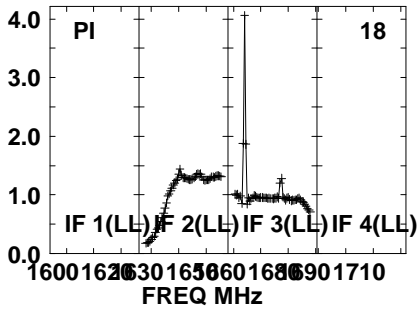
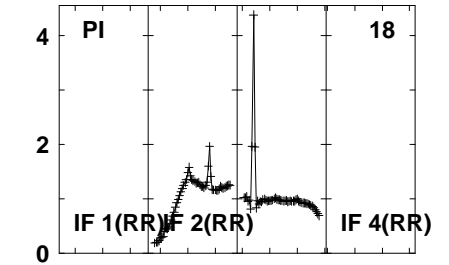
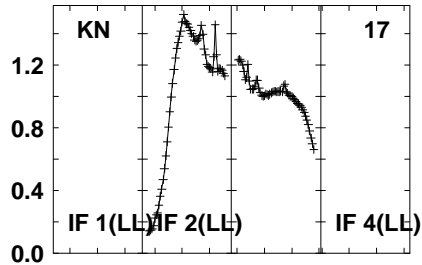
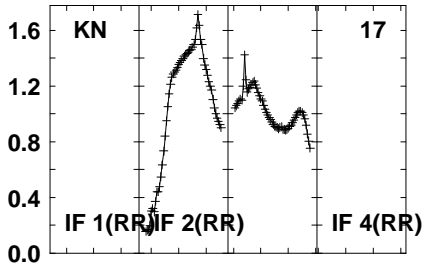
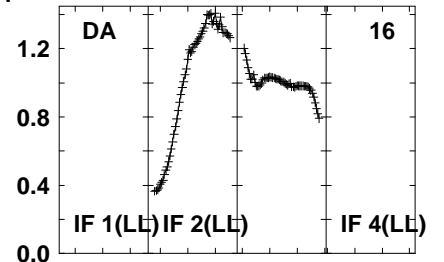
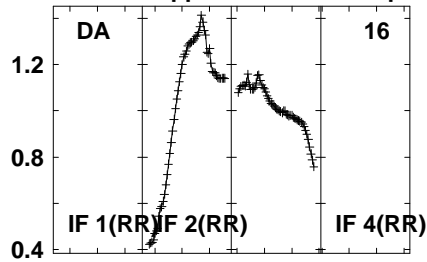
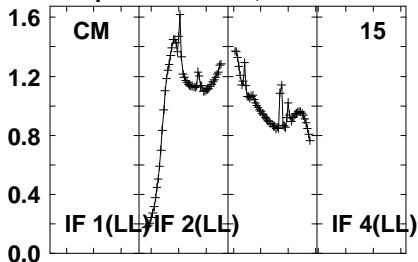

Lower frame: Real Jy  
Auto-corr total-power spectrum Antenna: \*  
Timerange: 00/18:35:01 to 00/18:38:29

Plot file version 928 created 05-OCT-2021 17:09:00

APM08279+525 GM076.UVDATA.1

Freq = 1.5945 GHz, Bw = 32.000 MH No calibration applied and no bandpass applied

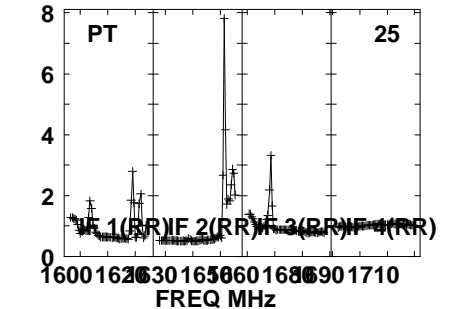
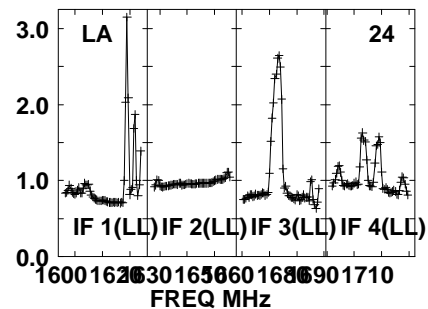
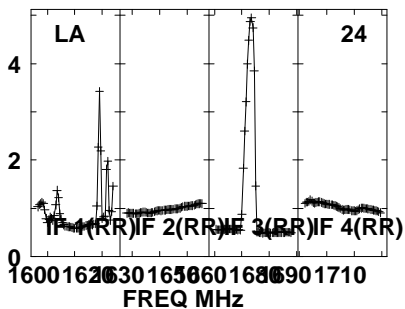
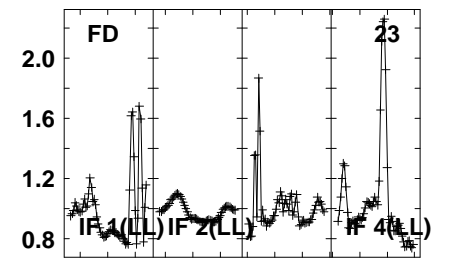
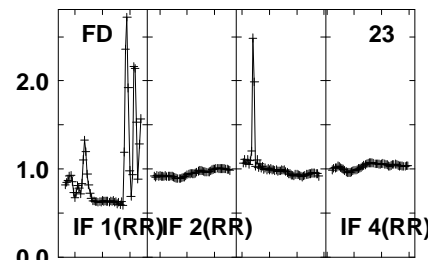
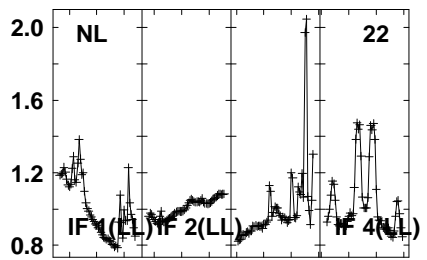
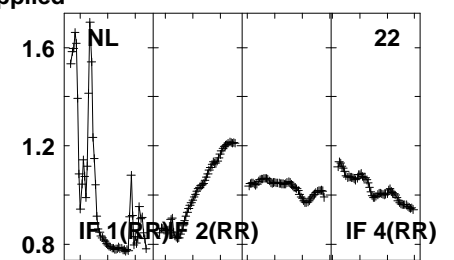
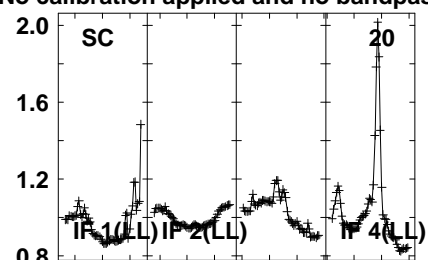
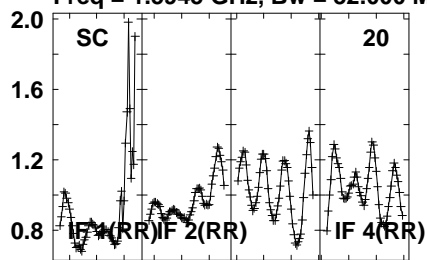

Lower frame: Real Jy  
Auto-corr total-power spectrum Antenna: \*  
Timerange: 00/18:35:01 to 00/18:38:29

Plot file version 929 created 05-OCT-2021 17:09:00

APM08279+525 GM076.UVDATA.1

Freq = 1.5945 GHz, Bw = 32.000 MH No calibration applied and no bandpass applied

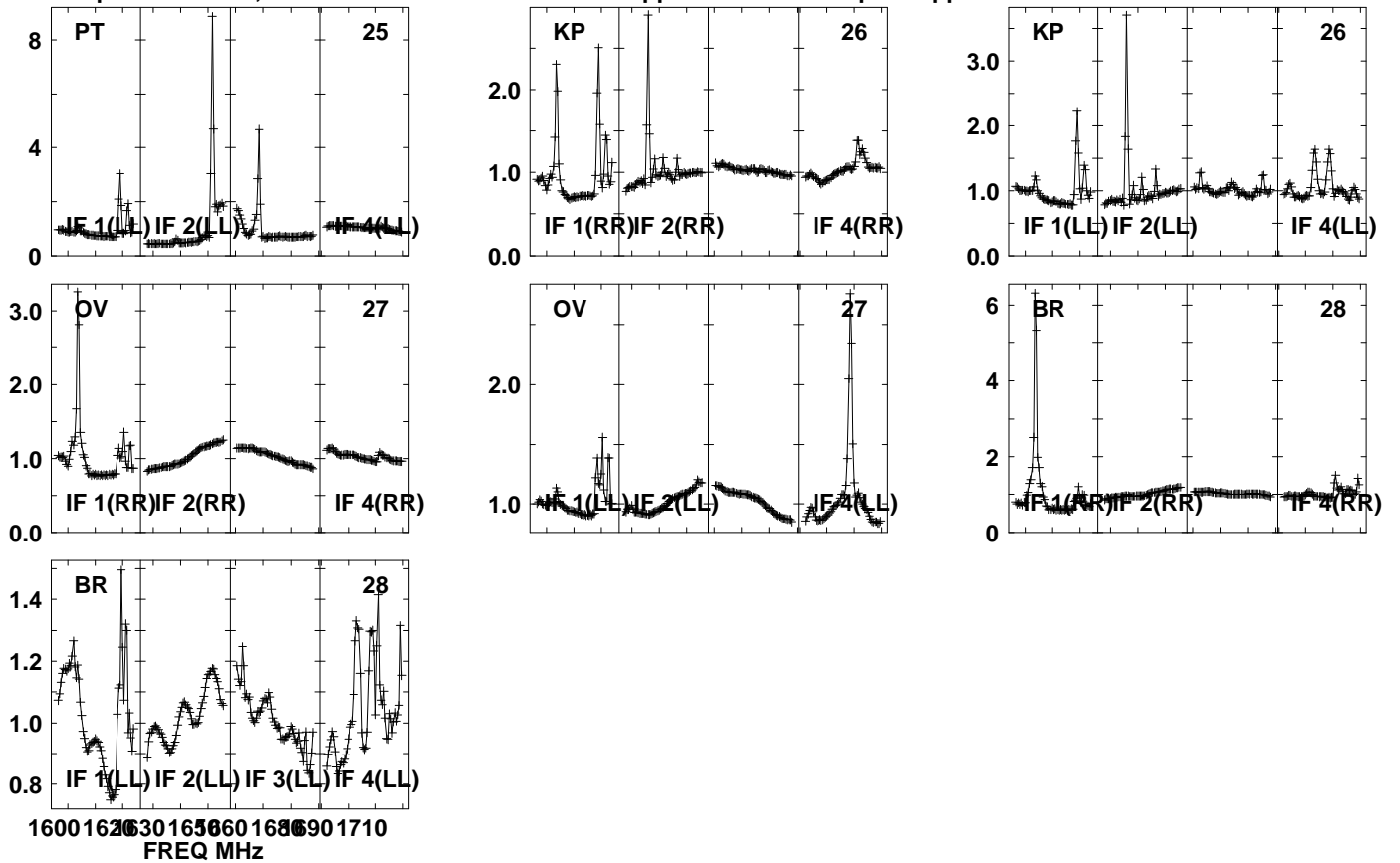

Lower frame: Real Jy

Auto-corr total-power spectrum Antenna: \*

Timerange: 00/18:35:01 to 00/18:38:29

Plot file version 930 created 05-OCT-2021 17:09:01

J0827+5217 GM076.UVDATA.1

Freq = 1.5945 GHz, Bw = 32.000 MH No calibration applied and no bandpass applied

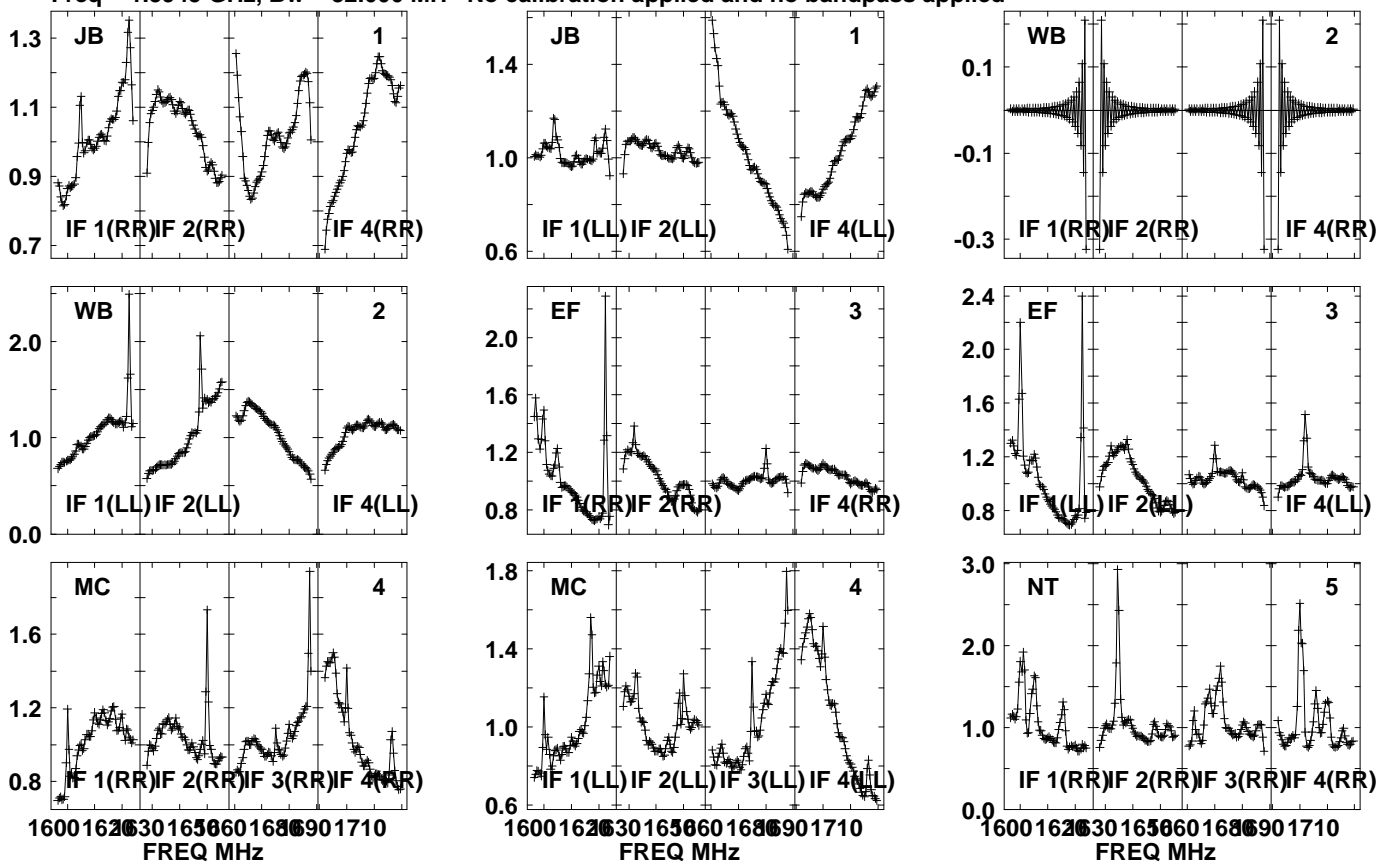

Lower frame: Real Jy  
Auto-corr total-power spectrum Antenna: \*  
Timerange: 00/18:38:31 to 00/18:39:59



Plot file version 931 created 05-OCT-2021 17:09:01

J0827+5217 GM076.UVDATA.1

Freq = 1.5945 GHz, Bw = 32.000 MH No calibration applied and no bandpass applied

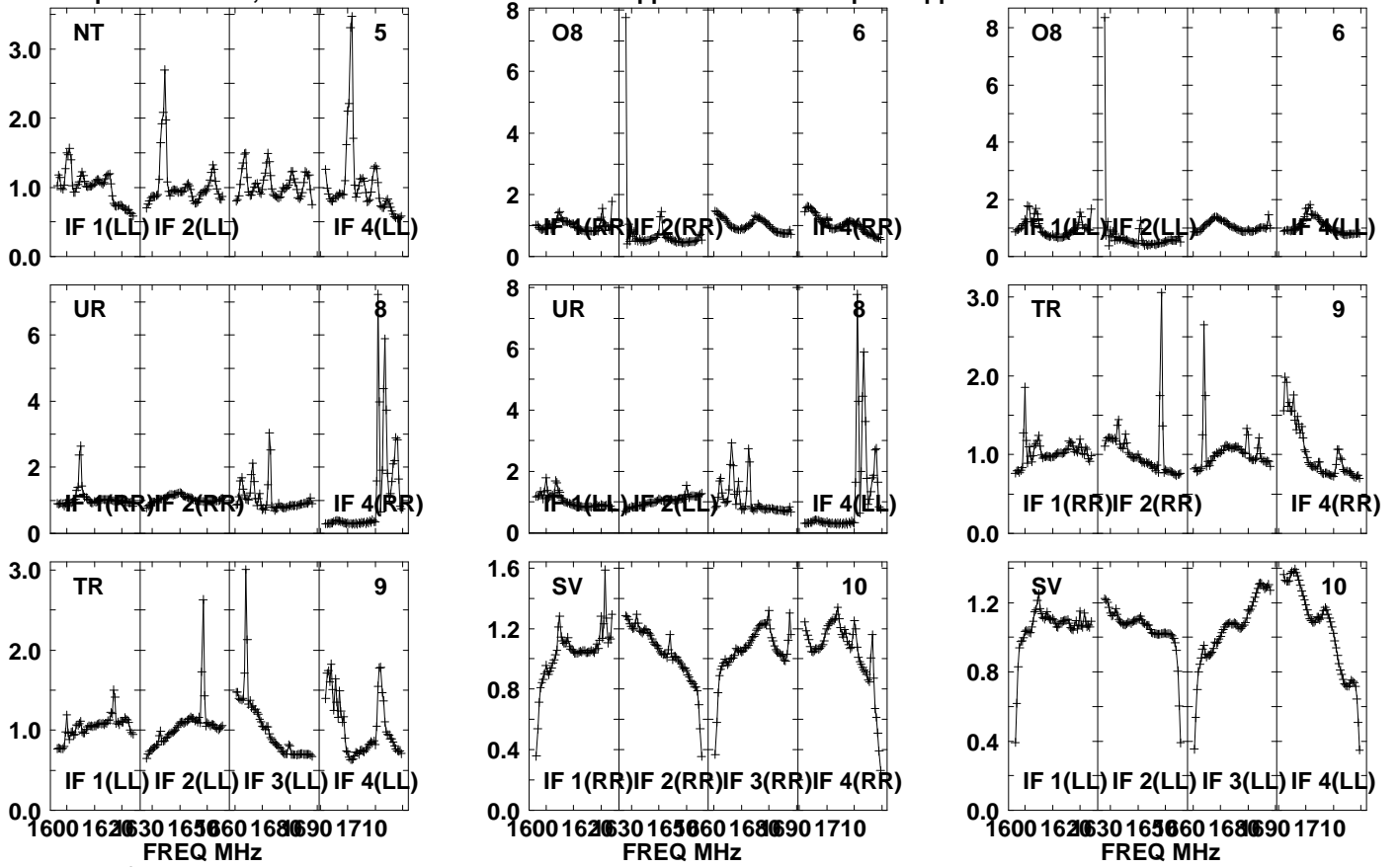

Lower frame: Real Jy  
Auto-corr total-power spectrum Antenna: \*  
Timerange: 00/18:38:31 to 00/18:39:59

Plot file version 932 created 05-OCT-2021 17:09:01

J0827+5217 GM076.UVDATA.1

Freq = 1.5945 GHz, Bw = 32.000 MH No calibration applied and no bandpass applied

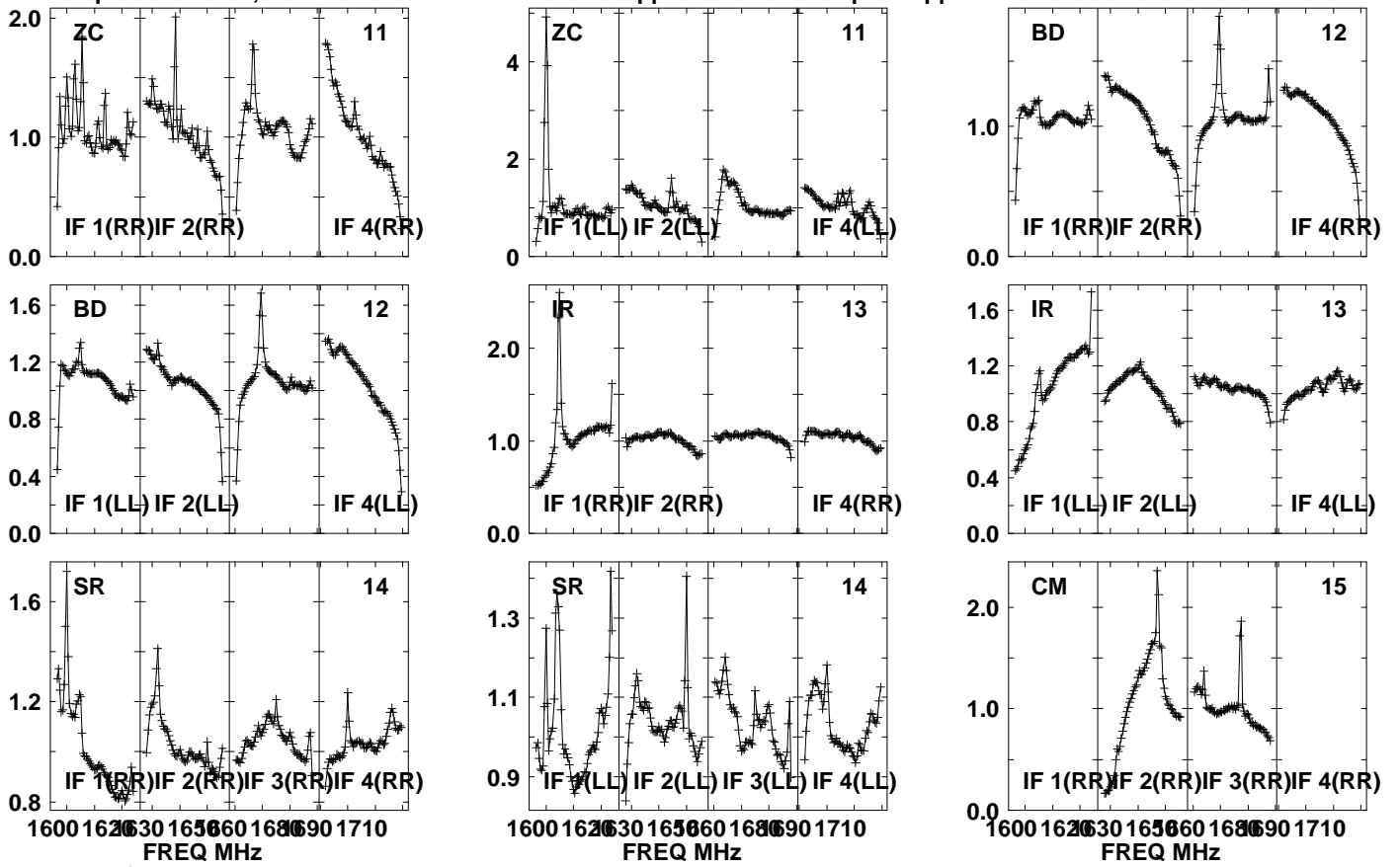

Lower frame: Real Jy

Auto-corr total-power spectrum Antenna: \*

Timerange: 00/18:38:31 to 00/18:39:59

Plot file version 933 created 05-OCT-2021 17:09:02

J0827+5217 GM076.UVDATA.1

Freq = 1.5945 GHz, Bw = 32.000 MH No calibration applied and no bandpass applied

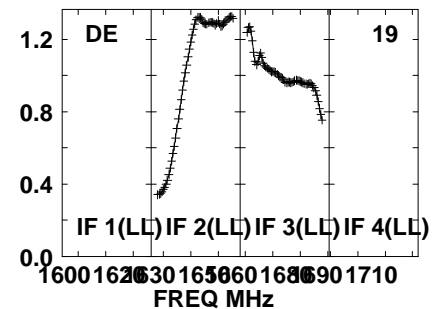
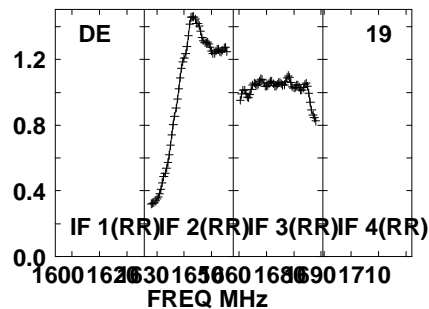
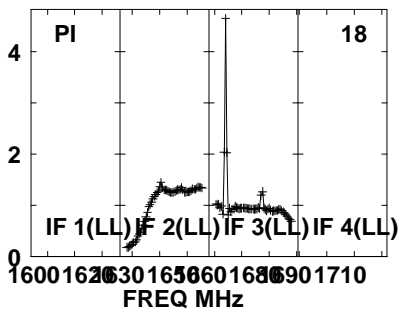
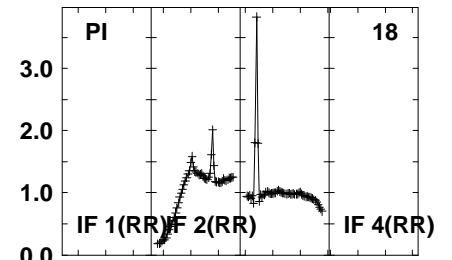
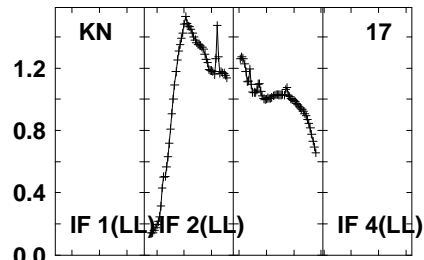
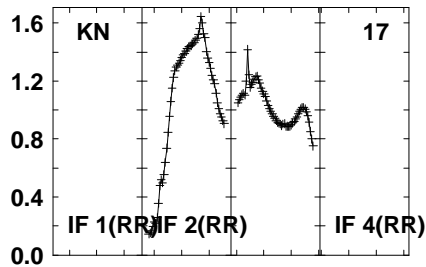
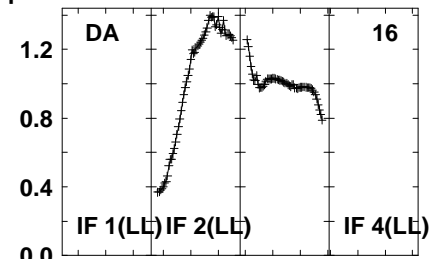
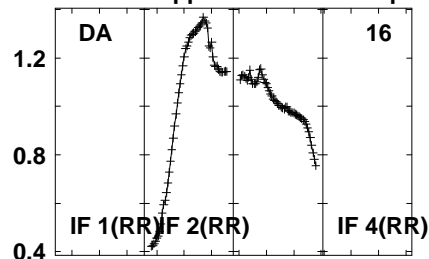
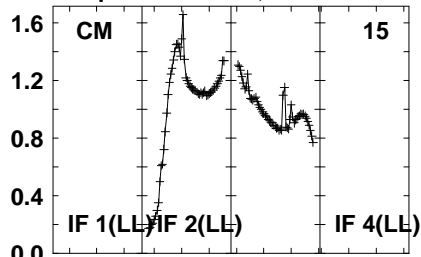

Lower frame: Real Jy  
Auto-corr total-power spectrum Antenna: \*  
Timerange: 00/18:38:31 to 00/18:39:59

Plot file version 934 created 05-OCT-2021 17:09:02

J0827+5217 GM076.UVDATA.1

Freq = 1.5945 GHz, Bw = 32.000 MH No calibration applied and no bandpass applied

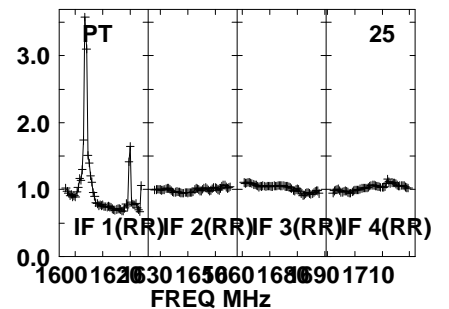
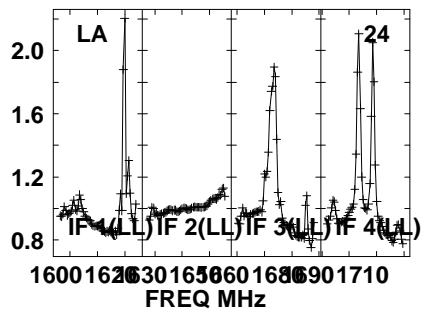
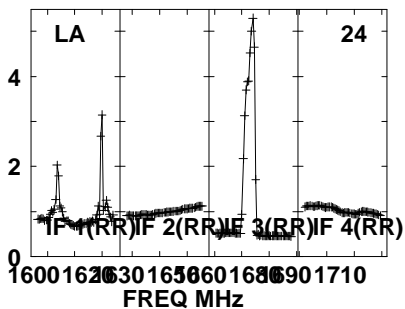
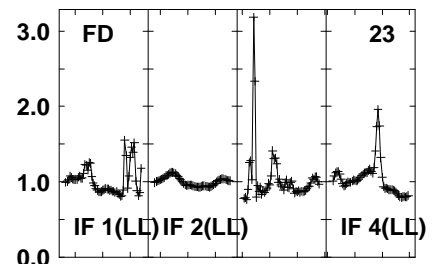
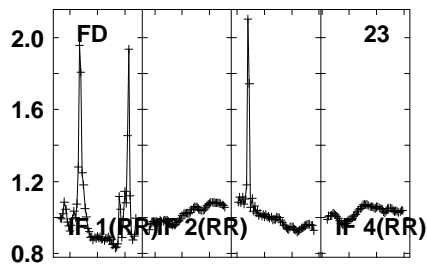
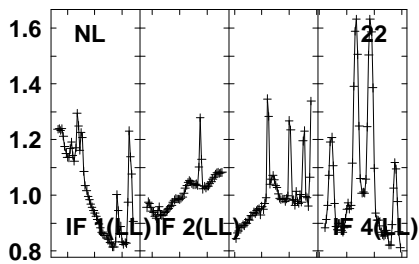
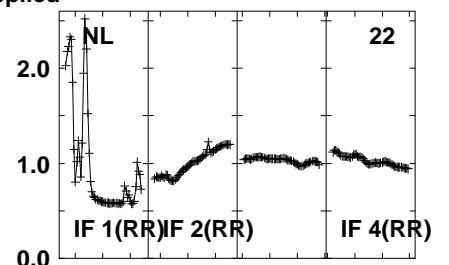
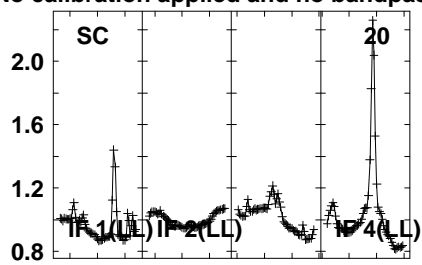
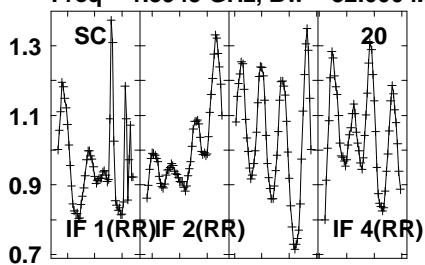

Lower frame: Real Jy  
Auto-corr total-power spectrum Antenna: \*  
Timerange: 00/18:38:31 to 00/18:39:59

Plot file version 935 created 05-OCT-2021 17:09:02

J0827+5217 GM076.UVDATA.1

Freq = 1.5945 GHz, Bw = 32.000 MH No calibration applied and no bandpass applied

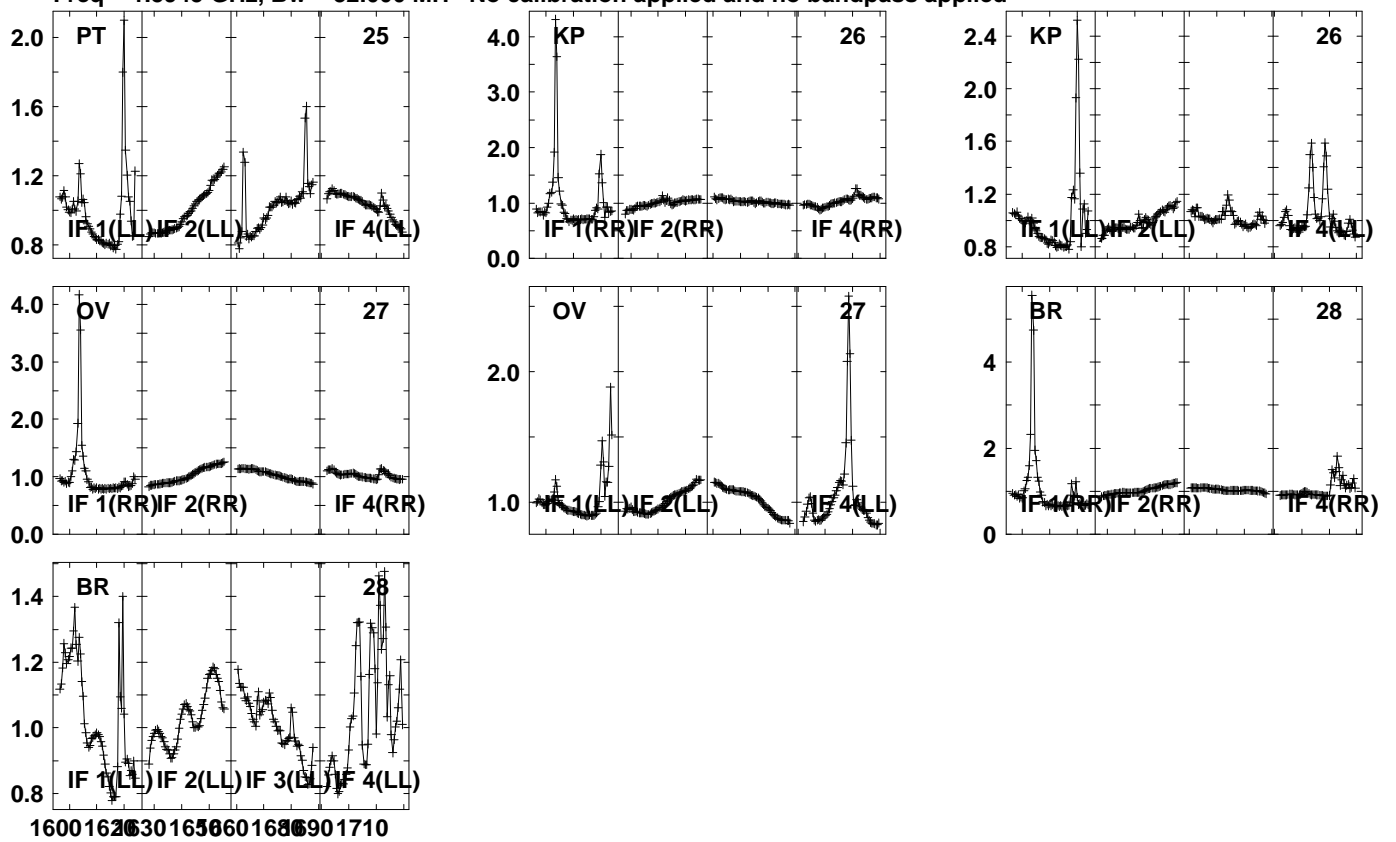

Lower frame: Real Jy

Auto-corr total-power spectrum Antenna: \*

Timerange: 00/18:38:31 to 00/18:39:59

Plot file version 936 created 05-OCT-2021 17:09:03

APM08279+525 GM076.UVDATA.1

Freq = 1.5945 GHz, Bw = 32.000 MH No calibration applied and no bandpass applied

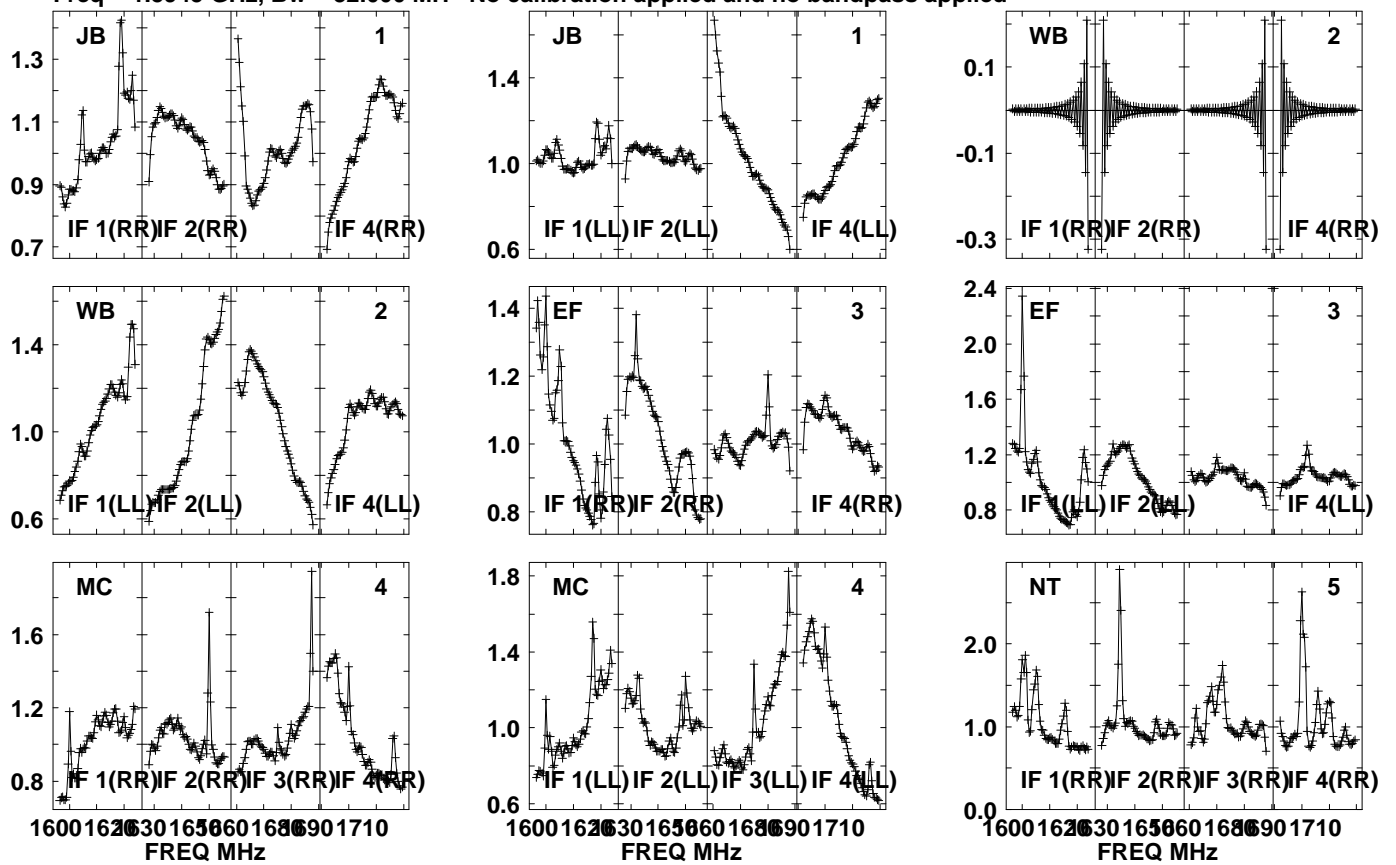

Lower frame: Real Jy  
Auto-corr total-power spectrum Antenna: \*  
Timerange: 00/18:40:01 to 00/18:43:29

Plot file version 937 created 05-OCT-2021 17:09:03

APM08279+525 GM076.UVDATA.1

Freq = 1.5945 GHz, Bw = 32.000 MH No calibration applied and no bandpass applied

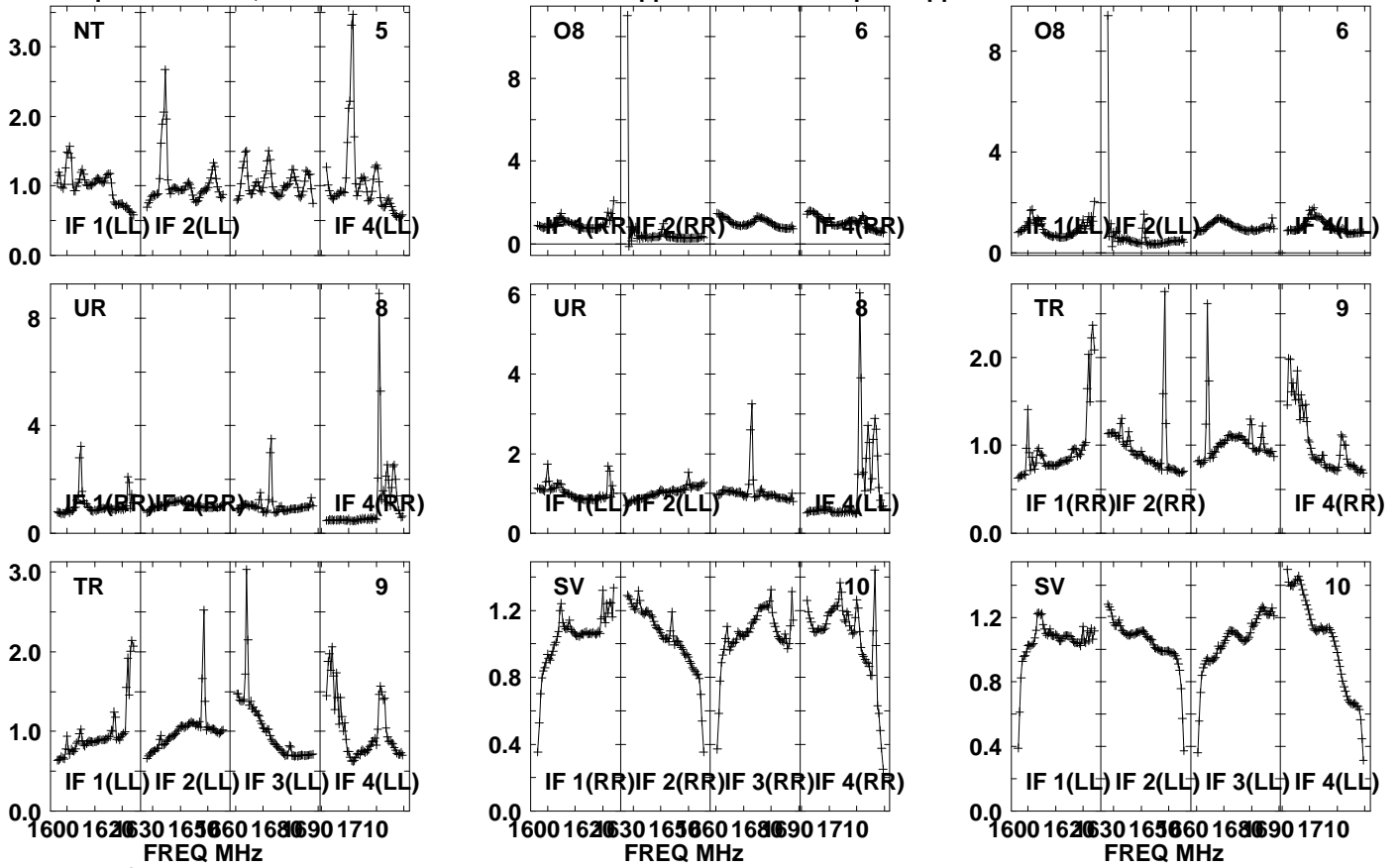

Lower frame: Real Jy

Auto-corr total-power spectrum Antenna: \*

Timerange: 00/18:40:01 to 00/18:43:29

Plot file version 938 created 05-OCT-2021 17:09:03

APM08279+525 GM076.UVDATA.1

Freq = 1.5945 GHz, Bw = 32.000 MH No calibration applied and no bandpass applied

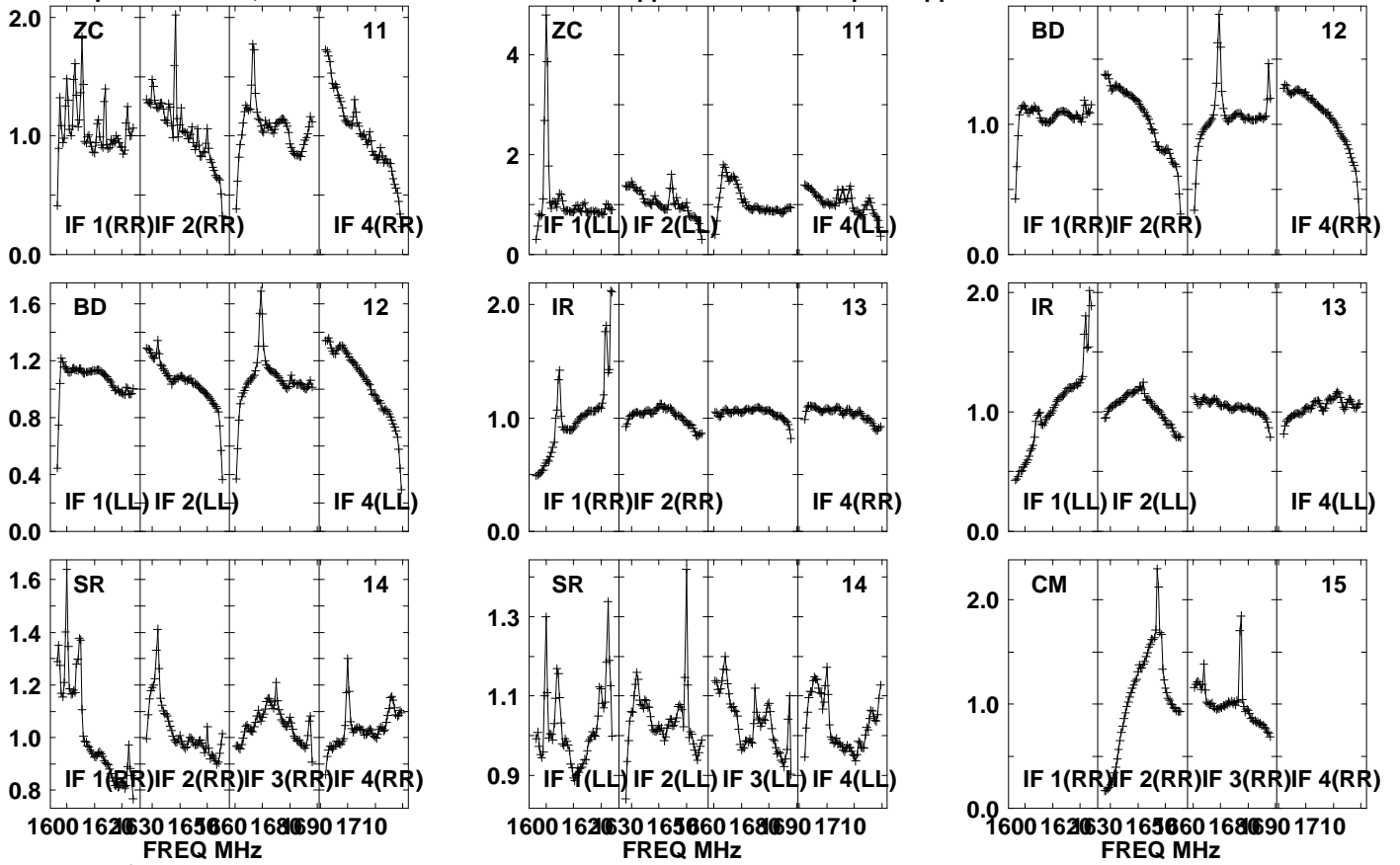

Lower frame: Real Jy  
Auto-corr total-power spectrum Antenna: \*  
Timerange: 00/18:40:01 to 00/18:43:29



Plot file version 939 created 05-OCT-2021 17:09:03

APM08279+525 GM076.UVDATA.1

Freq = 1.5945 GHz, Bw = 32.000 MH No calibration applied and no bandpass applied

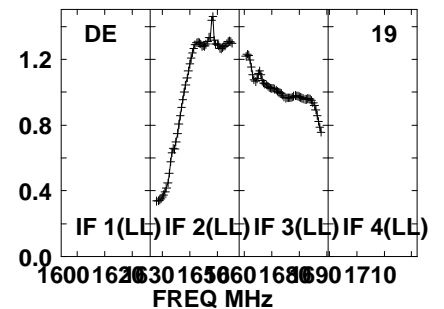
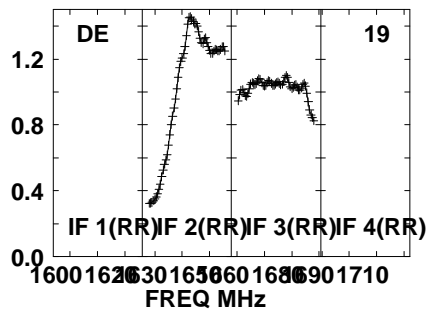
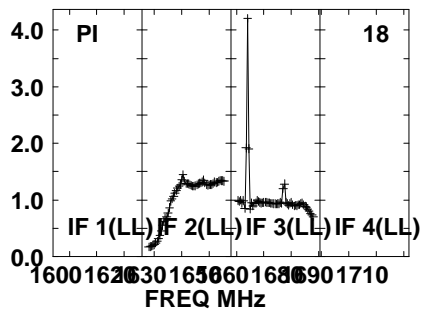
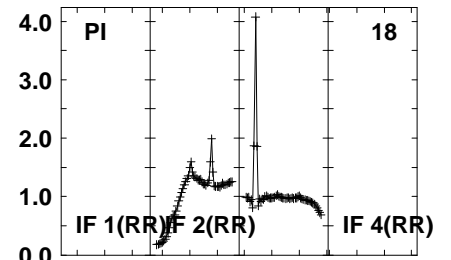
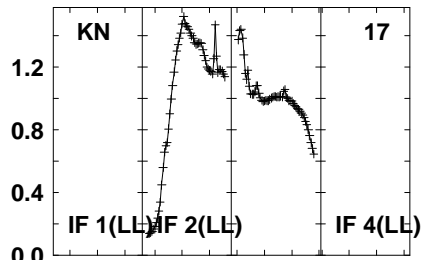
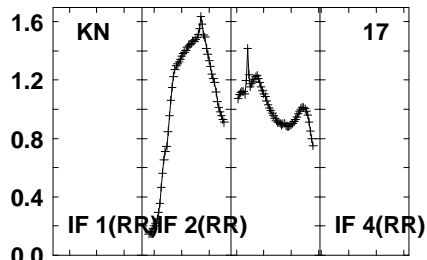
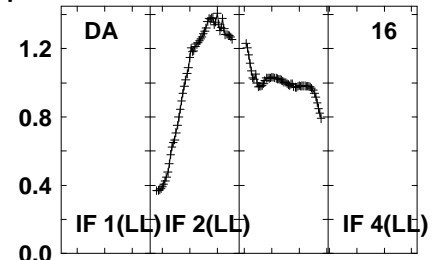
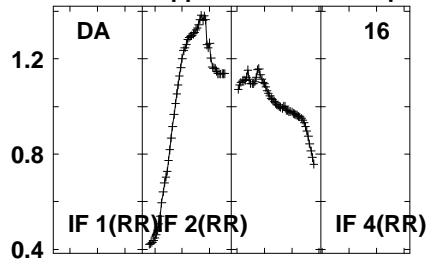
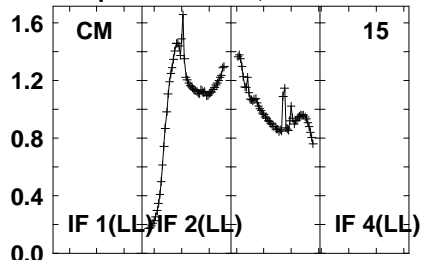

Lower frame: Real Jy  
Auto-corr total-power spectrum Antenna: \*  
Timerange: 00/18:40:01 to 00/18:43:29

Plot file version 940 created 05-OCT-2021 17:09:04

APM08279+525 GM076.UVDATA.1

Freq = 1.5945 GHz, Bw = 32.000 MH No calibration applied and no bandpass applied

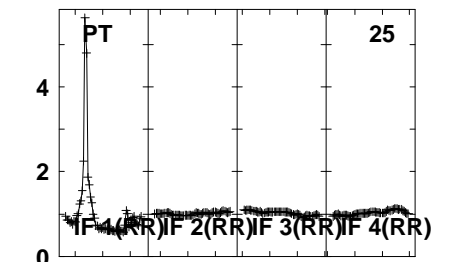
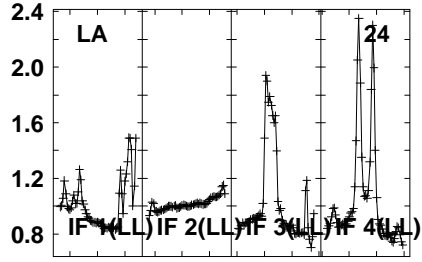
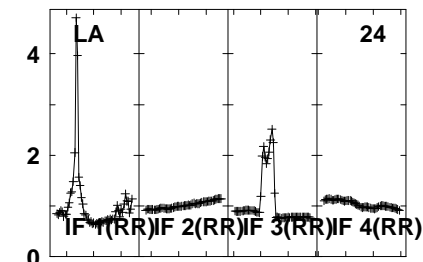
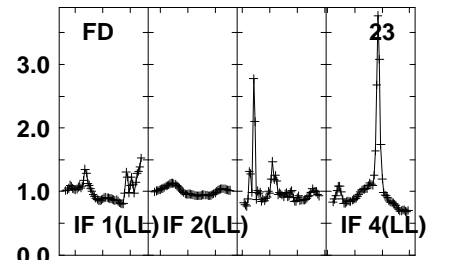
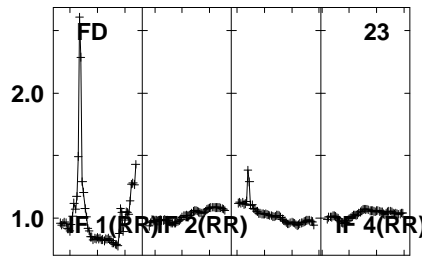
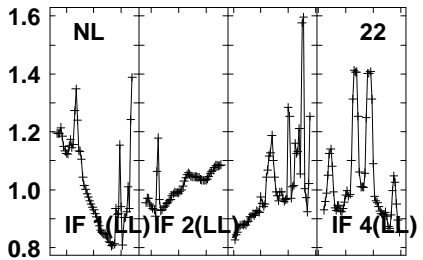
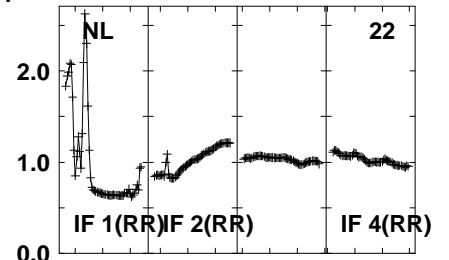
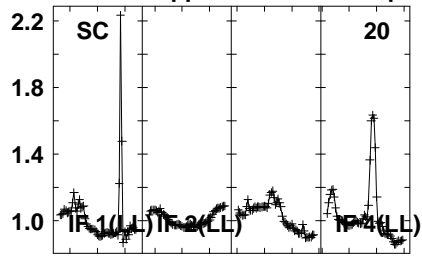
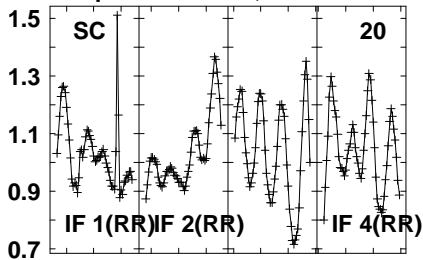

Lower frame: Real Jy  
Auto-corr total-power spectrum Antenna: \*  
Timerange: 00/18:40:01 to 00/18:43:29

Plot file version 941 created 05-OCT-2021 17:09:04

APM08279+525 GM076.UVDATA.1

Freq = 1.5945 GHz, Bw = 32.000 MH No calibration applied and no bandpass applied

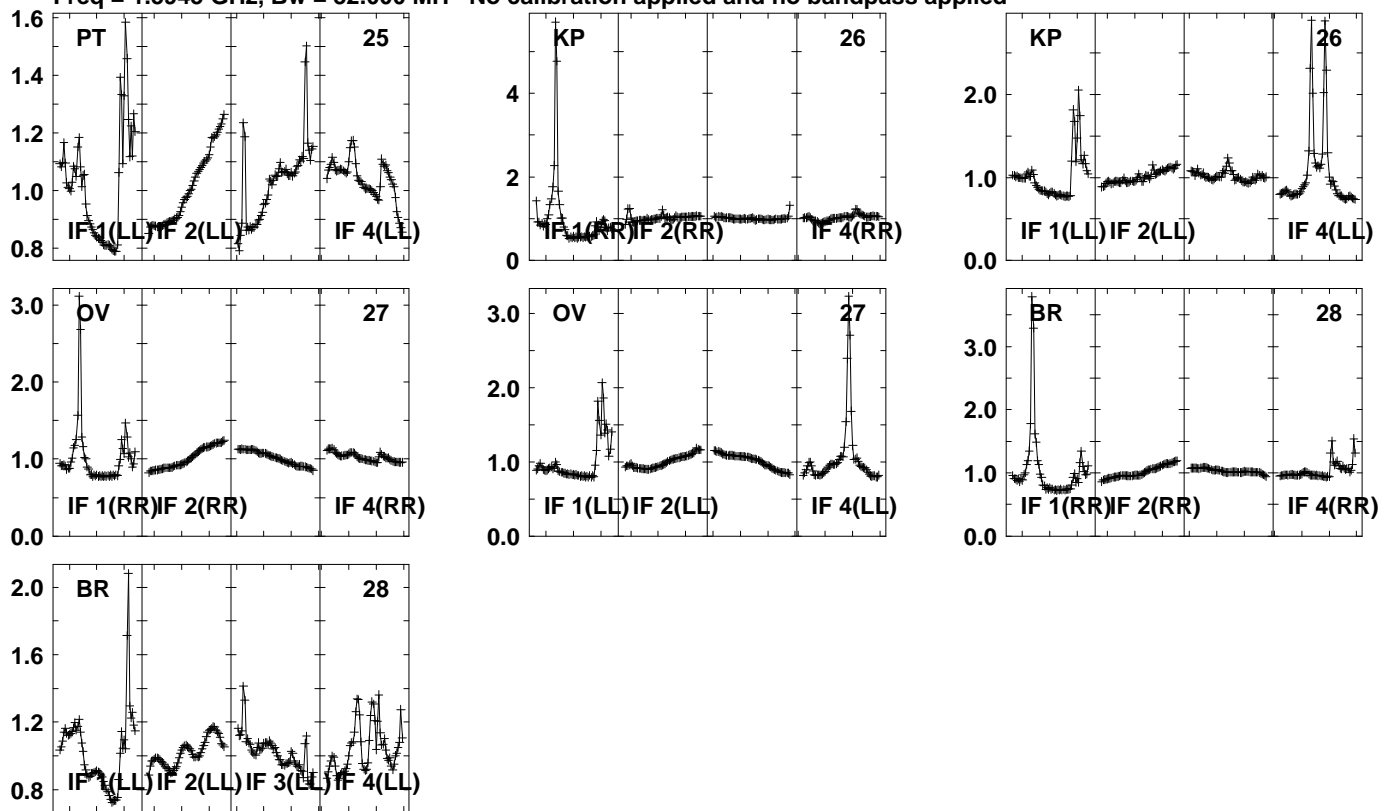

1600162063016506016806901710

FREQ MHz

Lower frame: Real Jy

Auto-corr total-power spectrum Antenna: \*

Timerange: 00/18:40:01 to 00/18:43:29

Plot file version 942 created 05-OCT-2021 17:09:04

J0827+5217 GM076.UVDATA.1

Freq = 1.5945 GHz, Bw = 32.000 MH No calibration applied and no bandpass applied

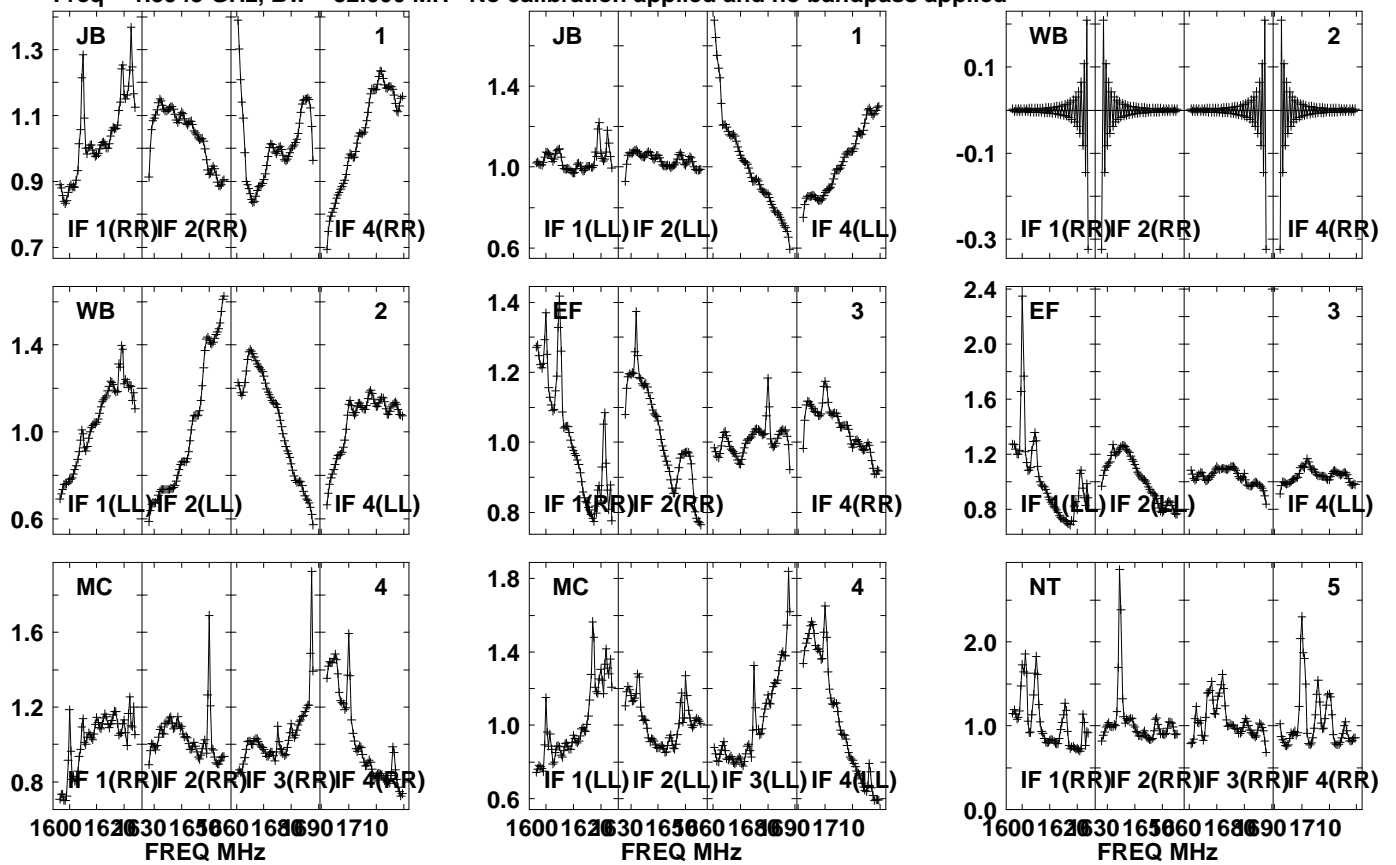

Lower frame: Real Jy  
Auto-corr total-power spectrum Antenna: \*  
Timerange: 00/18:44:01 to 00/18:45:29

Plot file version 943 created 05-OCT-2021 17:09:05

J0827+5217 GM076.UVDATA.1

Freq = 1.5945 GHz, Bw = 32.000 MH No calibration applied and no bandpass applied

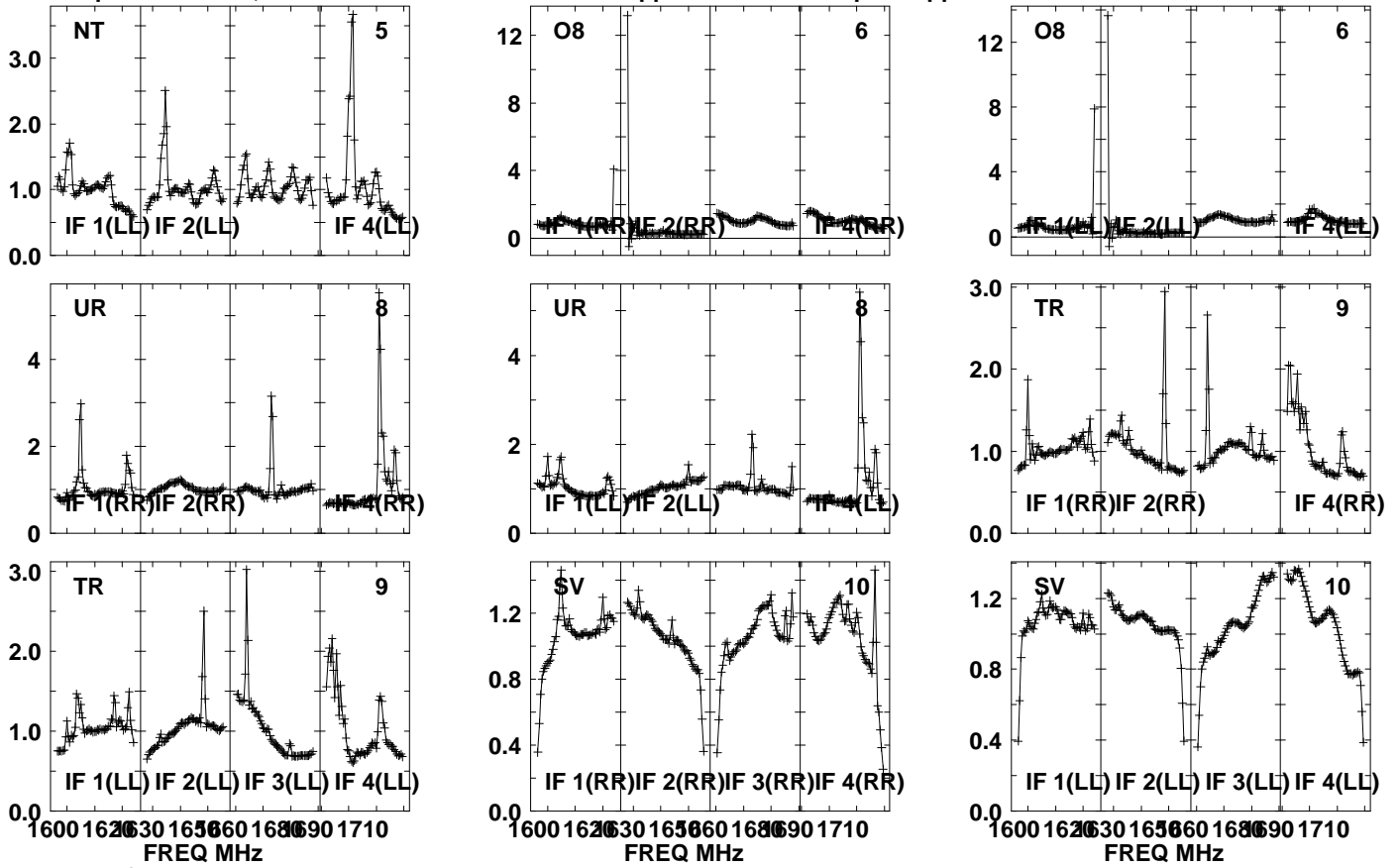

Lower frame: Real Jy  
Auto-corr total-power spectrum Antenna: \*  
Timerange: 00/18:44:01 to 00/18:45:29

Plot file version 944 created 05-OCT-2021 17:09:05

J0827+5217 GM076.UVDATA.1

Freq = 1.5945 GHz, Bw = 32.000 MH No calibration applied and no bandpass applied

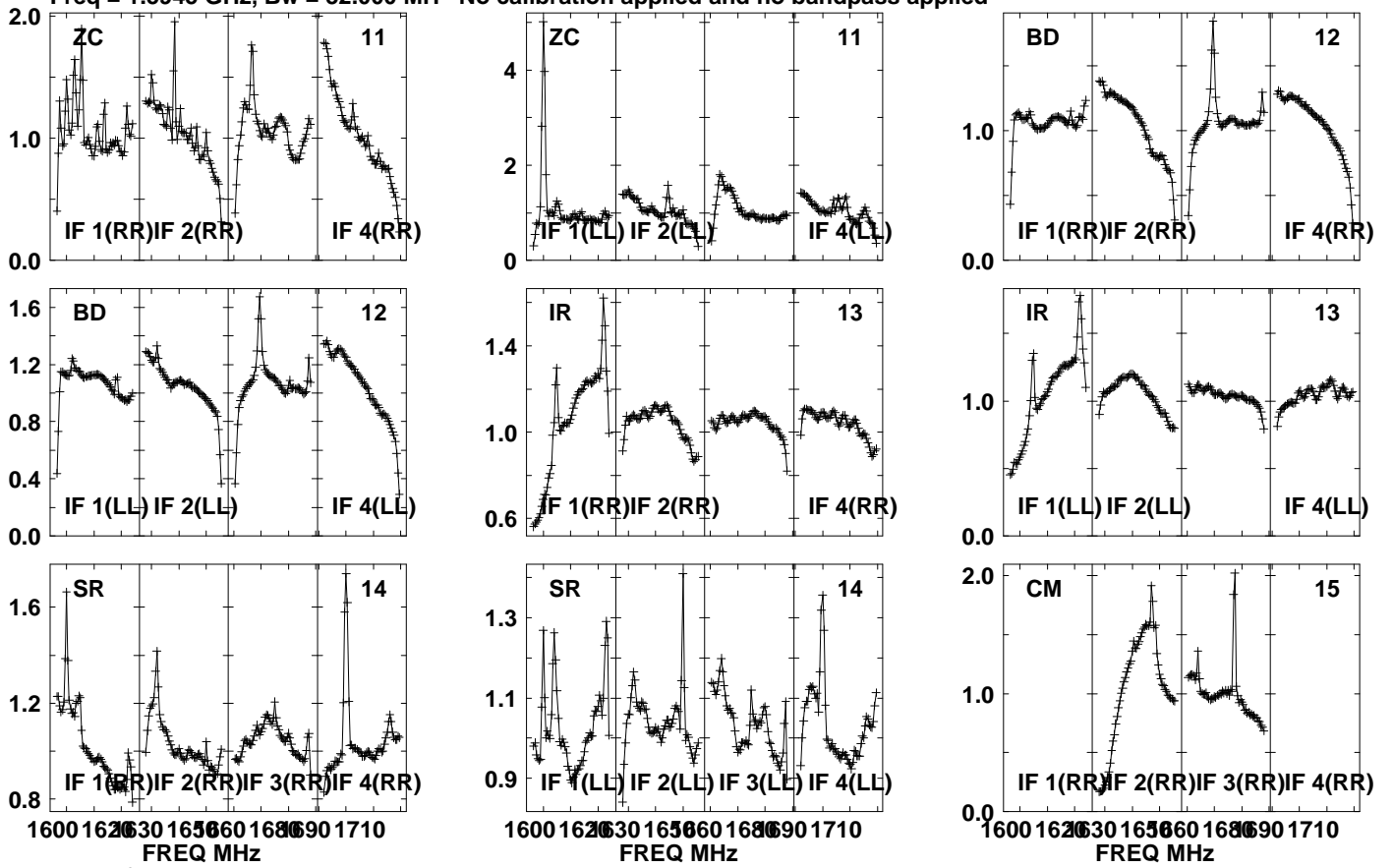

Lower frame: Real Jy  
Auto-corr total-power spectrum Antenna: \*  
Timerange: 00/18:44:01 to 00/18:45:29

Plot file version 945 created 05-OCT-2021 17:09:05

J0827+5217 GM076.UVDATA.1

Freq = 1.5945 GHz, Bw = 32.000 MH No calibration applied and no bandpass applied

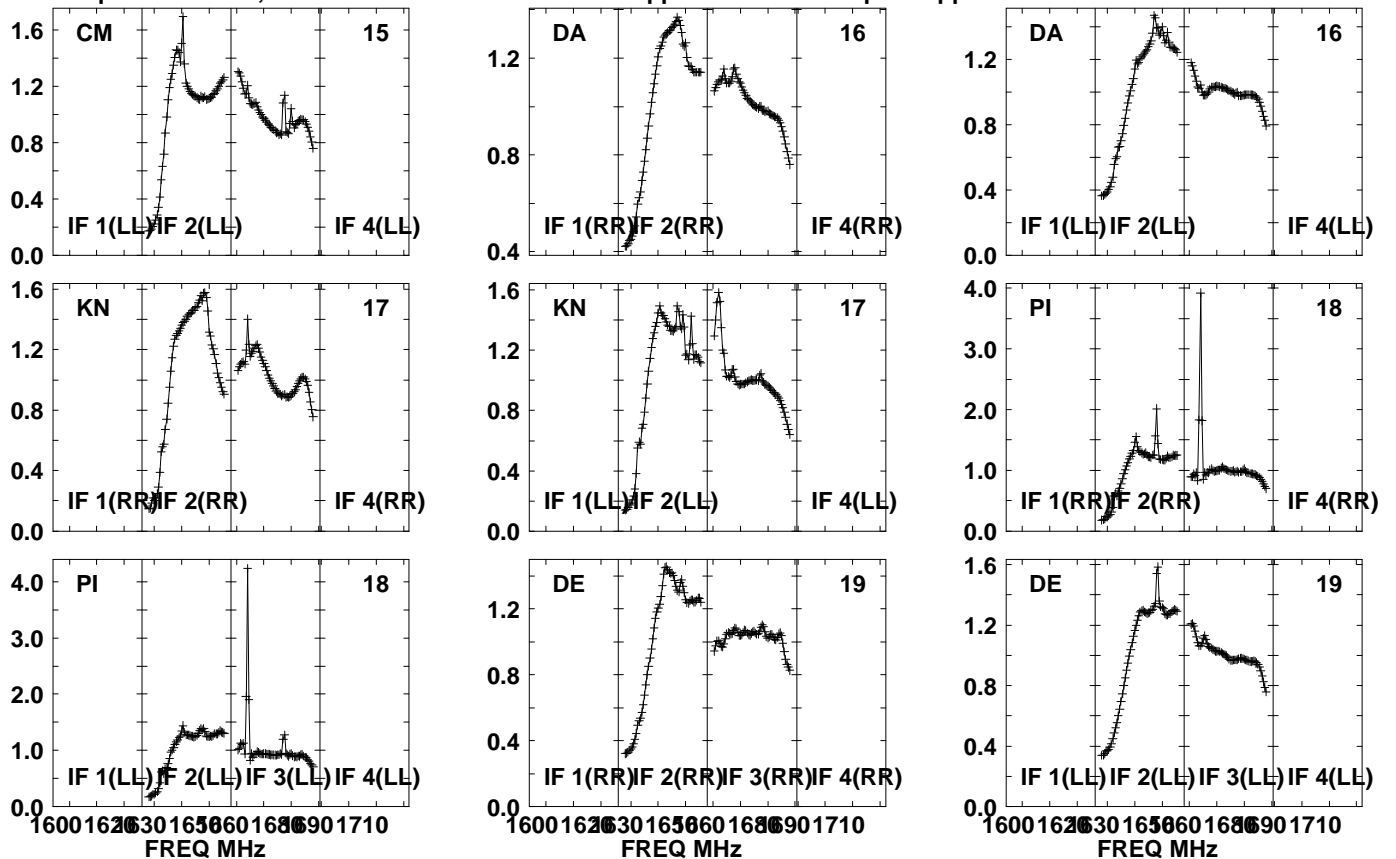

Lower frame: Real Jy  
Auto-corr total-power spectrum Antenna: \*  
Timerange: 00/18:44:01 to 00/18:45:29

Plot file version 946 created 05-OCT-2021 17:09:06

J0827+5217 GM076.UVDATA.1

Freq = 1.5945 GHz, Bw = 32.000 MH No calibration applied and no bandpass applied

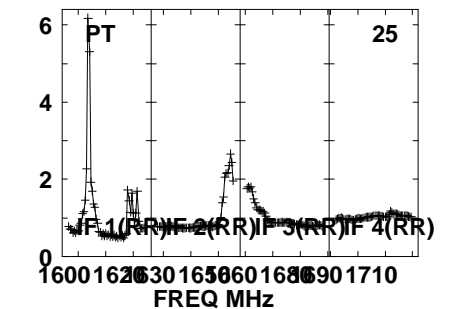
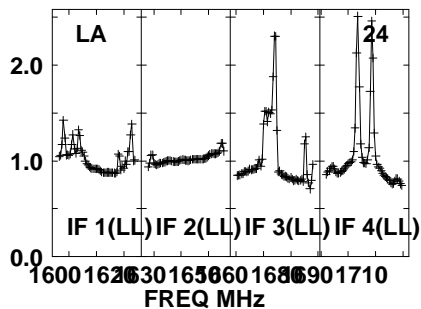
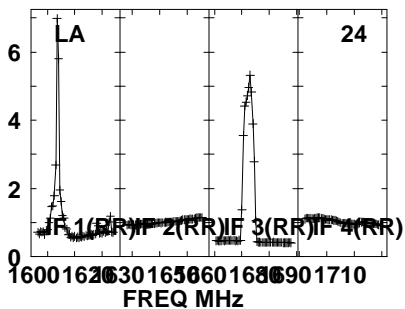
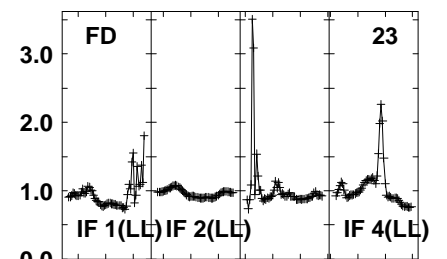
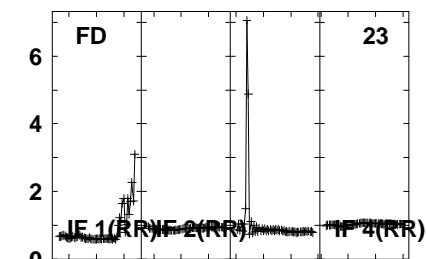
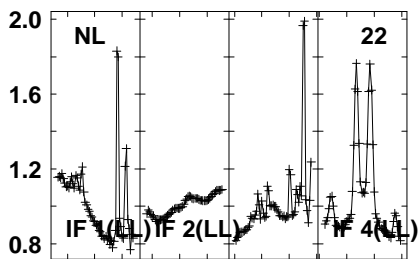
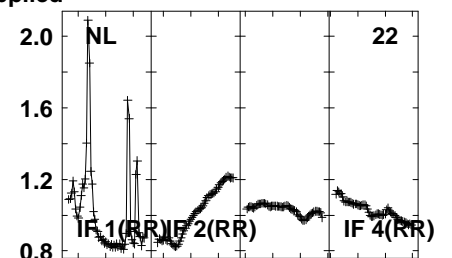
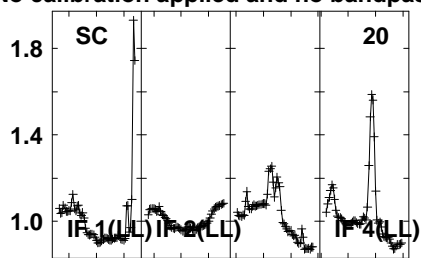
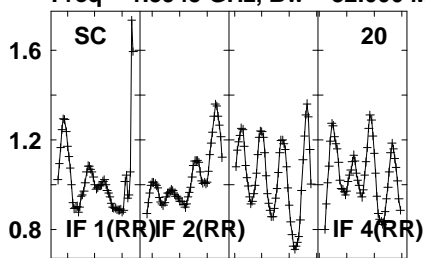

Lower frame: Real Jy  
Auto-corr total-power spectrum Antenna: \*  
Timerange: 00/18:44:01 to 00/18:45:29



Plot file version 947 created 05-OCT-2021 17:09:06

J0827+5217 GM076.UVDATA.1

Freq = 1.5945 GHz, Bw = 32.000 MH No calibration applied and no bandpass applied

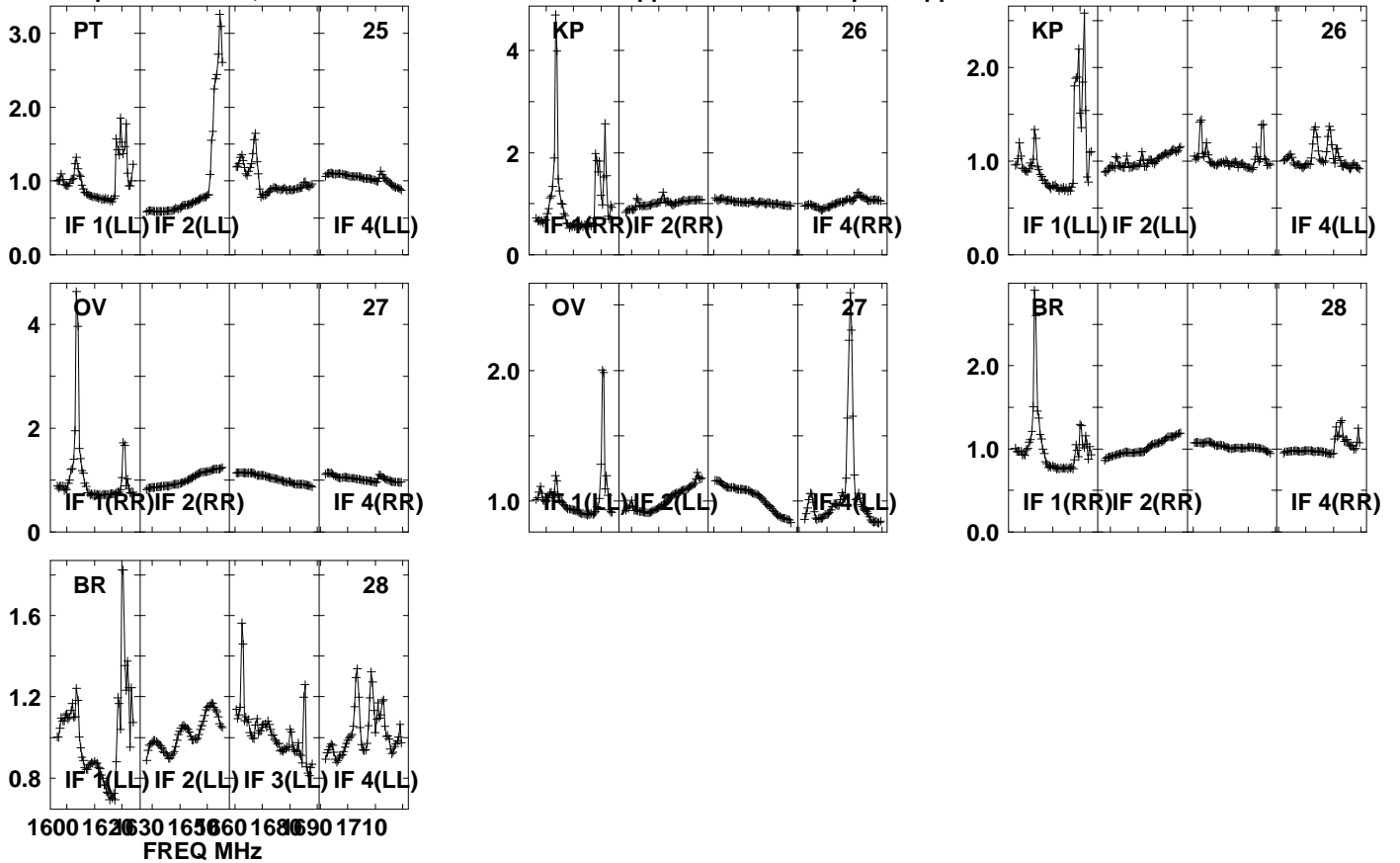

Lower frame: Real Jy

Auto-corr total-power spectrum Antenna: \*

Timerange: 00/18:44:01 to 00/18:45:29

Plot file version 948 created 05-OCT-2021 17:09:06

APM08279+525 GM076.UVDATA.1

Freq = 1.5945 GHz, Bw = 32.000 MH No calibration applied and no bandpass applied

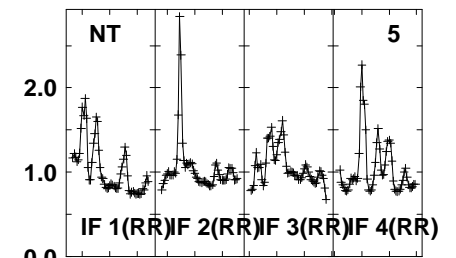
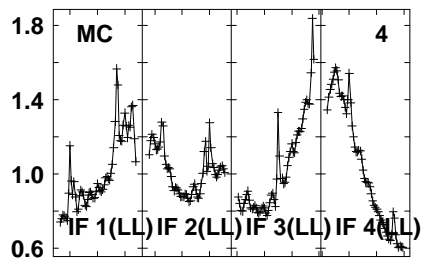
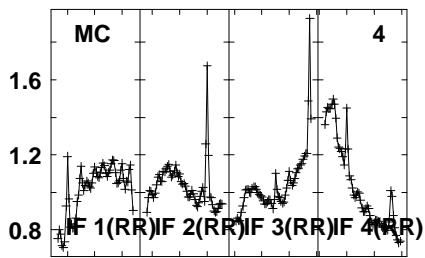
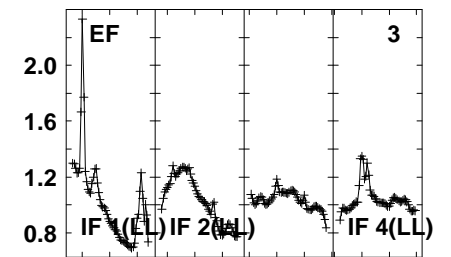
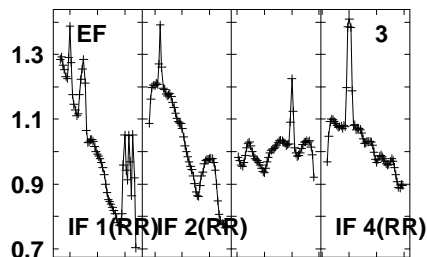
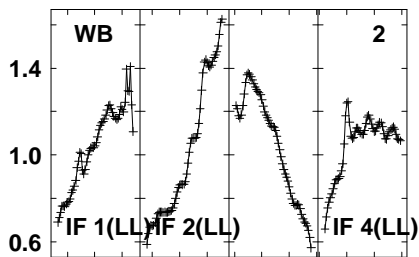
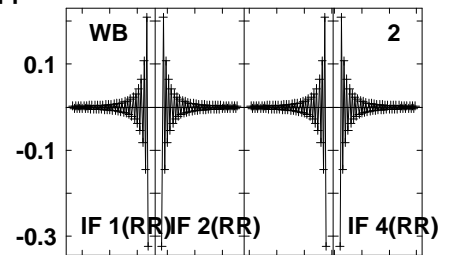
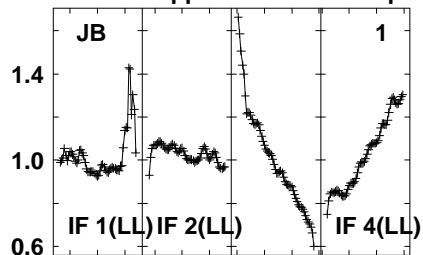
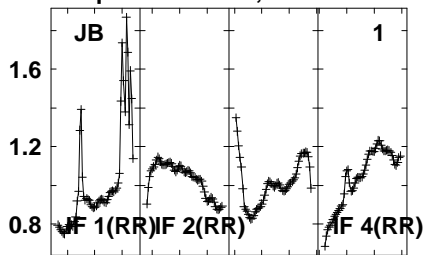

1600 1620 1630 1650 1660 1680 1690 1710  
FREQ MHz

1600 1620 1630 1650 1660 1680 1690 1710  
FREQ MHz

1600 1620 1630 1650 1660 1680 1690 1710  
FREQ MHz

Lower frame: Real Jy  
Auto-corr total-power spectrum Antenna: \*  
Timerange: 00/18:45:31 to 00/18:48:59

Plot file version 949 created 05-OCT-2021 17:09:07

APM08279+525 GM076.UVDATA.1

Freq = 1.5945 GHz, Bw = 32.000 MH No calibration applied and no bandpass applied

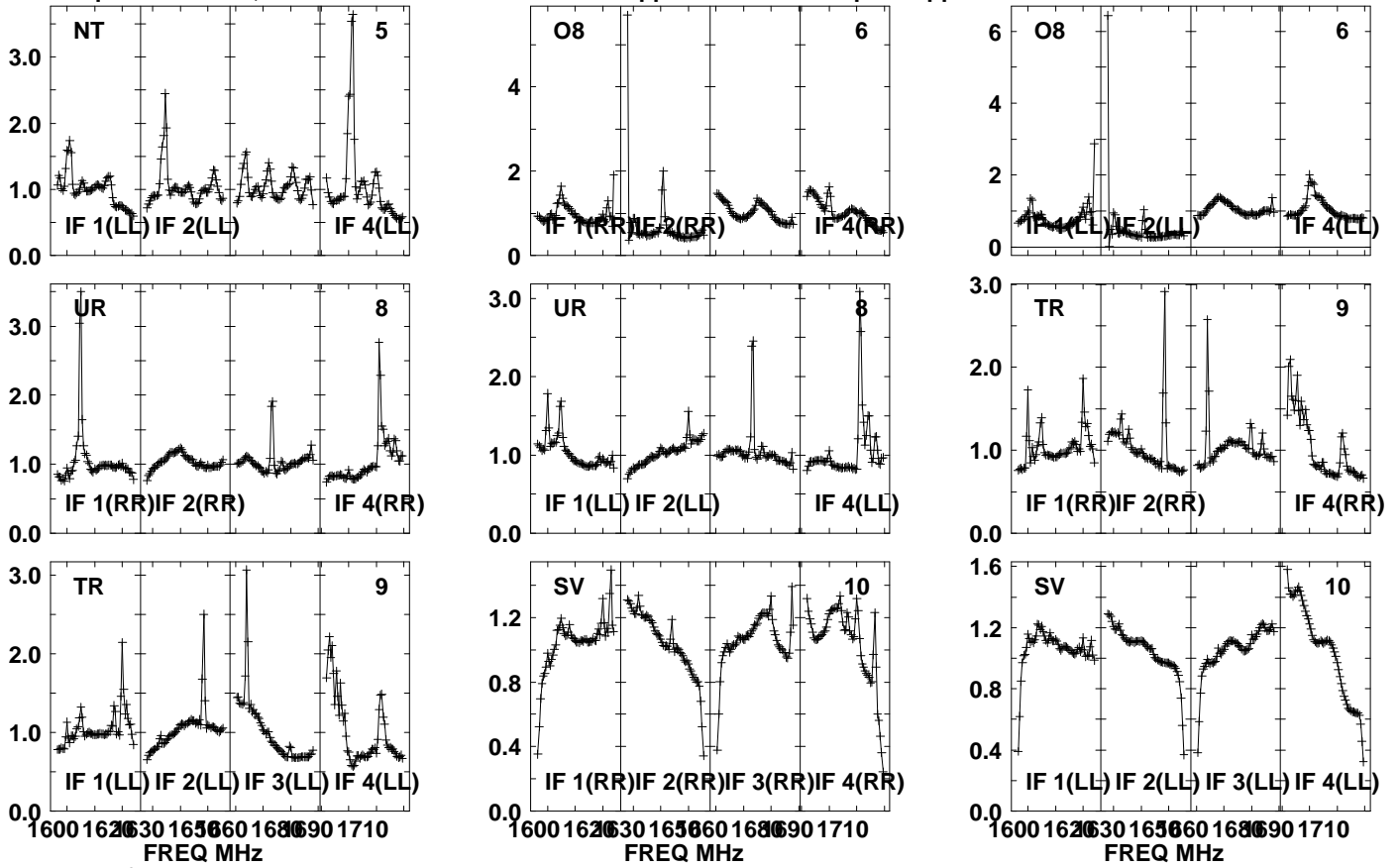

Lower frame: Real Jy

Auto-corr total-power spectrum Antenna: \*

Timerange: 00/18:45:31 to 00/18:48:59

Plot file version 950 created 05-OCT-2021 17:09:07

APM08279+525 GM076.UVDATA.1

Freq = 1.5945 GHz, Bw = 32.000 MH No calibration applied and no bandpass applied

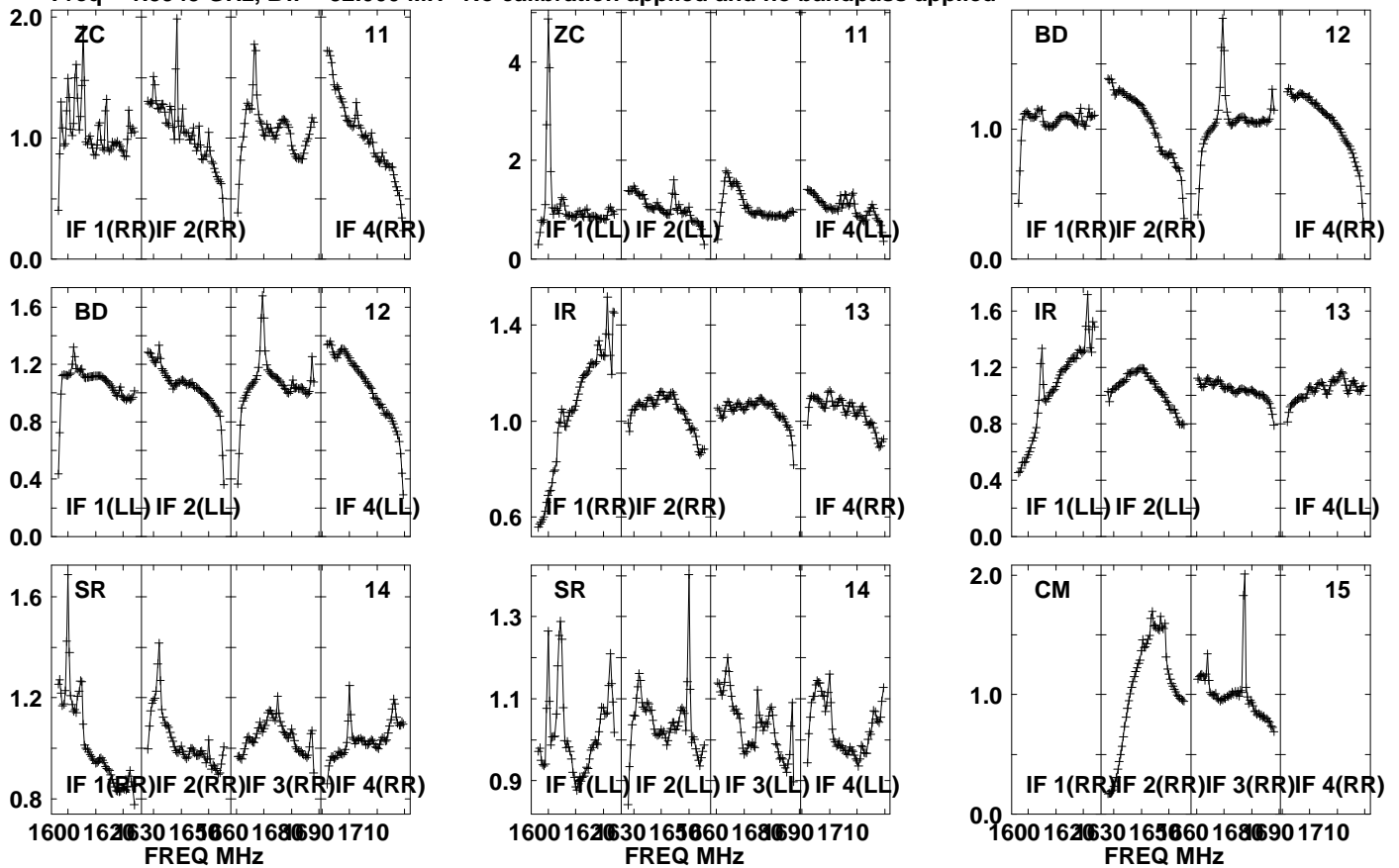

Lower frame: Real Jy

Auto-corr total-power spectrum Antenna: \*

Timerange: 00/18:45:31 to 00/18:48:59

Plot file version 951 created 05-OCT-2021 17:09:07

APM08279+525 GM076.UVDATA.1

Freq = 1.5945 GHz, Bw = 32.000 MH No calibration applied and no bandpass applied

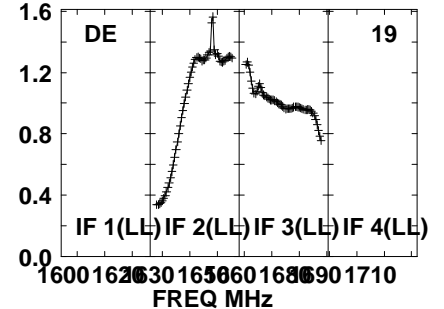
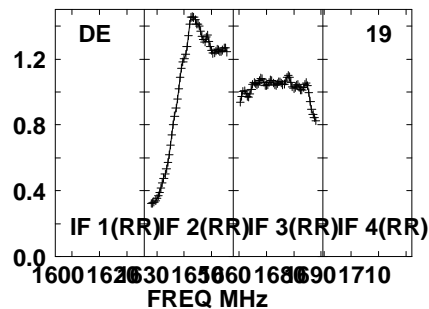
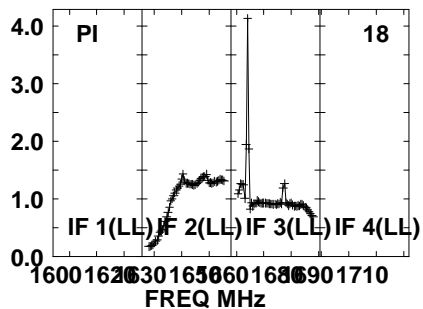
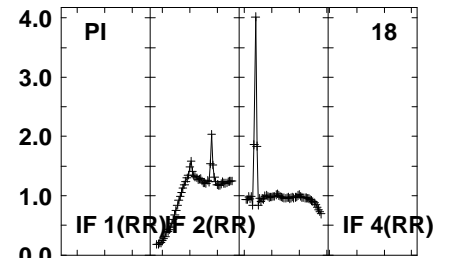
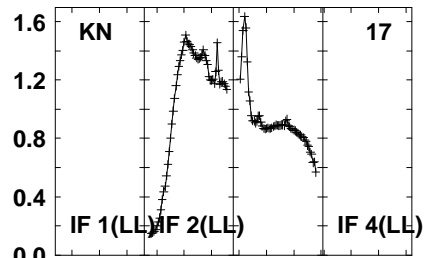
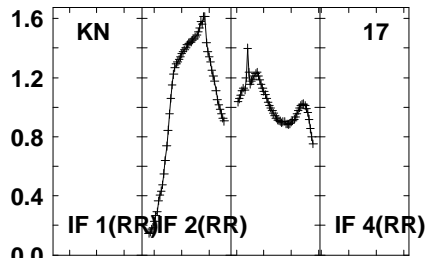
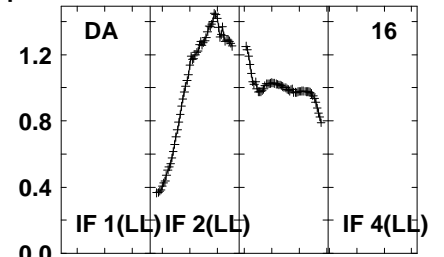
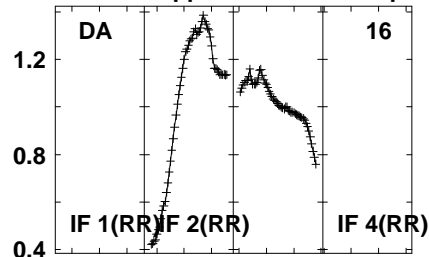
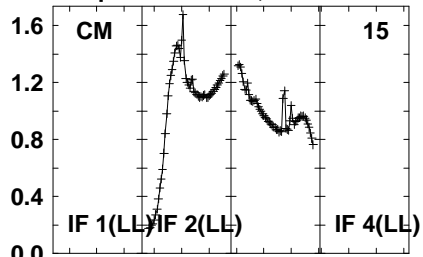

Lower frame: Real Jy  
Auto-corr total-power spectrum Antenna: \*  
Timerange: 00/18:45:31 to 00/18:48:59

Plot file version 952 created 05-OCT-2021 17:09:07

APM08279+525 GM076.UVDATA.1

Freq = 1.5945 GHz, Bw = 32.000 MH No calibration applied and no bandpass applied

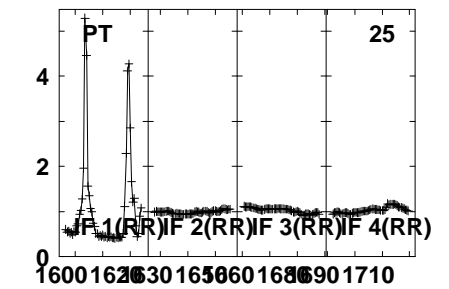
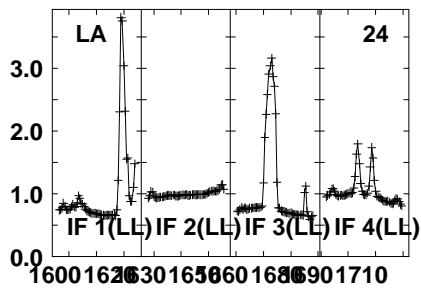
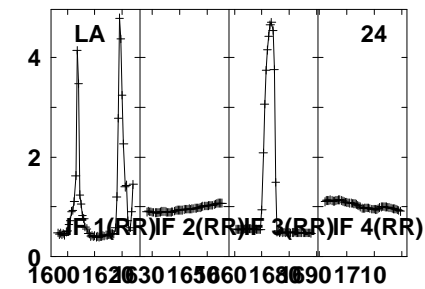
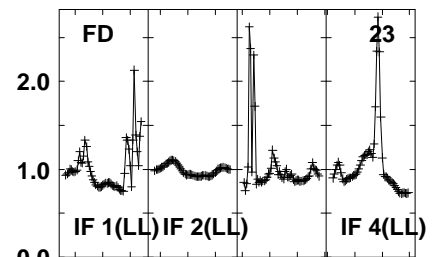
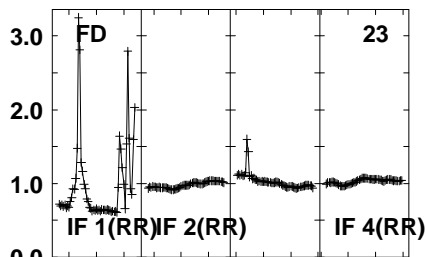
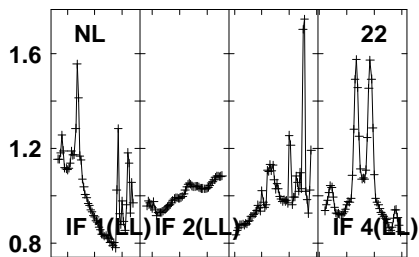
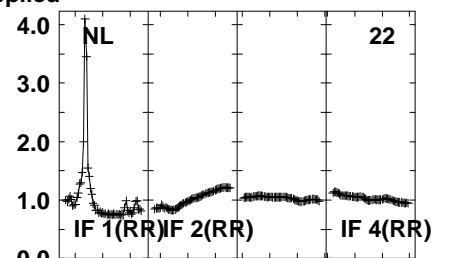
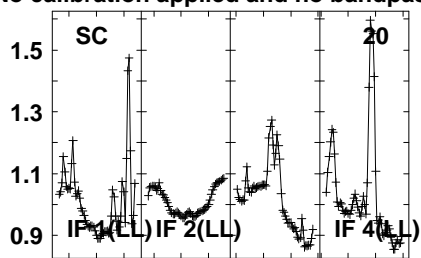
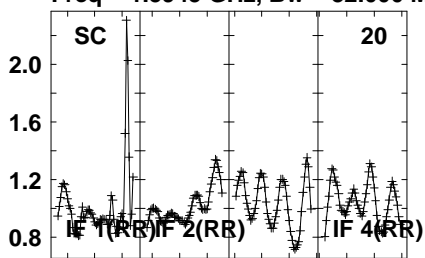

Lower frame: Real Jy  
Auto-corr total-power spectrum Antenna: \*  
Timerange: 00/18:45:31 to 00/18:48:59

Plot file version 953 created 05-OCT-2021 17:09:08

APM08279+525 GM076.UVDATA.1

Freq = 1.5945 GHz, Bw = 32.000 MH No calibration applied and no bandpass applied

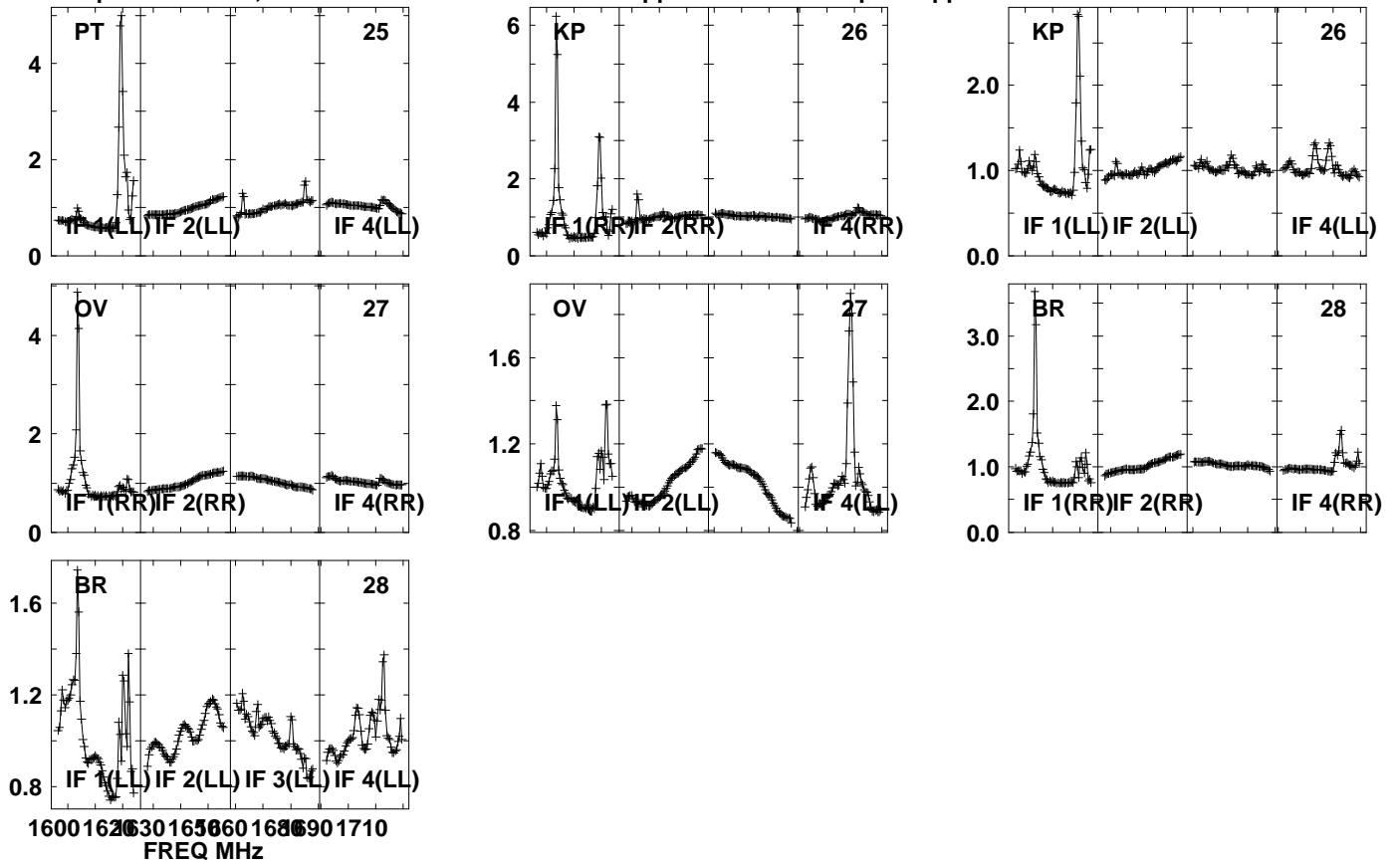

Lower frame: Real Jy

Auto-corr total-power spectrum Antenna: \*

Timerange: 00/18:45:31 to 00/18:48:59

Plot file version 954 created 05-OCT-2021 17:09:08

J0827+5217 GM076.UVDATA.1

Freq = 1.5945 GHz, Bw = 32.000 MH No calibration applied and no bandpass applied

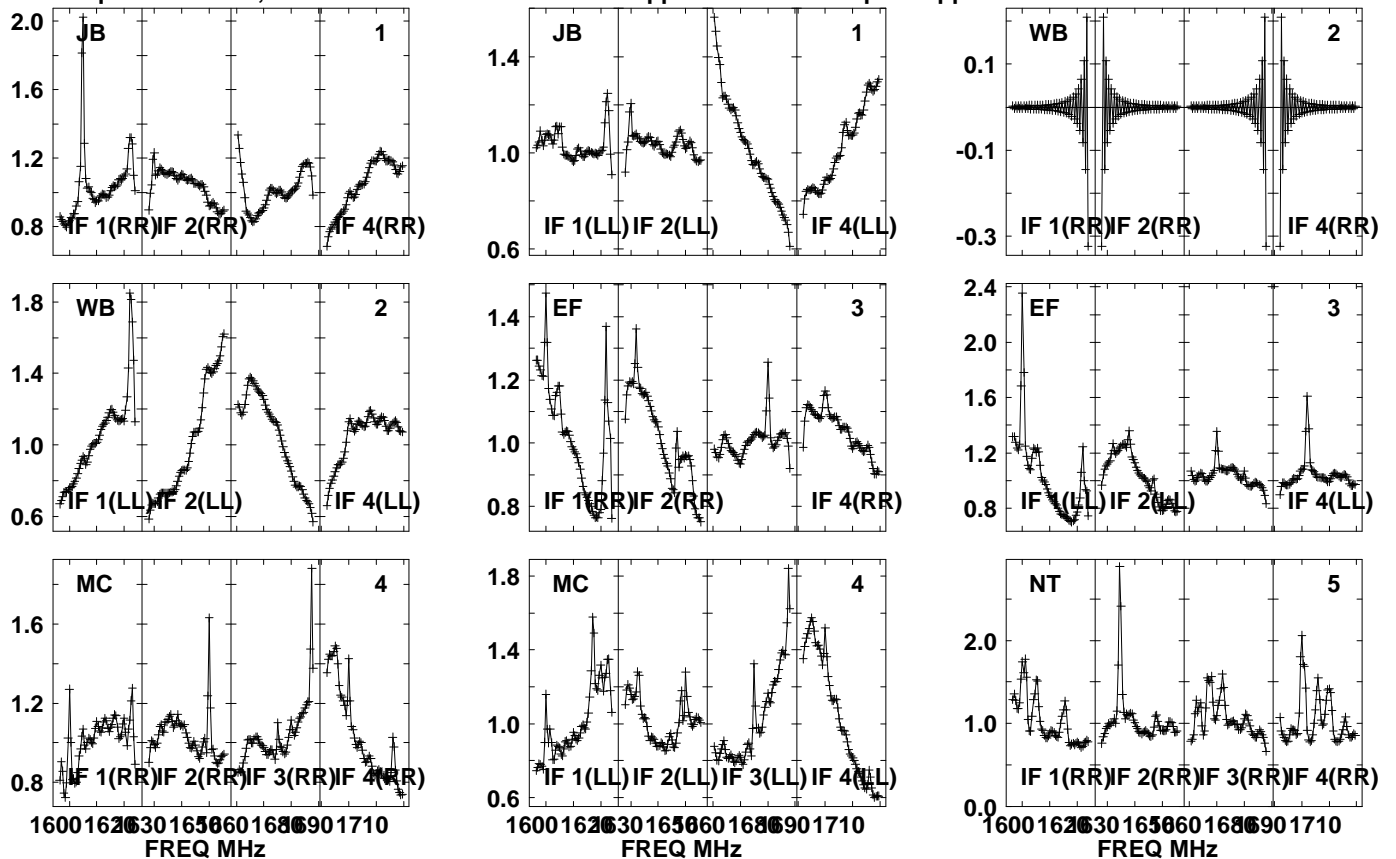

Lower frame: Real Jy  
Auto-corr total-power spectrum Antenna: \*  
Timerange: 00/18:49:01 to 00/18:50:29



Plot file version 955 created 05-OCT-2021 17:09:08

J0827+5217 GM076.UVDATA.1

Freq = 1.5945 GHz, Bw = 32.000 MH No calibration applied and no bandpass applied

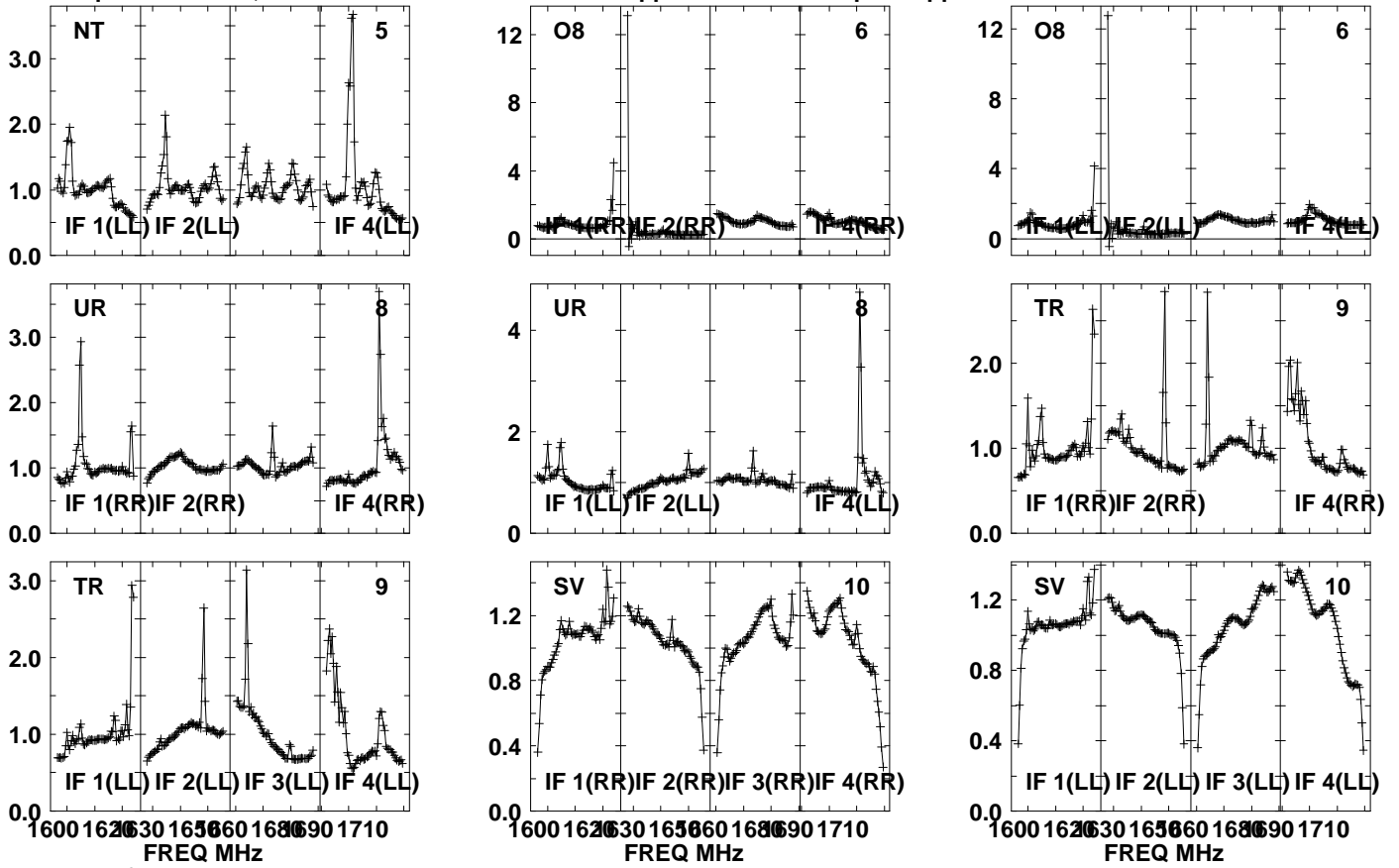

Lower frame: Real Jy

Auto-corr total-power spectrum Antenna: \*

Timerange: 00/18:49:01 to 00/18:50:29

Plot file version 956 created 05-OCT-2021 17:09:09

J0827+5217 GM076.UVDATA.1

Freq = 1.5945 GHz, Bw = 32.000 MH No calibration applied and no bandpass applied

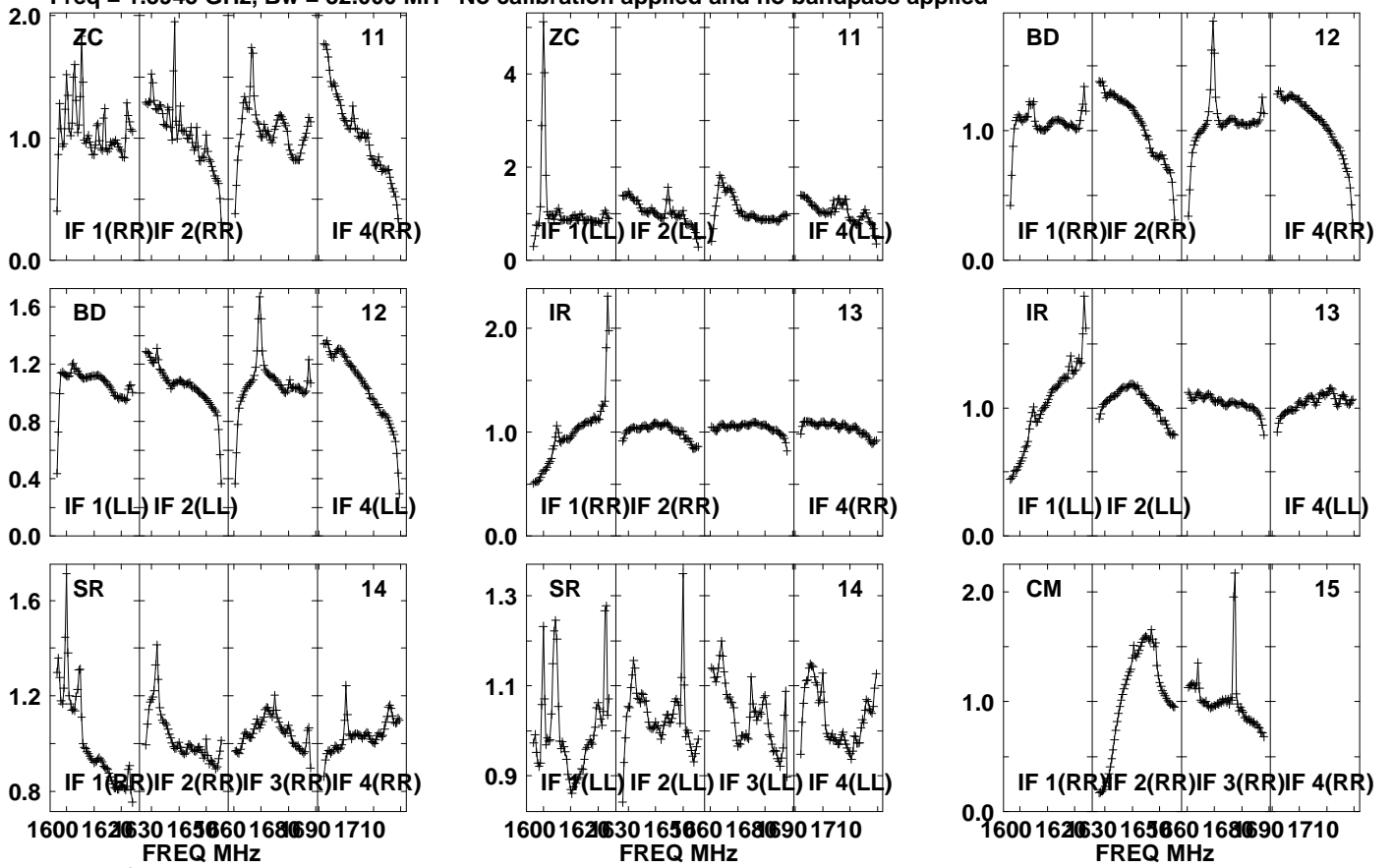

Lower frame: Real Jy  
Auto-corr total-power spectrum Antenna: \*  
Timerange: 00/18:49:01 to 00/18:50:29

Plot file version 957 created 05-OCT-2021 17:09:09

J0827+5217 GM076.UVDATA.1

Freq = 1.5945 GHz, Bw = 32.000 MH No calibration applied and no bandpass applied

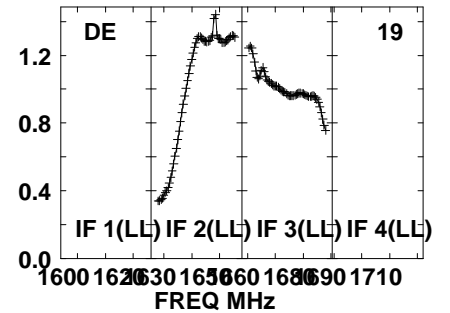
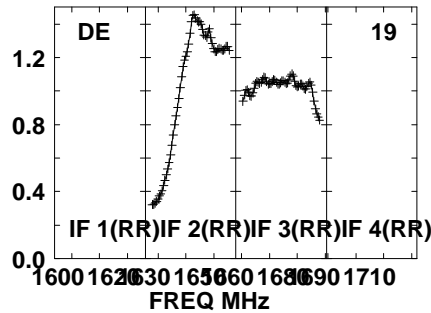
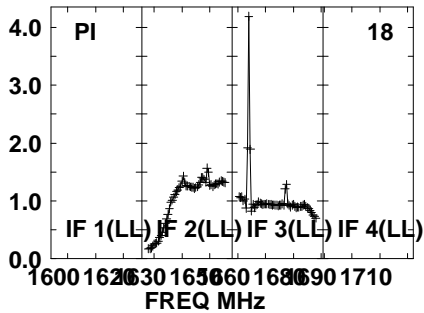
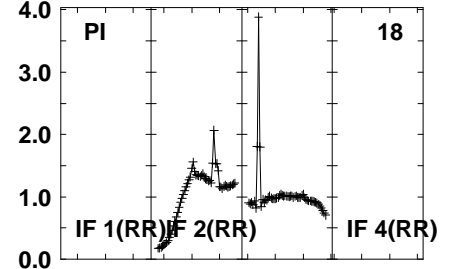
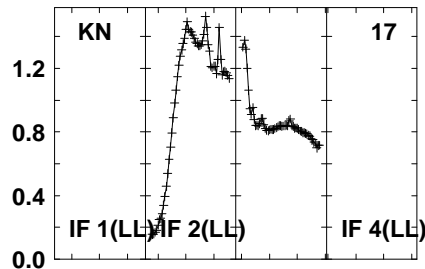
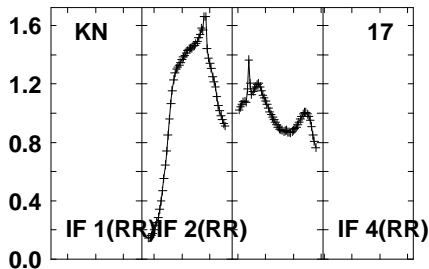
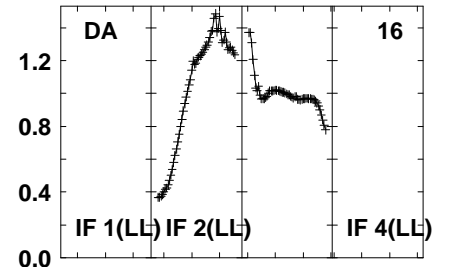
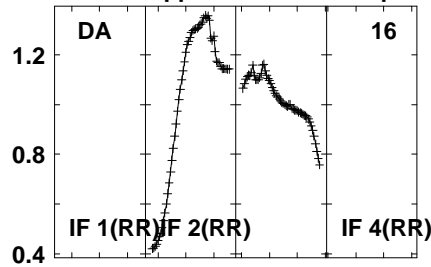
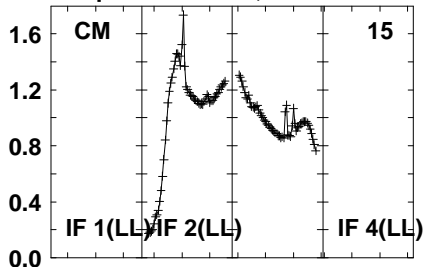

Lower frame: Real Jy

Auto-corr total-power spectrum Antenna: \*

Timerange: 00/18:49:01 to 00/18:50:29

Plot file version 958 created 05-OCT-2021 17:09:09

J0827+5217 GM076.UVDATA.1

Freq = 1.5945 GHz, Bw = 32.000 MH No calibration applied and no bandpass applied

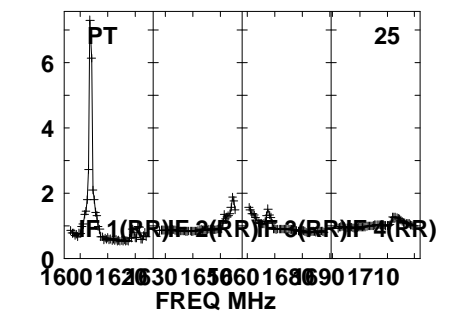
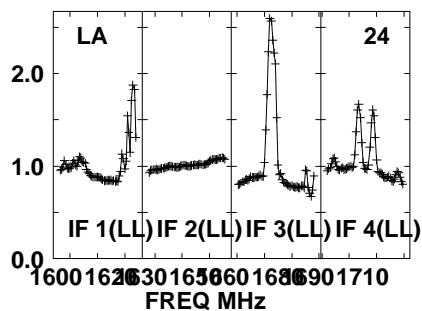
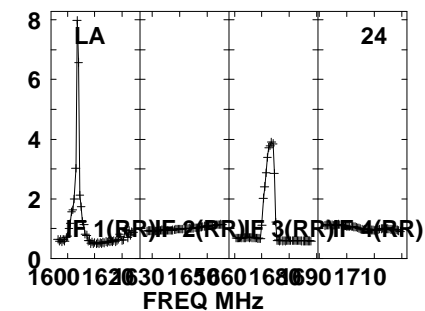
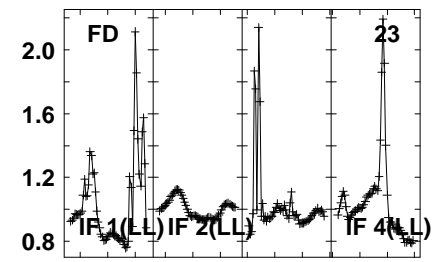
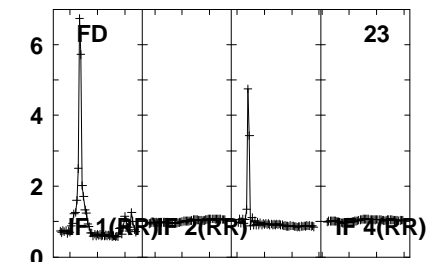
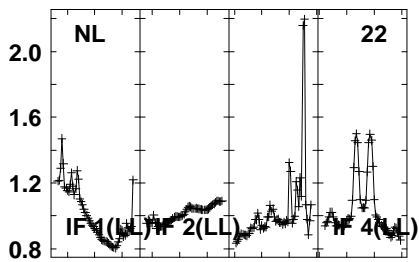
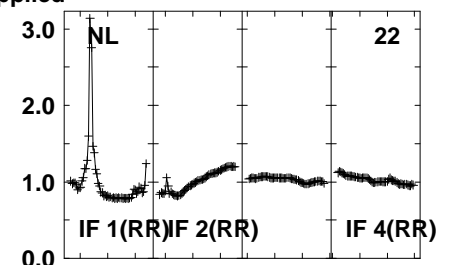
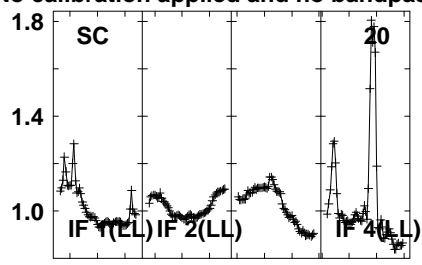
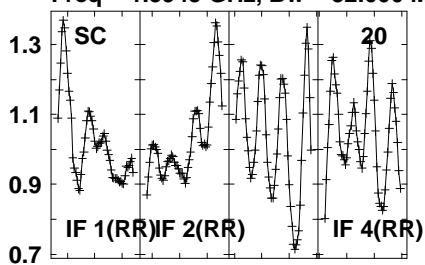

Lower frame: Real Jy  
Auto-corr total-power spectrum Antenna: \*  
Timerange: 00/18:49:01 to 00/18:50:29

Plot file version 959 created 05-OCT-2021 17:09:10

J0827+5217 GM076.UVDATA.1

Freq = 1.5945 GHz, Bw = 32.000 MH No calibration applied and no bandpass applied

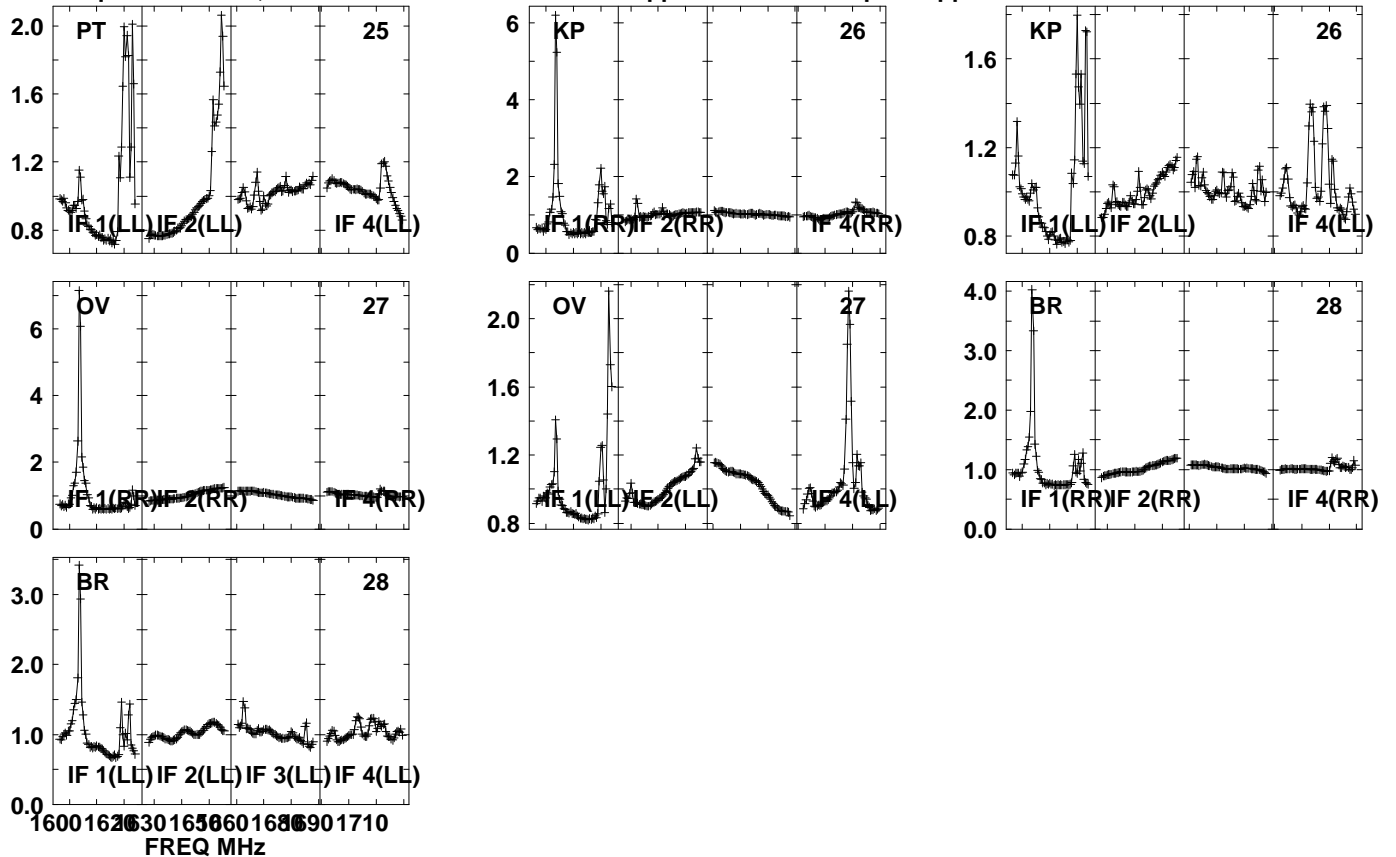

Lower frame: Real Jy  
Auto-corr total-power spectrum Antenna: \*  
Timerange: 00/18:49:01 to 00/18:50:29

Plot file version 960 created 05-OCT-2021 17:09:10

APM08279+525 GM076.UVDATA.1

Freq = 1.5945 GHz, Bw = 32.000 MH No calibration applied and no bandpass applied

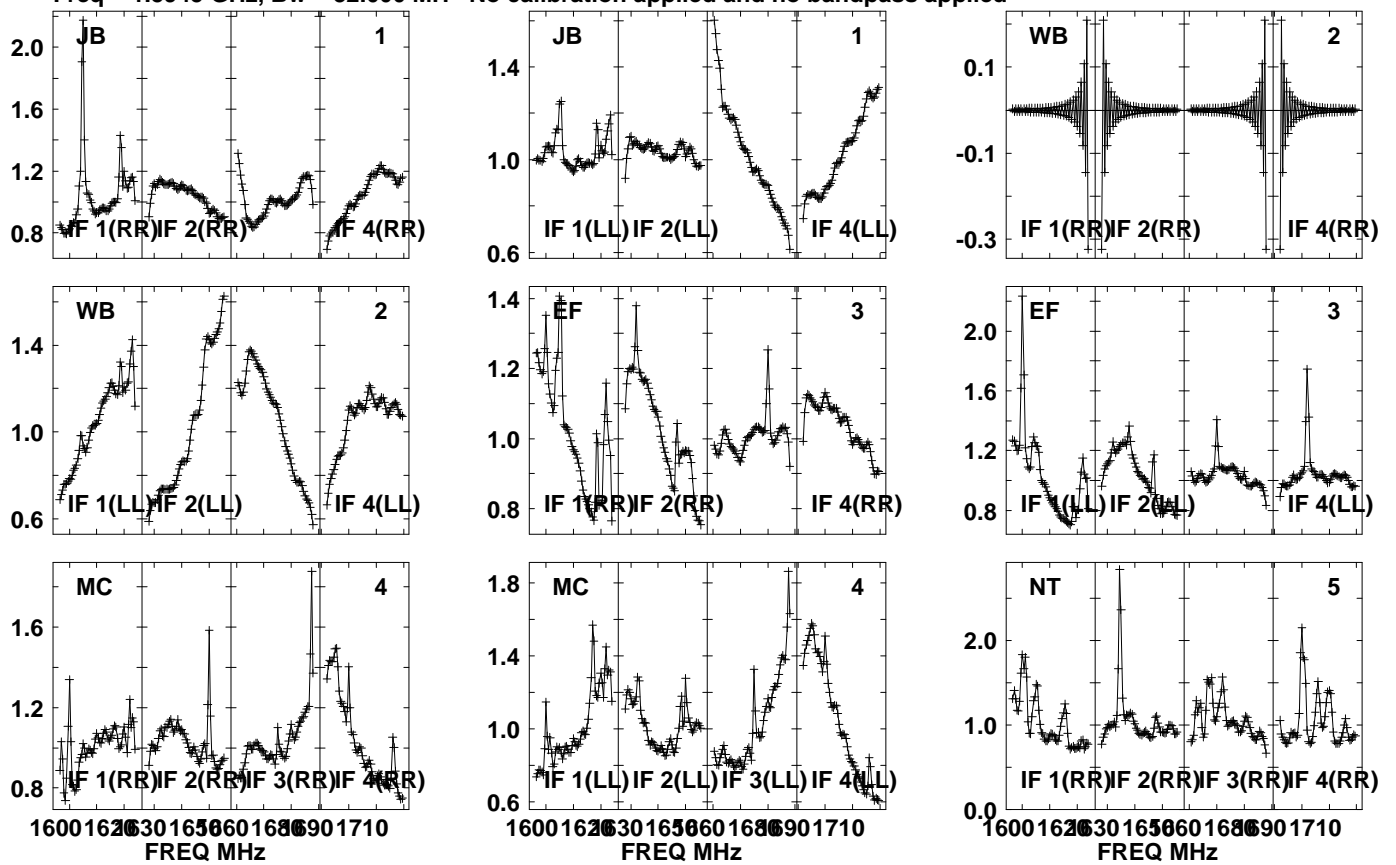

Lower frame: Real Jy  
Auto-corr total-power spectrum Antenna: \*  
Timerange: 00/18:50:31 to 00/18:53:59

Plot file version 961 created 05-OCT-2021 17:09:10

APM08279+525 GM076.UVDATA.1

Freq = 1.5945 GHz, Bw = 32.000 MH No calibration applied and no bandpass applied

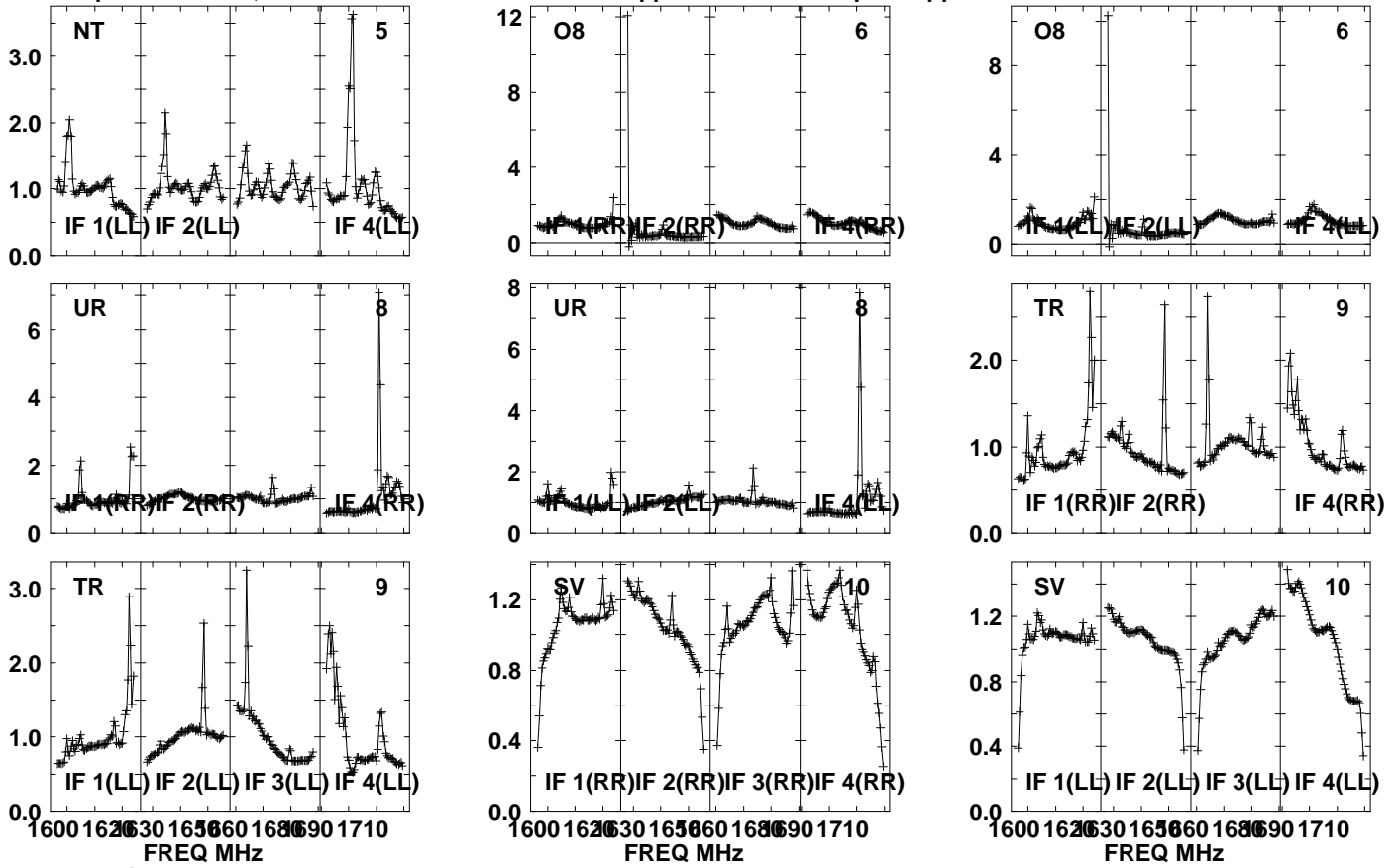

Lower frame: Real Jy

Auto-corr total-power spectrum Antenna: \*

Timerange: 00/18:50:31 to 00/18:53:59

Plot file version 962 created 05-OCT-2021 17:09:11

APM08279+525 GM076.UVDATA.1

Freq = 1.5945 GHz, Bw = 32.000 MH No calibration applied and no bandpass applied

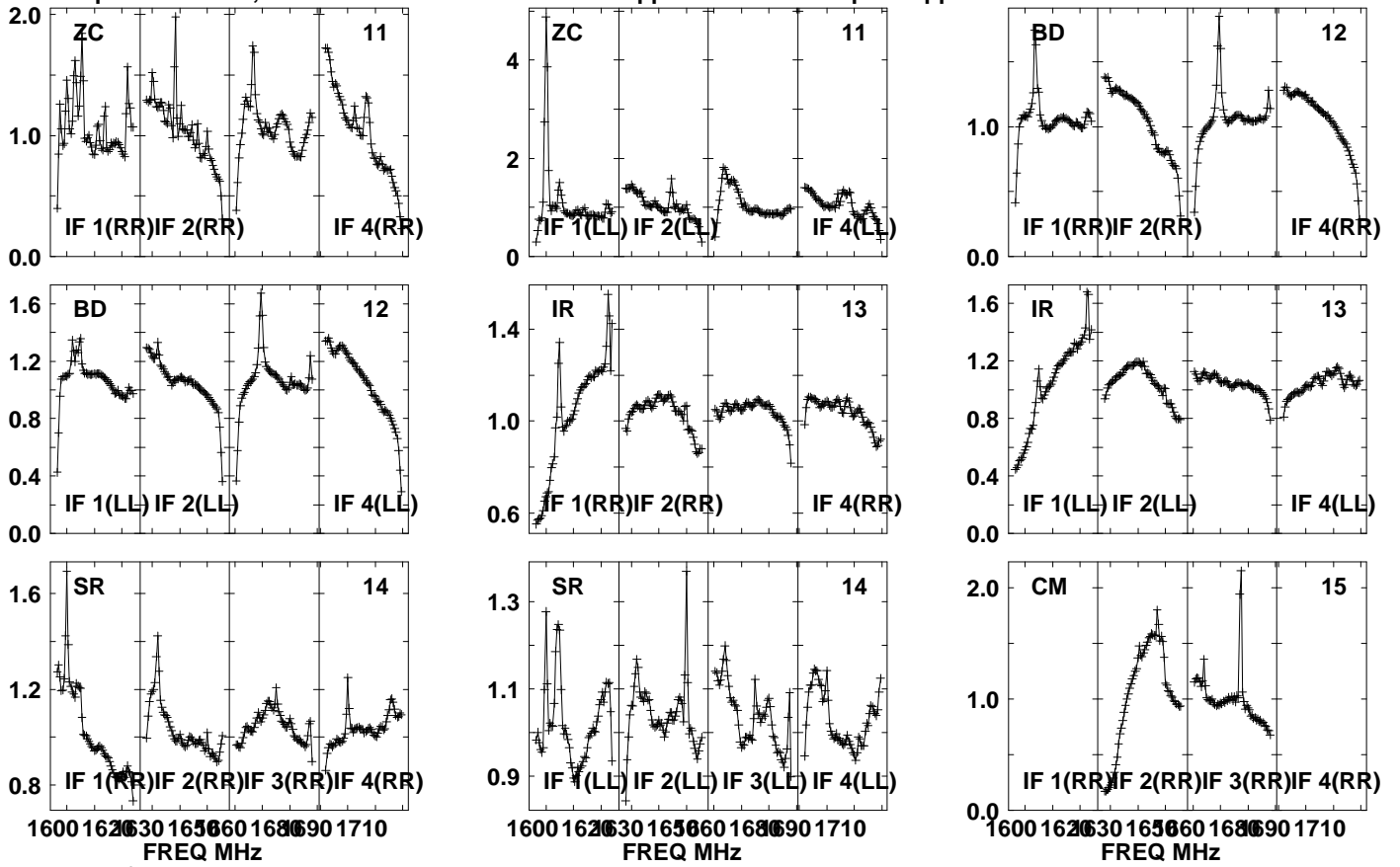

Lower frame: Real Jy  
Auto-corr total-power spectrum Antenna: \*  
Timerange: 00/18:50:31 to 00/18:53:59



Plot file version 963 created 05-OCT-2021 17:09:11

APM08279+525 GM076.UVDATA.1

Freq = 1.5945 GHz, Bw = 32.000 MH No calibration applied and no bandpass applied

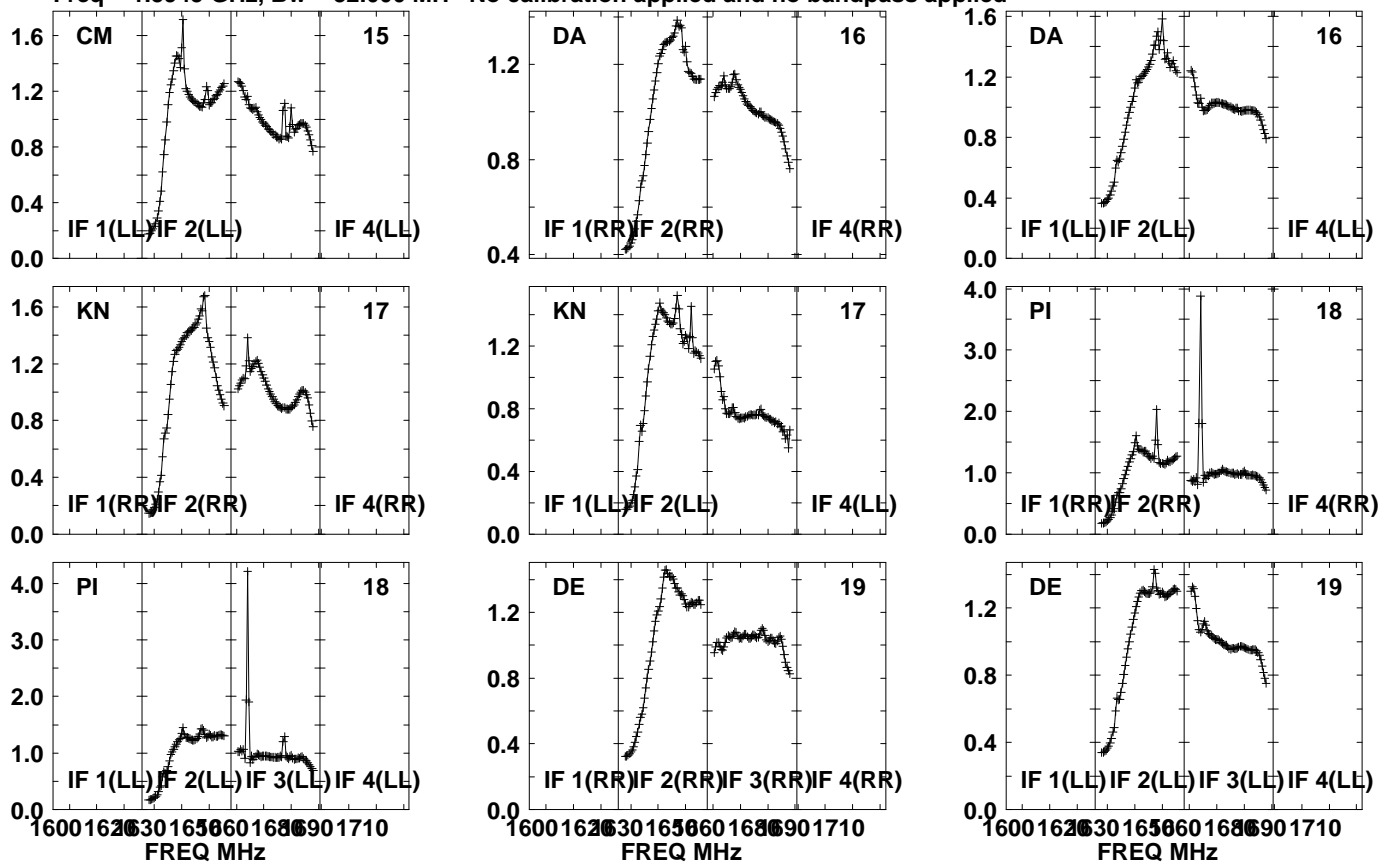

Lower frame: Real Jy  
Auto-corr total-power spectrum Antenna: \*  
Timerange: 00/18:50:31 to 00/18:53:59

Plot file version 964 created 05-OCT-2021 17:09:11

APM08279+525 GM076.UVDATA.1

Freq = 1.5945 GHz, Bw = 32.000 MH No calibration applied and no bandpass applied

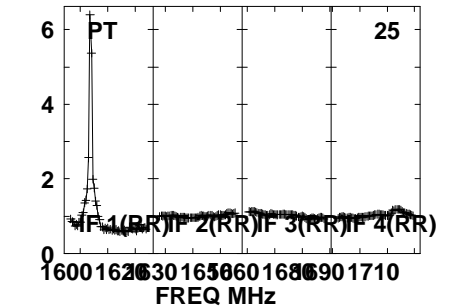
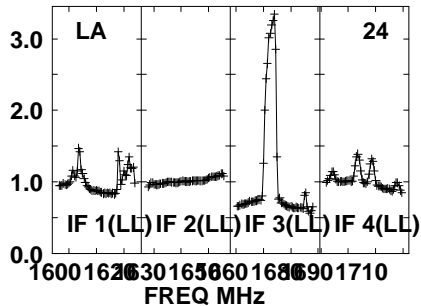
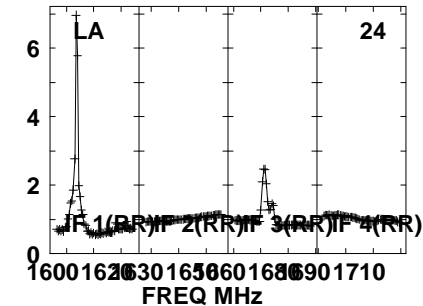
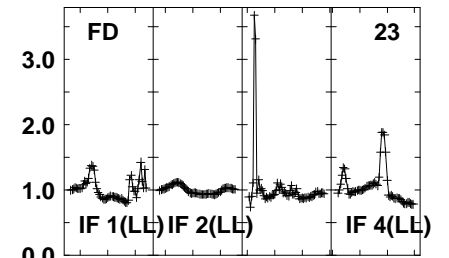
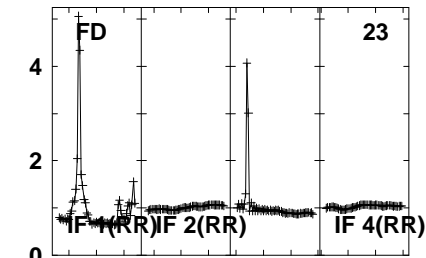
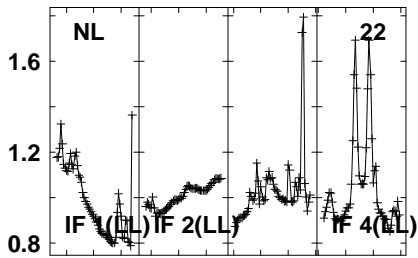
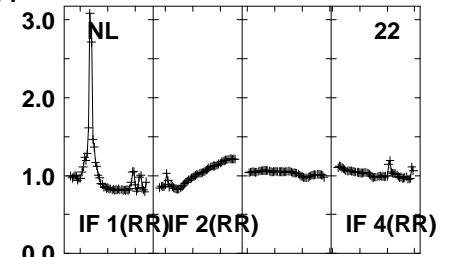
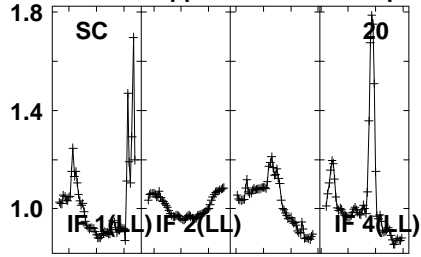
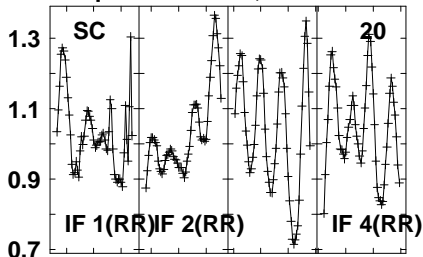

Lower frame: Real Jy  
Auto-corr total-power spectrum Antenna: \*  
Timerange: 00/18:50:31 to 00/18:53:59

Plot file version 965 created 05-OCT-2021 17:09:12

APM08279+525 GM076.UVDATA.1

Freq = 1.5945 GHz, Bw = 32.000 MH No calibration applied and no bandpass applied

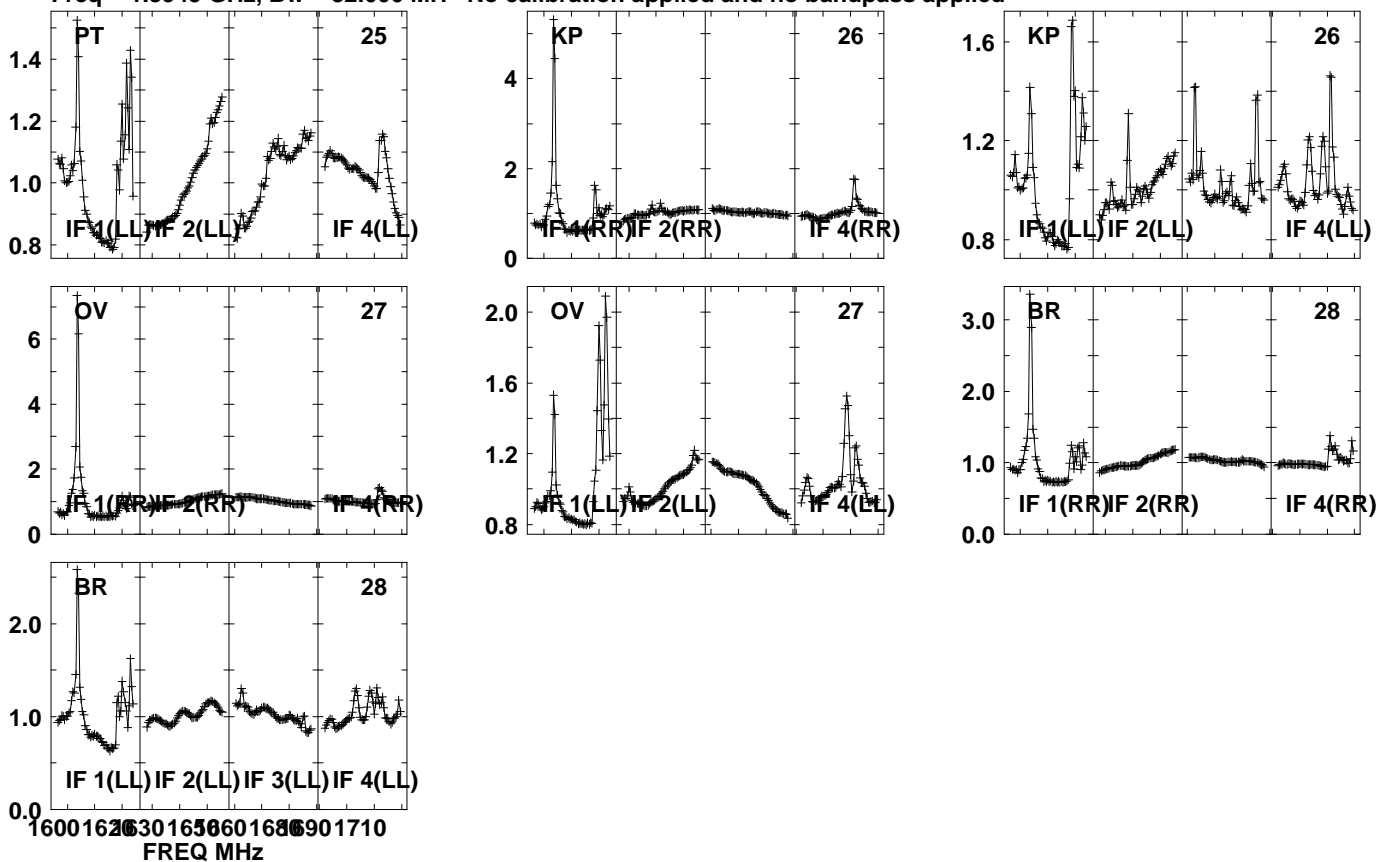

Lower frame: Real Jy  
Auto-corr total-power spectrum Antenna: \*  
Timerange: 00/18:50:31 to 00/18:53:59

Plot file version 966 created 05-OCT-2021 17:09:12

J0827+5217 GM076.UVDATA.1

Freq = 1.5945 GHz, Bw = 32.000 MH No calibration applied and no bandpass applied

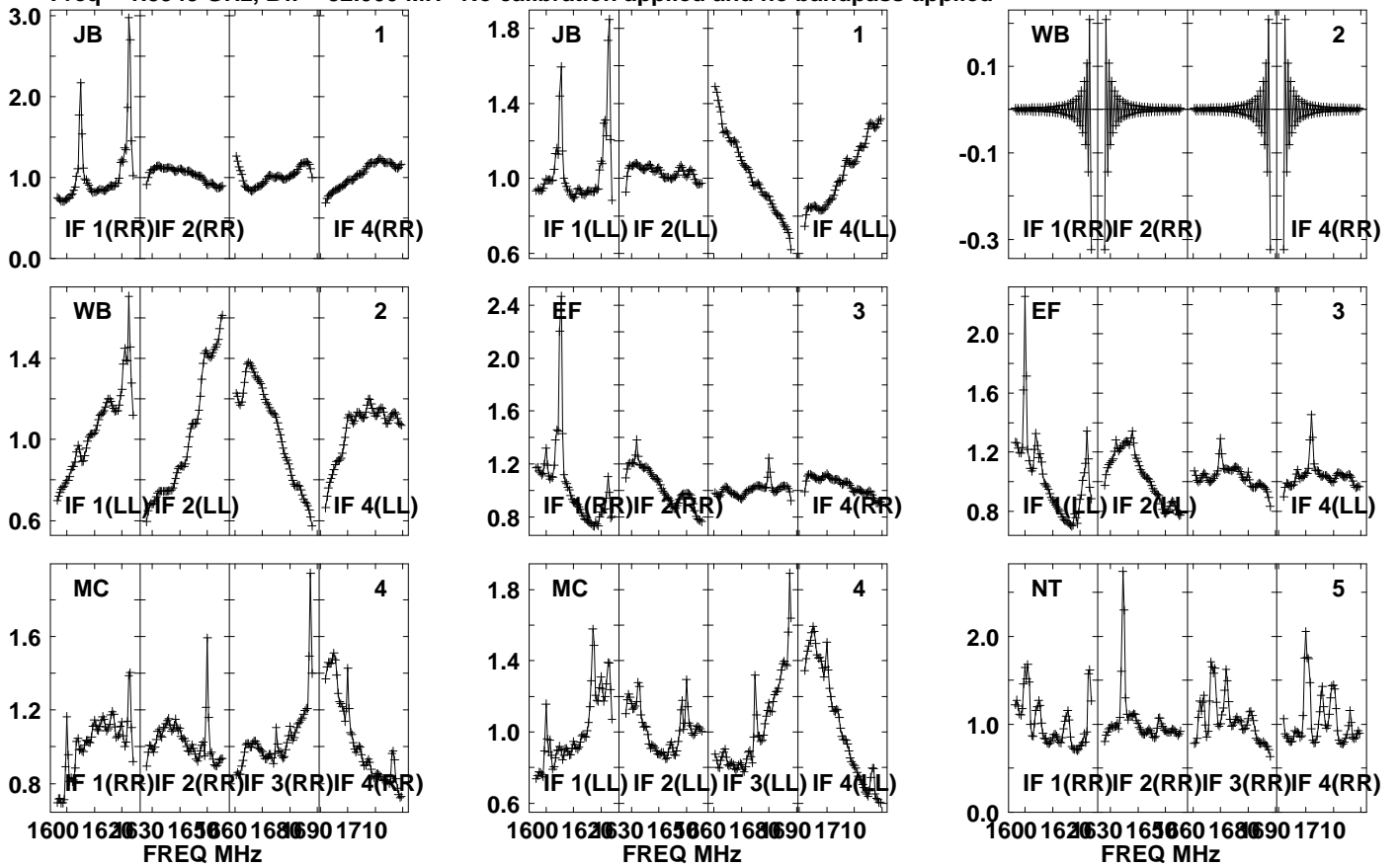

Lower frame: Real Jy  
Auto-corr total-power spectrum Antenna: \*  
Timerange: 00/18:54:31 to 00/18:55:59

Plot file version 967 created 05-OCT-2021 17:09:12

J0827+5217 GM076.UVDATA.1

Freq = 1.5945 GHz, Bw = 32.000 MH No calibration applied and no bandpass applied

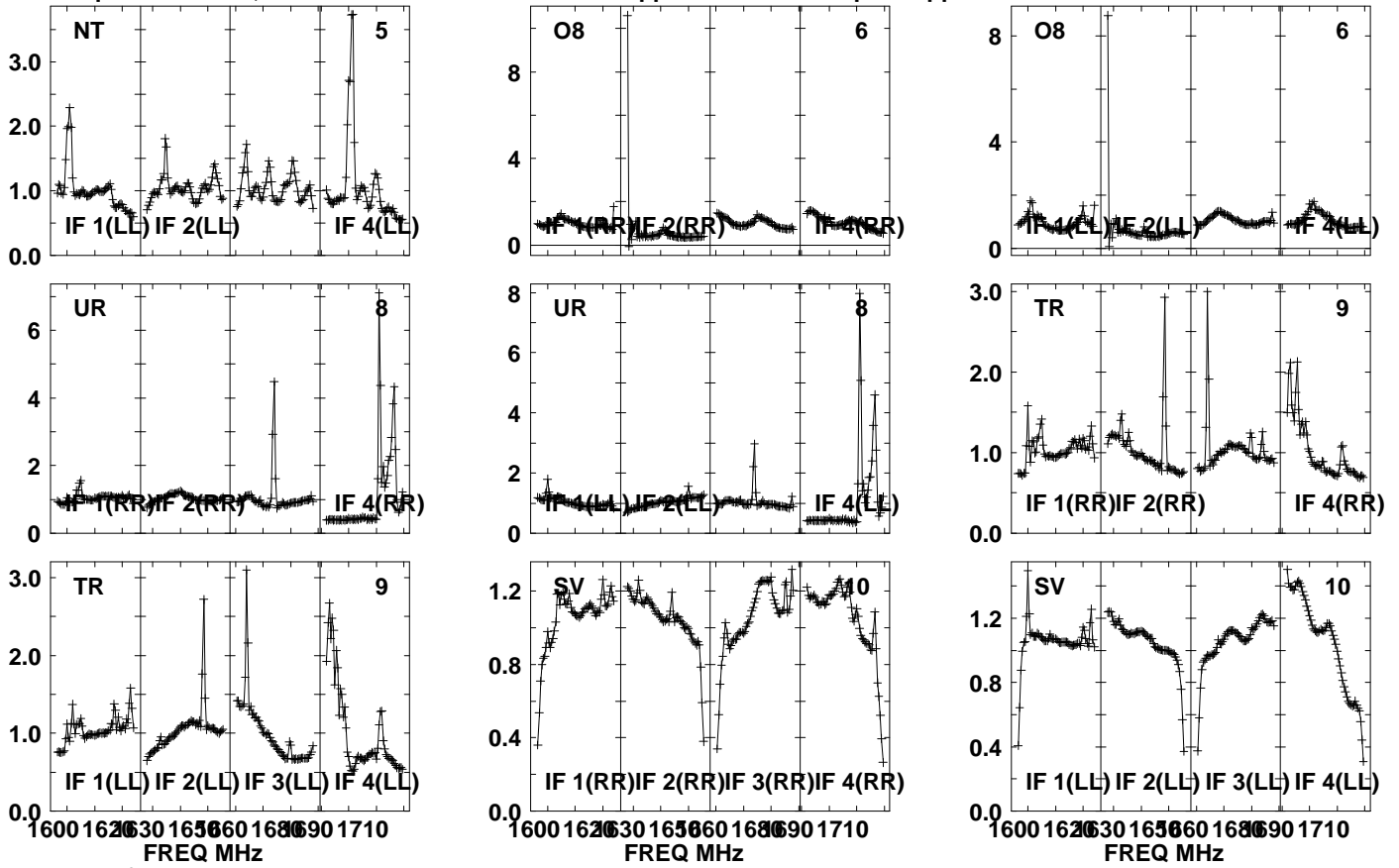

Lower frame: Real Jy

Auto-corr total-power spectrum Antenna: \*

Timerange: 00/18:54:31 to 00/18:55:59

Plot file version 968 created 05-OCT-2021 17:09:12

J0827+5217 GM076.UVDATA.1

Freq = 1.5945 GHz, Bw = 32.000 MH No calibration applied and no bandpass applied

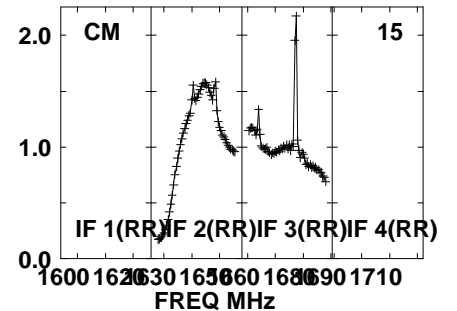
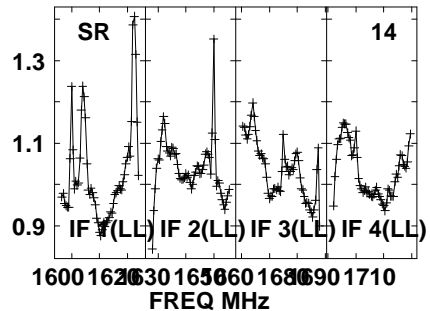
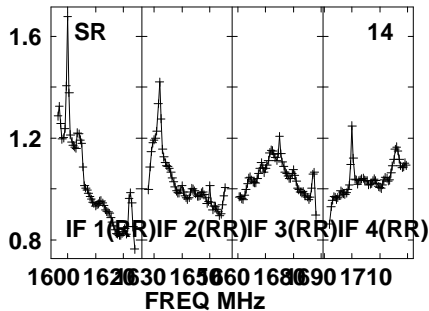
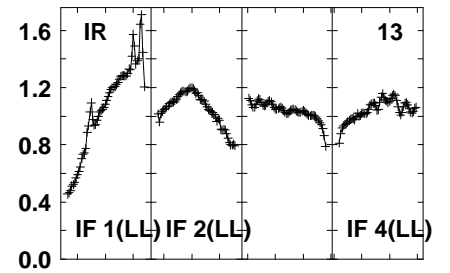
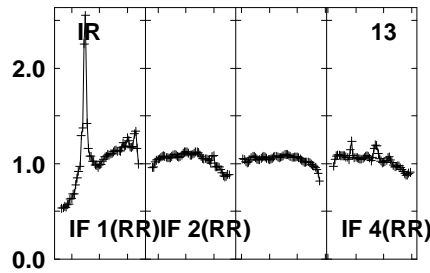
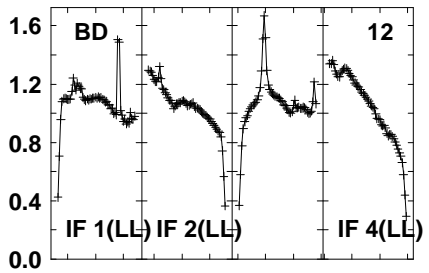
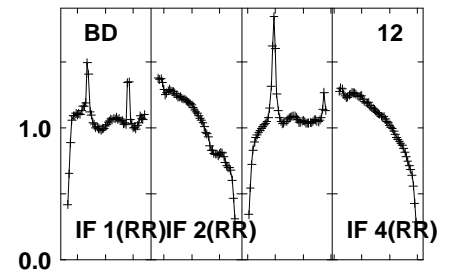
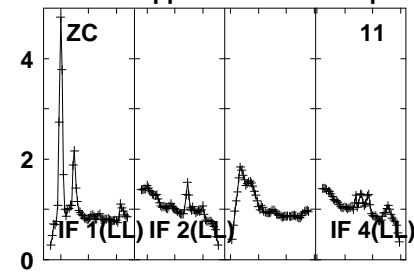
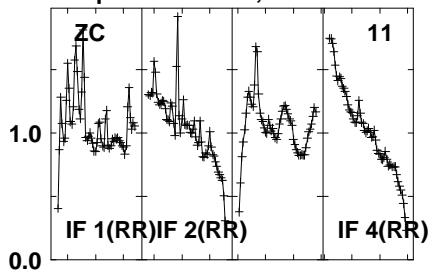

Lower frame: Real Jy

Auto-corr total-power spectrum Antenna: \*

Timerange: 00/18:54:31 to 00/18:55:59

Plot file version 969 created 05-OCT-2021 17:09:13

J0827+5217 GM076.UVDATA.1

Freq = 1.5945 GHz, Bw = 32.000 MH No calibration applied and no bandpass applied

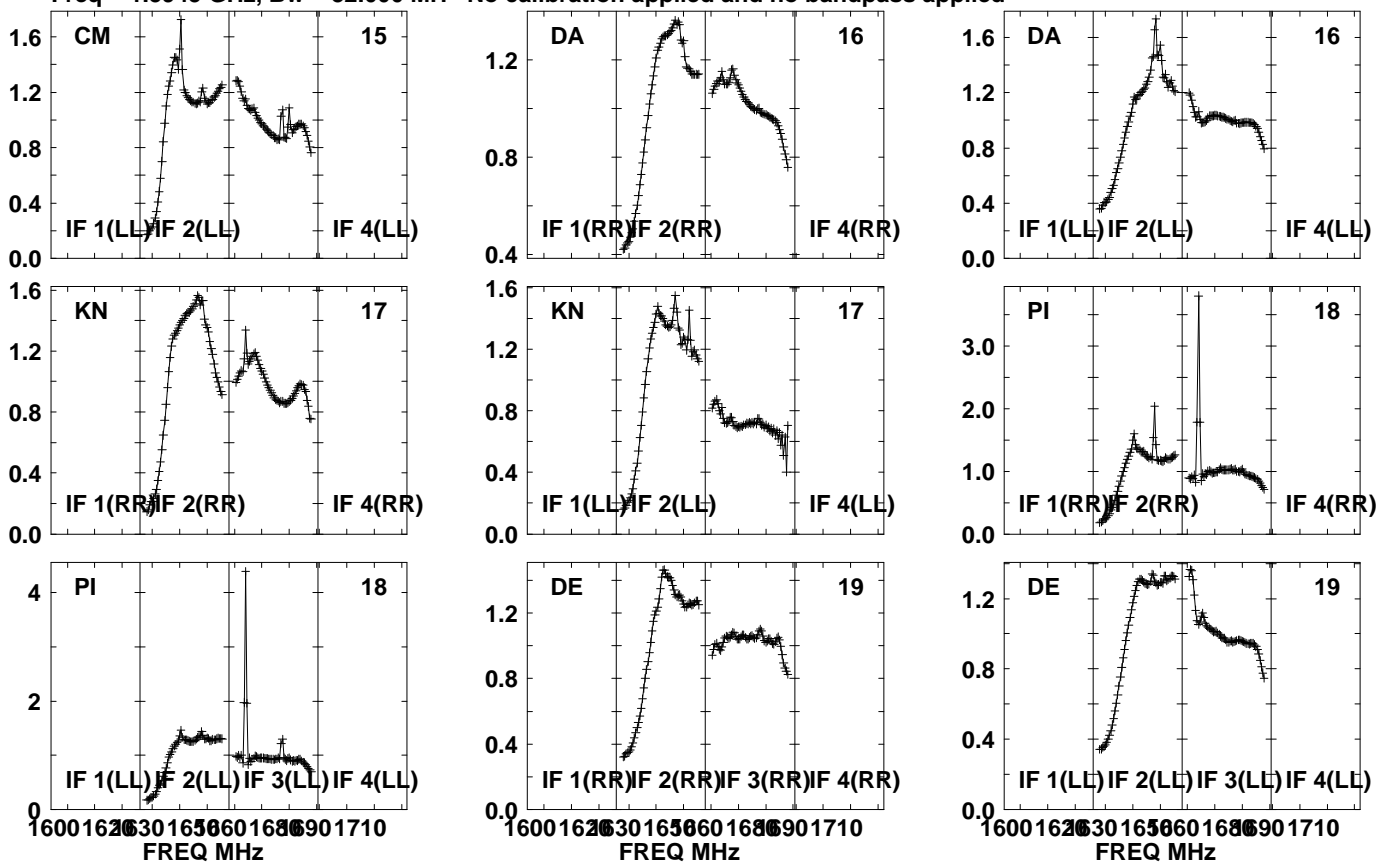

Lower frame: Real Jy  
Auto-corr total-power spectrum Antenna: \*  
Timerange: 00/18:54:31 to 00/18:55:59

Plot file version 970 created 05-OCT-2021 17:09:13

J0827+5217 GM076.UVDATA.1

Freq = 1.5945 GHz, Bw = 32.000 MH No calibration applied and no bandpass applied

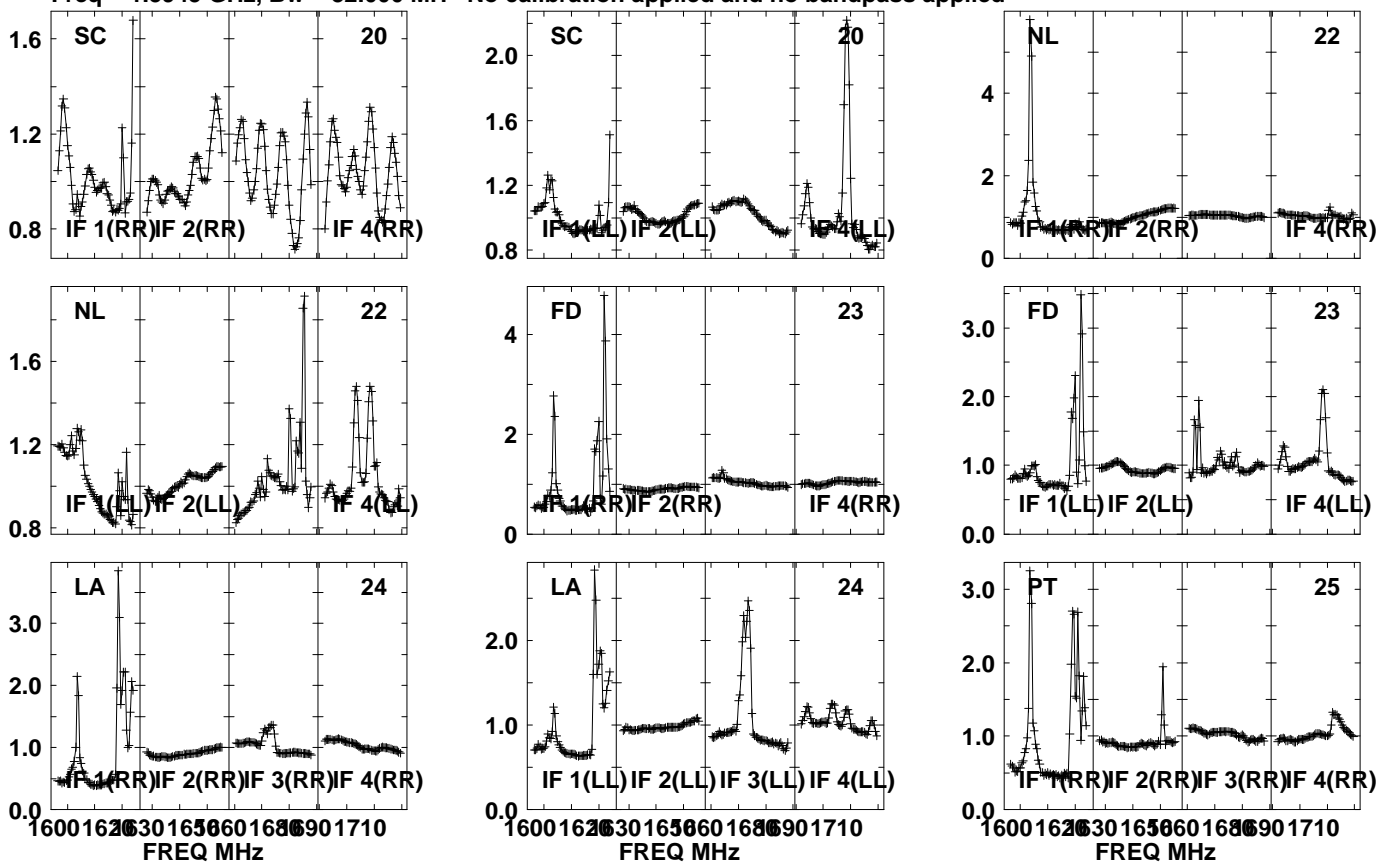

Lower frame: Real Jy  
Auto-corr total-power spectrum Antenna: \*  
Timerange: 00/18:54:31 to 00/18:55:59



Plot file version 971 created 05-OCT-2021 17:09:13

J0827+5217 GM076.UVDATA.1

Freq = 1.5945 GHz, Bw = 32.000 MH No calibration applied and no bandpass applied

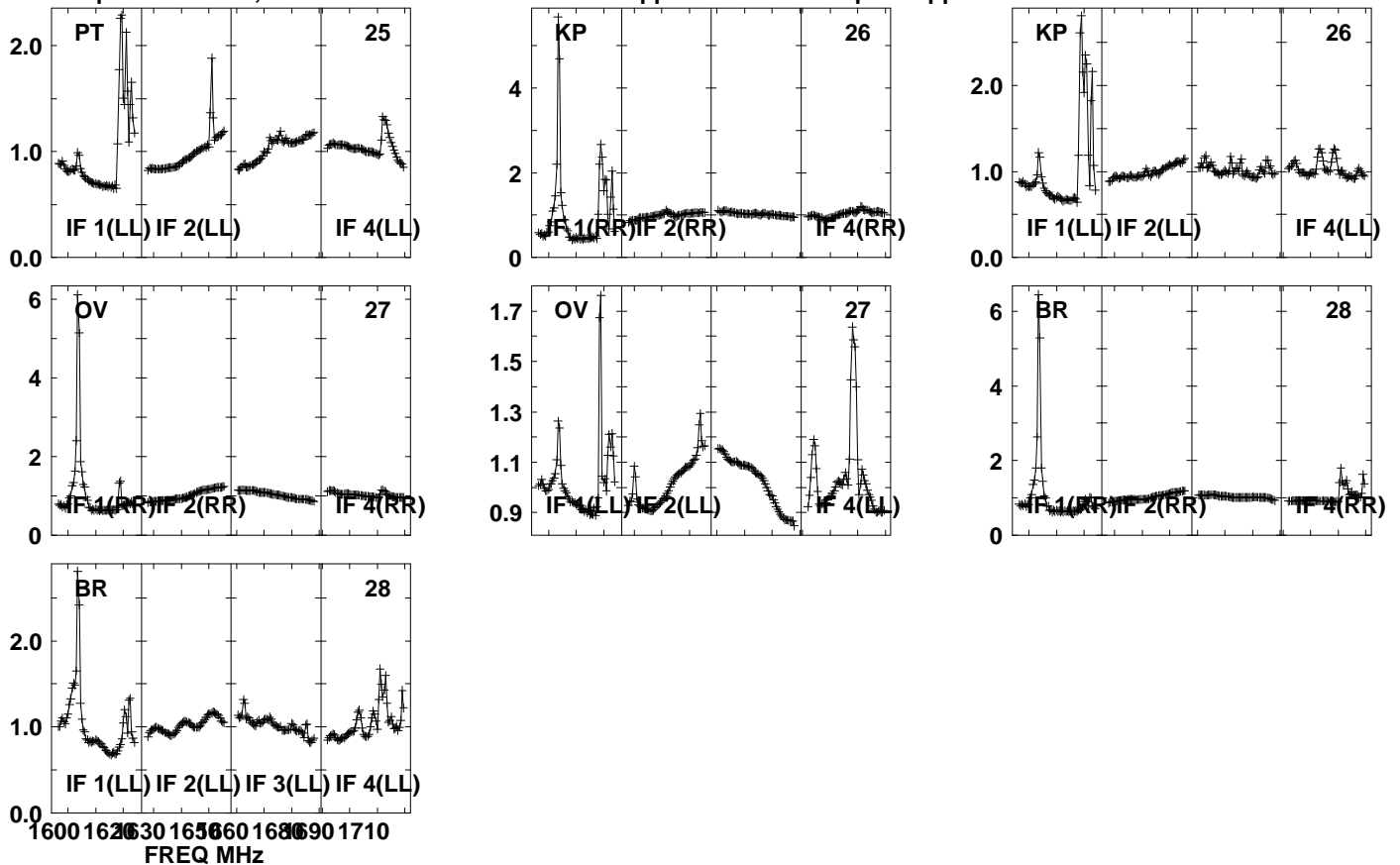

Lower frame: Real Jy

Auto-corr total-power spectrum Antenna: \*

Timerange: 00/18:54:31 to 00/18:55:59

Plot file version 972 created 05-OCT-2021 17:09:14

APM08279+525 GM076.UVDATA.1

Freq = 1.5945 GHz, Bw = 32.000 MH No calibration applied and no bandpass applied

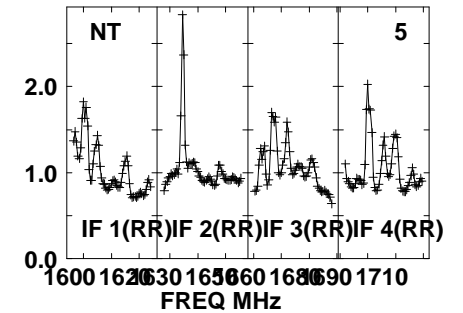
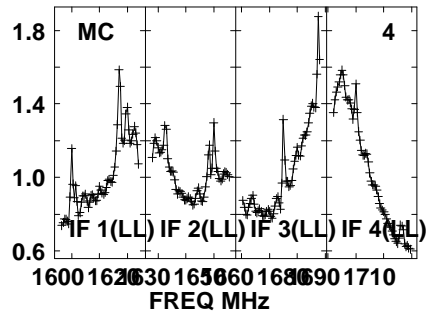
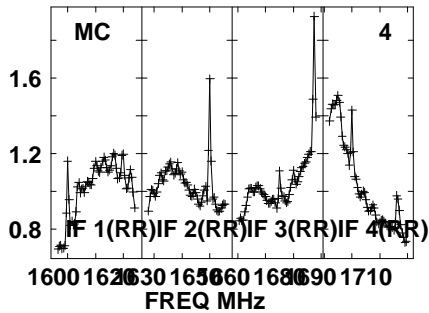
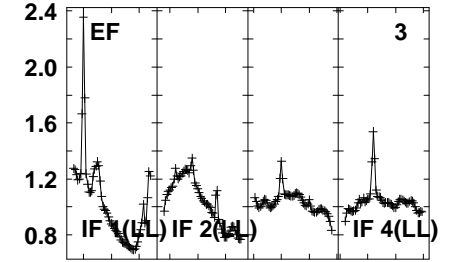
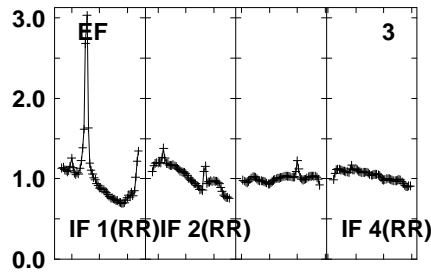
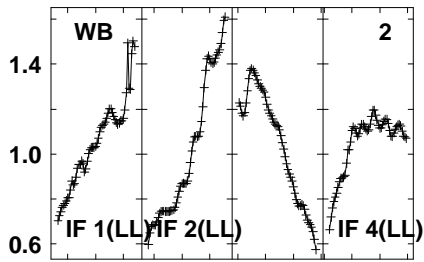
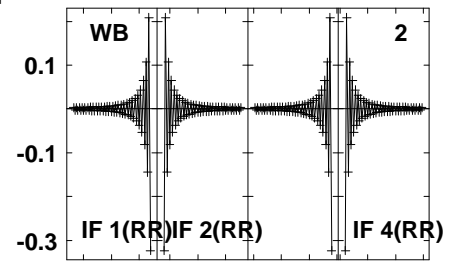
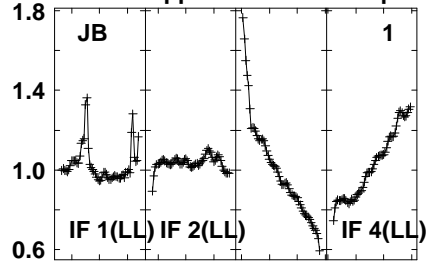
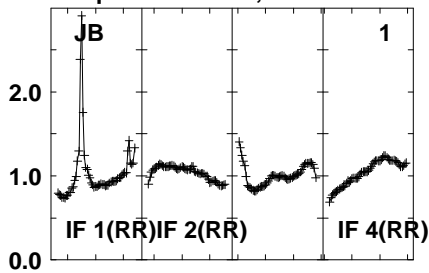

Lower frame: Real Jy

Auto-corr total-power spectrum Antenna: \*

Timerange: 00/18:56:01 to 00/18:59:29

Plot file version 973 created 05-OCT-2021 17:09:14

APM08279+525 GM076.UVDATA.1

Freq = 1.5945 GHz, Bw = 32.000 MH No calibration applied and no bandpass applied

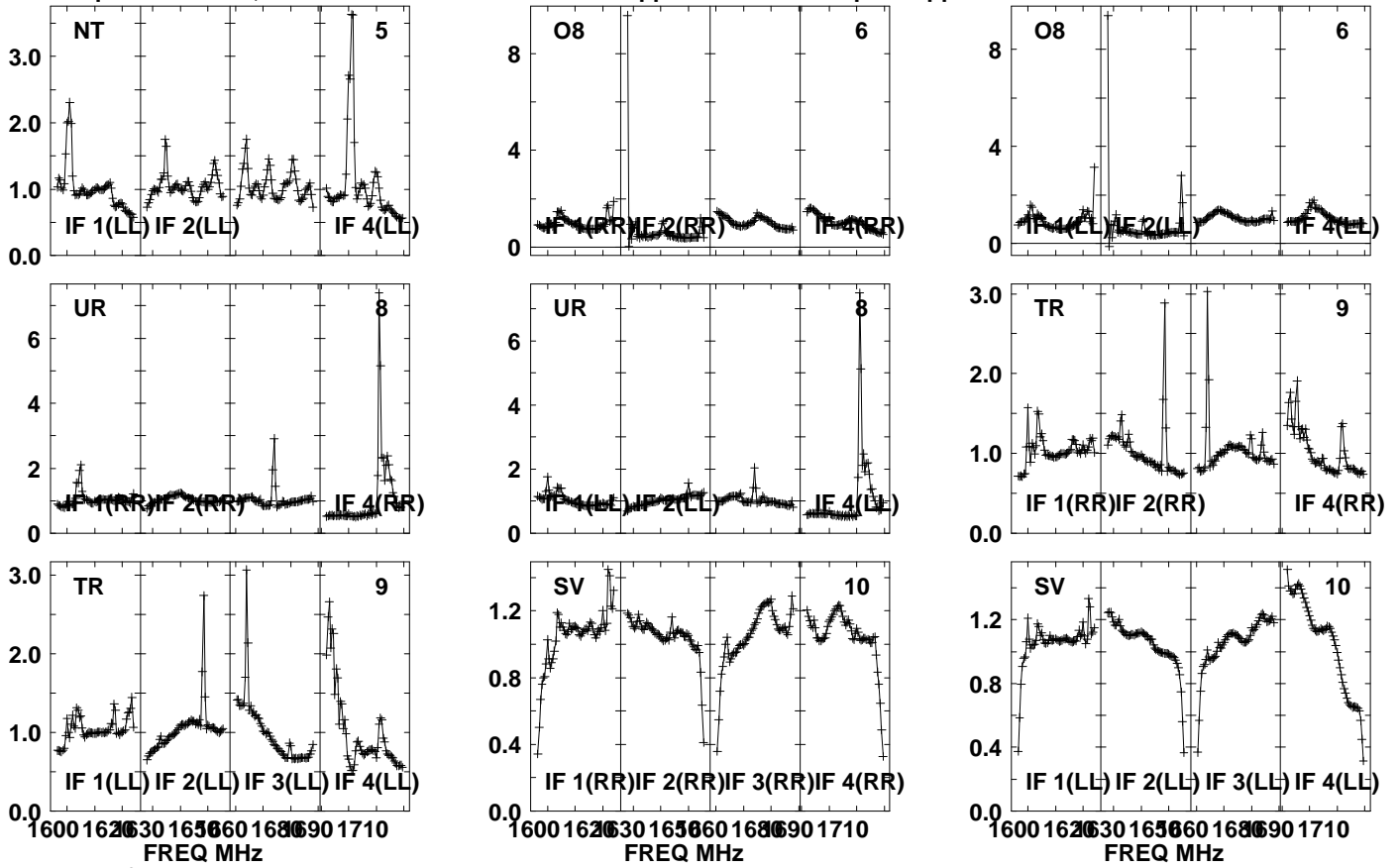

Lower frame: Real Jy

Auto-corr total-power spectrum Antenna: \*

Timerange: 00/18:56:01 to 00/18:59:29

Plot file version 974 created 05-OCT-2021 17:09:14

APM08279+525 GM076.UVDATA.1

Freq = 1.5945 GHz, Bw = 32.000 MH No calibration applied and no bandpass applied

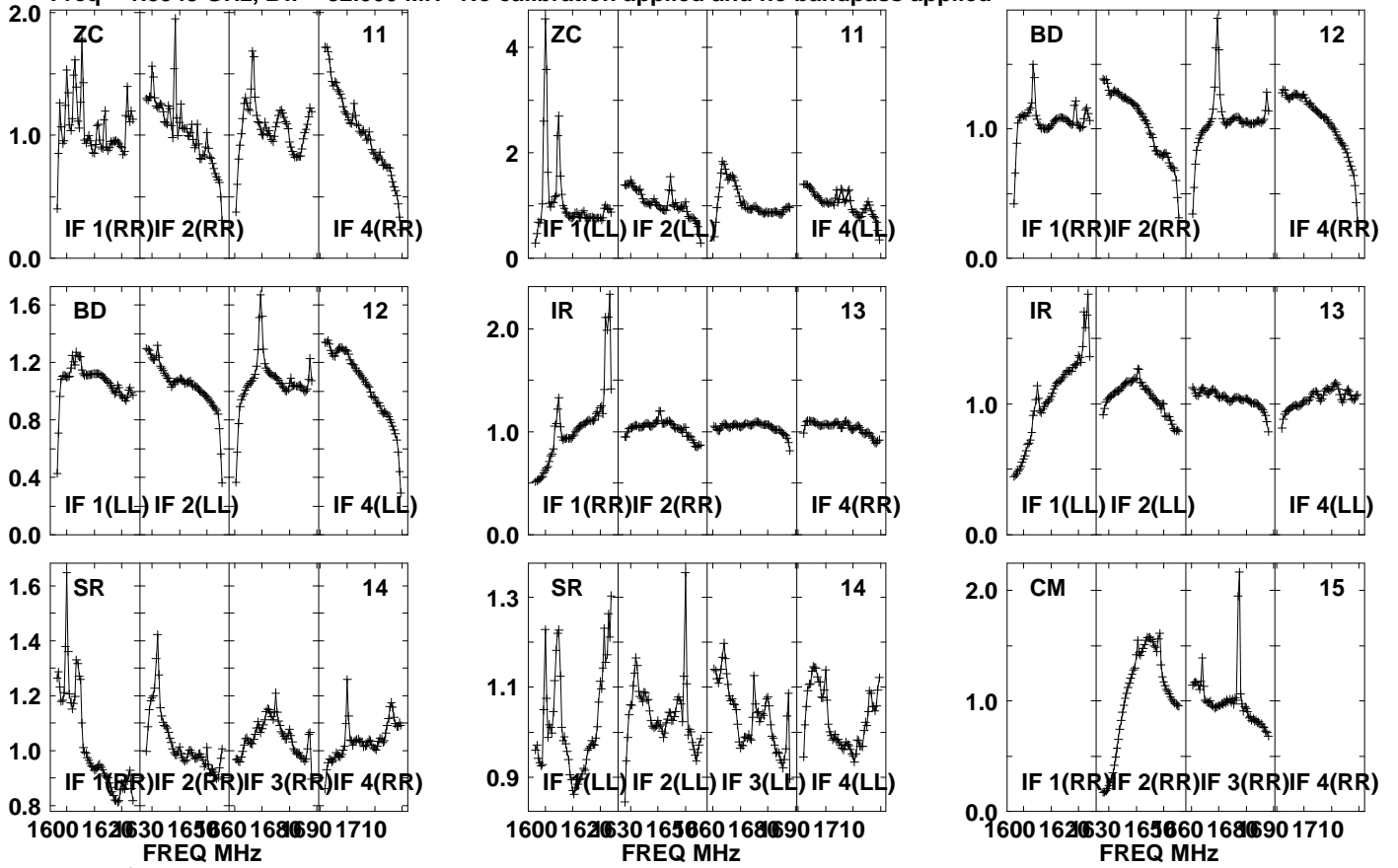

Lower frame: Real Jy  
Auto-corr total-power spectrum Antenna: \*  
Timerange: 00/18:56:01 to 00/18:59:29

Plot file version 975 created 05-OCT-2021 17:09:15

APM08279+525 GM076.UVDATA.1

Freq = 1.5945 GHz, Bw = 32.000 MH No calibration applied and no bandpass applied

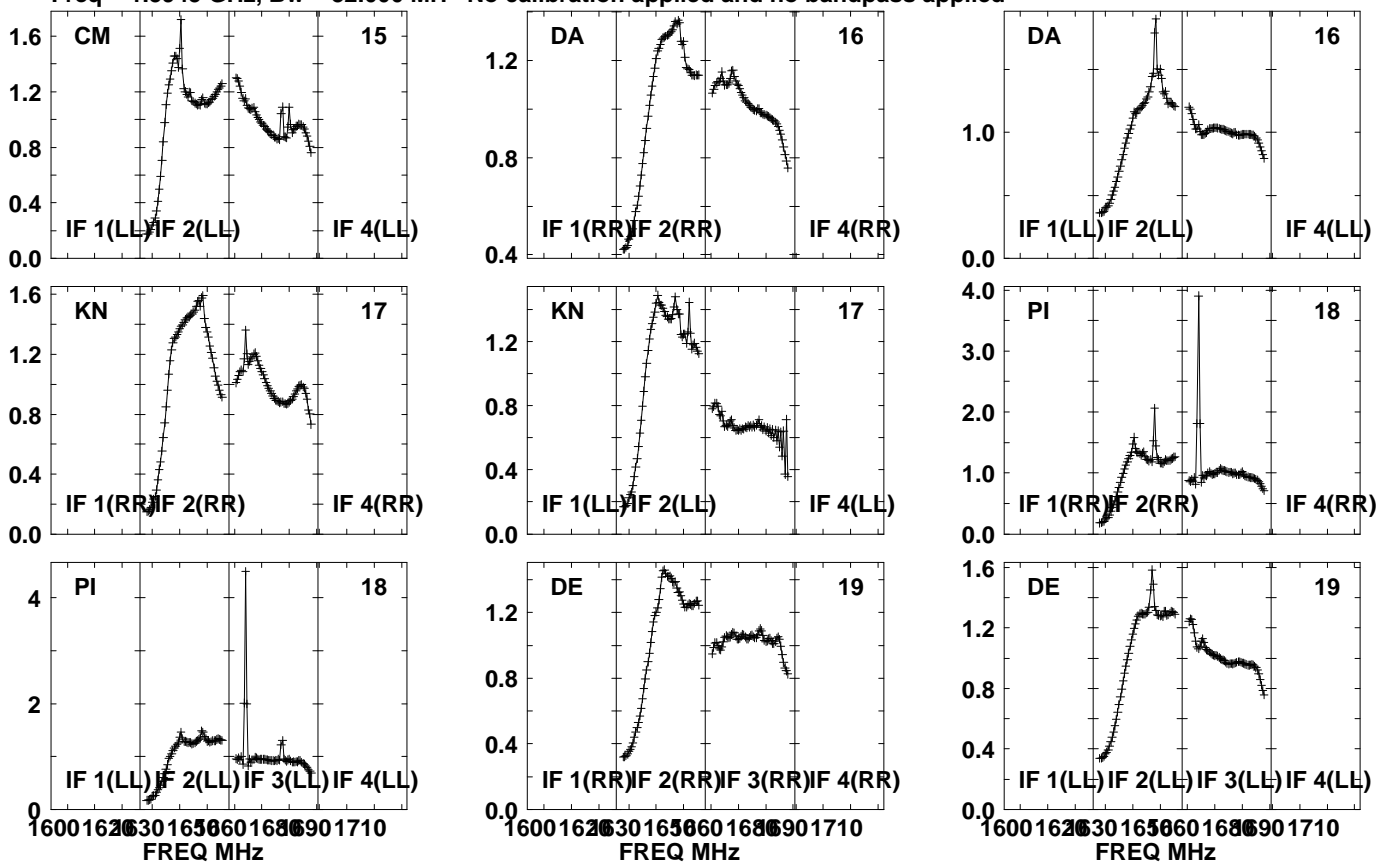

Lower frame: Real Jy  
Auto-corr total-power spectrum Antenna: \*  
Timerange: 00/18:56:01 to 00/18:59:29

Plot file version 976 created 05-OCT-2021 17:09:15

APM08279+525 GM076.UVDATA.1

Freq = 1.5945 GHz, Bw = 32.000 MH

No calibration applied and no bandpass applied

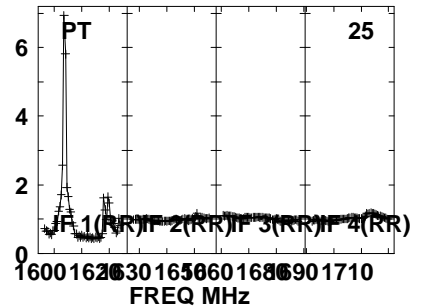
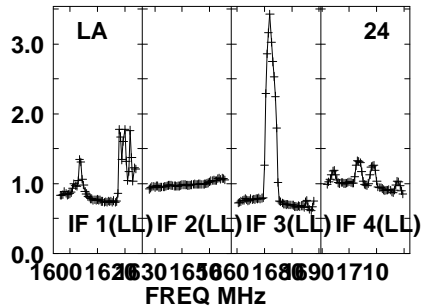
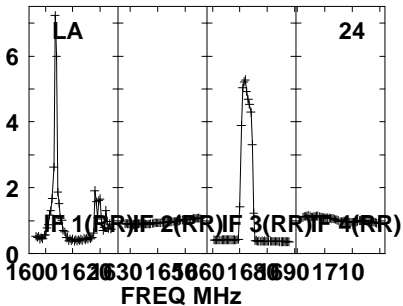
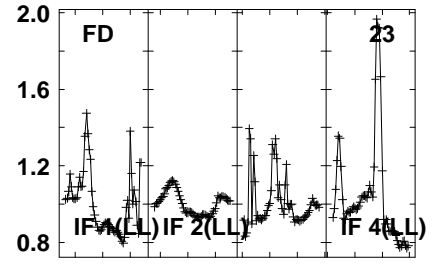
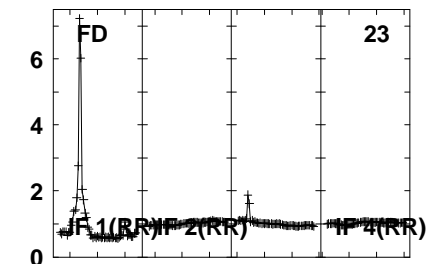
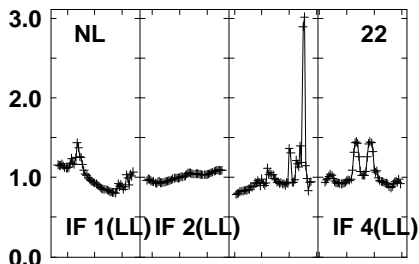
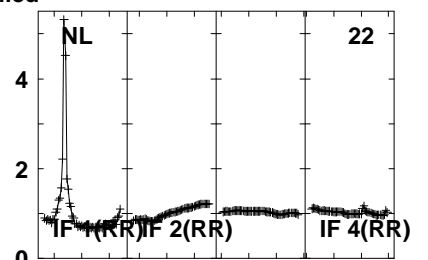
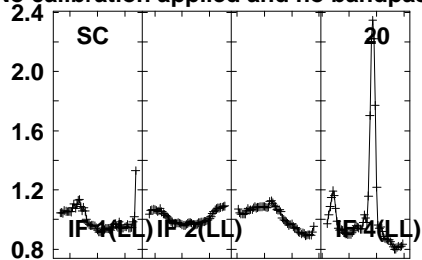
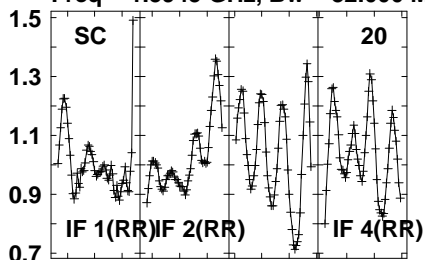

Lower frame: Real Jy  
Auto-corr total-power spectrum Antenna: \*  
Timerange: 00/18:56:01 to 00/18:59:29

Plot file version 977 created 05-OCT-2021 17:09:15

APM08279+525 GM076.UVDATA.1

Freq = 1.5945 GHz, Bw = 32.000 MH No calibration applied and no bandpass applied

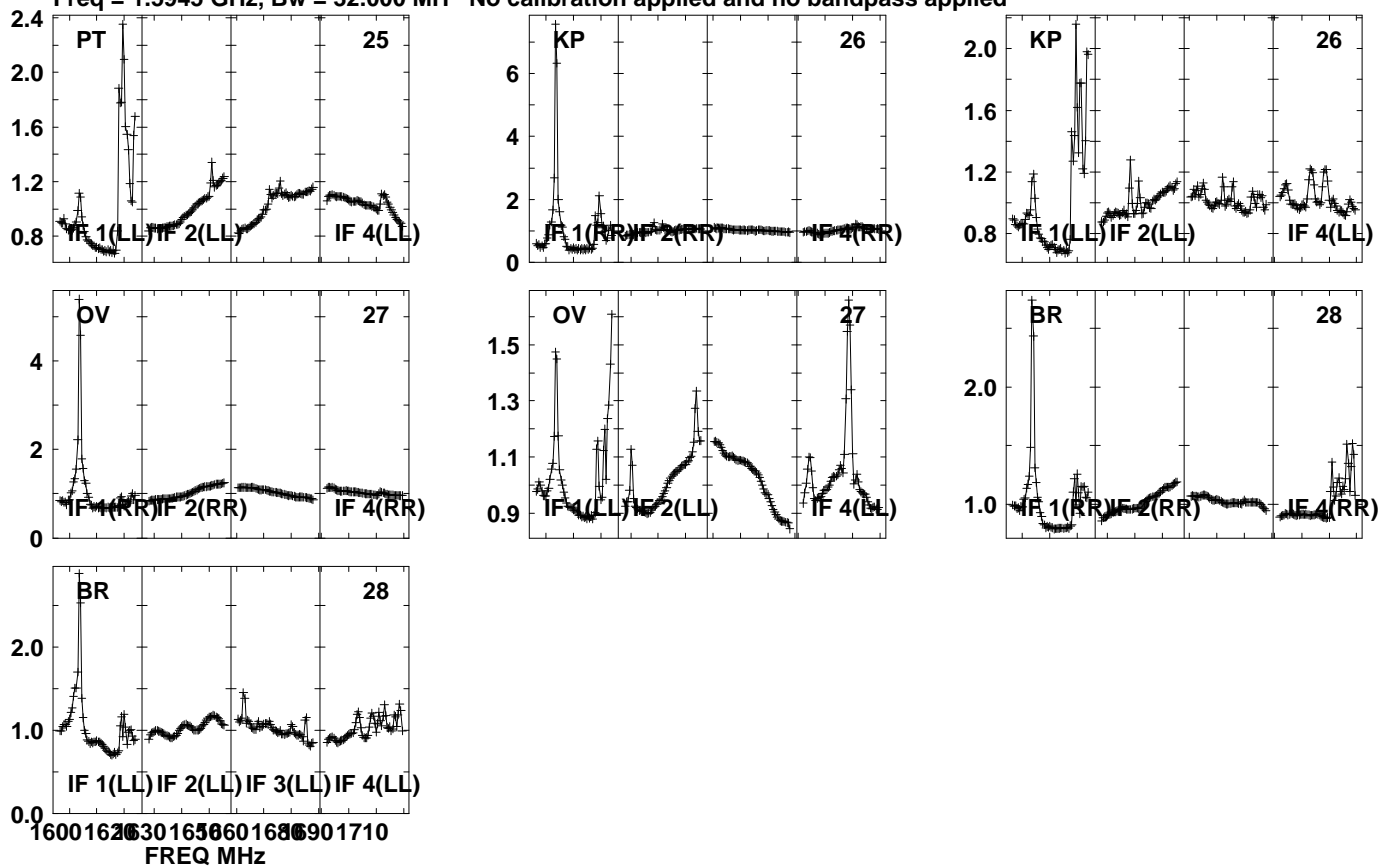

Lower frame: Real Jy  
Auto-corr total-power spectrum Antenna: \*  
Timerange: 00/18:56:01 to 00/18:59:29

Plot file version 978 created 05-OCT-2021 17:09:16

J0827+5217 GM076.UVDATA.1

Freq = 1.5945 GHz, Bw = 32.000 MH No calibration applied and no bandpass applied

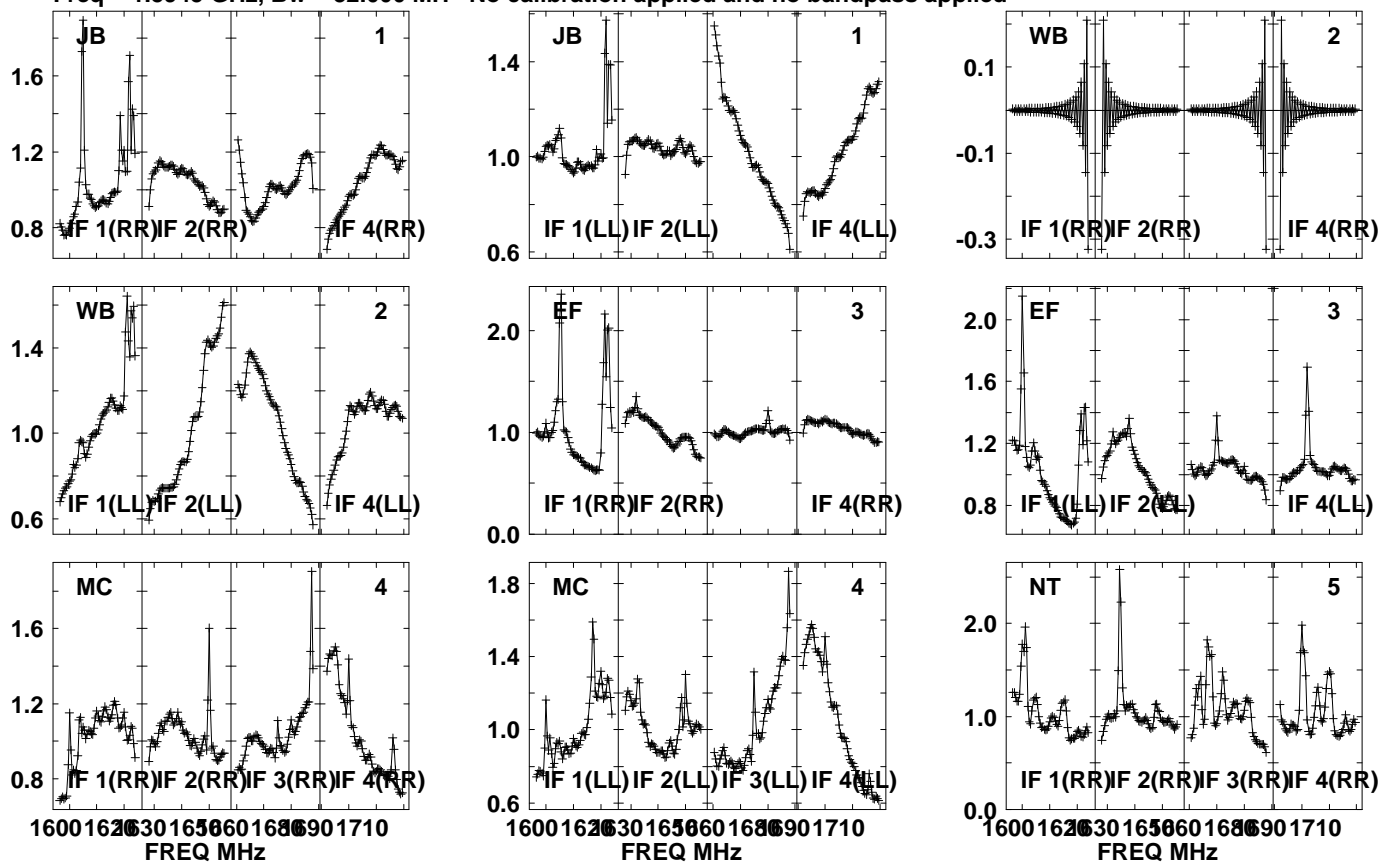

Lower frame: Real Jy  
Auto-corr total-power spectrum Antenna: \*  
Timerange: 00/18:59:31 to 00/19:00:59



Plot file version 979 created 05-OCT-2021 17:09:16

J0827+5217 GM076.UVDATA.1

Freq = 1.5945 GHz, Bw = 32.000 MH No calibration applied and no bandpass applied

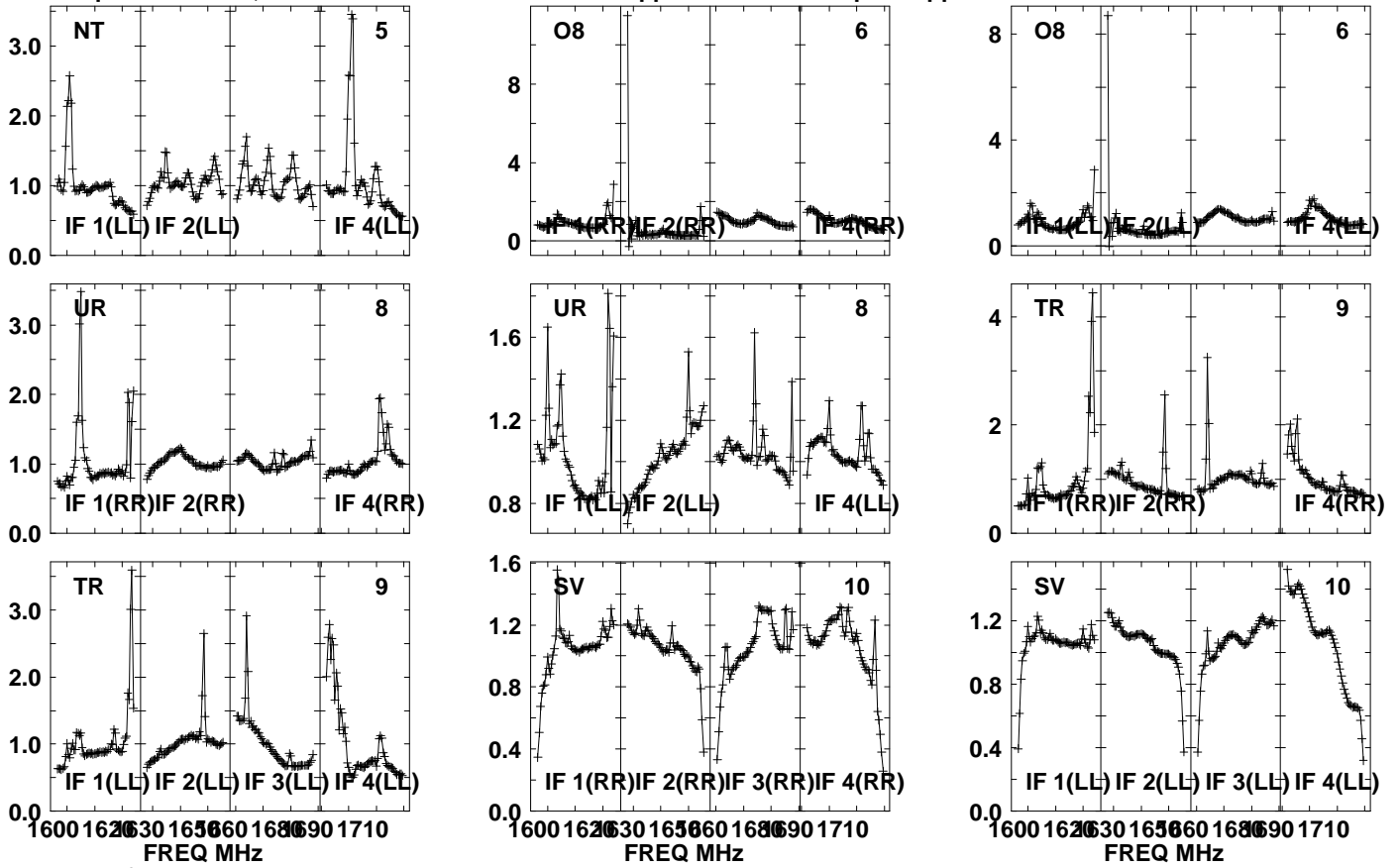

Lower frame: Real Jy

Auto-corr total-power spectrum Antenna: \*

Timerange: 00/18:59:31 to 00/19:00:59

Plot file version 980 created 05-OCT-2021 17:09:16

J0827+5217 GM076.UVDATA.1

Freq = 1.5945 GHz, Bw = 32.000 MH No calibration applied and no bandpass applied

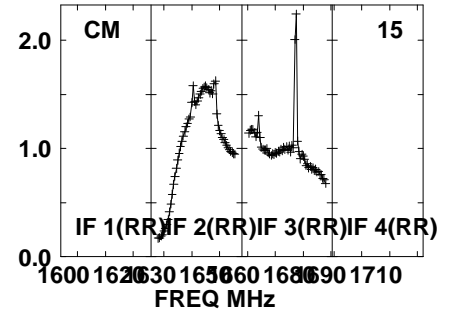
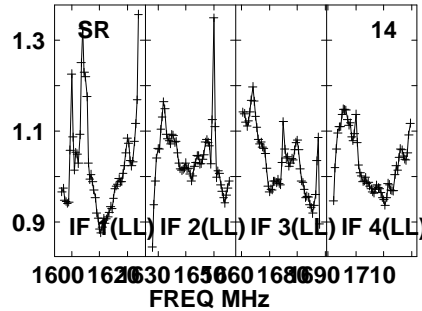
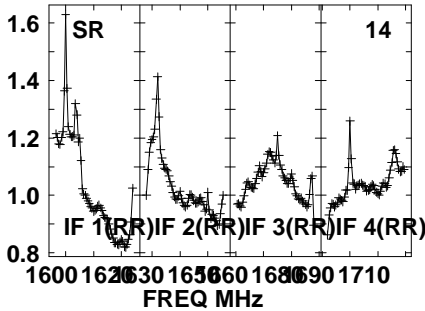
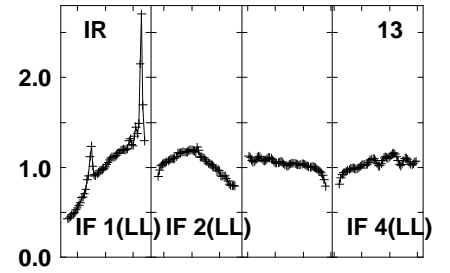
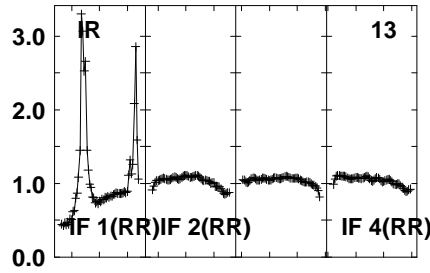
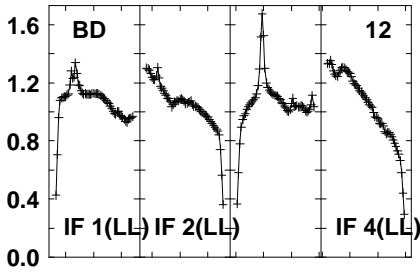
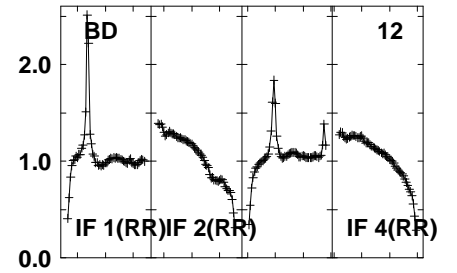
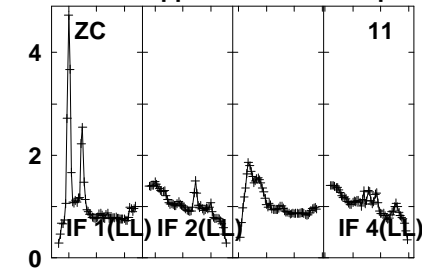
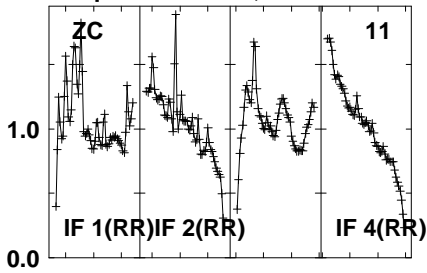

Lower frame: Real Jy

Auto-corr total-power spectrum Antenna: \*

Timerange: 00/18:59:31 to 00/19:00:59

Plot file version 981 created 05-OCT-2021 17:09:16

J0827+5217 GM076.UVDATA.1

Freq = 1.5945 GHz, Bw = 32.000 MH No calibration applied and no bandpass applied

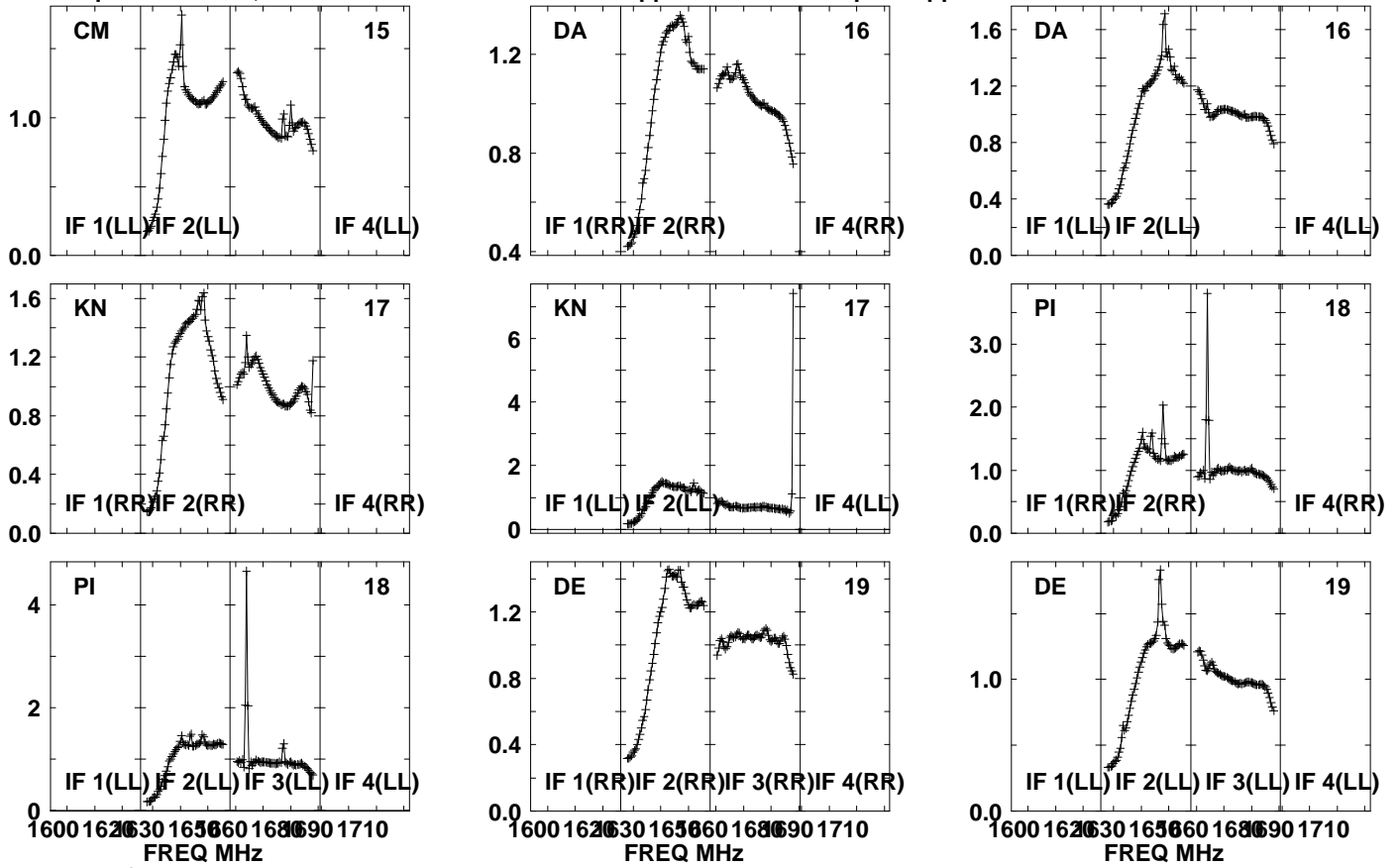

Lower frame: Real Jy  
Auto-corr total-power spectrum Antenna: \*  
Timerange: 00/18:59:31 to 00/19:00:59

Plot file version 982 created 05-OCT-2021 17:09:17

J0827+5217 GM076.UVDATA.1

Freq = 1.5945 GHz, Bw = 32.000 MH No calibration applied and no bandpass applied

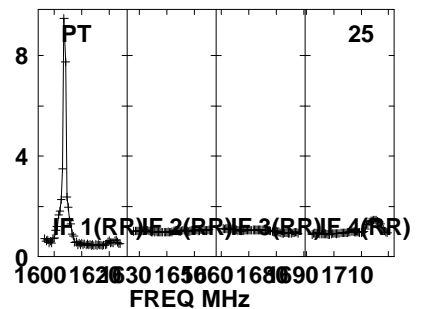
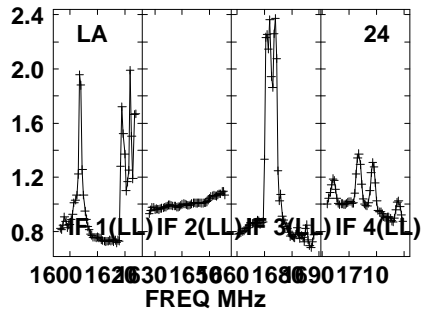
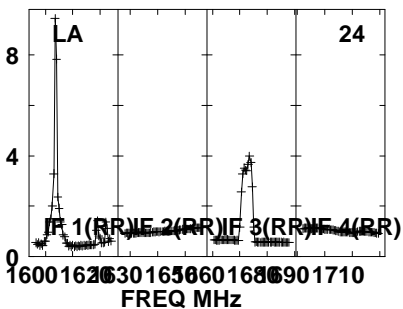
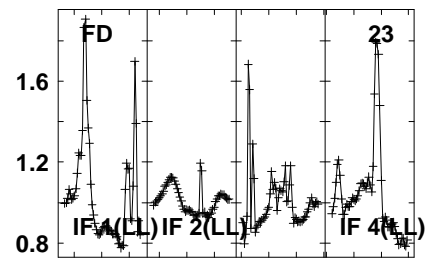
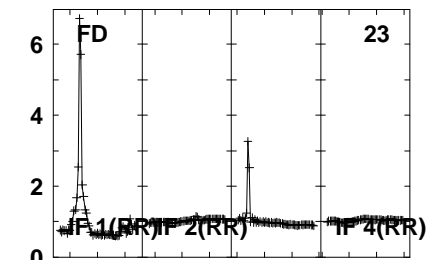
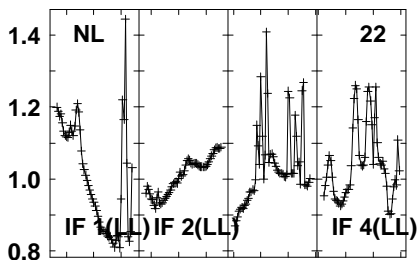
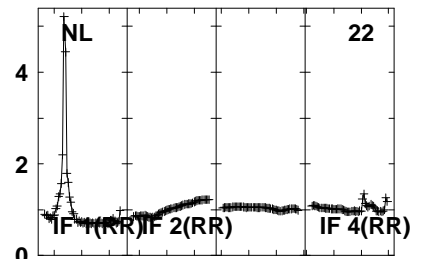
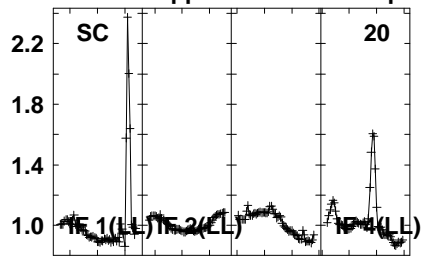
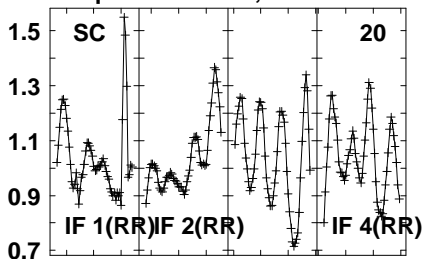

Lower frame: Real Jy  
Auto-corr total-power spectrum Antenna: \*  
Timerange: 00/18:59:31 to 00/19:00:59

Plot file version 983 created 05-OCT-2021 17:09:17

J0827+5217 GM076.UVDATA.1

Freq = 1.5945 GHz, Bw = 32.000 MH No calibration applied and no bandpass applied

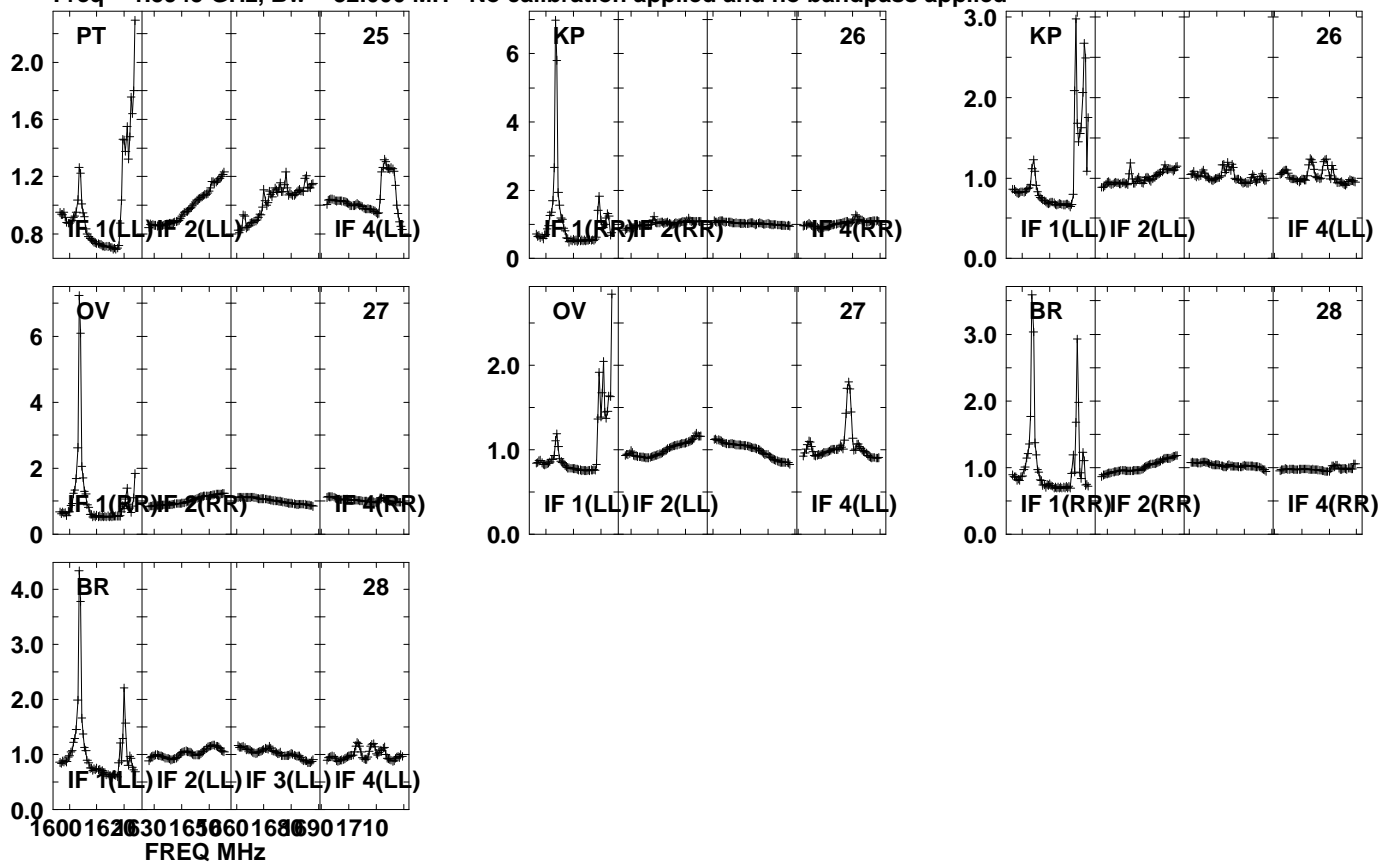

Lower frame: Real Jy

Auto-corr total-power spectrum Antenna: \*

Timerange: 00/18:59:31 to 00/19:00:59

Plot file version 984 created 05-OCT-2021 17:09:17

APM08279+525 GM076.UVDATA.1

Freq = 1.5945 GHz, Bw = 32.000 MH No calibration applied and no bandpass applied

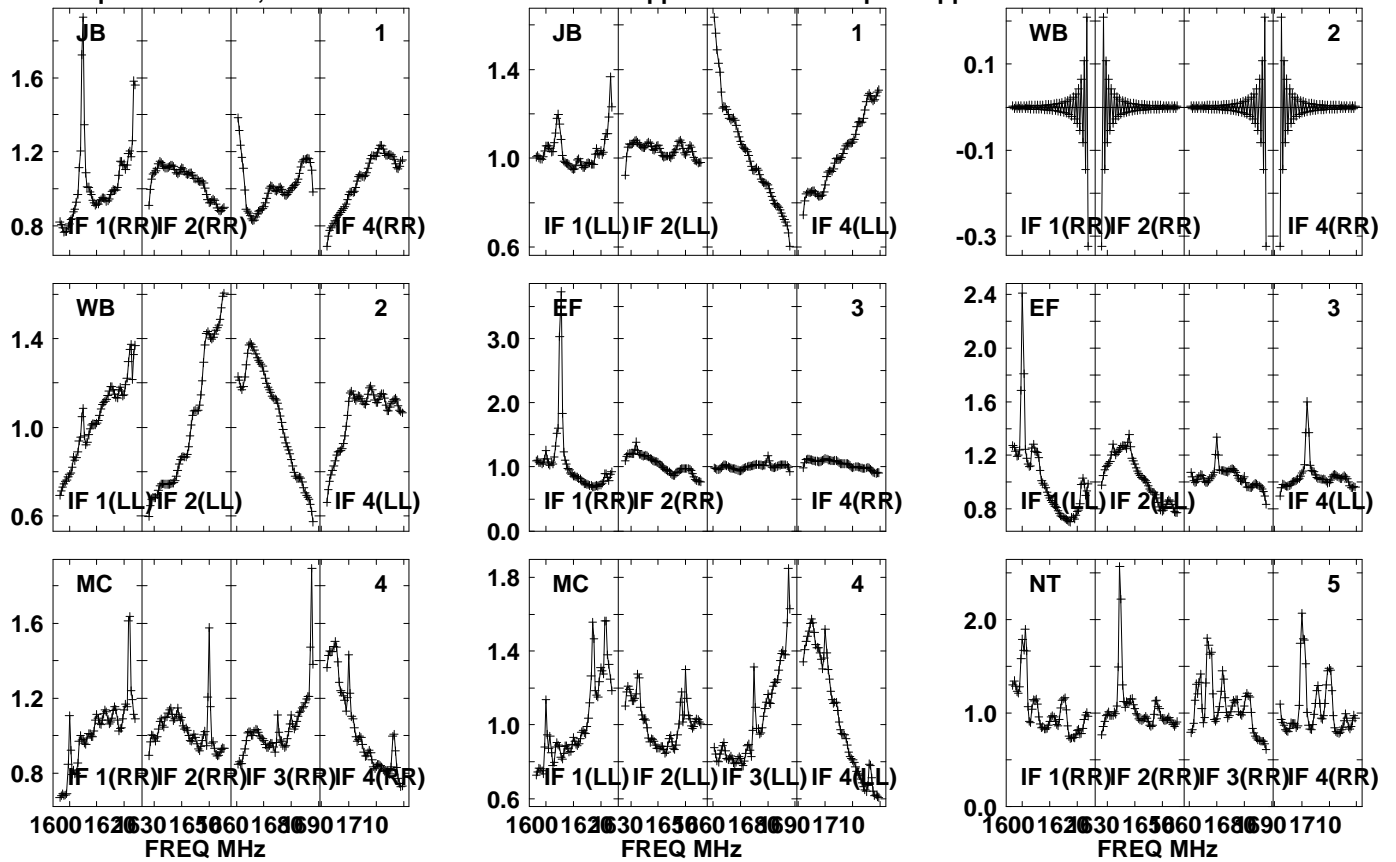

Lower frame: Real Jy  
Auto-corr total-power spectrum Antenna: \*  
Timerange: 00/19:01:01 to 00/19:04:29

Plot file version 985 created 05-OCT-2021 17:09:18

APM08279+525 GM076.UVDATA.1

Freq = 1.5945 GHz, Bw = 32.000 MH No calibration applied and no bandpass applied

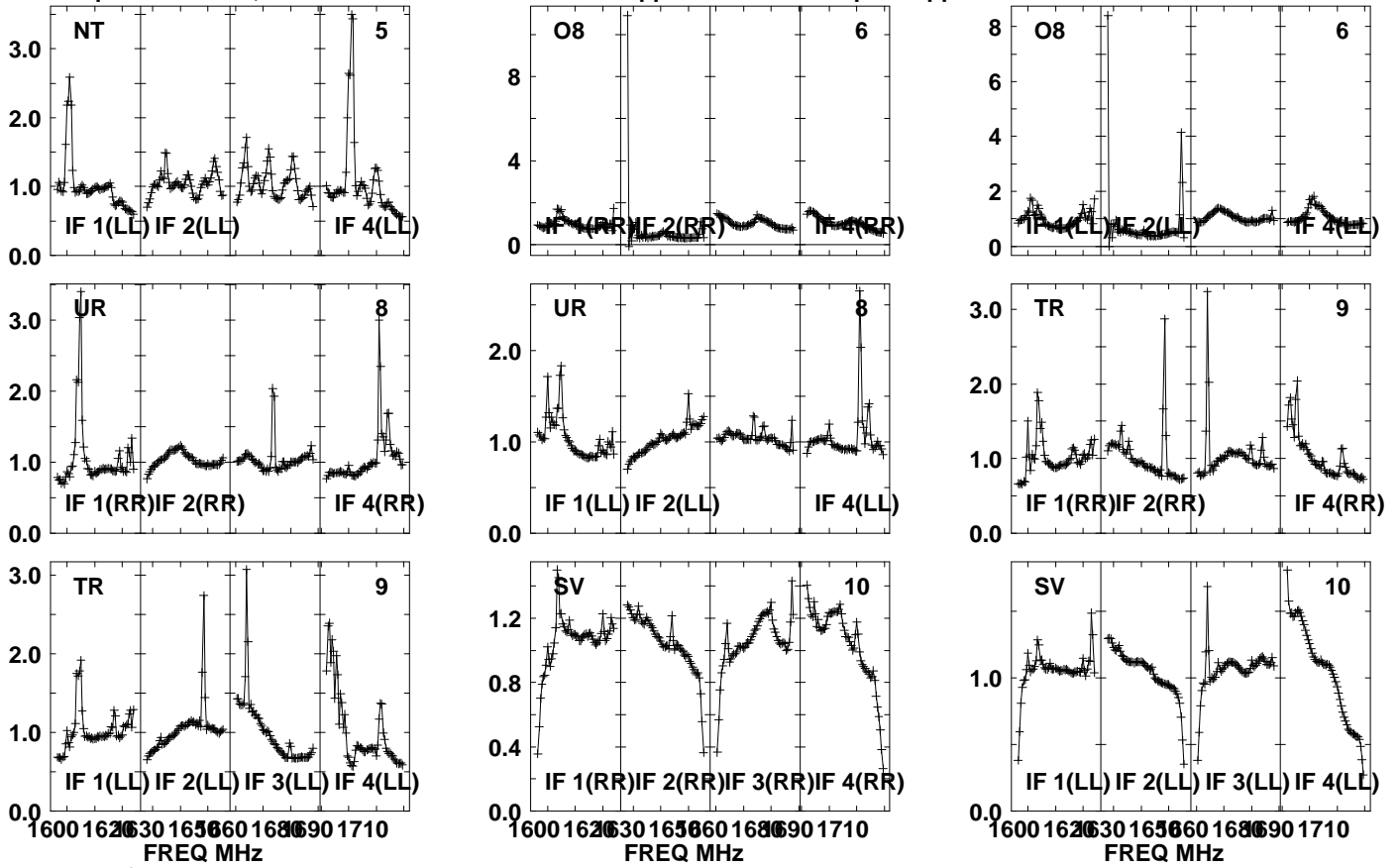

Lower frame: Real Jy

Auto-corr total-power spectrum Antenna: \*

Timerange: 00/19:01:01 to 00/19:04:29

Plot file version 986 created 05-OCT-2021 17:09:18

APM08279+525 GM076.UVDATA.1

Freq = 1.5945 GHz, Bw = 32.000 MH No calibration applied and no bandpass applied

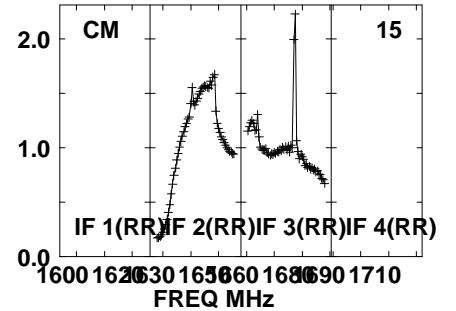
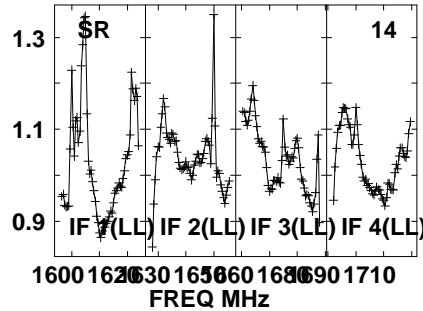
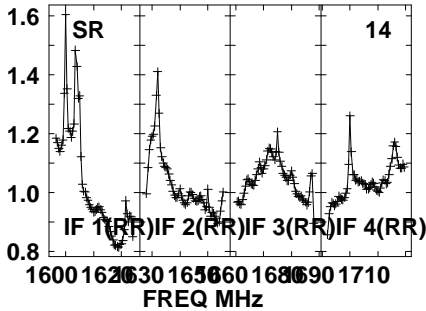
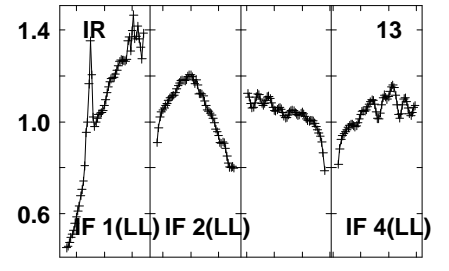
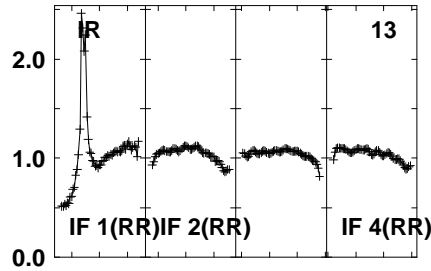
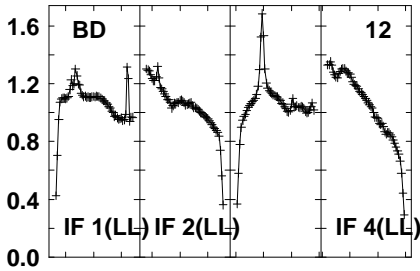
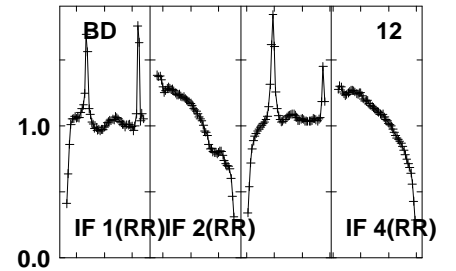
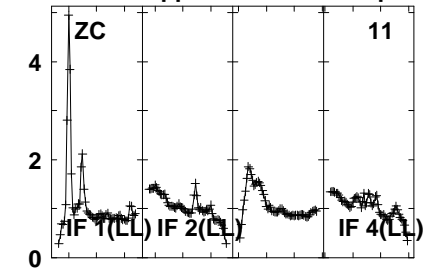
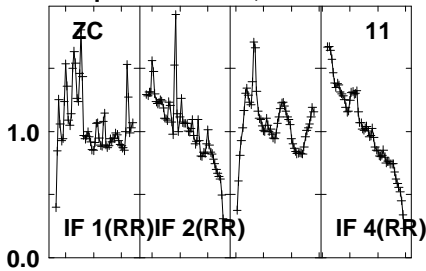

Lower frame: Real Jy

Auto-corr total-power spectrum Antenna: \*

Timerange: 00/19:01:01 to 00/19:04:29



Plot file version 987 created 05-OCT-2021 17:09:18

APM08279+525 GM076.UVDATA.1

Freq = 1.5945 GHz, Bw = 32.000 MH No calibration applied and no bandpass applied

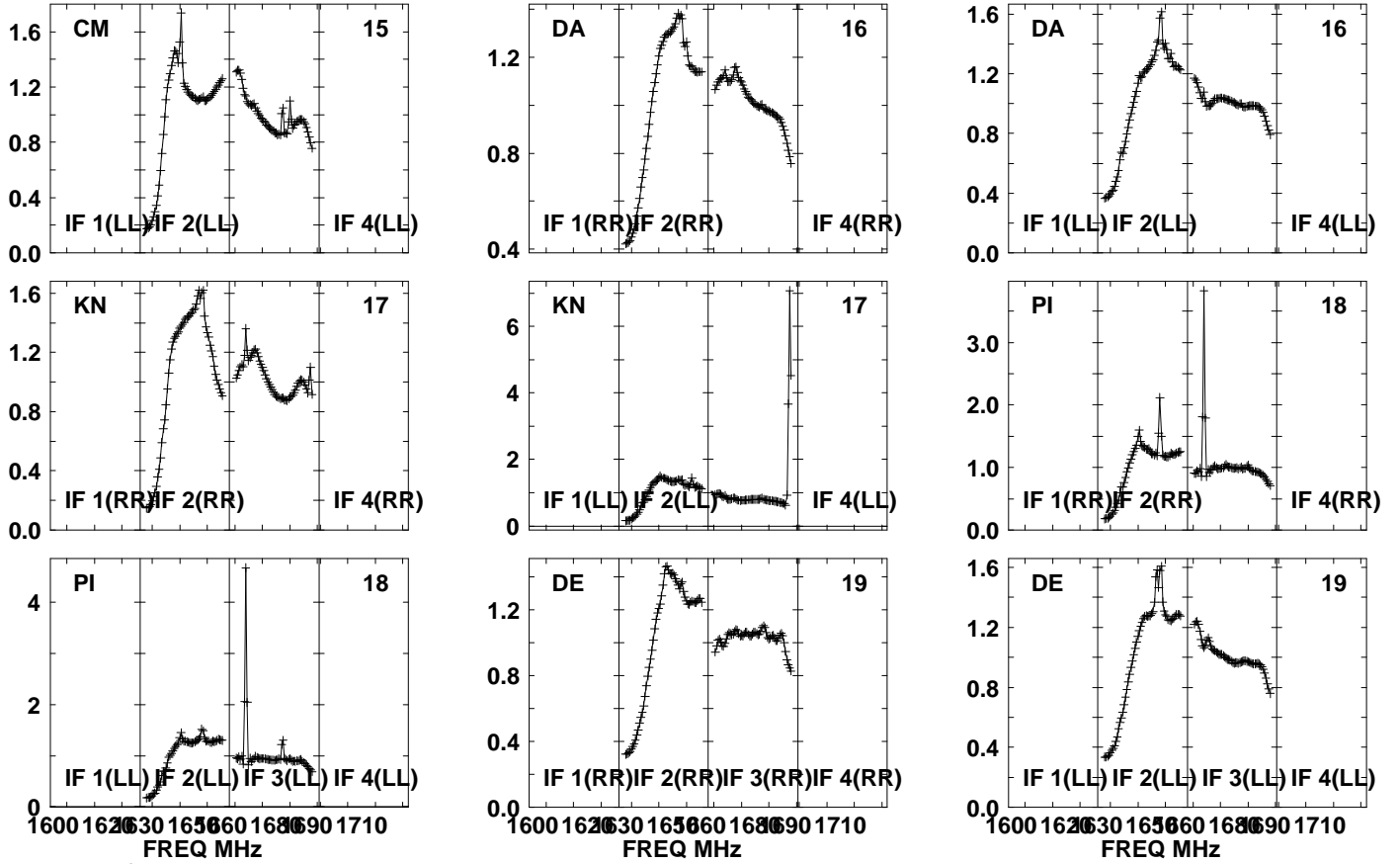

Lower frame: Real Jy

Auto-corr total-power spectrum Antenna: \*

Timerange: 00/19:01:01 to 00/19:04:29

Plot file version 988 created 05-OCT-2021 17:09:19

APM08279+525 GM076.UVDATA.1

Freq = 1.5945 GHz, Bw = 32.000 MH No calibration applied and no bandpass applied

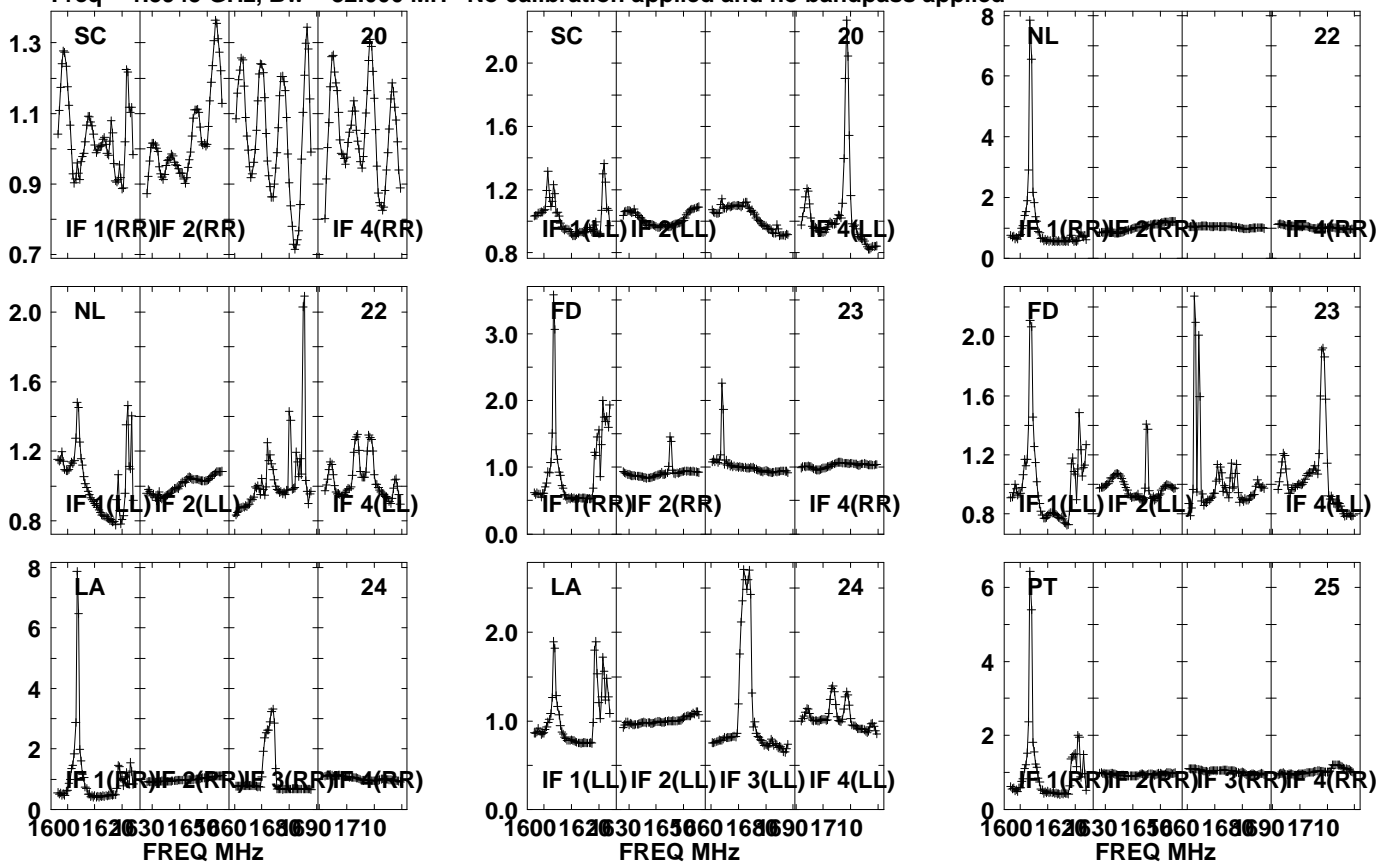

Lower frame: Real Jy  
Auto-corr total-power spectrum Antenna: \*  
Timerange: 00/19:01:01 to 00/19:04:29

Plot file version 989 created 05-OCT-2021 17:09:19

APM08279+525 GM076.UVDATA.1

Freq = 1.5945 GHz, Bw = 32.000 MH No calibration applied and no bandpass applied

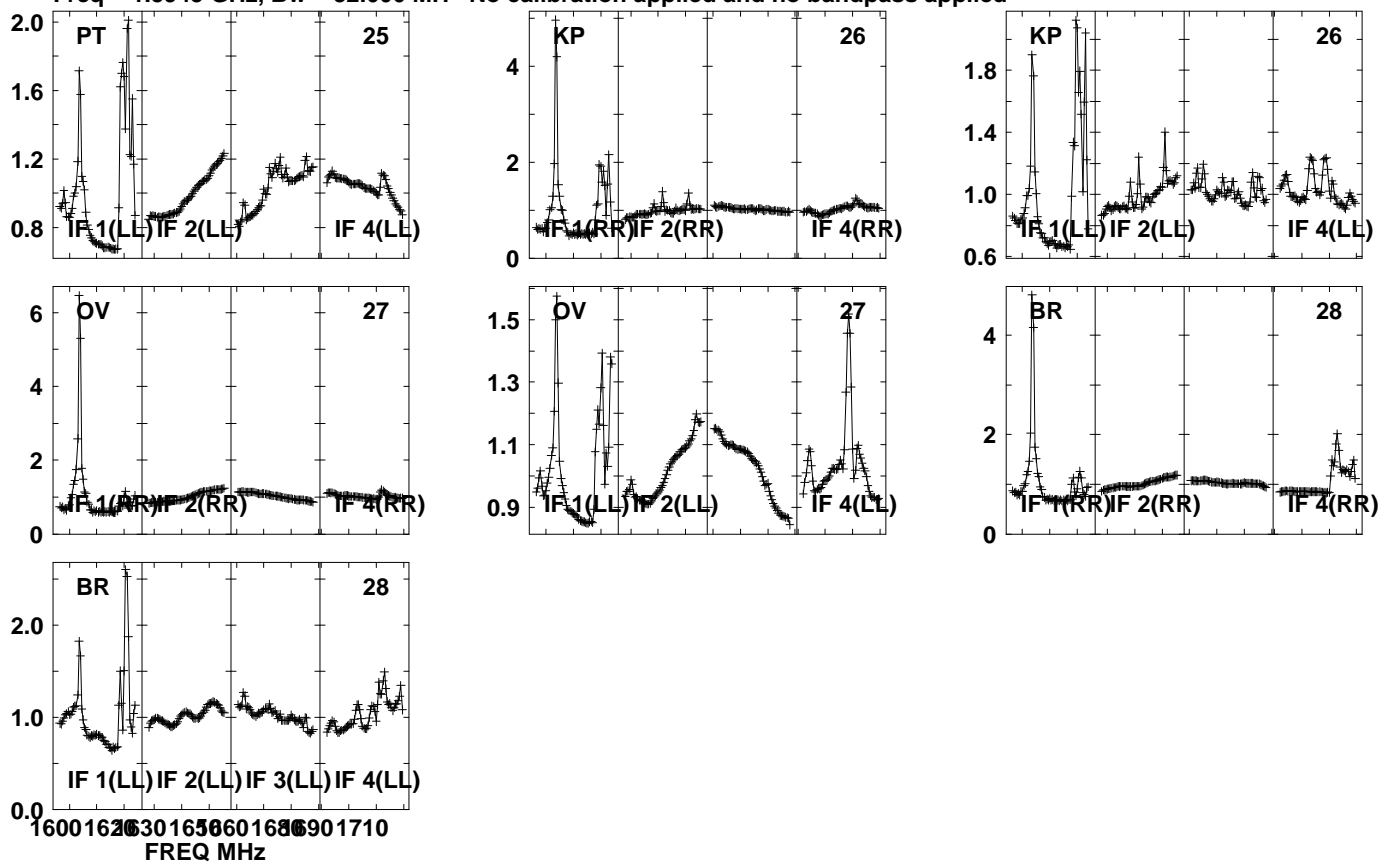

Lower frame: Real Jy

Auto-corr total-power spectrum Antenna: \*

Timerange: 00/19:01:01 to 00/19:04:29

Plot file version 990 created 05-OCT-2021 17:09:19

J0827+5217 GM076.UVDATA.1

Freq = 1.5945 GHz, Bw = 32.000 MH No calibration applied and no bandpass applied

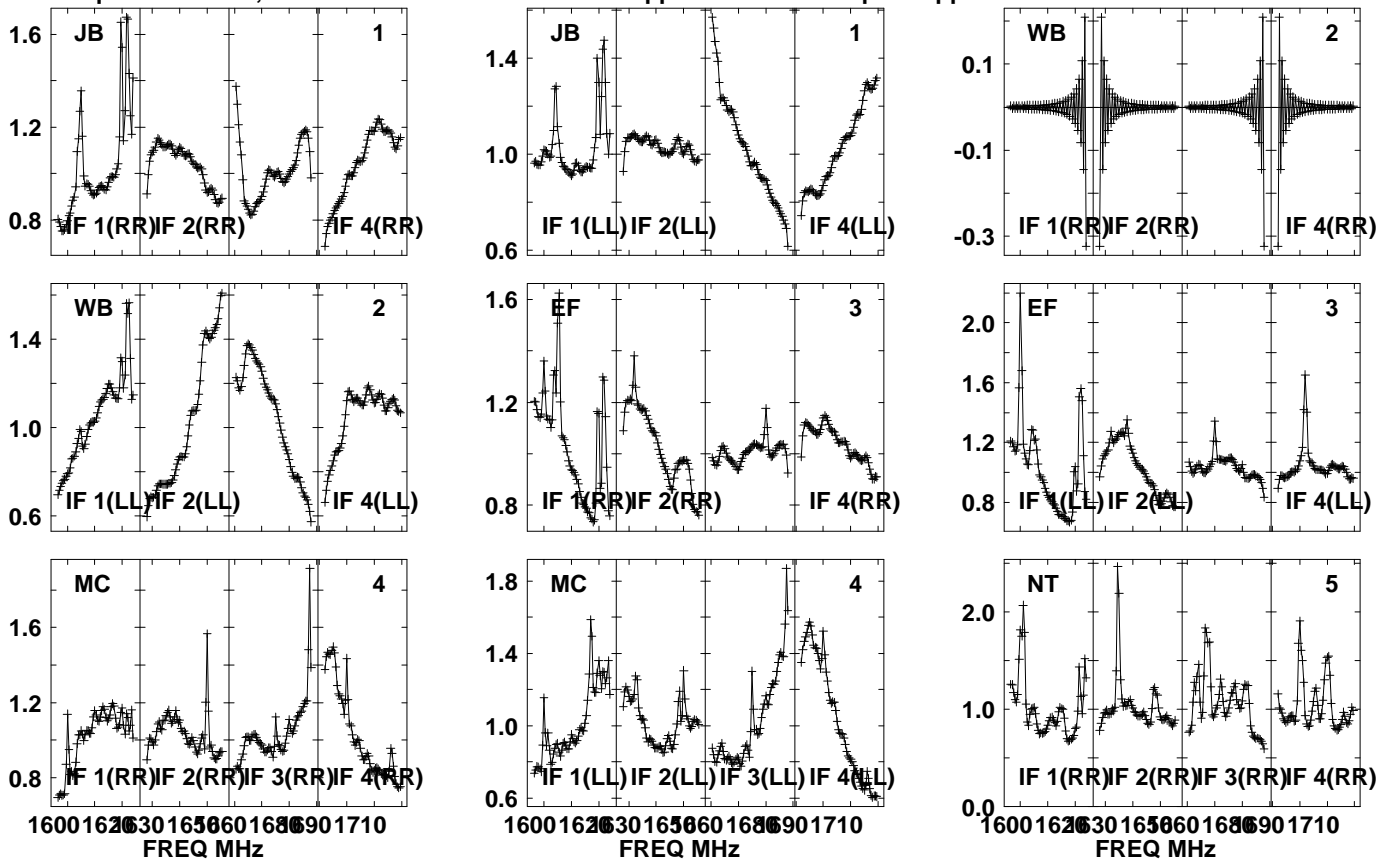

Lower frame: Real Jy

Auto-corr total-power spectrum Antenna: \*

Timerange: 00/19:05:01 to 00/19:06:29

Plot file version 991 created 05-OCT-2021 17:09:20

J0827+5217 GM076.UVDATA.1

Freq = 1.5945 GHz, Bw = 32.000 MH No calibration applied and no bandpass applied

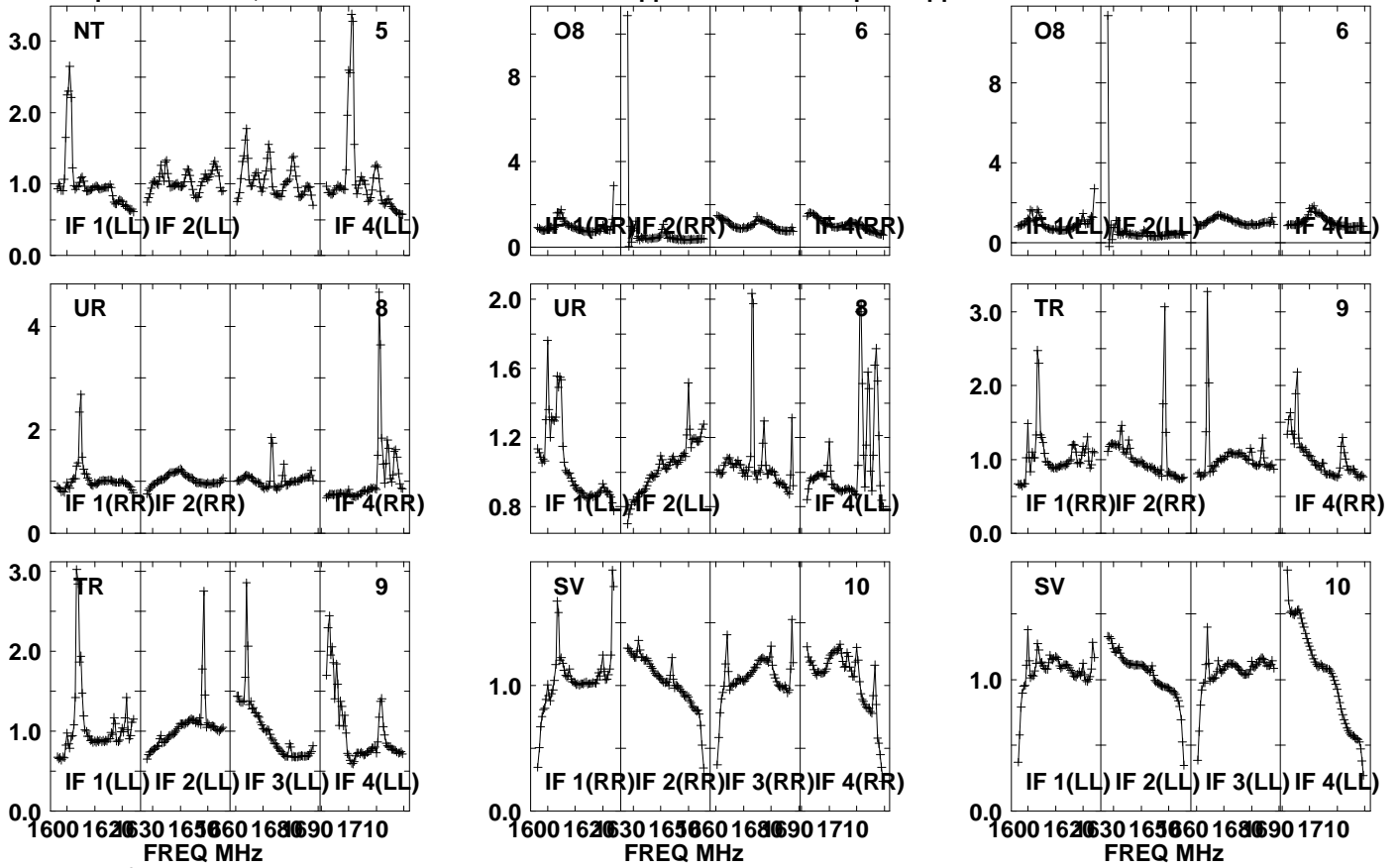

Lower frame: Real Jy

Auto-corr total-power spectrum Antenna: \*

Timerange: 00/19:05:01 to 00/19:06:29

Plot file version 992 created 05-OCT-2021 17:09:20

J0827+5217 GM076.UVDATA.1

Freq = 1.5945 GHz, Bw = 32.000 MH No calibration applied and no bandpass applied

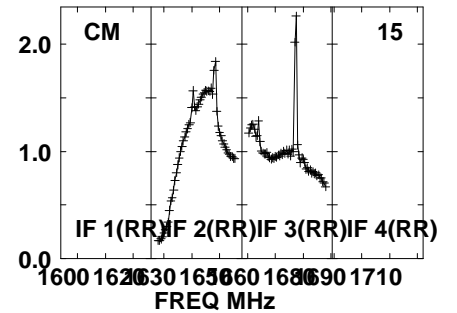
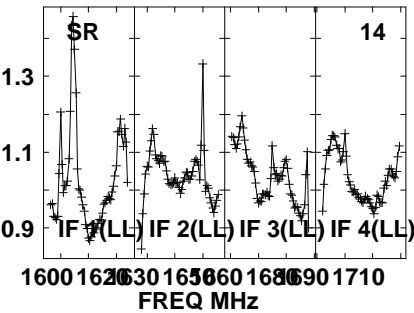
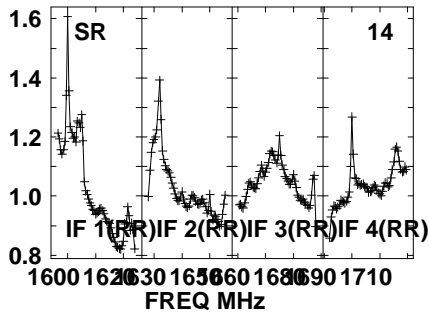
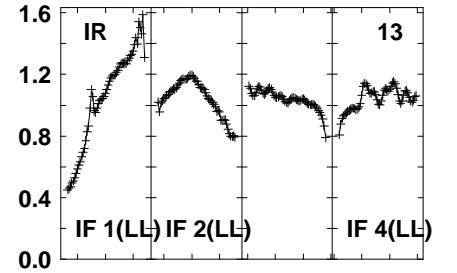
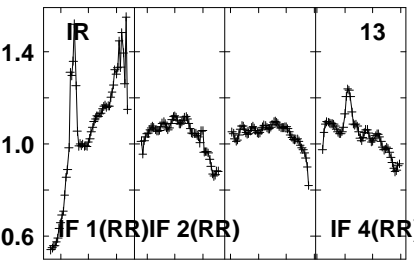
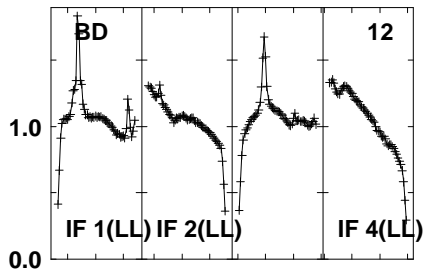
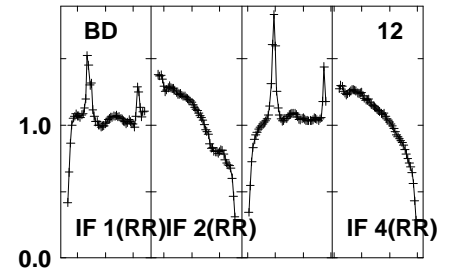
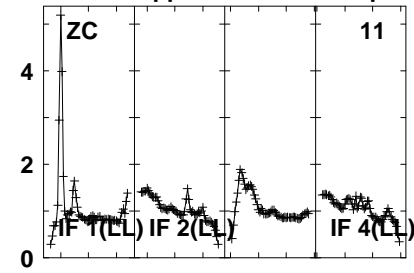
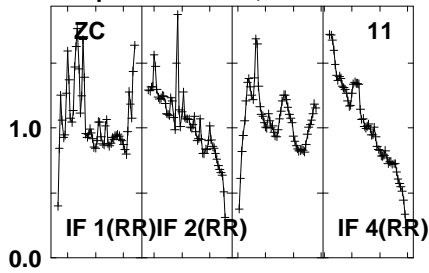

Lower frame: Real Jy

Auto-corr total-power spectrum Antenna: \*

Timerange: 00/19:05:01 to 00/19:06:29

Plot file version 993 created 05-OCT-2021 17:09:20

J0827+5217 GM076.UVDATA.1

Freq = 1.5945 GHz, Bw = 32.000 MH No calibration applied and no bandpass applied

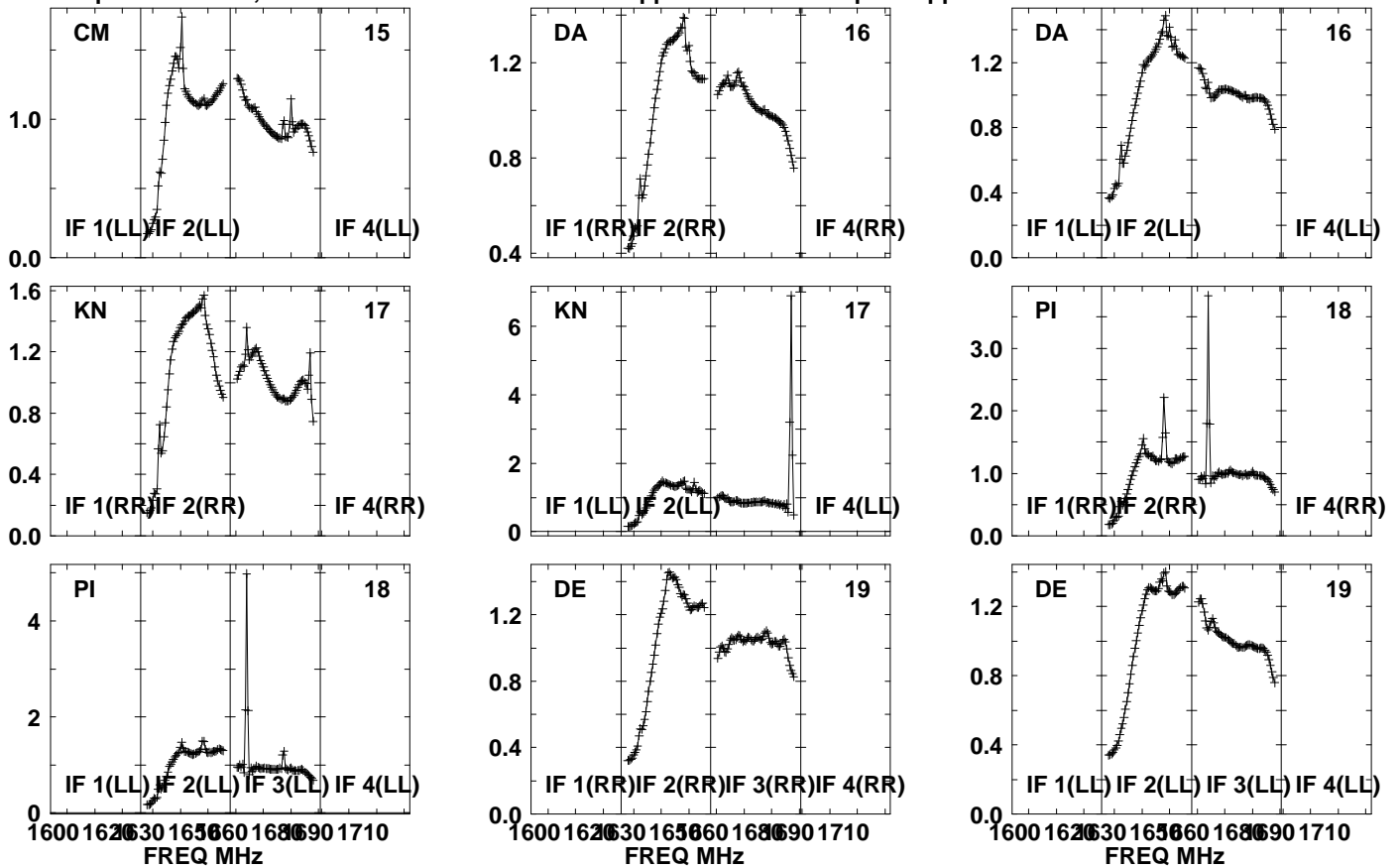

Lower frame: Real Jy  
Auto-corr total-power spectrum Antenna: \*  
Timerange: 00/19:05:01 to 00/19:06:29

Plot file version 994 created 05-OCT-2021 17:09:21

J0827+5217 GM076.UVDATA.1

Freq = 1.5945 GHz, Bw = 32.000 MH No calibration applied and no bandpass applied

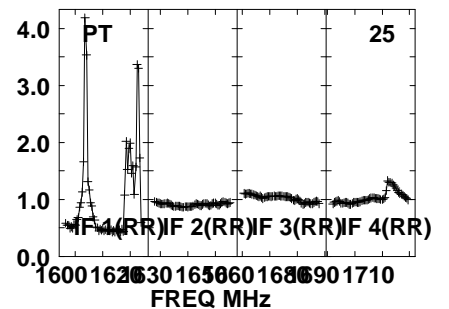
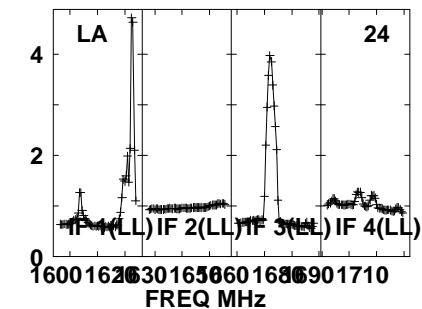
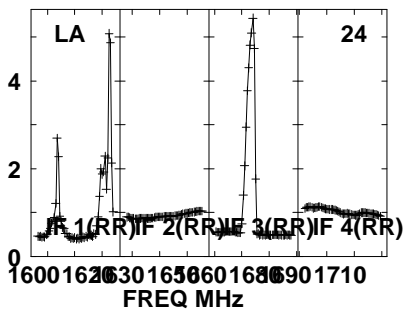
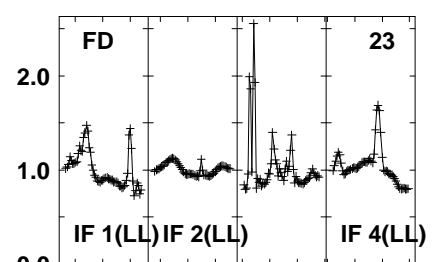
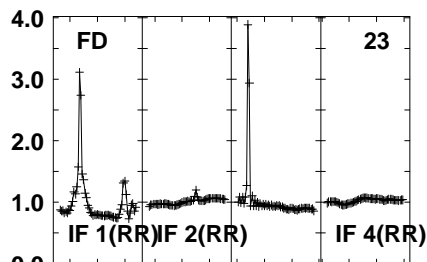
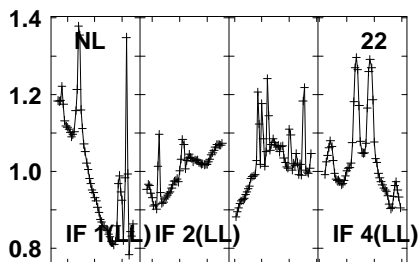
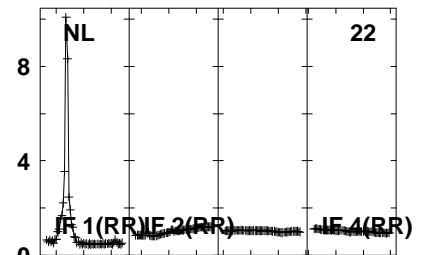
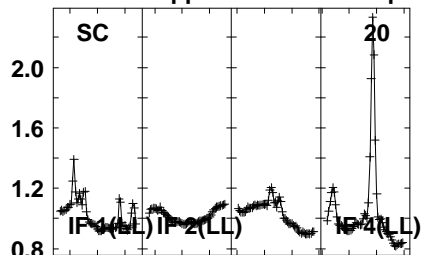
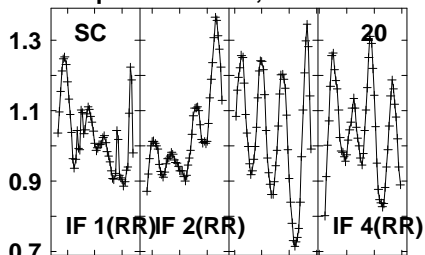

Lower frame: Real Jy  
Auto-corr total-power spectrum Antenna: \*  
Timerange: 00/19:05:01 to 00/19:06:29



Plot file version 995 created 05-OCT-2021 17:09:21

J0827+5217 GM076.UVDATA.1

Freq = 1.5945 GHz, Bw = 32.000 MH No calibration applied and no bandpass applied

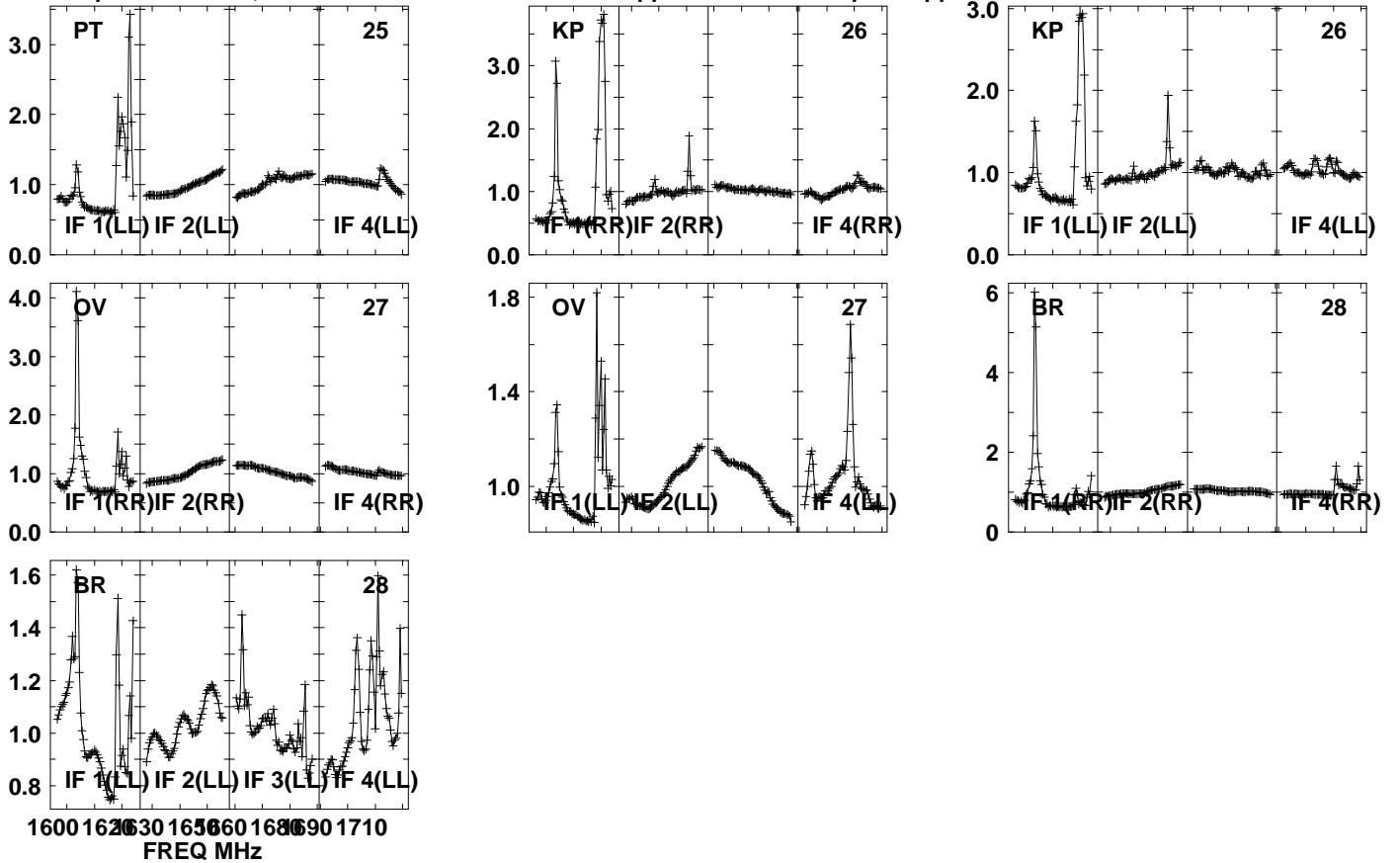

Lower frame: Real Jy  
Auto-corr total-power spectrum Antenna: \*  
Timerange: 00/19:05:01 to 00/19:06:29

Plot file version 996 created 05-OCT-2021 17:09:21

APM08279+525 GM076.UVDATA.1

Freq = 1.5945 GHz, Bw = 32.000 MH No calibration applied and no bandpass applied

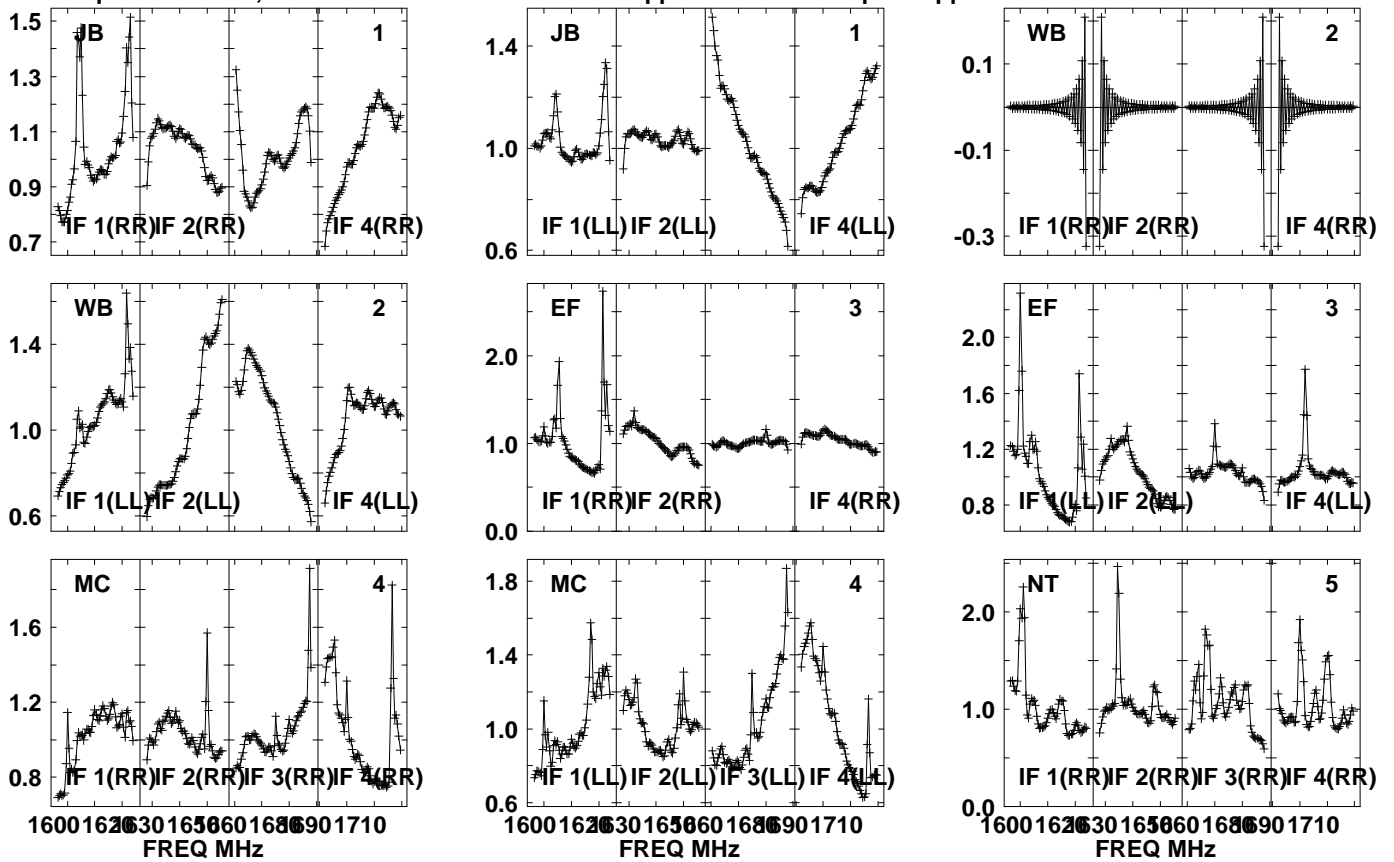

Lower frame: Real Jy  
Auto-corr total-power spectrum Antenna: \*  
Timerange: 00/19:06:31 to 00/19:09:59

Plot file version 997 created 05-OCT-2021 17:09:22

APM08279+525 GM076.UVDATA.1

Freq = 1.5945 GHz, Bw = 32.000 MH No calibration applied and no bandpass applied

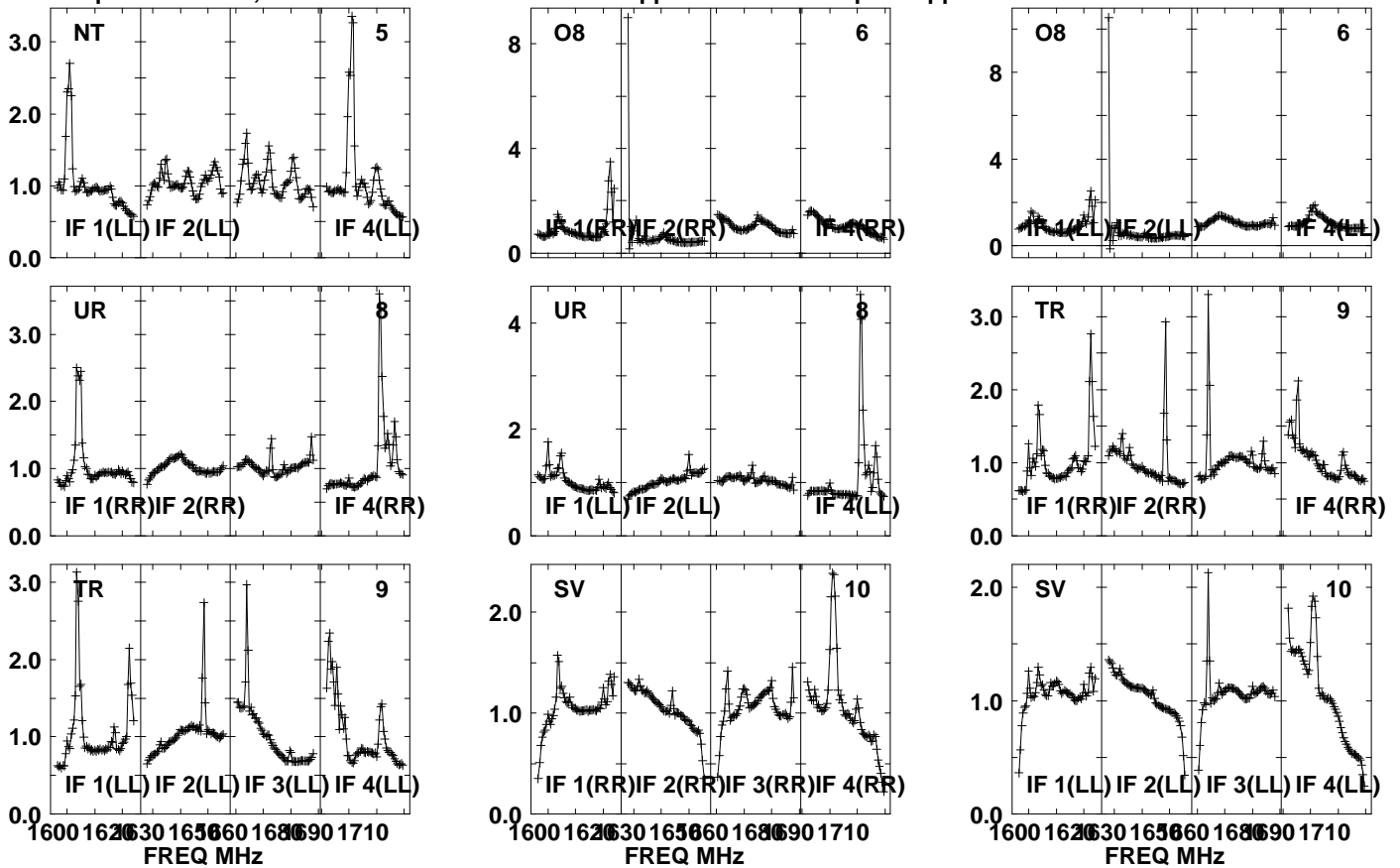

Lower frame: Real Jy

Auto-corr total-power spectrum Antenna: \*

Timerange: 00/19:06:31 to 00/19:09:59

Plot file version 998 created 05-OCT-2021 17:09:22

APM08279+525 GM076.UVDATA.1

Freq = 1.5945 GHz, Bw = 32.000 MH No calibration applied and no bandpass applied

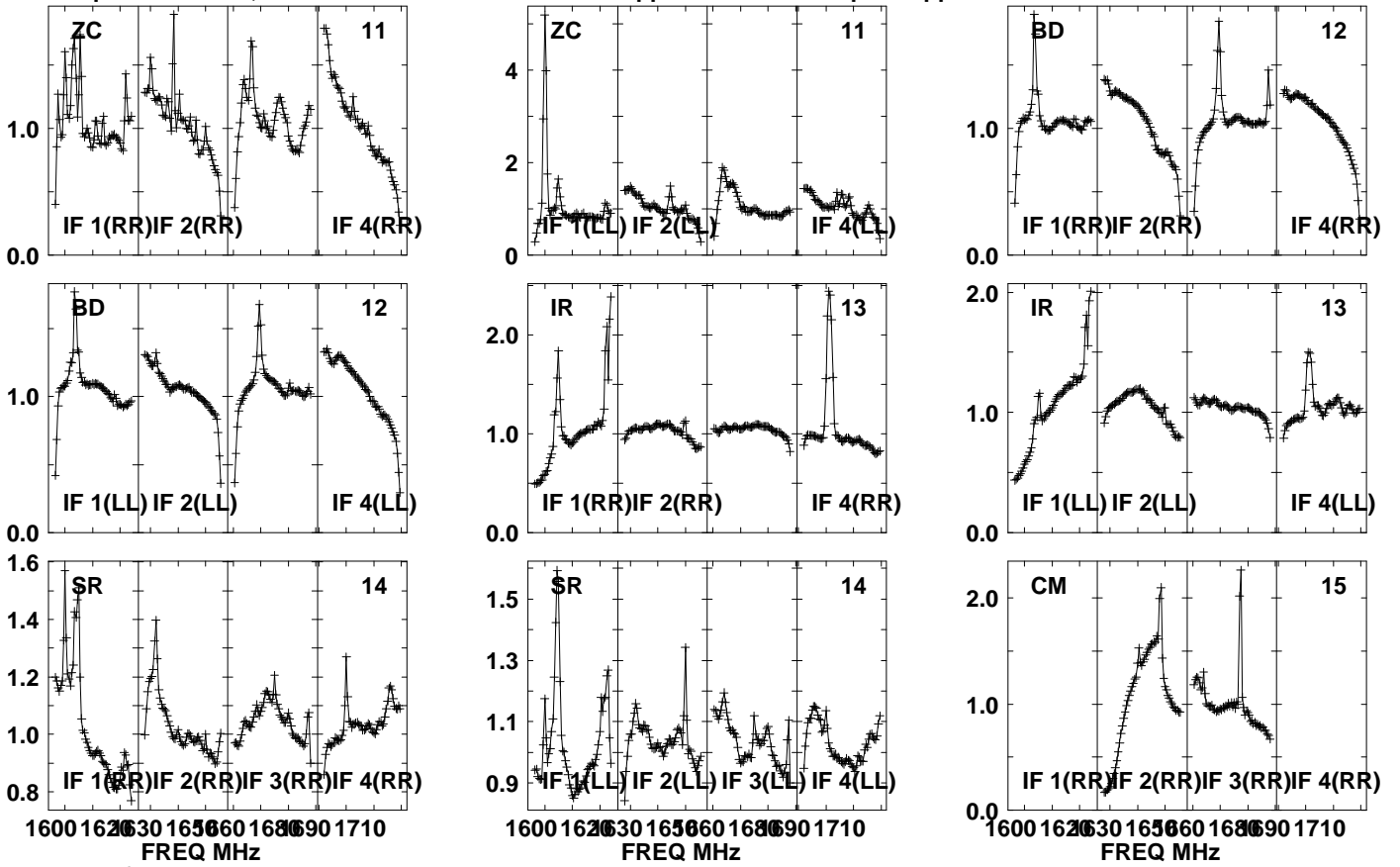

Lower frame: Real Jy  
Auto-corr total-power spectrum Antenna: \*  
Timerange: 00/19:06:31 to 00/19:09:59

Plot file version 999 created 05-OCT-2021 17:09:22

APM08279+525 GM076.UVDATA.1

Freq = 1.5945 GHz, Bw = 32.000 MH No calibration applied and no bandpass applied

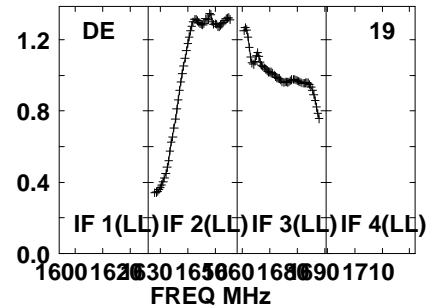
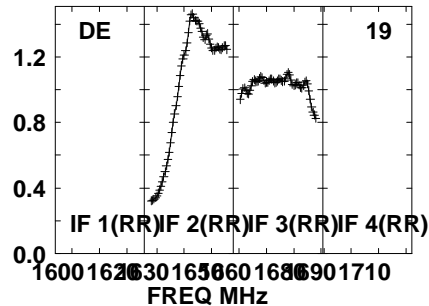
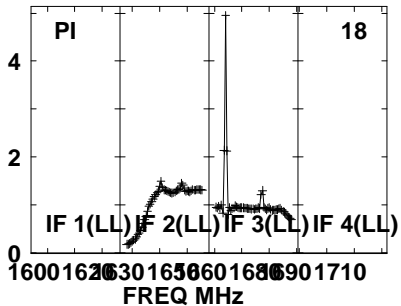
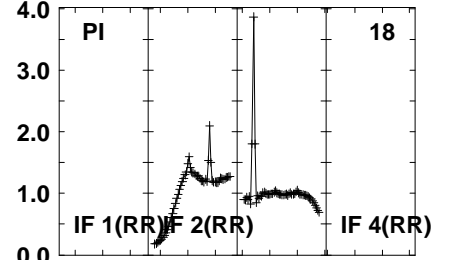
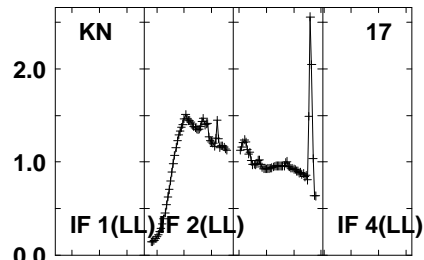
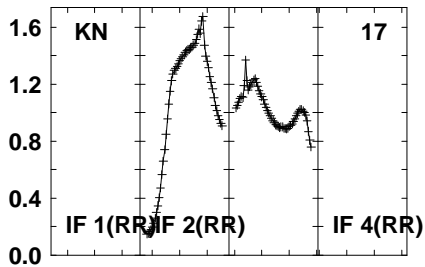
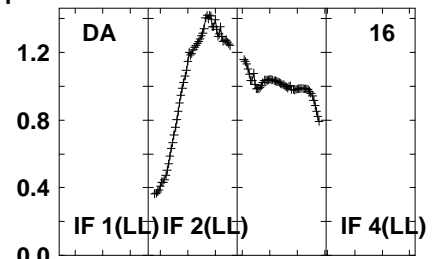
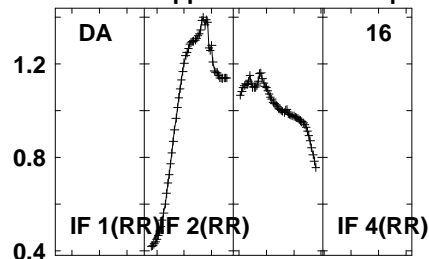
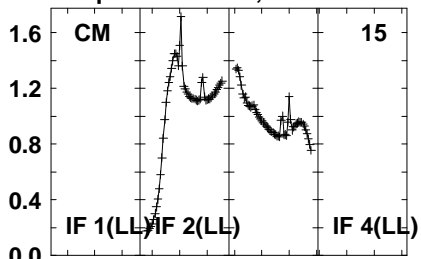

Lower frame: Real Jy  
Auto-corr total-power spectrum Antenna: \*  
Timerange: 00/19:06:31 to 00/19:09:59

Plot file version1000 created 05-OCT-2021 17:09:23

APM08279+525 GM076.UVDATA.1

Freq = 1.5945 GHz, Bw = 32.000 MH No calibration applied and no bandpass applied

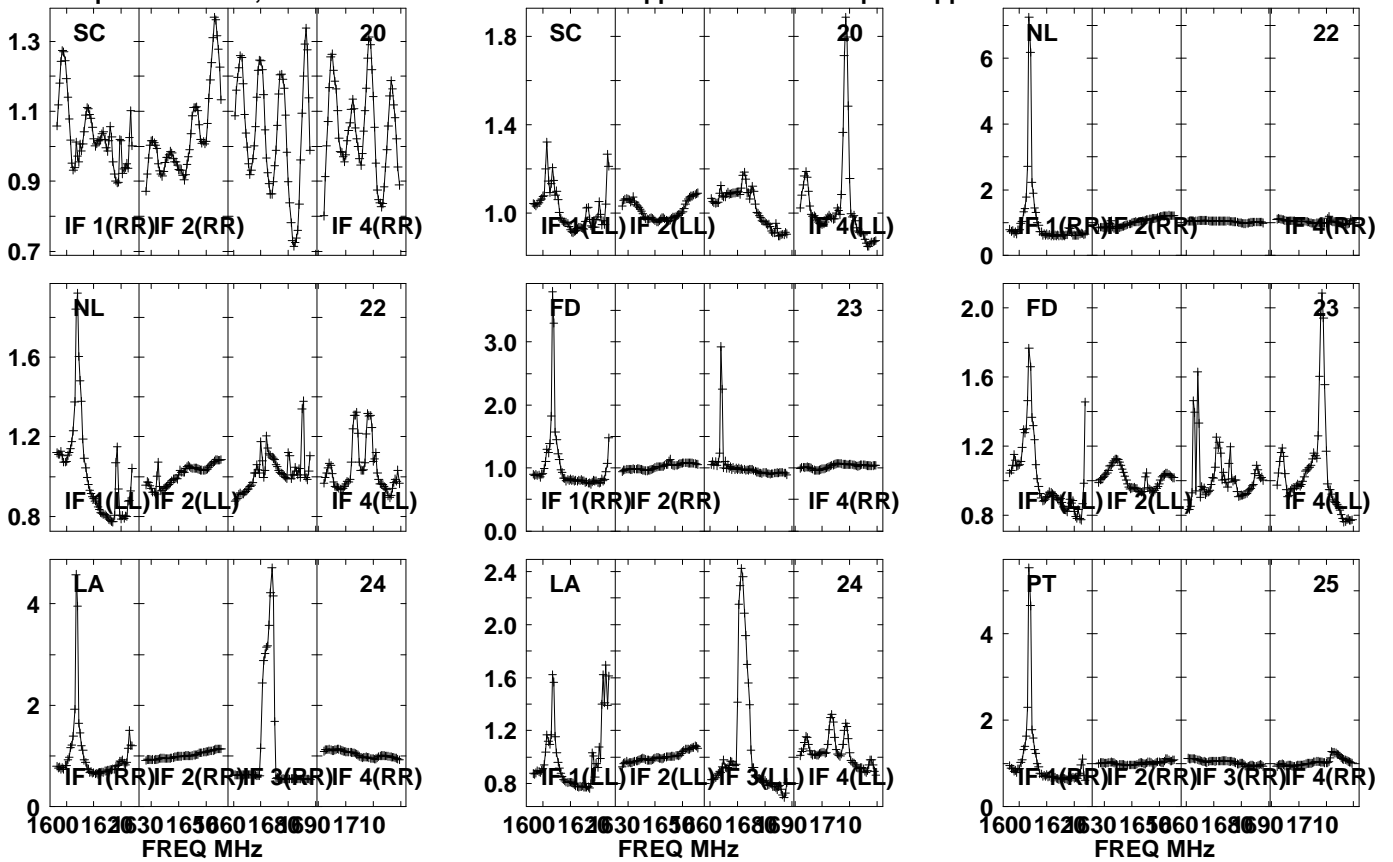

Lower frame: Real Jy  
Auto-corr total-power spectrum Antenna: \*  
Timerange: 00/19:06:31 to 00/19:09:59

Plot file version1001 created 05-OCT-2021 17:09:23

APM08279+525 GM076.UVDATA.1

Freq = 1.5945 GHz, Bw = 32.000 MH

No calibration applied and no bandpass applied

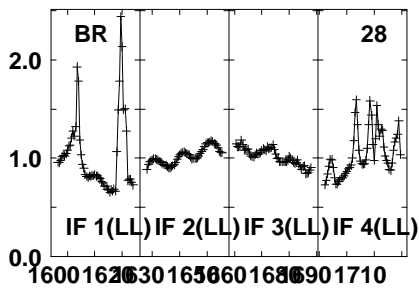
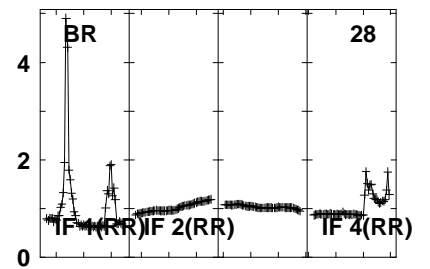
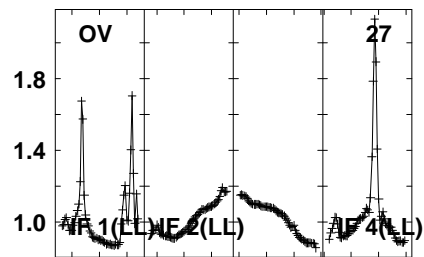
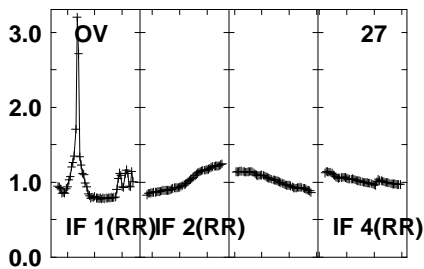
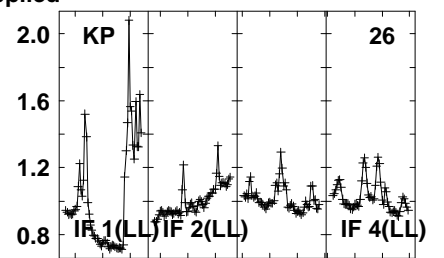
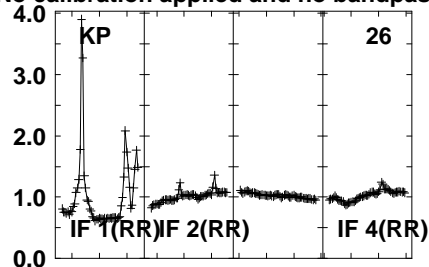
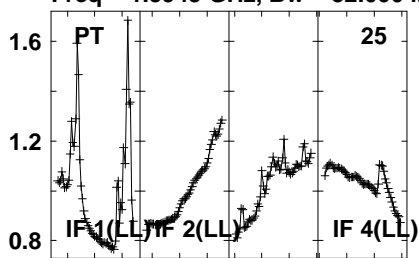

1600 1620 1630 1650 1660 1680 1690 1710  
FREQ MHz

Lower frame: Real Jy

Auto-corr total-power spectrum Antenna: \*

Timerange: 00/19:06:31 to 00/19:09:59

Plot file version1002 created 05-OCT-2021 17:09:23

J0827+5217 GM076.UVDATA.1

Freq = 1.5945 GHz, Bw = 32.000 MH No calibration applied and no bandpass applied

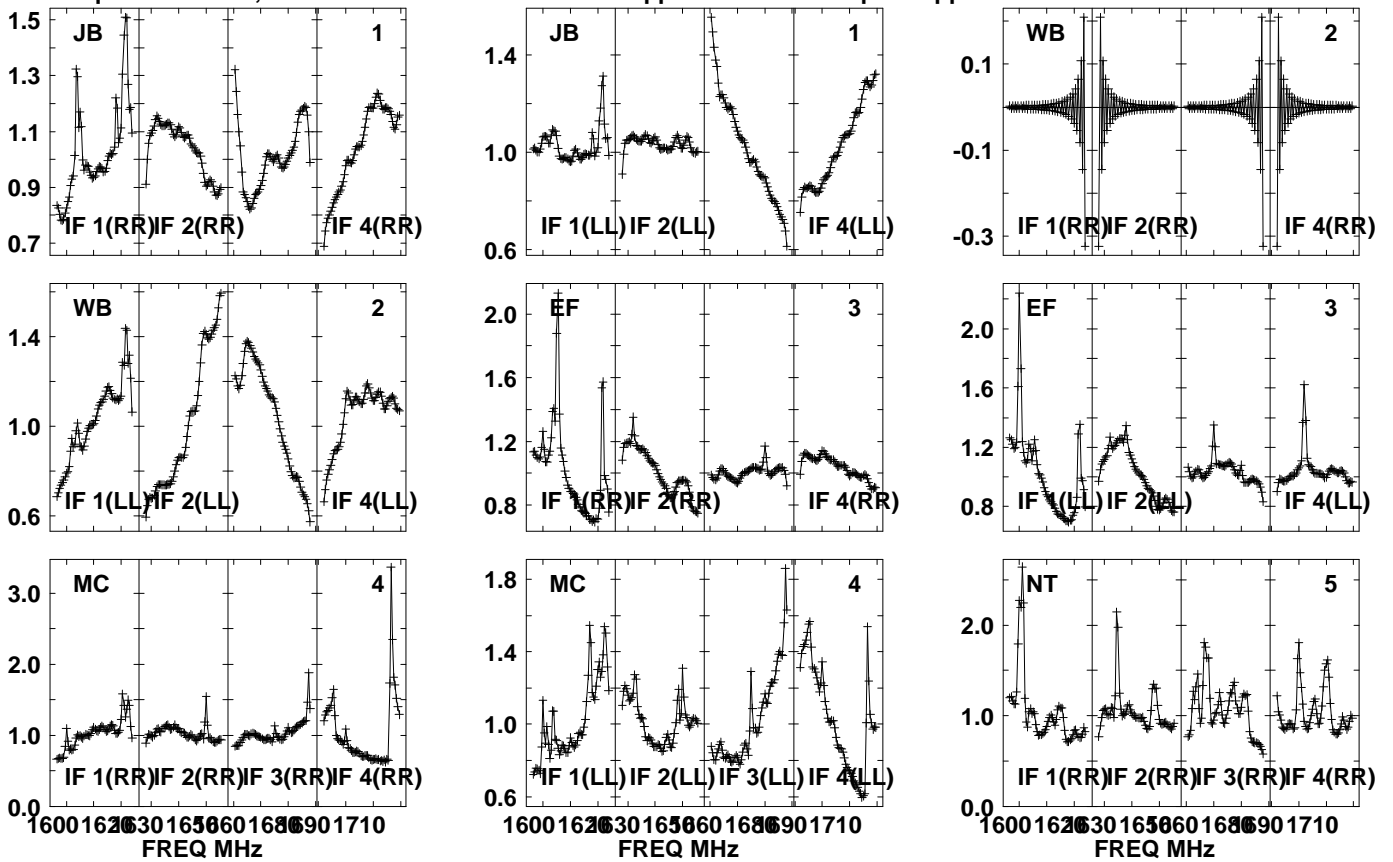

Lower frame: Real Jy

Auto-corr total-power spectrum Antenna: \*

Timerange: 00/19:10:01 to 00/19:11:29



Plot file version1003 created 05-OCT-2021 17:09:23

J0827+5217 GM076.UVDATA.1

Freq = 1.5945 GHz, Bw = 32.000 MH No calibration applied and no bandpass applied

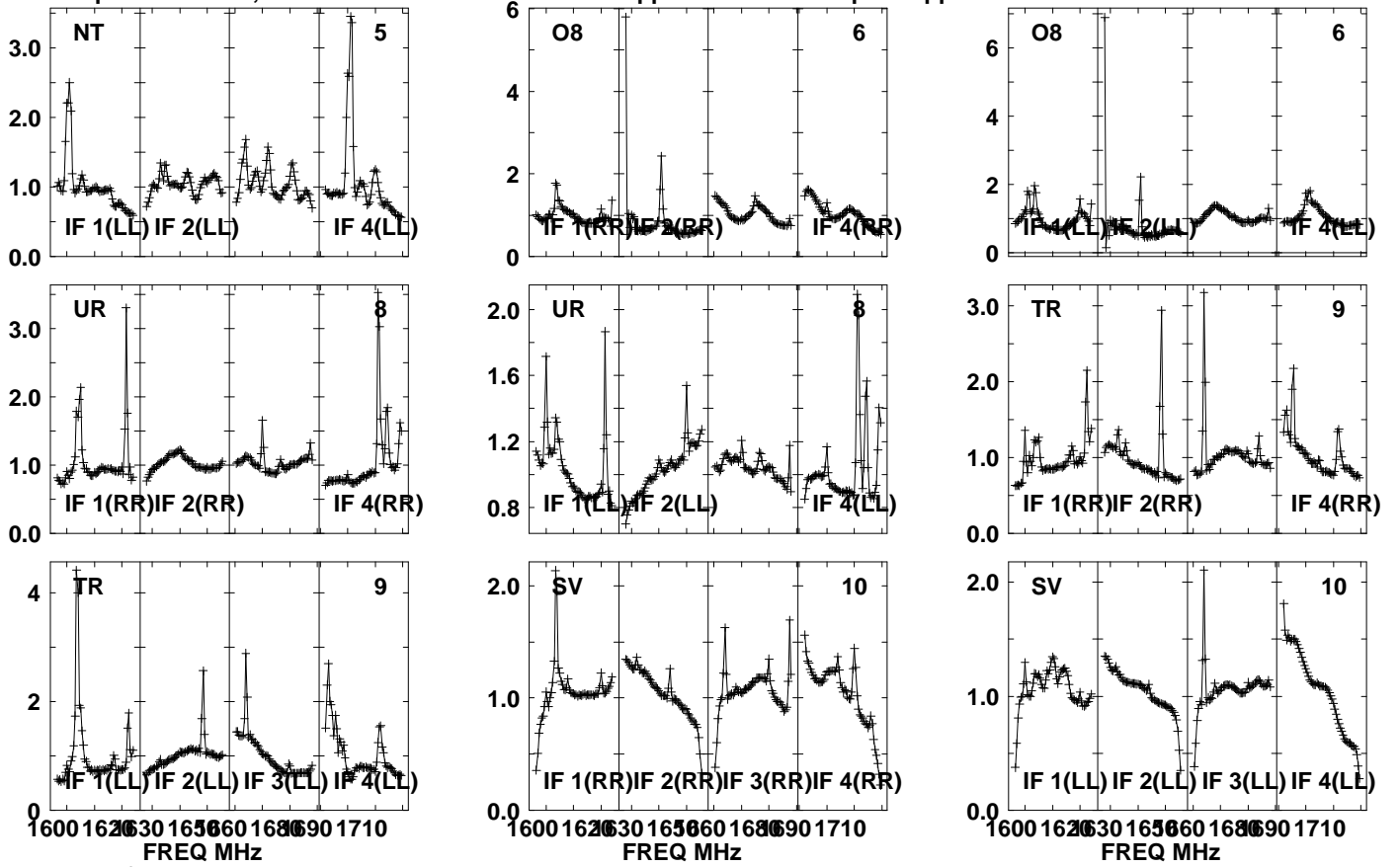

Lower frame: Real Jy

Auto-corr total-power spectrum Antenna: \*

Timerange: 00/19:10:01 to 00/19:11:29

Plot file version1004 created 05-OCT-2021 17:09:24

J0827+5217 GM076.UVDATA.1

Freq = 1.5945 GHz, Bw = 32.000 MH No calibration applied and no bandpass applied

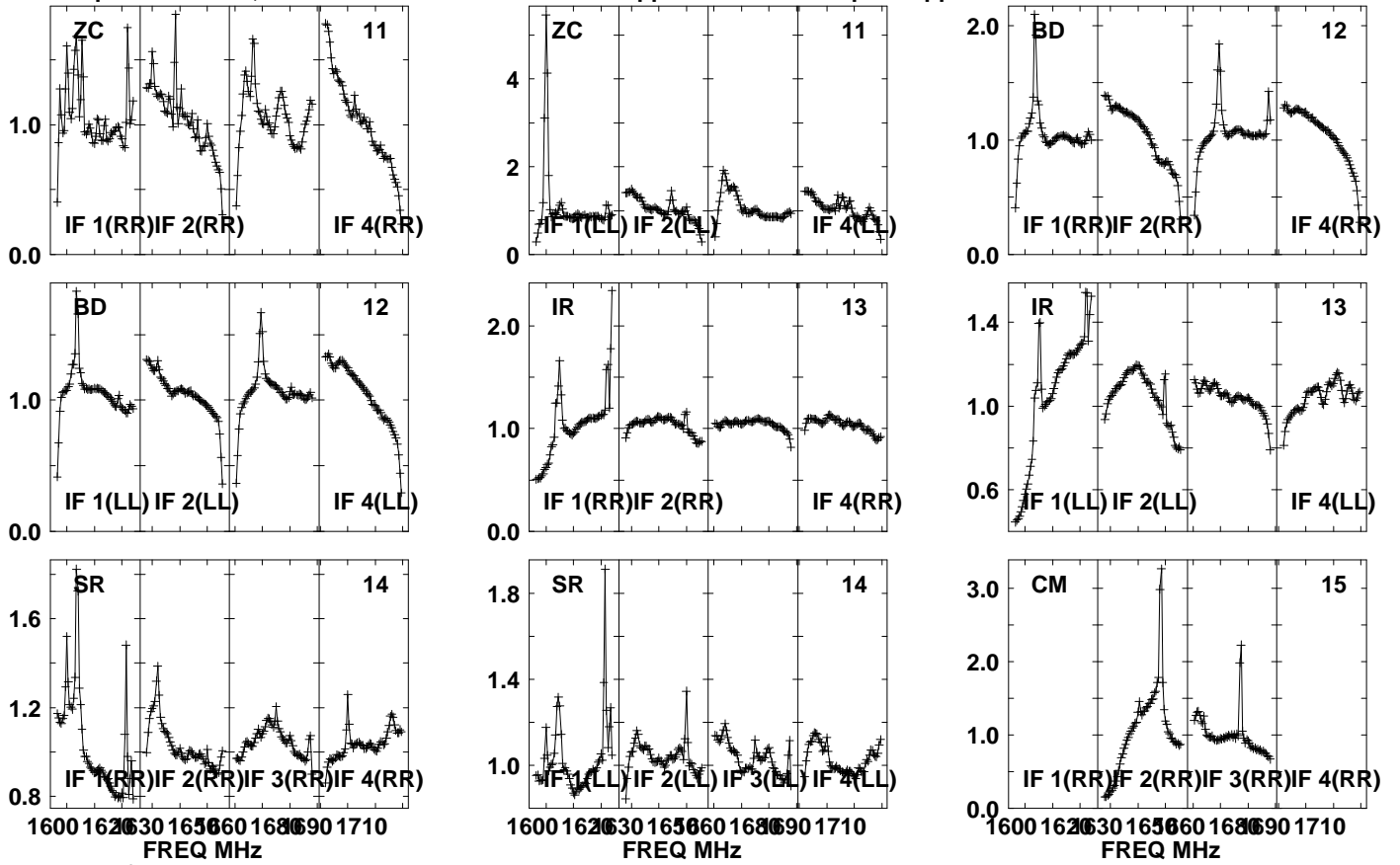

Lower frame: Real Jy

Auto-corr total-power spectrum Antenna: \*

Timerange: 00/19:10:01 to 00/19:11:29

Plot file version1005 created 05-OCT-2021 17:09:24

J0827+5217 GM076.UVDATA.1

Freq = 1.5945 GHz, Bw = 32.000 MH No calibration applied and no bandpass applied

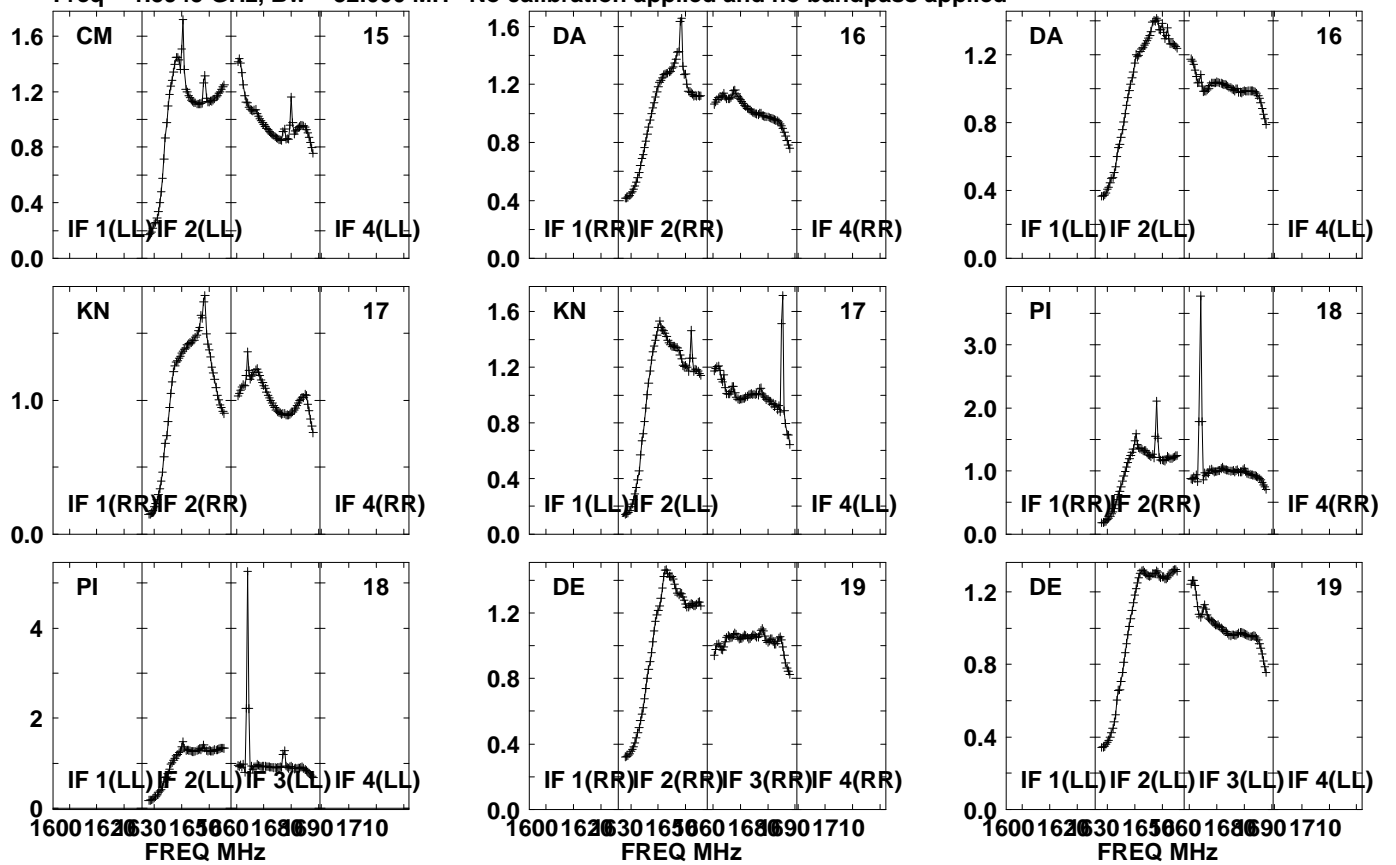

Lower frame: Real Jy  
Auto-corr total-power spectrum Antenna: \*  
Timerange: 00/19:10:01 to 00/19:11:29

Plot file version1006 created 05-OCT-2021 17:09:24

J0827+5217 GM076.UVDATA.1

Freq = 1.5945 GHz, Bw = 32.000 MH No calibration applied and no bandpass applied

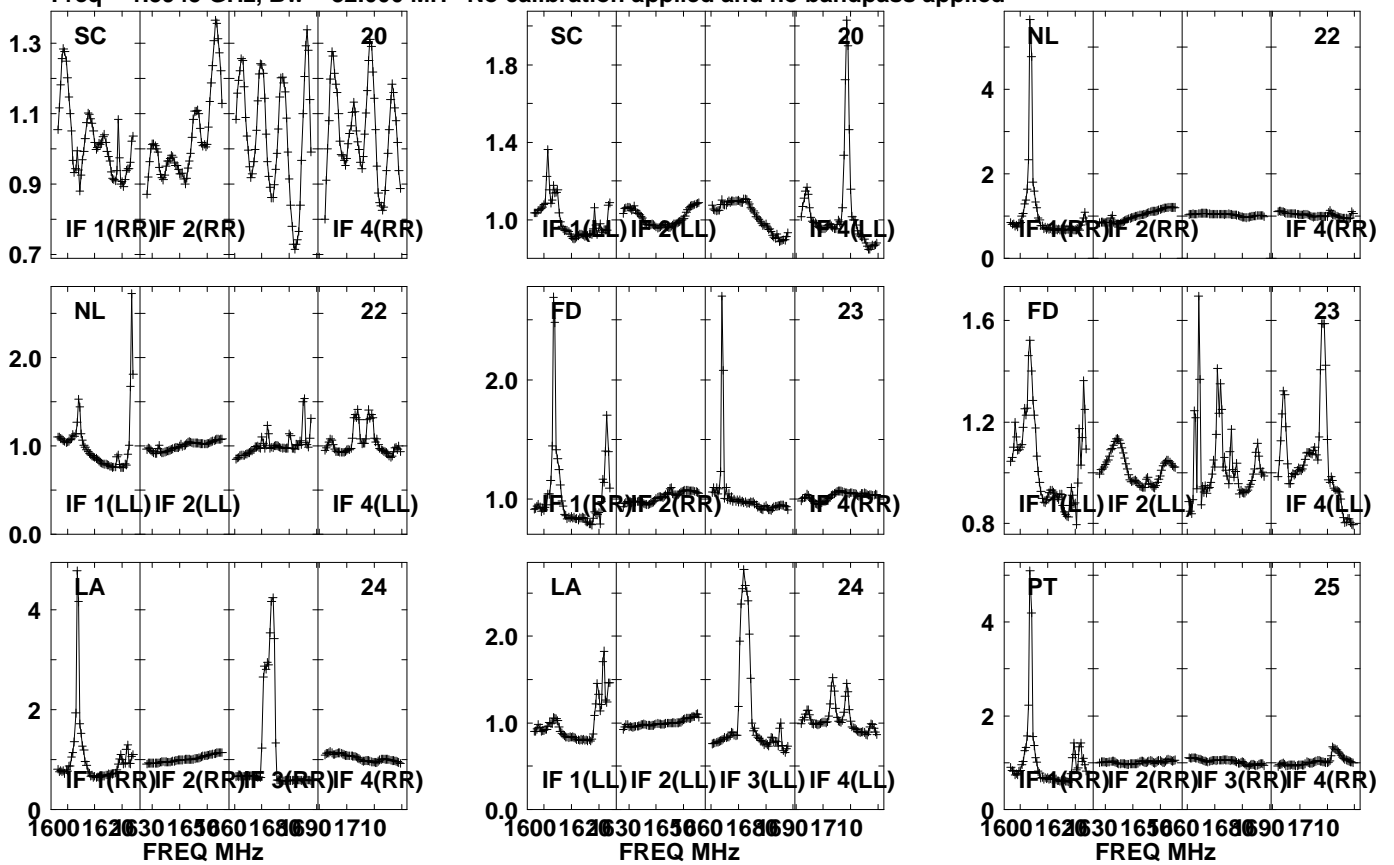

Lower frame: Real Jy  
Auto-corr total-power spectrum Antenna: \*  
Timerange: 00/19:10:01 to 00/19:11:29

Plot file version1007 created 05-OCT-2021 17:09:25

J0827+5217 GM076.UVDATA.1

Freq = 1.5945 GHz, Bw = 32.000 MH No calibration applied and no bandpass applied

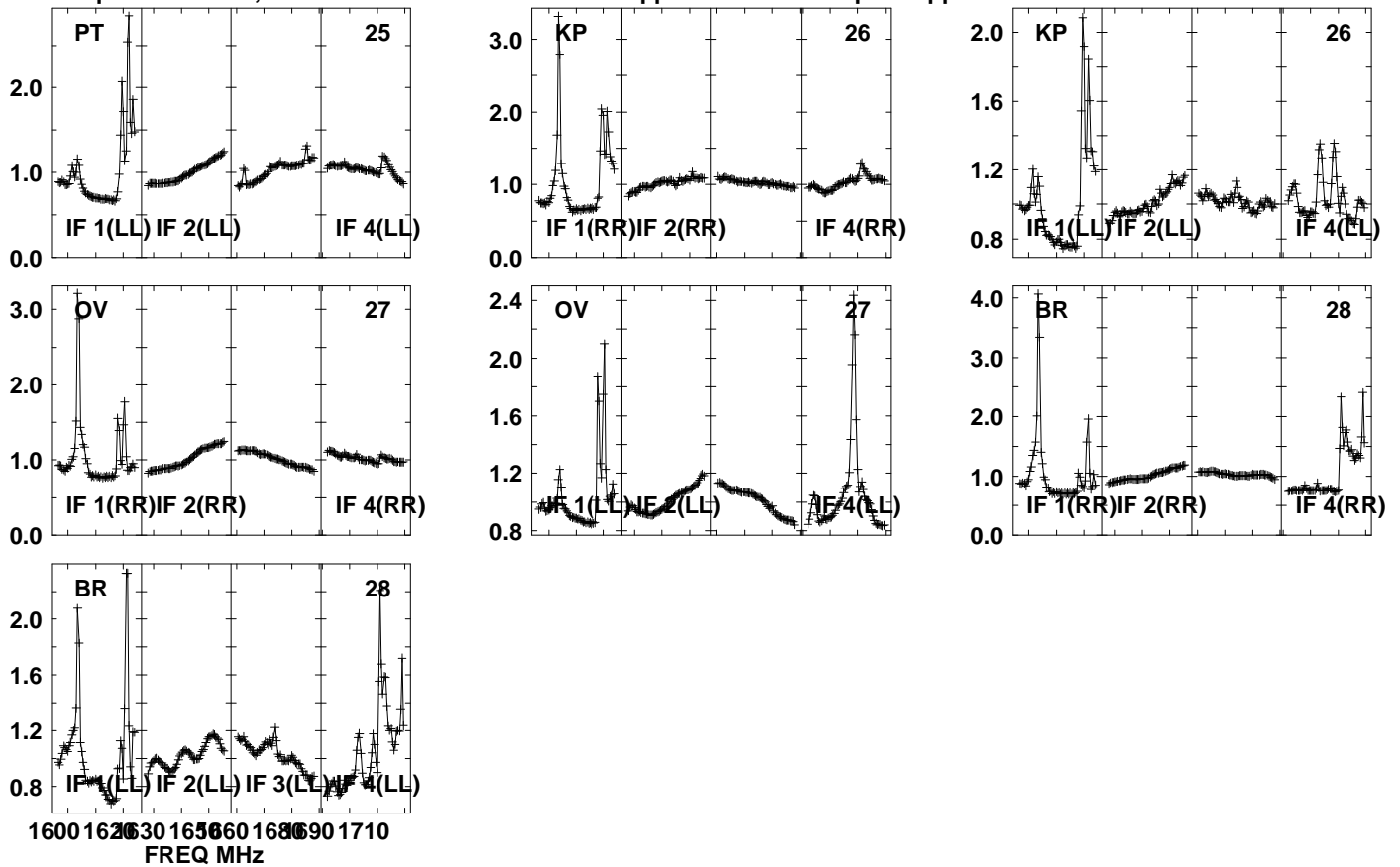

Lower frame: Real Jy

Auto-corr total-power spectrum Antenna: \*

Timerange: 00/19:10:01 to 00/19:11:29

Plot file version1008 created 05-OCT-2021 17:09:25

APM08279+525 GM076.UVDATA.1

Freq = 1.5945 GHz, Bw = 32.000 MH No calibration applied and no bandpass applied

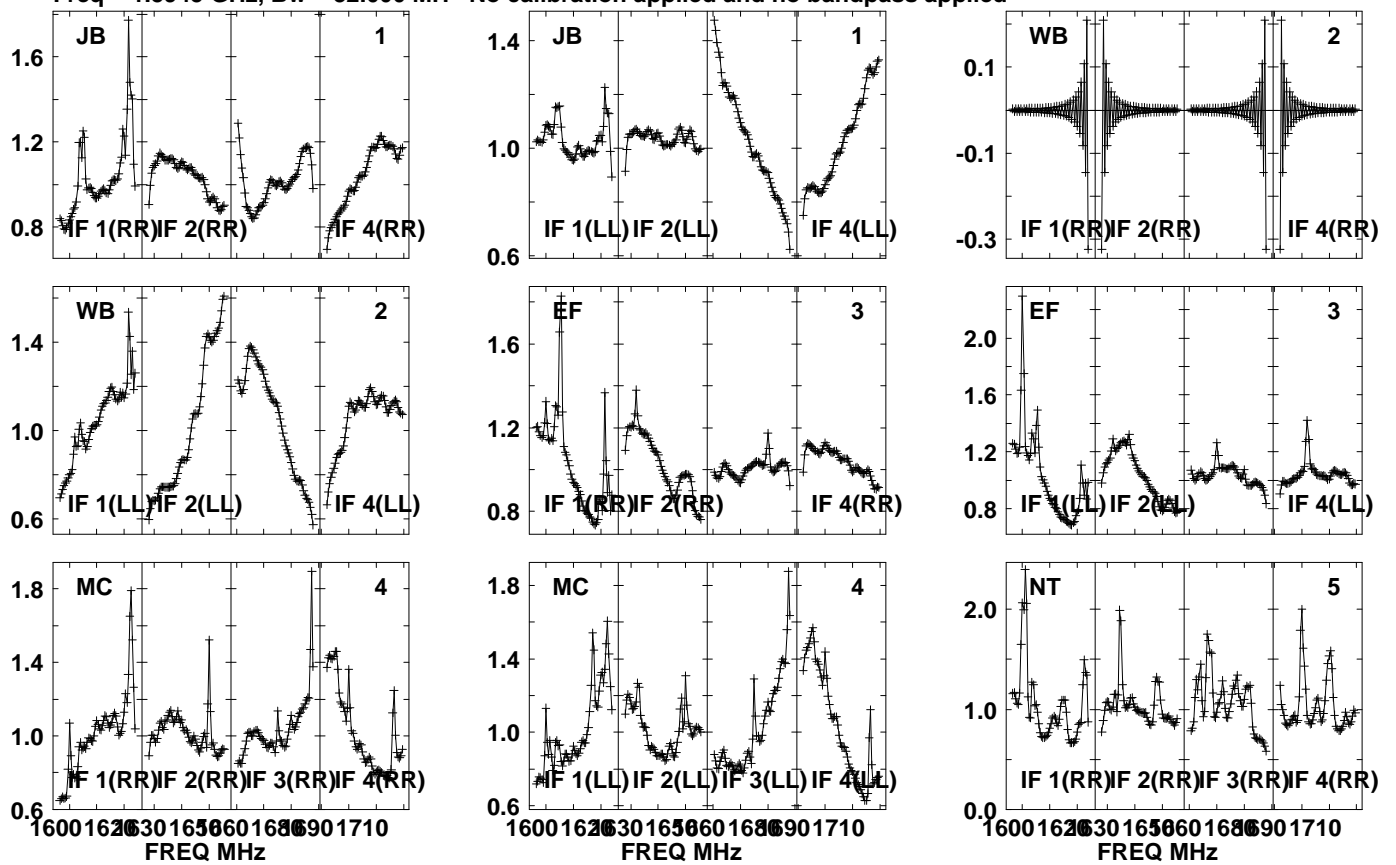

Lower frame: Real Jy  
Auto-corr total-power spectrum Antenna: \*  
Timerange: 00/19:11:31 to 00/19:14:59

Plot file version1009 created 05-OCT-2021 17:09:25

APM08279+525 GM076.UVDATA.1

Freq = 1.5945 GHz, Bw = 32.000 MH No calibration applied and no bandpass applied

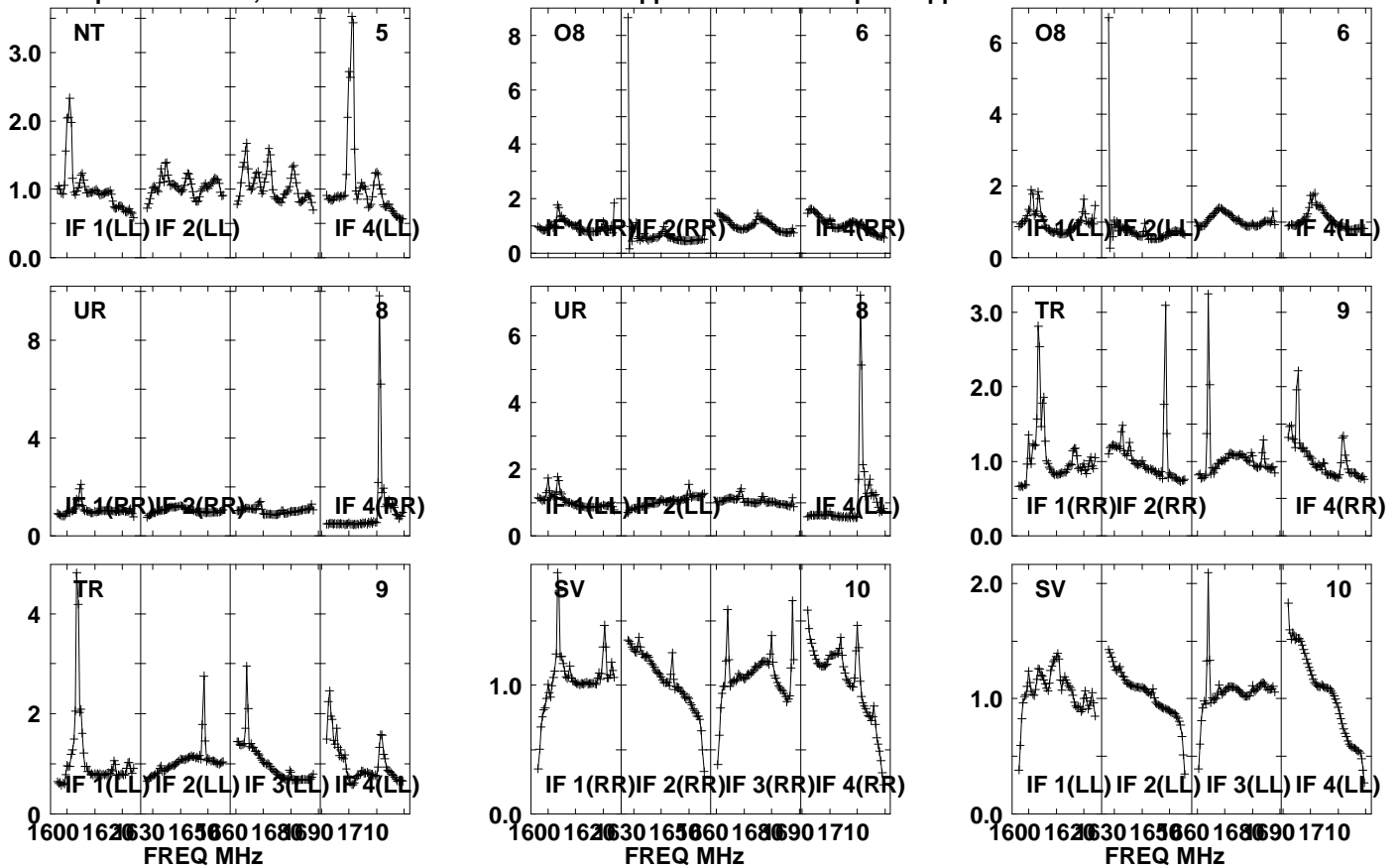

Lower frame: Real Jy

Auto-corr total-power spectrum Antenna: \*

Timerange: 00/19:11:31 to 00/19:14:59

Plot file version1010 created 05-OCT-2021 17:09:26

APM08279+525 GM076.UVDATA.1

Freq = 1.5945 GHz, Bw = 32.000 MH No calibration applied and no bandpass applied

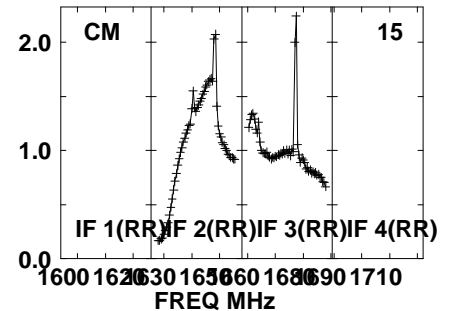
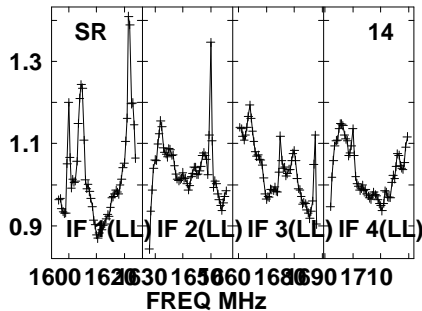
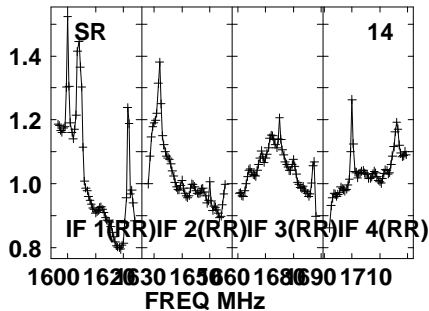
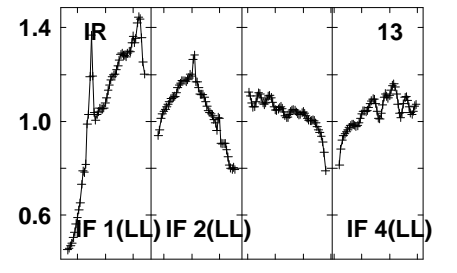
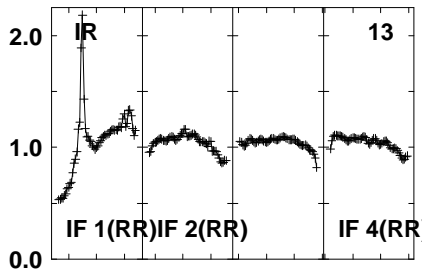
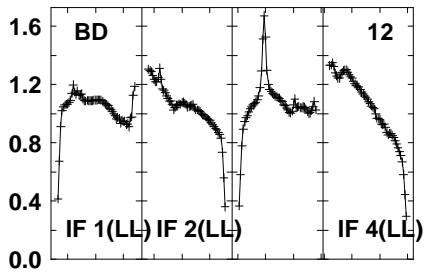
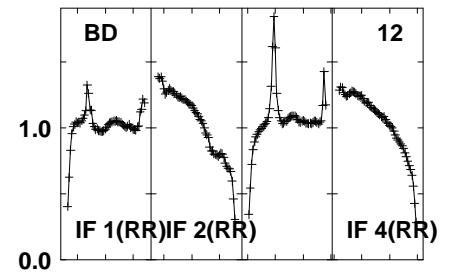
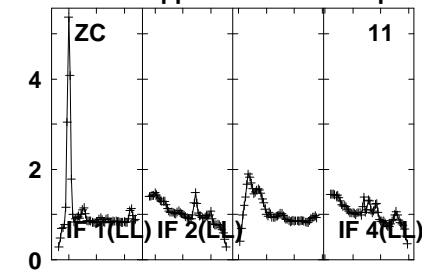
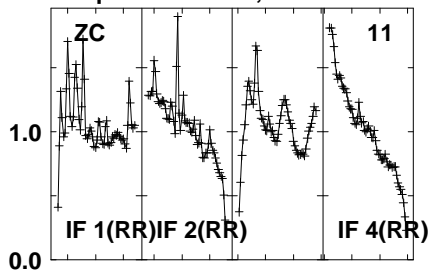

Lower frame: Real Jy

Auto-corr total-power spectrum Antenna: \*

Timerange: 00/19:11:31 to 00/19:14:59



Plot file version1011 created 05-OCT-2021 17:09:26

APM08279+525 GM076.UVDATA.1

Freq = 1.5945 GHz, Bw = 32.000 MH No calibration applied and no bandpass applied

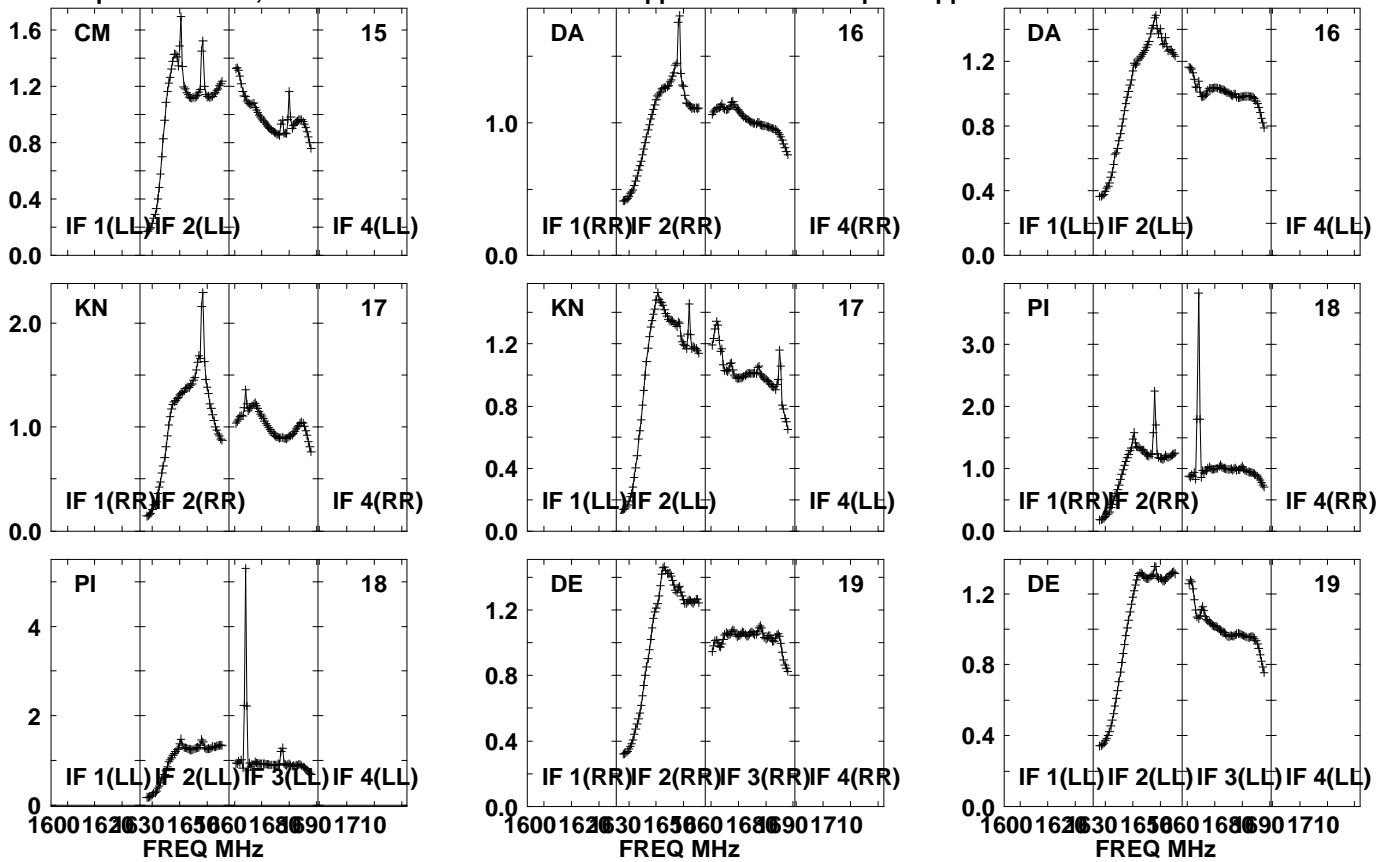

Lower frame: Real Jy  
Auto-corr total-power spectrum Antenna: \*  
Timerange: 00/19:11:31 to 00/19:14:59

Plot file version1012 created 05-OCT-2021 17:09:26

APM08279+525 GM076.UVDATA.1

Freq = 1.5945 GHz, Bw = 32.000 MH No calibration applied and no bandpass applied

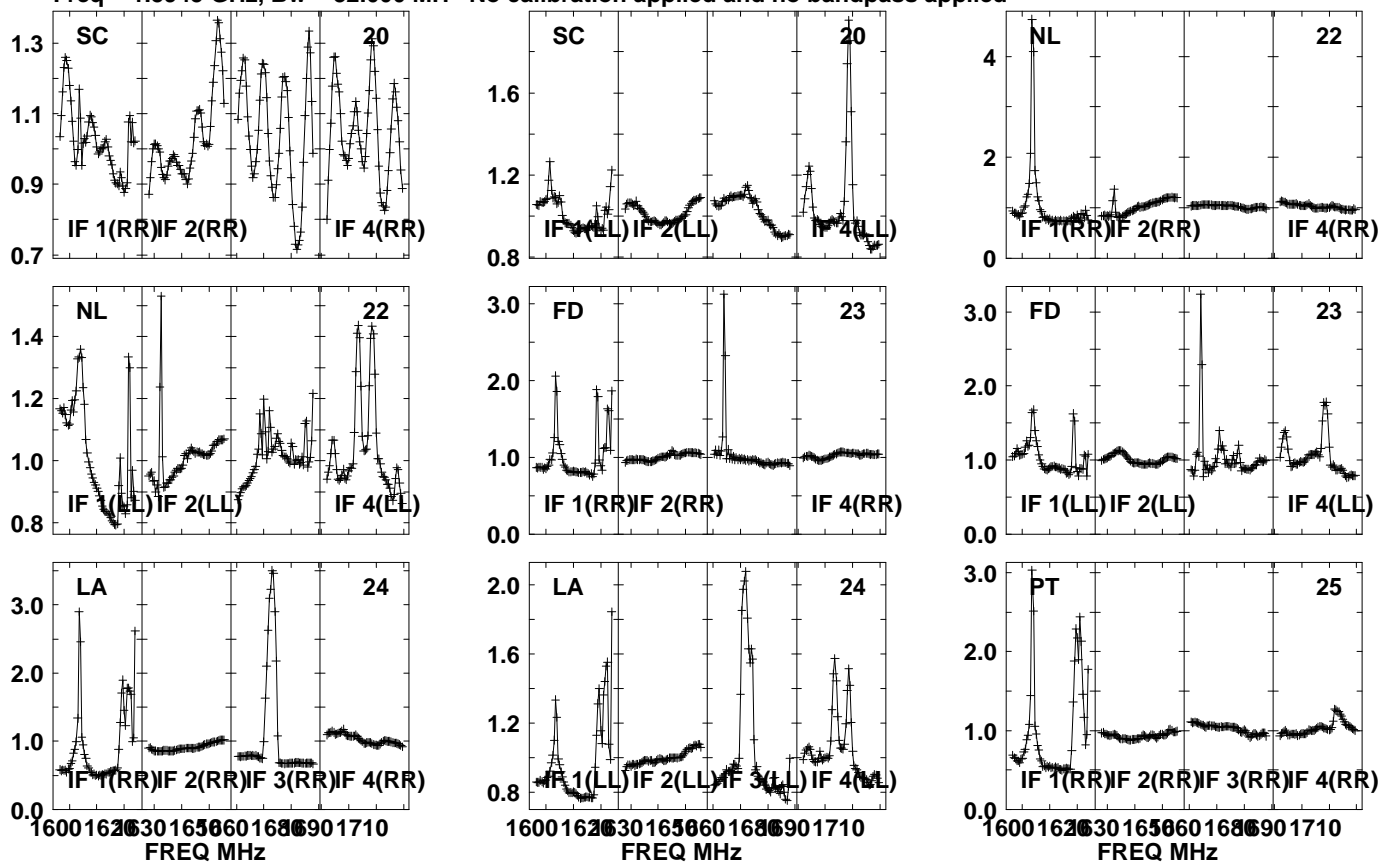

Lower frame: Real Jy  
Auto-corr total-power spectrum Antenna: \*  
Timerange: 00/19:11:31 to 00/19:14:59

Plot file version1013 created 05-OCT-2021 17:09:27

APM08279+525 GM076.UVDATA.1

Freq = 1.5945 GHz, Bw = 32.000 MH No calibration applied and no bandpass applied

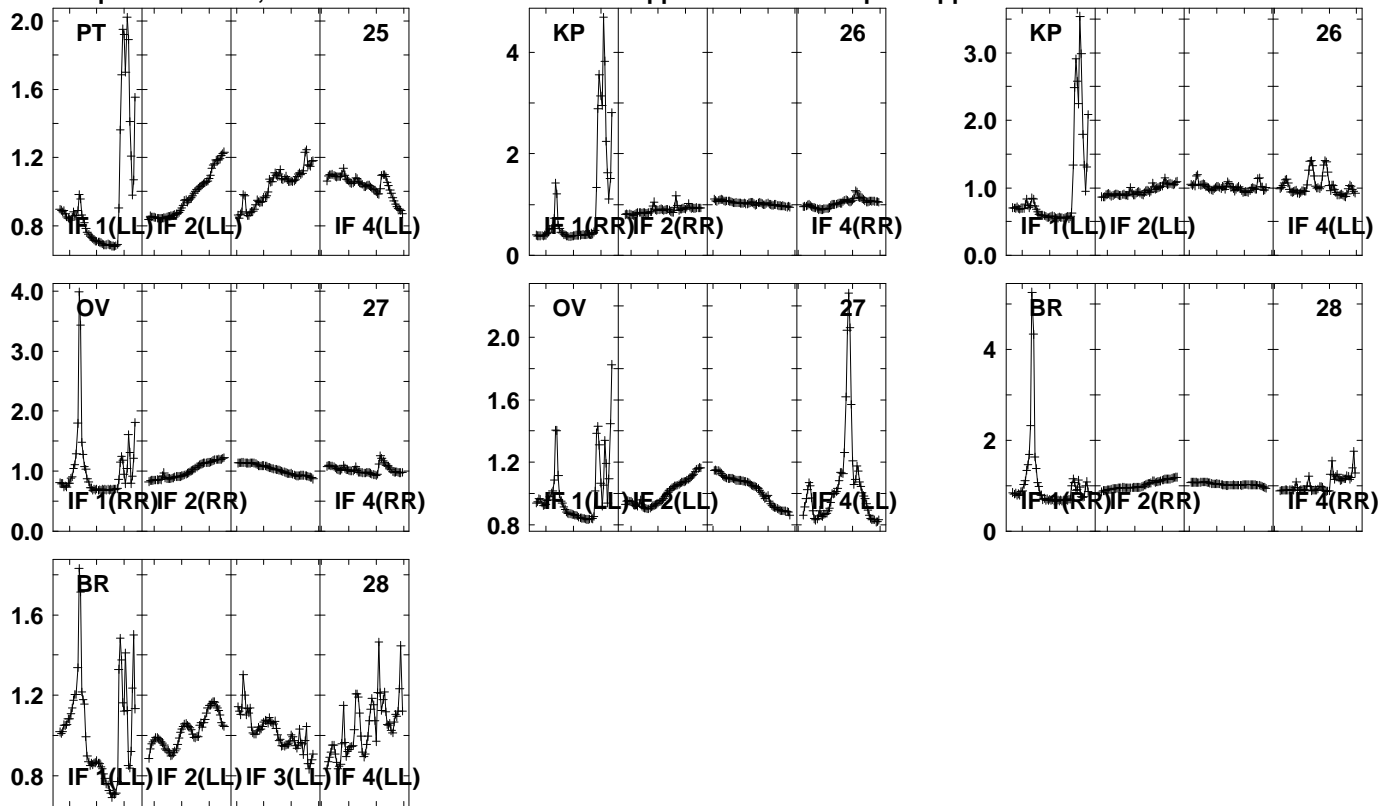

16001620301650601680901710

FREQ MHz

Lower frame: Real Jy

Auto-corr total-power spectrum Antenna: \*

Timerange: 00/19:11:31 to 00/19:14:59

Plot file version1014 created 05-OCT-2021 17:09:27

J0827+5217 GM076.UVDATA.1

Freq = 1.5945 GHz, Bw = 32.000 MH No calibration applied and no bandpass applied

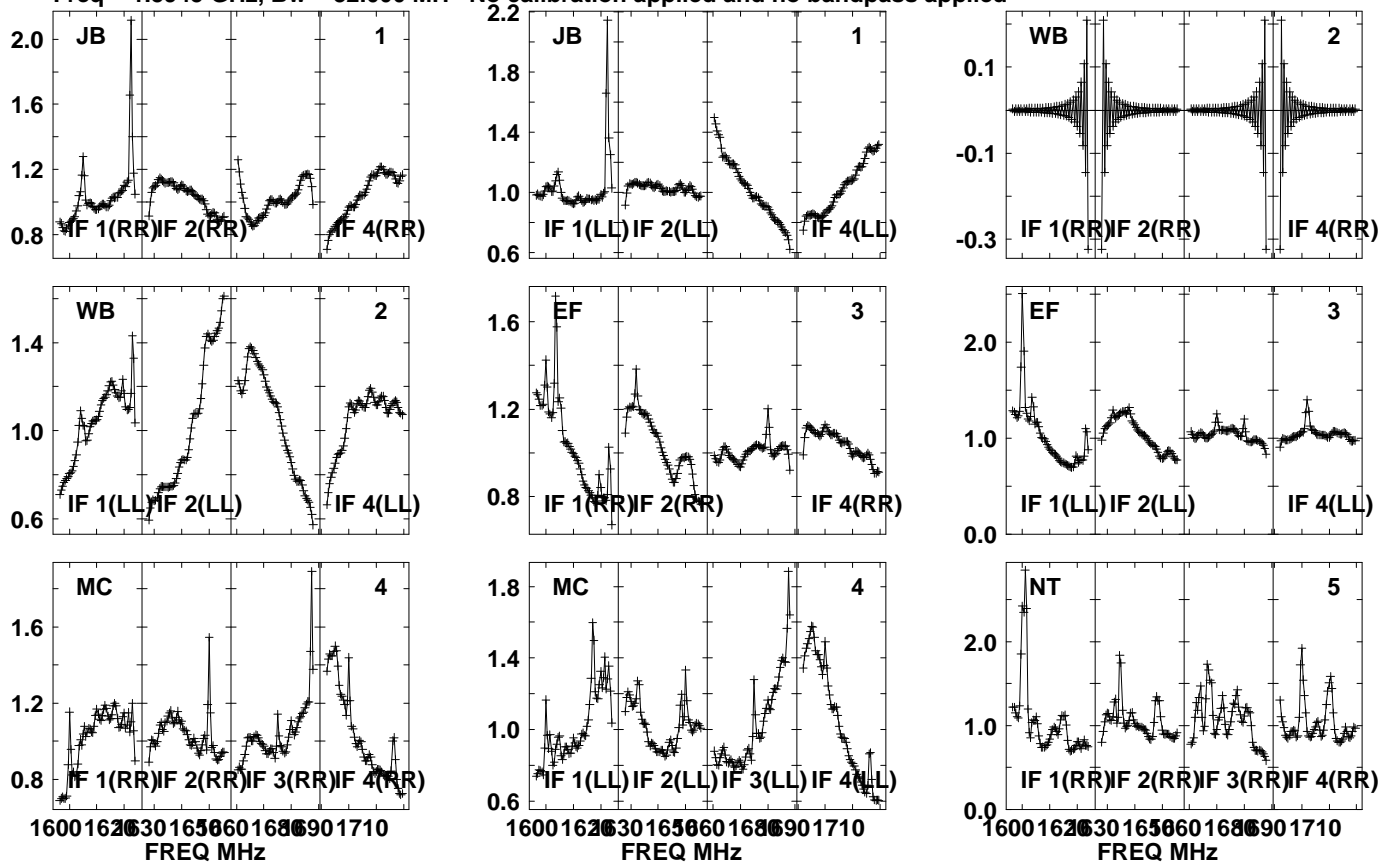

Lower frame: Real Jy  
Auto-corr total-power spectrum Antenna: \*  
Timerange: 00/19:15:31 to 00/19:16:59

Plot file version1015 created 05-OCT-2021 17:09:27

J0827+5217 GM076.UVDATA.1

Freq = 1.5945 GHz, Bw = 32.000 MH No calibration applied and no bandpass applied

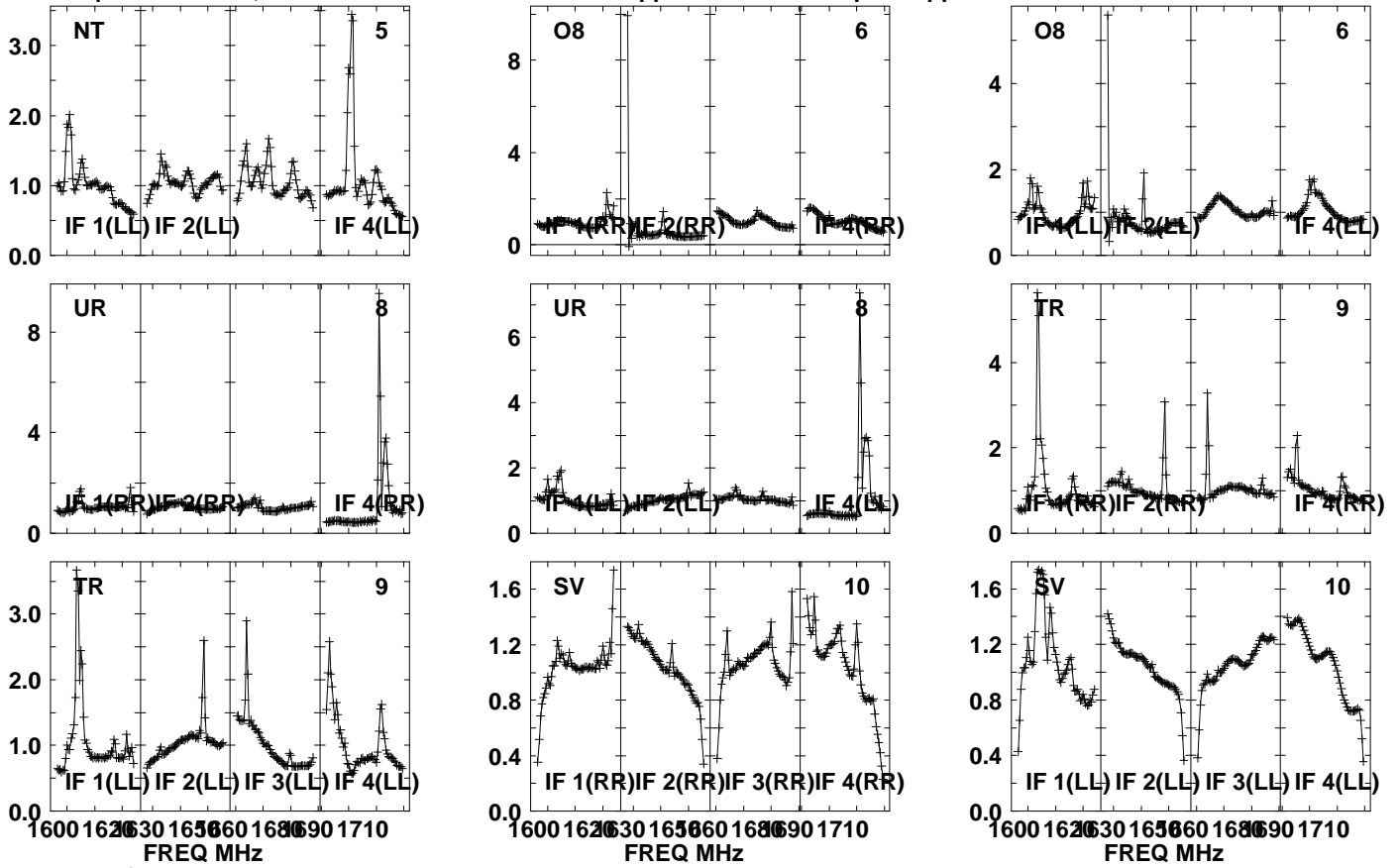

Lower frame: Real Jy  
Auto-corr total-power spectrum Antenna: \*  
Timerange: 00/19:15:31 to 00/19:16:59

Plot file version1016 created 05-OCT-2021 17:09:28

J0827+5217 GM076.UVDATA.1

Freq = 1.5945 GHz, Bw = 32.000 MH No calibration applied and no bandpass applied

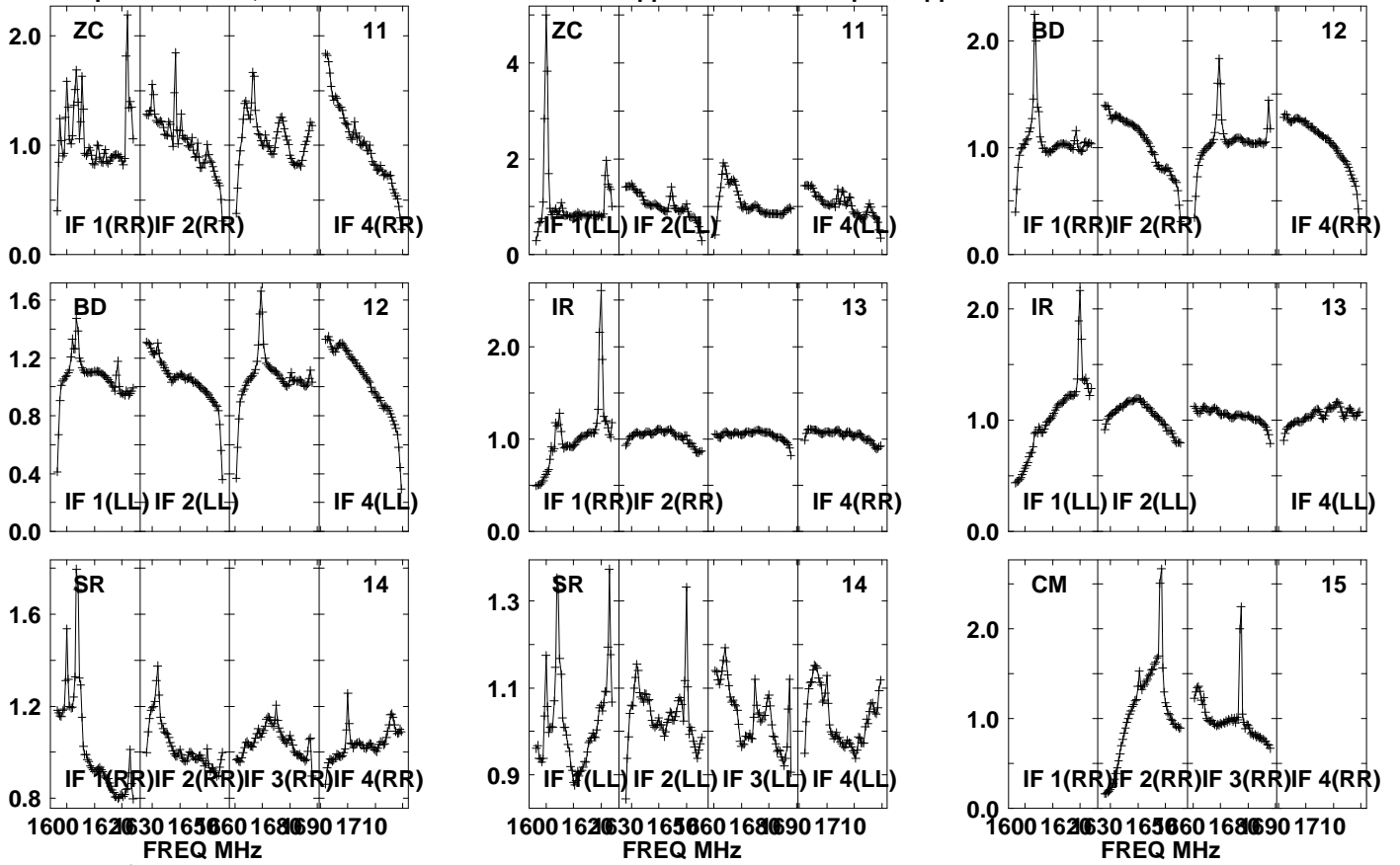

Lower frame: Real Jy

Auto-corr total-power spectrum Antenna: \*

Timerange: 00/19:15:31 to 00/19:16:59

Plot file version1017 created 05-OCT-2021 17:09:28

J0827+5217 GM076.UVDATA.1

Freq = 1.5945 GHz, Bw = 32.000 MH No calibration applied and no bandpass applied

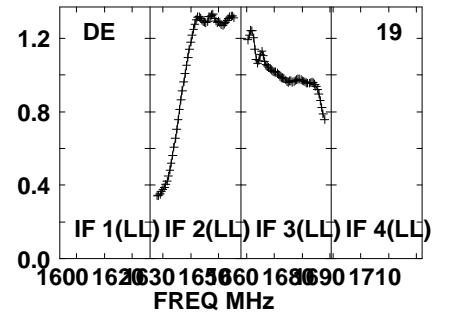
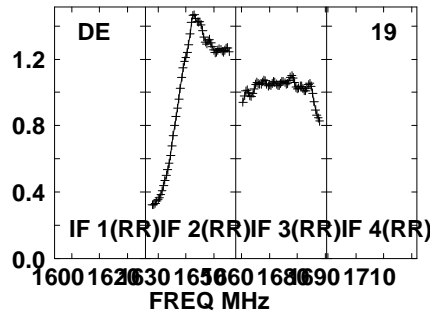
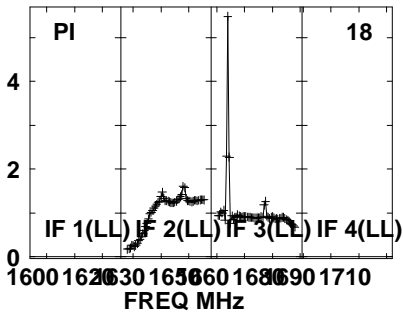
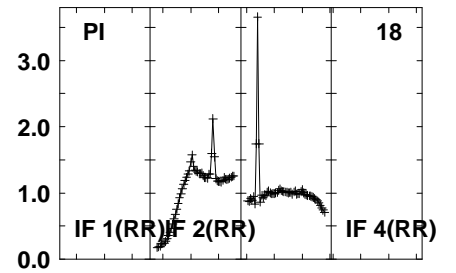
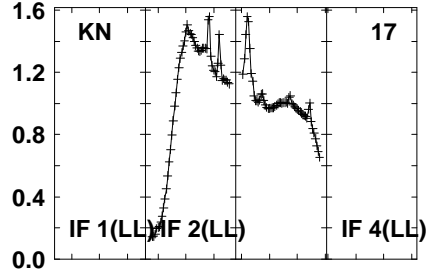
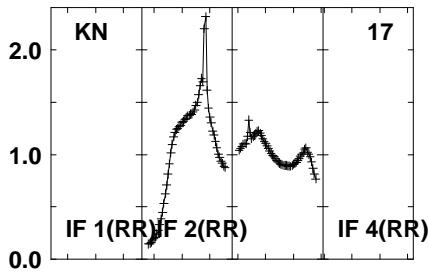
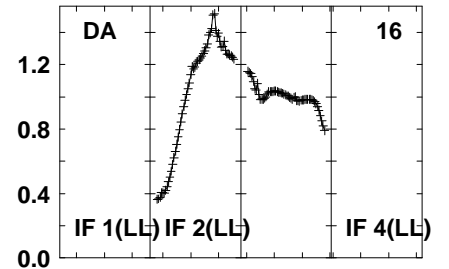
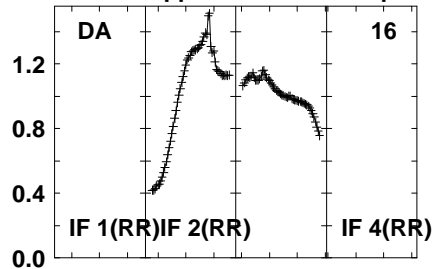
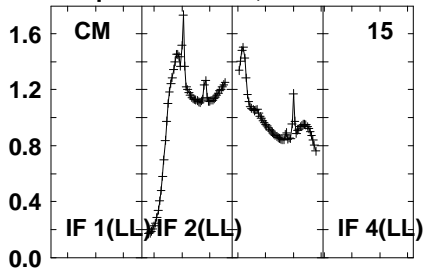

Lower frame: Real Jy  
Auto-corr total-power spectrum Antenna: \*  
Timerange: 00/19:15:31 to 00/19:16:59

Plot file version1018 created 05-OCT-2021 17:09:28

J0827+5217 GM076.UVDATA.1

Freq = 1.5945 GHz, Bw = 32.000 MH No calibration applied and no bandpass applied

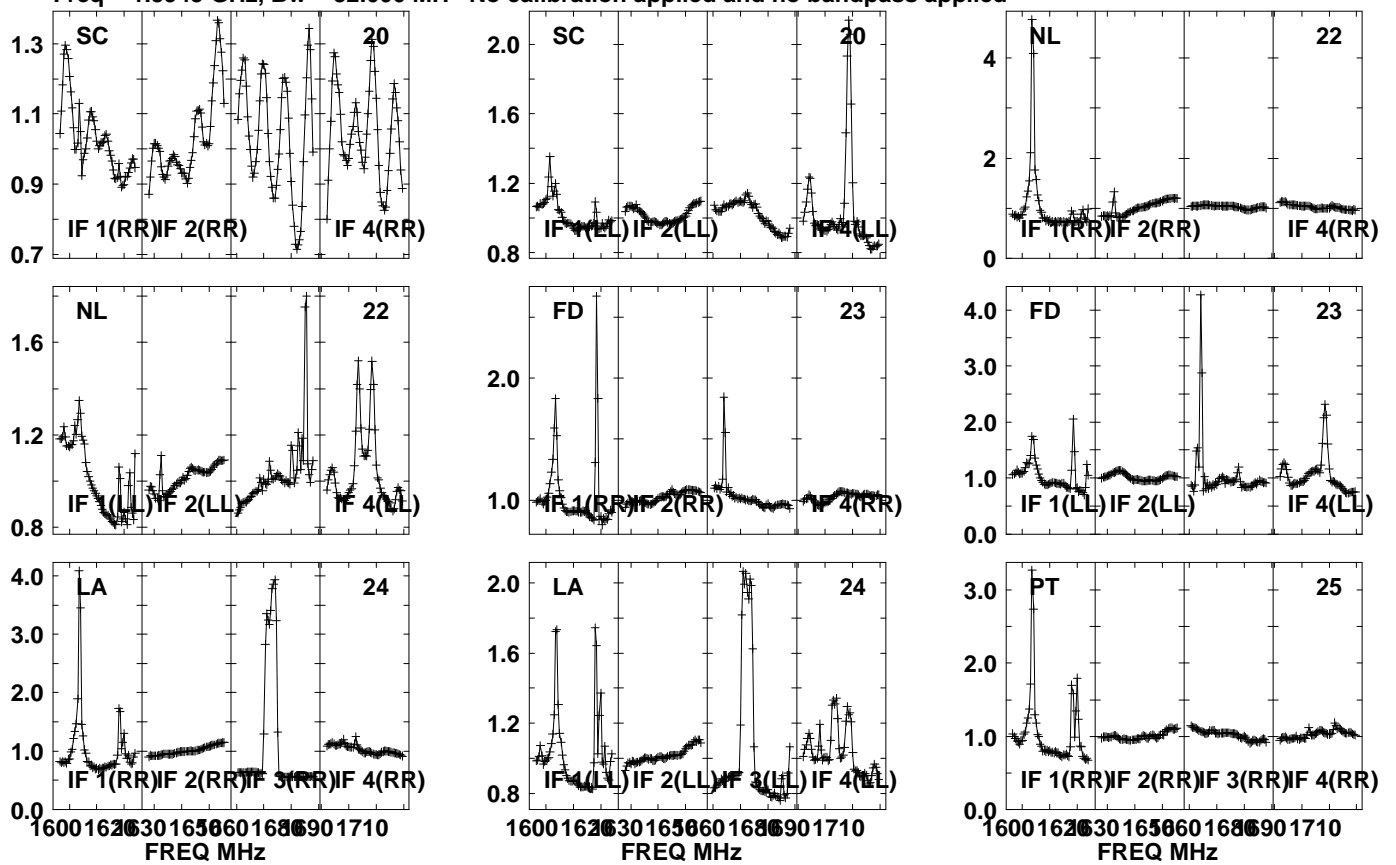

Lower frame: Real Jy  
Auto-corr total-power spectrum Antenna: \*  
Timerange: 00/19:15:31 to 00/19:16:59



Plot file version1019 created 05-OCT-2021 17:09:29

J0827+5217 GM076.UVDATA.1

Freq = 1.5945 GHz, Bw = 32.000 MH No calibration applied and no bandpass applied

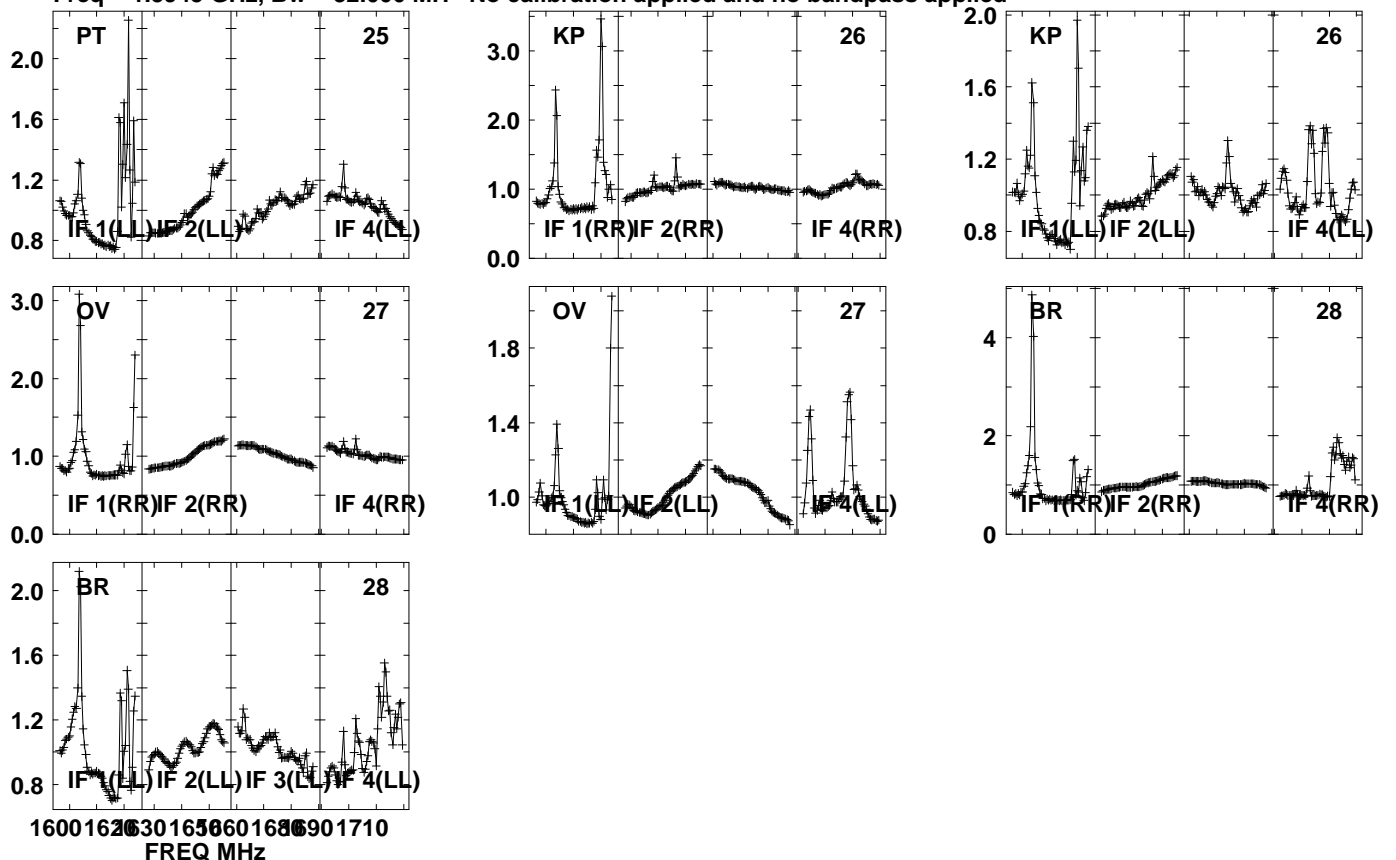

Lower frame: Real Jy

Auto-corr total-power spectrum Antenna: \*

Timerange: 00/19:15:31 to 00/19:16:59

Plot file version1020 created 05-OCT-2021 17:09:29

APM08279+525 GM076.UVDATA.1

Freq = 1.5945 GHz, Bw = 32.000 MH No calibration applied and no bandpass applied

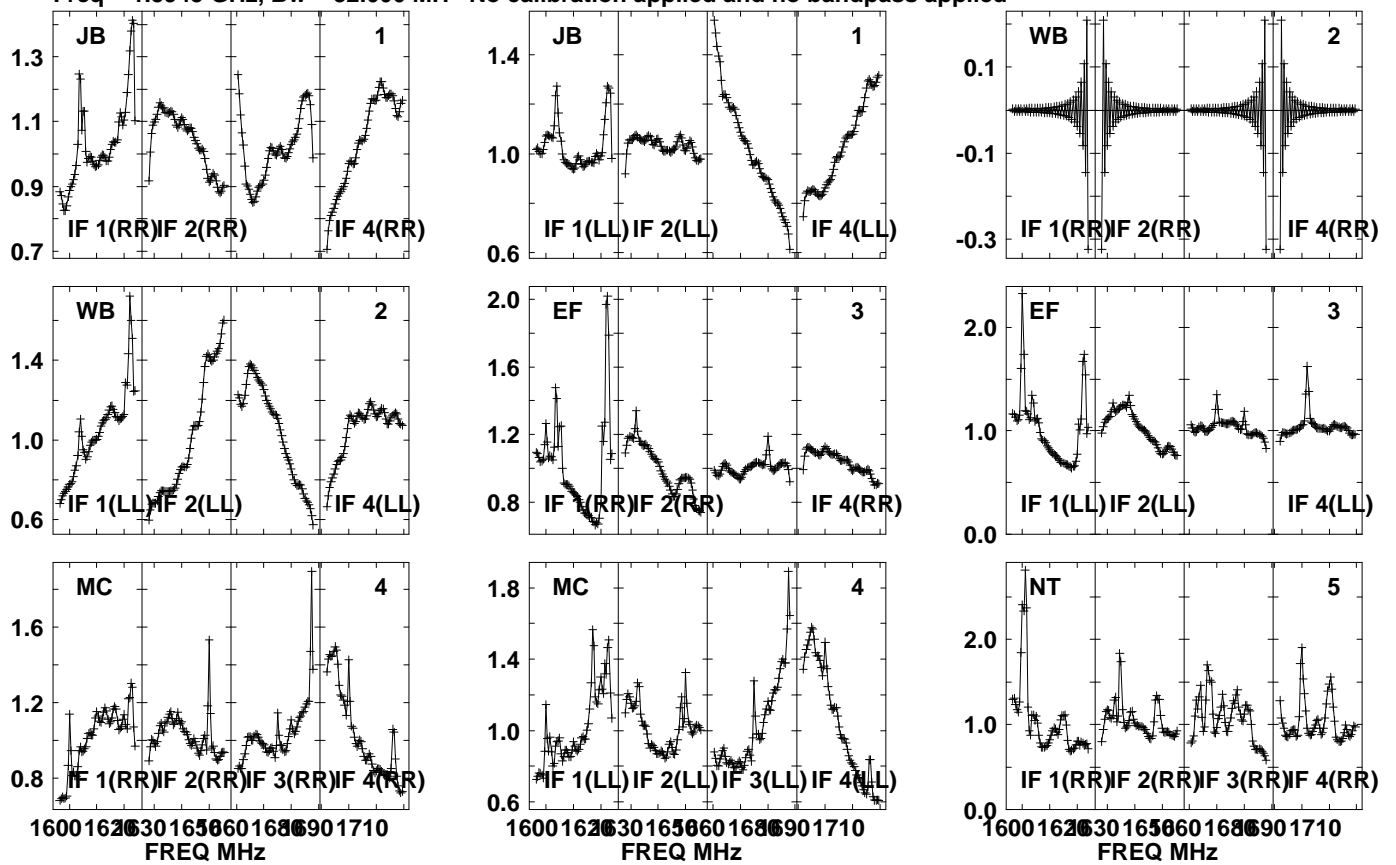

Lower frame: Real Jy  
Auto-corr total-power spectrum Antenna: \*  
Timerange: 00/19:17:01 to 00/19:20:29

Plot file version1021 created 05-OCT-2021 17:09:29

APM08279+525 GM076.UVDATA.1

Freq = 1.5945 GHz, Bw = 32.000 MH No calibration applied and no bandpass applied

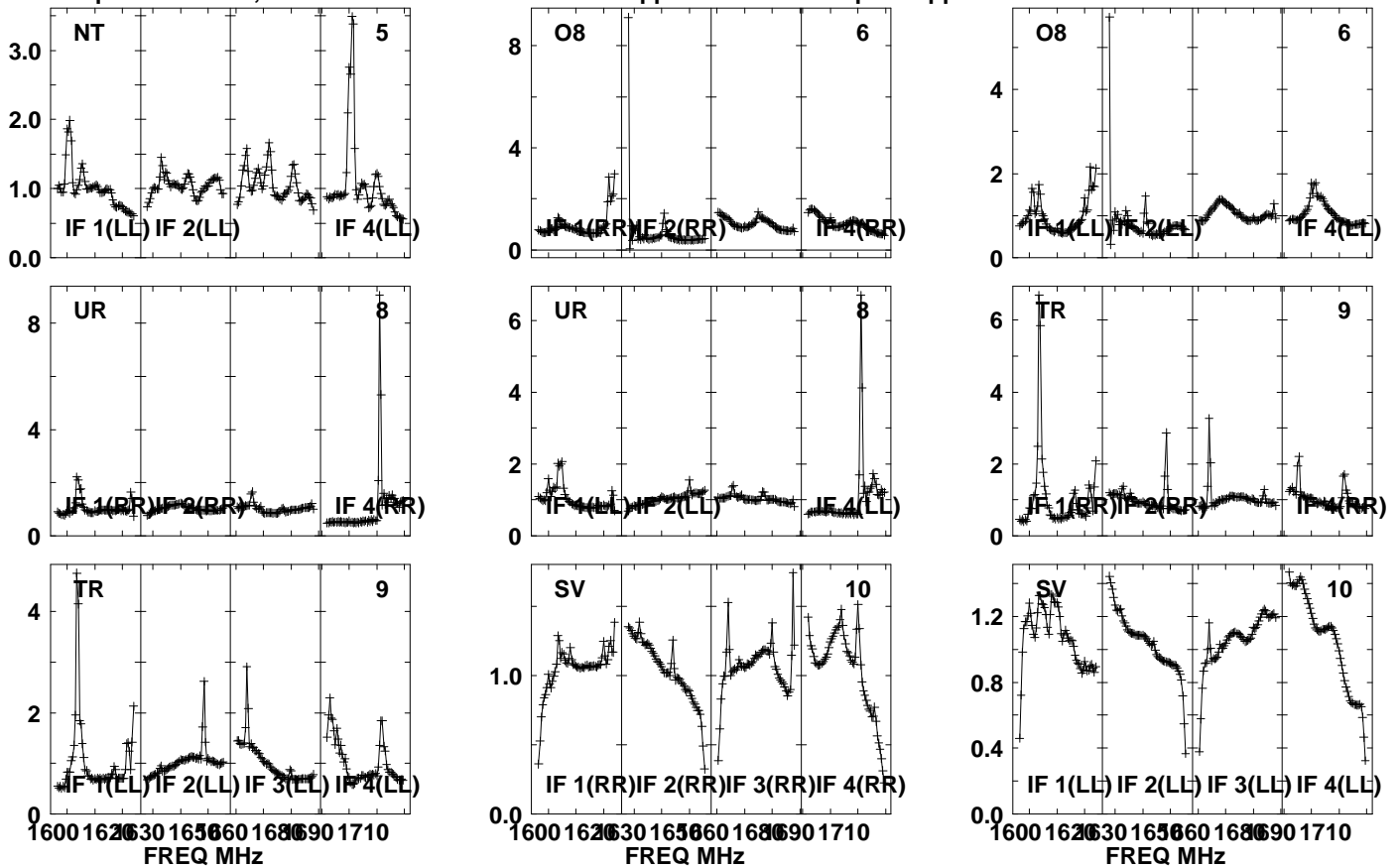

Lower frame: Real Jy

Auto-corr total-power spectrum Antenna: \*

Timerange: 00/19:17:01 to 00/19:20:29

Plot file version1022 created 05-OCT-2021 17:09:30

APM08279+525 GM076.UVDATA.1

Freq = 1.5945 GHz, Bw = 32.000 MH No calibration applied and no bandpass applied

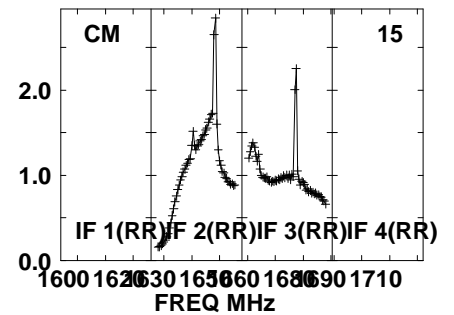
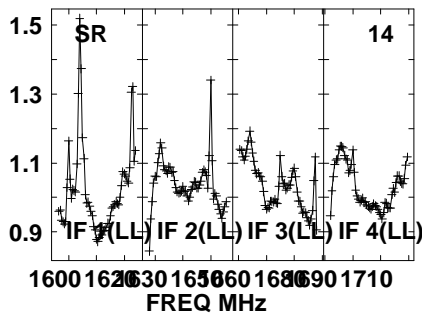
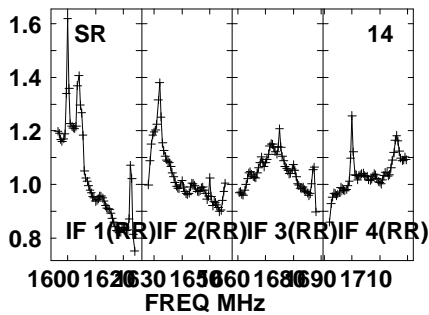
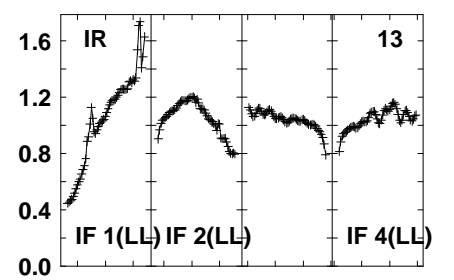
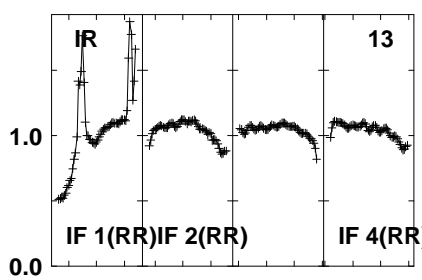
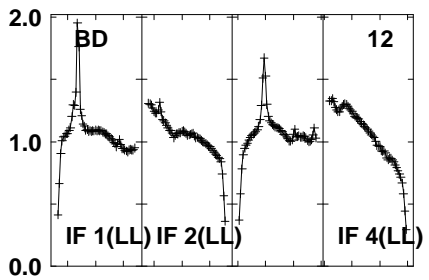
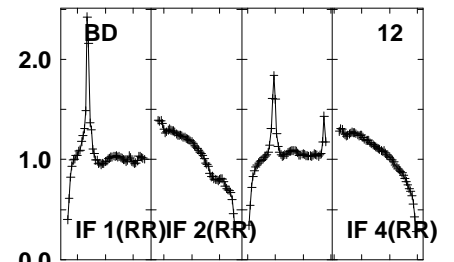
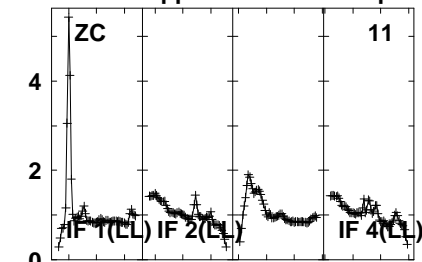
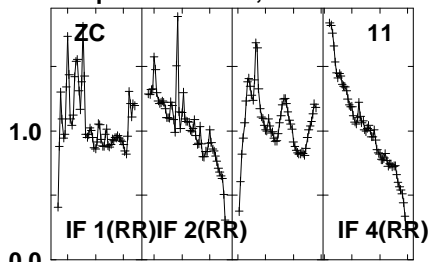

Lower frame: Real Jy

Auto-corr total-power spectrum Antenna: \*

Timerange: 00/19:17:01 to 00/19:20:29

Plot file version1023 created 05-OCT-2021 17:09:30

APM08279+525 GM076.UVDATA.1

Freq = 1.5945 GHz, Bw = 32.000 MH No calibration applied and no bandpass applied

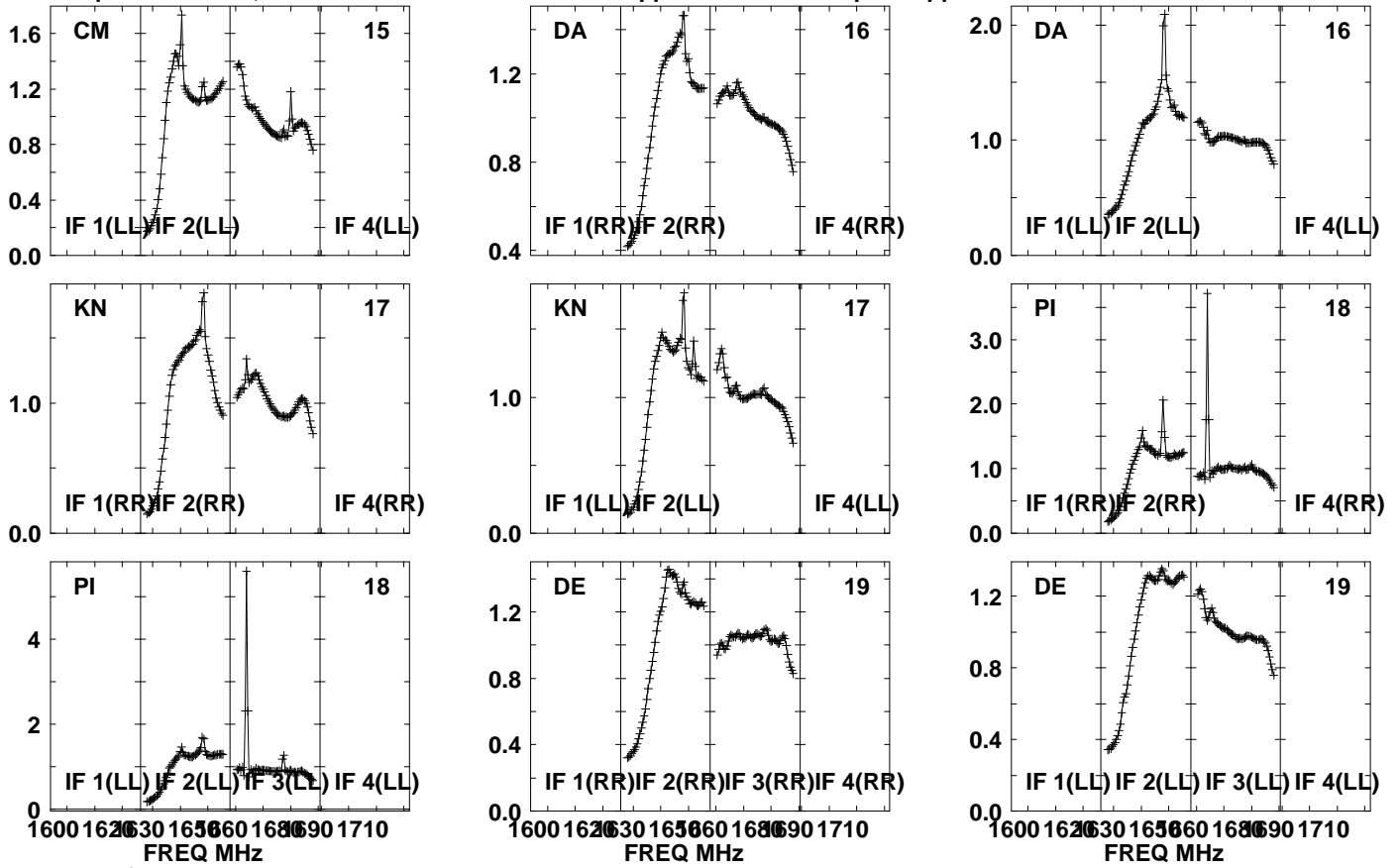

Lower frame: Real Jy  
Auto-corr total-power spectrum Antenna: \*  
Timerange: 00/19:17:01 to 00/19:20:29

Plot file version1024 created 05-OCT-2021 17:09:30

APM08279+525 GM076.UVDATA.1

Freq = 1.5945 GHz, Bw = 32.000 MH No calibration applied and no bandpass applied

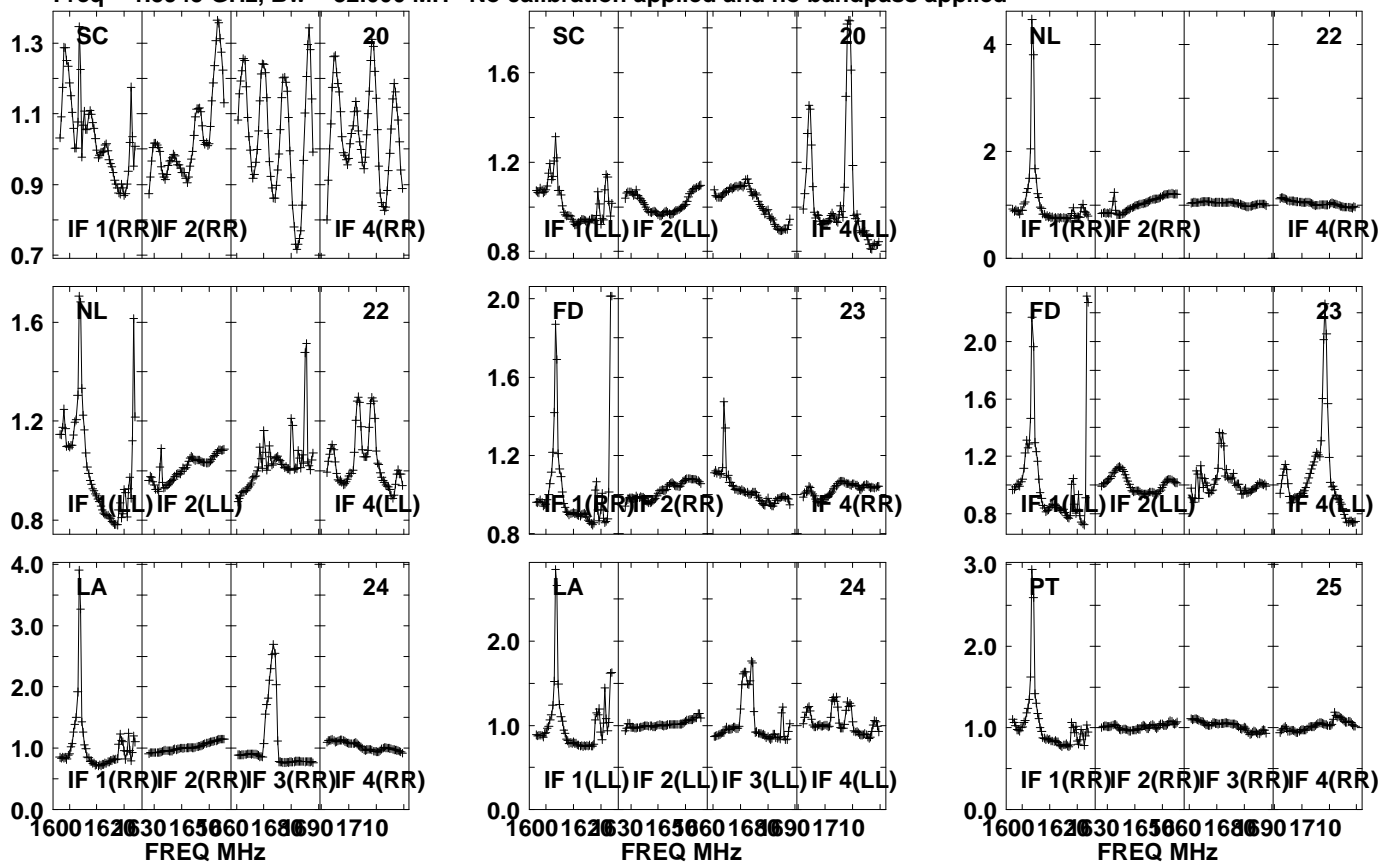

Lower frame: Real Jy  
Auto-corr total-power spectrum Antenna: \*  
Timerange: 00/19:17:01 to 00/19:20:29

Plot file version 1025 created 05-OCT-2021 17:09:30

APM08279+525 GM076.UVDATA.1

Freq = 1.5945 GHz, Bw = 32.000 MH No calibration applied and no bandpass applied

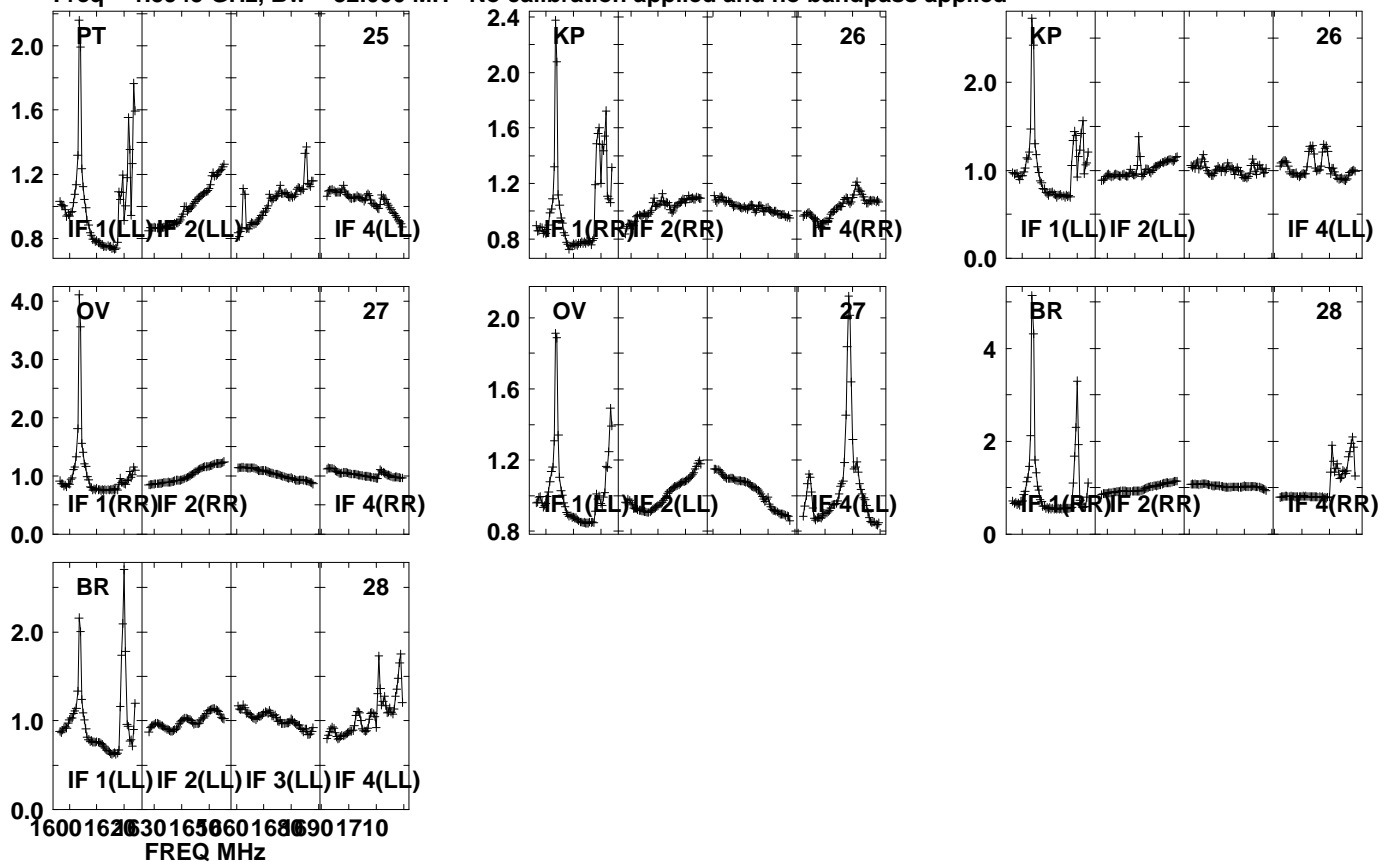

Lower frame: Real Jy  
Auto-corr total-power spectrum Antenna: \*  
Timerange: 00/19:17:01 to 00/19:20:29

Plot file version1026 created 05-OCT-2021 17:09:31

J0827+5217 GM076.UVDATA.1

Freq = 1.5945 GHz, Bw = 32.000 MH No calibration applied and no bandpass applied

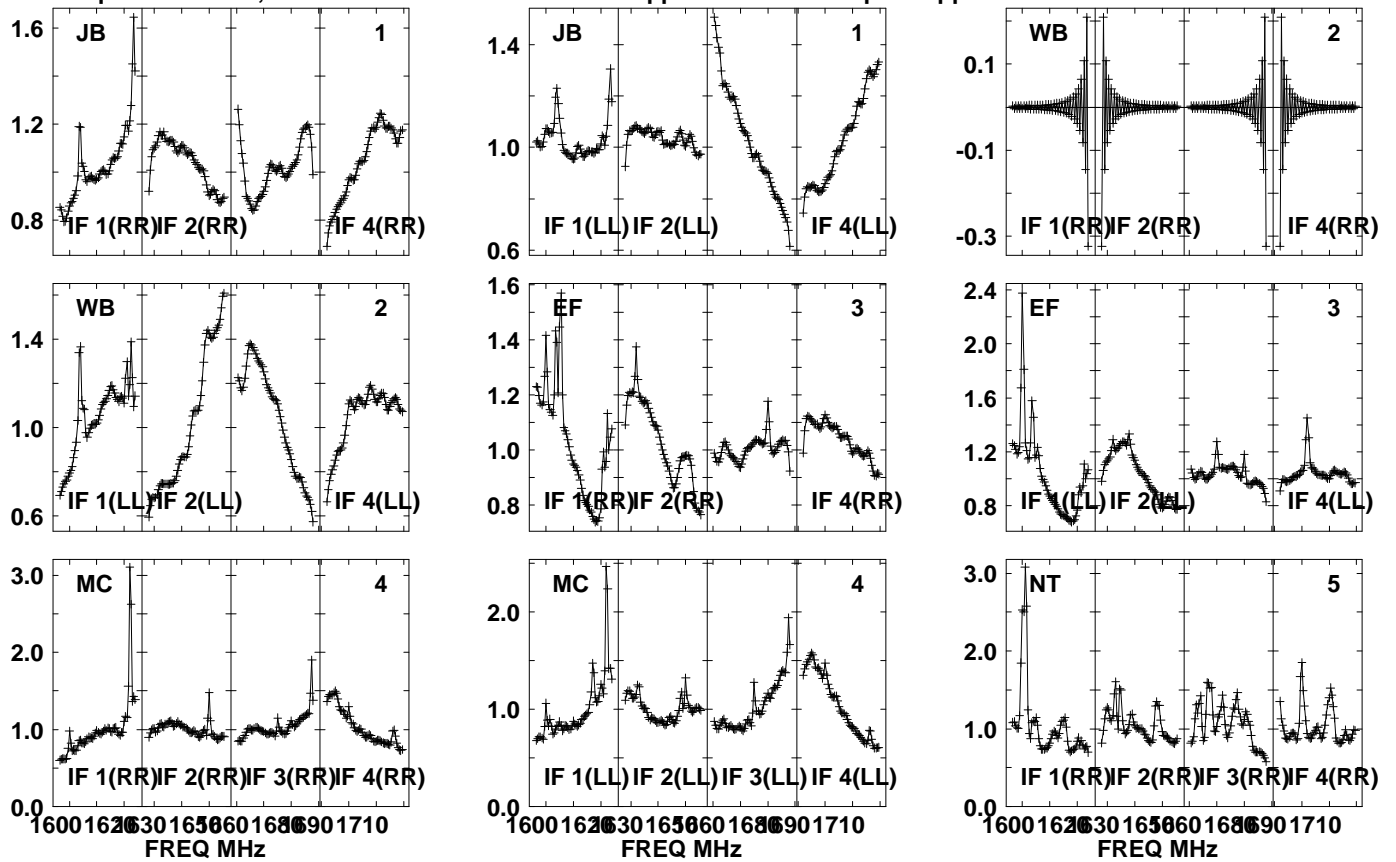

Lower frame: Real Jy  
Auto-corr total-power spectrum Antenna: \*  
Timerange: 00/19:20:31 to 00/19:21:59



Plot file version1027 created 05-OCT-2021 17:09:31

J0827+5217 GM076.UVDATA.1

Freq = 1.5945 GHz, Bw = 32.000 MH No calibration applied and no bandpass applied

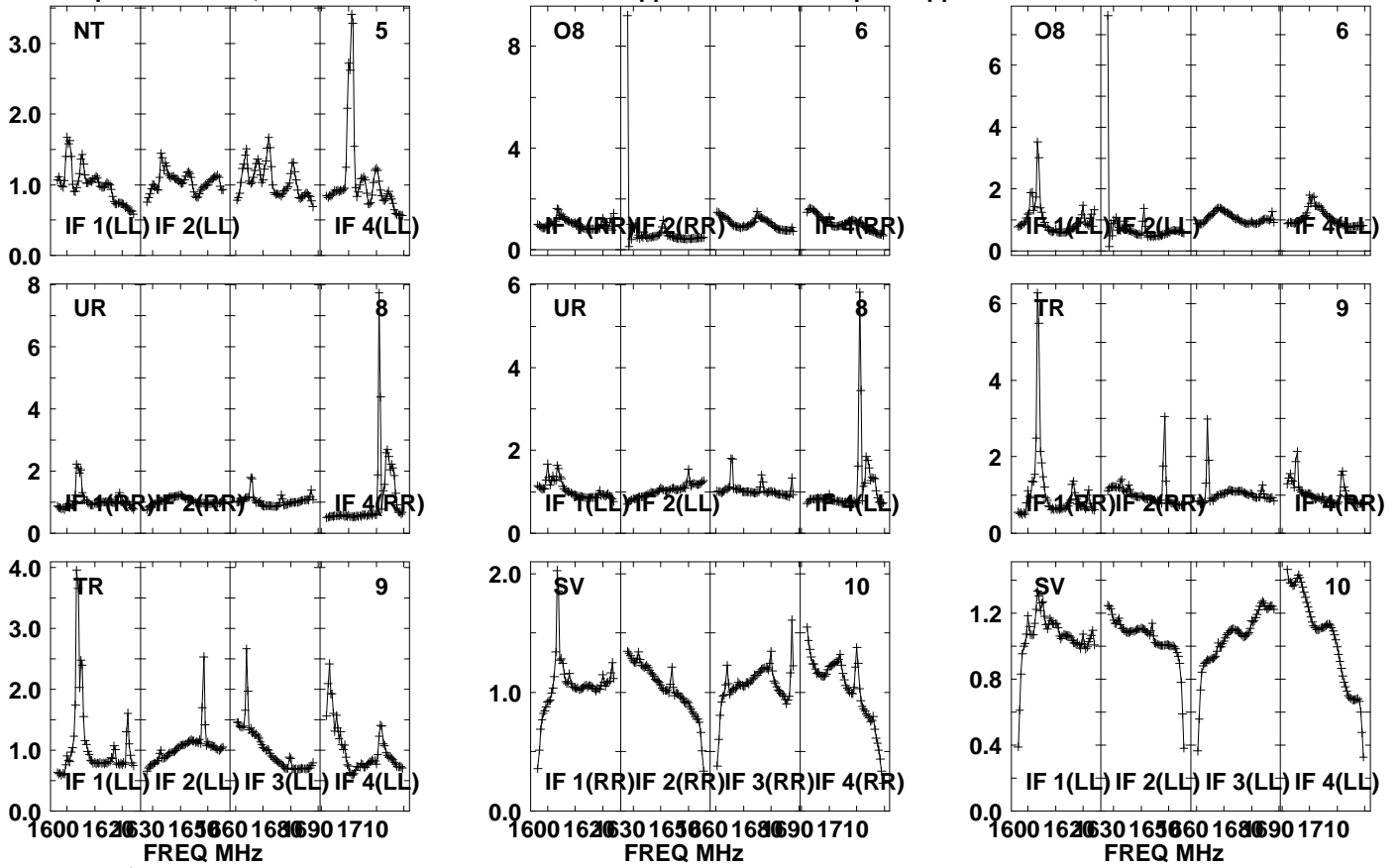

Lower frame: Real Jy

Auto-corr total-power spectrum Antenna: \*

Timerange: 00/19:20:31 to 00/19:21:59

Plot file version1028 created 05-OCT-2021 17:09:31

J0827+5217 GM076.UVDATA.1

Freq = 1.5945 GHz, Bw = 32.000 MH No calibration applied and no bandpass applied

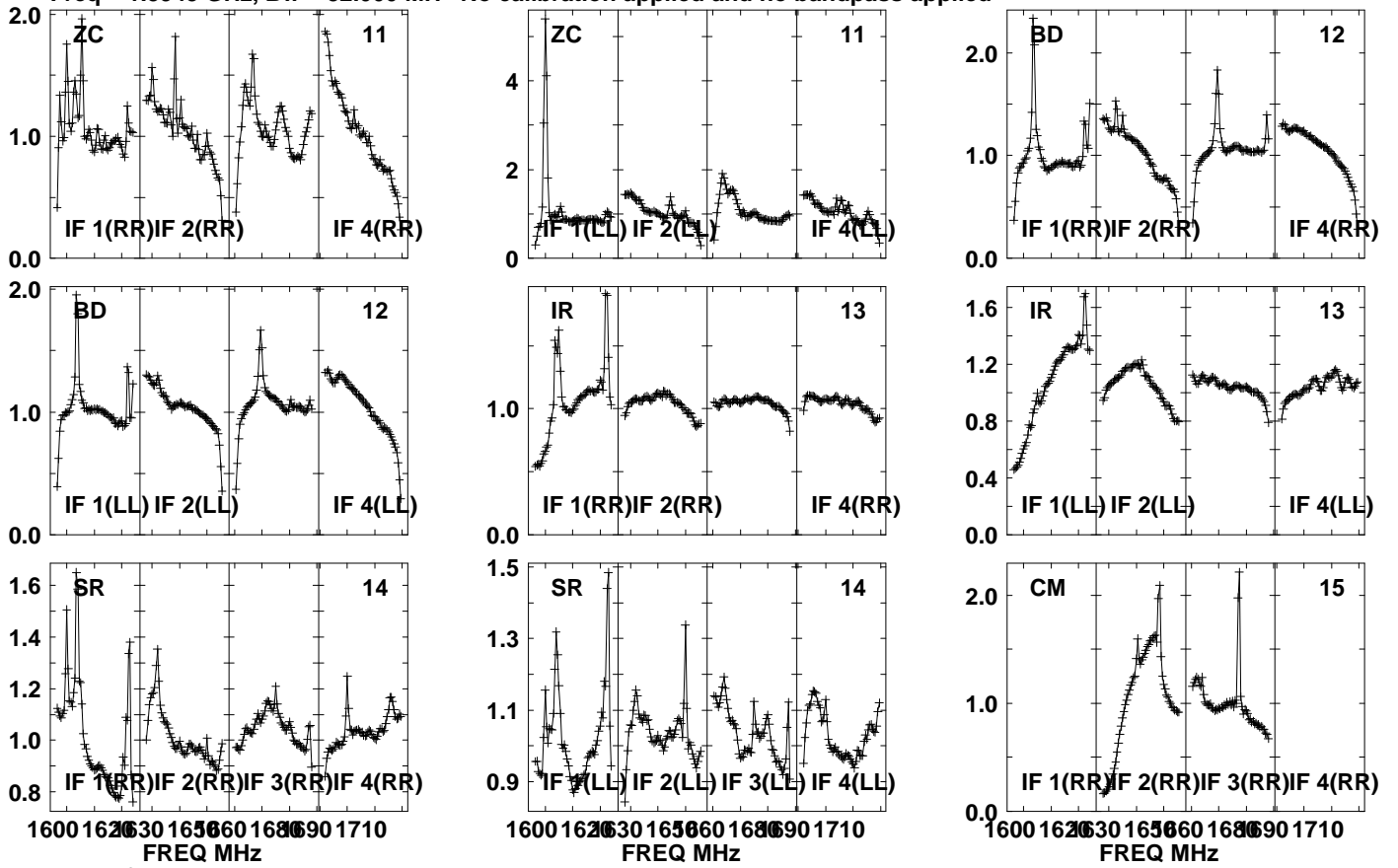

Lower frame: Real Jy  
Auto-corr total-power spectrum Antenna: \*  
Timerange: 00/19:20:31 to 00/19:21:59

Plot file version1029 created 05-OCT-2021 17:09:32

J0827+5217 GM076.UVDATA.1

Freq = 1.5945 GHz, Bw = 32.000 MH No calibration applied and no bandpass applied

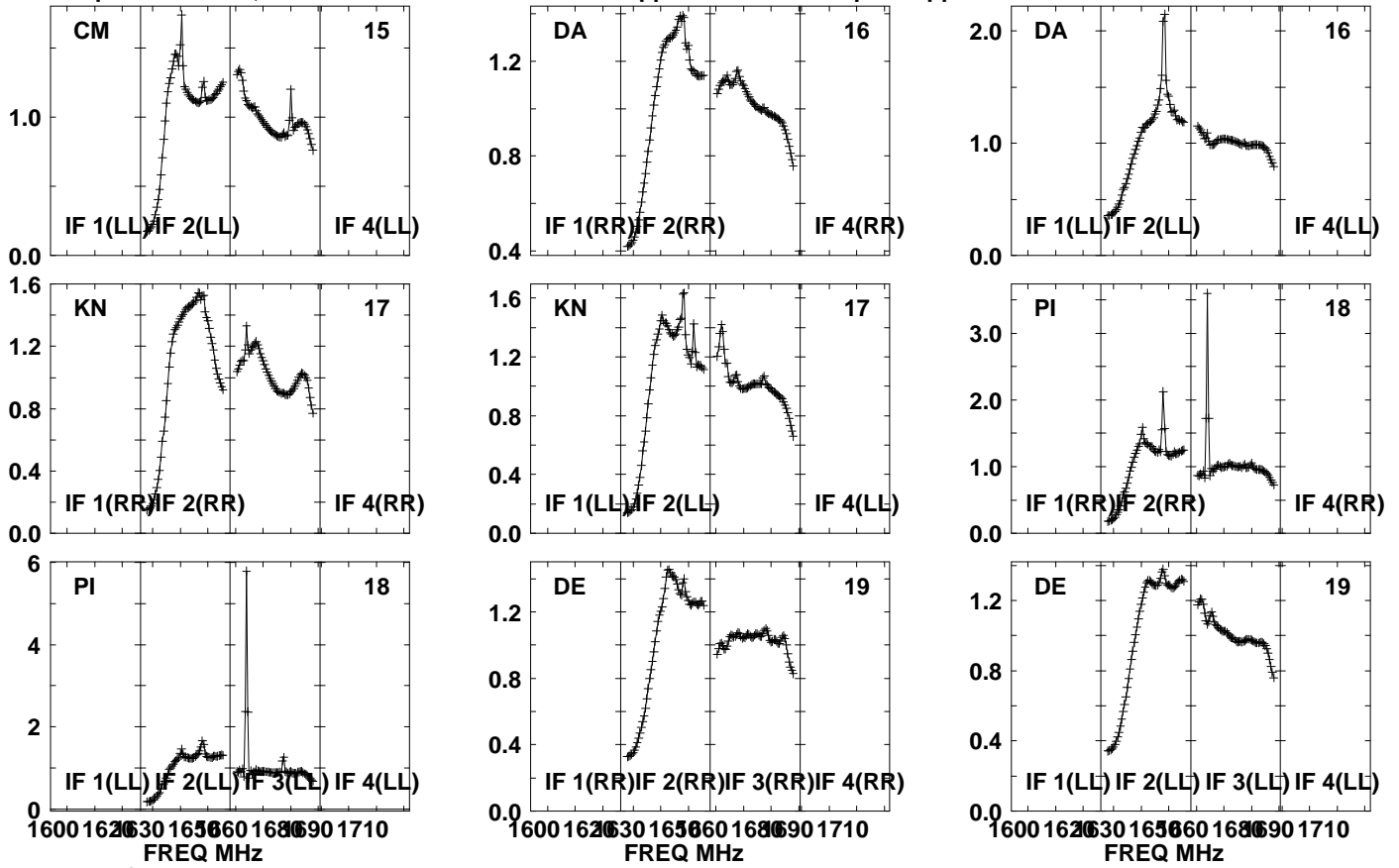

Lower frame: Real Jy  
Auto-corr total-power spectrum Antenna: \*  
Timerange: 00/19:20:31 to 00/19:21:59

Plot file version1030 created 05-OCT-2021 17:09:32

J0827+5217 GM076.UVDATA.1

Freq = 1.5945 GHz, Bw = 32.000 MH No calibration applied and no bandpass applied

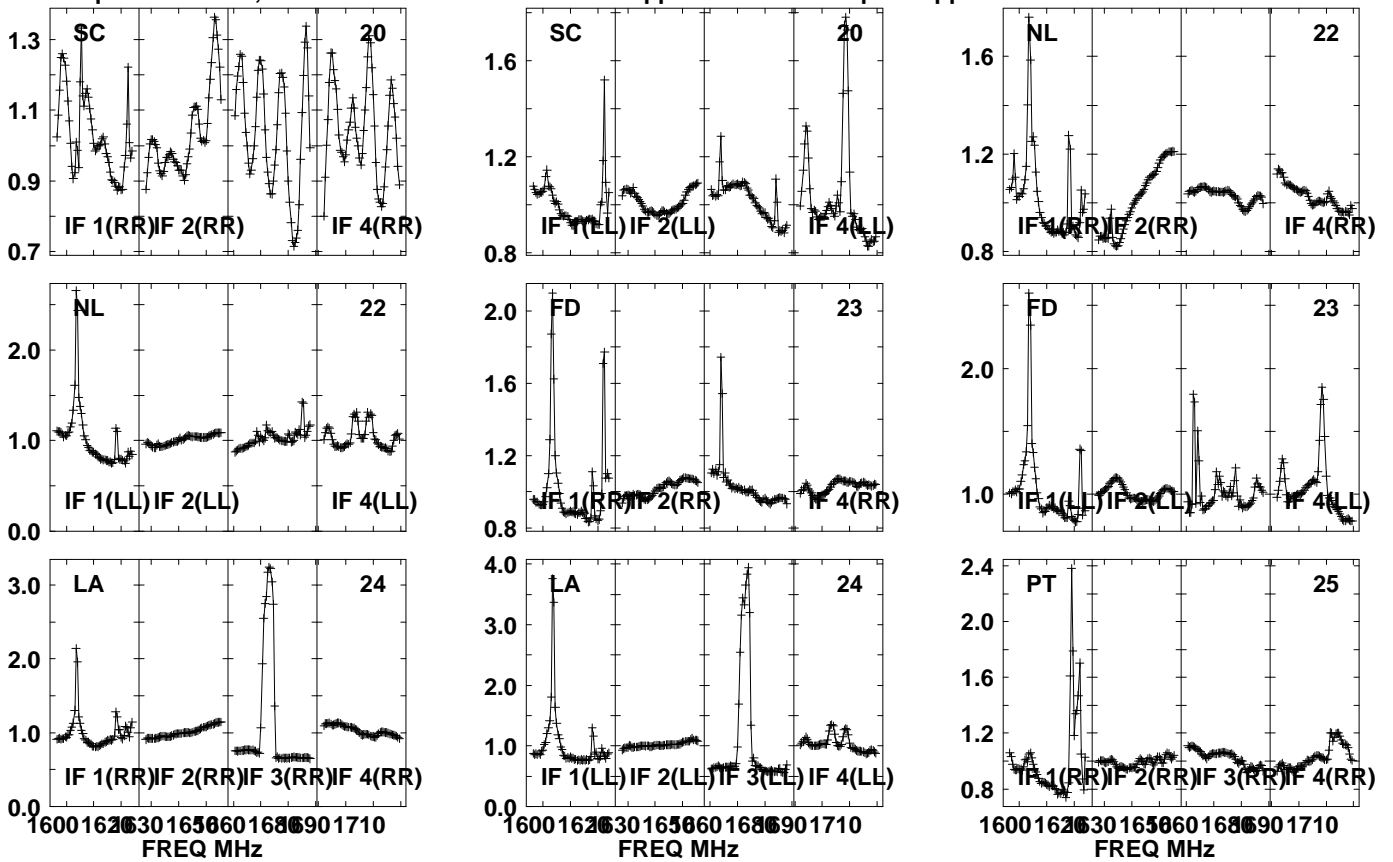

Lower frame: Real Jy  
Auto-corr total-power spectrum Antenna: \*  
Timerange: 00/19:20:31 to 00/19:21:59

Plot file version1031 created 05-OCT-2021 17:09:32

J0827+5217 GM076.UVDATA.1

Freq = 1.5945 GHz, Bw = 32.000 MH No calibration applied and no bandpass applied

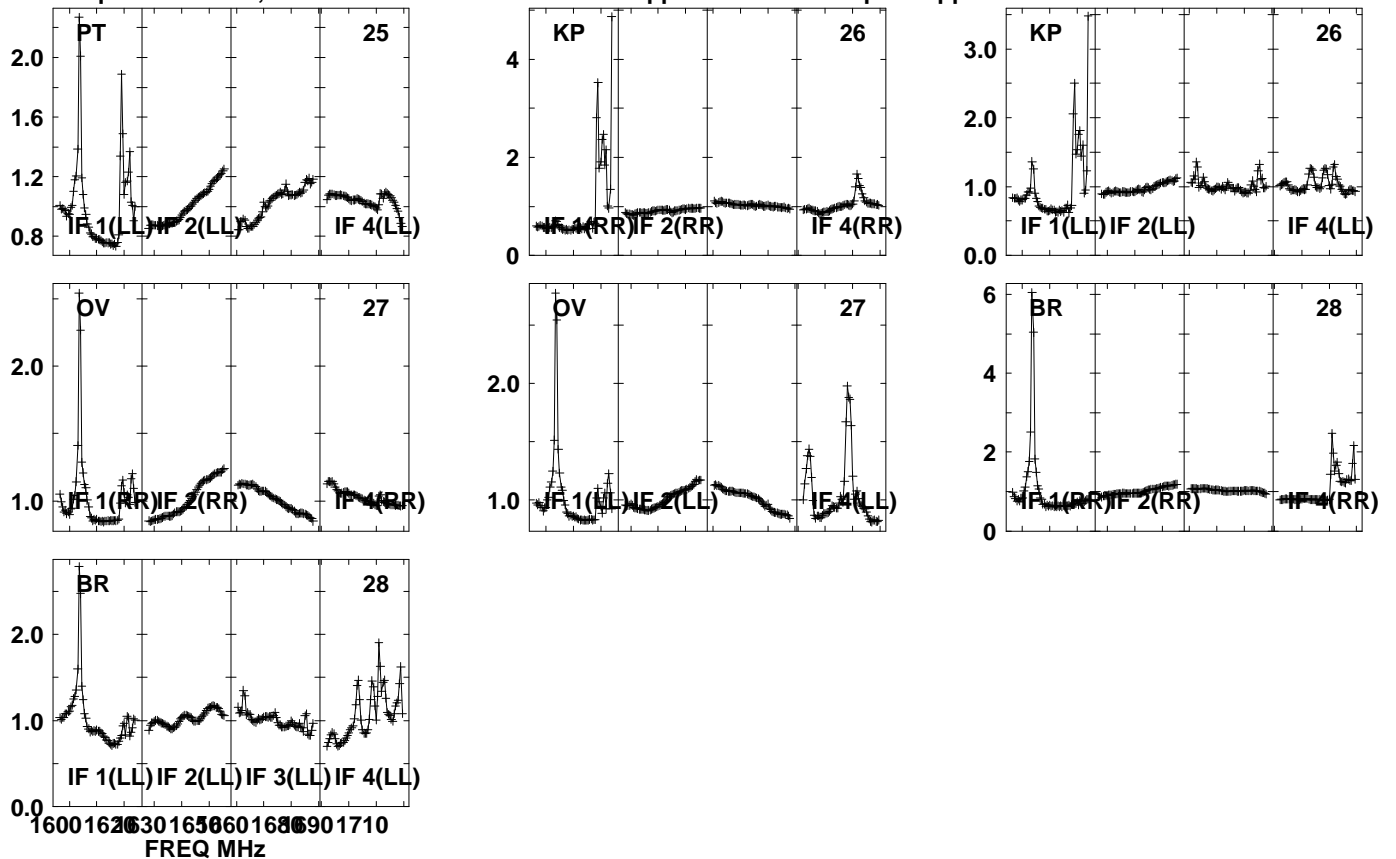

Lower frame: Real Jy

Auto-corr total-power spectrum Antenna: \*

Timerange: 00/19:20:31 to 00/19:21:59

Plot file version1032 created 05-OCT-2021 17:09:33

APM08279+525 GM076.UVDATA.1

Freq = 1.5945 GHz, Bw = 32.000 MH No calibration applied and no bandpass applied

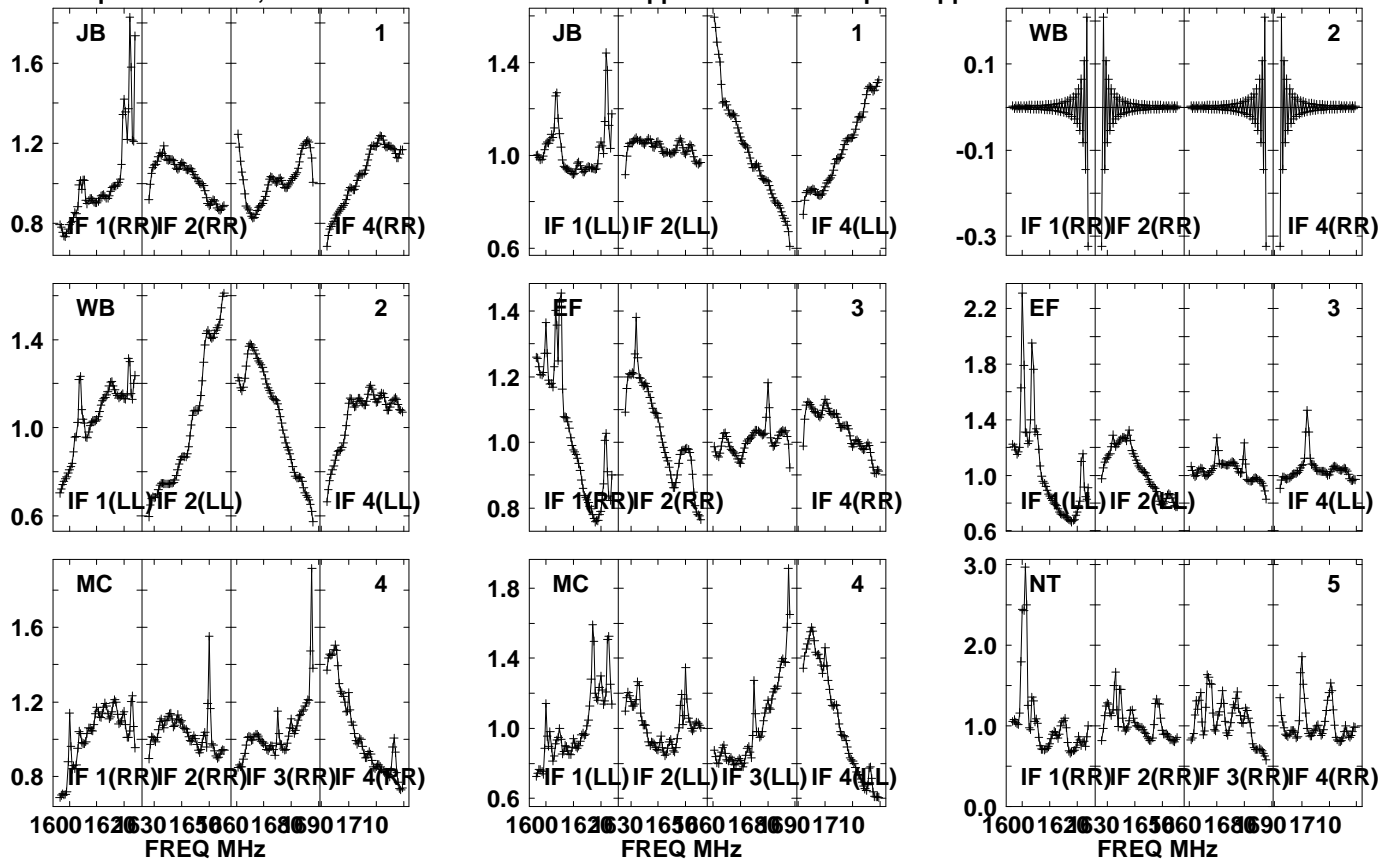

Lower frame: Real Jy  
Auto-corr total-power spectrum Antenna: \*  
Timerange: 00/19:22:01 to 00/19:25:29

Plot file version1033 created 05-OCT-2021 17:09:33

APM08279+525 GM076.UVDATA.1

Freq = 1.5945 GHz, Bw = 32.000 MH No calibration applied and no bandpass applied

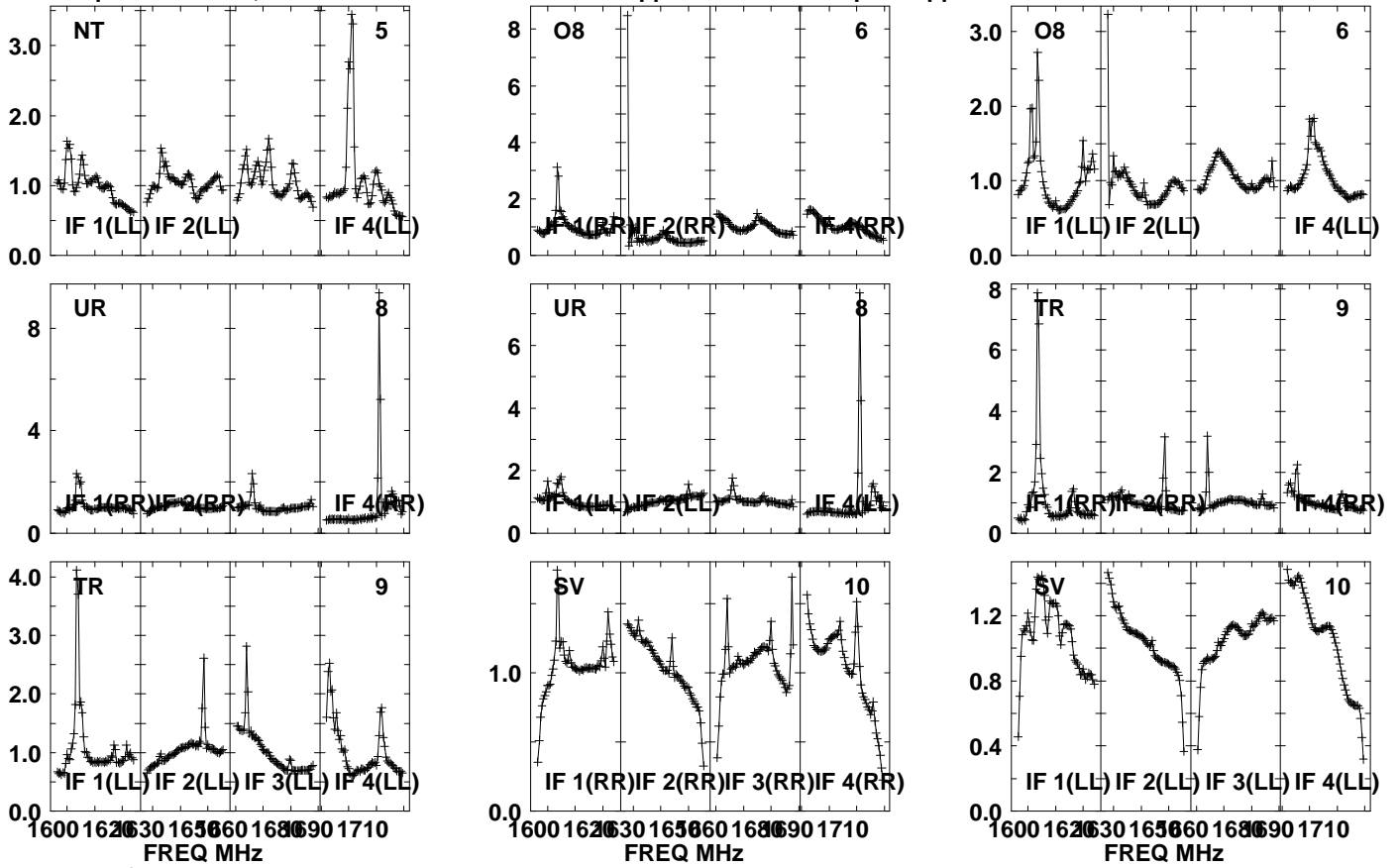

Lower frame: Real Jy

Auto-corr total-power spectrum Antenna: \*

Timerange: 00/19:22:01 to 00/19:25:29

Plot file version1034 created 05-OCT-2021 17:09:33

APM08279+525 GM076.UVDATA.1

Freq = 1.5945 GHz, Bw = 32.000 MH No calibration applied and no bandpass applied

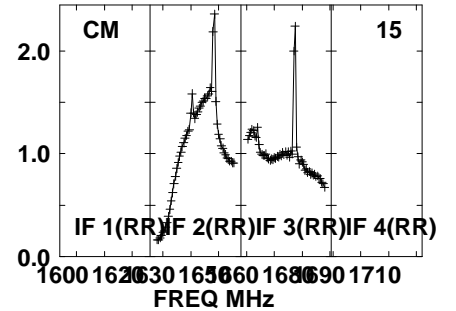
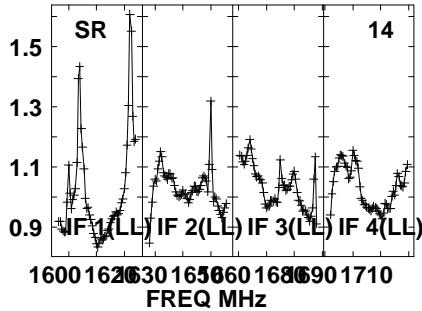
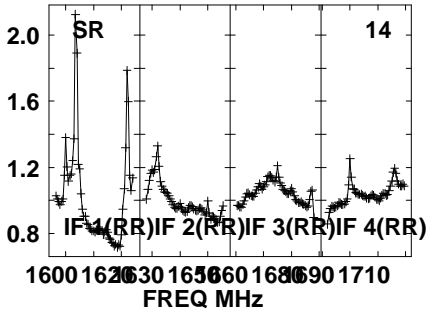
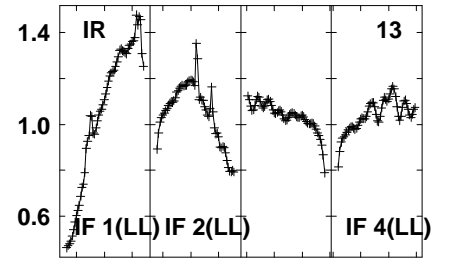
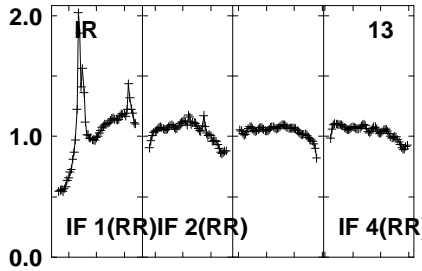
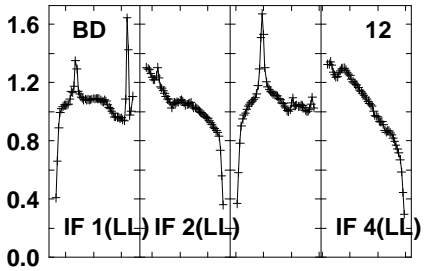
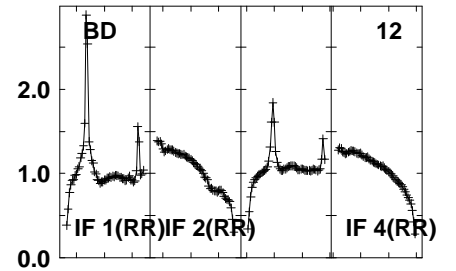
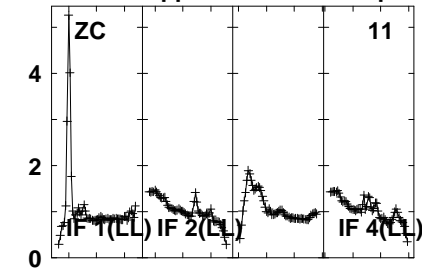
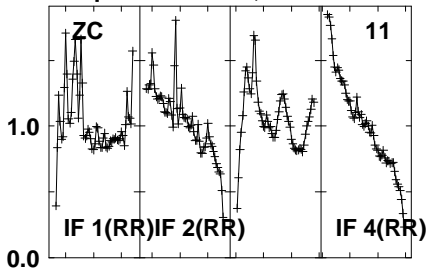

Lower frame: Real Jy

Auto-corr total-power spectrum Antenna: \*

Timerange: 00/19:22:01 to 00/19:25:29



Plot file version1035 created 05-OCT-2021 17:09:34

APM08279+525 GM076.UVDATA.1

Freq = 1.5945 GHz, Bw = 32.000 MH No calibration applied and no bandpass applied

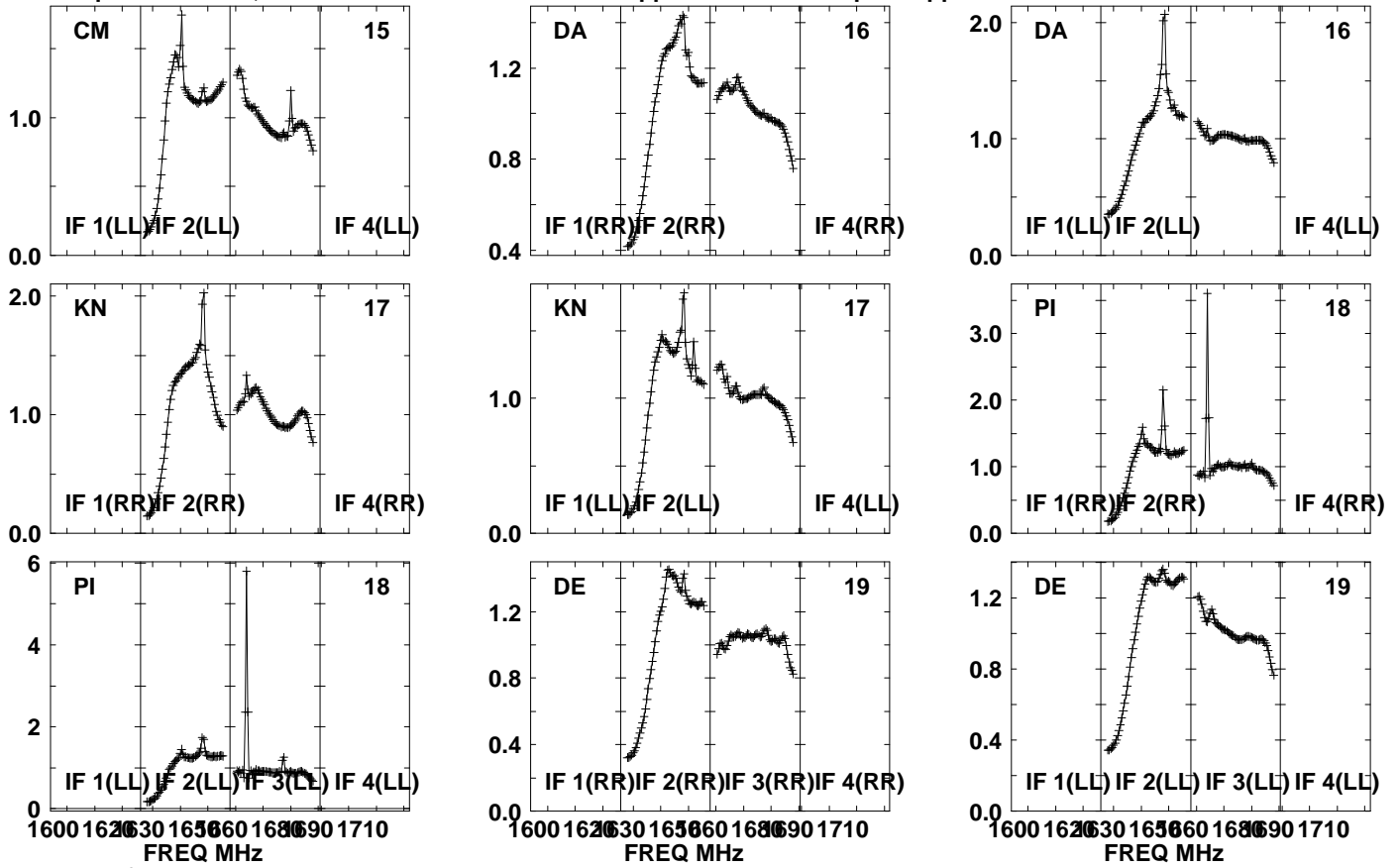

Lower frame: Real Jy

Auto-corr total-power spectrum Antenna: \*

Timerange: 00/19:22:01 to 00/19:25:29

Plot file version1036 created 05-OCT-2021 17:09:34

APM08279+525 GM076.UVDATA.1

Freq = 1.5945 GHz, Bw = 32.000 MH No calibration applied and no bandpass applied

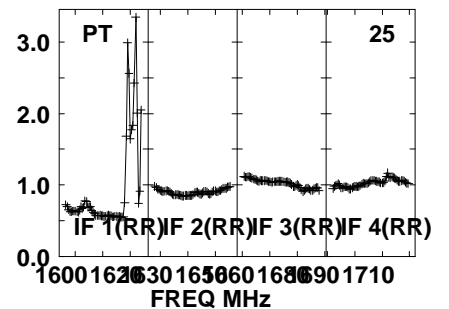
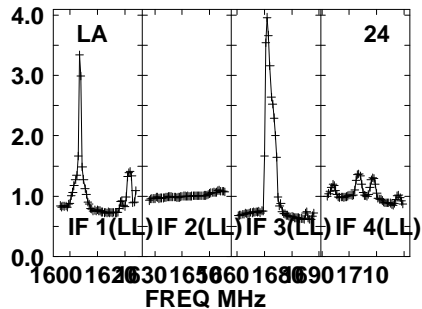
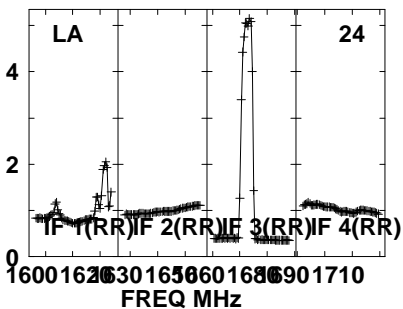
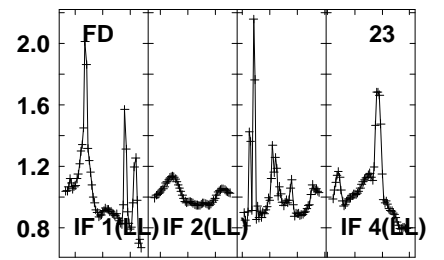
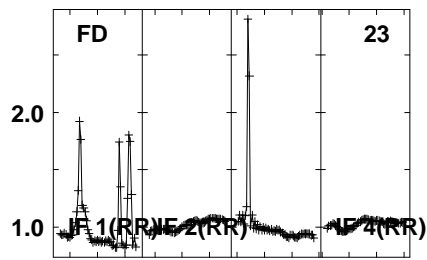
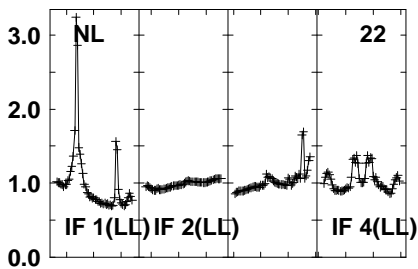
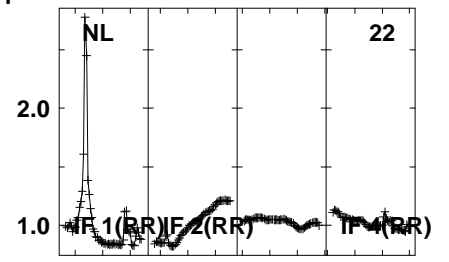
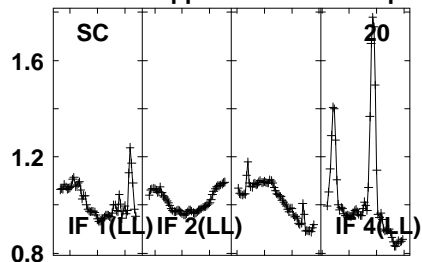
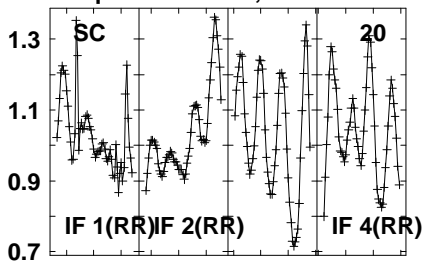

Lower frame: Real Jy  
Auto-corr total-power spectrum Antenna: \*  
Timerange: 00/19:22:01 to 00/19:25:29

Plot file version1037 created 05-OCT-2021 17:09:34

APM08279+525 GM076.UVDATA.1

Freq = 1.5945 GHz, Bw = 32.000 MH No calibration applied and no bandpass applied

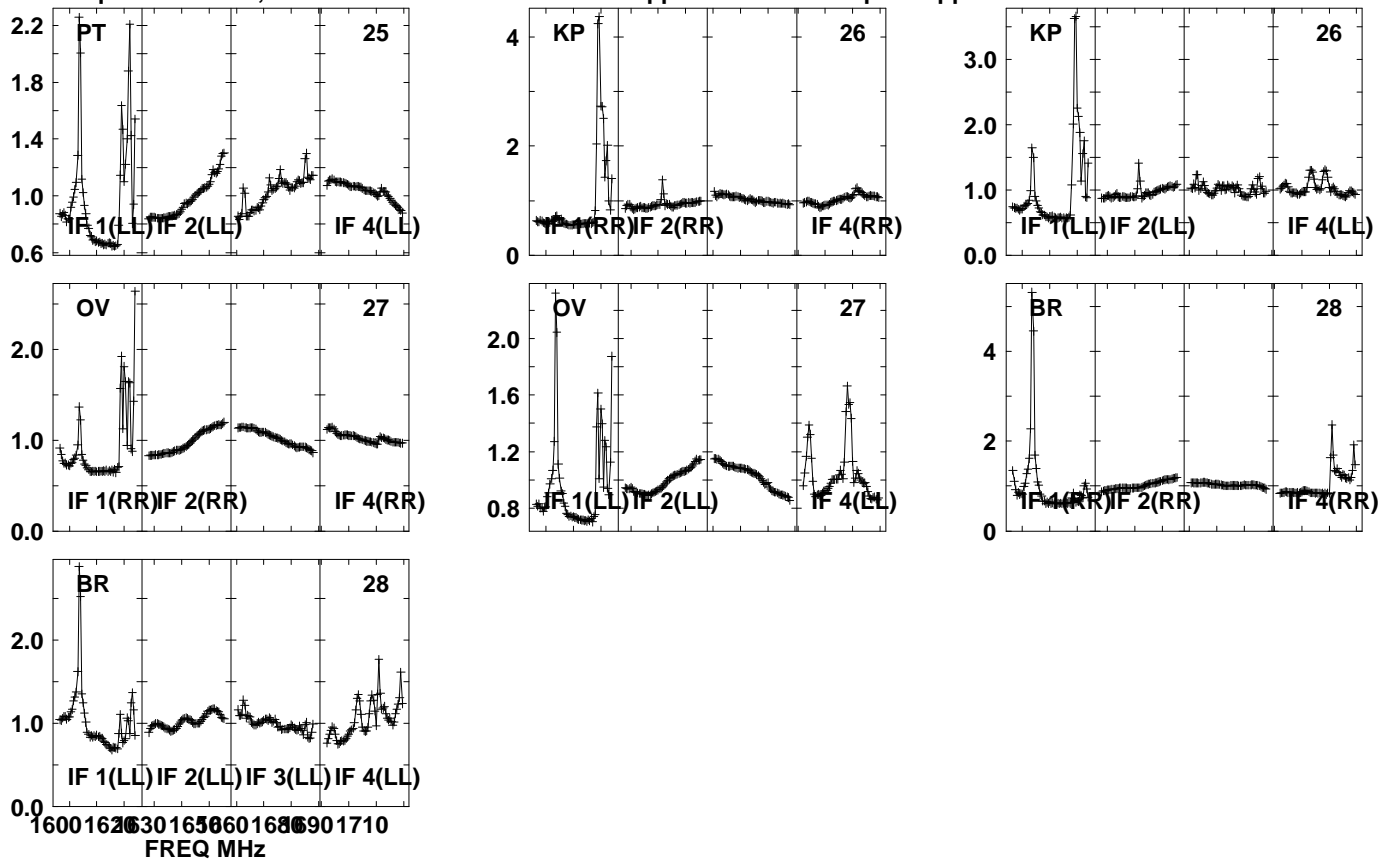

Lower frame: Real Jy  
Auto-corr total-power spectrum Antenna: \*  
Timerange: 00/19:22:01 to 00/19:25:29

Plot file version1038 created 05-OCT-2021 17:09:35

J0827+5217 GM076.UVDATA.1

Freq = 1.5945 GHz, Bw = 32.000 MH No calibration applied and no bandpass applied

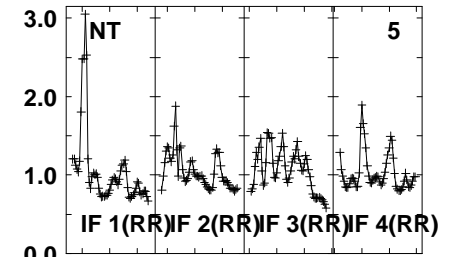
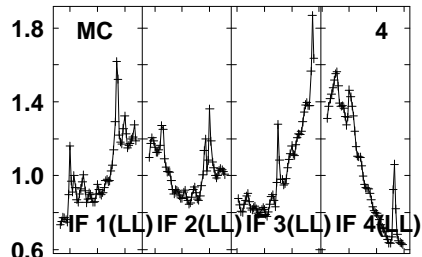
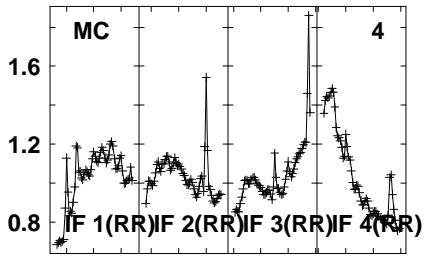
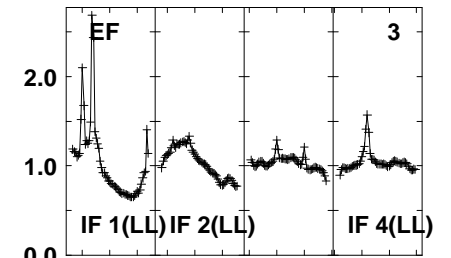
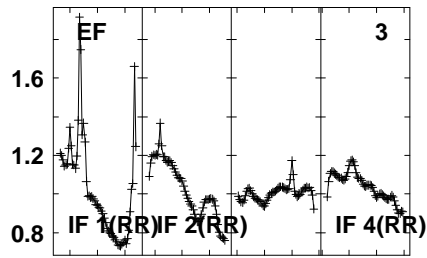
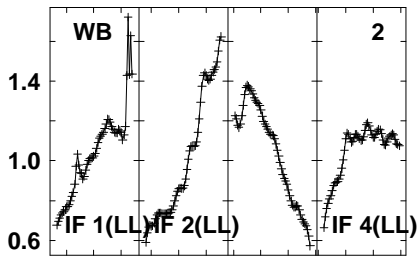
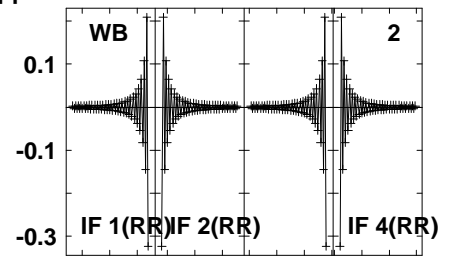
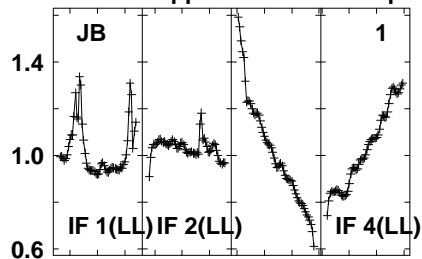
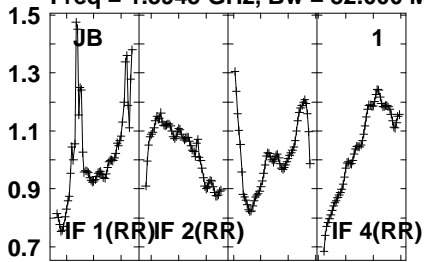

1600 1620 1630 1650 1660 1680 1690 1710  
FREQ MHz

1600 1620 1630 1650 1660 1680 1690 1710  
FREQ MHz

1600 1620 1630 1650 1660 1680 1690 1710  
FREQ MHz

Lower frame: Real Jy  
Auto-corr total-power spectrum Antenna: \*  
Timerange: 00/19:26:01 to 00/19:27:29

Plot file version1039 created 05-OCT-2021 17:09:35

J0827+5217 GM076.UVDATA.1

Freq = 1.5945 GHz, Bw = 32.000 MH No calibration applied and no bandpass applied

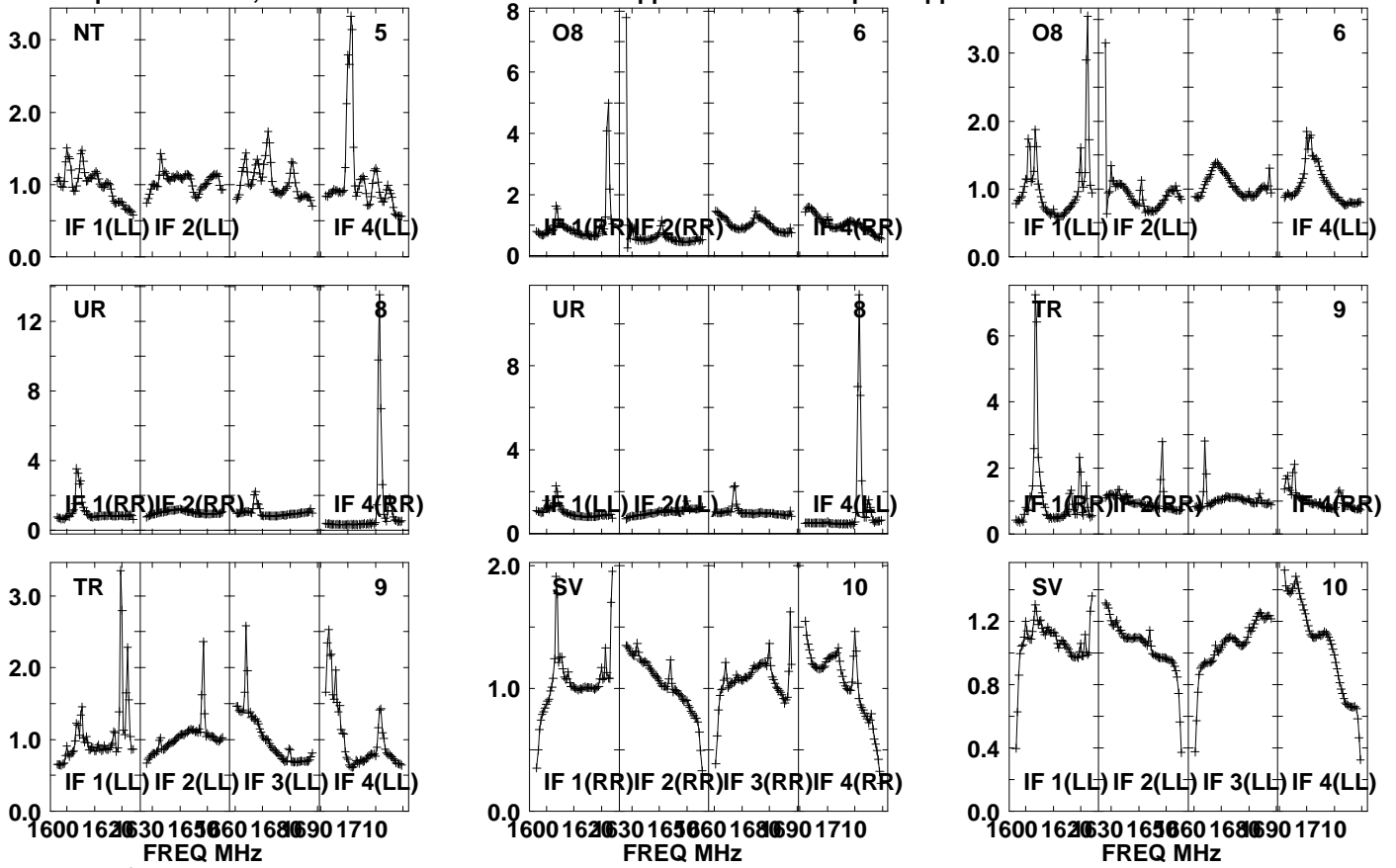

Lower frame: Real Jy  
Auto-corr total-power spectrum Antenna: \*  
Timerange: 00/19:26:01 to 00/19:27:29

Plot file version1040 created 05-OCT-2021 17:09:35

J0827+5217 GM076.UVDATA.1

Freq = 1.5945 GHz, Bw = 32.000 MH No calibration applied and no bandpass applied

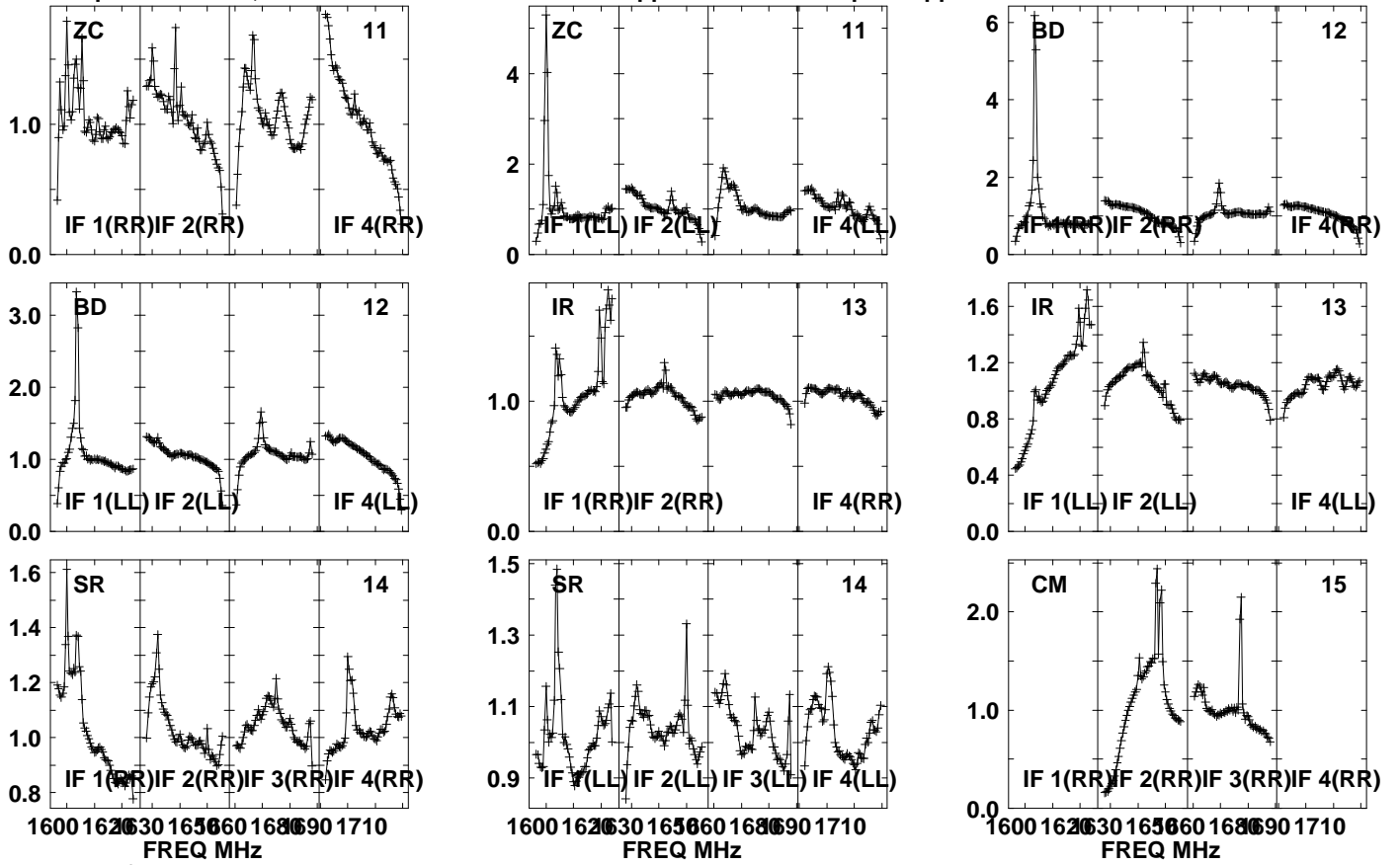

Lower frame: Real Jy

Auto-corr total-power spectrum Antenna: \*

Timerange: 00/19:26:01 to 00/19:27:29

Plot file version1041 created 05-OCT-2021 17:09:36

J0827+5217 GM076.UVDATA.1

Freq = 1.5945 GHz, Bw = 32.000 MH No calibration applied and no bandpass applied

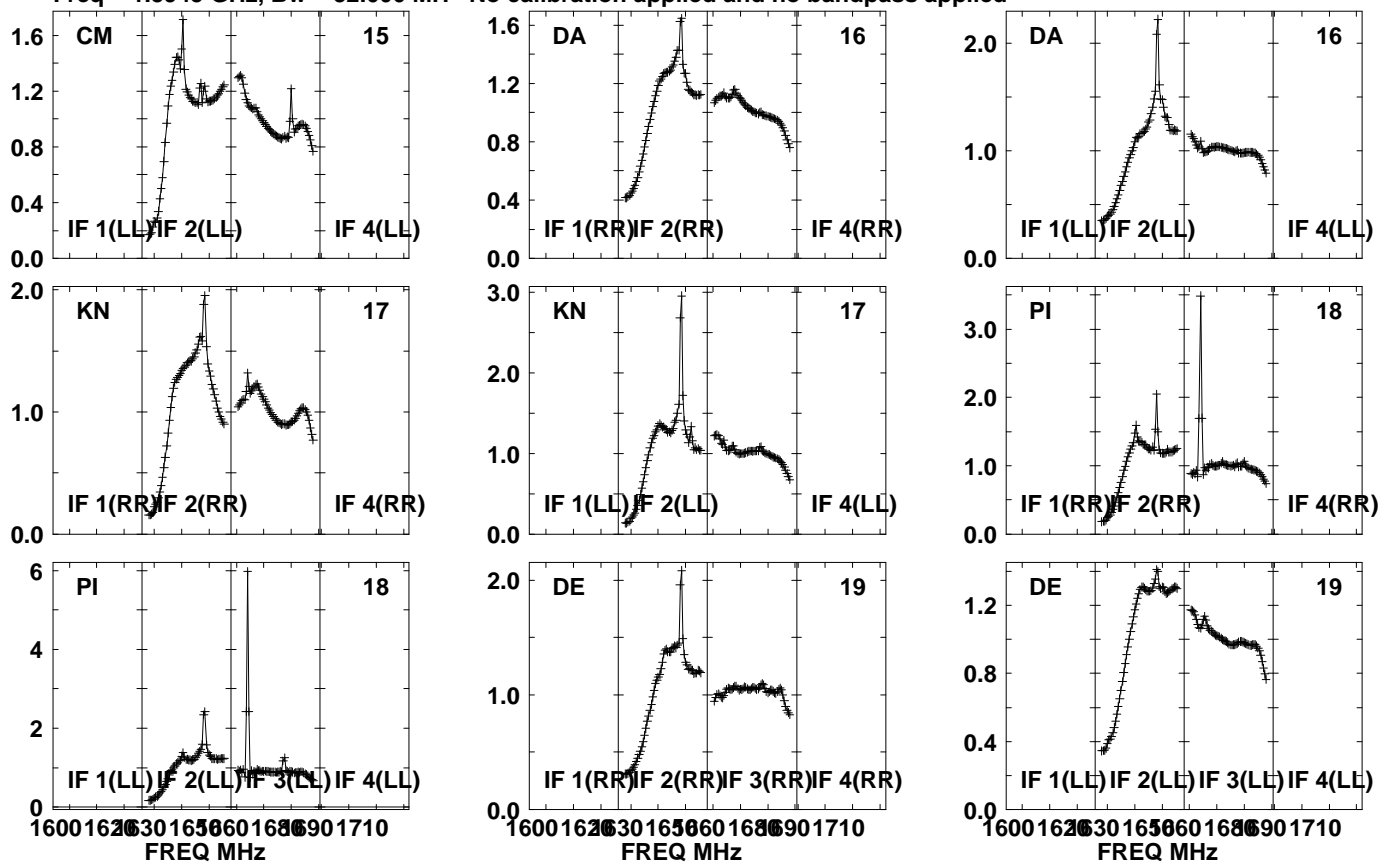

Lower frame: Real Jy  
Auto-corr total-power spectrum Antenna: \*  
Timerange: 00/19:26:01 to 00/19:27:29

Plot file version1042 created 05-OCT-2021 17:09:36

J0827+5217 GM076.UVDATA.1

Freq = 1.5945 GHz, Bw = 32.000 MH No calibration applied and no bandpass applied

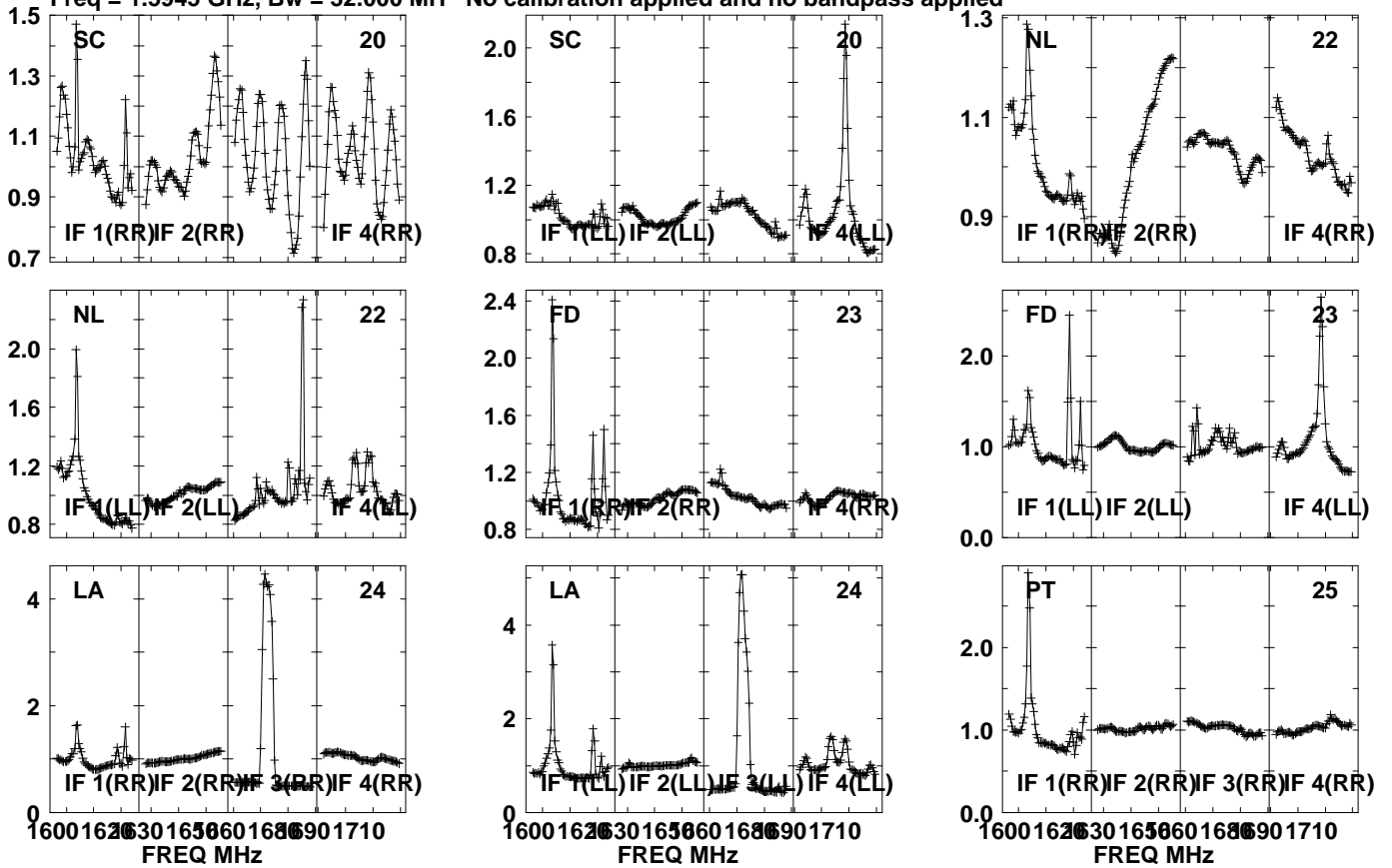

Lower frame: Real Jy  
Auto-corr total-power spectrum Antenna: \*  
Timerange: 00/19:26:01 to 00/19:27:29



Plot file version1043 created 05-OCT-2021 17:09:36

J0827+5217 GM076.UVDATA.1

Freq = 1.5945 GHz, Bw = 32.000 MH No calibration applied and no bandpass applied

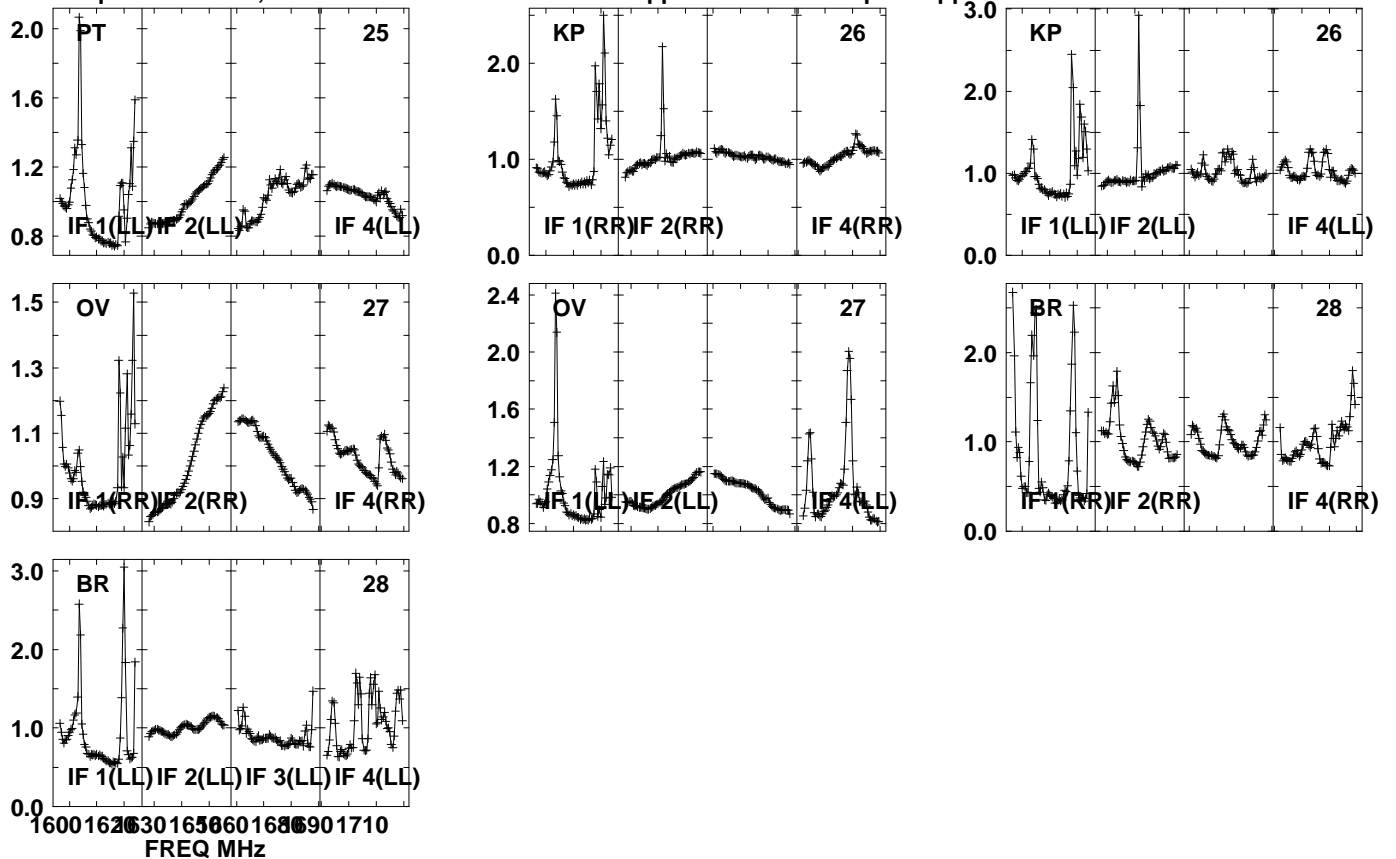

Lower frame: Real Jy  
Auto-corr total-power spectrum Antenna: \*  
Timerange: 00/19:26:01 to 00/19:27:29

Plot file version1044 created 05-OCT-2021 17:09:37

APM08279+525 GM076.UVDATA.1

Freq = 1.5945 GHz, Bw = 32.000 MH No calibration applied and no bandpass applied

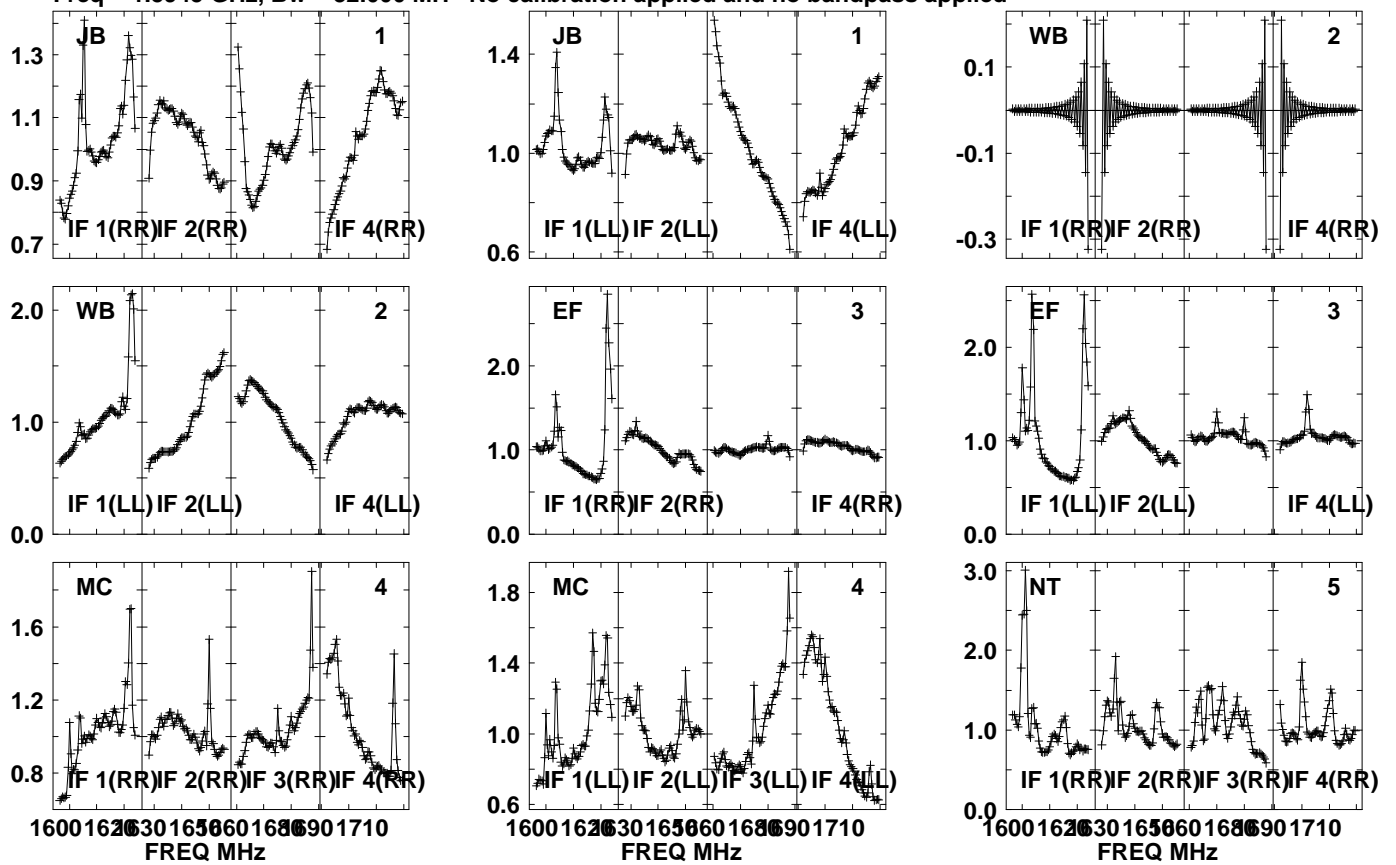

Lower frame: Real Jy  
Auto-corr total-power spectrum Antenna: \*  
Timerange: 00/19:27:31 to 00/19:30:59

Plot file version1045 created 05-OCT-2021 17:09:37

APM08279+525 GM076.UVDATA.1

Freq = 1.5945 GHz, Bw = 32.000 MH No calibration applied and no bandpass applied

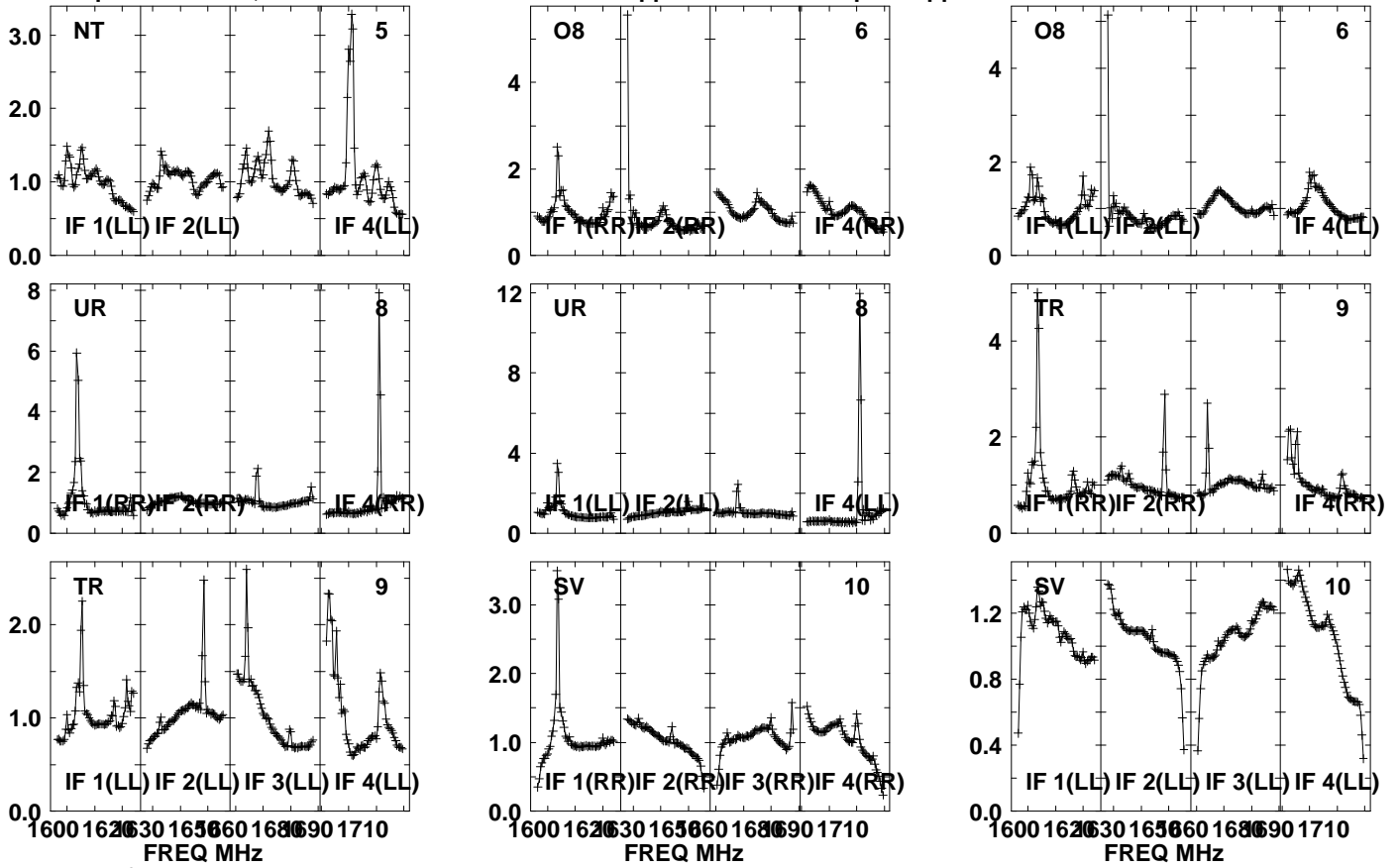

Lower frame: Real Jy

Auto-corr total-power spectrum Antenna: \*

Timerange: 00/19:27:31 to 00/19:30:59

Plot file version1046 created 05-OCT-2021 17:09:37

APM08279+525 GM076.UVDATA.1

Freq = 1.5945 GHz, Bw = 32.000 MH No calibration applied and no bandpass applied

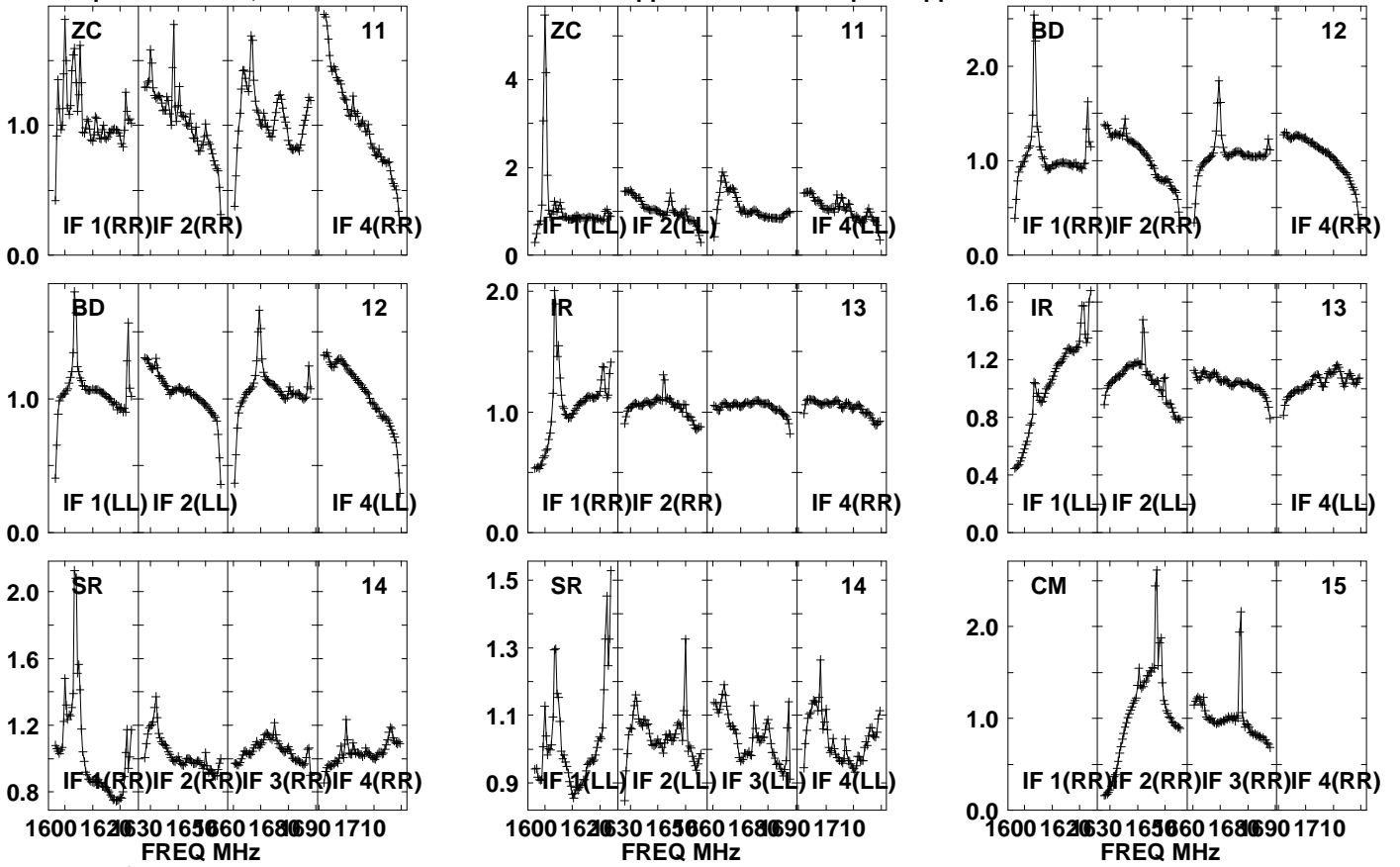

Lower frame: Real Jy

Auto-corr total-power spectrum Antenna: \*

Timerange: 00/19:27:31 to 00/19:30:59

Plot file version1047 created 05-OCT-2021 17:09:37

APM08279+525 GM076.UVDATA.1

Freq = 1.5945 GHz, Bw = 32.000 MH No calibration applied and no bandpass applied

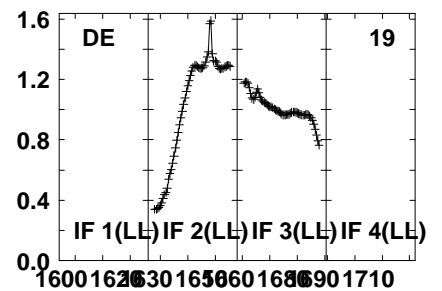
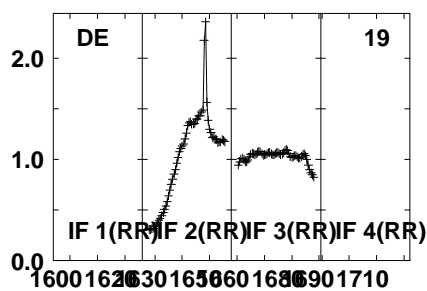
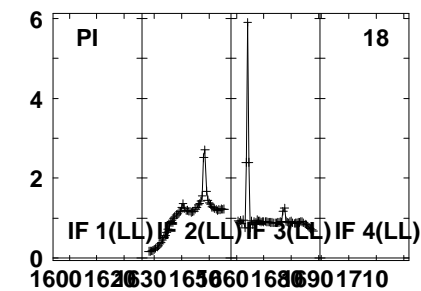
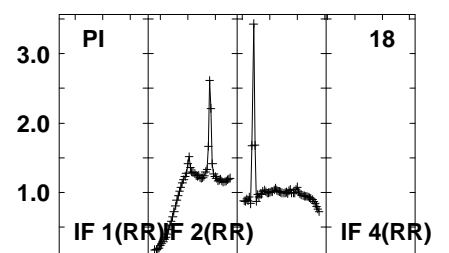
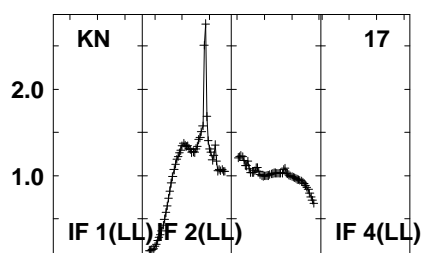
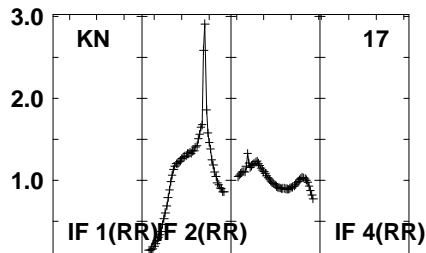
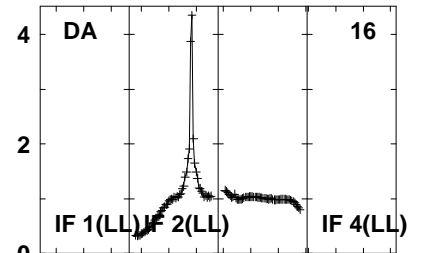
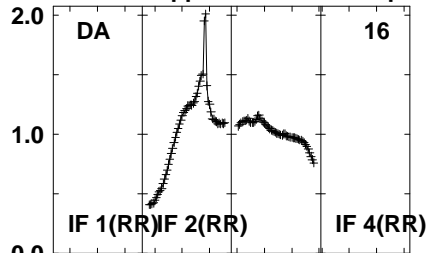
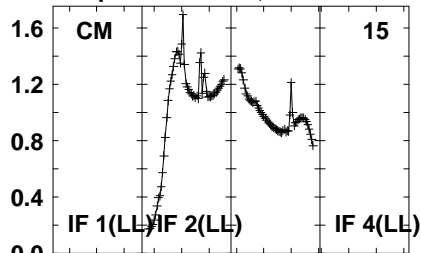

1600 1620 1630 1650 1660 1680 1690 1710  
FREQ MHz

Lower frame: Real Jy  
Auto-corr total-power spectrum Antenna: \*  
Timerange: 00/19:27:31 to 00/19:30:59

Plot file version1048 created 05-OCT-2021 17:09:38

APM08279+525 GM076.UVDATA.1

Freq = 1.5945 GHz, Bw = 32.000 MH No calibration applied and no bandpass applied

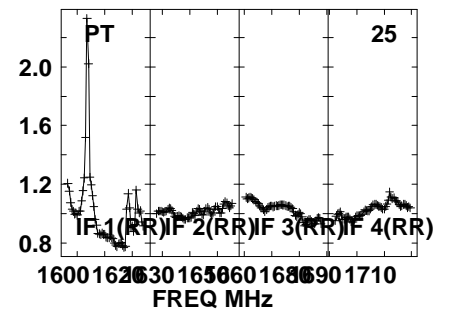
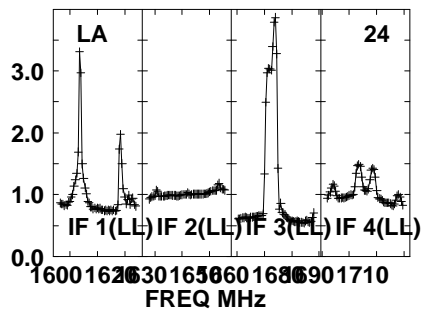
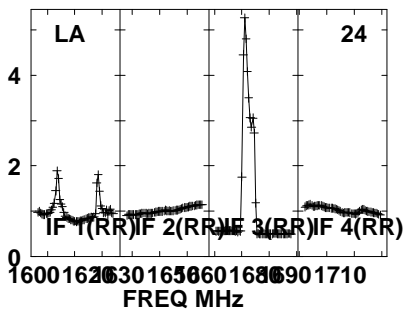
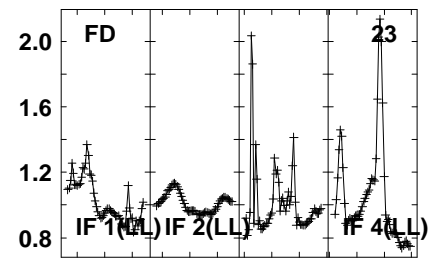
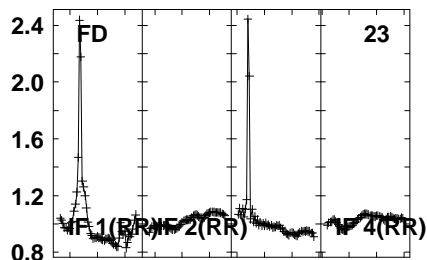
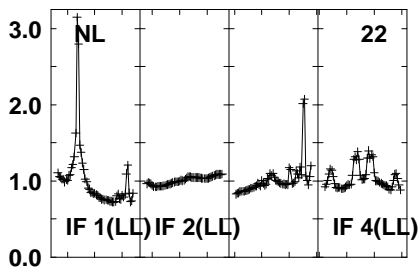
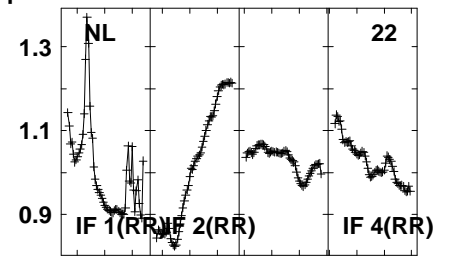
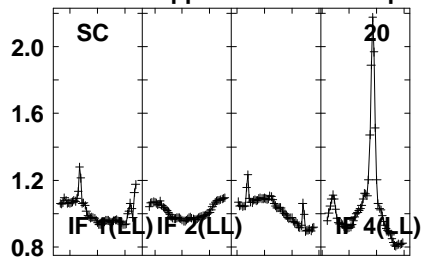
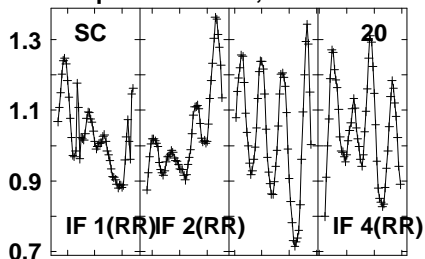

Lower frame: Real Jy  
Auto-corr total-power spectrum Antenna: \*  
Timerange: 00/19:27:31 to 00/19:30:59

Plot file version1049 created 05-OCT-2021 17:09:38

APM08279+525 GM076.UVDATA.1

Freq = 1.5945 GHz, Bw = 32.000 MH No calibration applied and no bandpass applied

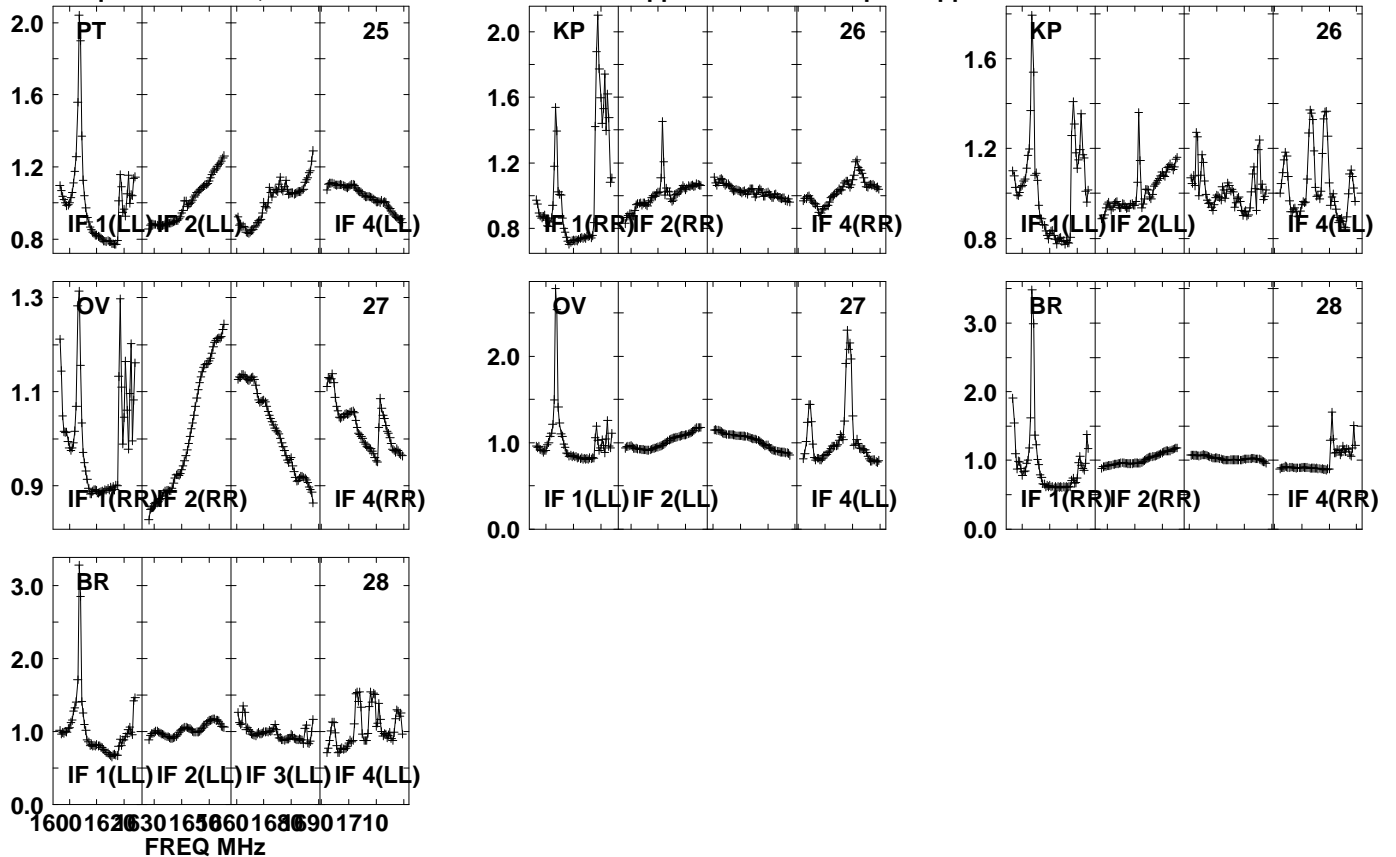

Lower frame: Real Jy  
Auto-corr total-power spectrum Antenna: \*  
Timerange: 00/19:27:31 to 00/19:30:59

Plot file version1050 created 05-OCT-2021 17:09:38

J0827+5217 GM076.UVDATA.1

Freq = 1.5945 GHz, Bw = 32.000 MH No calibration applied and no bandpass applied

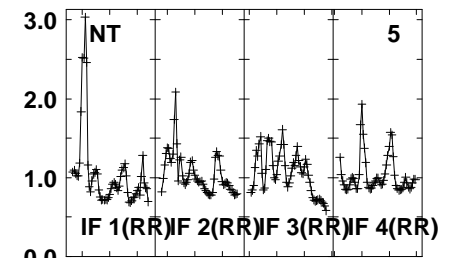
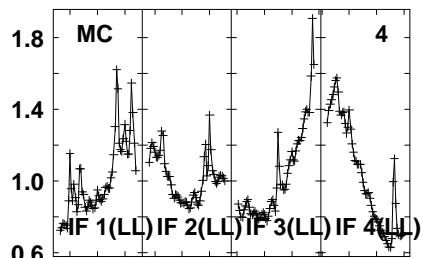
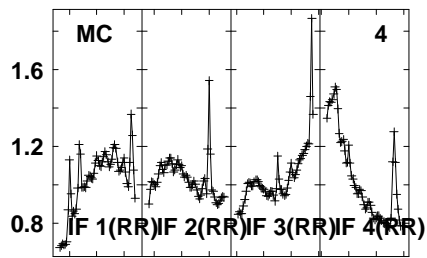
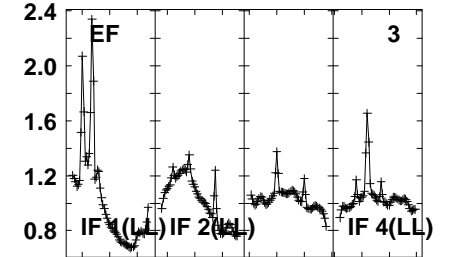
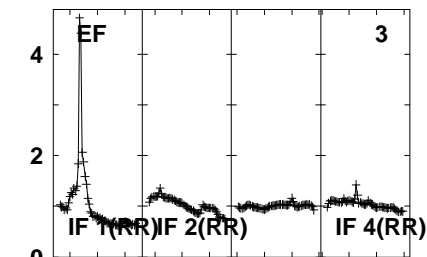
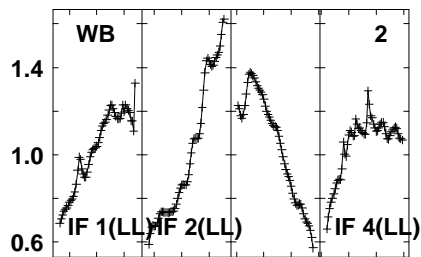
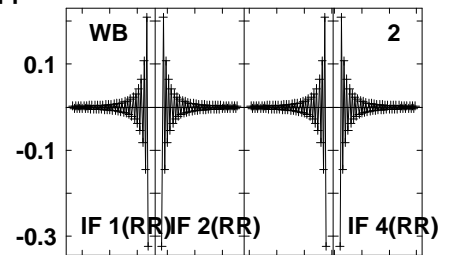
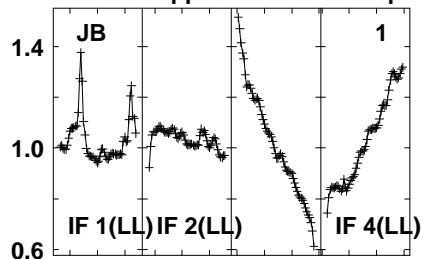
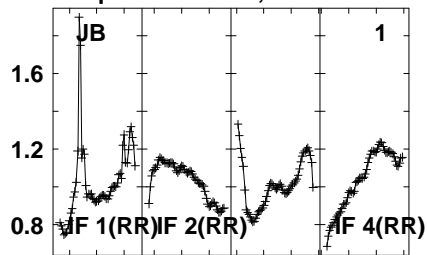

1600 1625 1650 1675 1700 1710  
FREQ MHz

1600 1625 1650 1675 1700 1710  
FREQ MHz

1600 1625 1650 1675 1700 1710  
FREQ MHz

Lower frame: Real Jy  
Auto-corr total-power spectrum Antenna: \*  
Timerange: 00/19:31:01 to 00/19:32:29



Plot file version1051 created 05-OCT-2021 17:09:39

J0827+5217 GM076.UVDATA.1

Freq = 1.5945 GHz, Bw = 32.000 MH No calibration applied and no bandpass applied

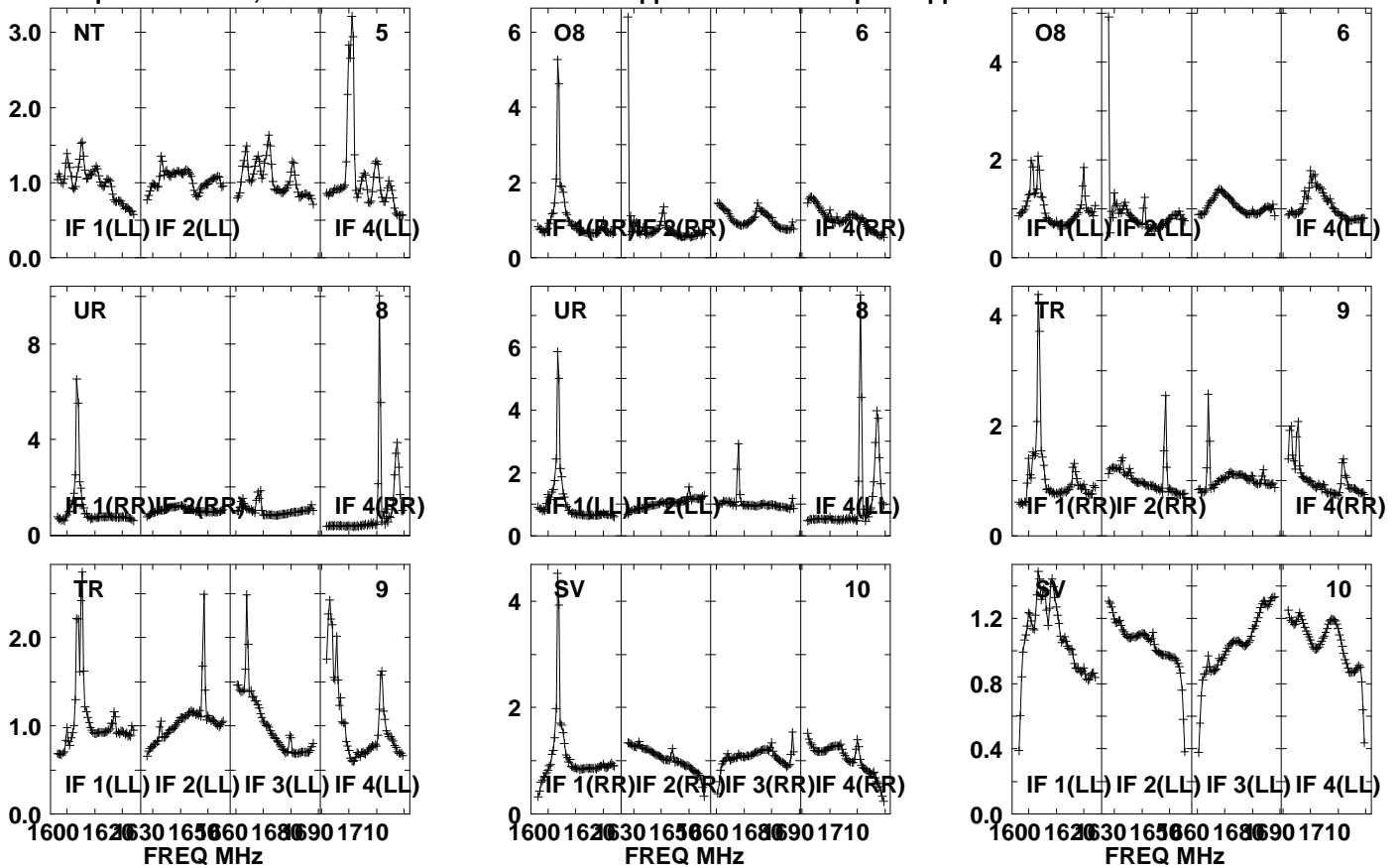

Lower frame: Real Jy

Auto-corr total-power spectrum Antenna: \*

Timerange: 00/19:31:01 to 00/19:32:29

Plot file version1052 created 05-OCT-2021 17:09:39

J0827+5217 GM076.UVDATA.1

Freq = 1.5945 GHz, Bw = 32.000 MH No calibration applied and no bandpass applied

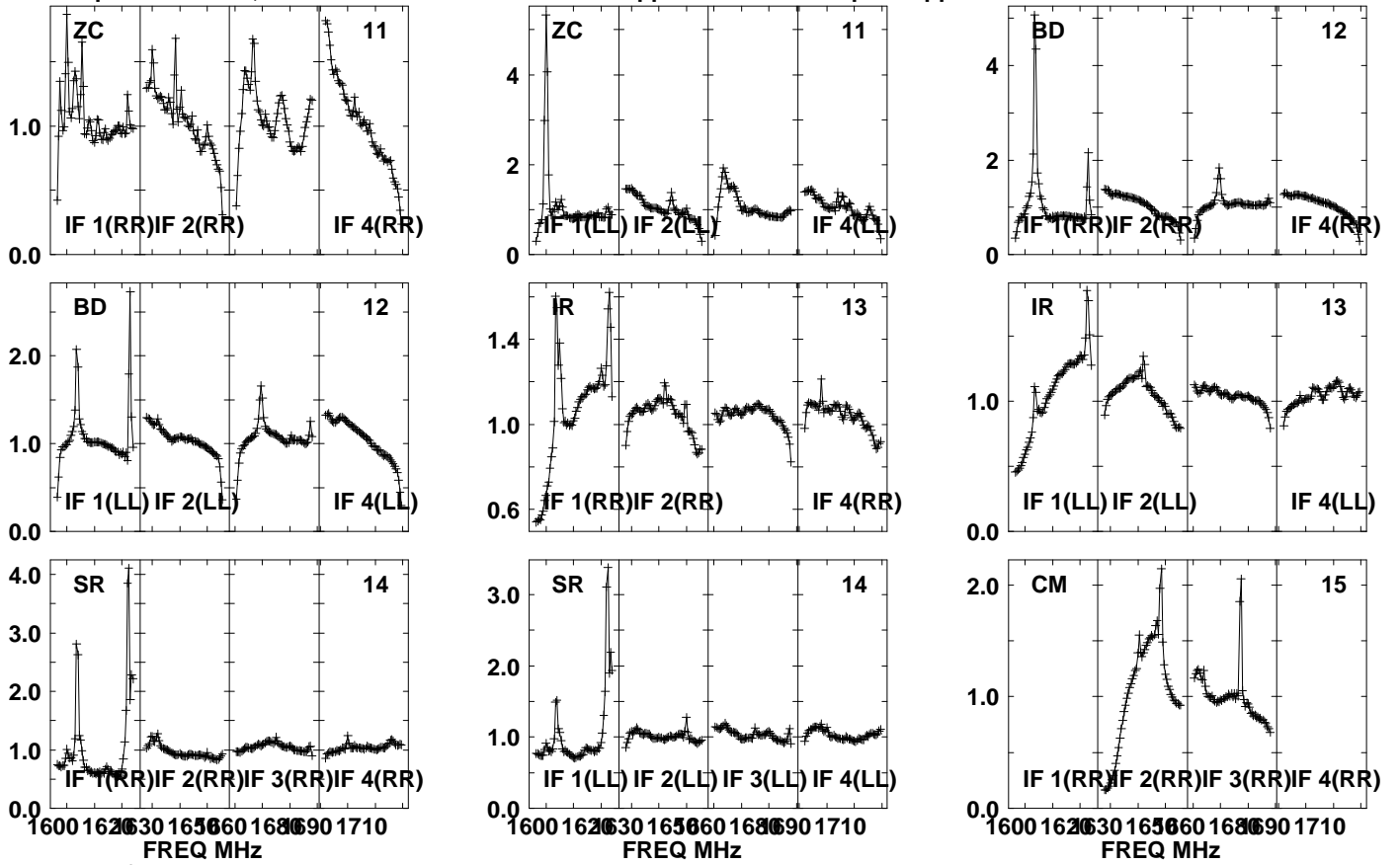

Lower frame: Real Jy

Auto-corr total-power spectrum Antenna: \*

Timerange: 00/19:31:01 to 00/19:32:29

Plot file version1053 created 05-OCT-2021 17:09:39

J0827+5217 GM076.UVDATA.1

Freq = 1.5945 GHz, Bw = 32.000 MH No calibration applied and no bandpass applied

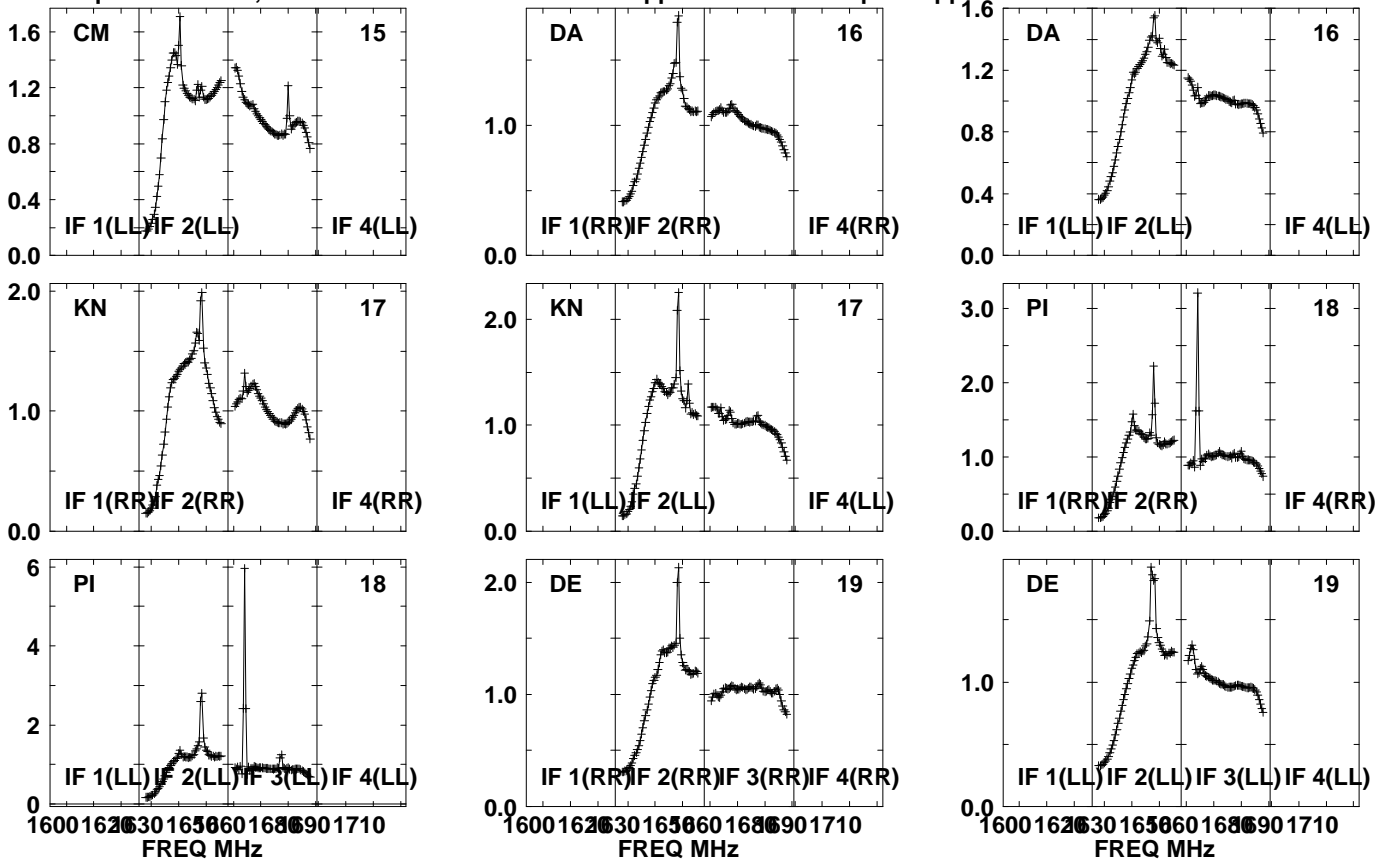

Lower frame: Real Jy  
Auto-corr total-power spectrum Antenna: \*  
Timerange: 00/19:31:01 to 00/19:32:29

Plot file version1054 created 05-OCT-2021 17:09:40

J0827+5217 GM076.UVDATA.1

Freq = 1.5945 GHz, Bw = 32.000 MH No calibration applied and no bandpass applied

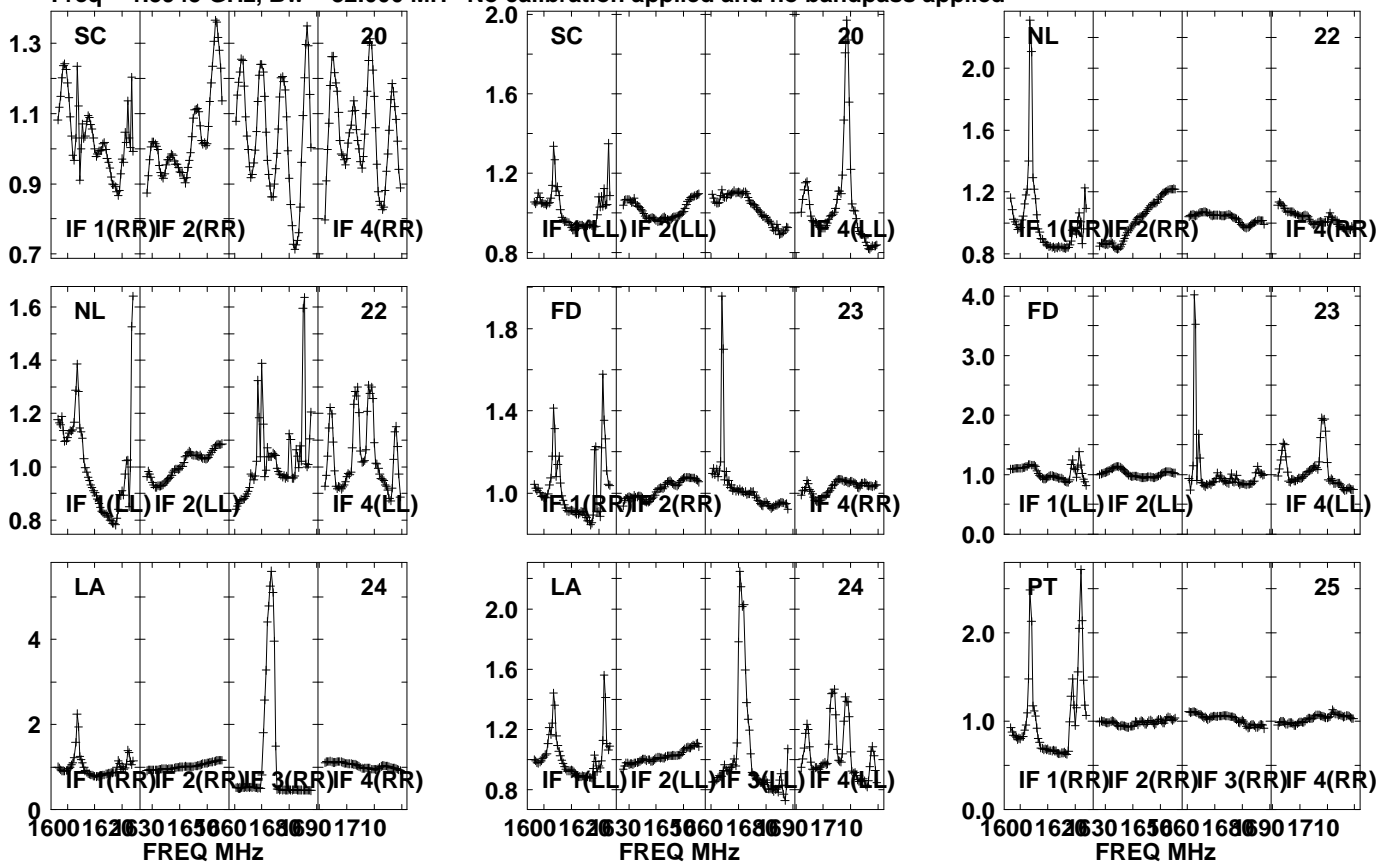

Lower frame: Real Jy  
Auto-corr total-power spectrum Antenna: \*  
Timerange: 00/19:31:01 to 00/19:32:29

Plot file version1055 created 05-OCT-2021 17:09:40

J0827+5217 GM076.UVDATA.1

Freq = 1.5945 GHz, Bw = 32.000 MH No calibration applied and no bandpass applied

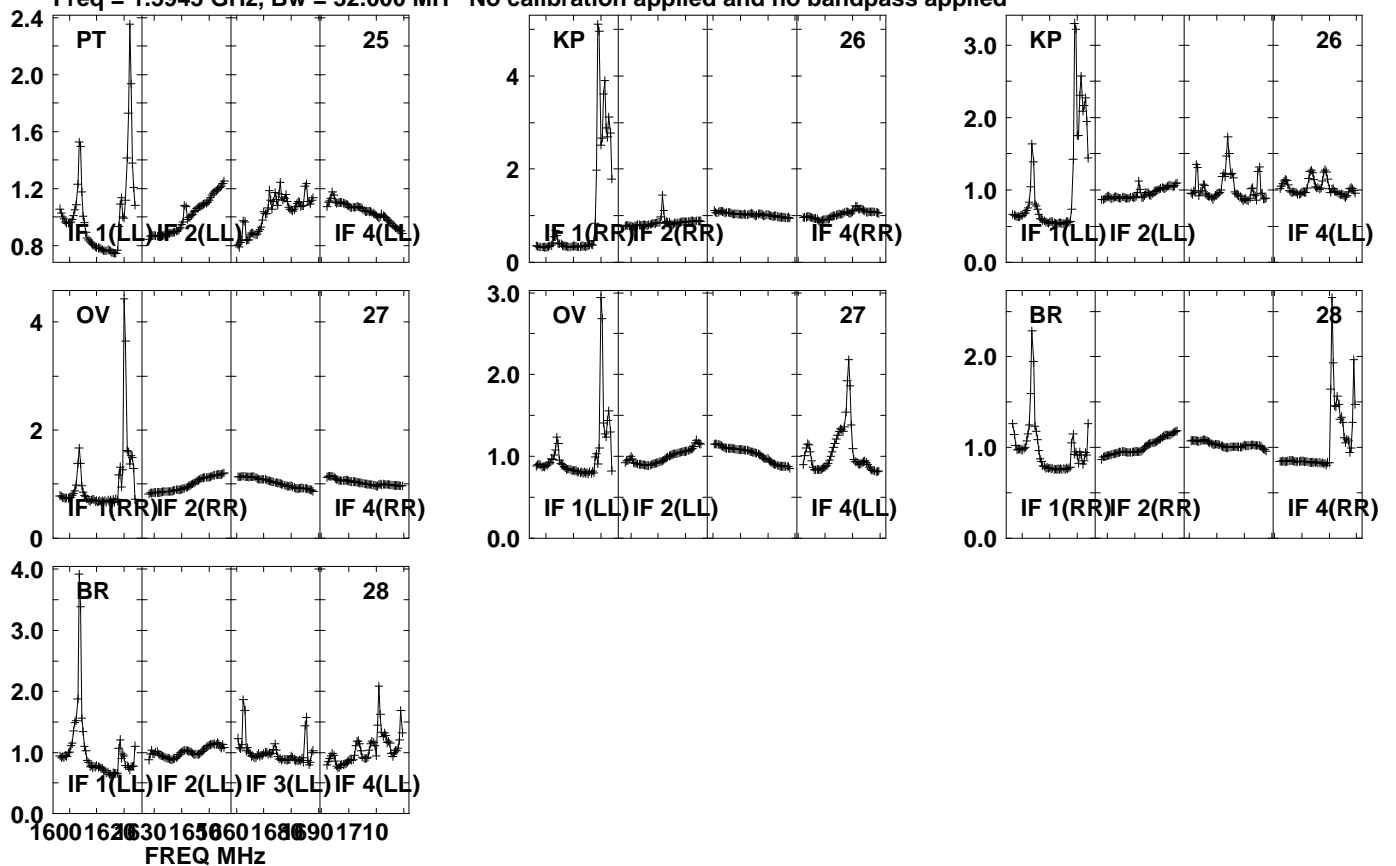

Lower frame: Real Jy

Auto-corr total-power spectrum Antenna: \*

Timerange: 00/19:31:01 to 00/19:32:29

Plot file version1056 created 05-OCT-2021 17:09:40

APM08279+525 GM076.UVDATA.1

Freq = 1.5945 GHz, Bw = 32.000 MH No calibration applied and no bandpass applied

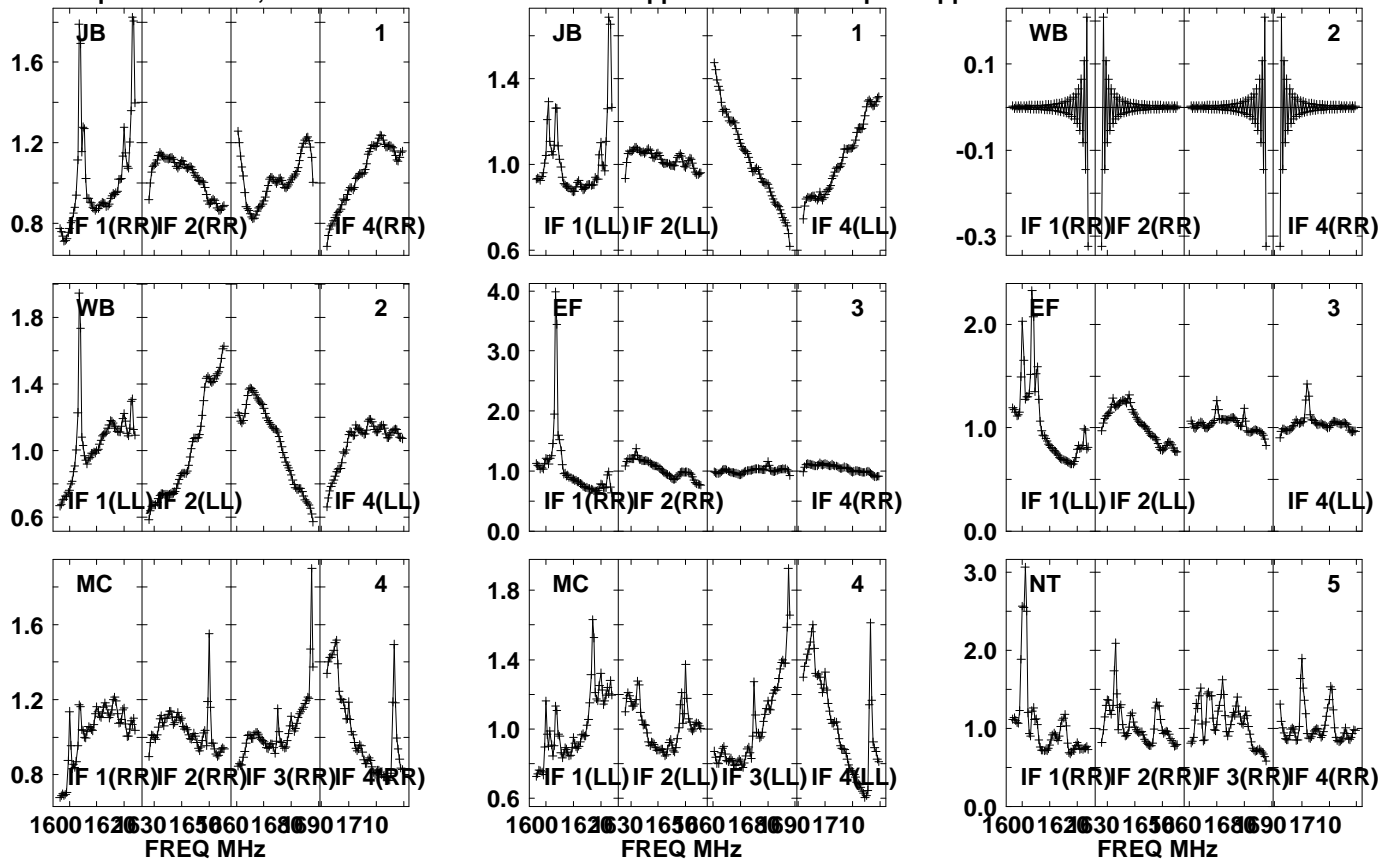

Lower frame: Real Jy  
Auto-corr total-power spectrum Antenna: \*  
Timerange: 00/19:32:31 to 00/19:35:59

Plot file version1057 created 05-OCT-2021 17:09:41

APM08279+525 GM076.UVDATA.1

Freq = 1.5945 GHz, Bw = 32.000 MH No calibration applied and no bandpass applied

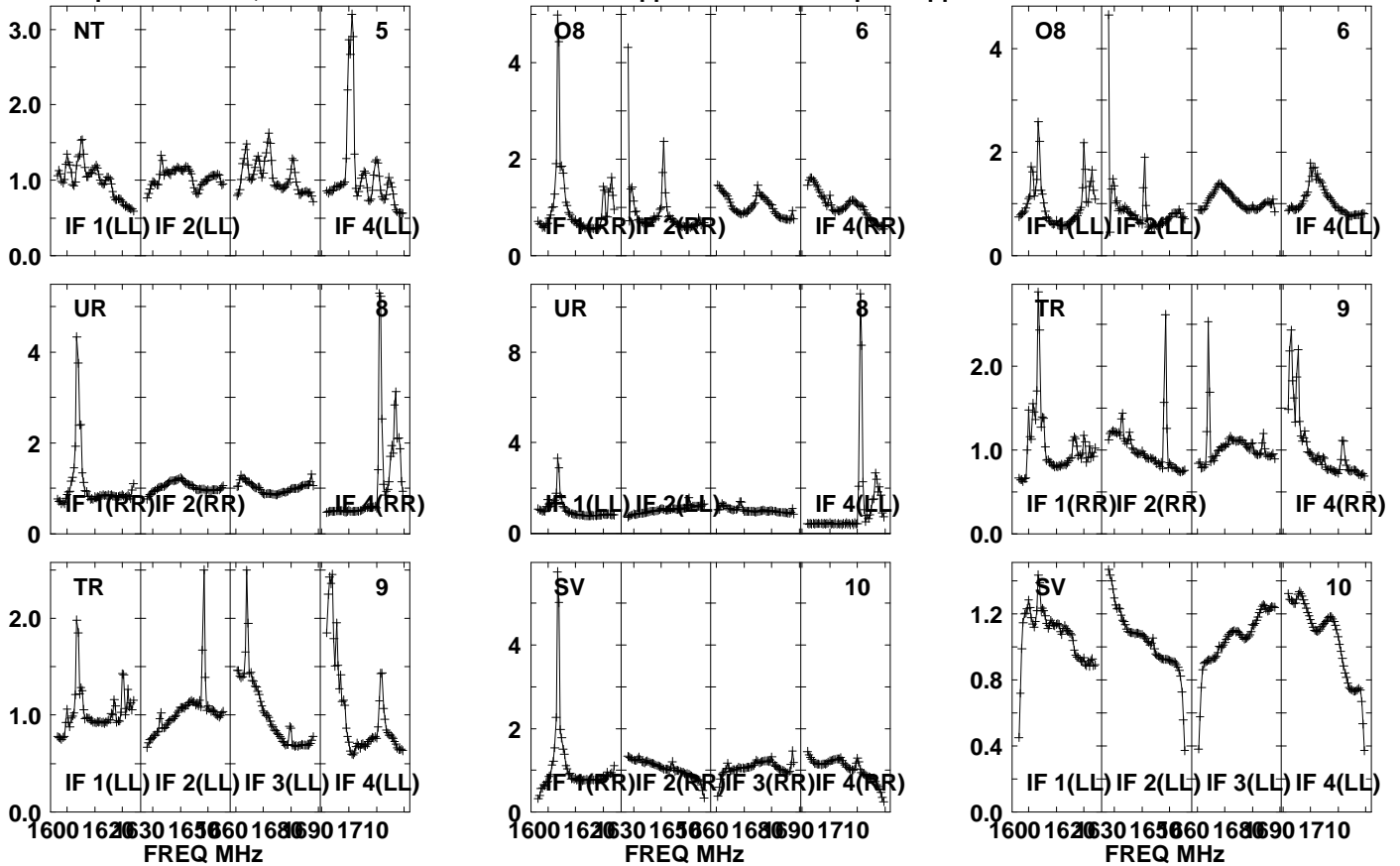

Lower frame: Real Jy

Auto-corr total-power spectrum Antenna: \*

Timerange: 00/19:32:31 to 00/19:35:59

Plot file version1058 created 05-OCT-2021 17:09:41

APM08279+525 GM076.UVDATA.1

Freq = 1.5945 GHz, Bw = 32.000 MH No calibration applied and no bandpass applied

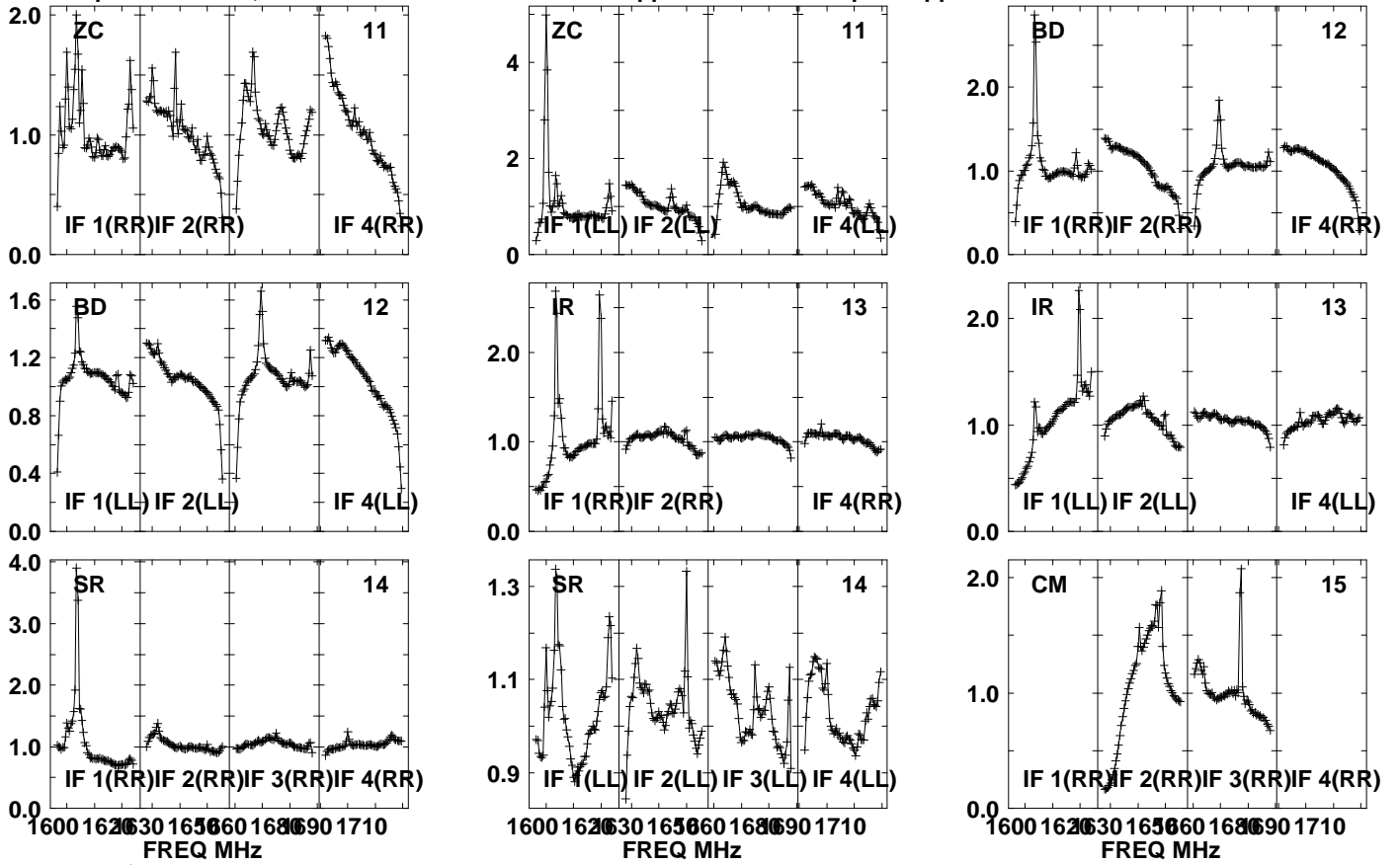

Lower frame: Real Jy

Auto-corr total-power spectrum Antenna: \*

Timerange: 00/19:32:31 to 00/19:35:59



Plot file version1059 created 05-OCT-2021 17:09:41

APM08279+525 GM076.UVDATA.1

Freq = 1.5945 GHz, Bw = 32.000 MH No calibration applied and no bandpass applied

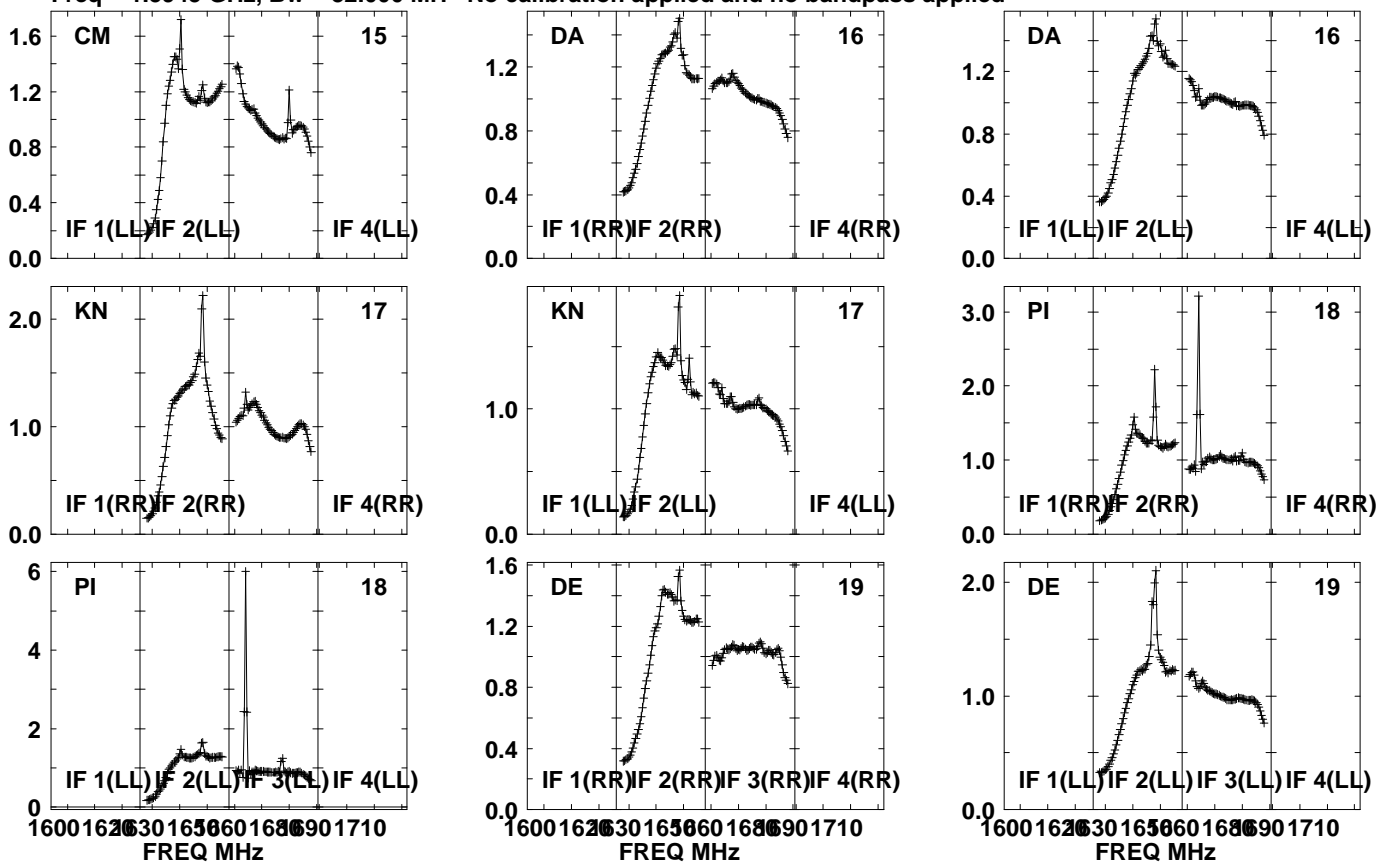

Lower frame: Real Jy  
Auto-corr total-power spectrum Antenna: \*  
Timerange: 00/19:32:31 to 00/19:35:59

Plot file version1060 created 05-OCT-2021 17:09:42

APM08279+525 GM076.UVDATA.1

Freq = 1.5945 GHz, Bw = 32.000 MH No calibration applied and no bandpass applied

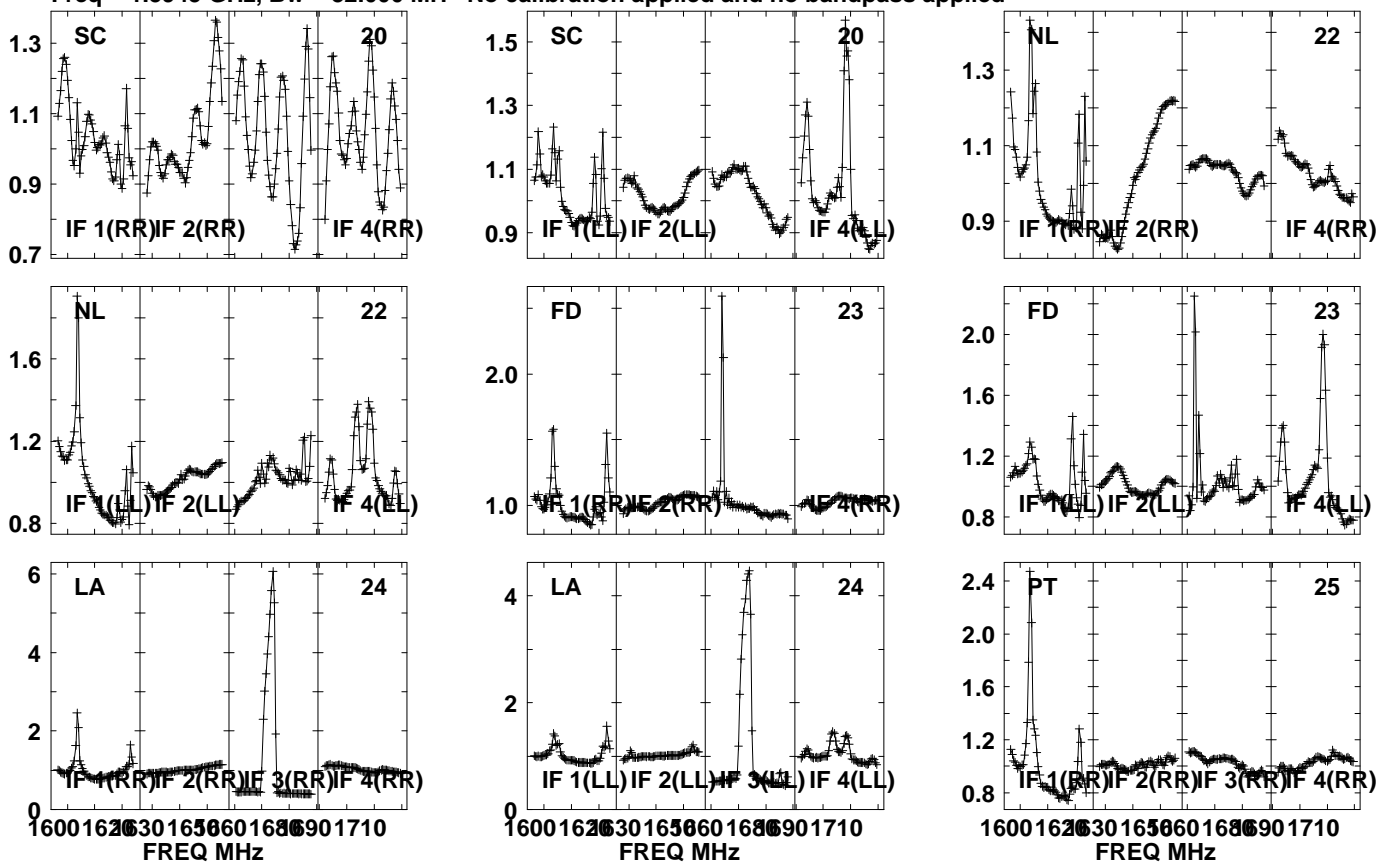

Lower frame: Real Jy  
Auto-corr total-power spectrum Antenna: \*  
Timerange: 00/19:32:31 to 00/19:35:59

Plot file version1061 created 05-OCT-2021 17:09:42

APM08279+525 GM076.UVDATA.1

Freq = 1.5945 GHz, Bw = 32.000 MH No calibration applied and no bandpass applied

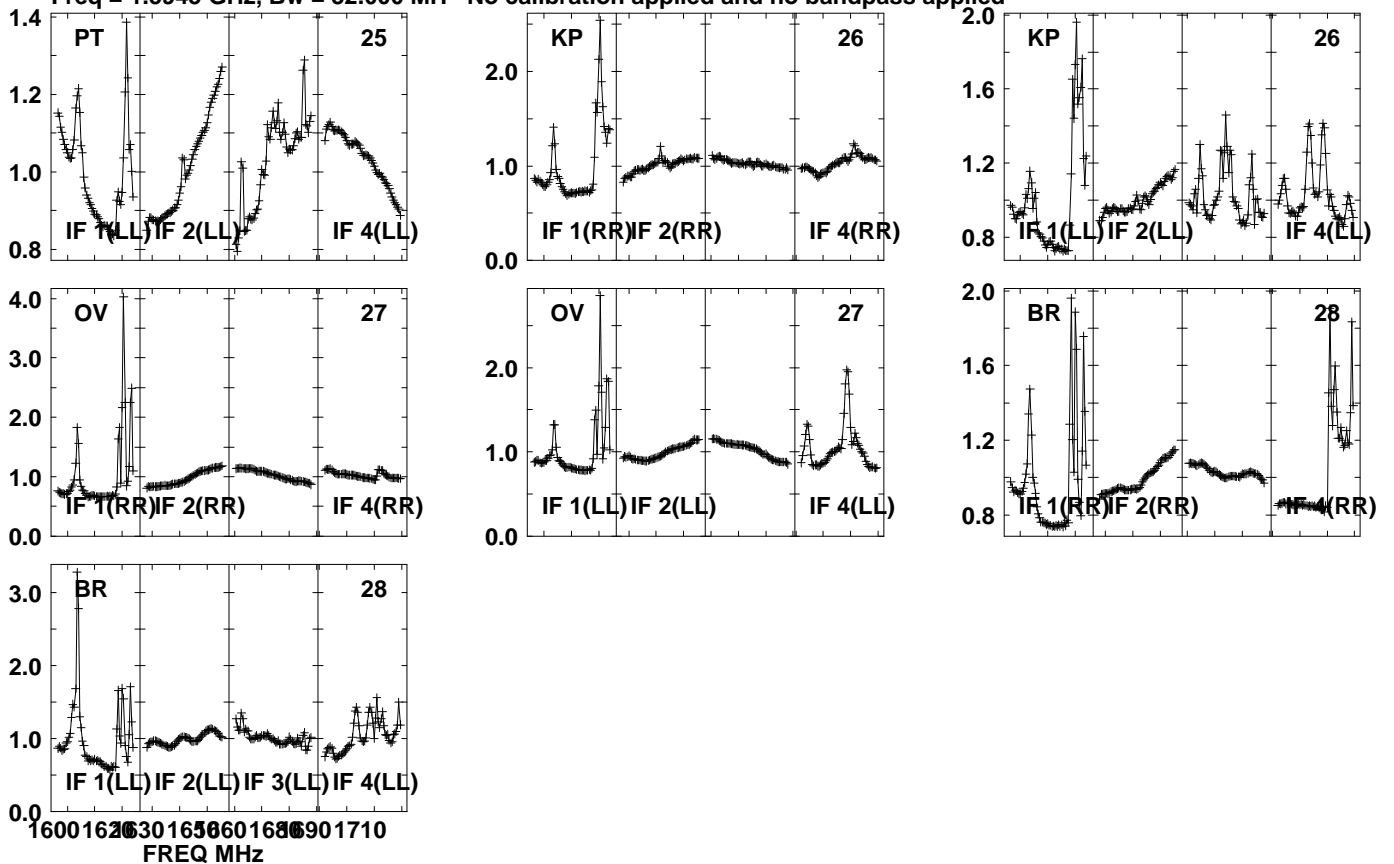

Lower frame: Real Jy  
Auto-corr total-power spectrum Antenna: \*  
Timerange: 00/19:32:31 to 00/19:35:59

Plot file version1062 created 05-OCT-2021 17:09:42

J0827+5217 GM076.UVDATA.1

Freq = 1.5945 GHz, Bw = 32.000 MH No calibration applied and no bandpass applied

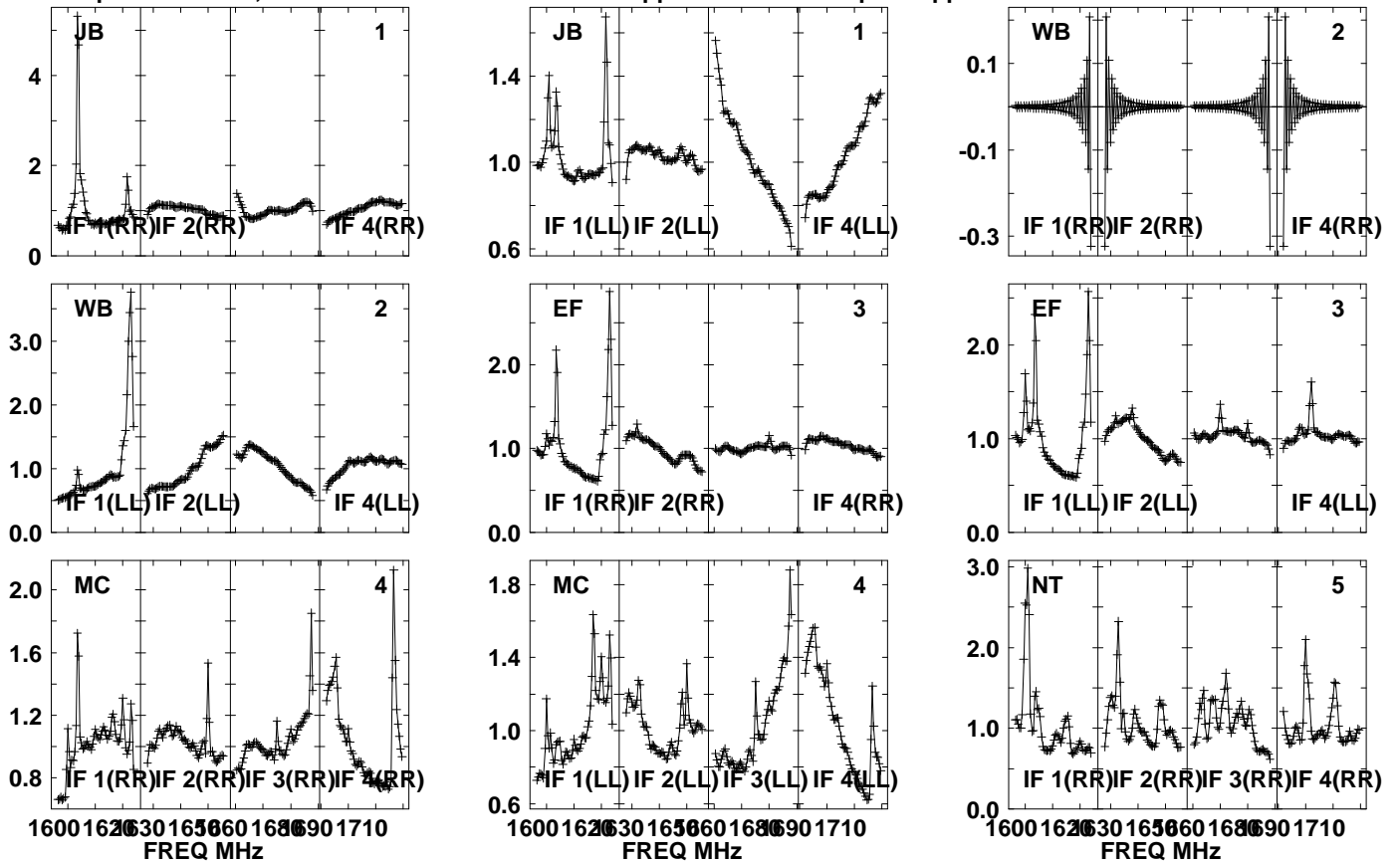

Lower frame: Real Jy

Auto-corr total-power spectrum Antenna: \*

Timerange: 00/19:36:31 to 00/19:37:59

Plot file version1063 created 05-OCT-2021 17:09:43

J0827+5217 GM076.UVDATA.1

Freq = 1.5945 GHz, Bw = 32.000 MH No calibration applied and no bandpass applied

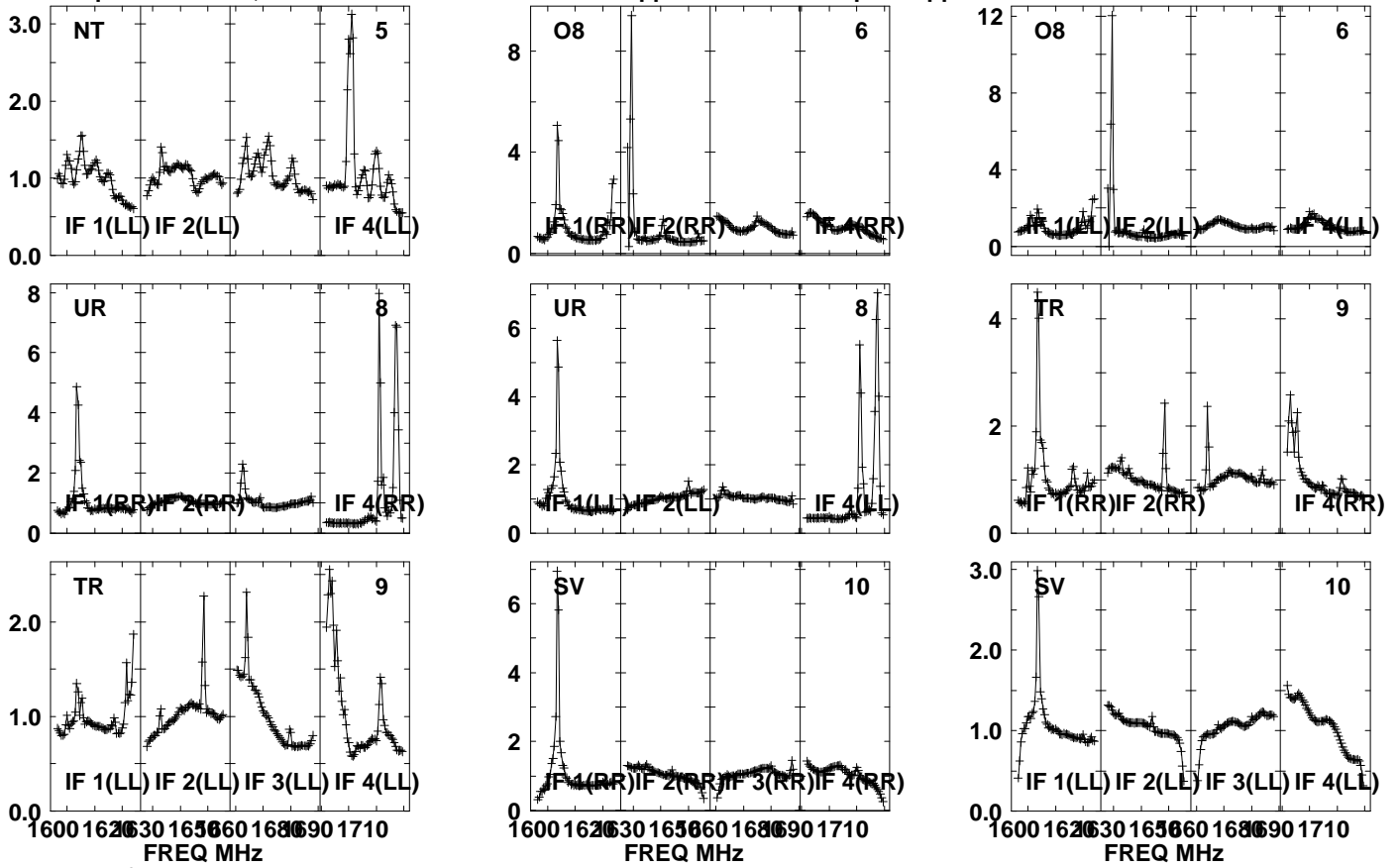

Lower frame: Real Jy

Auto-corr total-power spectrum Antenna: \*

Timerange: 00/19:36:31 to 00/19:37:59

Plot file version1064 created 05-OCT-2021 17:09:43

J0827+5217 GM076.UVDATA.1

Freq = 1.5945 GHz, Bw = 32.000 MH No calibration applied and no bandpass applied

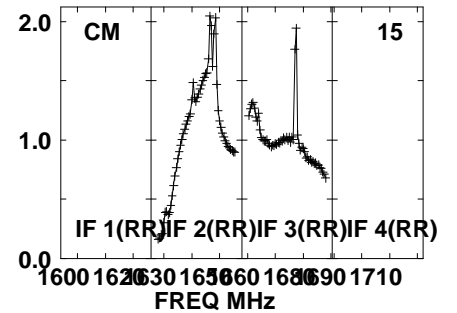
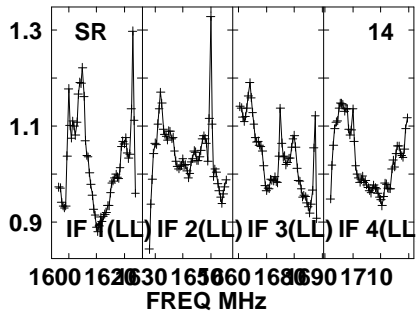
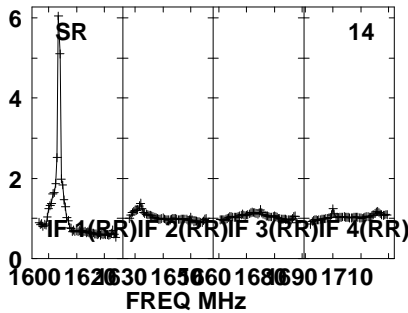
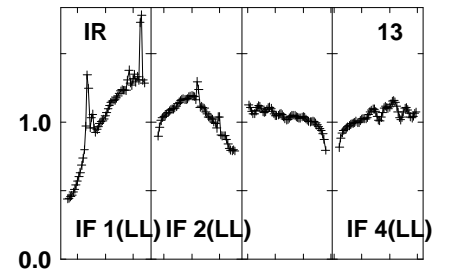
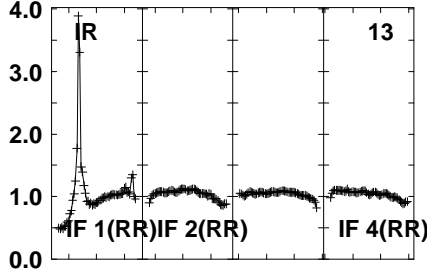
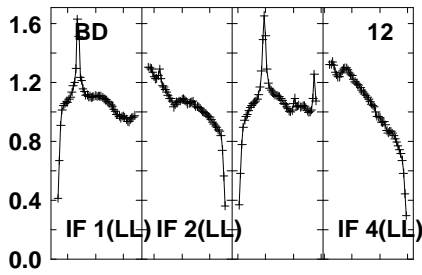
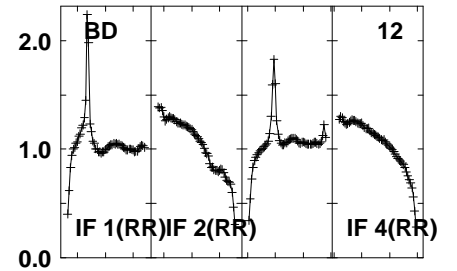
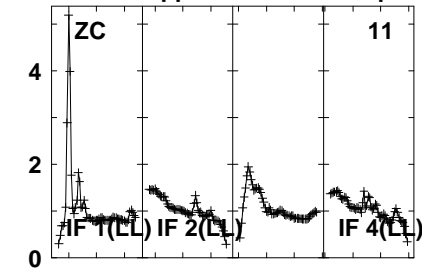
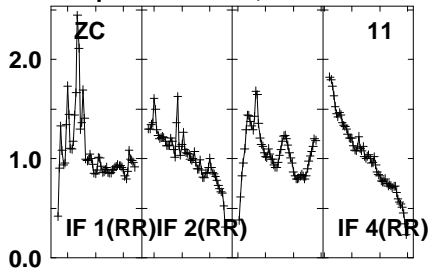

Lower frame: Real Jy

Auto-corr total-power spectrum Antenna: \*

Timerange: 00/19:36:31 to 00/19:37:59

Plot file version1065 created 05-OCT-2021 17:09:43

J0827+5217 GM076.UVDATA.1

Freq = 1.5945 GHz, Bw = 32.000 MH No calibration applied and no bandpass applied

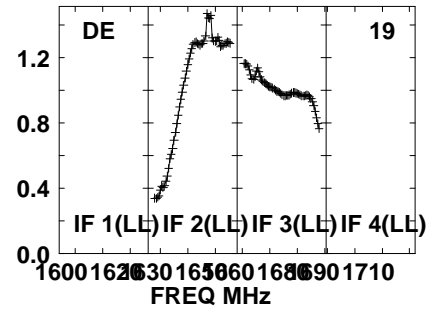
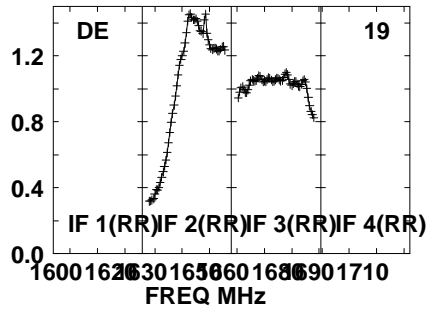
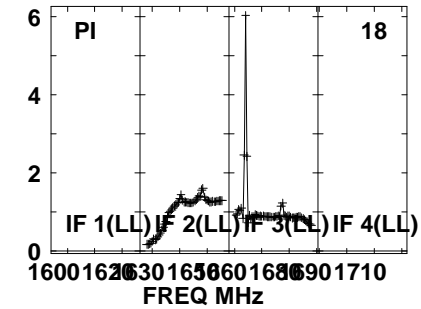
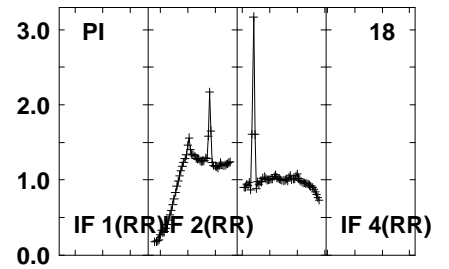
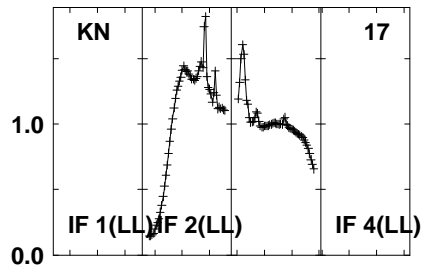
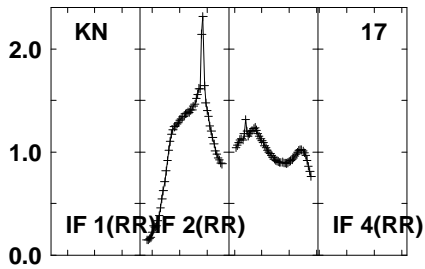
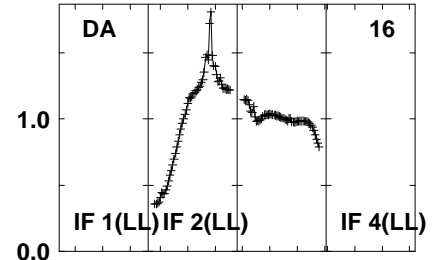
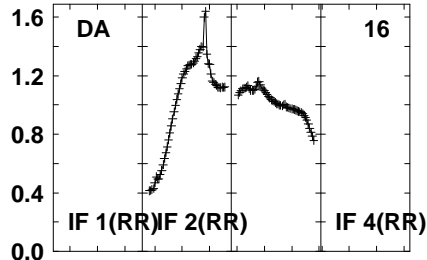
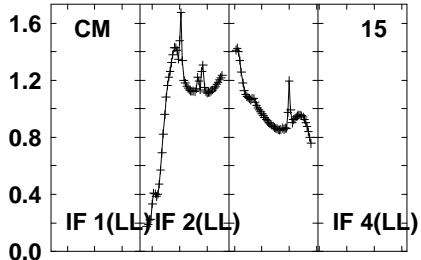

Lower frame: Real Jy  
Auto-corr total-power spectrum Antenna: \*  
Timerange: 00/19:36:31 to 00/19:37:59

Plot file version1066 created 05-OCT-2021 17:09:44

J0827+5217 GM076.UVDATA.1

Freq = 1.5945 GHz, Bw = 32.000 MH No calibration applied and no bandpass applied

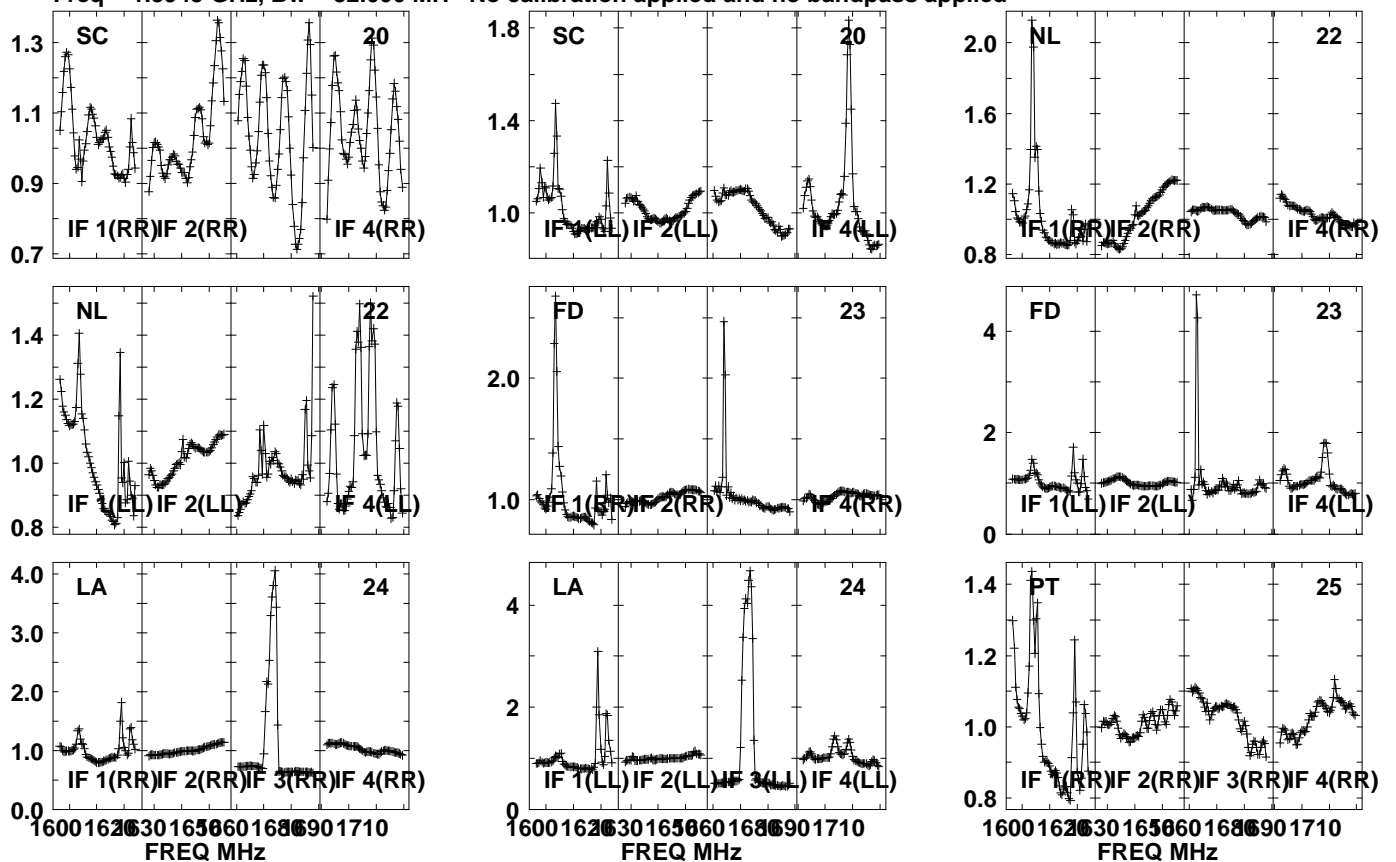

Lower frame: Real Jy  
Auto-corr total-power spectrum Antenna: \*  
Timerange: 00/19:36:31 to 00/19:37:59



Plot file version 1067 created 05-OCT-2021 17:09:44

J0827+5217 GM076.UVDATA.1

Freq = 1.5945 GHz, Bw = 32.000 MH No calibration applied and no bandpass applied

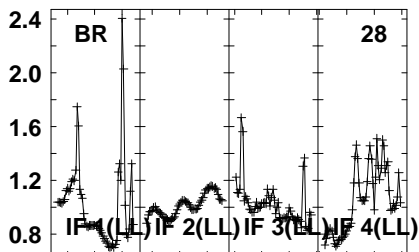
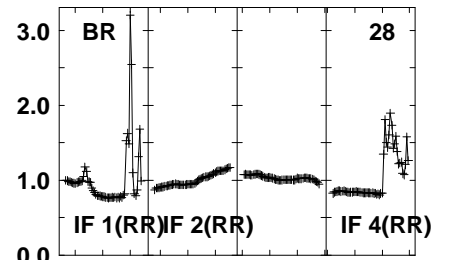
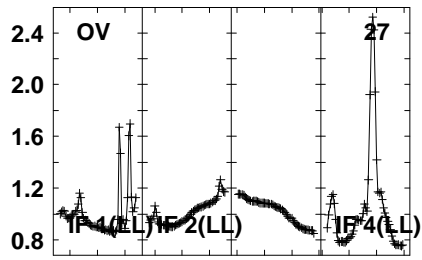
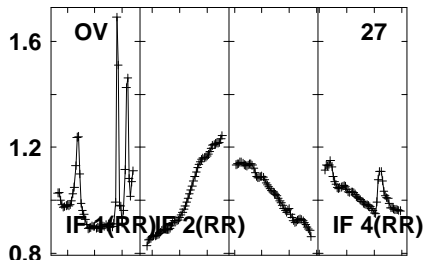
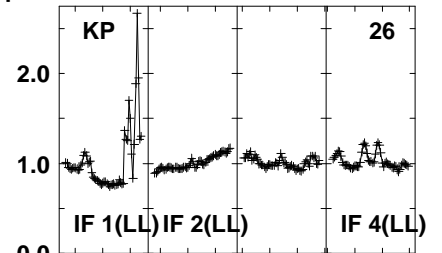
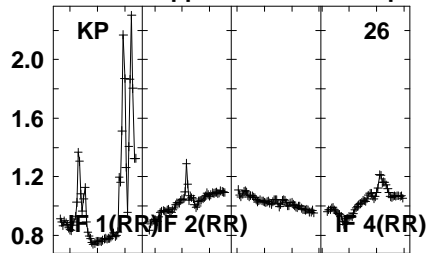
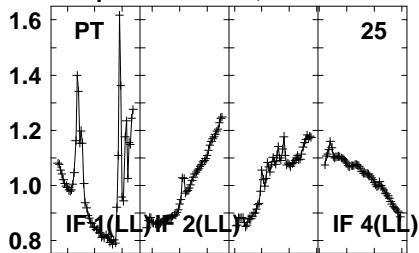

1600 1620 1630 1650 1660 1680 1690 1710

FREQ MHz

Lower frame: Real Jy

Auto-corr total-power spectrum Antenna: \*

Timerange: 00/19:36:31 to 00/19:37:59

Plot file version1068 created 05-OCT-2021 17:09:44

APM08279+525 GM076.UVDATA.1

Freq = 1.5945 GHz, Bw = 32.000 MH No calibration applied and no bandpass applied

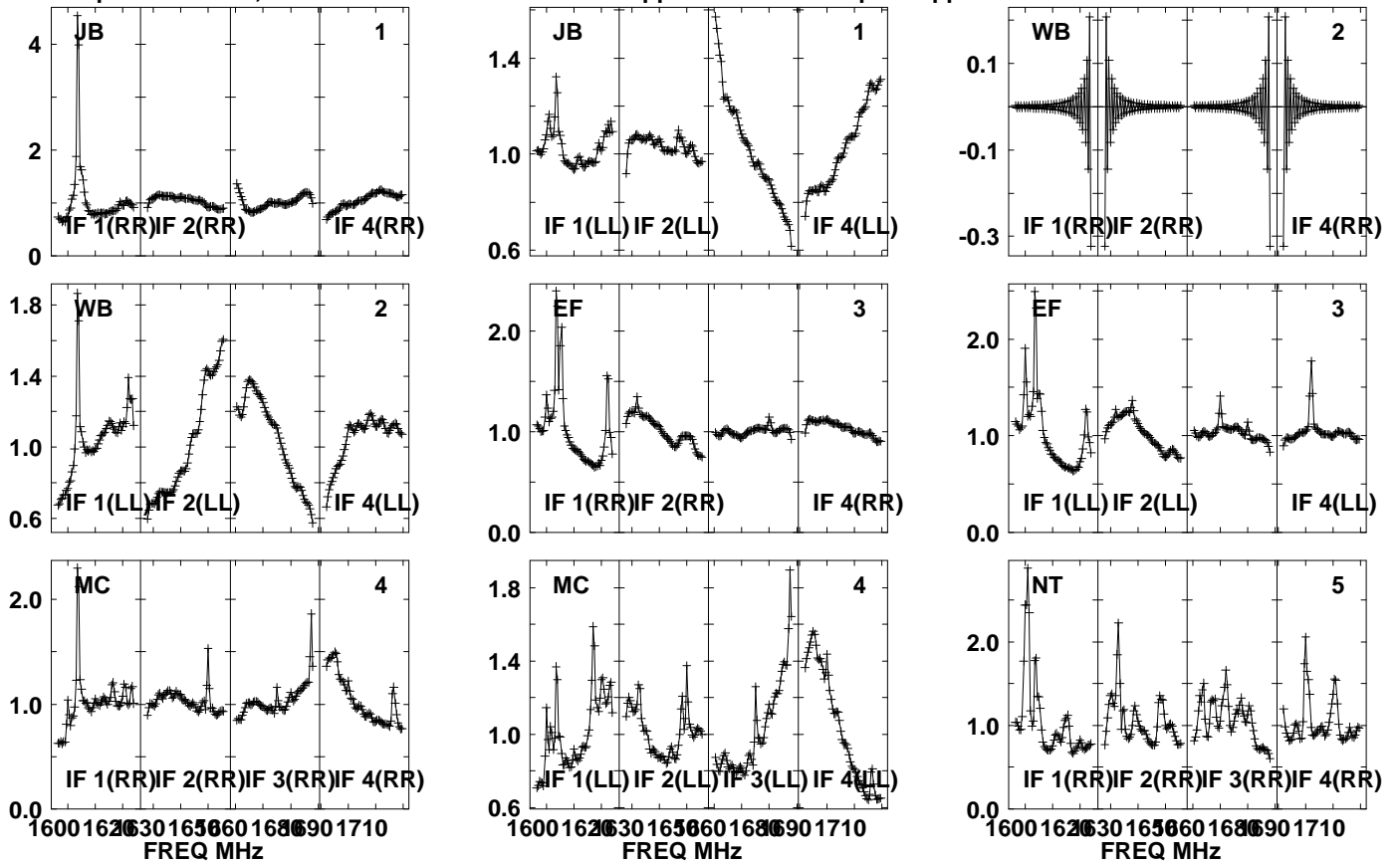

Lower frame: Real Jy

Auto-corr total-power spectrum Antenna: \*

Timerange: 00/19:38:01 to 00/19:41:29

Plot file version1069 created 05-OCT-2021 17:09:45

APM08279+525 GM076.UVDATA.1

Freq = 1.5945 GHz, Bw = 32.000 MH No calibration applied and no bandpass applied

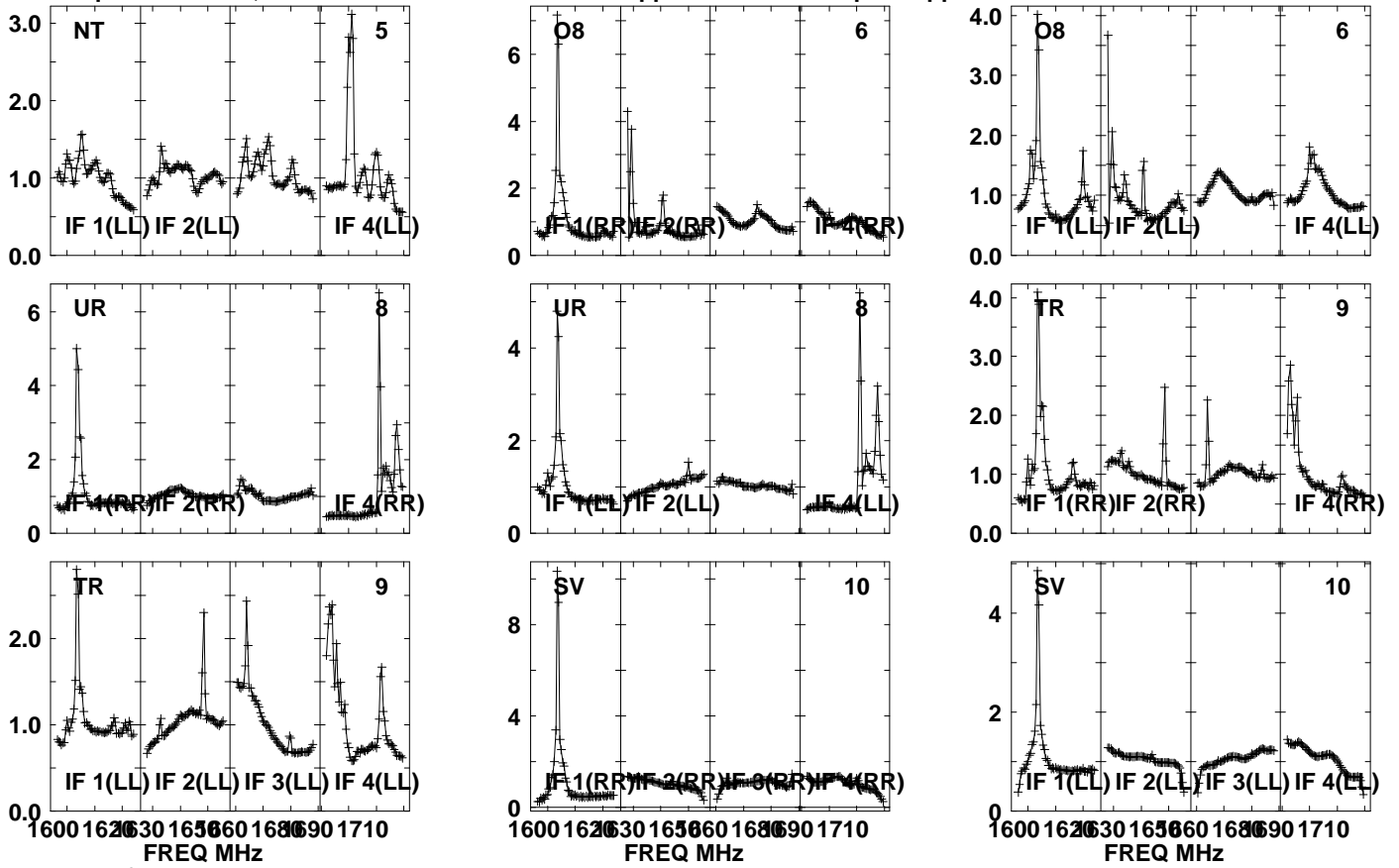

Lower frame: Real Jy

Auto-corr total-power spectrum Antenna: \*

Timerange: 00/19:38:01 to 00/19:41:29

Plot file version1070 created 05-OCT-2021 17:09:45

APM08279+525 GM076.UVDATA.1

Freq = 1.5945 GHz, Bw = 32.000 MH No calibration applied and no bandpass applied

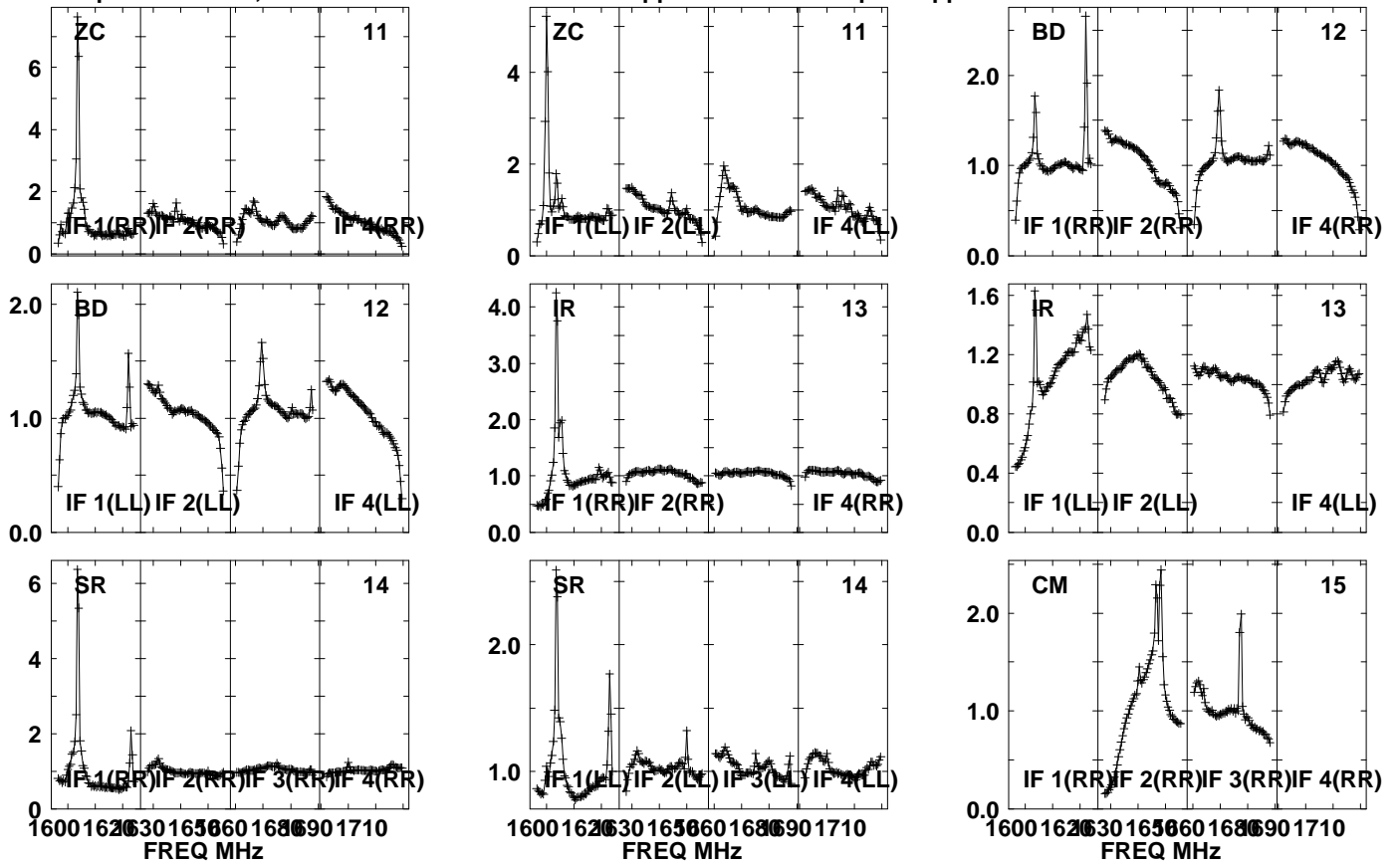

Lower frame: Real Jy

Auto-corr total-power spectrum Antenna: \*

Timerange: 00/19:38:01 to 00/19:41:29

Plot file version1071 created 05-OCT-2021 17:09:45

APM08279+525 GM076.UVDATA.1

Freq = 1.5945 GHz, Bw = 32.000 MH

No calibration applied and no bandpass applied

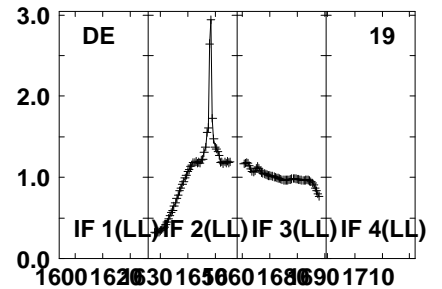
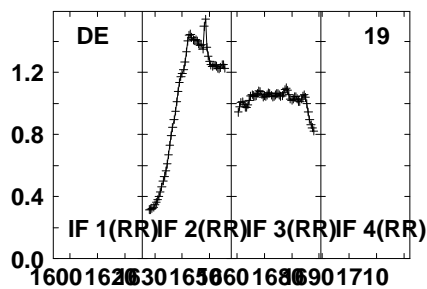
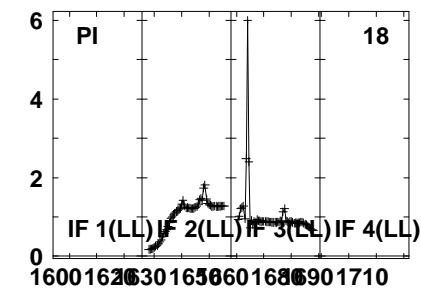
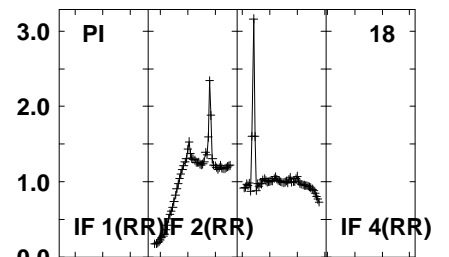
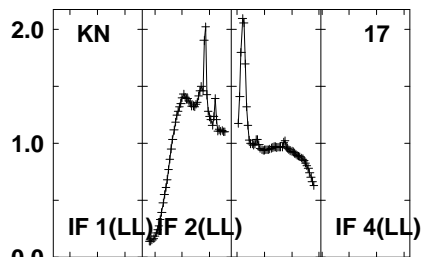
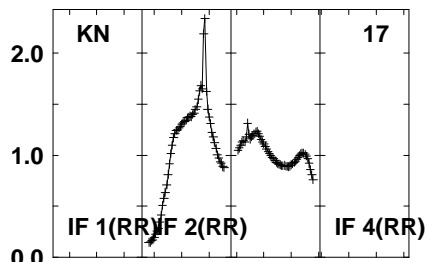
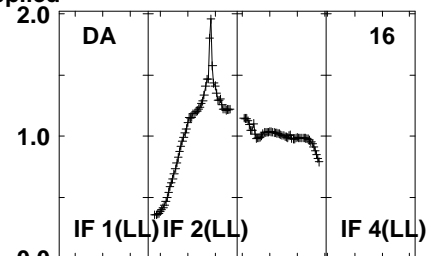
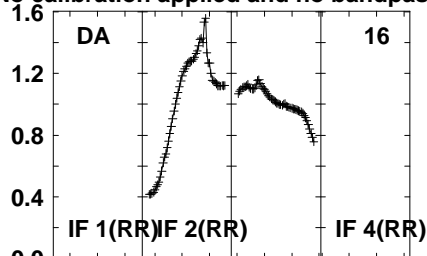
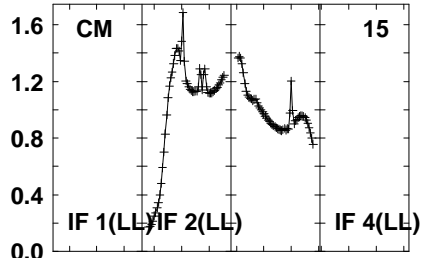

1600 1620 1630 1650 1660 1680 1690 1710  
FREQ MHz

1600 1620 1630 1650 1660 1680 1690 1710  
FREQ MHz

1600 1620 1630 1650 1660 1680 1690 1710  
FREQ MHz

Lower frame: Real Jy  
Auto-corr total-power spectrum Antenna: \*  
Timerange: 00/19:38:01 to 00/19:41:29

Plot file version1072 created 05-OCT-2021 17:09:46

APM08279+525 GM076.UVDATA.1

Freq = 1.5945 GHz, Bw = 32.000 MH No calibration applied and no bandpass applied

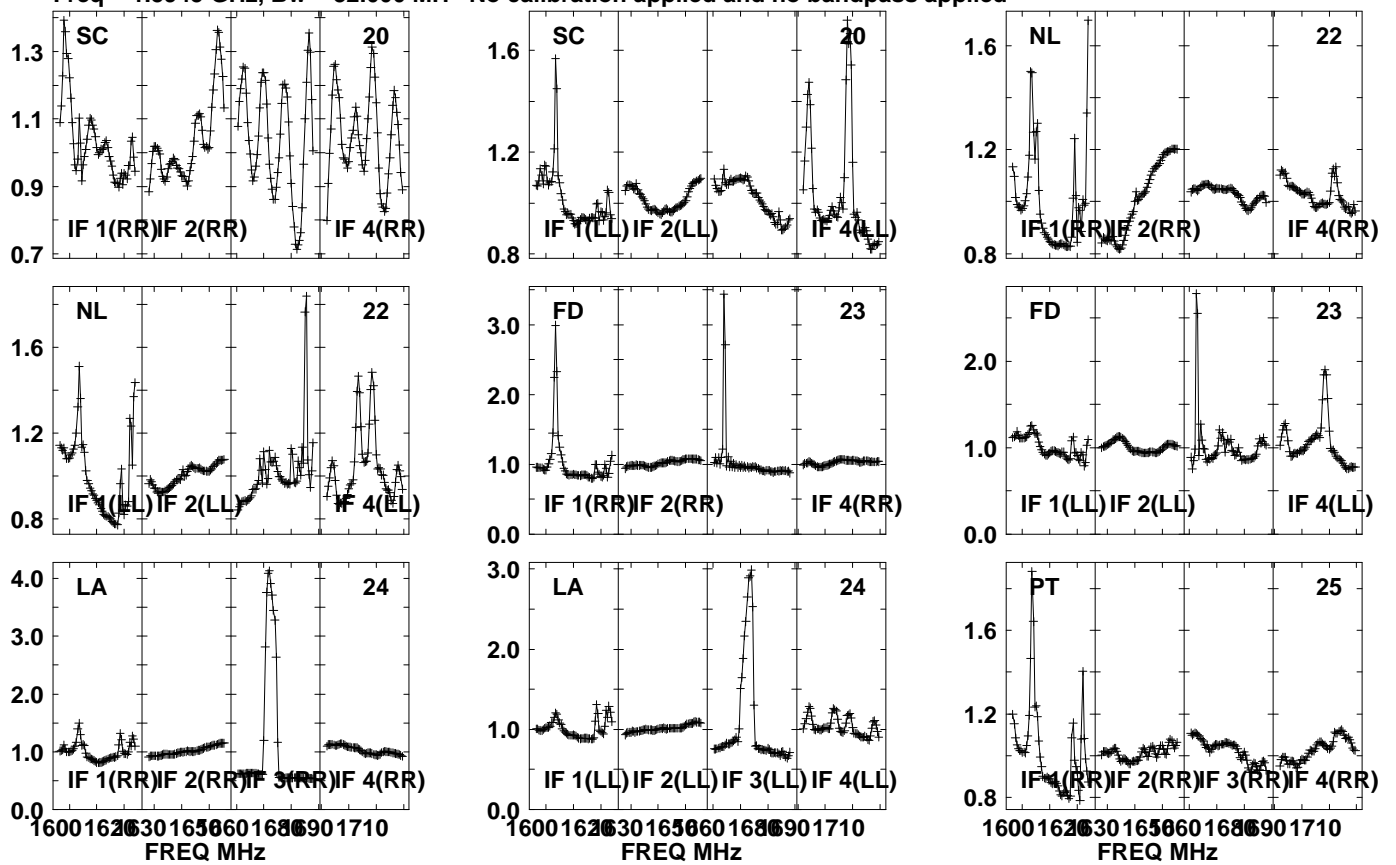

Lower frame: Real Jy  
Auto-corr total-power spectrum Antenna: \*  
Timerange: 00/19:38:01 to 00/19:41:29

Plot file version1073 created 05-OCT-2021 17:09:46

APM08279+525 GM076.UVDATA.1

Freq = 1.5945 GHz, Bw = 32.000 MH No calibration applied and no bandpass applied

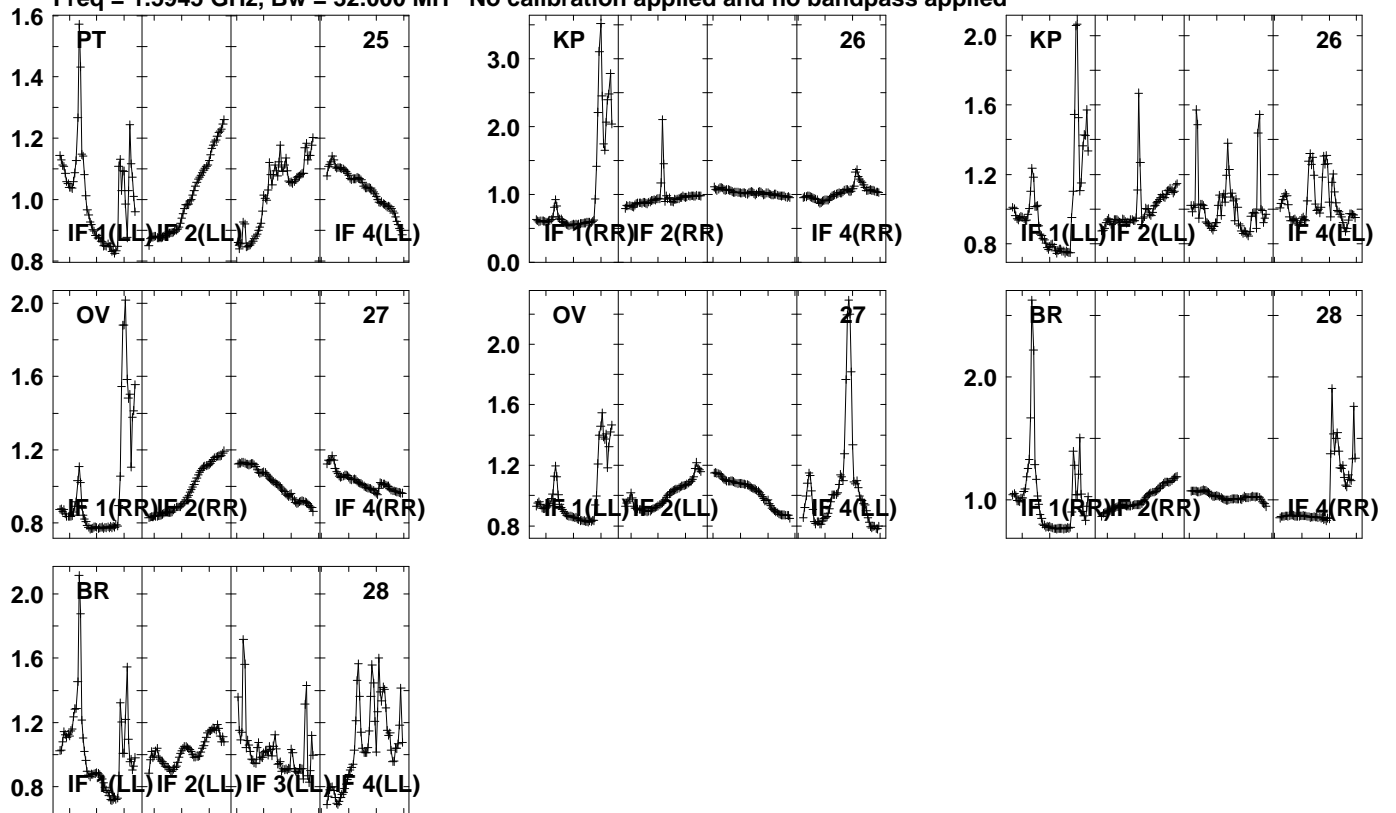

16001620301650601680901710

FREQ MHz

Lower frame: Real Jy

Auto-corr total-power spectrum Antenna: \*

Timerange: 00/19:38:01 to 00/19:41:29

Plot file version1074 created 05-OCT-2021 17:09:46

J0827+5217 GM076.UVDATA.1

Freq = 1.5945 GHz, Bw = 32.000 MH No calibration applied and no bandpass applied

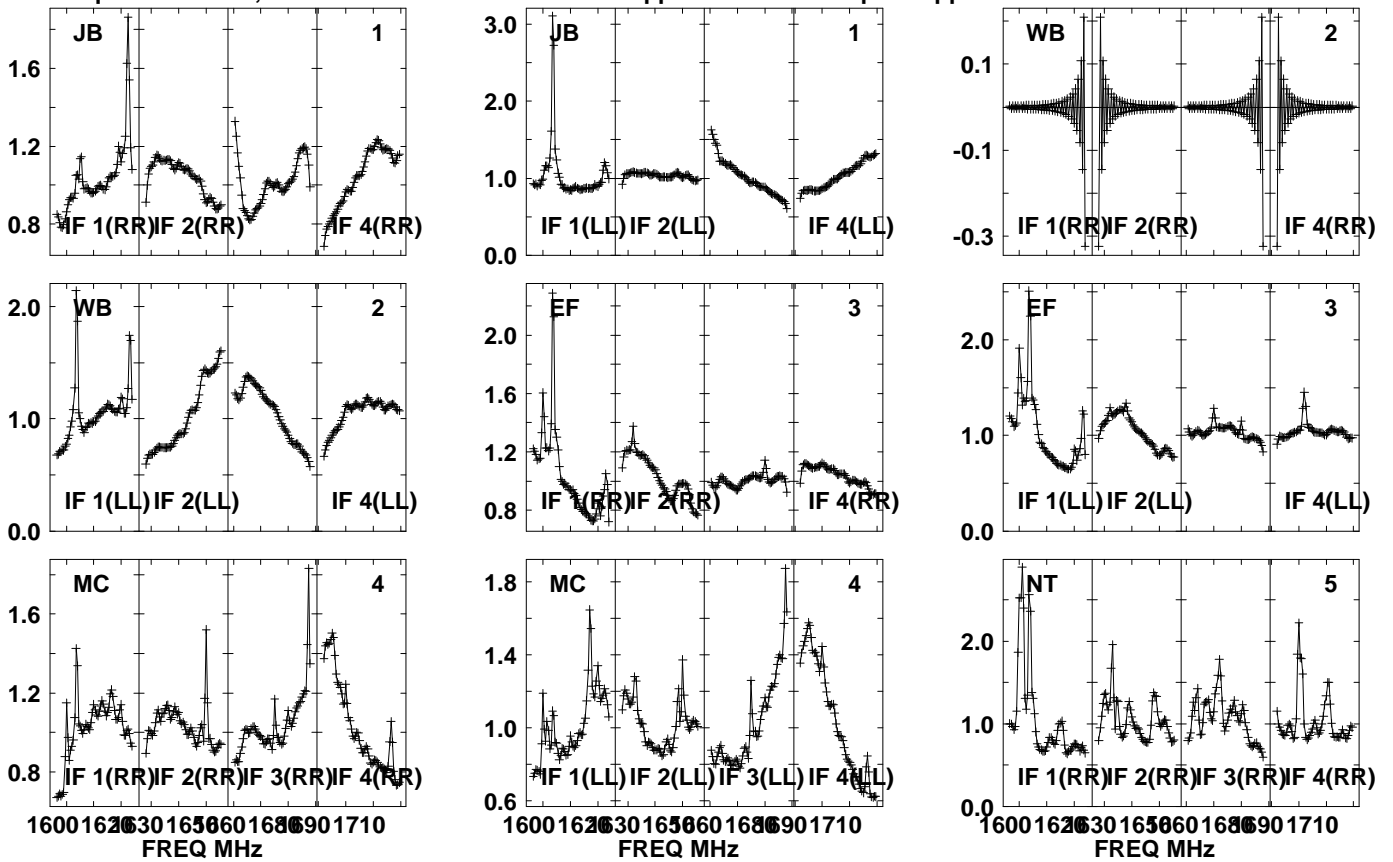

Lower frame: Real Jy  
Auto-corr total-power spectrum Antenna: \*  
Timerange: 00/19:41:31 to 00/19:42:59



Plot file version1075 created 05-OCT-2021 17:09:47

J0827+5217 GM076.UVDATA.1

Freq = 1.5945 GHz, Bw = 32.000 MH No calibration applied and no bandpass applied

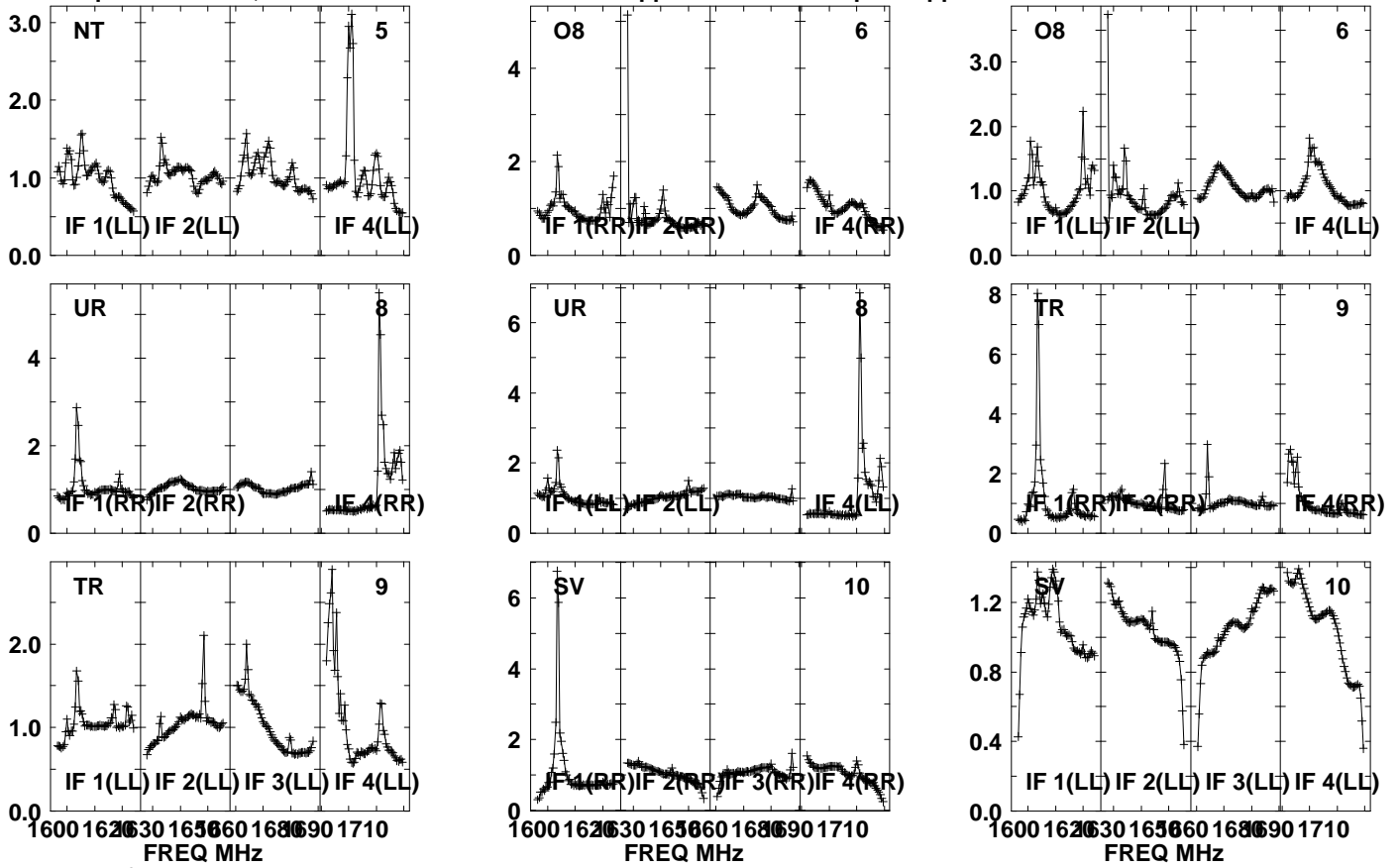

Lower frame: Real Jy  
Auto-corr total-power spectrum Antenna: \*  
Timerange: 00/19:41:31 to 00/19:42:59

Plot file version1076 created 05-OCT-2021 17:09:47

J0827+5217 GM076.UVDATA.1

Freq = 1.5945 GHz, Bw = 32.000 MH No calibration applied and no bandpass applied

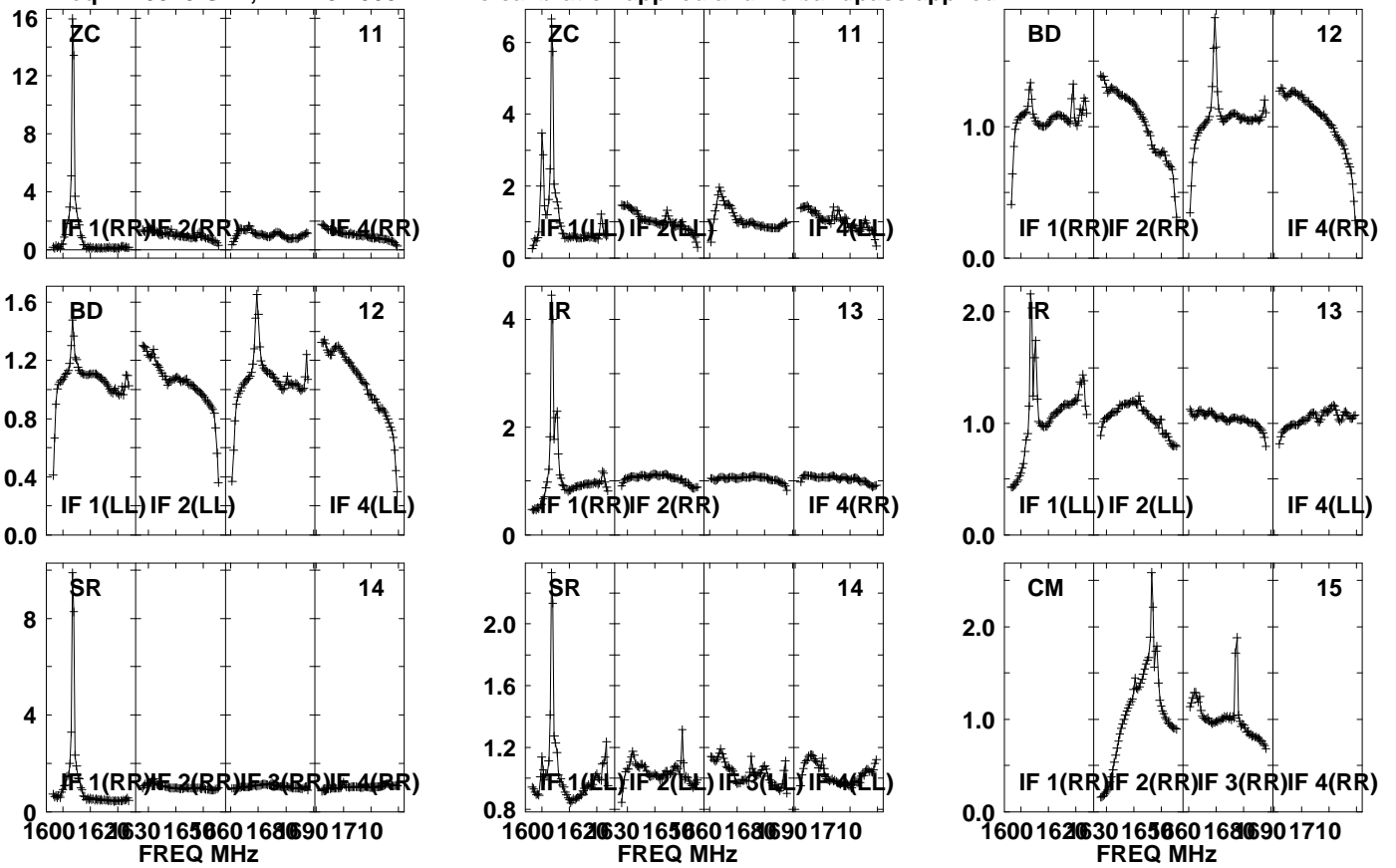

Lower frame: Real Jy

Auto-corr total-power spectrum Antenna: \*

Timerange: 00/19:41:31 to 00/19:42:59

Plot file version1077 created 05-OCT-2021 17:09:47

J0827+5217 GM076.UVDATA.1

Freq = 1.5945 GHz, Bw = 32.000 MH No calibration applied and no bandpass applied

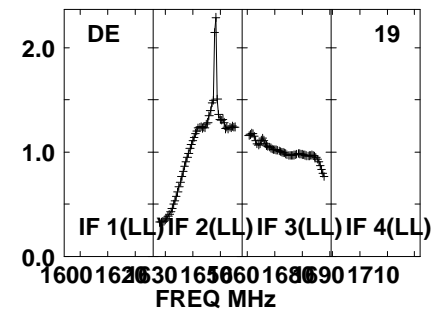
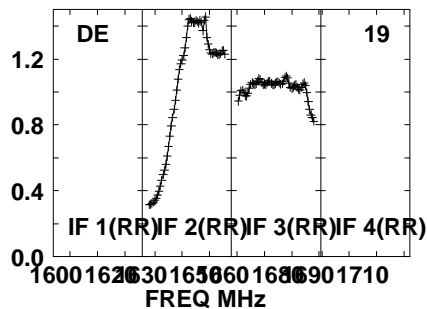
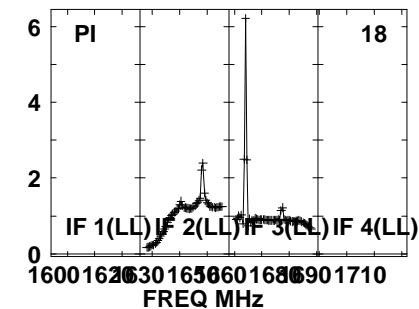
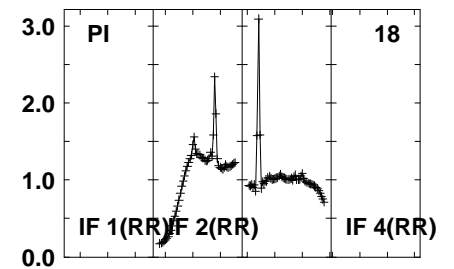
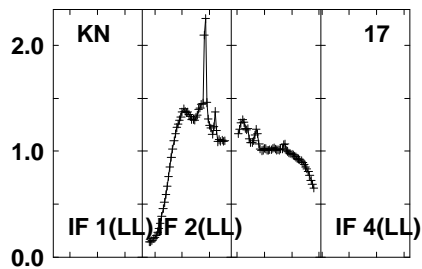
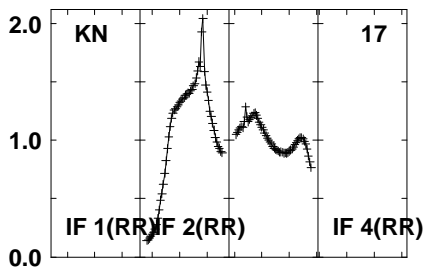
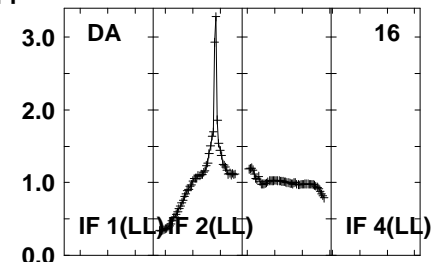
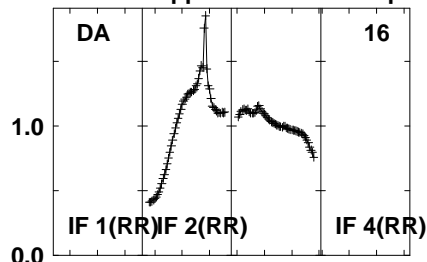
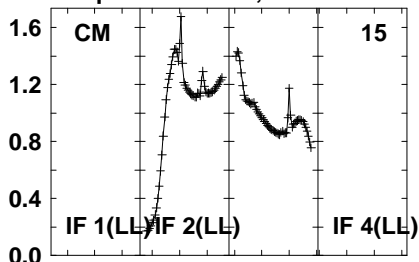

Lower frame: Real Jy  
Auto-corr total-power spectrum Antenna: \*  
Timerange: 00/19:41:31 to 00/19:42:59

Plot file version1078 created 05-OCT-2021 17:09:48

J0827+5217 GM076.UVDATA.1

Freq = 1.5945 GHz, Bw = 32.000 MH No calibration applied and no bandpass applied

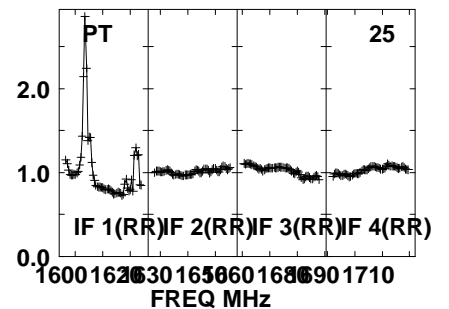
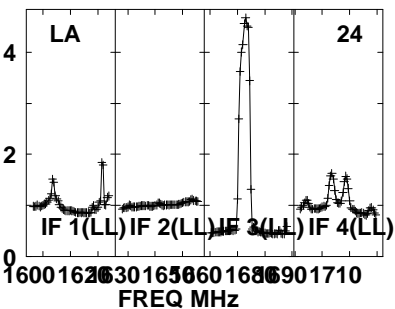
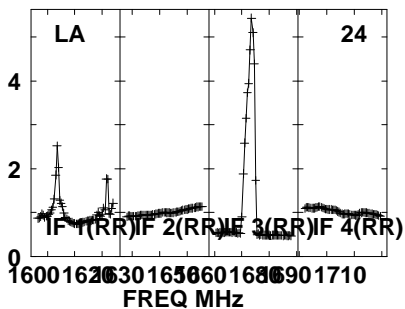
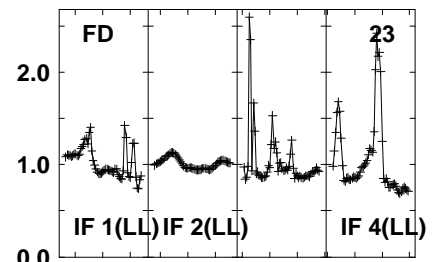
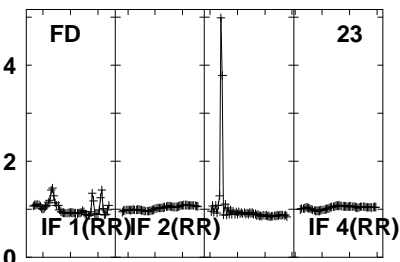
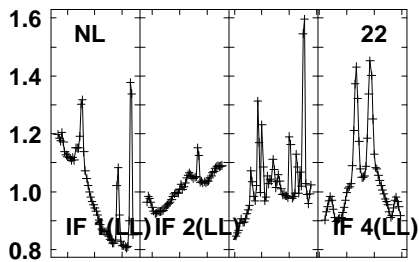
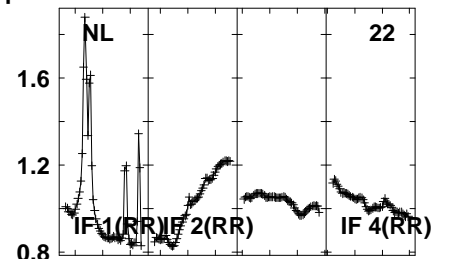
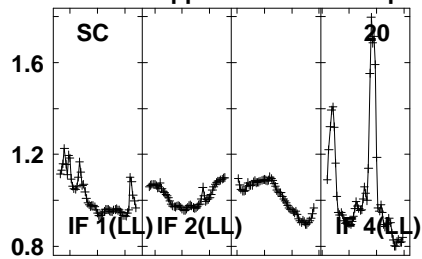
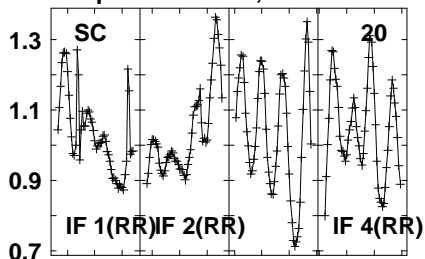

Lower frame: Real Jy  
Auto-corr total-power spectrum Antenna: \*  
Timerange: 00/19:41:31 to 00/19:42:59

Plot file version1079 created 05-OCT-2021 17:09:48

J0827+5217 GM076.UVDATA.1

Freq = 1.5945 GHz, Bw = 32.000 MH No calibration applied and no bandpass applied

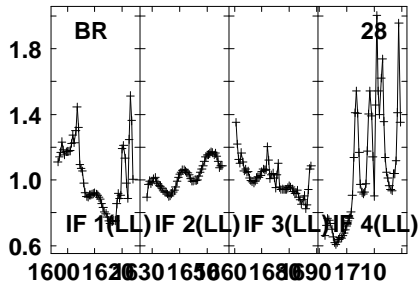
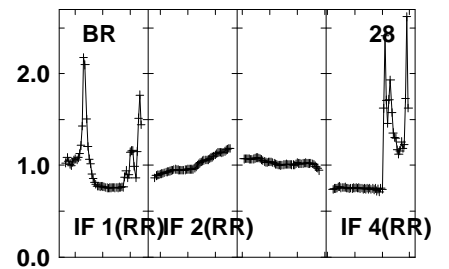
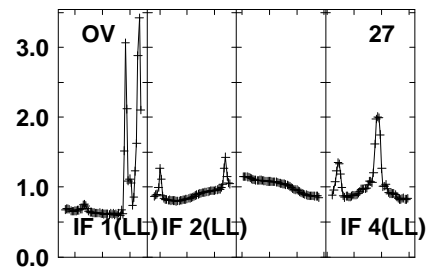
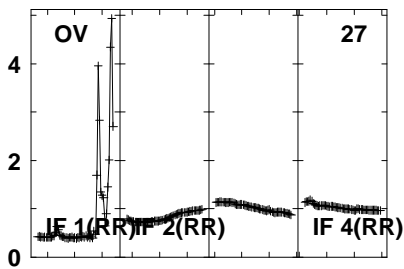
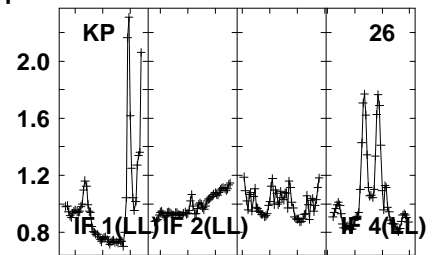
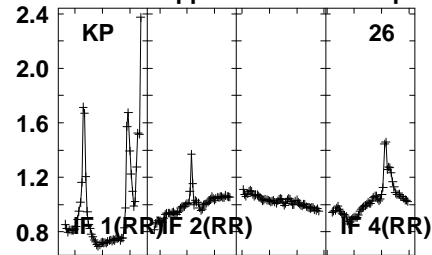
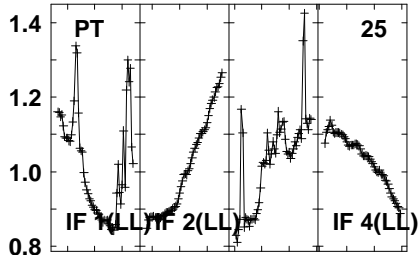

16001620163016501660168016901710  
FREQ MHz

Lower frame: Real Jy  
Auto-corr total-power spectrum Antenna: \*  
Timerange: 00/19:41:31 to 00/19:42:59

Plot file version1080 created 05-OCT-2021 17:09:48

APM08279+525 GM076.UVDATA.1

Freq = 1.5945 GHz, Bw = 32.000 MH No calibration applied and no bandpass applied

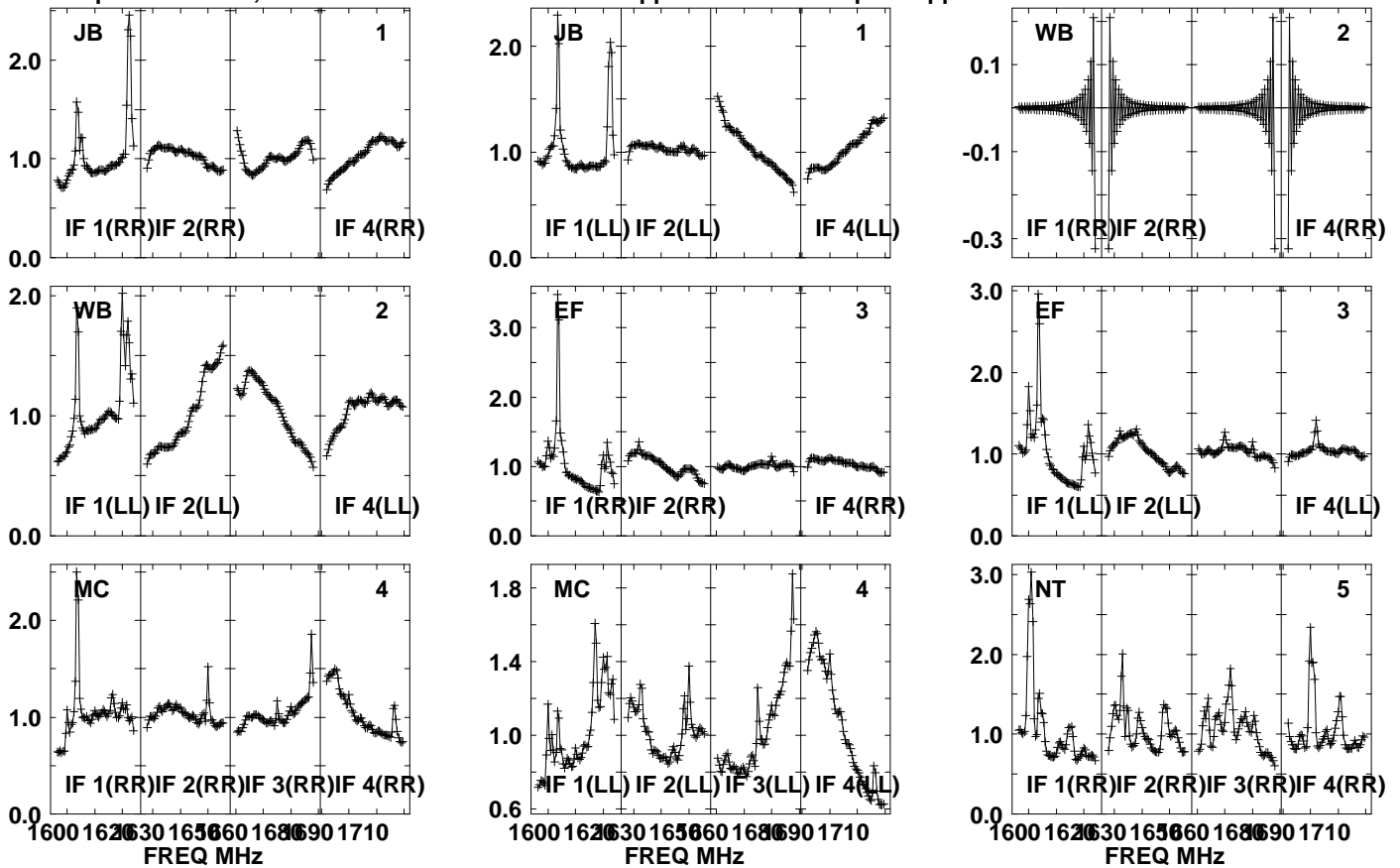

Lower frame: Real Jy

Auto-corr total-power spectrum Antenna: \*

Timerange: 00/19:43:01 to 00/19:46:29

Plot file version1081 created 05-OCT-2021 17:09:48

APM08279+525 GM076.UVDATA.1

Freq = 1.5945 GHz, Bw = 32.000 MH No calibration applied and no bandpass applied

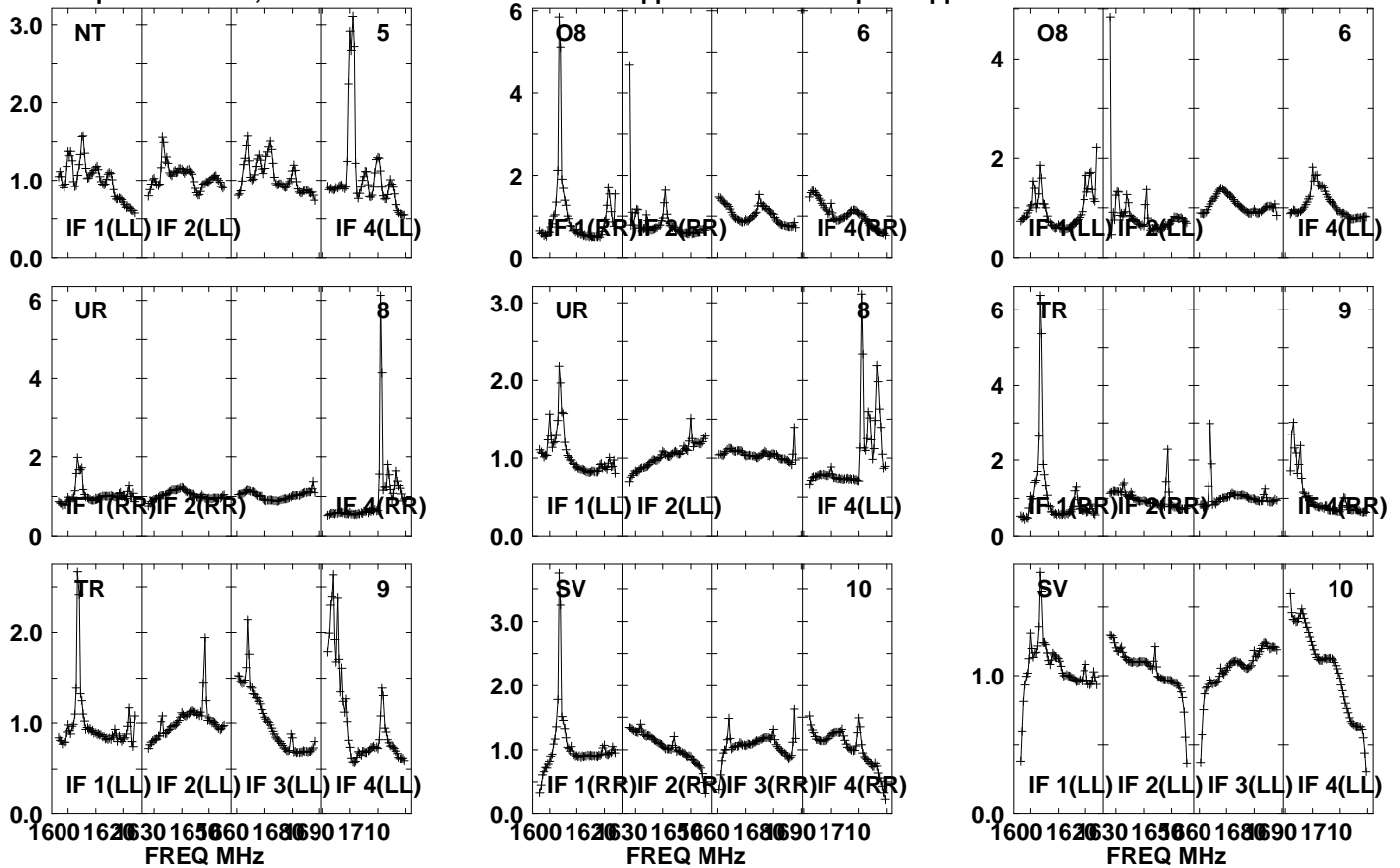

Lower frame: Real Jy

Auto-corr total-power spectrum Antenna: \*

Timerange: 00/19:43:01 to 00/19:46:29

Plot file version1082 created 05-OCT-2021 17:09:49

APM08279+525 GM076.UVDATA.1

Freq = 1.5945 GHz, Bw = 32.000 MH No calibration applied and no bandpass applied

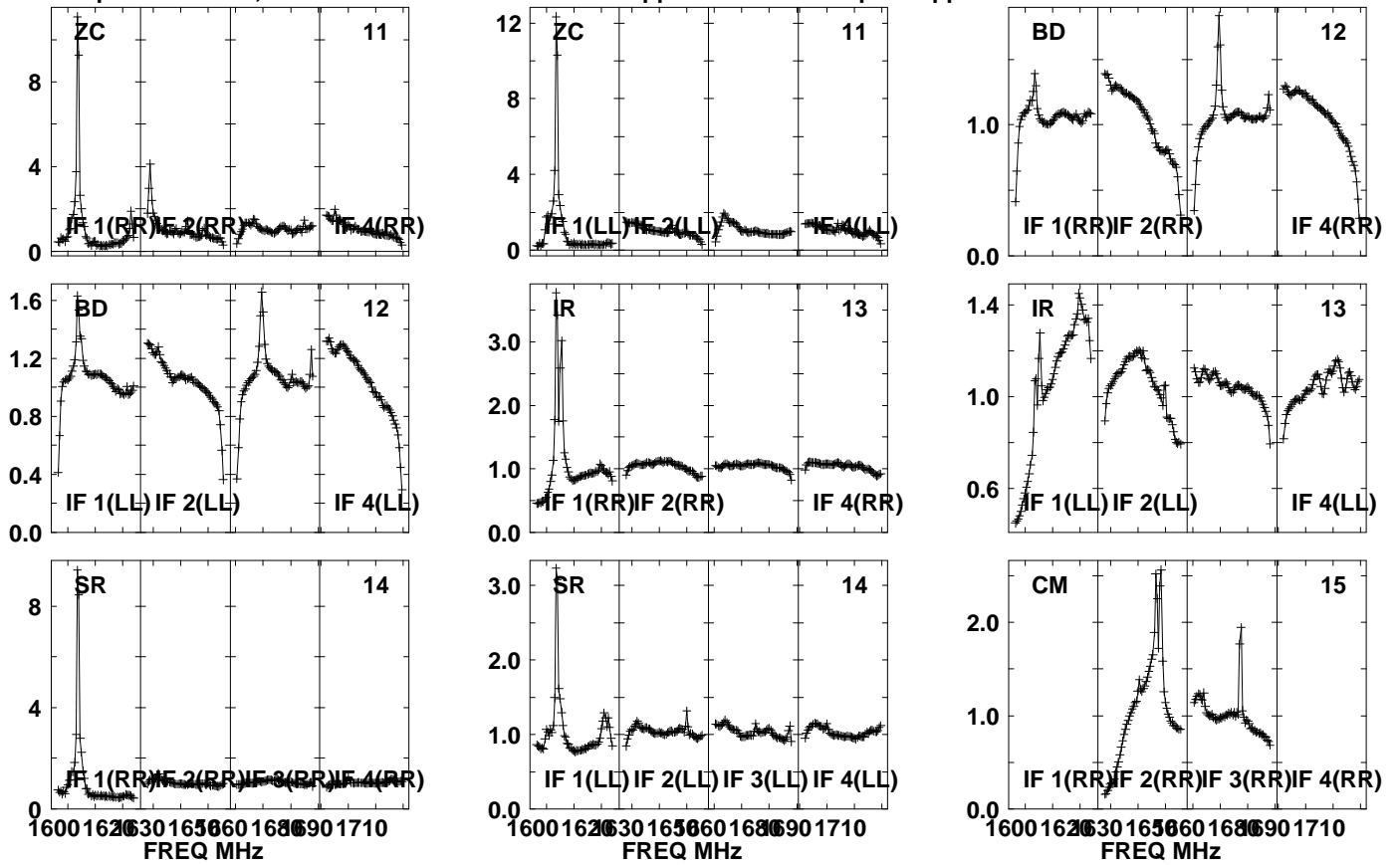

Lower frame: Real Jy  
Auto-corr total-power spectrum Antenna: \*  
Timerange: 00/19:43:01 to 00/19:46:29



Plot file version1083 created 05-OCT-2021 17:09:49

APM08279+525 GM076.UVDATA.1

Freq = 1.5945 GHz, Bw = 32.000 MH No calibration applied and no bandpass applied

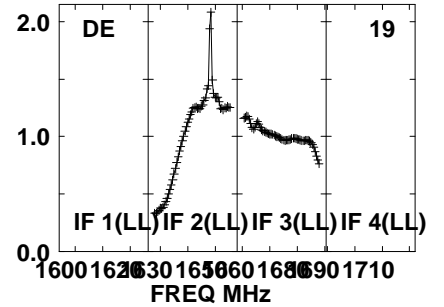
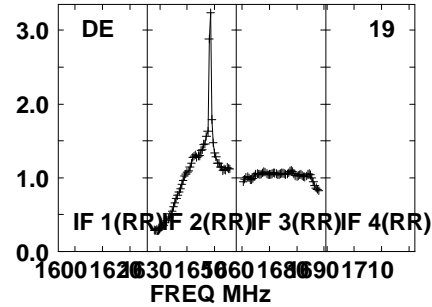
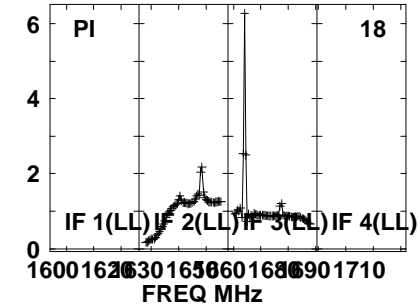
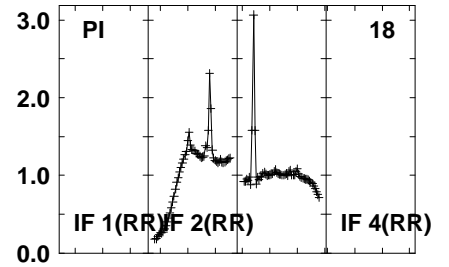
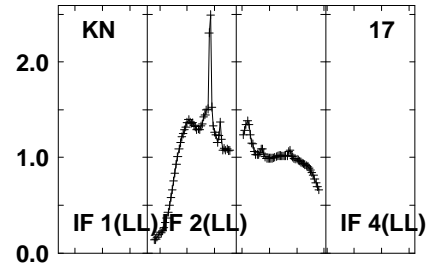
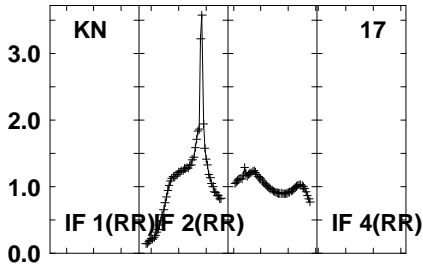
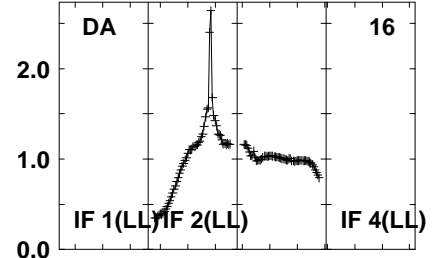
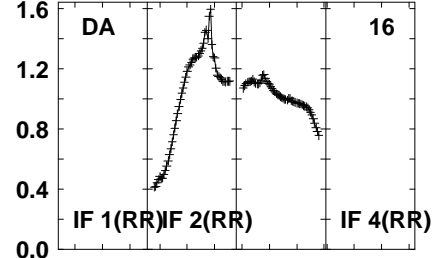
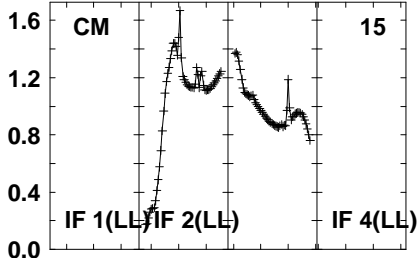

Lower frame: Real Jy  
Auto-corr total-power spectrum Antenna: \*  
Timerange: 00/19:43:01 to 00/19:46:29

Plot file version1084 created 05-OCT-2021 17:09:49

APM08279+525 GM076.UVDATA.1

Freq = 1.5945 GHz, Bw = 32.000 MH No calibration applied and no bandpass applied

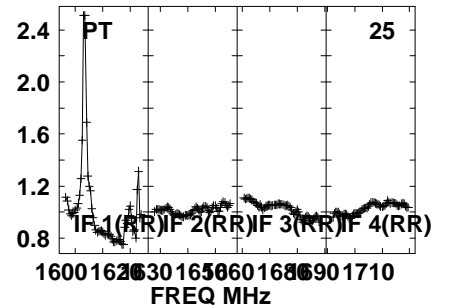
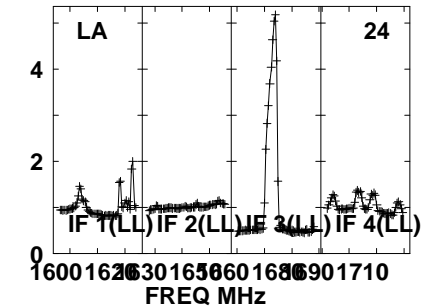
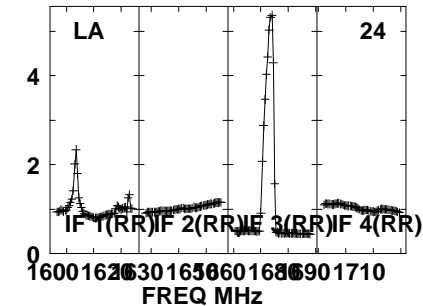
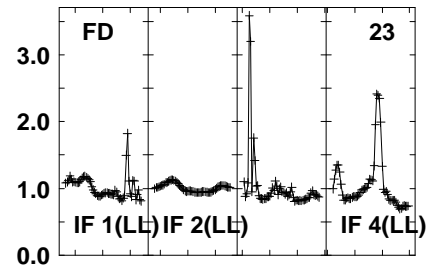
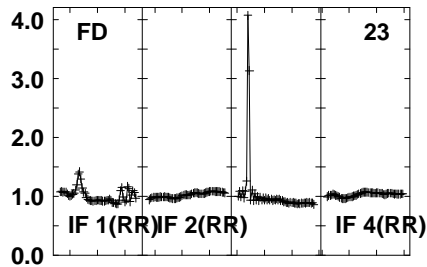
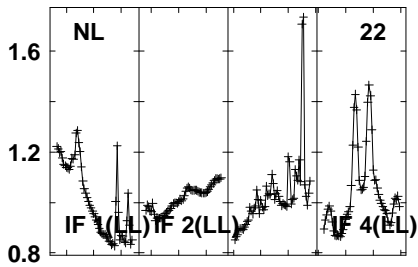
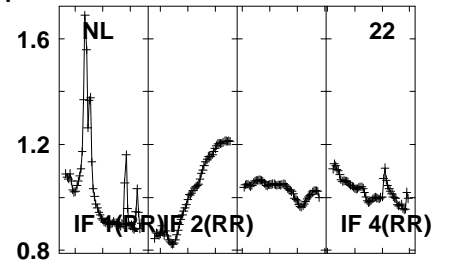
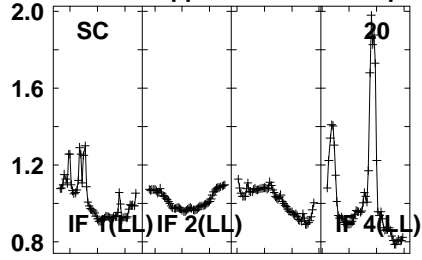
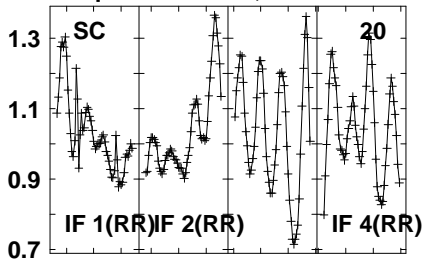

Lower frame: Real Jy  
Auto-corr total-power spectrum Antenna: \*  
Timerange: 00/19:43:01 to 00/19:46:29

Plot file version1085 created 05-OCT-2021 17:09:50

APM08279+525 GM076.UVDATA.1

Freq = 1.5945 GHz, Bw = 32.000 MH No calibration applied and no bandpass applied

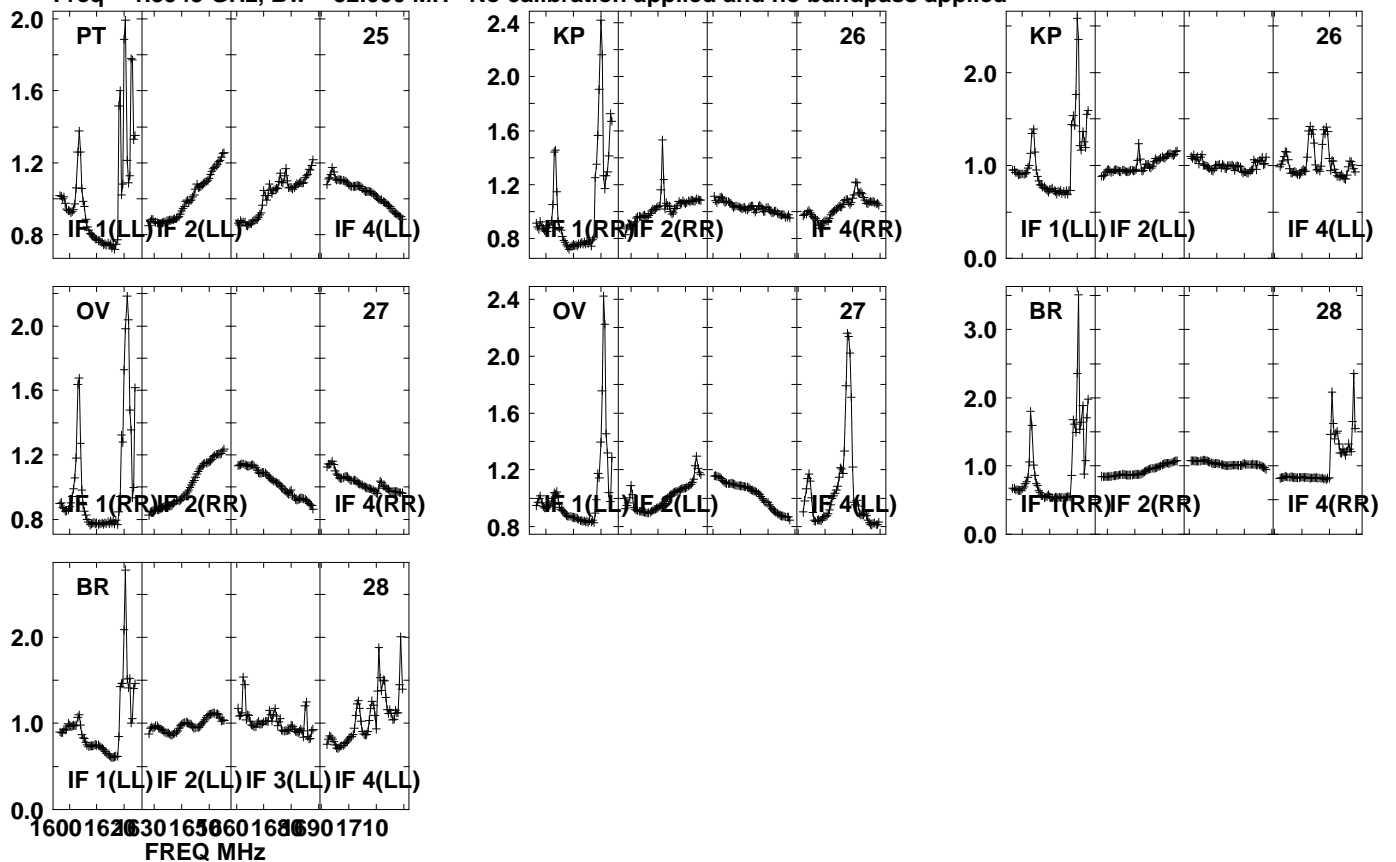

Lower frame: Real Jy  
Auto-corr total-power spectrum Antenna: \*  
Timerange: 00/19:43:01 to 00/19:46:29

Plot file version1086 created 05-OCT-2021 17:09:50

J0827+5217 GM076.UVDATA.1

Freq = 1.5945 GHz, Bw = 32.000 MH No calibration applied and no bandpass applied

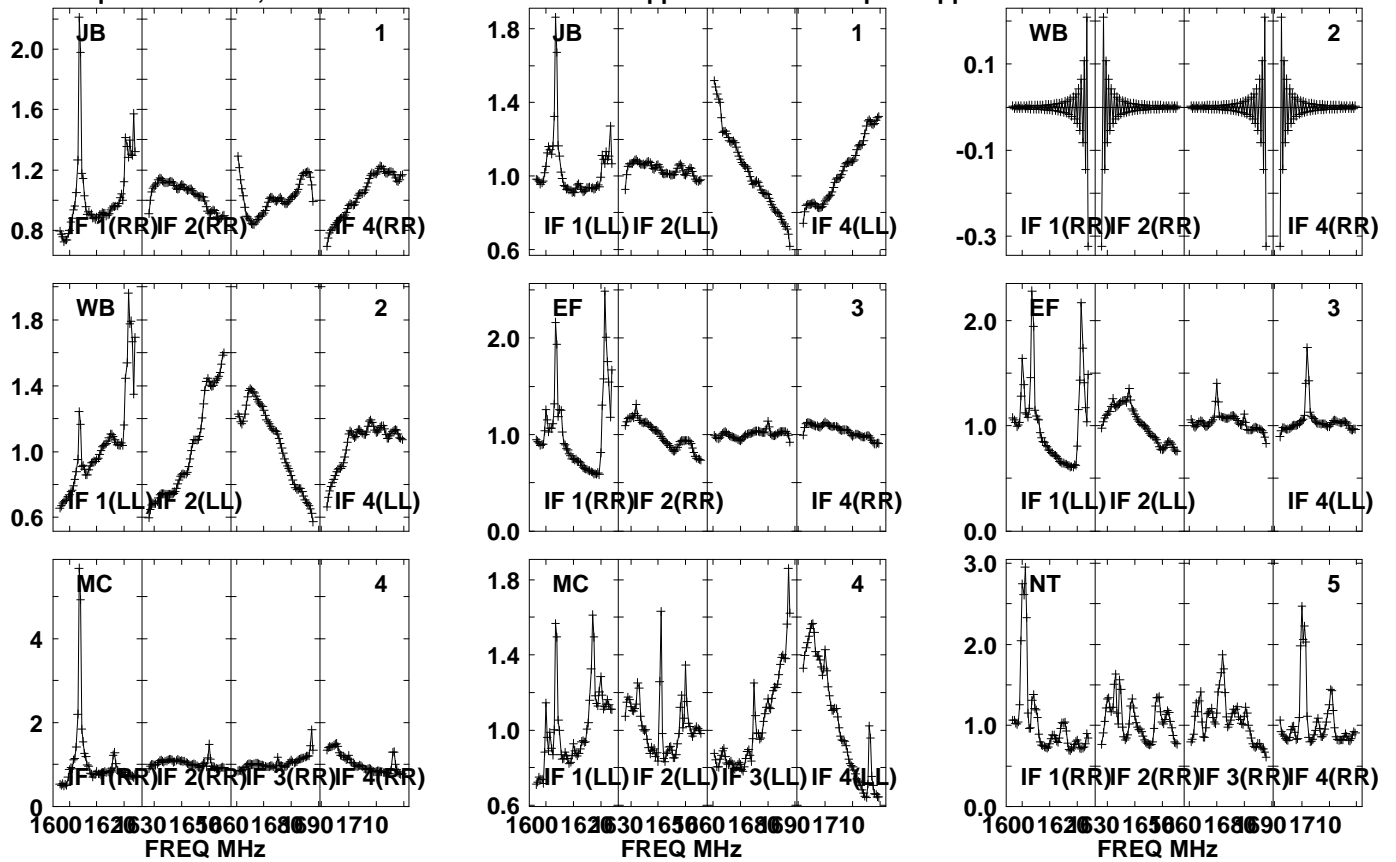

Lower frame: Real Jy  
Auto-corr total-power spectrum Antenna: \*  
Timerange: 00/19:47:01 to 00/19:48:29

Plot file version1087 created 05-OCT-2021 17:09:50

J0827+5217 GM076.UVDATA.1

Freq = 1.5945 GHz, Bw = 32.000 MH No calibration applied and no bandpass applied

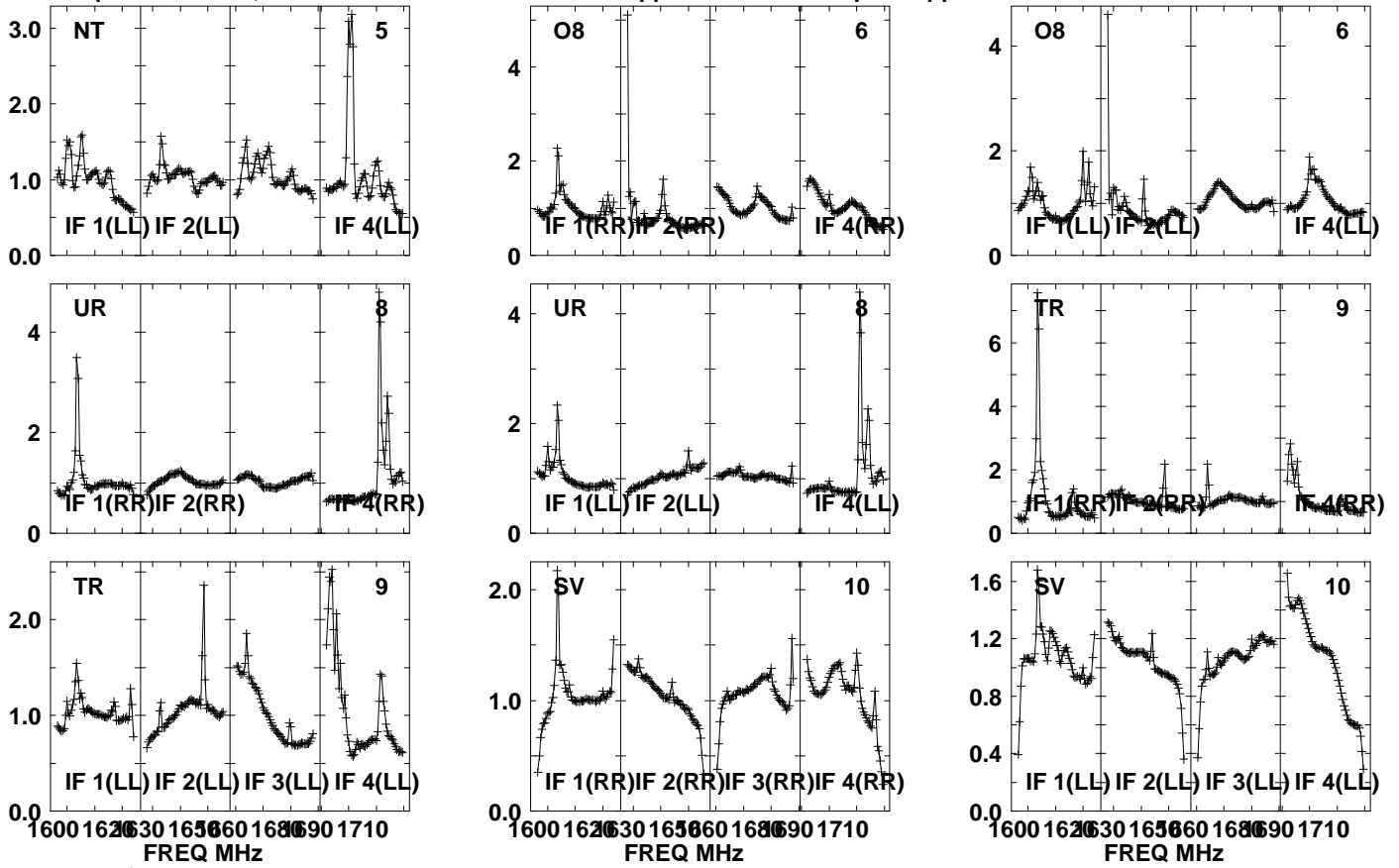

Lower frame: Real Jy

Auto-corr total-power spectrum Antenna: \*

Timerange: 00/19:47:01 to 00/19:48:29

Plot file version1088 created 05-OCT-2021 17:09:51

J0827+5217 GM076.UVDATA.1

Freq = 1.5945 GHz, Bw = 32.000 MH No calibration applied and no bandpass applied

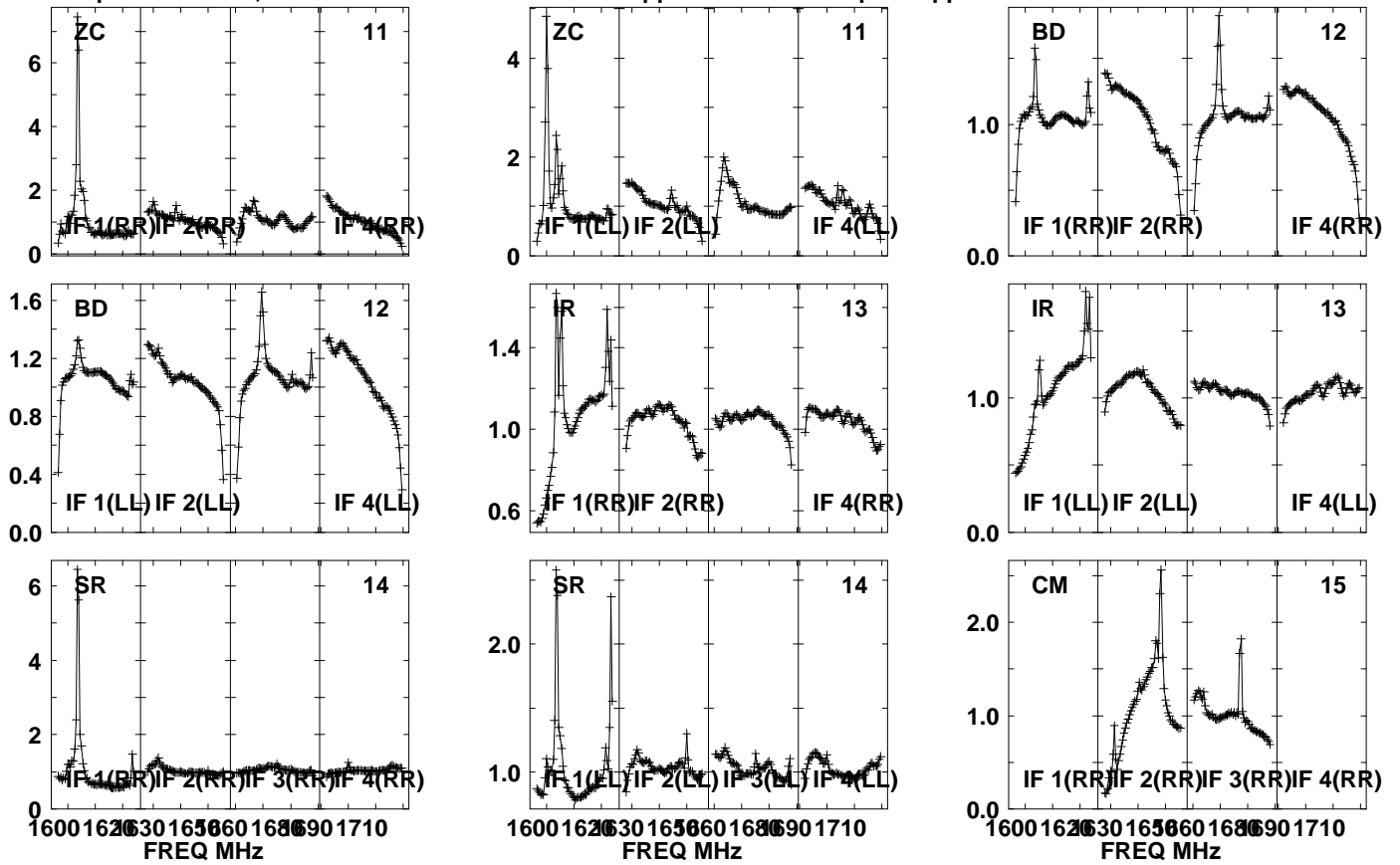

Lower frame: Real Jy  
Auto-corr total-power spectrum Antenna: \*  
Timerange: 00/19:47:01 to 00/19:48:29

Plot file version1089 created 05-OCT-2021 17:09:51

J0827+5217 GM076.UVDATA.1

Freq = 1.5945 GHz, Bw = 32.000 MH No calibration applied and no bandpass applied

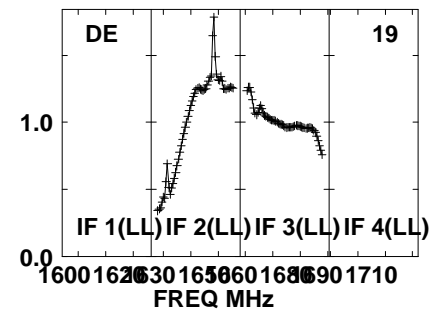
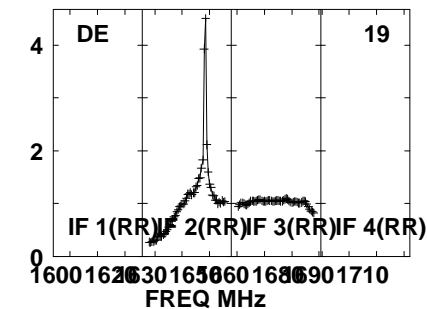
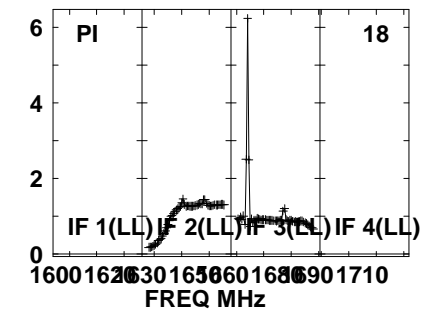
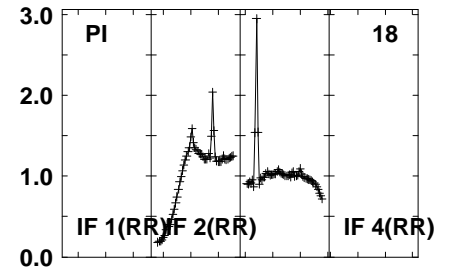
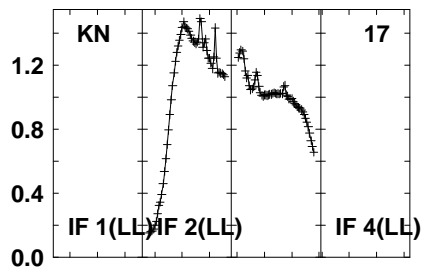
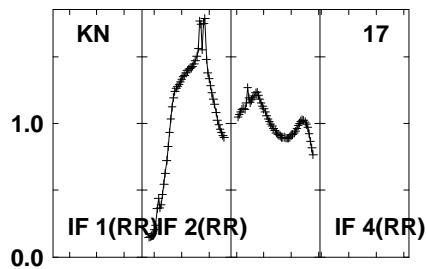
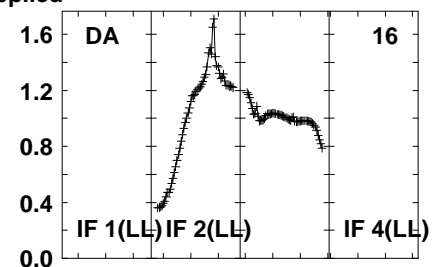
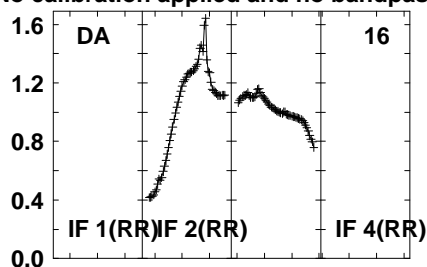
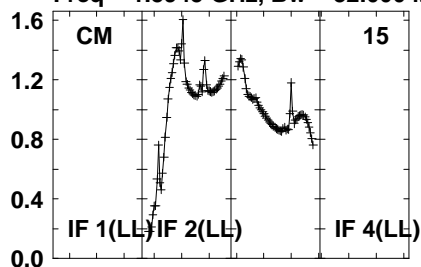

Lower frame: Real Jy  
Auto-corr total-power spectrum Antenna: \*  
Timerange: 00/19:47:01 to 00/19:48:29

Plot file version1090 created 05-OCT-2021 17:09:51

J0827+5217 GM076.UVDATA.1

Freq = 1.5945 GHz, Bw = 32.000 MH No calibration applied and no bandpass applied

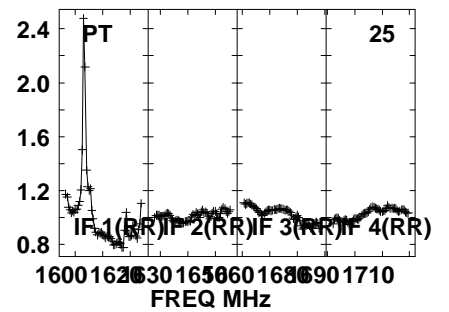
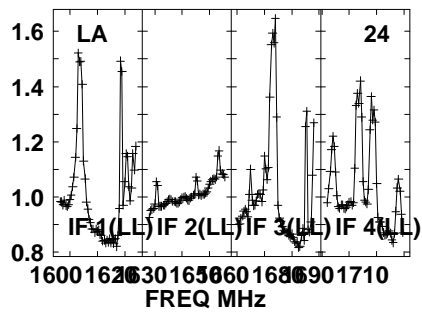
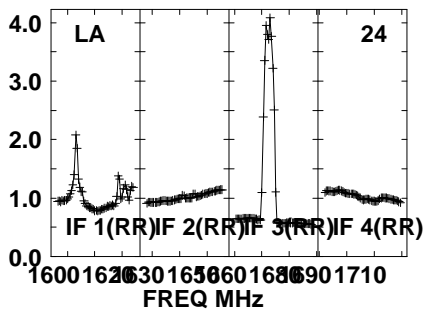
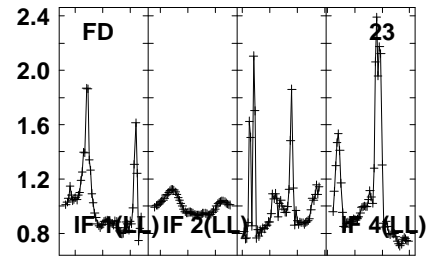
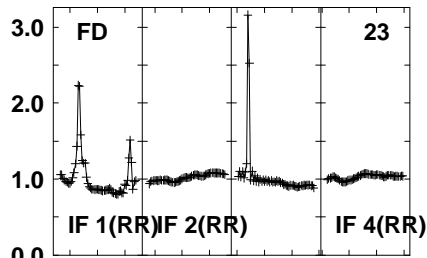
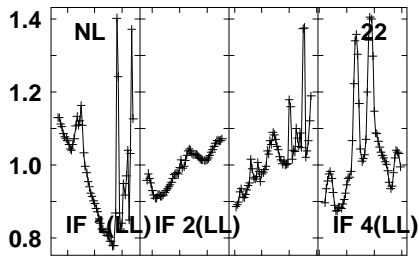
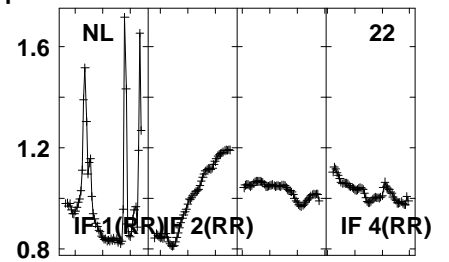
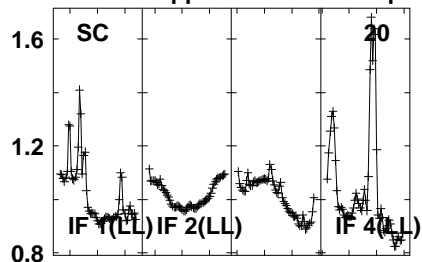
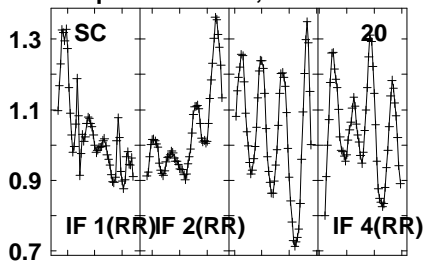

Lower frame: Real Jy  
Auto-corr total-power spectrum Antenna: \*  
Timerange: 00/19:47:01 to 00/19:48:29



Plot file version1091 created 05-OCT-2021 17:09:52

J0827+5217 GM076.UVDATA.1

Freq = 1.5945 GHz, Bw = 32.000 MH No calibration applied and no bandpass applied

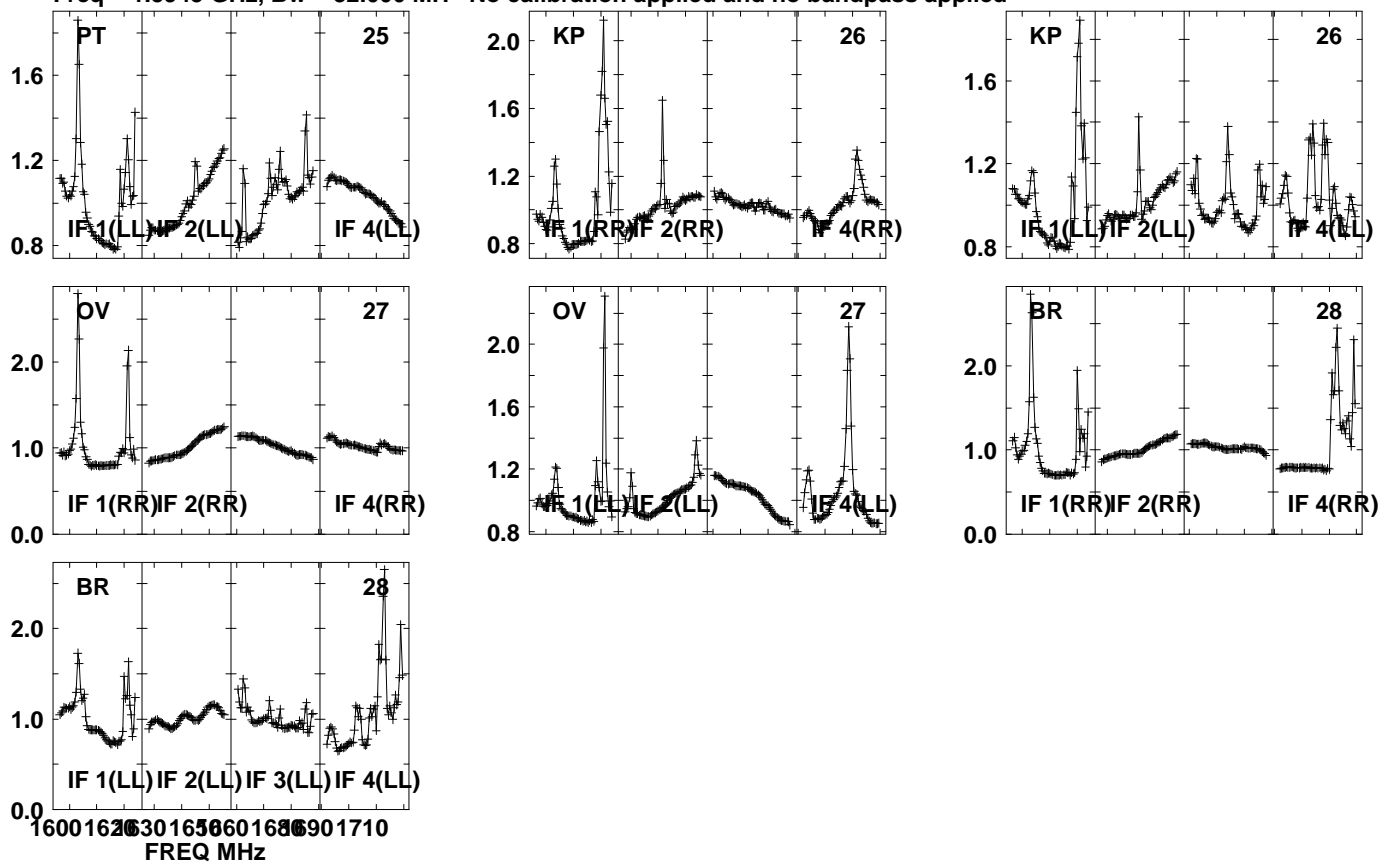

Lower frame: Real Jy

Auto-corr total-power spectrum Antenna: \*

Timerange: 00/19:47:01 to 00/19:48:29

Plot file version1092 created 05-OCT-2021 17:09:52

APM08279+525 GM076.UVDATA.1

Freq = 1.5945 GHz, Bw = 32.000 MH No calibration applied and no bandpass applied

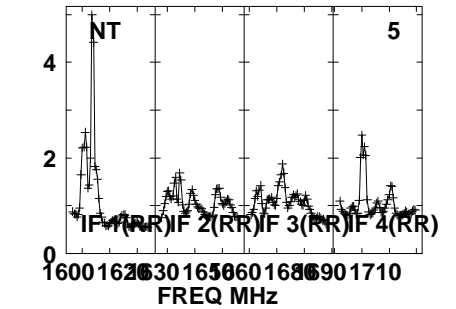
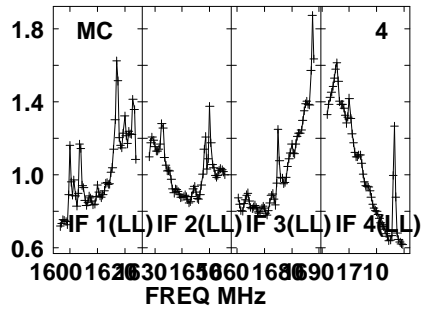
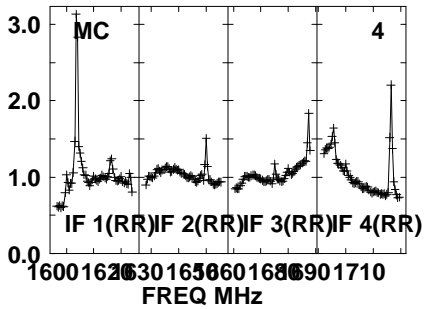
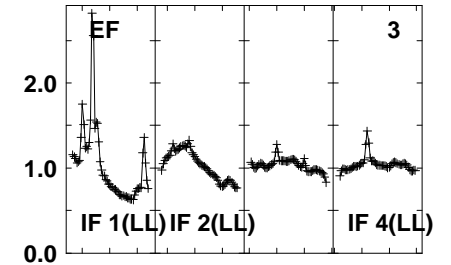
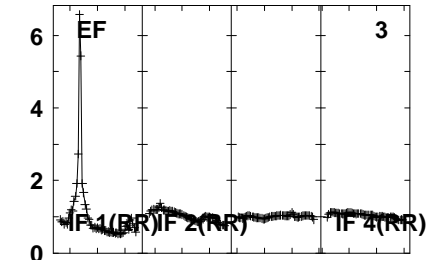
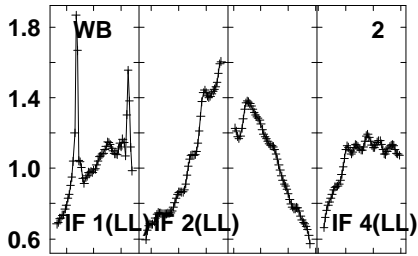
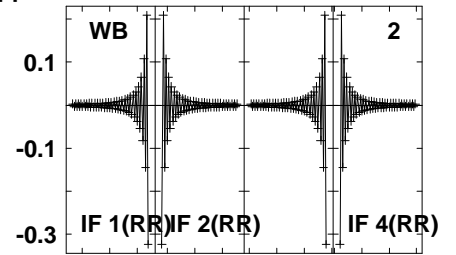
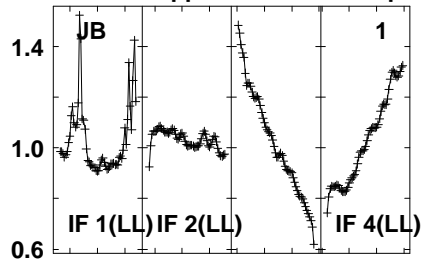
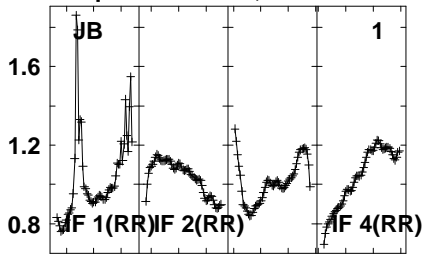

Lower frame: Real Jy  
Auto-corr total-power spectrum Antenna: \*  
Timerange: 00/19:48:31 to 00/19:51:59

Plot file version1093 created 05-OCT-2021 17:09:52

APM08279+525 GM076.UVDATA.1

Freq = 1.5945 GHz, Bw = 32.000 MH No calibration applied and no bandpass applied

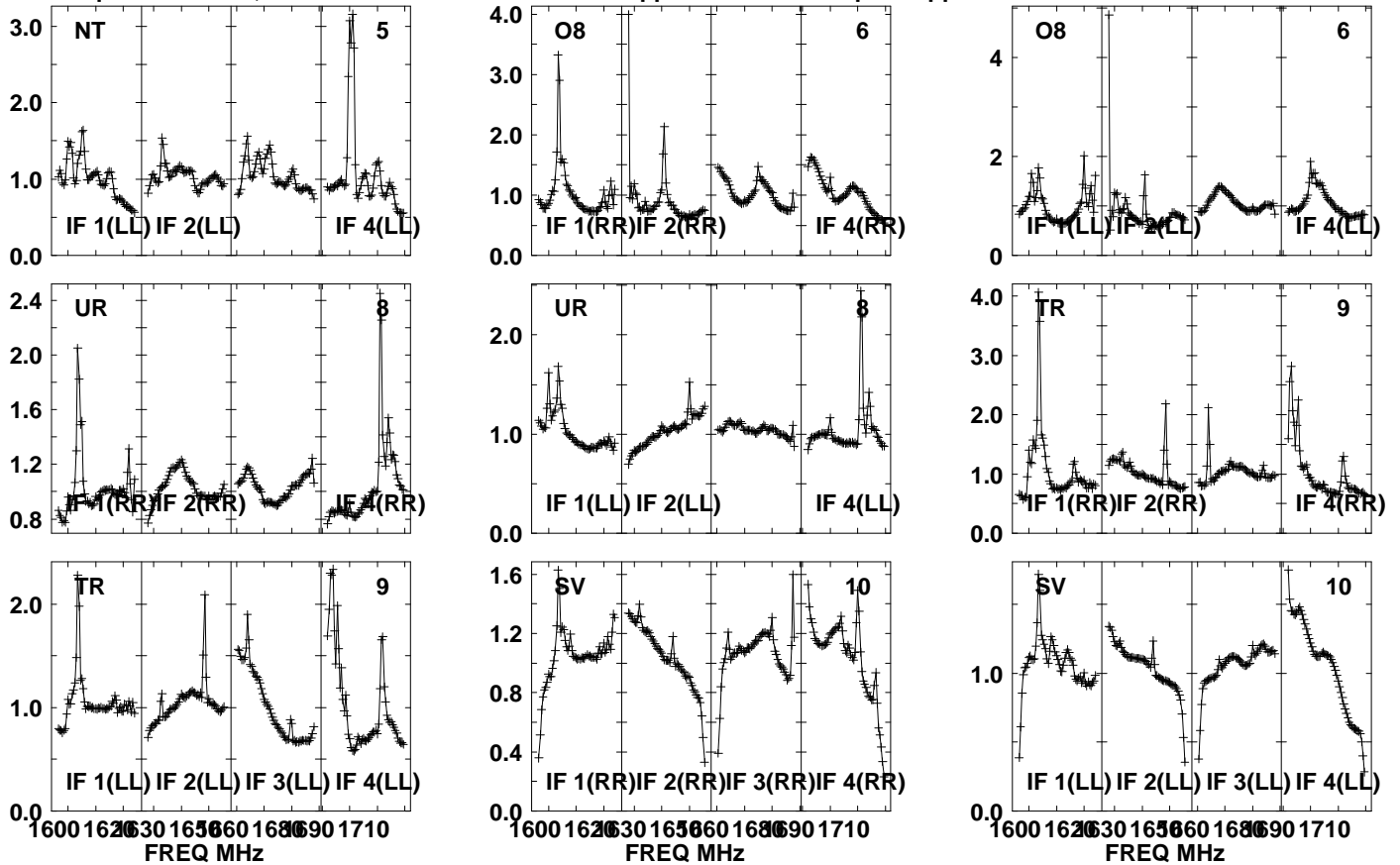

Lower frame: Real Jy

Auto-corr total-power spectrum Antenna: \*

Timerange: 00/19:48:31 to 00/19:51:59

Plot file version1094 created 05-OCT-2021 17:09:53

APM08279+525 GM076.UVDATA.1

Freq = 1.5945 GHz, Bw = 32.000 MH No calibration applied and no bandpass applied

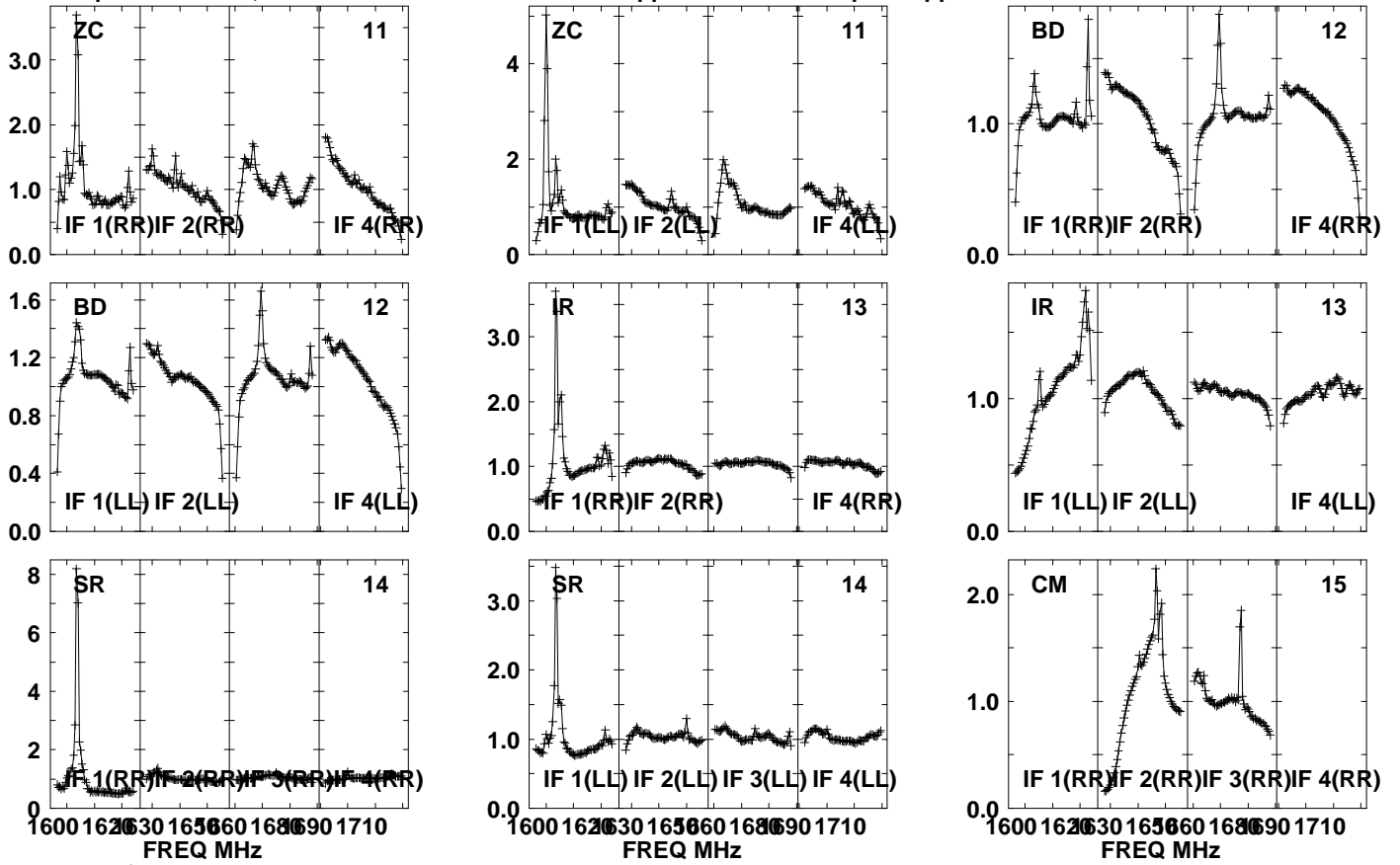

Lower frame: Real Jy

Auto-corr total-power spectrum Antenna: \*

Timerange: 00/19:48:31 to 00/19:51:59

Plot file version1095 created 05-OCT-2021 17:09:53

APM08279+525 GM076.UVDATA.1

Freq = 1.5945 GHz, Bw = 32.000 MH No calibration applied and no bandpass applied

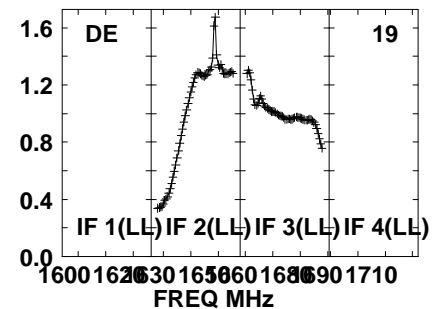
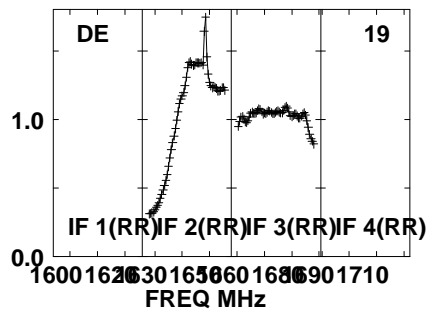
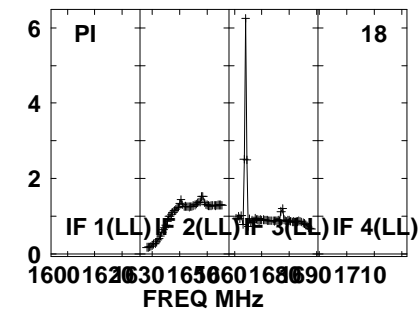
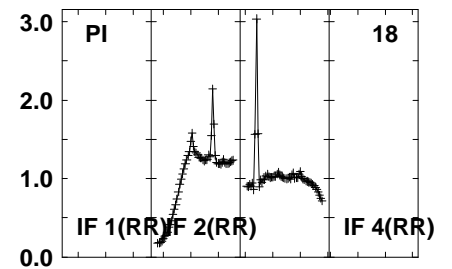
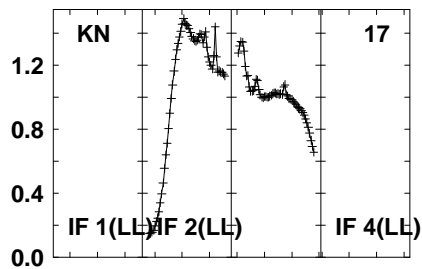
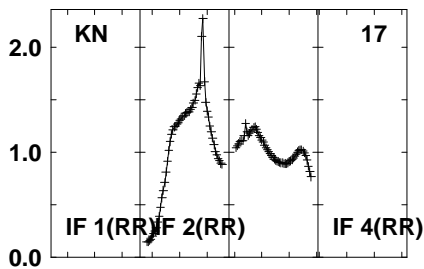
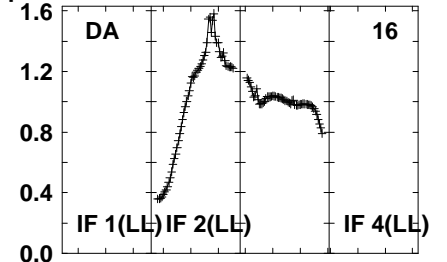
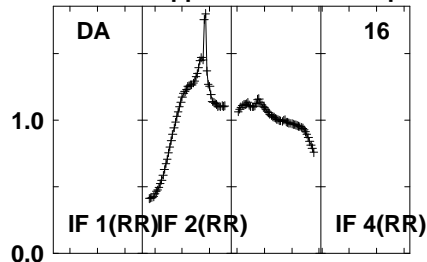
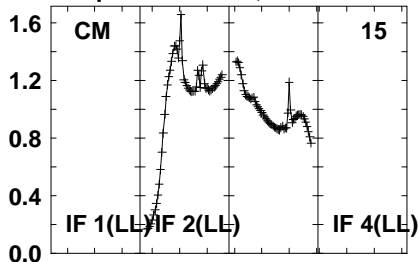

Lower frame: Real Jy  
Auto-corr total-power spectrum Antenna: \*  
Timerange: 00/19:48:31 to 00/19:51:59

Plot file version1096 created 05-OCT-2021 17:09:53

APM08279+525 GM076.UVDATA.1

Freq = 1.5945 GHz, Bw = 32.000 MH No calibration applied and no bandpass applied

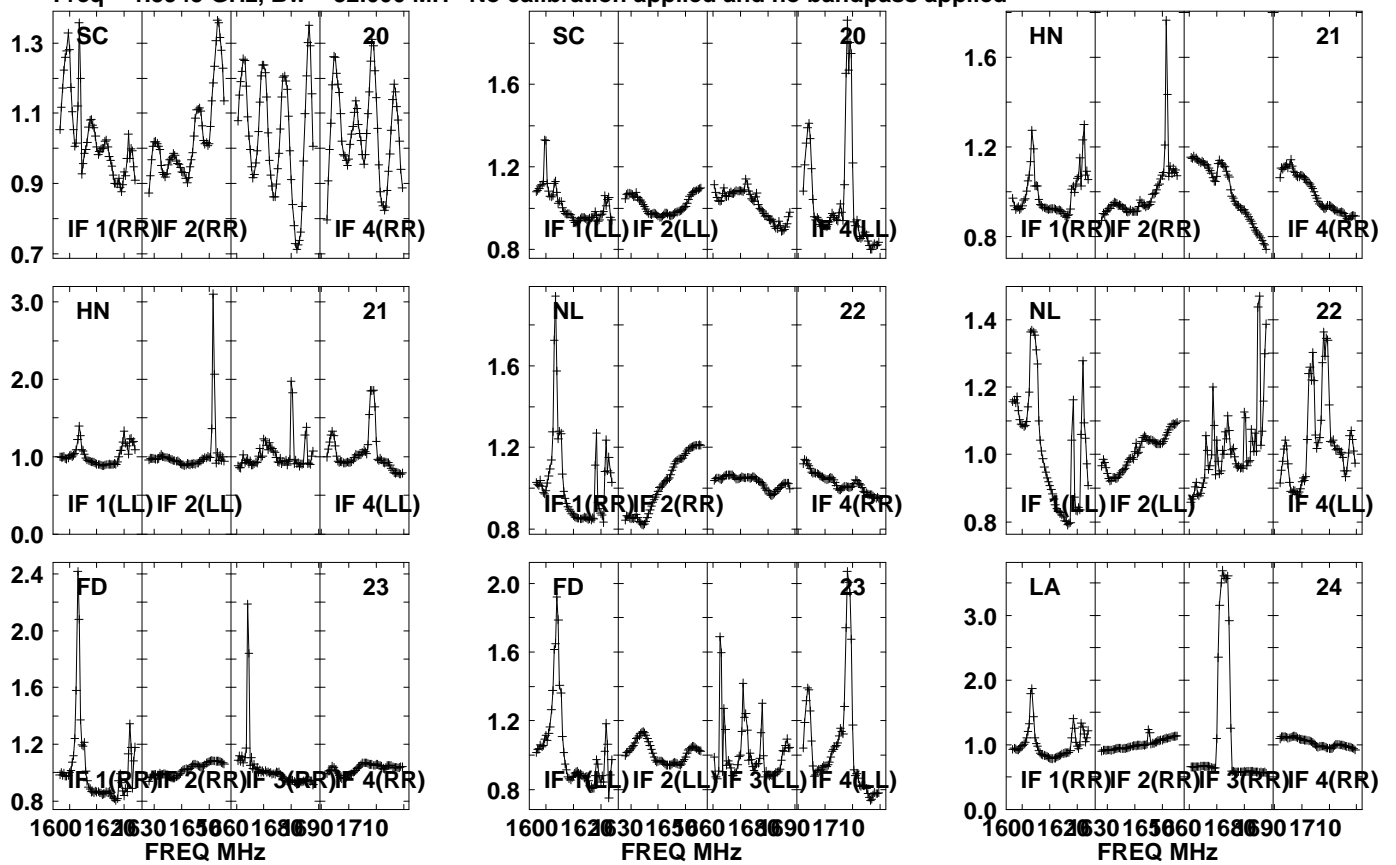

Lower frame: Real Jy  
Auto-corr total-power spectrum Antenna: \*  
Timerange: 00/19:48:31 to 00/19:51:59

Plot file version 1097 created 05-OCT-2021 17:09:54

APM08279+525 GM076.UVDATA.1

Freq = 1.5945 GHz, Bw = 32.000 MH No calibration applied and no bandpass applied

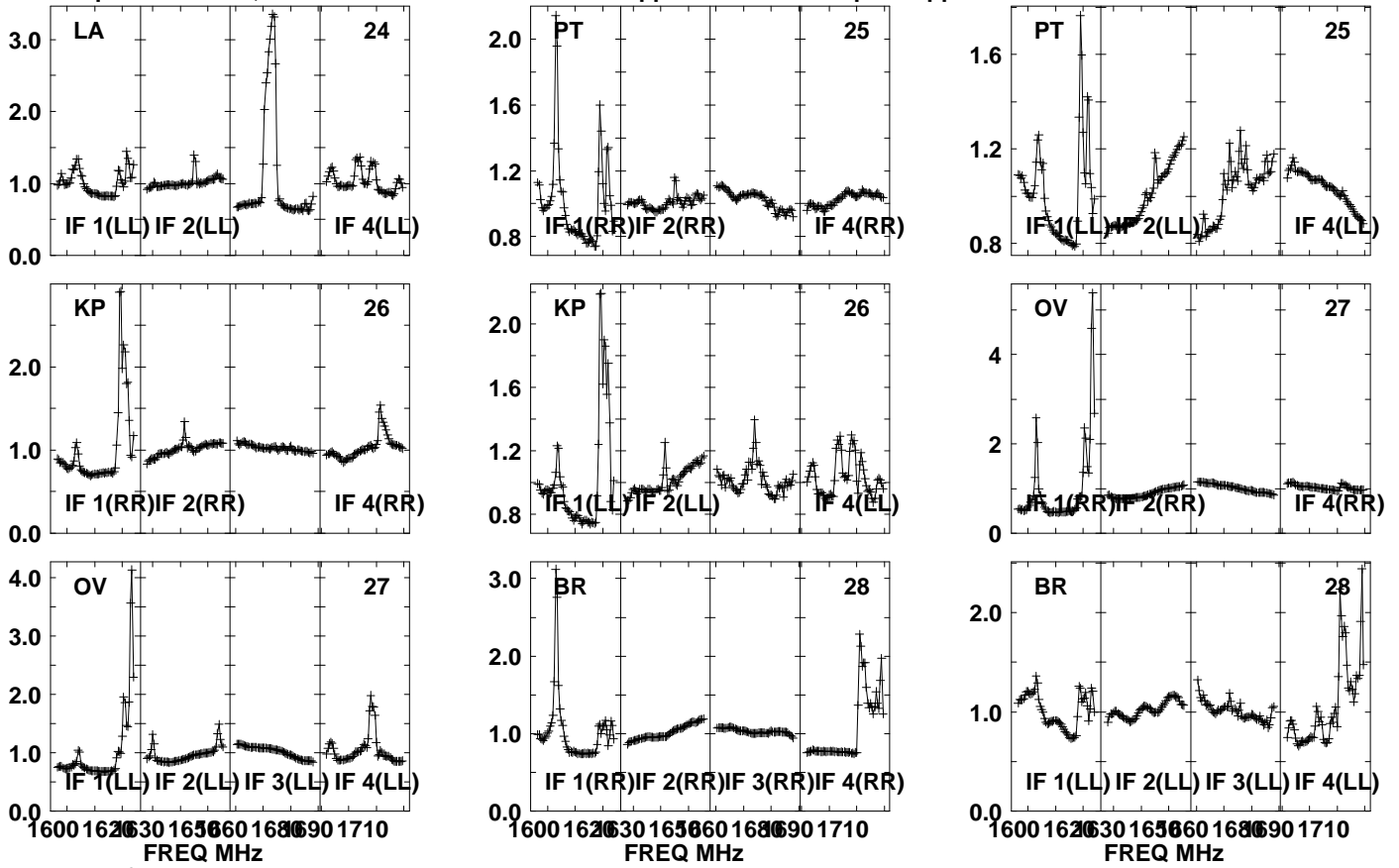

Lower frame: Real Jy  
Auto-corr total-power spectrum Antenna: \*  
Timerange: 00/19:48:31 to 00/19:51:59

Plot file version1098 created 05-OCT-2021 17:09:54

APM08279+525 GM076.UVDATA.1

Freq = 1.5945 GHz, Bw = 32.000 MH

No calibration applied and no bandpass applied

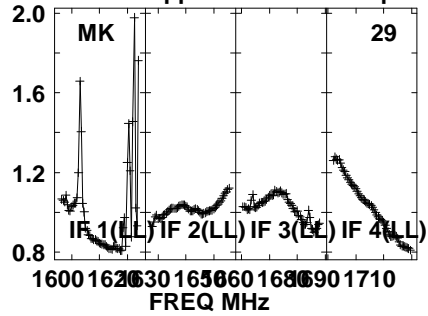
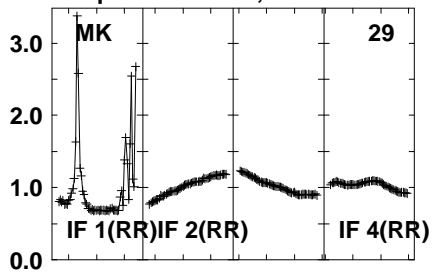

Lower frame: Real Jy

Auto-corr total-power spectrum Antenna: \*

Timerange: 00/19:48:31 to 00/19:51:59



Plot file version1099 created 05-OCT-2021 17:09:54

J0827+5217 GM076.UVDATA.1

Freq = 1.5945 GHz, Bw = 32.000 MH No calibration applied and no bandpass applied

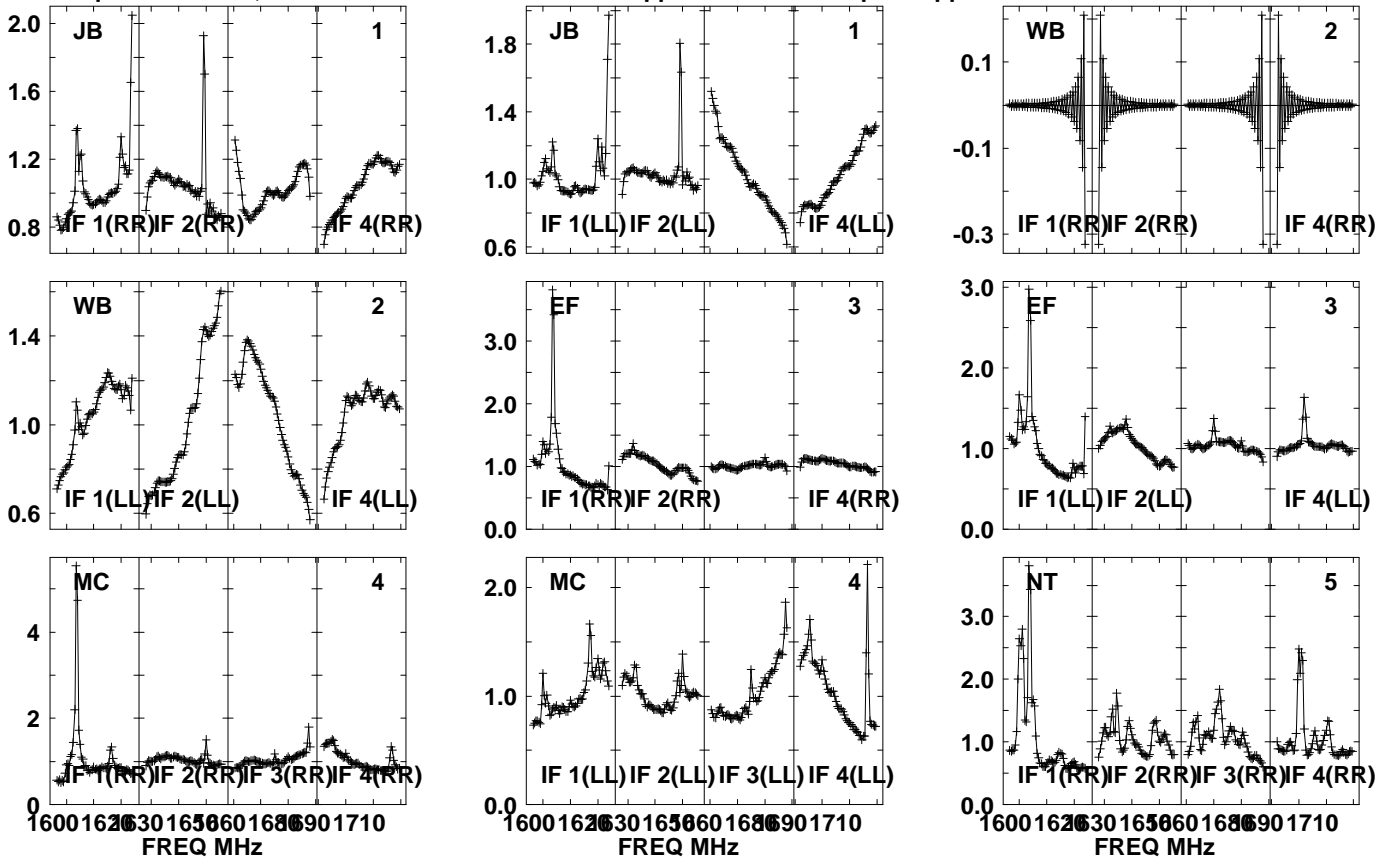

Lower frame: Real Jy  
Auto-corr total-power spectrum Antenna: \*  
Timerange: 00/19:52:01 to 00/19:53:29

Plot file version1100 created 05-OCT-2021 17:09:54

J0827+5217 GM076.UVDATA.1

Freq = 1.5945 GHz, Bw = 32.000 MH No calibration applied and no bandpass applied

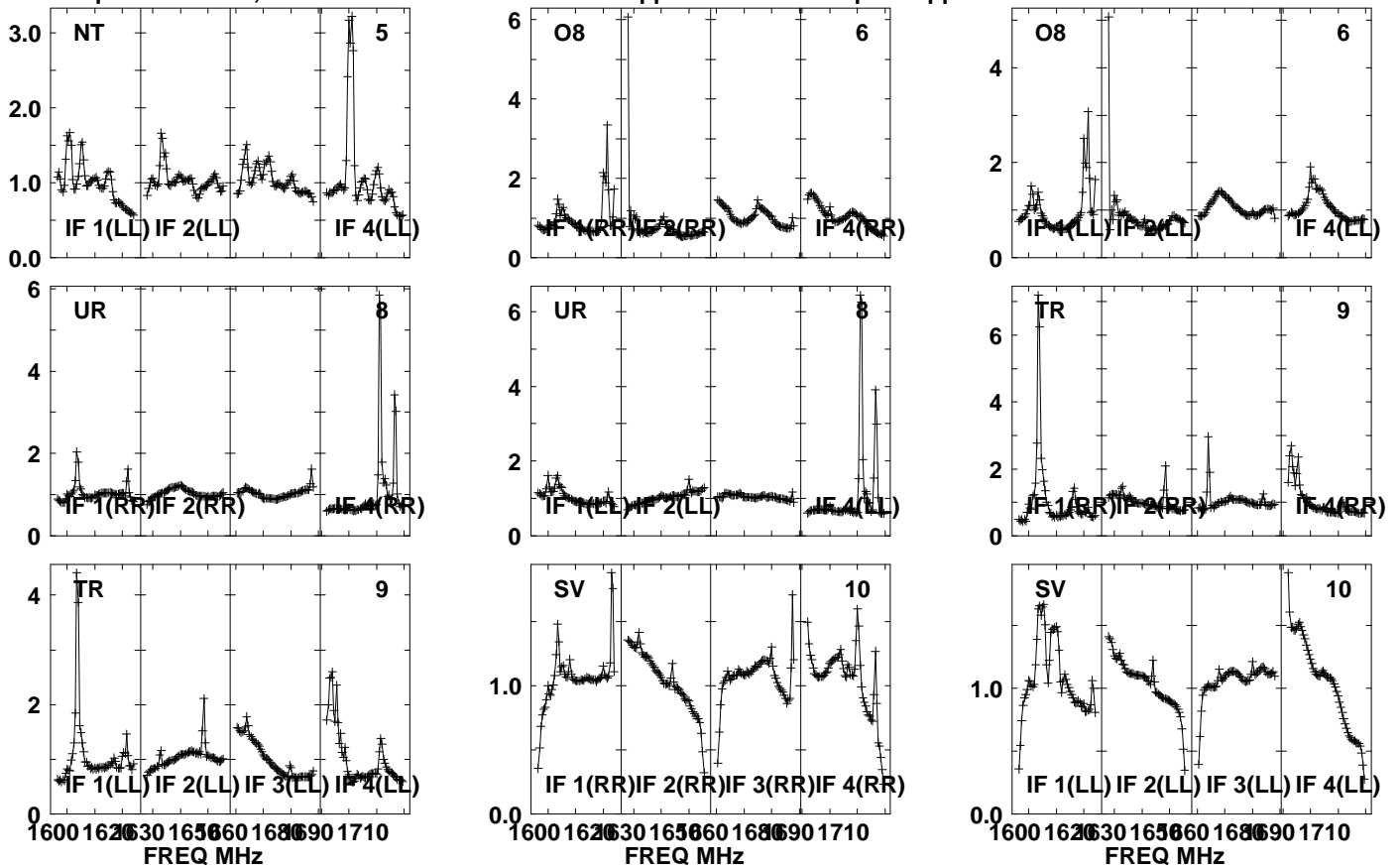

Lower frame: Real Jy

Auto-corr total-power spectrum Antenna: \*

Timerange: 00/19:52:01 to 00/19:53:29

Plot file version1101 created 05-OCT-2021 17:09:55

J0827+5217 GM076.UVDATA.1

Freq = 1.5945 GHz, Bw = 32.000 MH No calibration applied and no bandpass applied

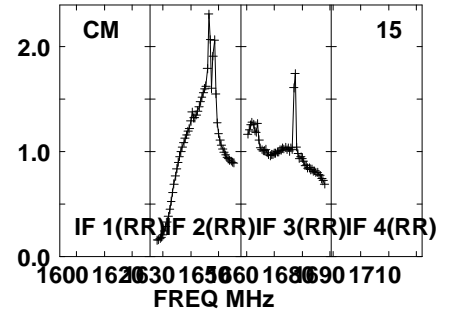
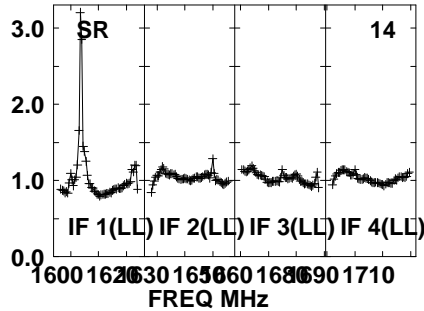
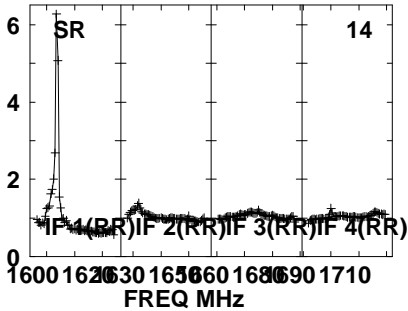
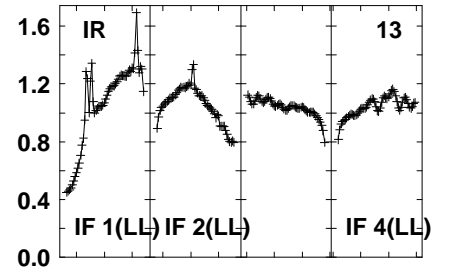
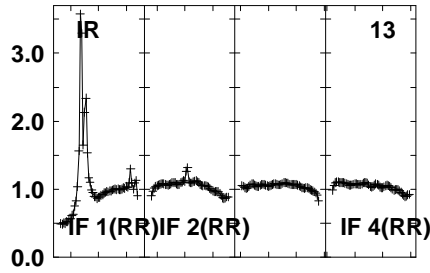
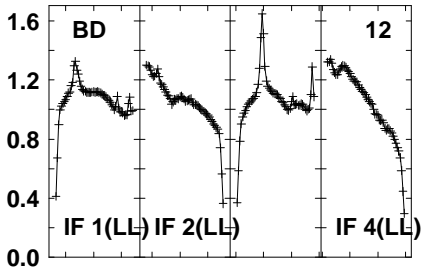
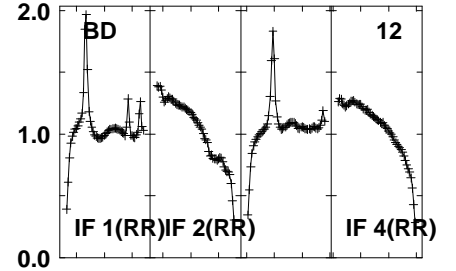
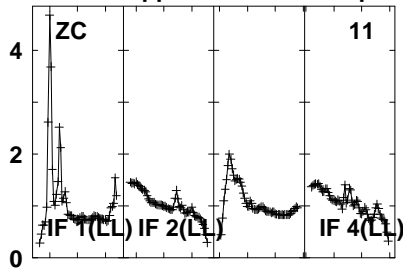
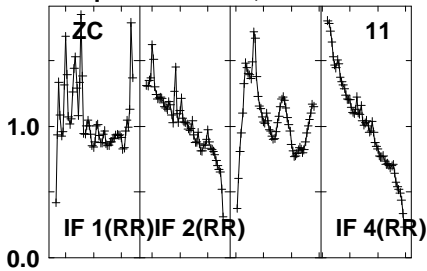

Lower frame: Real Jy

Auto-corr total-power spectrum Antenna: \*

Timerange: 00/19:52:01 to 00/19:53:29

Plot file version 1102 created 05-OCT-2021 17:09:55

J0827+5217 GM076.UVDATA.1

Freq = 1.5945 GHz, Bw = 32.000 MH No calibration applied and no bandpass applied

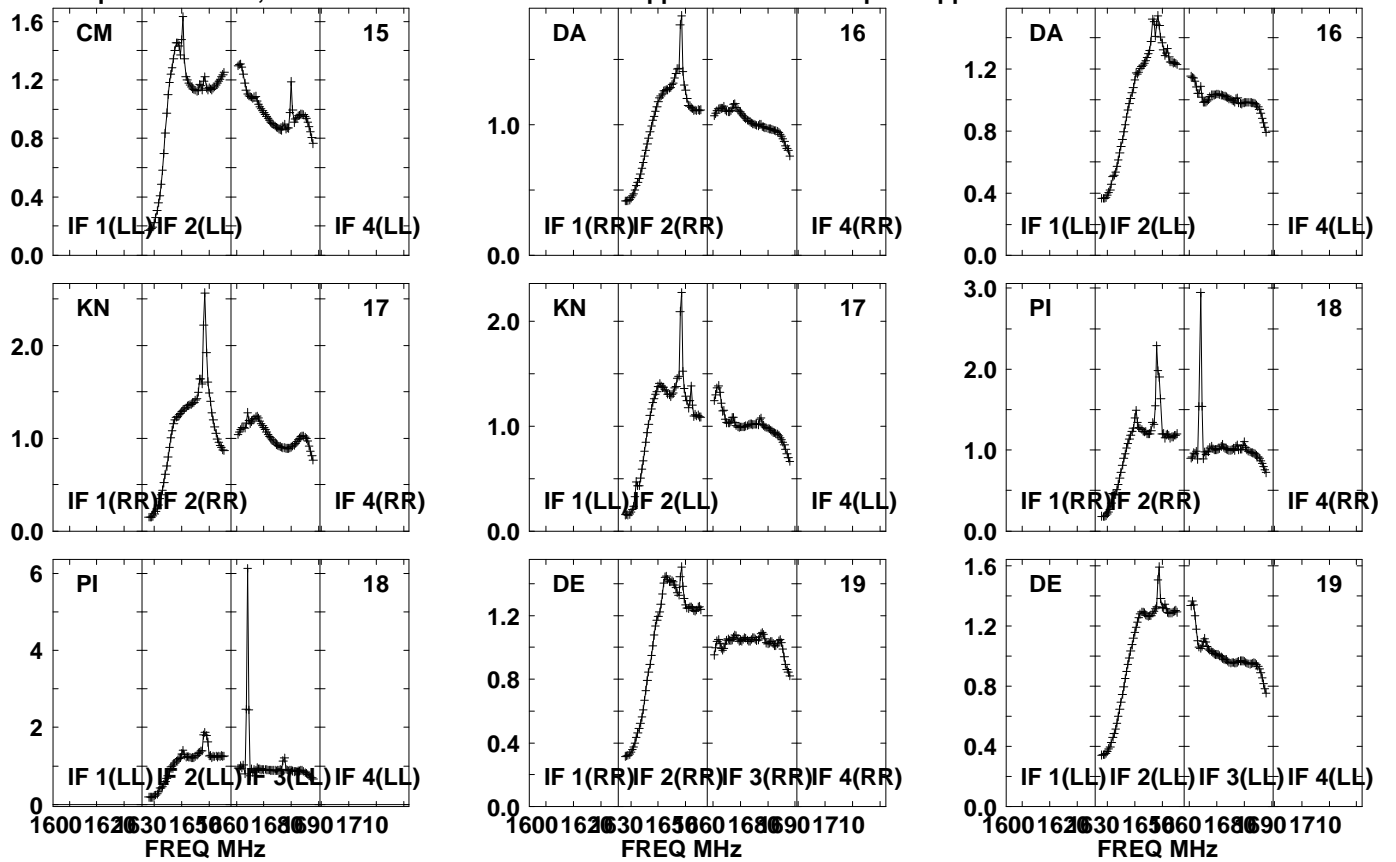

Lower frame: Real Jy

Auto-corr total-power spectrum Antenna: \*

Timerange: 00/19:52:01 to 00/19:53:29

Plot file version 1103 created 05-OCT-2021 17:09:56

J0827+5217 GM076.UVDATA.1

Freq = 1.5945 GHz, Bw = 32.000 MH No calibration applied and no bandpass applied

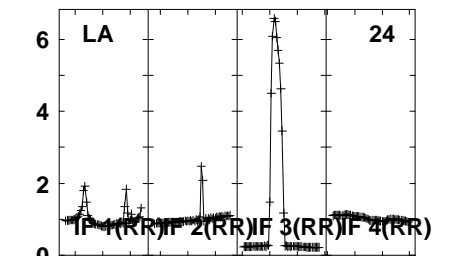
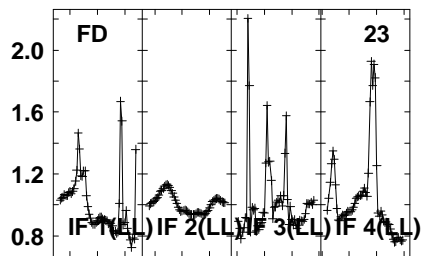
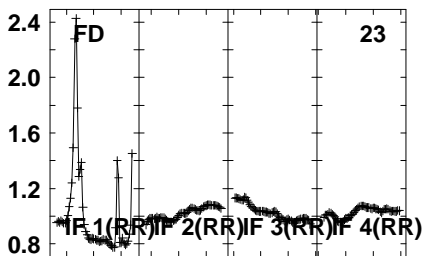
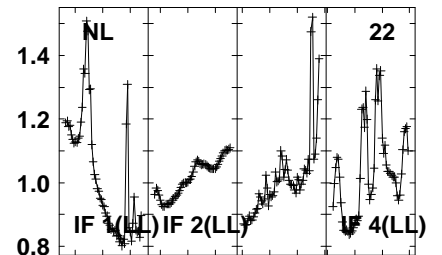
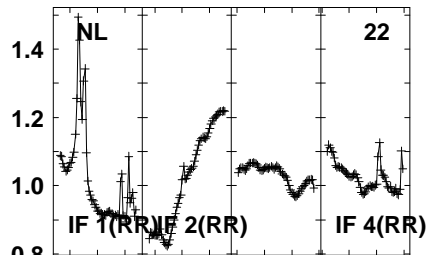
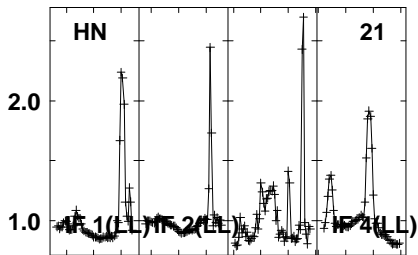
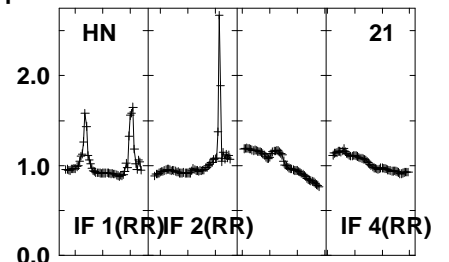
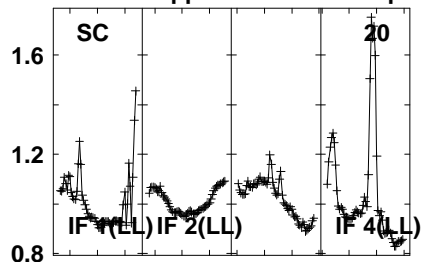
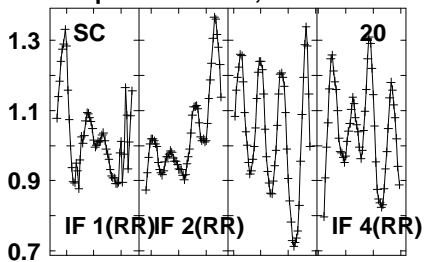

1600 1620 1630 1650 1660 1680 1690 1710  
FREQ MHz

1600 1620 1630 1650 1660 1680 1690 1710  
FREQ MHz

1600 1620 1630 1650 1660 1680 1690 1710  
FREQ MHz

Lower frame: Real Jy  
Auto-corr total-power spectrum Antenna: \*  
Timerange: 00/19:52:01 to 00/19:53:29

Plot file version1104 created 05-OCT-2021 17:09:56

J0827+5217 GM076.UVDATA.1

Freq = 1.5945 GHz, Bw = 32.000 MH No calibration applied and no bandpass applied

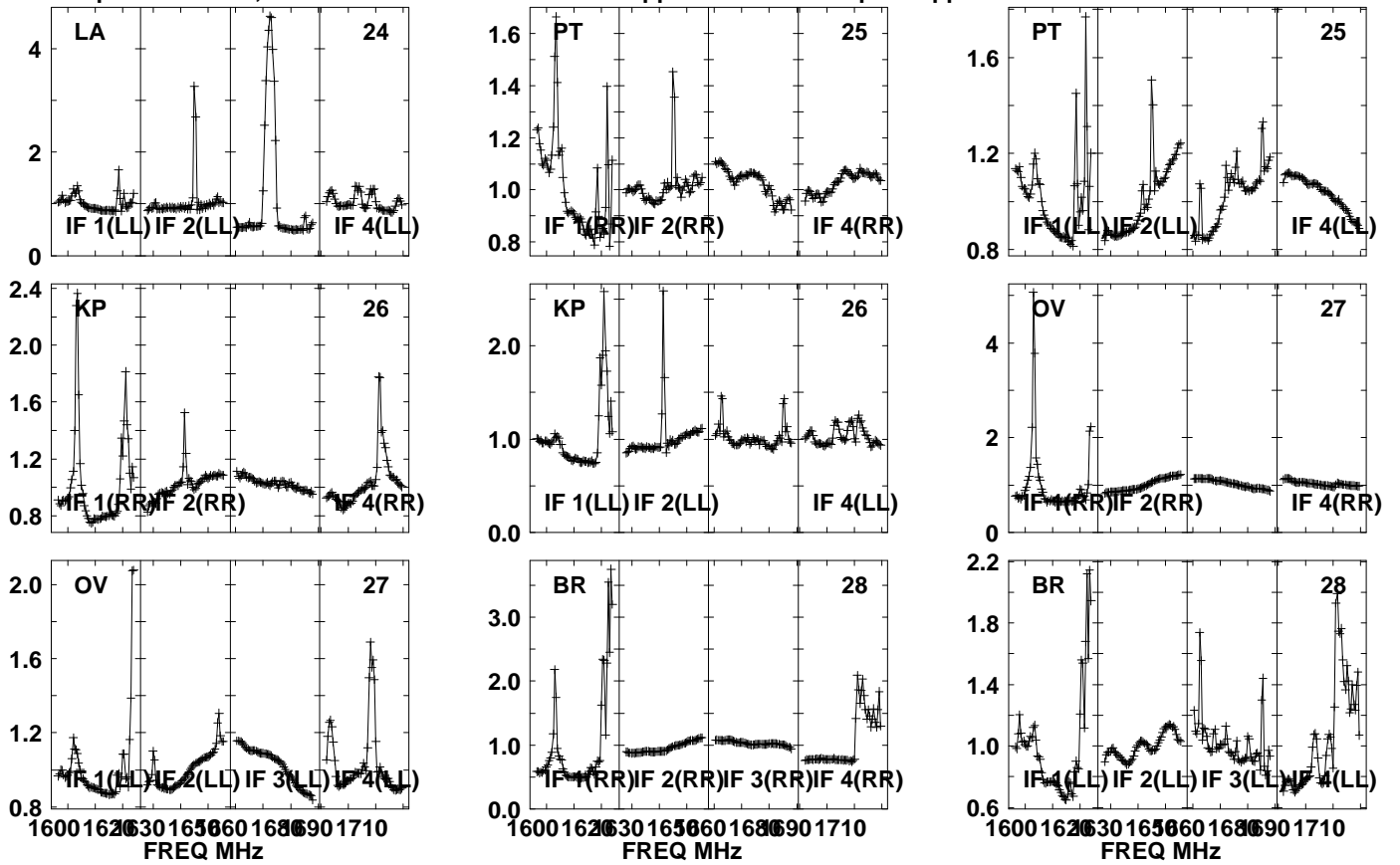

Lower frame: Real Jy

Auto-corr total-power spectrum Antenna: \*

Timerange: 00/19:52:01 to 00/19:53:29

Plot file version1105 created 05-OCT-2021 17:09:56

J0827+5217 GM076.UVDATA.1

Freq = 1.5945 GHz, Bw = 32.000 MH No calibration applied and no bandpass applied

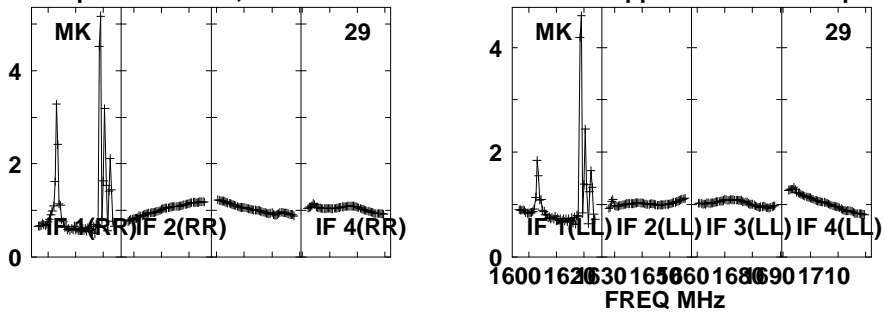

Lower frame: Real Jy  
Auto-corr total-power spectrum Antenna: \*  
Timerange: 00/19:52:01 to 00/19:53:29

Plot file version1106 created 05-OCT-2021 17:09:56

4C39.25 GM076.UVDATA.1

Freq = 1.5945 GHz, Bw = 32.000 MH No calibration applied and no bandpass applied

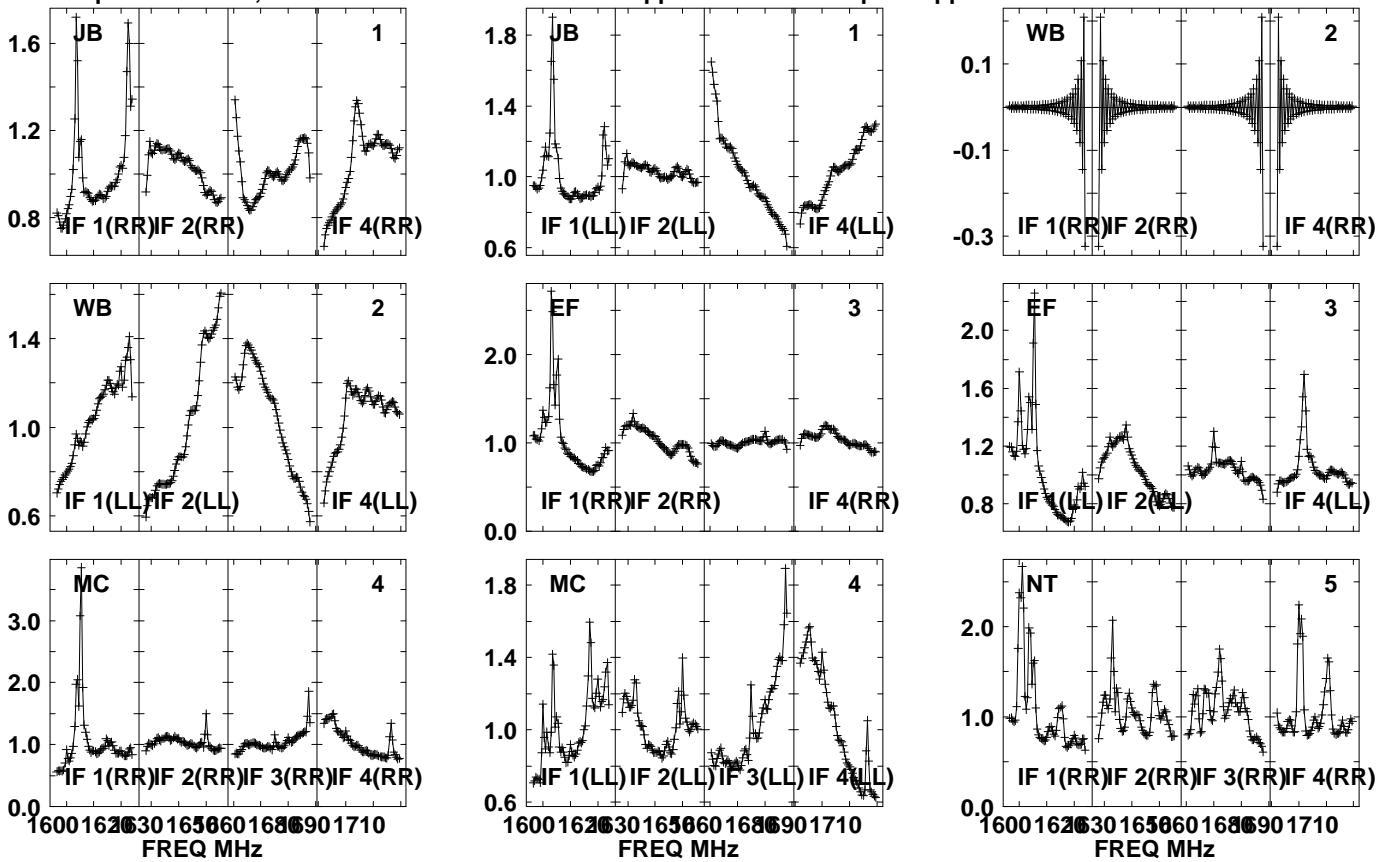

Lower frame: Real Jy  
Auto-corr total-power spectrum Antenna: \*  
Timerange: 00/19:58:31 to 00/20:03:29



Plot file version1107 created 05-OCT-2021 17:09:57

4C39.25 GM076.UVDATA.1

Freq = 1.5945 GHz, Bw = 32.000 MH No calibration applied and no bandpass applied

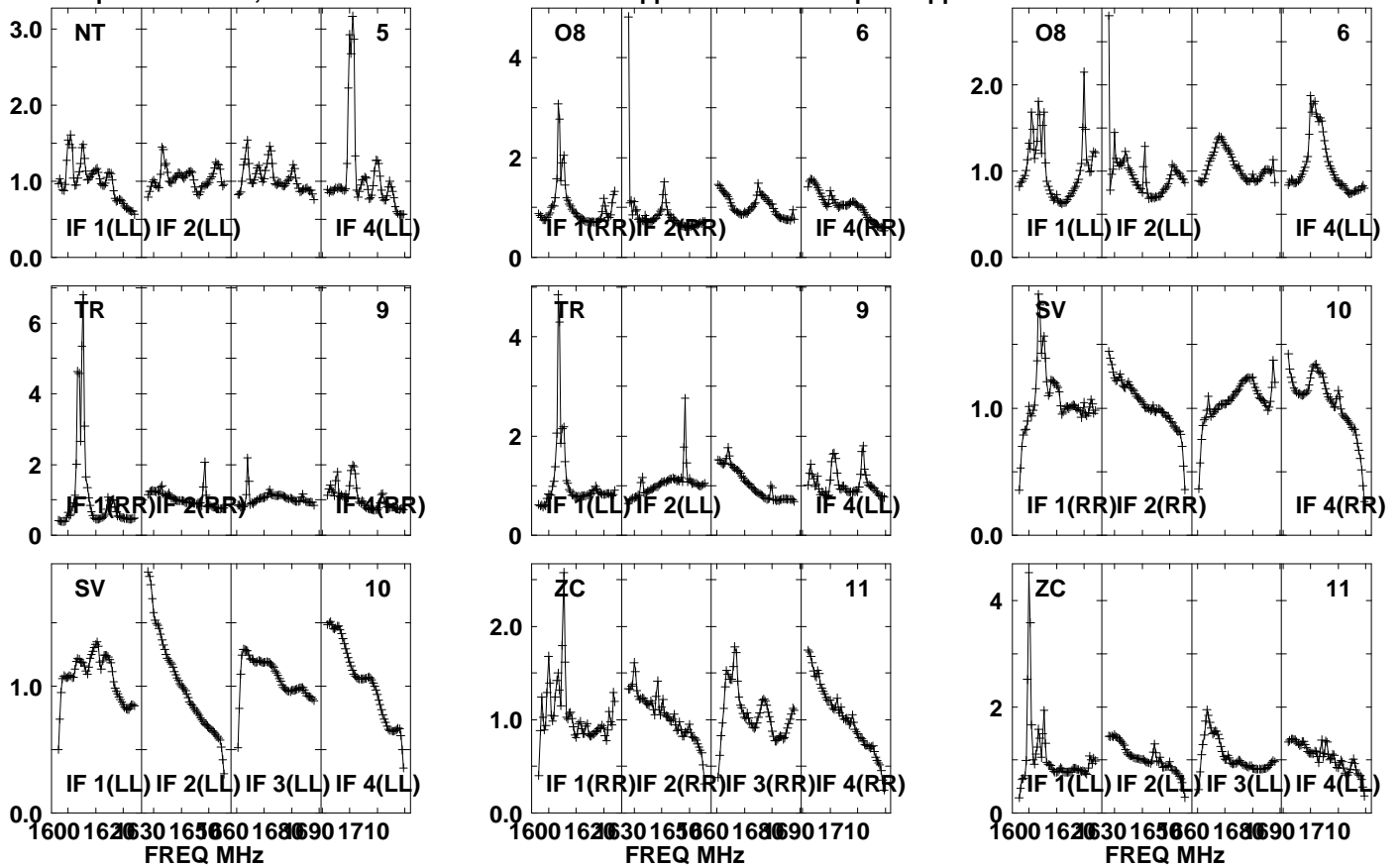

Lower frame: Real Jy

Auto-corr total-power spectrum Antenna: \*

Timerange: 00/19:58:31 to 00/20:03:29

Plot file version1108 created 05-OCT-2021 17:09:58

4C39.25 GM076.UVDATA.1

Freq = 1.5945 GHz, Bw = 32.000 MH No calibration applied and no bandpass applied

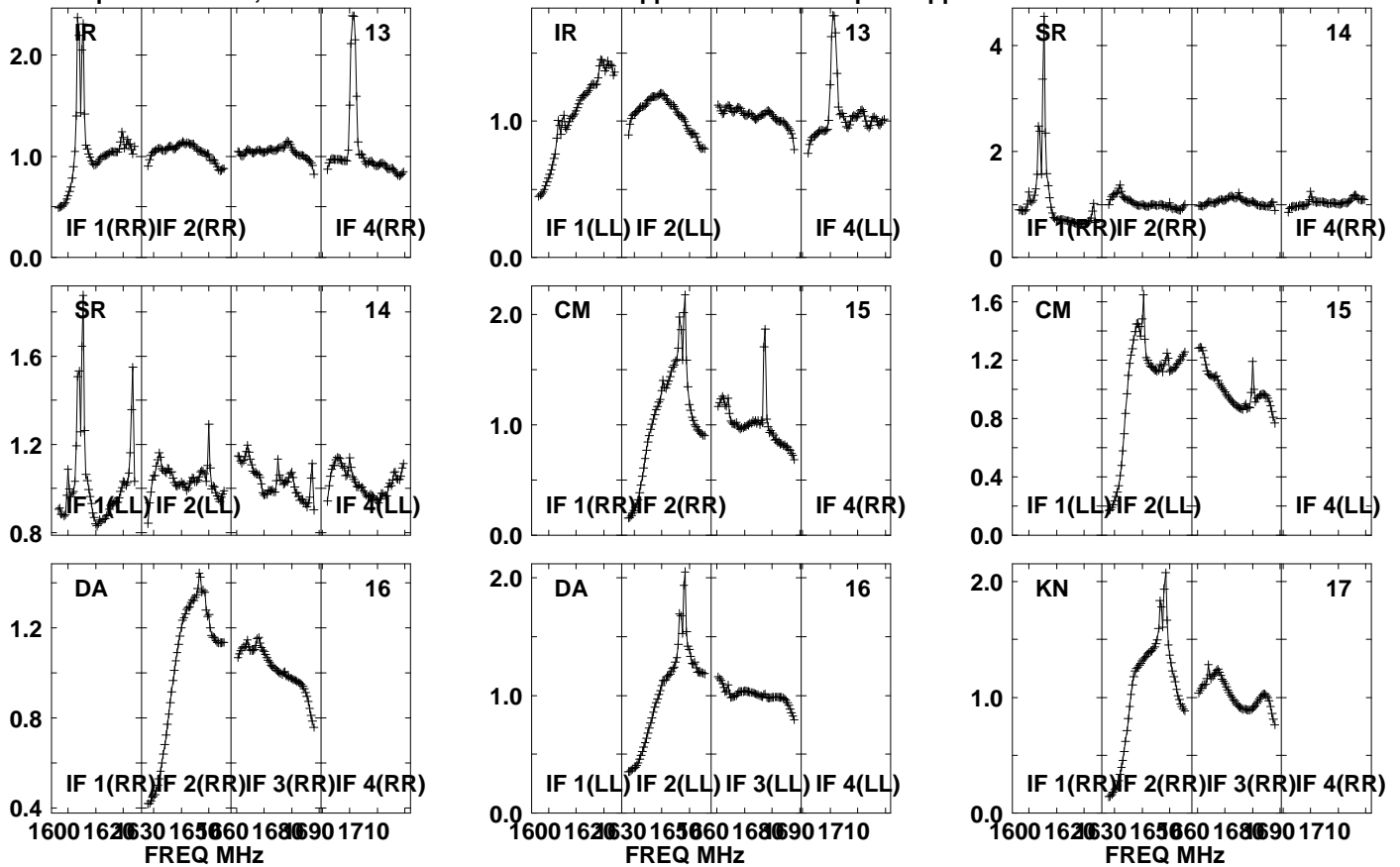

Lower frame: Real Jy

Auto-corr total-power spectrum Antenna: \*

Timerange: 00/19:58:31 to 00/20:03:29

Plot file version1109 created 05-OCT-2021 17:09:59

4C39.25 GM076.UVDATA.1

Freq = 1.5945 GHz, Bw = 32.000 MH No calibration applied and no bandpass applied

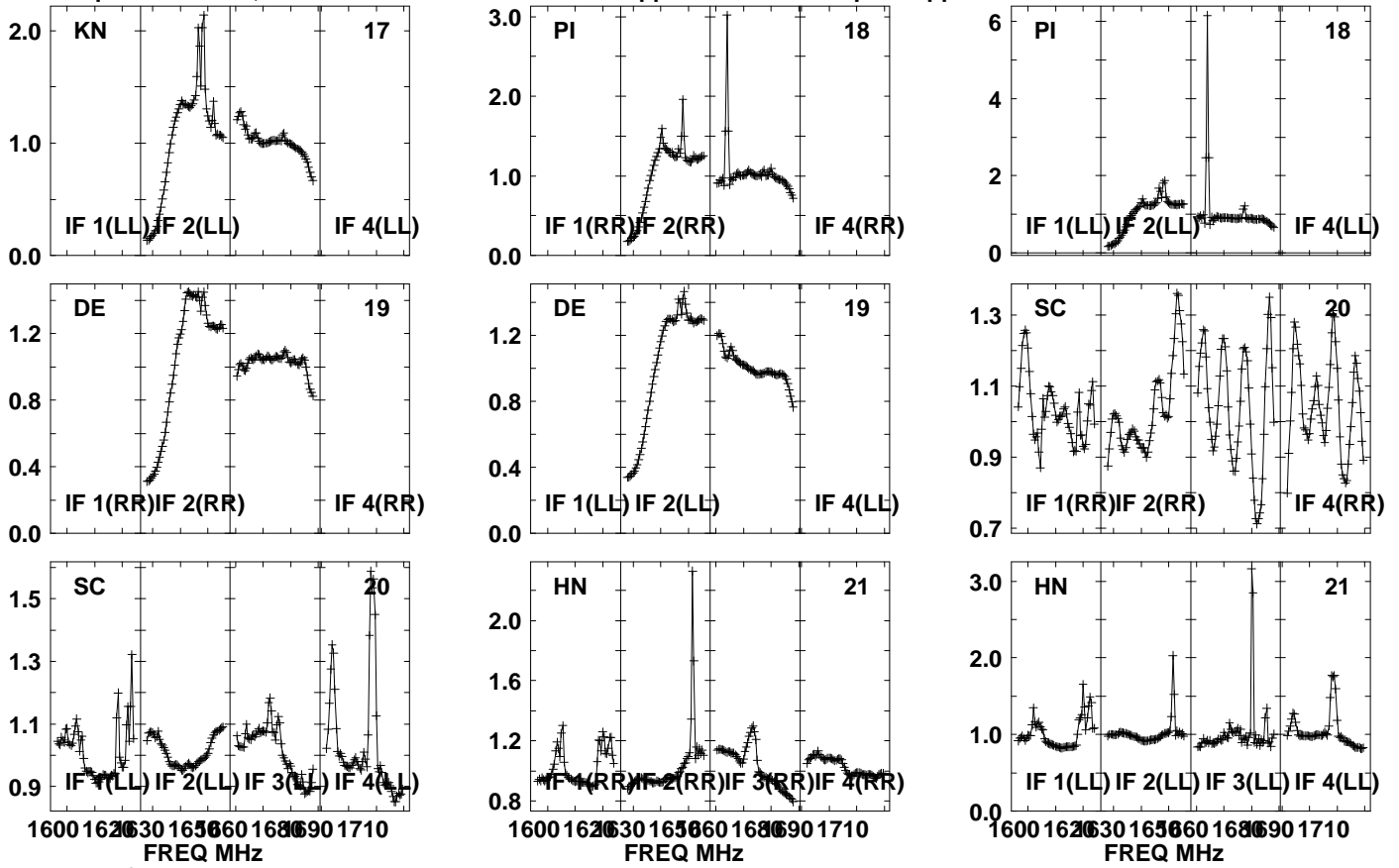

Lower frame: Real Jy  
Auto-corr total-power spectrum Antenna: \*  
Timerange: 00/19:58:31 to 00/20:03:29

Plot file version 1110 created 05-OCT-2021 17:09:59

4C39.25 GM076.UVDATA.1

Freq = 1.5945 GHz, Bw = 32.000 MH No calibration applied and no bandpass applied

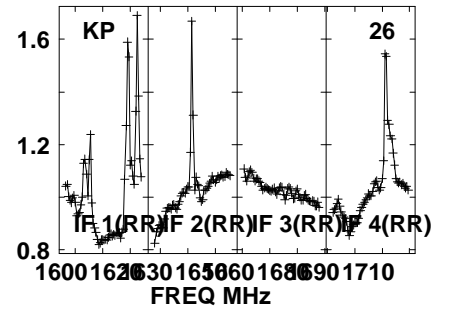
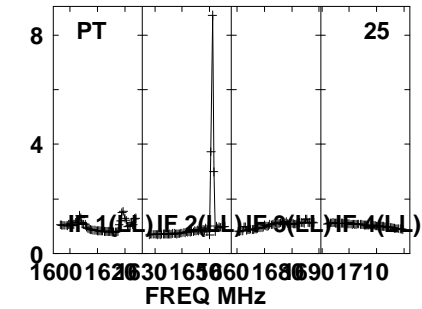
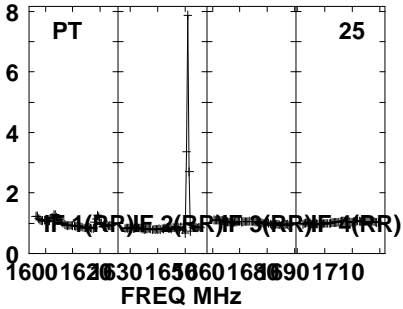
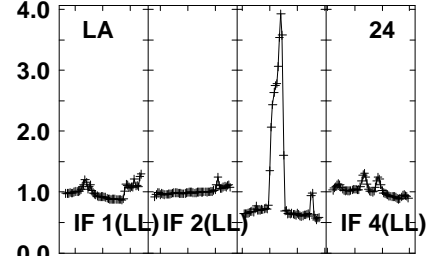
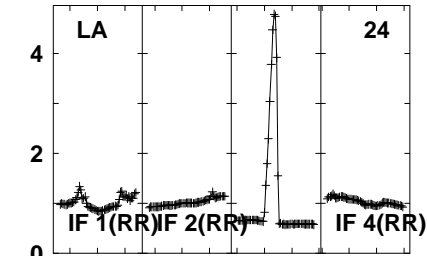
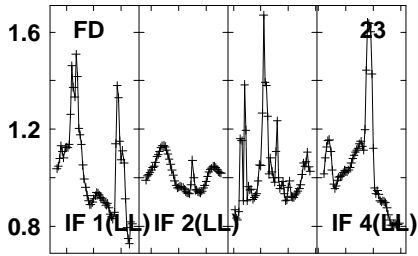
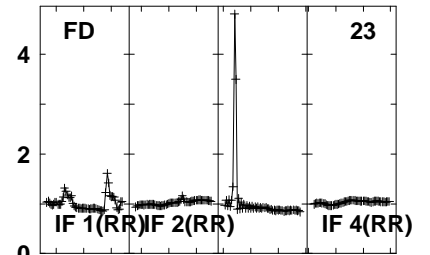
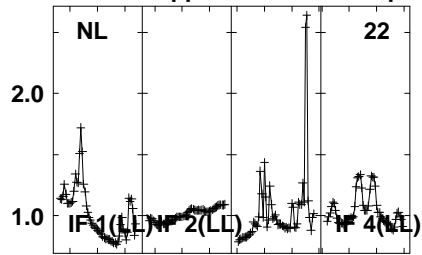
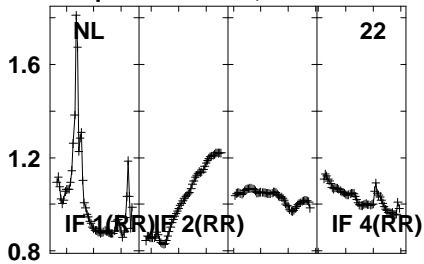

Lower frame: Real Jy  
Auto-corr total-power spectrum Antenna: \*  
Timerange: 00/19:58:31 to 00/20:03:29

Plot file version1111 created 05-OCT-2021 17:10:00

4C39.25 GM076.UVDATA.1

Freq = 1.5945 GHz, Bw = 32.000 MH No calibration applied and no bandpass applied

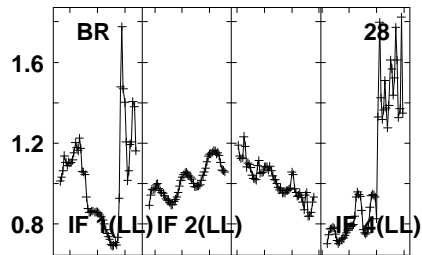
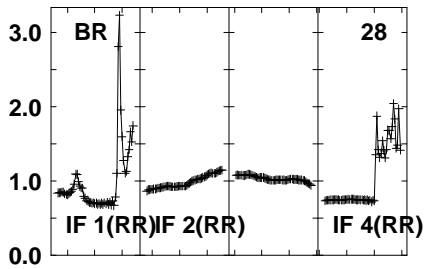
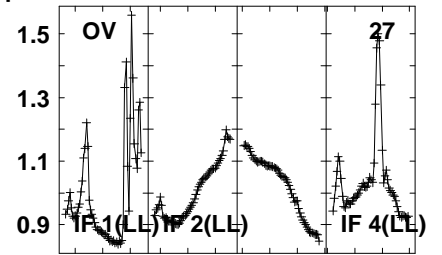
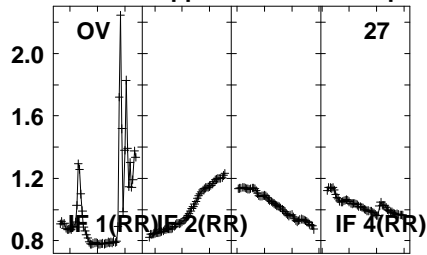
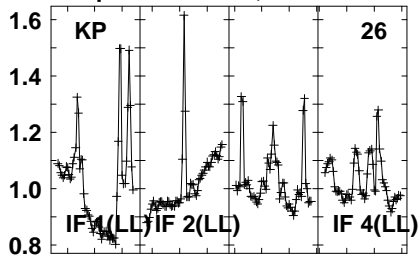

Lower frame: Real Jy  
Auto-corr total-power spectrum Antenna: \*  
Timerange: 00/19:58:31 to 00/20:03:29

Plot file version1112 created 05-OCT-2021 17:10:00  
 J0827+5217 GM076.UVDATA.1  
 Freq = 1.5945 GHz, Bw = 32.000 MH No calibration applied and no bandpass applied

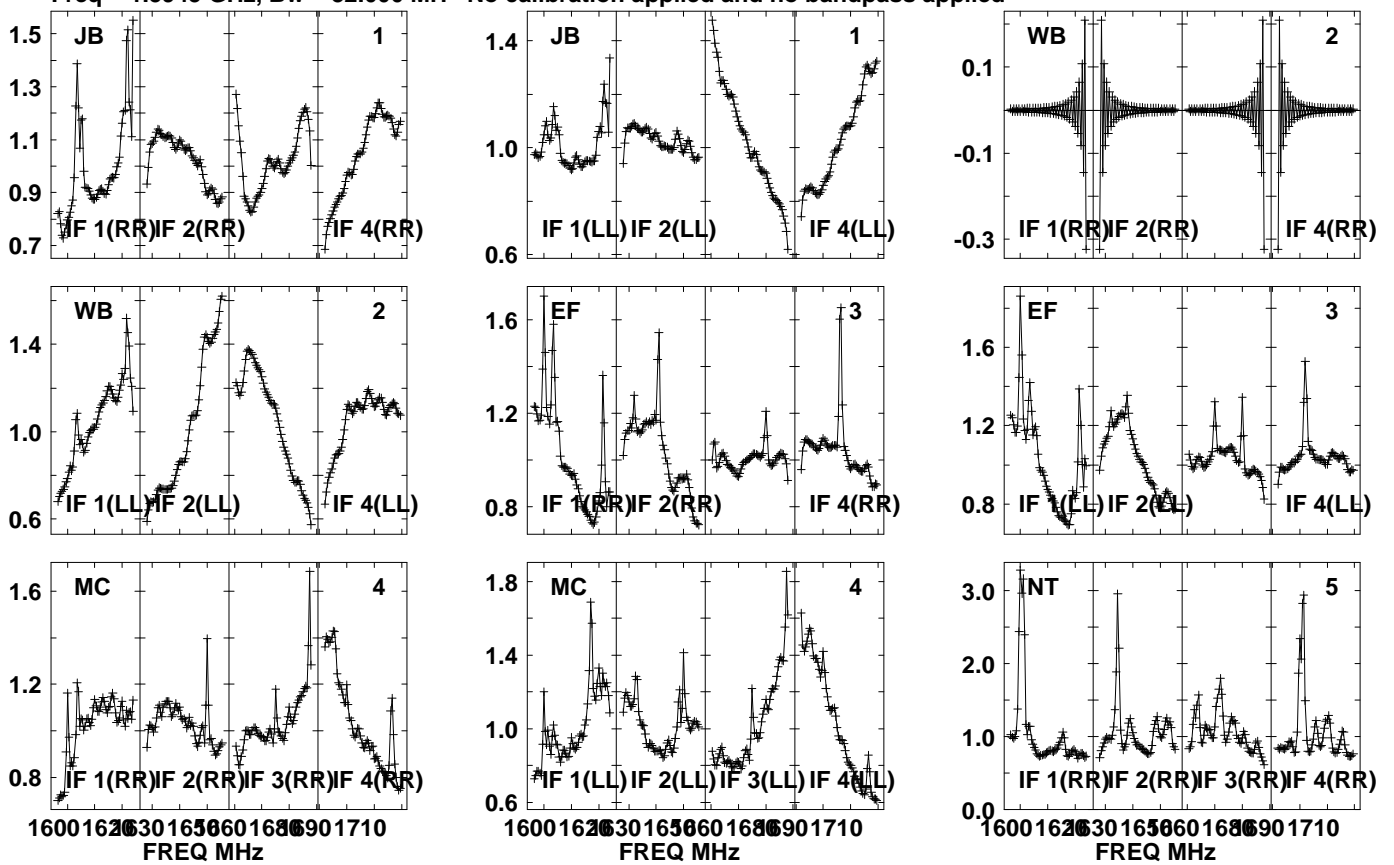

Lower frame: Real Jy  
 Auto-corr total-power spectrum Antenna: \*  
 Timerange: 00/20:08:31 to 00/20:13:29

Plot file version1113 created 05-OCT-2021 17:10:01

J0827+5217 GM076.UVDATA.1

Freq = 1.5945 GHz, Bw = 32.000 MH No calibration applied and no bandpass applied

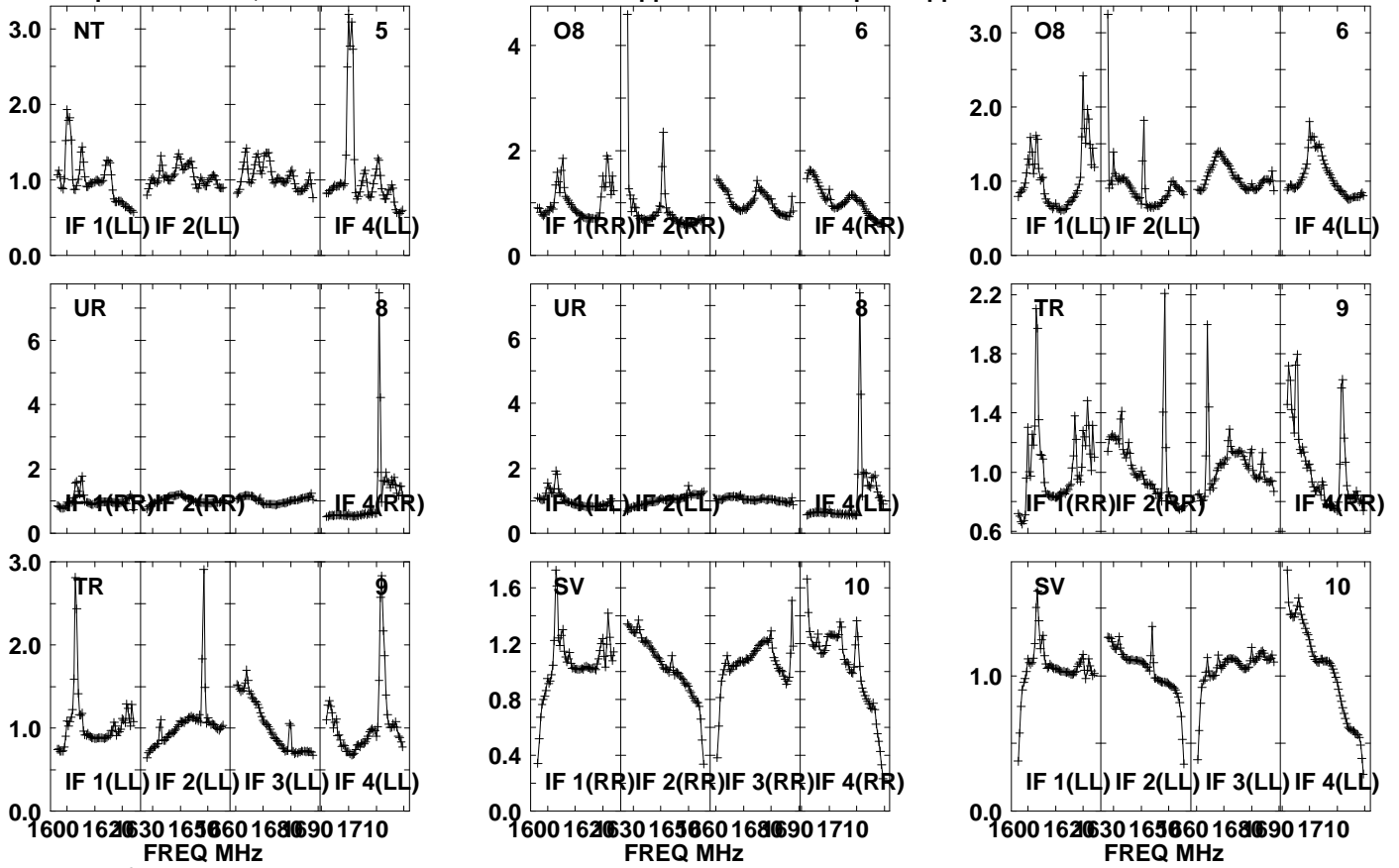

Lower frame: Real Jy  
Auto-corr total-power spectrum Antenna: \*  
Timerange: 00/20:08:31 to 00/20:13:29

Plot file version1114 created 05-OCT-2021 17:10:02

J0827+5217 GM076.UVDATA.1

Freq = 1.5945 GHz, Bw = 32.000 MH No calibration applied and no bandpass applied

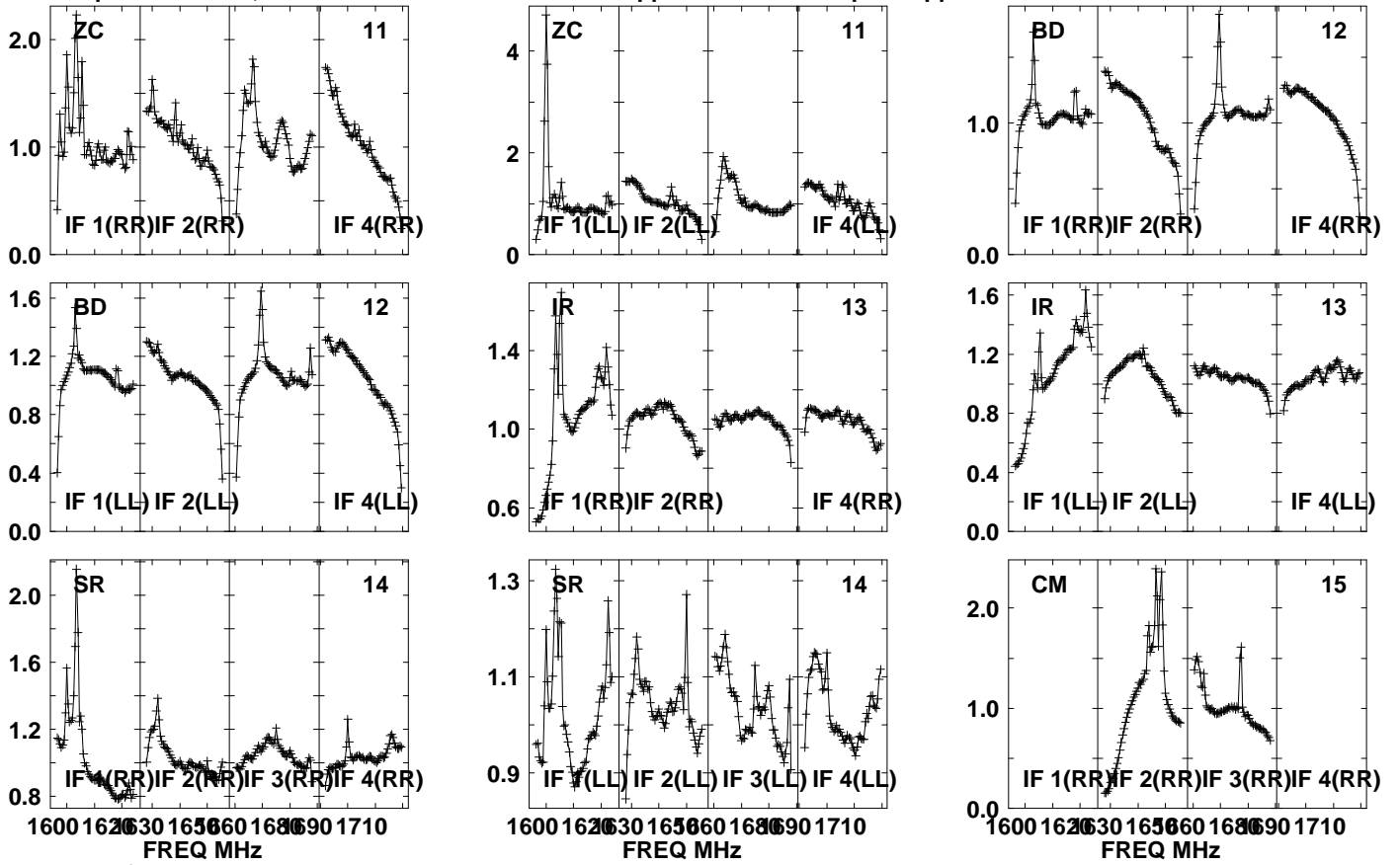

Lower frame: Real Jy  
Auto-corr total-power spectrum Antenna: \*  
Timerange: 00/20:08:31 to 00/20:13:29



Plot file version1115 created 05-OCT-2021 17:10:02

J0827+5217 GM076.UVDATA.1

Freq = 1.5945 GHz, Bw = 32.000 MH No calibration applied and no bandpass applied

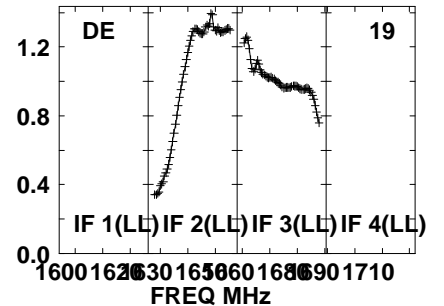
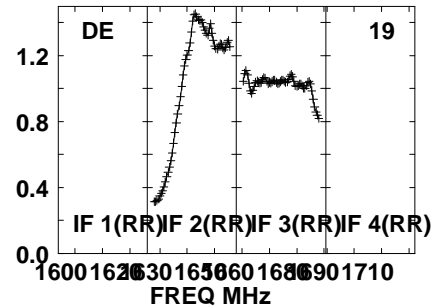
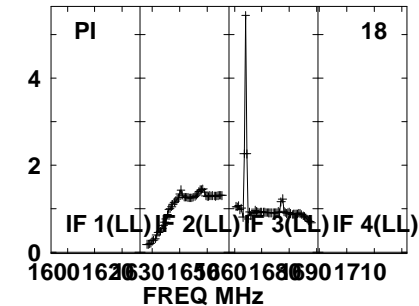
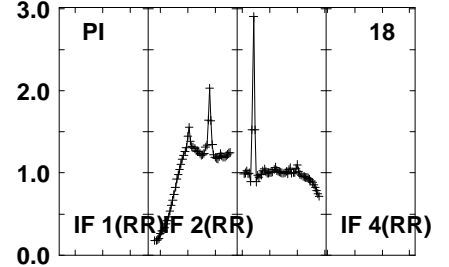
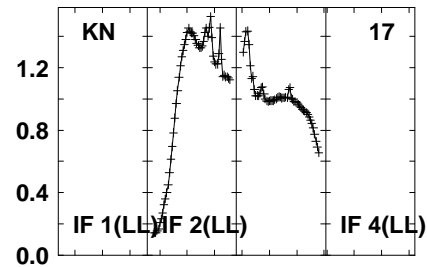
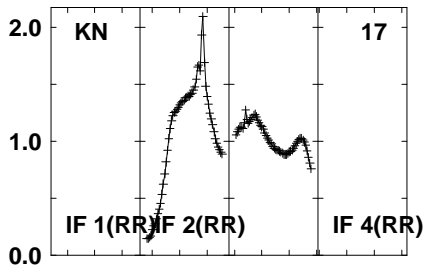
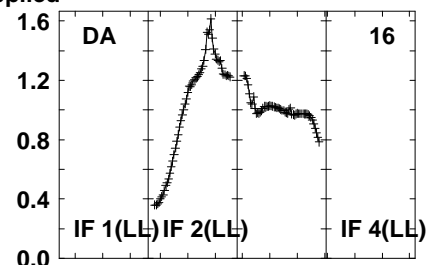
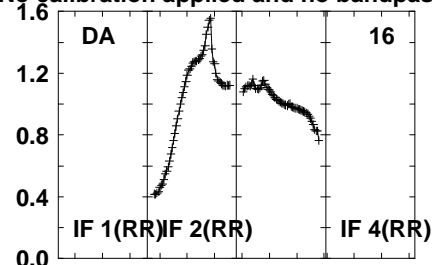
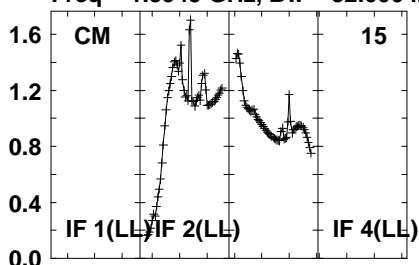

Lower frame: Real Jy  
Auto-corr total-power spectrum Antenna: \*  
Timerange: 00/20:08:31 to 00/20:13:29

Plot file version 1116 created 05-OCT-2021 17:10:03

J0827+5217 GM076.UVDATA.1

Freq = 1.5945 GHz, Bw = 32.000 MH No calibration applied and no bandpass applied

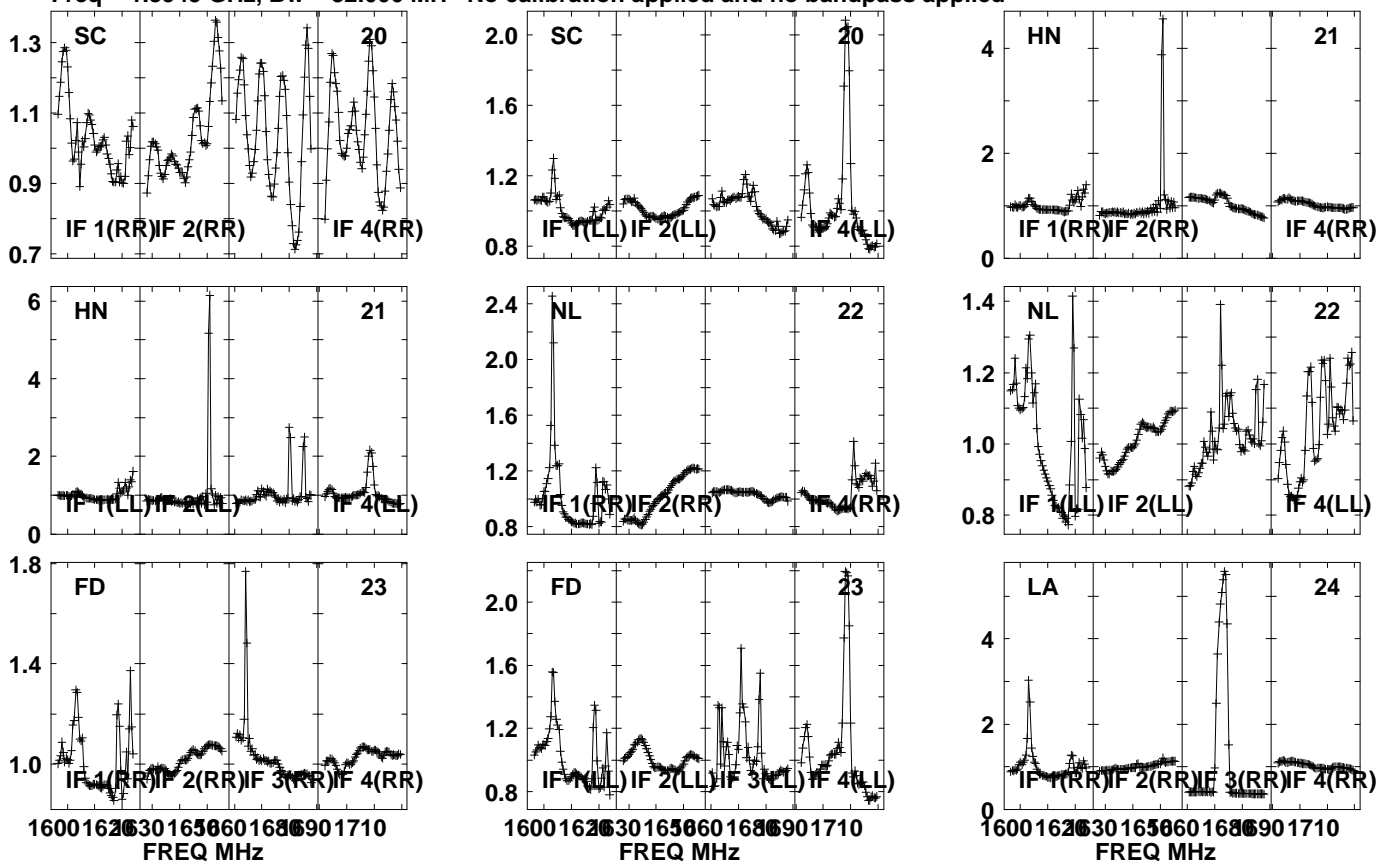

Lower frame: Real Jy  
Auto-corr total-power spectrum Antenna: \*  
Timerange: 00/20:08:31 to 00/20:13:29

Plot file version1117 created 05-OCT-2021 17:10:03

J0827+5217 GM076.UVDATA.1

Freq = 1.5945 GHz, Bw = 32.000 MH No calibration applied and no bandpass applied

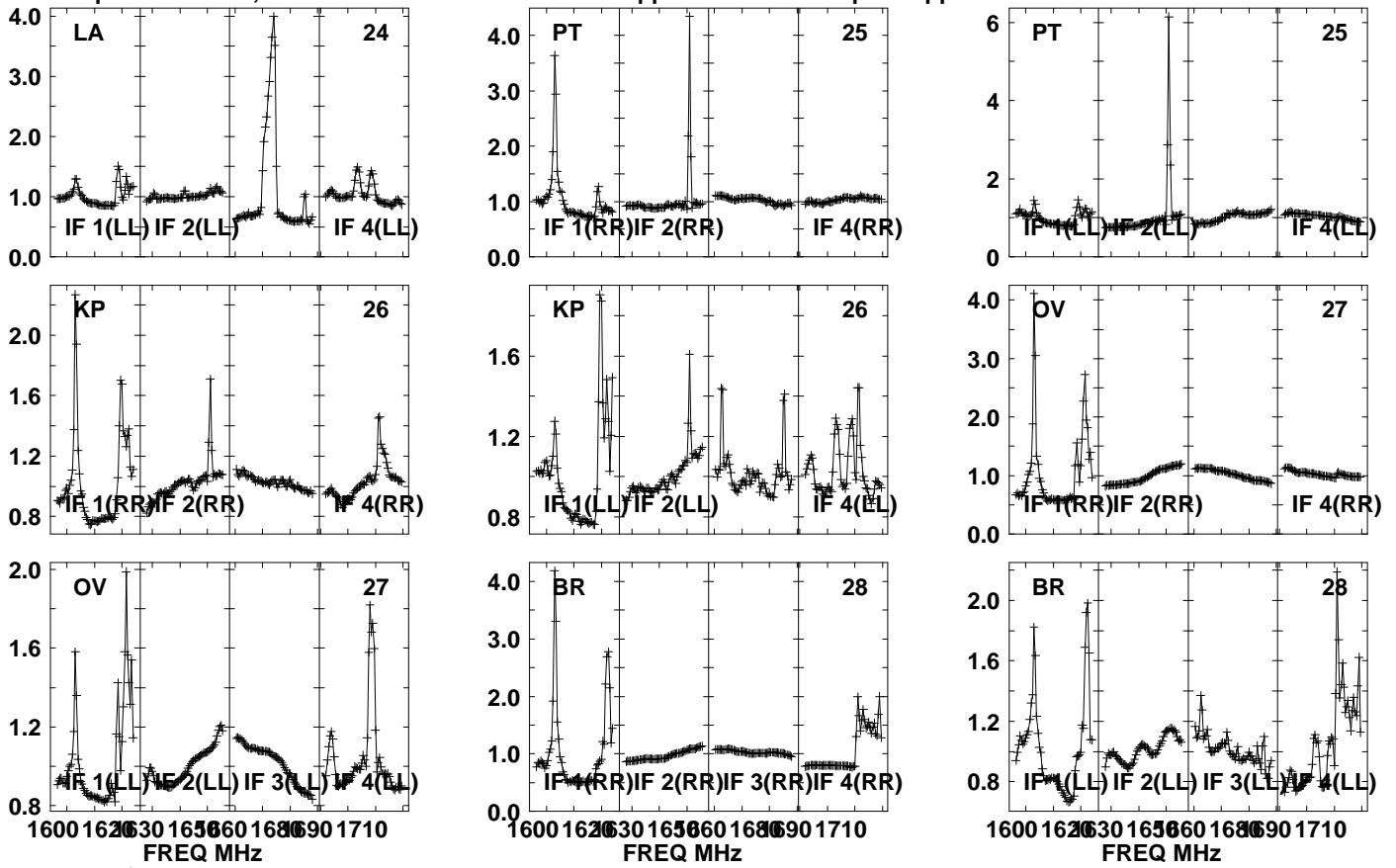

Lower frame: Real Jy

Auto-corr total-power spectrum Antenna: \*

Timerange: 00/20:08:31 to 00/20:13:29

Plot file version1118 created 05-OCT-2021 17:10:04

J0827+5217 GM076.UVDATA.1

Freq = 1.5945 GHz, Bw = 32.000 MH No calibration applied and no bandpass applied

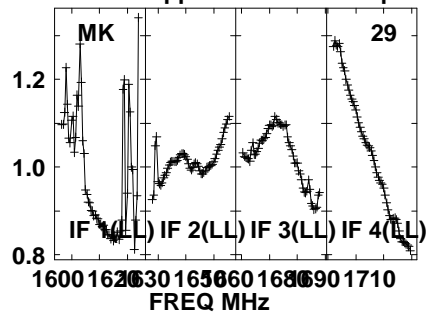
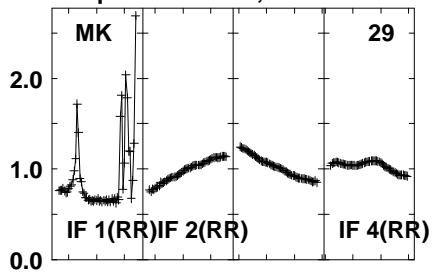

Lower frame: Real Jy

Auto-corr total-power spectrum Antenna: \*

Timerange: 00/20:08:31 to 00/20:13:29

Plot file version1119 created 05-OCT-2021 17:10:04

APM08279+525 GM076.UVDATA.1

Freq = 1.5945 GHz, Bw = 32.000 MH No calibration applied and no bandpass applied

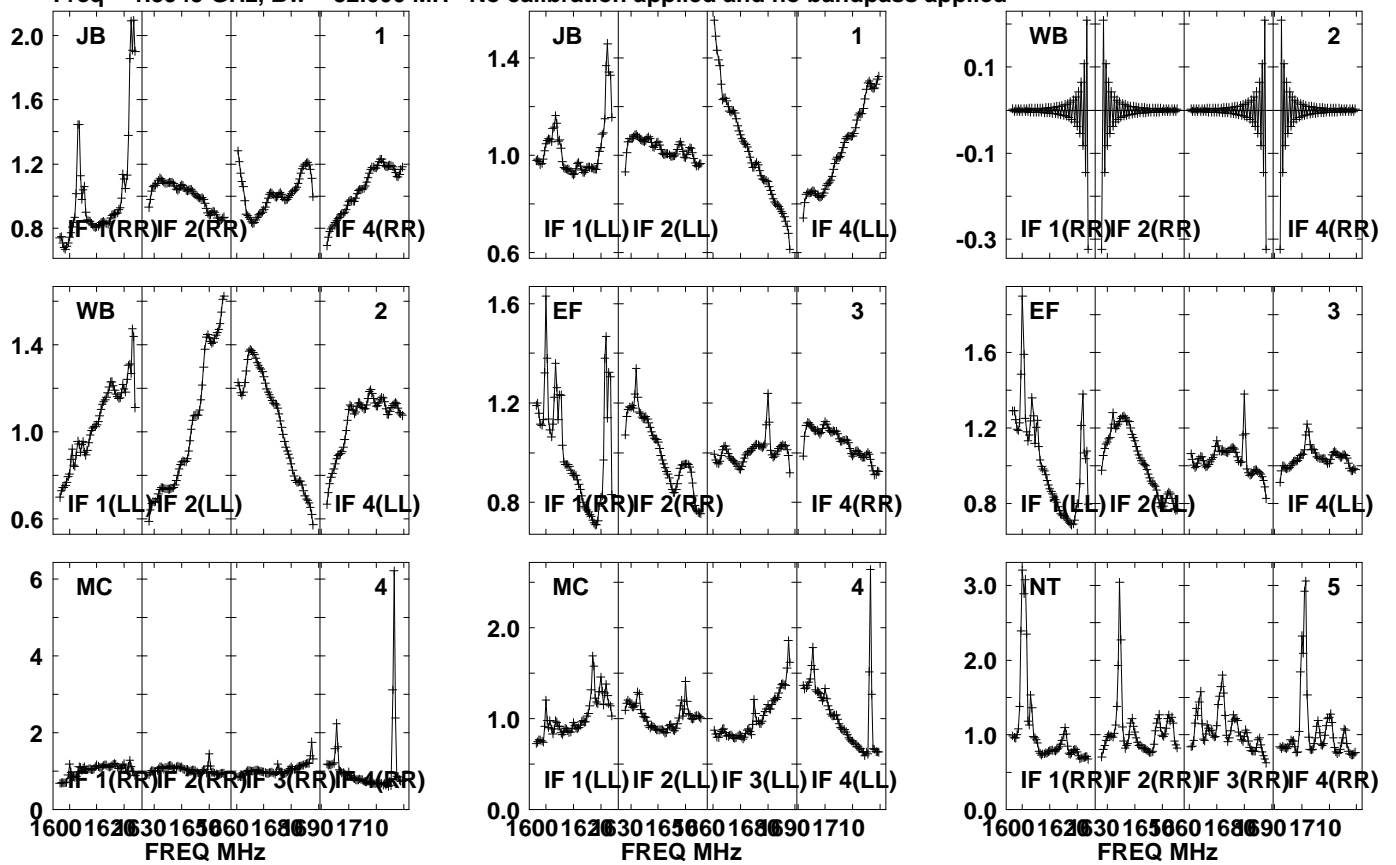

Lower frame: Real Jy  
Auto-corr total-power spectrum Antenna: \*  
Timerange: 00/20:13:31 to 00/20:16:59

Plot file version1120 created 05-OCT-2021 17:10:04

APM08279+525 GM076.UVDATA.1

Freq = 1.5945 GHz, Bw = 32.000 MH No calibration applied and no bandpass applied

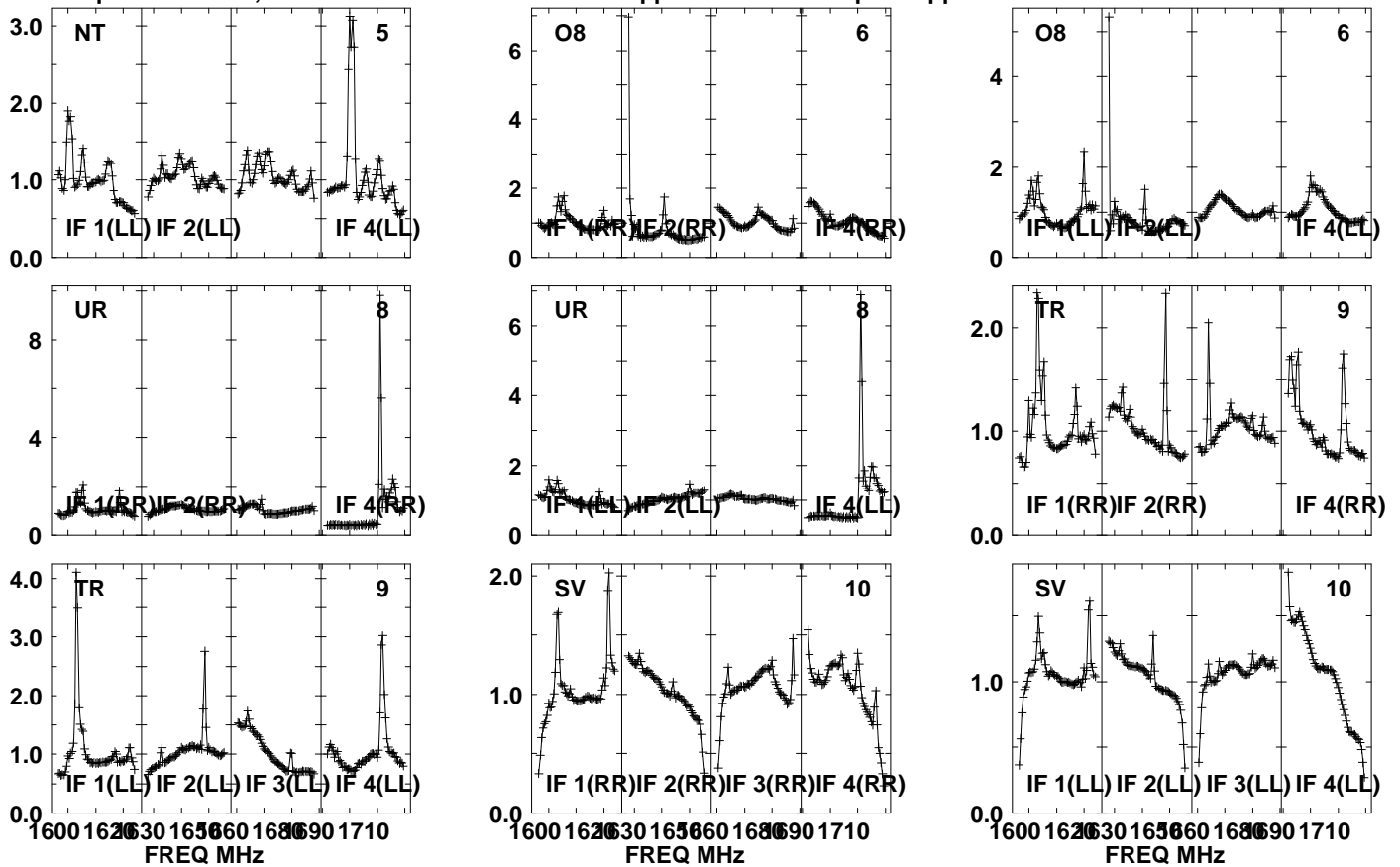

Lower frame: Real Jy

Auto-corr total-power spectrum Antenna: \*

Timerange: 00/20:13:31 to 00/20:16:59

Plot file version1121 created 05-OCT-2021 17:10:05

APM08279+525 GM076.UVDATA.1

Freq = 1.5945 GHz, Bw = 32.000 MH No calibration applied and no bandpass applied

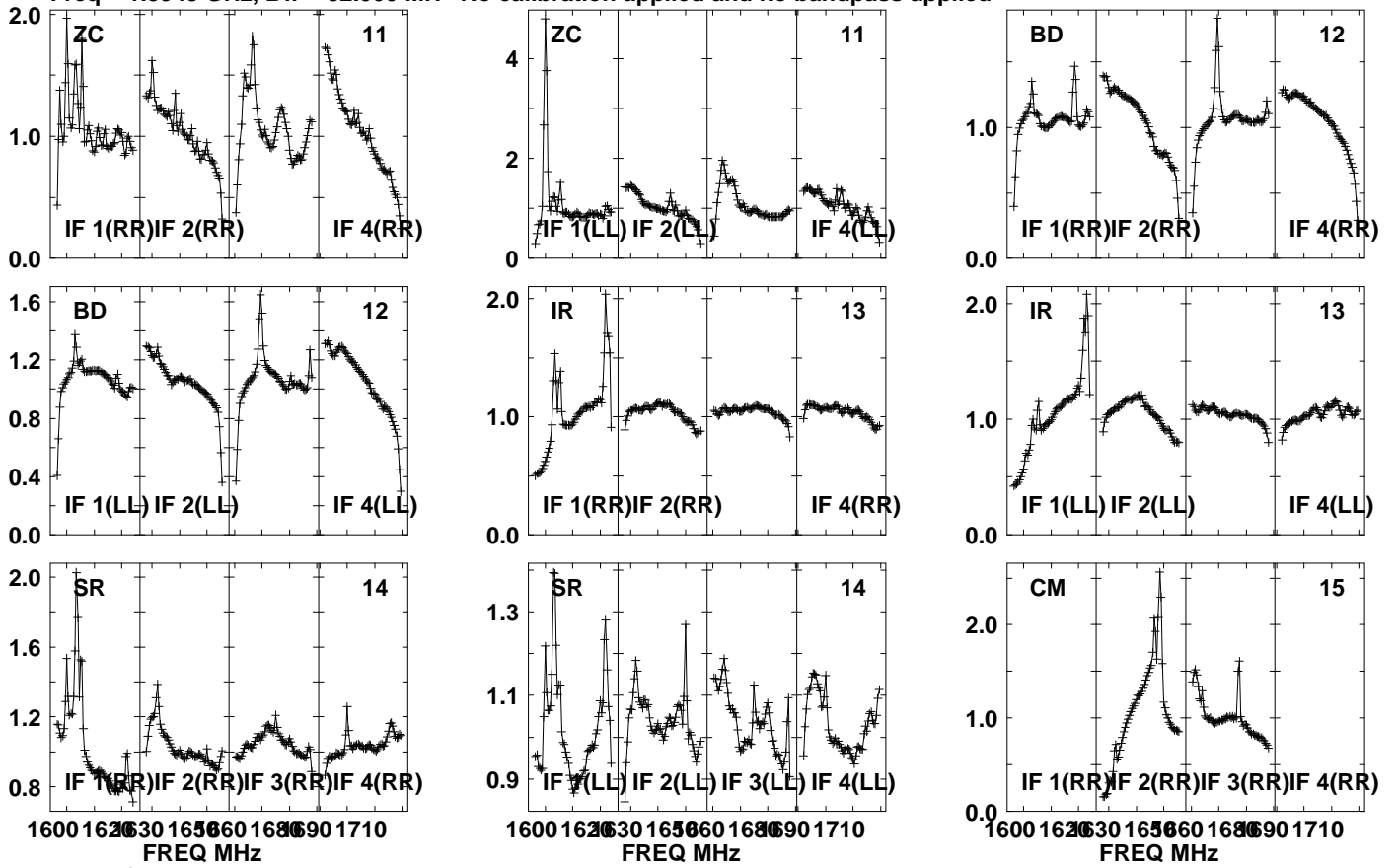

Lower frame: Real Jy  
Auto-corr total-power spectrum Antenna: \*  
Timerange: 00/20:13:31 to 00/20:16:59

Plot file version 1122 created 05-OCT-2021 17:10:05

APM08279+525 GM076.UVDATA.1

Freq = 1.5945 GHz, Bw = 32.000 MH No calibration applied and no bandpass applied

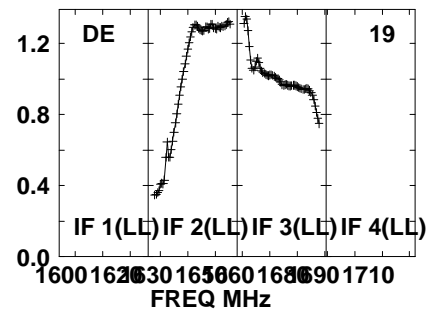
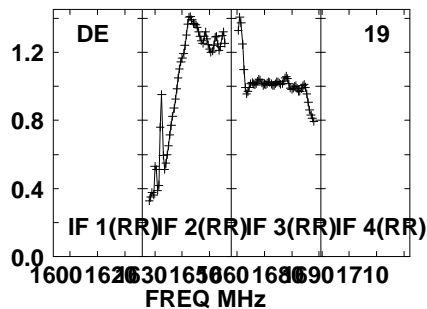
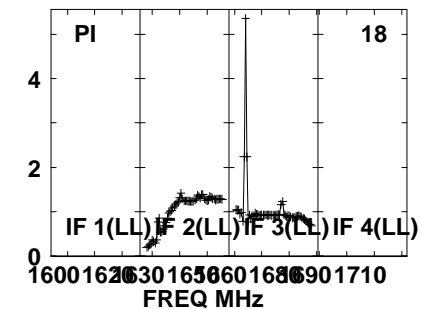
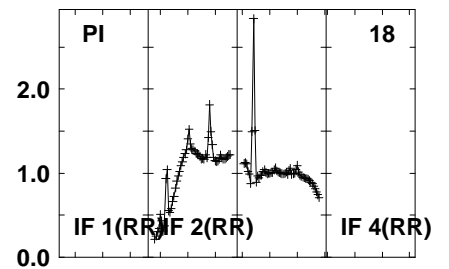
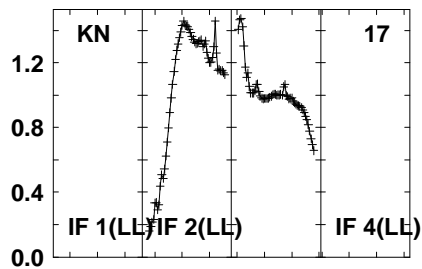
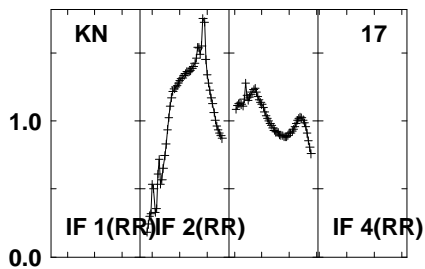
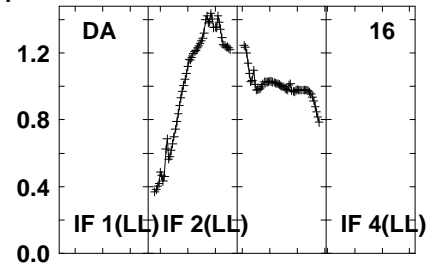
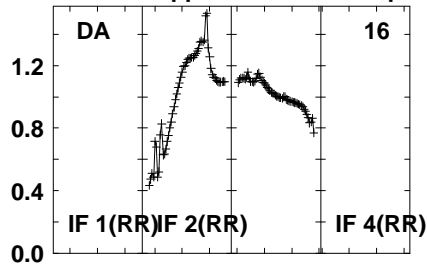
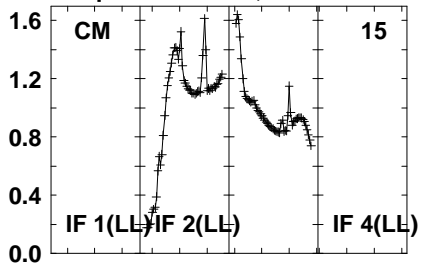

Lower frame: Real Jy  
Auto-corr total-power spectrum Antenna: \*  
Timerange: 00/20:13:31 to 00/20:16:59



Plot file version1123 created 05-OCT-2021 17:10:05

APM08279+525 GM076.UVDATA.1

Freq = 1.5945 GHz, Bw = 32.000 MH No calibration applied and no bandpass applied

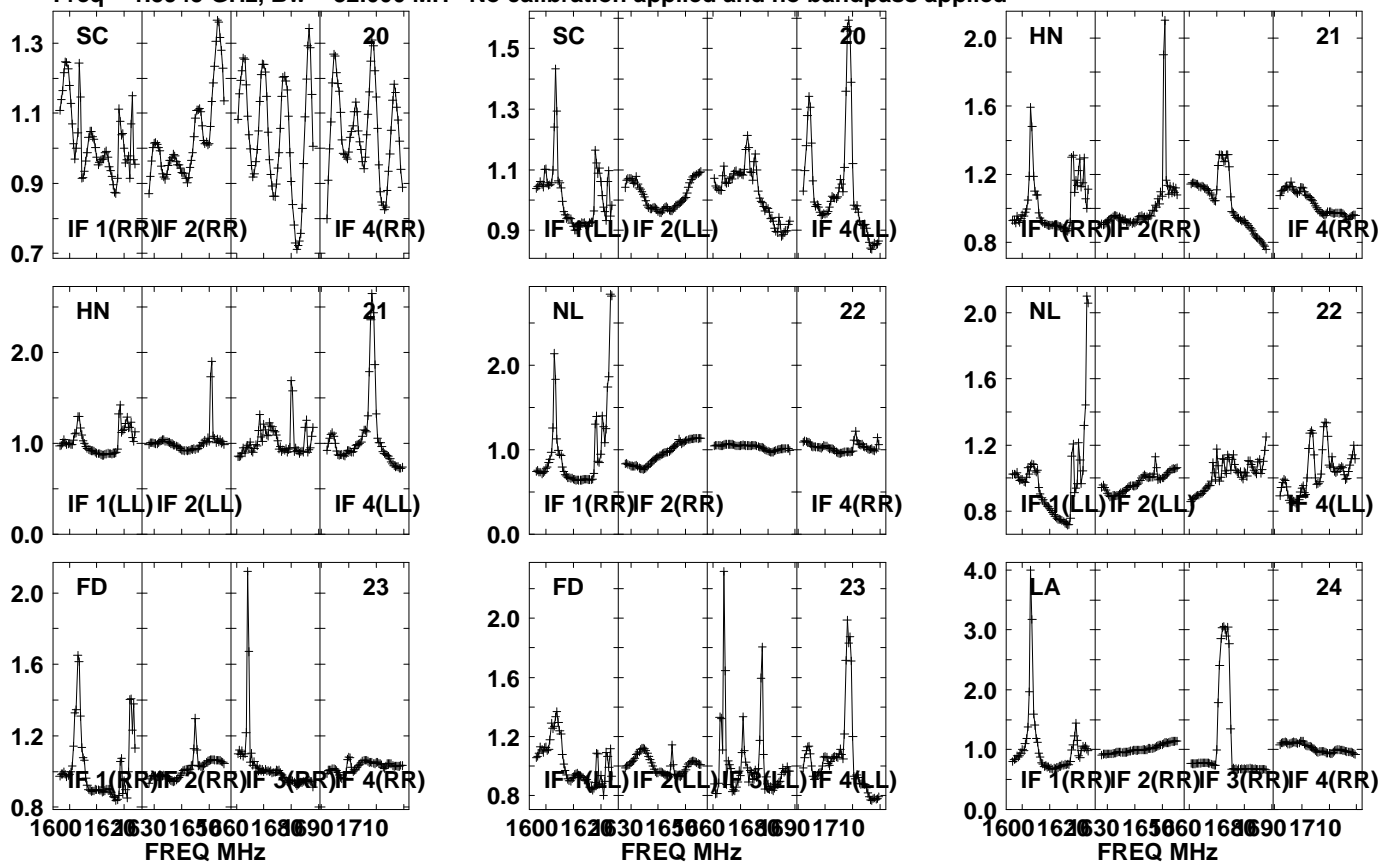

Lower frame: Real Jy  
Auto-corr total-power spectrum Antenna: \*  
Timerange: 00/20:13:31 to 00/20:16:59

Plot file version1124 created 05-OCT-2021 17:10:06

APM08279+525 GM076.UVDATA.1

Freq = 1.5945 GHz, Bw = 32.000 MH No calibration applied and no bandpass applied

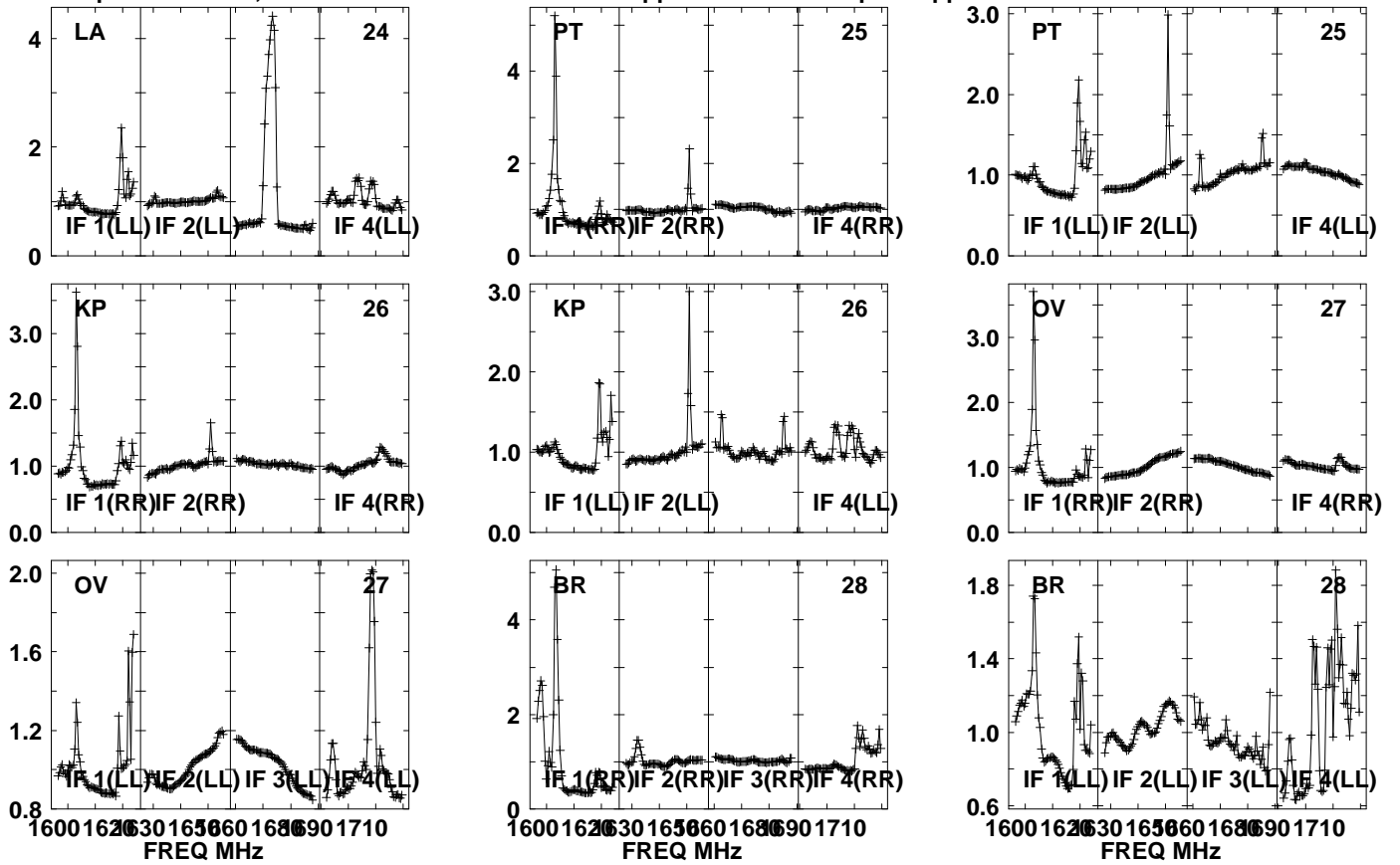

Lower frame: Real Jy  
Auto-corr total-power spectrum Antenna: \*  
Timerange: 00/20:13:31 to 00/20:16:59

Plot file version1125 created 05-OCT-2021 17:10:06

APM08279+525 GM076.UVDATA.1

Freq = 1.5945 GHz, Bw = 32.000 MH

No calibration applied and no bandpass applied

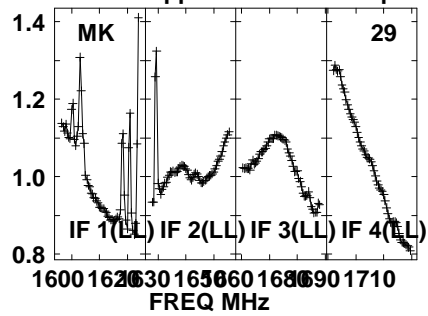
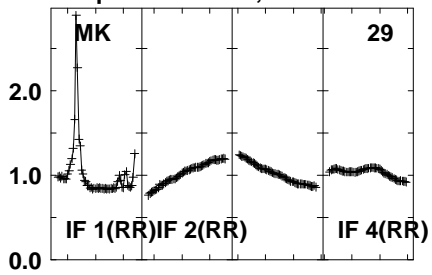

Lower frame: Real Jy

Auto-corr total-power spectrum Antenna: \*

Timerange: 00/20:13:31 to 00/20:16:59

Plot file version1126 created 05-OCT-2021 17:10:06

J0827+5217 GM076.UVDATA.1

Freq = 1.5945 GHz, Bw = 32.000 MH No calibration applied and no bandpass applied

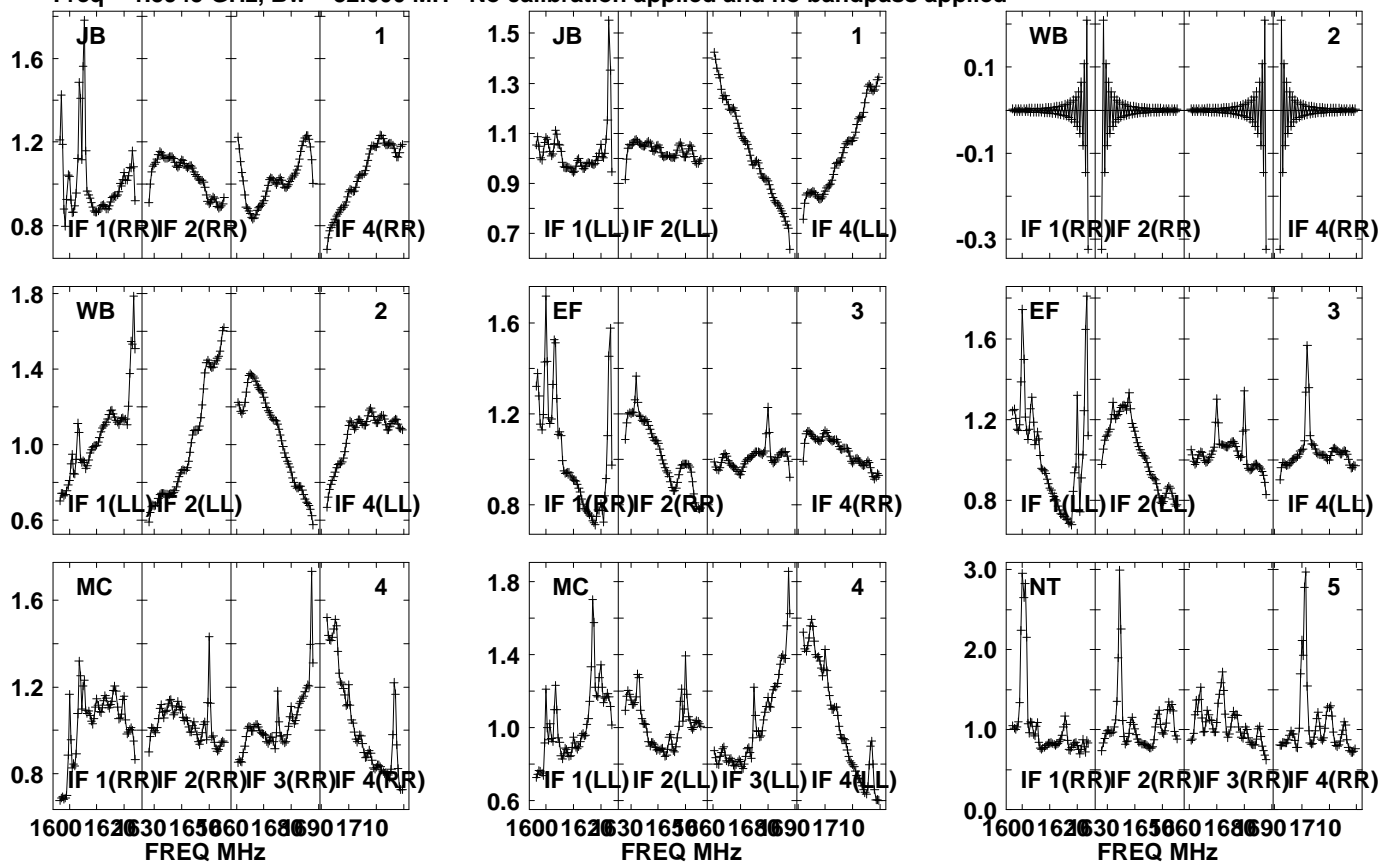

Lower frame: Real Jy  
Auto-corr total-power spectrum Antenna: \*  
Timerange: 00/20:17:31 to 00/20:18:59

Plot file version1127 created 05-OCT-2021 17:10:06

J0827+5217 GM076.UVDATA.1

Freq = 1.5945 GHz, Bw = 32.000 MH No calibration applied and no bandpass applied

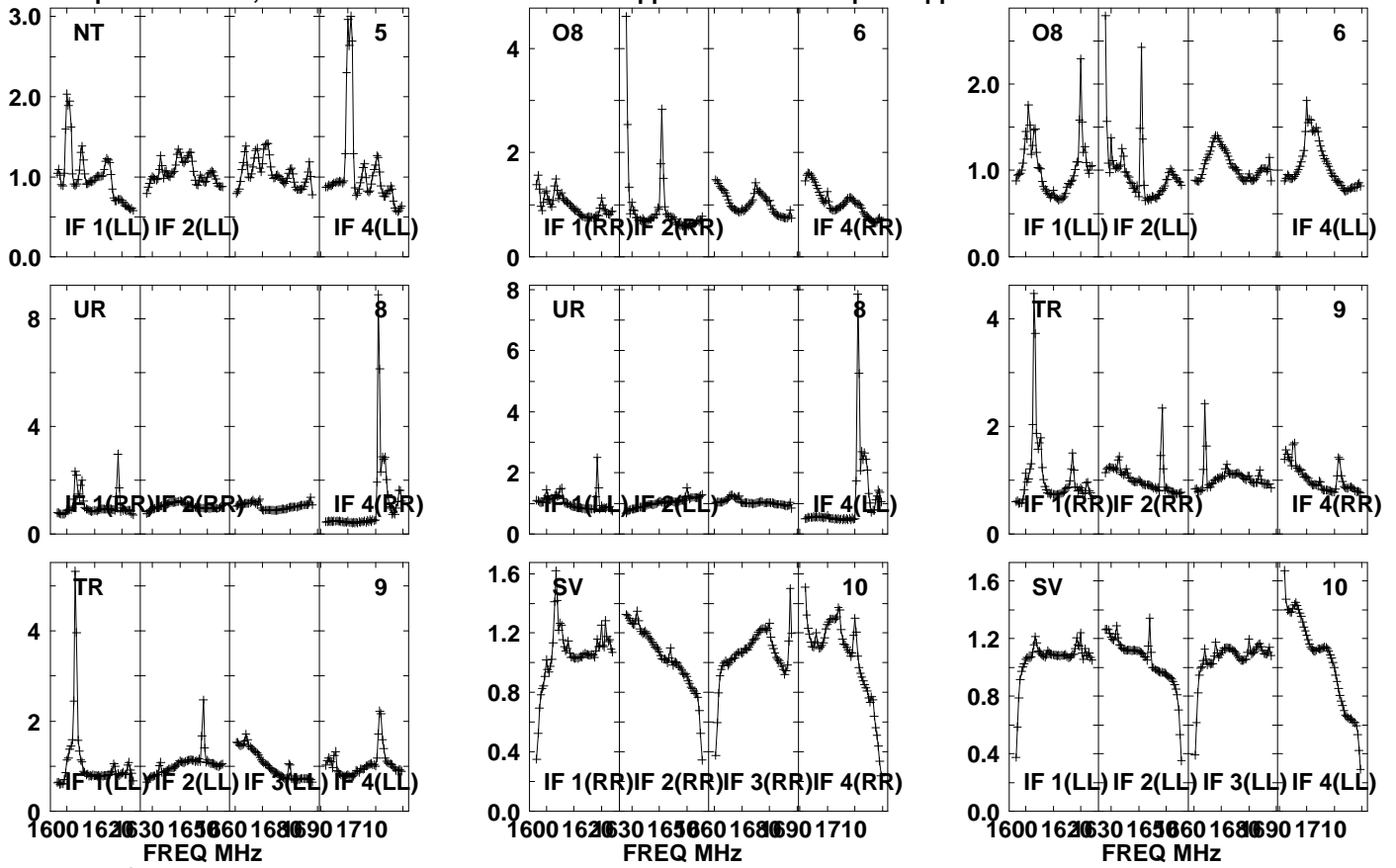

Lower frame: Real Jy  
Auto-corr total-power spectrum Antenna: \*  
Timerange: 00/20:17:31 to 00/20:18:59

Plot file version1128 created 05-OCT-2021 17:10:07

J0827+5217 GM076.UVDATA.1

Freq = 1.5945 GHz, Bw = 32.000 MH No calibration applied and no bandpass applied

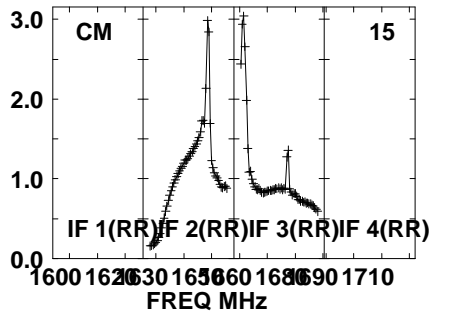
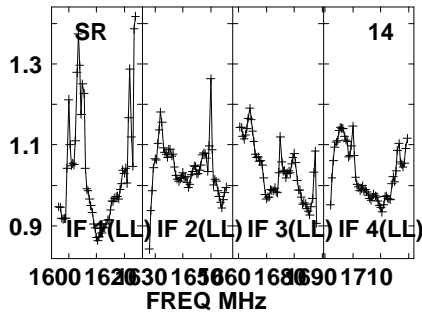
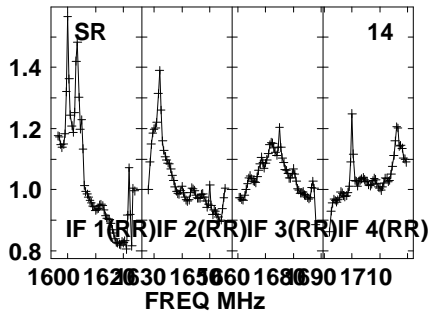
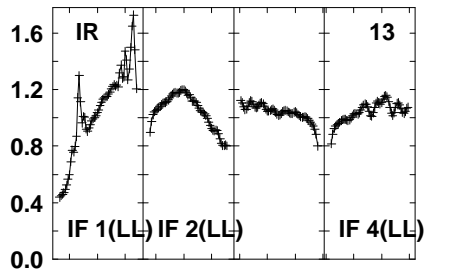
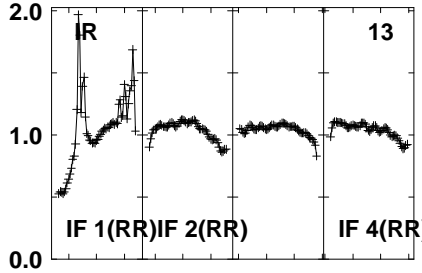
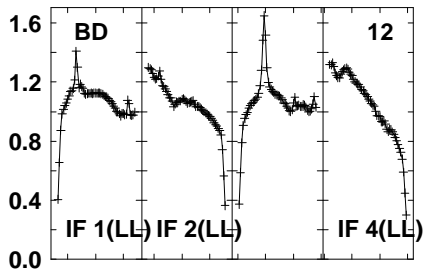
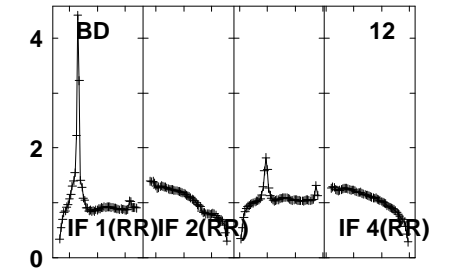
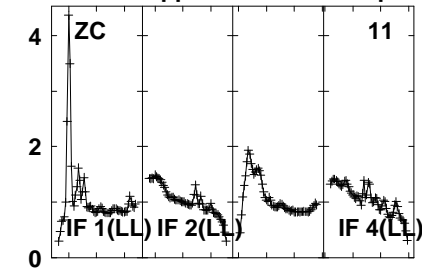
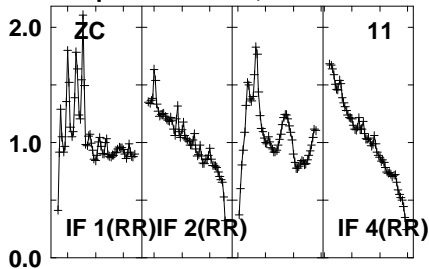

Lower frame: Real Jy

Auto-corr total-power spectrum Antenna: \*

Timerange: 00/20:17:31 to 00/20:18:59

Plot file version1129 created 05-OCT-2021 17:10:07

J0827+5217 GM076.UVDATA.1

Freq = 1.5945 GHz, Bw = 32.000 MH No calibration applied and no bandpass applied

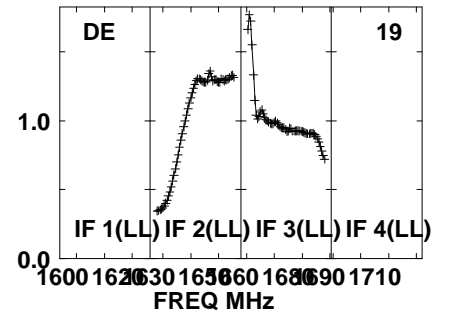
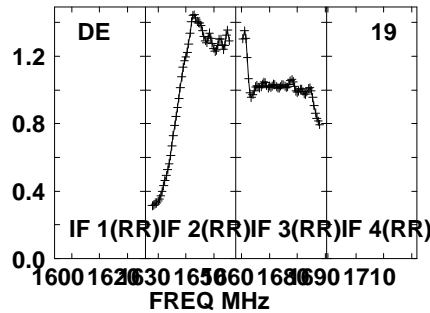
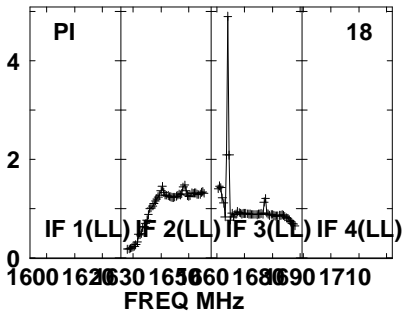
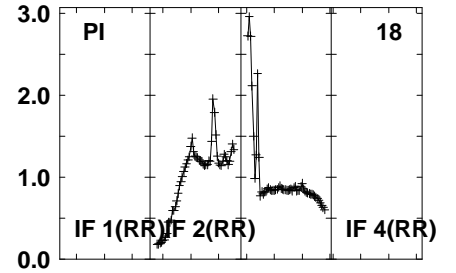
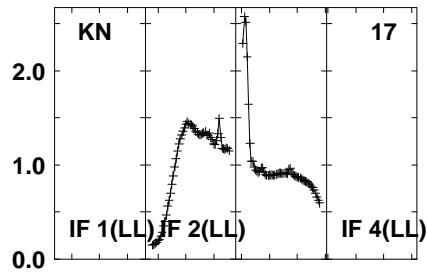
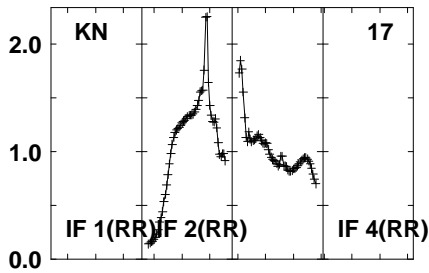
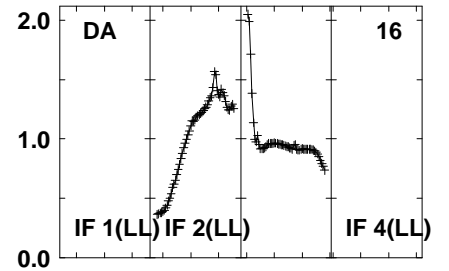
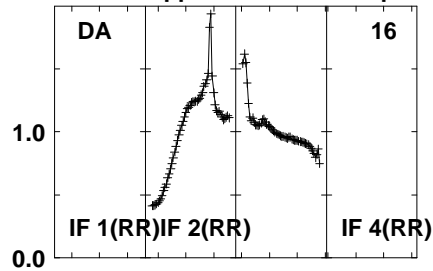
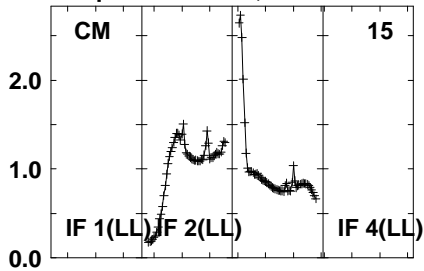

Lower frame: Real Jy  
Auto-corr total-power spectrum Antenna: \*  
Timerange: 00/20:17:31 to 00/20:18:59

Plot file version 1130 created 05-OCT-2021 17:10:08

J0827+5217 GM076.UVDATA.1

Freq = 1.5945 GHz, Bw = 32.000 MH No calibration applied and no bandpass applied

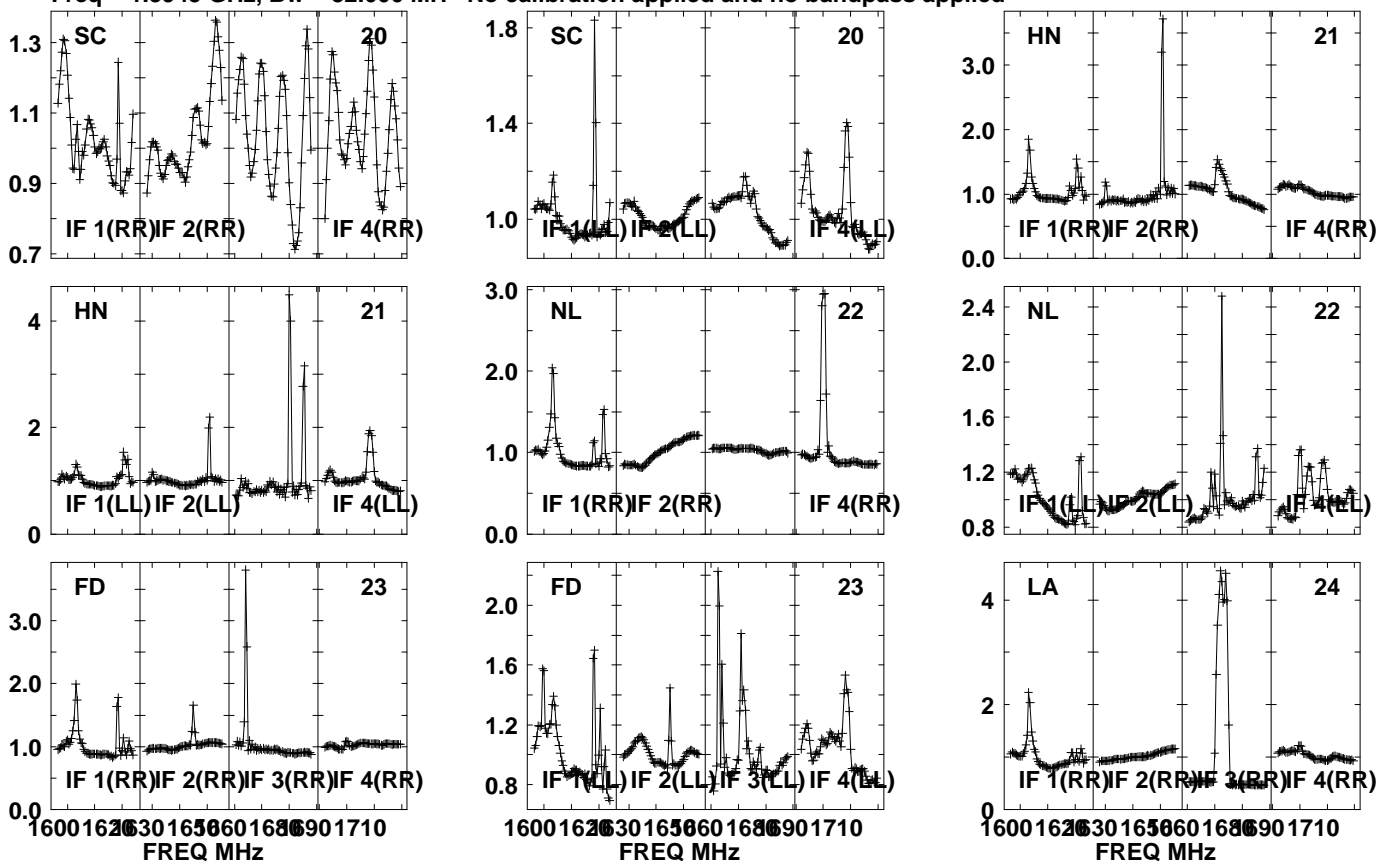

Lower frame: Real Jy  
Auto-corr total-power spectrum Antenna: \*  
Timerange: 00/20:17:31 to 00/20:18:59



Plot file version1131 created 05-OCT-2021 17:10:08

J0827+5217 GM076.UVDATA.1

Freq = 1.5945 GHz, Bw = 32.000 MH No calibration applied and no bandpass applied

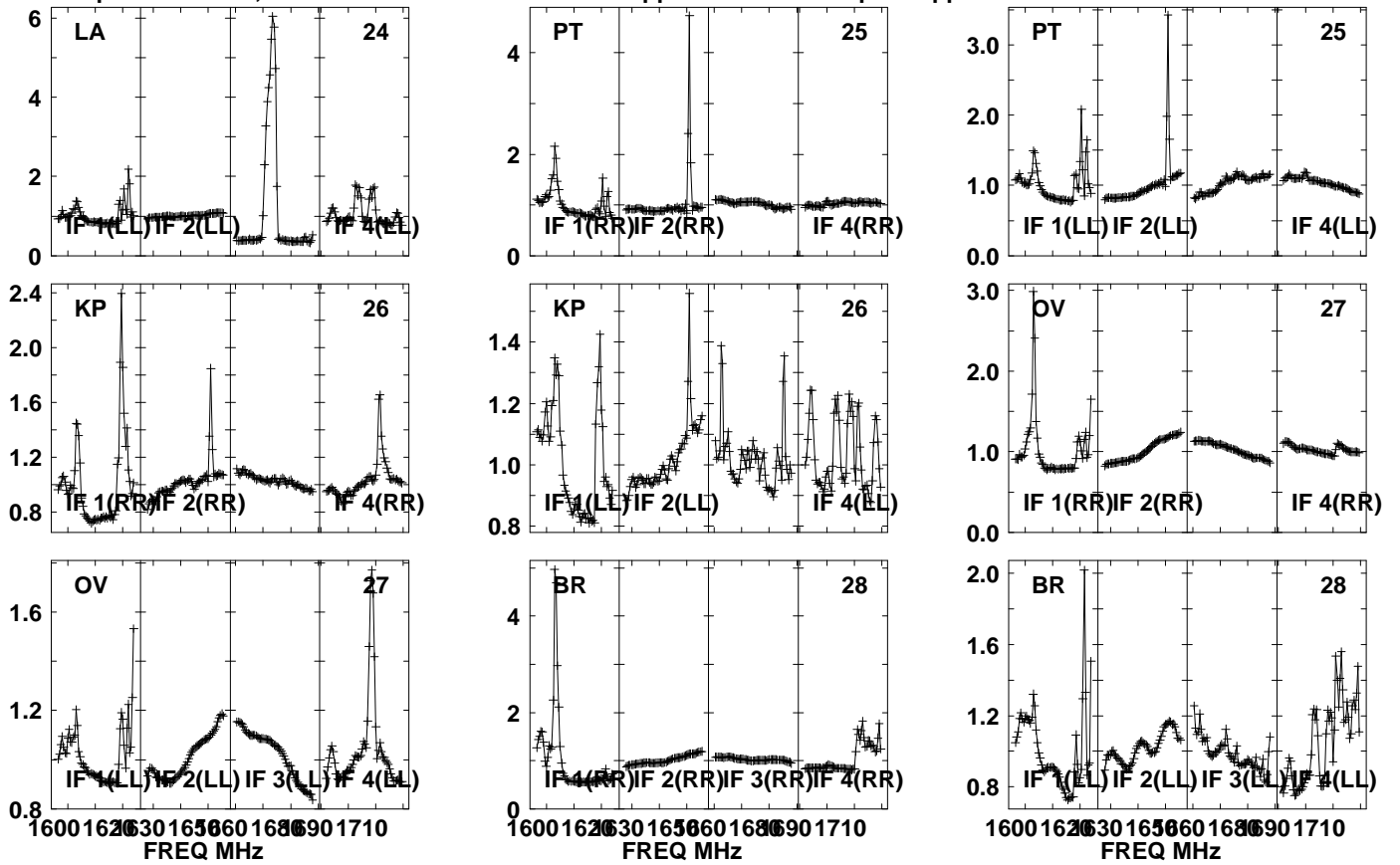

Lower frame: Real Jy  
Auto-corr total-power spectrum Antenna: \*  
Timerange: 00/20:17:31 to 00/20:18:59

Plot file version1132 created 05-OCT-2021 17:10:08

J0827+5217 GM076.UVDATA.1

Freq = 1.5945 GHz, Bw = 32.000 MH

No calibration applied and no bandpass applied

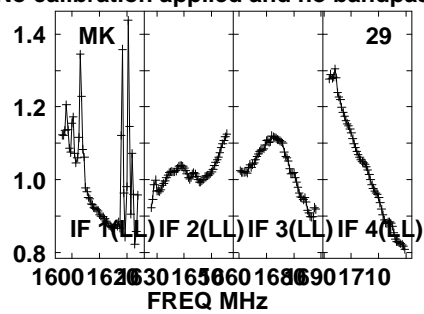
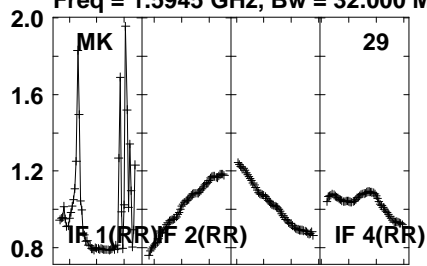

Lower frame: Real Jy  
Auto-corr total-power spectrum Antenna: \*  
Timerange: 00/20:17:31 to 00/20:18:59

Plot file version1133 created 05-OCT-2021 17:10:08

APM08279+525 GM076.UVDATA.1

Freq = 1.5945 GHz, Bw = 32.000 MH No calibration applied and no bandpass applied

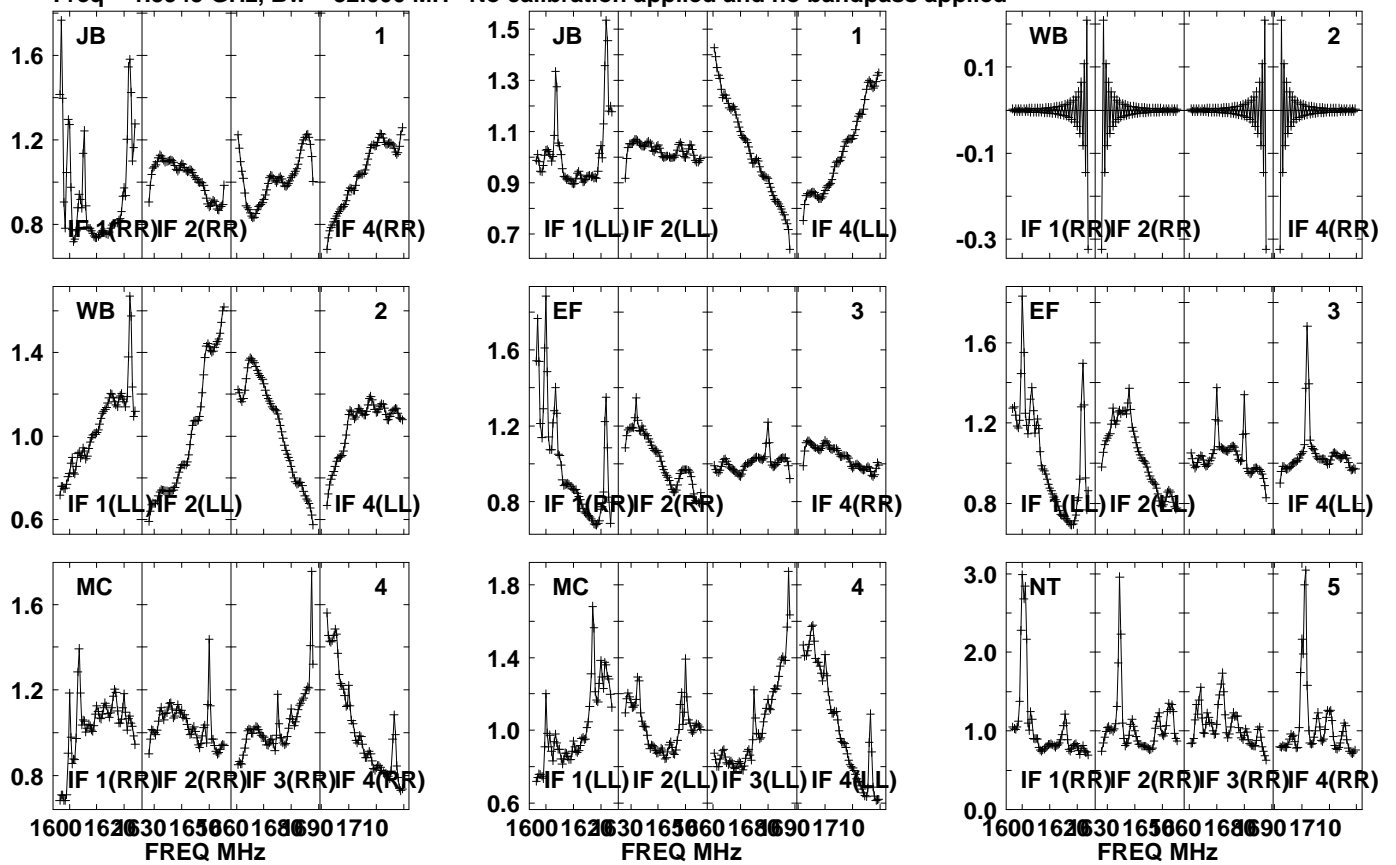

Lower frame: Real Jy  
Auto-corr total-power spectrum Antenna: \*  
Timerange: 00/20:19:01 to 00/20:22:29

Plot file version1134 created 05-OCT-2021 17:10:09

APM08279+525 GM076.UVDATA.1

Freq = 1.5945 GHz, Bw = 32.000 MH No calibration applied and no bandpass applied

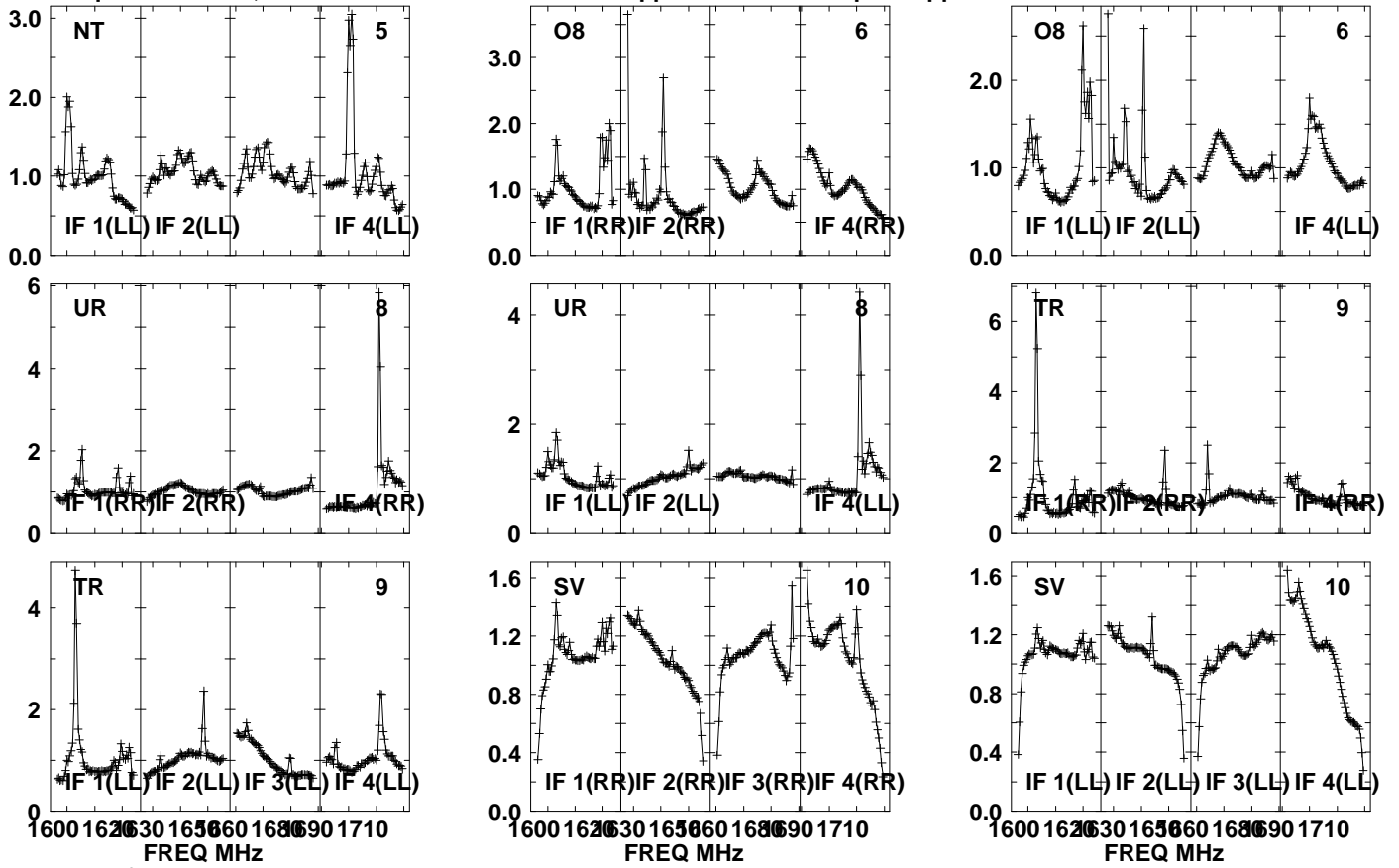

Lower frame: Real Jy

Auto-corr total-power spectrum Antenna: \*

Timerange: 00/20:19:01 to 00/20:22:29

Plot file version1135 created 05-OCT-2021 17:10:09

APM08279+525 GM076.UVDATA.1

Freq = 1.5945 GHz, Bw = 32.000 MH No calibration applied and no bandpass applied

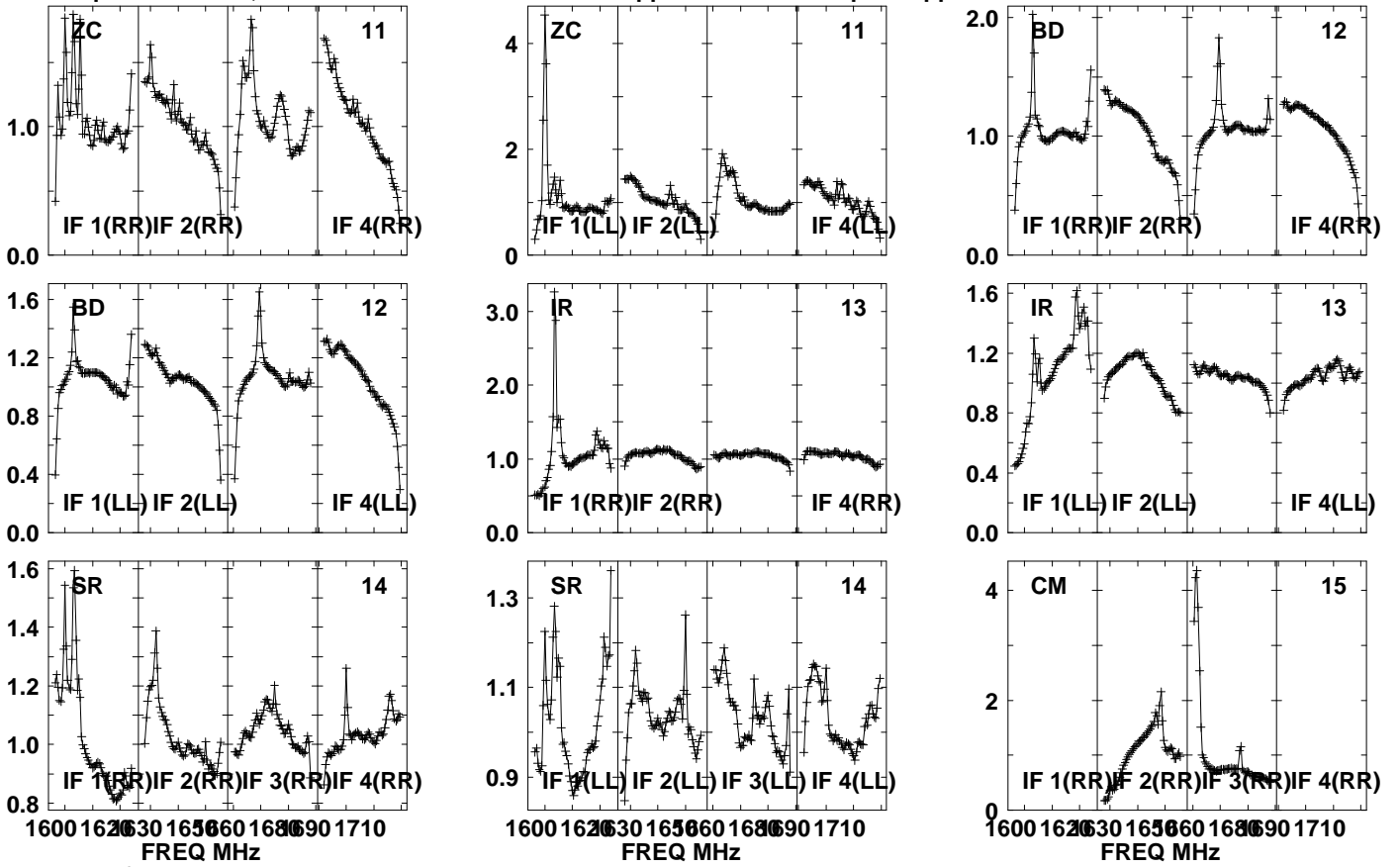

Lower frame: Real Jy  
Auto-corr total-power spectrum Antenna: \*  
Timerange: 00/20:19:01 to 00/20:22:29

Plot file version1136 created 05-OCT-2021 17:10:10

APM08279+525 GM076.UVDATA.1

Freq = 1.5945 GHz, Bw = 32.000 MH No calibration applied and no bandpass applied

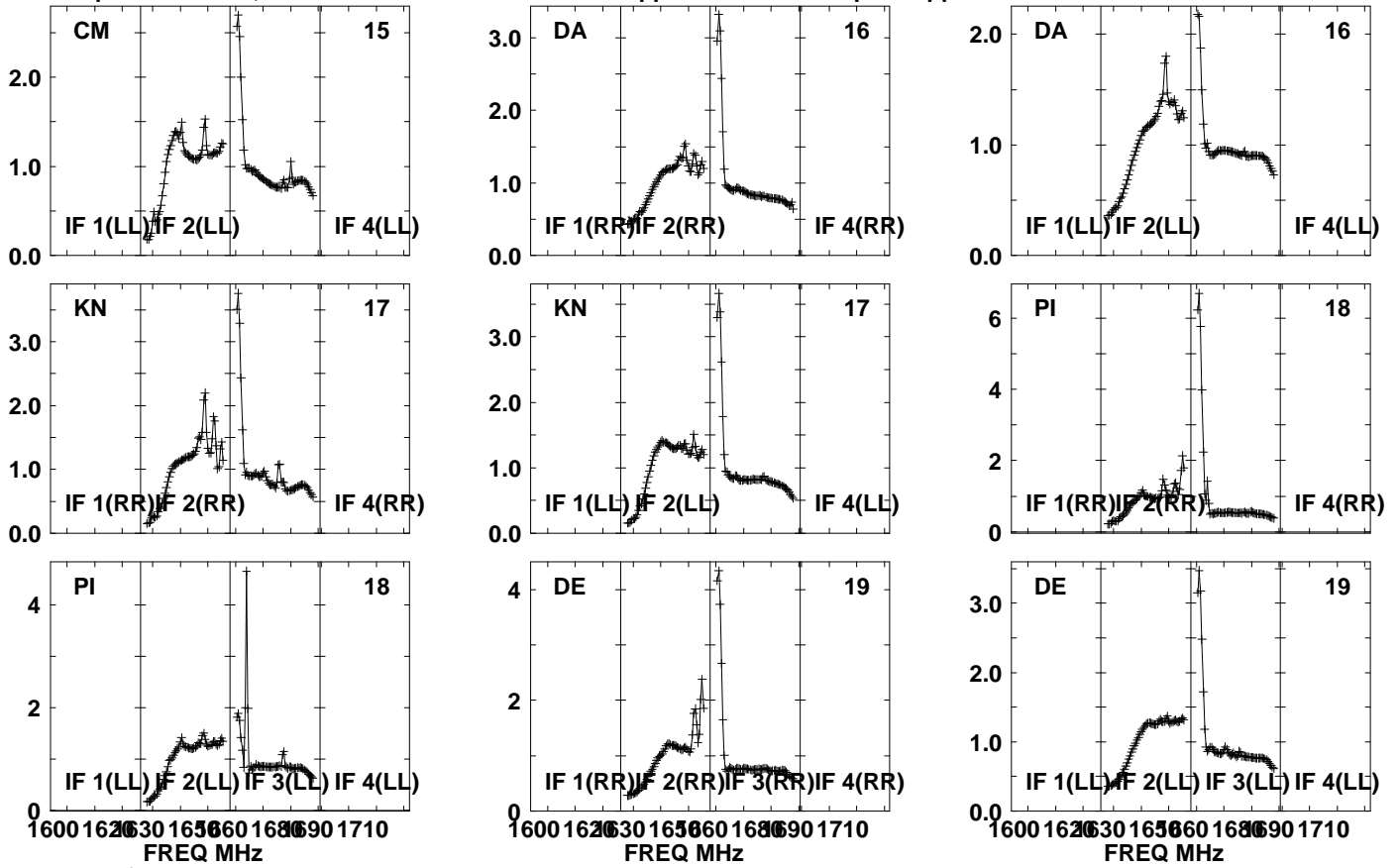

Lower frame: Real Jy

Auto-corr total-power spectrum Antenna: \*

Timerange: 00/20:19:01 to 00/20:22:29

Plot file version 1137 created 05-OCT-2021 17:10:10

APM08279+525 GM076.UVDATA.1

Freq = 1.5945 GHz, Bw = 32.000 MH No calibration applied and no bandpass applied

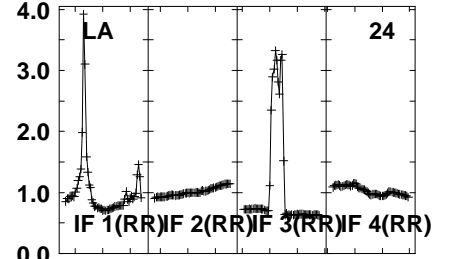
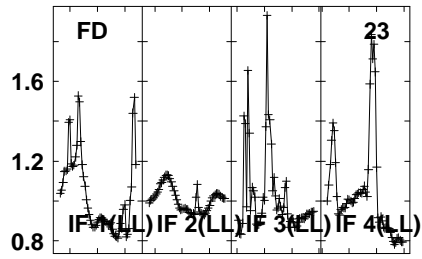
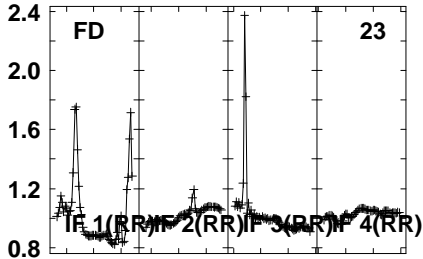
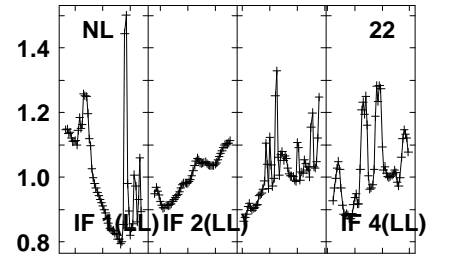
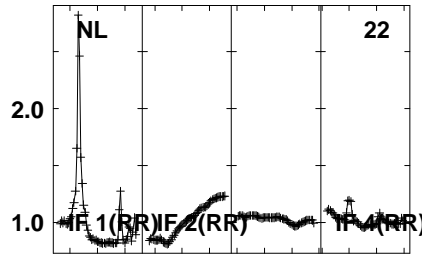
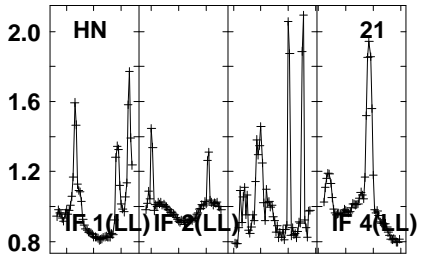
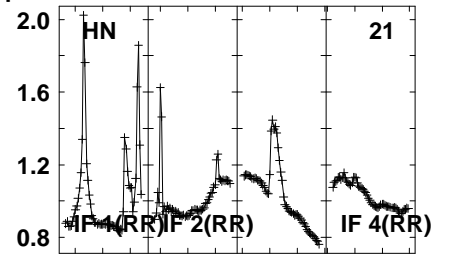
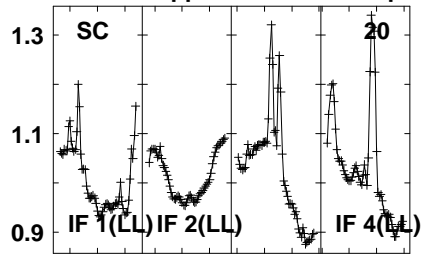
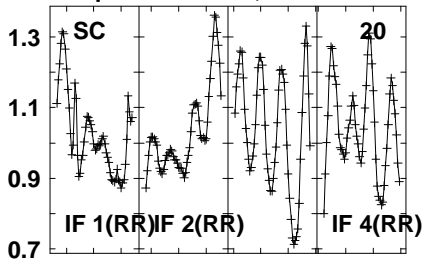

1600 1620 1630 1650 1660 1680 1690 1710  
FREQ MHz

1600 1620 1630 1650 1660 1680 1690 1710  
FREQ MHz

1600 1620 1630 1650 1660 1680 1690 1710  
FREQ MHz

Lower frame: Real Jy  
Auto-corr total-power spectrum Antenna: \*  
Timerange: 00/20:19:01 to 00/20:22:29

Plot file version1138 created 05-OCT-2021 17:10:10

APM08279+525 GM076.UVDATA.1

Freq = 1.5945 GHz, Bw = 32.000 MH No calibration applied and no bandpass applied

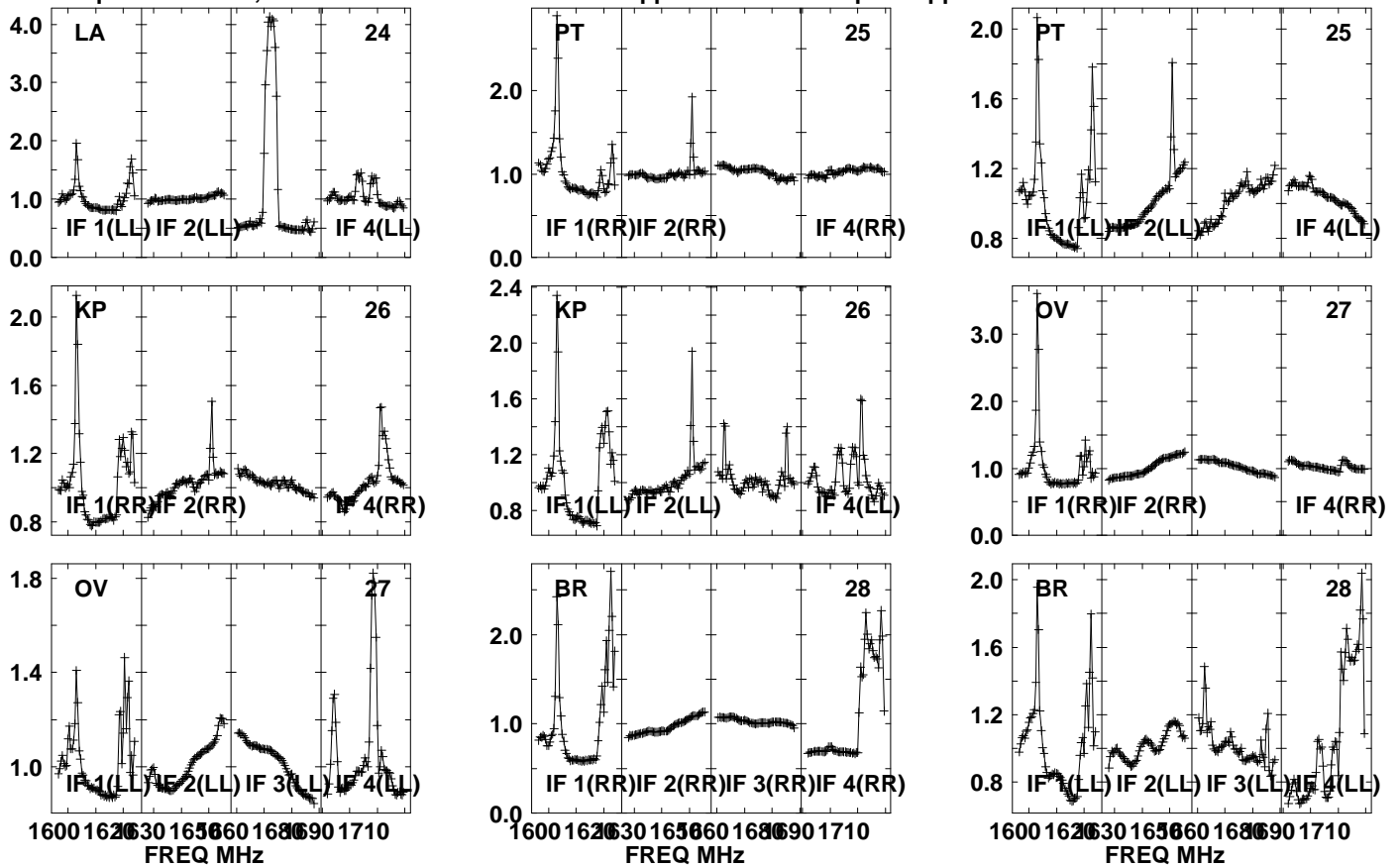

Lower frame: Real Jy

Auto-corr total-power spectrum Antenna: \*

Timerange: 00/20:19:01 to 00/20:22:29



Plot file version1139 created 05-OCT-2021 17:10:11

APM08279+525 GM076.UVDATA.1

Freq = 1.5945 GHz, Bw = 32.000 MH No calibration applied and no bandpass applied

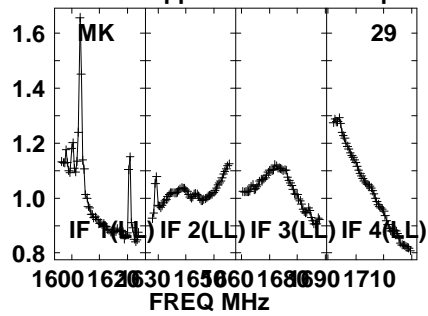
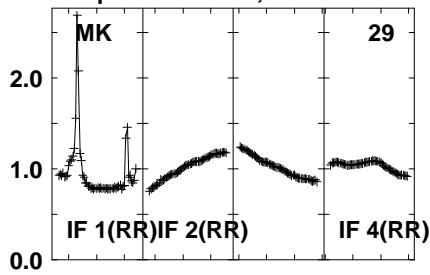

Lower frame: Real Jy

Auto-corr total-power spectrum Antenna: \*

Timerange: 00/20:19:01 to 00/20:22:29

Plot file version1140 created 05-OCT-2021 17:10:11

J0827+5217 GM076.UVDATA.1

Freq = 1.5945 GHz, Bw = 32.000 MH No calibration applied and no bandpass applied

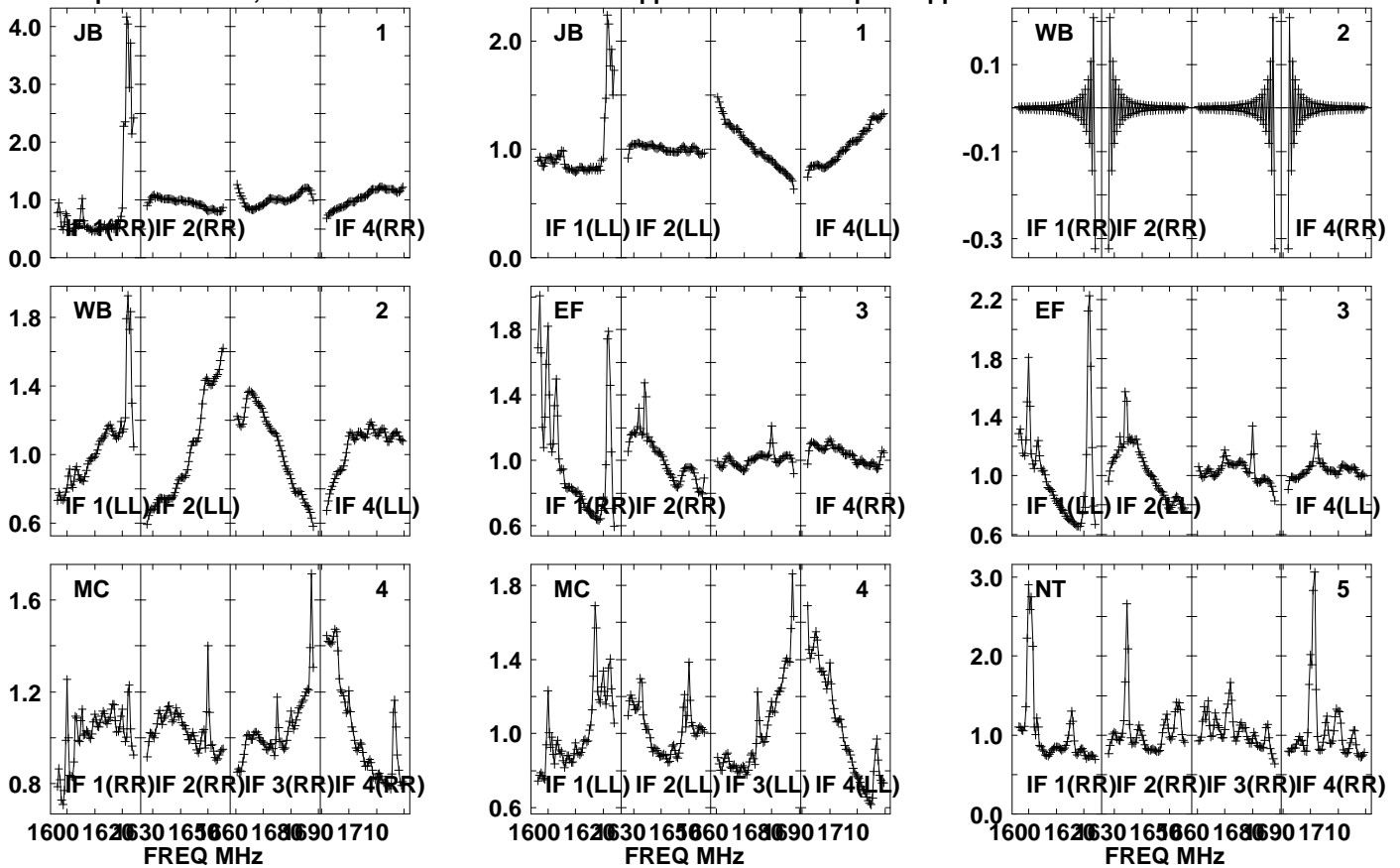

Lower frame: Real Jy

Auto-corr total-power spectrum Antenna: \*

Timerange: 00/20:22:31 to 00/20:23:59

Plot file version1141 created 05-OCT-2021 17:10:11

J0827+5217 GM076.UVDATA.1

Freq = 1.5945 GHz, Bw = 32.000 MH No calibration applied and no bandpass applied

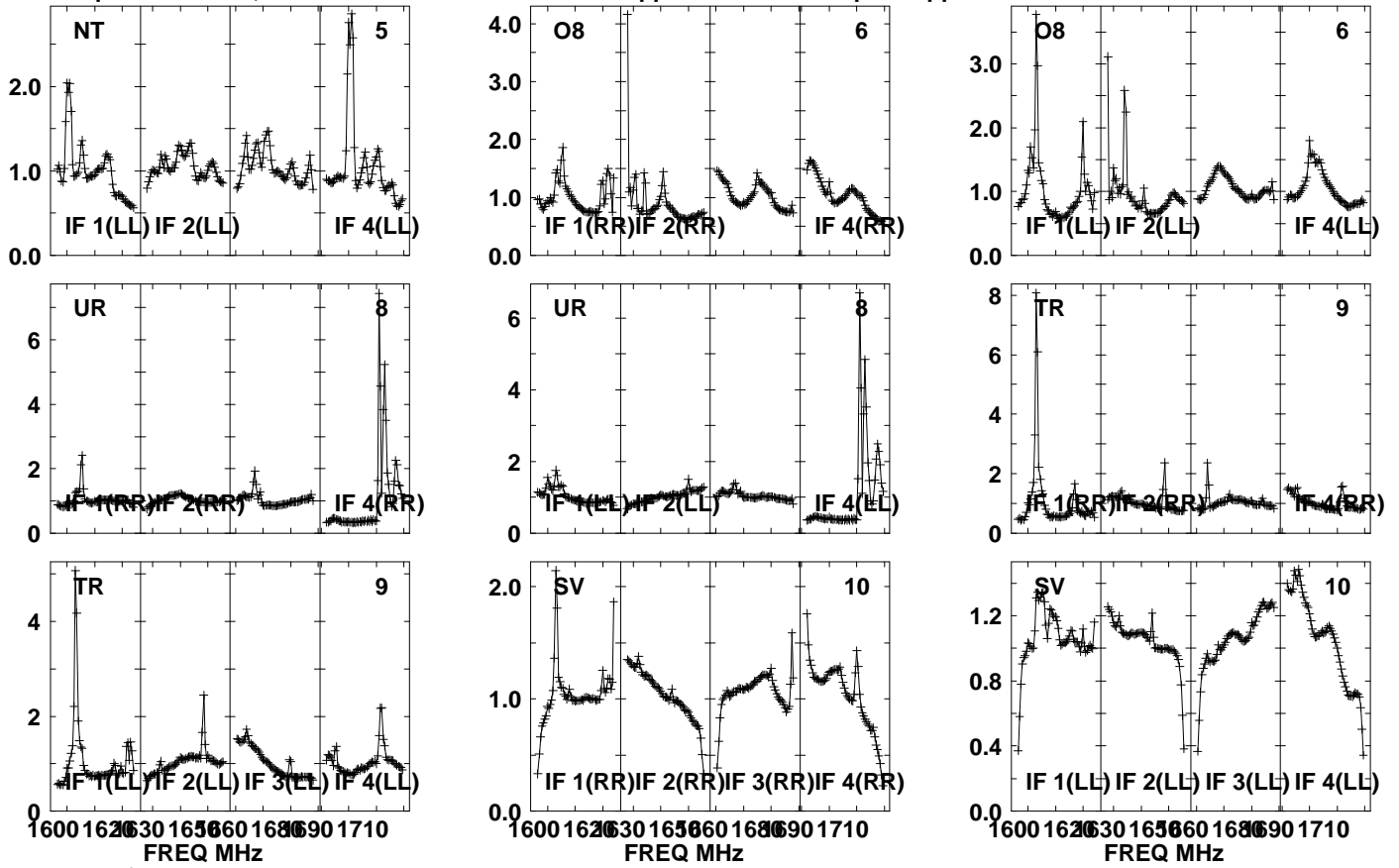

Lower frame: Real Jy

Auto-corr total-power spectrum Antenna: \*

Timerange: 00/20:22:31 to 00/20:23:59

Plot file version1142 created 05-OCT-2021 17:10:11

J0827+5217 GM076.UVDATA.1

Freq = 1.5945 GHz, Bw = 32.000 MH No calibration applied and no bandpass applied

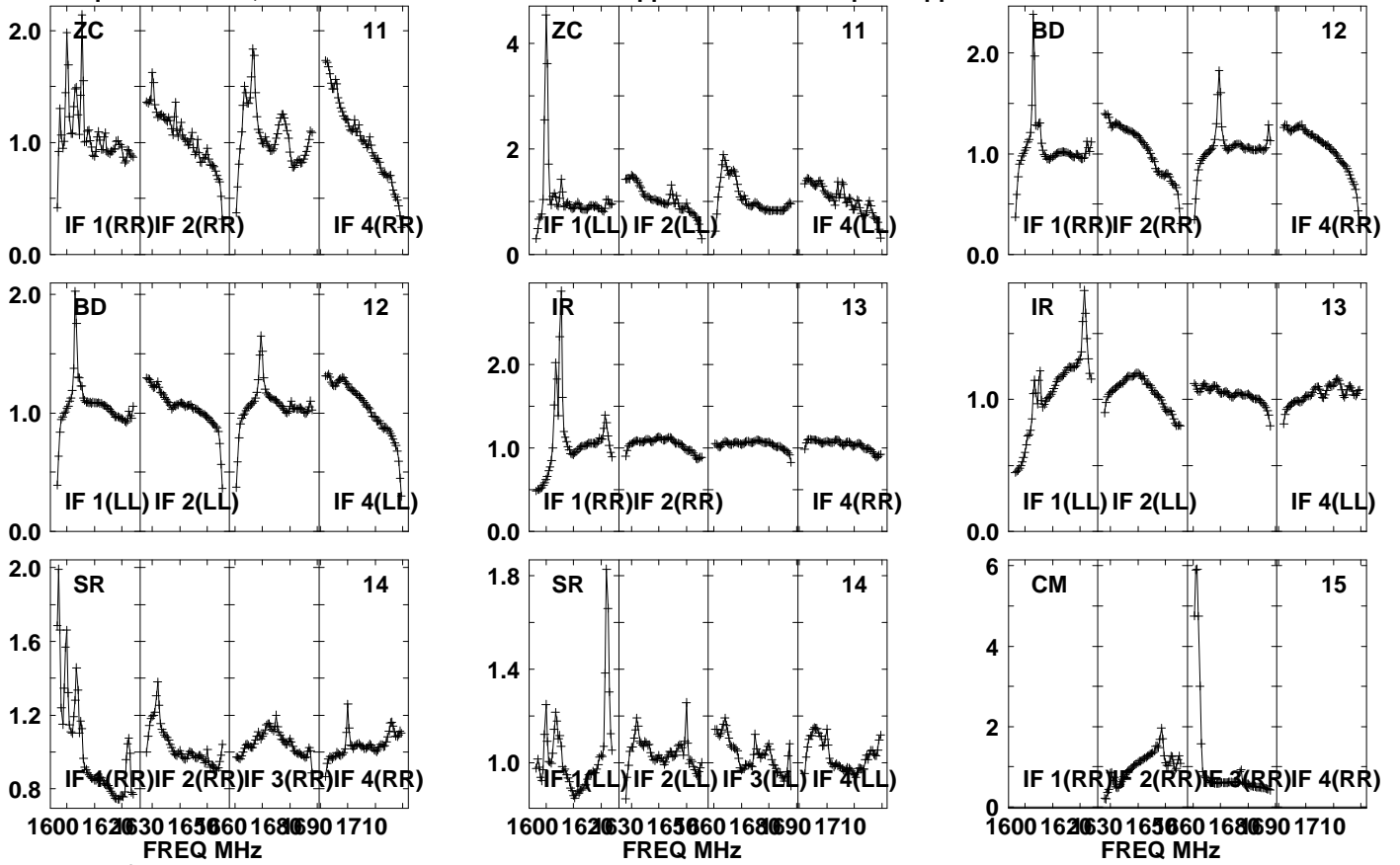

Lower frame: Real Jy  
Auto-corr total-power spectrum Antenna: \*  
Timerange: 00/20:22:31 to 00/20:23:59

Plot file version1143 created 05-OCT-2021 17:10:12

J0827+5217 GM076.UVDATA.1

Freq = 1.5945 GHz, Bw = 32.000 MH No calibration applied and no bandpass applied

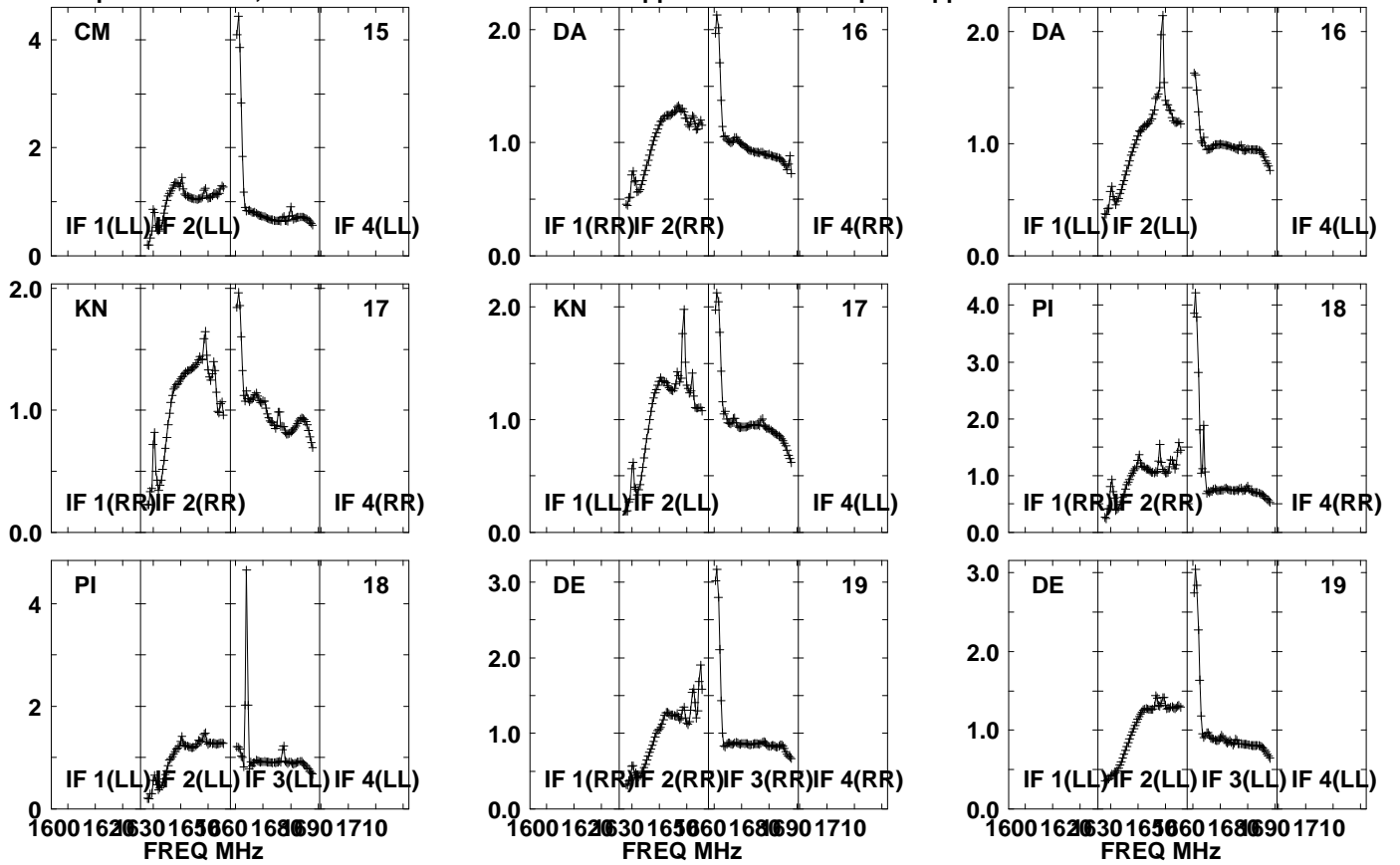

Lower frame: Real Jy

Auto-corr total-power spectrum Antenna: \*

Timerange: 00/20:22:31 to 00/20:23:59

Plot file version1144 created 05-OCT-2021 17:10:12

J0827+5217 GM076.UVDATA.1

Freq = 1.5945 GHz, Bw = 32.000 MH No calibration applied and no bandpass applied

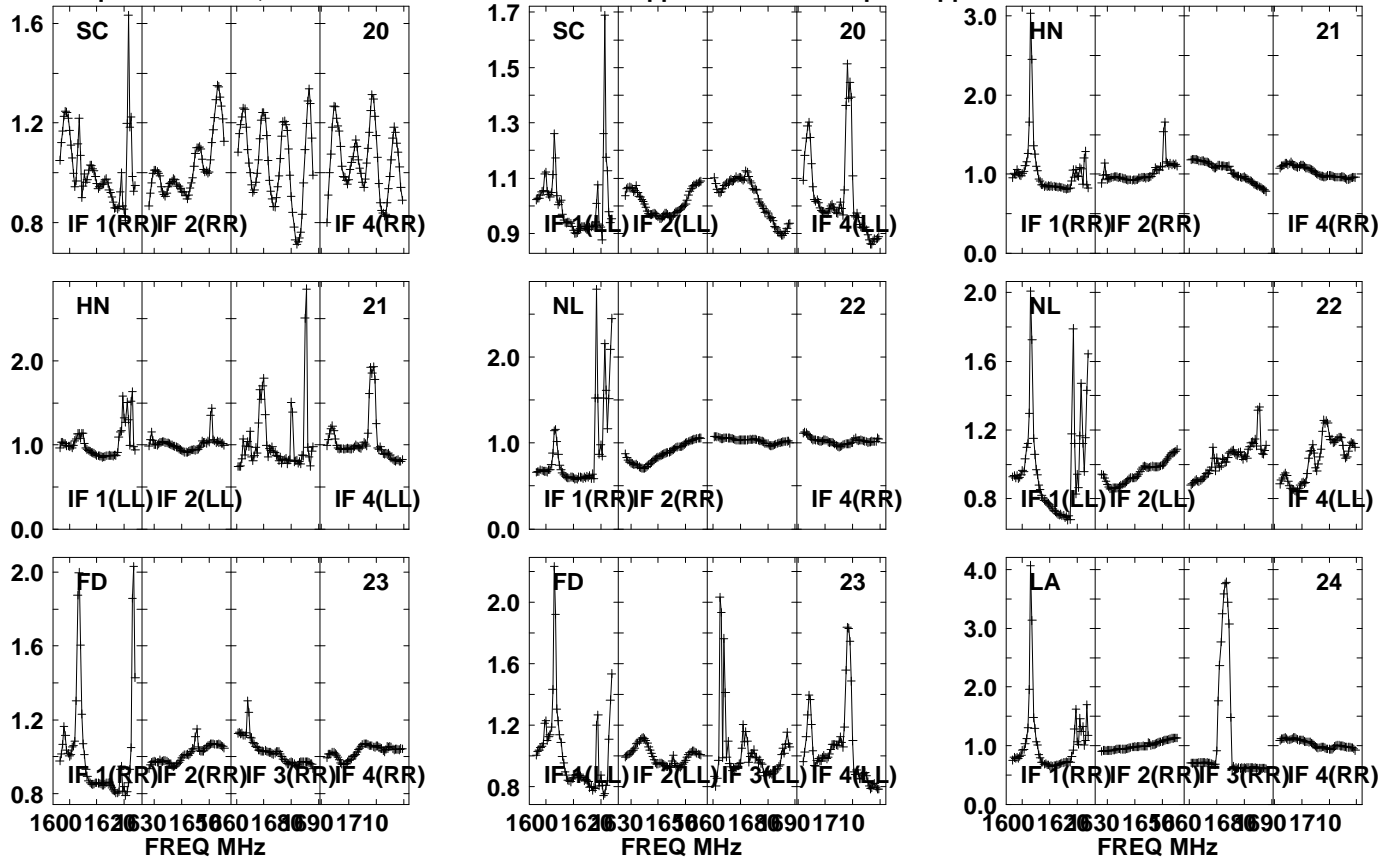

Lower frame: Real Jy  
Auto-corr total-power spectrum Antenna: \*  
Timerange: 00/20:22:31 to 00/20:23:59

Plot file version1145 created 05-OCT-2021 17:10:12

J0827+5217 GM076.UVDATA.1

Freq = 1.5945 GHz, Bw = 32.000 MH No calibration applied and no bandpass applied

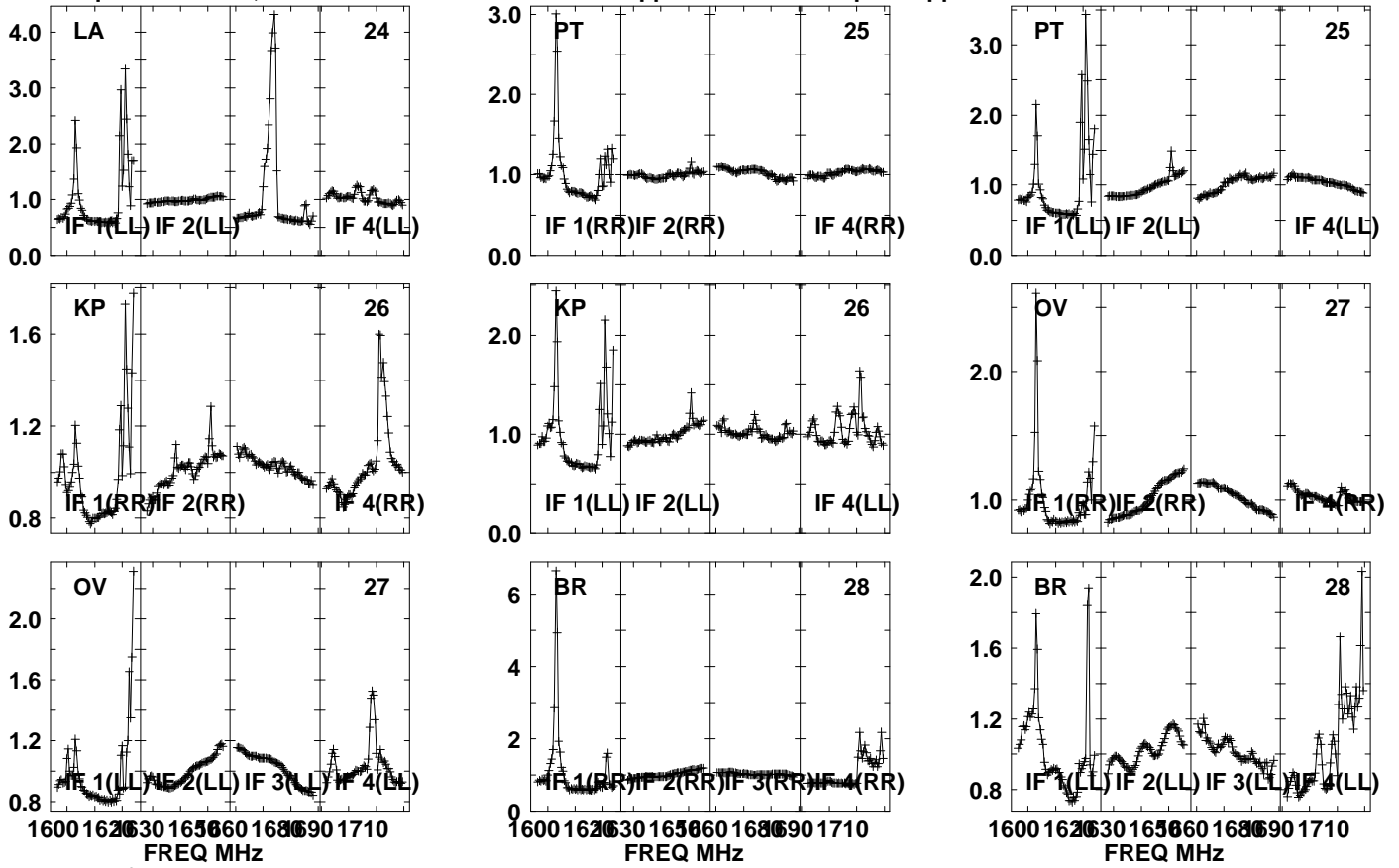

Lower frame: Real Jy  
Auto-corr total-power spectrum Antenna: \*  
Timerange: 00/20:22:31 to 00/20:23:59

Plot file version1146 created 05-OCT-2021 17:10:13

J0827+5217 GM076.UVDATA.1

Freq = 1.5945 GHz, Bw = 32.000 MH

No calibration applied and no bandpass applied

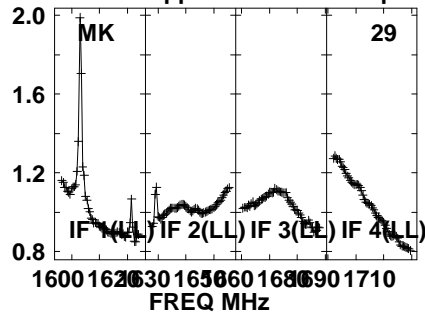
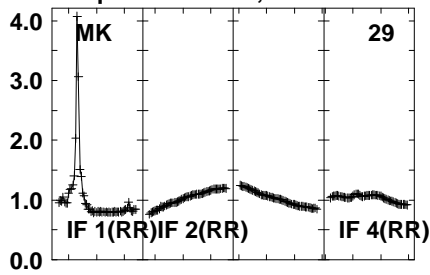

Lower frame: Real Jy

Auto-corr total-power spectrum Antenna: \*

Timerange: 00/20:22:31 to 00/20:23:59



Plot file version 1147 created 05-OCT-2021 17:10:13

APM08279+525 GM076.UVDATA.1

Freq = 1.5945 GHz, Bw = 32.000 MH No calibration applied and no bandpass applied

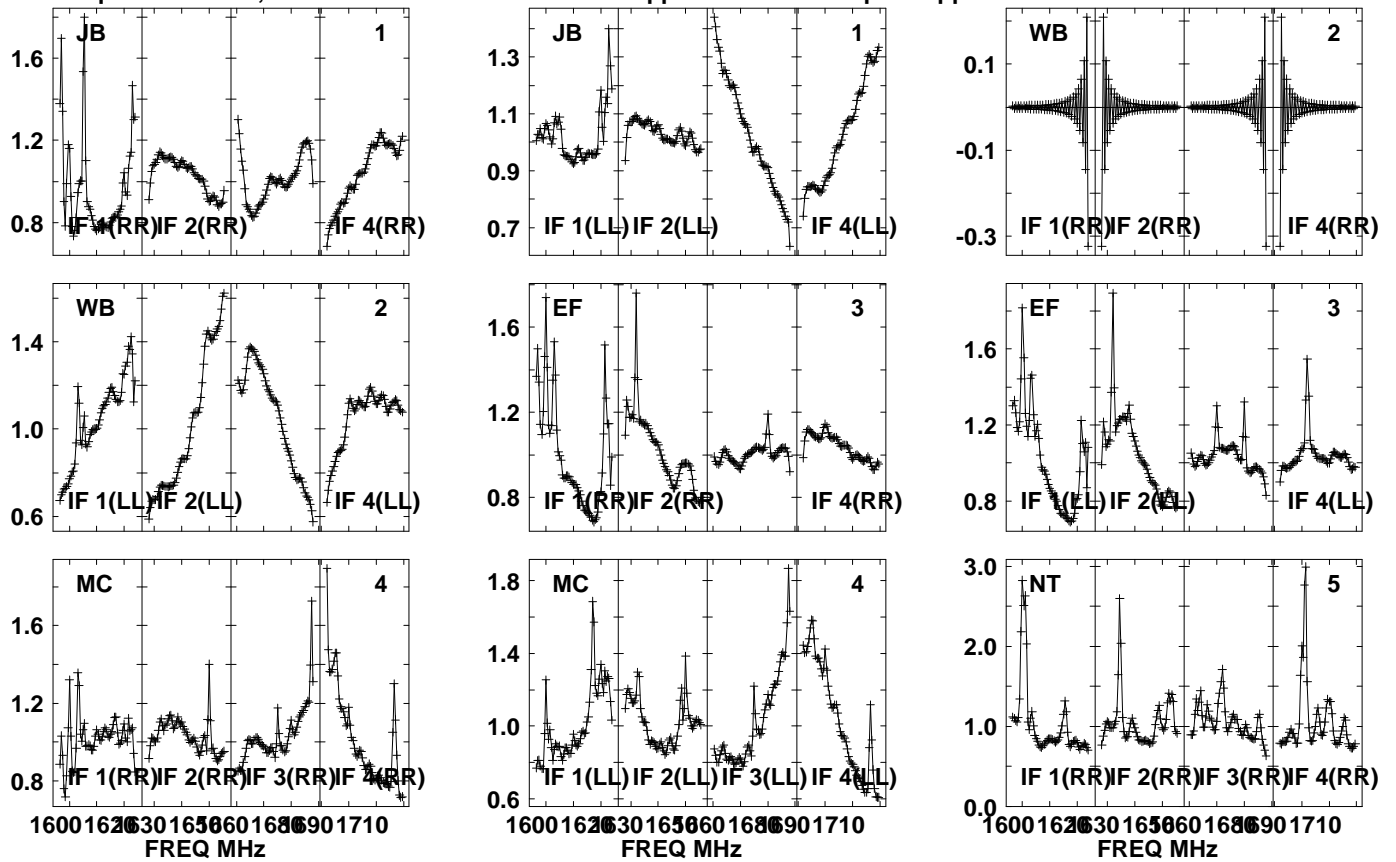

Lower frame: Real Jy  
Auto-corr total-power spectrum Antenna: \*  
Timerange: 00/20:24:01 to 00/20:27:29

Plot file version1148 created 05-OCT-2021 17:10:13

APM08279+525 GM076.UVDATA.1

Freq = 1.5945 GHz, Bw = 32.000 MH No calibration applied and no bandpass applied

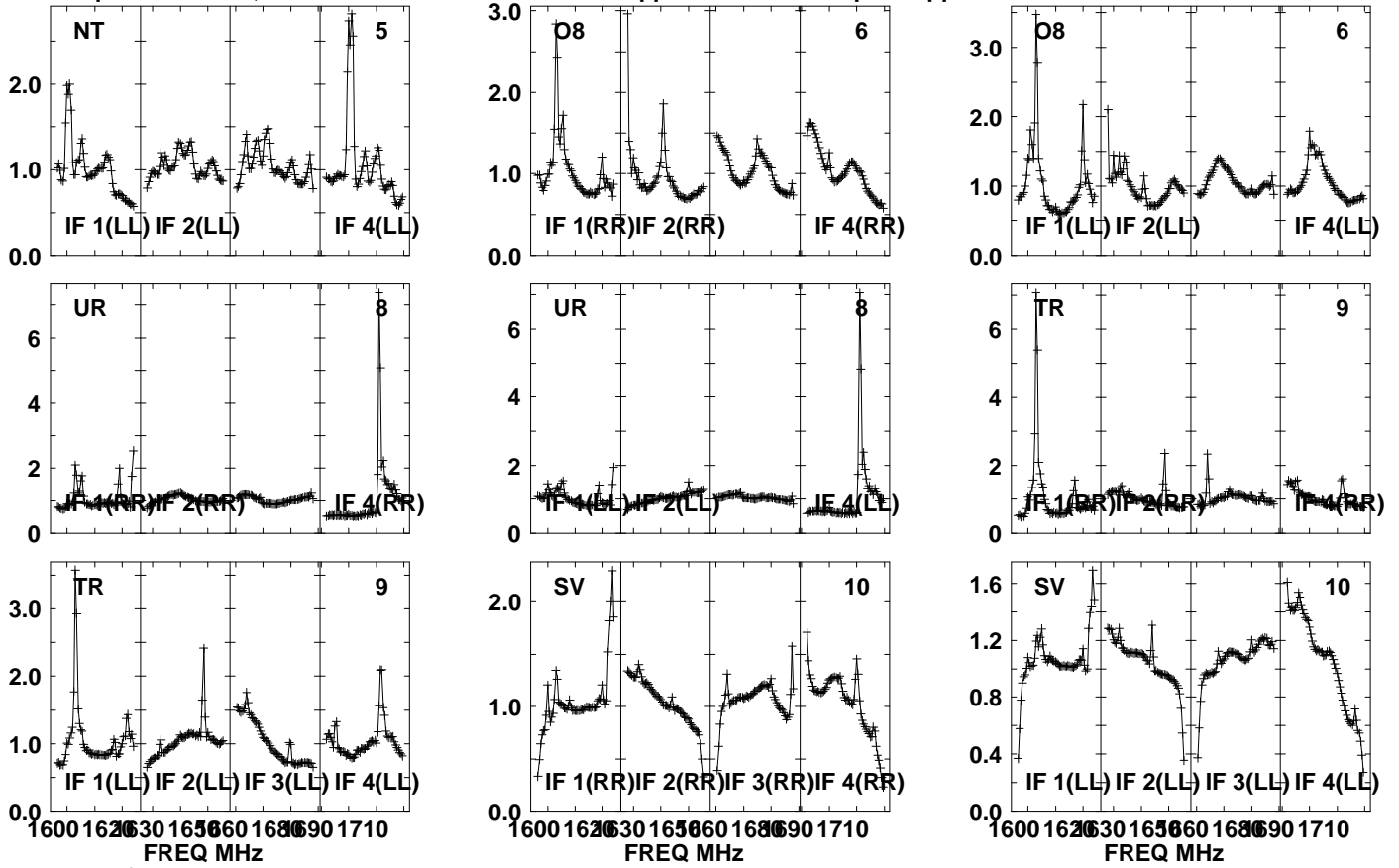

Lower frame: Real Jy

Auto-corr total-power spectrum Antenna: \*

Timerange: 00/20:24:01 to 00/20:27:29

Plot file version1149 created 05-OCT-2021 17:10:14

APM08279+525 GM076.UVDATA.1

Freq = 1.5945 GHz, Bw = 32.000 MH No calibration applied and no bandpass applied

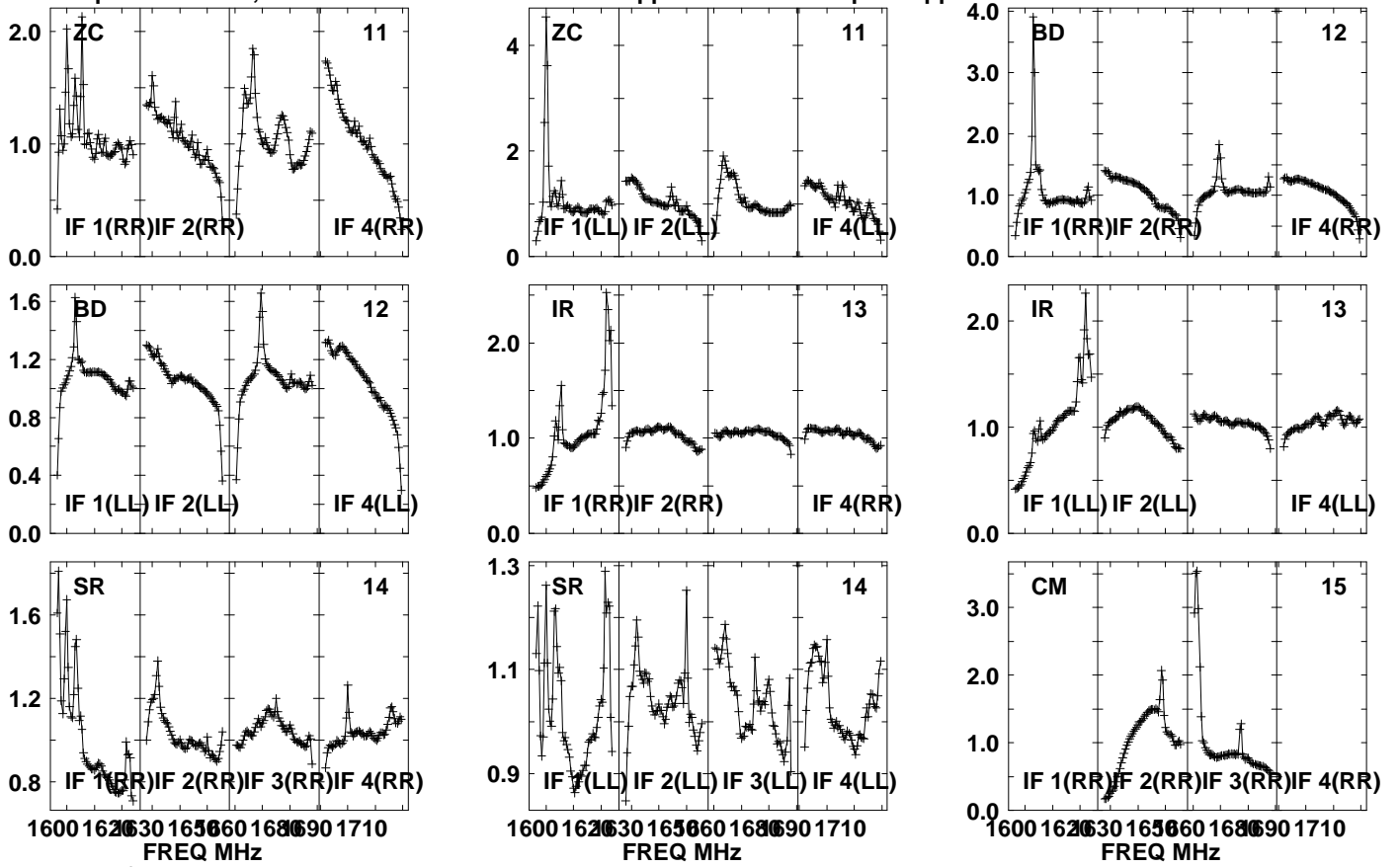

Lower frame: Real Jy  
Auto-corr total-power spectrum Antenna: \*  
Timerange: 00/20:24:01 to 00/20:27:29

Plot file version1150 created 05-OCT-2021 17:10:14

APM08279+525 GM076.UVDATA.1

Freq = 1.5945 GHz, Bw = 32.000 MH No calibration applied and no bandpass applied

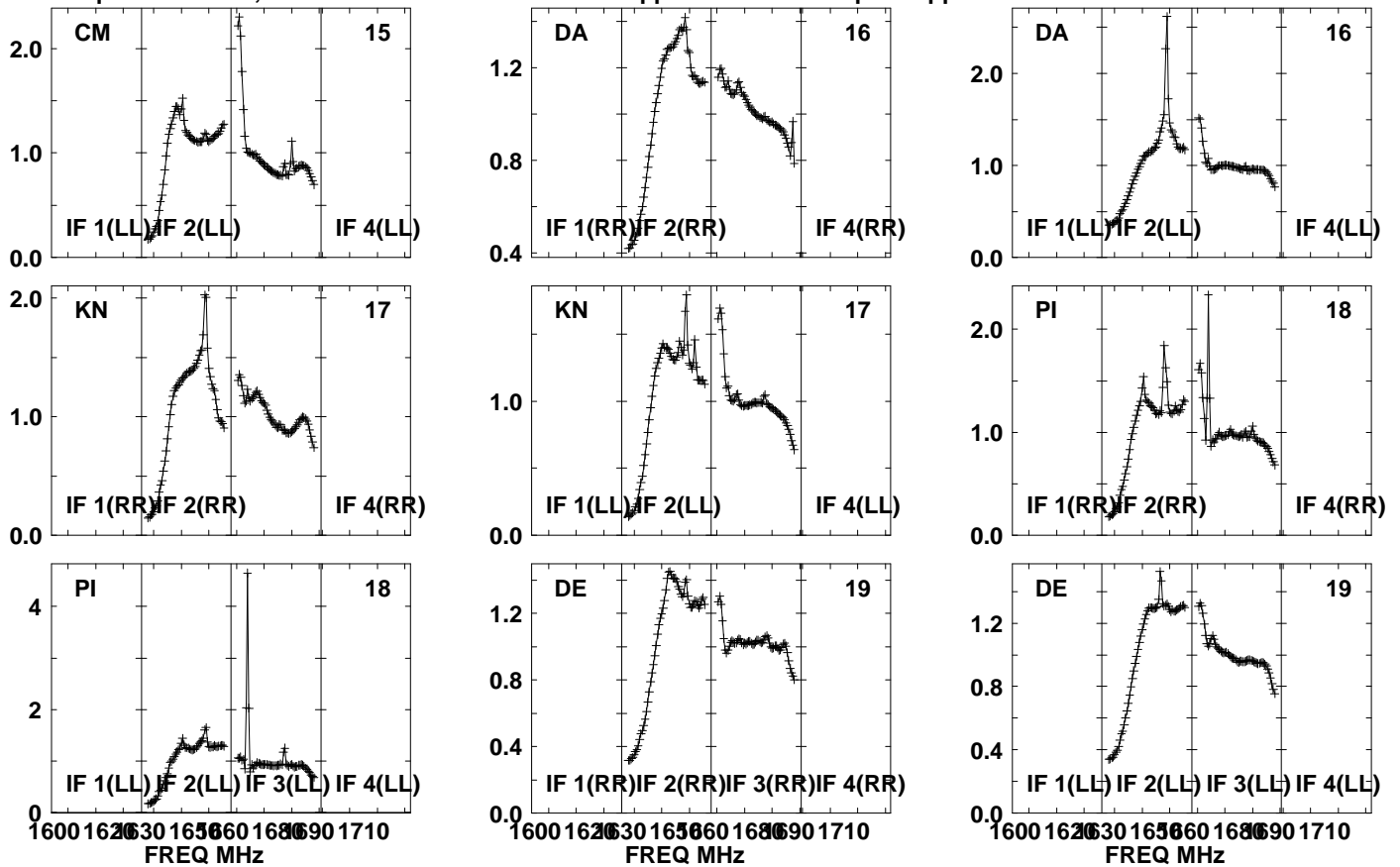

Lower frame: Real Jy

Auto-corr total-power spectrum Antenna: \*

Timerange: 00/20:24:01 to 00/20:27:29

Plot file version 1151 created 05-OCT-2021 17:10:14

APM08279+525 GM076.UVDATA.1

Freq = 1.5945 GHz, Bw = 32.000 MH No calibration applied and no bandpass applied

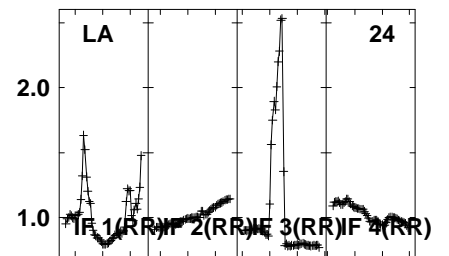
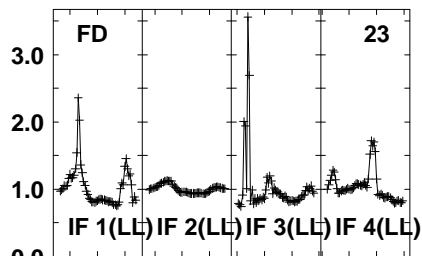
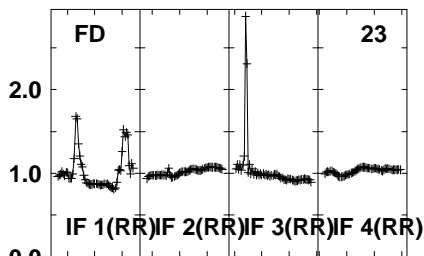
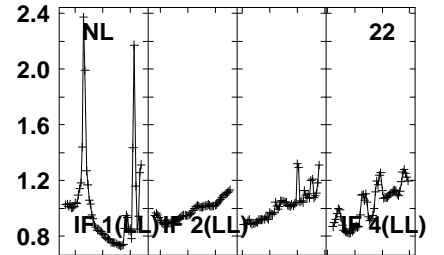
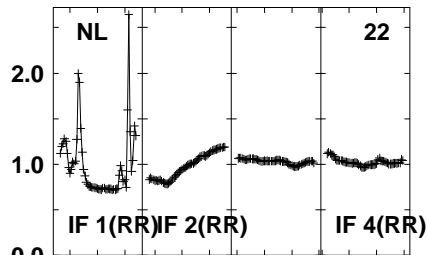
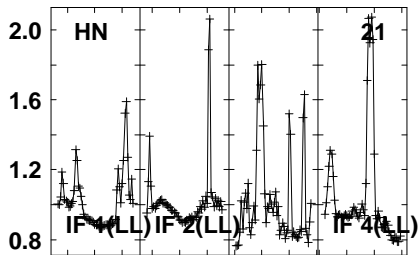
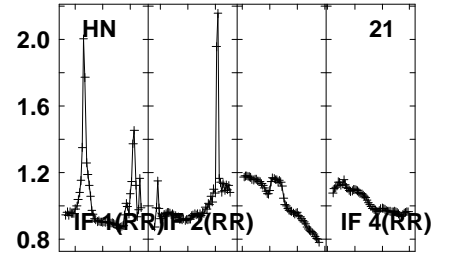
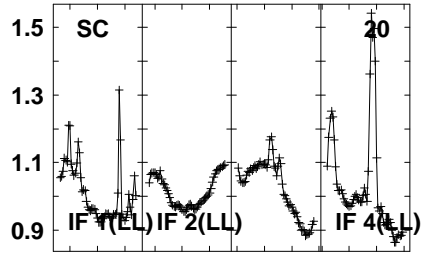
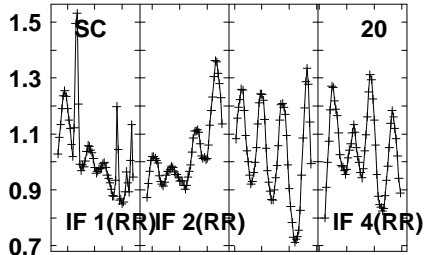

1600 1620 1630 1650 1660 1680 1690 1710  
FREQ MHz

1600 1620 1630 1650 1660 1680 1690 1710  
FREQ MHz

1600 1620 1630 1650 1660 1680 1690 1710  
FREQ MHz

Lower frame: Real Jy  
Auto-corr total-power spectrum Antenna: \*  
Timerange: 00/20:24:01 to 00/20:27:29

Plot file version1152 created 05-OCT-2021 17:10:15

APM08279+525 GM076.UVDATA.1

Freq = 1.5945 GHz, Bw = 32.000 MH No calibration applied and no bandpass applied

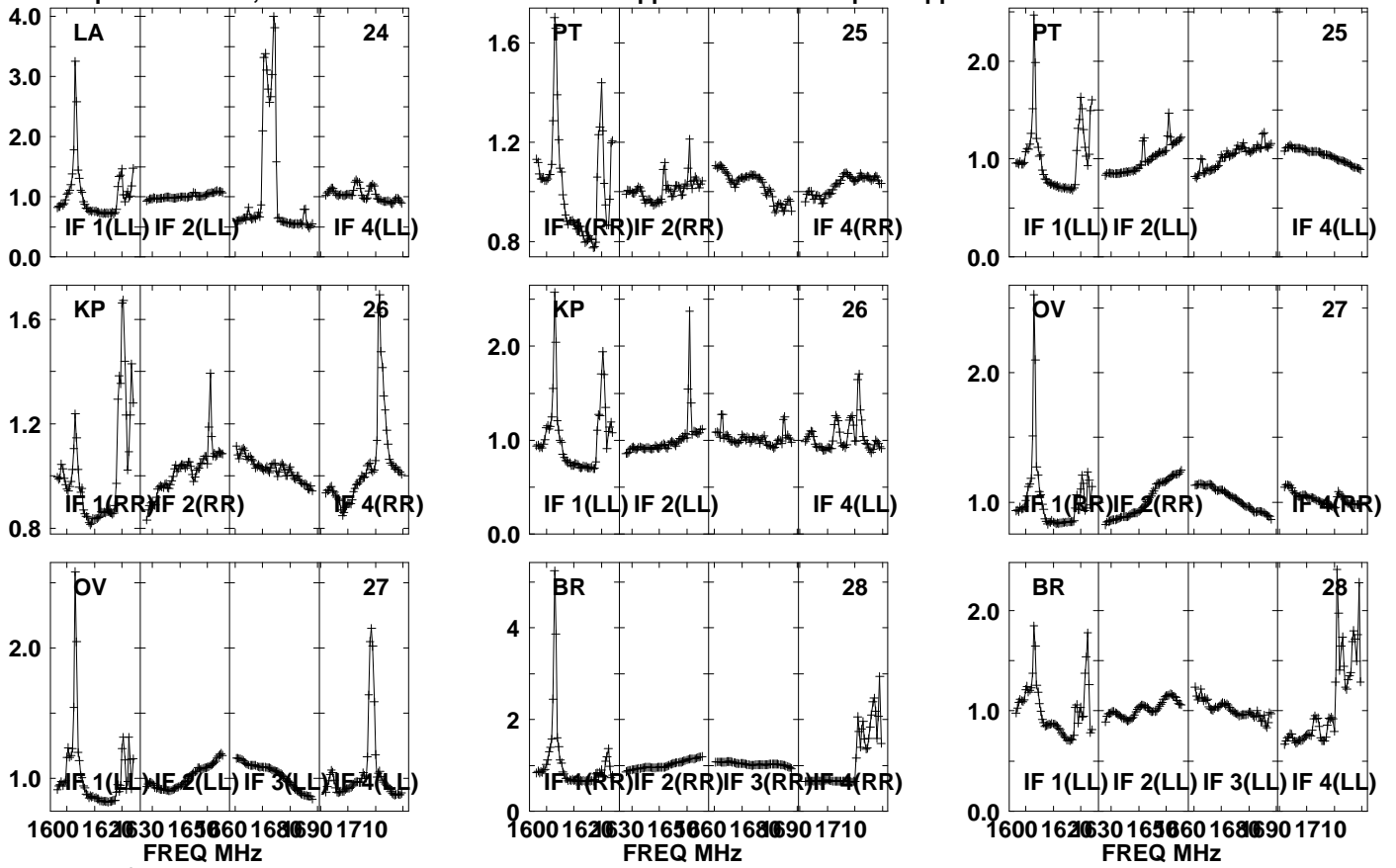

Lower frame: Real Jy  
Auto-corr total-power spectrum Antenna: \*  
Timerange: 00/20:24:01 to 00/20:27:29

Plot file version1153 created 05-OCT-2021 17:10:15

APM08279+525 GM076.UVDATA.1

Freq = 1.5945 GHz, Bw = 32.000 MH

No calibration applied and no bandpass applied

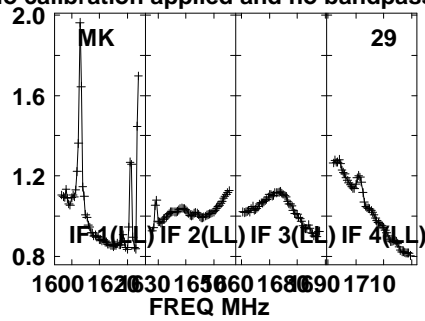
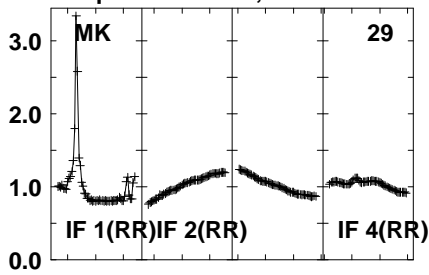

Lower frame: Real Jy

Auto-corr total-power spectrum Antenna: \*

Timerange: 00/20:24:01 to 00/20:27:29

Plot file version 1154 created 05-OCT-2021 17:10:15

J0827+5217 GM076.UVDATA.1

Freq = 1.5945 GHz, Bw = 32.000 MH No calibration applied and no bandpass applied

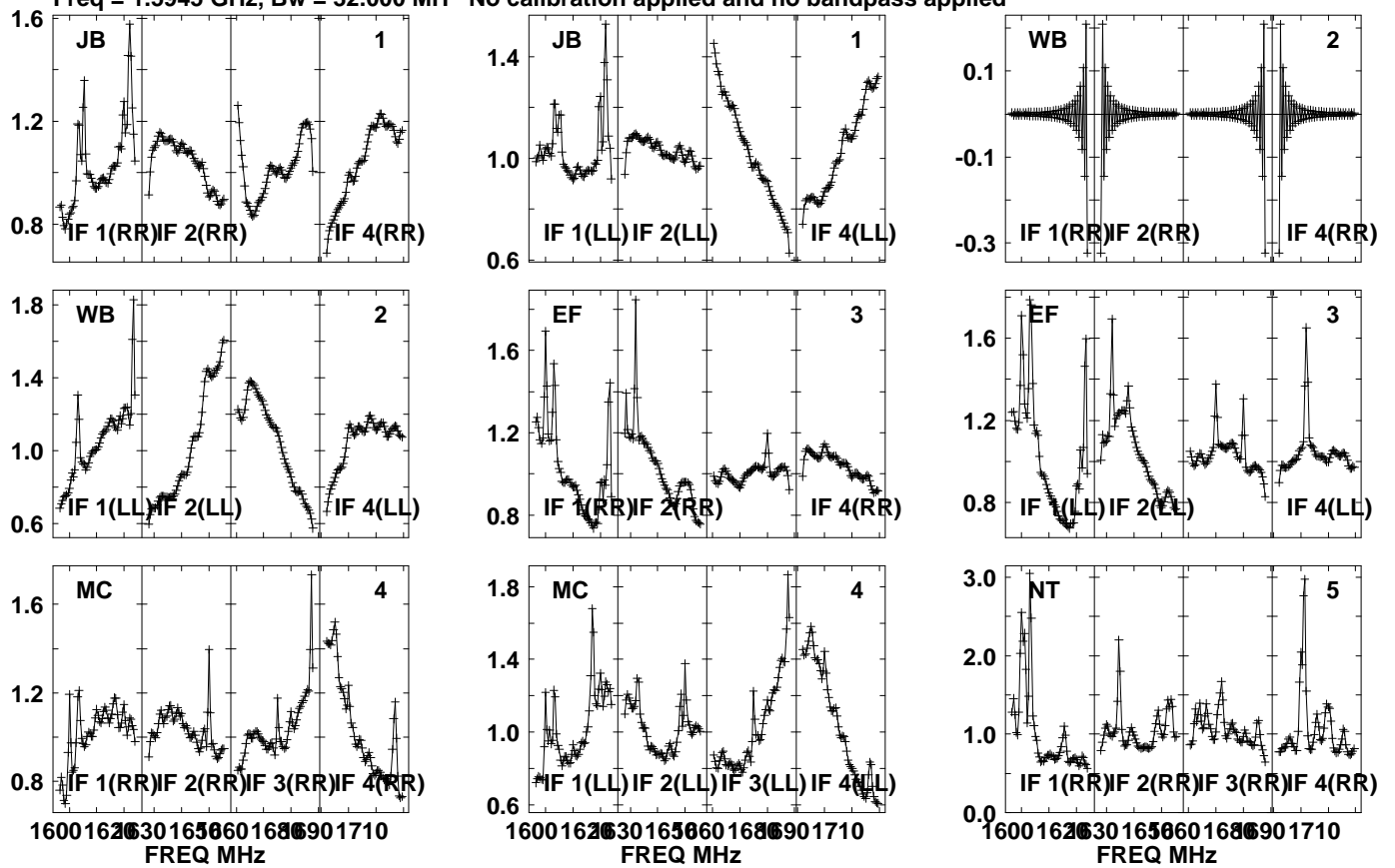

Lower frame: Real Jy  
Auto-corr total-power spectrum Antenna: \*  
Timerange: 00/20:28:01 to 00/20:29:29



Plot file version1155 created 05-OCT-2021 17:10:15

J0827+5217 GM076.UVDATA.1

Freq = 1.5945 GHz, Bw = 32.000 MH No calibration applied and no bandpass applied

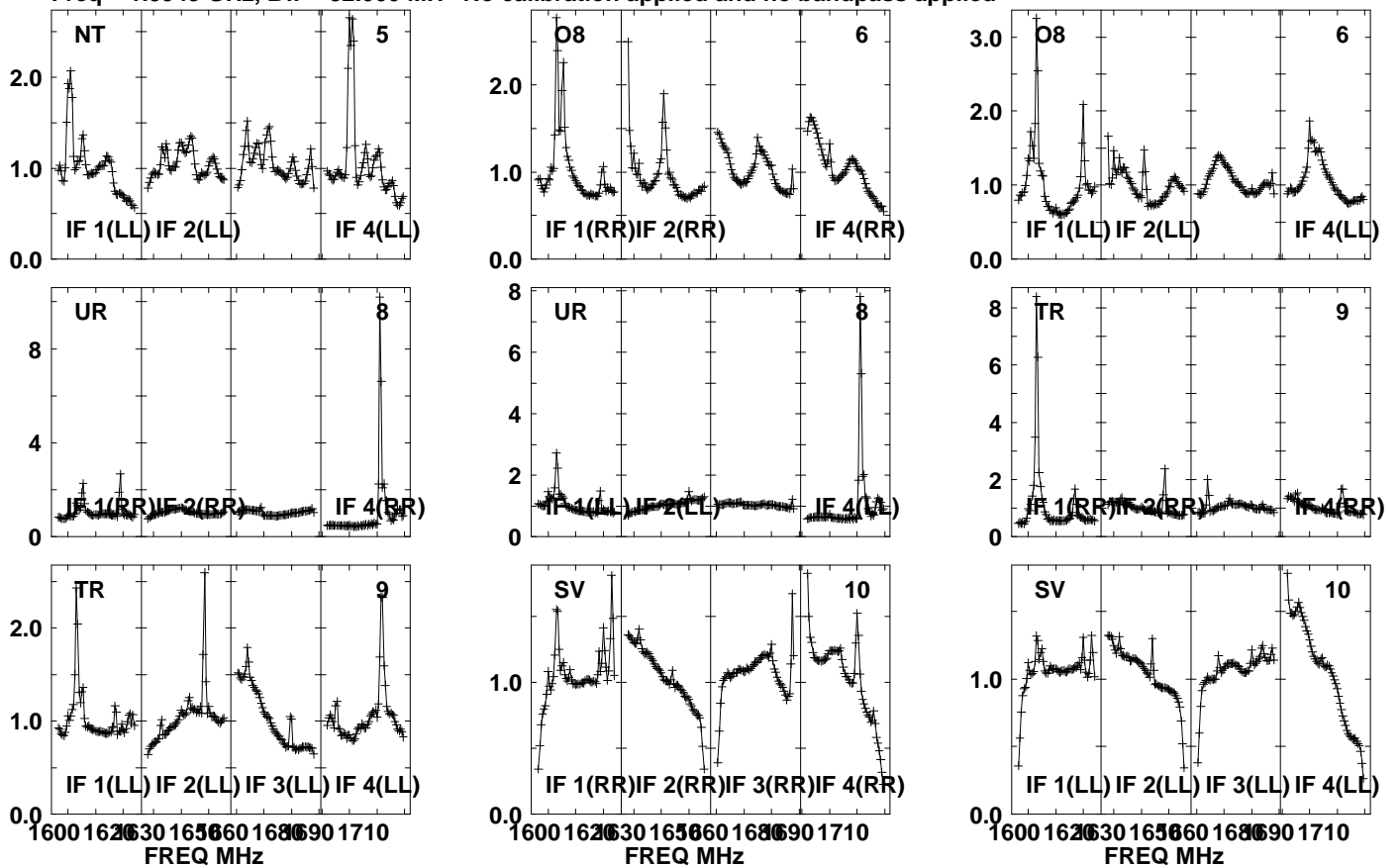

Lower frame: Real Jy

Auto-corr total-power spectrum Antenna: \*

Timerange: 00/20:28:01 to 00/20:29:29

Plot file version1156 created 05-OCT-2021 17:10:16

J0827+5217 GM076.UVDATA.1

Freq = 1.5945 GHz, Bw = 32.000 MH No calibration applied and no bandpass applied

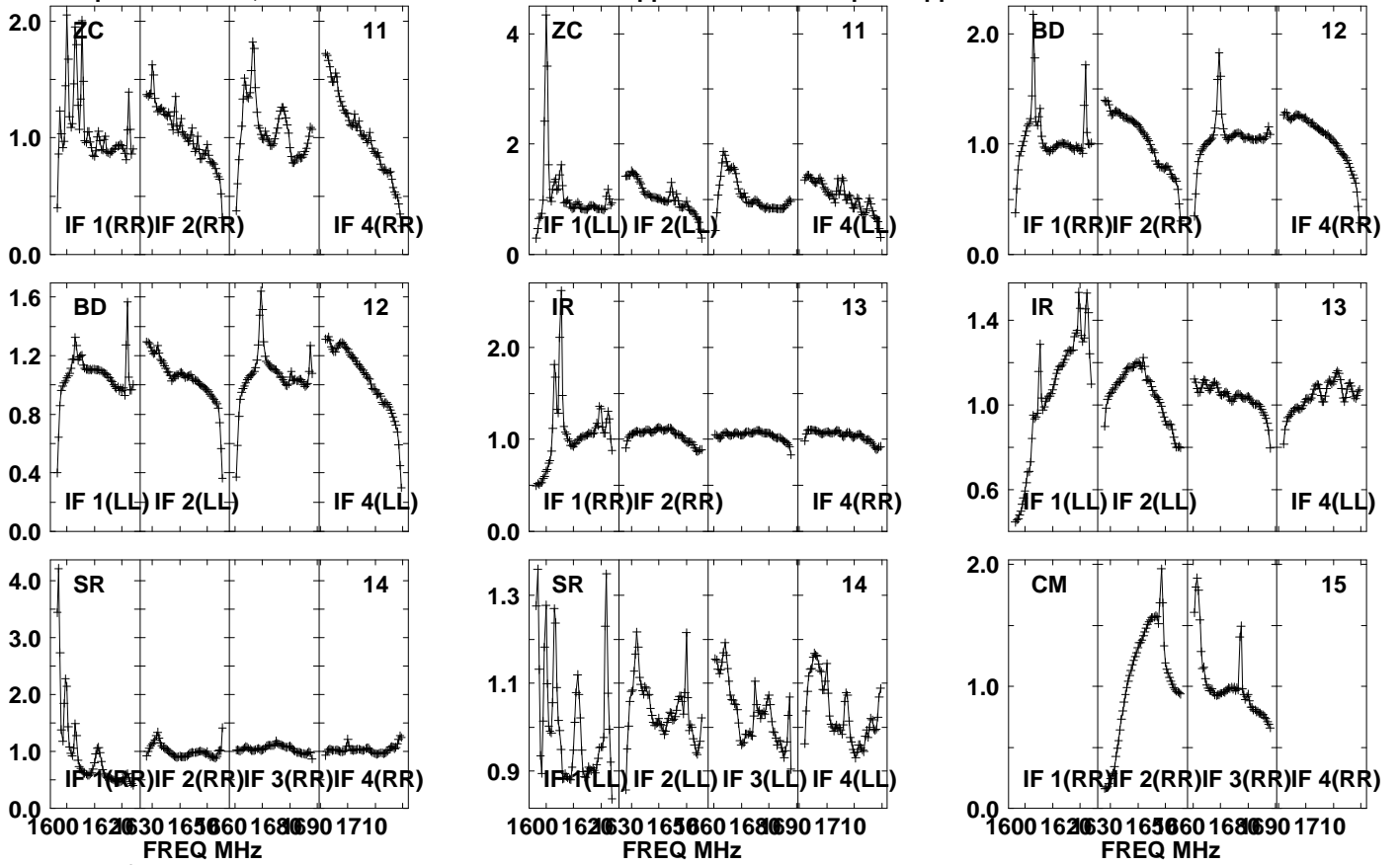

Lower frame: Real Jy  
Auto-corr total-power spectrum Antenna: \*  
Timerange: 00/20:28:01 to 00/20:29:29

Plot file version1157 created 05-OCT-2021 17:10:16

J0827+5217 GM076.UVDATA.1

Freq = 1.5945 GHz, Bw = 32.000 MH No calibration applied and no bandpass applied

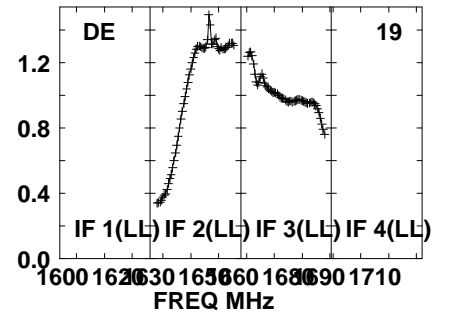
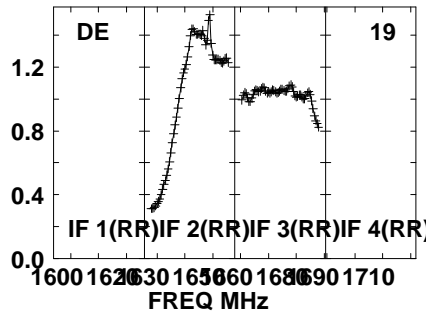
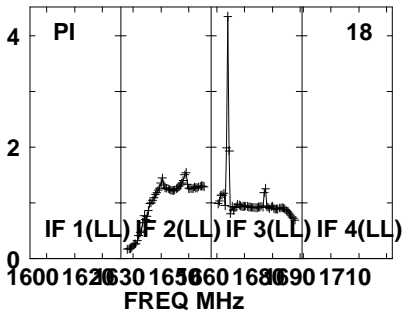
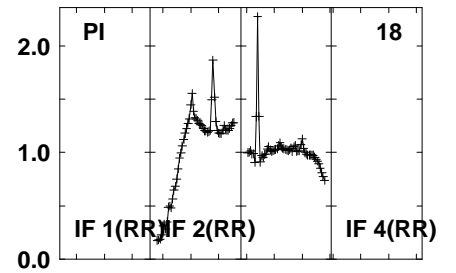
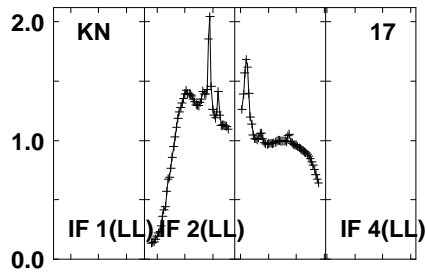
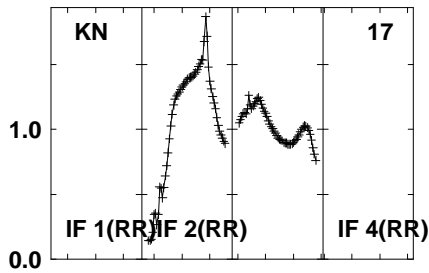
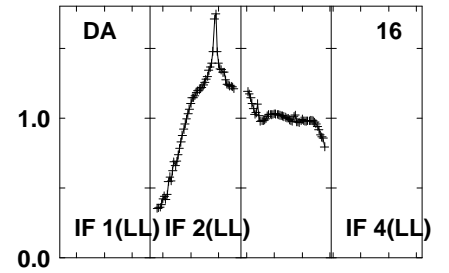
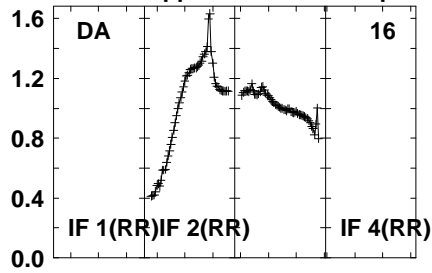
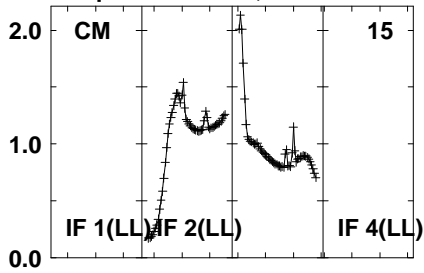

Lower frame: Real Jy

Auto-corr total-power spectrum Antenna: \*

Timerange: 00/20:28:01 to 00/20:29:29

Plot file version 1158 created 05-OCT-2021 17:10:16

J0827+5217 GM076.UVDATA.1

Freq = 1.5945 GHz, Bw = 32.000 MH No calibration applied and no bandpass applied

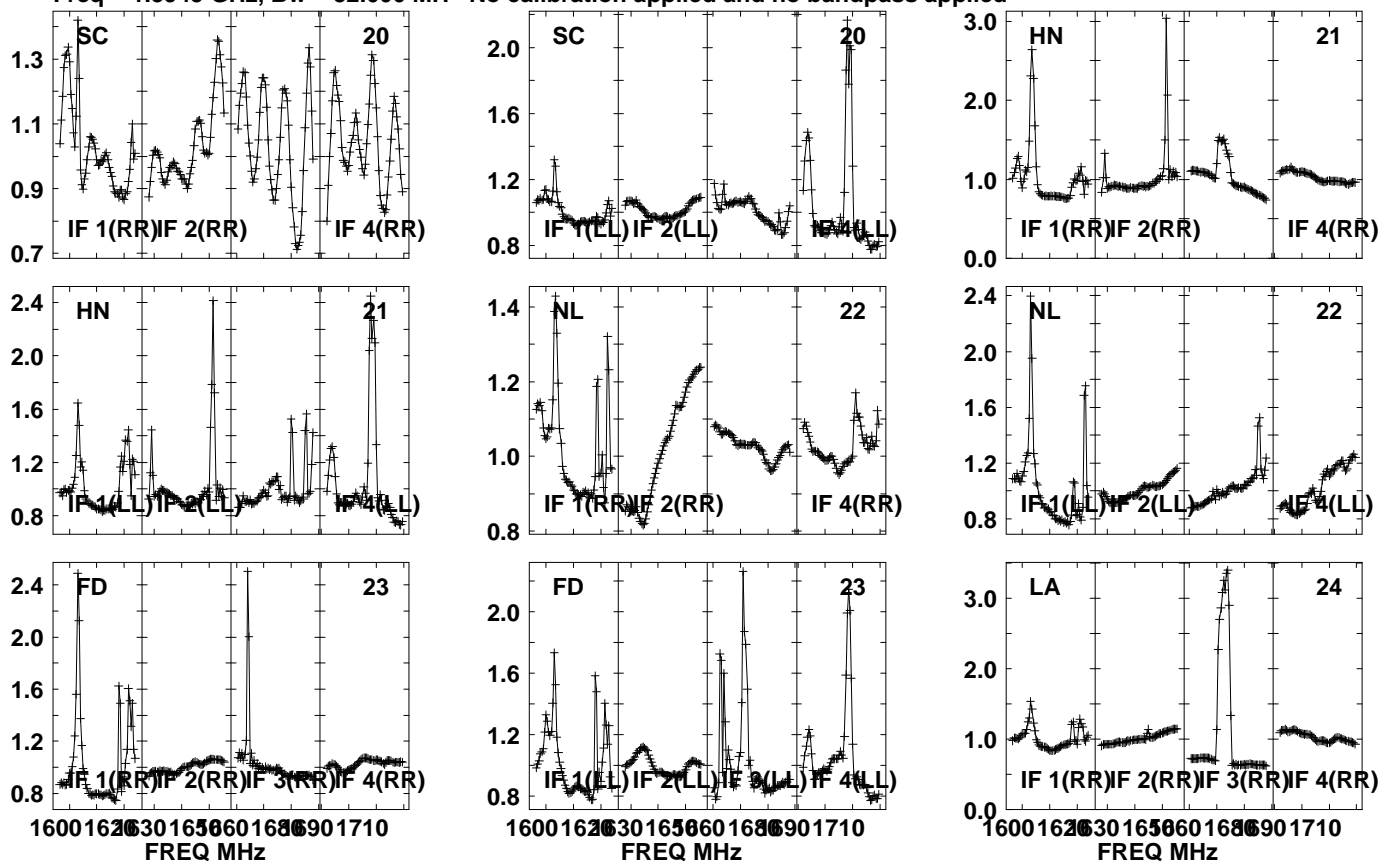

Lower frame: Real Jy  
Auto-corr total-power spectrum Antenna: \*  
Timerange: 00/20:28:01 to 00/20:29:29

Plot file version1159 created 05-OCT-2021 17:10:17

J0827+5217 GM076.UVDATA.1

Freq = 1.5945 GHz, Bw = 32.000 MH No calibration applied and no bandpass applied

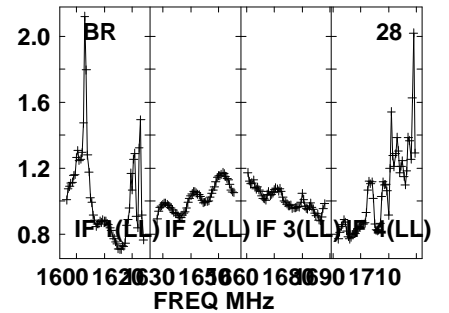
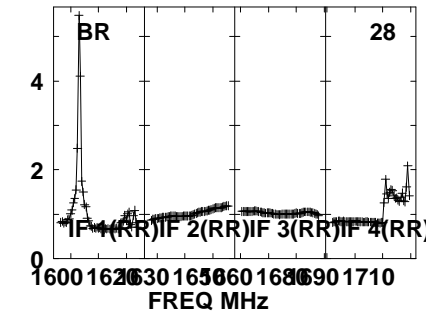
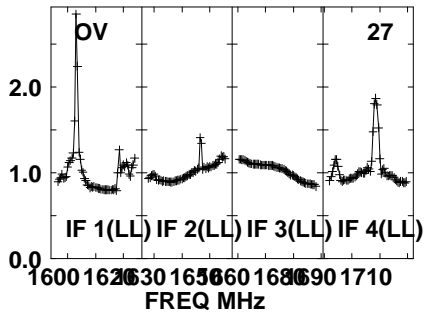
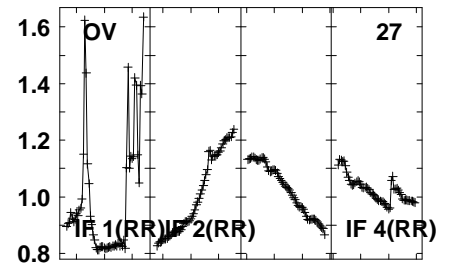
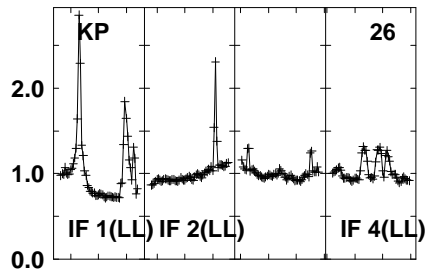
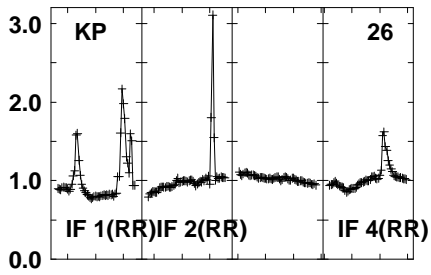
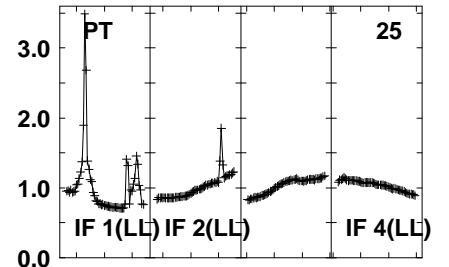
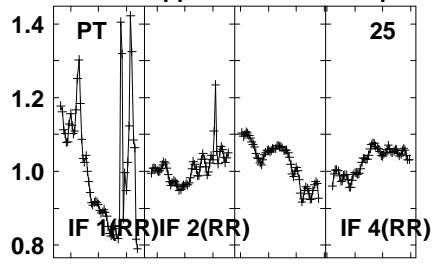
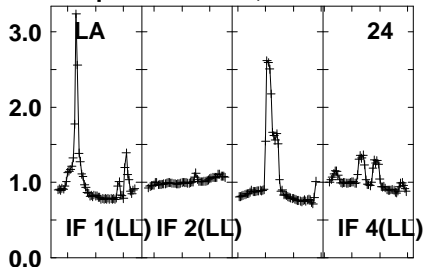

Lower frame: Real Jy

Auto-corr total-power spectrum Antenna: \*

Timerange: 00/20:28:01 to 00/20:29:29

Plot file version1160 created 05-OCT-2021 17:10:17

J0827+5217 GM076.UVDATA.1

Freq = 1.5945 GHz, Bw = 32.000 MH No calibration applied and no bandpass applied

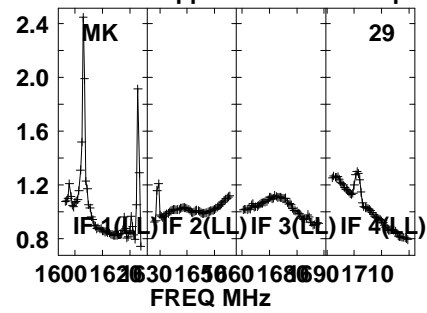
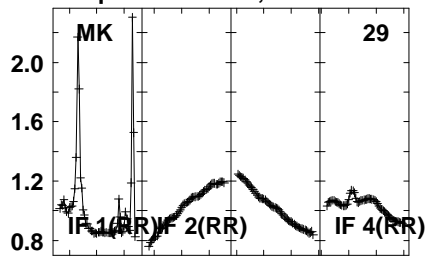

Lower frame: Real Jy  
Auto-corr total-power spectrum Antenna: \*  
Timerange: 00/20:28:01 to 00/20:29:29

Plot file version 1161 created 05-OCT-2021 17:10:17

APM08279+525 GM076.UVDATA.1

Freq = 1.5945 GHz, Bw = 32.000 MH No calibration applied and no bandpass applied

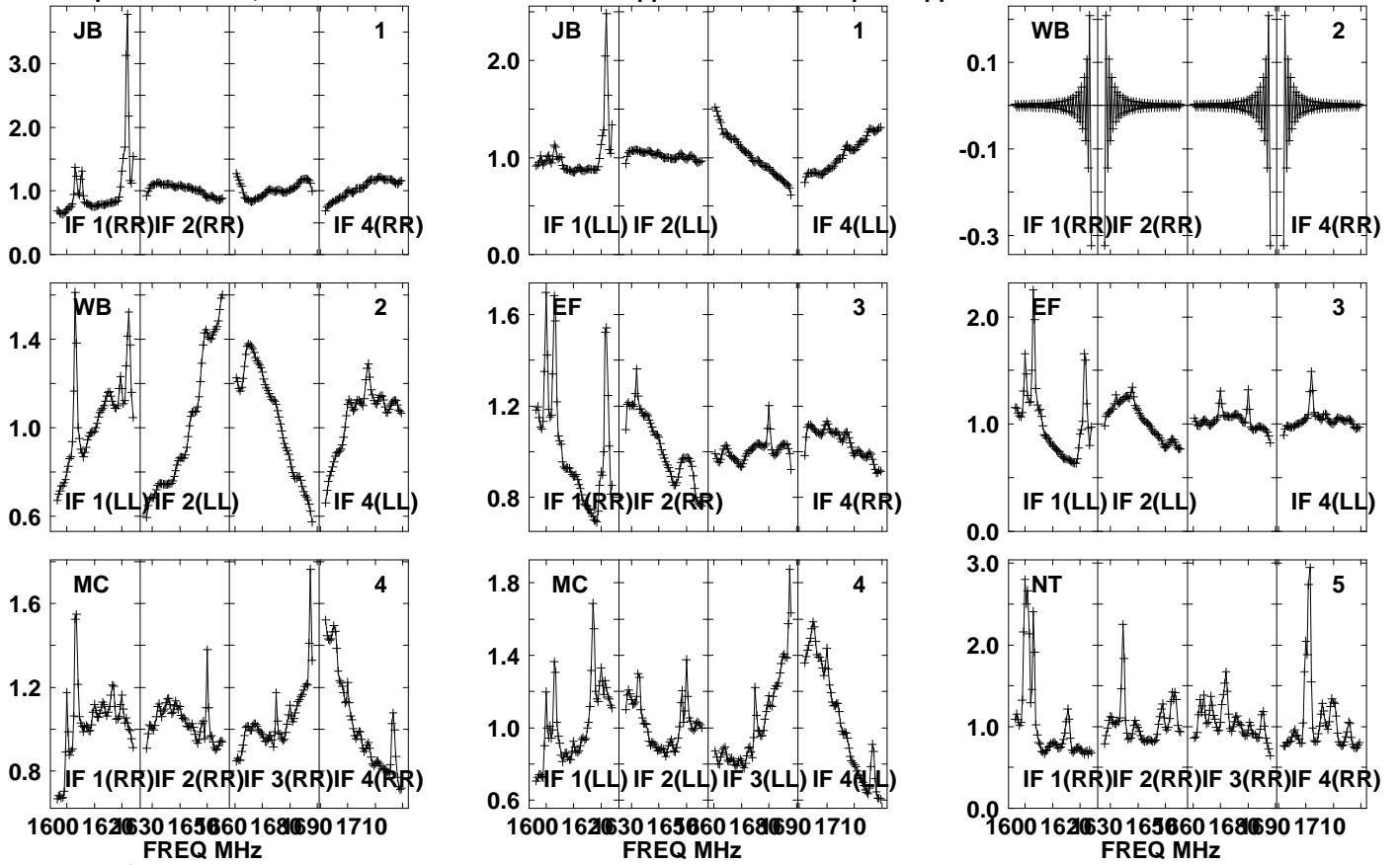

Lower frame: Real Jy

Auto-corr total-power spectrum Antenna: \*

Timerange: 00/20:29:31 to 00/20:32:59

Plot file version1162 created 05-OCT-2021 17:10:18

APM08279+525 GM076.UVDATA.1

Freq = 1.5945 GHz, Bw = 32.000 MH No calibration applied and no bandpass applied

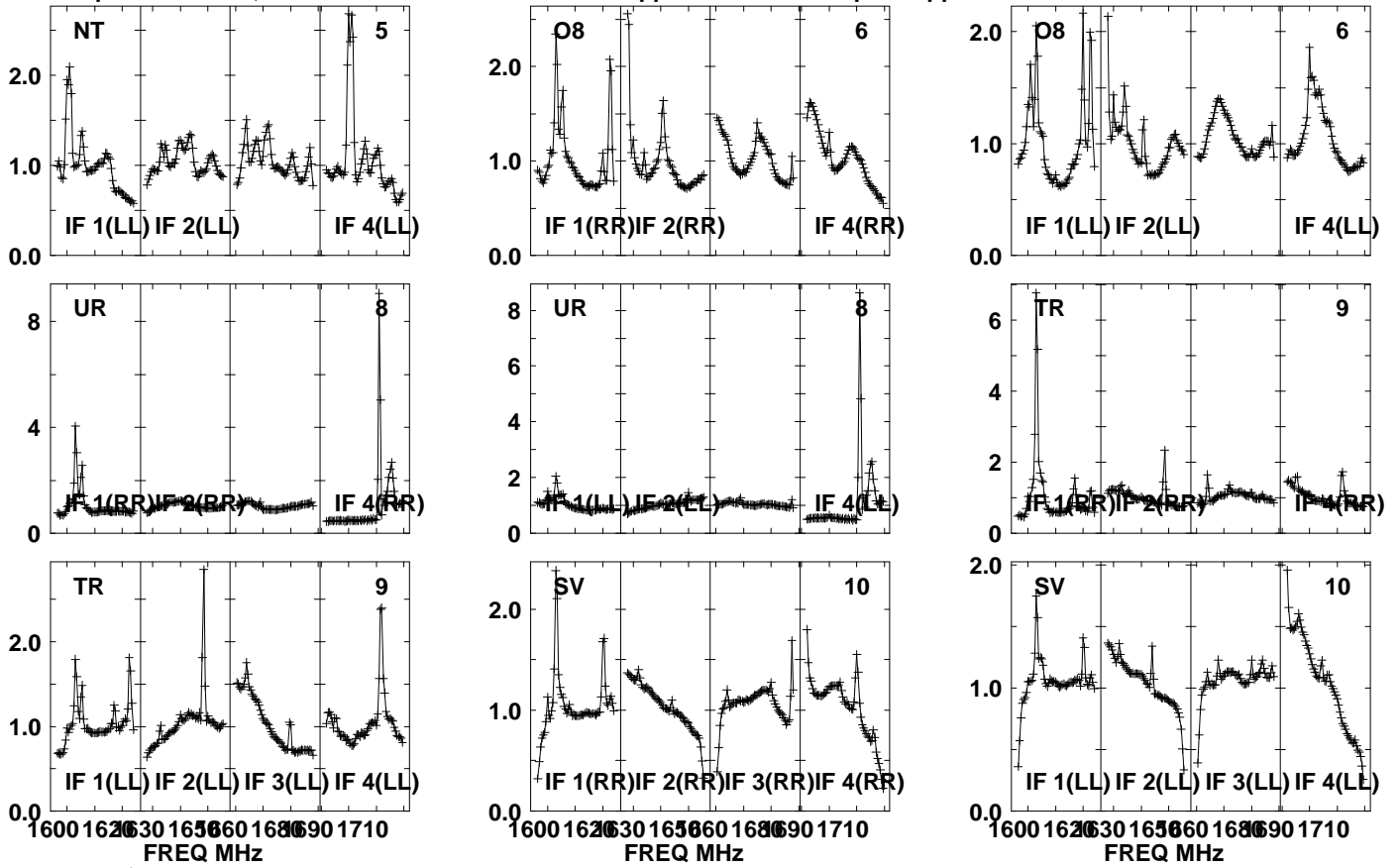

Lower frame: Real Jy

Auto-corr total-power spectrum Antenna: \*

Timerange: 00/20:29:31 to 00/20:32:59



Plot file version1163 created 05-OCT-2021 17:10:18

APM08279+525 GM076.UVDATA.1

Freq = 1.5945 GHz, Bw = 32.000 MH No calibration applied and no bandpass applied

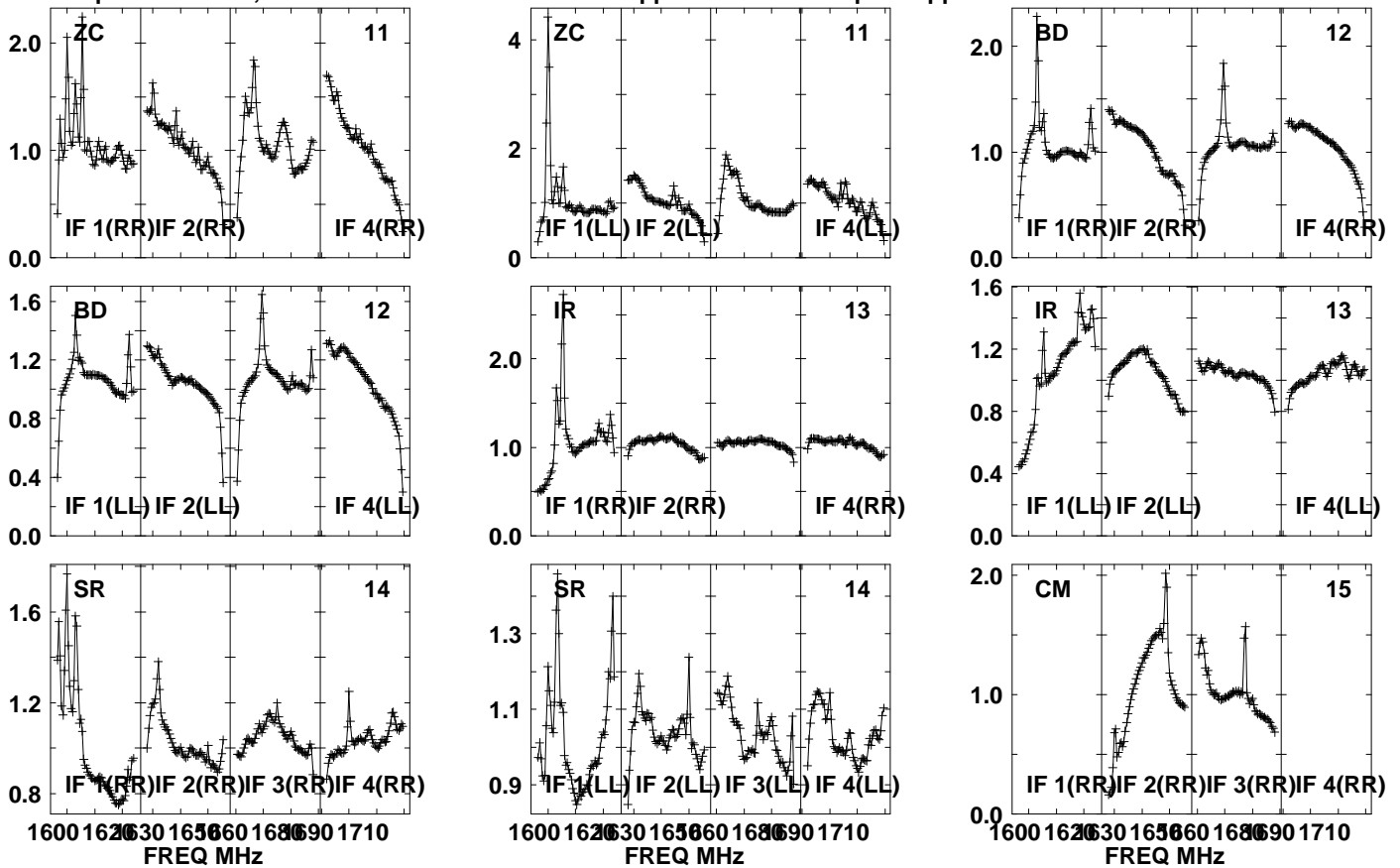

Lower frame: Real Jy

Auto-corr total-power spectrum Antenna: \*

Timerange: 00/20:29:31 to 00/20:32:59

Plot file version 1164 created 05-OCT-2021 17:10:18

APM08279+525 GM076.UVDATA.1

Freq = 1.5945 GHz, Bw = 32.000 MH No calibration applied and no bandpass applied

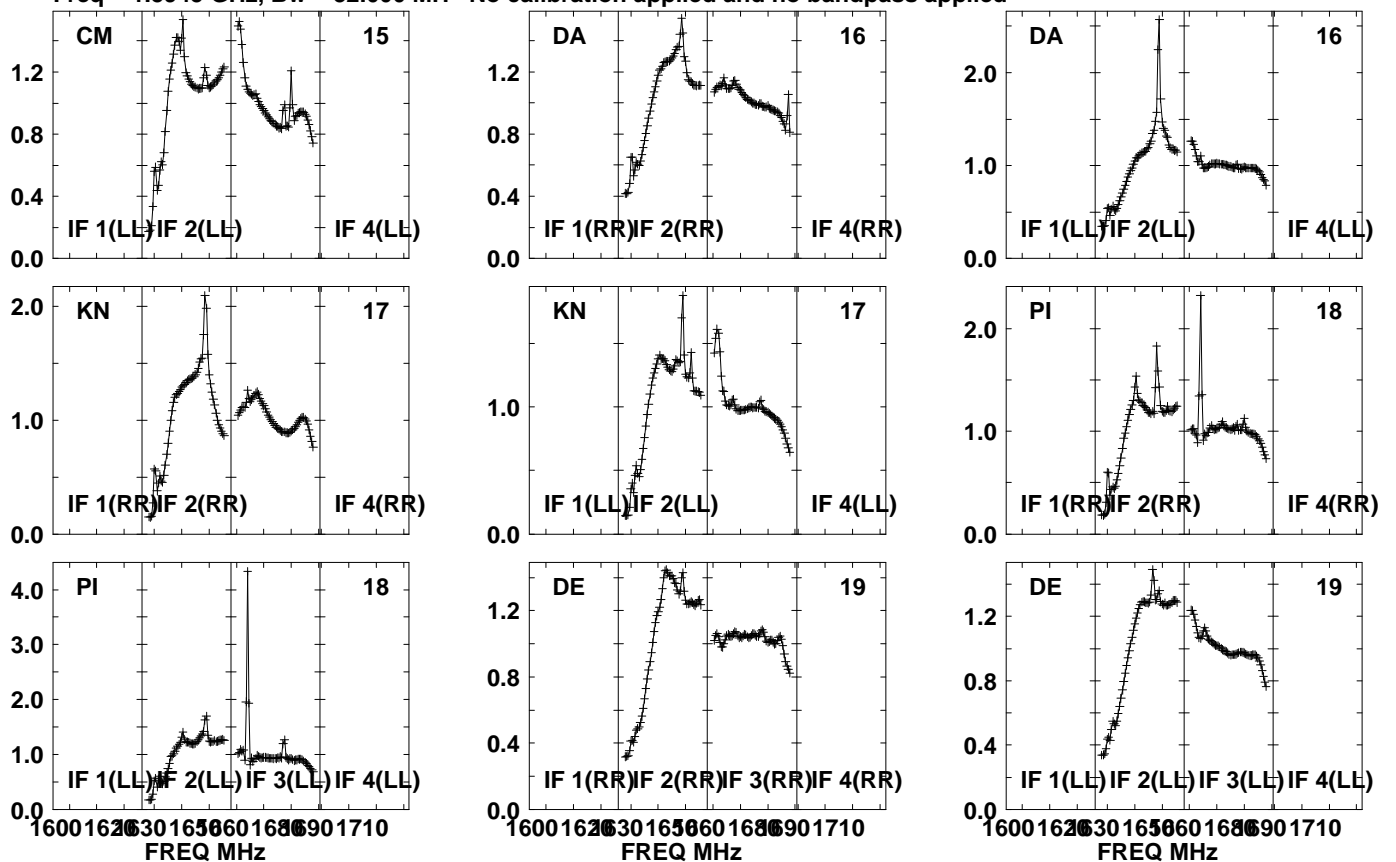

Lower frame: Real Jy  
Auto-corr total-power spectrum Antenna: \*  
Timerange: 00/20:29:31 to 00/20:32:59

Plot file version 1165 created 05-OCT-2021 17:10:19

APM08279+525 GM076.UVDATA.1

Freq = 1.5945 GHz, Bw = 32.000 MH No calibration applied and no bandpass applied

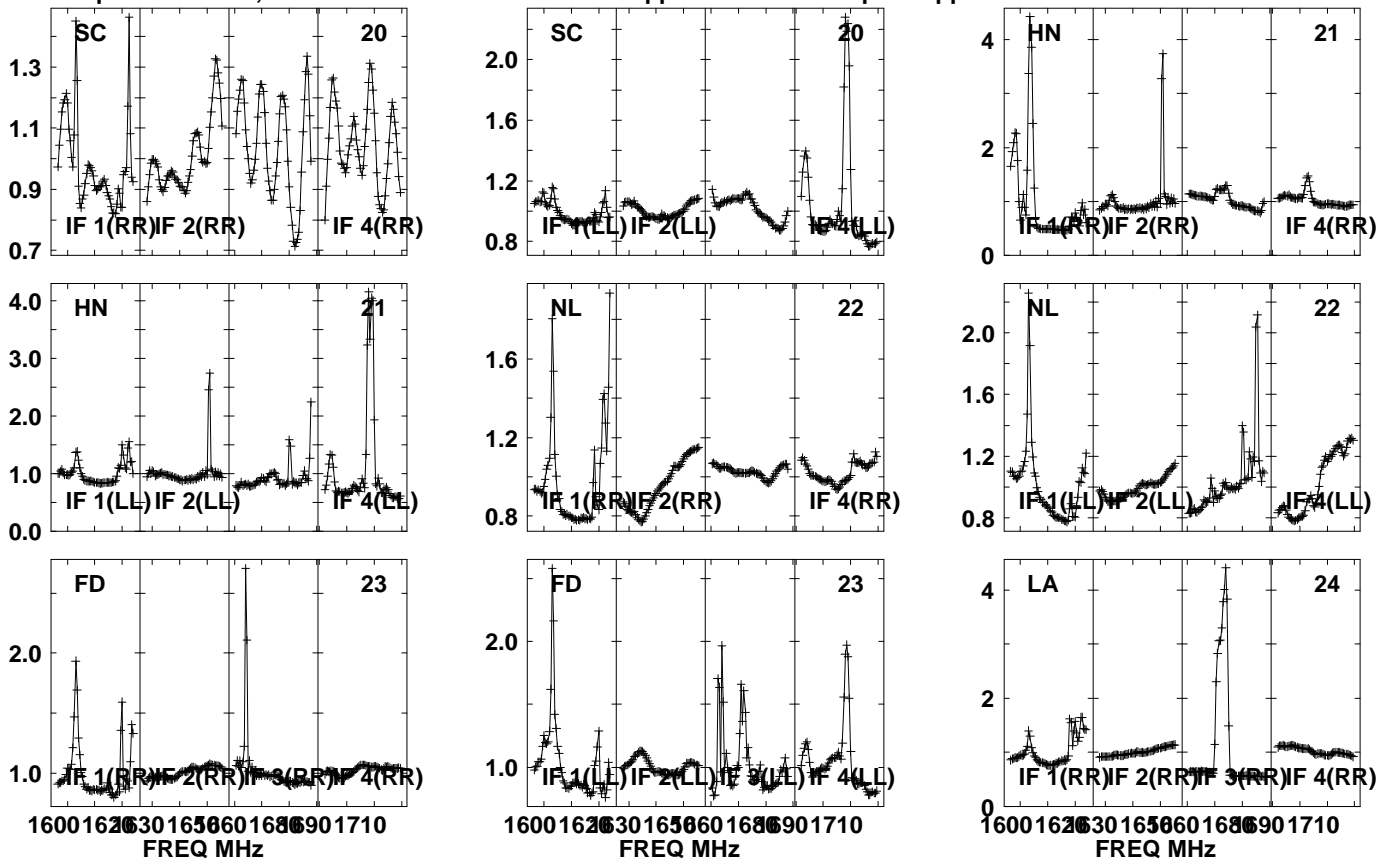

Lower frame: Real Jy  
Auto-corr total-power spectrum Antenna: \*  
Timerange: 00/20:29:31 to 00/20:32:59

Plot file version1166 created 05-OCT-2021 17:10:19

APM08279+525 GM076.UVDATA.1

Freq = 1.5945 GHz, Bw = 32.000 MH No calibration applied and no bandpass applied

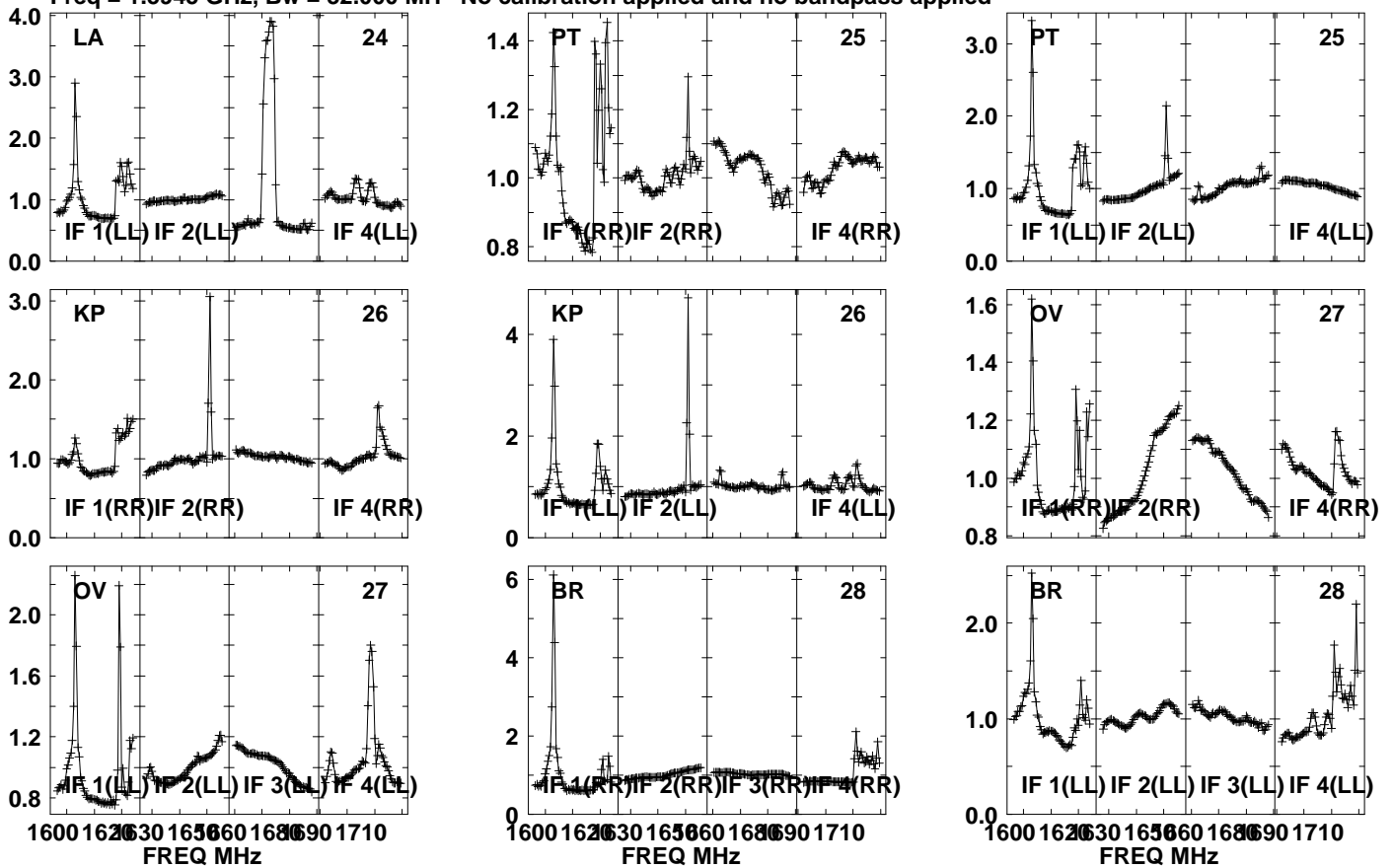

Lower frame: Real Jy  
Auto-corr total-power spectrum Antenna: \*  
Timerange: 00/20:29:31 to 00/20:32:59

Plot file version1167 created 05-OCT-2021 17:10:19

APM08279+525 GM076.UVDATA.1

Freq = 1.5945 GHz, Bw = 32.000 MH No calibration applied and no bandpass applied

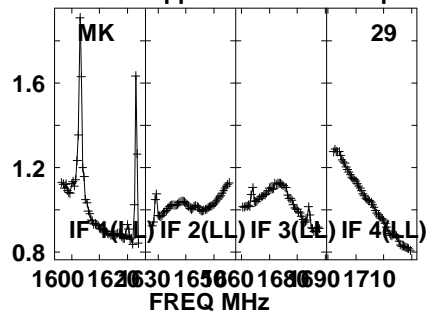
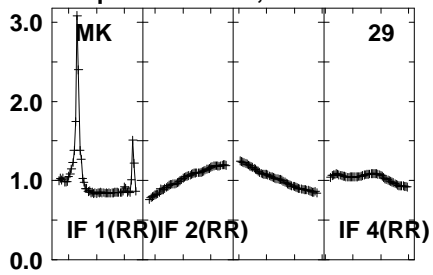

Lower frame: Real Jy

Auto-corr total-power spectrum Antenna: \*

Timerange: 00/20:29:31 to 00/20:32:59

Plot file version1168 created 05-OCT-2021 17:10:19

J0827+5217 GM076.UVDATA.1

Freq = 1.5945 GHz, Bw = 32.000 MH No calibration applied and no bandpass applied

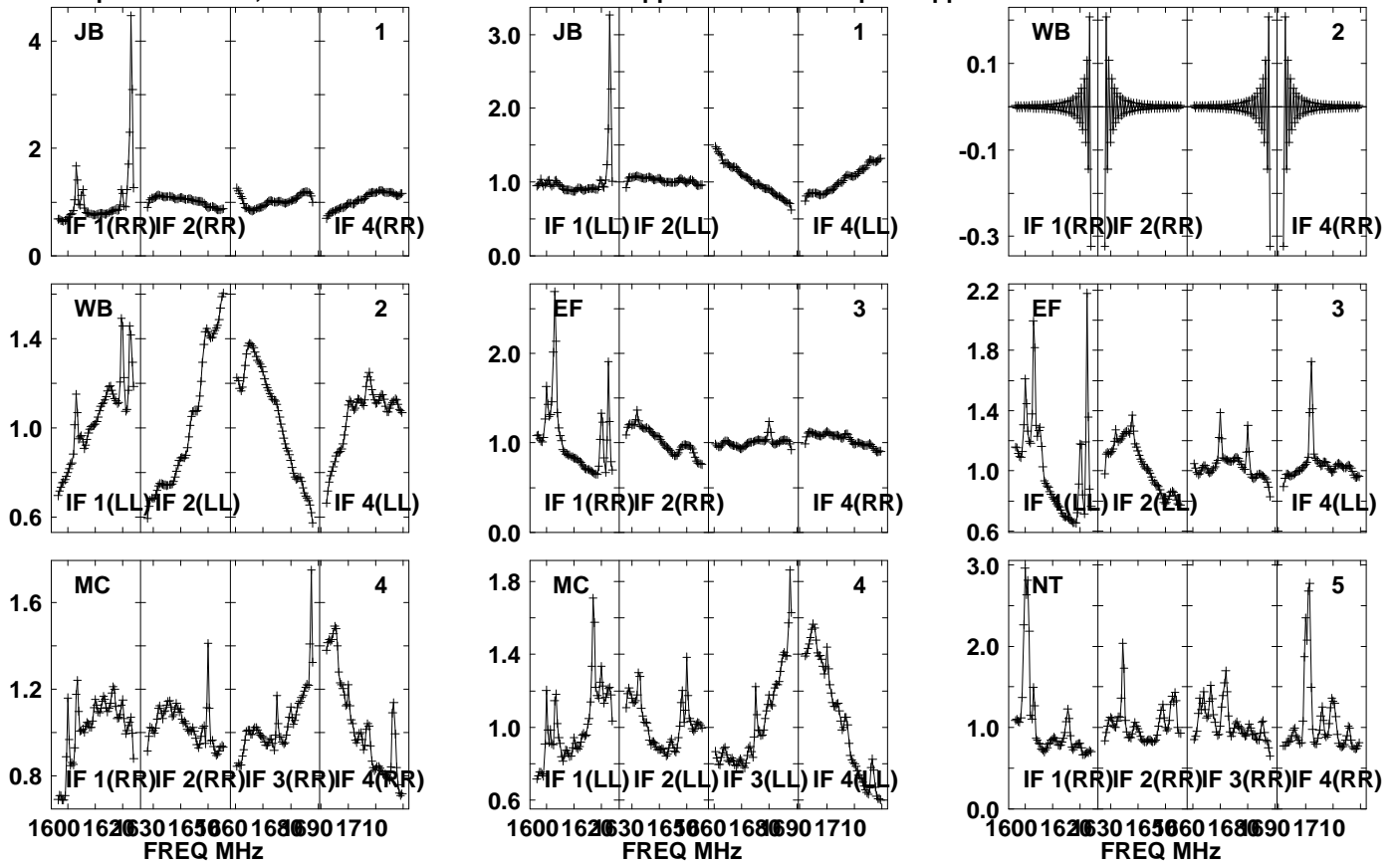

Lower frame: Real Jy  
Auto-corr total-power spectrum Antenna: \*  
Timerange: 00/20:33:01 to 00/20:34:29

Plot file version1169 created 05-OCT-2021 17:10:20

J0827+5217 GM076.UVDATA.1

Freq = 1.5945 GHz, Bw = 32.000 MH No calibration applied and no bandpass applied

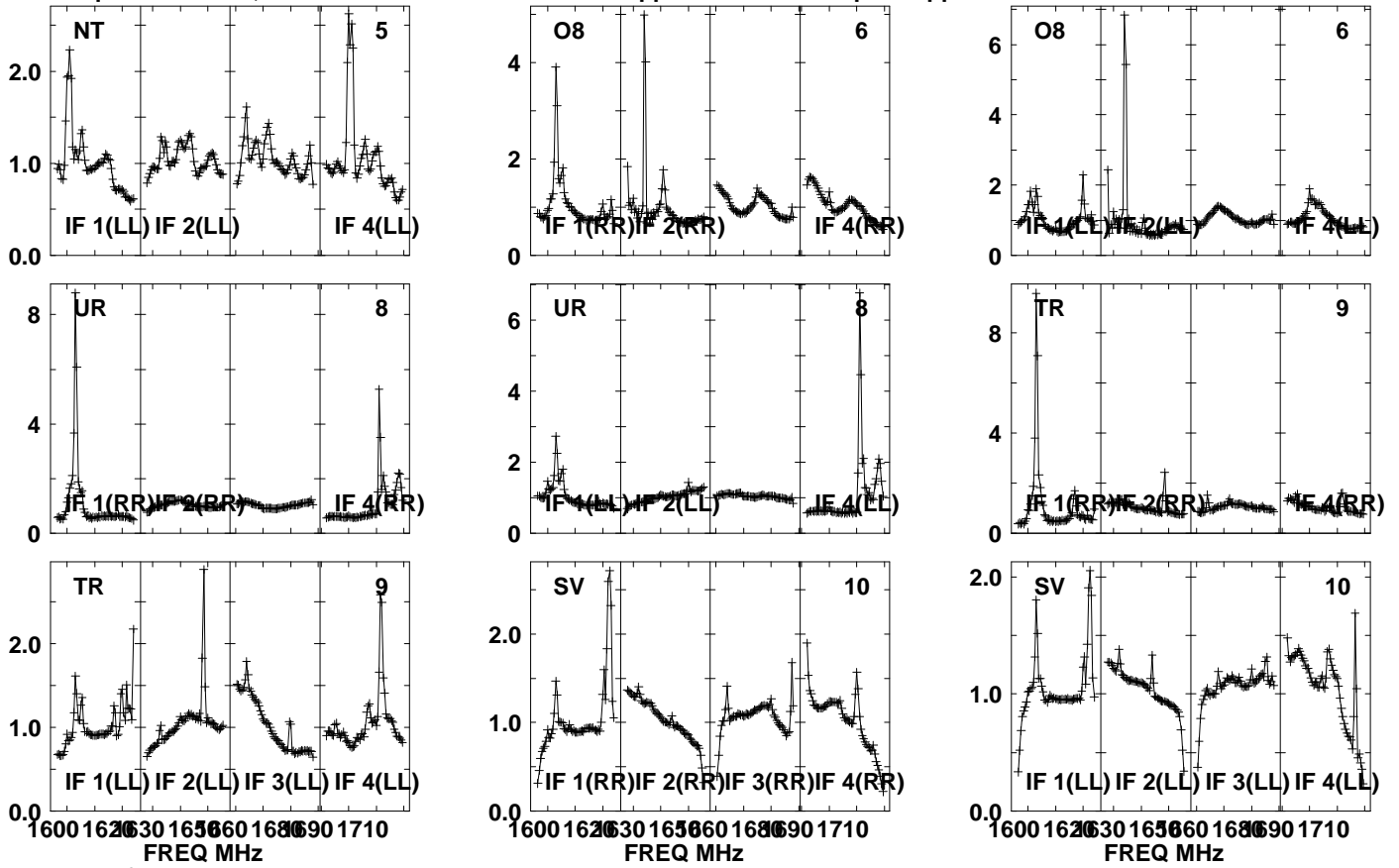

Lower frame: Real Jy

Auto-corr total-power spectrum Antenna: \*

Timerange: 00/20:33:01 to 00/20:34:29

Plot file version1170 created 05-OCT-2021 17:10:20

J0827+5217 GM076.UVDATA.1

Freq = 1.5945 GHz, Bw = 32.000 MH No calibration applied and no bandpass applied

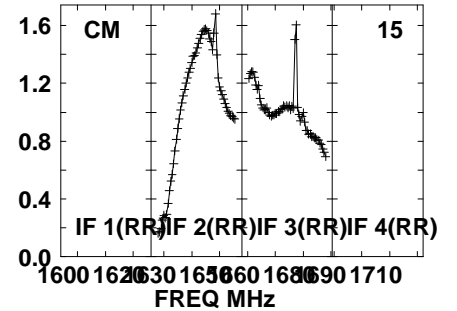
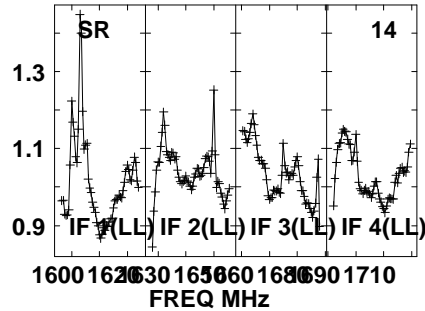
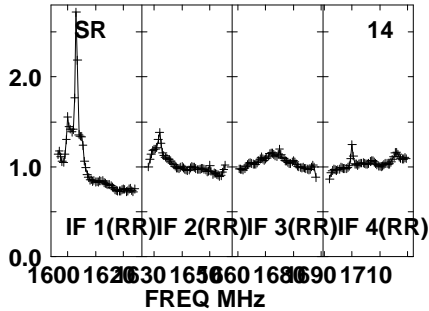
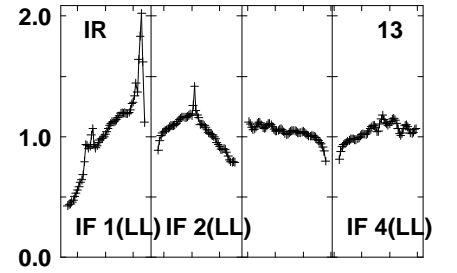
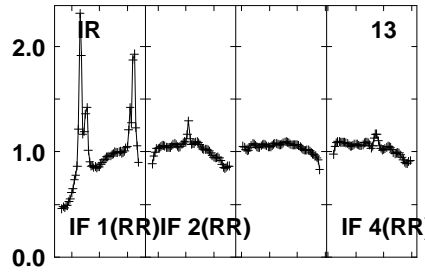
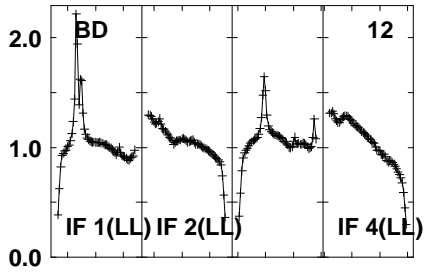
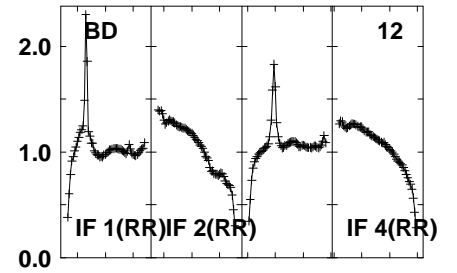
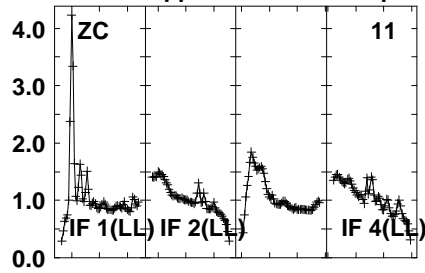
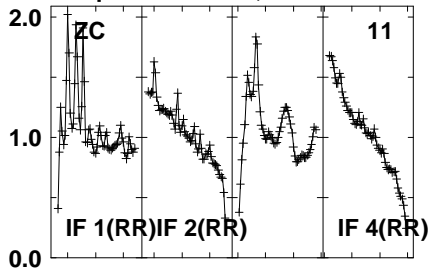

Lower frame: Real Jy

Auto-corr total-power spectrum Antenna: \*

Timerange: 00/20:33:01 to 00/20:34:29



Plot file version 1171 created 05-OCT-2021 17:10:20

J0827+5217 GM076.UVDATA.1

Freq = 1.5945 GHz, Bw = 32.000 MH No calibration applied and no bandpass applied

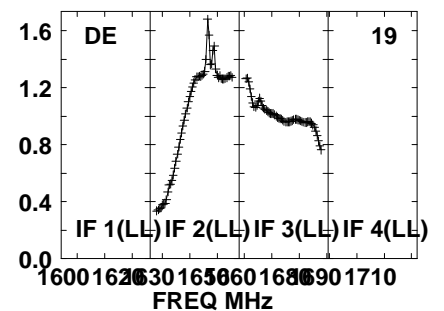
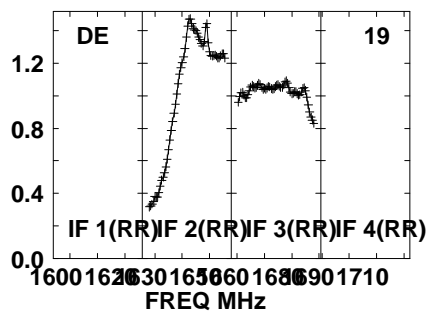
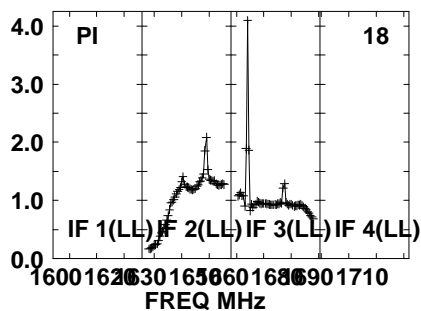
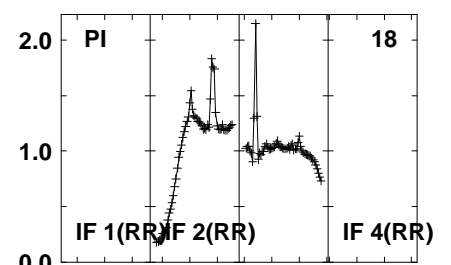
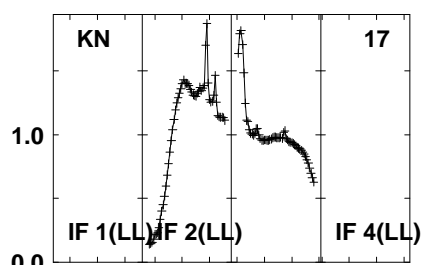
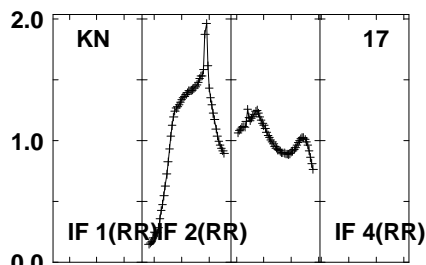
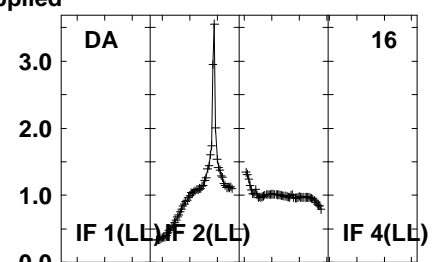
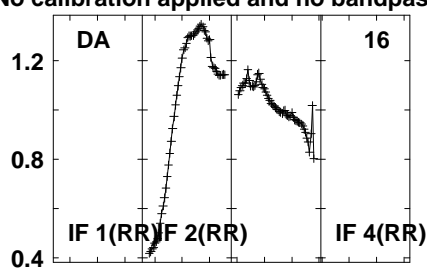
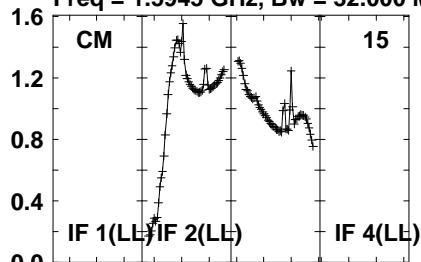

Lower frame: Real Jy  
Auto-corr total-power spectrum Antenna: \*  
Timerange: 00/20:33:01 to 00/20:34:29

Plot file version 1172 created 05-OCT-2021 17:10:21

J0827+5217 GM076.UVDATA.1

Freq = 1.5945 GHz, Bw = 32.000 MH No calibration applied and no bandpass applied

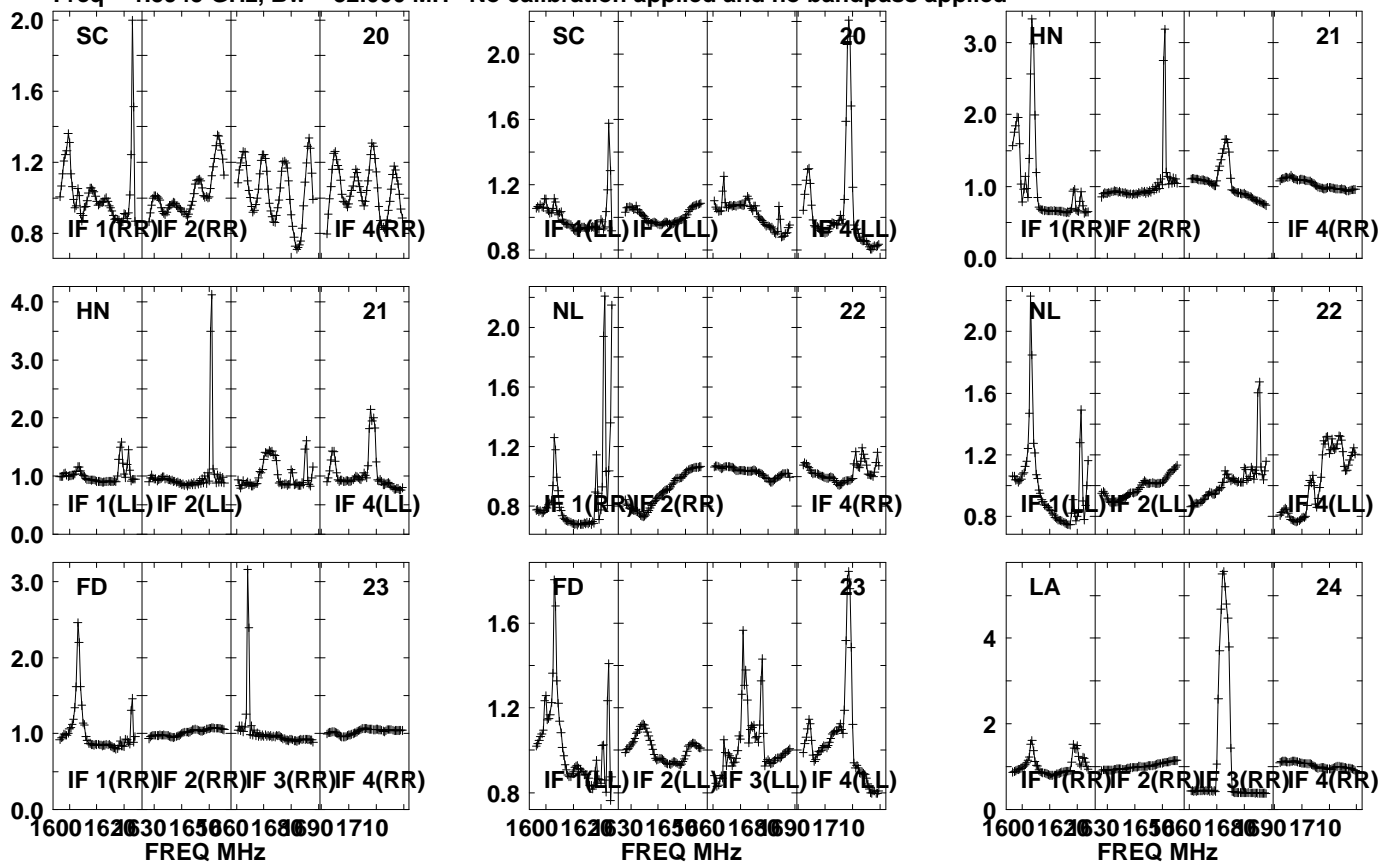

Lower frame: Real Jy  
Auto-corr total-power spectrum Antenna: \*  
Timerange: 00/20:33:01 to 00/20:34:29

Plot file version1173 created 05-OCT-2021 17:10:21

J0827+5217 GM076.UVDATA.1

Freq = 1.5945 GHz, Bw = 32.000 MH No calibration applied and no bandpass applied

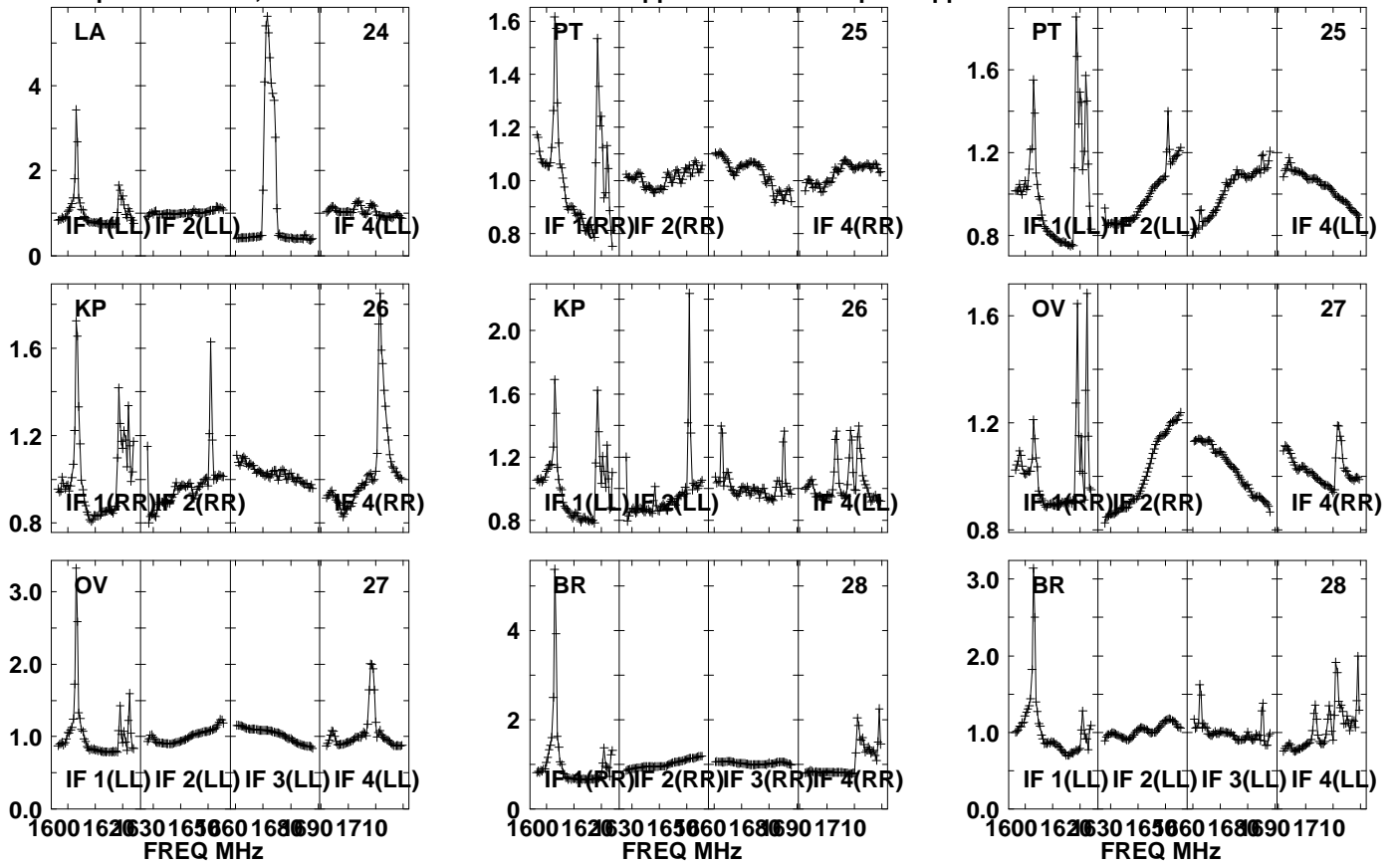

Lower frame: Real Jy  
Auto-corr total-power spectrum Antenna: \*  
Timerange: 00/20:33:01 to 00/20:34:29

Plot file version1174 created 05-OCT-2021 17:10:21

J0827+5217 GM076.UVDATA.1

Freq = 1.5945 GHz, Bw = 32.000 MH No calibration applied and no bandpass applied

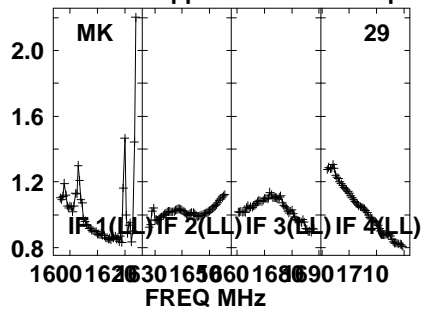
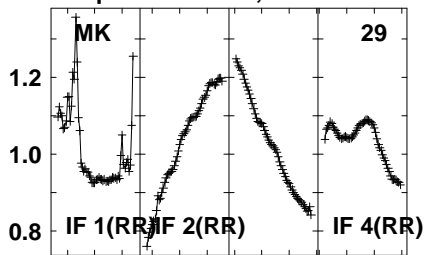

Lower frame: Real Jy  
Auto-corr total-power spectrum Antenna: \*  
Timerange: 00/20:33:01 to 00/20:34:29

Plot file version1175 created 05-OCT-2021 17:10:22

APM08279+525 GM076.UVDATA.1

Freq = 1.5945 GHz, Bw = 32.000 MH No calibration applied and no bandpass applied

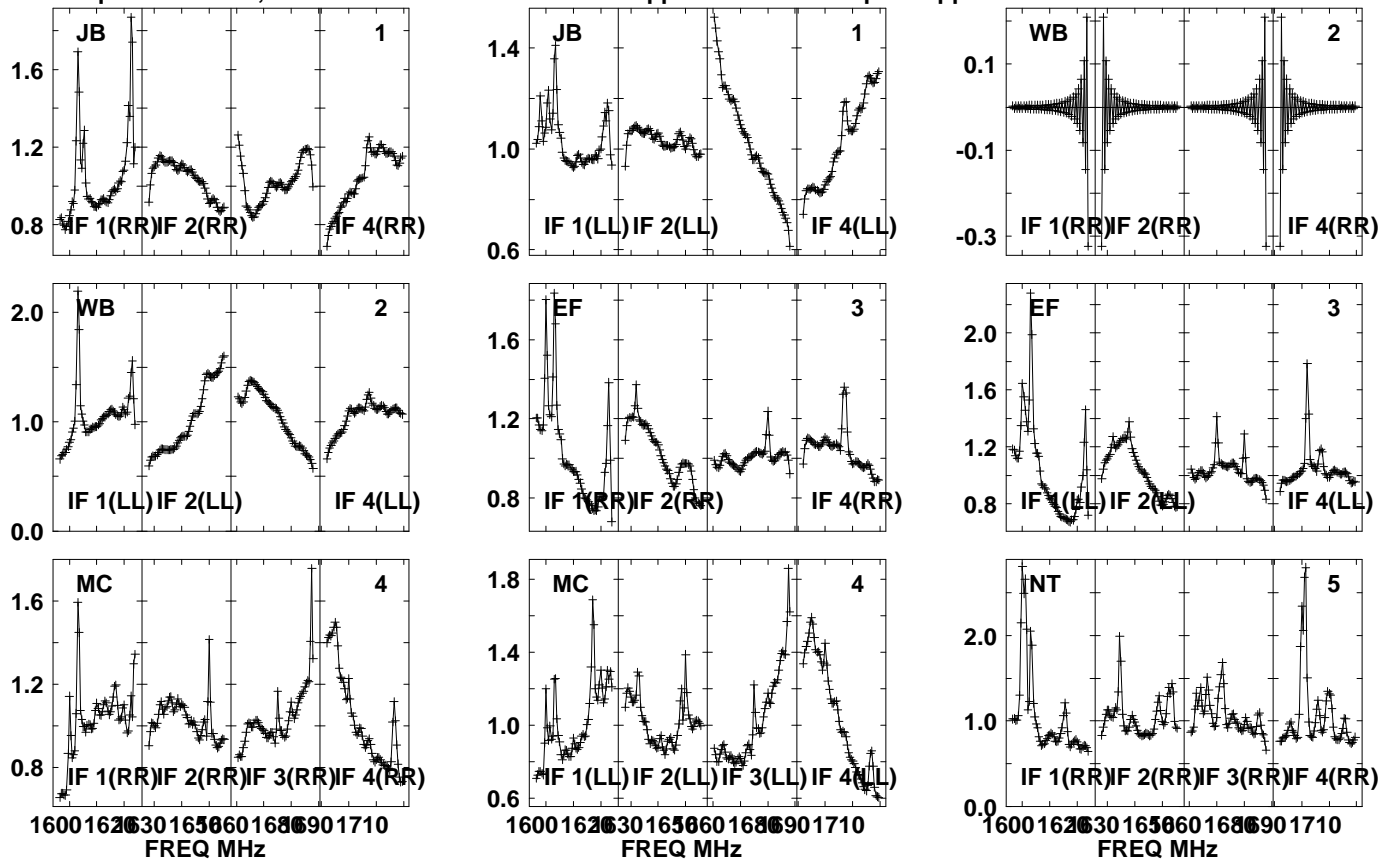

Lower frame: Real Jy  
Auto-corr total-power spectrum Antenna: \*  
Timerange: 00/20:34:31 to 00/20:37:59

Plot file version1176 created 05-OCT-2021 17:10:22

APM08279+525 GM076.UVDATA.1

Freq = 1.5945 GHz, Bw = 32.000 MH No calibration applied and no bandpass applied

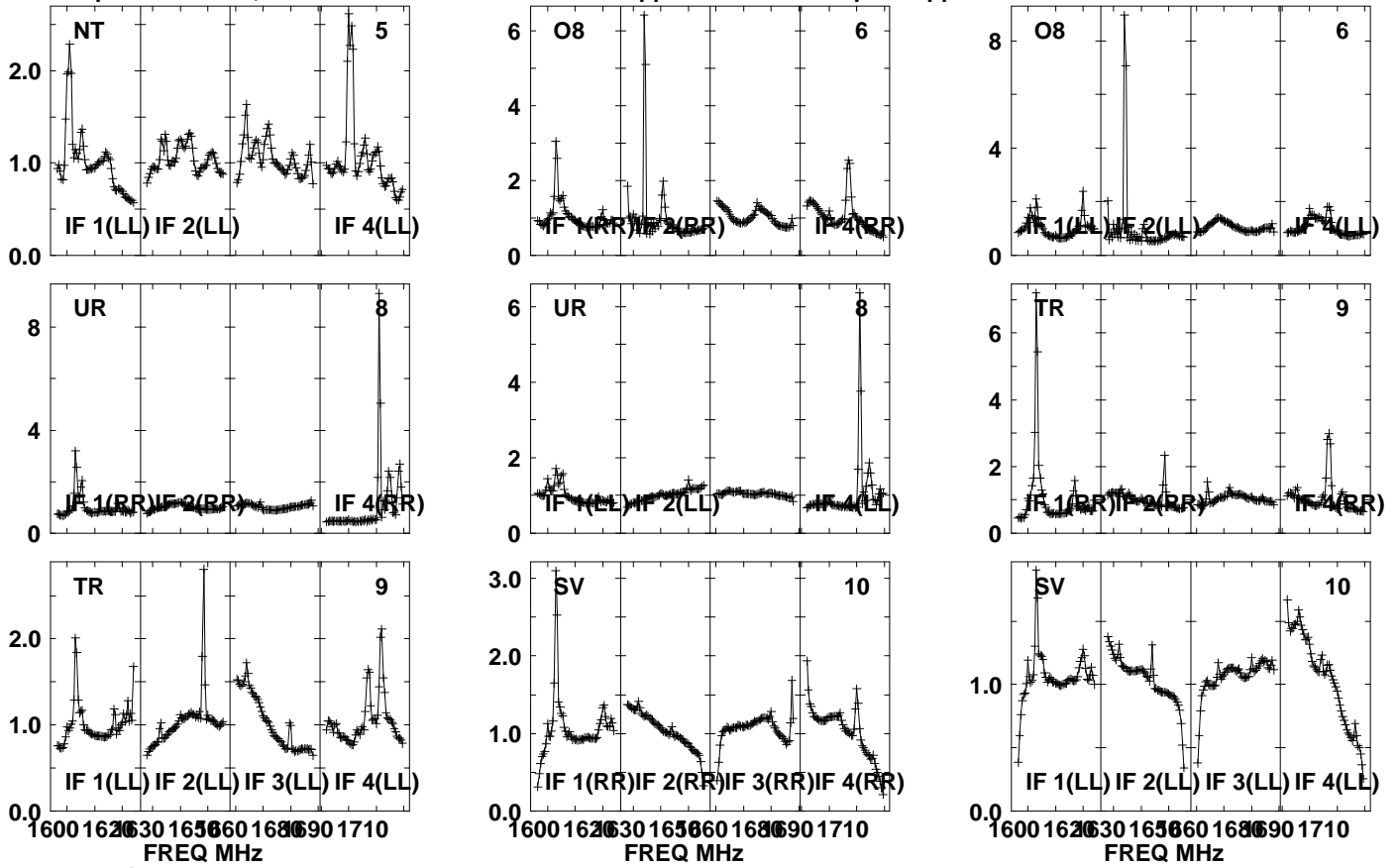

Lower frame: Real Jy

Auto-corr total-power spectrum Antenna: \*

Timerange: 00/20:34:31 to 00/20:37:59

Plot file version 1177 created 05-OCT-2021 17:10:22

APM08279+525 GM076.UVDATA.1

Freq = 1.5945 GHz, Bw = 32.000 MHz No calibration applied and no bandpass applied

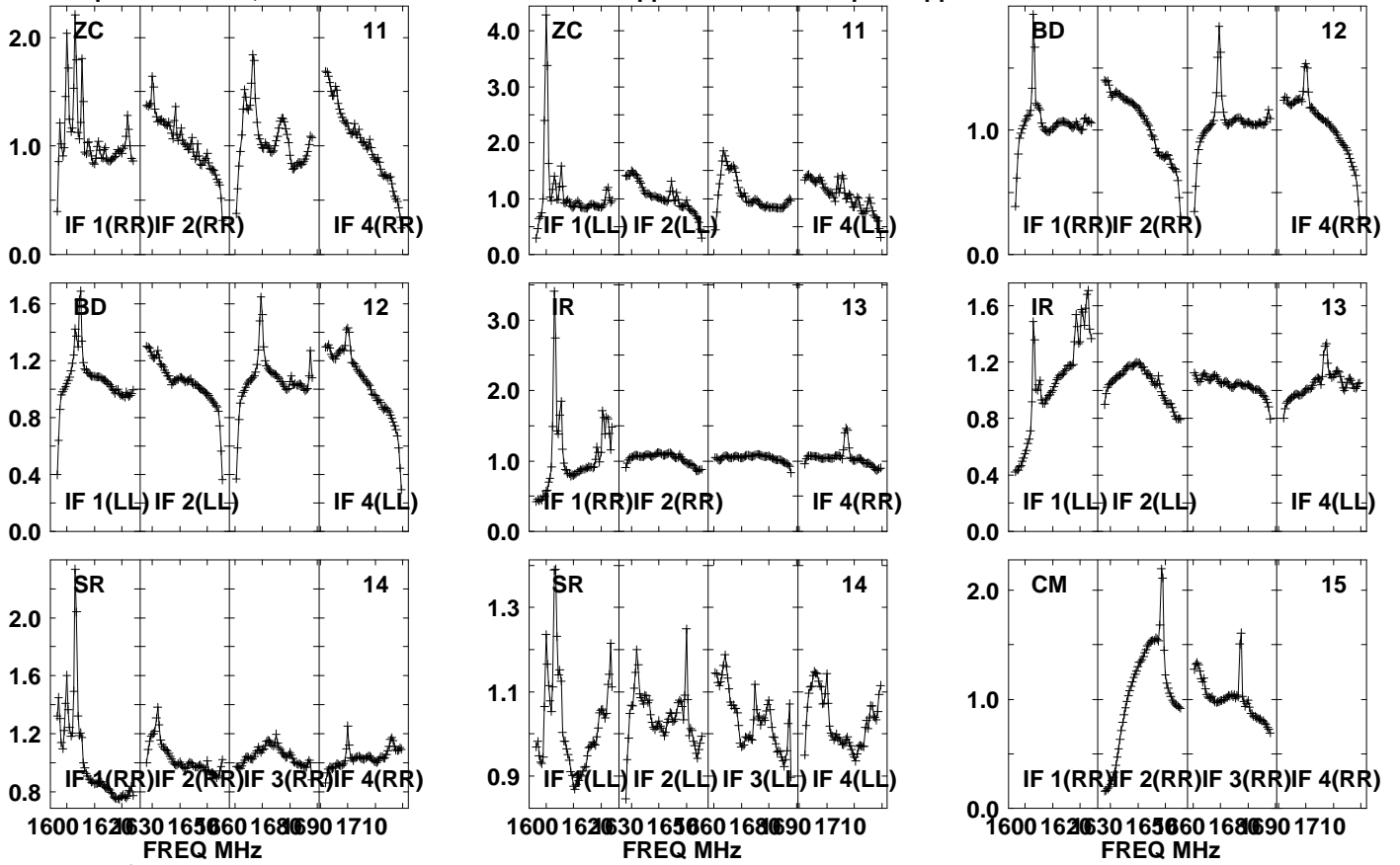

Lower frame: Real Jy

Auto-corr total-power spectrum Antenna: \*

Timerange: 00/20:34:31 to 00/20:37:59

Plot file version 1178 created 05-OCT-2021 17:10:23

APM08279+525 GM076.UVDATA.1

Freq = 1.5945 GHz, Bw = 32.000 MH No calibration applied and no bandpass applied

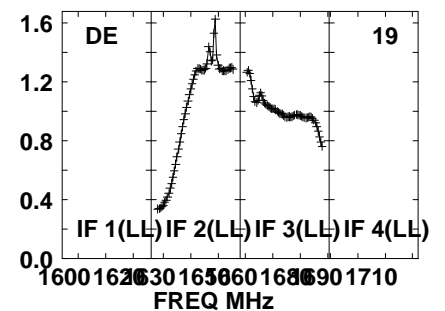
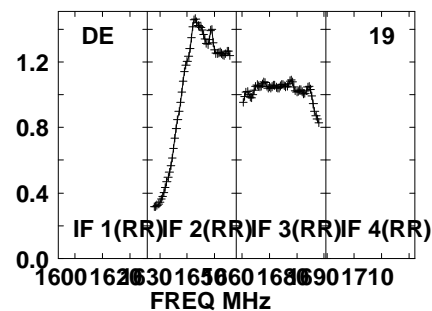
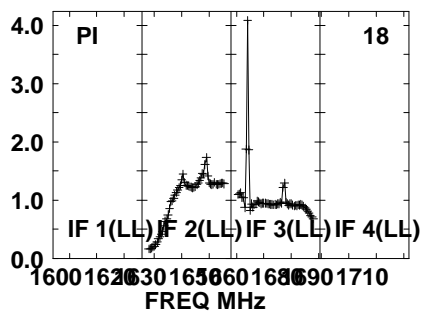
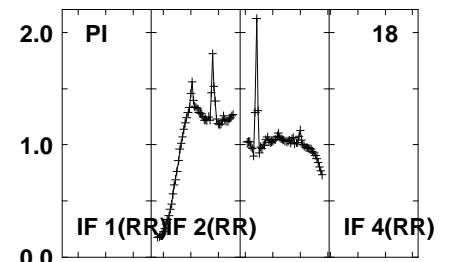
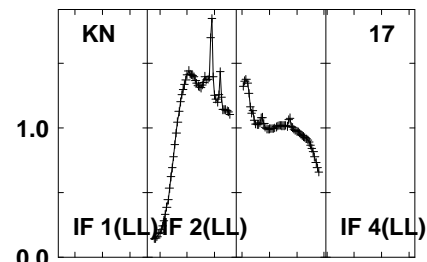
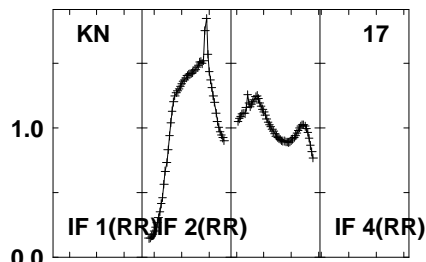
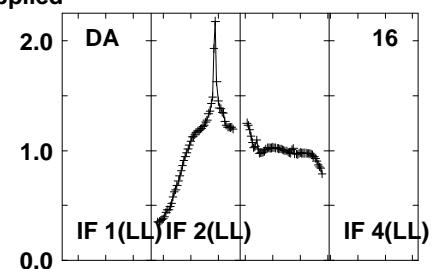
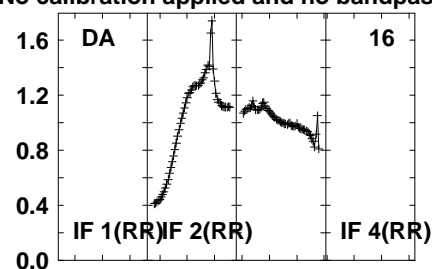
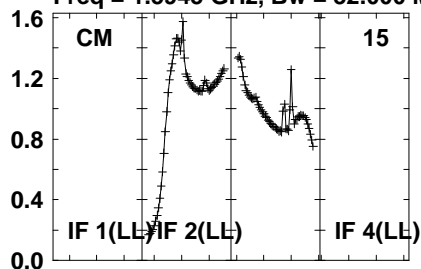

Lower frame: Real Jy  
Auto-corr total-power spectrum Antenna: \*  
Timerange: 00/20:34:31 to 00/20:37:59



Plot file version 1179 created 05-OCT-2021 17:10:23

APM08279+525 GM076.UVDATA.1

Freq = 1.5945 GHz, Bw = 32.000 MH No calibration applied and no bandpass applied

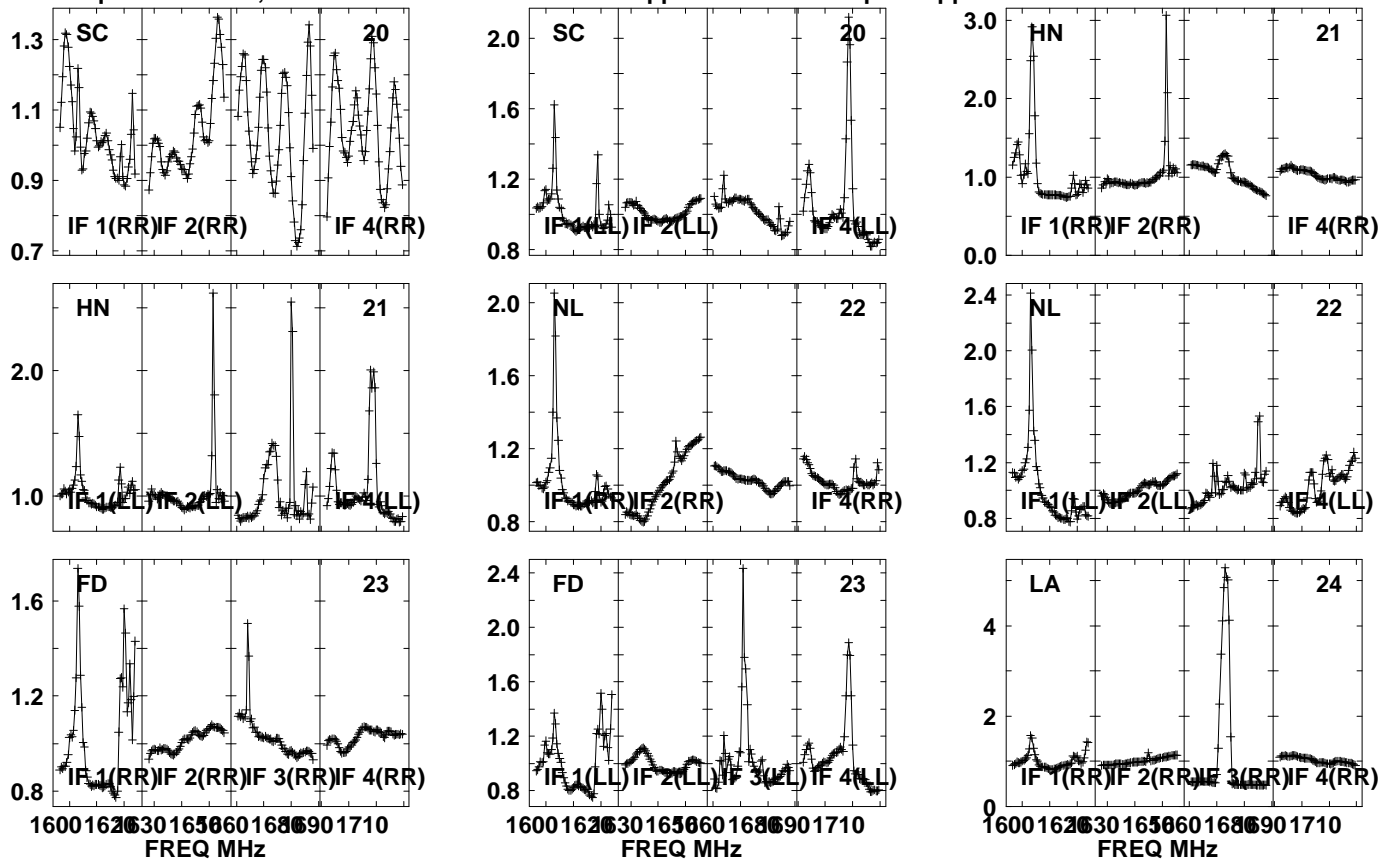

Lower frame: Real Jy  
Auto-corr total-power spectrum Antenna: \*  
Timerange: 00/20:34:31 to 00/20:37:59

Plot file version1180 created 05-OCT-2021 17:10:23

APM08279+525 GM076.UVDATA.1

Freq = 1.5945 GHz, Bw = 32.000 MH No calibration applied and no bandpass applied

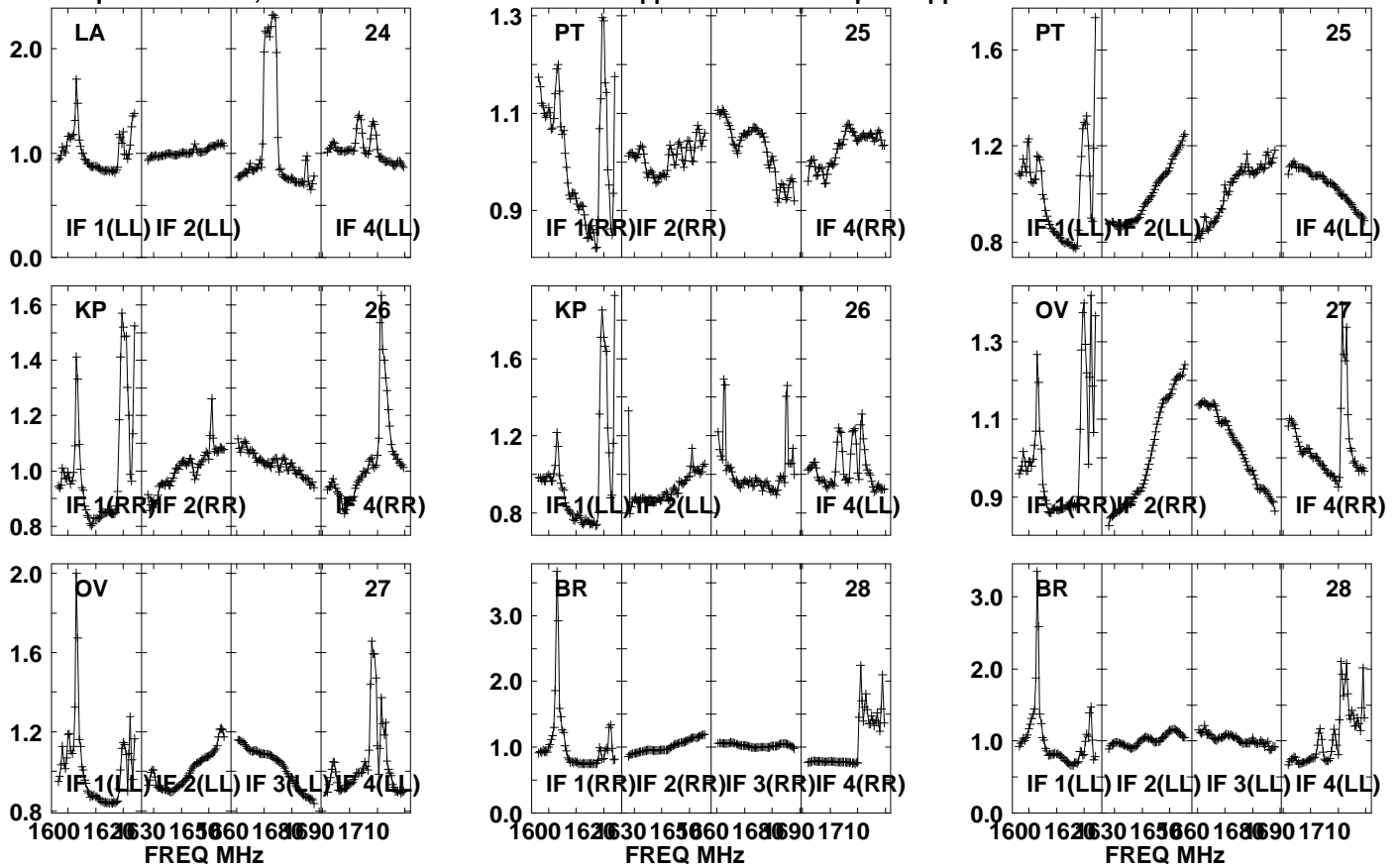

Lower frame: Real Jy

Auto-corr total-power spectrum Antenna: \*

Timerange: 00/20:34:31 to 00/20:37:59

Plot file version1181 created 05-OCT-2021 17:10:24

APM08279+525 GM076.UVDATA.1

Freq = 1.5945 GHz, Bw = 32.000 MH No calibration applied and no bandpass applied

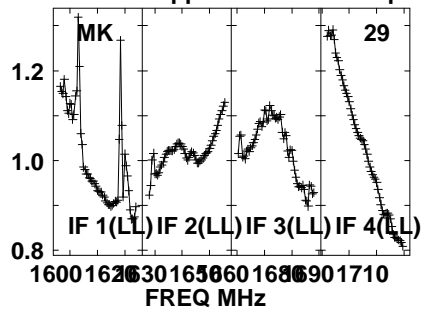
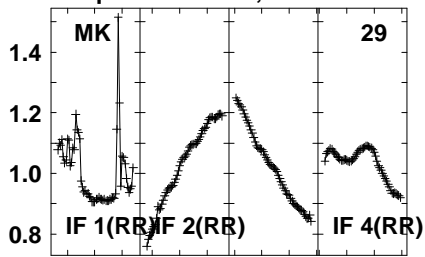

Lower frame: Real Jy  
Auto-corr total-power spectrum Antenna: \*  
Timerange: 00/20:34:31 to 00/20:37:59

Plot file version1182 created 05-OCT-2021 17:10:24

J0827+5217 GM076.UVDATA.1

Freq = 1.5945 GHz, Bw = 32.000 MH No calibration applied and no bandpass applied

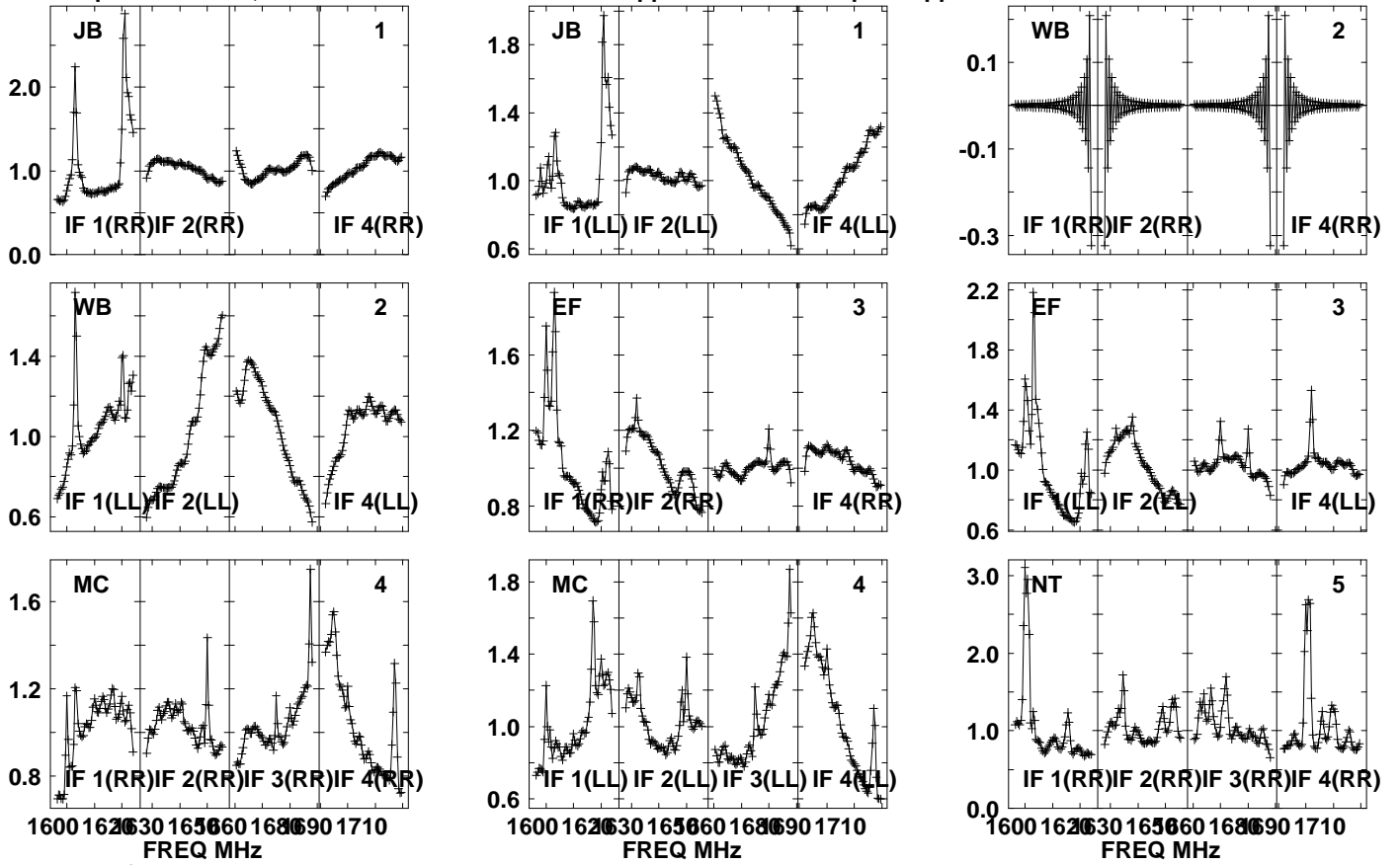

Lower frame: Real Jy

Auto-corr total-power spectrum Antenna: \*

Timerange: 00/20:38:31 to 00/20:39:59

Plot file version1183 created 05-OCT-2021 17:10:24

J0827+5217 GM076.UVDATA.1

Freq = 1.5945 GHz, Bw = 32.000 MH No calibration applied and no bandpass applied

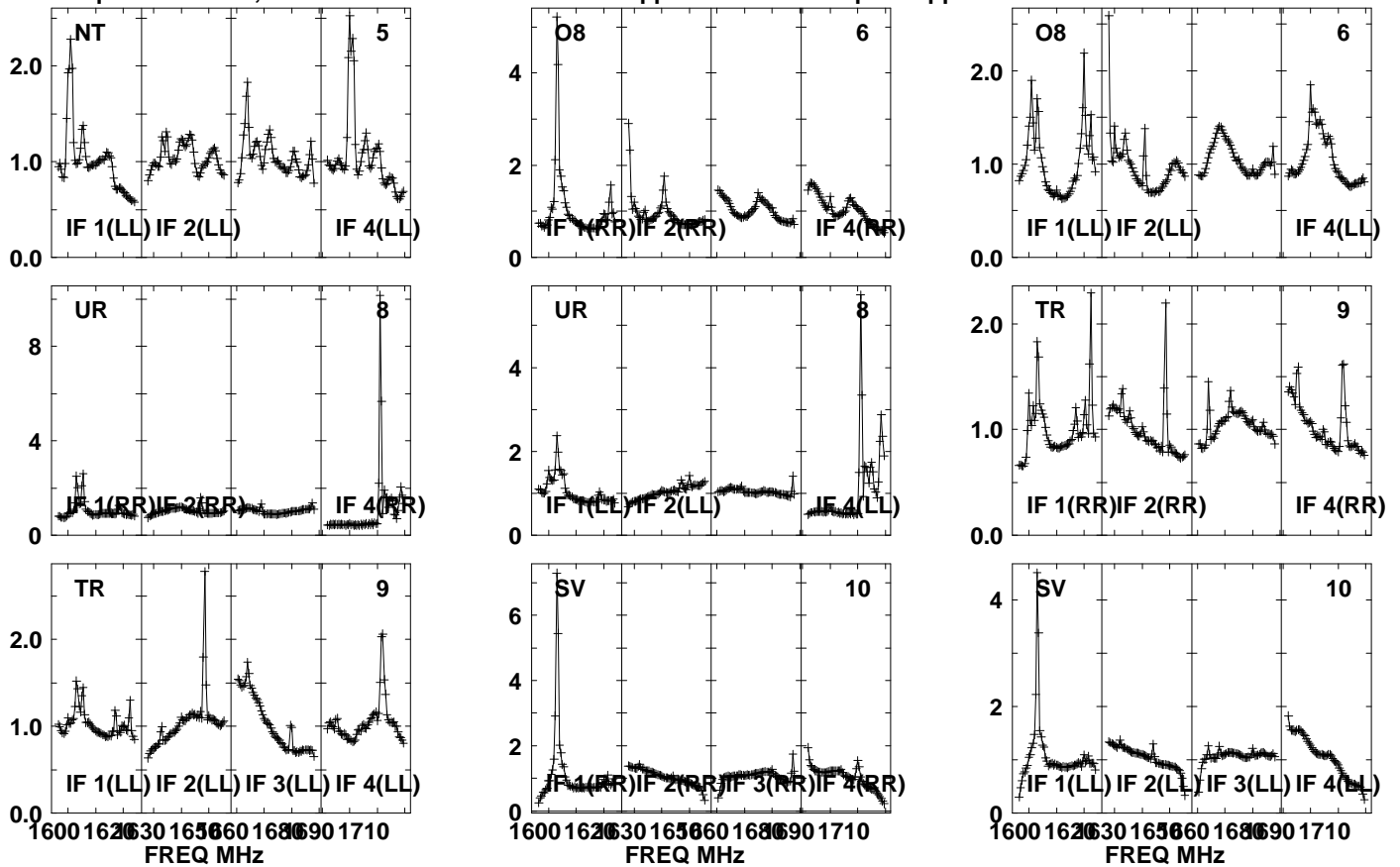

Lower frame: Real Jy

Auto-corr total-power spectrum Antenna: \*

Timerange: 00/20:38:31 to 00/20:39:59

Plot file version1184 created 05-OCT-2021 17:10:25

J0827+5217 GM076.UVDATA.1

Freq = 1.5945 GHz, Bw = 32.000 MH No calibration applied and no bandpass applied

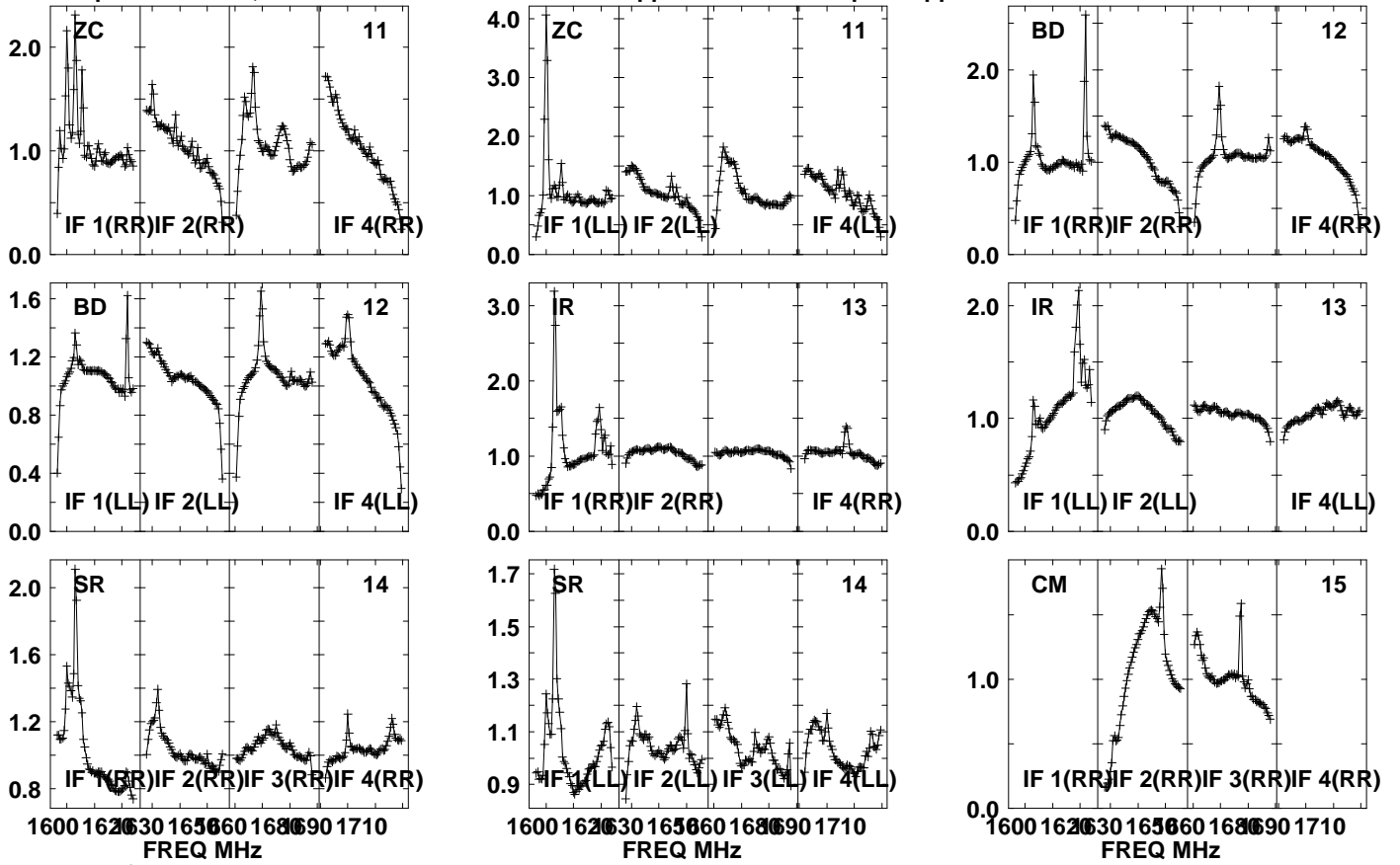

Lower frame: Real Jy

Auto-corr total-power spectrum Antenna: \*

Timerange: 00/20:38:31 to 00/20:39:59

Plot file version1185 created 05-OCT-2021 17:10:25

J0827+5217 GM076.UVDATA.1

Freq = 1.5945 GHz, Bw = 32.000 MH No calibration applied and no bandpass applied

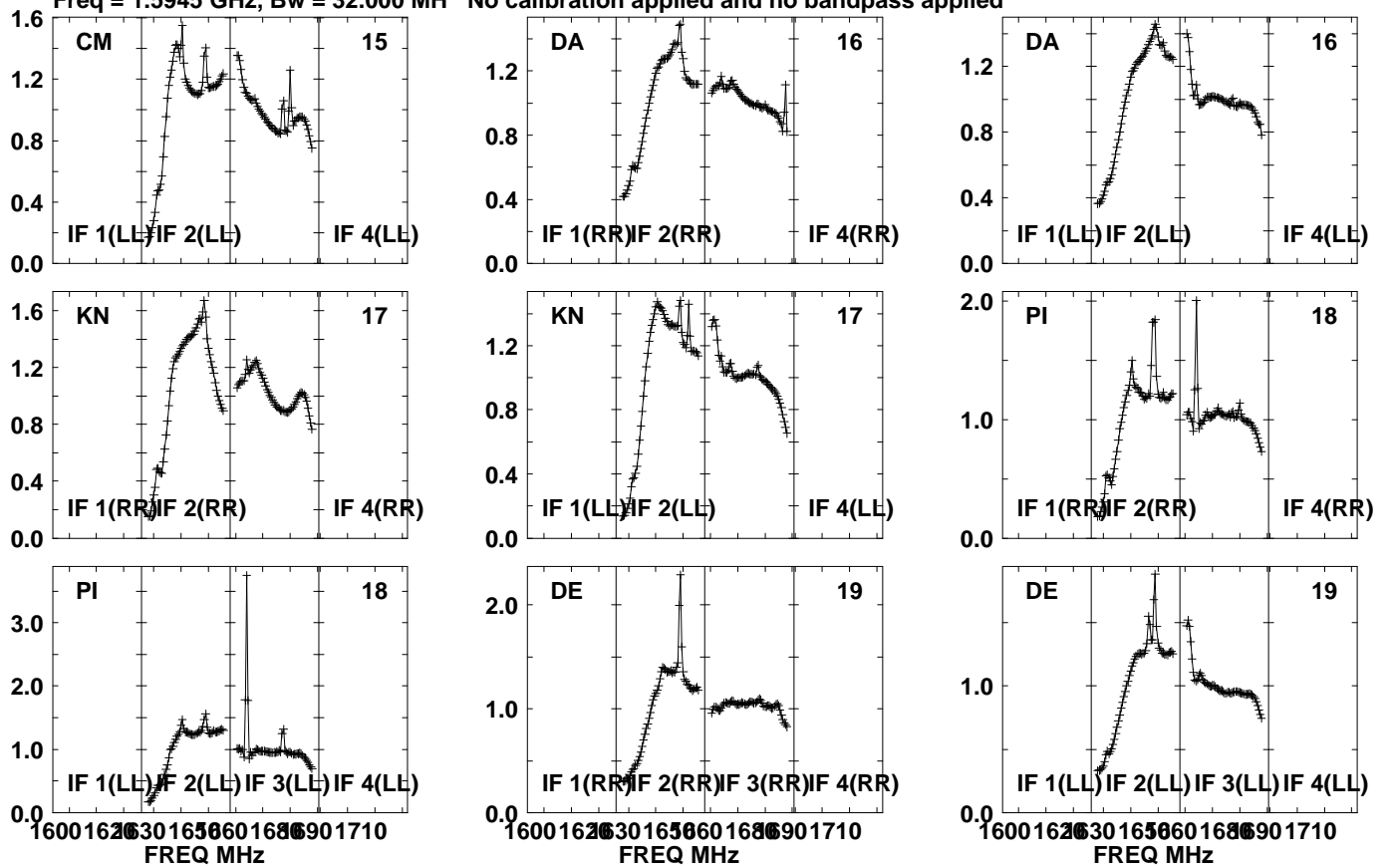

Lower frame: Real Jy  
Auto-corr total-power spectrum Antenna: \*  
Timerange: 00/20:38:31 to 00/20:39:59

Plot file version 1186 created 05-OCT-2021 17:10:25

J0827+5217 GM076.UVDATA.1

Freq = 1.5945 GHz, Bw = 32.000 MH No calibration applied and no bandpass applied

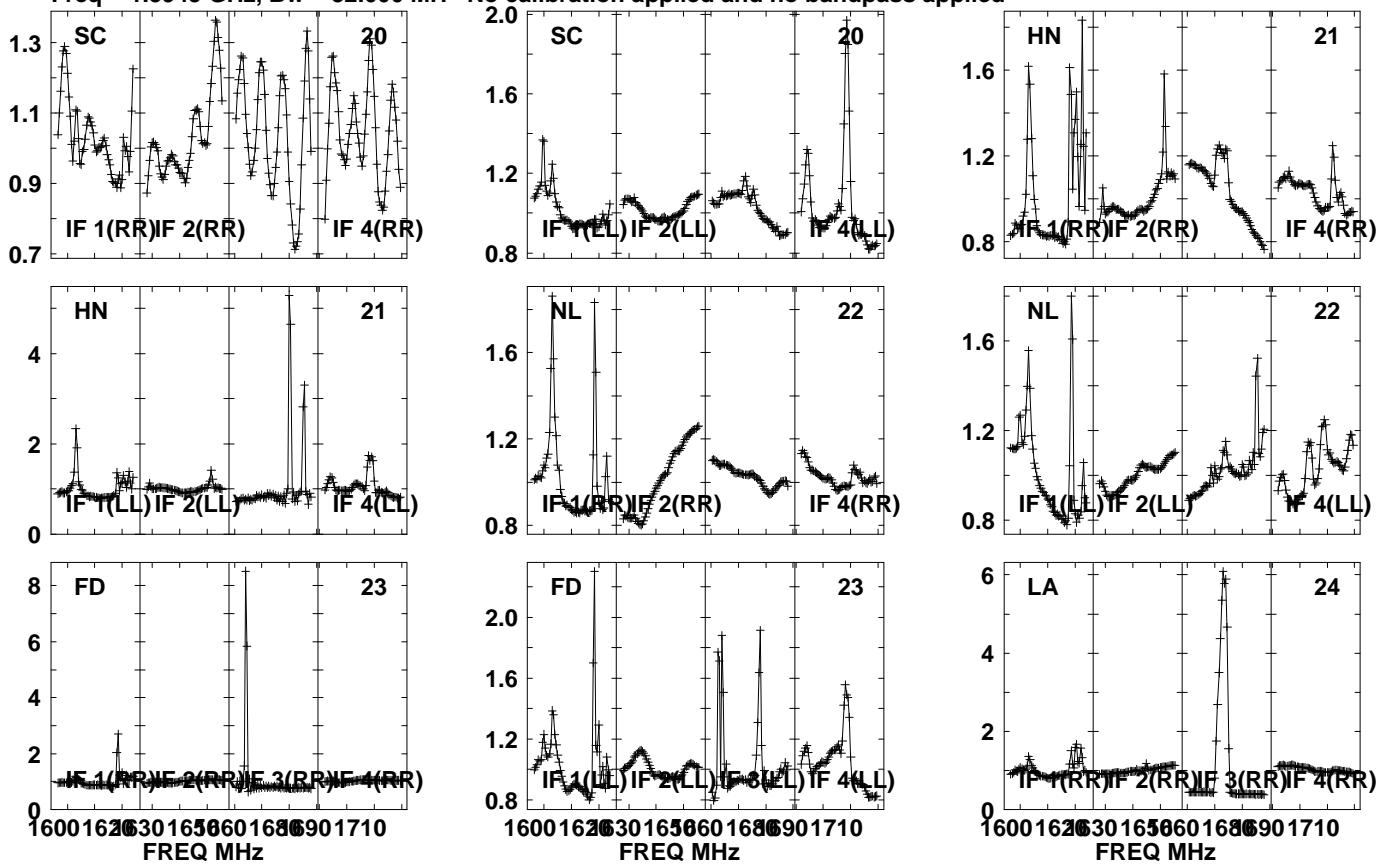

Lower frame: Real Jy  
Auto-corr total-power spectrum Antenna: \*  
Timerange: 00/20:38:31 to 00/20:39:59



Plot file version1187 created 05-OCT-2021 17:10:26

J0827+5217 GM076.UVDATA.1

Freq = 1.5945 GHz, Bw = 32.000 MH No calibration applied and no bandpass applied

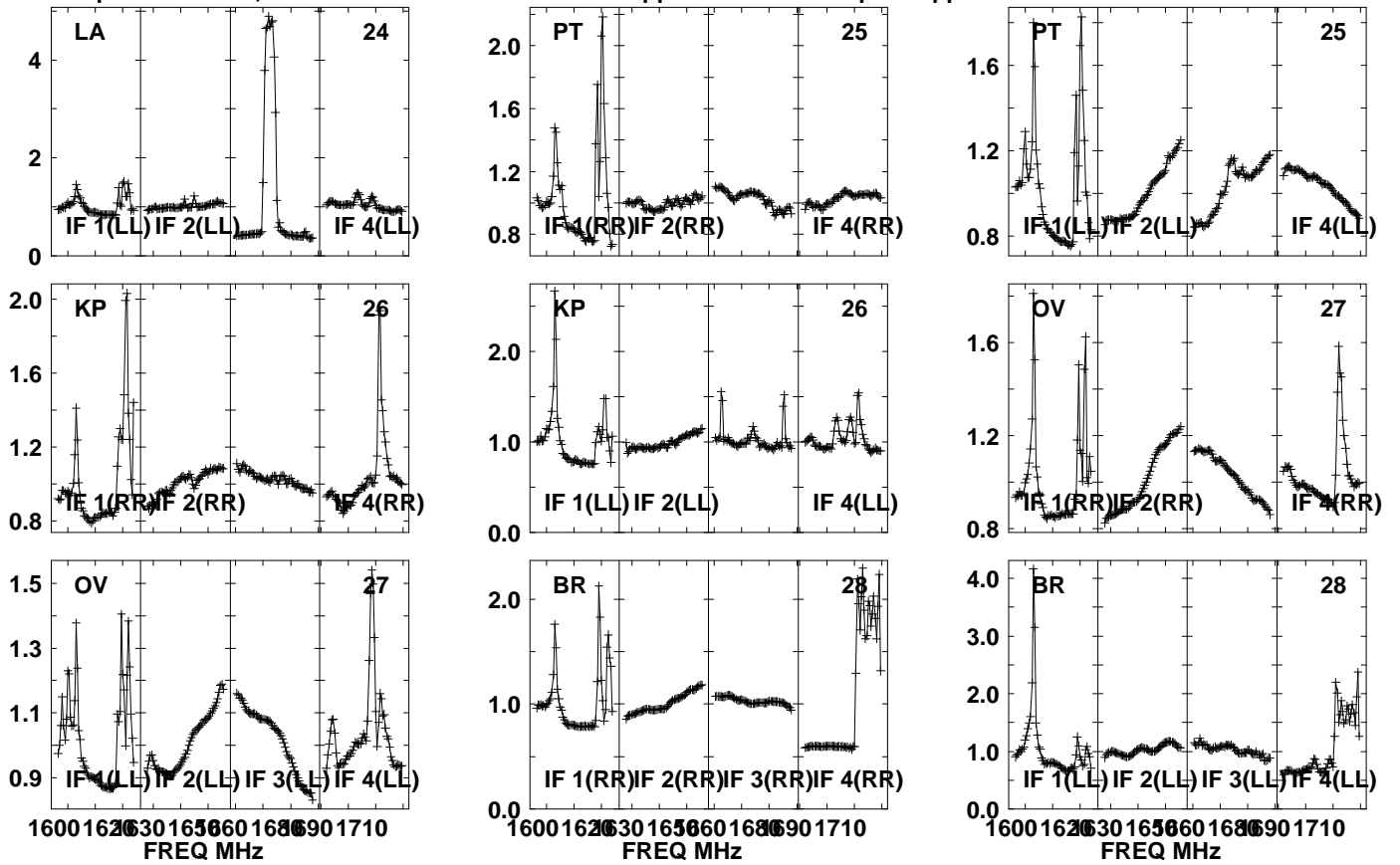

Lower frame: Real Jy

Auto-corr total-power spectrum Antenna: \*

Timerange: 00/20:38:31 to 00/20:39:59

Plot file version1188 created 05-OCT-2021 17:10:26

J0827+5217 GM076.UVDATA.1

Freq = 1.5945 GHz, Bw = 32.000 MH No calibration applied and no bandpass applied

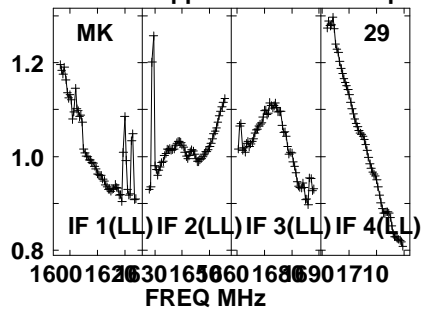
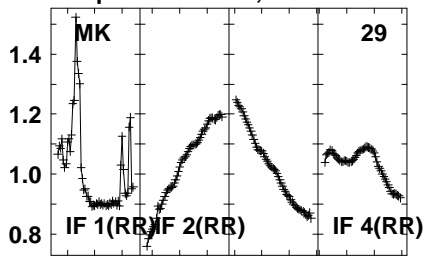

Lower frame: Real Jy  
Auto-corr total-power spectrum Antenna: \*  
Timerange: 00/20:38:31 to 00/20:39:59

Plot file version1189 created 05-OCT-2021 17:10:26

APM08279+525 GM076.UVDATA.1

Freq = 1.5945 GHz, Bw = 32.000 MH No calibration applied and no bandpass applied

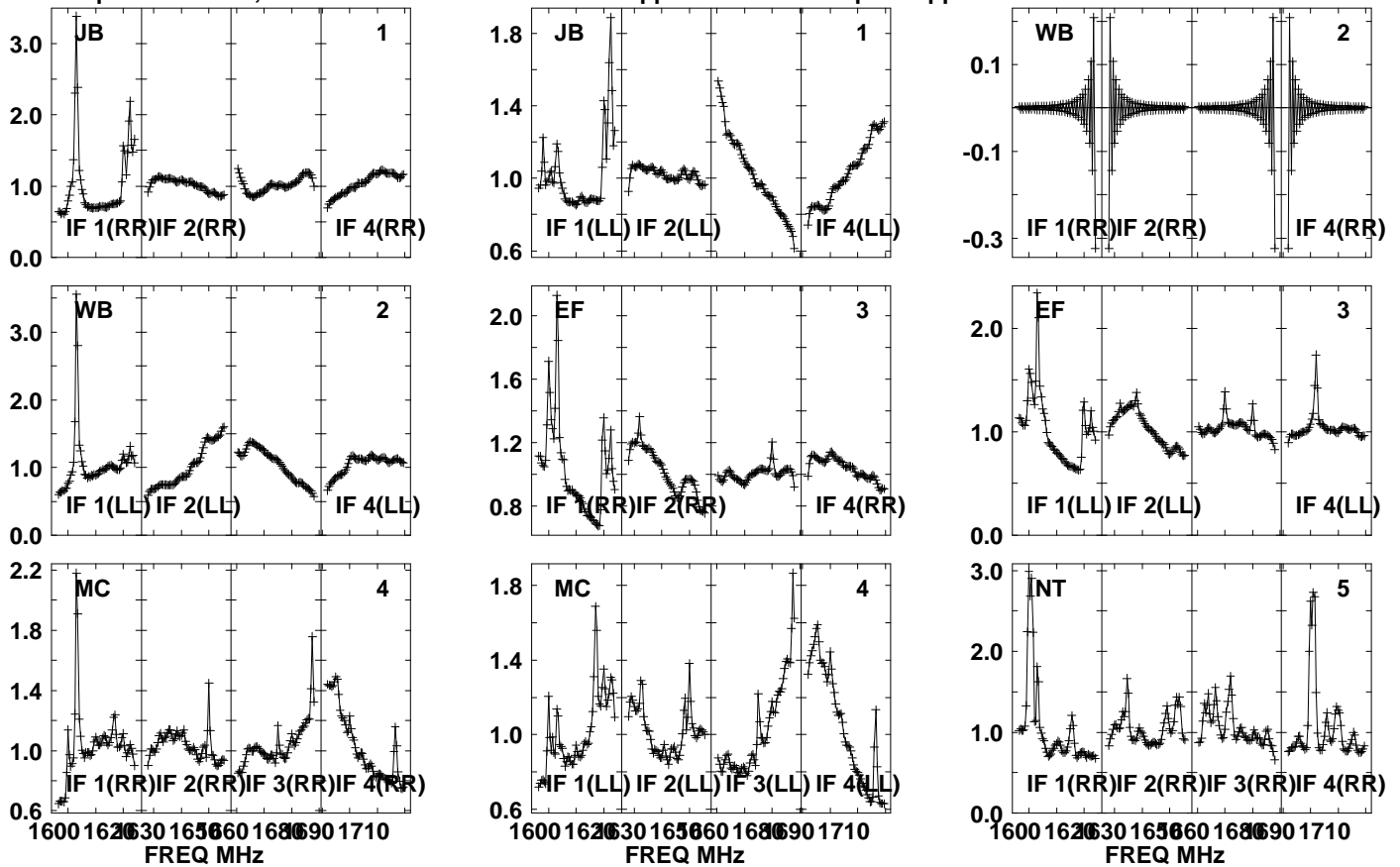

Lower frame: Real Jy

Auto-corr total-power spectrum Antenna: \*

Timerange: 00/20:40:01 to 00/20:43:29

Plot file version1190 created 05-OCT-2021 17:10:26

APM08279+525 GM076.UVDATA.1

Freq = 1.5945 GHz, Bw = 32.000 MH No calibration applied and no bandpass applied

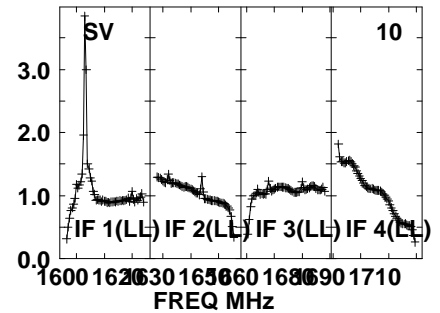
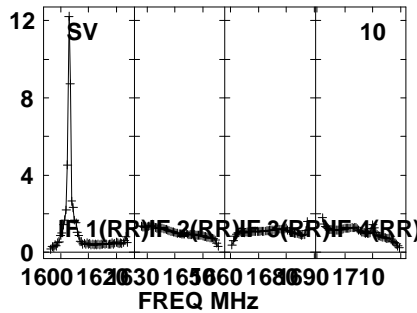
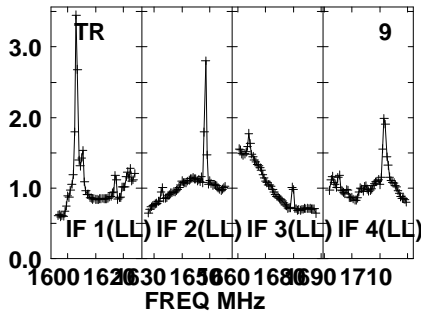
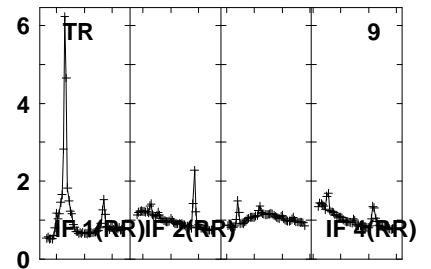
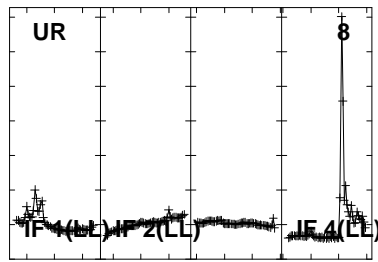
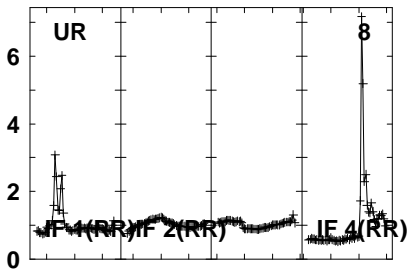
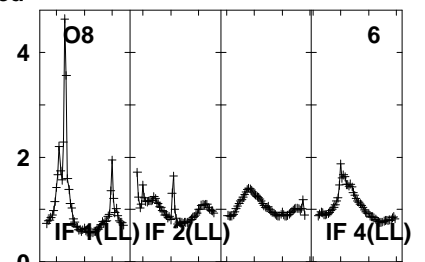
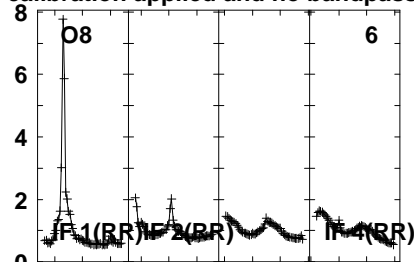
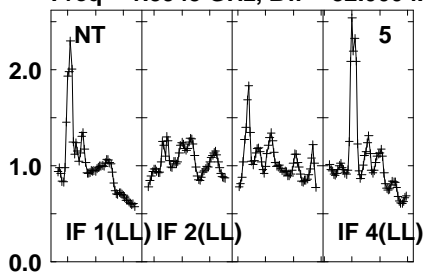

Lower frame: Real Jy

Auto-corr total-power spectrum Antenna: \*

Timerange: 00/20:40:01 to 00/20:43:29

Plot file version1191 created 05-OCT-2021 17:10:27

APM08279+525 GM076.UVDATA.1

Freq = 1.5945 GHz, Bw = 32.000 MH No calibration applied and no bandpass applied

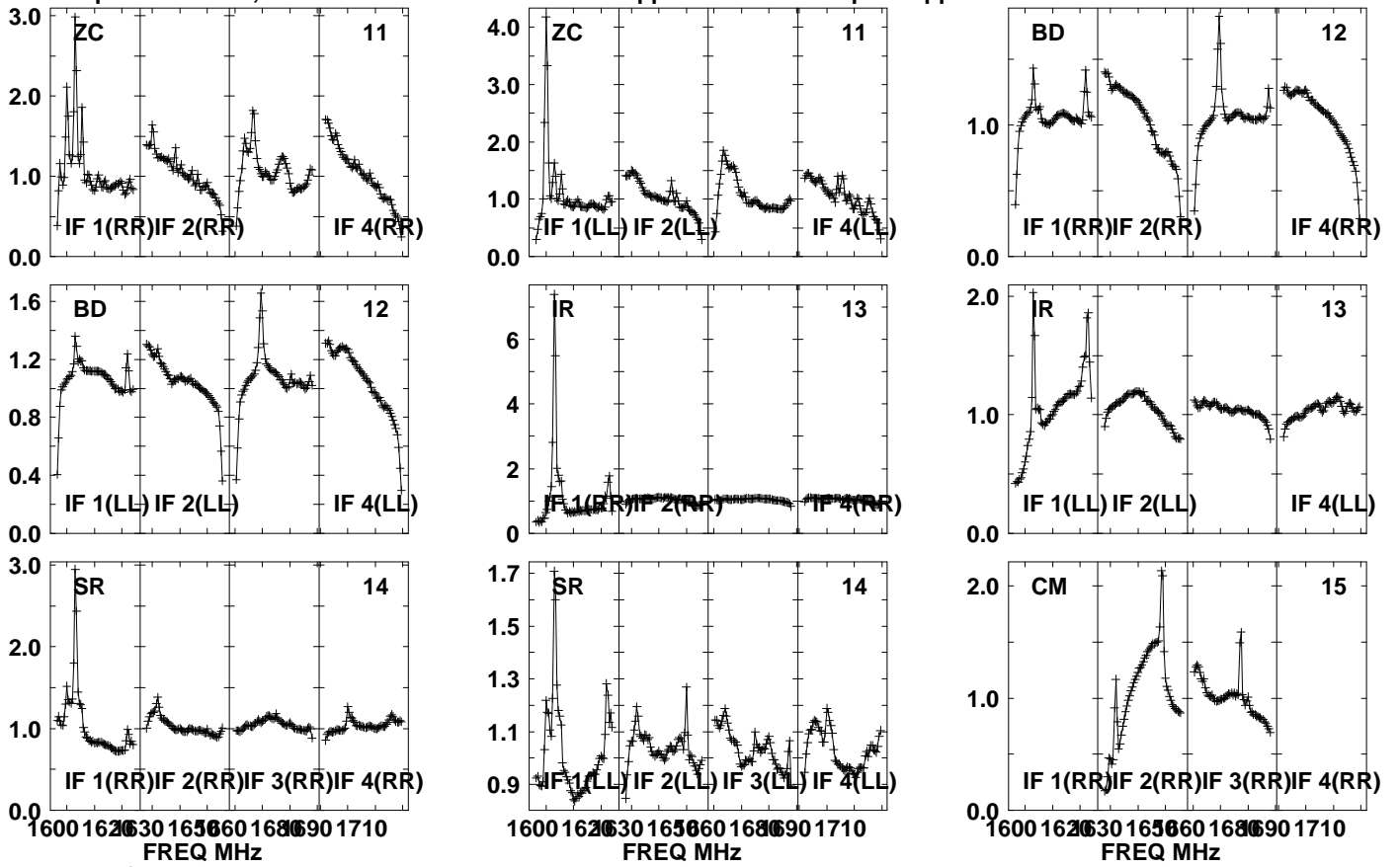

Lower frame: Real Jy  
Auto-corr total-power spectrum Antenna: \*  
Timerange: 00/20:40:01 to 00/20:43:29

Plot file version 1192 created 05-OCT-2021 17:10:27

APM08279+525 GM076.UVDATA.1

Freq = 1.5945 GHz, Bw = 32.000 MH No calibration applied and no bandpass applied

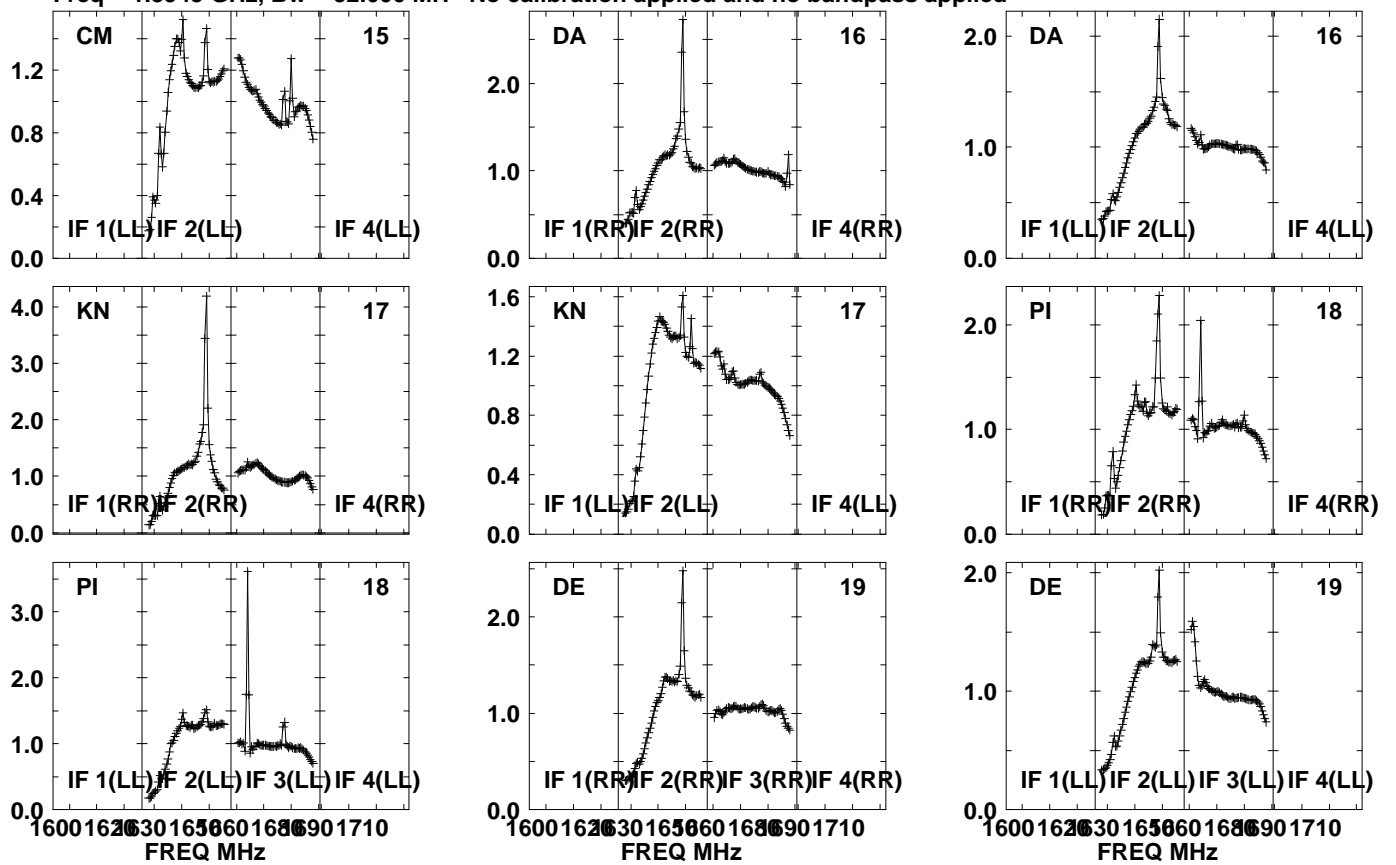

Lower frame: Real Jy  
Auto-corr total-power spectrum Antenna: \*  
Timerange: 00/20:40:01 to 00/20:43:29

Plot file version1193 created 05-OCT-2021 17:10:27

APM08279+525 GM076.UVDATA.1

Freq = 1.5945 GHz, Bw = 32.000 MH No calibration applied and no bandpass applied

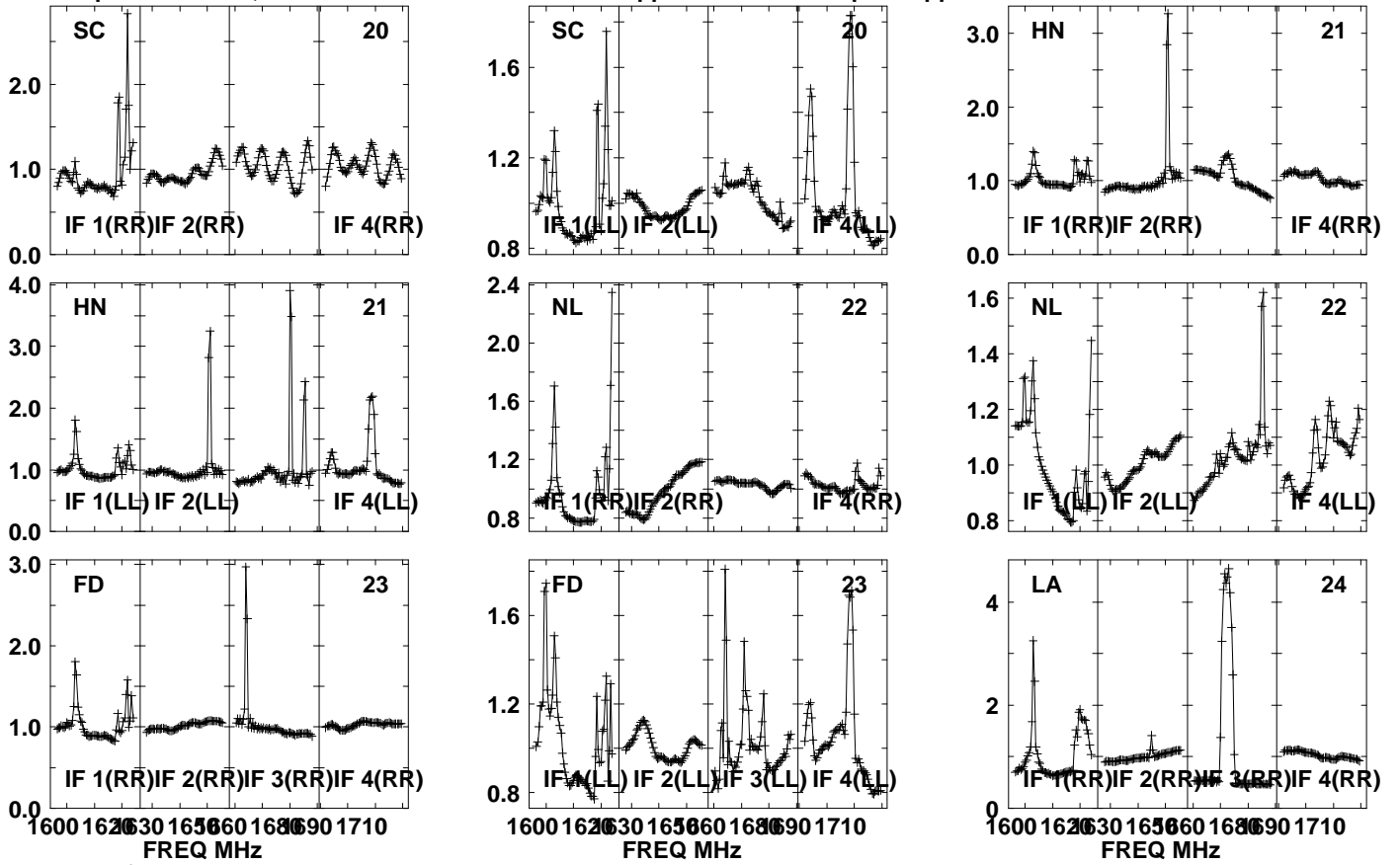

Lower frame: Real Jy

Auto-corr total-power spectrum Antenna: \*

Timerange: 00/20:40:01 to 00/20:43:29

Plot file version1194 created 05-OCT-2021 17:10:28

APM08279+525 GM076.UVDATA.1

Freq = 1.5945 GHz, Bw = 32.000 MH No calibration applied and no bandpass applied

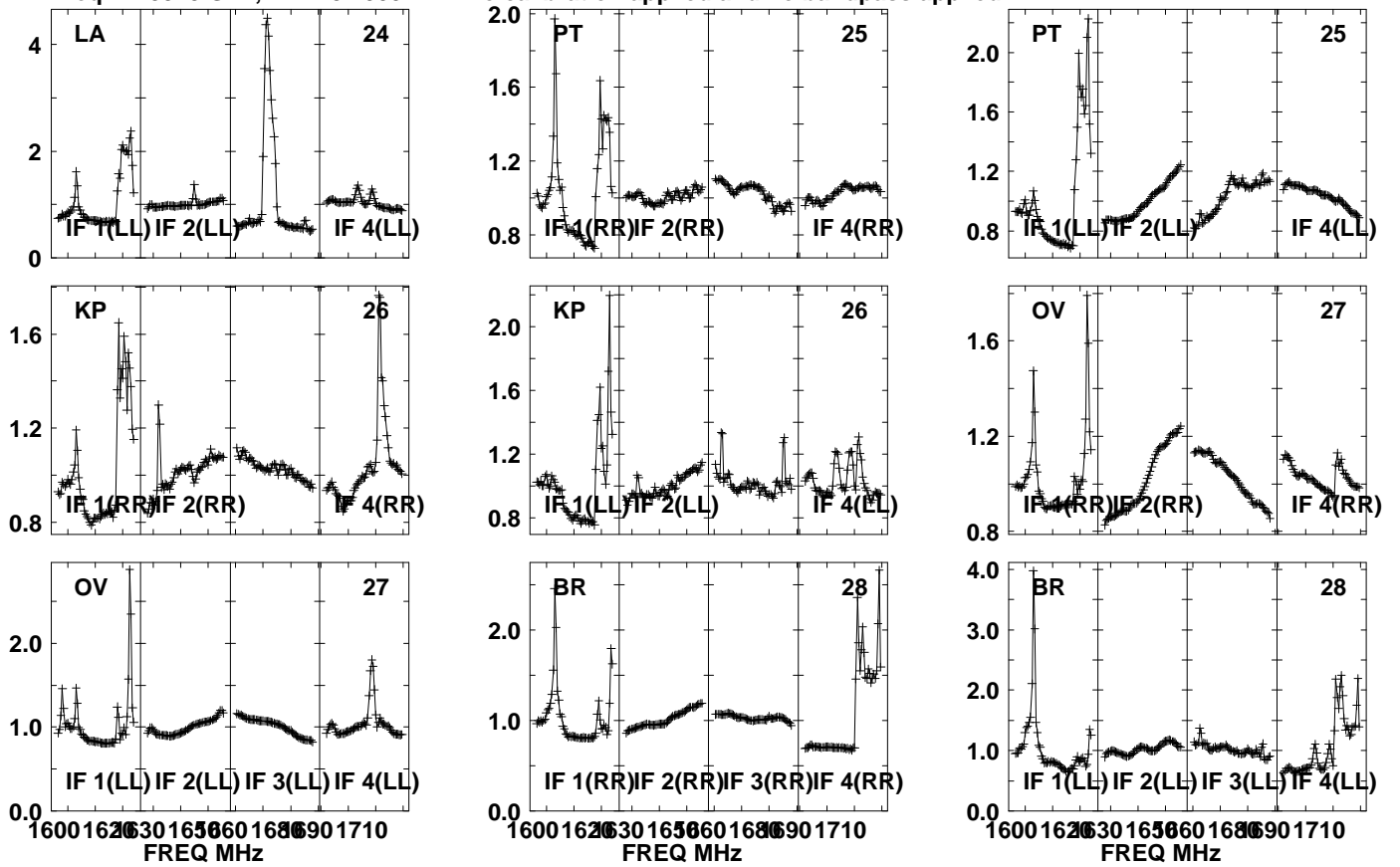

Lower frame: Real Jy  
Auto-corr total-power spectrum Antenna: \*  
Timerange: 00/20:40:01 to 00/20:43:29



Plot file version1195 created 05-OCT-2021 17:10:28

APM08279+525 GM076.UVDATA.1

Freq = 1.5945 GHz, Bw = 32.000 MH No calibration applied and no bandpass applied

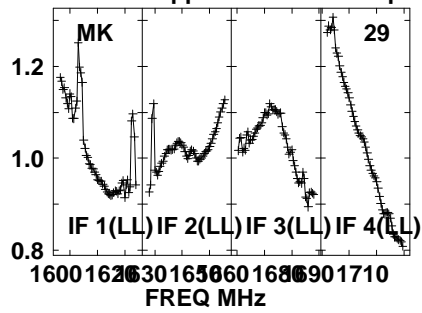
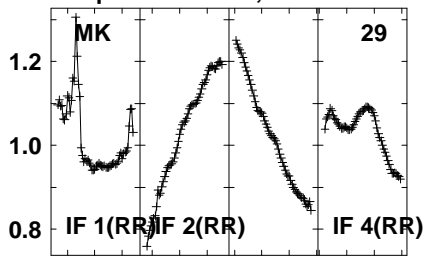

Lower frame: Real Jy  
Auto-corr total-power spectrum Antenna: \*  
Timerange: 00/20:40:01 to 00/20:43:29

Plot file version 1196 created 05-OCT-2021 17:10:28

J0827+5217 GM076.UVDATA.1

Freq = 1.5945 GHz, Bw = 32.000 MH No calibration applied and no bandpass applied

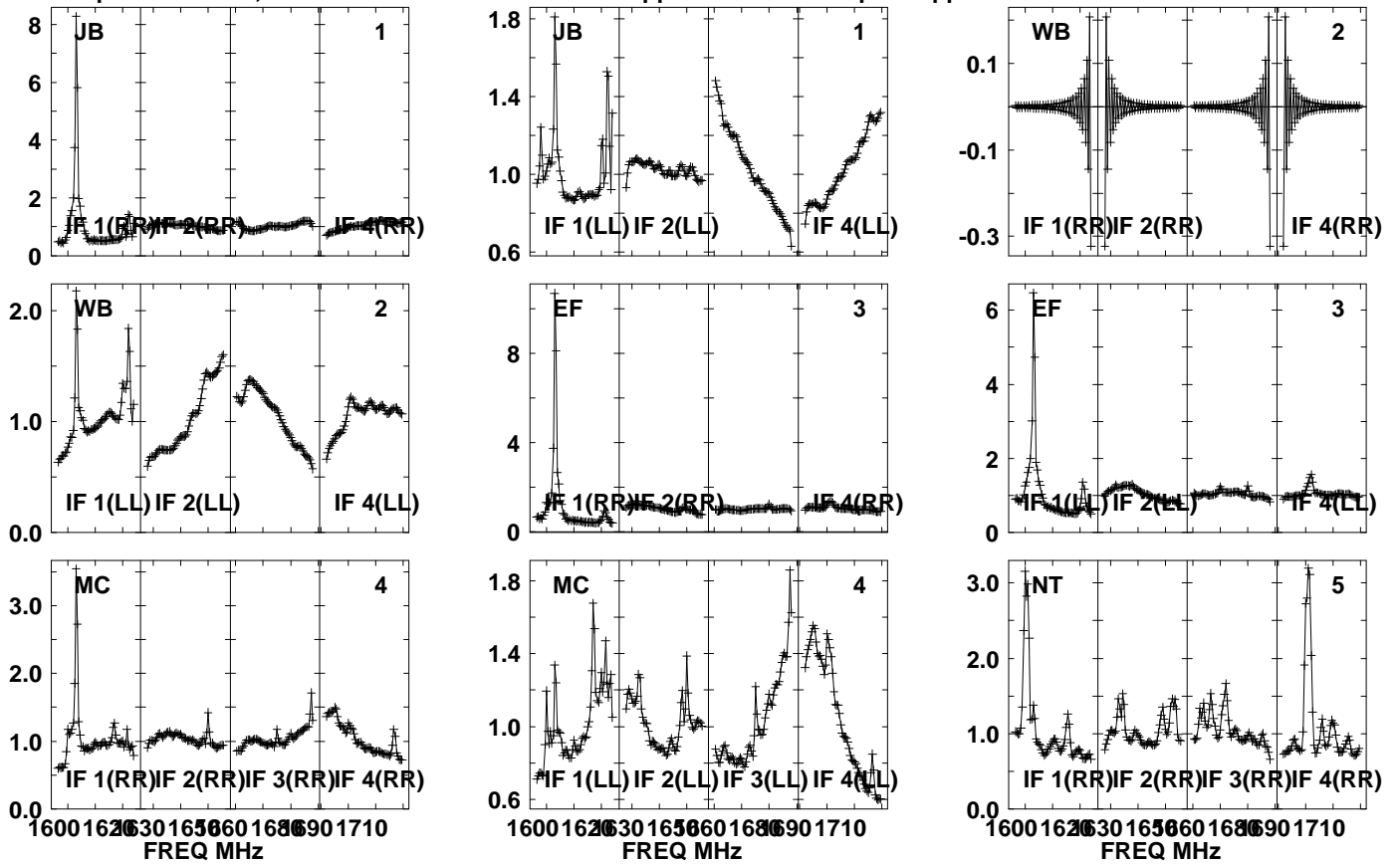

Lower frame: Real Jy

Auto-corr total-power spectrum Antenna: \*

Timerange: 00/20:43:31 to 00/20:44:59

Plot file version1197 created 05-OCT-2021 17:10:29

J0827+5217 GM076.UVDATA.1

Freq = 1.5945 GHz, Bw = 32.000 MH No calibration applied and no bandpass applied

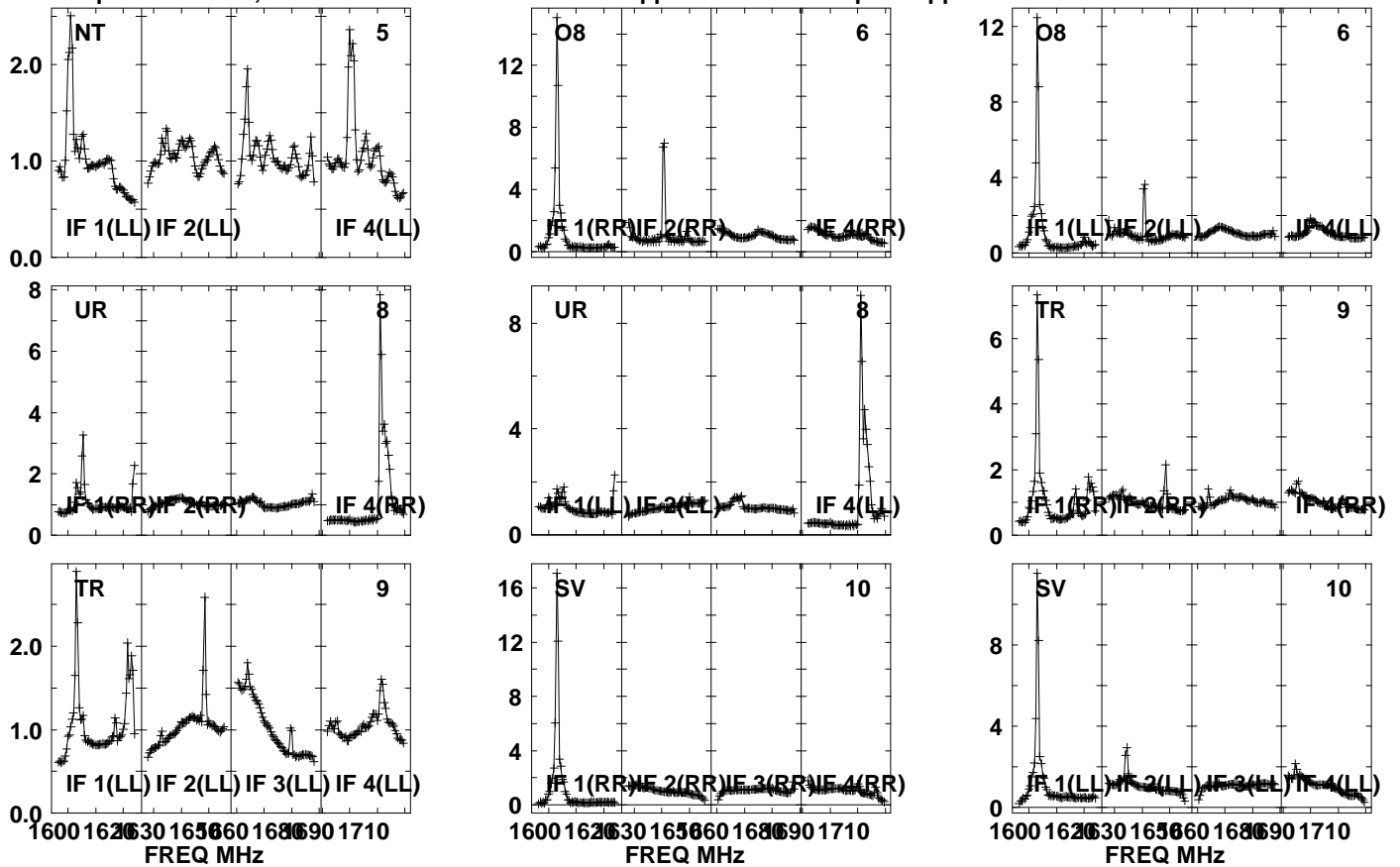

Lower frame: Real Jy

Auto-corr total-power spectrum Antenna: \*

Timerange: 00/20:43:31 to 00/20:44:59

Plot file version 1198 created 05-OCT-2021 17:10:29

J0827+5217 GM076.UVDATA.1

Freq = 1.5945 GHz, Bw = 32.000 MH No calibration applied and no bandpass applied

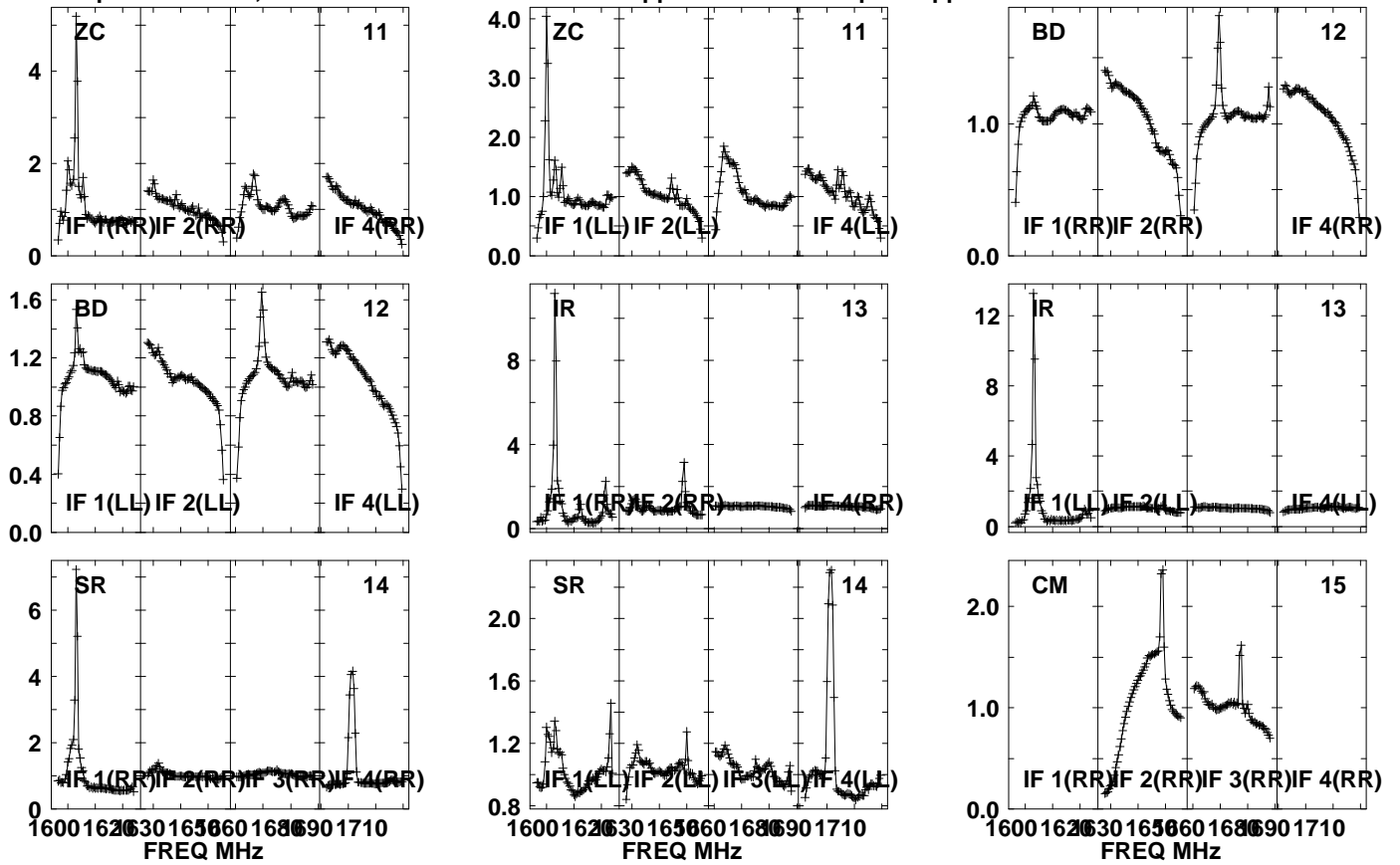

Lower frame: Real Jy

Auto-corr total-power spectrum Antenna: \*

Timerange: 00/20:43:31 to 00/20:44:59

Plot file version 1199 created 05-OCT-2021 17:10:29

J0827+5217 GM076.UVDATA.1

Freq = 1.5945 GHz, Bw = 32.000 MH No calibration applied and no bandpass applied

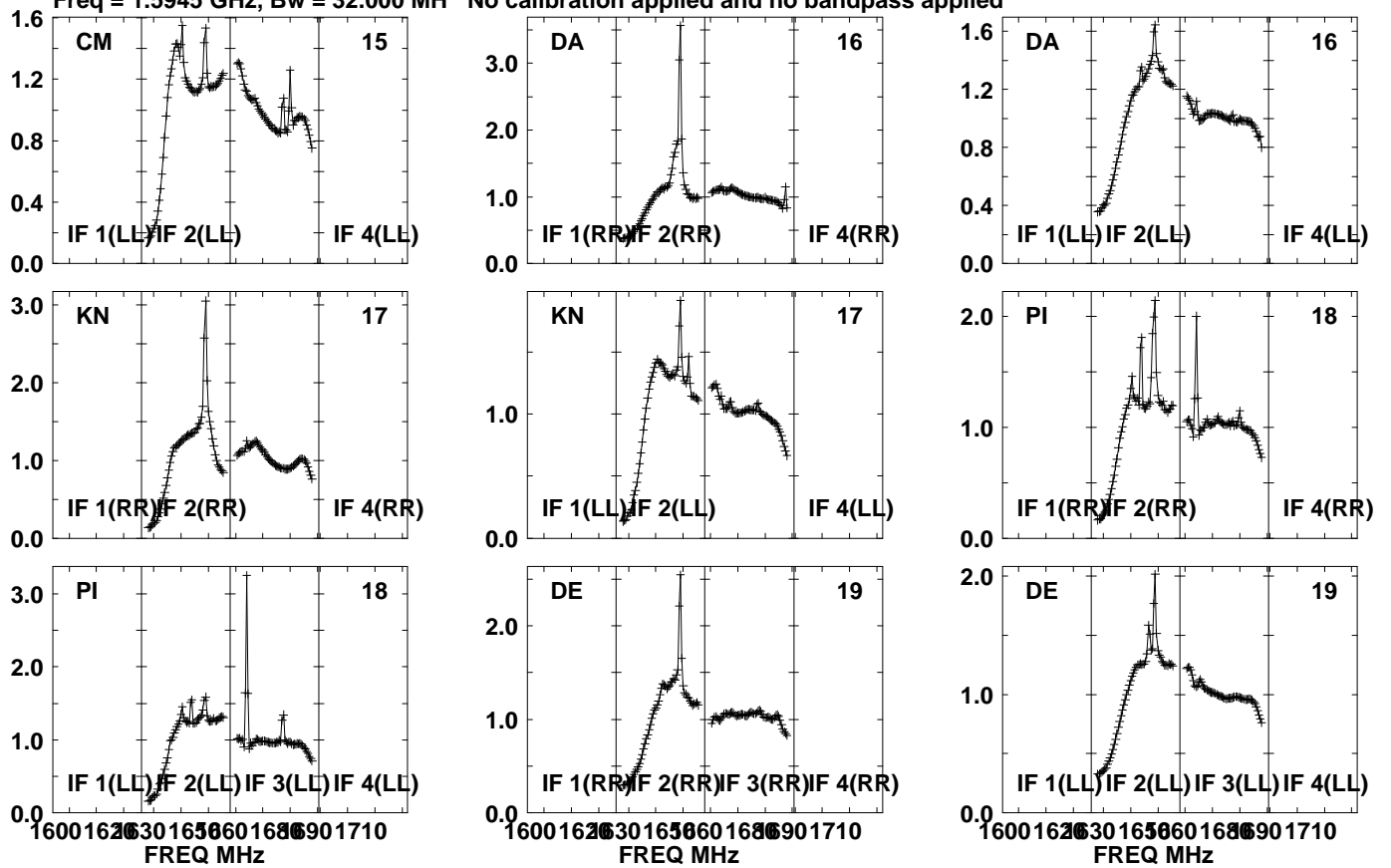

Lower frame: Real Jy  
Auto-corr total-power spectrum Antenna: \*  
Timerange: 00/20:43:31 to 00/20:44:59

Plot file version 1200 created 05-OCT-2021 17:10:30

J0827+5217 GM076.UVDATA.1

Freq = 1.5945 GHz, Bw = 32.000 MH No calibration applied and no bandpass applied

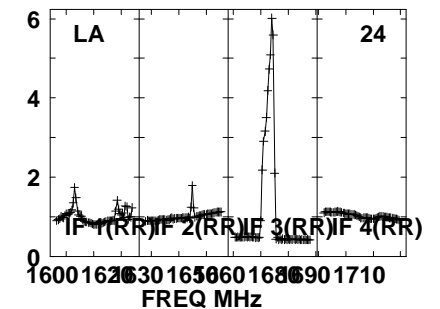
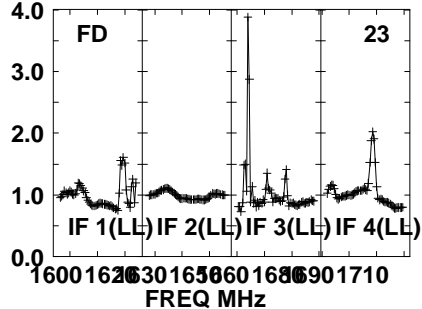
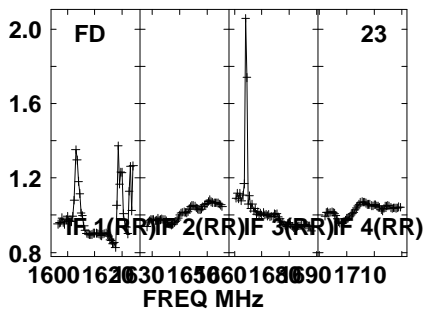
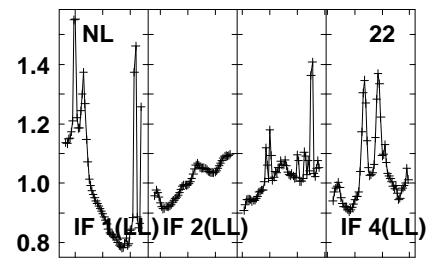
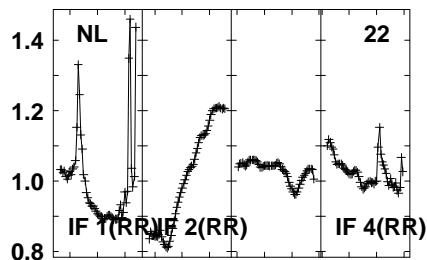
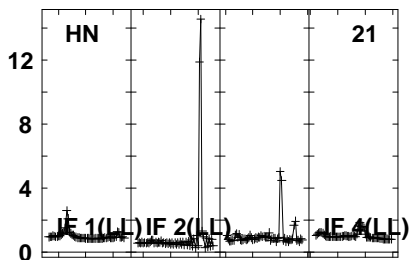
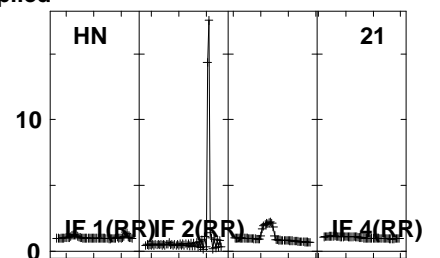
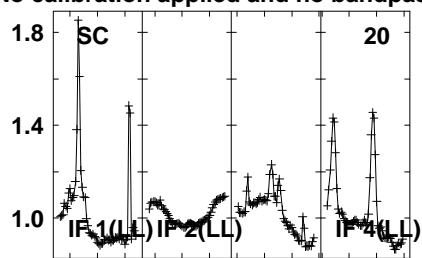
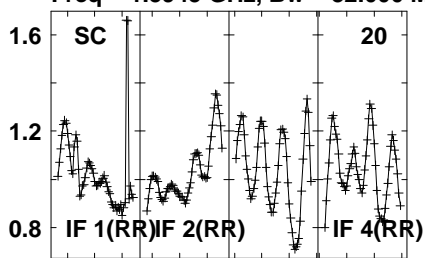

Lower frame: Real Jy  
Auto-corr total-power spectrum Antenna: \*  
Timerange: 00/20:43:31 to 00/20:44:59

Plot file version1201 created 05-OCT-2021 17:10:30

J0827+5217 GM076.UVDATA.1

Freq = 1.5945 GHz, Bw = 32.000 MH No calibration applied and no bandpass applied

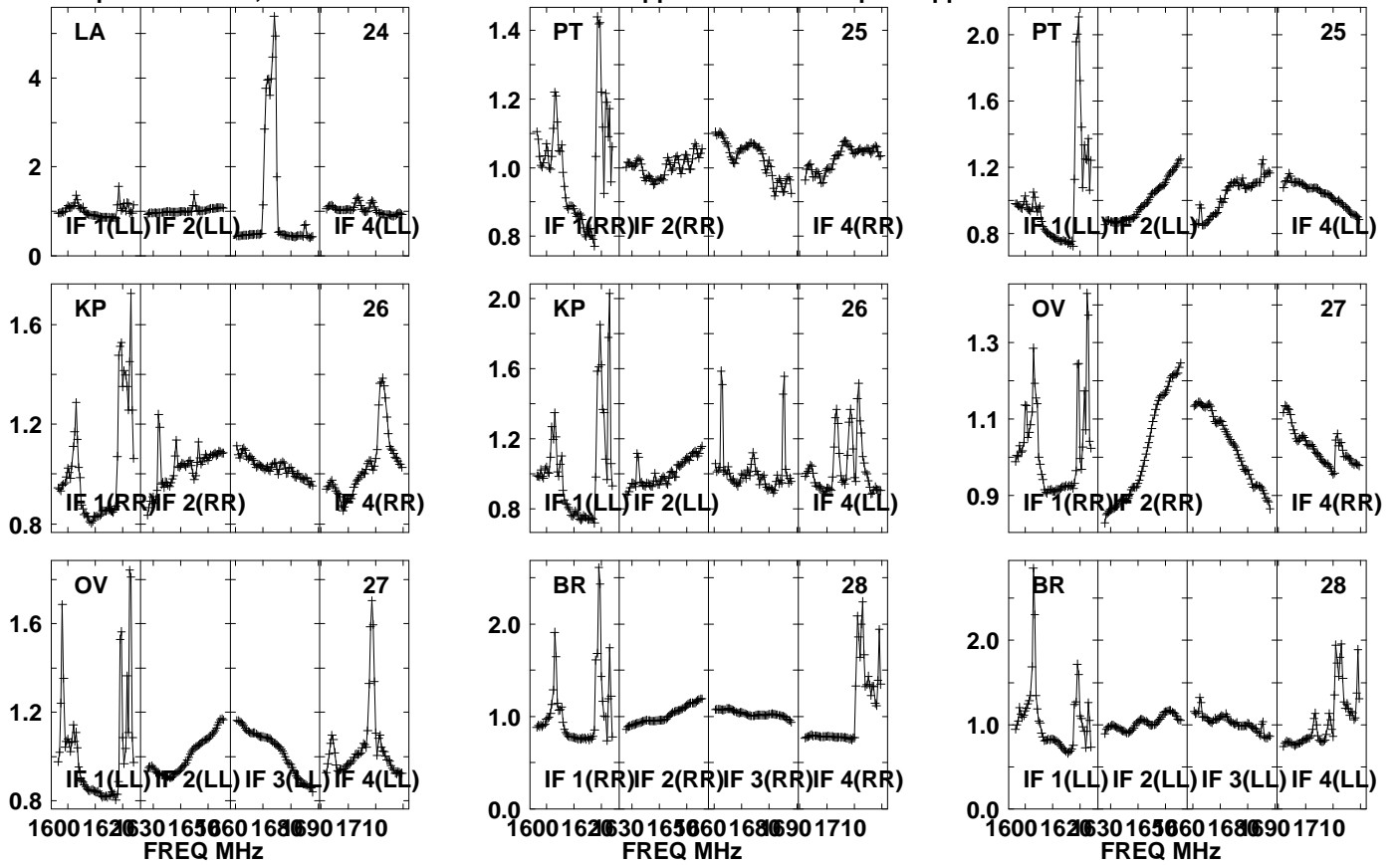

Lower frame: Real Jy  
Auto-corr total-power spectrum Antenna: \*  
Timerange: 00/20:43:31 to 00/20:44:59

Plot file version1202 created 05-OCT-2021 17:10:30

J0827+5217 GM076.UVDATA.1

Freq = 1.5945 GHz, Bw = 32.000 MH

No calibration applied and no bandpass applied

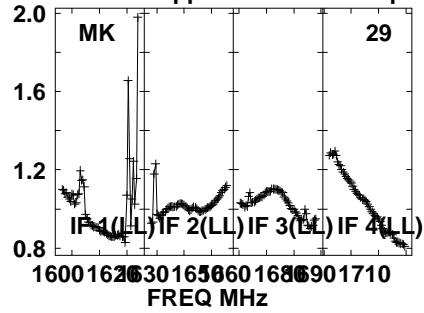
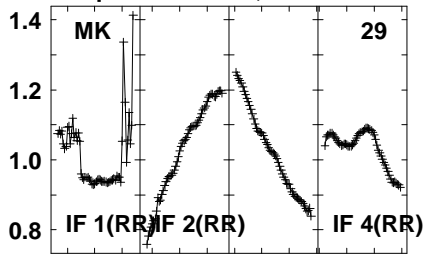

Lower frame: Real Jy  
Auto-corr total-power spectrum Antenna: \*  
Timerange: 00/20:43:31 to 00/20:44:59



Plot file version1203 created 05-OCT-2021 17:10:30

APM08279+525 GM076.UVDATA.1

Freq = 1.5945 GHz, Bw = 32.000 MH No calibration applied and no bandpass applied

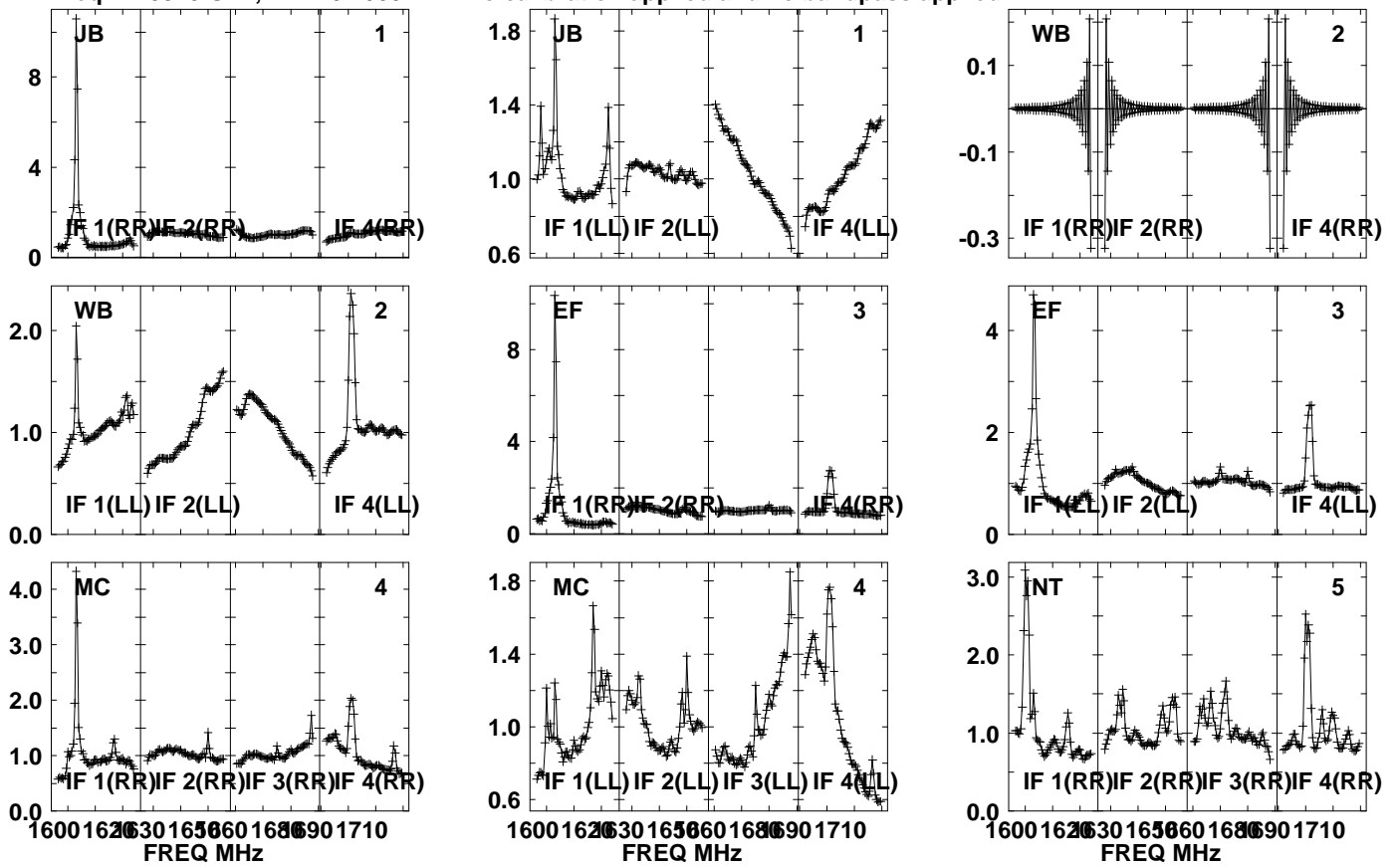

Lower frame: Real Jy  
Auto-corr total-power spectrum Antenna: \*  
Timerange: 00/20:45:01 to 00/20:48:29

Plot file version1204 created 05-OCT-2021 17:10:31

APM08279+525 GM076.UVDATA.1

Freq = 1.5945 GHz, Bw = 32.000 MH No calibration applied and no bandpass applied

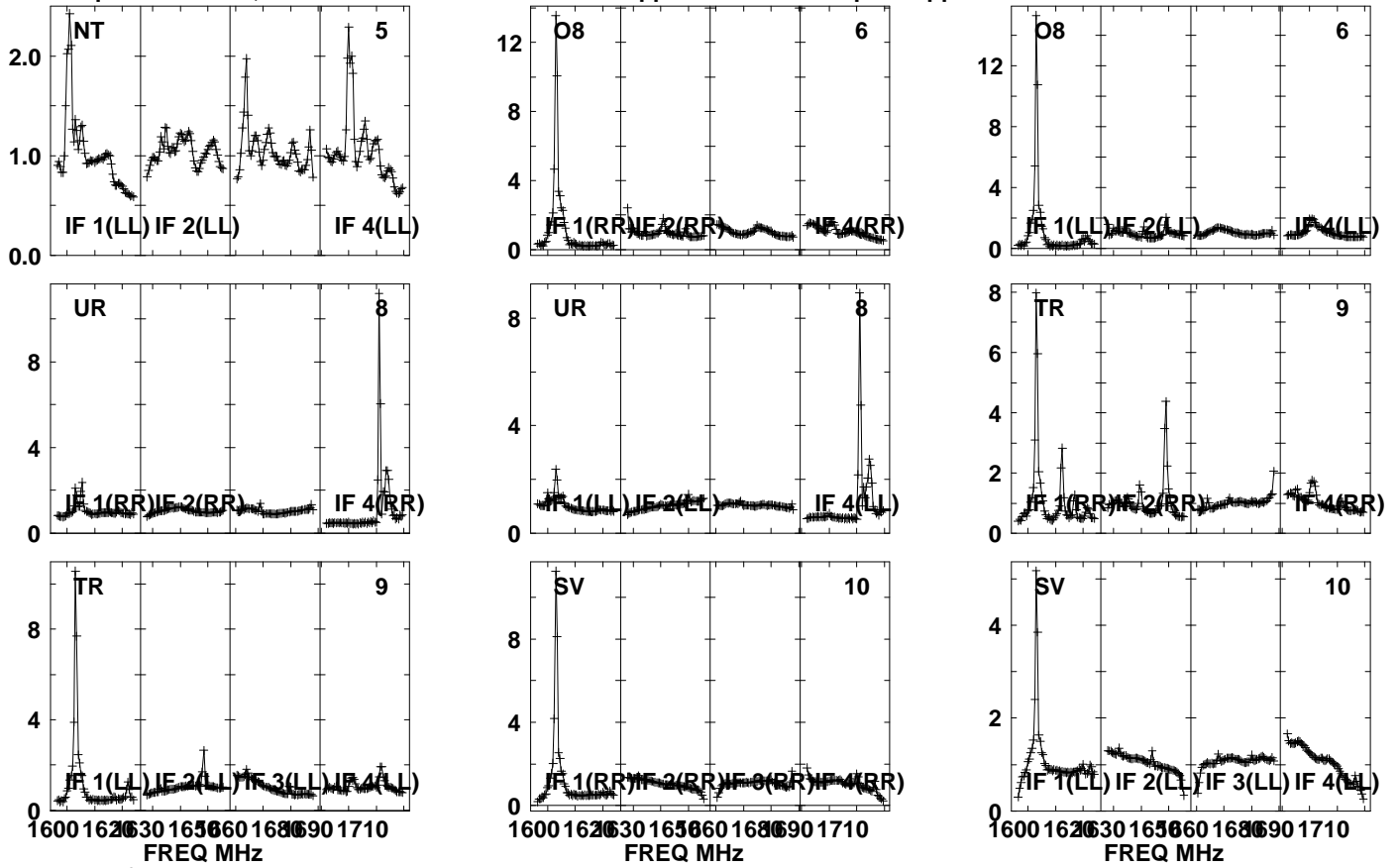

Lower frame: Real Jy

Auto-corr total-power spectrum Antenna: \*

Timerange: 00/20:45:01 to 00/20:48:29

Plot file version 1205 created 05-OCT-2021 17:10:31

APM08279+525 GM076.UVDATA.1

Freq = 1.5945 GHz, Bw = 32.000 MHz No calibration applied and no bandpass applied

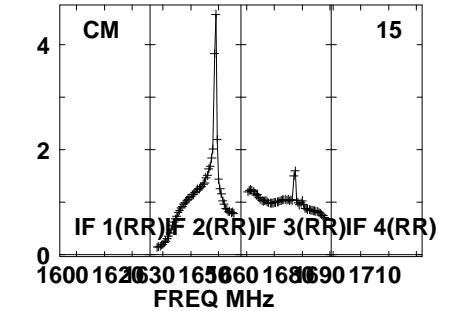
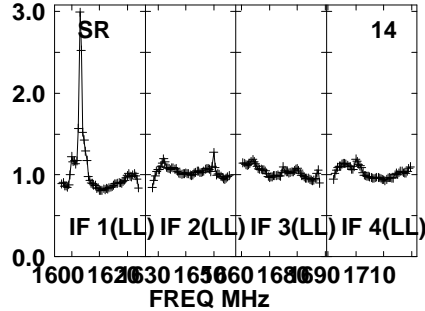
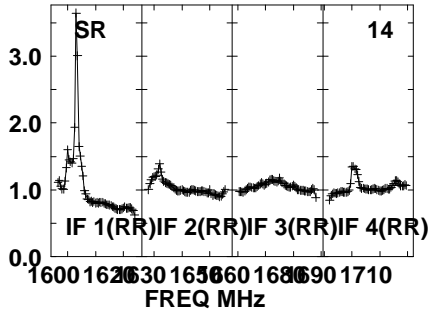
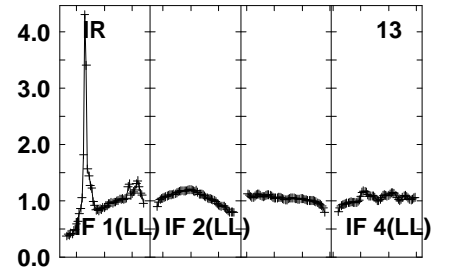
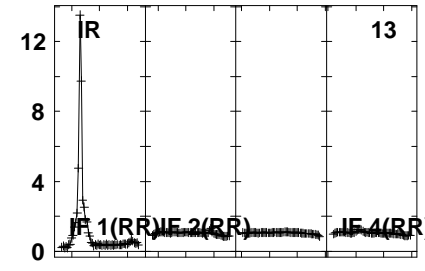
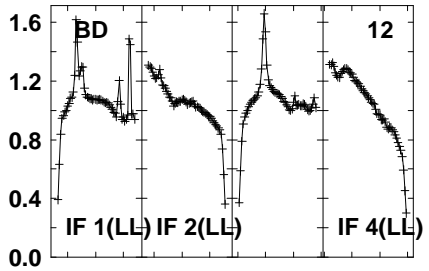
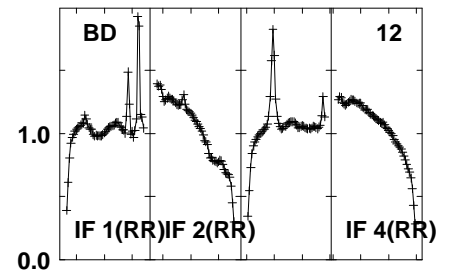
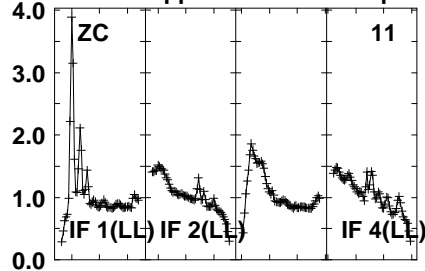
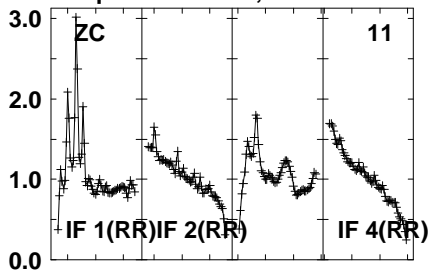

Lower frame: Real Jy  
Auto-corr total-power spectrum Antenna: \*  
Timerange: 00/20:45:01 to 00/20:48:29

Plot file version1206 created 05-OCT-2021 17:10:31

APM08279+525 GM076.UVDATA.1

Freq = 1.5945 GHz, Bw = 32.000 MH No calibration applied and no bandpass applied

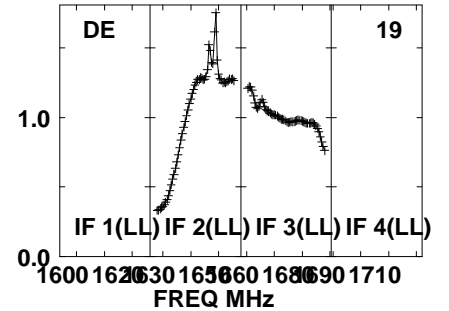
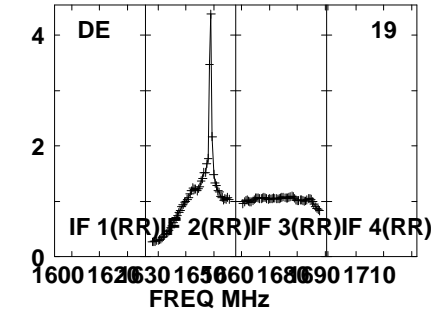
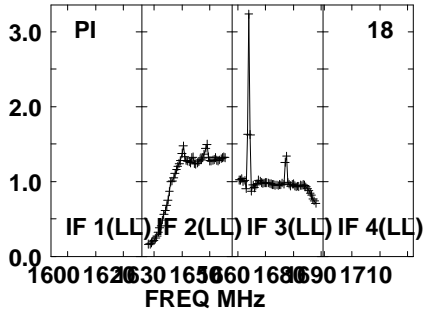
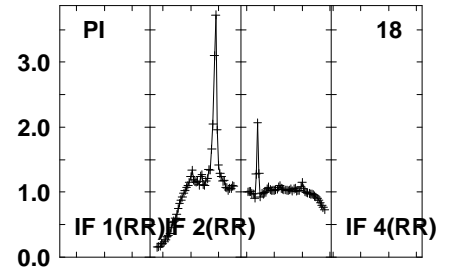
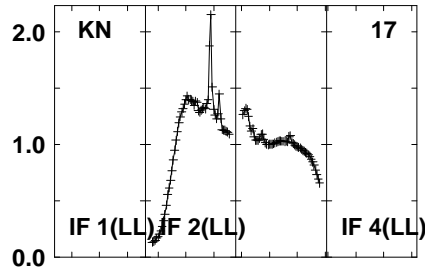
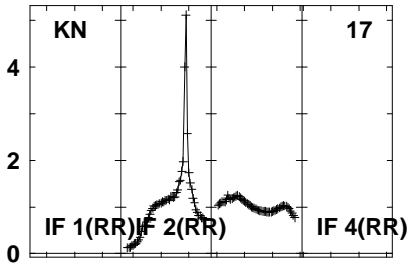
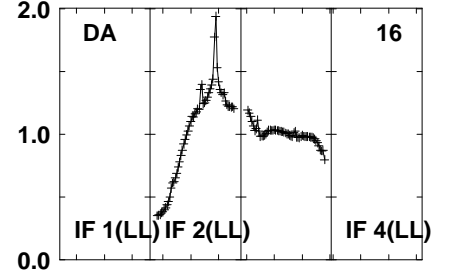
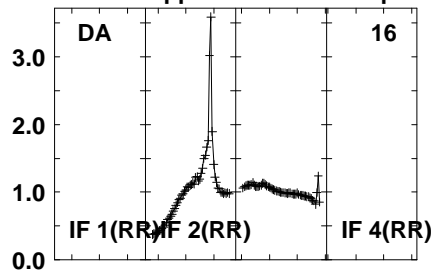
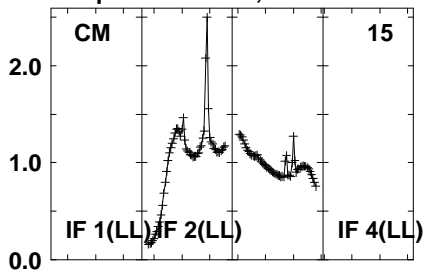

Lower frame: Real Jy

Auto-corr total-power spectrum Antenna: \*

Timerange: 00/20:45:01 to 00/20:48:29

Plot file version 1207 created 05-OCT-2021 17:10:32

APM08279+525 GM076.UVDATA.1

Freq = 1.5945 GHz, Bw = 32.000 MH No calibration applied and no bandpass applied

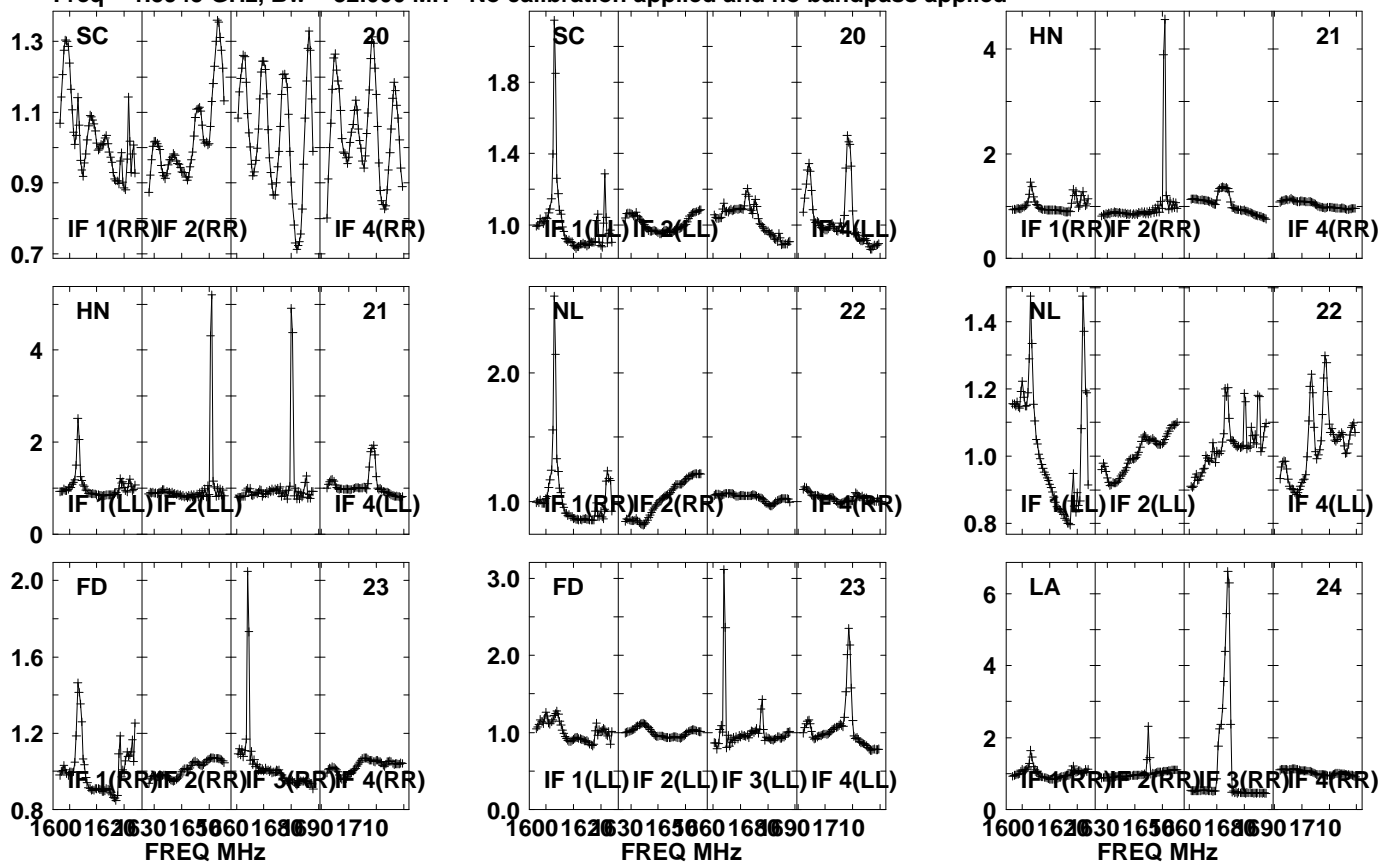

Lower frame: Real Jy  
Auto-corr total-power spectrum Antenna: \*  
Timerange: 00/20:45:01 to 00/20:48:29

Plot file version1208 created 05-OCT-2021 17:10:32

APM08279+525 GM076.UVDATA.1

Freq = 1.5945 GHz, Bw = 32.000 MH No calibration applied and no bandpass applied

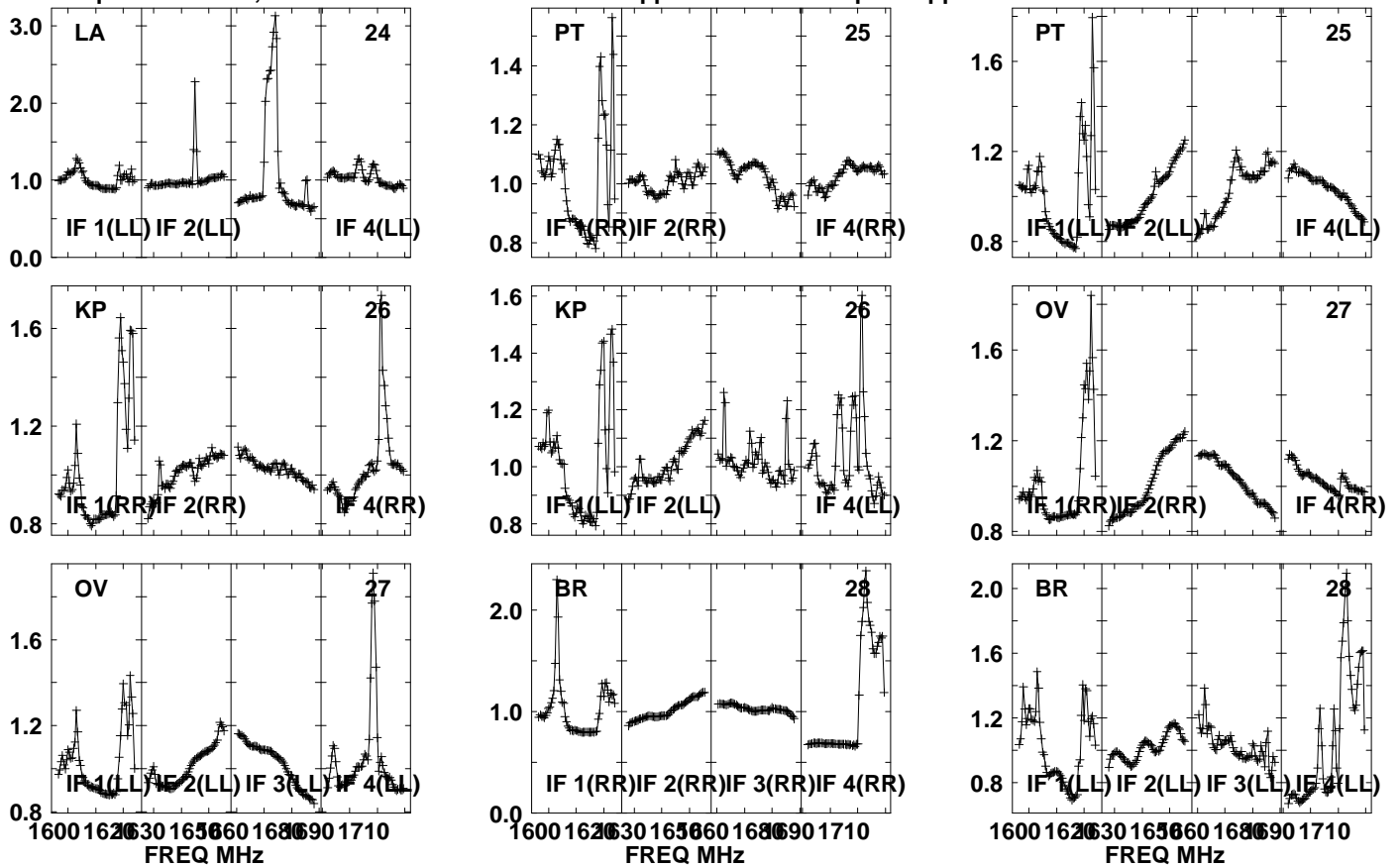

Lower frame: Real Jy

Auto-corr total-power spectrum Antenna: \*

Timerange: 00/20:45:01 to 00/20:48:29

Plot file version1209 created 05-OCT-2021 17:10:33

APM08279+525 GM076.UVDATA.1

Freq = 1.5945 GHz, Bw = 32.000 MH No calibration applied and no bandpass applied

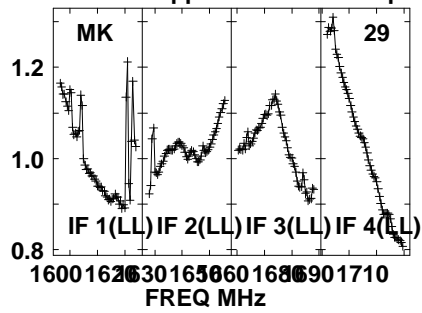
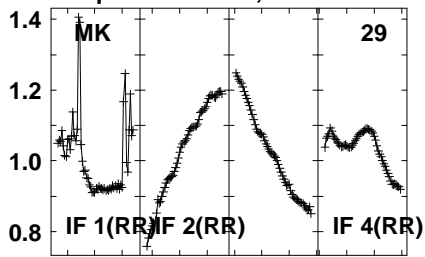

Lower frame: Real Jy  
Auto-corr total-power spectrum Antenna: \*  
Timerange: 00/20:45:01 to 00/20:48:29

Plot file version 1210 created 05-OCT-2021 17:10:33

J0827+5217 GM076.UVDATA.1

Freq = 1.5945 GHz, Bw = 32.000 MH No calibration applied and no bandpass applied

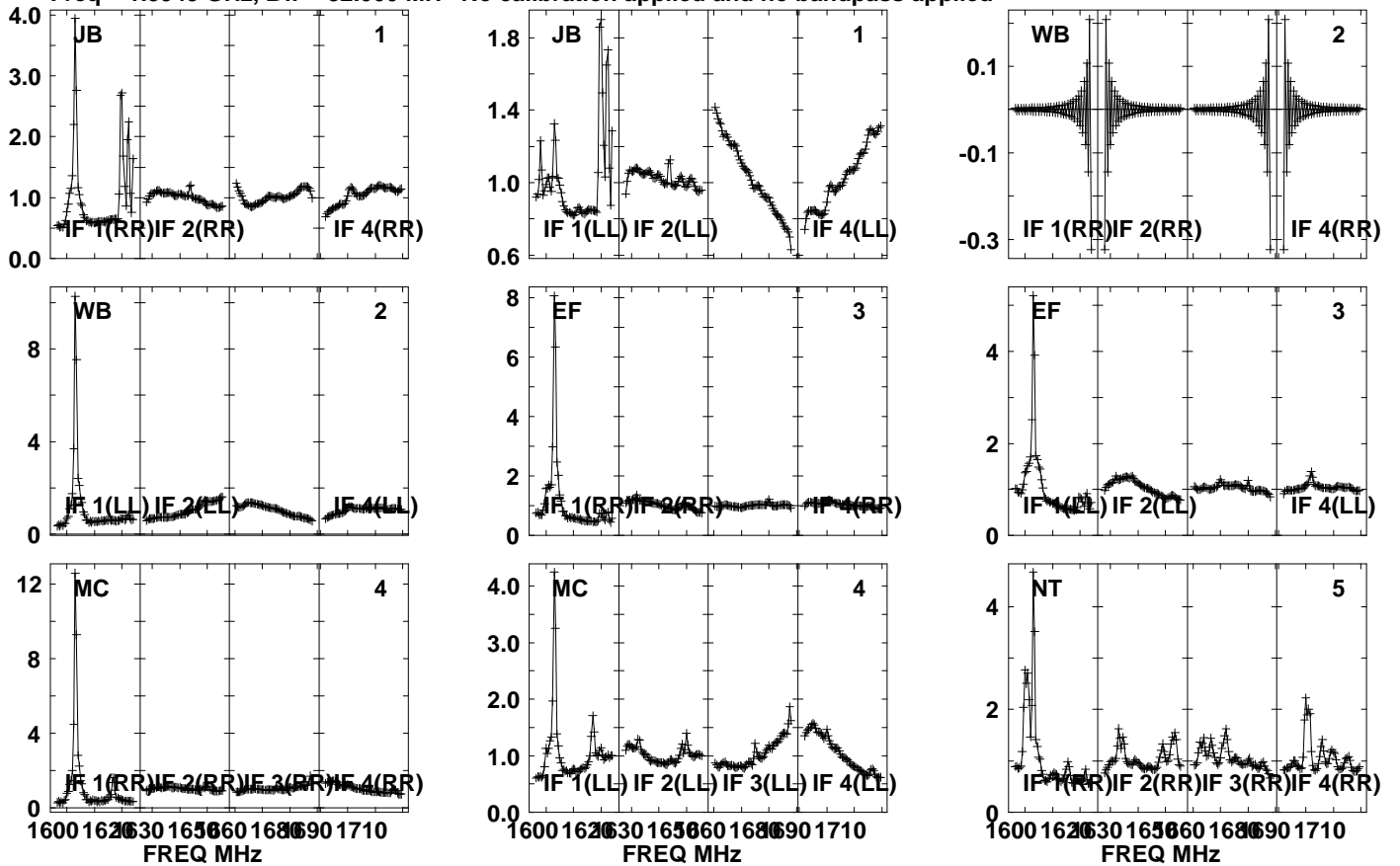

Lower frame: Real Jy

Auto-corr total-power spectrum Antenna: \*

Timerange: 00/20:49:01 to 00/20:50:29



Plot file version 1211 created 05-OCT-2021 17:10:33

J0827+5217 GM076.UVDATA.1

Freq = 1.5945 GHz, Bw = 32.000 MHz No calibration applied and no bandpass applied

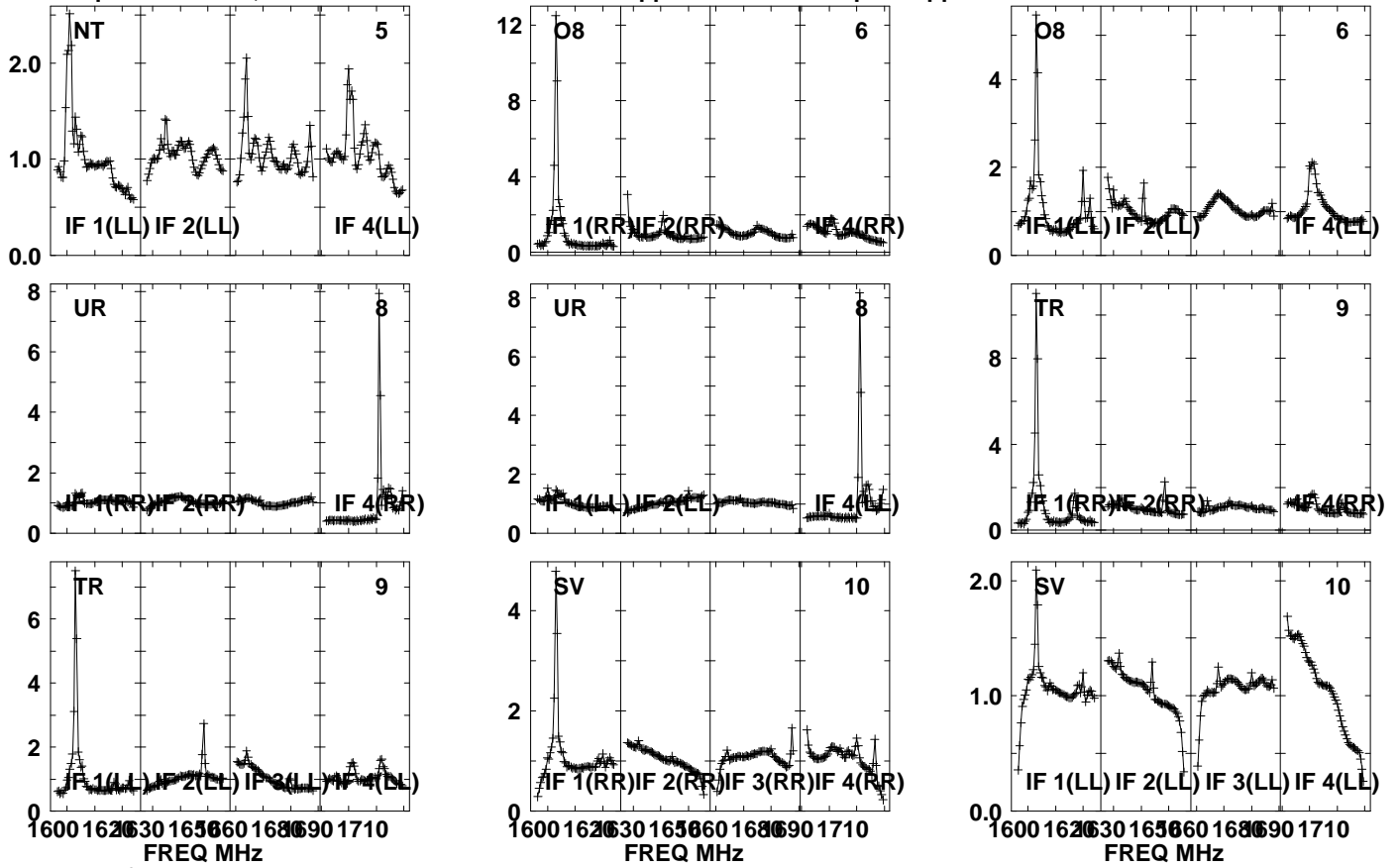

Lower frame: Real Jy

Auto-corr total-power spectrum Antenna: \*

Timerange: 00/20:49:01 to 00/20:50:29

Plot file version 1212 created 05-OCT-2021 17:10:34

J0827+5217 GM076.UVDATA.1

Freq = 1.5945 GHz, Bw = 32.000 MH No calibration applied and no bandpass applied

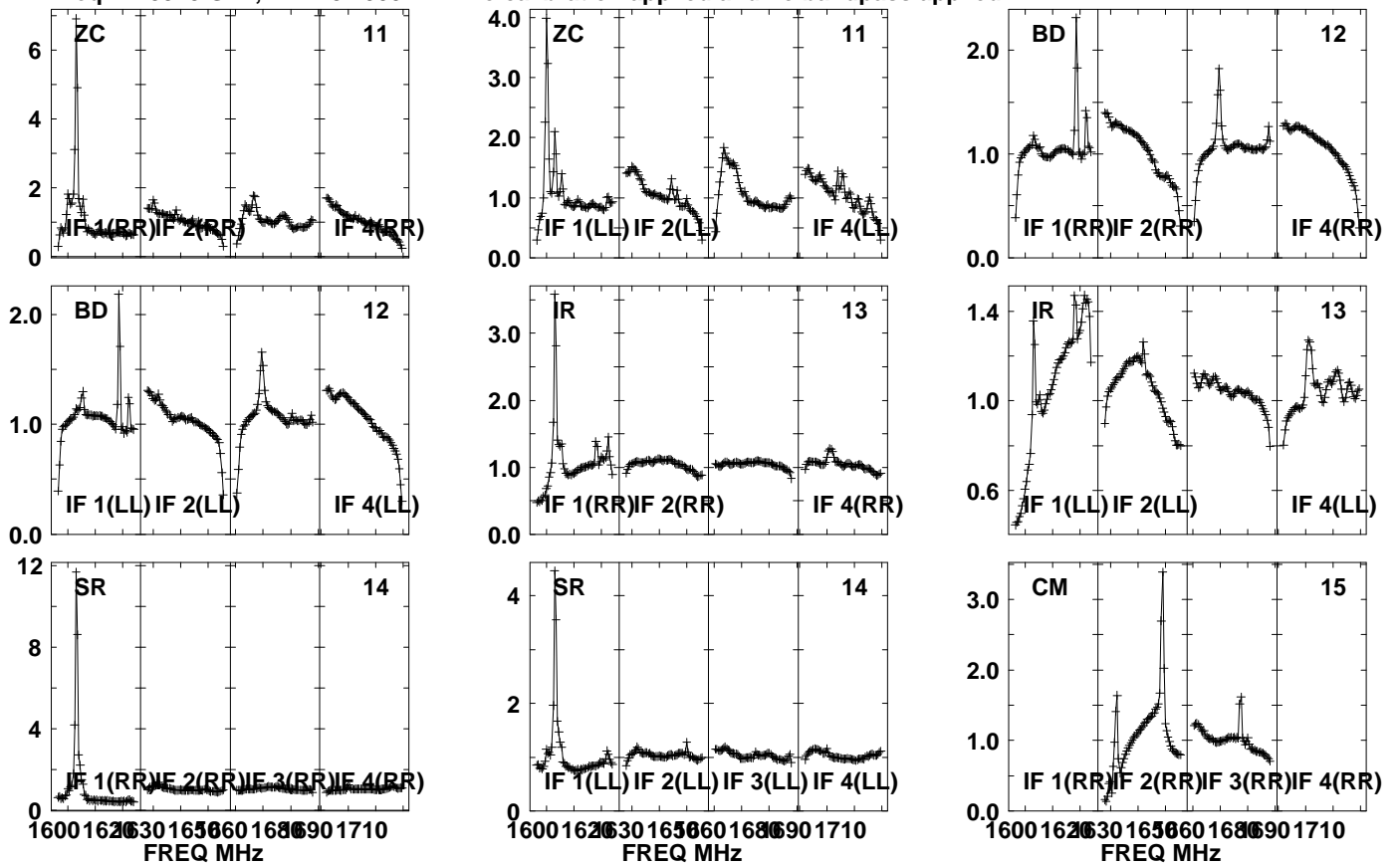

Lower frame: Real Jy

Auto-corr total-power spectrum Antenna: \*

Timerange: 00/20:49:01 to 00/20:50:29

Plot file version 1213 created 05-OCT-2021 17:10:34

J0827+5217 GM076.UVDATA.1

Freq = 1.5945 GHz, Bw = 32.000 MH No calibration applied and no bandpass applied

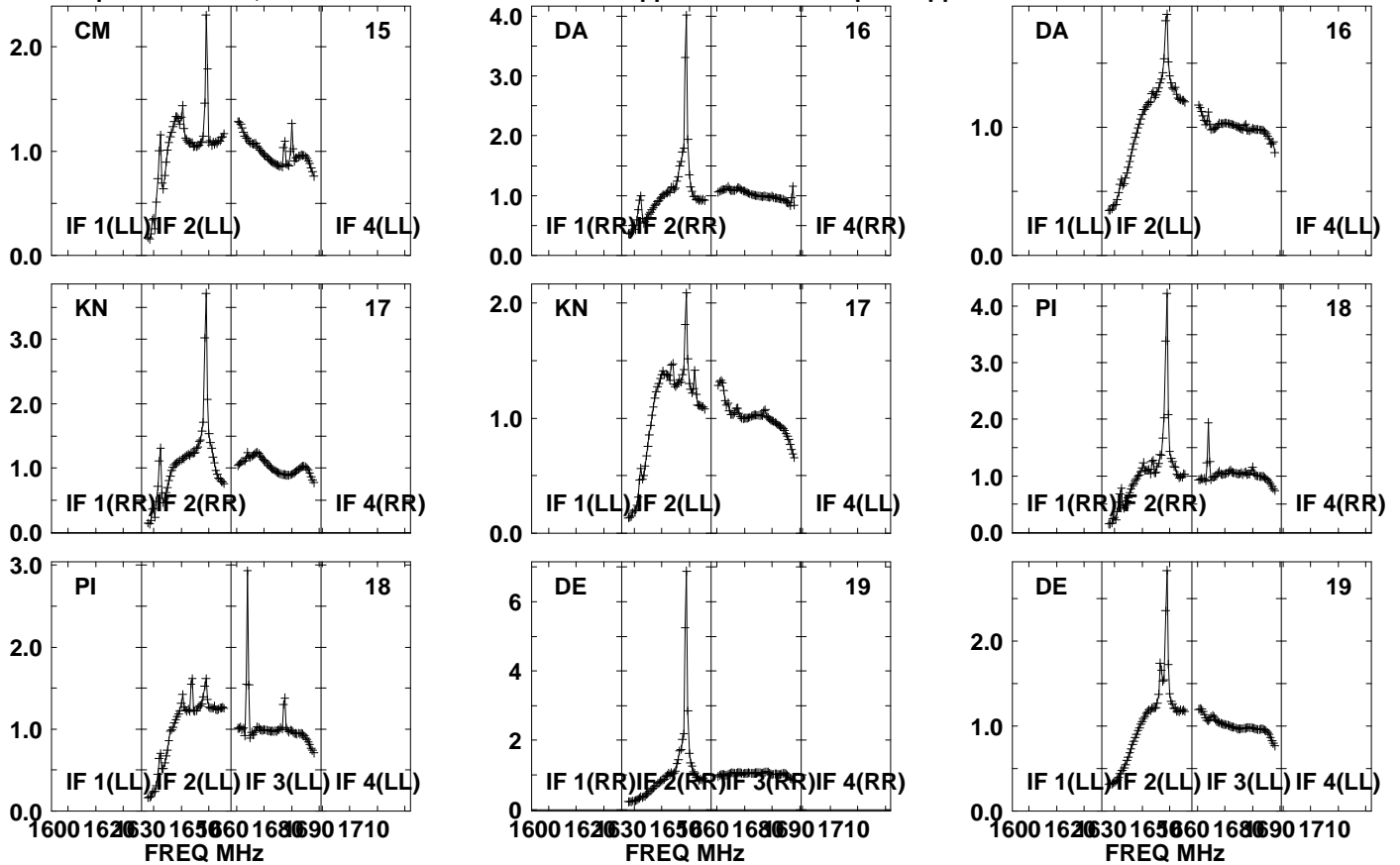

Lower frame: Real Jy

Auto-corr total-power spectrum Antenna: \*

Timerange: 00/20:49:01 to 00/20:50:29

Plot file version 1214 created 05-OCT-2021 17:10:34

J0827+5217 GM076.UVDATA.1

Freq = 1.5945 GHz, Bw = 32.000 MH No calibration applied and no bandpass applied

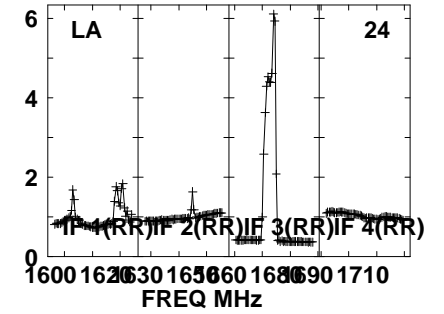
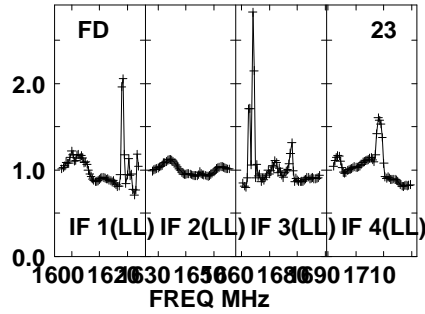
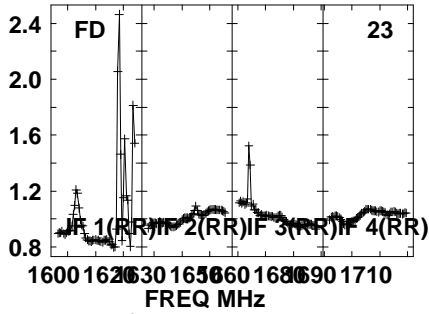
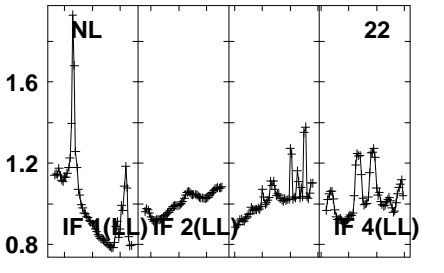
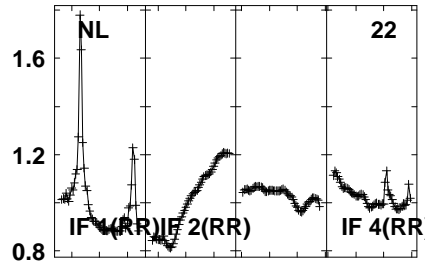
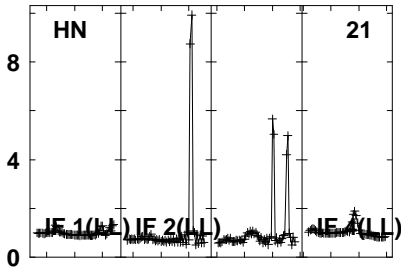
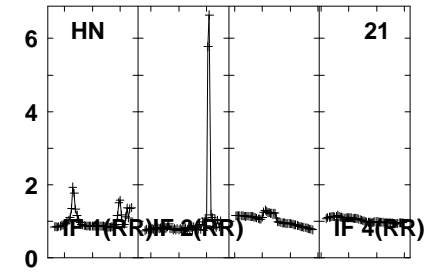
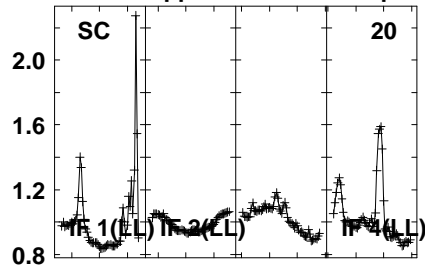
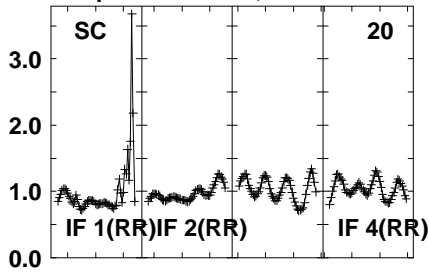

Lower frame: Real Jy  
Auto-corr total-power spectrum Antenna: \*  
Timerange: 00/20:49:01 to 00/20:50:29

Plot file version 1215 created 05-OCT-2021 17:10:35

J0827+5217 GM076.UVDATA.1

Freq = 1.5945 GHz, Bw = 32.000 MH No calibration applied and no bandpass applied

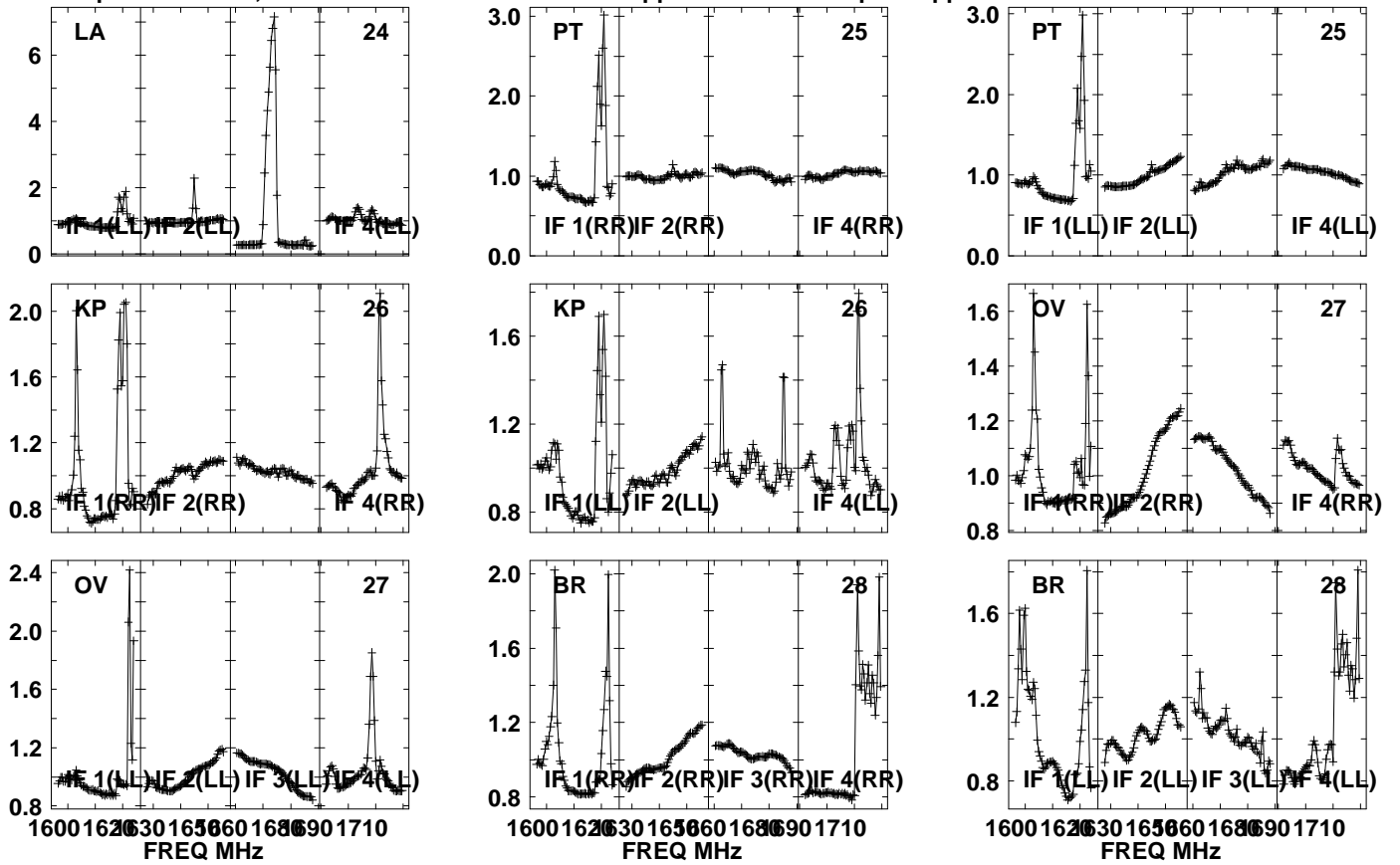

Lower frame: Real Jy  
Auto-corr total-power spectrum Antenna: \*  
Timerange: 00/20:49:01 to 00/20:50:29

Plot file version1216 created 05-OCT-2021 17:10:35

J0827+5217 GM076.UVDATA.1

Freq = 1.5945 GHz, Bw = 32.000 MH No calibration applied and no bandpass applied

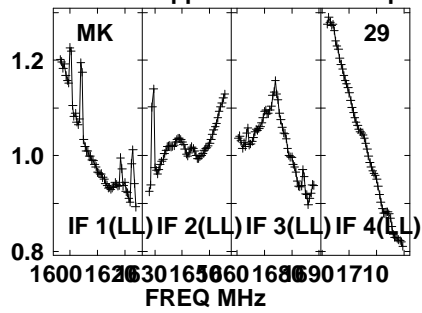
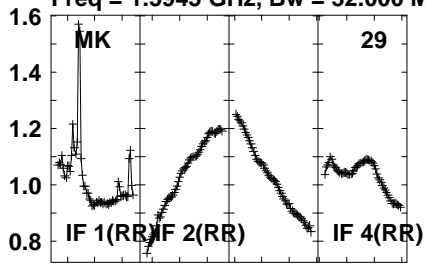

Lower frame: Real Jy  
Auto-corr total-power spectrum Antenna: \*  
Timerange: 00/20:49:01 to 00/20:50:29

Plot file version1217 created 05-OCT-2021 17:10:35

APM08279+525 GM076.UVDATA.1

Freq = 1.5945 GHz, Bw = 32.000 MH No calibration applied and no bandpass applied

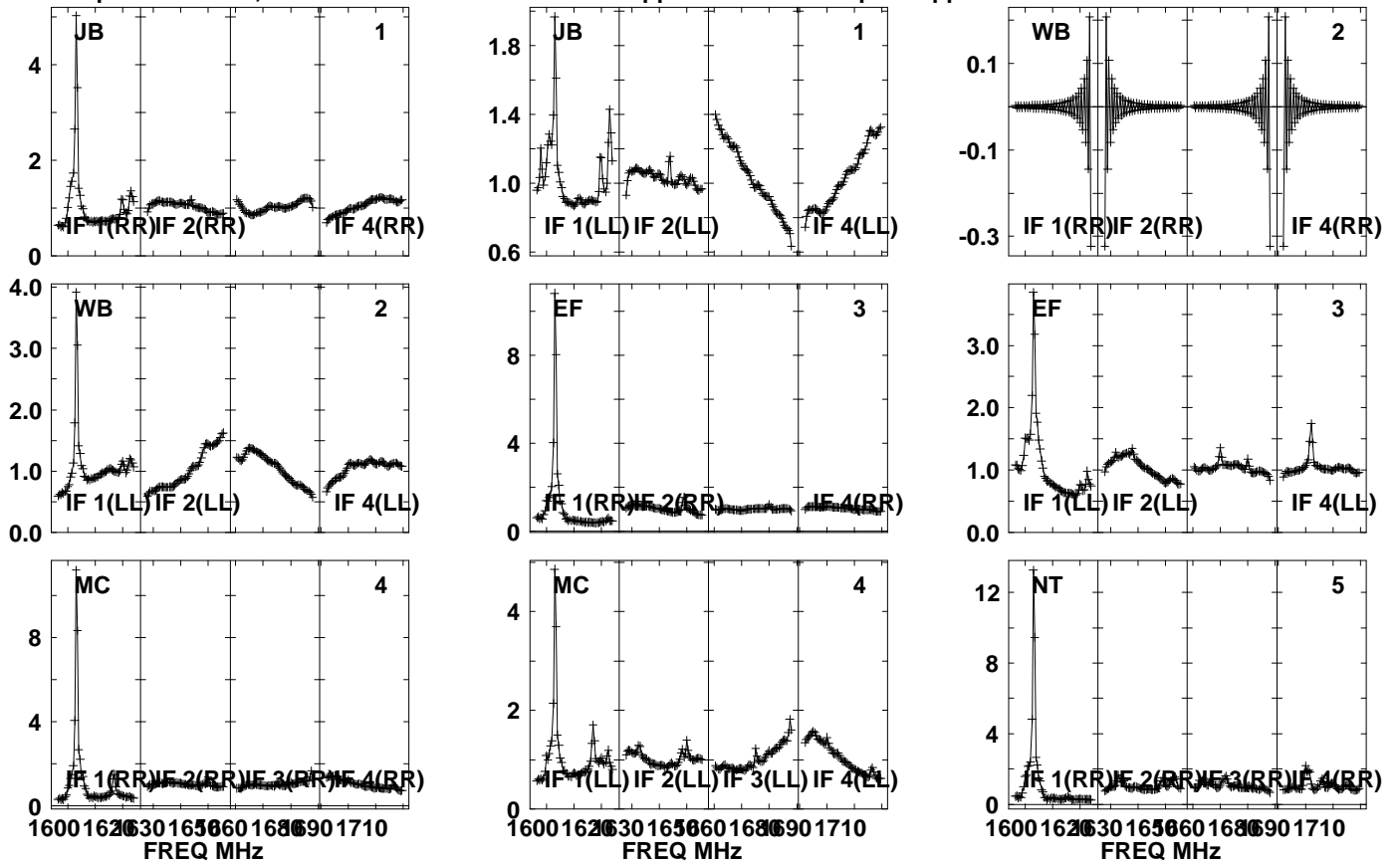

Lower frame: Real Jy

Auto-corr total-power spectrum Antenna: \*

Timerange: 00/20:50:31 to 00/20:53:59

Plot file version1218 created 05-OCT-2021 17:10:35

APM08279+525 GM076.UVDATA.1

Freq = 1.5945 GHz, Bw = 32.000 MH No calibration applied and no bandpass applied

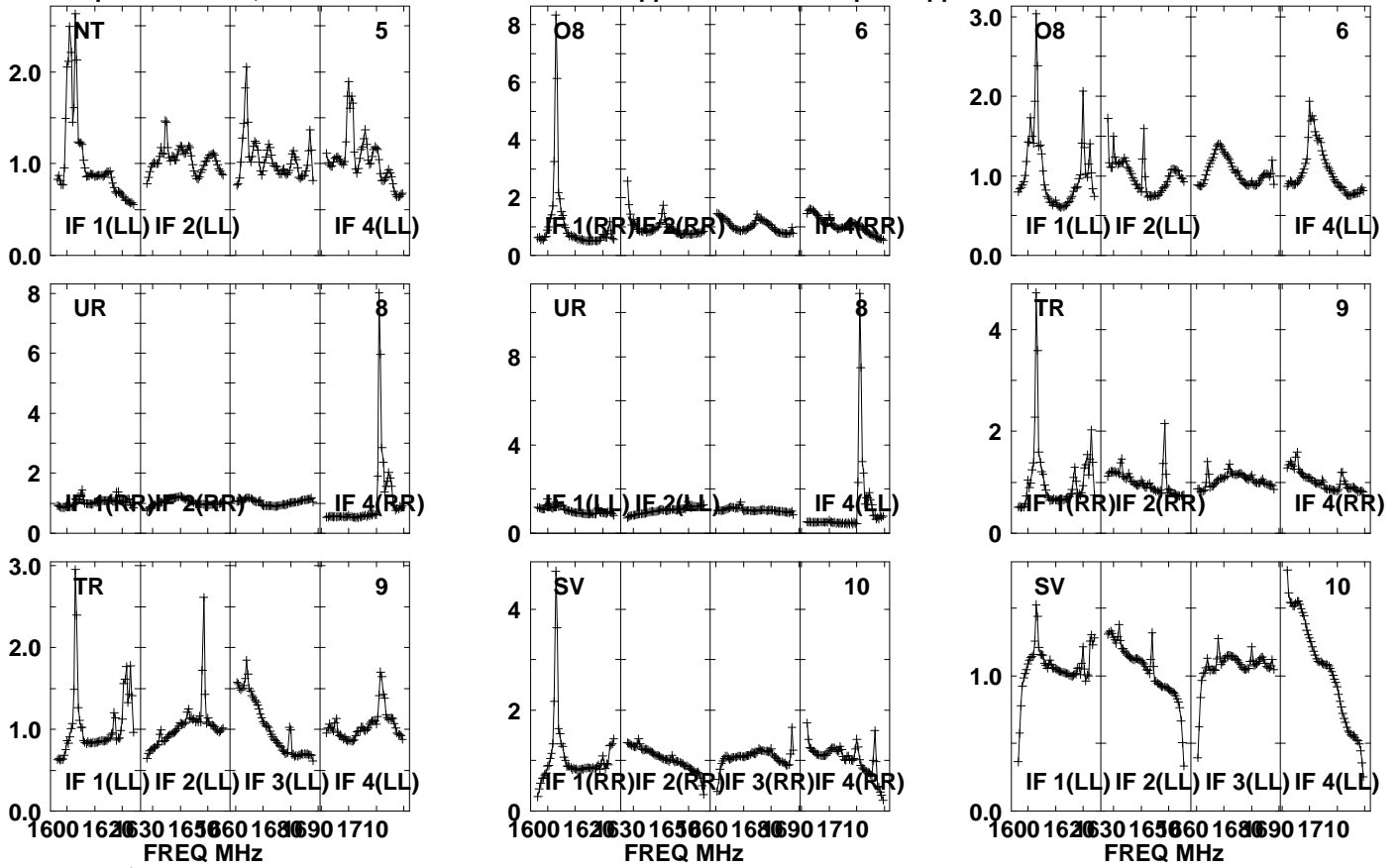

Lower frame: Real Jy

Auto-corr total-power spectrum Antenna: \*

Timerange: 00/20:50:31 to 00/20:53:59



Plot file version 1219 created 05-OCT-2021 17:10:36

APM08279+525 GM076.UVDATA.1

Freq = 1.5945 GHz, Bw = 32.000 MH

No calibration applied and no bandpass applied

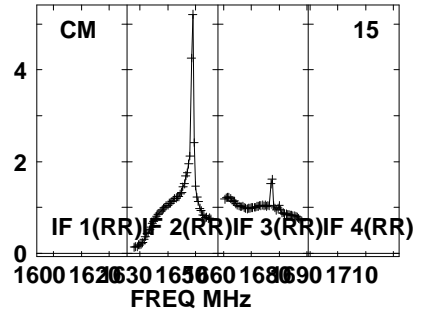
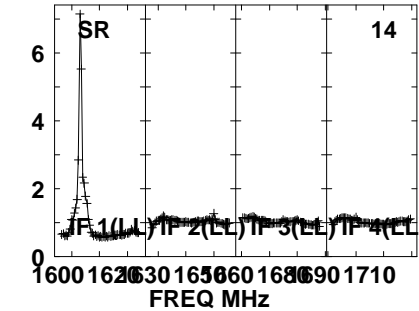
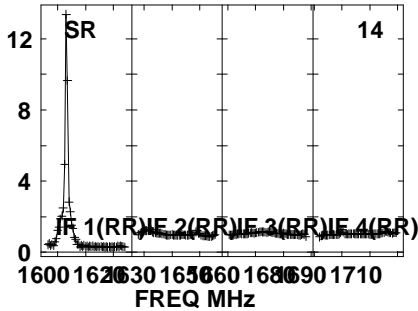
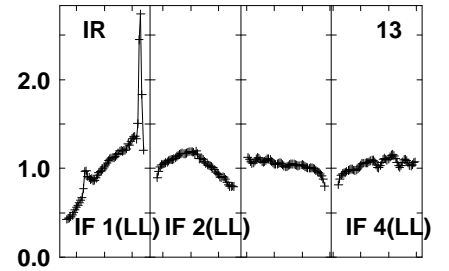
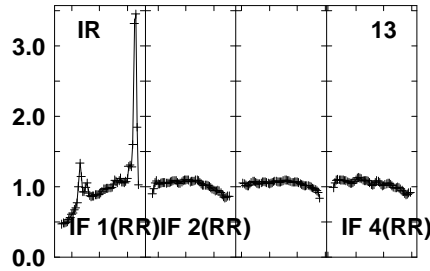
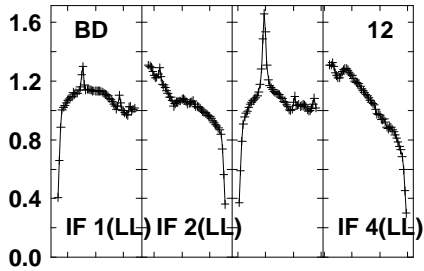
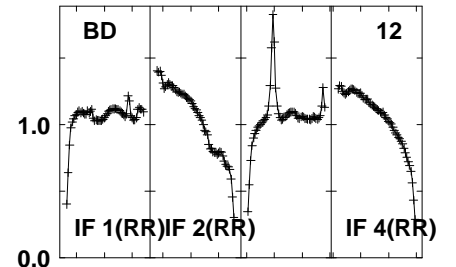
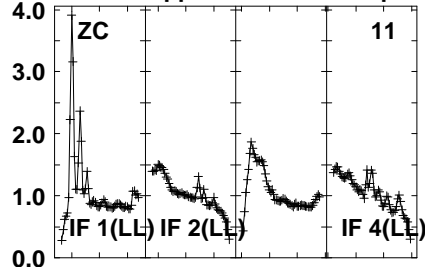
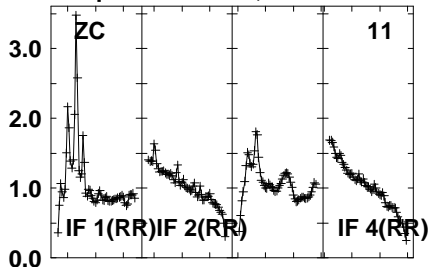

Lower frame: Real Jy

Auto-corr total-power spectrum Antenna: \*

Timerange: 00/20:50:31 to 00/20:53:59

Plot file version1220 created 05-OCT-2021 17:10:36

APM08279+525 GM076.UVDATA.1

Freq = 1.5945 GHz, Bw = 32.000 MH No calibration applied and no bandpass applied

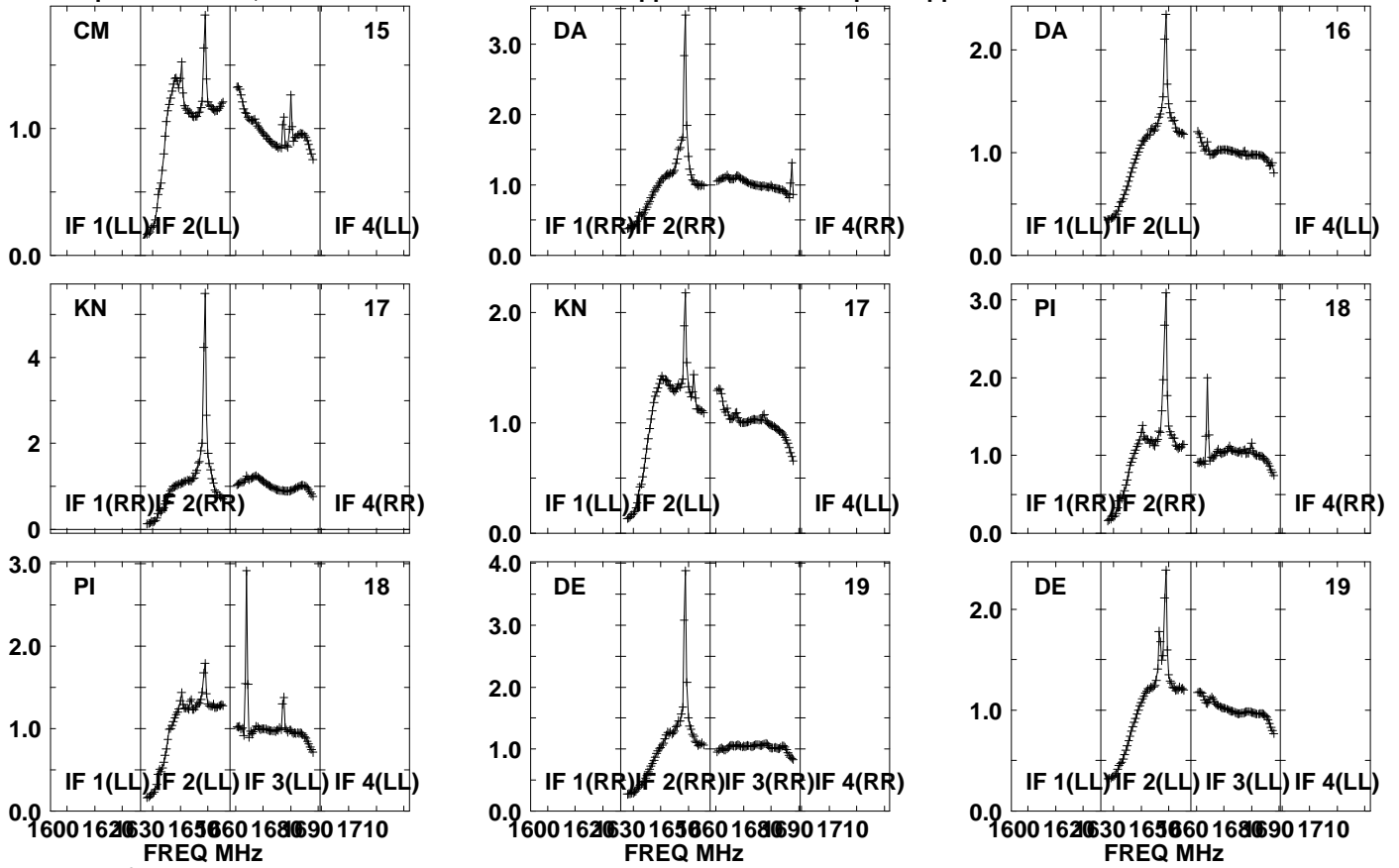

Lower frame: Real Jy

Auto-corr total-power spectrum Antenna: \*

Timerange: 00/20:50:31 to 00/20:53:59

Plot file version 1221 created 05-OCT-2021 17:10:36

APM08279+525 GM076.UVDATA.1

Freq = 1.5945 GHz, Bw = 32.000 MH No calibration applied and no bandpass applied

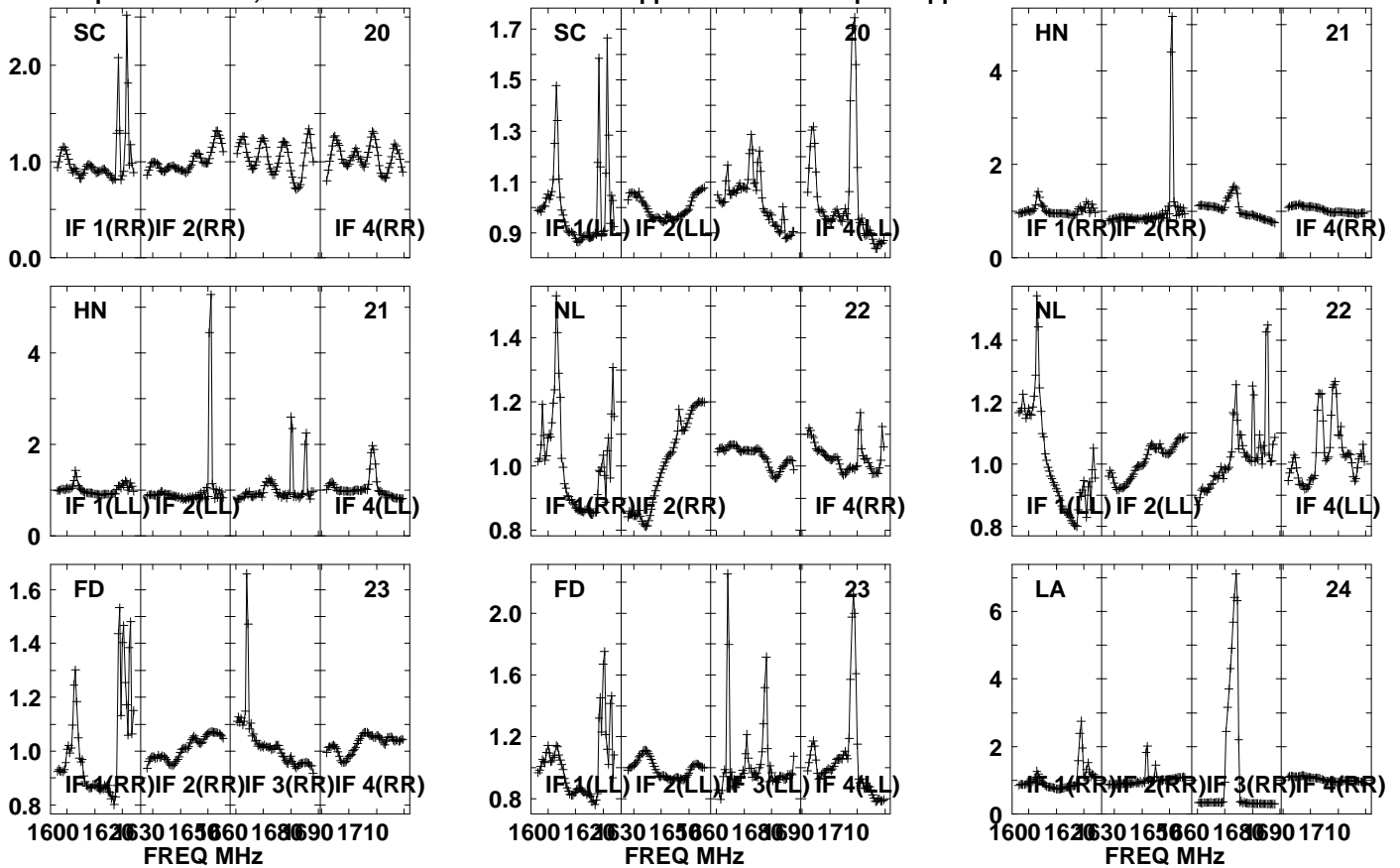

Lower frame: Real Jy

Auto-corr total-power spectrum Antenna: \*

Timerange: 00/20:50:31 to 00/20:53:59

Plot file version1222 created 05-OCT-2021 17:10:37

APM08279+525 GM076.UVDATA.1

Freq = 1.5945 GHz, Bw = 32.000 MH No calibration applied and no bandpass applied

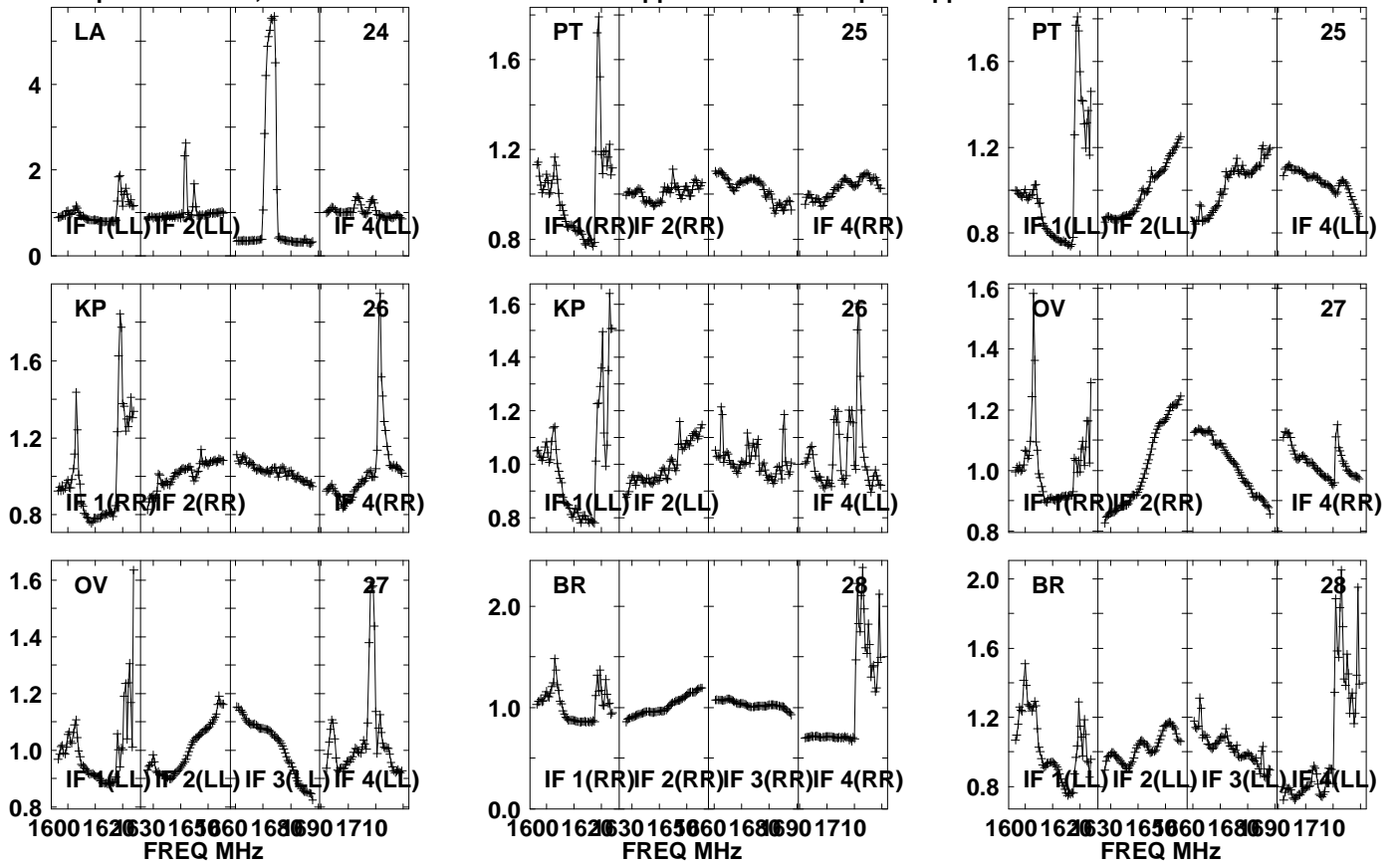

Lower frame: Real Jy

Auto-corr total-power spectrum Antenna: \*

Timerange: 00/20:50:31 to 00/20:53:59

Plot file version1223 created 05-OCT-2021 17:10:37

APM08279+525 GM076.UVDATA.1

Freq = 1.5945 GHz, Bw = 32.000 MH No calibration applied and no bandpass applied

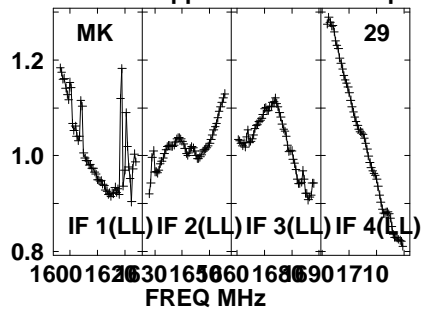
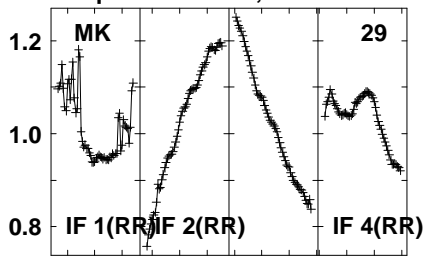

Lower frame: Real Jy  
Auto-corr total-power spectrum Antenna: \*  
Timerange: 00/20:50:31 to 00/20:53:59

Plot file version1224 created 05-OCT-2021 17:10:37

J0827+5217 GM076.UVDATA.1

Freq = 1.5945 GHz, Bw = 32.000 MH No calibration applied and no bandpass applied

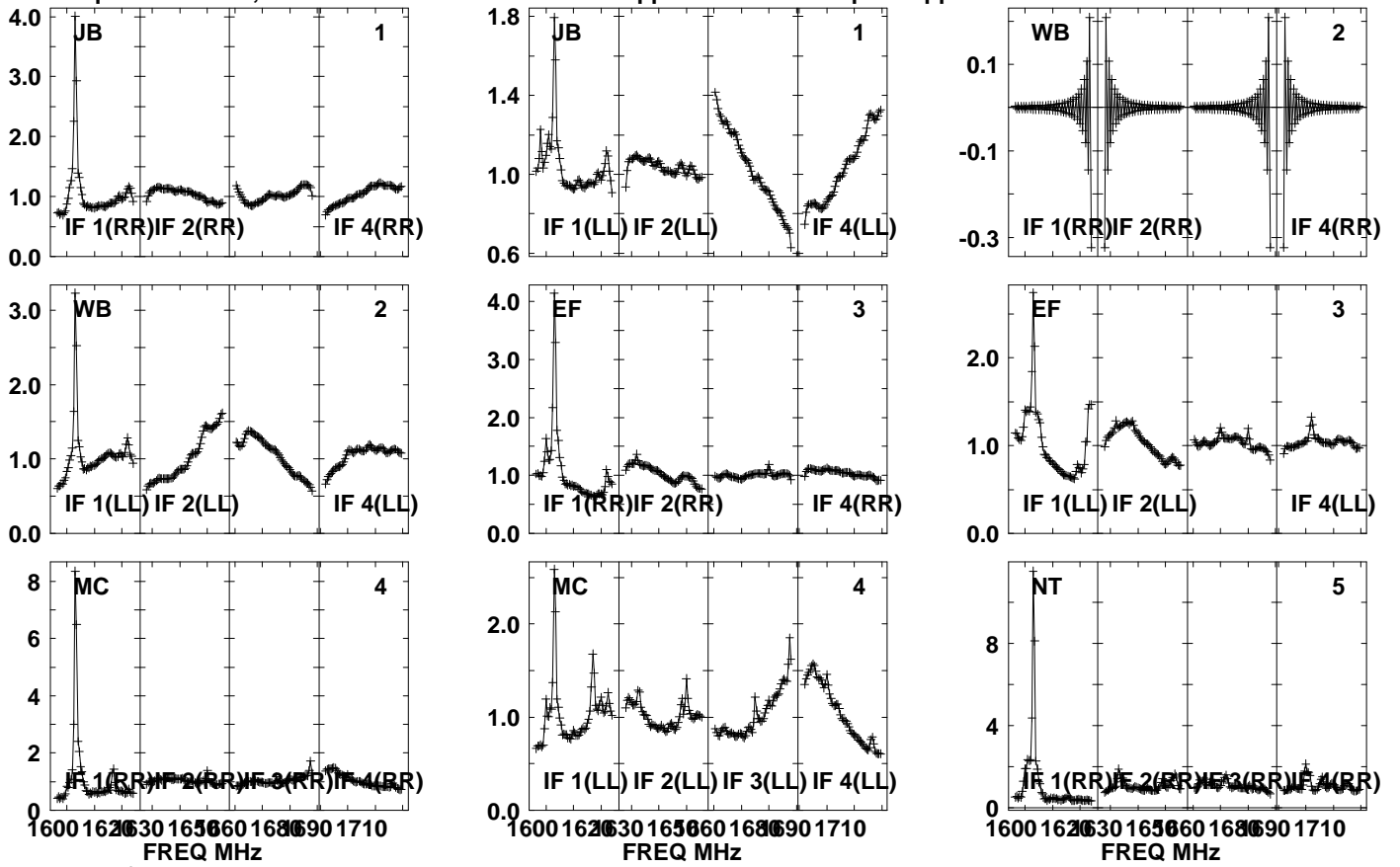

Lower frame: Real Jy  
Auto-corr total-power spectrum Antenna: \*  
Timerange: 00/20:54:01 to 00/20:55:29

Plot file version1225 created 05-OCT-2021 17:10:37

J0827+5217 GM076.UVDATA.1

Freq = 1.5945 GHz, Bw = 32.000 MH No calibration applied and no bandpass applied

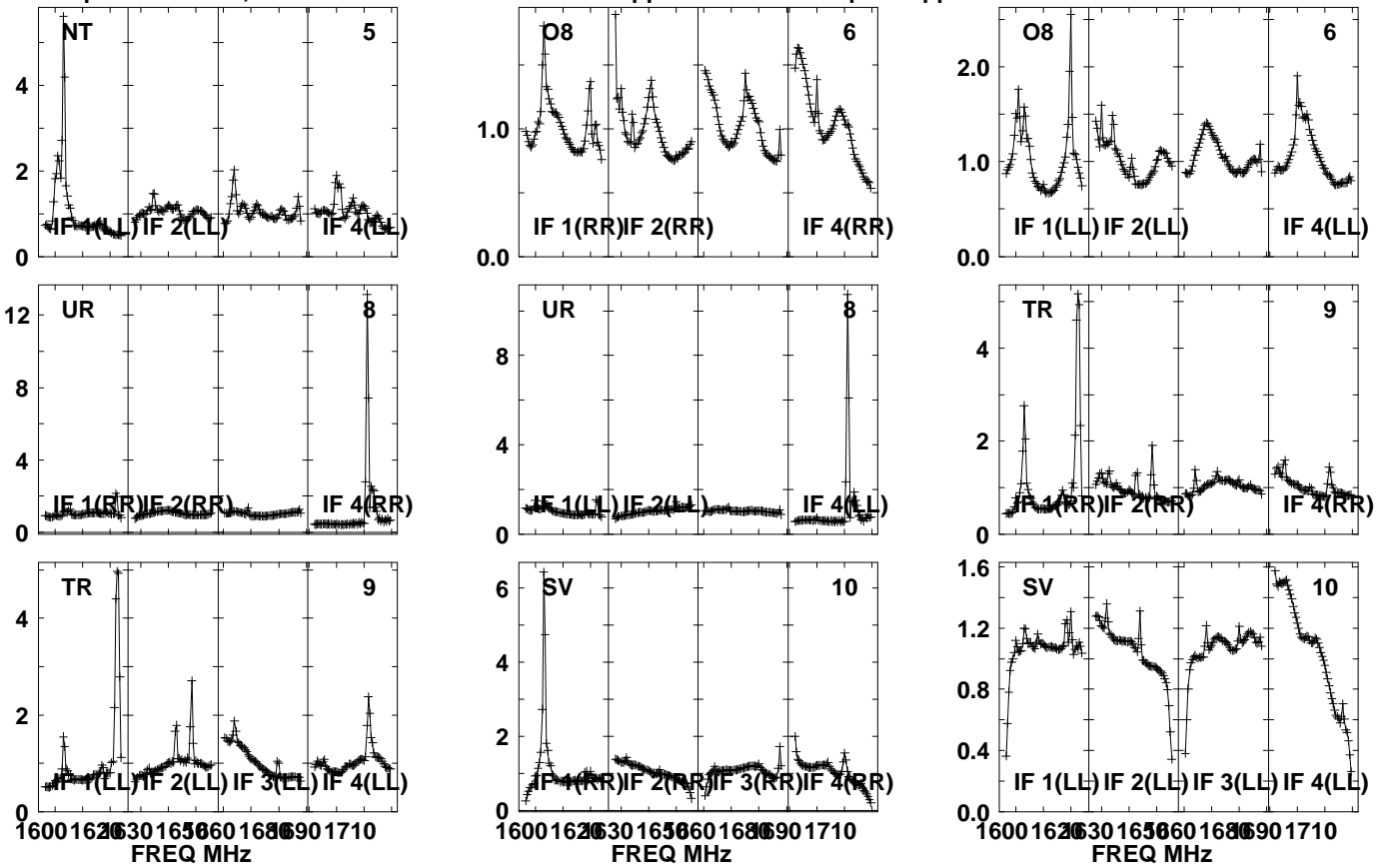

Lower frame: Real Jy

Auto-corr total-power spectrum Antenna: \*

Timerange: 00/20:54:01 to 00/20:55:29

Plot file version 1226 created 05-OCT-2021 17:10:38

J0827+5217 GM076.UVDATA.1

Freq = 1.5945 GHz, Bw = 32.000 MH No calibration applied and no bandpass applied

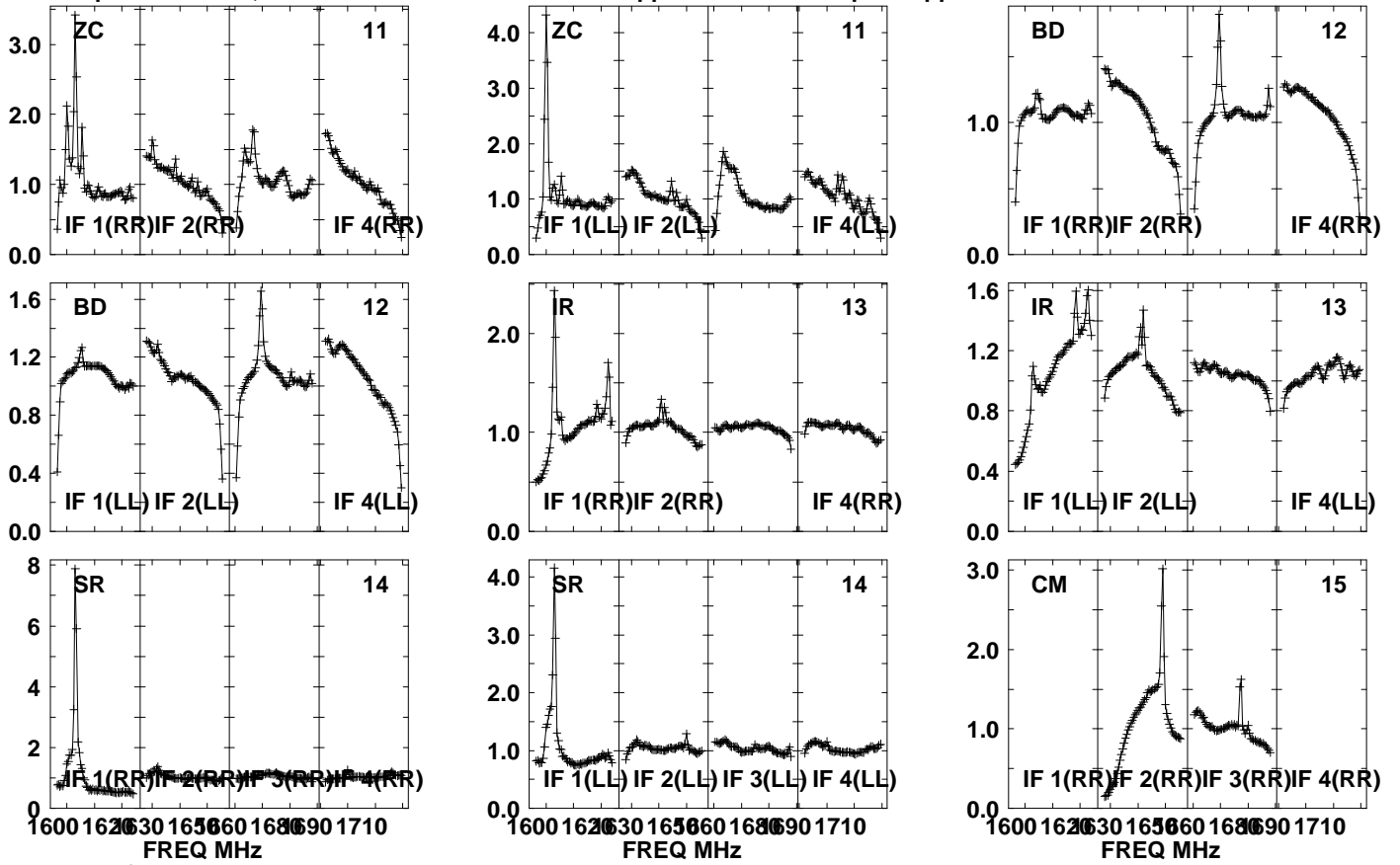

Lower frame: Real Jy

Auto-corr total-power spectrum Antenna: \*

Timerange: 00/20:54:01 to 00/20:55:29



Plot file version 1227 created 05-OCT-2021 17:10:38

J0827+5217 GM076.UVDATA.1

Freq = 1.5945 GHz, Bw = 32.000 MH No calibration applied and no bandpass applied

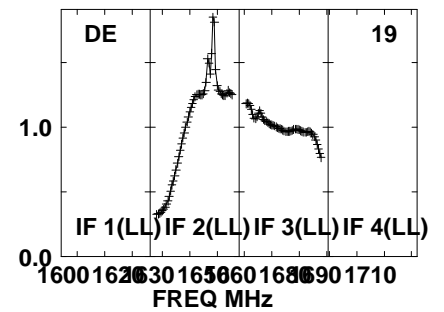
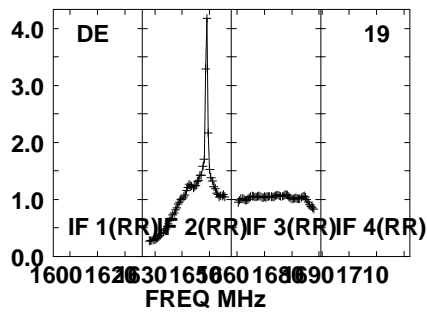
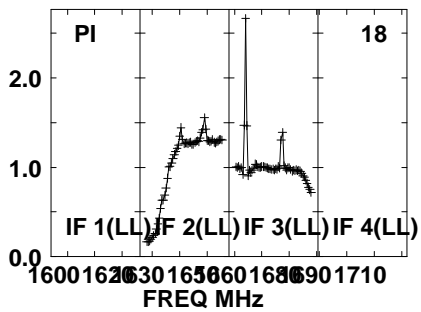
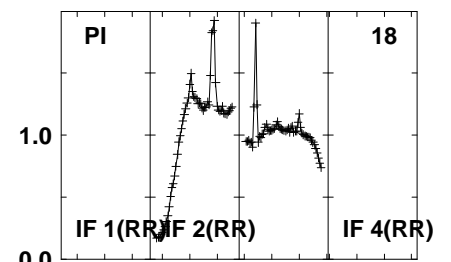
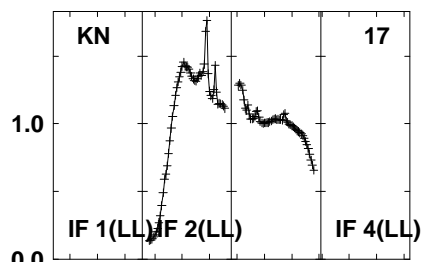
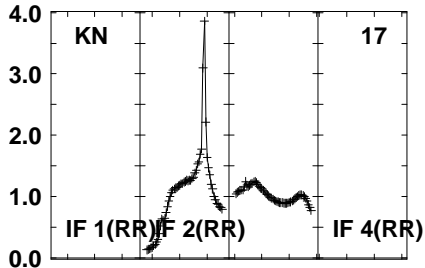
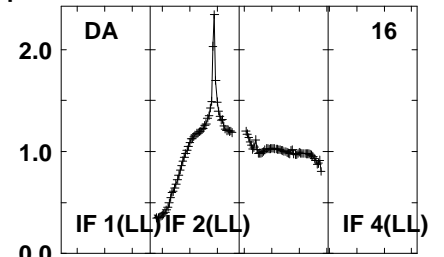
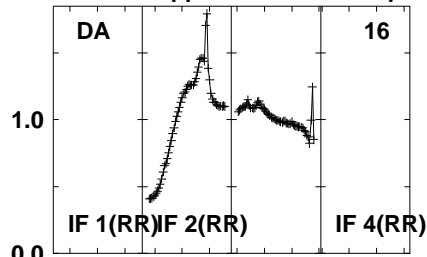
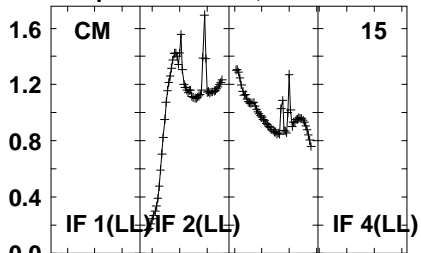

Lower frame: Real Jy  
Auto-corr total-power spectrum Antenna: \*  
Timerange: 00/20:54:01 to 00/20:55:29

Plot file version 1228 created 05-OCT-2021 17:10:38

J0827+5217 GM076.UVDATA.1

Freq = 1.5945 GHz, Bw = 32.000 MH No calibration applied and no bandpass applied

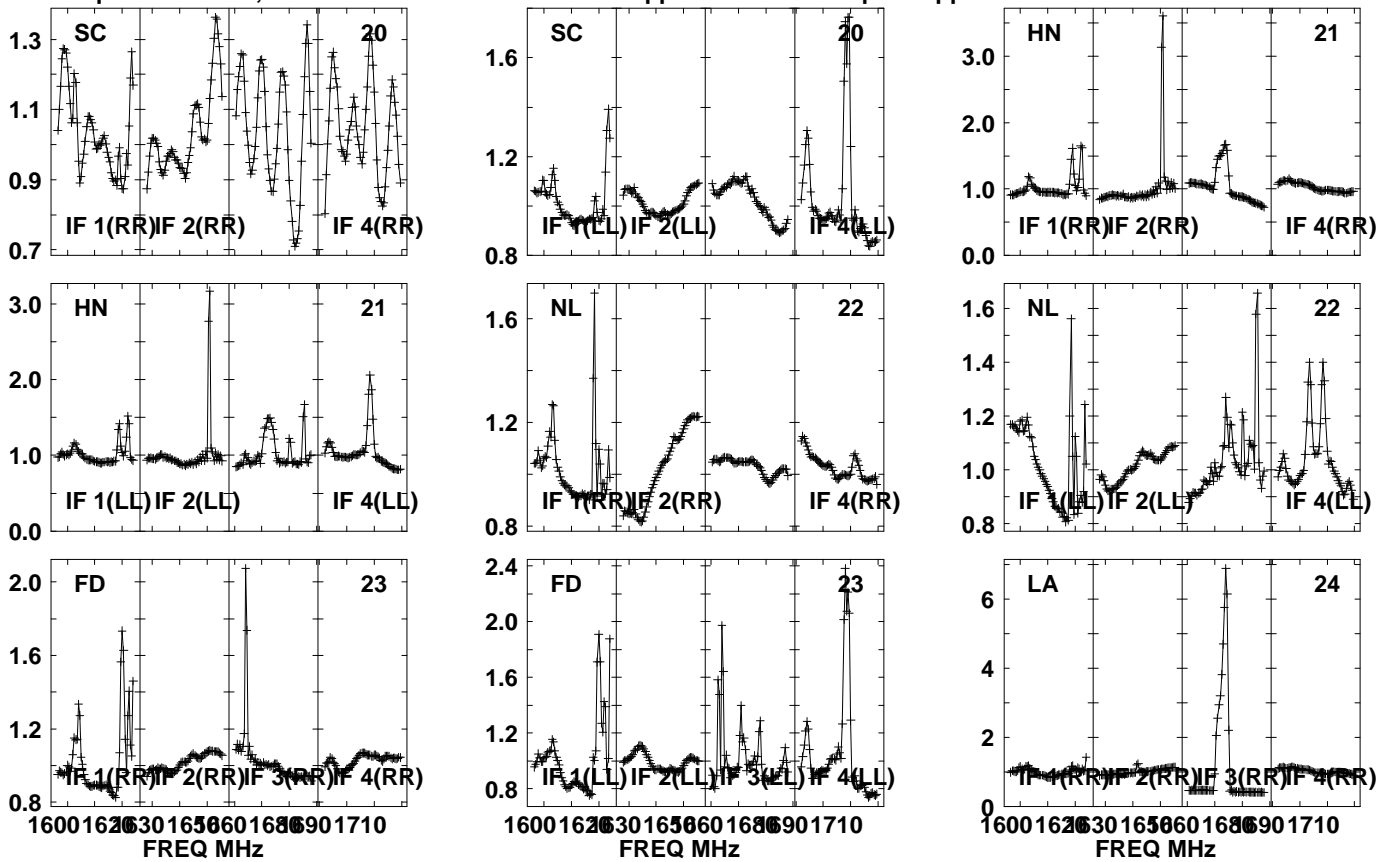

Lower frame: Real Jy  
Auto-corr total-power spectrum Antenna: \*  
Timerange: 00/20:54:01 to 00/20:55:29

Plot file version1229 created 05-OCT-2021 17:10:39

J0827+5217 GM076.UVDATA.1

Freq = 1.5945 GHz, Bw = 32.000 MH No calibration applied and no bandpass applied

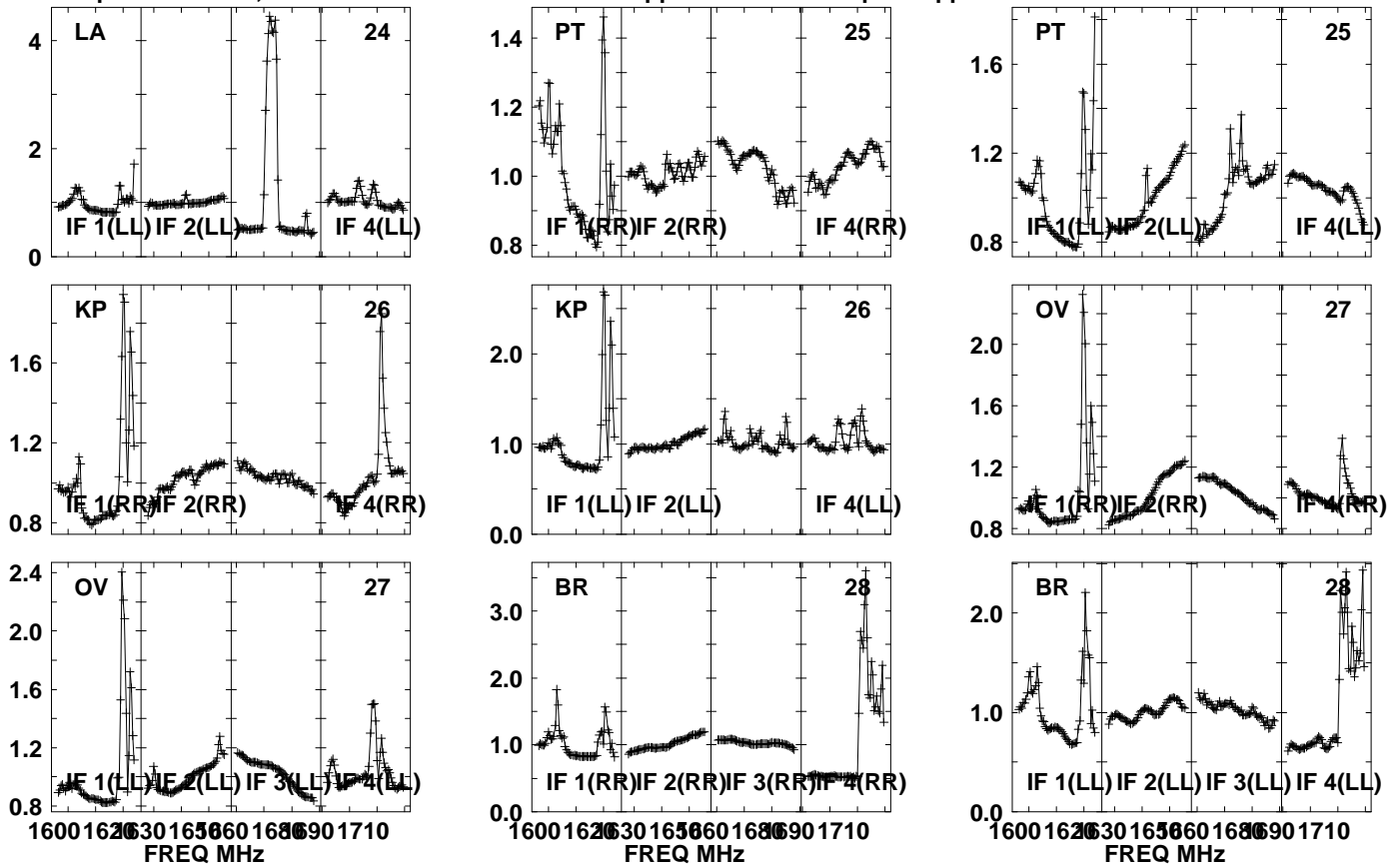

Lower frame: Real Jy

Auto-corr total-power spectrum Antenna: \*

Timerange: 00/20:54:01 to 00/20:55:29

Plot file version1230 created 05-OCT-2021 17:10:39

J0827+5217 GM076.UVDATA.1

Freq = 1.5945 GHz, Bw = 32.000 MH No calibration applied and no bandpass applied

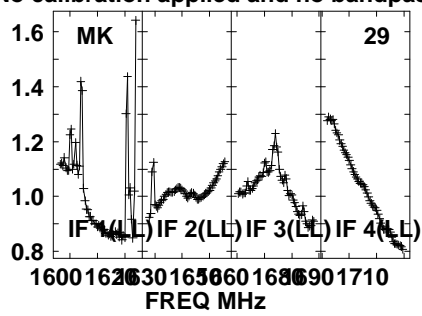
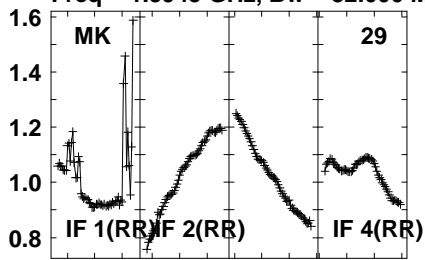

Lower frame: Real Jy  
Auto-corr total-power spectrum Antenna: \*  
Timerange: 00/20:54:01 to 00/20:55:29

Plot file version 1231 created 05-OCT-2021 17:10:39

APM08279+525 GM076.UVDATA.1

Freq = 1.5945 GHz, Bw = 32.000 MH No calibration applied and no bandpass applied

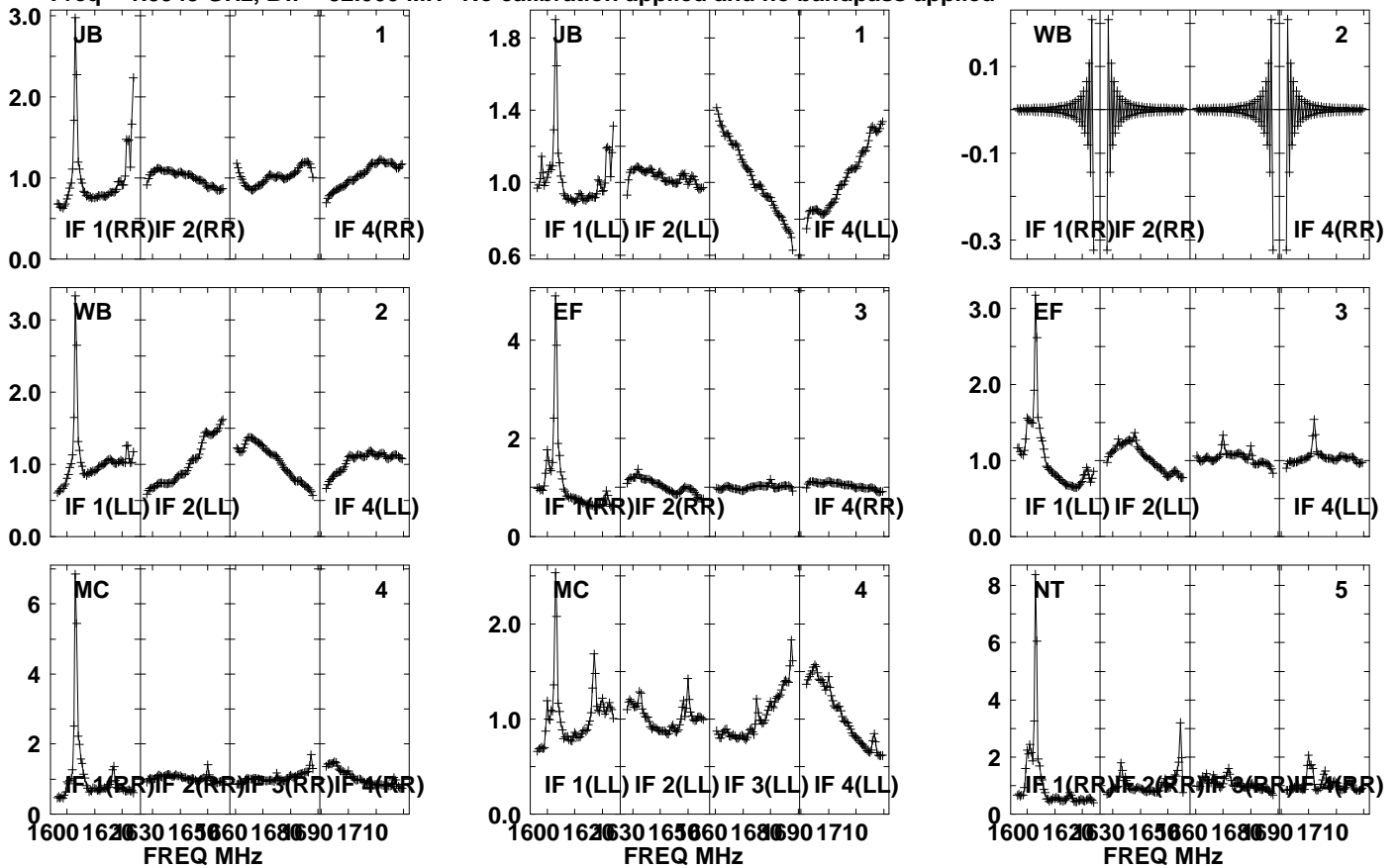

Lower frame: Real Jy

Auto-corr total-power spectrum Antenna: \*

Timerange: 00/20:55:31 to 00/20:58:59

Plot file version1232 created 05-OCT-2021 17:10:39

APM08279+525 GM076.UVDATA.1

Freq = 1.5945 GHz, Bw = 32.000 MH No calibration applied and no bandpass applied

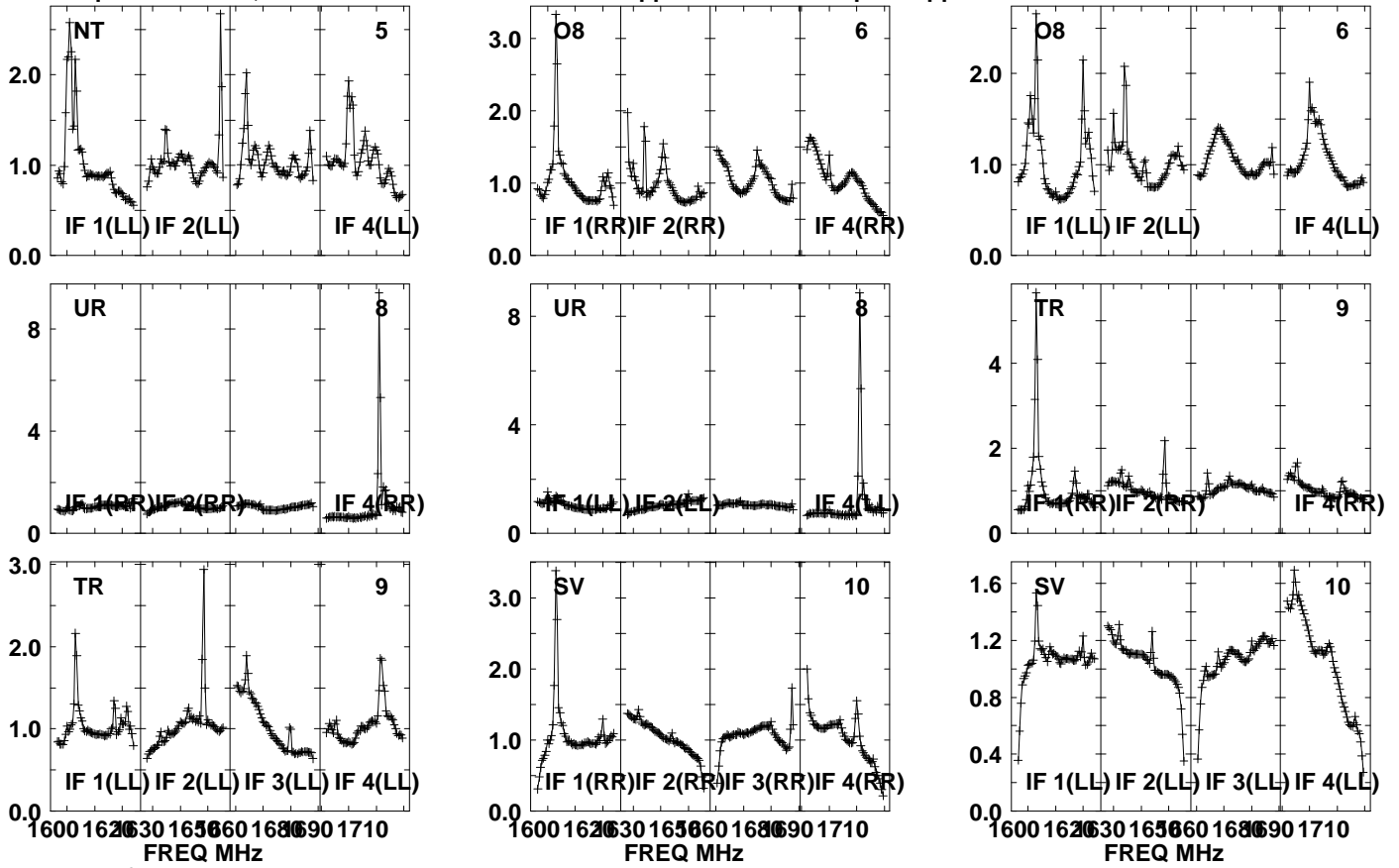

Lower frame: Real Jy

Auto-corr total-power spectrum Antenna: \*

Timerange: 00/20:55:31 to 00/20:58:59

Plot file version 1233 created 05-OCT-2021 17:10:40

APM08279+525 GM076.UVDATA.1

Freq = 1.5945 GHz, Bw = 32.000 MH No calibration applied and no bandpass applied

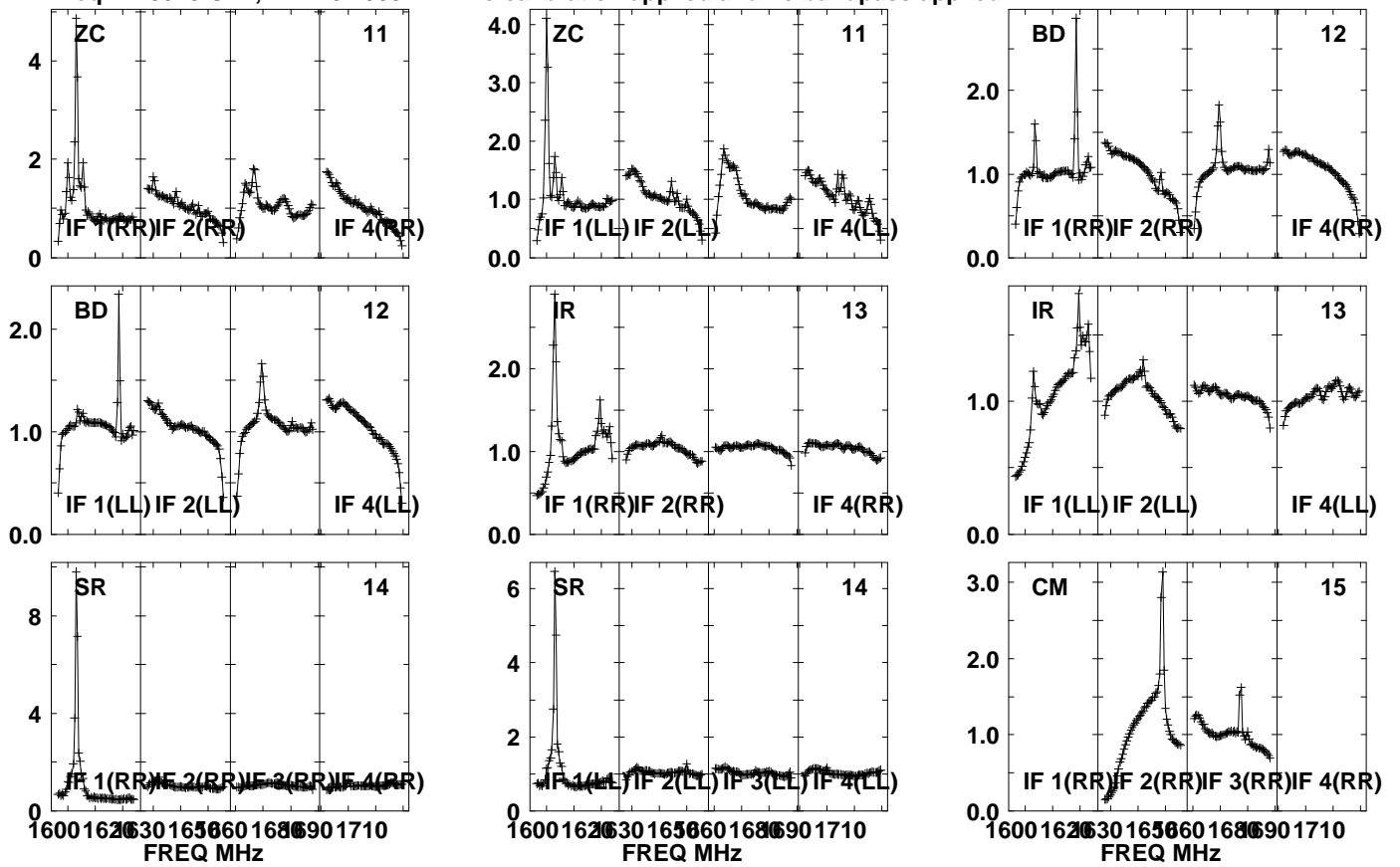

Lower frame: Real Jy

Auto-corr total-power spectrum Antenna: \*

Timerange: 00/20:55:31 to 00/20:58:59

Plot file version1234 created 05-OCT-2021 17:10:40

APM08279+525 GM076.UVDATA.1

Freq = 1.5945 GHz, Bw = 32.000 MH No calibration applied and no bandpass applied

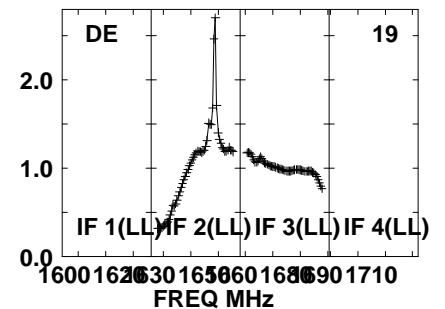
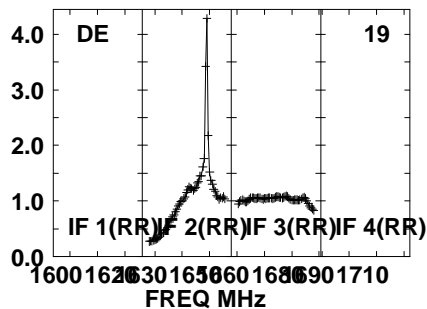
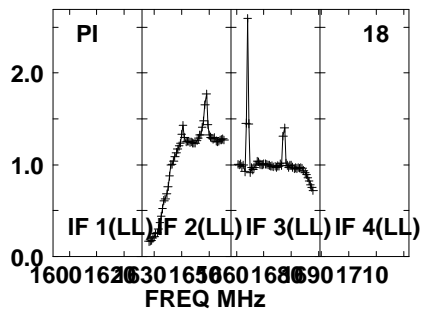
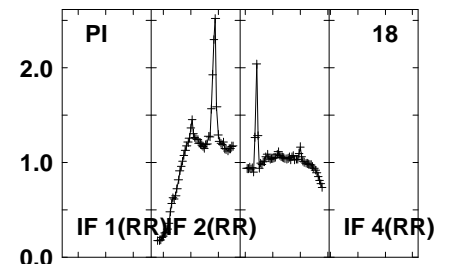
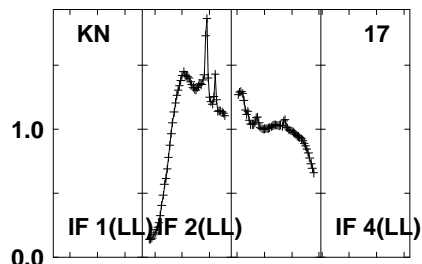
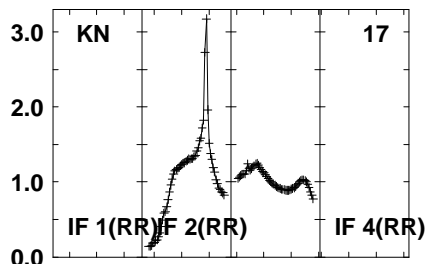
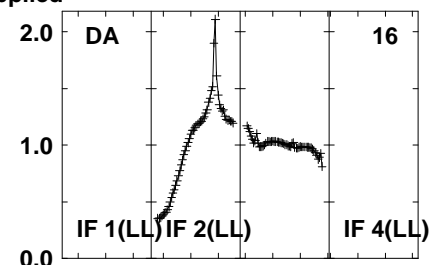
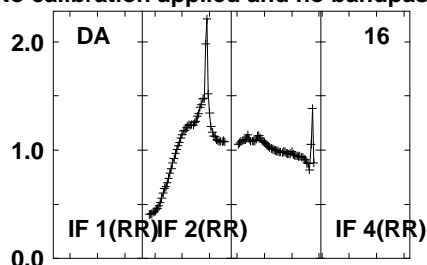
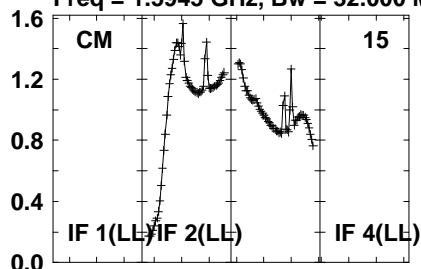

Lower frame: Real Jy  
Auto-corr total-power spectrum Antenna: \*  
Timerange: 00/20:55:31 to 00/20:58:59



Plot file version 1235 created 05-OCT-2021 17:10:41

APM08279+525 GM076.UVDATA.1

Freq = 1.5945 GHz, Bw = 32.000 MH No calibration applied and no bandpass applied

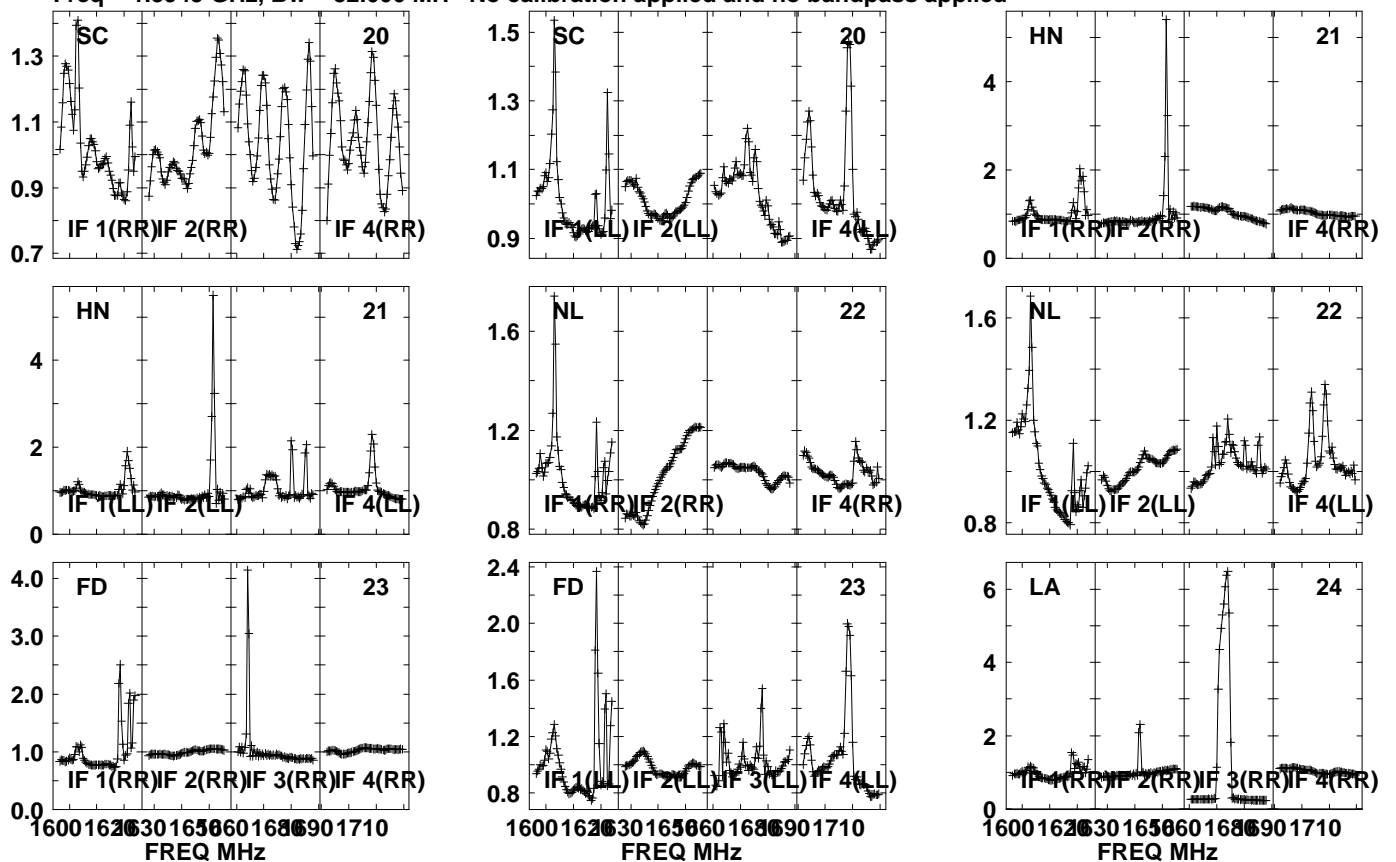

Lower frame: Real Jy  
Auto-corr total-power spectrum Antenna: \*  
Timerange: 00/20:55:31 to 00/20:58:59

Plot file version 1236 created 05-OCT-2021 17:10:41

APM08279+525 GM076.UVDATA.1

Freq = 1.5945 GHz, Bw = 32.000 MH No calibration applied and no bandpass applied

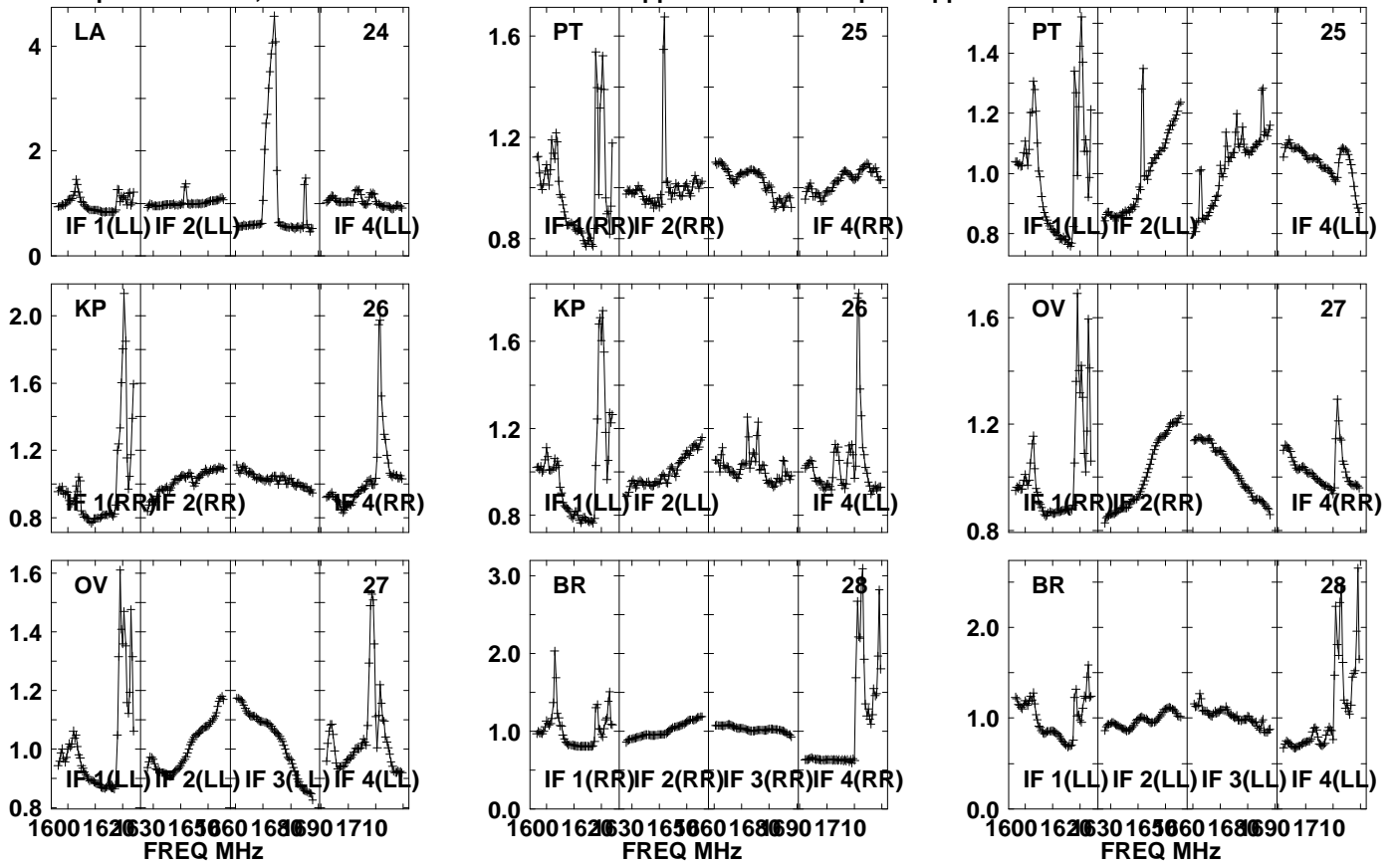

Lower frame: Real Jy  
Auto-corr total-power spectrum Antenna: \*  
Timerange: 00/20:55:31 to 00/20:58:59

Plot file version1237 created 05-OCT-2021 17:10:41

APM08279+525 GM076.UVDATA.1

Freq = 1.5945 GHz, Bw = 32.000 MH No calibration applied and no bandpass applied

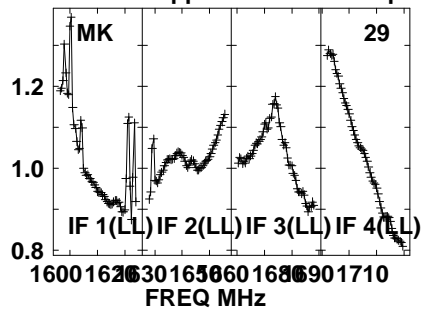
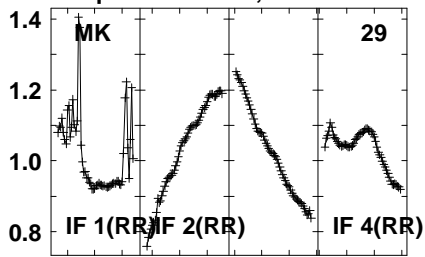

Lower frame: Real Jy  
Auto-corr total-power spectrum Antenna: \*  
Timerange: 00/20:55:31 to 00/20:58:59

Plot file version1238 created 05-OCT-2021 17:10:41

J0827+5217 GM076.UVDATA.1

Freq = 1.5945 GHz, Bw = 32.000 MH No calibration applied and no bandpass applied

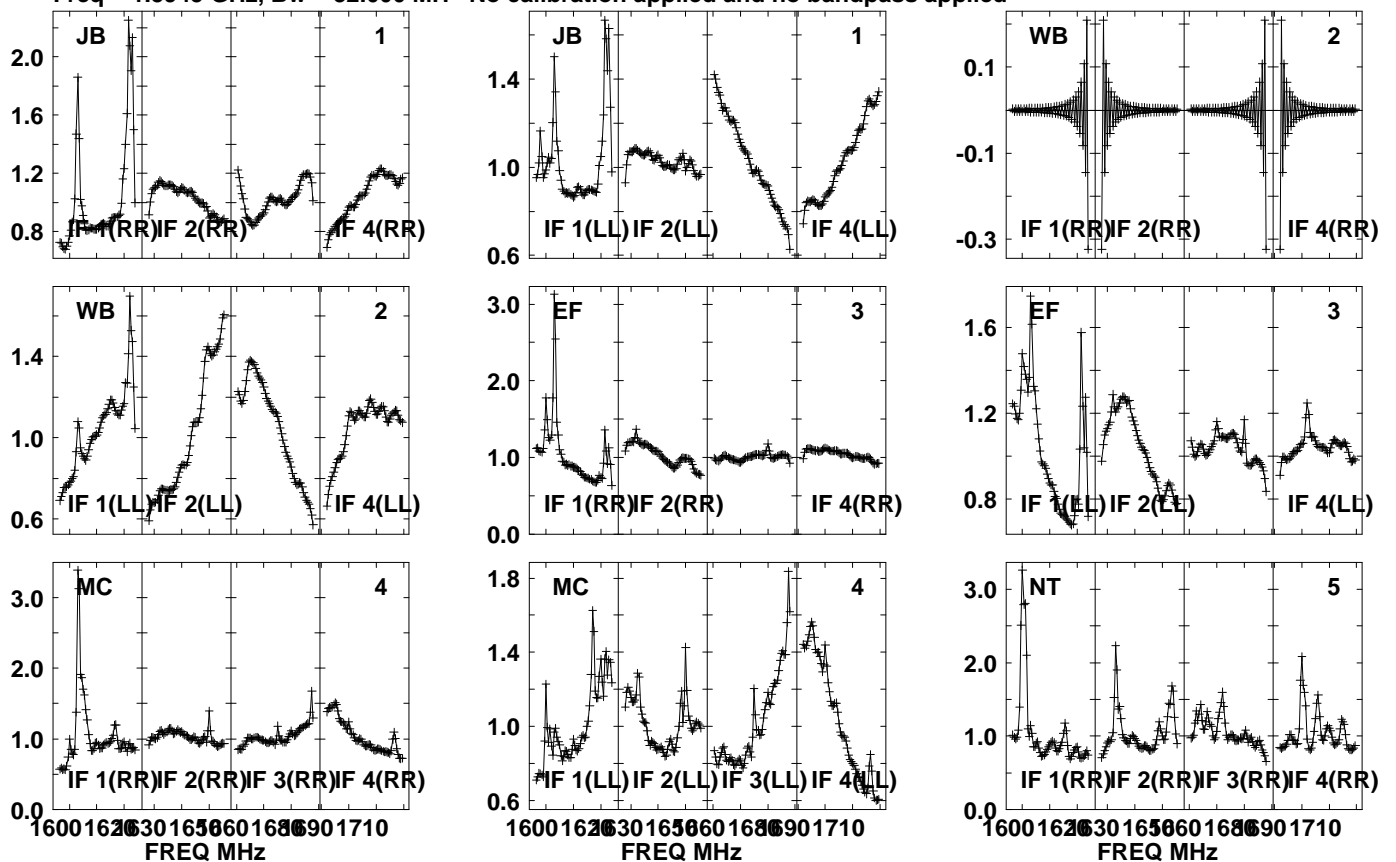

Lower frame: Real Jy  
Auto-corr total-power spectrum Antenna: \*  
Timerange: 00/20:59:31 to 00/21:00:59

Plot file version 1239 created 05-OCT-2021 17:10:42

J0827+5217 GM076.UVDATA.1

Freq = 1.5945 GHz, Bw = 32.000 MH No calibration applied and no bandpass applied

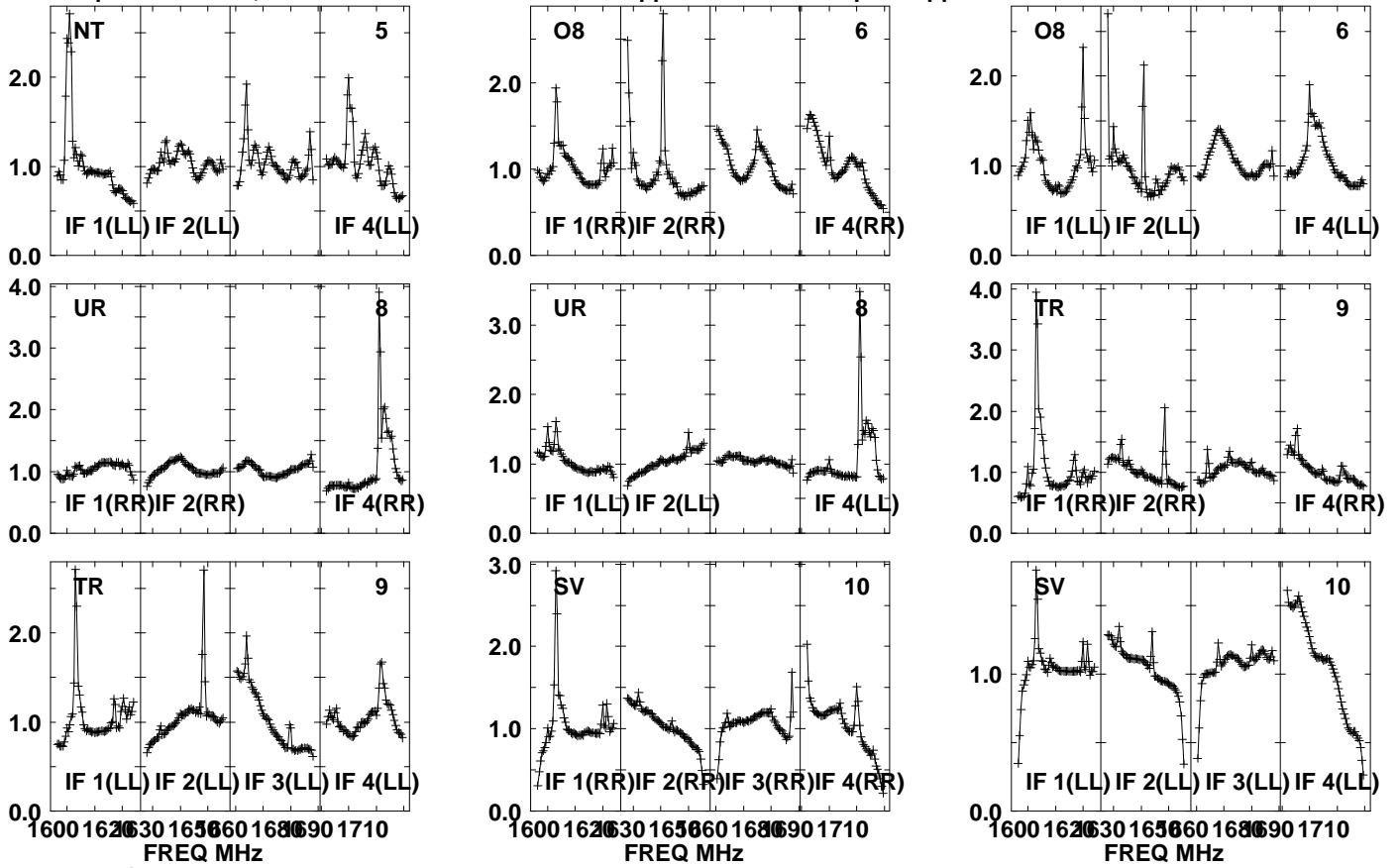

Lower frame: Real Jy  
Auto-corr total-power spectrum Antenna: \*  
Timerange: 00/20:59:31 to 00/21:00:59

Plot file version 1240 created 05-OCT-2021 17:10:42

J0827+5217 GM076.UVDATA.1

Freq = 1.5945 GHz, Bw = 32.000 MHz No calibration applied and no bandpass applied

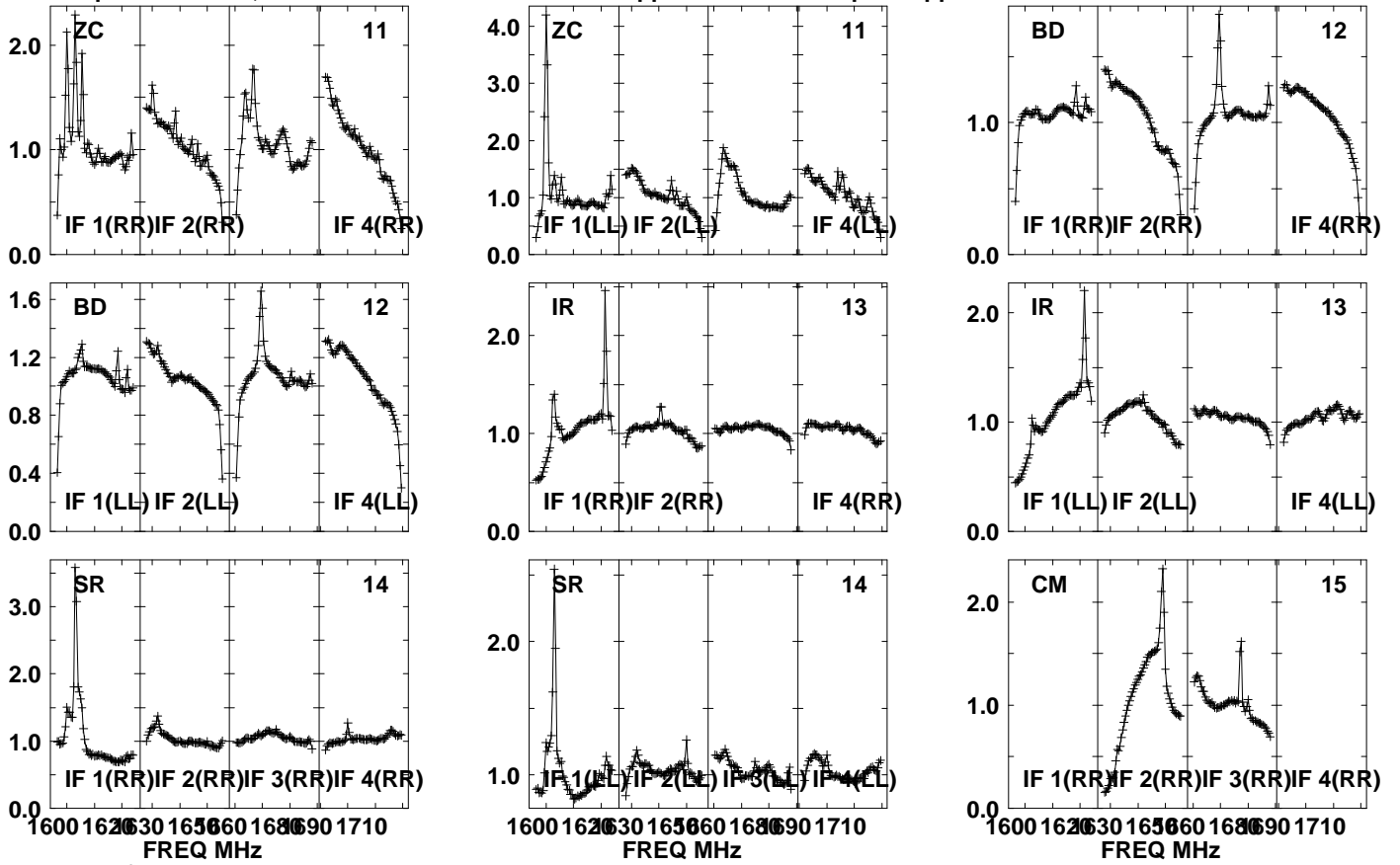

Lower frame: Real Jy  
Auto-corr total-power spectrum Antenna: \*  
Timerange: 00/20:59:31 to 00/21:00:59

Plot file version1241 created 05-OCT-2021 17:10:42

J0827+5217 GM076.UVDATA.1

Freq = 1.5945 GHz, Bw = 32.000 MH No calibration applied and no bandpass applied

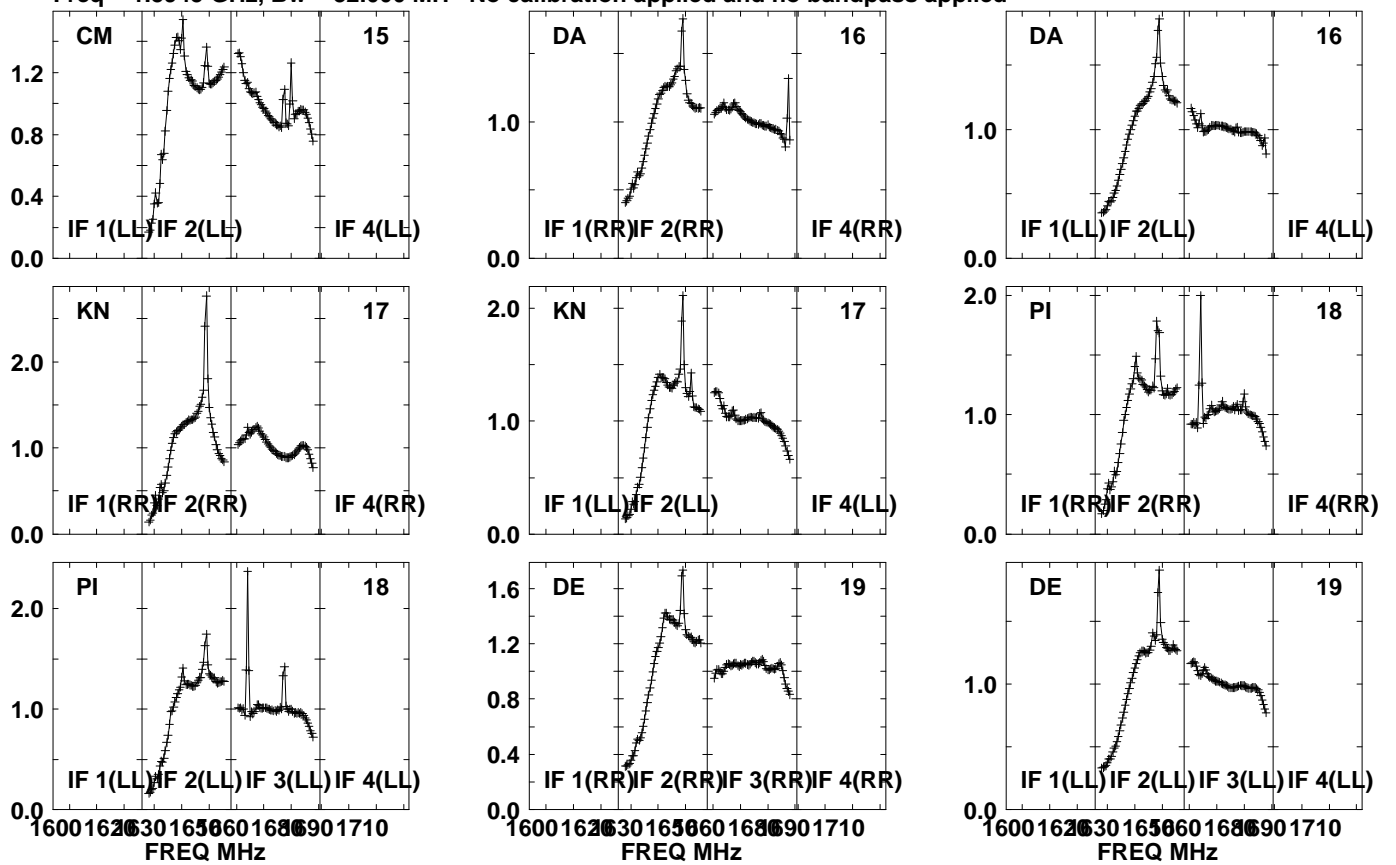

Lower frame: Real Jy  
Auto-corr total-power spectrum Antenna: \*  
Timerange: 00/20:59:31 to 00/21:00:59

Plot file version 1242 created 05-OCT-2021 17:10:43

J0827+5217 GM076.UVDATA.1

Freq = 1.5945 GHz, Bw = 32.000 MH No calibration applied and no bandpass applied

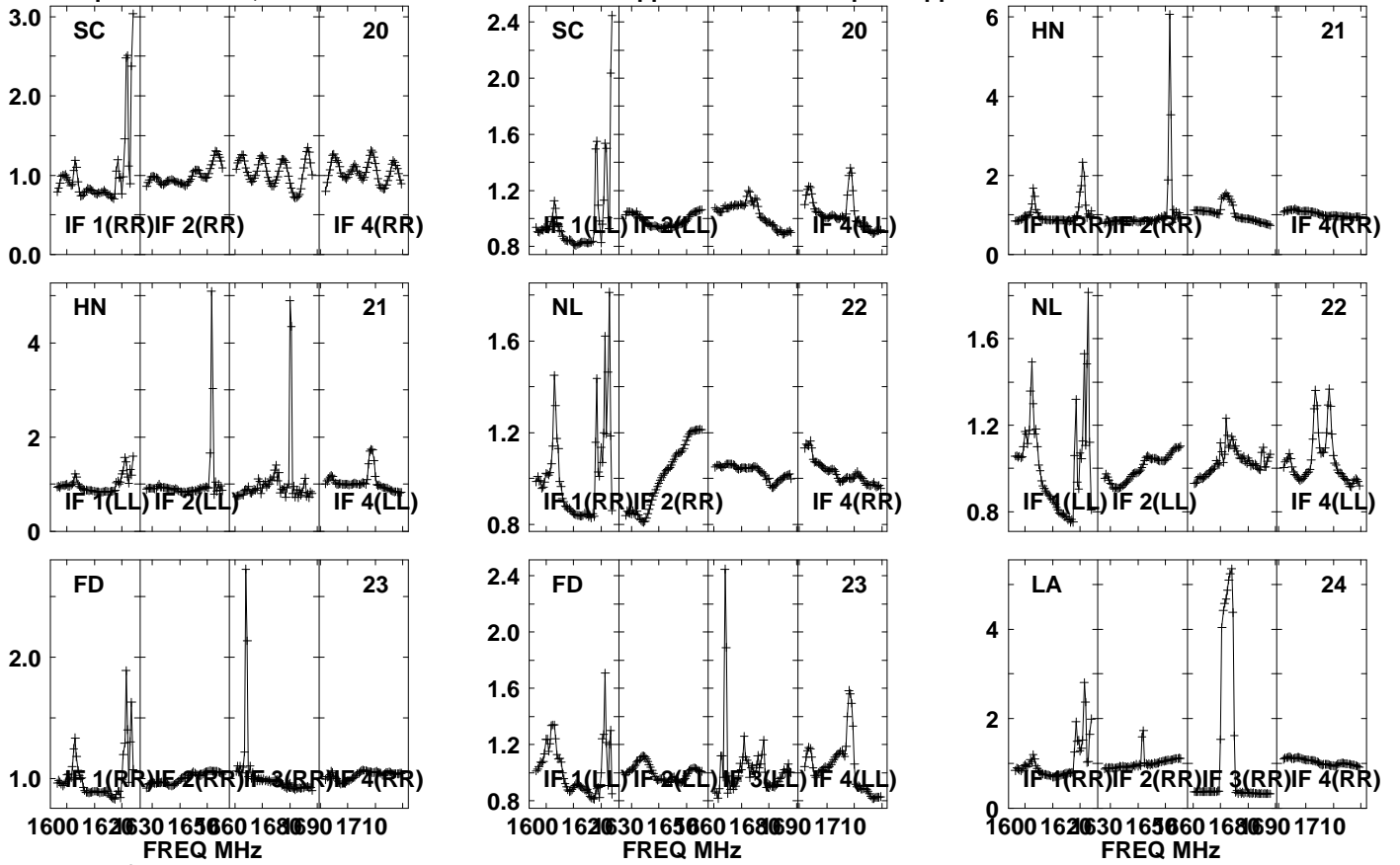

Lower frame: Real Jy

Auto-corr total-power spectrum Antenna: \*

Timerange: 00/20:59:31 to 00/21:00:59



Plot file version1243 created 05-OCT-2021 17:10:43

J0827+5217 GM076.UVDATA.1

Freq = 1.5945 GHz, Bw = 32.000 MH No calibration applied and no bandpass applied

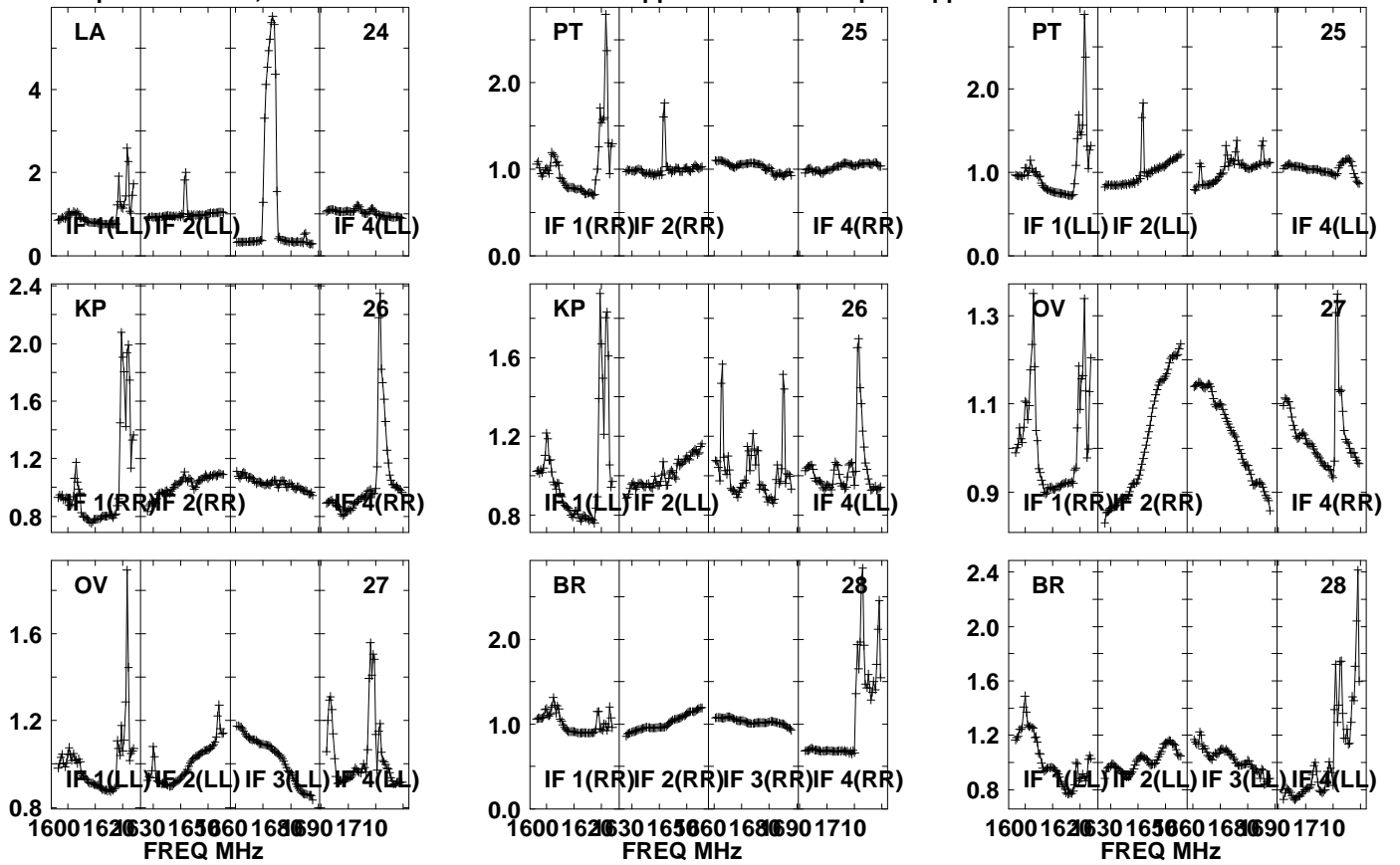

Lower frame: Real Jy

Auto-corr total-power spectrum Antenna: \*

Timerange: 00/20:59:31 to 00/21:00:59

Plot file version1244 created 05-OCT-2021 17:10:43

J0827+5217 GM076.UVDATA.1

Freq = 1.5945 GHz, Bw = 32.000 MH No calibration applied and no bandpass applied

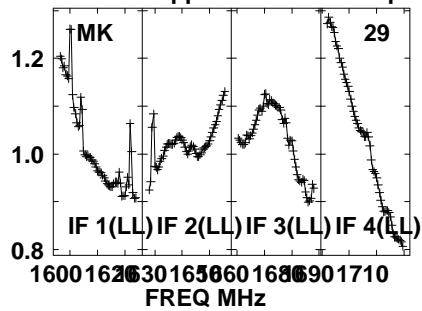
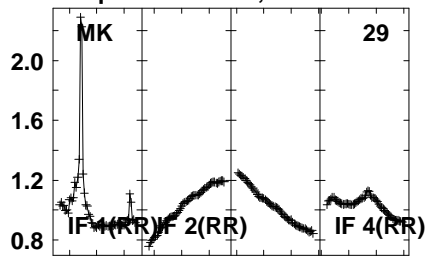

Lower frame: Real Jy  
Auto-corr total-power spectrum Antenna: \*  
Timerange: 00/20:59:31 to 00/21:00:59

Plot file version1245 created 05-OCT-2021 17:10:43

APM08279+525 GM076.UVDATA.1

Freq = 1.5945 GHz, Bw = 32.000 MH No calibration applied and no bandpass applied

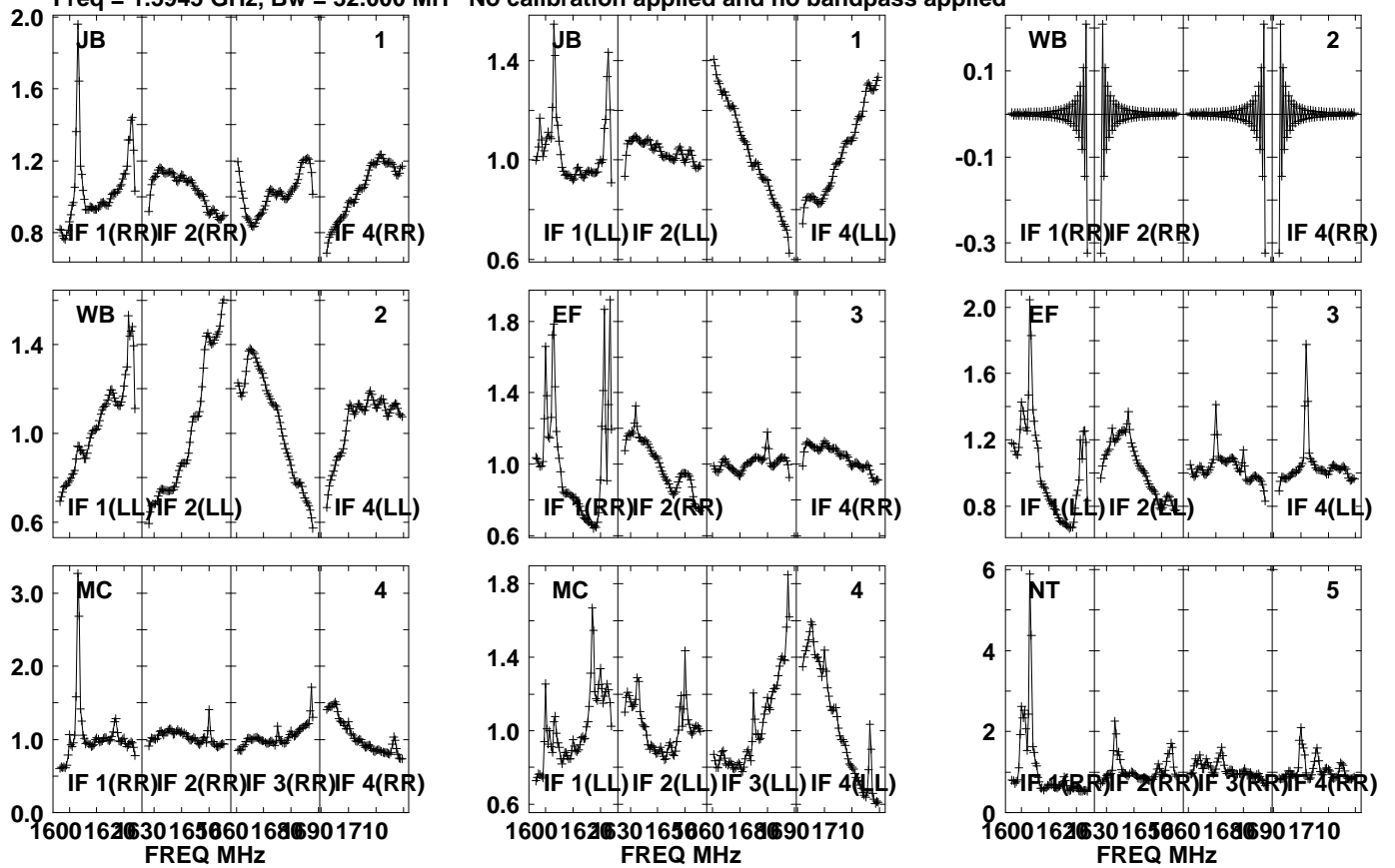

Lower frame: Real Jy  
Auto-corr total-power spectrum Antenna: \*  
Timerange: 00/21:01:01 to 00/21:04:29

Plot file version 1246 created 05-OCT-2021 17:10:44

APM08279+525 GM076.UVDATA.1

Freq = 1.5945 GHz, Bw = 32.000 MH No calibration applied and no bandpass applied

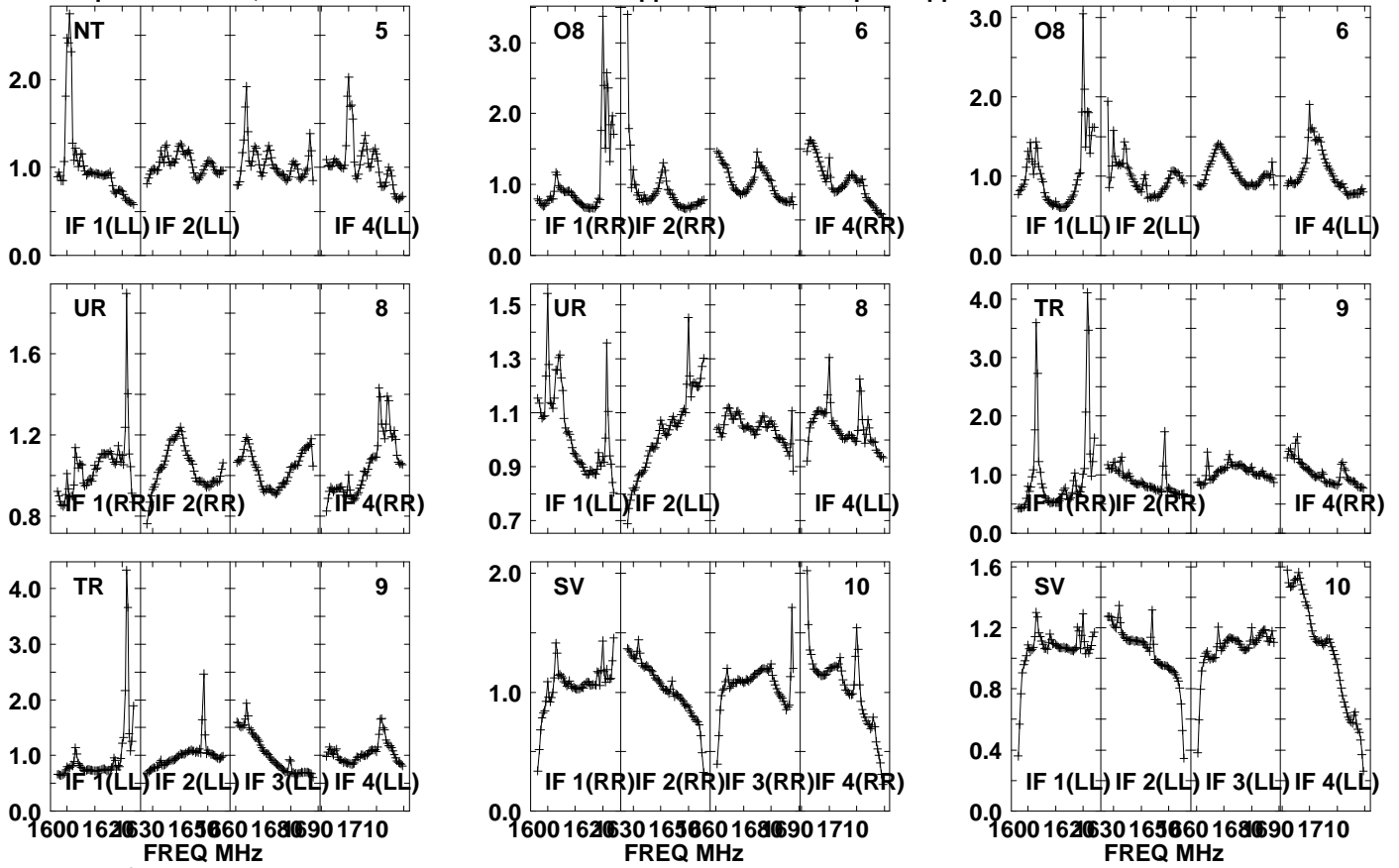

Lower frame: Real Jy  
Auto-corr total-power spectrum Antenna: \*  
Timerange: 00/21:01:01 to 00/21:04:29

Plot file version1247 created 05-OCT-2021 17:10:44

APM08279+525 GM076.UVDATA.1

Freq = 1.5945 GHz, Bw = 32.000 MH No calibration applied and no bandpass applied

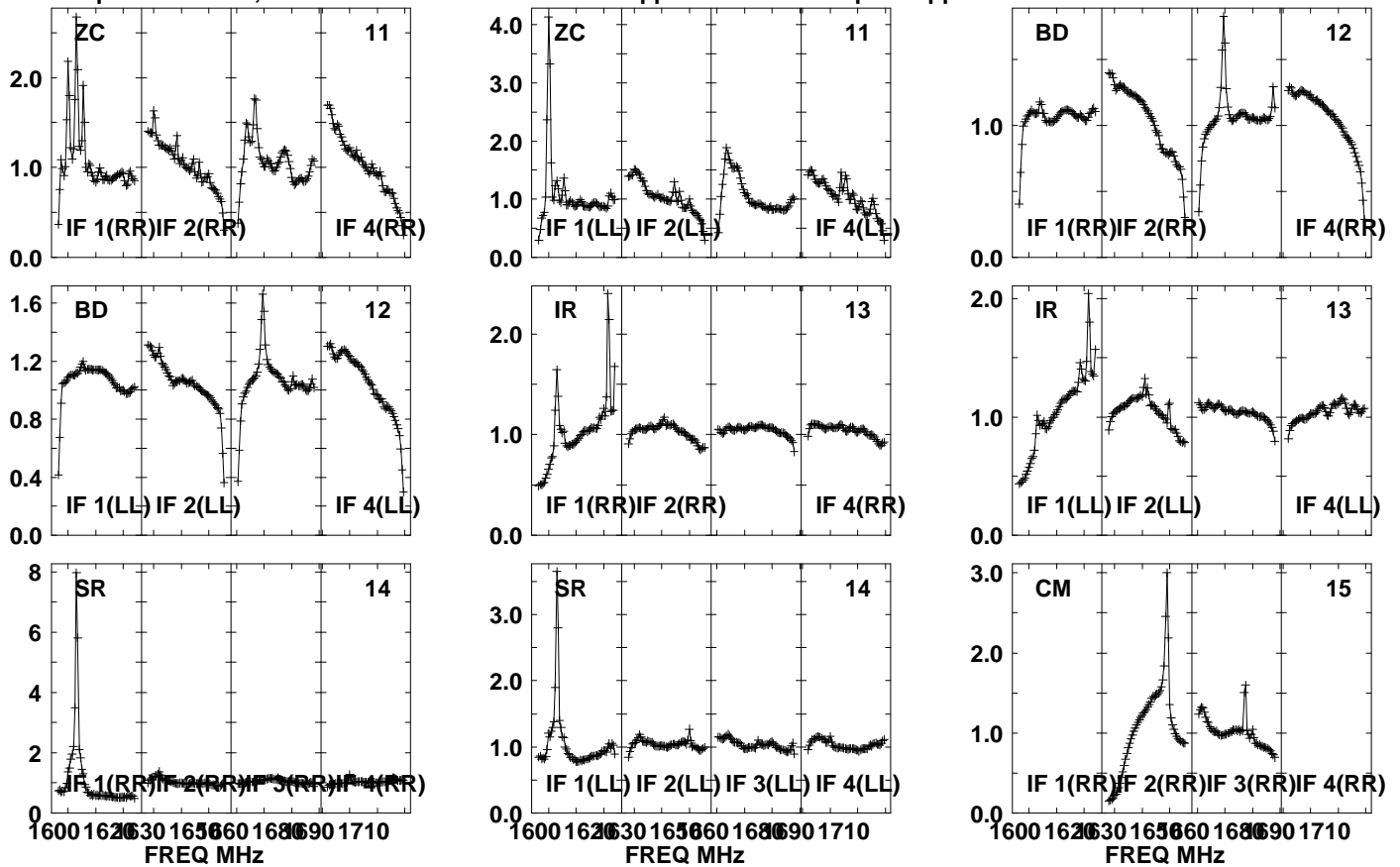

Lower frame: Real Jy

Auto-corr total-power spectrum Antenna: \*

Timerange: 00/21:01:01 to 00/21:04:29

Plot file version 1248 created 05-OCT-2021 17:10:44

APM08279+525 GM076.UVDATA.1

Freq = 1.5945 GHz, Bw = 32.000 MH No calibration applied and no bandpass applied

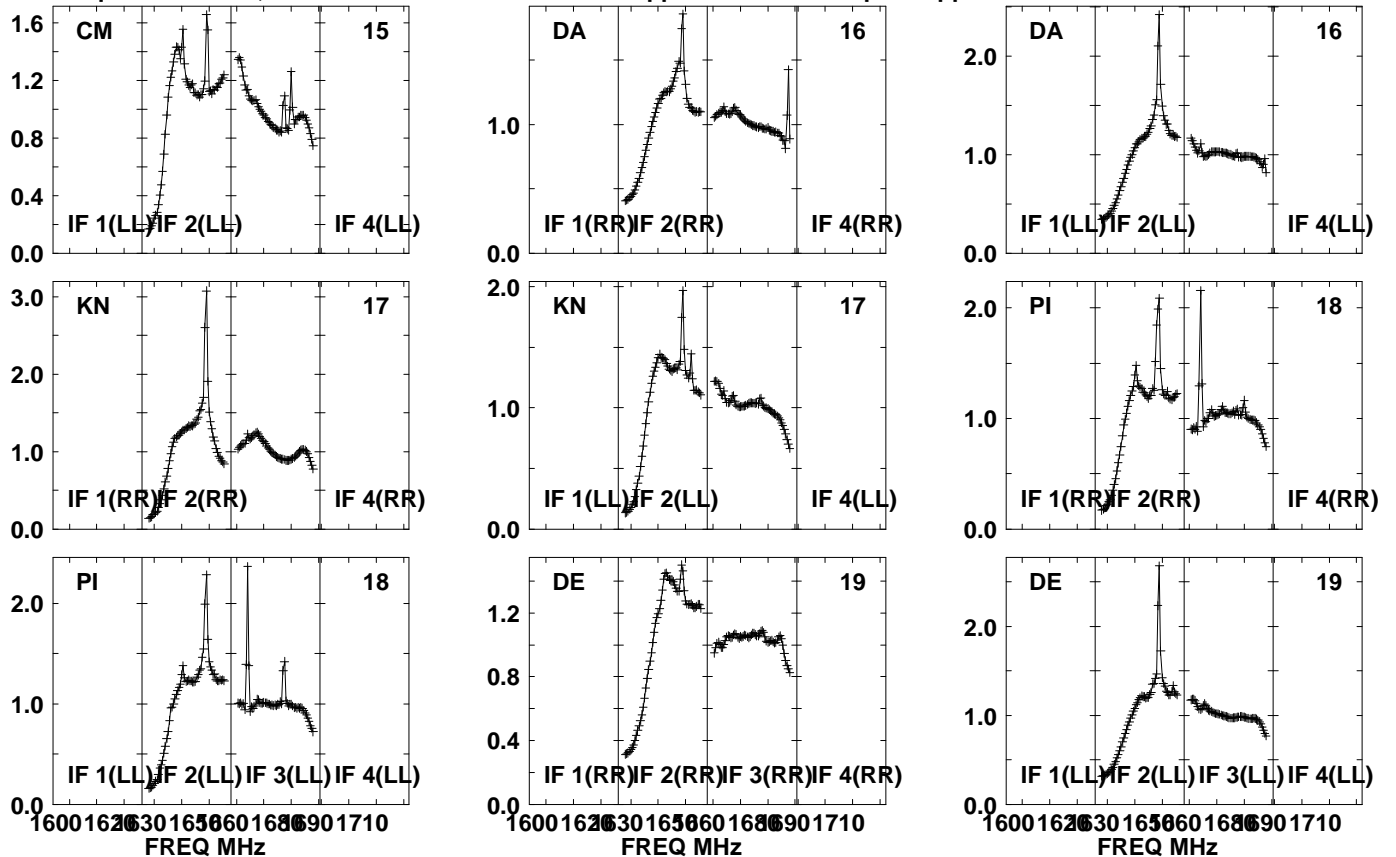

Lower frame: Real Jy  
Auto-corr total-power spectrum Antenna: \*  
Timerange: 00/21:01:01 to 00/21:04:29

Plot file version 1249 created 05-OCT-2021 17:10:45

APM08279+525 GM076.UVDATA.1

Freq = 1.5945 GHz, Bw = 32.000 MH No calibration applied and no bandpass applied

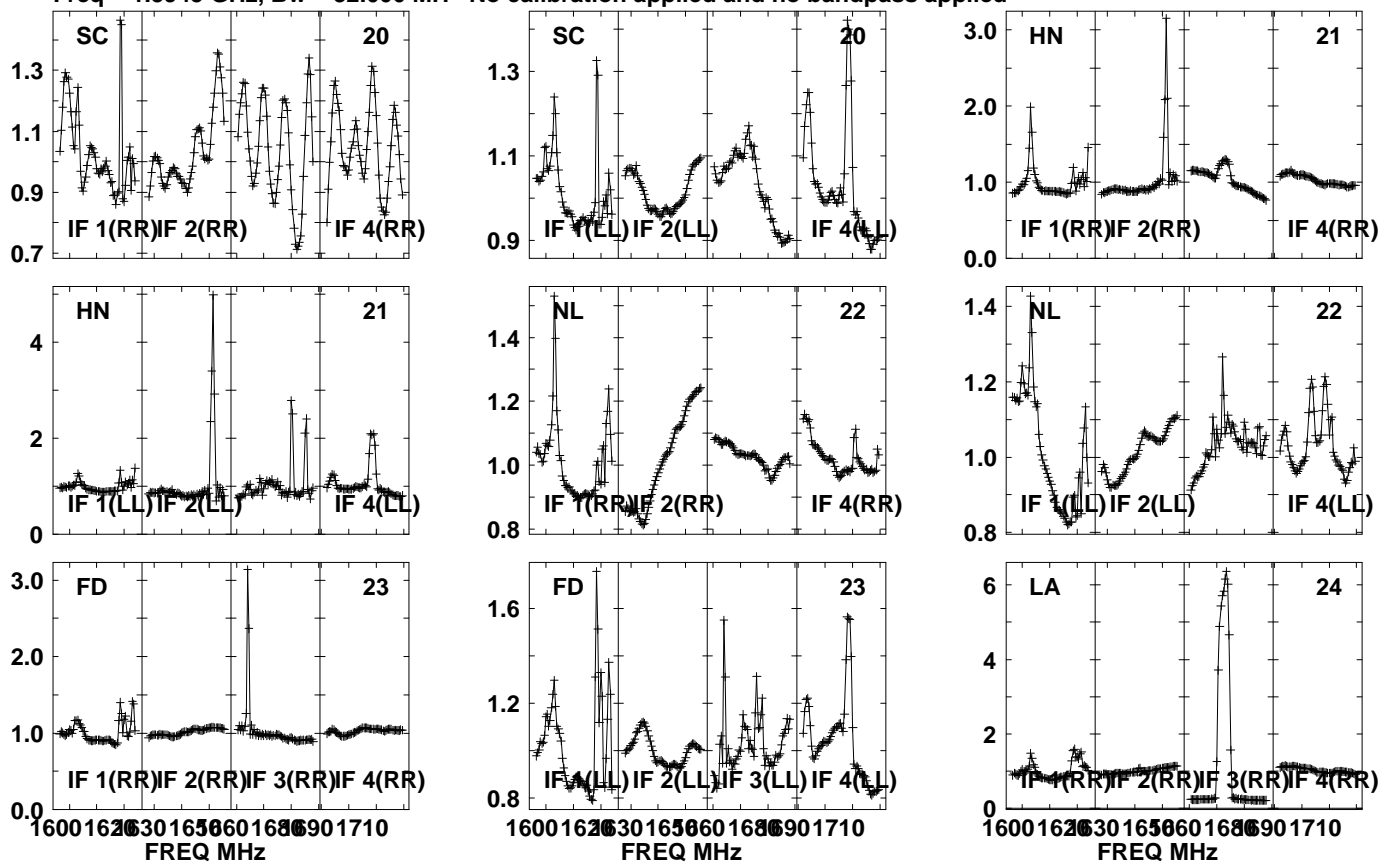

Lower frame: Real Jy  
Auto-corr total-power spectrum Antenna: \*  
Timerange: 00/21:01:01 to 00/21:04:29

Plot file version1250 created 05-OCT-2021 17:10:45

APM08279+525 GM076.UVDATA.1

Freq = 1.5945 GHz, Bw = 32.000 MH No calibration applied and no bandpass applied

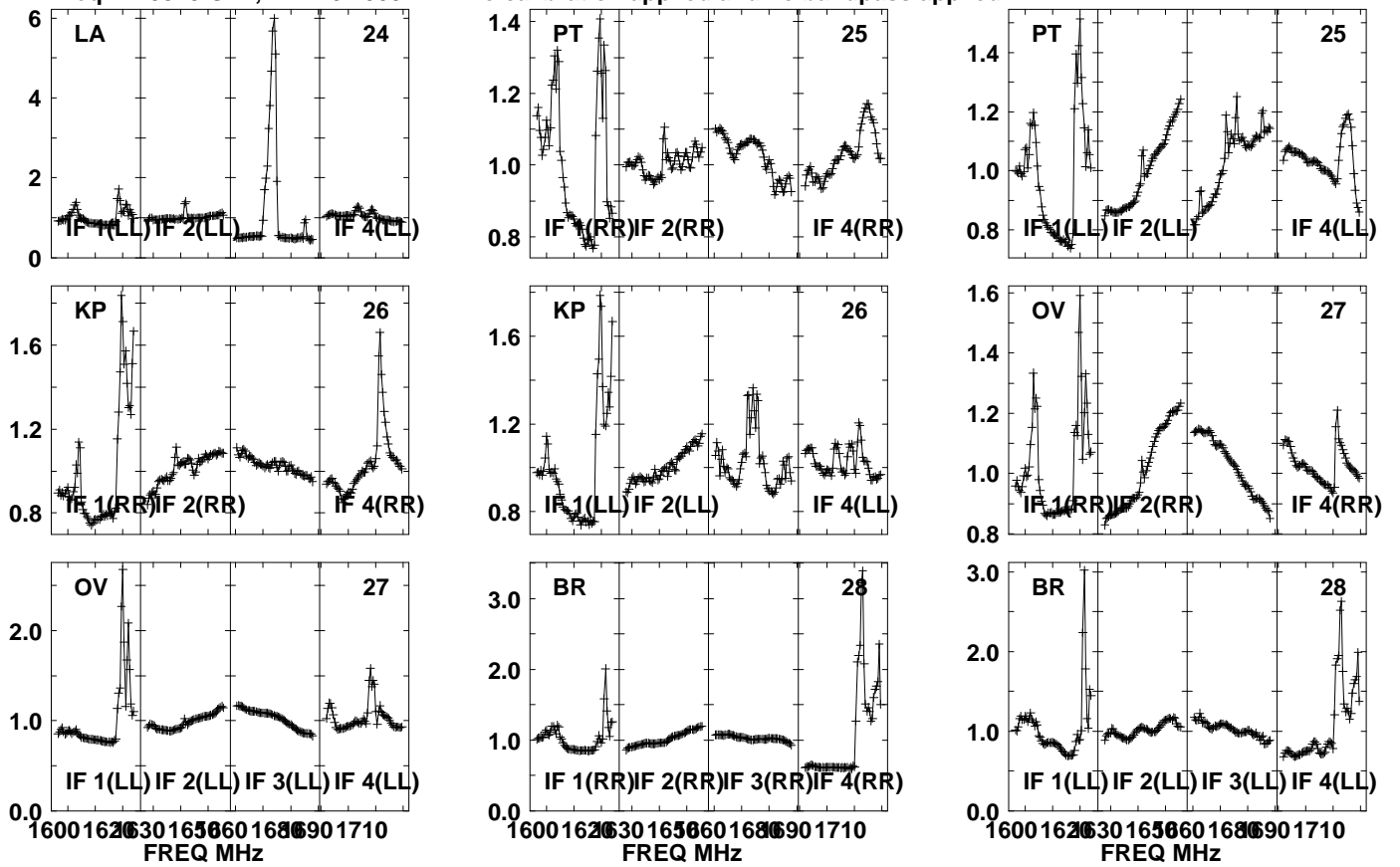

Lower frame: Real Jy  
Auto-corr total-power spectrum Antenna: \*  
Timerange: 00/21:01:01 to 00/21:04:29



Plot file version1251 created 05-OCT-2021 17:10:46

APM08279+525 GM076.UVDATA.1

Freq = 1.5945 GHz, Bw = 32.000 MH No calibration applied and no bandpass applied

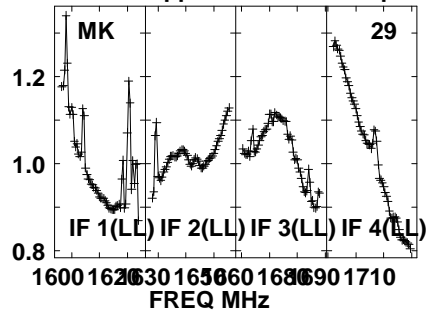
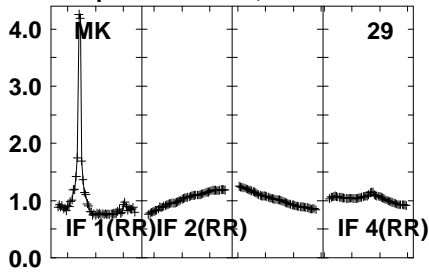

Lower frame: Real Jy

Auto-corr total-power spectrum Antenna: \*

Timerange: 00/21:01:01 to 00/21:04:29

Plot file version1252 created 05-OCT-2021 17:10:46

J0827+5217 GM076.UVDATA.1

Freq = 1.5945 GHz, Bw = 32.000 MH No calibration applied and no bandpass applied

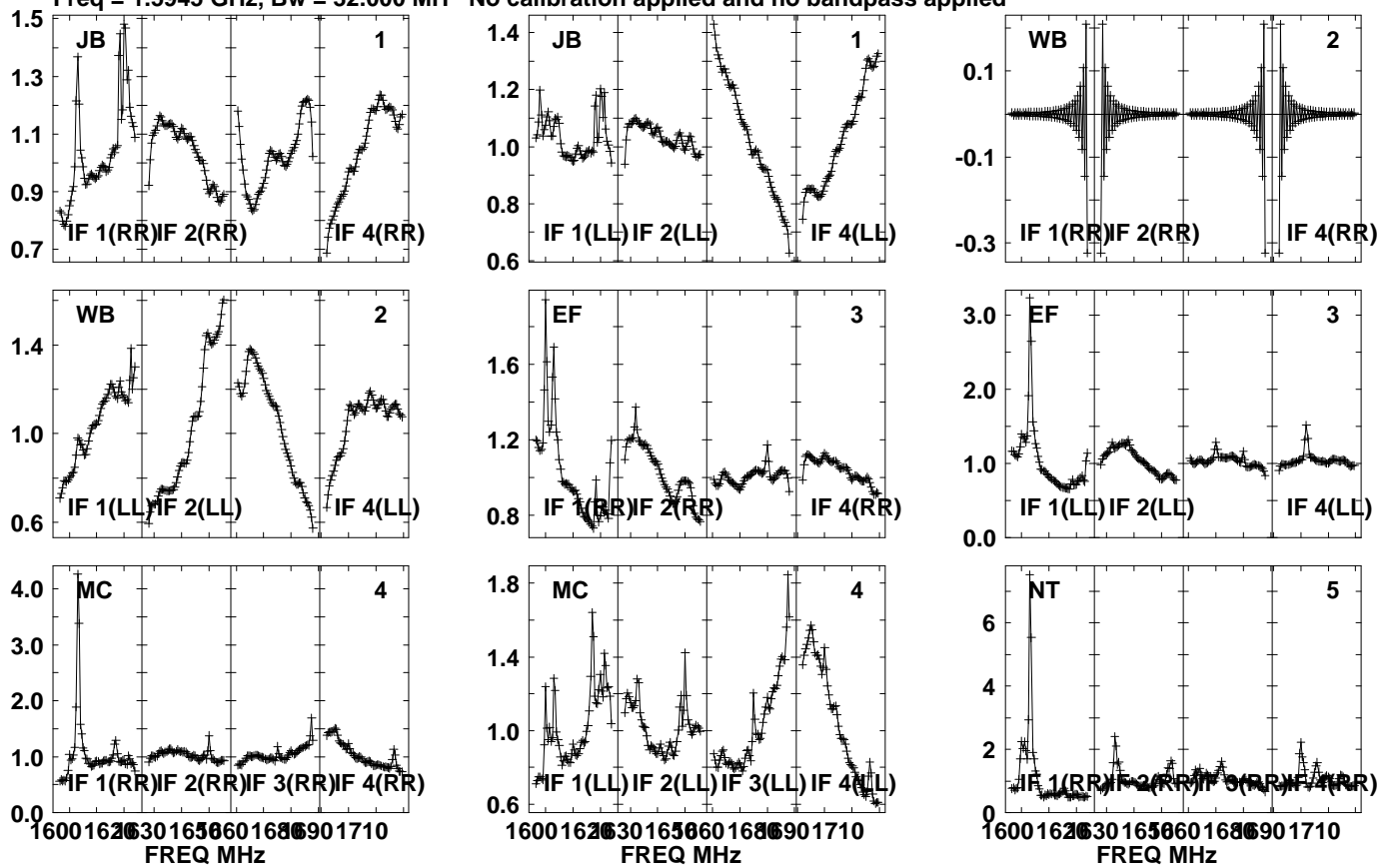

Lower frame: Real Jy  
Auto-corr total-power spectrum Antenna: \*  
Timerange: 00/21:04:31 to 00/21:05:59

Plot file version1253 created 05-OCT-2021 17:10:46

J0827+5217 GM076.UVDATA.1

Freq = 1.5945 GHz, Bw = 32.000 MH No calibration applied and no bandpass applied

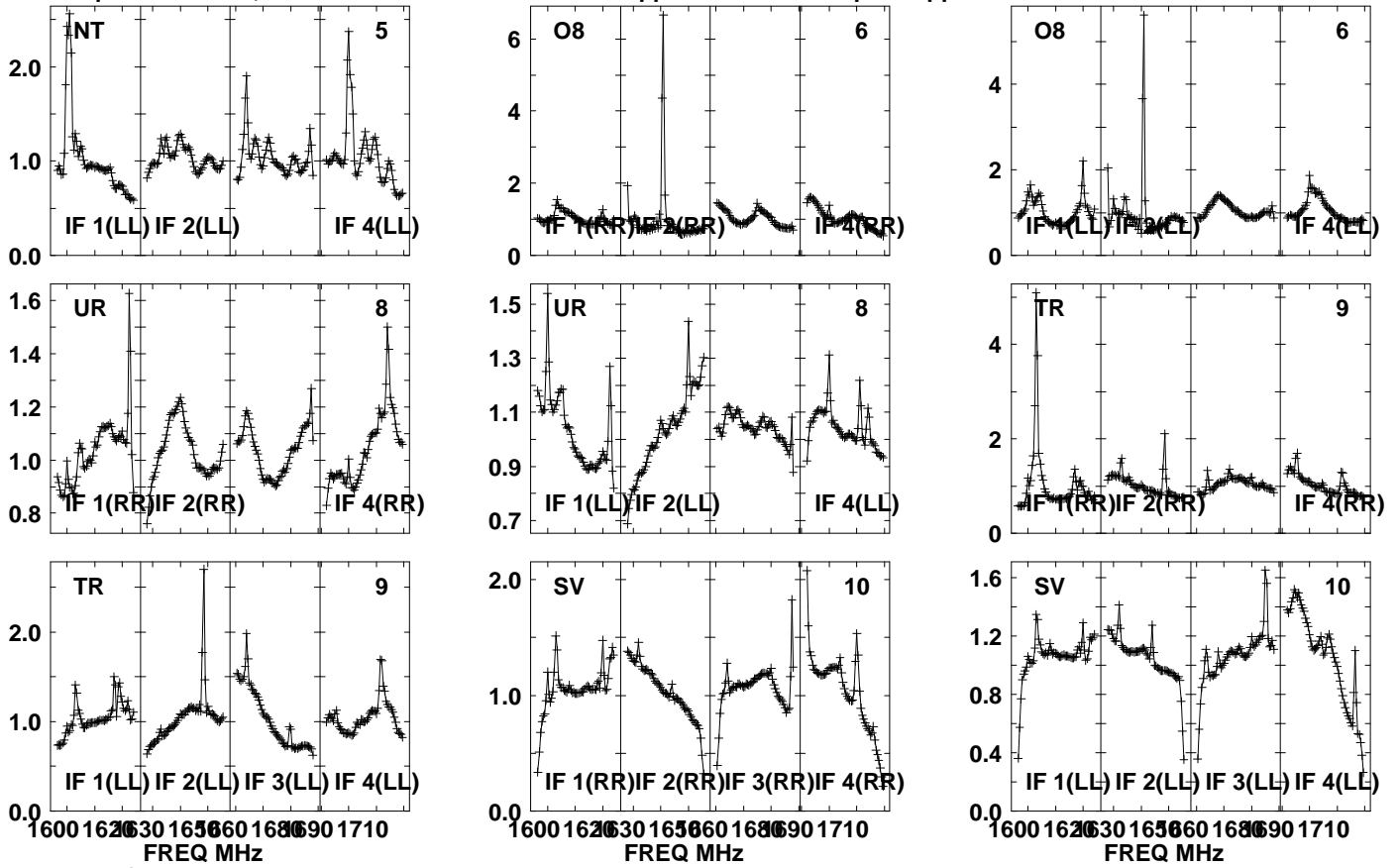

Lower frame: Real Jy  
Auto-corr total-power spectrum Antenna: \*  
Timerange: 00/21:04:31 to 00/21:05:59

Plot file version 1254 created 05-OCT-2021 17:10:46

J0827+5217 GM076.UVDATA.1

Freq = 1.5945 GHz, Bw = 32.000 MH No calibration applied and no bandpass applied

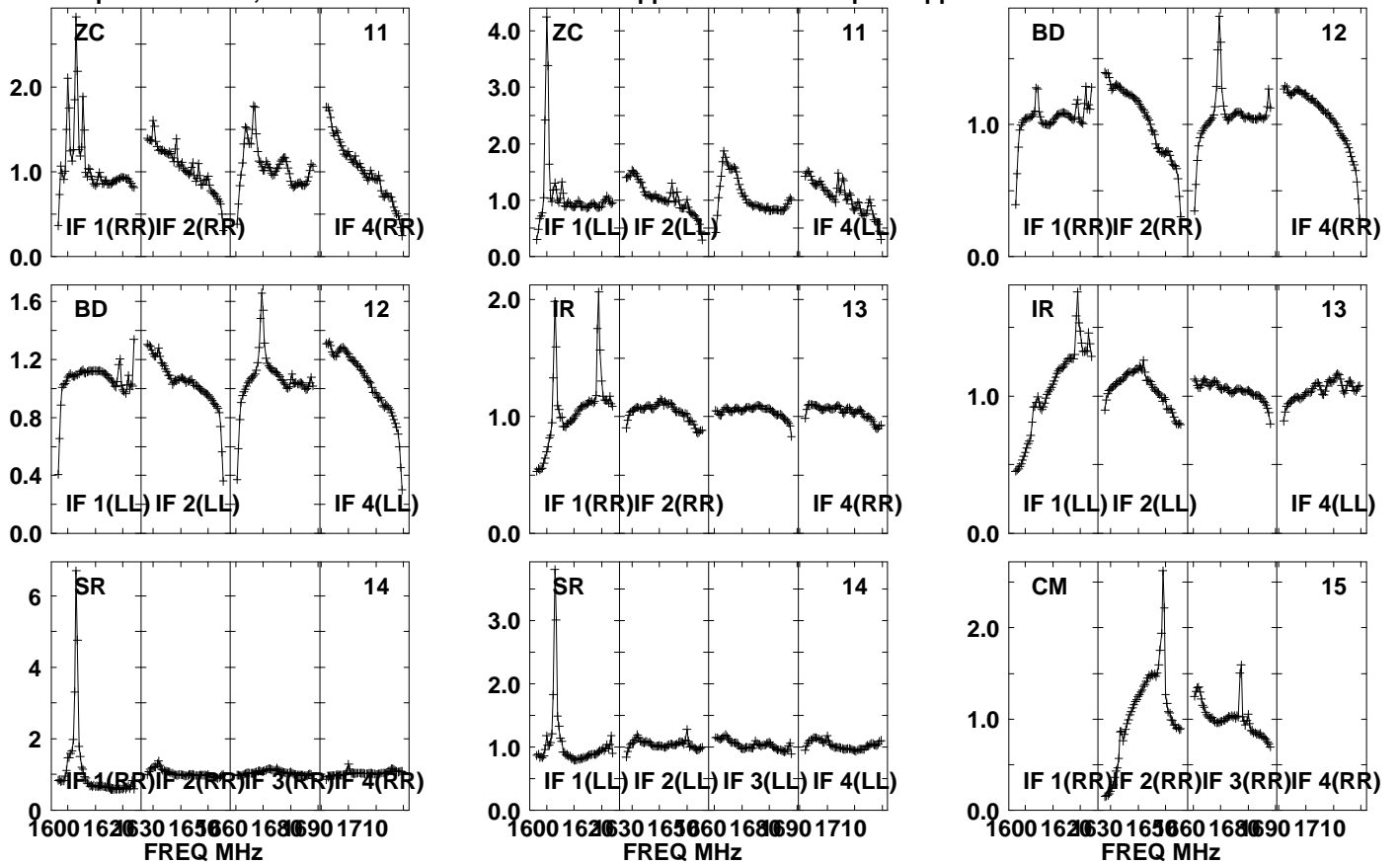

Lower frame: Real Jy

Auto-corr total-power spectrum Antenna: \*

Timerange: 00/21:04:31 to 00/21:05:59

Plot file version 1255 created 05-OCT-2021 17:10:47

J0827+5217 GM076.UVDATA.1

Freq = 1.5945 GHz, Bw = 32.000 MH No calibration applied and no bandpass applied

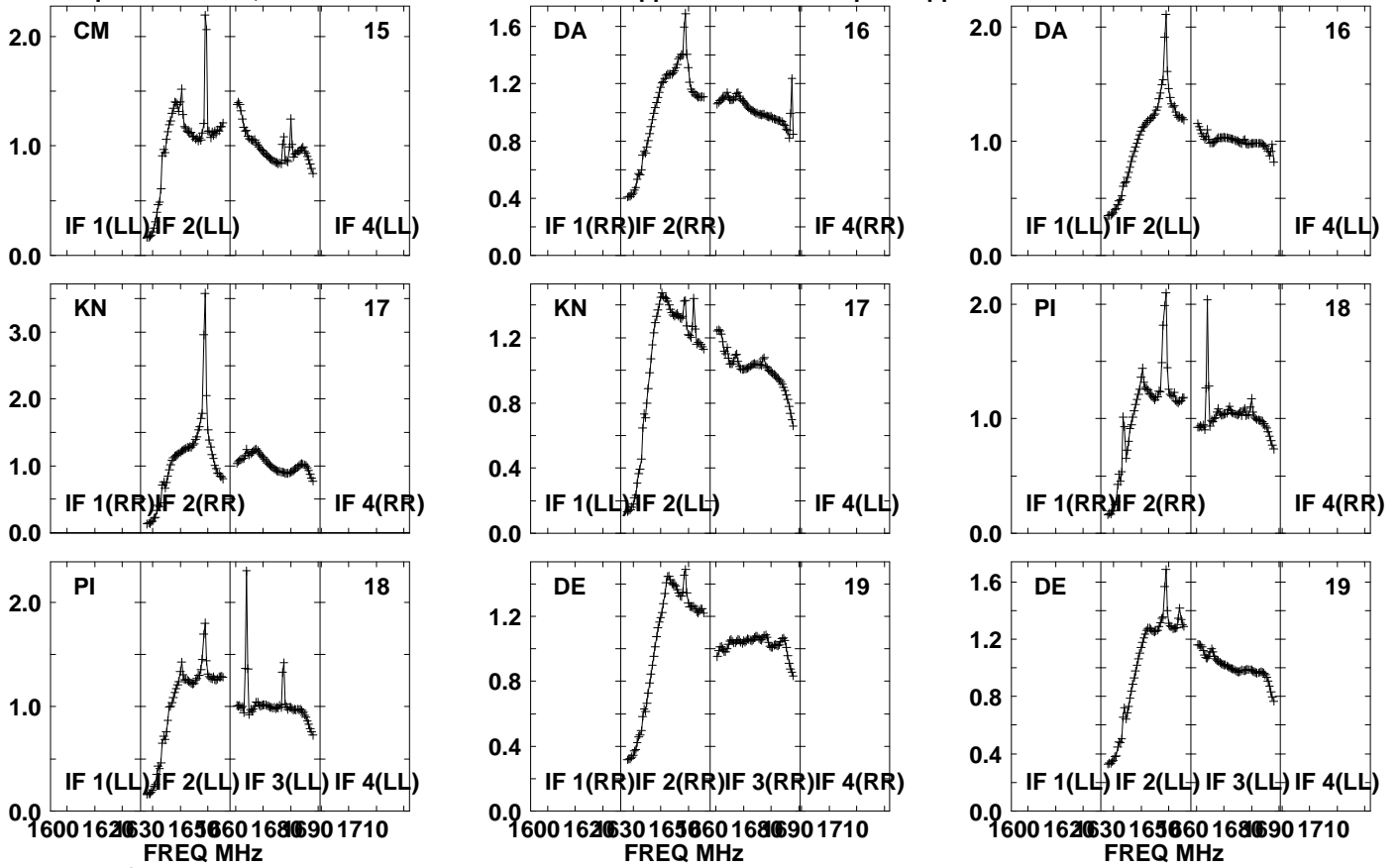

Lower frame: Real Jy

Auto-corr total-power spectrum Antenna: \*

Timerange: 00/21:04:31 to 00/21:05:59

Plot file version 1256 created 05-OCT-2021 17:10:47

J0827+5217 GM076.UVDATA.1

Freq = 1.5945 GHz, Bw = 32.000 MH No calibration applied and no bandpass applied

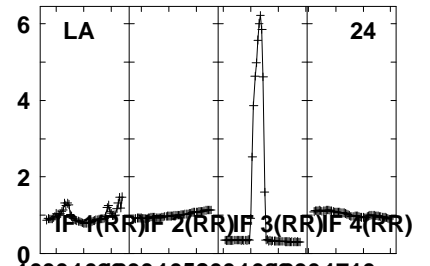
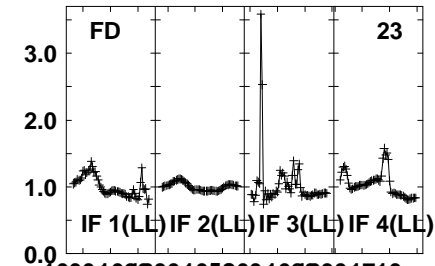
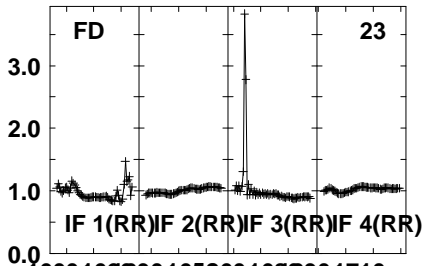
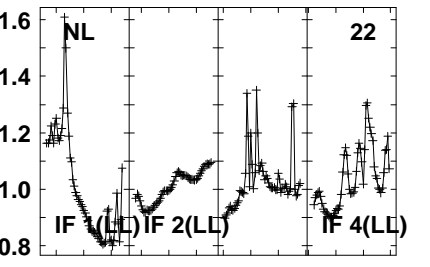
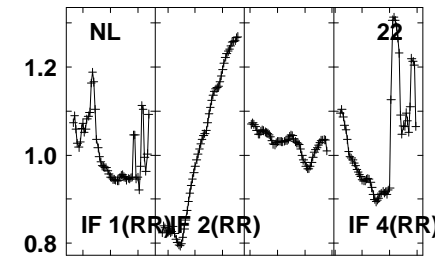
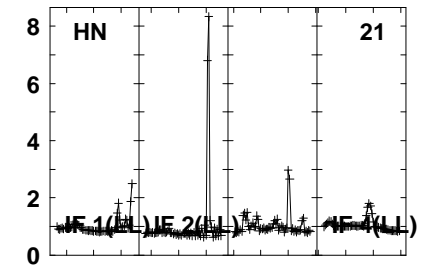
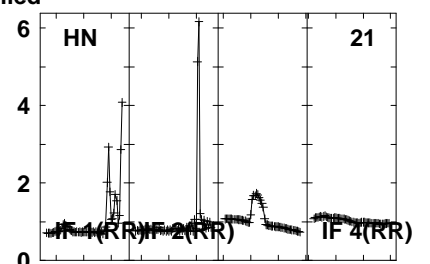
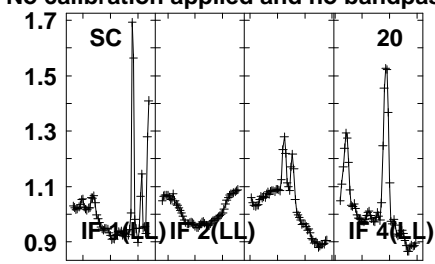
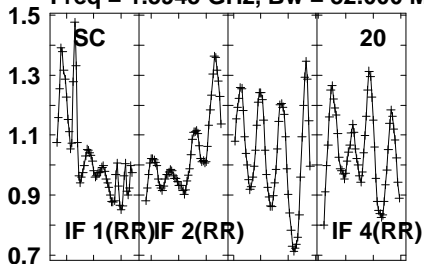

Lower frame: Real Jy  
Auto-corr total-power spectrum Antenna: \*  
Timerange: 00/21:04:31 to 00/21:05:59

Plot file version 1257 created 05-OCT-2021 17:10:47

J0827+5217 GM076.UVDATA.1

Freq = 1.5945 GHz, Bw = 32.000 MH No calibration applied and no bandpass applied

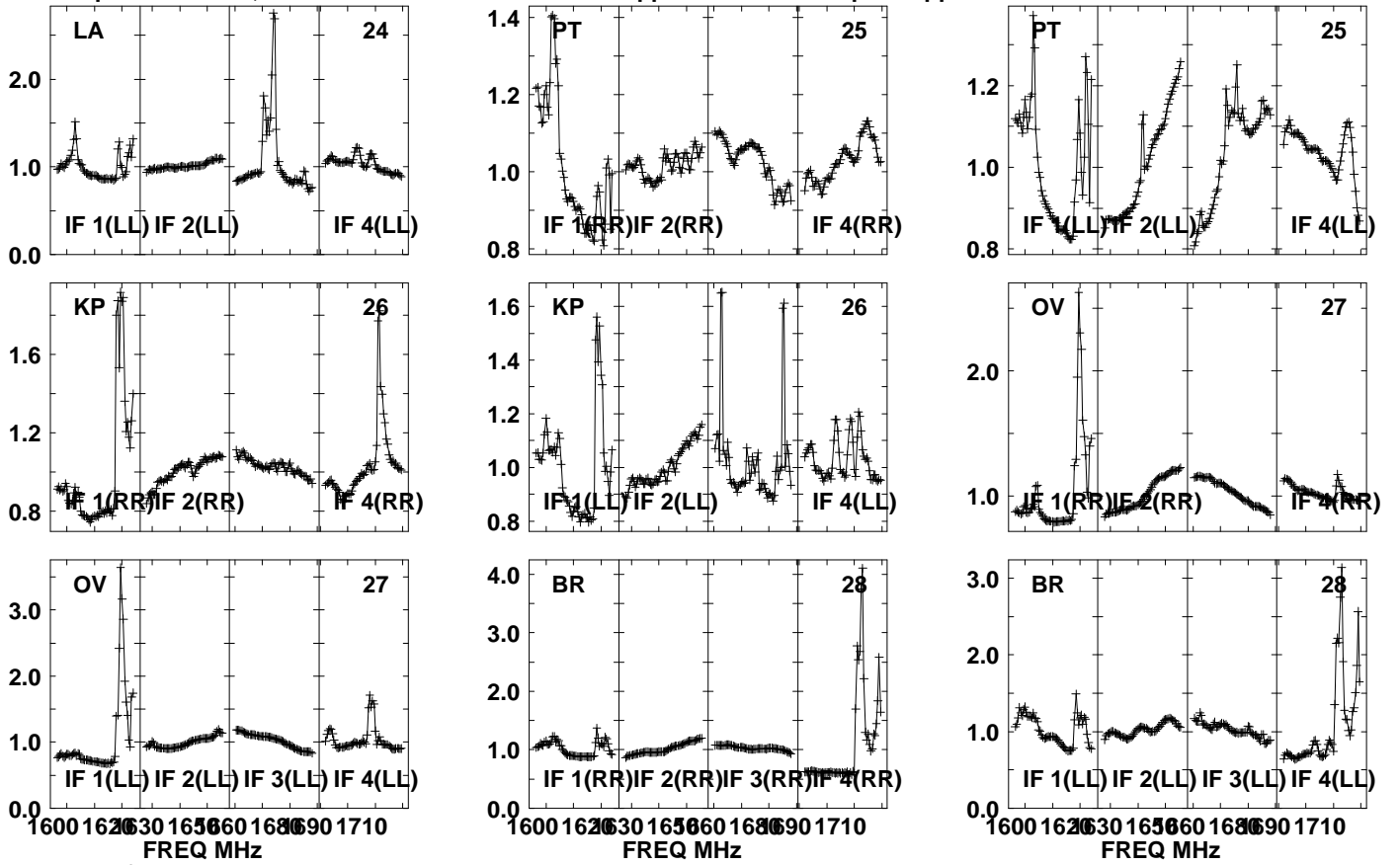

Lower frame: Real Jy

Auto-corr total-power spectrum Antenna: \*

Timerange: 00/21:04:31 to 00/21:05:59

Plot file version1258 created 05-OCT-2021 17:10:48

J0827+5217 GM076.UVDATA.1

Freq = 1.5945 GHz, Bw = 32.000 MH No calibration applied and no bandpass applied

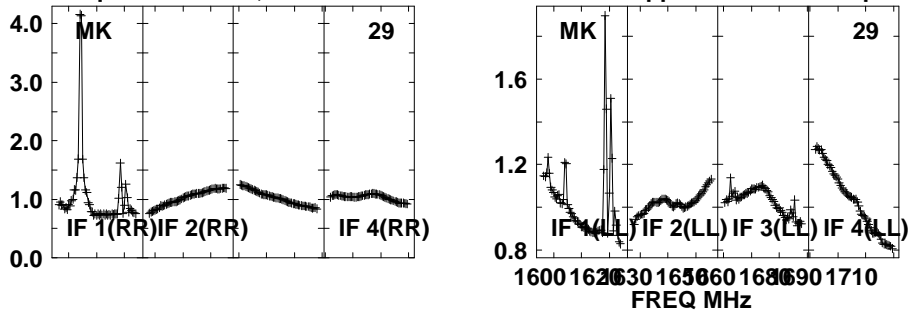

Lower frame: Real Jy

Auto-corr total-power spectrum Antenna: \*

Timerange: 00/21:04:31 to 00/21:05:59



Plot file version 1259 created 05-OCT-2021 17:10:48

APM08279+525 GM076.UVDATA.1

Freq = 1.5945 GHz, Bw = 32.000 MH No calibration applied and no bandpass applied

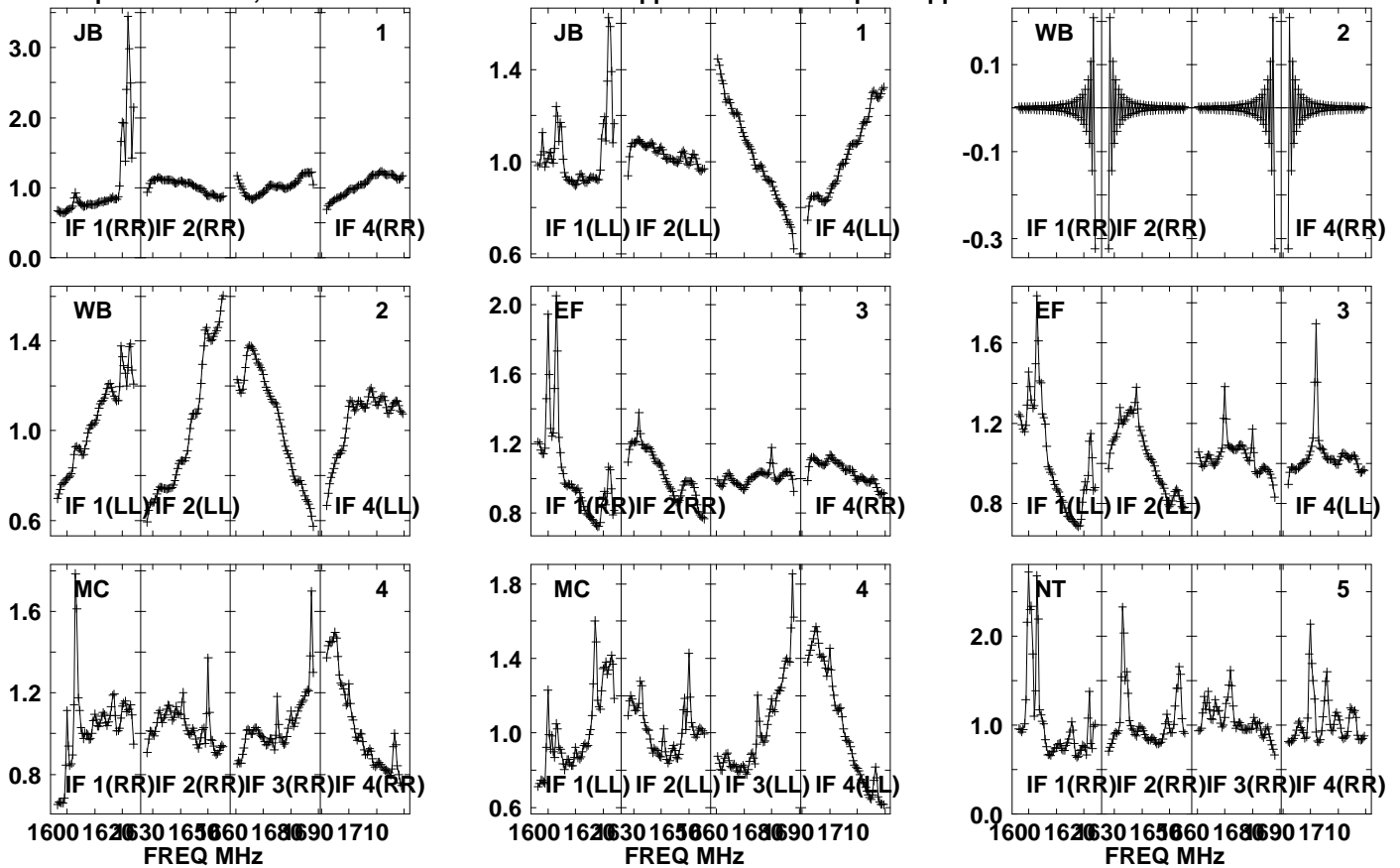

Lower frame: Real Jy

Auto-corr total-power spectrum Antenna: \*

Timerange: 00/21:06:01 to 00/21:09:29

Plot file version 1260 created 05-OCT-2021 17:10:48

APM08279+525 GM076.UVDATA.1

Freq = 1.5945 GHz, Bw = 32.000 MH No calibration applied and no bandpass applied

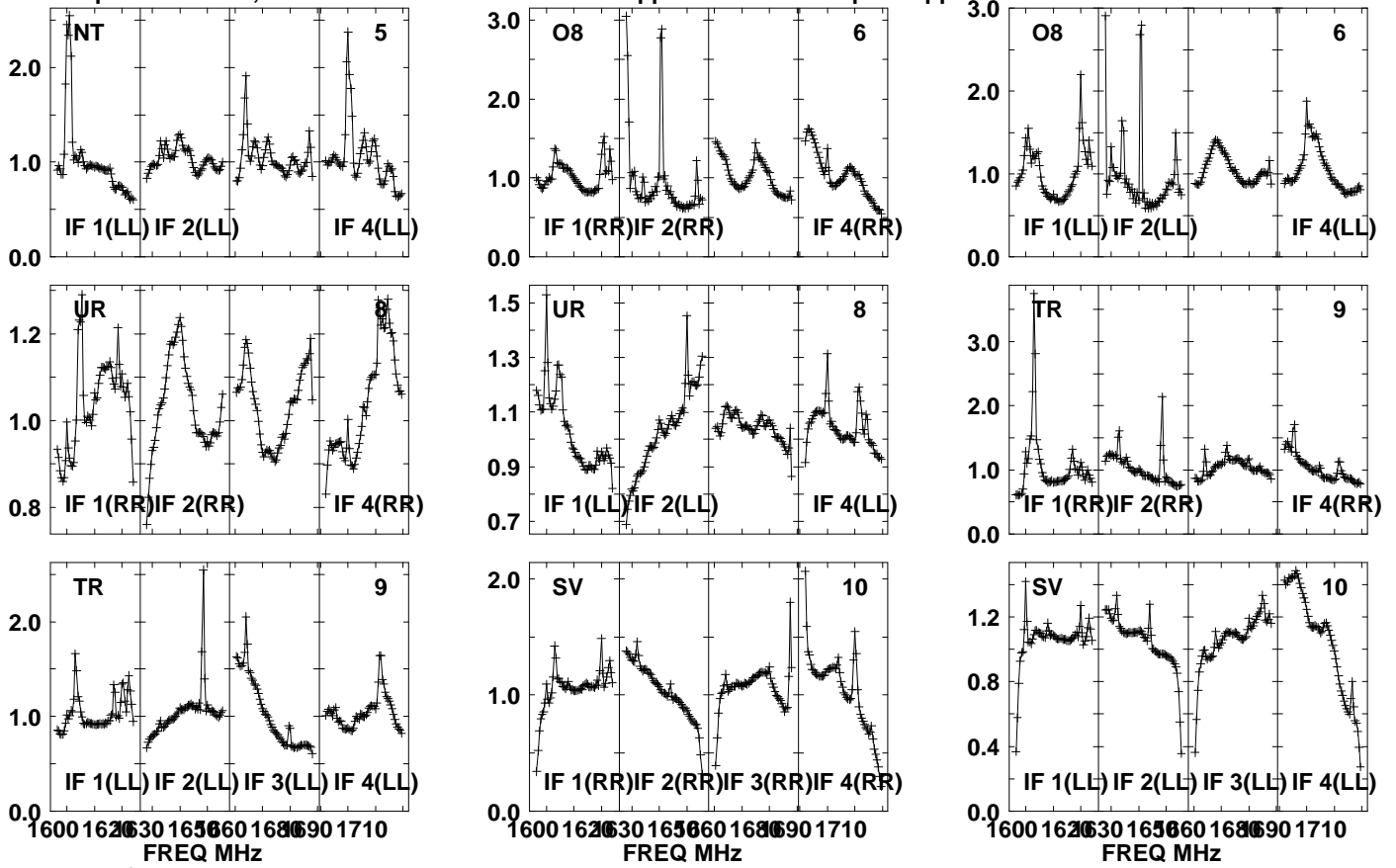

Lower frame: Real Jy

Auto-corr total-power spectrum Antenna: \*

Timerange: 00/21:06:01 to 00/21:09:29

Plot file version 1261 created 05-OCT-2021 17:10:48

APM08279+525 GM076.UVDATA.1

Freq = 1.5945 GHz, Bw = 32.000 MHz No calibration applied and no bandpass applied

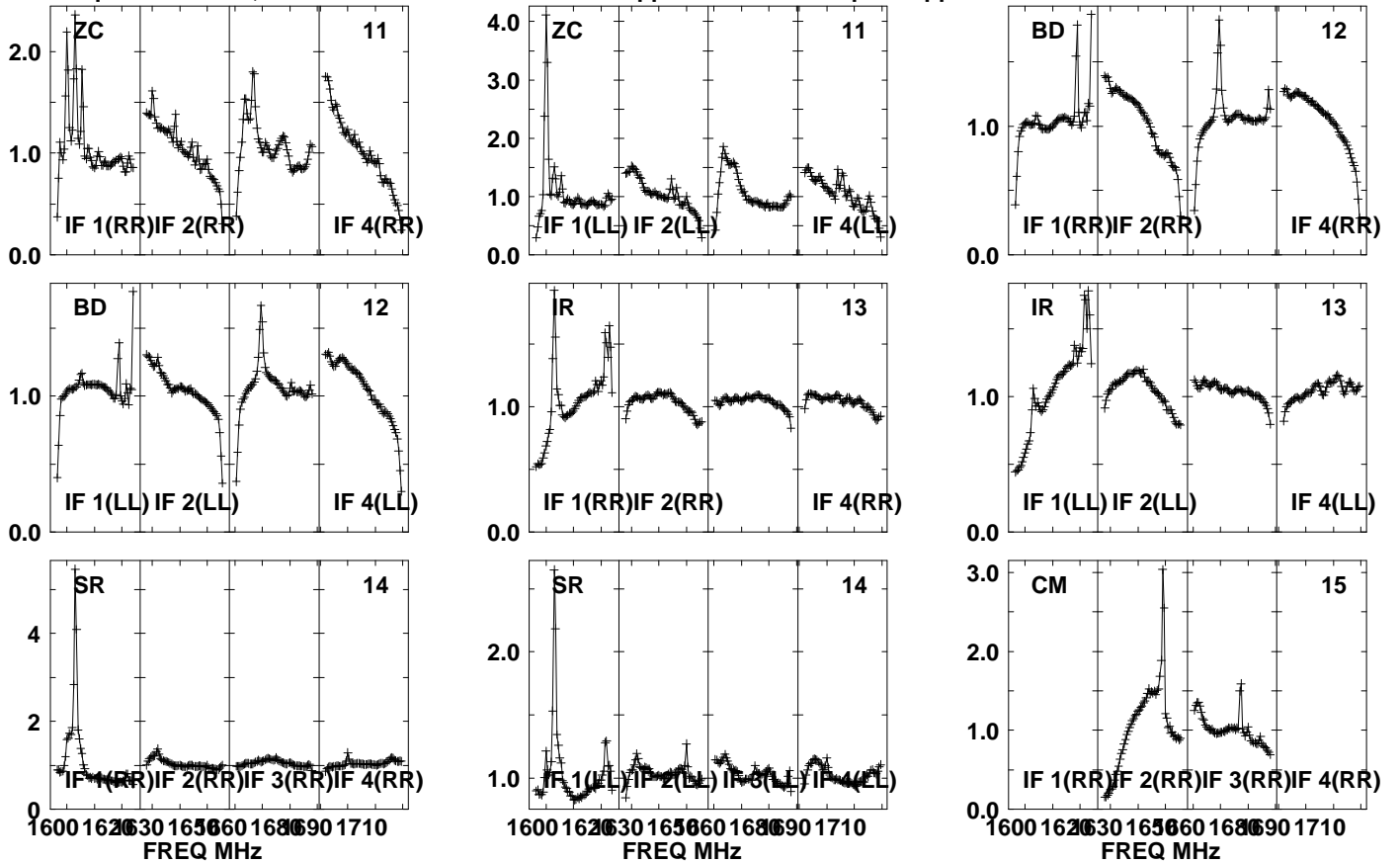

Lower frame: Real Jy

Auto-corr total-power spectrum Antenna: \*

Timerange: 00/21:06:01 to 00/21:09:29

Plot file version 1262 created 05-OCT-2021 17:10:49

APM08279+525 GM076.UVDATA.1

Freq = 1.5945 GHz, Bw = 32.000 MH No calibration applied and no bandpass applied

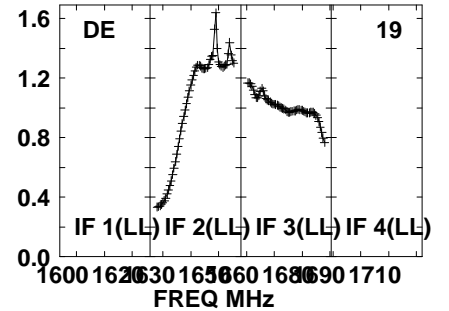
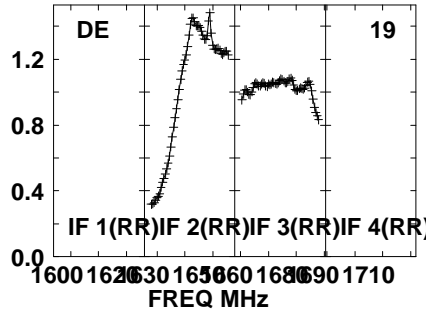
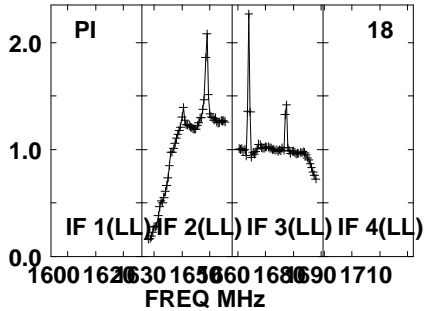
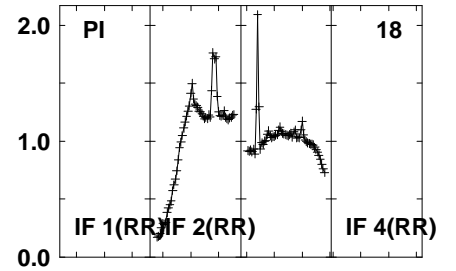
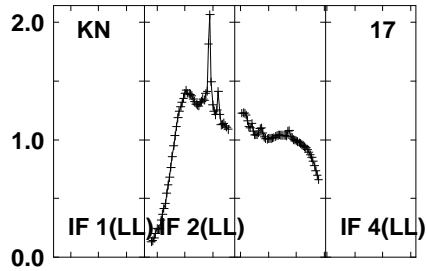
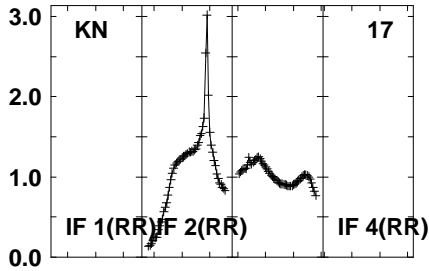
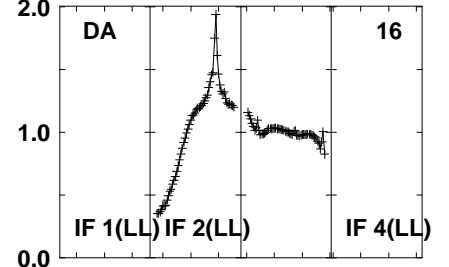
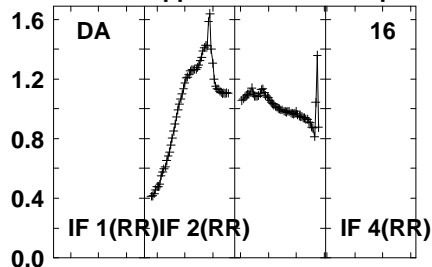
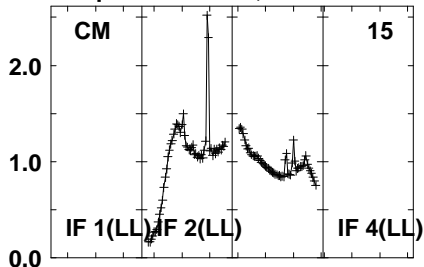

Lower frame: Real Jy

Auto-corr total-power spectrum Antenna: \*

Timerange: 00/21:06:01 to 00/21:09:29

Plot file version 1263 created 05-OCT-2021 17:10:49

APM08279+525 GM076.UVDATA.1

Freq = 1.5945 GHz, Bw = 32.000 MH No calibration applied and no bandpass applied

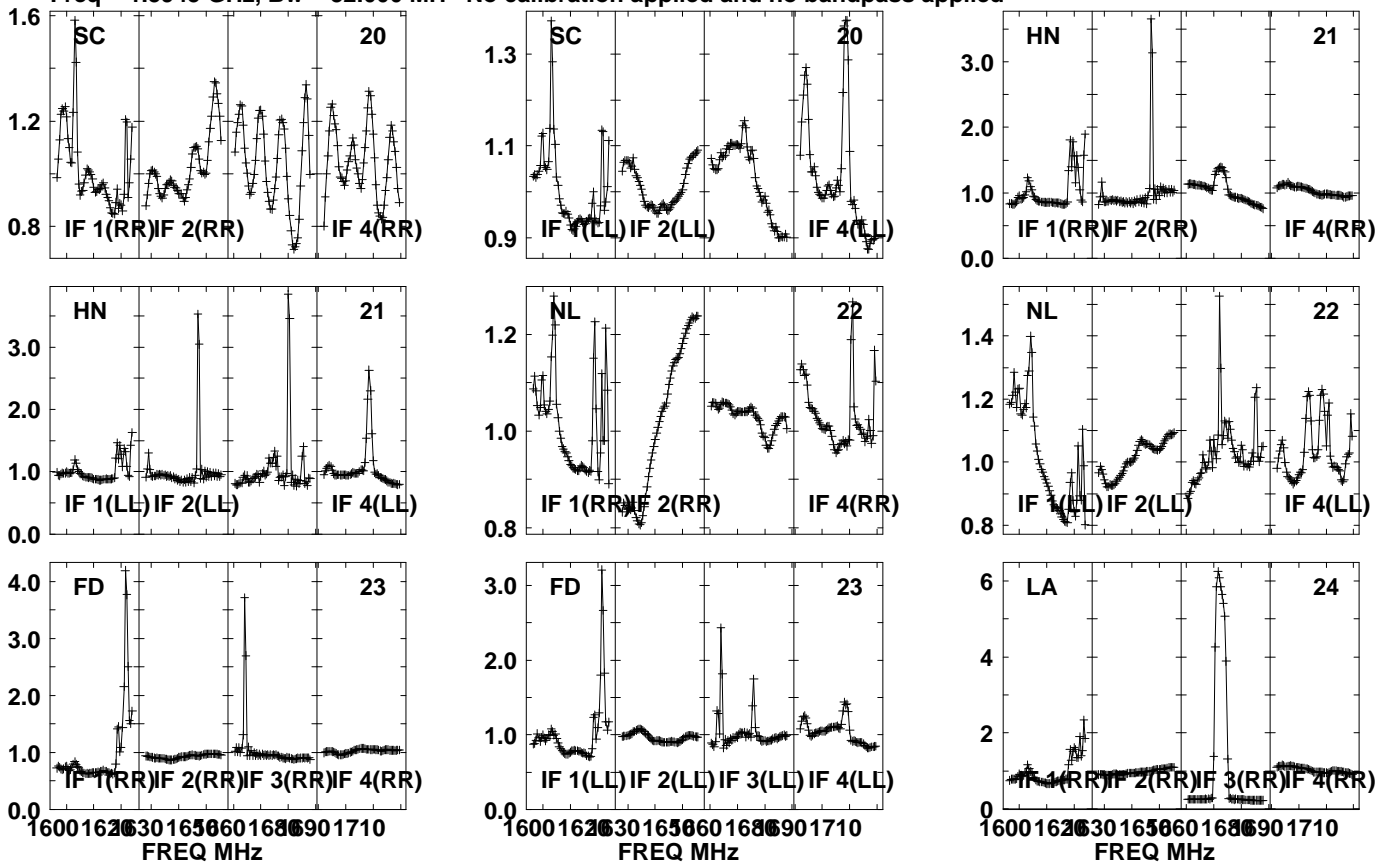

Lower frame: Real Jy  
Auto-corr total-power spectrum Antenna: \*  
Timerange: 00/21:06:01 to 00/21:09:29

Plot file version 1264 created 05-OCT-2021 17:10:49

APM08279+525 GM076.UVDATA.1

Freq = 1.5945 GHz, Bw = 32.000 MH No calibration applied and no bandpass applied

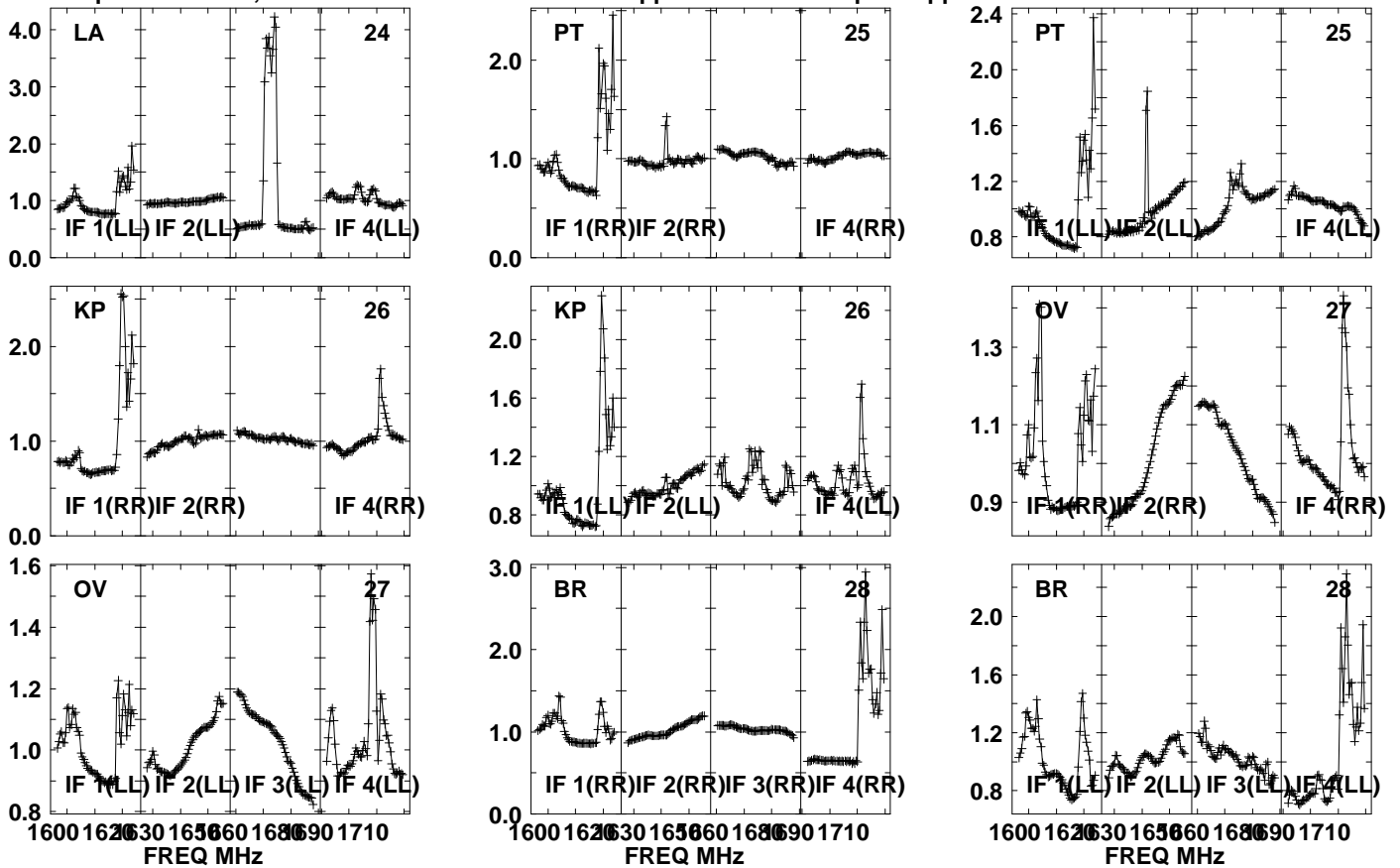

Lower frame: Real Jy

Auto-corr total-power spectrum Antenna: \*

Timerange: 00/21:06:01 to 00/21:09:29

Plot file version1265 created 05-OCT-2021 17:10:50

APM08279+525 GM076.UVDATA.1

Freq = 1.5945 GHz, Bw = 32.000 MH No calibration applied and no bandpass applied

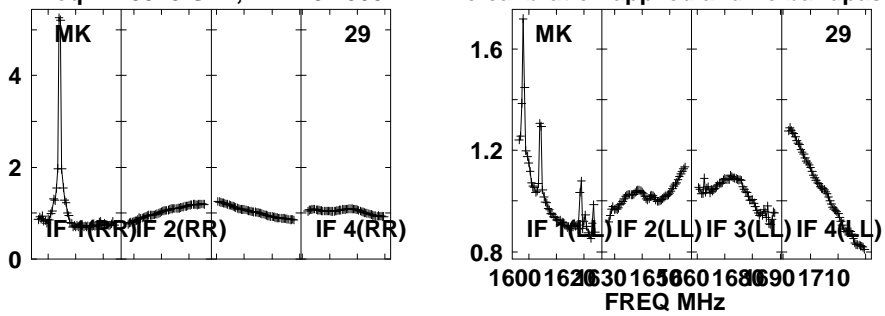

Lower frame: Real Jy  
Auto-corr total-power spectrum Antenna: \*  
Timerange: 00/21:06:01 to 00/21:09:29

Plot file version 1266 created 05-OCT-2021 17:10:50

J0827+5217 GM076.UVDATA.1

Freq = 1.5945 GHz, Bw = 32.000 MH No calibration applied and no bandpass applied

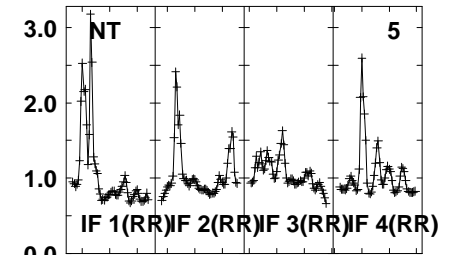
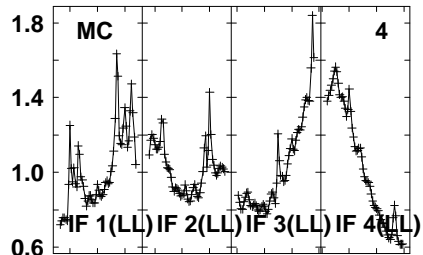
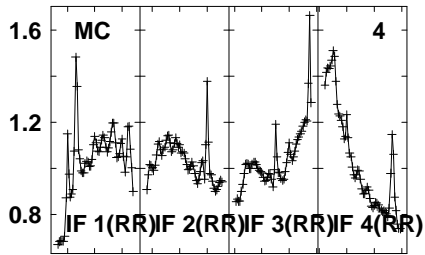
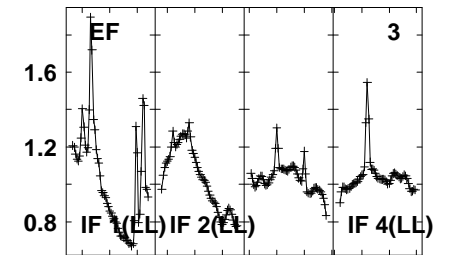
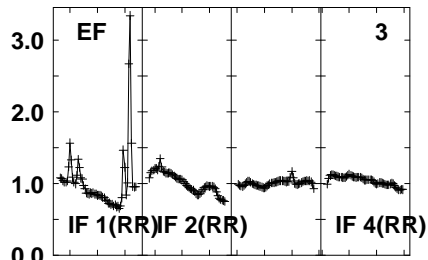
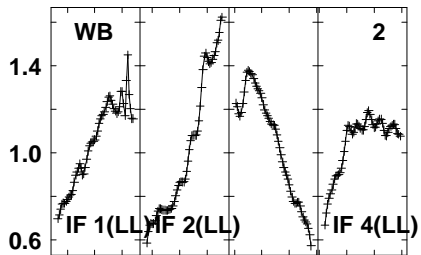
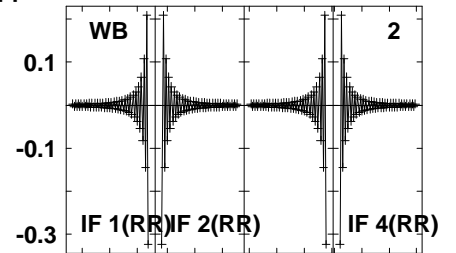
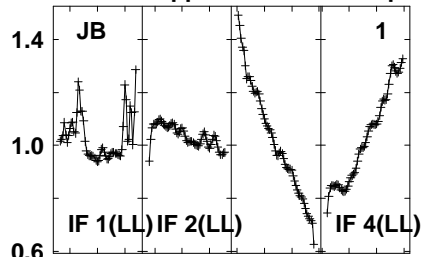
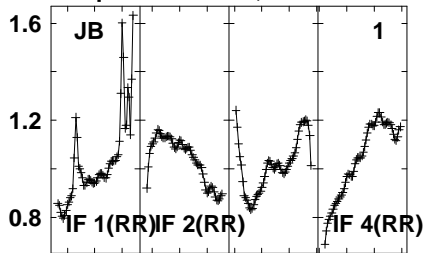

1600 1620 1630 1650 1660 1680 1690 1710  
FREQ MHz

1600 1620 1630 1650 1660 1680 1690 1710  
FREQ MHz

1600 1620 1630 1650 1660 1680 1690 1710  
FREQ MHz

Lower frame: Real Jy  
Auto-corr total-power spectrum Antenna: \*  
Timerange: 00/21:10:01 to 00/21:11:29



Plot file version 1267 created 05-OCT-2021 17:10:50

J0827+5217 GM076.UVDATA.1

Freq = 1.5945 GHz, Bw = 32.000 MH No calibration applied and no bandpass applied

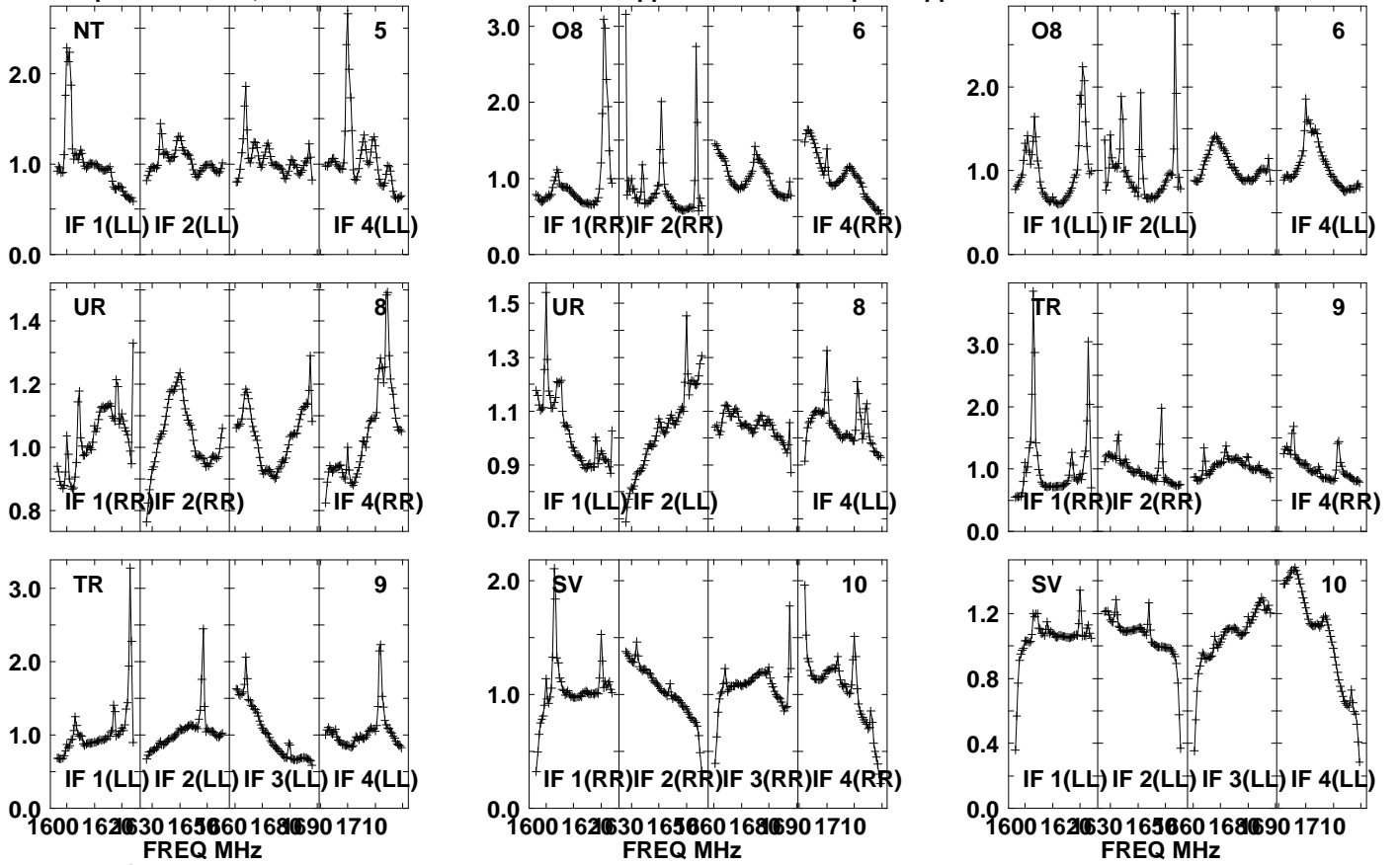

Lower frame: Real Jy

Auto-corr total-power spectrum Antenna: \*

Timerange: 00/21:10:01 to 00/21:11:29

Plot file version 1268 created 05-OCT-2021 17:10:50

J0827+5217 GM076.UVDATA.1

Freq = 1.5945 GHz, Bw = 32.000 MHz No calibration applied and no bandpass applied

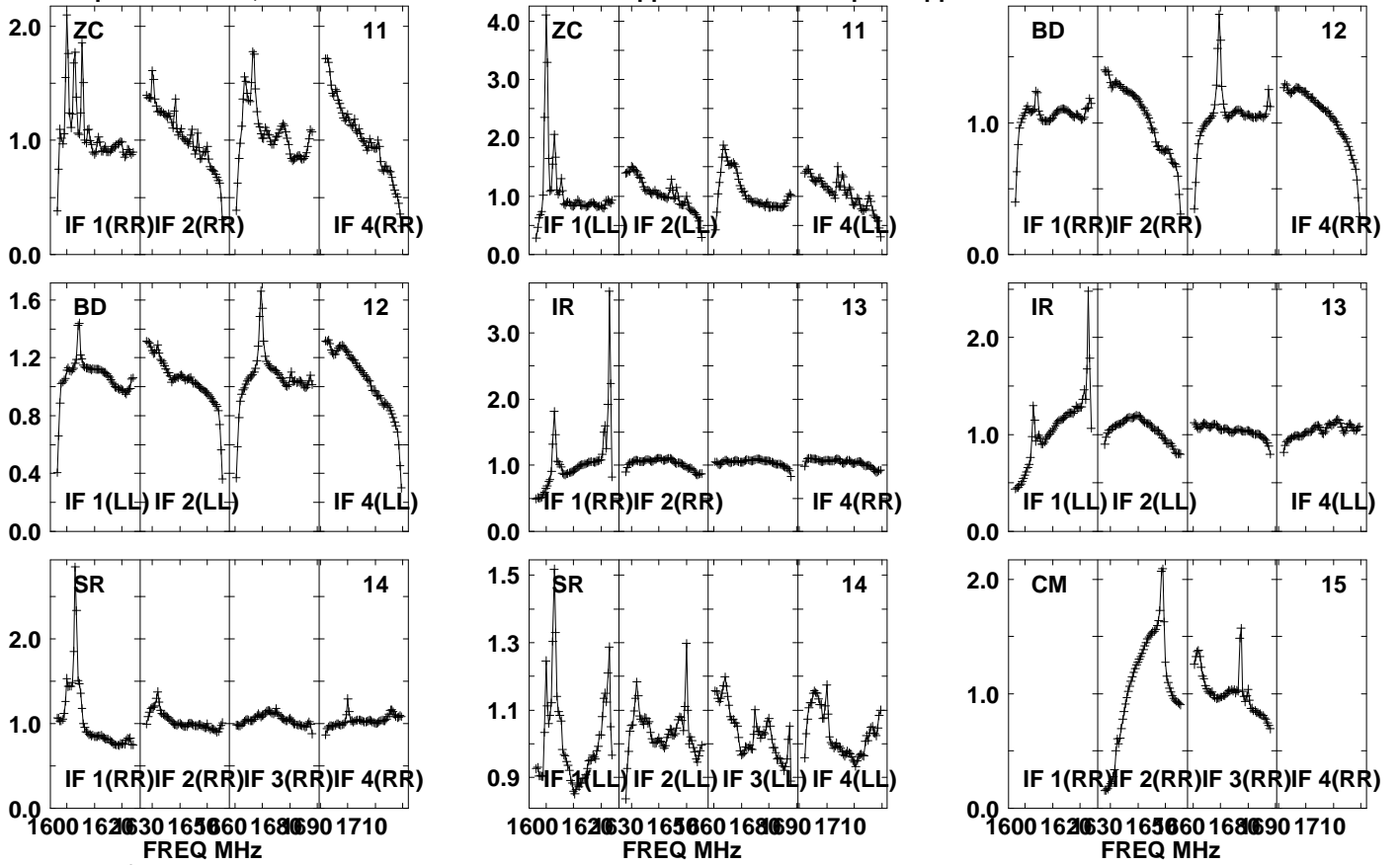

Lower frame: Real Jy  
Auto-corr total-power spectrum Antenna: \*  
Timerange: 00/21:10:01 to 00/21:11:29

Plot file version 1269 created 05-OCT-2021 17:10:51

J0827+5217 GM076.UVDATA.1

Freq = 1.5945 GHz, Bw = 32.000 MH No calibration applied and no bandpass applied

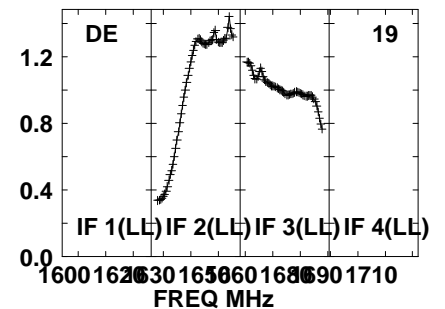
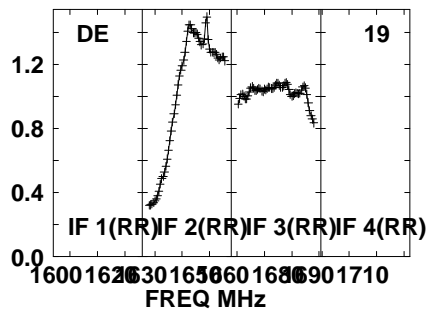
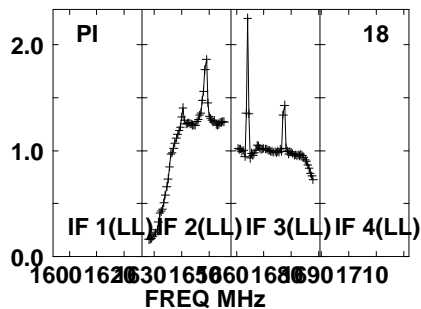
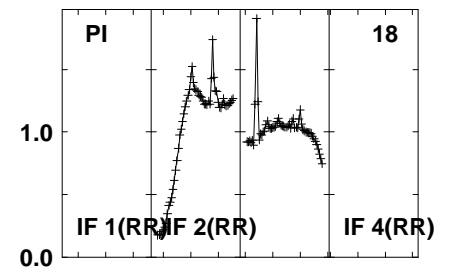
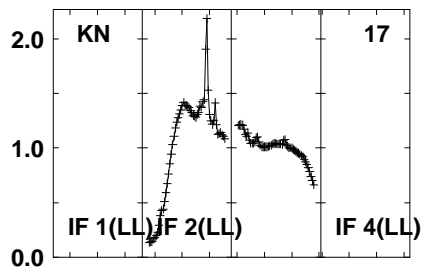
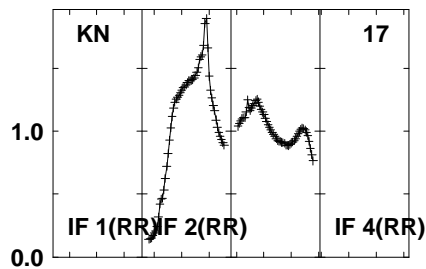
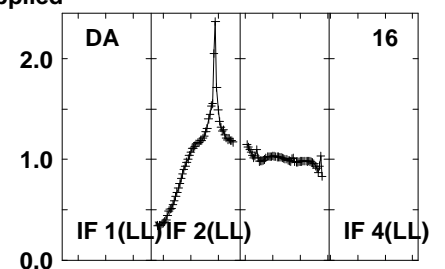
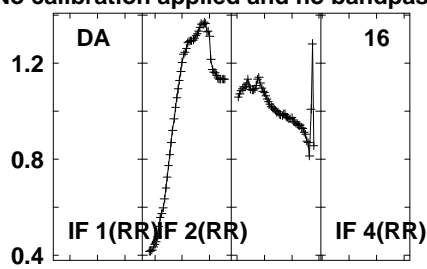
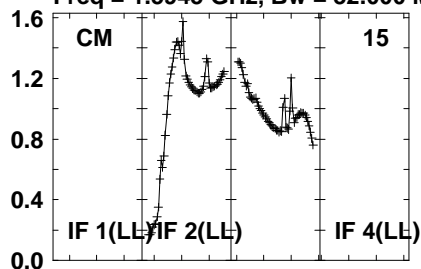

Lower frame: Real Jy  
Auto-corr total-power spectrum Antenna: \*  
Timerange: 00/21:10:01 to 00/21:11:29

Plot file version 1270 created 05-OCT-2021 17:10:51

J0827+5217 GM076.UVDATA.1

Freq = 1.5945 GHz, Bw = 32.000 MH No calibration applied and no bandpass applied

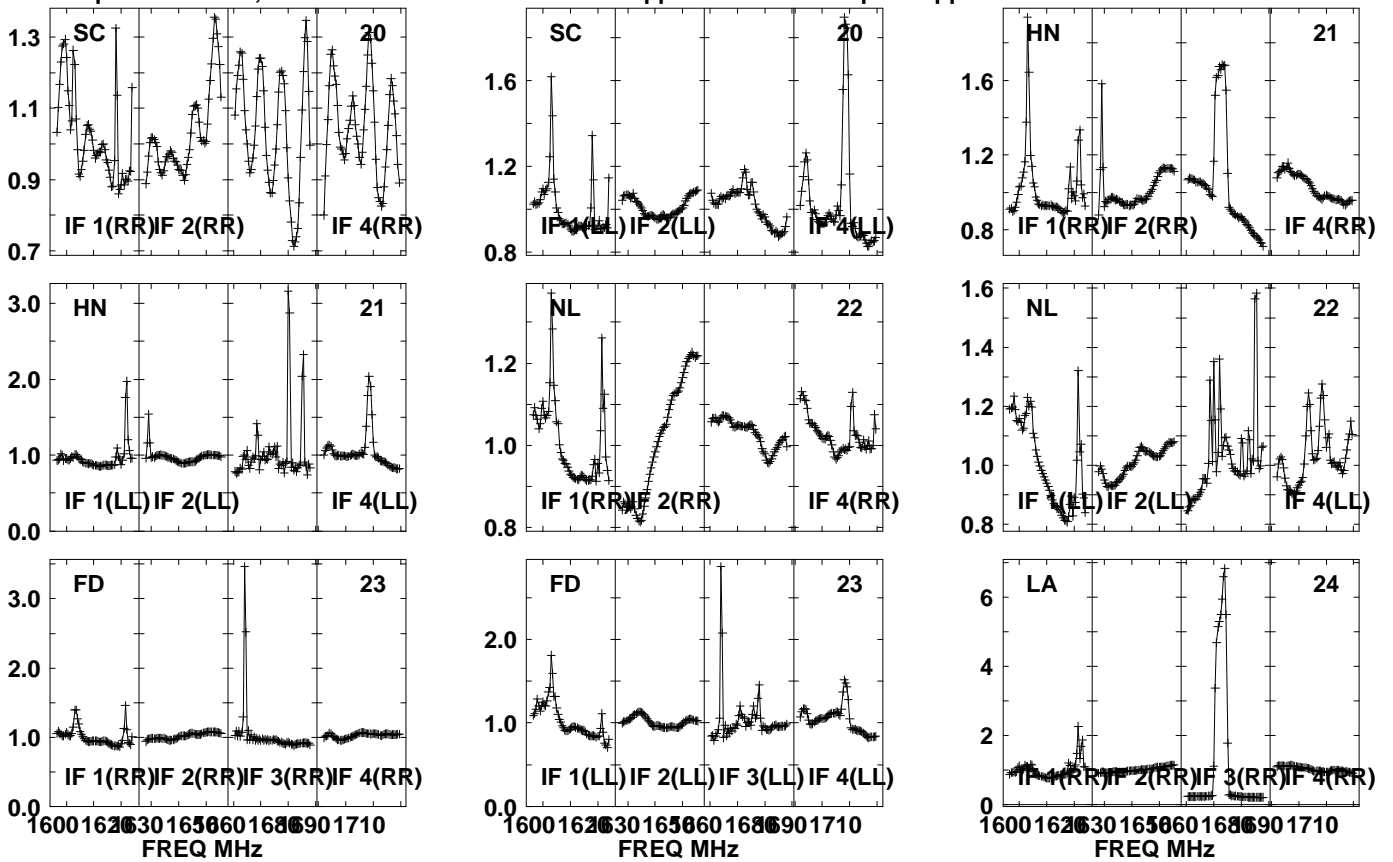

Lower frame: Real Jy  
Auto-corr total-power spectrum Antenna: \*  
Timerange: 00/21:10:01 to 00/21:11:29

Plot file version1271 created 05-OCT-2021 17:10:51

J0827+5217 GM076.UVDATA.1

Freq = 1.5945 GHz, Bw = 32.000 MH No calibration applied and no bandpass applied

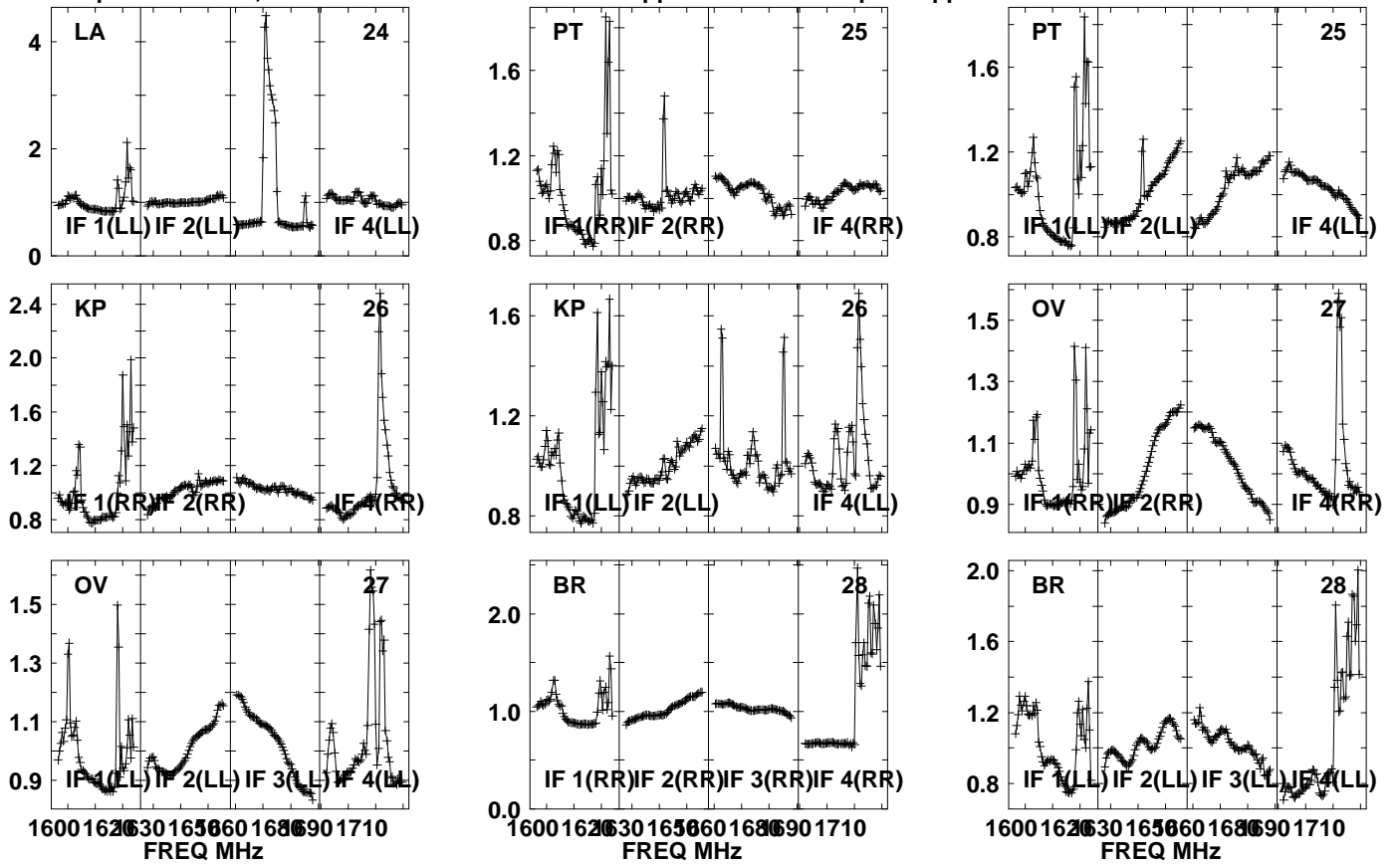

Lower frame: Real Jy

Auto-corr total-power spectrum Antenna: \*

Timerange: 00/21:10:01 to 00/21:11:29

Plot file version1272 created 05-OCT-2021 17:10:52

J0827+5217 GM076.UVDATA.1

Freq = 1.5945 GHz, Bw = 32.000 MH No calibration applied and no bandpass applied

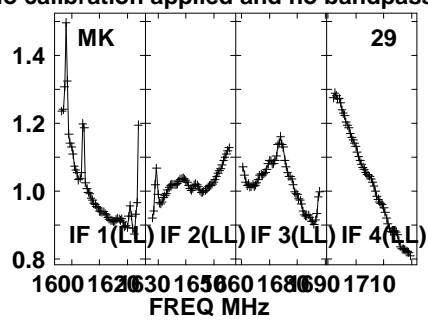
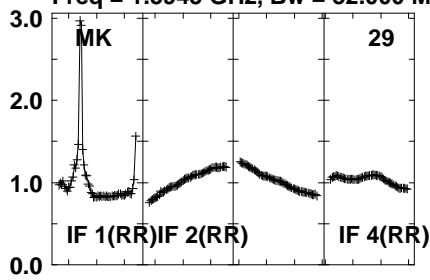

Lower frame: Real Jy

Auto-corr total-power spectrum Antenna: \*

Timerange: 00/21:10:01 to 00/21:11:29

Plot file version 1273 created 05-OCT-2021 17:10:52

APM08279+525 GM076.UVDATA.1

Freq = 1.5945 GHz, Bw = 32.000 MH No calibration applied and no bandpass applied

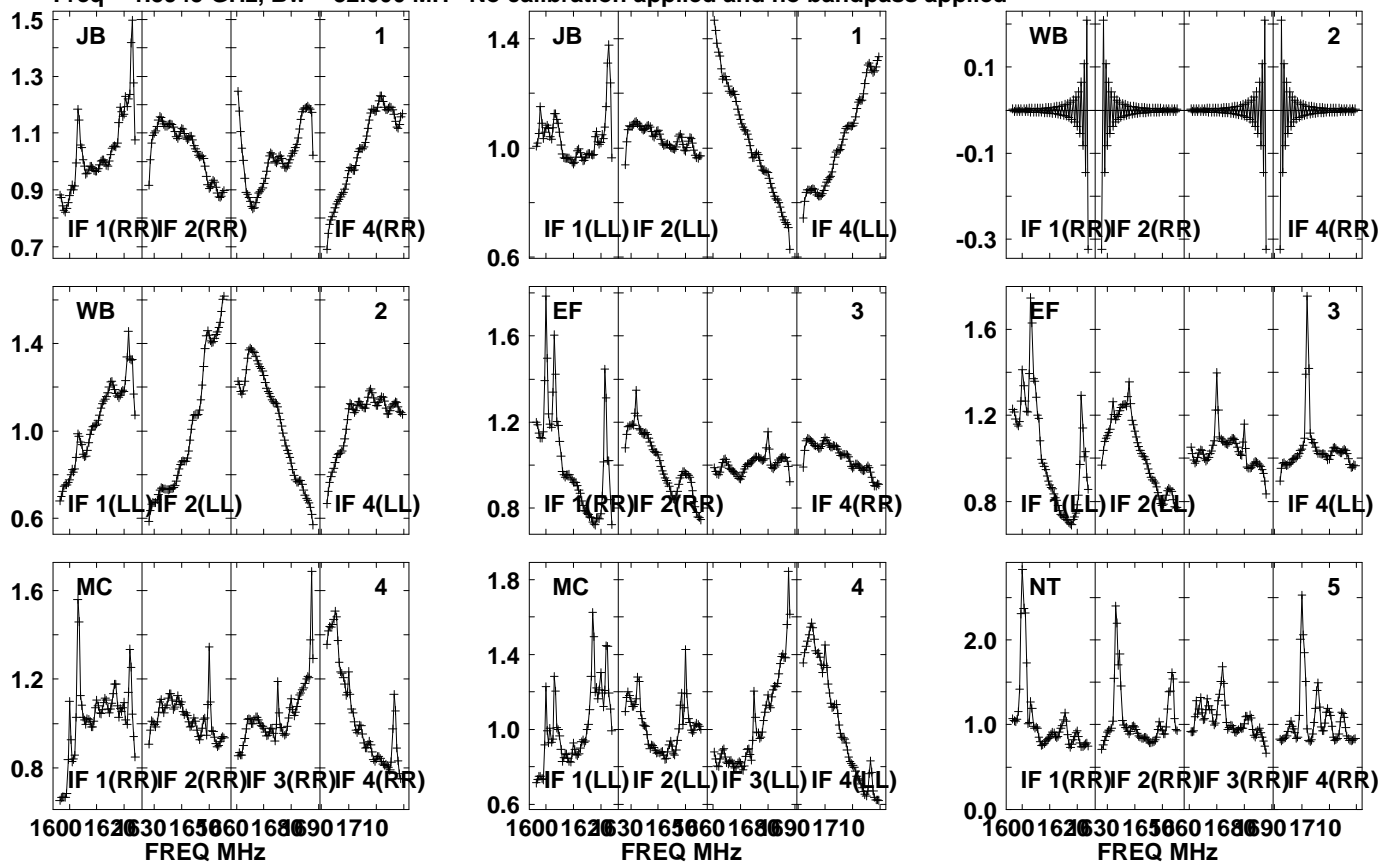

Lower frame: Real Jy  
Auto-corr total-power spectrum Antenna: \*  
Timerange: 00/21:11:31 to 00/21:14:59

Plot file version1274 created 05-OCT-2021 17:10:52

APM08279+525 GM076.UVDATA.1

Freq = 1.5945 GHz, Bw = 32.000 MH No calibration applied and no bandpass applied

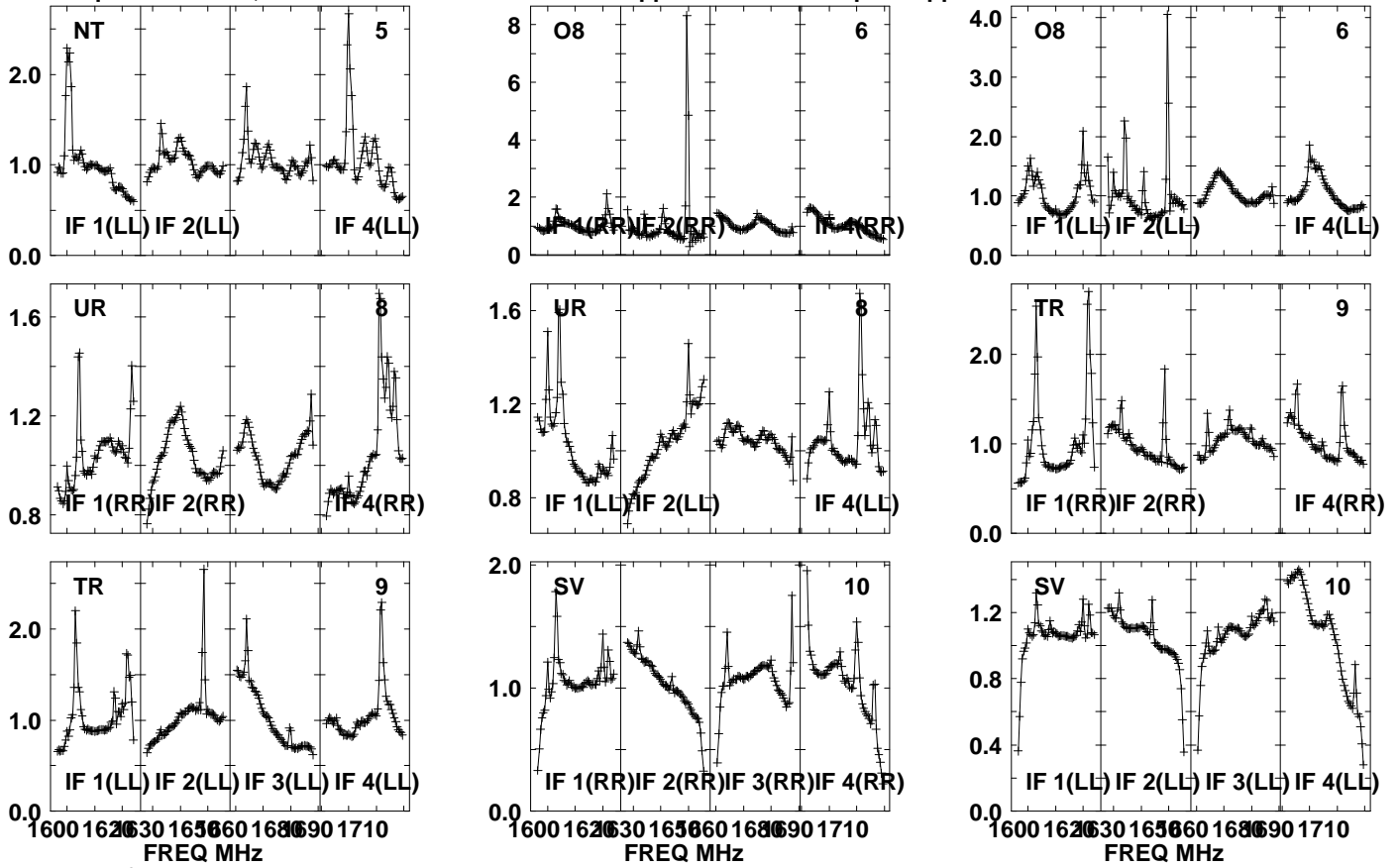

Lower frame: Real Jy  
Auto-corr total-power spectrum Antenna: \*  
Timerange: 00/21:11:31 to 00/21:14:59



Plot file version 1275 created 05-OCT-2021 17:10:52

APM08279+525 GM076.UVDATA.1

Freq = 1.5945 GHz, Bw = 32.000 MHz No calibration applied and no bandpass applied

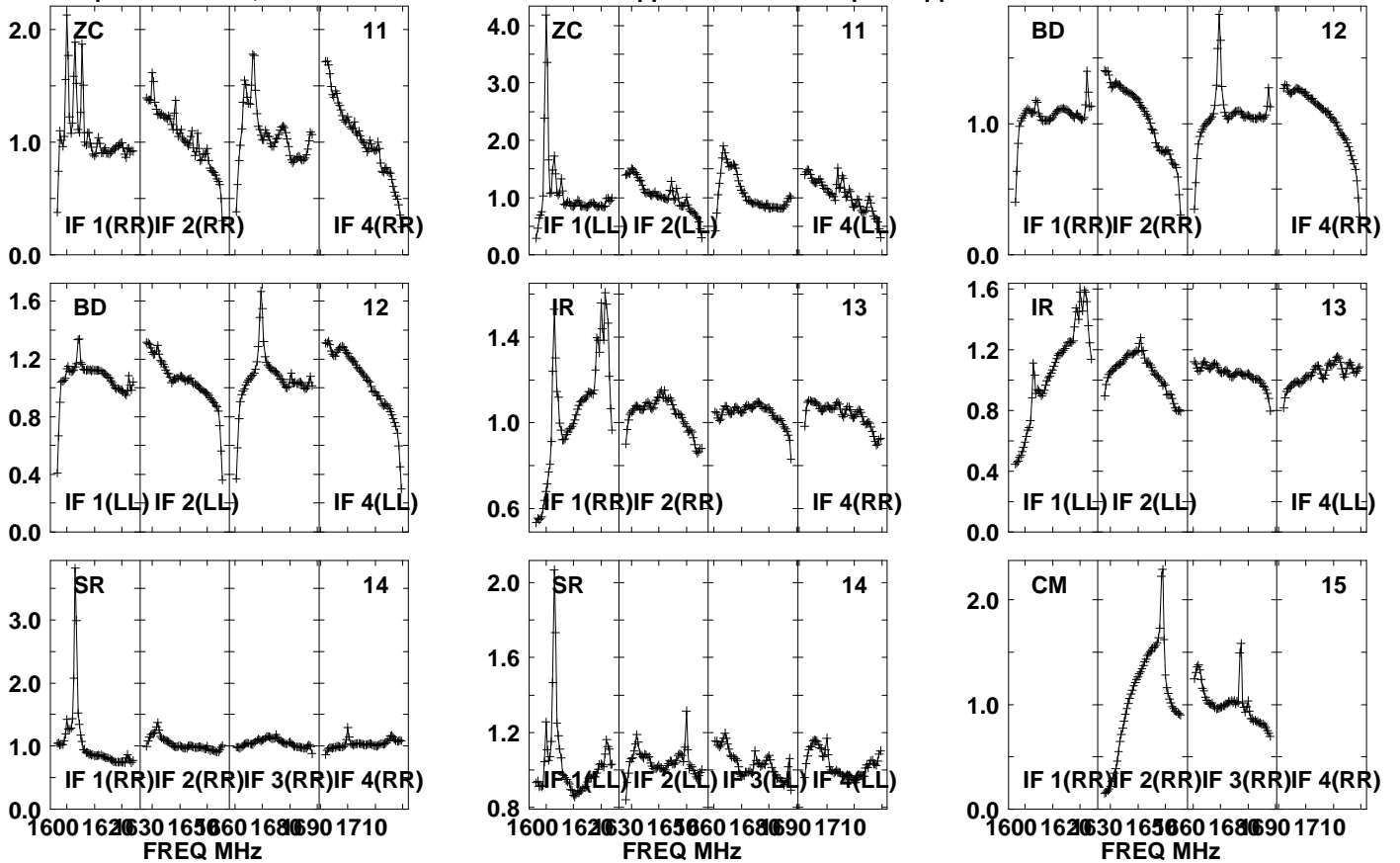

Lower frame: Real Jy  
Auto-corr total-power spectrum Antenna: \*  
Timerange: 00/21:11:31 to 00/21:14:59

Plot file version 1276 created 05-OCT-2021 17:10:53

APM08279+525 GM076.UVDATA.1

Freq = 1.5945 GHz, Bw = 32.000 MH No calibration applied and no bandpass applied

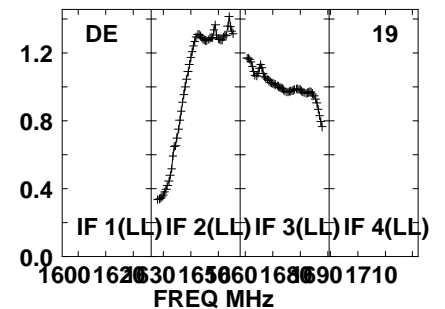
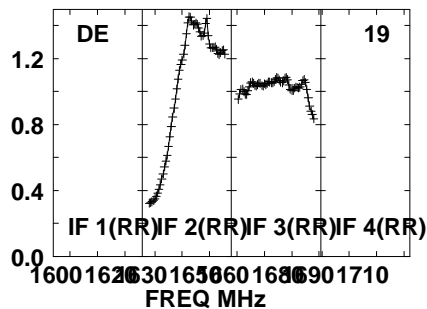
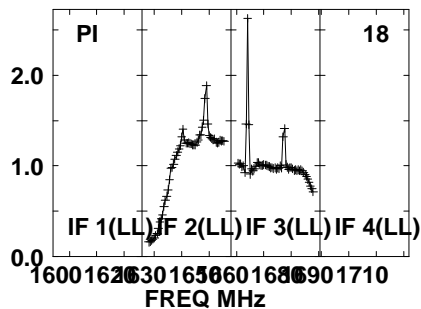
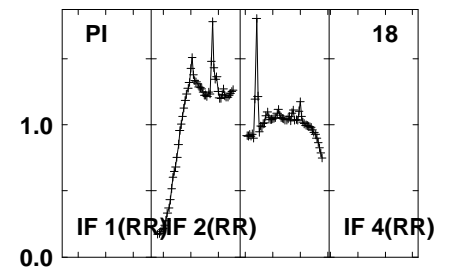
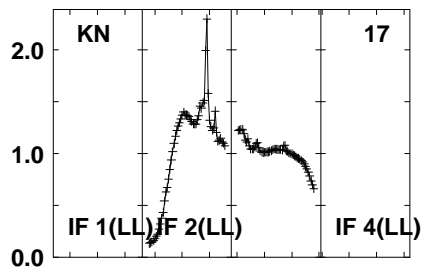
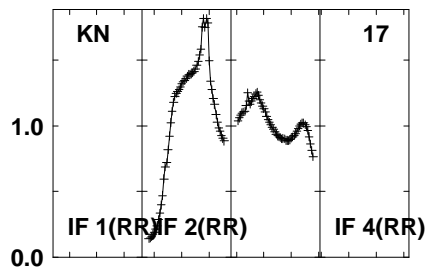
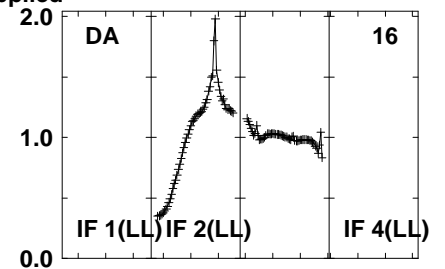
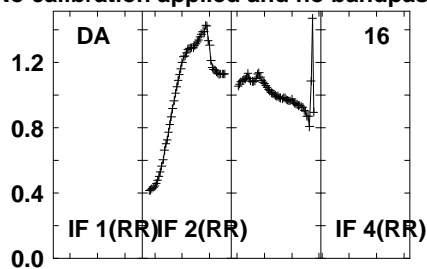
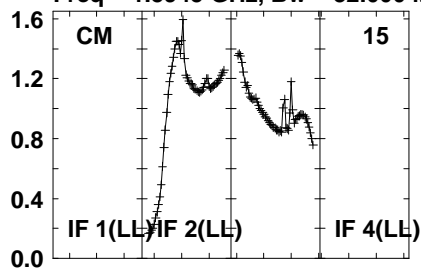

Lower frame: Real Jy  
Auto-corr total-power spectrum Antenna: \*  
Timerange: 00/21:11:31 to 00/21:14:59

Plot file version 1277 created 05-OCT-2021 17:10:53

APM08279+525 GM076.UVDATA.1

Freq = 1.5945 GHz, Bw = 32.000 MH No calibration applied and no bandpass applied

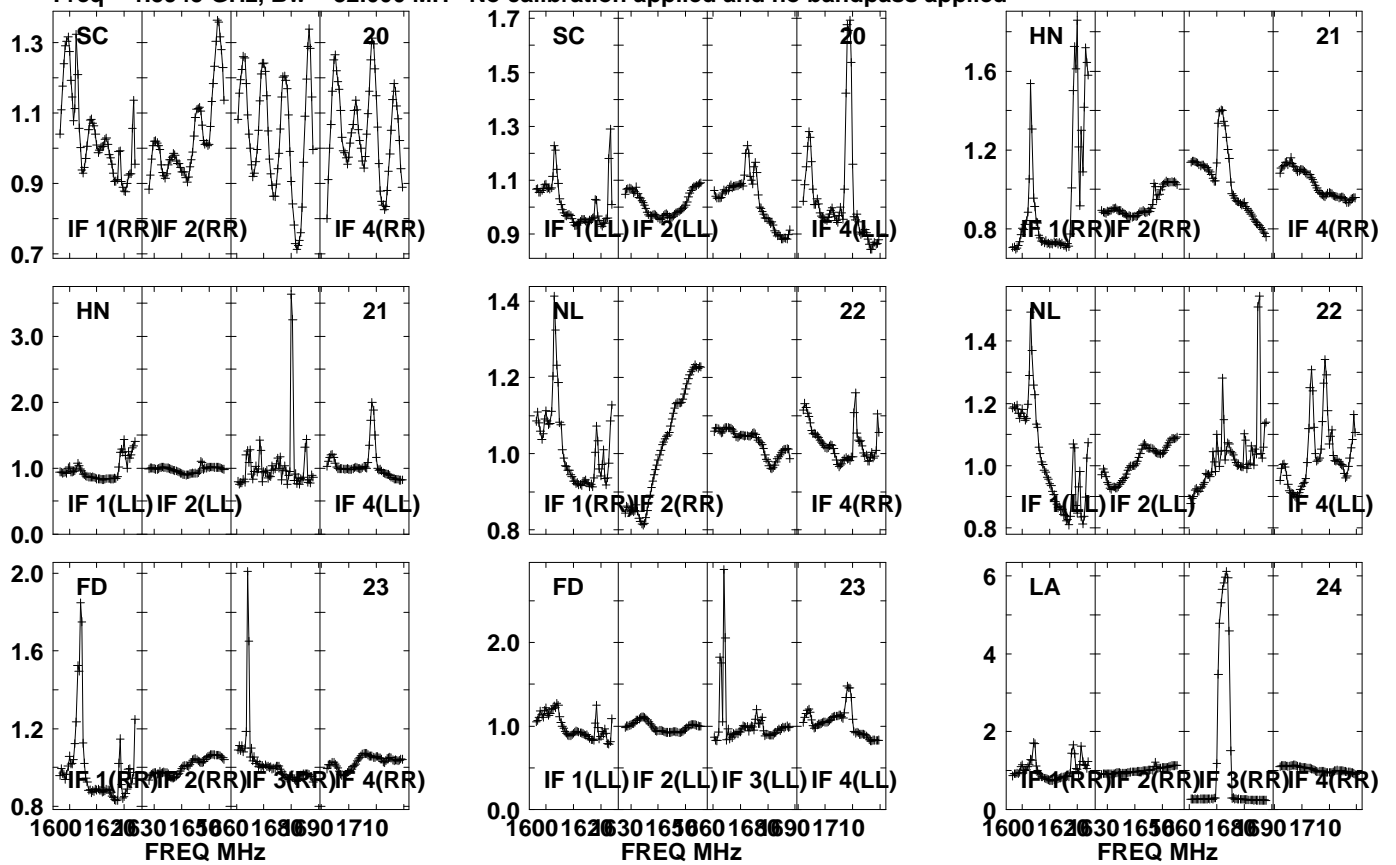

Lower frame: Real Jy  
Auto-corr total-power spectrum Antenna: \*  
Timerange: 00/21:11:31 to 00/21:14:59

Plot file version 1278 created 05-OCT-2021 17:10:53

APM08279+525 GM076.UVDATA.1

Freq = 1.5945 GHz, Bw = 32.000 MH No calibration applied and no bandpass applied

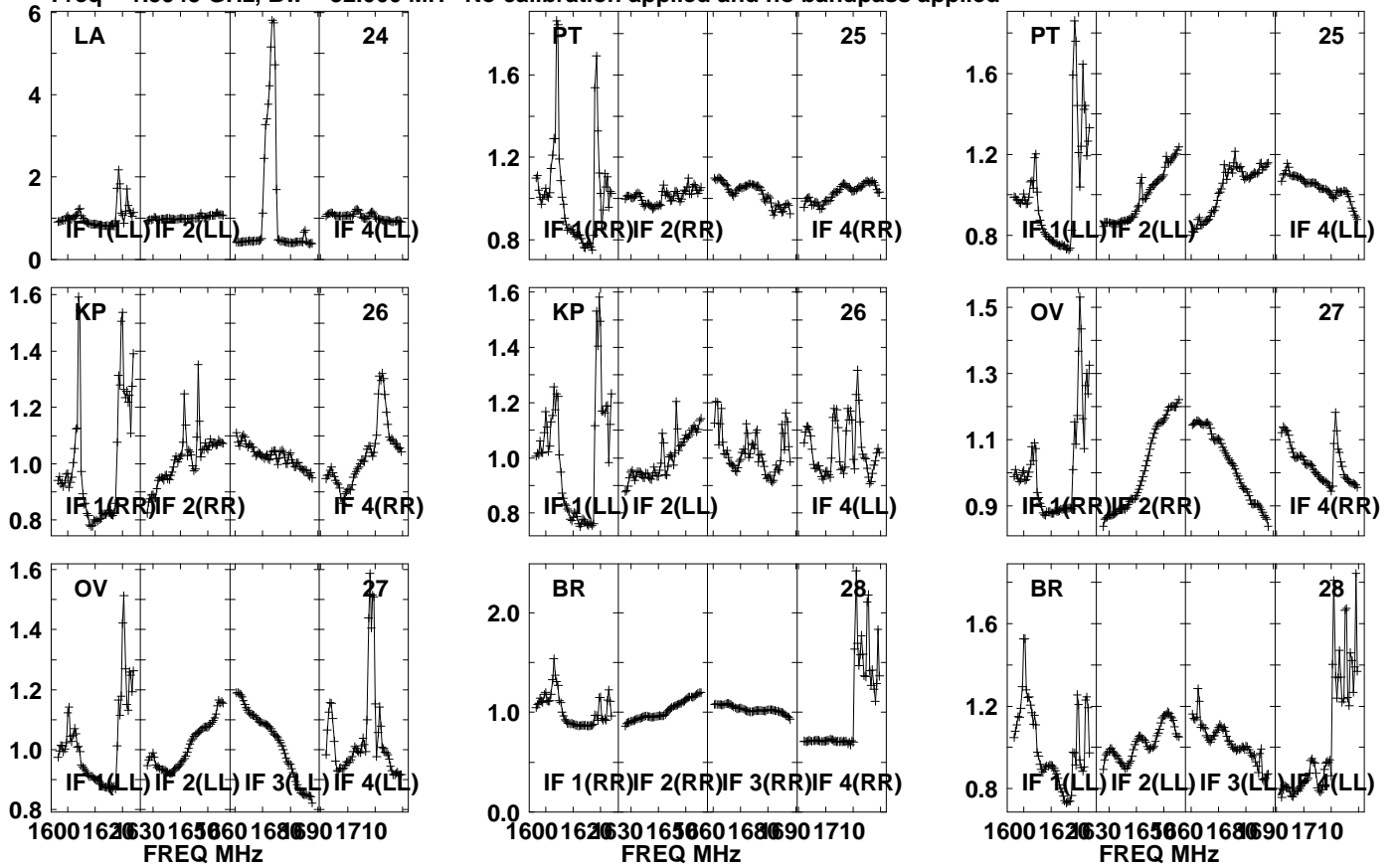

Lower frame: Real Jy

Auto-corr total-power spectrum Antenna: \*

Timerange: 00/21:11:31 to 00/21:14:59

Plot file version1279 created 05-OCT-2021 17:10:54

APM08279+525 GM076.UVDATA.1

Freq = 1.5945 GHz, Bw = 32.000 MH No calibration applied and no bandpass applied

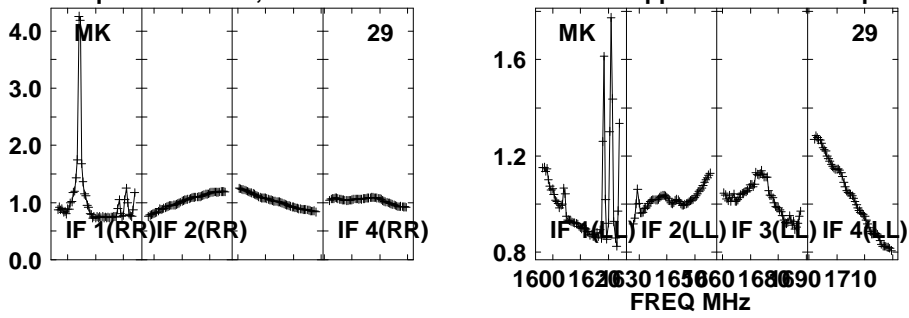

Lower frame: Real Jy

Auto-corr total-power spectrum Antenna: \*

Timerange: 00/21:11:31 to 00/21:14:59

Plot file version 1280 created 05-OCT-2021 17:10:54

J0827+5217 GM076.UVDATA.1

Freq = 1.5945 GHz, Bw = 32.000 MHz No calibration applied and no bandpass applied

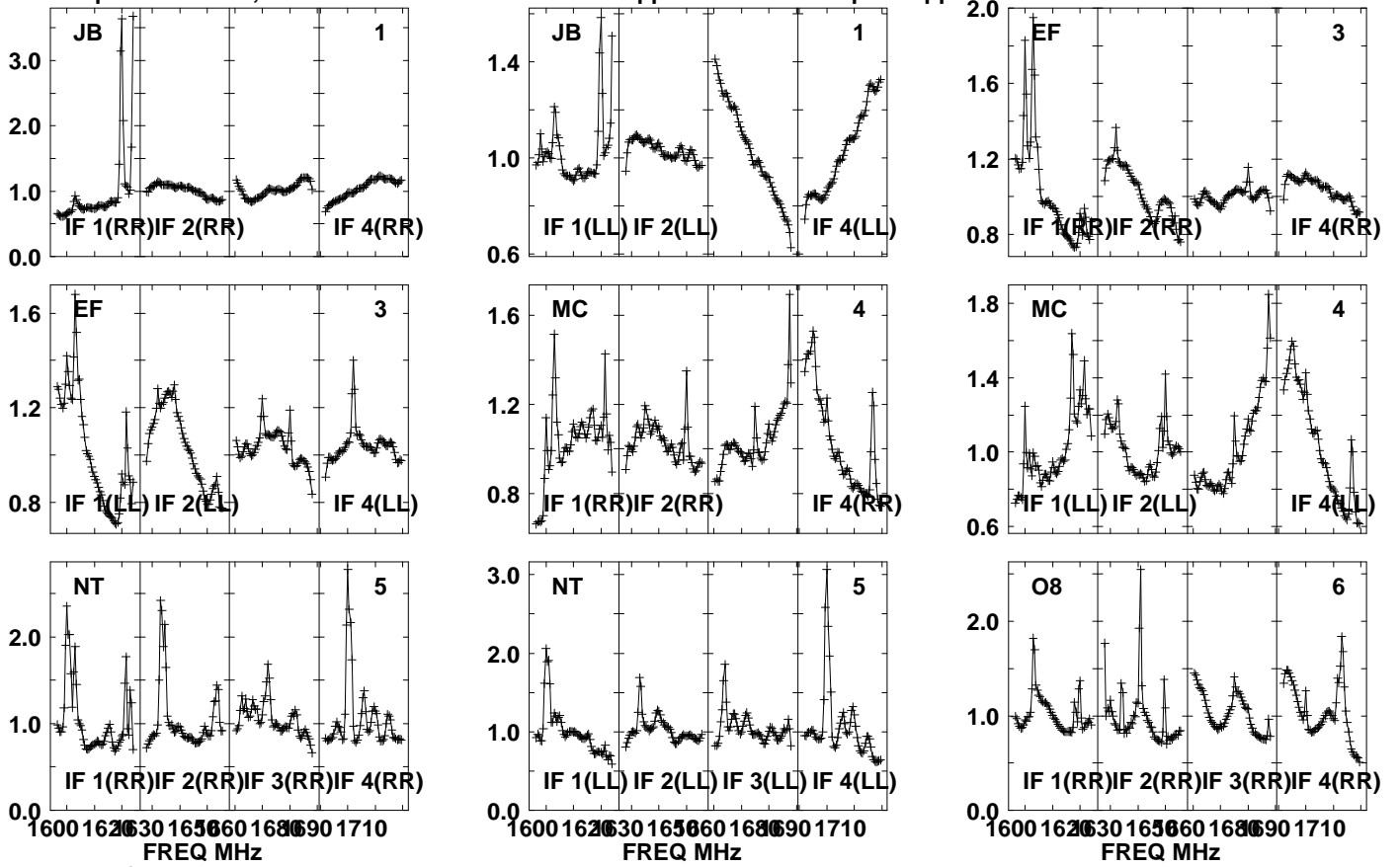

Lower frame: Real Jy

Auto-corr total-power spectrum Antenna: \*

Timerange: 00/21:15:01 to 00/21:16:29

Plot file version1281 created 05-OCT-2021 17:10:54

J0827+5217 GM076.UVDATA.1

Freq = 1.5945 GHz, Bw = 32.000 MH No calibration applied and no bandpass applied

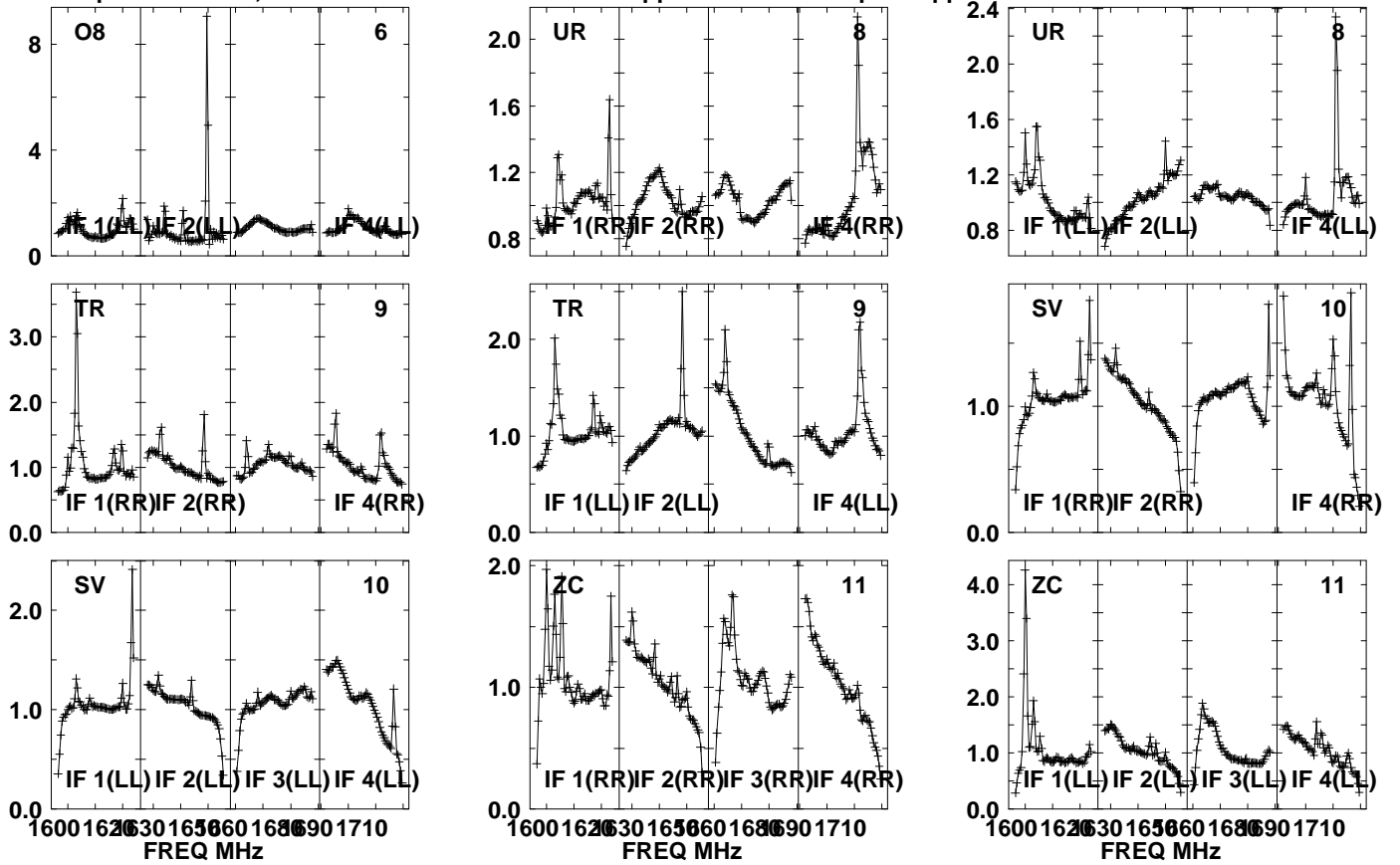

Lower frame: Real Jy  
Auto-corr total-power spectrum Antenna: \*  
Timerange: 00/21:15:01 to 00/21:16:29

Plot file version1282 created 05-OCT-2021 17:10:55

J0827+5217 GM076.UVDATA.1

Freq = 1.5945 GHz, Bw = 32.000 MH No calibration applied and no bandpass applied

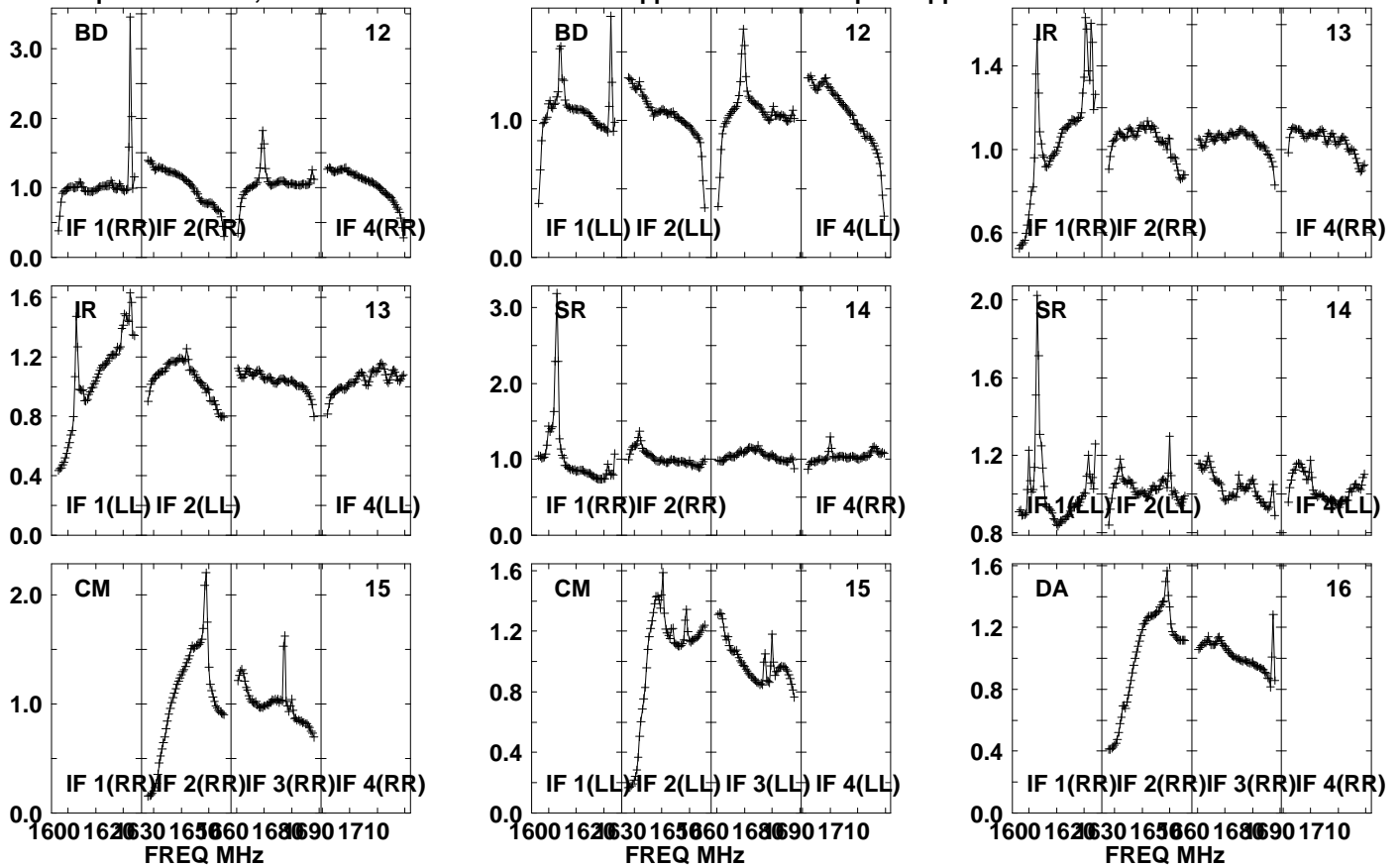

Lower frame: Real Jy

Auto-corr total-power spectrum Antenna: \*

Timerange: 00/21:15:01 to 00/21:16:29



Plot file version1283 created 05-OCT-2021 17:10:55

J0827+5217 GM076.UVDATA.1

Freq = 1.5945 GHz, Bw = 32.000 MH No calibration applied and no bandpass applied

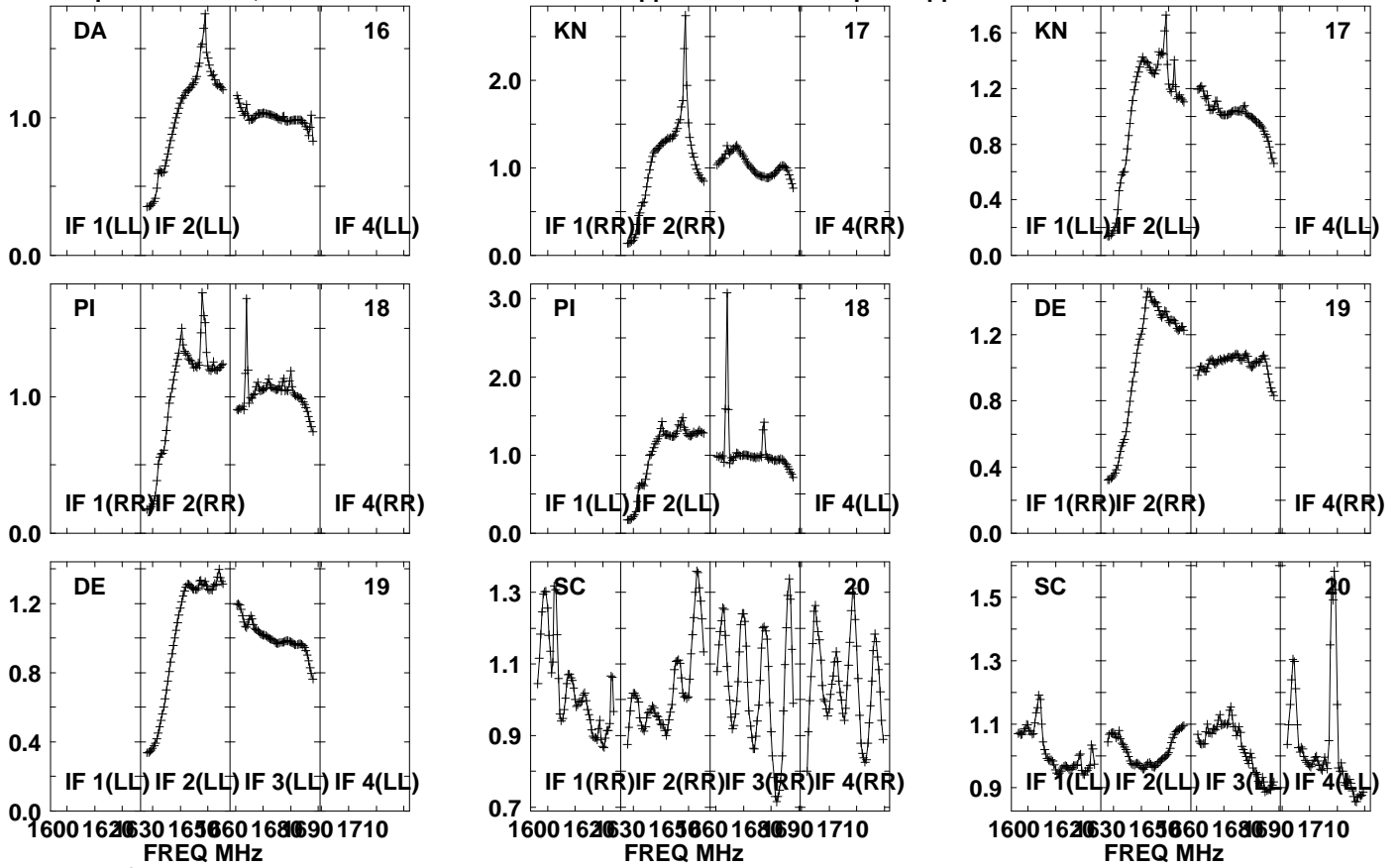

Lower frame: Real Jy  
Auto-corr total-power spectrum Antenna: \*  
Timerange: 00/21:15:01 to 00/21:16:29

Plot file version1284 created 05-OCT-2021 17:10:55

J0827+5217 GM076.UVDATA.1

Freq = 1.5945 GHz, Bw = 32.000 MH No calibration applied and no bandpass applied

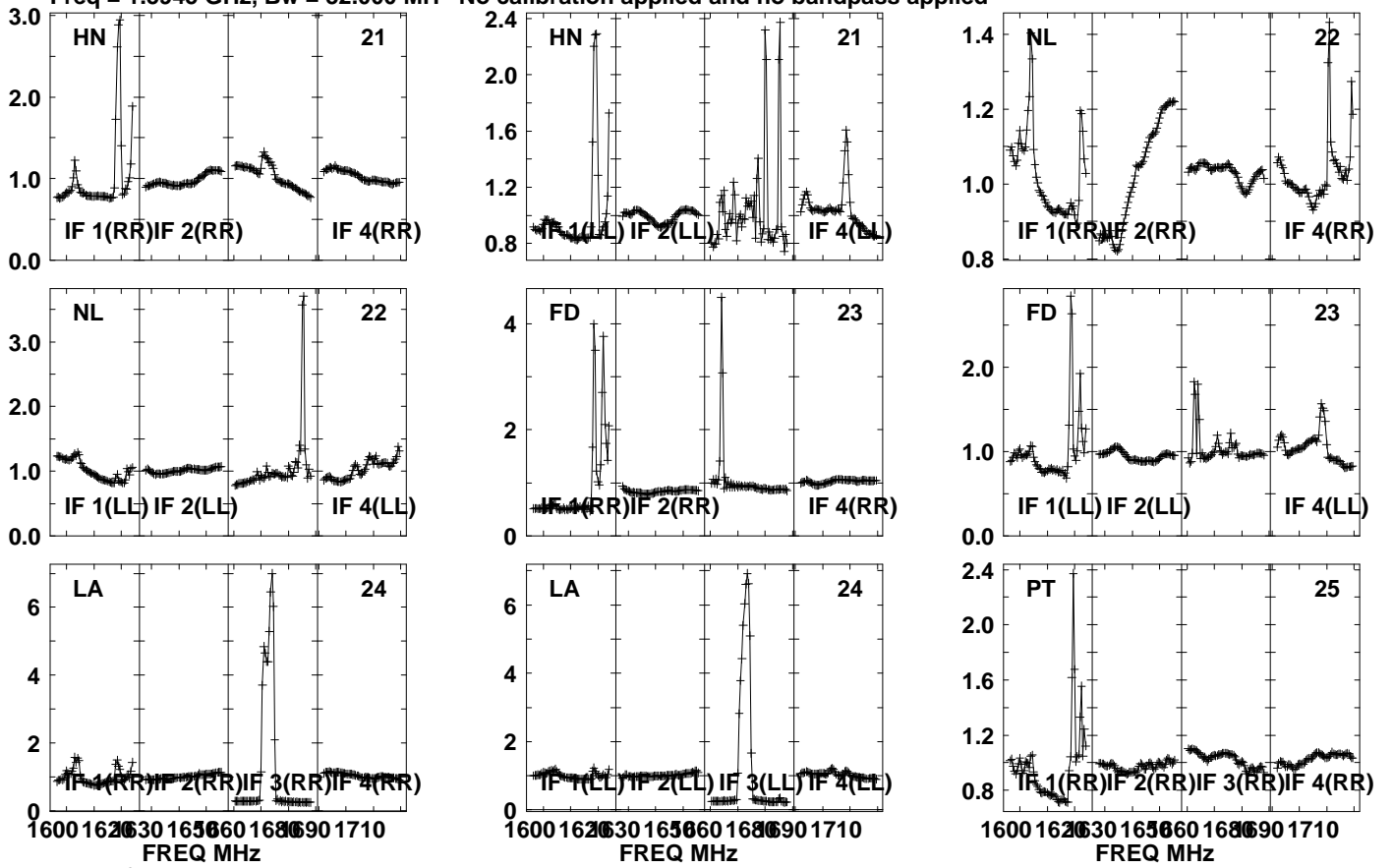

Lower frame: Real Jy  
Auto-corr total-power spectrum Antenna: \*  
Timerange: 00/21:15:01 to 00/21:16:29

Plot file version1285 created 05-OCT-2021 17:10:55

J0827+5217 GM076.UVDATA.1

Freq = 1.5945 GHz, Bw = 32.000 MH No calibration applied and no bandpass applied

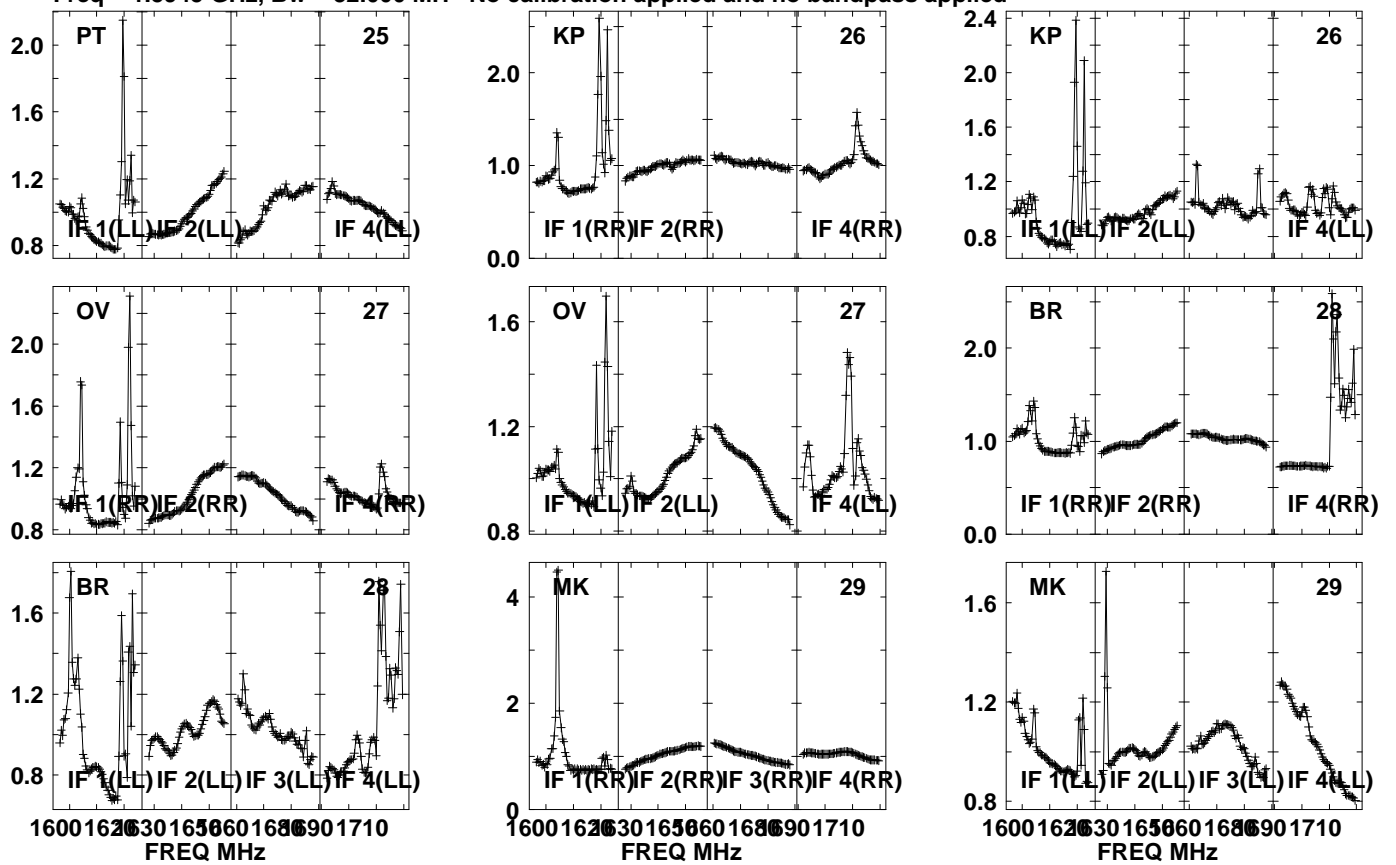

Lower frame: Real Jy  
Auto-corr total-power spectrum Antenna: \*  
Timerange: 00/21:15:01 to 00/21:16:29

Plot file version 1286 created 05-OCT-2021 17:10:56

APM08279+525 GM076.UVDATA.1

Freq = 1.5945 GHz, Bw = 32.000 MHz No calibration applied and no bandpass applied

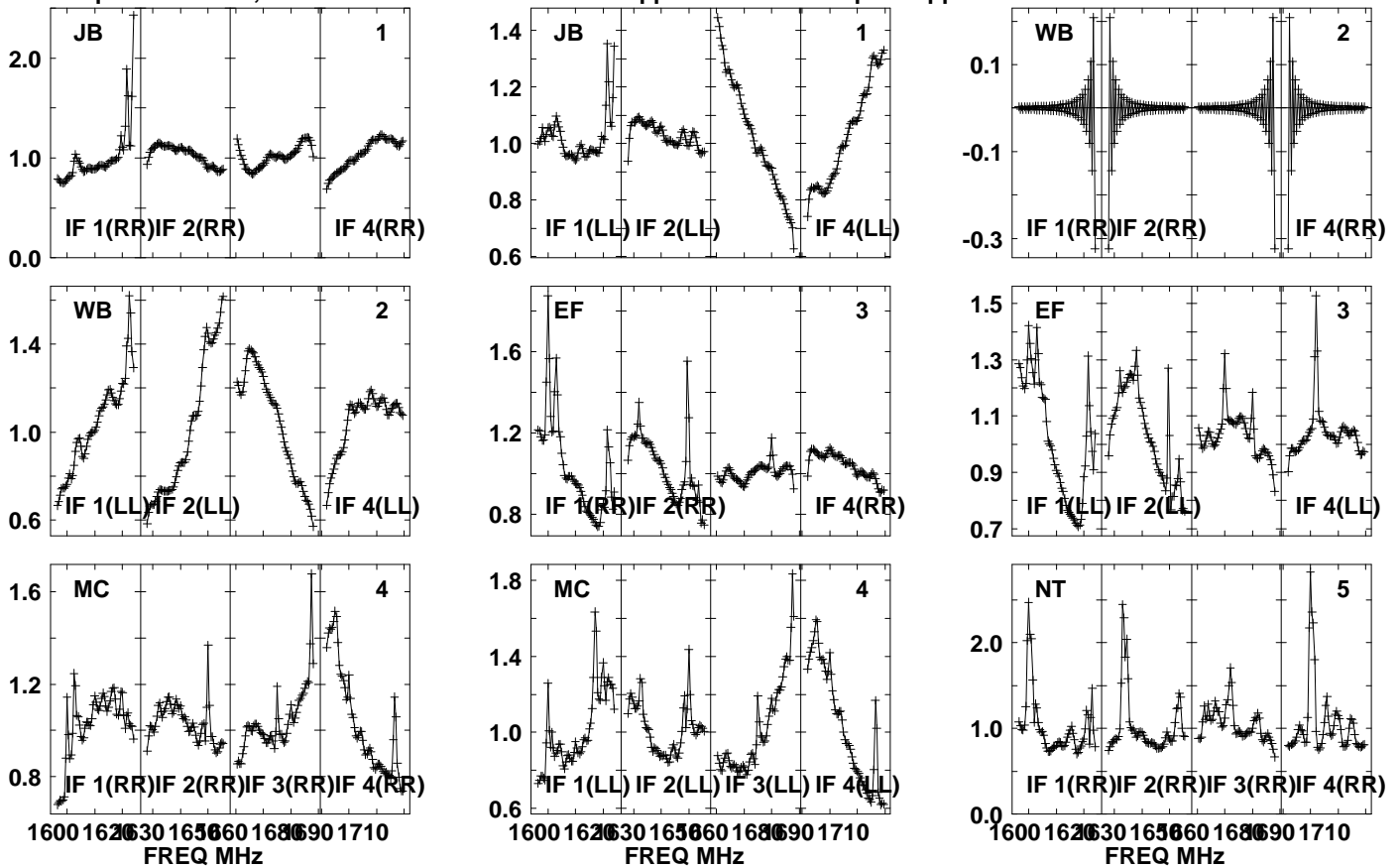

Lower frame: Real Jy

Auto-corr total-power spectrum Antenna: \*

Timerange: 00/21:16:31 to 00/21:19:59

Plot file version 1287 created 05-OCT-2021 17:10:56

APM08279+525 GM076.UVDATA.1

Freq = 1.5945 GHz, Bw = 32.000 MH No calibration applied and no bandpass applied

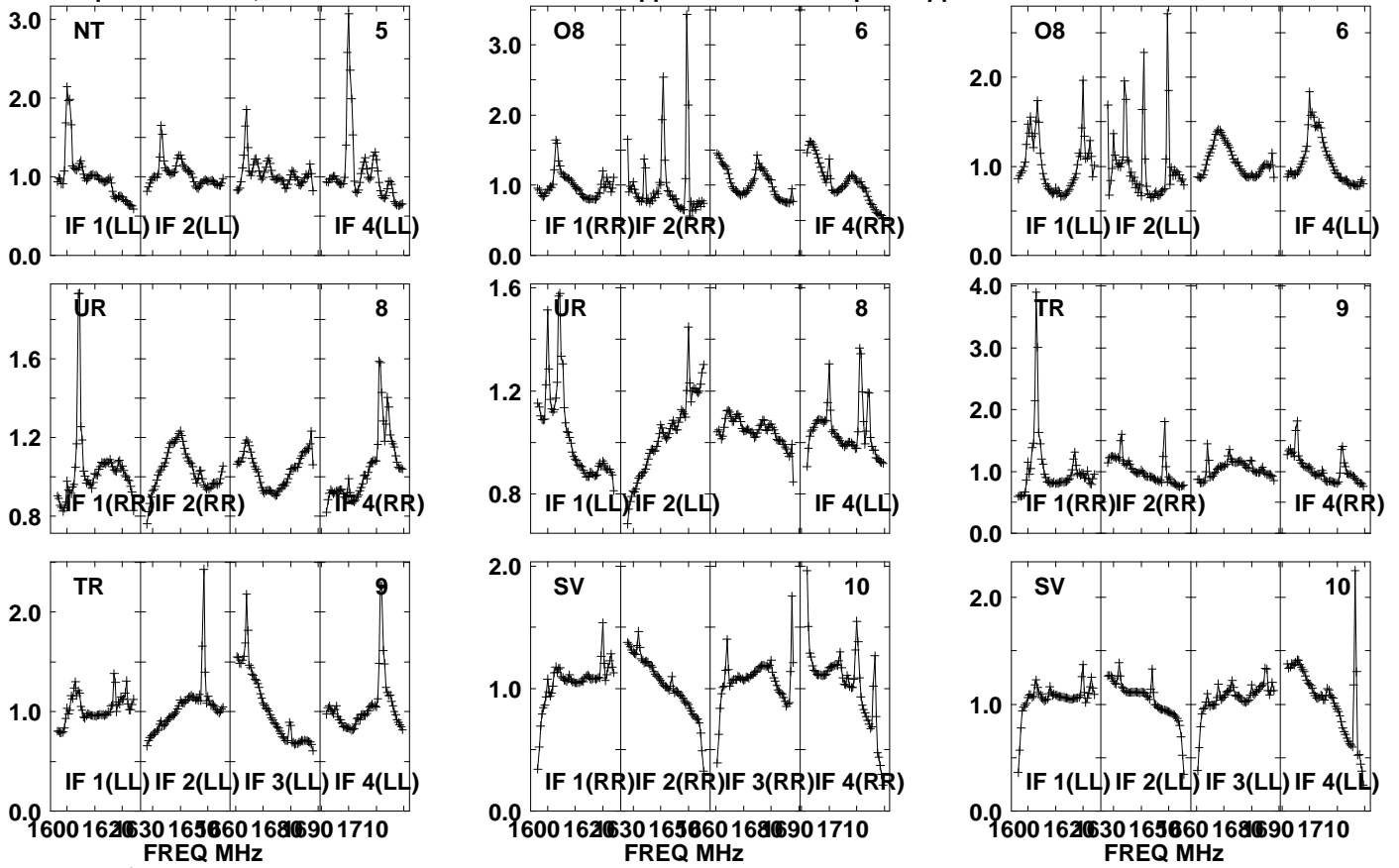

Lower frame: Real Jy  
Auto-corr total-power spectrum Antenna: \*  
Timerange: 00/21:16:31 to 00/21:19:59

Plot file version1288 created 05-OCT-2021 17:10:57

APM08279+525 GM076.UVDATA.1

Freq = 1.5945 GHz, Bw = 32.000 MH No calibration applied and no bandpass applied

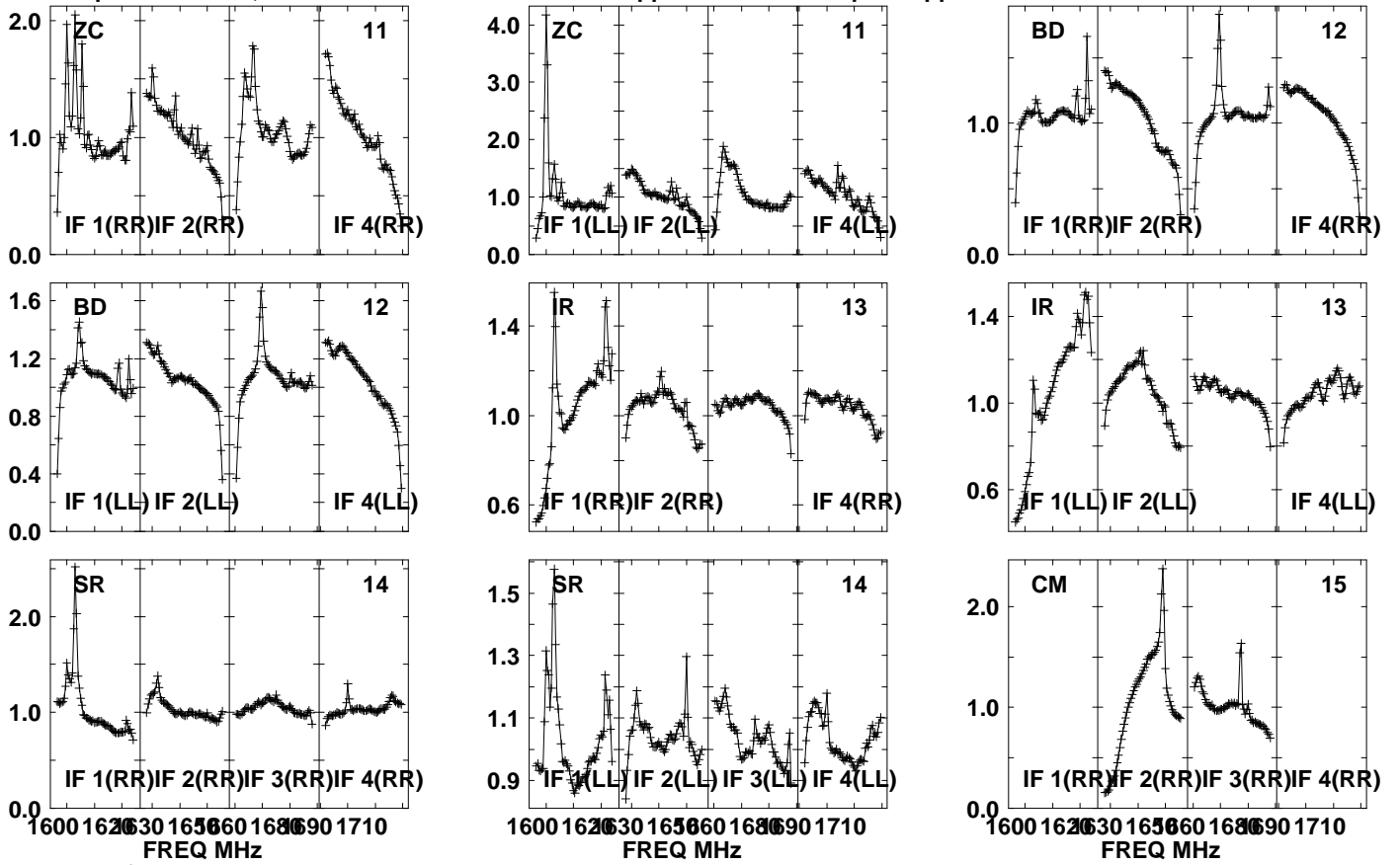

Lower frame: Real Jy

Auto-corr total-power spectrum Antenna: \*

Timerange: 00/21:16:31 to 00/21:19:59

Plot file version 1289 created 05-OCT-2021 17:10:57

APM08279+525 GM076.UVDATA.1

Freq = 1.5945 GHz, Bw = 32.000 MH No calibration applied and no bandpass applied

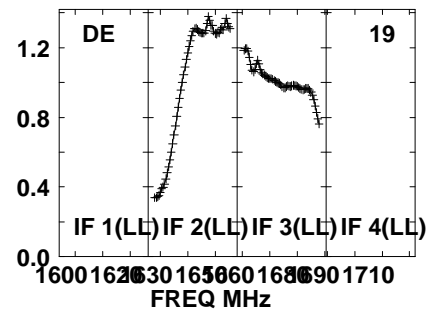
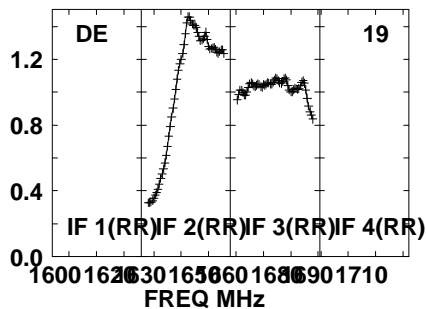
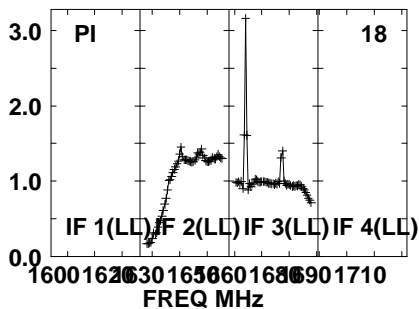
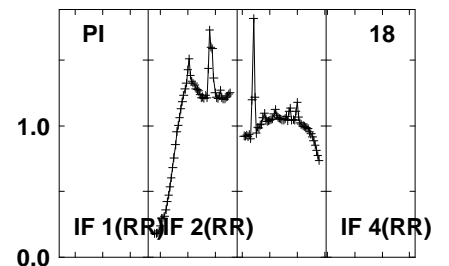
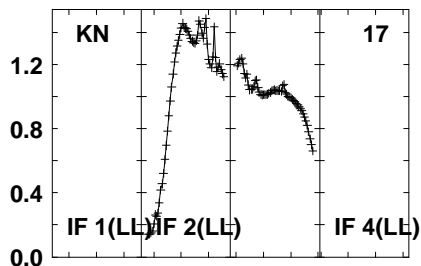
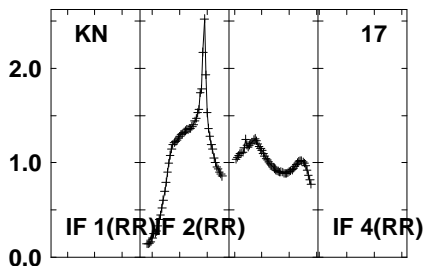
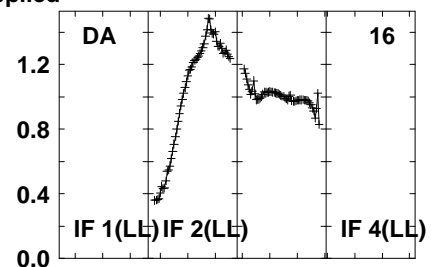
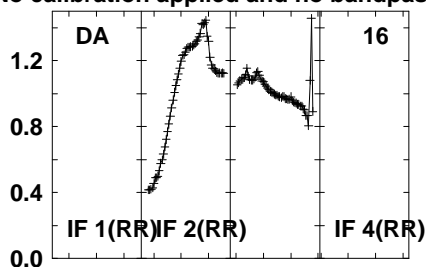
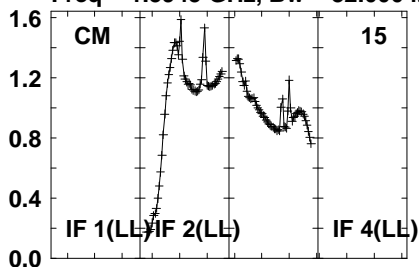

Lower frame: Real Jy  
Auto-corr total-power spectrum Antenna: \*  
Timerange: 00/21:16:31 to 00/21:19:59

Plot file version 1290 created 05-OCT-2021 17:10:57

APM08279+525 GM076.UVDATA.1

Freq = 1.5945 GHz, Bw = 32.000 MH No calibration applied and no bandpass applied

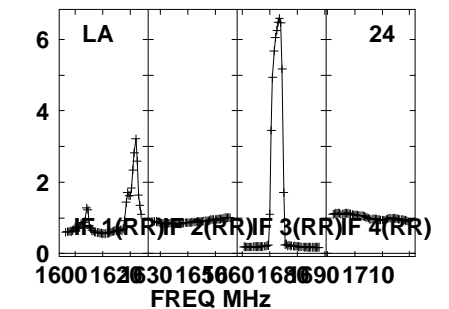
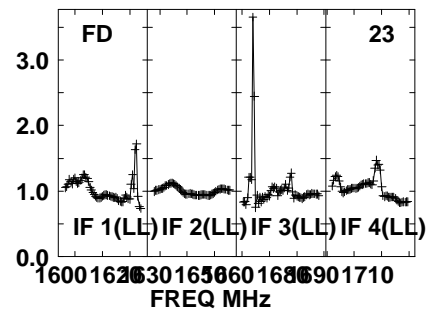
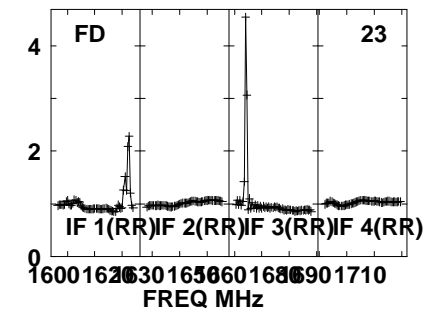
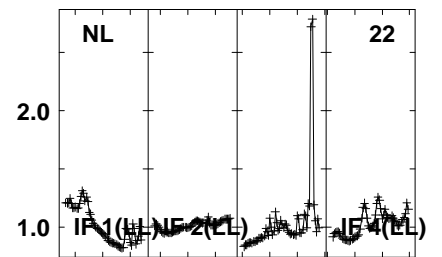
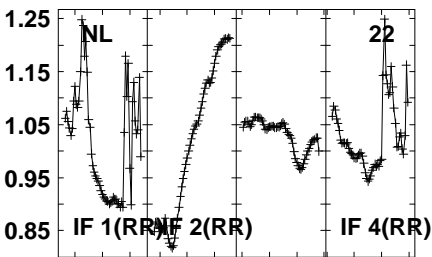
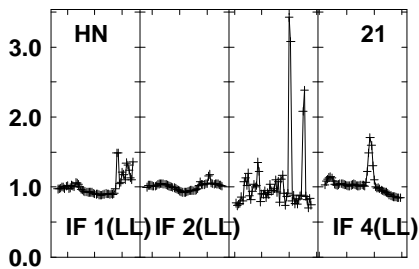
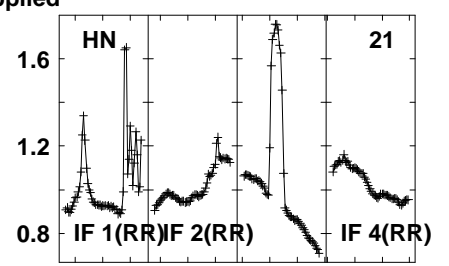
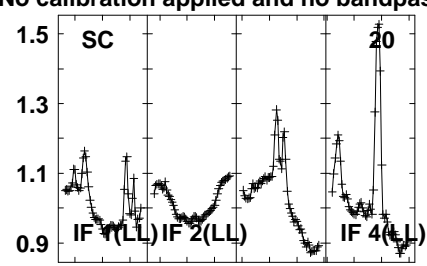
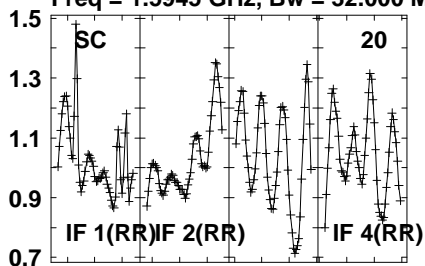

Lower frame: Real Jy  
Auto-corr total-power spectrum Antenna: \*  
Timerange: 00/21:16:31 to 00/21:19:59



Plot file version 1291 created 05-OCT-2021 17:10:57

APM08279+525 GM076.UVDATA.1

Freq = 1.5945 GHz, Bw = 32.000 MH No calibration applied and no bandpass applied

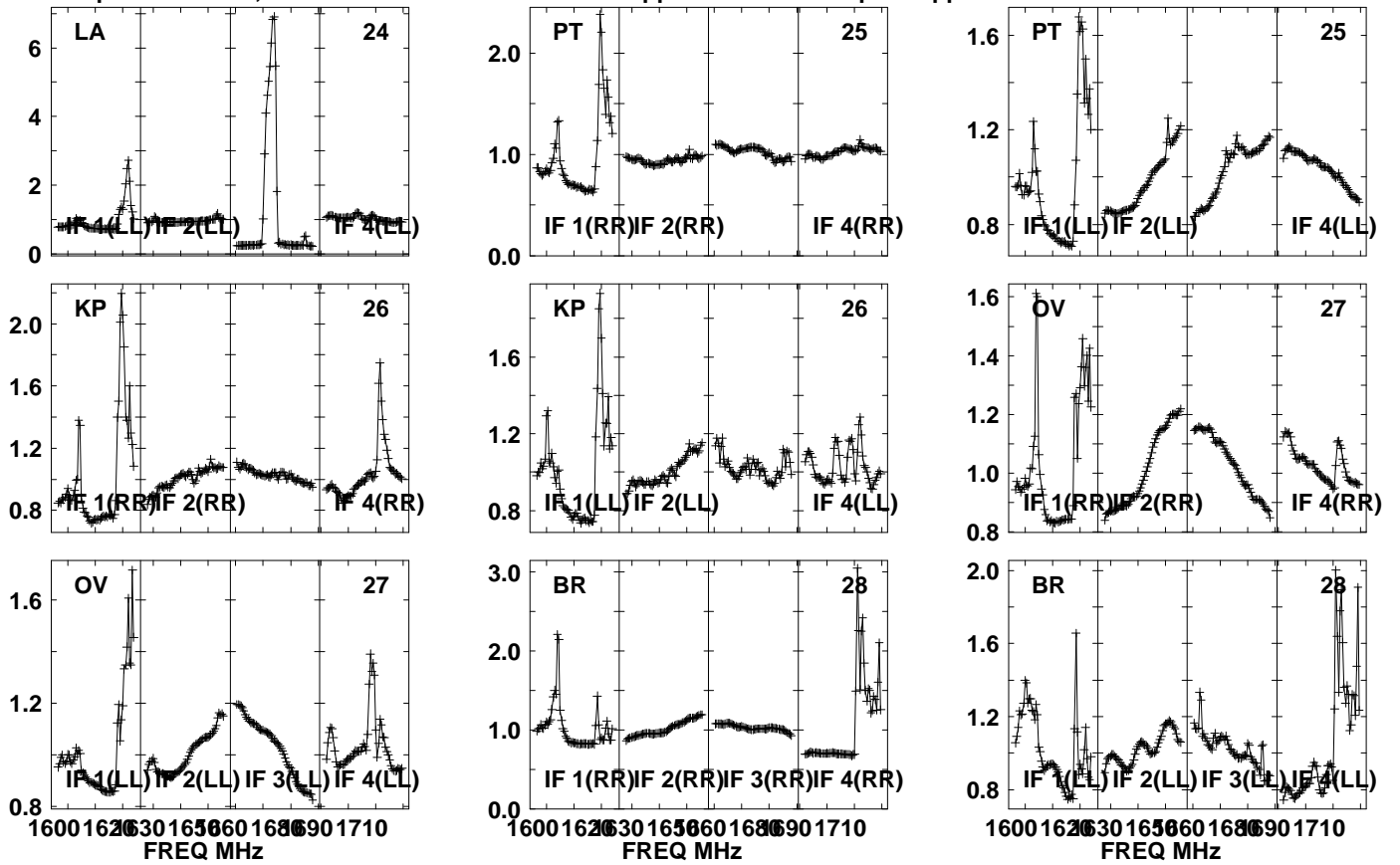

Lower frame: Real Jy  
Auto-corr total-power spectrum Antenna: \*  
Timerange: 00/21:16:31 to 00/21:19:59

Plot file version1292 created 05-OCT-2021 17:10:58

APM08279+525 GM076.UVDATA.1

Freq = 1.5945 GHz, Bw = 32.000 MH No calibration applied and no bandpass applied

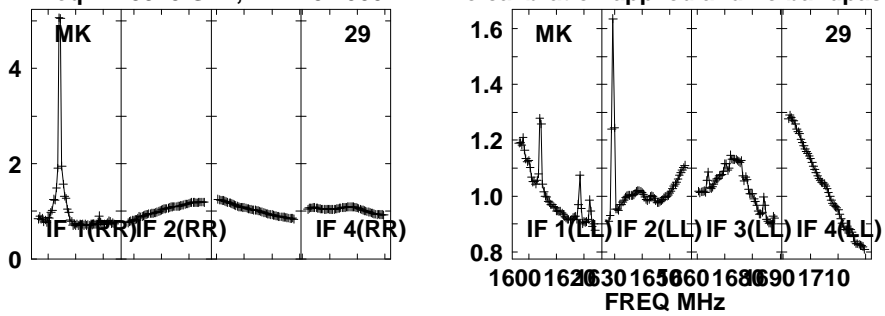

Lower frame: Real Jy  
Auto-corr total-power spectrum Antenna: \*  
Timerange: 00/21:16:31 to 00/21:19:59

Plot file version 1293 created 05-OCT-2021 17:10:58

J0827+5217 GM076.UVDATA.1

Freq = 1.5945 GHz, Bw = 32.000 MH No calibration applied and no bandpass applied

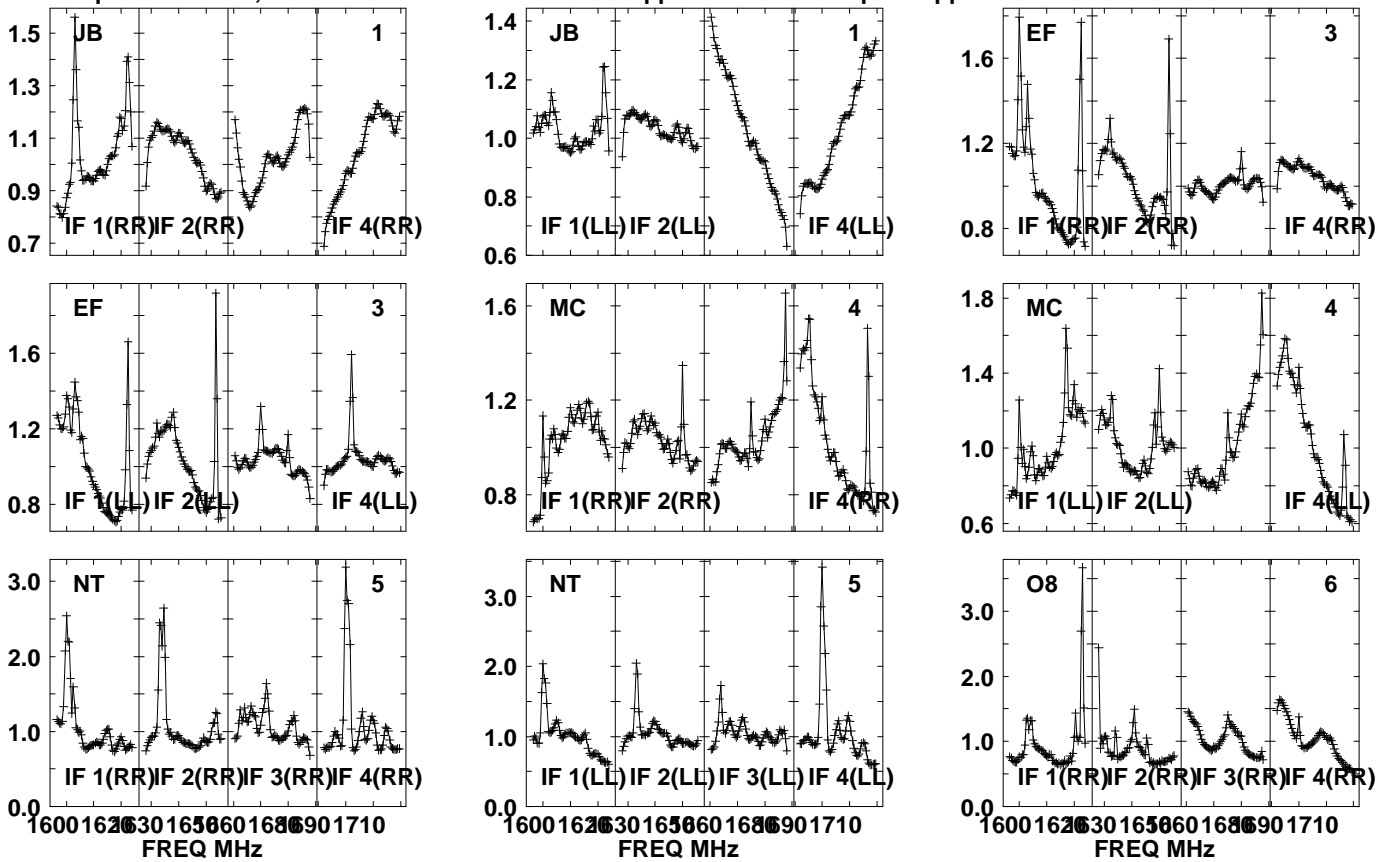

Lower frame: Real Jy  
Auto-corr total-power spectrum Antenna: \*  
Timerange: 00/21:20:31 to 00/21:21:59

Plot file version1294 created 05-OCT-2021 17:10:58

J0827+5217 GM076.UVDATA.1

Freq = 1.5945 GHz, Bw = 32.000 MH No calibration applied and no bandpass applied

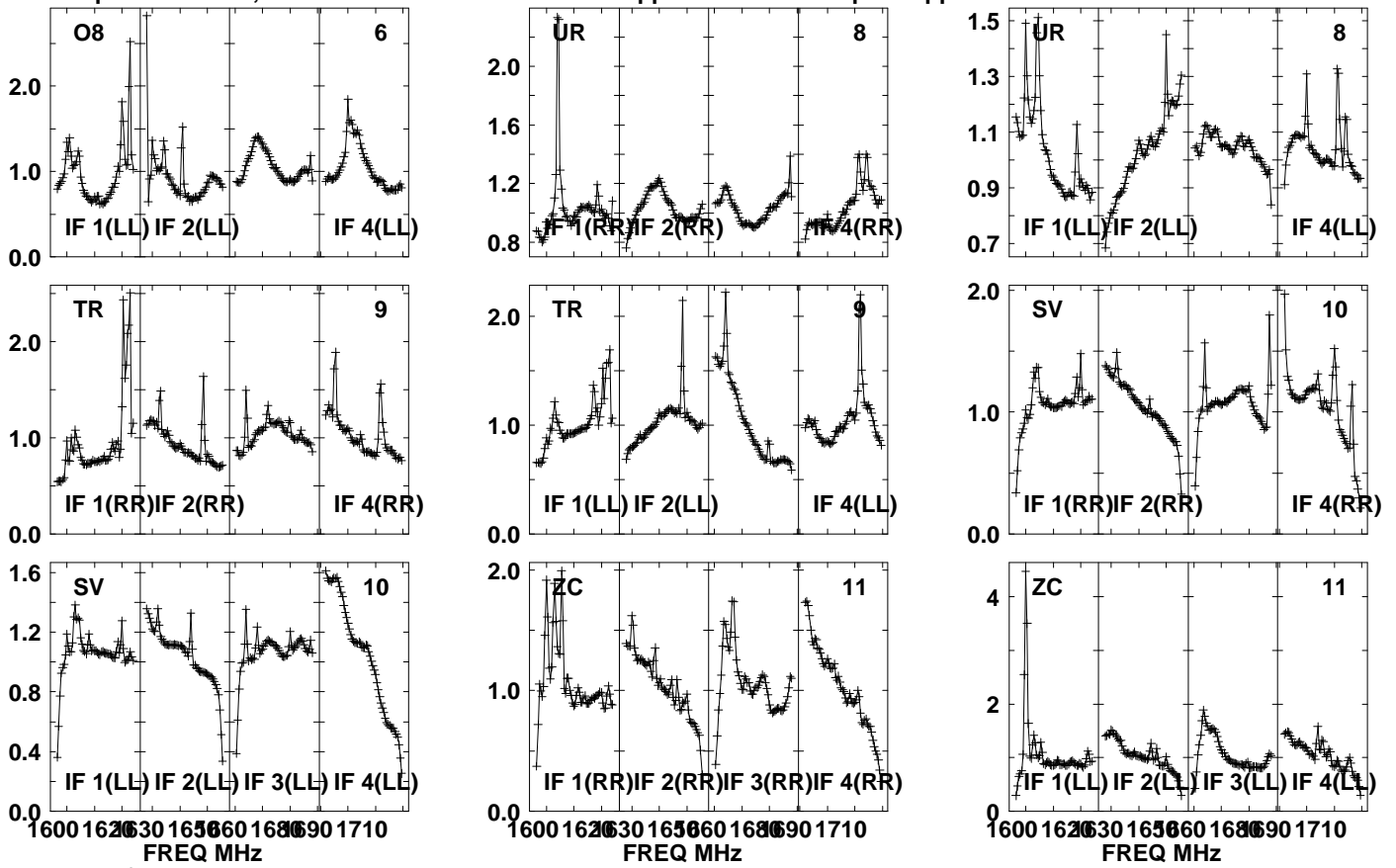

Lower frame: Real Jy

Auto-corr total-power spectrum Antenna: \*

Timerange: 00/21:20:31 to 00/21:21:59

Plot file version 1295 created 05-OCT-2021 17:10:59

J0827+5217 GM076.UVDATA.1

Freq = 1.5945 GHz, Bw = 32.000 MHz No calibration applied and no bandpass applied

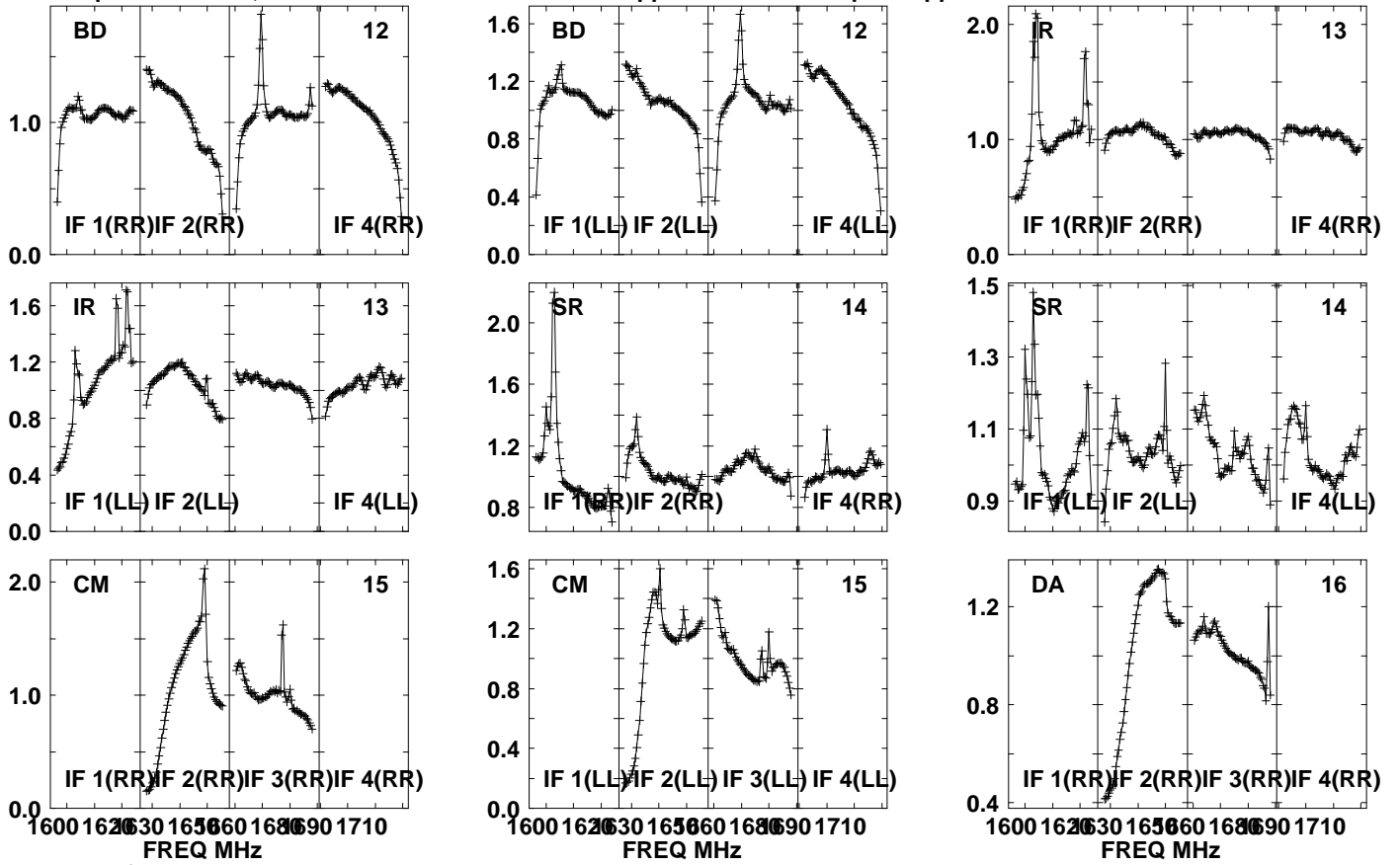

Lower frame: Real Jy

Auto-corr total-power spectrum Antenna: \*

Timerange: 00/21:20:31 to 00/21:21:59

Plot file version 1296 created 05-OCT-2021 17:10:59

J0827+5217 GM076.UVDATA.1

Freq = 1.5945 GHz, Bw = 32.000 MH No calibration applied and no bandpass applied

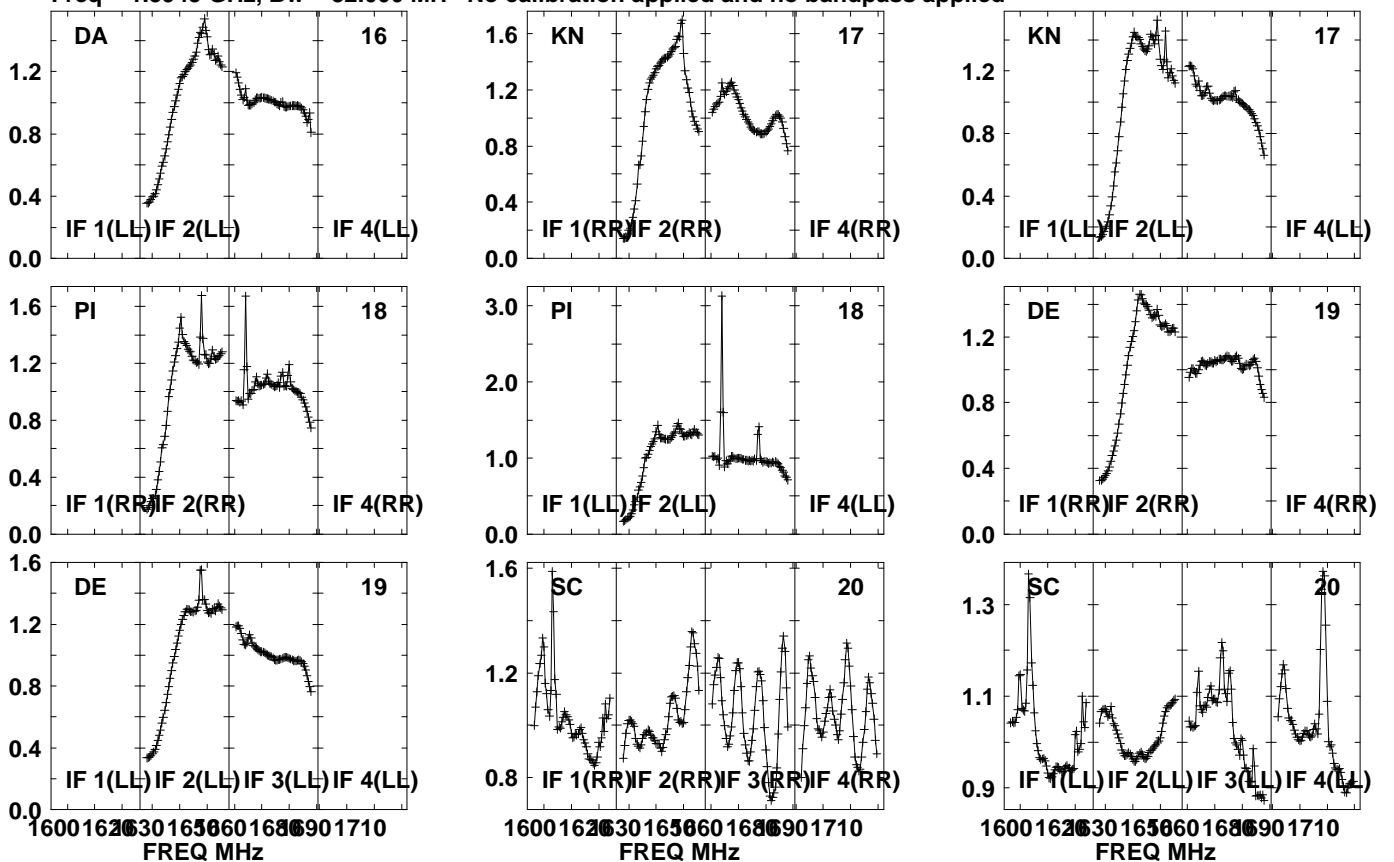

Lower frame: Real Jy  
Auto-corr total-power spectrum Antenna: \*  
Timerange: 00/21:20:31 to 00/21:21:59

Plot file version 1297 created 05-OCT-2021 17:10:59

J0827+5217 GM076.UVDATA.1

Freq = 1.5945 GHz, Bw = 32.000 MH No calibration applied and no bandpass applied

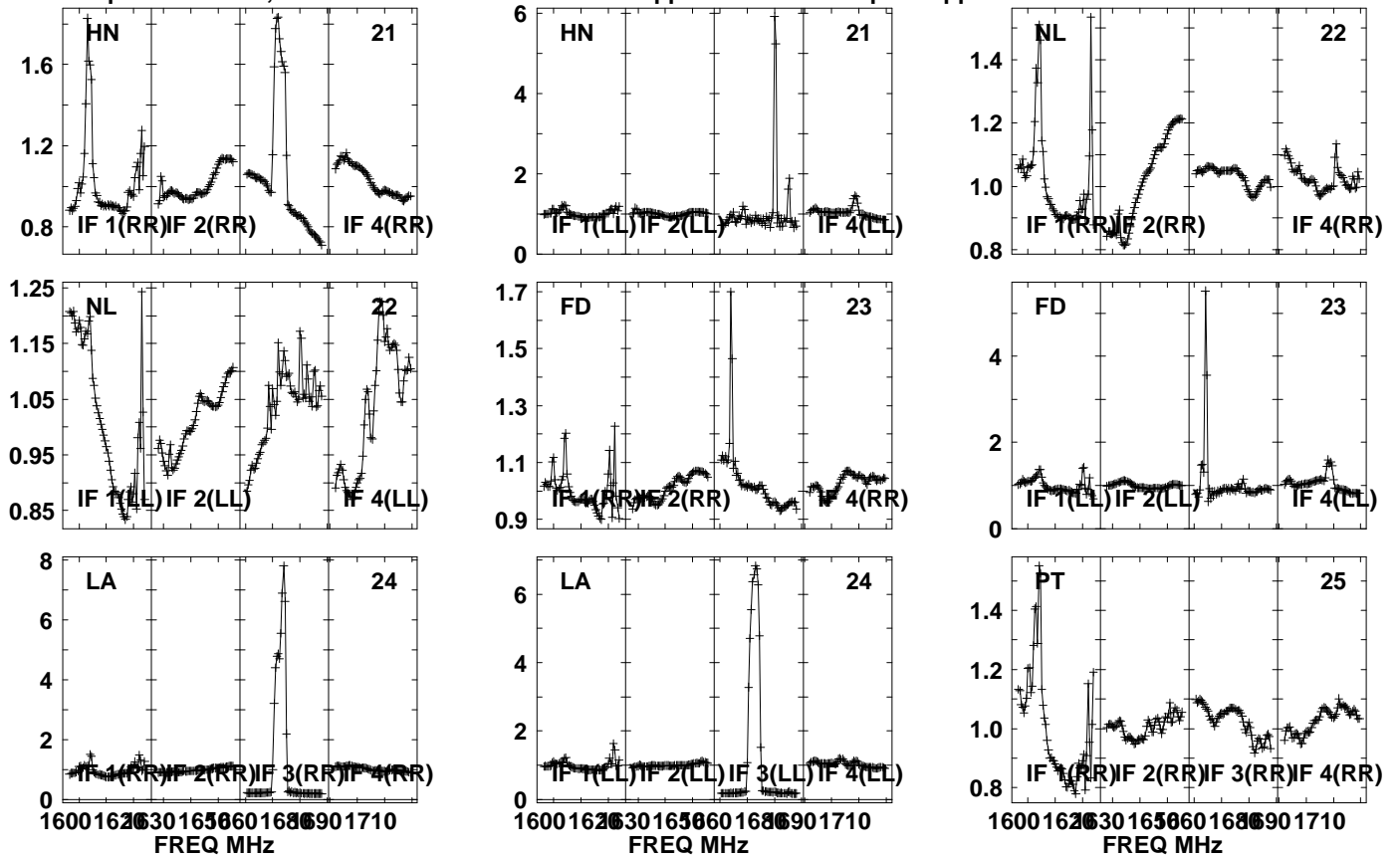

Lower frame: Real Jy  
Auto-corr total-power spectrum Antenna: \*  
Timerange: 00/21:20:31 to 00/21:21:59

Plot file version 1298 created 05-OCT-2021 17:11:00

J0827+5217 GM076.UVDATA.1

Freq = 1.5945 GHz, Bw = 32.000 MH No calibration applied and no bandpass applied

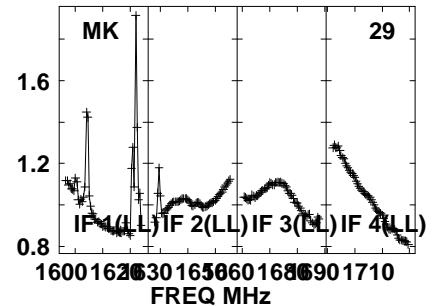
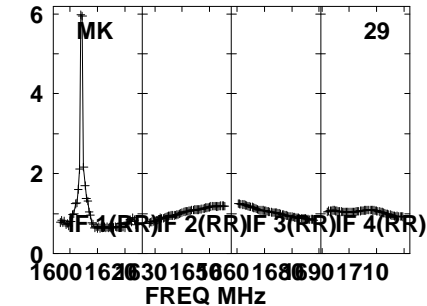
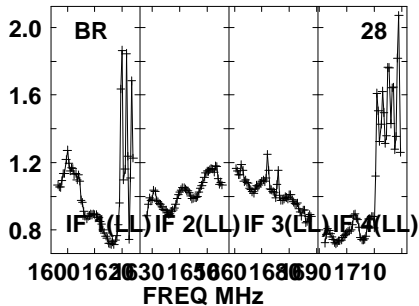
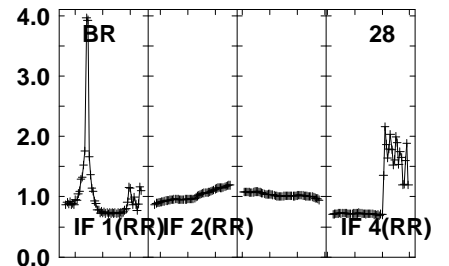
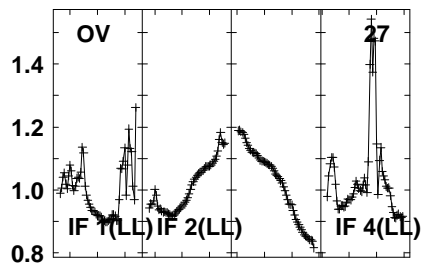
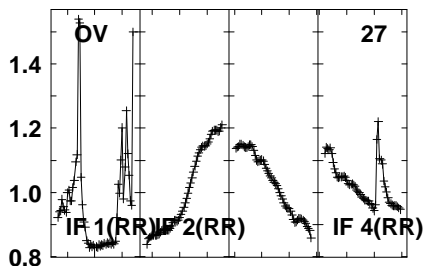
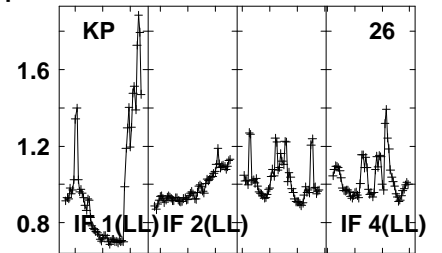
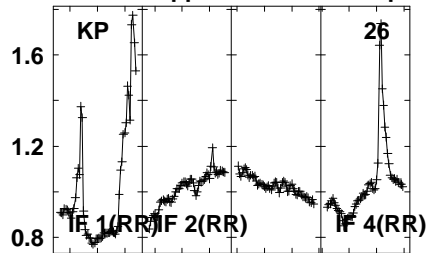
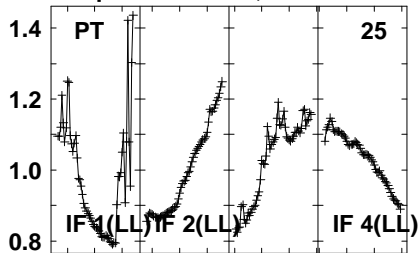

Lower frame: Real Jy  
Auto-corr total-power spectrum Antenna: \*  
Timerange: 00/21:20:31 to 00/21:21:59



Plot file version 1299 created 05-OCT-2021 17:11:00

APM08279+525 GM076.UVDATA.1

Freq = 1.5945 GHz, Bw = 32.000 MH No calibration applied and no bandpass applied

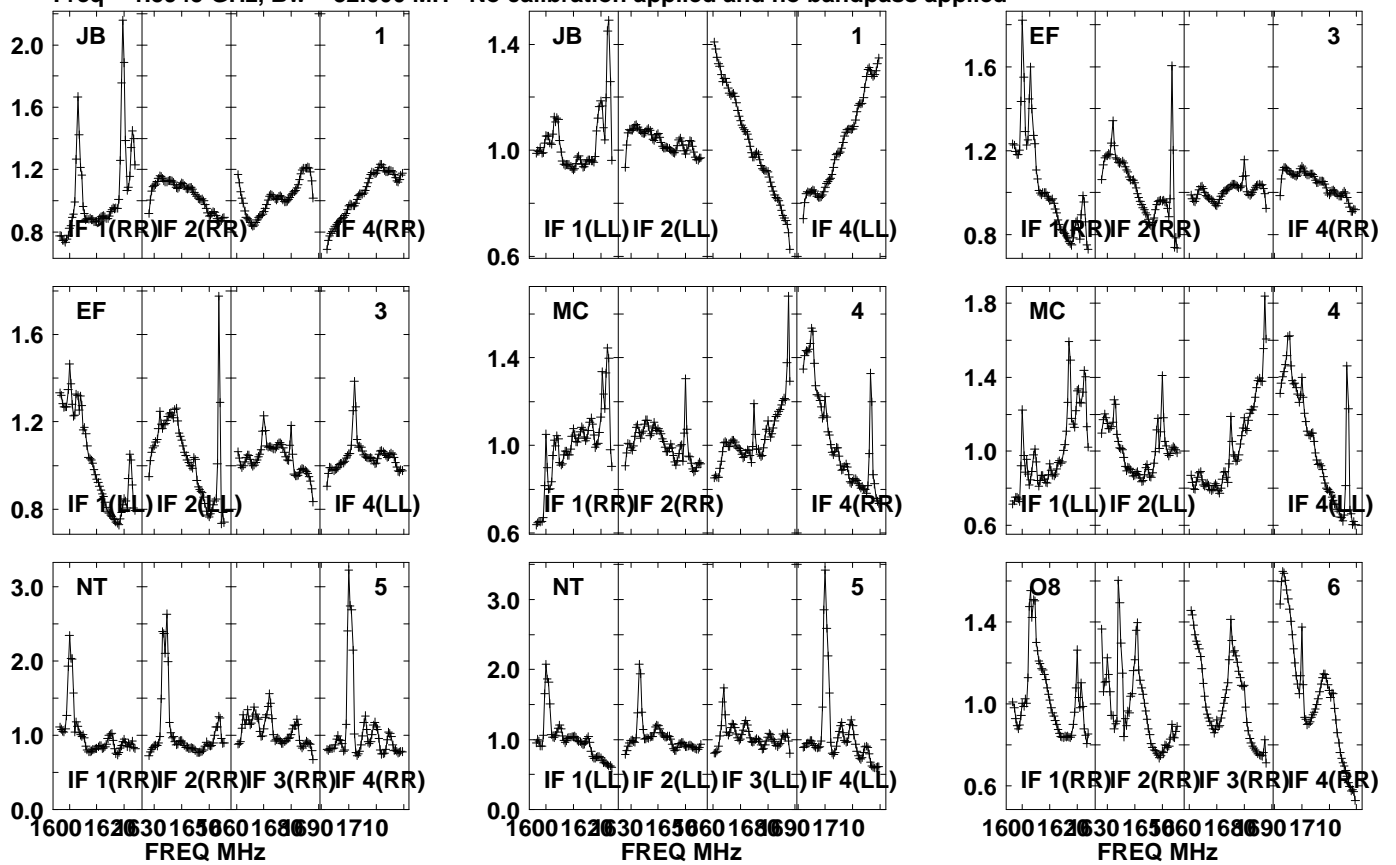

Lower frame: Real Jy  
Auto-corr total-power spectrum Antenna: \*  
Timerange: 00/21:22:01 to 00/21:25:29

Plot file version1300 created 05-OCT-2021 17:11:00

APM08279+525 GM076.UVDATA.1

Freq = 1.5945 GHz, Bw = 32.000 MH No calibration applied and no bandpass applied

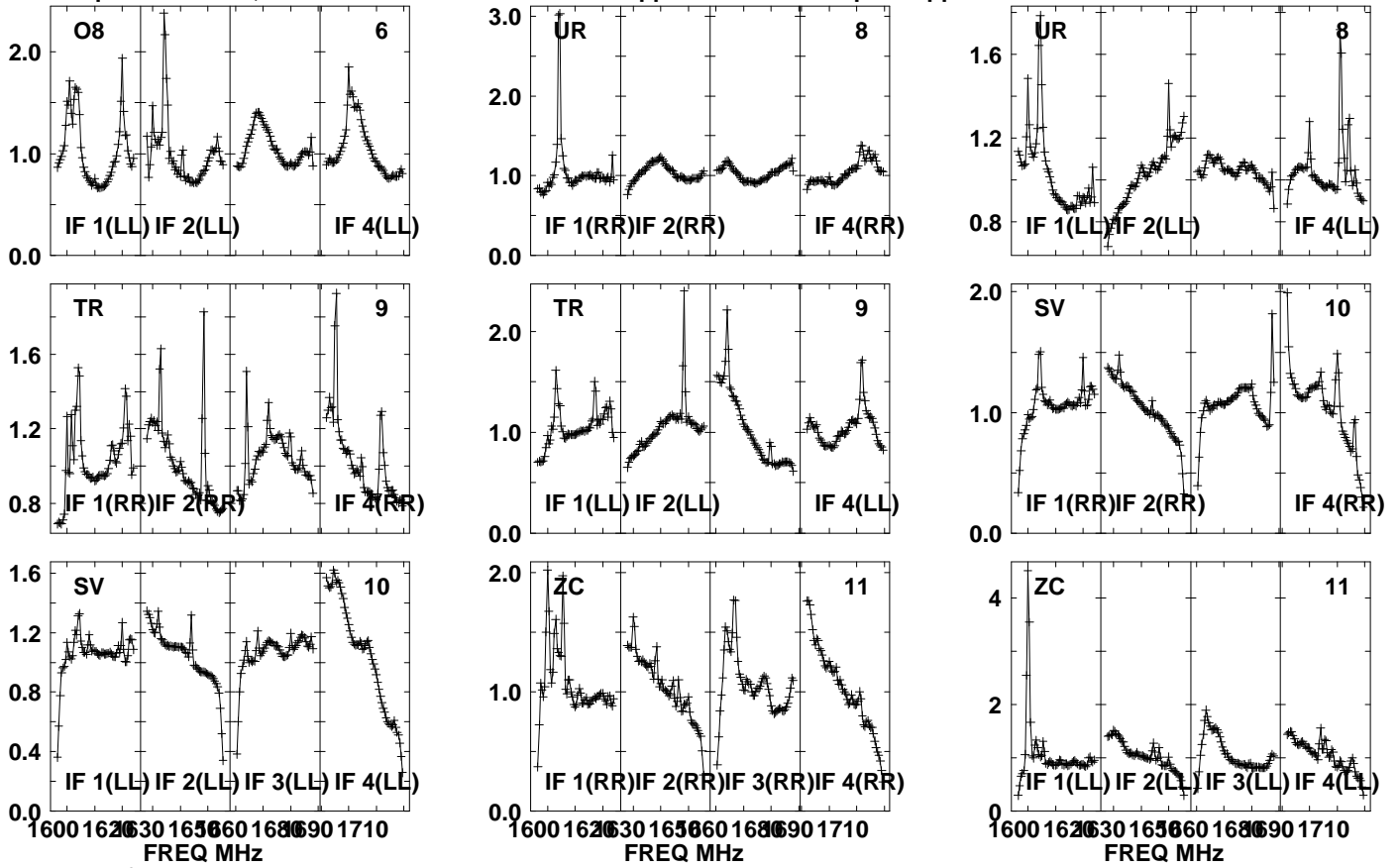

Lower frame: Real Jy  
Auto-corr total-power spectrum Antenna: \*  
Timerange: 00/21:22:01 to 00/21:25:29

Plot file version1301 created 05-OCT-2021 17:11:01

APM08279+525 GM076.UVDATA.1

Freq = 1.5945 GHz, Bw = 32.000 MH No calibration applied and no bandpass applied

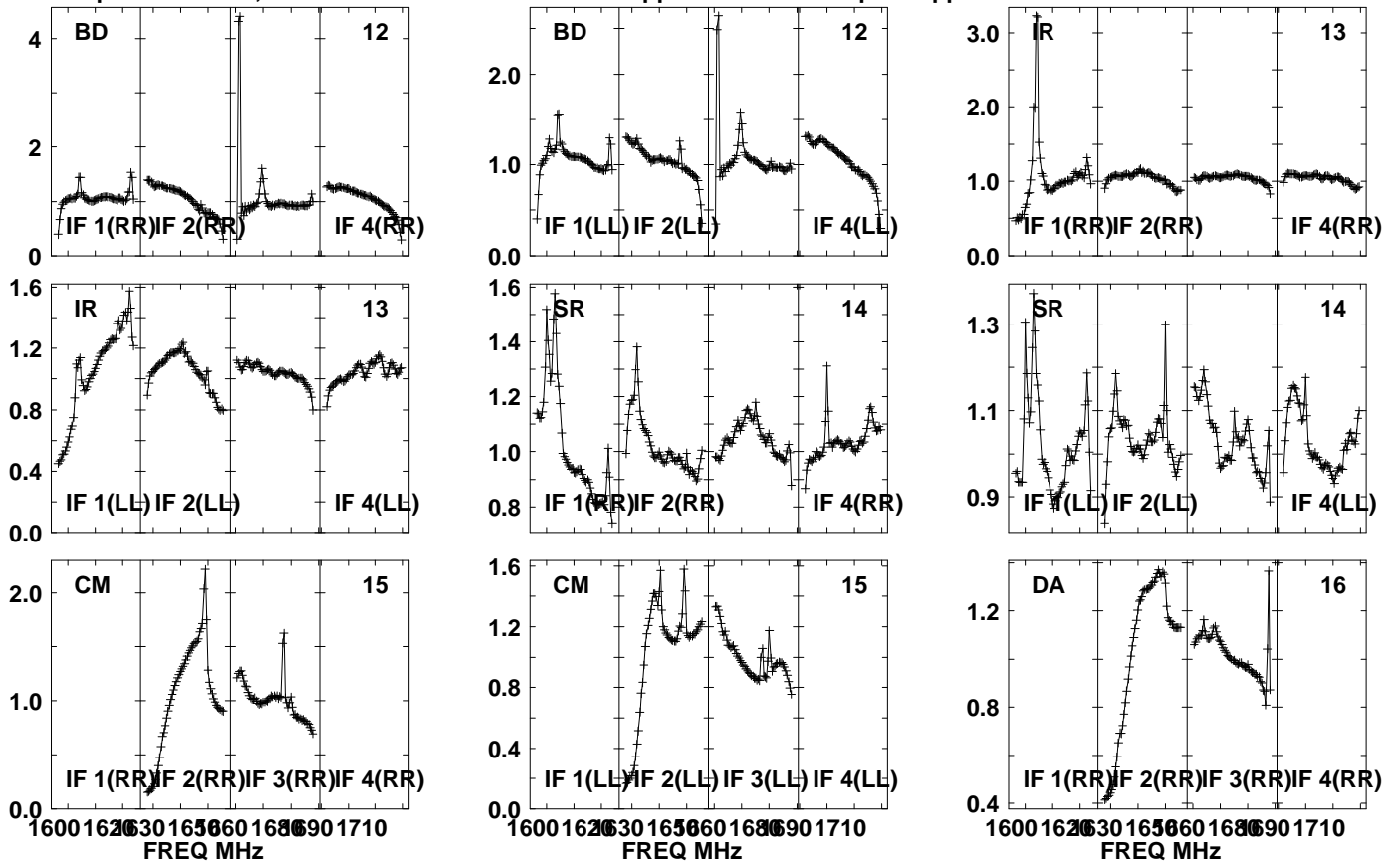

Lower frame: Real Jy

Auto-corr total-power spectrum Antenna: \*

Timerange: 00/21:22:01 to 00/21:25:29

Plot file version1302 created 05-OCT-2021 17:11:01

APM08279+525 GM076.UVDATA.1

Freq = 1.5945 GHz, Bw = 32.000 MH No calibration applied and no bandpass applied

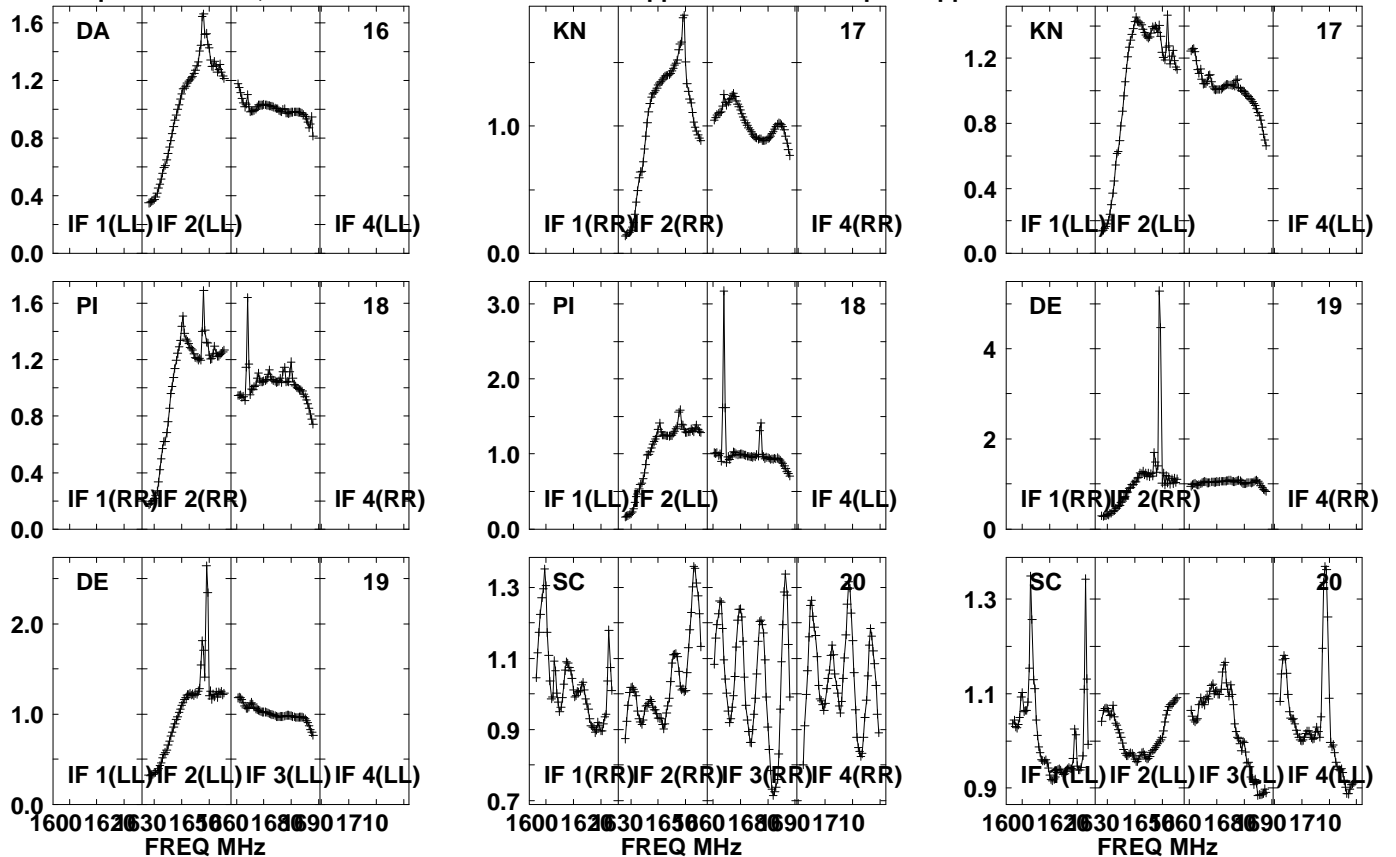

Lower frame: Real Jy  
Auto-corr total-power spectrum Antenna: \*  
Timerange: 00/21:22:01 to 00/21:25:29

Plot file version1303 created 05-OCT-2021 17:11:01

APM08279+525 GM076.UVDATA.1

Freq = 1.5945 GHz, Bw = 32.000 MH No calibration applied and no bandpass applied

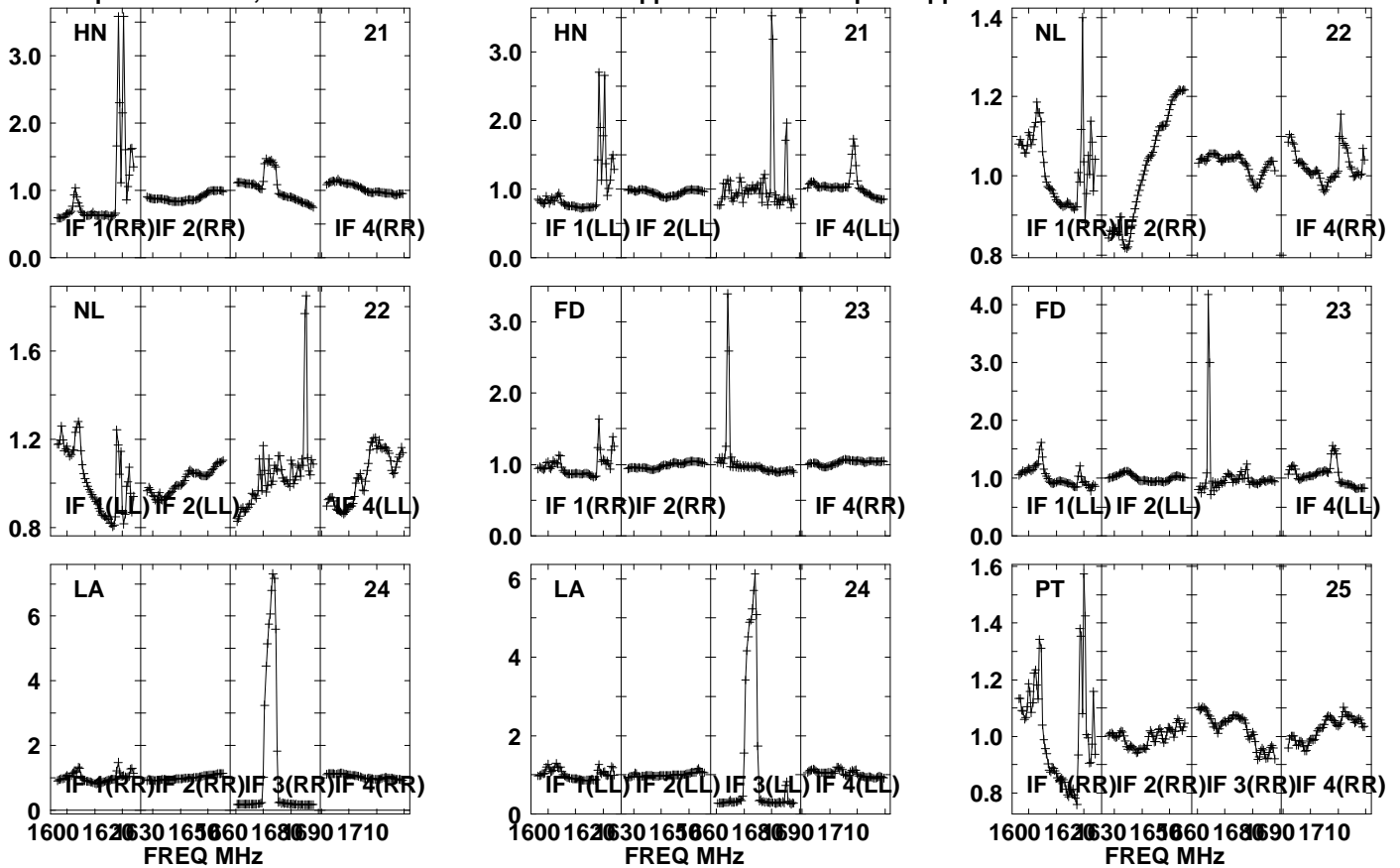

Lower frame: Real Jy

Auto-corr total-power spectrum Antenna: \*

Timerange: 00/21:22:01 to 00/21:25:29

Plot file version1304 created 05-OCT-2021 17:11:02

APM08279+525 GM076.UVDATA.1

Freq = 1.5945 GHz, Bw = 32.000 MH No calibration applied and no bandpass applied

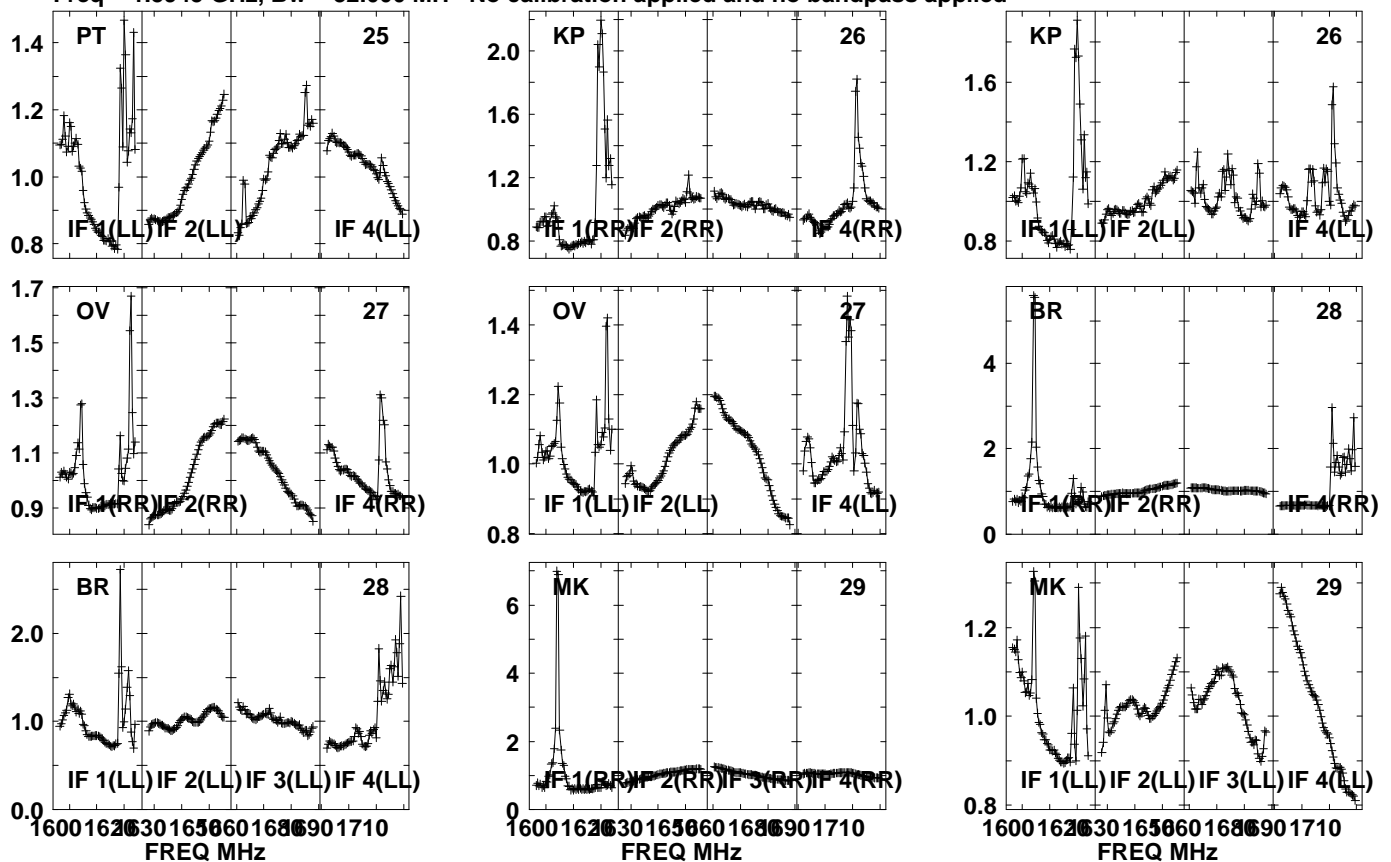

Lower frame: Real Jy  
Auto-corr total-power spectrum Antenna: \*  
Timerange: 00/21:22:01 to 00/21:25:29

Plot file version1305 created 05-OCT-2021 17:11:02

J0827+5217 GM076.UVDATA.1

Freq = 1.5945 GHz, Bw = 32.000 MH No calibration applied and no bandpass applied

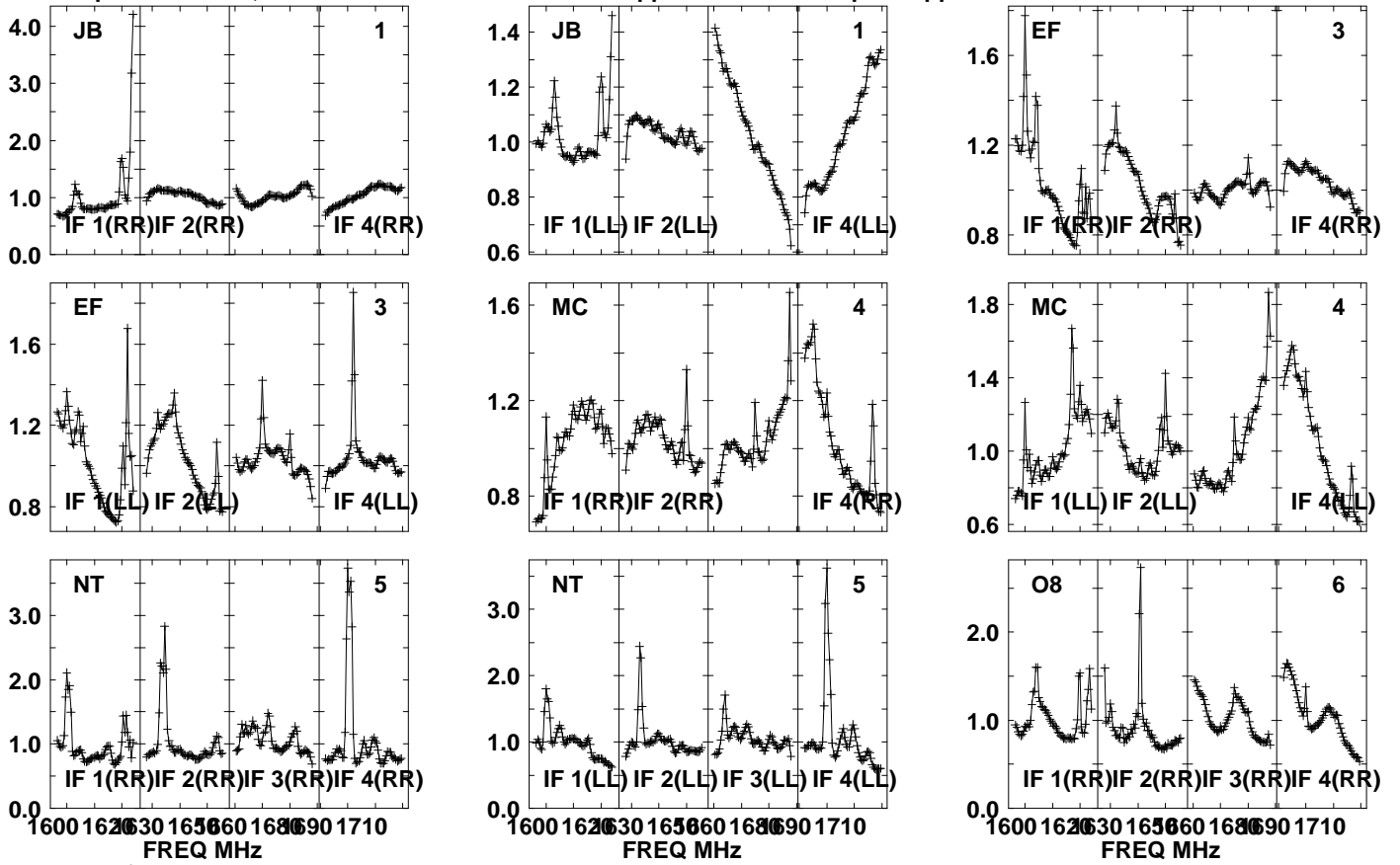

Lower frame: Real Jy

Auto-corr total-power spectrum Antenna: \*

Timerange: 00/21:25:31 to 00/21:26:59

Plot file version1306 created 05-OCT-2021 17:11:02

J0827+5217 GM076.UVDATA.1

Freq = 1.5945 GHz, Bw = 32.000 MH No calibration applied and no bandpass applied

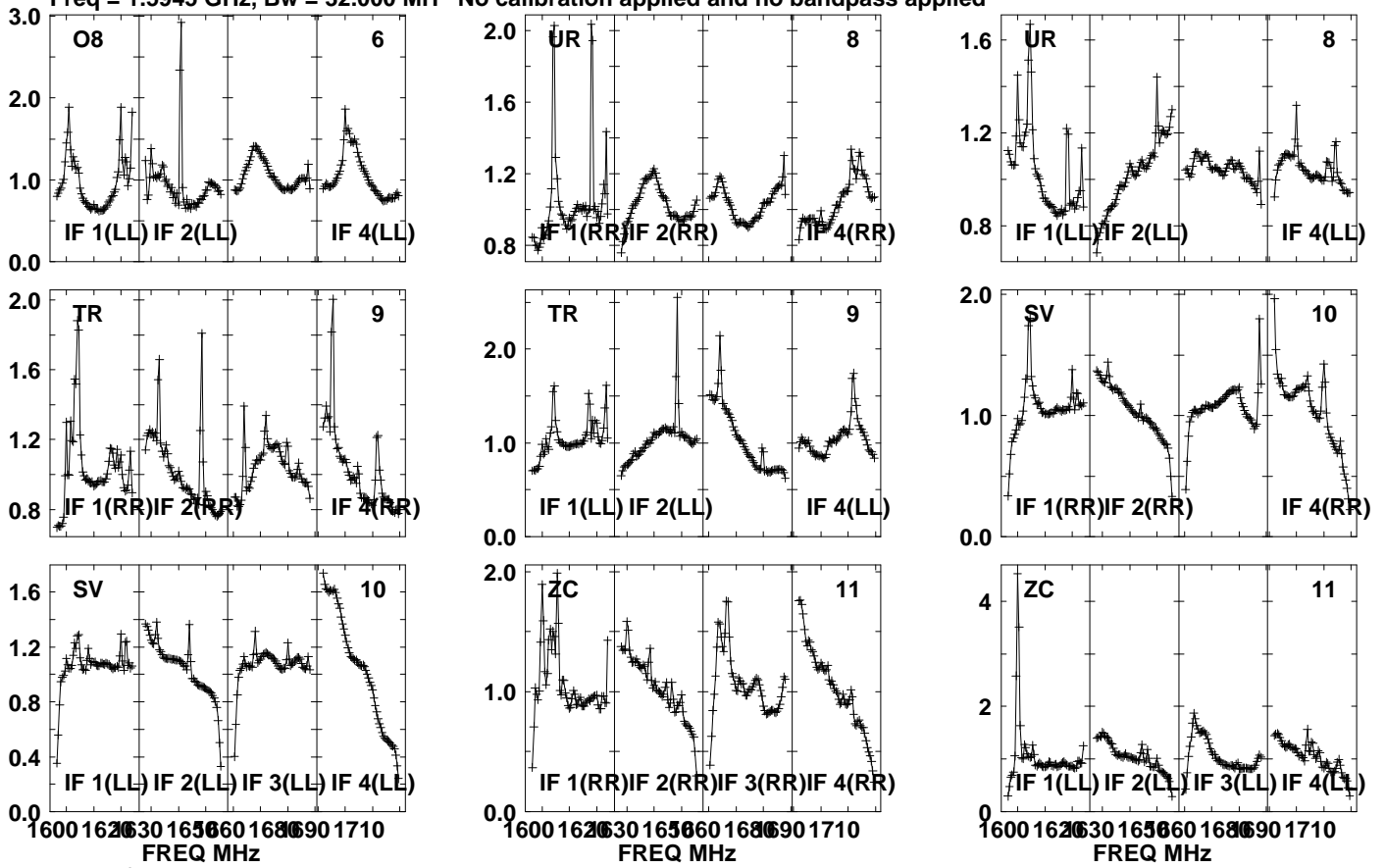

Auto-corr total-power spectrum Antenna: \*  
Timerange: 00/21:25:31 to 00/21:26:59



Plot file version1307 created 05-OCT-2021 17:11:03

J0827+5217 GM076.UVDATA.1

Freq = 1.5945 GHz, Bw = 32.000 MH No calibration applied and no bandpass applied

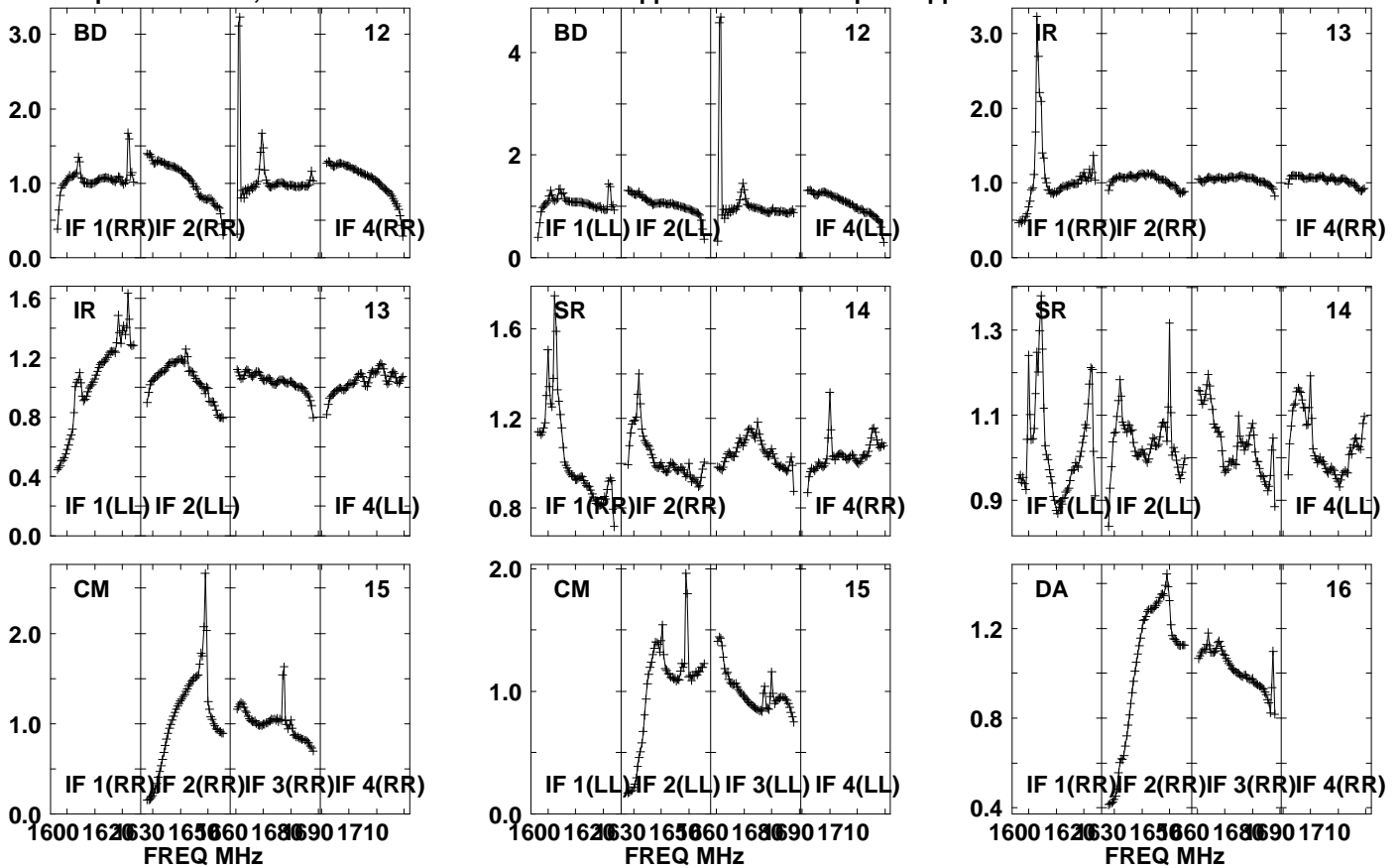

Lower frame: Real Jy

Auto-corr total-power spectrum Antenna: \*

Timerange: 00/21:25:31 to 00/21:26:59

Plot file version 1308 created 05-OCT-2021 17:11:03

J0827+5217 GM076.UVDATA.1

Freq = 1.5945 GHz, Bw = 32.000 MH No calibration applied and no bandpass applied

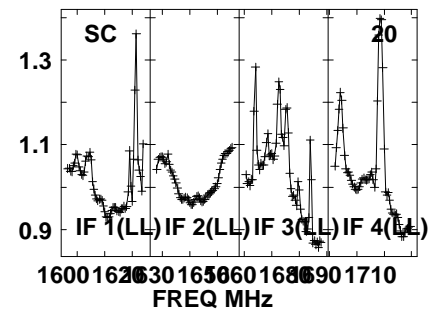
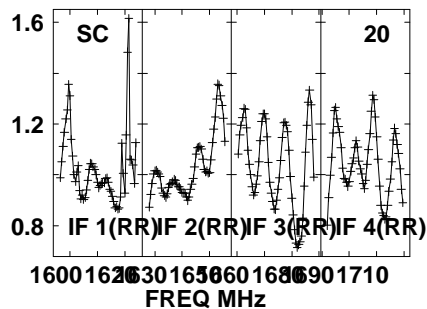
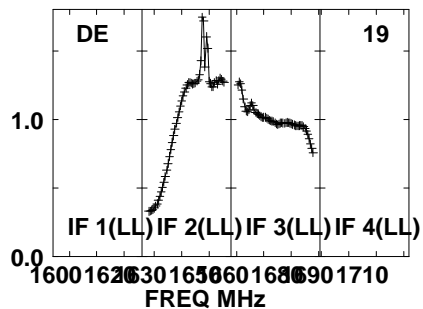
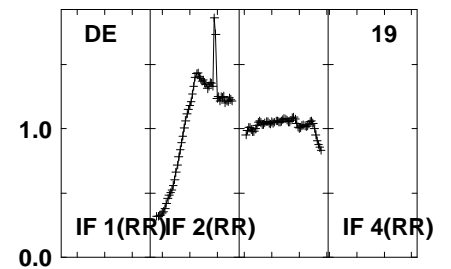
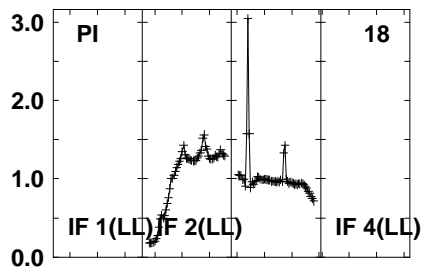
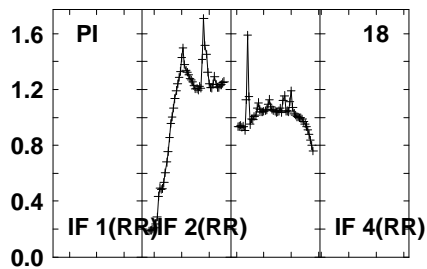
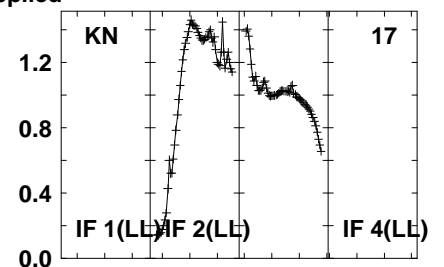
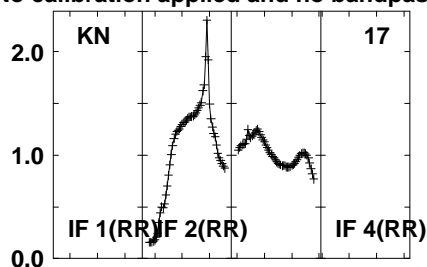
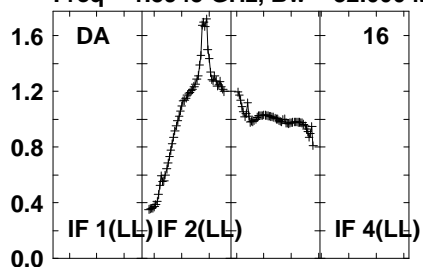

Lower frame: Real Jy  
Auto-corr total-power spectrum Antenna: \*  
Timerange: 00/21:25:31 to 00/21:26:59

Plot file version 1309 created 05-OCT-2021 17:11:03

J0827+5217 GM076.UVDATA.1

Freq = 1.5945 GHz, Bw = 32.000 MH No calibration applied and no bandpass applied

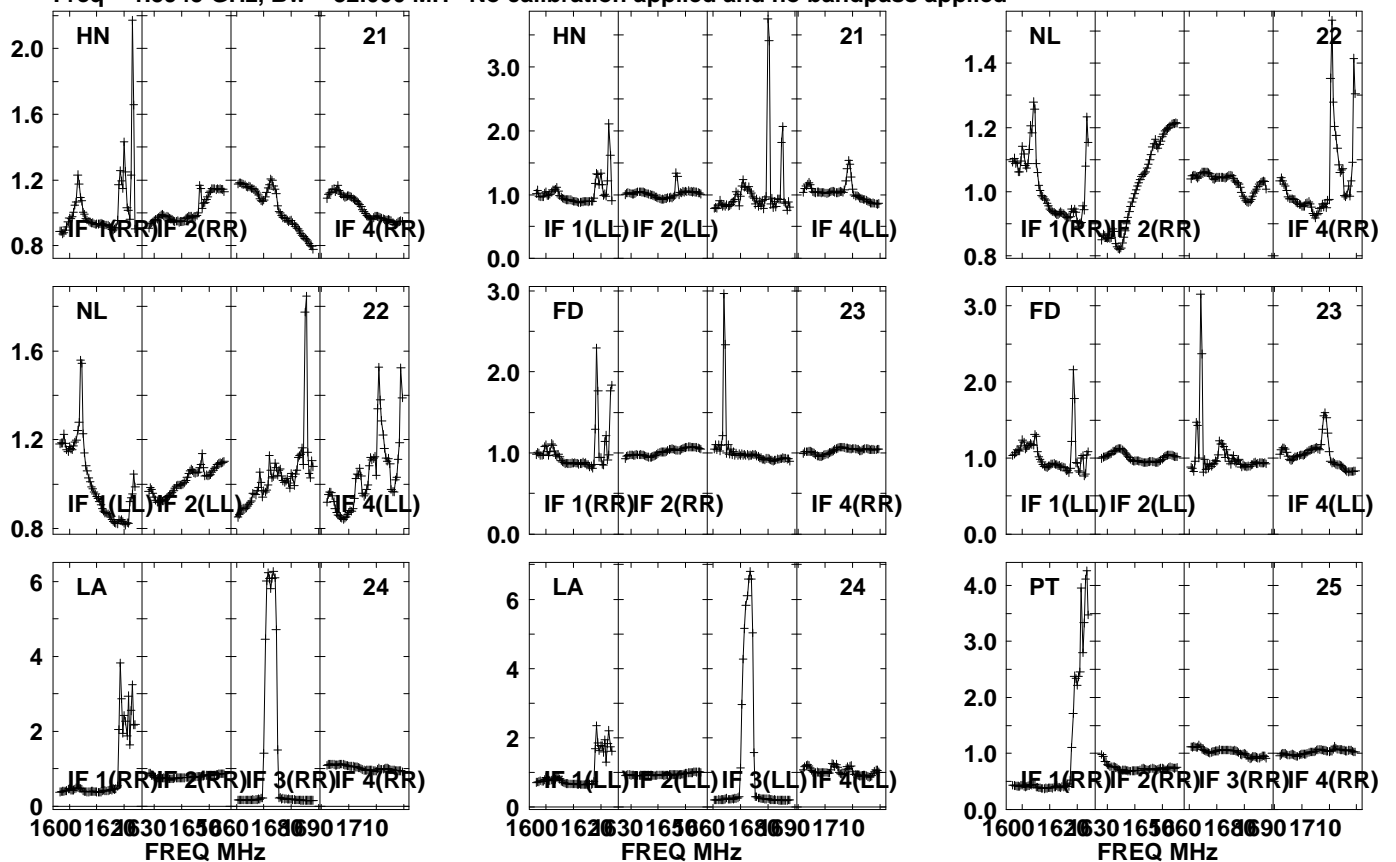

Lower frame: Real Jy  
Auto-corr total-power spectrum Antenna: \*  
Timerange: 00/21:25:31 to 00/21:26:59

Plot file version1310 created 05-OCT-2021 17:11:04

J0827+5217 GM076.UVDATA.1

Freq = 1.5945 GHz, Bw = 32.000 MH No calibration applied and no bandpass applied

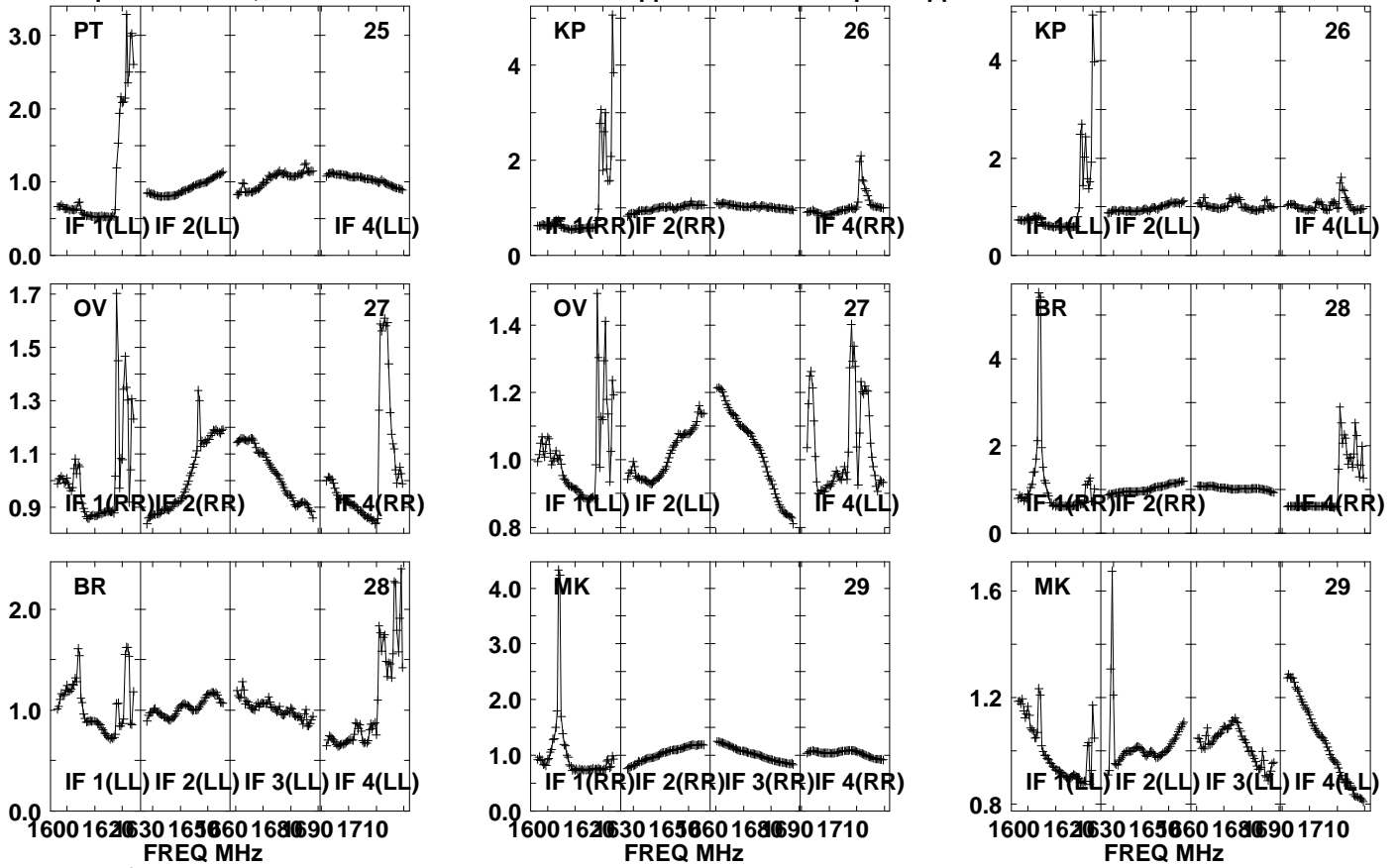

Lower frame: Real Jy  
Auto-corr total-power spectrum Antenna: \*  
Timerange: 00/21:25:31 to 00/21:26:59

Plot file version 1311 created 05-OCT-2021 17:11:04

APM08279+525 GM076.UVDATA.1

Freq = 1.5945 GHz, Bw = 32.000 MH No calibration applied and no bandpass applied

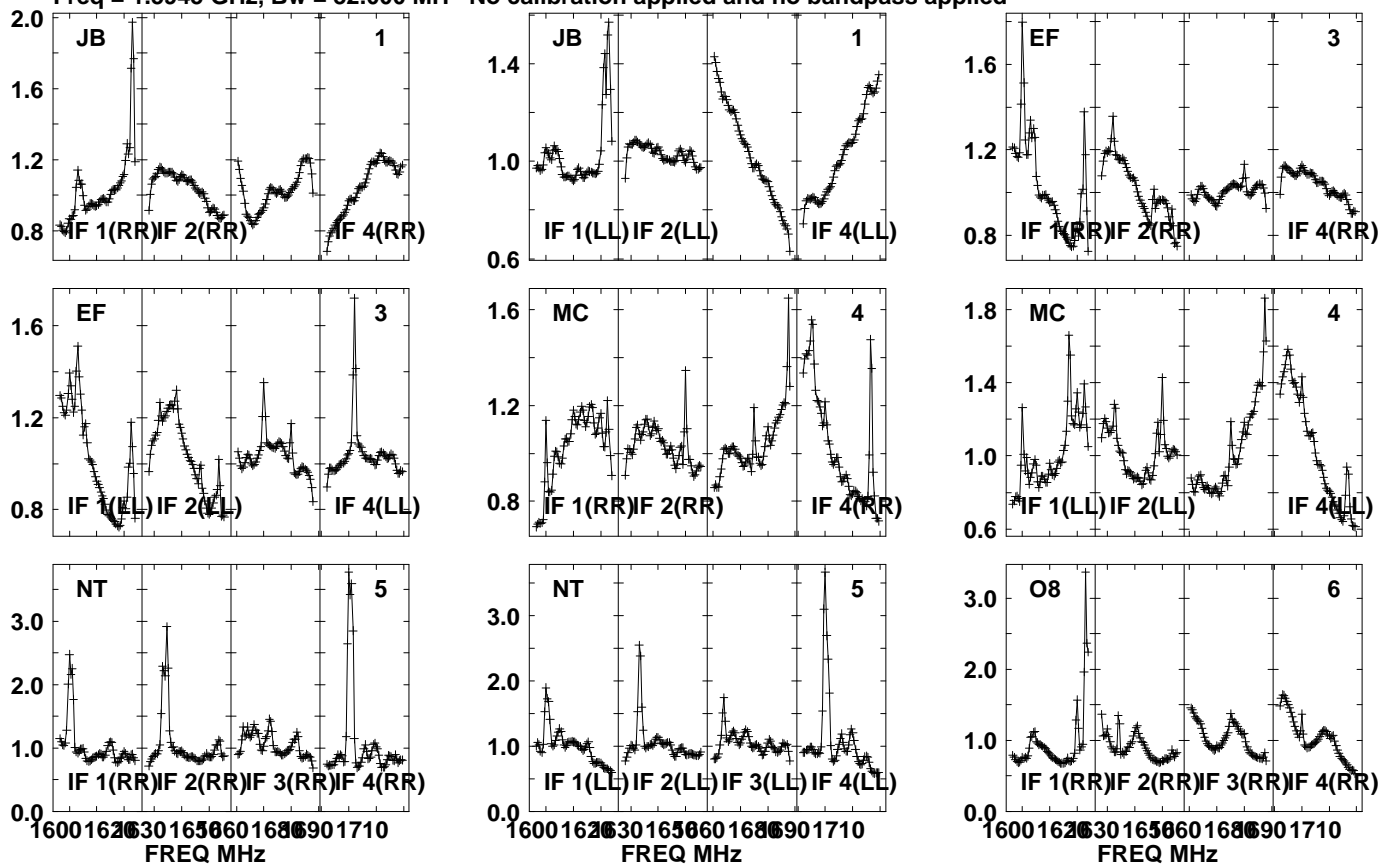

Lower frame: Real Jy  
Auto-corr total-power spectrum Antenna: \*  
Timerange: 00/21:27:01 to 00/21:30:29

Plot file version1312 created 05-OCT-2021 17:11:04

APM08279+525 GM076.UVDATA.1

Freq = 1.5945 GHz, Bw = 32.000 MH No calibration applied and no bandpass applied

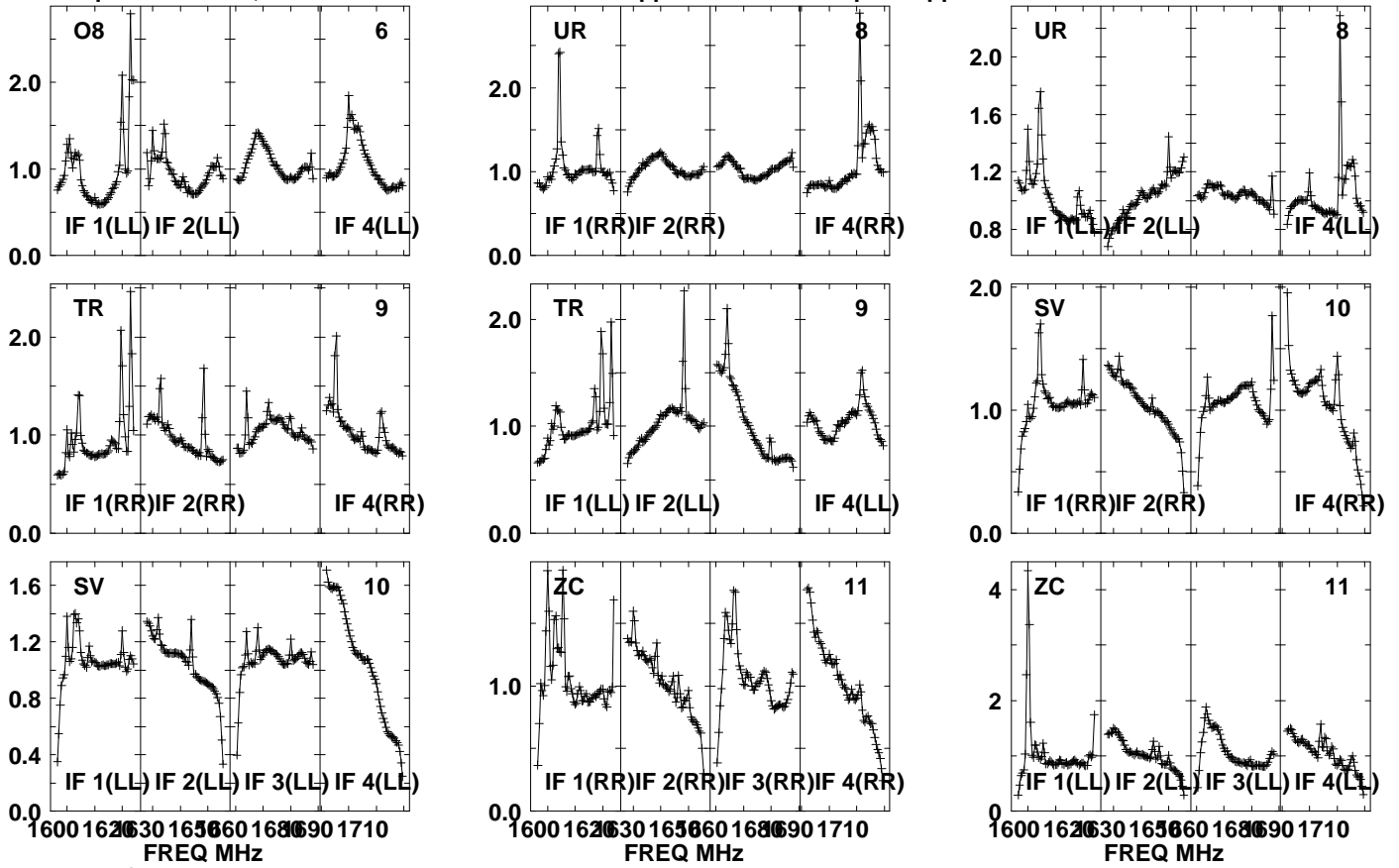

Lower frame: Real Jy

Auto-corr total-power spectrum Antenna: \*

Timerange: 00/21:27:01 to 00/21:30:29

Plot file version1313 created 05-OCT-2021 17:11:05

APM08279+525 GM076.UVDATA.1

Freq = 1.5945 GHz, Bw = 32.000 MH No calibration applied and no bandpass applied

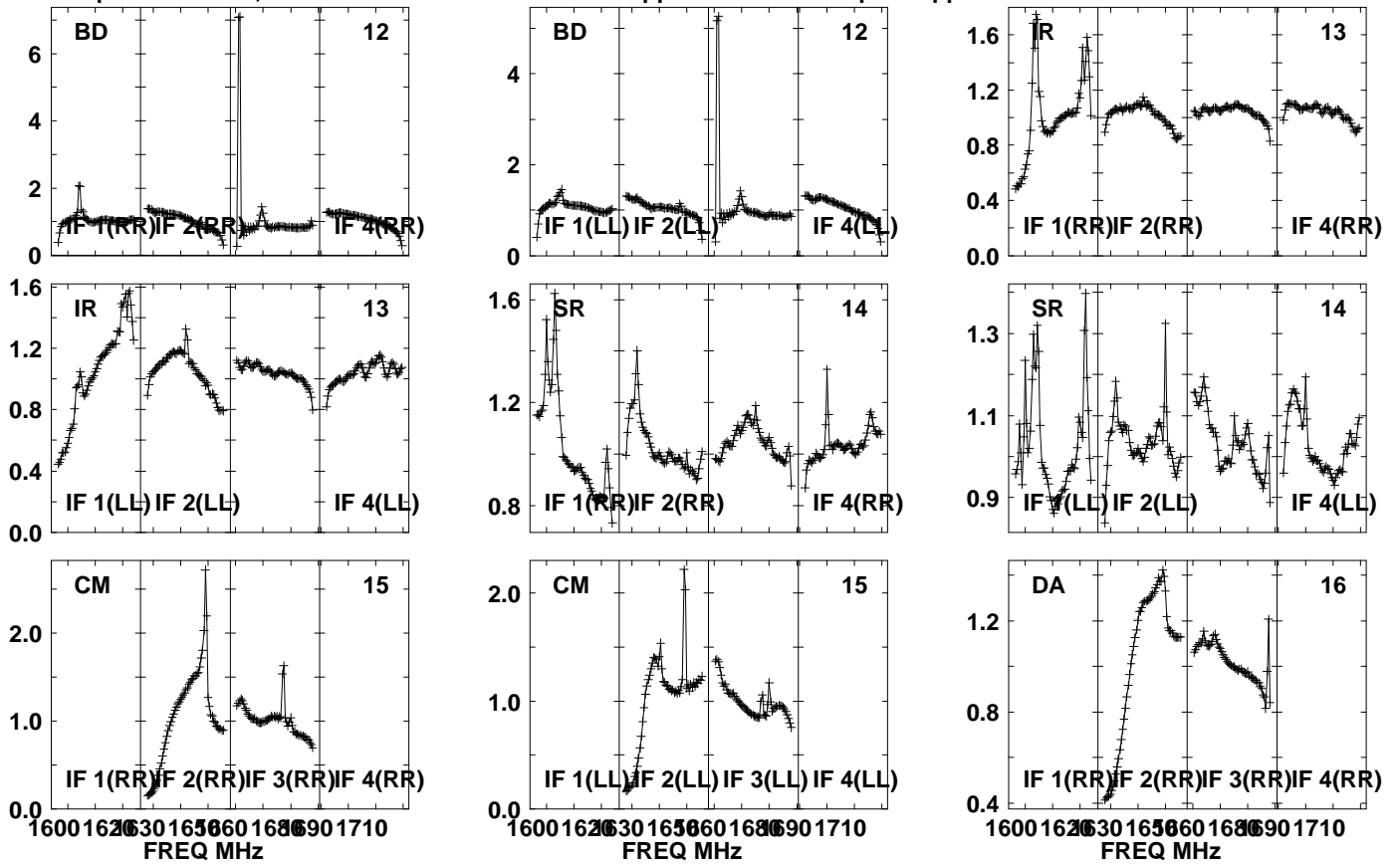

Lower frame: Real Jy

Auto-corr total-power spectrum Antenna: \*

Timerange: 00/21:27:01 to 00/21:30:29

Plot file version 1314 created 05-OCT-2021 17:11:05

APM08279+525 GM076.UVDATA.1

Freq = 1.5945 GHz, Bw = 32.000 MH No calibration applied and no bandpass applied

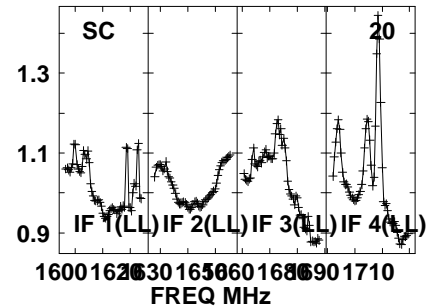
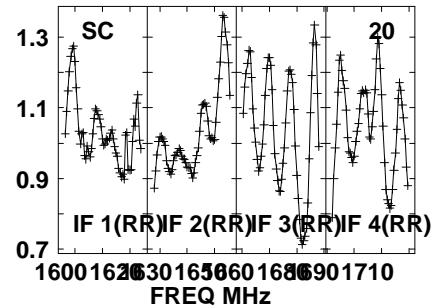
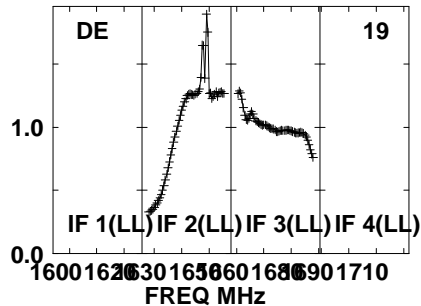
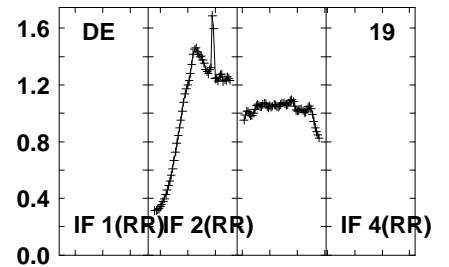
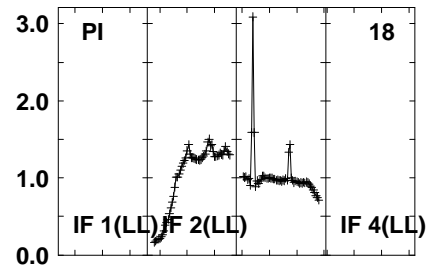
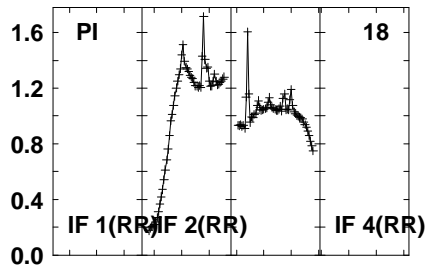
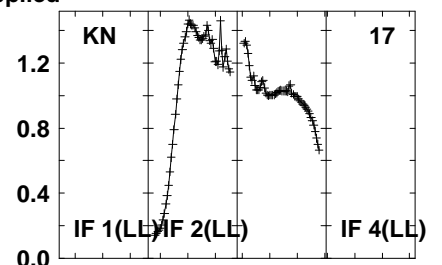
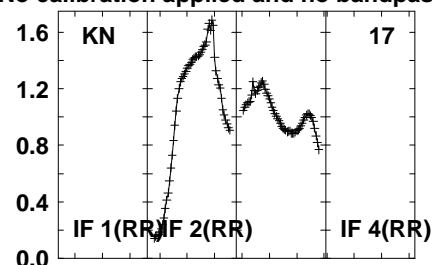
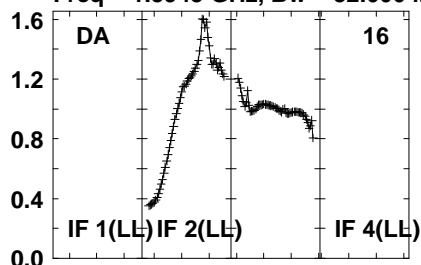

Lower frame: Real Jy  
Auto-corr total-power spectrum Antenna: \*  
Timerange: 00/21:27:01 to 00/21:30:29



Plot file version 1315 created 05-OCT-2021 17:11:06

APM08279+525 GM076.UVDATA.1

Freq = 1.5945 GHz, Bw = 32.000 MH No calibration applied and no bandpass applied

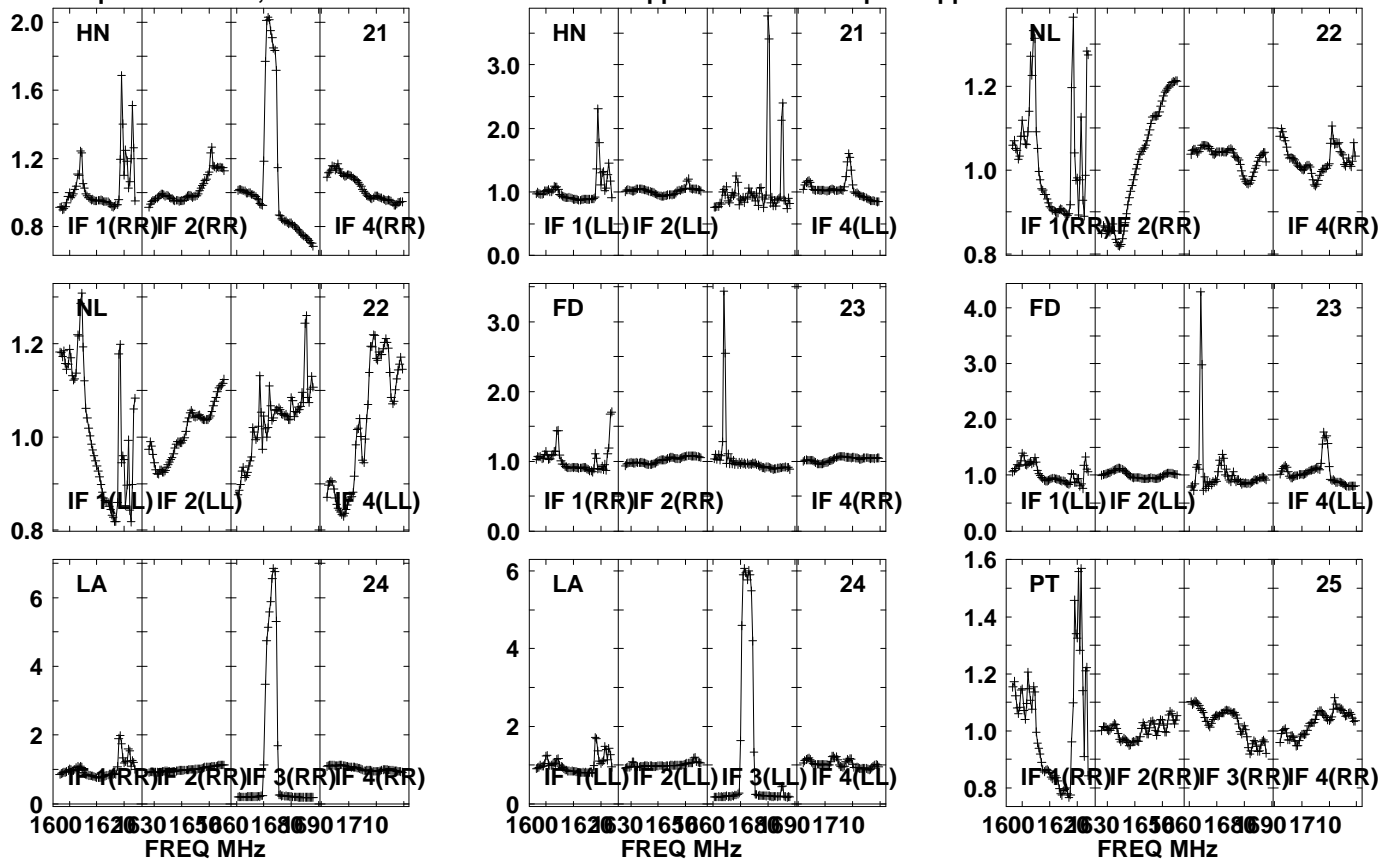

Lower frame: Real Jy  
Auto-corr total-power spectrum Antenna: \*  
Timerange: 00/21:27:01 to 00/21:30:29

Plot file version 1316 created 05-OCT-2021 17:11:06

APM08279+525 GM076.UVDATA.1

Freq = 1.5945 GHz, Bw = 32.000 MH No calibration applied and no bandpass applied

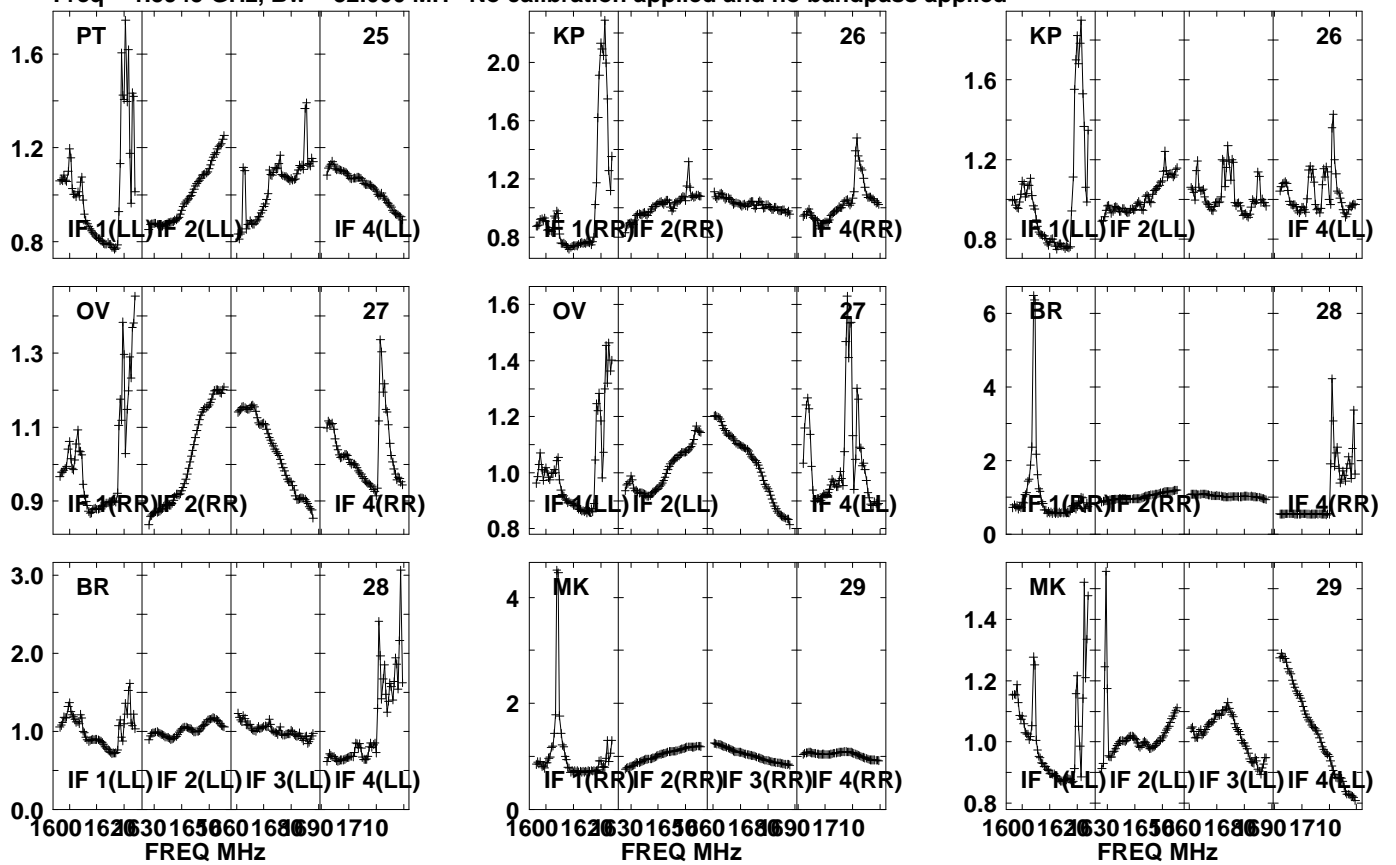

Lower frame: Real Jy  
Auto-corr total-power spectrum Antenna: \*  
Timerange: 00/21:27:01 to 00/21:30:29

Plot file version 1317 created 05-OCT-2021 17:11:06

J0827+5217 GM076.UVDATA.1

Freq = 1.5945 GHz, Bw = 32.000 MH No calibration applied and no bandpass applied

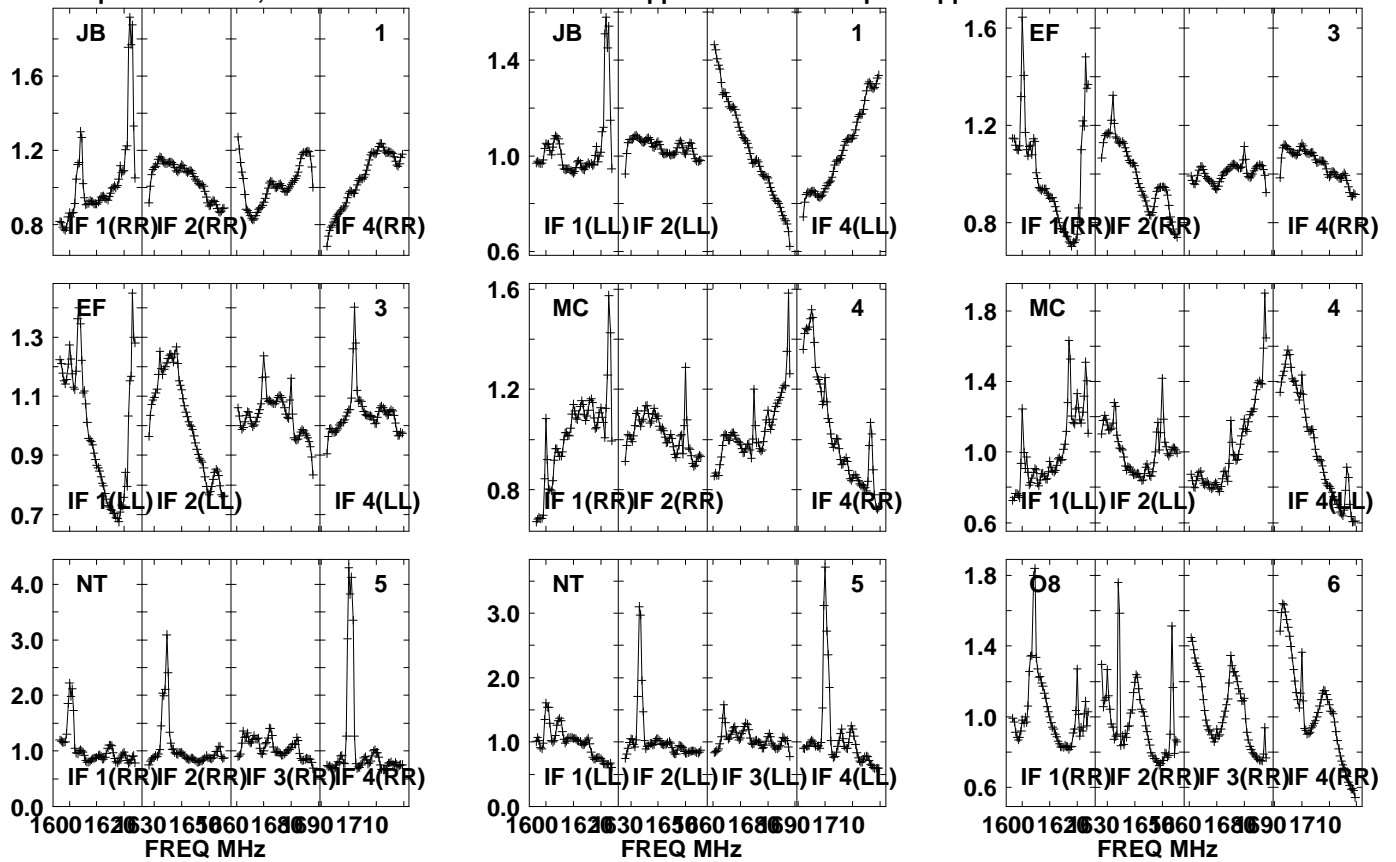

Lower frame: Real Jy  
Auto-corr total-power spectrum Antenna: \*  
Timerange: 00/21:31:01 to 00/21:32:29

Plot file version1318 created 05-OCT-2021 17:11:07

J0827+5217 GM076.UVDATA.1

Freq = 1.5945 GHz, Bw = 32.000 MH No calibration applied and no bandpass applied

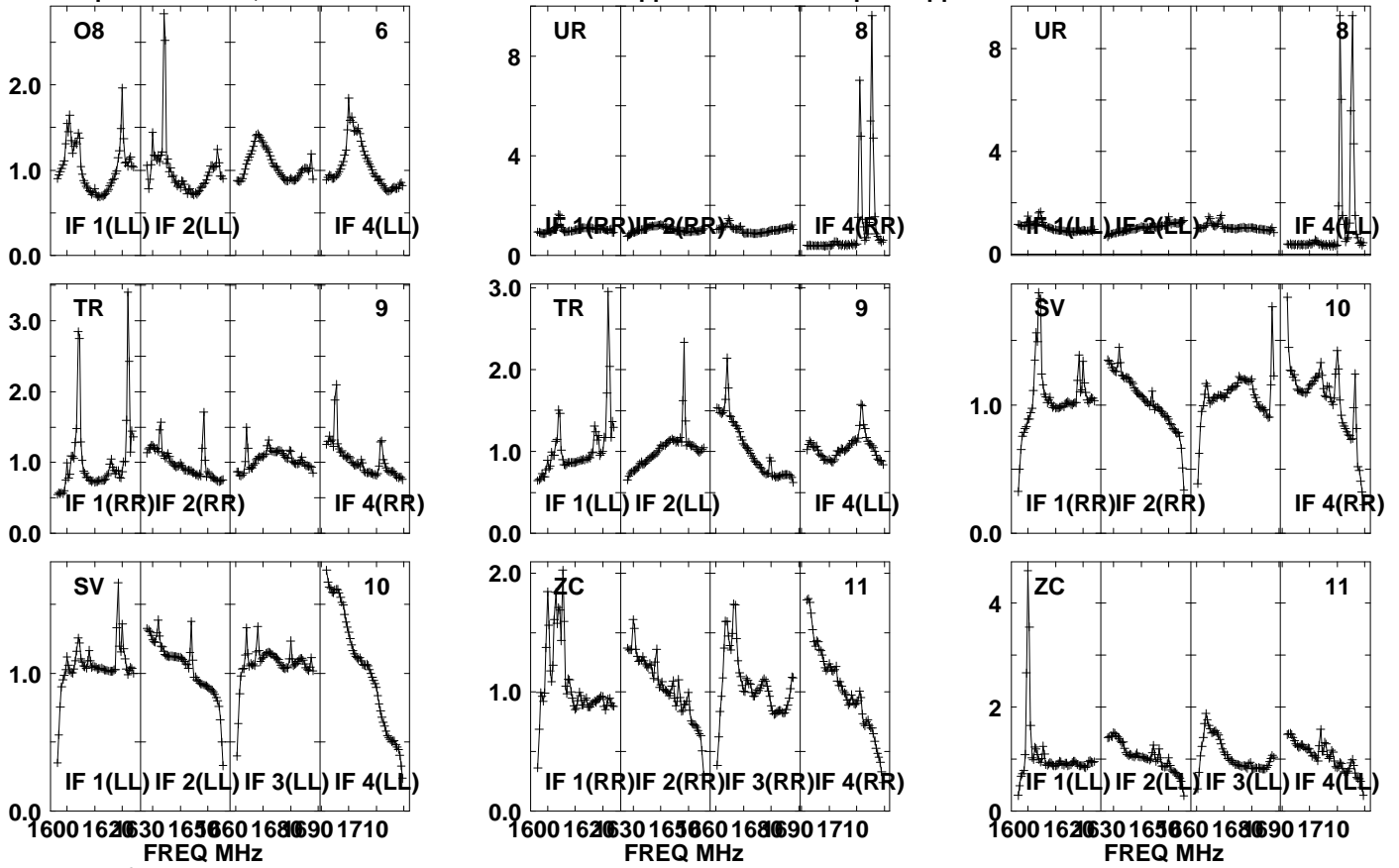

Lower frame: Real Jy

Auto-corr total-power spectrum Antenna: \*

Timerange: 00/21:31:01 to 00/21:32:29

Plot file version 1319 created 05-OCT-2021 17:11:07

J0827+5217 GM076.UVDATA.1

Freq = 1.5945 GHz, Bw = 32.000 MH No calibration applied and no bandpass applied

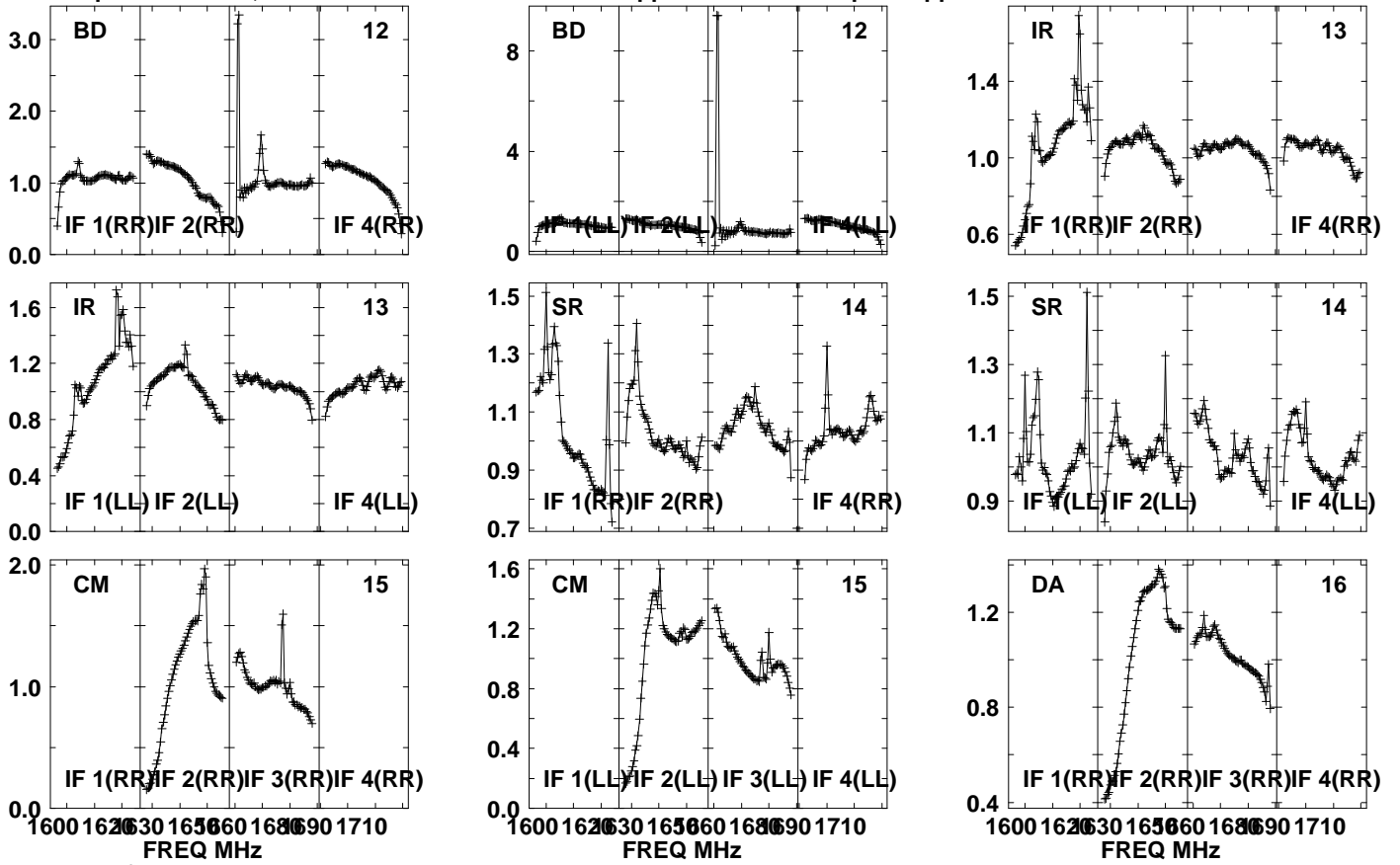

Lower frame: Real Jy

Auto-corr total-power spectrum Antenna: \*

Timerange: 00/21:31:01 to 00/21:32:29

Plot file version 1320 created 05-OCT-2021 17:11:07

J0827+5217 GM076.UVDATA.1

Freq = 1.5945 GHz, Bw = 32.000 MH No calibration applied and no bandpass applied

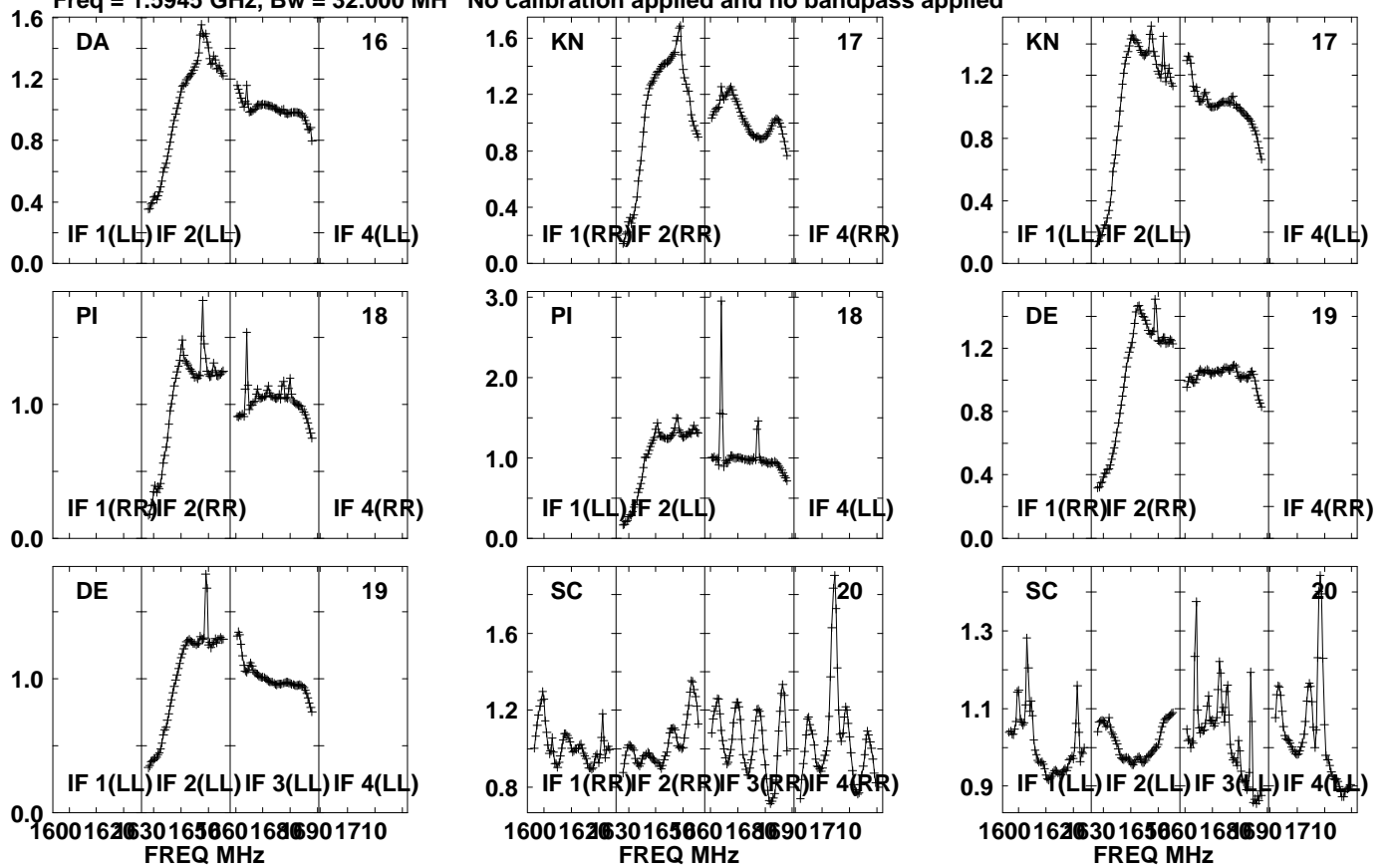

Lower frame: Real Jy  
Auto-corr total-power spectrum Antenna: \*  
Timerange: 00/21:31:01 to 00/21:32:29

Plot file version 1321 created 05-OCT-2021 17:11:08

J0827+5217 GM076.UVDATA.1

Freq = 1.5945 GHz, Bw = 32.000 MH No calibration applied and no bandpass applied

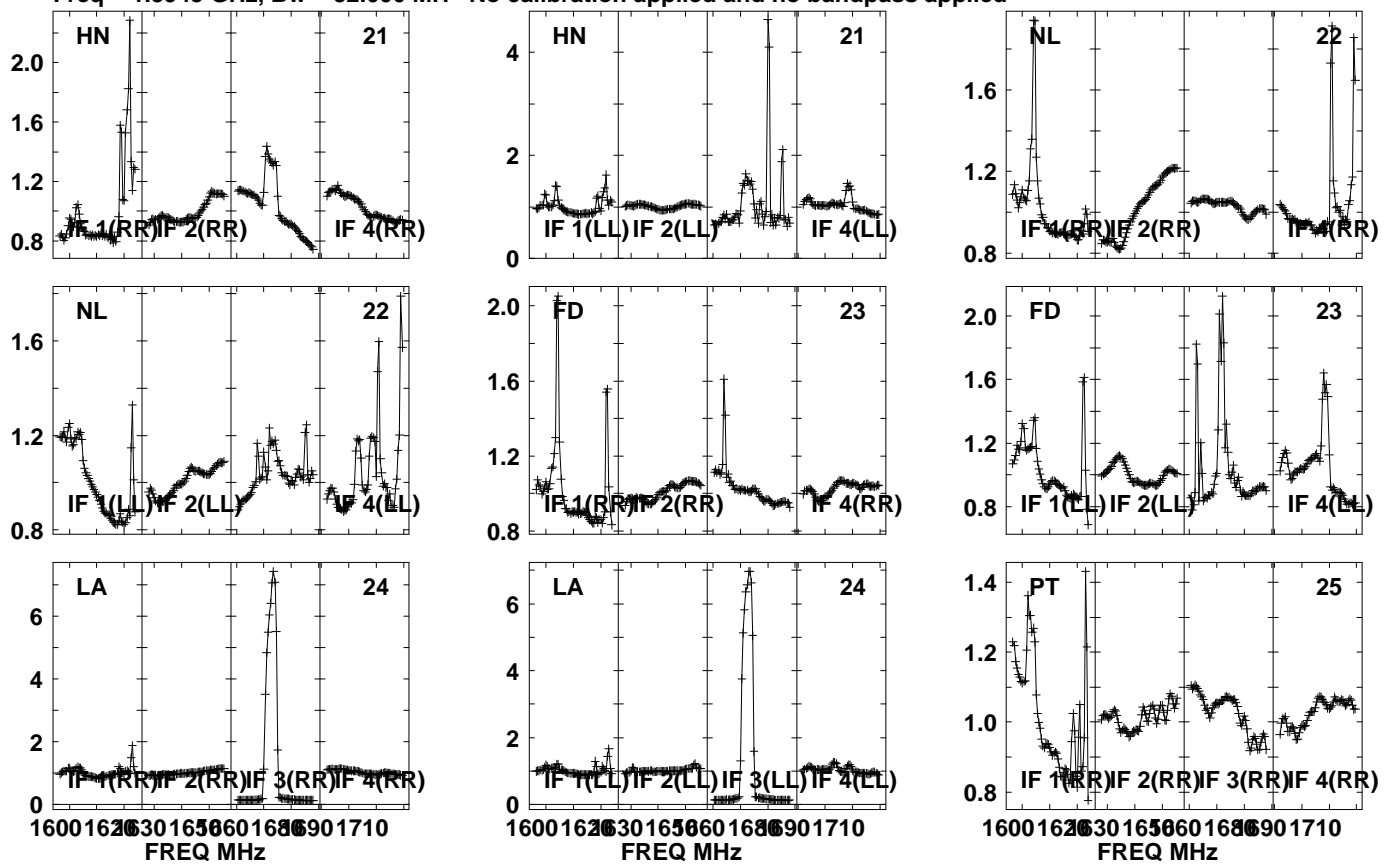

Lower frame: Real Jy  
Auto-corr total-power spectrum Antenna: \*  
Timerange: 00/21:31:01 to 00/21:32:29

Plot file version1322 created 05-OCT-2021 17:11:08

J0827+5217 GM076.UVDATA.1

Freq = 1.5945 GHz, Bw = 32.000 MH No calibration applied and no bandpass applied

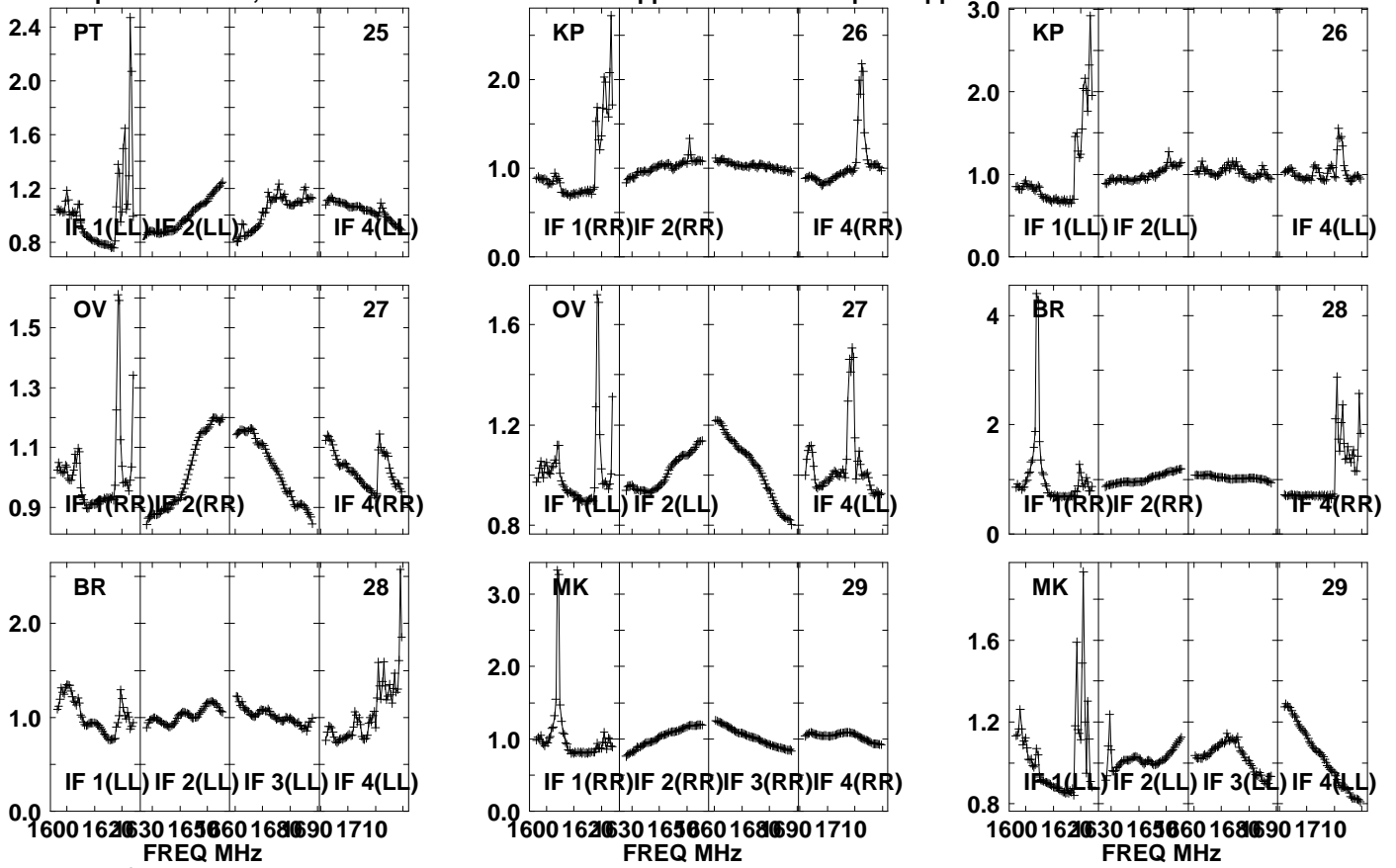

Lower frame: Real Jy  
Auto-corr total-power spectrum Antenna: \*  
Timerange: 00/21:31:01 to 00/21:32:29



Plot file version1323 created 05-OCT-2021 17:11:08

APM08279+525 GM076.UVDATA.1

Freq = 1.5945 GHz, Bw = 32.000 MH No calibration applied and no bandpass applied

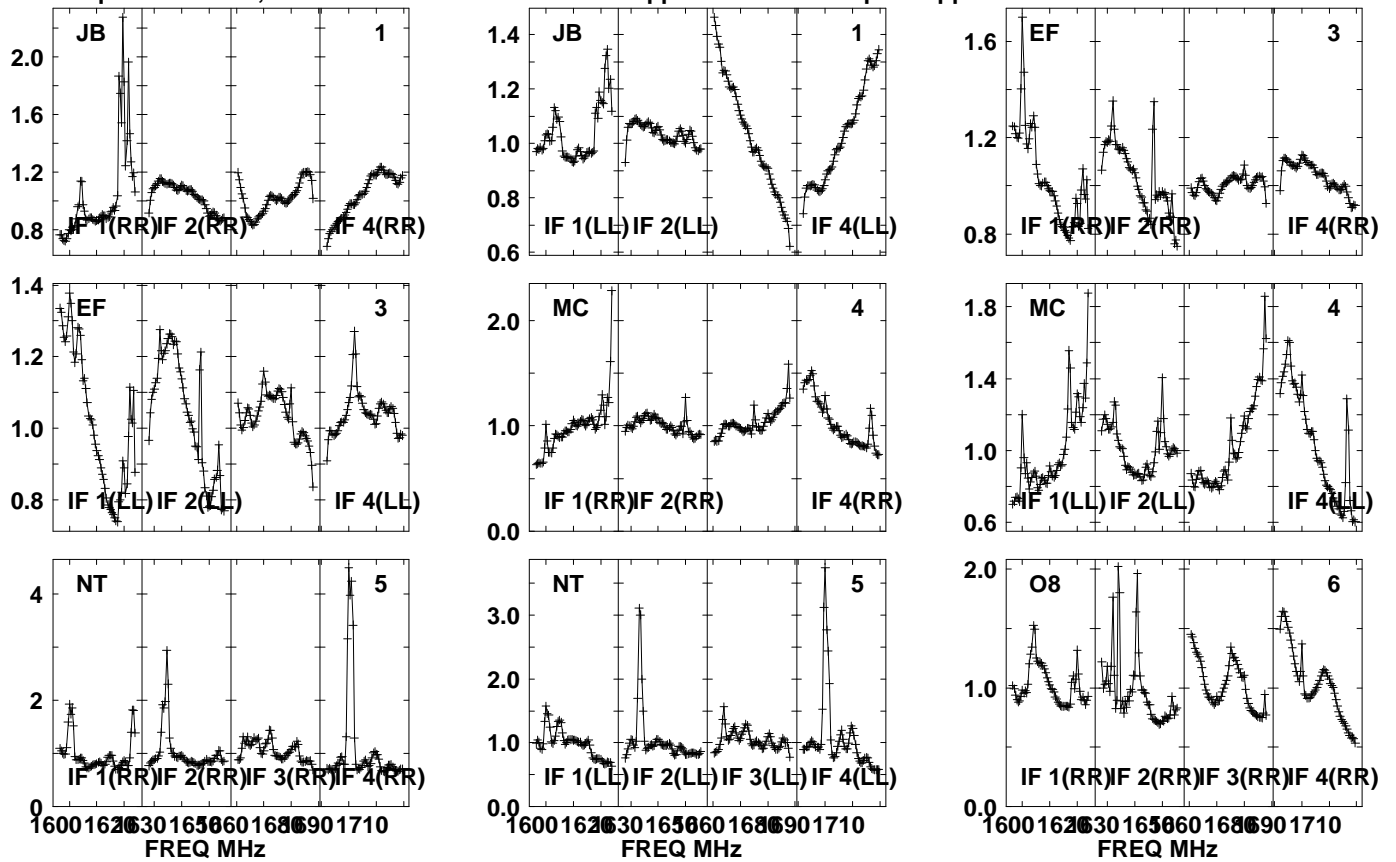

Lower frame: Real Jy  
Auto-corr total-power spectrum Antenna: \*  
Timerange: 00/21:32:31 to 00/21:35:59

Plot file version1324 created 05-OCT-2021 17:11:09

APM08279+525 GM076.UVDATA.1

Freq = 1.5945 GHz, Bw = 32.000 MH No calibration applied and no bandpass applied

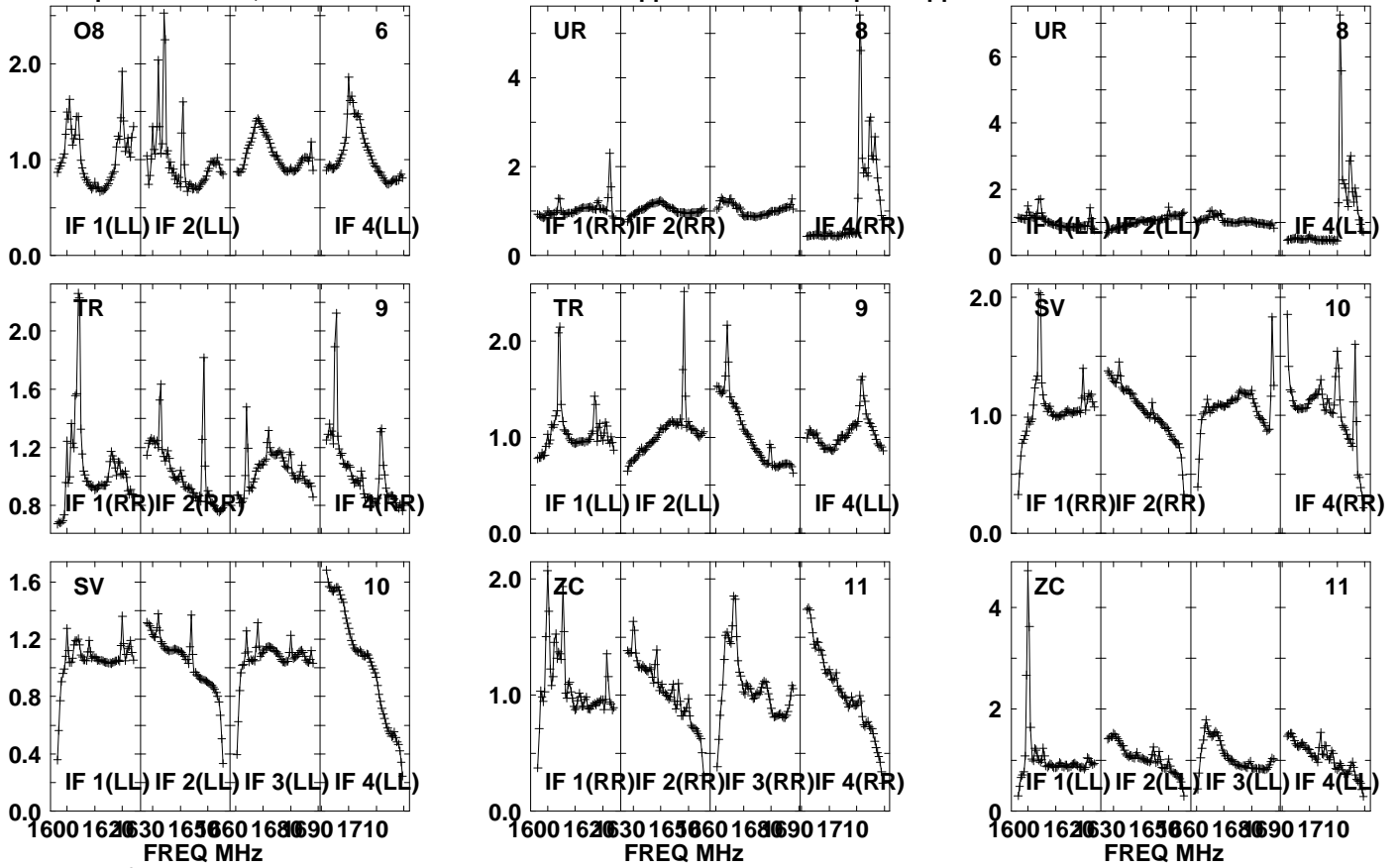

Lower frame: Real Jy

Auto-corr total-power spectrum Antenna: \*

Timerange: 00/21:32:31 to 00/21:35:59

Plot file version 1325 created 05-OCT-2021 17:11:09

APM08279+525 GM076.UVDATA.1

Freq = 1.5945 GHz, Bw = 32.000 MHz No calibration applied and no bandpass applied

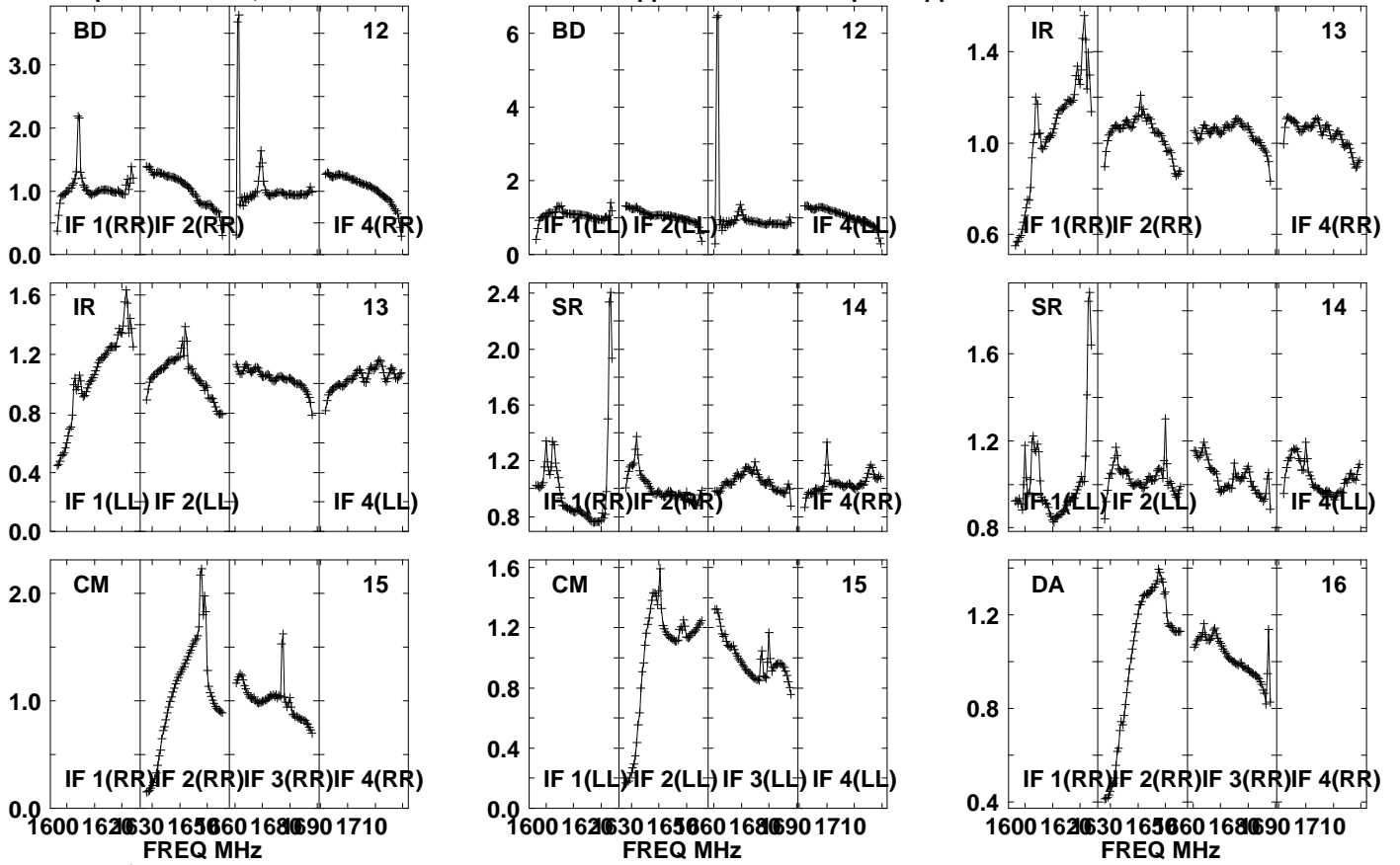

Lower frame: Real Jy

Auto-corr total-power spectrum Antenna: \*

Timerange: 00/21:32:31 to 00/21:35:59

Plot file version 1326 created 05-OCT-2021 17:11:10

APM08279+525 GM076.UVDATA.1

Freq = 1.5945 GHz, Bw = 32.000 MH No calibration applied and no bandpass applied

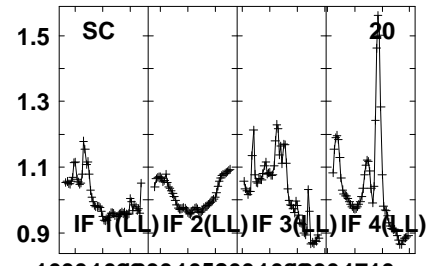
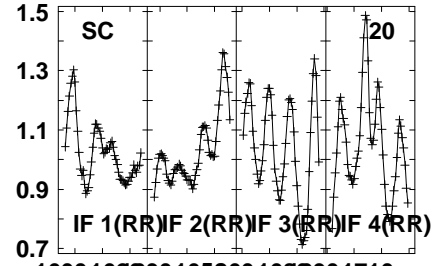
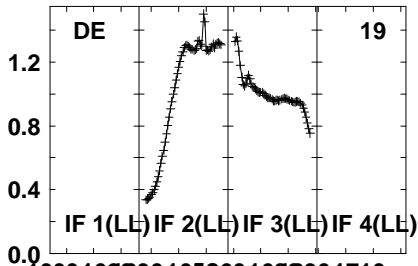
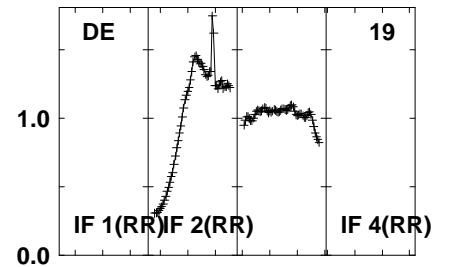
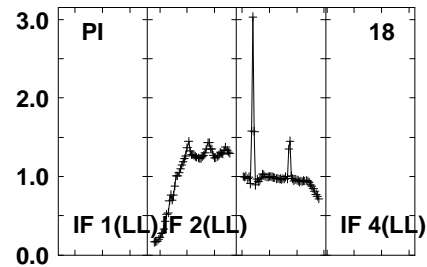
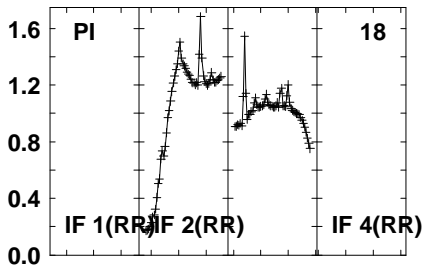
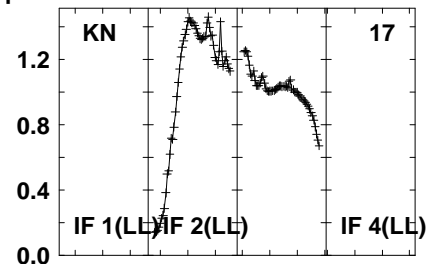
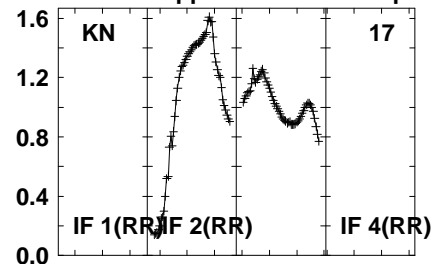
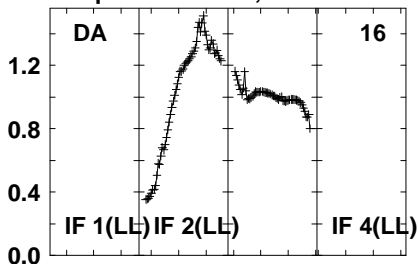

1600 1620 1630 1650 1660 1680 1690 1710  
FREQ MHz

1600 1620 1630 1650 1660 1680 1690 1710  
FREQ MHz

1600 1620 1630 1650 1660 1680 1690 1710  
FREQ MHz

Lower frame: Real Jy  
Auto-corr total-power spectrum Antenna: \*  
Timerange: 00/21:32:31 to 00/21:35:59

Plot file version1327 created 05-OCT-2021 17:11:10

APM08279+525 GM076.UVDATA.1

Freq = 1.5945 GHz, Bw = 32.000 MH No calibration applied and no bandpass applied

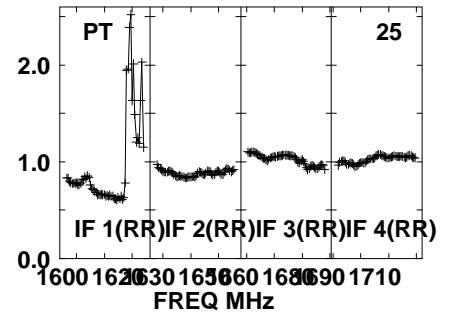
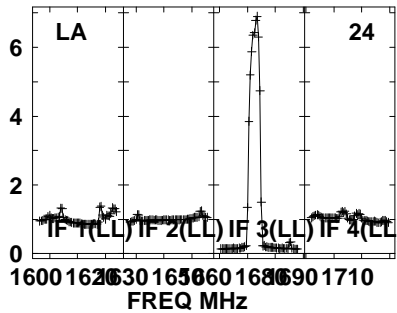
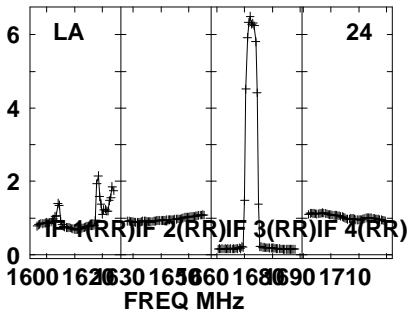
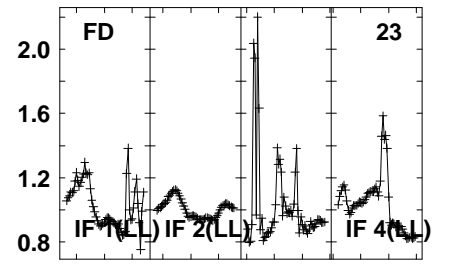
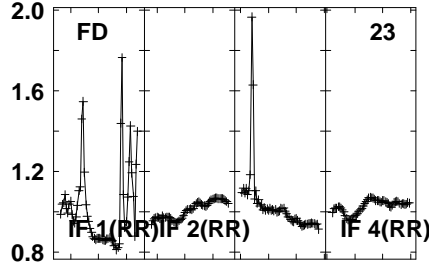
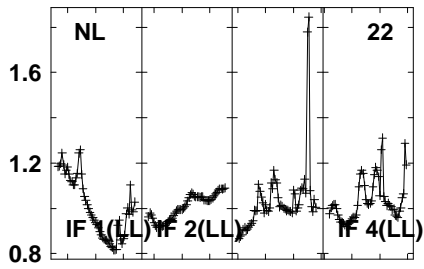
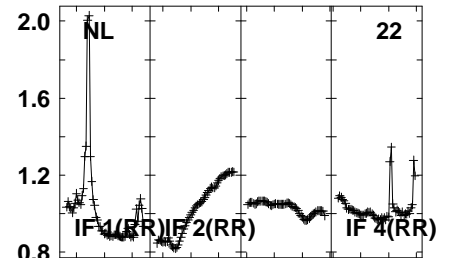
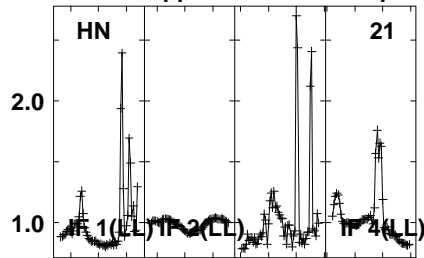
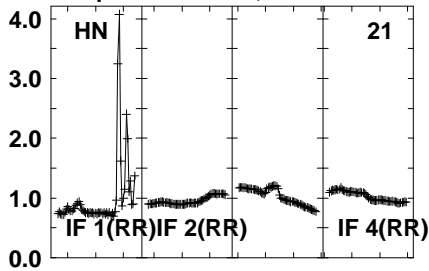

Lower frame: Real Jy

Auto-corr total-power spectrum Antenna: \*

Timerange: 00/21:32:31 to 00/21:35:59

Plot file version 1328 created 05-OCT-2021 17:11:10

APM08279+525 GM076.UVDATA.1

Freq = 1.5945 GHz, Bw = 32.000 MH No calibration applied and no bandpass applied

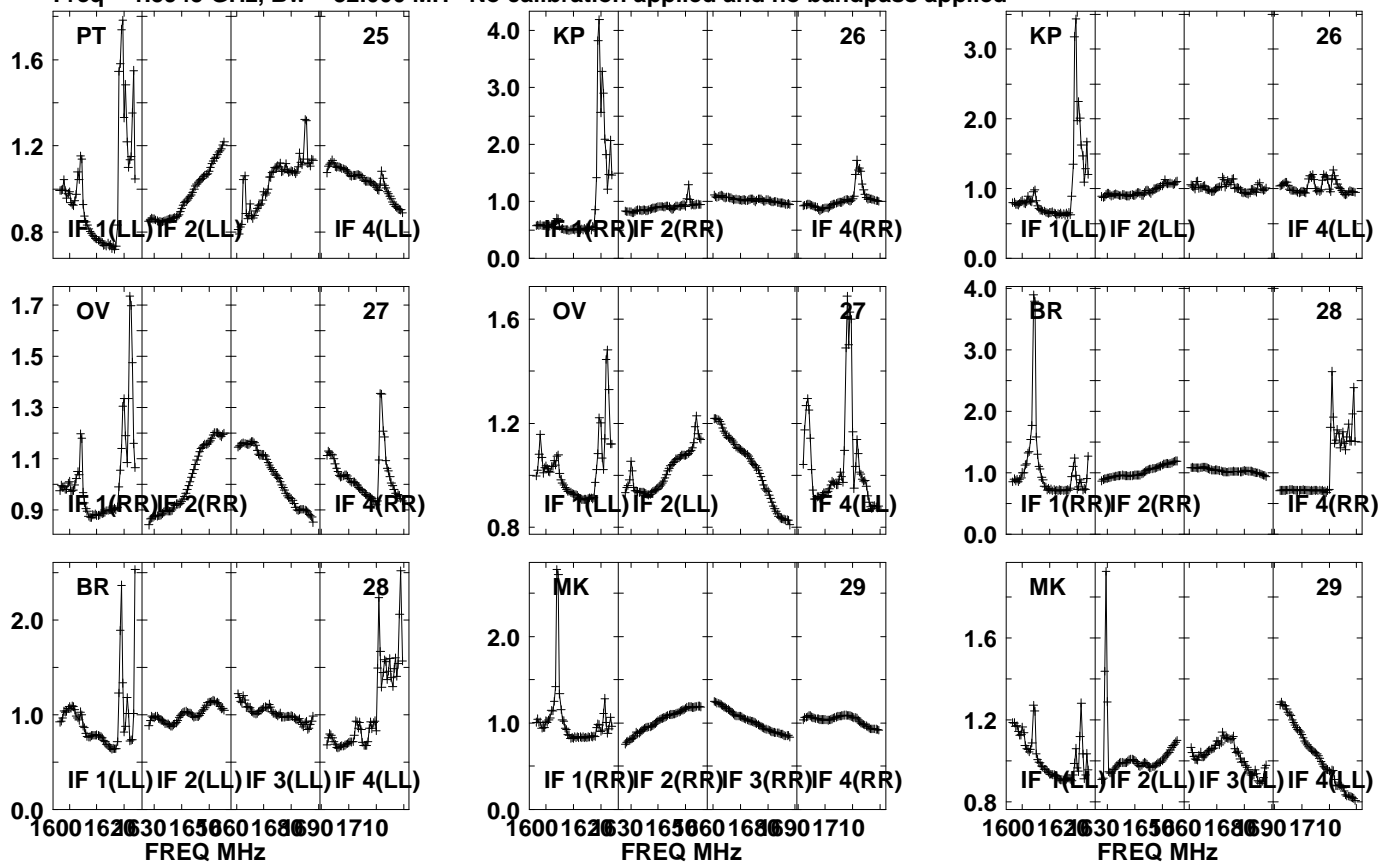

Lower frame: Real Jy  
Auto-corr total-power spectrum Antenna: \*  
Timerange: 00/21:32:31 to 00/21:35:59

Plot file version 1329 created 05-OCT-2021 17:11:11

J0827+5217 GM076.UVDATA.1

Freq = 1.5945 GHz, Bw = 32.000 MH No calibration applied and no bandpass applied

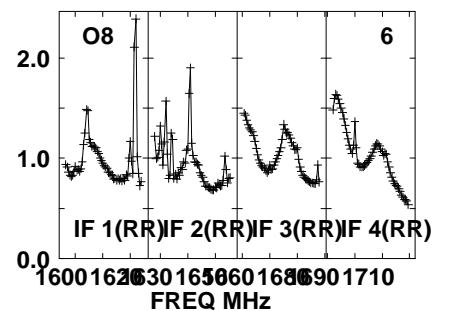
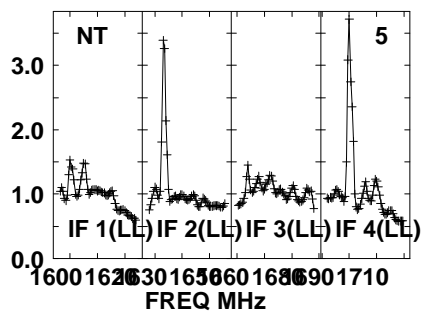
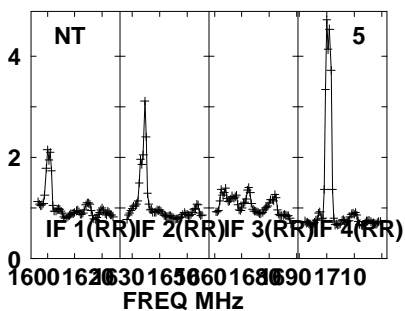
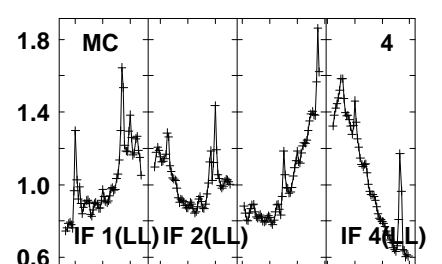
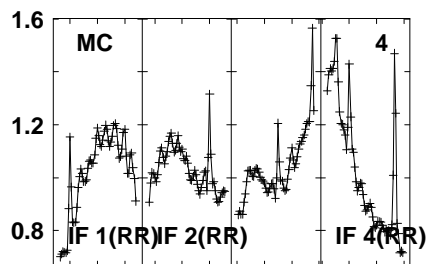
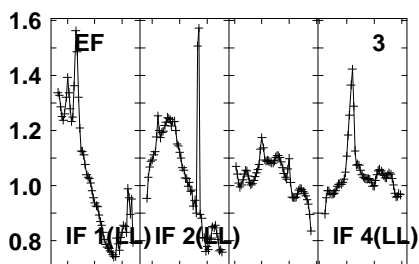
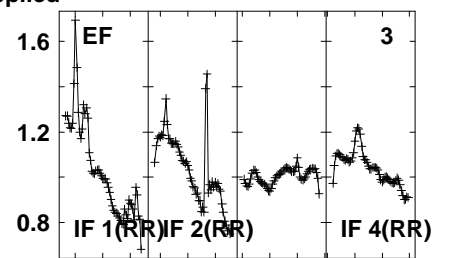
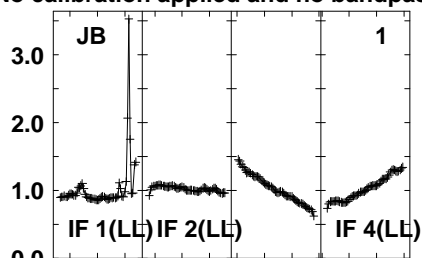
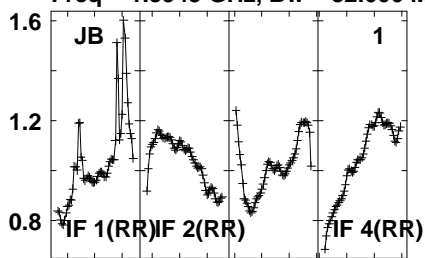

Lower frame: Real Jy  
Auto-corr total-power spectrum Antenna: \*  
Timerange: 00/21:36:01 to 00/21:37:29

Plot file version 1330 created 05-OCT-2021 17:11:11

J0827+5217 GM076.UVDATA.1

Freq = 1.5945 GHz, Bw = 32.000 MH No calibration applied and no bandpass applied

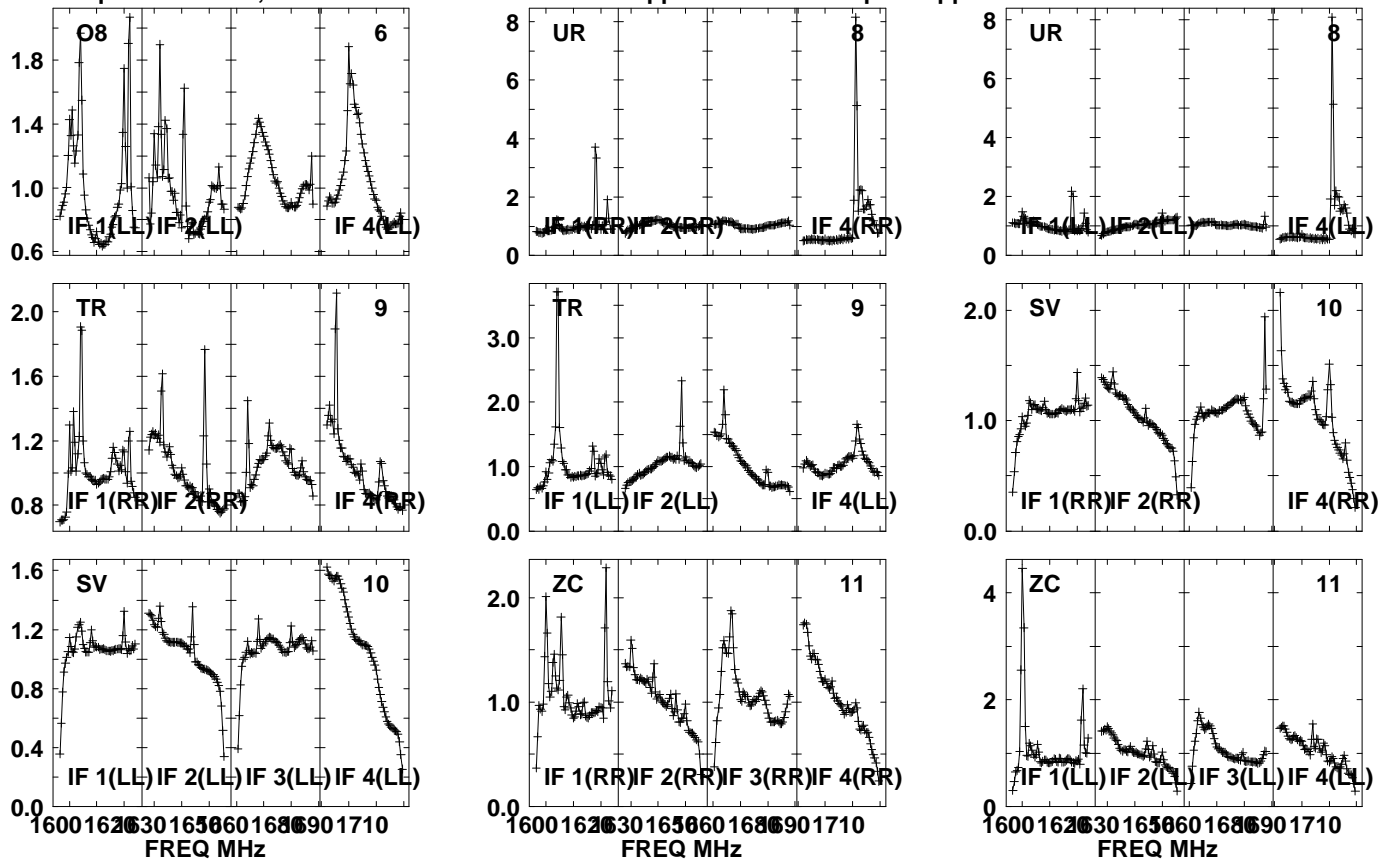

Lower frame: Real Jy  
Auto-corr total-power spectrum Antenna: \*  
Timerange: 00/21:36:01 to 00/21:37:29



Plot file version1331 created 05-OCT-2021 17:11:11

J0827+5217 GM076.UVDATA.1

Freq = 1.5945 GHz, Bw = 32.000 MH No calibration applied and no bandpass applied

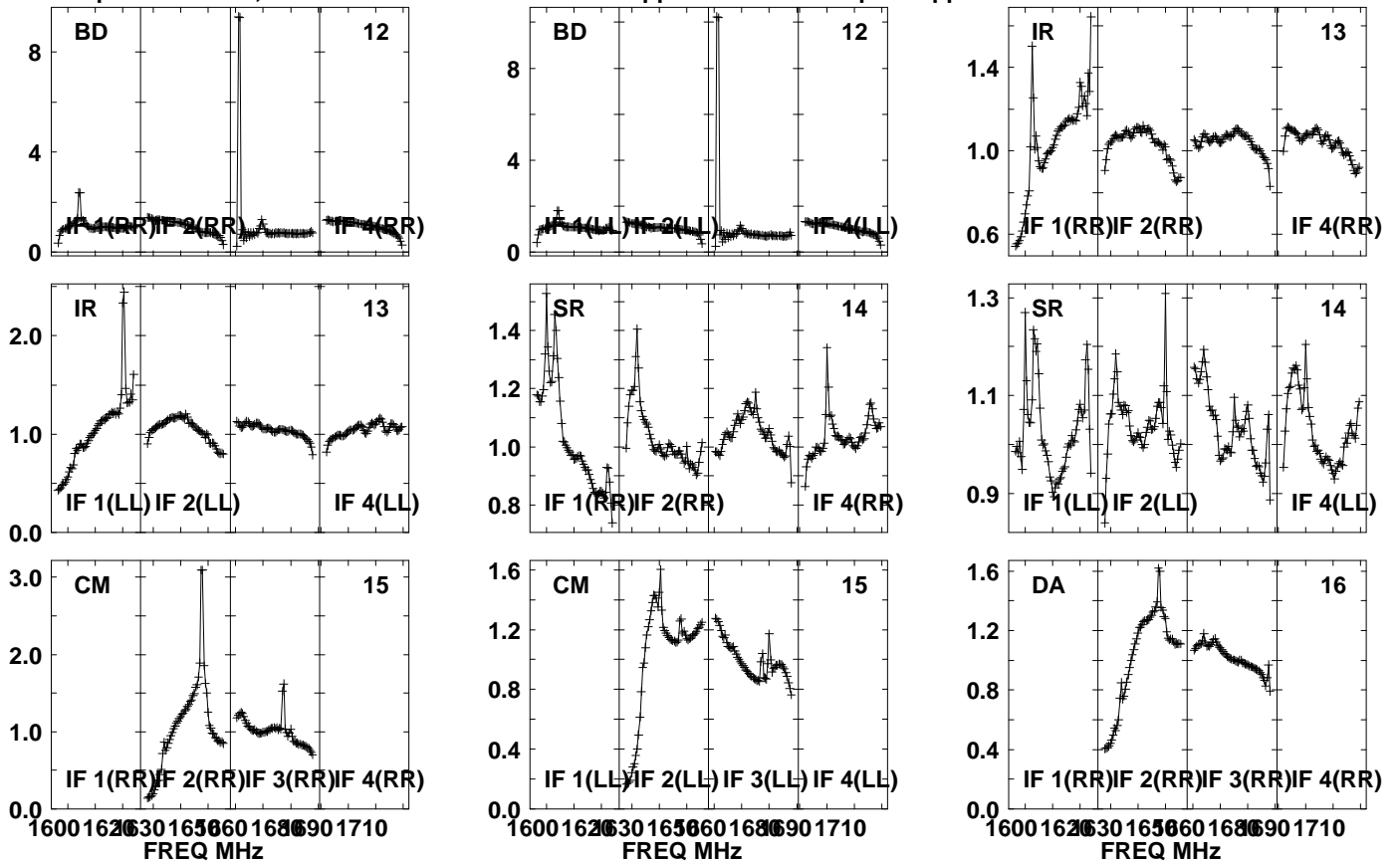

Lower frame: Real Jy

Auto-corr total-power spectrum Antenna: \*

Timerange: 00/21:36:01 to 00/21:37:29

Plot file version 1332 created 05-OCT-2021 17:11:12

J0827+5217 GM076.UVDATA.1

Freq = 1.5945 GHz, Bw = 32.000 MH No calibration applied and no bandpass applied

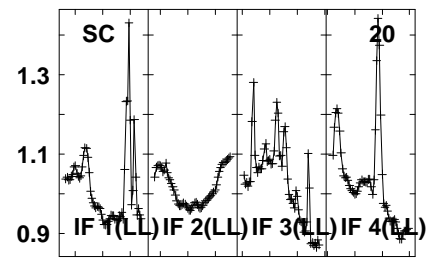
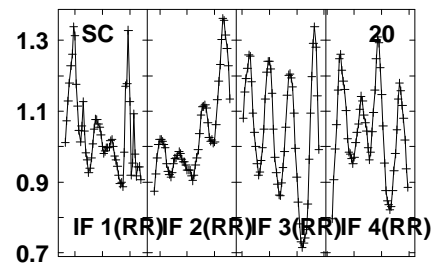
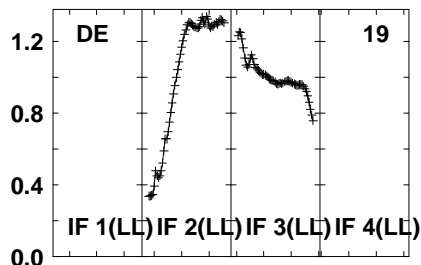
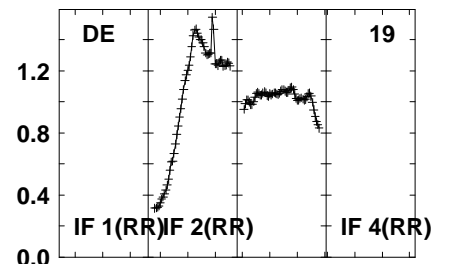
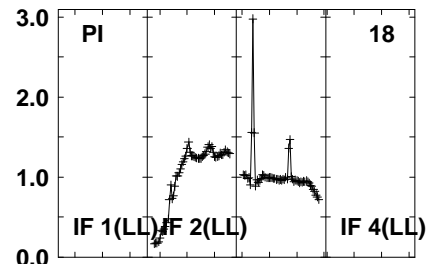
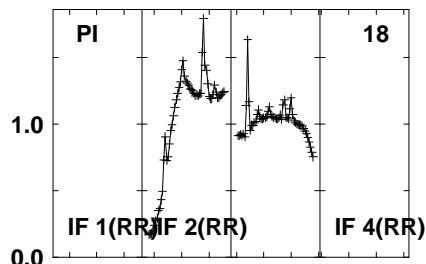
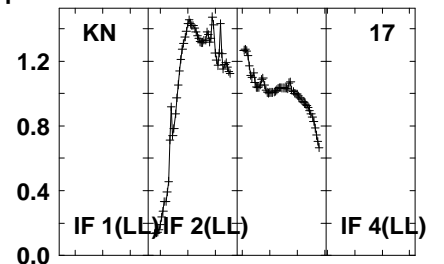
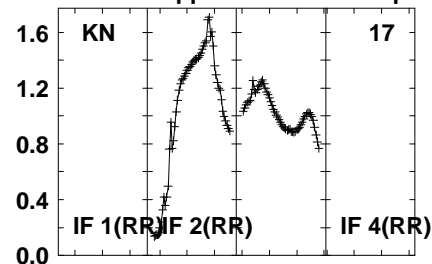
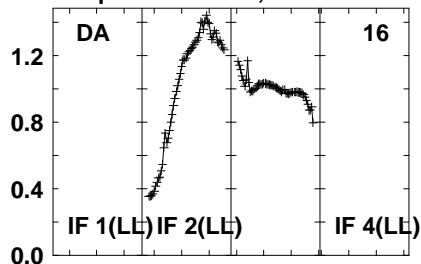

1600 1620 1630 1650 1660 1680 1690 1710  
FREQ MHz

1600 1620 1630 1650 1660 1680 1690 1710  
FREQ MHz

1600 1620 1630 1650 1660 1680 1690 1710  
FREQ MHz

Lower frame: Real Jy  
Auto-corr total-power spectrum Antenna: \*  
Timerange: 00/21:36:01 to 00/21:37:29

Plot file version1333 created 05-OCT-2021 17:11:12

J0827+5217 GM076.UVDATA.1

Freq = 1.5945 GHz, Bw = 32.000 MH No calibration applied and no bandpass applied

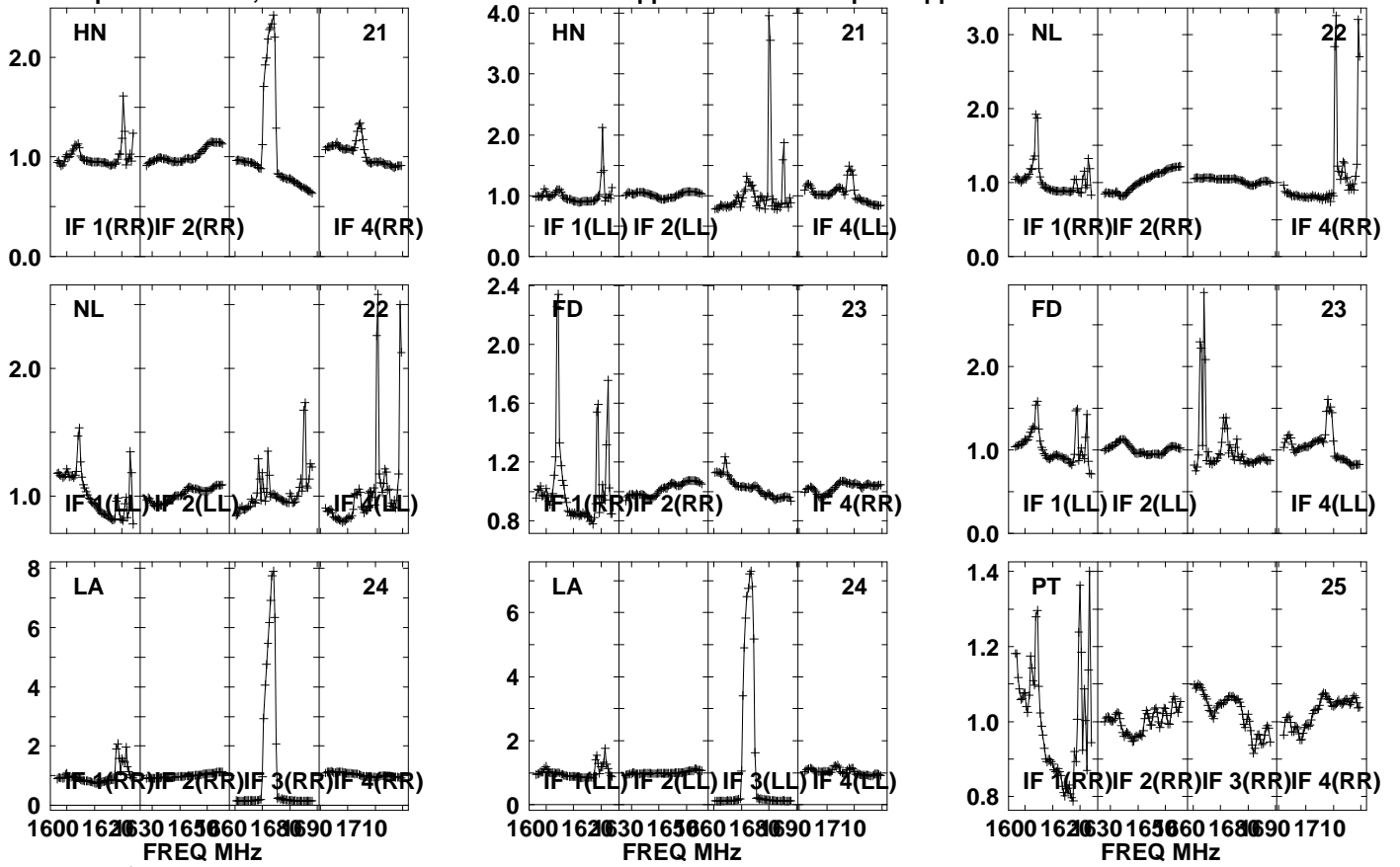

Lower frame: Real Jy  
Auto-corr total-power spectrum Antenna: \*  
Timerange: 00/21:36:01 to 00/21:37:29

Plot file version 1334 created 05-OCT-2021 17:11:12

J0827+5217 GM076.UVDATA.1

Freq = 1.5945 GHz, Bw = 32.000 MH No calibration applied and no bandpass applied

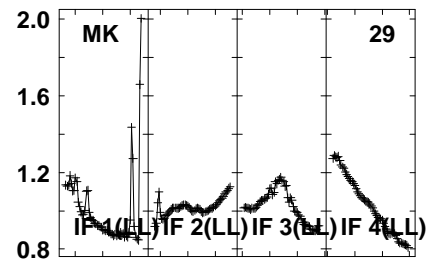
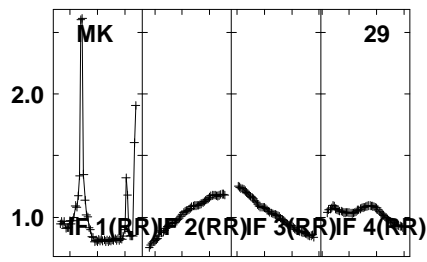
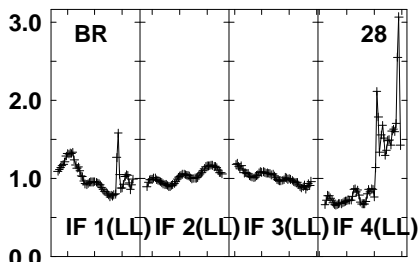
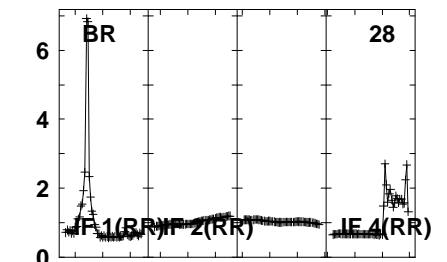
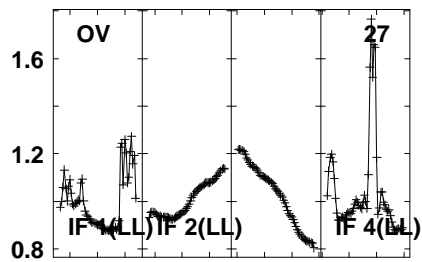
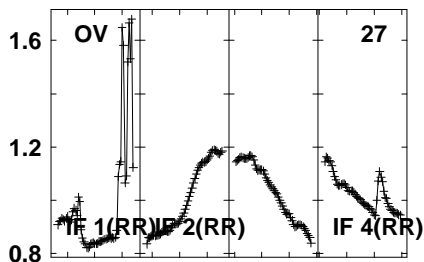
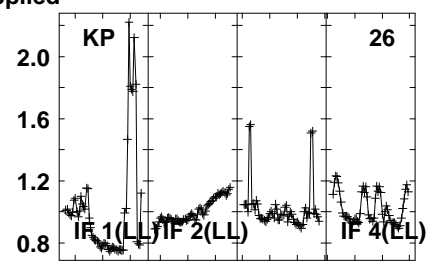
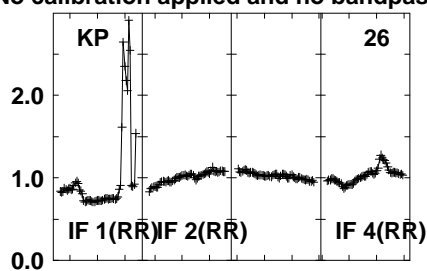
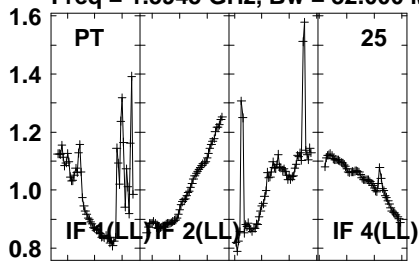

1600 1620 1630 1650 1660 1680 1690 1710  
FREQ MHz

1600 1620 1630 1650 1660 1680 1690 1710  
FREQ MHz

1600 1620 1630 1650 1660 1680 1690 1710  
FREQ MHz

Lower frame: Real Jy  
Auto-corr total-power spectrum Antenna: \*  
Timerange: 00/21:36:01 to 00/21:37:29

Plot file version1335 created 05-OCT-2021 17:11:12

APM08279+525 GM076.UVDATA.1

Freq = 1.5945 GHz, Bw = 32.000 MH No calibration applied and no bandpass applied

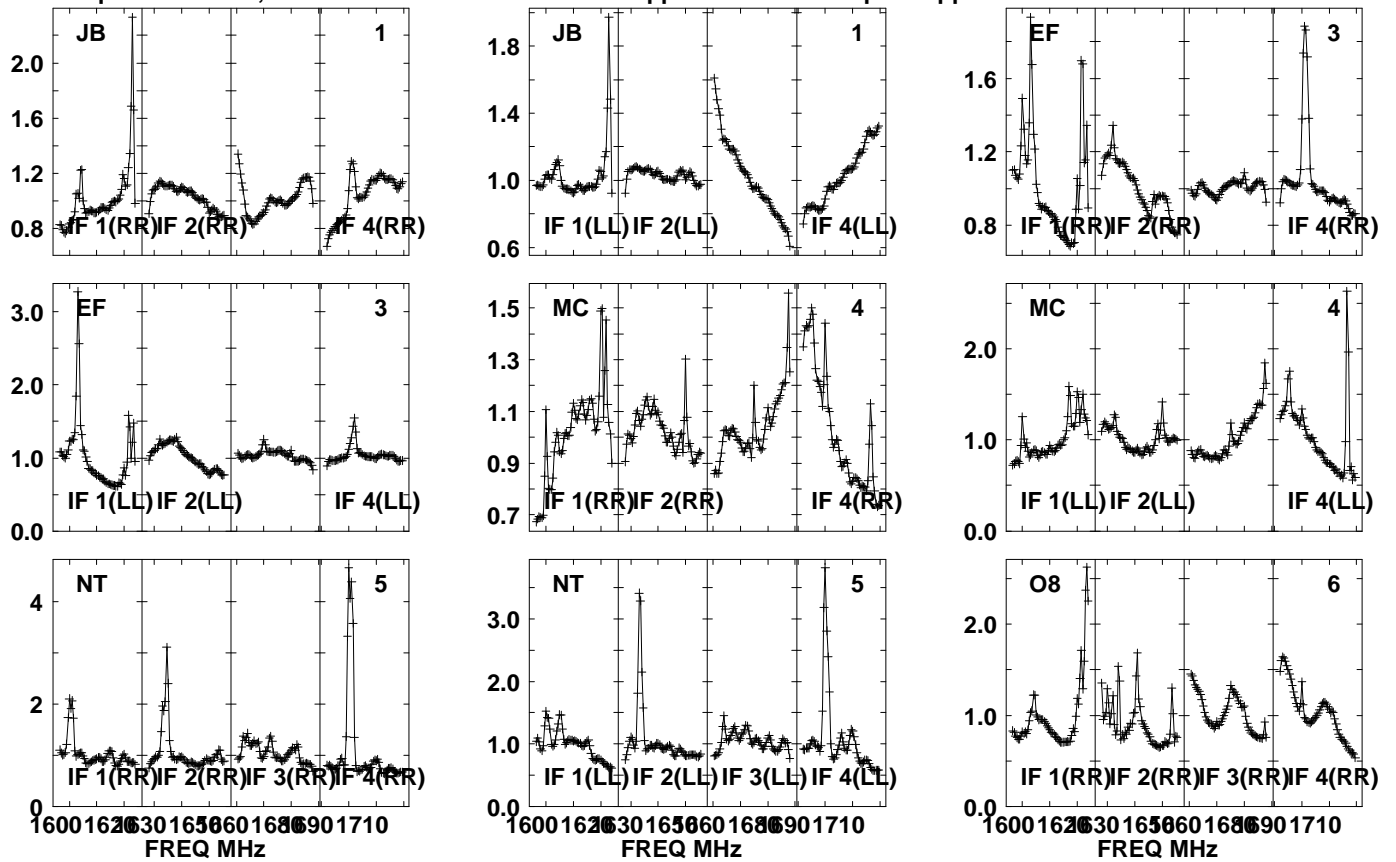

Lower frame: Real Jy  
Auto-corr total-power spectrum Antenna: \*  
Timerange: 00/21:37:31 to 00/21:40:59

Plot file version1336 created 05-OCT-2021 17:11:13

APM08279+525 GM076.UVDATA.1

Freq = 1.5945 GHz, Bw = 32.000 MH No calibration applied and no bandpass applied

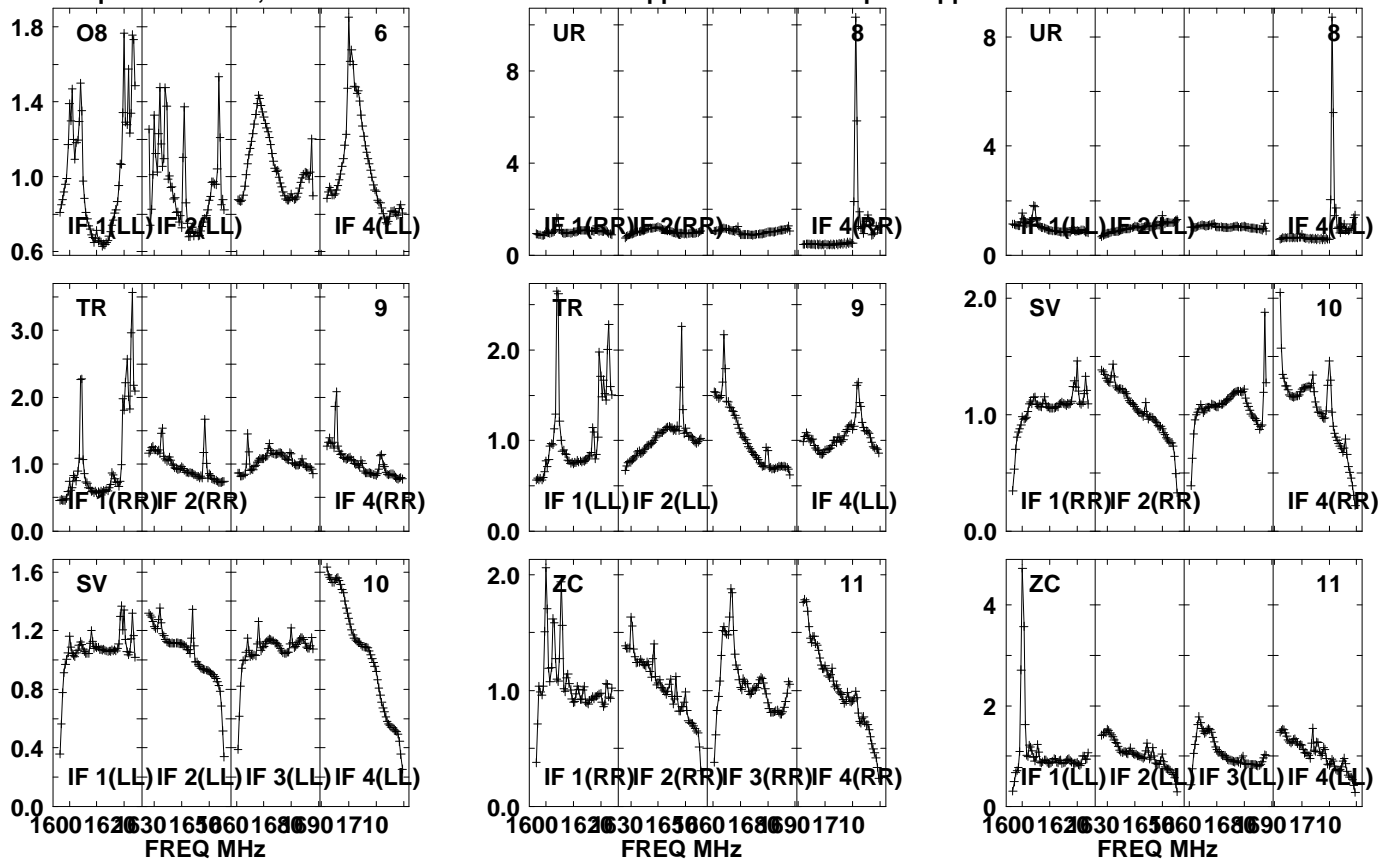

Lower frame: Real Jy  
Auto-corr total-power spectrum Antenna: \*  
Timerange: 00/21:37:31 to 00/21:40:59

Plot file version1337 created 05-OCT-2021 17:11:13

APM08279+525 GM076.UVDATA.1

Freq = 1.5945 GHz, Bw = 32.000 MH No calibration applied and no bandpass applied

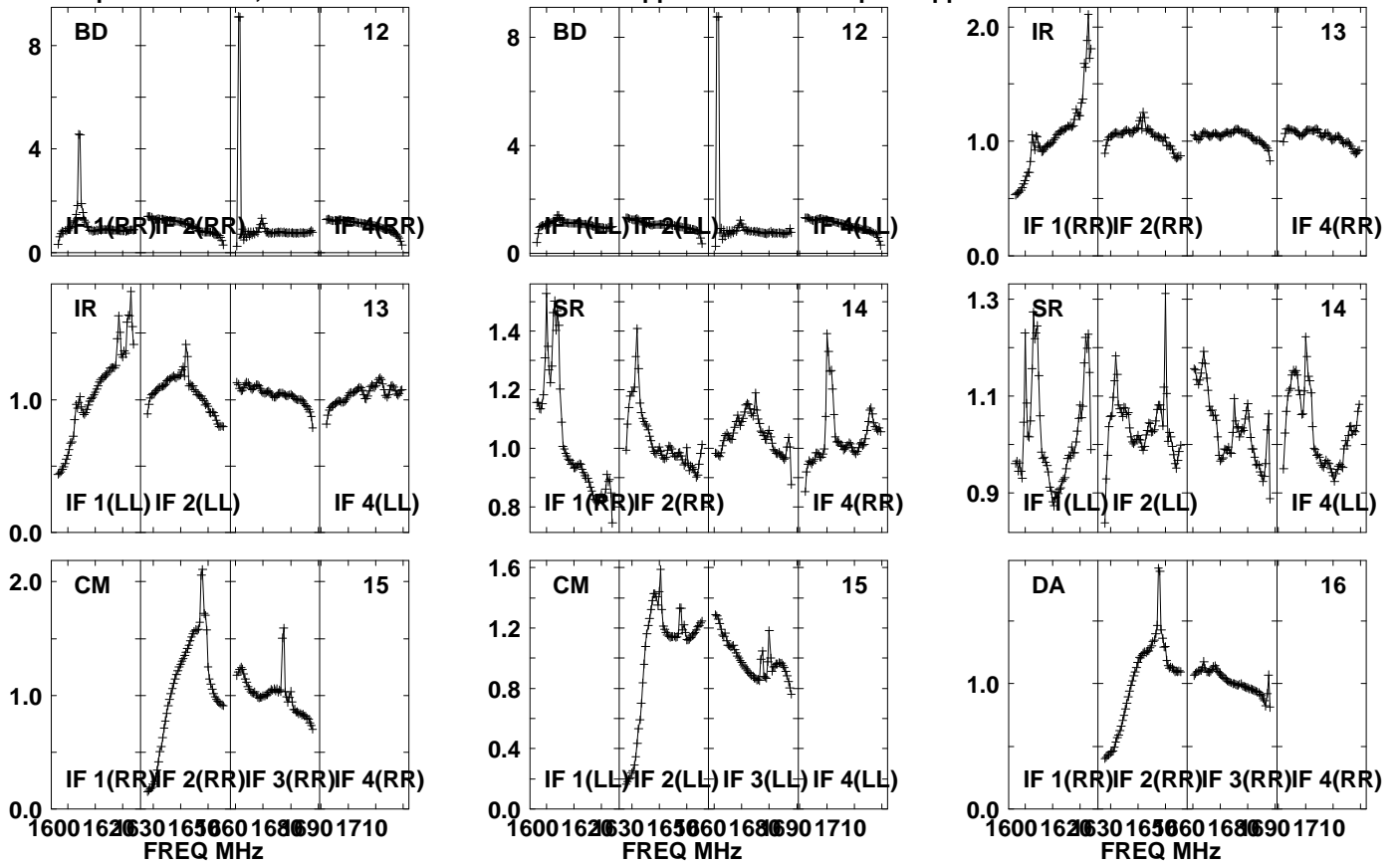

Lower frame: Real Jy

Auto-corr total-power spectrum Antenna: \*

Timerange: 00/21:37:31 to 00/21:40:59

Plot file version1338 created 05-OCT-2021 17:11:14

APM08279+525 GM076.UVDATA.1

Freq = 1.5945 GHz, Bw = 32.000 MH No calibration applied and no bandpass applied

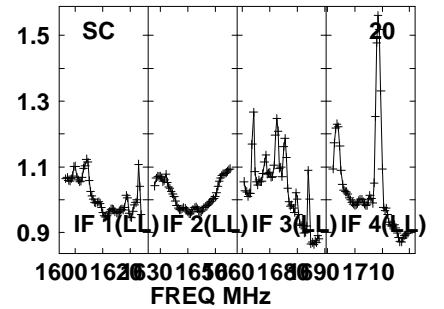
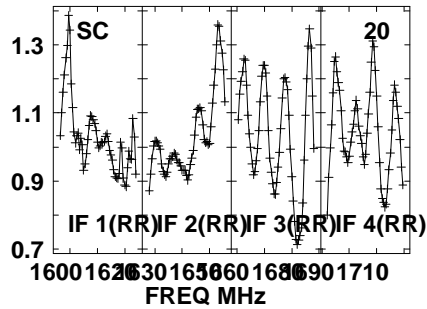
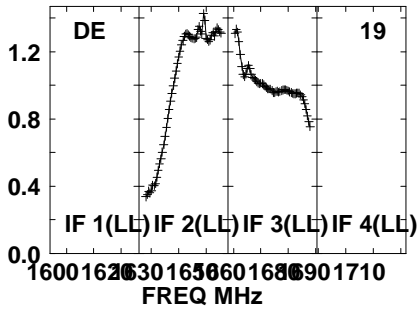
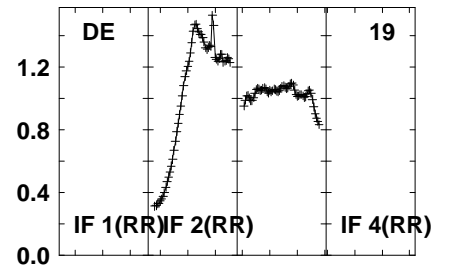
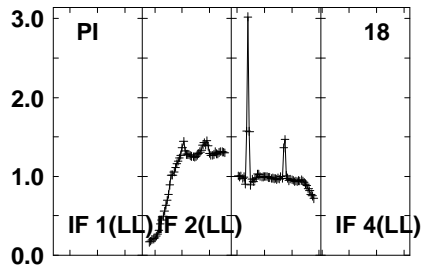
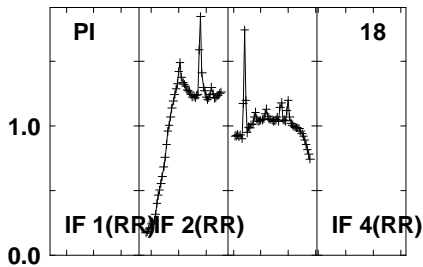
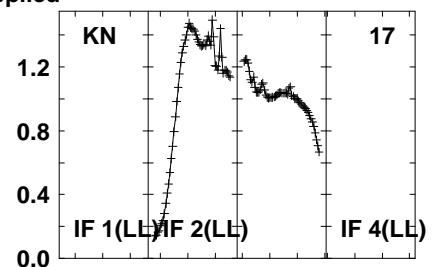
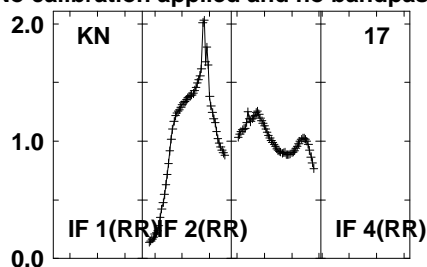
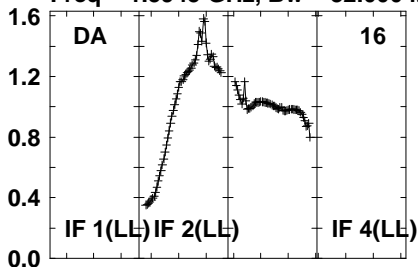

Lower frame: Real Jy  
Auto-corr total-power spectrum Antenna: \*  
Timerange: 00/21:37:31 to 00/21:40:59



Plot file version1339 created 05-OCT-2021 17:11:14

APM08279+525 GM076.UVDATA.1

Freq = 1.5945 GHz, Bw = 32.000 MH No calibration applied and no bandpass applied

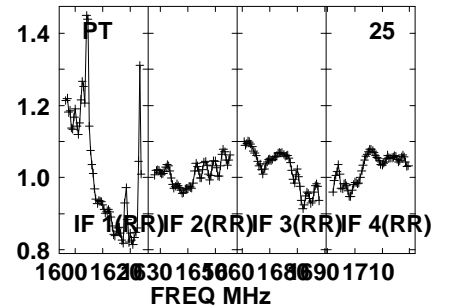
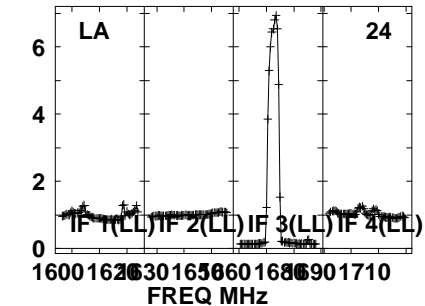
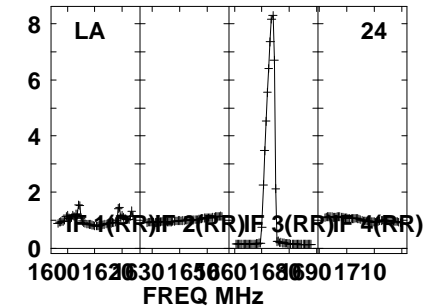
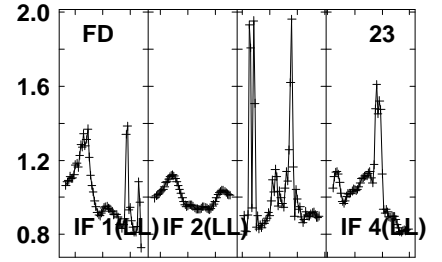
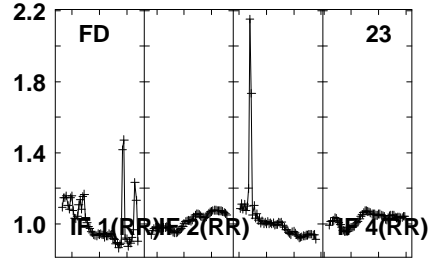
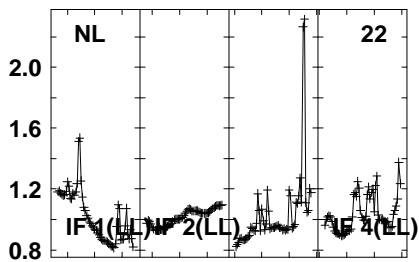
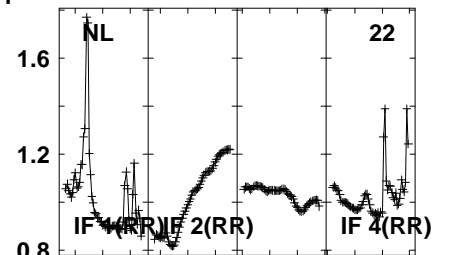
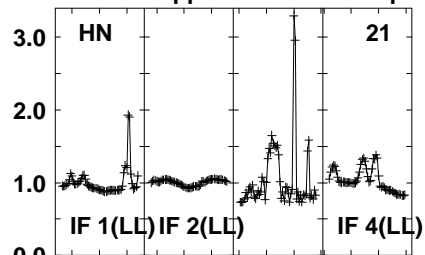
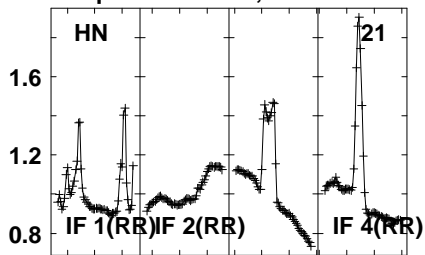

Lower frame: Real Jy  
Auto-corr total-power spectrum Antenna: \*  
Timerange: 00/21:37:31 to 00/21:40:59

Plot file version 1340 created 05-OCT-2021 17:11:14

APM08279+525 GM076.UVDATA.1

Freq = 1.5945 GHz, Bw = 32.000 MH

No calibration applied and no bandpass applied

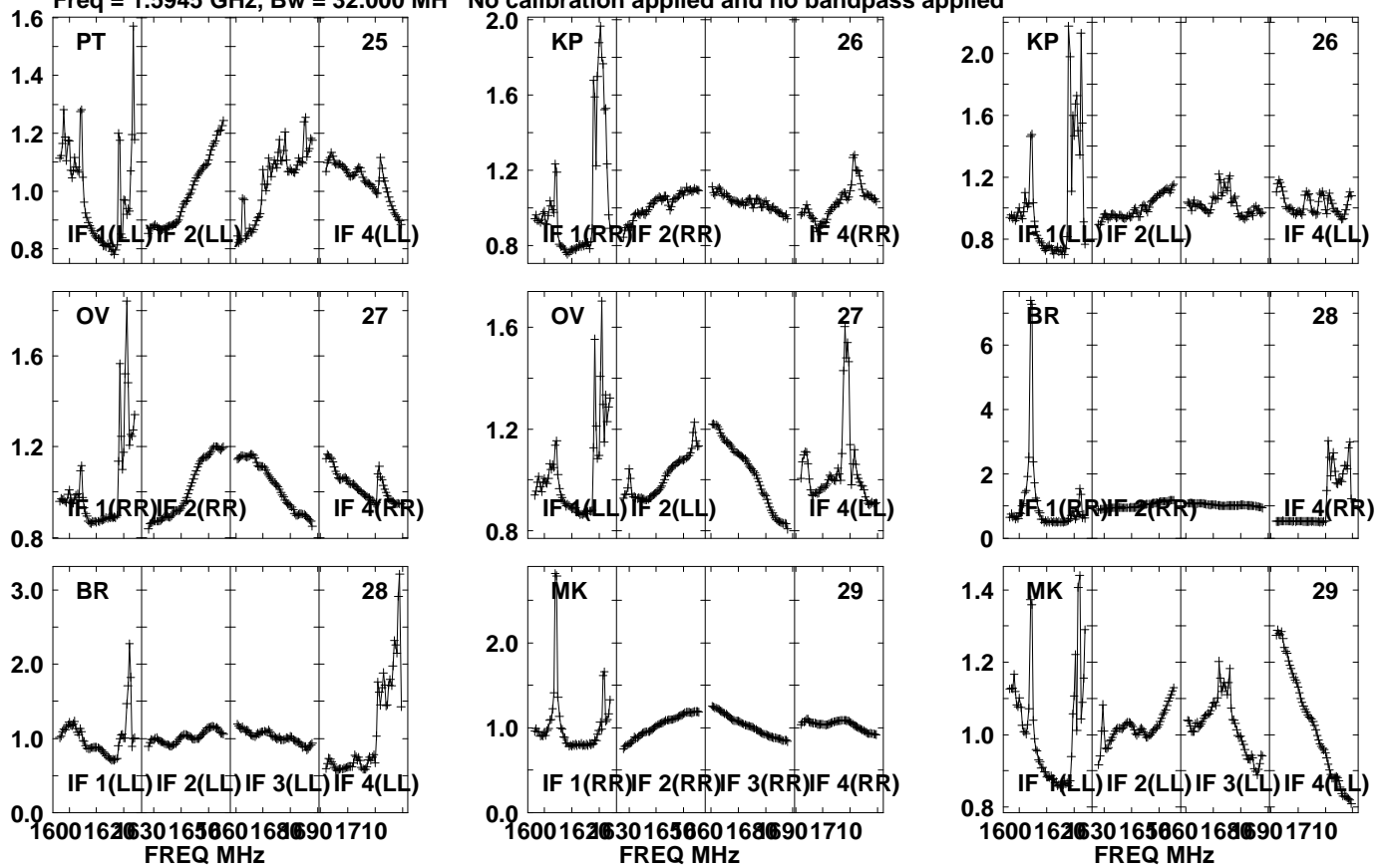

Lower frame: Real Jy  
Auto-corr total-power spectrum Antenna: \*  
Timerange: 00/21:37:31 to 00/21:40:59

Plot file version1341 created 05-OCT-2021 17:11:15

J0827+5217 GM076.UVDATA.1

Freq = 1.5945 GHz, Bw = 32.000 MH No calibration applied and no bandpass applied

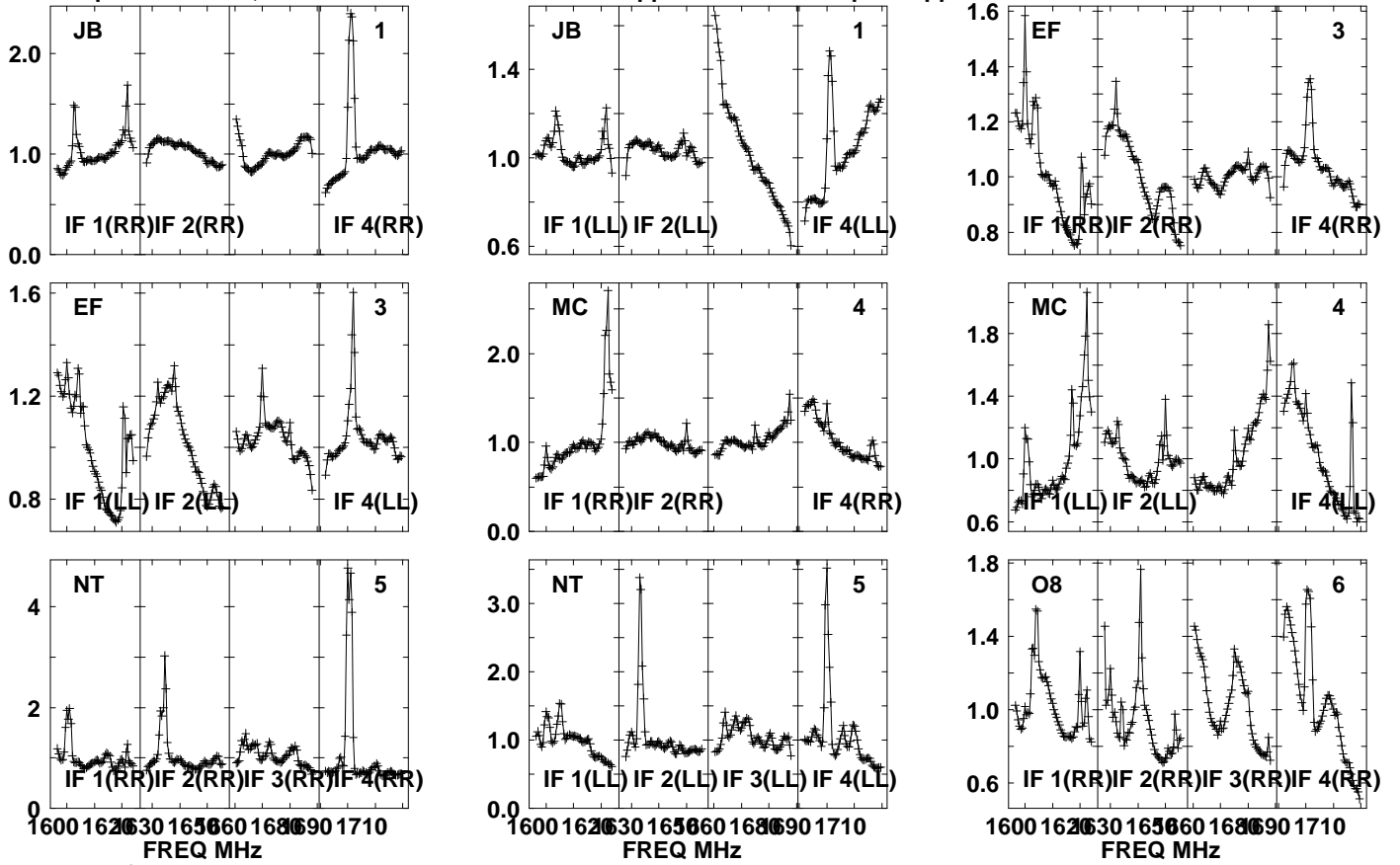

Lower frame: Real Jy

Auto-corr total-power spectrum Antenna: \*

Timerange: 00/21:41:31 to 00/21:42:59

Plot file version1342 created 05-OCT-2021 17:11:15

J0827+5217 GM076.UVDATA.1

Freq = 1.5945 GHz, Bw = 32.000 MH No calibration applied and no bandpass applied

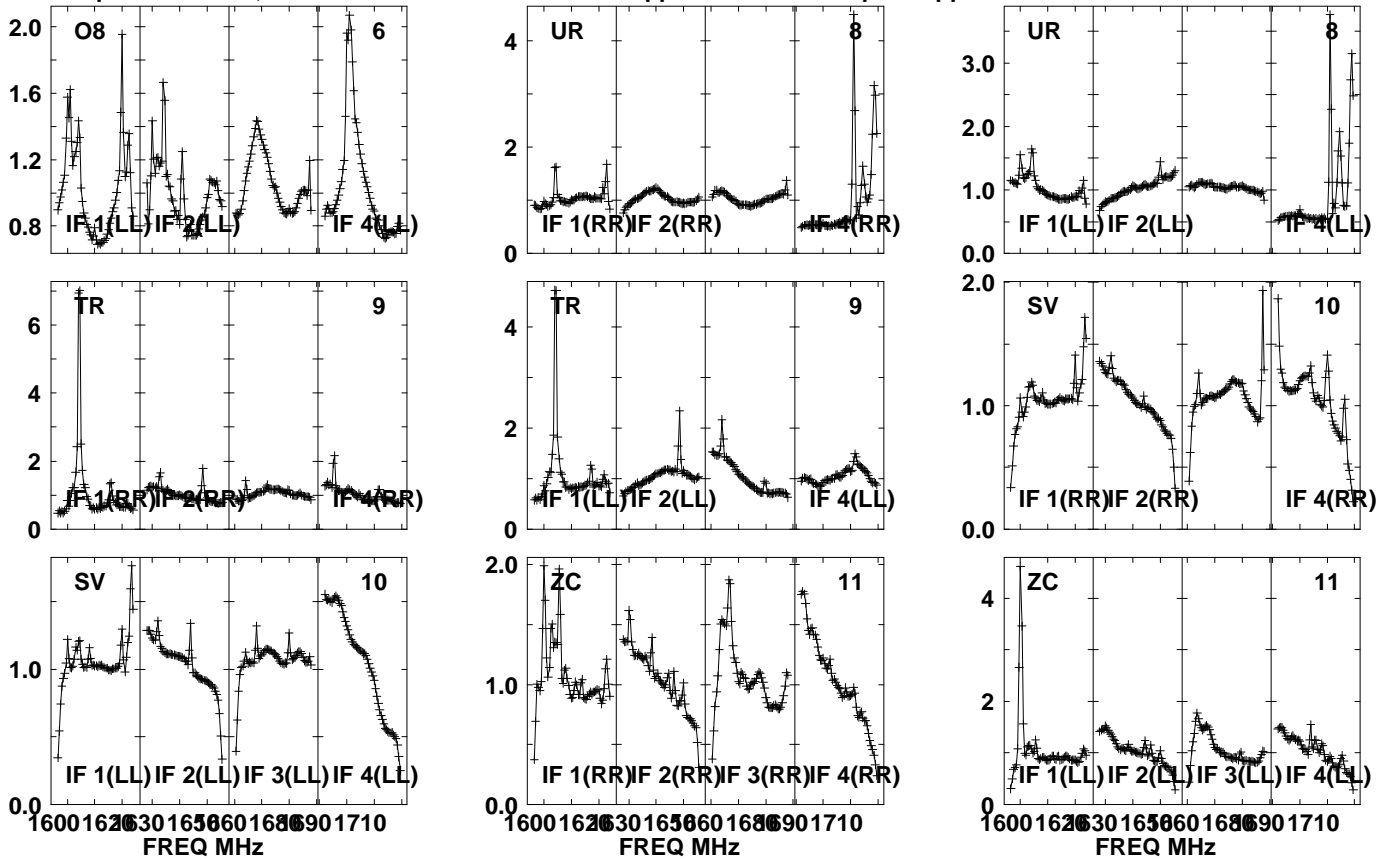

Lower frame: Real Jy

Auto-corr total-power spectrum Antenna: \*

Timerange: 00/21:41:31 to 00/21:42:59

Plot file version1343 created 05-OCT-2021 17:11:15

J0827+5217 GM076.UVDATA.1

Freq = 1.5945 GHz, Bw = 32.000 MH No calibration applied and no bandpass applied

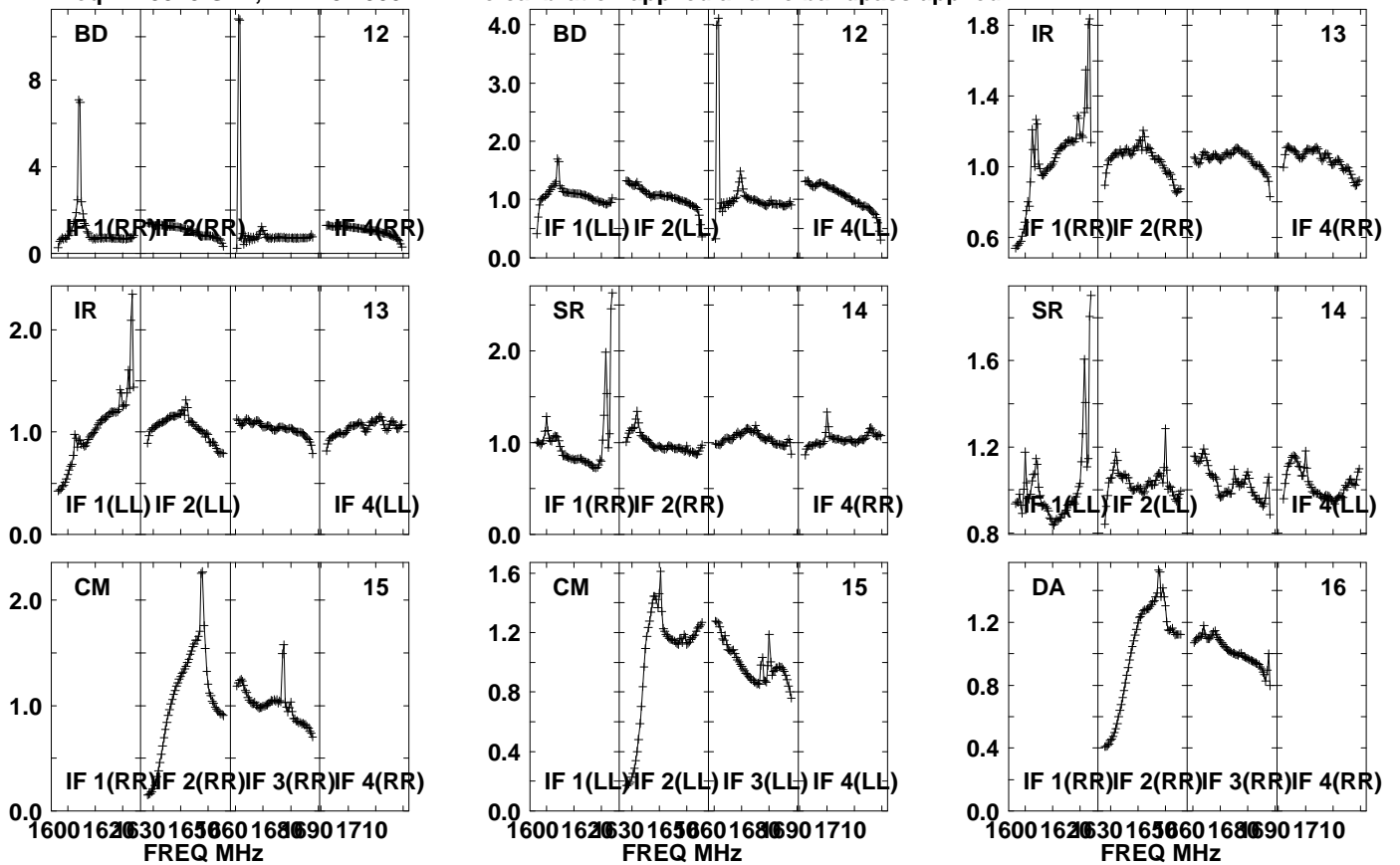

Lower frame: Real Jy

Auto-corr total-power spectrum Antenna: \*

Timerange: 00/21:41:31 to 00/21:42:59

Plot file version1344 created 05-OCT-2021 17:11:16

J0827+5217 GM076.UVDATA.1

Freq = 1.5945 GHz, Bw = 32.000 MH No calibration applied and no bandpass applied

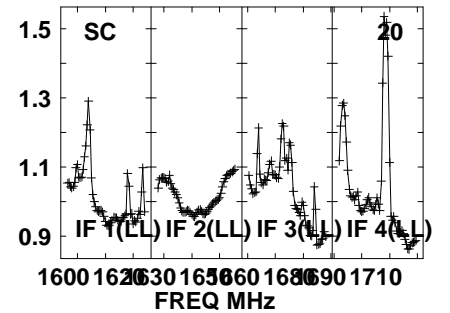
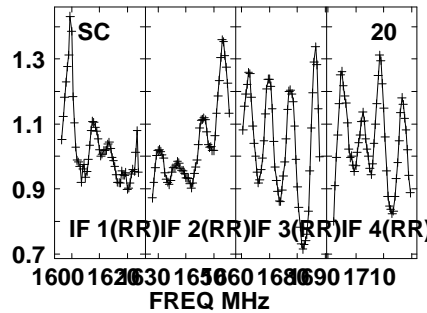
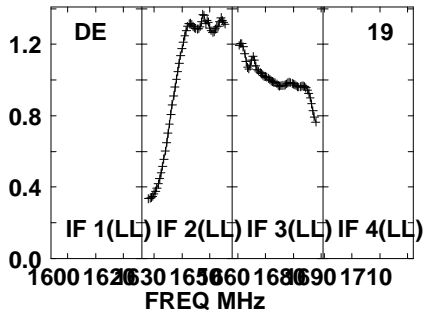
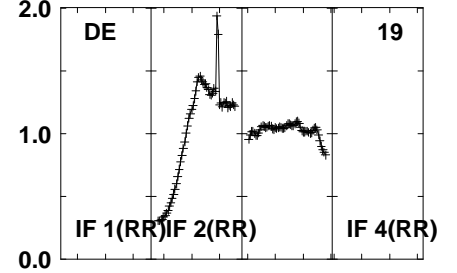
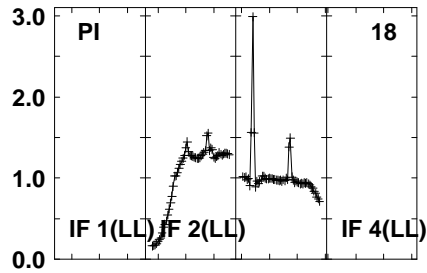
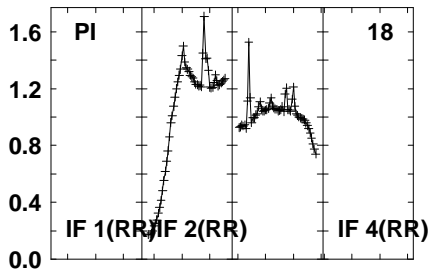
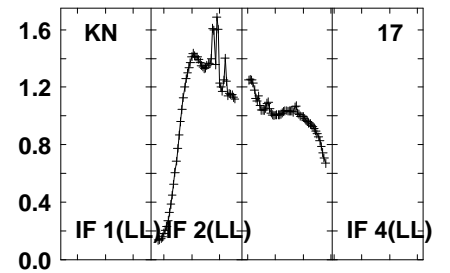
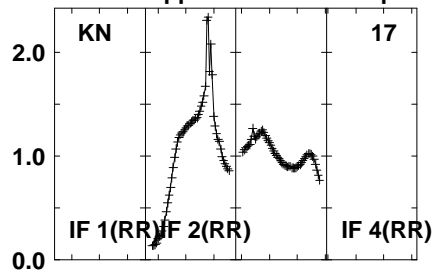
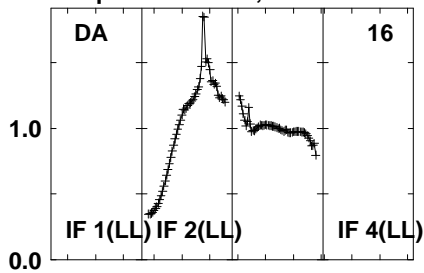

Lower frame: Real Jy  
Auto-corr total-power spectrum Antenna: \*  
Timerange: 00/21:41:31 to 00/21:42:59

Plot file version1345 created 05-OCT-2021 17:11:16

J0827+5217 GM076.UVDATA.1

Freq = 1.5945 GHz, Bw = 32.000 MH No calibration applied and no bandpass applied

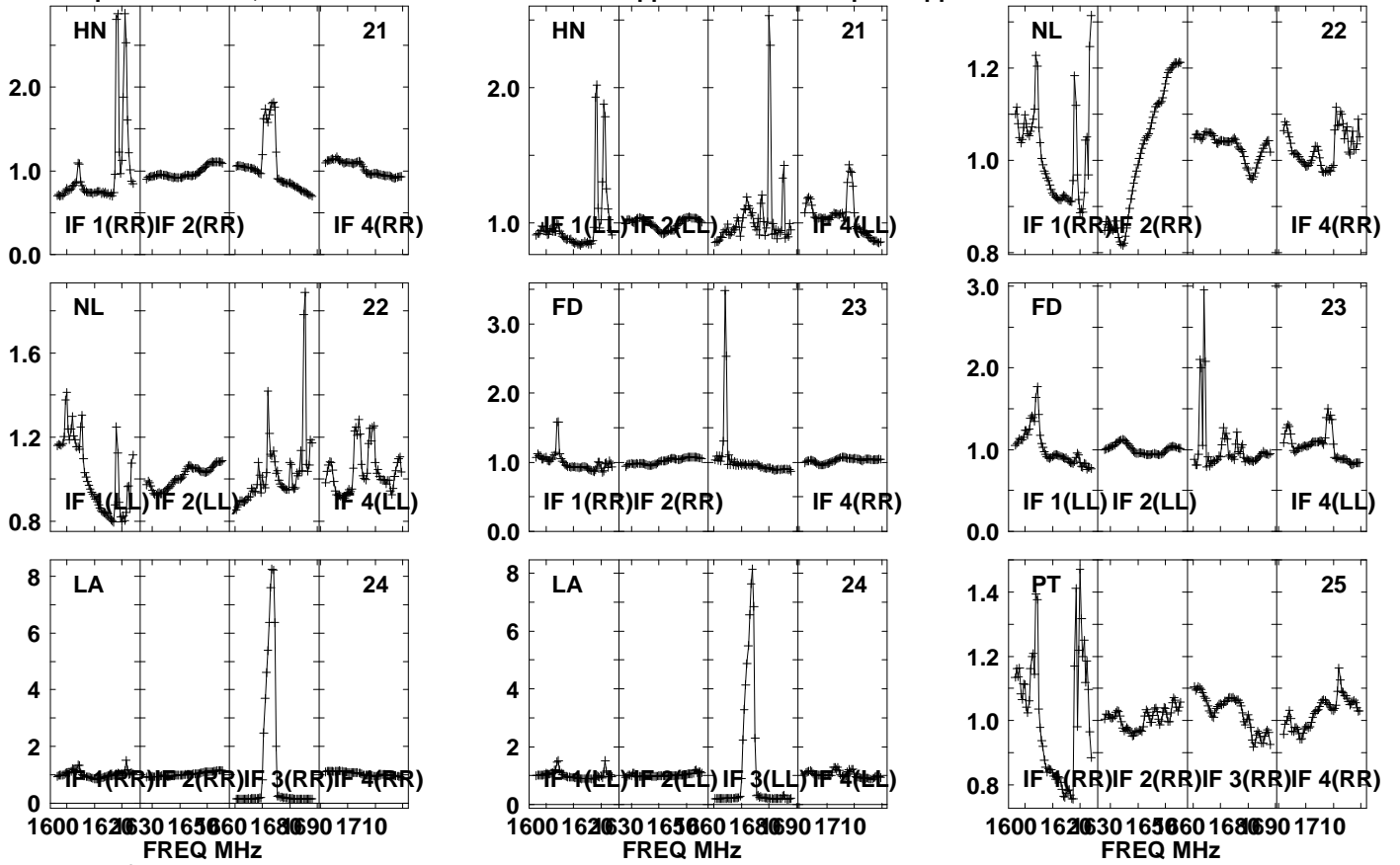

Lower frame: Real Jy  
Auto-corr total-power spectrum Antenna: \*  
Timerange: 00/21:41:31 to 00/21:42:59

Plot file version 1346 created 05-OCT-2021 17:11:16

J0827+5217 GM076.UVDATA.1

Freq = 1.5945 GHz, Bw = 32.000 MH No calibration applied and no bandpass applied

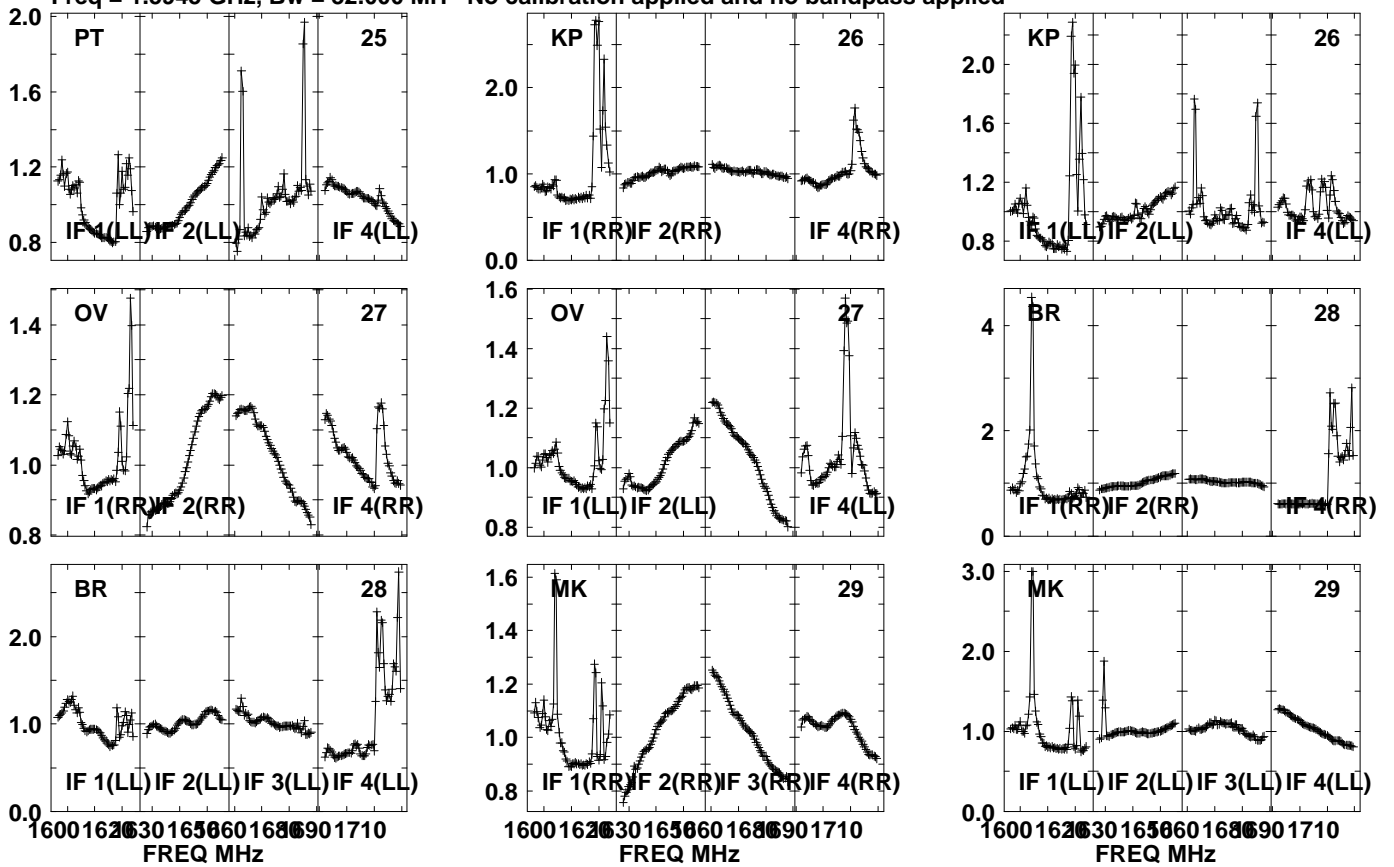

Lower frame: Real Jy  
Auto-corr total-power spectrum Antenna: \*  
Timerange: 00/21:41:31 to 00/21:42:59



Plot file version 1347 created 05-OCT-2021 17:11:17

APM08279+525 GM076.UVDATA.1

Freq = 1.5945 GHz, Bw = 32.000 MH No calibration applied and no bandpass applied

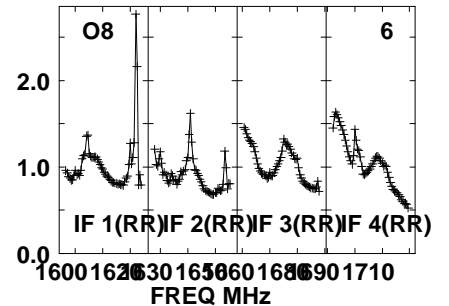
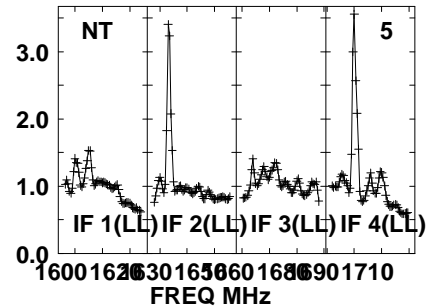
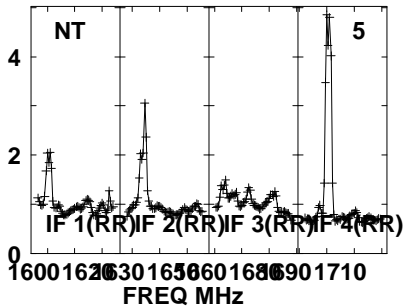
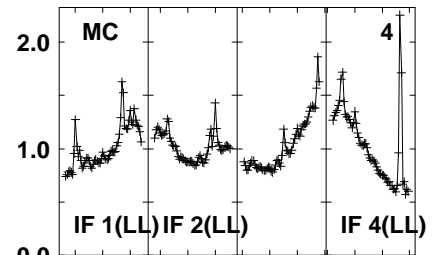
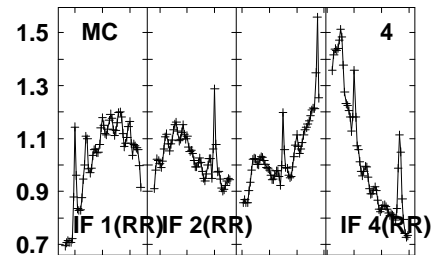
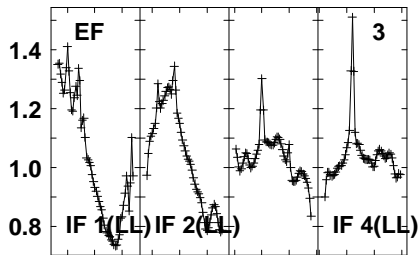
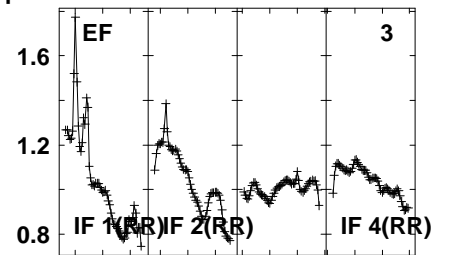
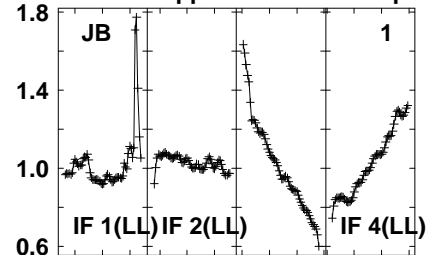
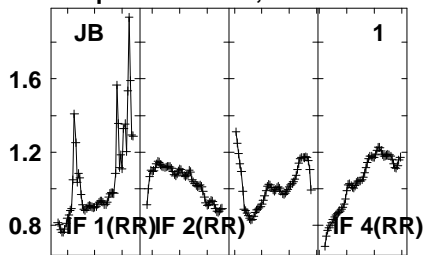

Lower frame: Real Jy  
Auto-corr total-power spectrum Antenna: \*  
Timerange: 00/21:43:01 to 00/21:46:29

Plot file version1348 created 05-OCT-2021 17:11:17

APM08279+525 GM076.UVDATA.1

Freq = 1.5945 GHz, Bw = 32.000 MH No calibration applied and no bandpass applied

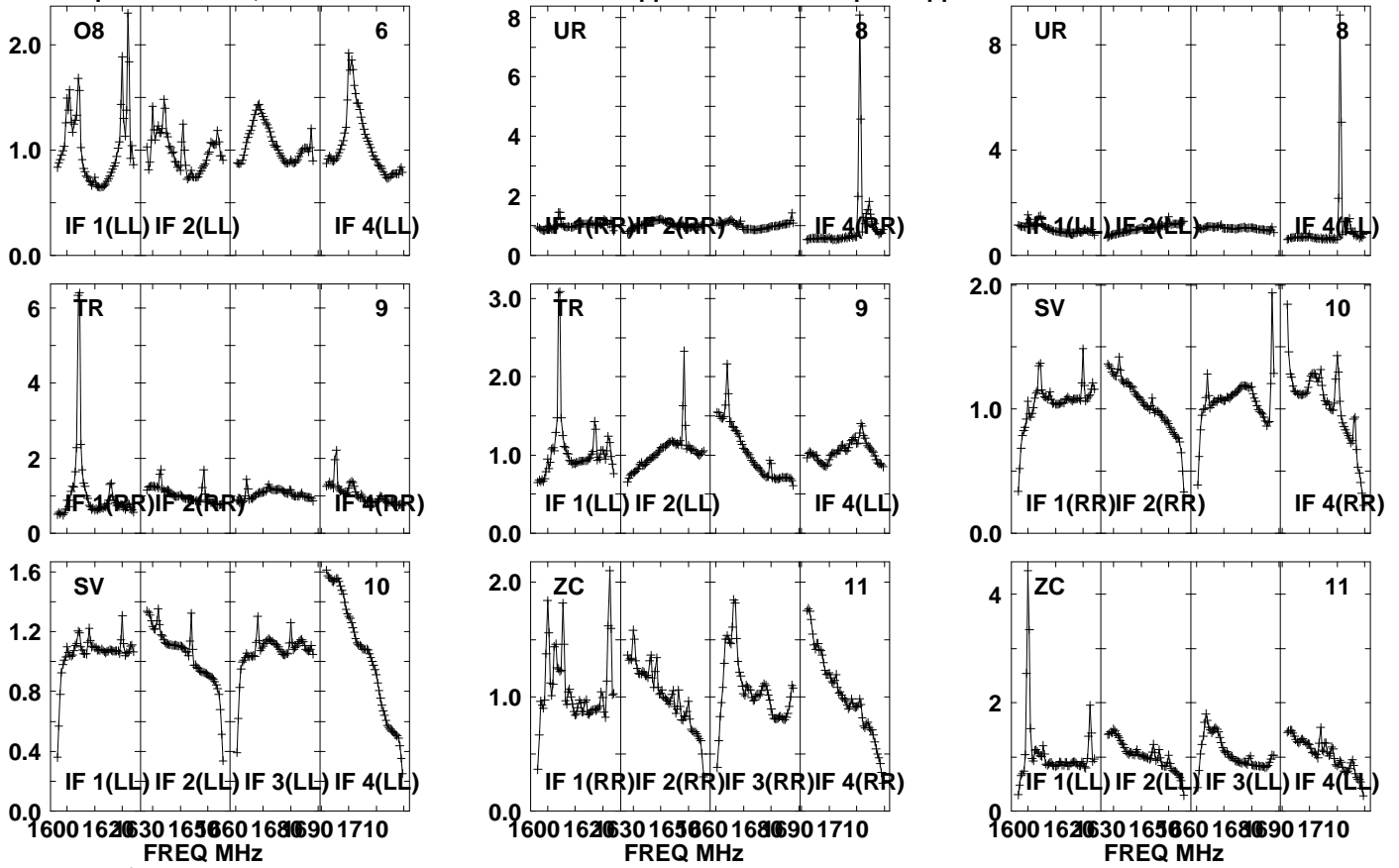

Lower frame: Real Jy

Auto-corr total-power spectrum Antenna: \*

Timerange: 00/21:43:01 to 00/21:46:29

Plot file version1349 created 05-OCT-2021 17:11:17

APM08279+525 GM076.UVDATA.1

Freq = 1.5945 GHz, Bw = 32.000 MH No calibration applied and no bandpass applied

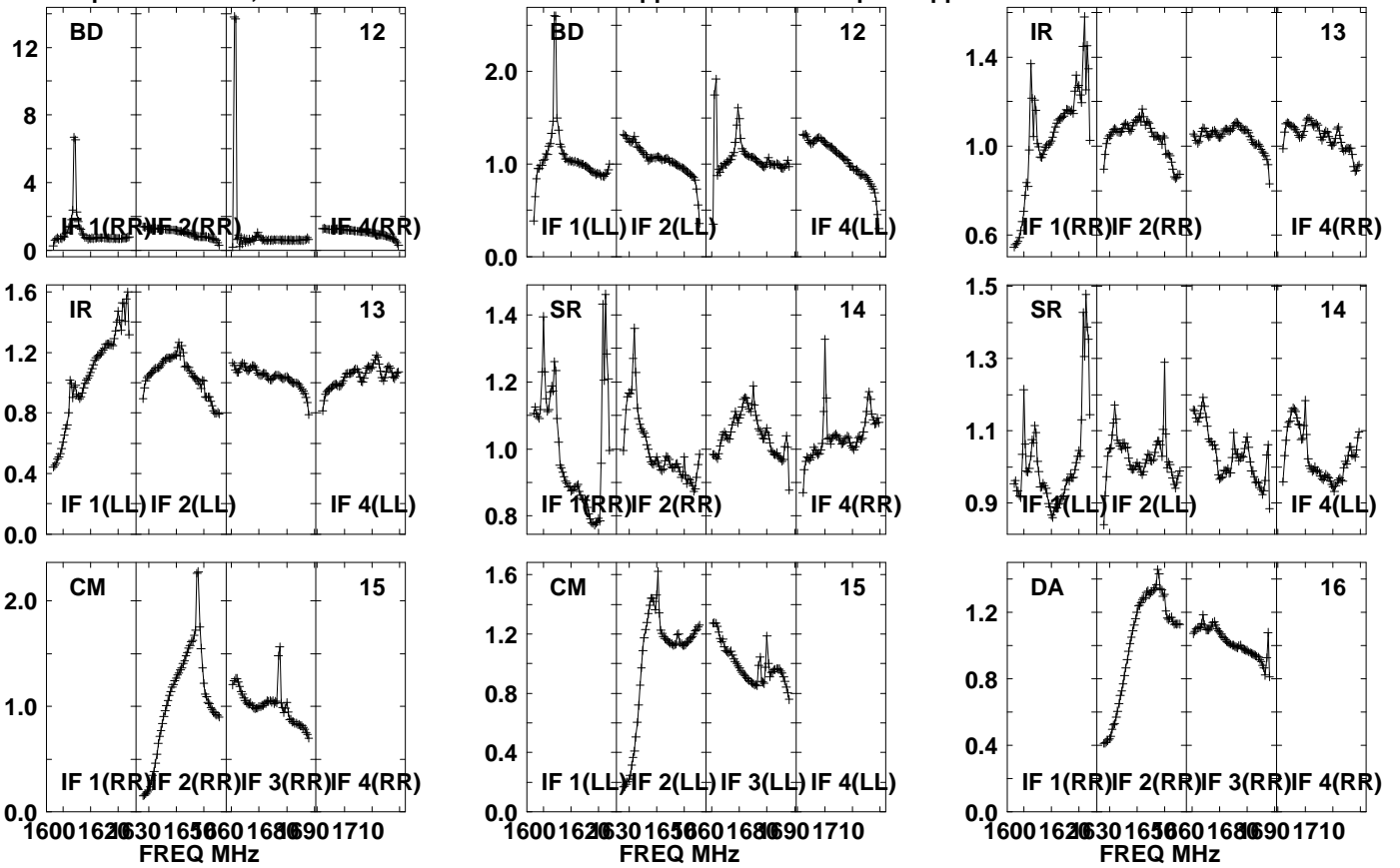

Lower frame: Real Jy  
Auto-corr total-power spectrum Antenna: \*  
Timerange: 00/21:43:01 to 00/21:46:29

Plot file version1350 created 05-OCT-2021 17:11:18

APM08279+525 GM076.UVDATA.1

Freq = 1.5945 GHz, Bw = 32.000 MH No calibration applied and no bandpass applied

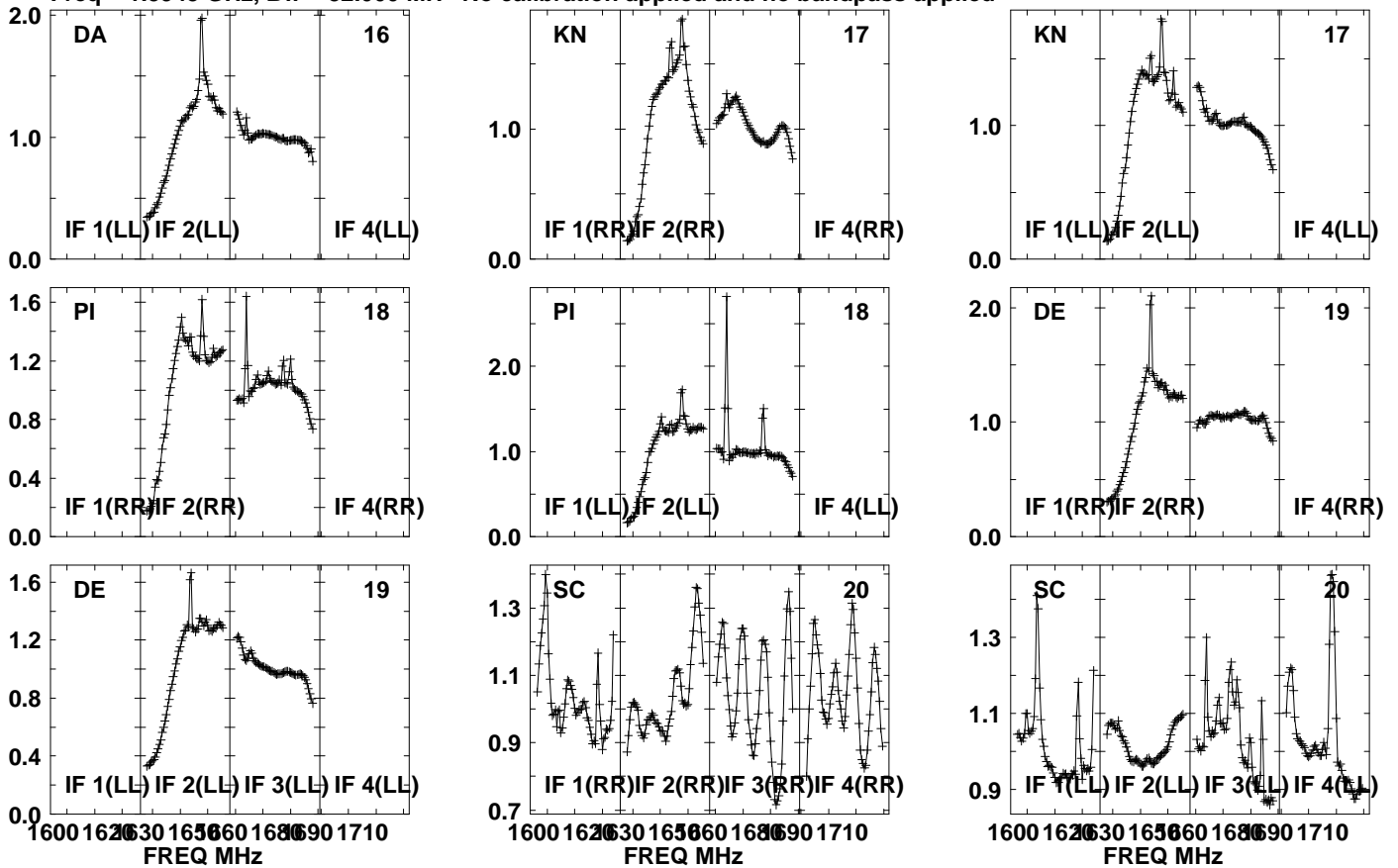

Lower frame: Real Jy  
Auto-corr total-power spectrum Antenna: \*  
Timerange: 00/21:43:01 to 00/21:46:29

Plot file version 1351 created 05-OCT-2021 17:11:18

APM08279+525 GM076.UVDATA.1

Freq = 1.5945 GHz, Bw = 32.000 MHz No calibration applied and no bandpass applied

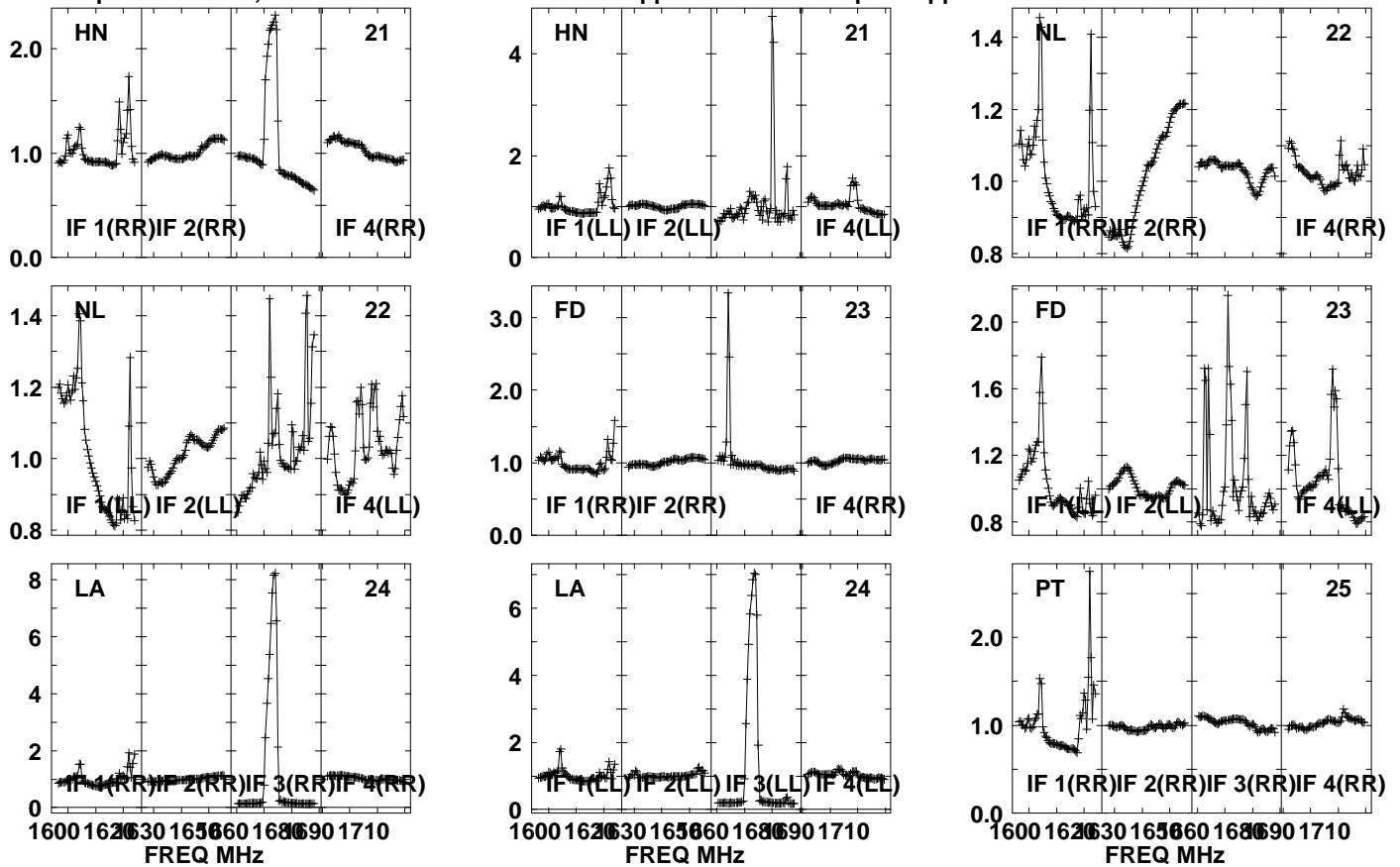

Lower frame: Real Jy

Auto-corr total-power spectrum Antenna: \*

Timerange: 00/21:43:01 to 00/21:46:29

Plot file version1352 created 05-OCT-2021 17:11:18

APM08279+525 GM076.UVDATA.1

Freq = 1.5945 GHz, Bw = 32.000 MH No calibration applied and no bandpass applied

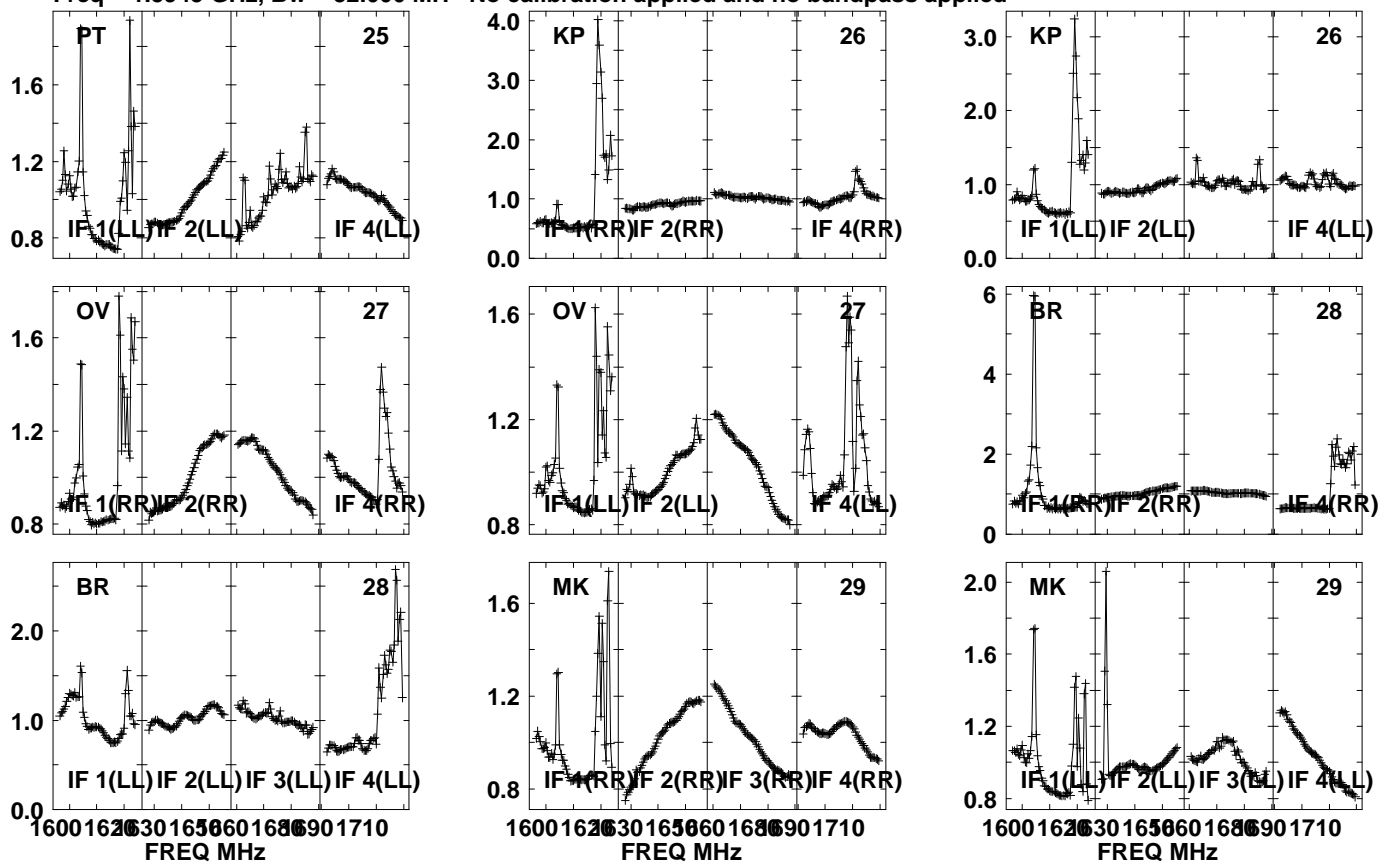

Lower frame: Real Jy  
Auto-corr total-power spectrum Antenna: \*  
Timerange: 00/21:43:01 to 00/21:46:29

Plot file version 1353 created 05-OCT-2021 17:11:19

J0827+5217 GM076.UVDATA.1

Freq = 1.5945 GHz, Bw = 32.000 MH No calibration applied and no bandpass applied

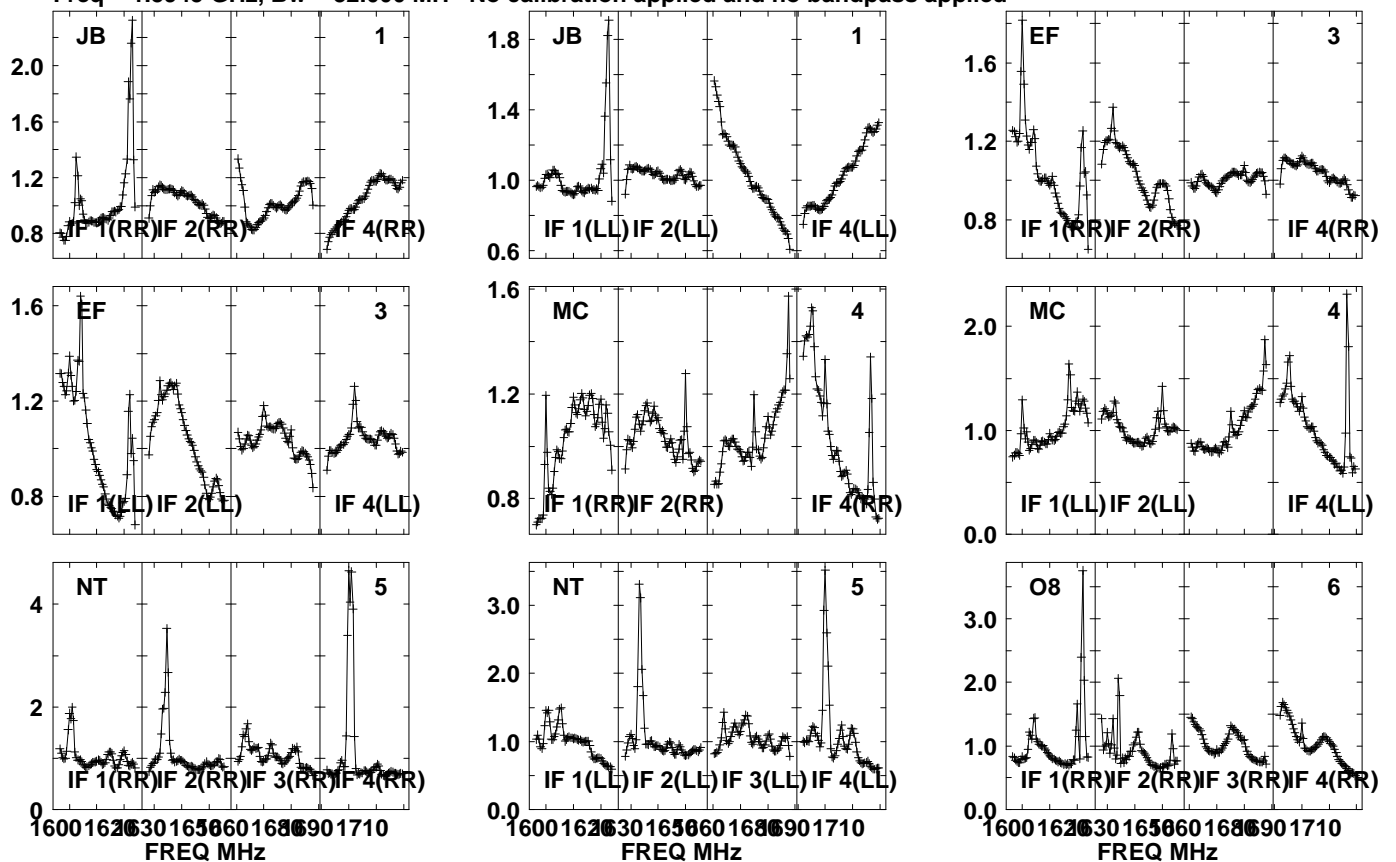

Lower frame: Real Jy  
Auto-corr total-power spectrum Antenna: \*  
Timerange: 00/21:46:31 to 00/21:47:59

Plot file version1354 created 05-OCT-2021 17:11:19

J0827+5217 GM076.UVDATA.1

Freq = 1.5945 GHz, Bw = 32.000 MH No calibration applied and no bandpass applied

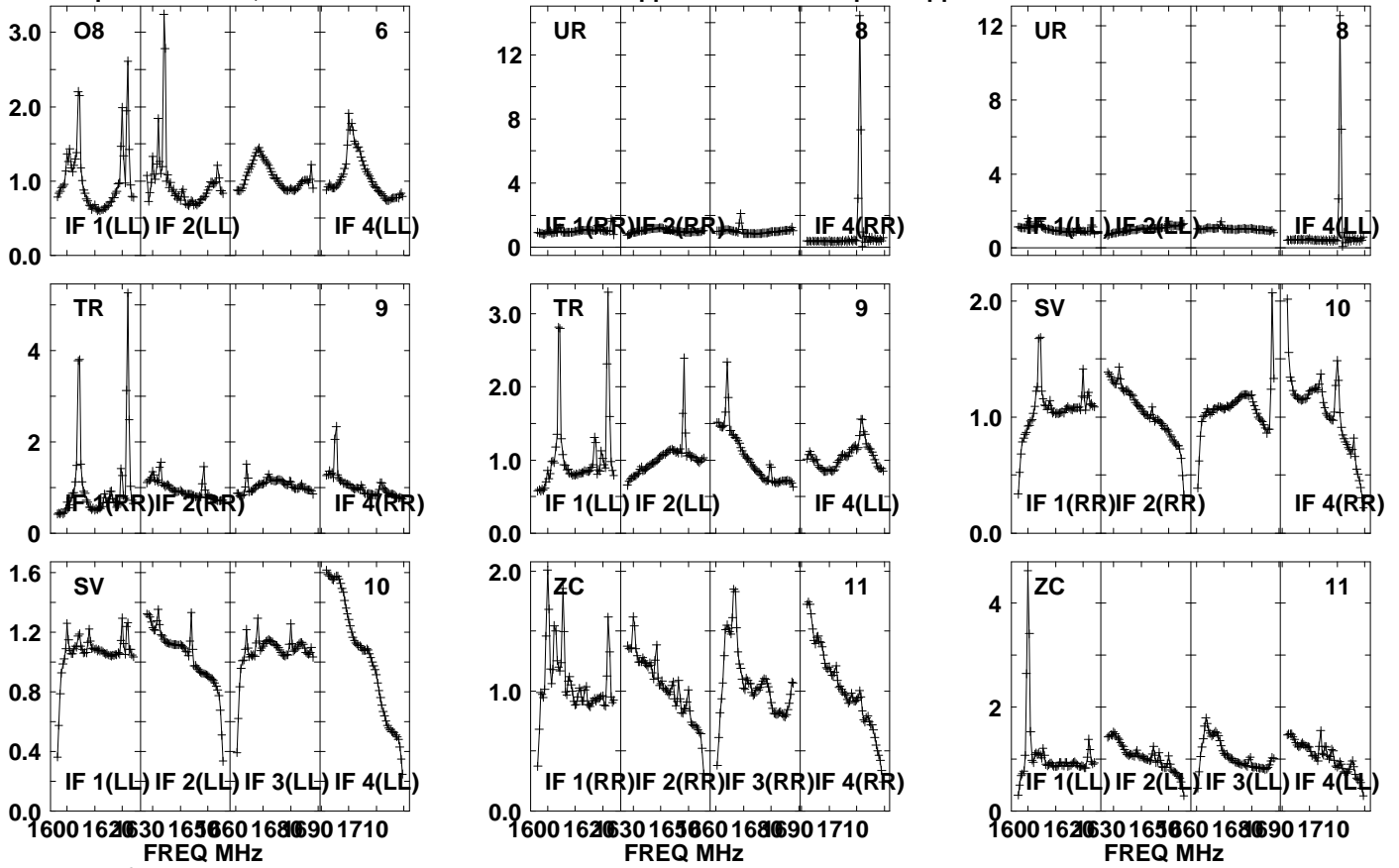

Lower frame: Real Jy  
Auto-corr total-power spectrum Antenna: \*  
Timerange: 00/21:46:31 to 00/21:47:59



Plot file version1355 created 05-OCT-2021 17:11:19

J0827+5217 GM076.UVDATA.1

Freq = 1.5945 GHz, Bw = 32.000 MH No calibration applied and no bandpass applied

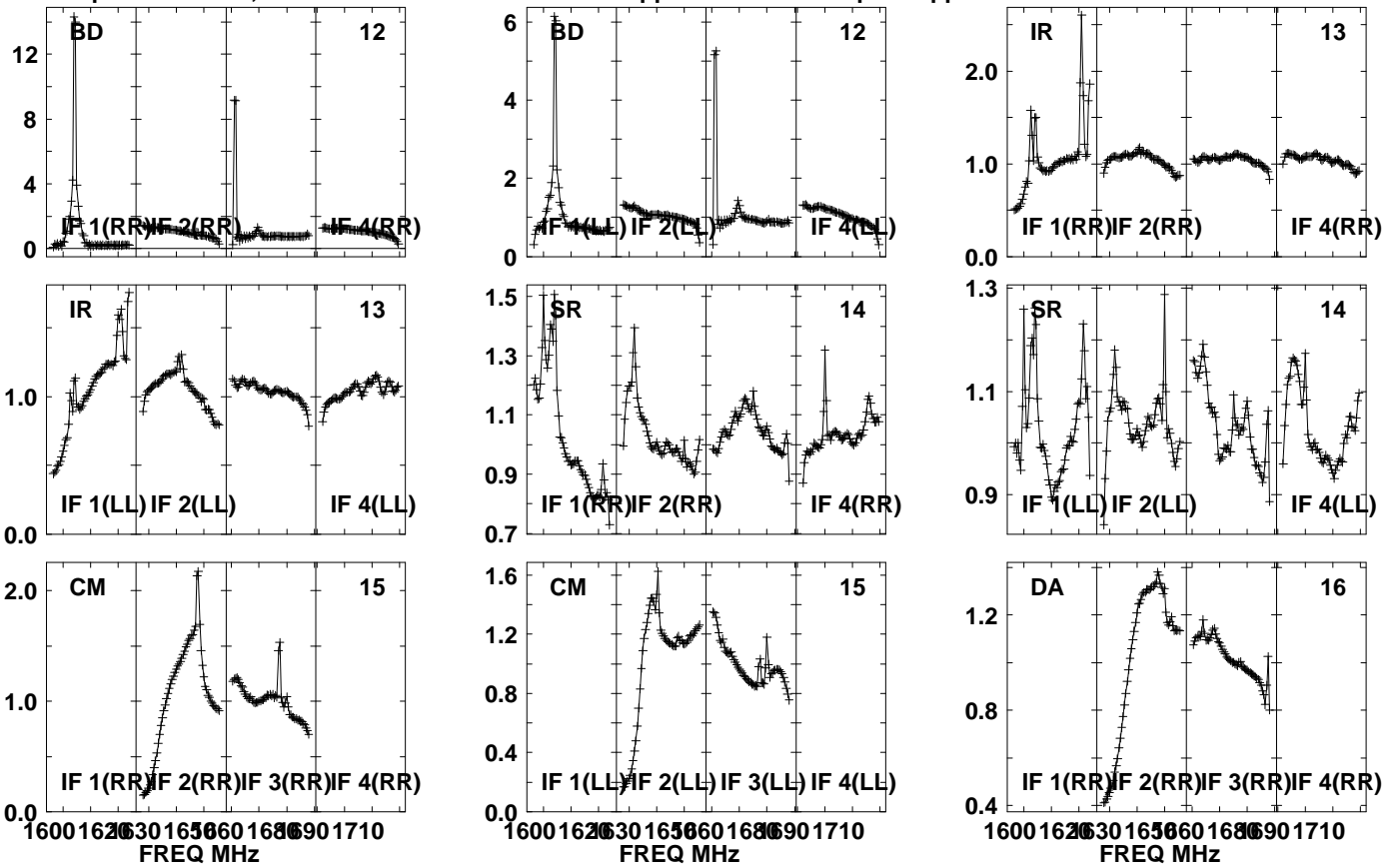

Lower frame: Real Jy

Auto-corr total-power spectrum Antenna: \*

Timerange: 00/21:46:31 to 00/21:47:59

Plot file version1356 created 05-OCT-2021 17:11:20

J0827+5217 GM076.UVDATA.1

Freq = 1.5945 GHz, Bw = 32.000 MH No calibration applied and no bandpass applied

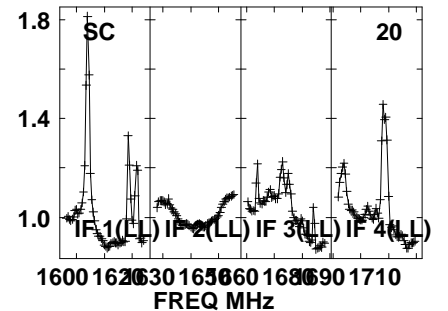
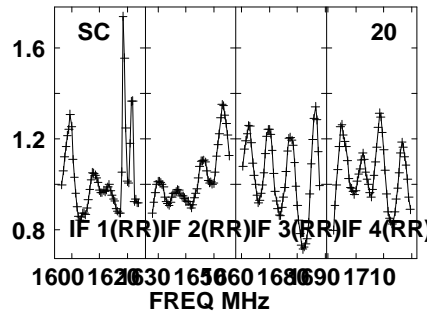
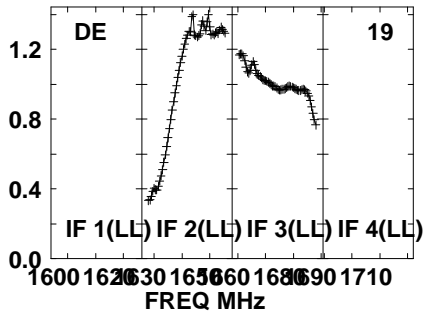
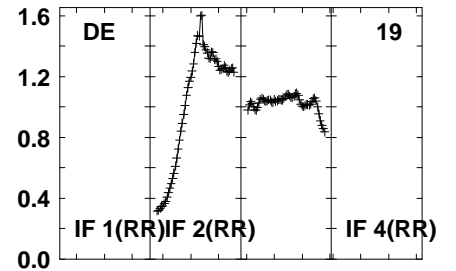
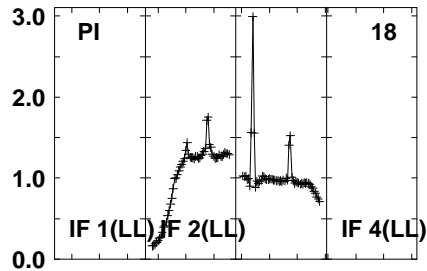
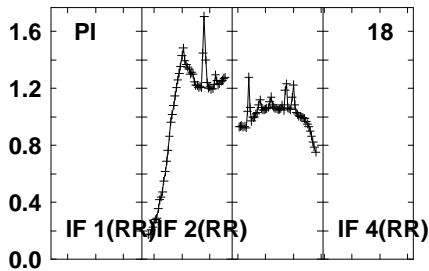
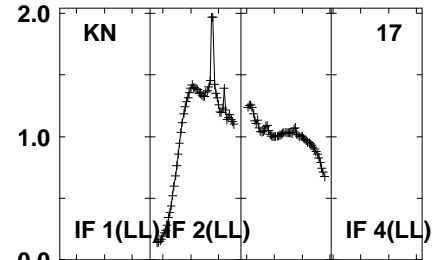
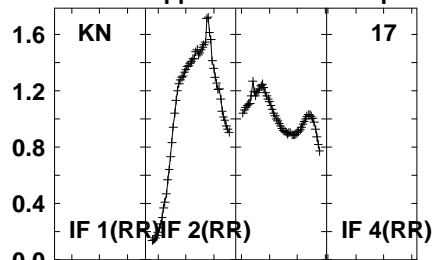
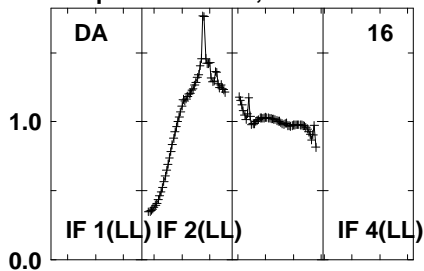

Lower frame: Real Jy

Auto-corr total-power spectrum Antenna: \*

Timerange: 00/21:46:31 to 00/21:47:59

Plot file version 1357 created 05-OCT-2021 17:11:20

J0827+5217 GM076.UVDATA.1

Freq = 1.5945 GHz, Bw = 32.000 MH No calibration applied and no bandpass applied

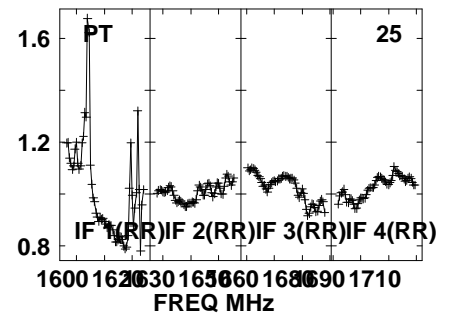
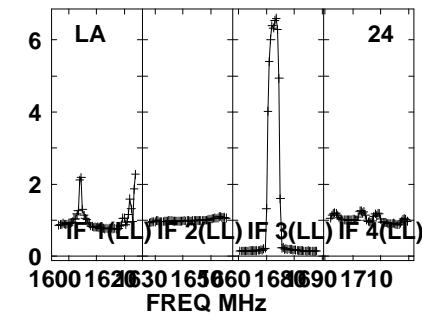
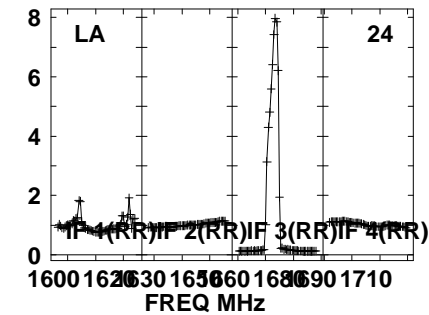
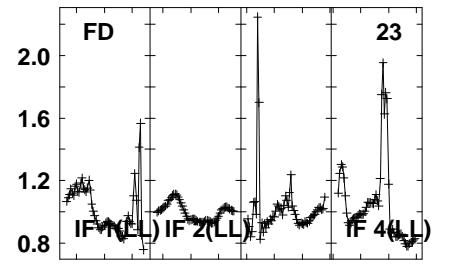
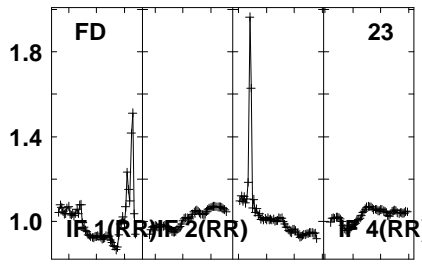
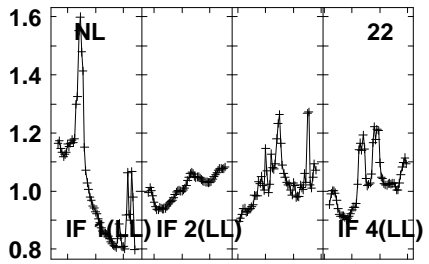
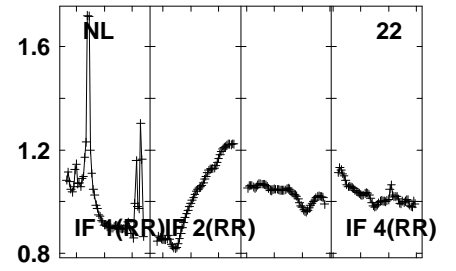
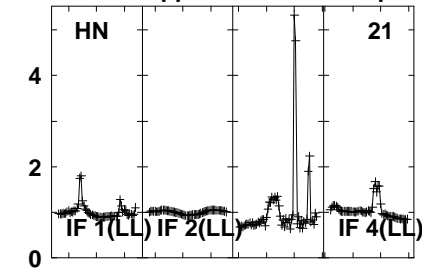
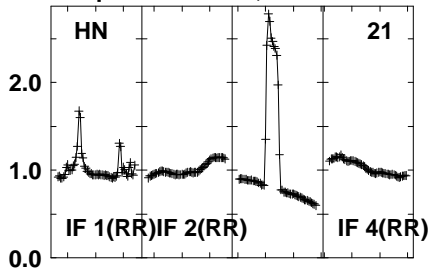

Lower frame: Real Jy

Auto-corr total-power spectrum Antenna: \*

Timerange: 00/21:46:31 to 00/21:47:59

Plot file version 1358 created 05-OCT-2021 17:11:20

J0827+5217 GM076.UVDATA.1

Freq = 1.5945 GHz, Bw = 32.000 MH No calibration applied and no bandpass applied

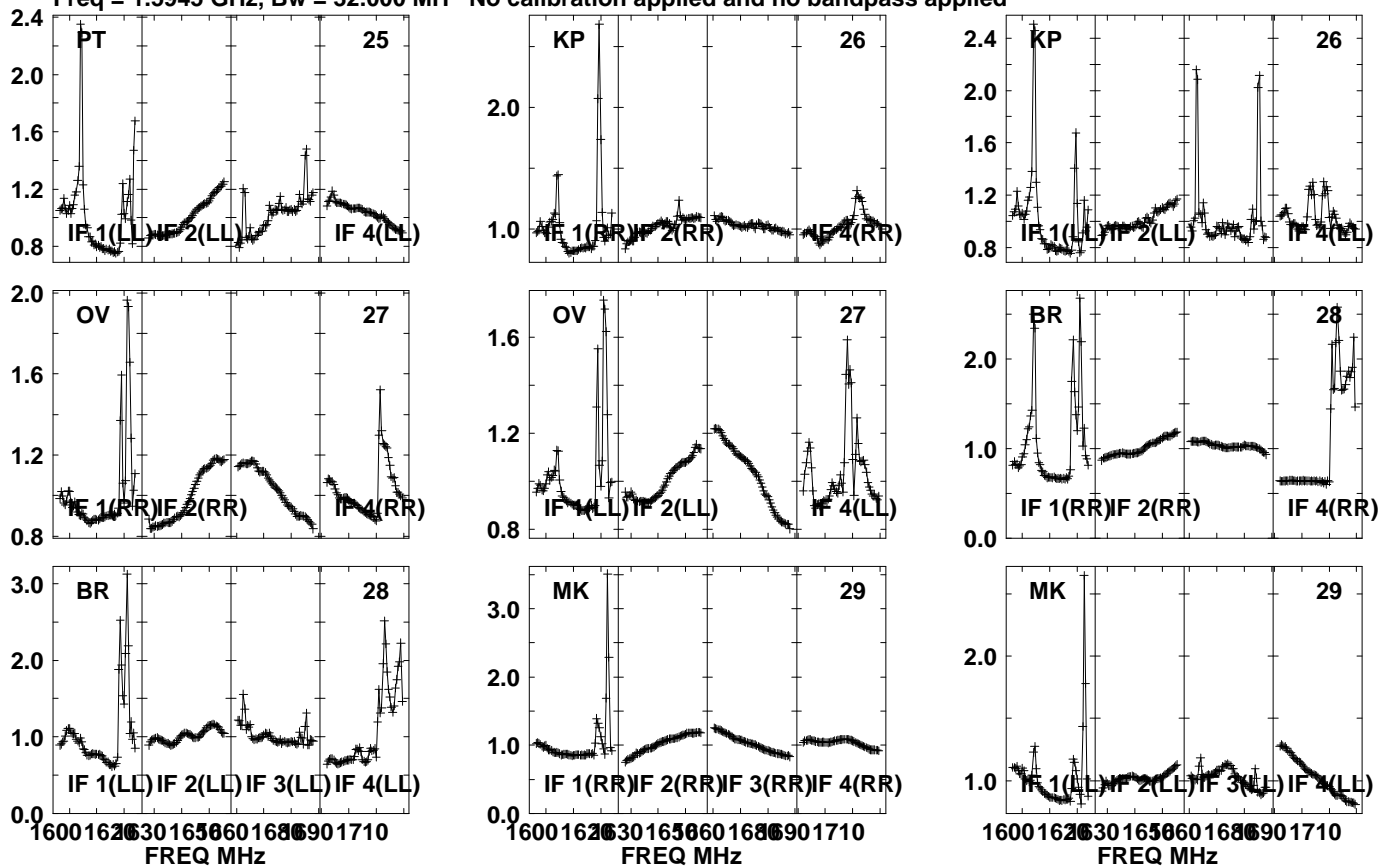

Lower frame: Real Jy  
Auto-corr total-power spectrum Antenna: \*  
Timerange: 00/21:46:31 to 00/21:47:59

Plot file version 1359 created 05-OCT-2021 17:11:21

APM08279+525 GM076.UVDATA.1

Freq = 1.5945 GHz, Bw = 32.000 MH No calibration applied and no bandpass applied

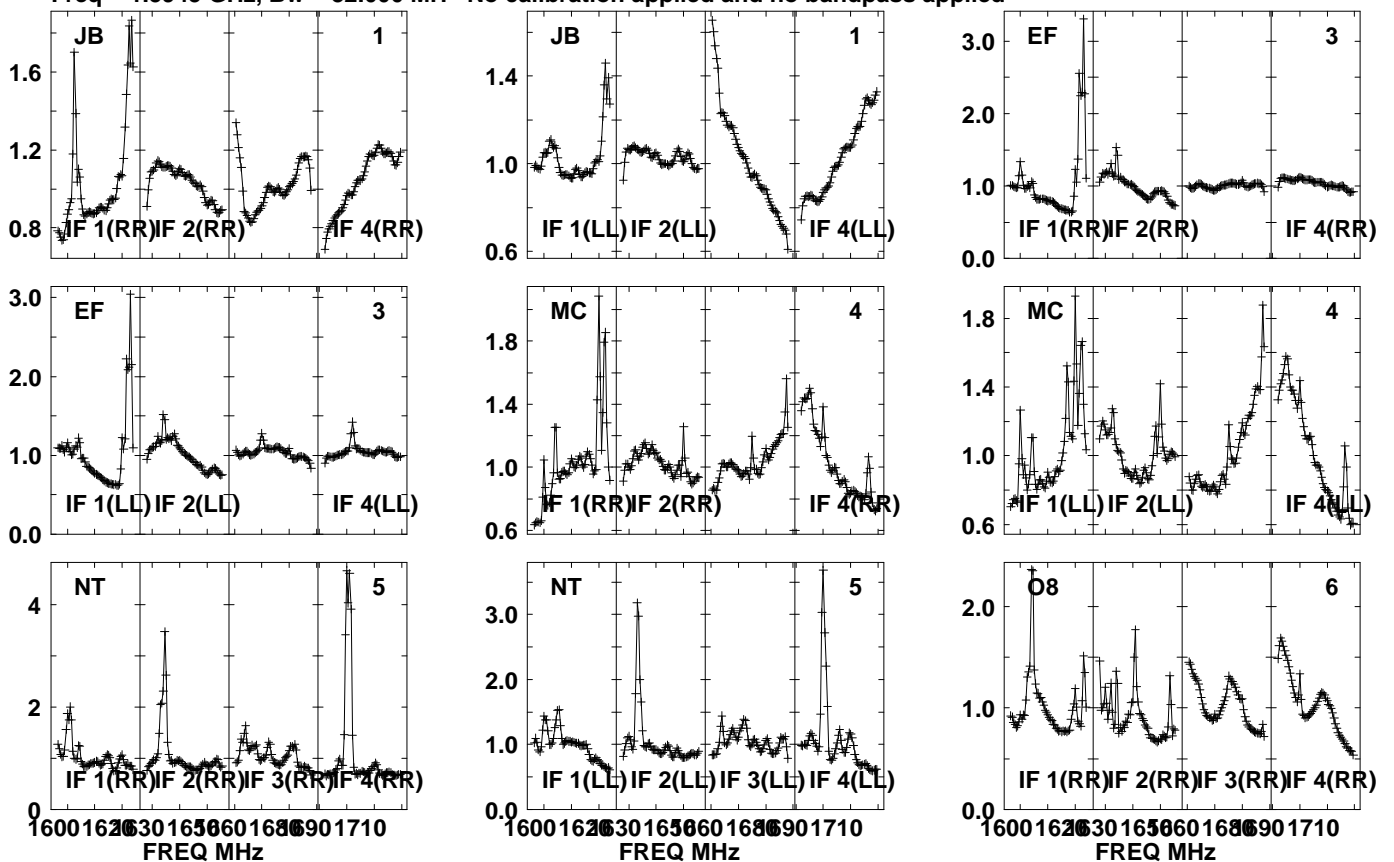

Lower frame: Real Jy  
Auto-corr total-power spectrum Antenna: \*  
Timerange: 00/21:48:01 to 00/21:51:29

Plot file version 1360 created 05-OCT-2021 17:11:21

APM08279+525 GM076.UVDATA.1

Freq = 1.5945 GHz, Bw = 32.000 MH No calibration applied and no bandpass applied

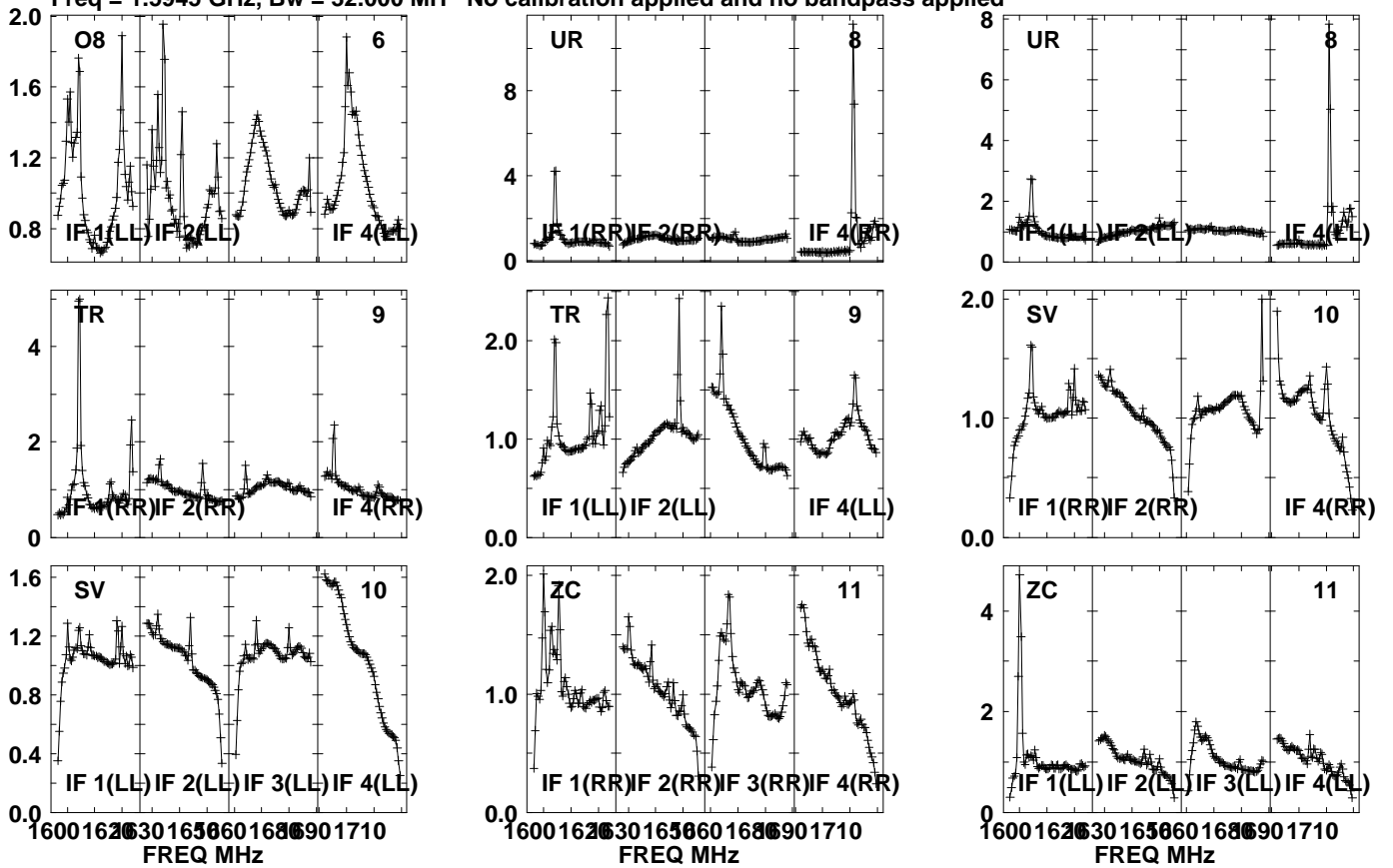

Lower frame: Real Jy  
Auto-corr total-power spectrum Antenna: \*  
Timerange: 00/21:48:01 to 00/21:51:29

Plot file version1361 created 05-OCT-2021 17:11:21

APM08279+525 GM076.UVDATA.1

Freq = 1.5945 GHz, Bw = 32.000 MH

No calibration applied and no bandpass applied

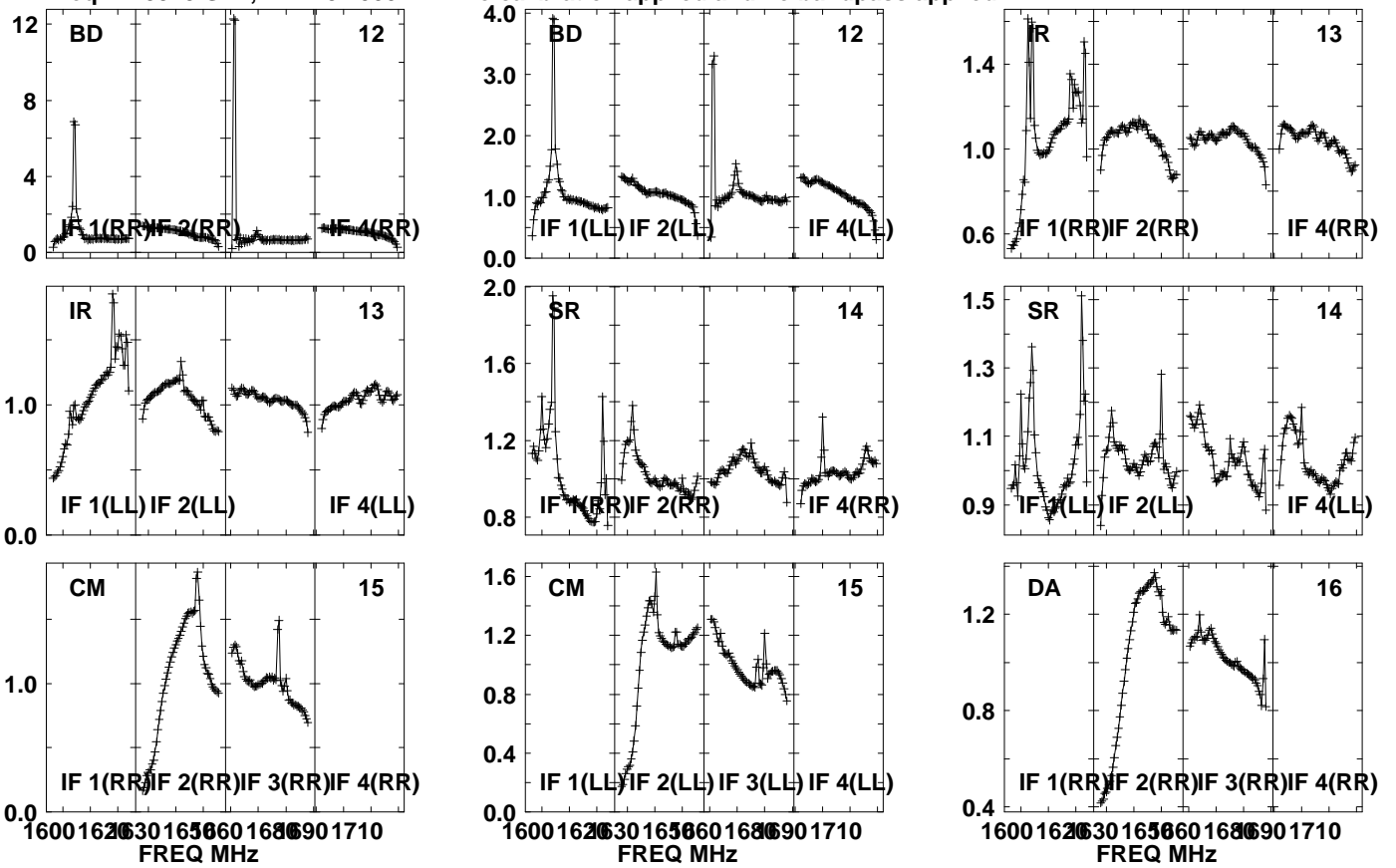

Lower frame: Real Jy

Auto-corr total-power spectrum Antenna: \*

Timerange: 00/21:48:01 to 00/21:51:29

Plot file version1362 created 05-OCT-2021 17:11:22

APM08279+525 GM076.UVDATA.1

Freq = 1.5945 GHz, Bw = 32.000 MH No calibration applied and no bandpass applied

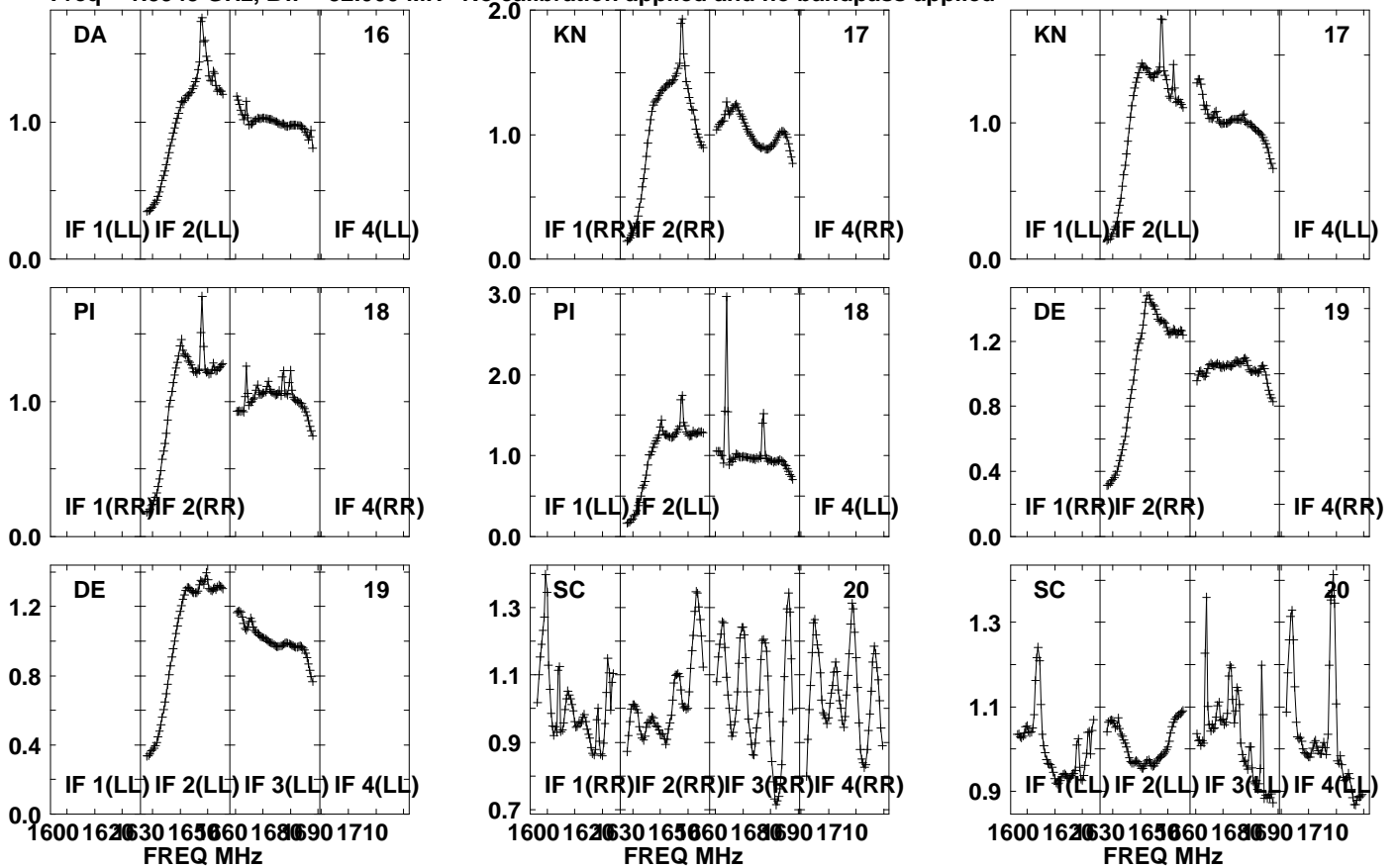

Lower frame: Real Jy  
Auto-corr total-power spectrum Antenna: \*  
Timerange: 00/21:48:01 to 00/21:51:29



Plot file version1363 created 05-OCT-2021 17:11:22

APM08279+525 GM076.UVDATA.1

Freq = 1.5945 GHz, Bw = 32.000 MH No calibration applied and no bandpass applied

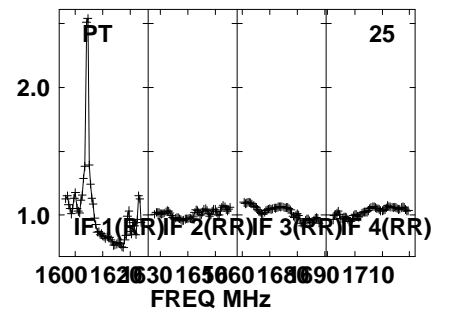
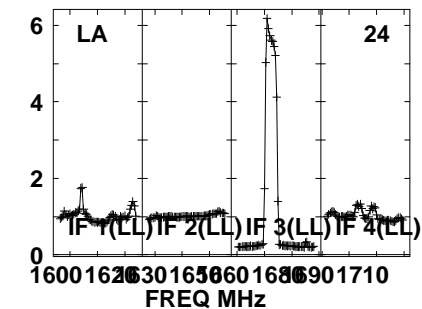
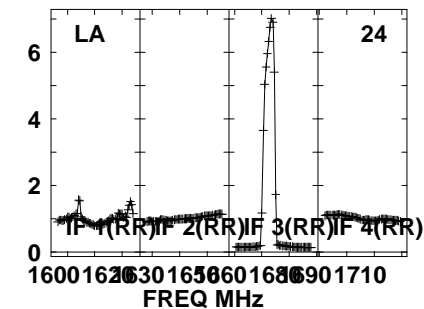
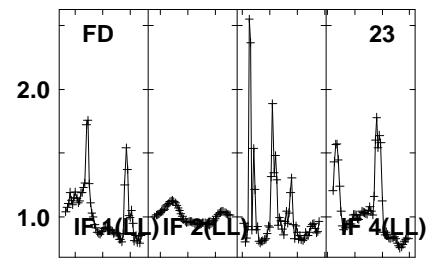
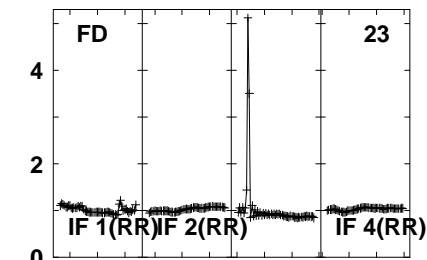
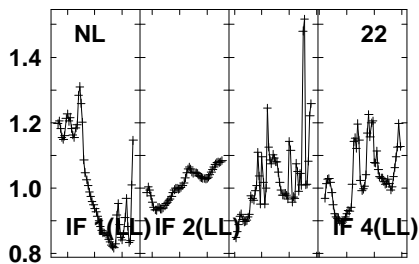
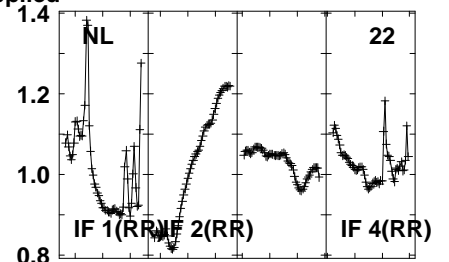
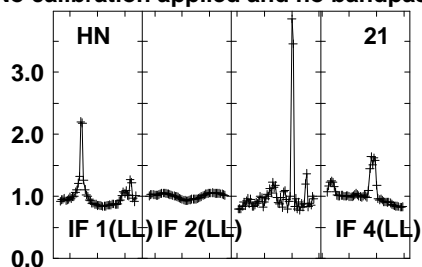
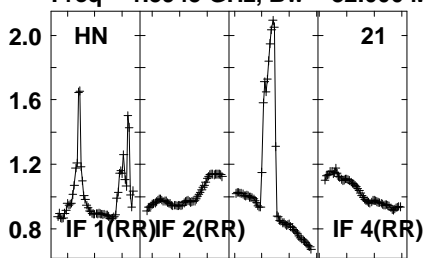

Lower frame: Real Jy  
Auto-corr total-power spectrum Antenna: \*  
Timerange: 00/21:48:01 to 00/21:51:29

Plot file version1364 created 05-OCT-2021 17:11:22

APM08279+525 GM076.UVDATA.1

Freq = 1.5945 GHz, Bw = 32.000 MH No calibration applied and no bandpass applied

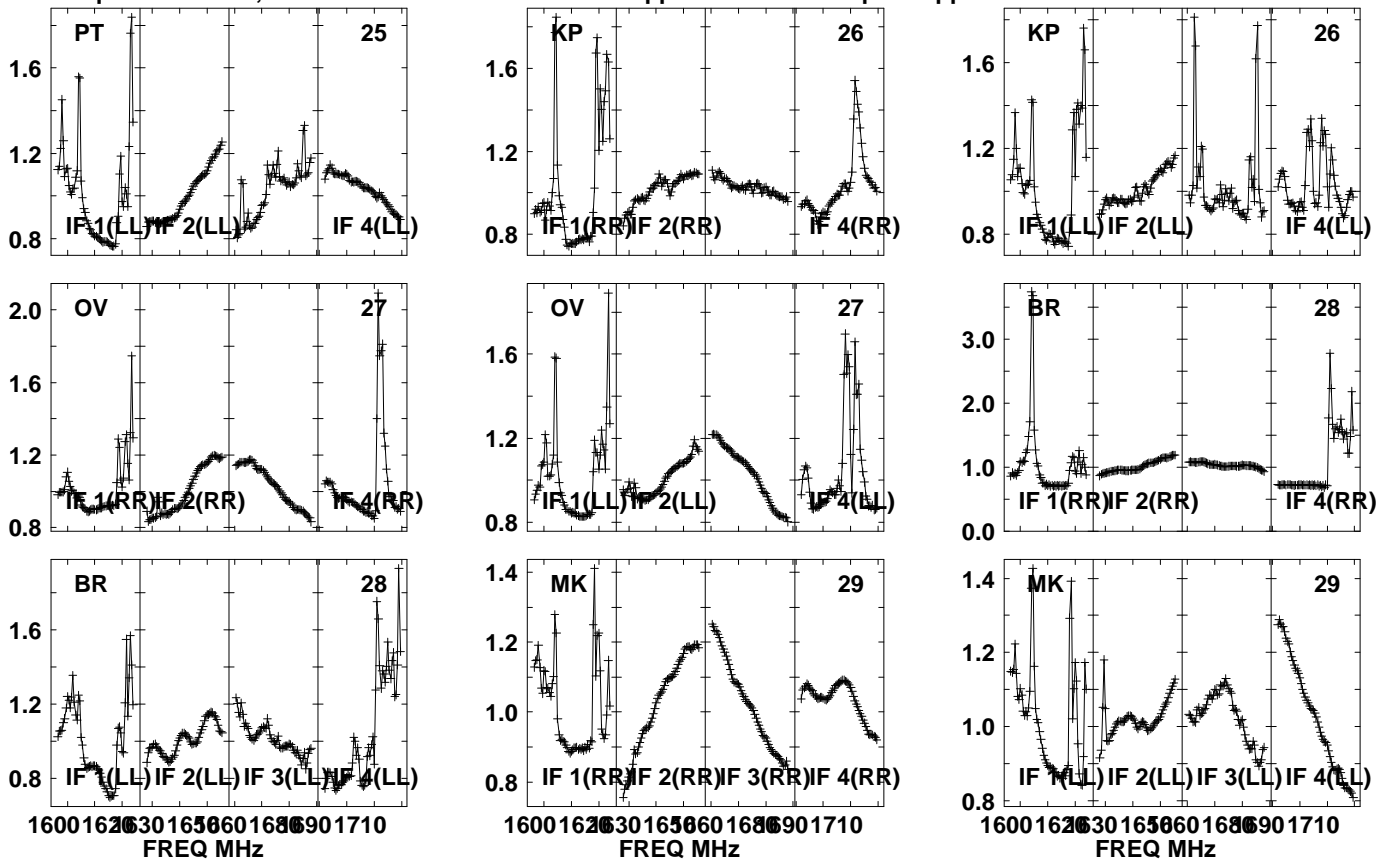

Lower frame: Real Jy  
Auto-corr total-power spectrum Antenna: \*  
Timerange: 00/21:48:01 to 00/21:51:29

Plot file version1365 created 05-OCT-2021 17:11:23

J0827+5217 GM076.UVDATA.1

Freq = 1.5945 GHz, Bw = 32.000 MH No calibration applied and no bandpass applied

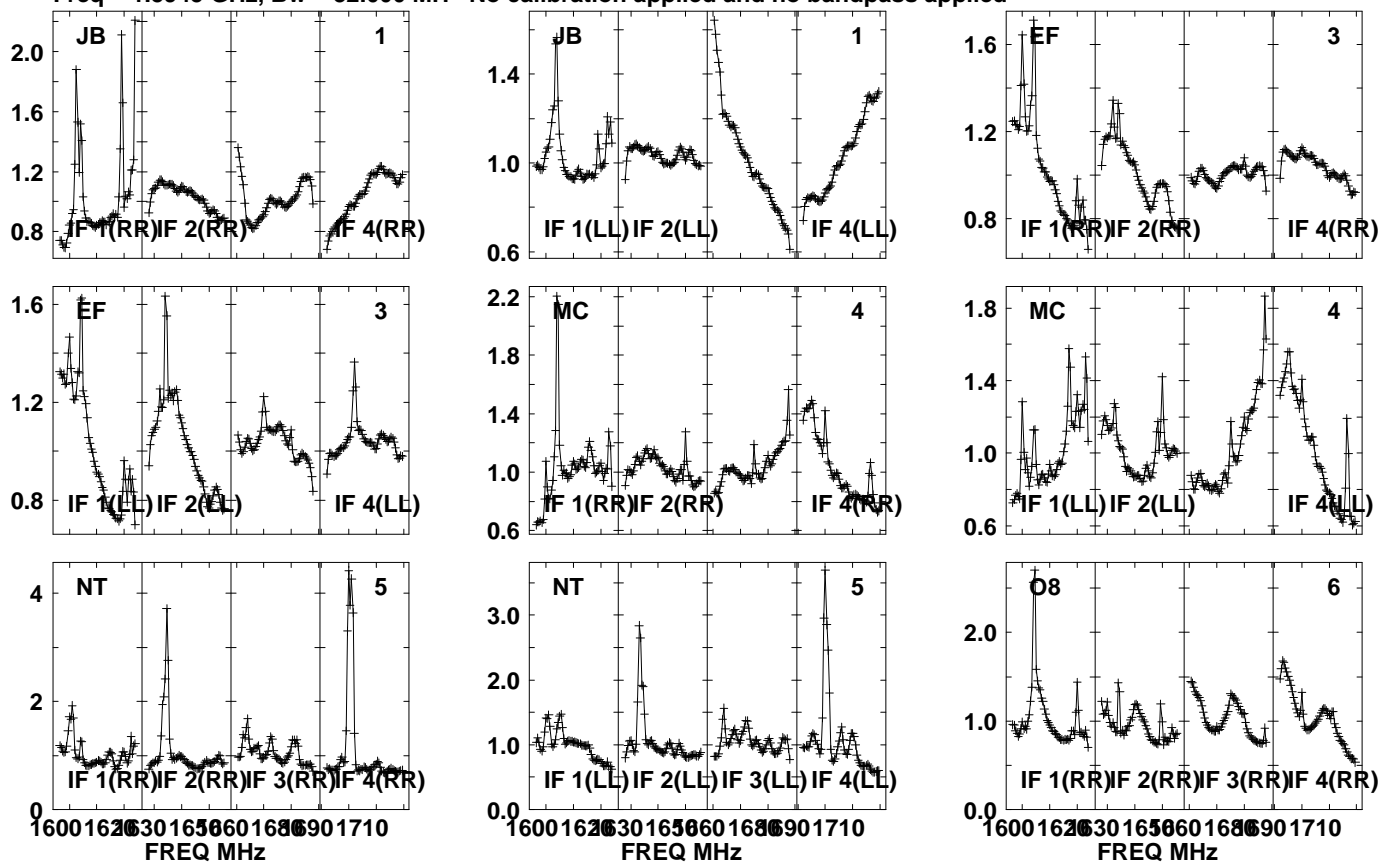

Lower frame: Real Jy  
Auto-corr total-power spectrum Antenna: \*  
Timerange: 00/21:52:01 to 00/21:53:29

Plot file version1366 created 05-OCT-2021 17:11:23

J0827+5217 GM076.UVDATA.1

Freq = 1.5945 GHz, Bw = 32.000 MH No calibration applied and no bandpass applied

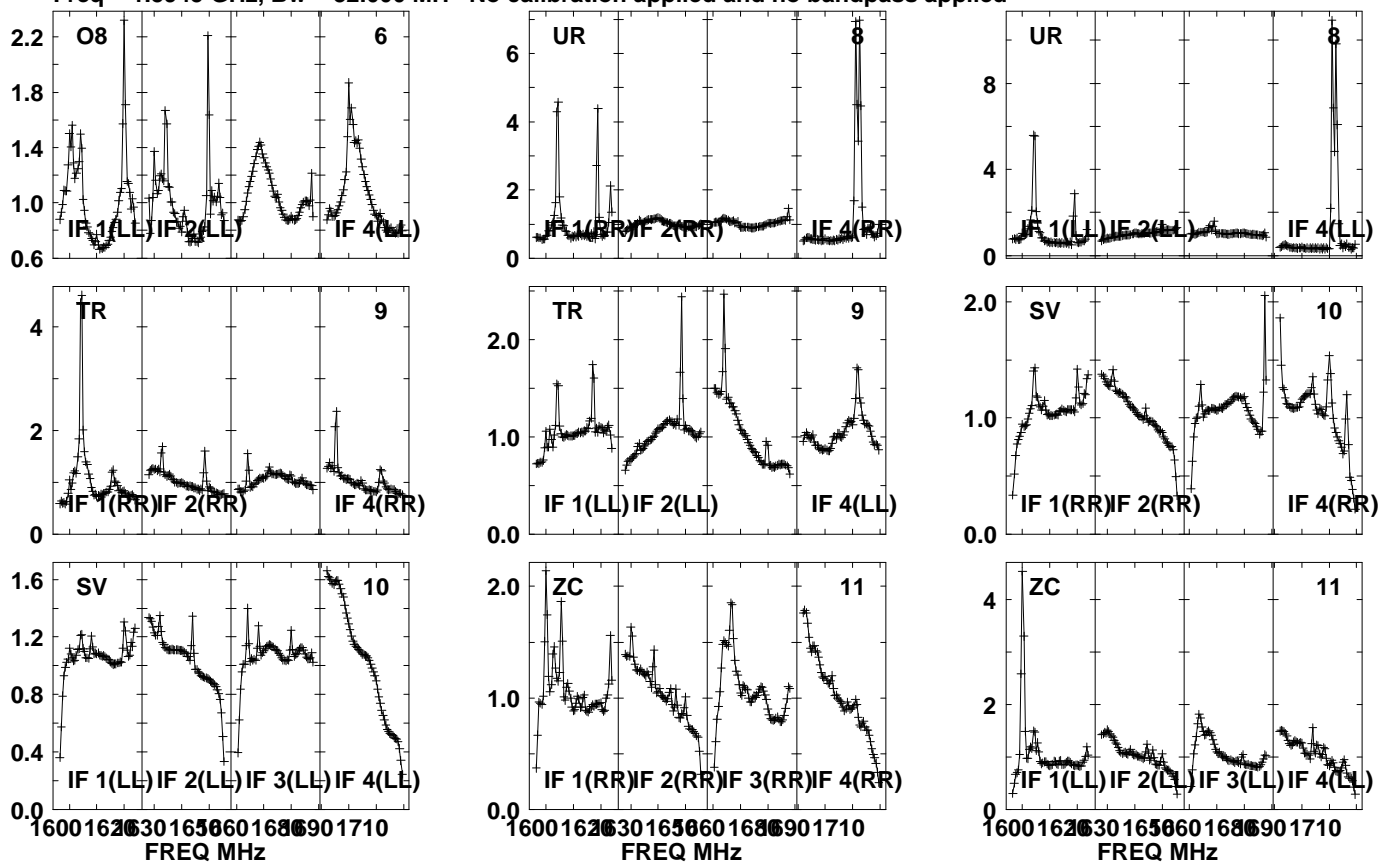

Lower frame: Real Jy  
Auto-corr total-power spectrum Antenna: \*  
Timerange: 00/21:52:01 to 00/21:53:29

Plot file version1367 created 05-OCT-2021 17:11:23

J0827+5217 GM076.UVDATA.1

Freq = 1.5945 GHz, Bw = 32.000 MH No calibration applied and no bandpass applied

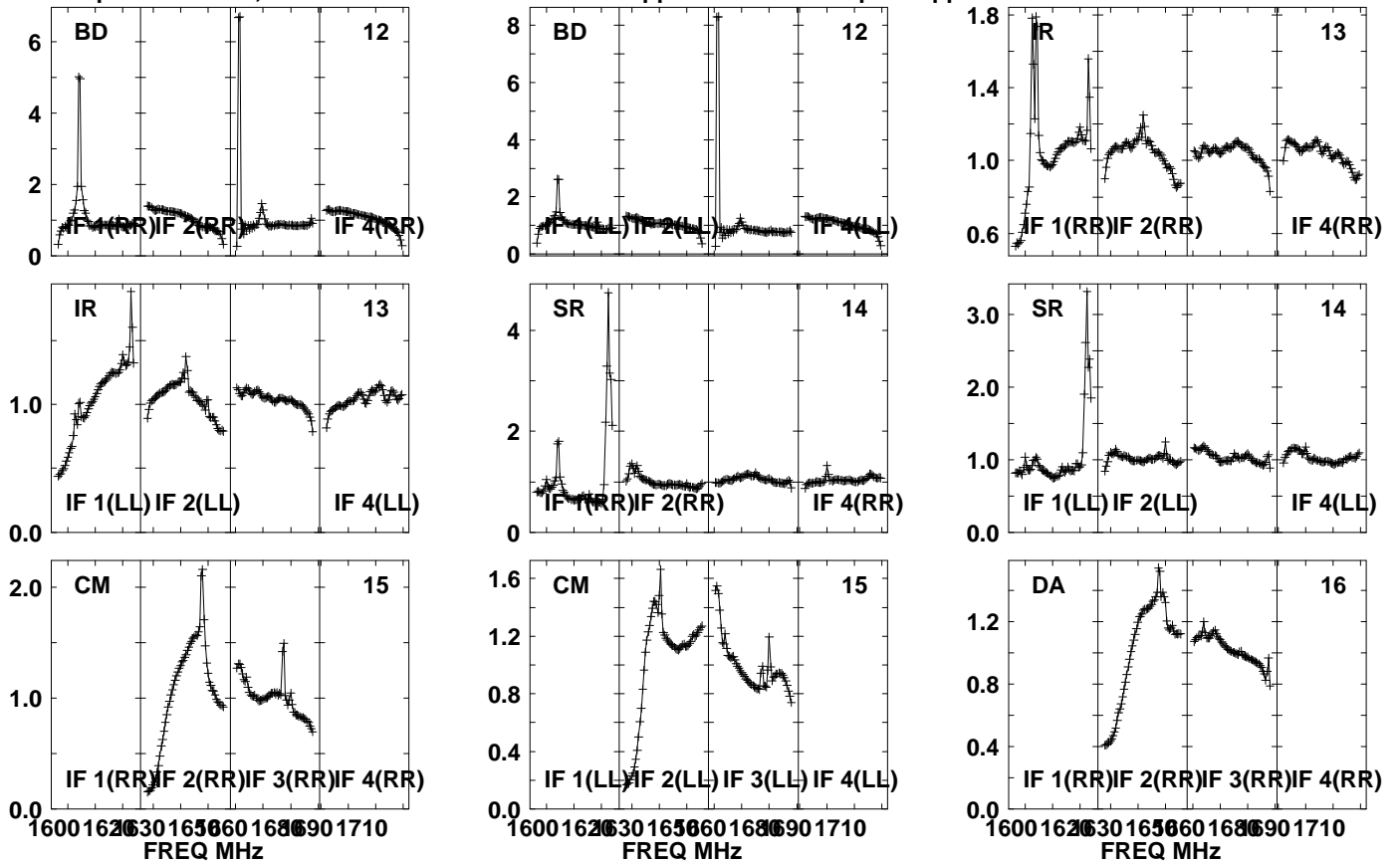

Lower frame: Real Jy

Auto-corr total-power spectrum Antenna: \*

Timerange: 00/21:52:01 to 00/21:53:29

Plot file version1368 created 05-OCT-2021 17:11:24

J0827+5217 GM076.UVDATA.1

Freq = 1.5945 GHz, Bw = 32.000 MH No calibration applied and no bandpass applied

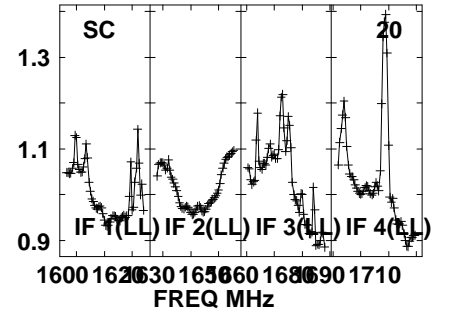
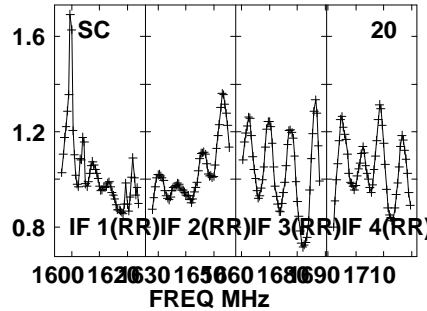
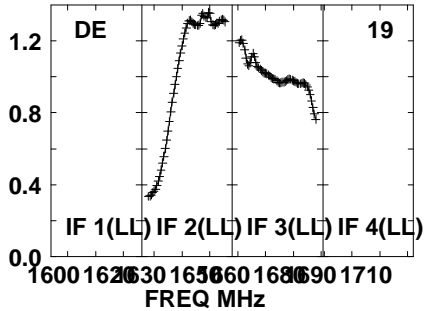
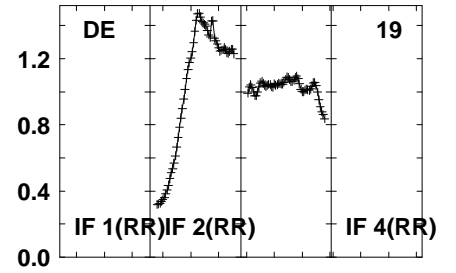
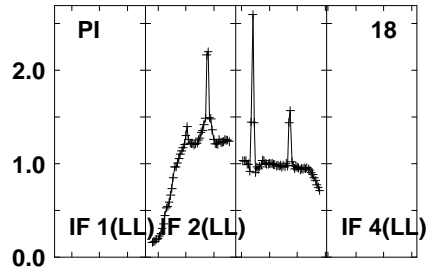
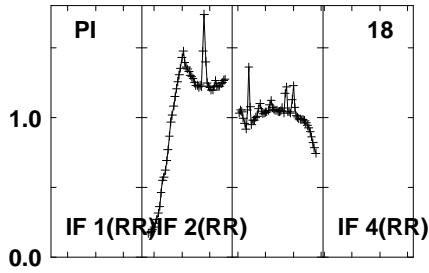
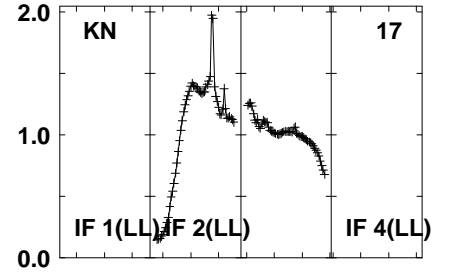
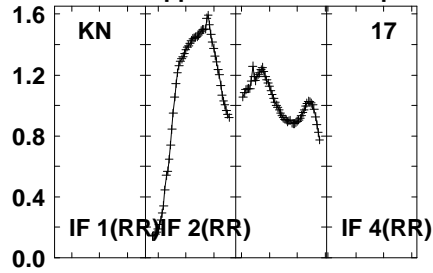
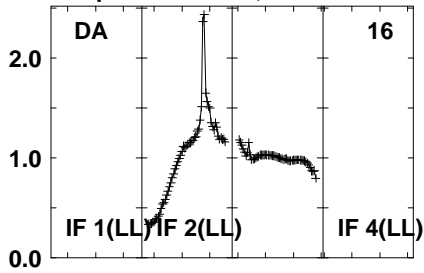

Lower frame: Real Jy  
Auto-corr total-power spectrum Antenna: \*  
Timerange: 00/21:52:01 to 00/21:53:29

Plot file version 1369 created 05-OCT-2021 17:11:24

J0827+5217 GM076.UVDATA.1

Freq = 1.5945 GHz, Bw = 32.000 MH No calibration applied and no bandpass applied

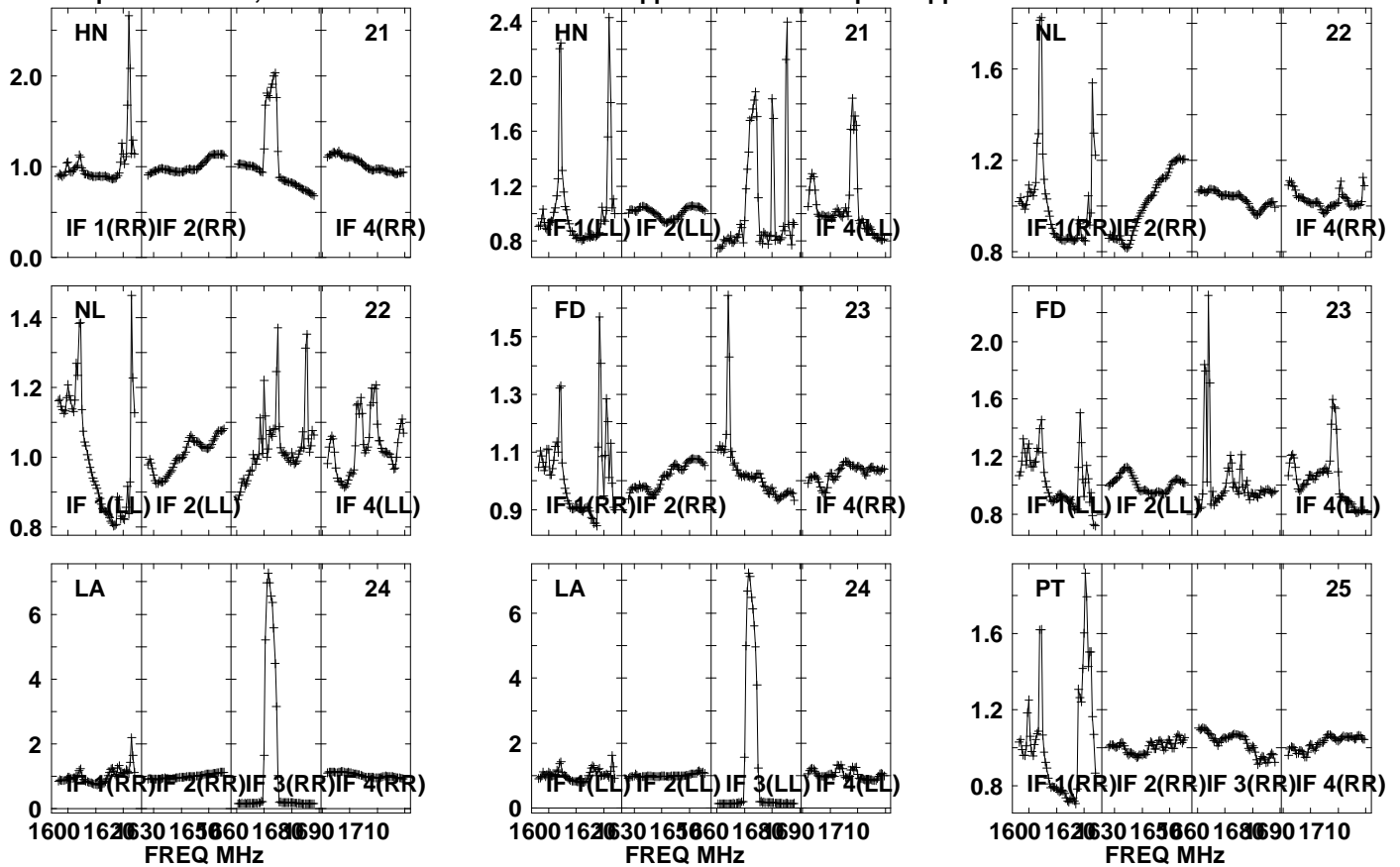

Lower frame: Real Jy

Auto-corr total-power spectrum Antenna: \*

Timerange: 00/21:52:01 to 00/21:53:29

Plot file version 1370 created 05-OCT-2021 17:11:24

J0827+5217 GM076.UVDATA.1

Freq = 1.5945 GHz, Bw = 32.000 MH No calibration applied and no bandpass applied

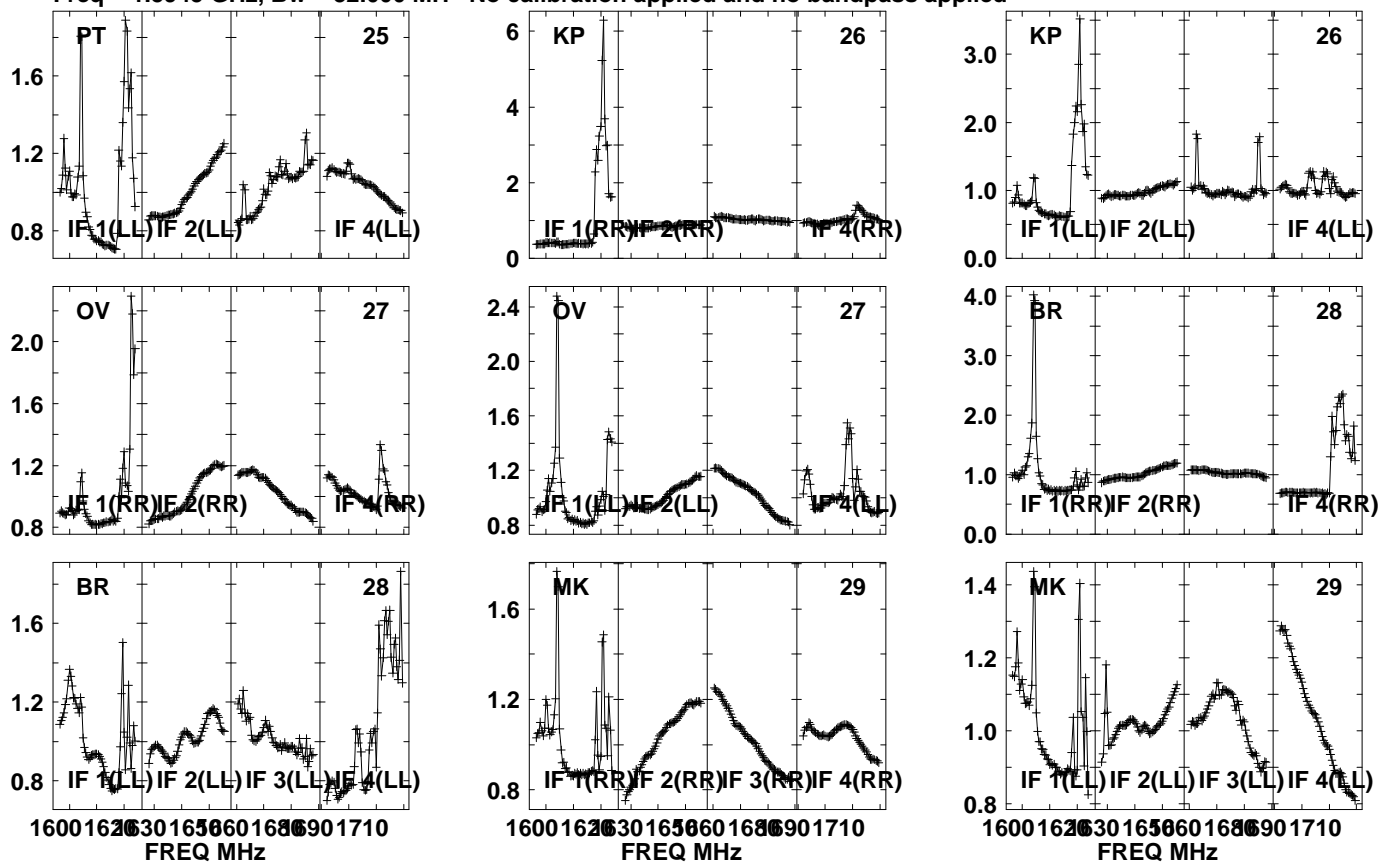

Lower frame: Real Jy  
Auto-corr total-power spectrum Antenna: \*  
Timerange: 00/21:52:01 to 00/21:53:29



Plot file version1371 created 05-OCT-2021 17:11:25

APM08279+525 GM076.UVDATA.1

Freq = 1.5945 GHz, Bw = 32.000 MH No calibration applied and no bandpass applied

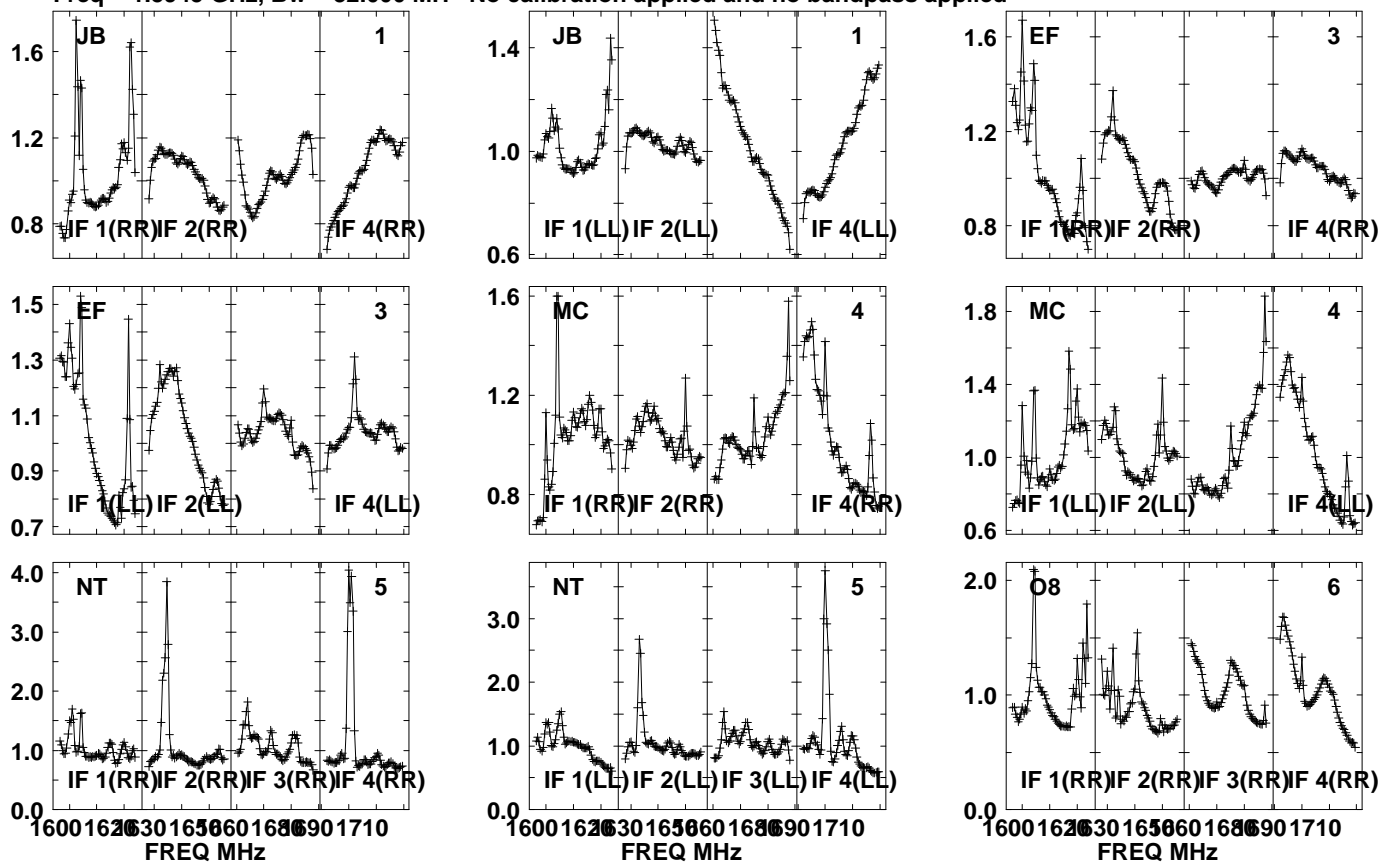

Lower frame: Real Jy  
Auto-corr total-power spectrum Antenna: \*  
Timerange: 00/21:53:31 to 00/21:56:59

Plot file version1372 created 05-OCT-2021 17:11:25

APM08279+525 GM076.UVDATA.1

Freq = 1.5945 GHz, Bw = 32.000 MH No calibration applied and no bandpass applied

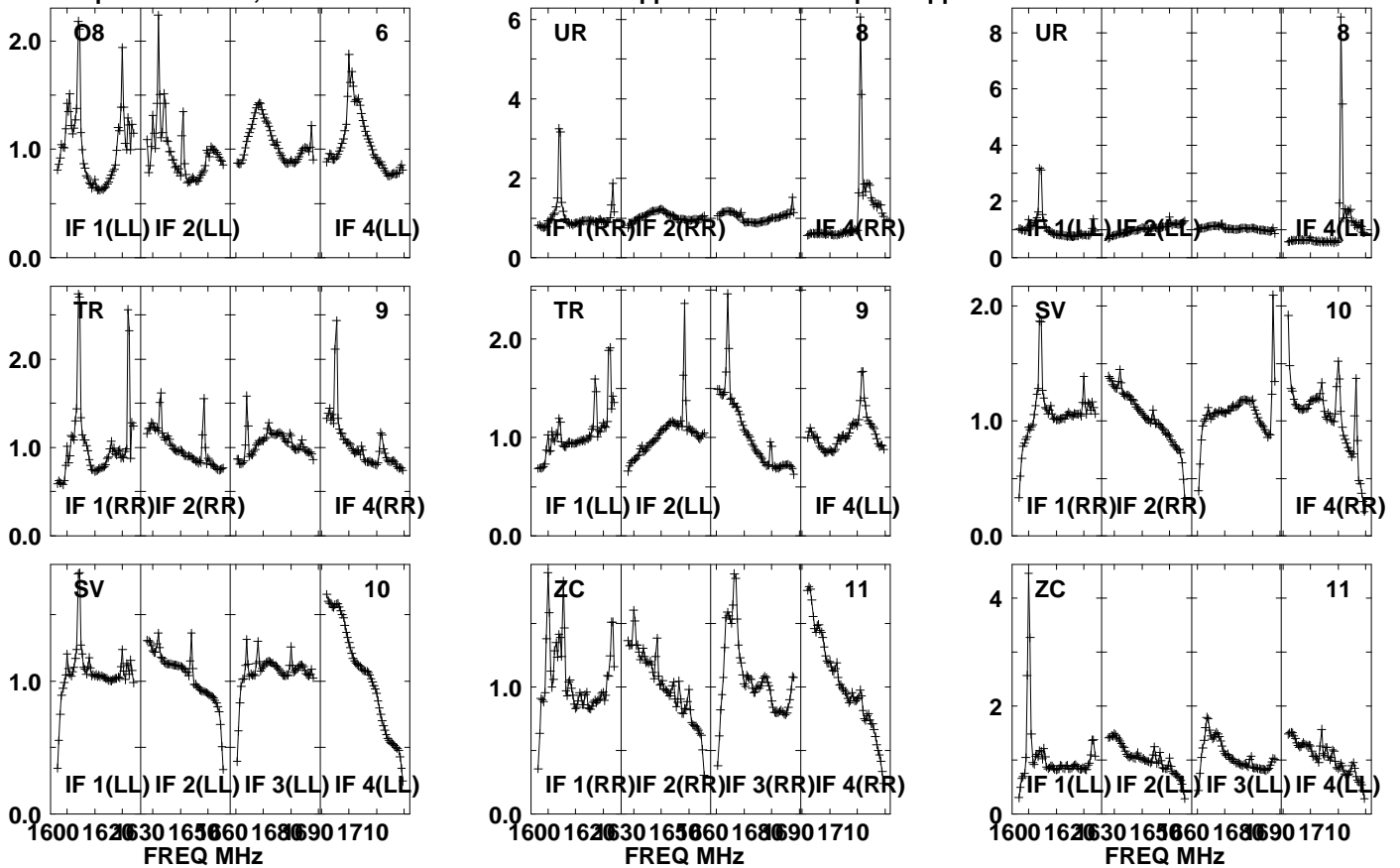

Lower frame: Real Jy

Auto-corr total-power spectrum Antenna: \*

Timerange: 00/21:53:31 to 00/21:56:59

Plot file version1373 created 05-OCT-2021 17:11:25

APM08279+525 GM076.UVDATA.1

Freq = 1.5945 GHz, Bw = 32.000 MH No calibration applied and no bandpass applied

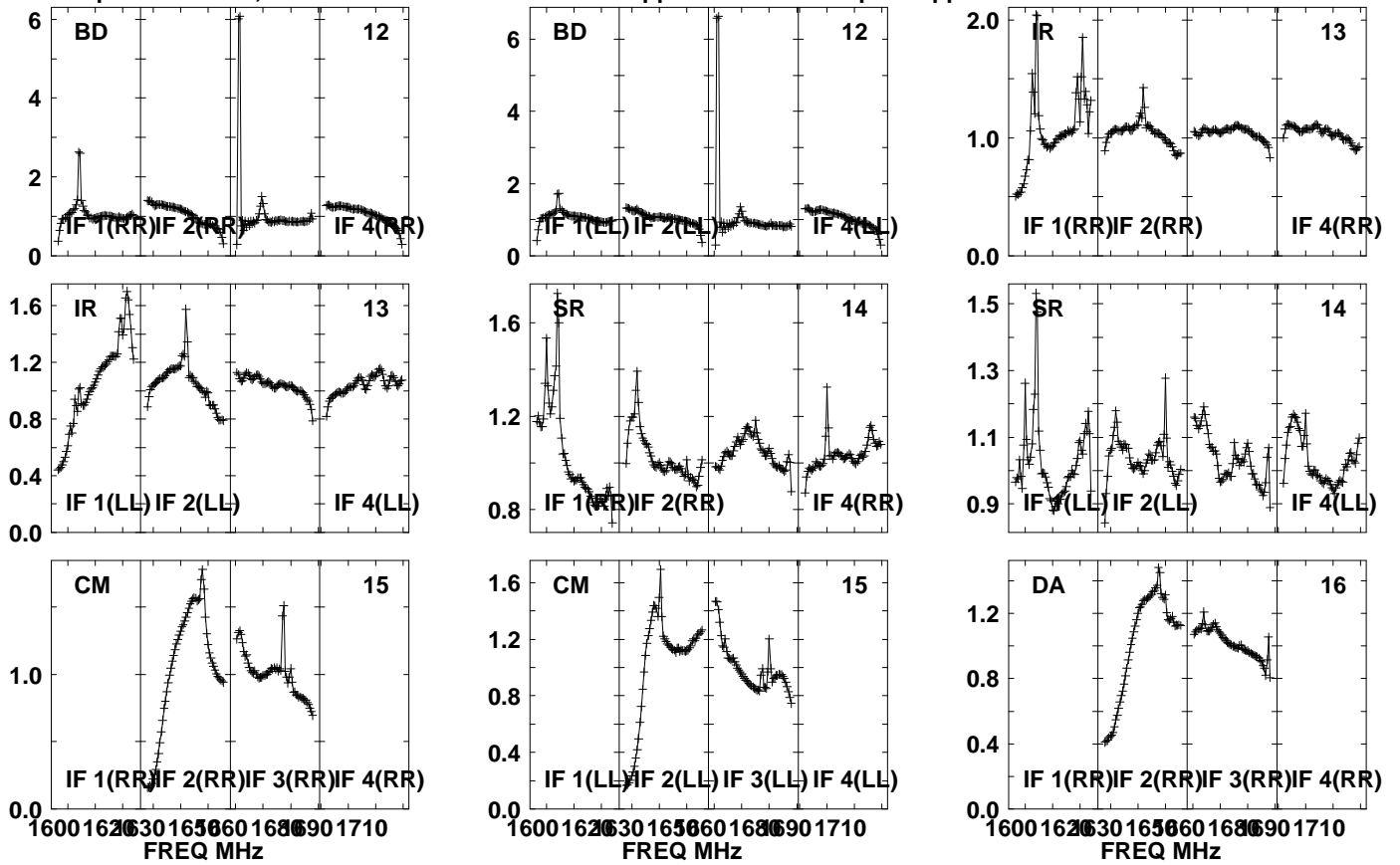

Lower frame: Real Jy  
Auto-corr total-power spectrum Antenna: \*  
Timerange: 00/21:53:31 to 00/21:56:59

Plot file version1374 created 05-OCT-2021 17:11:26

APM08279+525 GM076.UVDATA.1

Freq = 1.5945 GHz, Bw = 32.000 MH No calibration applied and no bandpass applied

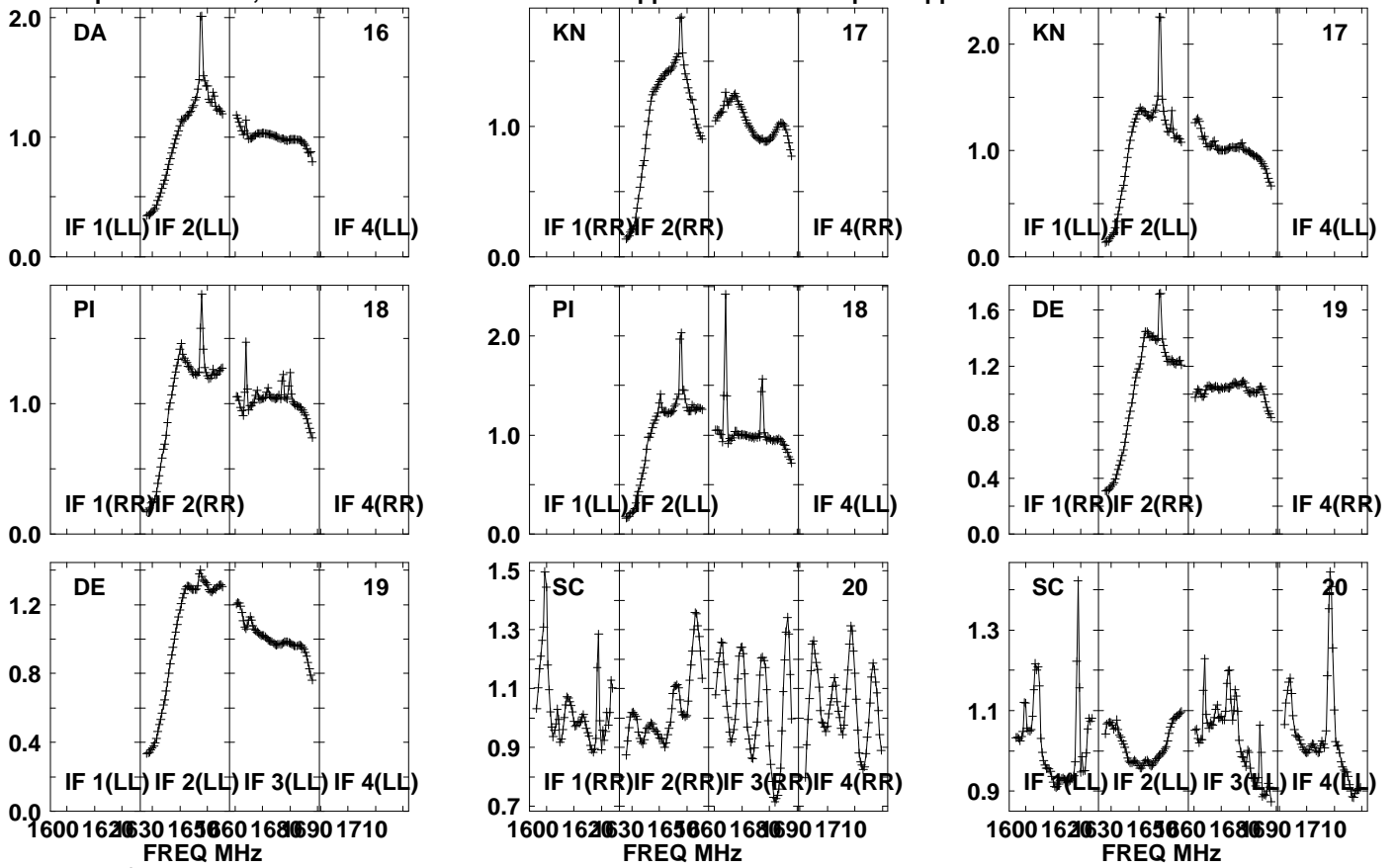

Lower frame: Real Jy  
Auto-corr total-power spectrum Antenna: \*  
Timerange: 00/21:53:31 to 00/21:56:59

Plot file version 1375 created 05-OCT-2021 17:11:26

APM08279+525 GM076.UVDATA.1

Freq = 1.5945 GHz, Bw = 32.000 MHz No calibration applied and no bandpass applied

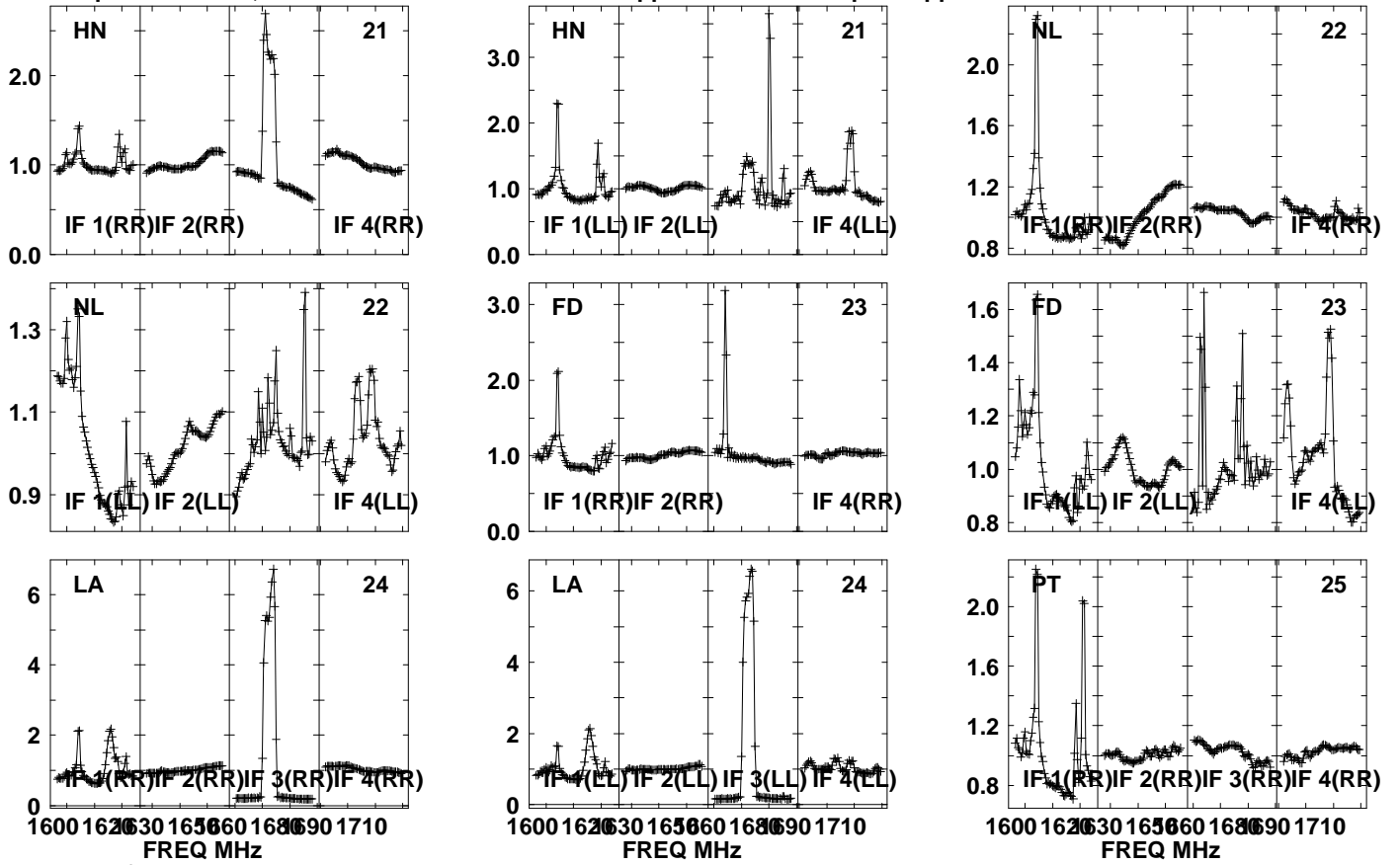

Lower frame: Real Jy  
Auto-corr total-power spectrum Antenna: \*  
Timerange: 00/21:53:31 to 00/21:56:59

Plot file version1376 created 05-OCT-2021 17:11:26

APM08279+525 GM076.UVDATA.1

Freq = 1.5945 GHz, Bw = 32.000 MH No calibration applied and no bandpass applied

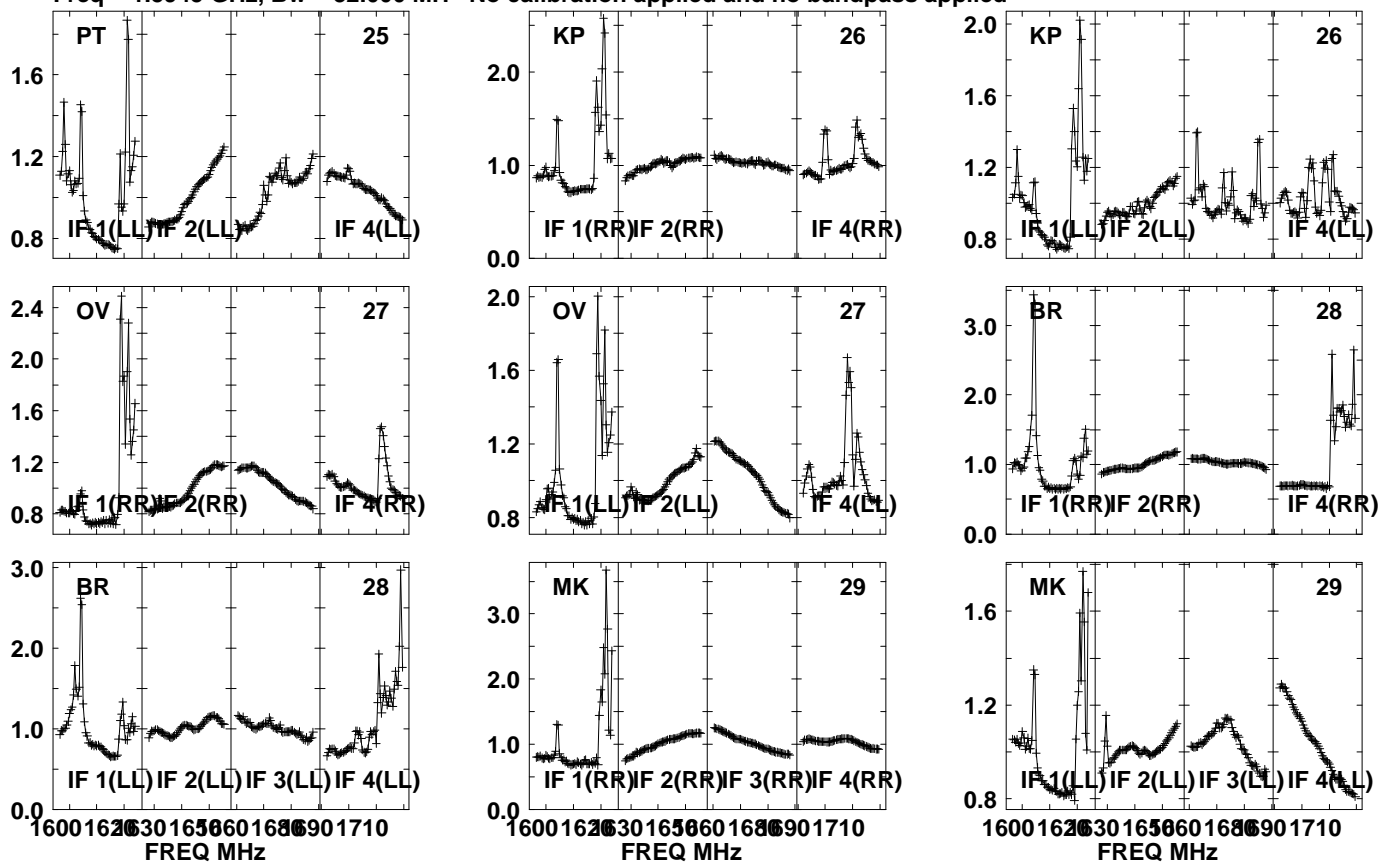

Lower frame: Real Jy  
Auto-corr total-power spectrum Antenna: \*  
Timerange: 00/21:53:31 to 00/21:56:59

Plot file version1377 created 05-OCT-2021 17:11:27

J0827+5217 GM076.UVDATA.1

Freq = 1.5945 GHz, Bw = 32.000 MH No calibration applied and no bandpass applied

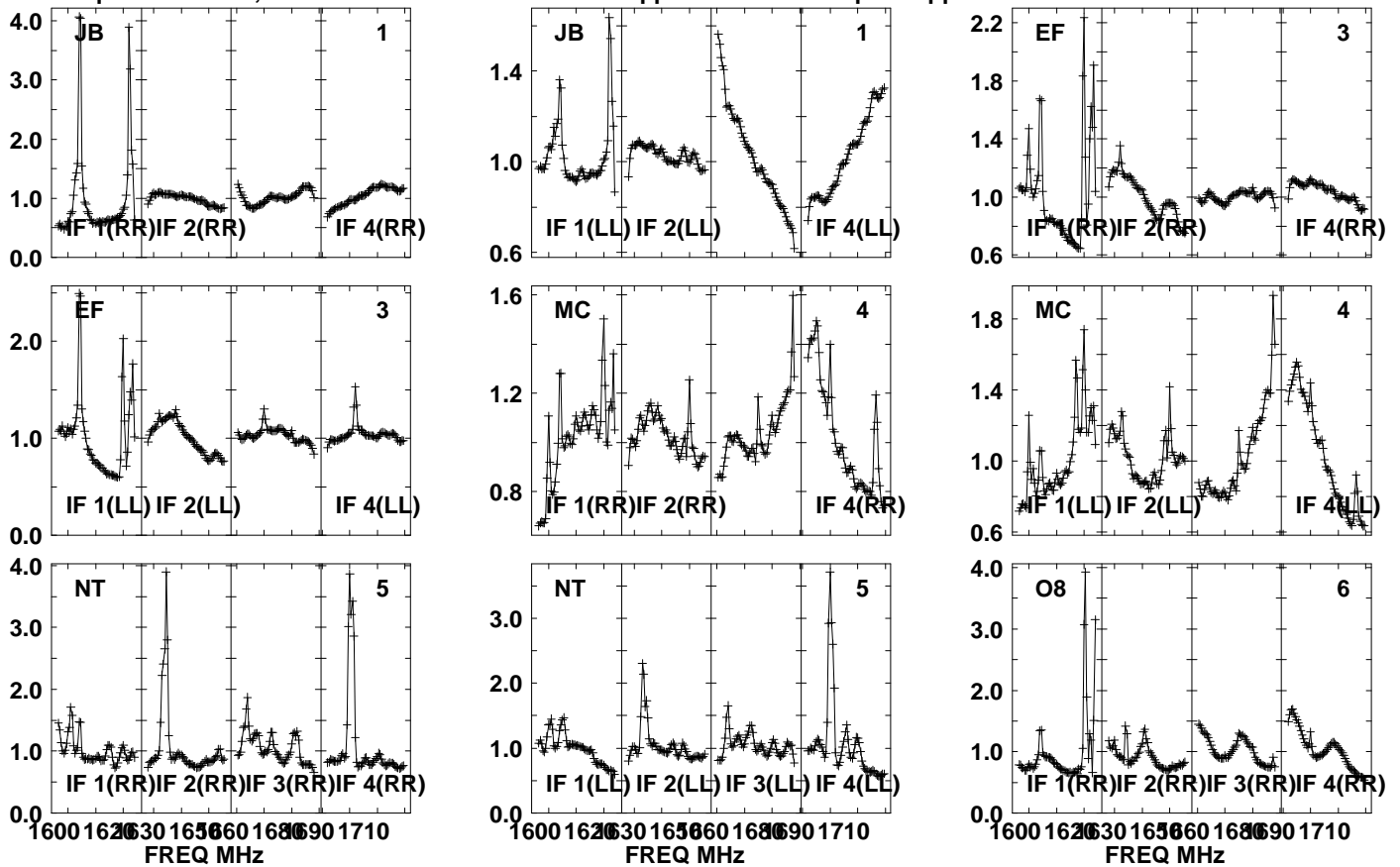

Lower frame: Real Jy

Auto-corr total-power spectrum Antenna: \*

Timerange: 00/21:57:01 to 00/21:58:29

Plot file version1378 created 05-OCT-2021 17:11:27

J0827+5217 GM076.UVDATA.1

Freq = 1.5945 GHz, Bw = 32.000 MH No calibration applied and no bandpass applied

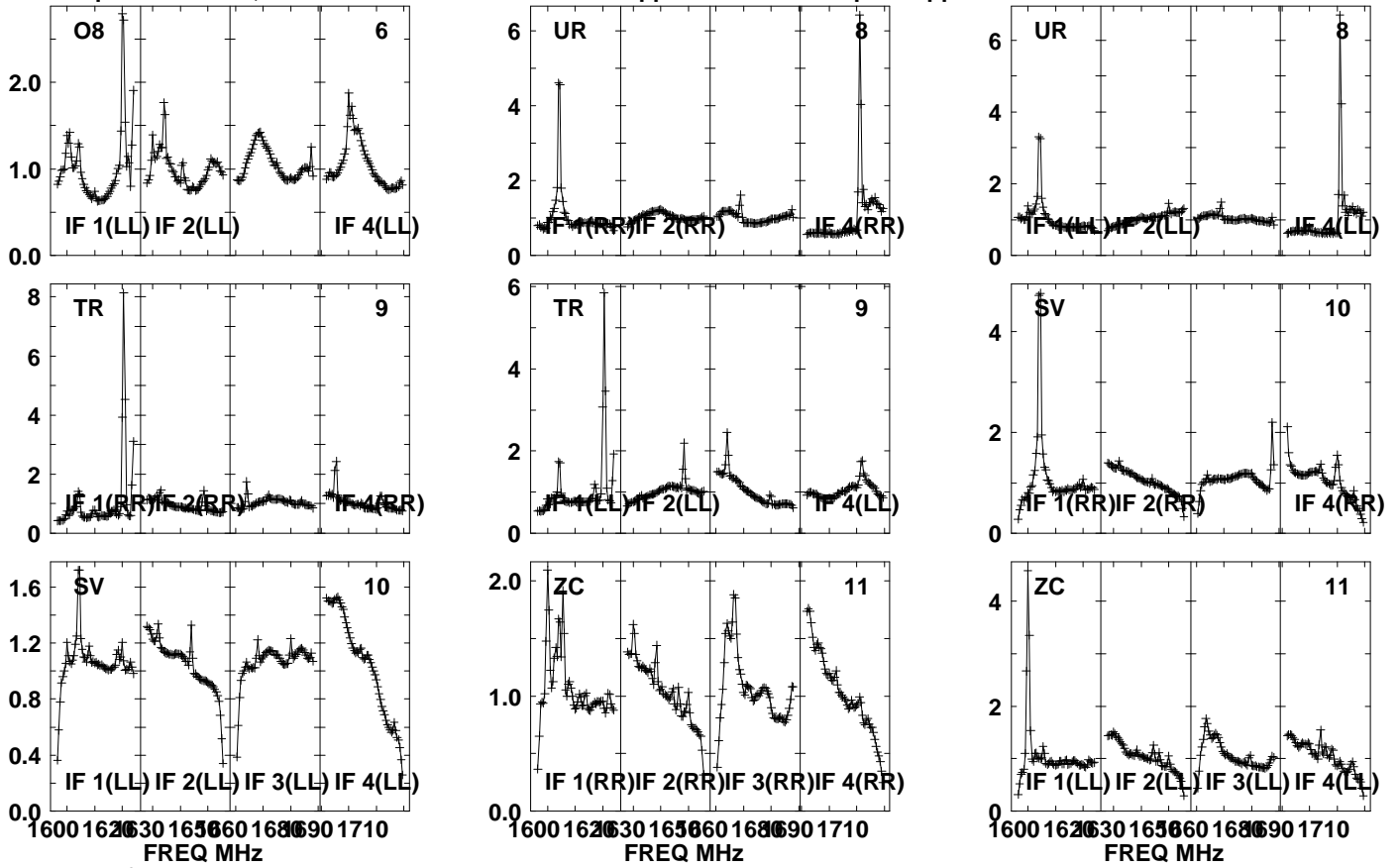

Lower frame: Real Jy  
Auto-corr total-power spectrum Antenna: \*  
Timerange: 00/21:57:01 to 00/21:58:29



Plot file version1379 created 05-OCT-2021 17:11:28

J0827+5217 GM076.UVDATA.1

Freq = 1.5945 GHz, Bw = 32.000 MH No calibration applied and no bandpass applied

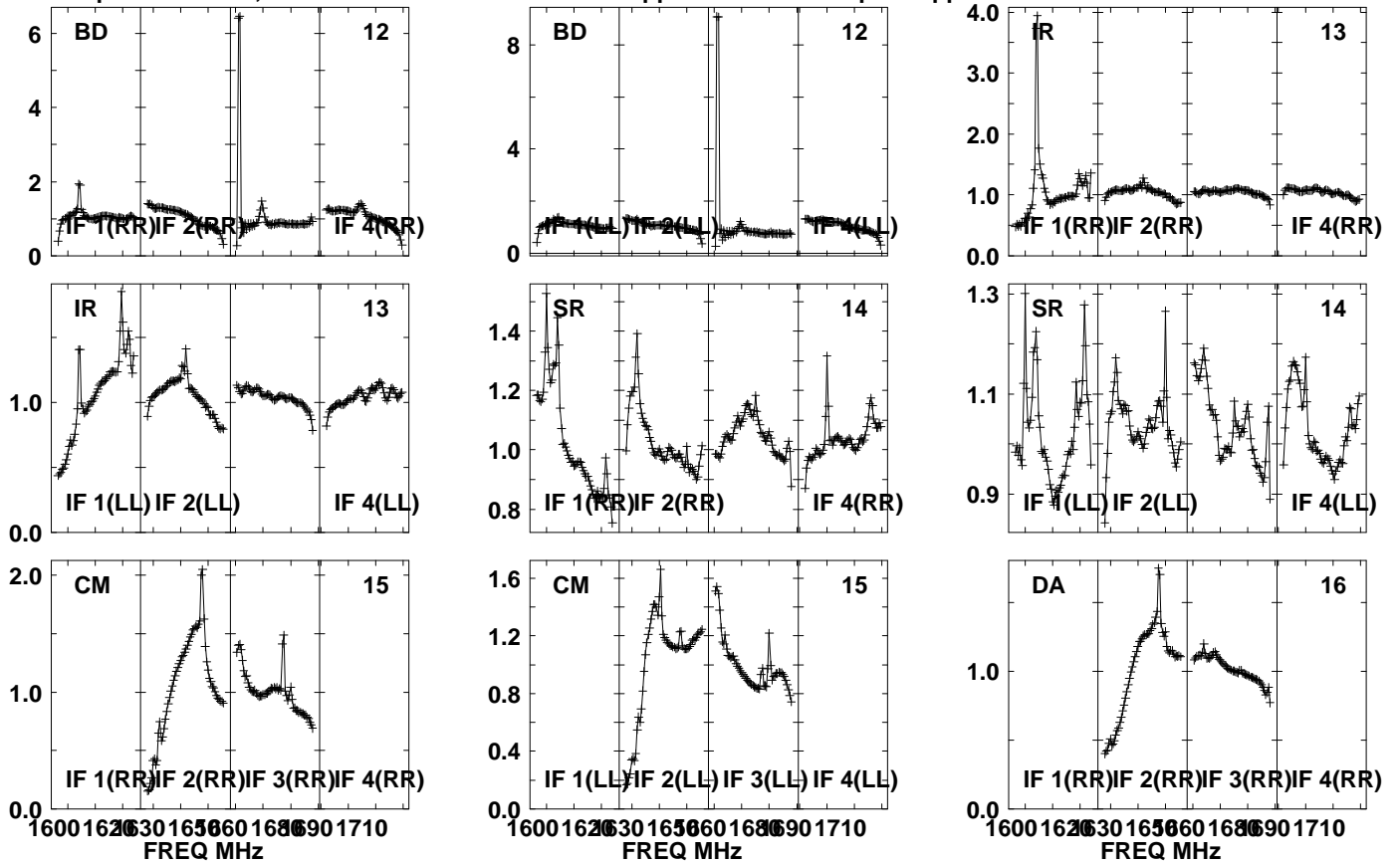

Lower frame: Real Jy

Auto-corr total-power spectrum Antenna: \*

Timerange: 00/21:57:01 to 00/21:58:29

Plot file version1380 created 05-OCT-2021 17:11:28

J0827+5217 GM076.UVDATA.1

Freq = 1.5945 GHz, Bw = 32.000 MH No calibration applied and no bandpass applied

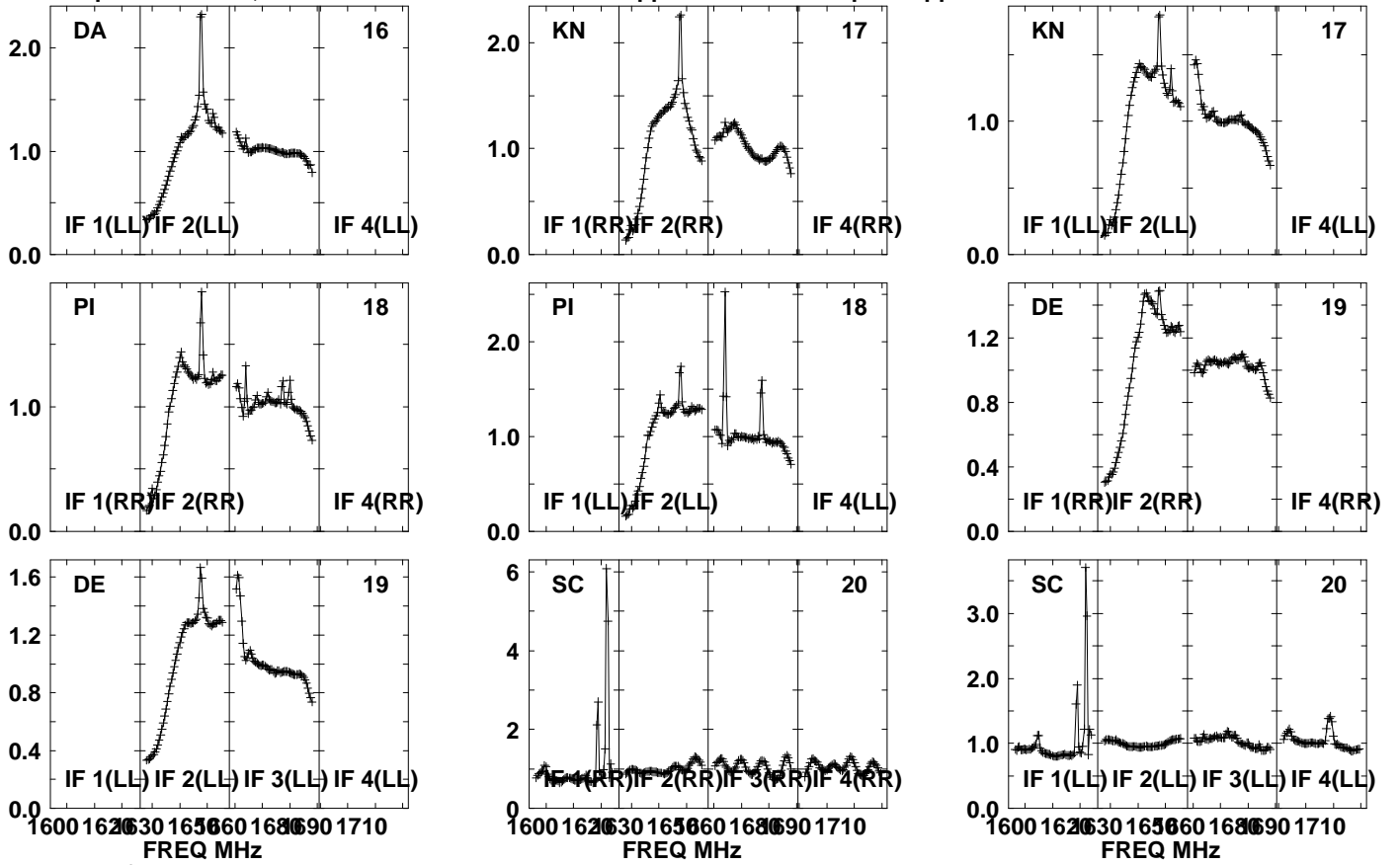

Lower frame: Real Jy  
Auto-corr total-power spectrum Antenna: \*  
Timerange: 00:21:57:01 to 00:21:58:29

Plot file version 1381 created 05-OCT-2021 17:11:28

J0827+5217 GM076.UVDATA.1

Freq = 1.5945 GHz, Bw = 32.000 MH No calibration applied and no bandpass applied

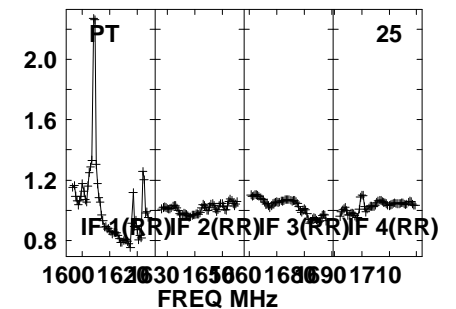
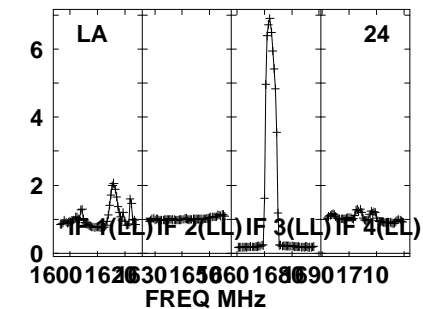
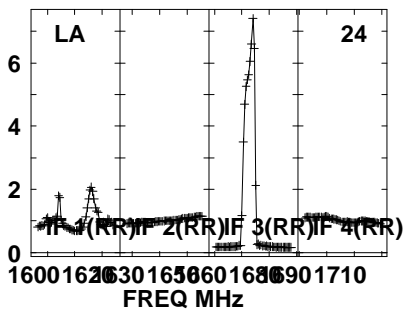
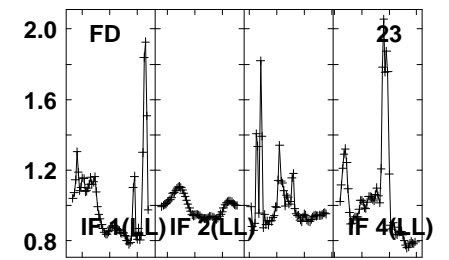
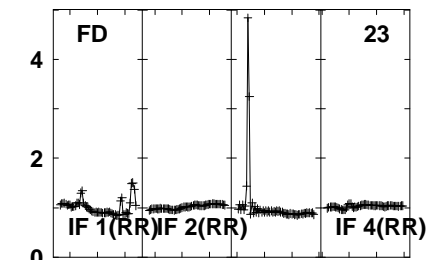
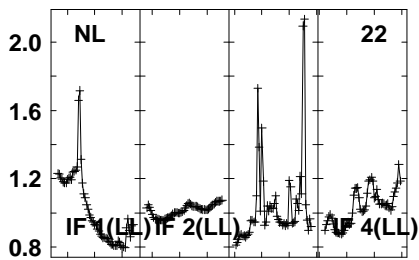
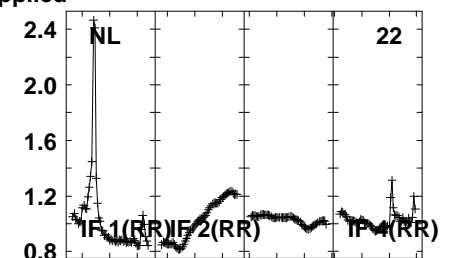
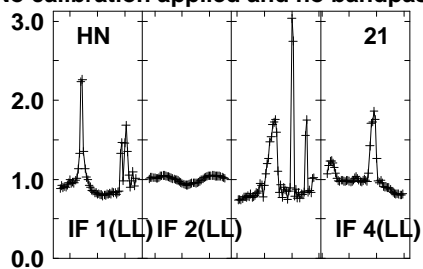
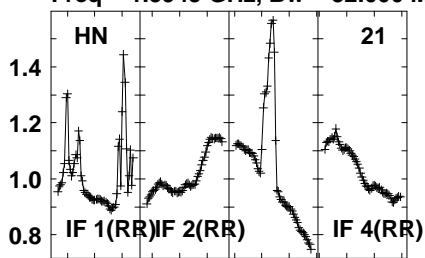

Lower frame: Real Jy  
Auto-corr total-power spectrum Antenna: \*  
Timerange: 00/21:57:01 to 00/21:58:29

Plot file version 1382 created 05-OCT-2021 17:11:29

J0827+5217 GM076.UVDATA.1

Freq = 1.5945 GHz, Bw = 32.000 MH No calibration applied and no bandpass applied

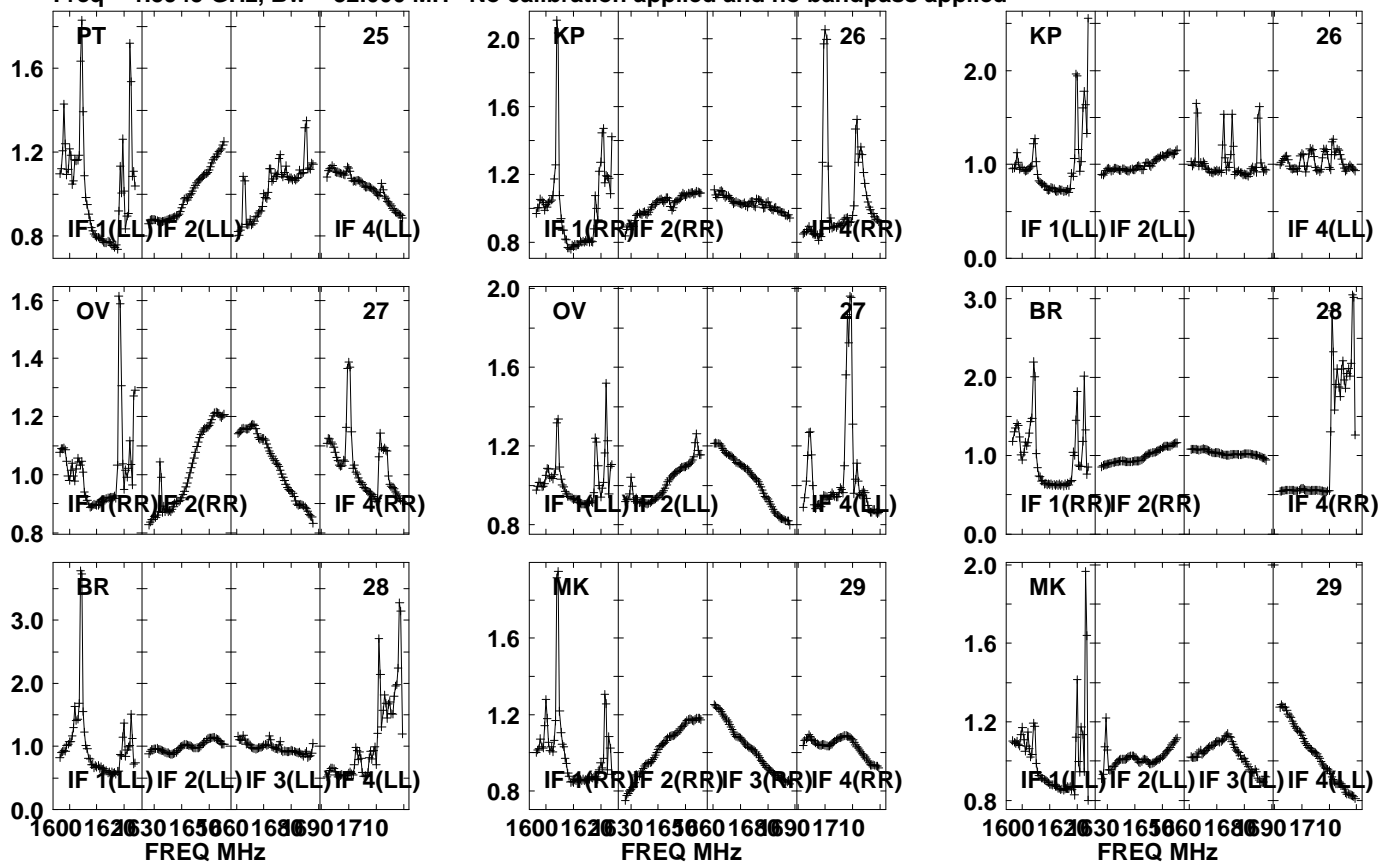

Lower frame: Real Jy  
Auto-corr total-power spectrum Antenna: \*  
Timerange: 00/21:57:01 to 00/21:58:29

Plot file version1383 created 05-OCT-2021 17:11:29

APM08279+525 GM076.UVDATA.1

Freq = 1.5945 GHz, Bw = 32.000 MH No calibration applied and no bandpass applied

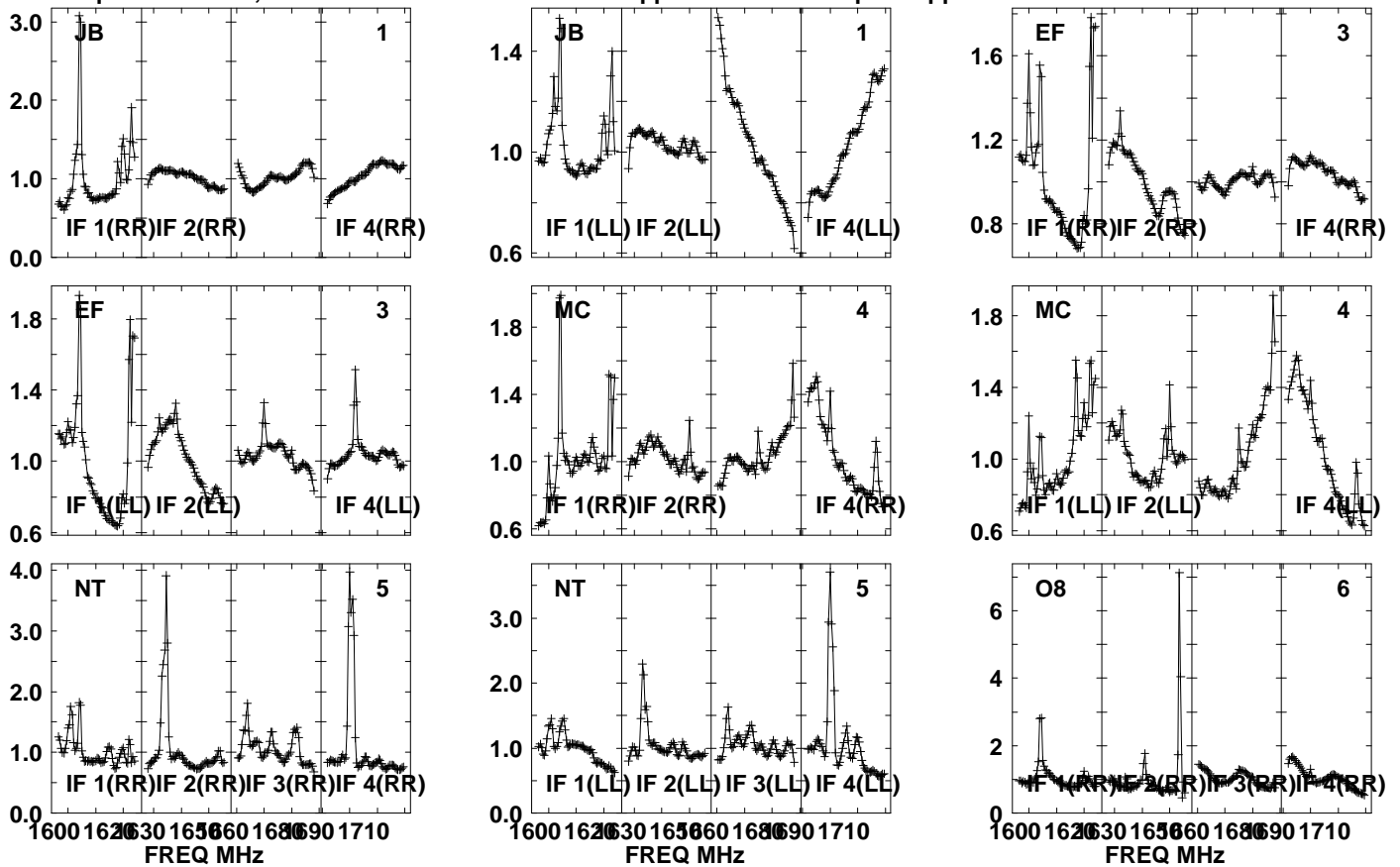

Lower frame: Real Jy

Auto-corr total-power spectrum Antenna: \*

Timerange: 00/21:58:31 to 00/22:01:59

Plot file version1384 created 05-OCT-2021 17:11:29

APM08279+525 GM076.UVDATA.1

Freq = 1.5945 GHz, Bw = 32.000 MH No calibration applied and no bandpass applied

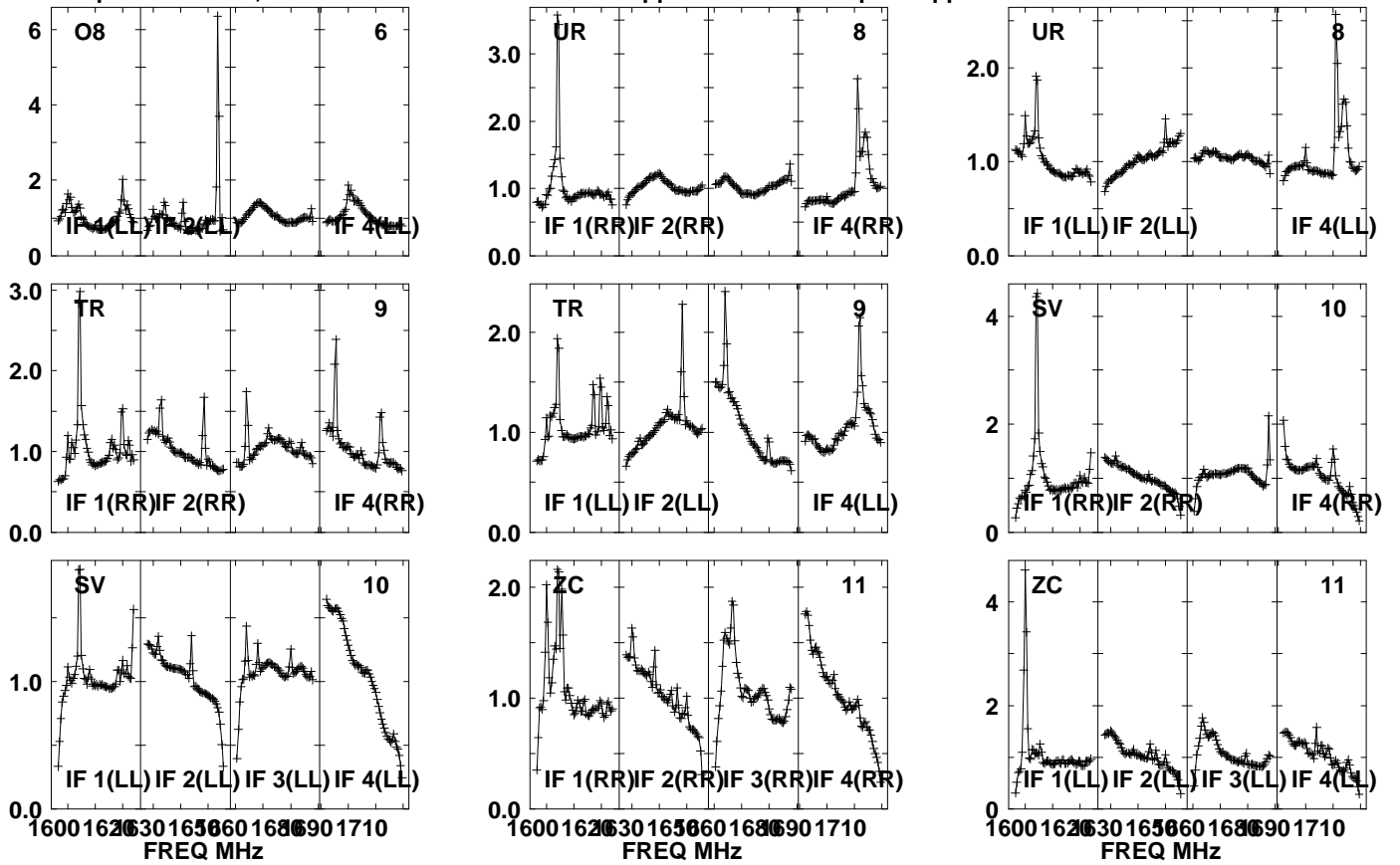

Lower frame: Real Jy

Auto-corr total-power spectrum Antenna: \*

Timerange: 00/21:58:31 to 00/22:01:59

Plot file version 1385 created 05-OCT-2021 17:11:30

APM08279+525 GM076.UVDATA.1

Freq = 1.5945 GHz, Bw = 32.000 MH No calibration applied and no bandpass applied

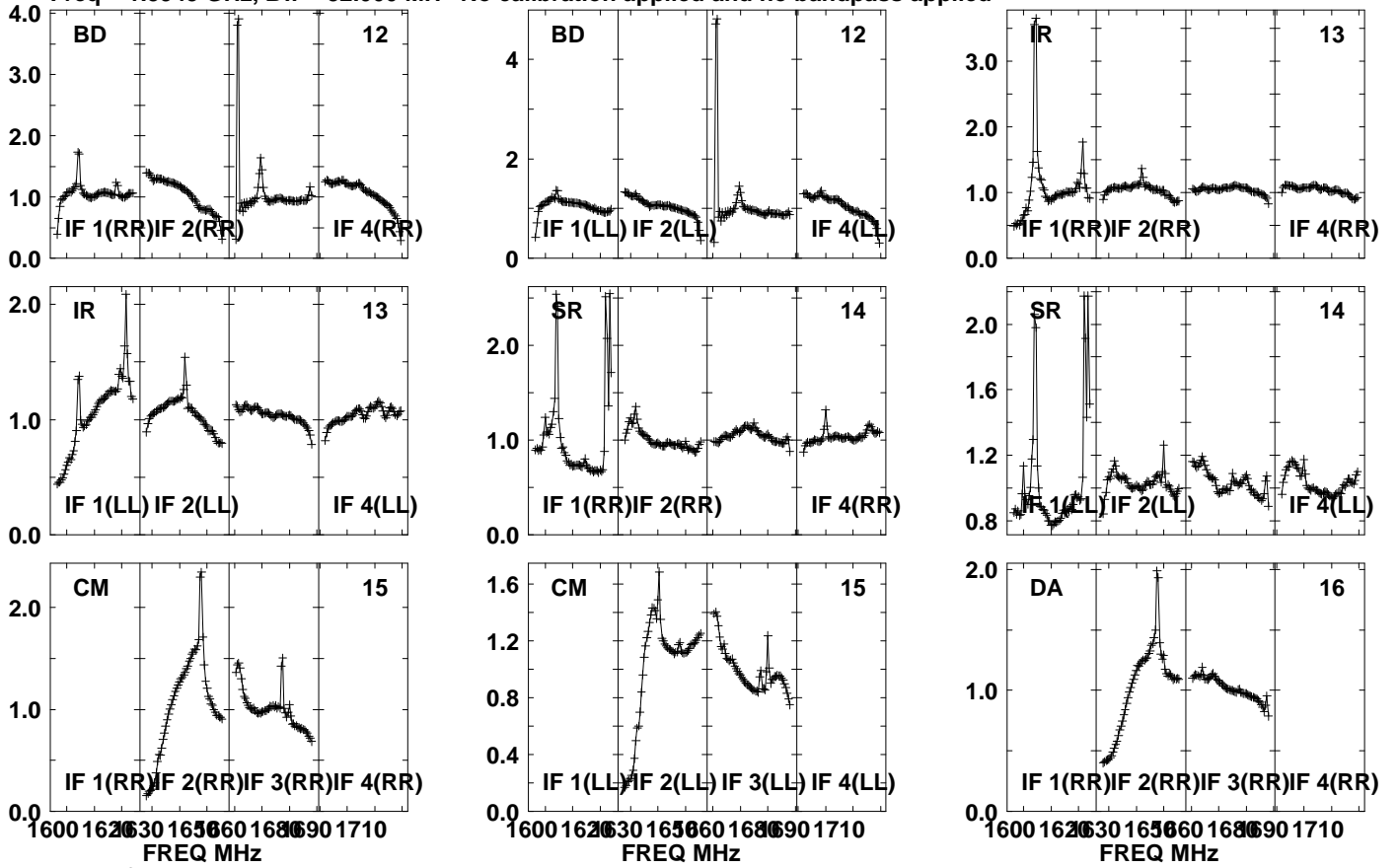

Lower frame: Real Jy  
Auto-corr total-power spectrum Antenna: \*  
Timerange: 00/21:58:31 to 00/22:01:59

Plot file version 1386 created 05-OCT-2021 17:11:30

APM08279+525 GM076.UVDATA.1

Freq = 1.5945 GHz, Bw = 32.000 MH No calibration applied and no bandpass applied

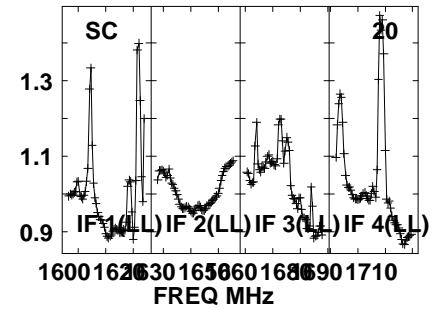
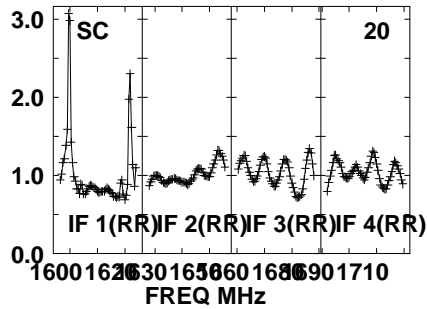
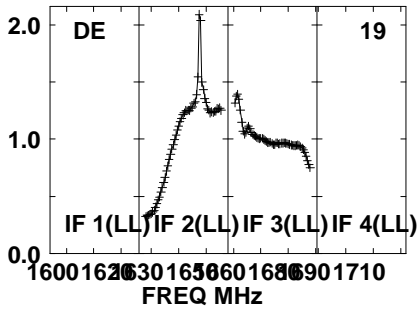
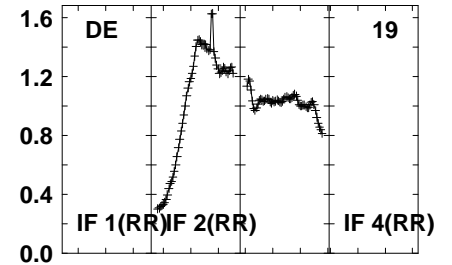
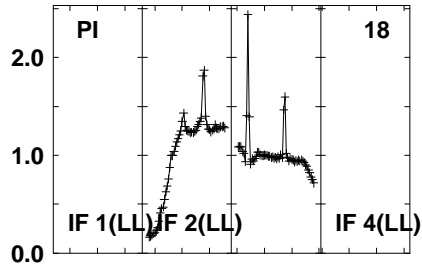
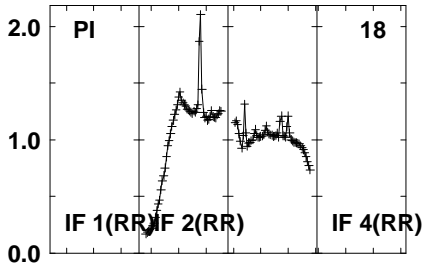
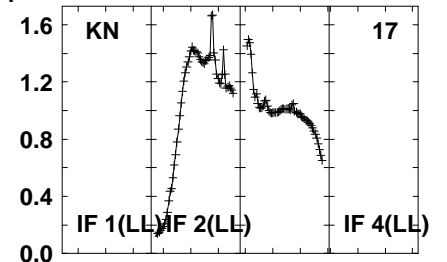
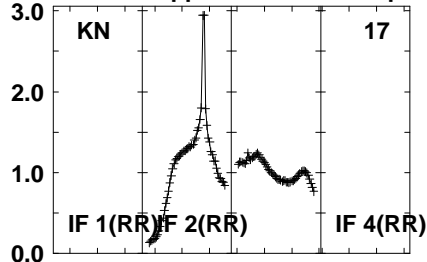
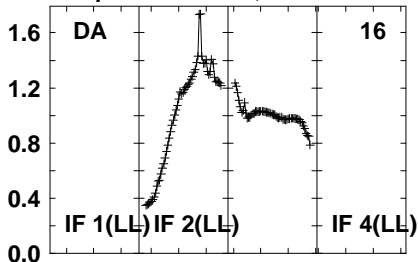

Lower frame: Real Jy  
Auto-corr total-power spectrum Antenna: \*  
Timerange: 00/21:58:31 to 00/22:01:59



Plot file version1387 created 05-OCT-2021 17:11:30

APM08279+525 GM076.UVDATA.1

Freq = 1.5945 GHz, Bw = 32.000 MH No calibration applied and no bandpass applied

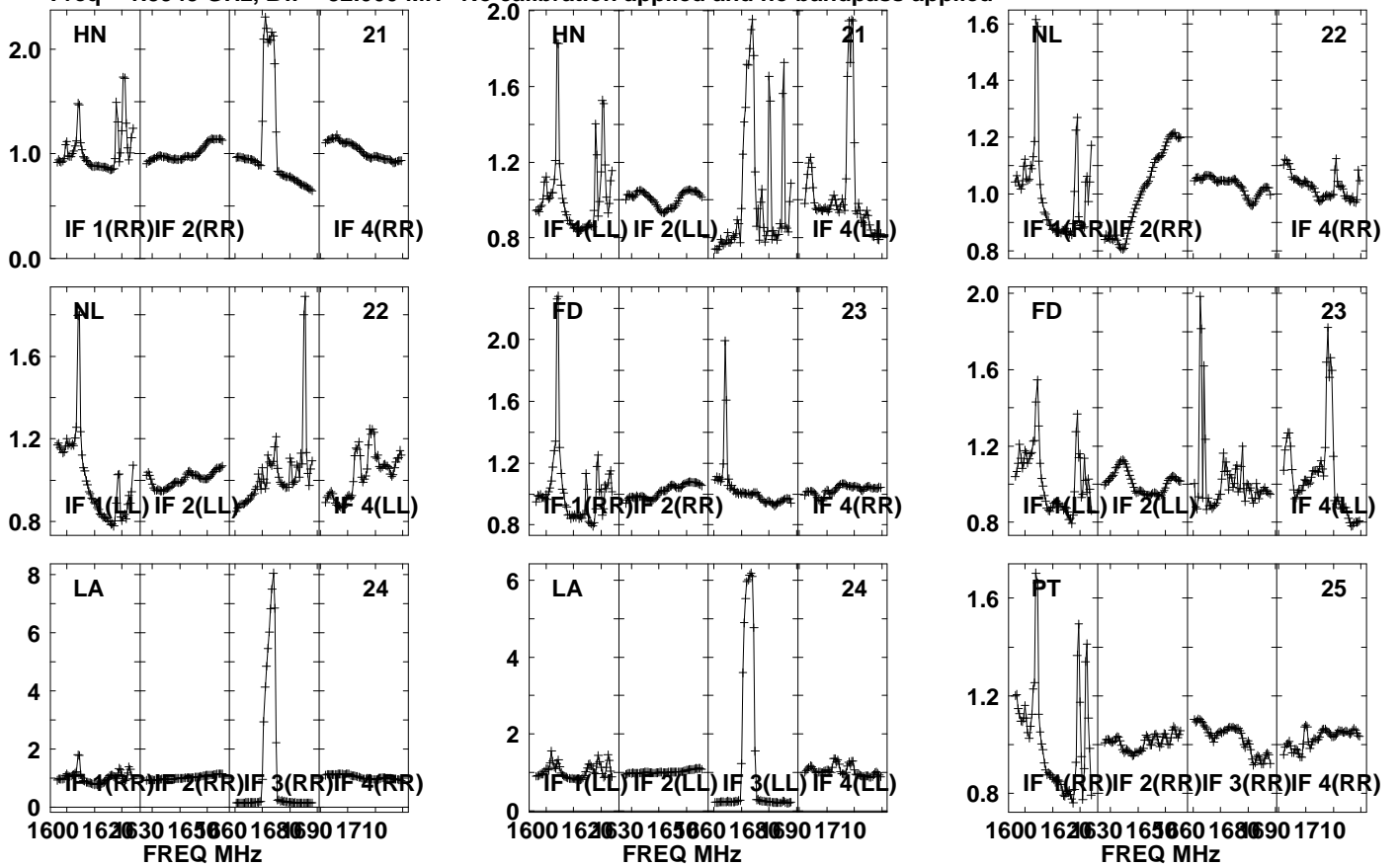

Lower frame: Real Jy  
Auto-corr total-power spectrum Antenna: \*  
Timerange: 00/21:58:31 to 00/22:01:59

Plot file version1388 created 05-OCT-2021 17:11:31

APM08279+525 GM076.UVDATA.1

Freq = 1.5945 GHz, Bw = 32.000 MH No calibration applied and no bandpass applied

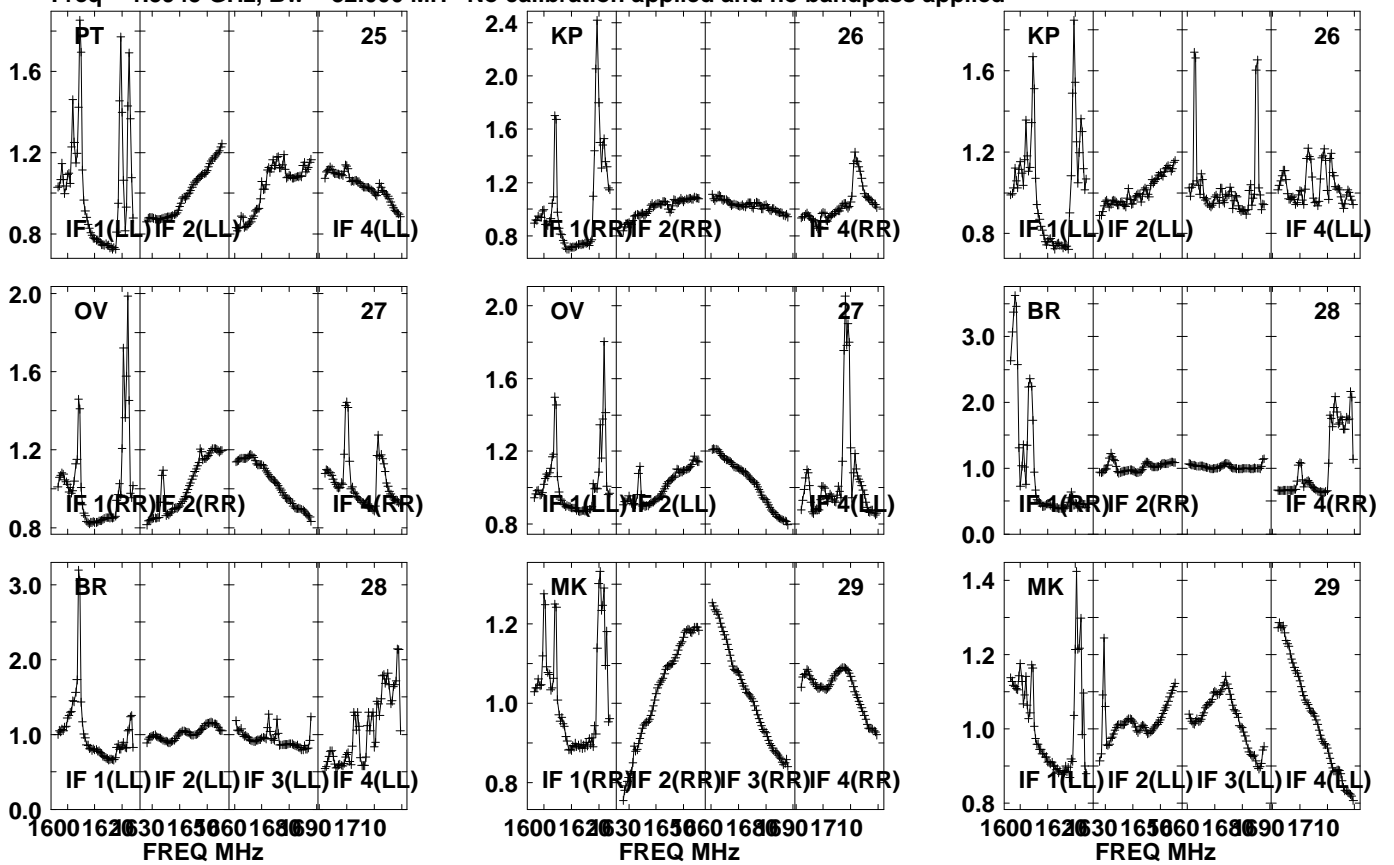

Lower frame: Real Jy  
Auto-corr total-power spectrum Antenna: \*  
Timerange: 00/21:58:31 to 00/22:01:59

Plot file version1389 created 05-OCT-2021 17:11:31

J0827+5217 GM076.UVDATA.1

Freq = 1.5945 GHz, Bw = 32.000 MH No calibration applied and no bandpass applied

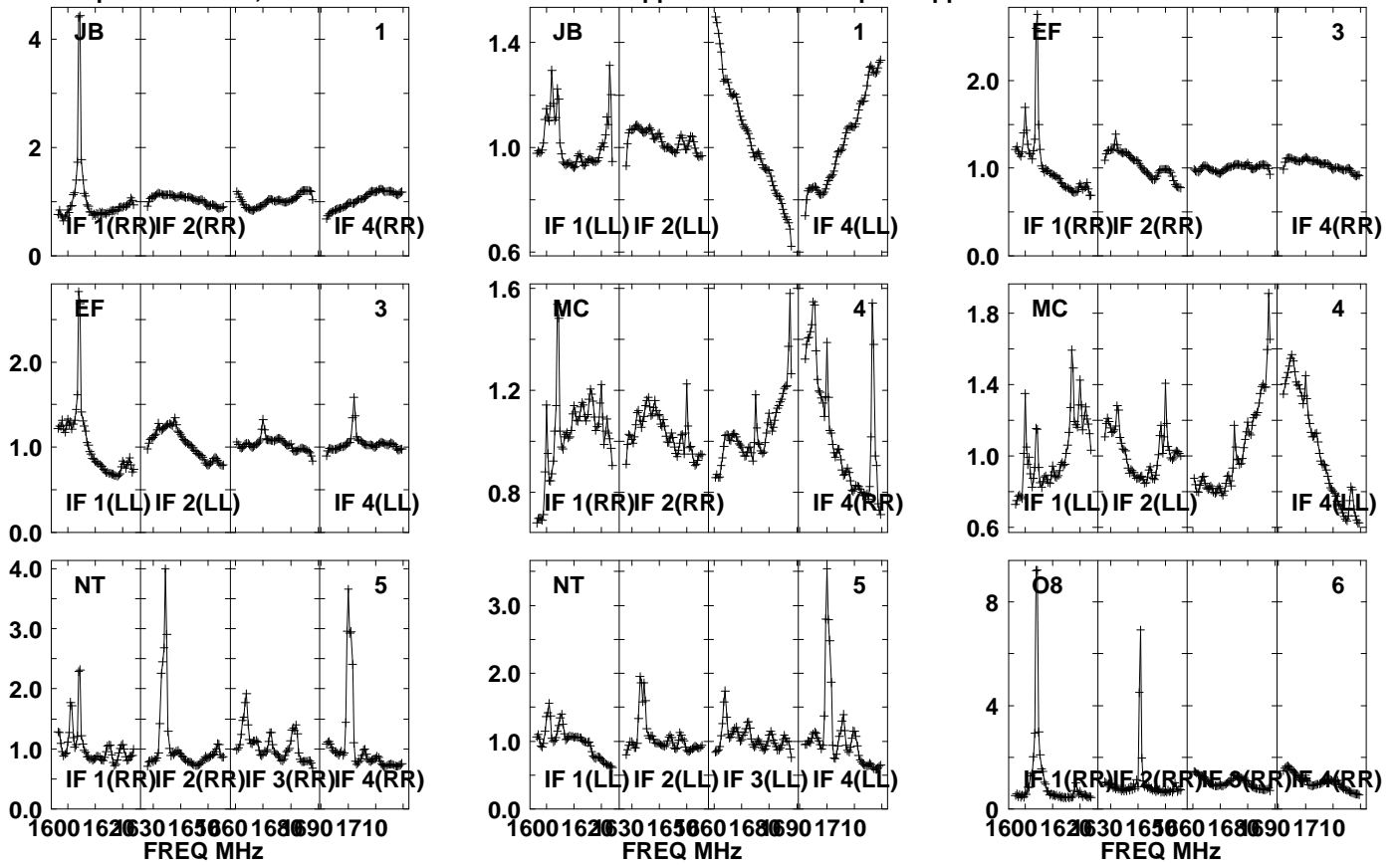

Lower frame: Real Jy

Auto-corr total-power spectrum Antenna: \*

Timerange: 00/22:02:31 to 00/22:03:59

Plot file version1390 created 05-OCT-2021 17:11:31

J0827+5217 GM076.UVDATA.1

Freq = 1.5945 GHz, Bw = 32.000 MH No calibration applied and no bandpass applied

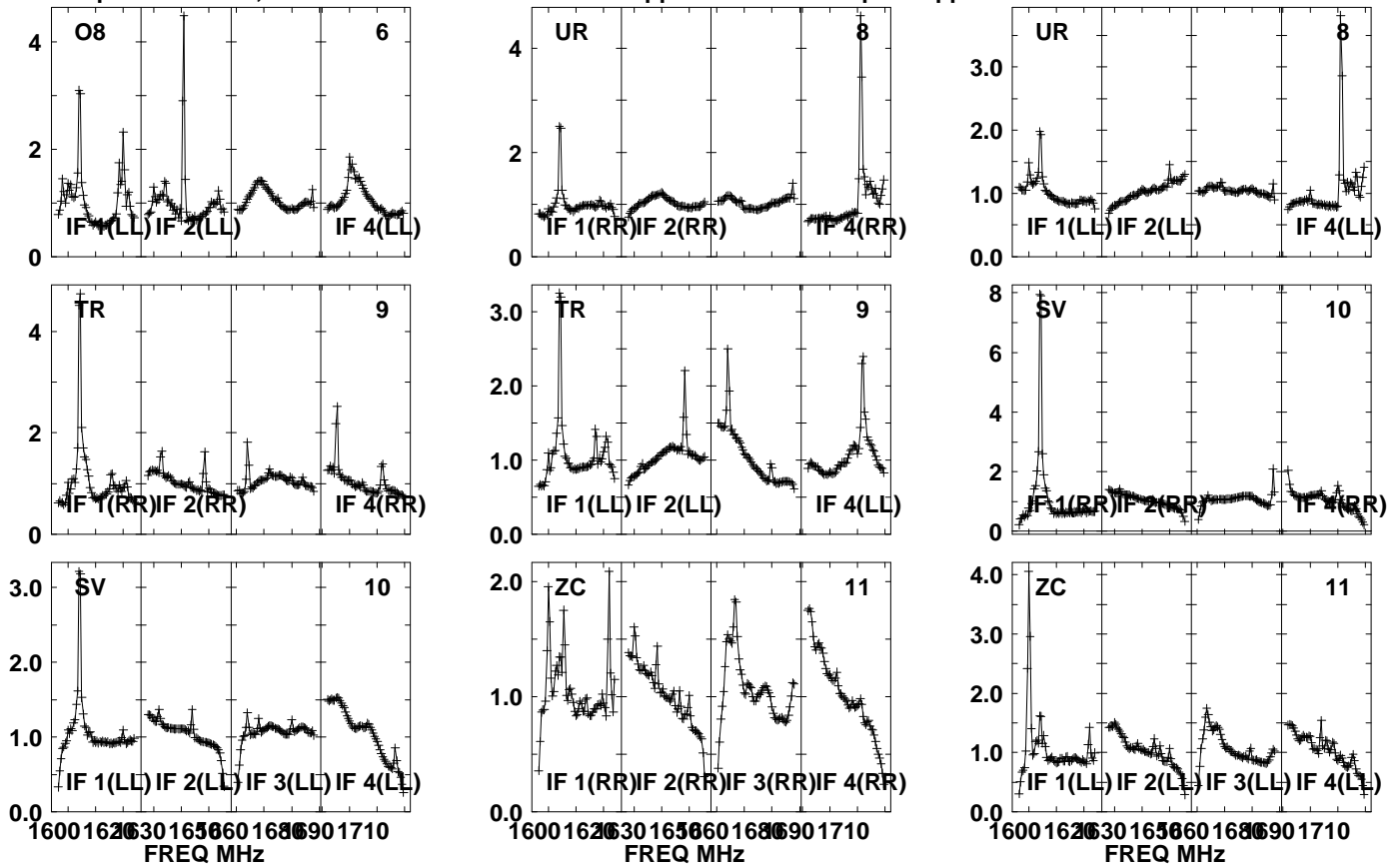

Lower frame: Real Jy  
Auto-corr total-power spectrum Antenna: \*  
Timerange: 00/22:02:31 to 00/22:03:59

Plot file version1391 created 05-OCT-2021 17:11:32

J0827+5217 GM076.UVDATA.1

Freq = 1.5945 GHz, Bw = 32.000 MH No calibration applied and no bandpass applied

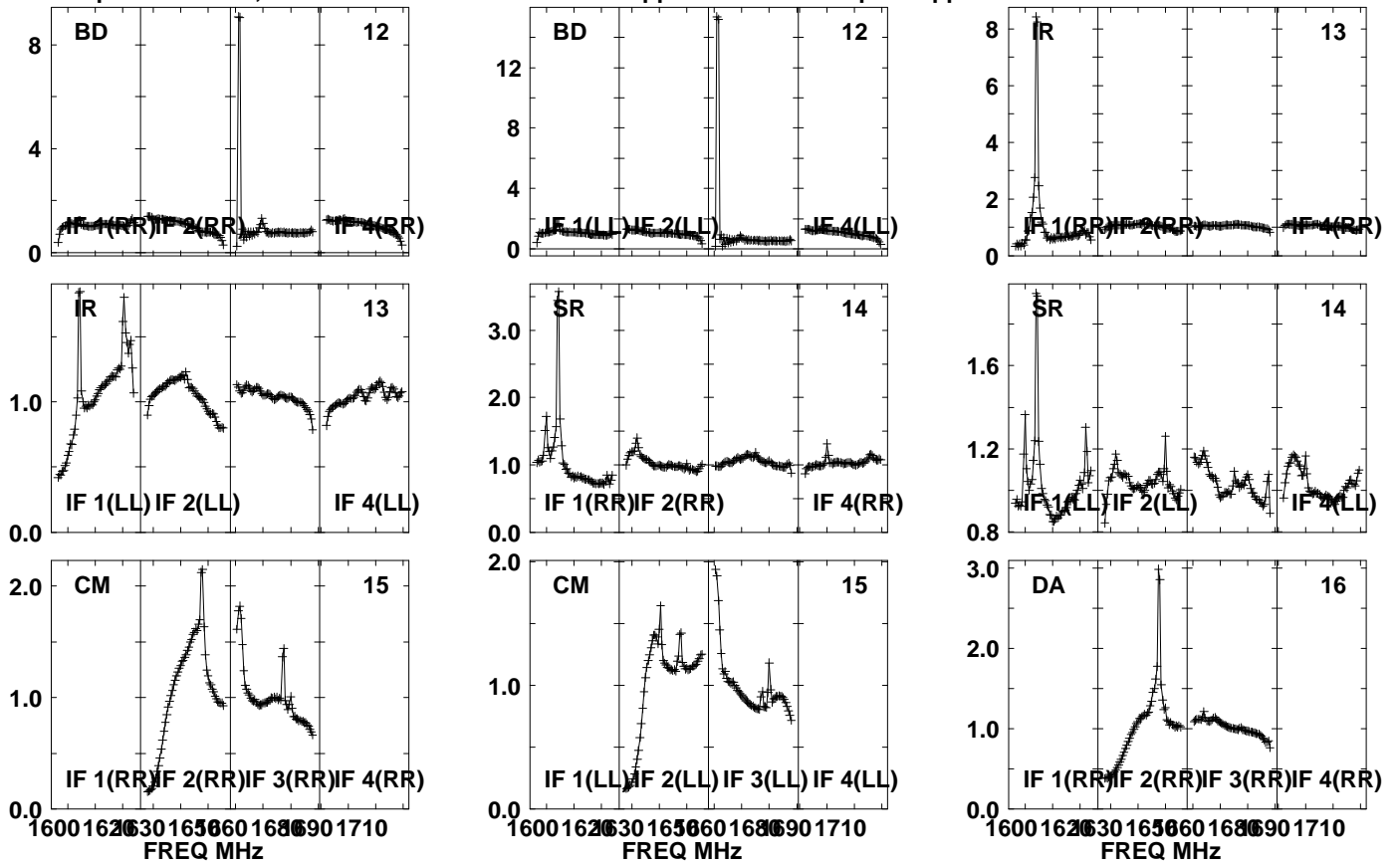

Lower frame: Real Jy

Auto-corr total-power spectrum Antenna: \*

Timerange: 00/22:02:31 to 00/22:03:59

Plot file version1392 created 05-OCT-2021 17:11:32

J0827+5217 GM076.UVDATA.1

Freq = 1.5945 GHz, Bw = 32.000 MH No calibration applied and no bandpass applied

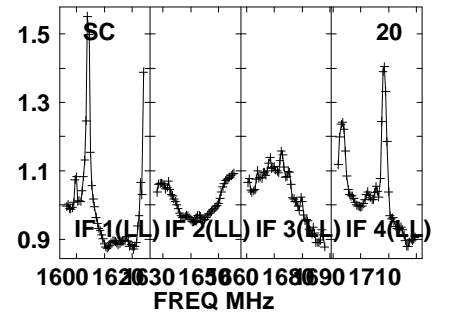
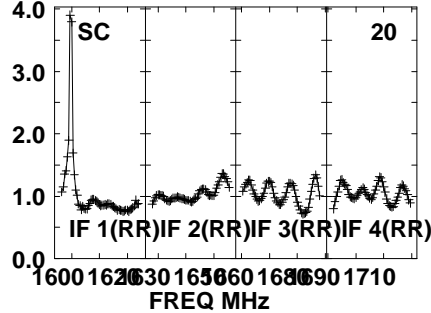
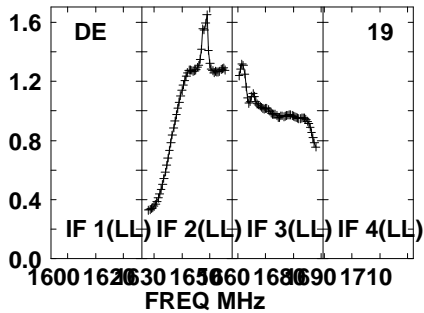
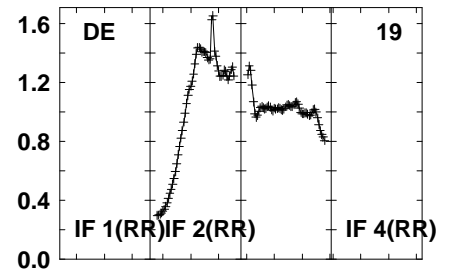
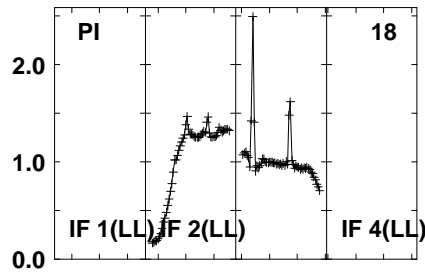
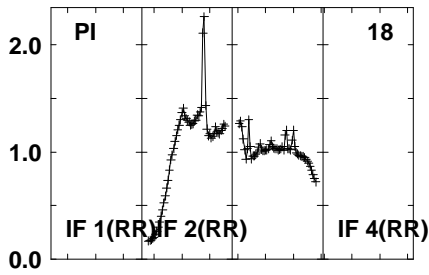
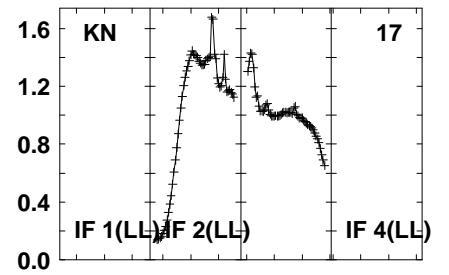
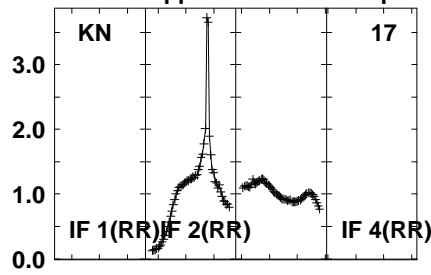
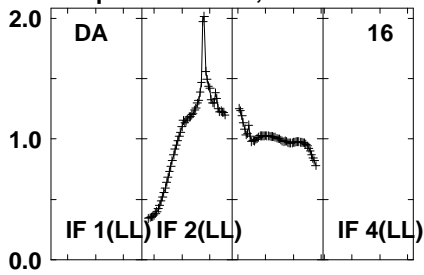

Lower frame: Real Jy  
Auto-corr total-power spectrum Antenna: \*  
Timerange: 00/22:02:31 to 00/22:03:59

Plot file version 1393 created 05-OCT-2021 17:11:32

J0827+5217 GM076.UVDATA.1

Freq = 1.5945 GHz, Bw = 32.000 MH No calibration applied and no bandpass applied

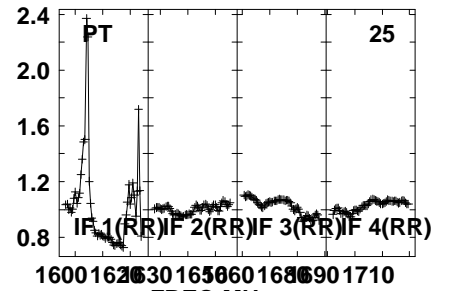
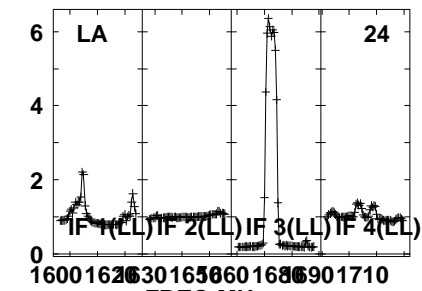
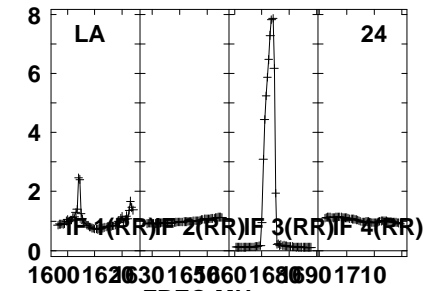
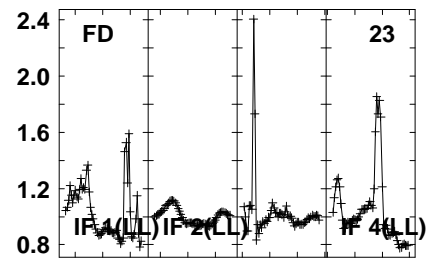
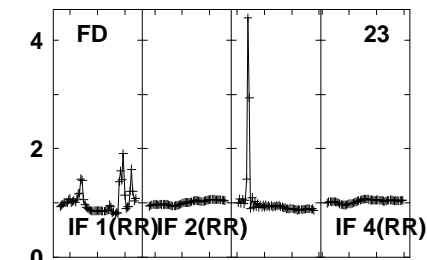
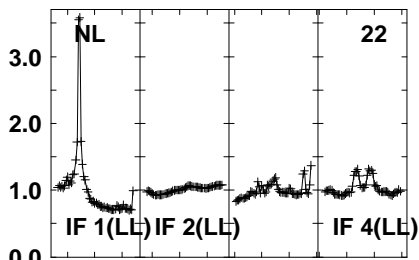
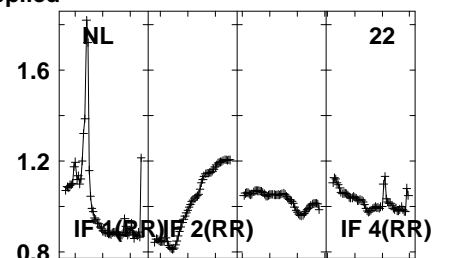
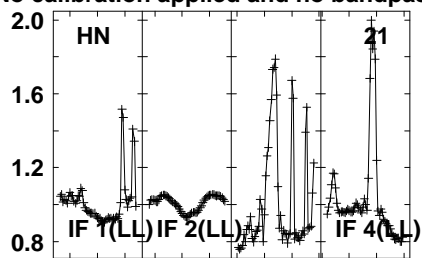
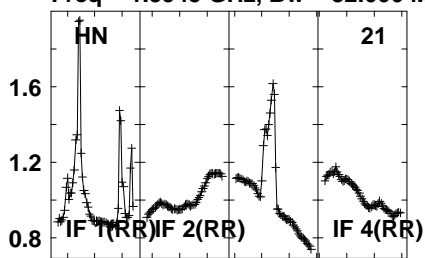

Lower frame: Real Jy  
Auto-corr total-power spectrum Antenna: \*  
Timerange: 00/22:02:31 to 00/22:03:59

Plot file version 1394 created 05-OCT-2021 17:11:33

J0827+5217 GM076.UVDATA.1

Freq = 1.5945 GHz, Bw = 32.000 MH No calibration applied and no bandpass applied

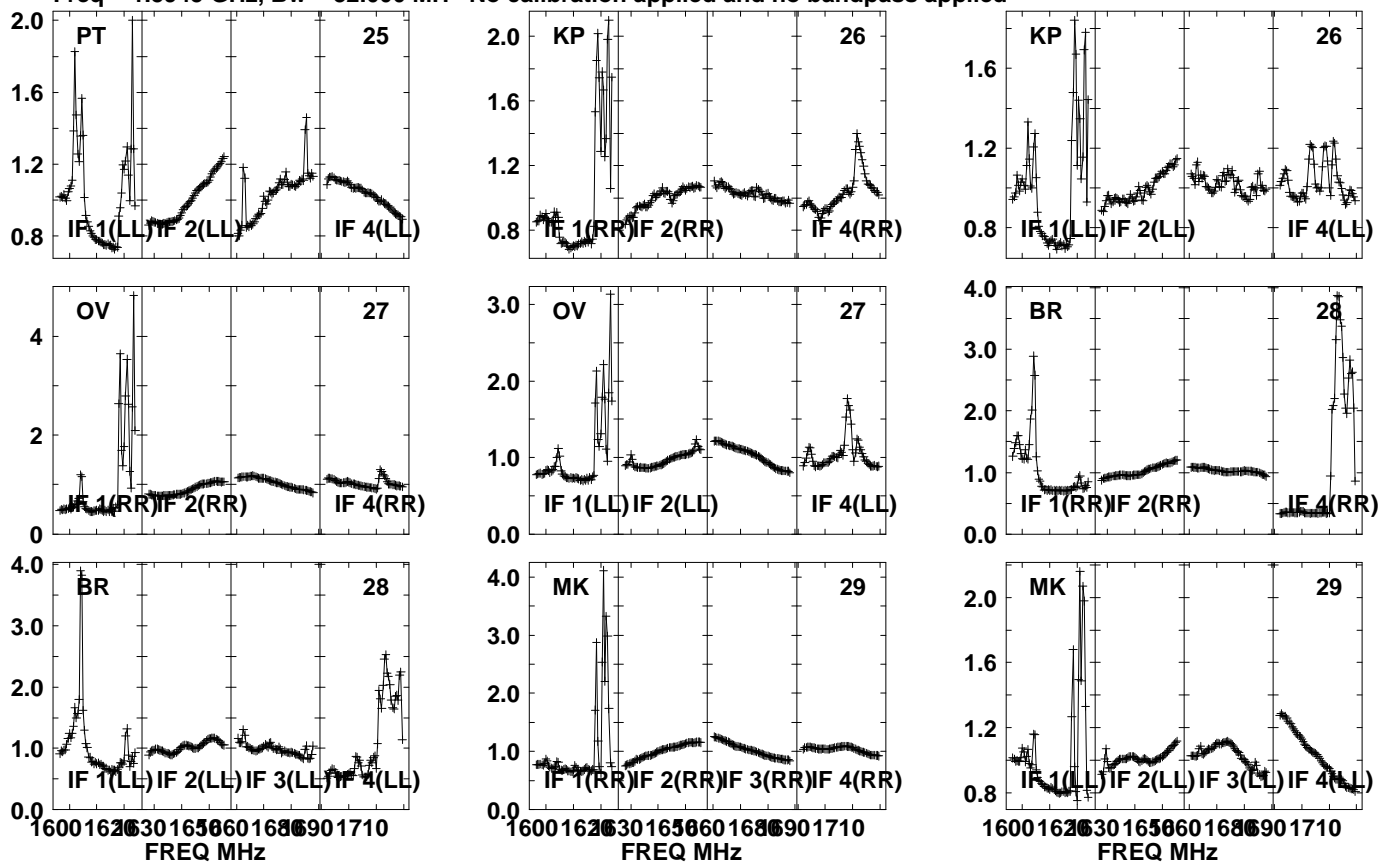

Lower frame: Real Jy  
Auto-corr total-power spectrum Antenna: \*  
Timerange: 00/22:02:31 to 00/22:03:59



Plot file version1395 created 05-OCT-2021 17:11:33

APM08279+525 GM076.UVDATA.1

Freq = 1.5945 GHz, Bw = 32.000 MH No calibration applied and no bandpass applied

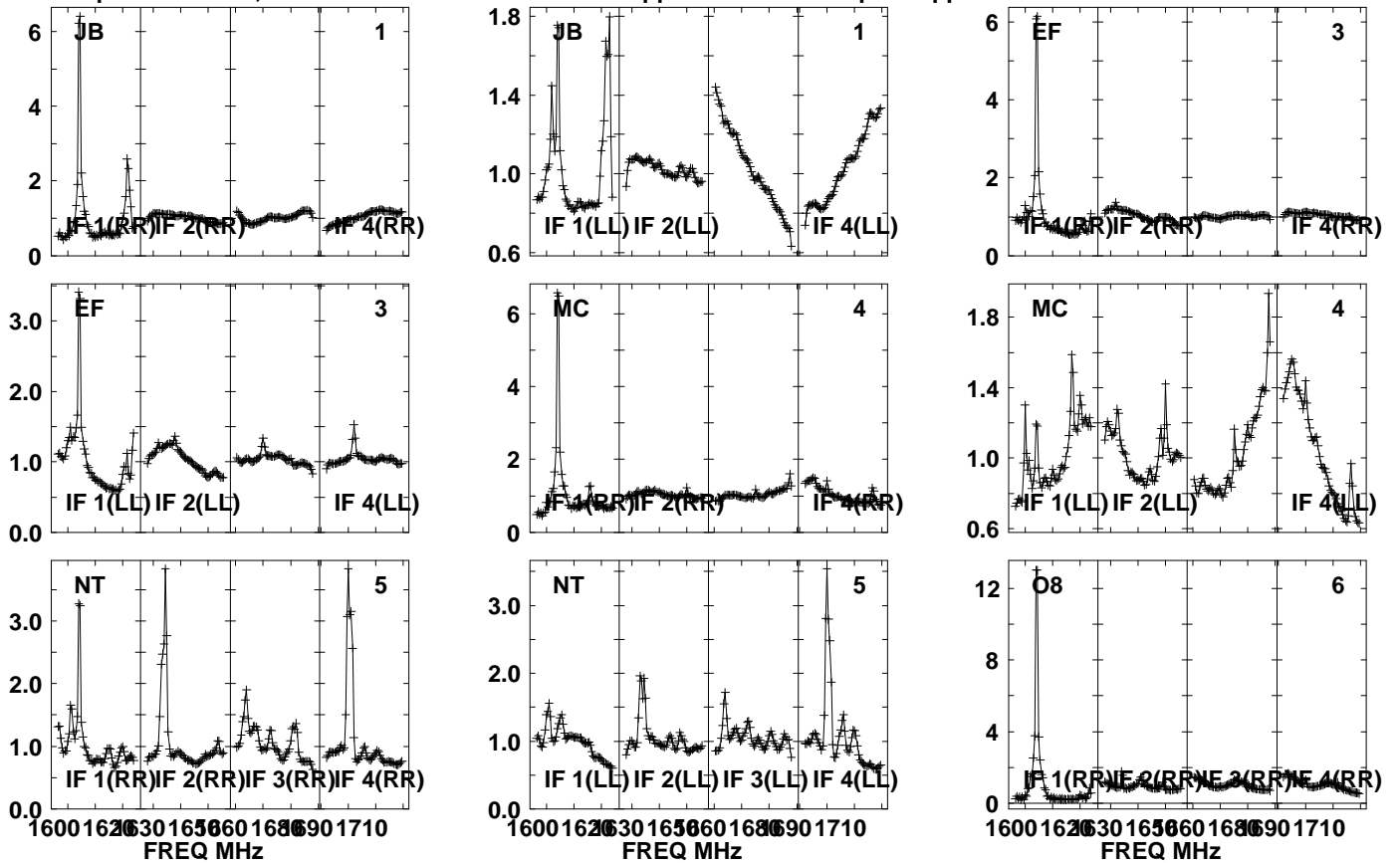

Lower frame: Real Jy

Auto-corr total-power spectrum Antenna: \*

Timerange: 00/22:04:01 to 00/22:07:29

Plot file version1396 created 05-OCT-2021 17:11:33

APM08279+525 GM076.UVDATA.1

Freq = 1.5945 GHz, Bw = 32.000 MH No calibration applied and no bandpass applied

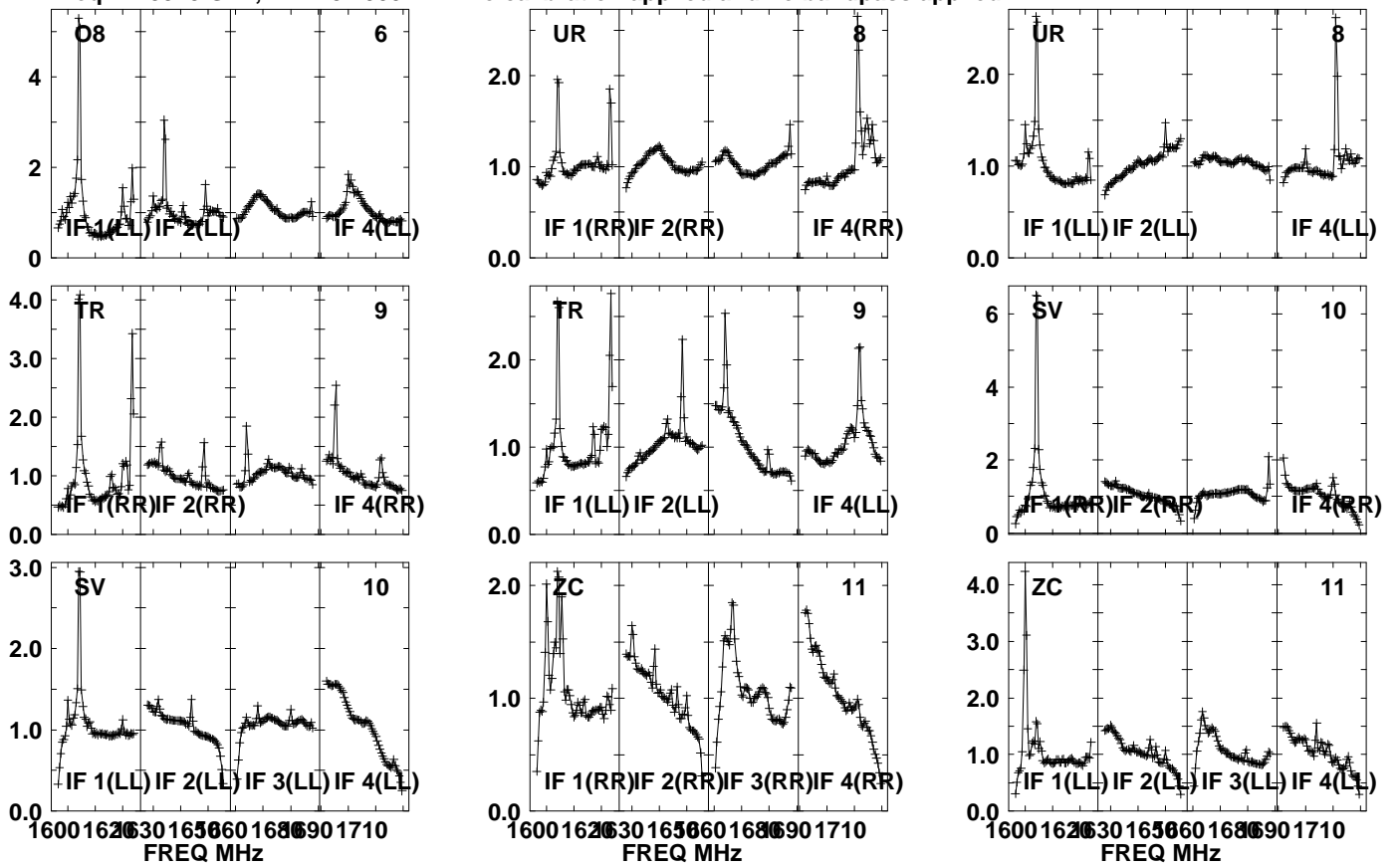

Lower frame: Real Jy

Auto-corr total-power spectrum Antenna: \*

Timerange: 00/22:04:01 to 00/22:07:29

Plot file version1397 created 05-OCT-2021 17:11:34

APM08279+525 GM076.UVDATA.1

Freq = 1.5945 GHz, Bw = 32.000 MH No calibration applied and no bandpass applied

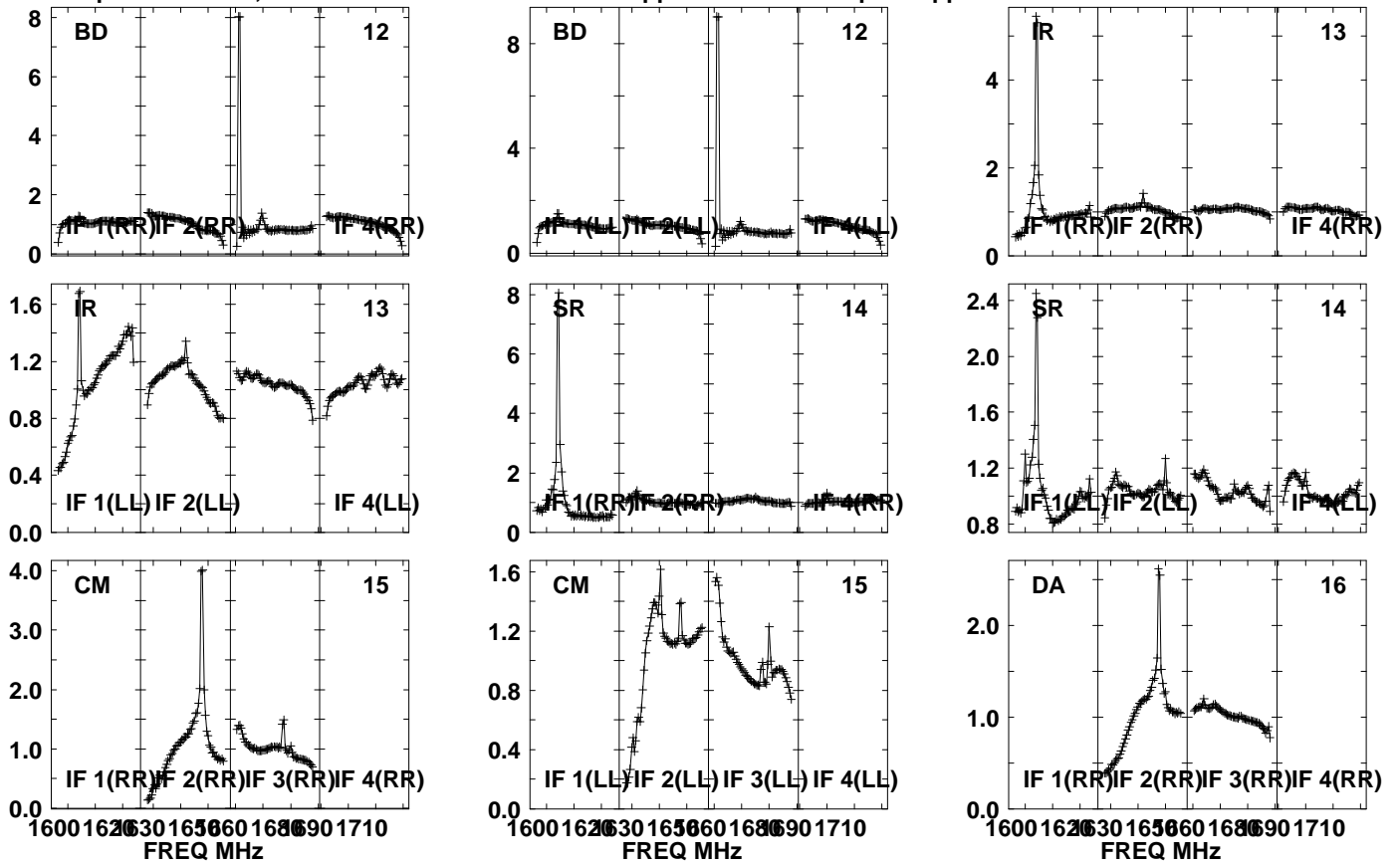

Lower frame: Real Jy

Auto-corr total-power spectrum Antenna: \*

Timerange: 00/22:04:01 to 00/22:07:29

Plot file version1398 created 05-OCT-2021 17:11:34

APM08279+525 GM076.UVDATA.1

Freq = 1.5945 GHz, Bw = 32.000 MH No calibration applied and no bandpass applied

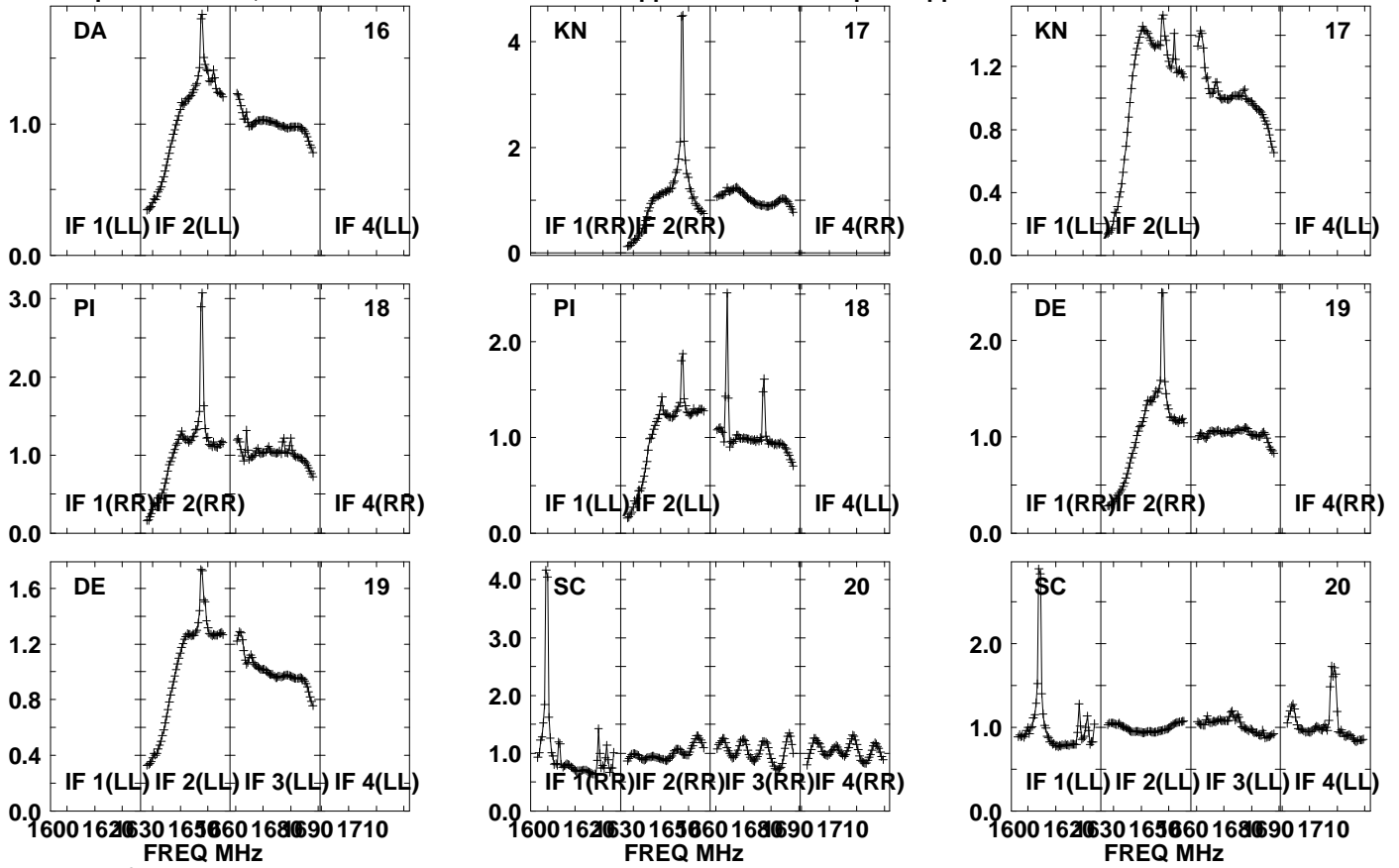

Lower frame: Real Jy

Auto-corr total-power spectrum Antenna: \*

Timerange: 00/22:04:01 to 00/22:07:29

Plot file version 1399 created 05-OCT-2021 17:11:35

APM08279+525 GM076.UVDATA.1

Freq = 1.5945 GHz, Bw = 32.000 MH No calibration applied and no bandpass applied

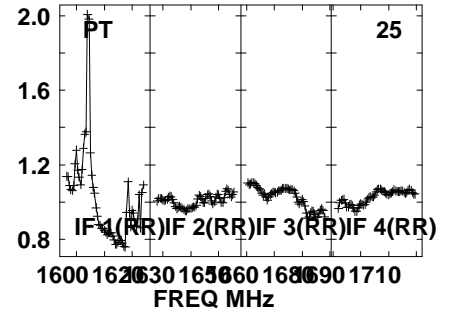
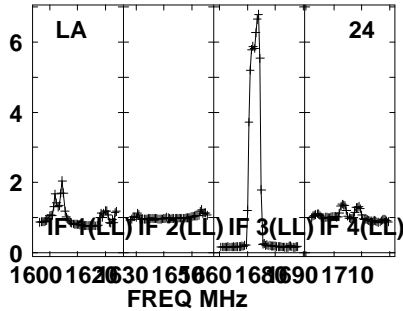
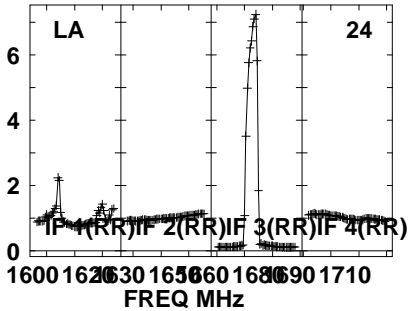
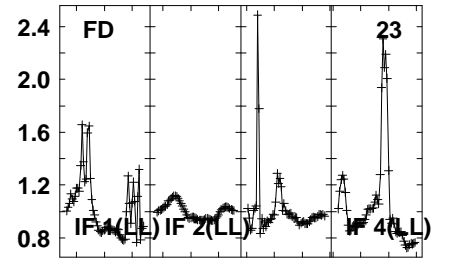
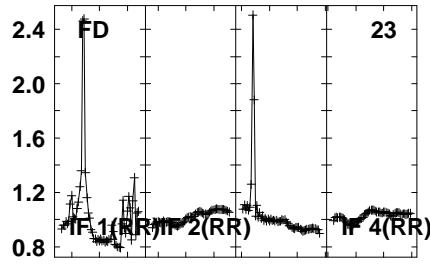
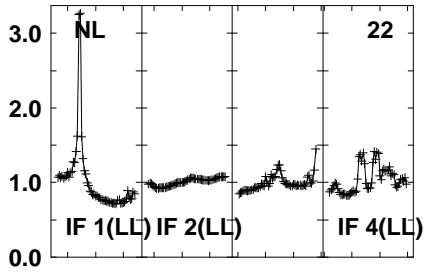
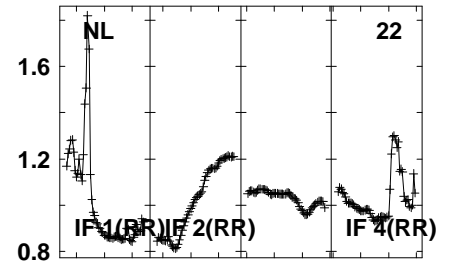
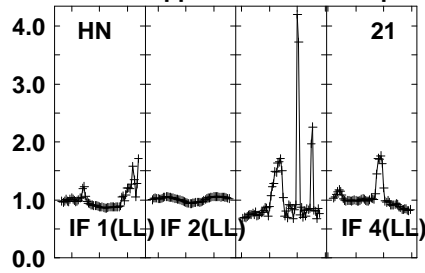
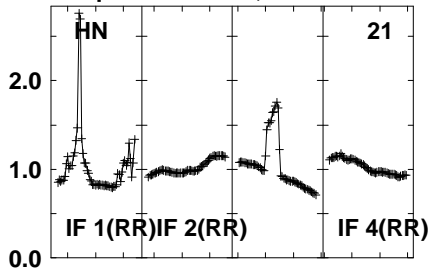

Lower frame: Real Jy  
Auto-corr total-power spectrum Antenna: \*  
Timerange: 00/22:04:01 to 00/22:07:29

Plot file version 1400 created 05-OCT-2021 17:11:35

APM08279+525 GM076.UVDATA.1

Freq = 1.5945 GHz, Bw = 32.000 MH No calibration applied and no bandpass applied

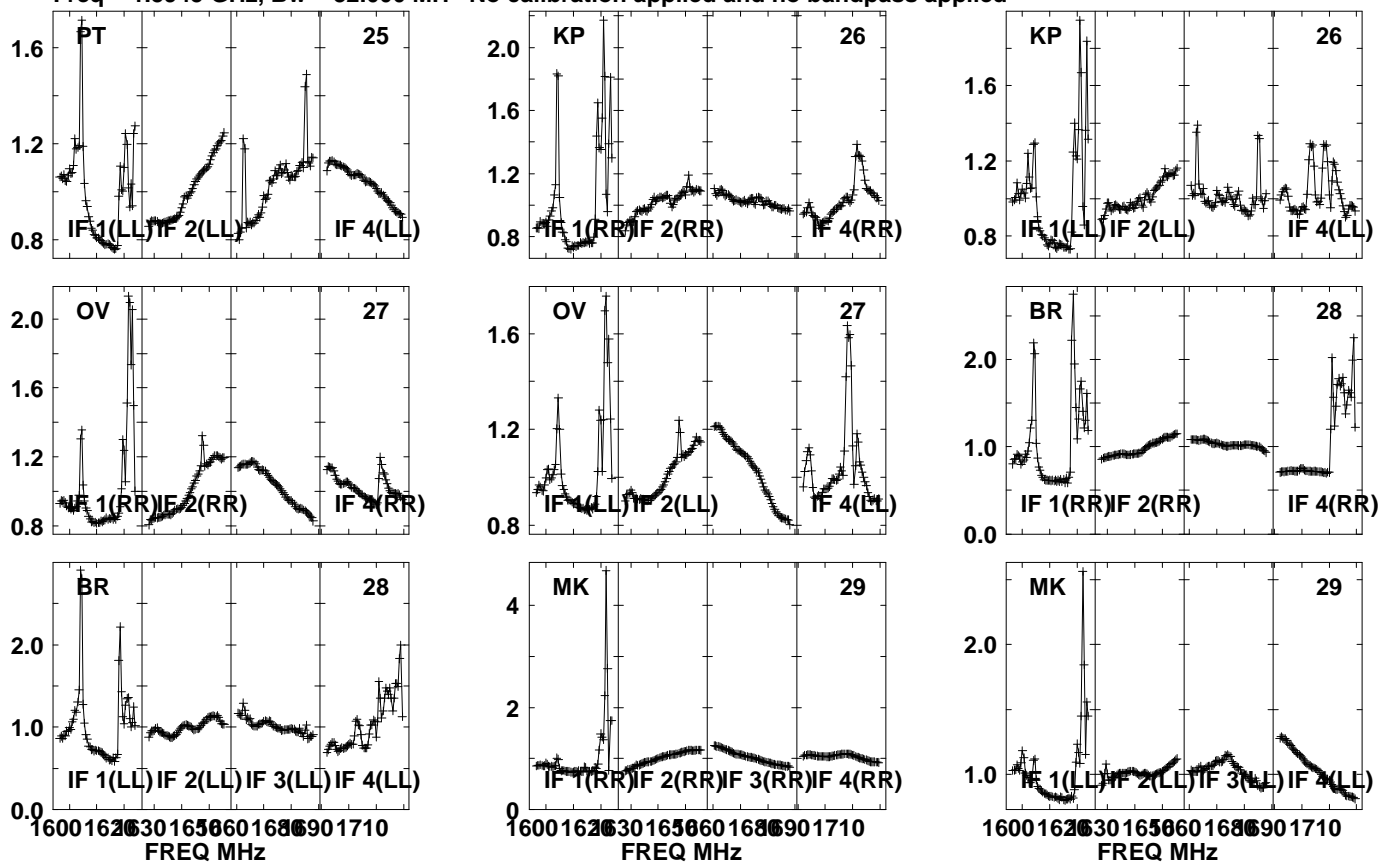

Lower frame: Real Jy  
Auto-corr total-power spectrum Antenna: \*  
Timerange: 00/22:04:01 to 00/22:07:29

Plot file version1401 created 05-OCT-2021 17:11:35

J0827+5217 GM076.UVDATA.1

Freq = 1.5945 GHz, Bw = 32.000 MH No calibration applied and no bandpass applied

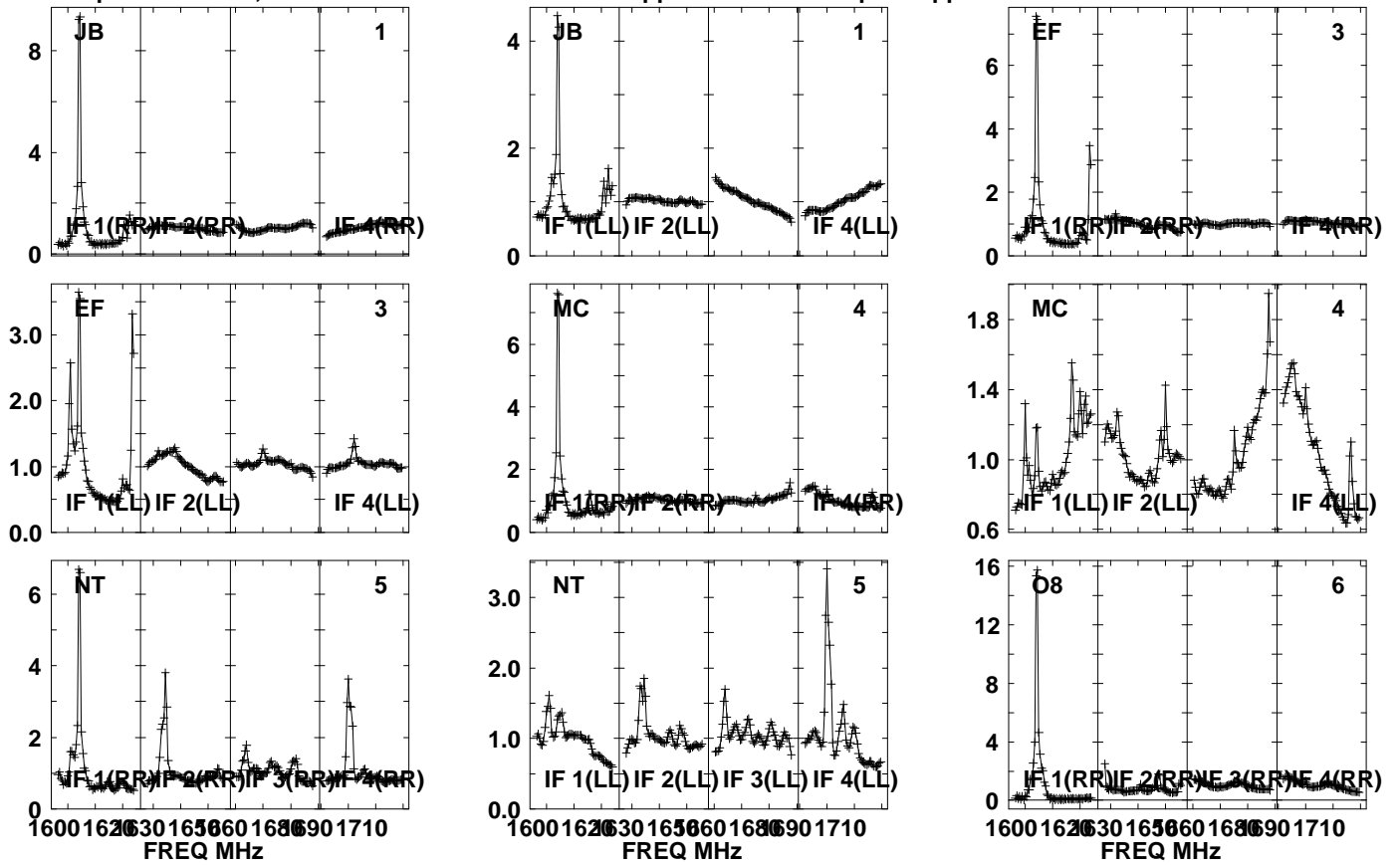

Lower frame: Real Jy

Auto-corr total-power spectrum Antenna: \*

Timerange: 00/22:07:31 to 00/22:08:59

Plot file version1402 created 05-OCT-2021 17:11:36

J0827+5217 GM076.UVDATA.1

Freq = 1.5945 GHz, Bw = 32.000 MH No calibration applied and no bandpass applied

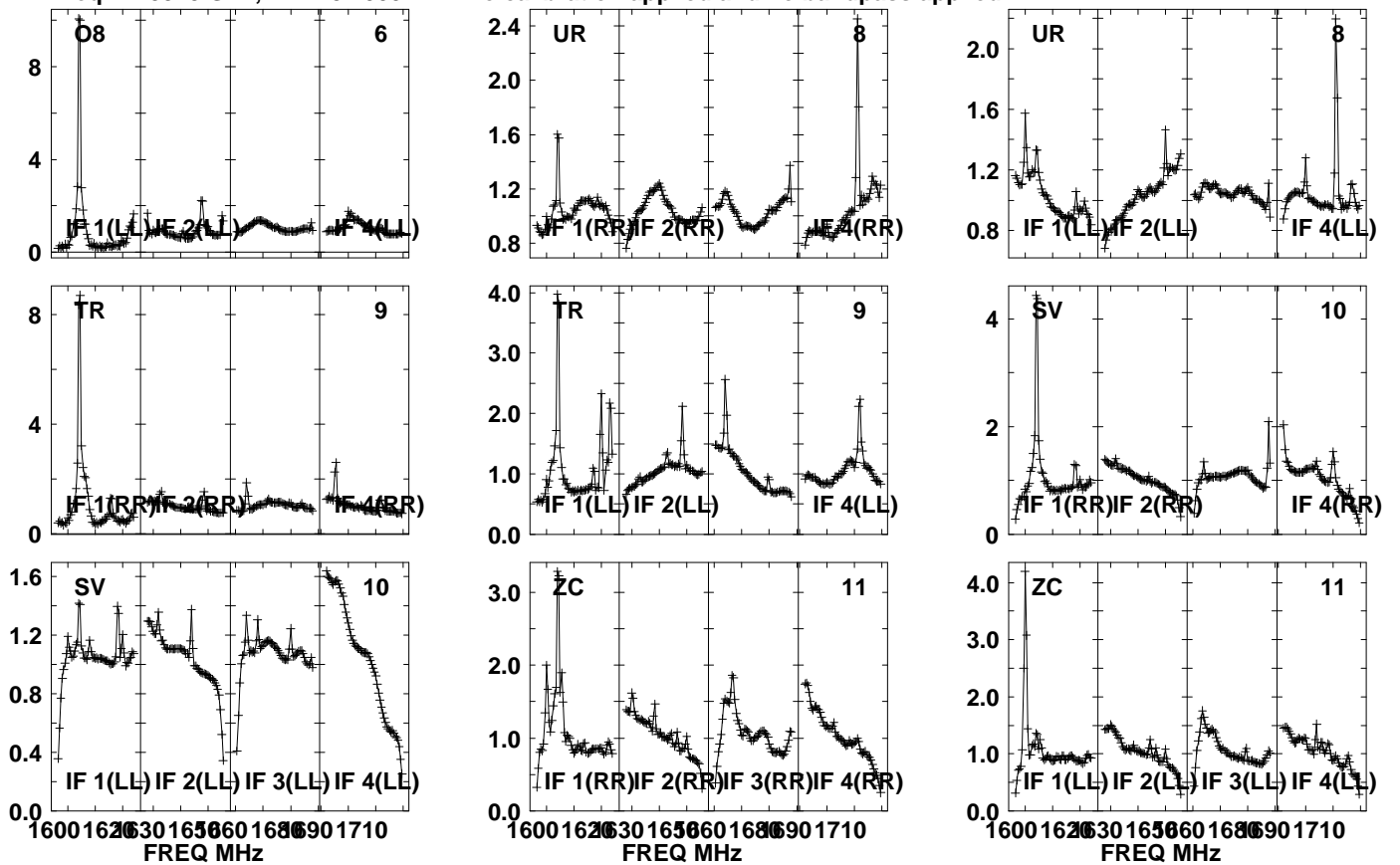

Lower frame: Real Jy

Auto-corr total-power spectrum Antenna: \*

Timerange: 00/22:07:31 to 00/22:08:59



Plot file version1403 created 05-OCT-2021 17:11:36

J0827+5217 GM076.UVDATA.1

Freq = 1.5945 GHz, Bw = 32.000 MH No calibration applied and no bandpass applied

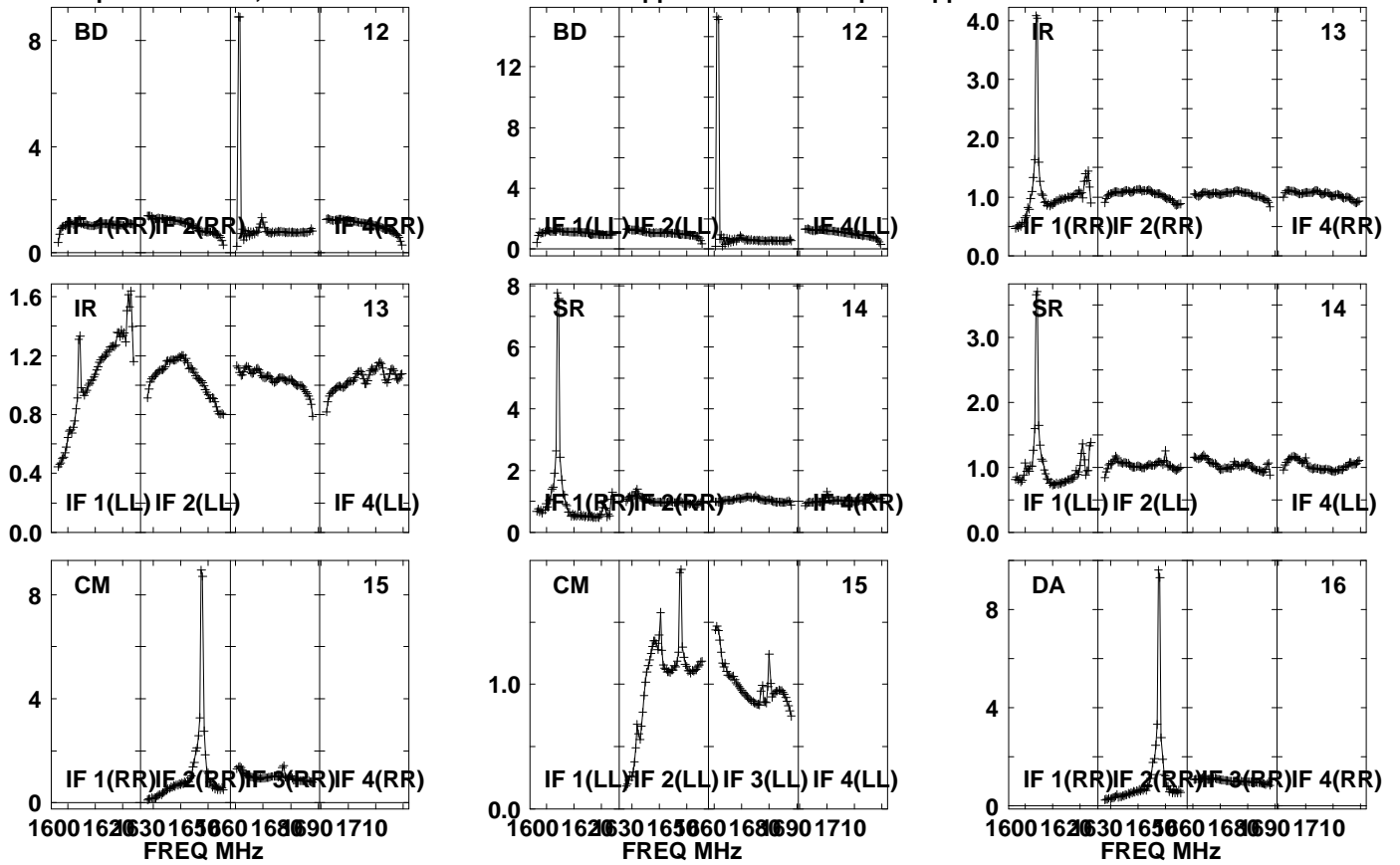

Lower frame: Real Jy  
Auto-corr total-power spectrum Antenna: \*  
Timerange: 00/22:07:31 to 00/22:08:59

Plot file version1404 created 05-OCT-2021 17:11:36

J0827+5217 GM076.UVDATA.1

Freq = 1.5945 GHz, Bw = 32.000 MH No calibration applied and no bandpass applied

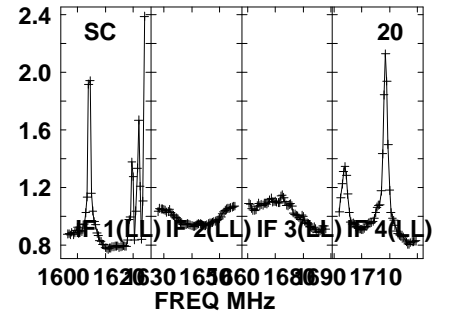
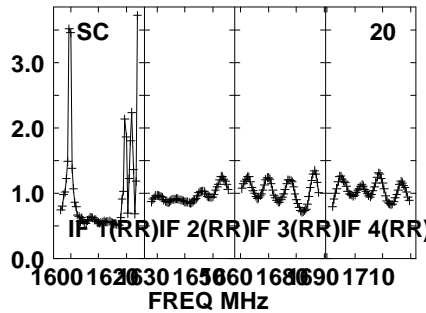
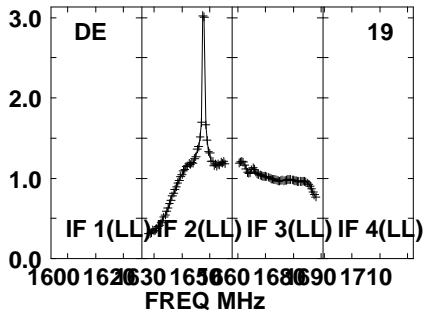
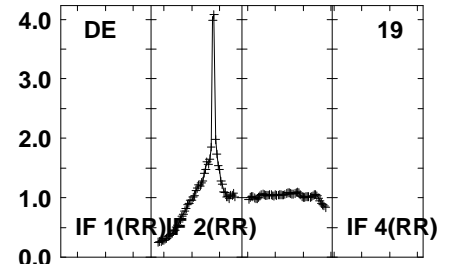
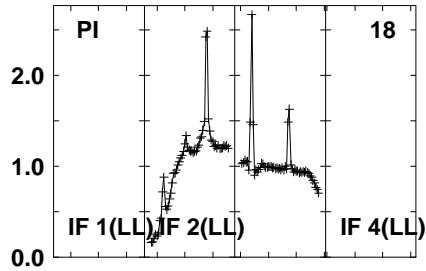
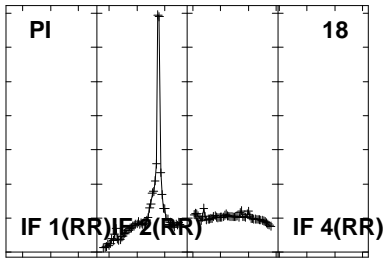
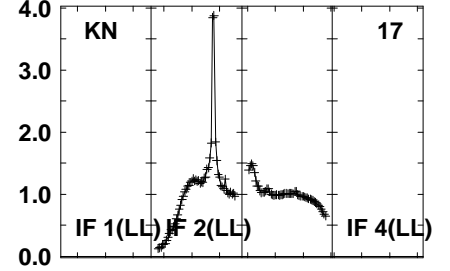
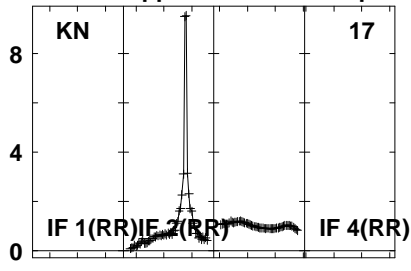
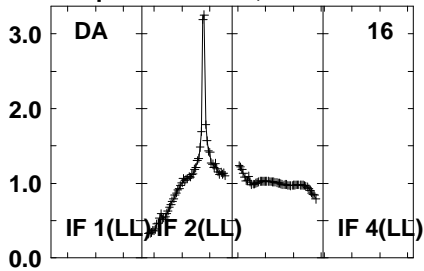

Lower frame: Real Jy

Auto-corr total-power spectrum Antenna: \*

Timerange: 00/22:07:31 to 00/22:08:59

Plot file version1405 created 05-OCT-2021 17:11:37

J0827+5217 GM076.UVDATA.1

Freq = 1.5945 GHz, Bw = 32.000 MH No calibration applied and no bandpass applied

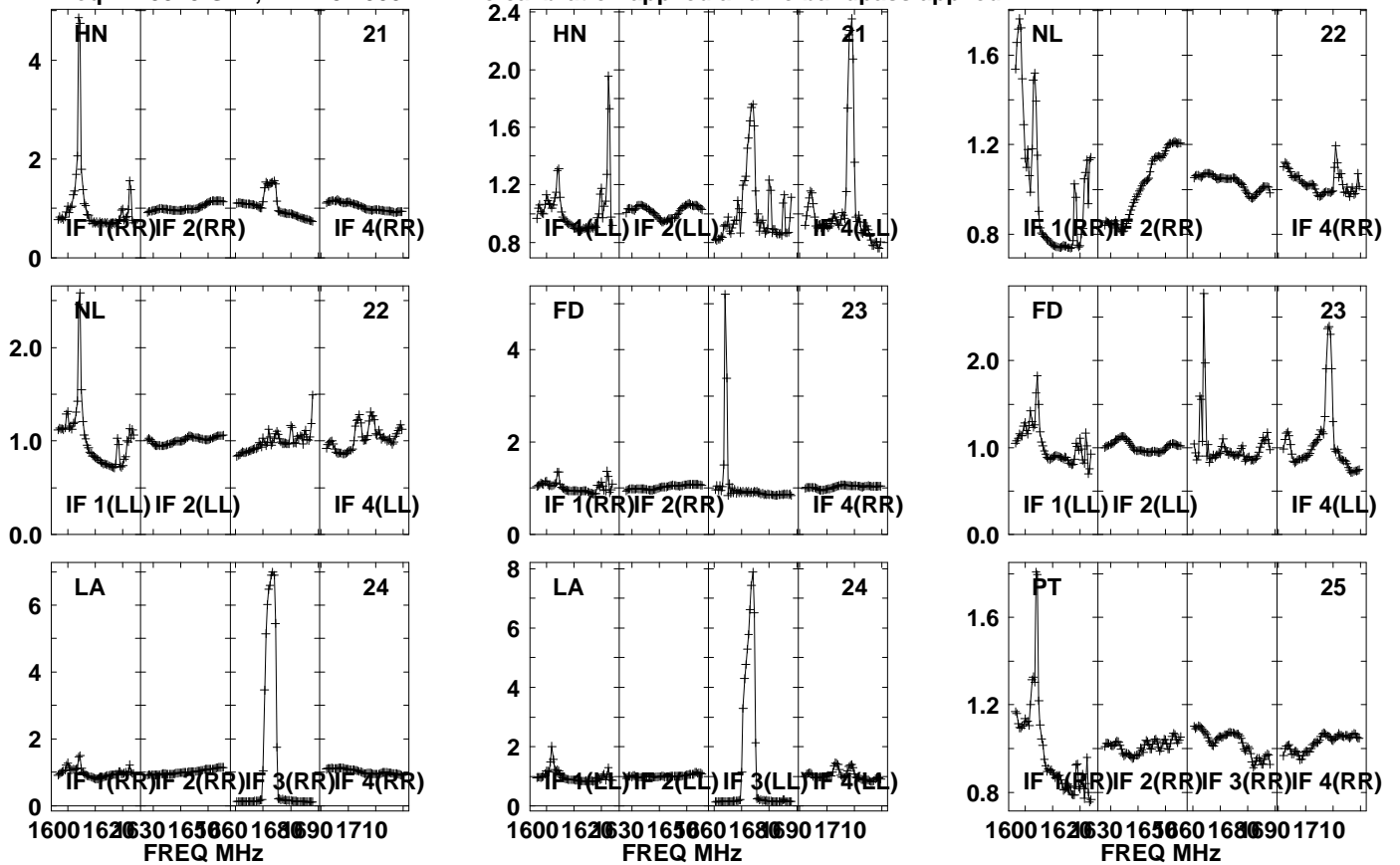

Lower frame: Real Jy

Auto-corr total-power spectrum Antenna: \*

Timerange: 00/22:07:31 to 00/22:08:59

Plot file version 1406 created 05-OCT-2021 17:11:37

J0827+5217 GM076.UVDATA.1

Freq = 1.5945 GHz, Bw = 32.000 MH No calibration applied and no bandpass applied

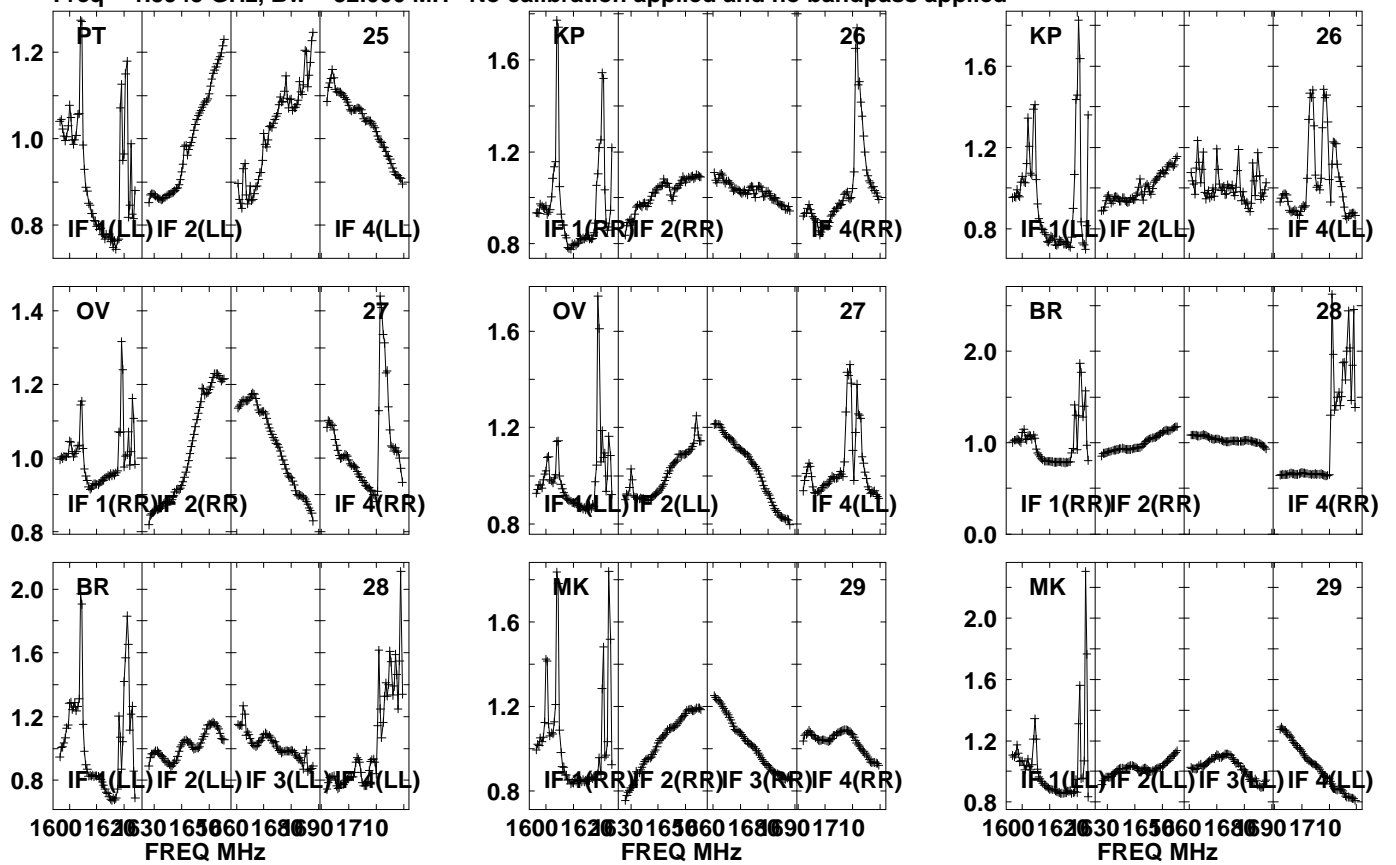

Lower frame: Real Jy  
Auto-corr total-power spectrum Antenna: \*  
Timerange: 00/22:07:31 to 00/22:08:59

Plot file version1407 created 05-OCT-2021 17:11:37

APM08279+525 GM076.UVDATA.1

Freq = 1.5945 GHz, Bw = 32.000 MH No calibration applied and no bandpass applied

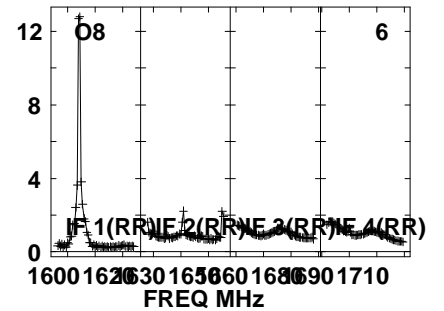
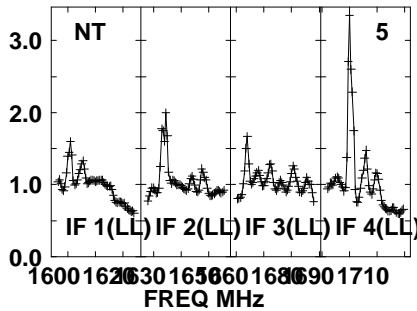
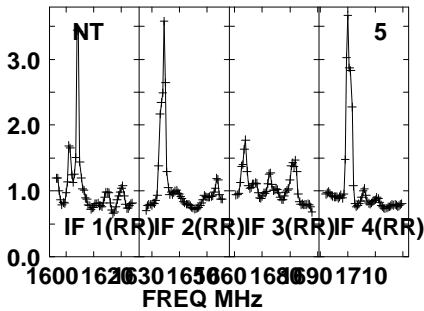
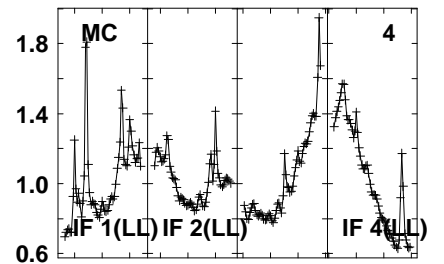
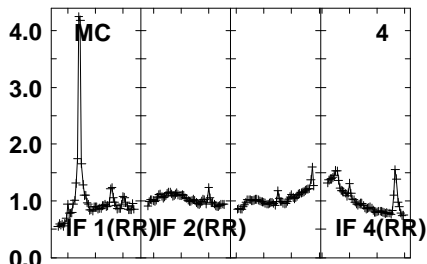
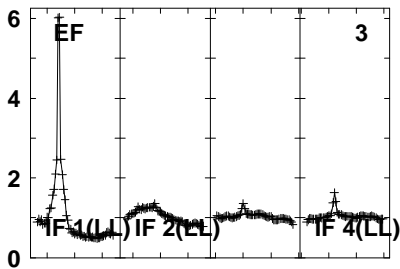
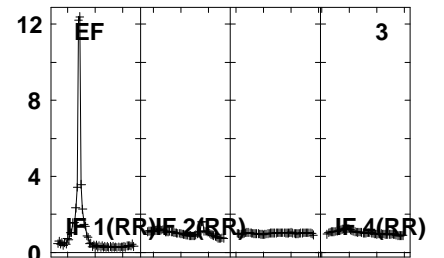
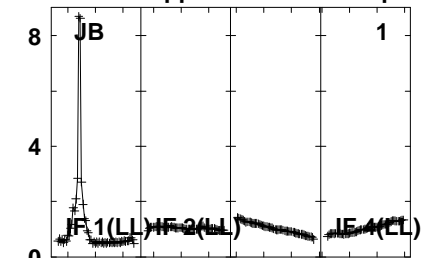
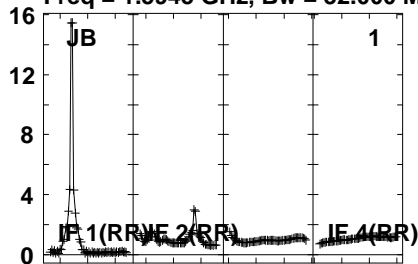

Lower frame: Real Jy

Auto-corr total-power spectrum Antenna: \*

Timerange: 00/22:09:01 to 00/22:12:29

Plot file version1408 created 05-OCT-2021 17:11:38

APM08279+525 GM076.UVDATA.1

Freq = 1.5945 GHz, Bw = 32.000 MH No calibration applied and no bandpass applied

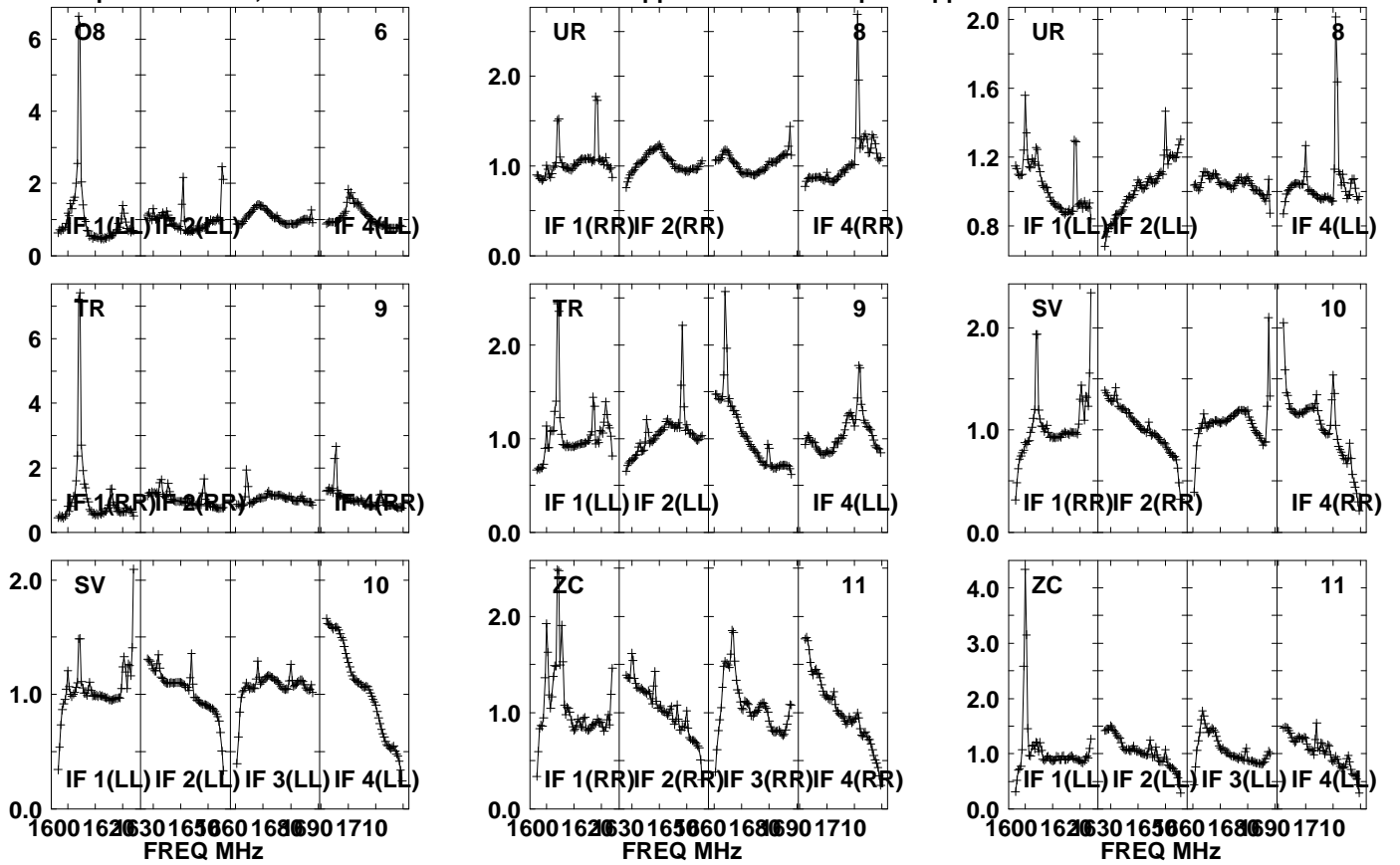

Lower frame: Real Jy

Auto-corr total-power spectrum Antenna: \*

Timerange: 00/22:09:01 to 00/22:12:29

Plot file version1409 created 05-OCT-2021 17:11:38

APM08279+525 GM076.UVDATA.1

Freq = 1.5945 GHz, Bw = 32.000 MH No calibration applied and no bandpass applied

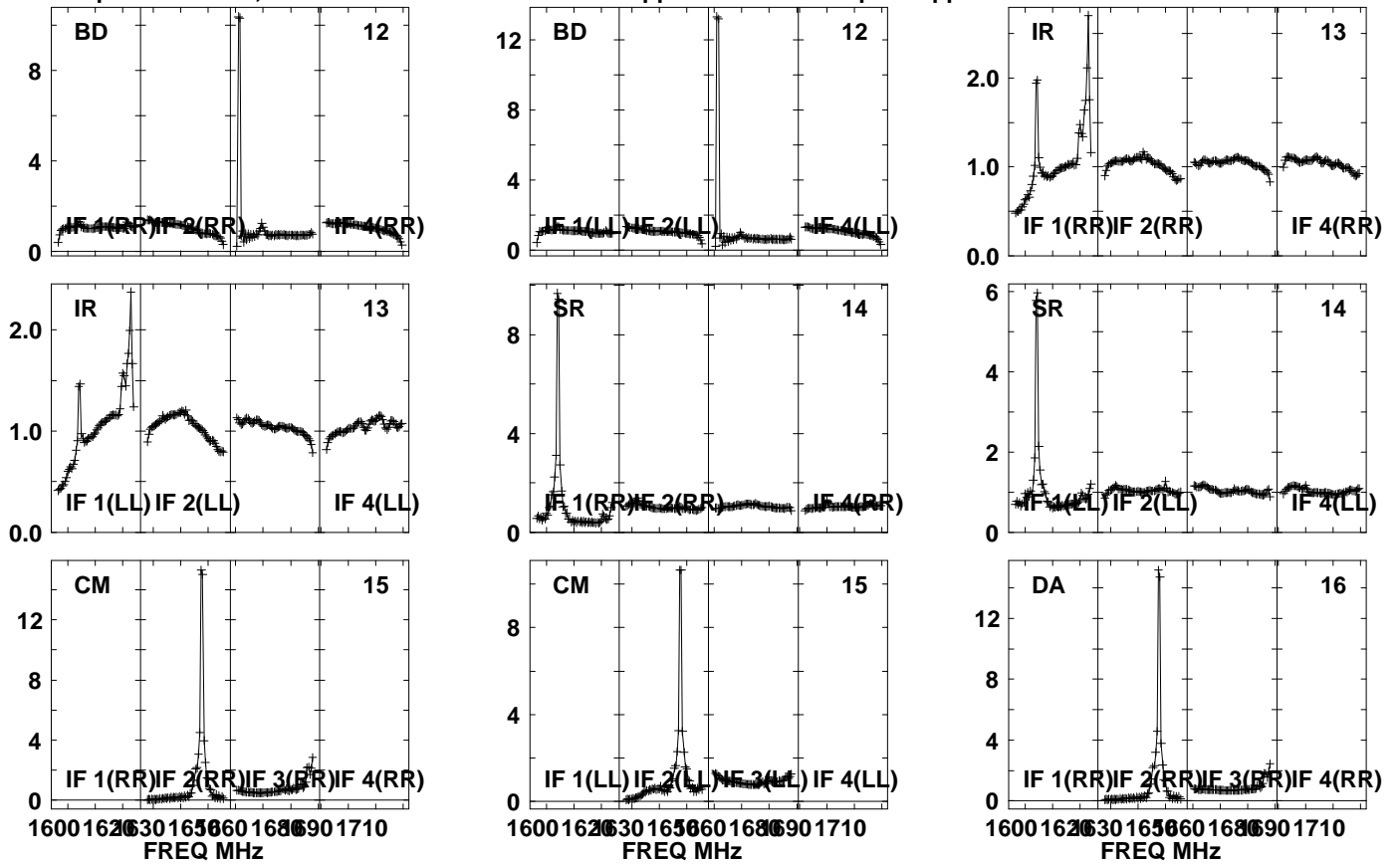

Lower frame: Real Jy  
Auto-corr total-power spectrum Antenna: \*  
Timerange: 00/22:09:01 to 00/22:12:29

Plot file version 1410 created 05-OCT-2021 17:11:38

APM08279+525 GM076.UVDATA.1

Freq = 1.5945 GHz, Bw = 32.000 MH No calibration applied and no bandpass applied

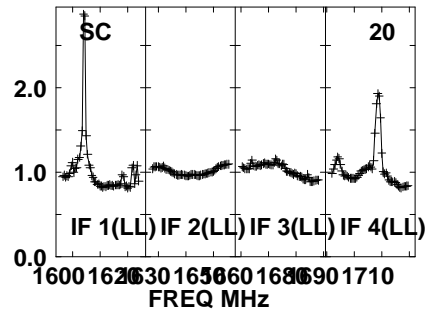
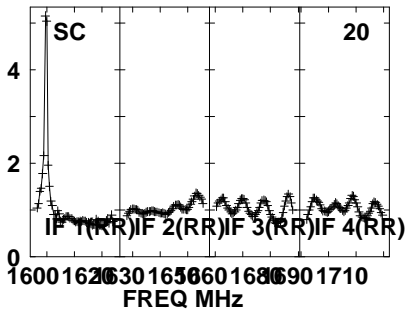
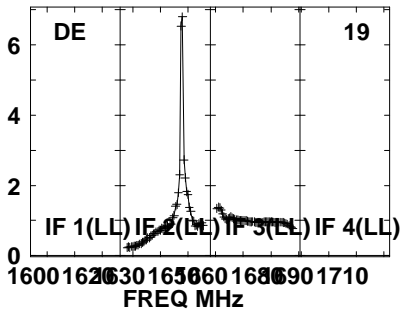
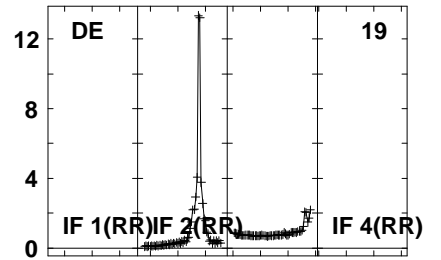
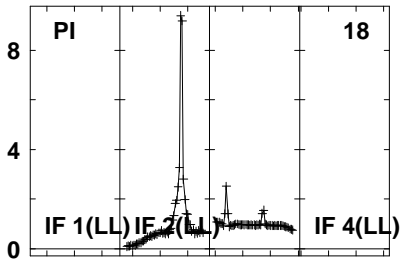
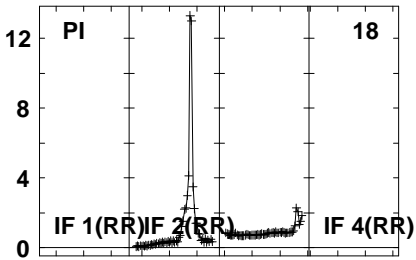
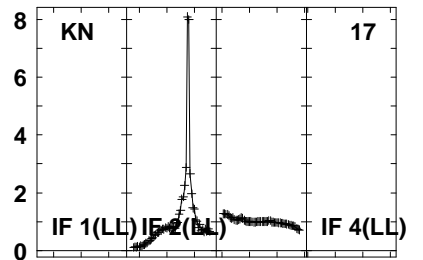
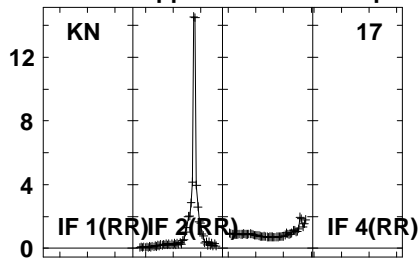
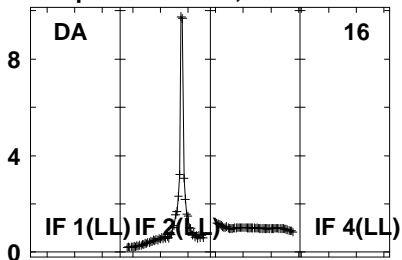

Lower frame: Real Jy

Auto-corr total-power spectrum Antenna: \*

Timerange: 00/22:09:01 to 00/22:12:29



Plot file version1411 created 05-OCT-2021 17:11:39

APM08279+525 GM076.UVDATA.1

Freq = 1.5945 GHz, Bw = 32.000 MH No calibration applied and no bandpass applied

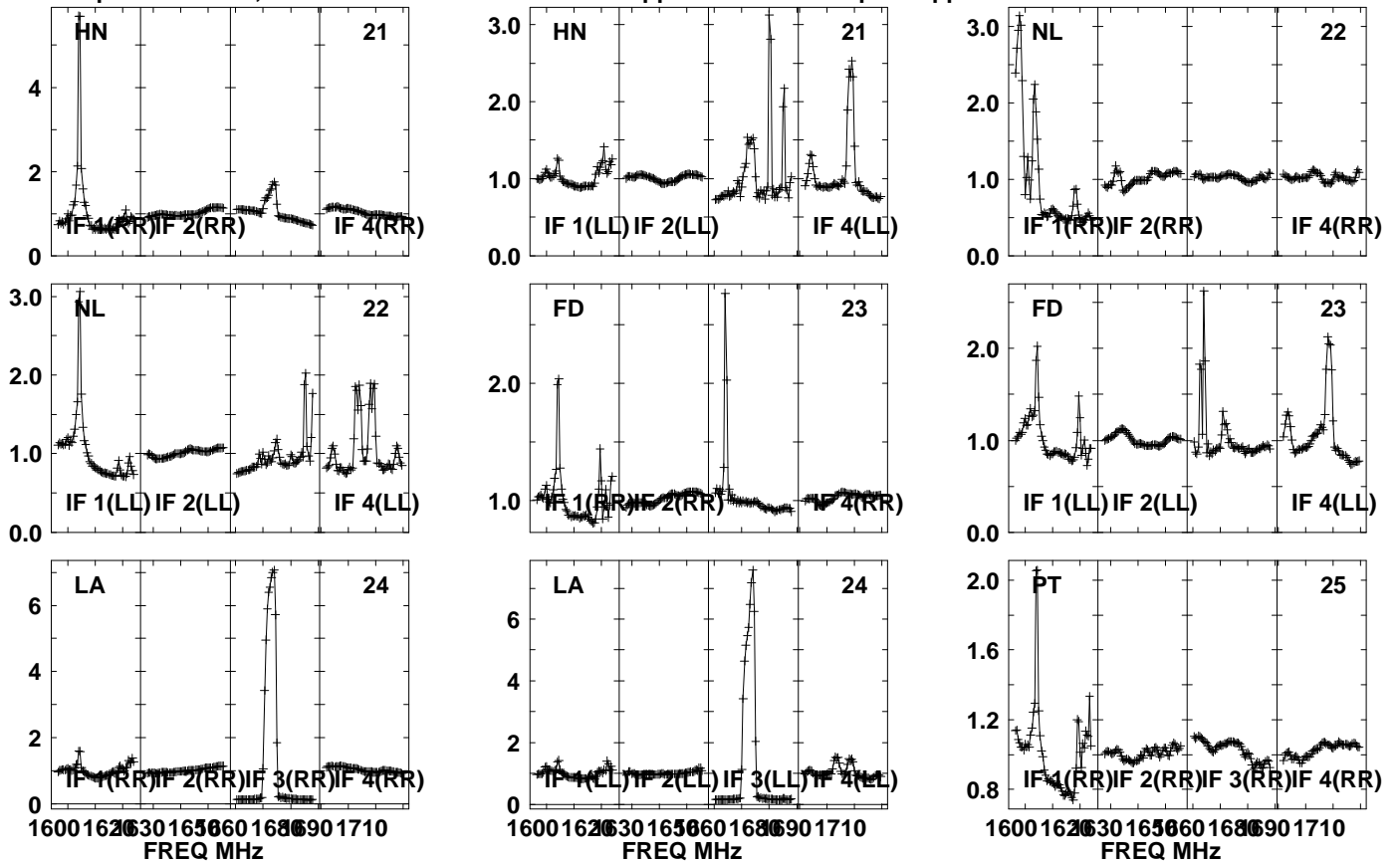

Lower frame: Real Jy

Auto-corr total-power spectrum Antenna: \*

Timerange: 00/22:09:01 to 00/22:12:29

Plot file version 1412 created 05-OCT-2021 17:11:39

APM08279+525 GM076.UVDATA.1

Freq = 1.5945 GHz, Bw = 32.000 MH No calibration applied and no bandpass applied

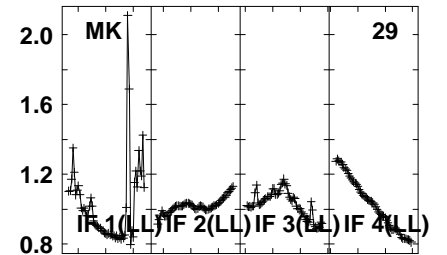
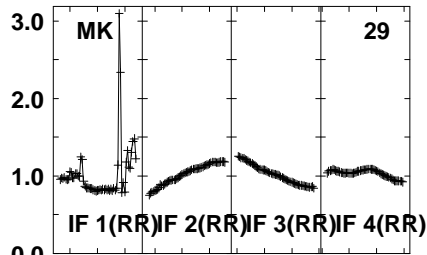
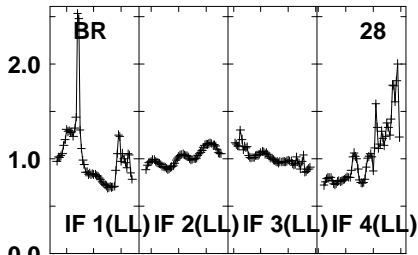
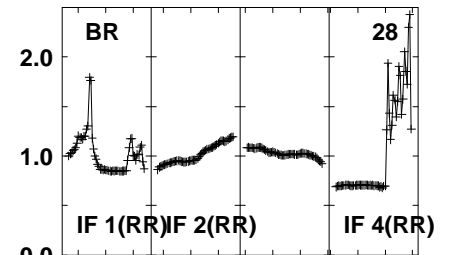
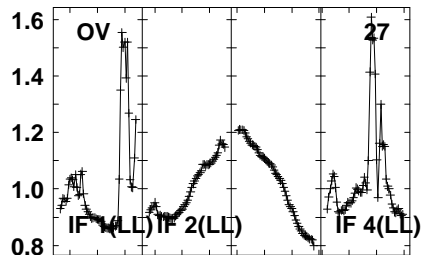
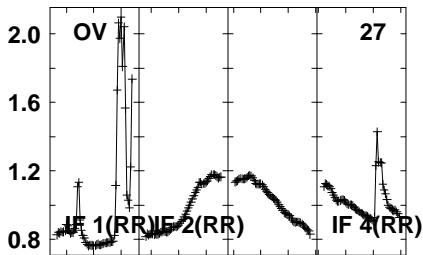
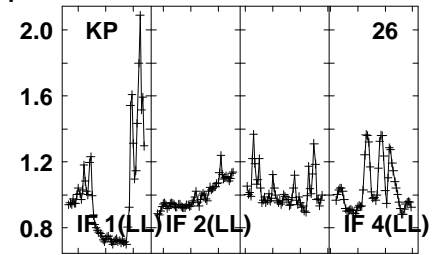
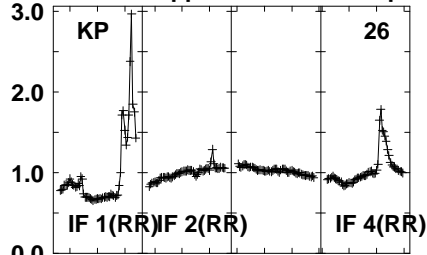
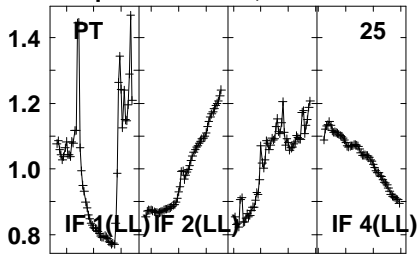

1600 1625 1650 1675 1700 1710  
FREQ MHz

1600 1625 1650 1675 1700 1710  
FREQ MHz

1600 1625 1650 1675 1700 1710  
FREQ MHz

Lower frame: Real Jy  
Auto-corr total-power spectrum Antenna: \*  
Timerange: 00/22:09:01 to 00/22:12:29

Plot file version 1413 created 05-OCT-2021 17:11:39

J0827+5217 GM076.UVDATA.1

Freq = 1.5945 GHz, Bw = 32.000 MH No calibration applied and no bandpass applied

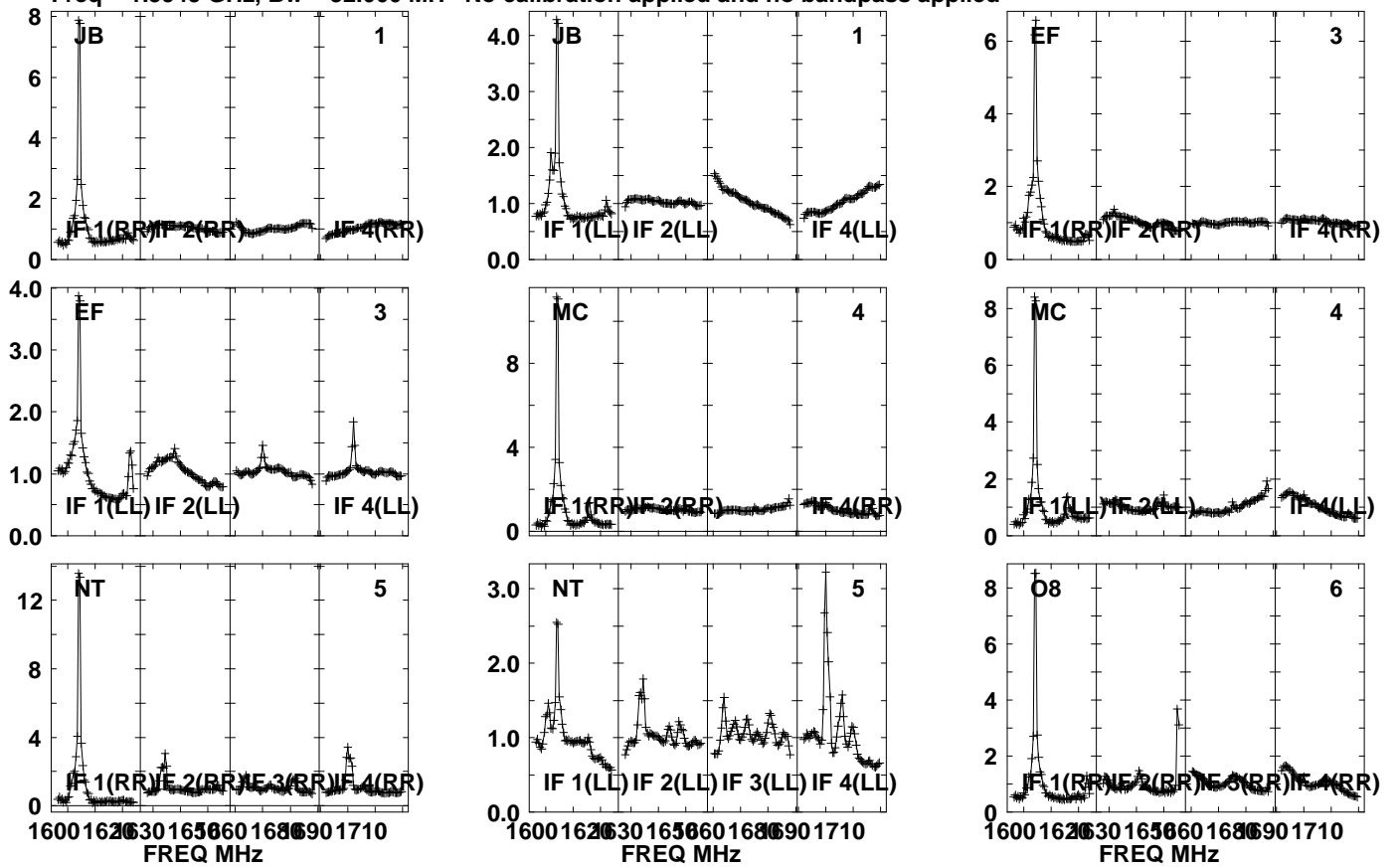

Lower frame: Real Jy

Auto-corr total-power spectrum Antenna: \*

Timerange: 00/22:13:01 to 00/22:14:29

Plot file version1414 created 05-OCT-2021 17:11:40

J0827+5217 GM076.UVDATA.1

Freq = 1.5945 GHz, Bw = 32.000 MH No calibration applied and no bandpass applied

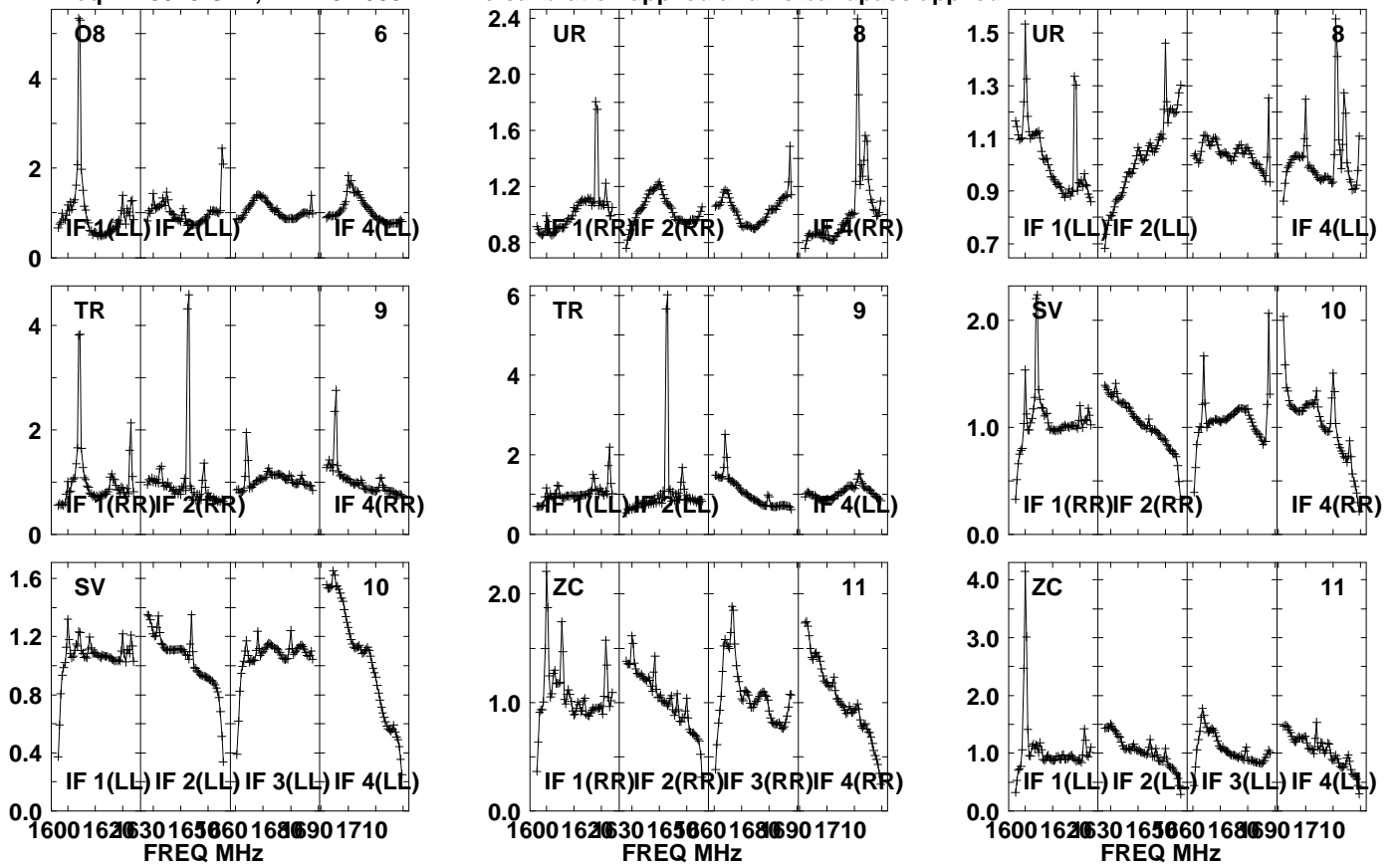

Lower frame: Real Jy

Auto-corr total-power spectrum Antenna: \*

Timerange: 00/22:13:01 to 00/22:14:29

Plot file version 1415 created 05-OCT-2021 17:11:40

J0827+5217 GM076.UVDATA.1

Freq = 1.5945 GHz, Bw = 32.000 MH No calibration applied and no bandpass applied

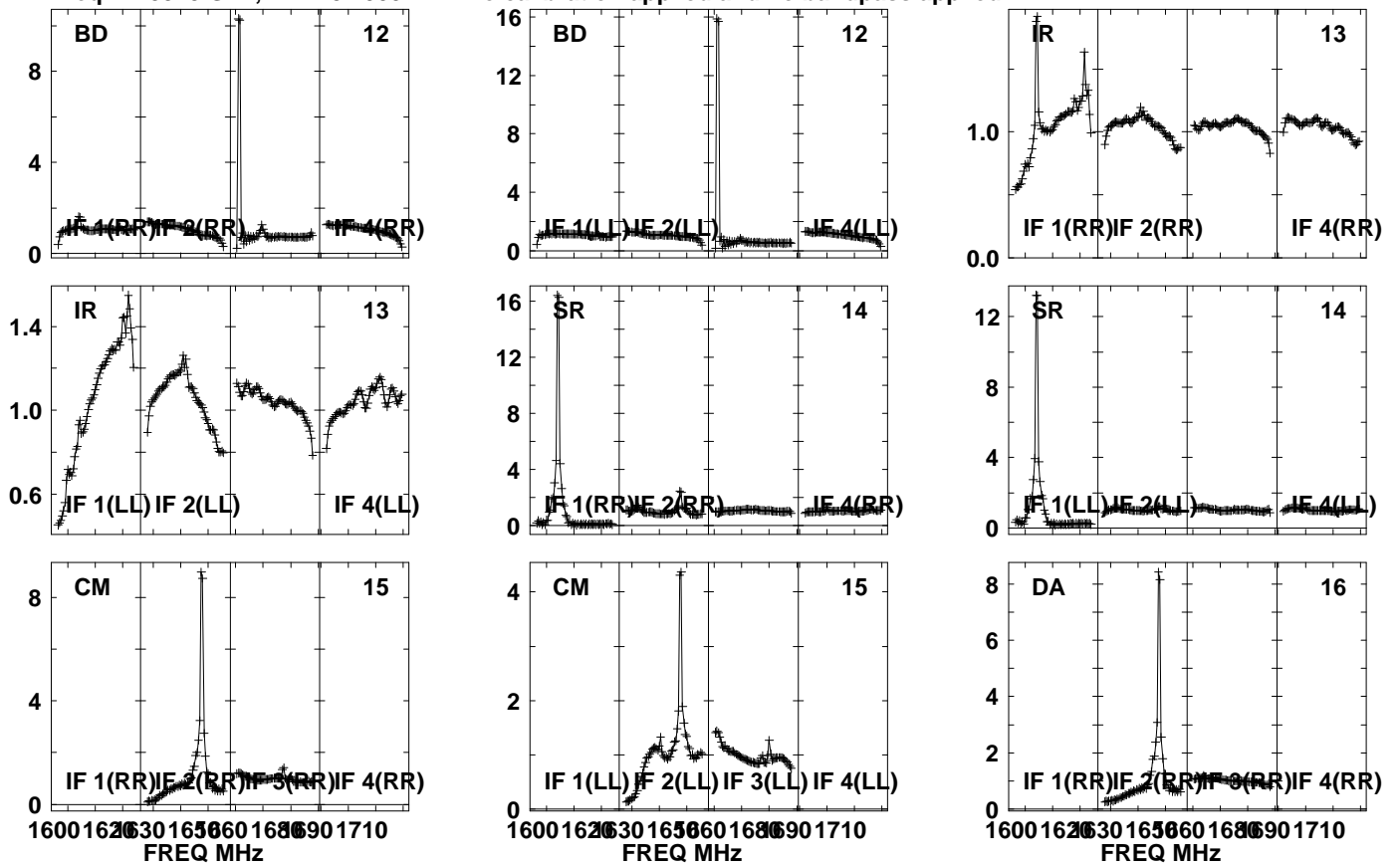

Lower frame: Real Jy

Auto-corr total-power spectrum Antenna: \*

Timerange: 00/22:13:01 to 00/22:14:29

Plot file version 1416 created 05-OCT-2021 17:11:40

J0827+5217 GM076.UVDATA.1

Freq = 1.5945 GHz, Bw = 32.000 MHz No calibration applied and no bandpass applied

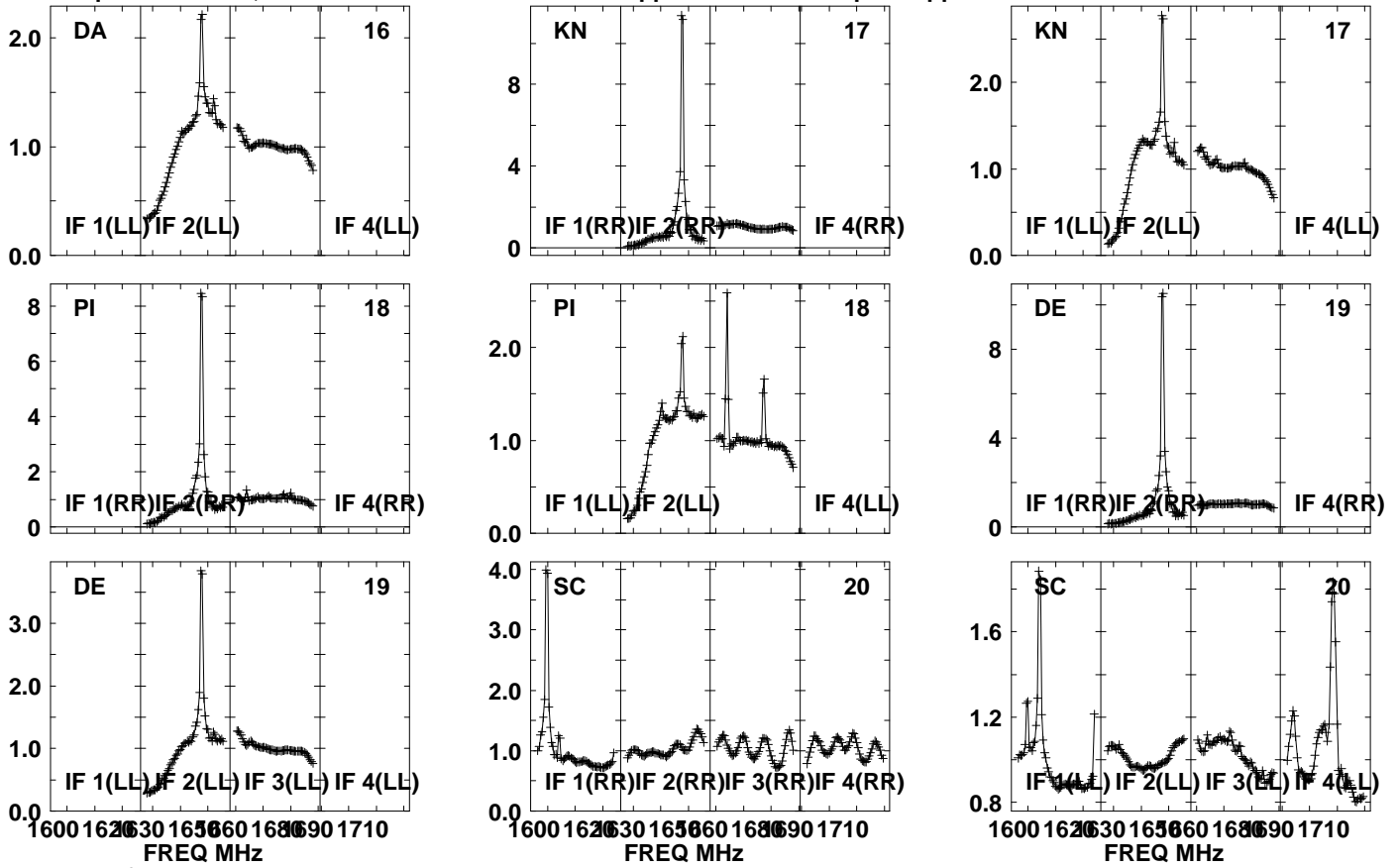

Lower frame: Real Jy  
Auto-corr total-power spectrum Antenna: \*  
Timerange: 00/22:13:01 to 00/22:14:29

Plot file version1417 created 05-OCT-2021 17:11:41

J0827+5217 GM076.UVDATA.1

Freq = 1.5945 GHz, Bw = 32.000 MH No calibration applied and no bandpass applied

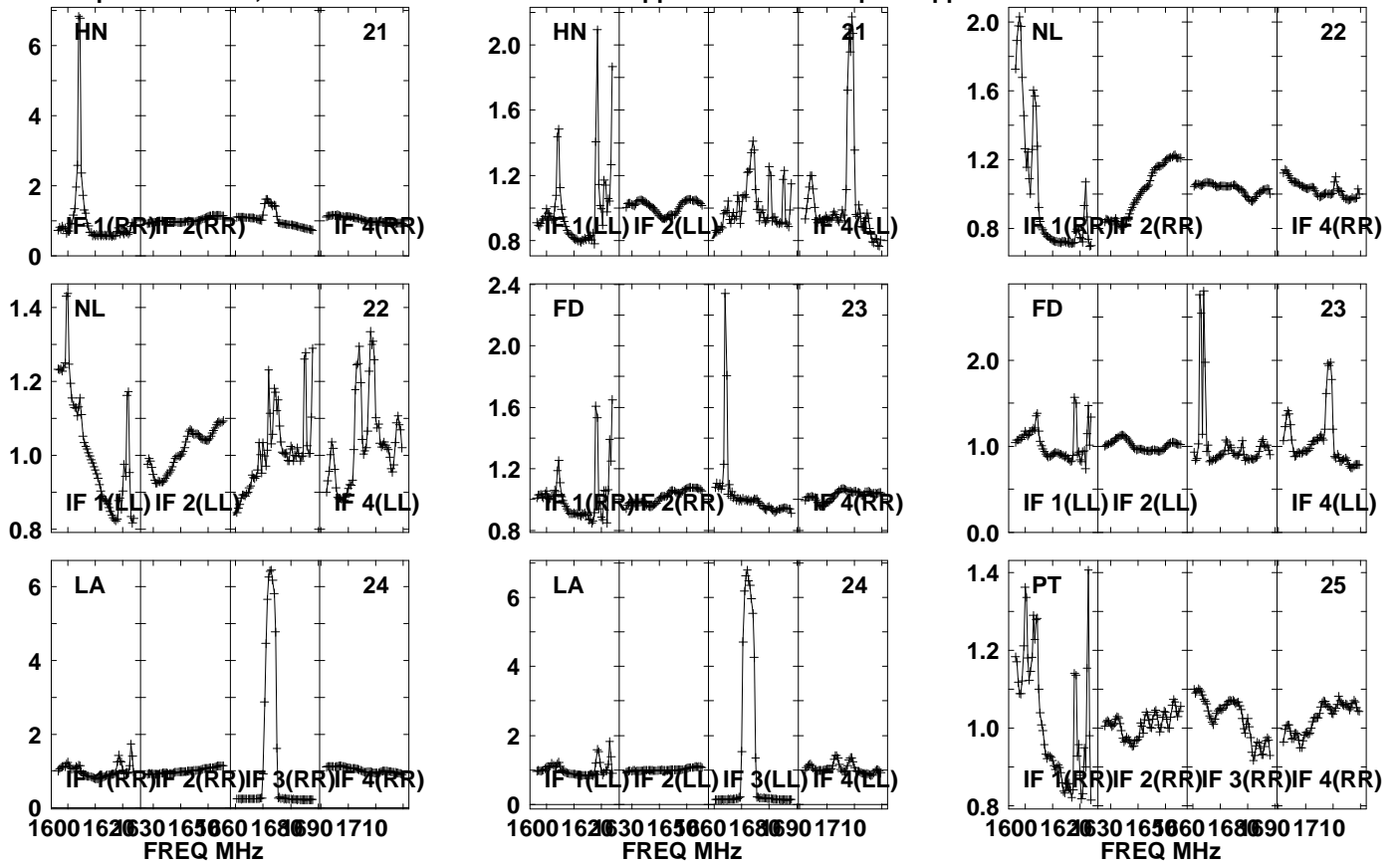

Lower frame: Real Jy

Auto-corr total-power spectrum Antenna: \*

Timerange: 00/22:13:01 to 00/22:14:29

Plot file version 1418 created 05-OCT-2021 17:11:41

J0827+5217 GM076.UVDATA.1

Freq = 1.5945 GHz, Bw = 32.000 MH No calibration applied and no bandpass applied

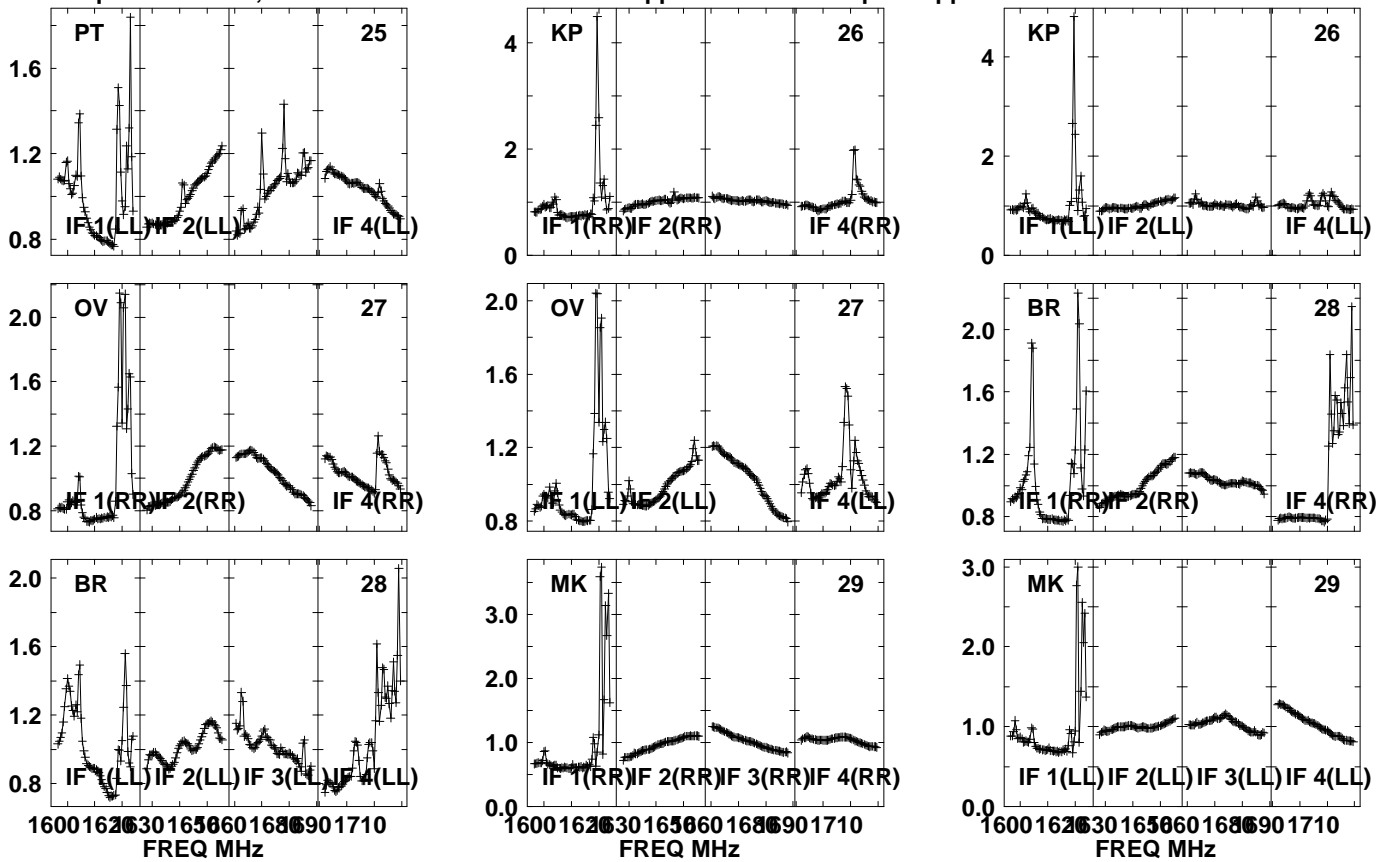

Lower frame: Real Jy  
Auto-corr total-power spectrum Antenna: \*  
Timerange: 00/22:13:01 to 00/22:14:29



Plot file version1419 created 05-OCT-2021 17:11:41

APM08279+525 GM076.UVDATA.1

Freq = 1.5945 GHz, Bw = 32.000 MH No calibration applied and no bandpass applied

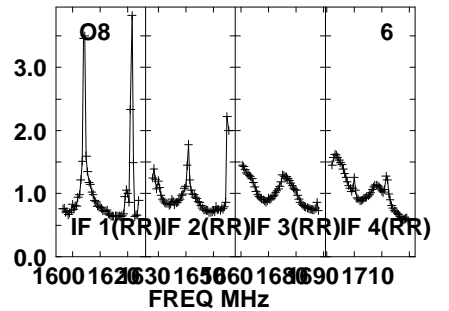
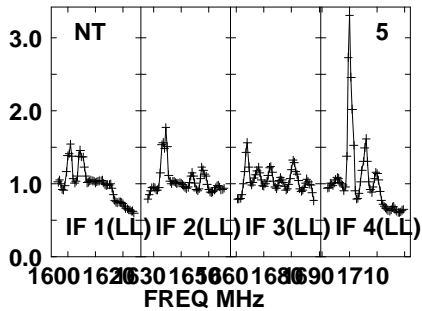
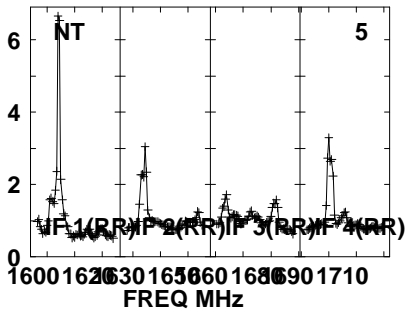
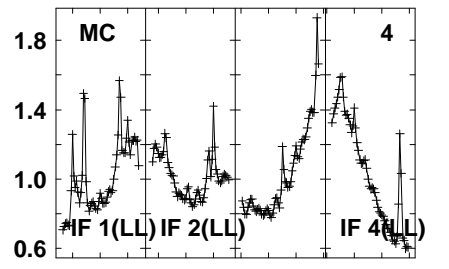
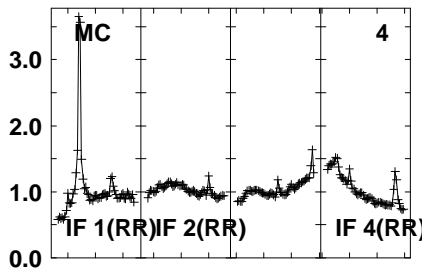
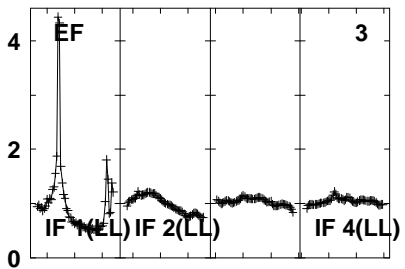
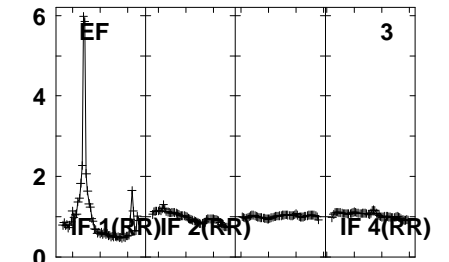
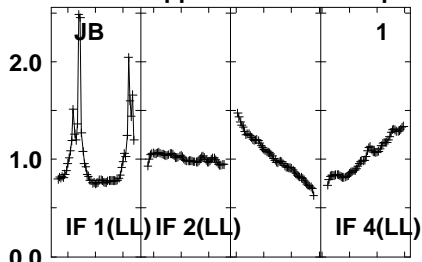
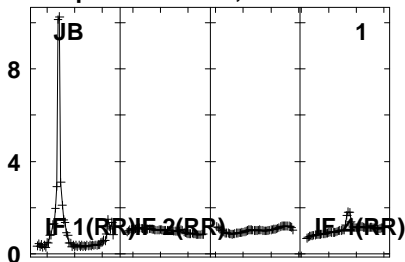

Lower frame: Real Jy

Auto-corr total-power spectrum Antenna: \*

Timerange: 00/22:14:31 to 00/22:17:59

Plot file version 1420 created 05-OCT-2021 17:11:42

APM08279+525 GM076.UVDATA.1

Freq = 1.5945 GHz, Bw = 32.000 MHz No calibration applied and no bandpass applied

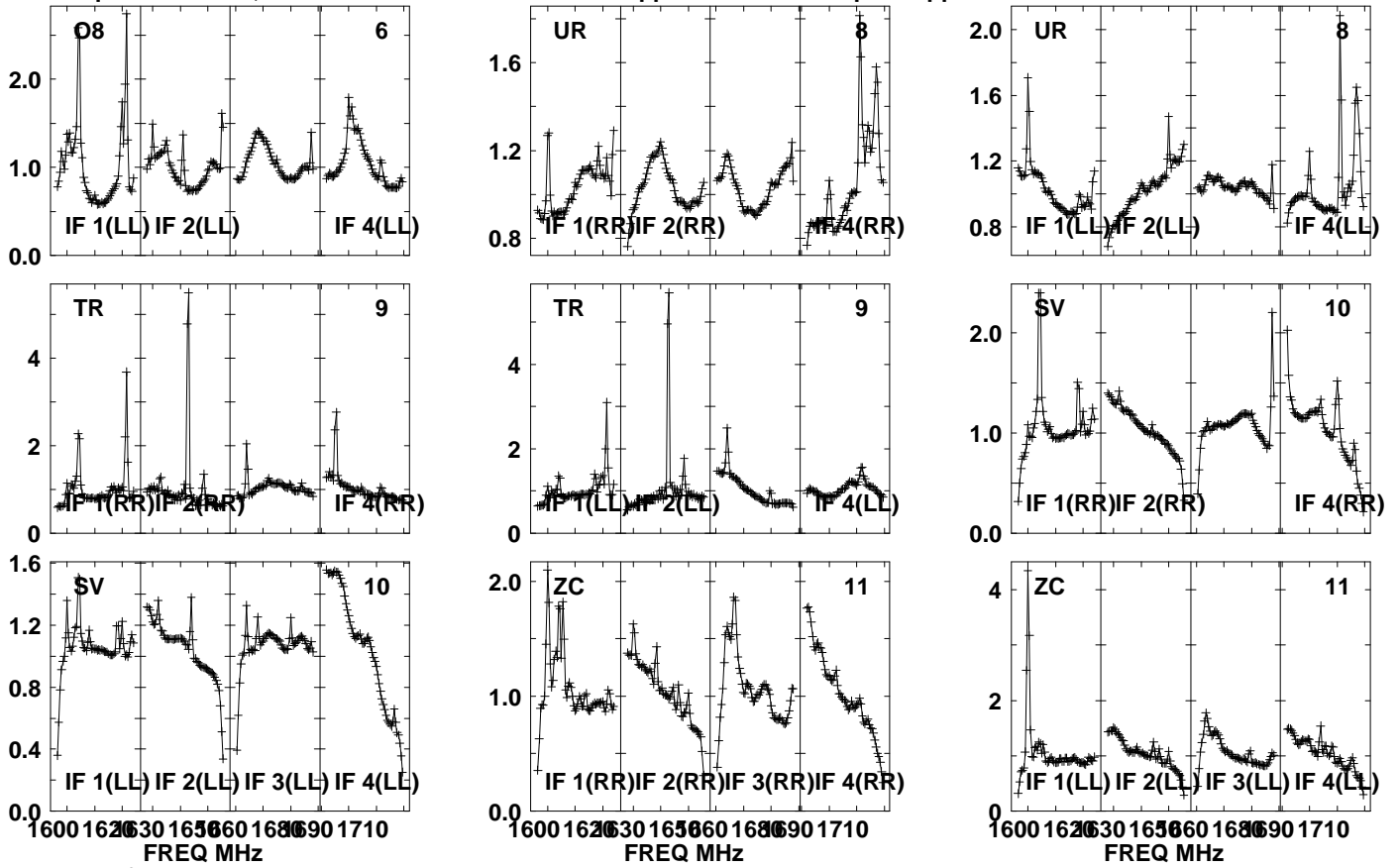

Lower frame: Real Jy  
Auto-corr total-power spectrum Antenna: \*  
Timerange: 00/22:14:31 to 00/22:17:59

Plot file version1421 created 05-OCT-2021 17:11:42

APM08279+525 GM076.UVDATA.1

Freq = 1.5945 GHz, Bw = 32.000 MH No calibration applied and no bandpass applied

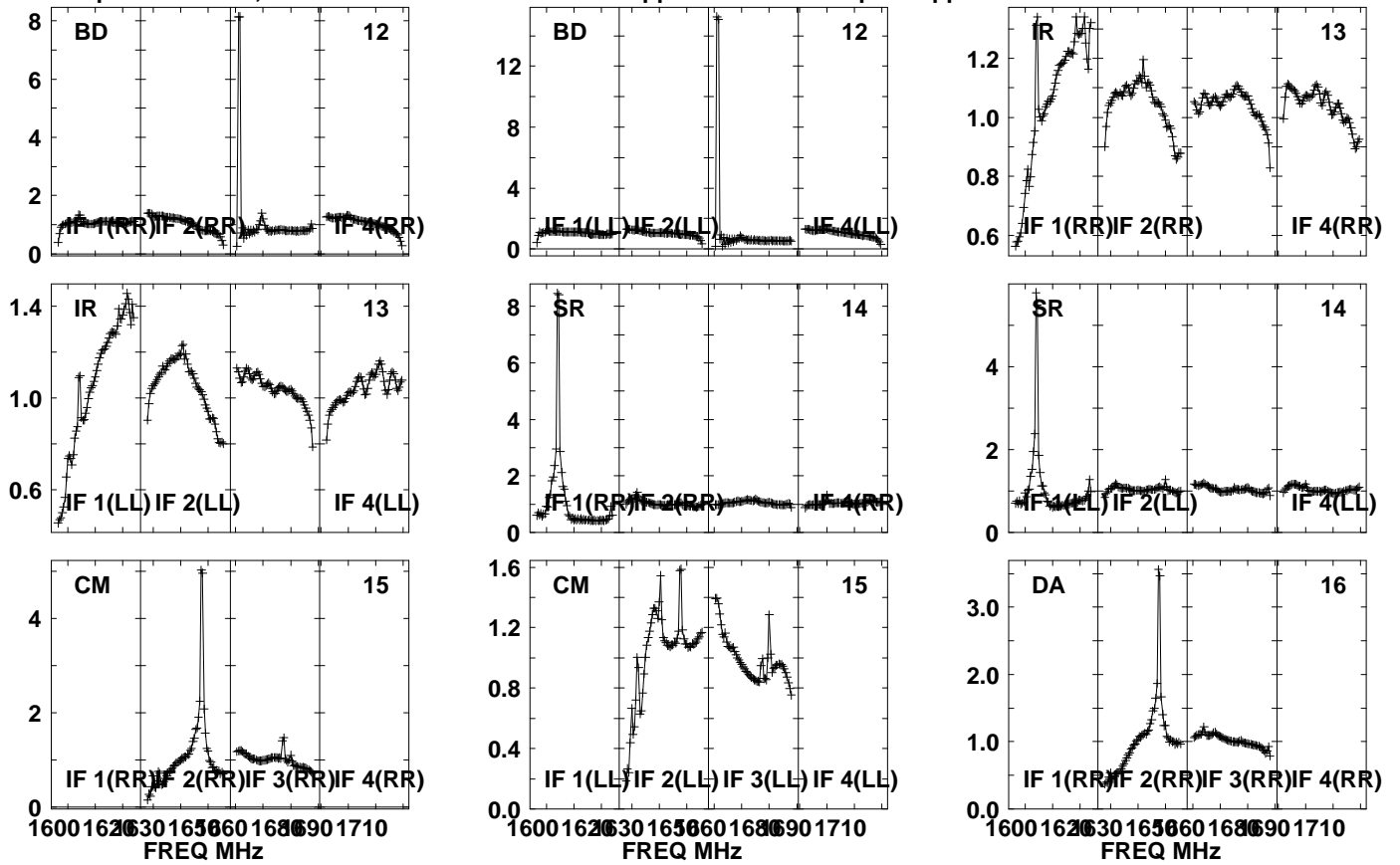

Lower frame: Real Jy

Auto-corr total-power spectrum Antenna: \*

Timerange: 00/22:14:31 to 00/22:17:59

Plot file version 1422 created 05-OCT-2021 17:11:43

APM08279+525 GM076.UVDATA.1

Freq = 1.5945 GHz, Bw = 32.000 MH No calibration applied and no bandpass applied

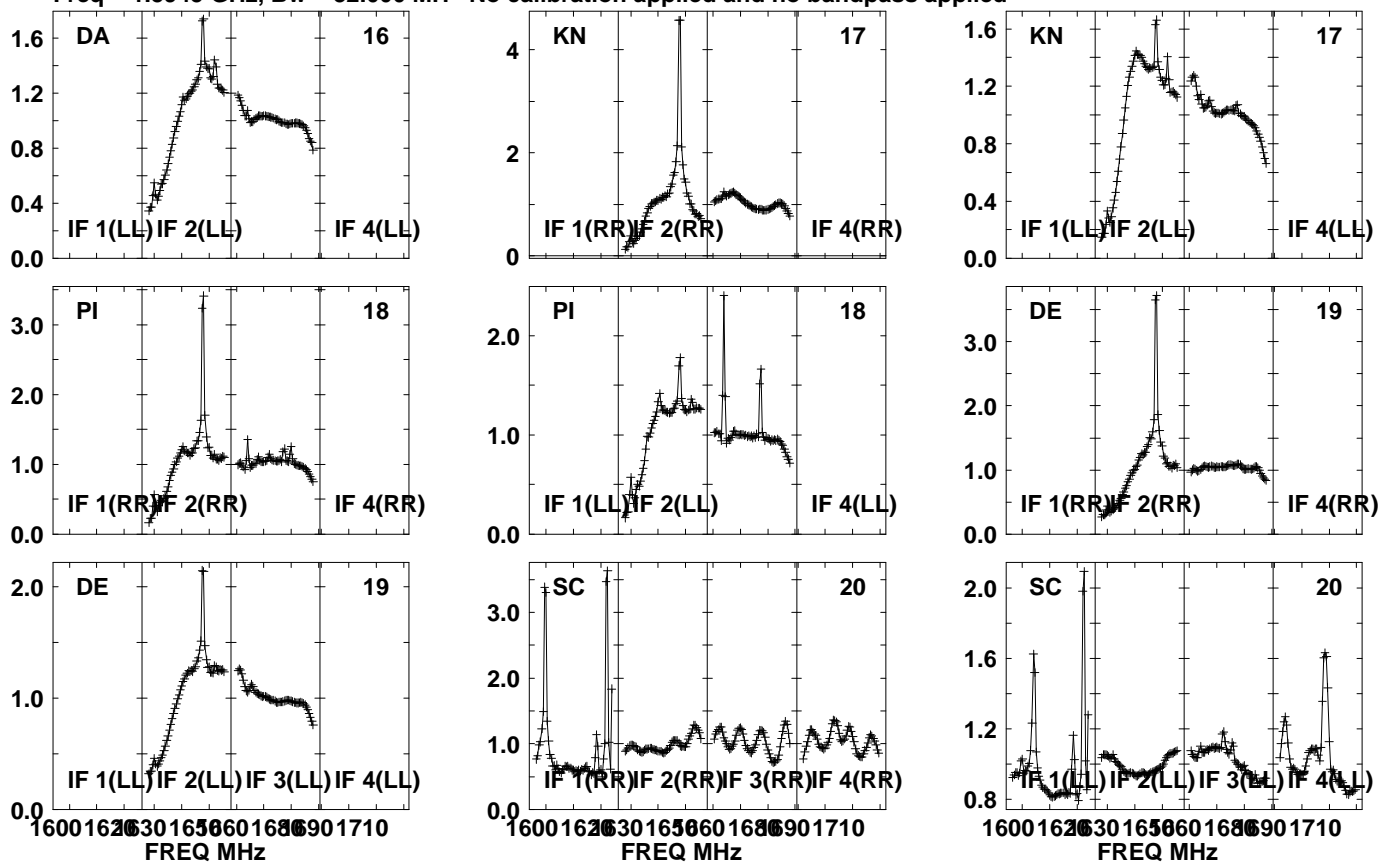

Lower frame: Real Jy  
Auto-corr total-power spectrum Antenna: \*  
Timerange: 00/22:14:31 to 00/22:17:59

Plot file version 1423 created 05-OCT-2021 17:11:43

APM08279+525 GM076.UVDATA.1

Freq = 1.5945 GHz, Bw = 32.000 MH No calibration applied and no bandpass applied

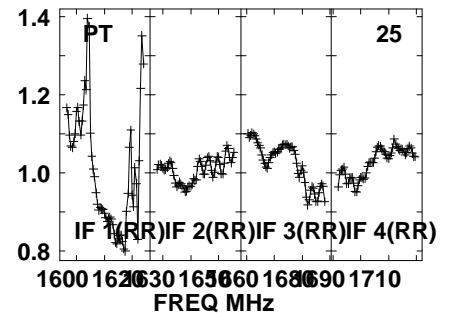
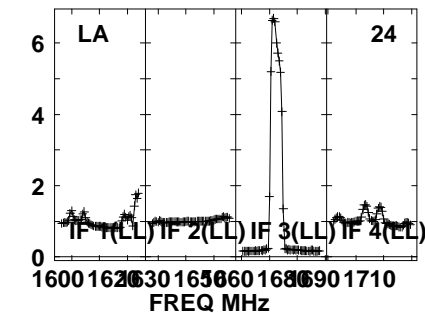
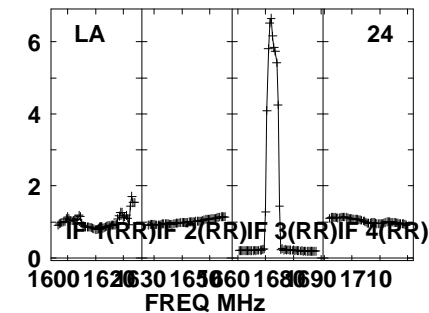
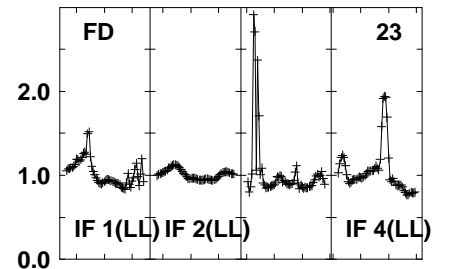
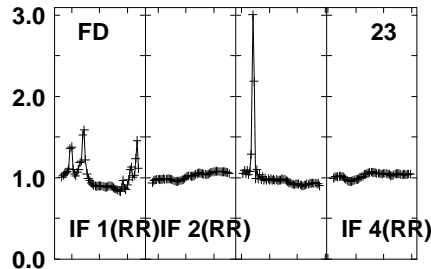
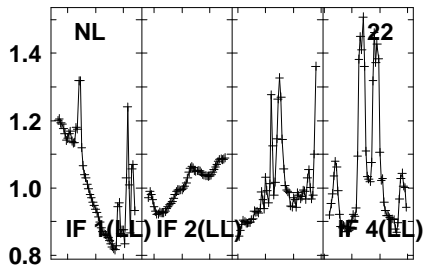
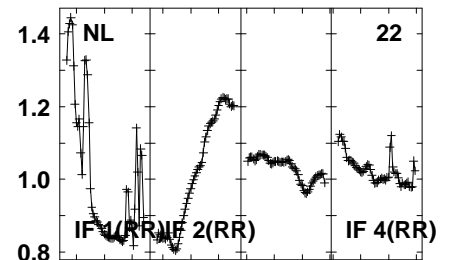
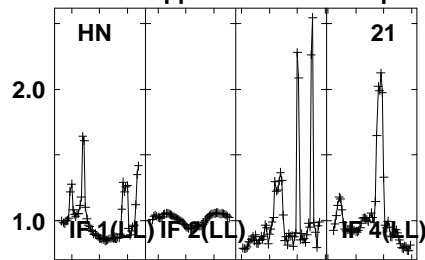
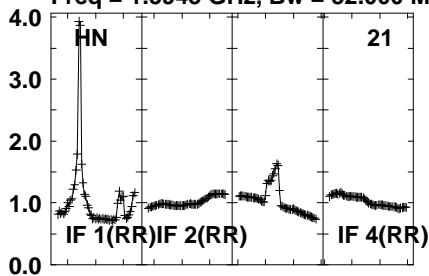

Lower frame: Real Jy

Auto-corr total-power spectrum Antenna: \*

Timerange: 00/22:14:31 to 00/22:17:59

Plot file version1424 created 05-OCT-2021 17:11:43

APM08279+525 GM076.UVDATA.1

Freq = 1.5945 GHz, Bw = 32.000 MH No calibration applied and no bandpass applied

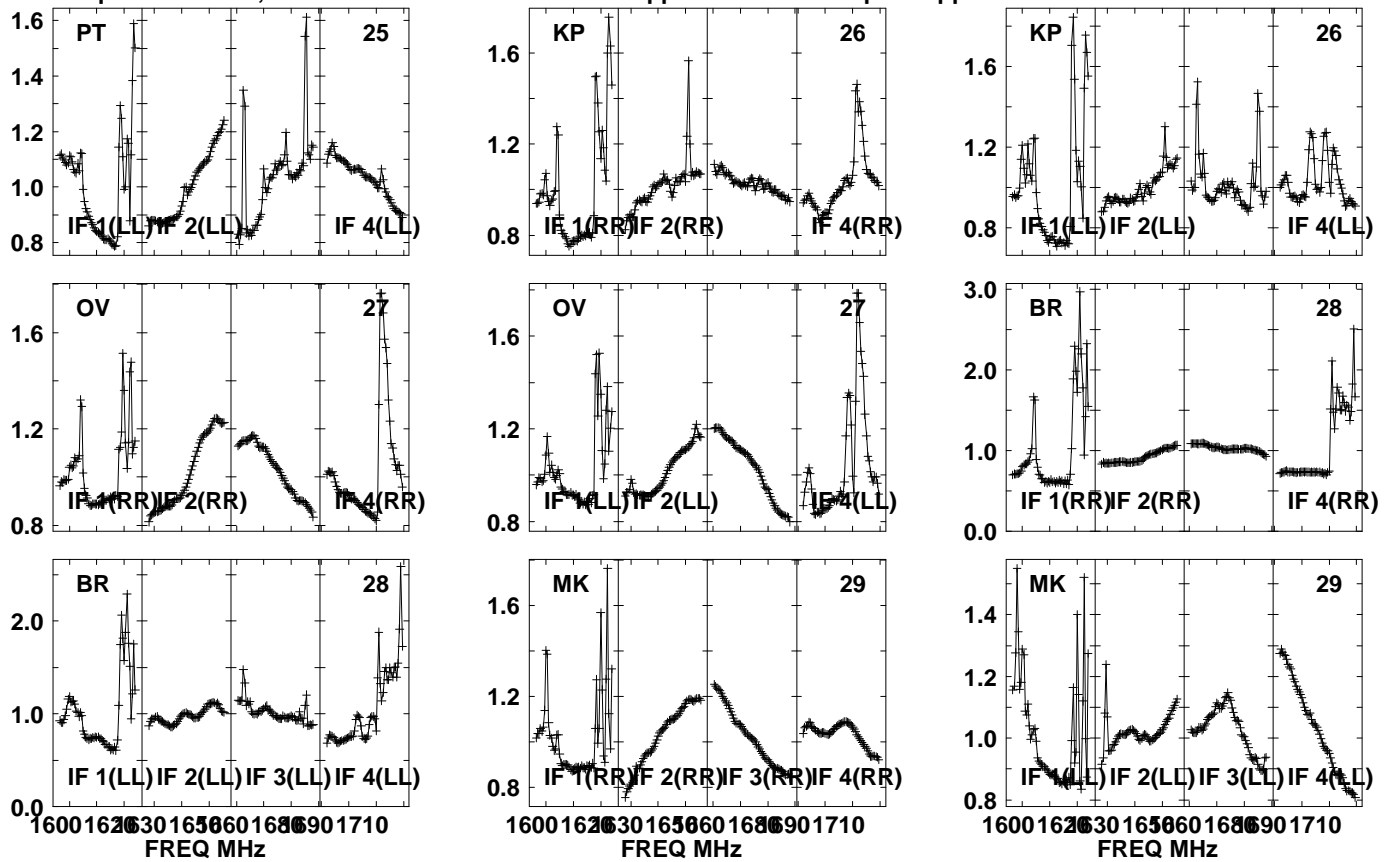

Lower frame: Real Jy  
Auto-corr total-power spectrum Antenna: \*  
Timerange: 00/22:14:31 to 00/22:17:59

Plot file version1425 created 05-OCT-2021 17:11:44

J0827+5217 GM076.UVDATA.1

Freq = 1.5945 GHz, Bw = 32.000 MH No calibration applied and no bandpass applied

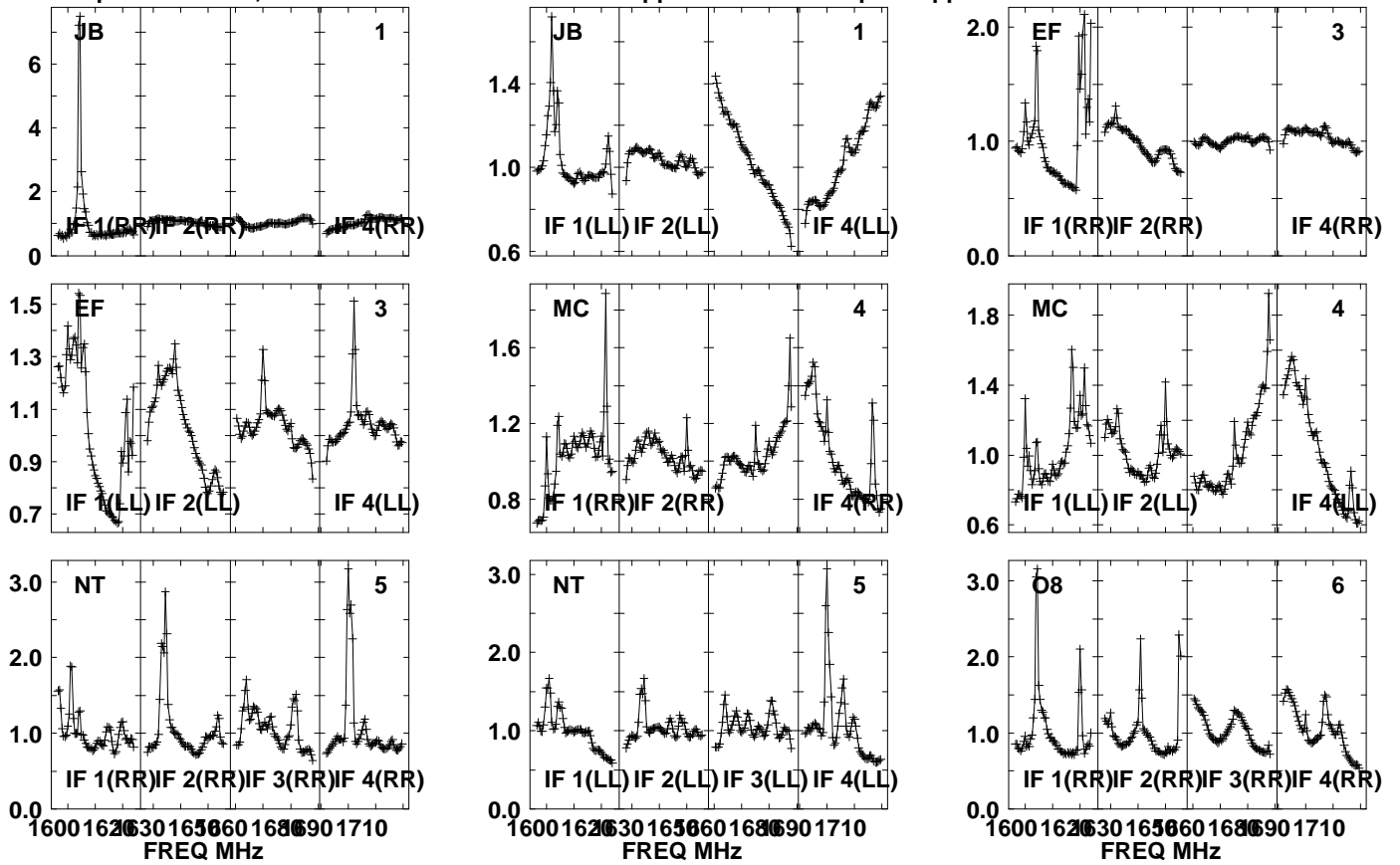

Lower frame: Real Jy

Auto-corr total-power spectrum Antenna: \*

Timerange: 00/22:18:01 to 00/22:19:29

Plot file version 1426 created 05-OCT-2021 17:11:44

J0827+5217 GM076.UVDATA.1

Freq = 1.5945 GHz, Bw = 32.000 MHz No calibration applied and no bandpass applied

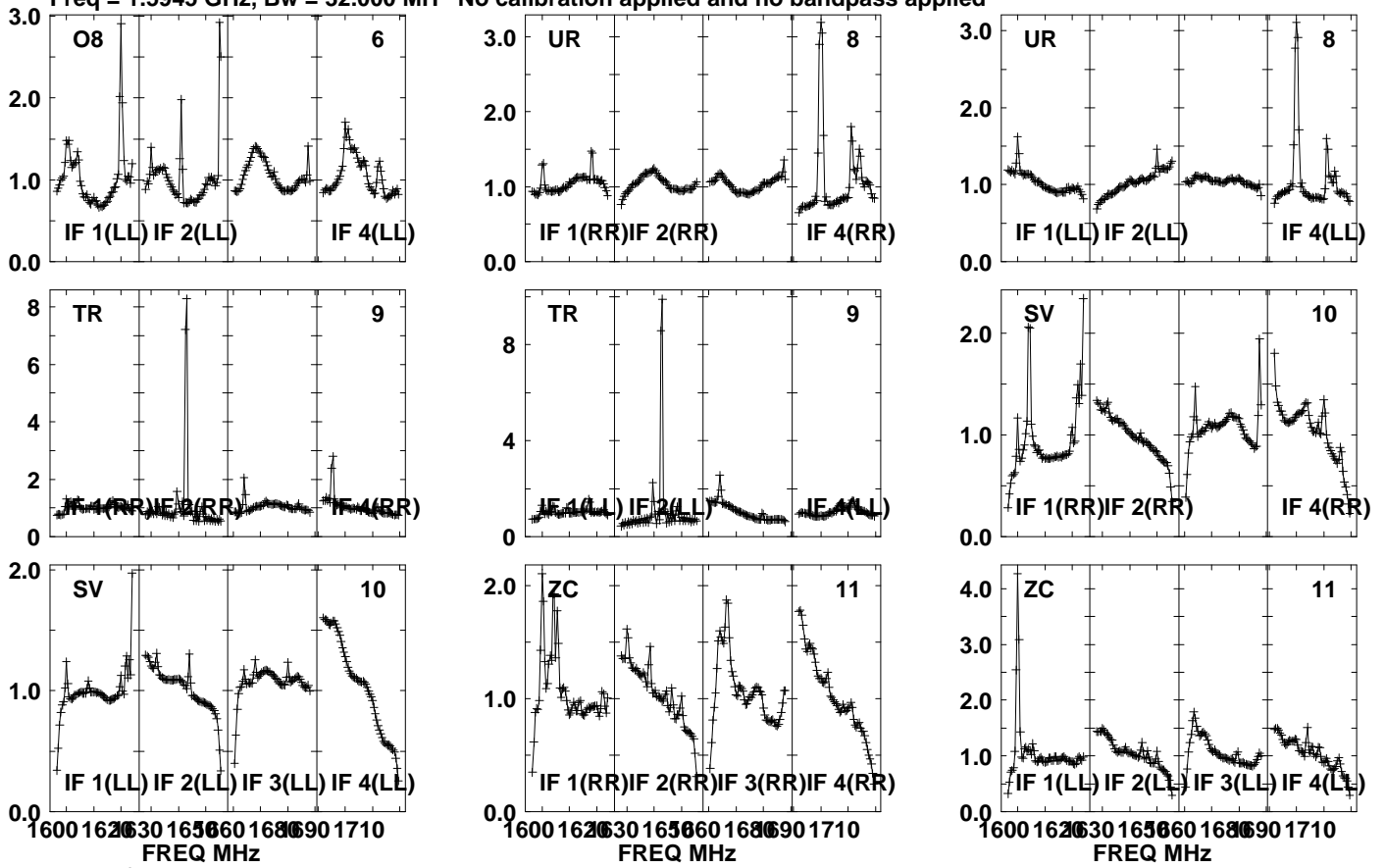

Lower frame: Real Jy  
Auto-corr total-power spectrum Antenna: \*  
Timerange: 00/22:18:01 to 00/22:19:29



Plot file version1427 created 05-OCT-2021 17:11:44

J0827+5217 GM076.UVDATA.1

Freq = 1.5945 GHz, Bw = 32.000 MH No calibration applied and no bandpass applied

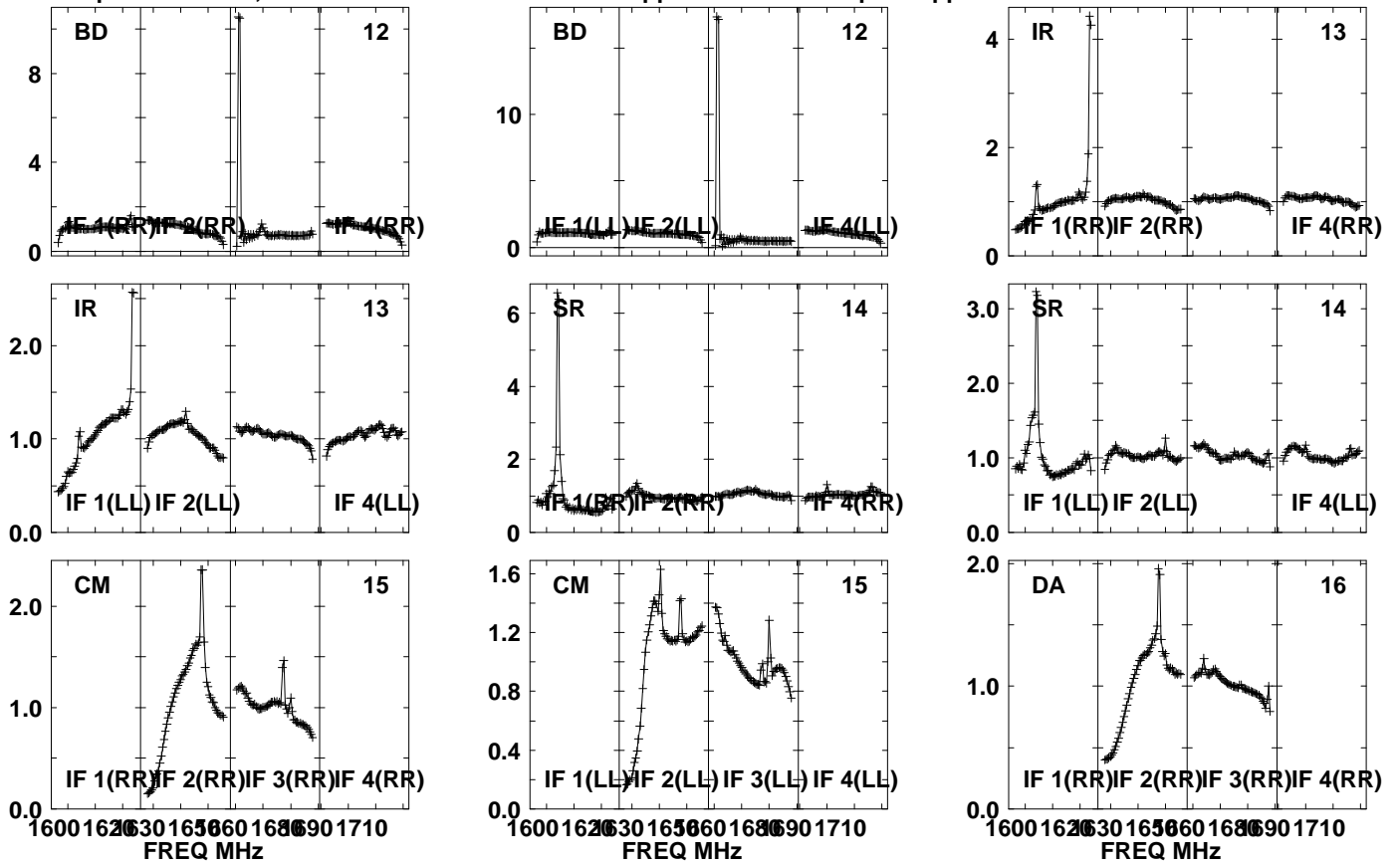

Lower frame: Real Jy  
Auto-corr total-power spectrum Antenna: \*  
Timerange: 00/22:18:01 to 00/22:19:29

Plot file version1428 created 05-OCT-2021 17:11:45

J0827+5217 GM076.UVDATA.1

Freq = 1.5945 GHz, Bw = 32.000 MH No calibration applied and no bandpass applied

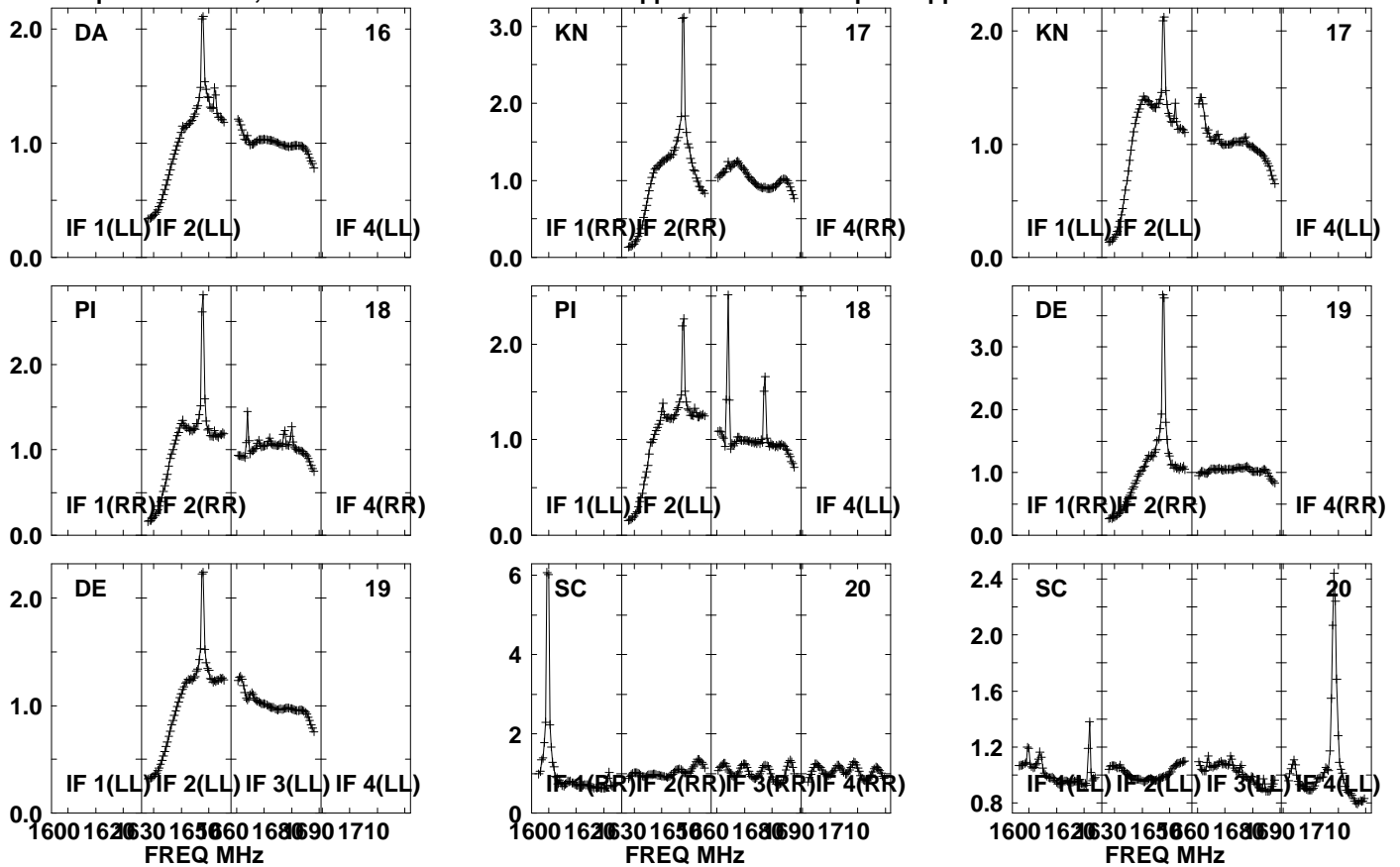

Lower frame: Real Jy

Auto-corr total-power spectrum Antenna: \*

Timerange: 00/22:18:01 to 00/22:19:29

Plot file version 1429 created 05-OCT-2021 17:11:45

J0827+5217 GM076.UVDATA.1

Freq = 1.5945 GHz, Bw = 32.000 MH No calibration applied and no bandpass applied

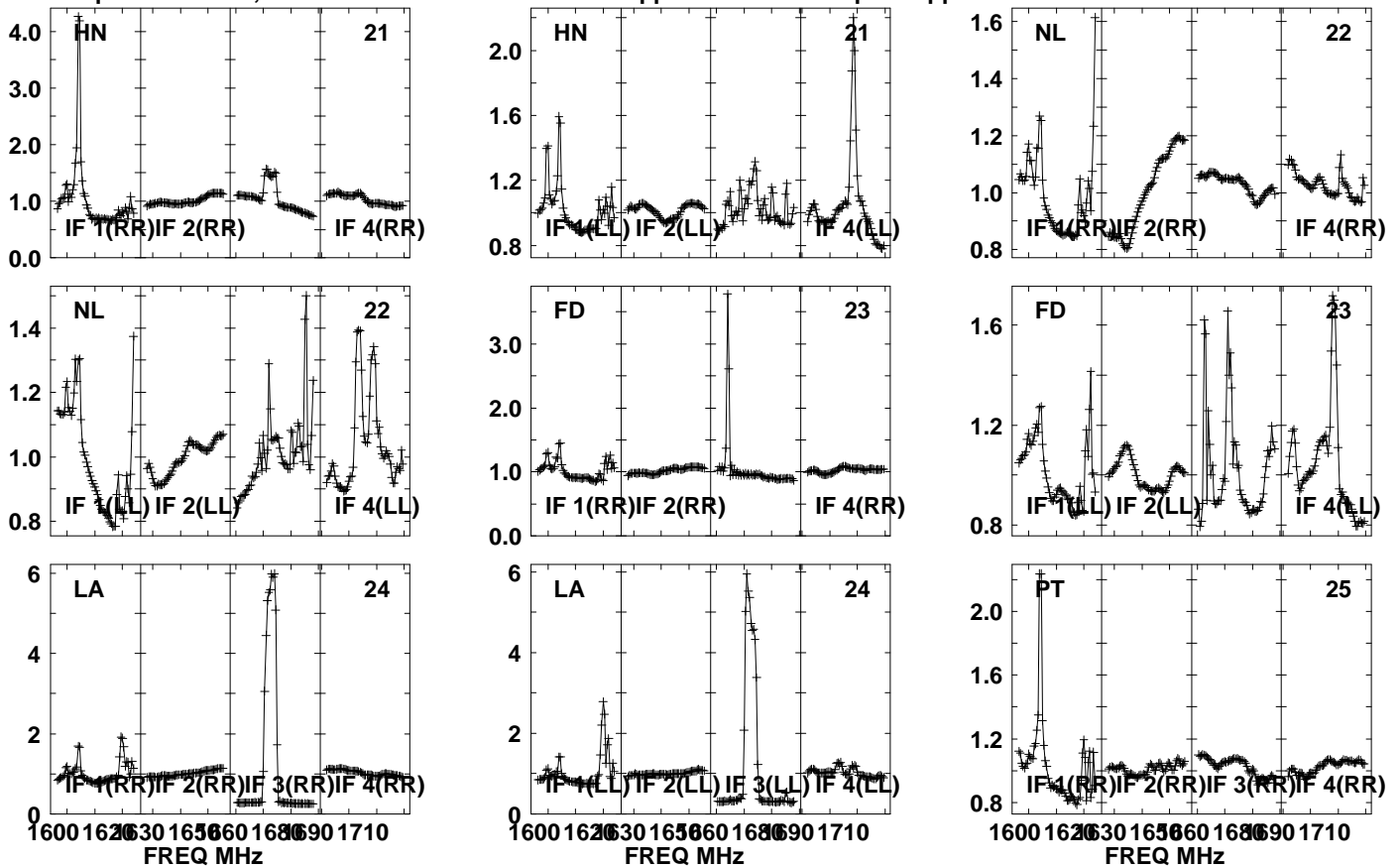

Lower frame: Real Jy

Auto-corr total-power spectrum Antenna: \*

Timerange: 00/22:18:01 to 00/22:19:29

Plot file version 1430 created 05-OCT-2021 17:11:45

J0827+5217 GM076.UVDATA.1

Freq = 1.5945 GHz, Bw = 32.000 MH No calibration applied and no bandpass applied

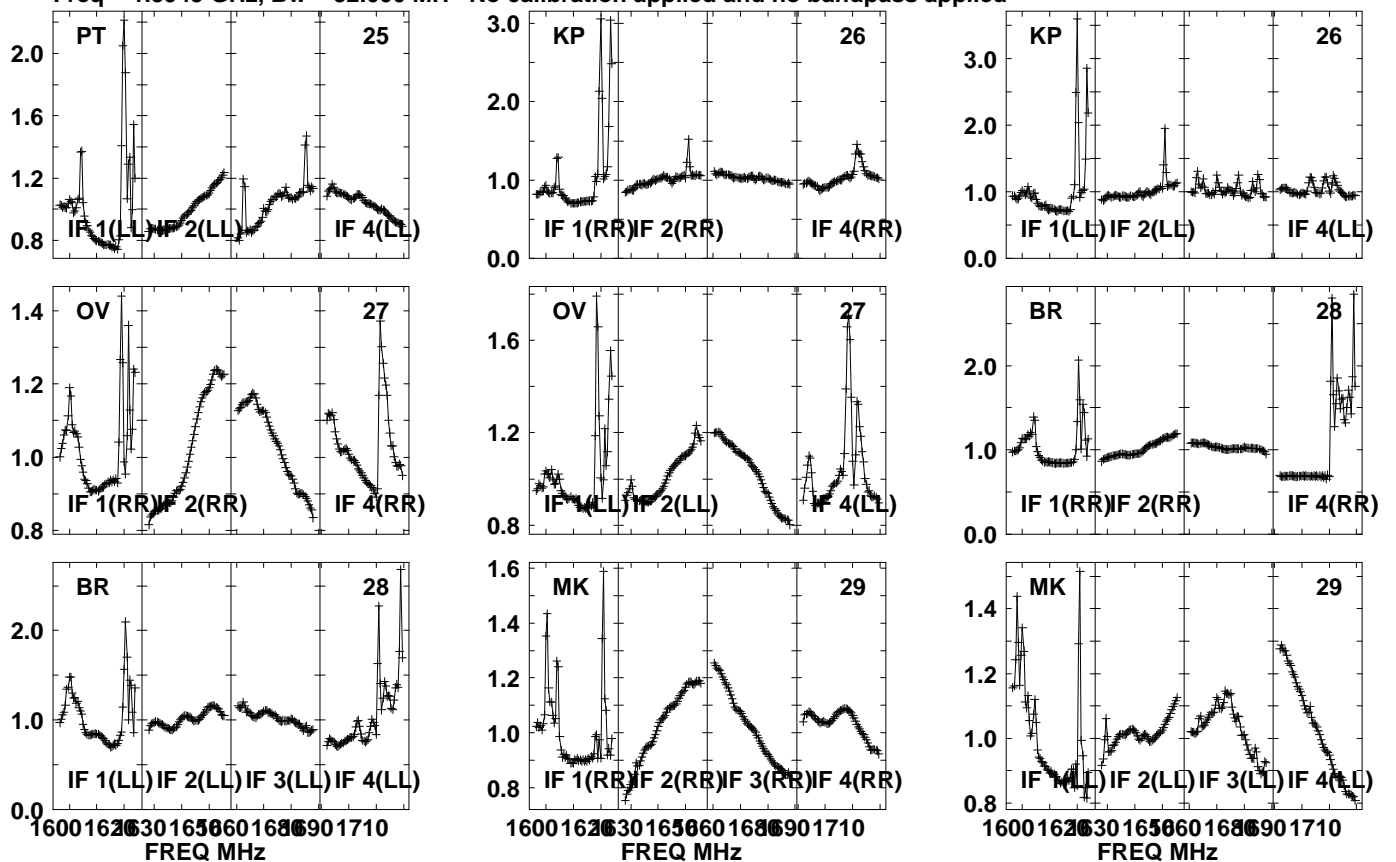

Lower frame: Real Jy  
Auto-corr total-power spectrum Antenna: \*  
Timerange: 00/22:18:01 to 00/22:19:29

Plot file version 1431 created 05-OCT-2021 17:11:46

APM08279+525 GM076.UVDATA.1

Freq = 1.5945 GHz, Bw = 32.000 MH No calibration applied and no bandpass applied

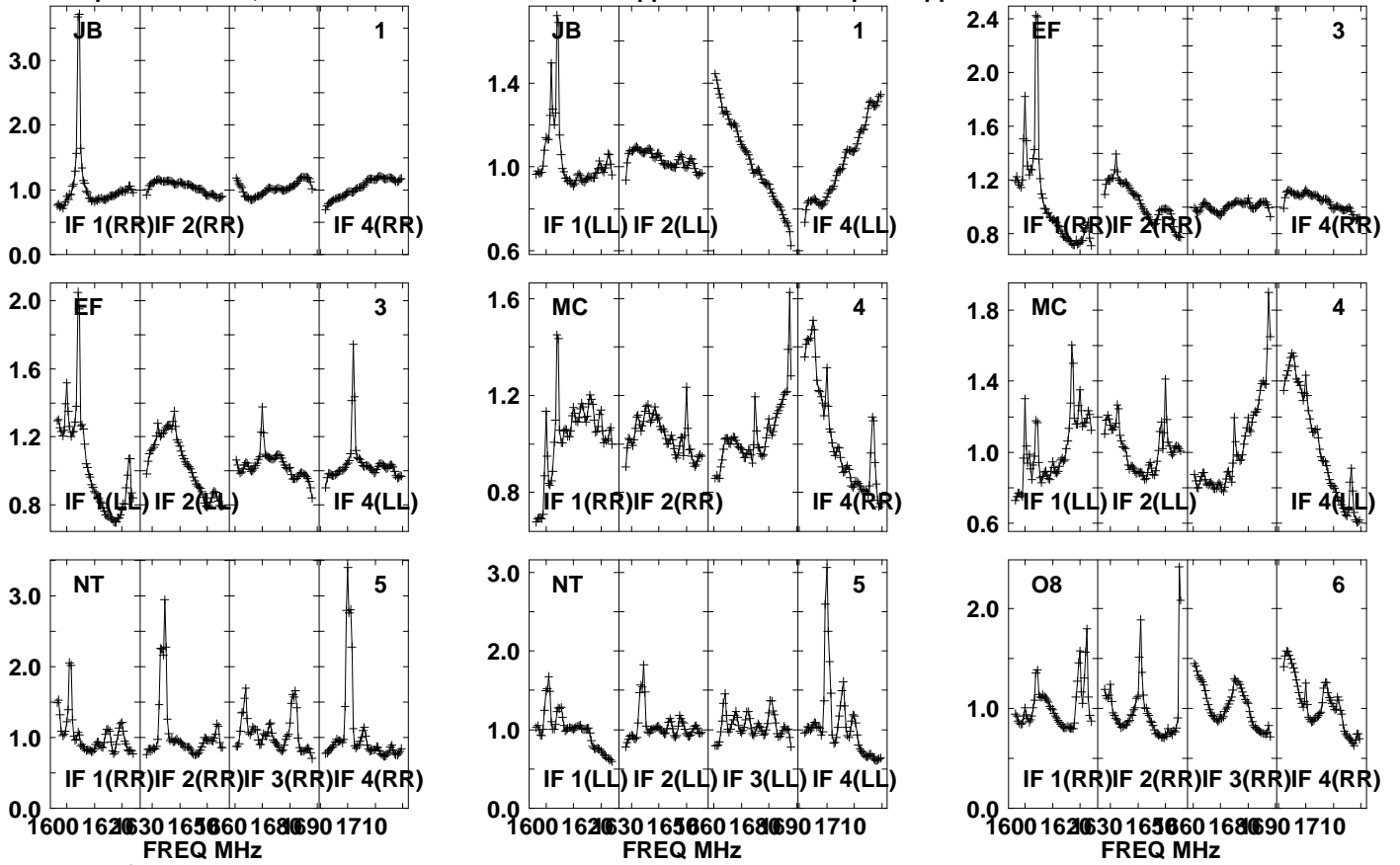

Lower frame: Real Jy

Auto-corr total-power spectrum Antenna: \*

Timerange: 00/22:19:31 to 00/22:22:59

Plot file version1432 created 05-OCT-2021 17:11:46

APM08279+525 GM076.UVDATA.1

Freq = 1.5945 GHz, Bw = 32.000 MH No calibration applied and no bandpass applied

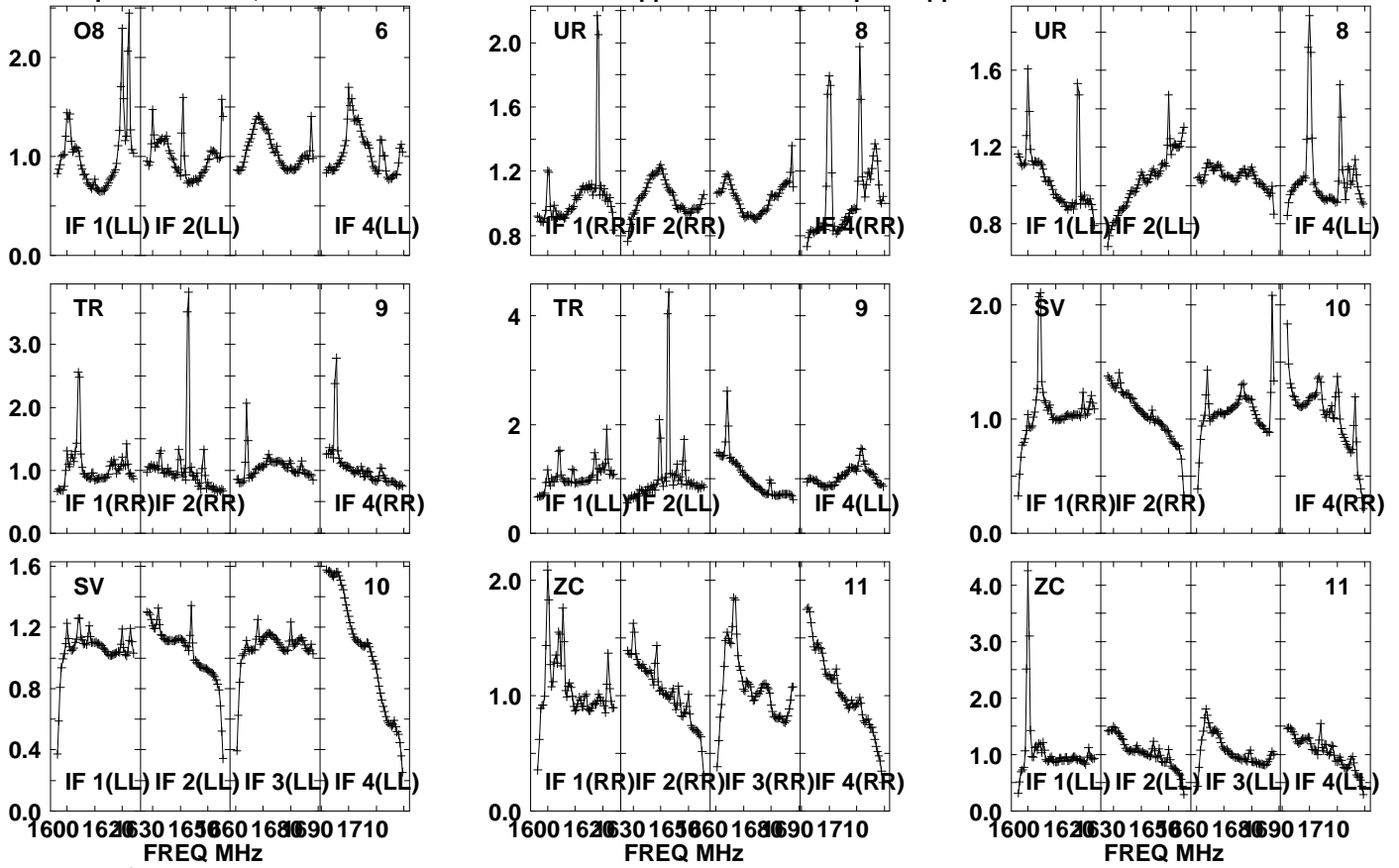

Lower frame: Real Jy

Auto-corr total-power spectrum Antenna: \*

Timerange: 00/22:19:31 to 00/22:22:59

Plot file version1433 created 05-OCT-2021 17:11:46

APM08279+525 GM076.UVDATA.1

Freq = 1.5945 GHz, Bw = 32.000 MH No calibration applied and no bandpass applied

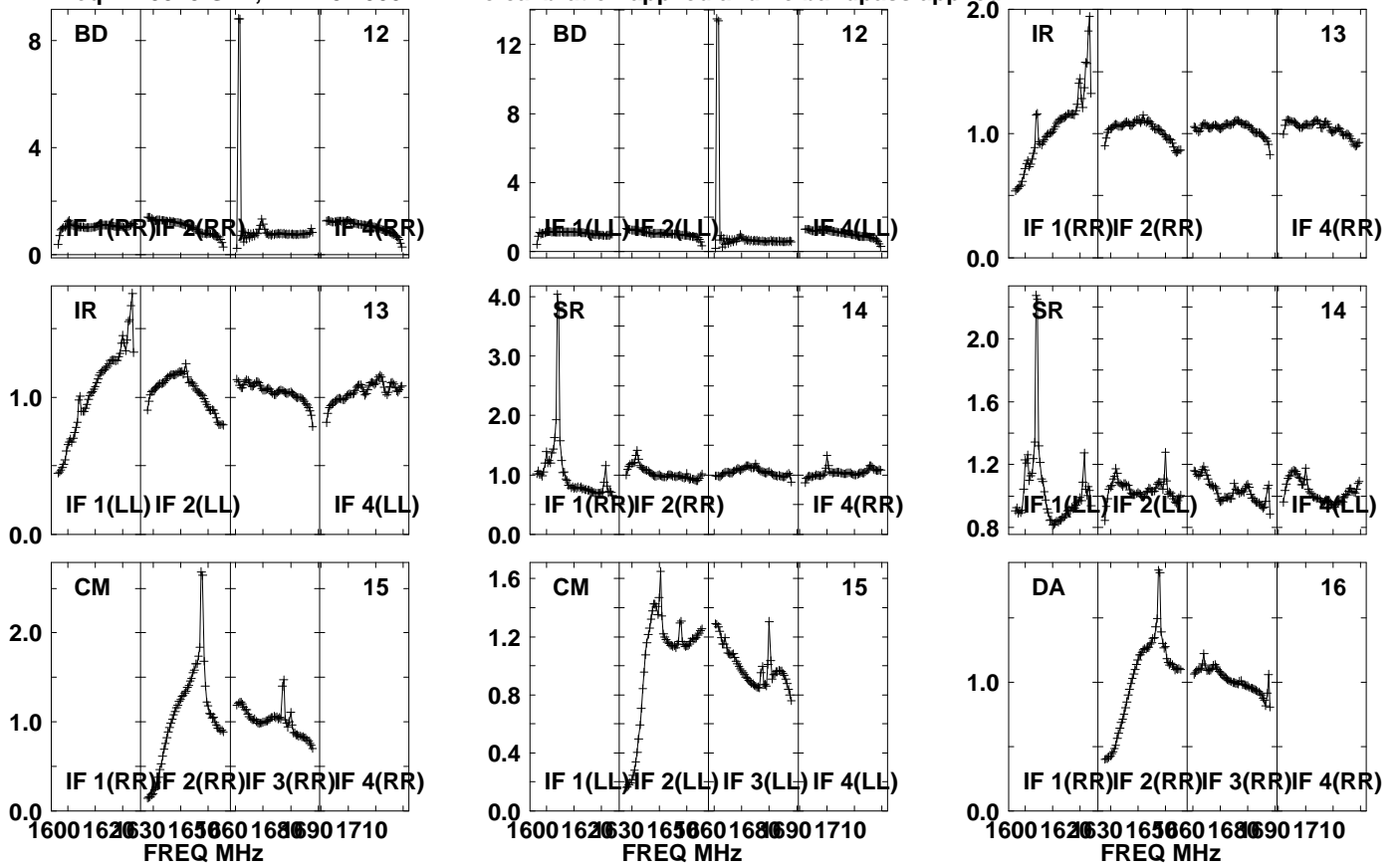

Lower frame: Real Jy

Auto-corr total-power spectrum Antenna: \*

Timerange: 00/22:19:31 to 00/22:22:59

Plot file version 1434 created 05-OCT-2021 17:11:47

APM08279+525 GM076.UVDATA.1

Freq = 1.5945 GHz, Bw = 32.000 MH No calibration applied and no bandpass applied

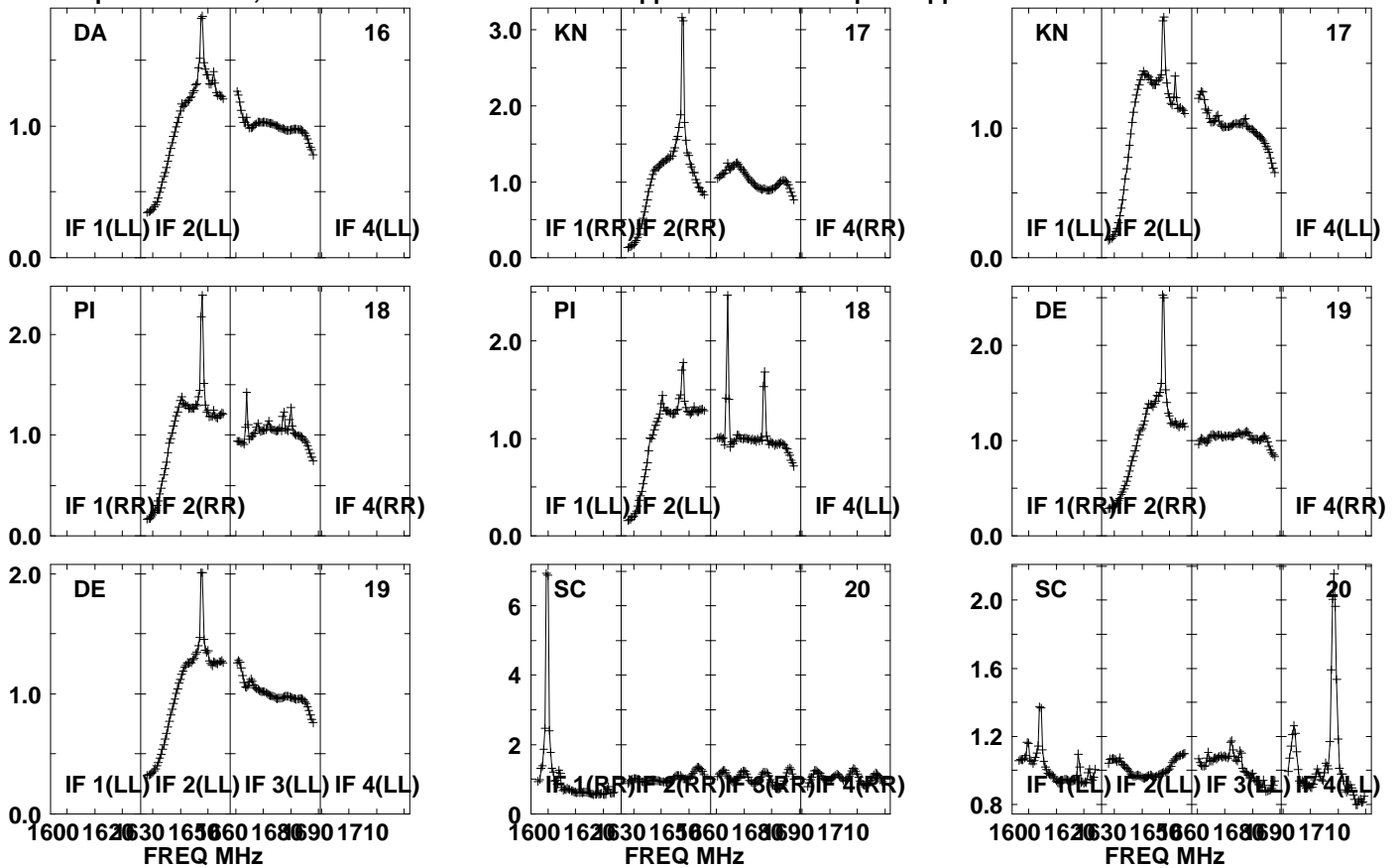

Lower frame: Real Jy

Auto-corr total-power spectrum Antenna: \*

Timerange: 00/22:19:31 to 00/22:22:59



Plot file version1435 created 05-OCT-2021 17:11:47

APM08279+525 GM076.UVDATA.1

Freq = 1.5945 GHz, Bw = 32.000 MH No calibration applied and no bandpass applied

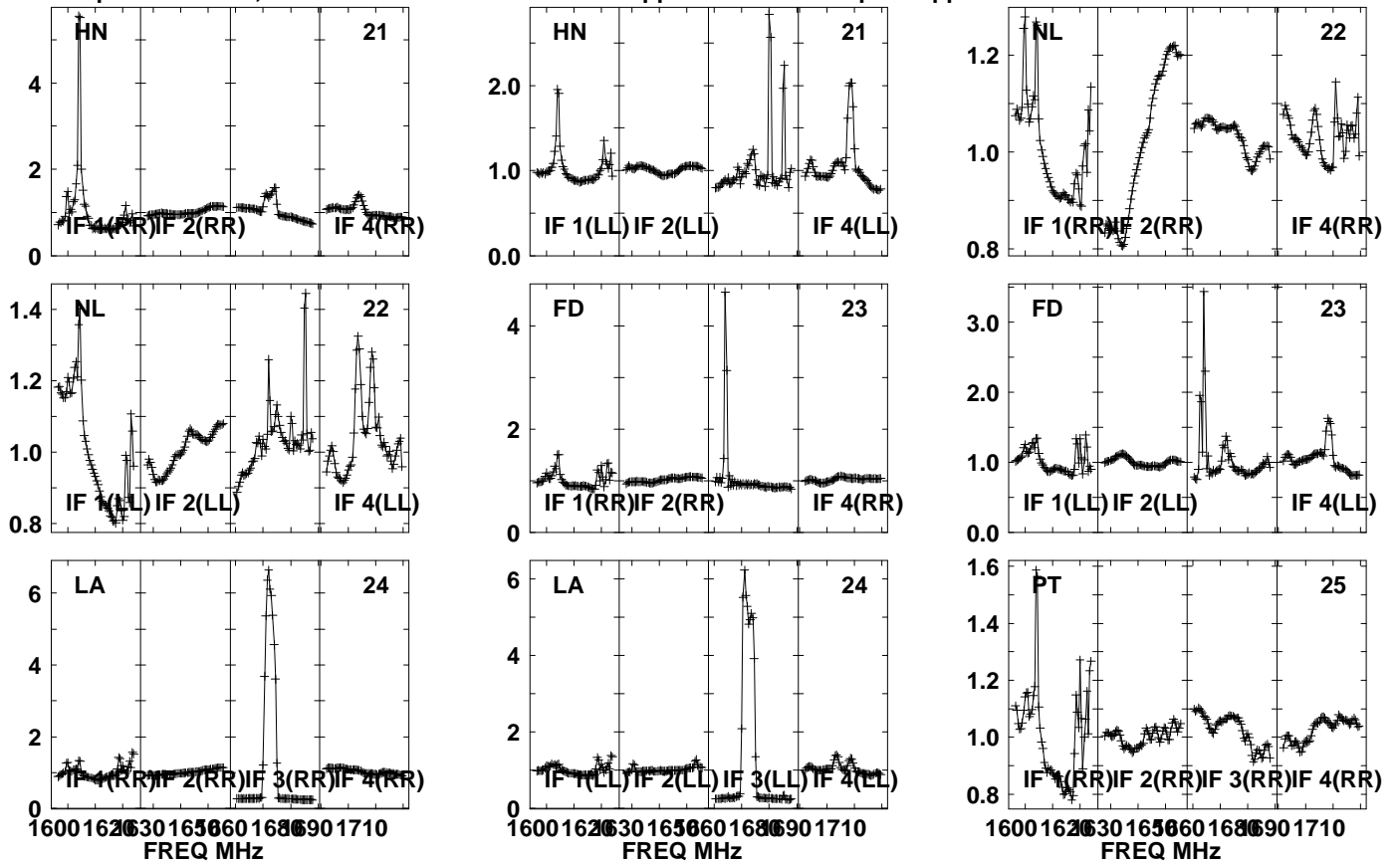

Lower frame: Real Jy

Auto-corr total-power spectrum Antenna: \*

Timerange: 00/22:19:31 to 00/22:22:59

Plot file version1436 created 05-OCT-2021 17:11:47

APM08279+525 GM076.UVDATA.1

Freq = 1.5945 GHz, Bw = 32.000 MH No calibration applied and no bandpass applied

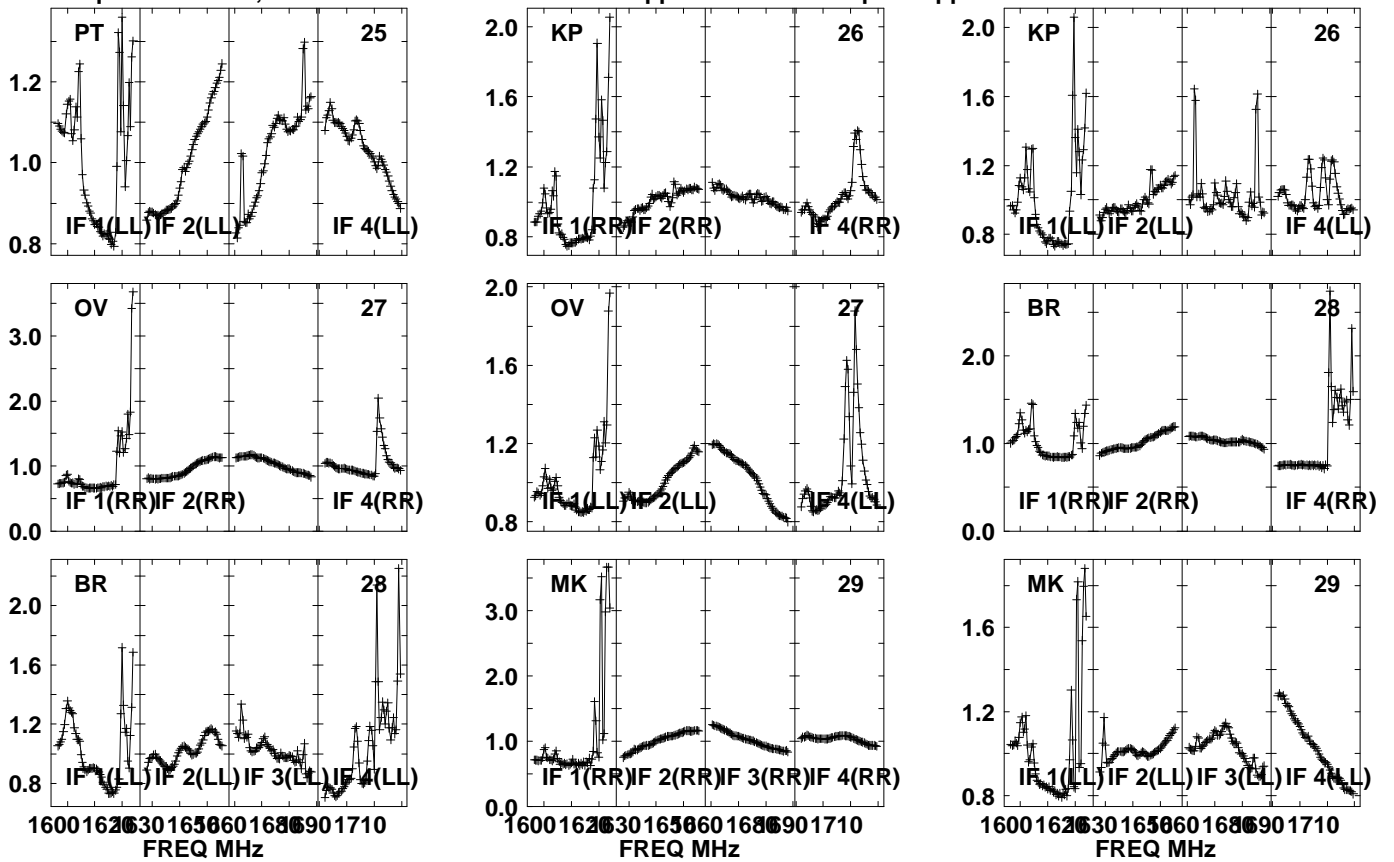

Lower frame: Real Jy  
Auto-corr total-power spectrum Antenna: \*  
Timerange: 00/22:19:31 to 00/22:22:59

Plot file version 1437 created 05-OCT-2021 17:11:48

J0827+5217 GM076.UVDATA.1

Freq = 1.5945 GHz, Bw = 32.000 MHz No calibration applied and no bandpass applied

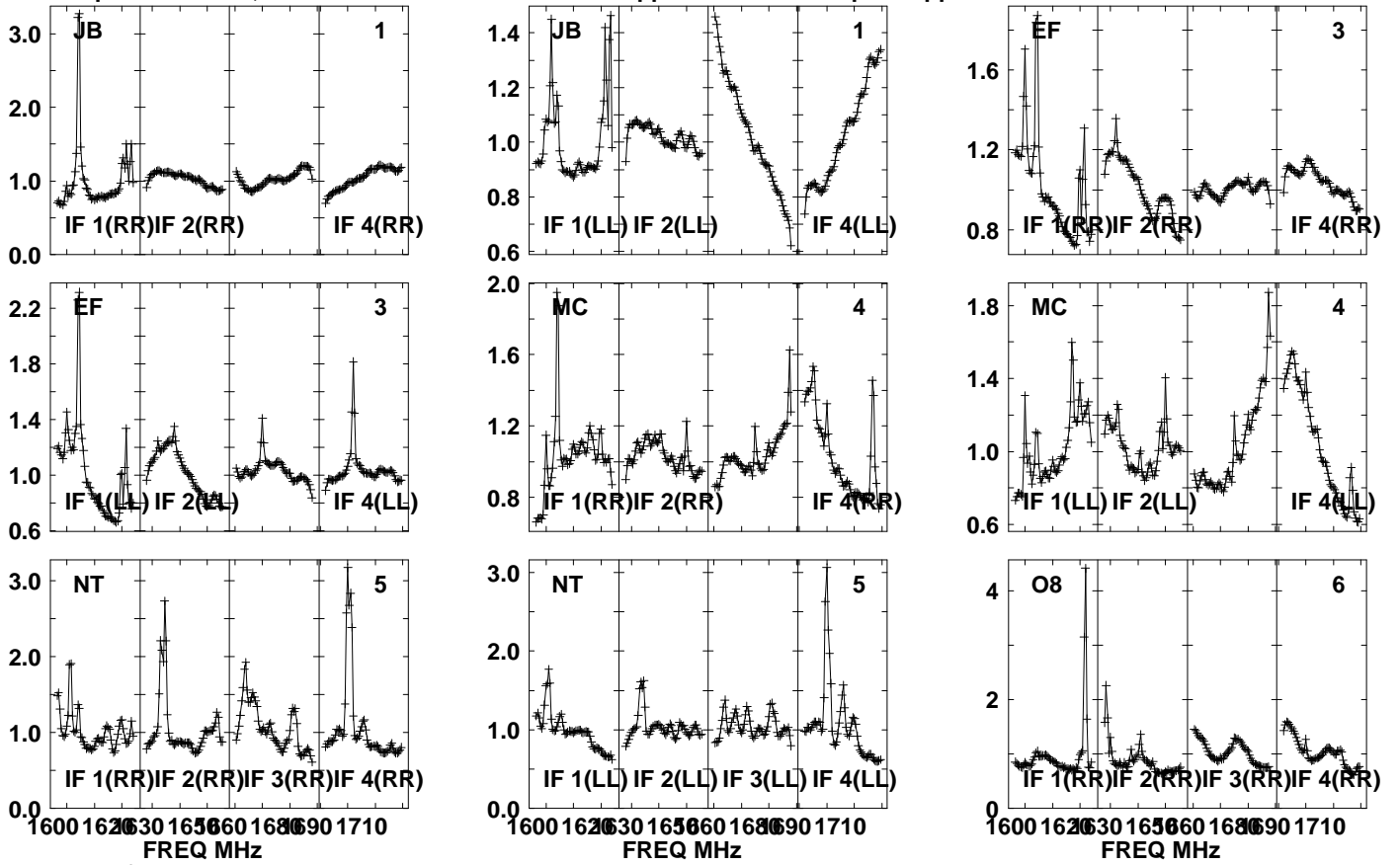

Lower frame: Real Jy

Auto-corr total-power spectrum Antenna: \*

Timerange: 00/22:23:31 to 00/22:24:59

Plot file version1438 created 05-OCT-2021 17:11:48

J0827+5217 GM076.UVDATA.1

Freq = 1.5945 GHz, Bw = 32.000 MH No calibration applied and no bandpass applied

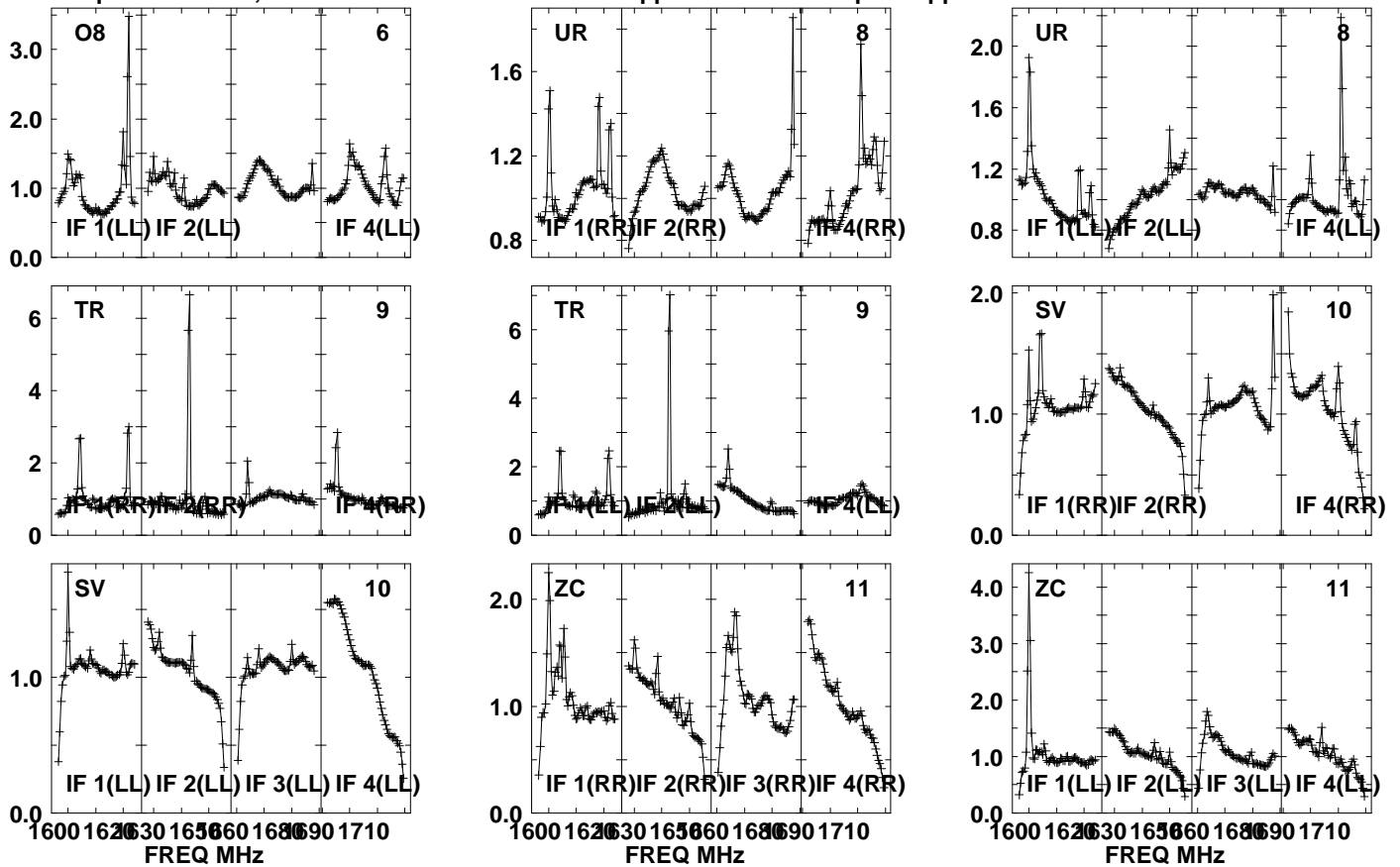

Lower frame: Real Jy

Auto-corr total-power spectrum Antenna: \*

Timerange: 00/22:23:31 to 00/22:24:59

Plot file version1439 created 05-OCT-2021 17:11:48

J0827+5217 GM076.UVDATA.1

Freq = 1.5945 GHz, Bw = 32.000 MH No calibration applied and no bandpass applied

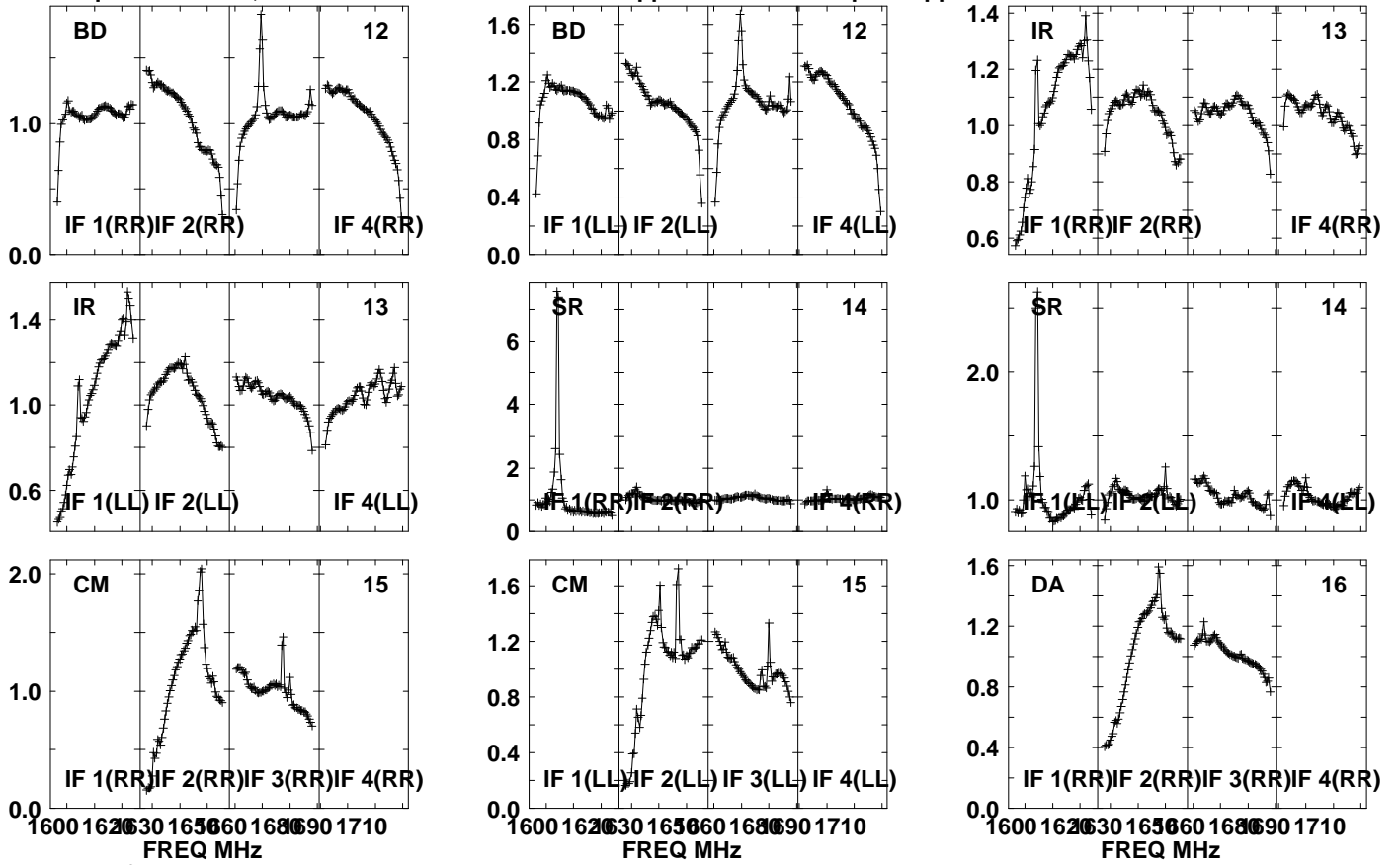

Lower frame: Real Jy

Auto-corr total-power spectrum Antenna: \*

Timerange: 00/22:23:31 to 00/22:24:59

Plot file version1440 created 05-OCT-2021 17:11:49

J0827+5217 GM076.UVDATA.1

Freq = 1.5945 GHz, Bw = 32.000 MH No calibration applied and no bandpass applied

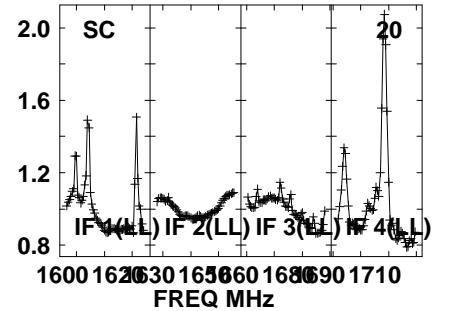
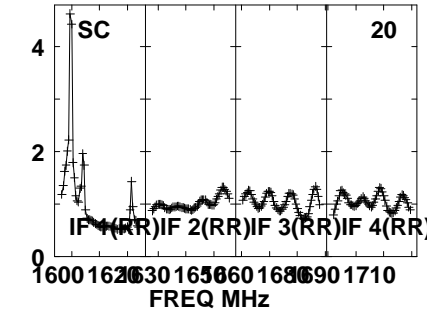
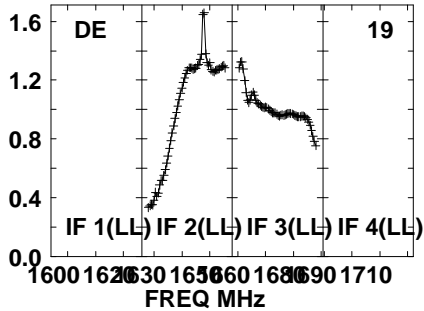
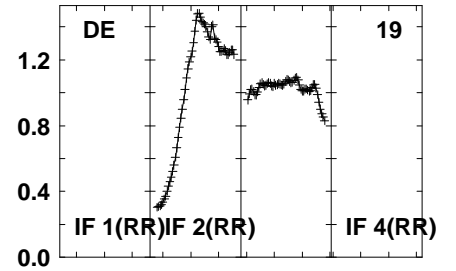
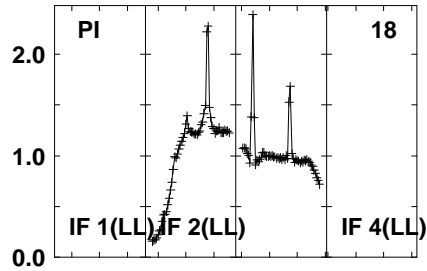
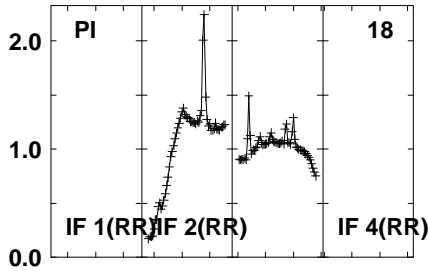
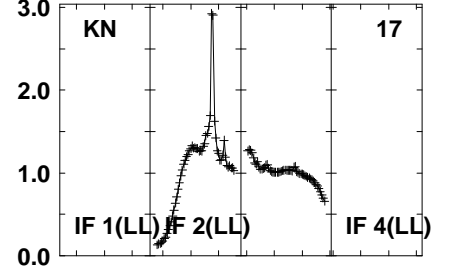
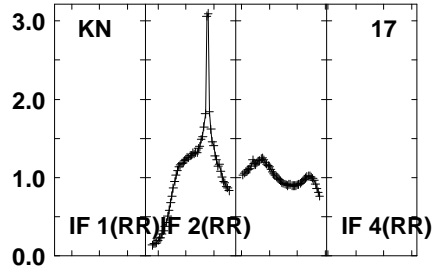
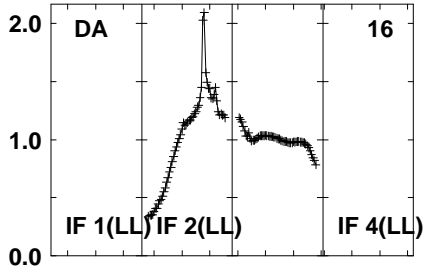

Lower frame: Real Jy

Auto-corr total-power spectrum Antenna: \*

Timerange: 00/22:23:31 to 00/22:24:59

Plot file version1441 created 05-OCT-2021 17:11:49

J0827+5217 GM076.UVDATA.1

Freq = 1.5945 GHz, Bw = 32.000 MH

No calibration applied and no bandpass applied

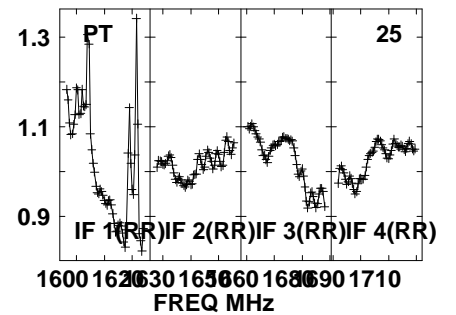
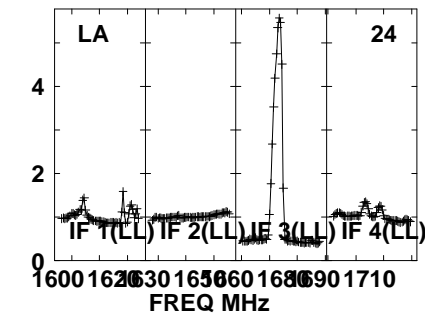
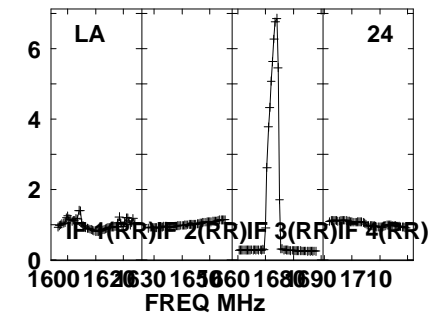
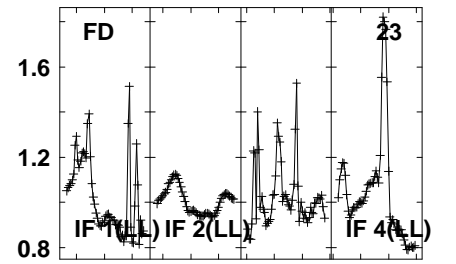
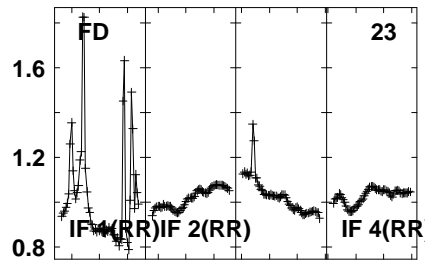
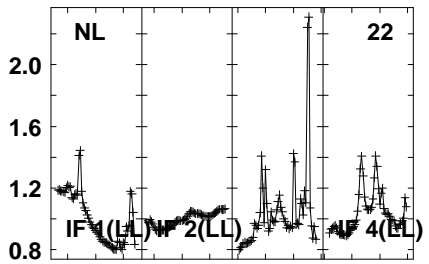
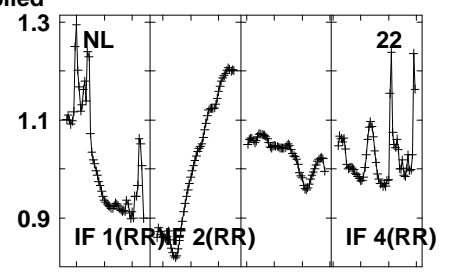
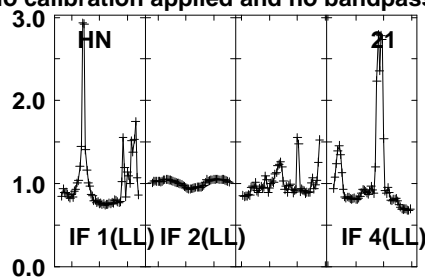
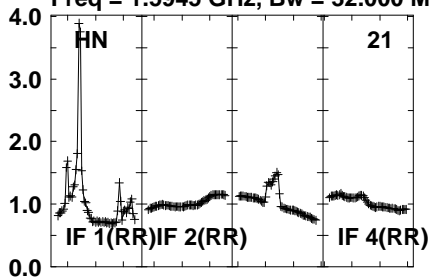

Lower frame: Real Jy

Auto-corr total-power spectrum Antenna: \*

Timerange: 00/22:23:31 to 00/22:24:59

Plot file version 1442 created 05-OCT-2021 17:11:49

J0827+5217 GM076.UVDATA.1

Freq = 1.5945 GHz, Bw = 32.000 MH No calibration applied and no bandpass applied

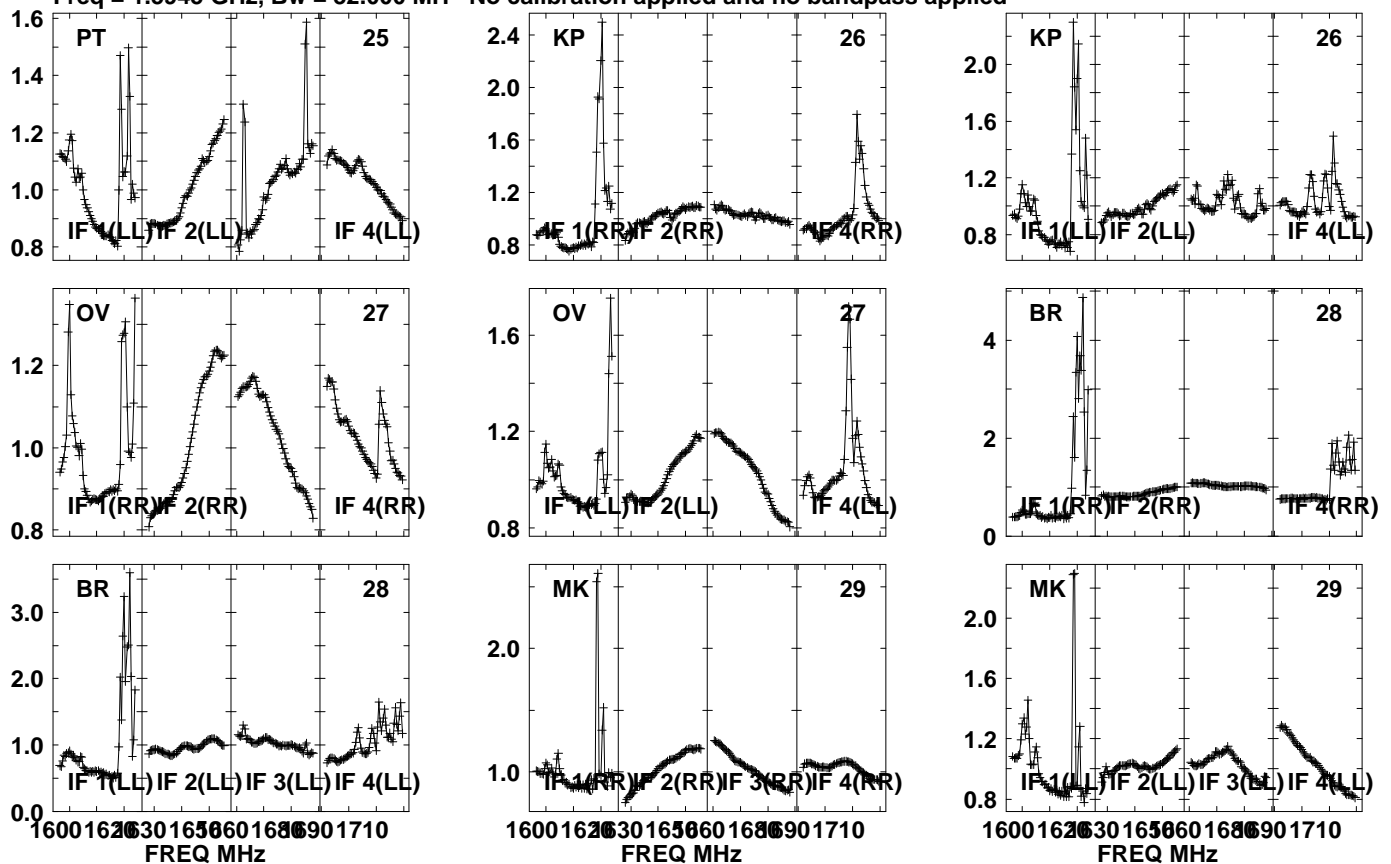

Lower frame: Real Jy  
Auto-corr total-power spectrum Antenna: \*  
Timerange: 00/22:23:31 to 00/22:24:59



Plot file version1443 created 05-OCT-2021 17:11:50

APM08279+525 GM076.UVDATA.1

Freq = 1.5945 GHz, Bw = 32.000 MH No calibration applied and no bandpass applied

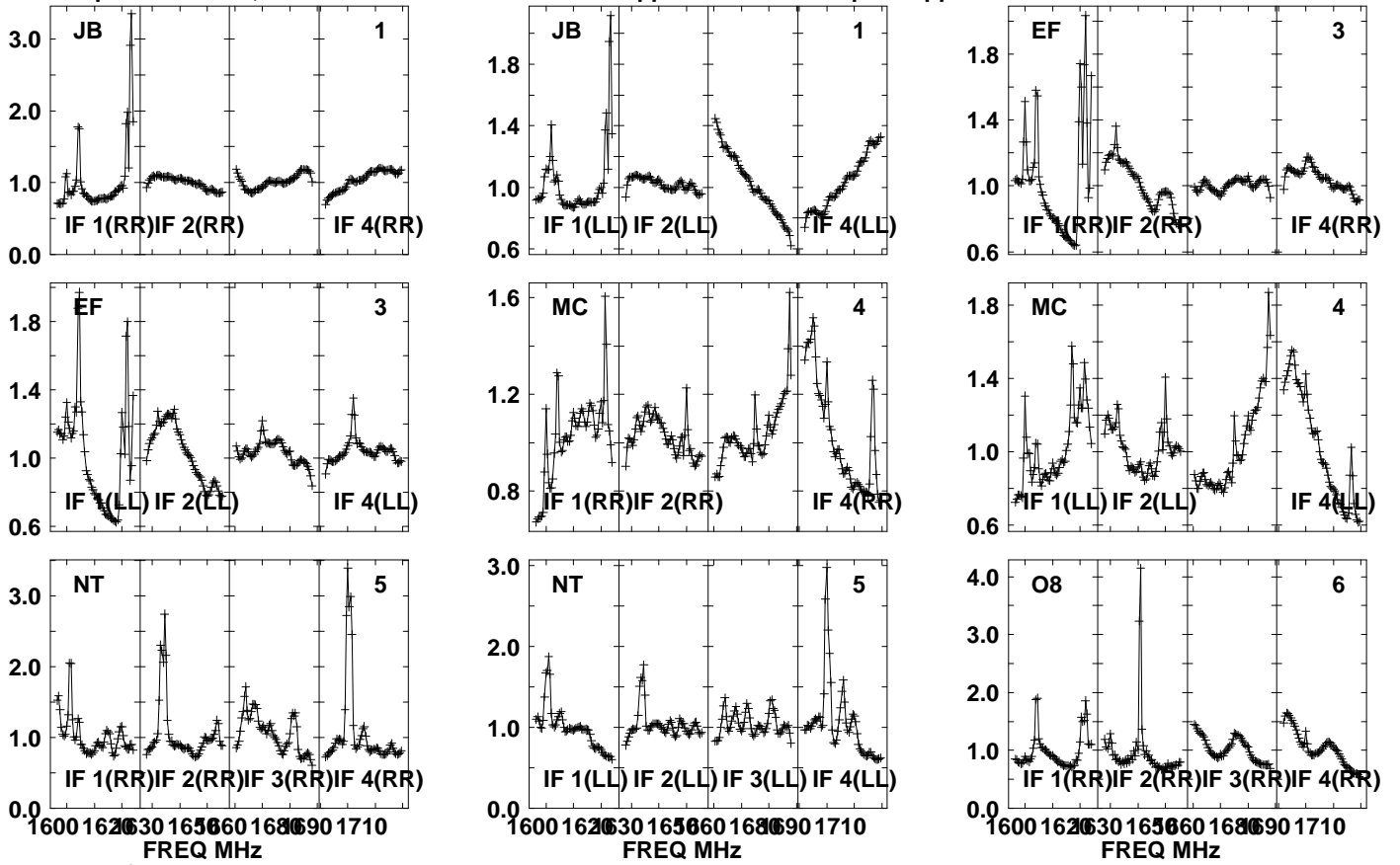

Lower frame: Real Jy

Auto-corr total-power spectrum Antenna: \*

Timerange: 00/22:25:01 to 00/22:28:29

Plot file version1444 created 05-OCT-2021 17:11:50

APM08279+525 GM076.UVDATA.1

Freq = 1.5945 GHz, Bw = 32.000 MH No calibration applied and no bandpass applied

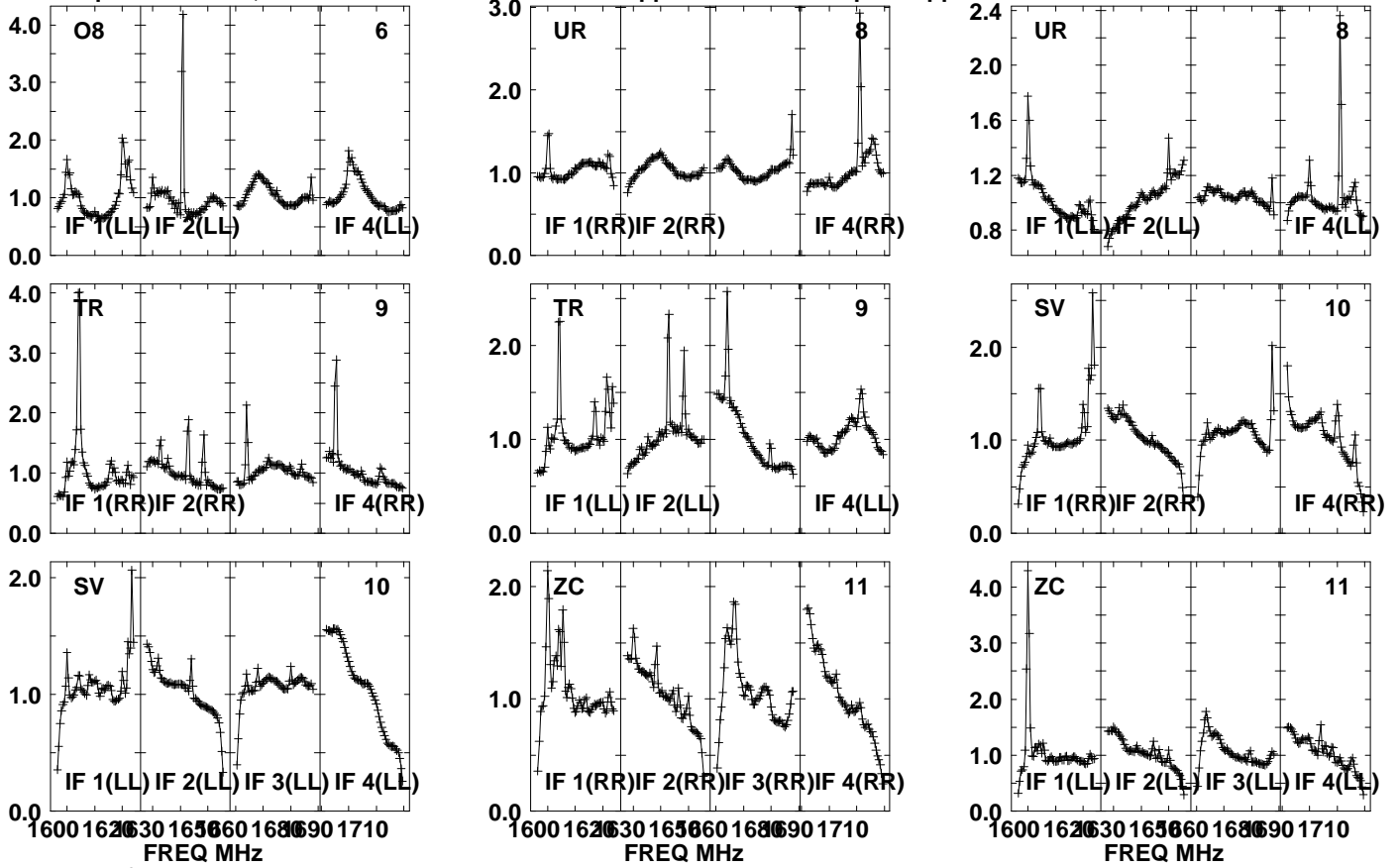

Lower frame: Real Jy  
Auto-corr total-power spectrum Antenna: \*  
Timerange: 00/22:25:01 to 00/22:28:29

Plot file version1445 created 05-OCT-2021 17:11:50

APM08279+525 GM076.UVDATA.1

Freq = 1.5945 GHz, Bw = 32.000 MH No calibration applied and no bandpass applied

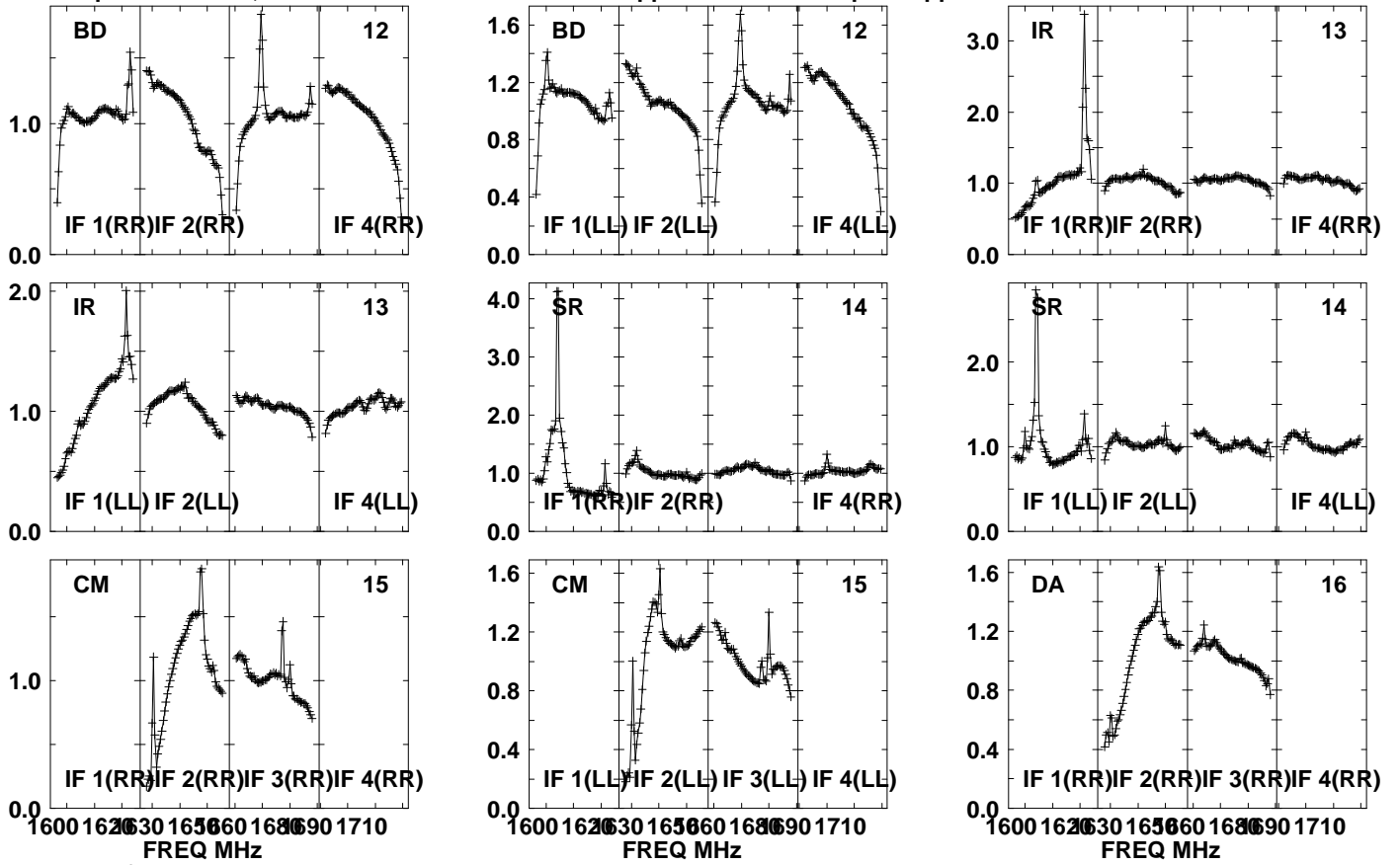

Lower frame: Real Jy

Auto-corr total-power spectrum Antenna: \*

Timerange: 00/22:25:01 to 00/22:28:29

Plot file version1446 created 05-OCT-2021 17:11:51

APM08279+525 GM076.UVDATA.1

Freq = 1.5945 GHz, Bw = 32.000 MH No calibration applied and no bandpass applied

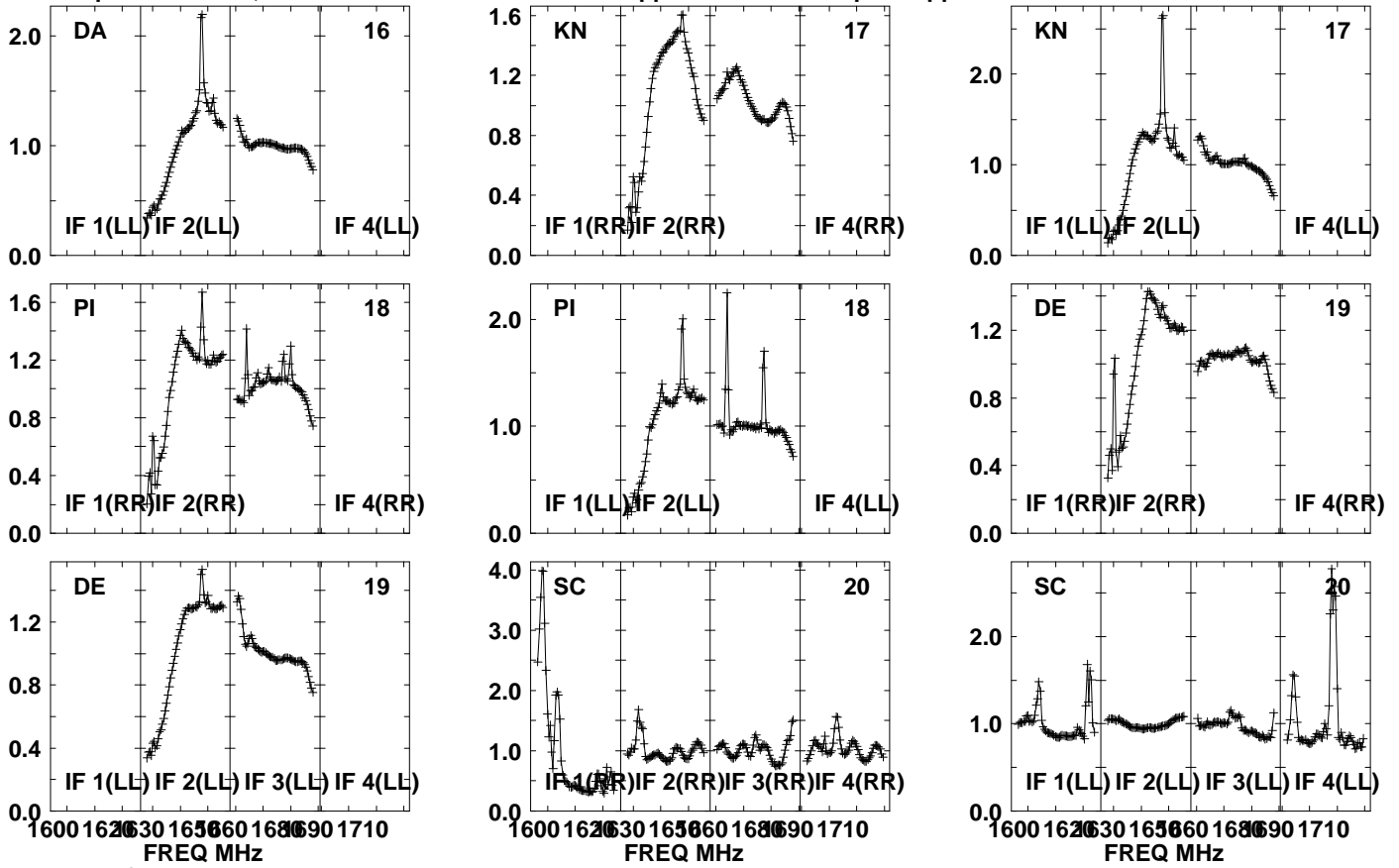

Lower frame: Real Jy

Auto-corr total-power spectrum Antenna: \*

Timerange: 00/22:25:01 to 00/22:28:29

Plot file version 1447 created 05-OCT-2021 17:11:51

APM08279+525 GM076.UVDATA.1

Freq = 1.5945 GHz, Bw = 32.000 MH No calibration applied and no bandpass applied

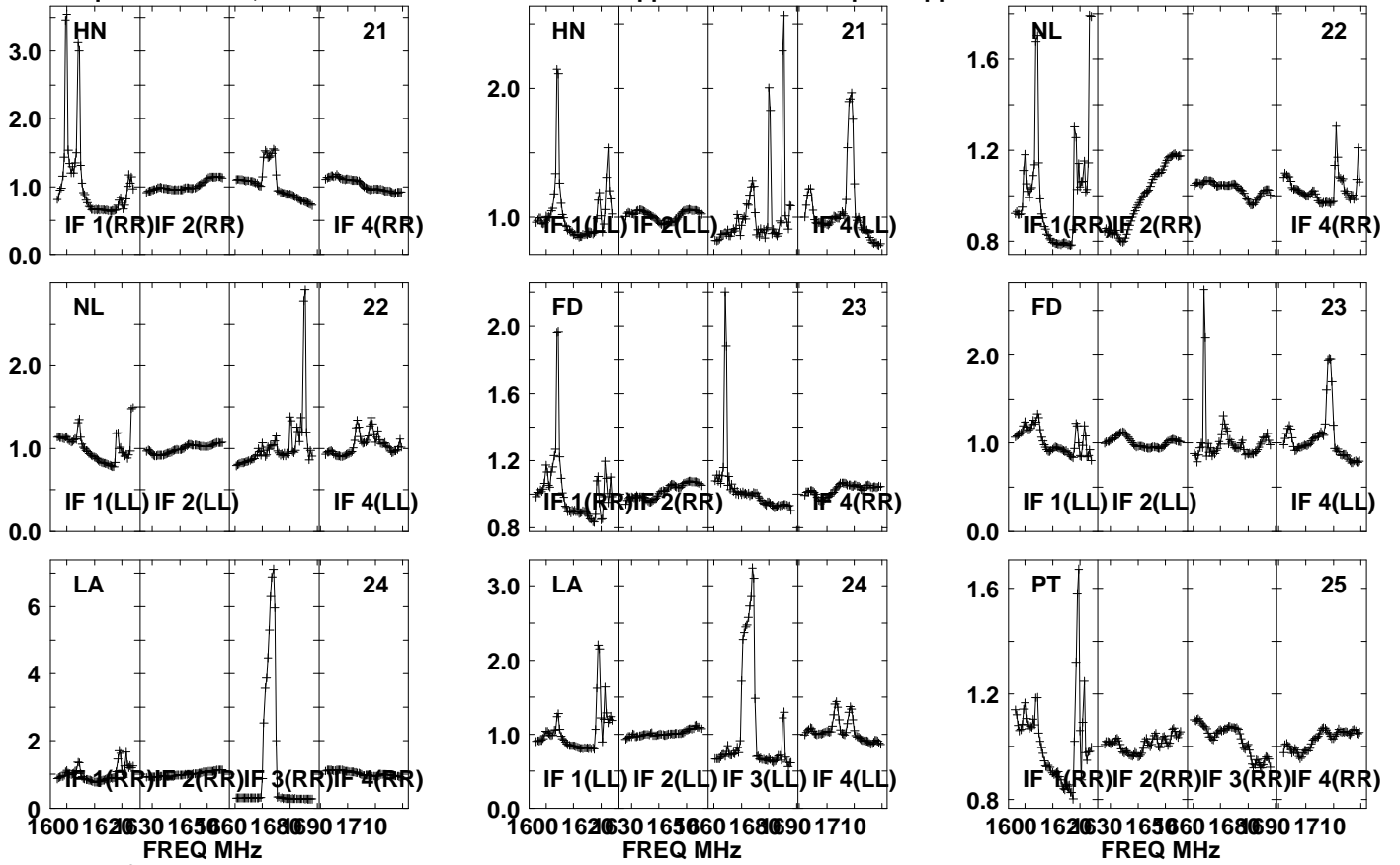

Lower frame: Real Jy

Auto-corr total-power spectrum Antenna: \*

Timerange: 00/22:25:01 to 00/22:28:29

Plot file version1448 created 05-OCT-2021 17:11:51

APM08279+525 GM076.UVDATA.1

Freq = 1.5945 GHz, Bw = 32.000 MH No calibration applied and no bandpass applied

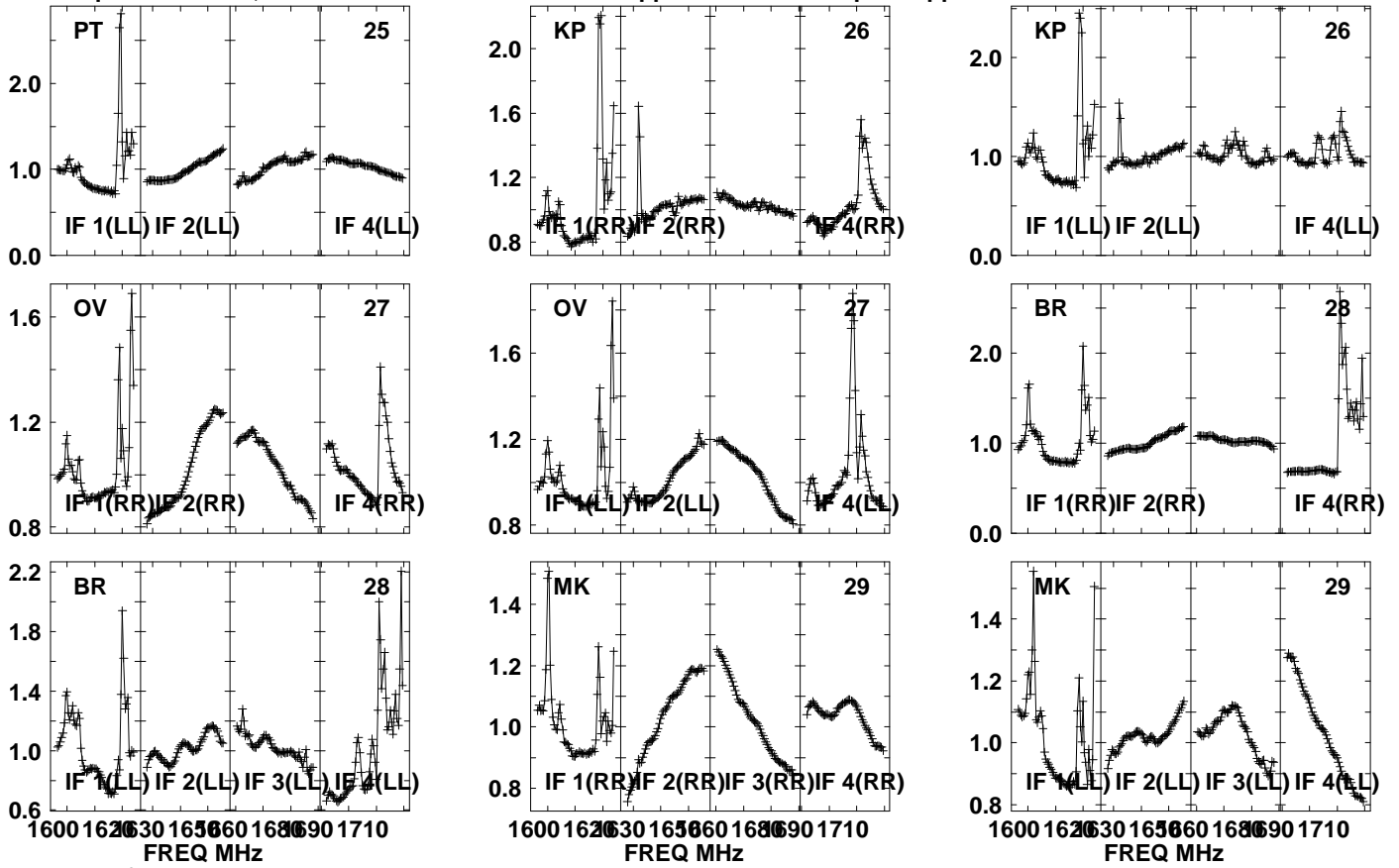

Lower frame: Real Jy

Auto-corr total-power spectrum Antenna: \*

Timerange: 00/22:25:01 to 00/22:28:29

Plot file version 1449 created 05-OCT-2021 17:11:52

J0827+5217 GM076.UVDATA.1

Freq = 1.5945 GHz, Bw = 32.000 MH No calibration applied and no bandpass applied

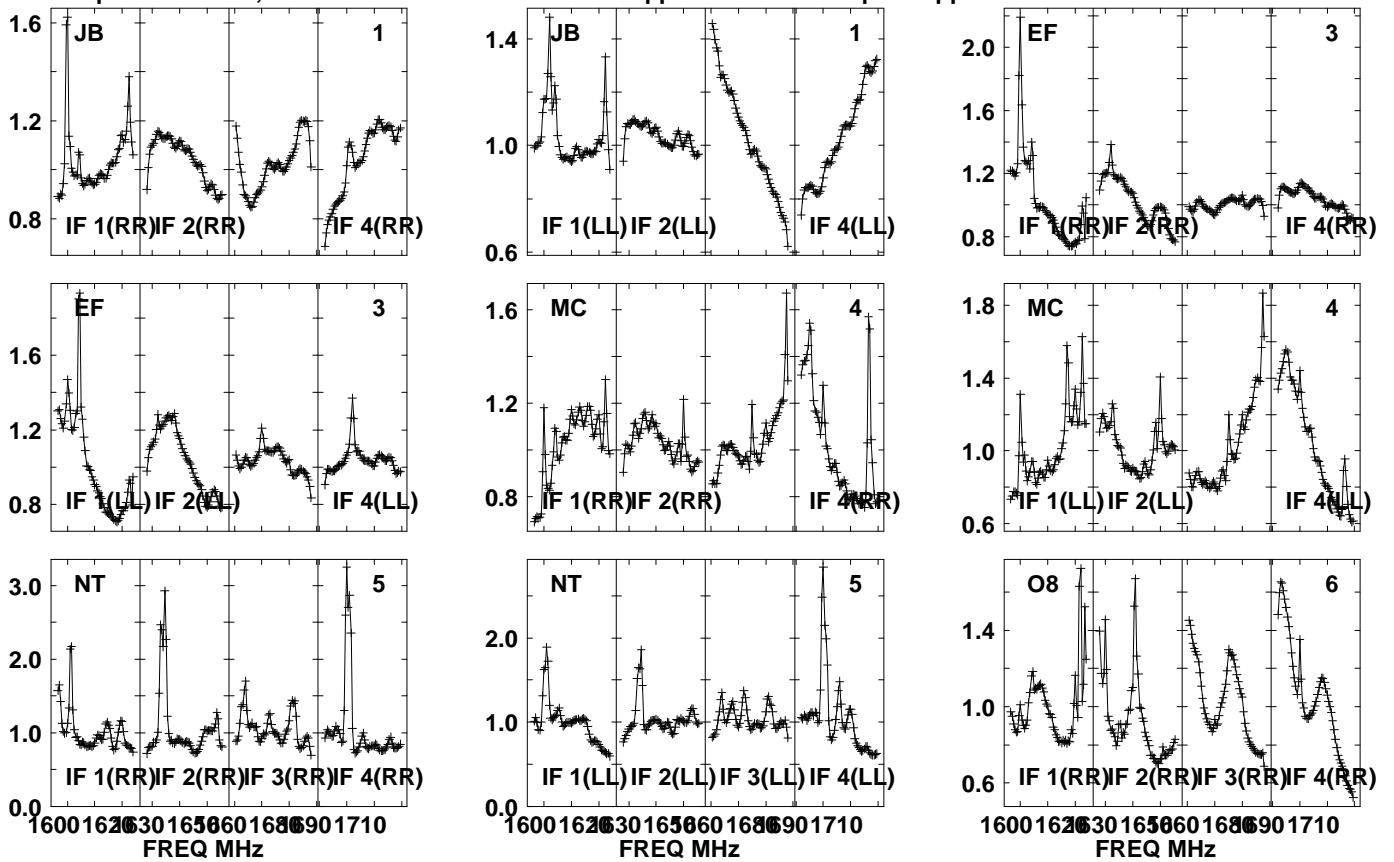

Lower frame: Real Jy  
Auto-corr total-power spectrum Antenna: \*  
Timerange: 00/22:28:31 to 00/22:29:59

Plot file version1450 created 05-OCT-2021 17:11:52

J0827+5217 GM076.UVDATA.1

Freq = 1.5945 GHz, Bw = 32.000 MH No calibration applied and no bandpass applied

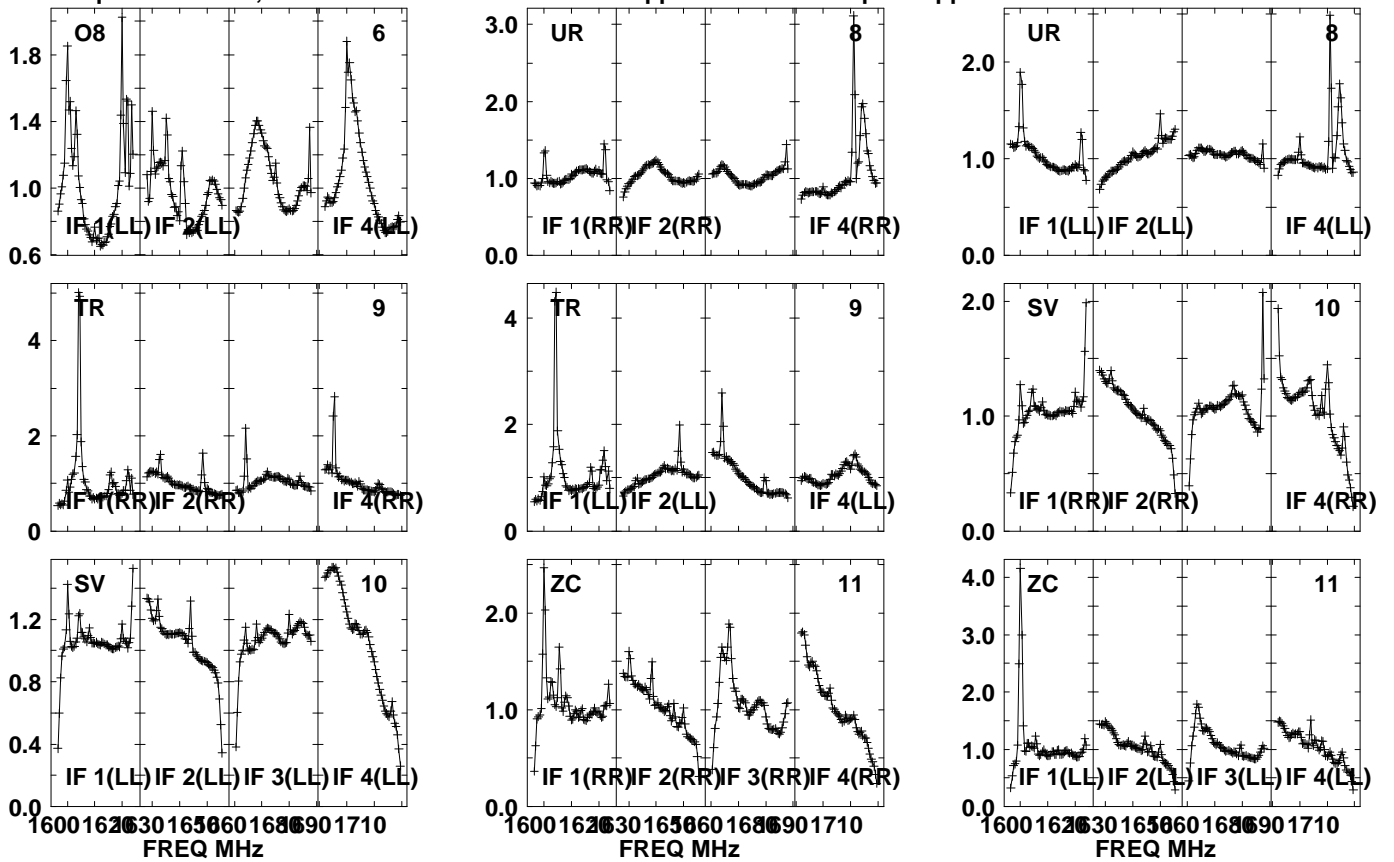

Lower frame: Real Jy  
Auto-corr total-power spectrum Antenna: \*  
Timerange: 00/22:28:31 to 00/22:29:59



Plot file version1451 created 05-OCT-2021 17:11:52

J0827+5217 GM076.UVDATA.1

Freq = 1.5945 GHz, Bw = 32.000 MH No calibration applied and no bandpass applied

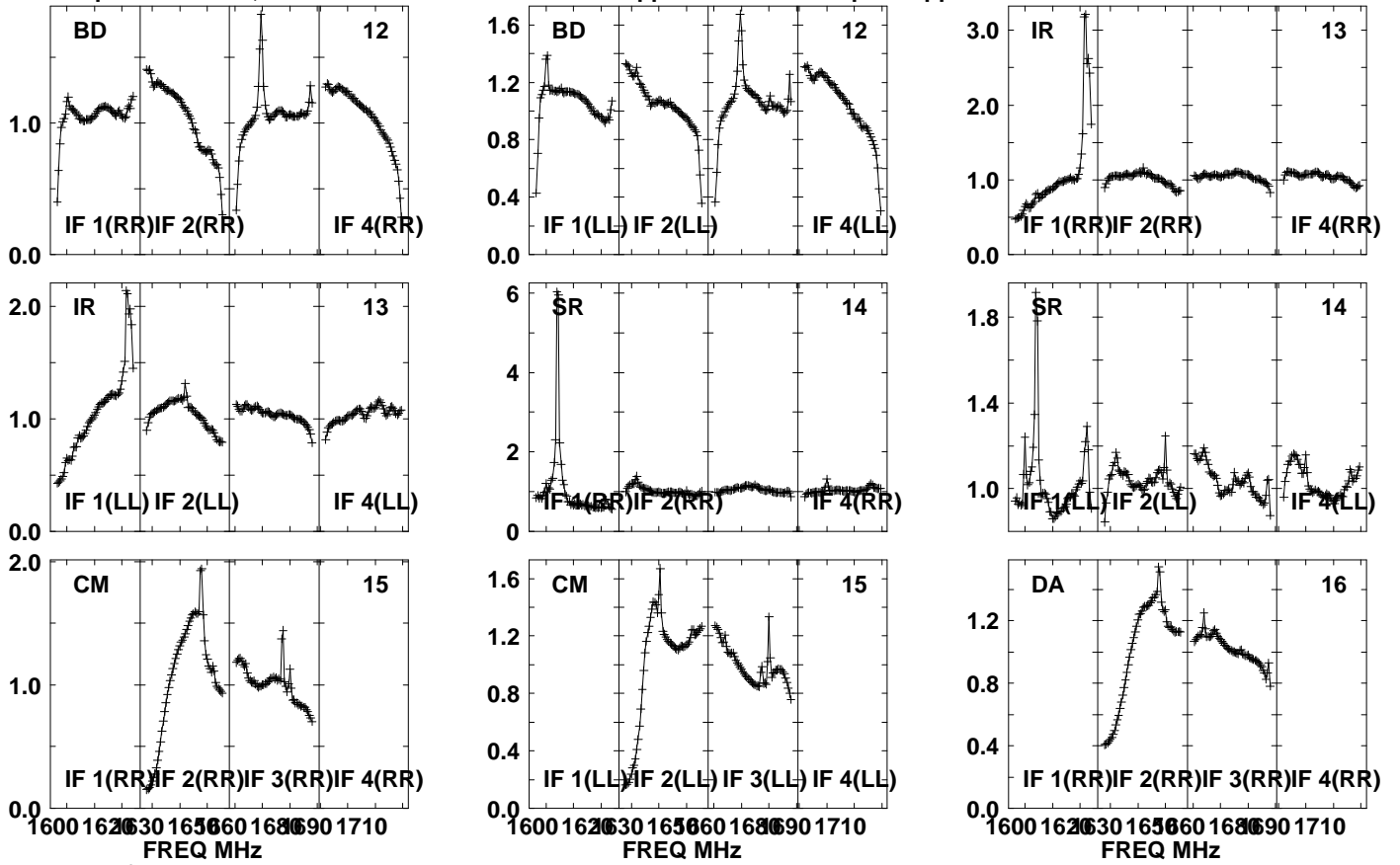

Lower frame: Real Jy

Auto-corr total-power spectrum Antenna: \*

Timerange: 00/22:28:31 to 00/22:29:59

Plot file version1452 created 05-OCT-2021 17:11:52

J0827+5217 GM076.UVDATA.1

Freq = 1.5945 GHz, Bw = 32.000 MH No calibration applied and no bandpass applied

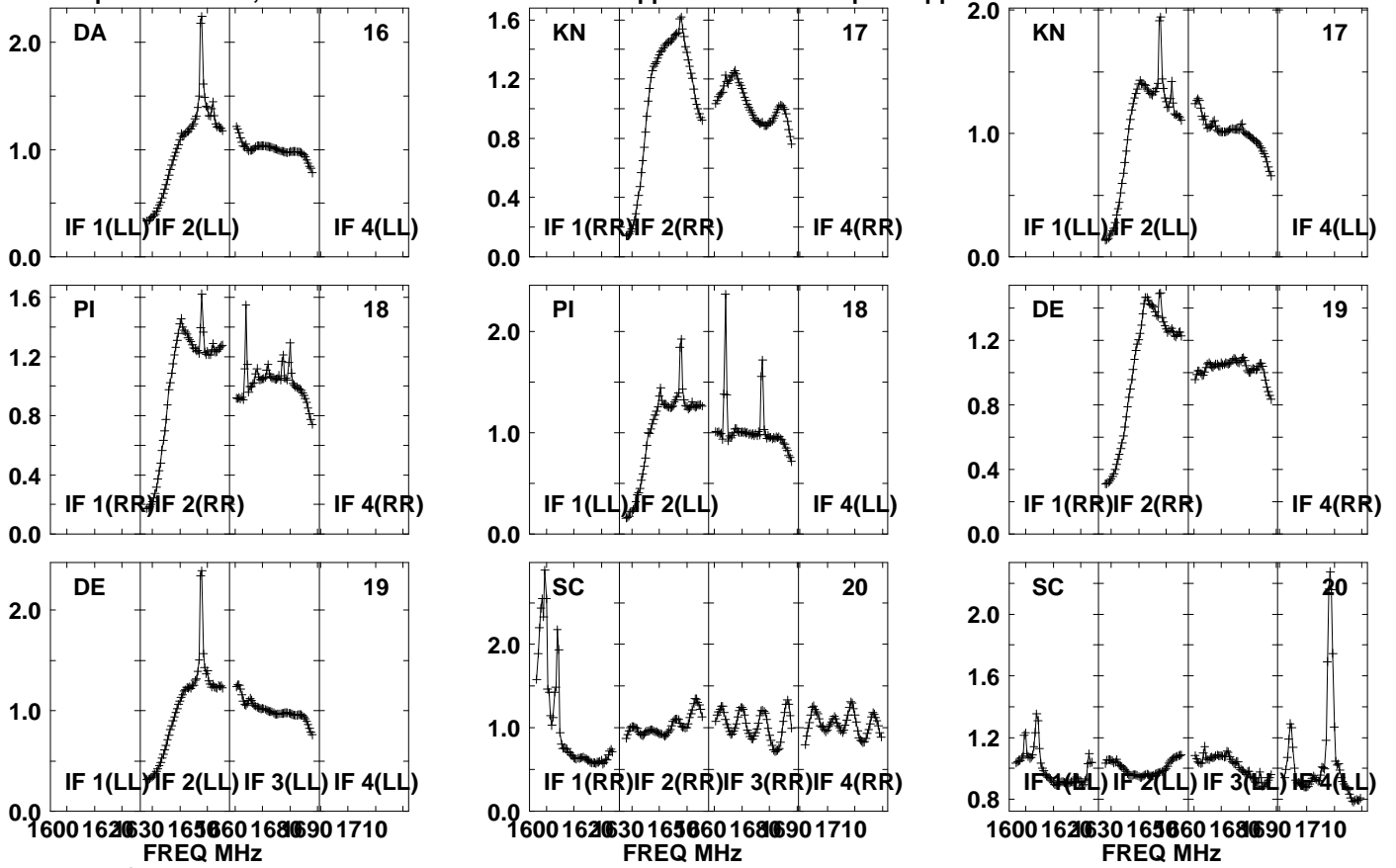

Lower frame: Real Jy  
Auto-corr total-power spectrum Antenna: \*  
Timerange: 00/22:28:31 to 00/22:29:59

Plot file version 1453 created 05-OCT-2021 17:11:52

J0827+5217 GM076.UVDATA.1

Freq = 1.5945 GHz, Bw = 32.000 MH No calibration applied and no bandpass applied

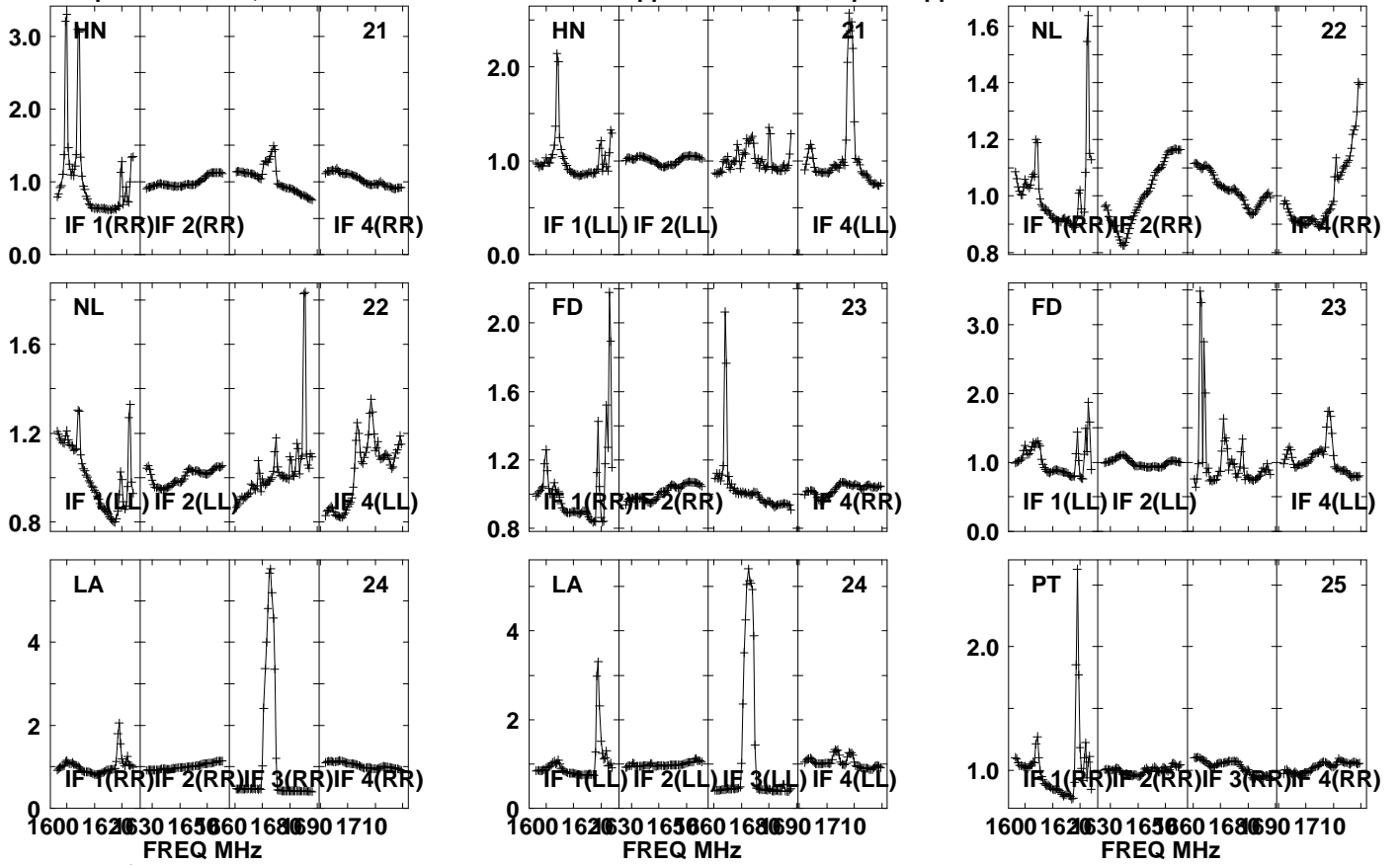

Lower frame: Real Jy

Auto-corr total-power spectrum Antenna: \*

Timerange: 00/22:28:31 to 00/22:29:59

Plot file version 1454 created 05-OCT-2021 17:11:52

J0827+5217 GM076.UVDATA.1

Freq = 1.5945 GHz, Bw = 32.000 MH No calibration applied and no bandpass applied

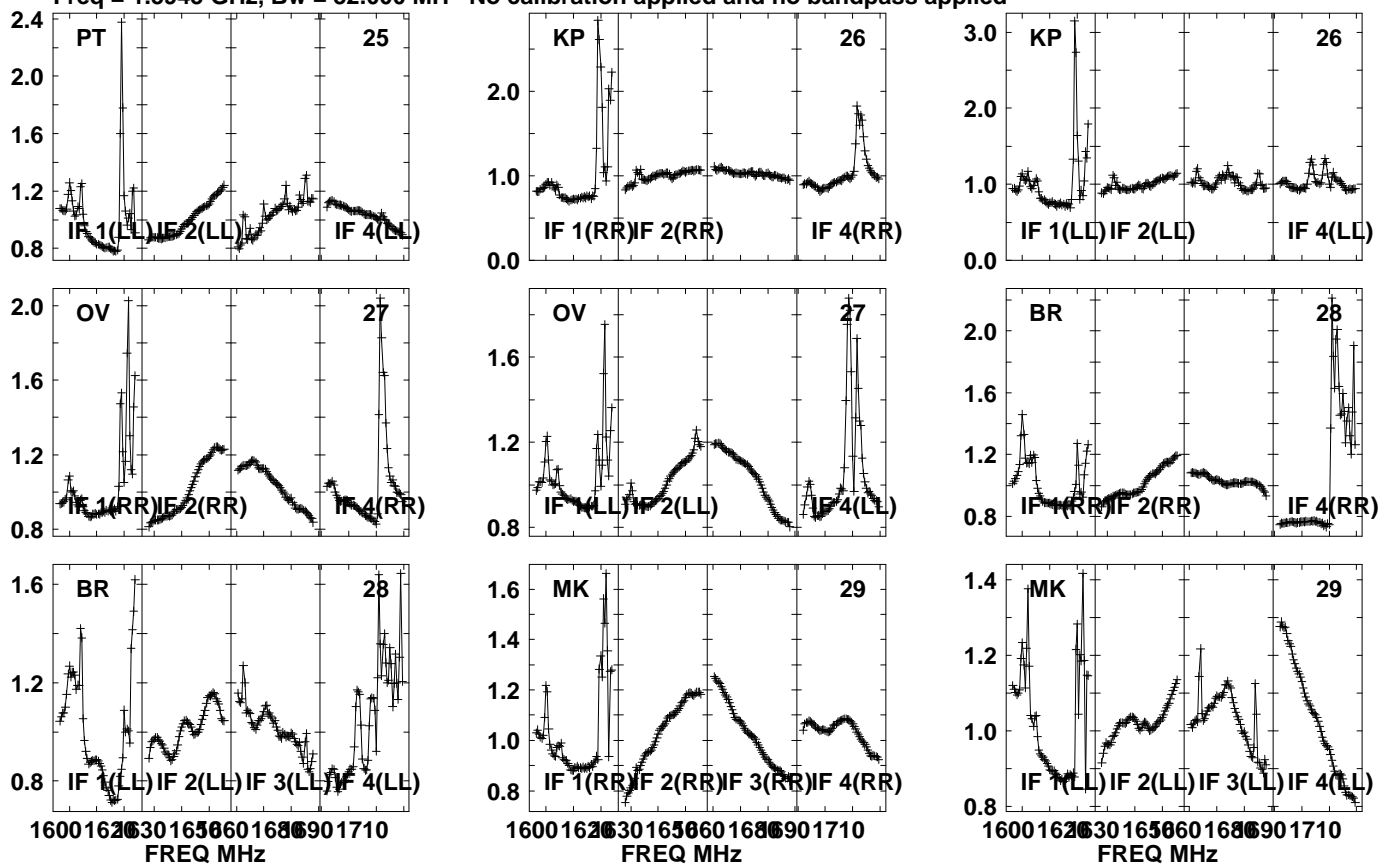

Lower frame: Real Jy  
Auto-corr total-power spectrum Antenna: \*  
Timerange: 00/22:28:31 to 00/22:29:59

Plot file version1455 created 05-OCT-2021 17:11:53

APM08279+525 GM076.UVDATA.1

Freq = 1.5945 GHz, Bw = 32.000 MH No calibration applied and no bandpass applied

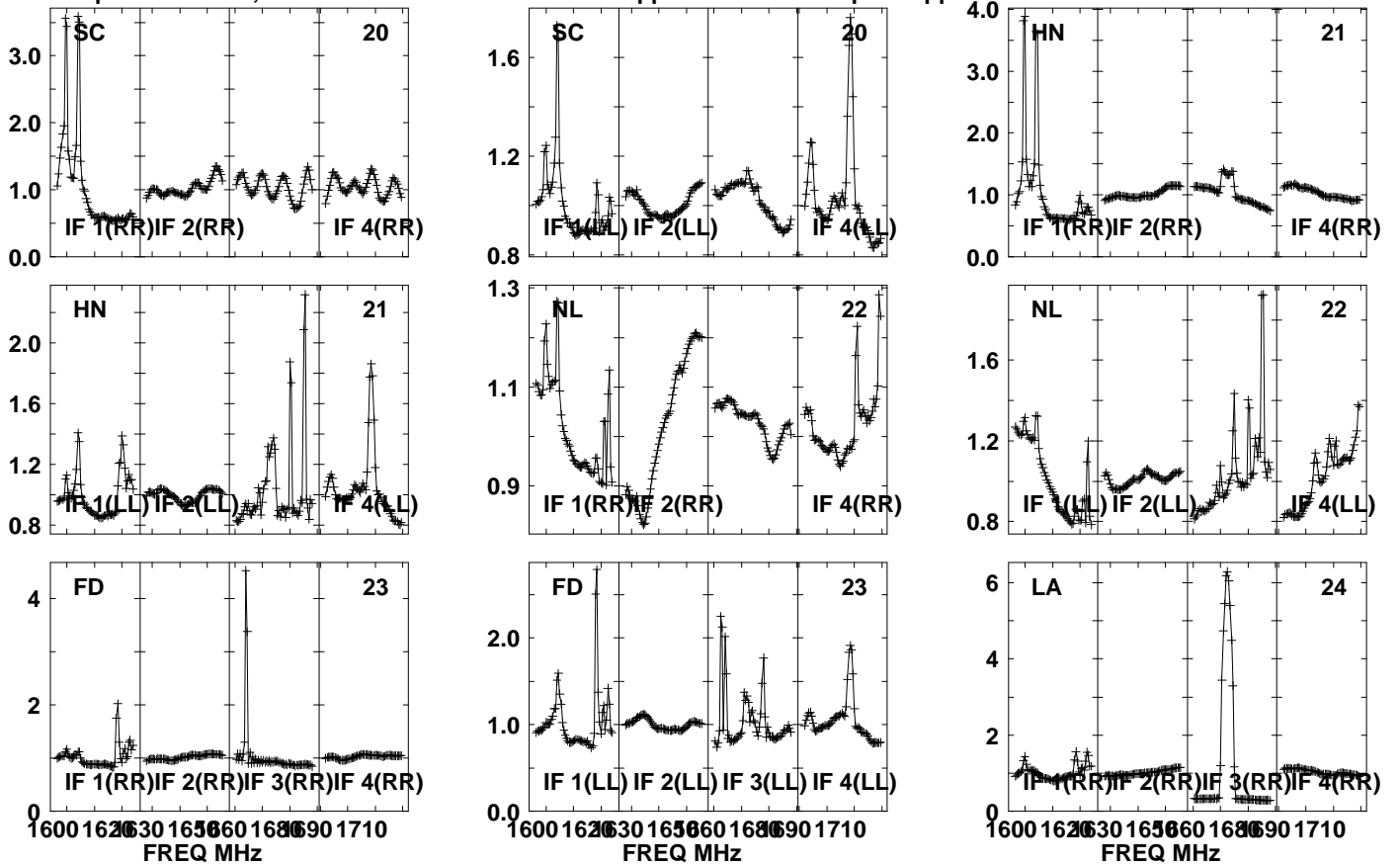

Lower frame: Real Jy

Auto-corr total-power spectrum Antenna: \*

Timerange: 00/22:30:09 to 00/22:33:29

Plot file version 1456 created 05-OCT-2021 17:11:53

APM08279+525 GM076.UVDATA.1

Freq = 1.5945 GHz, Bw = 32.000 MH No calibration applied and no bandpass applied

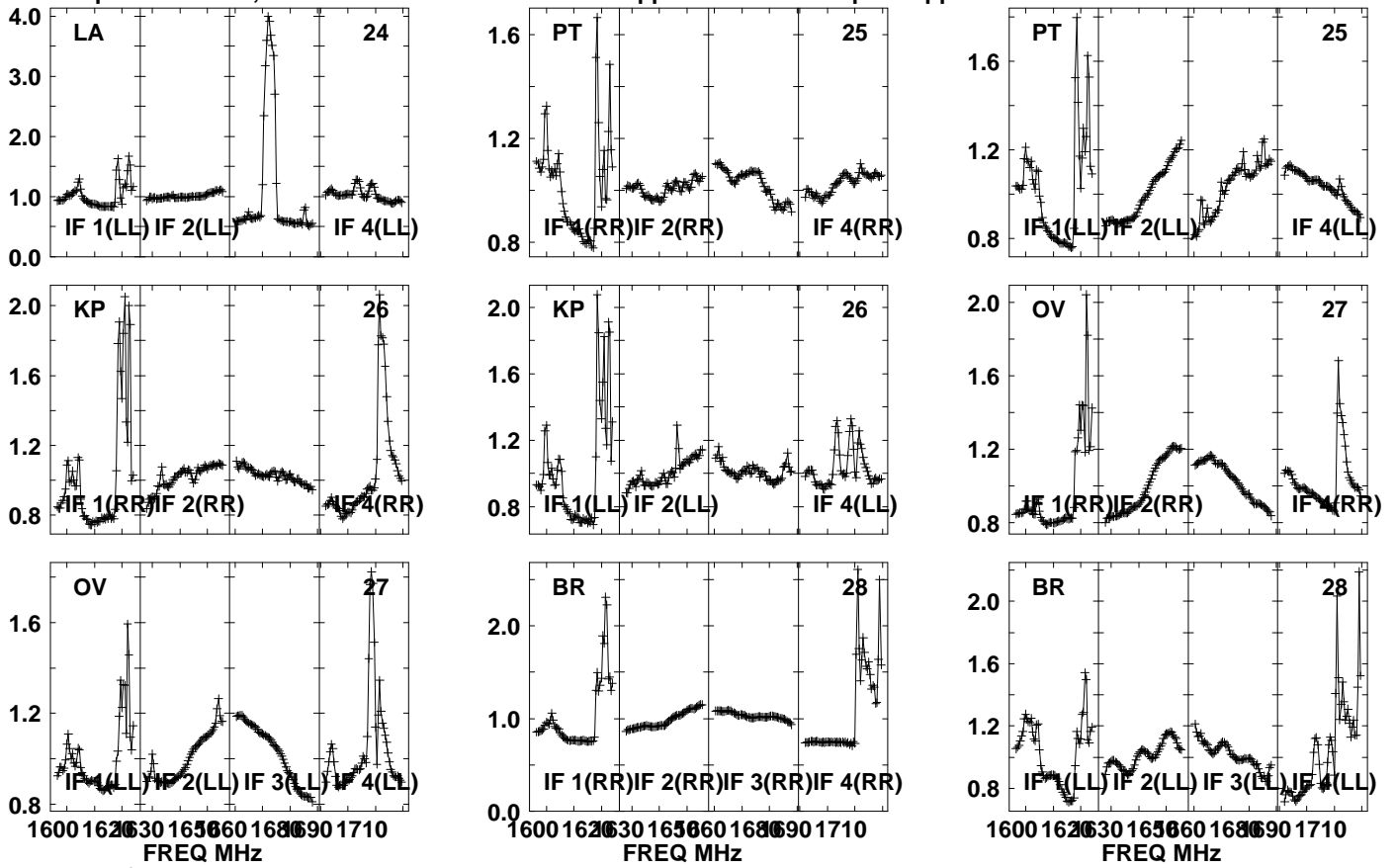

Lower frame: Real Jy

Auto-corr total-power spectrum Antenna: \*

Timerange: 00/22:30:09 to 00/22:33:29

Plot file version1457 created 05-OCT-2021 17:11:53

APM08279+525 GM076.UVDATA.1

Freq = 1.5945 GHz, Bw = 32.000 MH No calibration applied and no bandpass applied

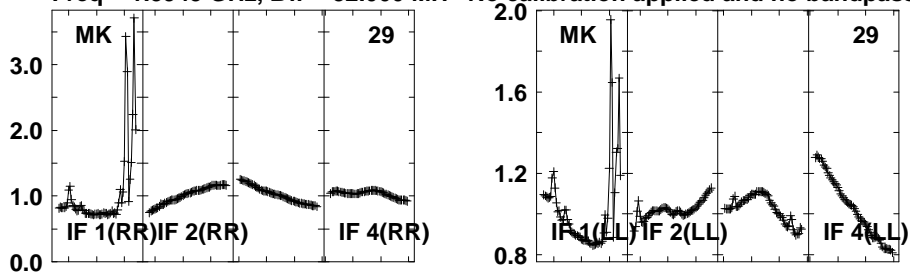

Lower frame: Real Jy

Auto-corr total-power spectrum Antenna: \*

Timerange: 00/22:30:09 to 00/22:33:29

Plot file version1458 created 05-OCT-2021 17:11:53

J0827+5217 GM076.UVDATA.1

Freq = 1.5945 GHz, Bw = 32.000 MH No calibration applied and no bandpass applied

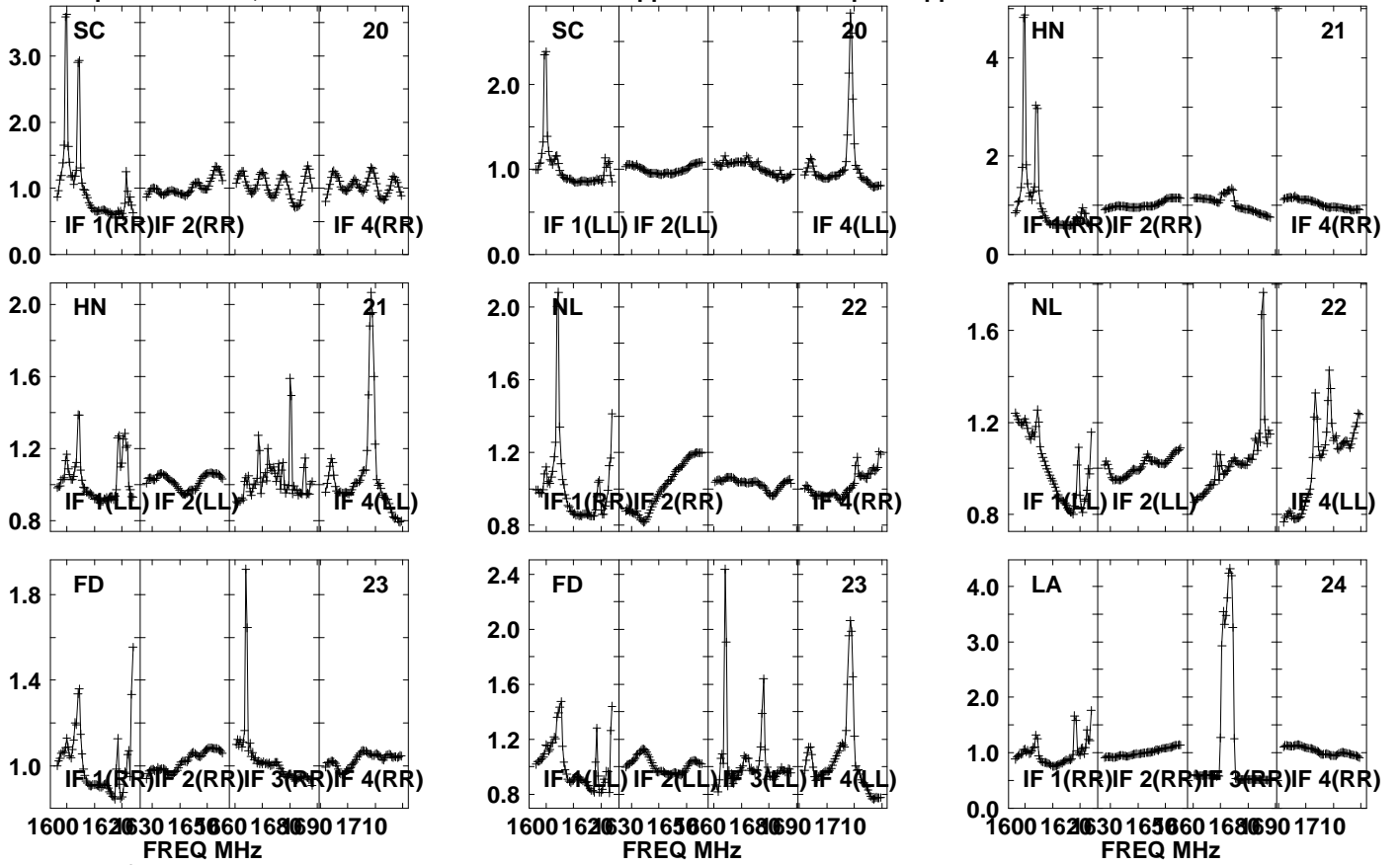

Lower frame: Real Jy

Auto-corr total-power spectrum Antenna: \*

Timerange: 00/22:34:01 to 00/22:35:29



Plot file version 1459 created 05-OCT-2021 17:11:53

J0827+5217 GM076.UVDATA.1

Freq = 1.5945 GHz, Bw = 32.000 MH No calibration applied and no bandpass applied

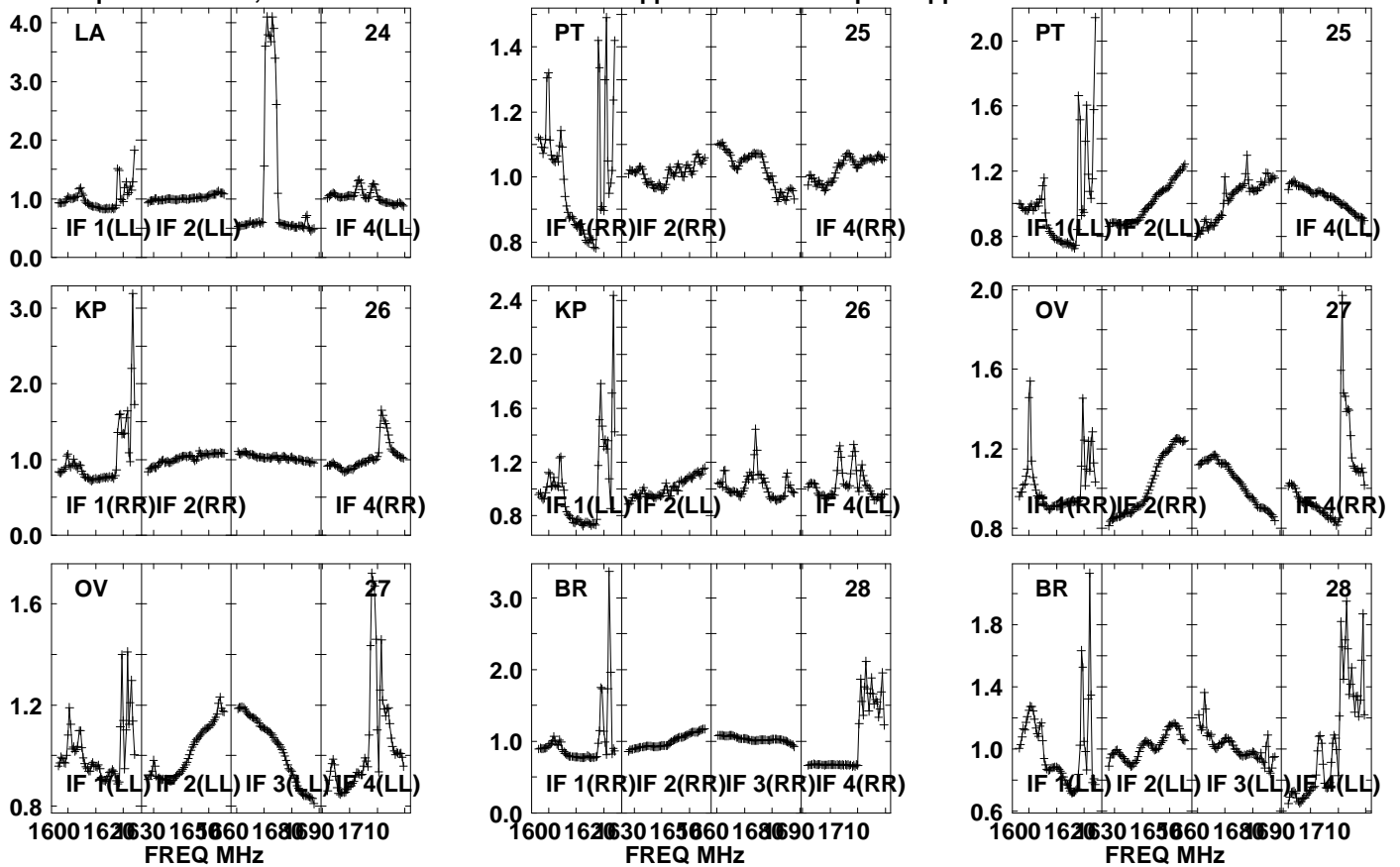

Lower frame: Real Jy

Auto-corr total-power spectrum Antenna: \*

Timerange: 00/22:34:01 to 00/22:35:29

Plot file version1460 created 05-OCT-2021 17:11:53

J0827+5217 GM076.UVDATA.1

Freq = 1.5945 GHz, Bw = 32.000 MH No calibration applied and no bandpass applied

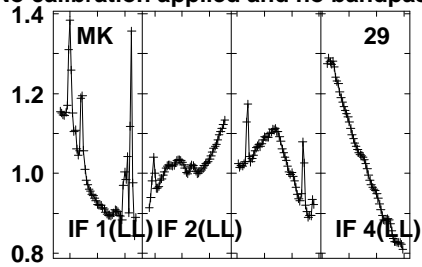
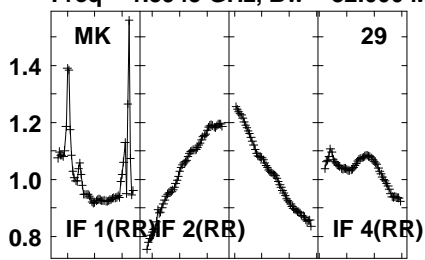

Lower frame: Real Jy  
Auto-corr total-power spectrum Antenna: \*  
Timerange: 00/22:34:01 to 00/22:35:29

Plot file version 1461 created 05-OCT-2021 17:11:54

APM08279+525 GM076.UVDATA.1

Freq = 1.5945 GHz, Bw = 32.000 MH No calibration applied and no bandpass applied

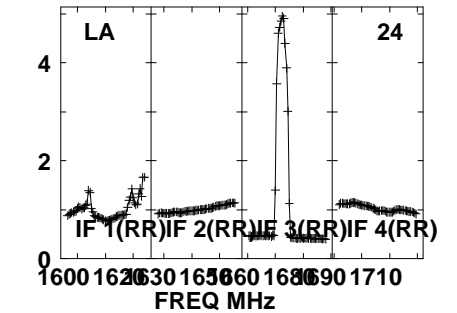
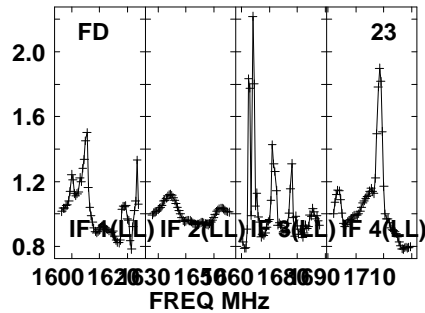
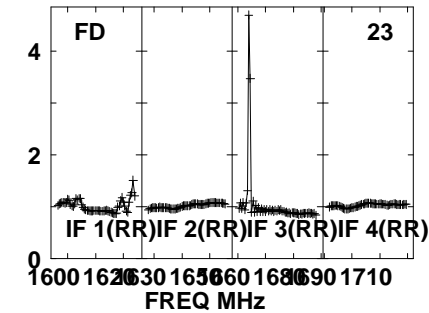
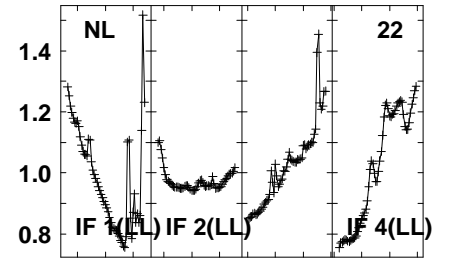
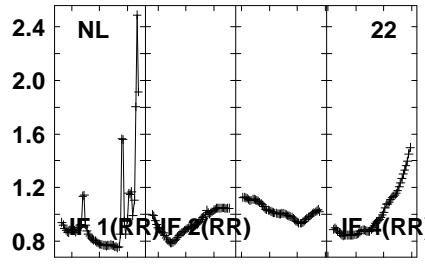
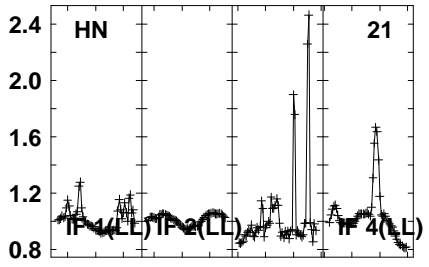
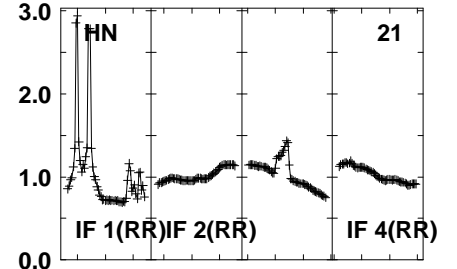
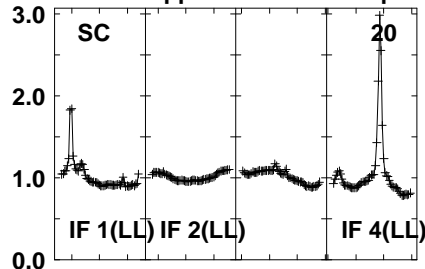
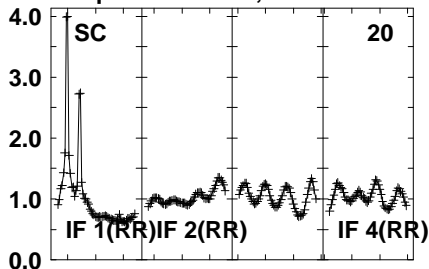

Lower frame: Real Jy  
Auto-corr total-power spectrum Antenna: \*  
Timerange: 00/22:35:39 to 00/22:38:59

Plot file version 1462 created 05-OCT-2021 17:11:54

APM08279+525 GM076.UVDATA.1

Freq = 1.5945 GHz, Bw = 32.000 MHz No calibration applied and no bandpass applied

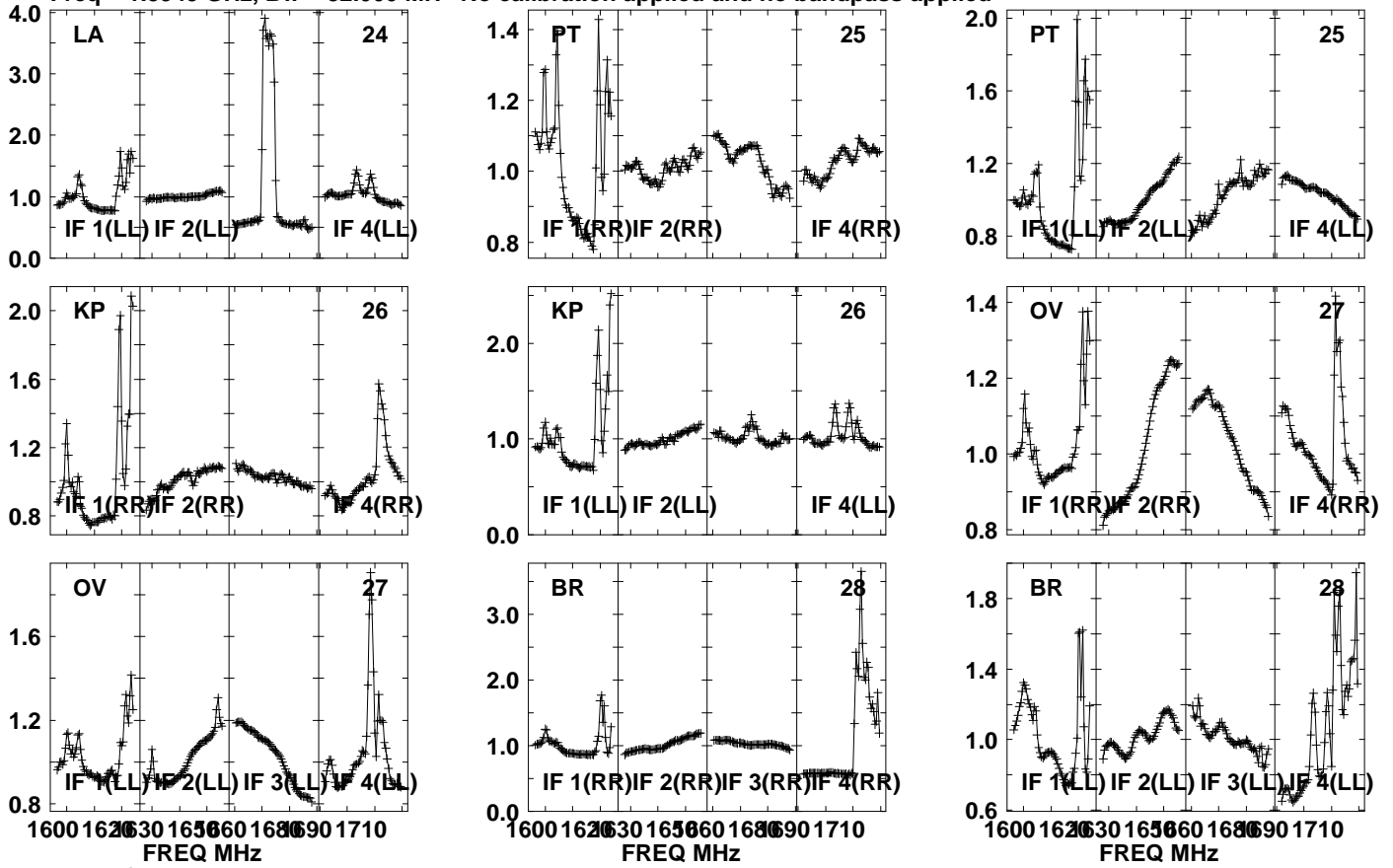

Lower frame: Real Jy

Auto-corr total-power spectrum Antenna: \*

Timerange: 00/22:35:39 to 00/22:38:59

Plot file version1463 created 05-OCT-2021 17:11:54

APM08279+525 GM076.UVDATA.1

Freq = 1.5945 GHz, Bw = 32.000 MH No calibration applied and no bandpass applied

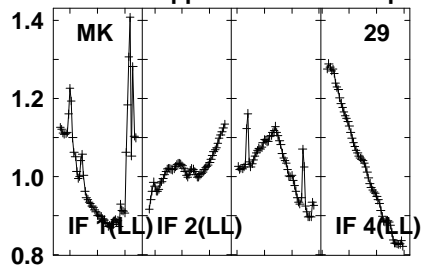
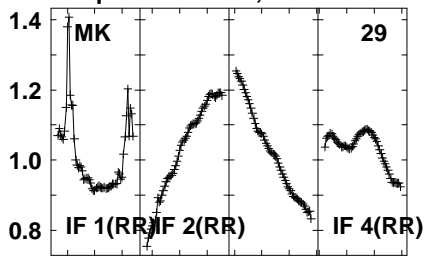

Lower frame: Real Jy  
Auto-corr total-power spectrum Antenna: \*  
Timerange: 00/22:35:39 to 00/22:38:59

Plot file version1464 created 05-OCT-2021 17:11:54

J0827+5217 GM076.UVDATA.1

Freq = 1.5945 GHz, Bw = 32.000 MH No calibration applied and no bandpass applied

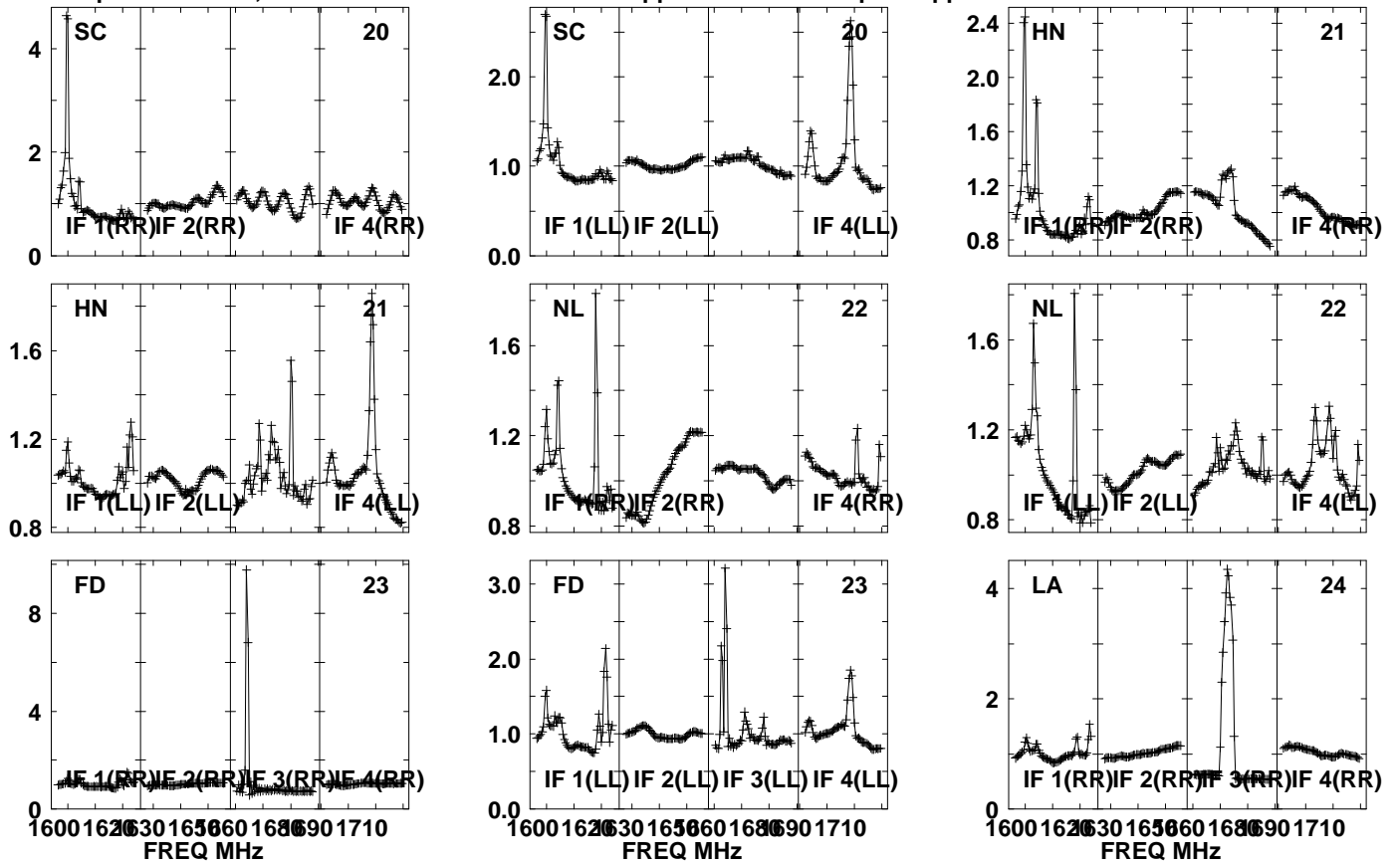

Lower frame: Real Jy

Auto-corr total-power spectrum Antenna: \*

Timerange: 00/22:39:31 to 00/22:40:59

Plot file version1465 created 05-OCT-2021 17:11:54

J0827+5217 GM076.UVDATA.1

Freq = 1.5945 GHz, Bw = 32.000 MH No calibration applied and no bandpass applied

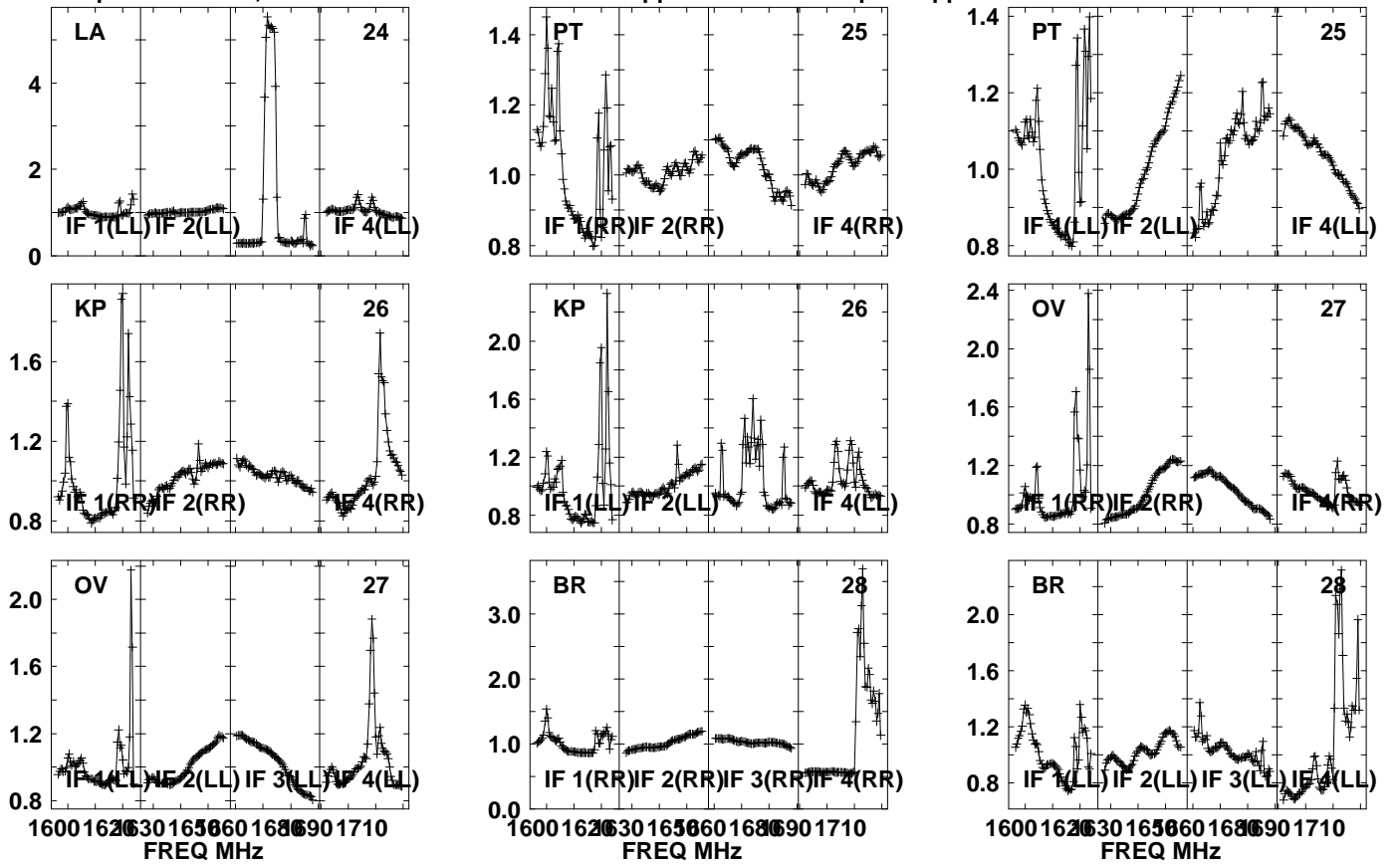

Lower frame: Real Jy  
Auto-corr total-power spectrum Antenna: \*  
Timerange: 00/22:39:31 to 00/22:40:59

Plot file version1466 created 05-OCT-2021 17:11:54

J0827+5217 GM076.UVDATA.1

Freq = 1.5945 GHz, Bw = 32.000 MH No calibration applied and no bandpass applied

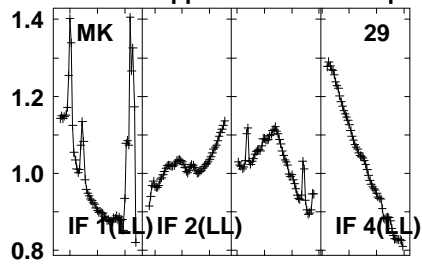
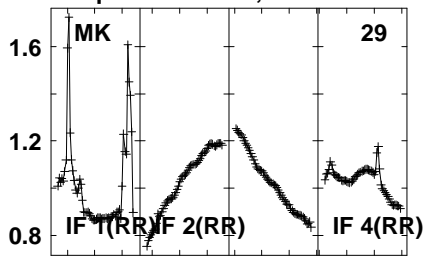

Lower frame: Real Jy  
Auto-corr total-power spectrum Antenna: \*  
Timerange: 00/22:39:31 to 00/22:40:59



Plot file version 1467 created 05-OCT-2021 17:11:54

APM08279+525 GM076.UVDATA.1

Freq = 1.5945 GHz, Bw = 32.000 MH No calibration applied and no bandpass applied

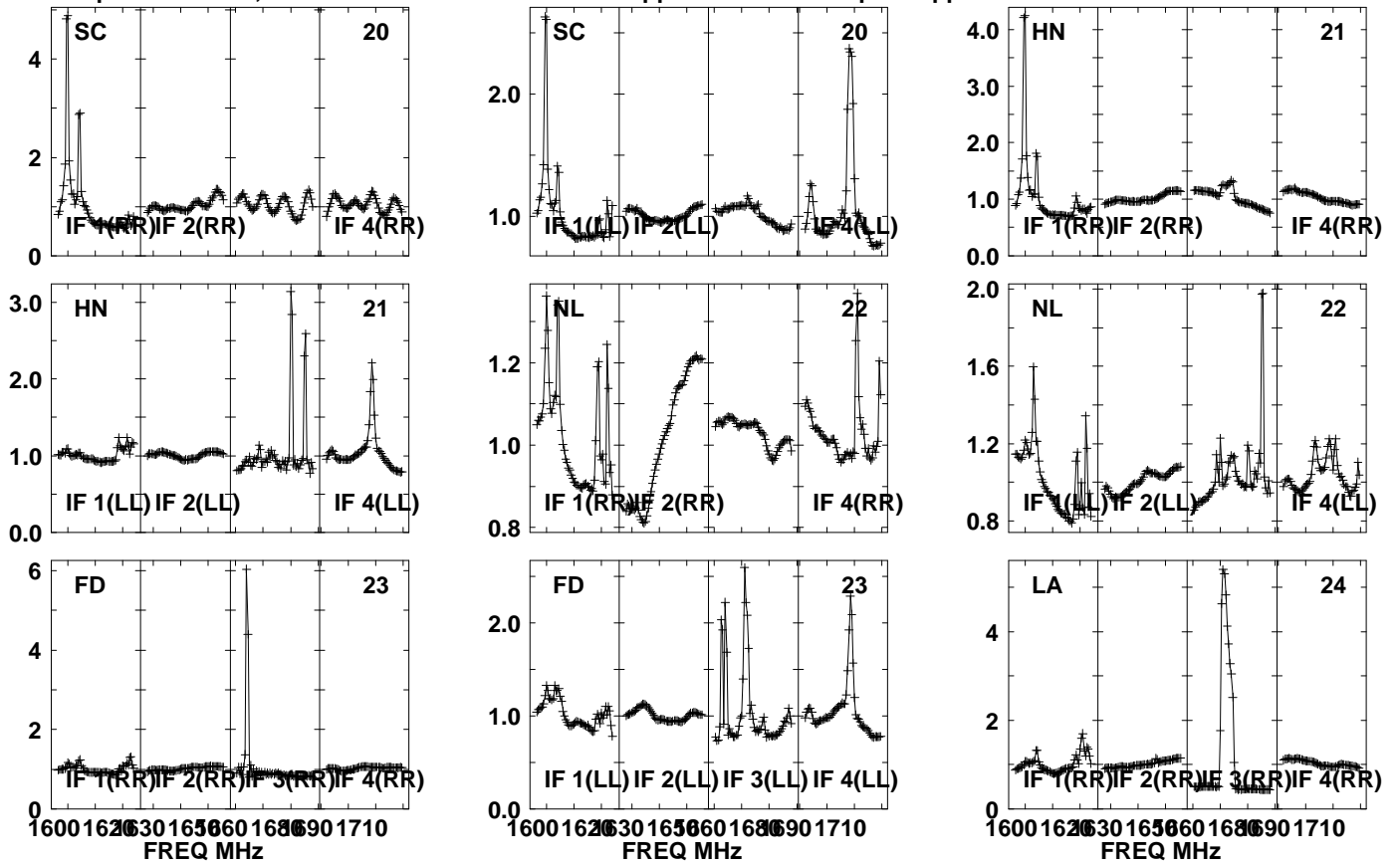

Lower frame: Real Jy

Auto-corr total-power spectrum Antenna: \*

Timerange: 00/22:41:09 to 00/22:44:29

Plot file version1468 created 05-OCT-2021 17:11:54

APM08279+525 GM076.UVDATA.1

Freq = 1.5945 GHz, Bw = 32.000 MH No calibration applied and no bandpass applied

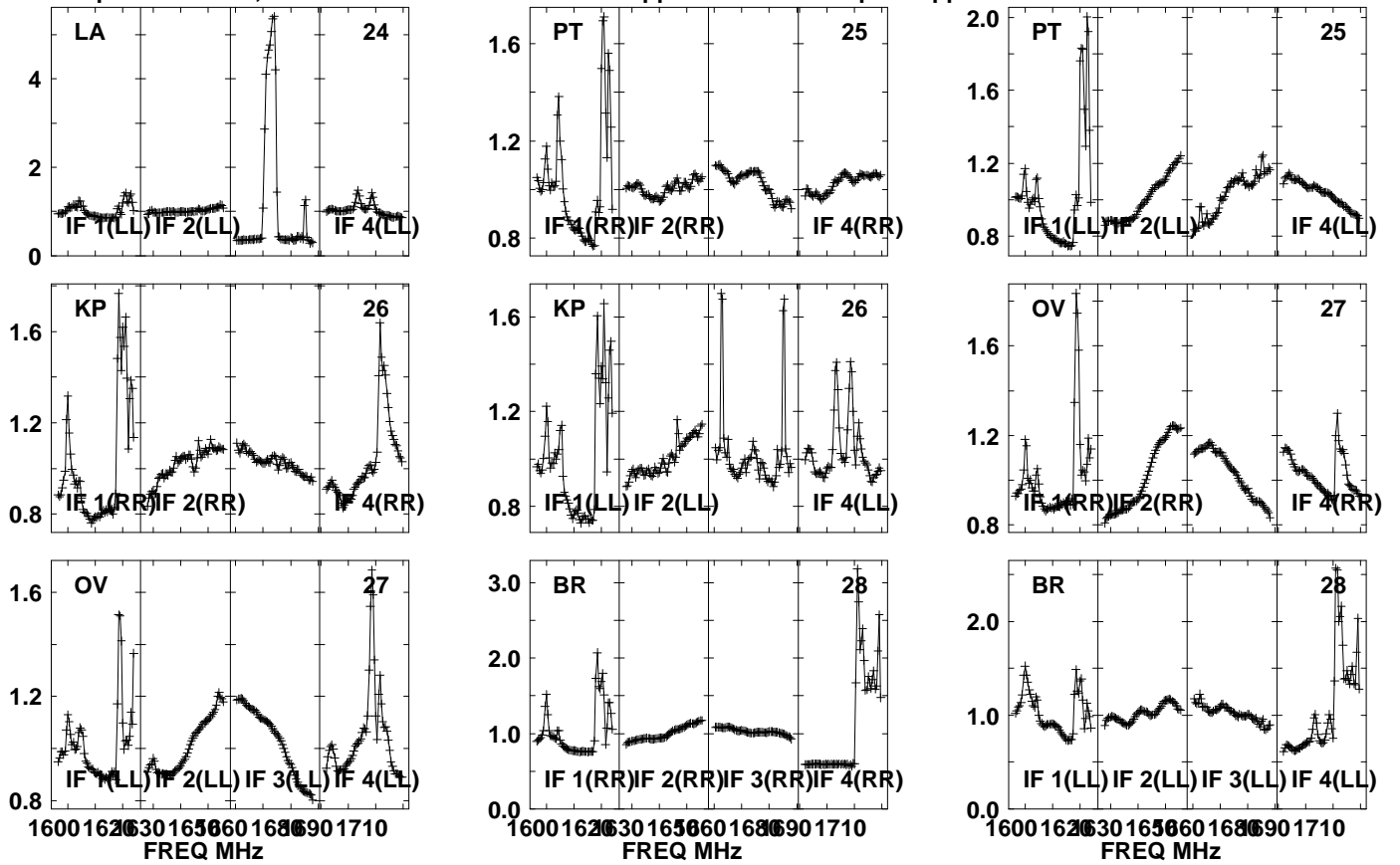

Lower frame: Real Jy

Auto-corr total-power spectrum Antenna: \*

Timerange: 00/22:41:09 to 00/22:44:29

Plot file version1469 created 05-OCT-2021 17:11:55

APM08279+525 GM076.UVDATA.1

Freq = 1.5945 GHz, Bw = 32.000 MH No calibration applied and no bandpass applied

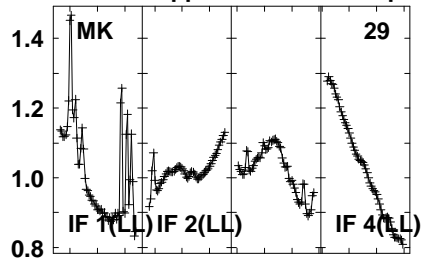
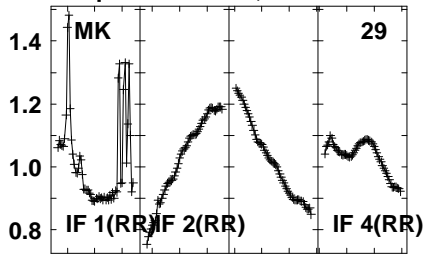

Lower frame: Real Jy  
Auto-corr total-power spectrum Antenna: \*  
Timerange: 00/22:41:09 to 00/22:44:29

Plot file version 1470 created 05-OCT-2021 17:11:55

J0827+5217 GM076.UVDATA.1

Freq = 1.5945 GHz, Bw = 32.000 MH No calibration applied and no bandpass applied

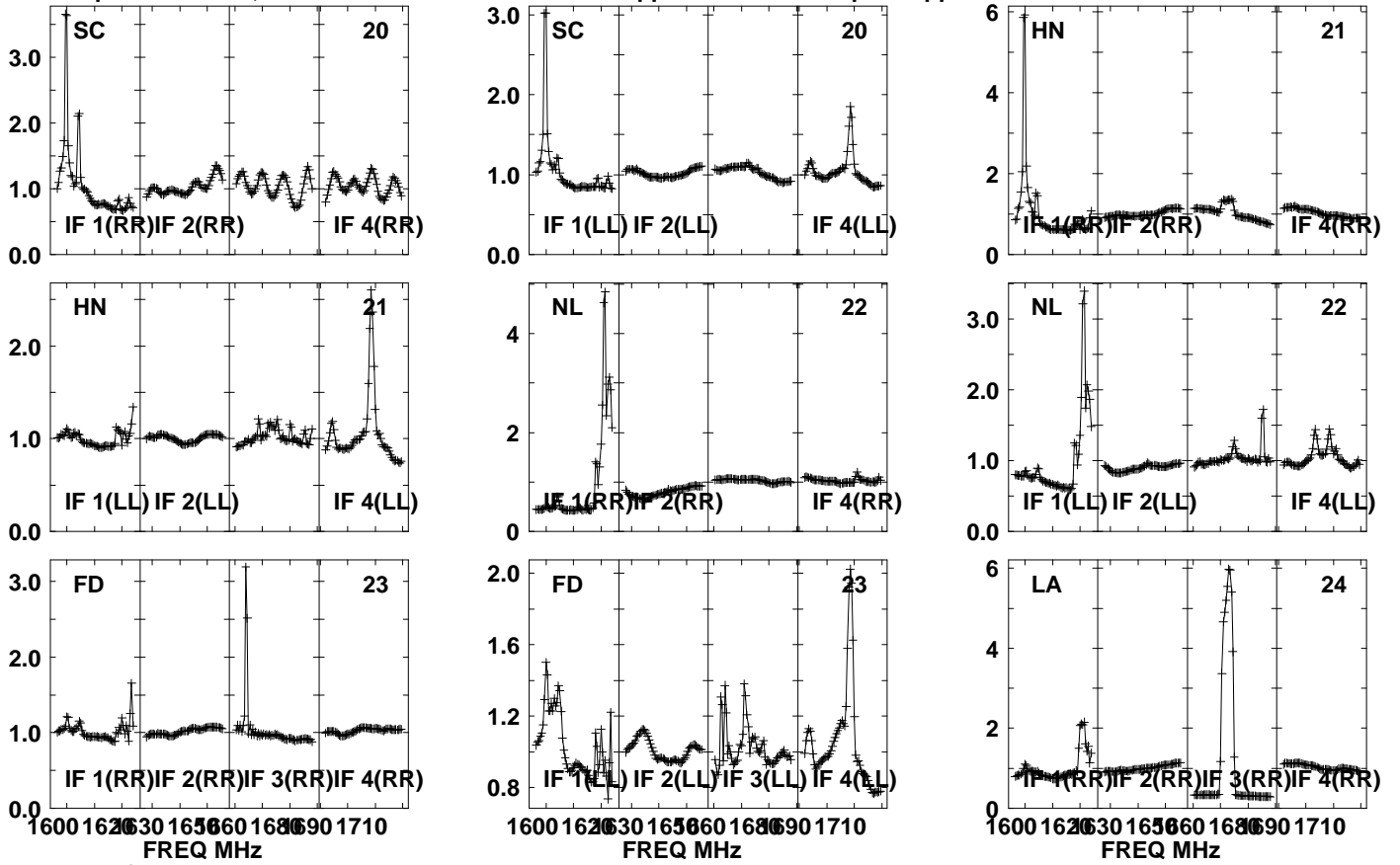

Lower frame: Real Jy  
Auto-corr total-power spectrum Antenna: \*  
Timerange: 00/22:45:01 to 00/22:46:29

Plot file version1471 created 05-OCT-2021 17:11:55

J0827+5217 GM076.UVDATA.1

Freq = 1.5945 GHz, Bw = 32.000 MH No calibration applied and no bandpass applied

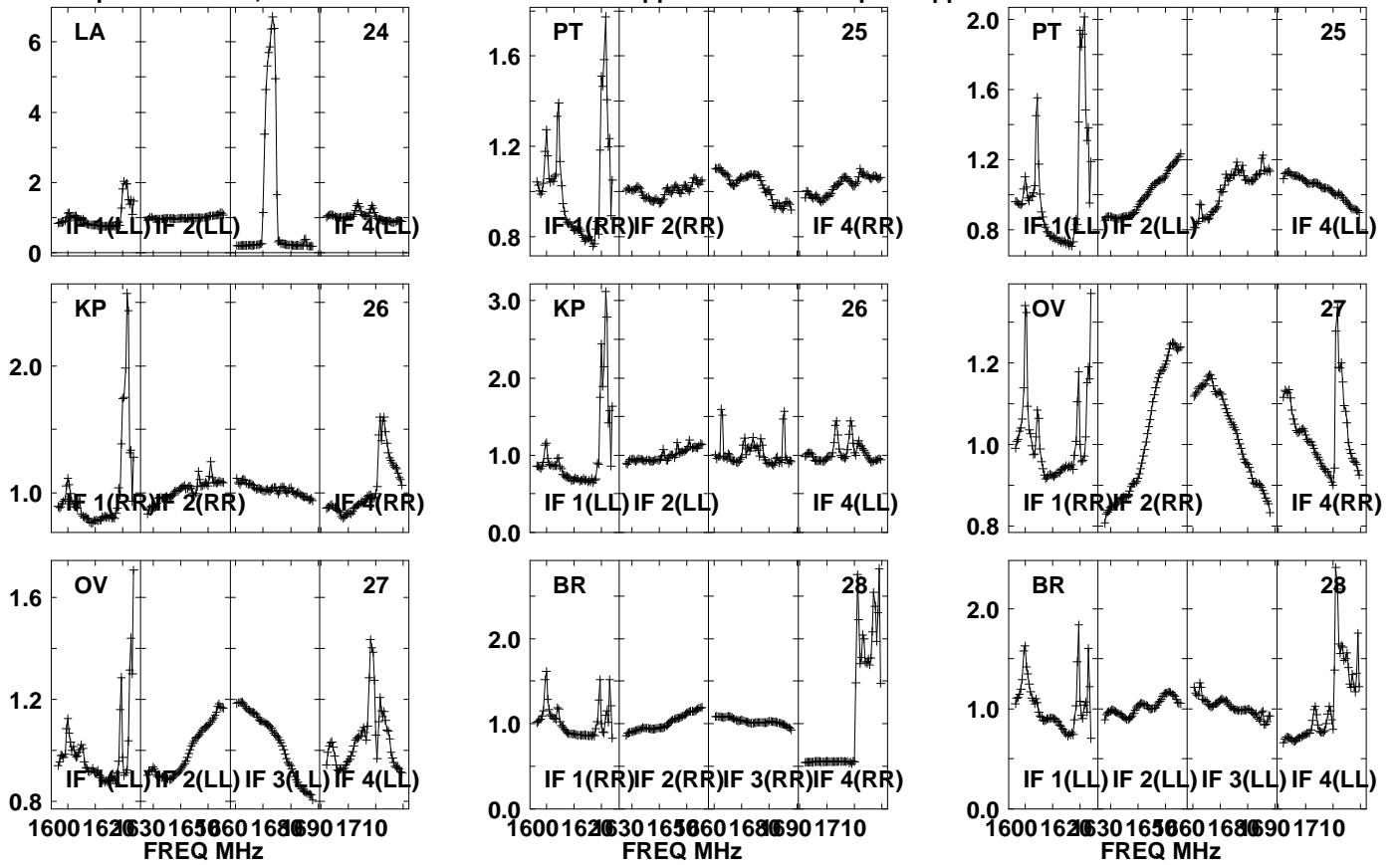

Lower frame: Real Jy

Auto-corr total-power spectrum Antenna: \*

Timerange: 00/22:45:01 to 00/22:46:29

Plot file version1472 created 05-OCT-2021 17:11:55

J0827+5217 GM076.UVDATA.1

Freq = 1.5945 GHz, Bw = 32.000 MH No calibration applied and no bandpass applied

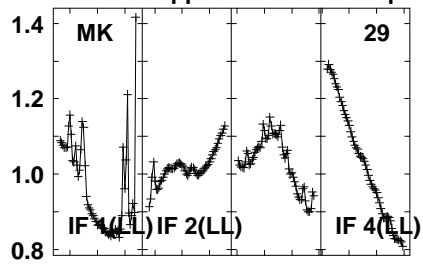
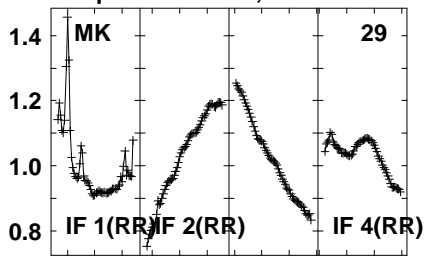

Lower frame: Real Jy  
Auto-corr total-power spectrum Antenna: \*  
Timerange: 00/22:45:01 to 00/22:46:29

Plot file version 1473 created 05-OCT-2021 17:11:55

APM08279+525 GM076.UVDATA.1

Freq = 1.5945 GHz, Bw = 32.000 MH No calibration applied and no bandpass applied

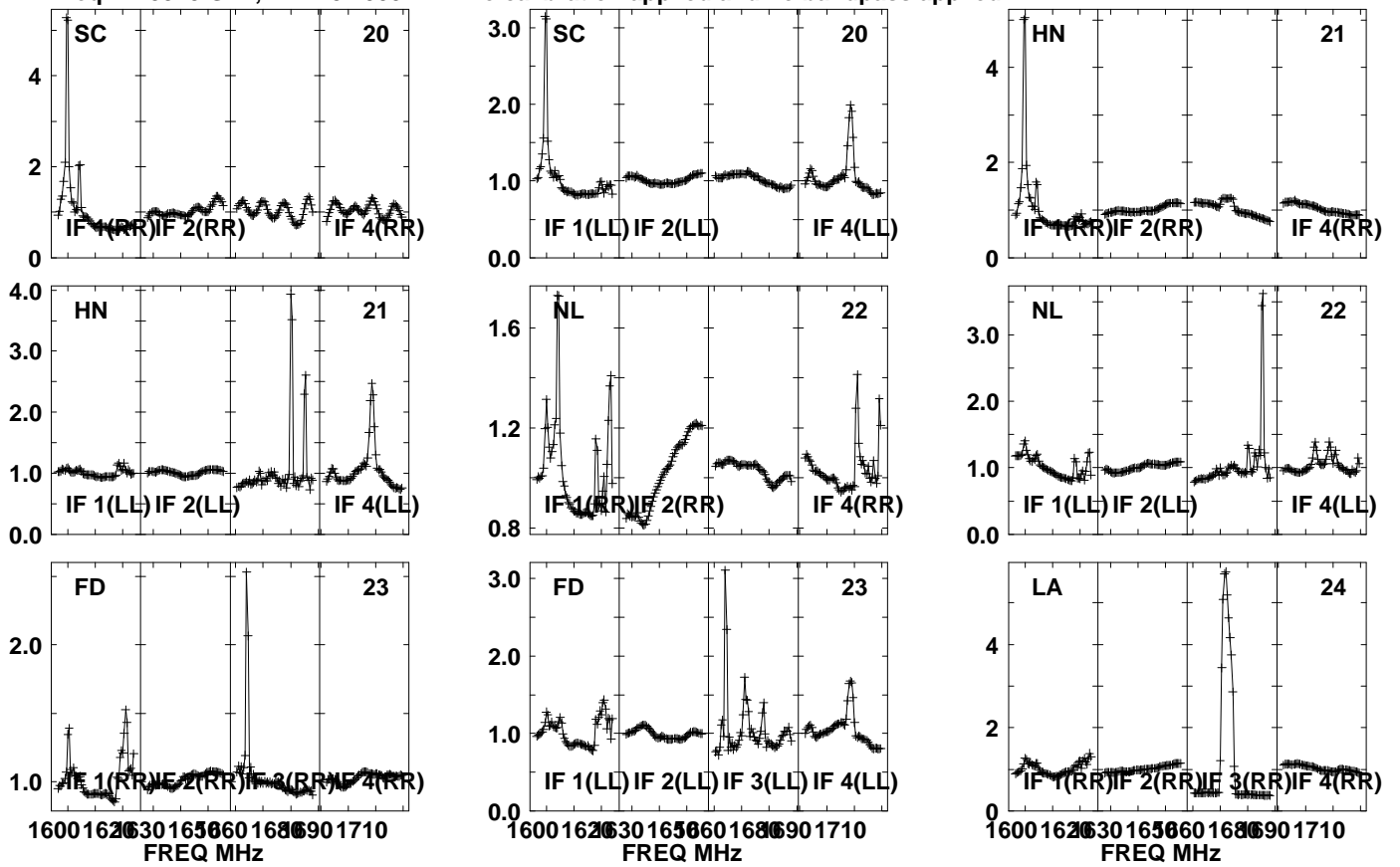

Lower frame: Real Jy

Auto-corr total-power spectrum Antenna: \*

Timerange: 00/22:46:39 to 00/22:49:59

Plot file version 1474 created 05-OCT-2021 17:11:55

APM08279+525 GM076.UVDATA.1

Freq = 1.5945 GHz, Bw = 32.000 MH No calibration applied and no bandpass applied

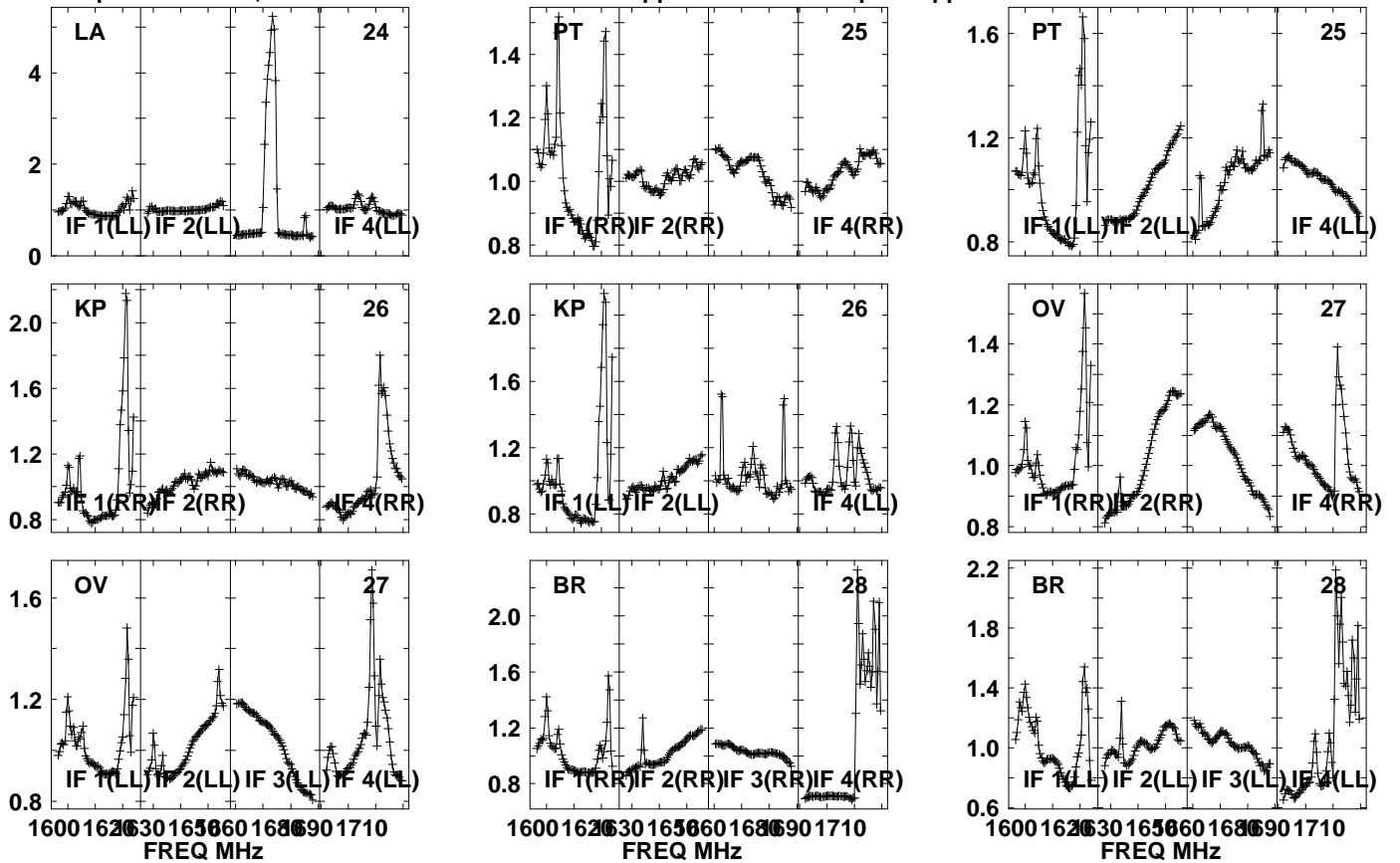

Lower frame: Real Jy

Auto-corr total-power spectrum Antenna: \*

Timerange: 00/22:46:39 to 00/22:49:59



Plot file version1475 created 05-OCT-2021 17:11:55

APM08279+525 GM076.UVDATA.1

Freq = 1.5945 GHz, Bw = 32.000 MH No calibration applied and no bandpass applied

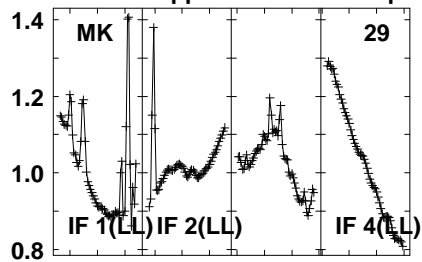
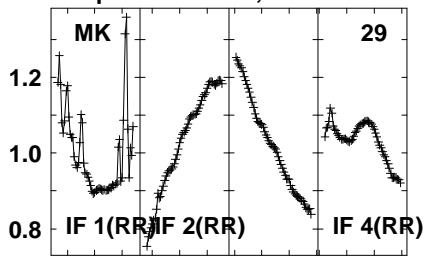

Lower frame: Real Jy  
Auto-corr total-power spectrum Antenna: \*  
Timerange: 00/22:46:39 to 00/22:49:59

Plot file version 1476 created 05-OCT-2021 17:11:56

J0827+5217 GM076.UVDATA.1

Freq = 1.5945 GHz, Bw = 32.000 MH No calibration applied and no bandpass applied

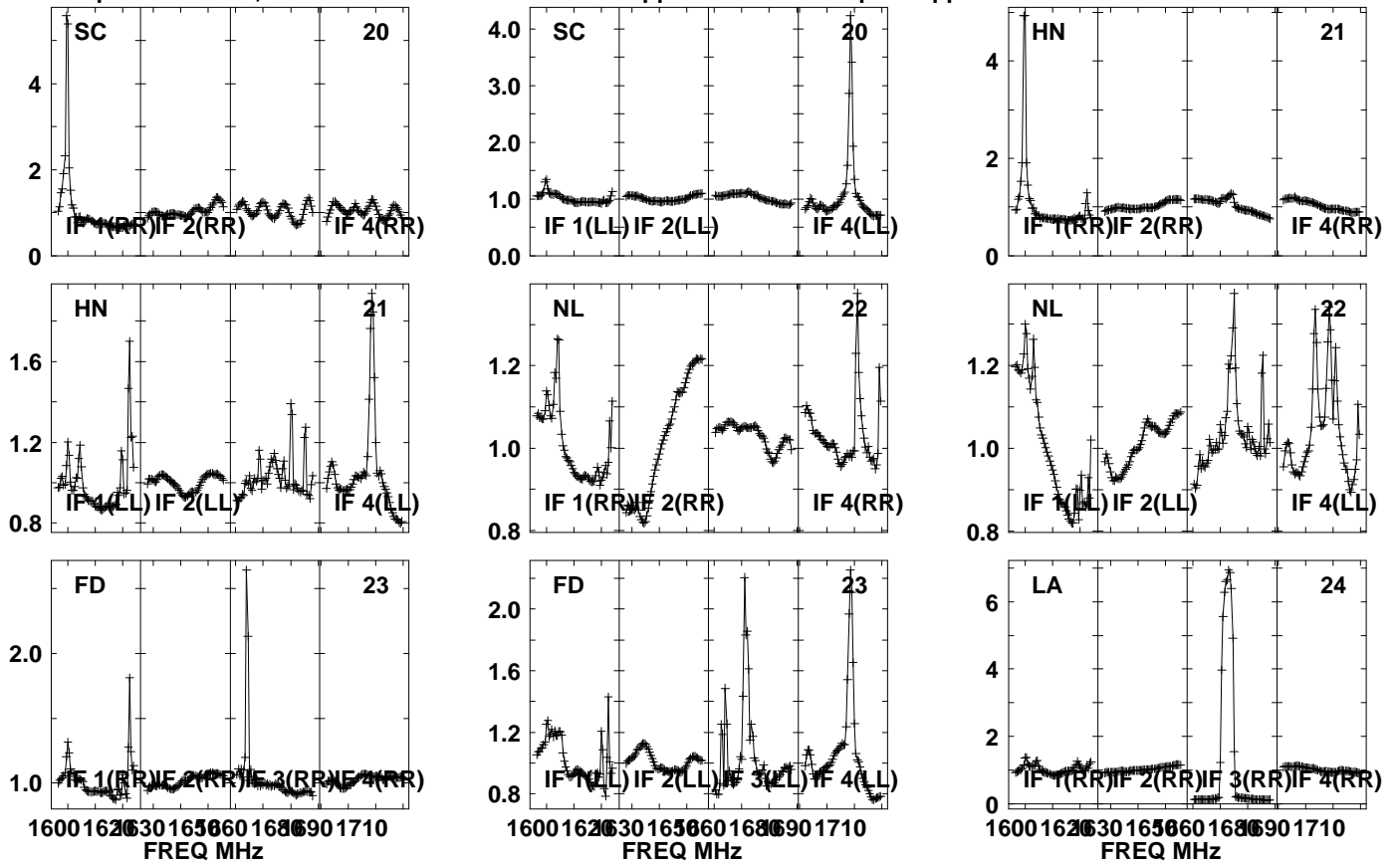

Lower frame: Real Jy  
Auto-corr total-power spectrum Antenna: \*  
Timerange: 00/22:50:31 to 00/22:51:59

Plot file version1477 created 05-OCT-2021 17:11:56

J0827+5217 GM076.UVDATA.1

Freq = 1.5945 GHz, Bw = 32.000 MH No calibration applied and no bandpass applied

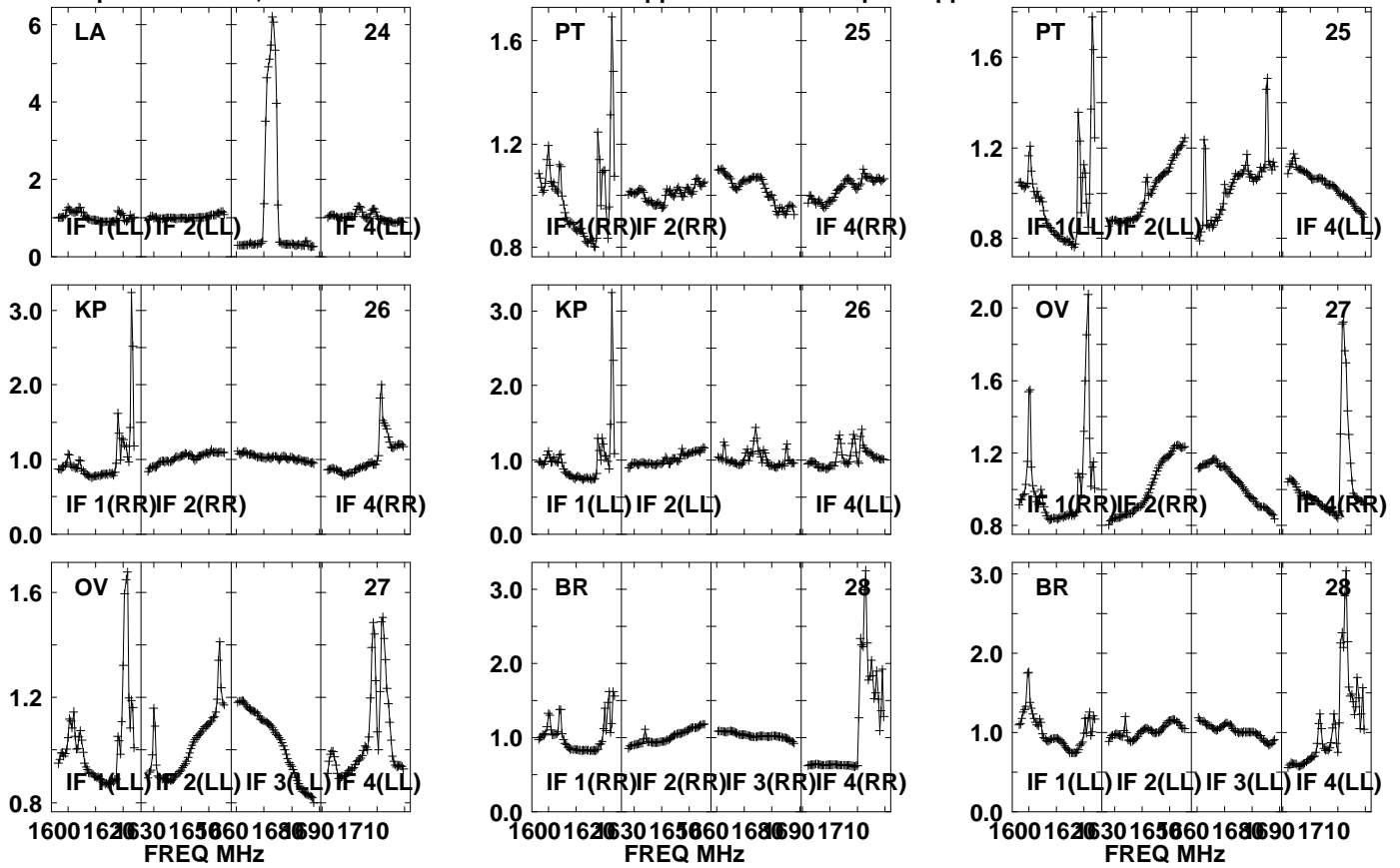

Lower frame: Real Jy  
Auto-corr total-power spectrum Antenna: \*  
Timerange: 00/22:50:31 to 00/22:51:59

Plot file version1478 created 05-OCT-2021 17:11:56

J0827+5217 GM076.UVDATA.1

Freq = 1.5945 GHz, Bw = 32.000 MH No calibration applied and no bandpass applied

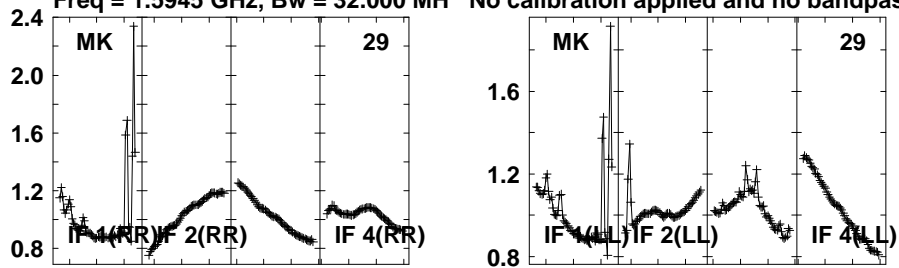

Lower frame: Real Jy  
Auto-corr total-power spectrum Antenna: \*  
Timerange: 00/22:50:31 to 00/22:51:59

Plot file version1479 created 05-OCT-2021 17:11:56

APM08279+525 GM076.UVDATA.1

Freq = 1.5945 GHz, Bw = 32.000 MH No calibration applied and no bandpass applied

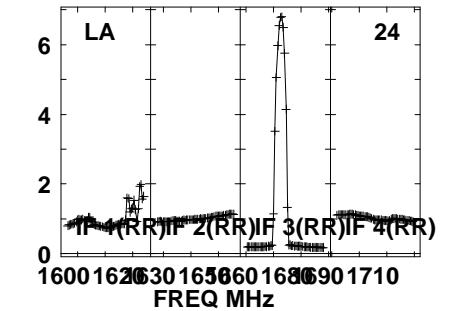
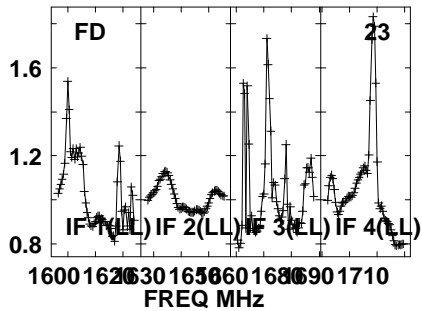
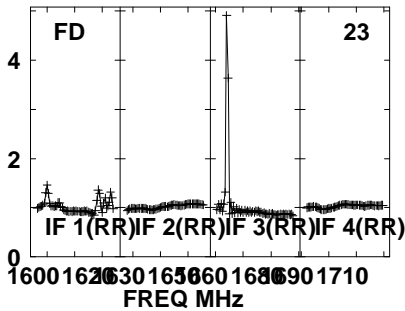
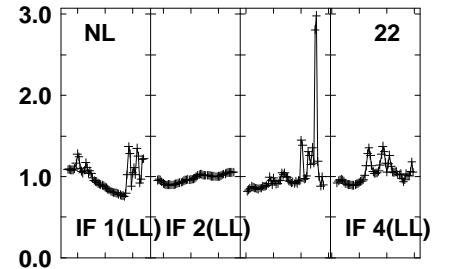
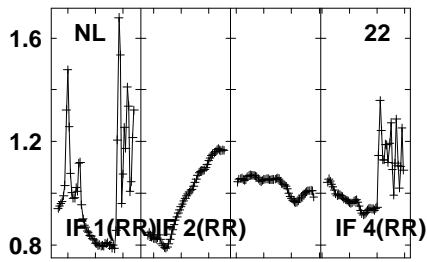
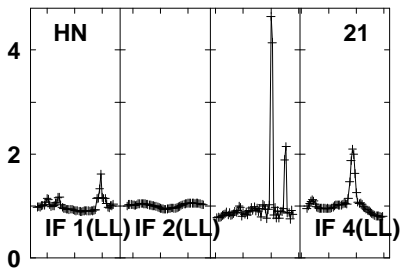
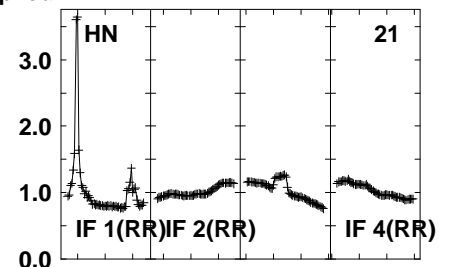
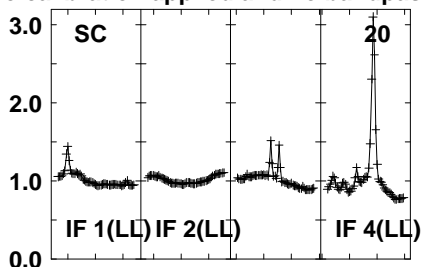
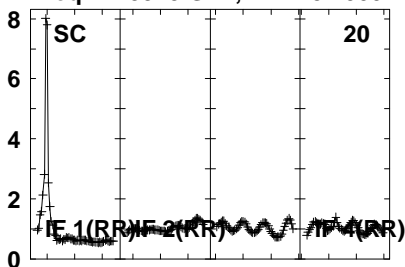

Lower frame: Real Jy

Auto-corr total-power spectrum Antenna: \*

Timerange: 00/22:52:09 to 00/22:55:29

Plot file version1480 created 05-OCT-2021 17:11:56

APM08279+525 GM076.UVDATA.1

Freq = 1.5945 GHz, Bw = 32.000 MH No calibration applied and no bandpass applied

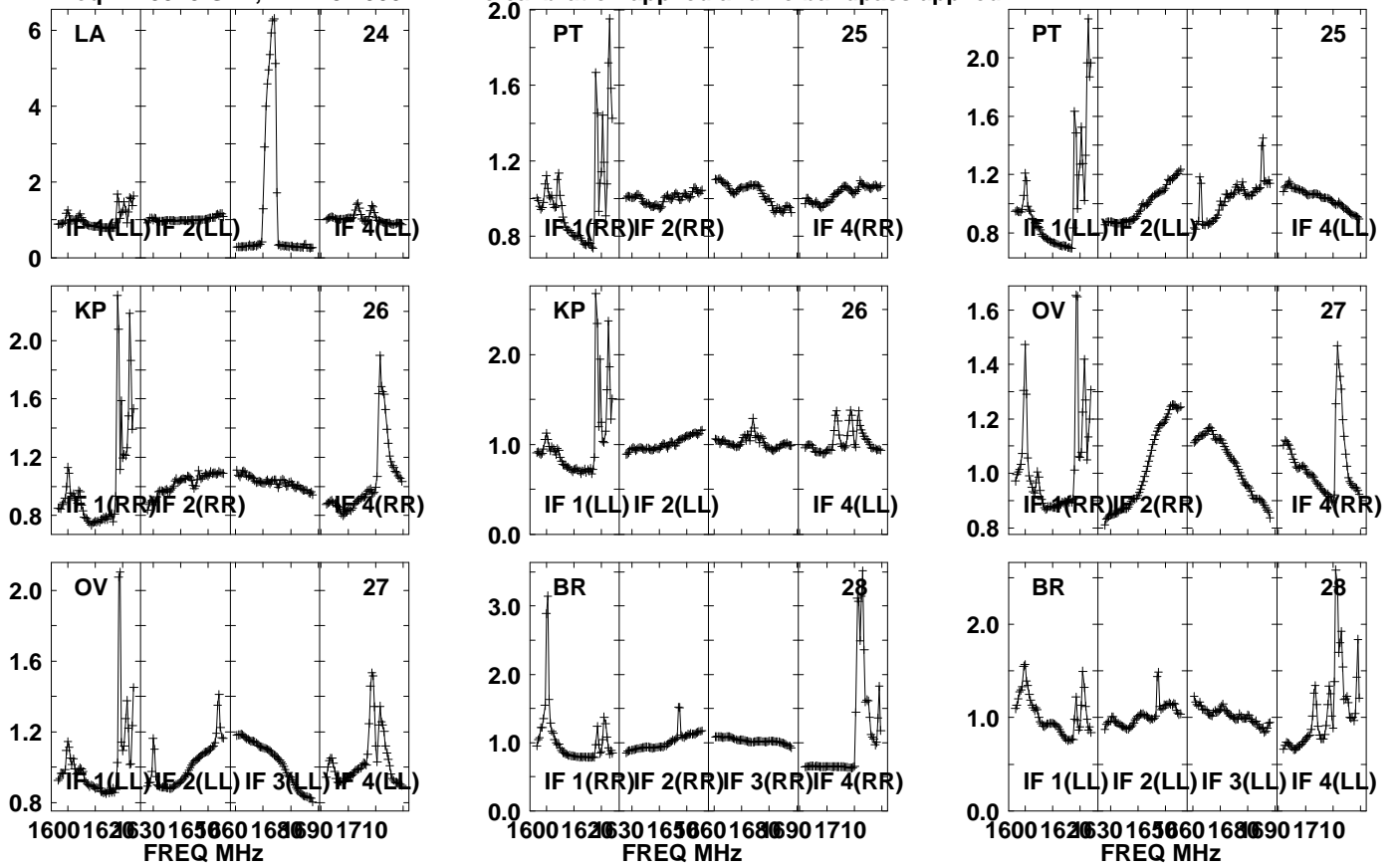

Lower frame: Real Jy

Auto-corr total-power spectrum Antenna: \*

Timerange: 00/22:52:09 to 00/22:55:29

Plot file version1481 created 05-OCT-2021 17:11:56

APM08279+525 GM076.UVDATA.1

Freq = 1.5945 GHz, Bw = 32.000 MH No calibration applied and no bandpass applied

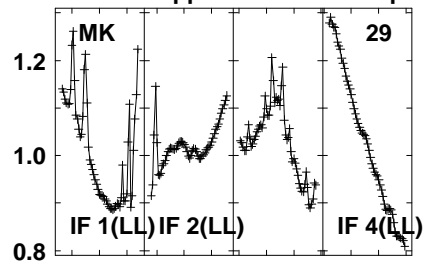
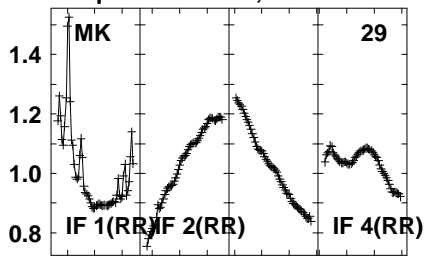

Lower frame: Real Jy  
Auto-corr total-power spectrum Antenna: \*  
Timerange: 00/22:52:09 to 00/22:55:29

Plot file version1482 created 05-OCT-2021 17:11:56

J0827+5217 GM076.UVDATA.1

Freq = 1.5945 GHz, Bw = 32.000 MH No calibration applied and no bandpass applied

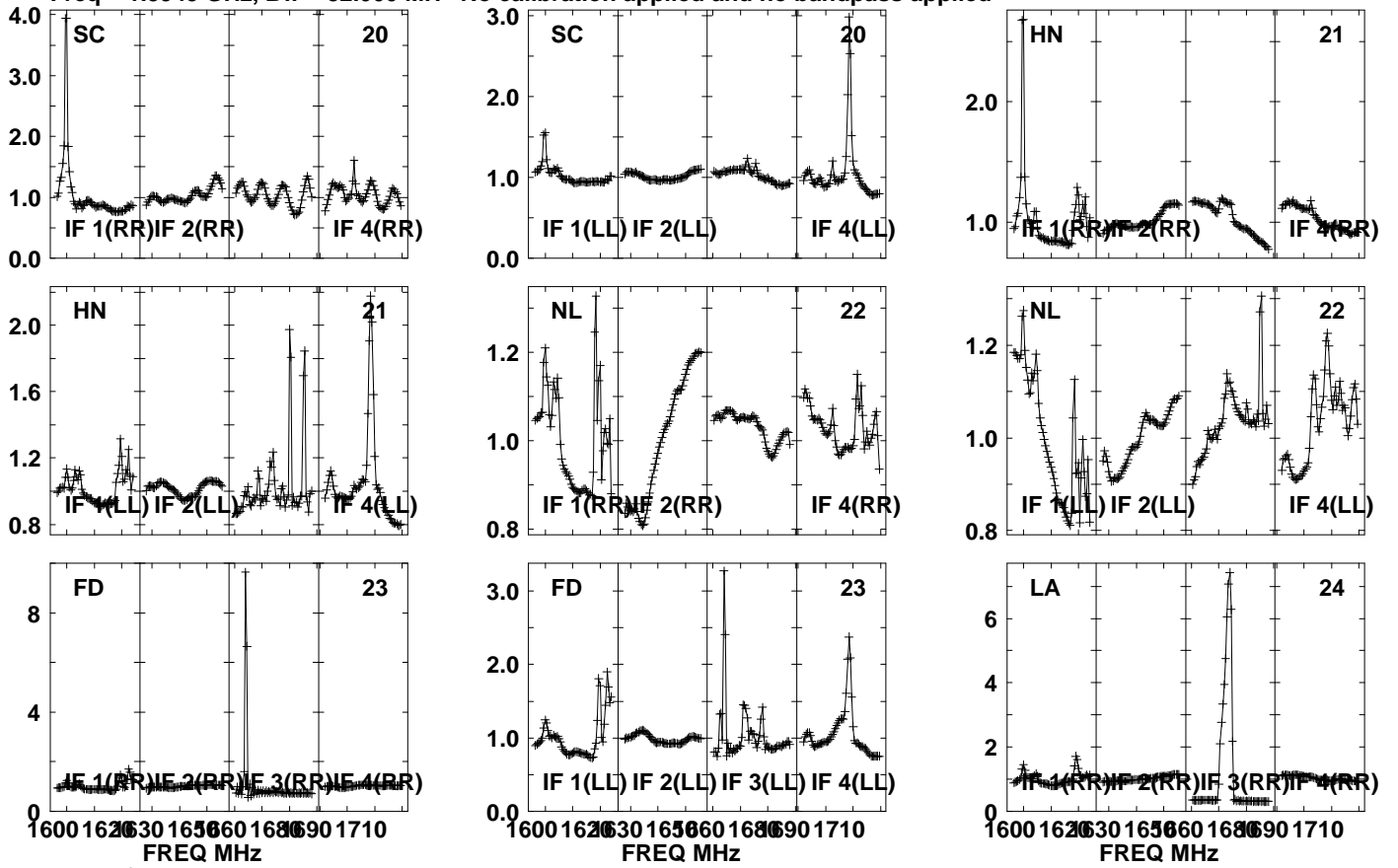

Lower frame: Real Jy  
Auto-corr total-power spectrum Antenna: \*  
Timerange: 00/22:56:01 to 00/22:57:29



Plot file version1483 created 05-OCT-2021 17:11:56

J0827+5217 GM076.UVDATA.1

Freq = 1.5945 GHz, Bw = 32.000 MH No calibration applied and no bandpass applied

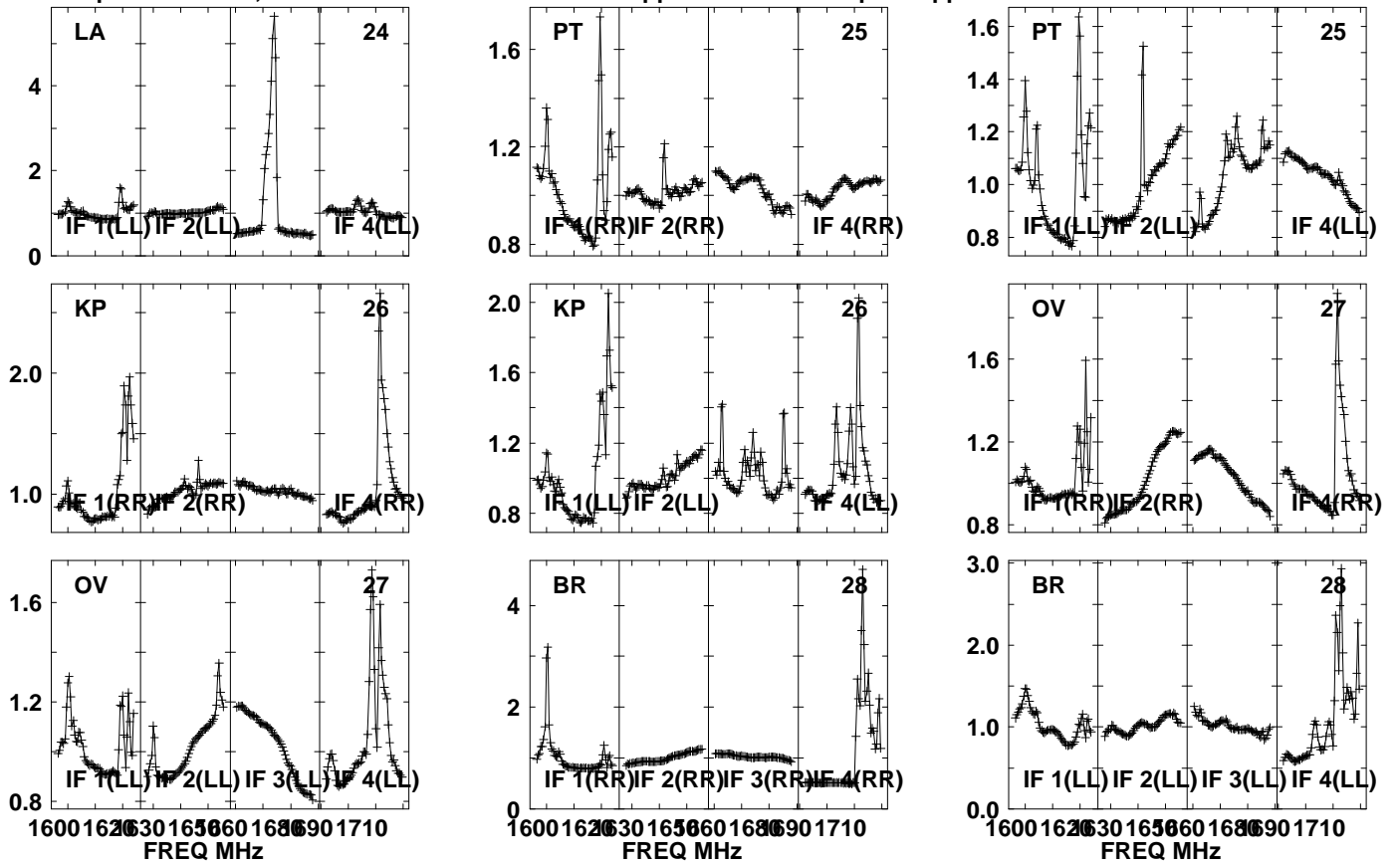

Lower frame: Real Jy

Auto-corr total-power spectrum Antenna: \*

Timerange: 00/22:56:01 to 00/22:57:29

Plot file version1484 created 05-OCT-2021 17:11:56  
J0827+5217 GM076.UVDATA.1  
Freq = 1.5945 GHz, Bw = 32.000 MH No calibration applied and no bandpass applied

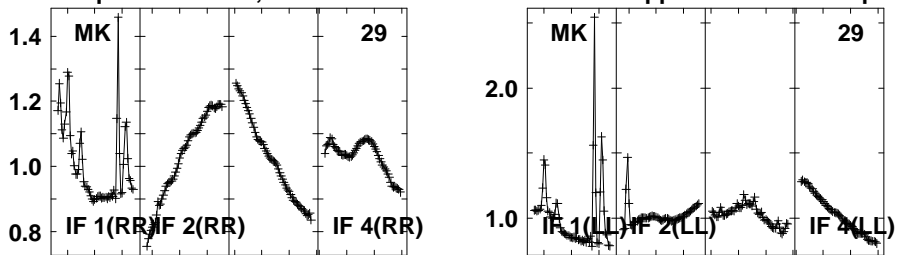

Lower frame: Real Jy  
Auto-corr total-power spectrum Antenna: \*  
Timerange: 00/22:56:01 to 00/22:57:29

Plot file version 1485 created 05-OCT-2021 17:11:57

APM08279+525 GM076.UVDATA.1

Freq = 1.5945 GHz, Bw = 32.000 MH No calibration applied and no bandpass applied

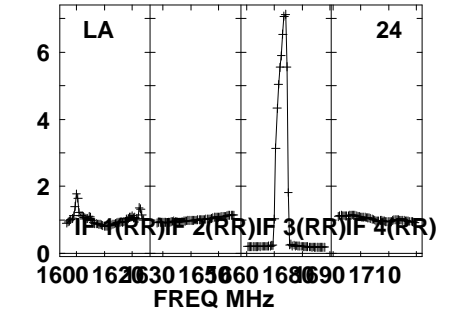
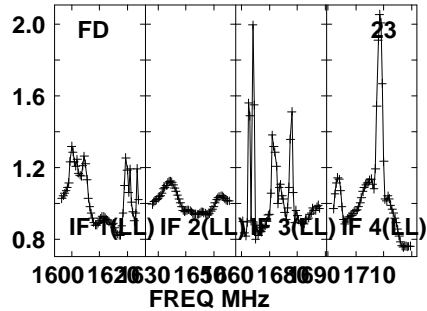
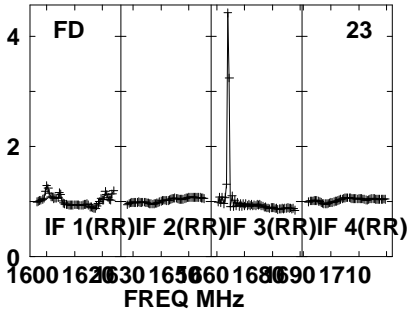
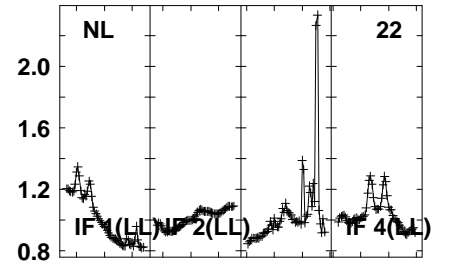
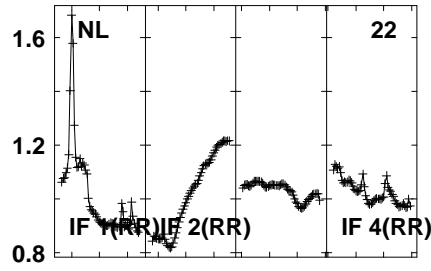
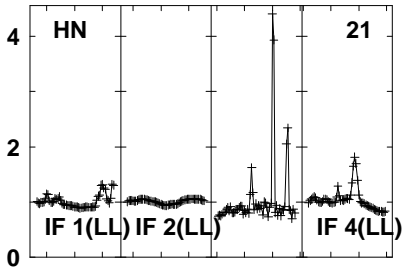
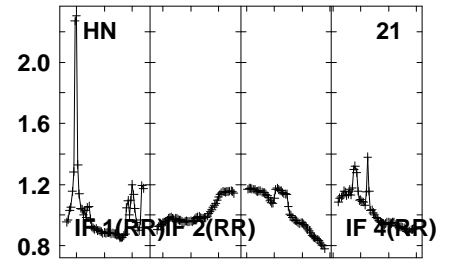
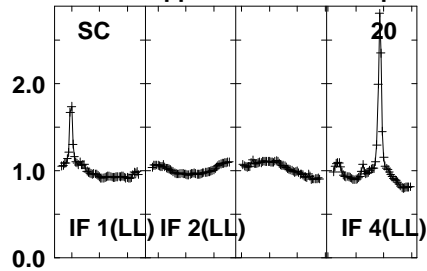
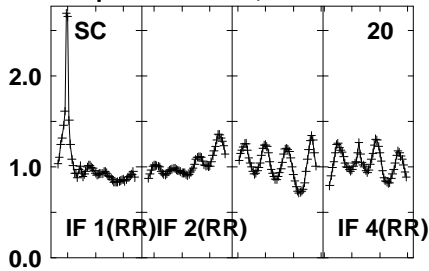

Lower frame: Real Jy

Auto-corr total-power spectrum Antenna: \*

Timerange: 00/22:57:39 to 00/23:00:59

Plot file version 1486 created 05-OCT-2021 17:11:57

APM08279+525 GM076.UVDATA.1

Freq = 1.5945 GHz, Bw = 32.000 MH

No calibration applied and no bandpass applied

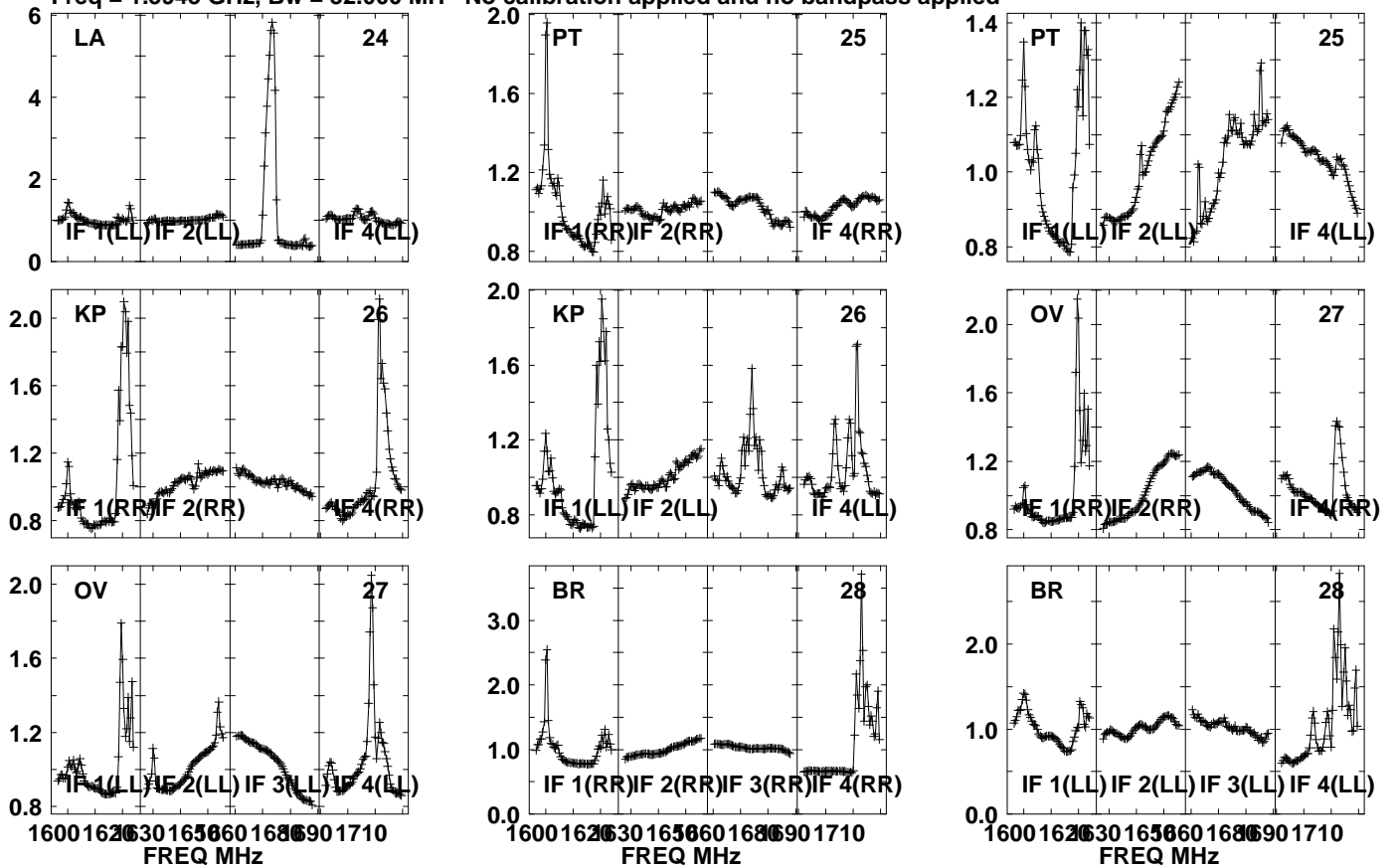

Lower frame: Real Jy

Auto-corr total-power spectrum Antenna: \*

Timerange: 00/22:57:39 to 00/23:00:59

Plot file version1487 created 05-OCT-2021 17:11:57

APM08279+525 GM076.UVDATA.1

Freq = 1.5945 GHz, Bw = 32.000 MH No calibration applied and no bandpass applied

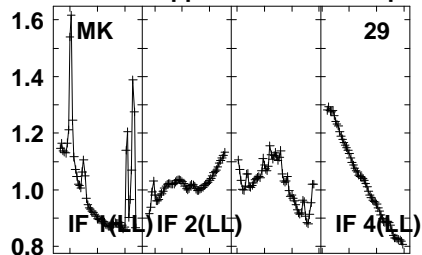
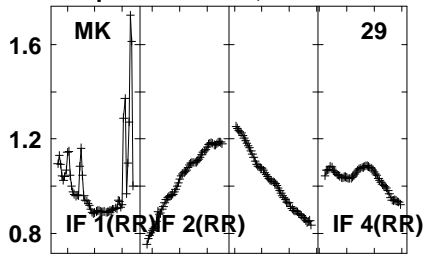

Lower frame: Real Jy  
Auto-corr total-power spectrum Antenna: \*  
Timerange: 00/22:57:39 to 00/23:00:59

Plot file version1488 created 05-OCT-2021 17:11:57

J0827+5217 GM076.UVDATA.1

Freq = 1.5945 GHz, Bw = 32.000 MH No calibration applied and no bandpass applied

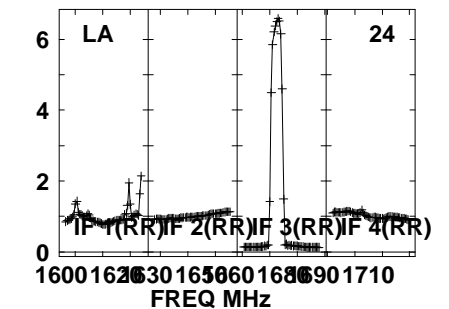
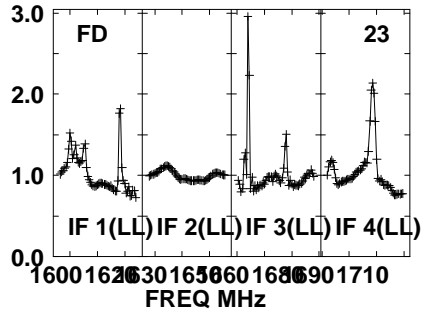
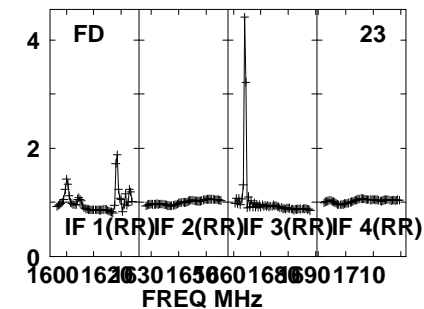
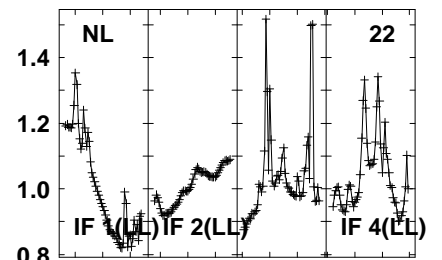
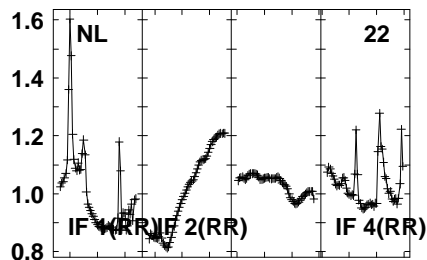
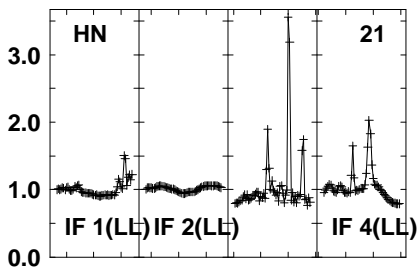
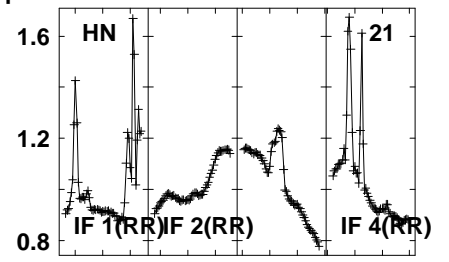
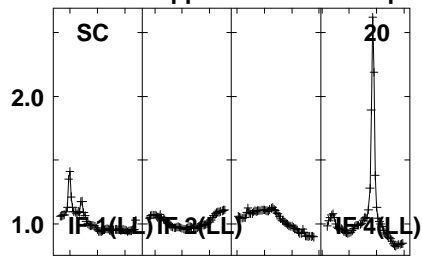
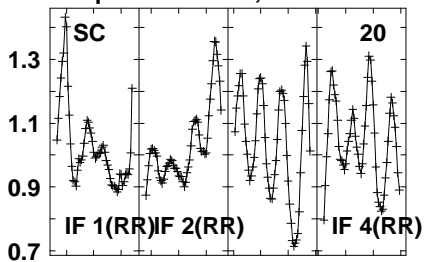

Lower frame: Real Jy  
Auto-corr total-power spectrum Antenna: \*  
Timerange: 00/23:01:31 to 00/23:02:59

Plot file version1489 created 05-OCT-2021 17:11:57

J0827+5217 GM076.UVDATA.1

Freq = 1.5945 GHz, Bw = 32.000 MH No calibration applied and no bandpass applied

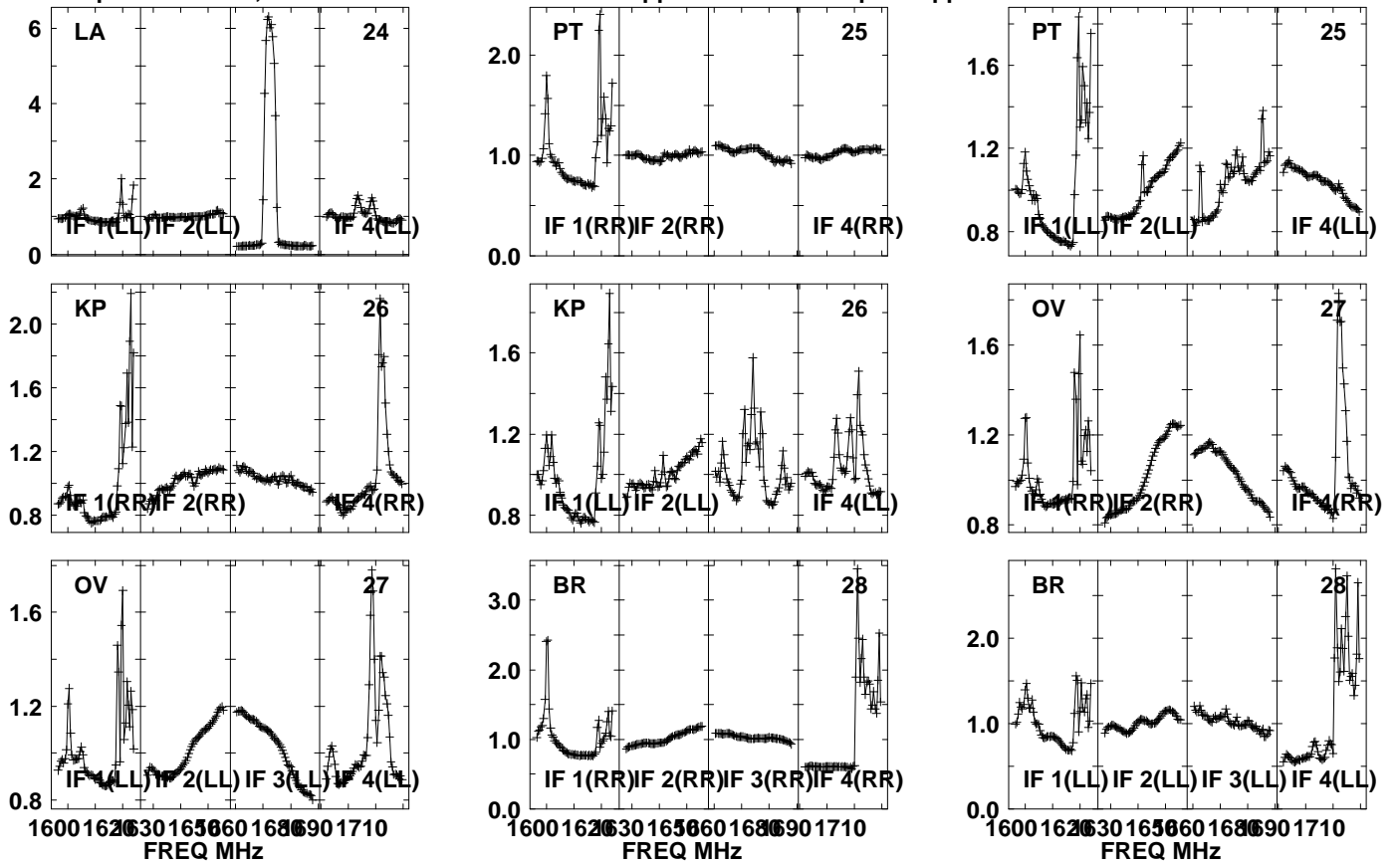

Lower frame: Real Jy  
Auto-corr total-power spectrum Antenna: \*  
Timerange: 00/23:01:31 to 00/23:02:59

Plot file version1490 created 05-OCT-2021 17:11:57

J0827+5217 GM076.UVDATA.1

Freq = 1.5945 GHz, Bw = 32.000 MH No calibration applied and no bandpass applied

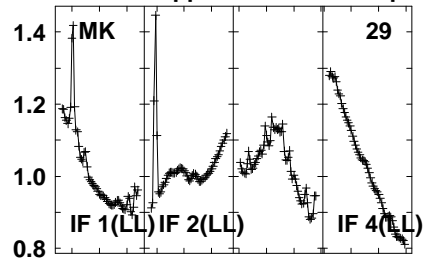
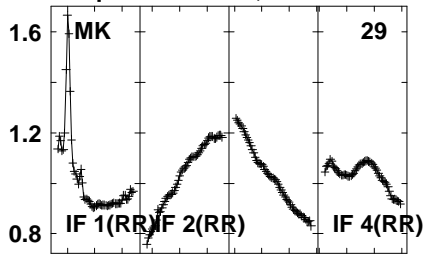

Lower frame: Real Jy  
Auto-corr total-power spectrum Antenna: \*  
Timerange: 00/23:01:31 to 00/23:02:59



Plot file version 1491 created 05-OCT-2021 17:11:57

APM08279+525 GM076.UVDATA.1

Freq = 1.5945 GHz, Bw = 32.000 MH No calibration applied and no bandpass applied

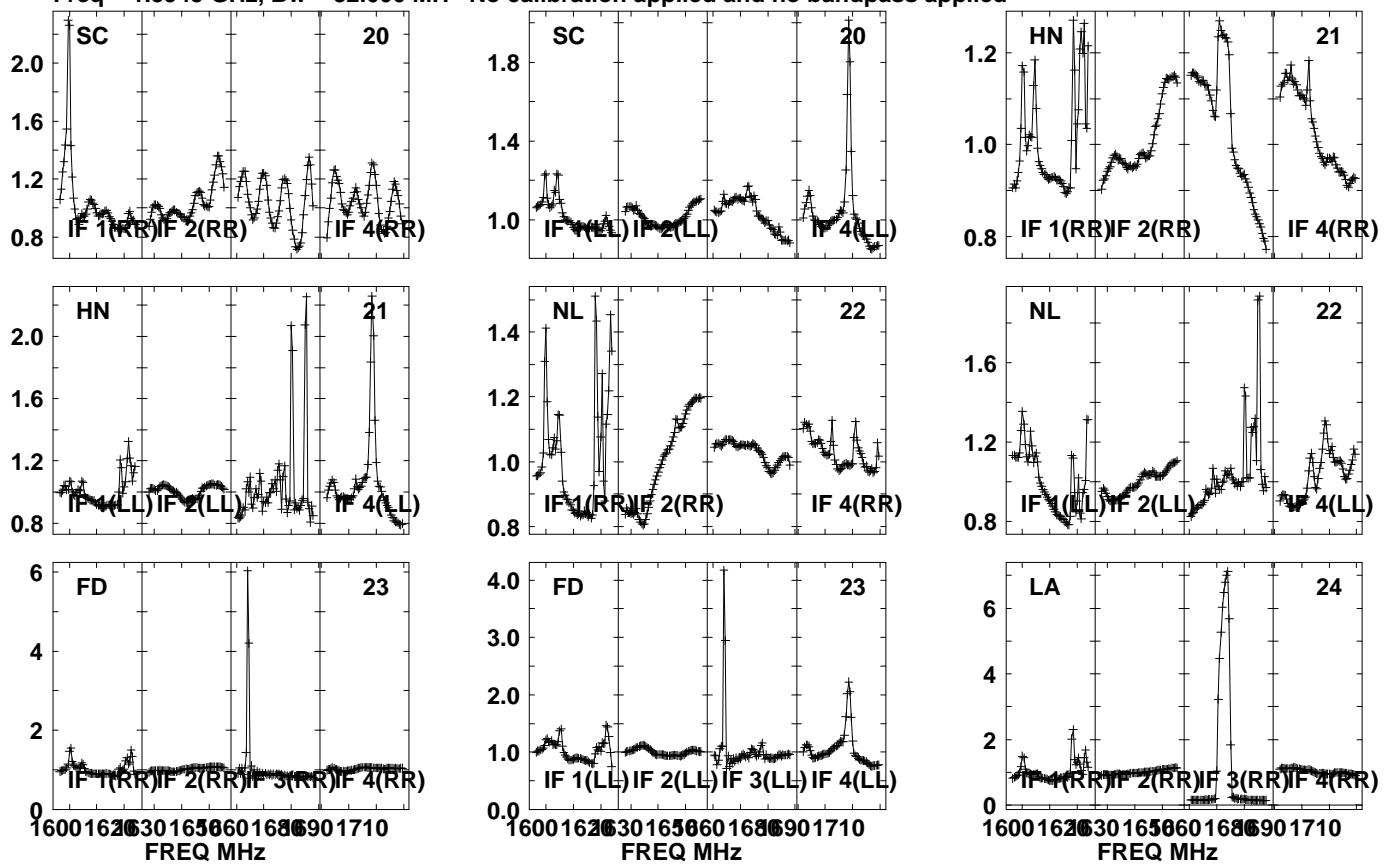

Lower frame: Real Jy  
Auto-corr total-power spectrum Antenna: \*  
Timerange: 00/23:03:09 to 00/23:06:29

Plot file version1492 created 05-OCT-2021 17:11:57

APM08279+525 GM076.UVDATA.1

Freq = 1.5945 GHz, Bw = 32.000 MH No calibration applied and no bandpass applied

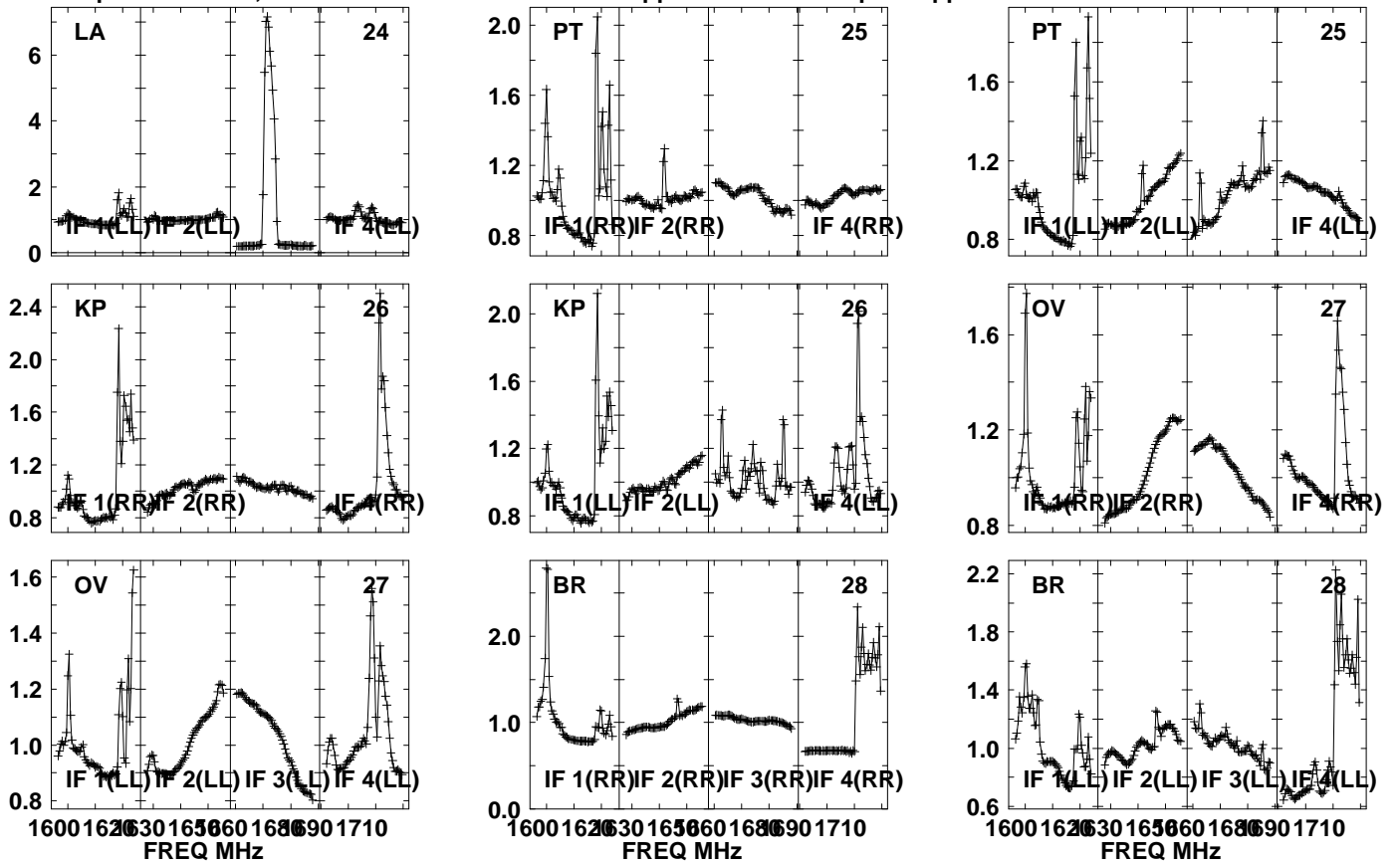

Lower frame: Real Jy

Auto-corr total-power spectrum Antenna: \*

Timerange: 00/23:03:09 to 00/23:06:29

Plot file version1493 created 05-OCT-2021 17:11:58

APM08279+525 GM076.UVDATA.1

Freq = 1.5945 GHz, Bw = 32.000 MH No calibration applied and no bandpass applied

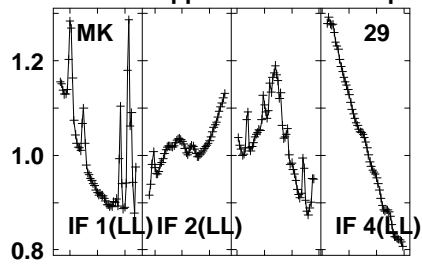
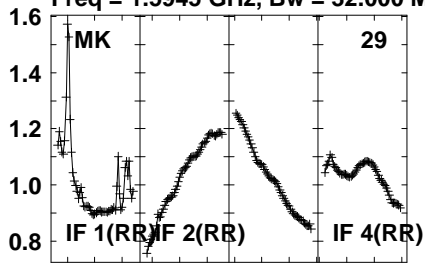

Lower frame: Real Jy  
Auto-corr total-power spectrum Antenna: \*  
Timerange: 00/23:03:09 to 00/23:06:29

Plot file version 1494 created 05-OCT-2021 17:11:58

J0827+5217 GM076.UVDATA.1

Freq = 1.5945 GHz, Bw = 32.000 MH No calibration applied and no bandpass applied

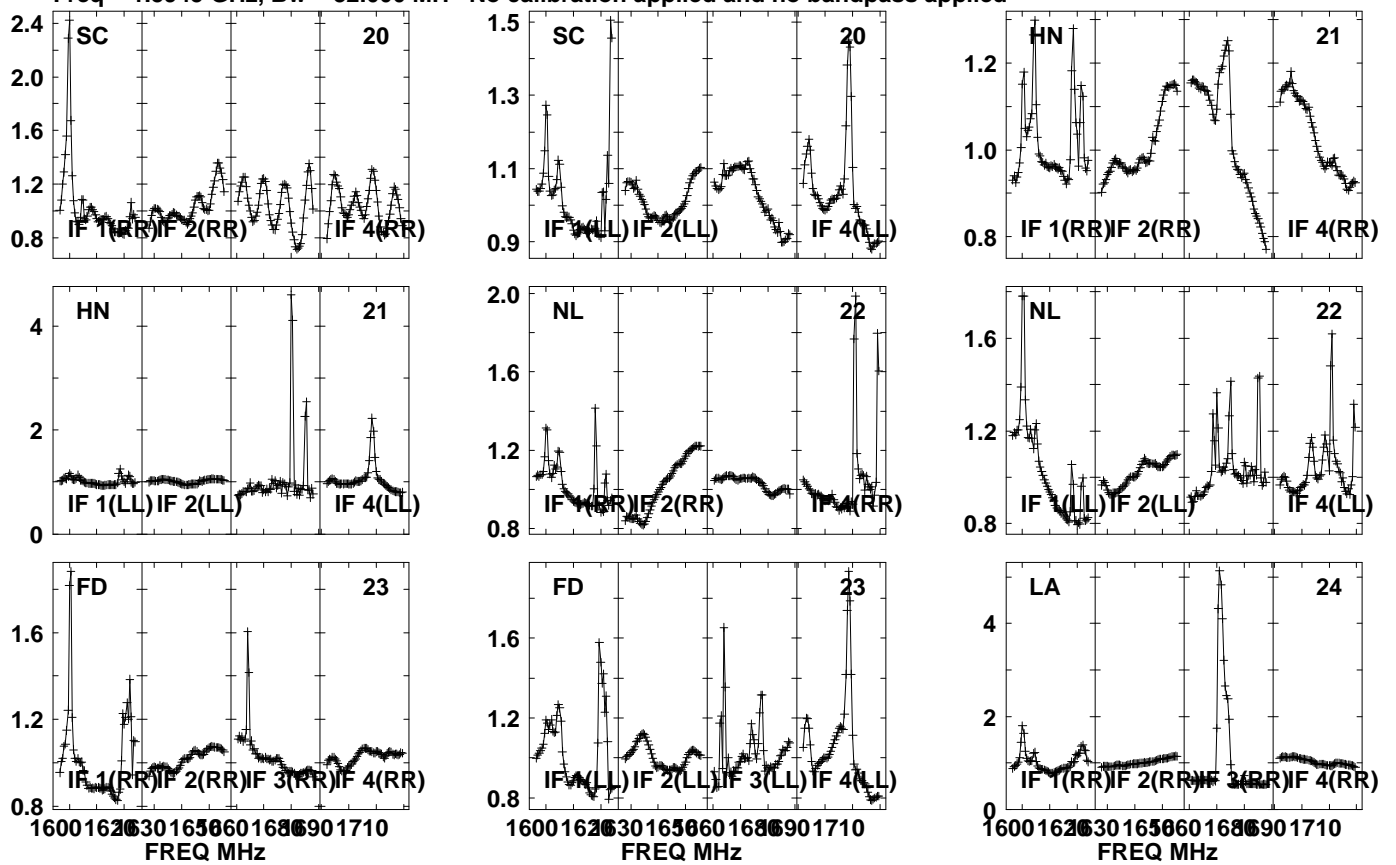

Lower frame: Real Jy  
Auto-corr total-power spectrum Antenna: \*  
Timerange: 00/23:07:01 to 00/23:08:29

Plot file version1495 created 05-OCT-2021 17:11:58

J0827+5217 GM076.UVDATA.1

Freq = 1.5945 GHz, Bw = 32.000 MH No calibration applied and no bandpass applied

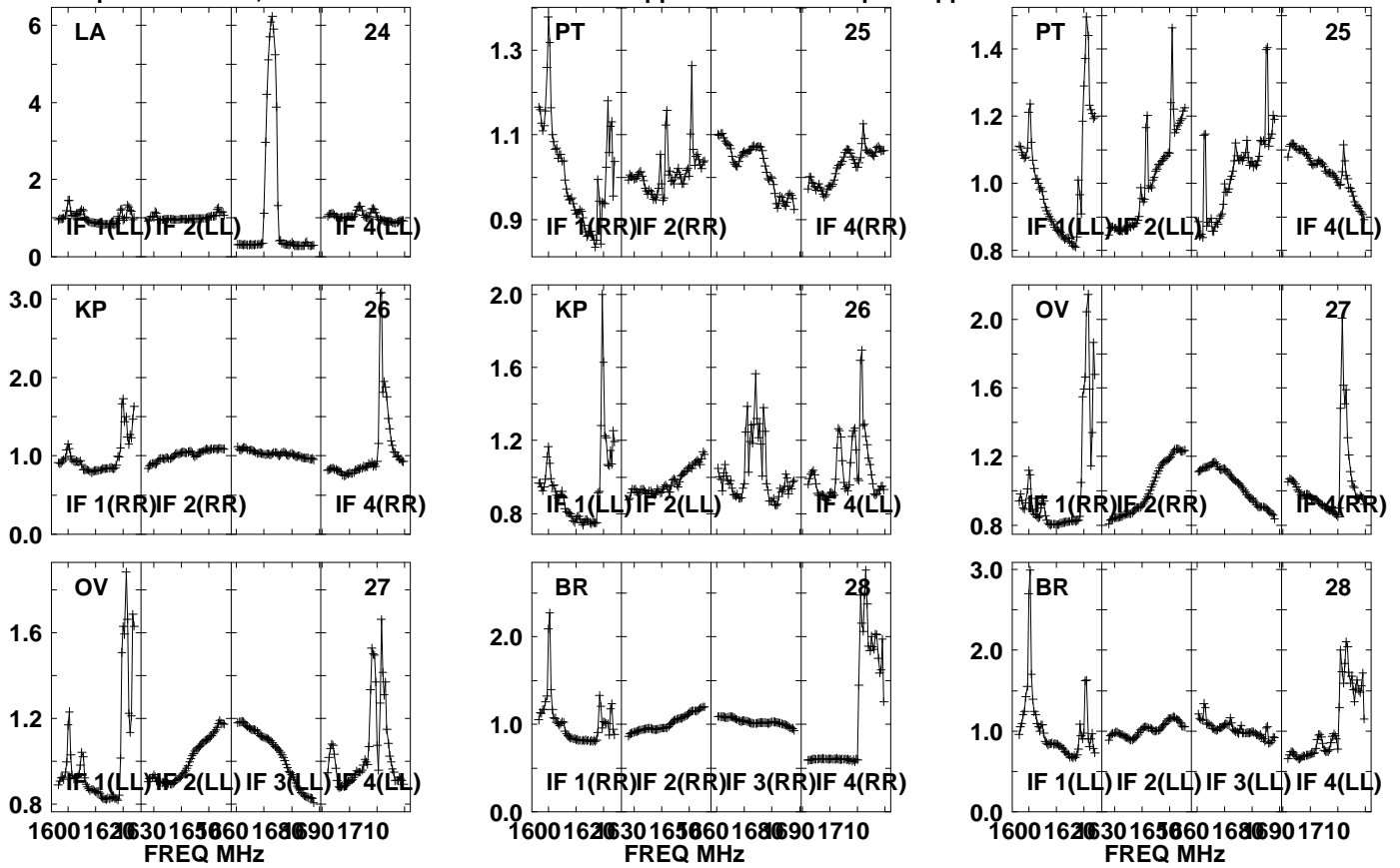

Lower frame: Real Jy

Auto-corr total-power spectrum Antenna: \*

Timerange: 00/23:07:01 to 00/23:08:29

Plot file version1496 created 05-OCT-2021 17:11:58

J0827+5217 GM076.UVDATA.1

Freq = 1.5945 GHz, Bw = 32.000 MH No calibration applied and no bandpass applied

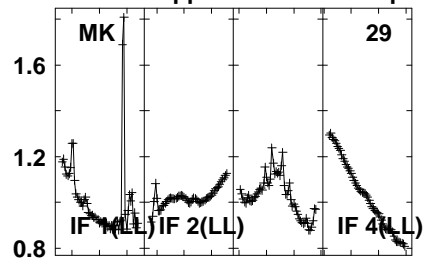
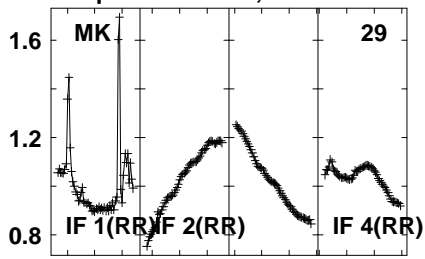

Lower frame: Real Jy  
Auto-corr total-power spectrum Antenna: \*  
Timerange: 00/23:07:01 to 00/23:08:29

Plot file version 1497 created 05-OCT-2021 17:11:58

APM08279+525 GM076.UVDATA.1

Freq = 1.5945 GHz, Bw = 32.000 MH No calibration applied and no bandpass applied

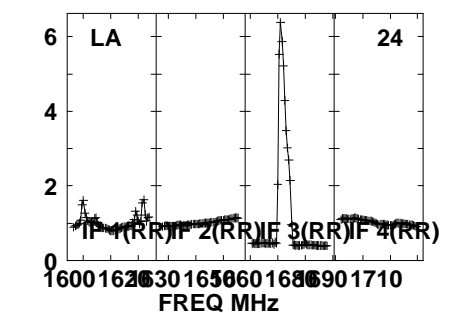
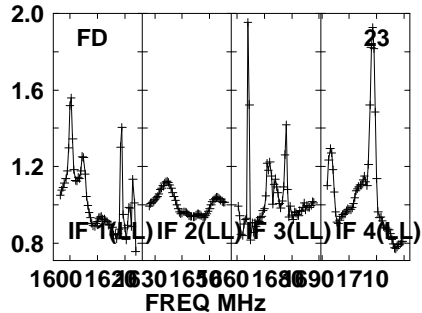
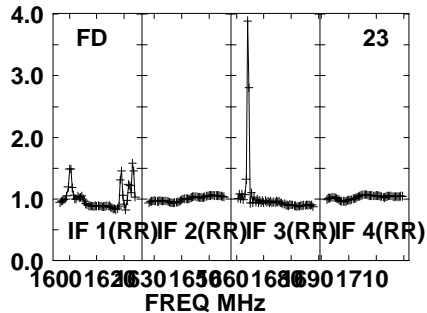
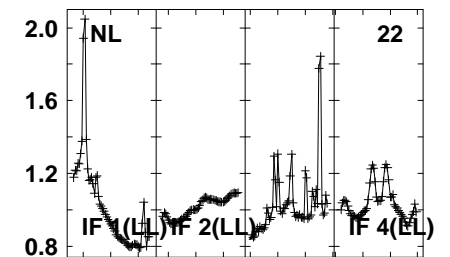
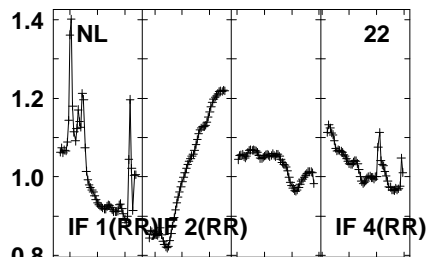
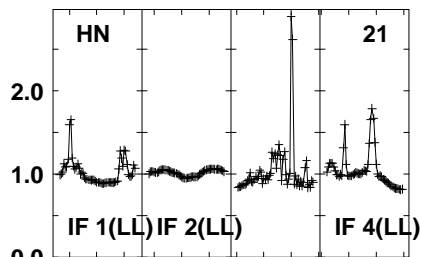
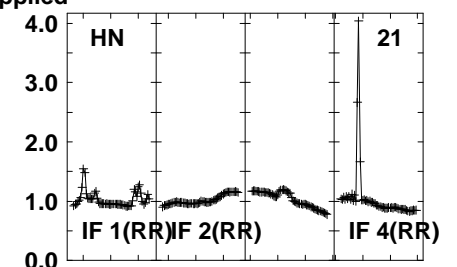
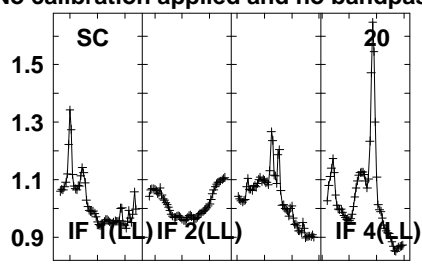
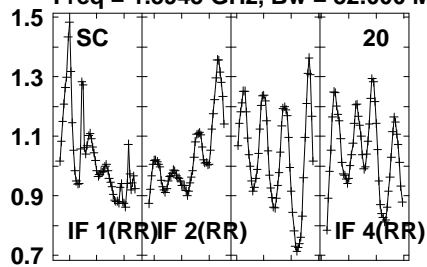

Lower frame: Real Jy  
Auto-corr total-power spectrum Antenna: \*  
Timerange: 00/23:08:39 to 00/23:11:59

Plot file version1498 created 05-OCT-2021 17:11:58

APM08279+525 GM076.UVDATA.1

Freq = 1.5945 GHz, Bw = 32.000 MH No calibration applied and no bandpass applied

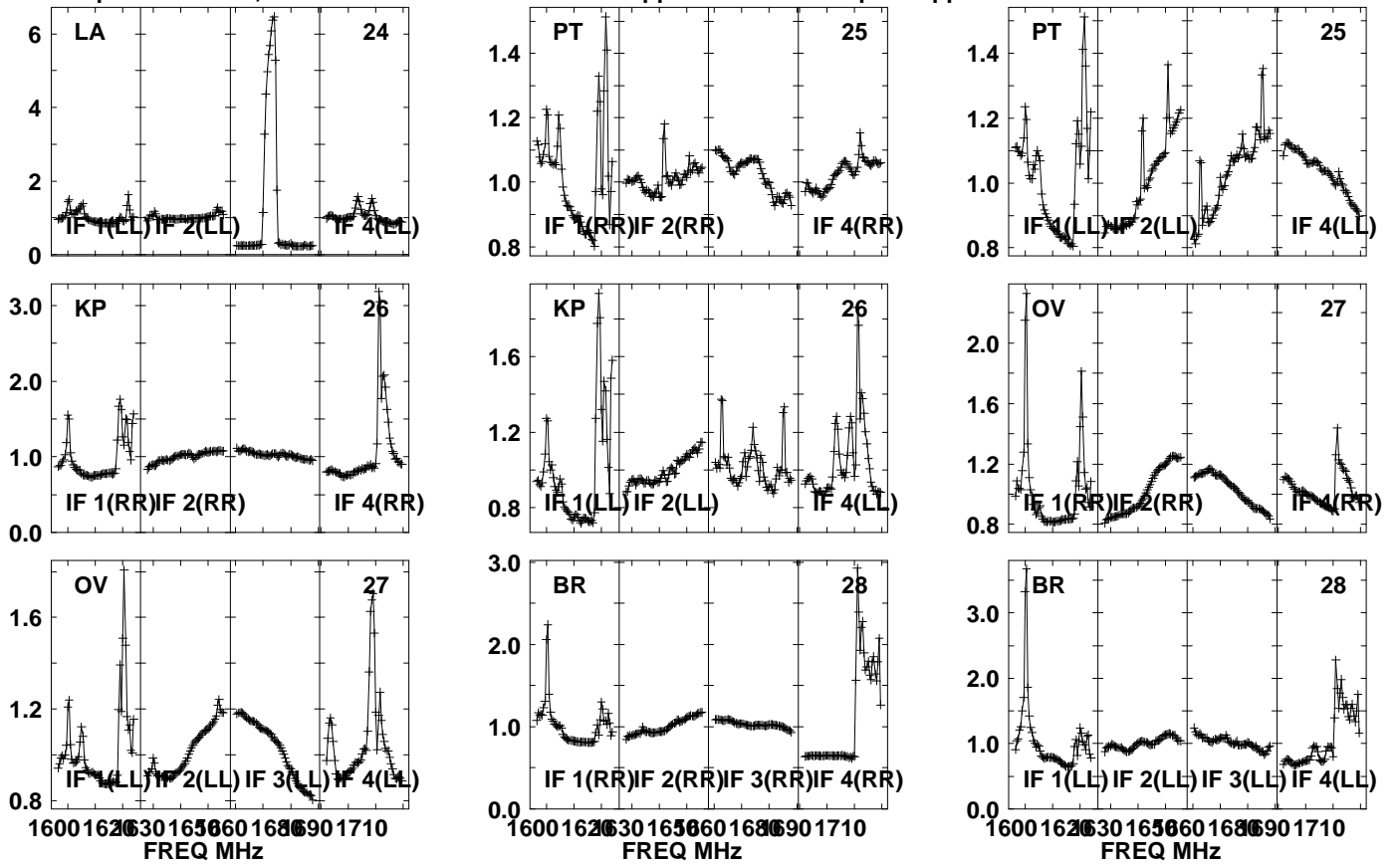

Lower frame: Real Jy  
Auto-corr total-power spectrum Antenna: \*  
Timerange: 00/23:08:39 to 00/23:11:59



Plot file version1499 created 05-OCT-2021 17:11:58

APM08279+525 GM076.UVDATA.1

Freq = 1.5945 GHz, Bw = 32.000 MH No calibration applied and no bandpass applied

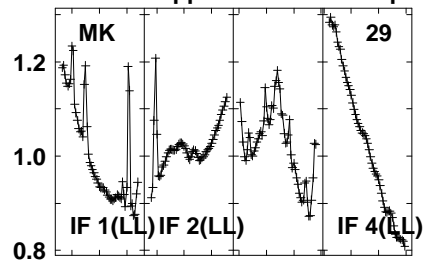
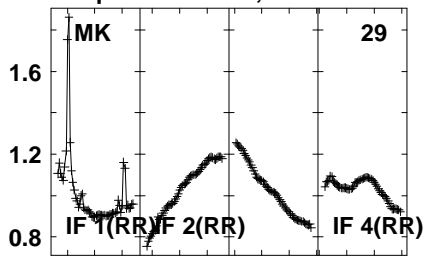

Lower frame: Real Jy  
Auto-corr total-power spectrum Antenna: \*  
Timerange: 00/23:08:39 to 00/23:11:59

Plot file version1500 created 05-OCT-2021 17:11:59

J0827+5217 GM076.UVDATA.1

Freq = 1.5945 GHz, Bw = 32.000 MH No calibration applied and no bandpass applied

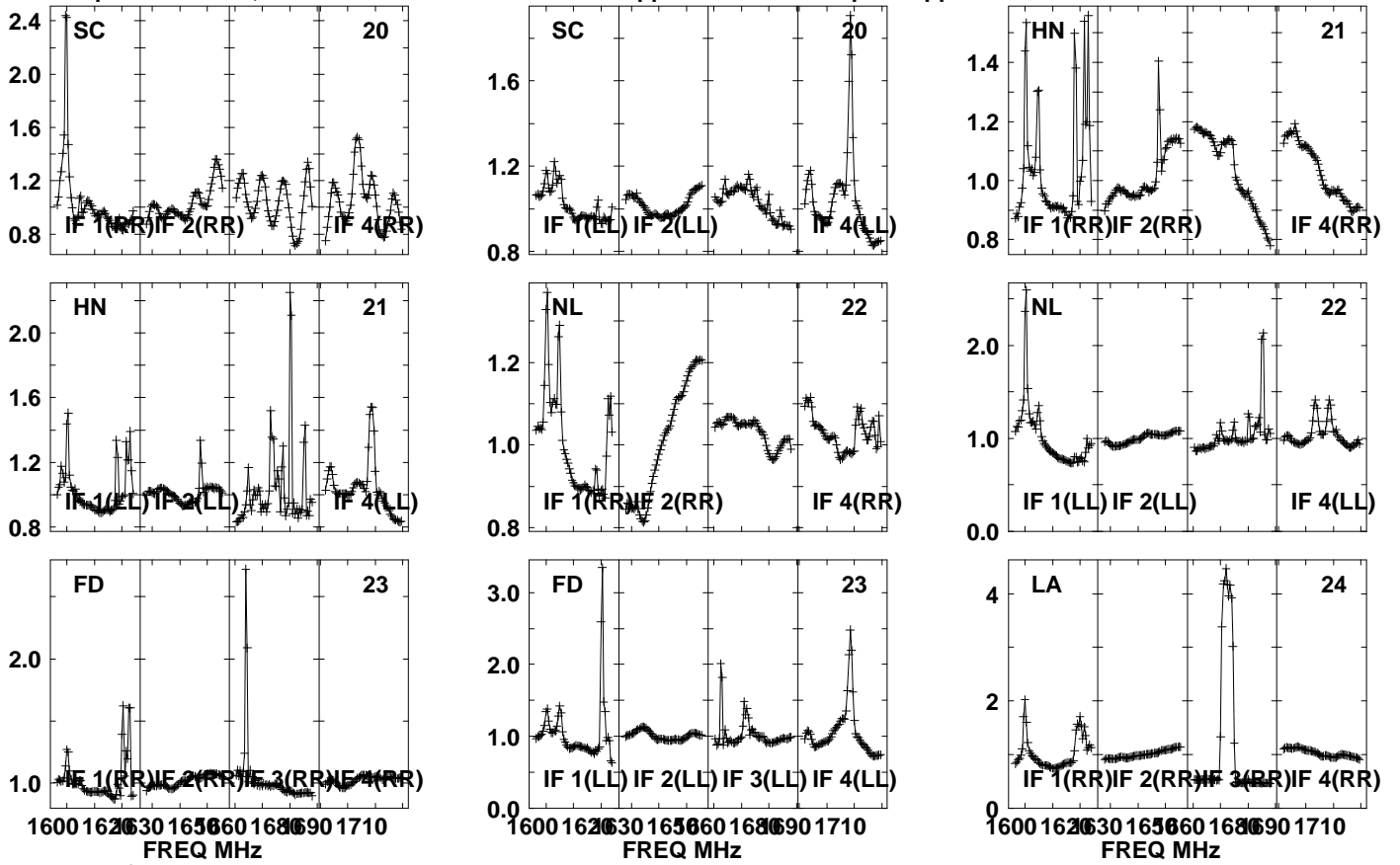

Lower frame: Real Jy

Auto-corr total-power spectrum Antenna: \*

Timerange: 00/23:12:31 to 00/23:13:59

Plot file version1501 created 05-OCT-2021 17:11:59

J0827+5217 GM076.UVDATA.1

Freq = 1.5945 GHz, Bw = 32.000 MH No calibration applied and no bandpass applied

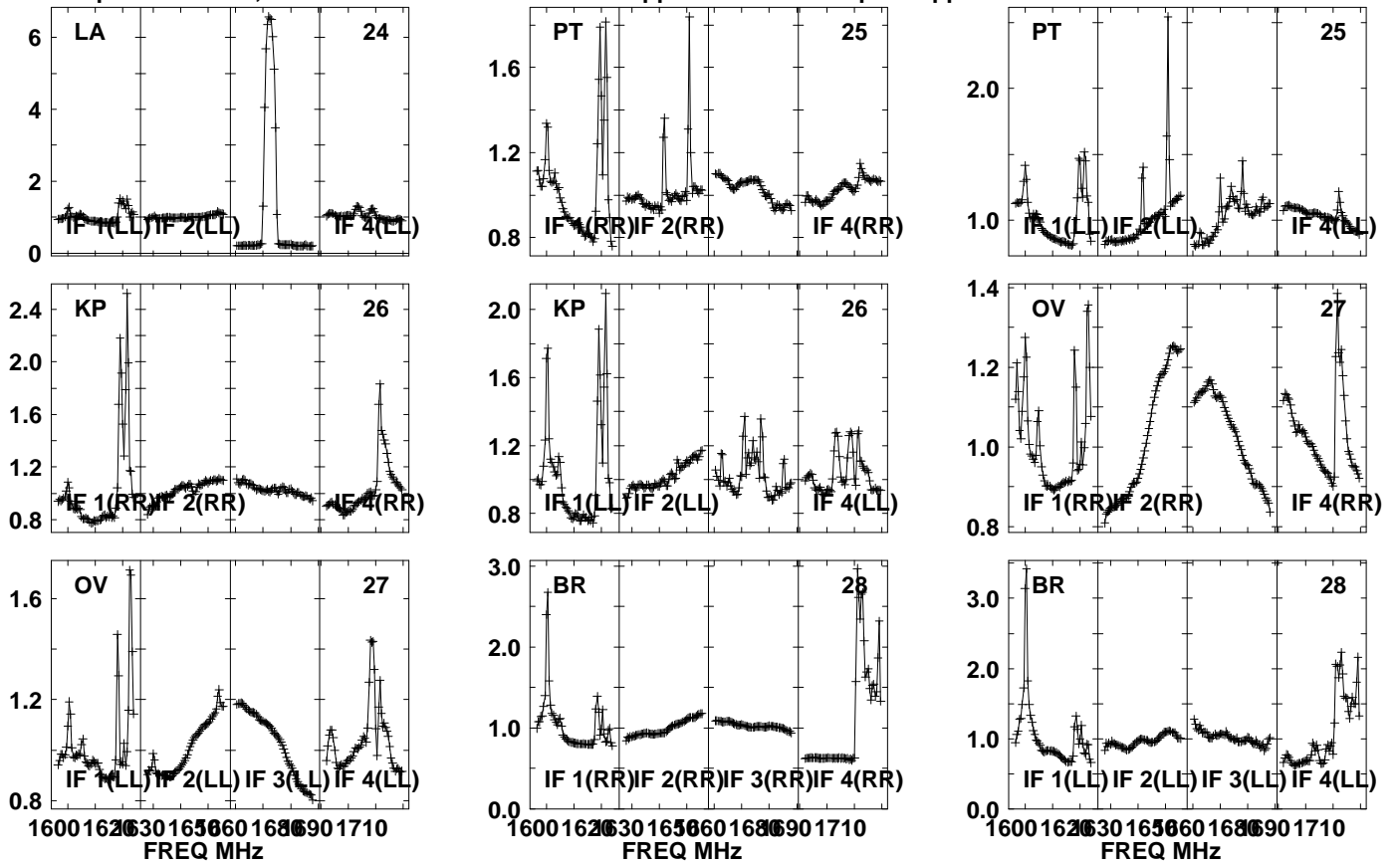

Lower frame: Real Jy

Auto-corr total-power spectrum Antenna: \*

Timerange: 00/23:12:31 to 00/23:13:59

Plot file version1502 created 05-OCT-2021 17:11:59

J0827+5217 GM076.UVDATA.1

Freq = 1.5945 GHz, Bw = 32.000 MH No calibration applied and no bandpass applied

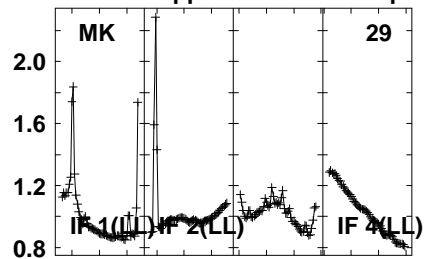
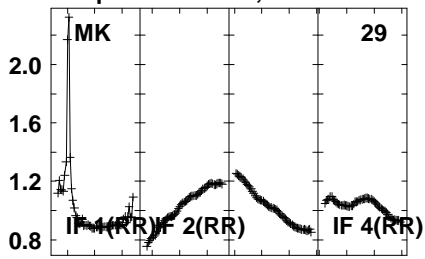

Lower frame: Real Jy  
Auto-corr total-power spectrum Antenna: \*  
Timerange: 00/23:12:31 to 00/23:13:59

Plot file version1503 created 05-OCT-2021 17:11:59

APM08279+525 GM076.UVDATA.1

Freq = 1.5945 GHz, Bw = 32.000 MH No calibration applied and no bandpass applied

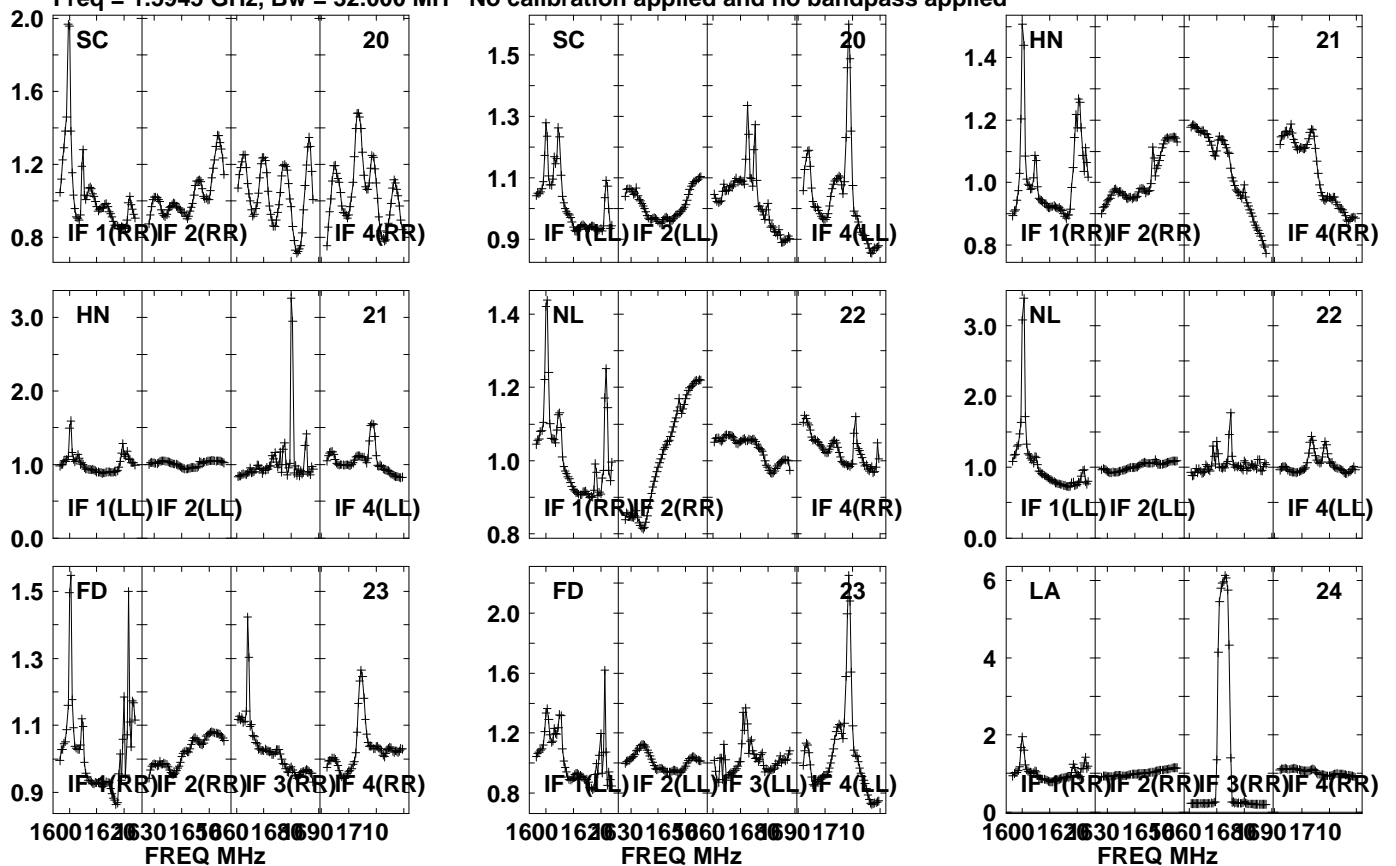

Lower frame: Real Jy  
Auto-corr total-power spectrum Antenna: \*  
Timerange: 00/23:14:09 to 00/23:17:29

Plot file version1504 created 05-OCT-2021 17:11:59

APM08279+525 GM076.UVDATA.1

Freq = 1.5945 GHz, Bw = 32.000 MH No calibration applied and no bandpass applied

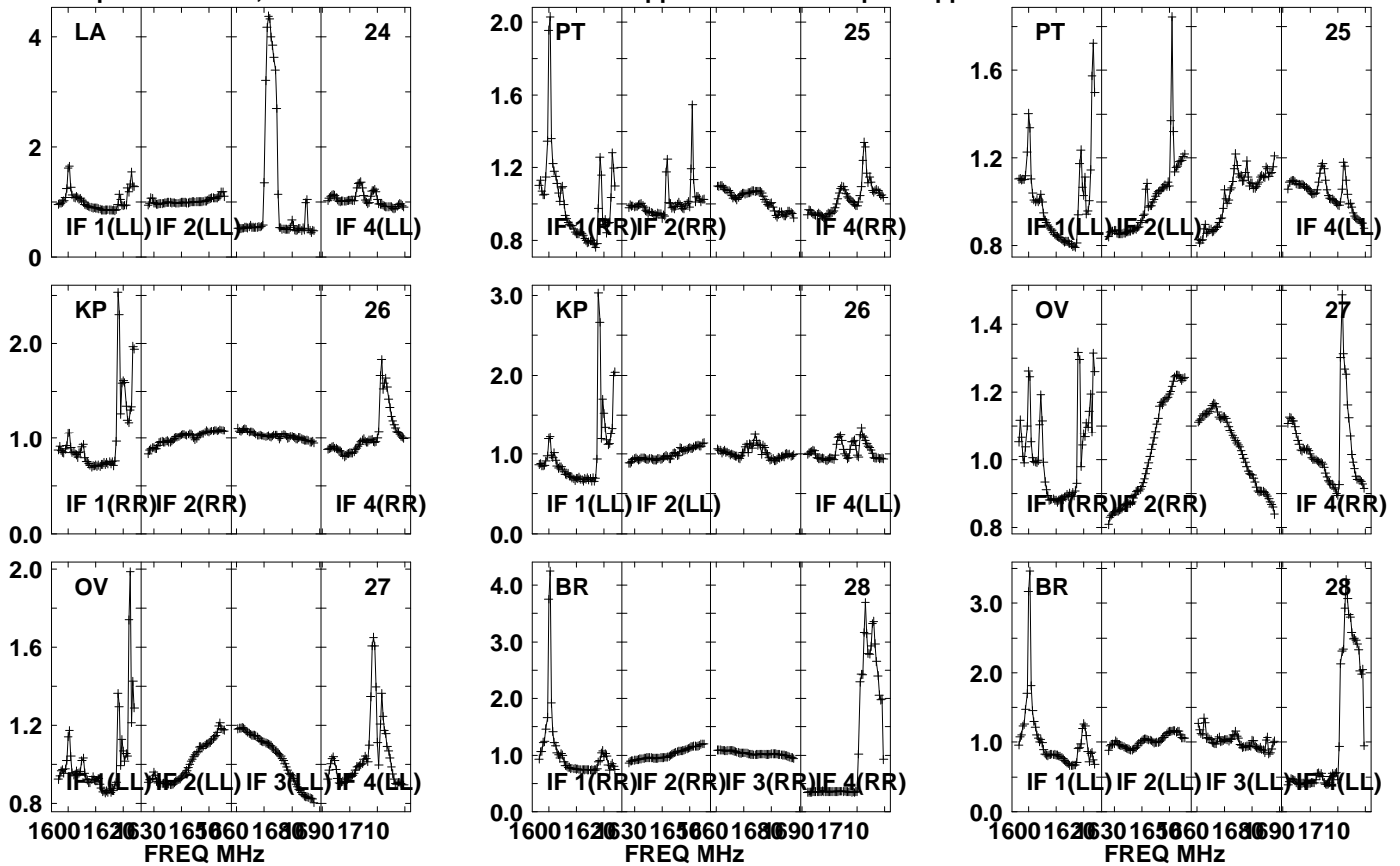

Lower frame: Real Jy

Auto-corr total-power spectrum Antenna: \*

Timerange: 00/23:14:09 to 00/23:17:29

Plot file version1505 created 05-OCT-2021 17:11:59

APM08279+525 GM076.UVDATA.1

Freq = 1.5945 GHz, Bw = 32.000 MH No calibration applied and no bandpass applied

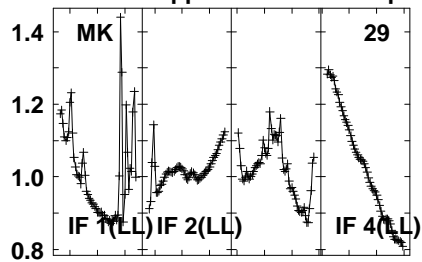
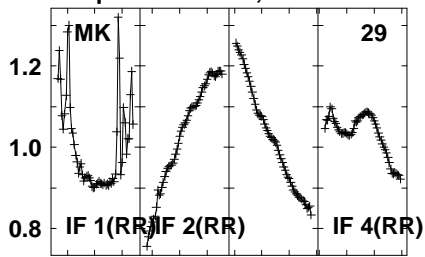

Lower frame: Real Jy  
Auto-corr total-power spectrum Antenna: \*  
Timerange: 00/23:14:09 to 00/23:17:29

Plot file version1506 created 05-OCT-2021 17:11:59

J0827+5217 GM076.UVDATA.1

Freq = 1.5945 GHz, Bw = 32.000 MH No calibration applied and no bandpass applied

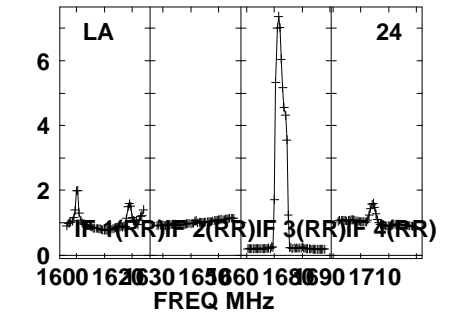
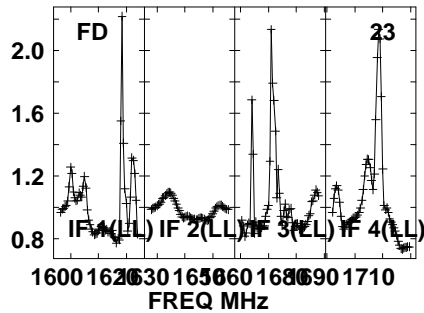
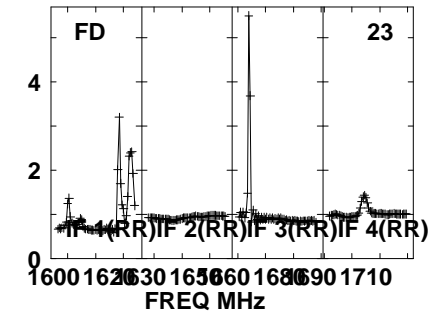
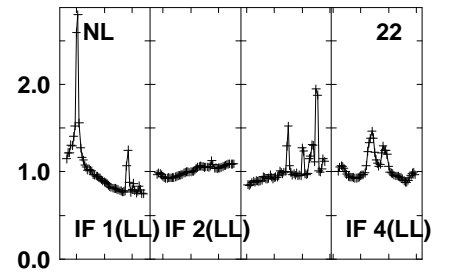
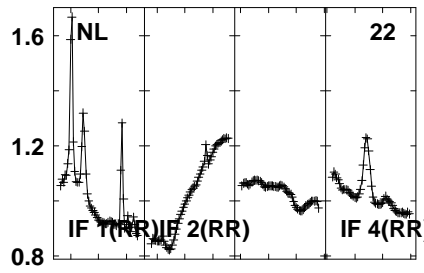
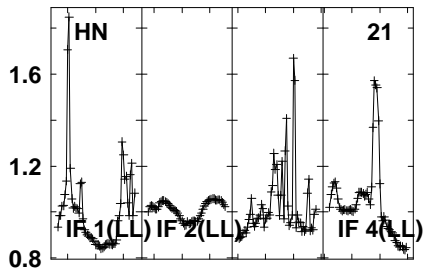
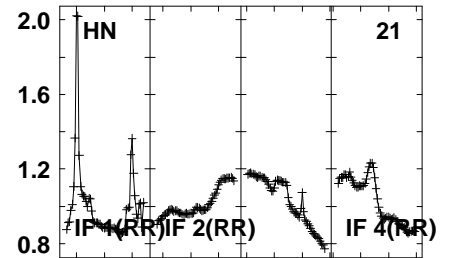
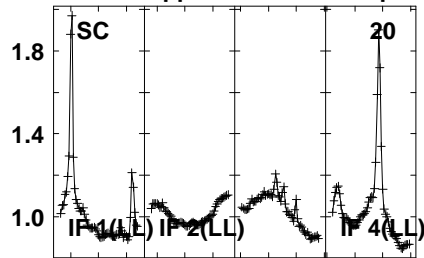
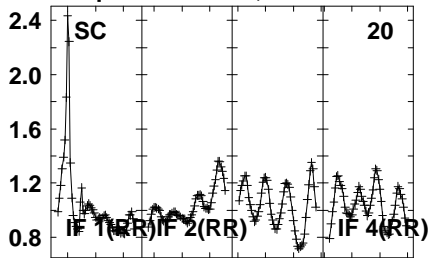

Lower frame: Real Jy

Auto-corr total-power spectrum Antenna: \*

Timerange: 00/23:18:01 to 00/23:19:29



Plot file version1507 created 05-OCT-2021 17:11:59

J0827+5217 GM076.UVDATA.1

Freq = 1.5945 GHz, Bw = 32.000 MH No calibration applied and no bandpass applied

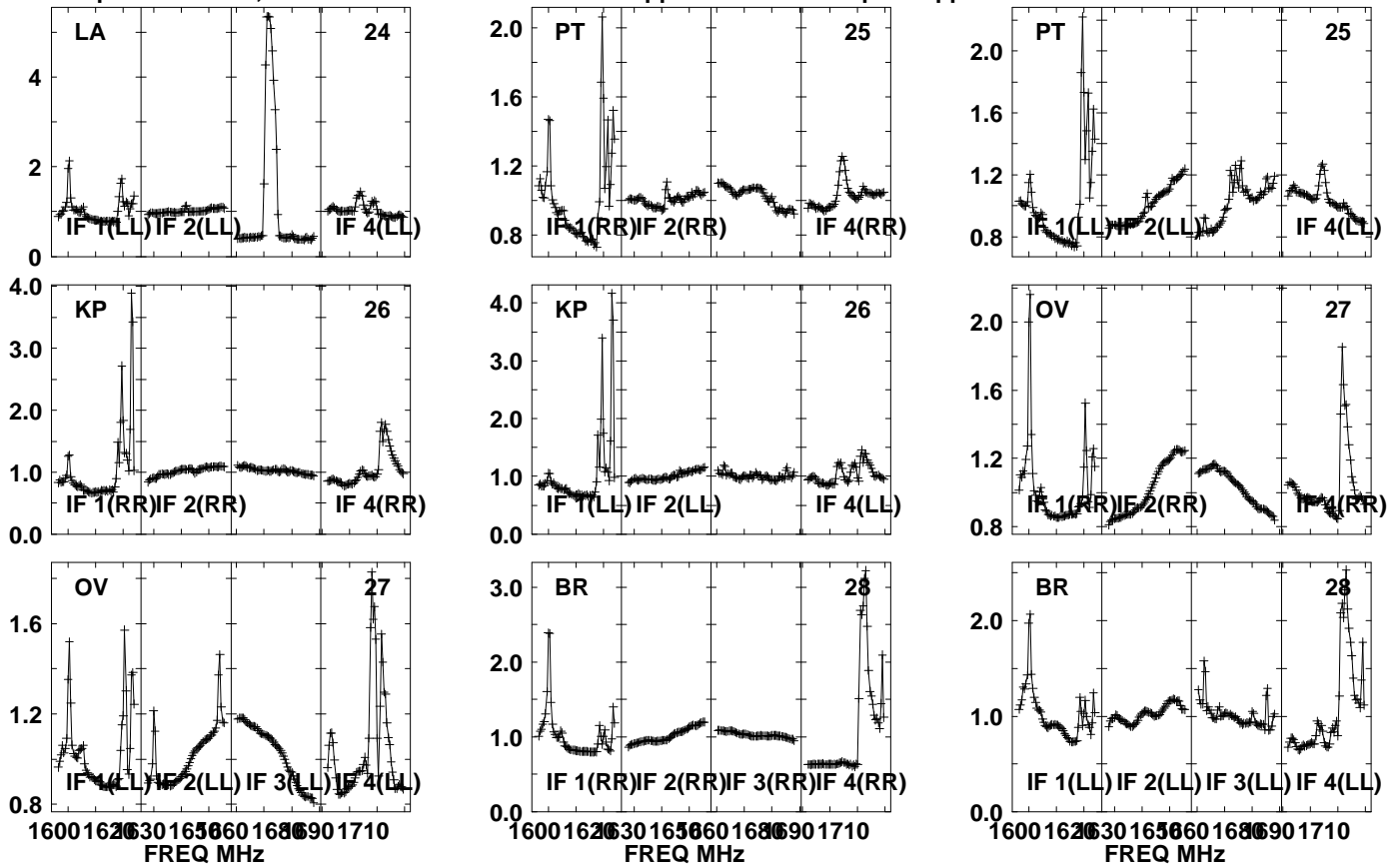

Lower frame: Real Jy  
Auto-corr total-power spectrum Antenna: \*  
Timerange: 00/23:18:01 to 00/23:19:29

Plot file version1508 created 05-OCT-2021 17:11:59  
J0827+5217 GM076.UVDATA.1  
Freq = 1.5945 GHz, Bw = 32.000 MH No calibration applied and no bandpass applied

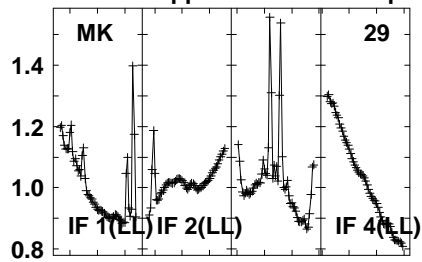
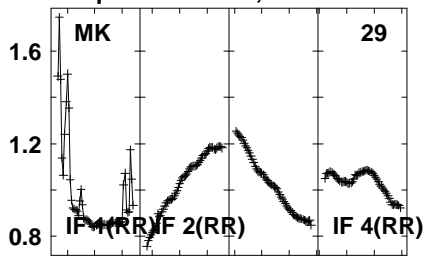

Lower frame: Real Jy  
Auto-corr total-power spectrum Antenna: \*  
Timerange: 00/23:18:01 to 00/23:19:29

Plot file version1509 created 05-OCT-2021 17:11:59

APM08279+525 GM076.UVDATA.1

Freq = 1.5945 GHz, Bw = 32.000 MH No calibration applied and no bandpass applied

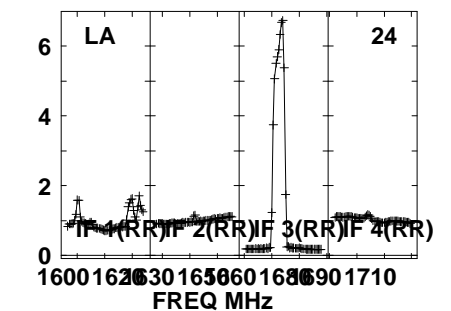
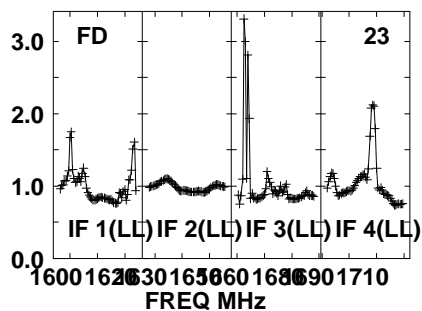
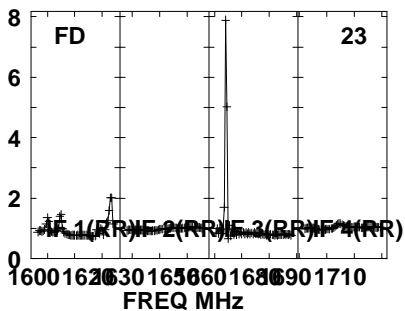
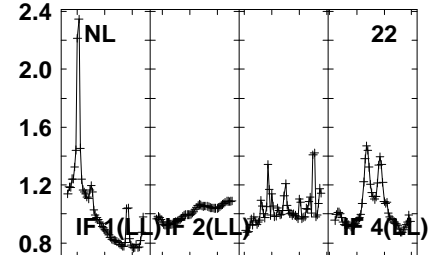
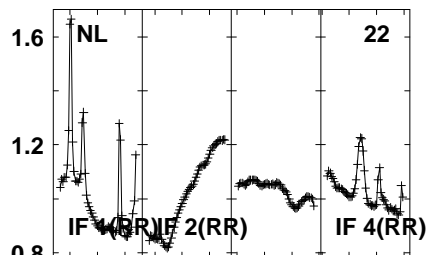
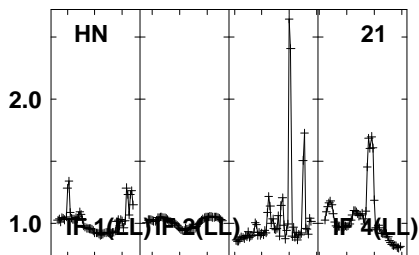
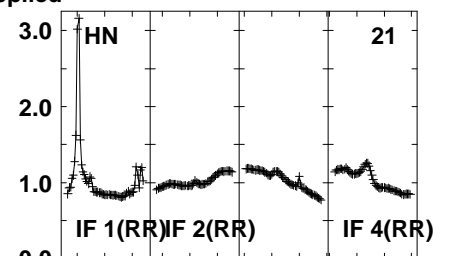
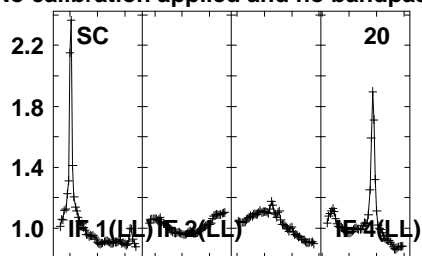
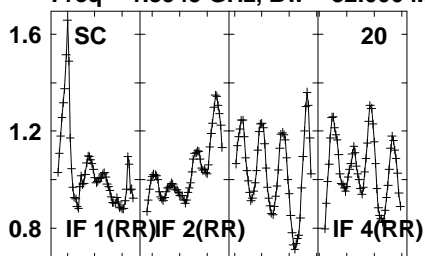

Lower frame: Real Jy  
Auto-corr total-power spectrum Antenna: \*  
Timerange: 00/23:19:39 to 00/23:22:59

Plot file version1510 created 05-OCT-2021 17:12:00

APM08279+525 GM076.UVDATA.1

Freq = 1.5945 GHz, Bw = 32.000 MH No calibration applied and no bandpass applied

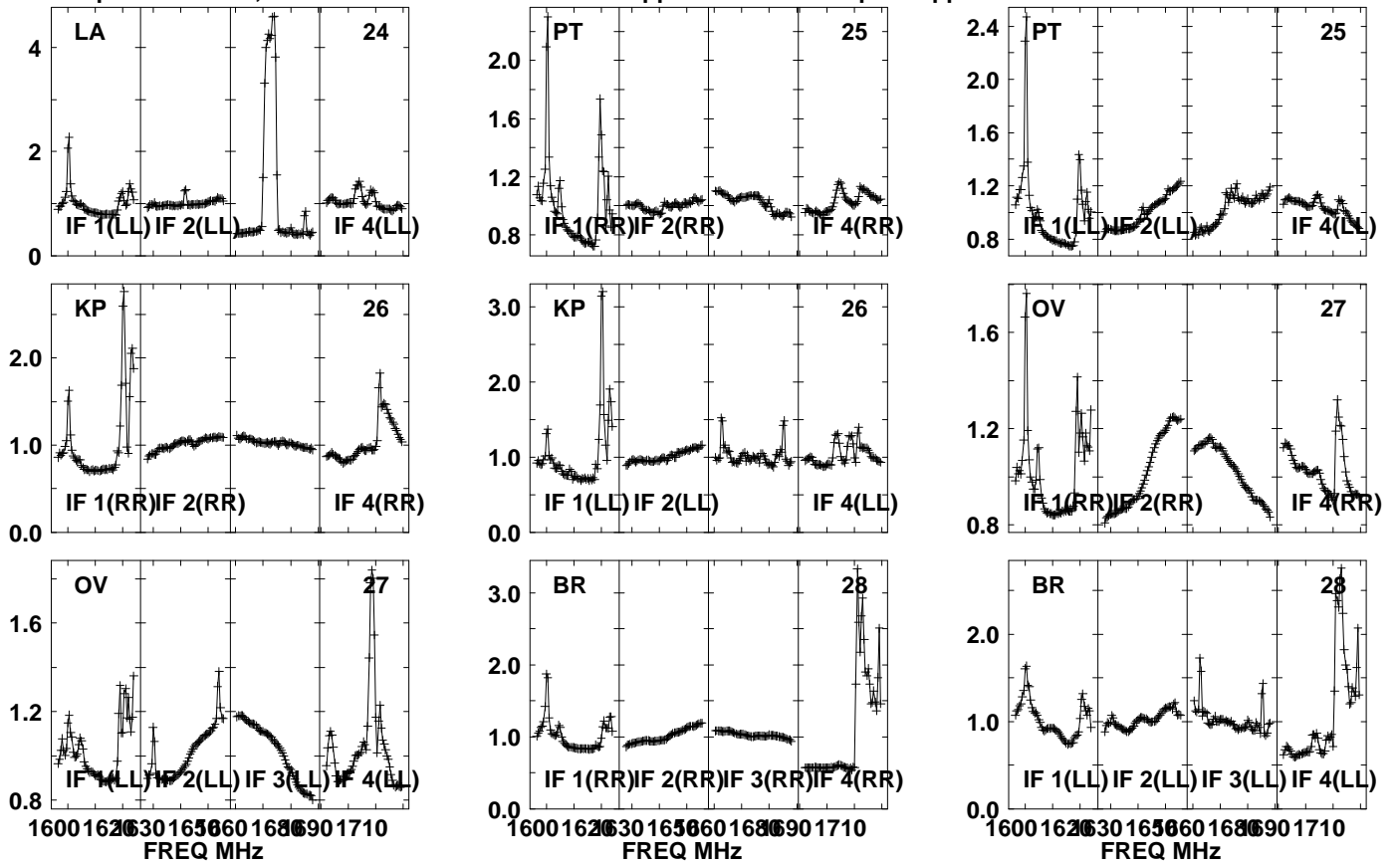

Lower frame: Real Jy  
Auto-corr total-power spectrum Antenna: \*  
Timerange: 00/23:19:39 to 00/23:22:59

Plot file version1511 created 05-OCT-2021 17:12:00

APM08279+525 GM076.UVDATA.1

Freq = 1.5945 GHz, Bw = 32.000 MH No calibration applied and no bandpass applied

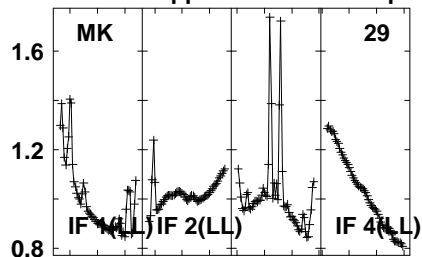
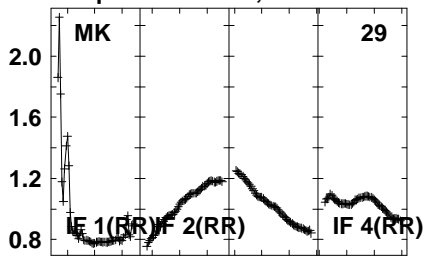

Lower frame: Real Jy  
Auto-corr total-power spectrum Antenna: \*  
Timerange: 00/23:19:39 to 00/23:22:59

Plot file version 1512 created 05-OCT-2021 17:12:00

J0827+5217 GM076.UVDATA.1

Freq = 1.5945 GHz, Bw = 32.000 MH No calibration applied and no bandpass applied

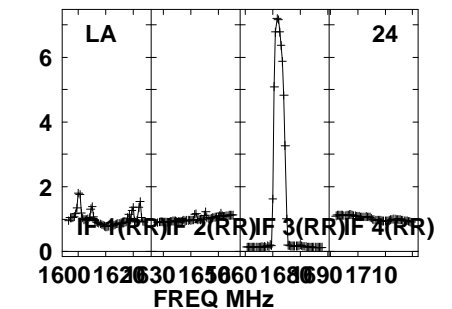
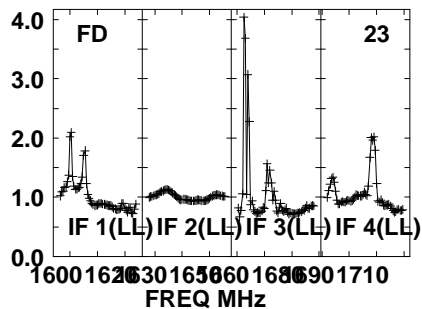
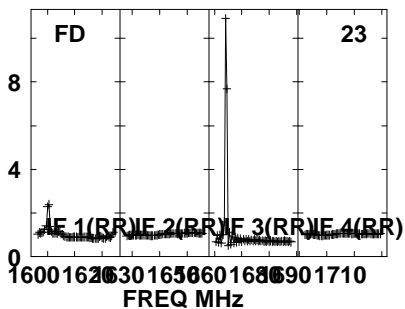
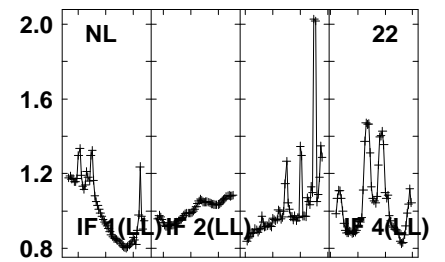
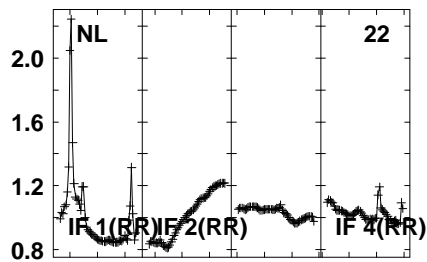
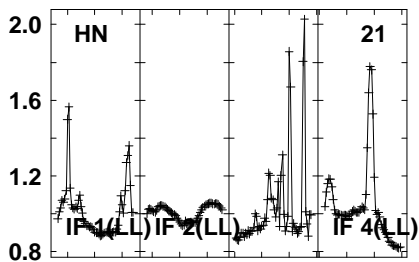
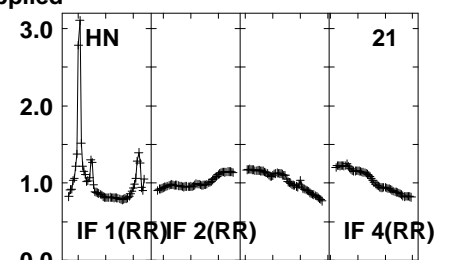
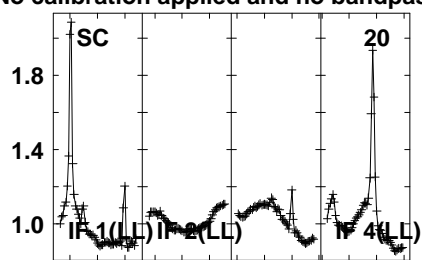
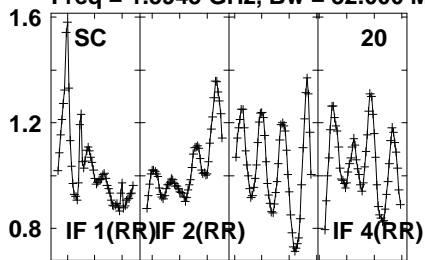

Lower frame: Real Jy  
Auto-corr total-power spectrum Antenna: \*  
Timerange: 00/23:23:31 to 00/23:24:59

Plot file version1513 created 05-OCT-2021 17:12:00

J0827+5217 GM076.UVDATA.1

Freq = 1.5945 GHz, Bw = 32.000 MH No calibration applied and no bandpass applied

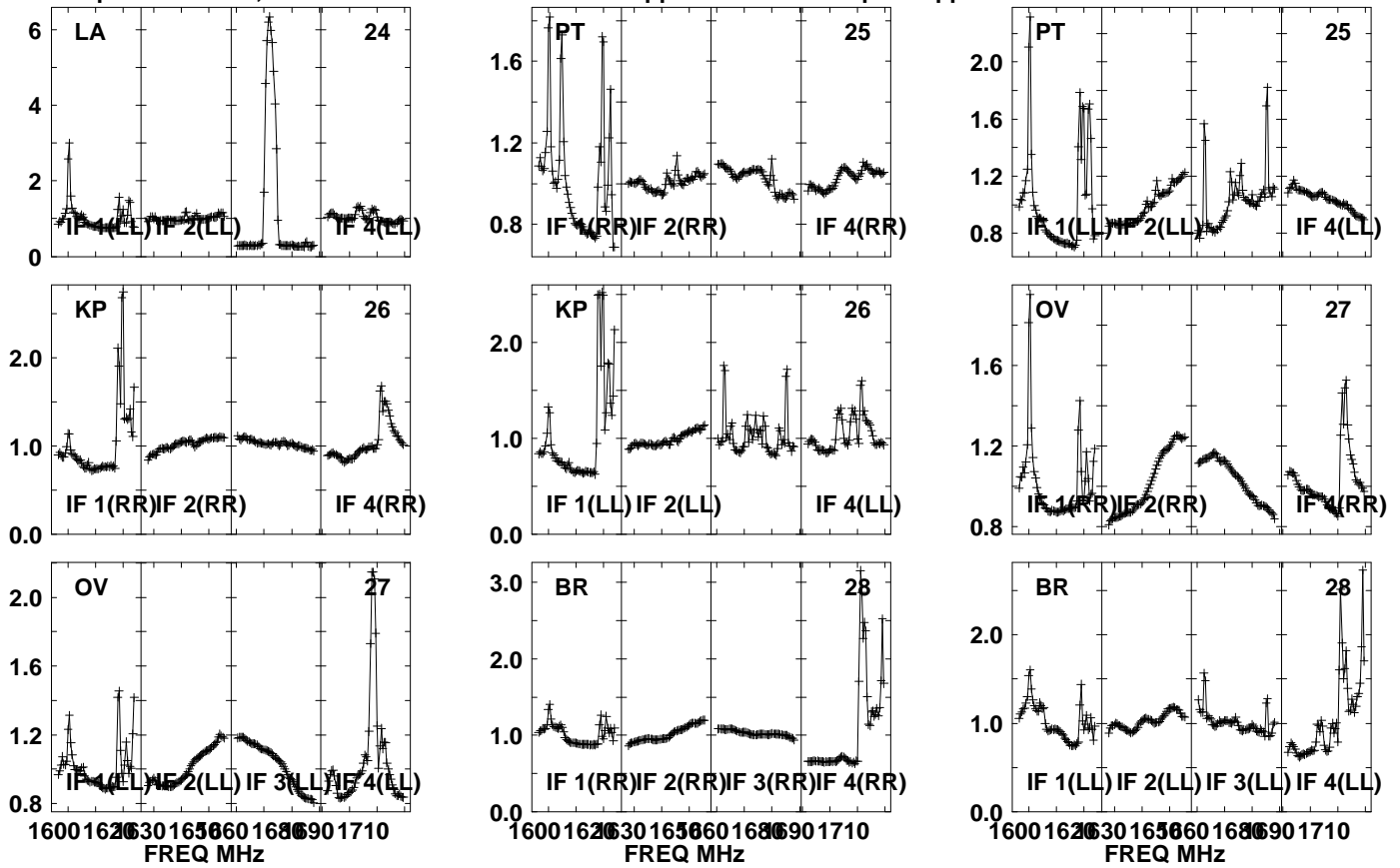

Lower frame: Real Jy

Auto-corr total-power spectrum Antenna: \*

Timerange: 00/23:23:31 to 00/23:24:59

Plot file version1514 created 05-OCT-2021 17:12:00

J0827+5217 GM076.UVDATA.1

Freq = 1.5945 GHz, Bw = 32.000 MH No calibration applied and no bandpass applied

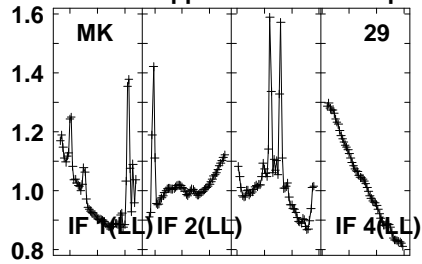
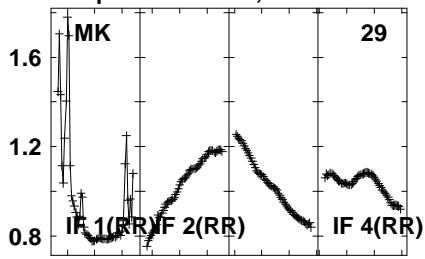

Lower frame: Real Jy  
Auto-corr total-power spectrum Antenna: \*  
Timerange: 00/23:23:31 to 00/23:24:59



Plot file version1515 created 05-OCT-2021 17:12:00

APM08279+525 GM076.UVDATA.1

Freq = 1.5945 GHz, Bw = 32.000 MH No calibration applied and no bandpass applied

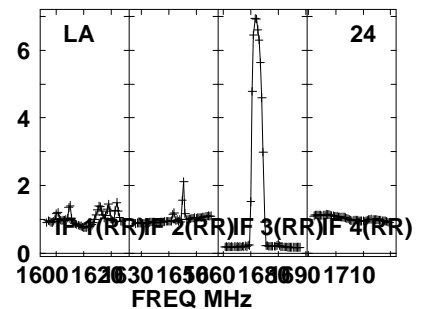
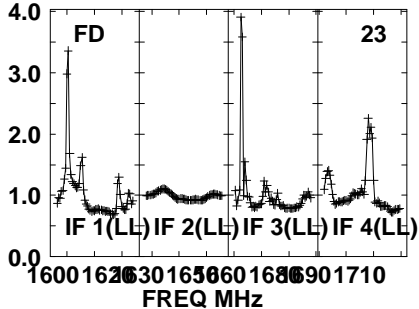
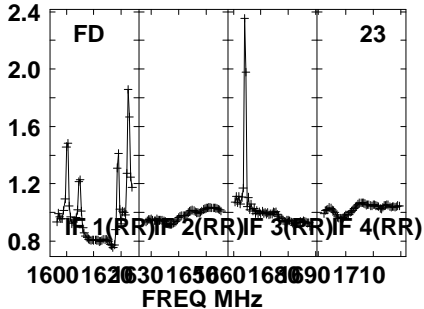
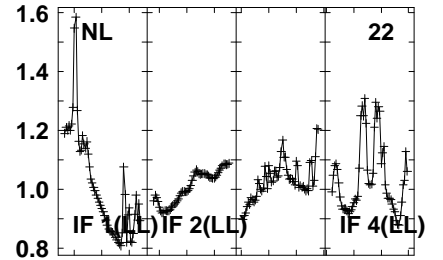
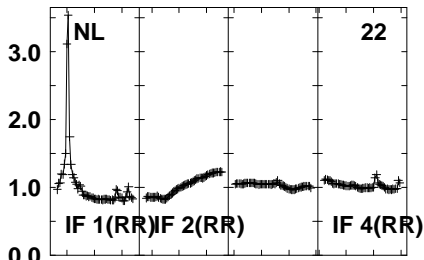
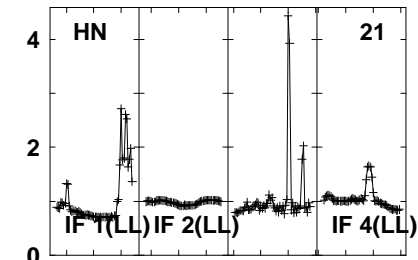
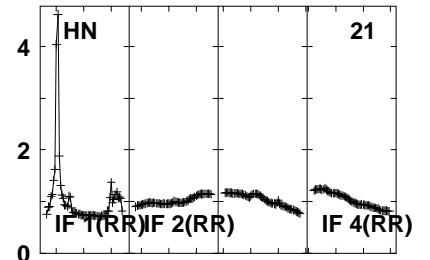
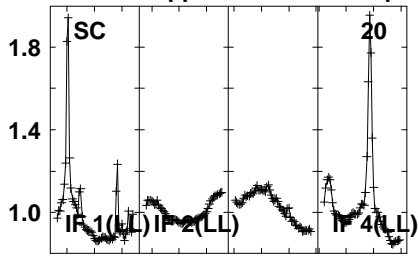
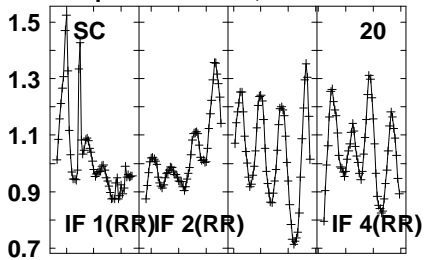

Lower frame: Real Jy  
Auto-corr total-power spectrum Antenna: \*  
Timerange: 00/23:25:09 to 00/23:28:29

Plot file version 1516 created 05-OCT-2021 17:12:00

APM08279+525 GM076.UVDATA.1

Freq = 1.5945 GHz, Bw = 32.000 MH No calibration applied and no bandpass applied

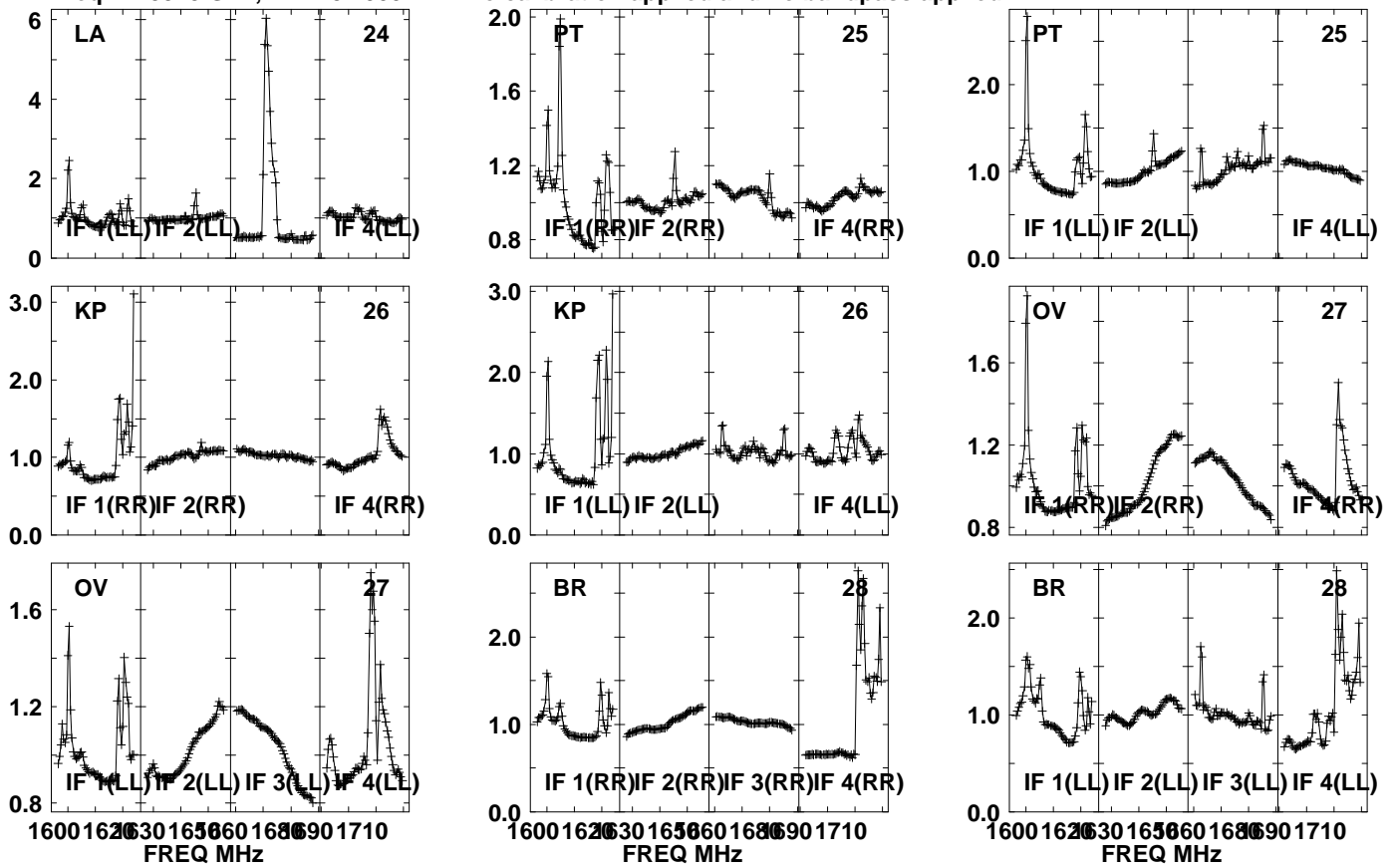

Lower frame: Real Jy  
Auto-corr total-power spectrum Antenna: \*  
Timerange: 00/23:25:09 to 00/23:28:29

Plot file version1517 created 05-OCT-2021 17:12:00

APM08279+525 GM076.UVDATA.1

Freq = 1.5945 GHz, Bw = 32.000 MH No calibration applied and no bandpass applied

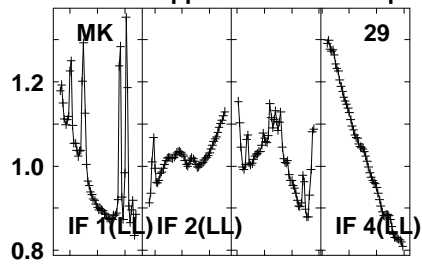
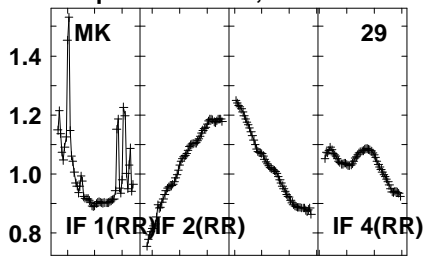

Lower frame: Real Jy  
Auto-corr total-power spectrum Antenna: \*  
Timerange: 00/23:25:09 to 00/23:28:29

Plot file version1518 created 05-OCT-2021 17:12:01

J0827+5217 GM076.UVDATA.1

Freq = 1.5945 GHz, Bw = 32.000 MH No calibration applied and no bandpass applied

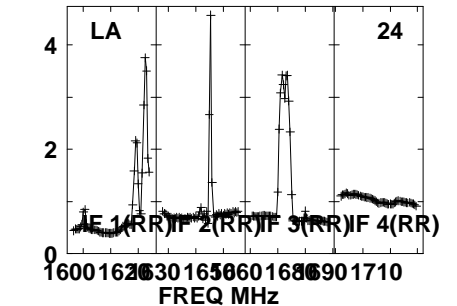
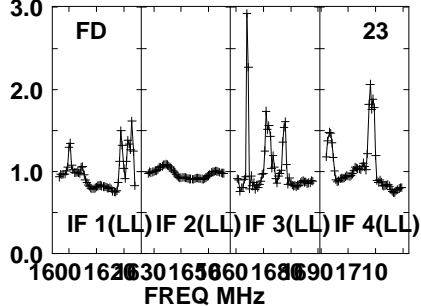
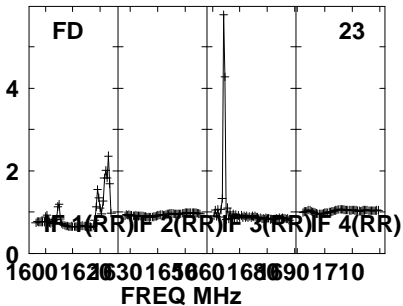
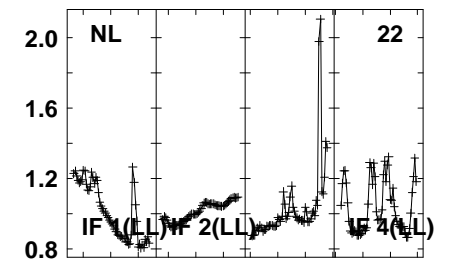
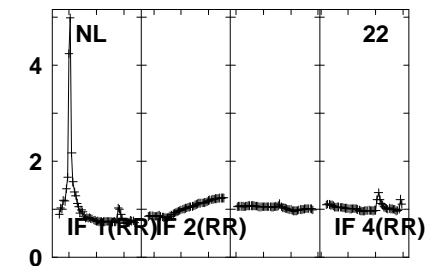
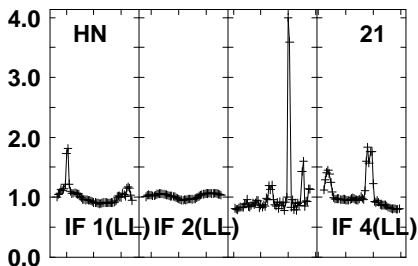
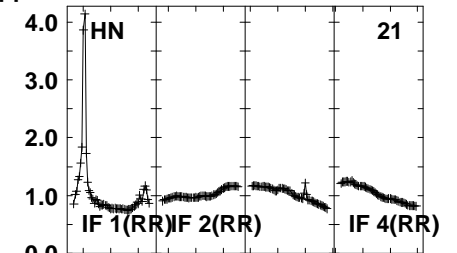
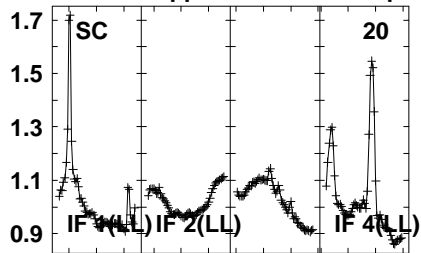
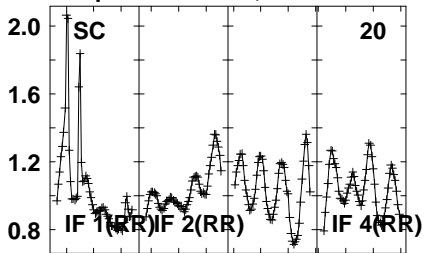

Lower frame: Real Jy  
Auto-corr total-power spectrum Antenna: \*  
Timerange: 00/23:29:01 to 00/23:30:29

Plot file version1519 created 05-OCT-2021 17:12:01

J0827+5217 GM076.UVDATA.1

Freq = 1.5945 GHz, Bw = 32.000 MH No calibration applied and no bandpass applied

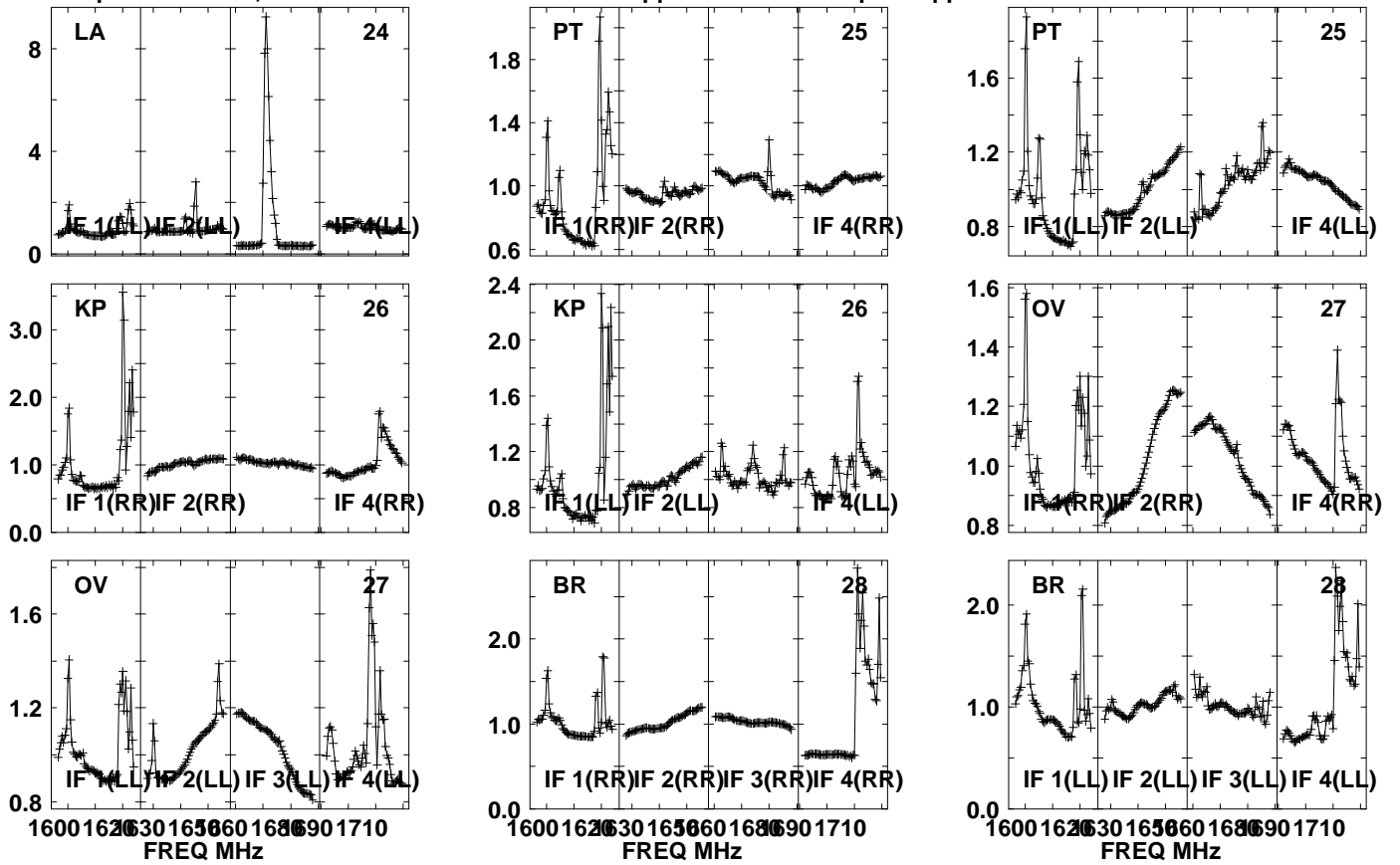

Lower frame: Real Jy  
Auto-corr total-power spectrum Antenna: \*  
Timerange: 00/23:29:01 to 00/23:30:29

Plot file version1520 created 05-OCT-2021 17:12:01  
J0827+5217 GM076.UVDATA.1  
Freq = 1.5945 GHz, Bw = 32.000 MH No calibration applied and no bandpass applied

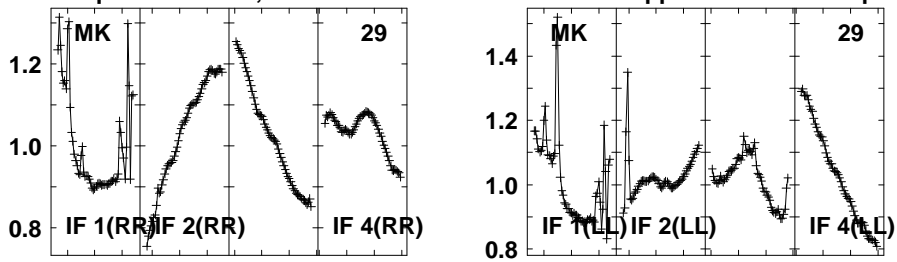

Lower frame: Real Jy  
Auto-corr total-power spectrum Antenna: \*  
Timerange: 00/23:29:01 to 00/23:30:29

Plot file version1521 created 05-OCT-2021 17:12:01

APM08279+525 GM076.UVDATA.1

Freq = 1.5945 GHz, Bw = 32.000 MH No calibration applied and no bandpass applied

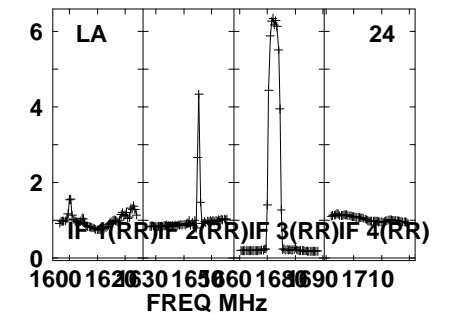
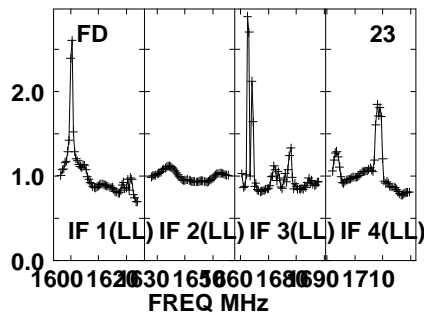
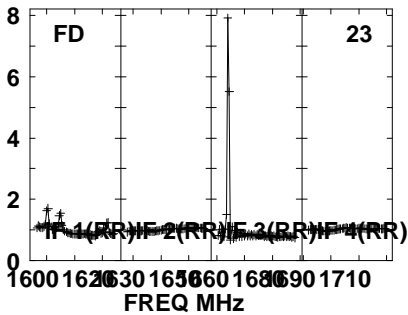
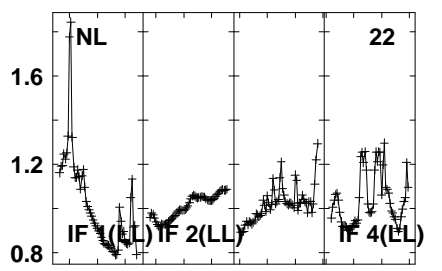
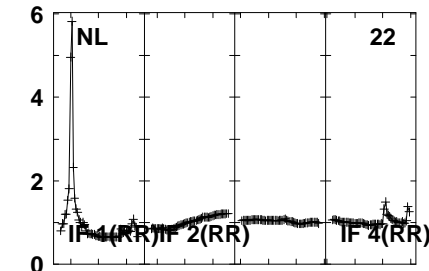
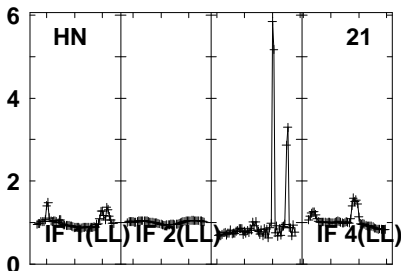
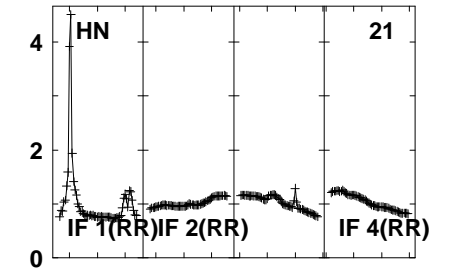
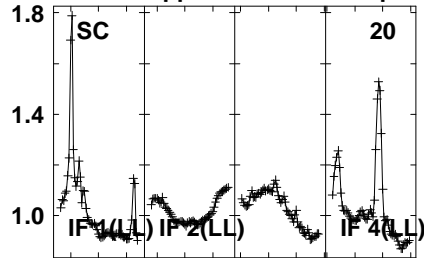
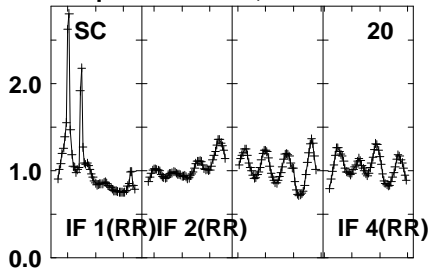

Lower frame: Real Jy

Auto-corr total-power spectrum Antenna: \*

Timerange: 00/23:30:39 to 00/23:33:59

Plot file version1522 created 05-OCT-2021 17:12:01

APM08279+525 GM076.UVDATA.1

Freq = 1.5945 GHz, Bw = 32.000 MH No calibration applied and no bandpass applied

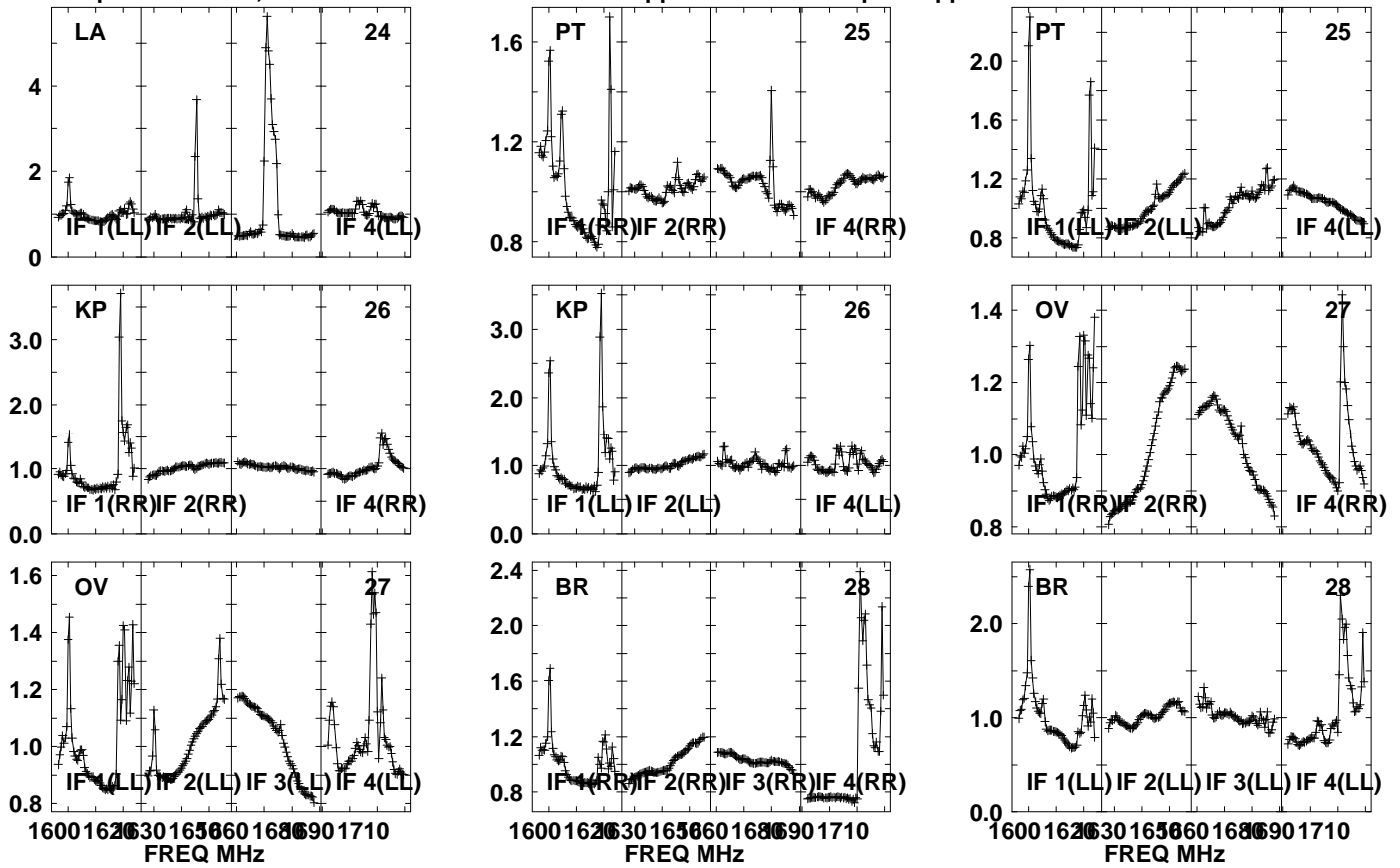

Lower frame: Real Jy

Auto-corr total-power spectrum Antenna: \*

Timerange: 00/23:30:39 to 00/23:33:59



Plot file version1523 created 05-OCT-2021 17:12:01

APM08279+525 GM076.UVDATA.1

Freq = 1.5945 GHz, Bw = 32.000 MH No calibration applied and no bandpass applied

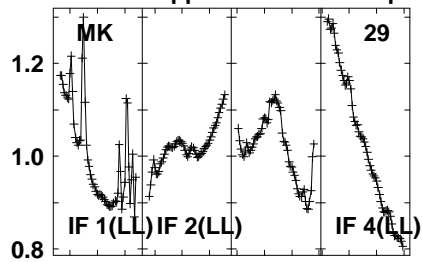
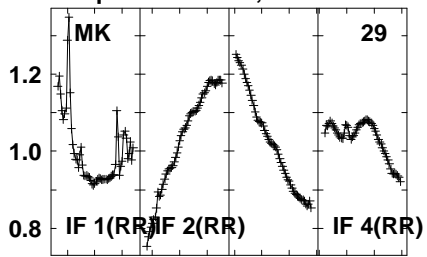

Lower frame: Real Jy  
Auto-corr total-power spectrum Antenna: \*  
Timerange: 00/23:30:39 to 00/23:33:59

Plot file version1524 created 05-OCT-2021 17:12:01

J0827+5217 GM076.UVDATA.1

Freq = 1.5945 GHz, Bw = 32.000 MH No calibration applied and no bandpass applied

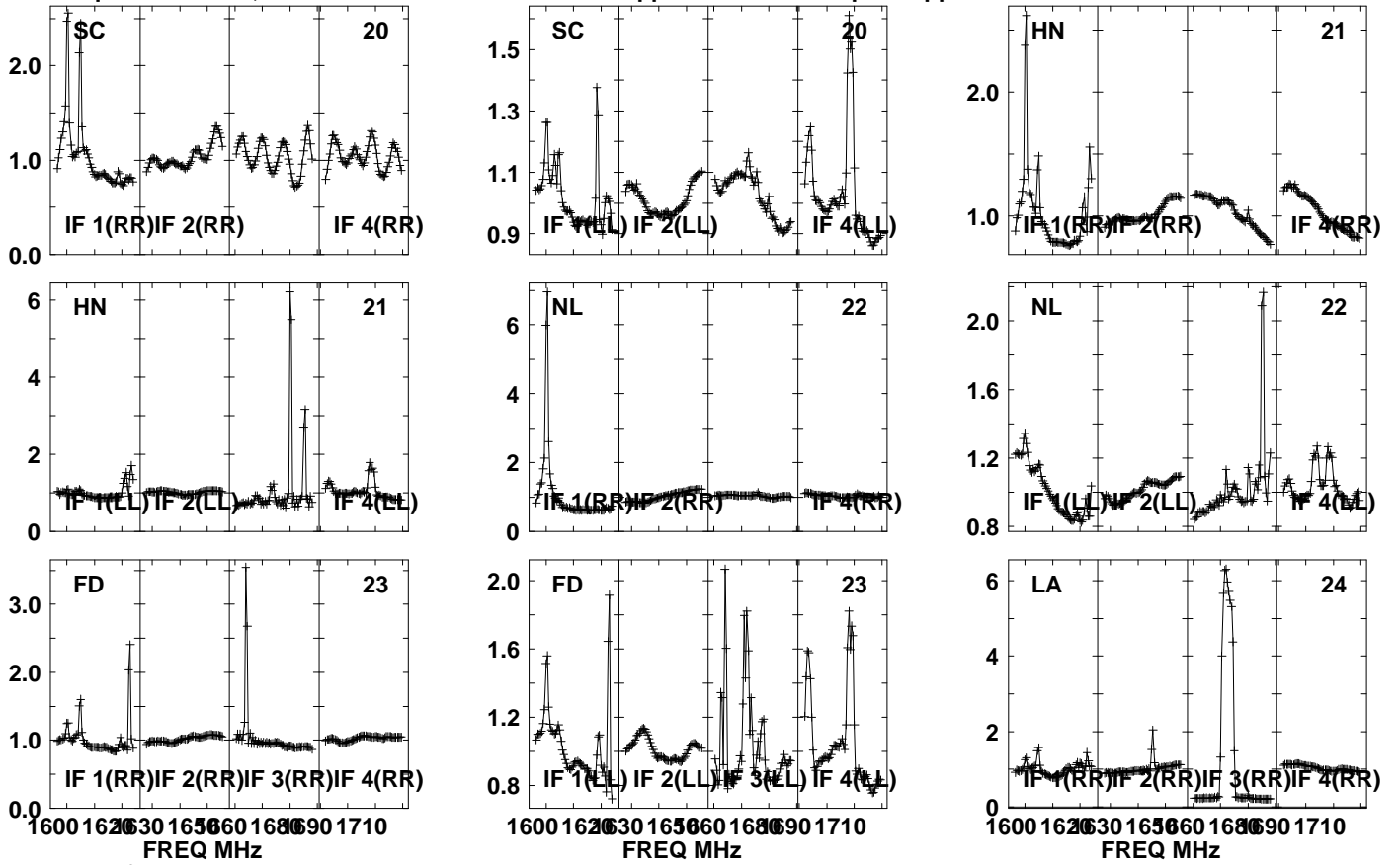

Lower frame: Real Jy

Auto-corr total-power spectrum Antenna: \*

Timerange: 00/23:34:31 to 00/23:35:59

Plot file version1525 created 05-OCT-2021 17:12:01

J0827+5217 GM076.UVDATA.1

Freq = 1.5945 GHz, Bw = 32.000 MH No calibration applied and no bandpass applied

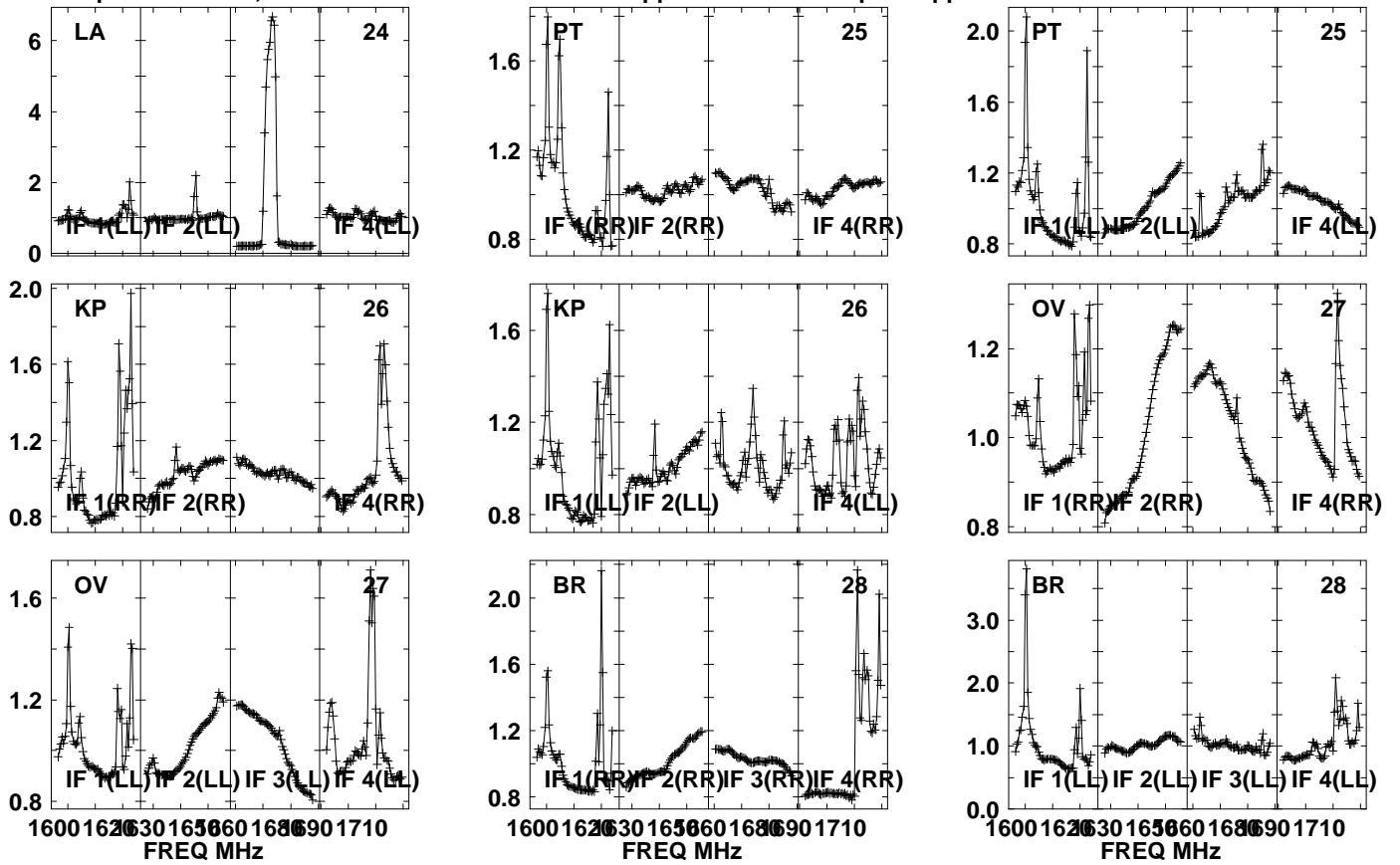

Lower frame: Real Jy

Auto-corr total-power spectrum Antenna: \*

Timerange: 00/23:34:31 to 00/23:35:59

Plot file version1526 created 05-OCT-2021 17:12:01

J0827+5217 GM076.UVDATA.1

Freq = 1.5945 GHz, Bw = 32.000 MH No calibration applied and no bandpass applied

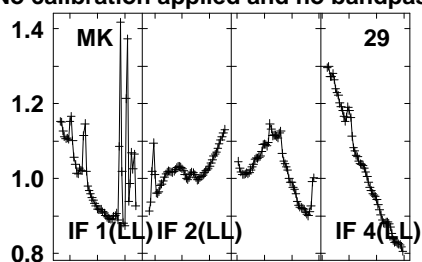
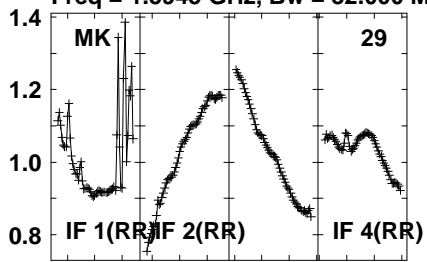

Lower frame: Real Jy  
Auto-corr total-power spectrum Antenna: \*  
Timerange: 00/23:34:31 to 00/23:35:59

Plot file version 1527 created 05-OCT-2021 17:12:02

APM08279+525 GM076.UVDATA.1

Freq = 1.5945 GHz, Bw = 32.000 MH No calibration applied and no bandpass applied

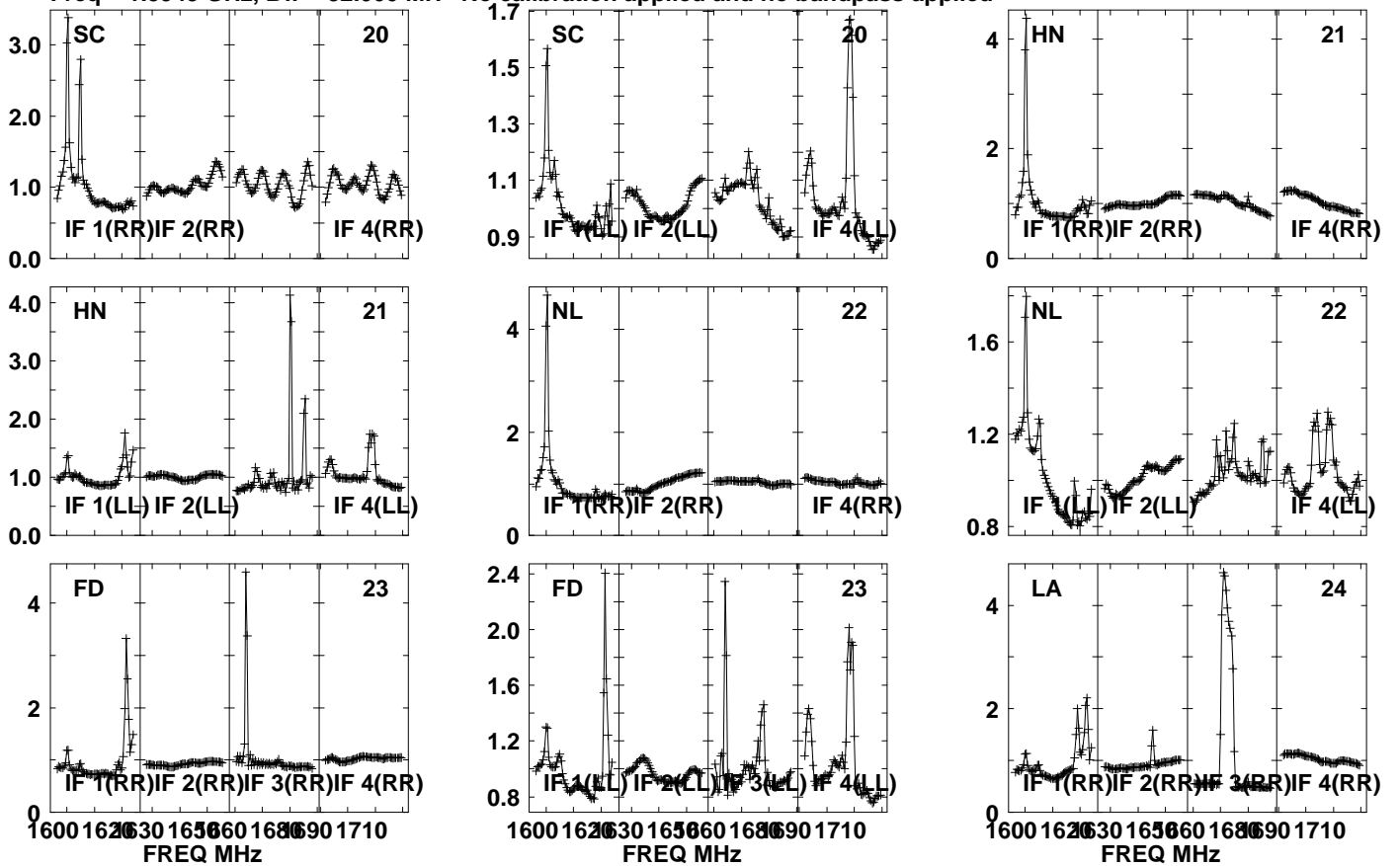

Lower frame: Real Jy  
Auto-corr total-power spectrum Antenna: \*  
Timerange: 00/23:36:11 to 00/23:39:29

Plot file version1528 created 05-OCT-2021 17:12:02

APM08279+525 GM076.UVDATA.1

Freq = 1.5945 GHz, Bw = 32.000 MH No calibration applied and no bandpass applied

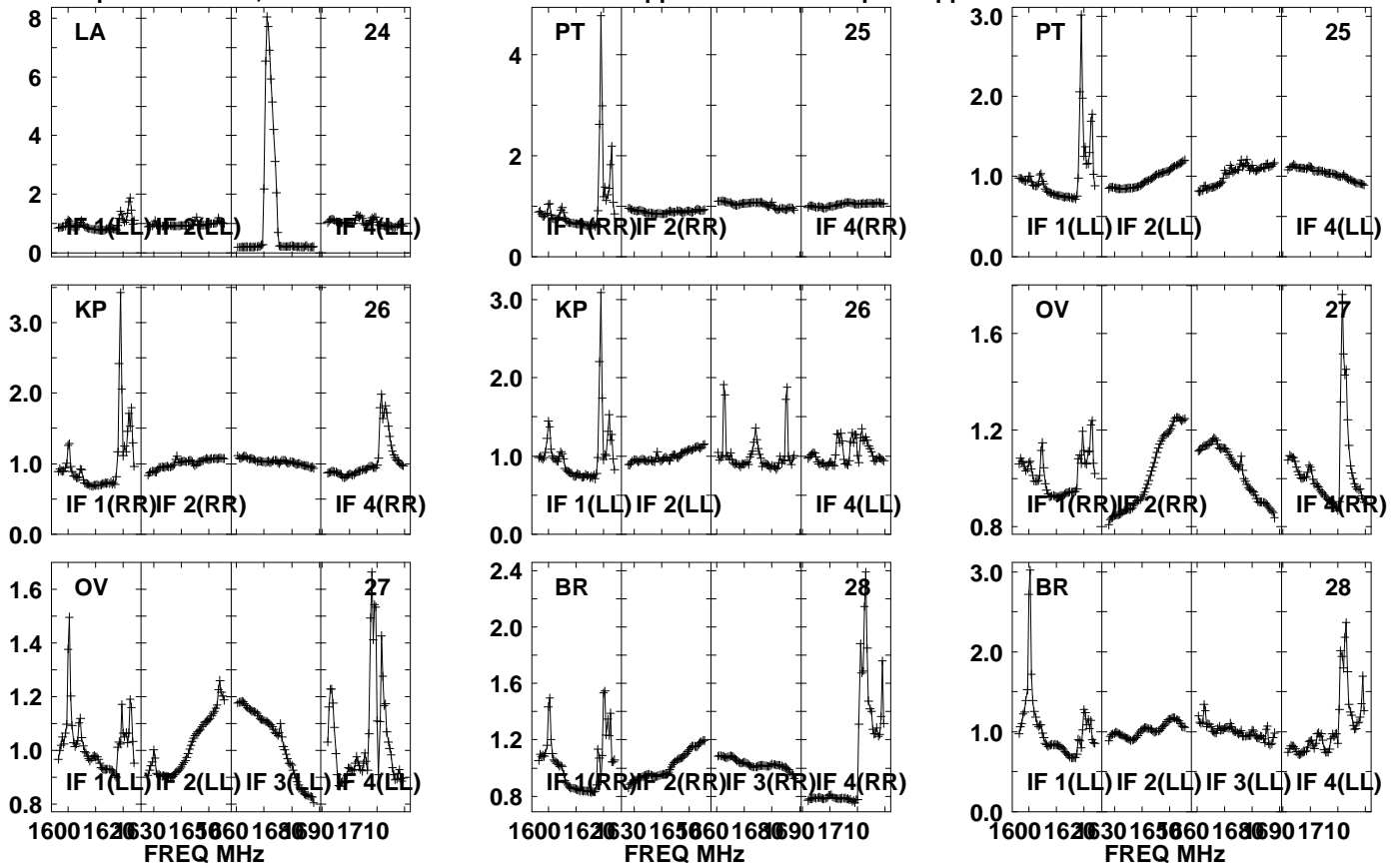

Lower frame: Real Jy  
Auto-corr total-power spectrum Antenna: \*  
Timerange: 00/23:36:11 to 00/23:39:29

Plot file version1529 created 05-OCT-2021 17:12:02  
APM08279+525 GM076.UVDATA.1  
Freq = 1.5945 GHz, Bw = 32.000 MH No calibration applied and no bandpass applied

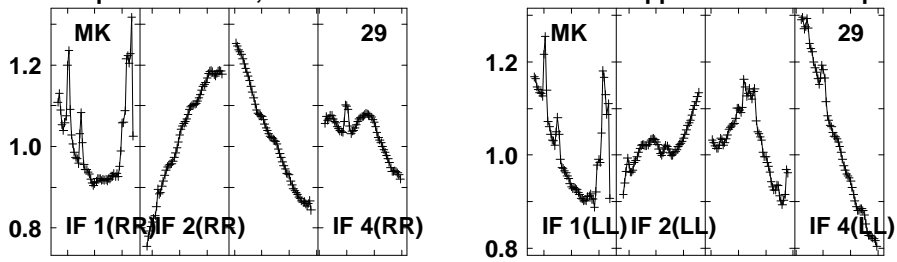

Lower frame: Real Jy  
Auto-corr total-power spectrum Antenna: \*  
Timerange: 00/23:36:11 to 00/23:39:29

Plot file version1530 created 05-OCT-2021 17:12:02

J0827+5217 GM076.UVDATA.1

Freq = 1.5945 GHz, Bw = 32.000 MH No calibration applied and no bandpass applied

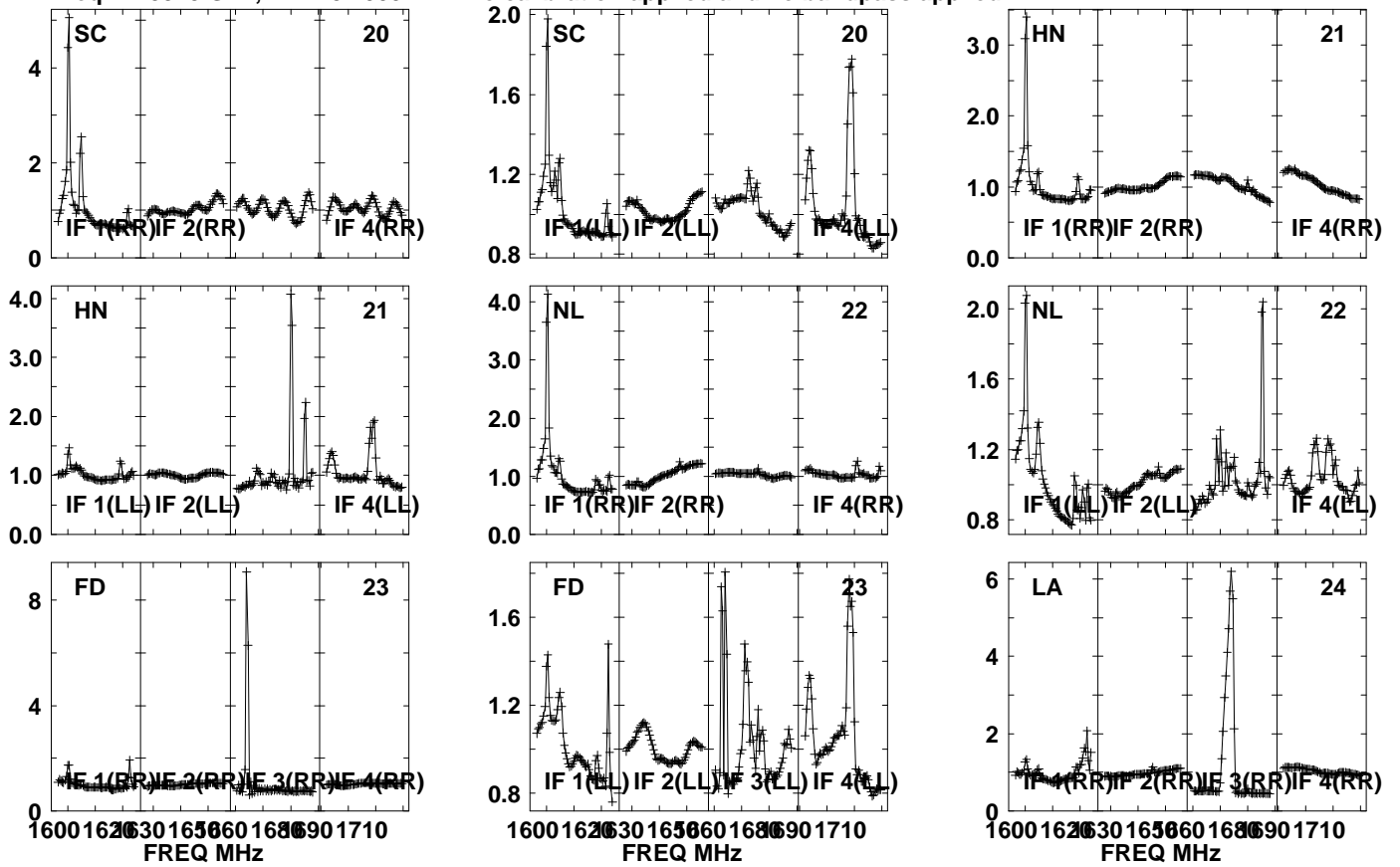

Lower frame: Real Jy  
Auto-corr total-power spectrum Antenna: \*  
Timerange: 00/23:40:01 to 00/23:41:29



Plot file version1531 created 05-OCT-2021 17:12:02

J0827+5217 GM076.UVDATA.1

Freq = 1.5945 GHz, Bw = 32.000 MH No calibration applied and no bandpass applied

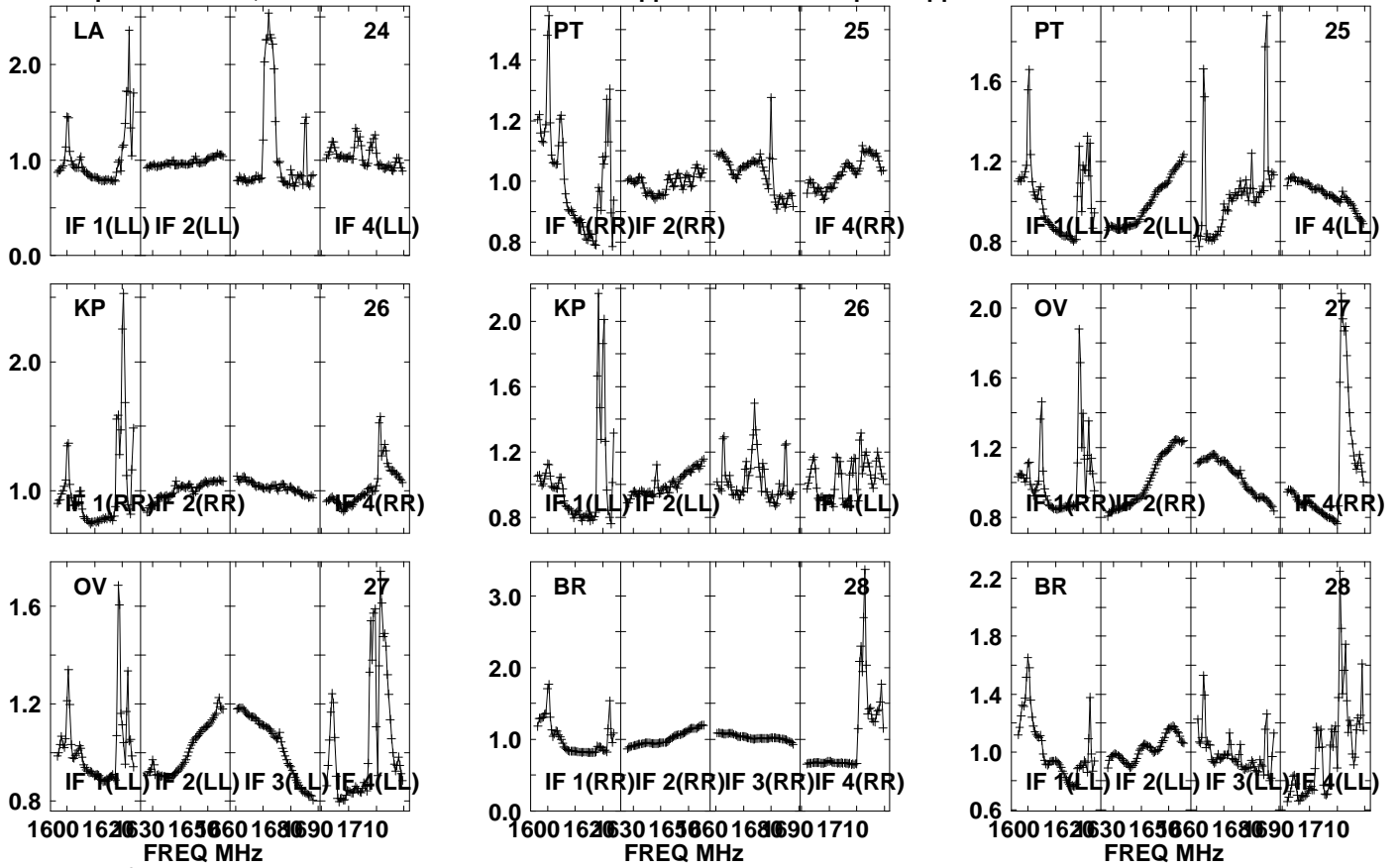

Lower frame: Real Jy

Auto-corr total-power spectrum Antenna: \*

Timerange: 00/23:40:01 to 00/23:41:29

Plot file version1532 created 05-OCT-2021 17:12:02  
J0827+5217 GM076.UVDATA.1  
Freq = 1.5945 GHz, Bw = 32.000 MH No calibration applied and no bandpass applied

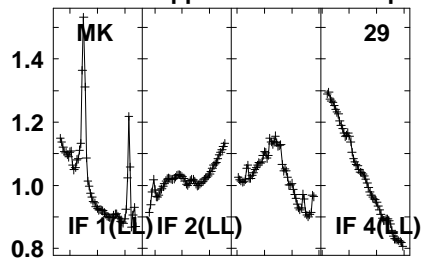
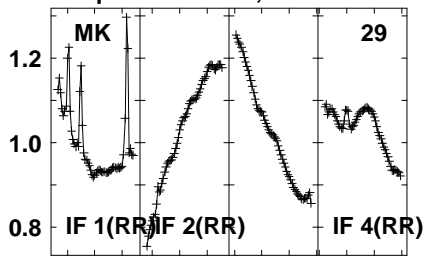

Lower frame: Real Jy  
Auto-corr total-power spectrum Antenna: \*  
Timerange: 00/23:40:01 to 00/23:41:29

Plot file version1533 created 05-OCT-2021 17:12:02

APM08279+525 GM076.UVDATA.1

Freq = 1.5945 GHz, Bw = 32.000 MH No calibration applied and no bandpass applied

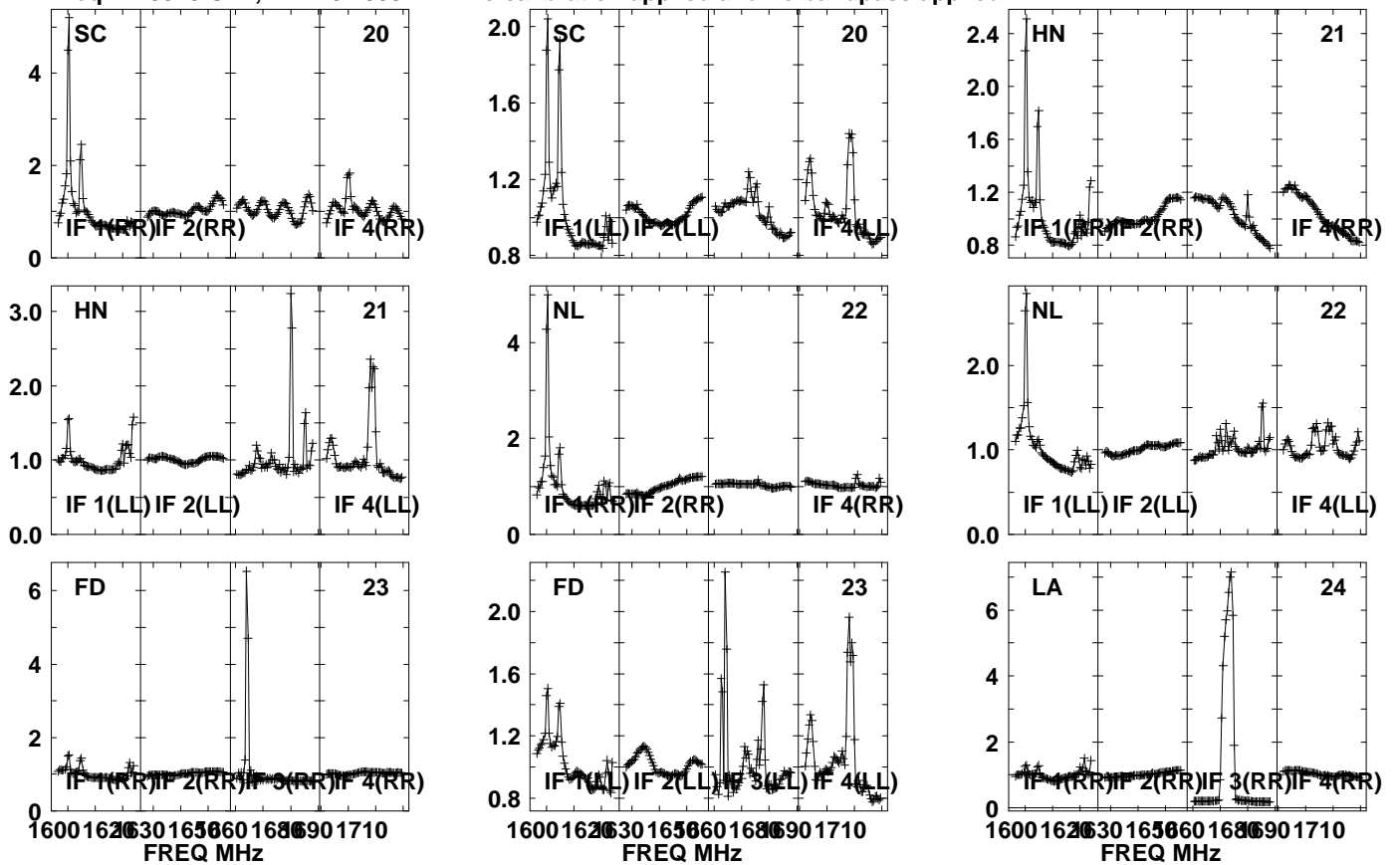

Lower frame: Real Jy

Auto-corr total-power spectrum Antenna: \*

Timerange: 00/23:41:41 to 00/23:44:59

Plot file version1534 created 05-OCT-2021 17:12:02

APM08279+525 GM076.UVDATA.1

Freq = 1.5945 GHz, Bw = 32.000 MH No calibration applied and no bandpass applied

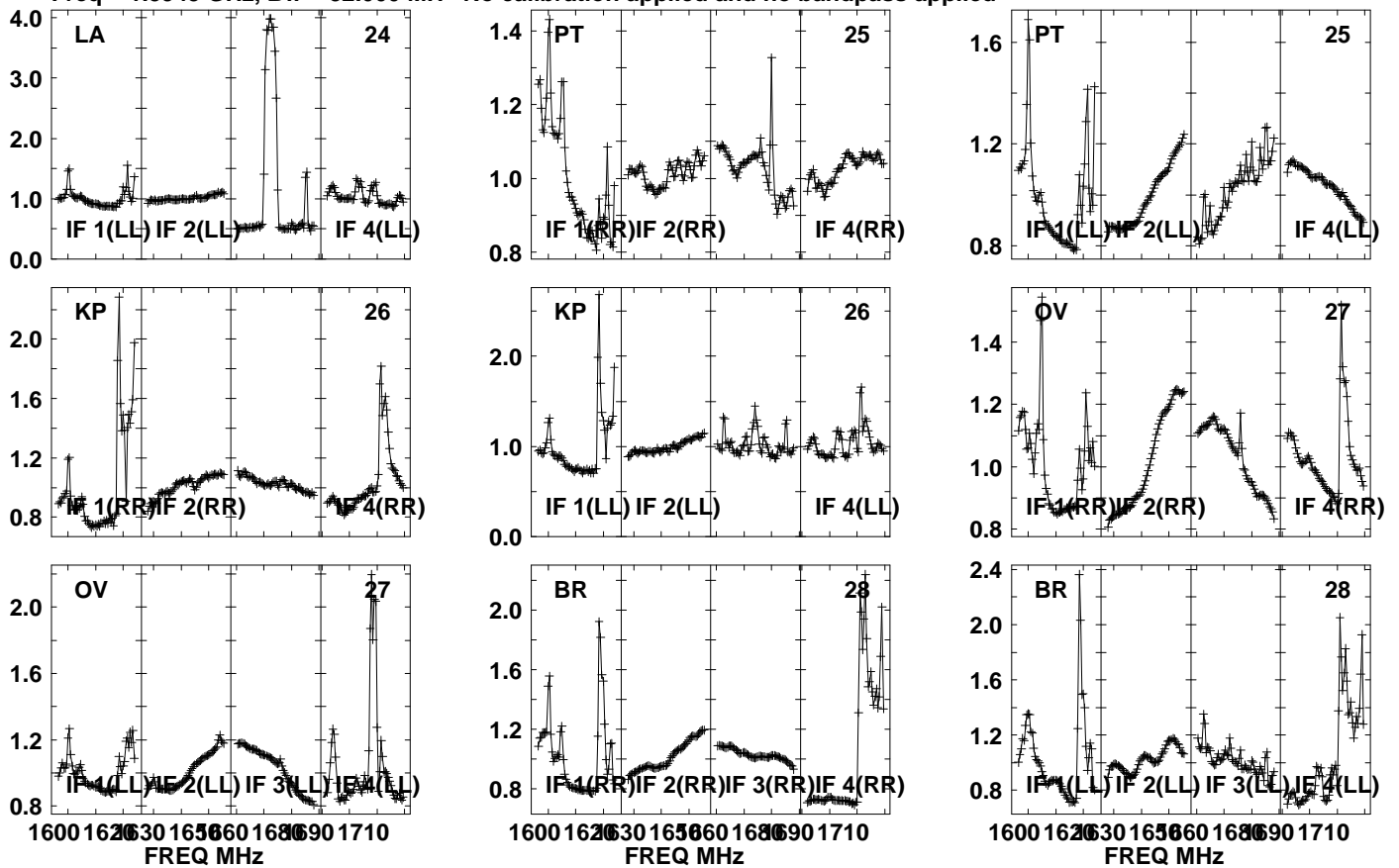

Lower frame: Real Jy

Auto-corr total-power spectrum Antenna: \*

Timerange: 00/23:41:41 to 00/23:44:59

Plot file version1535 created 05-OCT-2021 17:12:02

APM08279+525 GM076.UVDATA.1

Freq = 1.5945 GHz, Bw = 32.000 MH No calibration applied and no bandpass applied

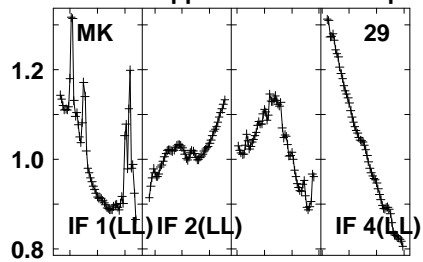
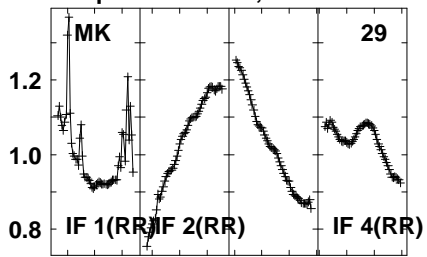

Lower frame: Real Jy  
Auto-corr total-power spectrum Antenna: \*  
Timerange: 00/23:41:41 to 00/23:44:59

Plot file version1536 created 05-OCT-2021 17:12:03

J0827+5217 GM076.UVDATA.1

Freq = 1.5945 GHz, Bw = 32.000 MH No calibration applied and no bandpass applied

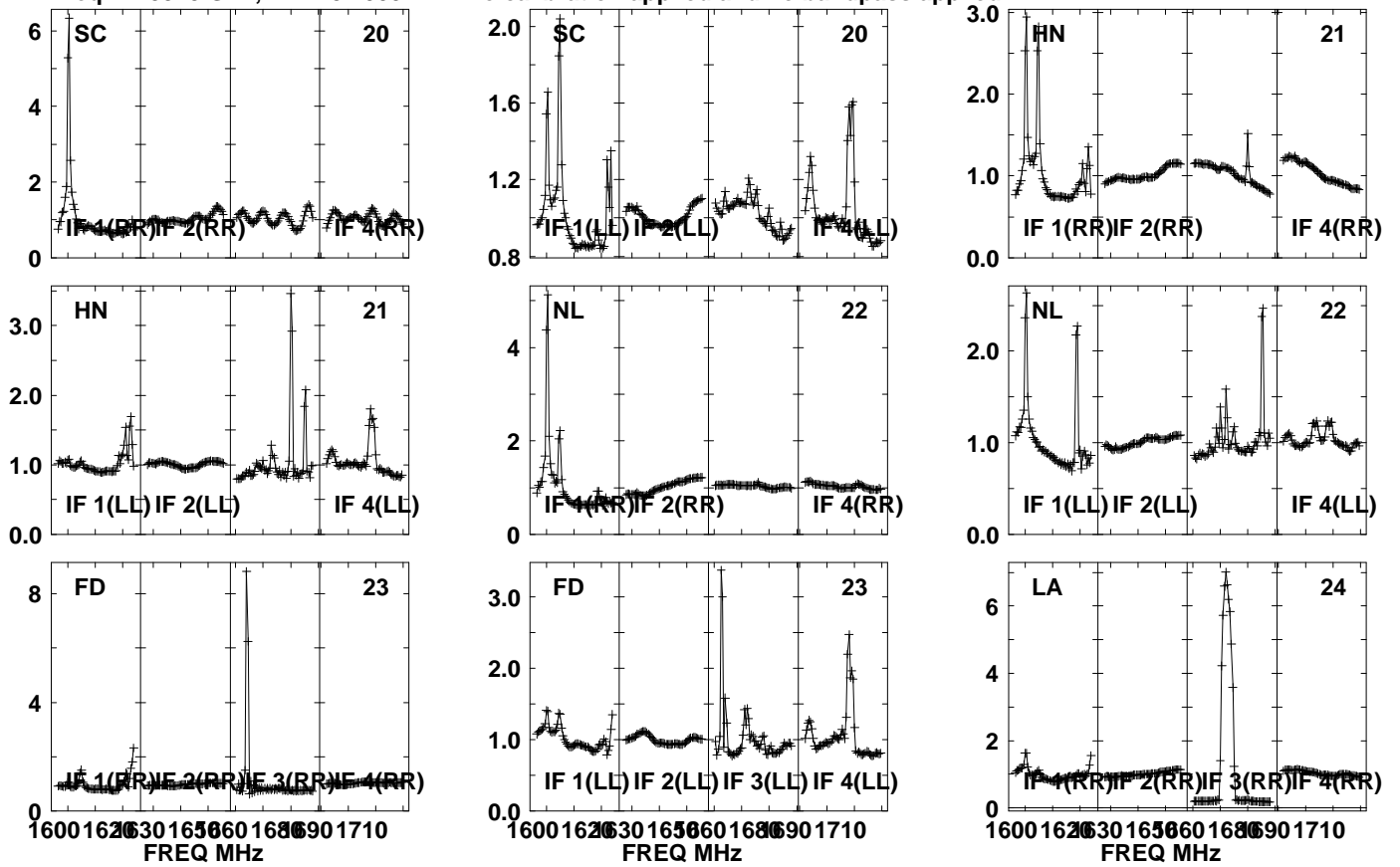

Lower frame: Real Jy  
Auto-corr total-power spectrum Antenna: \*  
Timerange: 00/23:45:31 to 00/23:46:59

Plot file version1537 created 05-OCT-2021 17:12:03

J0827+5217 GM076.UVDATA.1

Freq = 1.5945 GHz, Bw = 32.000 MH No calibration applied and no bandpass applied

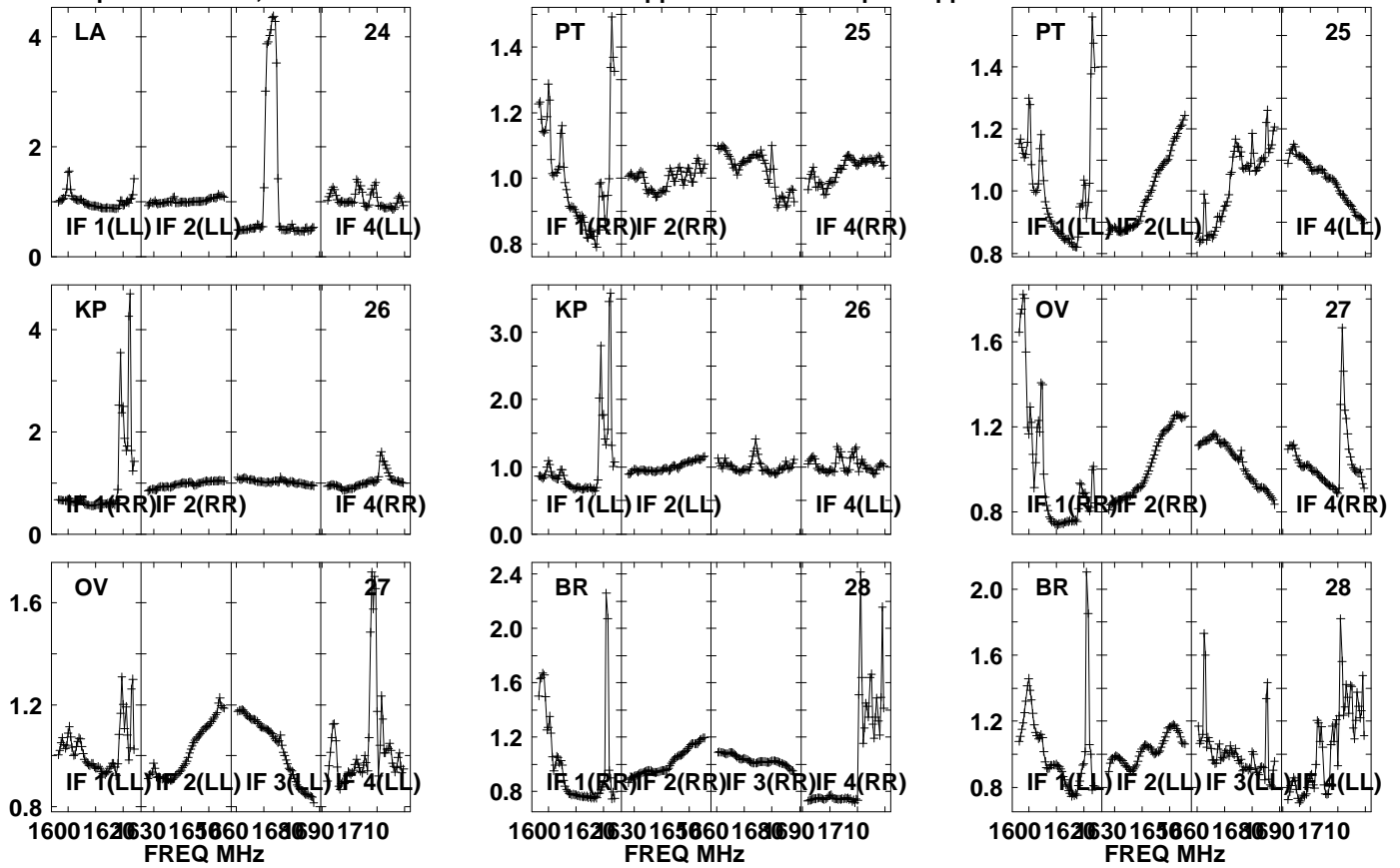

Lower frame: Real Jy  
Auto-corr total-power spectrum Antenna: \*  
Timerange: 00/23:45:31 to 00/23:46:59

Plot file version1538 created 05-OCT-2021 17:12:03

J0827+5217 GM076.UVDATA.1

Freq = 1.5945 GHz, Bw = 32.000 MH No calibration applied and no bandpass applied

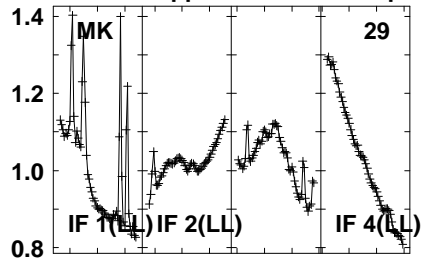
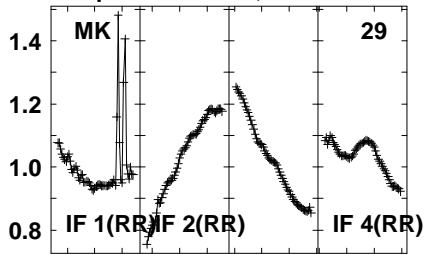

Lower frame: Real Jy  
Auto-corr total-power spectrum Antenna: \*  
Timerange: 00/23:45:31 to 00/23:46:59



Plot file version1539 created 05-OCT-2021 17:12:03

APM08279+525 GM076.UVDATA.1

Freq = 1.5945 GHz, Bw = 32.000 MH No calibration applied and no bandpass applied

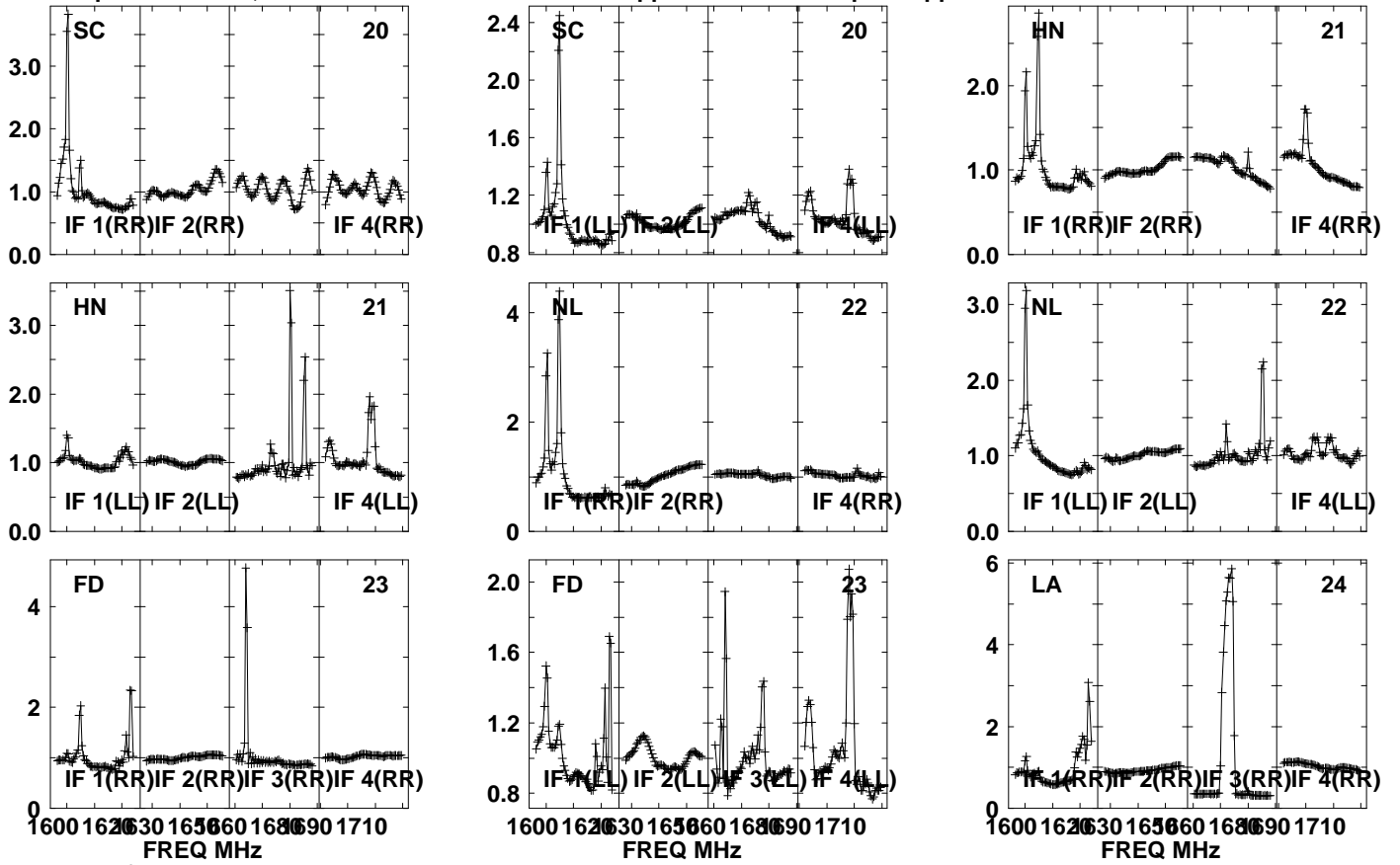

Lower frame: Real Jy

Auto-corr total-power spectrum Antenna: \*

Timerange: 00/23:47:11 to 00/23:50:29

Plot file version1540 created 05-OCT-2021 17:12:03

APM08279+525 GM076.UVDATA.1

Freq = 1.5945 GHz, Bw = 32.000 MH No calibration applied and no bandpass applied

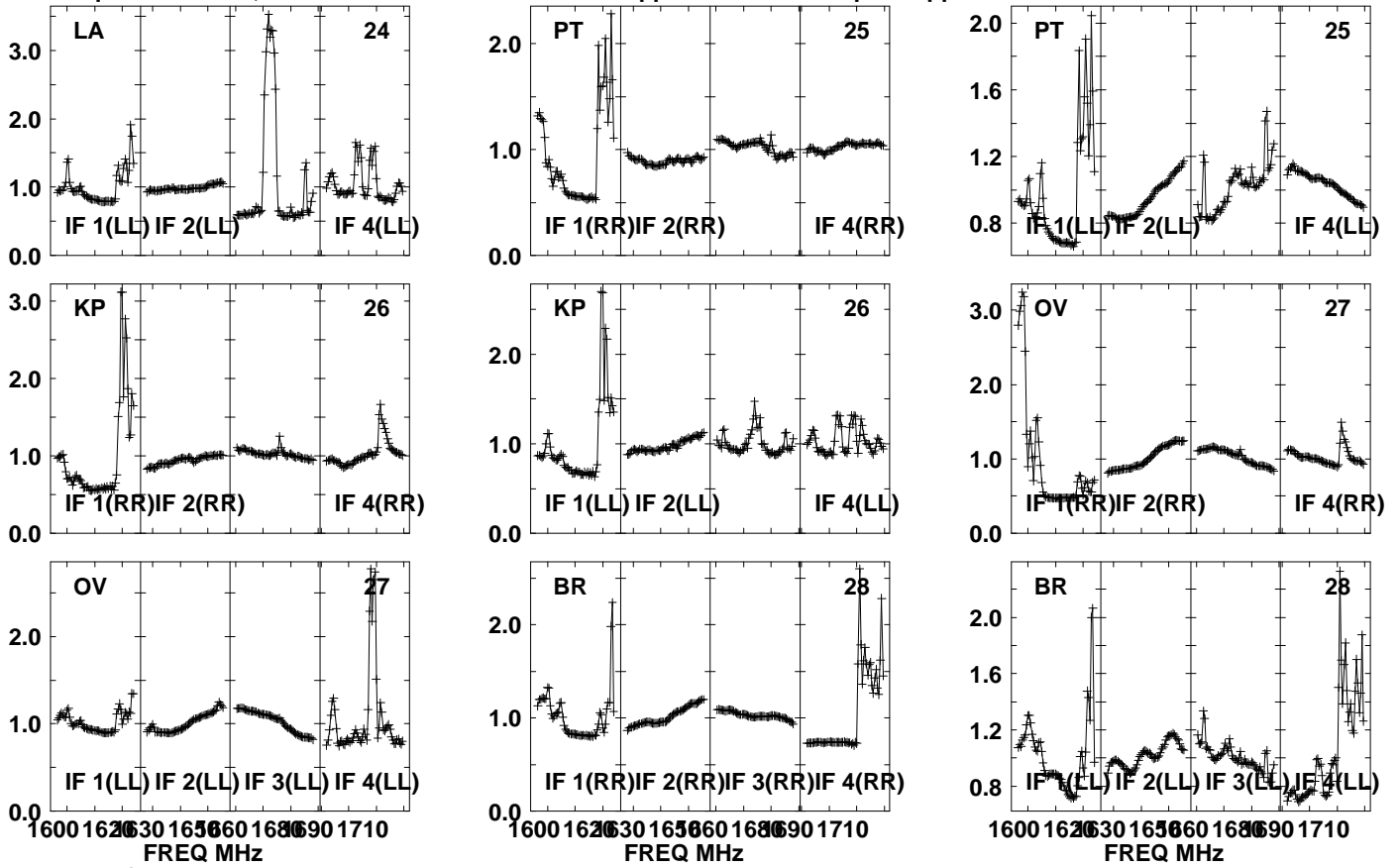

Lower frame: Real Jy

Auto-corr total-power spectrum Antenna: \*

Timerange: 00/23:47:11 to 00/23:50:29

Plot file version1541 created 05-OCT-2021 17:12:03

APM08279+525 GM076.UVDATA.1

Freq = 1.5945 GHz, Bw = 32.000 MH No calibration applied and no bandpass applied

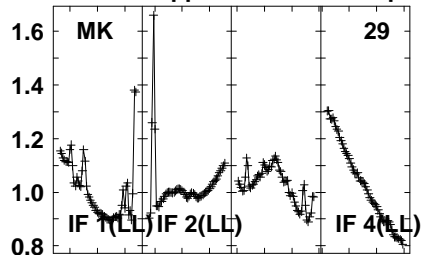
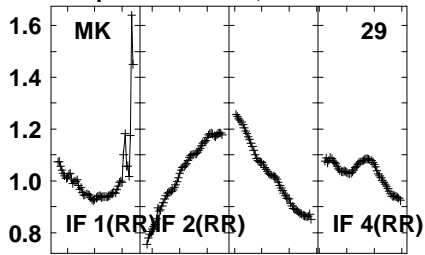

Lower frame: Real Jy  
Auto-corr total-power spectrum Antenna: \*  
Timerange: 00/23:47:11 to 00/23:50:29

Plot file version1542 created 05-OCT-2021 17:12:03

J0827+5217 GM076.UVDATA.1

Freq = 1.5945 GHz, Bw = 32.000 MH No calibration applied and no bandpass applied

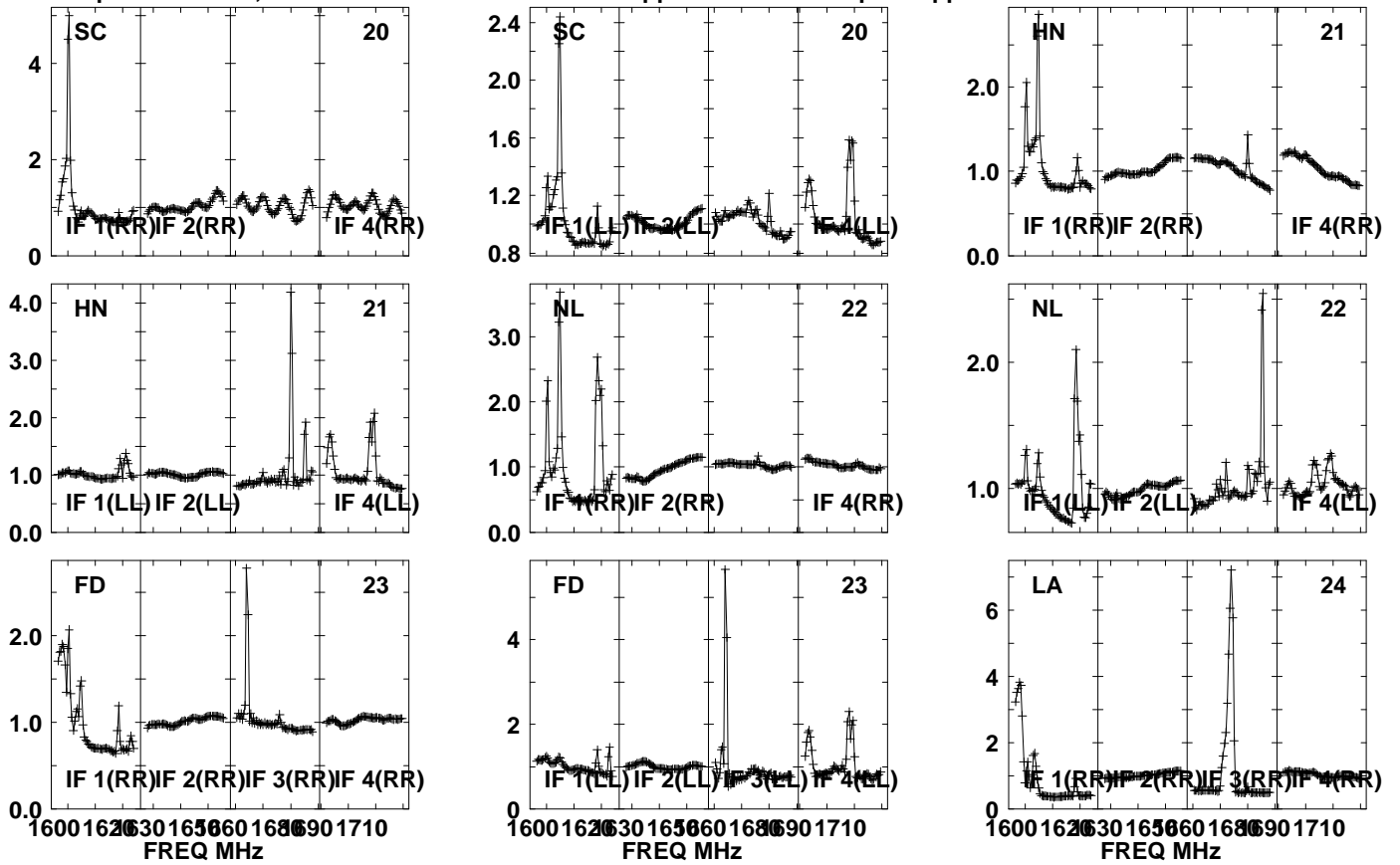

Lower frame: Real Jy

Auto-corr total-power spectrum Antenna: \*

Timerange: 00/23:51:01 to 00/23:52:29

Plot file version1543 created 05-OCT-2021 17:12:03

J0827+5217 GM076.UVDATA.1

Freq = 1.5945 GHz, Bw = 32.000 MH No calibration applied and no bandpass applied

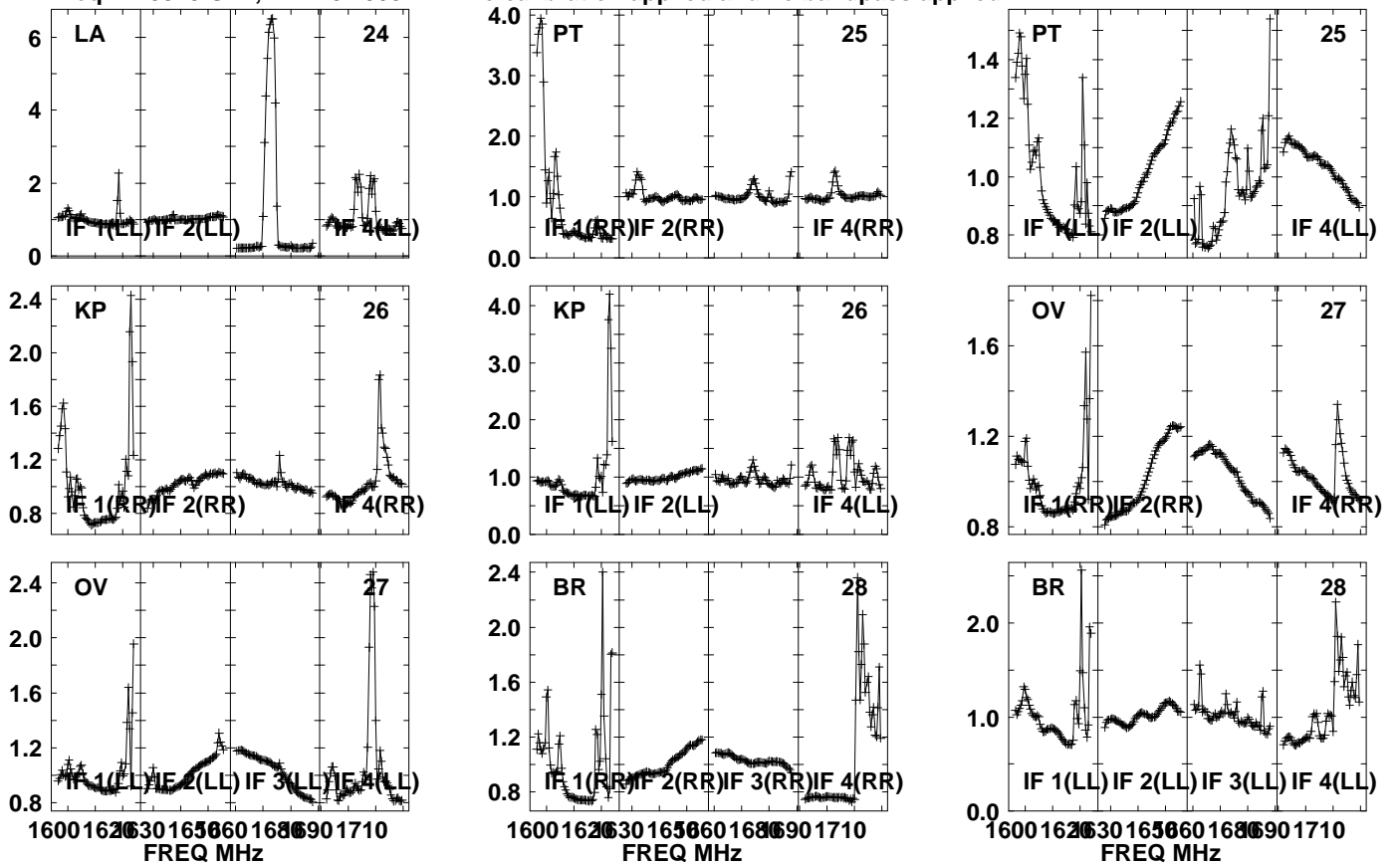

Lower frame: Real Jy

Auto-corr total-power spectrum Antenna: \*

Timerange: 00/23:51:01 to 00/23:52:29

Plot file version1544 created 05-OCT-2021 17:12:03

J0827+5217 GM076.UVDATA.1

Freq = 1.5945 GHz, Bw = 32.000 MH No calibration applied and no bandpass applied

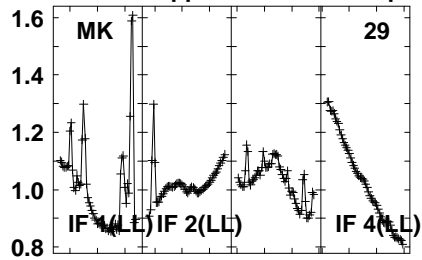
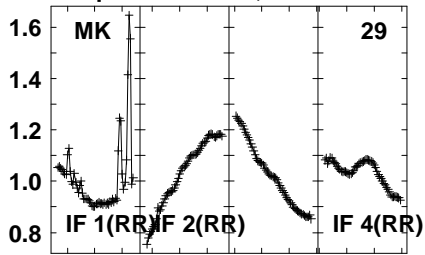

Lower frame: Real Jy  
Auto-corr total-power spectrum Antenna: \*  
Timerange: 00/23:51:01 to 00/23:52:29

Plot file version1545 created 05-OCT-2021 17:12:04

APM08279+525 GM076.UVDATA.1

Freq = 1.5945 GHz, Bw = 32.000 MH

No calibration applied and no bandpass applied

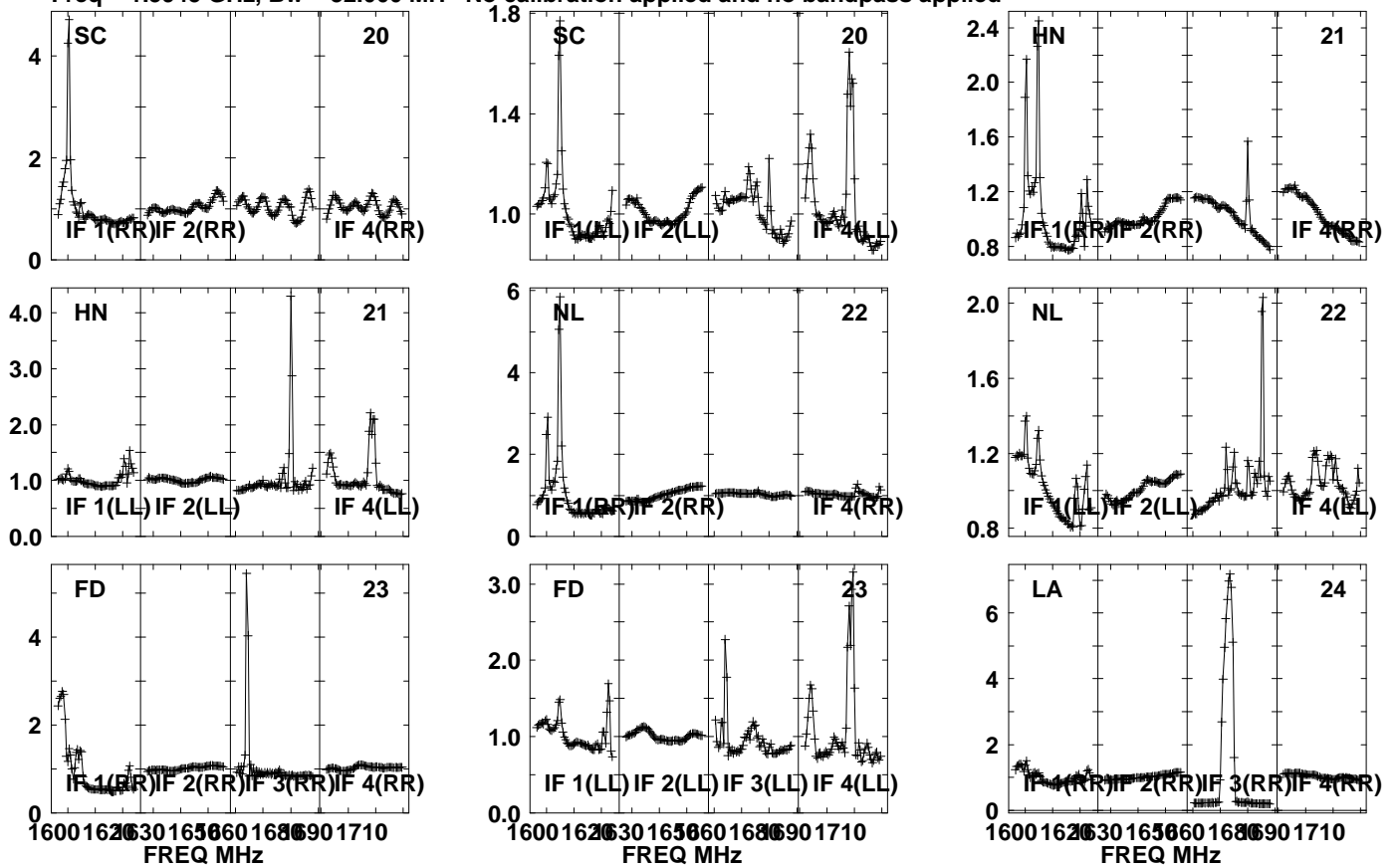

Lower frame: Real Jy

Auto-corr total-power spectrum Antenna: \*

Timerange: 00/23:52:41 to 00/23:55:59

Plot file version1546 created 05-OCT-2021 17:12:04

APM08279+525 GM076.UVDATA.1

Freq = 1.5945 GHz, Bw = 32.000 MH No calibration applied and no bandpass applied

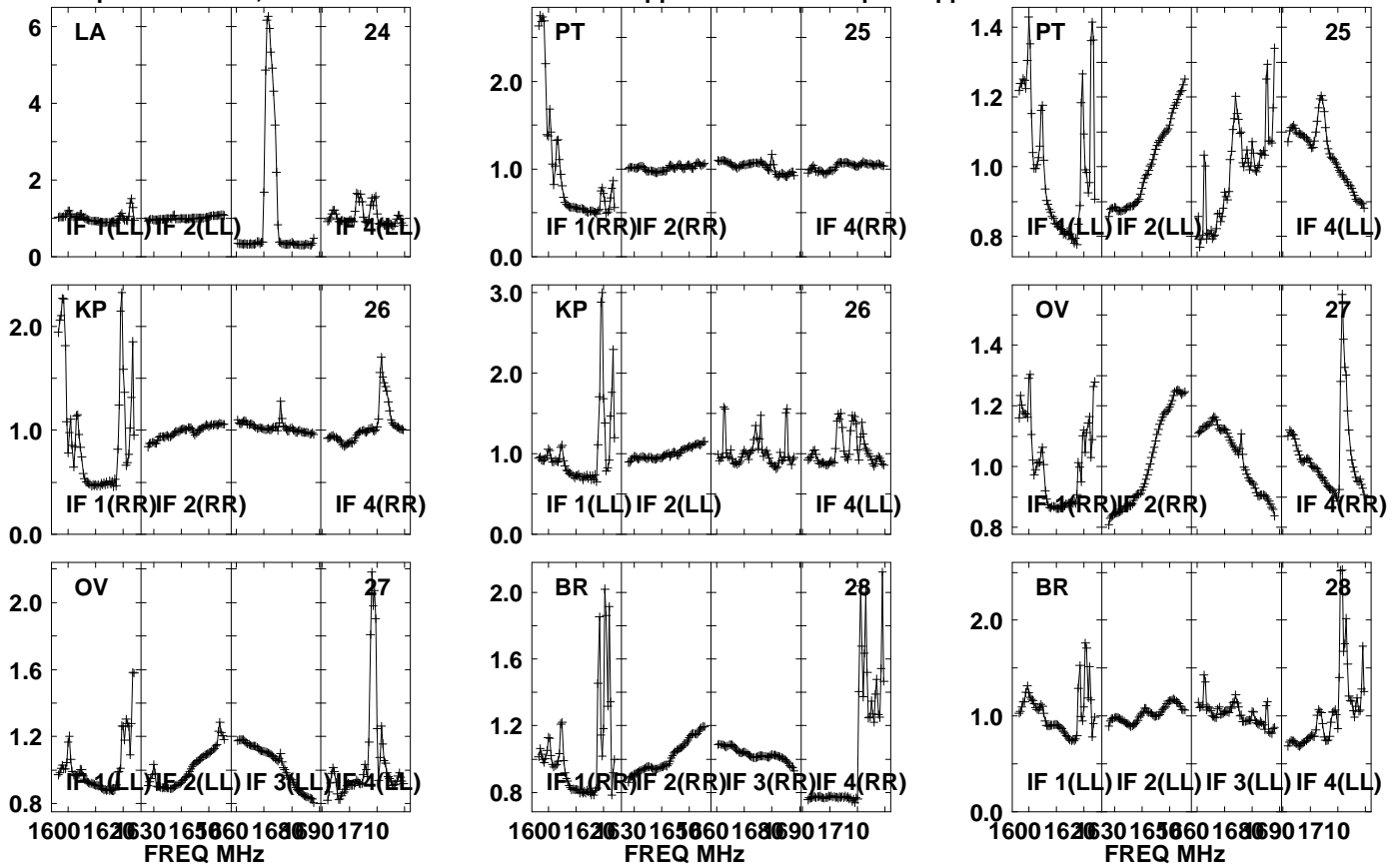

Lower frame: Real Jy  
Auto-corr total-power spectrum Antenna: \*  
Timerange: 00/23:52:41 to 00/23:55:59



Plot file version1547 created 05-OCT-2021 17:12:04

APM08279+525 GM076.UVDATA.1

Freq = 1.5945 GHz, Bw = 32.000 MH

No calibration applied and no bandpass applied

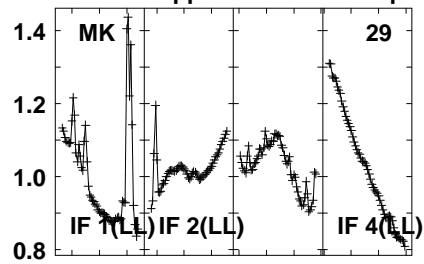
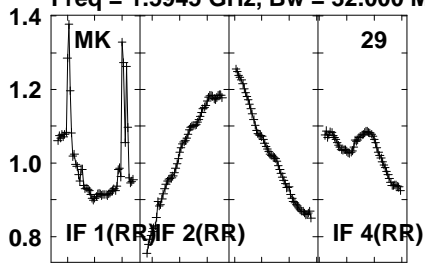

Lower frame: Real Jy  
Auto-corr total-power spectrum Antenna: \*  
Timerange: 00/23:52:41 to 00/23:55:59

Plot file version1548 created 05-OCT-2021 17:12:04

J0827+5217 GM076.UVDATA.1

Freq = 1.5945 GHz, Bw = 32.000 MH No calibration applied and no bandpass applied

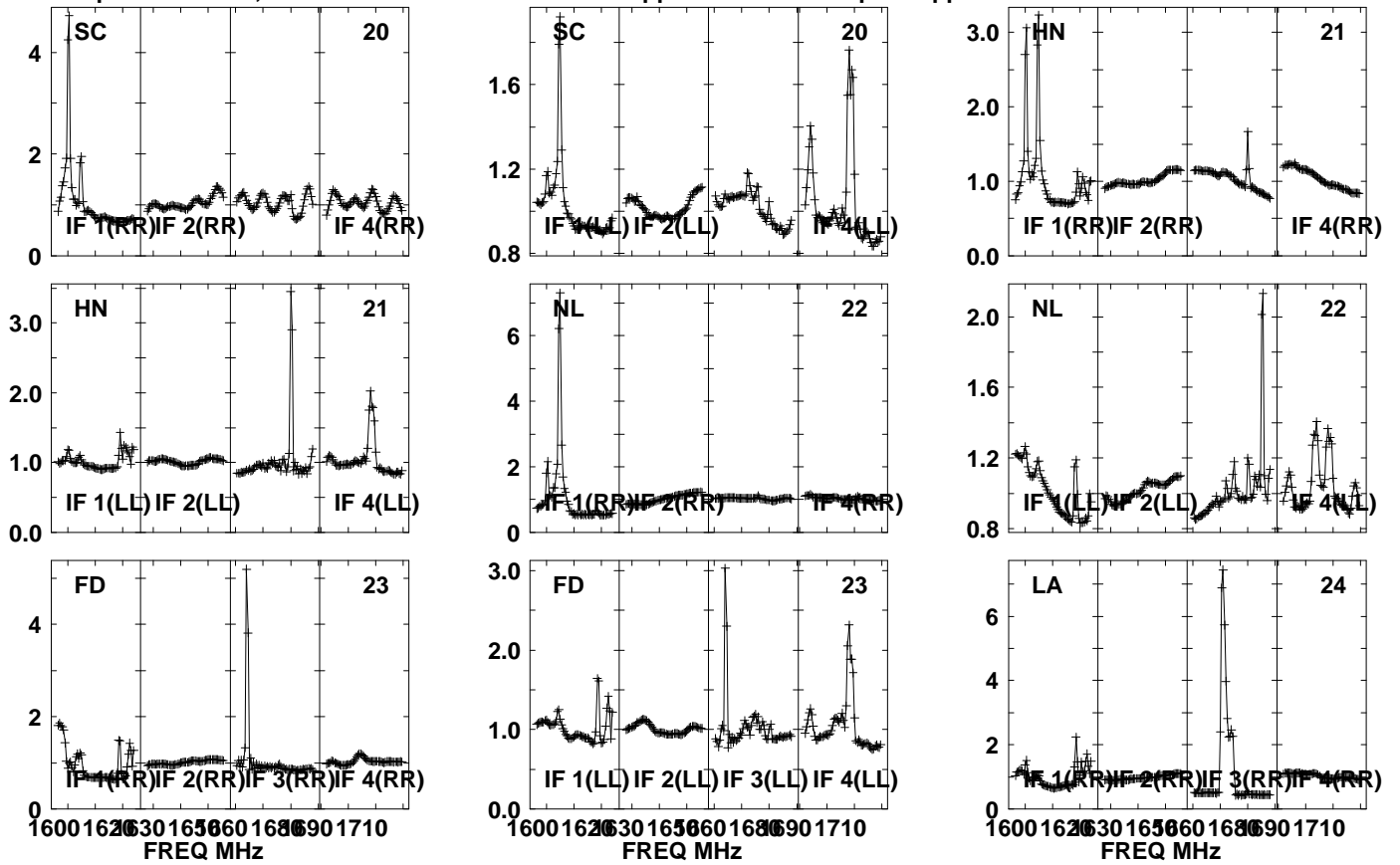

Lower frame: Real Jy

Auto-corr total-power spectrum Antenna: \*

Timerange: 00/23:56:31 to 00/23:57:59

Plot file version1549 created 05-OCT-2021 17:12:04

J0827+5217 GM076.UVDATA.1

Freq = 1.5945 GHz, Bw = 32.000 MH No calibration applied and no bandpass applied

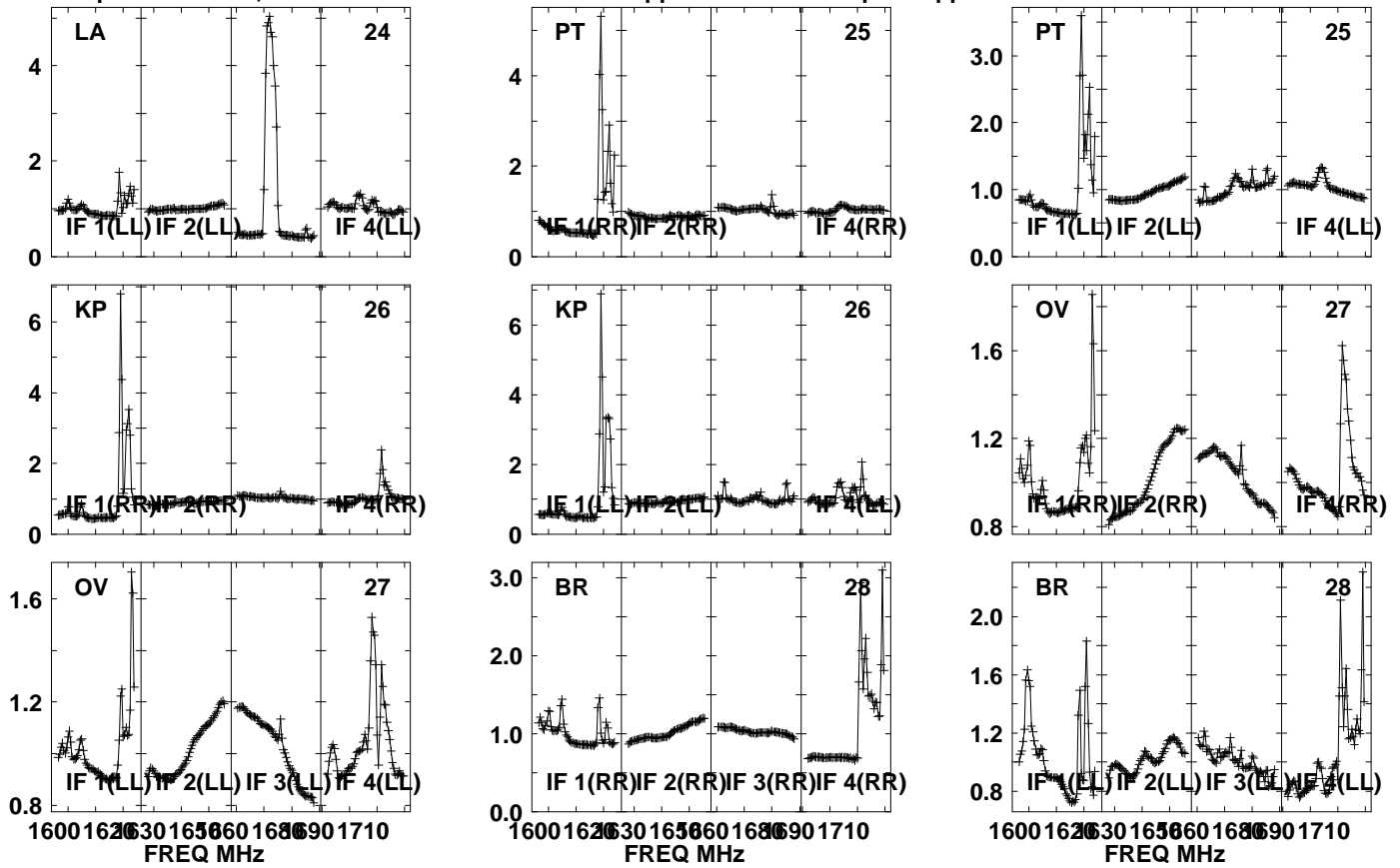

Lower frame: Real Jy

Auto-corr total-power spectrum Antenna: \*

Timerange: 00/23:56:31 to 00/23:57:59

Plot file version1550 created 05-OCT-2021 17:12:04

J0827+5217 GM076.UVDATA.1

Freq = 1.5945 GHz, Bw = 32.000 MH No calibration applied and no bandpass applied

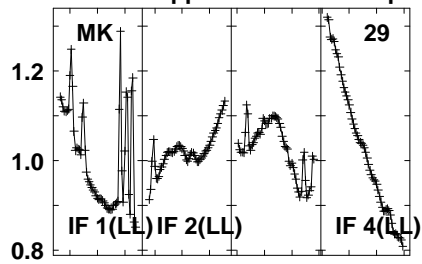
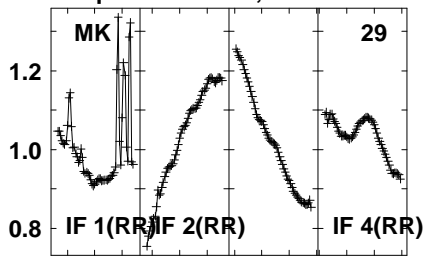

Lower frame: Real Jy  
Auto-corr total-power spectrum Antenna: \*  
Timerange: 00/23:56:31 to 00/23:57:59

Plot file version 1551 created 05-OCT-2021 17:12:04

APM08279+525 GM076.UVDATA.1

Freq = 1.5945 GHz, Bw = 32.000 MH No calibration applied and no bandpass applied

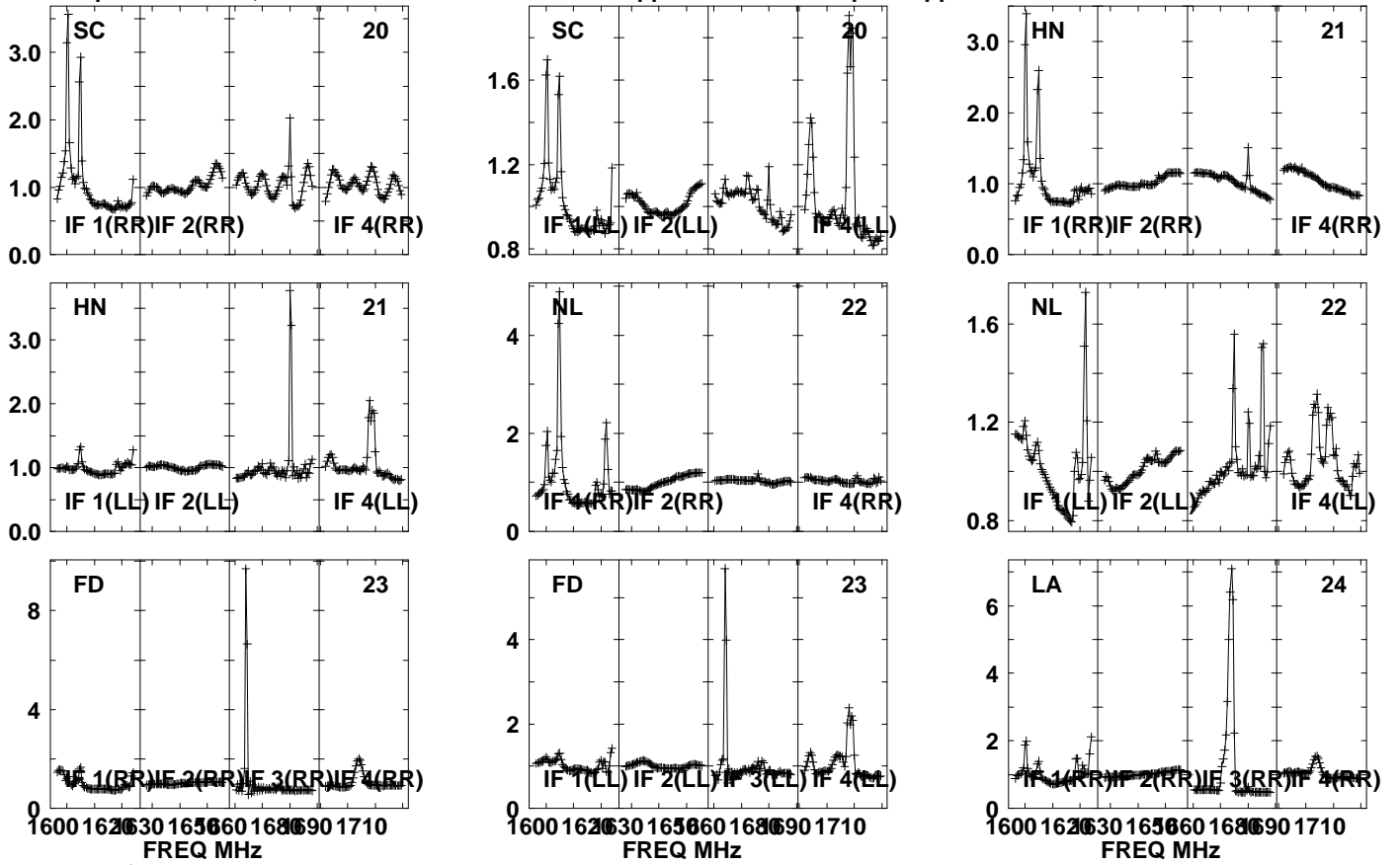

Lower frame: Real Jy

Auto-corr total-power spectrum Antenna: \*

Timerange: 00/23:58:11 to 01/00:01:29

Plot file version1552 created 05-OCT-2021 17:12:04

APM08279+525 GM076.UVDATA.1

Freq = 1.5945 GHz, Bw = 32.000 MH No calibration applied and no bandpass applied

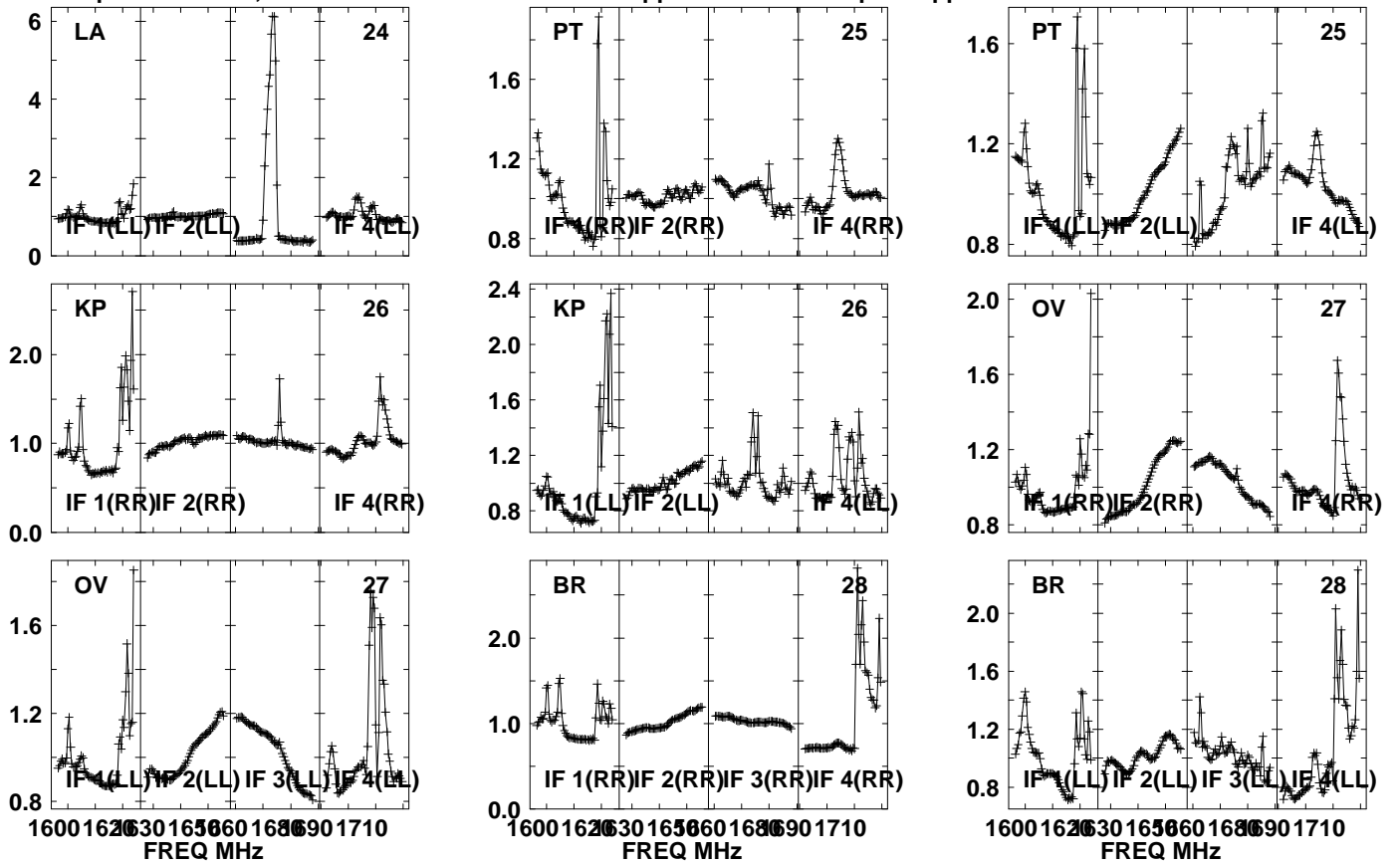

Lower frame: Real Jy

Auto-corr total-power spectrum Antenna: \*

Timerange: 00/23:58:11 to 01/00:01:29

Plot file version1553 created 05-OCT-2021 17:12:04

APM08279+525 GM076.UVDATA.1

Freq = 1.5945 GHz, Bw = 32.000 MH No calibration applied and no bandpass applied

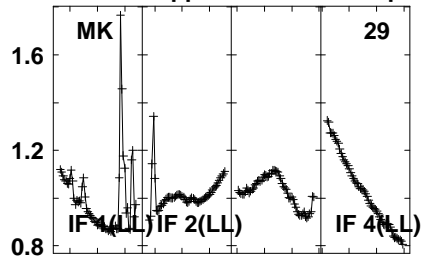
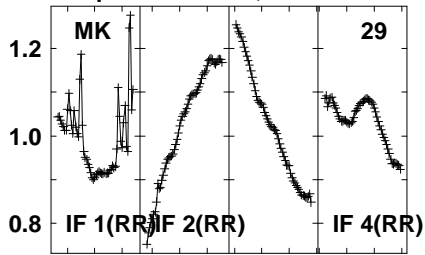

Lower frame: Real Jy  
Auto-corr total-power spectrum Antenna: \*  
Timerange: 00/23:58:11 to 01/00:01:29

Plot file version1554 created 05-OCT-2021 17:12:05

J0827+5217 GM076.UVDATA.1

Freq = 1.5945 GHz, Bw = 32.000 MH No calibration applied and no bandpass applied

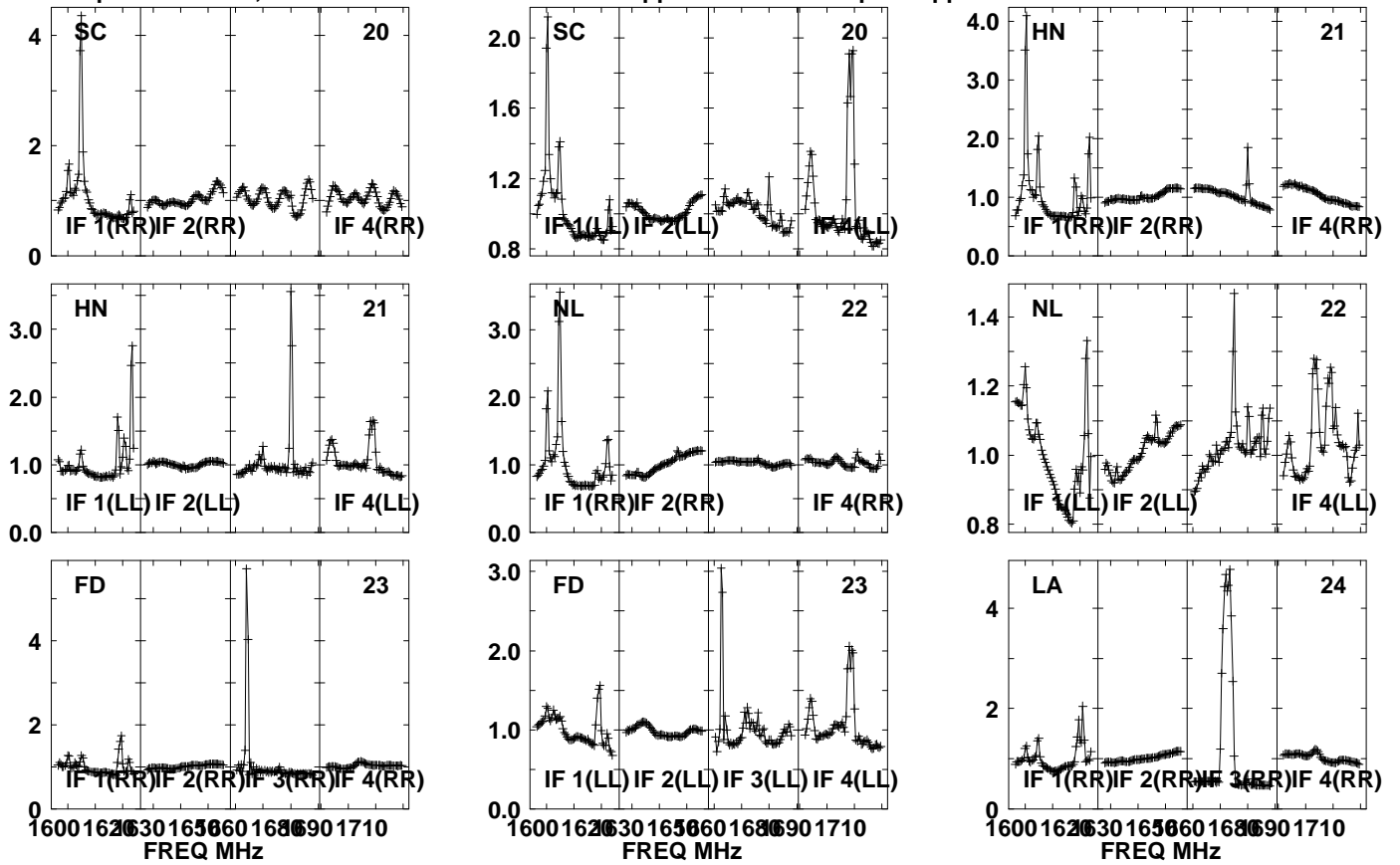

Lower frame: Real Jy  
Auto-corr total-power spectrum Antenna: \*  
Timerange: 01/00:02:01 to 01/00:03:29



Plot file version1555 created 05-OCT-2021 17:12:05

J0827+5217 GM076.UVDATA.1

Freq = 1.5945 GHz, Bw = 32.000 MH No calibration applied and no bandpass applied

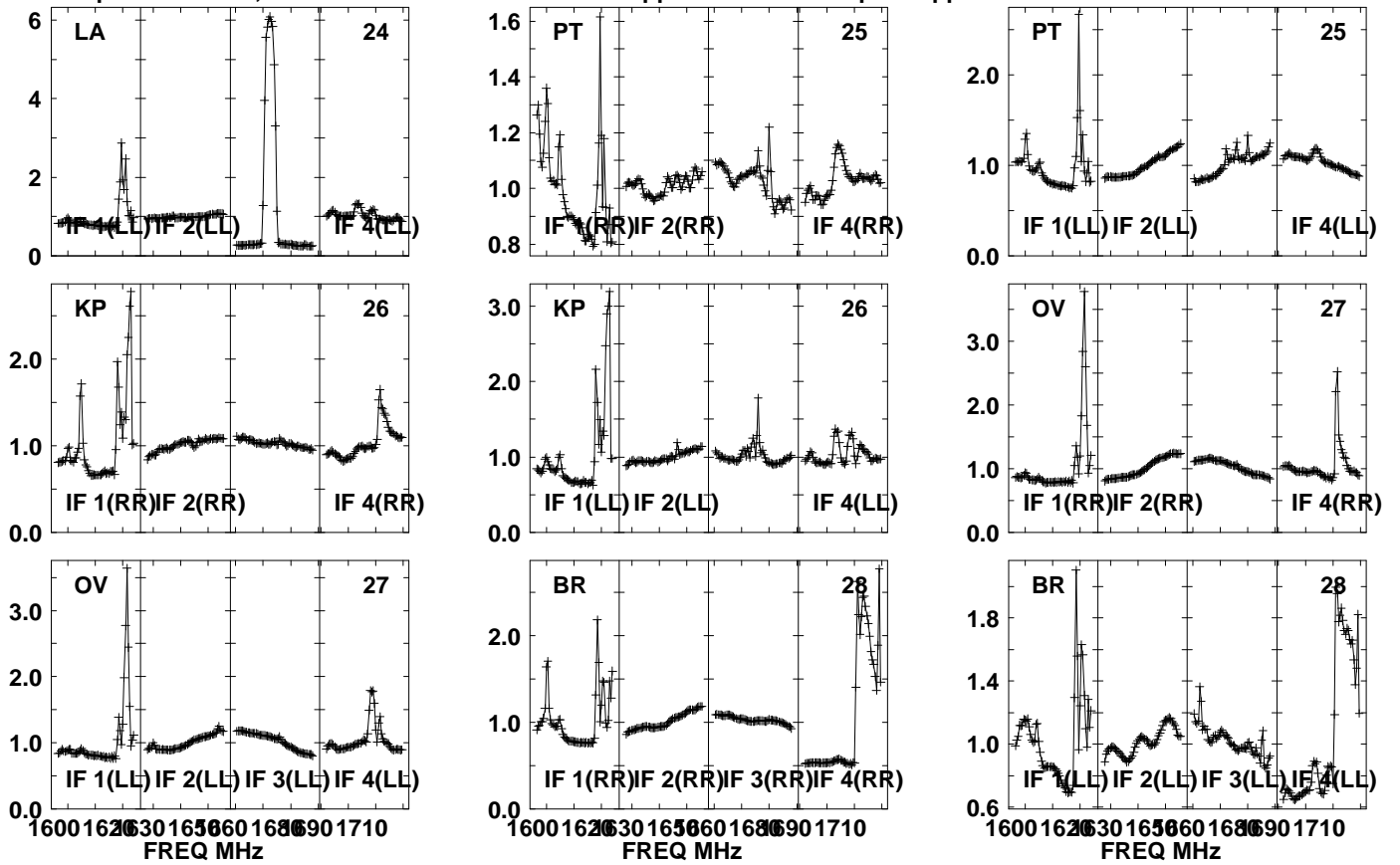

Lower frame: Real Jy  
Auto-corr total-power spectrum Antenna: \*  
Timerange: 01/00:02:01 to 01/00:03:29

Plot file version1556 created 05-OCT-2021 17:12:05

J0827+5217 GM076.UVDATA.1

Freq = 1.5945 GHz, Bw = 32.000 MH No calibration applied and no bandpass applied

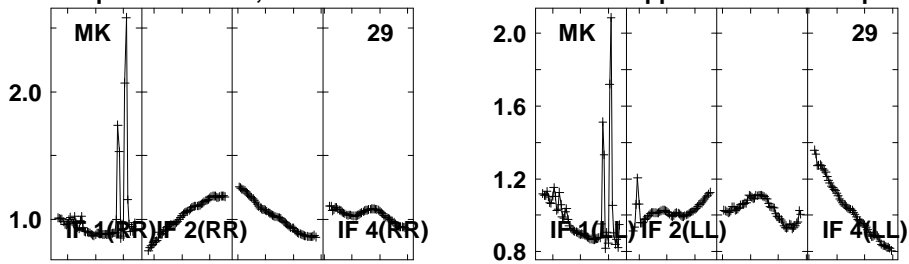

Lower frame: Real Jy

Auto-corr total-power spectrum Antenna: \*

Timerange: 01/00:02:01 to 01/00:03:29

Plot file version 1557 created 05-OCT-2021 17:12:05

APM08279+525 GM076.UVDATA.1

Freq = 1.5945 GHz, Bw = 32.000 MH No calibration applied and no bandpass applied

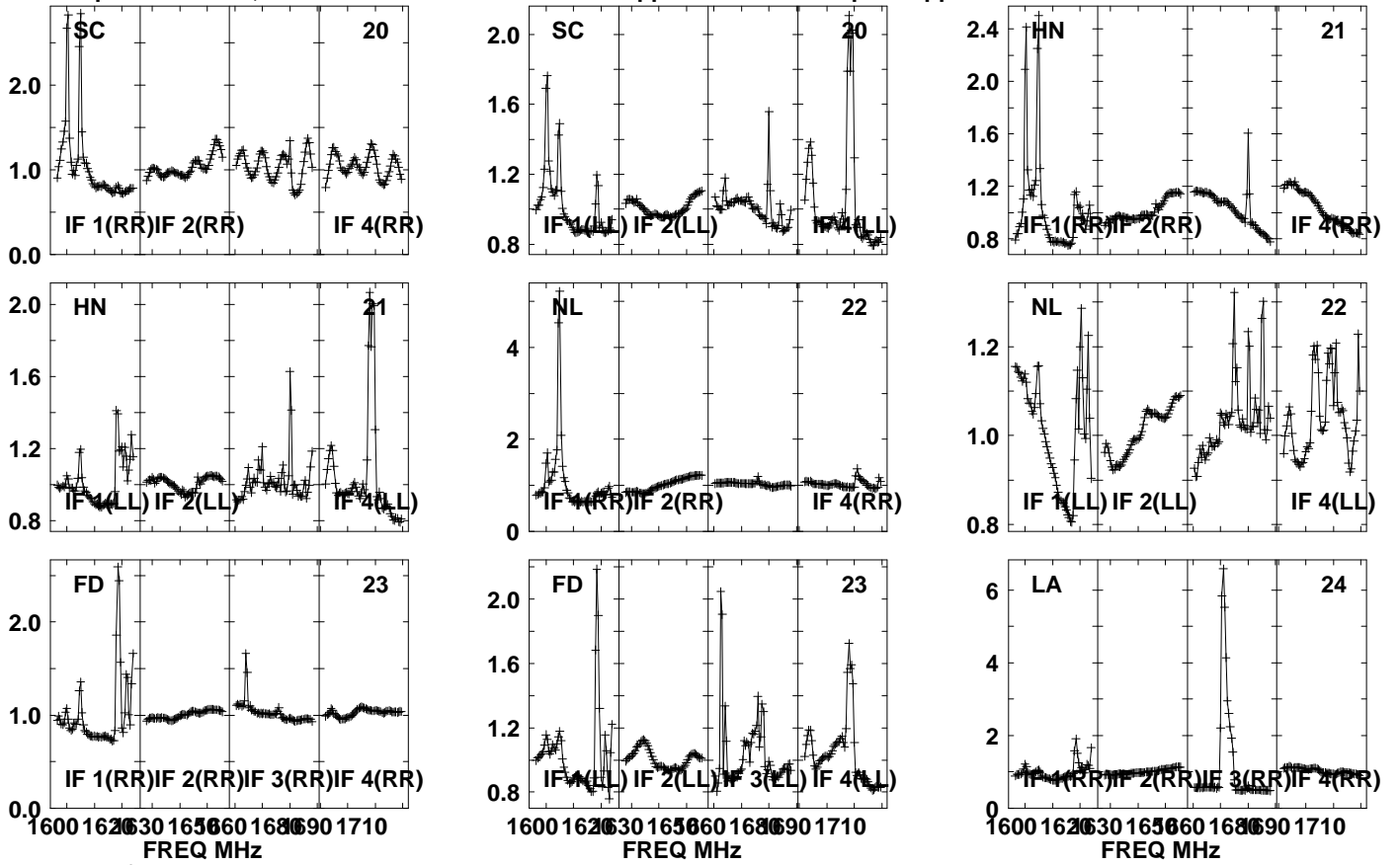

Lower frame: Real Jy

Auto-corr total-power spectrum Antenna: \*

Timerange: 01/00:03:41 to 01/00:06:59

Plot file version1558 created 05-OCT-2021 17:12:05

APM08279+525 GM076.UVDATA.1

Freq = 1.5945 GHz, Bw = 32.000 MH No calibration applied and no bandpass applied

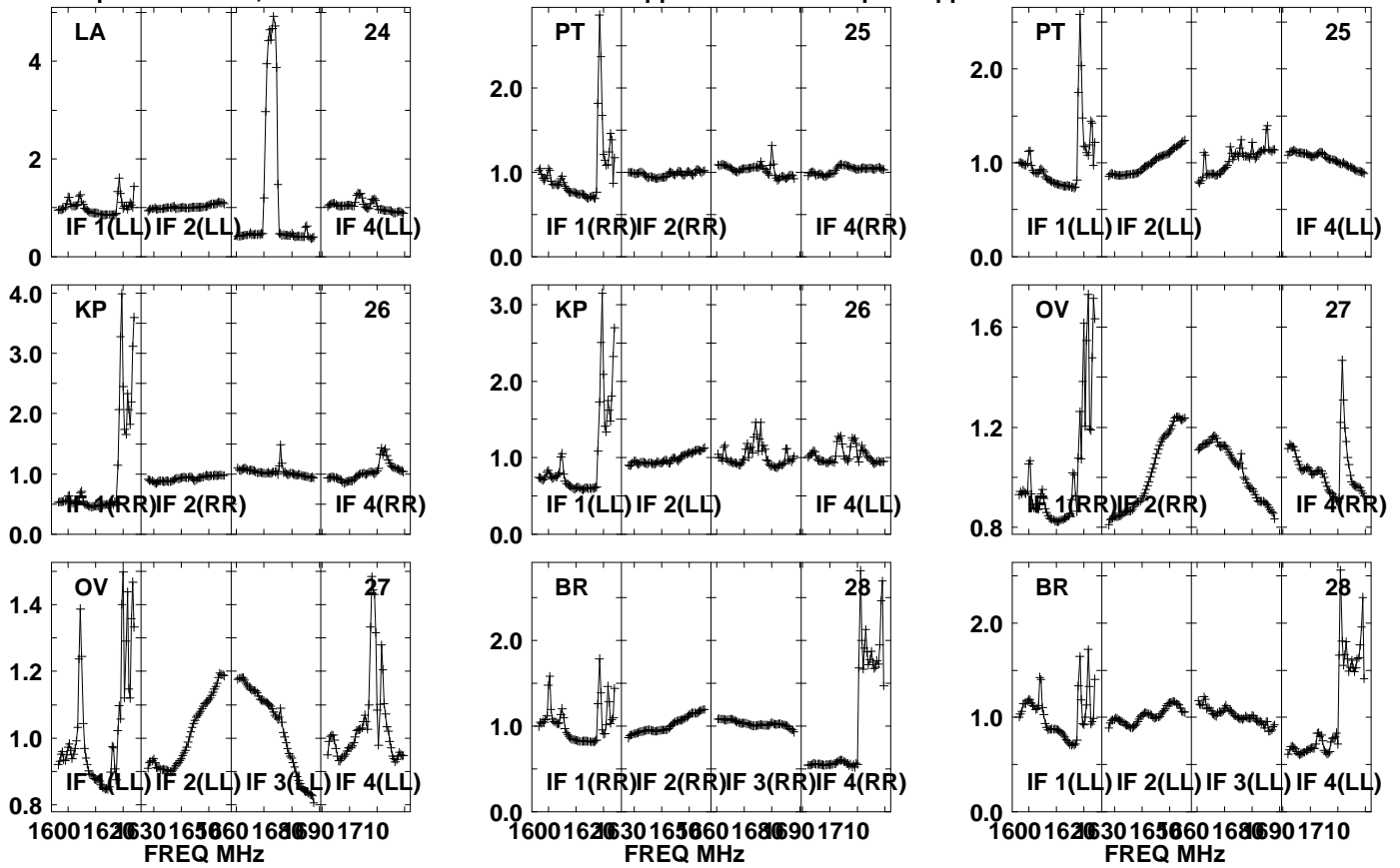

Lower frame: Real Jy

Auto-corr total-power spectrum Antenna: \*

Timerange: 01/00:03:41 to 01/00:06:59

Plot file version1559 created 05-OCT-2021 17:12:05

APM08279+525 GM076.UVDATA.1

Freq = 1.5945 GHz, Bw = 32.000 MH No calibration applied and no bandpass applied

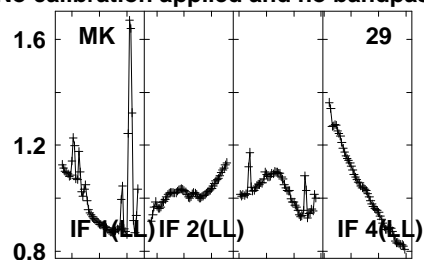
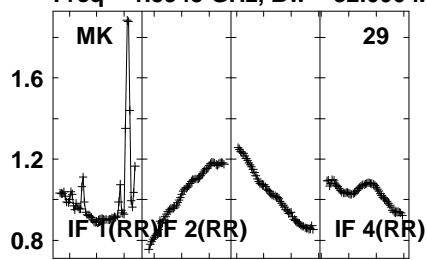

Lower frame: Real Jy  
Auto-corr total-power spectrum Antenna: \*  
Timerange: 01/00:03:41 to 01/00:06:59

Plot file version1560 created 05-OCT-2021 17:12:05

J0827+5217 GM076.UVDATA.1

Freq = 1.5945 GHz, Bw = 32.000 MH No calibration applied and no bandpass applied

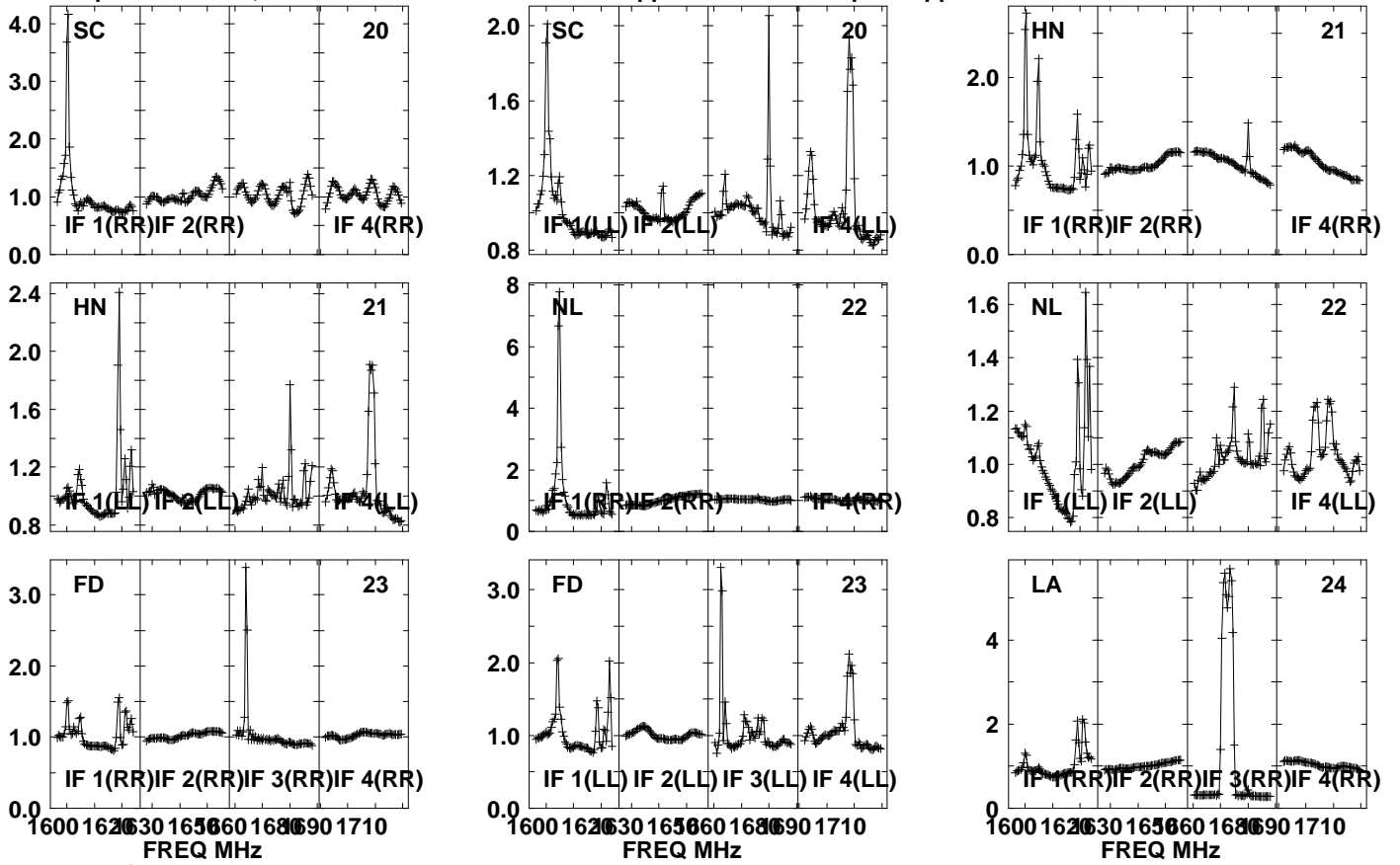

Lower frame: Real Jy

Auto-corr total-power spectrum Antenna: \*

Timerange: 01/00:07:31 to 01/00:08:59

Plot file version1561 created 05-OCT-2021 17:12:05

J0827+5217 GM076.UVDATA.1

Freq = 1.5945 GHz, Bw = 32.000 MH No calibration applied and no bandpass applied

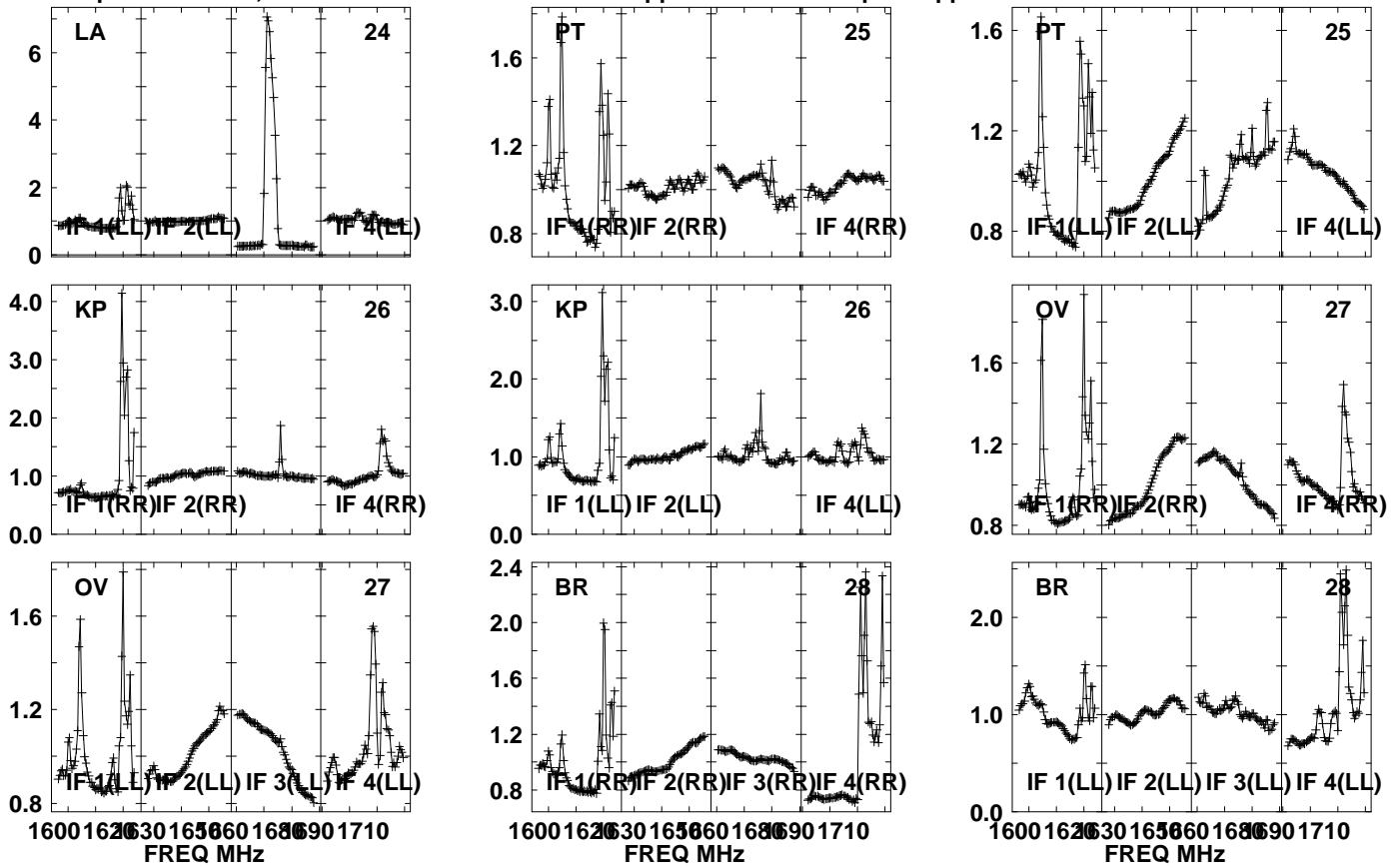

Lower frame: Real Jy  
Auto-corr total-power spectrum Antenna: \*  
Timerange: 01/00:07:31 to 01/00:08:59

Plot file version1562 created 05-OCT-2021 17:12:05

J0827+5217 GM076.UVDATA.1

Freq = 1.5945 GHz, Bw = 32.000 MH No calibration applied and no bandpass applied

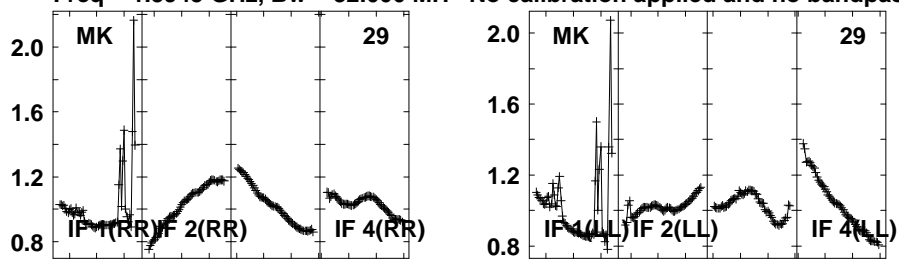

Lower frame: Real Jy  
Auto-corr total-power spectrum Antenna: \*  
Timerange: 01/00:07:31 to 01/00:08:59



Plot file version1563 created 05-OCT-2021 17:12:06

APM08279+525 GM076.UVDATA.1

Freq = 1.5945 GHz, Bw = 32.000 MH No calibration applied and no bandpass applied

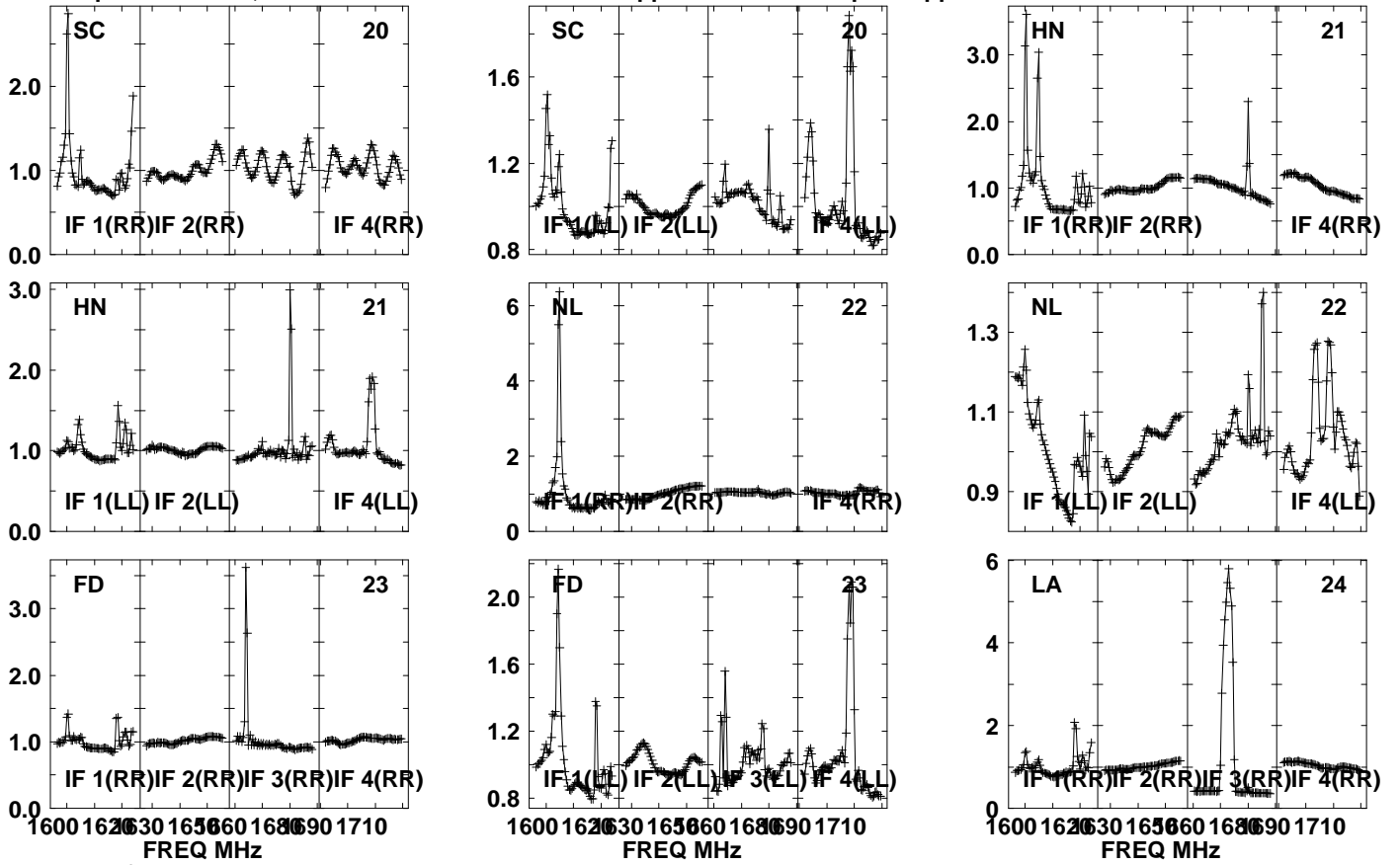

Lower frame: Real Jy

Auto-corr total-power spectrum Antenna: \*

Timerange: 01/00:09:11 to 01/00:12:29

Plot file version1564 created 05-OCT-2021 17:12:06

APM08279+525 GM076.UVDATA.1

Freq = 1.5945 GHz, Bw = 32.000 MH No calibration applied and no bandpass applied

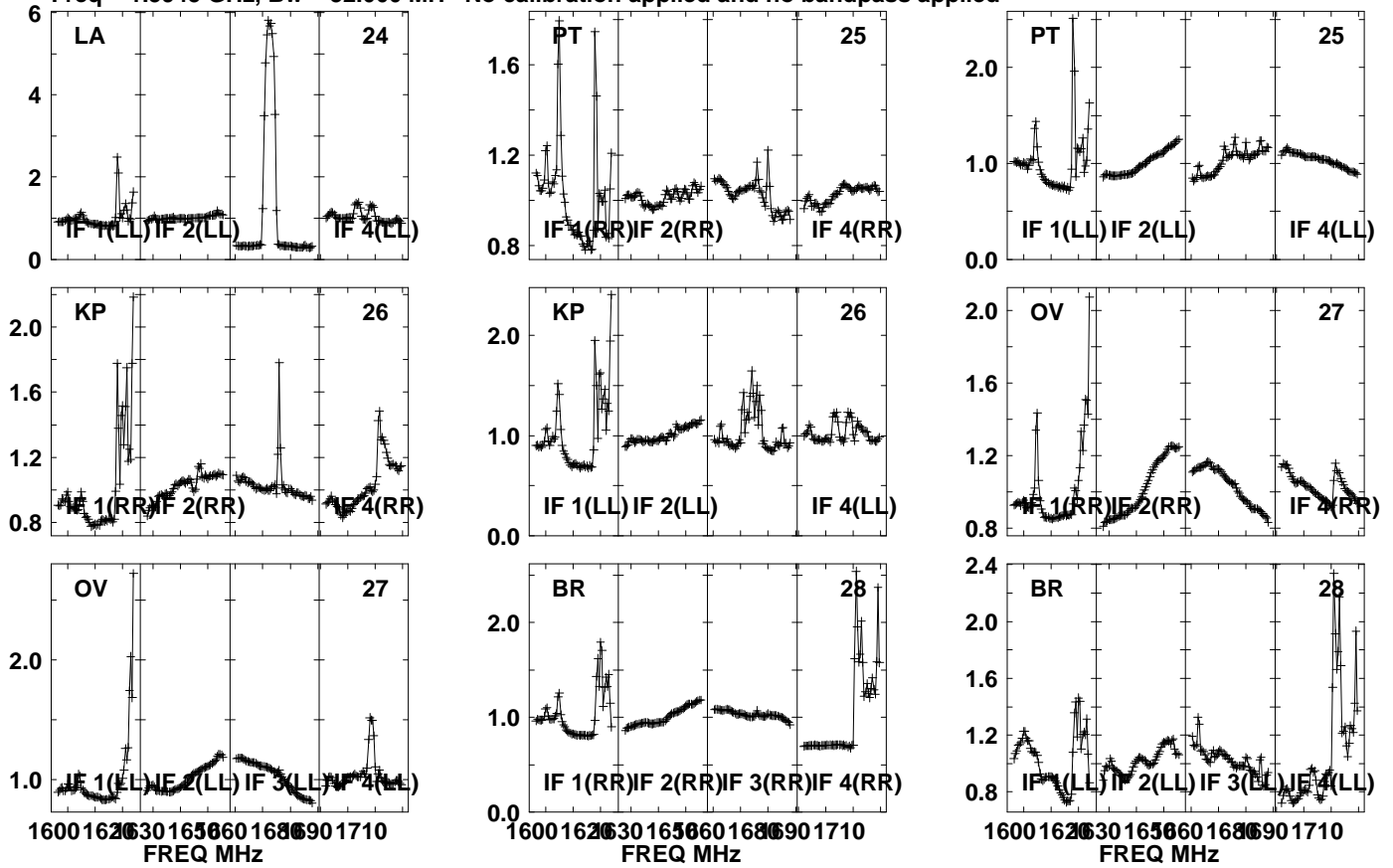

Lower frame: Real Jy  
Auto-corr total-power spectrum Antenna: \*  
Timerange: 01/00:09:11 to 01/00:12:29

Plot file version1565 created 05-OCT-2021 17:12:06

APM08279+525 GM076.UVDATA.1

Freq = 1.5945 GHz, Bw = 32.000 MH No calibration applied and no bandpass applied

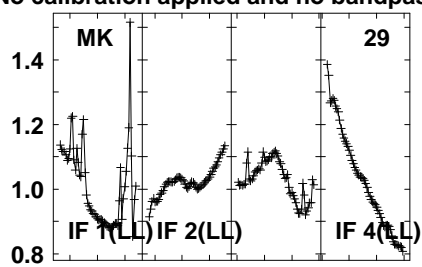
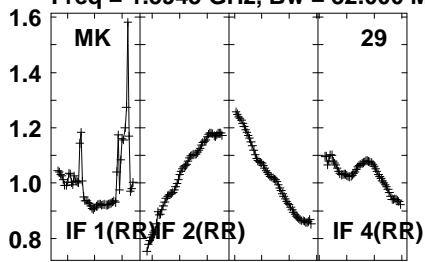

Lower frame: Real Jy  
Auto-corr total-power spectrum Antenna: \*  
Timerange: 01/00:09:11 to 01/00:12:29

Plot file version1566 created 05-OCT-2021 17:12:06

J0827+5217 GM076.UVDATA.1

Freq = 1.5945 GHz, Bw = 32.000 MH No calibration applied and no bandpass applied

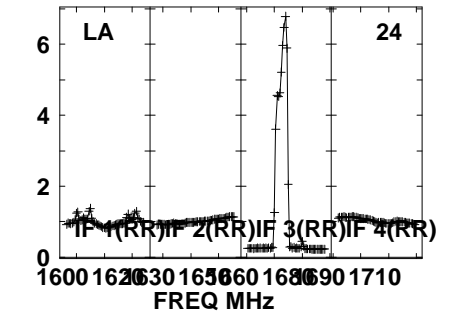
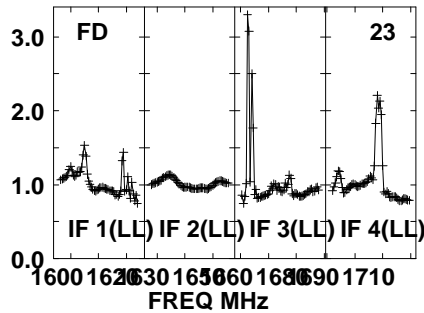
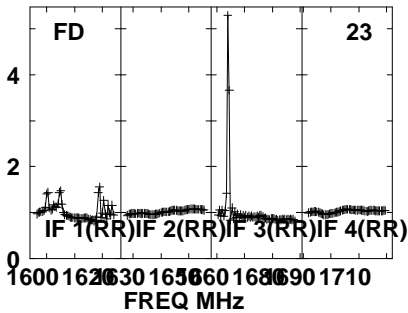
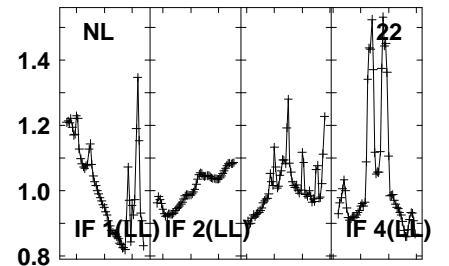
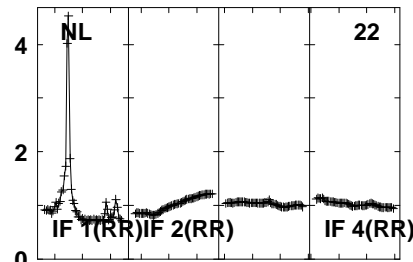
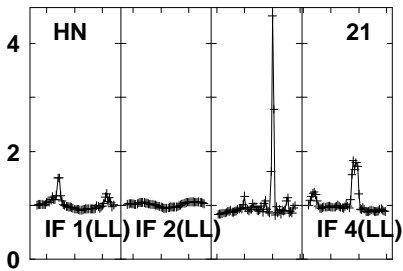
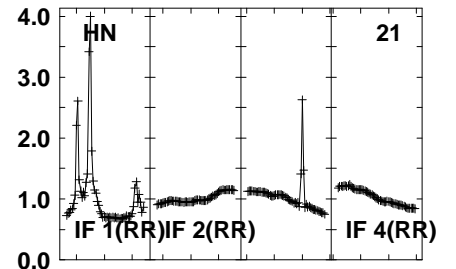
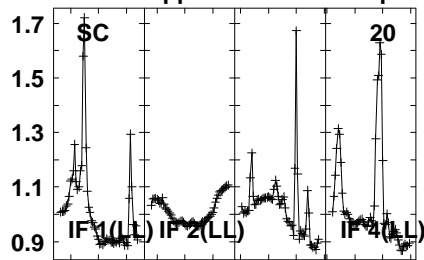
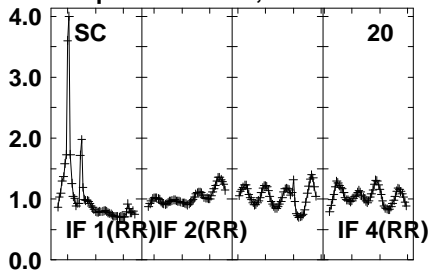

Lower frame: Real Jy

Auto-corr total-power spectrum Antenna: \*

Timerange: 01/00:13:01 to 01/00:14:29

Plot file version1567 created 05-OCT-2021 17:12:06

J0827+5217 GM076.UVDATA.1

Freq = 1.5945 GHz, Bw = 32.000 MH No calibration applied and no bandpass applied

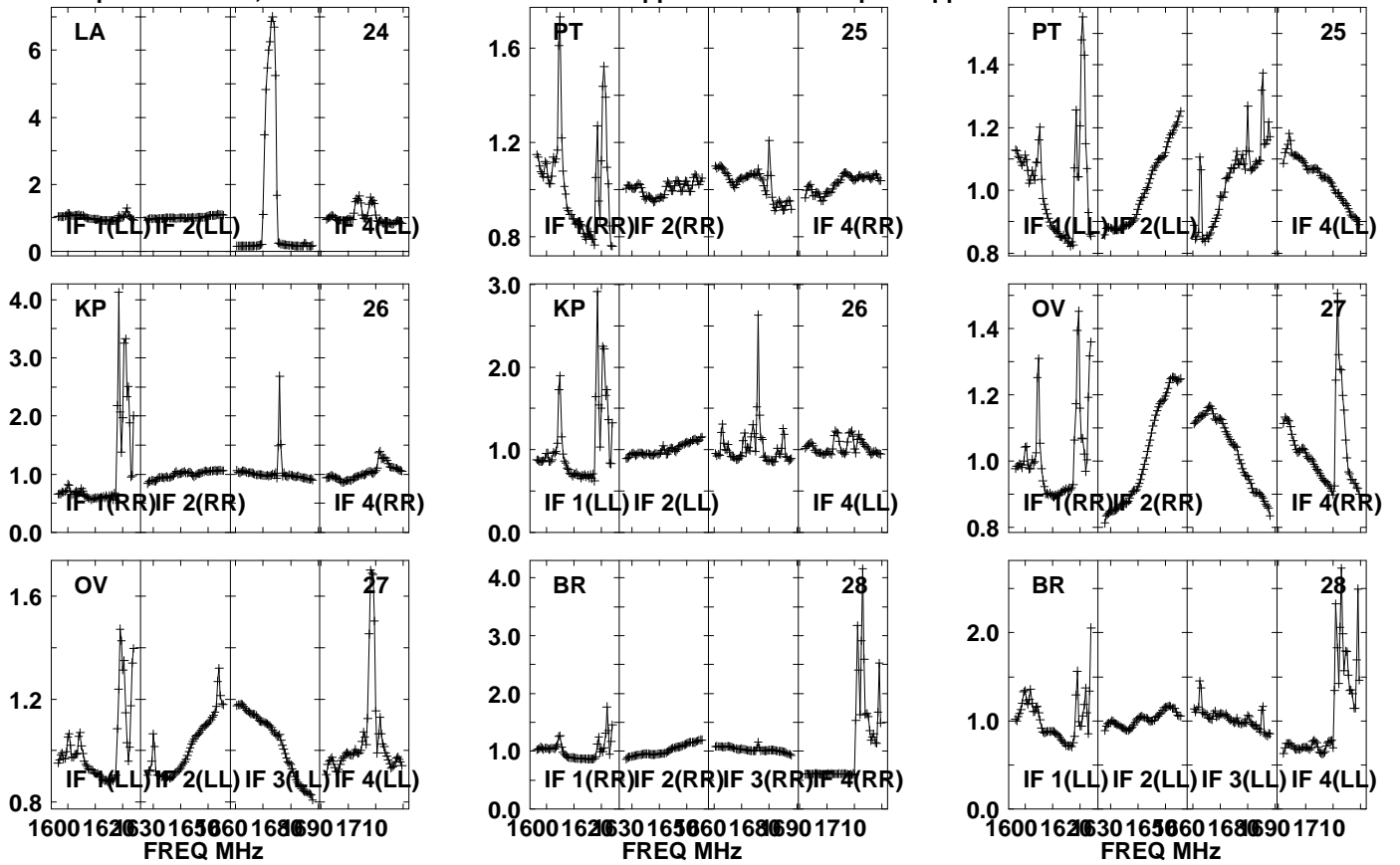

Lower frame: Real Jy  
Auto-corr total-power spectrum Antenna: \*  
Timerange: 01/00:13:01 to 01/00:14:29

Plot file version1568 created 05-OCT-2021 17:12:06

J0827+5217 GM076.UVDATA.1

Freq = 1.5945 GHz, Bw = 32.000 MH No calibration applied and no bandpass applied

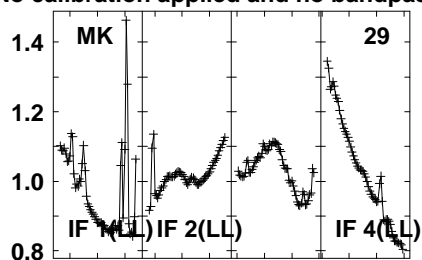
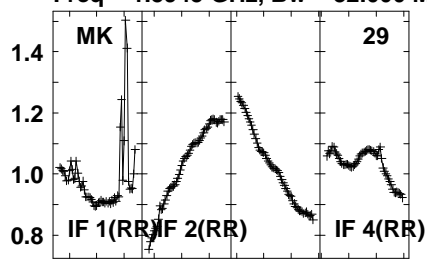

Lower frame: Real Jy  
Auto-corr total-power spectrum Antenna: \*  
Timerange: 01/00:13:01 to 01/00:14:29

Plot file version 1569 created 05-OCT-2021 17:12:06

APM08279+525 GM076.UVDATA.1

Freq = 1.5945 GHz, Bw = 32.000 MH No calibration applied and no bandpass applied

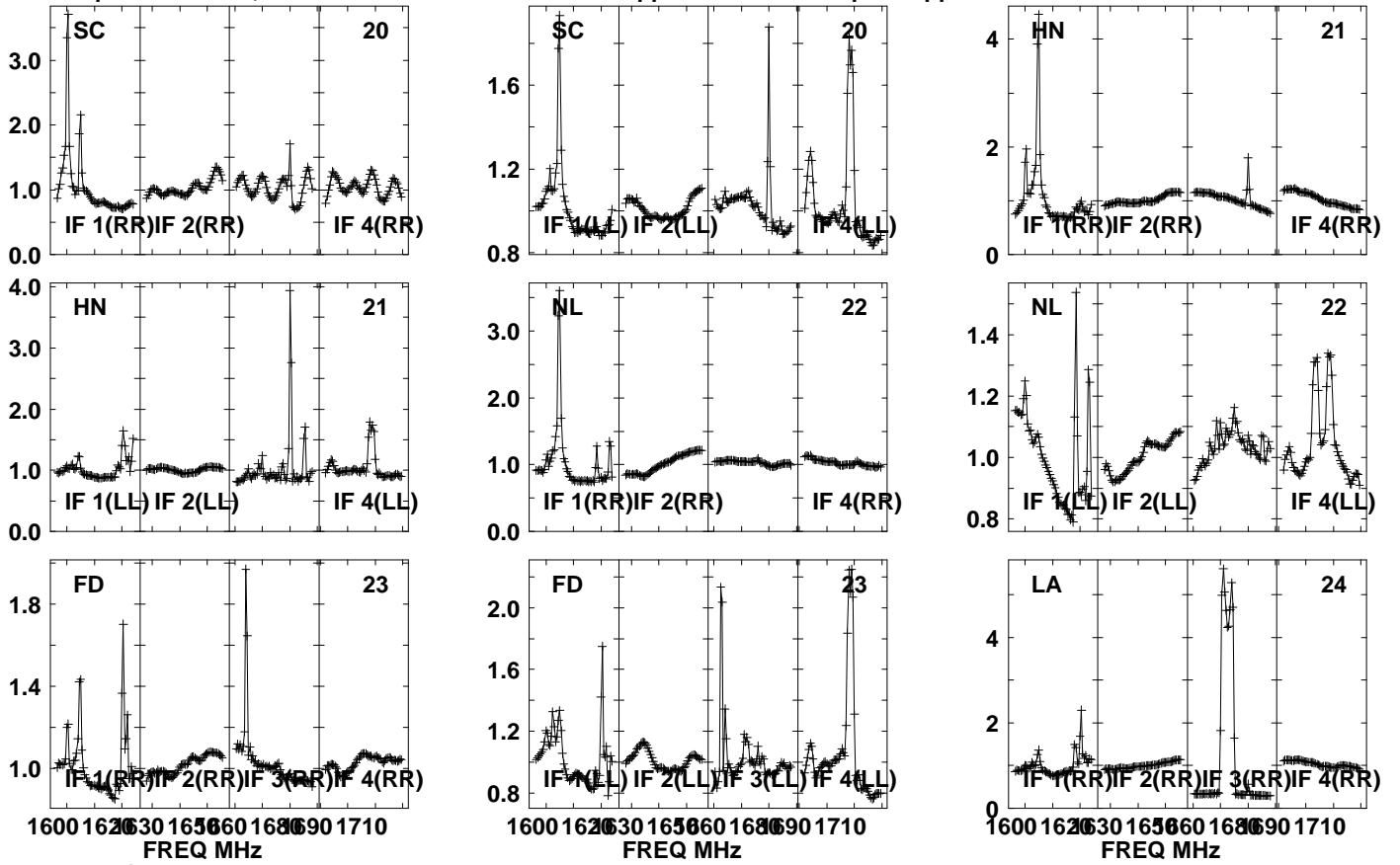

Lower frame: Real Jy

Auto-corr total-power spectrum Antenna: \*

Timerange: 01/00:14:41 to 01/00:17:59

Plot file version1570 created 05-OCT-2021 17:12:06

APM08279+525 GM076.UVDATA.1

Freq = 1.5945 GHz, Bw = 32.000 MH No calibration applied and no bandpass applied

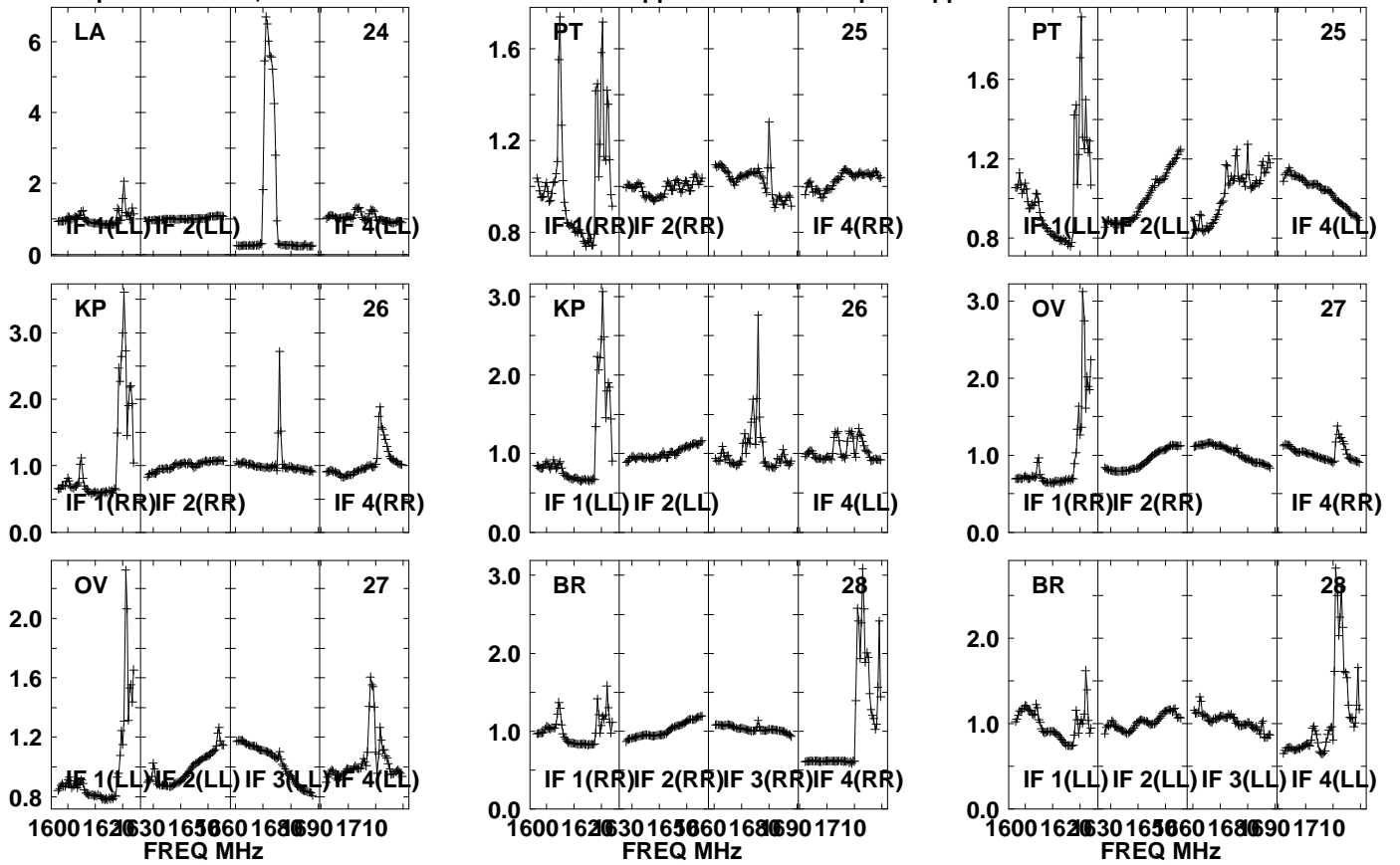

Lower frame: Real Jy

Auto-corr total-power spectrum Antenna: \*

Timerange: 01/00:14:41 to 01/00:17:59



Plot file version1571 created 05-OCT-2021 17:12:07

APM08279+525 GM076.UVDATA.1

Freq = 1.5945 GHz, Bw = 32.000 MH No calibration applied and no bandpass applied

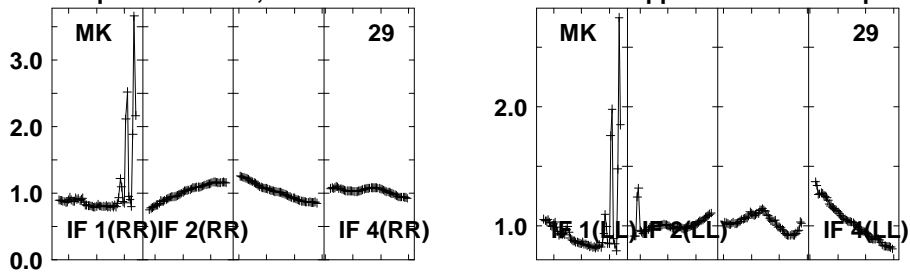

Lower frame: Real Jy

Auto-corr total-power spectrum Antenna: \*

Timerange: 01/00:14:41 to 01/00:17:59

Plot file version1572 created 05-OCT-2021 17:12:07

J0827+5217 GM076.UVDATA.1

Freq = 1.5945 GHz, Bw = 32.000 MH No calibration applied and no bandpass applied

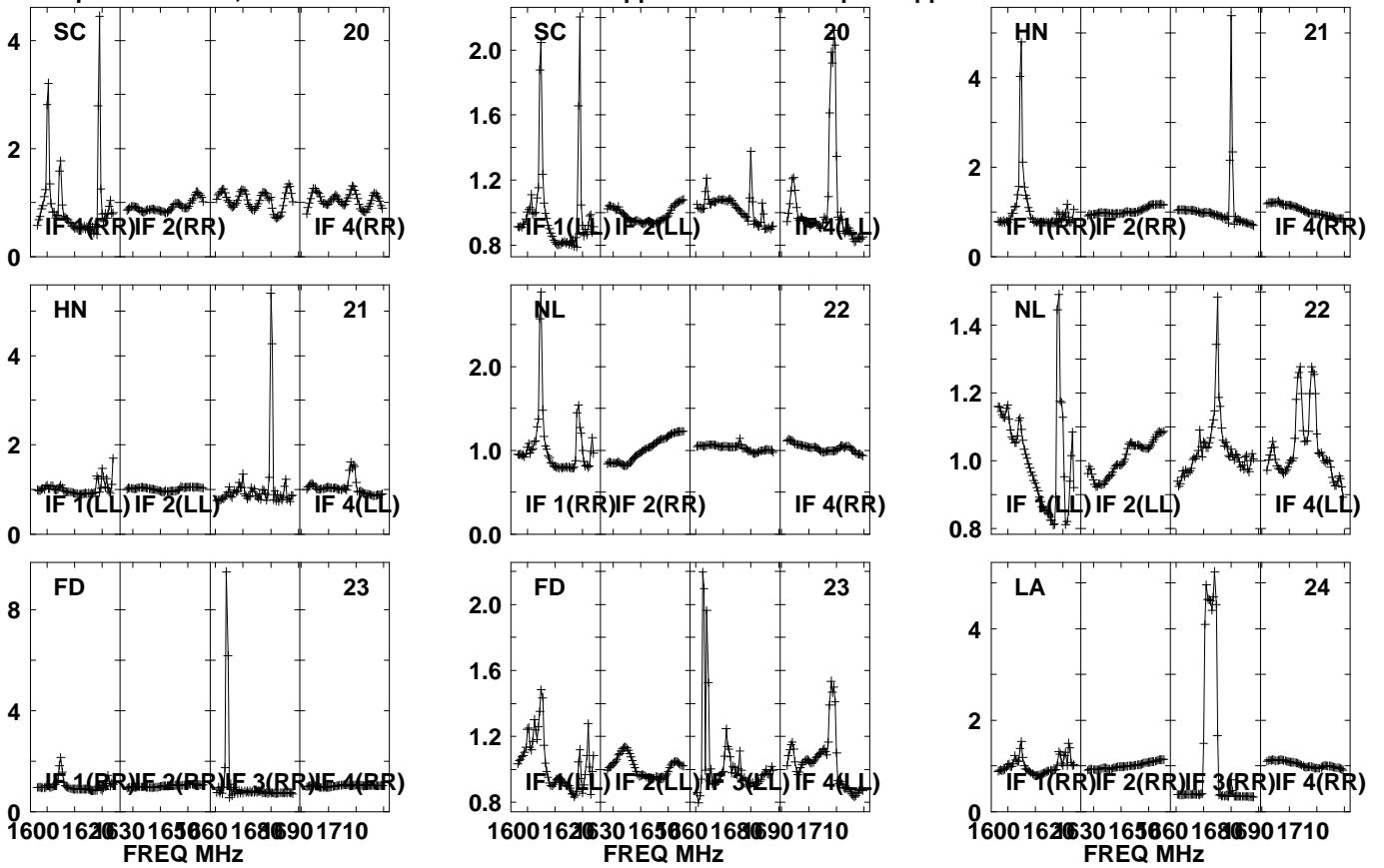

Lower frame: Real Jy

Auto-corr total-power spectrum Antenna: \*

Timerange: 01/00:18:31 to 01/00:19:59

Plot file version1573 created 05-OCT-2021 17:12:07

J0827+5217 GM076.UVDATA.1

Freq = 1.5945 GHz, Bw = 32.000 MH No calibration applied and no bandpass applied

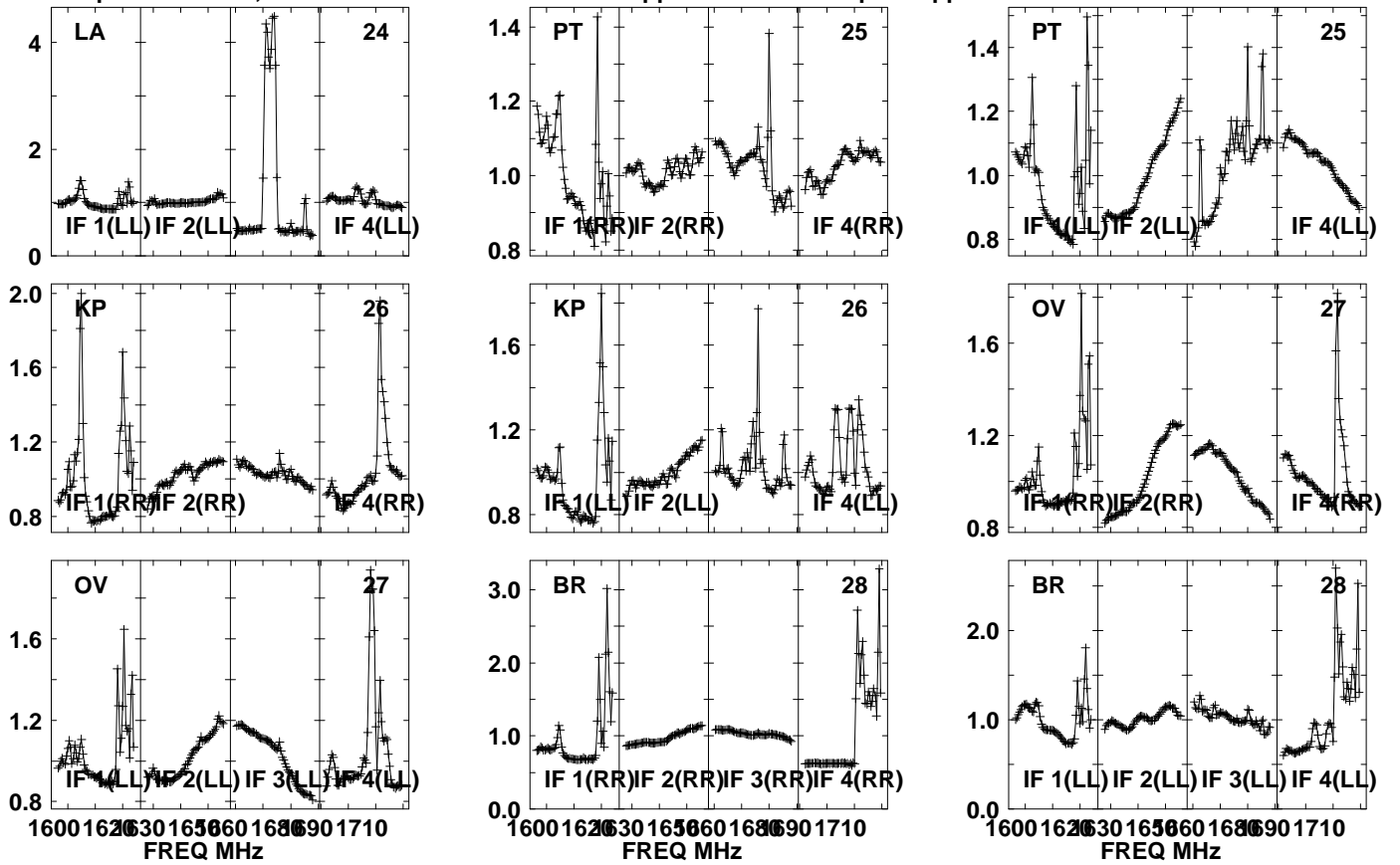

Lower frame: Real Jy

Auto-corr total-power spectrum Antenna: \*

Timerange: 01/00:18:31 to 01/00:19:59

Plot file version1574 created 05-OCT-2021 17:12:07

J0827+5217 GM076.UVDATA.1

Freq = 1.5945 GHz, Bw = 32.000 MH No calibration applied and no bandpass applied

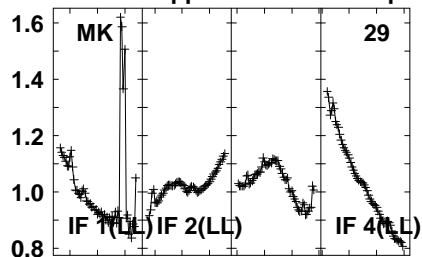
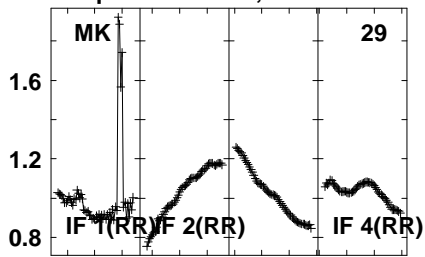

Lower frame: Real Jy  
Auto-corr total-power spectrum Antenna: \*  
Timerange: 01/00:18:31 to 01/00:19:59

Plot file version 1575 created 05-OCT-2021 17:12:07

4C39.25 GM076.UVDATA.1

Freq = 1.5945 GHz, Bw = 32.000 MHz No calibration applied and no bandpass applied

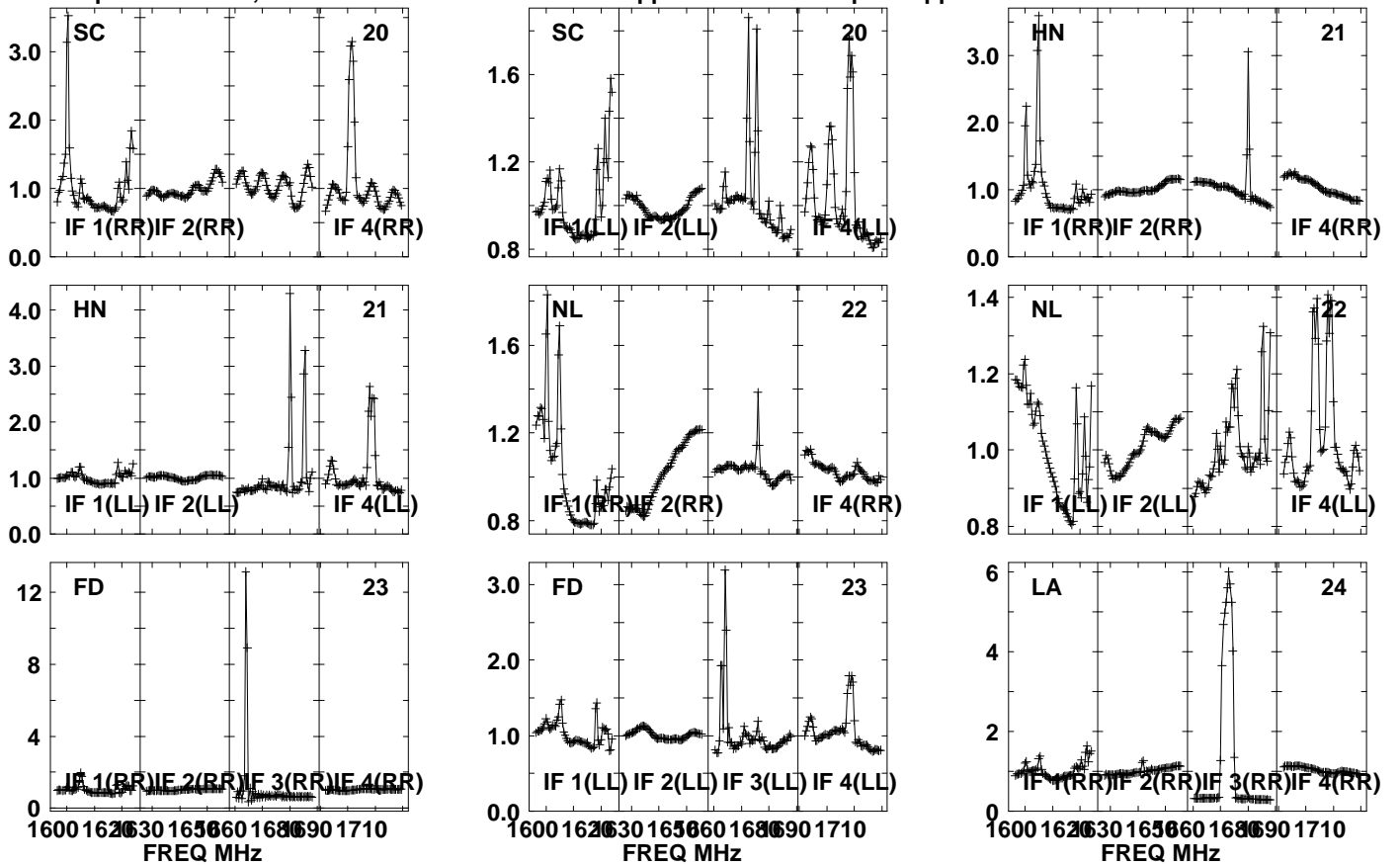

Lower frame: Real Jy

Auto-corr total-power spectrum Antenna: \*

Timerange: 01/00:25:01 to 01/00:29:59

Plot file version1576 created 05-OCT-2021 17:12:07

4C39.25 GM076.UVDATA.1

Freq = 1.5945 GHz, Bw = 32.000 MH No calibration applied and no bandpass applied

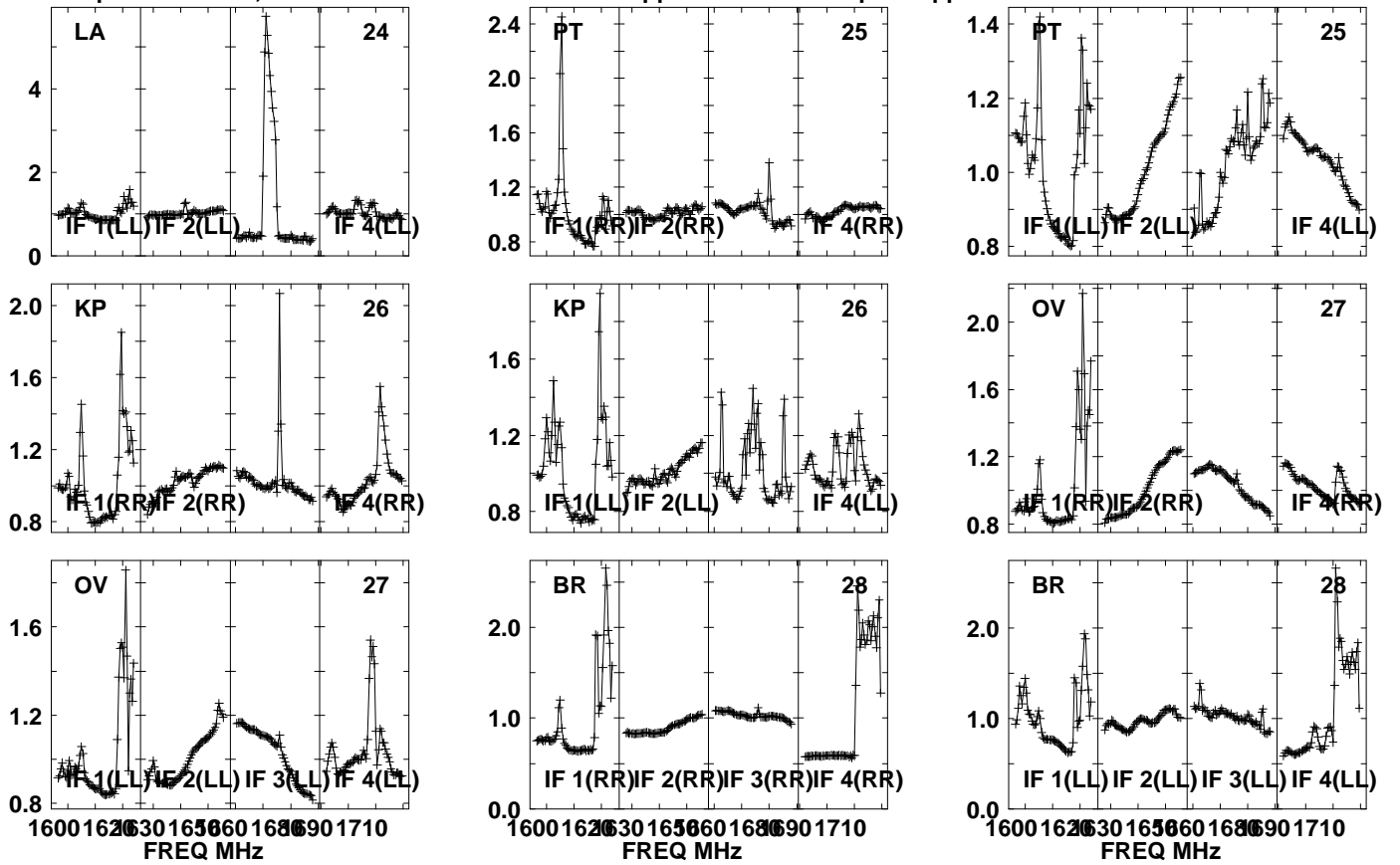

Lower frame: Real Jy  
Auto-corr total-power spectrum Antenna: \*  
Timerange: 01/00:25:01 to 01/00:29:59

Plot file version1577 created 05-OCT-2021 17:12:08

4C39.25 GM076.UVDATA.1

Freq = 1.5945 GHz, Bw = 32.000 MH No calibration applied and no bandpass applied

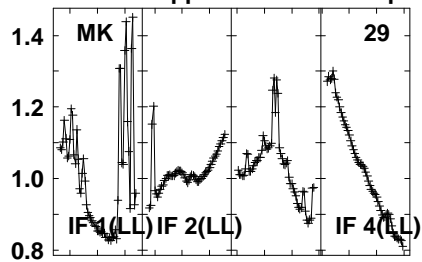
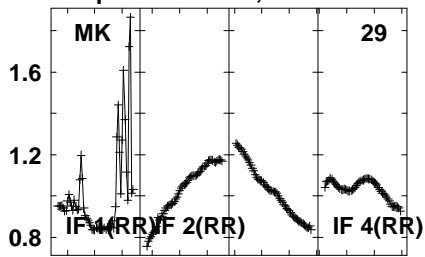

Lower frame: Real Jy  
Auto-corr total-power spectrum Antenna: \*  
Timerange: 01/00:25:01 to 01/00:29:59

Plot file version1578 created 05-OCT-2021 17:12:08

J0827+5217 GM076.UVDATA.1

Freq = 1.5945 GHz, Bw = 32.000 MH No calibration applied and no bandpass applied

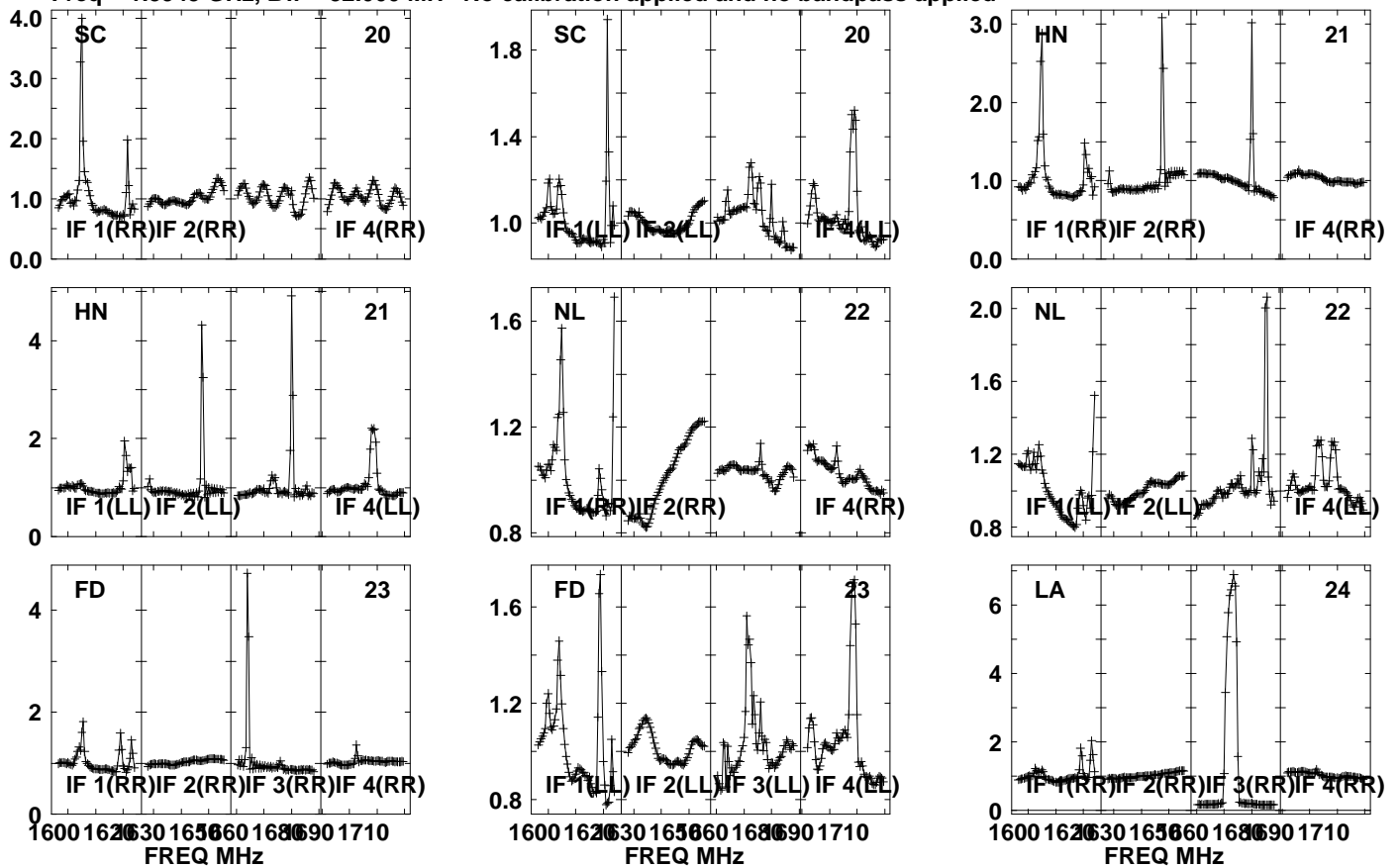

Lower frame: Real Jy

Auto-corr total-power spectrum Antenna: \*

Timerange: 01/00:34:31 to 01/00:36:29



Plot file version1579 created 05-OCT-2021 17:12:08

J0827+5217 GM076.UVDATA.1

Freq = 1.5945 GHz, Bw = 32.000 MH No calibration applied and no bandpass applied

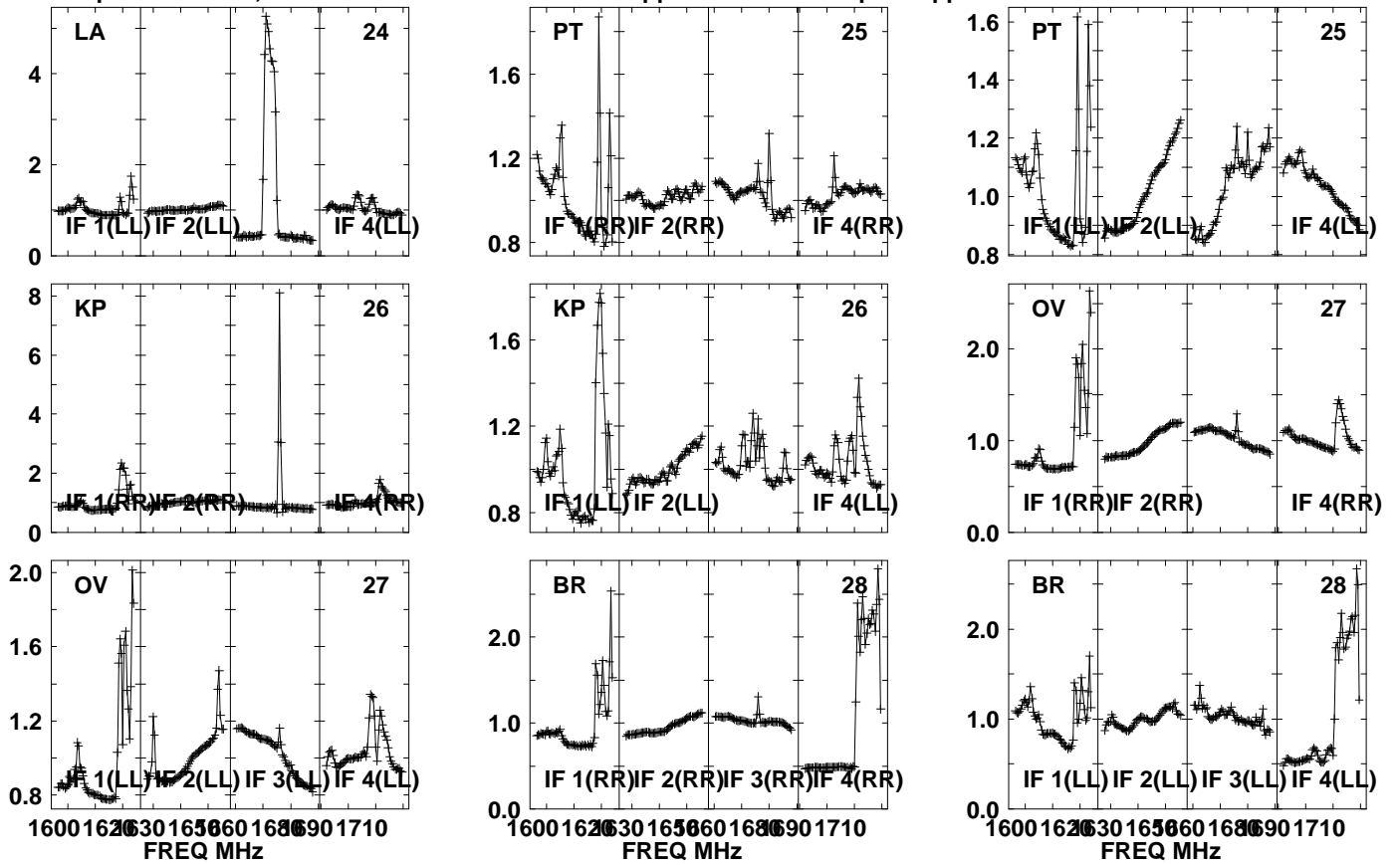

Lower frame: Real Jy

Auto-corr total-power spectrum Antenna: \*

Timerange: 01/00:34:31 to 01/00:36:29

Plot file version1580 created 05-OCT-2021 17:12:08

J0827+5217 GM076.UVDATA.1

Freq = 1.5945 GHz, Bw = 32.000 MH No calibration applied and no bandpass applied

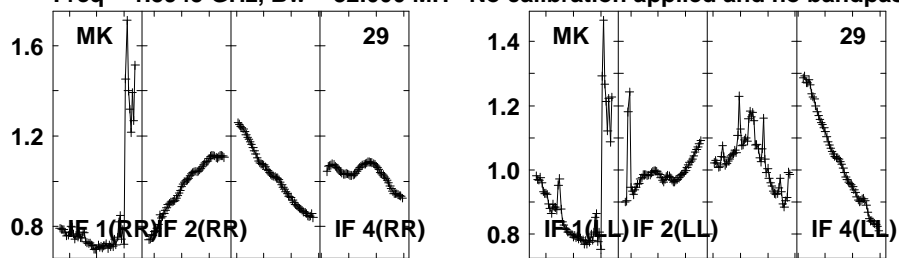

Lower frame: Real Jy  
Auto-corr total-power spectrum Antenna: \*  
Timerange: 01/00:34:31 to 01/00:36:29

Plot file version1581 created 05-OCT-2021 17:12:08

APM08279+525 GM076.UVDATA.1

Freq = 1.5945 GHz, Bw = 32.000 MH No calibration applied and no bandpass applied

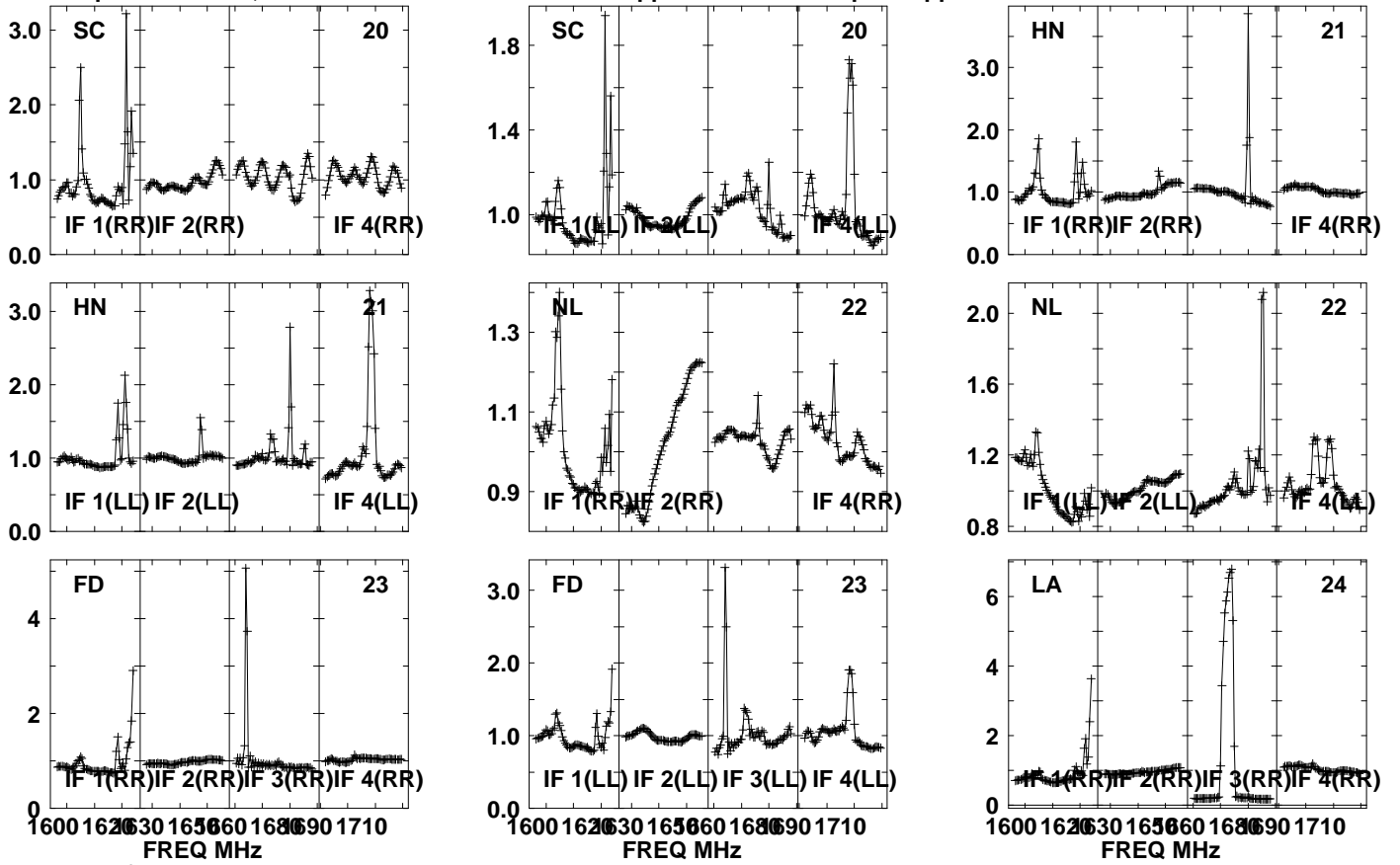

Lower frame: Real Jy

Auto-corr total-power spectrum Antenna: \*

Timerange: 01/00:36:41 to 01/00:39:59

Plot file version1582 created 05-OCT-2021 17:12:08

APM08279+525 GM076.UVDATA.1

Freq = 1.5945 GHz, Bw = 32.000 MH No calibration applied and no bandpass applied

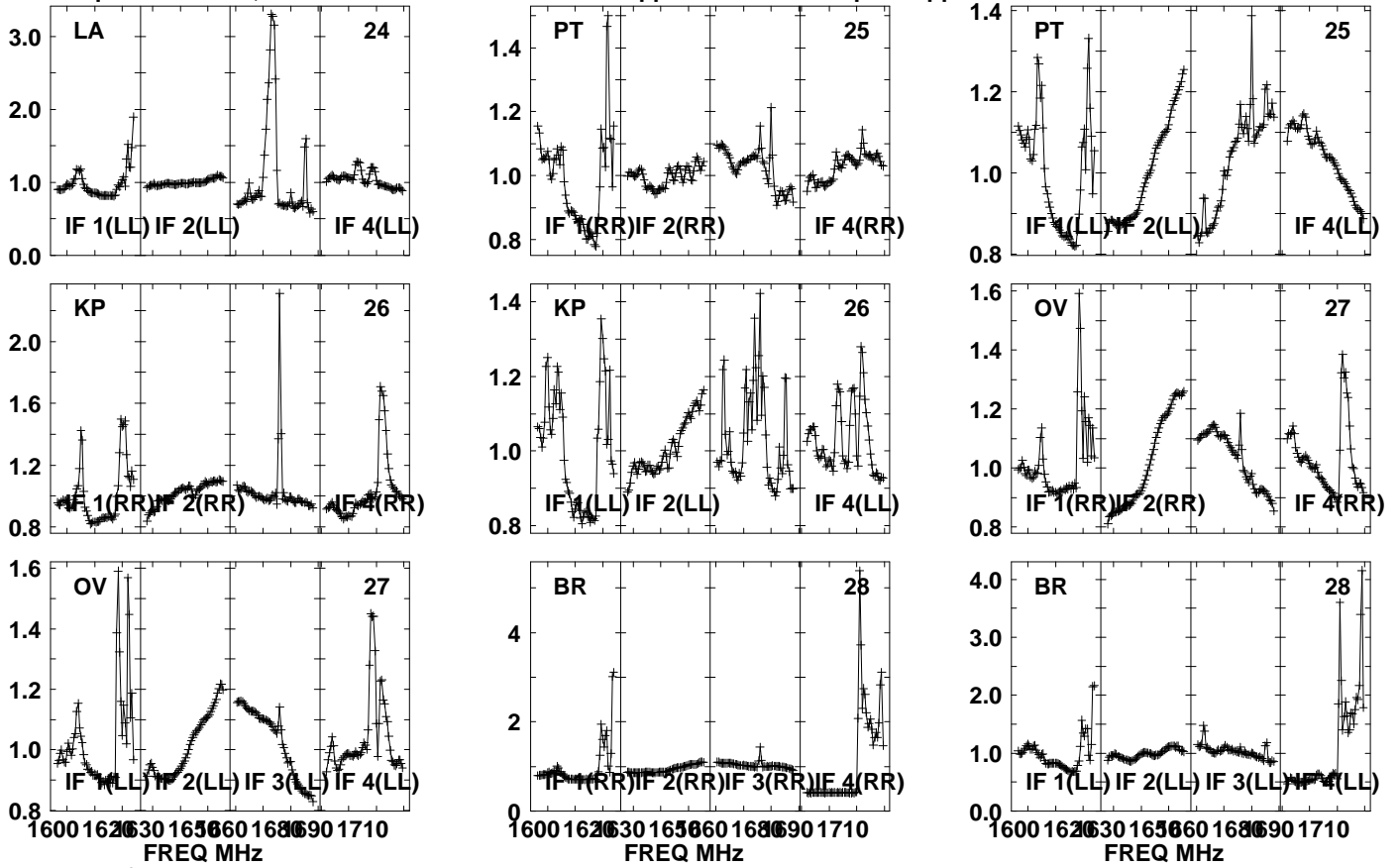

Lower frame: Real Jy

Auto-corr total-power spectrum Antenna: \*

Timerange: 01/00:36:41 to 01/00:39:59

Plot file version1583 created 05-OCT-2021 17:12:08

APM08279+525 GM076.UVDATA.1

Freq = 1.5945 GHz, Bw = 32.000 MH No calibration applied and no bandpass applied

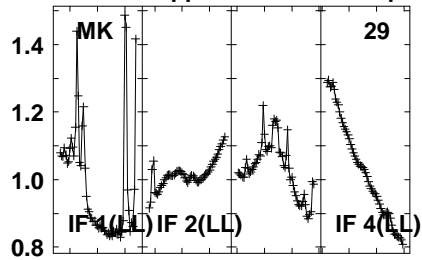
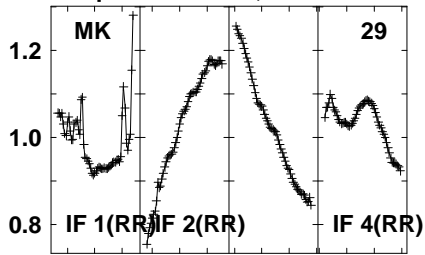

Lower frame: Real Jy  
Auto-corr total-power spectrum Antenna: \*  
Timerange: 01/00:36:41 to 01/00:39:59

Plot file version1584 created 05-OCT-2021 17:12:08

J0827+5217 GM076.UVDATA.1

Freq = 1.5945 GHz, Bw = 32.000 MH No calibration applied and no bandpass applied

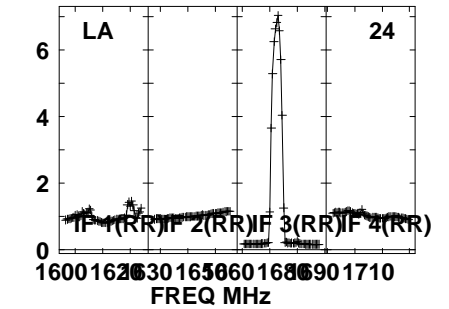
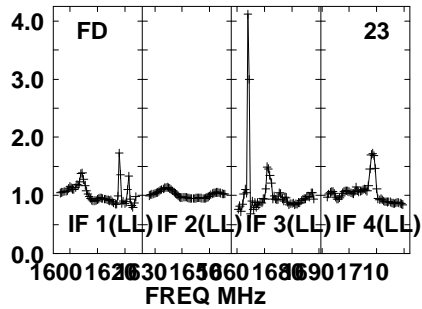
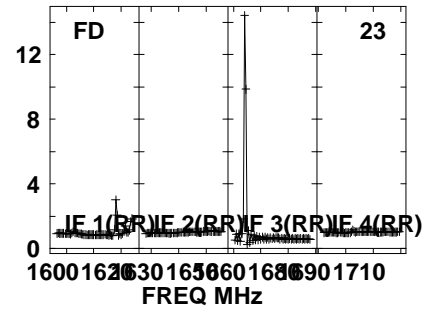
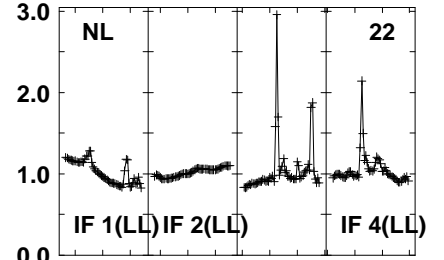
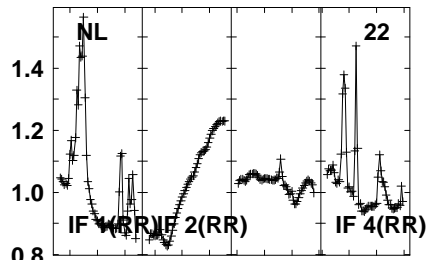
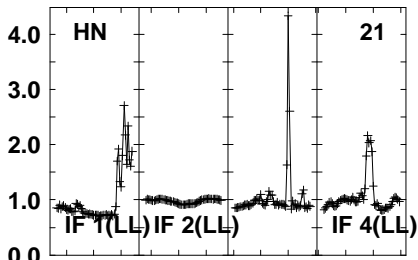
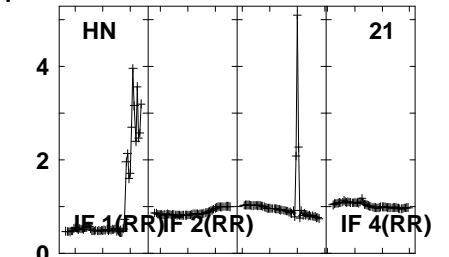
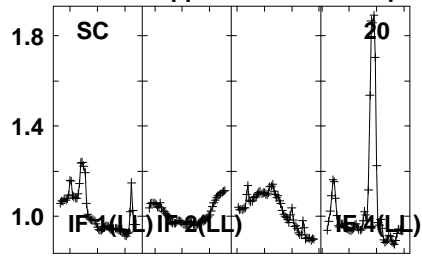
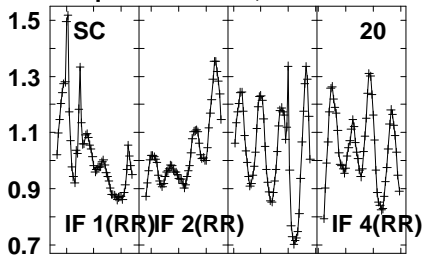

Lower frame: Real Jy  
Auto-corr total-power spectrum Antenna: \*  
Timerange: 01/00:40:31 to 01/00:41:59

Plot file version1585 created 05-OCT-2021 17:12:08

J0827+5217 GM076.UVDATA.1

Freq = 1.5945 GHz, Bw = 32.000 MH No calibration applied and no bandpass applied

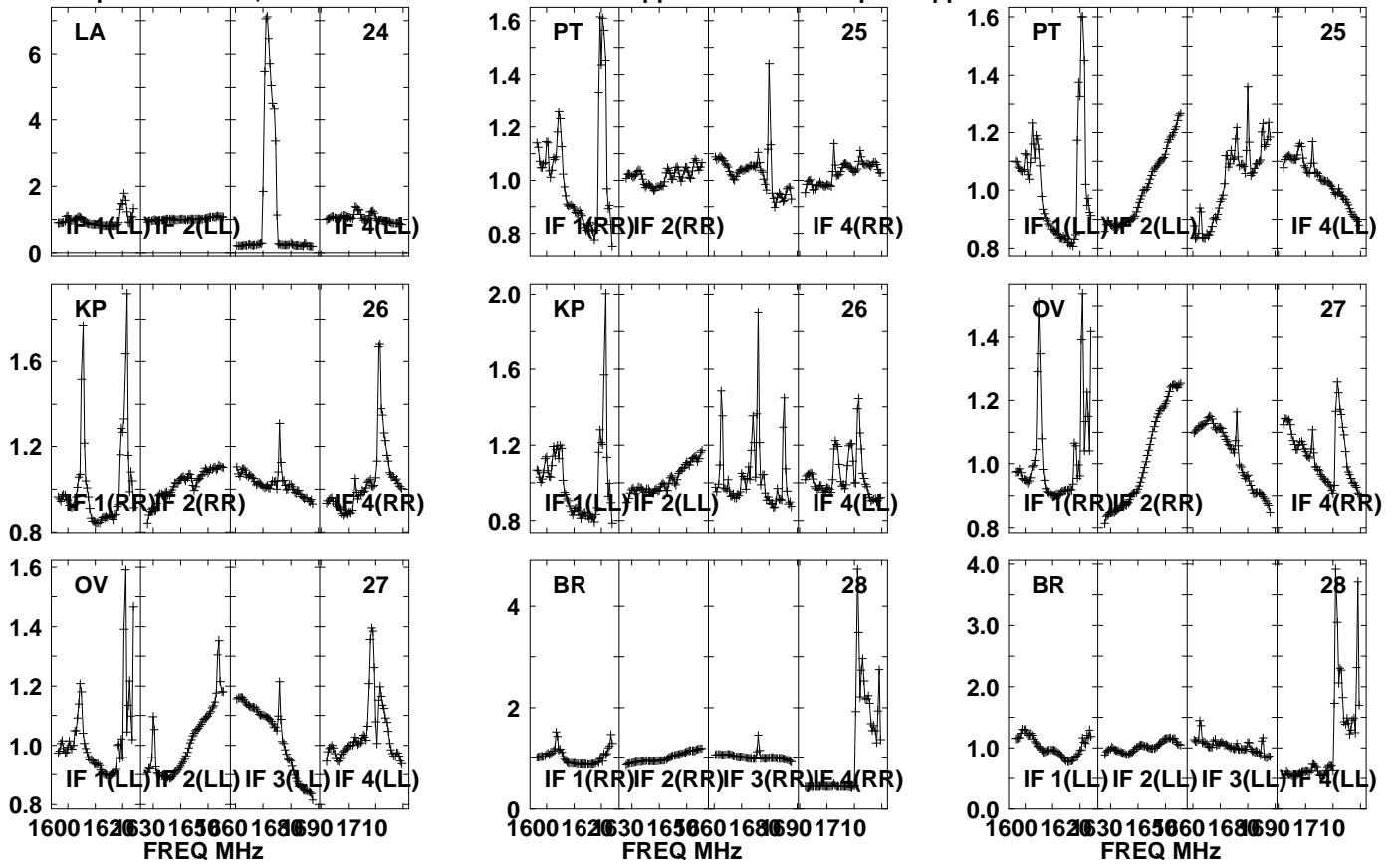

Lower frame: Real Jy  
Auto-corr total-power spectrum Antenna: \*  
Timerange: 01/00:40:31 to 01/00:41:59

Plot file version1586 created 05-OCT-2021 17:12:08

J0827+5217 GM076.UVDATA.1

Freq = 1.5945 GHz, Bw = 32.000 MH No calibration applied and no bandpass applied

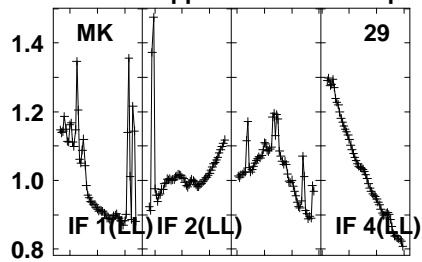
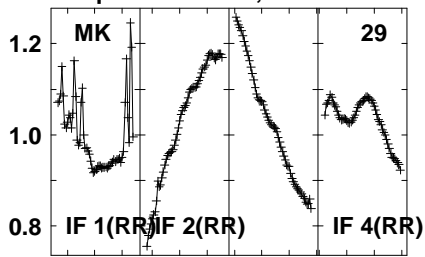

Lower frame: Real Jy  
Auto-corr total-power spectrum Antenna: \*  
Timerange: 01/00:40:31 to 01/00:41:59



Plot file version1587 created 05-OCT-2021 17:12:09

APM08279+525 GM076.UVDATA.1

Freq = 1.5945 GHz, Bw = 32.000 MH No calibration applied and no bandpass applied

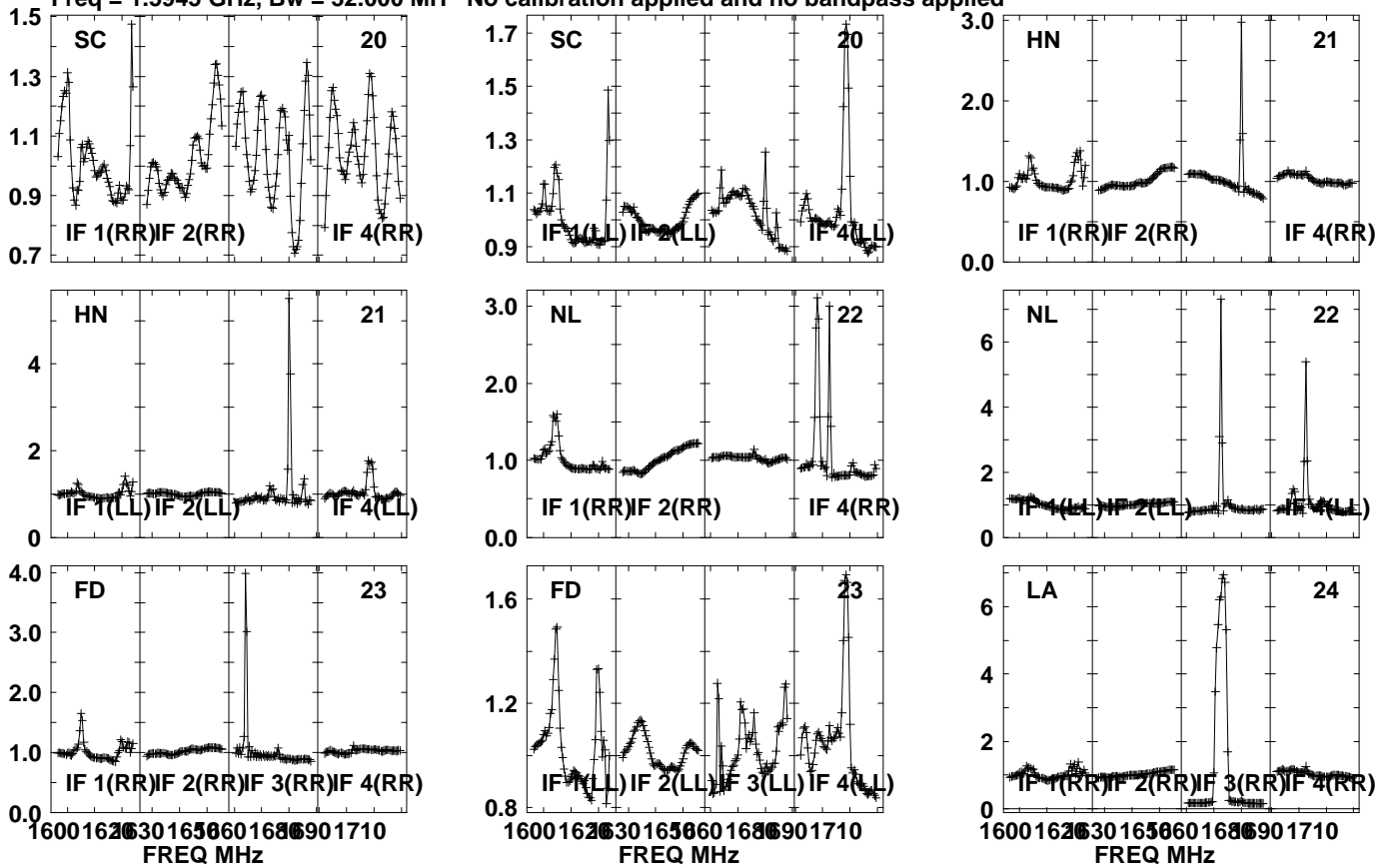

Lower frame: Real Jy  
Auto-corr total-power spectrum Antenna: \*  
Timerange: 01/00:42:11 to 01/00:45:29

Plot file version1588 created 05-OCT-2021 17:12:09

APM08279+525 GM076.UVDATA.1

Freq = 1.5945 GHz, Bw = 32.000 MH No calibration applied and no bandpass applied

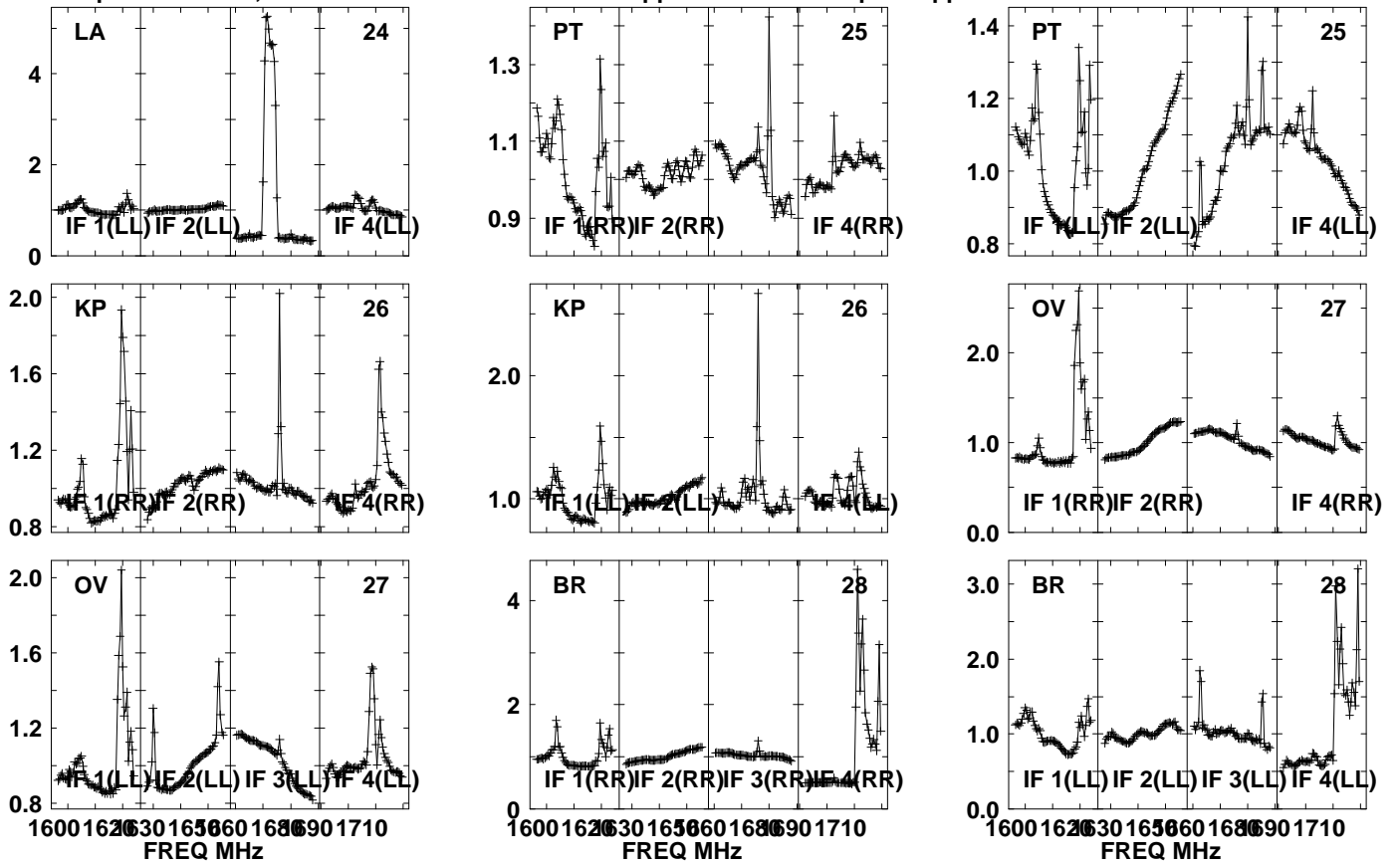

Lower frame: Real Jy

Auto-corr total-power spectrum Antenna: \*

Timerange: 01/00:42:11 to 01/00:45:29

Plot file version1589 created 05-OCT-2021 17:12:09

APM08279+525 GM076.UVDATA.1

Freq = 1.5945 GHz, Bw = 32.000 MH No calibration applied and no bandpass applied

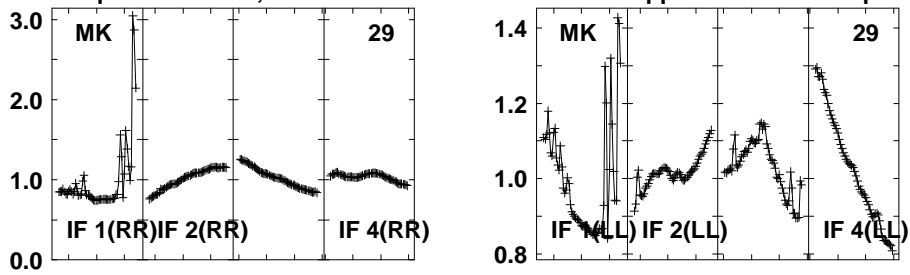

Lower frame: Real Jy

Auto-corr total-power spectrum Antenna: \*

Timerange: 01/00:42:11 to 01/00:45:29

Plot file version1590 created 05-OCT-2021 17:12:09

J0827+5217 GM076.UVDATA.1

Freq = 1.5945 GHz, Bw = 32.000 MH No calibration applied and no bandpass applied

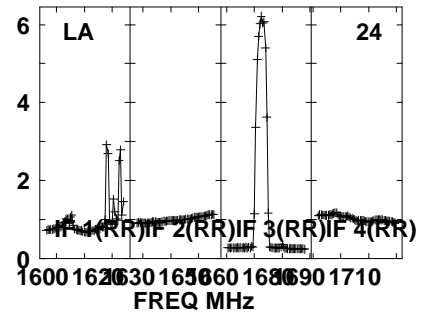
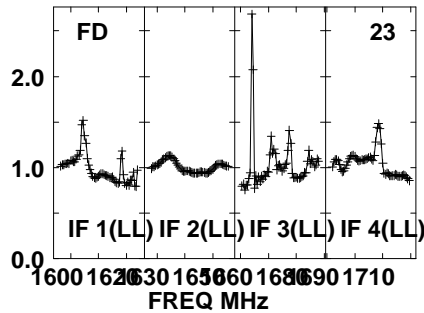
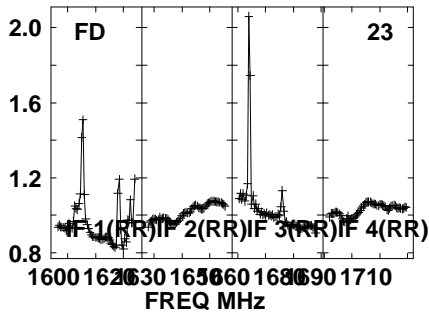
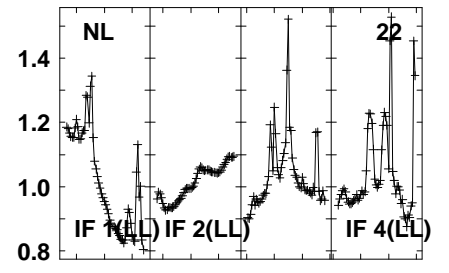
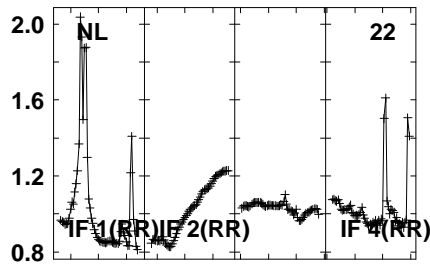
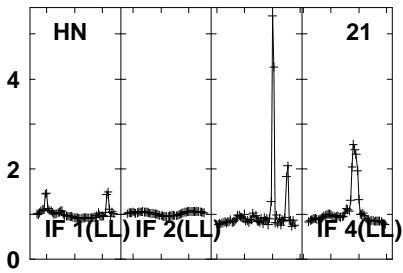
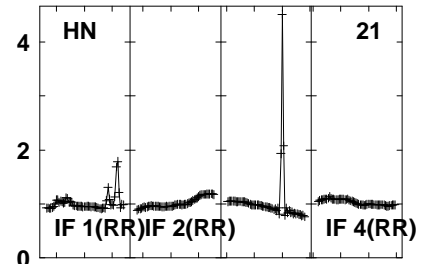
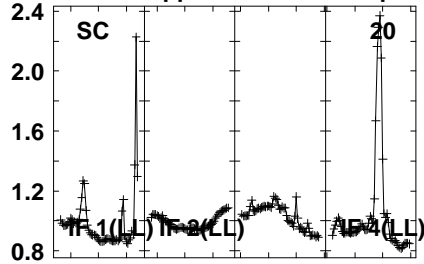
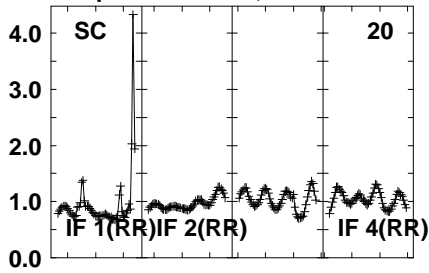

Lower frame: Real Jy  
Auto-corr total-power spectrum Antenna: \*  
Timerange: 01/00:46:01 to 01/00:47:29

Plot file version1591 created 05-OCT-2021 17:12:09

J0827+5217 GM076.UVDATA.1

Freq = 1.5945 GHz, Bw = 32.000 MH No calibration applied and no bandpass applied

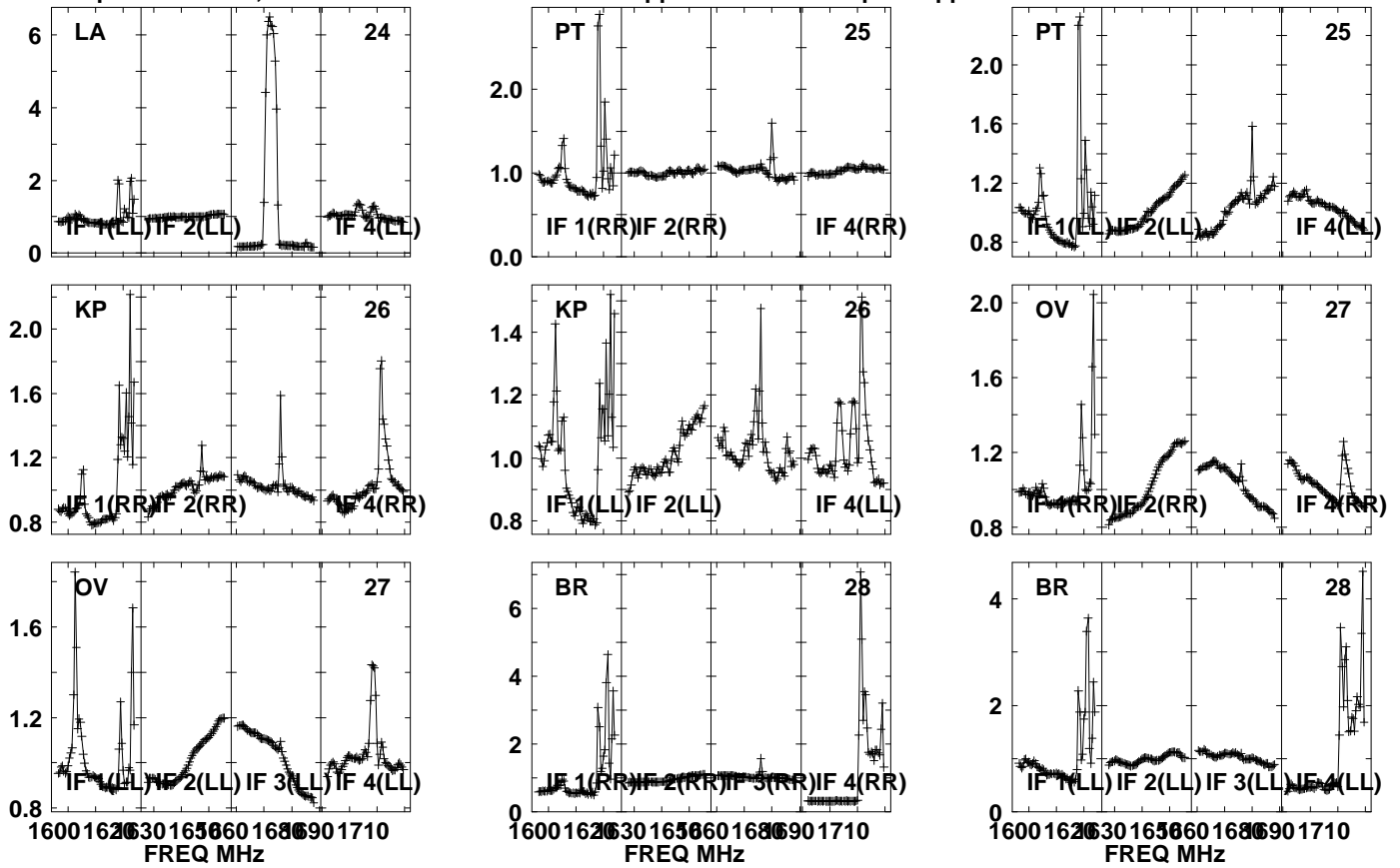

Lower frame: Real Jy  
Auto-corr total-power spectrum Antenna: \*  
Timerange: 01/00:46:01 to 01/00:47:29

Plot file version1592 created 05-OCT-2021 17:12:09

J0827+5217 GM076.UVDATA.1

Freq = 1.5945 GHz, Bw = 32.000 MH No calibration applied and no bandpass applied

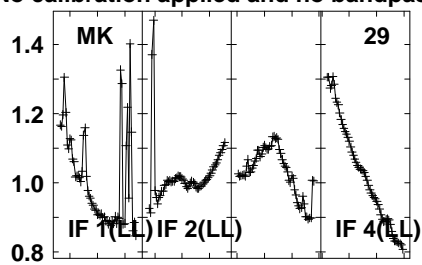
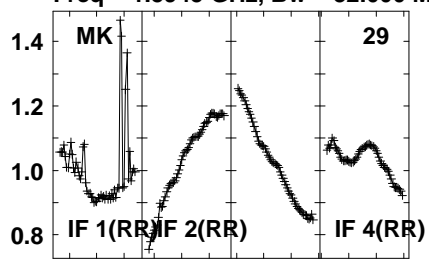

Lower frame: Real Jy  
Auto-corr total-power spectrum Antenna: \*  
Timerange: 01/00:46:01 to 01/00:47:29

Plot file version1593 created 05-OCT-2021 17:12:09

APM08279+525 GM076.UVDATA.1

Freq = 1.5945 GHz, Bw = 32.000 MH No calibration applied and no bandpass applied

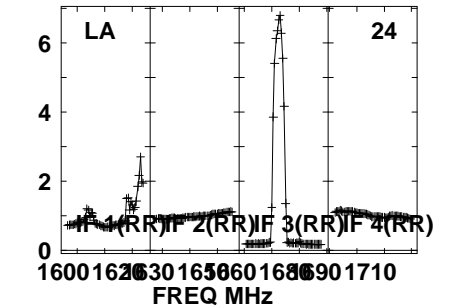
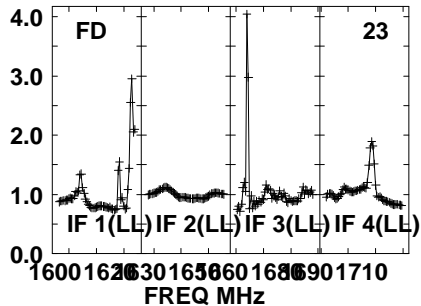
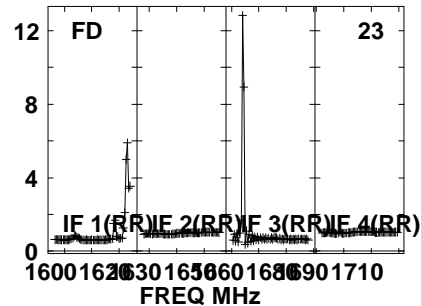
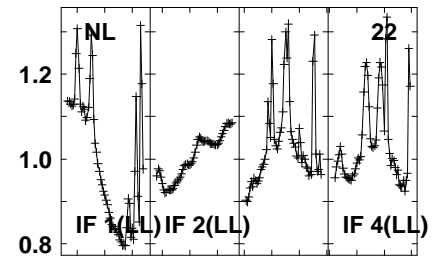
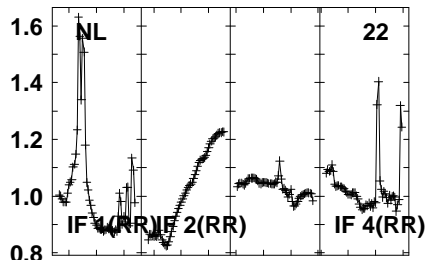
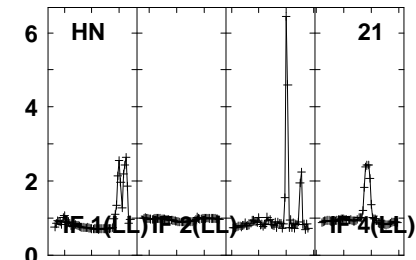
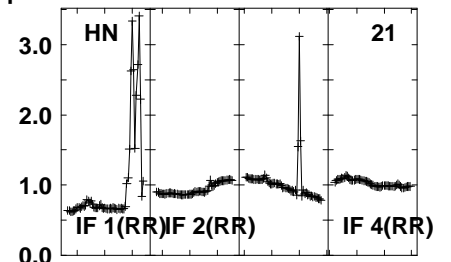
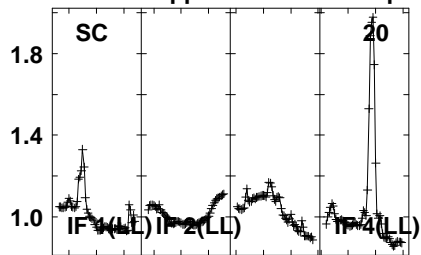
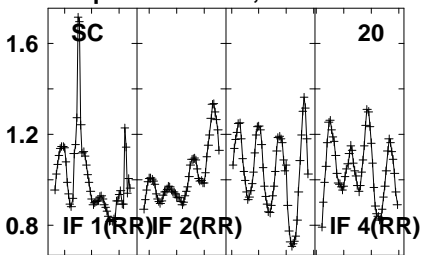

Lower frame: Real Jy  
Auto-corr total-power spectrum Antenna: \*  
Timerange: 01/00:47:41 to 01/00:50:59

Plot file version1594 created 05-OCT-2021 17:12:09

APM08279+525 GM076.UVDATA.1

Freq = 1.5945 GHz, Bw = 32.000 MH No calibration applied and no bandpass applied

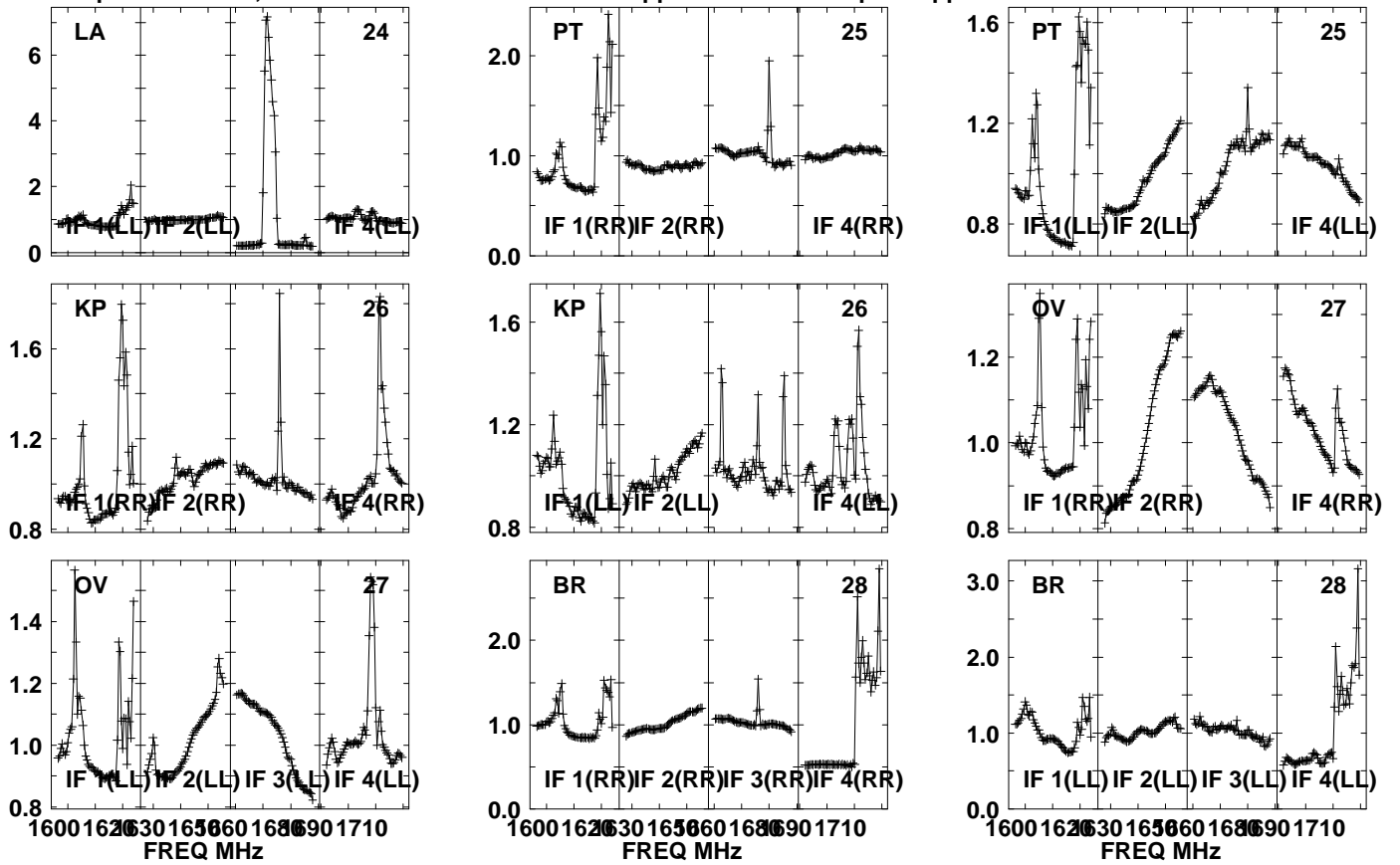

Lower frame: Real Jy

Auto-corr total-power spectrum Antenna: \*

Timerange: 01/00:47:41 to 01/00:50:59



Plot file version1595 created 05-OCT-2021 17:12:10

APM08279+525 GM076.UVDATA.1

Freq = 1.5945 GHz, Bw = 32.000 MH No calibration applied and no bandpass applied

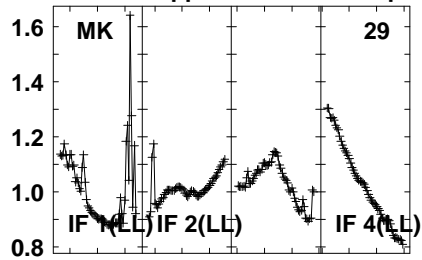
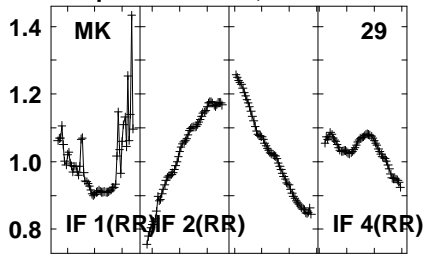

Lower frame: Real Jy  
Auto-corr total-power spectrum Antenna: \*  
Timerange: 01/00:47:41 to 01/00:50:59

Plot file version1596 created 05-OCT-2021 17:12:10

J0827+5217 GM076.UVDATA.1

Freq = 1.5945 GHz, Bw = 32.000 MH No calibration applied and no bandpass applied

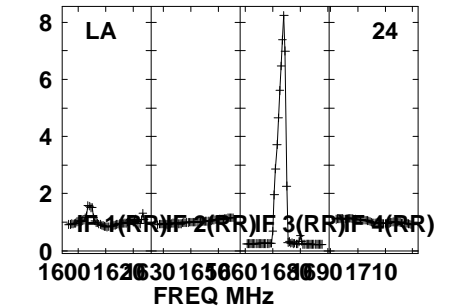
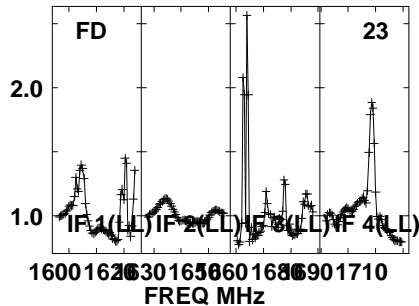
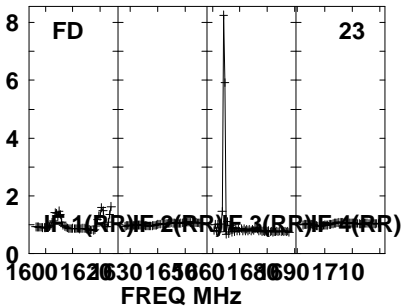
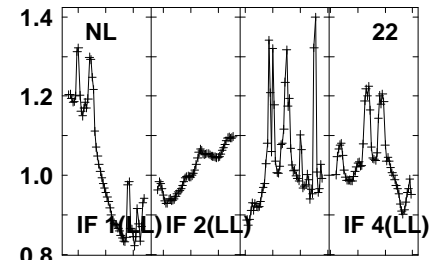
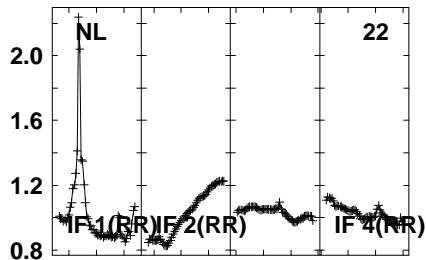
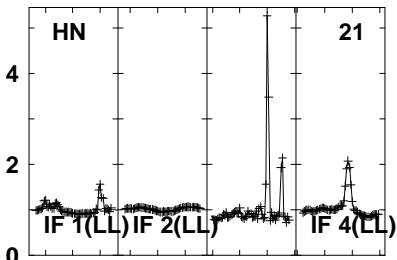
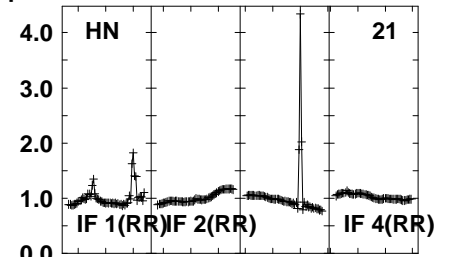
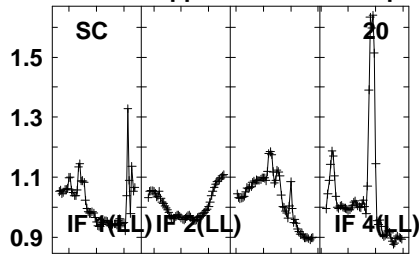
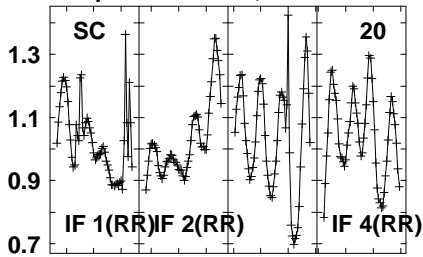

Lower frame: Real Jy  
Auto-corr total-power spectrum Antenna: \*  
Timerange: 01/00:51:31 to 01/00:52:59

Plot file version 1597 created 05-OCT-2021 17:12:10

J0827+5217 GM076.UVDATA.1

Freq = 1.5945 GHz, Bw = 32.000 MH No calibration applied and no bandpass applied

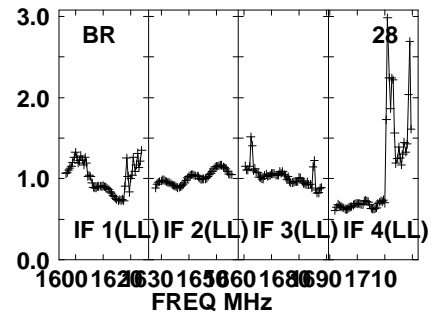
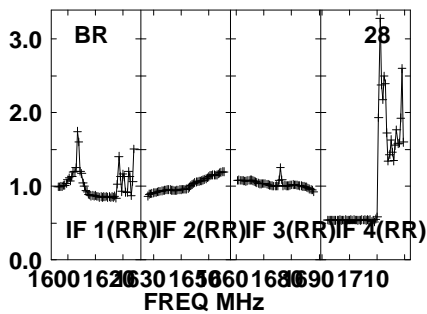
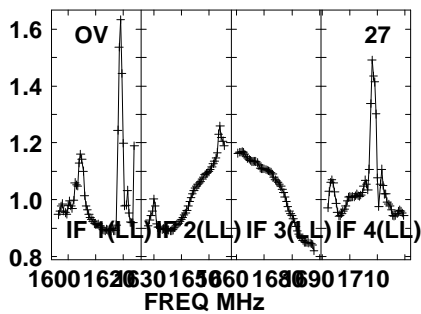
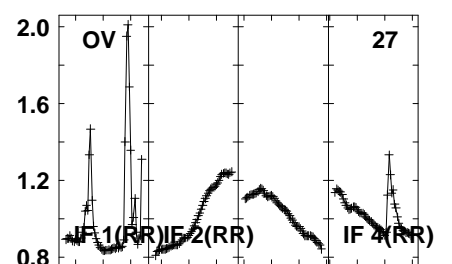
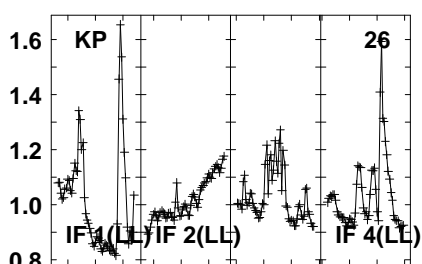
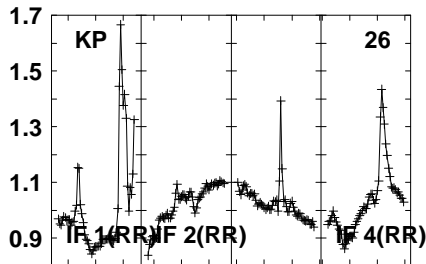
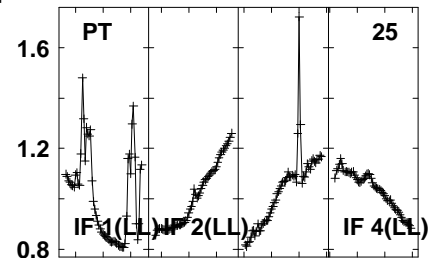
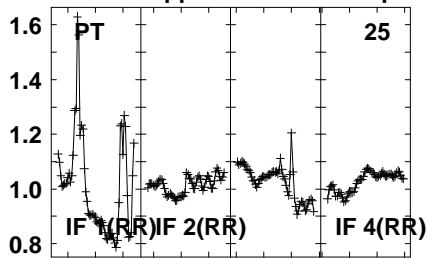
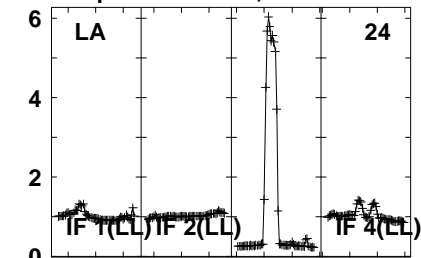

Lower frame: Real Jy

Auto-corr total-power spectrum Antenna: \*

Timerange: 01/00:51:31 to 01/00:52:59

Plot file version1598 created 05-OCT-2021 17:12:10

J0827+5217 GM076.UVDATA.1

Freq = 1.5945 GHz, Bw = 32.000 MH No calibration applied and no bandpass applied

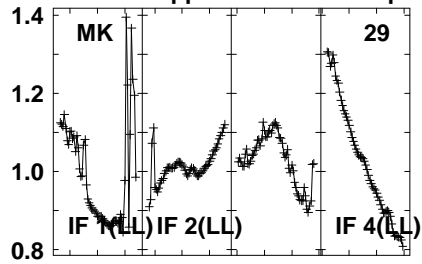
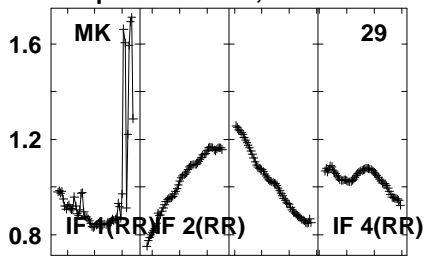

Lower frame: Real Jy  
Auto-corr total-power spectrum Antenna: \*  
Timerange: 01/00:51:31 to 01/00:52:59

Plot file version1599 created 05-OCT-2021 17:12:10

APM08279+525 GM076.UVDATA.1

Freq = 1.5945 GHz, Bw = 32.000 MH No calibration applied and no bandpass applied

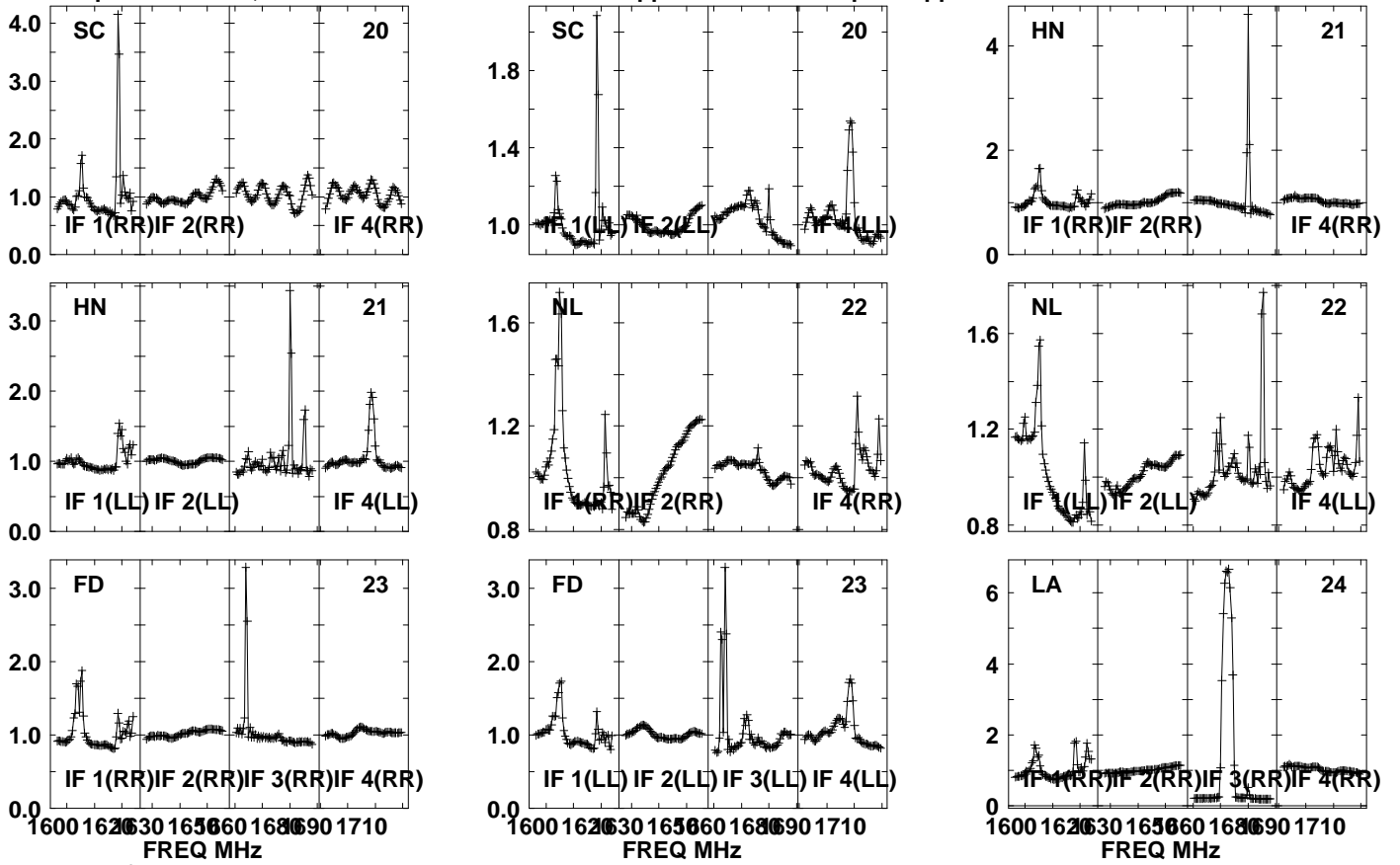

Lower frame: Real Jy  
Auto-corr total-power spectrum Antenna: \*  
Timerange: 01/00:53:11 to 01/00:56:29

Plot file version1600 created 05-OCT-2021 17:12:10

APM08279+525 GM076.UVDATA.1

Freq = 1.5945 GHz, Bw = 32.000 MH No calibration applied and no bandpass applied

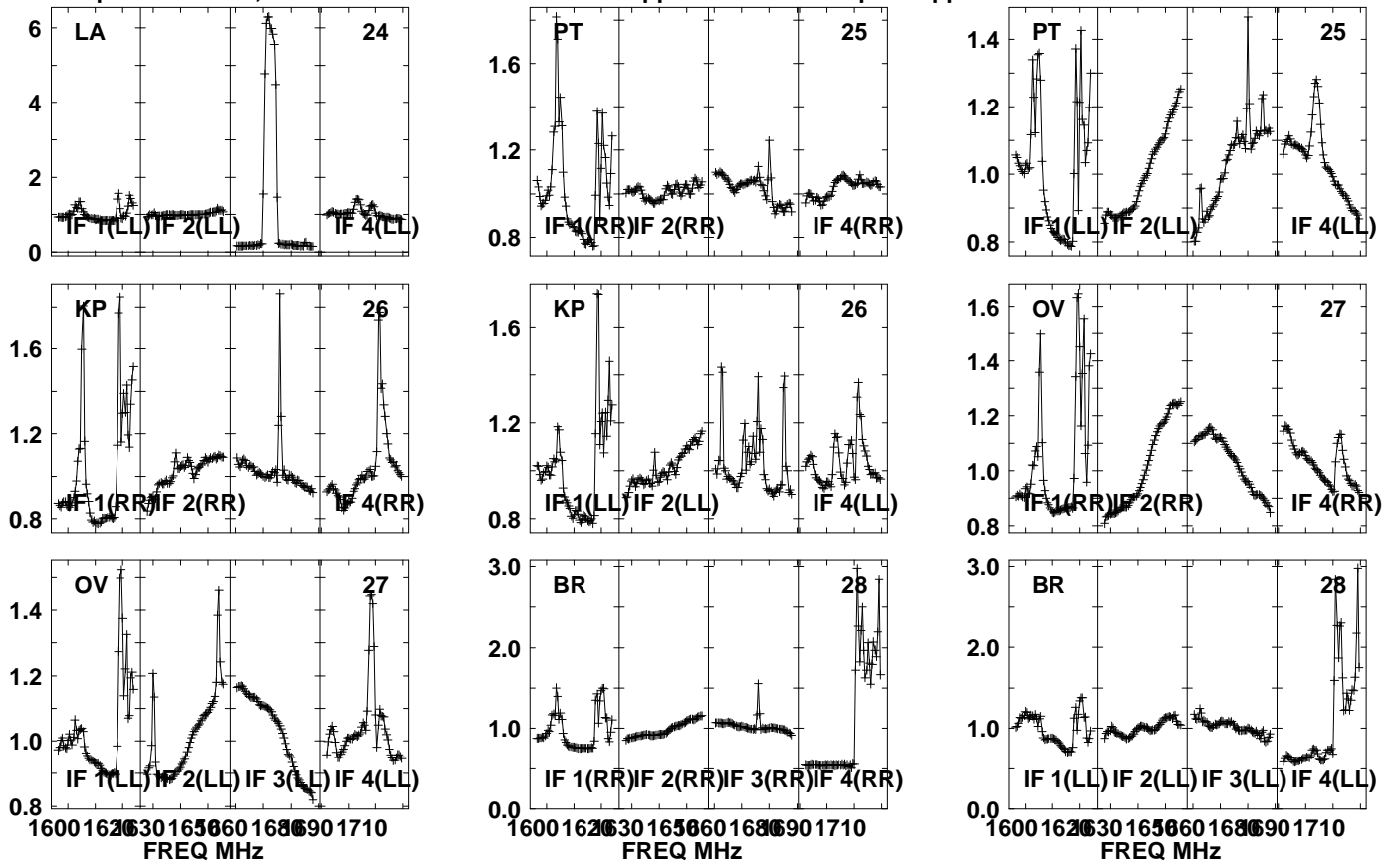

Lower frame: Real Jy  
Auto-corr total-power spectrum Antenna: \*  
Timerange: 01/00:53:11 to 01/00:56:29

Plot file version1601 created 05-OCT-2021 17:12:10

APM08279+525 GM076.UVDATA.1

Freq = 1.5945 GHz, Bw = 32.000 MH No calibration applied and no bandpass applied

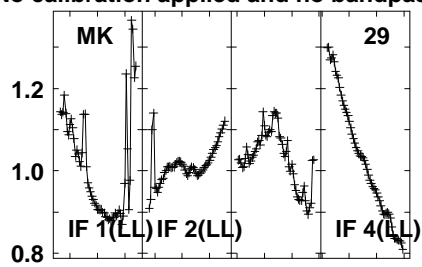
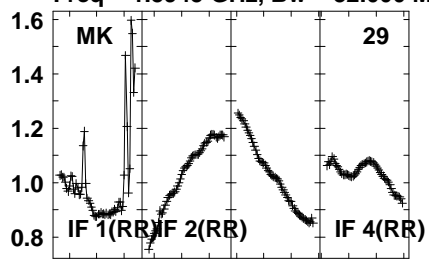

Lower frame: Real Jy  
Auto-corr total-power spectrum Antenna: \*  
Timerange: 01/00:53:11 to 01/00:56:29

Plot file version1602 created 05-OCT-2021 17:12:10

J0827+5217 GM076.UVDATA.1

Freq = 1.5945 GHz, Bw = 32.000 MH No calibration applied and no bandpass applied

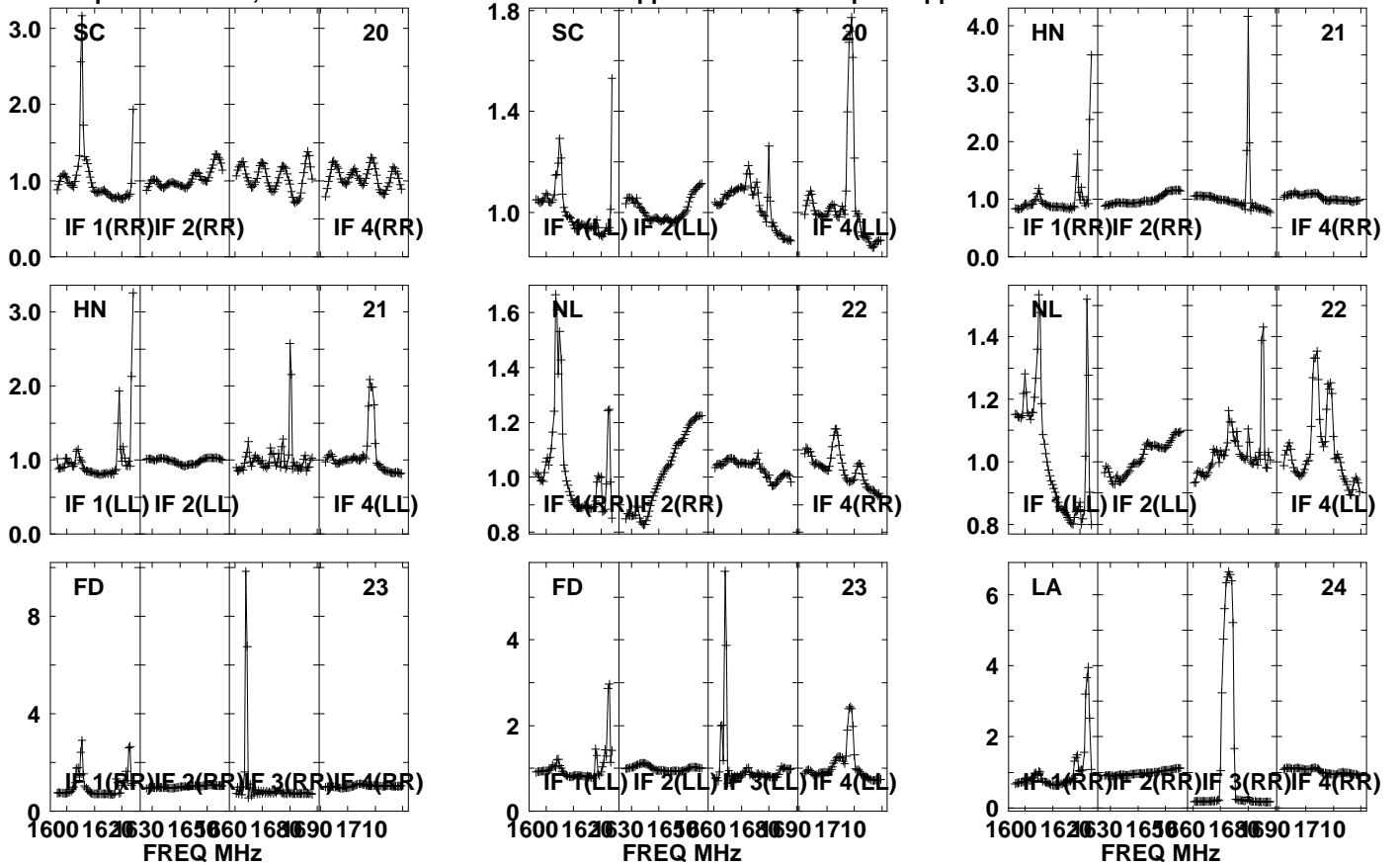

Lower frame: Real Jy

Auto-corr total-power spectrum Antenna: \*

Timerange: 01/00:57:01 to 01/00:58:29



Plot file version1603 created 05-OCT-2021 17:12:10

J0827+5217 GM076.UVDATA.1

Freq = 1.5945 GHz, Bw = 32.000 MH No calibration applied and no bandpass applied

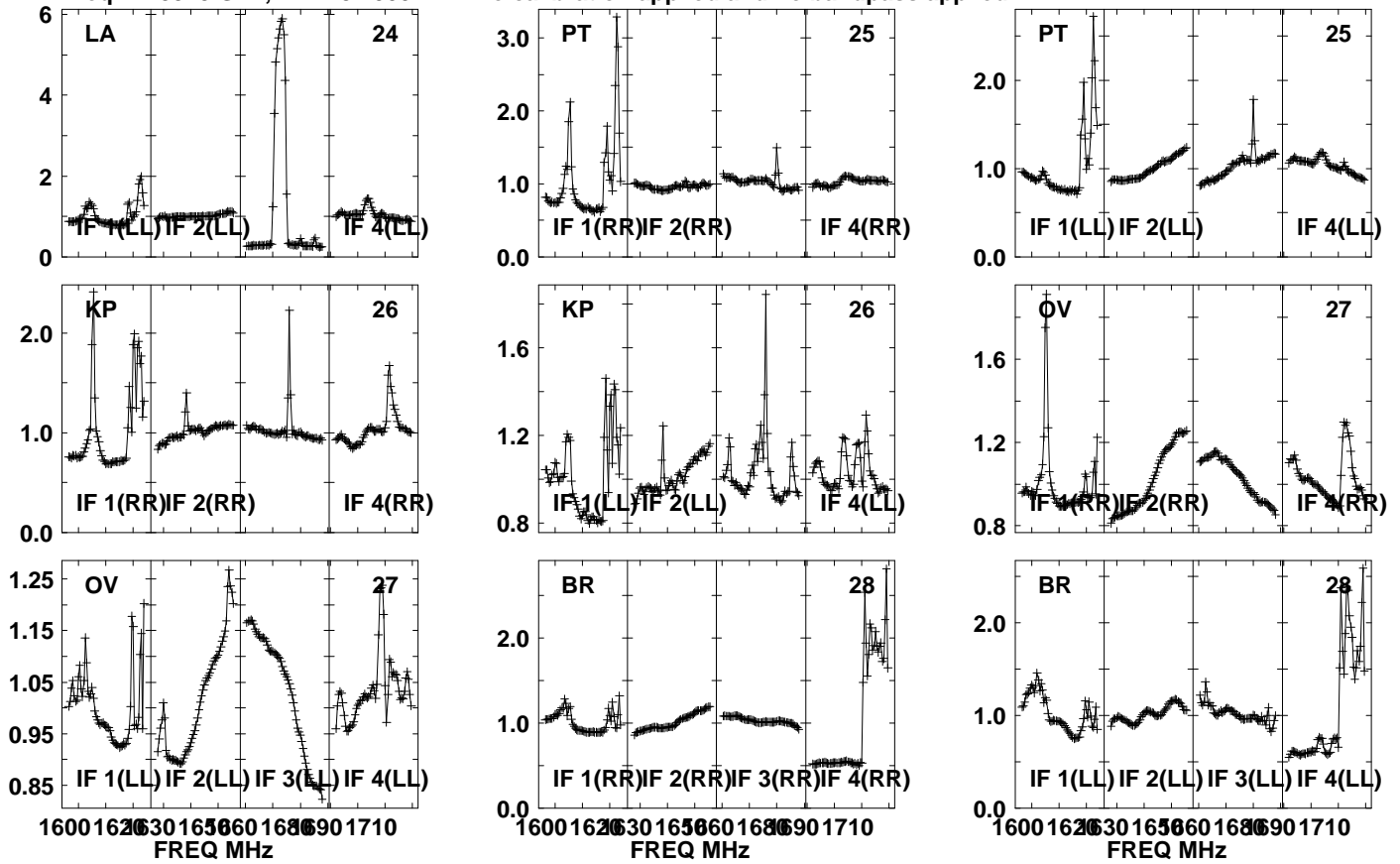

Lower frame: Real Jy

Auto-corr total-power spectrum Antenna: \*

Timerange: 01/00:57:01 to 01/00:58:29

Plot file version1604 created 05-OCT-2021 17:12:11  
J0827+5217 GM076.UVDATA.1  
Freq = 1.5945 GHz, Bw = 32.000 MH No calibration applied and no bandpass applied

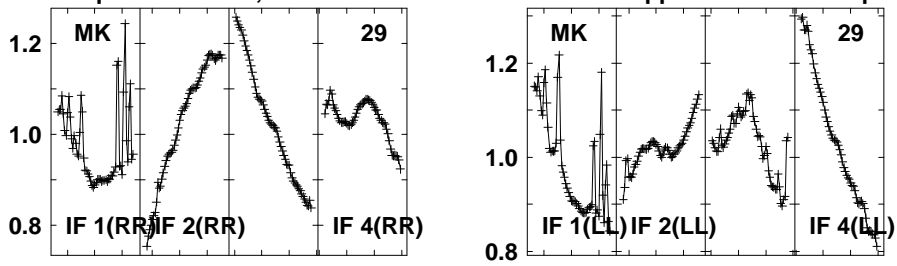

Lower frame: Real Jy  
Auto-corr total-power spectrum Antenna: \*  
Timerange: 01/00:57:01 to 01/00:58:29

Plot file version1605 created 05-OCT-2021 17:12:11

APM08279+525 GM076.UVDATA.1

Freq = 1.5945 GHz, Bw = 32.000 MH No calibration applied and no bandpass applied

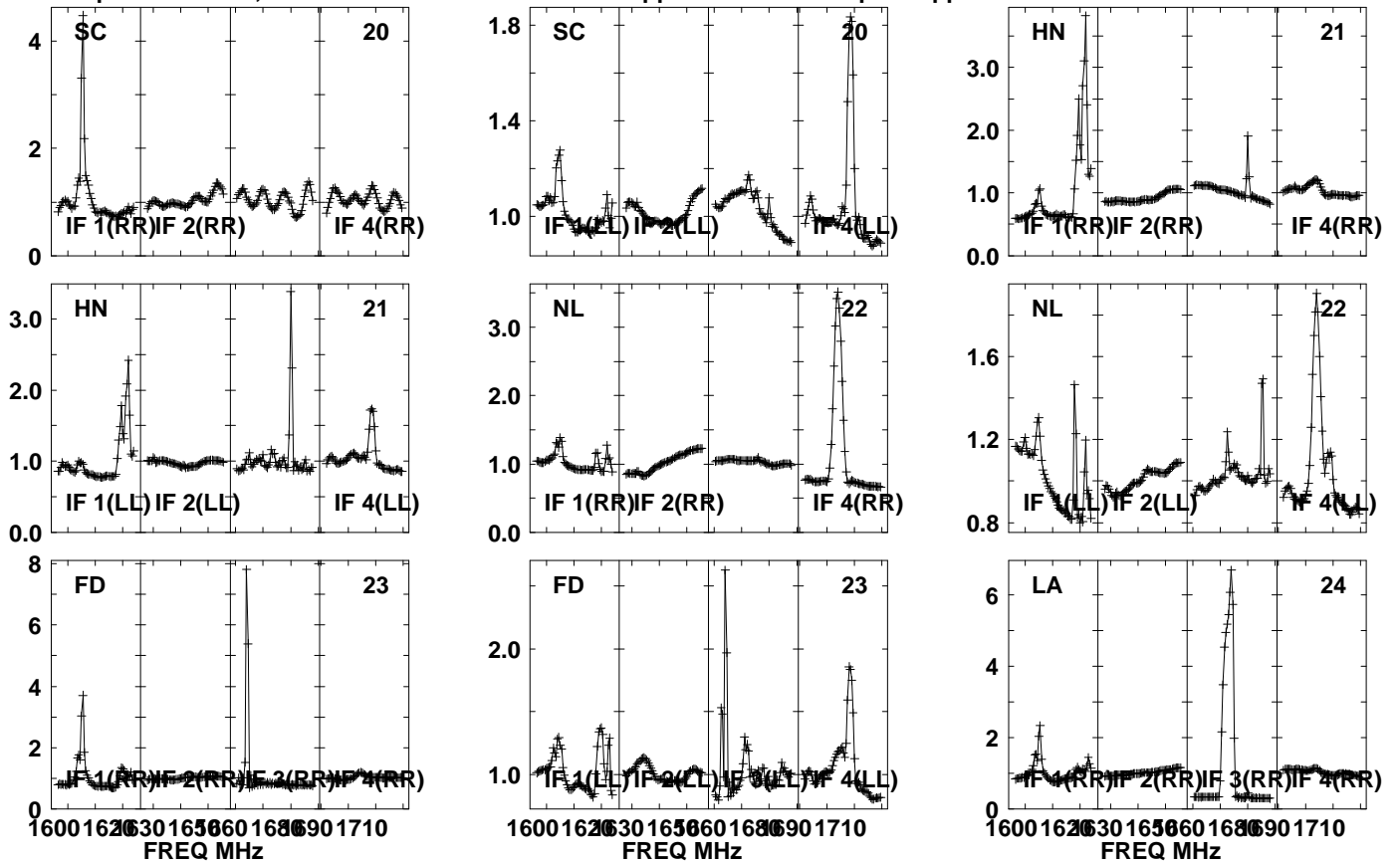

Lower frame: Real Jy

Auto-corr total-power spectrum Antenna: \*

Timerange: 01/00:58:41 to 01/01:01:59

Plot file version1606 created 05-OCT-2021 17:12:11

APM08279+525 GM076.UVDATA.1

Freq = 1.5945 GHz, Bw = 32.000 MH No calibration applied and no bandpass applied

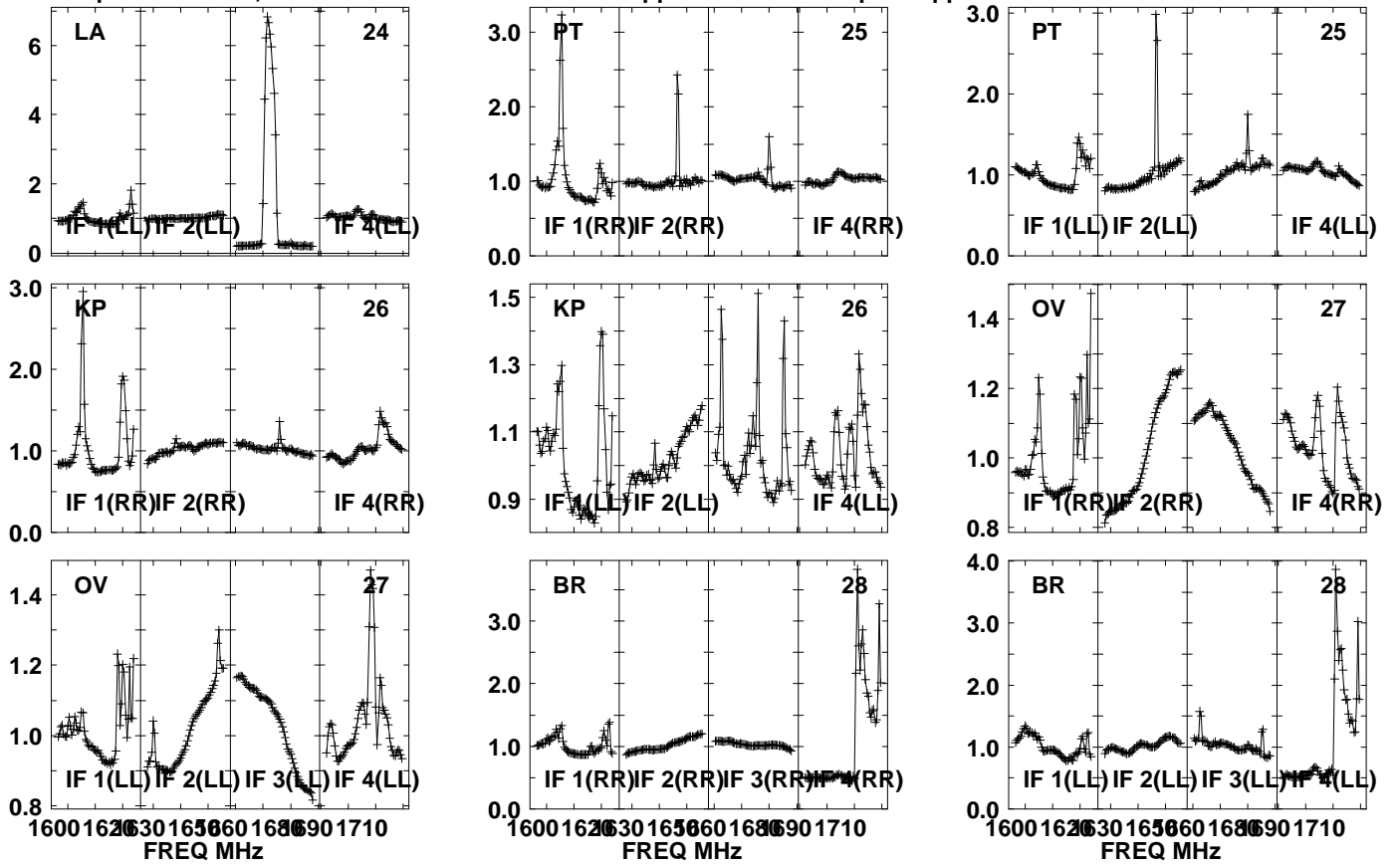

Lower frame: Real Jy  
 Auto-corr total-power spectrum Antenna: \*  
 Timerange: 01/00:58:41 to 01/01:01:59

Plot file version1607 created 05-OCT-2021 17:12:11

APM08279+525 GM076.UVDATA.1

Freq = 1.5945 GHz, Bw = 32.000 MH No calibration applied and no bandpass applied

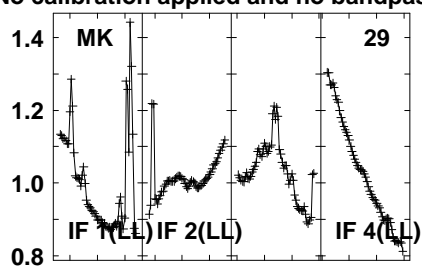
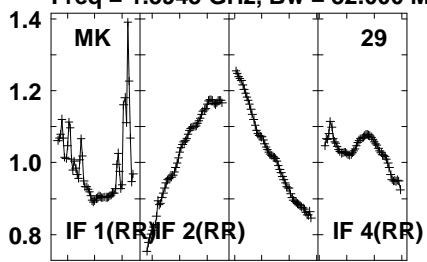

Lower frame: Real Jy  
Auto-corr total-power spectrum Antenna: \*  
Timerange: 01/00:58:41 to 01/01:01:59

Plot file version1608 created 05-OCT-2021 17:12:11

J0827+5217 GM076.UVDATA.1

Freq = 1.5945 GHz, Bw = 32.000 MH No calibration applied and no bandpass applied

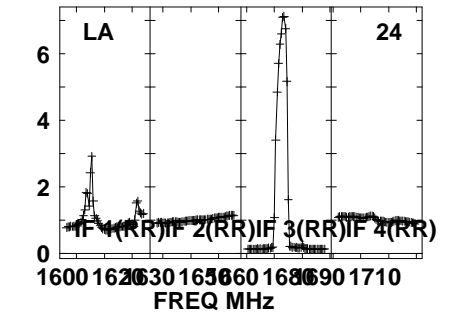
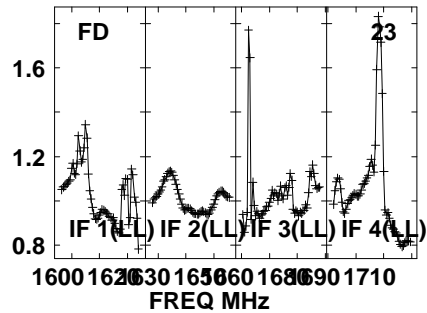
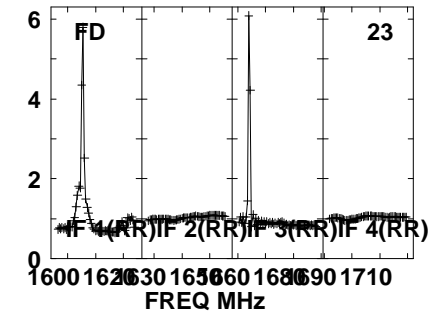
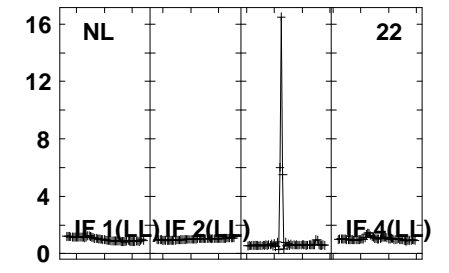
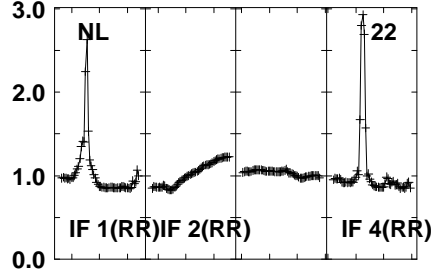
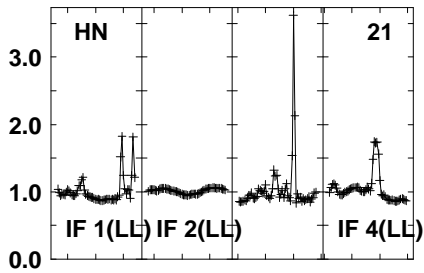
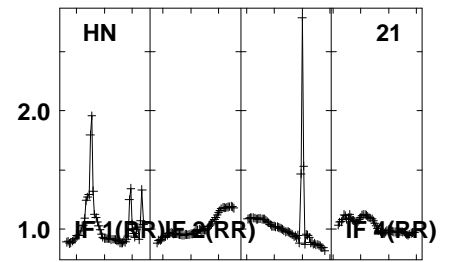
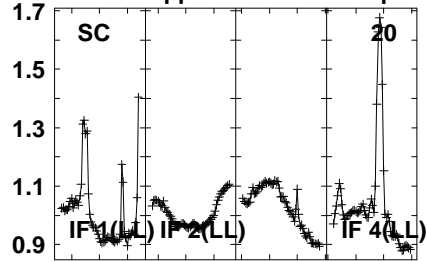
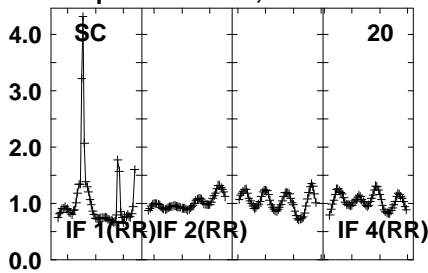

Lower frame: Real Jy

Auto-corr total-power spectrum Antenna: \*

Timerange: 01/01:02:31 to 01/01:03:59

Plot file version1609 created 05-OCT-2021 17:12:11

J0827+5217 GM076.UVDATA.1

Freq = 1.5945 GHz, Bw = 32.000 MH No calibration applied and no bandpass applied

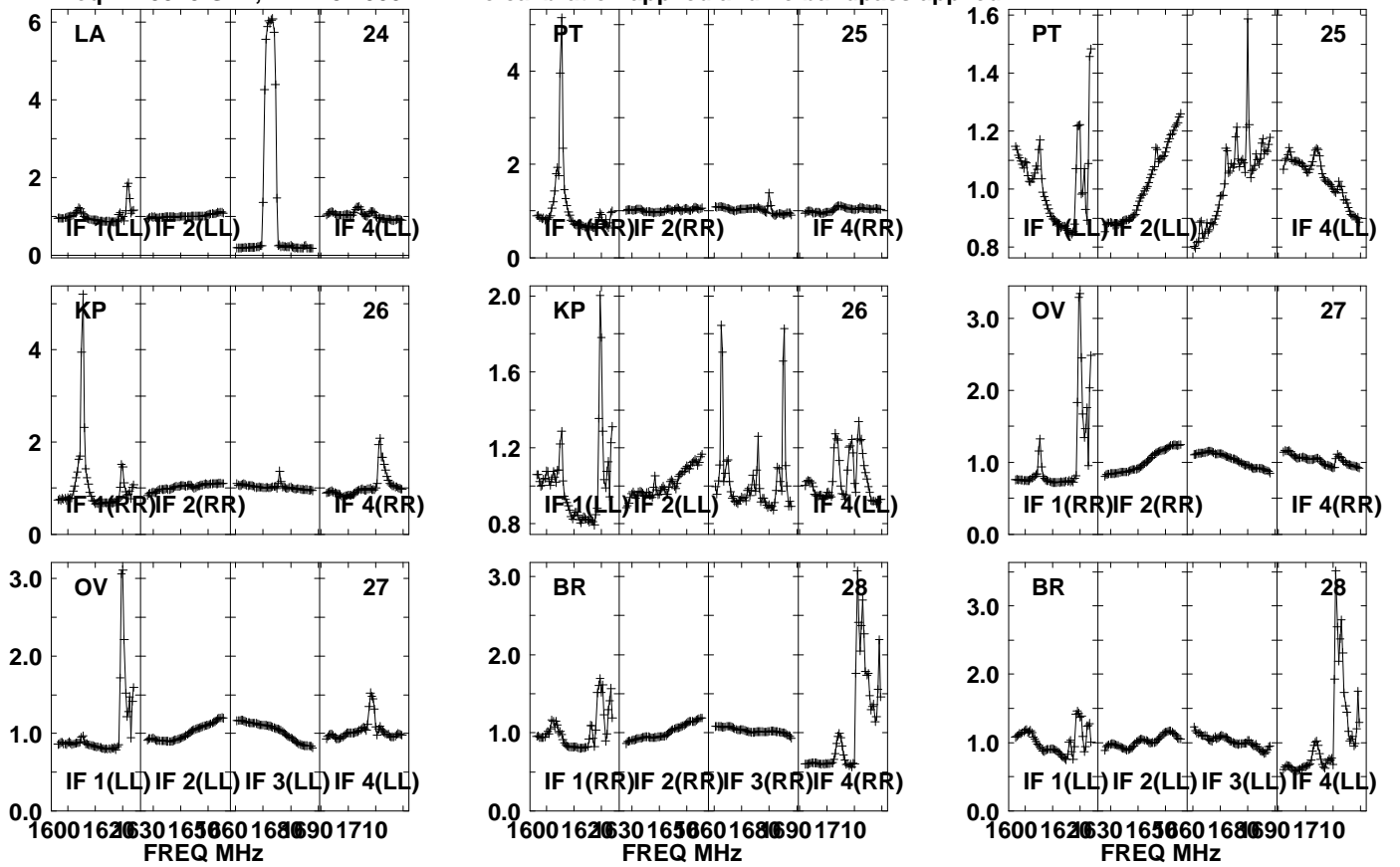

Lower frame: Real Jy  
Auto-corr total-power spectrum Antenna: \*  
Timerange: 01/01:02:31 to 01/01:03:59

Plot file version1610 created 05-OCT-2021 17:12:11

J0827+5217 GM076.UVDATA.1

Freq = 1.5945 GHz, Bw = 32.000 MH No calibration applied and no bandpass applied

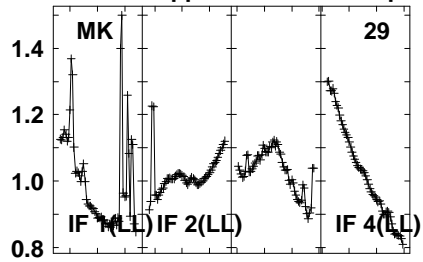
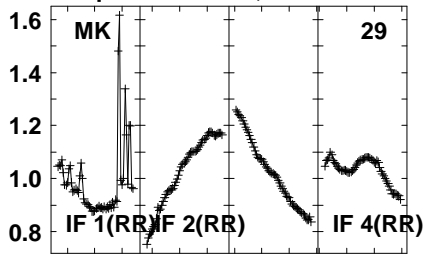

Lower frame: Real Jy  
Auto-corr total-power spectrum Antenna: \*  
Timerange: 01/01:02:31 to 01/01:03:59



Plot file version 1611 created 05-OCT-2021 17:12:11

APM08279+525 GM076.UVDATA.1

Freq = 1.5945 GHz, Bw = 32.000 MH No calibration applied and no bandpass applied

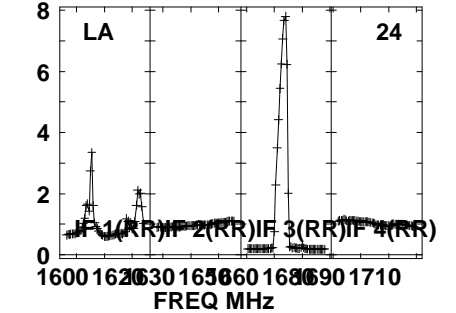
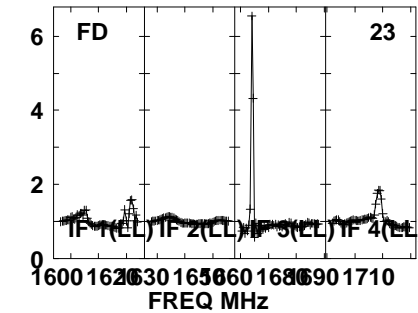
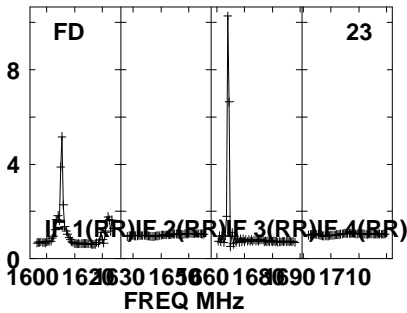
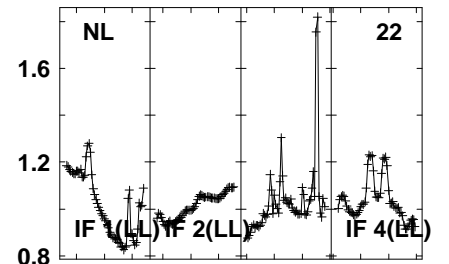
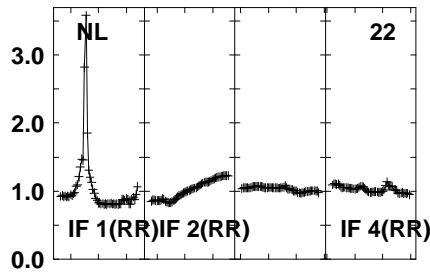
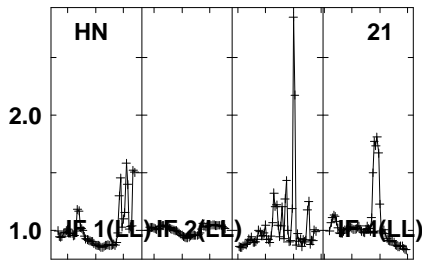
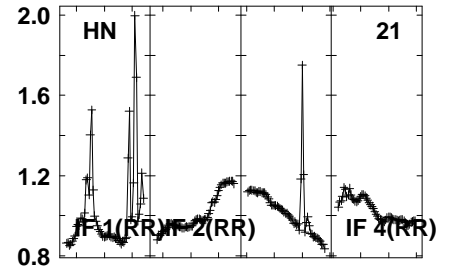
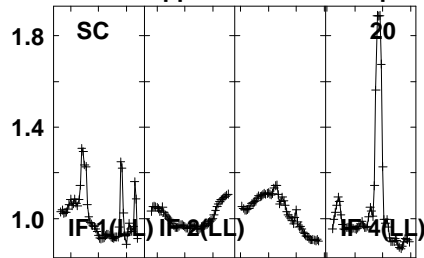
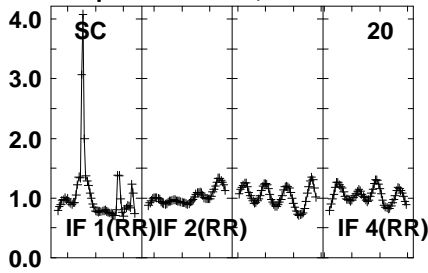

Lower frame: Real Jy

Auto-corr total-power spectrum Antenna: \*

Timerange: 01/01:04:09 to 01/01:07:29

Plot file version 1612 created 05-OCT-2021 17:12:12

APM08279+525 GM076.UVDATA.1

Freq = 1.5945 GHz, Bw = 32.000 MH No calibration applied and no bandpass applied

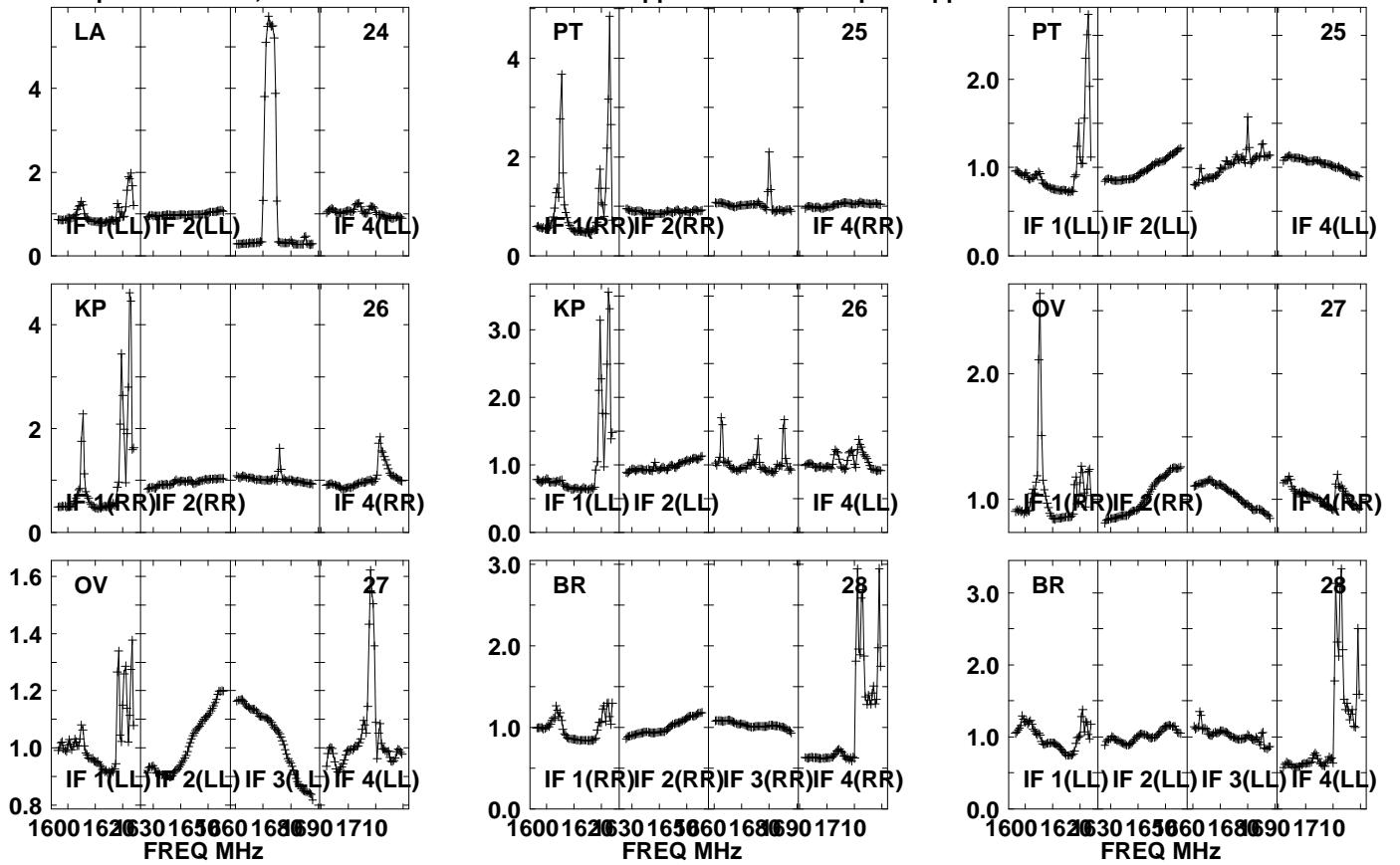

Lower frame: Real Jy

Auto-corr total-power spectrum Antenna: \*

Timerange: 01/01:04:09 to 01/01:07:29

Plot file version1613 created 05-OCT-2021 17:12:12

APM08279+525 GM076.UVDATA.1

Freq = 1.5945 GHz, Bw = 32.000 MH No calibration applied and no bandpass applied

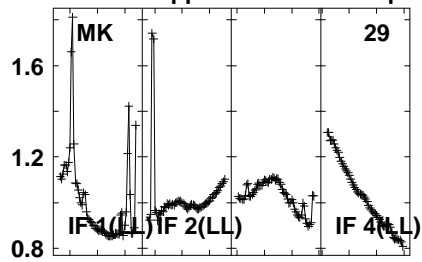
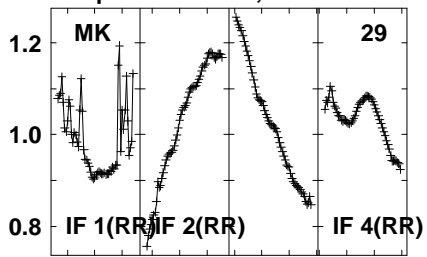

Lower frame: Real Jy  
Auto-corr total-power spectrum Antenna: \*  
Timerange: 01/01:04:09 to 01/01:07:29

Plot file version 1614 created 05-OCT-2021 17:12:12

J0827+5217 GM076.UVDATA.1

Freq = 1.5945 GHz, Bw = 32.000 MH No calibration applied and no bandpass applied

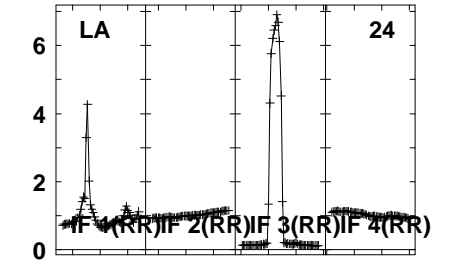
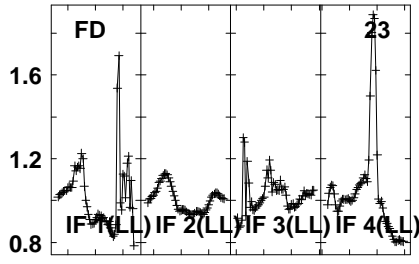
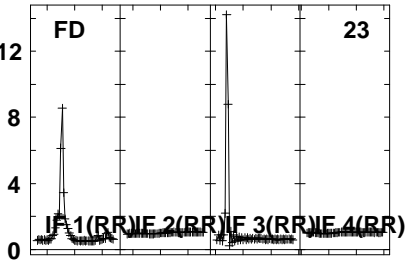
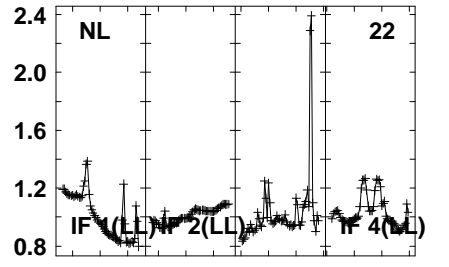
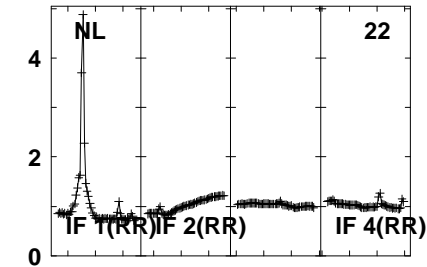
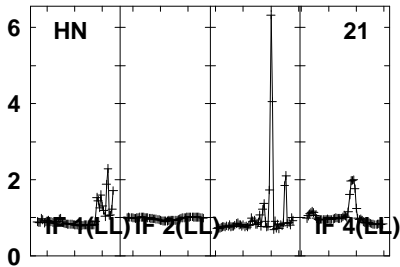
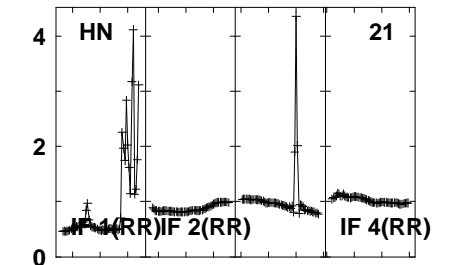
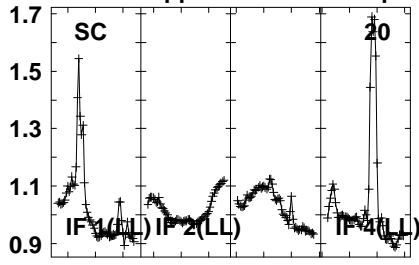
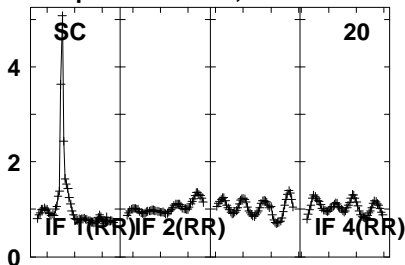

1600 1620 1630 1650 1660 1680 1690 1710  
FREQ MHz

1600 1620 1630 1650 1660 1680 1690 1710  
FREQ MHz

1600 1620 1630 1650 1660 1680 1690 1710  
FREQ MHz

Lower frame: Real Jy

Auto-corr total-power spectrum Antenna: \*

Timerange: 01/01:08:01 to 01/01:09:29

Plot file version 1615 created 05-OCT-2021 17:12:12

J0827+5217 GM076.UVDATA.1

Freq = 1.5945 GHz, Bw = 32.000 MH No calibration applied and no bandpass applied

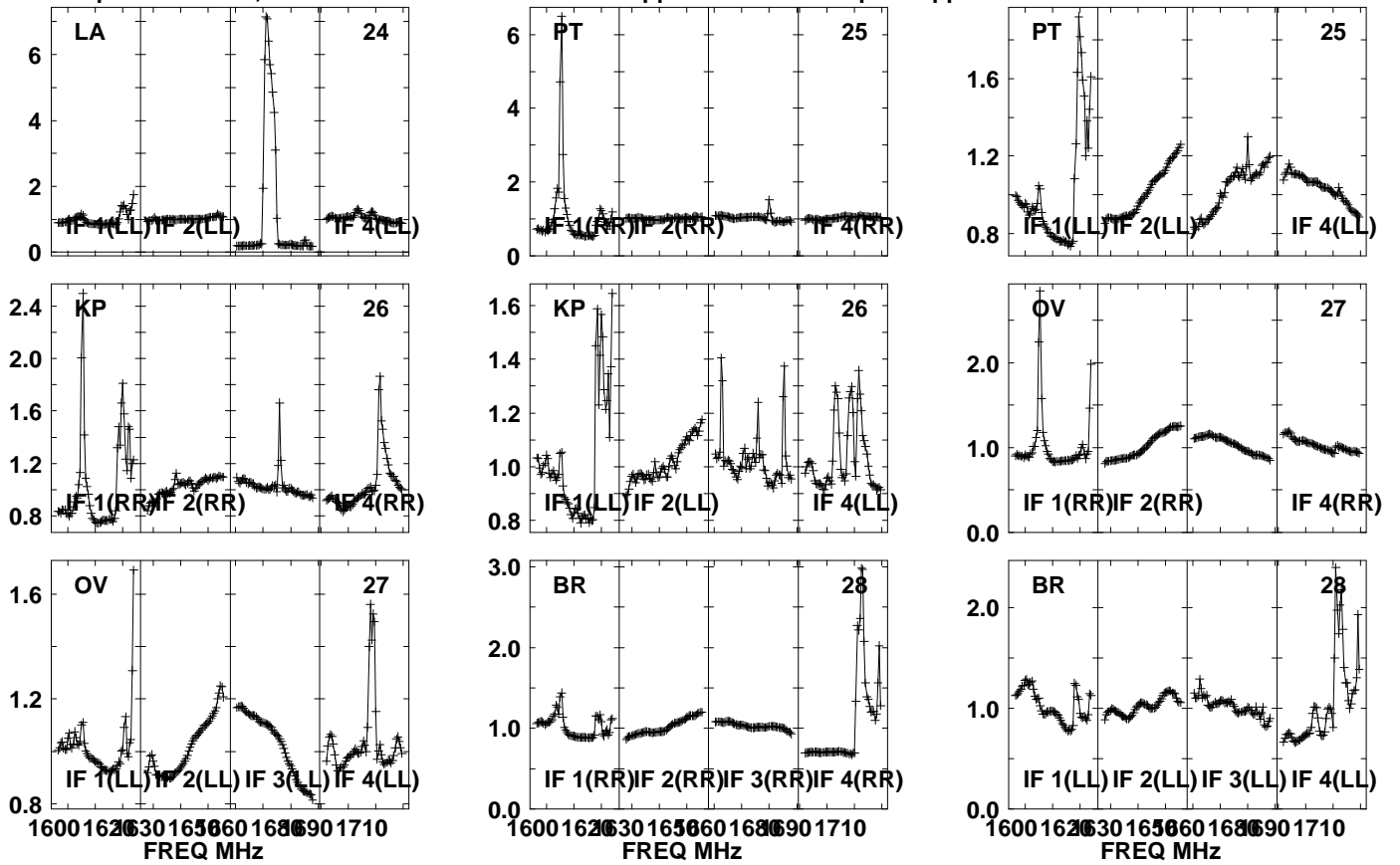

Lower frame: Real Jy  
Auto-corr total-power spectrum Antenna: \*  
Timerange: 01/01:08:01 to 01/01:09:29

Plot file version1616 created 05-OCT-2021 17:12:12  
J0827+5217 GM076.UVDATA.1  
Freq = 1.5945 GHz, Bw = 32.000 MH No calibration applied and no bandpass applied

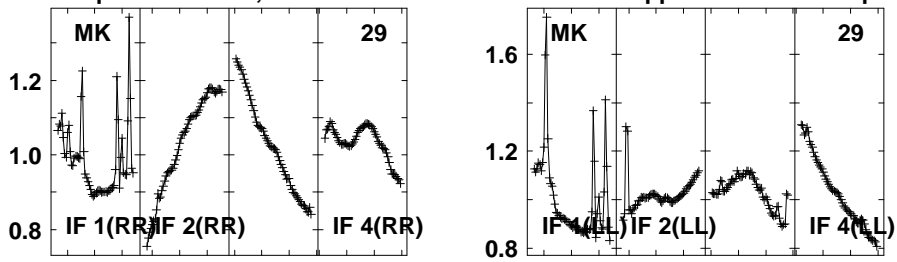

Lower frame: Real Jy  
Auto-corr total-power spectrum Antenna: \*  
Timerange: 01/01:08:01 to 01/01:09:29

Plot file version 1617 created 05-OCT-2021 17:12:12

APM08279+525 GM076.UVDATA.1

Freq = 1.5945 GHz, Bw = 32.000 MH No calibration applied and no bandpass applied

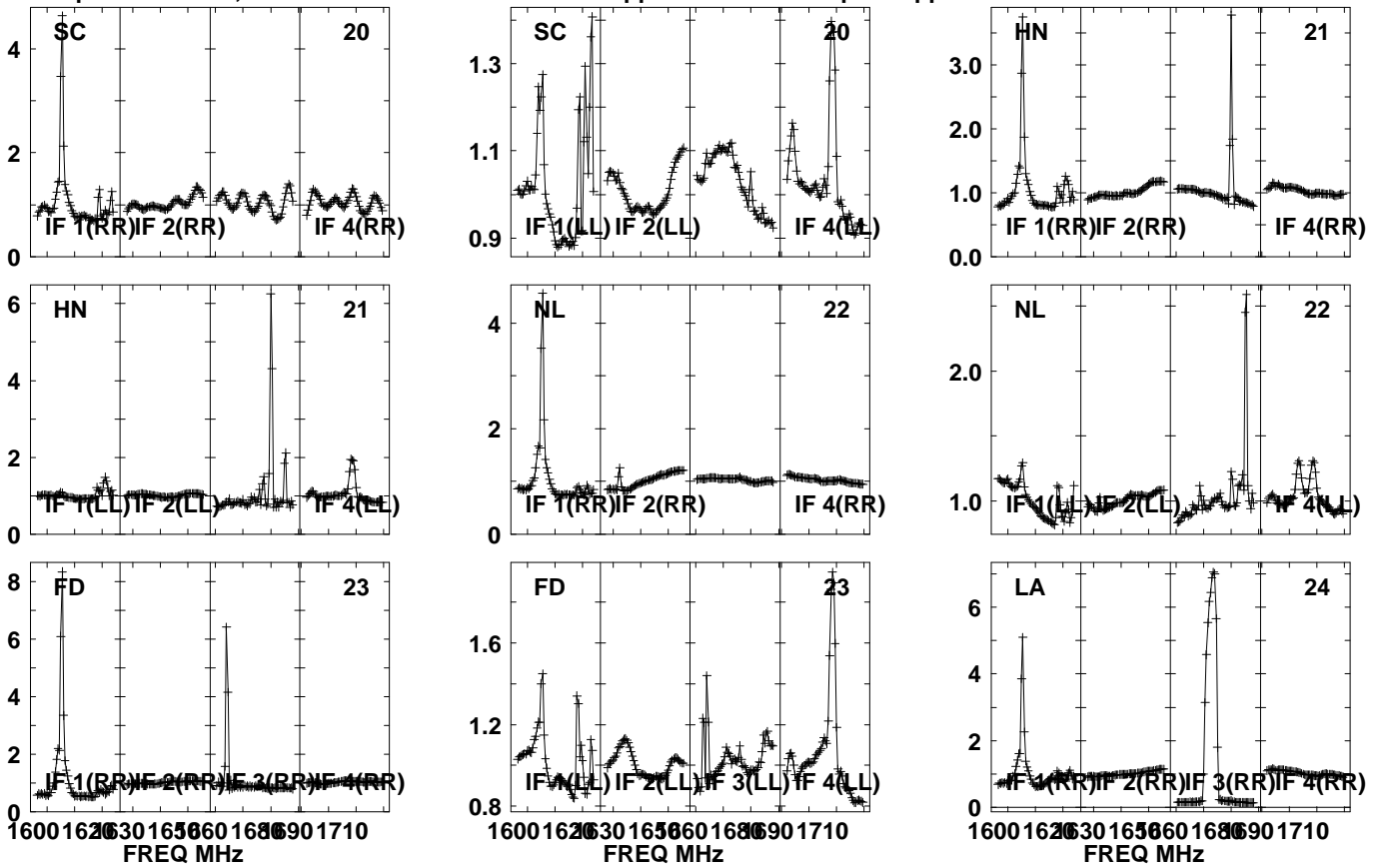

Lower frame: Real Jy

Auto-corr total-power spectrum Antenna: \*

Timerange: 01/01:09:39 to 01/01:12:59

Plot file version 1618 created 05-OCT-2021 17:12:12

APM08279+525 GM076.UVDATA.1

Freq = 1.5945 GHz, Bw = 32.000 MH No calibration applied and no bandpass applied

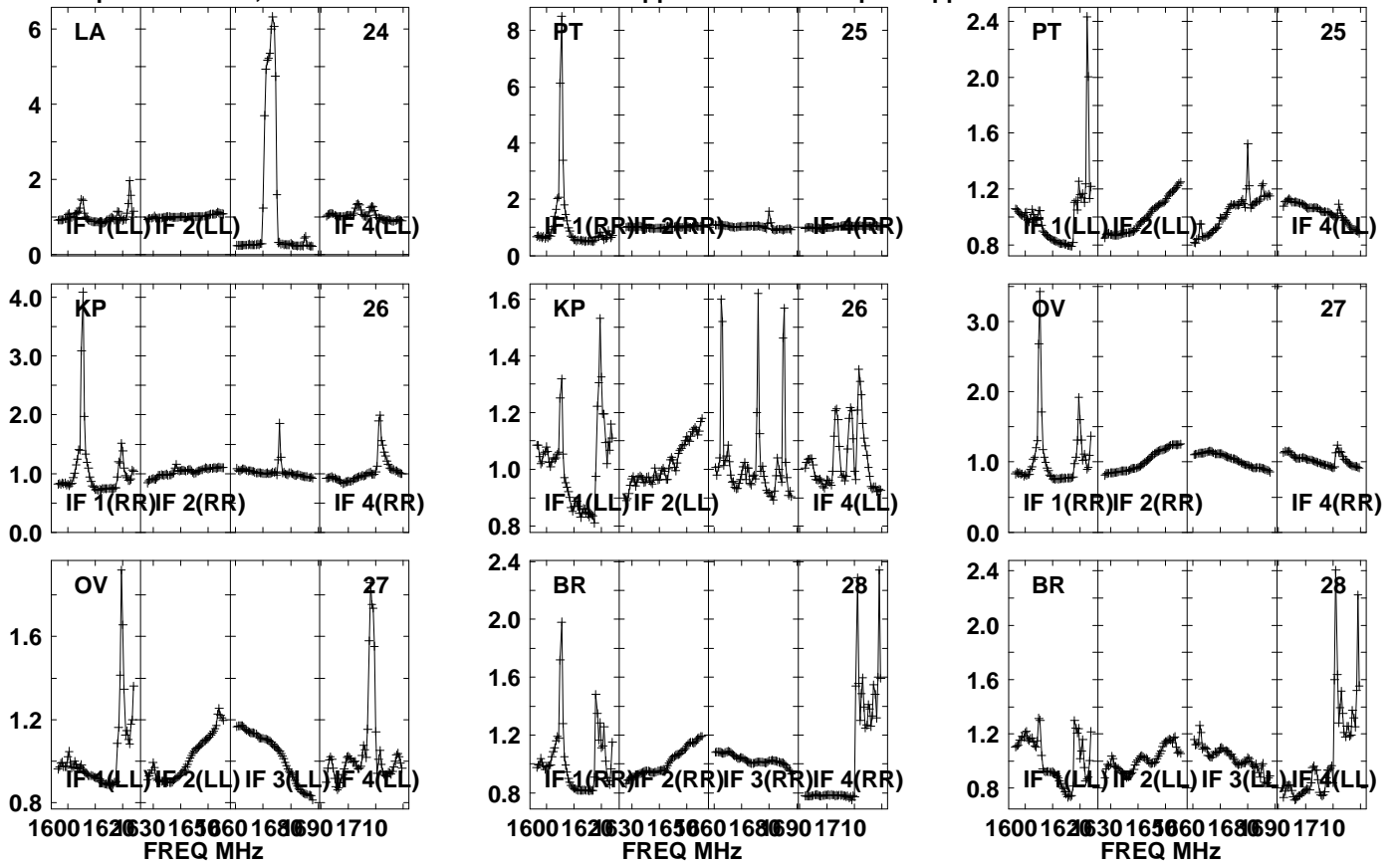

Lower frame: Real Jy  
Auto-corr total-power spectrum Antenna: \*  
Timerange: 01/01:09:39 to 01/01:12:59



Plot file version1619 created 05-OCT-2021 17:12:12

APM08279+525 GM076.UVDATA.1

Freq = 1.5945 GHz, Bw = 32.000 MH No calibration applied and no bandpass applied

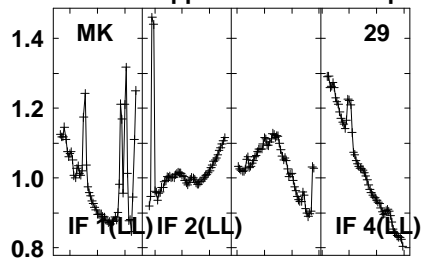
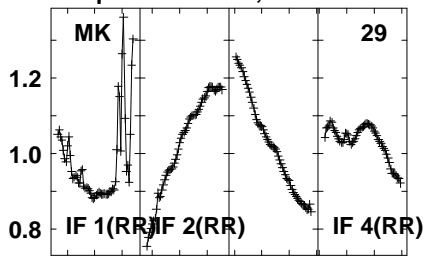

Lower frame: Real Jy  
Auto-corr total-power spectrum Antenna: \*  
Timerange: 01/01:09:39 to 01/01:12:59

Plot file version 1620 created 05-OCT-2021 17:12:13

J0827+5217 GM076.UVDATA.1

Freq = 1.5945 GHz, Bw = 32.000 MH No calibration applied and no bandpass applied

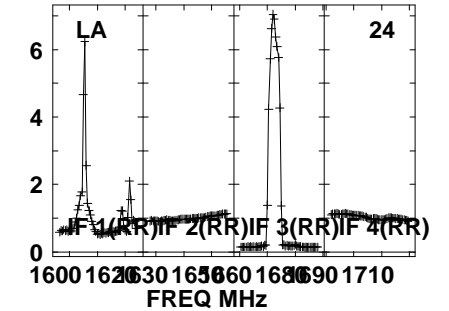
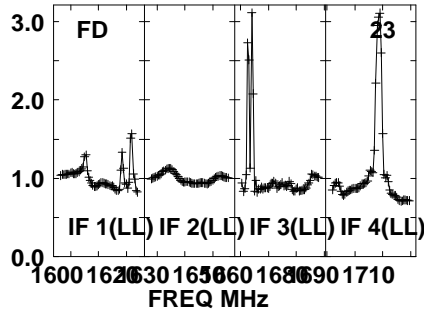
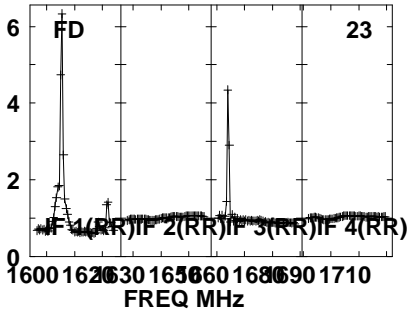
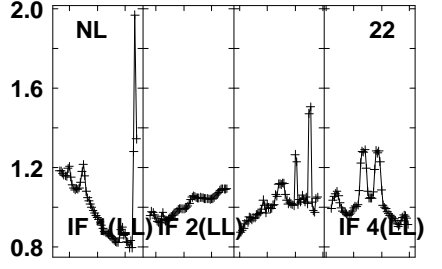
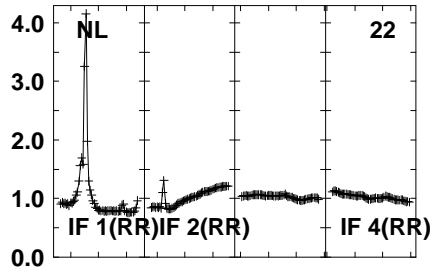
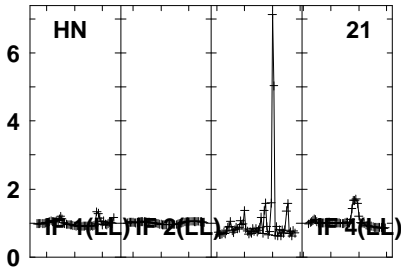
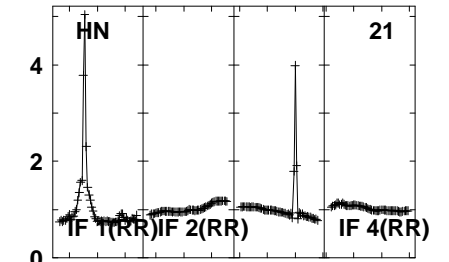
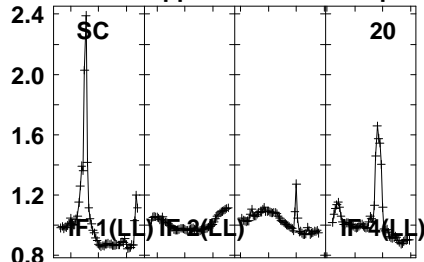
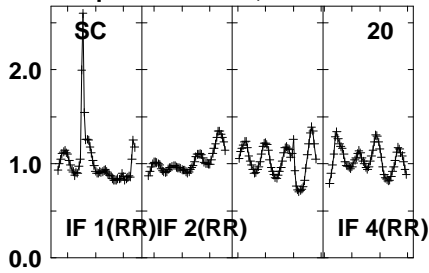

Lower frame: Real Jy  
Auto-corr total-power spectrum Antenna: \*  
Timerange: 01/01:13:31 to 01/01:14:59

Plot file version1621 created 05-OCT-2021 17:12:13

J0827+5217 GM076.UVDATA.1

Freq = 1.5945 GHz, Bw = 32.000 MH No calibration applied and no bandpass applied

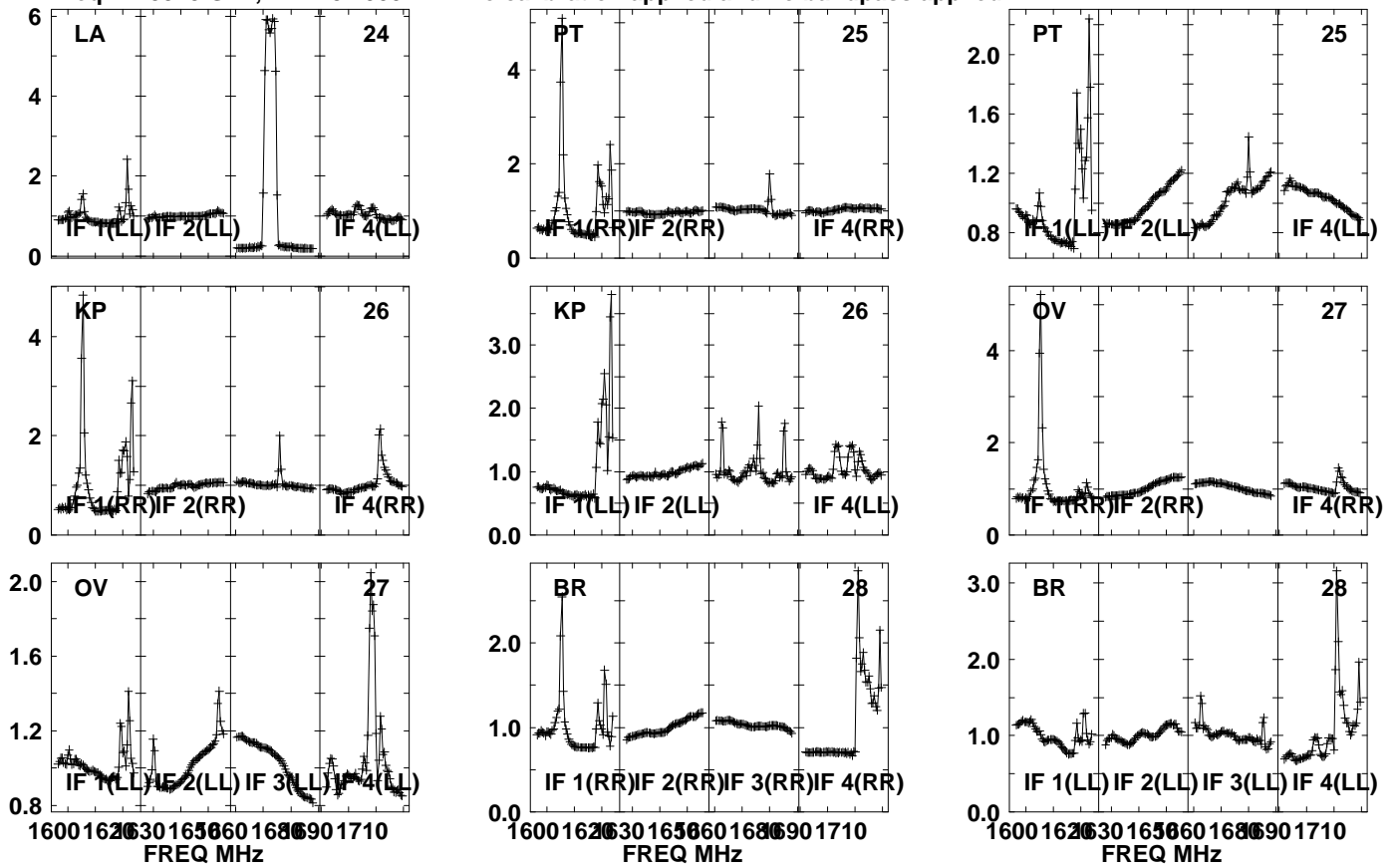

Lower frame: Real Jy  
Auto-corr total-power spectrum Antenna: \*  
Timerange: 01/01:13:31 to 01/01:14:59

Plot file version1622 created 05-OCT-2021 17:12:13  
J0827+5217 GM076.UVDATA.1  
Freq = 1.5945 GHz, Bw = 32.000 MH No calibration applied and no bandpass applied

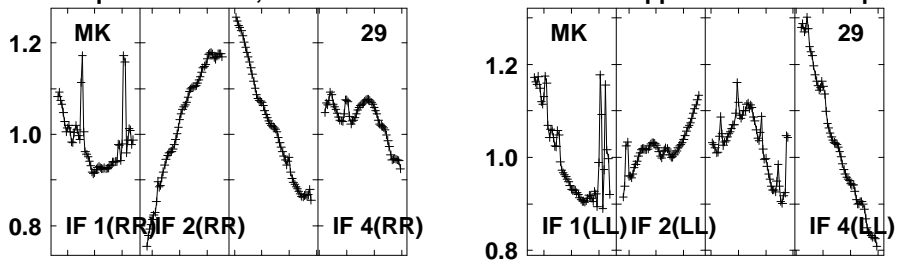

Lower frame: Real Jy  
Auto-corr total-power spectrum Antenna: \*  
Timerange: 01/01:13:31 to 01/01:14:59

Plot file version 1623 created 05-OCT-2021 17:12:13

APM08279+525 GM076.UV DATA.1

Freq = 1.5945 GHz, Bw = 32.000 MHz No calibration applied and no bandpass applied

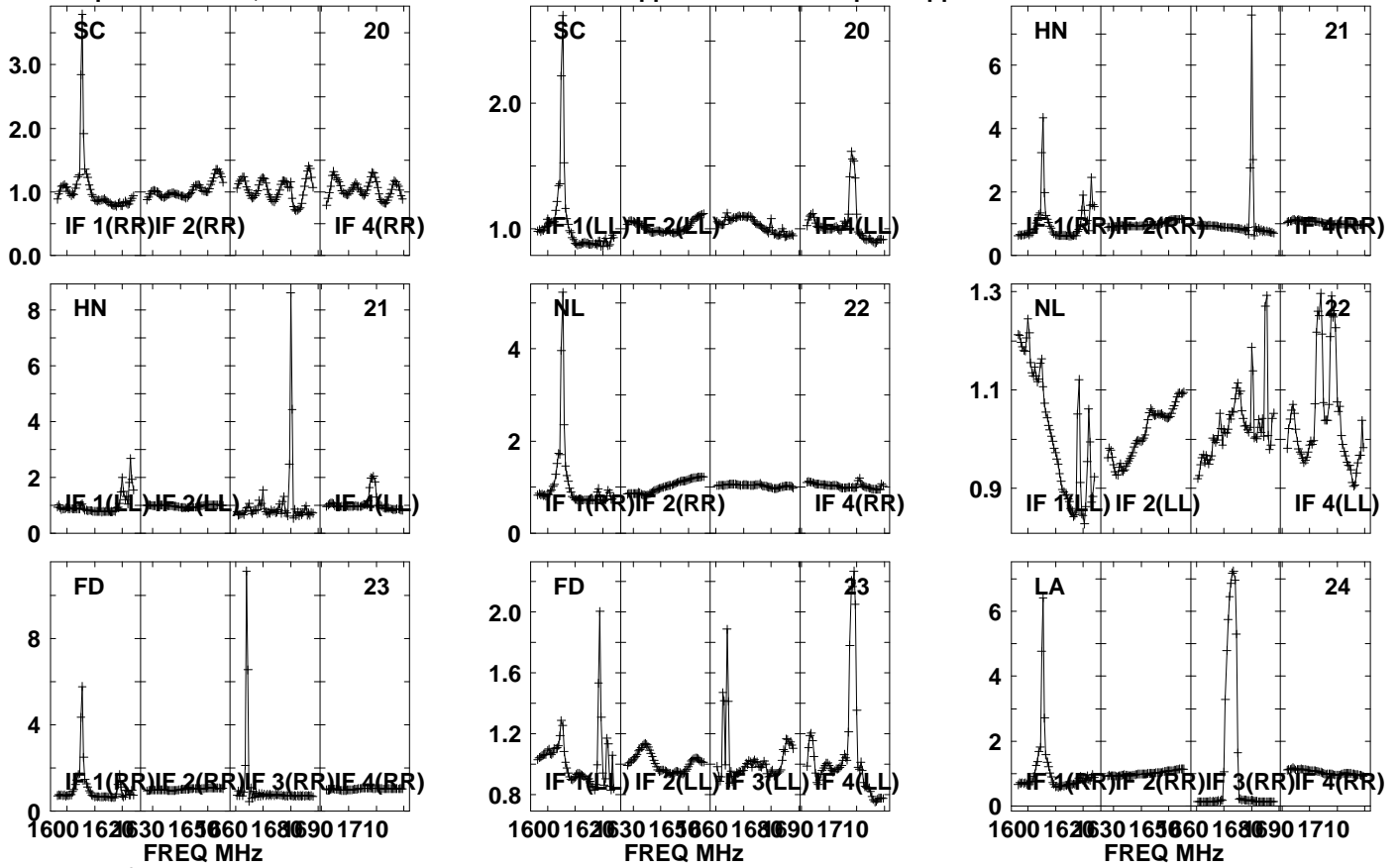

Lower frame: Real Jy

Auto-corr total-power spectrum Antenna: \*

Timerange: 01/01:15:09 to 01/01:18:29

Plot file version1624 created 05-OCT-2021 17:12:13

APM08279+525 GM076.UVDATA.1

Freq = 1.5945 GHz, Bw = 32.000 MH No calibration applied and no bandpass applied

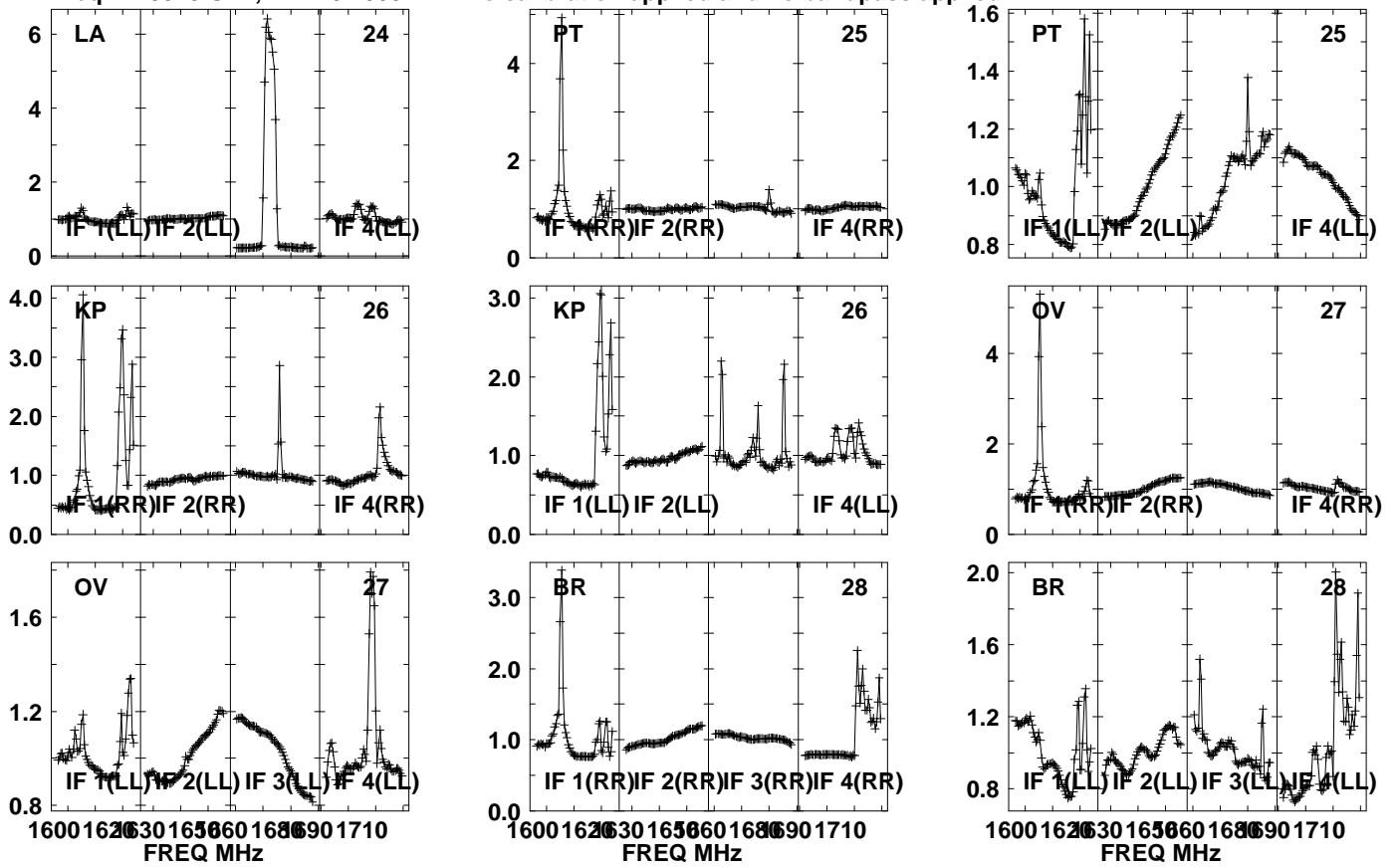

Lower frame: Real Jy  
Auto-corr total-power spectrum Antenna: \*  
Timerange: 01/01:15:09 to 01/01:18:29

Plot file version1625 created 05-OCT-2021 17:12:13

APM08279+525 GM076.UVDATA.1

Freq = 1.5945 GHz, Bw = 32.000 MH

No calibration applied and no bandpass applied

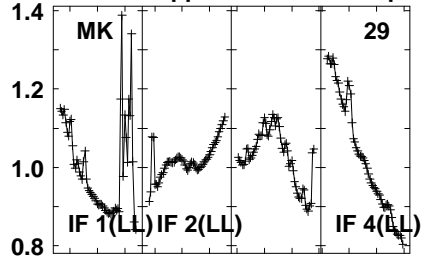
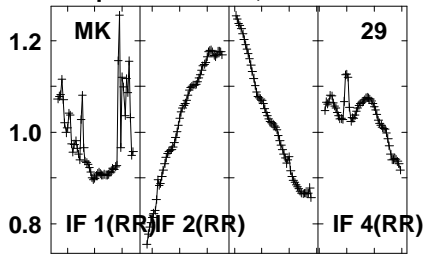

Lower frame: Real Jy  
Auto-corr total-power spectrum Antenna: \*  
Timerange: 01/01:15:09 to 01/01:18:29

Plot file version 1626 created 05-OCT-2021 17:12:13

J0827+5217 GM076.UVDATA.1

Freq = 1.5945 GHz, Bw = 32.000 MH No calibration applied and no bandpass applied

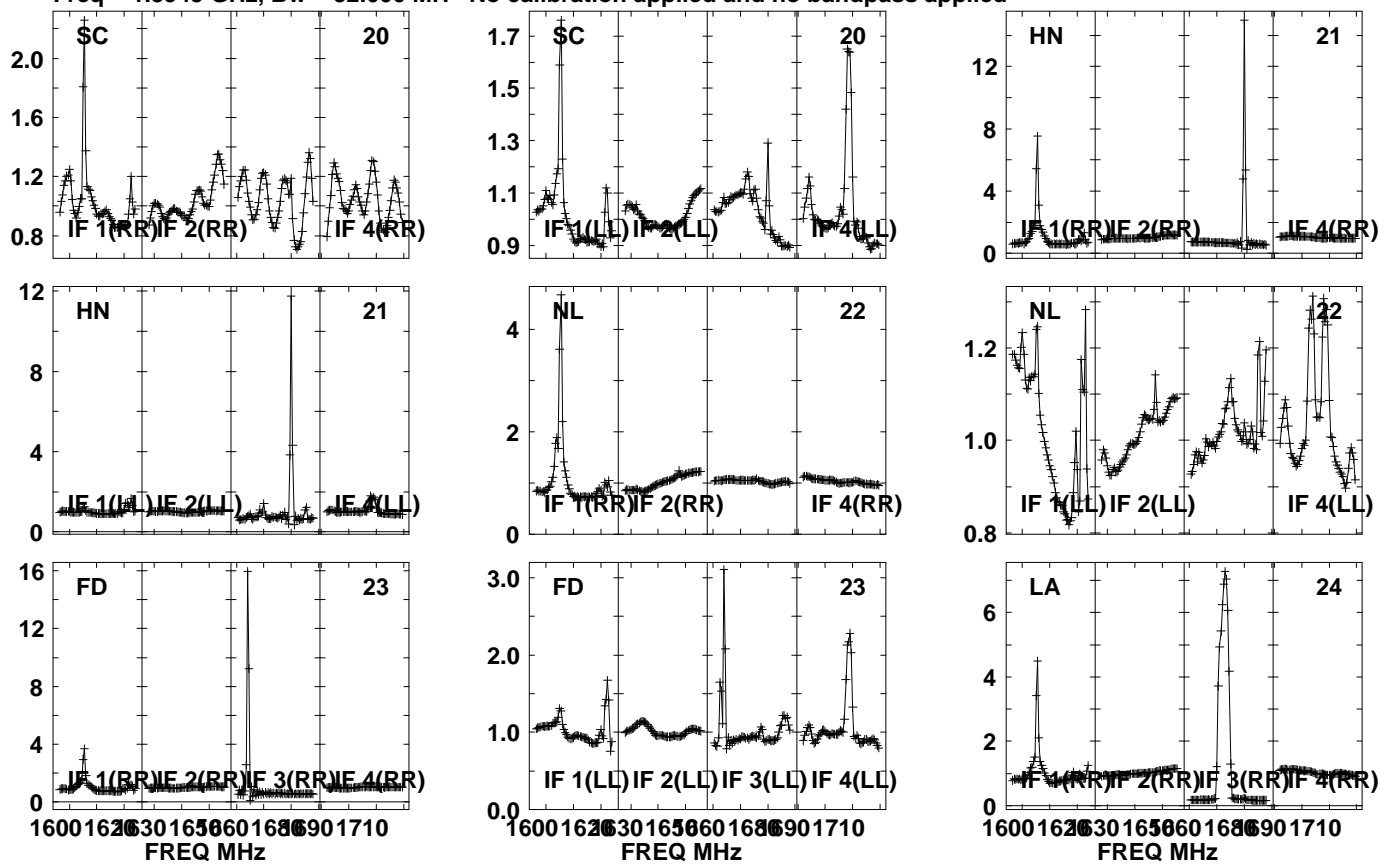

Lower frame: Real Jy  
Auto-corr total-power spectrum Antenna: \*  
Timerange: 01/01:19:01 to 01/01:20:29



Plot file version1627 created 05-OCT-2021 17:12:13

J0827+5217 GM076.UVDATA.1

Freq = 1.5945 GHz, Bw = 32.000 MH No calibration applied and no bandpass applied

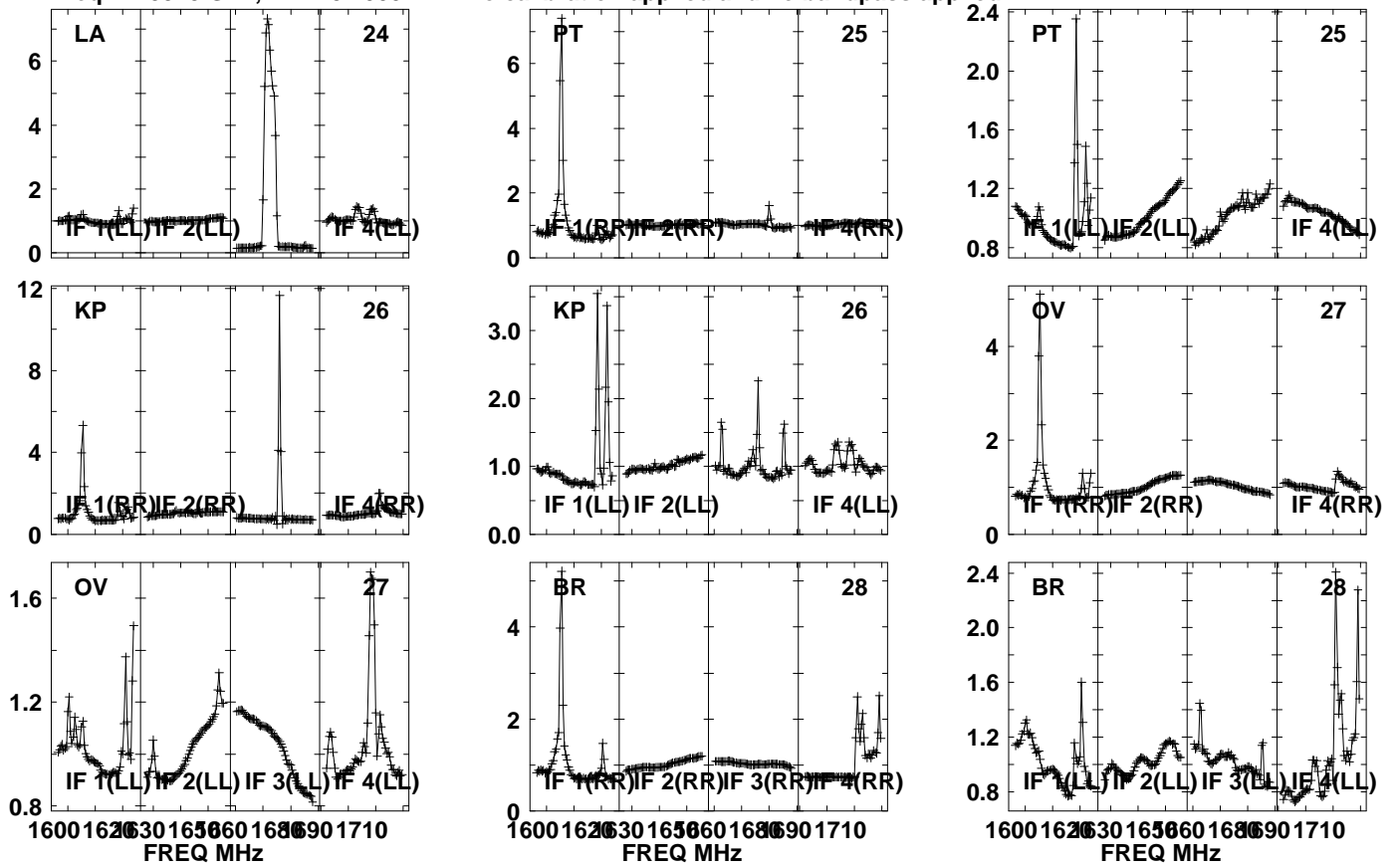

Lower frame: Real Jy  
Auto-corr total-power spectrum Antenna: \*  
Timerange: 01/01:19:01 to 01/01:20:29

Plot file version1628 created 05-OCT-2021 17:12:13

J0827+5217 GM076.UVDATA.1

Freq = 1.5945 GHz, Bw = 32.000 MH No calibration applied and no bandpass applied

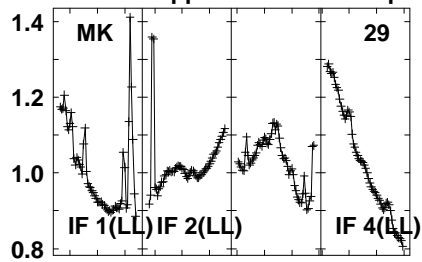
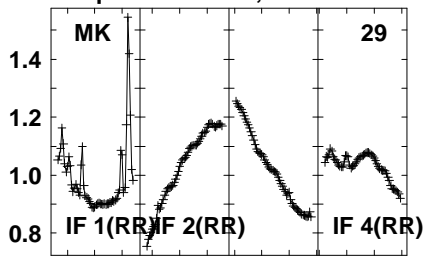

Lower frame: Real Jy  
Auto-corr total-power spectrum Antenna: \*  
Timerange: 01/01:19:01 to 01/01:20:29

Plot file version 1629 created 05-OCT-2021 17:12:14

APM08279+525 GM076.UVDATA.1

Freq = 1.5945 GHz, Bw = 32.000 MH No calibration applied and no bandpass applied

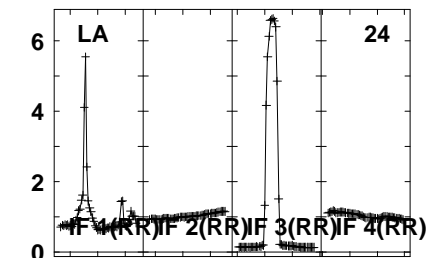
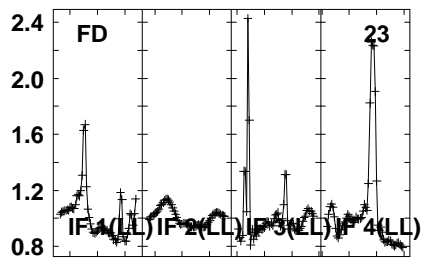
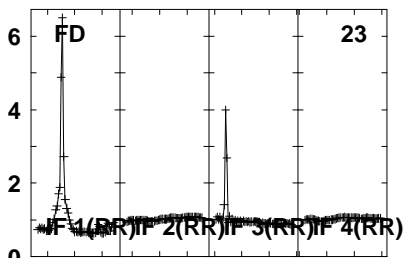
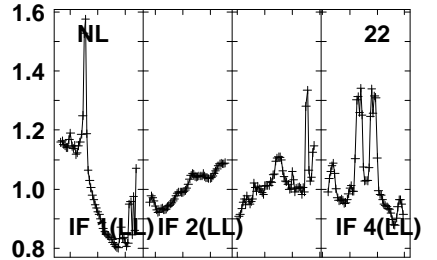
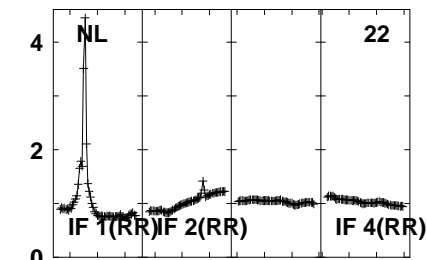
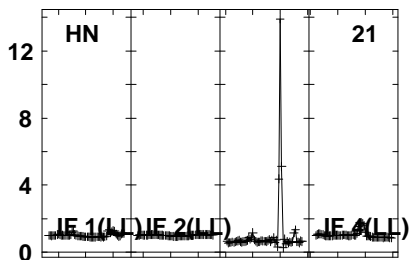
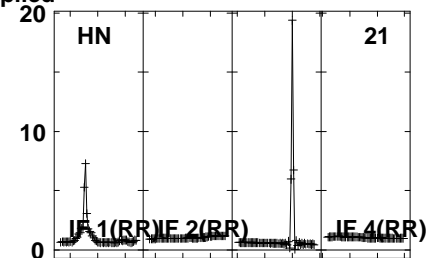
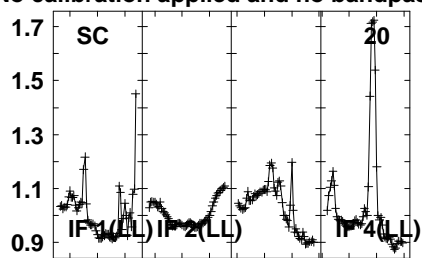
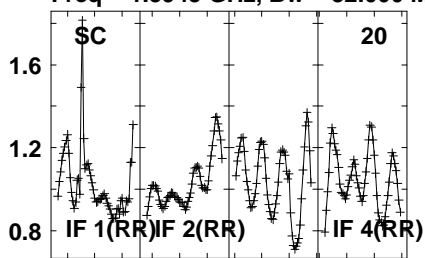

1600 1625 1650 1675 1700  
FREQ MHz

1600 1625 1650 1675 1700  
FREQ MHz

1600 1625 1650 1675 1700  
FREQ MHz

Lower frame: Real Jy  
Auto-corr total-power spectrum Antenna: \*  
Timerange: 01/01:20:39 to 01/01:23:59

Plot file version1630 created 05-OCT-2021 17:12:14

APM08279+525 GM076.UVDATA.1

Freq = 1.5945 GHz, Bw = 32.000 MH No calibration applied and no bandpass applied

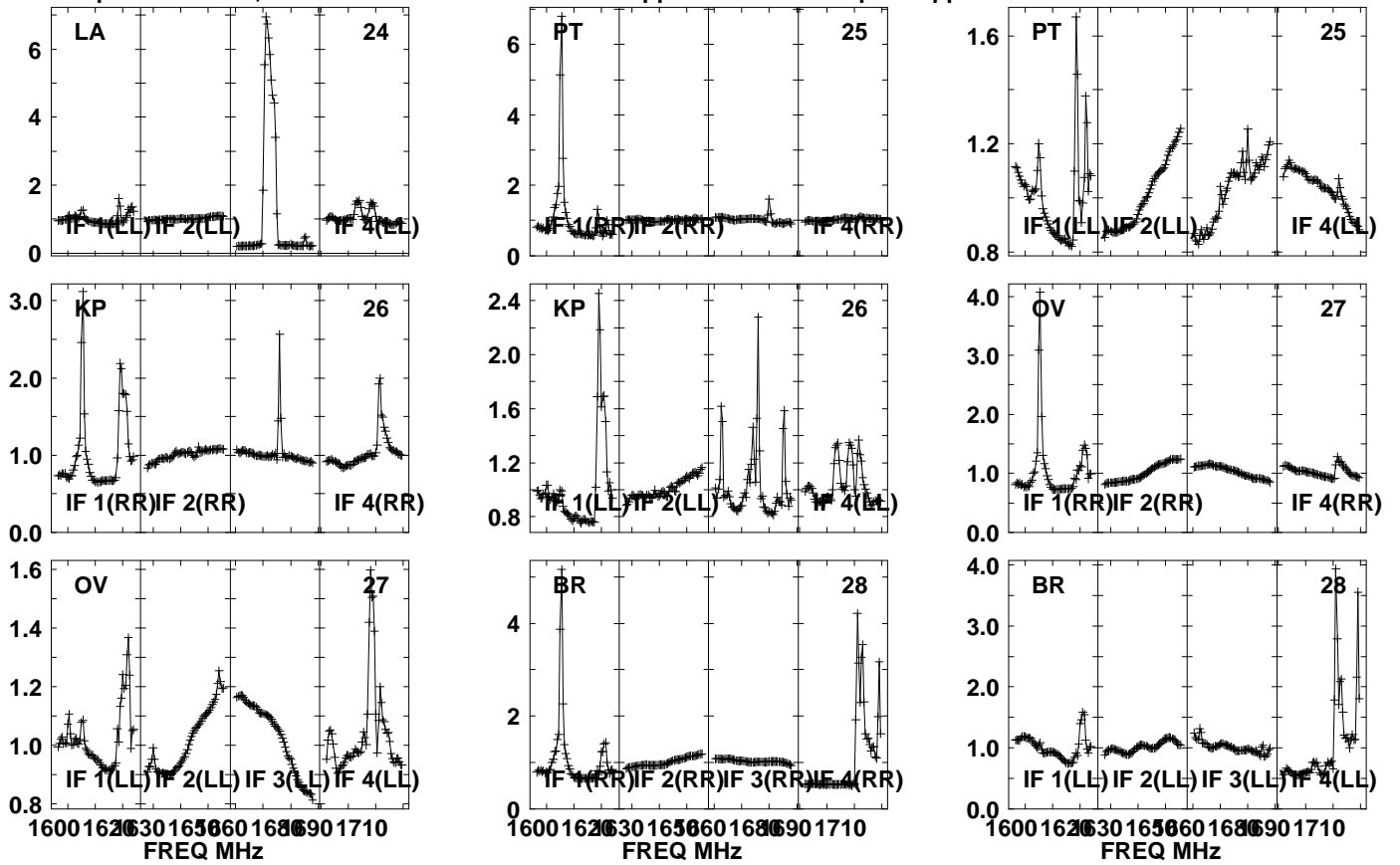

Lower frame: Real Jy

Auto-corr total-power spectrum Antenna: \*

Timerange: 01/01:20:39 to 01/01:23:59

Plot file version1631 created 05-OCT-2021 17:12:14

APM08279+525 GM076.UVDATA.1

Freq = 1.5945 GHz, Bw = 32.000 MH No calibration applied and no bandpass applied

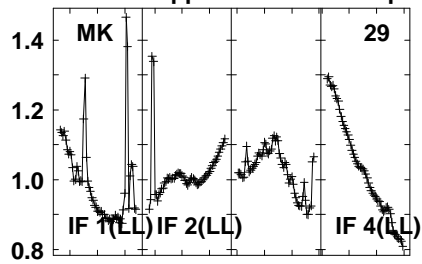
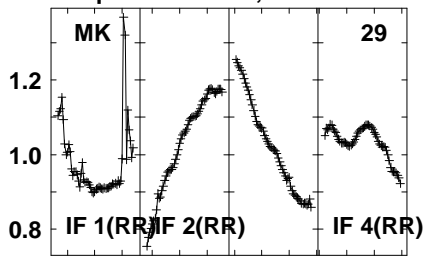

Lower frame: Real Jy  
Auto-corr total-power spectrum Antenna: \*  
Timerange: 01/01:20:39 to 01/01:23:59

Plot file version 1632 created 05-OCT-2021 17:12:14

J0827+5217 GM076.UVDATA.1

Freq = 1.5945 GHz, Bw = 32.000 MH No calibration applied and no bandpass applied

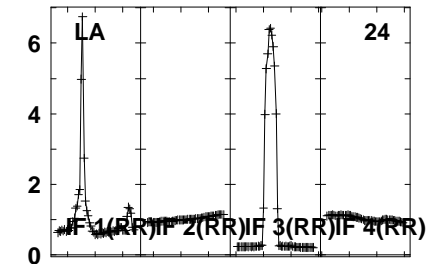
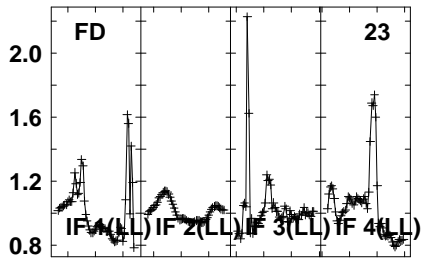
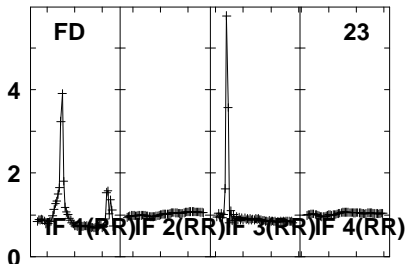
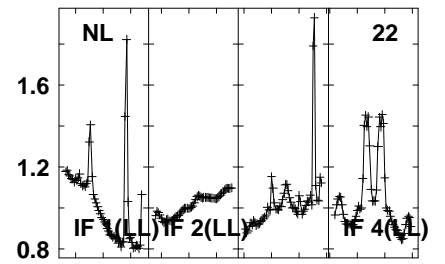
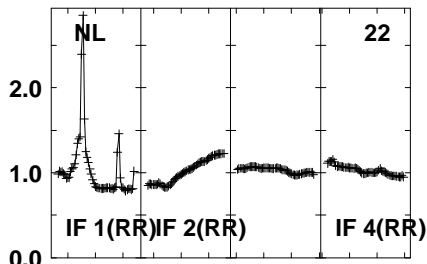
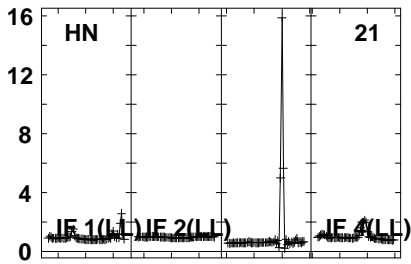
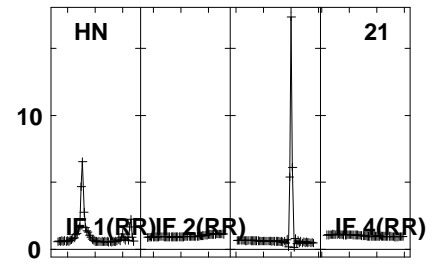
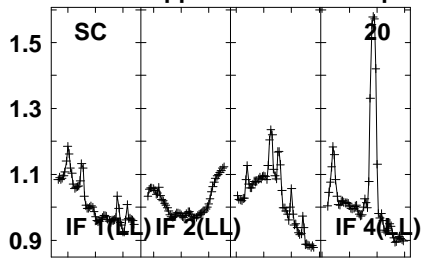
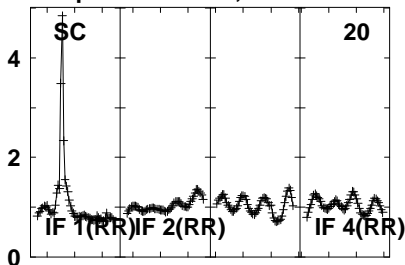

1600 1620 1630 1650 1660 1680 1690 1710  
FREQ MHz

1600 1620 1630 1650 1660 1680 1690 1710  
FREQ MHz

1600 1620 1630 1650 1660 1680 1690 1710  
FREQ MHz

Lower frame: Real Jy

Auto-corr total-power spectrum Antenna: \*

Timerange: 01/01:24:31 to 01/01:25:59

Plot file version 1633 created 05-OCT-2021 17:12:14

J0827+5217 GM076.UVDATA.1

Freq = 1.5945 GHz, Bw = 32.000 MH No calibration applied and no bandpass applied

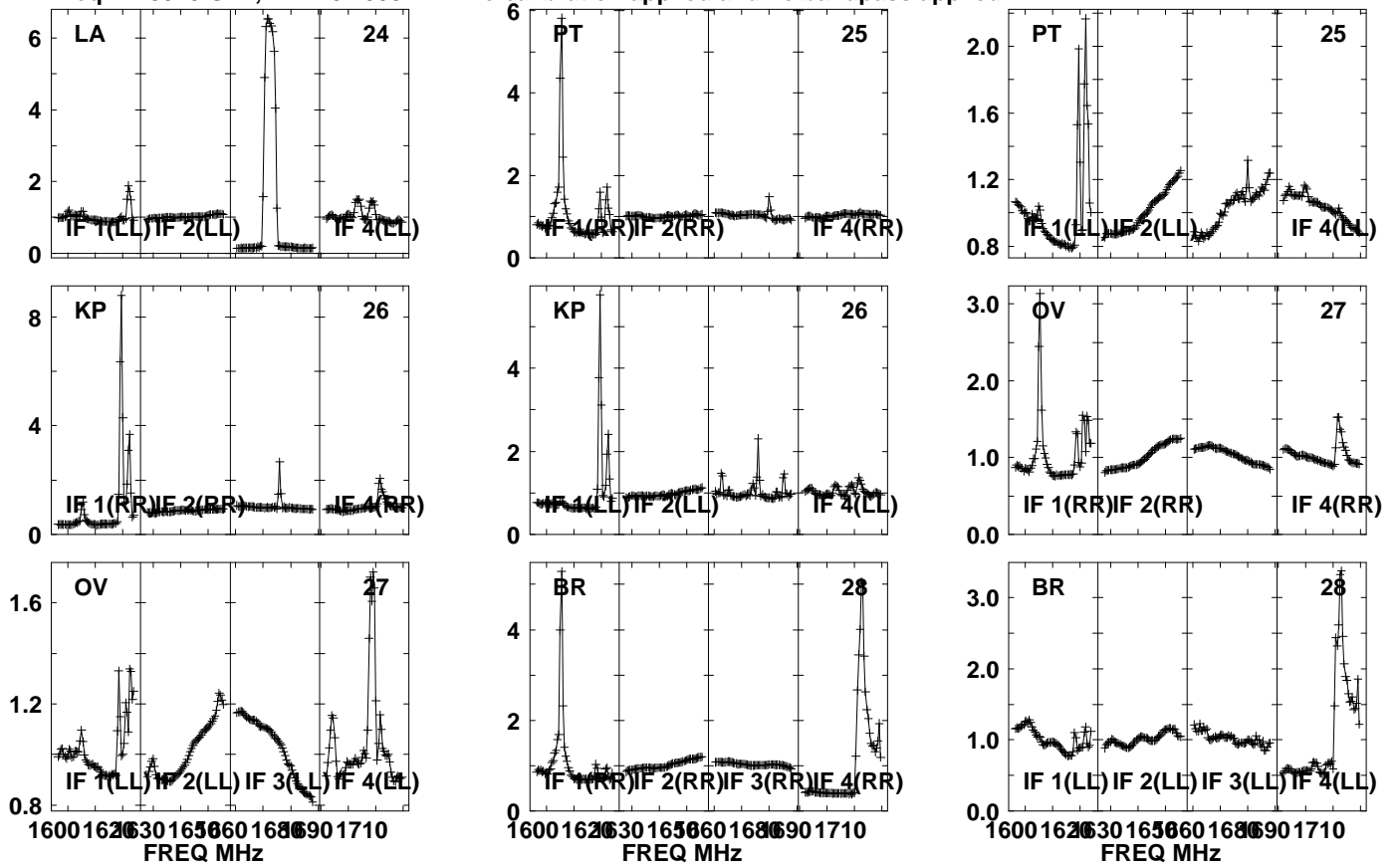

Lower frame: Real Jy

Auto-corr total-power spectrum Antenna: \*

Timerange: 01/01:24:31 to 01/01:25:59

Plot file version1634 created 05-OCT-2021 17:12:14

J0827+5217 GM076.UVDATA.1

Freq = 1.5945 GHz, Bw = 32.000 MH No calibration applied and no bandpass applied

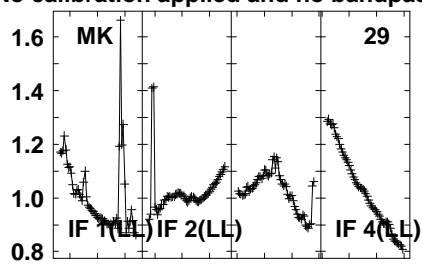
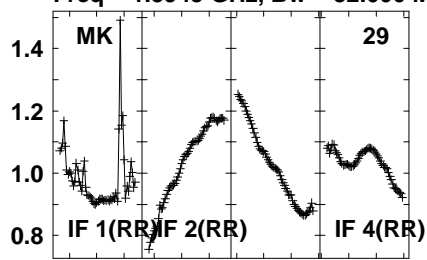

Lower frame: Real Jy  
Auto-corr total-power spectrum Antenna: \*  
Timerange: 01/01:24:31 to 01/01:25:59



Plot file version 1635 created 05-OCT-2021 17:12:14

APM08279+525 GM076.UVDATA.1

Freq = 1.5945 GHz, Bw = 32.000 MH No calibration applied and no bandpass applied

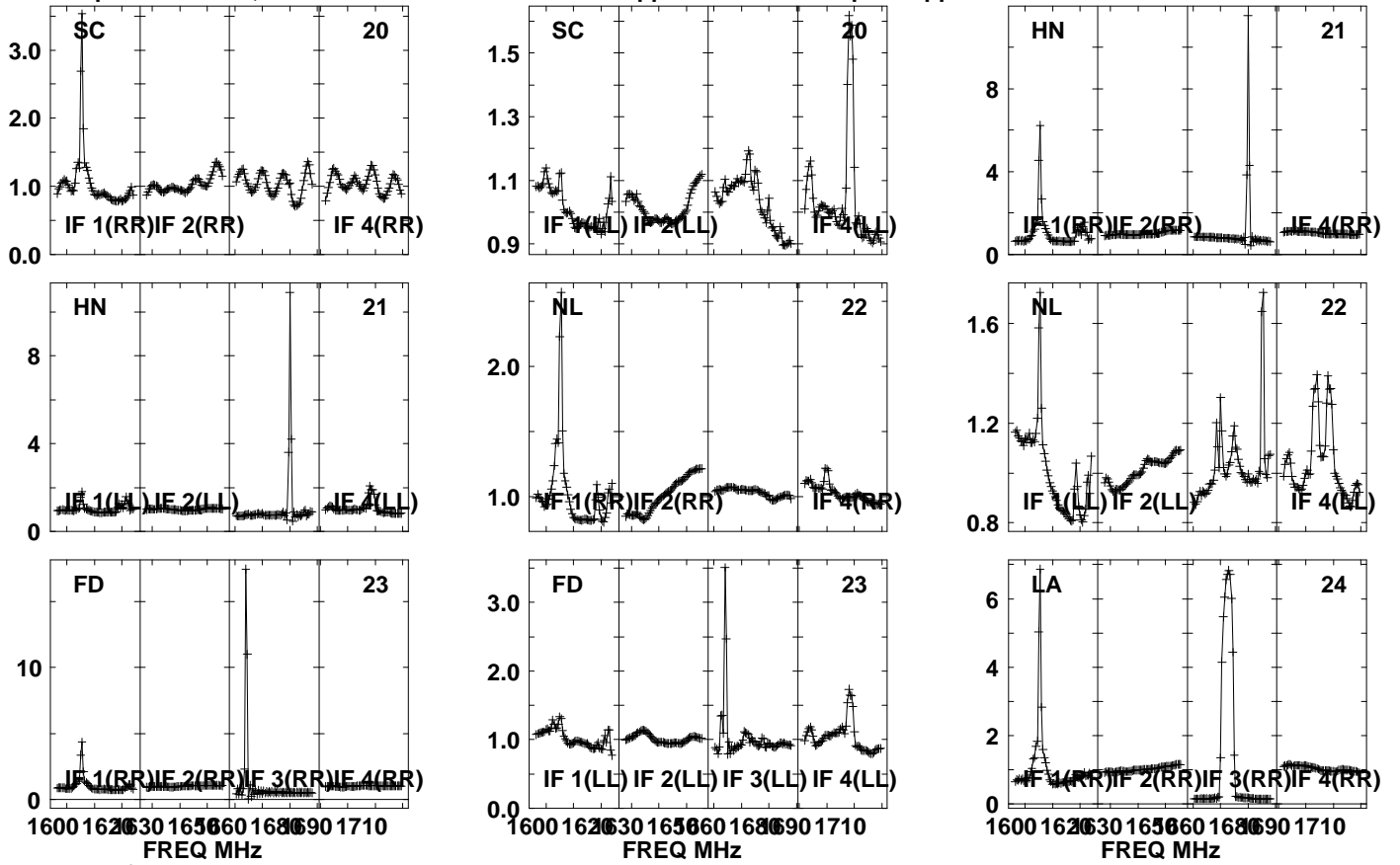

Lower frame: Real Jy

Auto-corr total-power spectrum Antenna: \*

Timerange: 01/01:26:11 to 01/01:29:29

Plot file version 1636 created 05-OCT-2021 17:12:14

APM08279+525 GM076.UVDATA.1

Freq = 1.5945 GHz, Bw = 32.000 MH No calibration applied and no bandpass applied

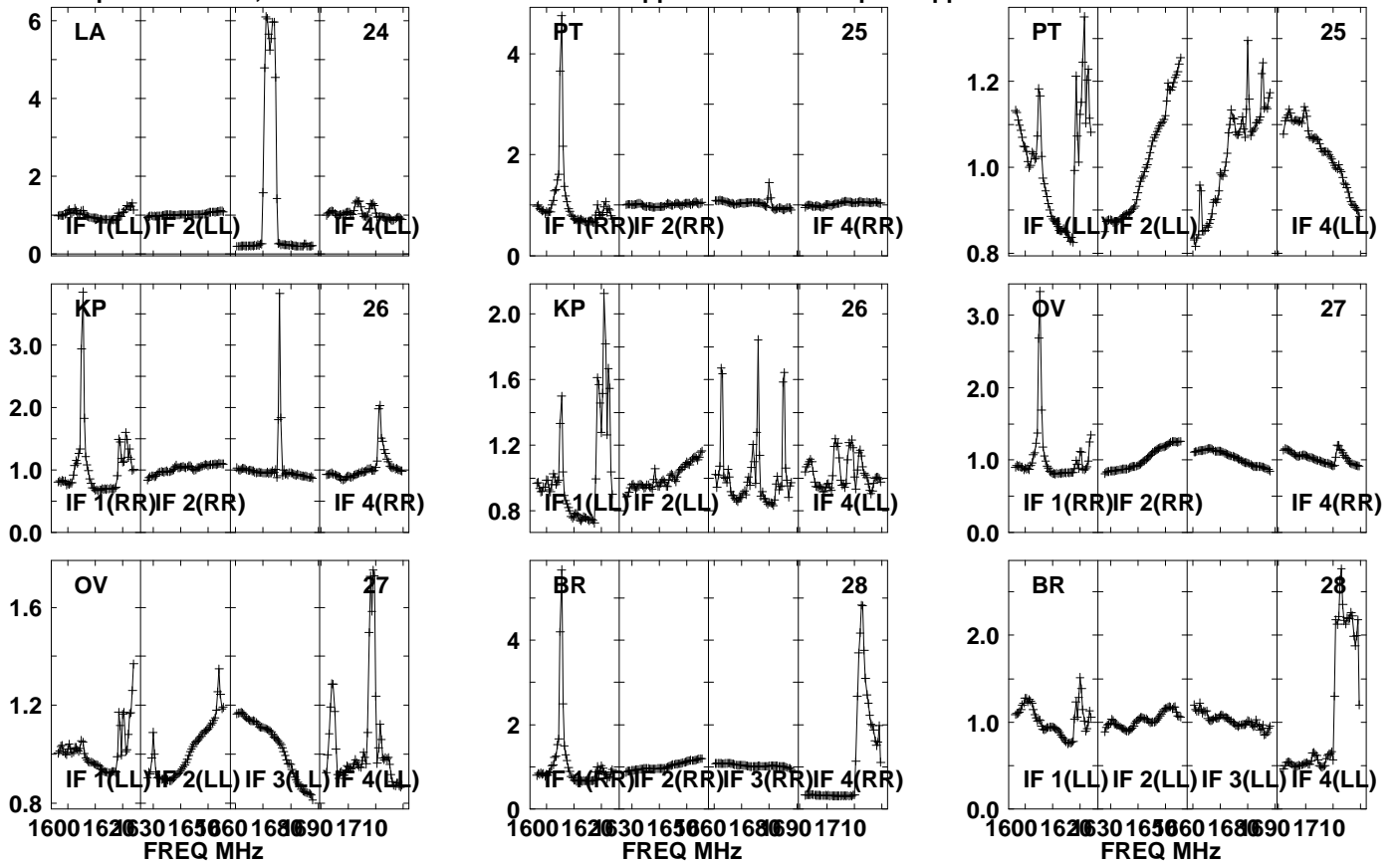

Lower frame: Real Jy  
Auto-corr total-power spectrum Antenna: \*  
Timerange: 01/01:26:11 to 01/01:29:29

Plot file version1637 created 05-OCT-2021 17:12:14

APM08279+525 GM076.UVDATA.1

Freq = 1.5945 GHz, Bw = 32.000 MH No calibration applied and no bandpass applied

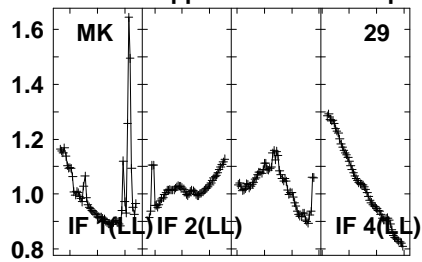
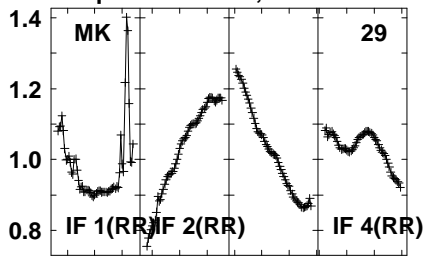

Lower frame: Real Jy  
Auto-corr total-power spectrum Antenna: \*  
Timerange: 01/01:26:11 to 01/01:29:29

Plot file version 1638 created 05-OCT-2021 17:12:15

J0827+5217 GM076.UVDATA.1

Freq = 1.5945 GHz, Bw = 32.000 MHz No calibration applied and no bandpass applied

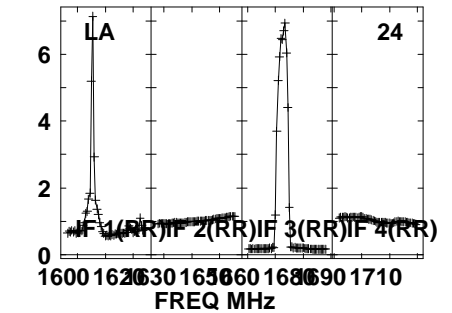
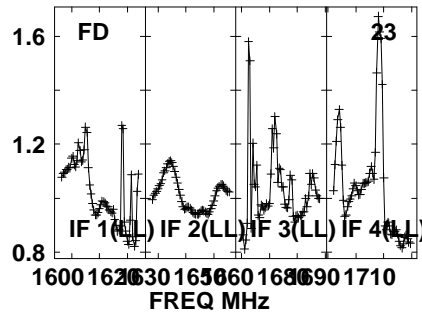
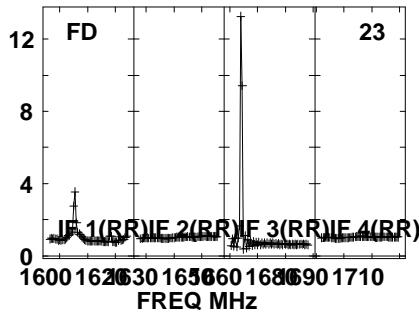
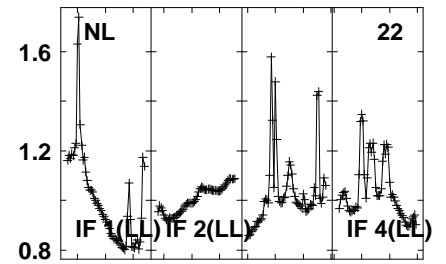
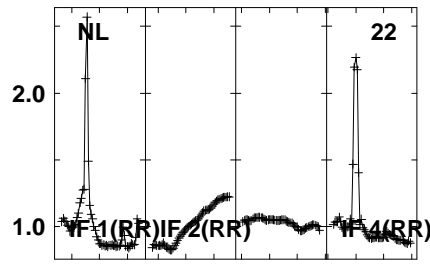
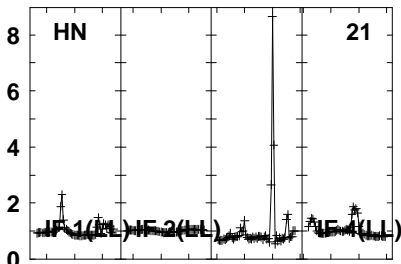
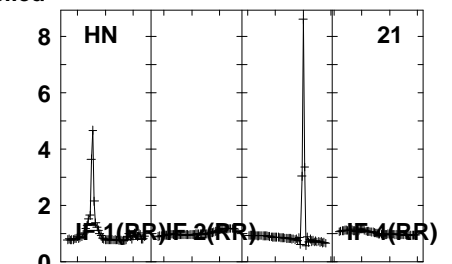
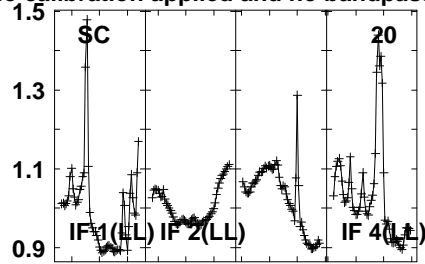
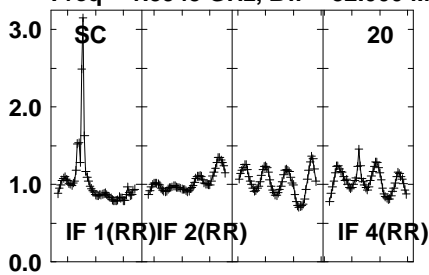

Lower frame: Real Jy

Auto-corr total-power spectrum Antenna: \*

Timerange: 01/01:30:01 to 01/01:31:29

Plot file version1639 created 05-OCT-2021 17:12:15

J0827+5217 GM076.UVDATA.1

Freq = 1.5945 GHz, Bw = 32.000 MH No calibration applied and no bandpass applied

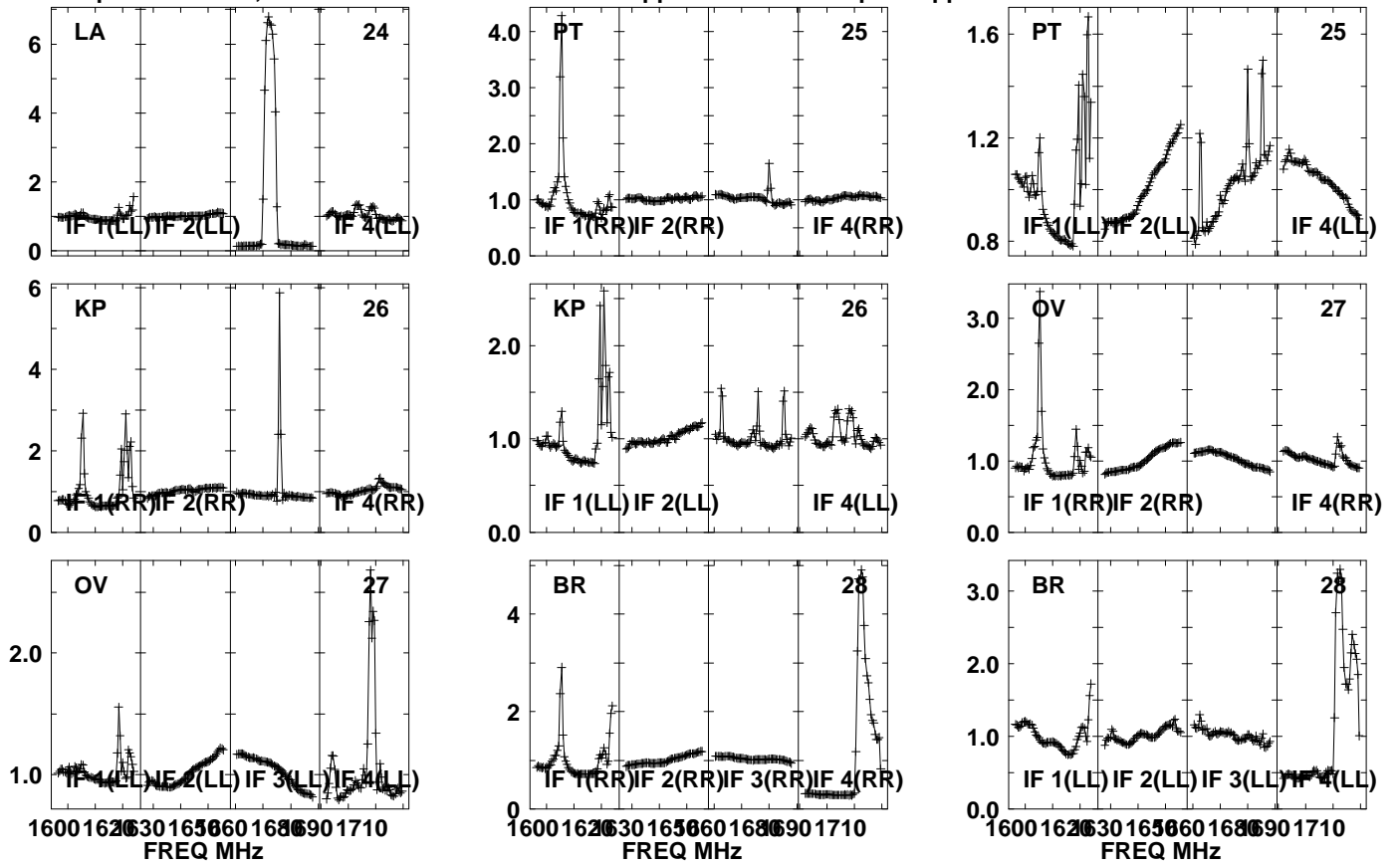

Lower frame: Real Jy

Auto-corr total-power spectrum Antenna: \*

Timerange: 01/01:30:01 to 01/01:31:29

Plot file version1640 created 05-OCT-2021 17:12:15

J0827+5217 GM076.UVDATA.1

Freq = 1.5945 GHz, Bw = 32.000 MH No calibration applied and no bandpass applied

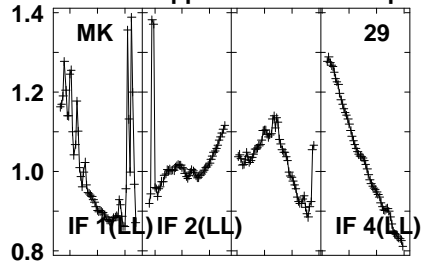
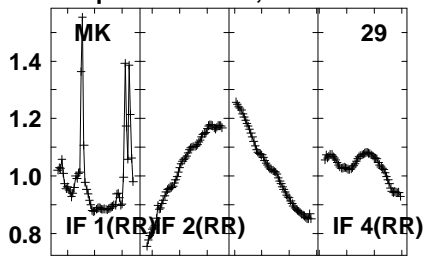

Lower frame: Real Jy  
Auto-corr total-power spectrum Antenna: \*  
Timerange: 01/01:30:01 to 01/01:31:29

Plot file version1641 created 05-OCT-2021 17:12:15

APM08279+525 GM076.UVDATA.1

Freq = 1.5945 GHz, Bw = 32.000 MH No calibration applied and no bandpass applied

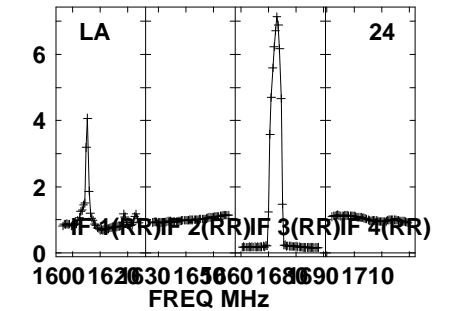
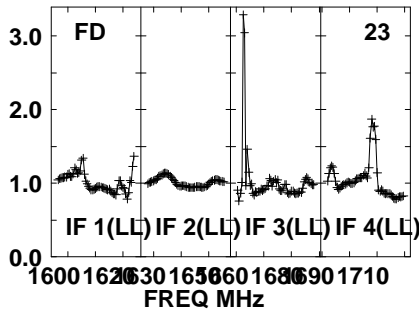
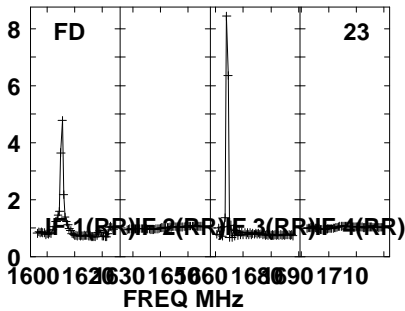
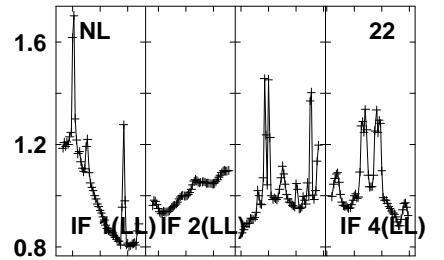
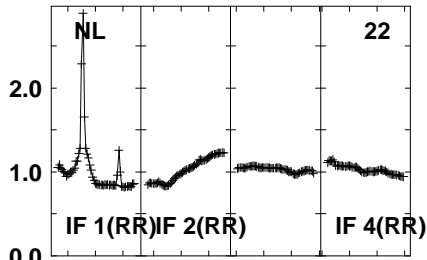
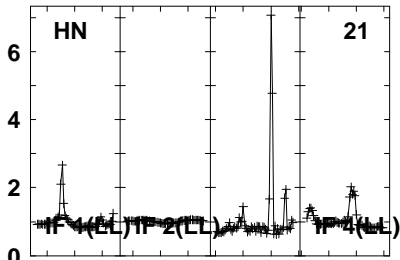
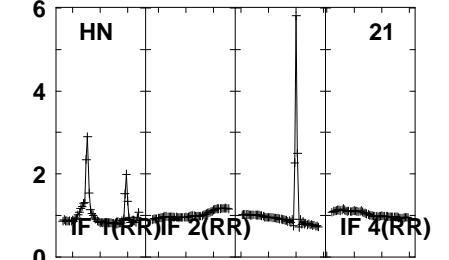
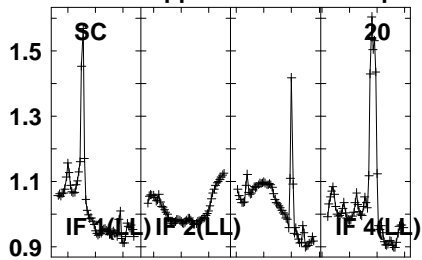
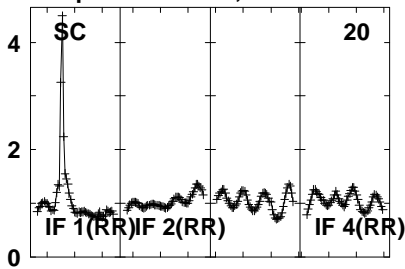

Lower frame: Real Jy

Auto-corr total-power spectrum Antenna: \*

Timerange: 01/01:31:41 to 01/01:34:59

Plot file version1642 created 05-OCT-2021 17:12:15

APM08279+525 GM076.UVDATA.1

Freq = 1.5945 GHz, Bw = 32.000 MH No calibration applied and no bandpass applied

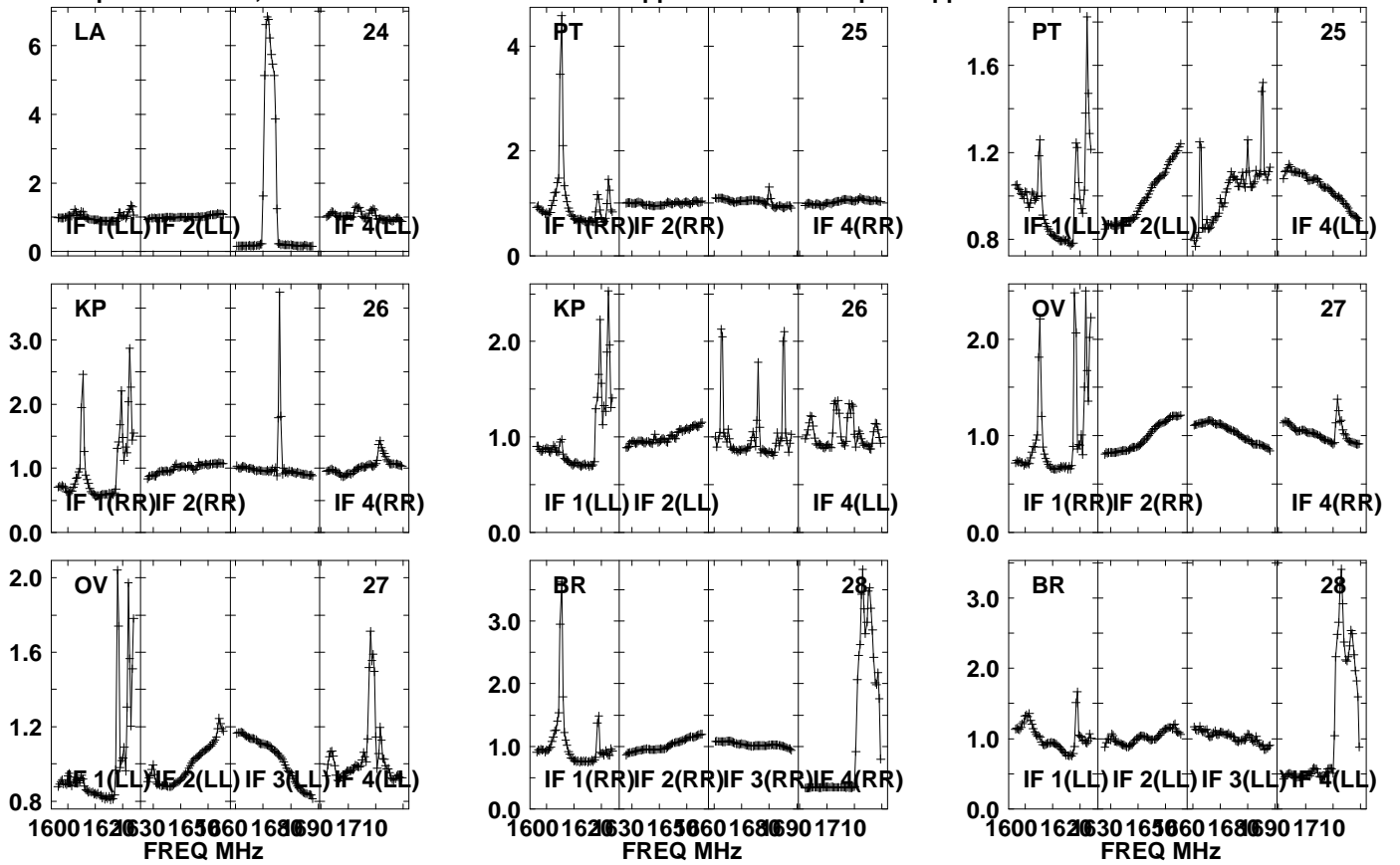

Lower frame: Real Jy

Auto-corr total-power spectrum Antenna: \*

Timerange: 01/01:31:41 to 01/01:34:59



Plot file version1643 created 05-OCT-2021 17:12:15

APM08279+525 GM076.UVDATA.1

Freq = 1.5945 GHz, Bw = 32.000 MH No calibration applied and no bandpass applied

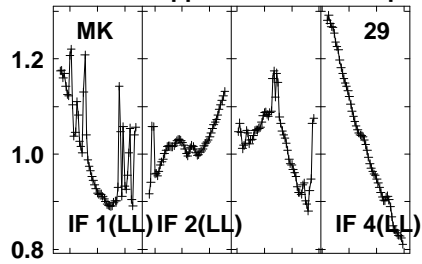
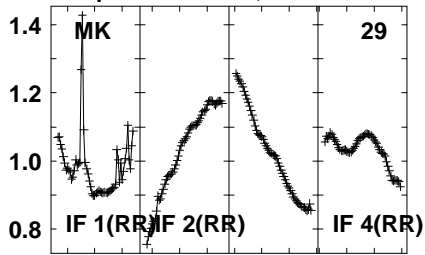

Lower frame: Real Jy  
Auto-corr total-power spectrum Antenna: \*  
Timerange: 01/01:31:41 to 01/01:34:59

Plot file version1644 created 05-OCT-2021 17:12:15

J0827+5217 GM076.UVDATA.1

Freq = 1.5945 GHz, Bw = 32.000 MH No calibration applied and no bandpass applied

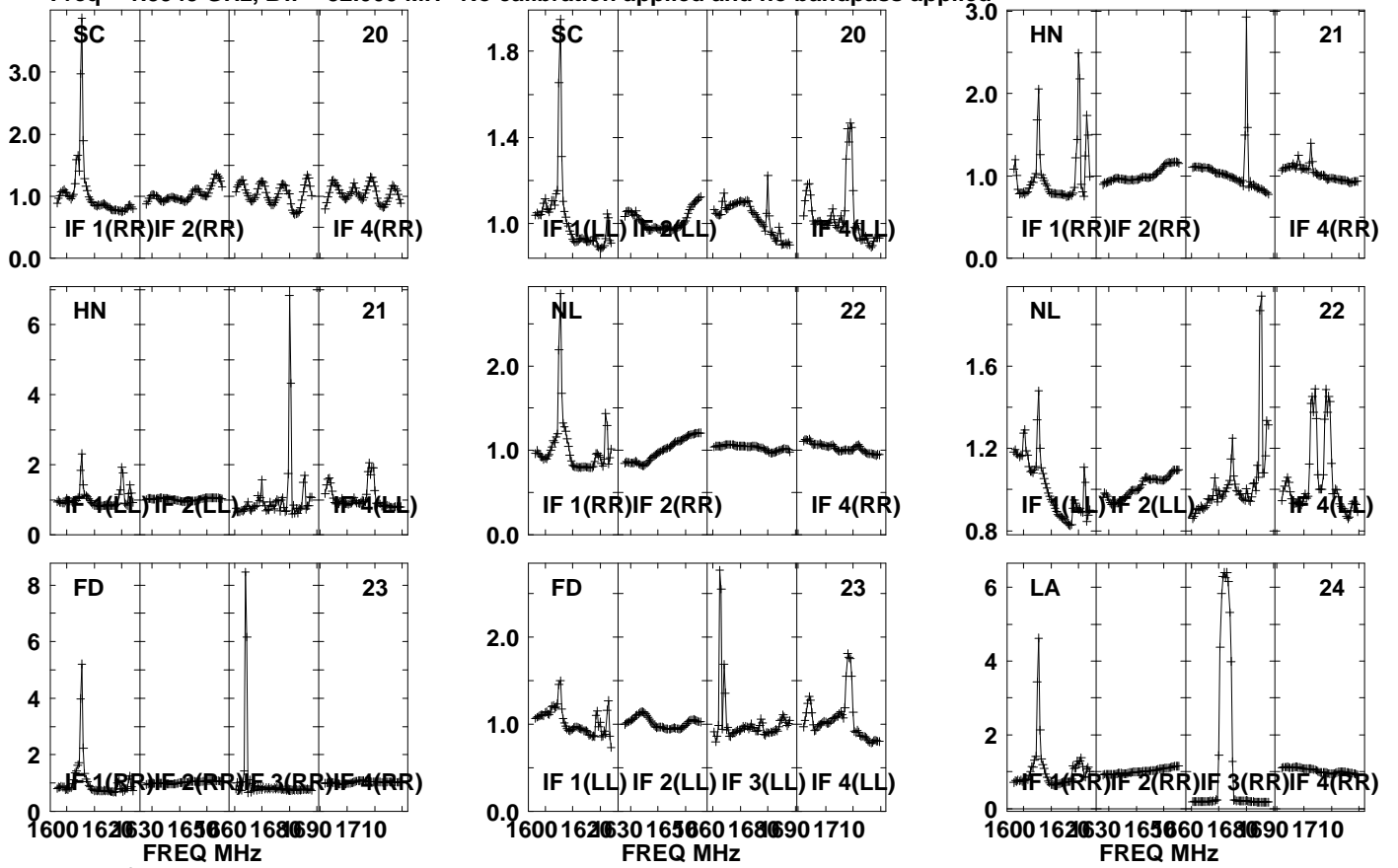

Lower frame: Real Jy

Auto-corr total-power spectrum Antenna: \*

Timerange: 01/01:35:31 to 01/01:36:59

Plot file version1645 created 05-OCT-2021 17:12:15

J0827+5217 GM076.UVDATA.1

Freq = 1.5945 GHz, Bw = 32.000 MH No calibration applied and no bandpass applied

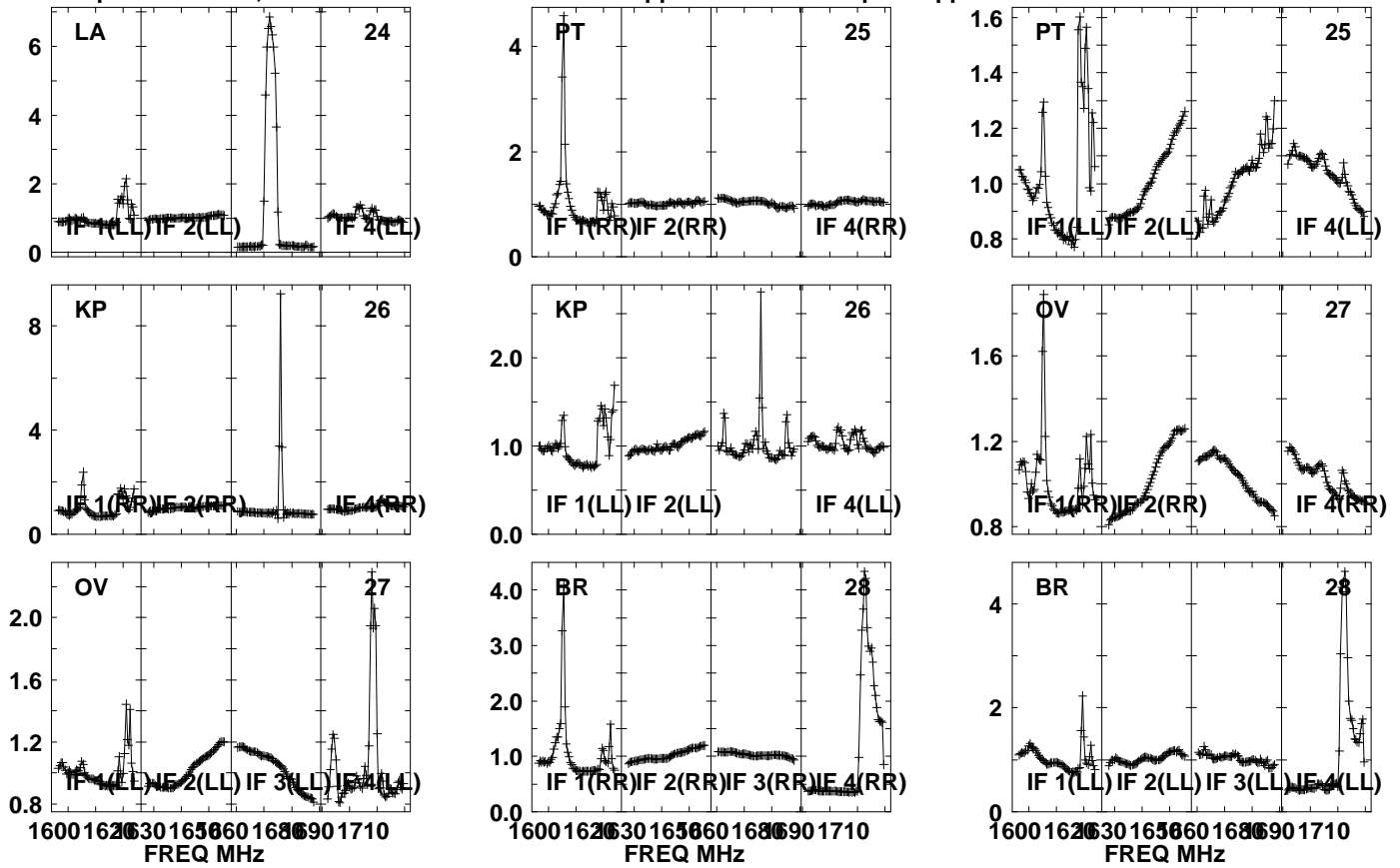

Lower frame: Real Jy

Auto-corr total-power spectrum Antenna: \*

Timerange: 01/01:35:31 to 01/01:36:59

Plot file version1646 created 05-OCT-2021 17:12:16

J0827+5217 GM076.UVDATA.1

Freq = 1.5945 GHz, Bw = 32.000 MH No calibration applied and no bandpass applied

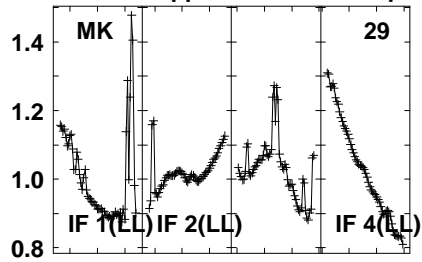
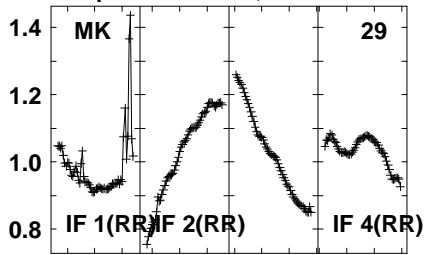

Lower frame: Real Jy  
Auto-corr total-power spectrum Antenna: \*  
Timerange: 01/01:35:31 to 01/01:36:59

Plot file version 1647 created 05-OCT-2021 17:12:16

APM08279+525 GM076.UVDATA.1

Freq = 1.5945 GHz, Bw = 32.000 MH No calibration applied and no bandpass applied

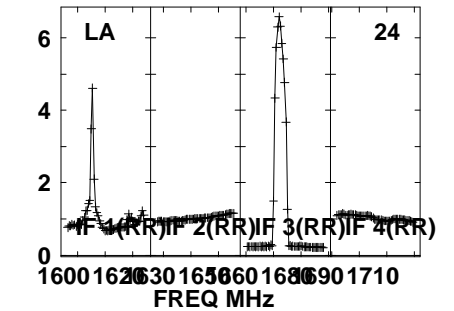
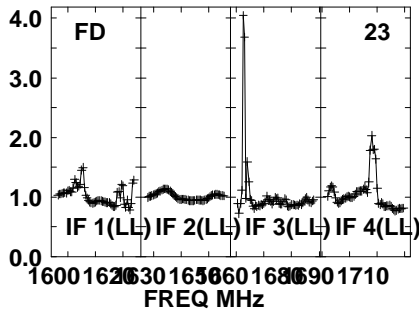
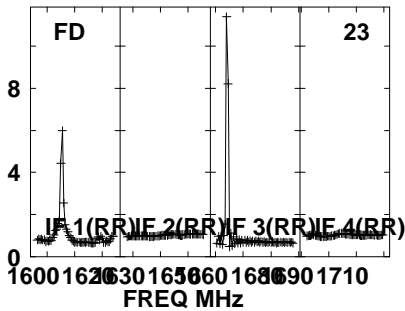
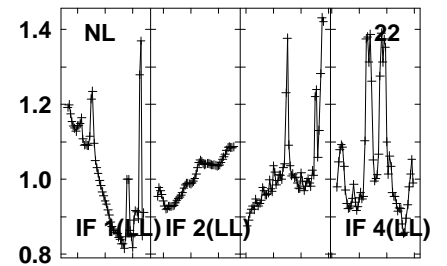
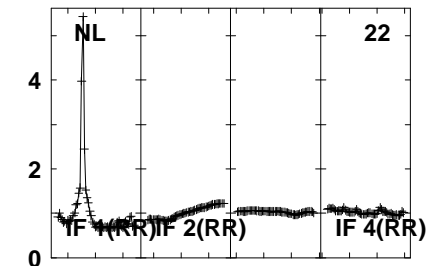
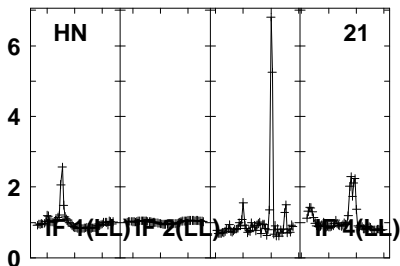
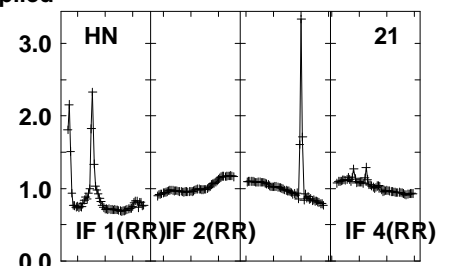
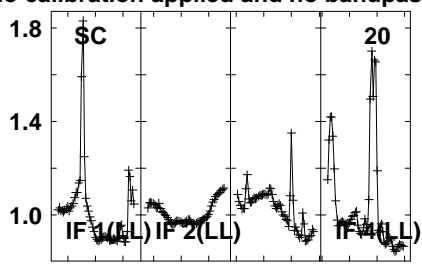
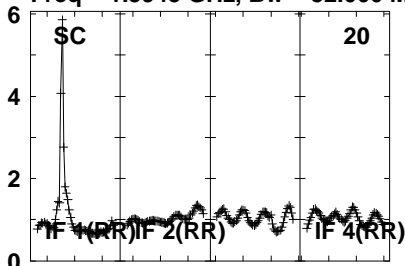

Lower frame: Real Jy

Auto-corr total-power spectrum Antenna: \*

Timerange: 01/01:37:09 to 01/01:40:29

Plot file version1648 created 05-OCT-2021 17:12:16

APM08279+525 GM076.UVDATA.1

Freq = 1.5945 GHz, Bw = 32.000 MH No calibration applied and no bandpass applied

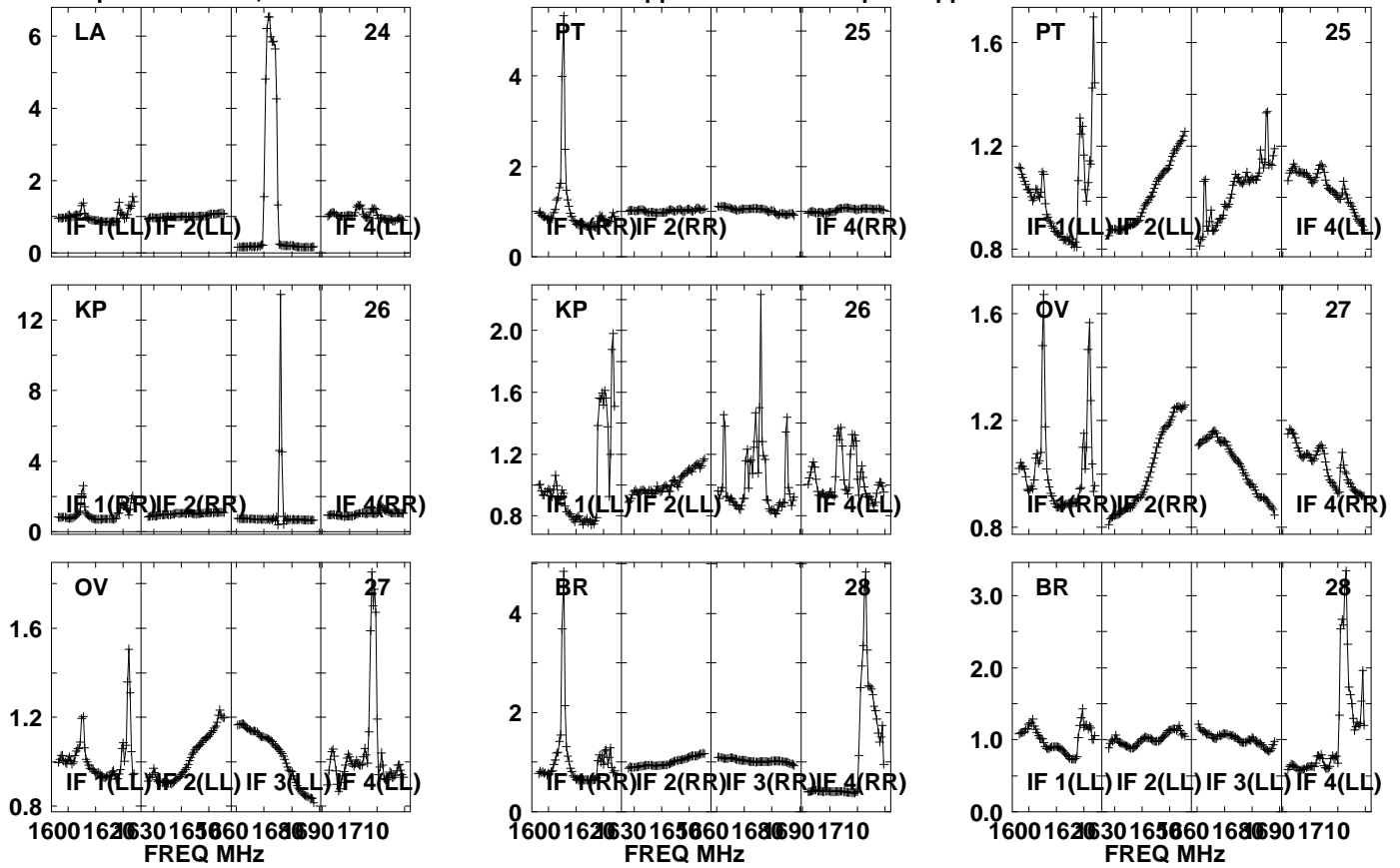

Lower frame: Real Jy

Auto-corr total-power spectrum Antenna: \*

Timerange: 01/01:37:09 to 01/01:40:29

Plot file version1649 created 05-OCT-2021 17:12:16  
APM08279+525 GM076.UVDATA.1  
Freq = 1.5945 GHz, Bw = 32.000 MH No calibration applied and no bandpass applied

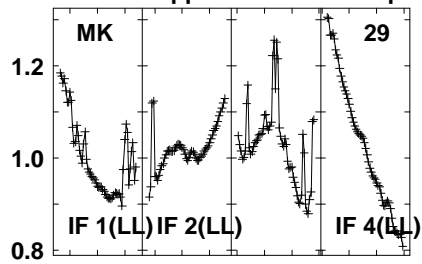
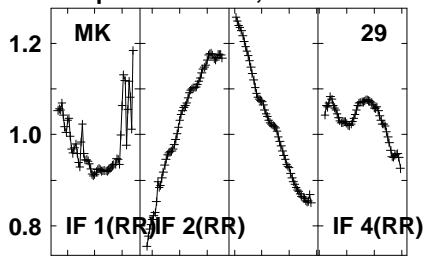

Lower frame: Real Jy  
Auto-corr total-power spectrum Antenna: \*  
Timerange: 01/01:37:09 to 01/01:40:29

Plot file version 1650 created 05-OCT-2021 17:12:16

J0827+5217 GM076.UVDATA.1

Freq = 1.5945 GHz, Bw = 32.000 MH No calibration applied and no bandpass applied

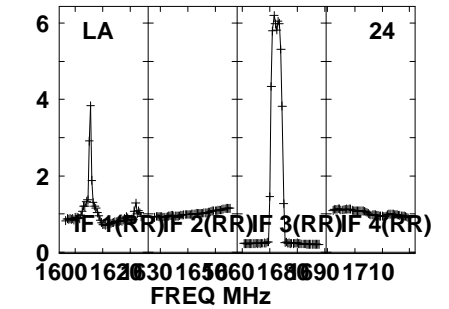
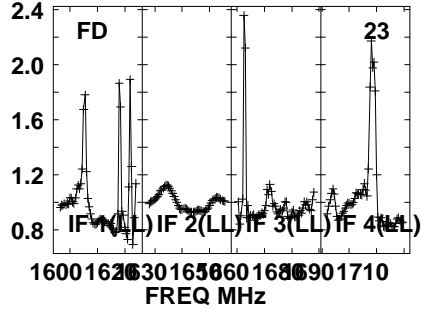
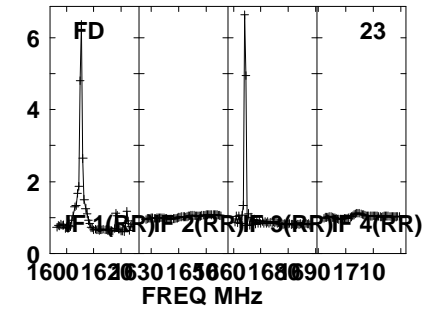
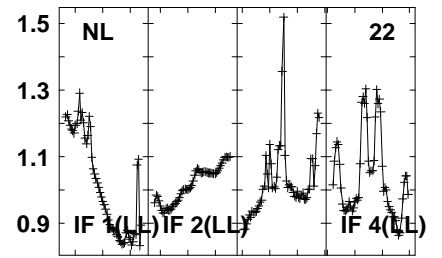
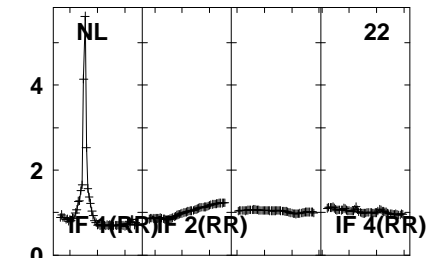
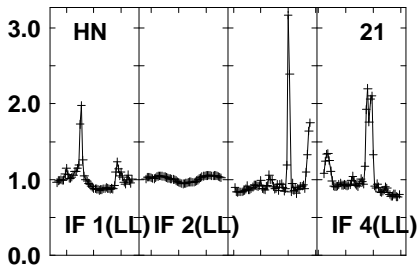
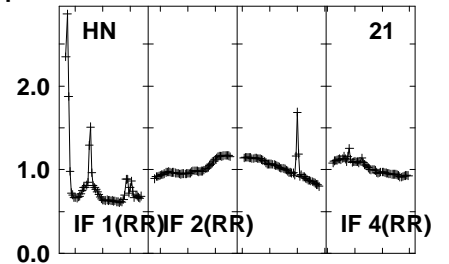
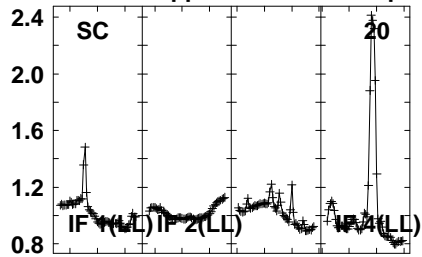
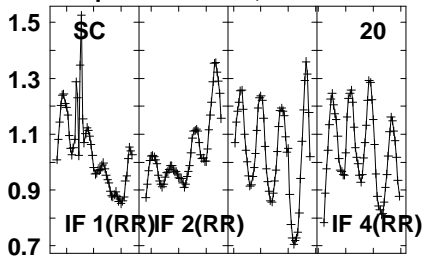

Lower frame: Real Jy  
Auto-corr total-power spectrum Antenna: \*  
Timerange: 01/01:41:01 to 01/01:42:29



Plot file version 1651 created 05-OCT-2021 17:12:16

J0827+5217 GM076.UVDATA.1

Freq = 1.5945 GHz, Bw = 32.000 MH No calibration applied and no bandpass applied

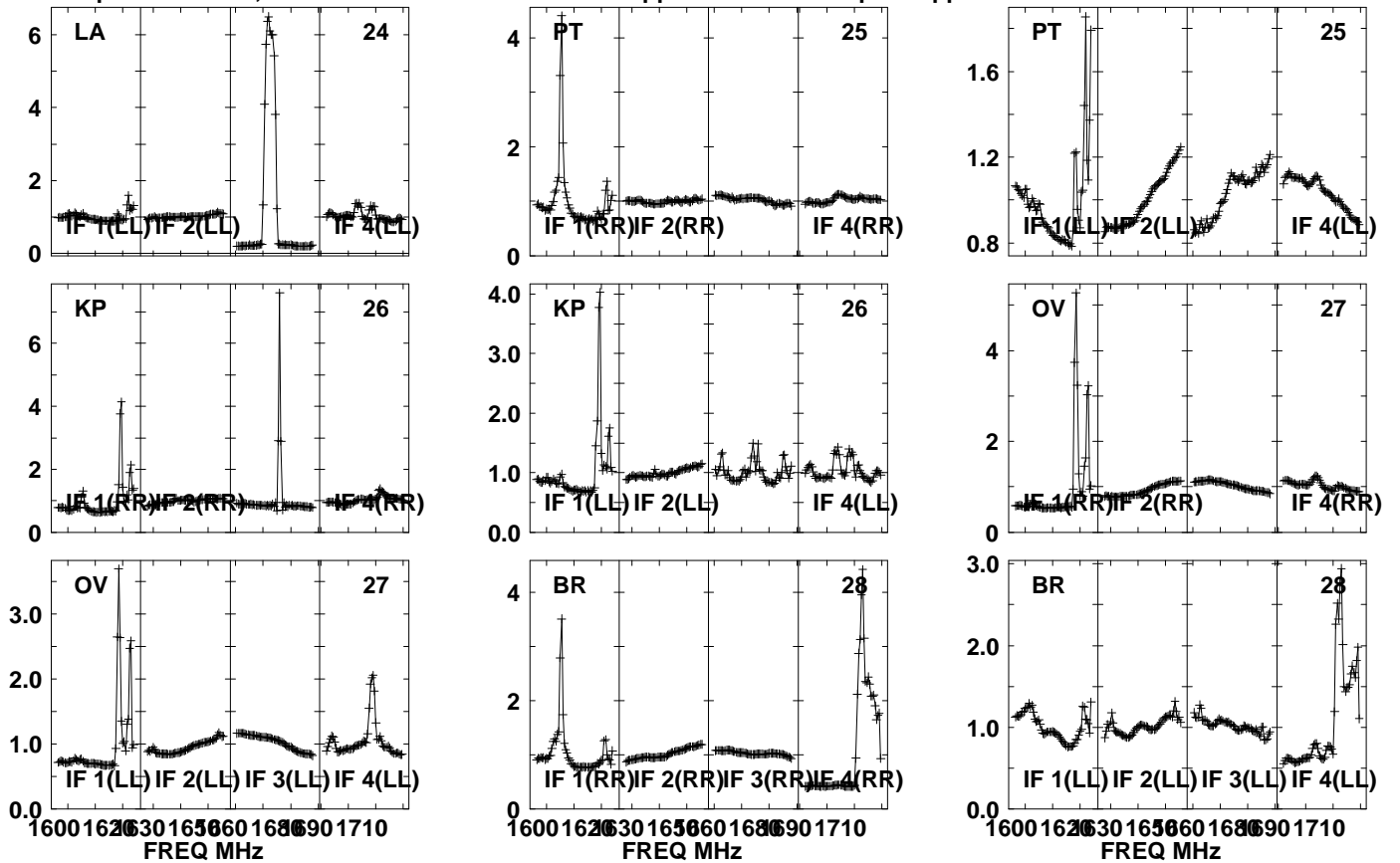

Lower frame: Real Jy

Auto-corr total-power spectrum Antenna: \*

Timerange: 01/01:41:01 to 01/01:42:29

Plot file version1652 created 05-OCT-2021 17:12:16  
J0827+5217 GM076.UVDATA.1  
Freq = 1.5945 GHz, Bw = 32.000 MH No calibration applied and no bandpass applied

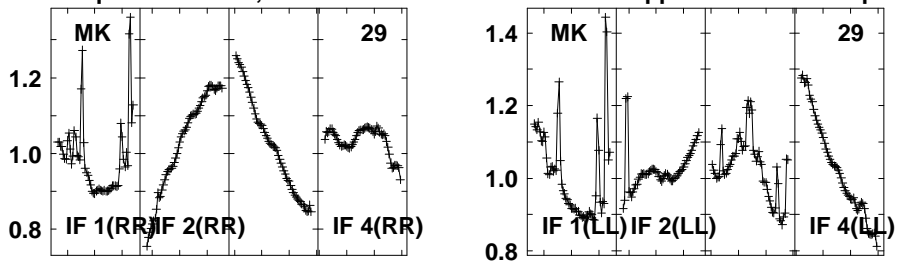

Lower frame: Real Jy  
Auto-corr total-power spectrum Antenna: \*  
Timerange: 01/01:41:01 to 01/01:42:29

Plot file version 1653 created 05-OCT-2021 17:12:16

APM08279+525 GM076.UVDATA.1

Freq = 1.5945 GHz, Bw = 32.000 MH No calibration applied and no bandpass applied

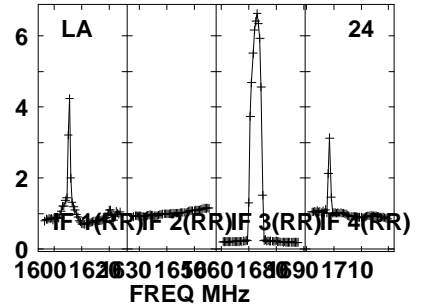
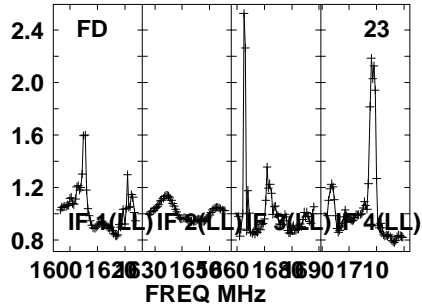
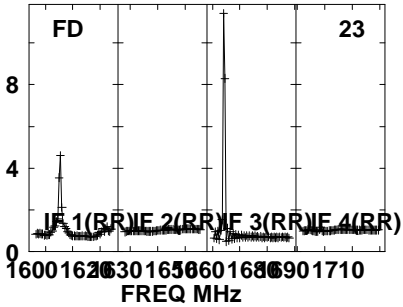
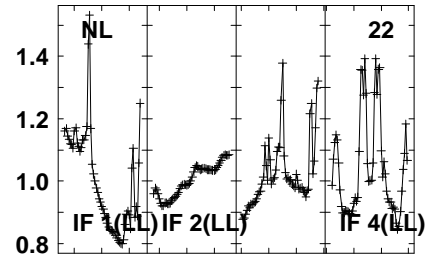
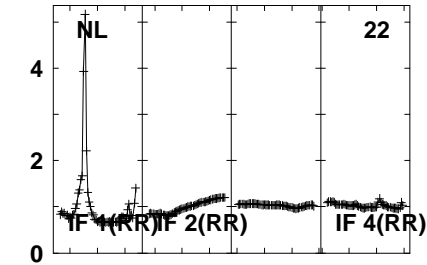
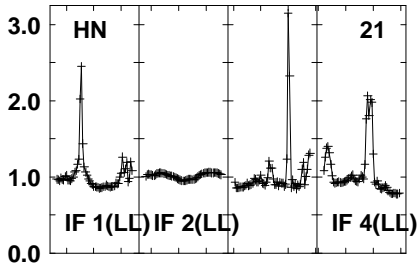
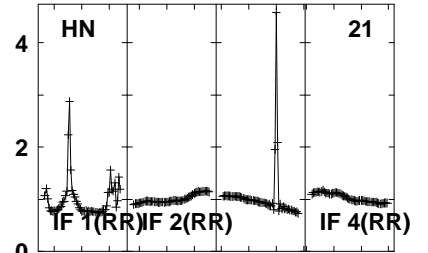
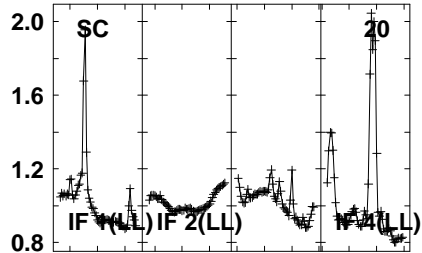
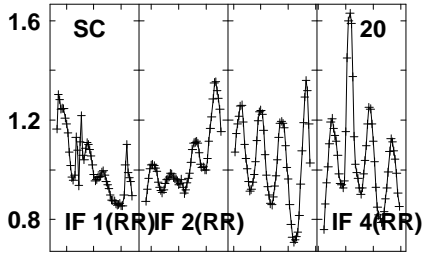

Lower frame: Real Jy  
Auto-corr total-power spectrum Antenna: \*  
Timerange: 01/01:42:39 to 01/01:45:59

Plot file version 1654 created 05-OCT-2021 17:12:17

APM08279+525 GM076.UVDATA.1

Freq = 1.5945 GHz, Bw = 32.000 MH No calibration applied and no bandpass applied

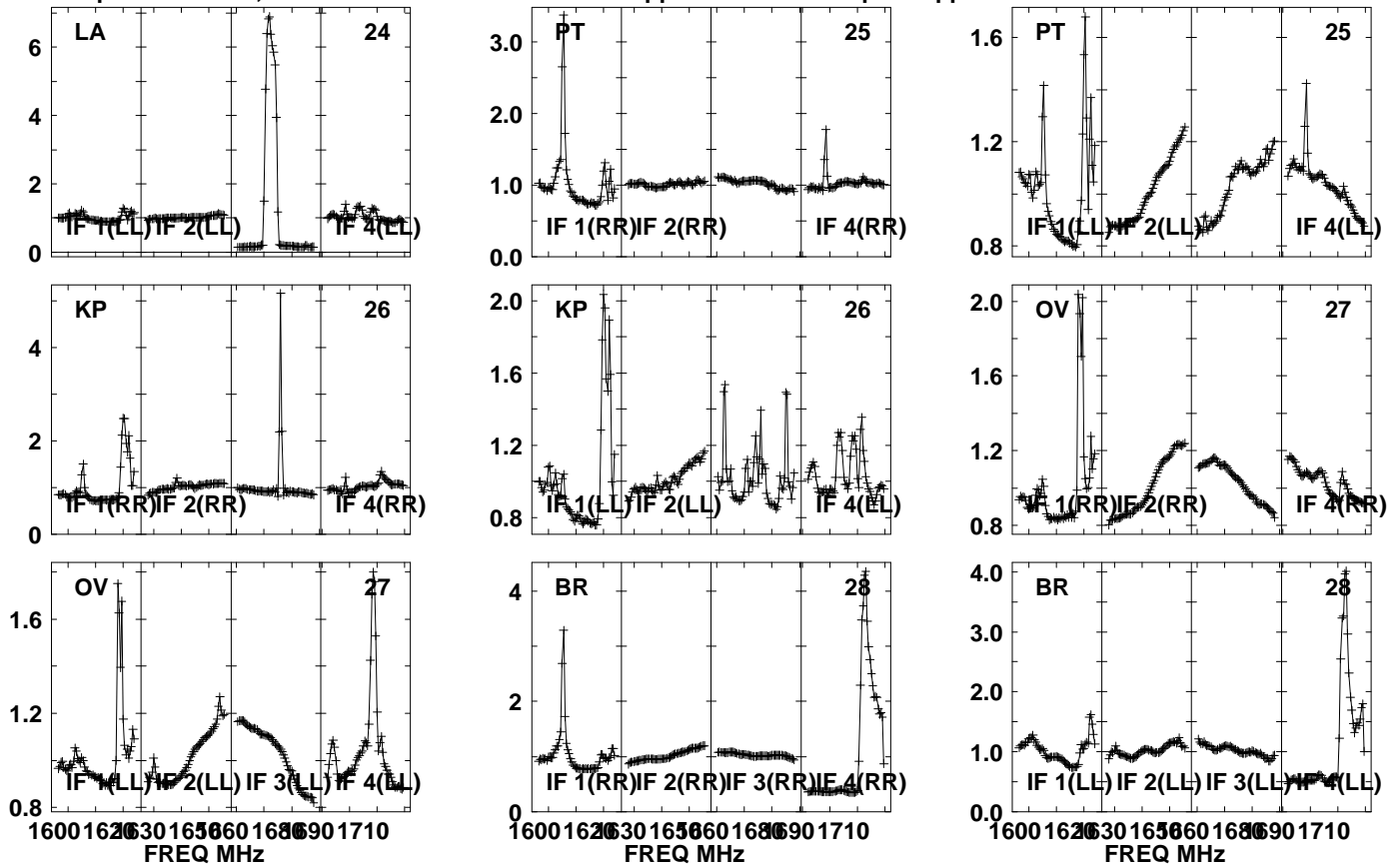

Lower frame: Real Jy

Auto-corr total-power spectrum Antenna: \*

Timerange: 01/01:42:39 to 01/01:45:59

Plot file version1655 created 05-OCT-2021 17:12:17  
APM08279+525 GM076.UVDATA.1  
Freq = 1.5945 GHz, Bw = 32.000 MH No calibration applied and no bandpass applied

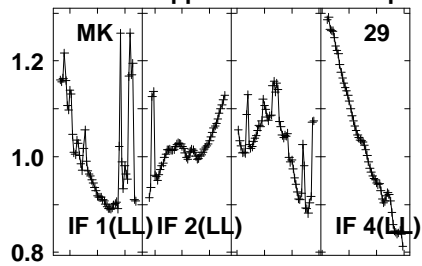
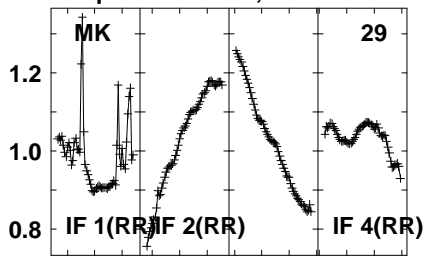

Lower frame: Real Jy  
Auto-corr total-power spectrum Antenna: \*  
Timerange: 01/01:42:39 to 01/01:45:59

Plot file version 1656 created 05-OCT-2021 17:12:17

J0827+5217 GM076.UVDATA.1

Freq = 1.5945 GHz, Bw = 32.000 MHz No calibration applied and no bandpass applied

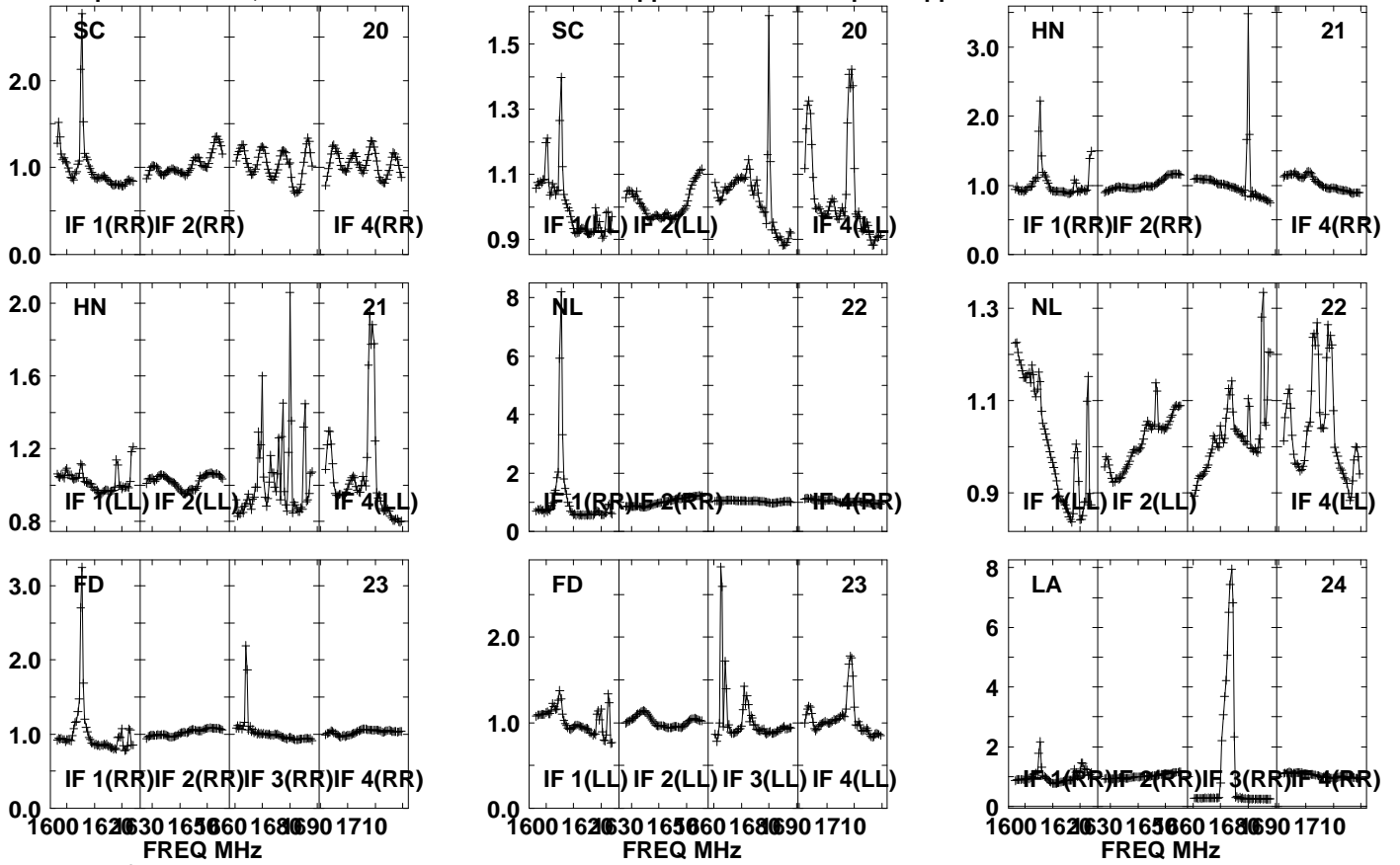

Lower frame: Real Jy  
Auto-corr total-power spectrum Antenna: \*  
Timerange: 01/01:46:31 to 01/01:47:59

Plot file version 1657 created 05-OCT-2021 17:12:17

J0827+5217 GM076.UVDATA.1

Freq = 1.5945 GHz, Bw = 32.000 MH No calibration applied and no bandpass applied

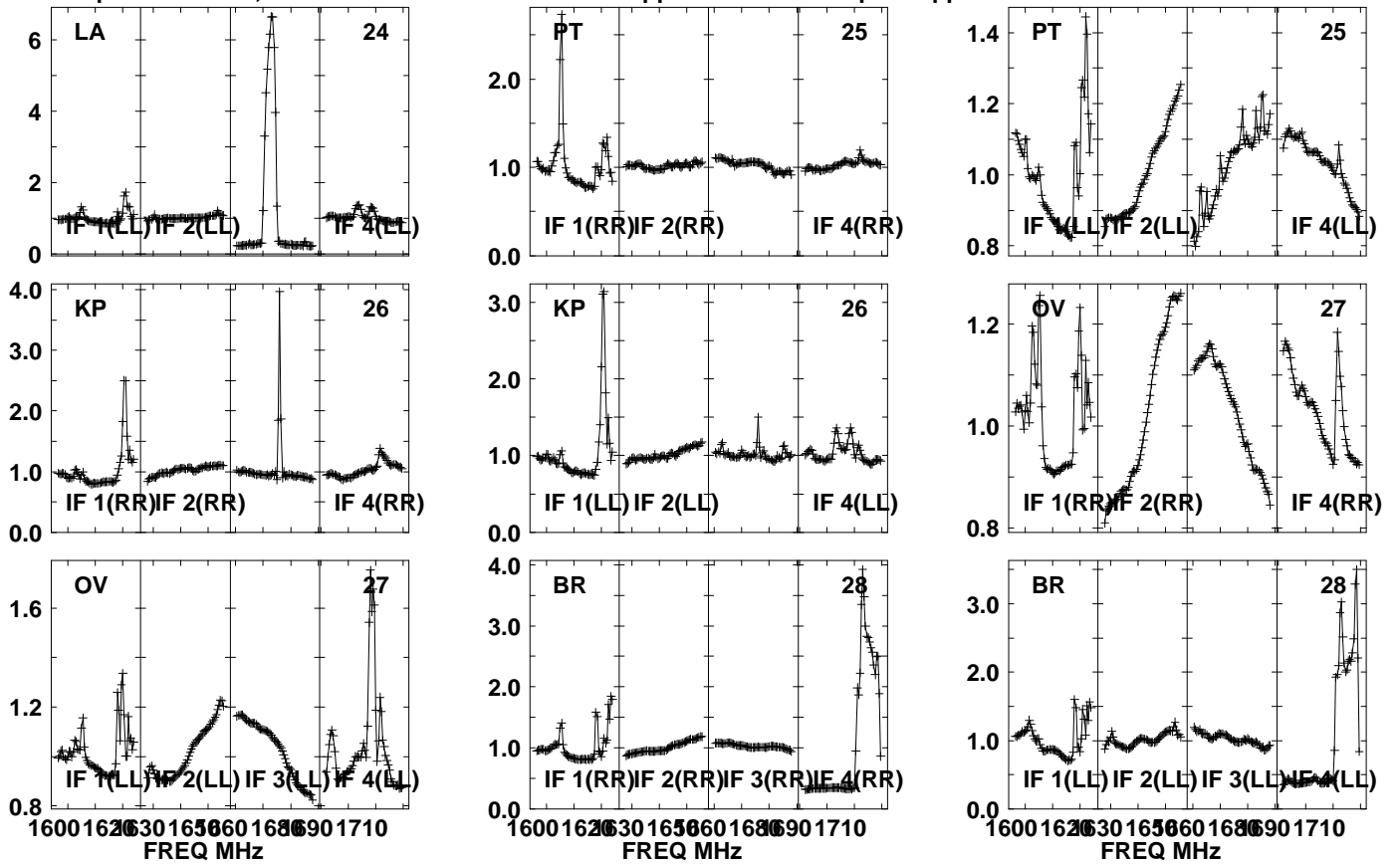

Lower frame: Real Jy  
Auto-corr total-power spectrum Antenna: \*  
Timerange: 01/01:46:31 to 01/01:47:59

Plot file version1658 created 05-OCT-2021 17:12:17  
J0827+5217 GM076.UVDATA.1  
Freq = 1.5945 GHz, Bw = 32.000 MH No calibration applied and no bandpass applied

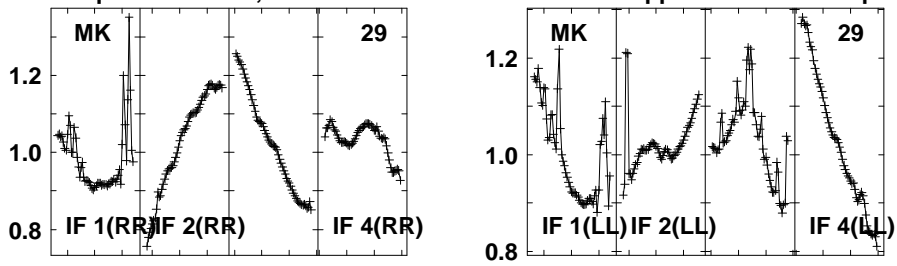

Lower frame: Real Jy  
Auto-corr total-power spectrum Antenna: \*  
Timerange: 01/01:46:31 to 01/01:47:59



Plot file version 1659 created 05-OCT-2021 17:12:17

APM08279+525 GM076.UVDATA.1

Freq = 1.5945 GHz, Bw = 32.000 MH No calibration applied and no bandpass applied

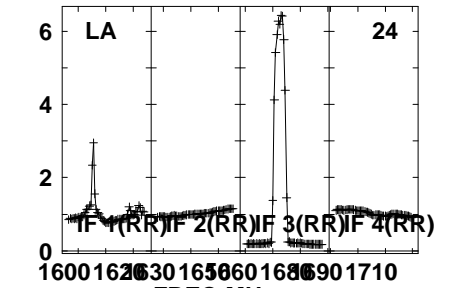
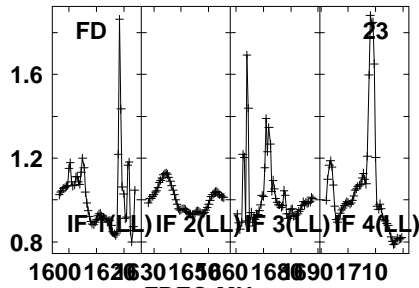
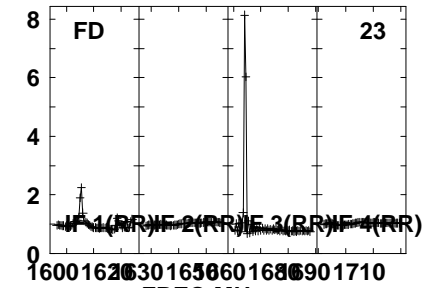
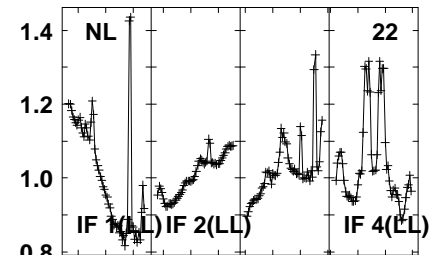
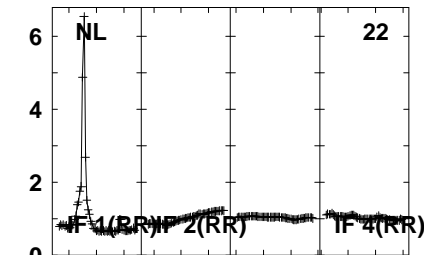
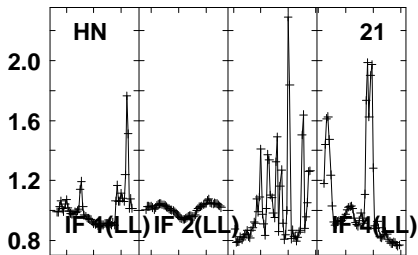
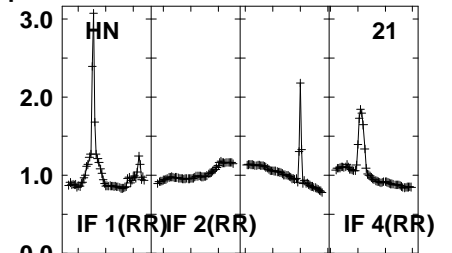
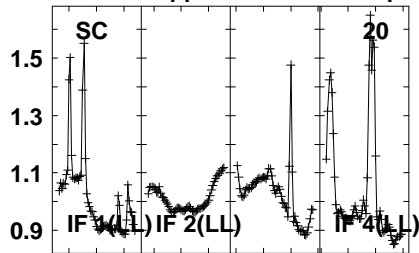
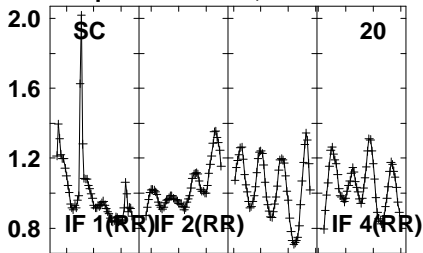

Lower frame: Real Jy  
Auto-corr total-power spectrum Antenna: \*  
Timerange: 01/01:48:11 to 01/01:51:29

Plot file version1660 created 05-OCT-2021 17:12:17

APM08279+525 GM076.UVDATA.1

Freq = 1.5945 GHz, Bw = 32.000 MH No calibration applied and no bandpass applied

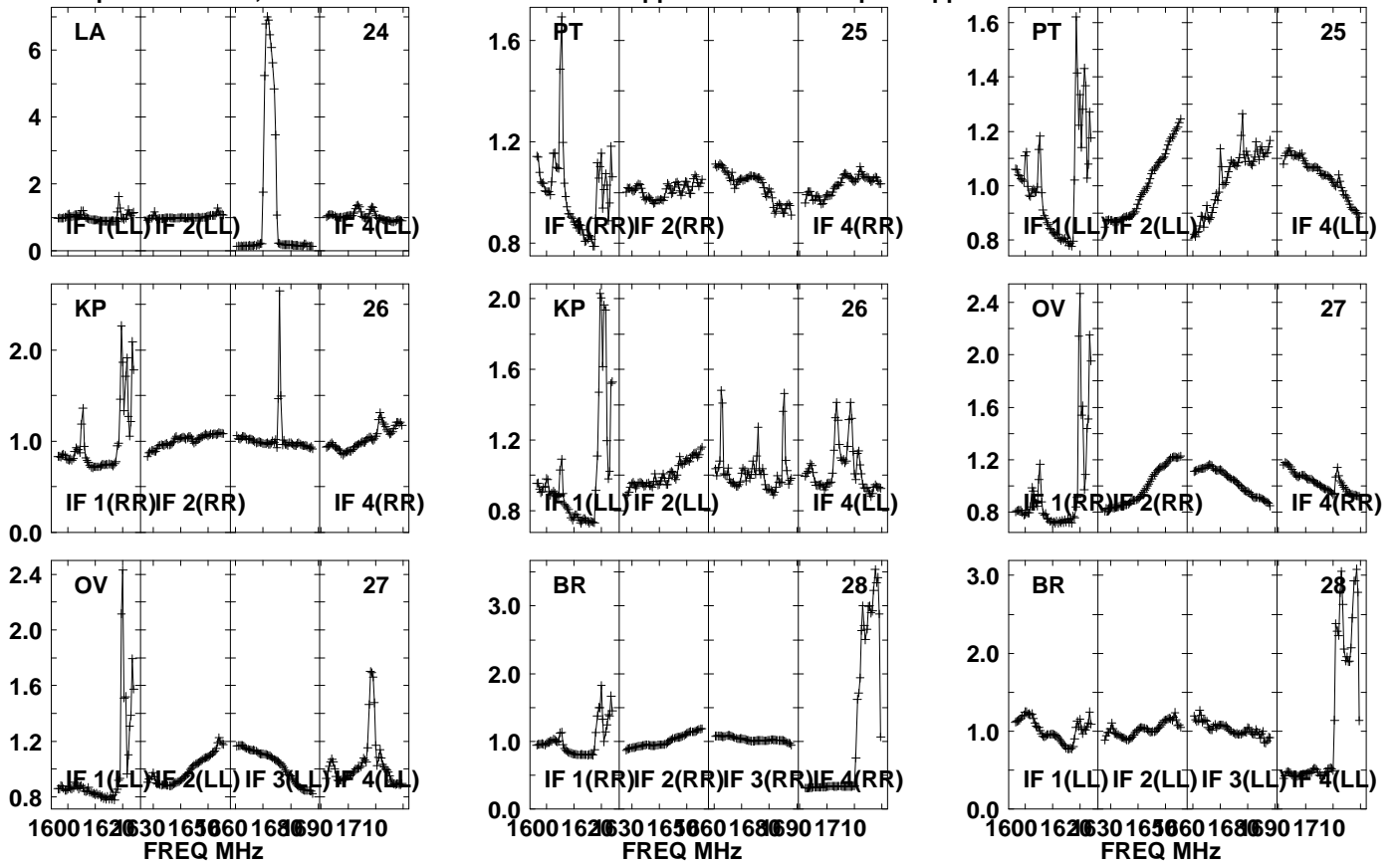

Lower frame: Real Jy

Auto-corr total-power spectrum Antenna: \*

Timerange: 01/01:48:11 to 01/01:51:29

Plot file version1661 created 05-OCT-2021 17:12:17  
APM08279+525 GM076.UVDATA.1  
Freq = 1.5945 GHz, Bw = 32.000 MH No calibration applied and no bandpass applied

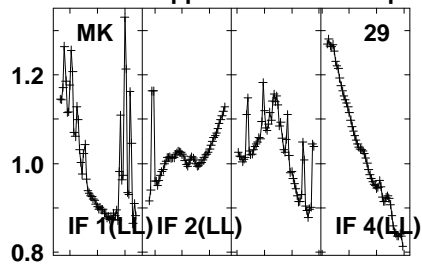
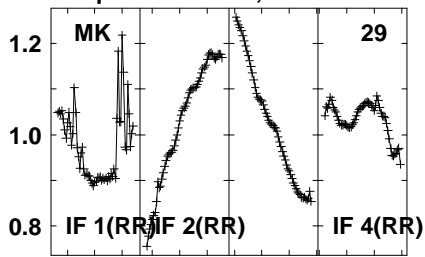

Lower frame: Real Jy  
Auto-corr total-power spectrum Antenna: \*  
Timerange: 01/01:48:11 to 01/01:51:29

Plot file version 1662 created 05-OCT-2021 17:12:17

J0827+5217 GM076.UVDATA.1

Freq = 1.5945 GHz, Bw = 32.000 MH No calibration applied and no bandpass applied

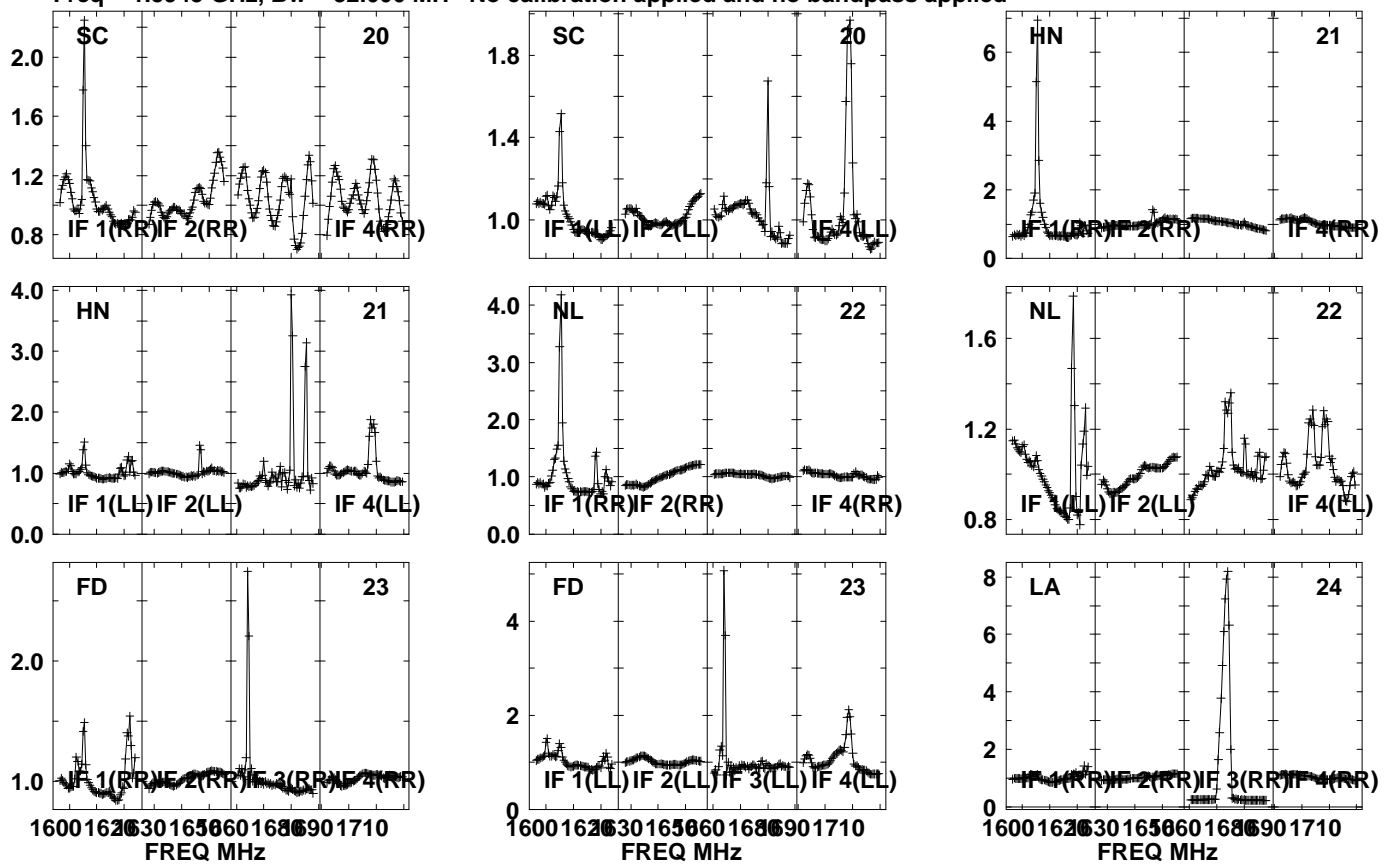

Lower frame: Real Jy  
Auto-corr total-power spectrum Antenna: \*  
Timerange: 01/01:52:01 to 01/01:53:29

Plot file version1663 created 05-OCT-2021 17:12:18

J0827+5217 GM076.UVDATA.1

Freq = 1.5945 GHz, Bw = 32.000 MH No calibration applied and no bandpass applied

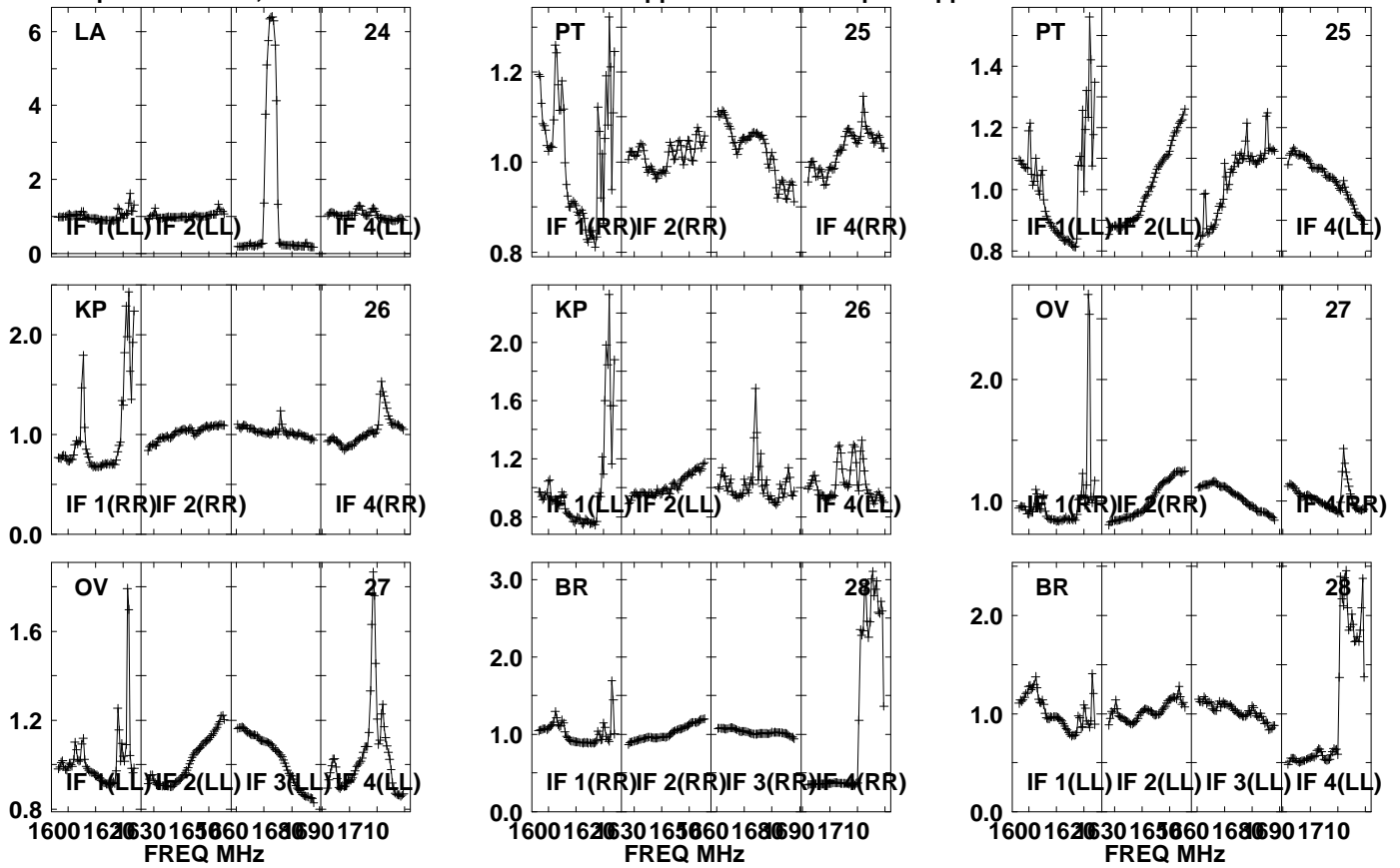

Lower frame: Real Jy

Auto-corr total-power spectrum Antenna: \*

Timerange: 01/01:52:01 to 01/01:53:29

Plot file version1664 created 05-OCT-2021 17:12:18

J0827+5217 GM076.UVDATA.1

Freq = 1.5945 GHz, Bw = 32.000 MH No calibration applied and no bandpass applied

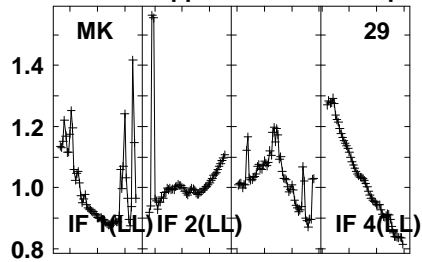
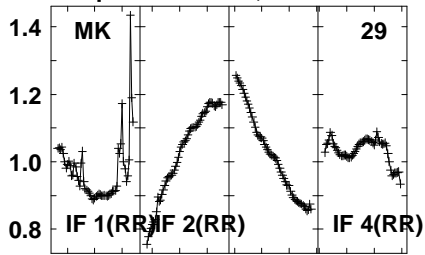

Lower frame: Real Jy  
Auto-corr total-power spectrum Antenna: \*  
Timerange: 01/01:52:01 to 01/01:53:29

Plot file version 1665 created 05-OCT-2021 17:12:18

APM08279+525 GM076.UVDATA.1

Freq = 1.5945 GHz, Bw = 32.000 MH No calibration applied and no bandpass applied

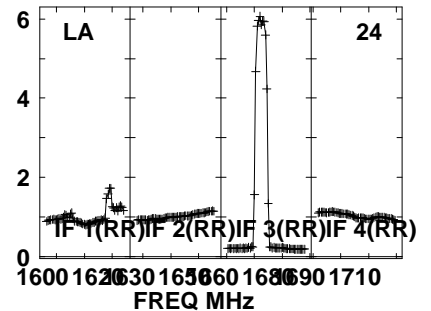
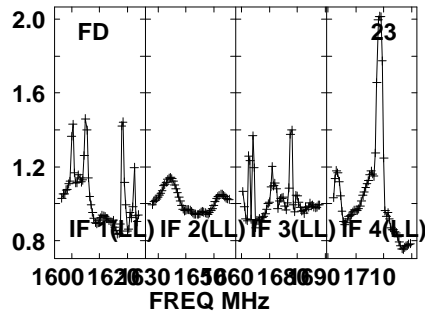
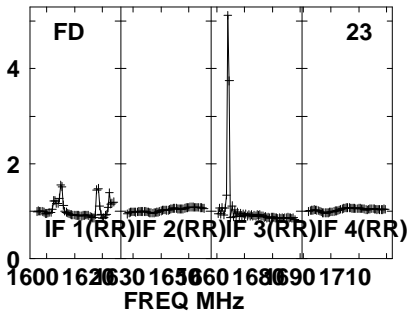
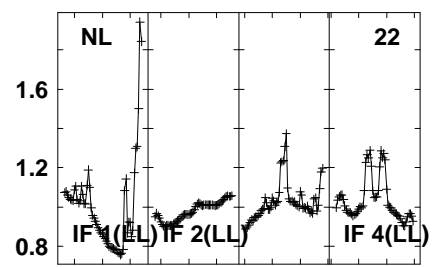
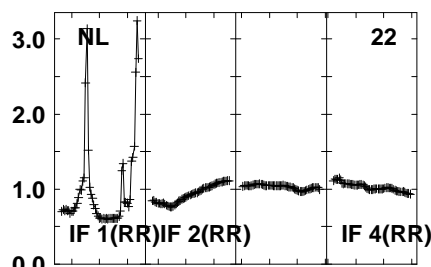
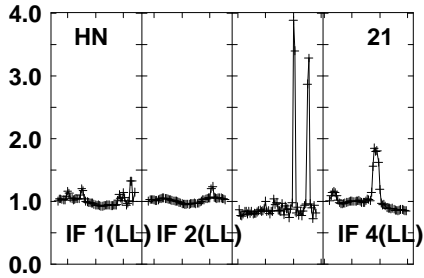
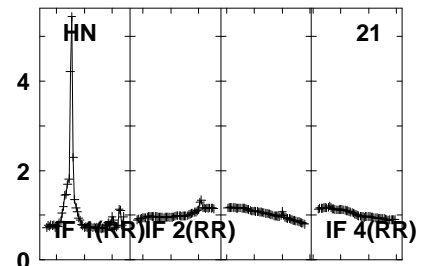
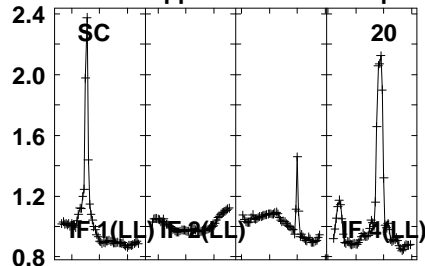
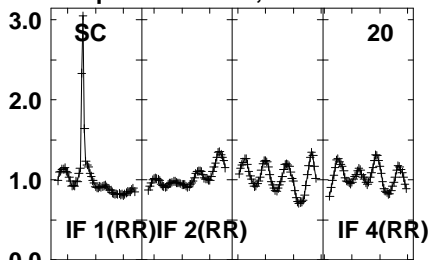

Lower frame: Real Jy

Auto-corr total-power spectrum Antenna: \*

Timerange: 01/01:53:41 to 01/01:56:59

Plot file version 1666 created 05-OCT-2021 17:12:18

APM08279+525 GM076.UVDATA.1

Freq = 1.5945 GHz, Bw = 32.000 MH No calibration applied and no bandpass applied

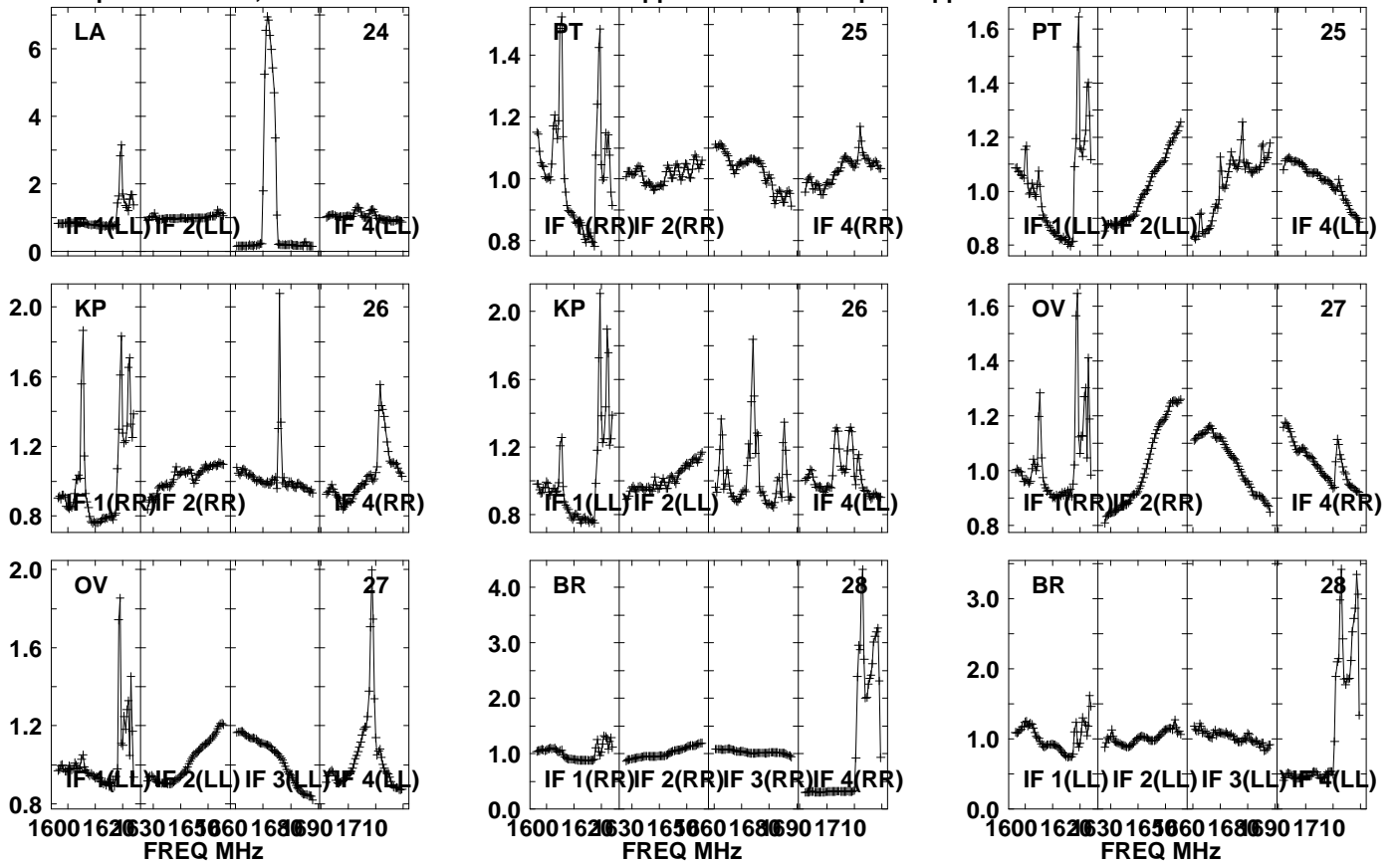

Lower frame: Real Jy

Auto-corr total-power spectrum Antenna: \*

Timerange: 01/01:53:41 to 01/01:56:59



Plot file version1667 created 05-OCT-2021 17:12:18

APM08279+525 GM076.UVDATA.1

Freq = 1.5945 GHz, Bw = 32.000 MH No calibration applied and no bandpass applied

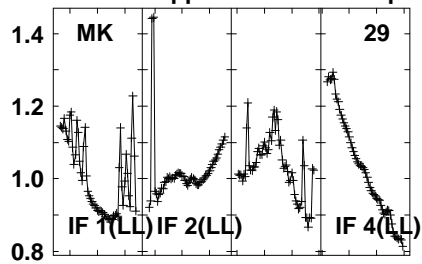
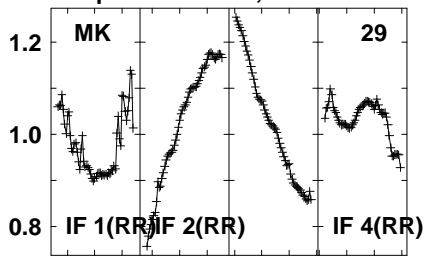

Lower frame: Real Jy  
Auto-corr total-power spectrum Antenna: \*  
Timerange: 01/01:53:41 to 01/01:56:59

Plot file version1668 created 05-OCT-2021 17:12:18

J0827+5217 GM076.UVDATA.1

Freq = 1.5945 GHz, Bw = 32.000 MH No calibration applied and no bandpass applied

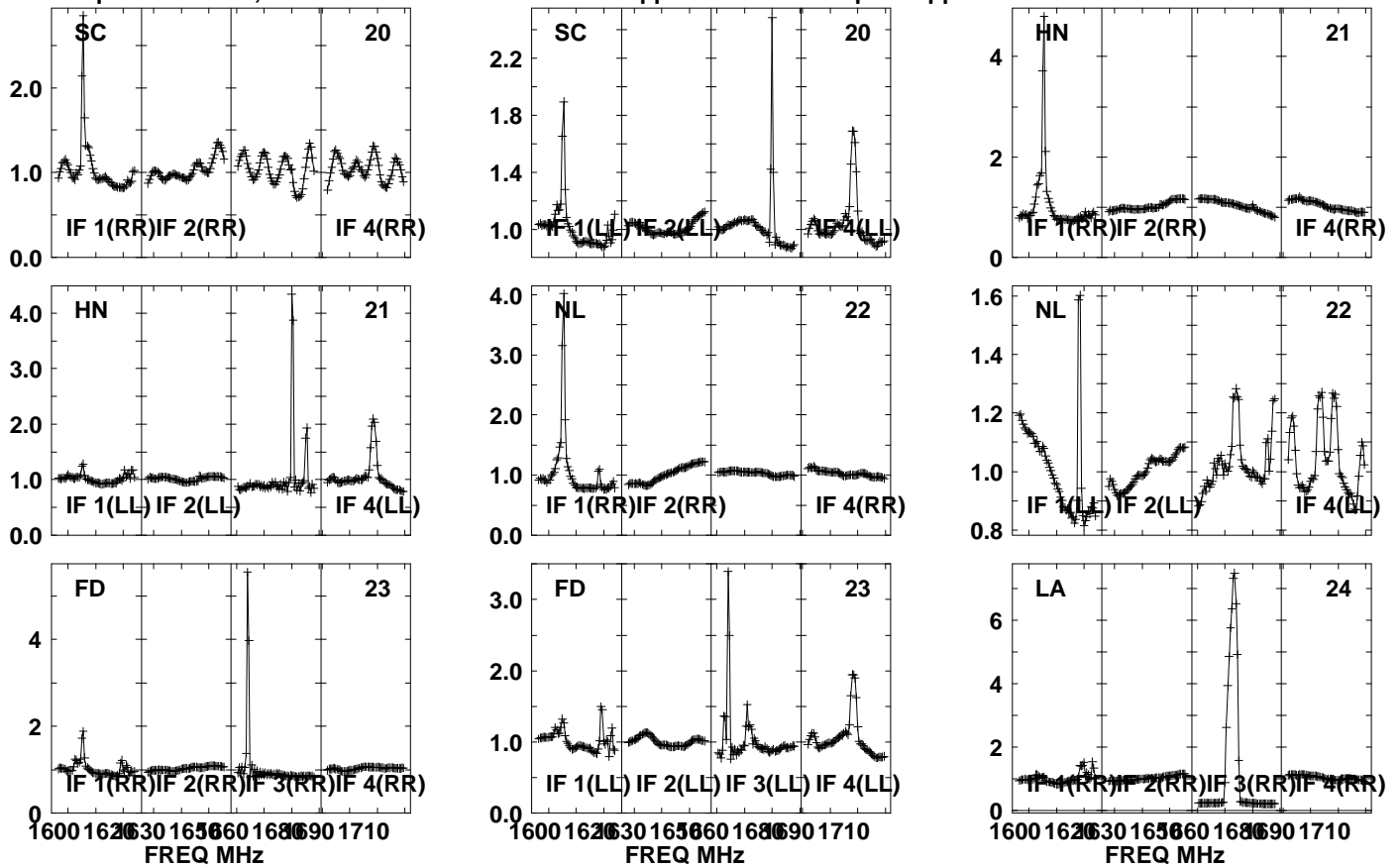

Lower frame: Real Jy

Auto-corr total-power spectrum Antenna: \*

Timerange: 01/01:57:31 to 01/01:58:59

Plot file version 1669 created 05-OCT-2021 17:12:18

J0827+5217 GM076.UVDATA.1

Freq = 1.5945 GHz, Bw = 32.000 MH No calibration applied and no bandpass applied

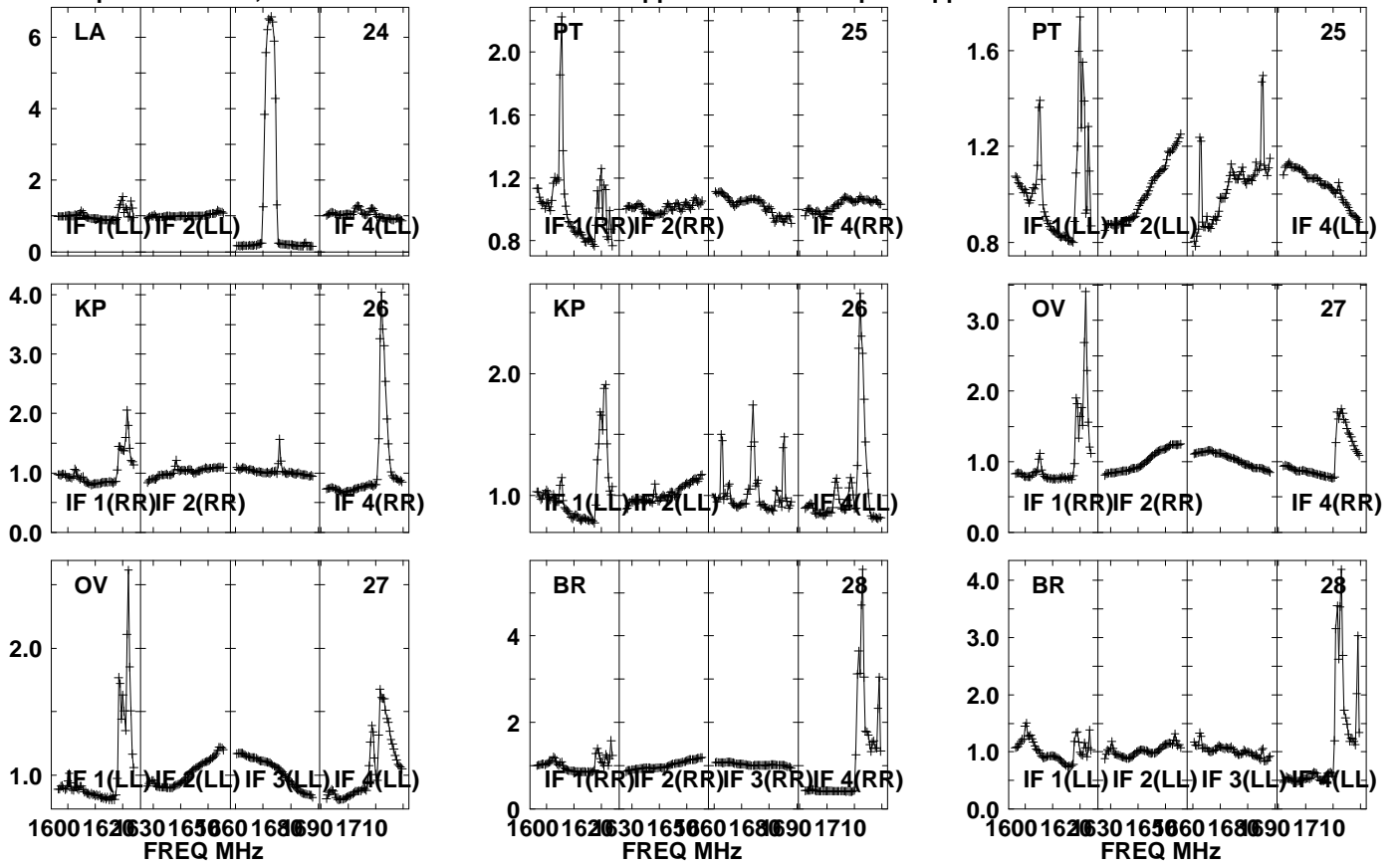

Lower frame: Real Jy  
Auto-corr total-power spectrum Antenna: \*  
Timerange: 01/01:57:31 to 01/01:58:59

Plot file version1670 created 05-OCT-2021 17:12:18

J0827+5217 GM076.UVDATA.1

Freq = 1.5945 GHz, Bw = 32.000 MH No calibration applied and no bandpass applied

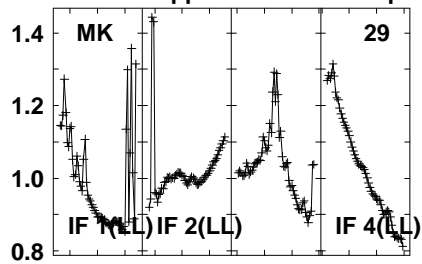
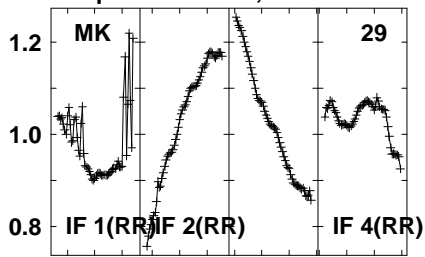

Lower frame: Real Jy  
Auto-corr total-power spectrum Antenna: \*  
Timerange: 01/01:57:31 to 01/01:58:59

Plot file version 1671 created 05-OCT-2021 17:12:19

APM08279+525 GM076.UVDATA.1

Freq = 1.5945 GHz, Bw = 32.000 MH No calibration applied and no bandpass applied

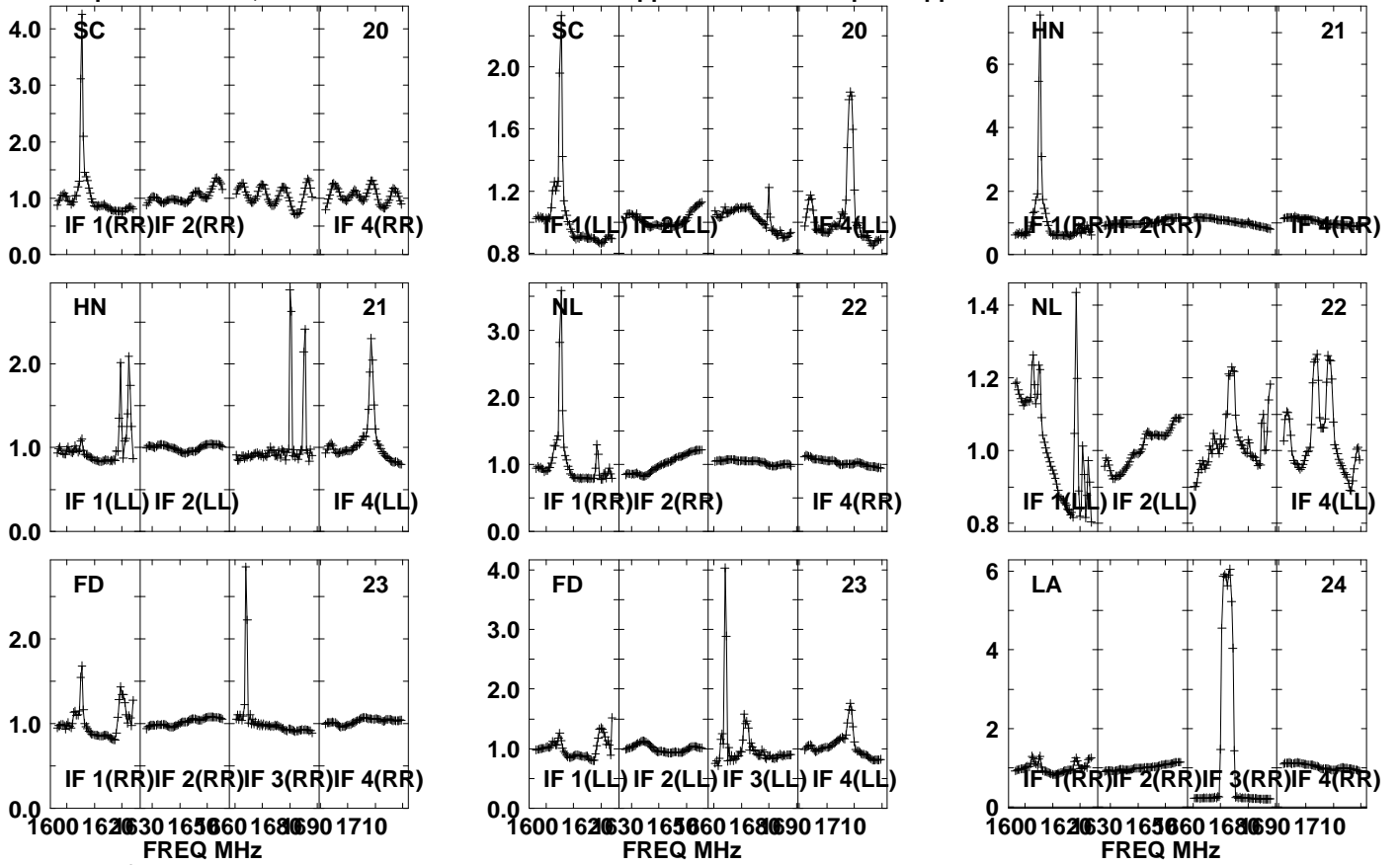

Lower frame: Real Jy

Auto-corr total-power spectrum Antenna: \*

Timerange: 01/01:59:11 to 01/02:02:29

Plot file version1672 created 05-OCT-2021 17:12:19

APM08279+525 GM076.UVDATA.1

Freq = 1.5945 GHz, Bw = 32.000 MH No calibration applied and no bandpass applied

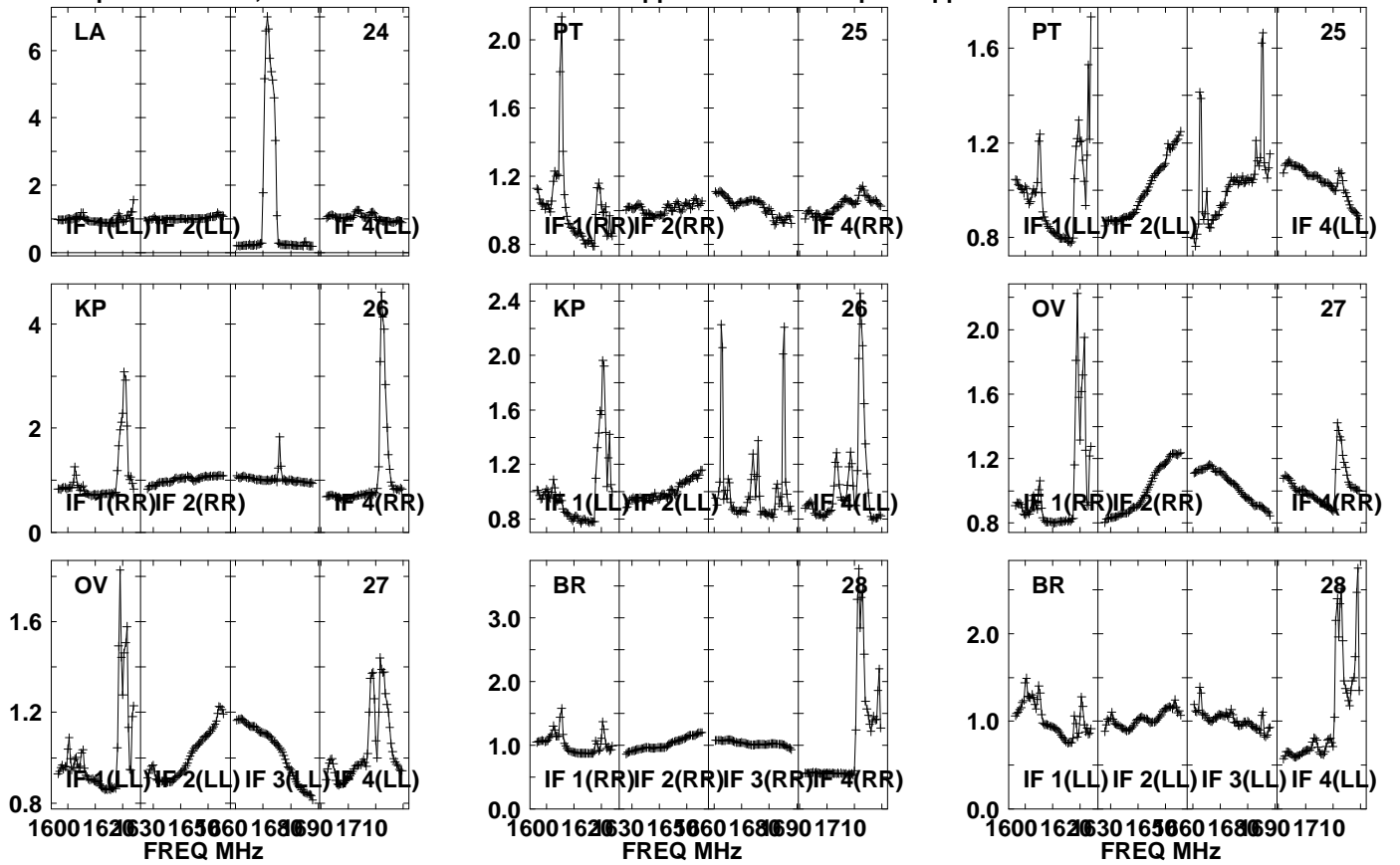

Lower frame: Real Jy  
Auto-corr total-power spectrum Antenna: \*  
Timerange: 01/01:59:11 to 01/02:02:29

Plot file version1673 created 05-OCT-2021 17:12:19

APM08279+525 GM076.UVDATA.1

Freq = 1.5945 GHz, Bw = 32.000 MH No calibration applied and no bandpass applied

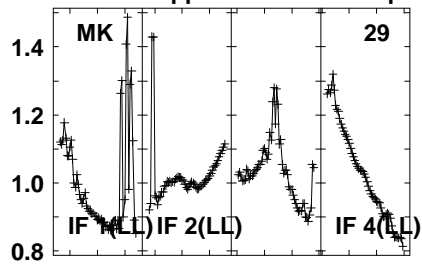
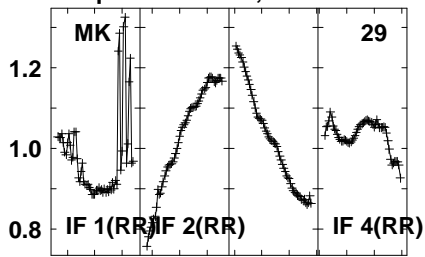

Lower frame: Real Jy  
Auto-corr total-power spectrum Antenna: \*  
Timerange: 01/01:59:11 to 01/02:02:29

Plot file version1674 created 05-OCT-2021 17:12:19

J0827+5217 GM076.UVDATA.1

Freq = 1.5945 GHz, Bw = 32.000 MH No calibration applied and no bandpass applied

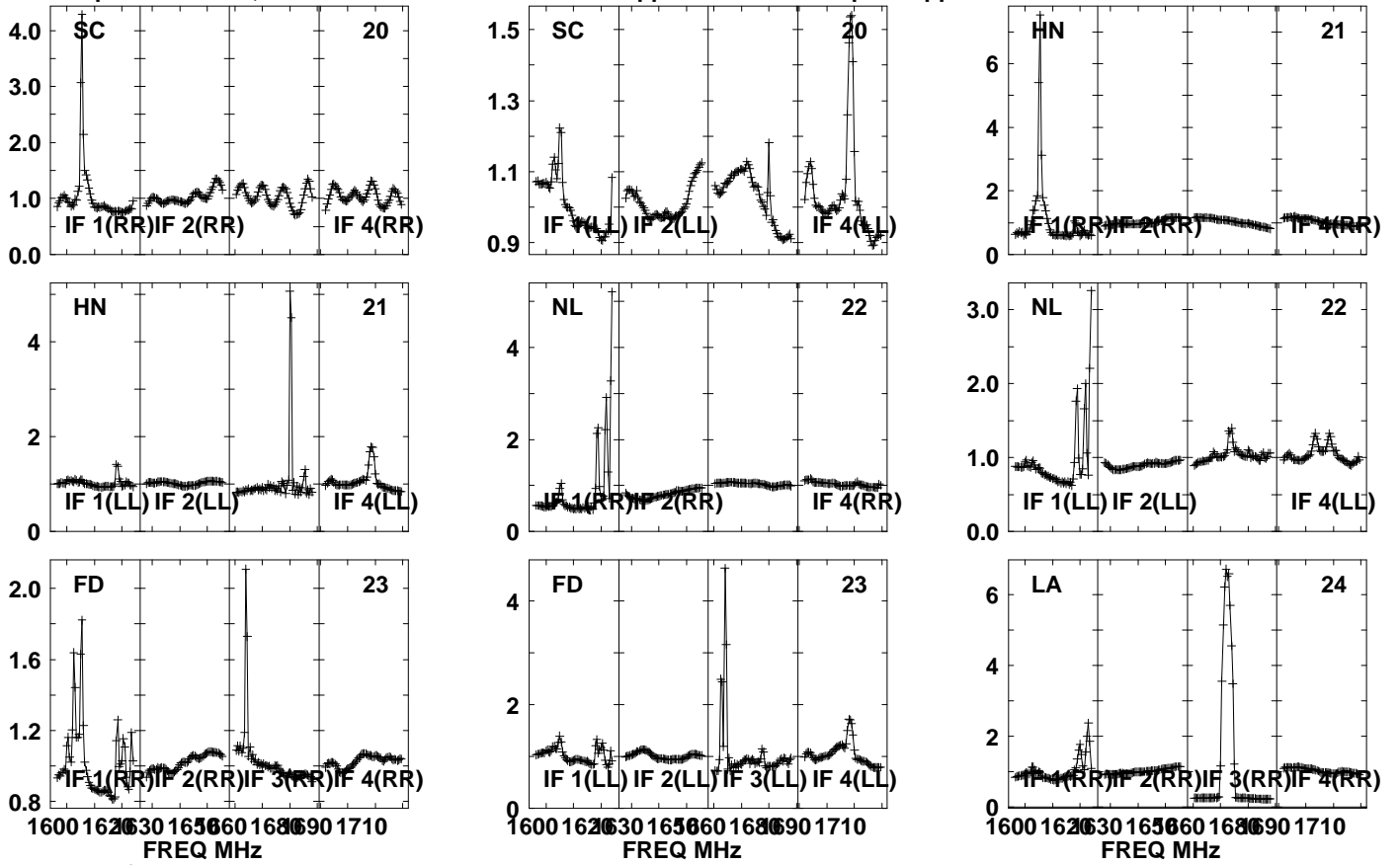

Lower frame: Real Jy

Auto-corr total-power spectrum Antenna: \*

Timerange: 01/02:03:01 to 01/02:04:29



Plot file version 1675 created 05-OCT-2021 17:12:19

J0827+5217 GM076.UVDATA.1

Freq = 1.5945 GHz, Bw = 32.000 MH No calibration applied and no bandpass applied

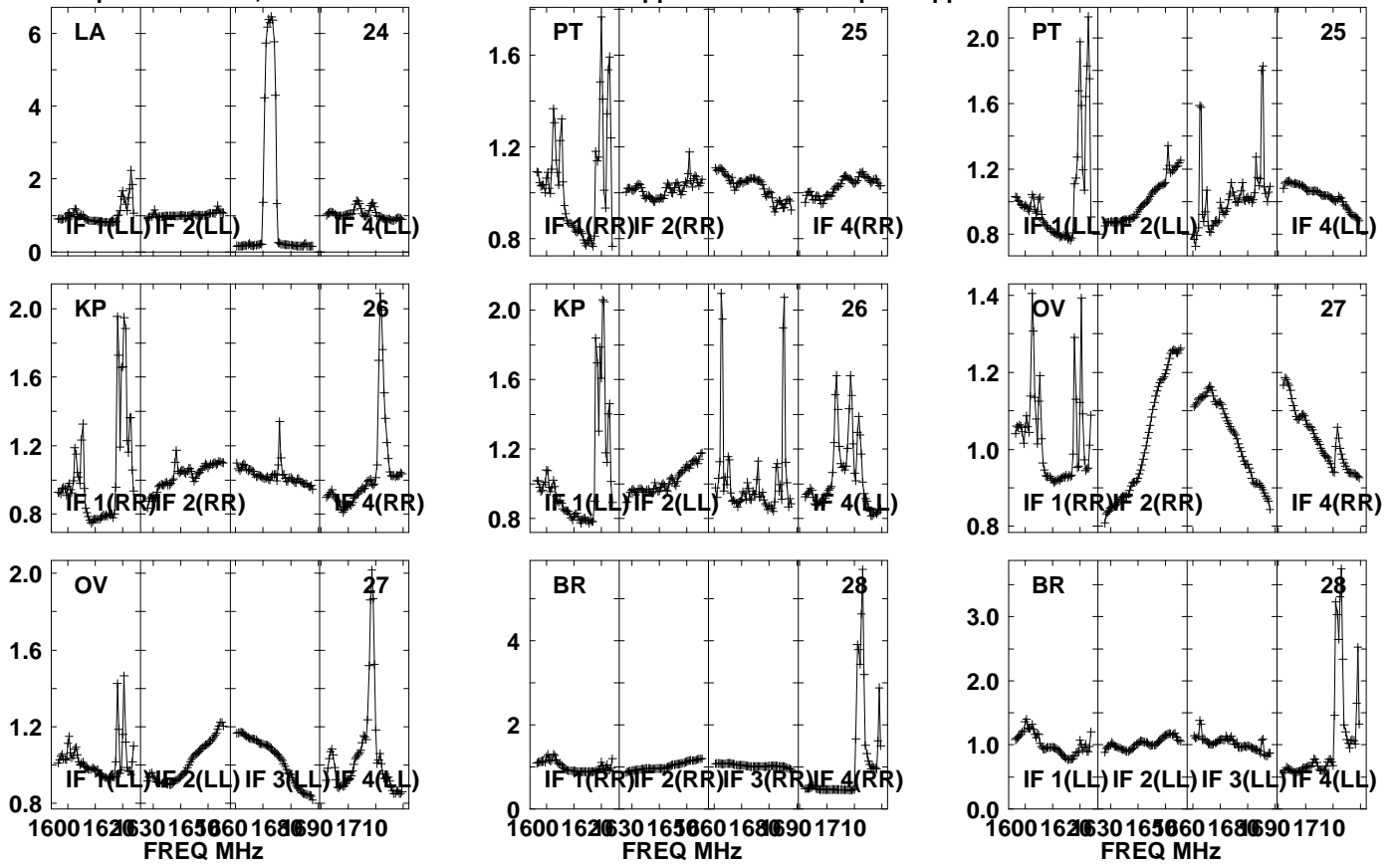

Lower frame: Real Jy

Auto-corr total-power spectrum Antenna: \*

Timerange: 01/02:03:01 to 01/02:04:29

Plot file version1676 created 05-OCT-2021 17:12:19

J0827+5217 GM076.UVDATA.1

Freq = 1.5945 GHz, Bw = 32.000 MH No calibration applied and no bandpass applied

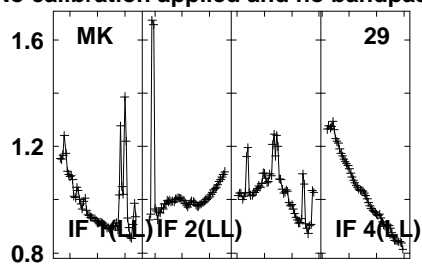
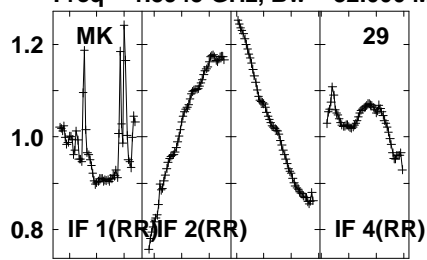

Lower frame: Real Jy  
Auto-corr total-power spectrum Antenna: \*  
Timerange: 01/02:03:01 to 01/02:04:29

Plot file version 1677 created 05-OCT-2021 17:12:19

APM08279+525 GM076.UVDATA.1

Freq = 1.5945 GHz, Bw = 32.000 MH No calibration applied and no bandpass applied

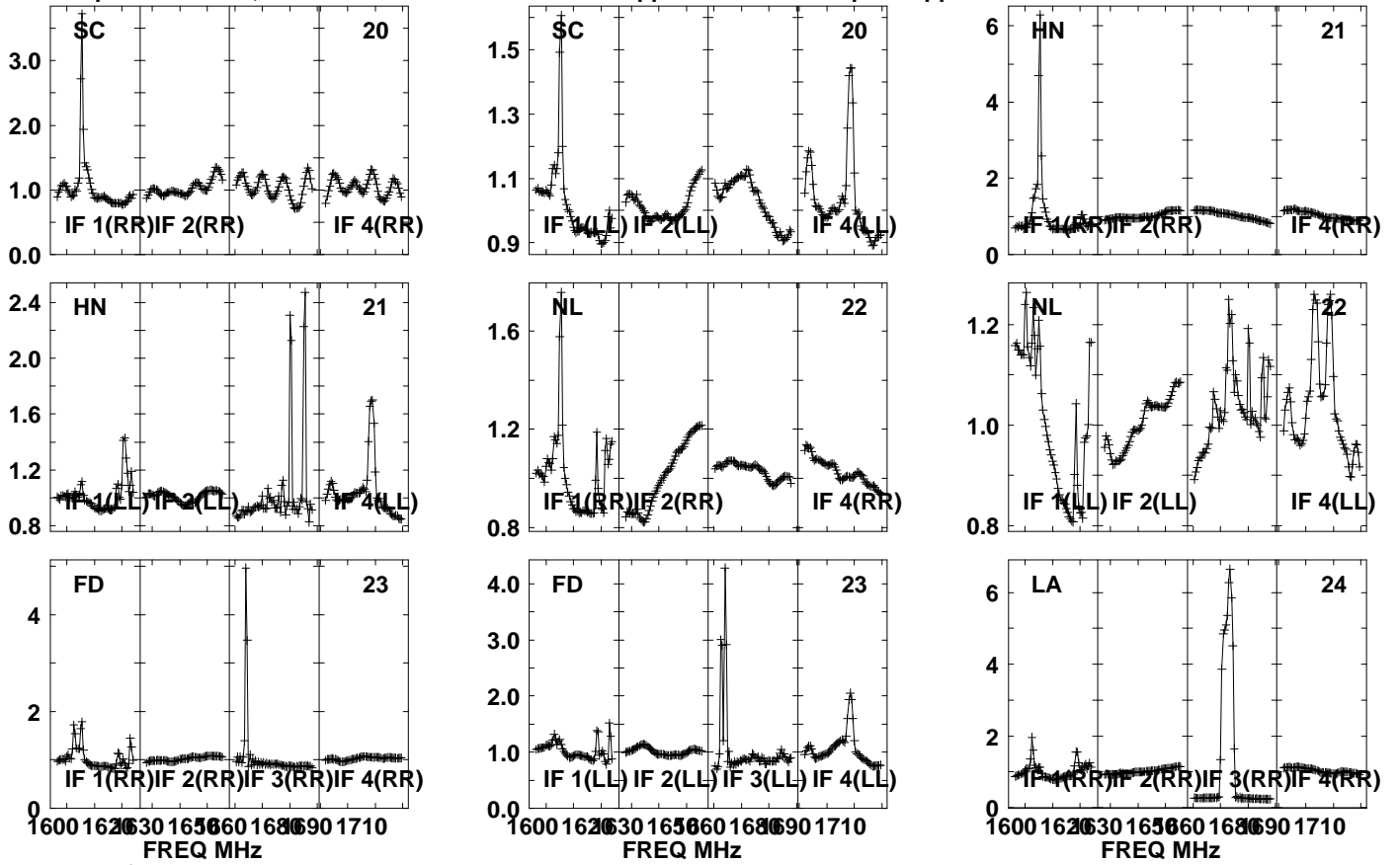

Lower frame: Real Jy  
Auto-corr total-power spectrum Antenna: \*  
Timerange: 01/02:04:41 to 01/02:07:59

Plot file version 1678 created 05-OCT-2021 17:12:19

APM08279+525 GM076.UVDATA.1

Freq = 1.5945 GHz, Bw = 32.000 MH No calibration applied and no bandpass applied

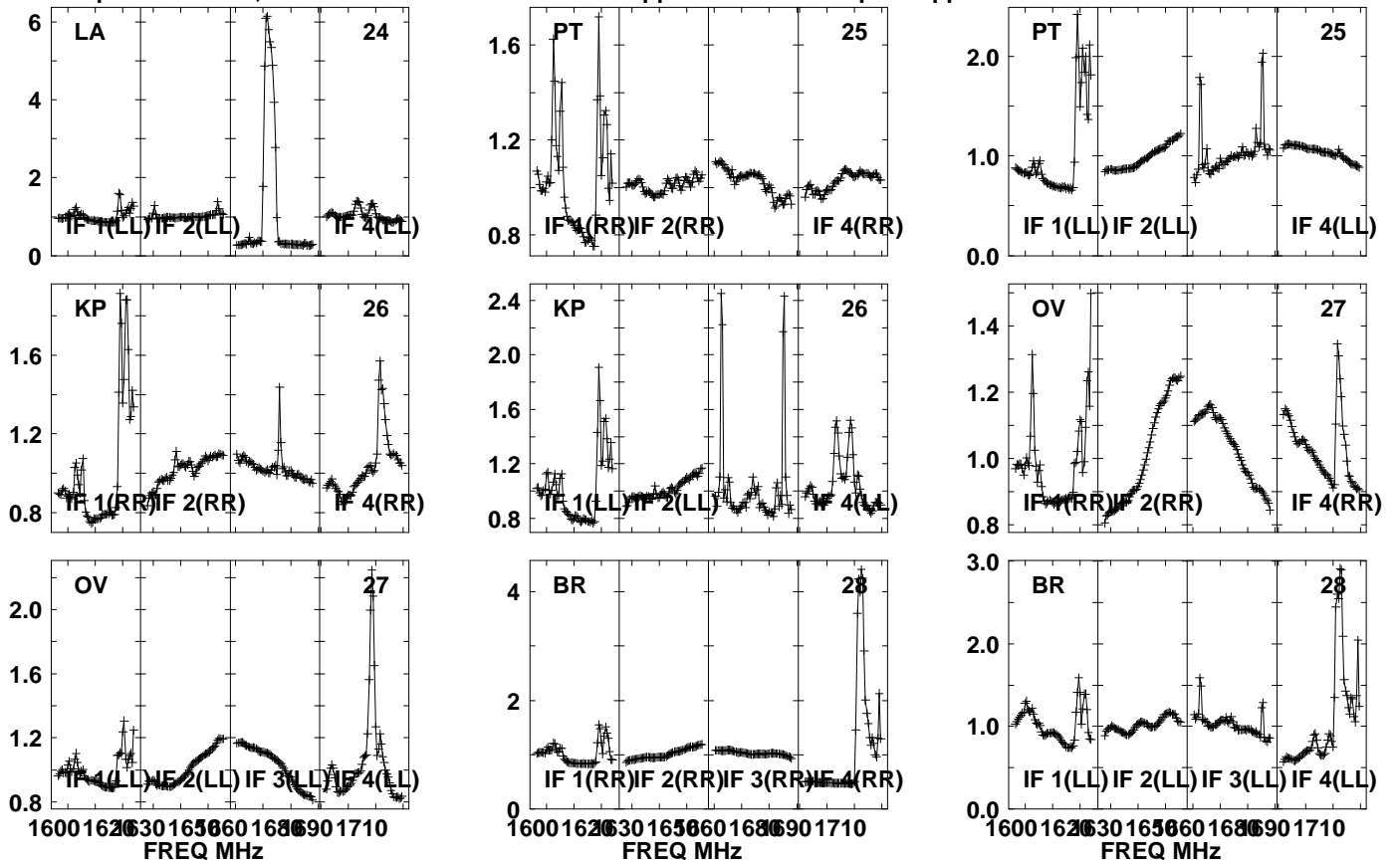

Lower frame: Real Jy  
Auto-corr total-power spectrum Antenna: \*  
Timerange: 01/02:04:41 to 01/02:07:59

Plot file version 1679 created 05-OCT-2021 17:12:19

APM08279+525 GM076.UVDATA.1

Freq = 1.5945 GHz, Bw = 32.000 MH No calibration applied and no bandpass applied

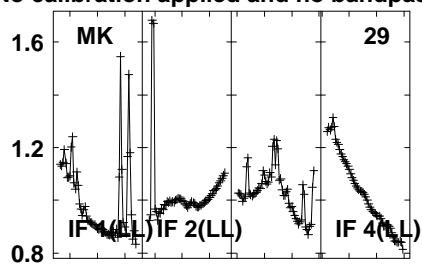
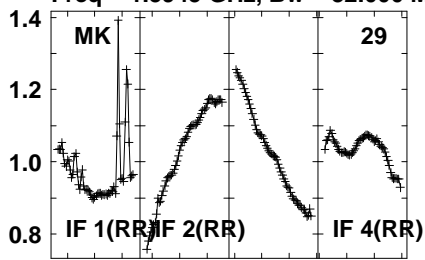

Lower frame: Real Jy  
Auto-corr total-power spectrum Antenna: \*  
Timerange: 01/02:04:41 to 01/02:07:59

Plot file version 1680 created 05-OCT-2021 17:12:20

J0827+5217 GM076.UVDATA.1

Freq = 1.5945 GHz, Bw = 32.000 MH No calibration applied and no bandpass applied

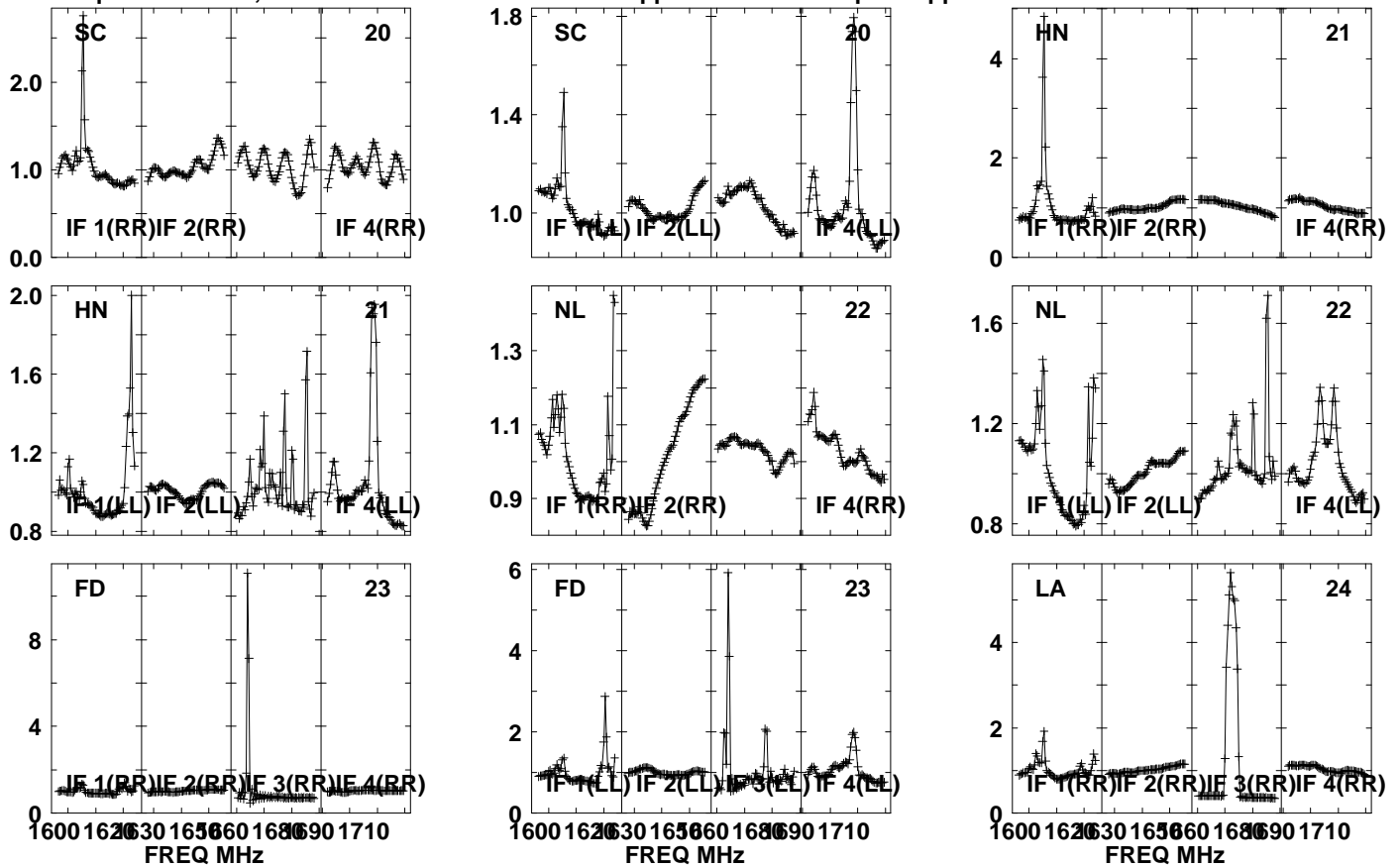

Lower frame: Real Jy

Auto-corr total-power spectrum Antenna: \*

Timerange: 01/02:08:31 to 01/02:09:59

Plot file version1681 created 05-OCT-2021 17:12:20

J0827+5217 GM076.UVDATA.1

Freq = 1.5945 GHz, Bw = 32.000 MH No calibration applied and no bandpass applied

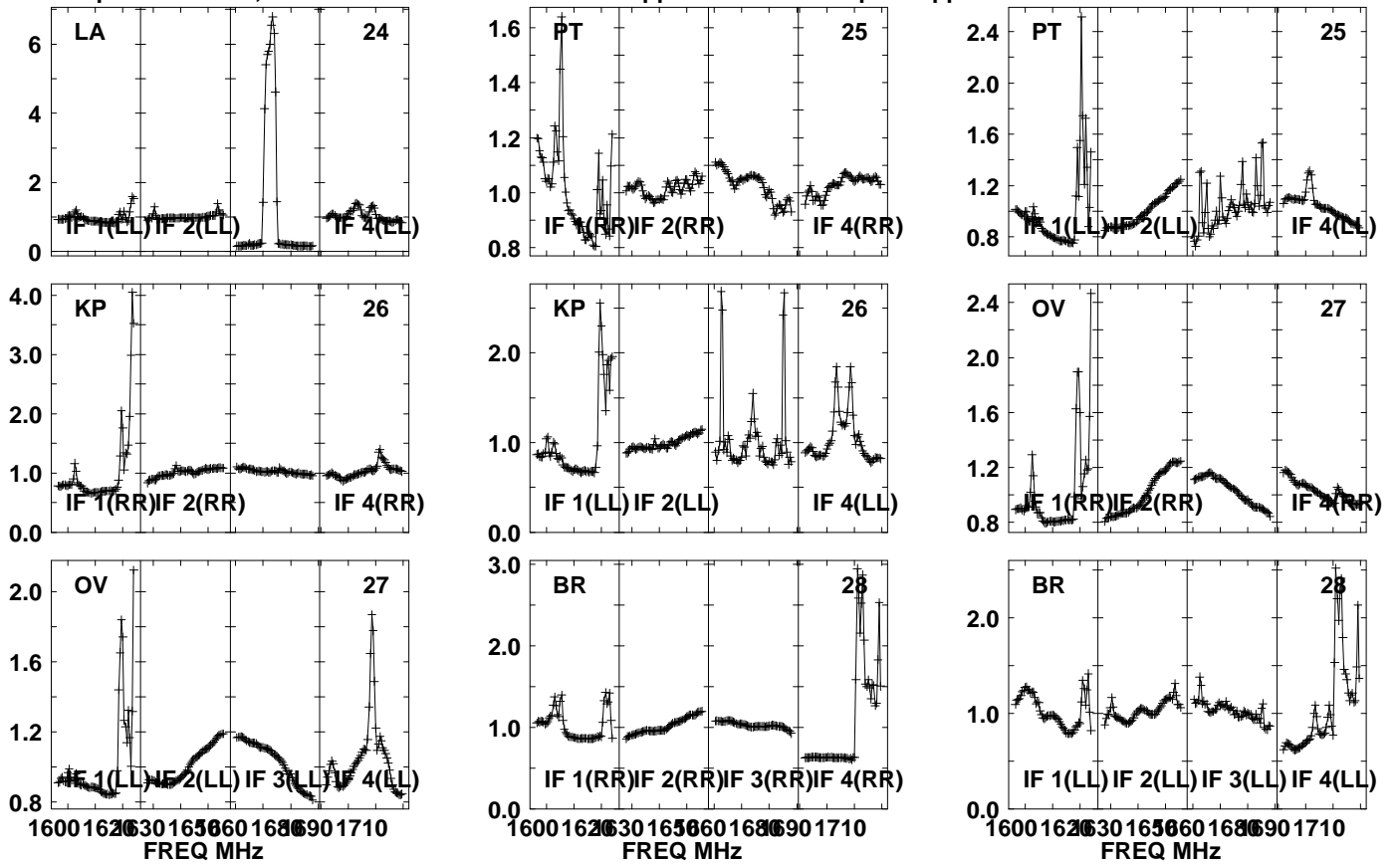

Lower frame: Real Jy  
Auto-corr total-power spectrum Antenna: \*  
Timerange: 01/02:08:31 to 01/02:09:59

Plot file version1682 created 05-OCT-2021 17:12:20

J0827+5217 GM076.UVDATA.1

Freq = 1.5945 GHz, Bw = 32.000 MH No calibration applied and no bandpass applied

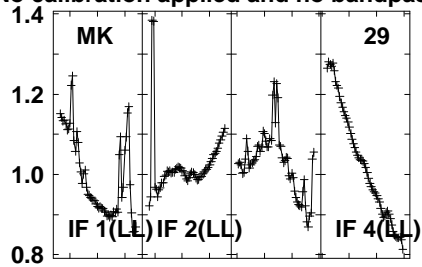
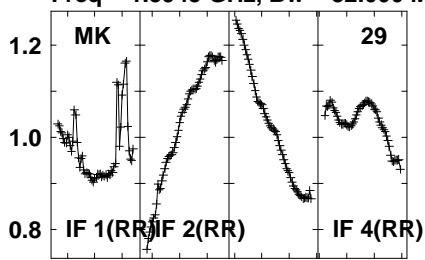

Lower frame: Real Jy  
Auto-corr total-power spectrum Antenna: \*  
Timerange: 01/02:08:31 to 01/02:09:59



Plot file version 1683 created 05-OCT-2021 17:12:20

APM08279+525 GM076.UVDATA.1

Freq = 1.5945 GHz, Bw = 32.000 MH No calibration applied and no bandpass applied

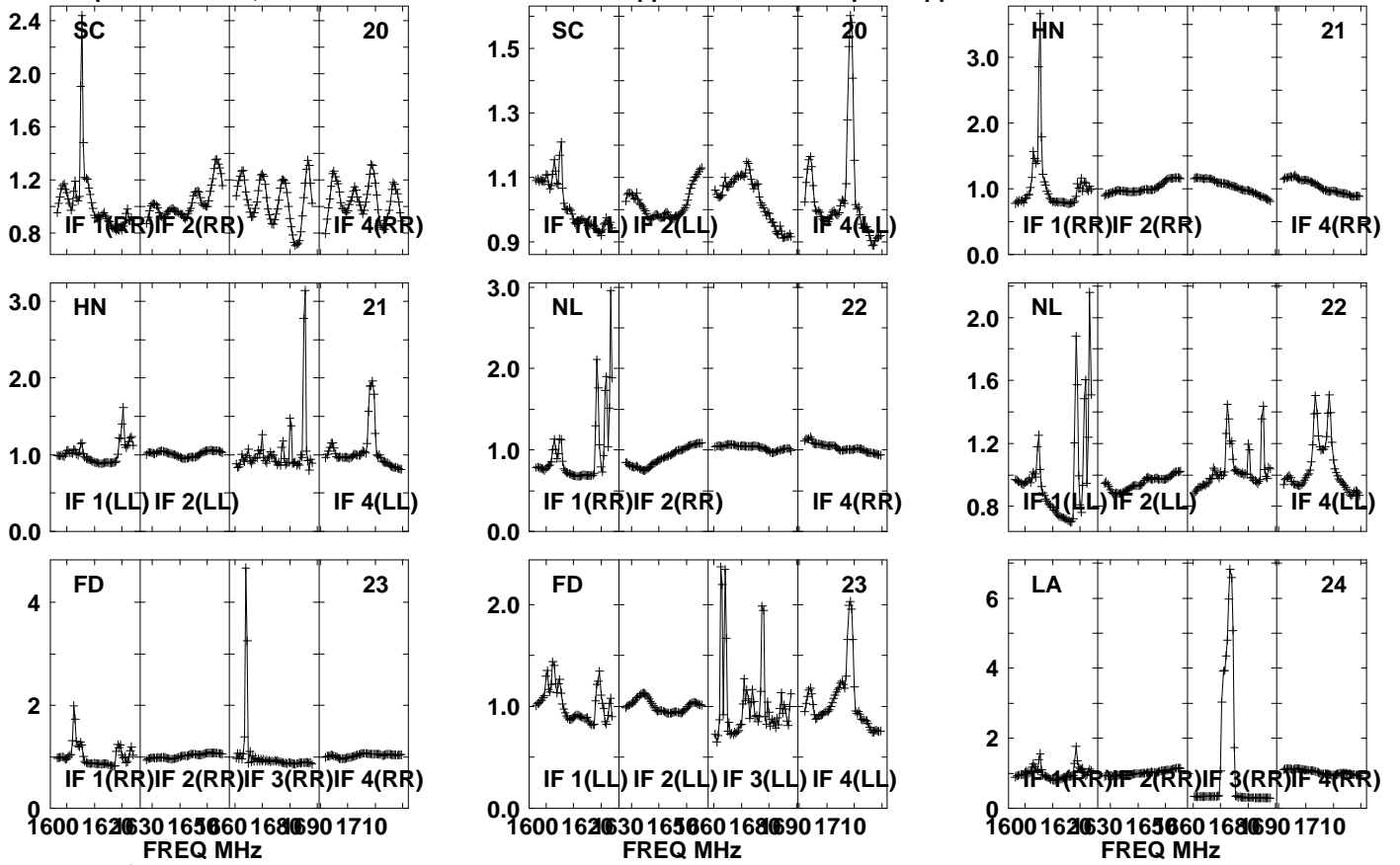

Lower frame: Real Jy  
Auto-corr total-power spectrum Antenna: \*  
Timerange: 01/02:10:11 to 01/02:13:29

Plot file version 1684 created 05-OCT-2021 17:12:20

APM08279+525 GM076.UVDATA.1

Freq = 1.5945 GHz, Bw = 32.000 MH No calibration applied and no bandpass applied

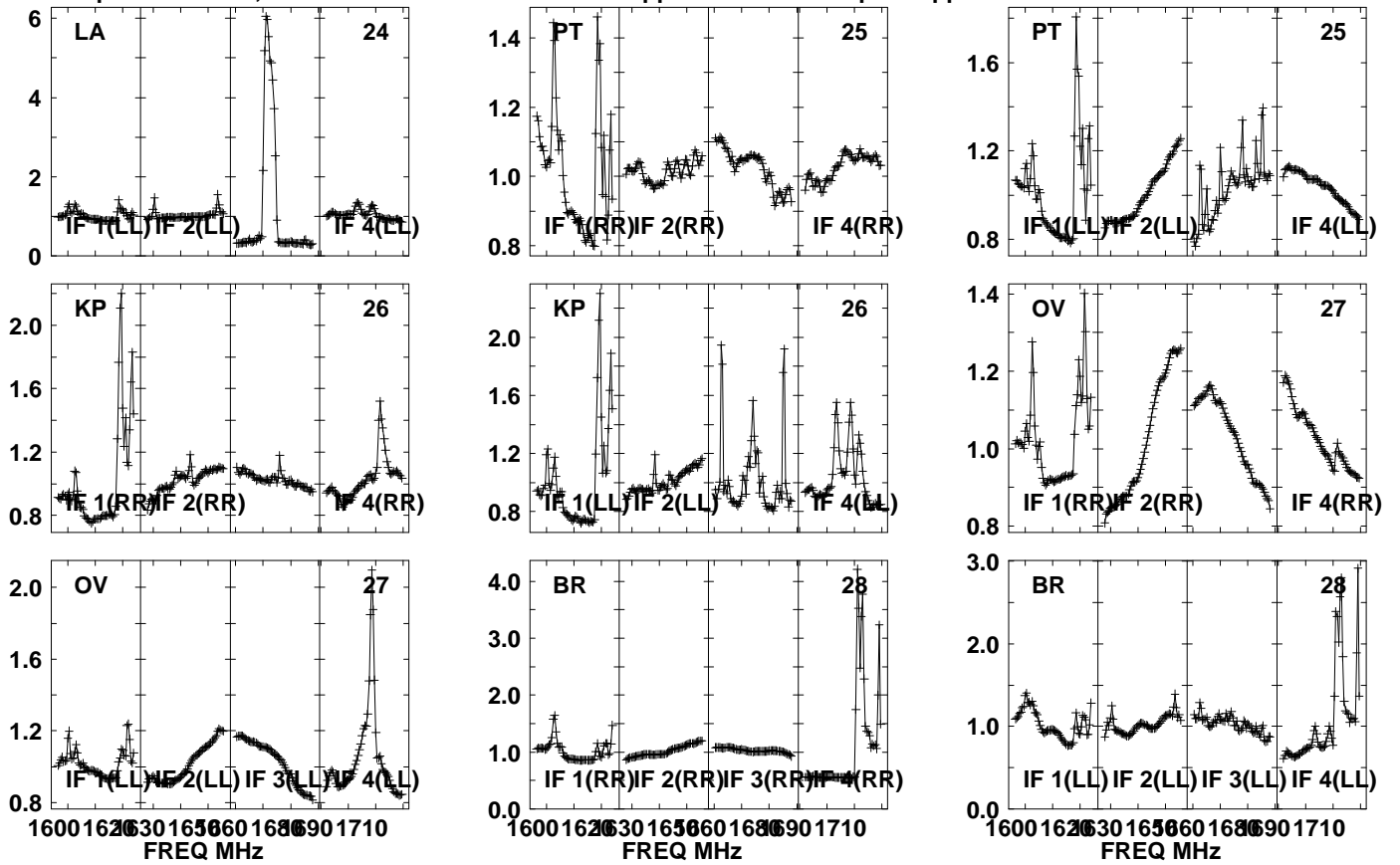

Lower frame: Real Jy  
Auto-corr total-power spectrum Antenna: \*  
Timerange: 01/02:10:11 to 01/02:13:29

Plot file version1685 created 05-OCT-2021 17:12:20

APM08279+525 GM076.UVDATA.1

Freq = 1.5945 GHz, Bw = 32.000 MH No calibration applied and no bandpass applied

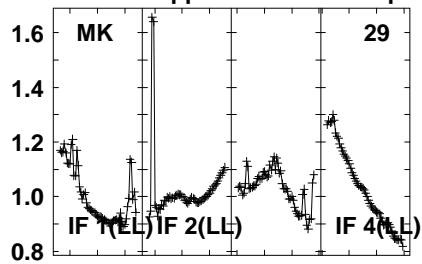
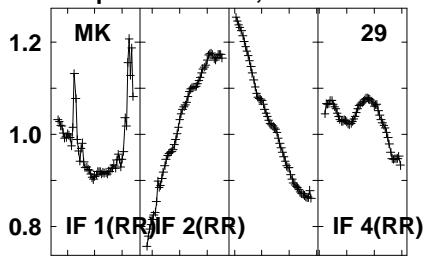

Lower frame: Real Jy  
Auto-corr total-power spectrum Antenna: \*  
Timerange: 01/02:10:11 to 01/02:13:29

Plot file version 1686 created 05-OCT-2021 17:12:20

J0827+5217 GM076.UVDATA.1

Freq = 1.5945 GHz, Bw = 32.000 MHz No calibration applied and no bandpass applied

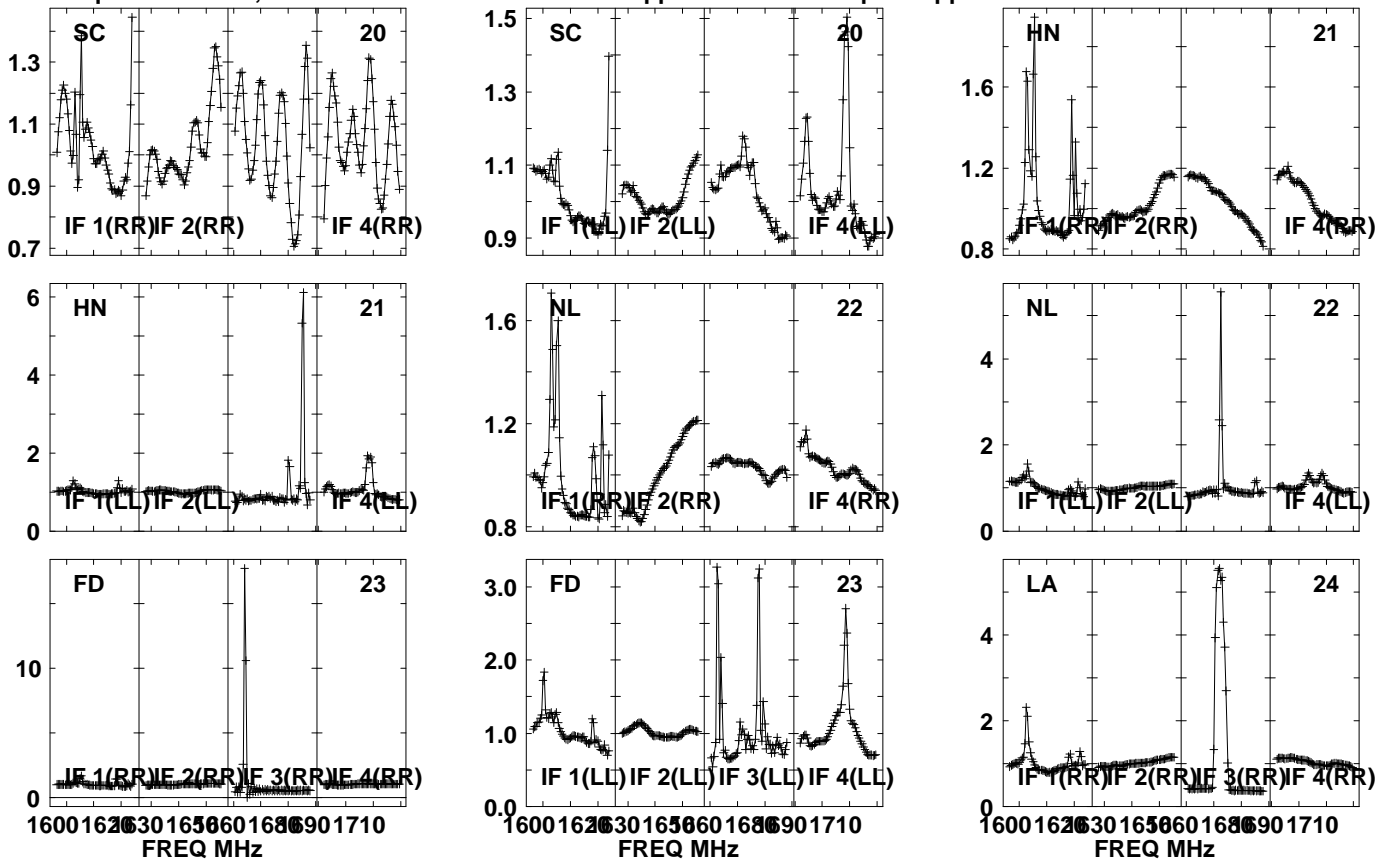

Lower frame: Real Jy  
Auto-corr total-power spectrum Antenna: \*  
Timerange: 01/02:14:01 to 01/02:15:29

Plot file version1687 created 05-OCT-2021 17:12:20

J0827+5217 GM076.UVDATA.1

Freq = 1.5945 GHz, Bw = 32.000 MH No calibration applied and no bandpass applied

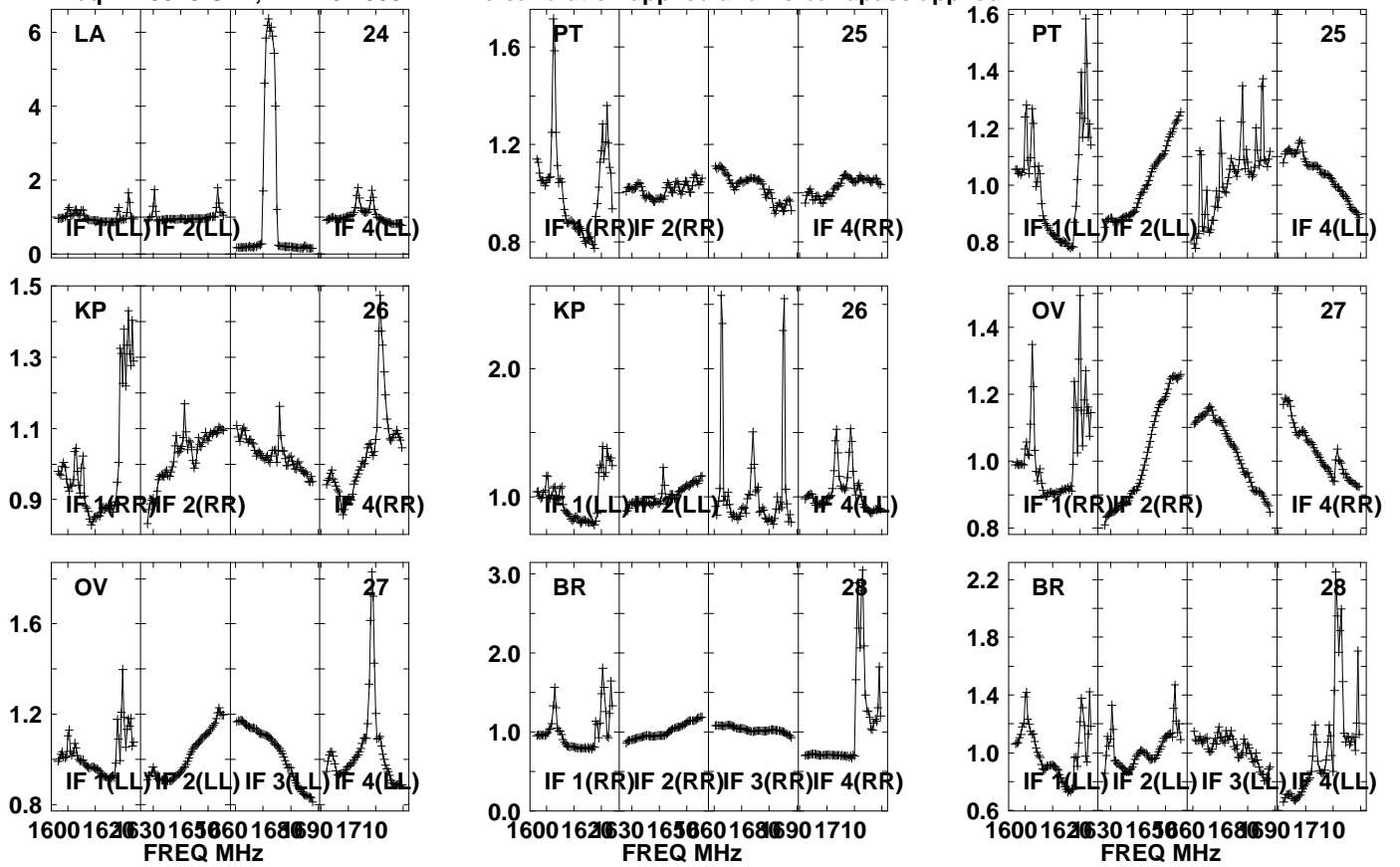

Lower frame: Real Jy  
Auto-corr total-power spectrum Antenna: \*  
Timerange: 01/02:14:01 to 01/02:15:29

Plot file version1688 created 05-OCT-2021 17:12:21

J0827+5217 GM076.UVDATA.1

Freq = 1.5945 GHz, Bw = 32.000 MH No calibration applied and no bandpass applied

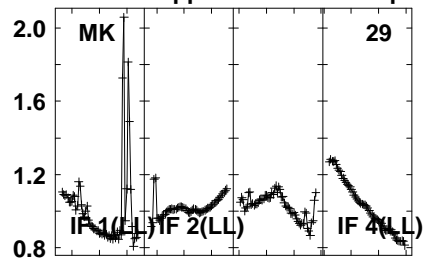
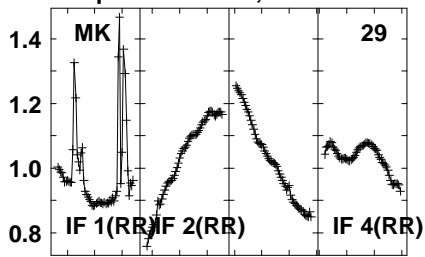

Lower frame: Real Jy  
Auto-corr total-power spectrum Antenna: \*  
Timerange: 01/02:14:01 to 01/02:15:29

Plot file version 1689 created 05-OCT-2021 17:12:21

APM08279+525 GM076.UVDATA.1

Freq = 1.5945 GHz, Bw = 32.000 MH No calibration applied and no bandpass applied

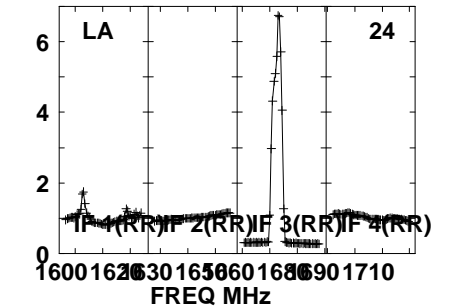
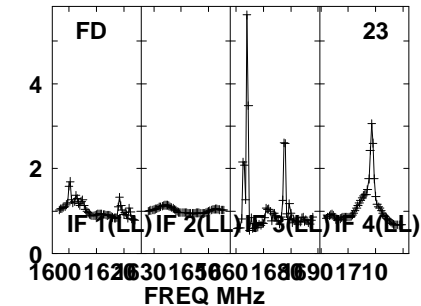
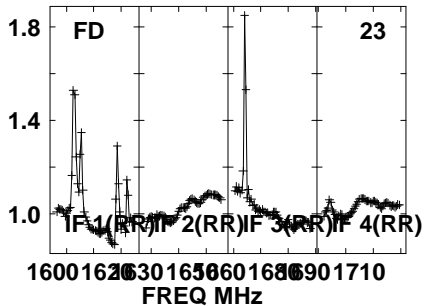
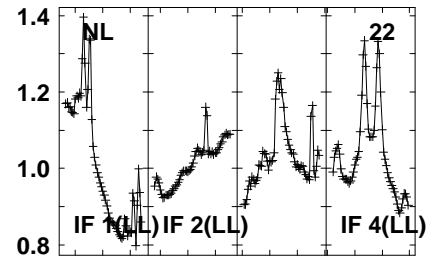
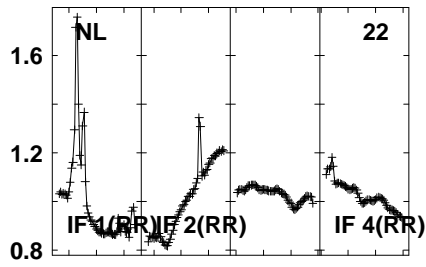
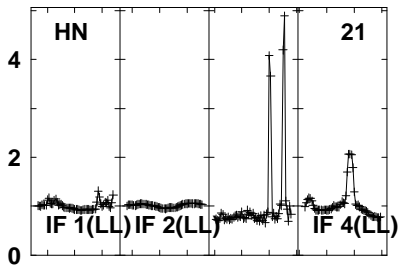
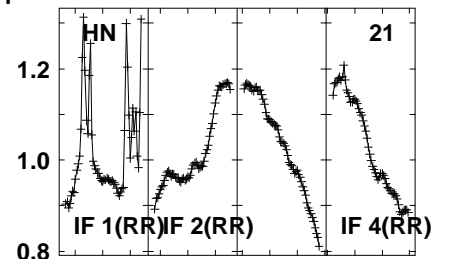
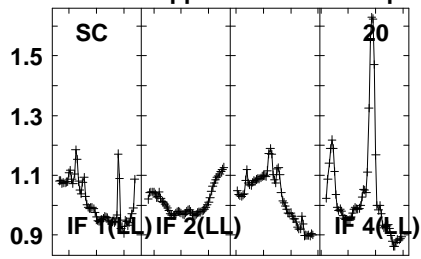
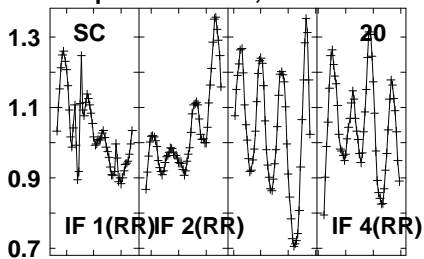

Lower frame: Real Jy  
Auto-corr total-power spectrum Antenna: \*  
Timerange: 01/02:15:41 to 01/02:18:59

Plot file version1690 created 05-OCT-2021 17:12:21

APM08279+525 GM076.UVDATA.1

Freq = 1.5945 GHz, Bw = 32.000 MH No calibration applied and no bandpass applied

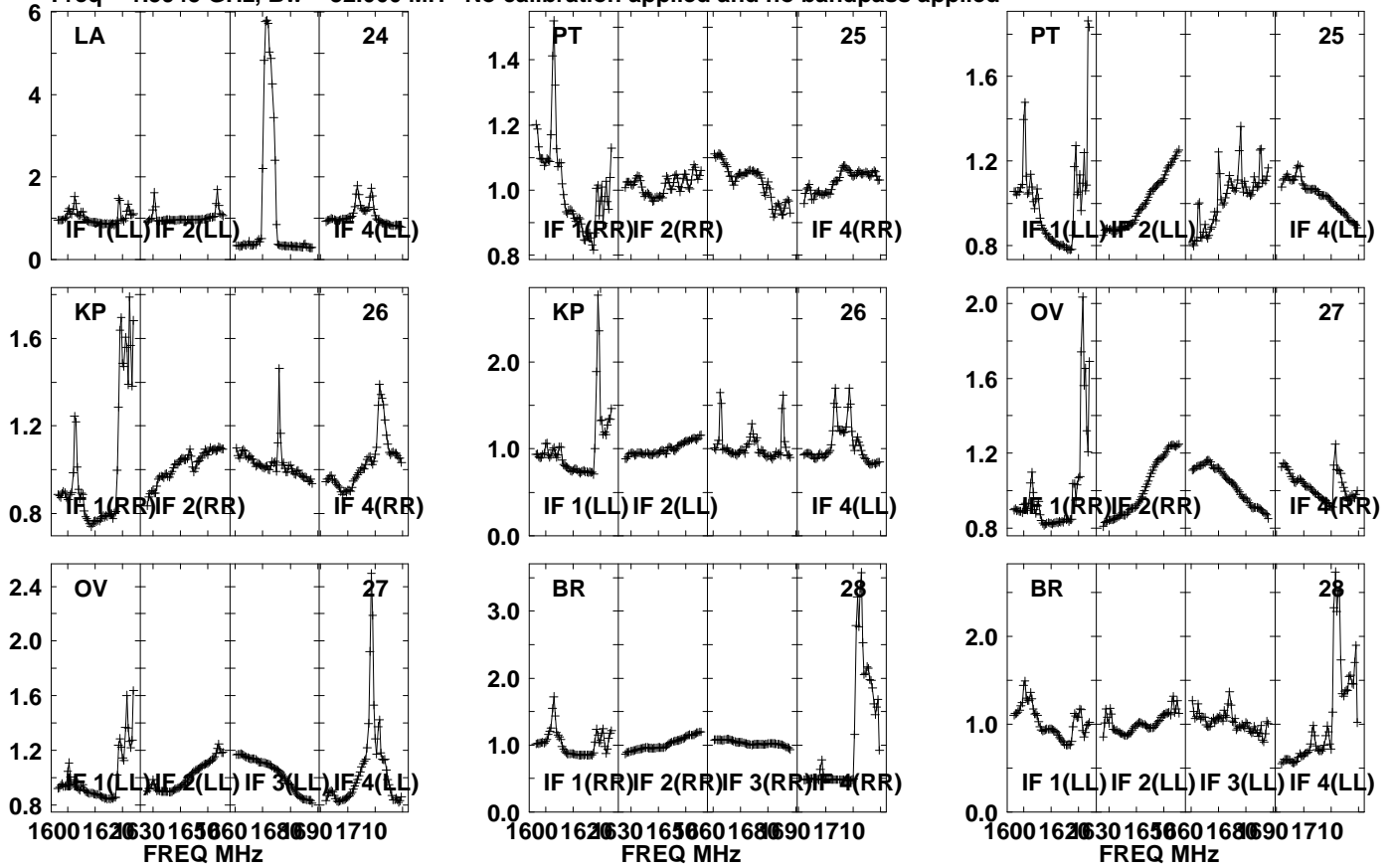

Lower frame: Real Jy  
Auto-corr total-power spectrum Antenna: \*  
Timerange: 01/02:15:41 to 01/02:18:59



Plot file version1691 created 05-OCT-2021 17:12:21  
APM08279+525 GM076.UVDATA.1  
Freq = 1.5945 GHz, Bw = 32.000 MH No calibration applied and no bandpass applied

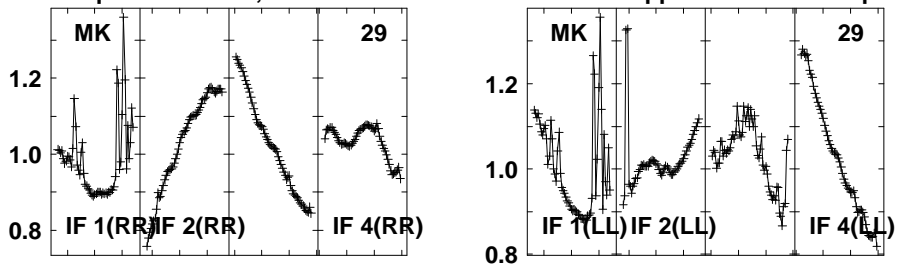

Lower frame: Real Jy  
Auto-corr total-power spectrum Antenna: \*  
Timerange: 01/02:15:41 to 01/02:18:59

Plot file version 1692 created 05-OCT-2021 17:12:21

J0827+5217 GM076.UVDATA.1

Freq = 1.5945 GHz, Bw = 32.000 MH No calibration applied and no bandpass applied

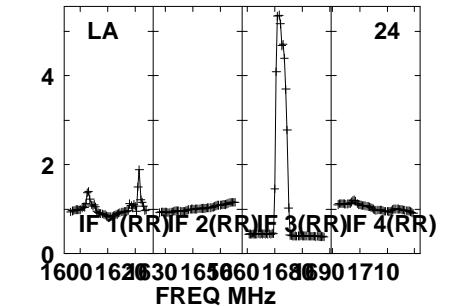
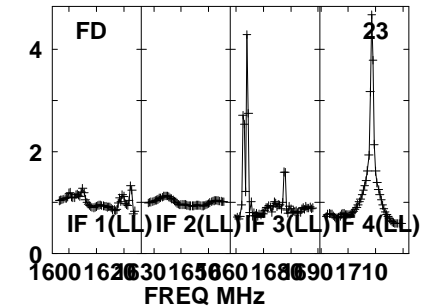
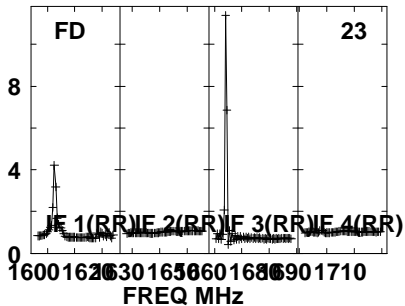
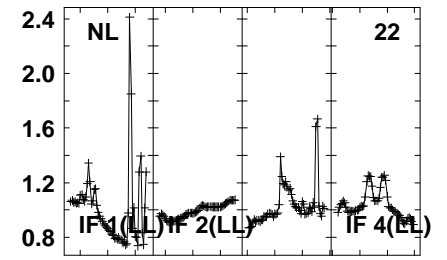
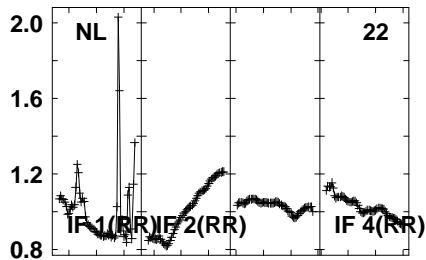
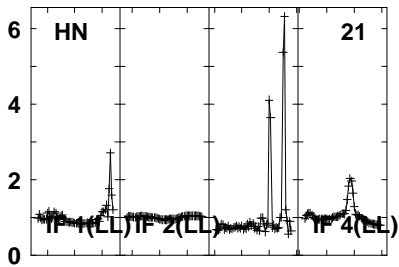
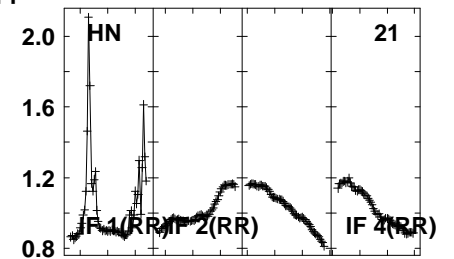
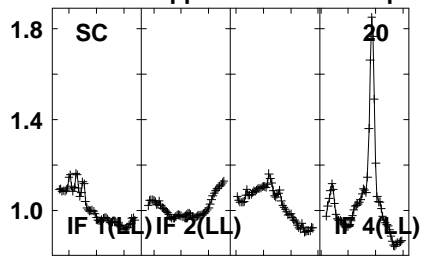
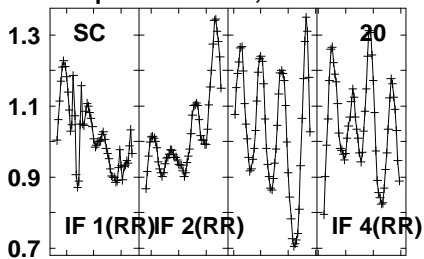

Lower frame: Real Jy  
Auto-corr total-power spectrum Antenna: \*  
Timerange: 01/02:19:31 to 01/02:20:59

Plot file version1693 created 05-OCT-2021 17:12:21

J0827+5217 GM076.UVDATA.1

Freq = 1.5945 GHz, Bw = 32.000 MH No calibration applied and no bandpass applied

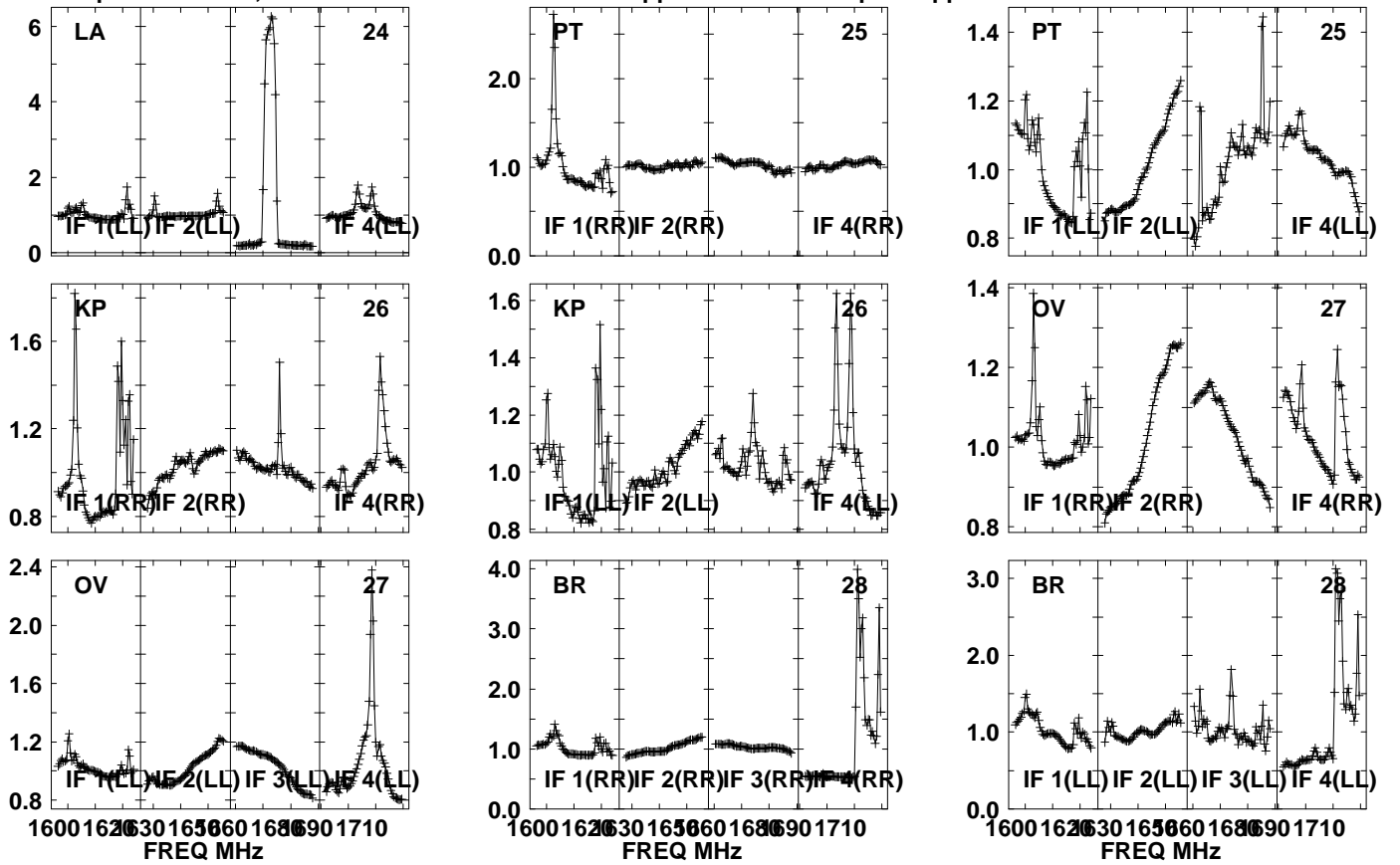

Lower frame: Real Jy  
Auto-corr total-power spectrum Antenna: \*  
Timerange: 01/02:19:31 to 01/02:20:59

Plot file version1694 created 05-OCT-2021 17:12:21

J0827+5217 GM076.UVDATA.1

Freq = 1.5945 GHz, Bw = 32.000 MH No calibration applied and no bandpass applied

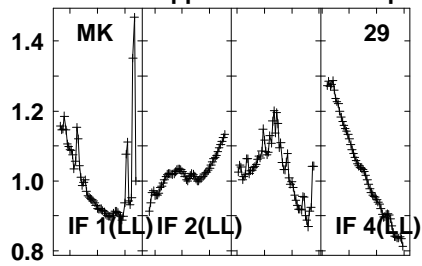
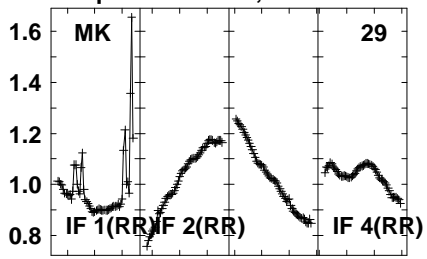

Lower frame: Real Jy  
Auto-corr total-power spectrum Antenna: \*  
Timerange: 01/02:19:31 to 01/02:20:59

Plot file version 1695 created 05-OCT-2021 17:12:21

APM08279+525 GM076.UVDATA.1

Freq = 1.5945 GHz, Bw = 32.000 MH No calibration applied and no bandpass applied

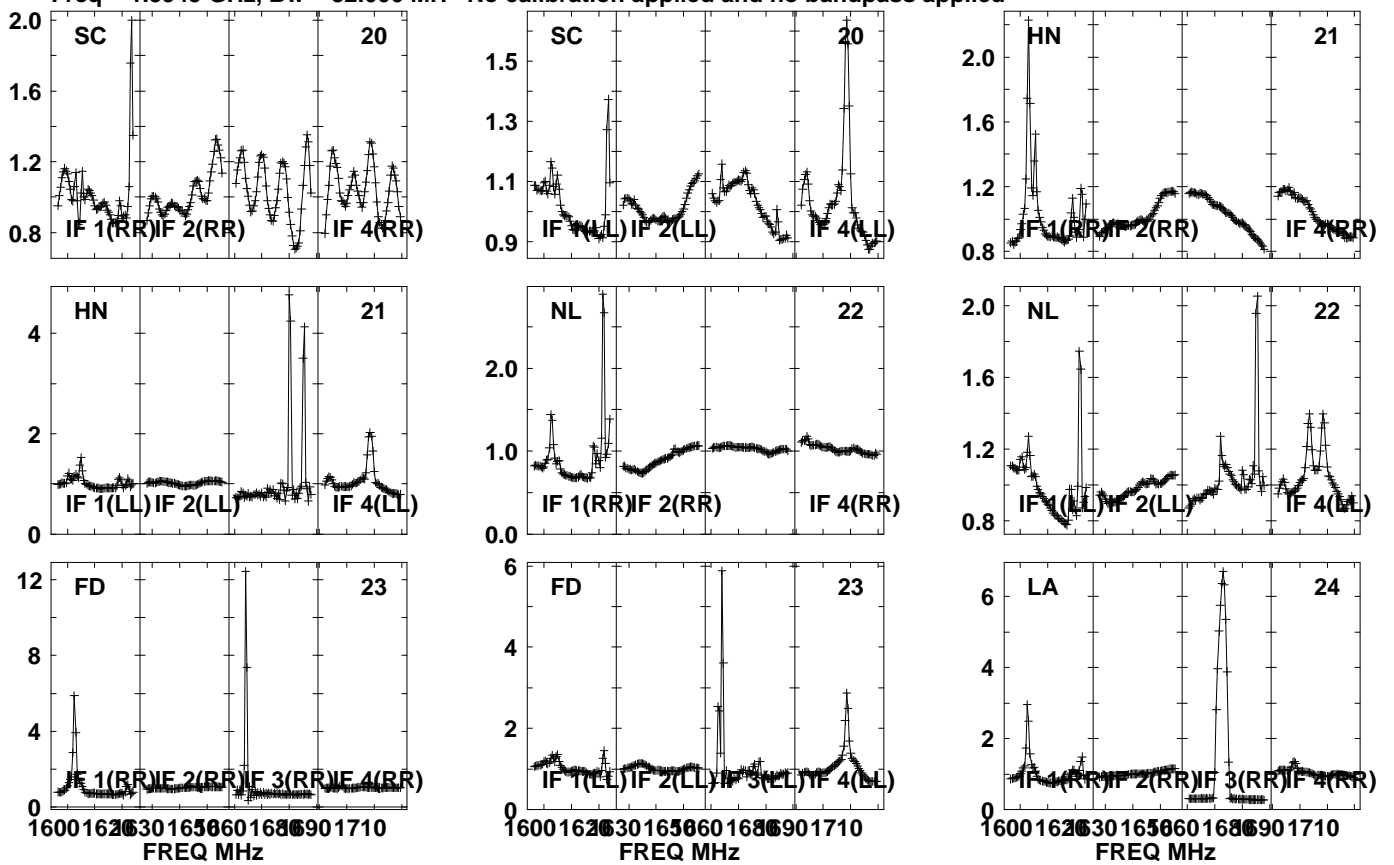

Lower frame: Real Jy  
Auto-corr total-power spectrum Antenna: \*  
Timerange: 01/02:21:09 to 01/02:24:29

Plot file version 1696 created 05-OCT-2021 17:12:21

APM08279+525 GM076.UVDATA.1

Freq = 1.5945 GHz, Bw = 32.000 MH No calibration applied and no bandpass applied

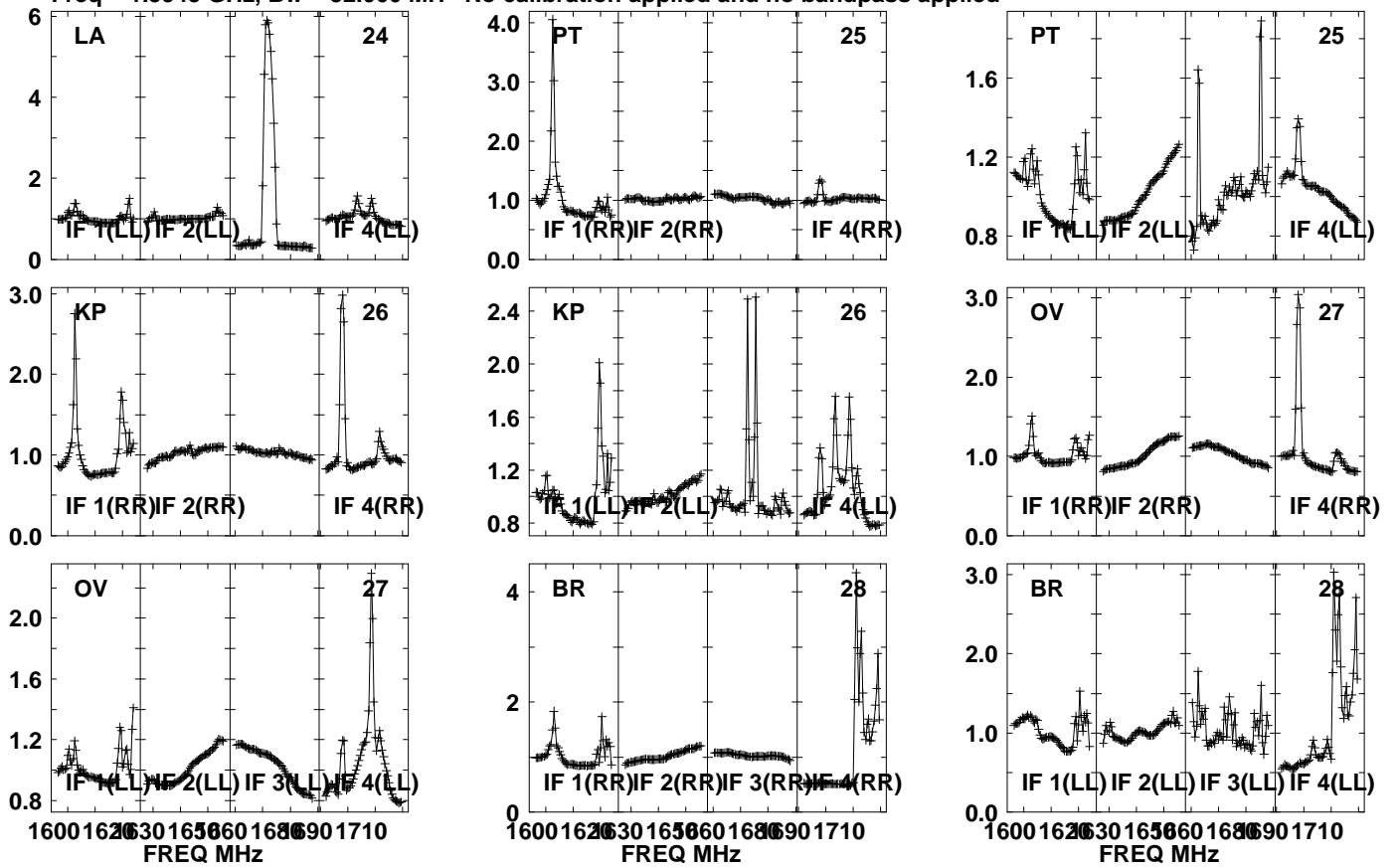

Lower frame: Real Jy

Auto-corr total-power spectrum Antenna: \*

Timerange: 01/02:21:09 to 01/02:24:29

Plot file version1697 created 05-OCT-2021 17:12:22

APM08279+525 GM076.UVDATA.1

Freq = 1.5945 GHz, Bw = 32.000 MH

No calibration applied and no bandpass applied

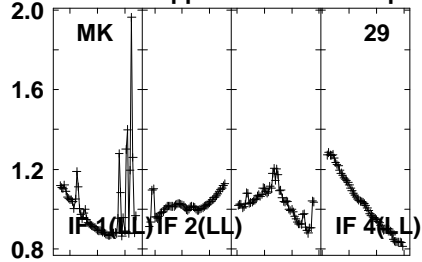
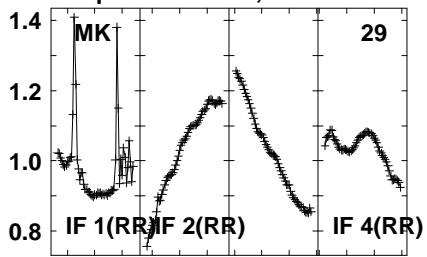

Lower frame: Real Jy  
Auto-corr total-power spectrum Antenna: \*  
Timerange: 01/02:21:09 to 01/02:24:29

Plot file version 1698 created 05-OCT-2021 17:12:22

J0827+5217 GM076.UVDATA.1

Freq = 1.5945 GHz, Bw = 32.000 MH No calibration applied and no bandpass applied

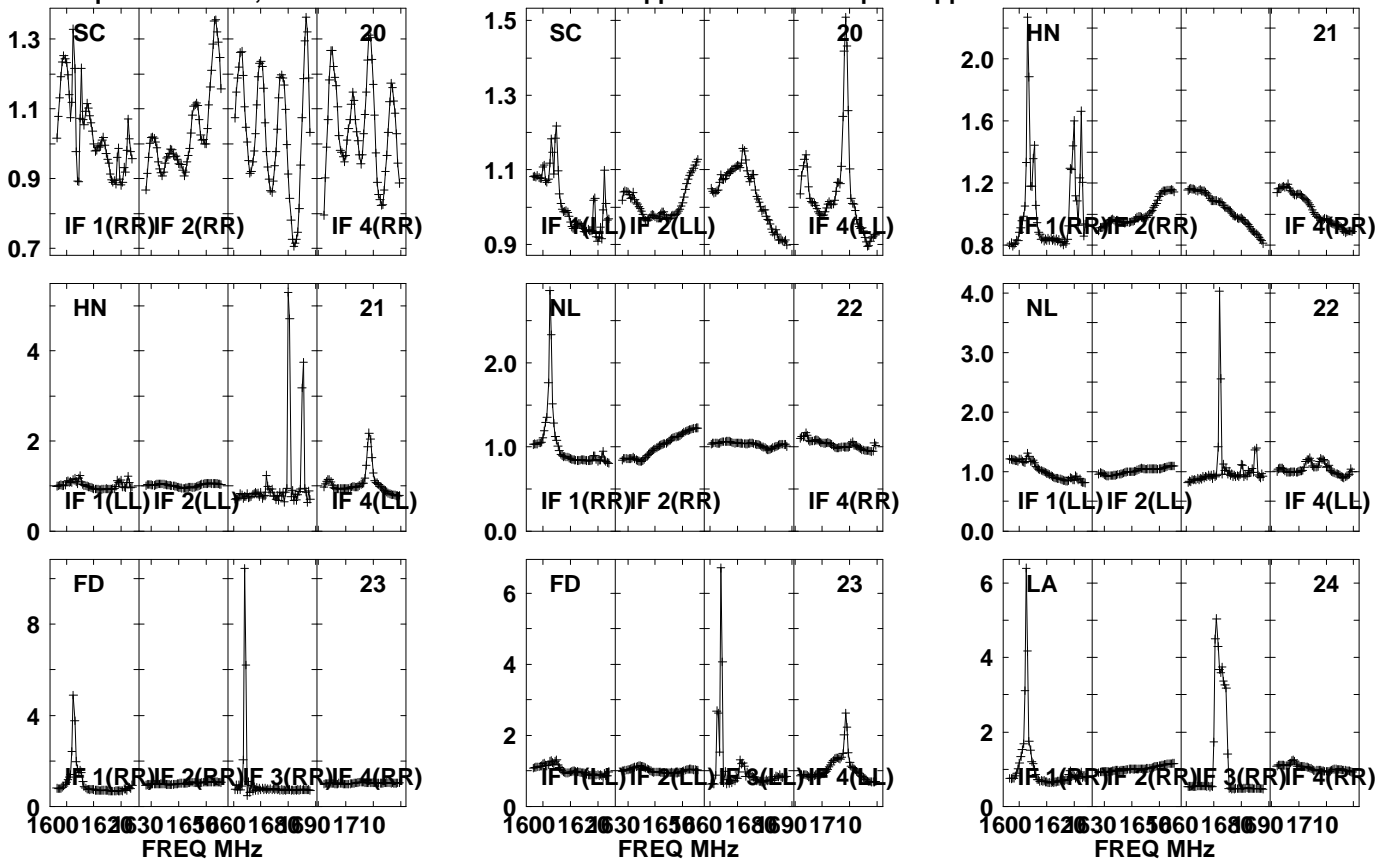

Lower frame: Real Jy  
Auto-corr total-power spectrum Antenna: \*  
Timerange: 01/02:25:01 to 01/02:26:29



Plot file version1699 created 05-OCT-2021 17:12:22

J0827+5217 GM076.UVDATA.1

Freq = 1.5945 GHz, Bw = 32.000 MH No calibration applied and no bandpass applied

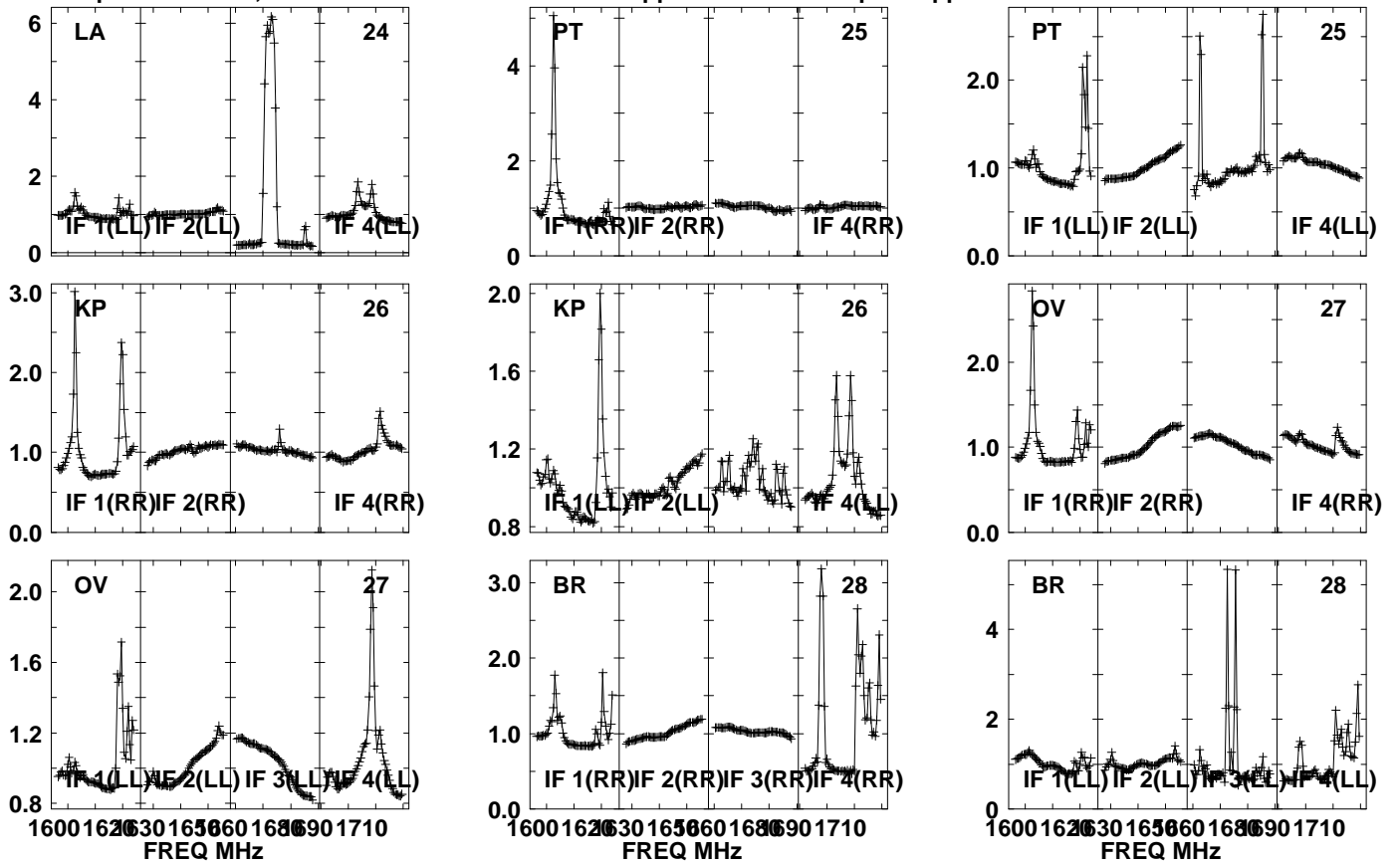

Lower frame: Real Jy

Auto-corr total-power spectrum Antenna: \*

Timerange: 01/02:25:01 to 01/02:26:29

Plot file version1700 created 05-OCT-2021 17:12:22  
J0827+5217 GM076.UVDATA.1  
Freq = 1.5945 GHz, Bw = 32.000 MH No calibration applied and no bandpass applied

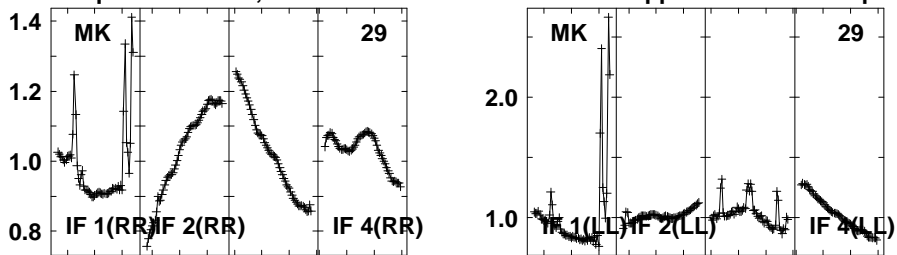

Lower frame: Real Jy  
Auto-corr total-power spectrum Antenna: \*  
Timerange: 01/02:25:01 to 01/02:26:29

Plot file version1701 created 05-OCT-2021 17:12:22

APM08279+525 GM076.UVDATA.1

Freq = 1.5945 GHz, Bw = 32.000 MH No calibration applied and no bandpass applied

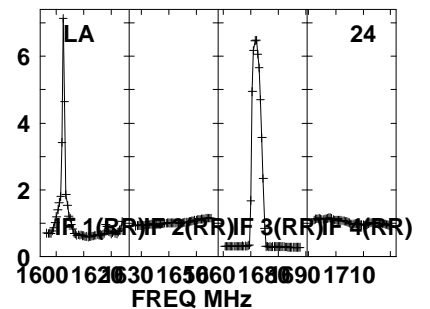
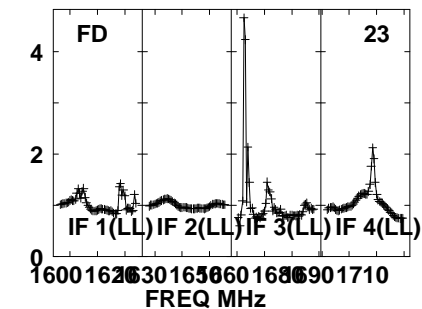
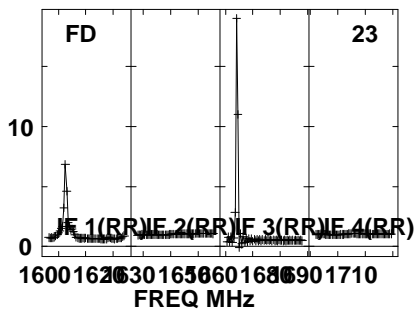
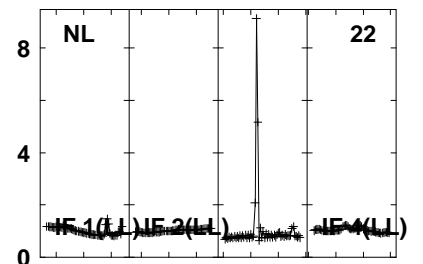
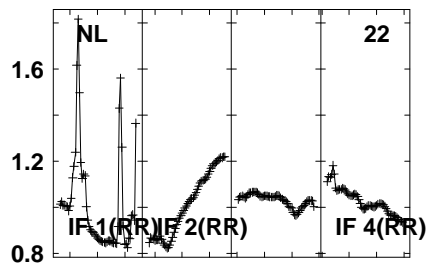
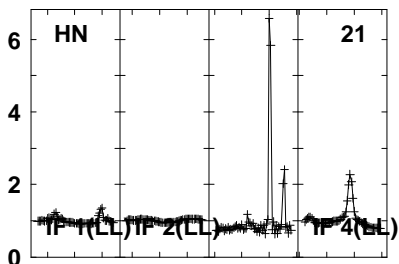
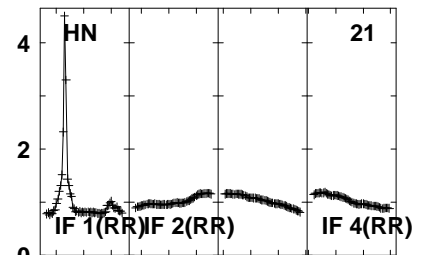
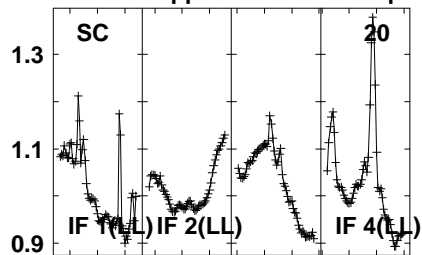
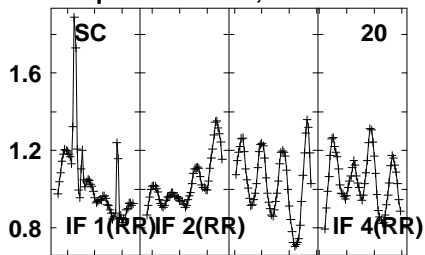

Lower frame: Real Jy  
Auto-corr total-power spectrum Antenna: \*  
Timerange: 01/02:26:41 to 01/02:29:59

Plot file version1702 created 05-OCT-2021 17:12:22

APM08279+525 GM076.UVDATA.1

Freq = 1.5945 GHz, Bw = 32.000 MH No calibration applied and no bandpass applied

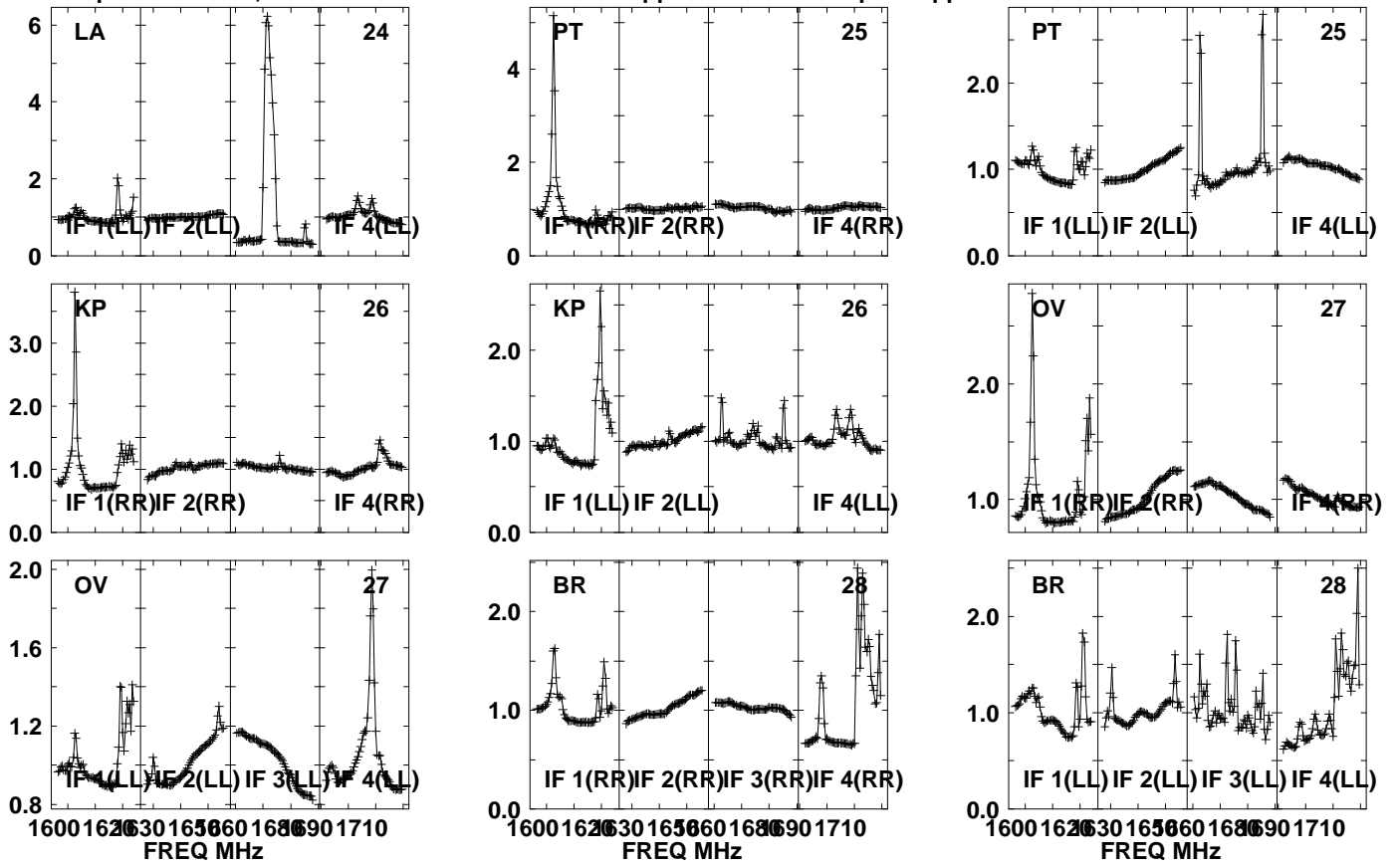

Lower frame: Real Jy

Auto-corr total-power spectrum Antenna: \*

Timerange: 01/02:26:41 to 01/02:29:59

Plot file version1703 created 05-OCT-2021 17:12:22

APM08279+525 GM076.UVDATA.1

Freq = 1.5945 GHz, Bw = 32.000 MH No calibration applied and no bandpass applied

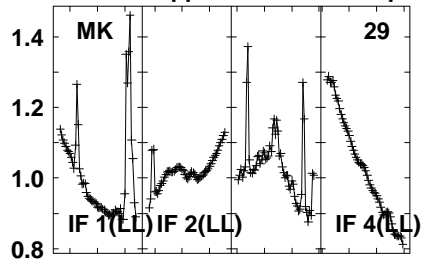
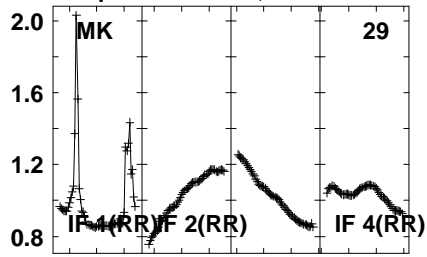

Lower frame: Real Jy  
Auto-corr total-power spectrum Antenna: \*  
Timerange: 01/02:26:41 to 01/02:29:59