

Plot file version 1 created 03-MAR-2016 01:11:56

J1545+5400 GN002C 1.UVDATA.1

Freq = 1.2770 GHz, Bw = 16.000 MH Calibrated with CL # 3 and BP # 1 (BP mode 1)

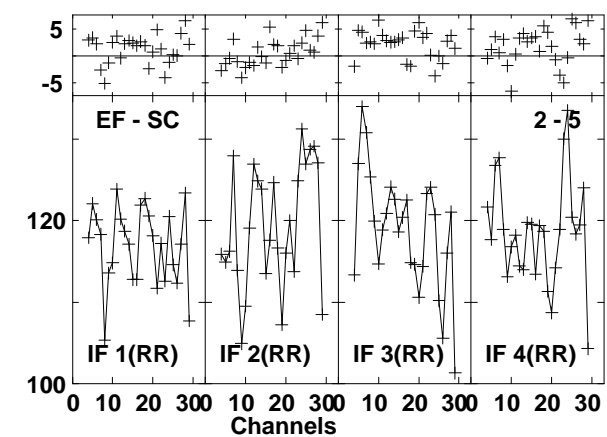
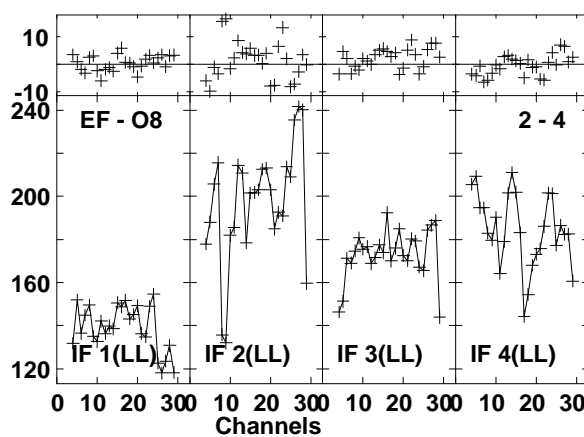
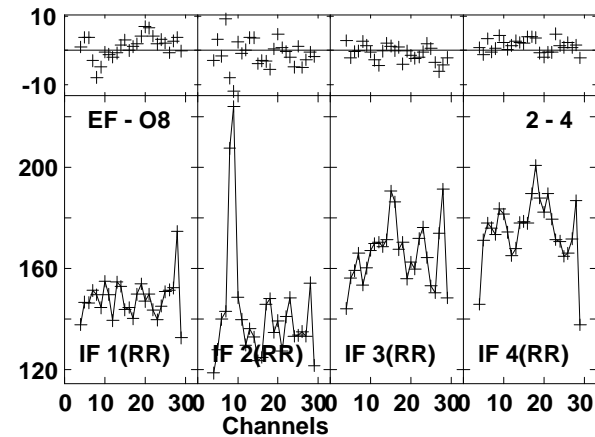
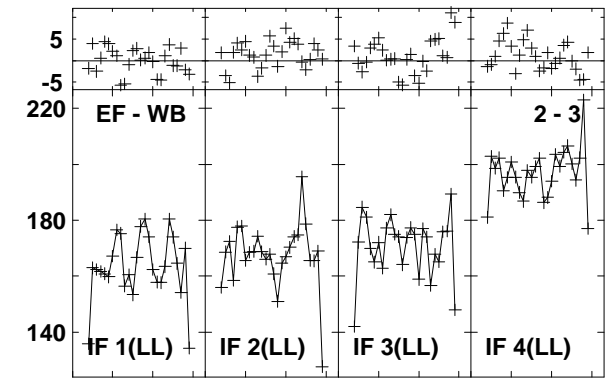
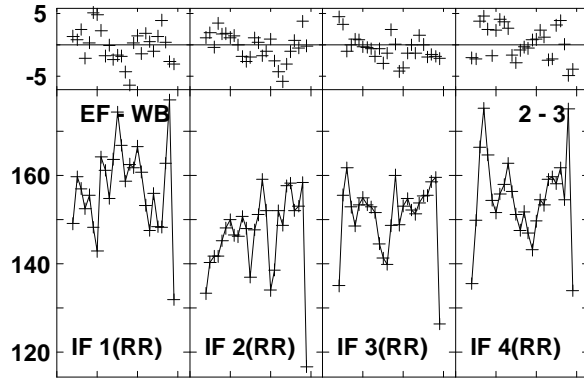
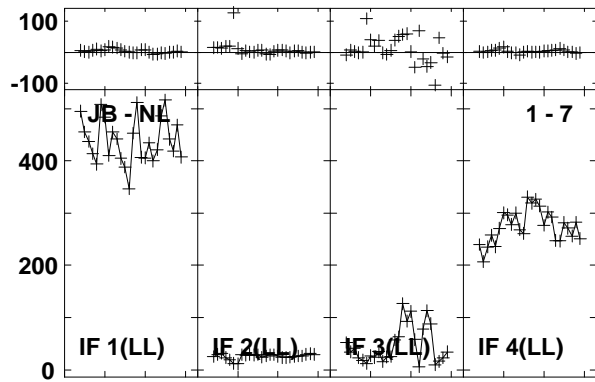
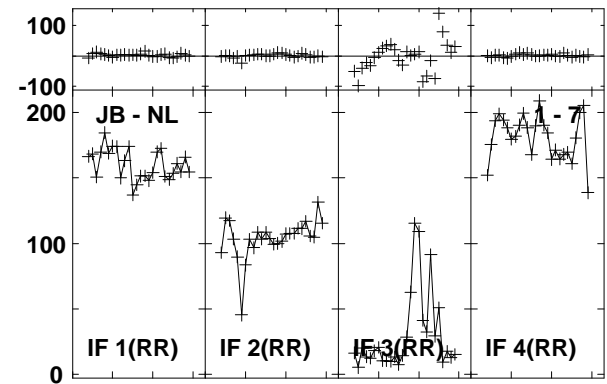
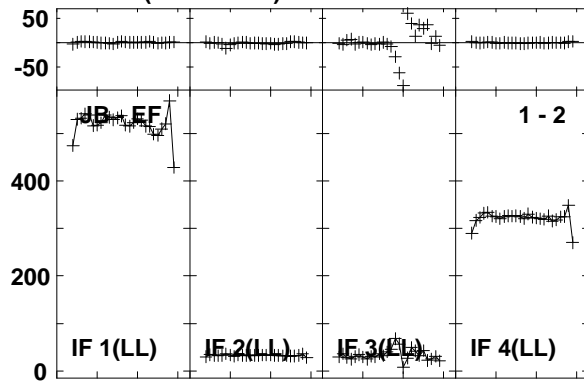
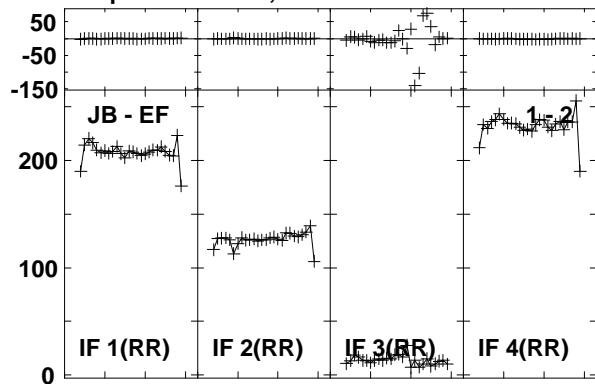

Lower frame: Milli Ampl Jy Top frame: Phas deg
Vector averaged cross-power spectrum Baseline: JB (01) - EF (02)
Timerange: 00/15:30:01 to 00/15:31:59

Plot file version 2 created 03-MAR-2016 01:11:57

J1545+5400 GN002C 1.UVDATA.1

Freq = 1.2770 GHz, Bw = 16.000 MH Calibrated with CL # 3 and BP # 1 (BP mode 1)

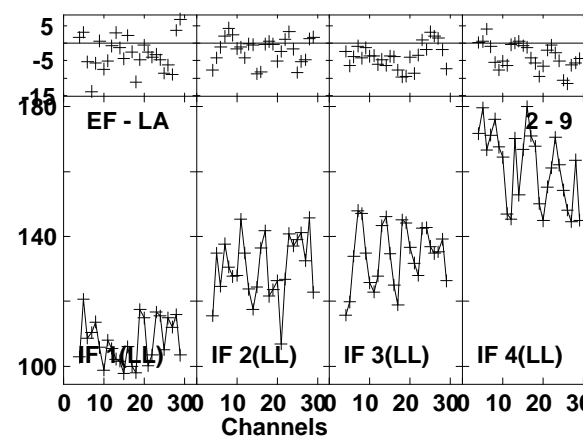
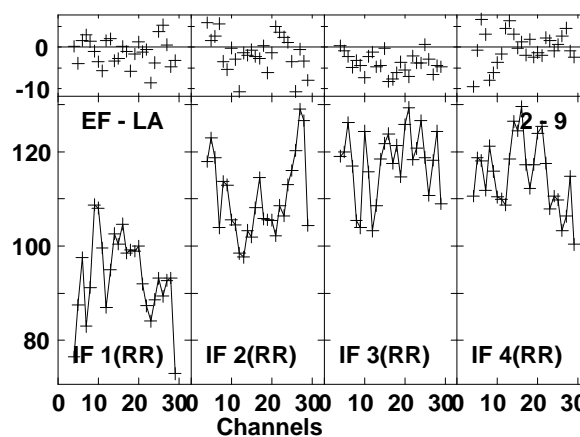
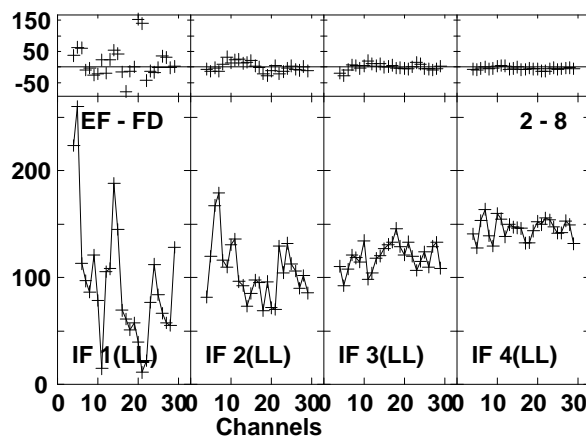
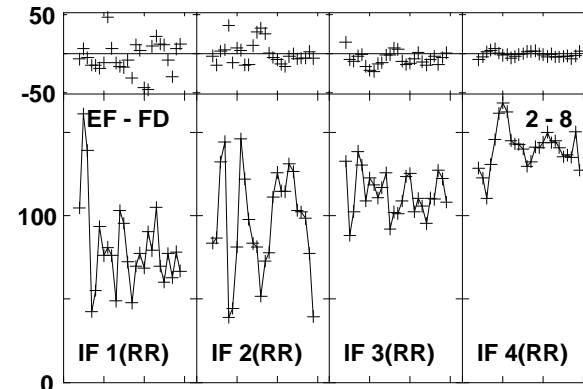
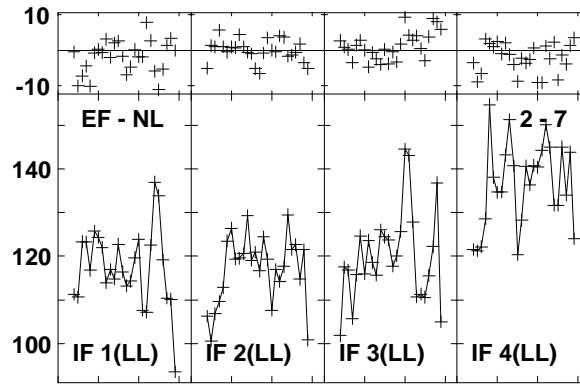
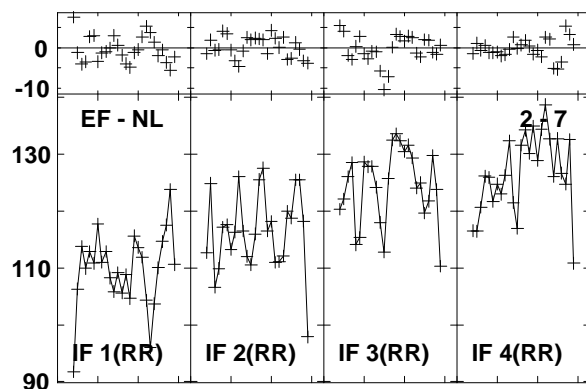
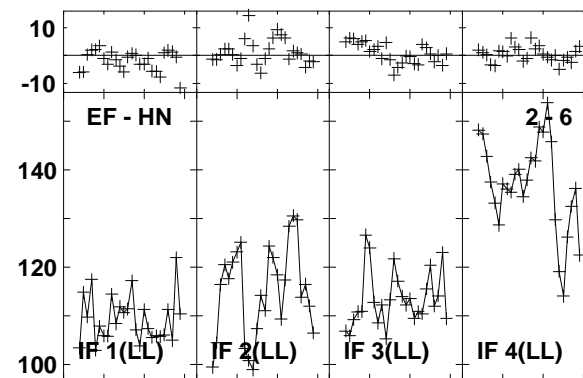
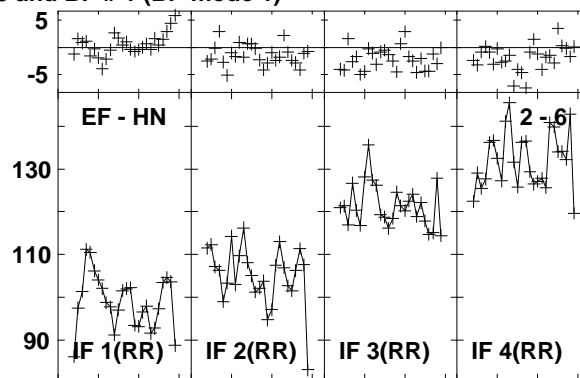
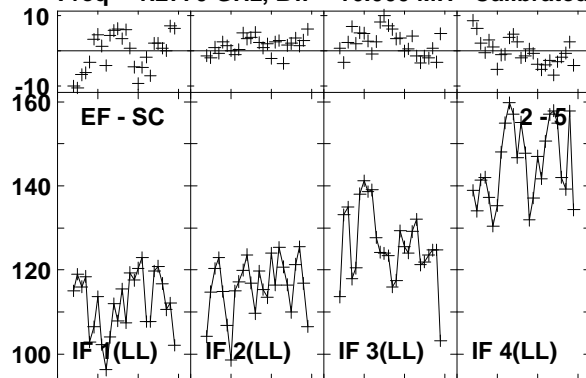

Lower frame: Milli Ampl Jy Top frame: Phas deg
Vector averaged cross-power spectrum Baseline: EF (02) - SC (05)
Timerange: 00/15:30:01 to 00/15:31:59

Plot file version 3 created 03-MAR-2016 01:11:57

J1545+5400 GN002C 1.UVDATA.1

Freq = 1.2770 GHz, Bw = 16.000 MH Calibrated with CL # 3 and BP # 1 (BP mode 1)

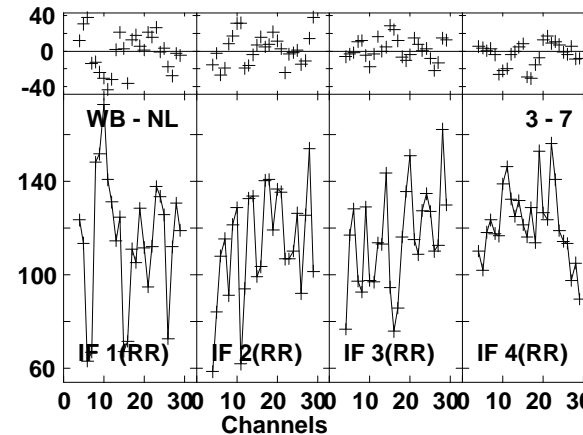
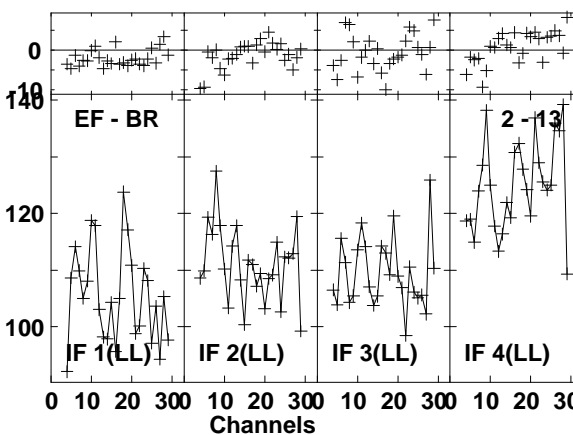
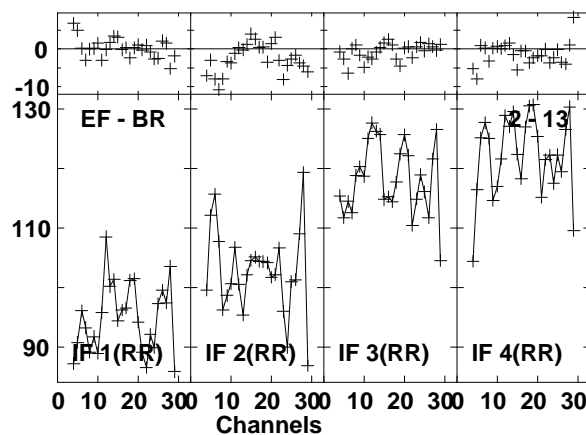
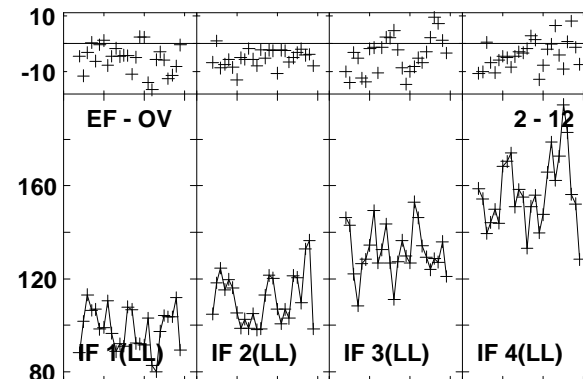
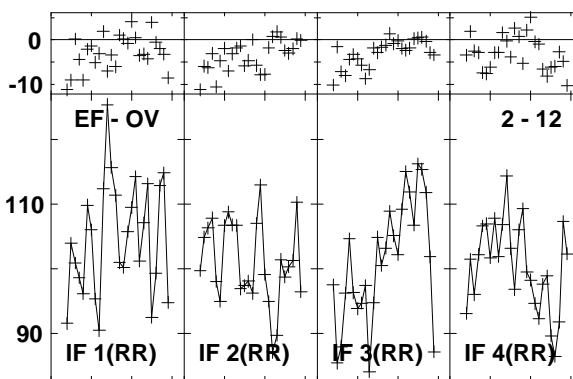
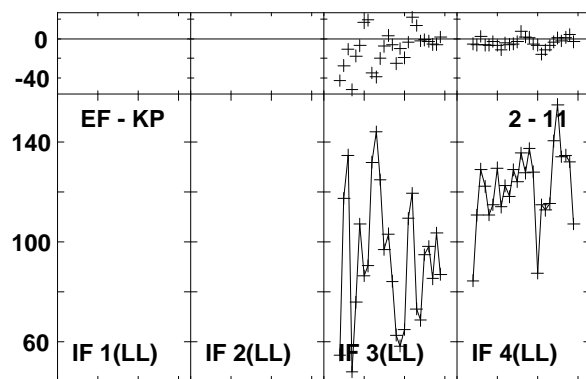
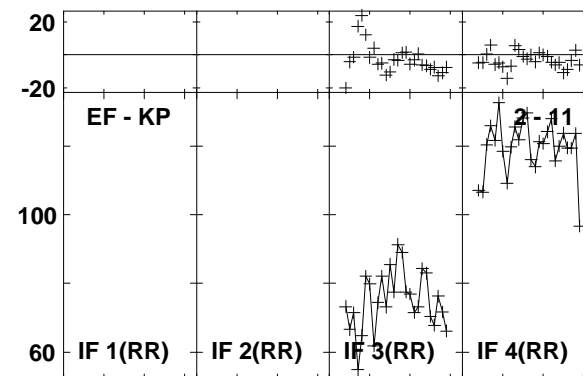
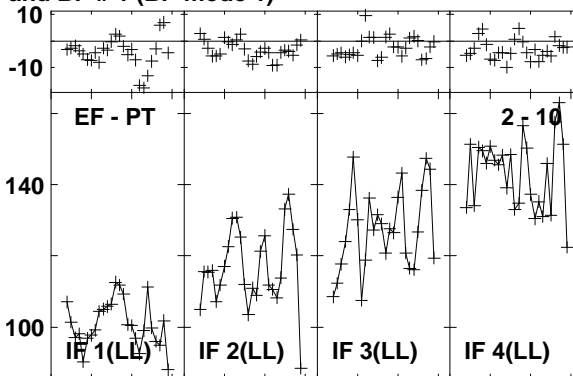
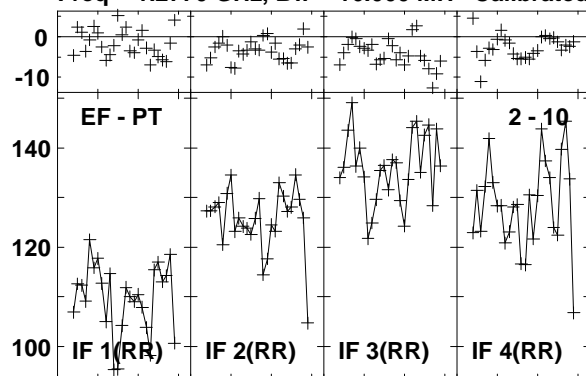

Lower frame: Milli Ampl Jy Top frame: Phas deg
Vector averaged cross-power spectrum Baseline: EF (02) - PT (10)
Timerange: 00/15:30:01 to 00/15:31:59

Plot file version 4 created 03-MAR-2016 01:11:57
 J1545+5400 GN002C 1.UVDATA.1
 Freq = 1.2770 GHz, Bw = 16.000 MH Calibrated with CL # 3 and BP # 1 (BP mode 1)

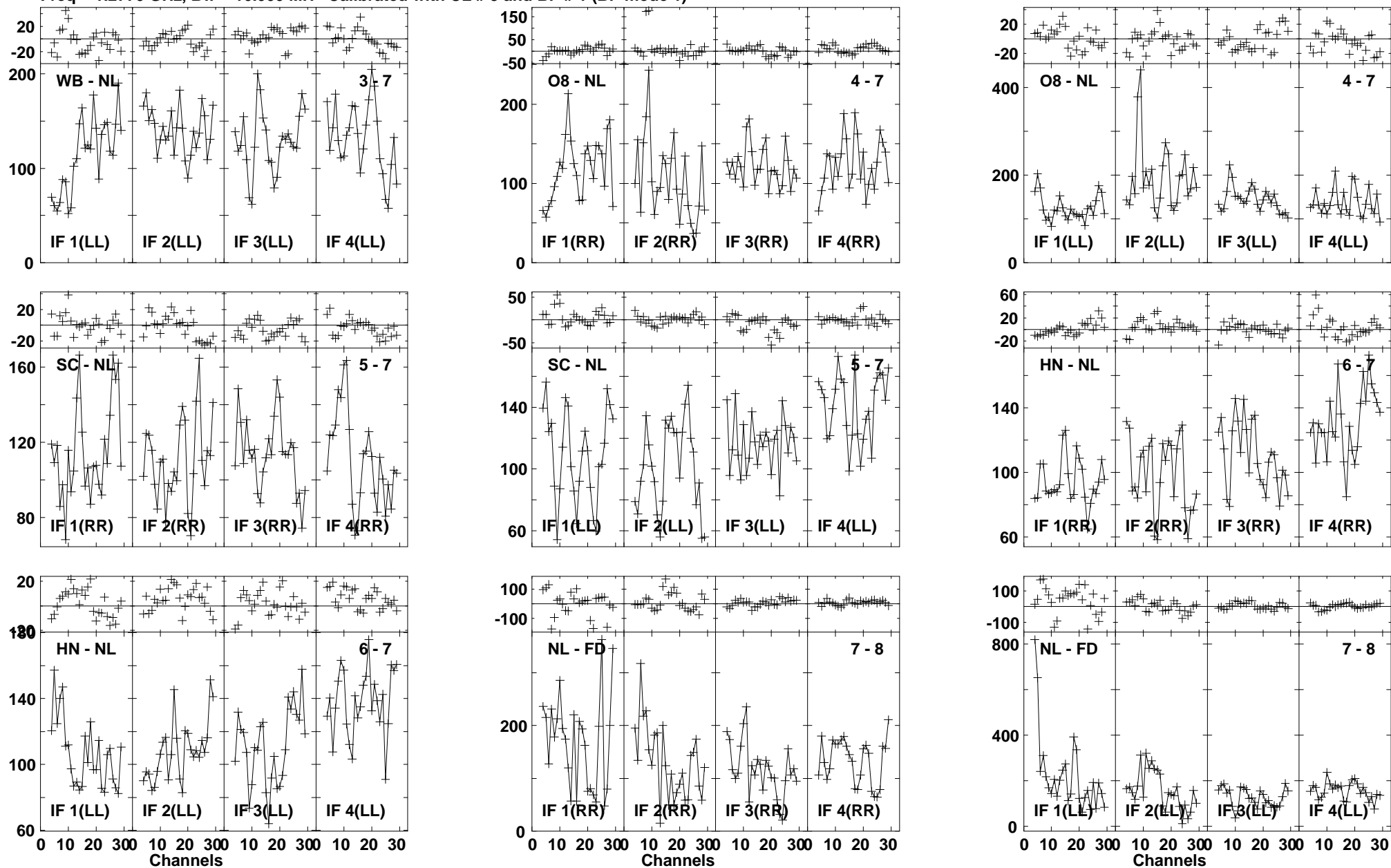

Lower frame: Milli Ampl Jy Top frame: Phas deg
 Vector averaged cross-power spectrum Baseline: WB (03) - NL (07)
 Timerange: 00/15:30:01 to 00/15:31:59

Plot file version 5 created 03-MAR-2016 01:11:57

J1545+5400 GN002C 1.UVDATA.1

Freq = 1.2770 GHz, Bw = 16.000 MH Calibrated with CL # 3 and BP # 1 (BP mode 1)

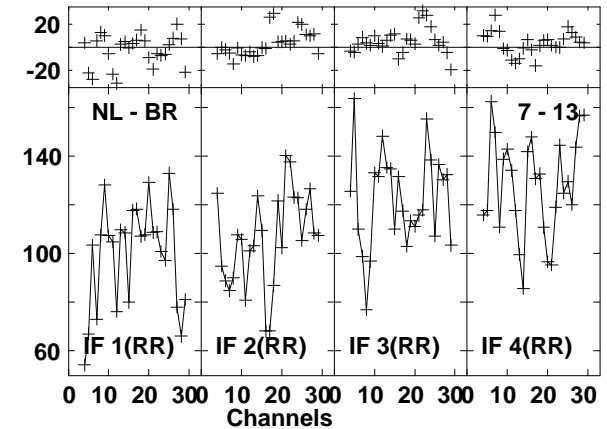
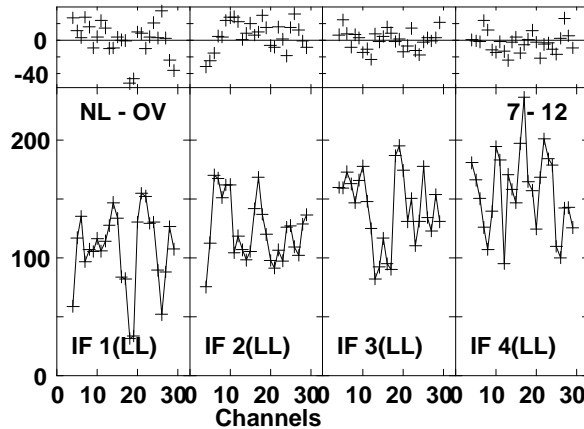
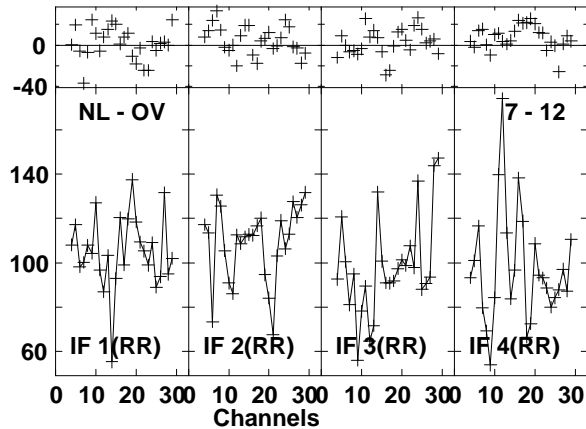
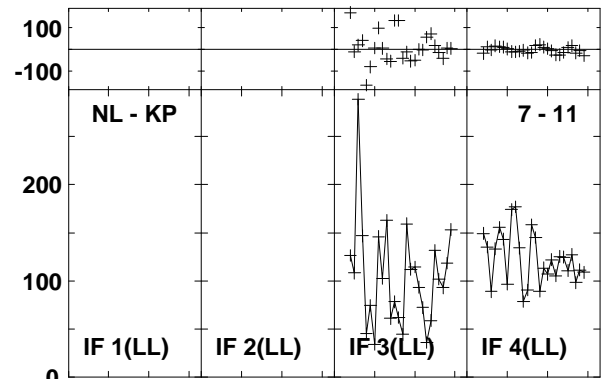
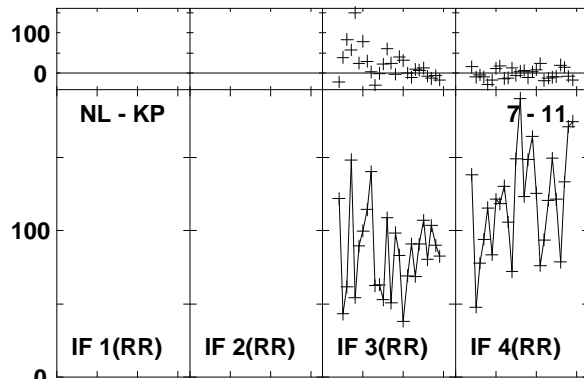
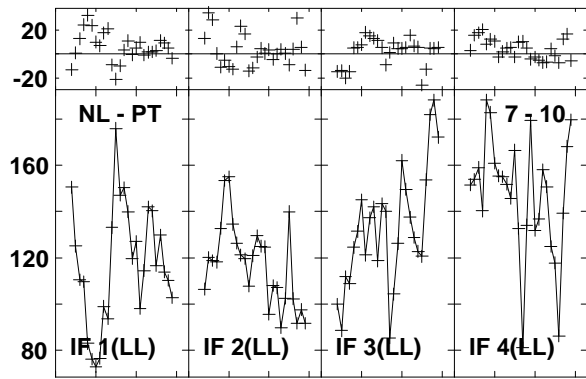
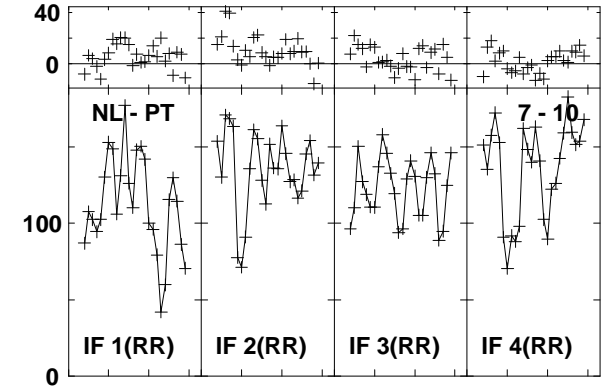
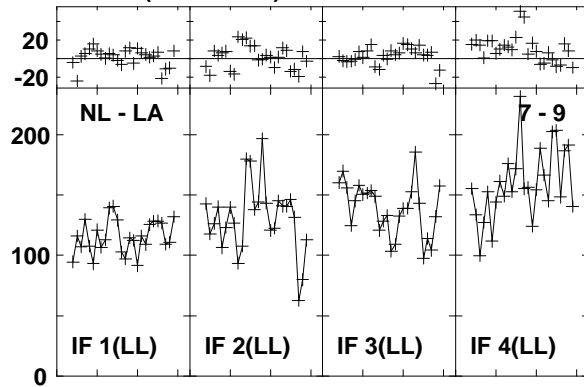
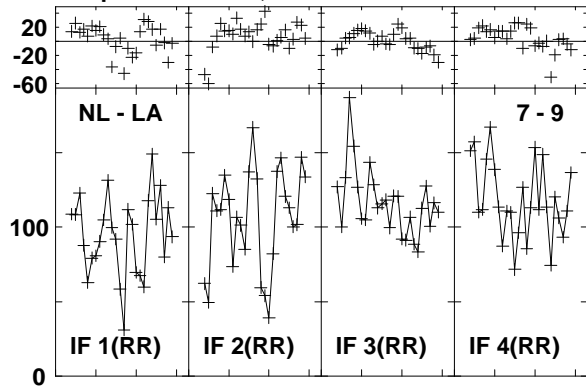

Lower frame: Milli Ampl Jy Top frame: Phas deg
Vector averaged cross-power spectrum Baseline: NL (07) - LA (09)
Timerange: 00/15:30:01 to 00/15:31:59

Plot file version 6 created 03-MAR-2016 01:11:57
J1545+5400 GN002C 1.UVDATA.1
Freq = 1.2770 GHz, Bw = 16.000 MH Calibrated with CL # 3 and BP # 1 (BP mode 1)

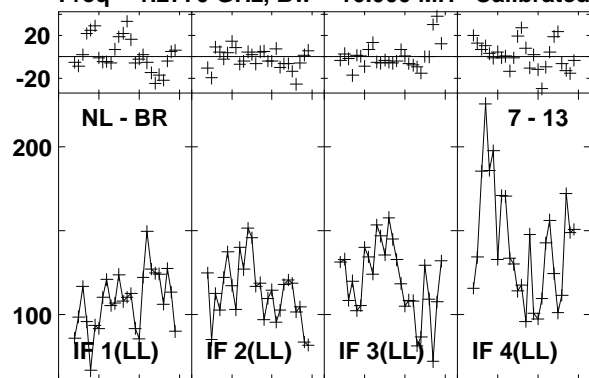

Lower frame: Milli Ampl Jy Top frame: Phas deg
Vector averaged cross-power spectrum Baseline: NL (07) - BR (13)
Timerange: 00/15:30:01 to 00/15:31:59

Plot file version 7 created 03-MAR-2016 01:11:57

4C52 GN002C 1.UVDATA.1

Freq = 1.2770 GHz, Bw = 16.000 MH Calibrated with CL # 3 and BP # 1 (BP mode 1)

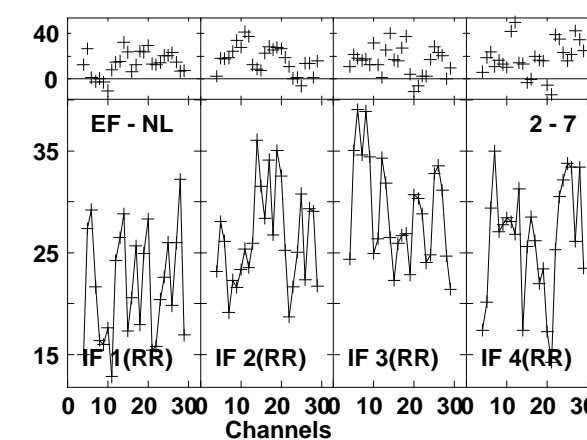
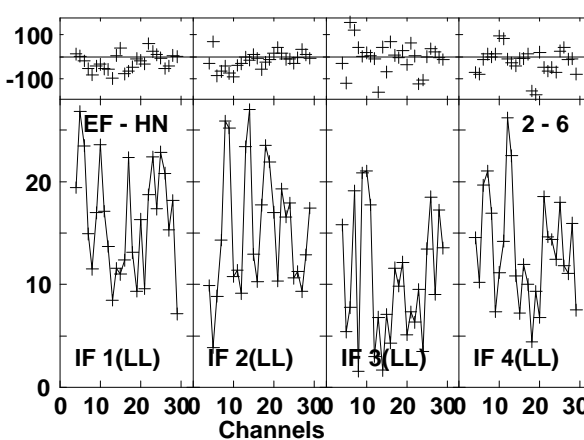
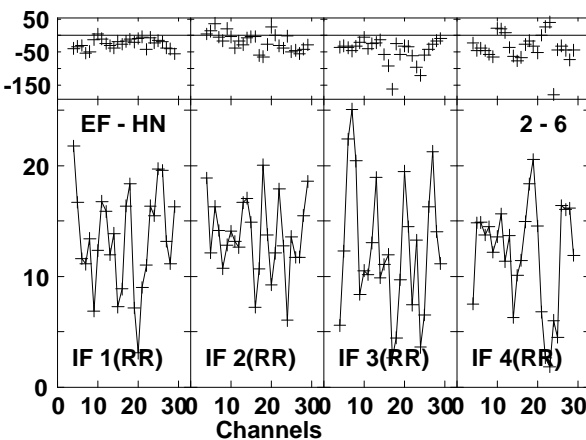
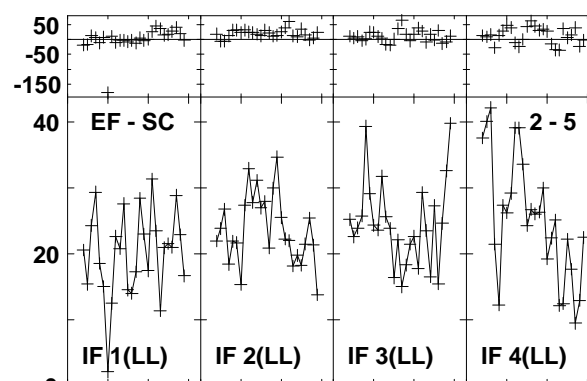
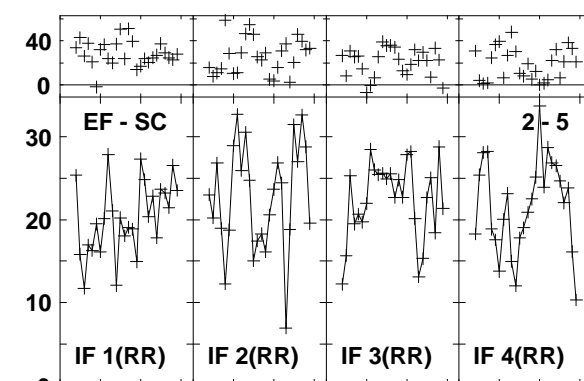
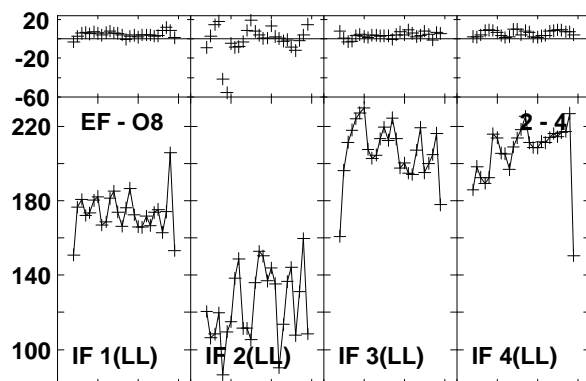
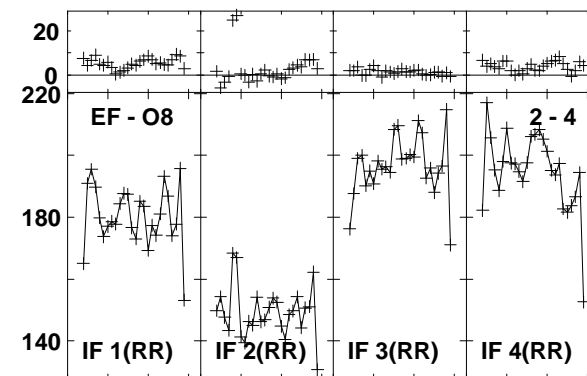
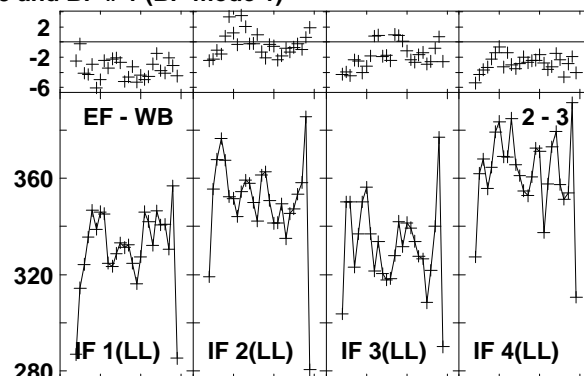
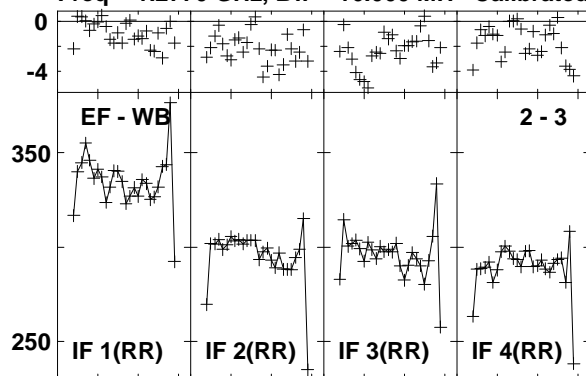

Lower frame: Milli Ampl Jy Top frame: Phas deg
Vector averaged cross-power spectrum Baseline: EF (02) - WB (03)
Timerange: 00/15:32:12 to 00/15:34:58

Plot file version 8 created 03-MAR-2016 01:11:58

4C52 GN002C 1.UVDATA.1

Freq = 1.2770 GHz, Bw = 16.000 MH Calibrated with CL # 3 and BP # 1 (BP mode 1)

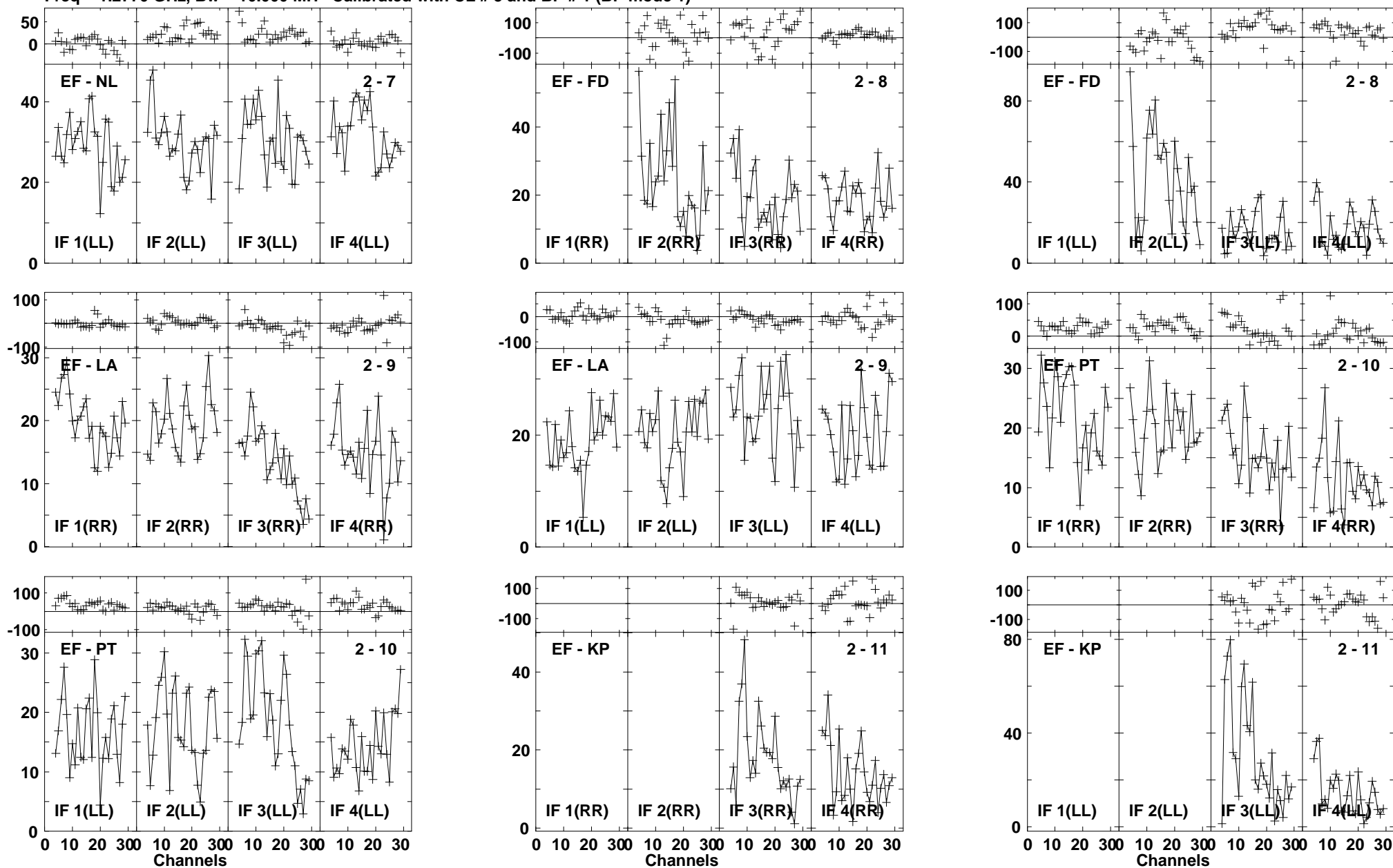

Lower frame: Milli Ampl Jy Top frame: Phas deg
Vector averaged cross-power spectrum Baseline: EF (02) - NL (07)
Timerange: 00/15:32:12 to 00/15:34:58

Plot file version 9 created 03-MAR-2016 01:11:58

4C52 GN002C 1.UVDATA.1

Freq = 1.2770 GHz, Bw = 16.000 MH Calibrated with CL # 3 and BP # 1 (BP mode 1)

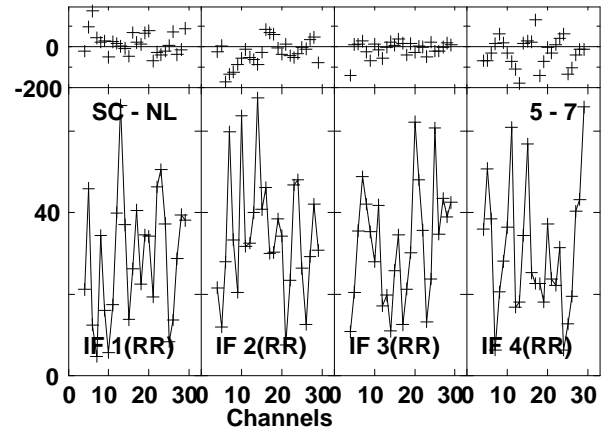
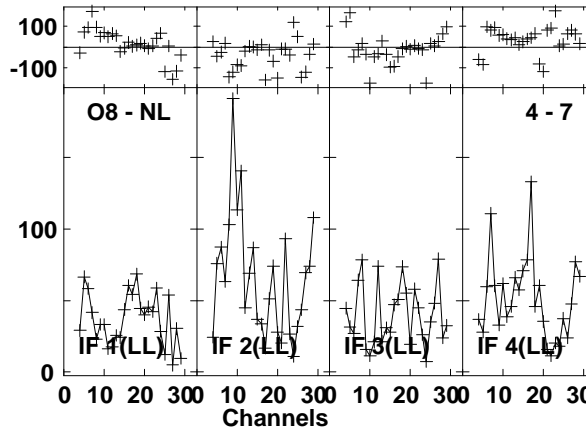
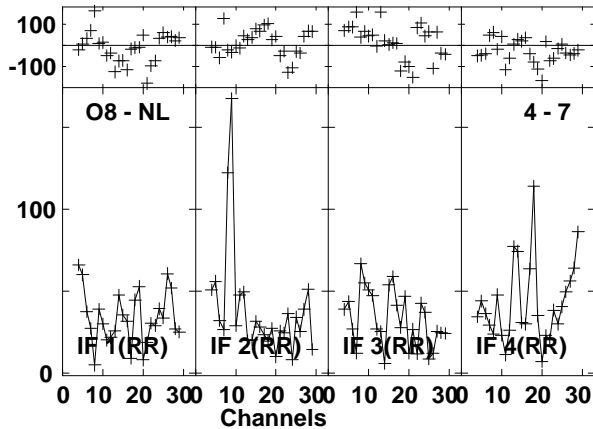
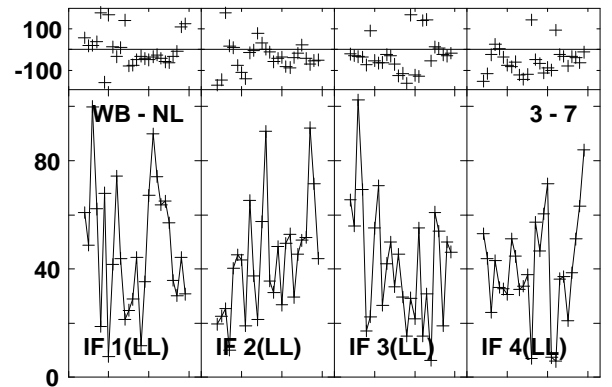
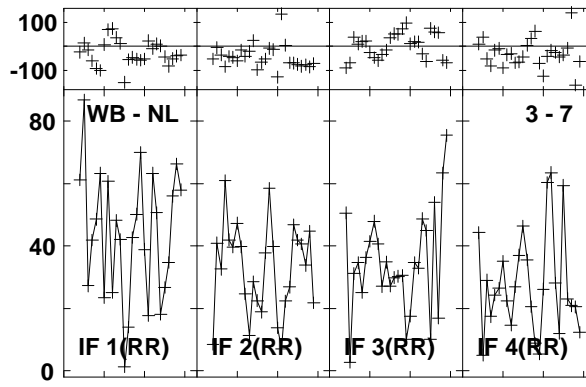
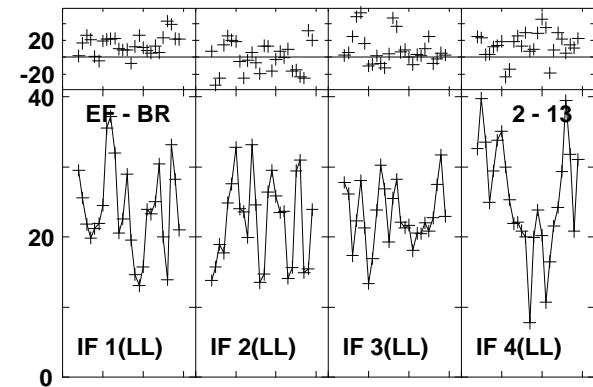
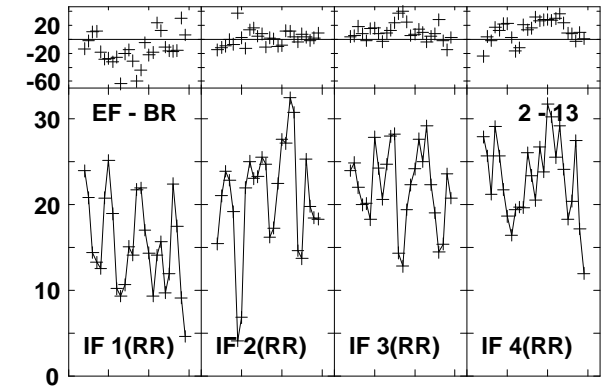
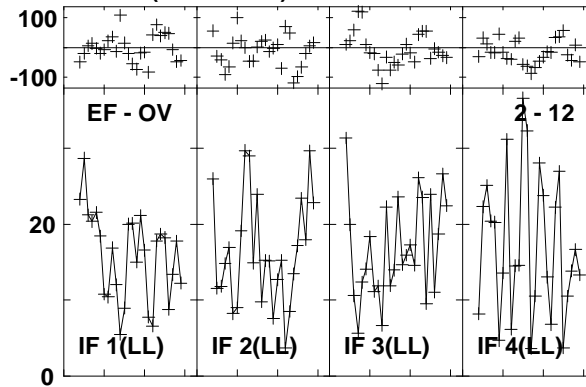
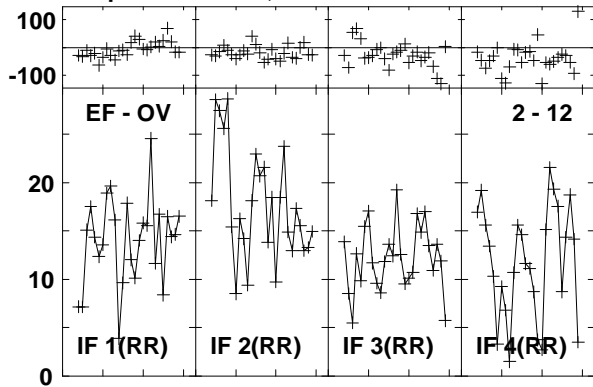

Lower frame: Milli Ampl Jy Top frame: Phas deg
Vector averaged cross-power spectrum Baseline: EF (02) - OV (12)
Timerange: 00/15:32:12 to 00/15:34:58

Plot file version 10 created 03-MAR-2016 01:11:58

4C52 GN002C 1.UVDATA.1

Freq = 1.2770 GHz, Bw = 16.000 MH Calibrated with CL # 3 and BP # 1 (BP mode 1)

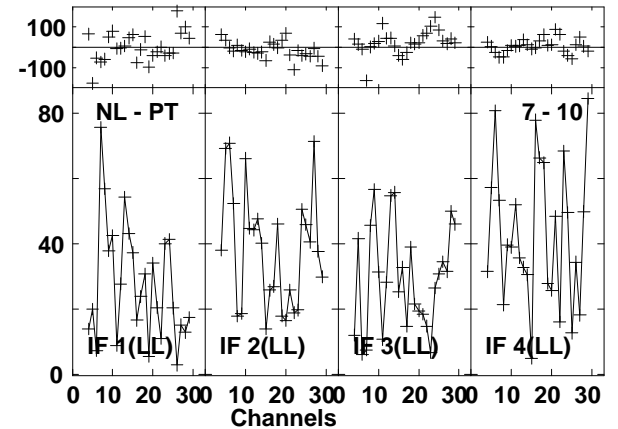
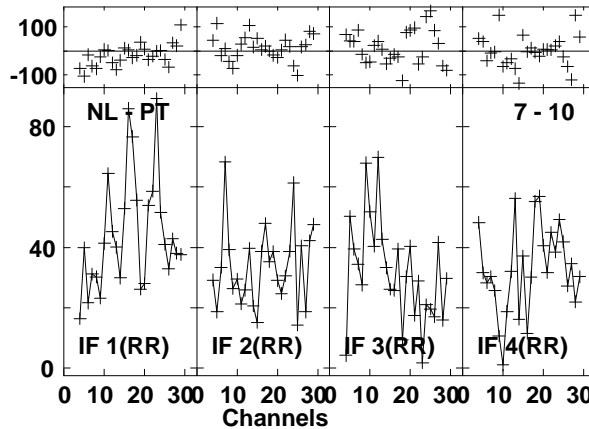
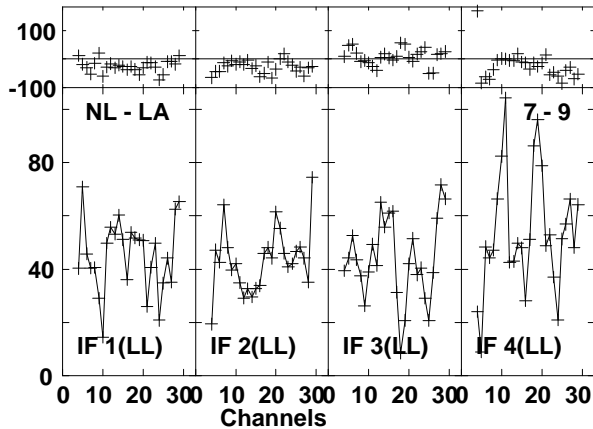
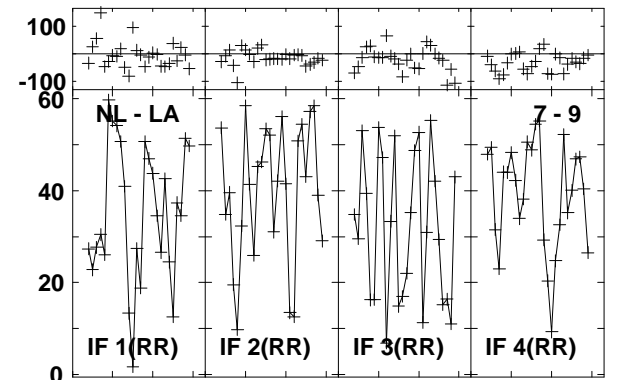
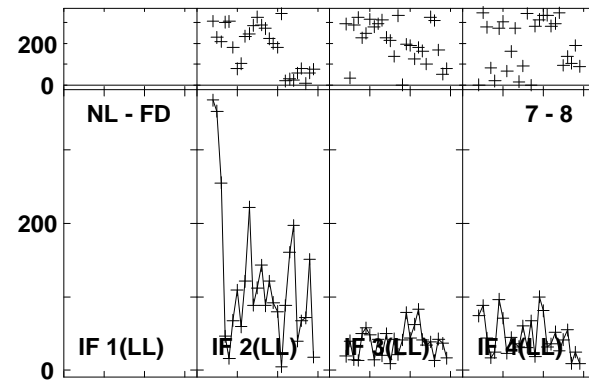
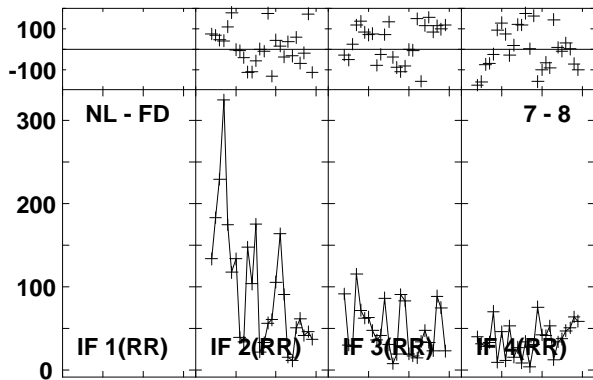
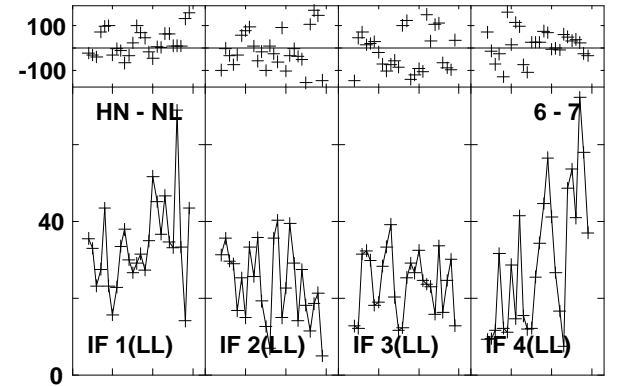
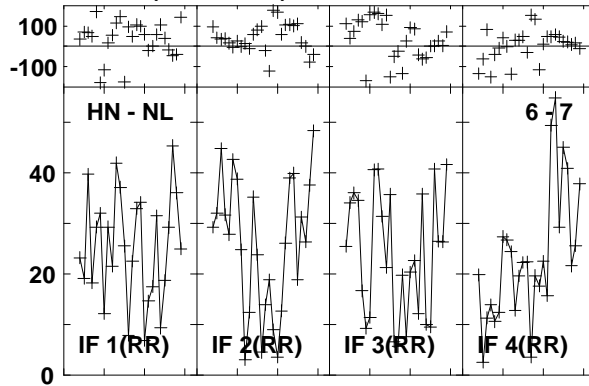
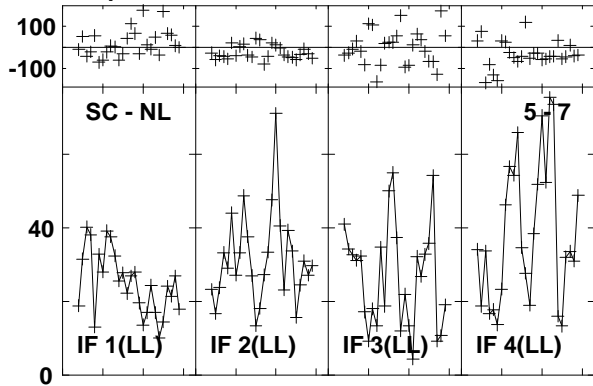

Lower frame: Milli Ampl Jy Top frame: Phas deg

Vector averaged cross-power spectrum Baseline: SC (05) - NL (07)

Timerange: 00/15:32:12 to 00/15:34:58

Plot file version 11 created 03-MAR-2016 01:11:58

4C52 GN002C 1.UVDATA.1

Freq = 1.2770 GHz, Bw = 16.000 MH Calibrated with CL # 3 and BP # 1 (BP mode 1)

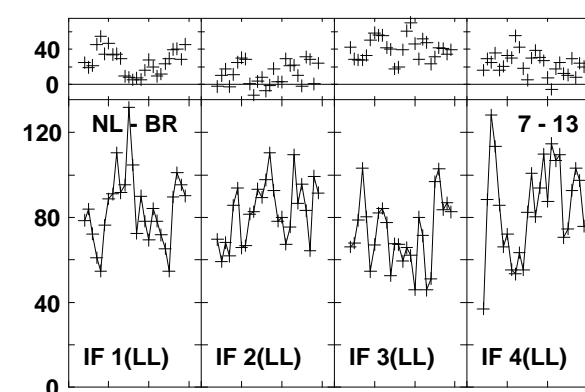
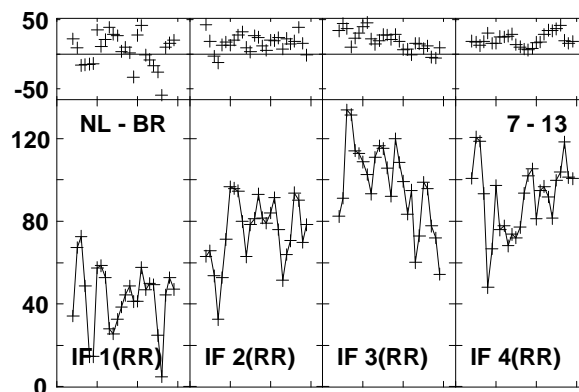
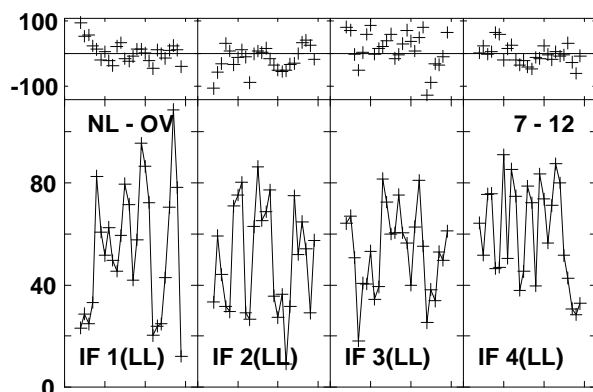
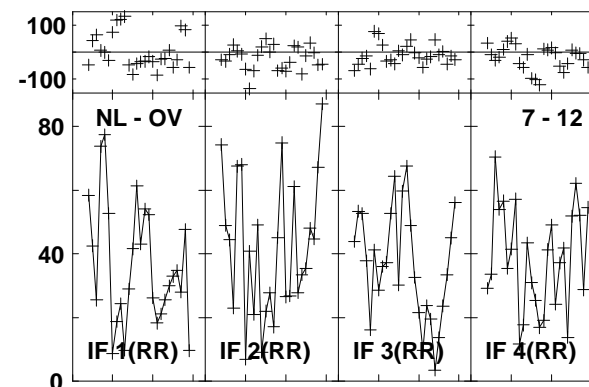
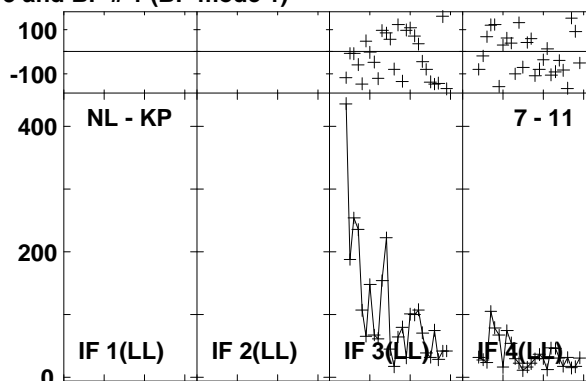
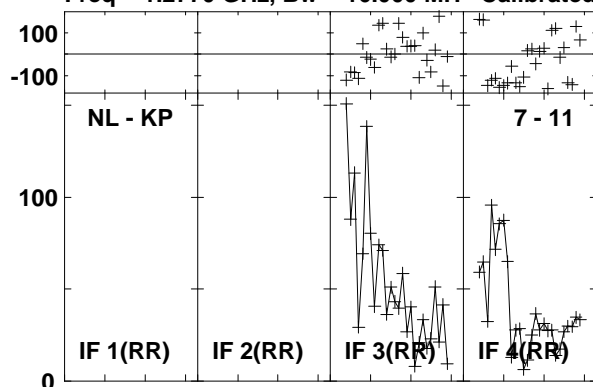

Lower frame: Milli Ampl Jy Top frame: Phas deg

Vector averaged cross-power spectrum Baseline: NL (07) - KP (11)

Timerange: 00/15:32:12 to 00/15:34:58

Plot file version 12 created 03-MAR-2016 01:11:58

J1545+5400 GN002C 1.UVDATA.1

Freq = 1.2770 GHz, Bw = 16.000 MH Calibrated with CL # 3 and BP # 1 (BP mode 1)

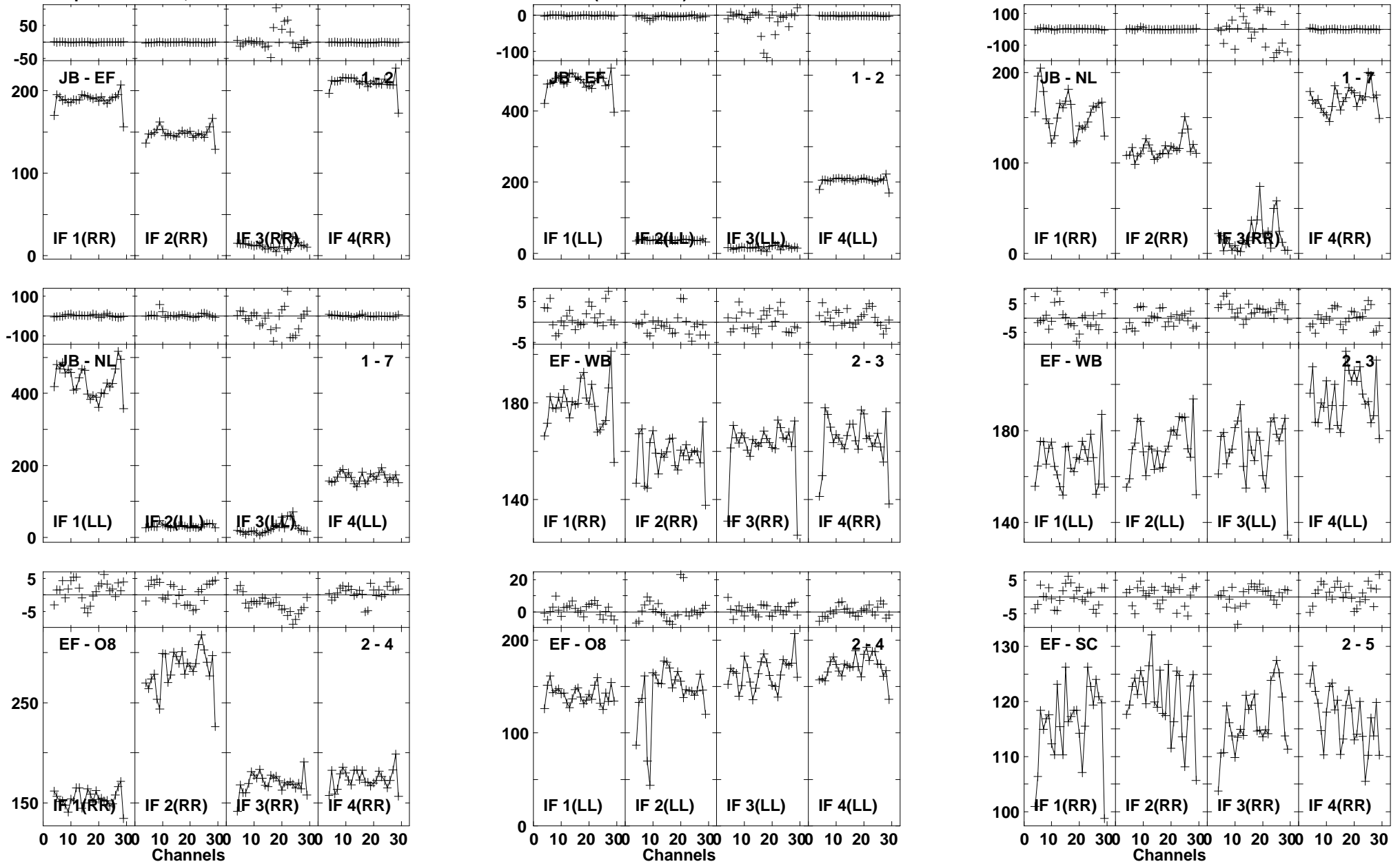

Lower frame: Milli Ampl Jy Top frame: Phas deg
Vector averaged cross-power spectrum Baseline: JB (01) - EF (02)
Timerange: 00/15:35:51 to 00/15:37:49

Plot file version 13 created 03-MAR-2016 01:11:59

J1545+5400 GN002C 1.UVDATA.1

Freq = 1.2770 GHz, Bw = 16.000 MH Calibrated with CL # 3 and BP # 1 (BP mode 1)

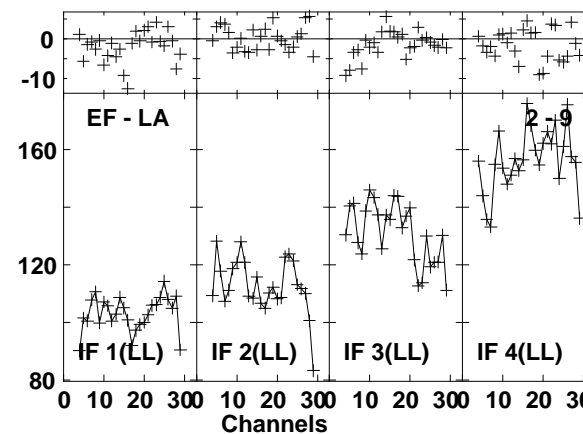
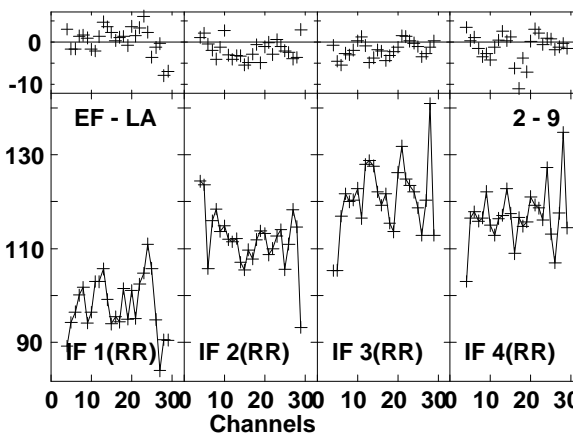
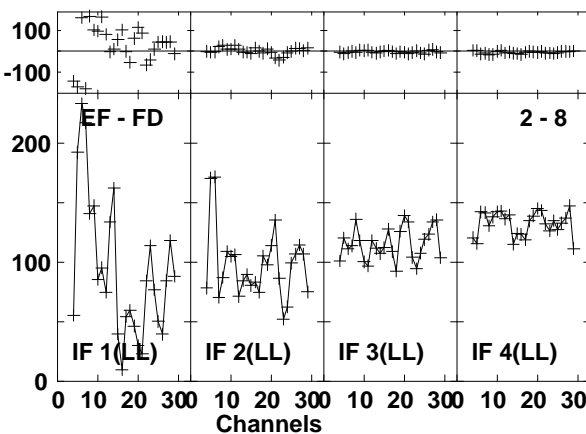
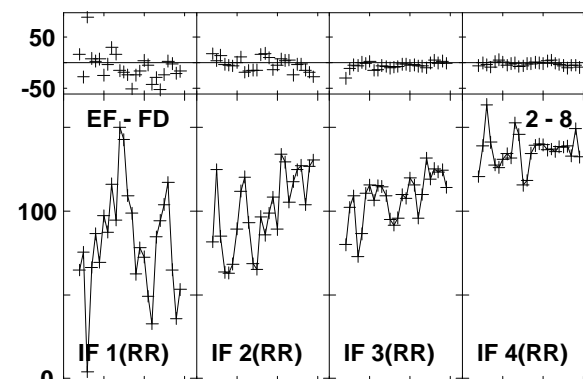
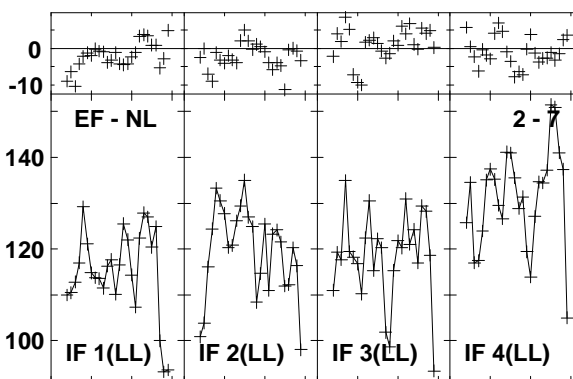
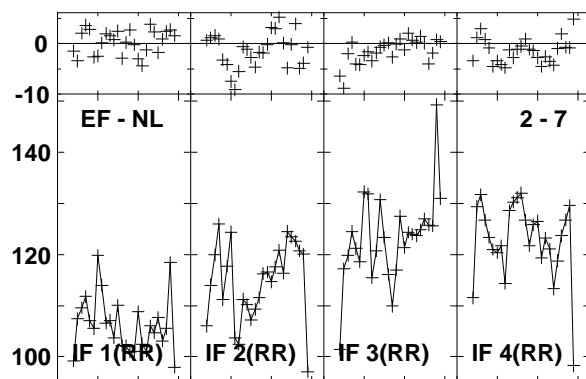
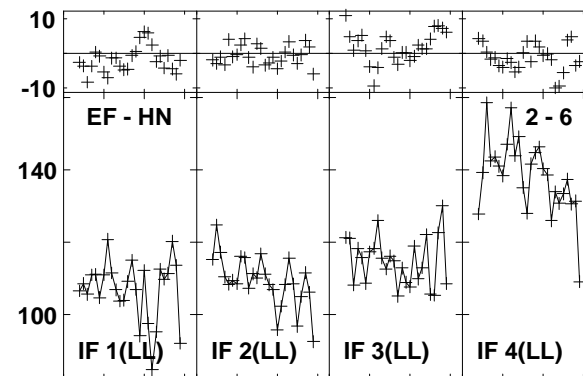
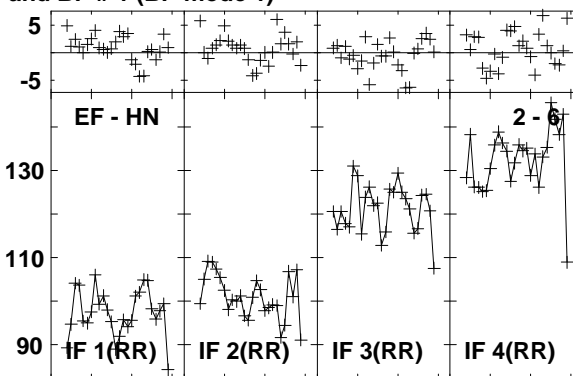
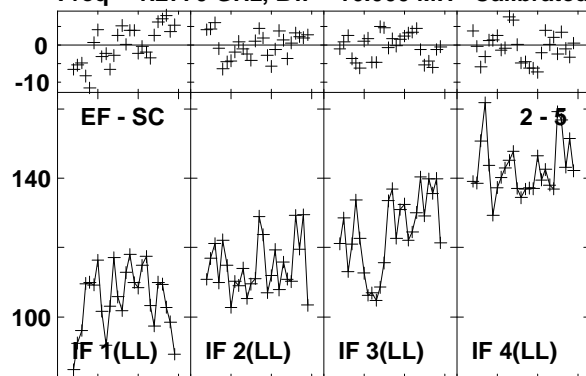

Lower frame: Milli Ampl Jy Top frame: Phas deg
Vector averaged cross-power spectrum Baseline: EF (02) - SC (05)
Timerange: 00/15:35:51 to 00/15:37:49

Plot file version 14 created 03-MAR-2016 01:11:59

J1545+5400 GN002C 1.UVDATA.1

Freq = 1.2770 GHz, Bw = 16.000 MH Calibrated with CL # 3 and BP # 1 (BP mode 1)

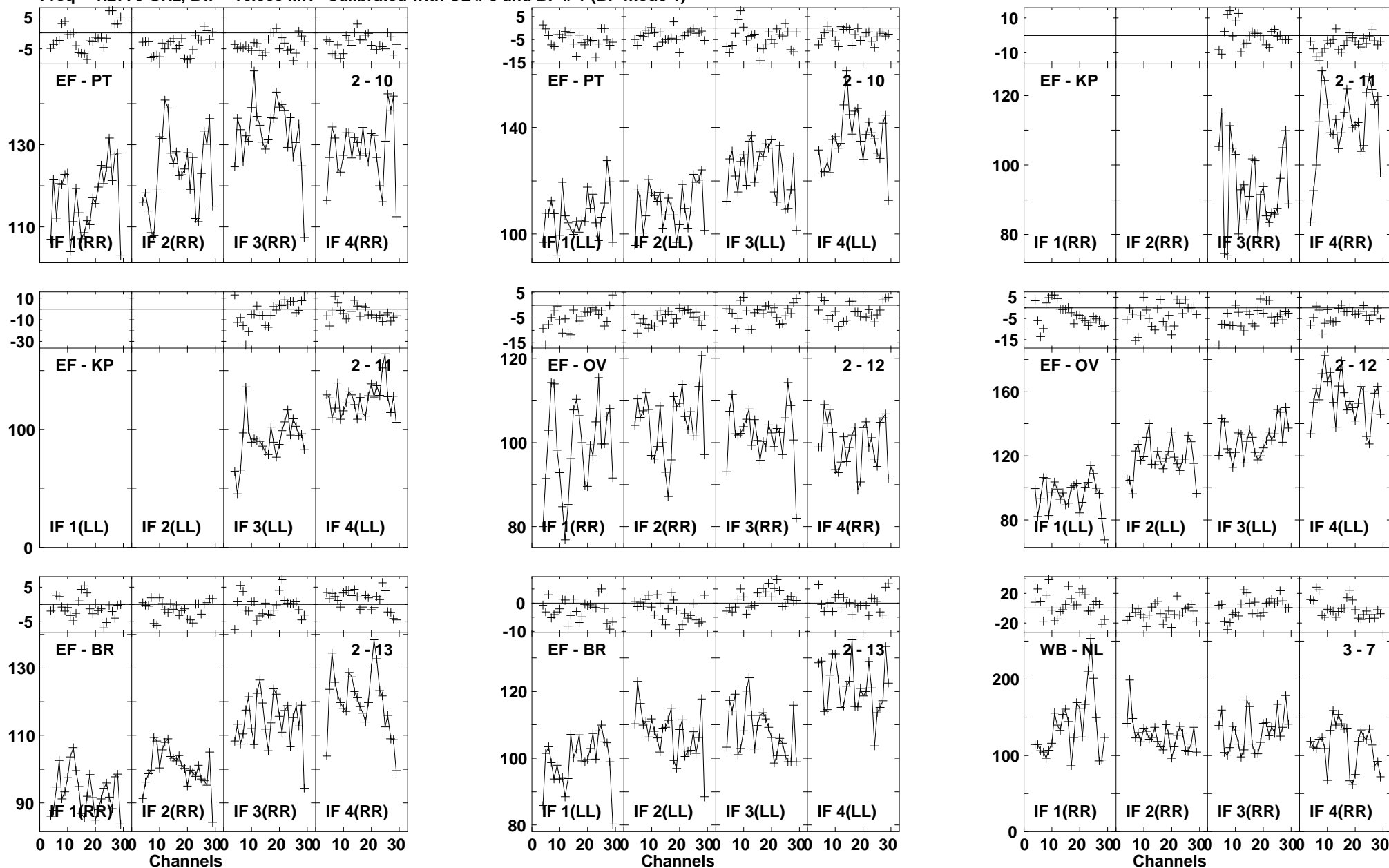

Lower frame: Milli Ampl Jy Top frame: Phas deg
Vector averaged cross-power spectrum Baseline: EF (02) - PT (10)
Timerange: 00/15:35:51 to 00/15:37:49

Plot file version 15 created 03-MAR-2016 01:11:59

J1545+5400 GN002C 1.UVDATA.1

Freq = 1.2770 GHz, Bw = 16.000 MH Calibrated with CL # 3 and BP # 1 (BP mode 1)

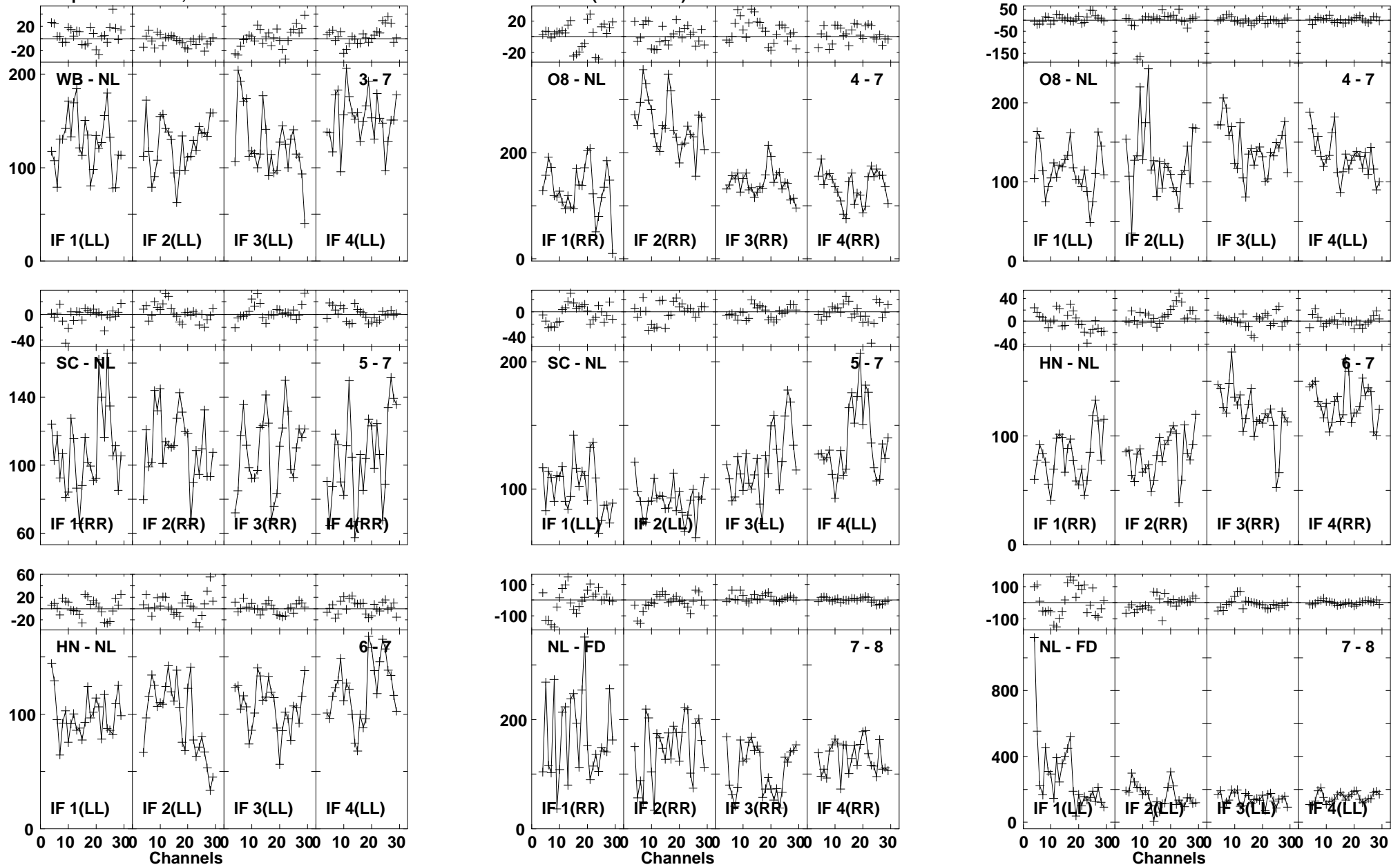

Lower frame: Milli Ampl Jy Top frame: Phas deg
Vector averaged cross-power spectrum Baseline: WB (03) - NL (07)
Timerange: 00/15:35:51 to 00/15:37:49

Plot file version 16 created 03-MAR-2016 01:11:59

J1545+5400 GN002C 1.UVDATA.1

Freq = 1.2770 GHz, Bw = 16.000 MH Calibrated with CL # 3 and BP # 1 (BP mode 1)

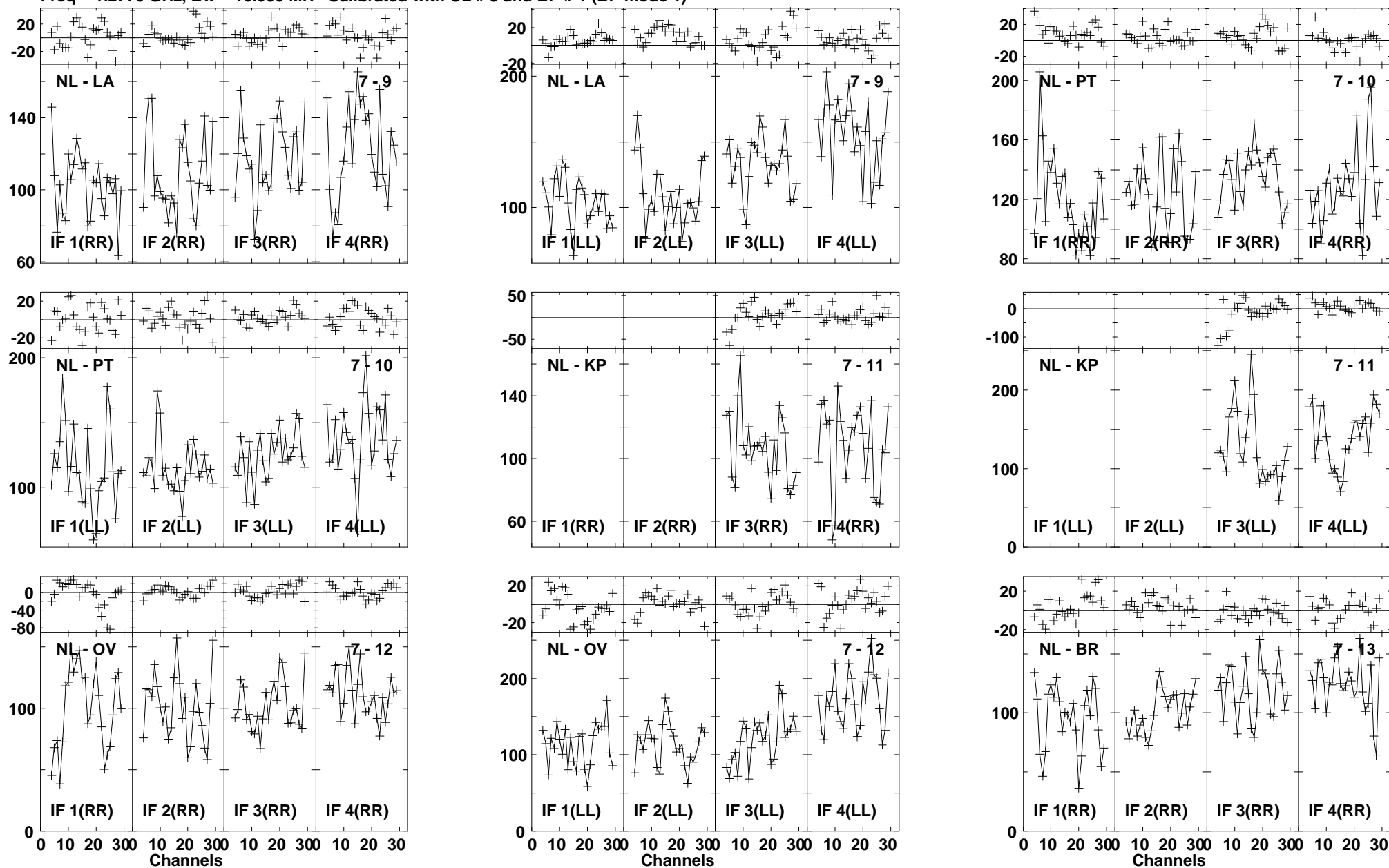

Lower frame: Milli Ampl Jy Top frame: Phas deg
Vector averaged cross-power spectrum Baseline: NL (07) - LA (09)
Timerange: 00/15:35:51 to 00/15:37:49

Plot file version 17 created 03-MAR-2016 01:11:59

J1545+5400 GN002C 1.UVDATA.1

Freq = 1.2770 GHz, Bw = 16.000 MH Calibrated with CL # 3 and BP # 1 (BP mode 1)

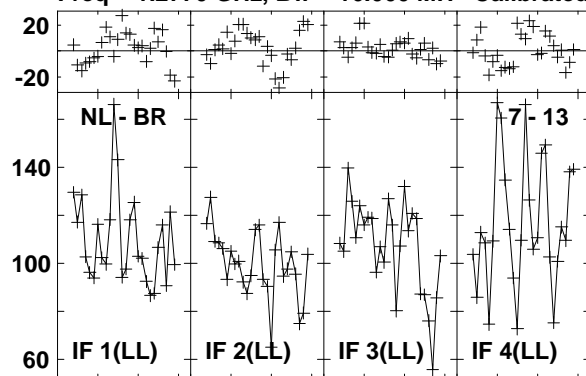

Lower frame: Milli Ampl Jy Top frame: Phas deg
Vector averaged cross-power spectrum Baseline: NL (07) - BR (13)
Timerange: 00/15:35:51 to 00/15:37:49

Plot file version 18 created 03-MAR-2016 01:11:59

4C52 GN002C 1.UVDATA.1

Freq = 1.2770 GHz, Bw = 16.000 MH Calibrated with CL # 3 and BP # 1 (BP mode 1)

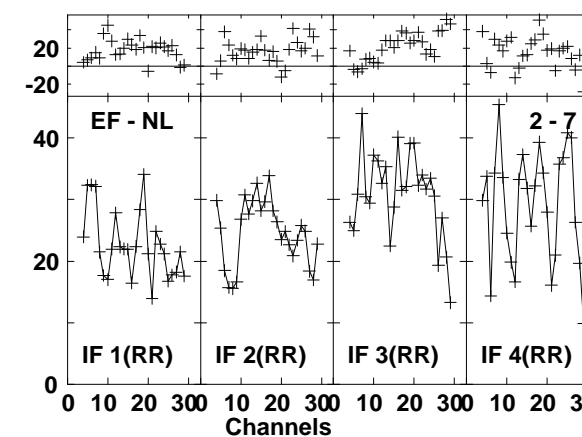
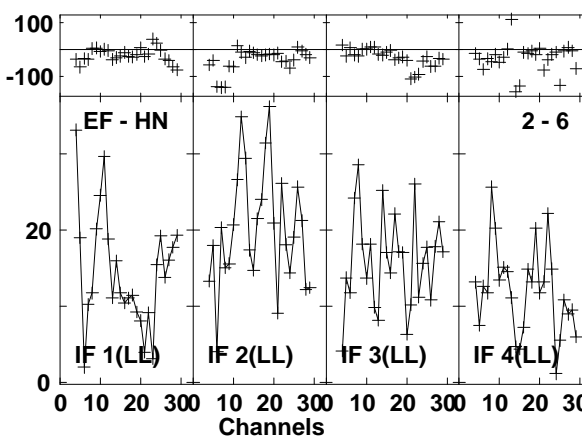
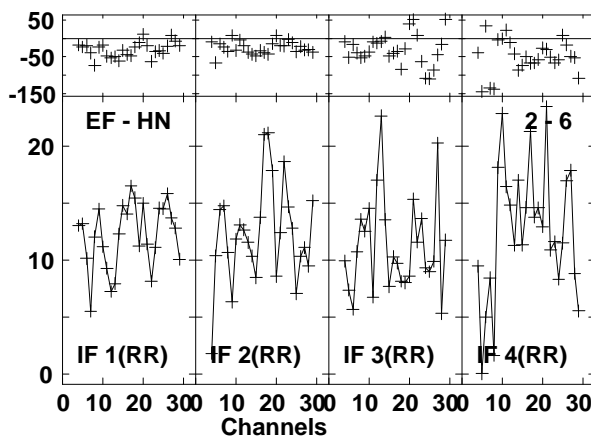
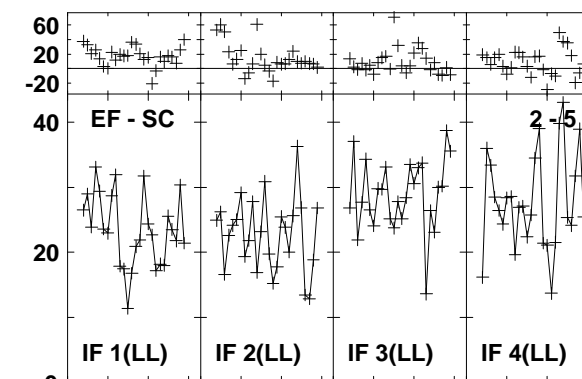
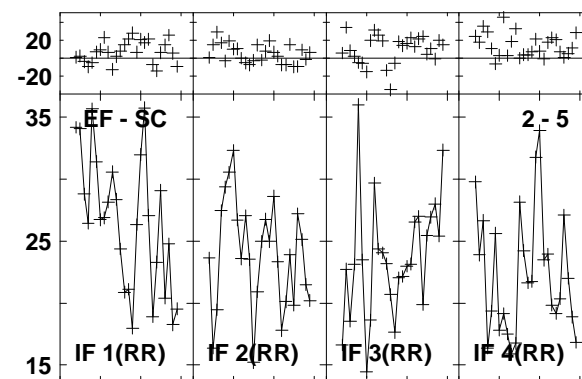
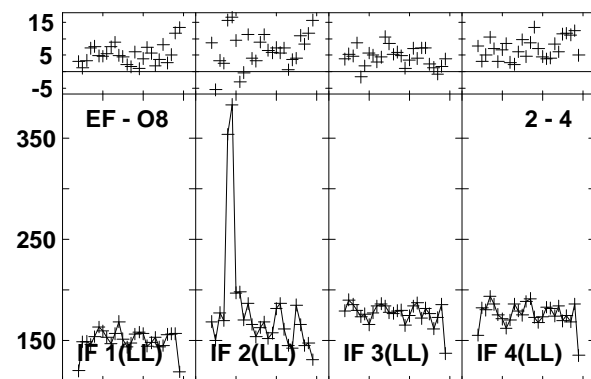
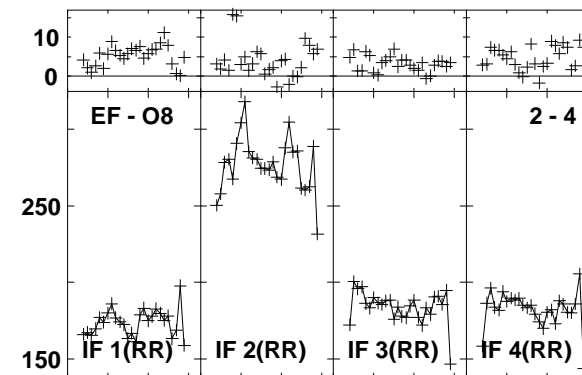
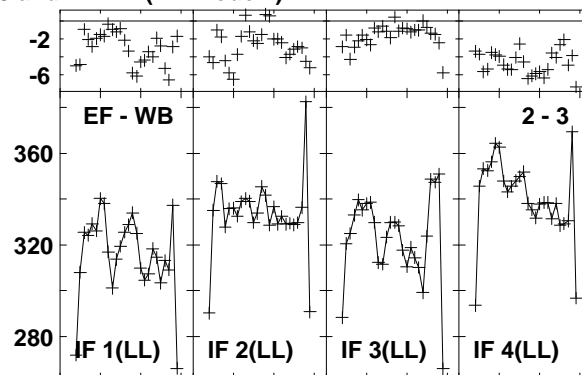
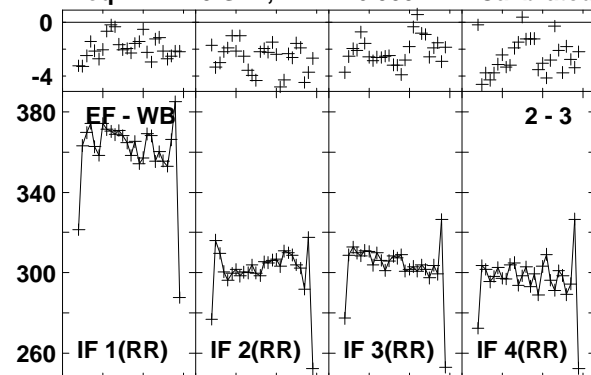

Lower frame: Milli Ampl Jy Top frame: Phas deg
Vector averaged cross-power spectrum Baseline: EF (02) - WB (03)
Timerange: 00/15:38:02 to 00/15:40:48

Plot file version 19 created 03-MAR-2016 01:12:00

4C52 GN002C 1.UVDATA.1

Freq = 1.2770 GHz, Bw = 16.000 MH Calibrated with CL # 3 and BP # 1 (BP mode 1)

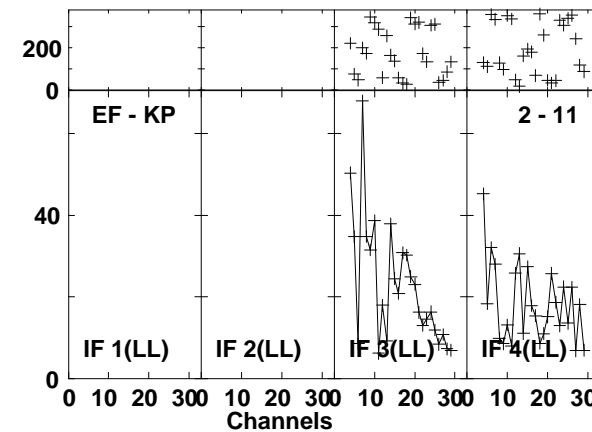
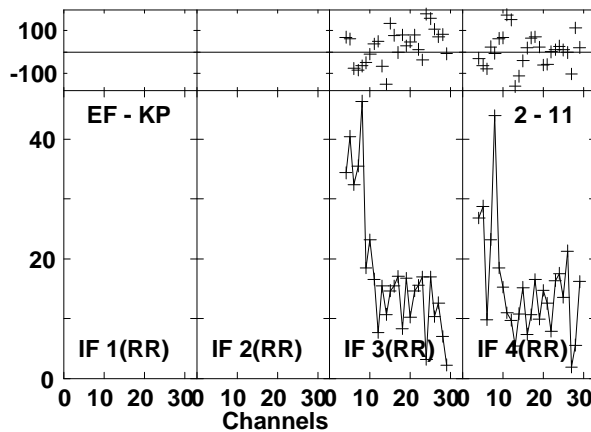
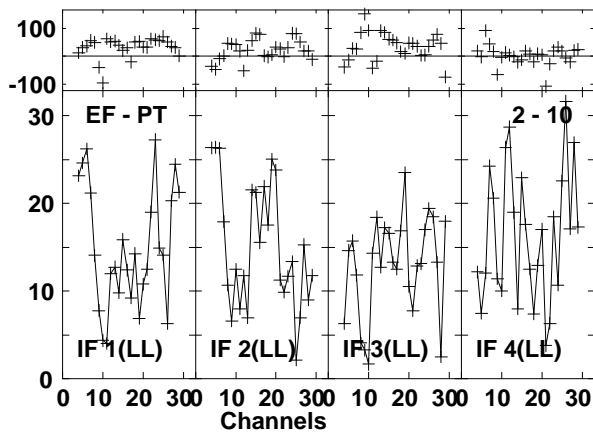
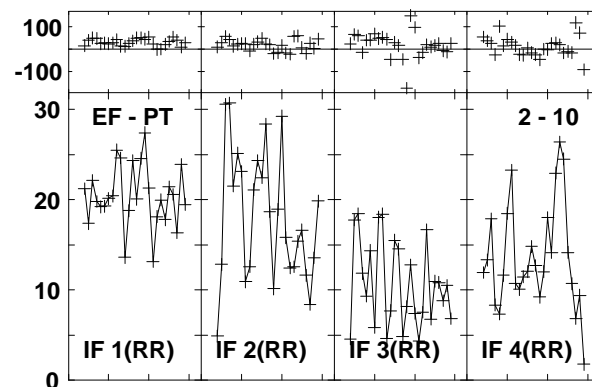
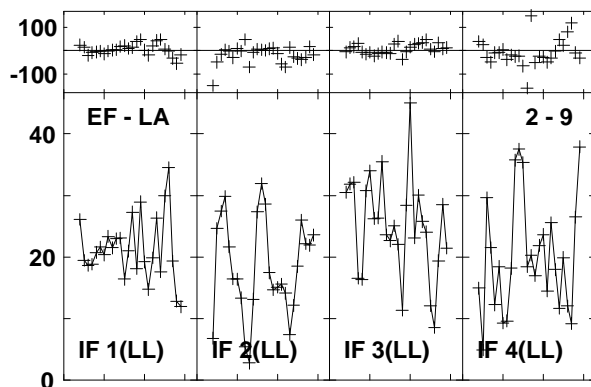
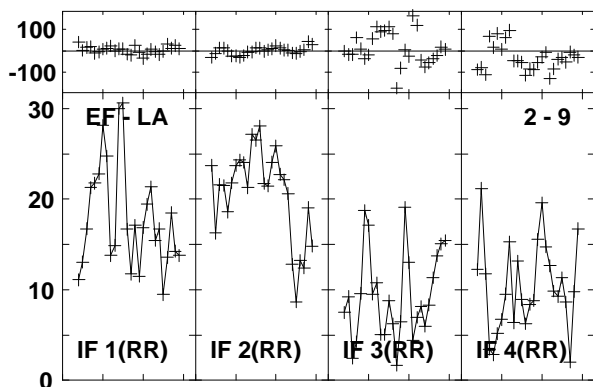
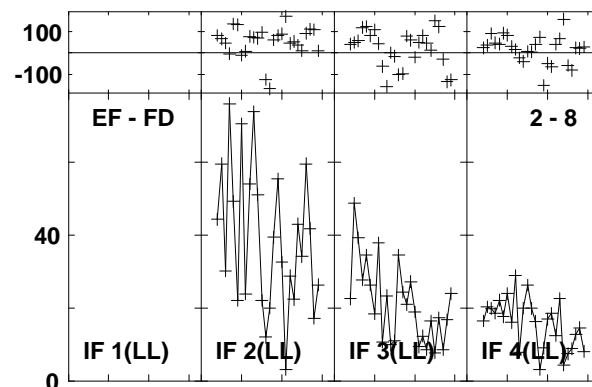
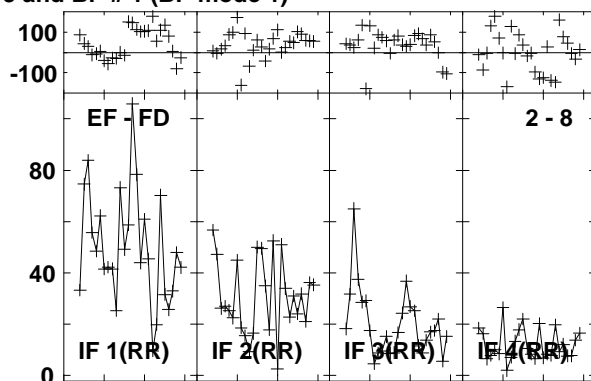
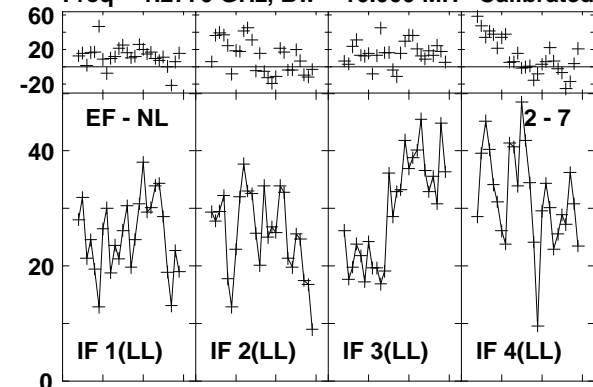

Lower frame: Milli Ampl Jy Top frame: Phas deg
Vector averaged cross-power spectrum Baseline: EF (02) - NL (07)
Timerange: 00/15:38:02 to 00/15:40:48

Plot file version 20 created 03-MAR-2016 01:12:00

4C52 GN002C 1.UVDATA.1

Freq = 1.2770 GHz, Bw = 16.000 MH Calibrated with CL # 3 and BP # 1 (BP mode 1)

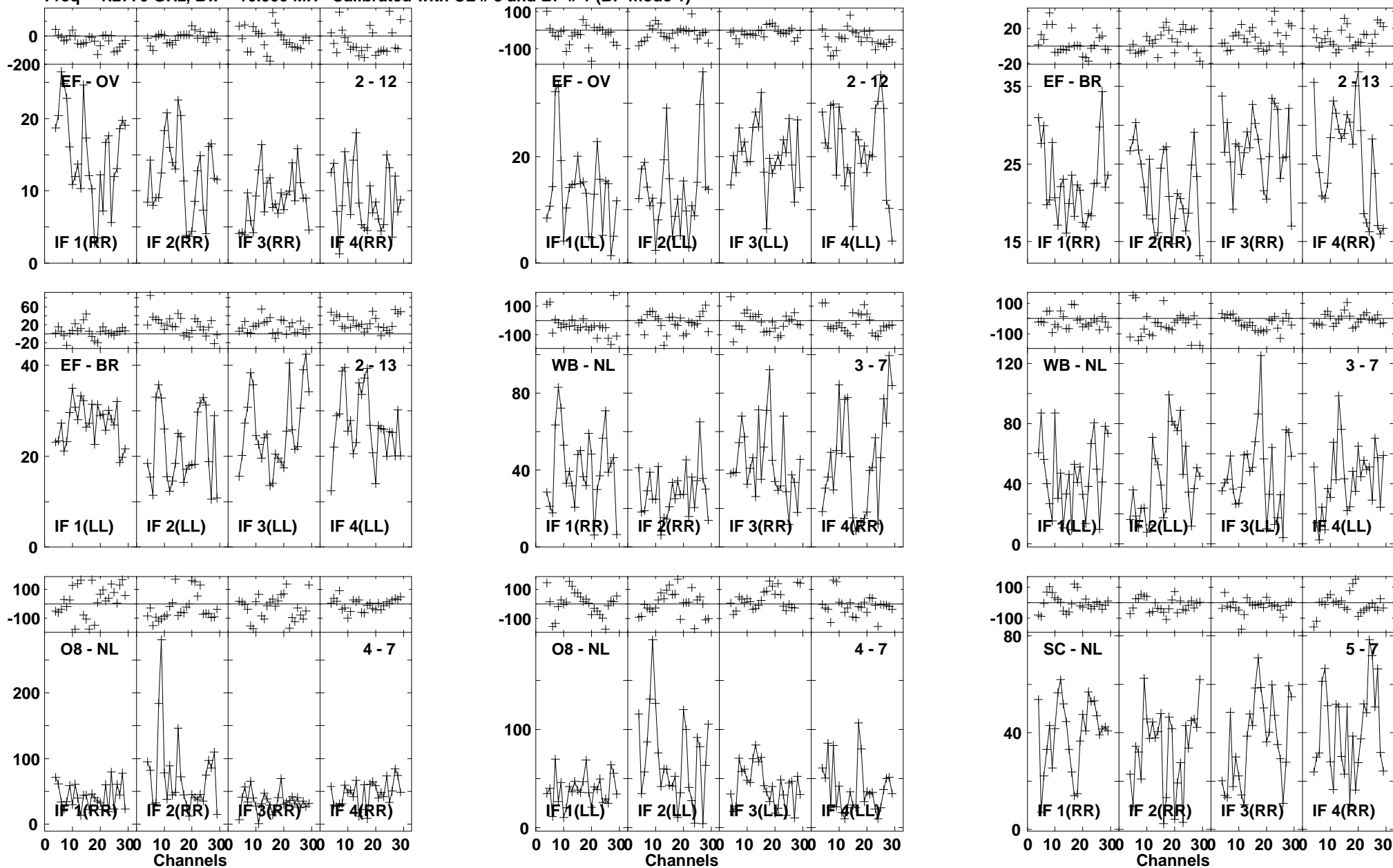

Lower frame: Milli Ampl Jy Top frame: Phas deg
Vector averaged cross-power spectrum Baseline: EF (02) - OV (12)
Timerange: 00/15:38:02 to 00/15:40:48

Plot file version 21 created 03-MAR-2016 01:12:00

4C52 GN002C 1.UVDATA.1

Freq = 1.2770 GHz, Bw = 16.000 MH Calibrated with CL # 3 and BP # 1 (BP mode 1)

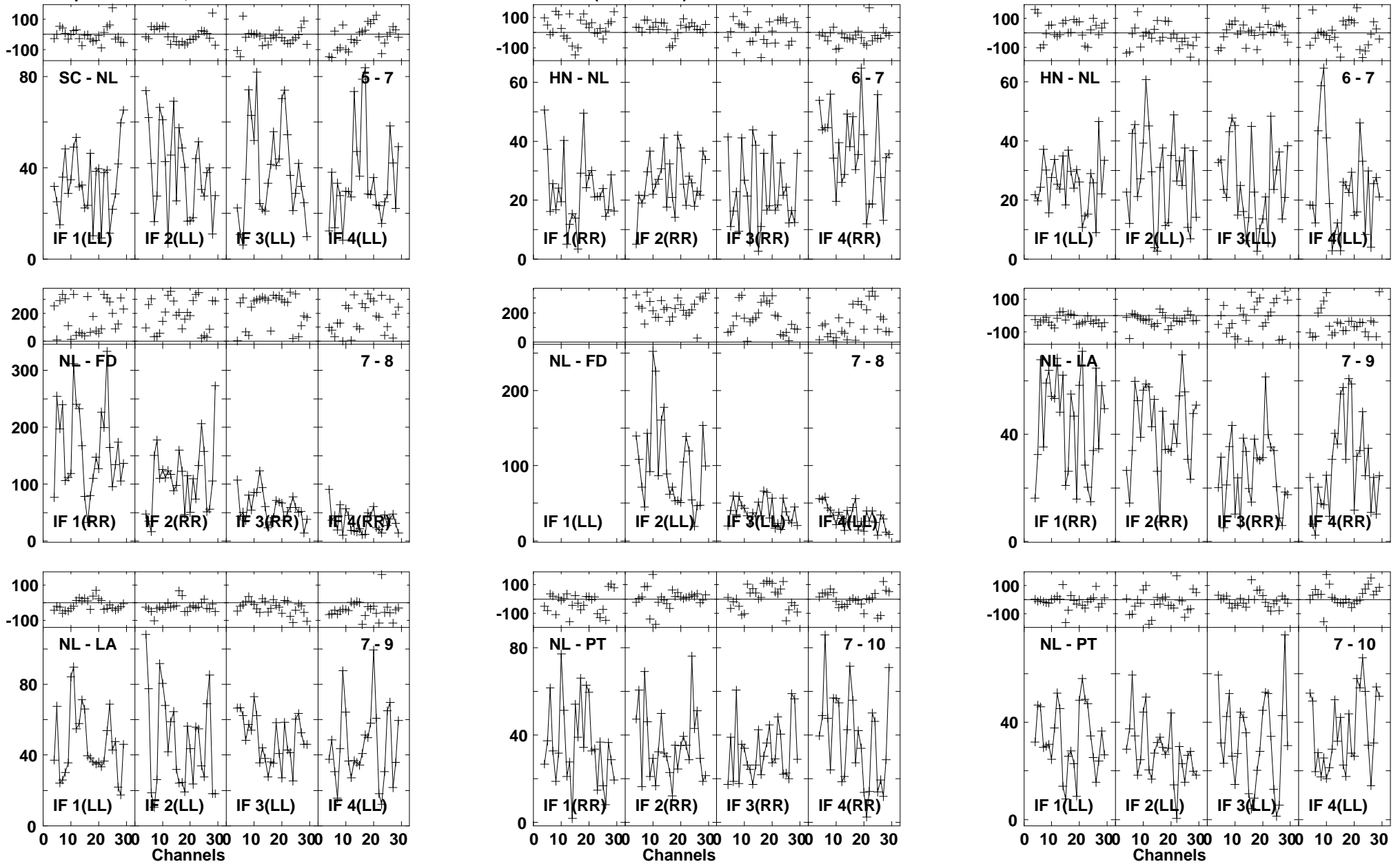

Lower frame: Milli Ampl Jy Top frame: Phas deg
Vector averaged cross-power spectrum Baseline: SC (05) - NL (07)
Timerange: 00/15:38:02 to 00/15:40:48

Plot file version 22 created 03-MAR-2016 01:12:00
 4C52 GN002C 1.UVDATA.1
 Freq = 1.2770 GHz, Bw = 16.000 MH Calibrated with CL # 3 and BP # 1 (BP mode 1)

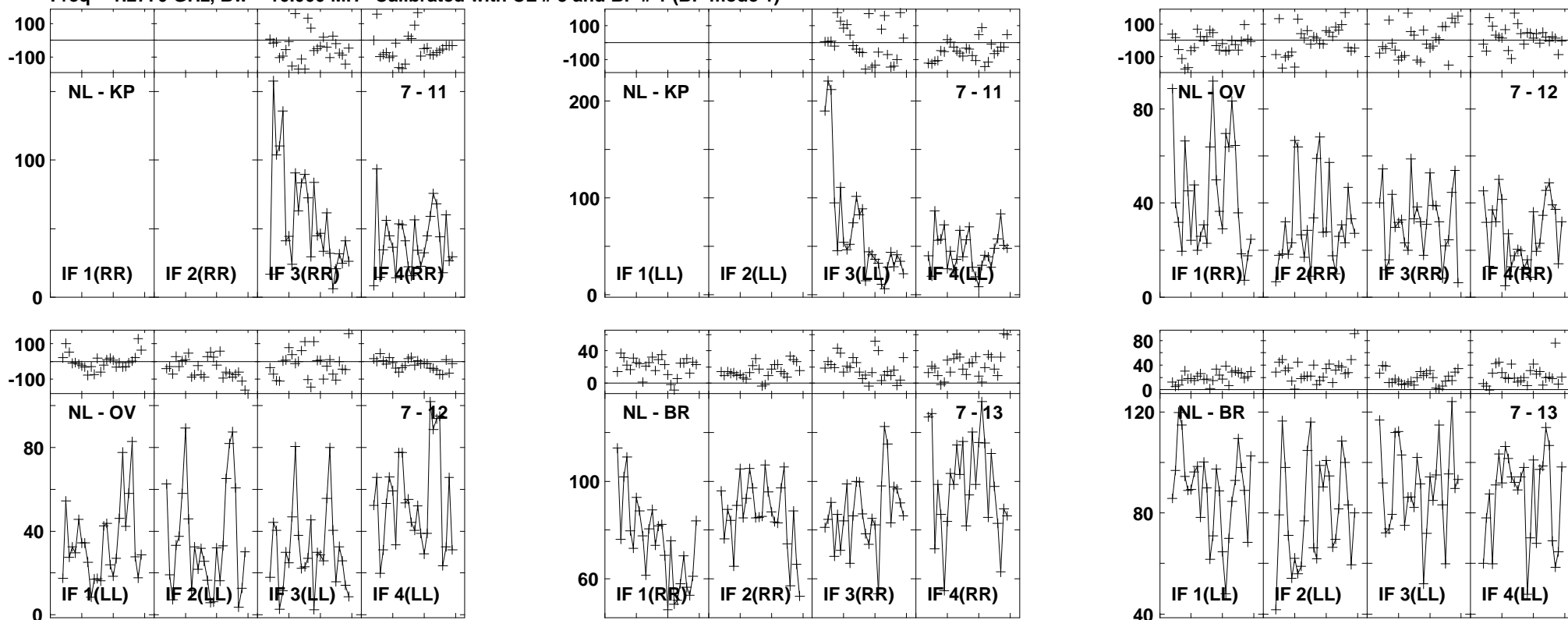

Lower frame: Milli Ampl Jy Top frame: Phas deg
 Vector averaged cross-power spectrum Baseline: NL (07) - KP (11)
 Timerange: 00/15:38:02 to 00/15:40:48

Plot file version 23 created 03-MAR-2016 01:12:00
 J1545+5400 GN002C 1.UVDATA.1
 Freq = 1.2770 GHz, Bw = 16.000 MH Calibrated with CL # 3 and BP # 1 (BP mode 1)

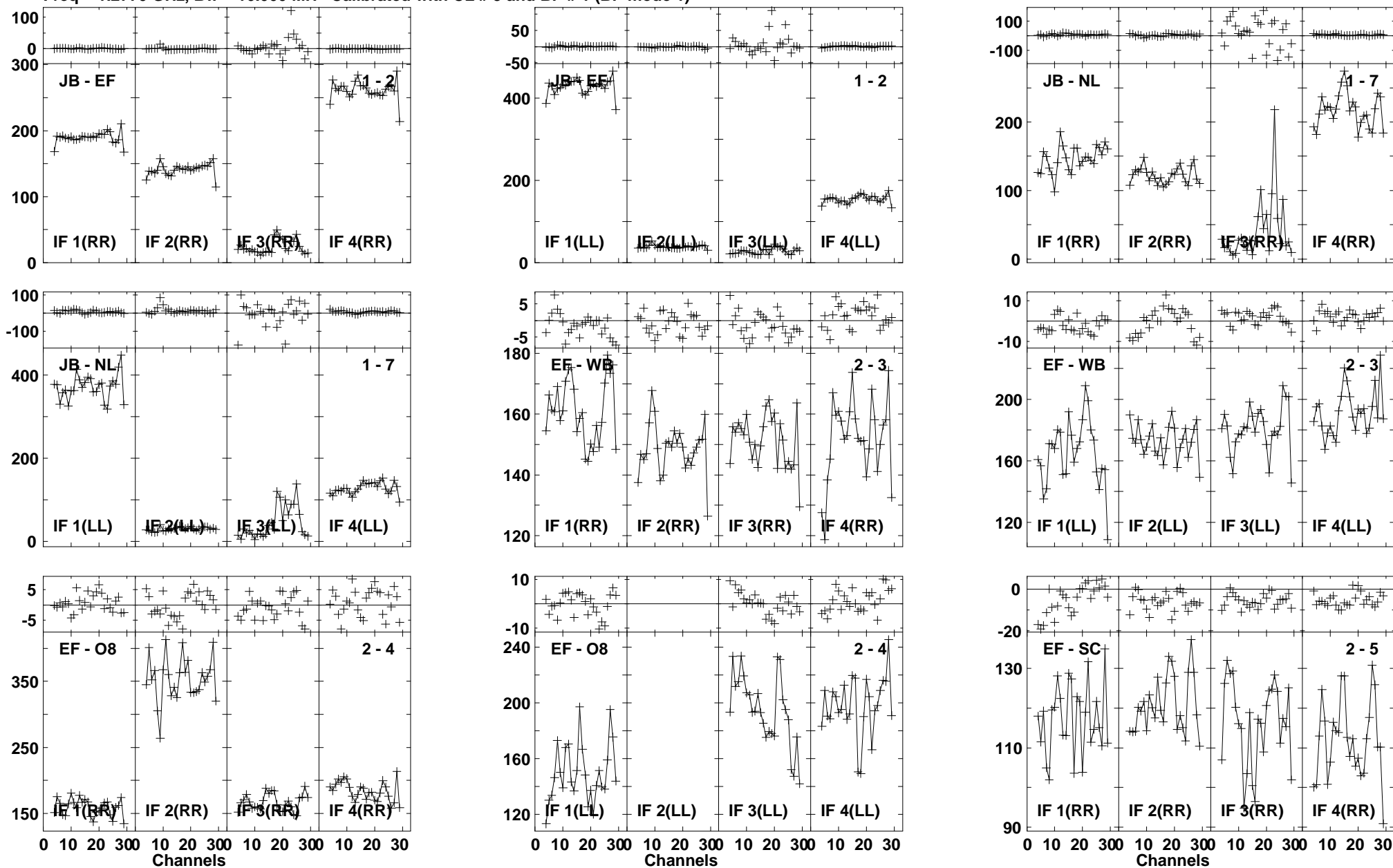

Lower frame: Milli Ampl Jy Top frame: Phas deg
 Vector averaged cross-power spectrum Baseline: JB (01) - EF (02)
 Timerange: 00/15:41:41 to 00/15:42:39

Plot file version 24 created 03-MAR-2016 01:12:00
 J1545+5400 GN002C 1.UVDATA.1
 Freq = 1.2770 GHz, Bw = 16.000 MH Calibrated with CL # 3 and BP # 1 (BP mode 1)

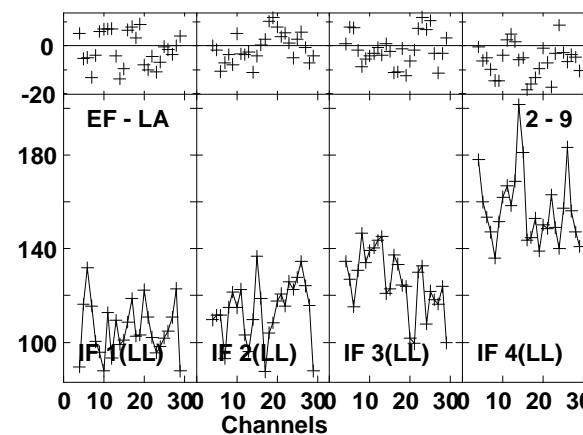
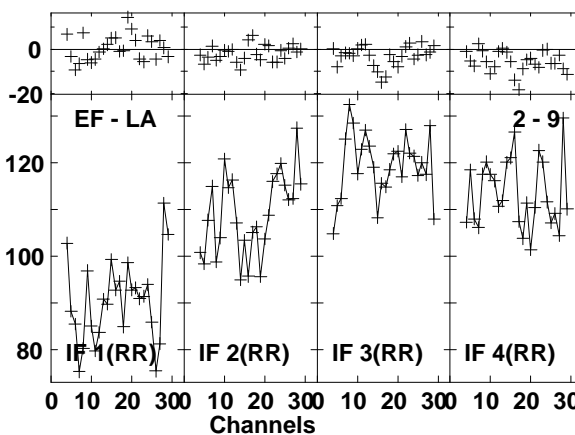
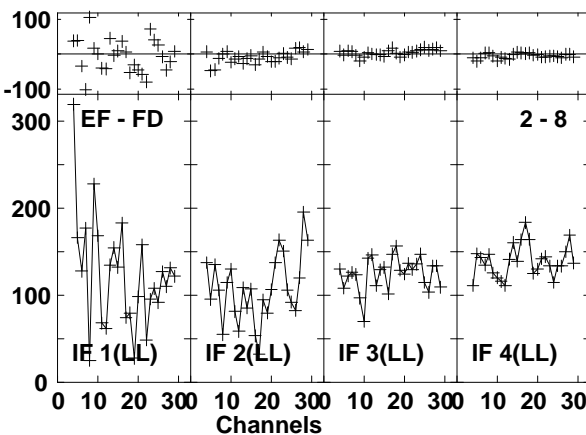
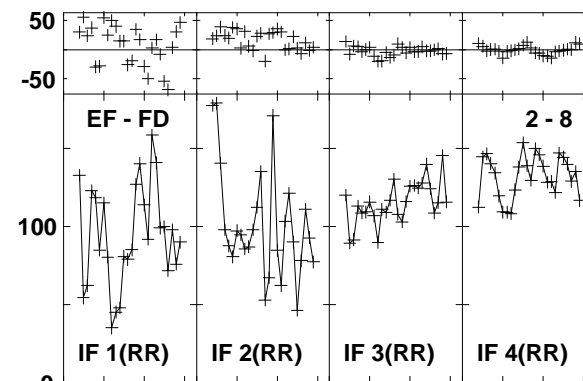
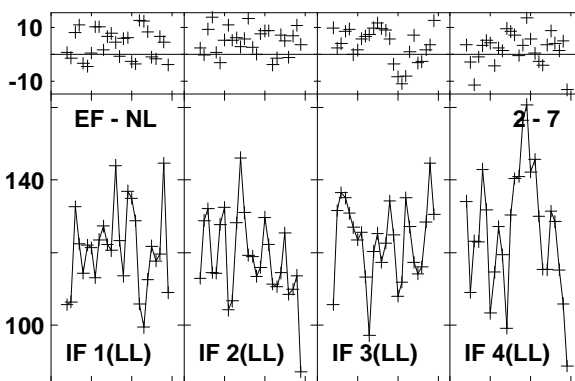
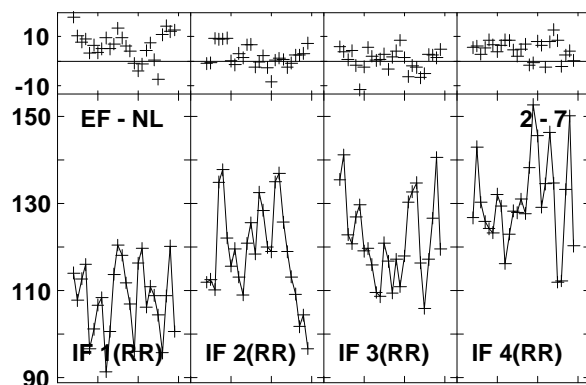
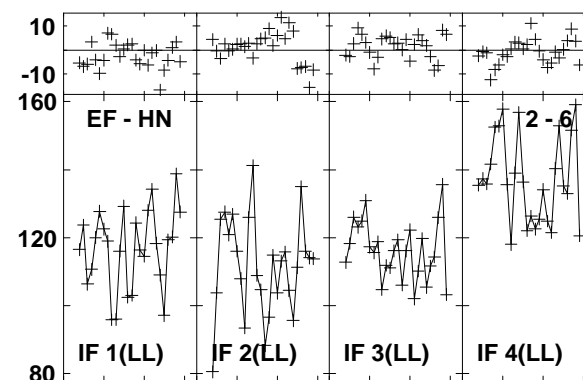
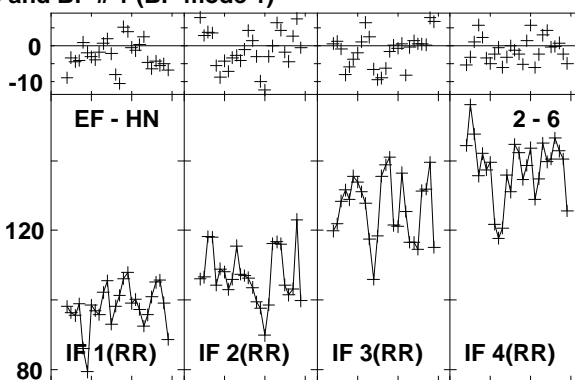
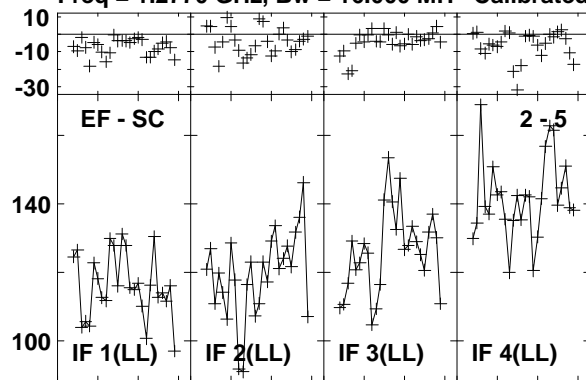

Lower frame: Milli Ampl Jy Top frame: Phas deg
 Vector averaged cross-power spectrum Baseline: EF (02) - SC (05)
 Timerange: 00/15:41:41 to 00/15:42:39

Plot file version 25 created 03-MAR-2016 01:12:01

J1545+5400 GN002C 1.UVDATA.1

Freq = 1.2770 GHz, Bw = 16.000 MH Calibrated with CL # 3 and BP # 1 (BP mode 1)

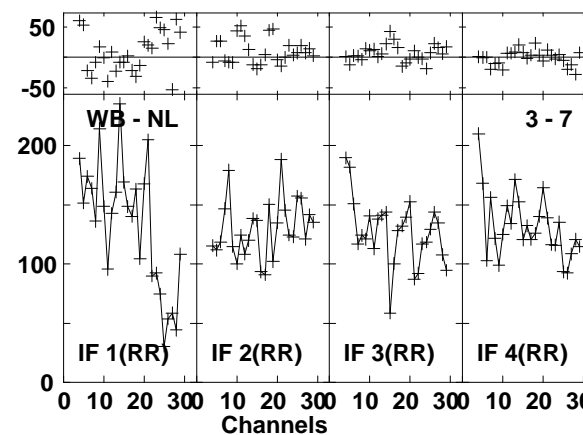
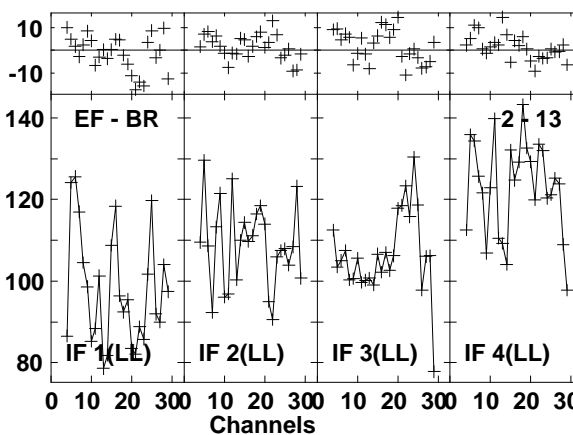
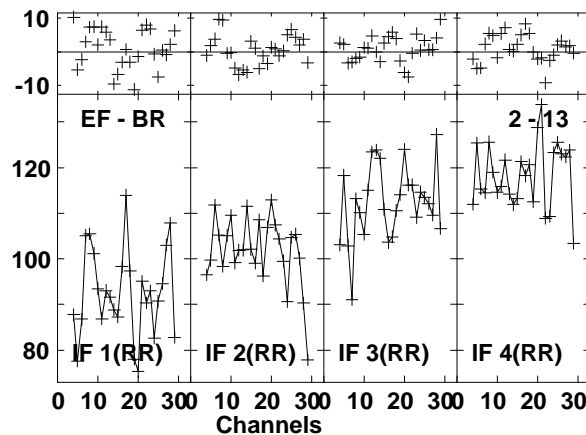
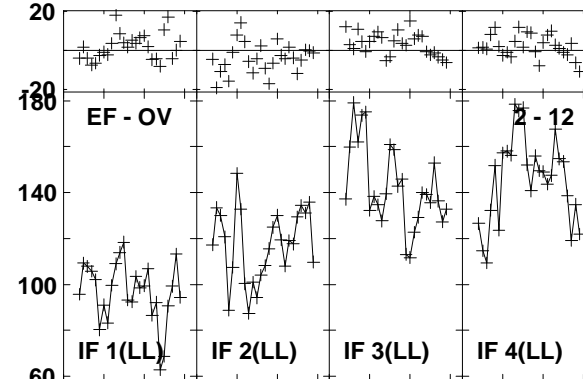
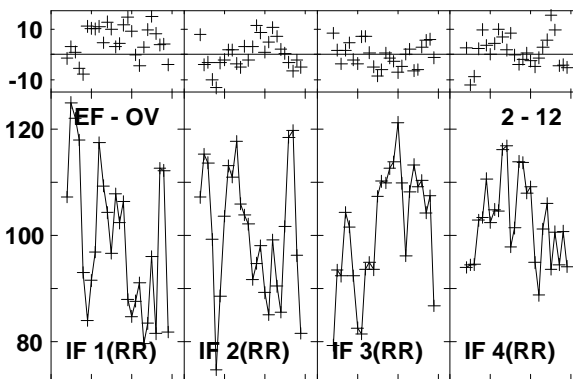
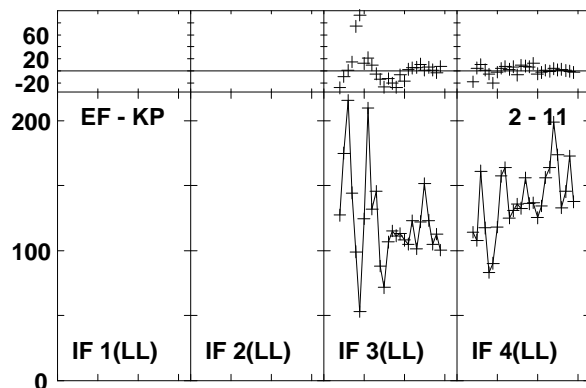
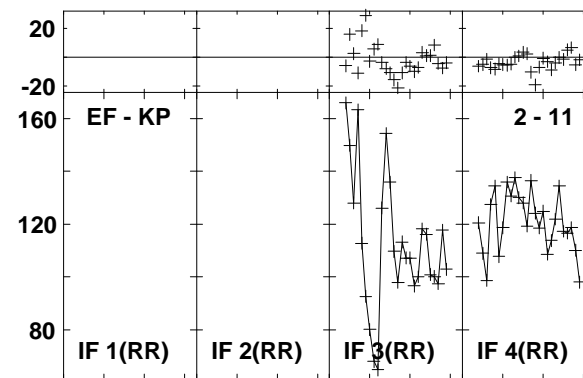
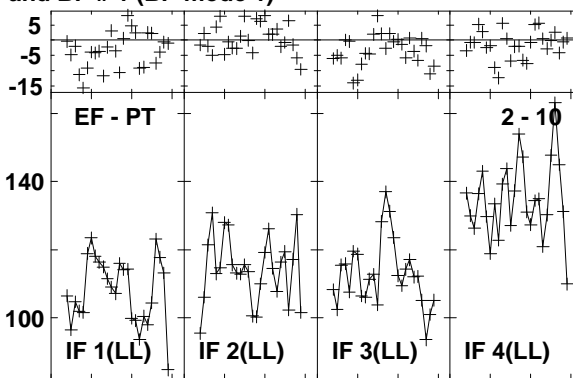
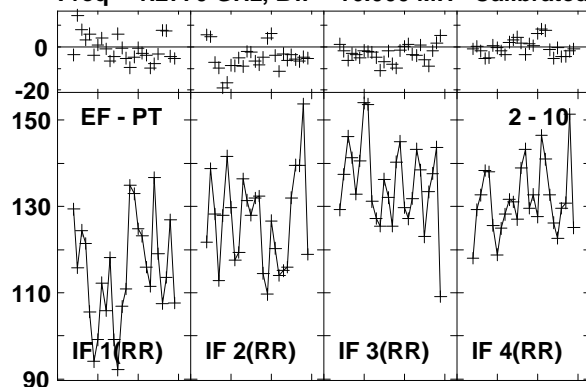

Lower frame: Milli Ampl Jy Top frame: Phas deg
Vector averaged cross-power spectrum Baseline: EF (02) - PT (10)
Timerange: 00/15:41:41 to 00/15:42:39

Plot file version 26 created 03-MAR-2016 01:12:01
 J1545+5400 GN002C 1.UVDATA.1
 Freq = 1.2770 GHz, Bw = 16.000 MH Calibrated with CL # 3 and BP # 1 (BP mode 1)

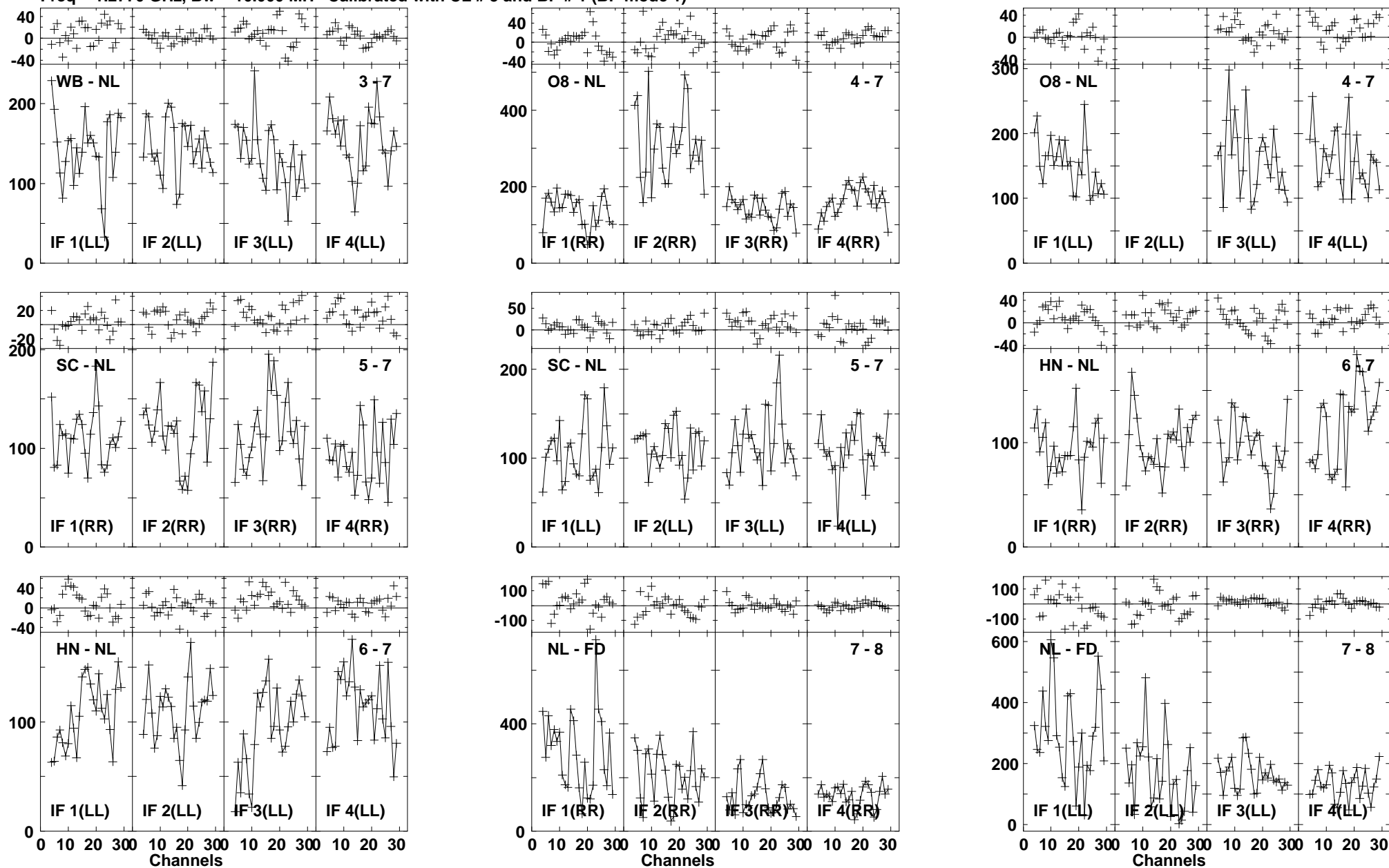

Lower frame: Milli Ampl Jy Top frame: Phas deg
 Vector averaged cross-power spectrum Baseline: WB (03) - NL (07)
 Timerange: 00/15:41:41 to 00/15:42:39

Plot file version 27 created 03-MAR-2016 01:12:01

J1545+5400 GN002C 1.UVDATA.1

Freq = 1.2770 GHz, Bw = 16.000 MH Calibrated with CL # 3 and BP # 1 (BP mode 1)

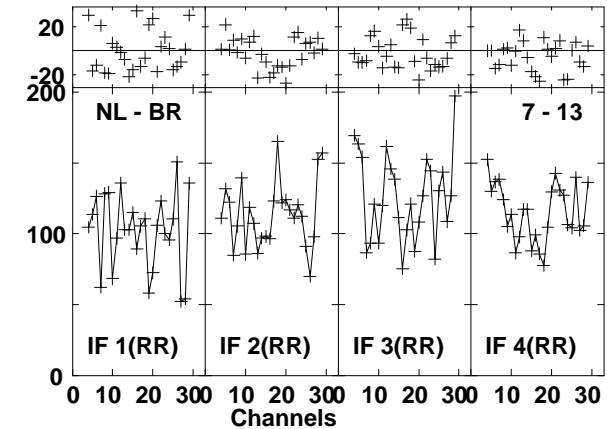
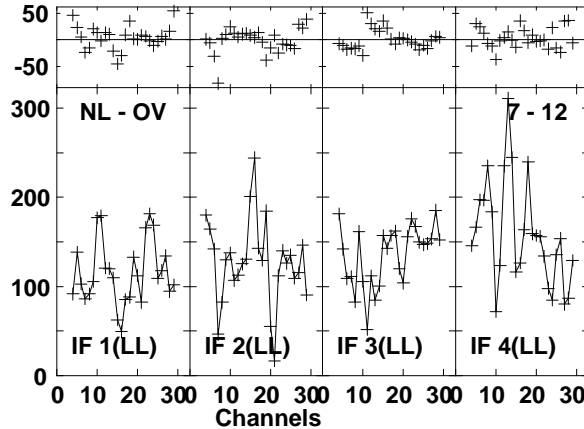
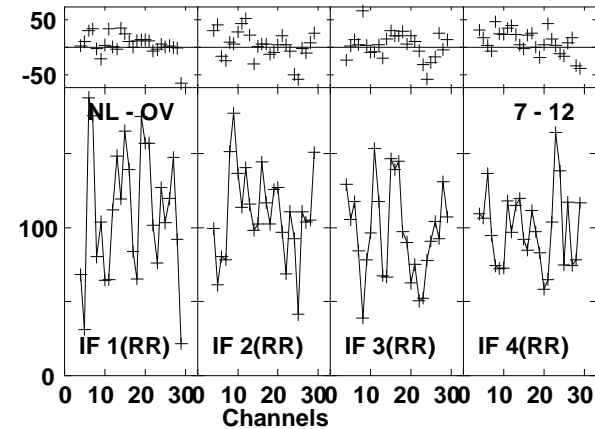
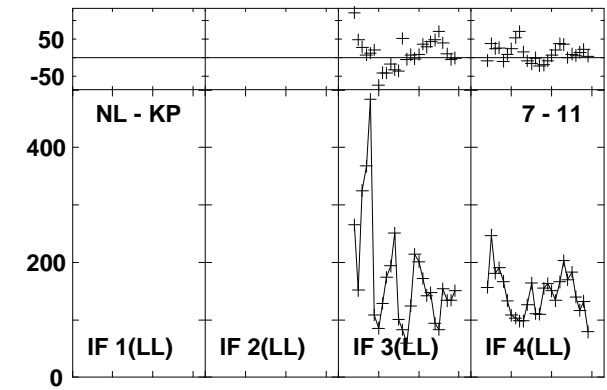
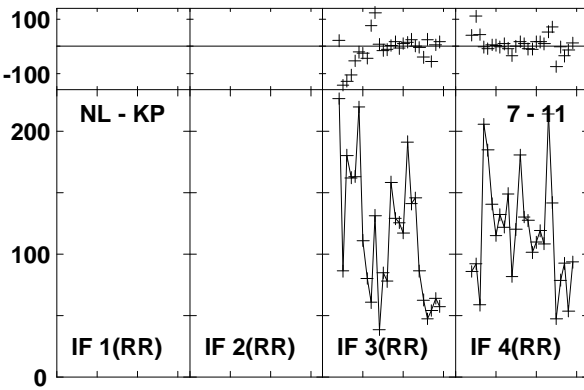
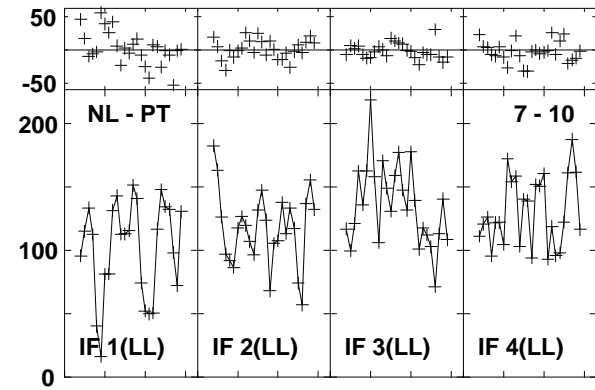
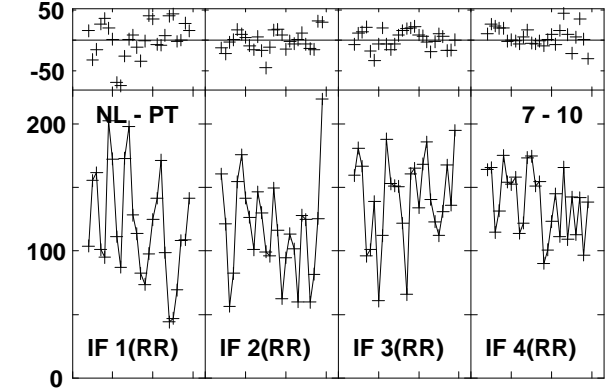
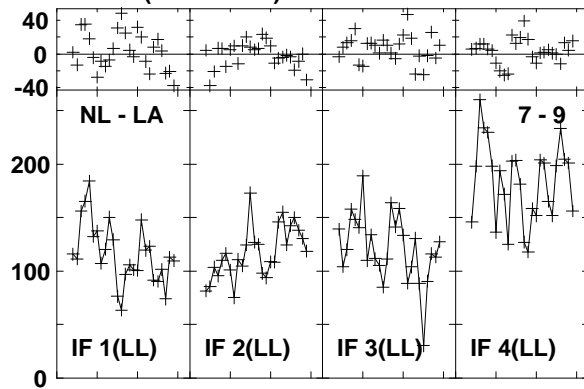
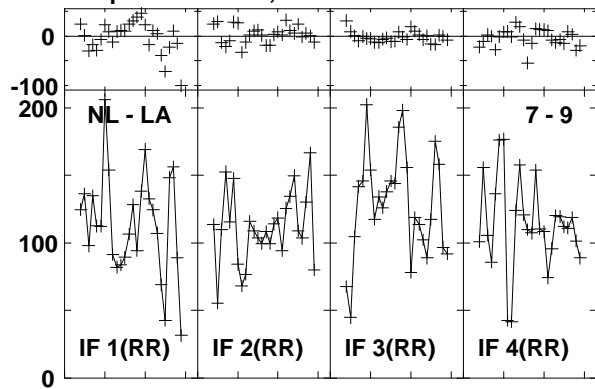

Lower frame: Milli Ampl Jy Top frame: Phas deg
Vector averaged cross-power spectrum Baseline: NL (07) - LA (09)
Timerange: 00/15:41:41 to 00/15:42:39

Plot file version 28 created 03-MAR-2016 01:12:01
J1545+5400 GN002C 1.UVDATA.1
Freq = 1.2770 GHz, Bw = 16.000 MH Calibrated with CL # 3 and BP # 1 (BP mode 1)

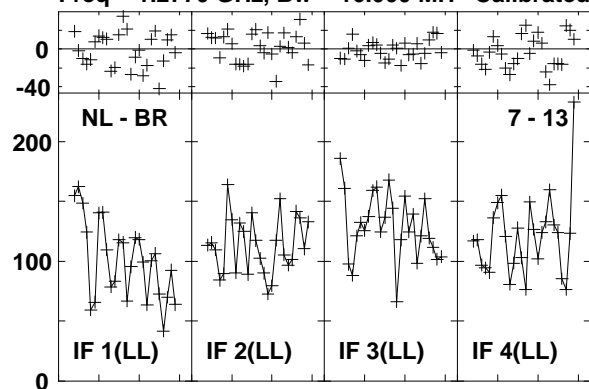

Lower frame: Milli Ampl Jy Top frame: Phas deg
Vector averaged cross-power spectrum Baseline: NL (07) - BR (13)
Timerange: 00/15:41:41 to 00/15:42:39

Plot file version 29 created 03-MAR-2016 01:12:01

4C52 GN002C 1.UVDATA.1

Freq = 1.2770 GHz, Bw = 16.000 MH Calibrated with CL # 3 and BP # 1 (BP mode 1)

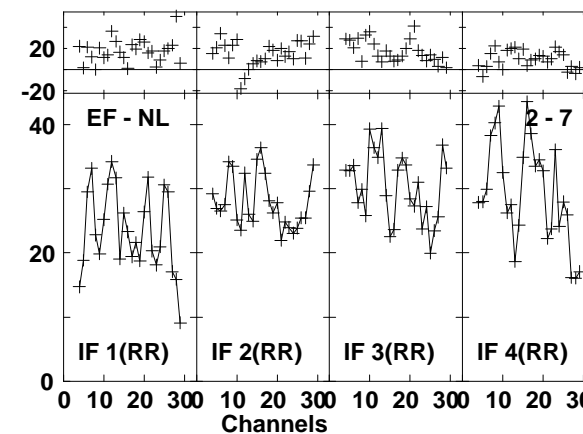
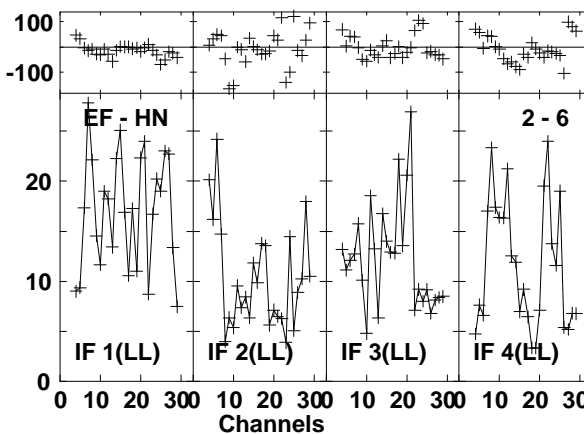
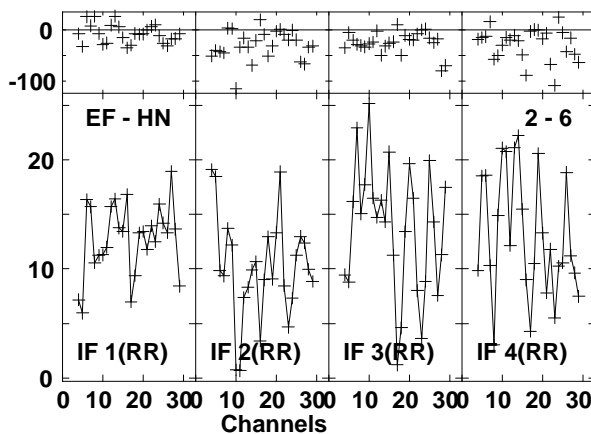
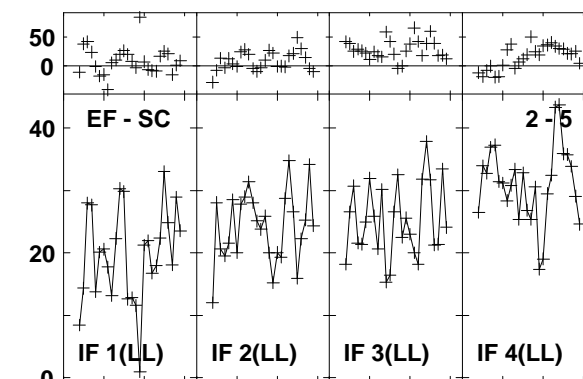
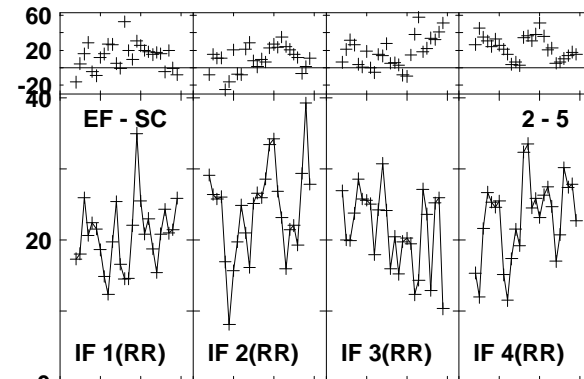
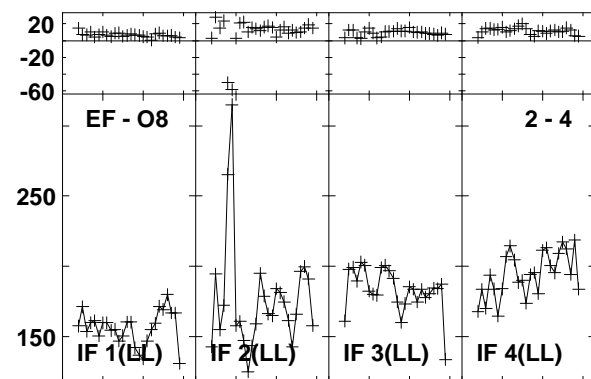
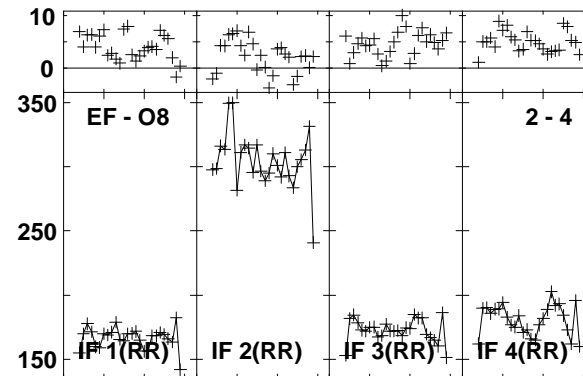
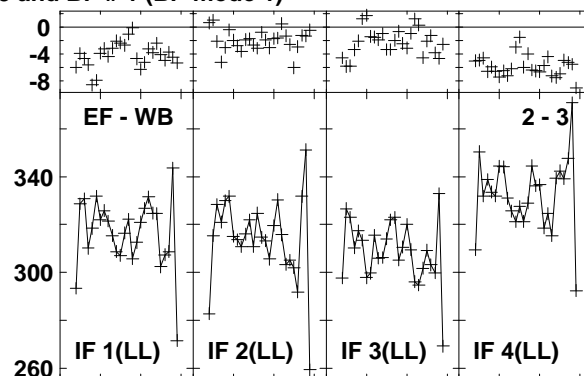
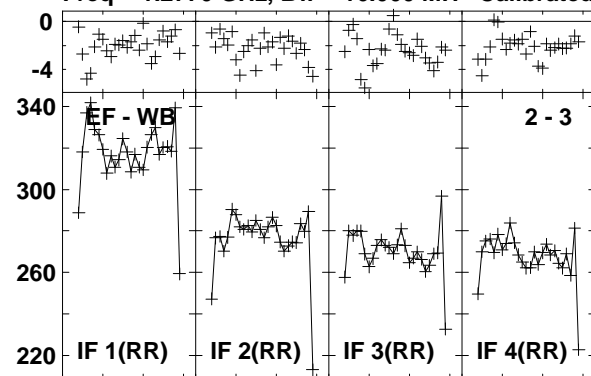

Lower frame: Milli Ampl Jy Top frame: Phas deg
Vector averaged cross-power spectrum Baseline: EF (02) - WB (03)
Timerange: 00/15:42:52 to 00/15:45:38

Plot file version 30 created 03-MAR-2016 01:12:02

4C52 GN002C 1.UVDATA.1

Freq = 1.2770 GHz, Bw = 16.000 MH Calibrated with CL # 3 and BP # 1 (BP mode 1)

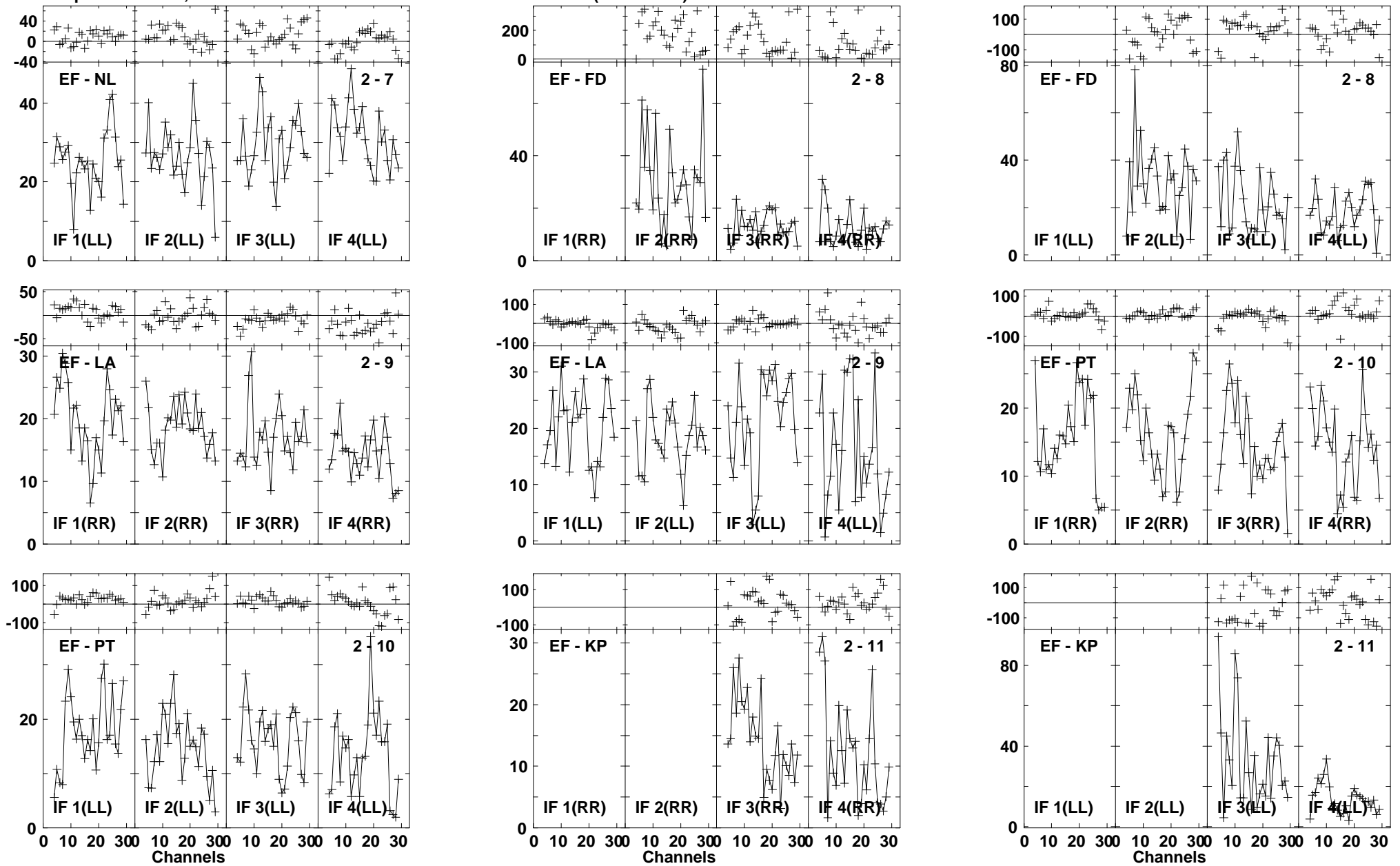

Lower frame: Milli Ampl Jy Top frame: Phas deg
Vector averaged cross-power spectrum Baseline: EF (02) - NL (07)
Timerange: 00/15:42:52 to 00/15:45:38

Plot file version 31 created 03-MAR-2016 01:12:02

4C52 GN002C 1.UVDATA.1

Freq = 1.2770 GHz, Bw = 16.000 MH Calibrated with CL # 3 and BP # 1 (BP mode 1)

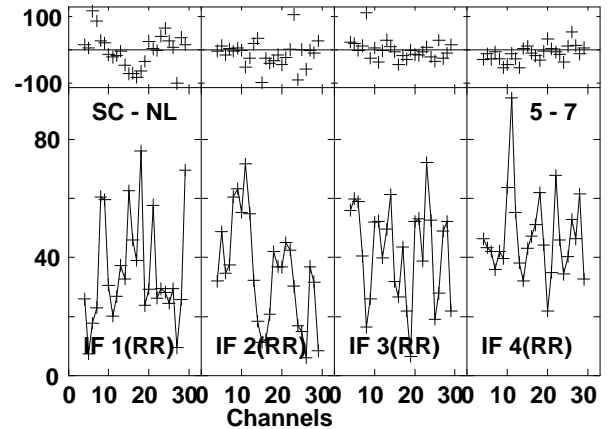
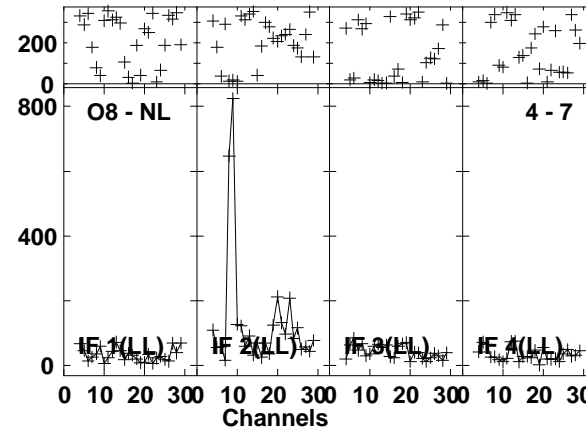
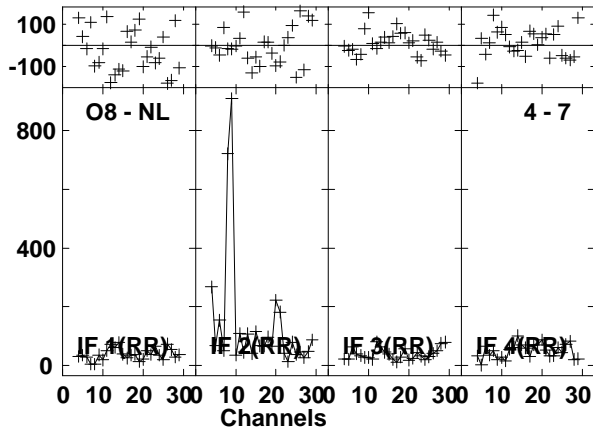
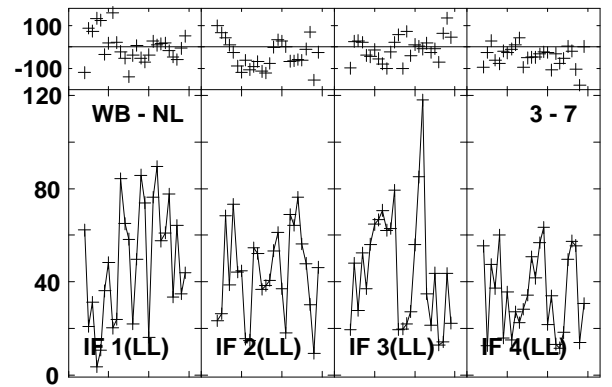
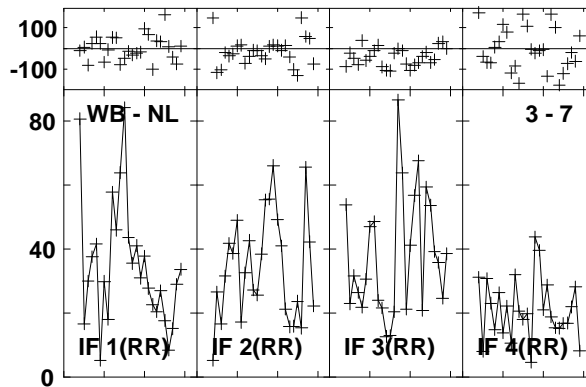
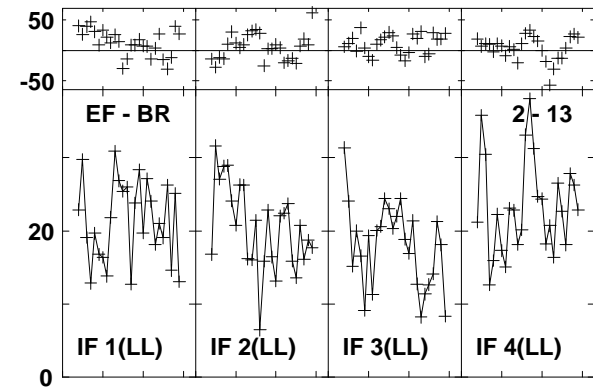
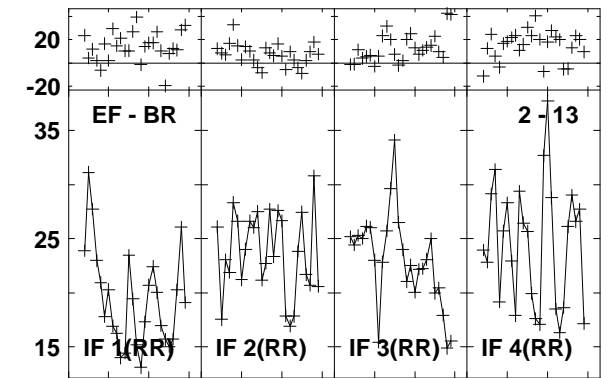
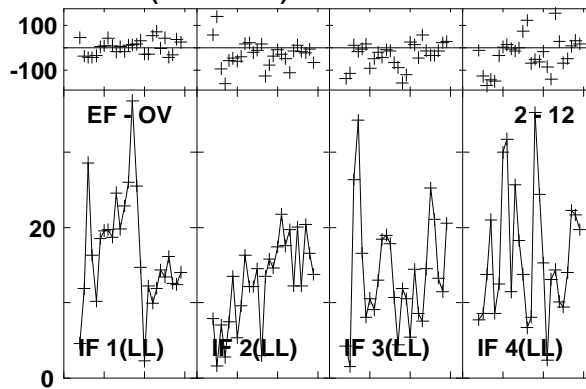
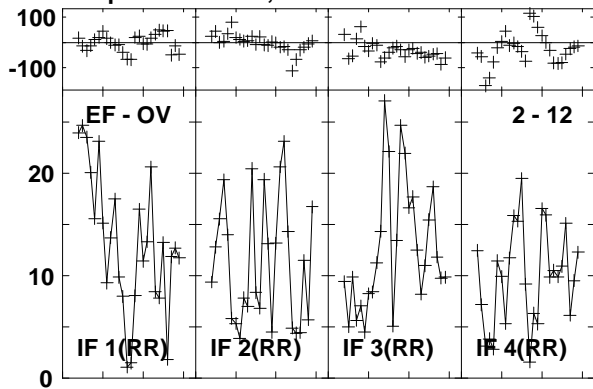

Lower frame: Milli Ampl Jy Top frame: Phas deg
Vector averaged cross-power spectrum Baseline: EF (02) - OV (12)
Timerange: 00/15:42:52 to 00/15:45:38

Plot file version 32 created 03-MAR-2016 01:12:02

4C52 GN002C 1.UVDATA.1

Freq = 1.2770 GHz, Bw = 16.000 MH Calibrated with CL # 3 and BP # 1 (BP mode 1)

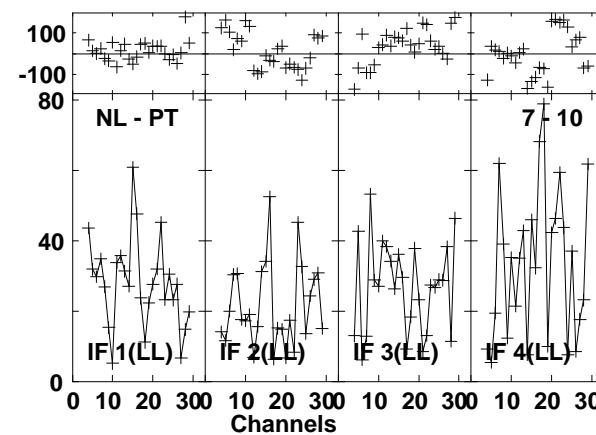
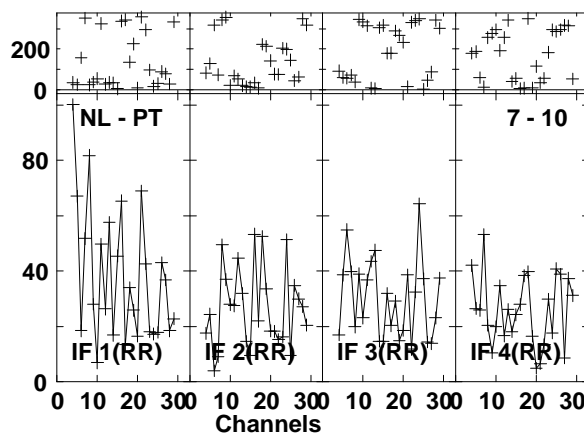
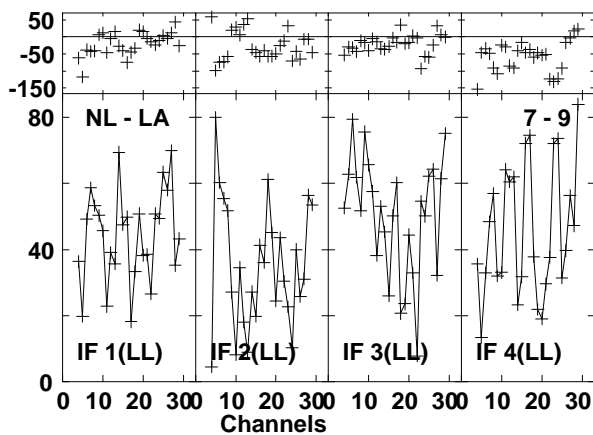
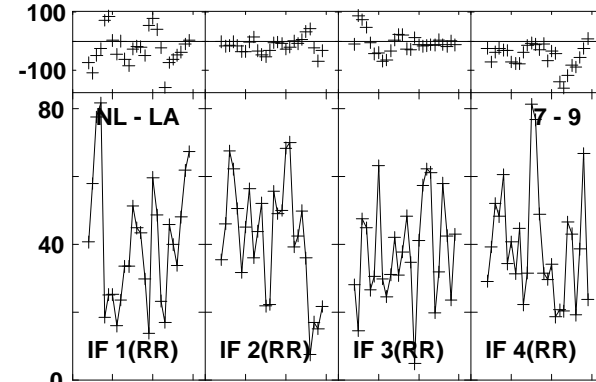
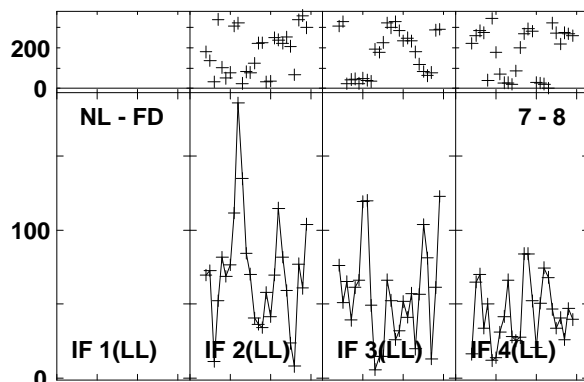
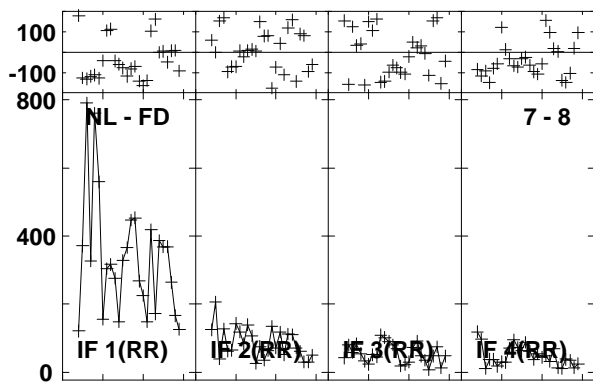
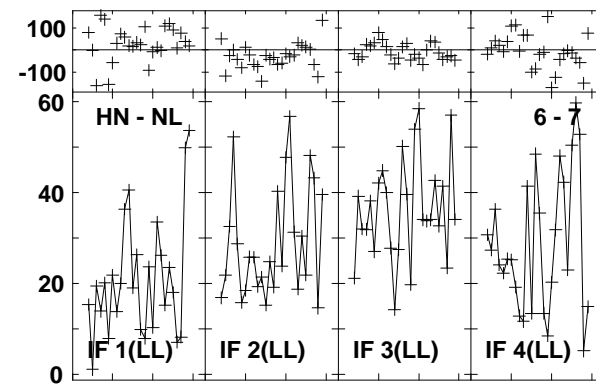
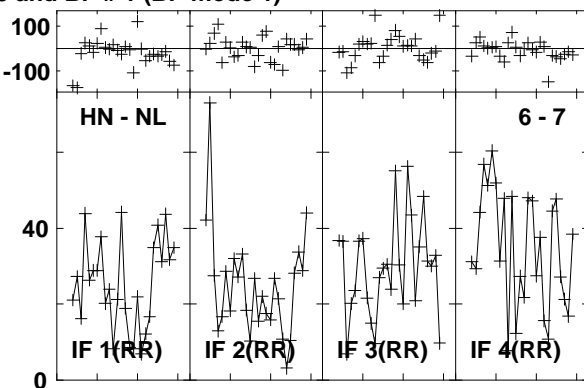
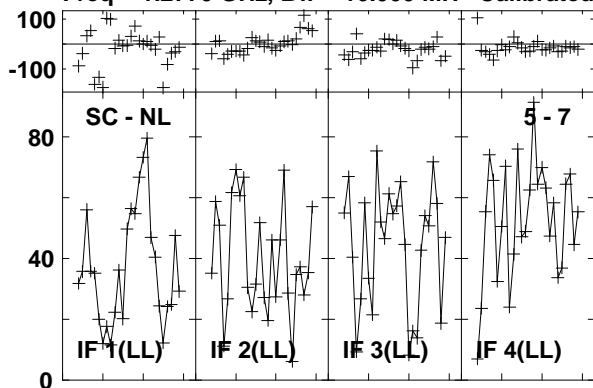

Lower frame: Milli Ampl Jy Top frame: Phas deg
Vector averaged cross-power spectrum Baseline: SC (05) - NL (07)
Timerange: 00/15:42:52 to 00/15:45:38

Plot file version 33 created 03-MAR-2016 01:12:02
 4C52 GN002C 1.UVDATA.1
 Freq = 1.2770 GHz, Bw = 16.000 MH Calibrated with CL # 3 and BP # 1 (BP mode 1)

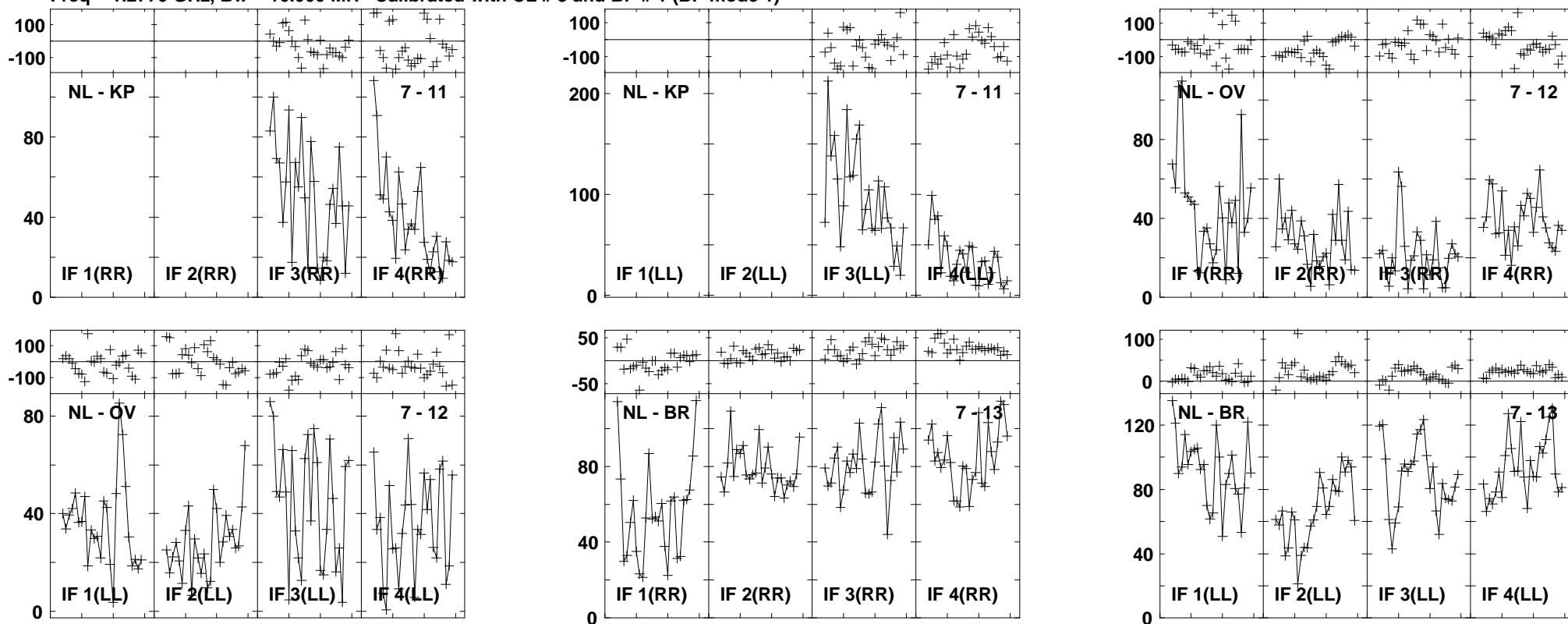

Lower frame: Milli Ampl Jy Top frame: Phas deg
 Vector averaged cross-power spectrum Baseline: NL (07) - KP (11)
 Timerange: 00/15:42:52 to 00/15:45:38

Plot file version 34 created 03-MAR-2016 01:12:02

J1545+5400 GN002C 1.UVDATA.1

Freq = 1.2770 GHz, Bw = 16.000 MH Calibrated with CL # 3 and BP # 1 (BP mode 1)

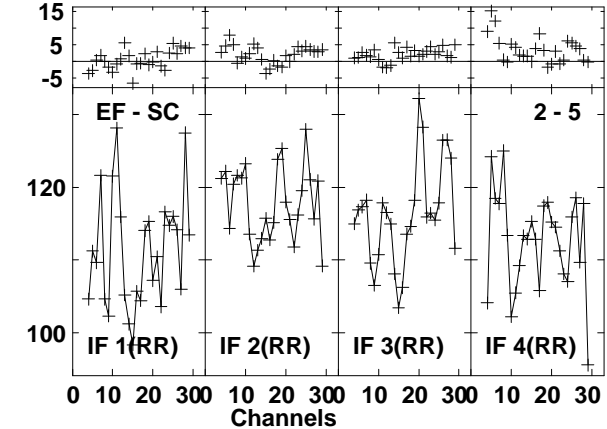
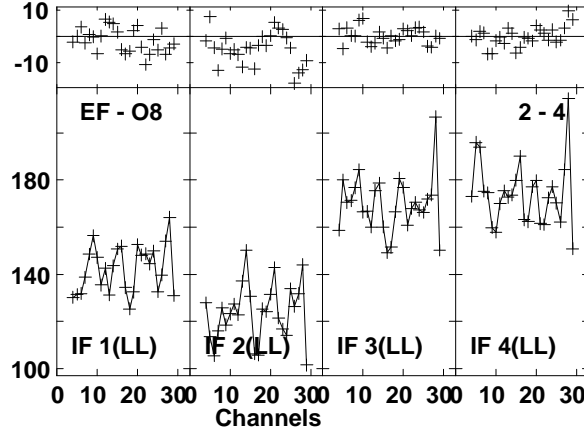
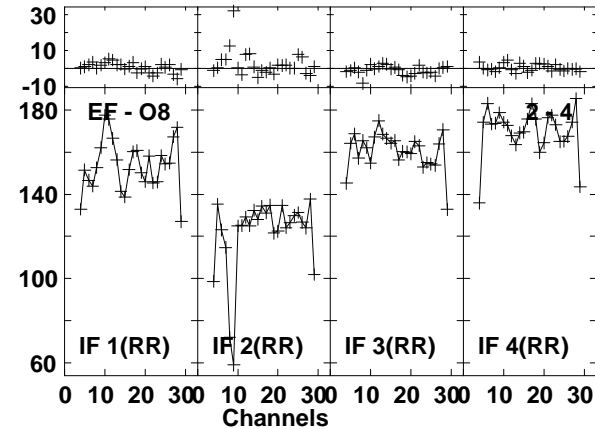
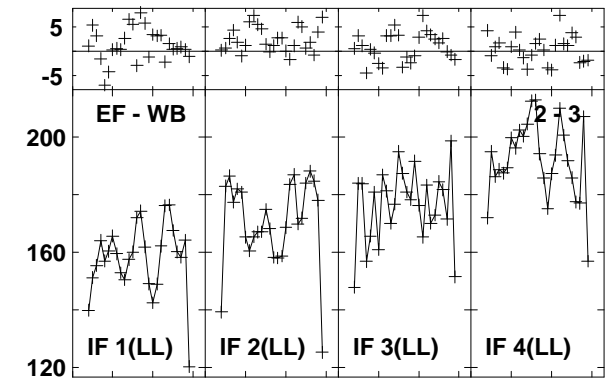
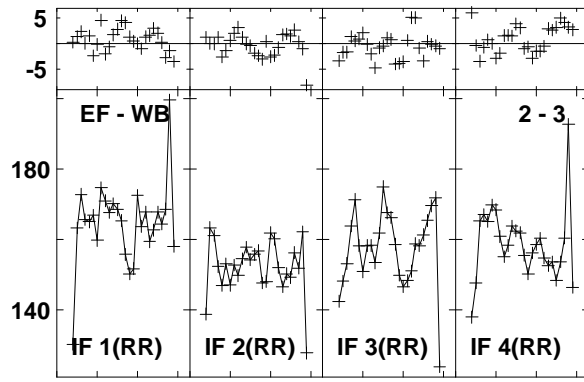
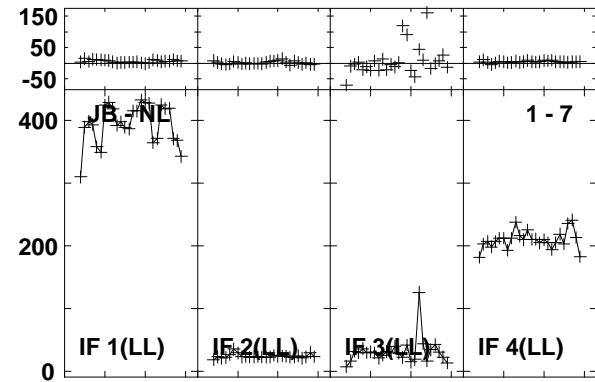
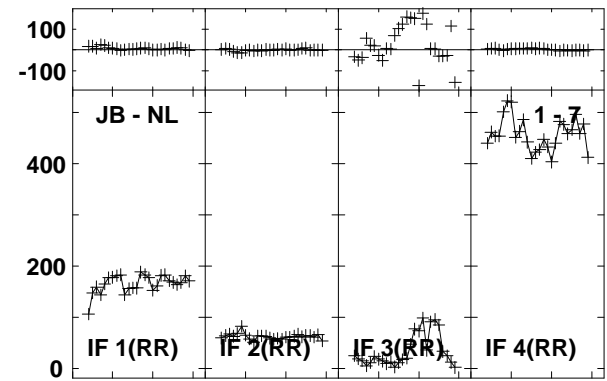
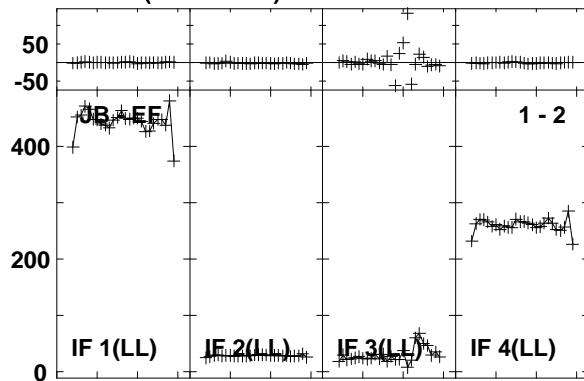
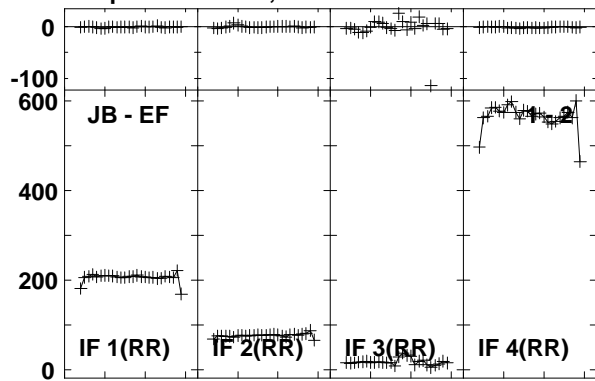

Lower frame: Milli Ampl Jy Top frame: Phas deg
Vector averaged cross-power spectrum Baseline: JB (01) - EF (02)
Timerange: 00/15:46:31 to 00/15:48:29

Plot file version 35 created 03-MAR-2016 01:12:03

J1545+5400 GN002C 1.UVDATA.1

Freq = 1.2770 GHz, Bw = 16.000 MH Calibrated with CL # 3 and BP # 1 (BP mode 1)

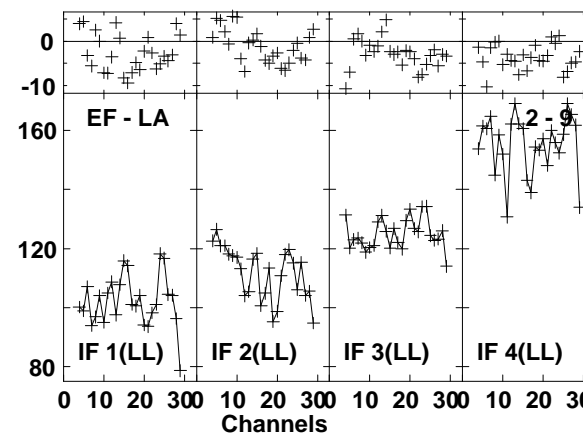
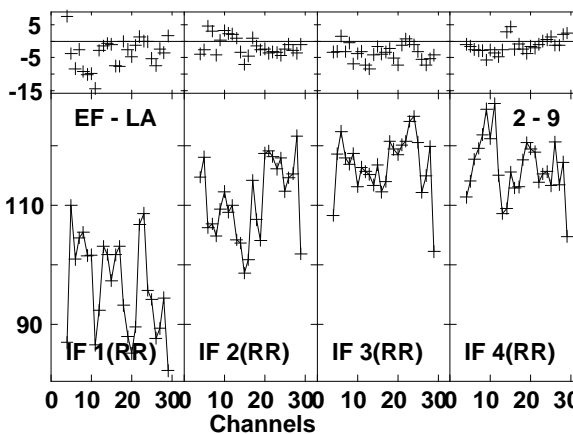
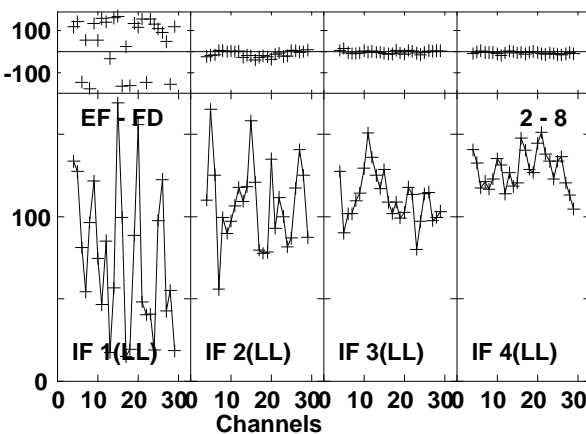
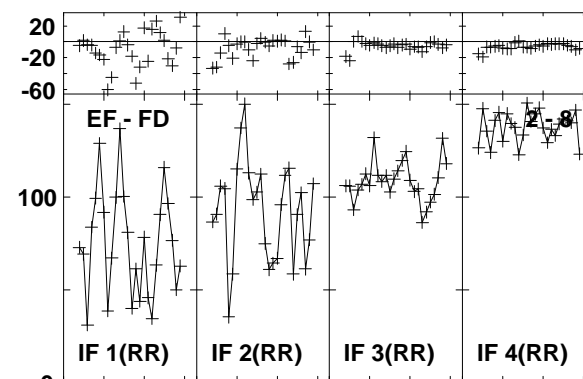
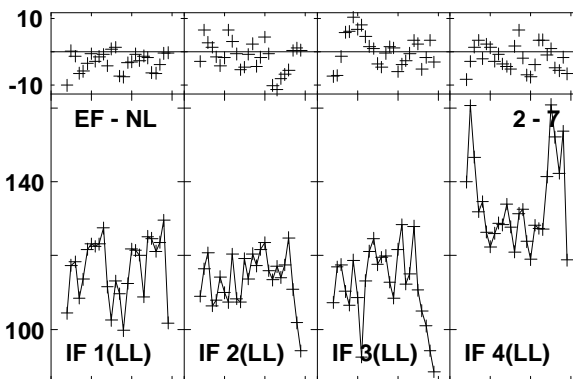
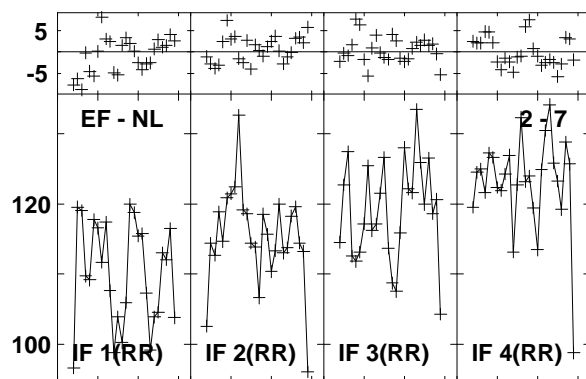
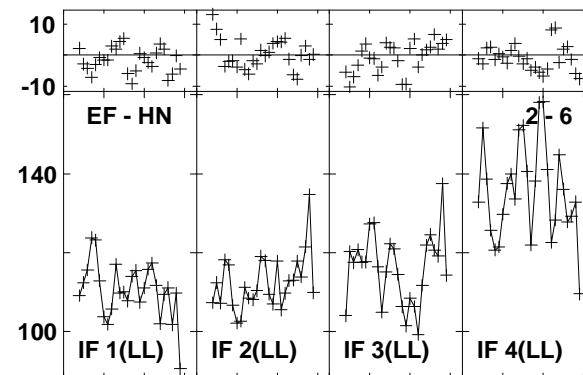
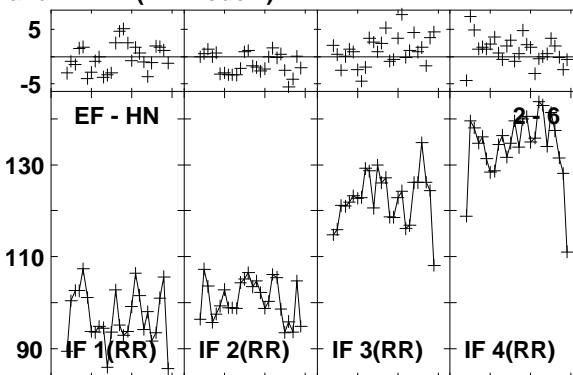
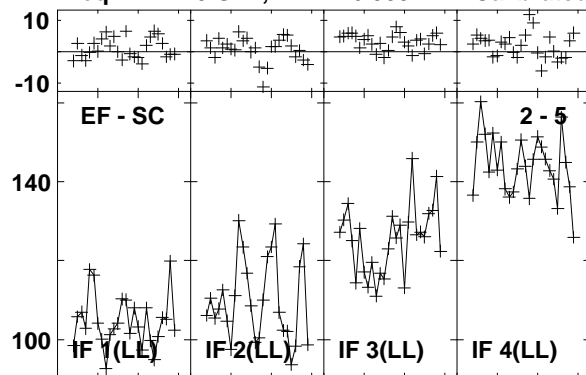

Lower frame: Milli Ampl Jy Top frame: Phas deg
Vector averaged cross-power spectrum Baseline: EF (02) - SC (05)
Timerange: 00/15:46:31 to 00/15:48:29

Plot file version 36 created 03-MAR-2016 01:12:03

J1545+5400 GN002C 1.UVDATA.1

Freq = 1.2770 GHz, Bw = 16.000 MH Calibrated with CL # 3 and BP # 1 (BP mode 1)

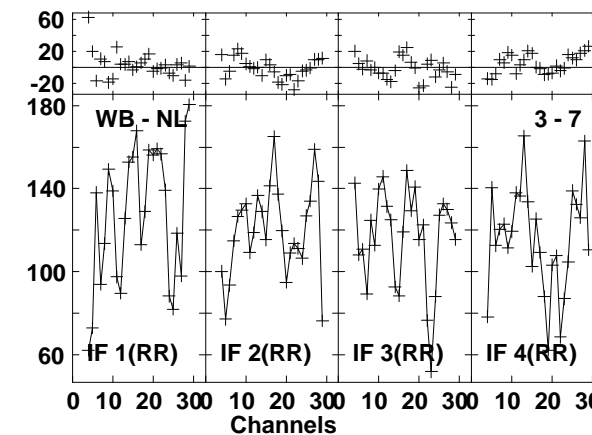
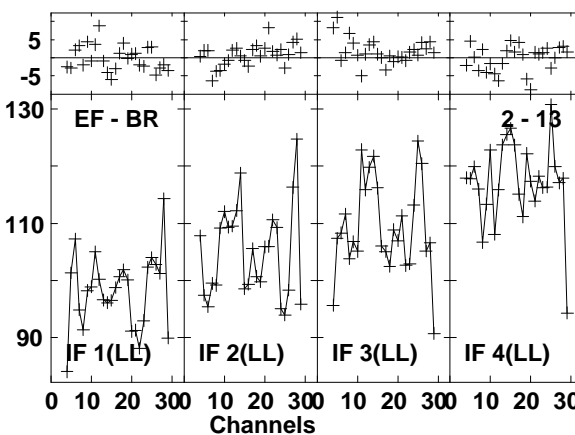
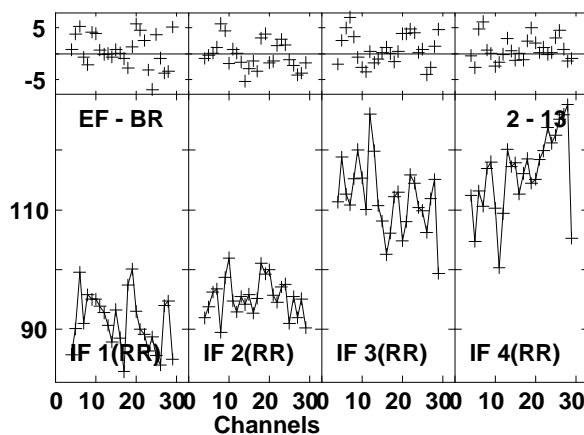
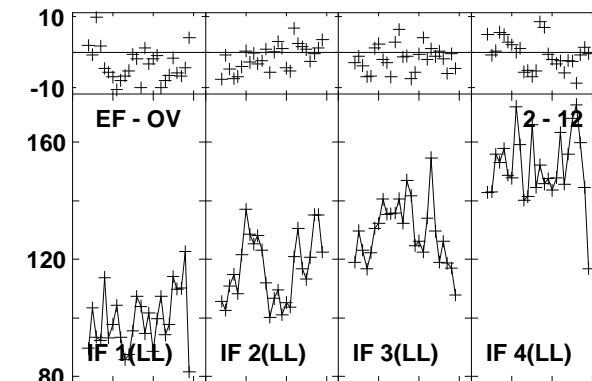
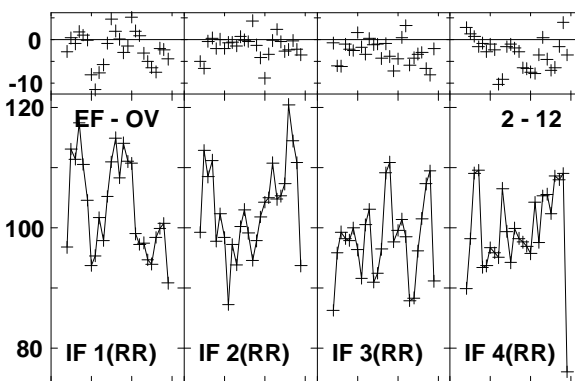
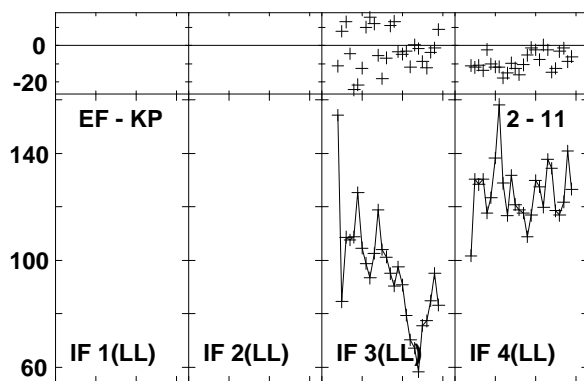
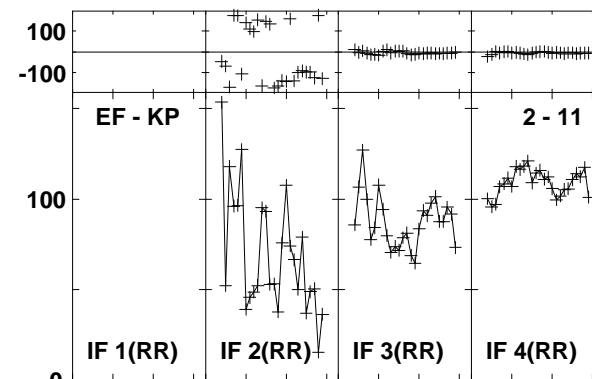
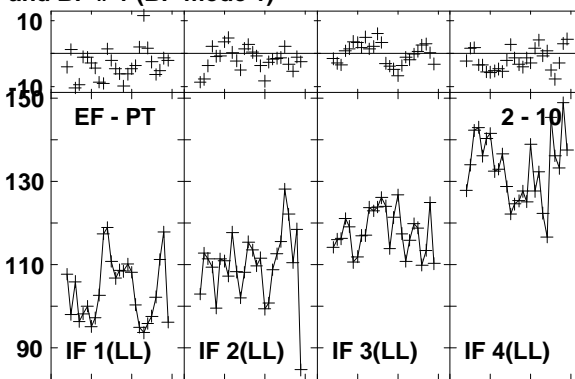
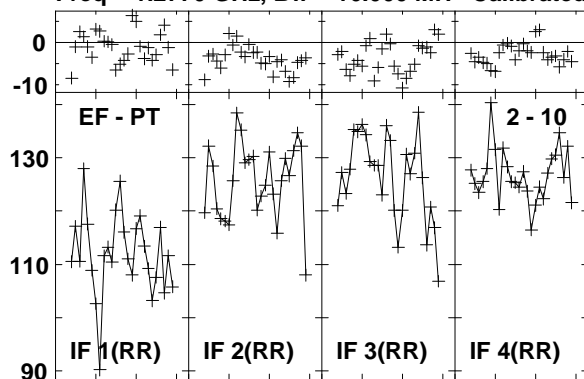

Lower frame: Milli Ampl Jy Top frame: Phas deg
Vector averaged cross-power spectrum Baseline: EF (02) - PT (10)
Timerange: 00/15:46:31 to 00/15:48:29

Plot file version 37 created 03-MAR-2016 01:12:03

J1545+5400 GN002C 1.UVDATA.1

Freq = 1.2770 GHz, Bw = 16.000 MH Calibrated with CL # 3 and BP # 1 (BP mode 1)

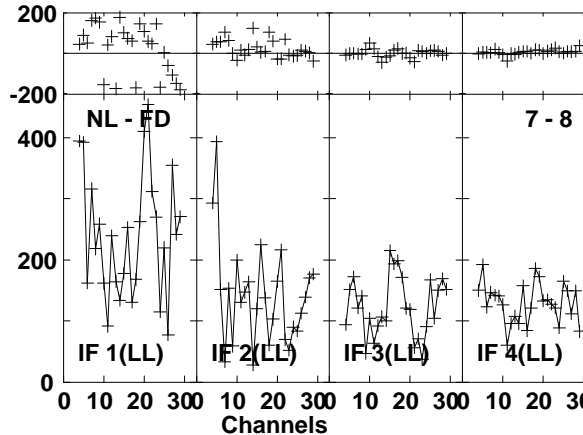
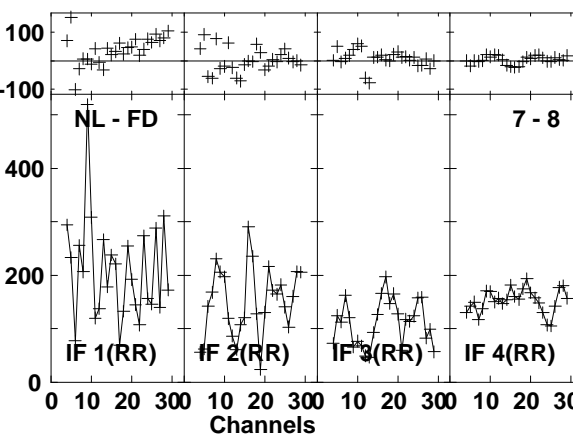
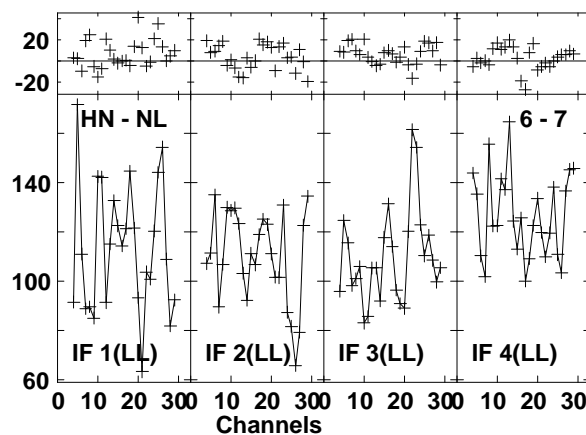
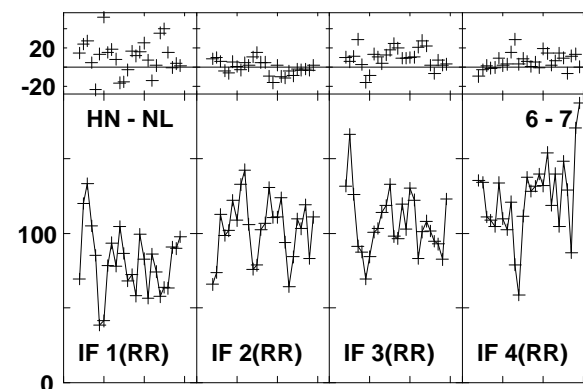
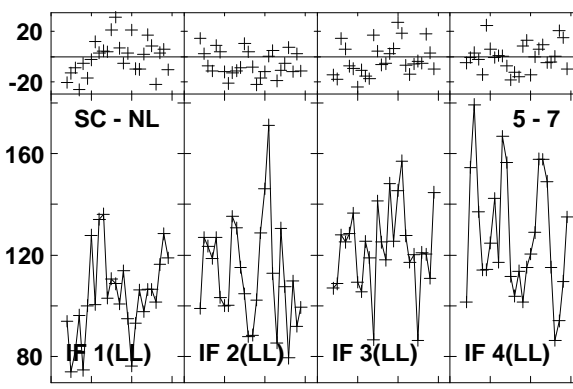
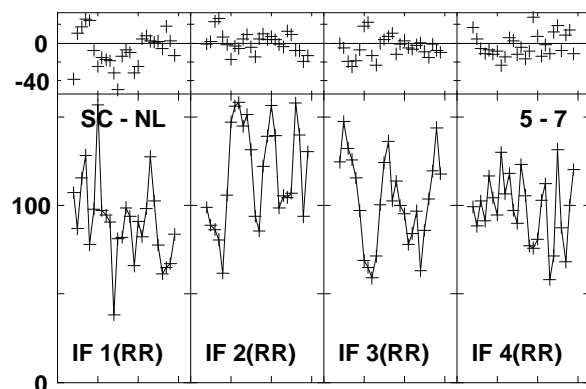
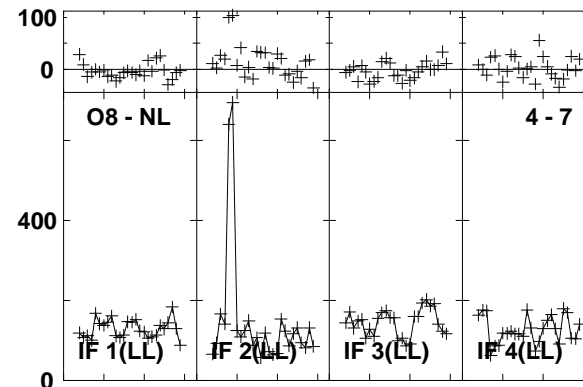
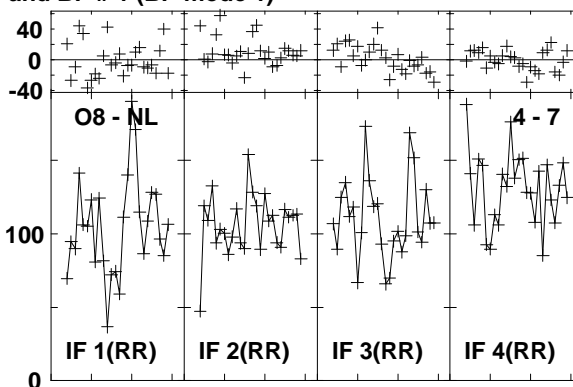
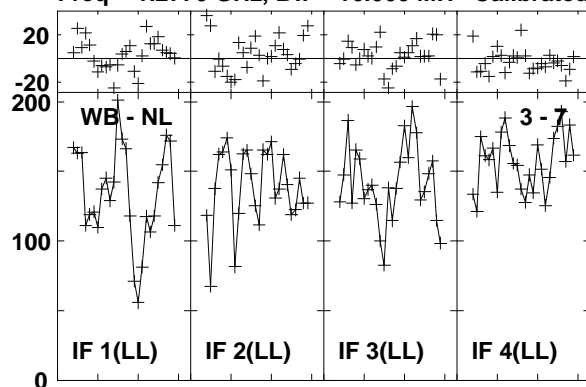

Lower frame: Milli Ampl Jy Top frame: Phas deg
Vector averaged cross-power spectrum Baseline: WB (03) - NL (07)
Timerange: 00/15:46:31 to 00/15:48:29

Plot file version 38 created 03-MAR-2016 01:12:03

J1545+5400 GN002C 1.UVDATA.1

Freq = 1.2770 GHz, Bw = 16.000 MH Calibrated with CL # 3 and BP # 1 (BP mode 1)

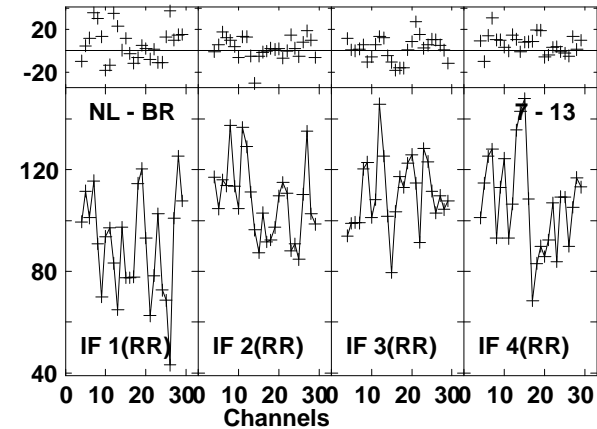
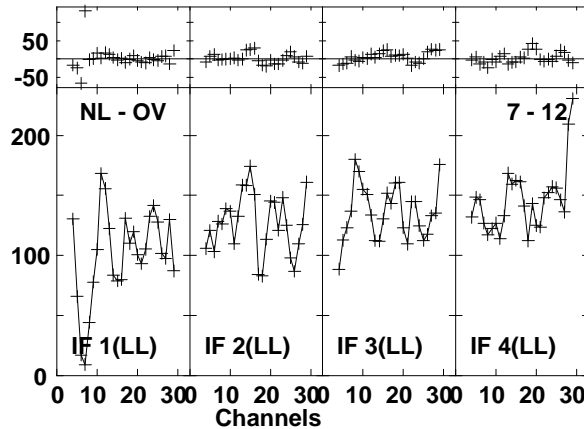
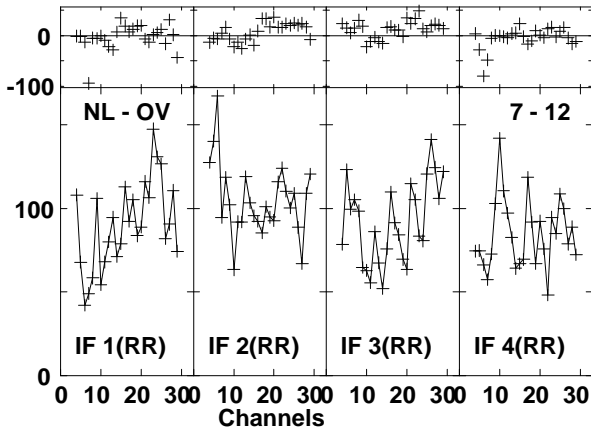
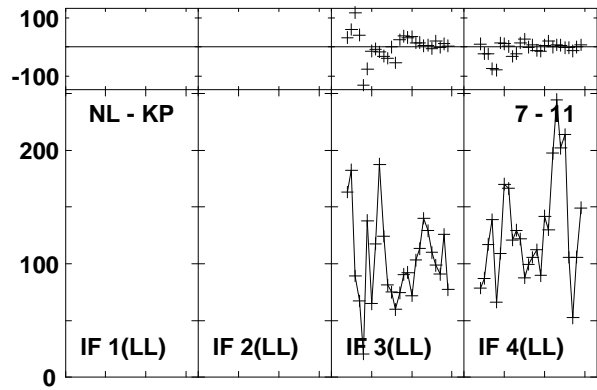
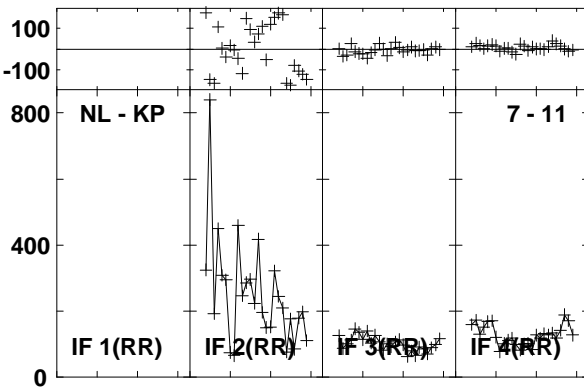
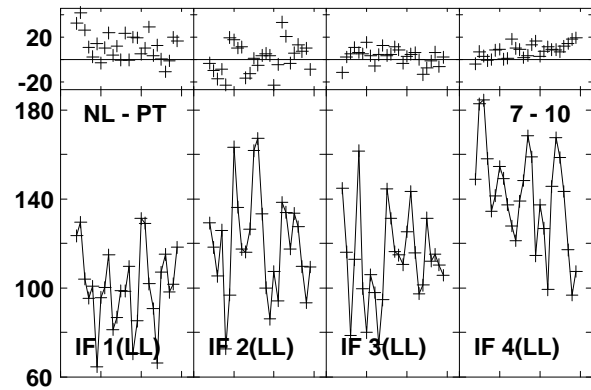
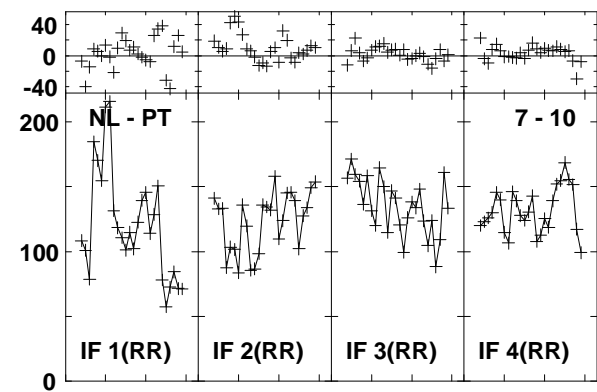
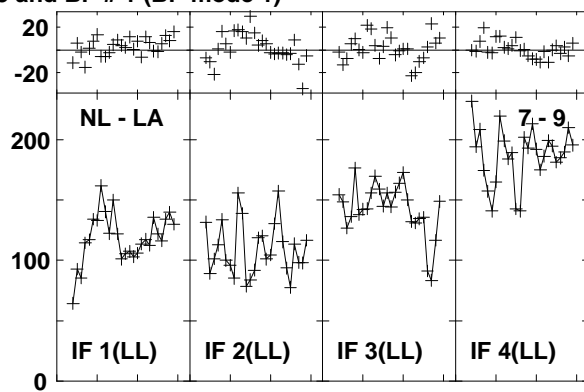
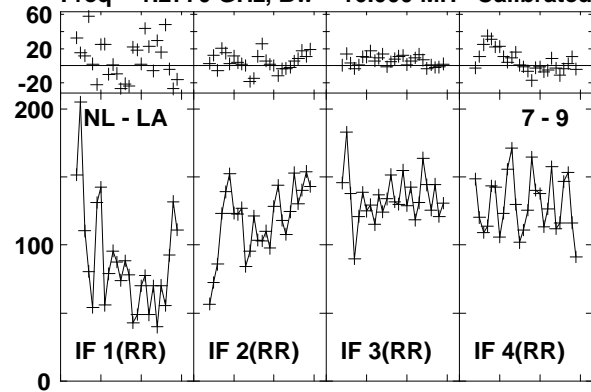

Lower frame: Milli Ampl Jy Top frame: Phas deg
Vector averaged cross-power spectrum Baseline: NL (07) - LA (09)
Timerange: 00/15:46:31 to 00/15:48:29

Plot file version 39 created 03-MAR-2016 01:12:03
J1545+5400 GN002C 1.UVDATA.1
Freq = 1.2770 GHz, Bw = 16.000 MH Calibrated with CL # 3 and BP # 1 (BP mode 1)

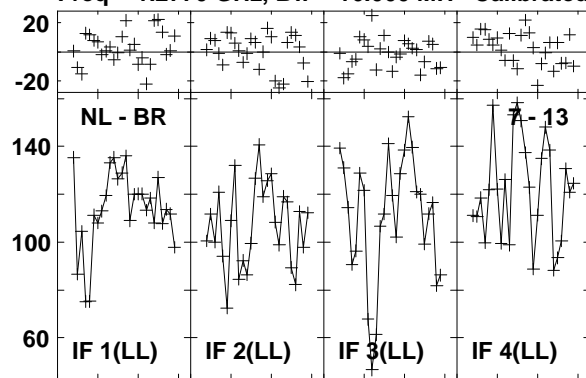

Lower frame: Milli Ampl Jy Top frame: Phas deg
Vector averaged cross-power spectrum Baseline: NL (07) - BR (13)
Timerange: 00/15:46:31 to 00/15:48:29

Plot file version 40 created 03-MAR-2016 01:12:03

4C52 GN002C 1.UVDATA.1

Freq = 1.2770 GHz, Bw = 16.000 MH Calibrated with CL # 3 and BP # 1 (BP mode 1)

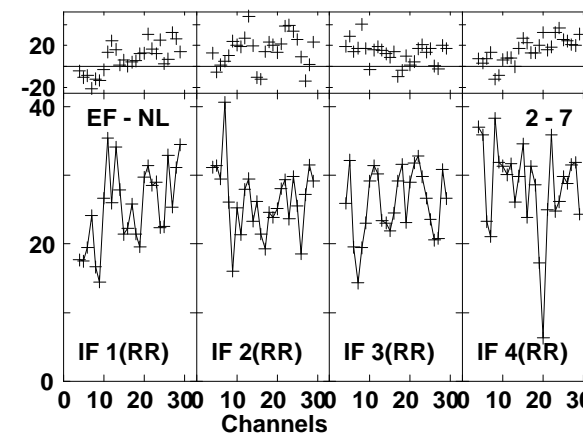
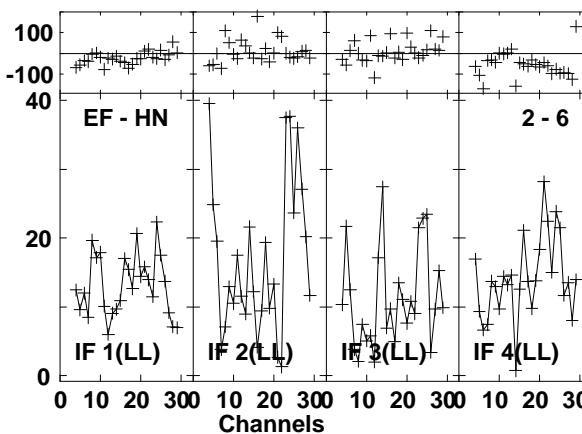
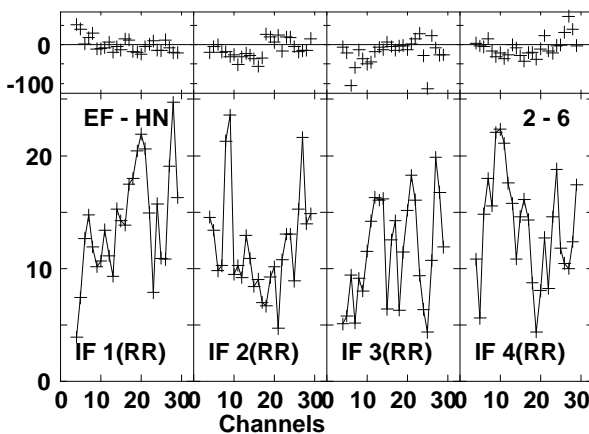
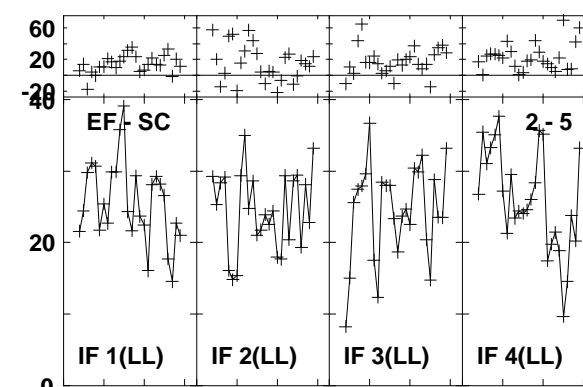
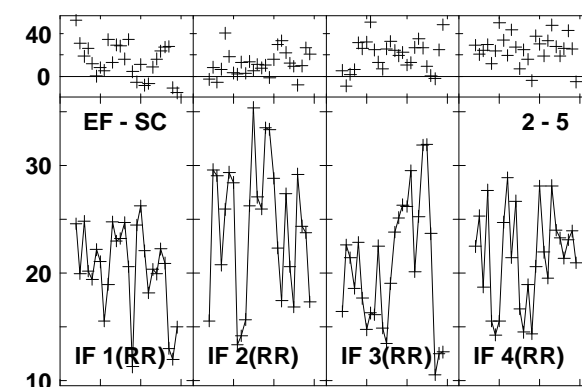
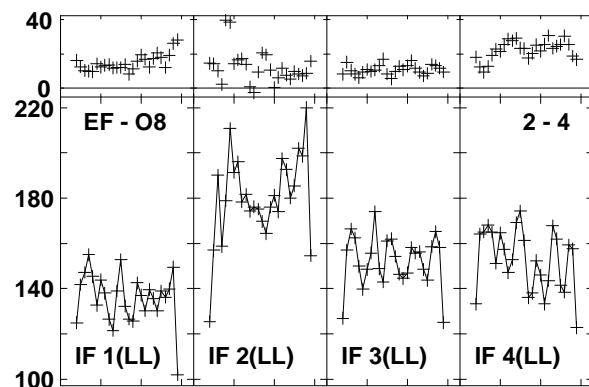
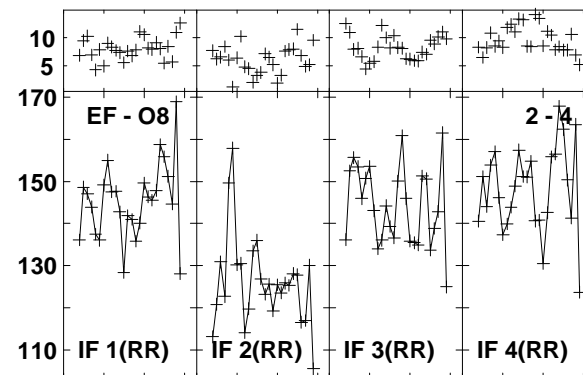
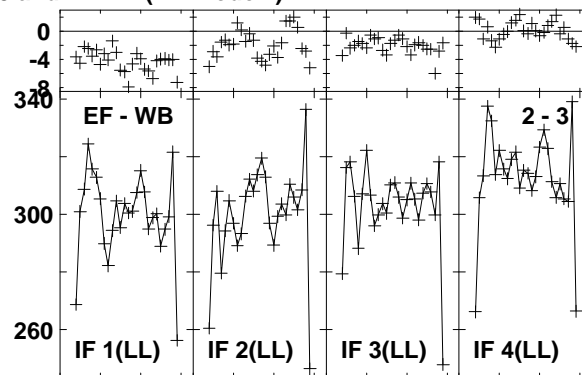
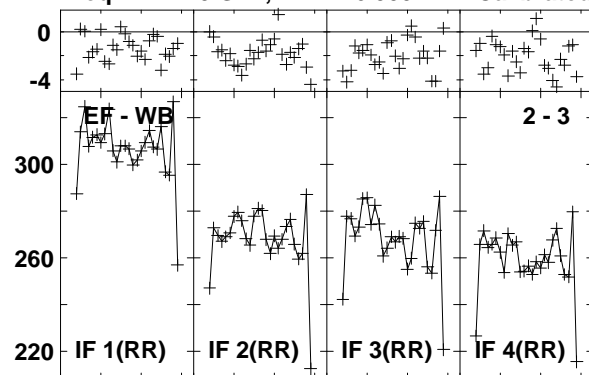

Lower frame: Milli Ampl Jy Top frame: Phas deg
Vector averaged cross-power spectrum Baseline: EF (02) - WB (03)
Timerange: 00/15:48:42 to 00/15:51:28

Plot file version 41 created 03-MAR-2016 01:12:04

4C52 GN002C 1.UVDATA.1

Freq = 1.2770 GHz, Bw = 16.000 MH Calibrated with CL # 3 and BP # 1 (BP mode 1)

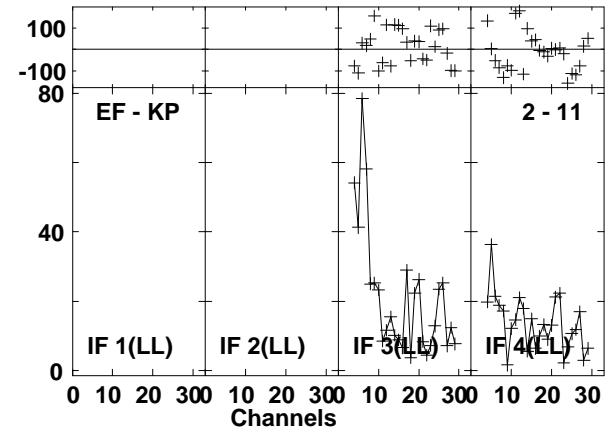
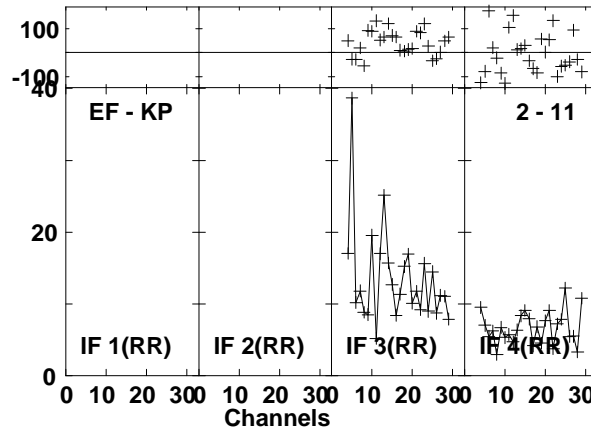
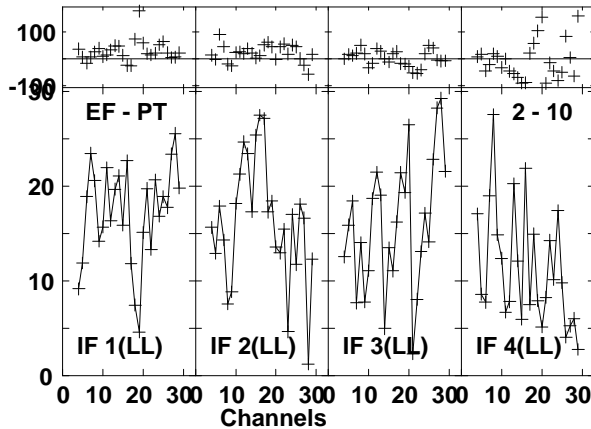
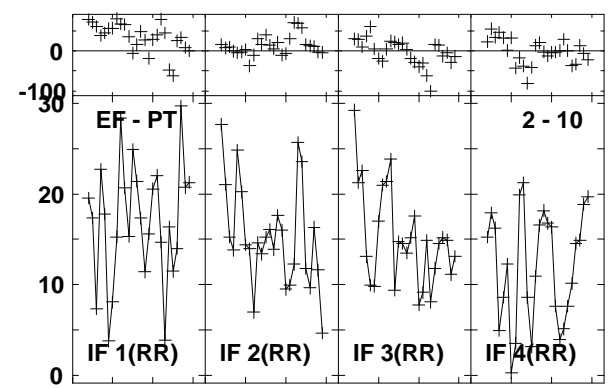
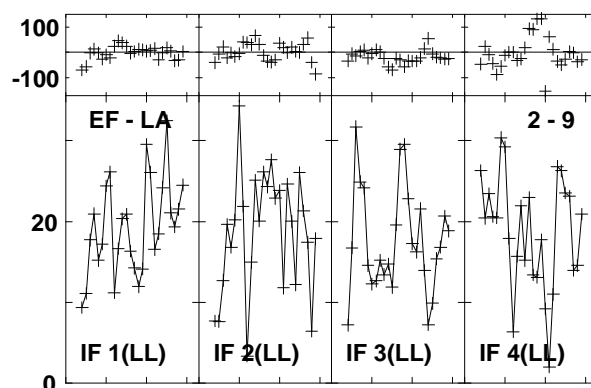
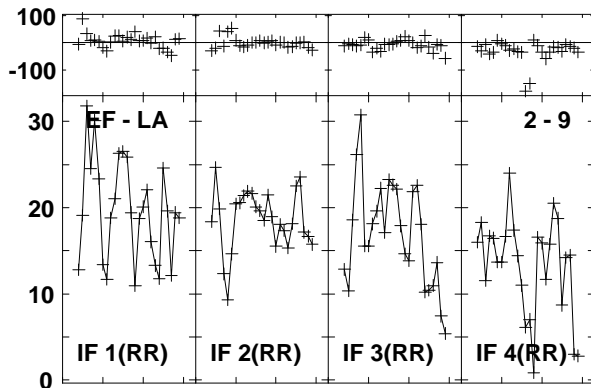
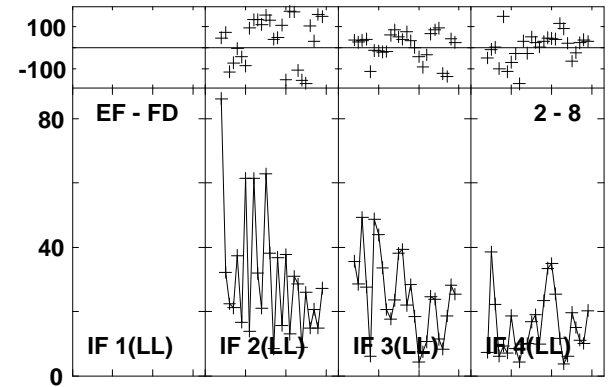
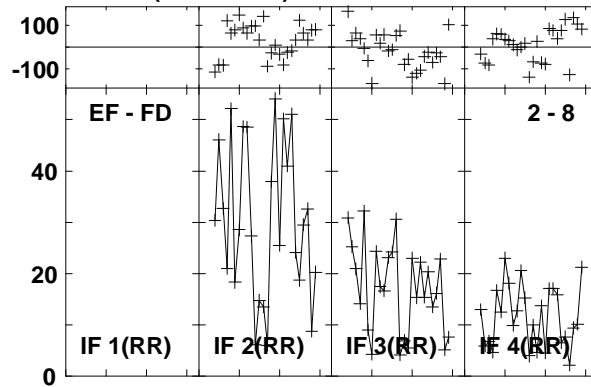
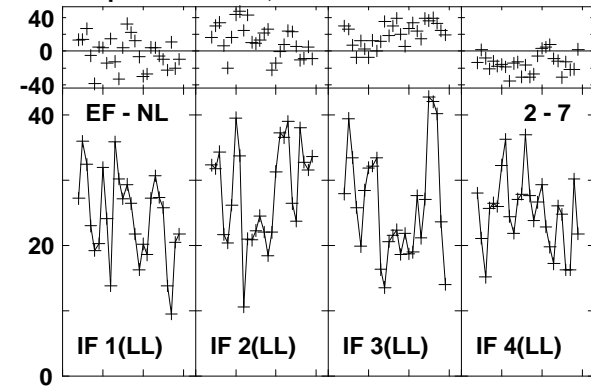

Lower frame: Milli Ampl Jy Top frame: Phas deg
Vector averaged cross-power spectrum Baseline: EF (02) - NL (07)
Timerange: 00/15:48:42 to 00/15:51:28

Plot file version 42 created 03-MAR-2016 01:12:04

4C52 GN002C 1.UVDATA.1

Freq = 1.2770 GHz, Bw = 16.000 MH Calibrated with CL # 3 and BP # 1 (BP mode 1)

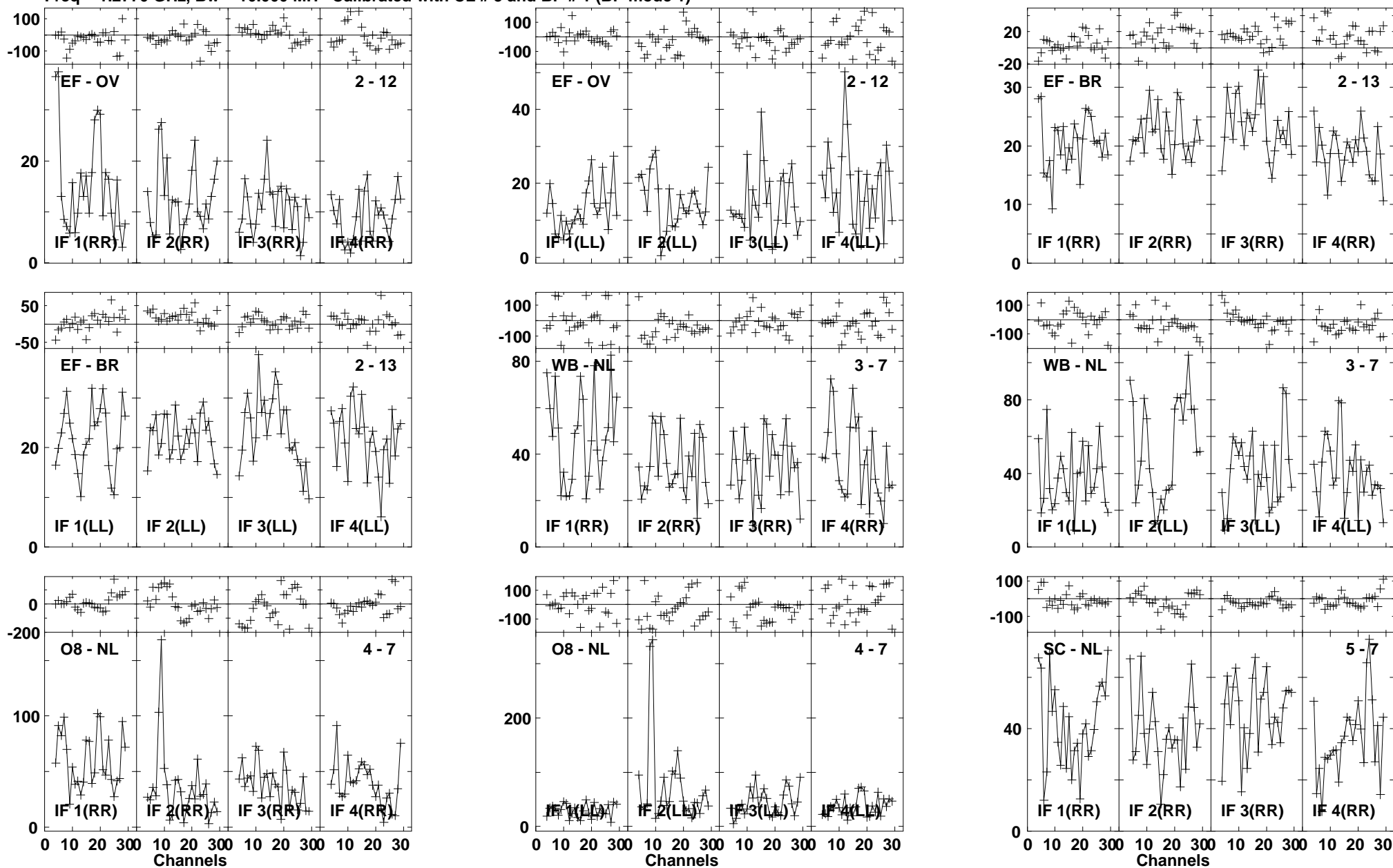

Lower frame: Milli Ampl Jy Top frame: Phas deg
Vector averaged cross-power spectrum Baseline: EF (02) - OV (12)
Timerange: 00/15:48:42 to 00/15:51:28

Plot file version 43 created 03-MAR-2016 01:12:04

4C52 GN002C 1.UVDATA.1

Freq = 1.2770 GHz, Bw = 16.000 MH Calibrated with CL # 3 and BP # 1 (BP mode 1)

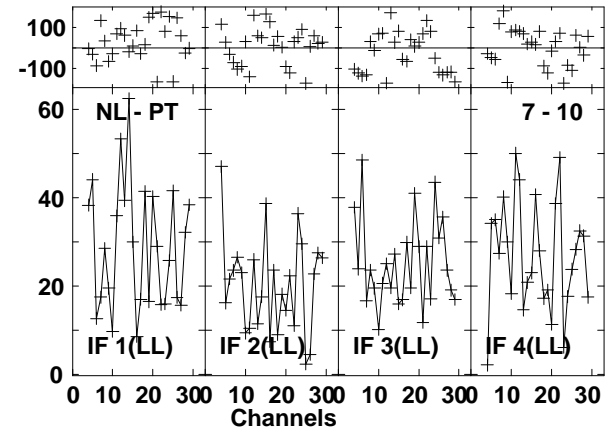
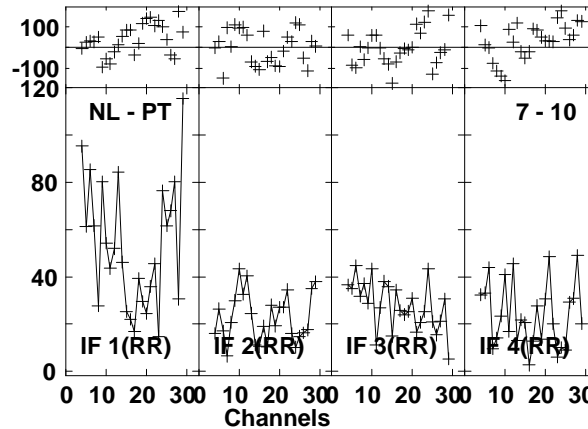
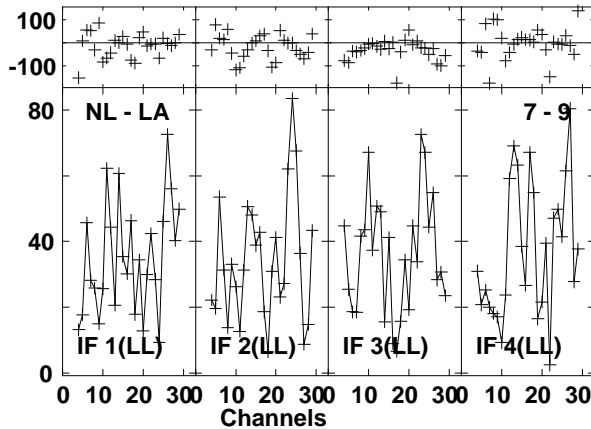
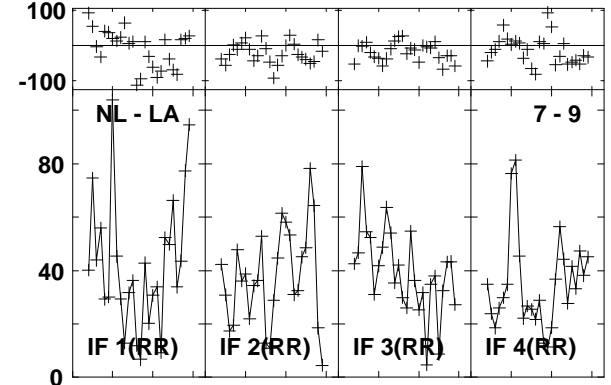
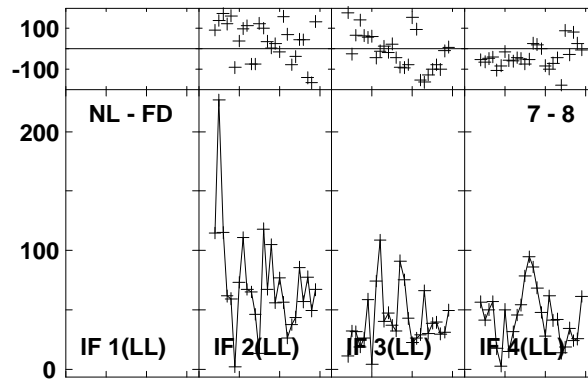
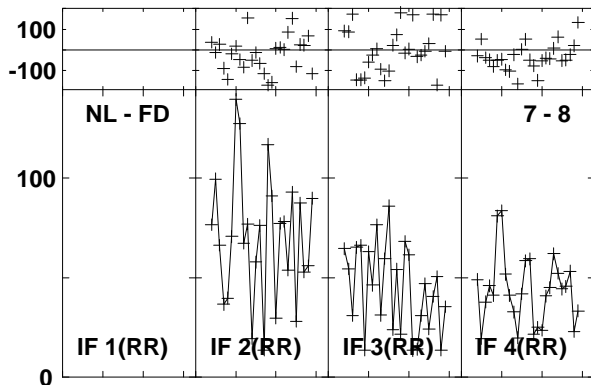
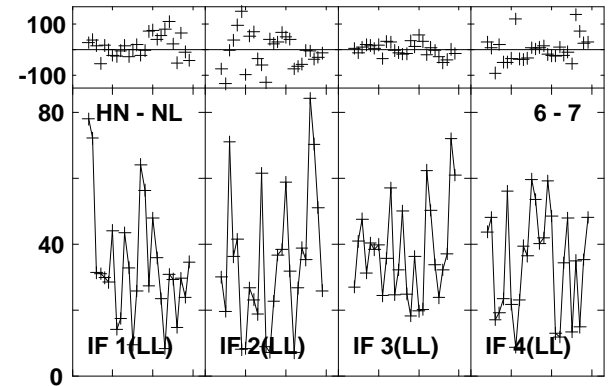
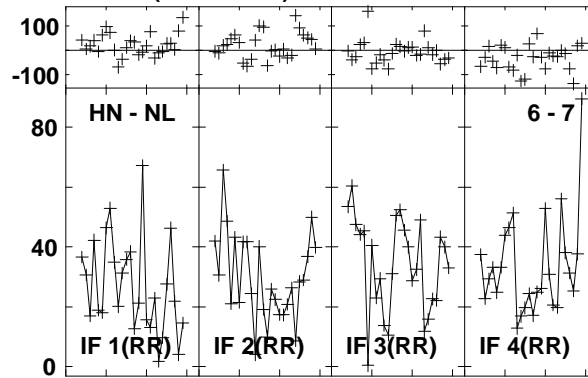
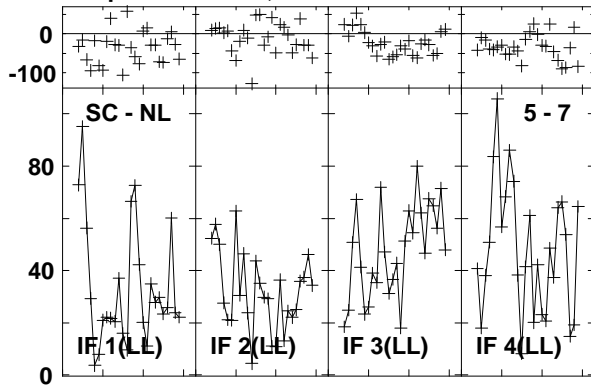

Lower frame: Milli Ampl Jy Top frame: Phas deg

Vector averaged cross-power spectrum Baseline: SC (05) - NL (07)

Timerange: 00/15:48:42 to 00/15:51:28

Plot file version 44 created 03-MAR-2016 01:12:04
 4C52 GN002C 1.UVDATA.1
 Freq = 1.2770 GHz, Bw = 16.000 MH Calibrated with CL # 3 and BP # 1 (BP mode 1)

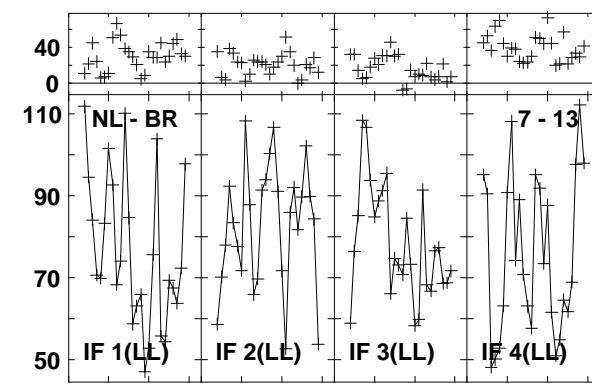
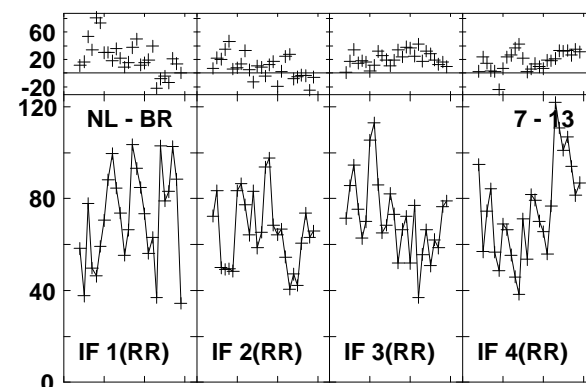
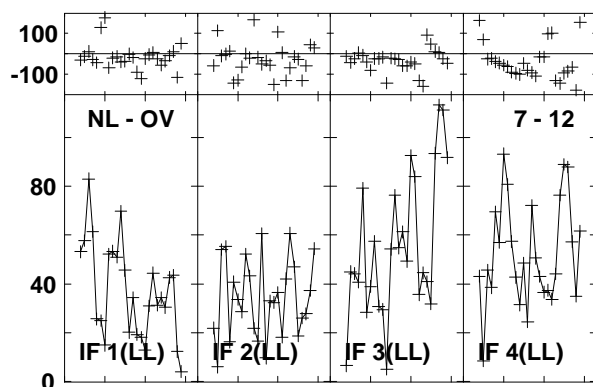
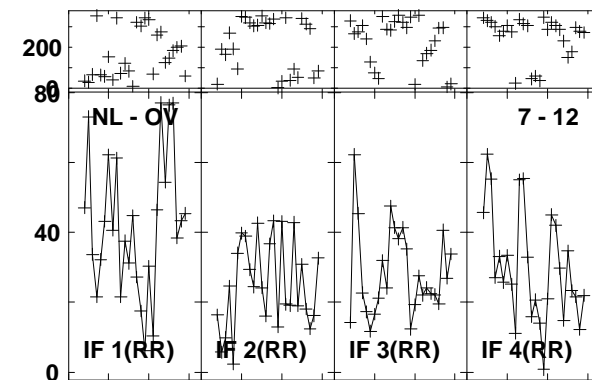
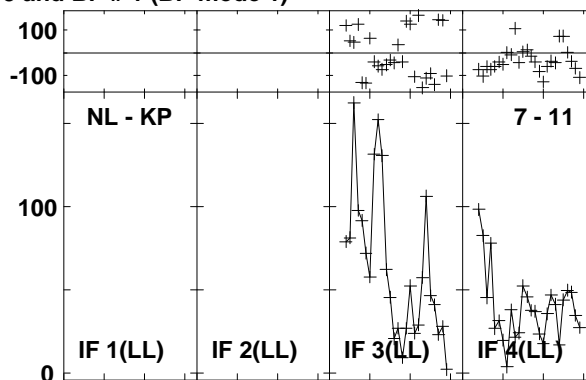
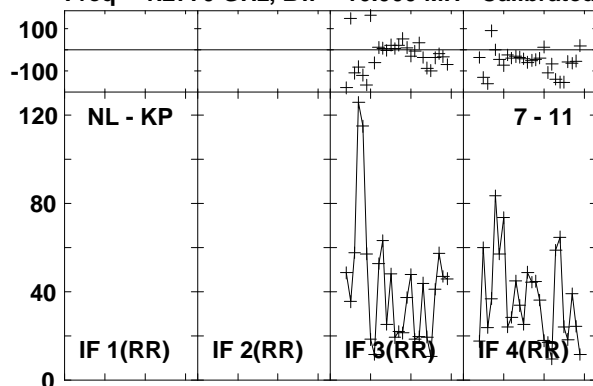

Lower frame: Milli Ampl Jy Top frame: Phas deg
 Vector averaged cross-power spectrum Baseline: NL (07) - KP (11)
 Timerange: 00/15:48:42 to 00/15:51:28

Plot file version 45 created 03-MAR-2016 01:12:04

J1545+5400 GN002C 1.UVDATA.1

Freq = 1.2770 GHz, Bw = 16.000 MH Calibrated with CL # 3 and BP # 1 (BP mode 1)

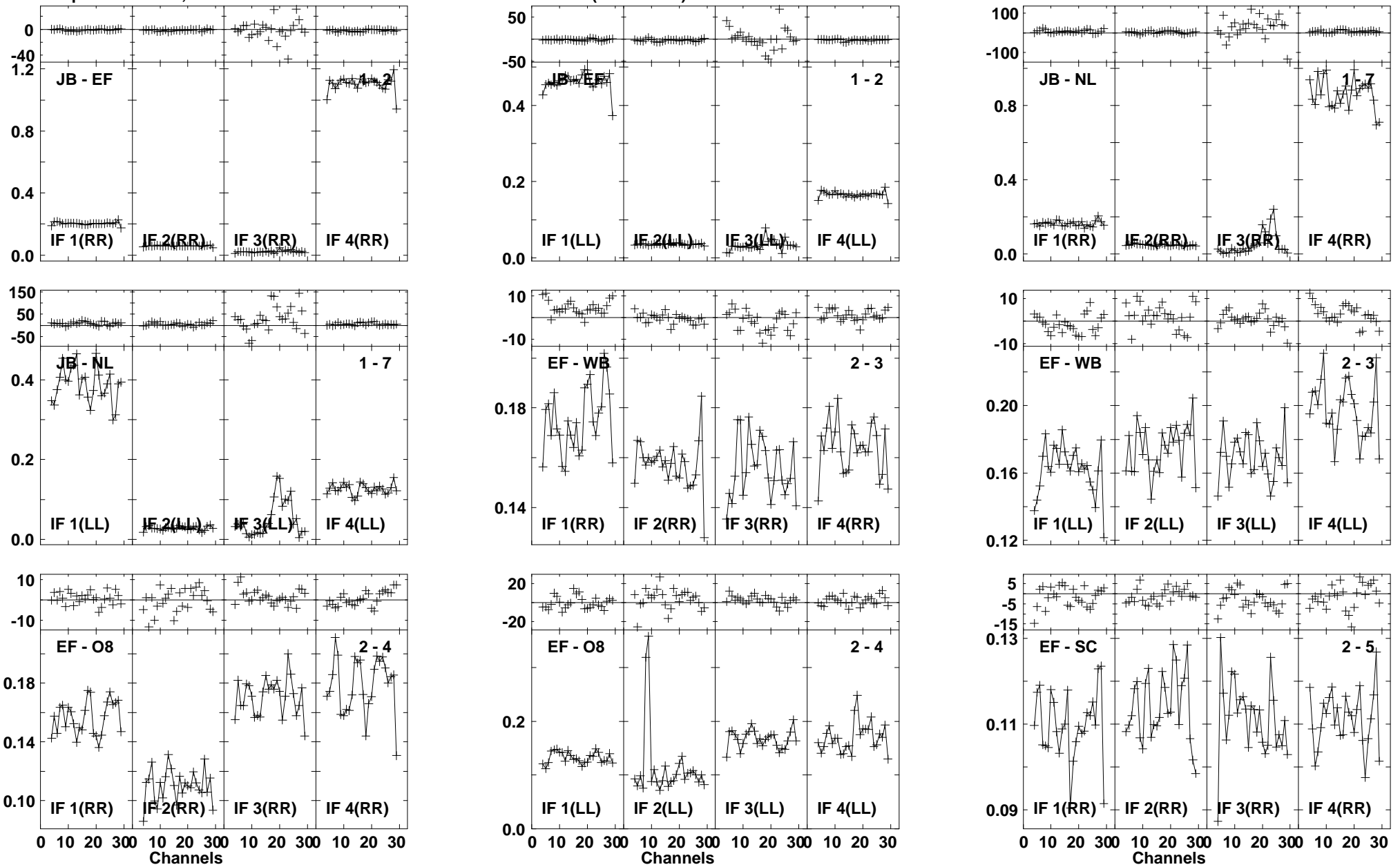

Lower frame: Ampl Jy Top frame: Phas deg
Vector averaged cross-power spectrum Baseline: JB (01) - EF (02)
Timerange: 00/15:52:21 to 00/15:53:19

Plot file version 46 created 03-MAR-2016 01:12:05

J1545+5400 GN002C 1.UVDATA.1

Freq = 1.2770 GHz, Bw = 16.000 MH Calibrated with CL # 3 and BP # 1 (BP mode 1)

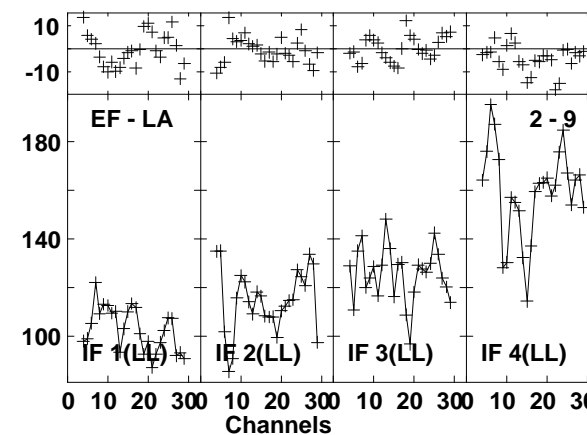
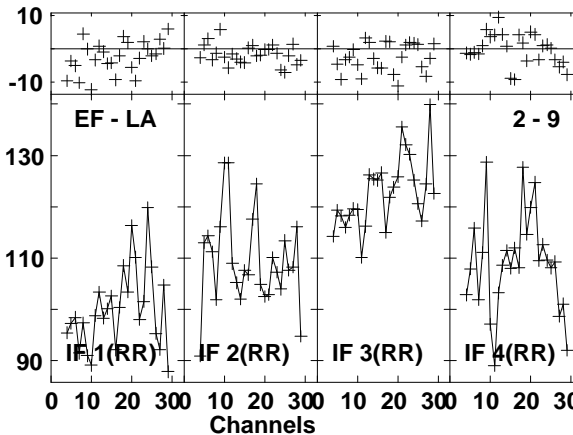
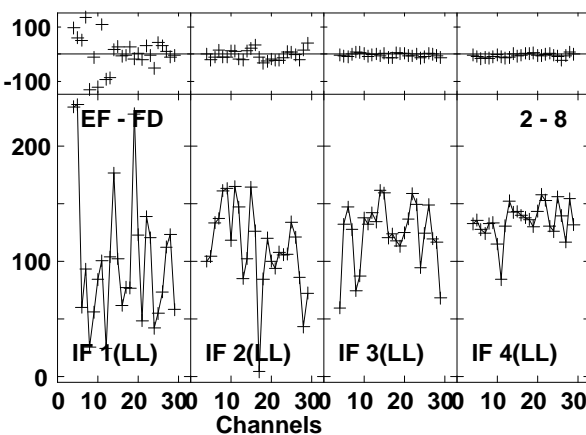
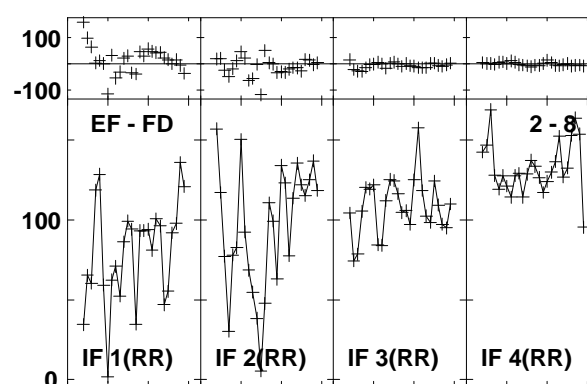
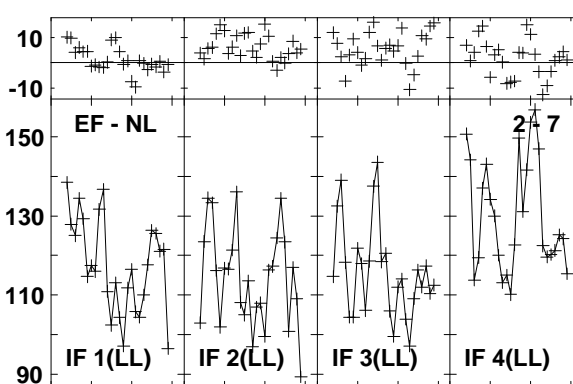
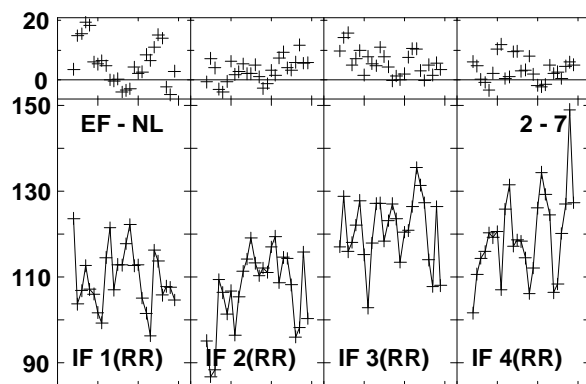
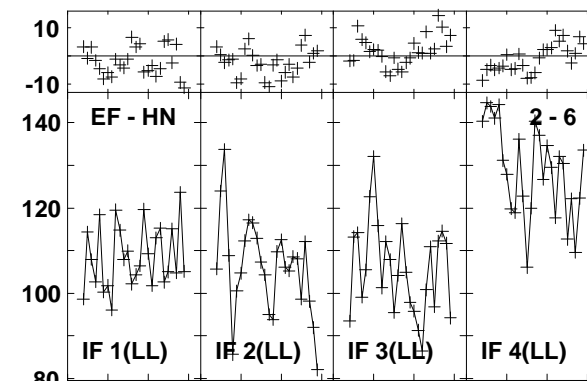
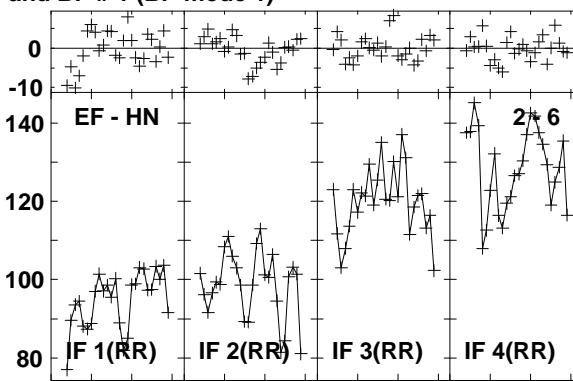
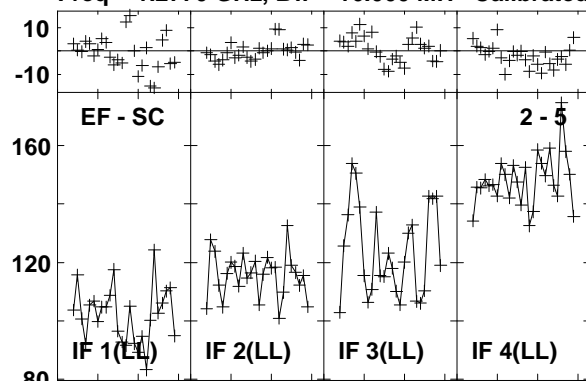

Lower frame: Milli Ampl Jy Top frame: Phas deg
Vector averaged cross-power spectrum Baseline: EF (02) - SC (05)
Timerange: 00/15:52:21 to 00/15:53:19

Plot file version 47 created 03-MAR-2016 01:12:05

J1545+5400 GN002C 1.UVDATA.1

Freq = 1.2770 GHz, Bw = 16.000 MH Calibrated with CL # 3 and BP # 1 (BP mode 1)

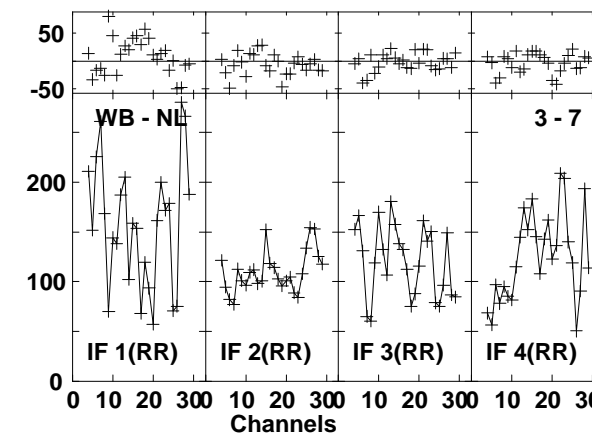
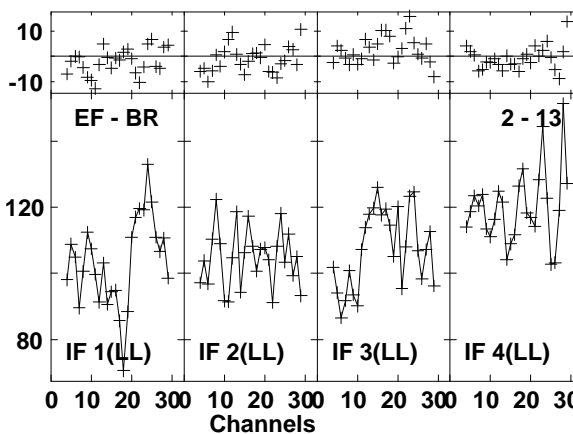
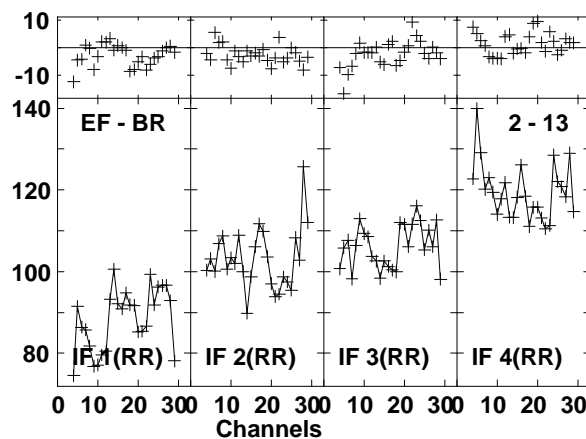
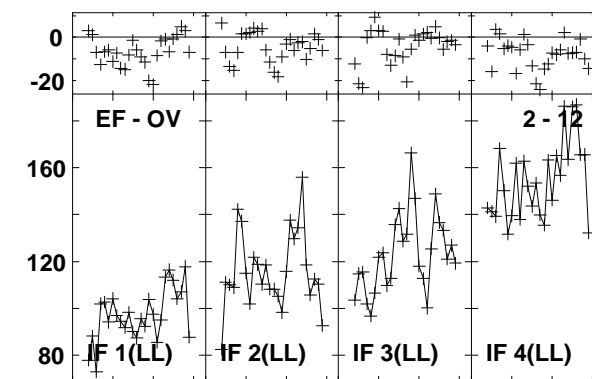
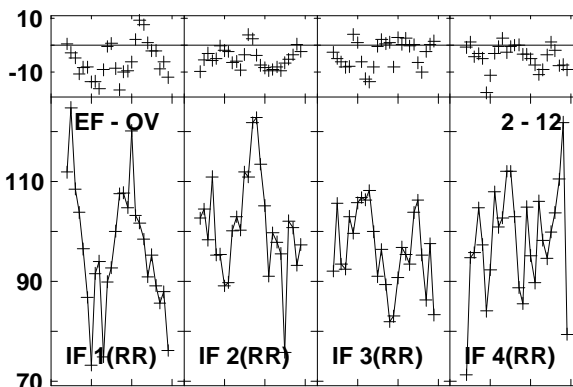
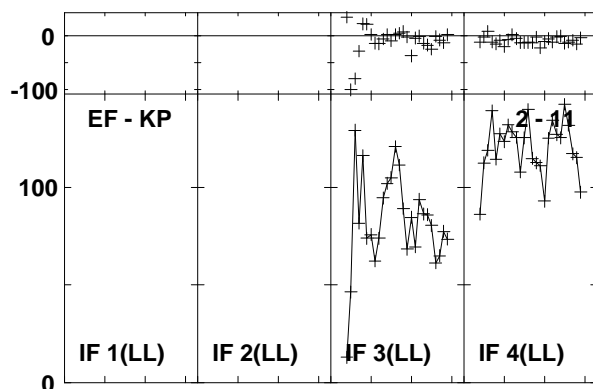
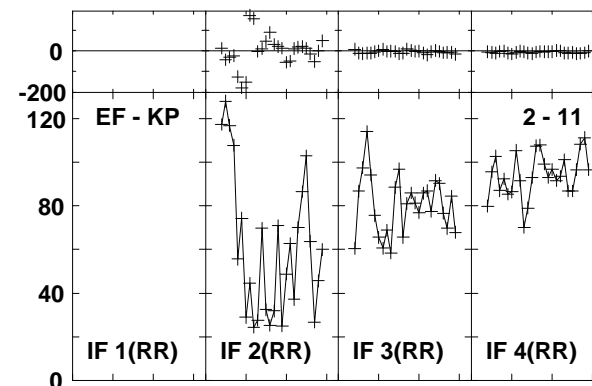
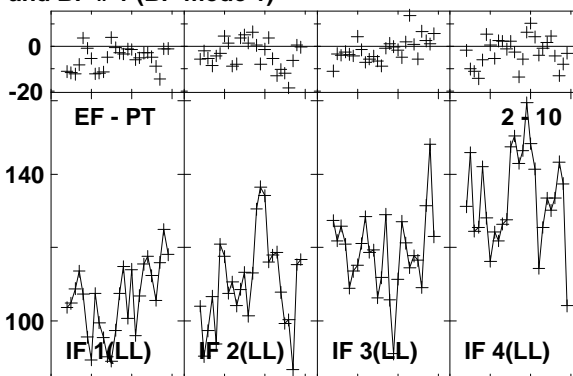
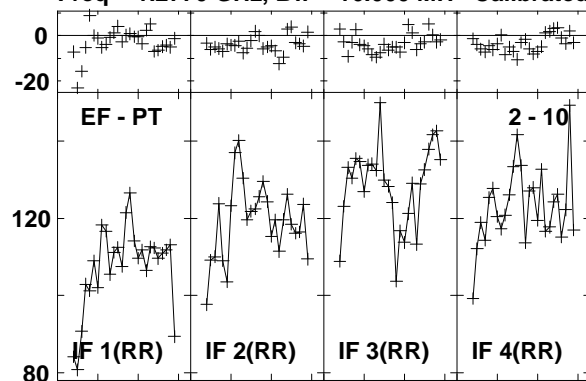

Lower frame: Milli Ampl Jy Top frame: Phas deg
Vector averaged cross-power spectrum Baseline: EF (02) - PT (10)
Timerange: 00/15:52:21 to 00/15:53:19

Plot file version 48 created 03-MAR-2016 01:12:05

J1545+5400 GN002C 1.UVDATA.1

Freq = 1.2770 GHz, Bw = 16.000 MH Calibrated with CL # 3 and BP # 1 (BP mode 1)

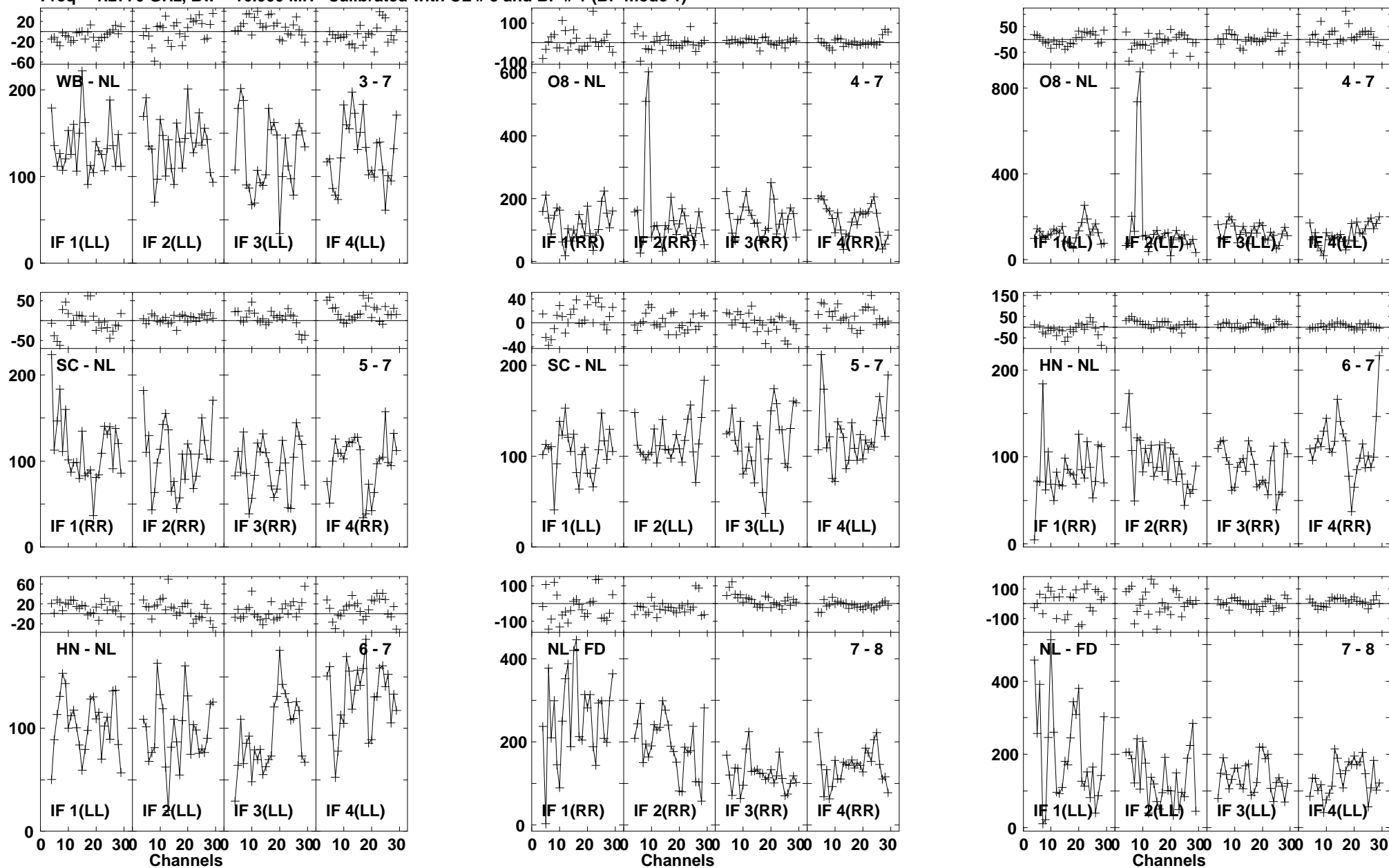

Lower frame: Milli Ampl Jy Top frame: Phas deg
Vector averaged cross-power spectrum Baseline: WB (03) - NL (07)
Timerange: 00/15:52:21 to 00/15:53:19

Plot file version 49 created 03-MAR-2016 01:12:05

J1545+5400 GN002C 1.UVDATA.1

Freq = 1.2770 GHz, Bw = 16.000 MH Calibrated with CL # 3 and BP # 1 (BP mode 1)

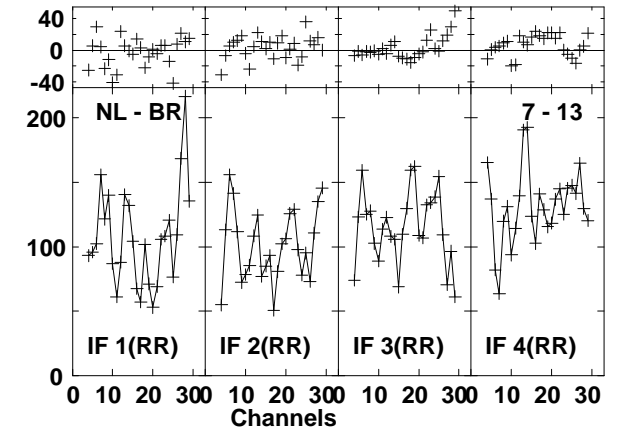
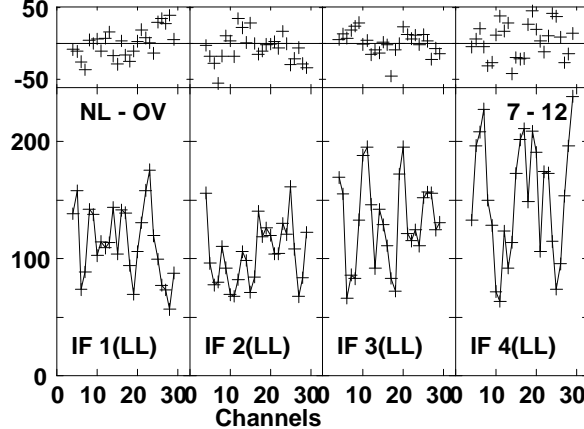
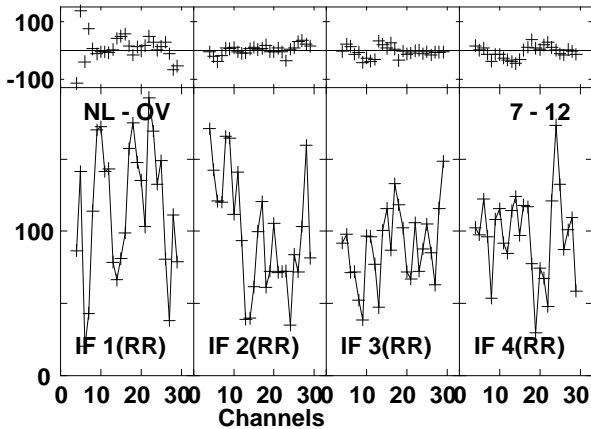
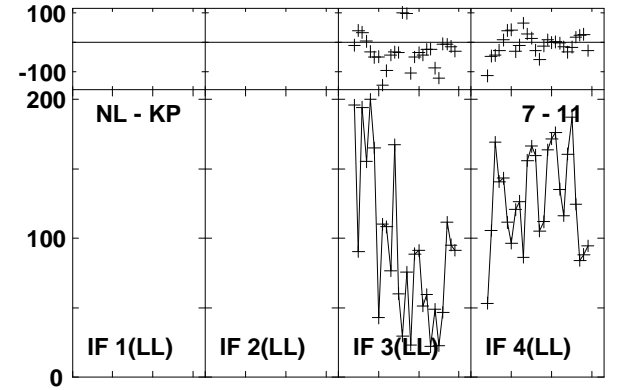
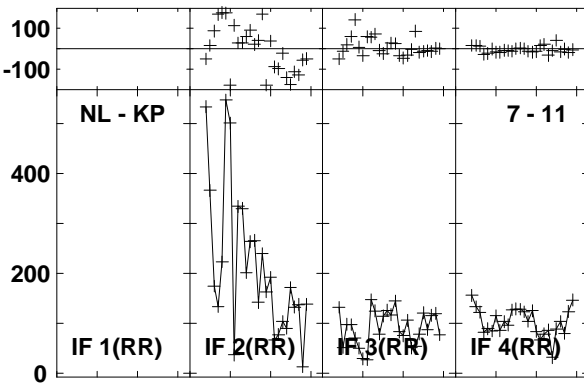
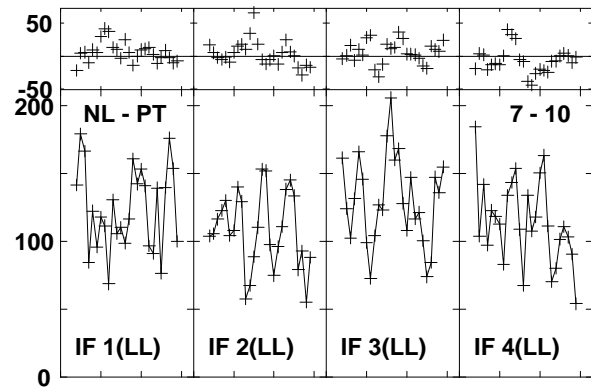
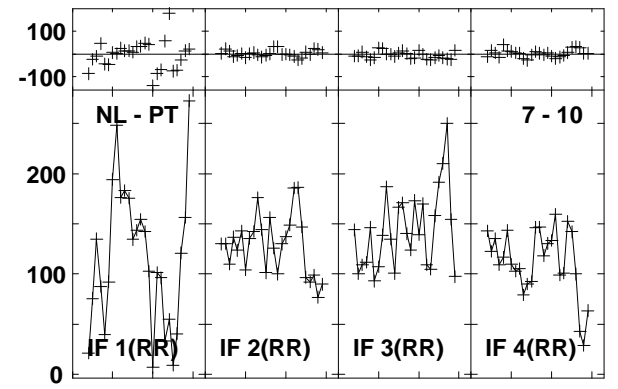
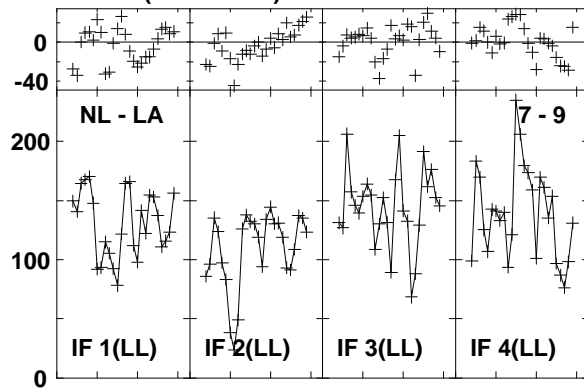
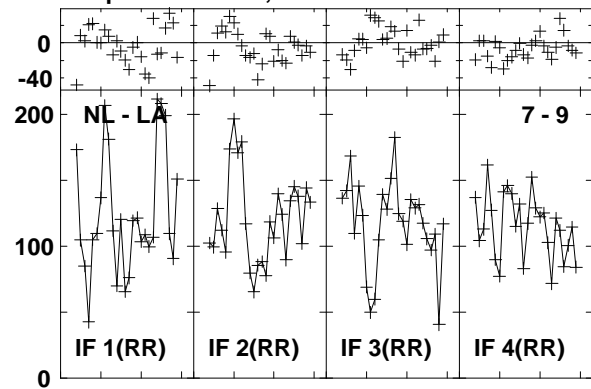

Lower frame: Milli Ampl Jy Top frame: Phas deg
Vector averaged cross-power spectrum Baseline: NL (07) - LA (09)
Timerange: 00/15:52:21 to 00/15:53:19

Plot file version 50 created 03-MAR-2016 01:12:05
J1545+5400 GN002C 1.UVDATA.1
Freq = 1.2770 GHz, Bw = 16.000 MH Calibrated with CL # 3 and BP # 1 (BP mode 1)

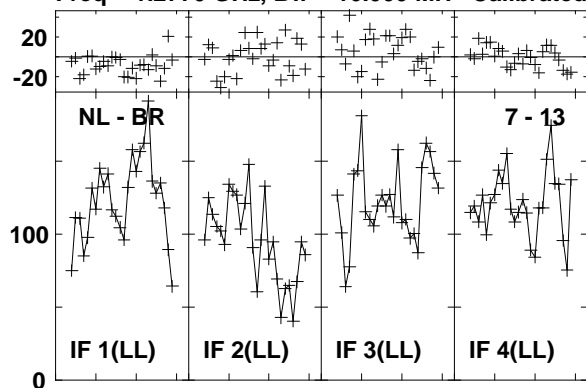

Lower frame: Milli Ampl Jy Top frame: Phas deg
Vector averaged cross-power spectrum Baseline: NL (07) - BR (13)
Timerange: 00/15:52:21 to 00/15:53:19

Plot file version 51 created 03-MAR-2016 01:12:05

4C52 GN002C 1.UVDATA.1

Freq = 1.2770 GHz, Bw = 16.000 MH Calibrated with CL # 3 and BP # 1 (BP mode 1)

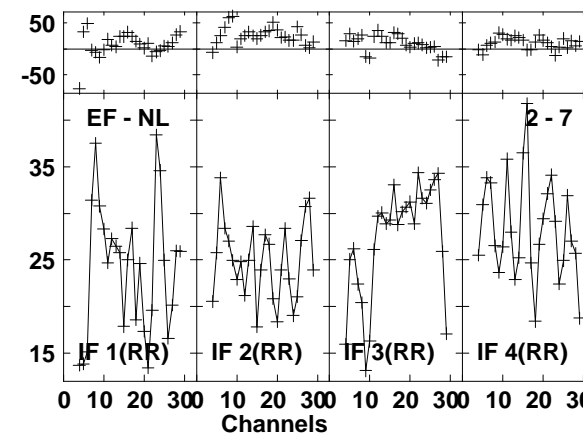
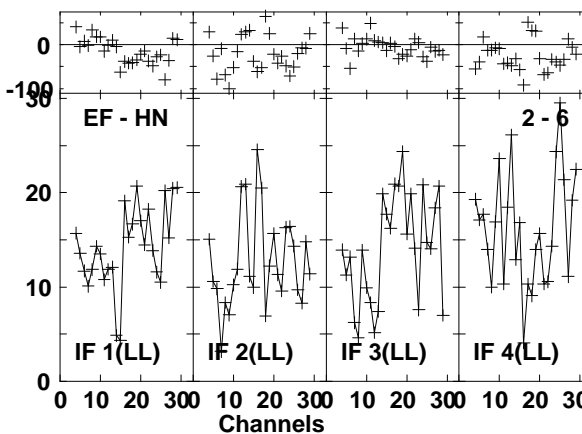
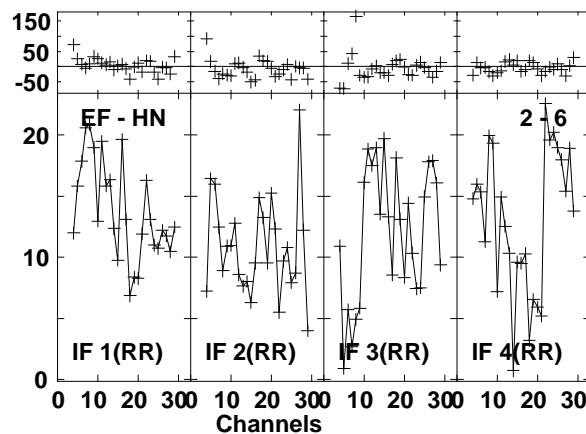
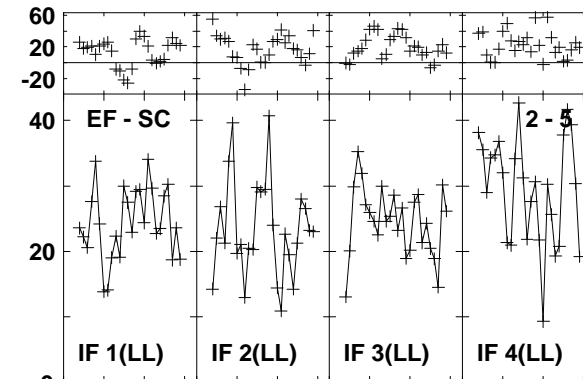
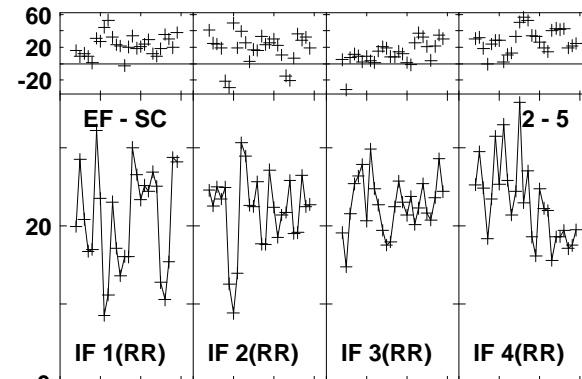
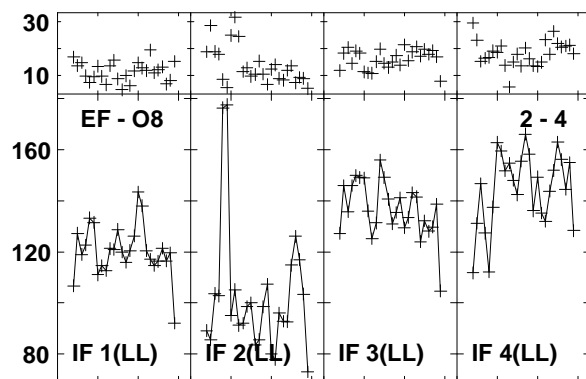
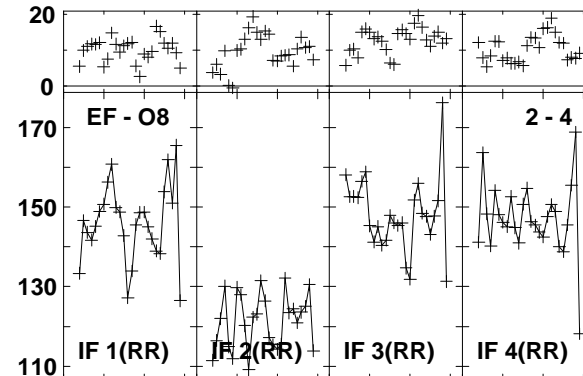
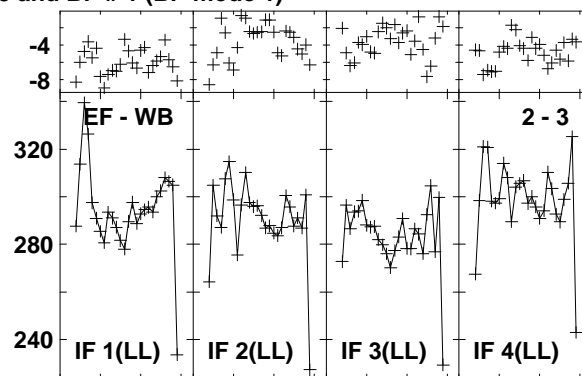
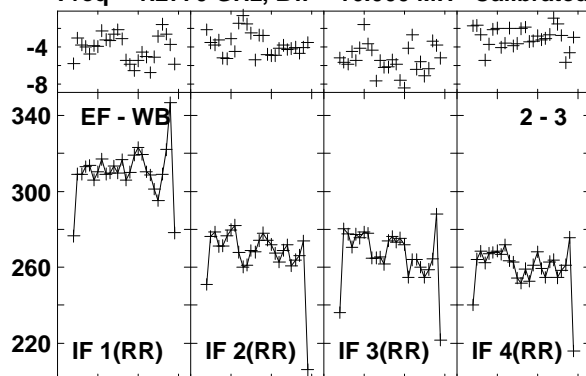

Lower frame: Milli Ampl Jy Top frame: Phas deg
Vector averaged cross-power spectrum Baseline: EF (02) - WB (03)
Timerange: 00/15:53:32 to 00/15:56:18

Plot file version 52 created 03-MAR-2016 01:12:06

4C52 GN002C 1.UVDATA.1

Freq = 1.2770 GHz, Bw = 16.000 MH Calibrated with CL # 3 and BP # 1 (BP mode 1)

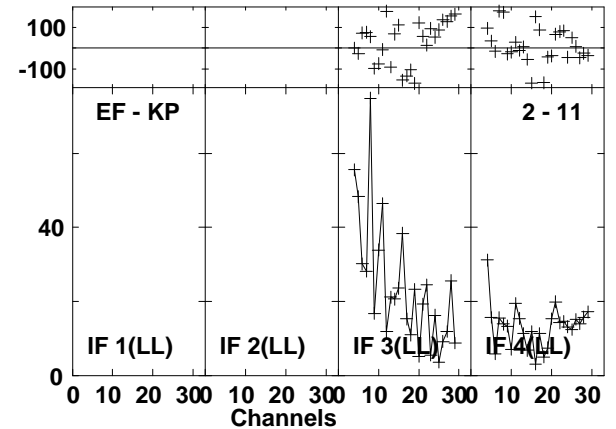
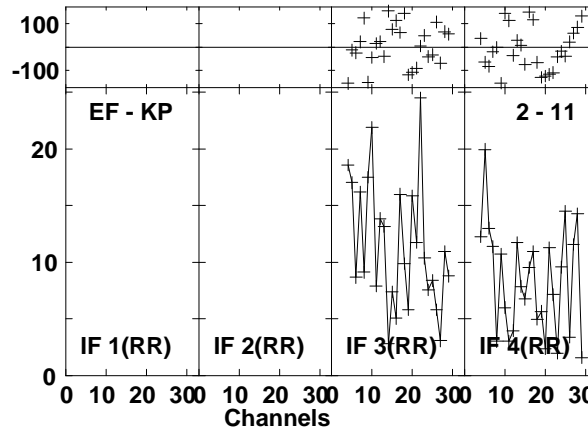
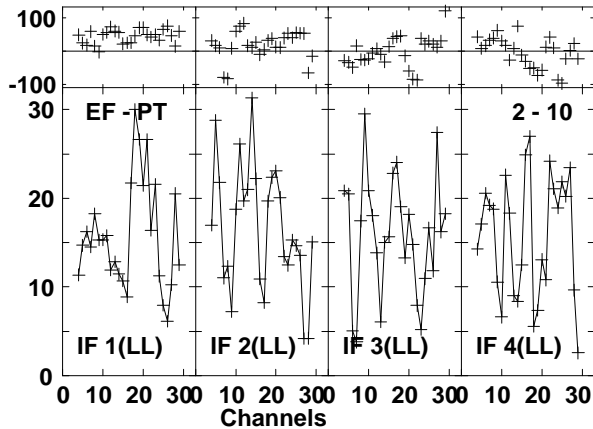
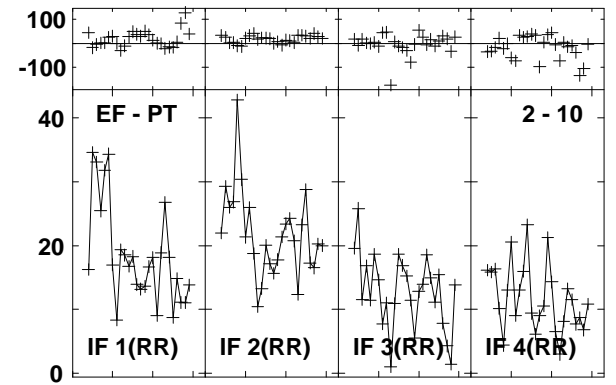
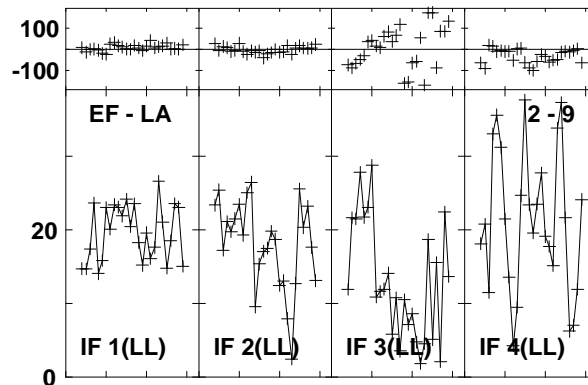
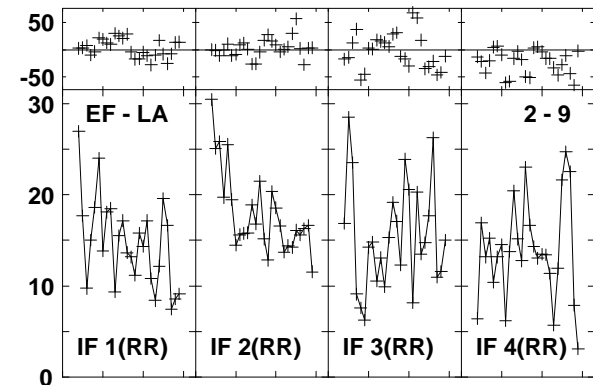
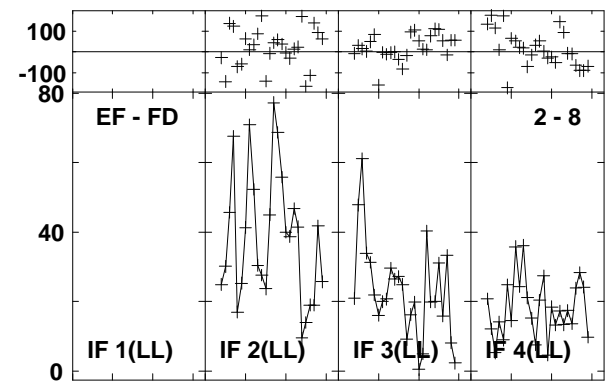
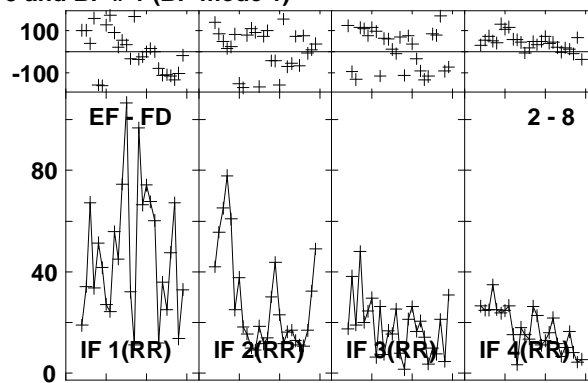
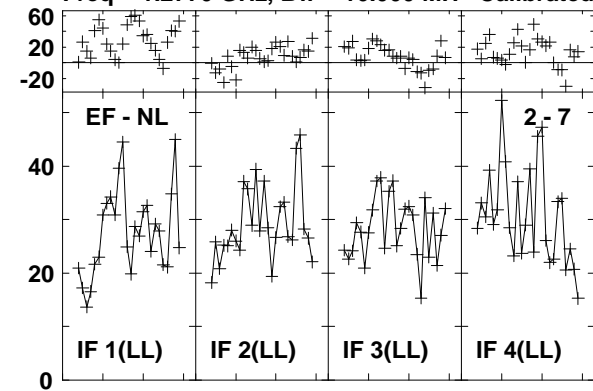

Lower frame: Milli Ampl Jy Top frame: Phas deg
Vector averaged cross-power spectrum Baseline: EF (02) - NL (07)
Timerange: 00/15:53:32 to 00/15:56:18

Plot file version 53 created 03-MAR-2016 01:12:06

4C52 GN002C 1.UVDATA.1

Freq = 1.2770 GHz, Bw = 16.000 MH Calibrated with CL # 3 and BP # 1 (BP mode 1)

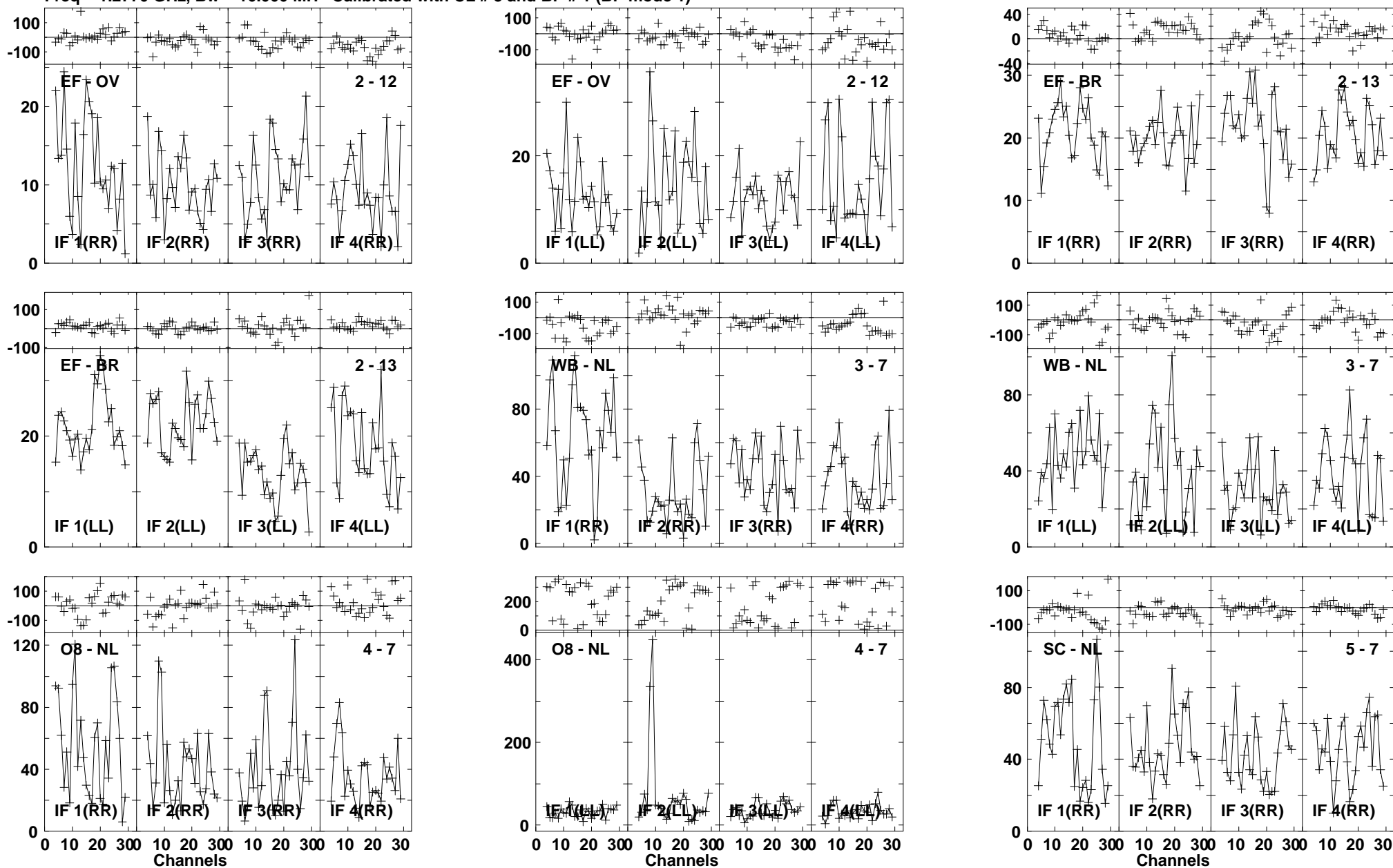

Lower frame: Milli Ampl Jy Top frame: Phas deg
Vector averaged cross-power spectrum Baseline: EF (02) - OV (12)
Timerange: 00/15:53:32 to 00/15:56:18

Plot file version 54 created 03-MAR-2016 01:12:06

4C52 GN002C 1.UVDATA.1

Freq = 1.2770 GHz, Bw = 16.000 MH Calibrated with CL # 3 and BP # 1 (BP mode 1)

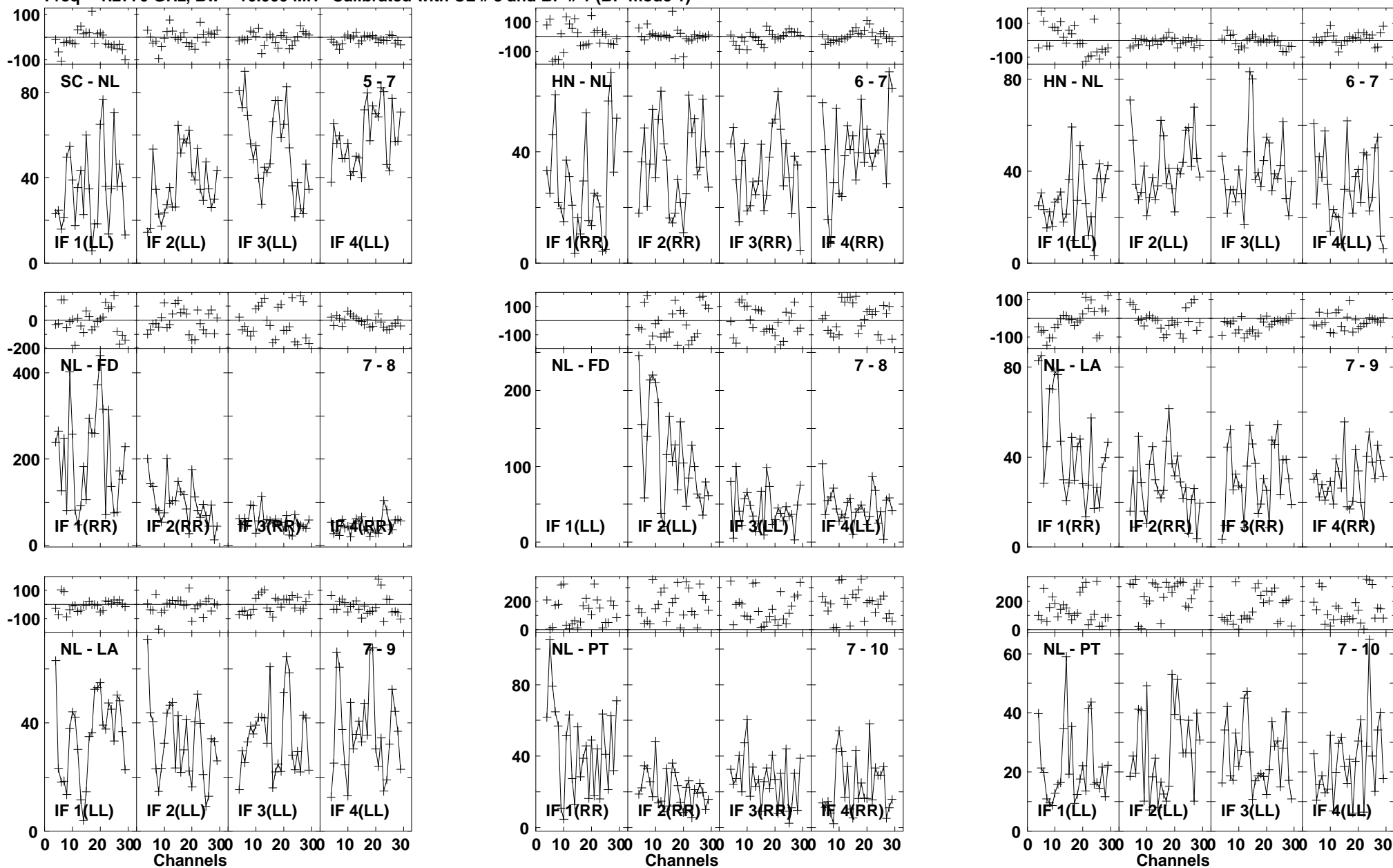

Lower frame: Milli Ampl Jy Top frame: Phas deg
Vector averaged cross-power spectrum Baseline: SC (05) - NL (07)
Timerange: 00/15:53:32 to 00/15:56:18

Plot file version 55 created 03-MAR-2016 01:12:06

4C52 GN002C 1.UVDATA.1

Freq = 1.2770 GHz, Bw = 16.000 MH Calibrated with CL # 3 and BP # 1 (BP mode 1)

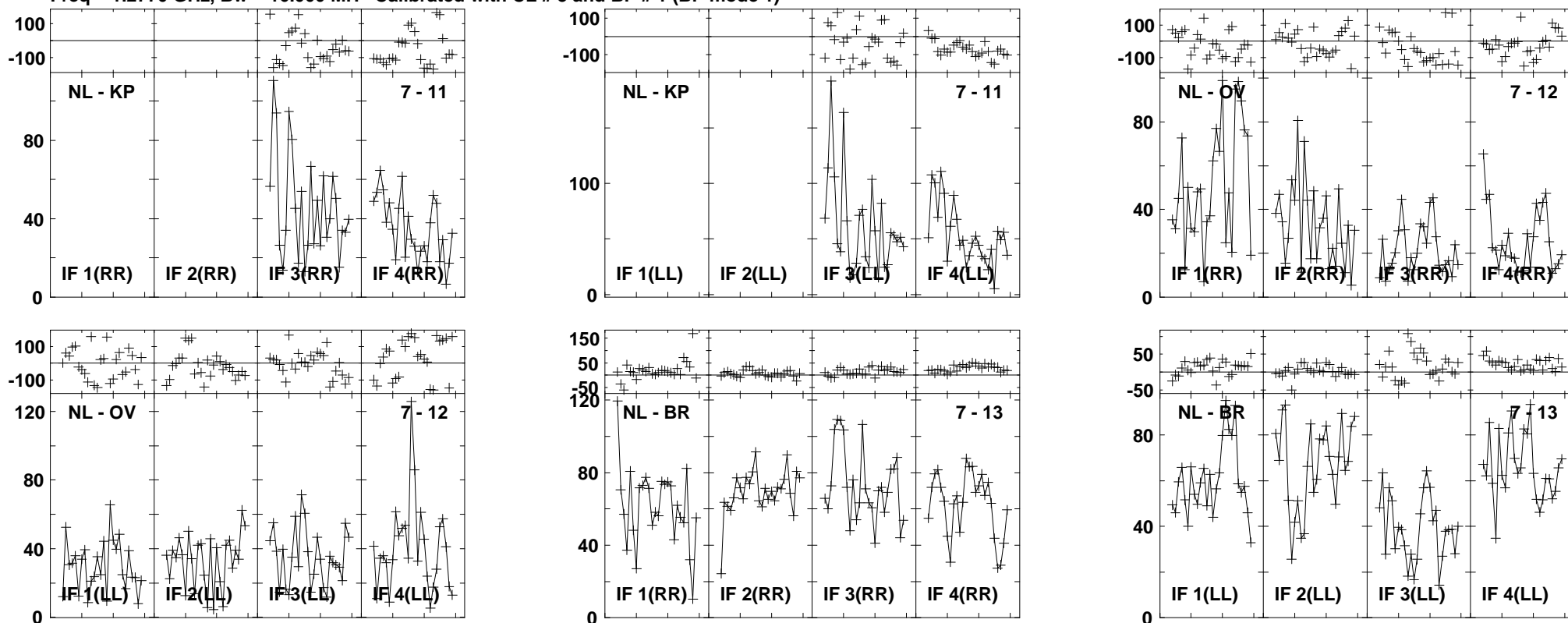

Lower frame: Milli Ampl Jy Top frame: Phas deg
Vector averaged cross-power spectrum Baseline: NL (07) - KP (11)
Timerange: 00/15:53:32 to 00/15:56:18

Plot file version 56 created 03-MAR-2016 01:12:06

J1545+5400 GN002C 1.UVDATA.1

Freq = 1.2770 GHz, Bw = 16.000 MH Calibrated with CL # 3 and BP # 1 (BP mode 1)

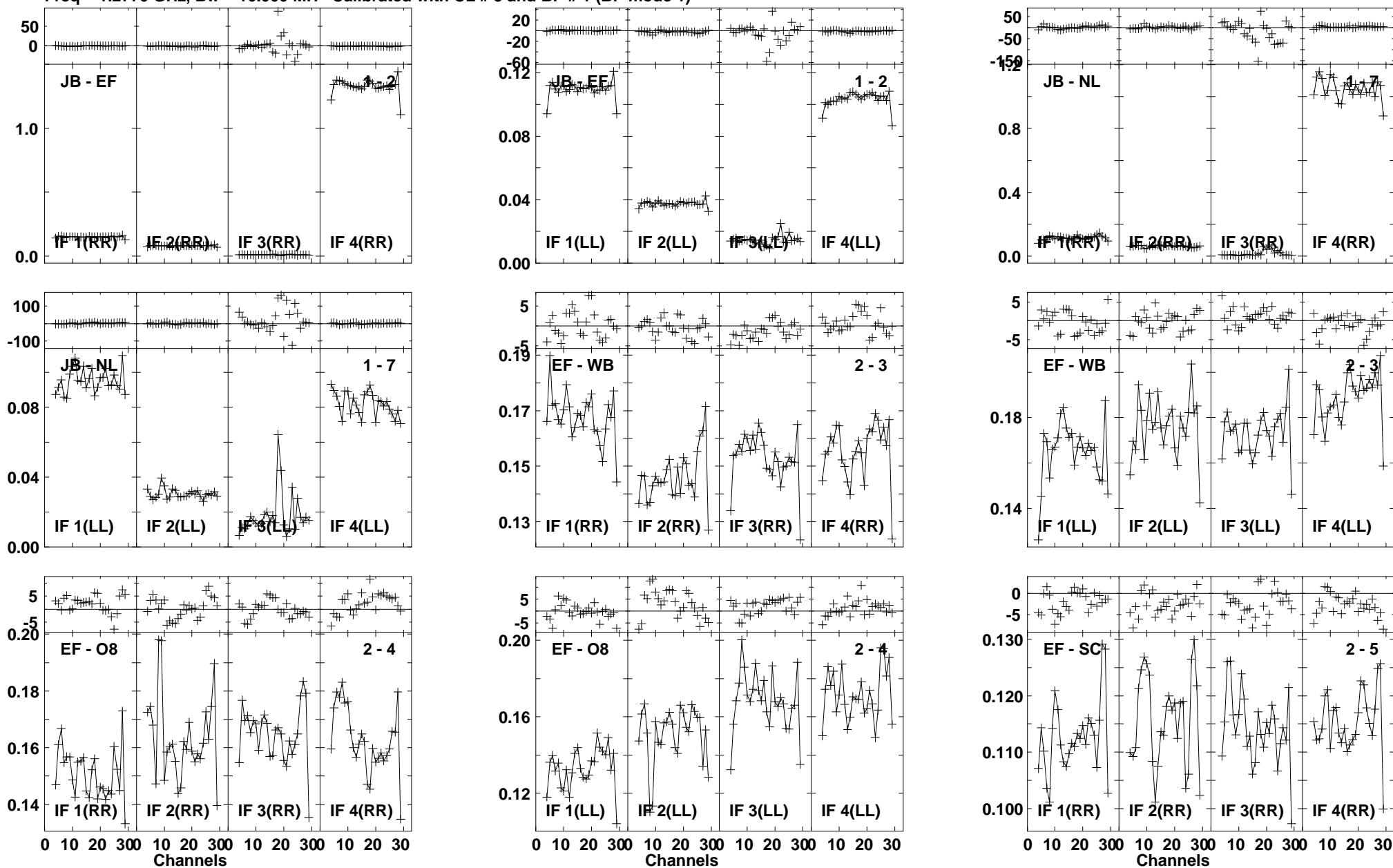

Lower frame: Ampl Jy Top frame: Phas deg
Vector averaged cross-power spectrum Baseline: JB (01) - EF (02)
Timerange: 00/15:57:11 to 00/15:59:09

Plot file version 57 created 03-MAR-2016 01:12:06

J1545+5400 GN002C 1.UVDATA.1

Freq = 1.2770 GHz, Bw = 16.000 MH Calibrated with CL # 3 and BP # 1 (BP mode 1)

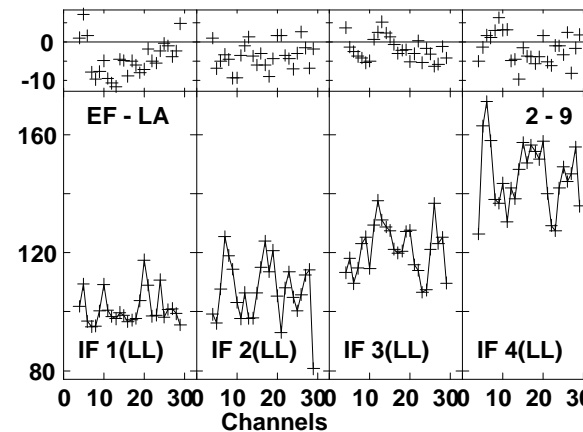
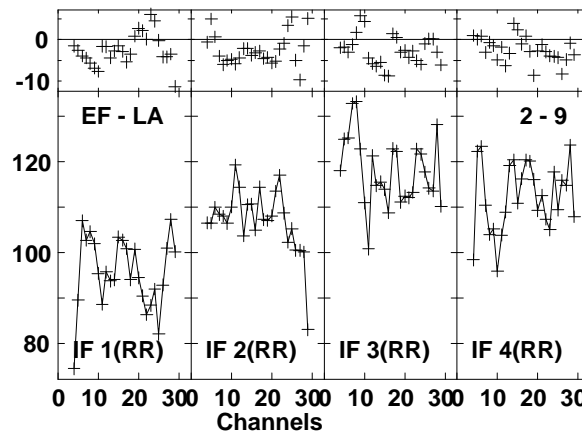
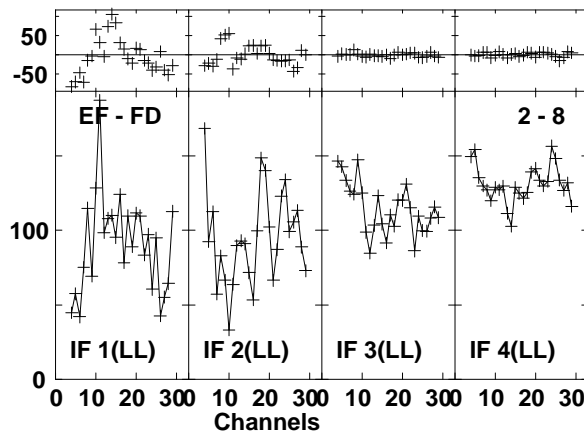
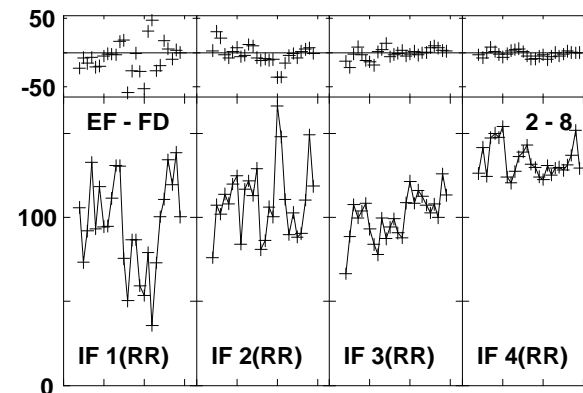
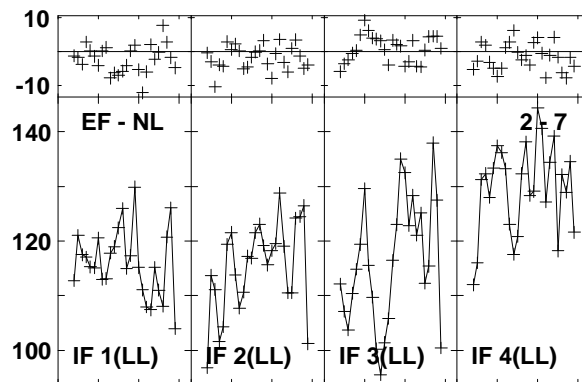
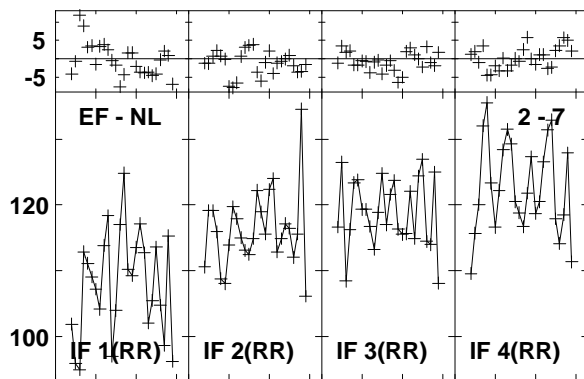
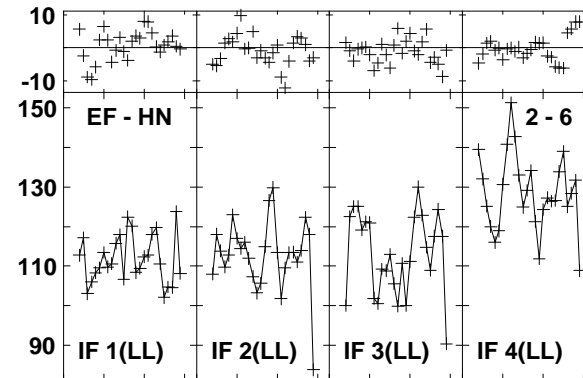
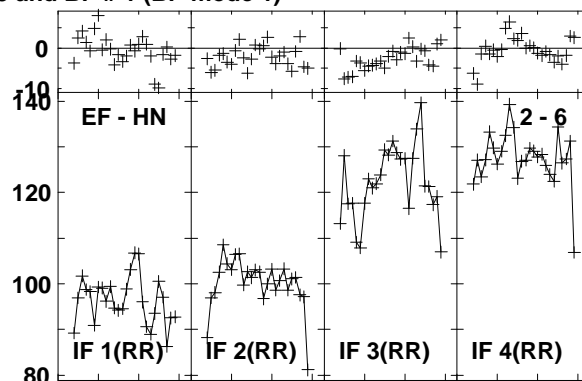
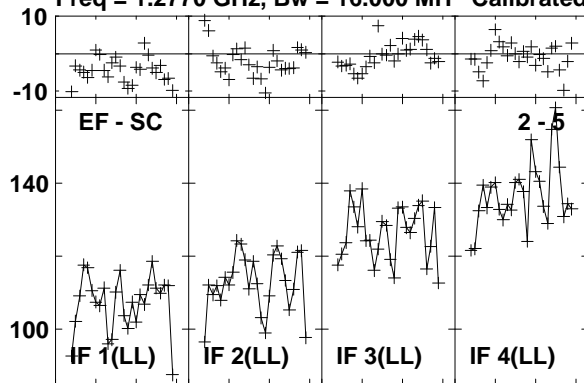

Lower frame: Milli Ampl Jy Top frame: Phas deg
Vector averaged cross-power spectrum Baseline: EF (02) - SC (05)
Timerange: 00/15:57:11 to 00/15:59:09

Plot file version 58 created 03-MAR-2016 01:12:07

J1545+5400 GN002C 1.UVDATA.1

Freq = 1.2770 GHz, Bw = 16.000 MH Calibrated with CL # 3 and BP # 1 (BP mode 1)

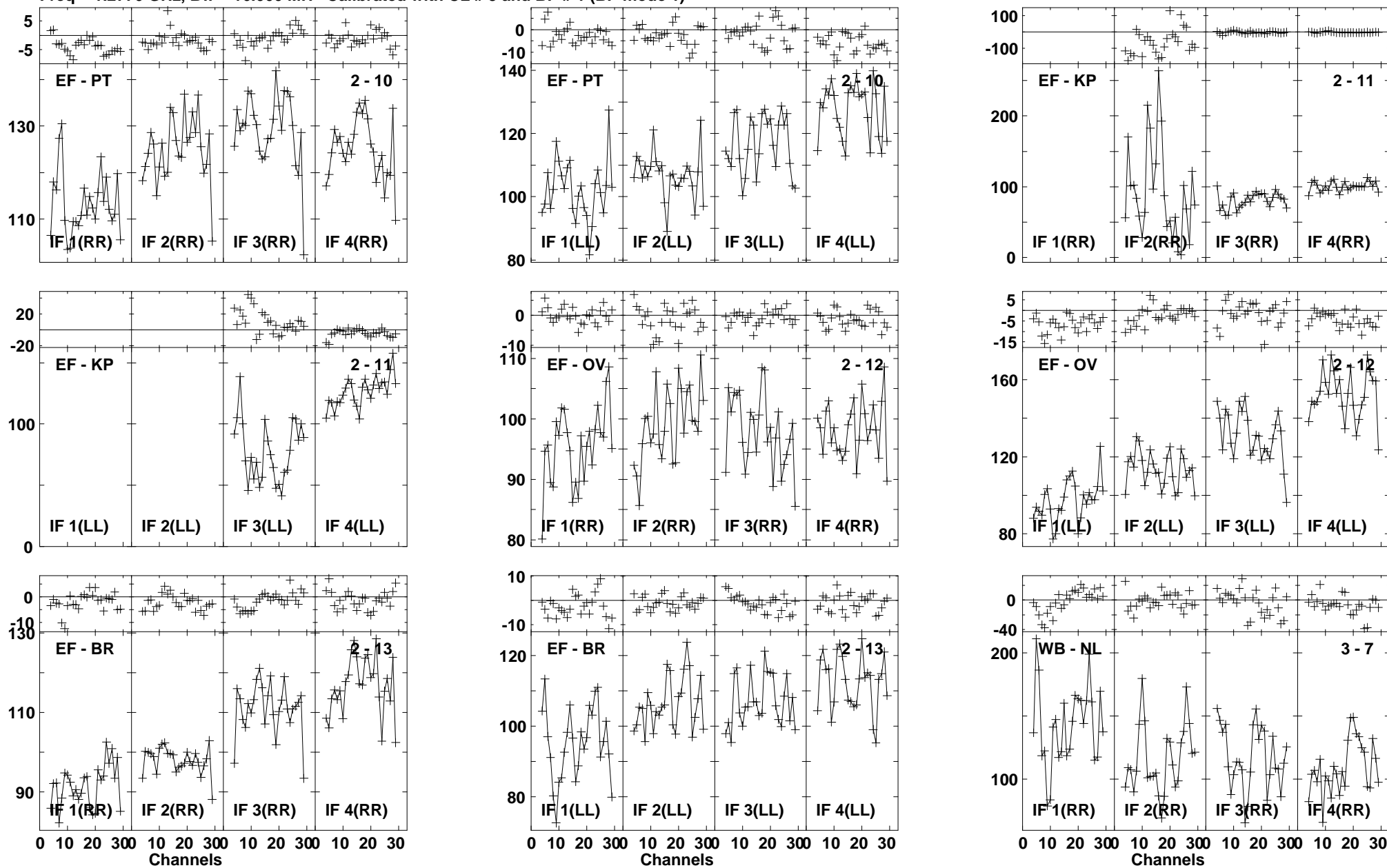

Lower frame: Milli Ampl Jy Top frame: Phas deg
Vector averaged cross-power spectrum Baseline: EF (02) - PT (10)
Timerange: 00/15:57:11 to 00/15:59:09

Plot file version 59 created 03-MAR-2016 01:12:07

J1545+5400 GN002C 1.UVDATA.1

Freq = 1.2770 GHz, Bw = 16.000 MH Calibrated with CL # 3 and BP # 1 (BP mode 1)

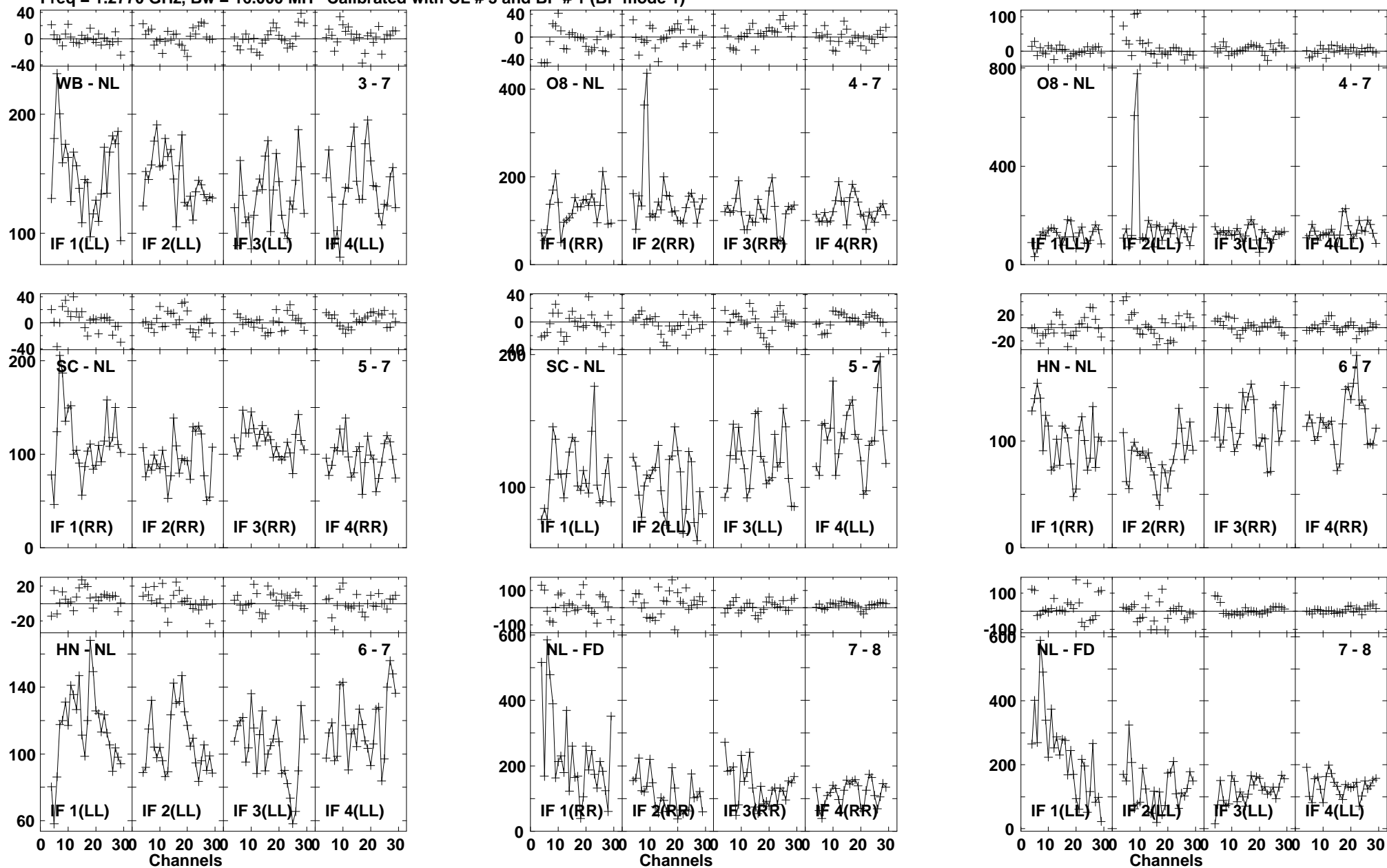

Lower frame: Milli Ampl Jy Top frame: Phas deg
Vector averaged cross-power spectrum Baseline: WB (03) - NL (07)
Timerange: 00:15:57:11 to 00:15:59:09

Plot file version 60 created 03-MAR-2016 01:12:07

J1545+5400 GN002C 1.UVDATA.1

Freq = 1.2770 GHz, Bw = 16.000 MH Calibrated with CL # 3 and BP # 1 (BP mode 1)

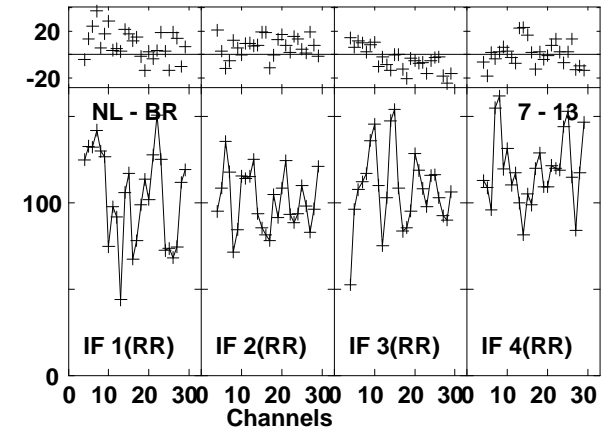
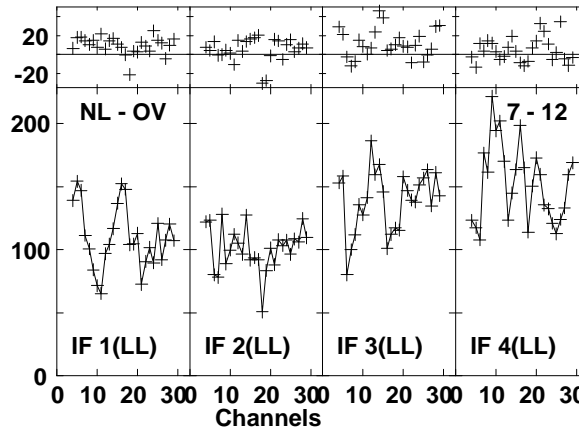
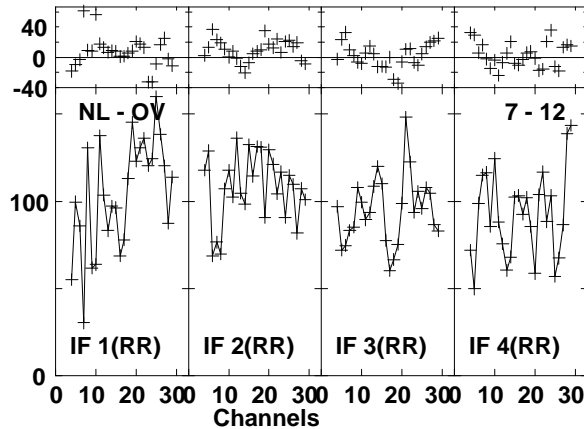
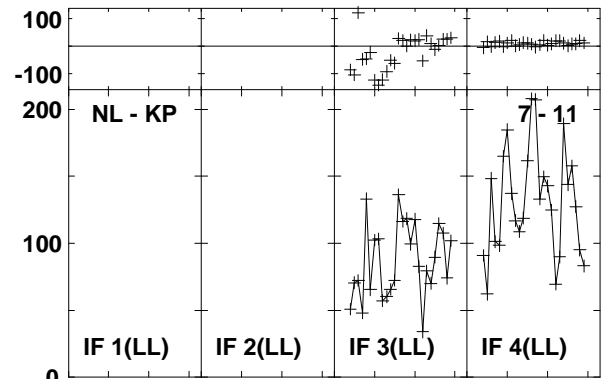
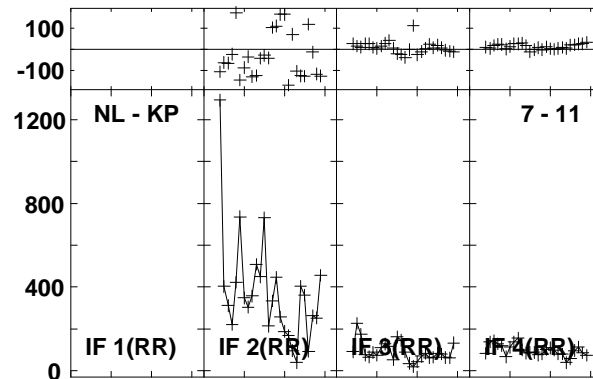
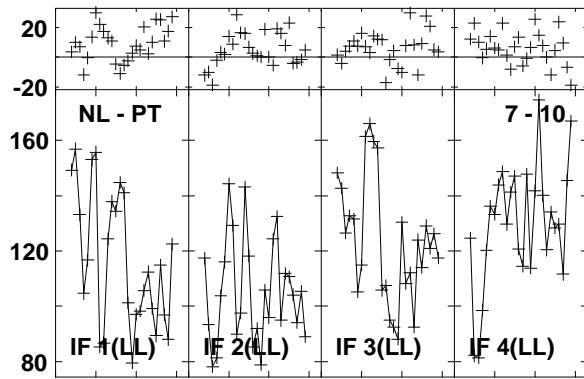
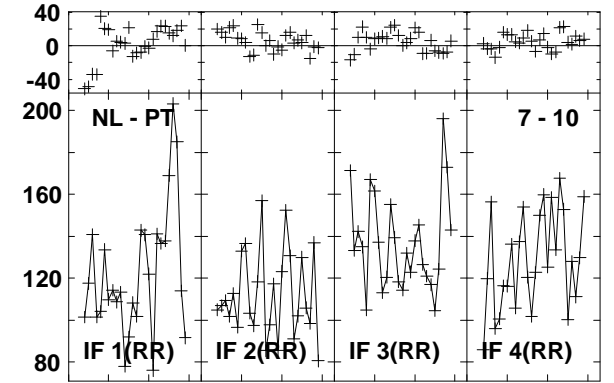
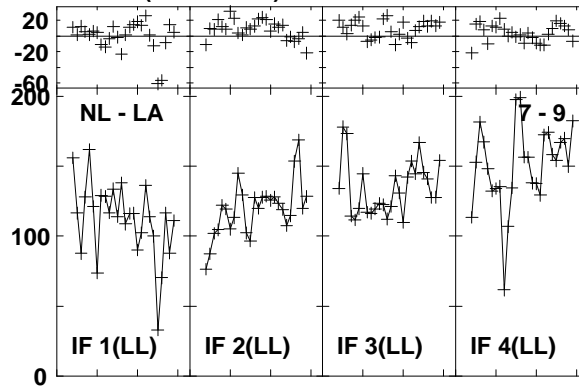
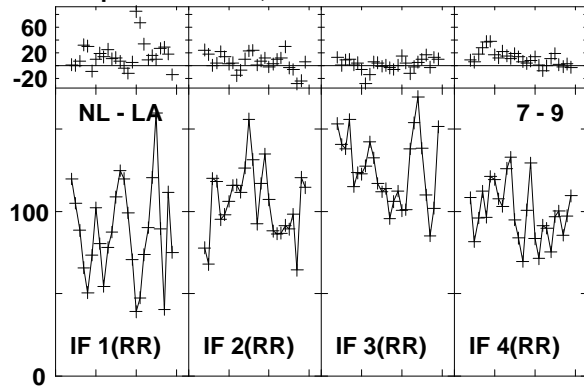

Lower frame: Milli Ampl Jy Top frame: Phas deg
Vector averaged cross-power spectrum Baseline: NL (07) - LA (09)
Timerange: 00/15:57:11 to 00/15:59:09

Plot file version 61 created 03-MAR-2016 01:12:07
J1545+5400 GN002C 1.UVDATA.1
Freq = 1.2770 GHz, Bw = 16.000 MH Calibrated with CL # 3 and BP # 1 (BP mode 1)

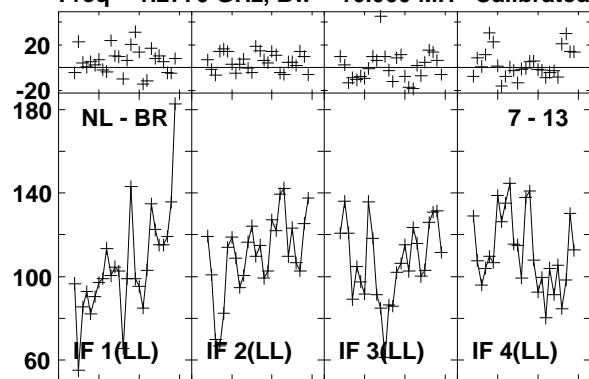

Lower frame: Milli Ampl Jy Top frame: Phas deg
Vector averaged cross-power spectrum Baseline: NL (07) - BR (13)
Timerange: 00/15:57:11 to 00/15:59:09

Plot file version 62 created 03-MAR-2016 01:12:07

4C52 GN002C 1.UVDATA.1

Freq = 1.2770 GHz, Bw = 16.000 MH Calibrated with CL # 3 and BP # 1 (BP mode 1)

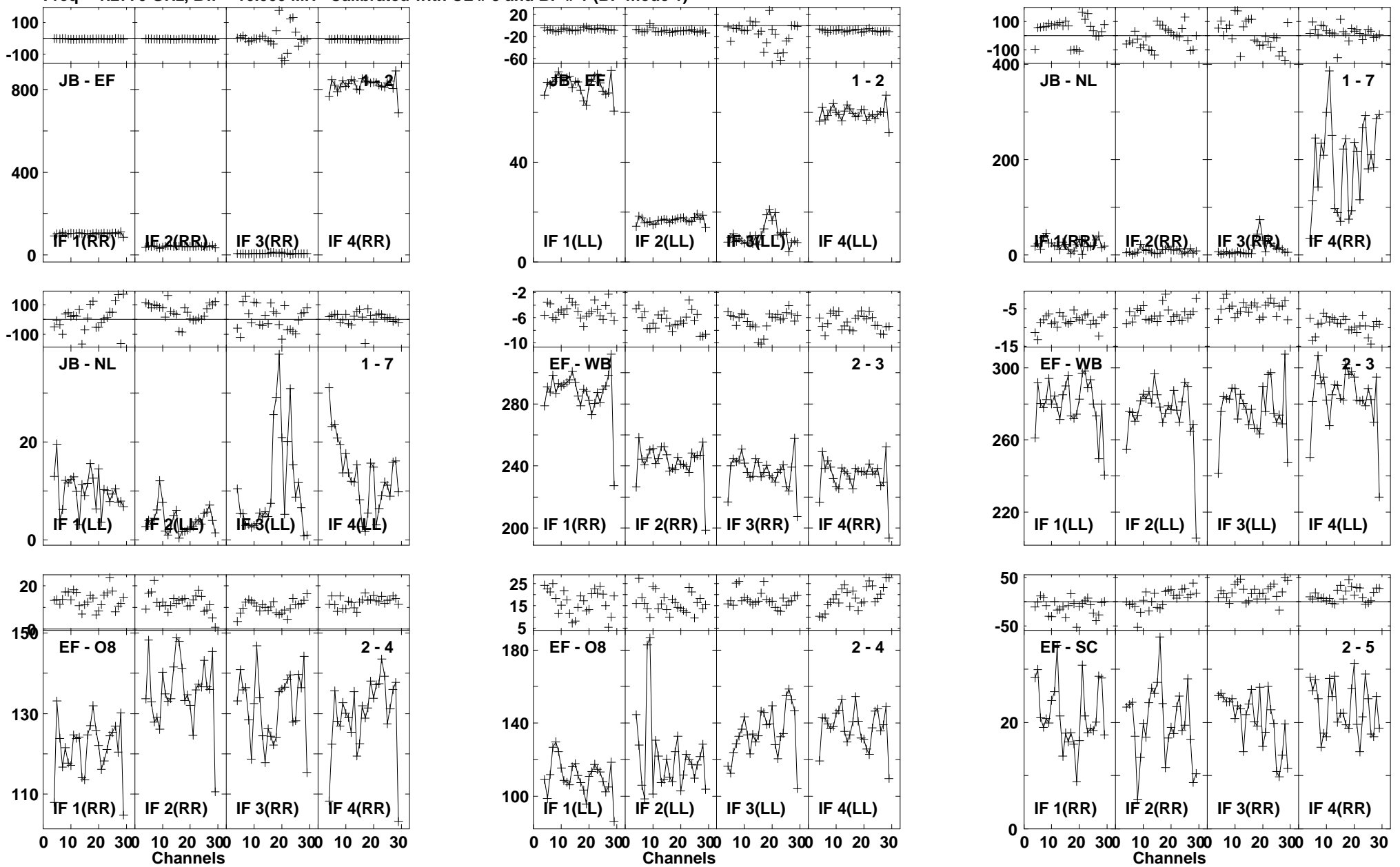

Lower frame: Milli Ampl Jy Top frame: Phas deg
Vector averaged cross-power spectrum Baseline: JB (01) - EF (02)
Timerange: 00/15:59:22 to 00/16:02:08

Plot file version 63 created 03-MAR-2016 01:12:08

4C52 GN002C 1.UVDATA.1

Freq = 1.2770 GHz, Bw = 16.000 MH Calibrated with CL # 3 and BP # 1 (BP mode 1)

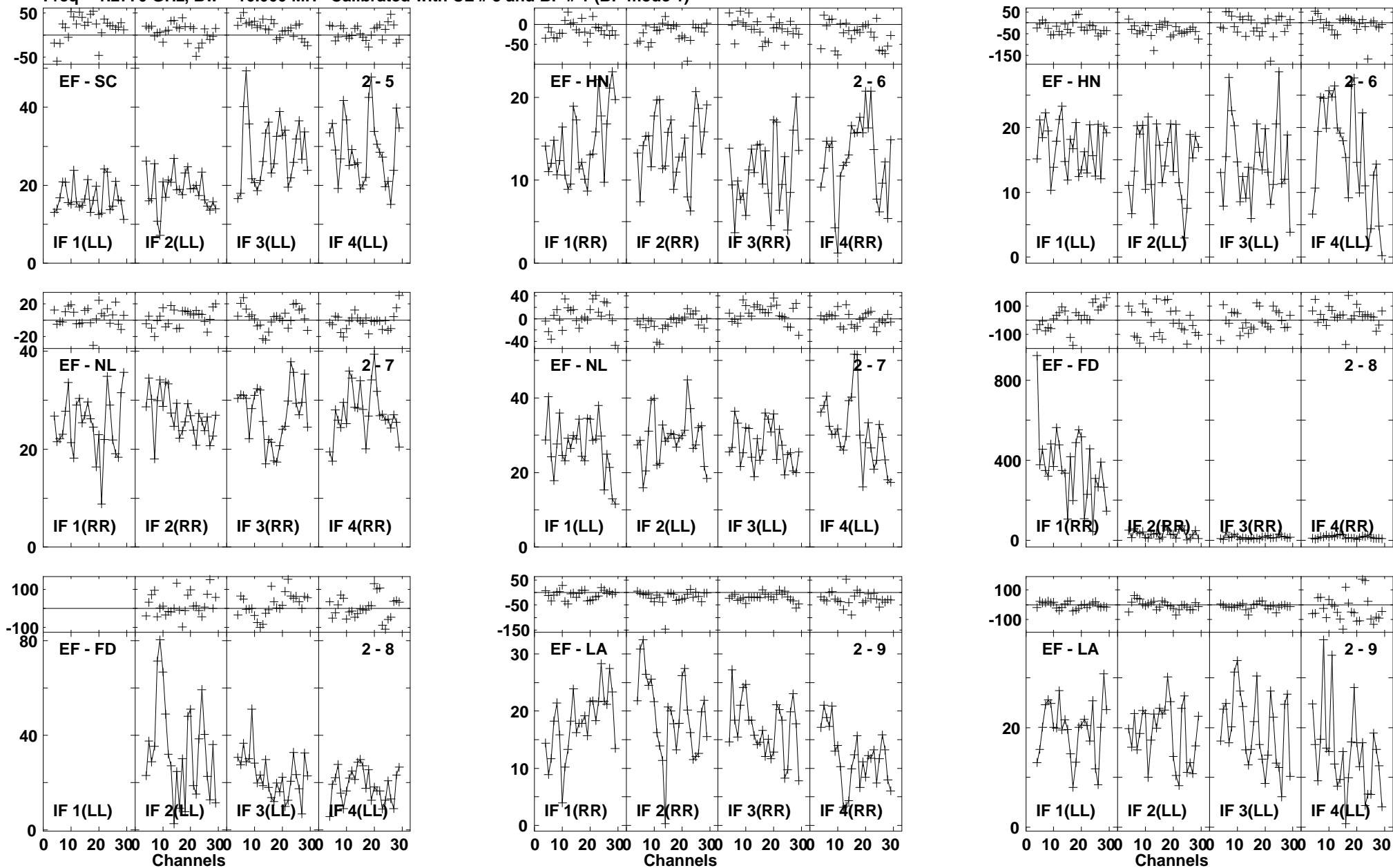

Lower frame: Milli Ampl Jy Top frame: Phas deg
Vector averaged cross-power spectrum Baseline: EF (02) - SC (05)
Timerange: 00/15:59:22 to 00/16:02:08

Plot file version 64 created 03-MAR-2016 01:12:08

4C52 GN002C 1.UVDATA.1

Freq = 1.2770 GHz, Bw = 16.000 MH Calibrated with CL # 3 and BP # 1 (BP mode 1)

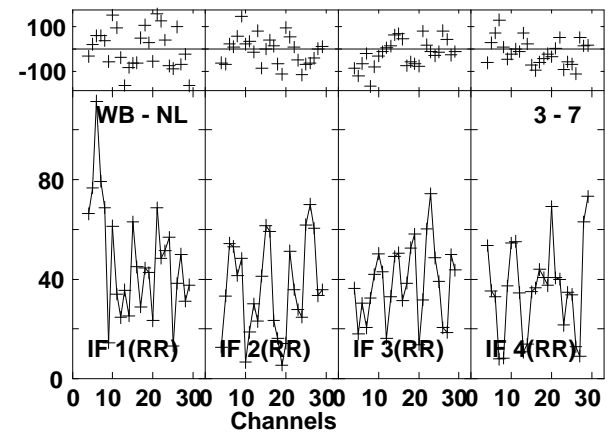
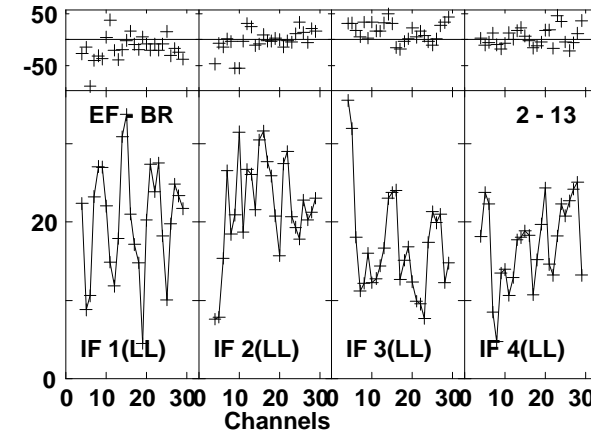
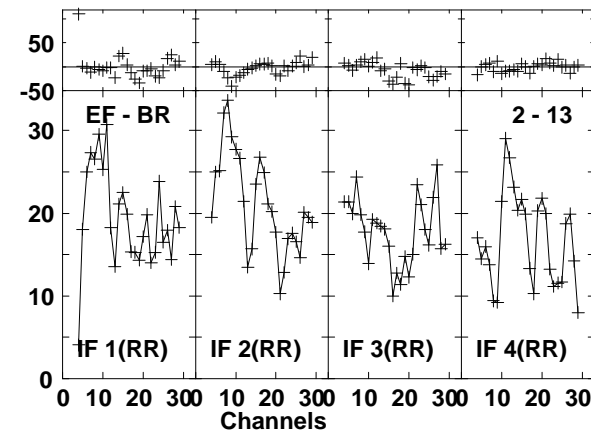
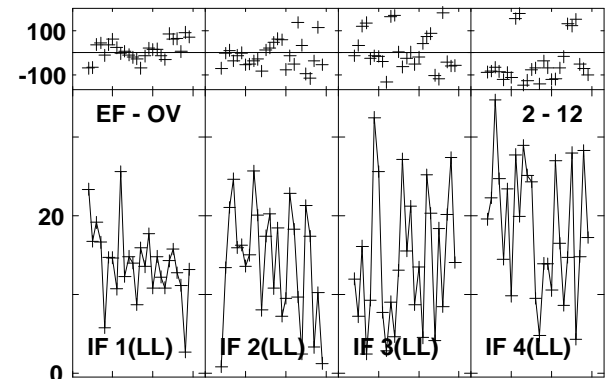
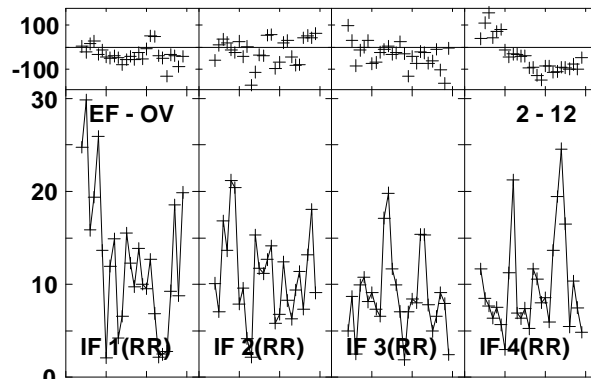
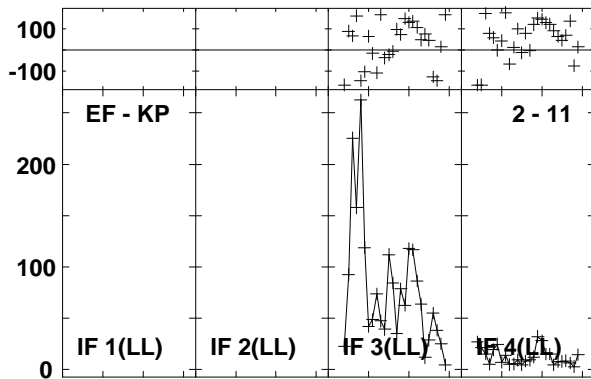
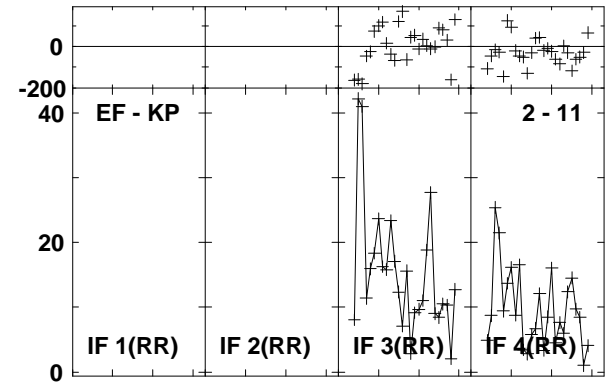
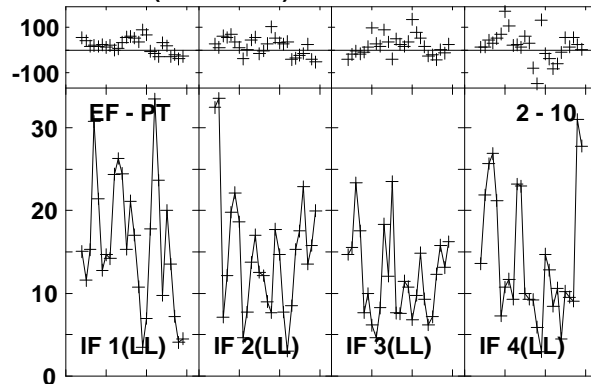
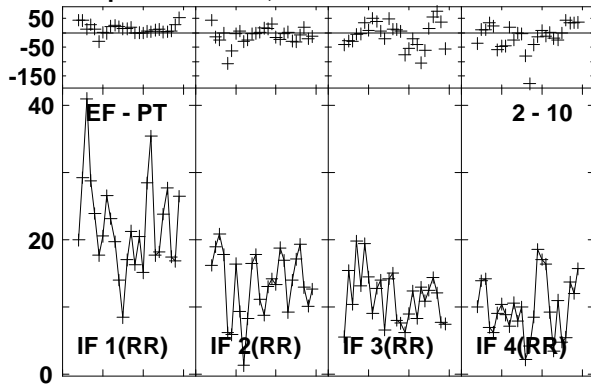

Lower frame: Milli Ampl Jy Top frame: Phas deg
Vector averaged cross-power spectrum Baseline: EF (02) - PT (10)
Timerange: 00/15:59:22 to 00/16:02:08

Plot file version 65 created 03-MAR-2016 01:12:08

4C52 GN002C 1.UVDATA.1

Freq = 1.2770 GHz, Bw = 16.000 MH Calibrated with CL # 3 and BP # 1 (BP mode 1)

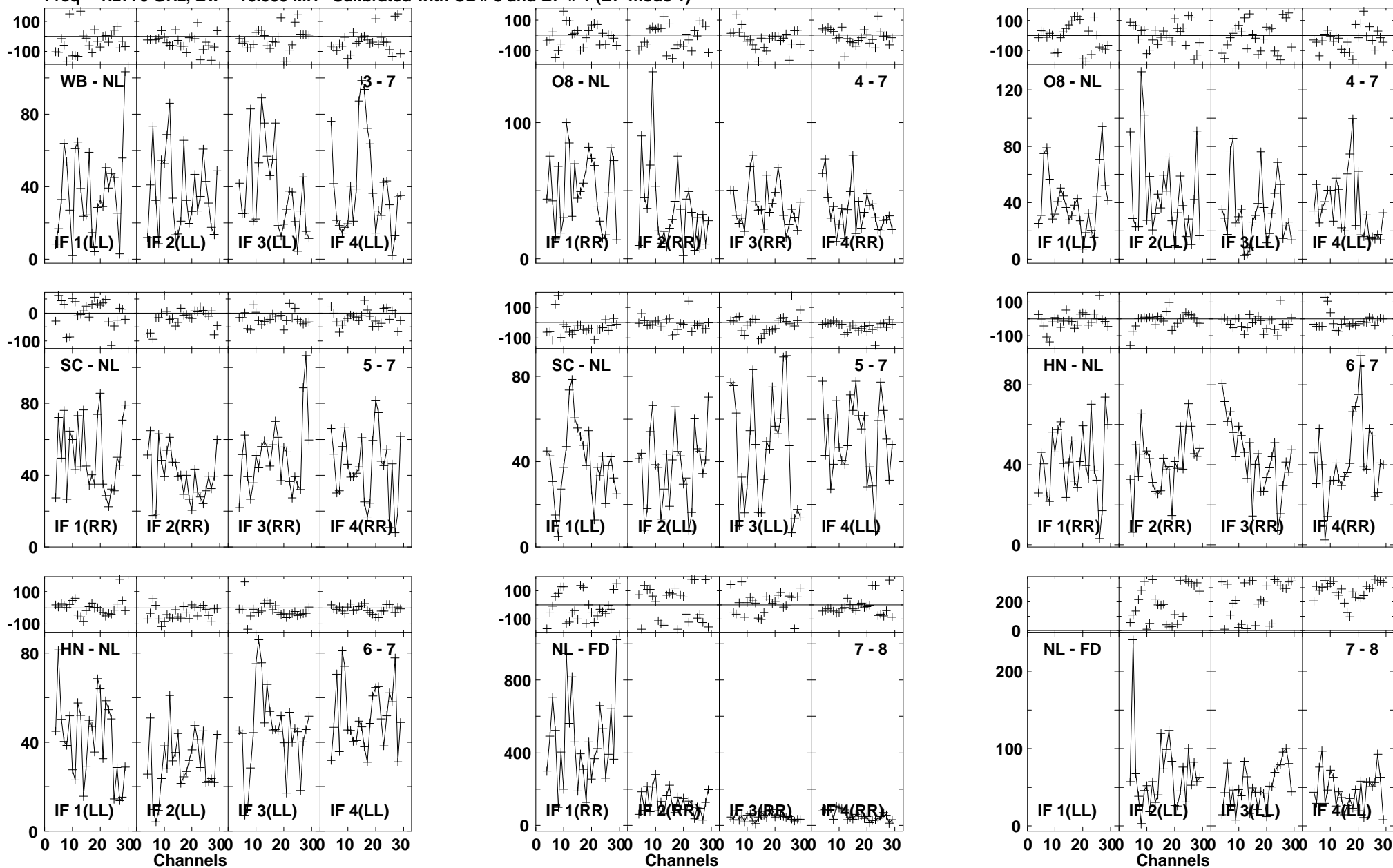

Lower frame: Milli Ampl Jy Top frame: Phas deg
Vector averaged cross-power spectrum Baseline: WB (03) - NL (07)
Timerange: 00/15:59:22 to 00/16:02:08

Plot file version 66 created 03-MAR-2016 01:12:08

4C52 GN002C 1.UVDATA.1

Freq = 1.2770 GHz, Bw = 16.000 MH Calibrated with CL # 3 and BP # 1 (BP mode 1)

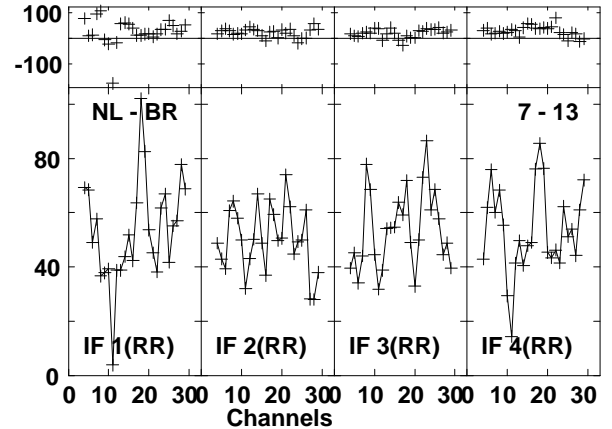
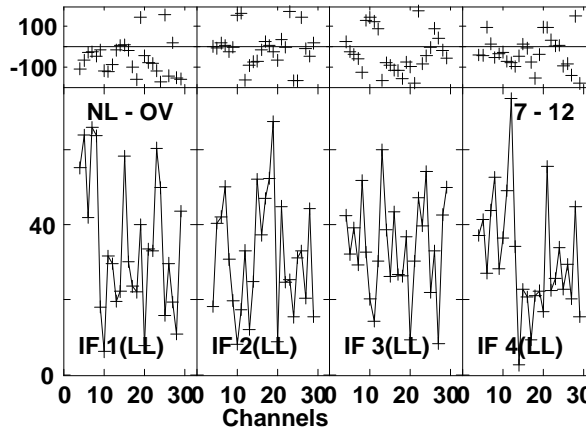
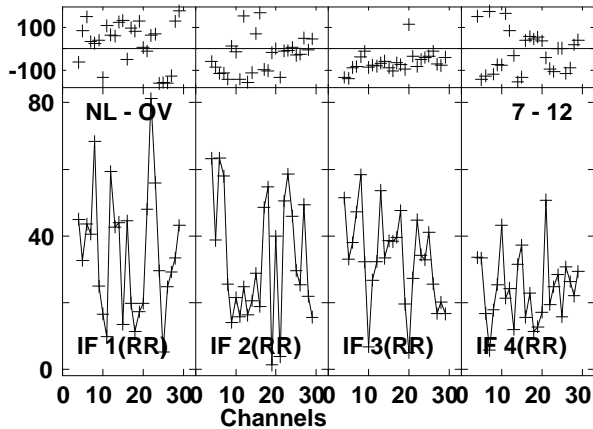
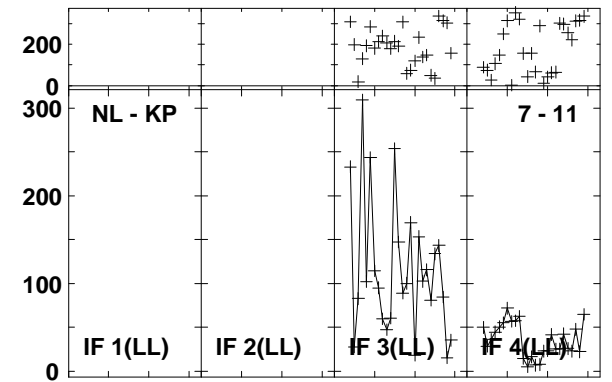
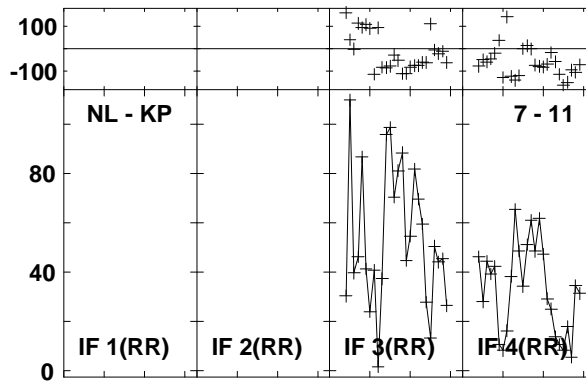
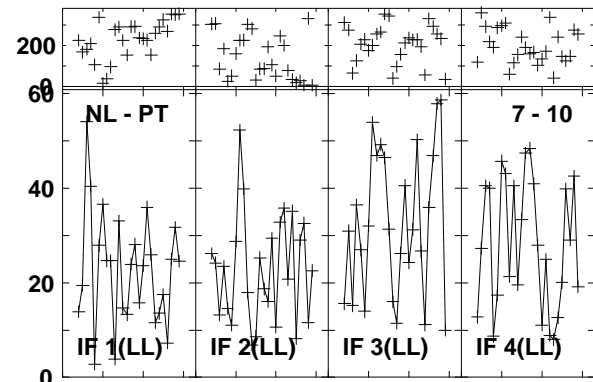
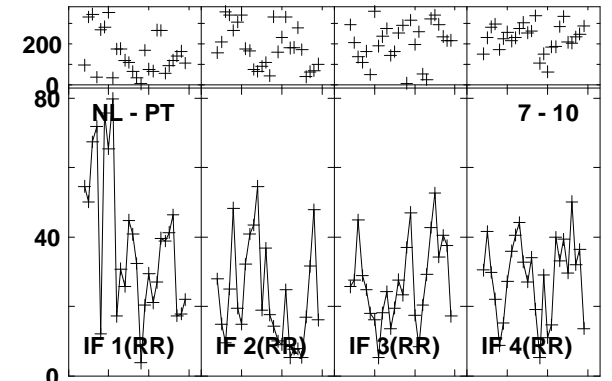
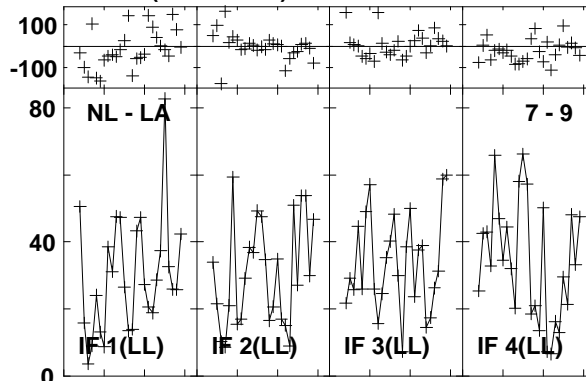
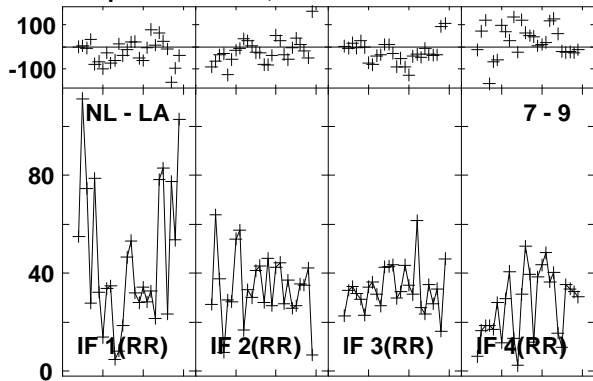

Lower frame: Milli Ampl Jy Top frame: Phas deg
Vector averaged cross-power spectrum Baseline: NL (07) - LA (09)
Timerange: 00/15:59:22 to 00/16:02:08

Plot file version 67 created 03-MAR-2016 01:12:08

4C52 GN002C 1.UVDATA.1

Freq = 1.2770 GHz, Bw = 16.000 MH Calibrated with CL # 3 and BP # 1 (BP mode 1)

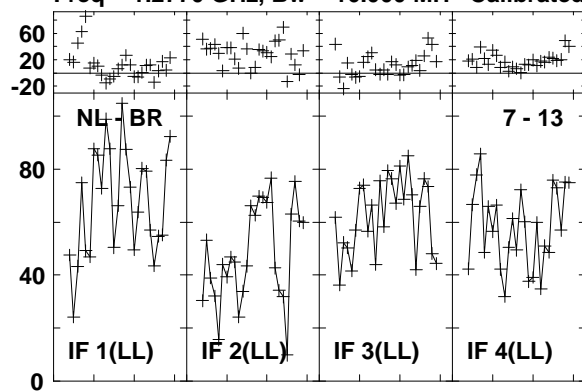

Lower frame: Milli Ampl Jy Top frame: Phas deg
Vector averaged cross-power spectrum Baseline: NL (07) - BR (13)
Timerange: 00/15:59:22 to 00/16:02:08

Plot file version 68 created 03-MAR-2016 01:12:08
 J1545+5400 GN002C 1.UVDATA.1
 Freq = 1.2770 GHz, Bw = 16.000 MH Calibrated with CL # 3 and BP # 1 (BP mode 1)

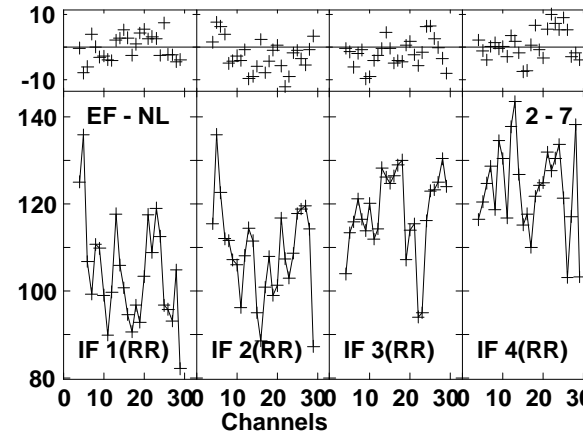
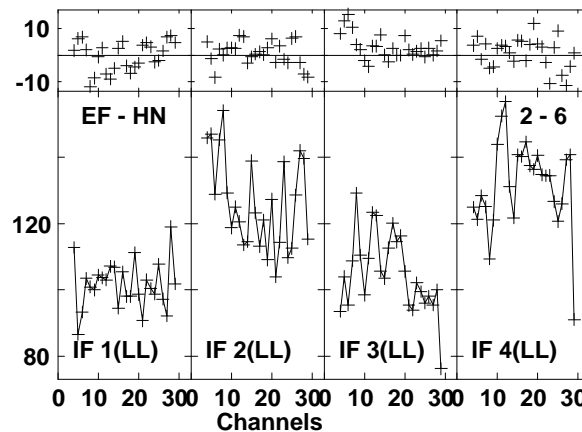
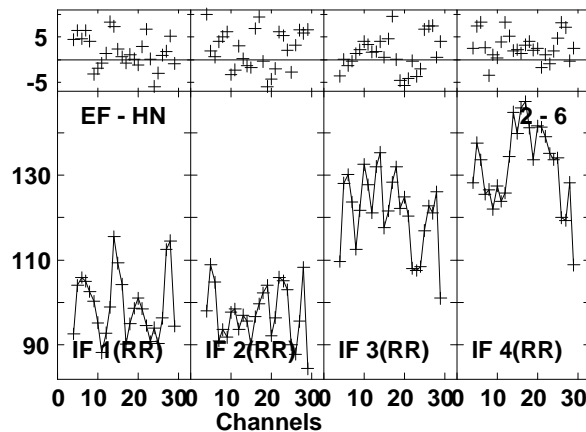
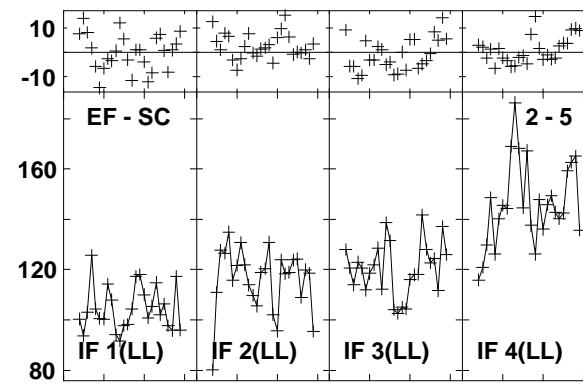
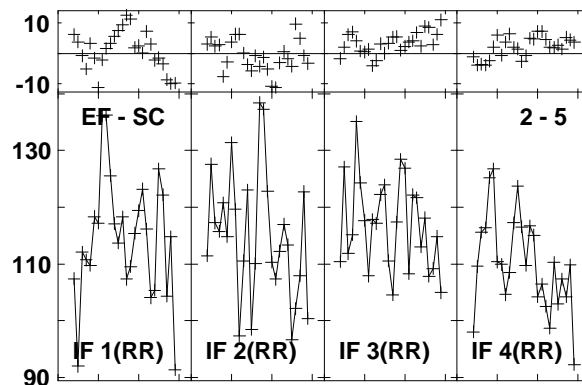
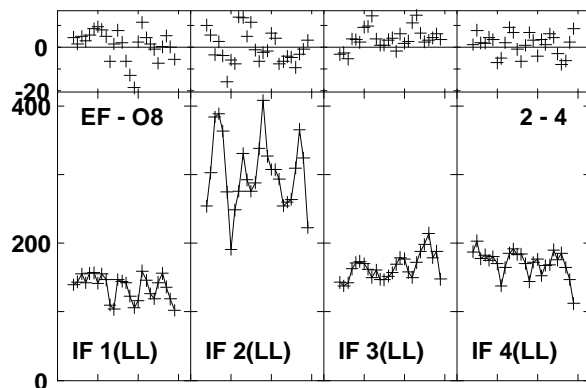
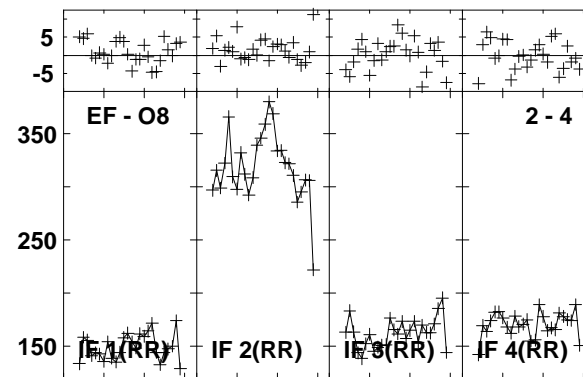
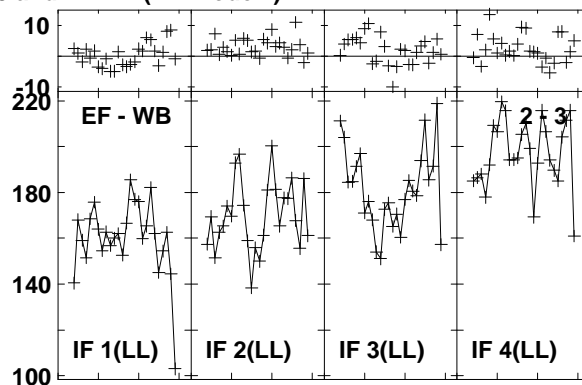
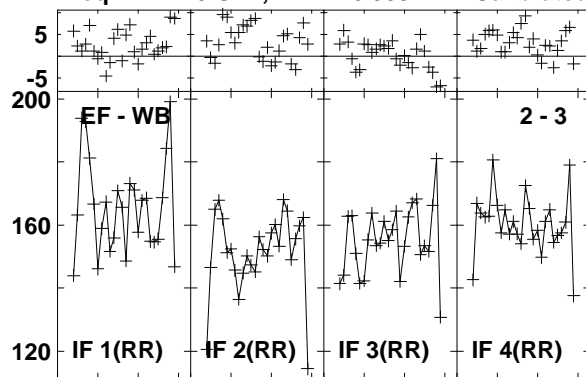

Lower frame: Milli Ampl Jy Top frame: Phas deg
 Vector averaged cross-power spectrum Baseline: EF (02) - WB (03)
 Timerange: 00/16:03:01 to 00/16:03:59

Plot file version 69 created 03-MAR-2016 01:12:09

J1545+5400 GN002C 1.UVDATA.1

Freq = 1.2770 GHz, Bw = 16.000 MH Calibrated with CL # 3 and BP # 1 (BP mode 1)

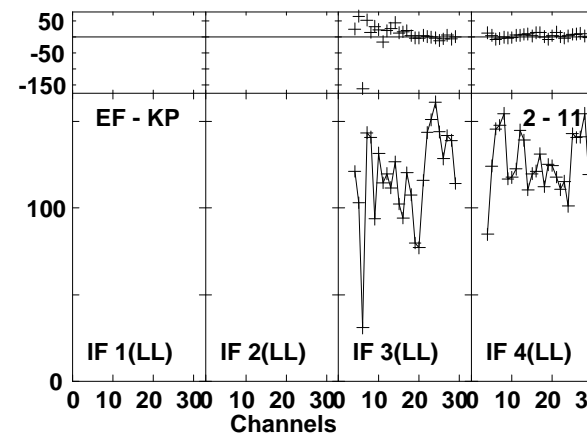
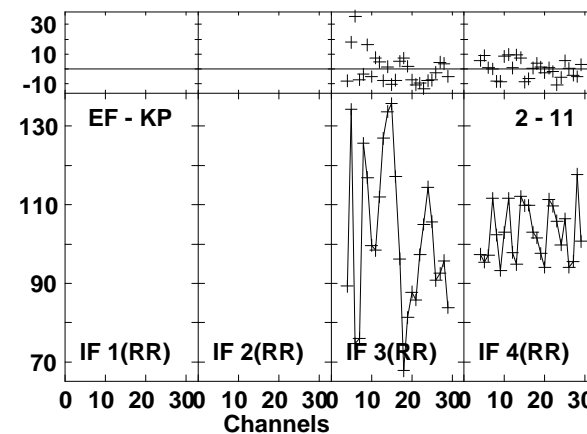
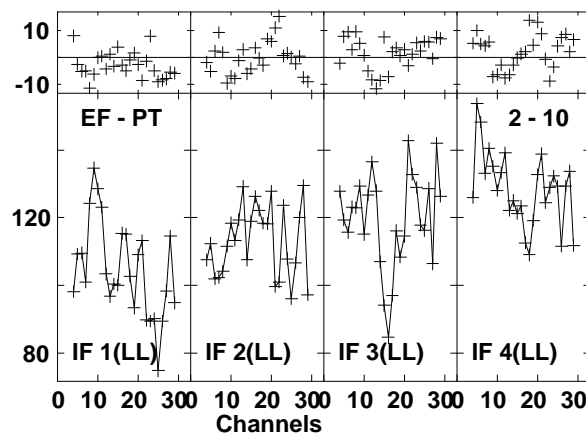
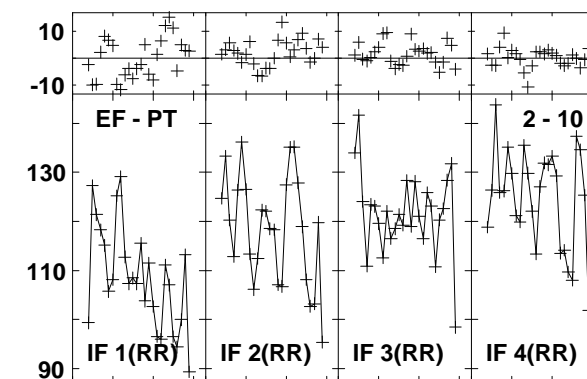
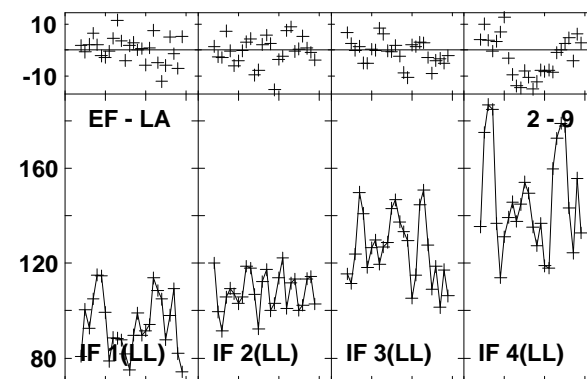
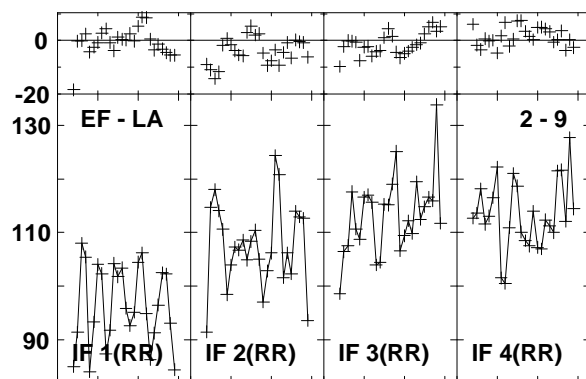
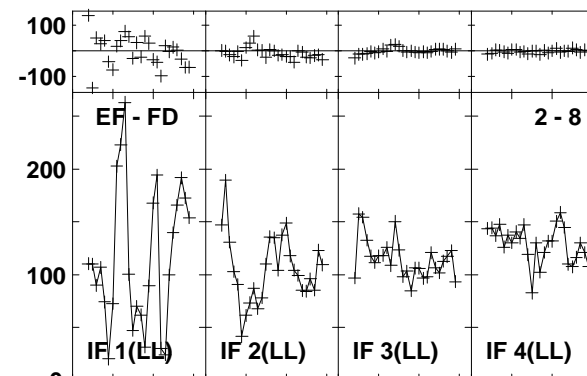
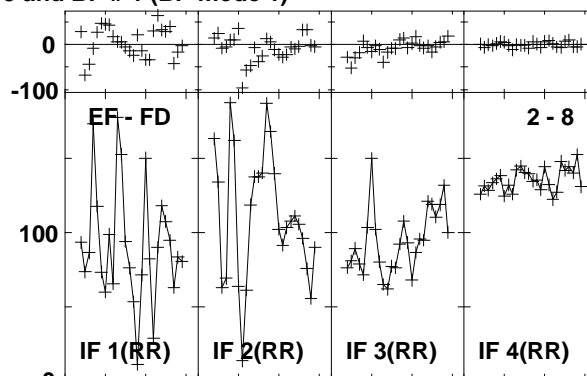
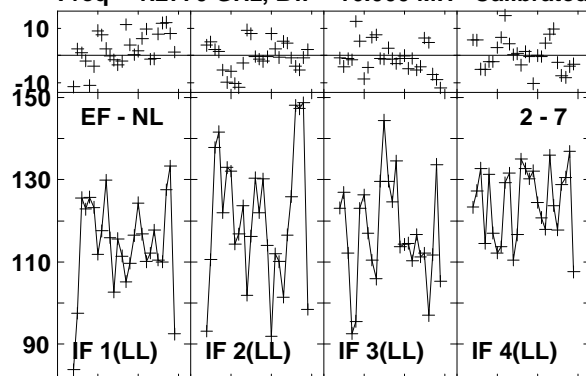

Lower frame: Milli Ampl Jy Top frame: Phas deg
Vector averaged cross-power spectrum Baseline: EF (02) - NL (07)
Timerange: 00/16:03:01 to 00/16:03:59

Plot file version 70 created 03-MAR-2016 01:12:09

J1545+5400 GN002C 1.UVDATA.1

Freq = 1.2770 GHz, Bw = 16.000 MH Calibrated with CL # 3 and BP # 1 (BP mode 1)

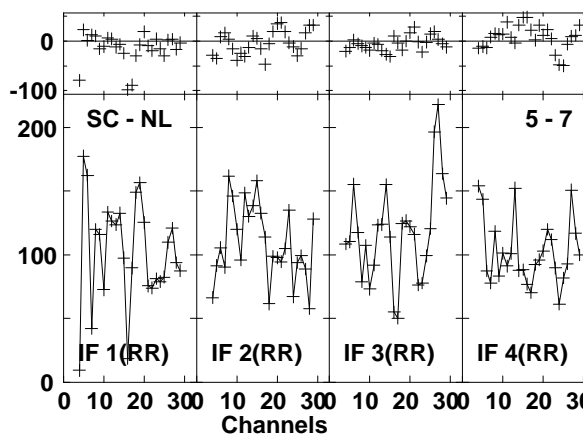
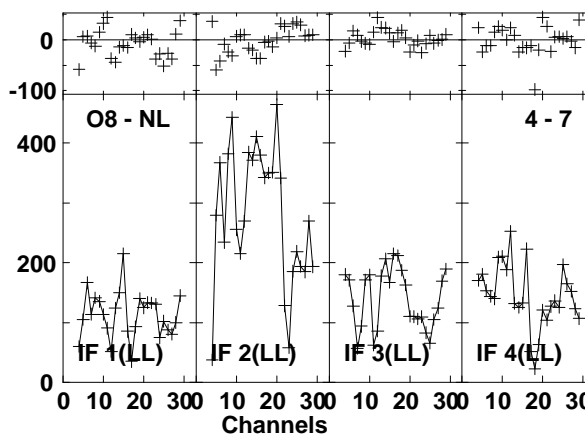
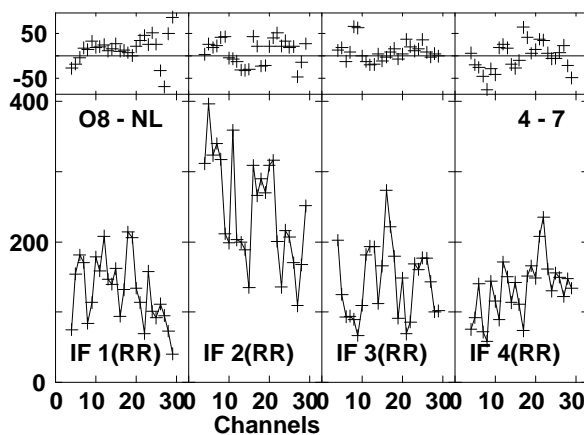
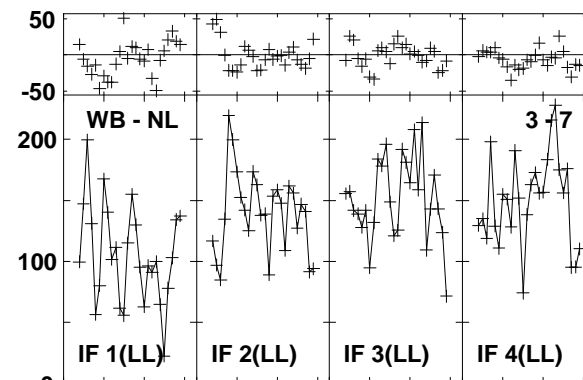
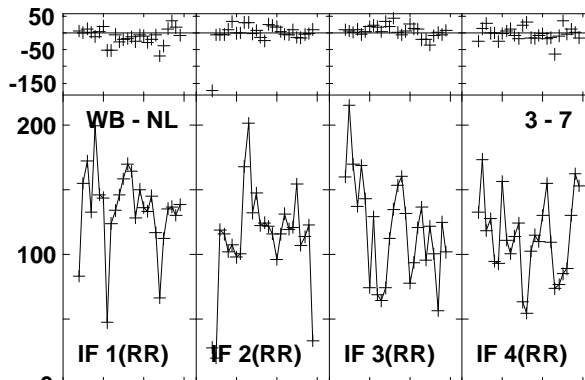
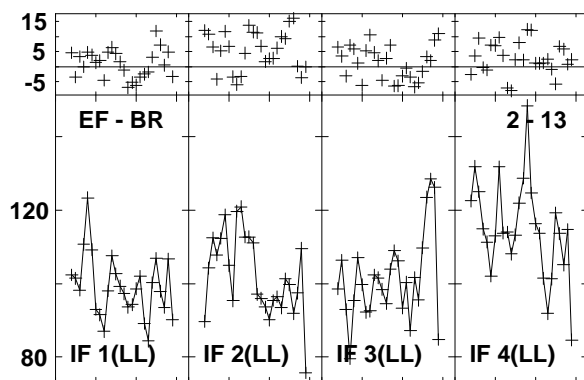
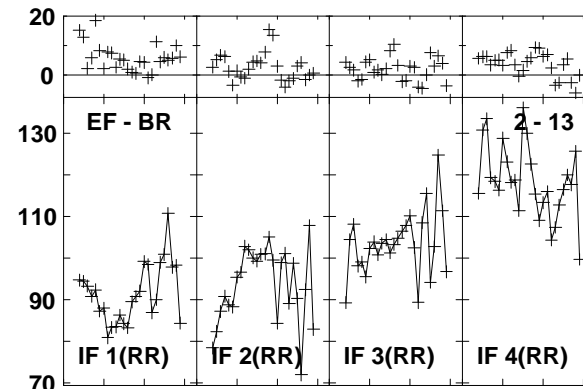
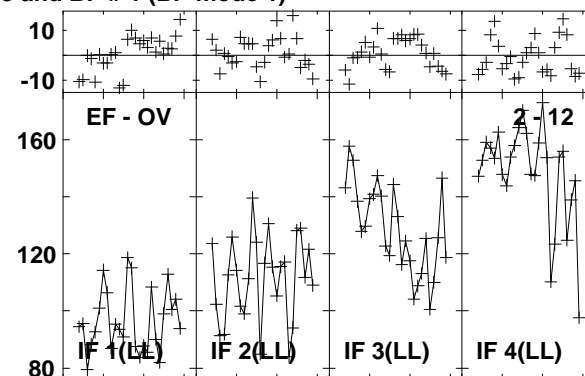
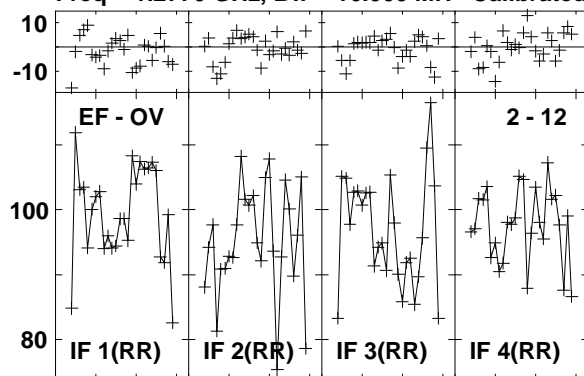

Lower frame: Milli Ampl Jy Top frame: Phas deg
Vector averaged cross-power spectrum Baseline: EF (02) - OV (12)
Timerange: 00/16:03:01 to 00/16:03:59

Plot file version 71 created 03-MAR-2016 01:12:09

J1545+5400 GN002C 1.UVDATA.1

Freq = 1.2770 GHz, Bw = 16.000 MH Calibrated with CL # 3 and BP # 1 (BP mode 1)

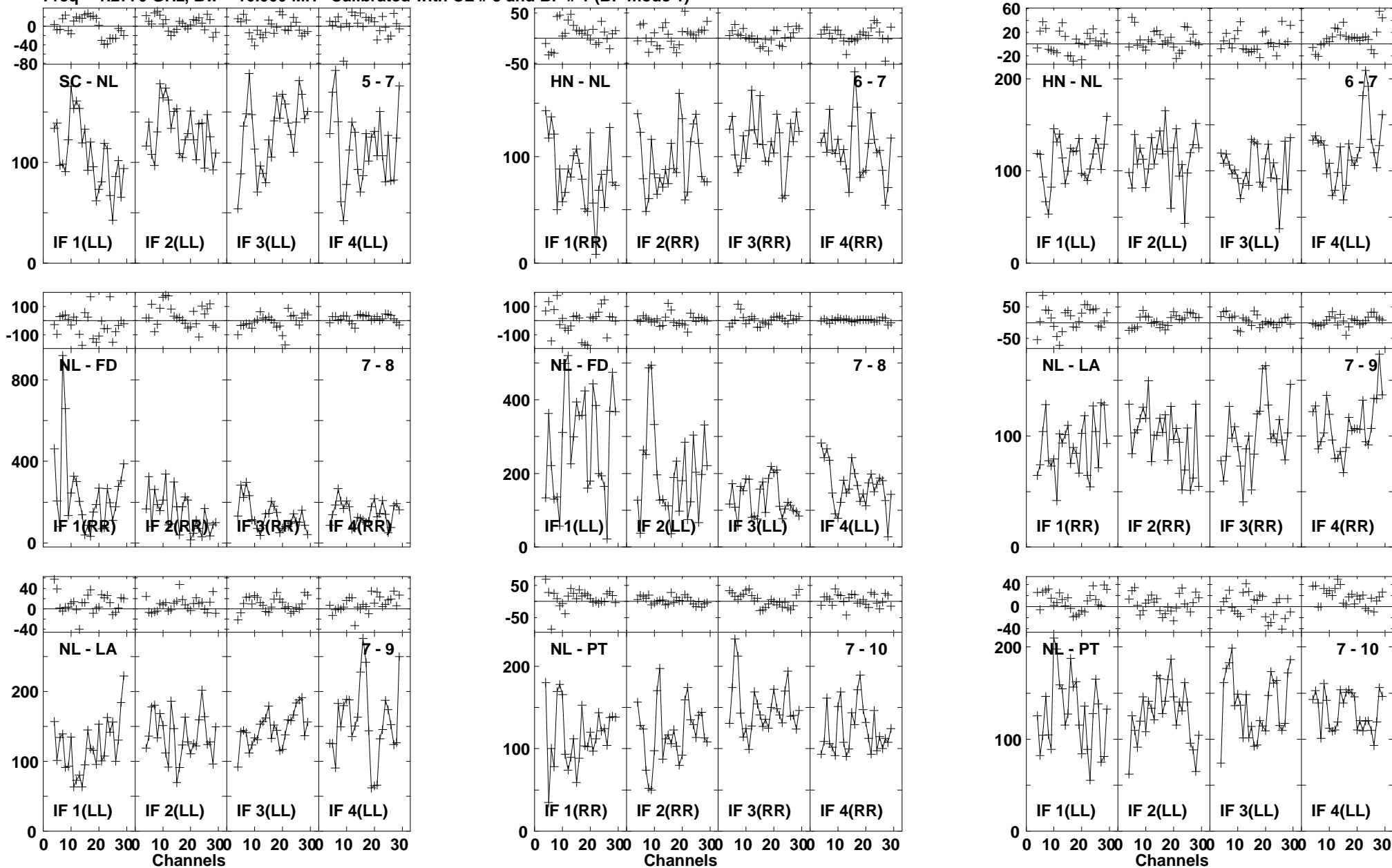

Lower frame: Milli Ampl Jy Top frame: Phas deg
Vector averaged cross-power spectrum Baseline: SC (05) - NL (07)
Timerange: 00/16:03:01 to 00/16:03:59

Plot file version 72 created 03-MAR-2016 01:12:09
 J1545+5400 GN002C 1.UVDATA.1
 Freq = 1.2770 GHz, Bw = 16.000 MH Calibrated with CL # 3 and BP # 1 (BP mode 1)

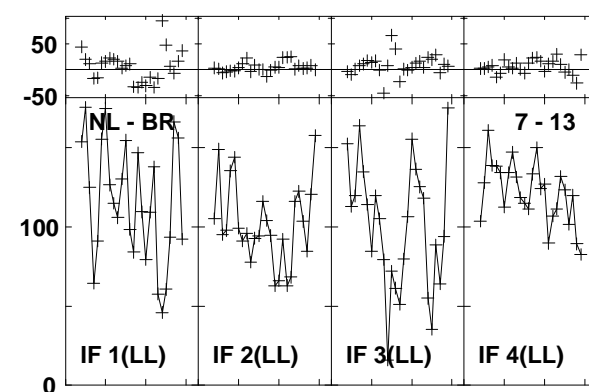
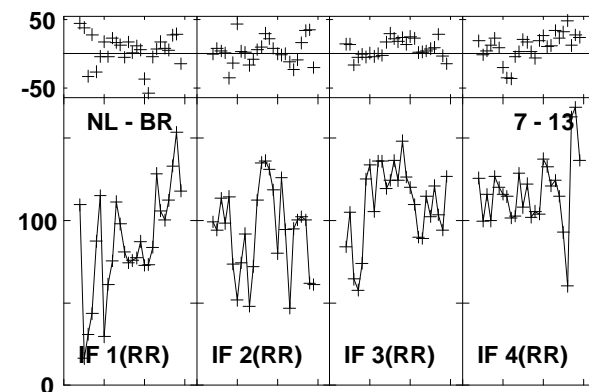
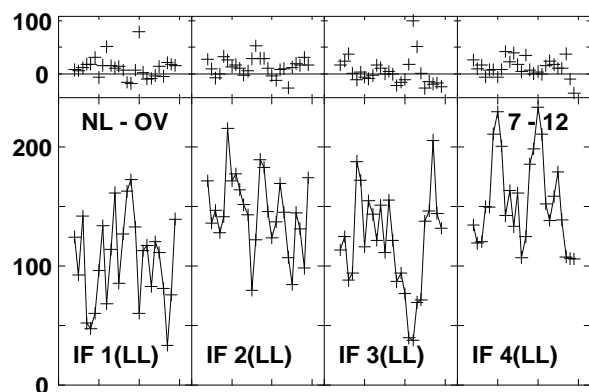
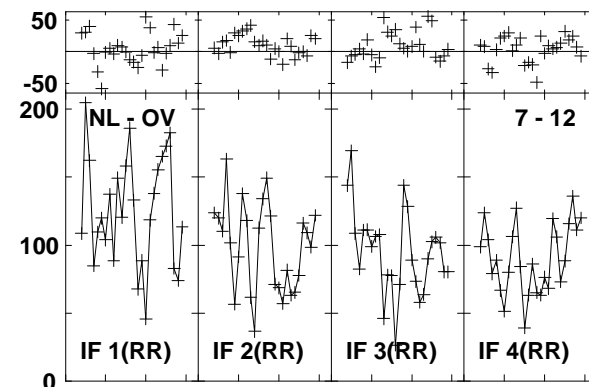
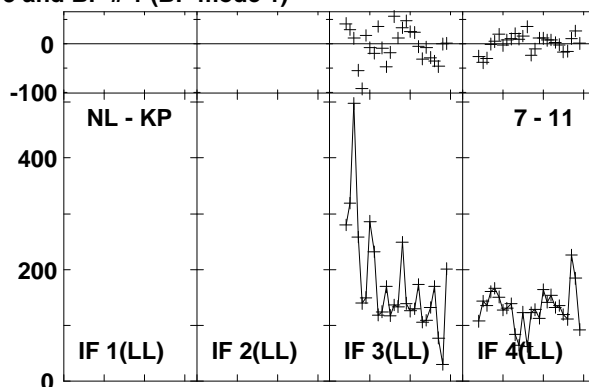
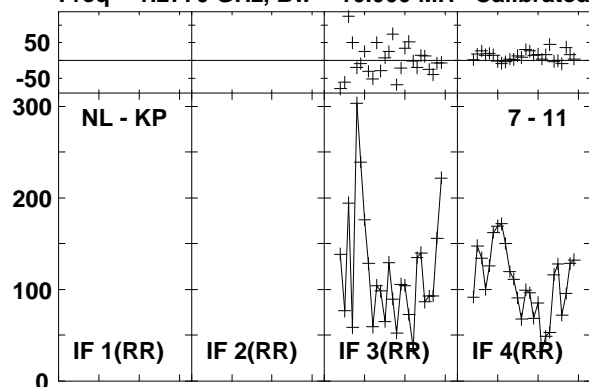

Lower frame: Milli Ampl Jy Top frame: Phas deg
 Vector averaged cross-power spectrum Baseline: NL (07) - KP (11)
 Timerange: 00/16:03:01 to 00/16:03:59

Plot file version 73 created 03-MAR-2016 01:12:09

4C52 GN002C 1.UVDATA.1

Freq = 1.2770 GHz, Bw = 16.000 MH Calibrated with CL # 3 and BP # 1 (BP mode 1)

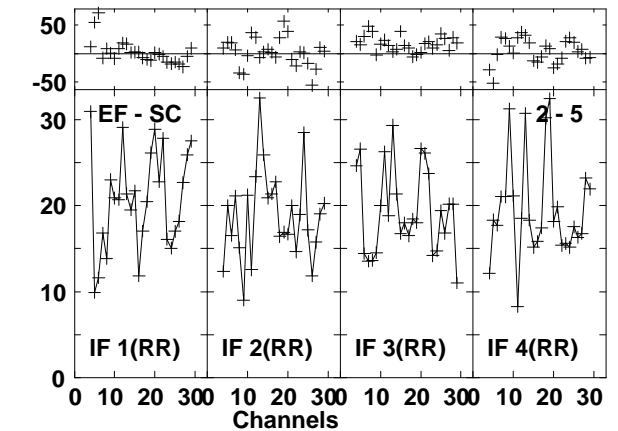
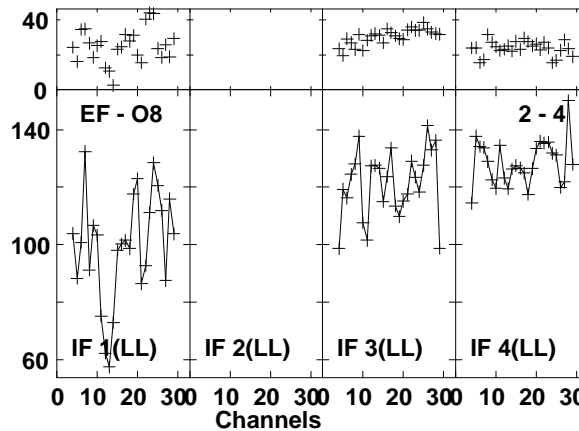
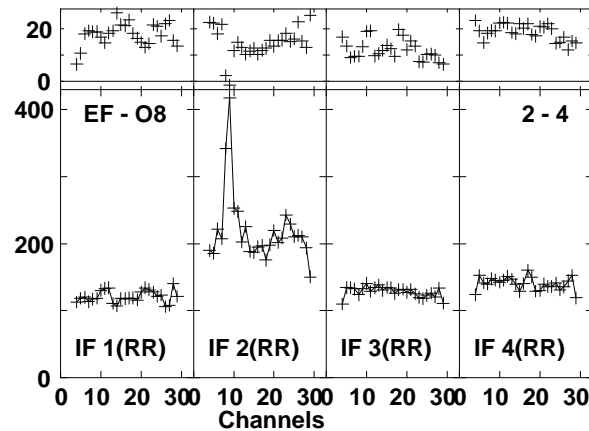
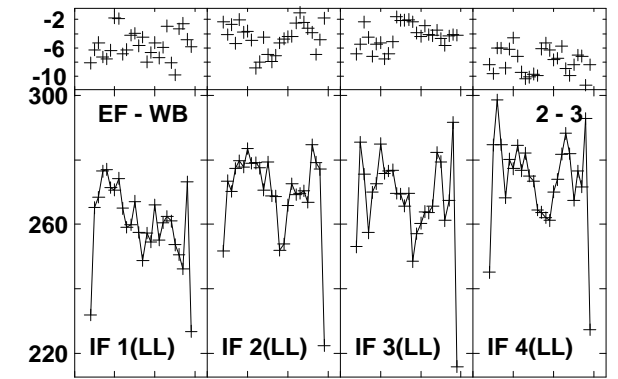
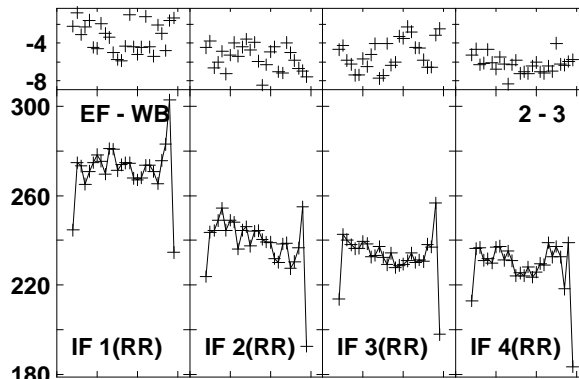
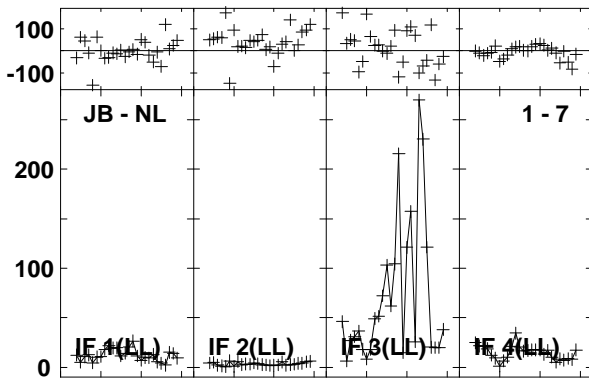
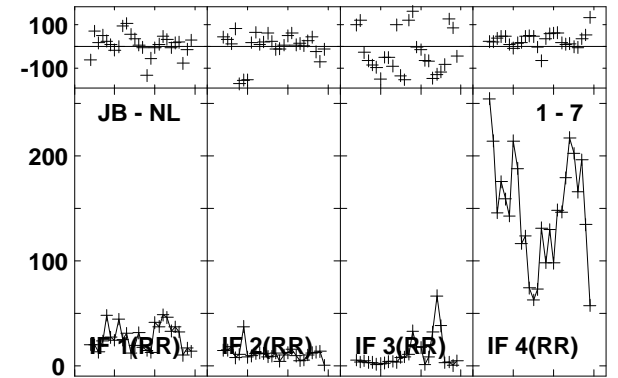
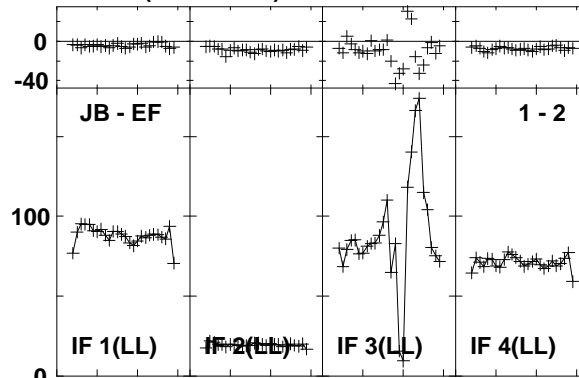
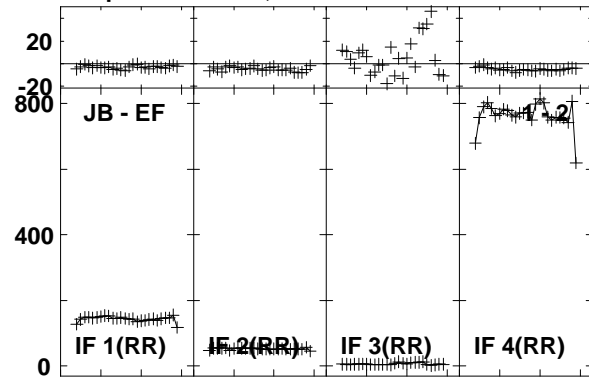

Lower frame: Milli Ampl Jy Top frame: Phas deg
Vector averaged cross-power spectrum Baseline: JB (01) - EF (02)
Timerange: 00/16:04:04 to 00/16:06:58

Plot file version 74 created 03-MAR-2016 01:12:10

4C52 GN002C 1.UVDATA.1

Freq = 1.2770 GHz, Bw = 16.000 MH Calibrated with CL # 3 and BP # 1 (BP mode 1)

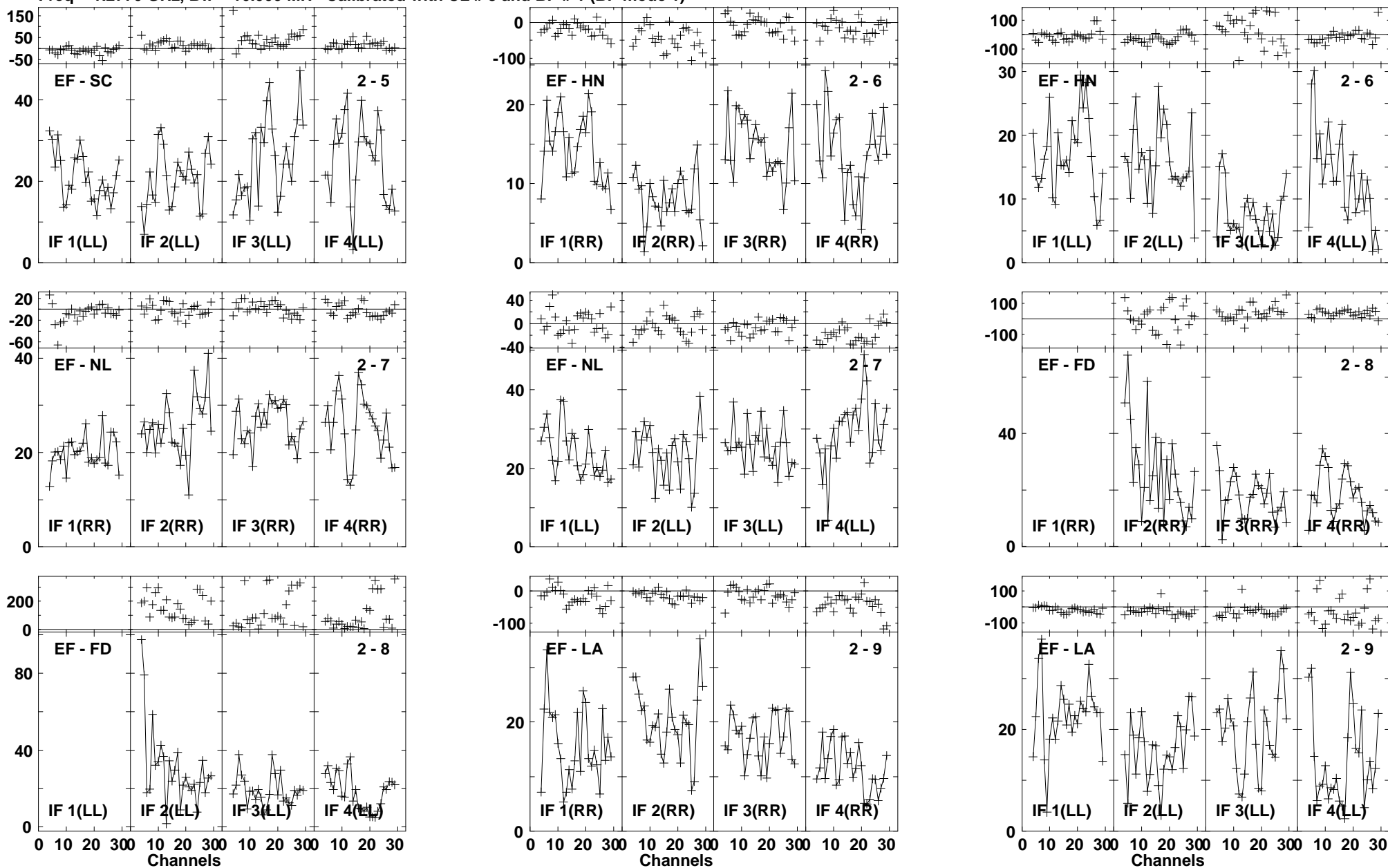

Lower frame: Milli Ampl Jy Top frame: Phas deg
Vector averaged cross-power spectrum Baseline: EF (02) - SC (05)
Timerange: 00/16:04:04 to 00/16:06:58

Plot file version 75 created 03-MAR-2016 01:12:10

4C52 GN002C 1.UVDATA.1

Freq = 1.2770 GHz, Bw = 16.000 MH Calibrated with CL # 3 and BP # 1 (BP mode 1)

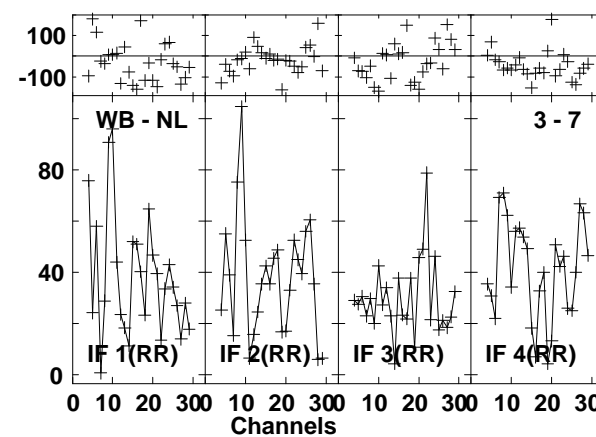
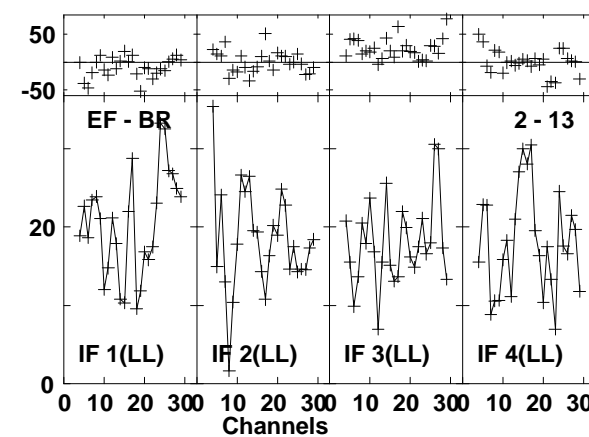
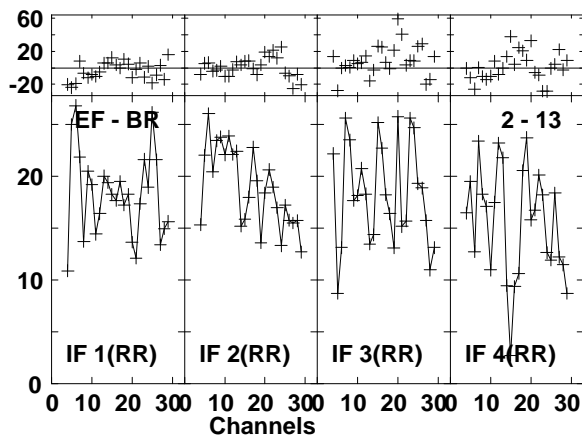
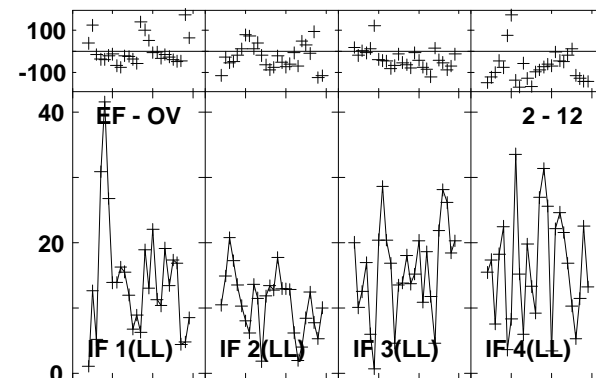
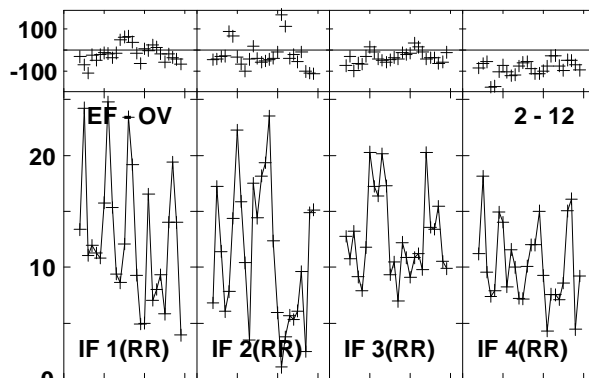
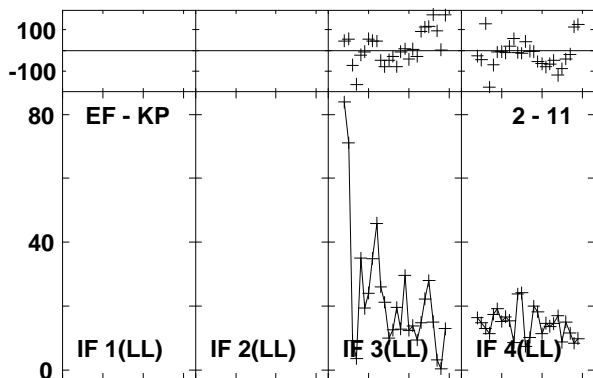
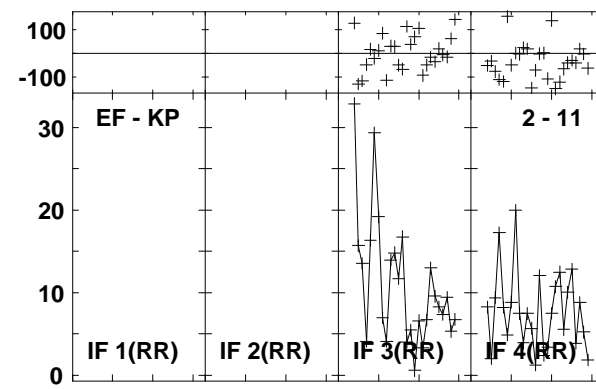
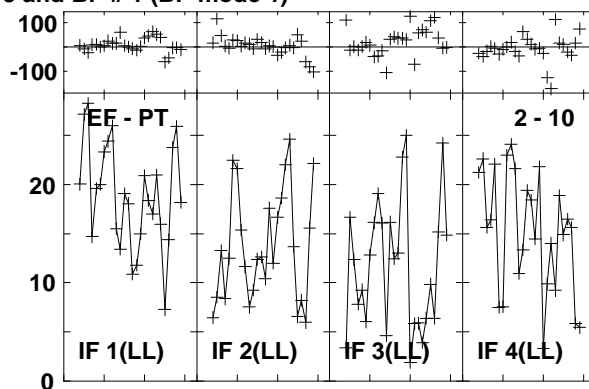
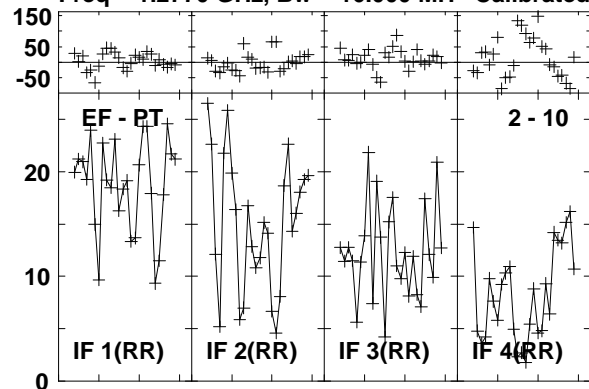

Lower frame: Milli Ampl Jy Top frame: Phas deg
Vector averaged cross-power spectrum Baseline: EF (02) - PT (10)
Timerange: 00/16:04:04 to 00/16:06:58

Plot file version 76 created 03-MAR-2016 01:12:10

4C52 GN002C 1.UVDATA.1

Freq = 1.2770 GHz, Bw = 16.000 MH Calibrated with CL # 3 and BP # 1 (BP mode 1)

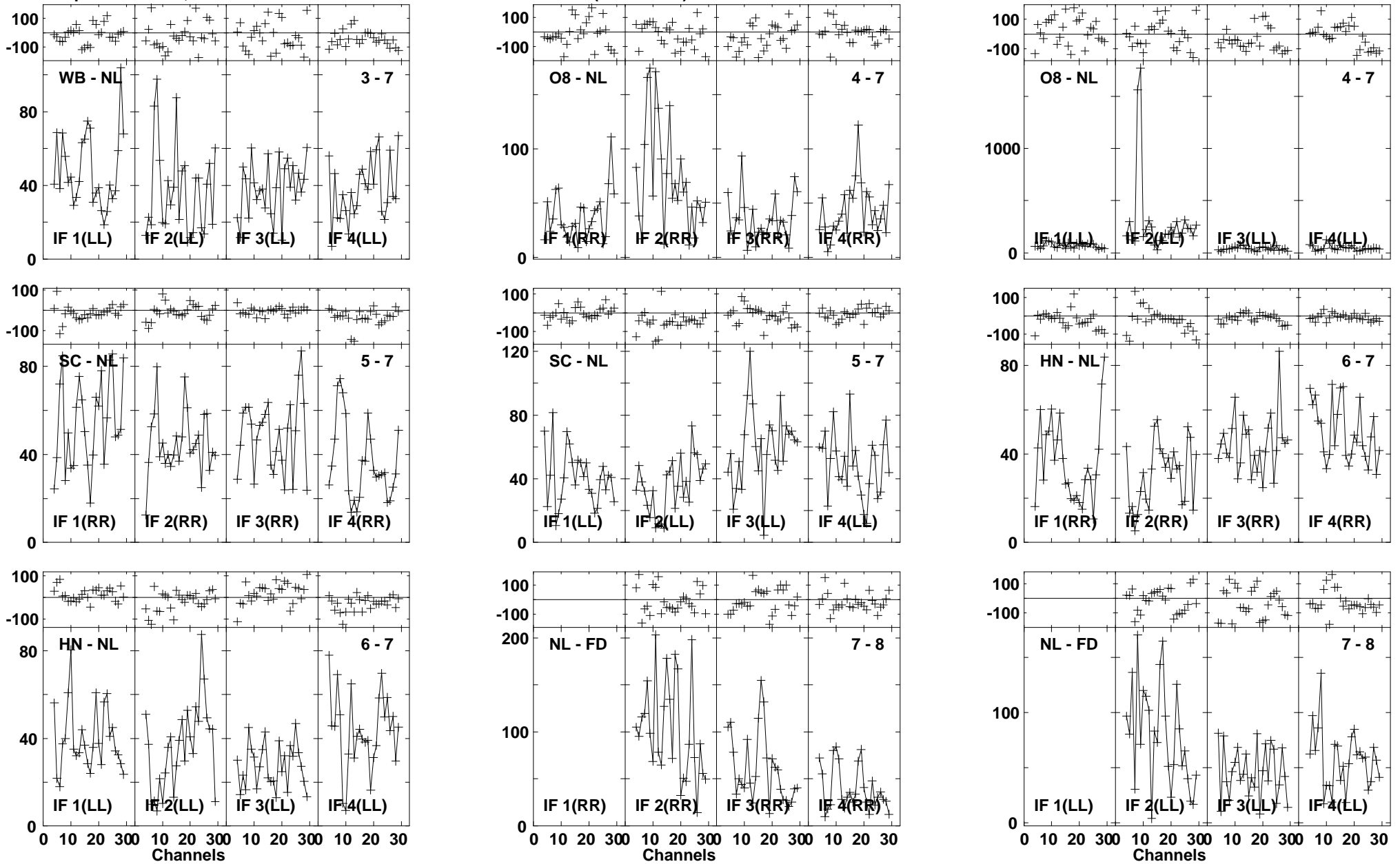

Lower frame: Milli Ampl Jy Top frame: Phas deg
Vector averaged cross-power spectrum Baseline: WB (03) - NL (07)
Timerange: 00/16:04:04 to 00/16:06:58

Plot file version 77 created 03-MAR-2016 01:12:10

4C52 GN002C 1.UVDATA.1

Freq = 1.2770 GHz, Bw = 16.000 MH Calibrated with CL # 3 and BP # 1 (BP mode 1)

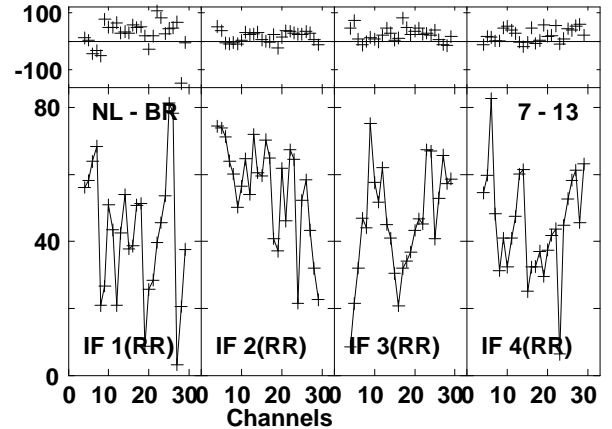
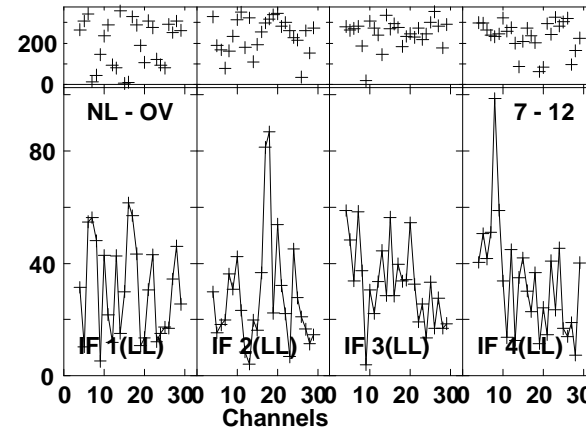
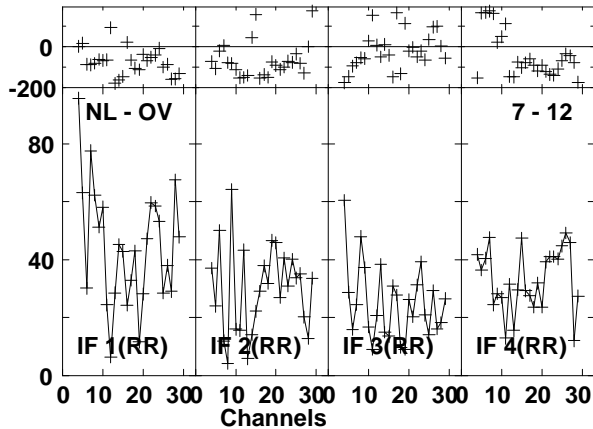
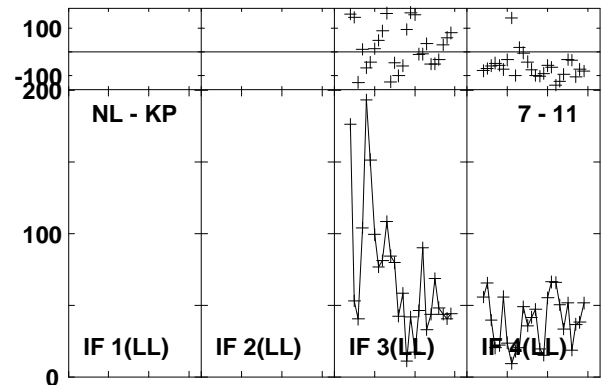
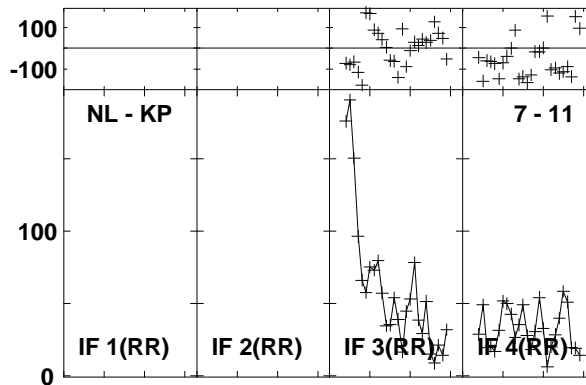
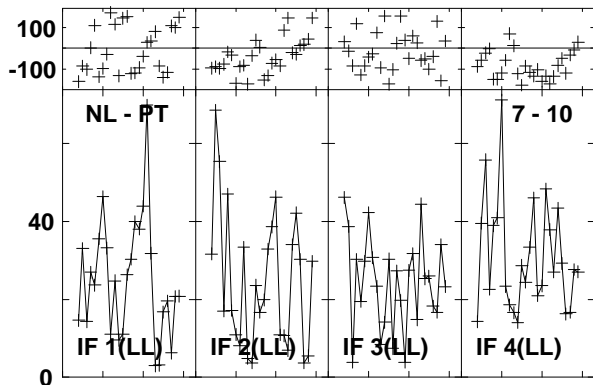
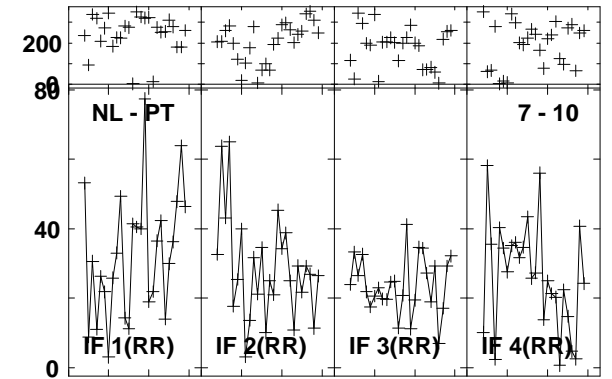
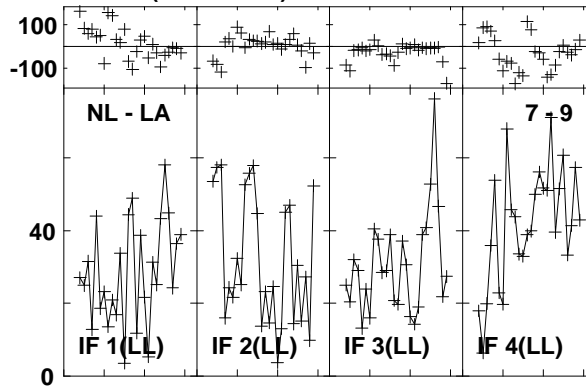
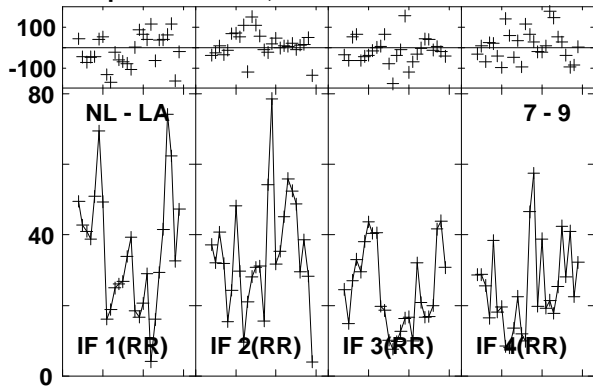

Lower frame: Milli Ampl Jy Top frame: Phas deg
Vector averaged cross-power spectrum Baseline: NL (07) - LA (09)
Timerange: 00/16:04:04 to 00/16:06:58

Plot file version 78 created 03-MAR-2016 01:12:10
4C52 GN002C 1.UVDATA.1
Freq = 1.2770 GHz, Bw = 16.000 MH Calibrated with CL # 3 and BP # 1 (BP mode 1)

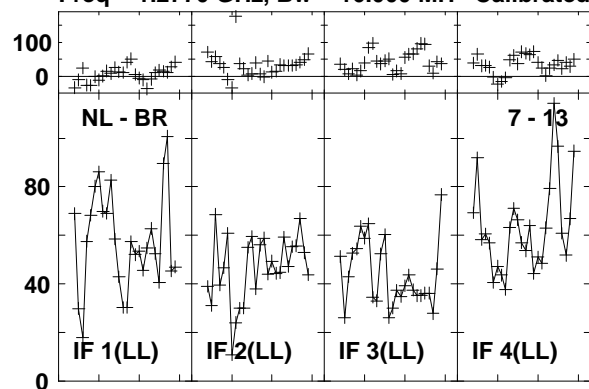

Lower frame: Milli Ampl Jy Top frame: Phas deg
Vector averaged cross-power spectrum Baseline: NL (07) - BR (13)
Timerange: 00/16:04:04 to 00/16:06:58

Plot file version 79 created 03-MAR-2016 01:12:10
 J1545+5400 GN002C 1.UVDATA.1
 Freq = 1.2770 GHz, Bw = 16.000 MH Calibrated with CL # 3 and BP # 1 (BP mode 1)

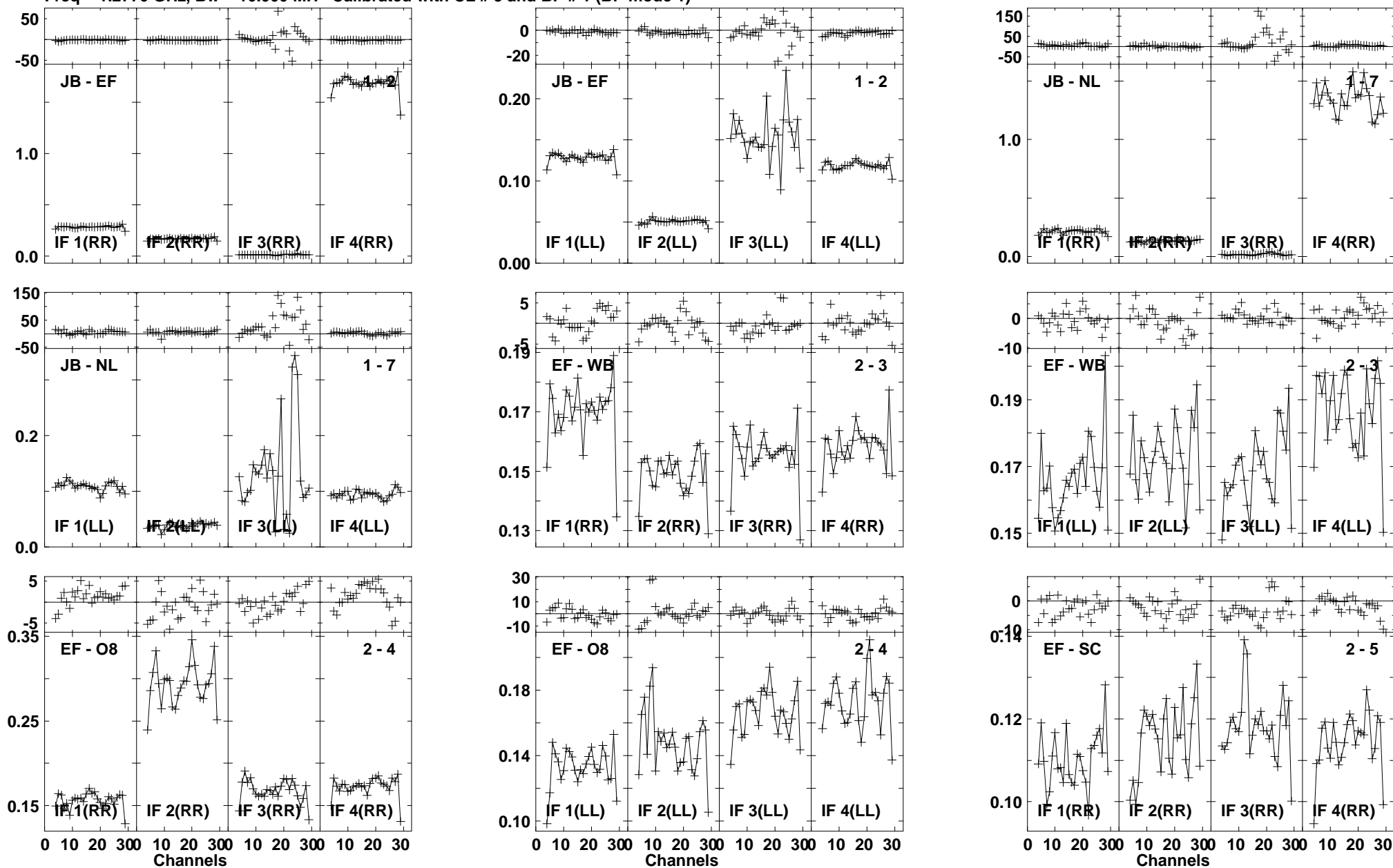

Lower frame: Ampl Jy Top frame: Phas deg
 Vector averaged cross-power spectrum Baseline: JB (01) - EF (02)
 Timerange: 00/16:07:51 to 00/16:09:49

Plot file version 80 created 03-MAR-2016 01:12:11

J1545+5400 GN002C 1.UVDATA.1

Freq = 1.2770 GHz, Bw = 16.000 MH Calibrated with CL # 3 and BP # 1 (BP mode 1)

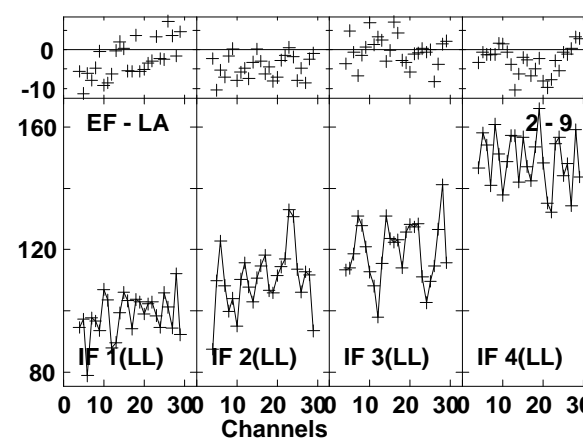
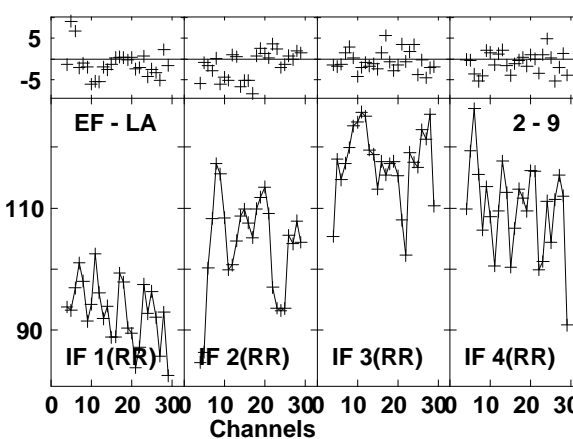
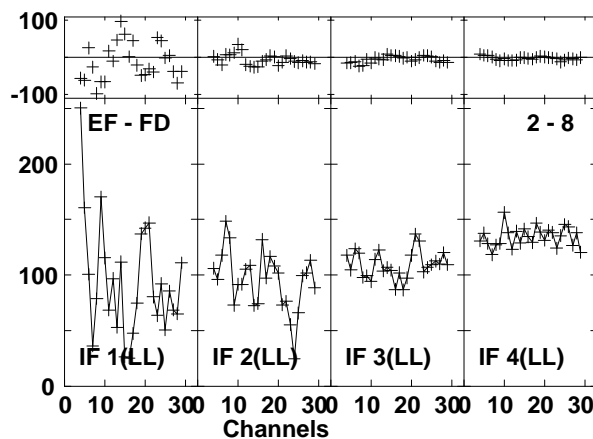
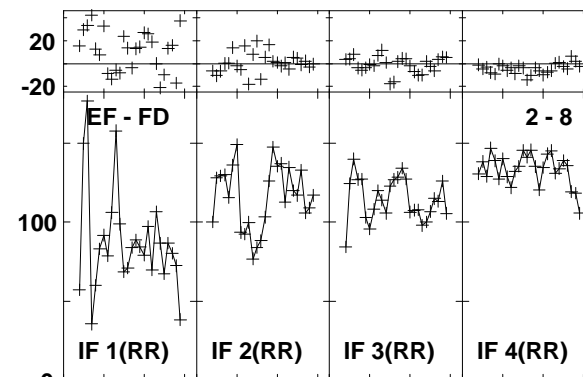
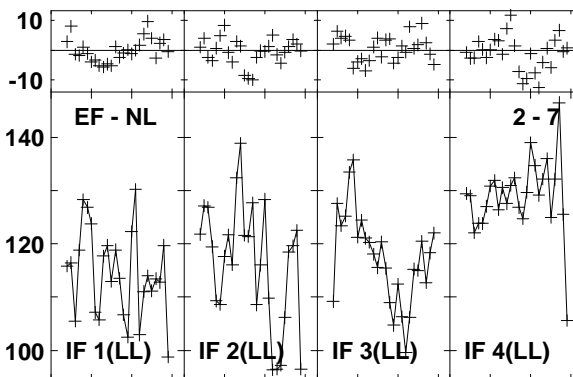
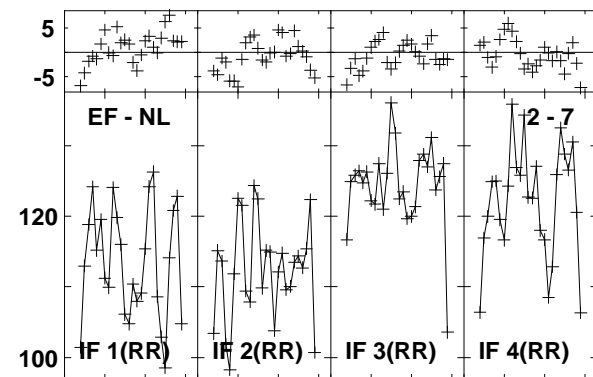
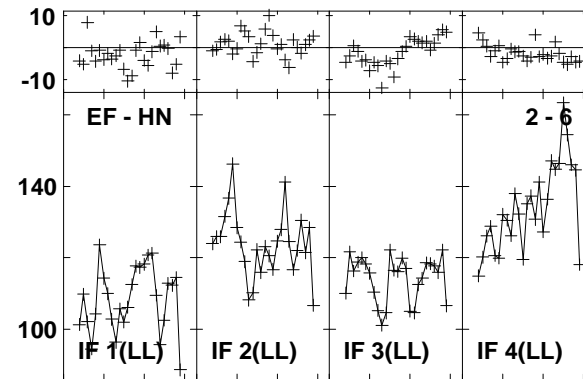
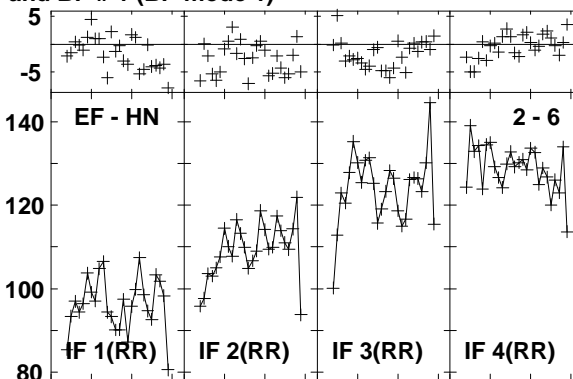
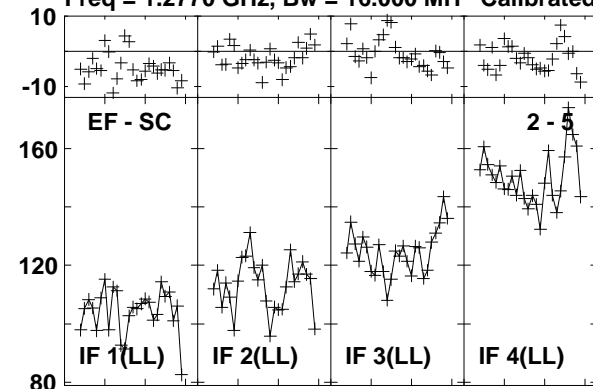

Lower frame: Milli Ampl Jy Top frame: Phas deg
Vector averaged cross-power spectrum Baseline: EF (02) - SC (05)
Timerange: 00/16:07:51 to 00/16:09:49

Plot file version 81 created 03-MAR-2016 01:12:11

J1545+5400 GN002C 1.UVDATA.1

Freq = 1.2770 GHz, Bw = 16.000 MH Calibrated with CL # 3 and BP # 1 (BP mode 1)

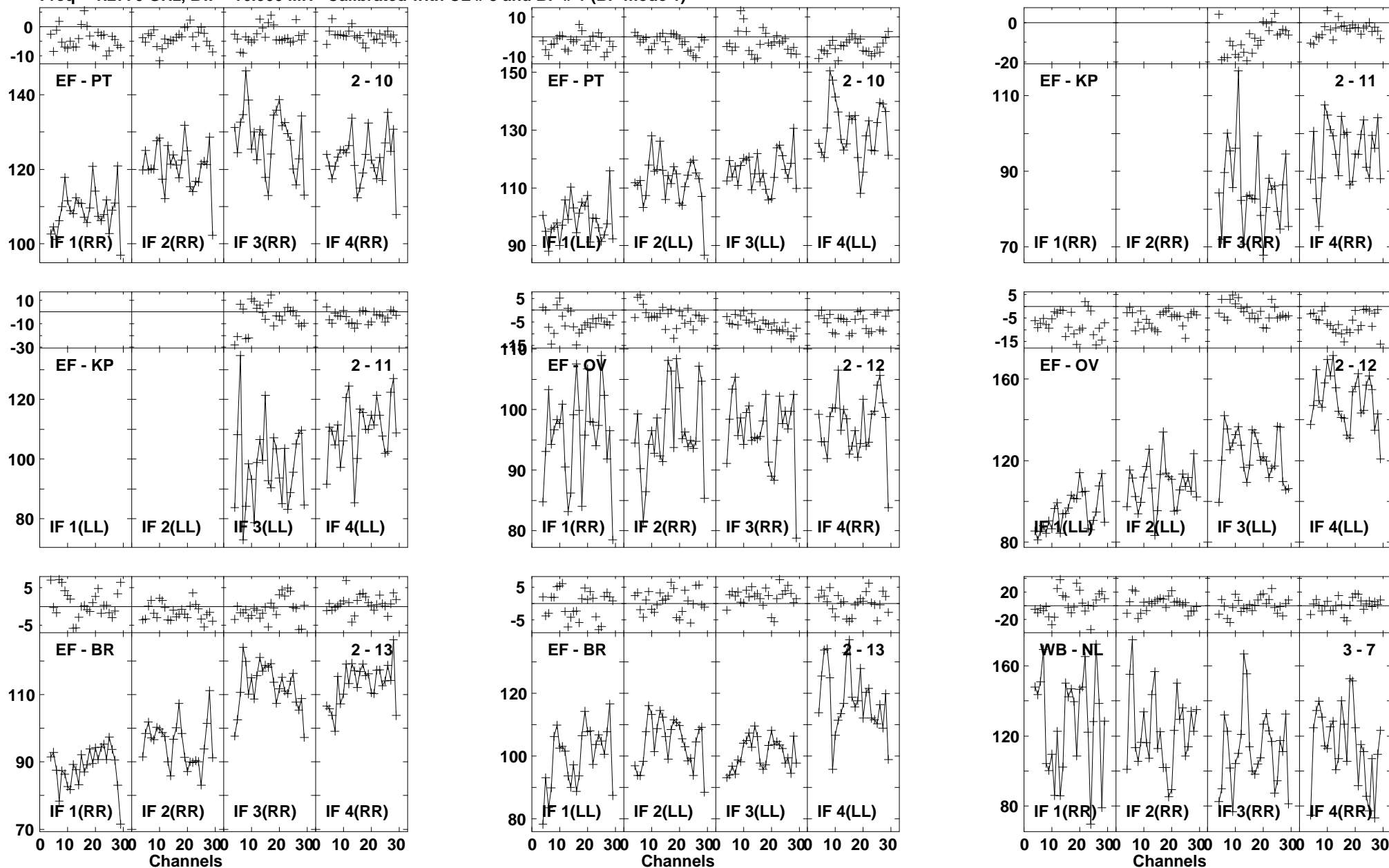

Lower frame: Milli Ampl Jy Top frame: Phas deg
Vector averaged cross-power spectrum Baseline: EF (02) - PT (10)
Timerange: 00/16:07:51 to 00/16:09:49

Plot file version 82 created 03-MAR-2016 01:12:11

J1545+5400 GN002C 1.UVDATA.1

Freq = 1.2770 GHz, Bw = 16.000 MH Calibrated with CL # 3 and BP # 1 (BP mode 1)

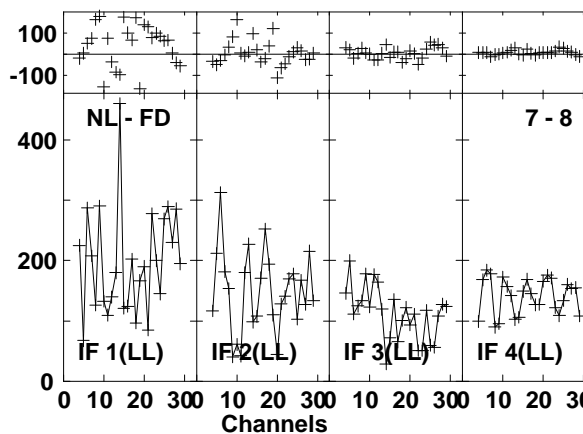
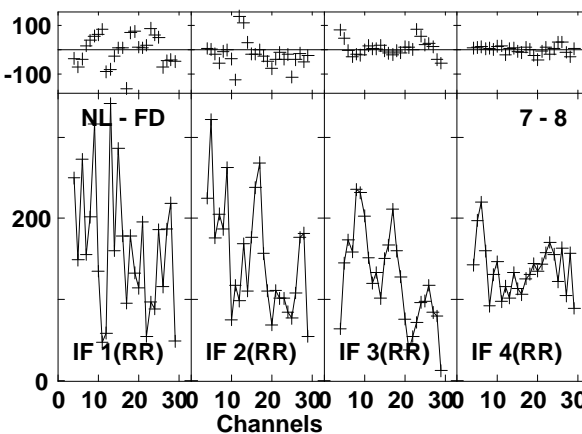
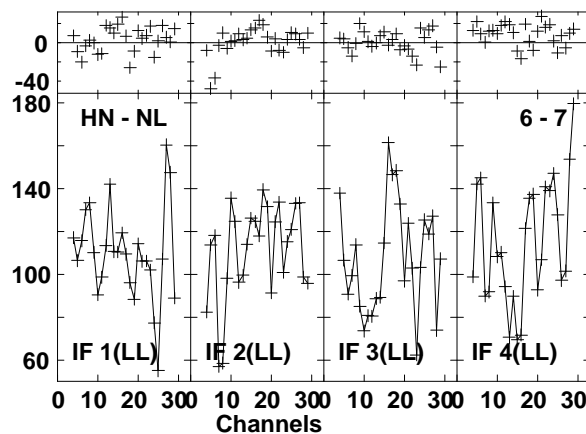
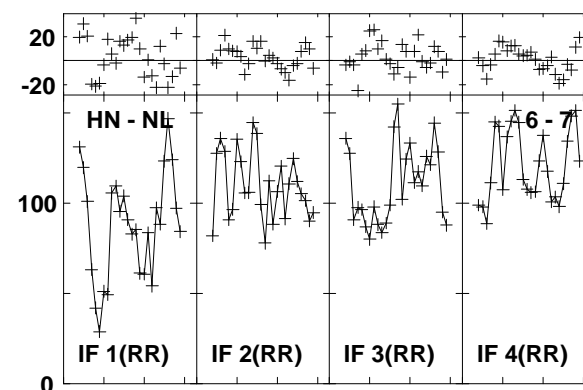
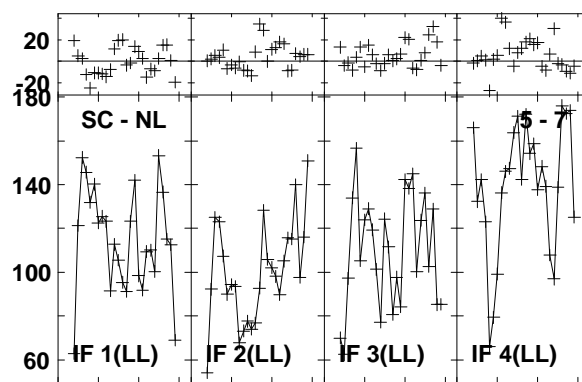
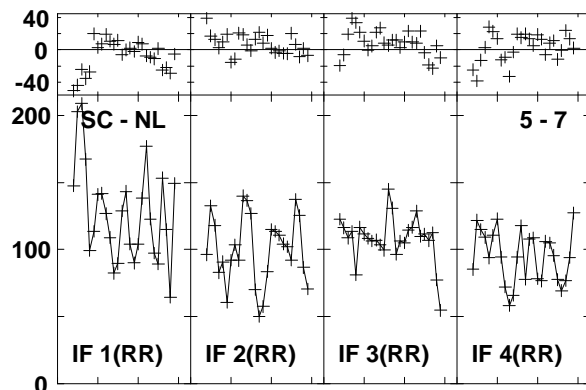
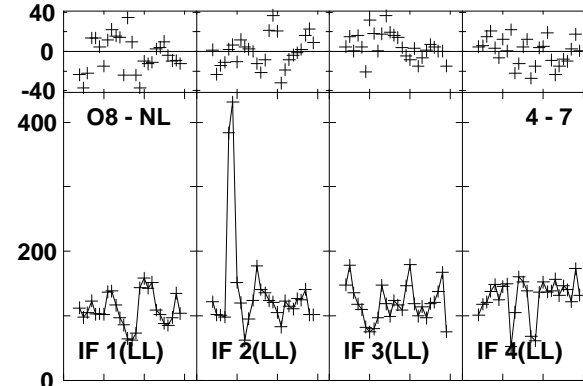
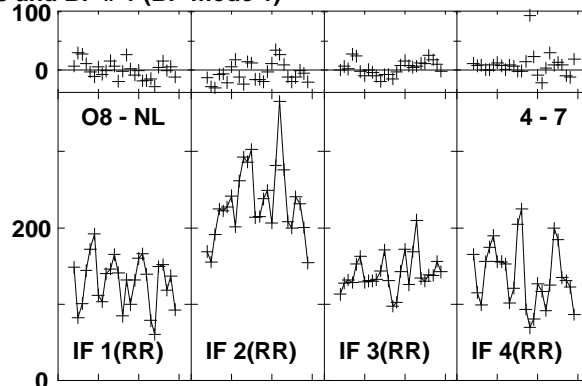
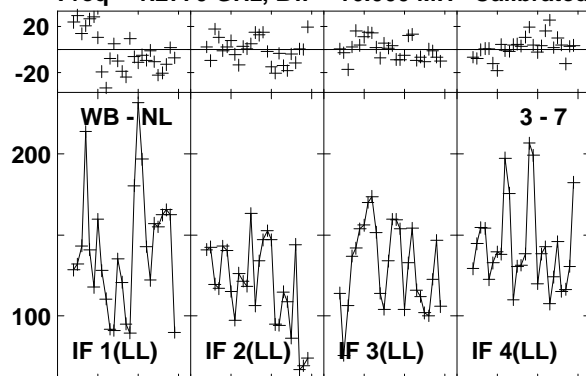

Lower frame: Milli Ampl Jy Top frame: Phas deg
Vector averaged cross-power spectrum Baseline: WB (03) - NL (07)
Timerange: 00/16:07:51 to 00/16:09:49

Plot file version 83 created 03-MAR-2016 01:12:11

J1545+5400 GN002C 1.UVDATA.1

Freq = 1.2770 GHz, Bw = 16.000 MH Calibrated with CL # 3 and BP # 1 (BP mode 1)

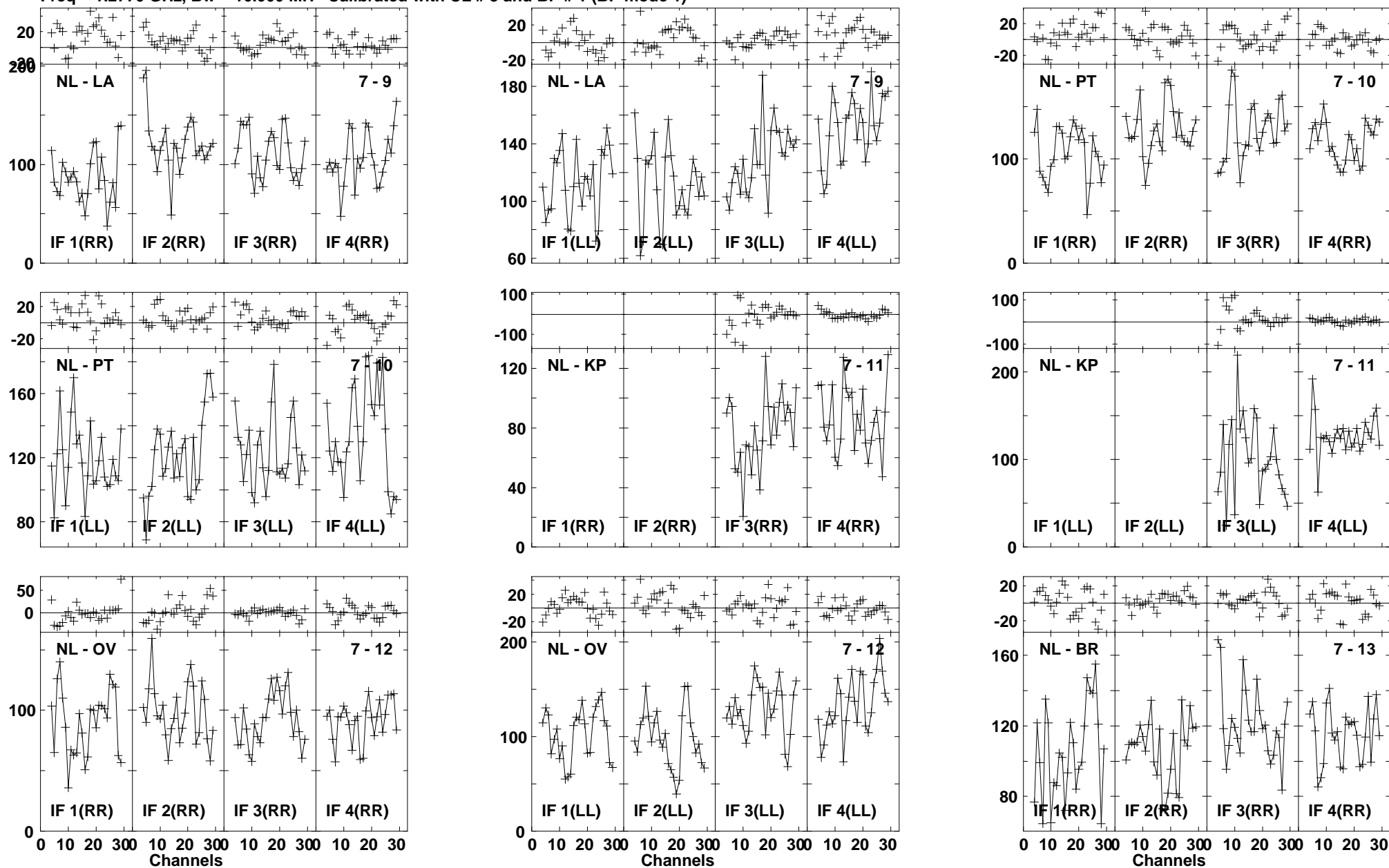

Lower frame: Milli Ampl Jy Top frame: Phas deg
Vector averaged cross-power spectrum Baseline: NL (07) - LA (09)
Timerange: 00/16:07:51 to 00/16:09:49

Plot file version 84 created 03-MAR-2016 01:12:11
J1545+5400 GN002C 1.UVDATA.1
Freq = 1.2770 GHz, Bw = 16.000 MH Calibrated with CL # 3 and BP # 1 (BP mode 1)

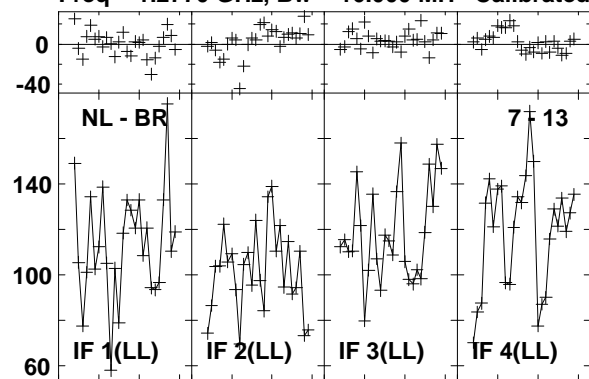

Lower frame: Milli Ampl Jy Top frame: Phas deg
Vector averaged cross-power spectrum Baseline: NL (07) - BR (13)
Timerange: 00/16:07:51 to 00/16:09:49

Plot file version 85 created 03-MAR-2016 01:12:11

4C52 GN002C 1.UVDATA.1

Freq = 1.2770 GHz, Bw = 16.000 MH Calibrated with CL # 3 and BP # 1 (BP mode 1)

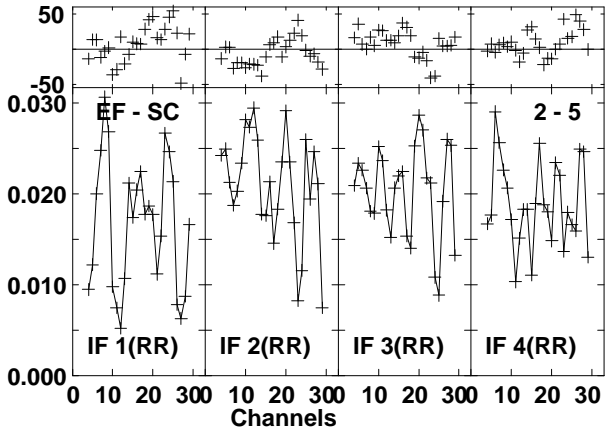
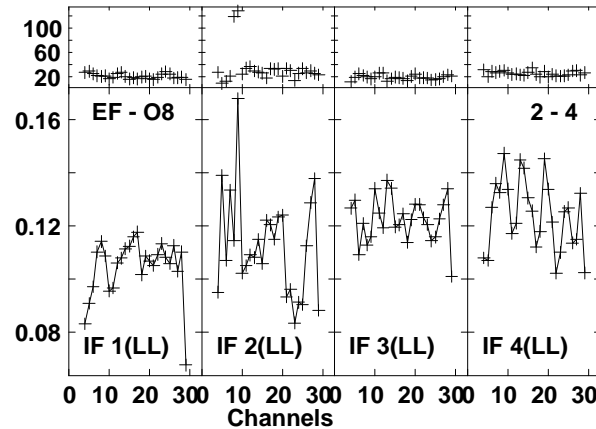
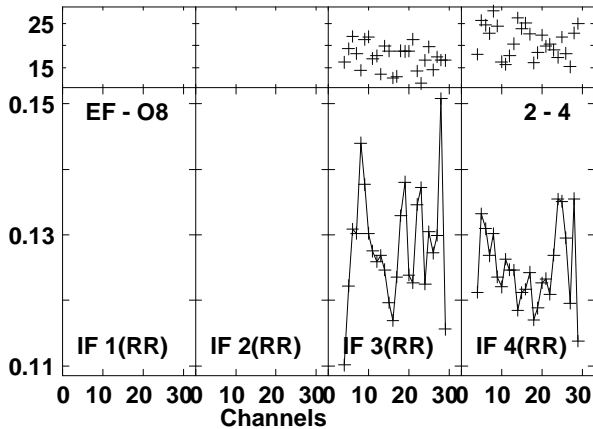
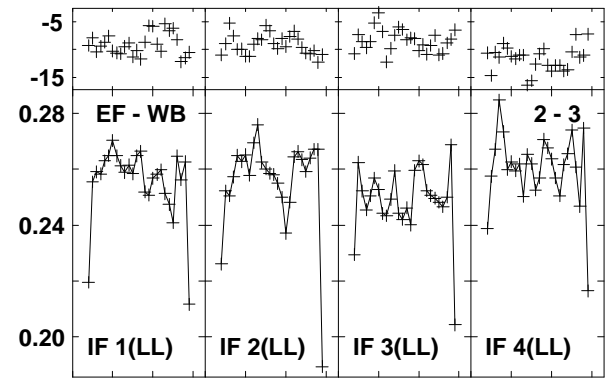
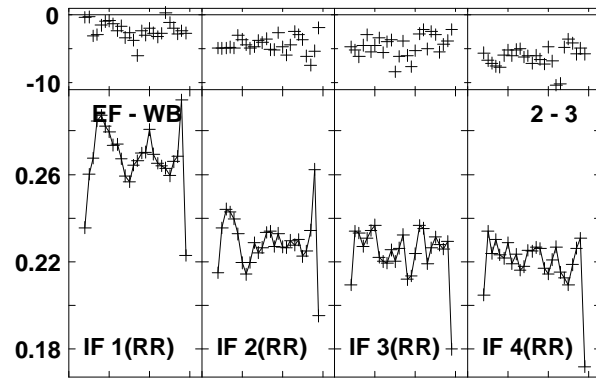
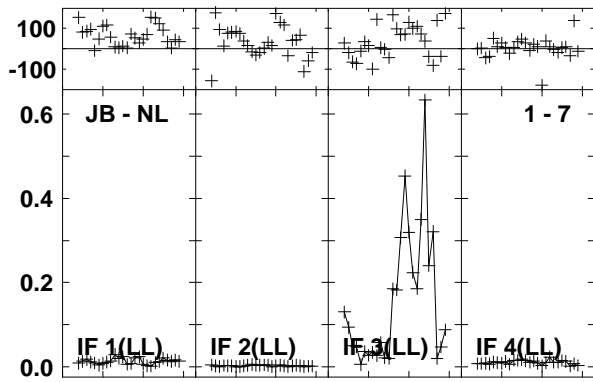
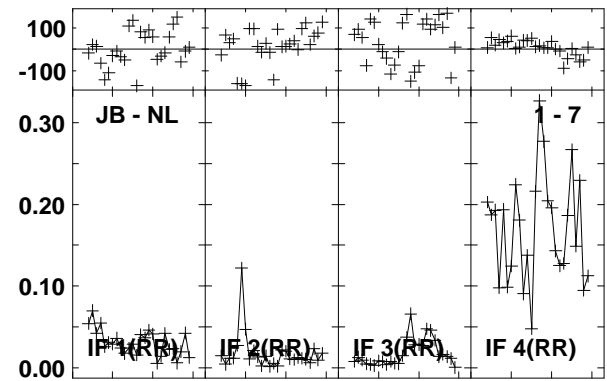
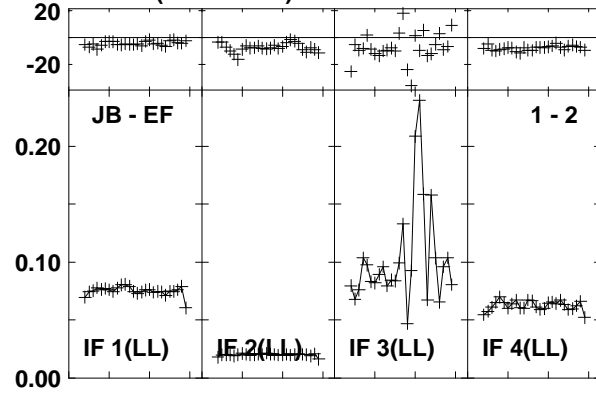
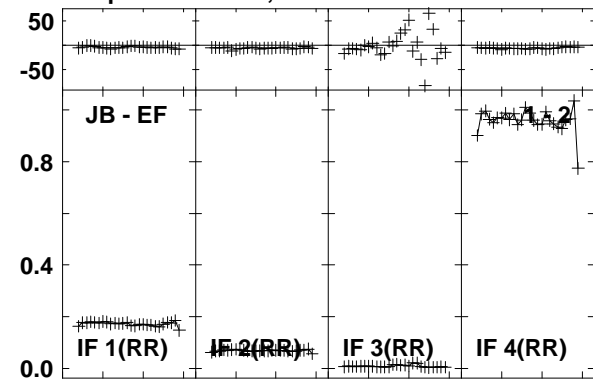

Lower frame: Ampl Jy Top frame: Phas deg
Vector averaged cross-power spectrum Baseline: JB (01) - EF (02)
Timerange: 00/16:10:02 to 00/16:12:48

Plot file version 86 created 03-MAR-2016 01:12:12

4C52 GN002C 1.UVDATA.1

Freq = 1.2770 GHz, Bw = 16.000 MH Calibrated with CL # 3 and BP # 1 (BP mode 1)

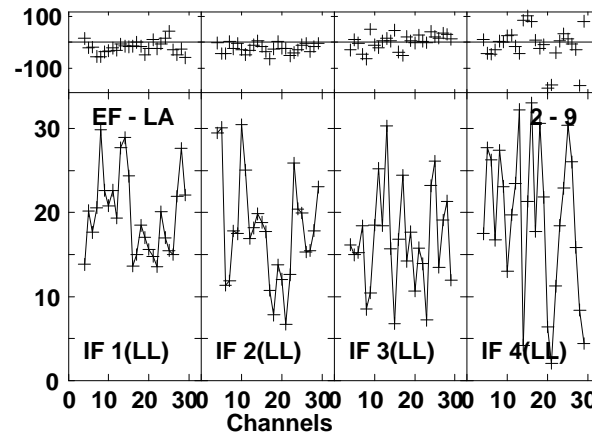
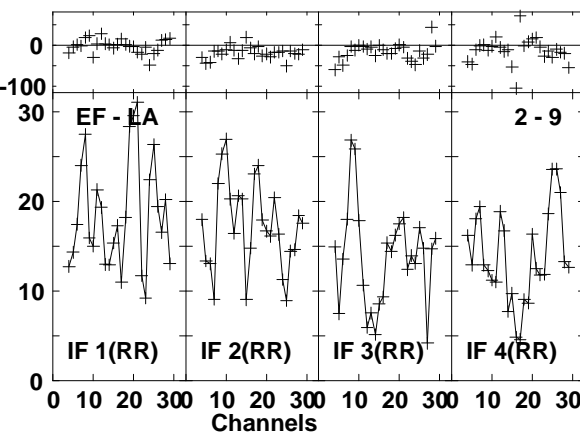
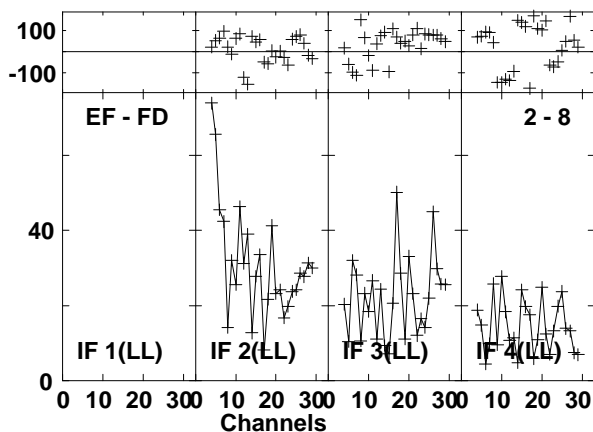
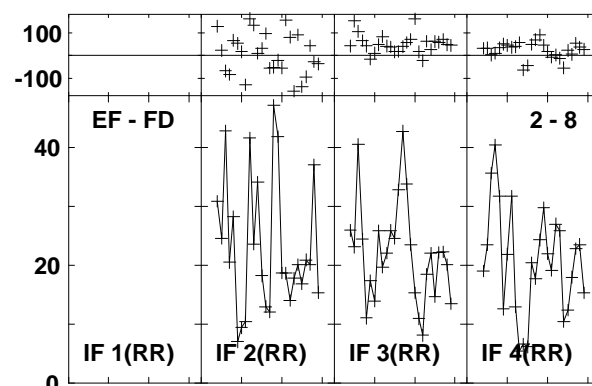
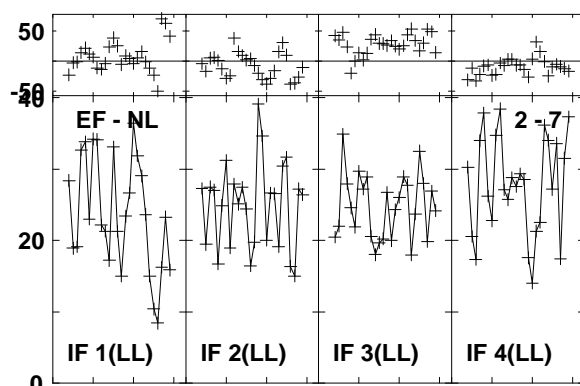
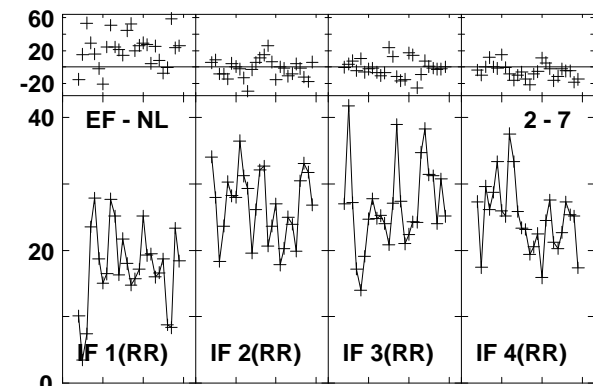
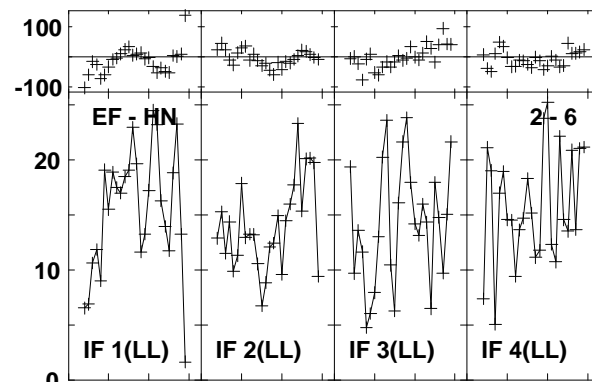
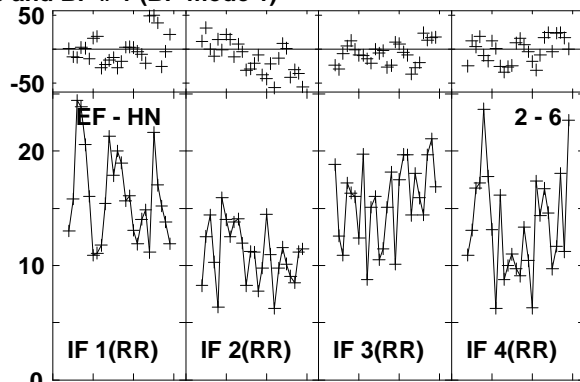
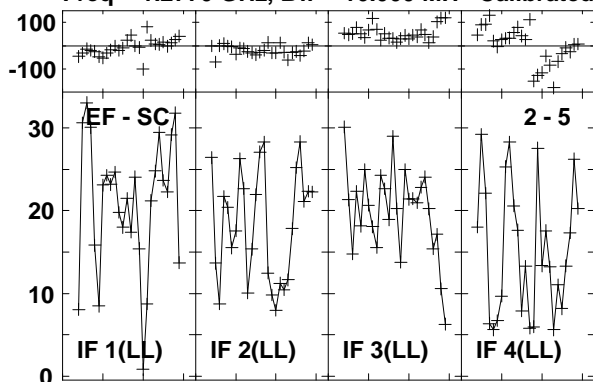

Lower frame: Milli Ampl Jy Top frame: Phas deg

Vector averaged cross-power spectrum Baseline: EF (02) - SC (05)

Timerange: 00/16:10:02 to 00/16:12:48

Plot file version 87 created 03-MAR-2016 01:12:12

4C52 GN002C 1.UVDATA.1

Freq = 1.2770 GHz, Bw = 16.000 MH Calibrated with CL # 3 and BP # 1 (BP mode 1)

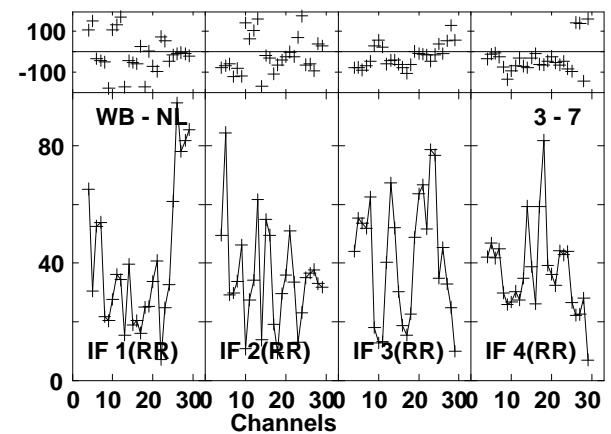
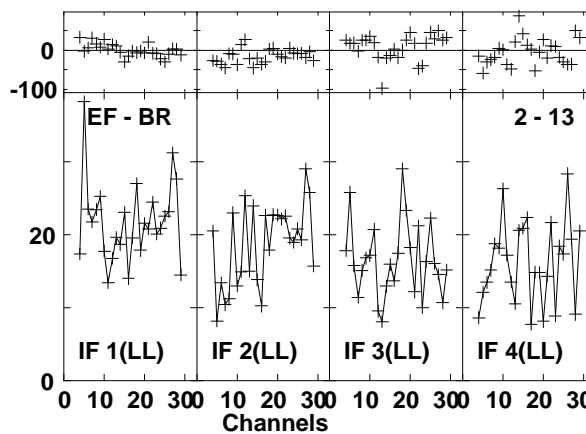
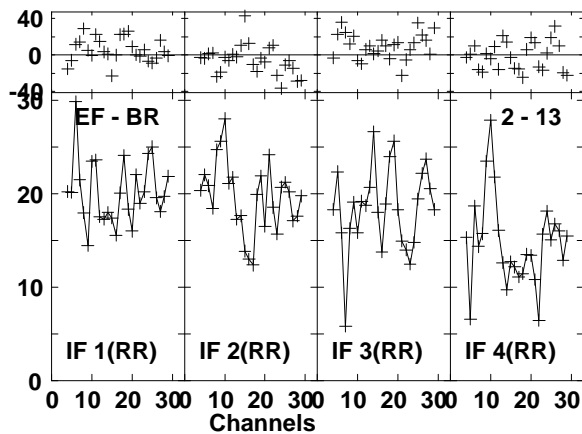
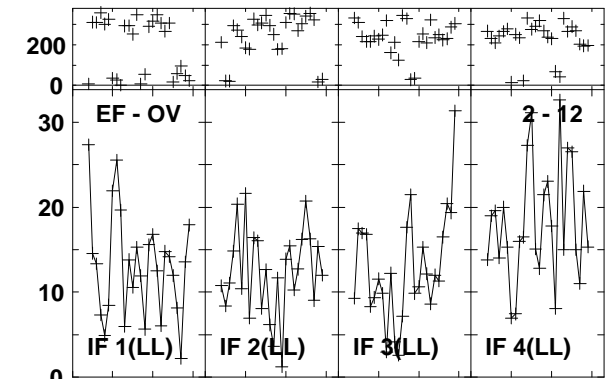
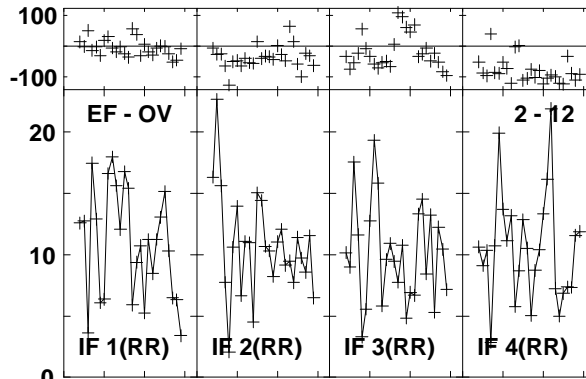
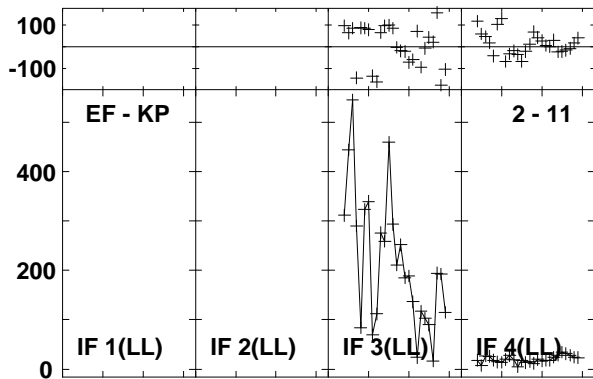
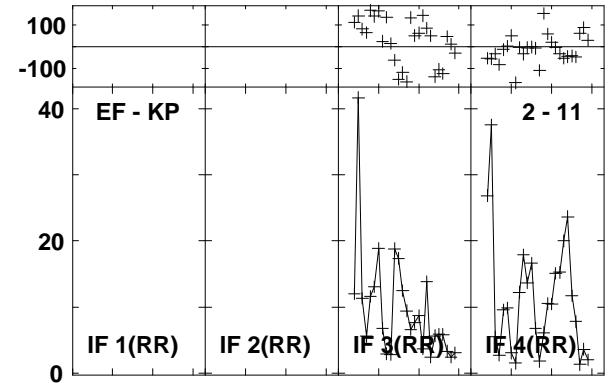
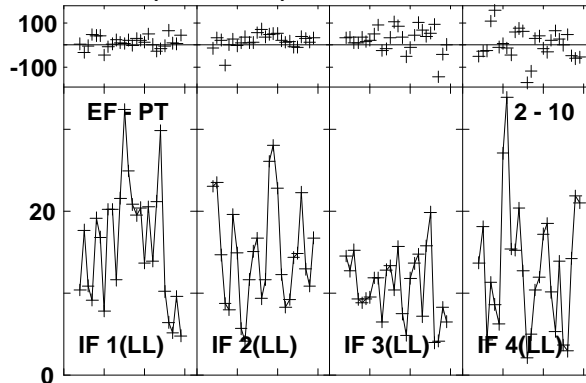
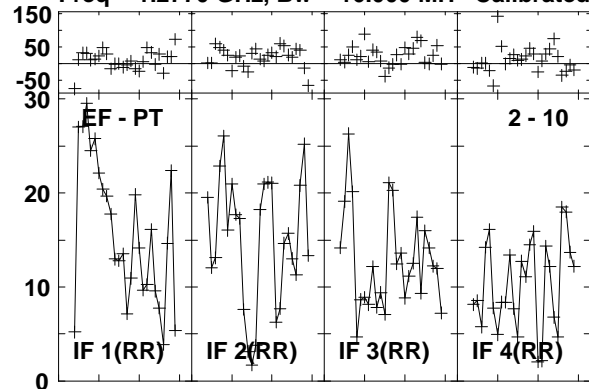

Lower frame: Milli Ampl Jy Top frame: Phas deg
Vector averaged cross-power spectrum Baseline: EF (02) - PT (10)
Timerange: 00/16:10:02 to 00/16:12:48

Plot file version 88 created 03-MAR-2016 01:12:12

4C52 GN002C 1.UVDATA.1

Freq = 1.2770 GHz, Bw = 16.000 MH Calibrated with CL # 3 and BP # 1 (BP mode 1)

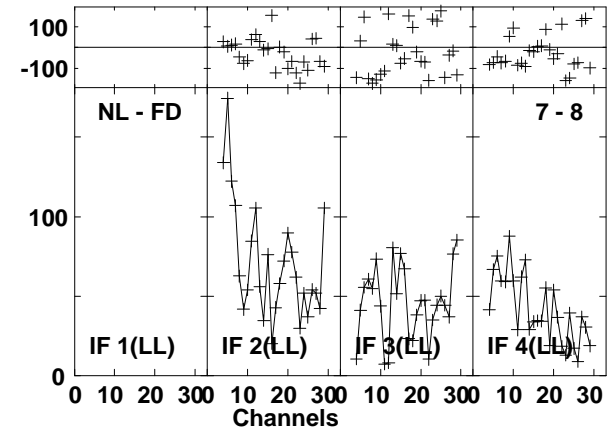
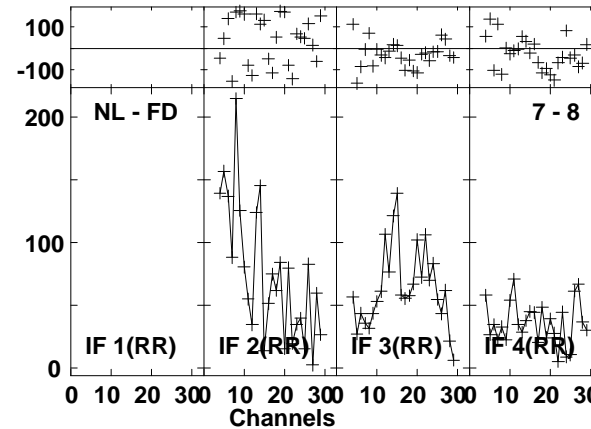
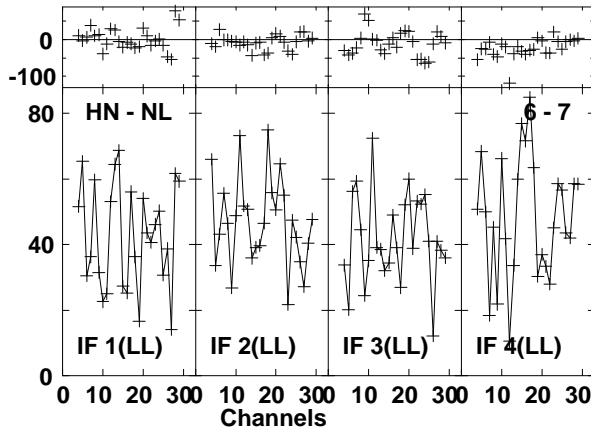
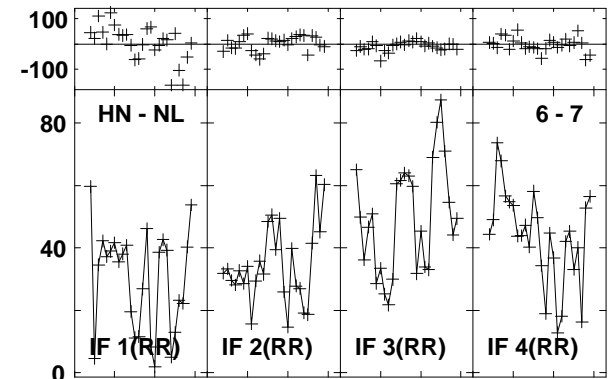
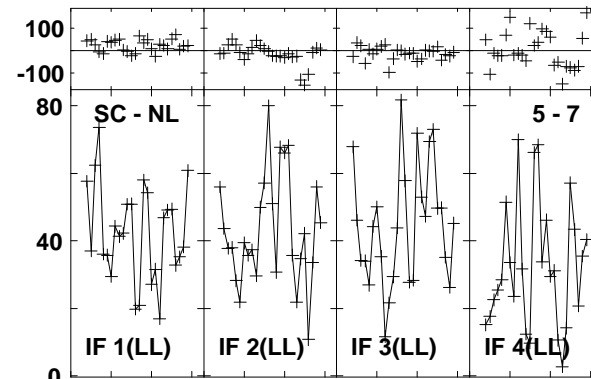
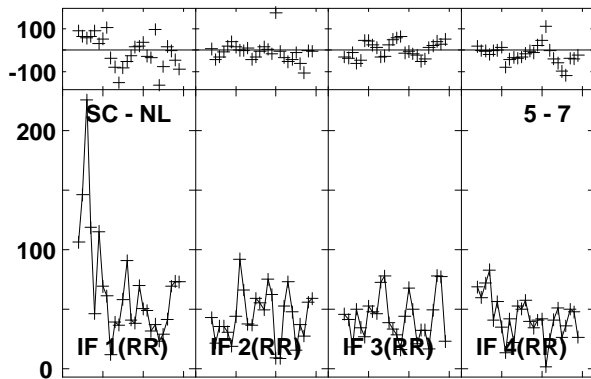
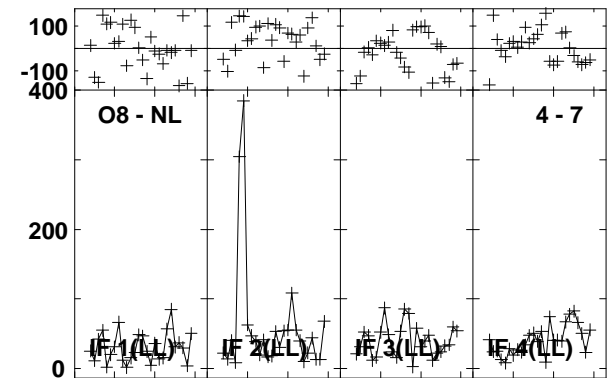
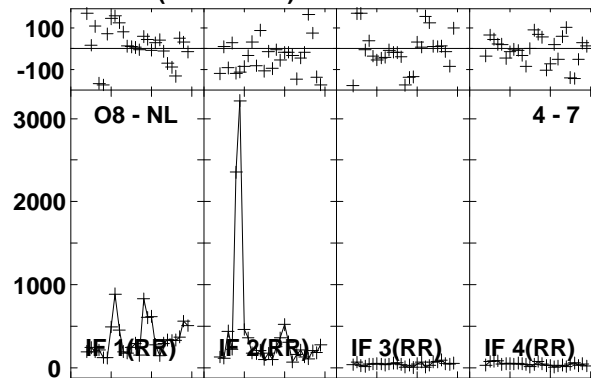
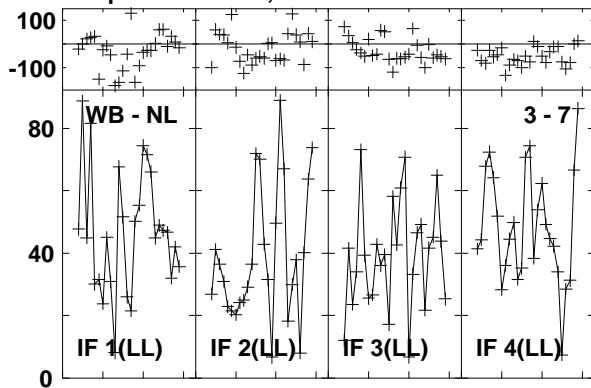

Lower frame: Milli Ampl Jy Top frame: Phas deg
Vector averaged cross-power spectrum Baseline: WB (03) - NL (07)
Timerange: 00/16:10:02 to 00/16:12:48

Plot file version 89 created 03-MAR-2016 01:12:12

4C52 GN002C 1.UVDATA.1

Freq = 1.2770 GHz, Bw = 16.000 MH Calibrated with CL # 3 and BP # 1 (BP mode 1)

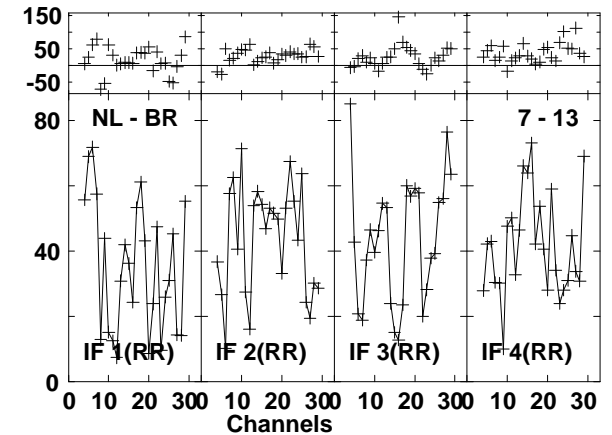
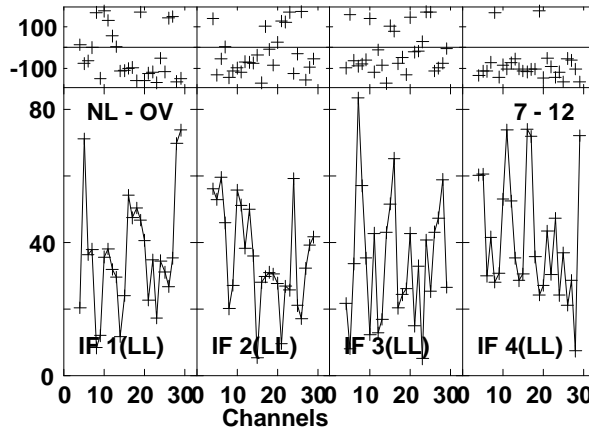
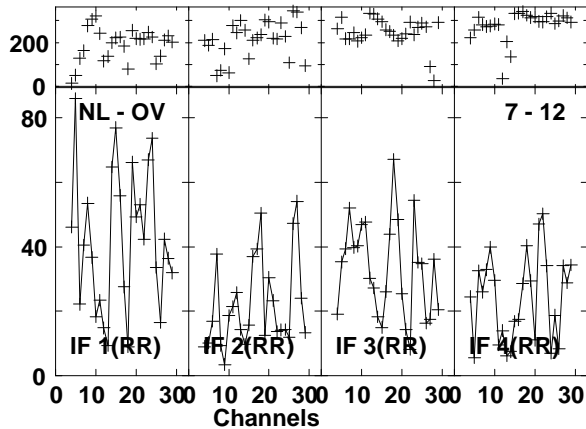
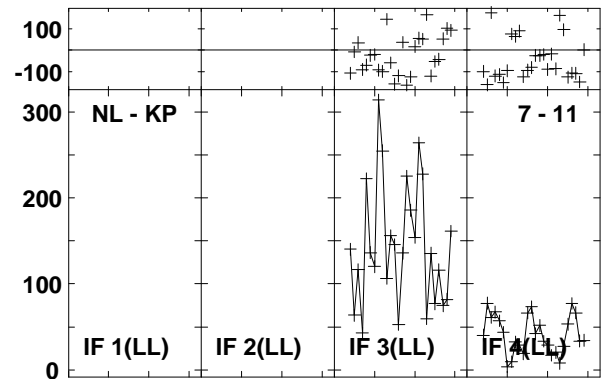
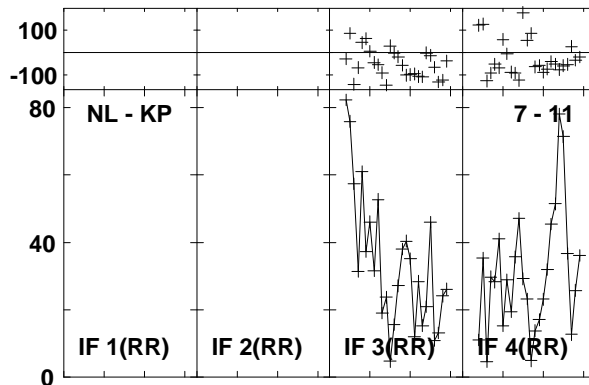
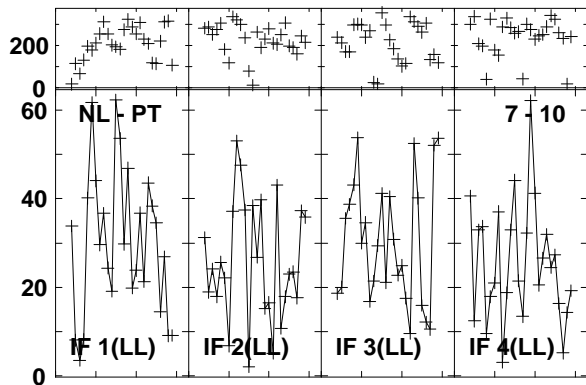
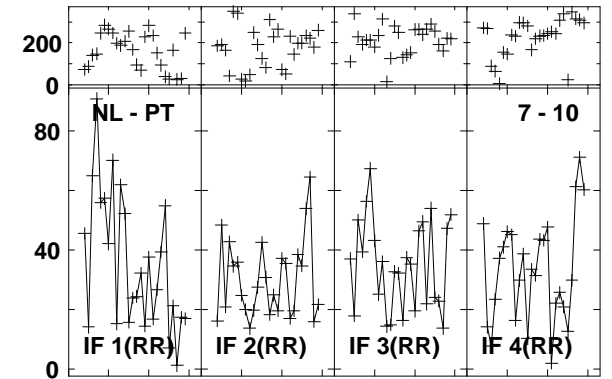
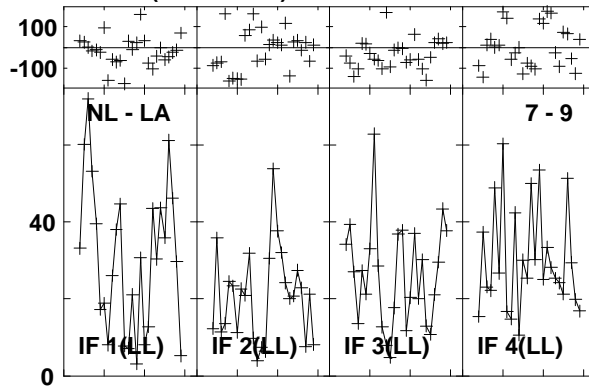
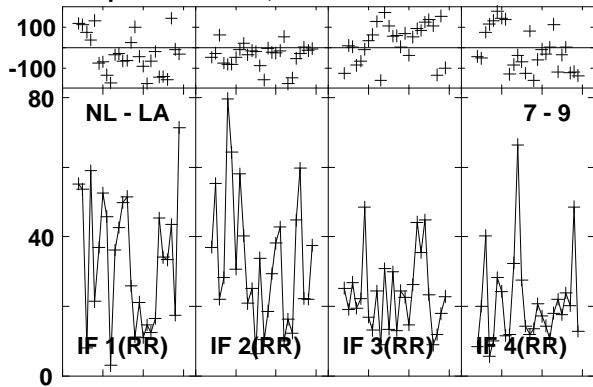

Lower frame: Milli Ampl Jy Top frame: Phas deg
Vector averaged cross-power spectrum Baseline: NL (07) - LA (09)
Timerange: 00/16:10:02 to 00/16:12:48

Plot file version 90 created 03-MAR-2016 01:12:12
4C52 GN002C 1.UVDATA.1
Freq = 1.2770 GHz, Bw = 16.000 MH Calibrated with CL # 3 and BP # 1 (BP mode 1)

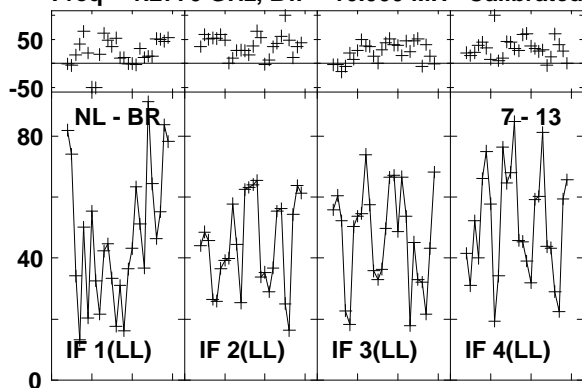

Lower frame: Milli Ampl Jy Top frame: Phas deg
Vector averaged cross-power spectrum Baseline: NL (07) - BR (13)
Timerange: 00/16:10:02 to 00/16:12:48

Plot file version 91 created 03-MAR-2016 01:12:13

J1545+5400 GN002C 1.UVDATA.1

Freq = 1.2770 GHz, Bw = 16.000 MH Calibrated with CL # 3 and BP # 1 (BP mode 1)

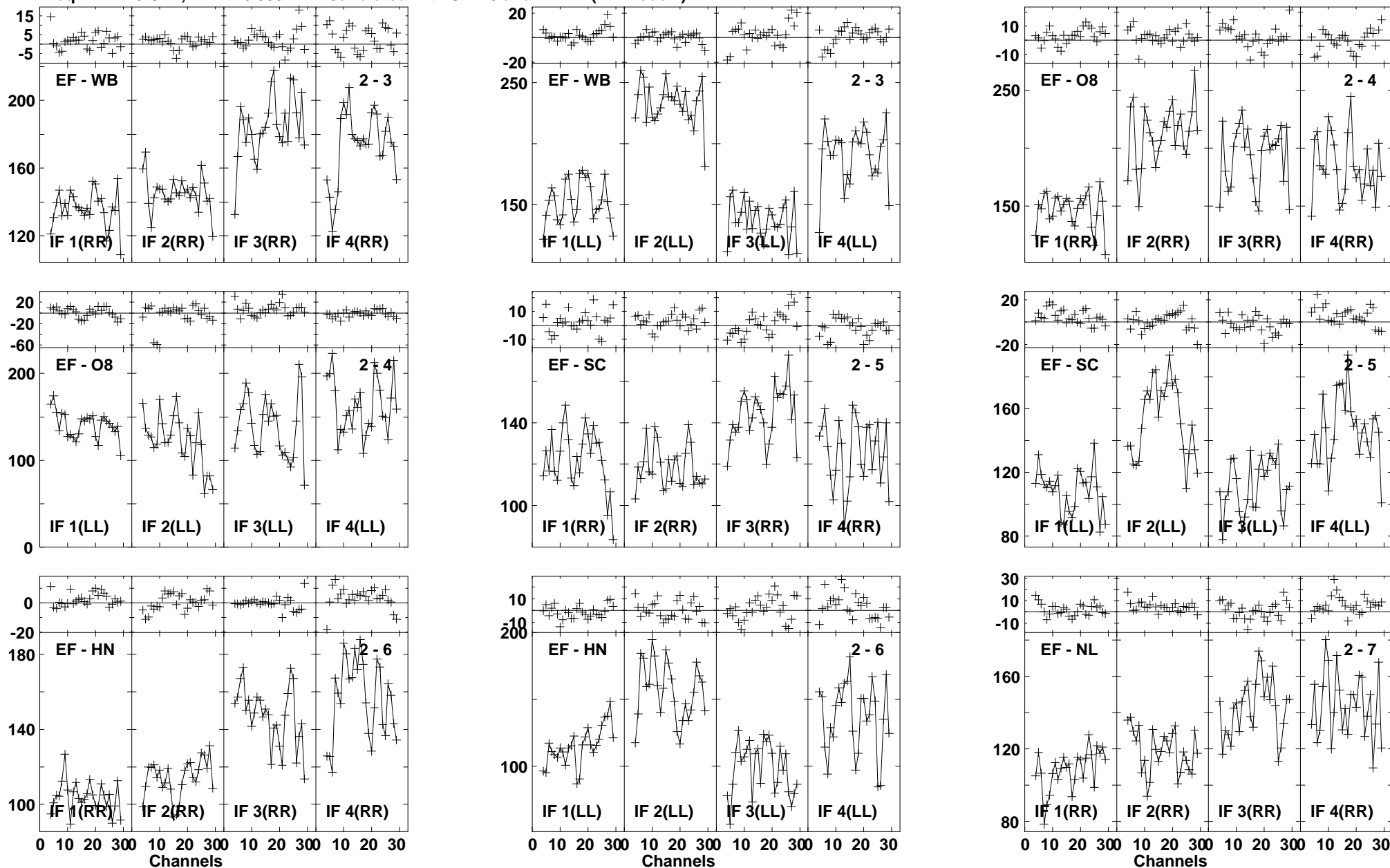

Lower frame: Milli Ampl Jy Top frame: Phas deg
Vector averaged cross-power spectrum Baseline: EF (02) - WB (03)
Timerange: 00/16:13:41 to 00/16:14:39

Plot file version 92 created 03-MAR-2016 01:12:13

J1545+5400 GN002C 1.UVDATA.1

Freq = 1.2770 GHz, Bw = 16.000 MH Calibrated with CL # 3 and BP # 1 (BP mode 1)

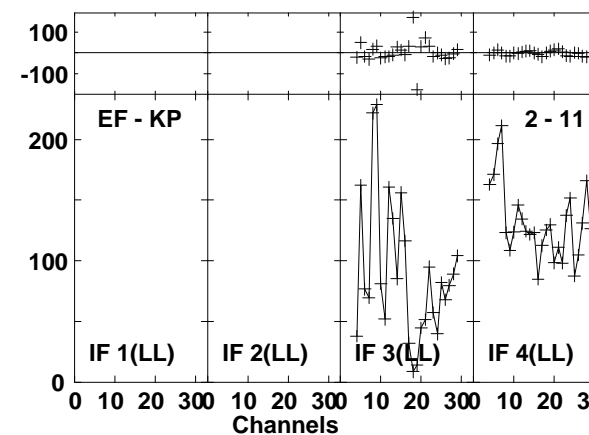
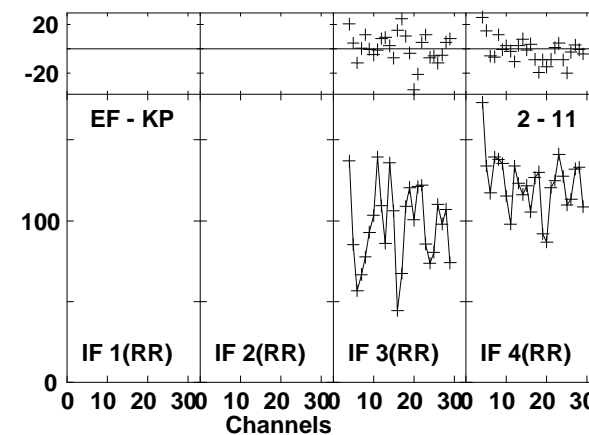
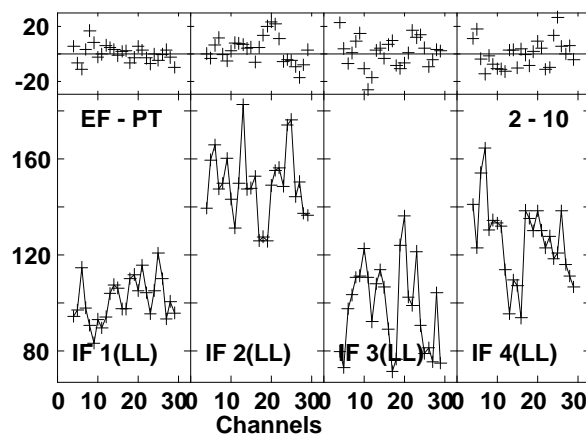
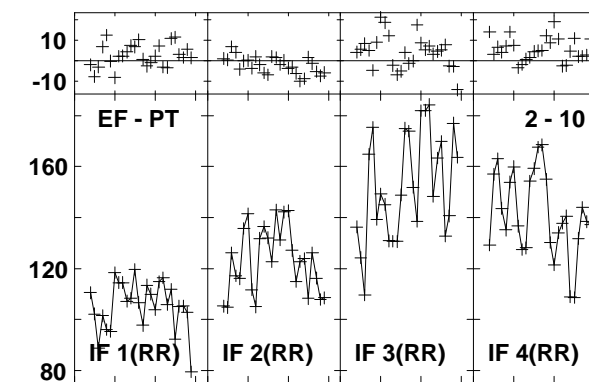
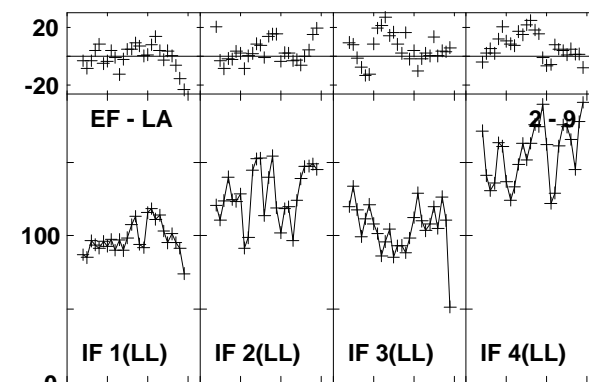
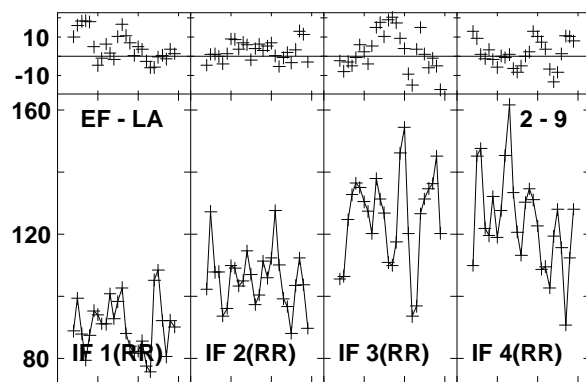
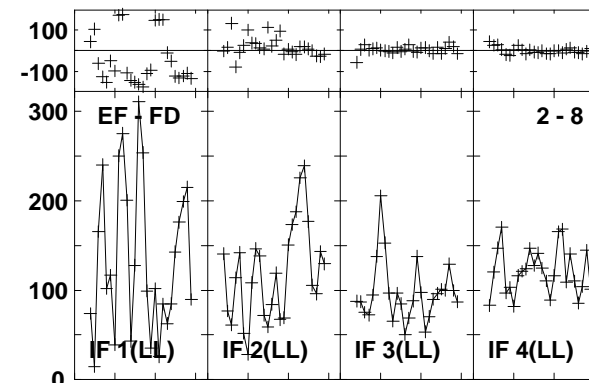
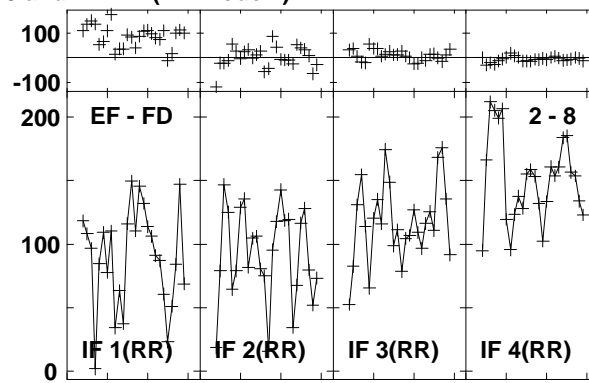
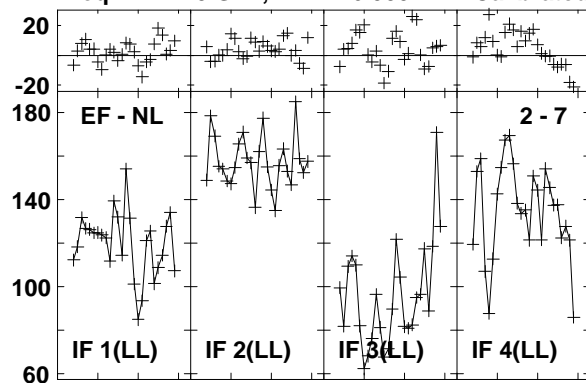

Lower frame: Milli Ampl Jy Top frame: Phas deg
Vector averaged cross-power spectrum Baseline: EF (02) - NL (07)
Timerange: 00/16:13:41 to 00/16:14:39

Plot file version 93 created 03-MAR-2016 01:12:13

J1545+5400 GN002C 1.UVDATA.1

Freq = 1.2770 GHz, Bw = 16.000 MH Calibrated with CL # 3 and BP # 1 (BP mode 1)

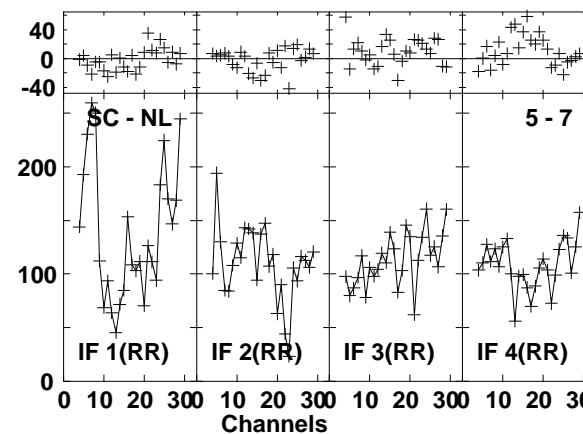
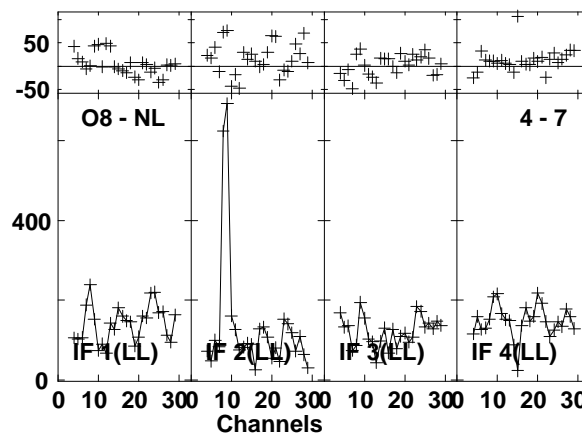
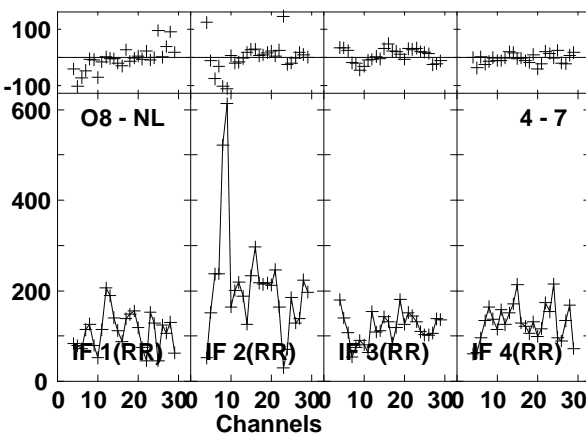
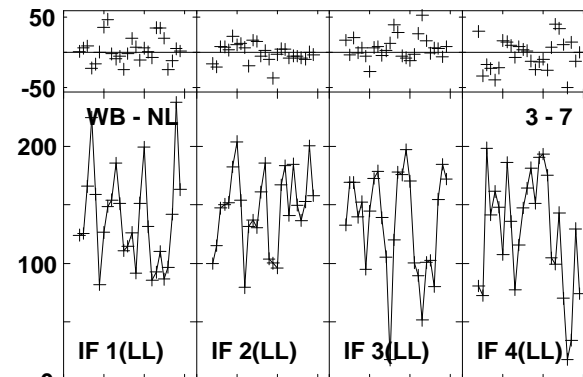
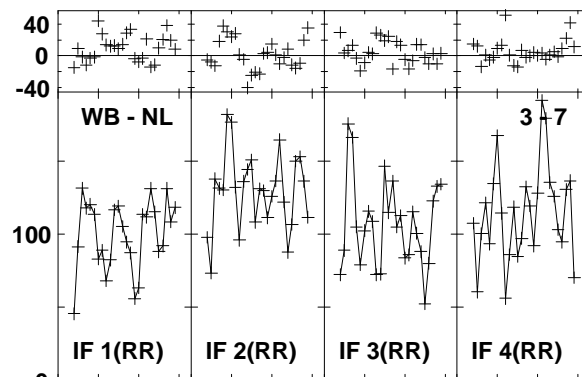
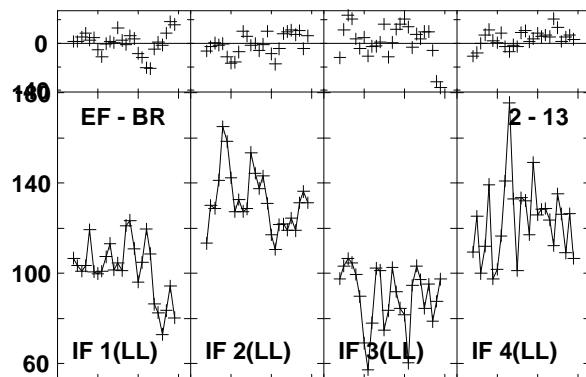
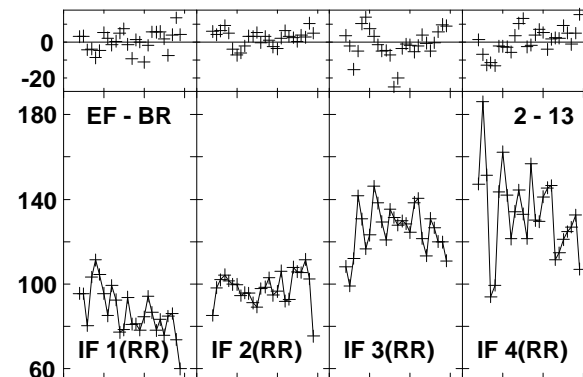
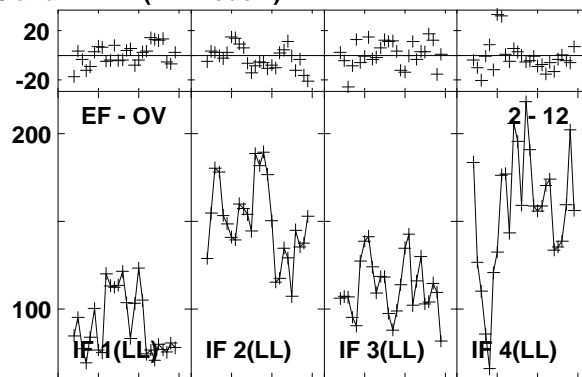
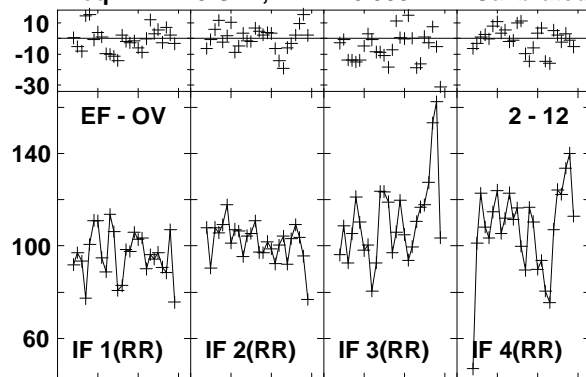

Lower frame: Milli Ampl Jy Top frame: Phas deg
Vector averaged cross-power spectrum Baseline: EF (02) - OV (12)
Timerange: 00/16:13:41 to 00/16:14:39

Plot file version 94 created 03-MAR-2016 01:12:13

J1545+5400 GN002C 1.UVDATA.1

Freq = 1.2770 GHz, Bw = 16.000 MH Calibrated with CL # 3 and BP # 1 (BP mode 1)

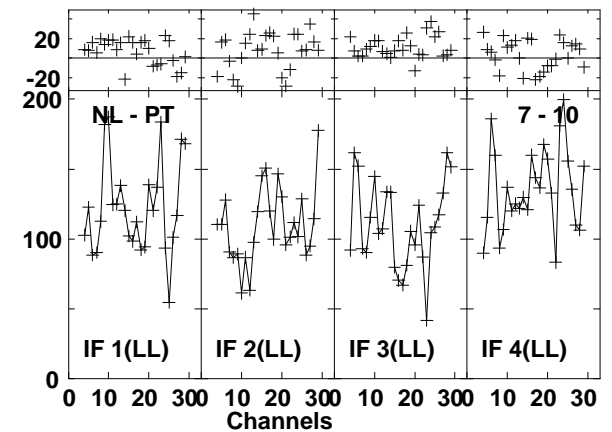
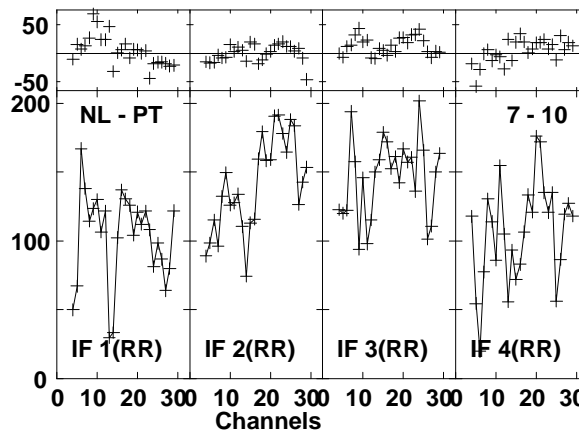
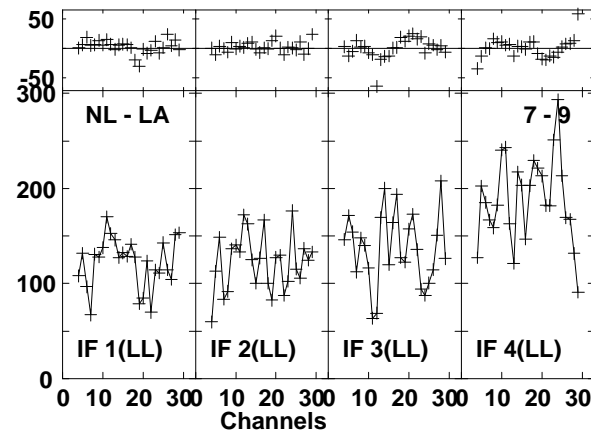
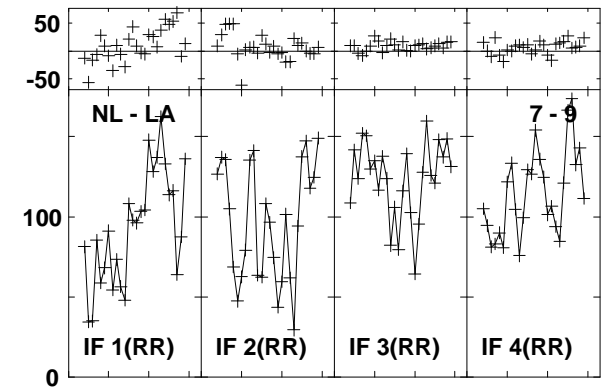
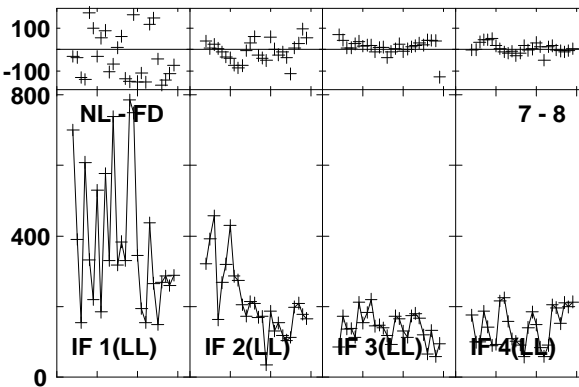
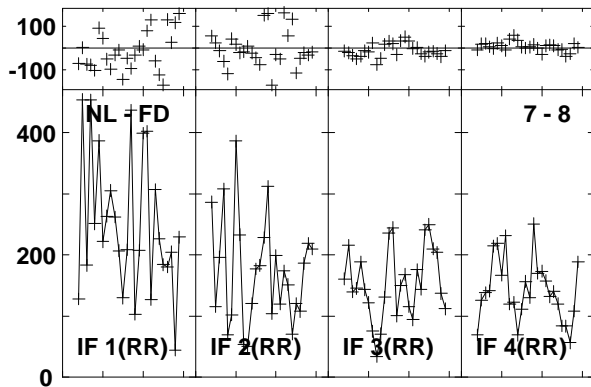
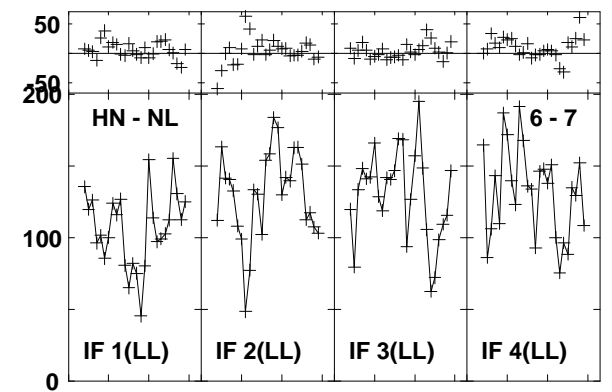
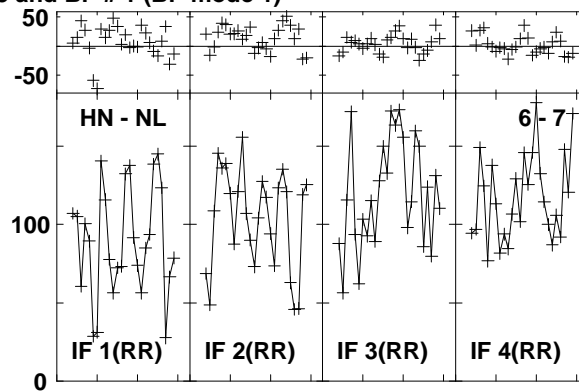
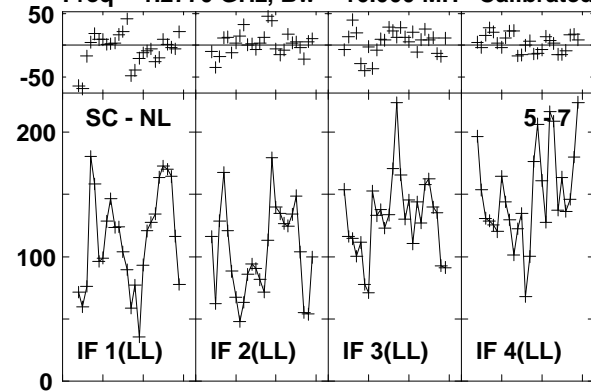

Lower frame: Milli Ampl Jy Top frame: Phas deg
Vector averaged cross-power spectrum Baseline: SC (05) - NL (07)
Timerange: 00/16:13:41 to 00/16:14:39

Plot file version 95 created 03-MAR-2016 01:12:13
 J1545+5400 GN002C 1.UVDATA.1
 Freq = 1.2770 GHz, Bw = 16.000 MH Calibrated with CL # 3 and BP # 1 (BP mode 1)

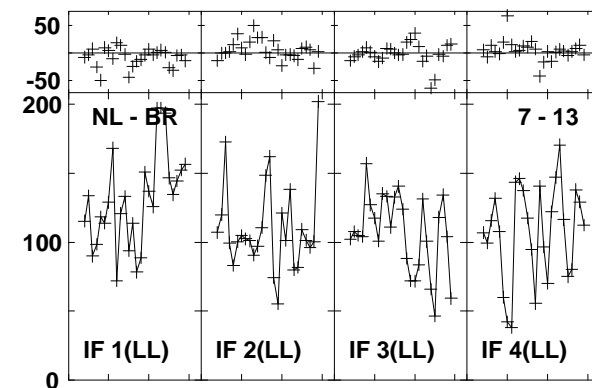
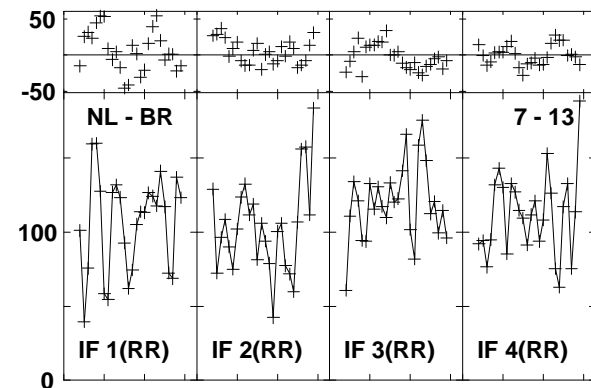
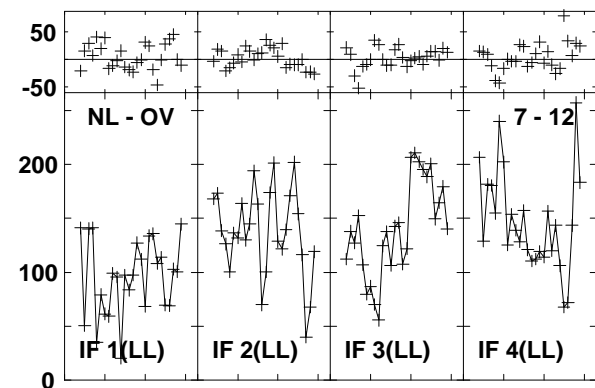
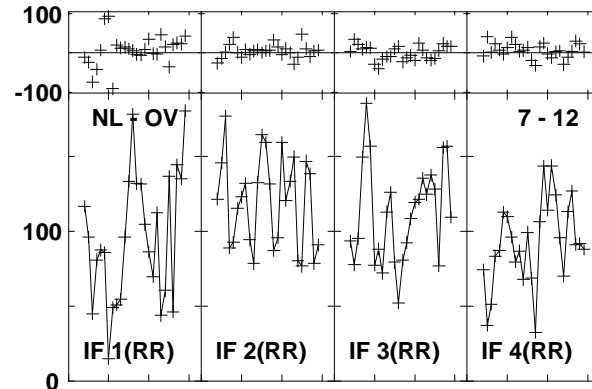
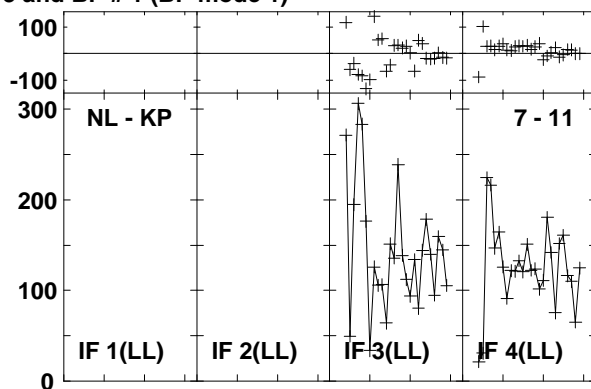
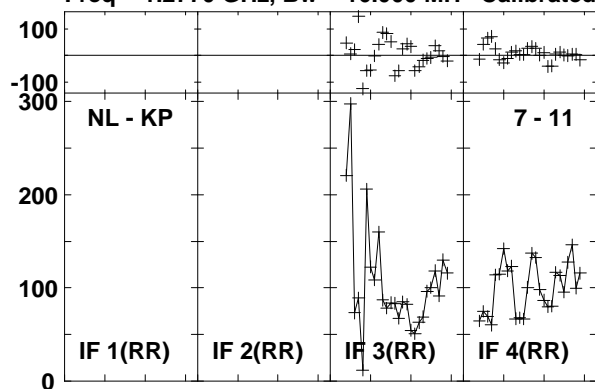

Lower frame: Milli Ampl Jy Top frame: Phas deg
 Vector averaged cross-power spectrum Baseline: NL (07) - KP (11)
 Timerange: 00/16:13:41 to 00/16:14:39

Plot file version 96 created 03-MAR-2016 01:12:13

4C52 GN002C 1.UVDATA.1

Freq = 1.2770 GHz, Bw = 16.000 MH Calibrated with CL # 3 and BP # 1 (BP mode 1)

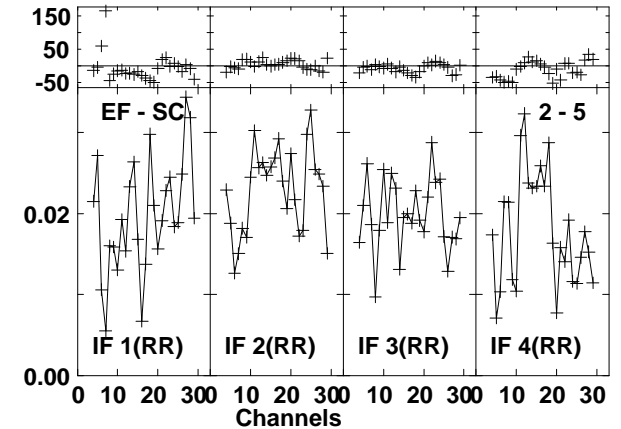
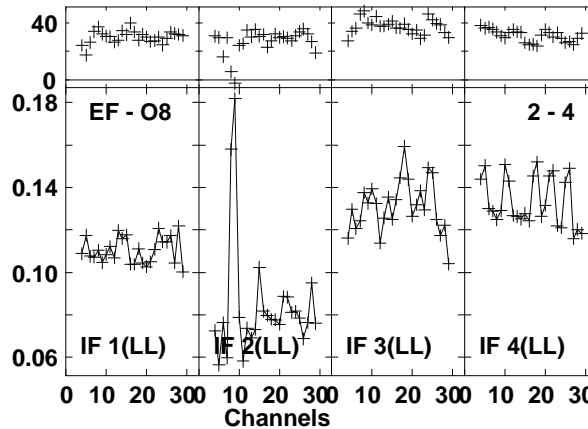
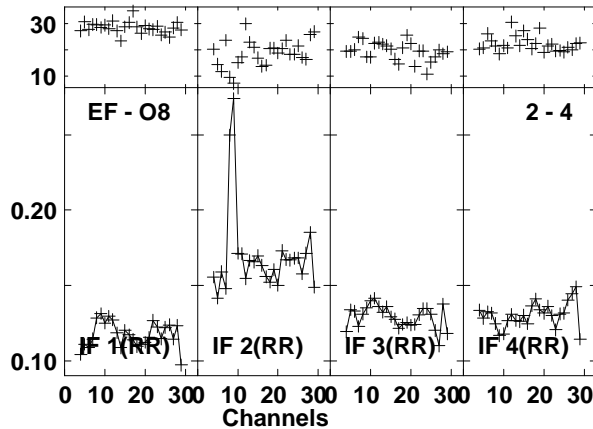
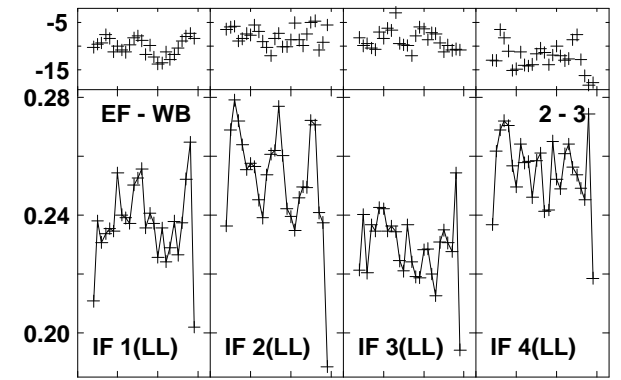
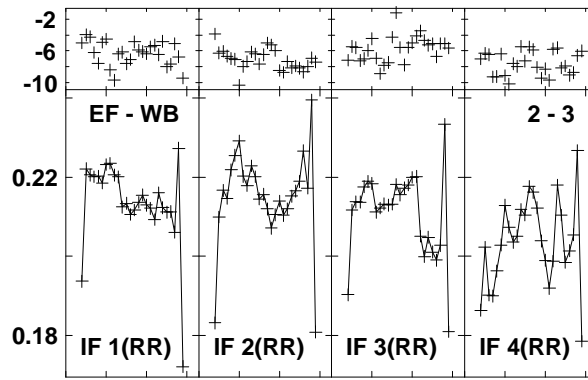
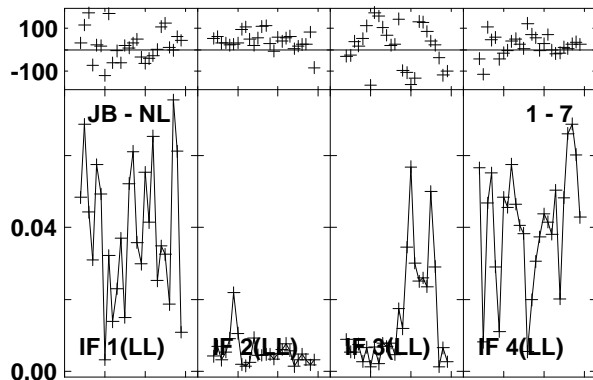
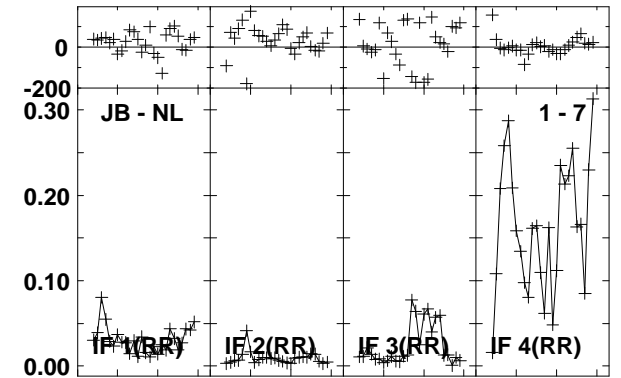
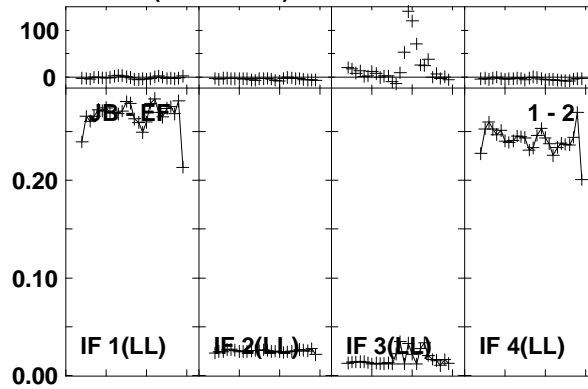
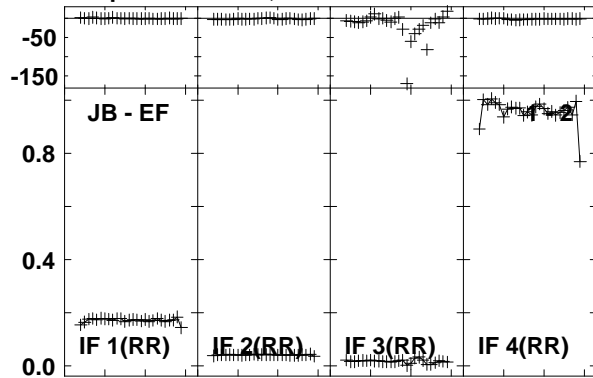

Lower frame: Ampl Jy Top frame: Phas deg
Vector averaged cross-power spectrum Baseline: JB (01) - EF (02)
Timerange: 00/16:14:44 to 00/16:17:38

Plot file version 97 created 03-MAR-2016 01:12:13

4C52 GN002C 1.UVDATA.1

Freq = 1.2770 GHz, Bw = 16.000 MH Calibrated with CL # 3 and BP # 1 (BP mode 1)

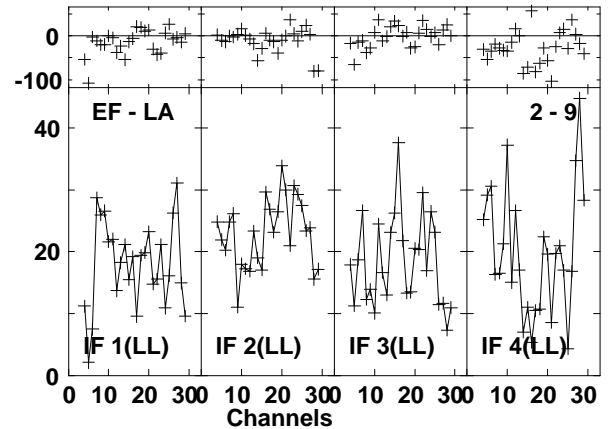
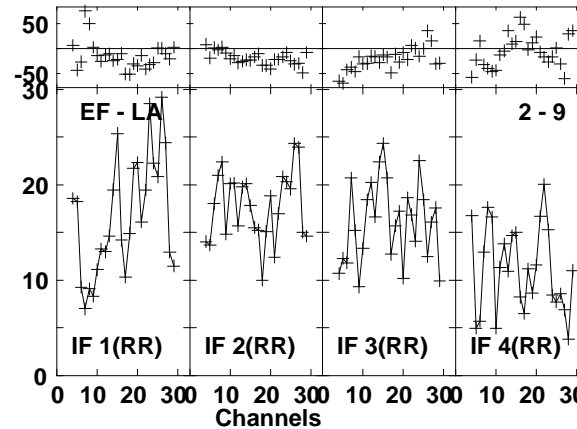
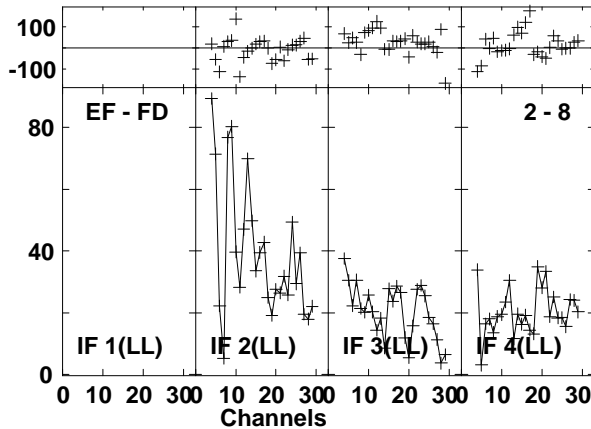
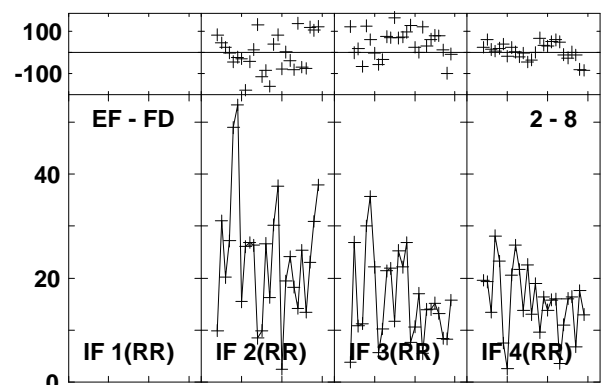
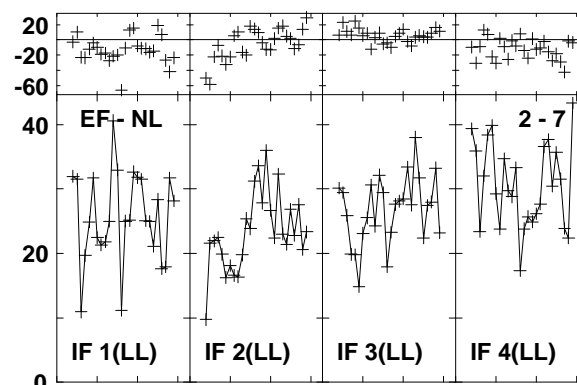
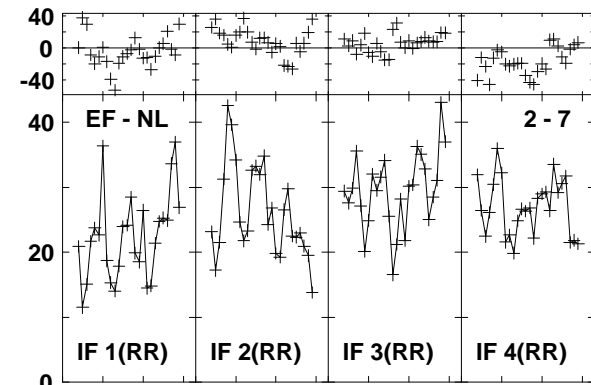
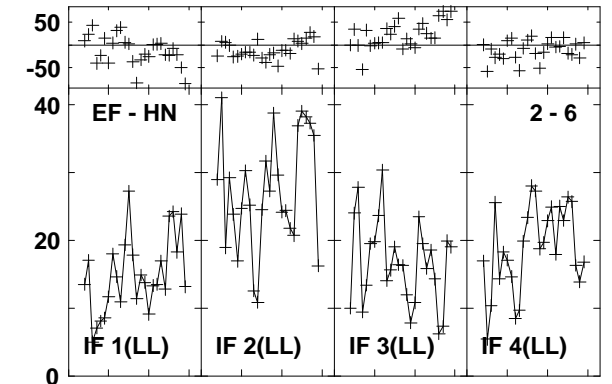
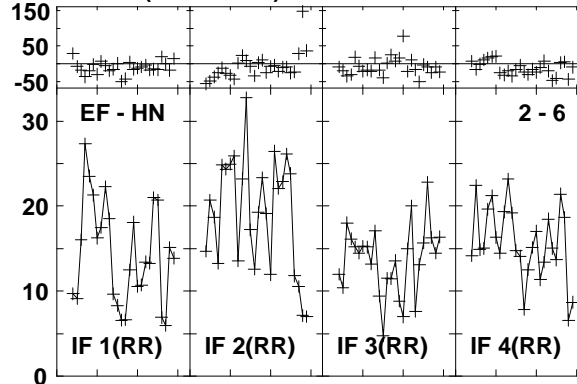
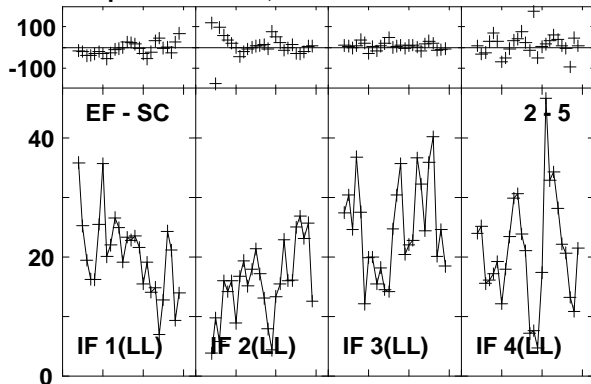

Lower frame: Milli Ampl Jy Top frame: Phas deg
Vector averaged cross-power spectrum Baseline: EF (02) - SC (05)
Timerange: 00/16:14:44 to 00/16:17:38

Plot file version 98 created 03-MAR-2016 01:12:14

4C52 GN002C 1.UVDATA.1

Freq = 1.2770 GHz, Bw = 16.000 MH Calibrated with CL # 3 and BP # 1 (BP mode 1)

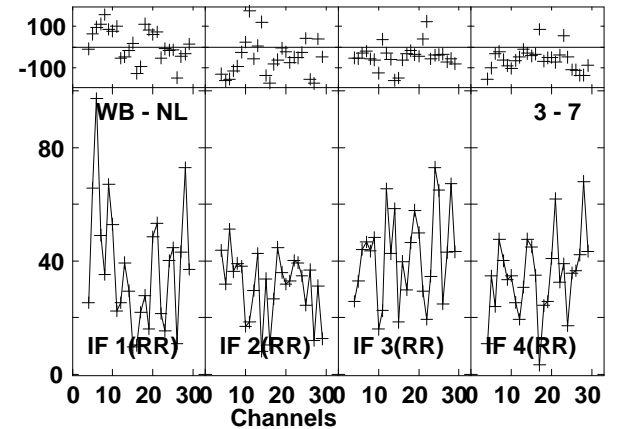
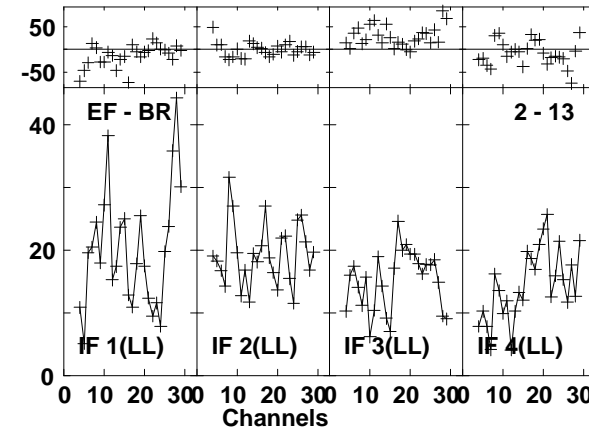
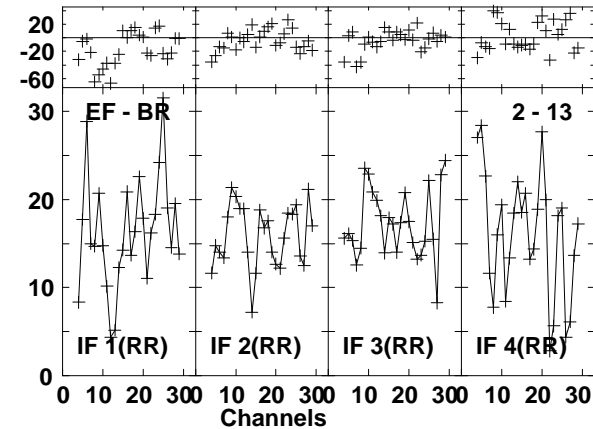
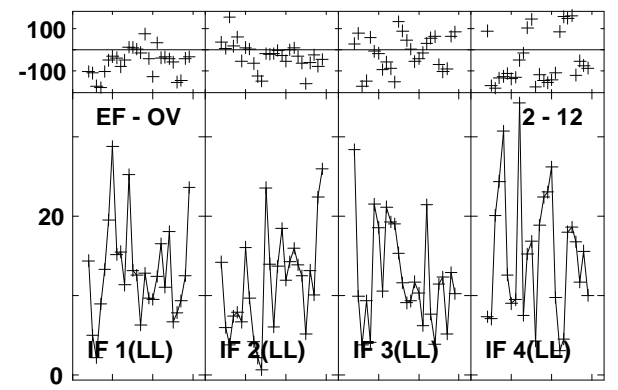
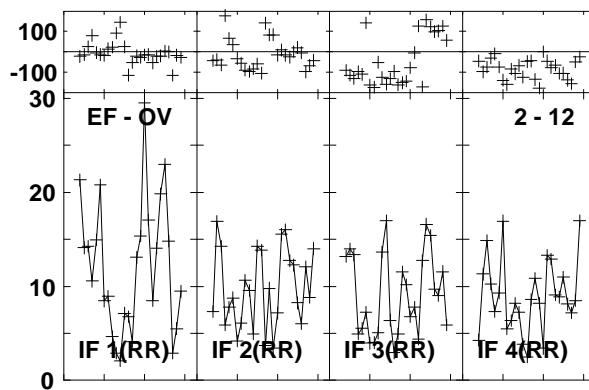
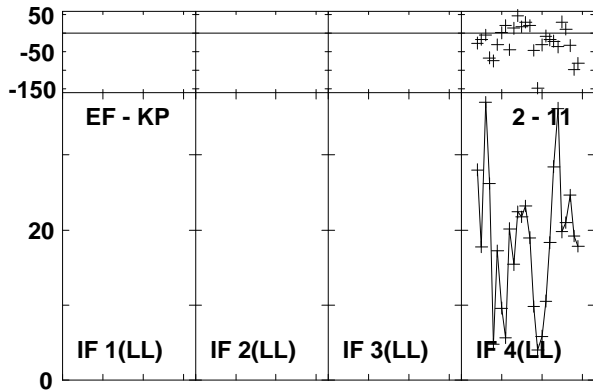
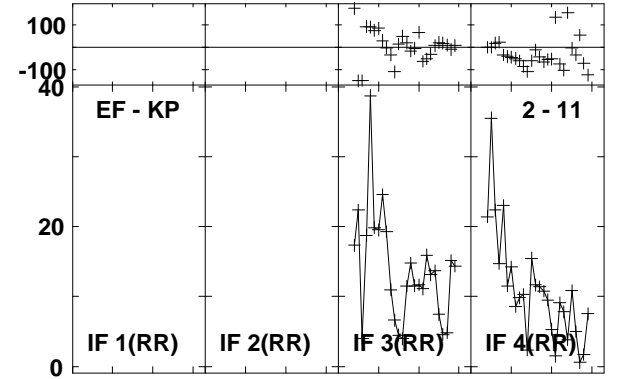
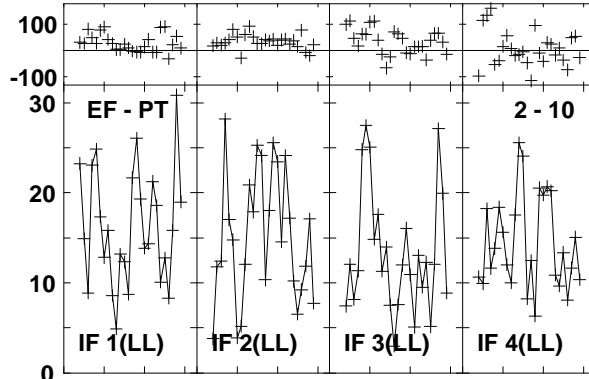
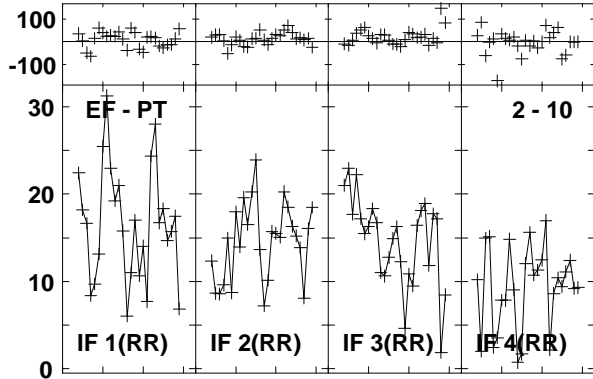

Lower frame: Milli Ampl Jy Top frame: Phas deg
Vector averaged cross-power spectrum Baseline: EF (02) - PT (10)
Timerange: 00/16:14:44 to 00/16:17:38

Plot file version 99 created 03-MAR-2016 01:12:14

4C52 GN002C 1.UVDATA.1

Freq = 1.2770 GHz, Bw = 16.000 MH Calibrated with CL # 3 and BP # 1 (BP mode 1)

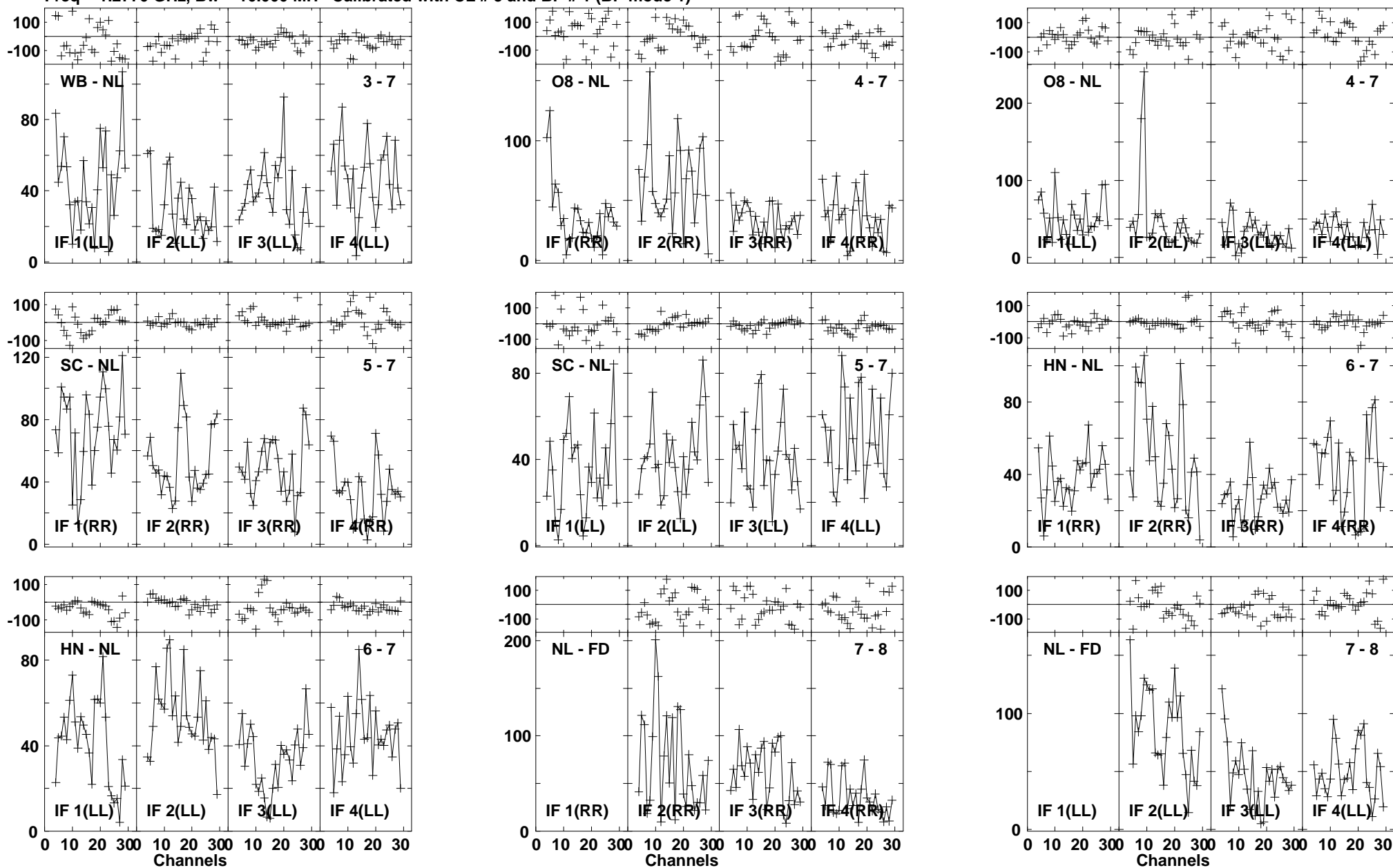

Lower frame: Milli Ampl Jy Top frame: Phas deg
Vector averaged cross-power spectrum Baseline: WB (03) - NL (07)
Timerange: 00/16:14:44 to 00/16:17:38

Plot file version 100 created 03-MAR-2016 01:12:14

4C52 GN002C 1.UVDATA.1

Freq = 1.2770 GHz, Bw = 16.000 MH Calibrated with CL # 3 and BP # 1 (BP mode 1)

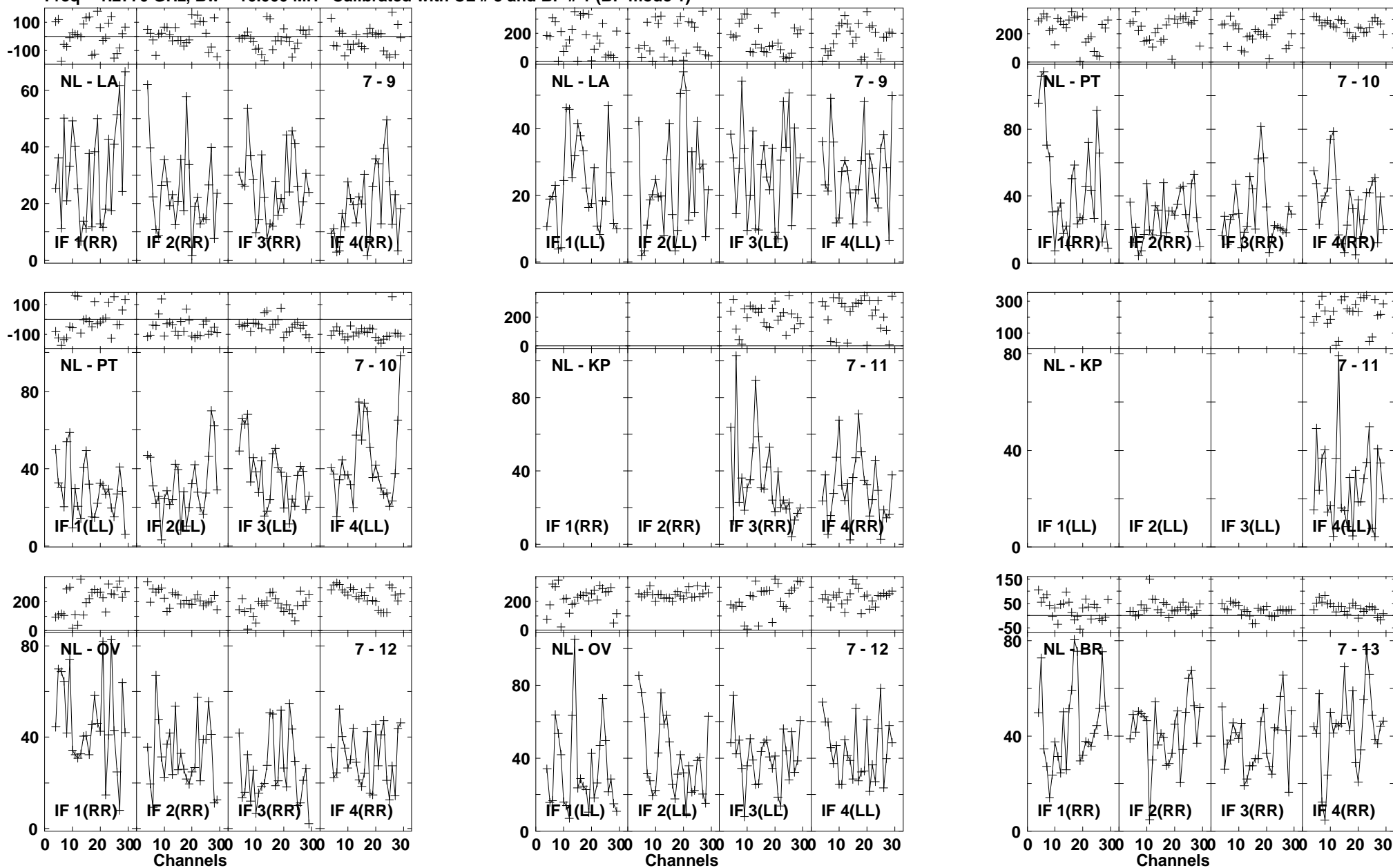

Lower frame: Milli Ampl Jy Top frame: Phas deg
Vector averaged cross-power spectrum Baseline: NL (07) - LA (09)
Timerange: 00/16:14:44 to 00/16:17:38

Plot file version 101 created 03-MAR-2016 01:12:14
4C52 GN002C 1.UVDATA.1
Freq = 1.2770 GHz, Bw = 16.000 MH Calibrated with CL # 3 and BP # 1 (BP mode 1)

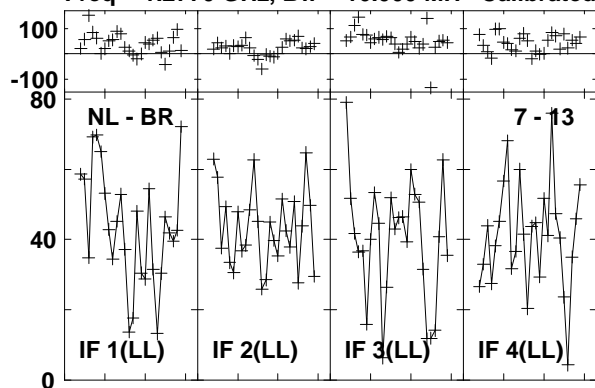

Lower frame: Milli Ampl Jy Top frame: Phas deg
Vector averaged cross-power spectrum Baseline: NL (07) - BR (13)
Timerange: 00/16:14:44 to 00/16:17:38

Plot file version 102 created 03-MAR-2016 01:12:14

J1545+5400 GN002C 1.UVDATA.1

Freq = 1.2770 GHz, Bw = 16.000 MH Calibrated with CL # 3 and BP # 1 (BP mode 1)

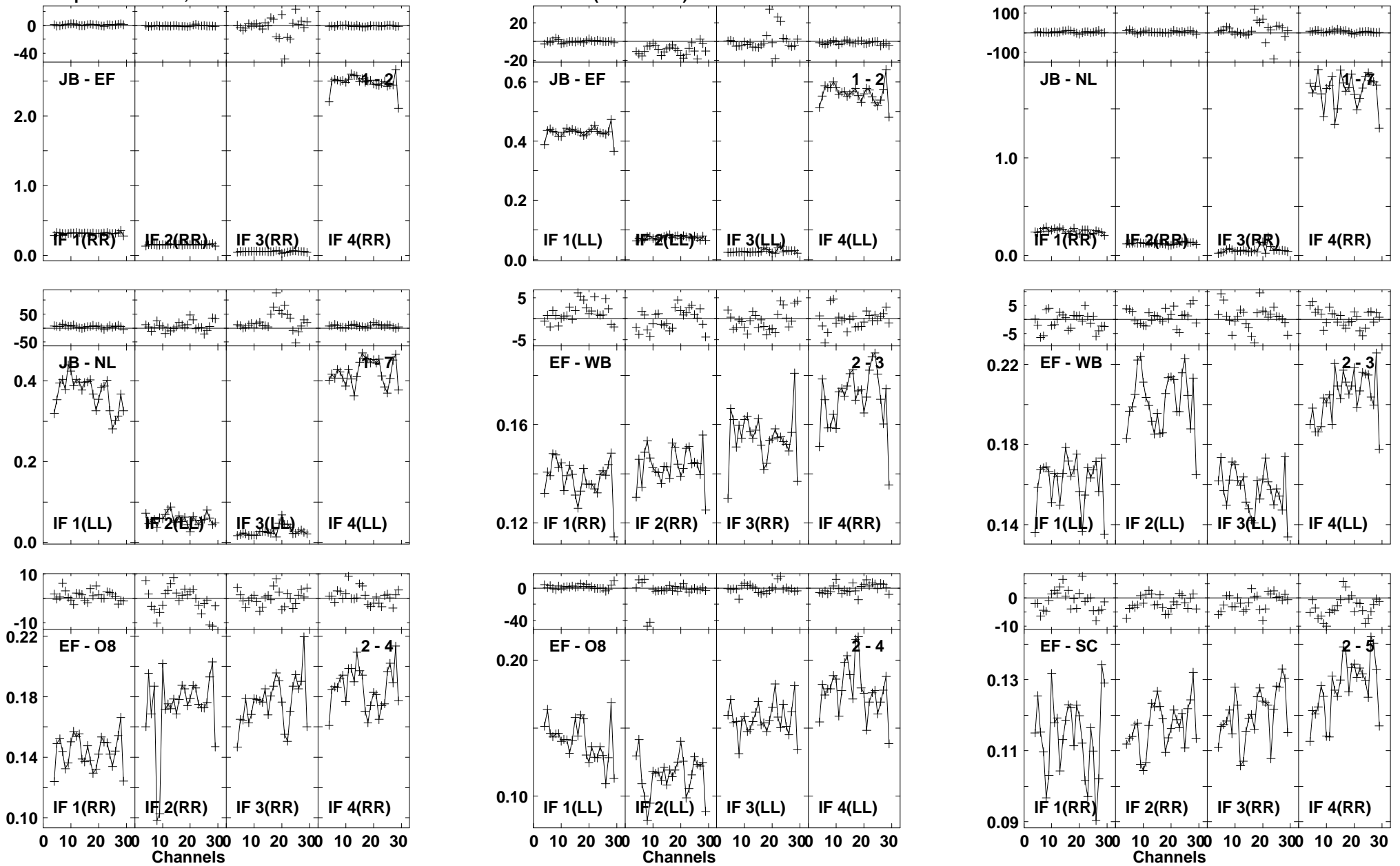

Lower frame: Ampl Jy Top frame: Phas deg
Vector averaged cross-power spectrum Baseline: JB (01) - EF (02)
Timerange: 00/16:18:31 to 00/16:20:29

Plot file version 103 created 03-MAR-2016 01:12:14

J1545+5400 GN002C 1.UVDATA.1

Freq = 1.2770 GHz, Bw = 16.000 MH Calibrated with CL # 3 and BP # 1 (BP mode 1)

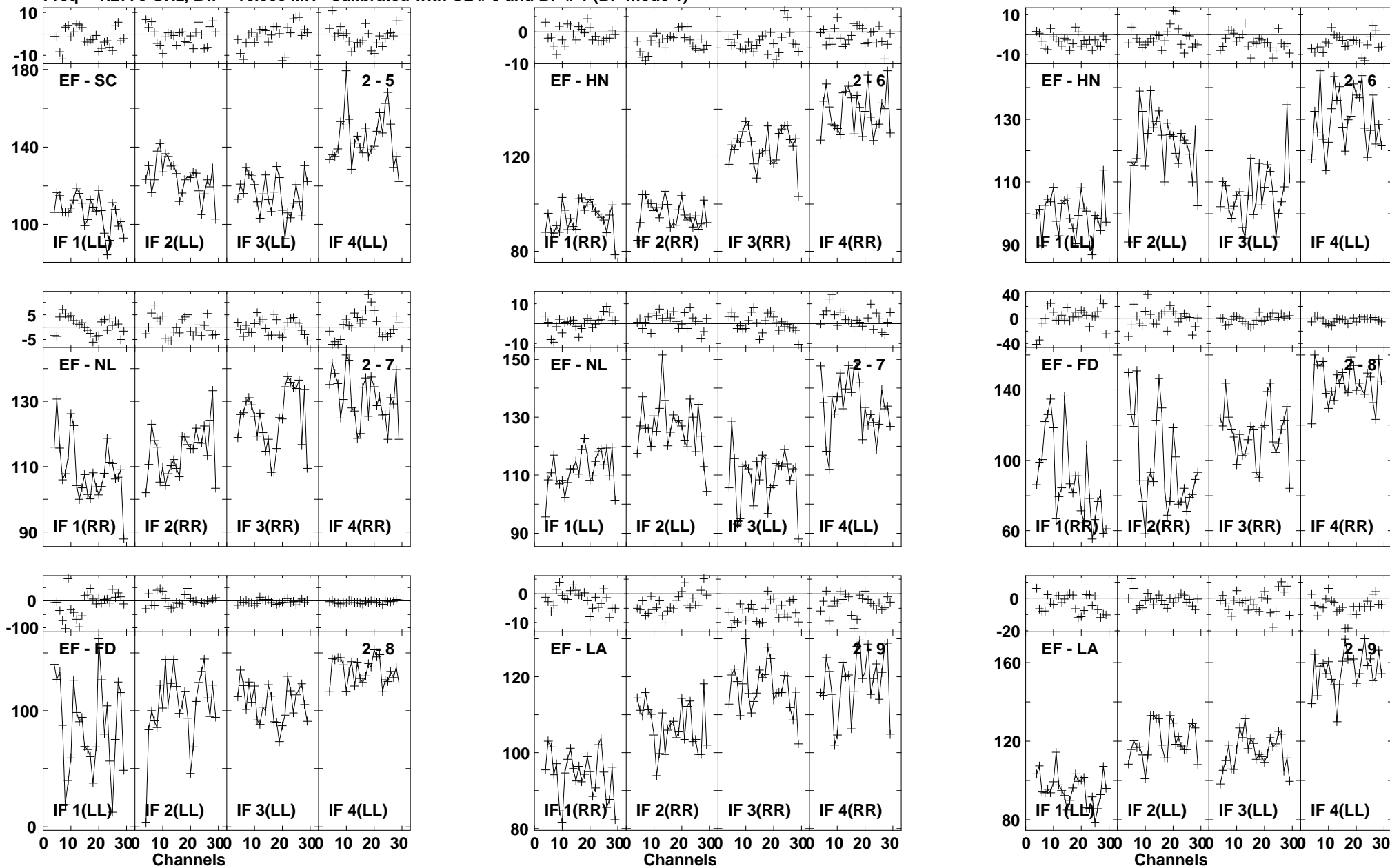

Lower frame: Milli Ampl Jy Top frame: Phas deg
Vector averaged cross-power spectrum Baseline: EF (02) - SC (05)
Timerange: 00/16:18:31 to 00/16:20:29

Plot file version 104 created 03-MAR-2016 01:12:15

J1545+5400 GN002C 1.UVDATA.1

Freq = 1.2770 GHz, Bw = 16.000 MH Calibrated with CL # 3 and BP # 1 (BP mode 1)

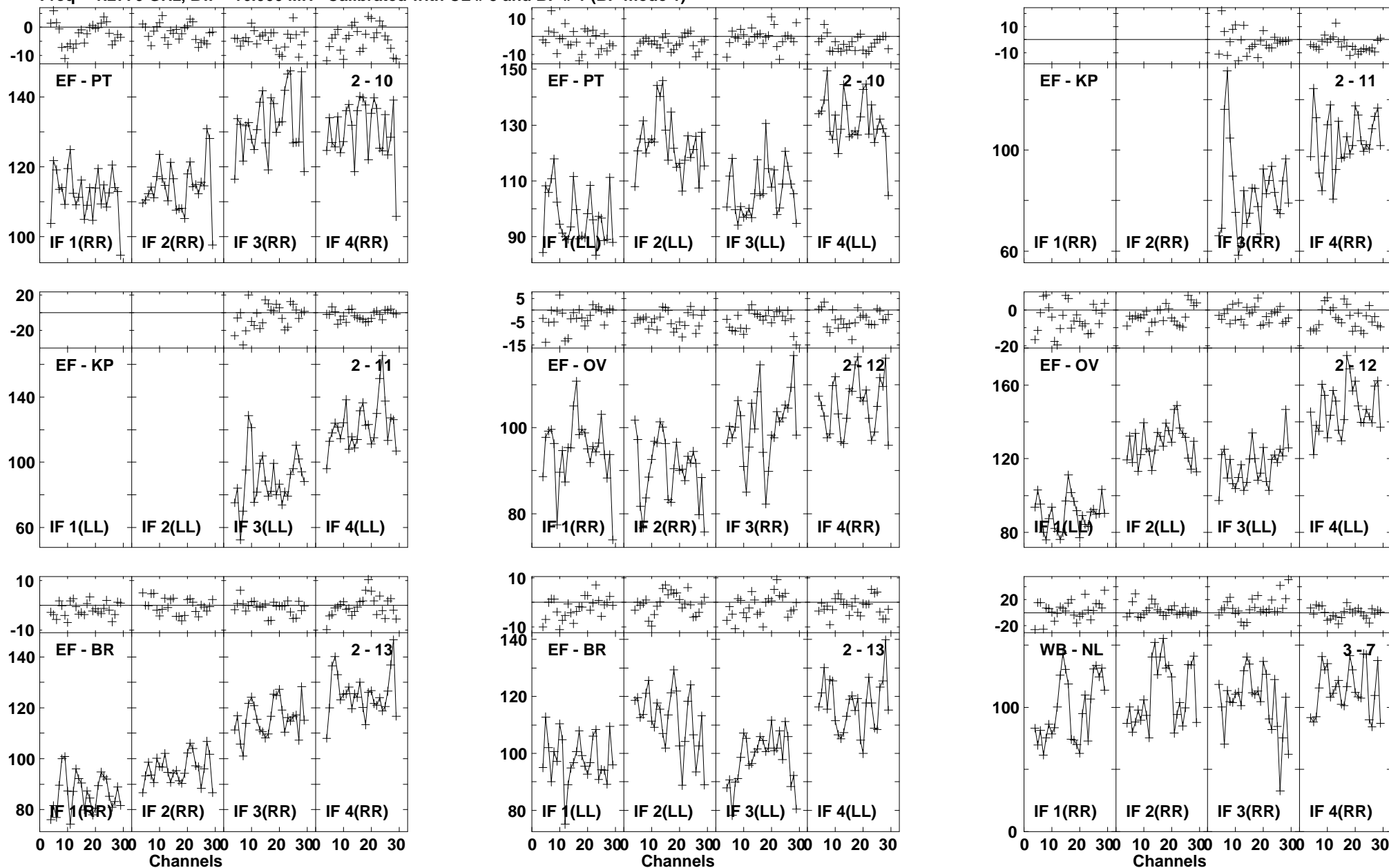

Lower frame: Milli Ampl Jy Top frame: Phas deg
Vector averaged cross-power spectrum Baseline: EF (02) - PT (10)
Timerange: 00/16:18:31 to 00/16:20:29

Plot file version 105 created 03-MAR-2016 01:12:15

J1545+5400 GN002C 1.UVDATA.1

Freq = 1.2770 GHz, Bw = 16.000 MH Calibrated with CL # 3 and BP # 1 (BP mode 1)

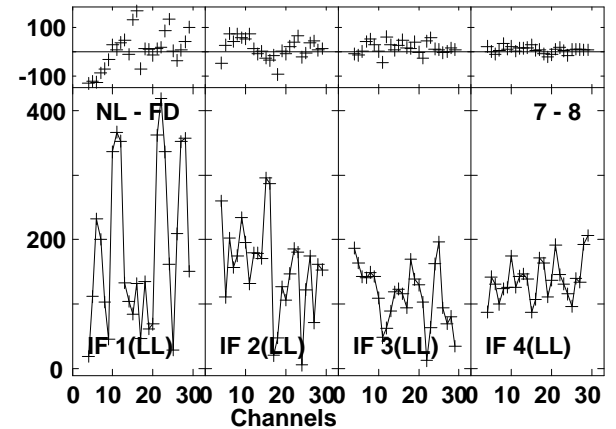
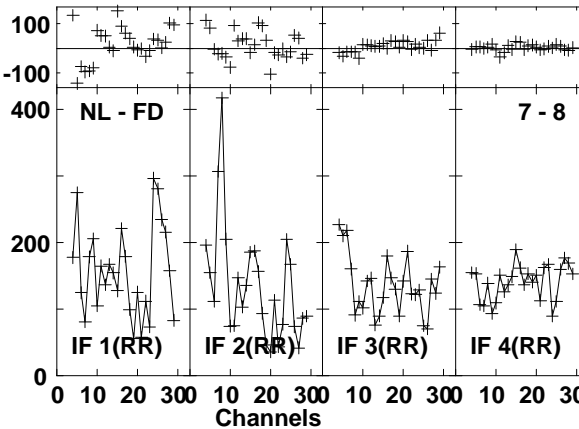
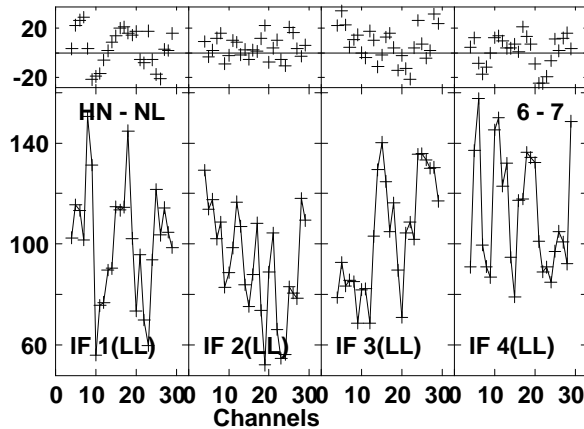
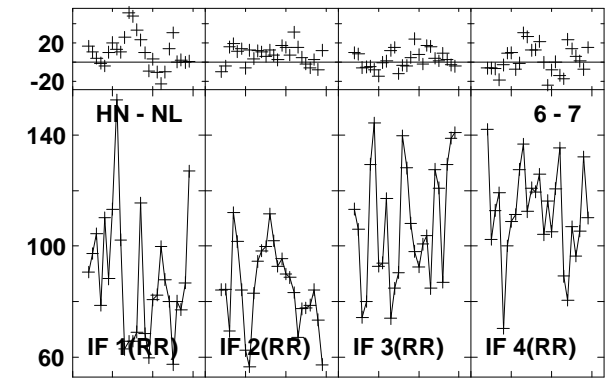
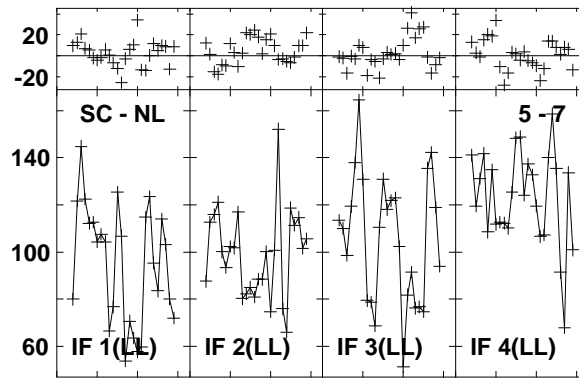
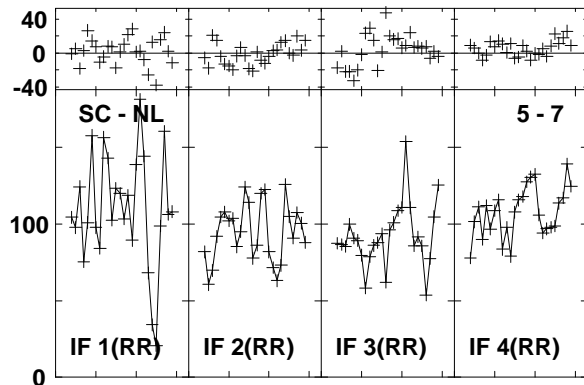
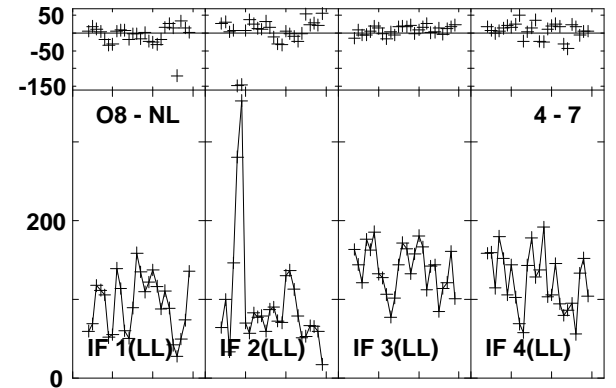
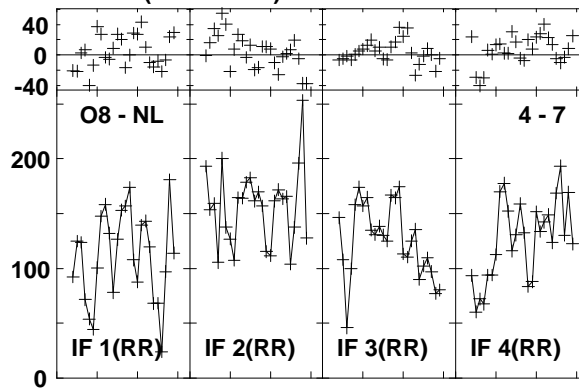
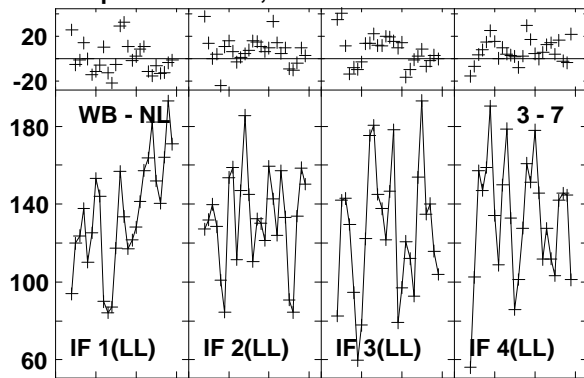

Lower frame: Milli Ampl Jy Top frame: Phas deg
Vector averaged cross-power spectrum Baseline: WB (03) - NL (07)
Timerange: 00/16:18:31 to 00/16:20:29

Plot file version 106 created 03-MAR-2016 01:12:15

J1545+5400 GN002C 1.UVDATA.1

Freq = 1.2770 GHz, Bw = 16.000 MH Calibrated with CL # 3 and BP # 1 (BP mode 1)

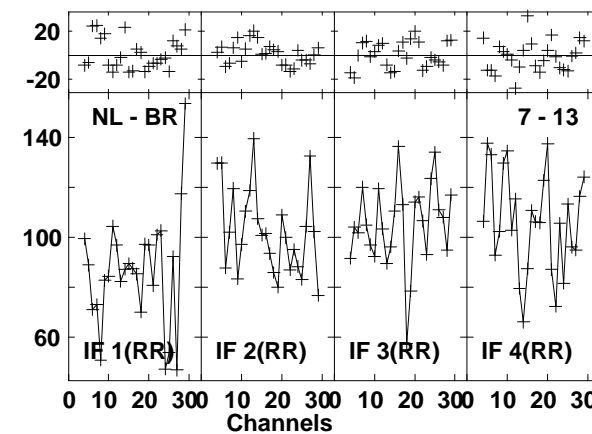
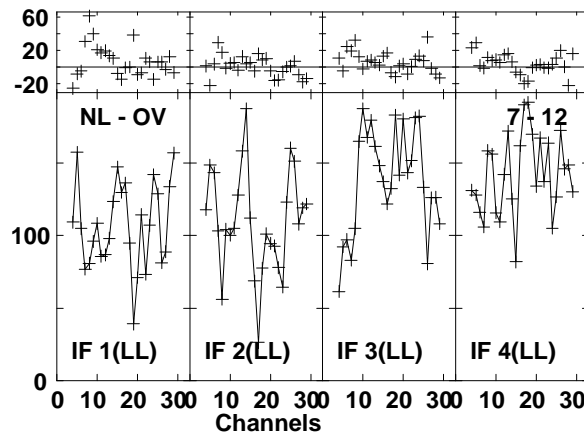
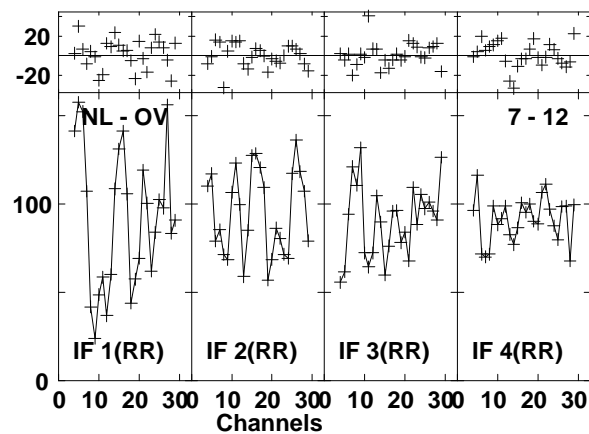
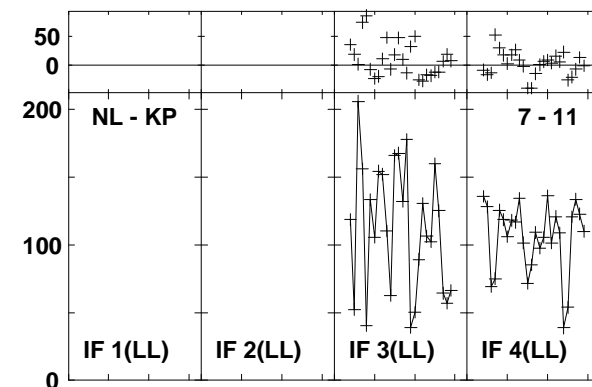
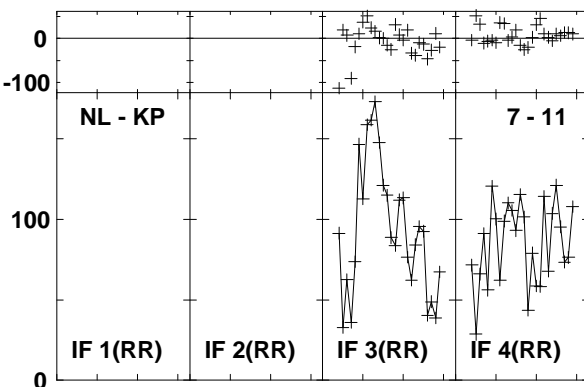
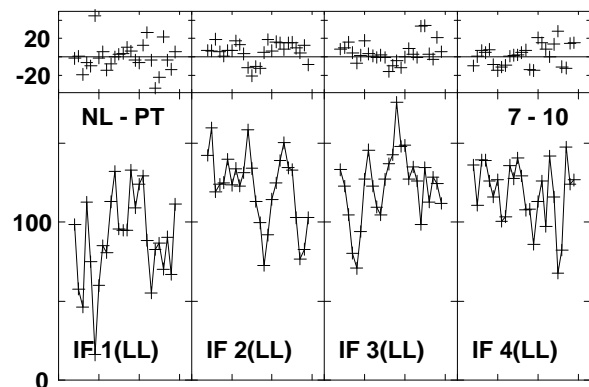
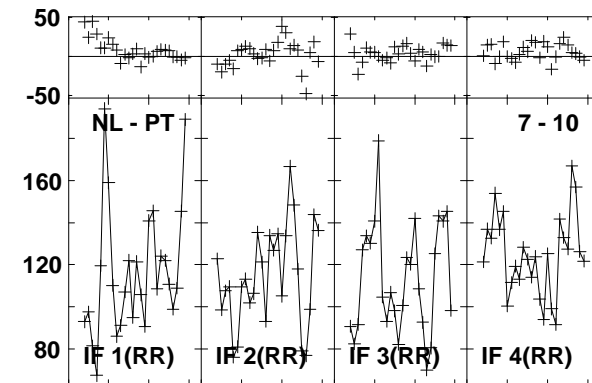
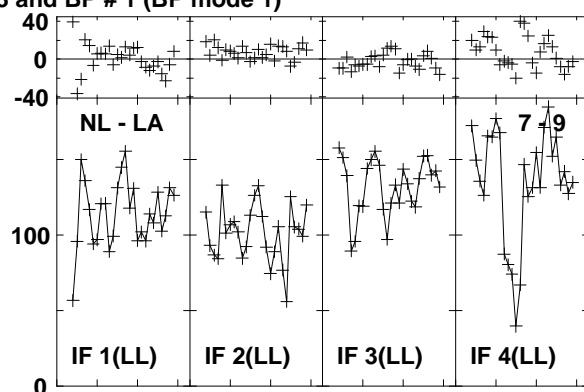
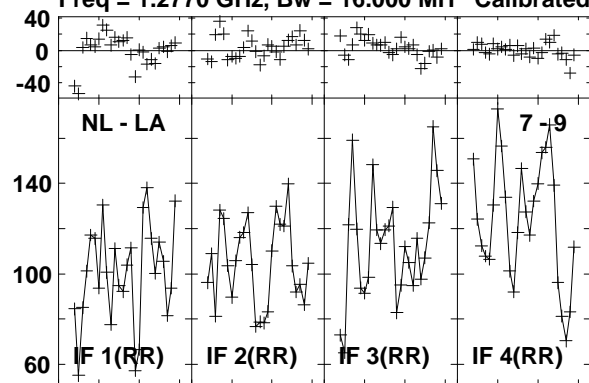

Lower frame: Milli Ampl Jy Top frame: Phas deg
Vector averaged cross-power spectrum Baseline: NL (07) - LA (09)
Timerange: 00/16:18:31 to 00/16:20:29

Plot file version 107 created 03-MAR-2016 01:12:15
J1545+5400 GN002C 1.UVDATA.1
Freq = 1.2770 GHz, Bw = 16.000 MH Calibrated with CL # 3 and BP # 1 (BP mode 1)

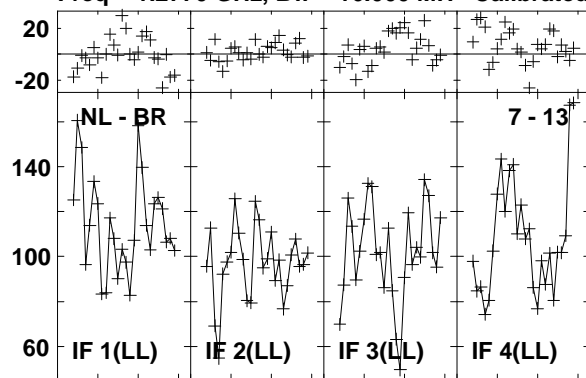

Lower frame: Milli Ampl Jy Top frame: Phas deg
Vector averaged cross-power spectrum Baseline: NL (07) - BR (13)
Timerange: 00/16:18:31 to 00/16:20:29

Plot file version 108 created 03-MAR-2016 01:12:15

4C52 GN002C 1.UVDATA.1

Freq = 1.2770 GHz, Bw = 16.000 MH Calibrated with CL # 3 and BP # 1 (BP mode 1)

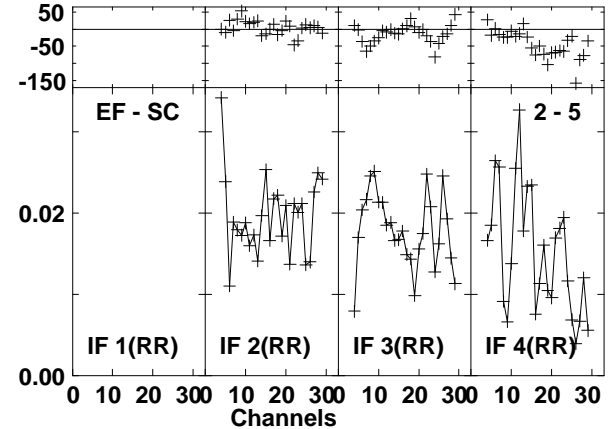
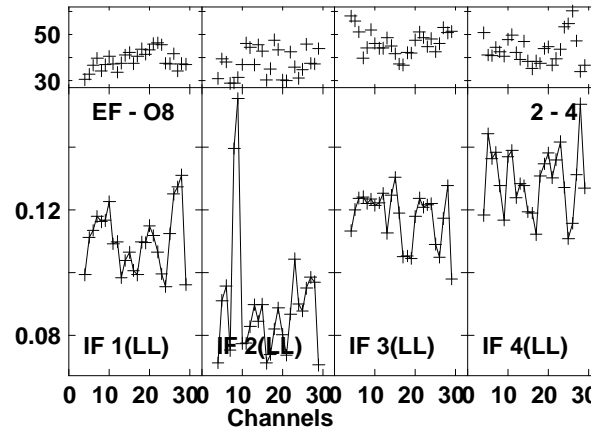
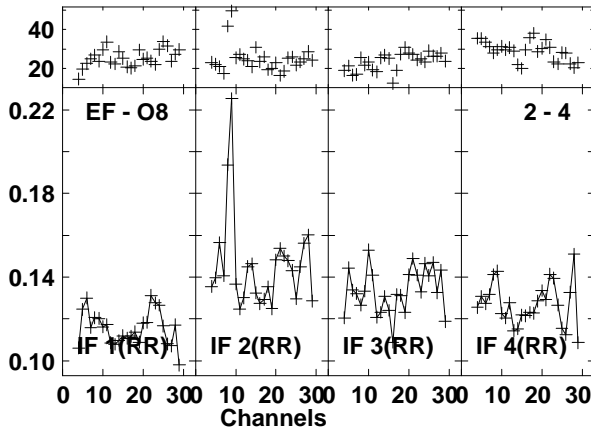
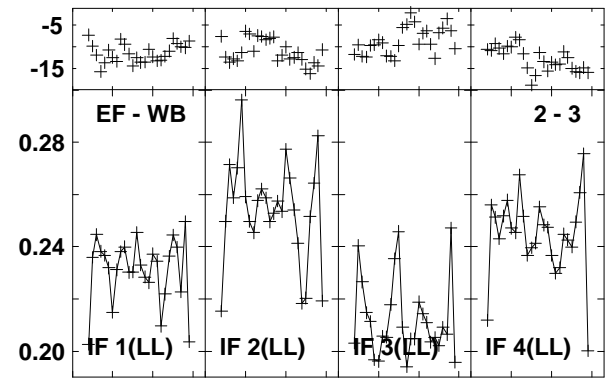
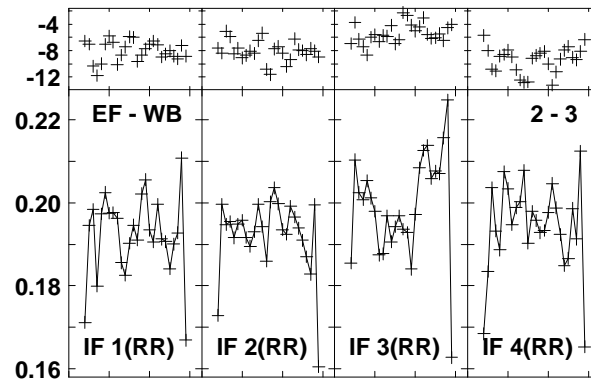
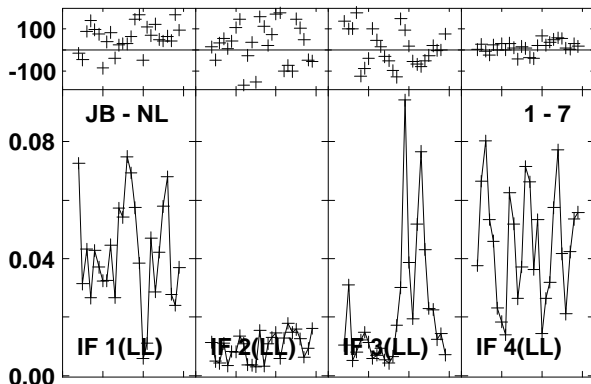
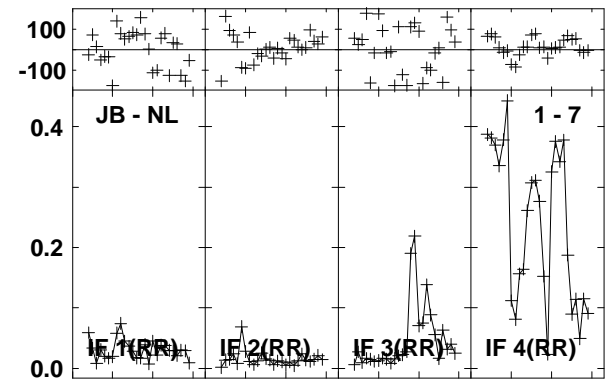
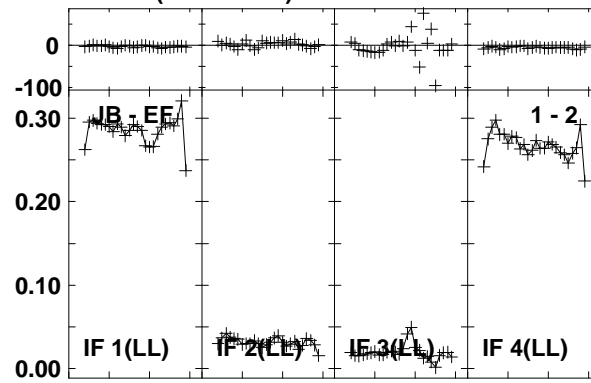
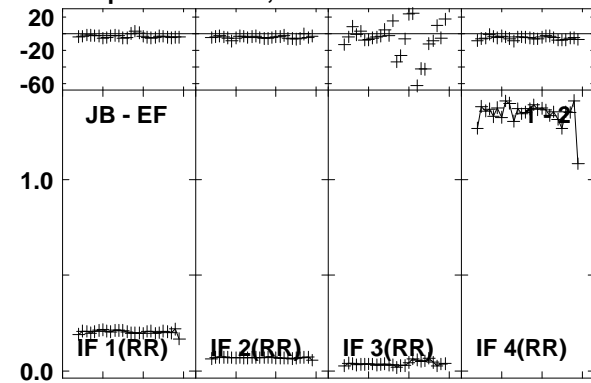

Lower frame: Ampl Jy Top frame: Phas deg
Vector averaged cross-power spectrum Baseline: JB (01) - EF (02)
Timerange: 00/16:20:42 to 00/16:23:28

Plot file version 109 created 03-MAR-2016 01:12:15

4C52 GN002C 1.UVDATA.1

Freq = 1.2770 GHz, Bw = 16.000 MH Calibrated with CL # 3 and BP # 1 (BP mode 1)

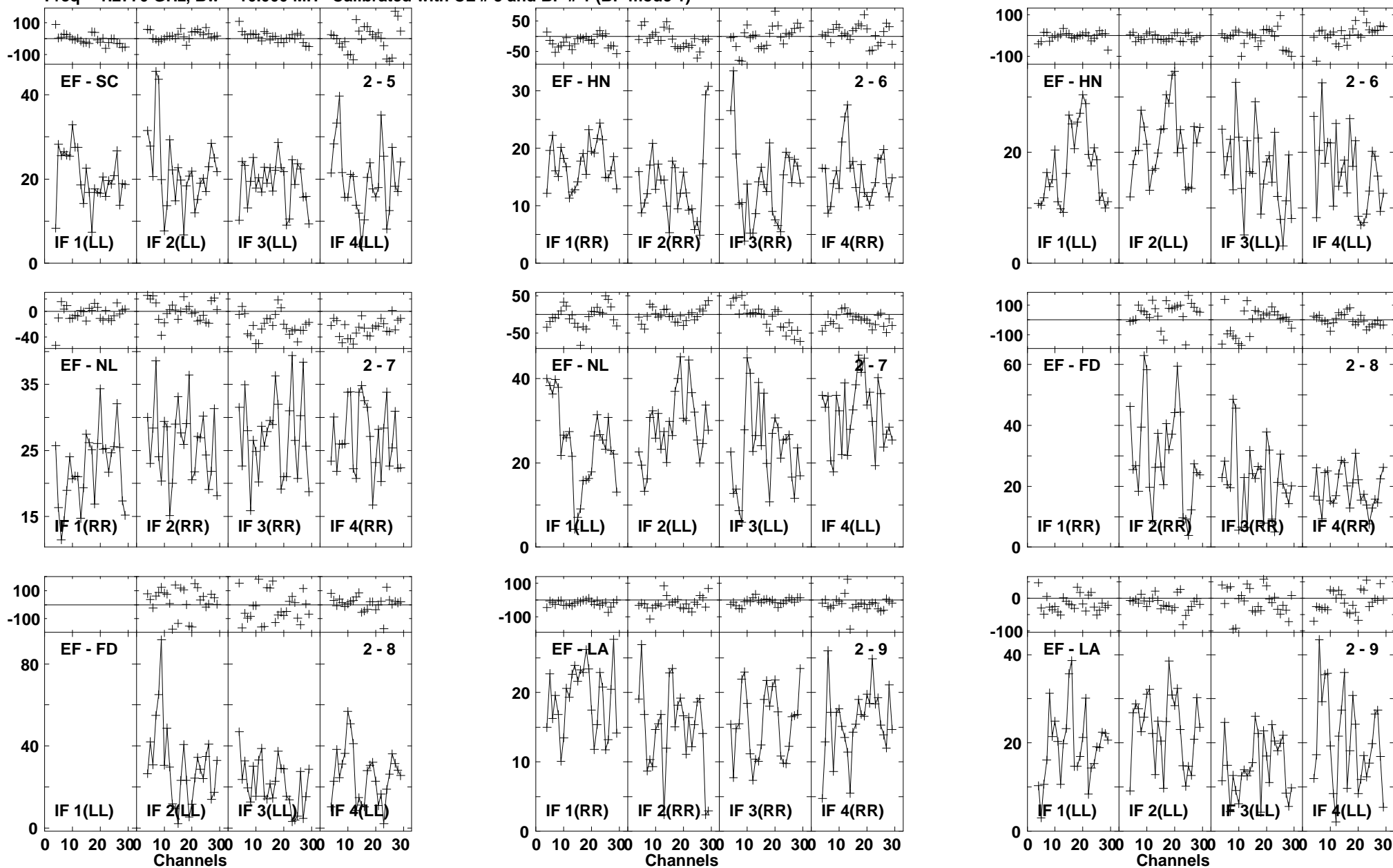

Lower frame: Milli Ampl Jy Top frame: Phas deg
Vector averaged cross-power spectrum Baseline: EF (02) - SC (05)
Timerange: 00/16:20:42 to 00/16:23:28

Plot file version 110 created 03-MAR-2016 01:12:16

4C52 GN002C 1.UVDATA.1

Freq = 1.2770 GHz, Bw = 16.000 MH Calibrated with CL # 3 and BP # 1 (BP mode 1)

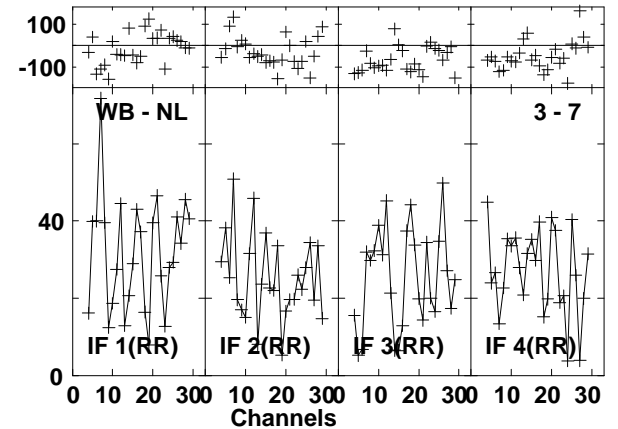
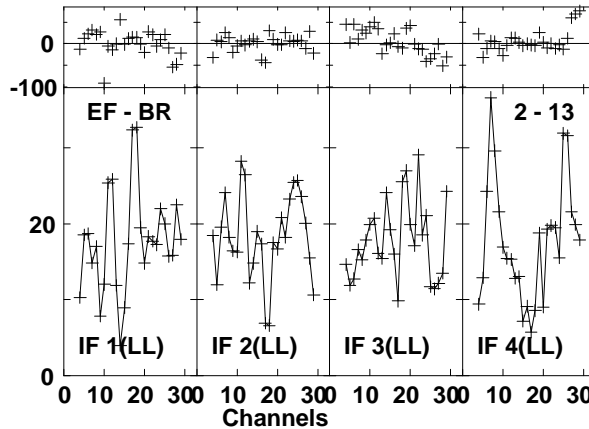
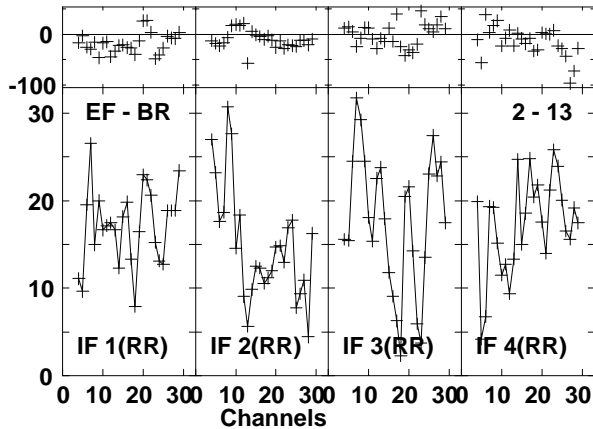
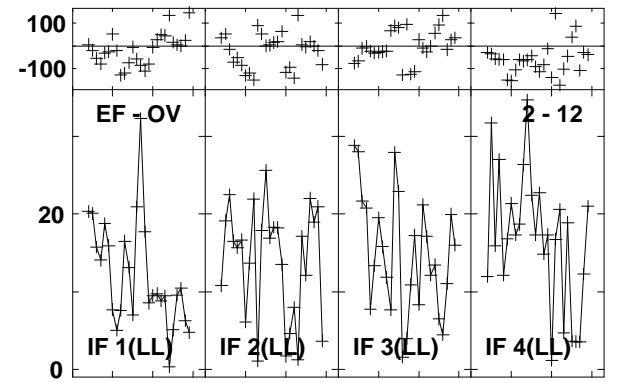
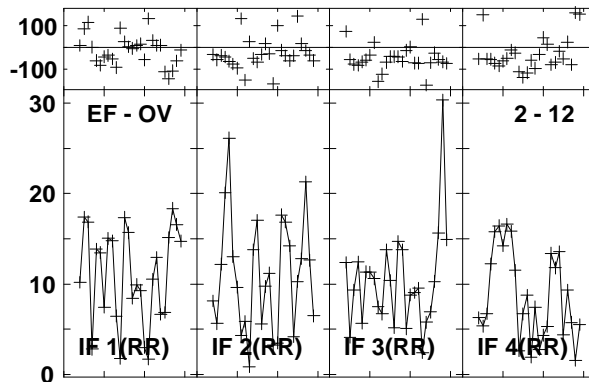
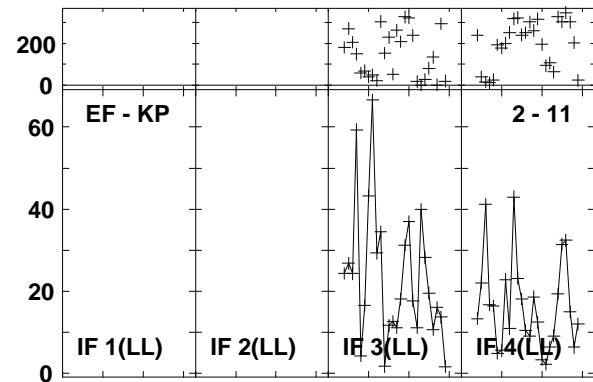
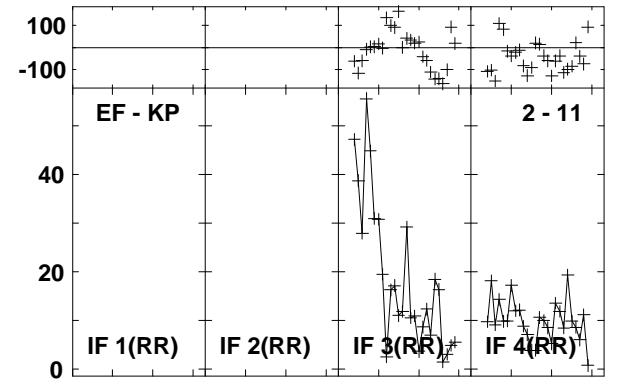
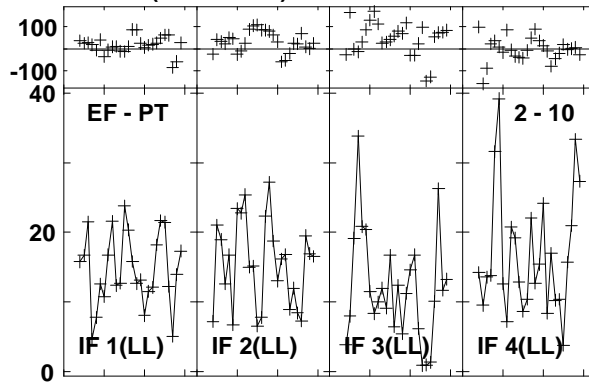
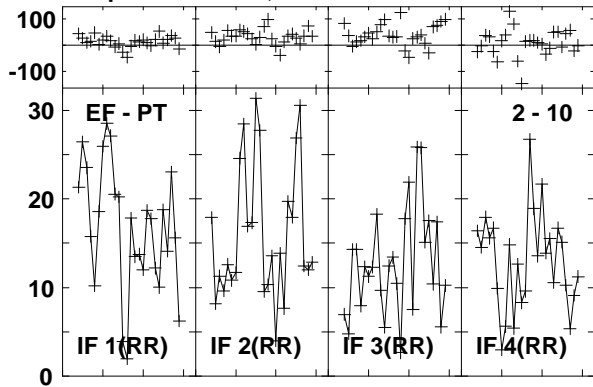

Lower frame: Milli Ampl Jy Top frame: Phas deg
Vector averaged cross-power spectrum Baseline: EF (02) - PT (10)
Timerange: 00/16:20:42 to 00/16:23:28

Plot file version 111 created 03-MAR-2016 01:12:16

4C52 GN002C 1.UVDATA.1

Freq = 1.2770 GHz, Bw = 16.000 MH Calibrated with CL # 3 and BP # 1 (BP mode 1)

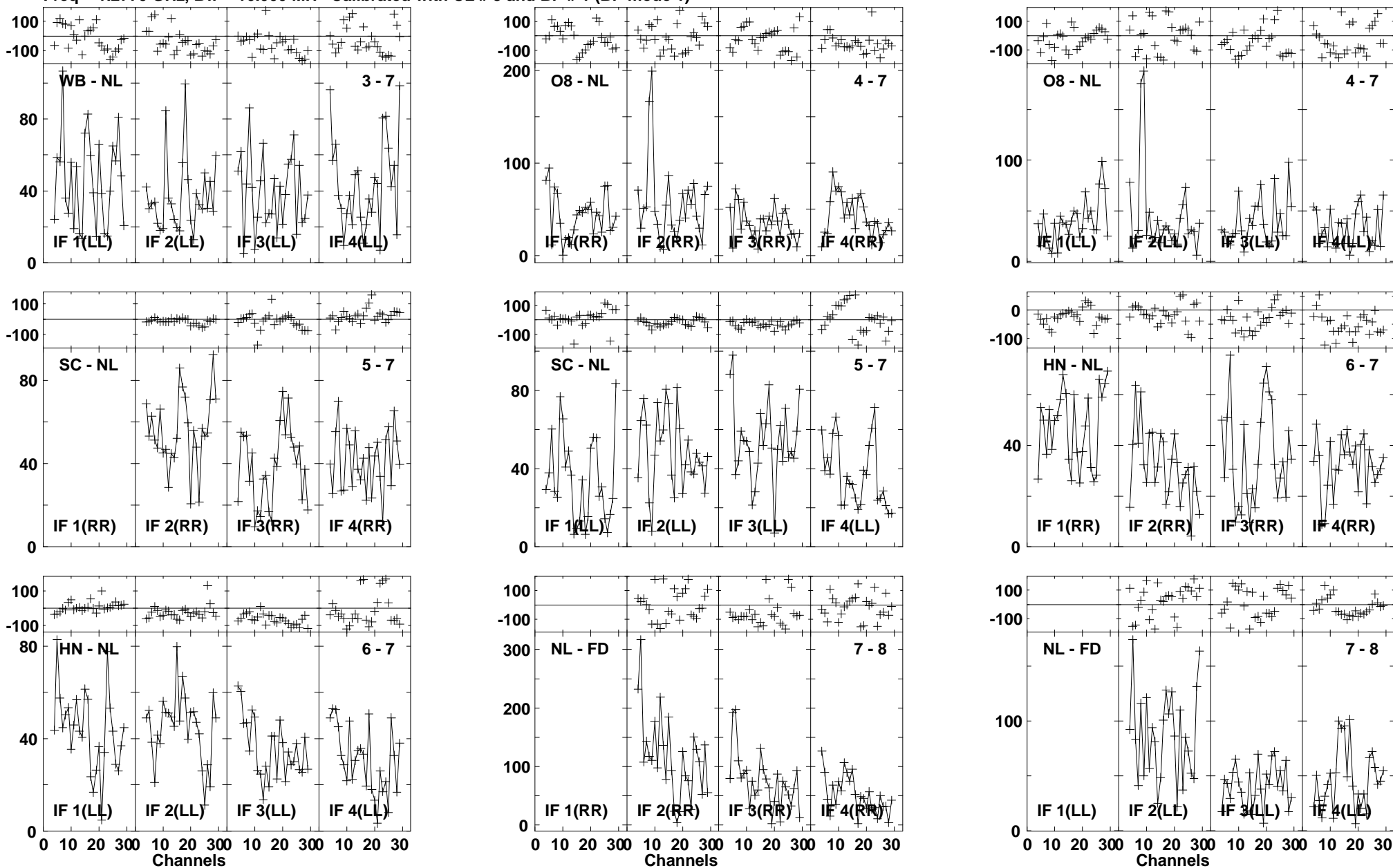

Lower frame: Milli Ampl Jy Top frame: Phas deg
Vector averaged cross-power spectrum Baseline: WB (03) - NL (07)
Timerange: 00/16:20:42 to 00/16:23:28

Plot file version 112 created 03-MAR-2016 01:12:16

4C52 GN002C 1.UVDATA.1

Freq = 1.2770 GHz, Bw = 16.000 MH Calibrated with CL # 3 and BP # 1 (BP mode 1)

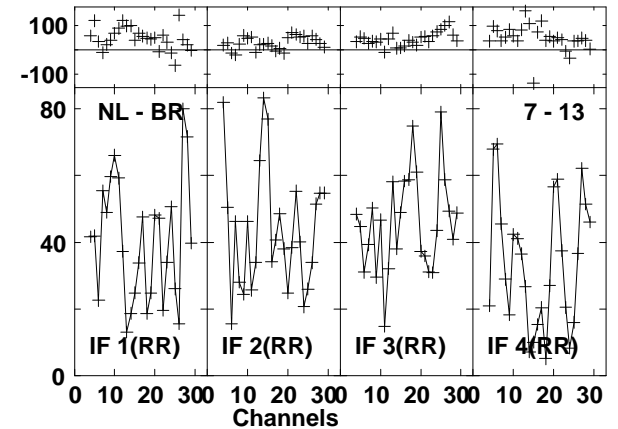
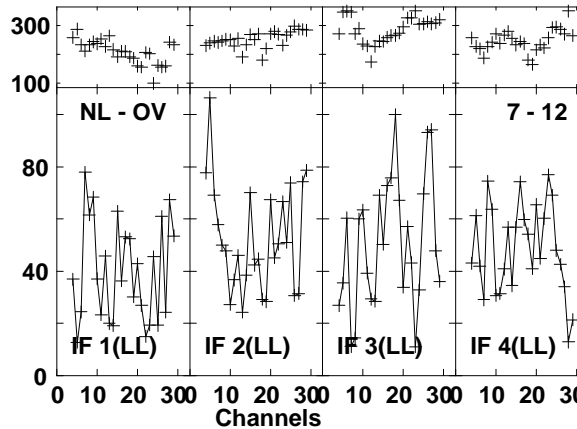
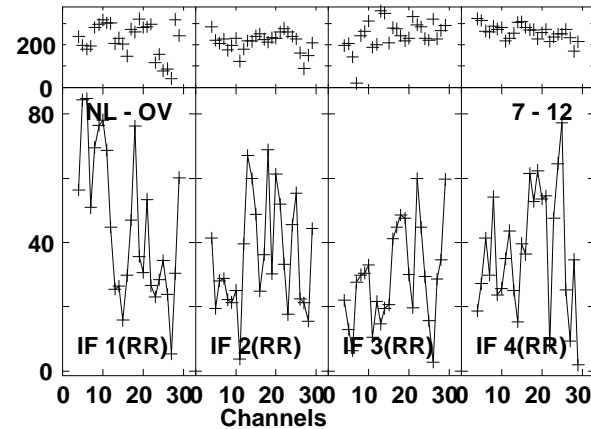
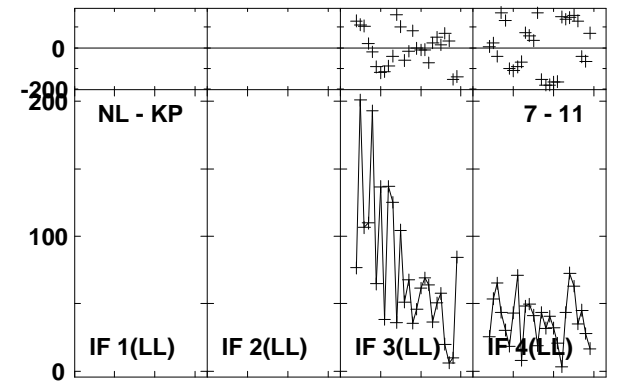
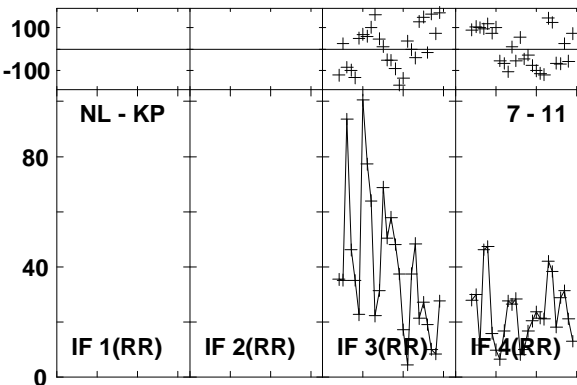
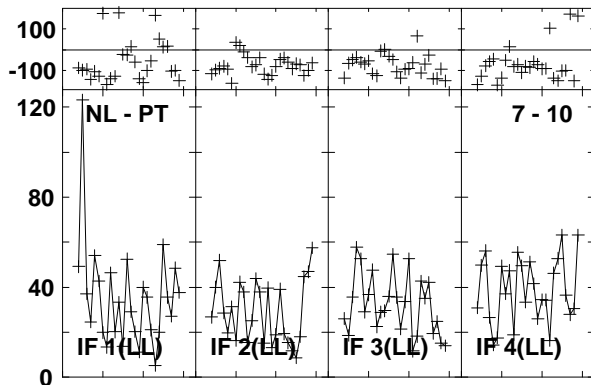
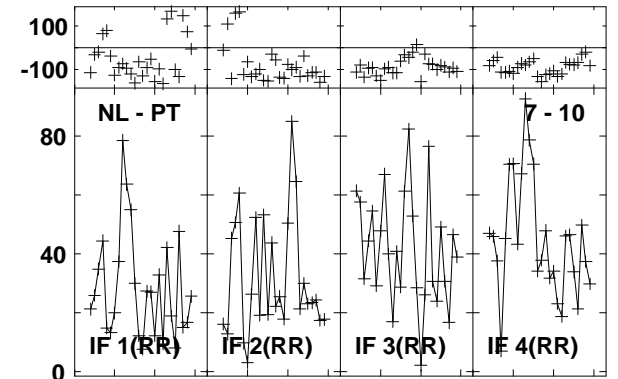
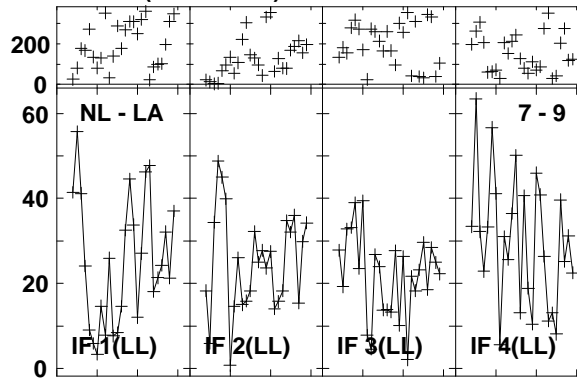
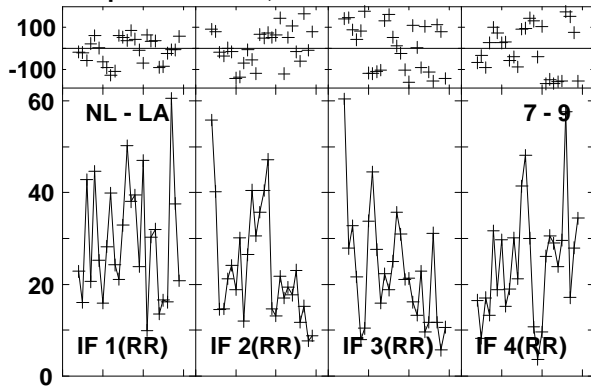

Lower frame: Milli Ampl Jy Top frame: Phas deg
Vector averaged cross-power spectrum Baseline: NL (07) - LA (09)
Timerange: 00/16:20:42 to 00/16:23:28

Plot file version 113 created 03-MAR-2016 01:12:16

4C52 GN002C 1.UVDATA.1

Freq = 1.2770 GHz, Bw = 16.000 MH Calibrated with CL # 3 and BP # 1 (BP mode 1)

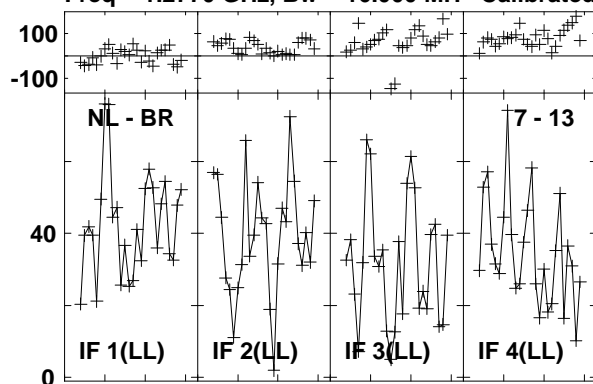

Lower frame: Milli Ampl Jy Top frame: Phas deg

Vector averaged cross-power spectrum Baseline: NL (07) - BR (13)

Timerange: 00/16:20:42 to 00/16:23:28

Plot file version 114 created 03-MAR-2016 01:12:16

J1545+5400 GN002C 1.UVDATA.1

Freq = 1.2770 GHz, Bw = 16.000 MH Calibrated with CL # 3 and BP # 1 (BP mode 1)

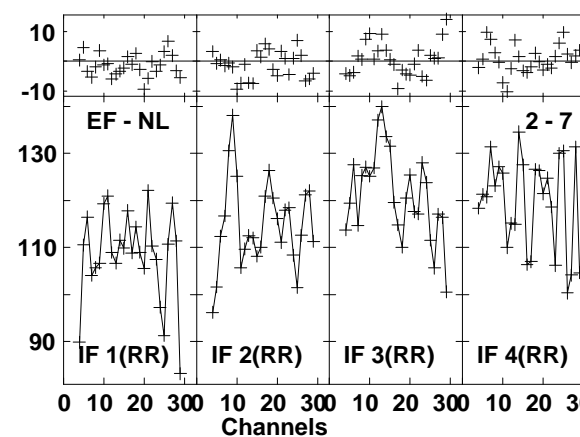
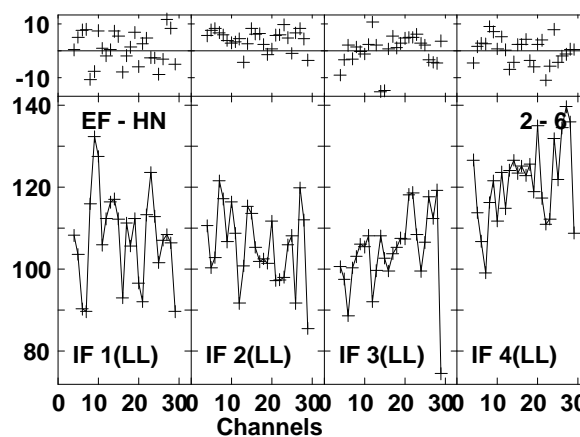
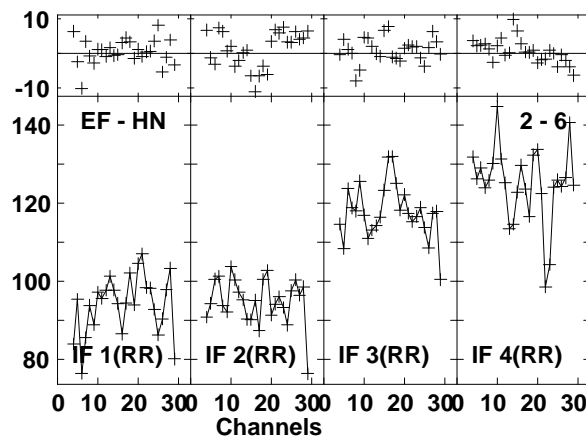
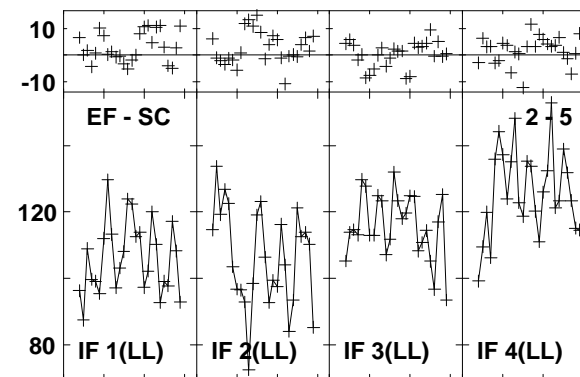
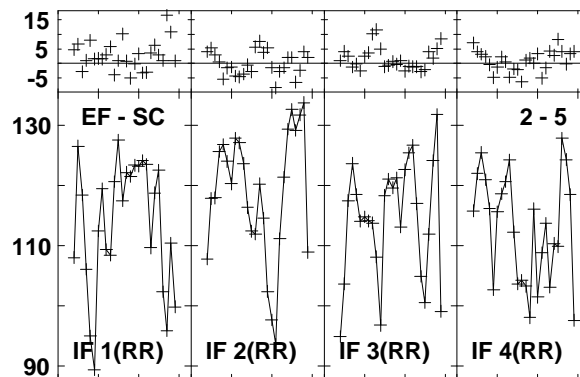
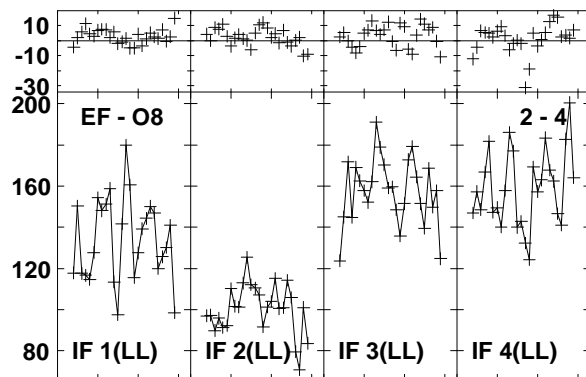
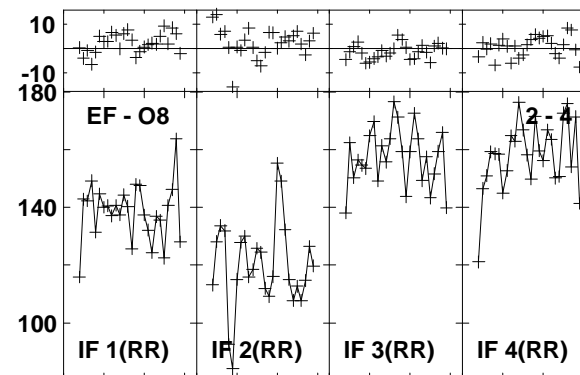
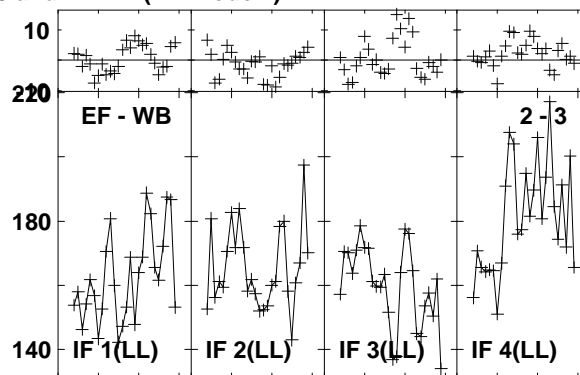
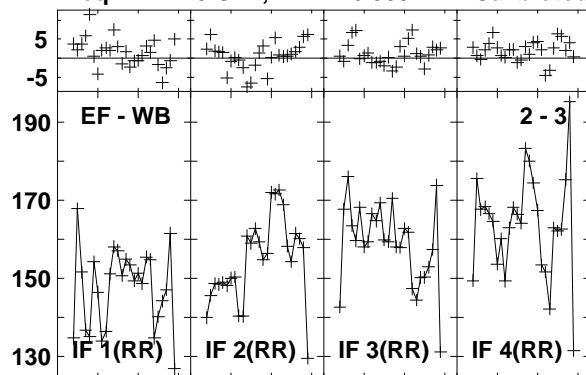

Lower frame: Milli Ampl Jy Top frame: Phas deg
Vector averaged cross-power spectrum Baseline: EF (02) - WB (03)
Timerange: 00/16:24:21 to 00/16:25:19

Plot file version 115 created 03-MAR-2016 01:12:16

J1545+5400 GN002C 1.UVDATA.1

Freq = 1.2770 GHz, Bw = 16.000 MH Calibrated with CL # 3 and BP # 1 (BP mode 1)

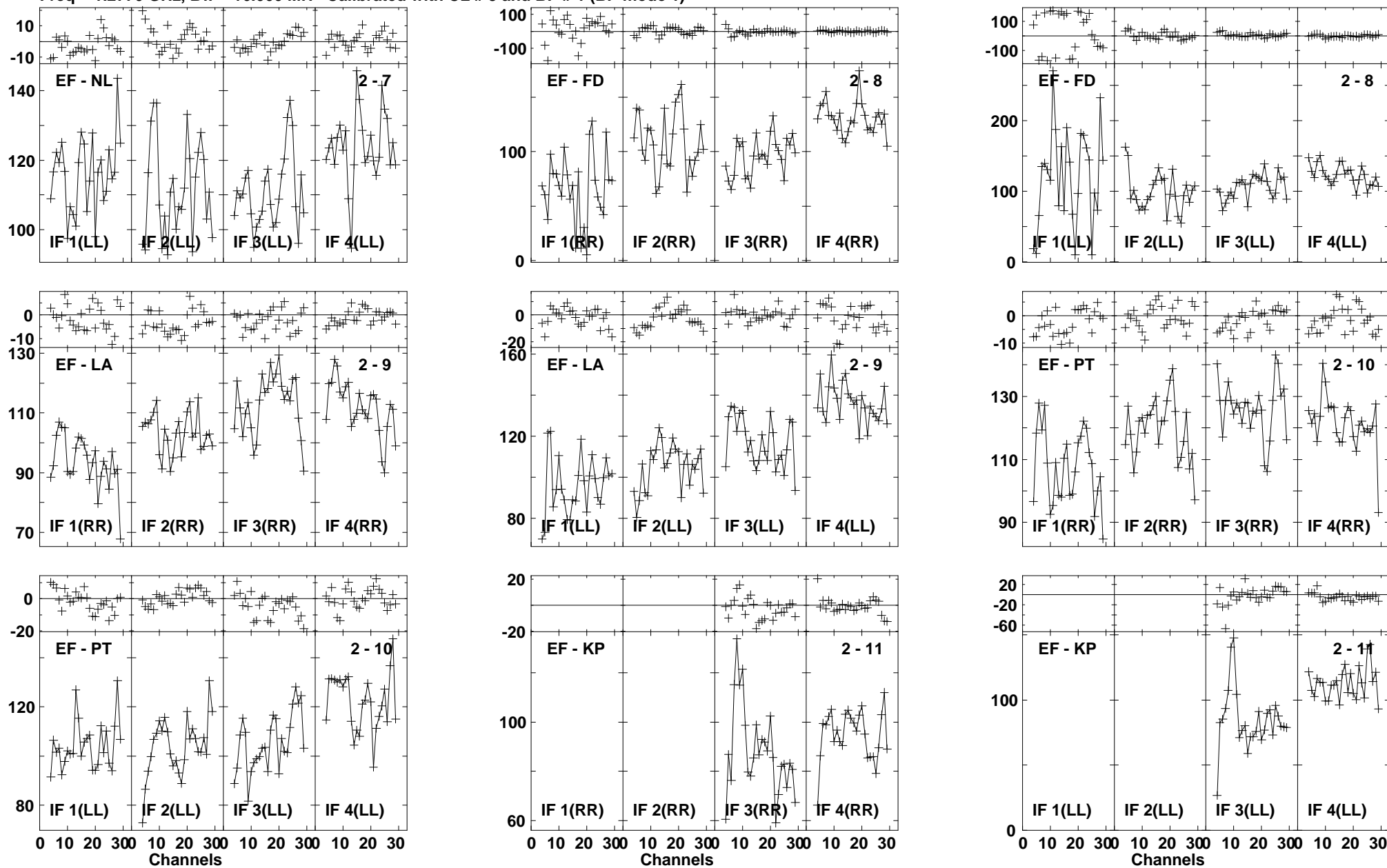

Lower frame: Milli Ampl Jy Top frame: Phas deg
Vector averaged cross-power spectrum Baseline: EF (02) - NL (07)
Timerange: 00/16:24:21 to 00/16:25:19

Plot file version 116 created 03-MAR-2016 01:12:17

J1545+5400 GN002C 1.UVDATA.1

Freq = 1.2770 GHz, Bw = 16.000 MH Calibrated with CL # 3 and BP # 1 (BP mode 1)

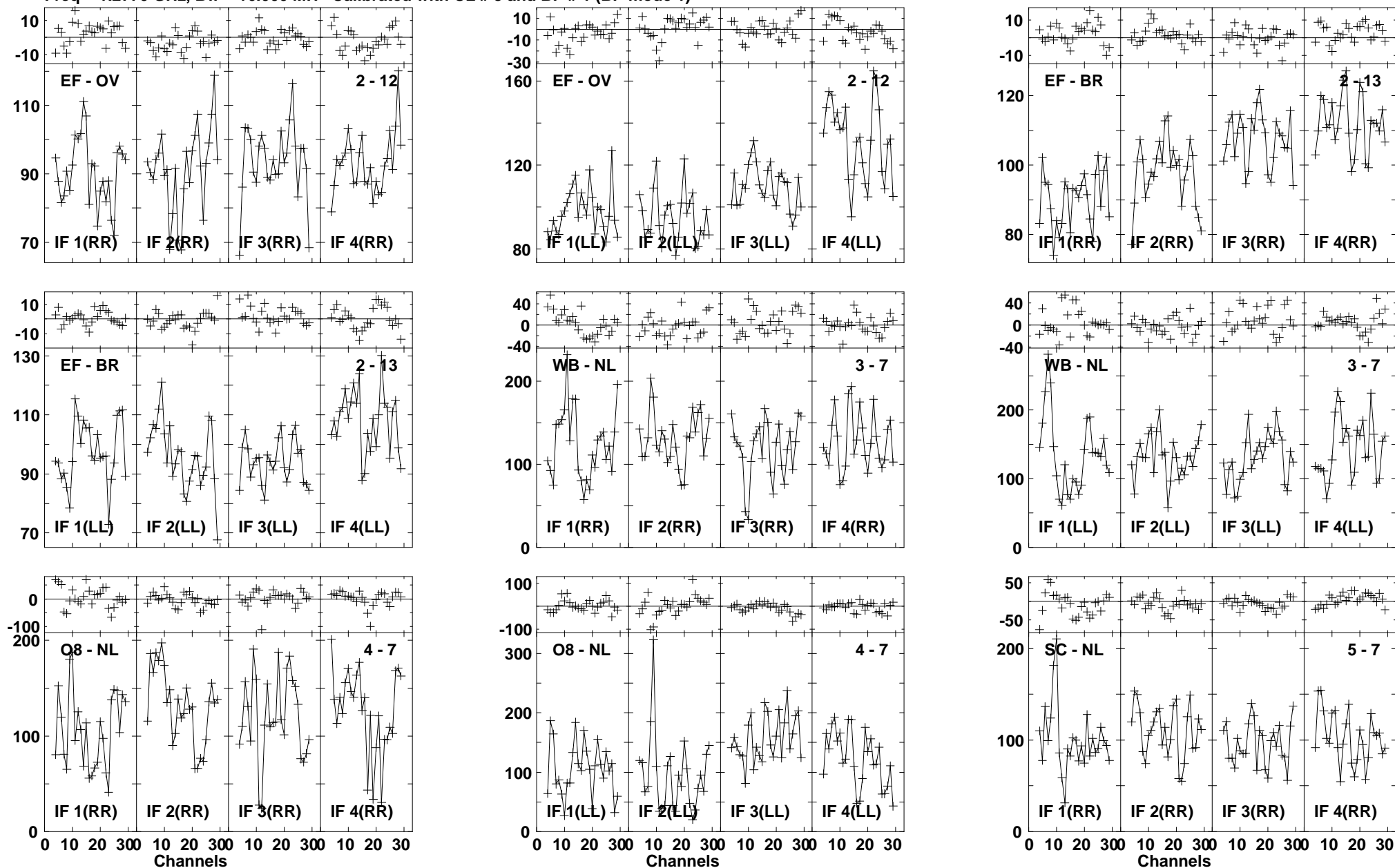

Lower frame: Milli Ampl Jy Top frame: Phas deg
Vector averaged cross-power spectrum Baseline: EF (02) - OV (12)
Timerange: 00/16:24:21 to 00/16:25:19

Plot file version 117 created 03-MAR-2016 01:12:17

J1545+5400 GN002C 1.UVDATA.1

Freq = 1.2770 GHz, Bw = 16.000 MH Calibrated with CL # 3 and BP # 1 (BP mode 1)

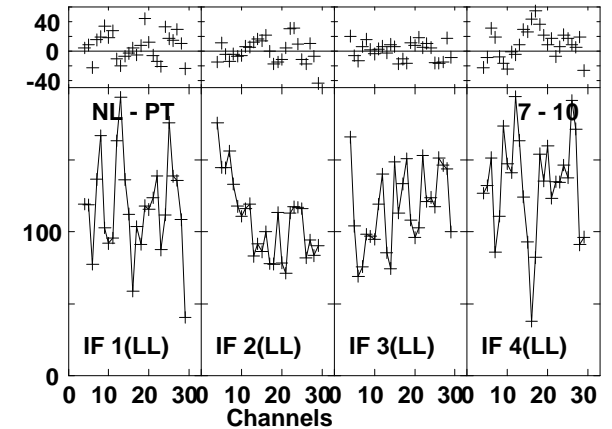
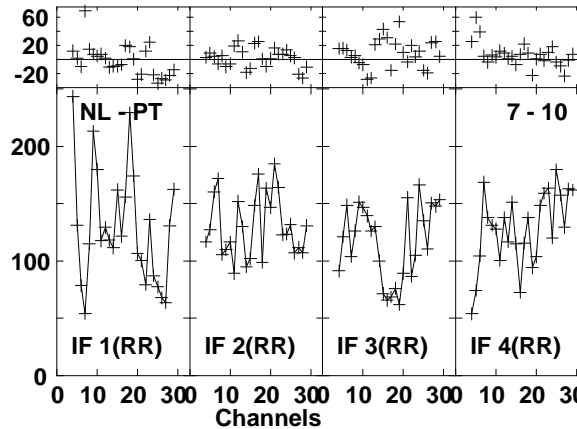
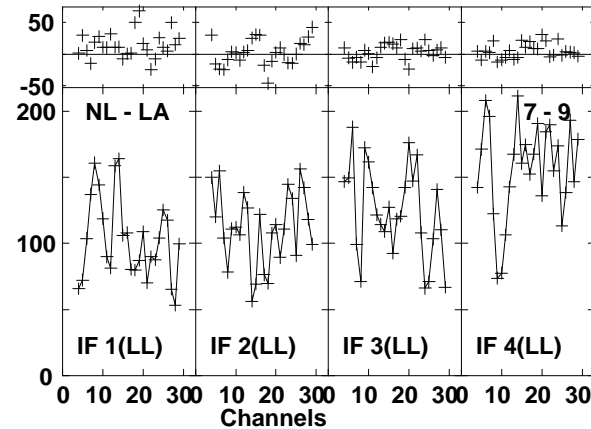
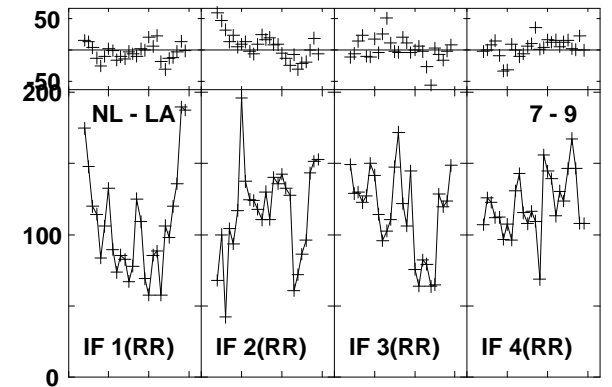
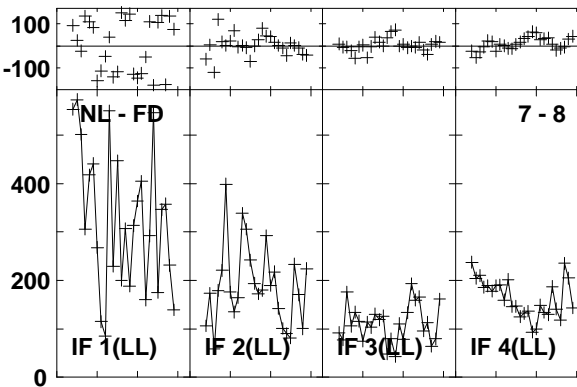
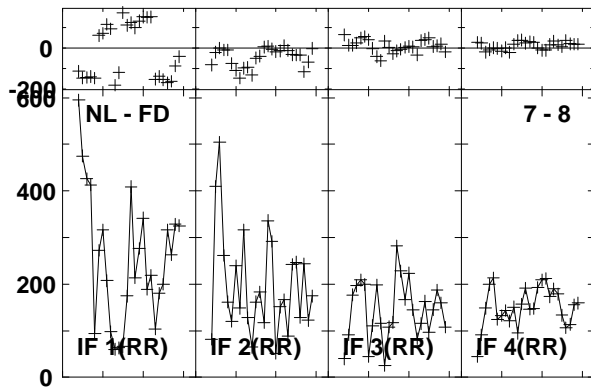
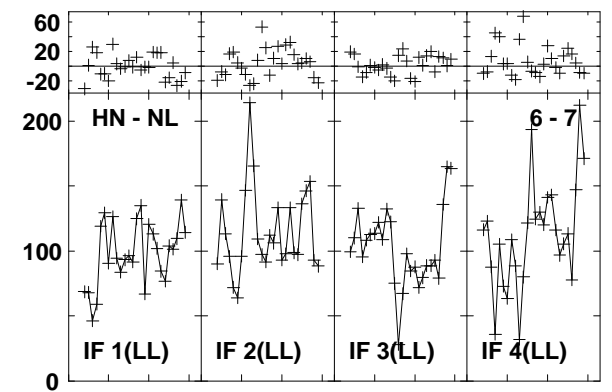
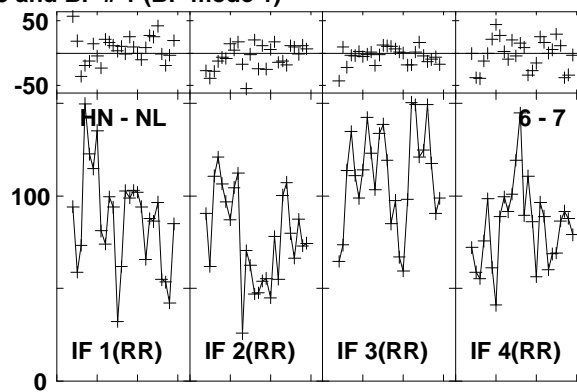
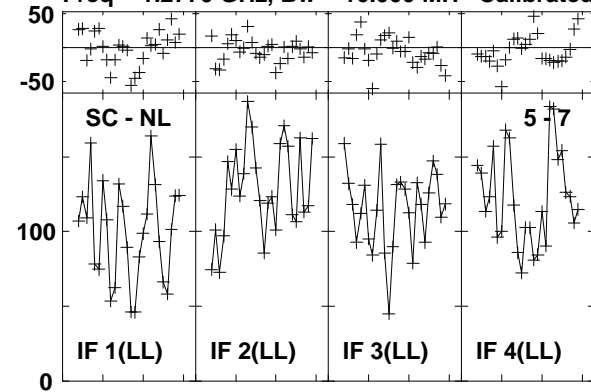

Lower frame: Milli Ampl Jy Top frame: Phas deg

Vector averaged cross-power spectrum Baseline: SC (05) - NL (07)

Timerange: 00/16:24:21 to 00/16:25:19

Plot file version 118 created 03-MAR-2016 01:12:17
 J1545+5400 GN002C 1.UVDATA.1
 Freq = 1.2770 GHz, Bw = 16.000 MH Calibrated with CL # 3 and BP # 1 (BP mode 1)

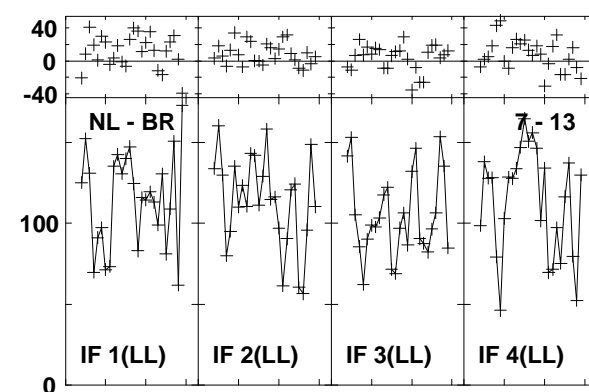
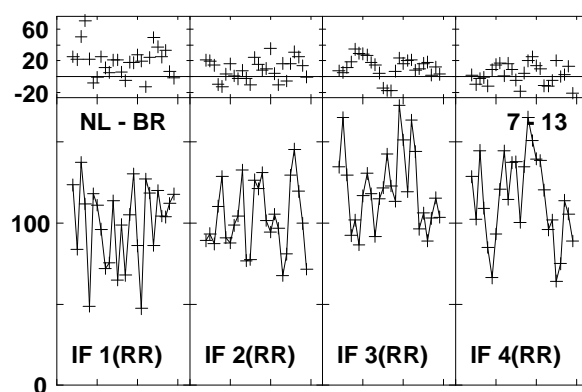
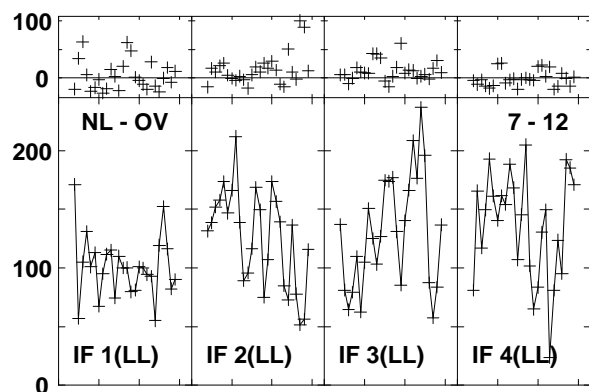
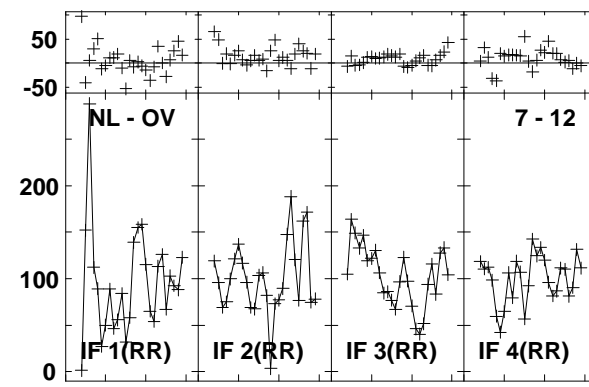
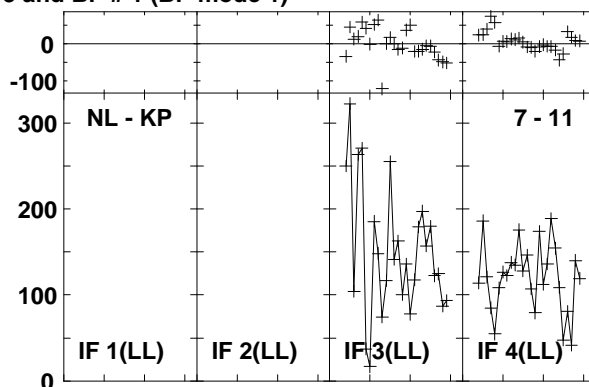
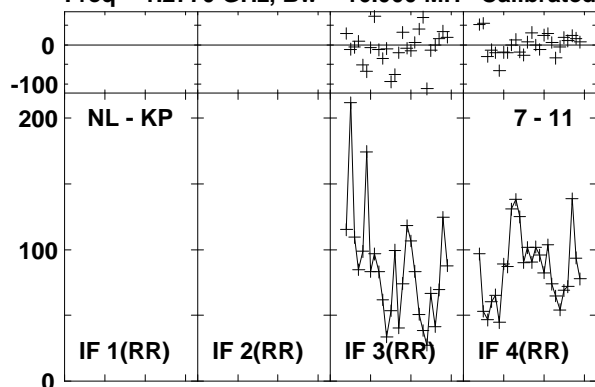

Lower frame: Milli Ampl Jy Top frame: Phas deg
 Vector averaged cross-power spectrum Baseline: NL (07) - KP (11)
 Timerange: 00/16:24:21 to 00/16:25:19

Plot file version 119 created 03-MAR-2016 01:12:17

4C52 GN002C 1.UVDATA.1

Freq = 1.2770 GHz, Bw = 16.000 MH Calibrated with CL # 3 and BP # 1 (BP mode 1)

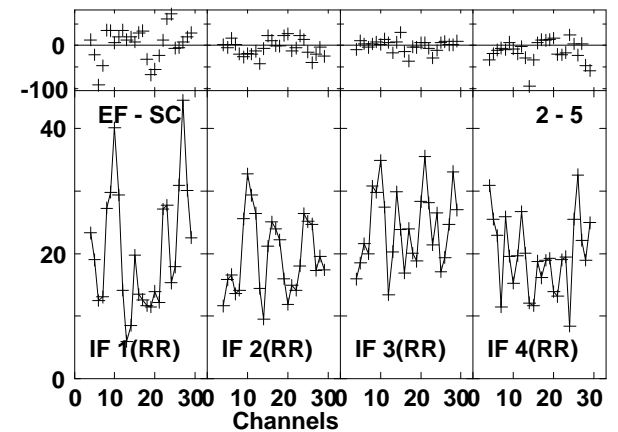
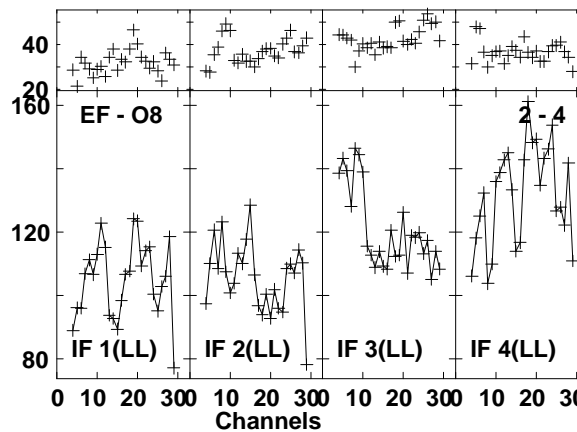
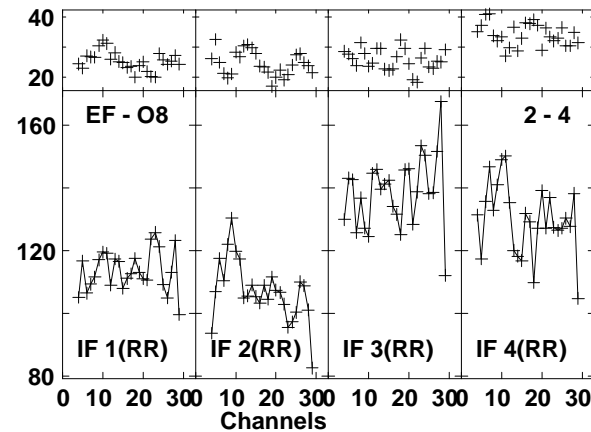
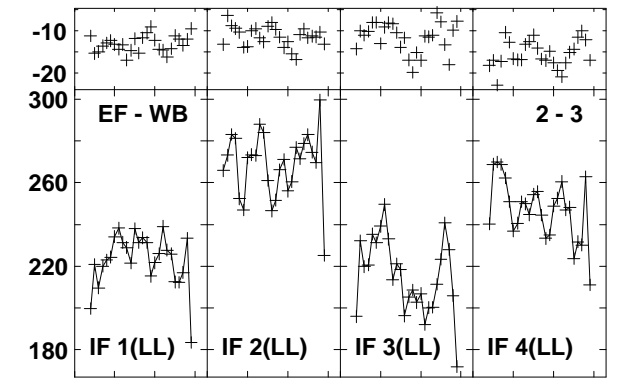
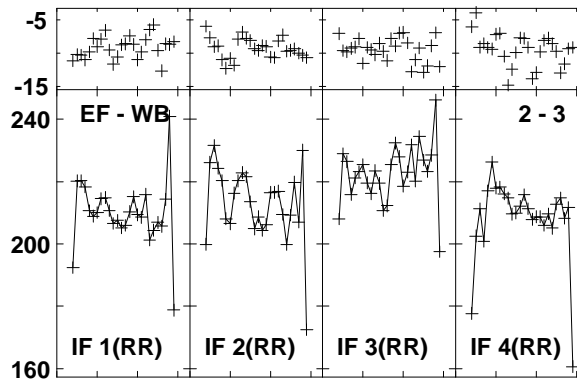
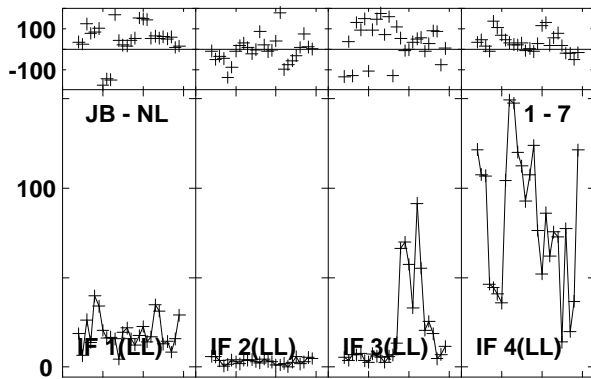
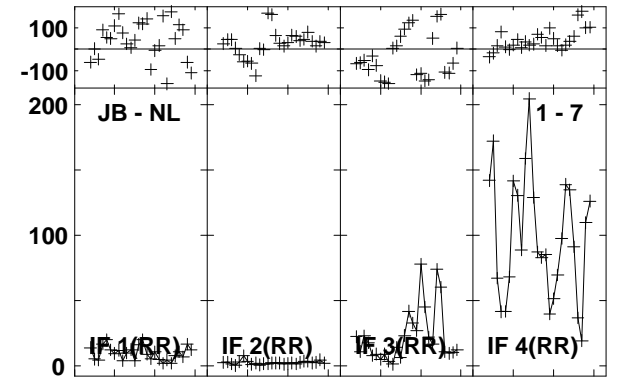
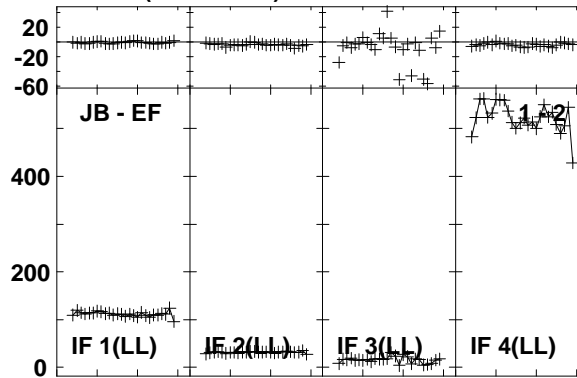
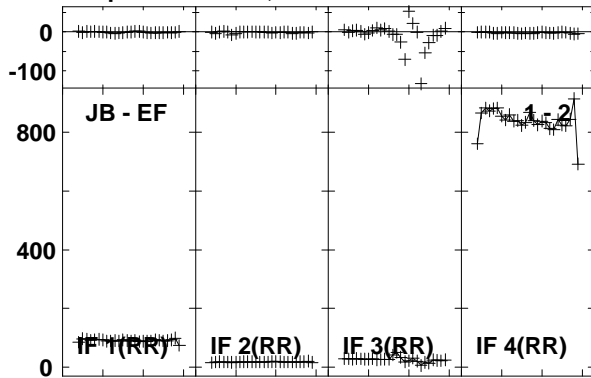

Lower frame: Milli Ampl Jy Top frame: Phas deg
Vector averaged cross-power spectrum Baseline: JB (01) - EF (02)
Timerange: 00/16:25:24 to 00/16:28:18

Plot file version 120 created 03-MAR-2016 01:12:17

4C52 GN002C 1.UVDATA.1

Freq = 1.2770 GHz, Bw = 16.000 MH Calibrated with CL # 3 and BP # 1 (BP mode 1)

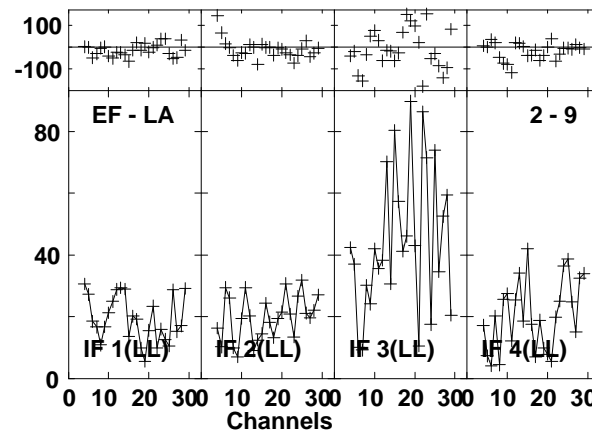
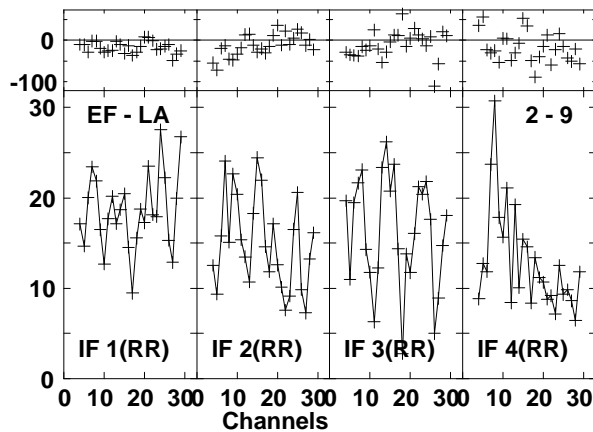
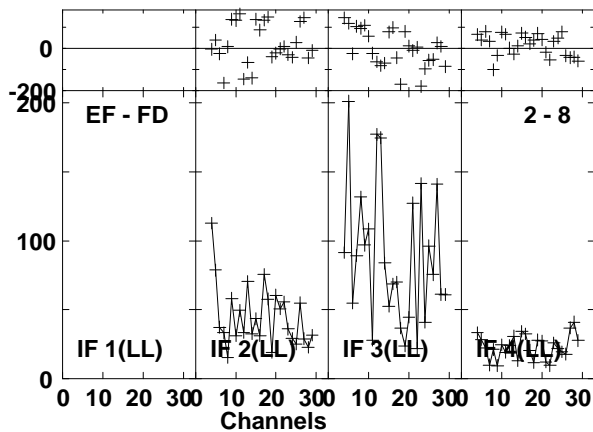
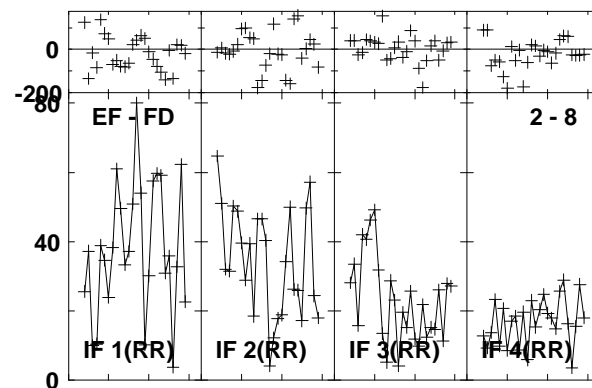
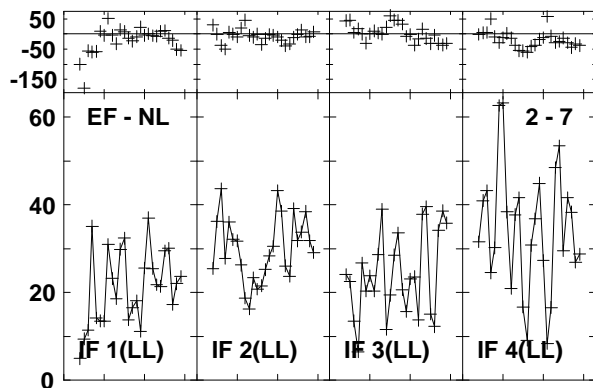
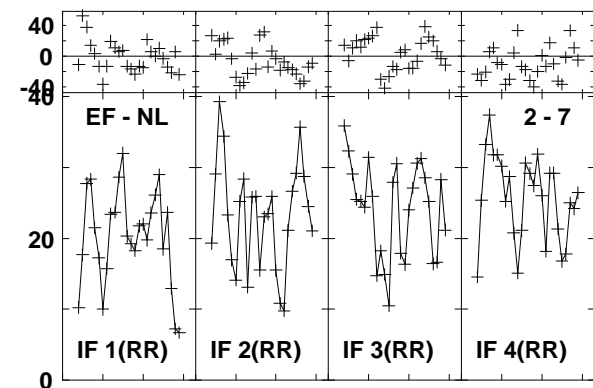
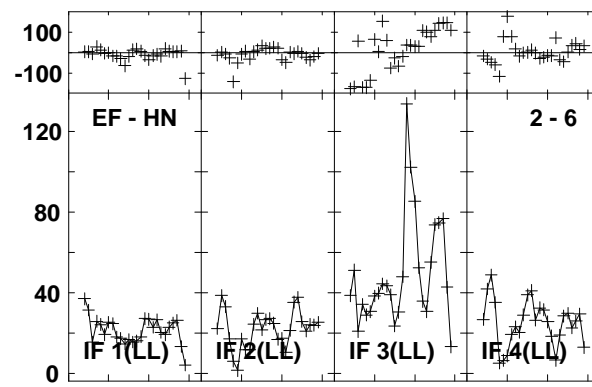
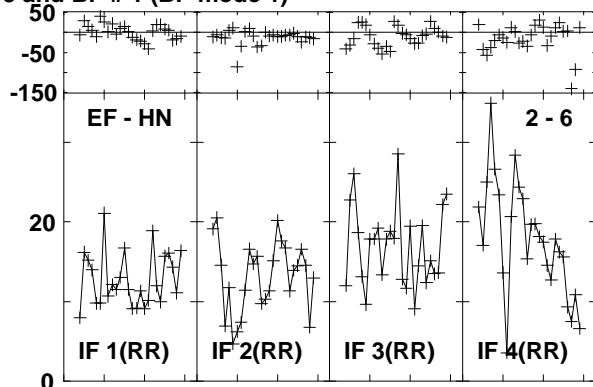
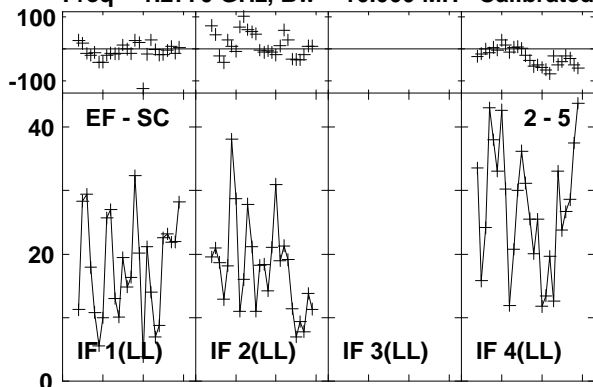

Lower frame: Milli Ampl Jy Top frame: Phas deg
Vector averaged cross-power spectrum Baseline: EF (02) - SC (05)
Timerange: 00/16:25:24 to 00/16:28:18

Plot file version 121 created 03-MAR-2016 01:12:18

4C52 GN002C 1.UVDATA.1

Freq = 1.2770 GHz, Bw = 16.000 MH Calibrated with CL # 3 and BP # 1 (BP mode 1)

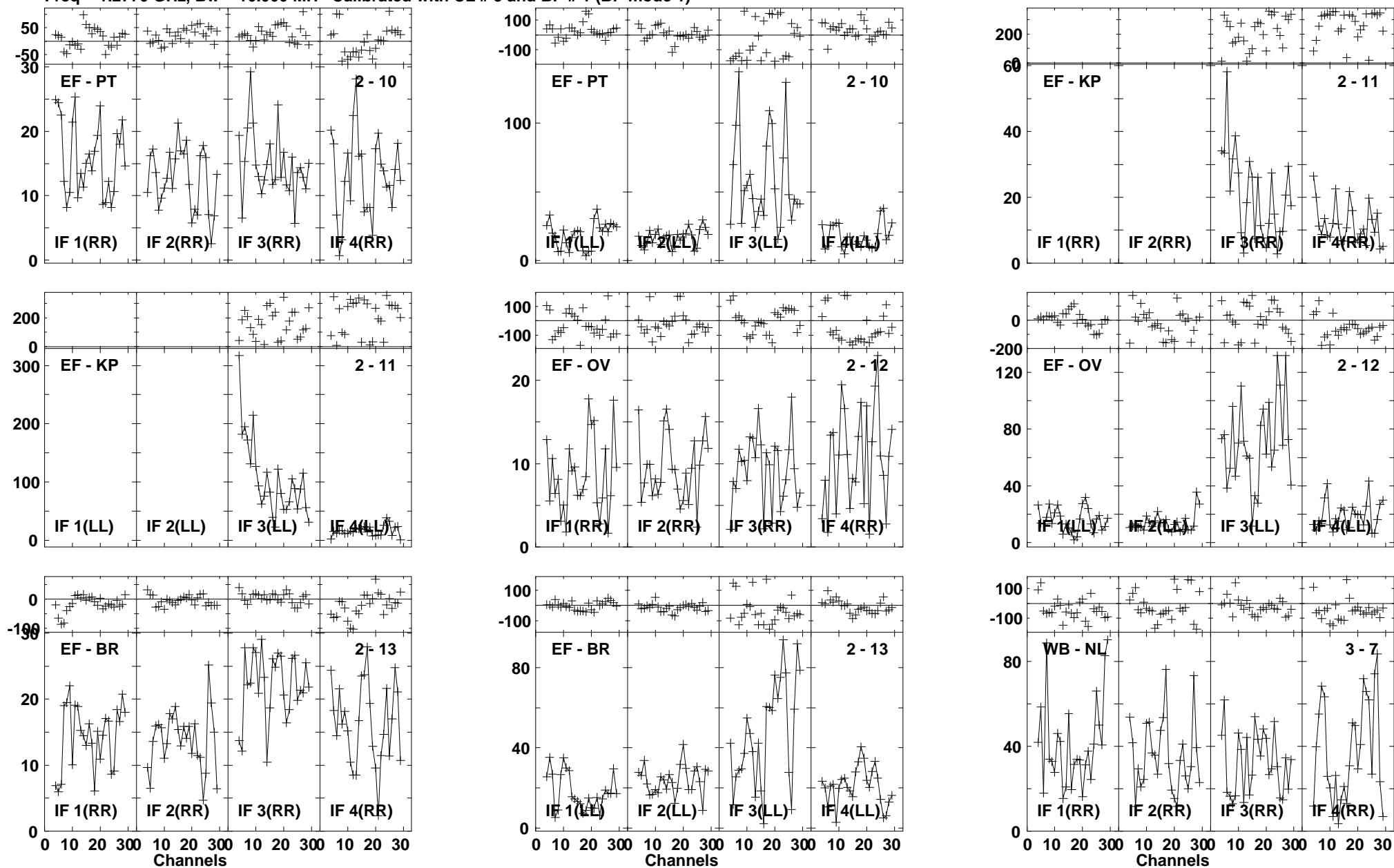

Lower frame: Milli Ampl Jy Top frame: Phas deg
Vector averaged cross-power spectrum Baseline: EF (02) - PT (10)
Timerange: 00/16:25:24 to 00/16:28:18

Plot file version 122 created 03-MAR-2016 01:12:18

4C52 GN002C 1.UVDATA.1

Freq = 1.2770 GHz, Bw = 16.000 MH Calibrated with CL # 3 and BP # 1 (BP mode 1)

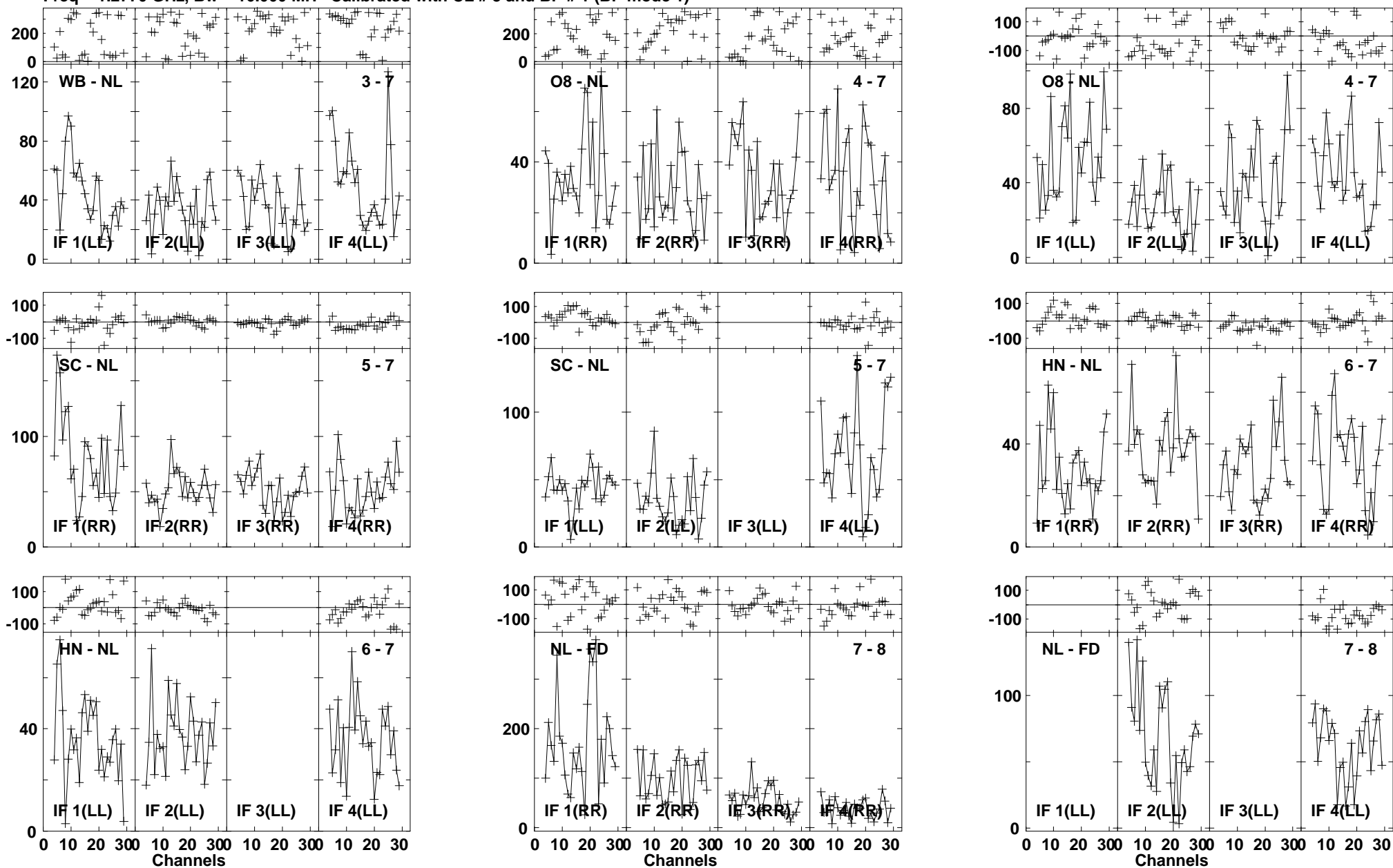

Lower frame: Milli Ampl Jy Top frame: Phas deg
Vector averaged cross-power spectrum Baseline: WB (03) - NL (07)
Timerange: 00/16:25:24 to 00/16:28:18

Plot file version 123 created 03-MAR-2016 01:12:18
 4C52 GN002C 1.UVDATA.1
 Freq = 1.2770 GHz, Bw = 16.000 MH Calibrated with CL # 3 and BP # 1 (BP mode 1)

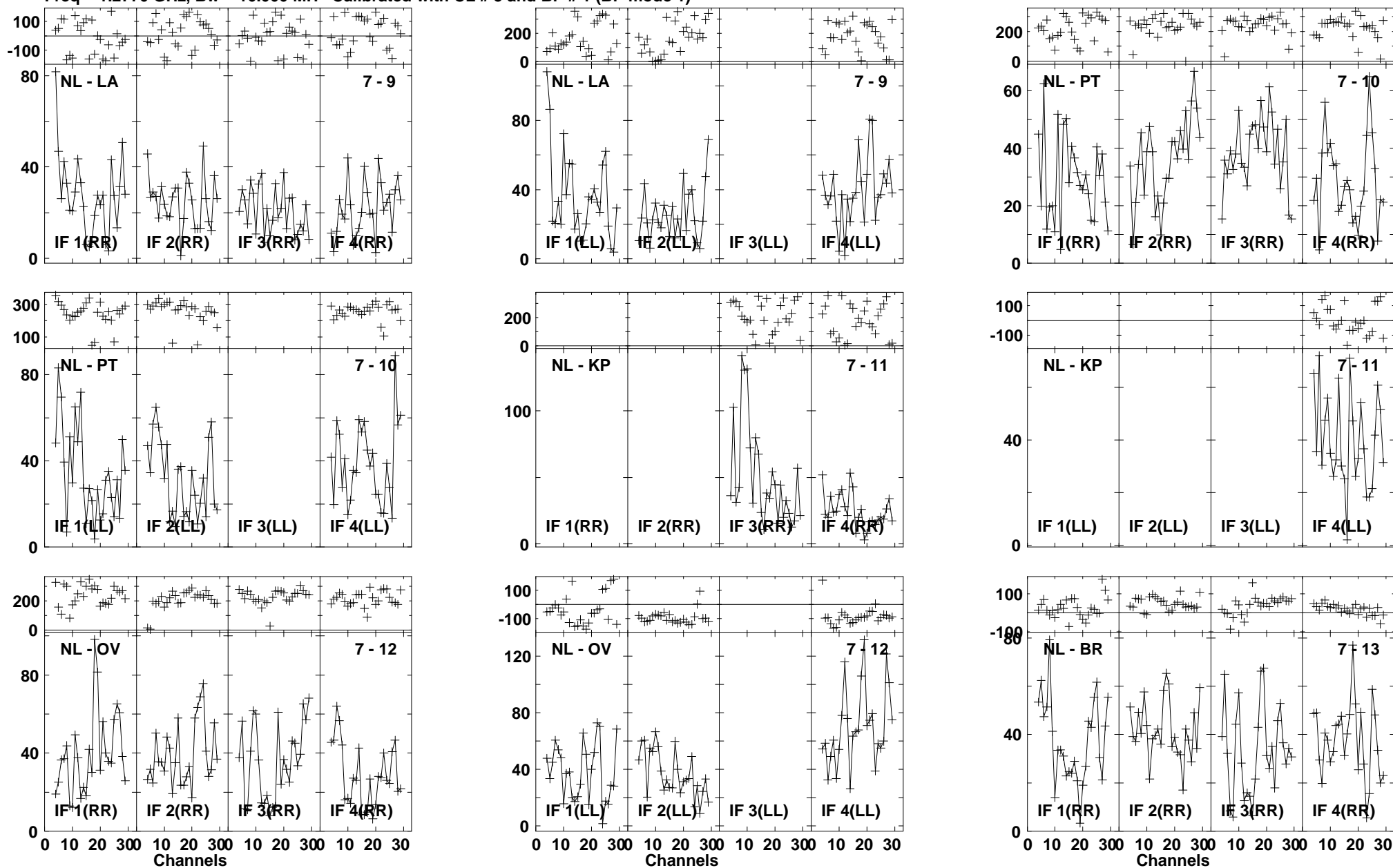

Lower frame: Milli Ampl Jy Top frame: Phas deg
 Vector averaged cross-power spectrum Baseline: NL (07) - LA (09)
 Timerange: 00/16:25:24 to 00/16:28:18

Plot file version 124 created 03-MAR-2016 01:12:18
4C52 GN002C 1.UVDATA.1
Freq = 1.2770 GHz, Bw = 16.000 MH Calibrated with CL # 3 and BP # 1 (BP mode 1)

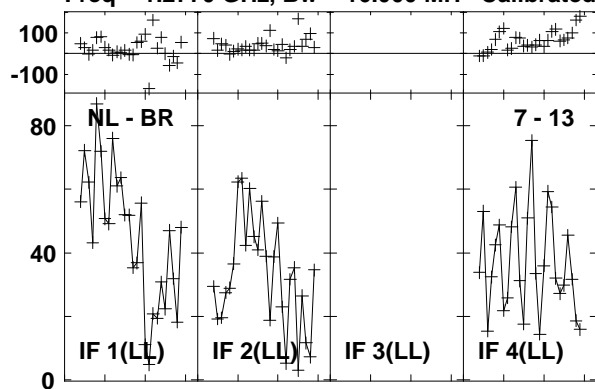

Lower frame: Milli Ampl Jy Top frame: Phas deg
Vector averaged cross-power spectrum Baseline: NL (07) - BR (13)
Timerange: 00/16:25:24 to 00/16:28:18

Plot file version 125 created 03-MAR-2016 01:12:18

J1545+5400 GN002C 1.UVDATA.1

Freq = 1.2770 GHz, Bw = 16.000 MH Calibrated with CL # 3 and BP # 1 (BP mode 1)

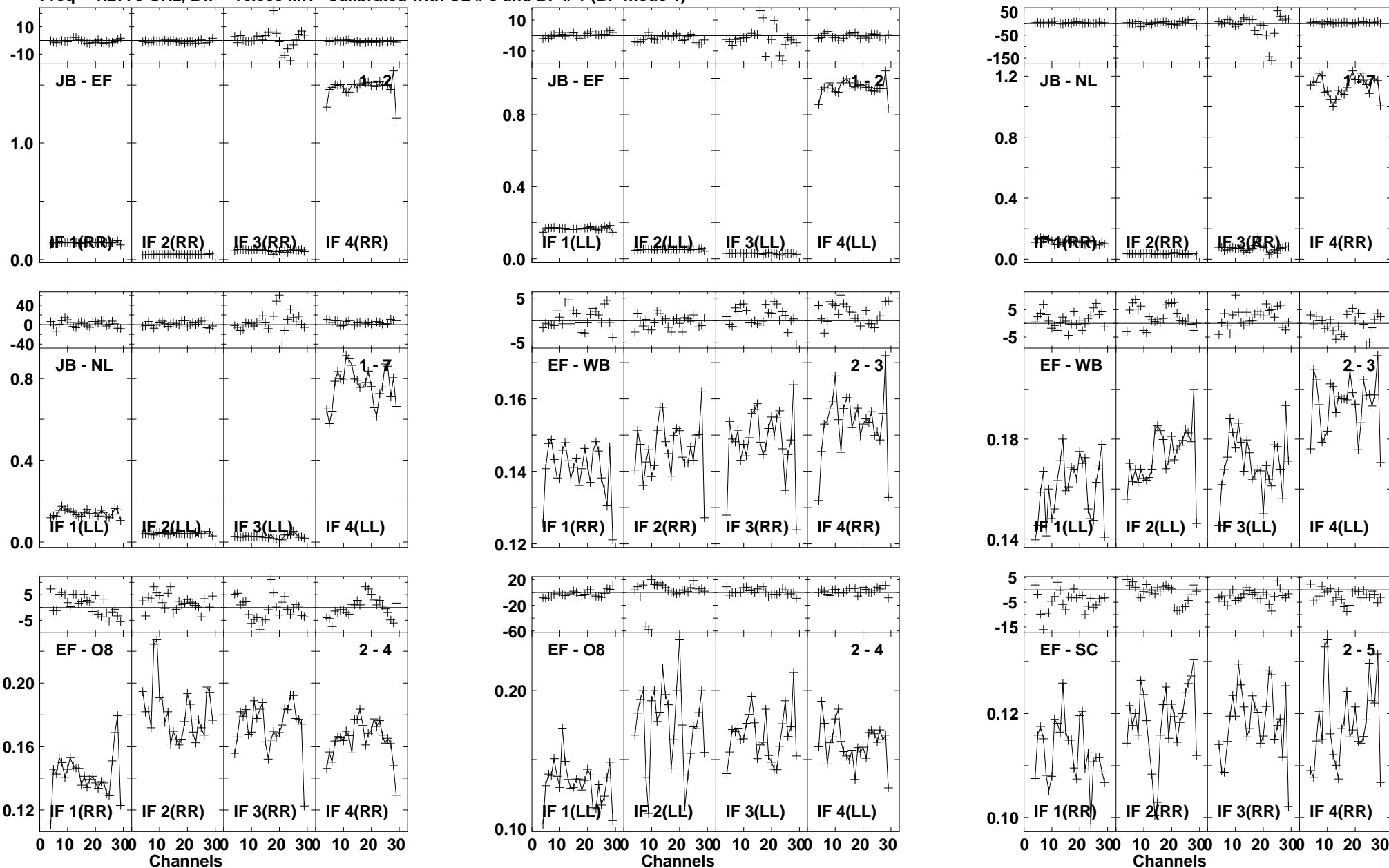

Lower frame: Ampl Jy Top frame: Phas deg
Vector averaged cross-power spectrum Baseline: JB (01) - EF (02)
Timerange: 00/16:29:11 to 00/16:31:09

Plot file version 126 created 03-MAR-2016 01:12:18

J1545+5400 GN002C 1.UVDATA.1

Freq = 1.2770 GHz, Bw = 16.000 MH Calibrated with CL # 3 and BP # 1 (BP mode 1)

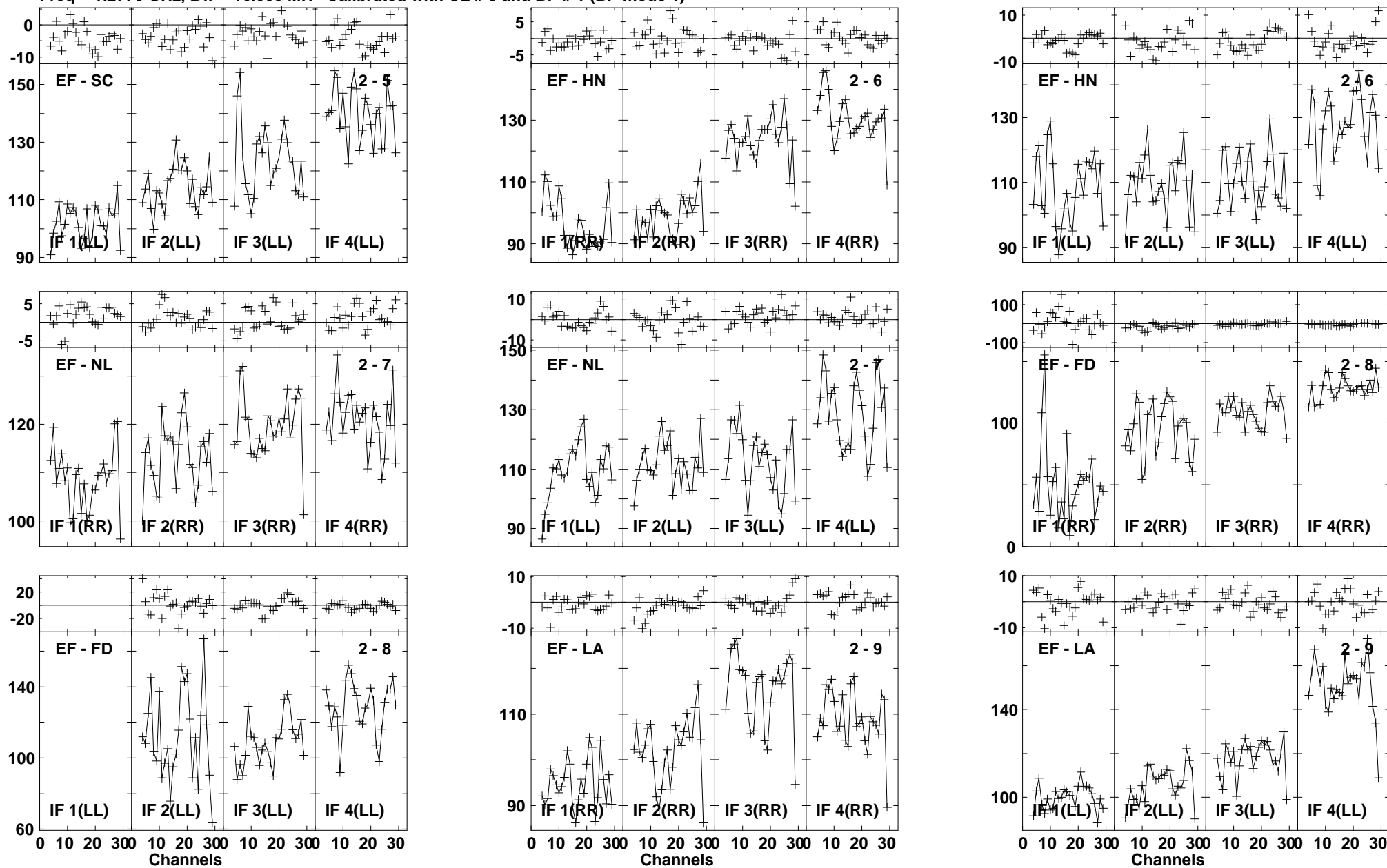

Lower frame: Milli Ampl Jy Top frame: Phas deg
Vector averaged cross-power spectrum Baseline: EF (02) - SC (05)
Timerange: 00/16:29:11 to 00/16:31:09

Plot file version 127 created 03-MAR-2016 01:12:19

J1545+5400 GN002C 1.UVDATA.1

Freq = 1.2770 GHz, Bw = 16.000 MH Calibrated with CL # 3 and BP # 1 (BP mode 1)

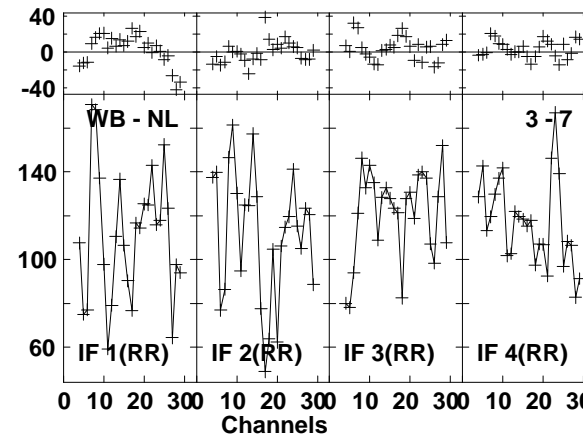
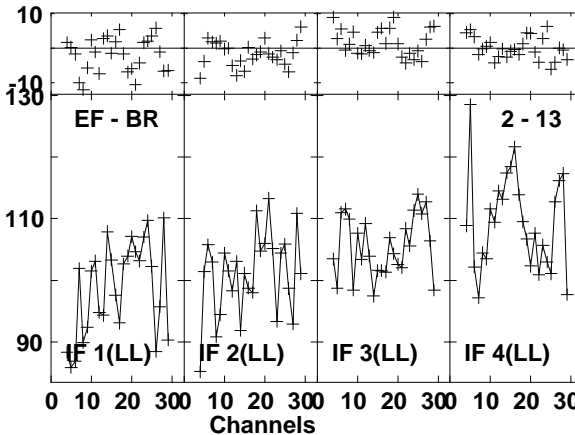
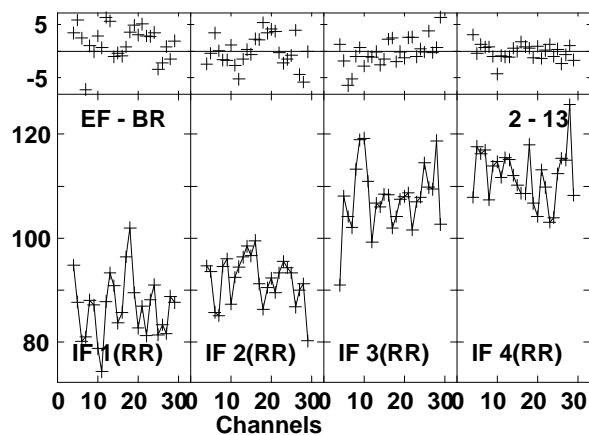
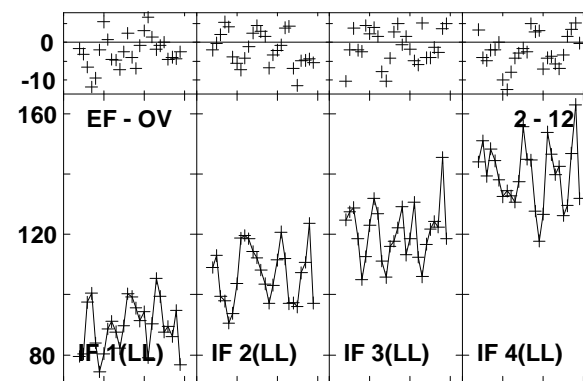
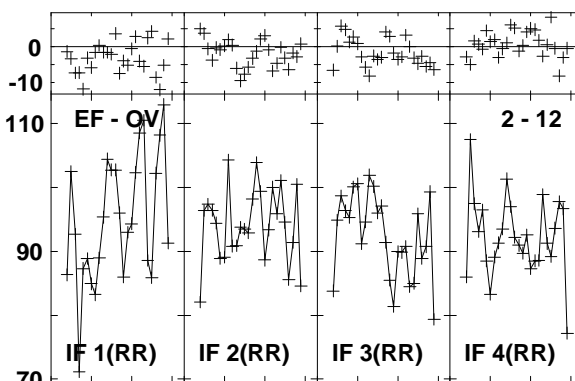
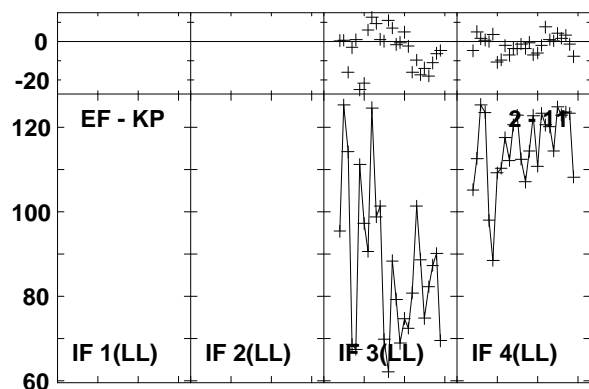
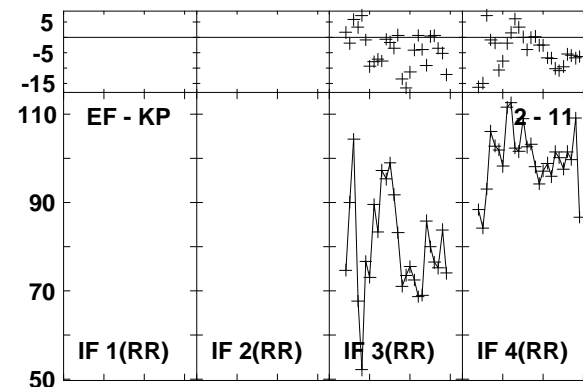
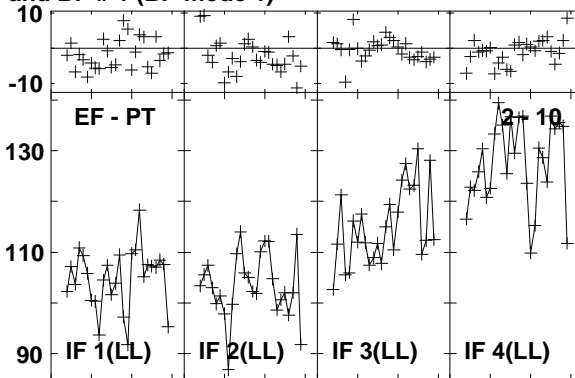
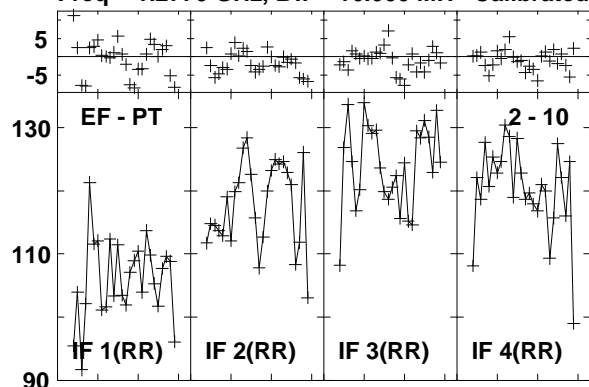

Lower frame: Milli Ampl Jy Top frame: Phas deg
Vector averaged cross-power spectrum Baseline: EF (02) - PT (10)
Timerange: 00/16:29:11 to 00/16:31:09

Plot file version 128 created 03-MAR-2016 01:12:19

J1545+5400 GN002C 1.UVDATA.1

Freq = 1.2770 GHz, Bw = 16.000 MH Calibrated with CL # 3 and BP # 1 (BP mode 1)

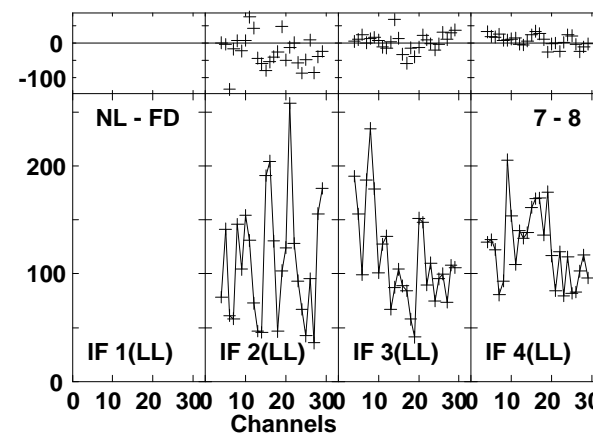
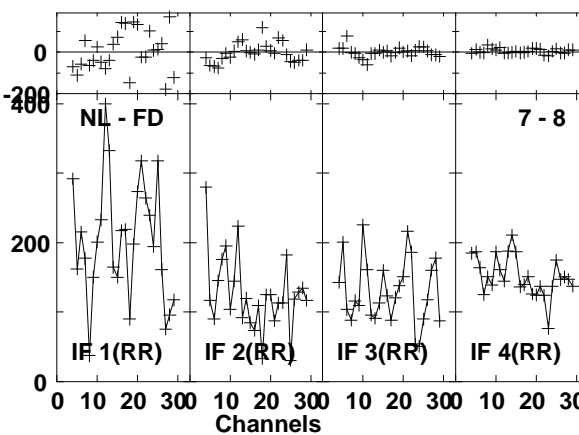
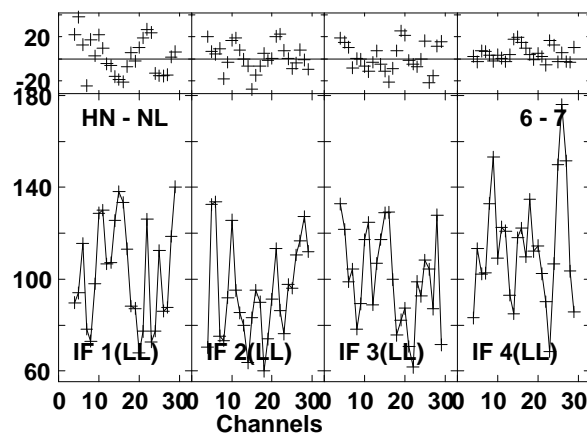
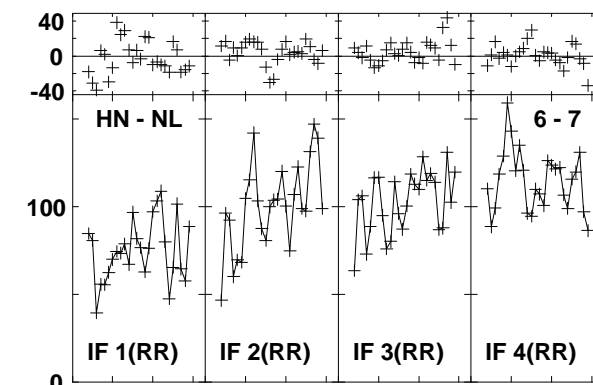
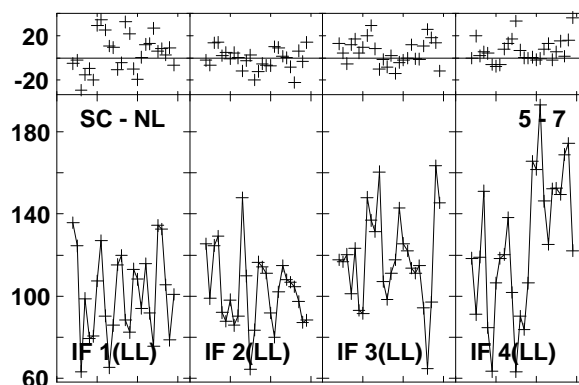
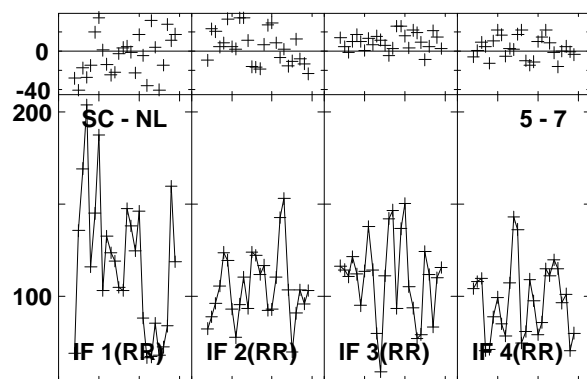
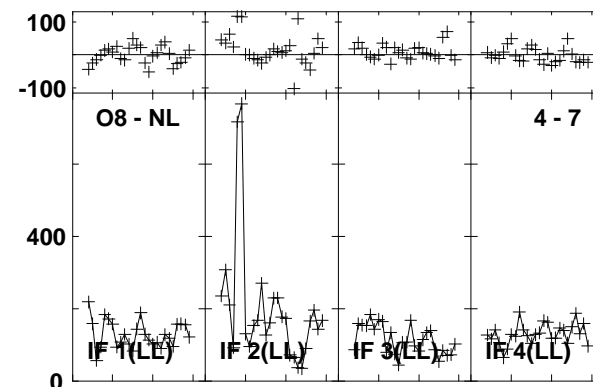
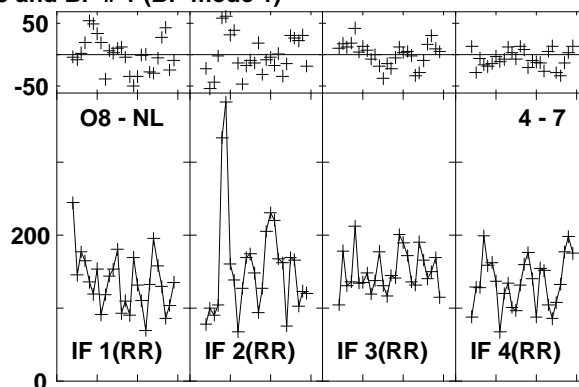
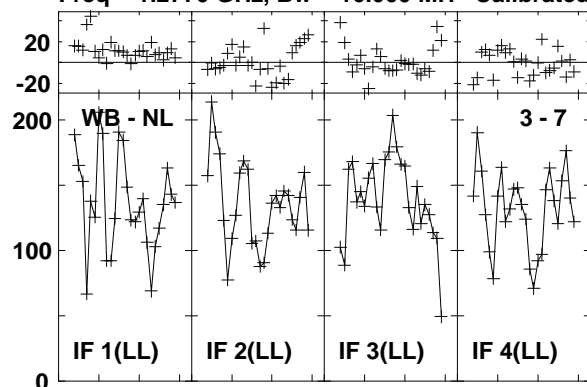

Lower frame: Milli Ampl Jy Top frame: Phas deg

Vector averaged cross-power spectrum Baseline: WB (03) - NL (07)

Timerange: 00/16:29:11 to 00/16:31:09

Plot file version 129 created 03-MAR-2016 01:12:19

J1545+5400 GN002C 1.UVDATA.1

Freq = 1.2770 GHz, Bw = 16.000 MH Calibrated with CL # 3 and BP # 1 (BP mode 1)

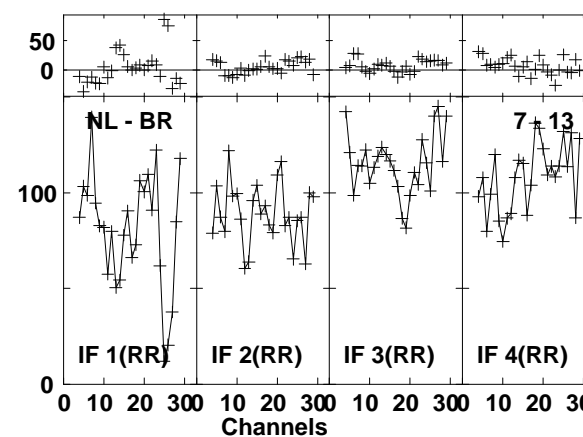
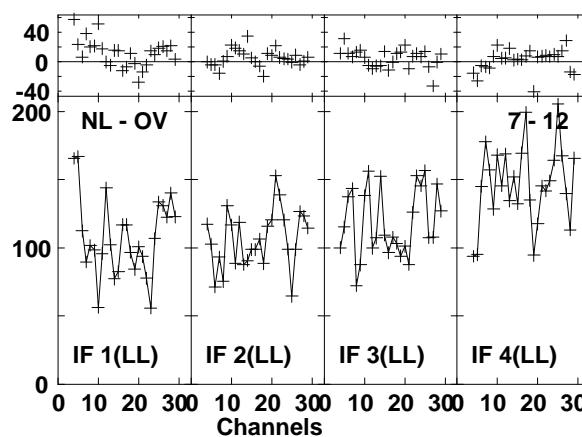
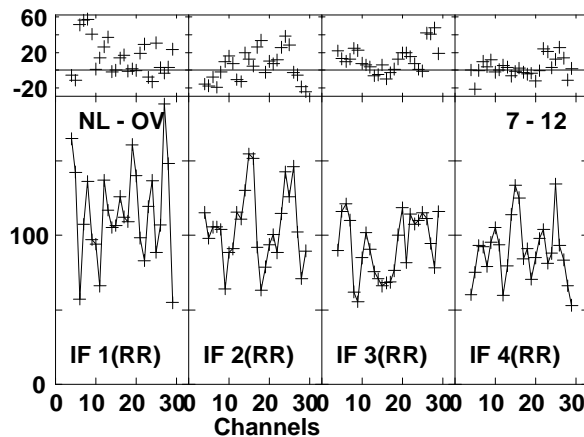
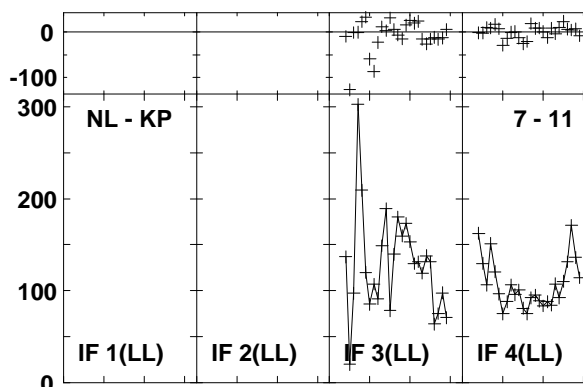
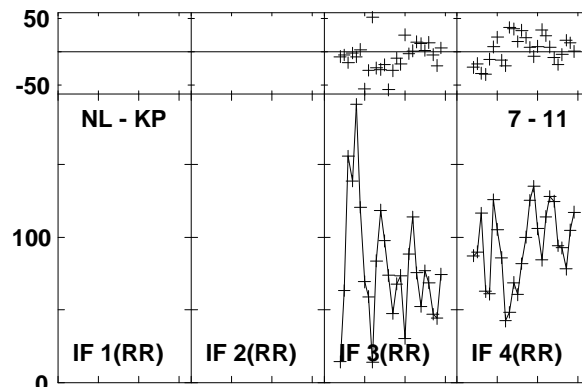
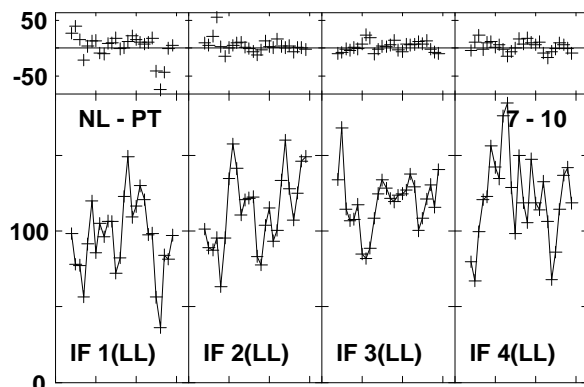
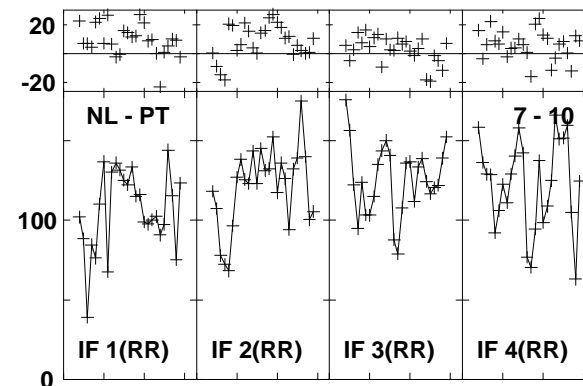
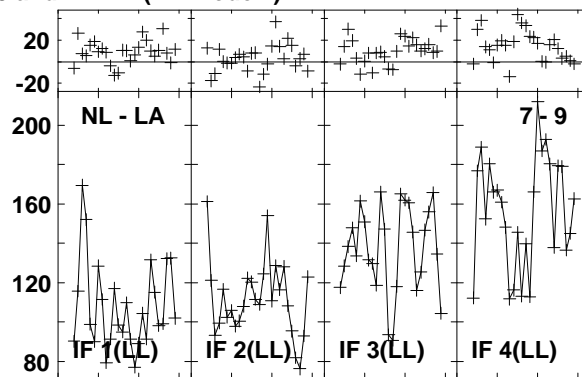
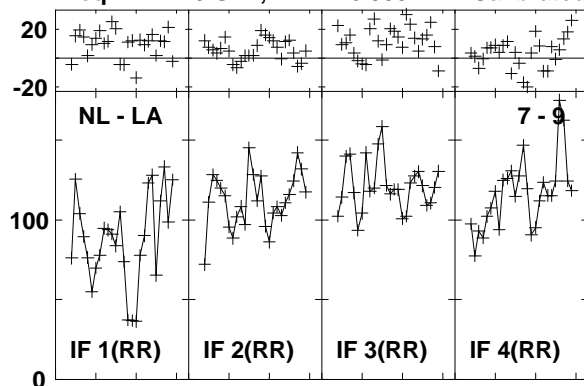

Lower frame: Milli Ampl Jy Top frame: Phas deg
Vector averaged cross-power spectrum Baseline: NL (07) - LA (09)
Timerange: 00/16:29:11 to 00/16:31:09

Plot file version 130 created 03-MAR-2016 01:12:19
J1545+5400 GN002C 1.UVDATA.1
Freq = 1.2770 GHz, Bw = 16.000 MH Calibrated with CL # 3 and BP # 1 (BP mode 1)

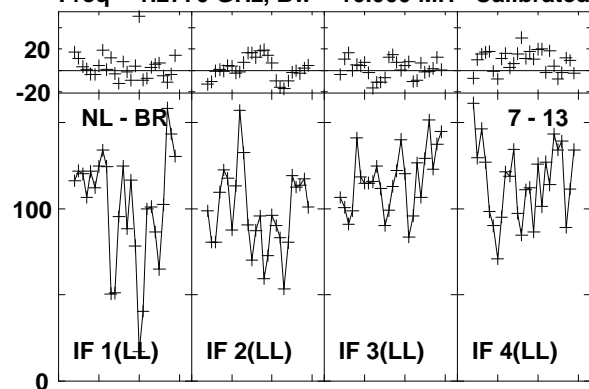

Lower frame: Milli Ampl Jy Top frame: Phas deg
Vector averaged cross-power spectrum Baseline: NL (07) - BR (13)
Timerange: 00/16:29:11 to 00/16:31:09

Plot file version 131 created 03-MAR-2016 01:12:19

4C52 GN002C 1.UVDATA.1

Freq = 1.2770 GHz, Bw = 16.000 MH Calibrated with CL # 3 and BP # 1 (BP mode 1)

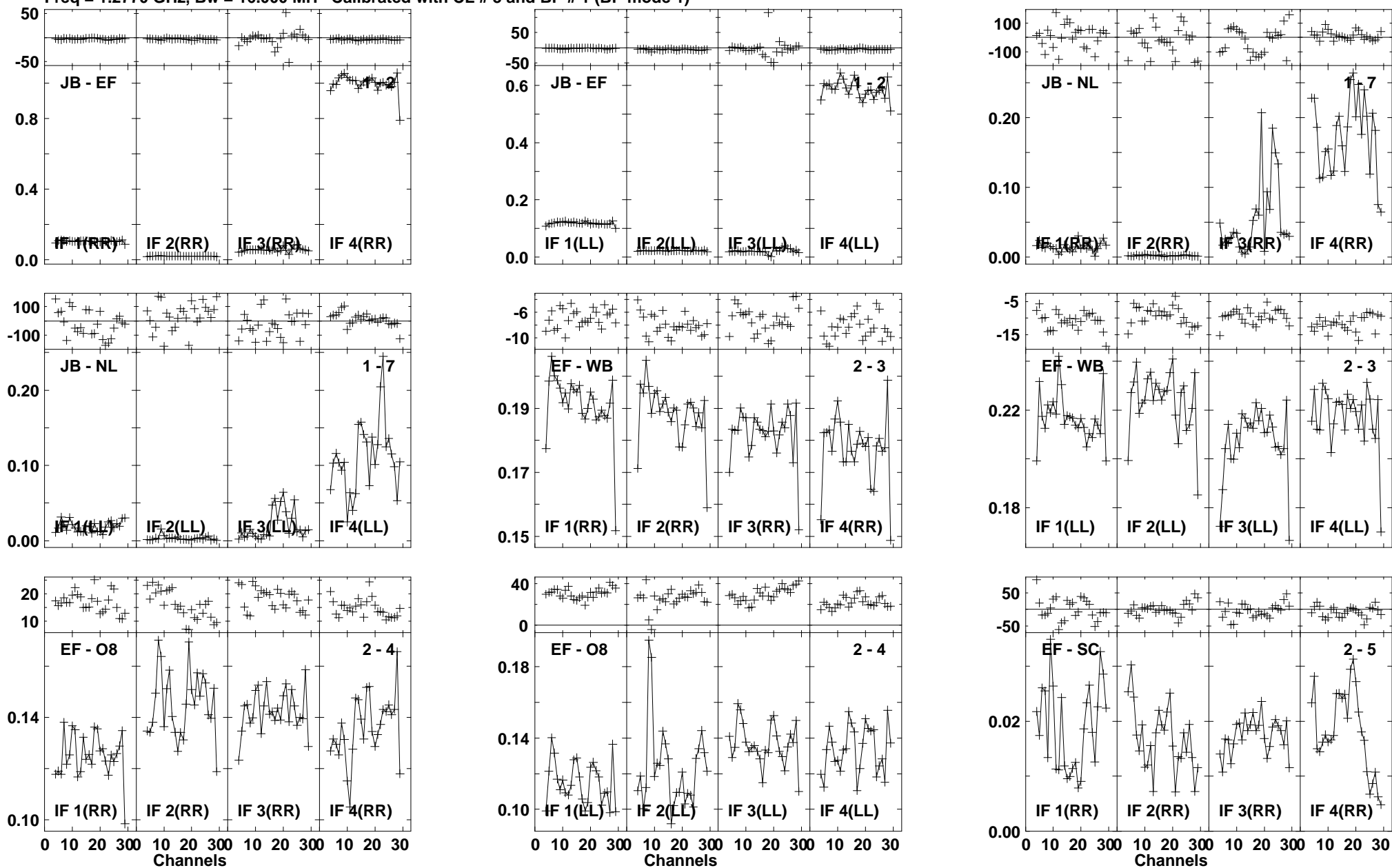

Plot file version 132 created 03-MAR-2016 01:12:20

4C52 GN002C 1.UVDATA.1

Freq = 1.2770 GHz, Bw = 16.000 MH Calibrated with CL # 3 and BP # 1 (BP mode 1)

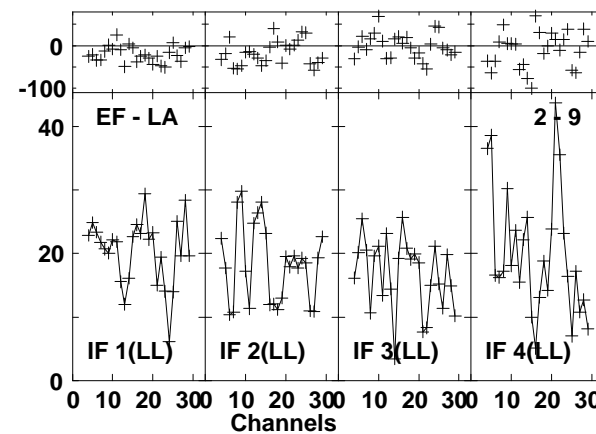
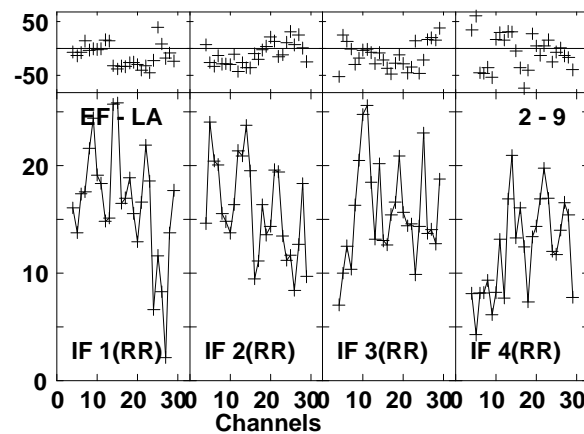
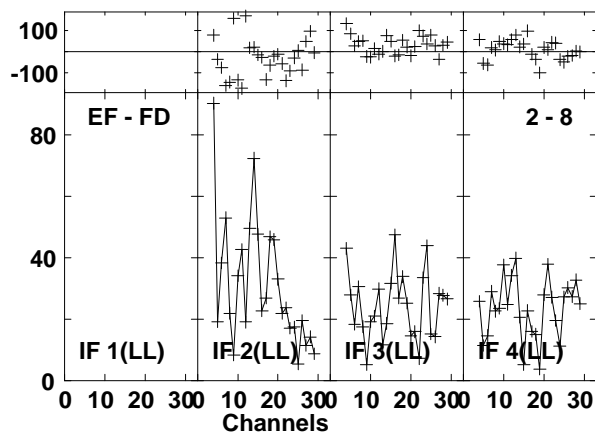
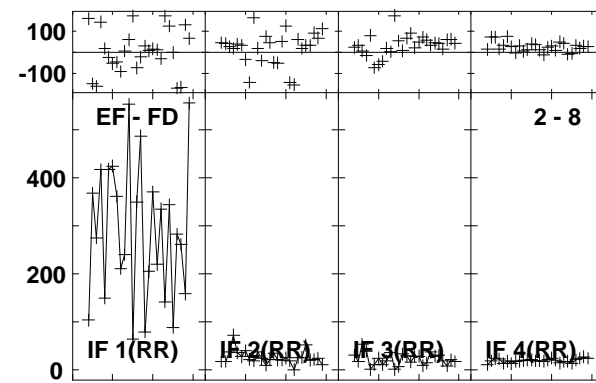
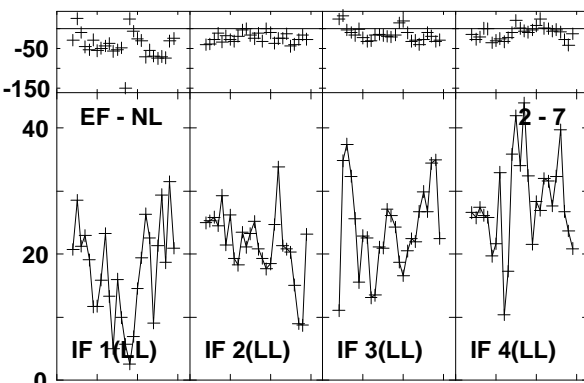
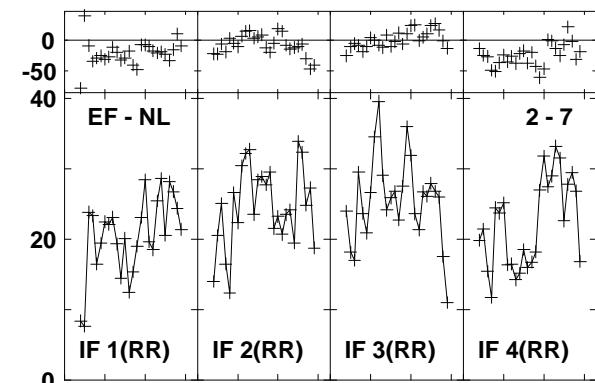
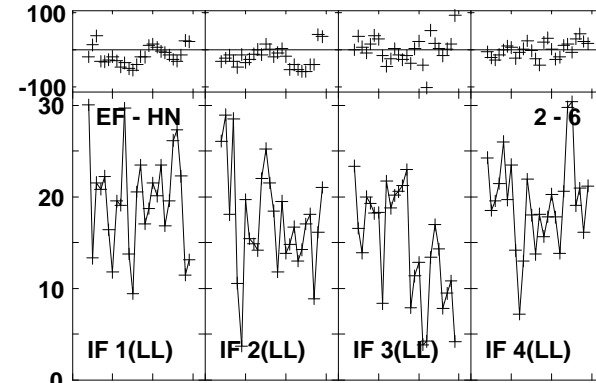
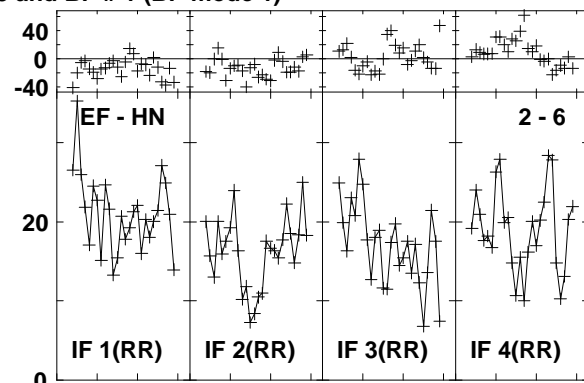
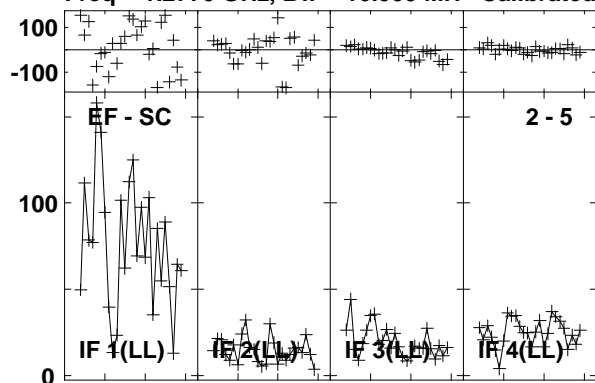

Lower frame: Milli Ampl Jy Top frame: Phas deg
Vector averaged cross-power spectrum Baseline: EF (02) - SC (05)
Timerange: 00/16:31:22 to 00/16:34:08

Plot file version 133 created 03-MAR-2016 01:12:20

4C52 GN002C 1.UVDATA.1

Freq = 1.2770 GHz, Bw = 16.000 MH Calibrated with CL # 3 and BP # 1 (BP mode 1)

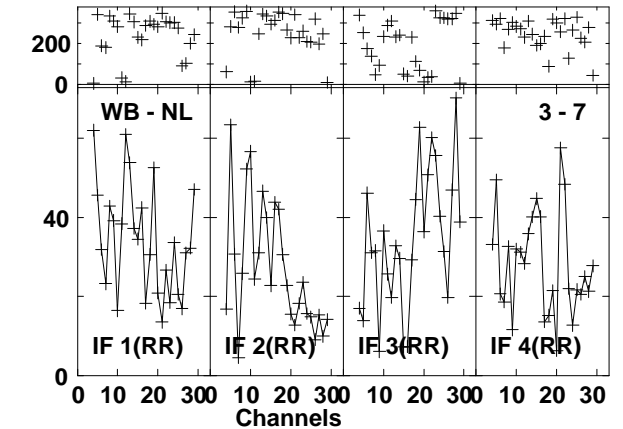
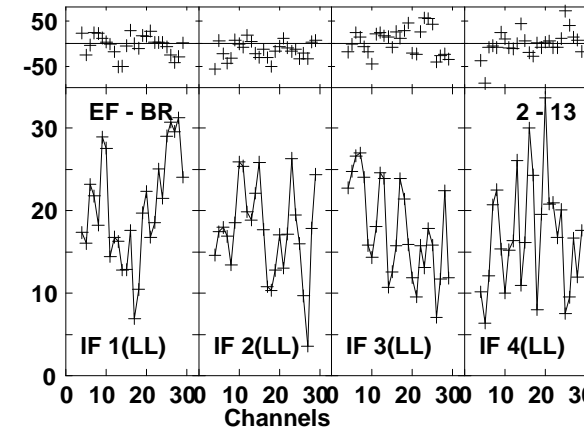
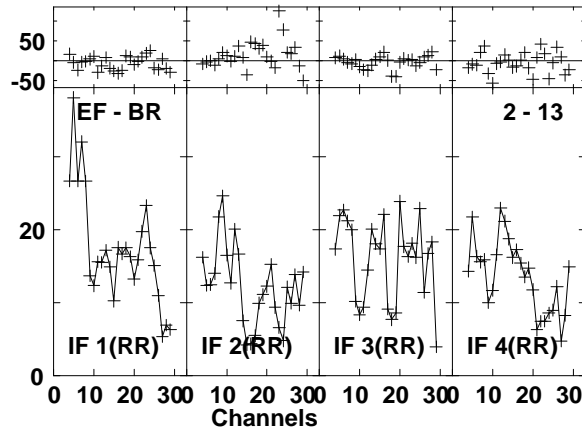
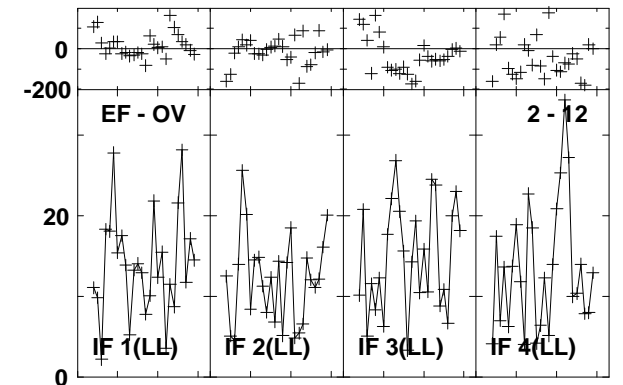
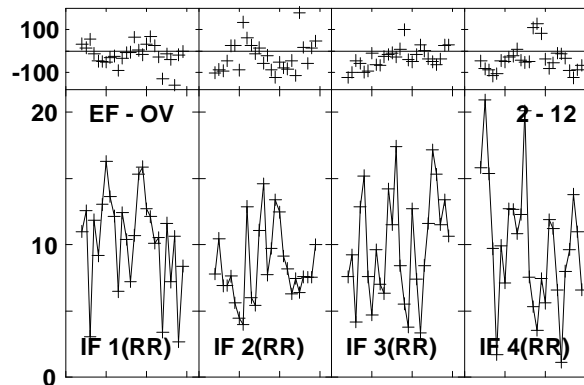
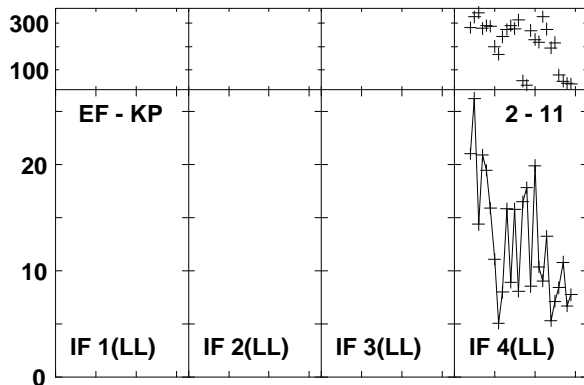
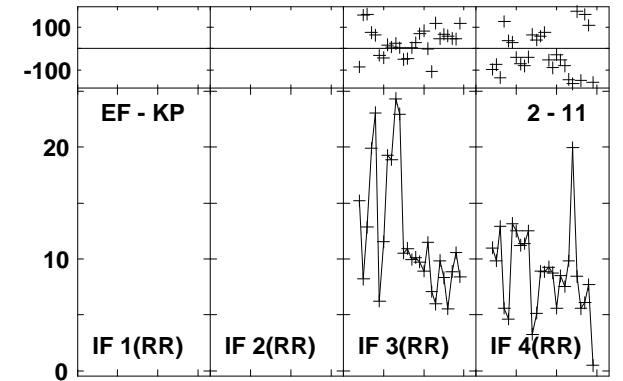
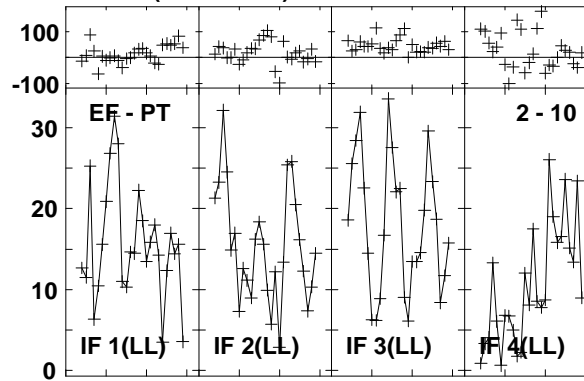
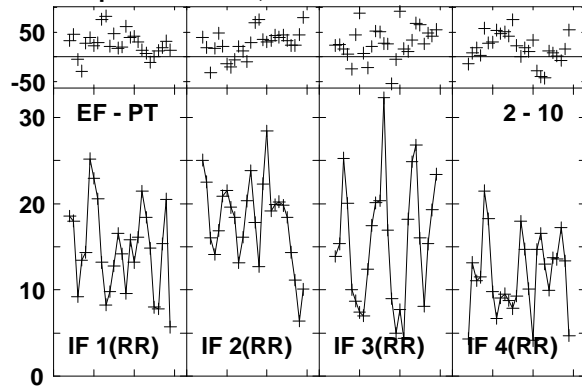

Lower frame: Milli Ampl Jy Top frame: Phas deg
Vector averaged cross-power spectrum Baseline: EF (02) - PT (10)
Timerange: 00/16:31:22 to 00/16:34:08

Plot file version 134 created 03-MAR-2016 01:12:20

4C52 GN002C 1.UVDATA.1

Freq = 1.2770 GHz, Bw = 16.000 MH Calibrated with CL # 3 and BP # 1 (BP mode 1)

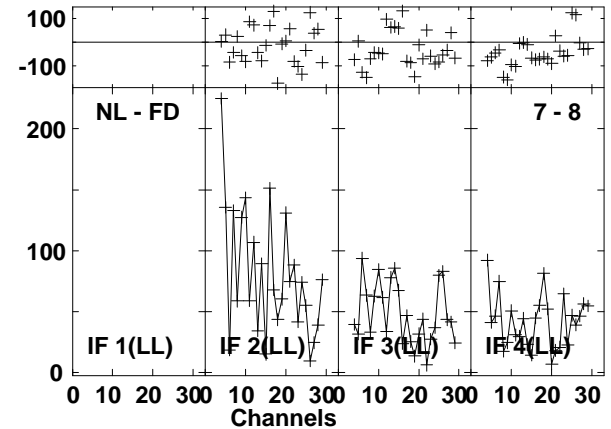
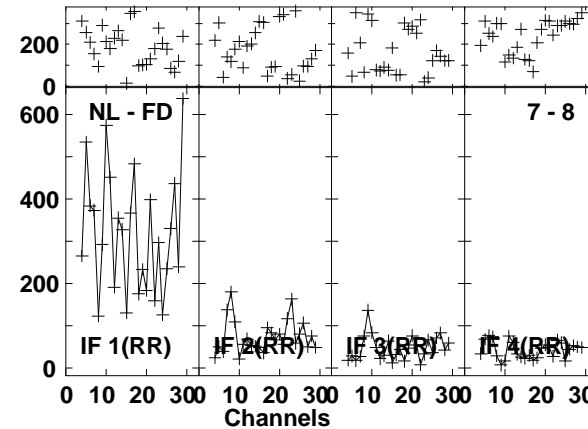
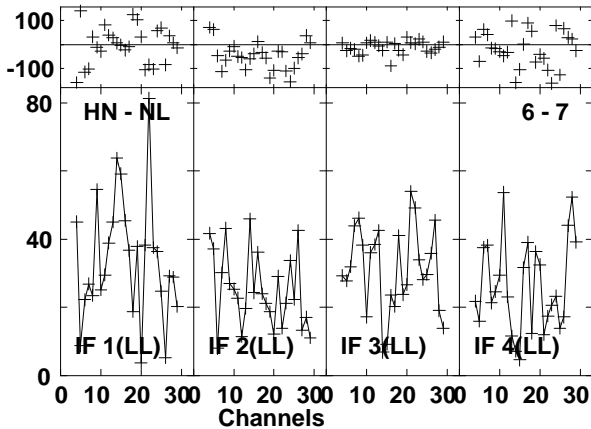
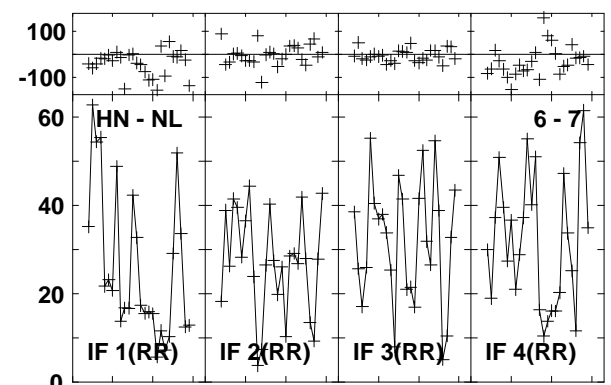
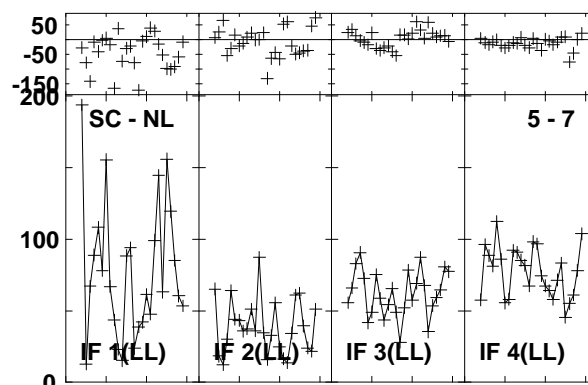
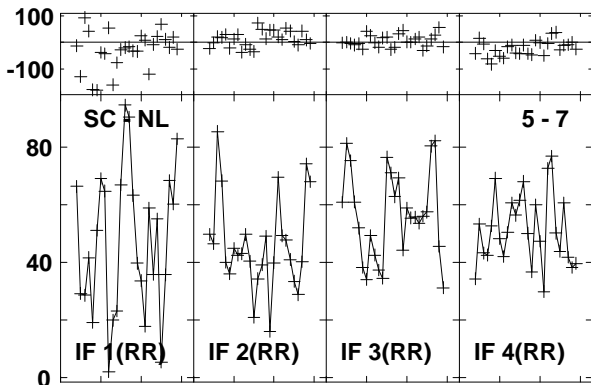
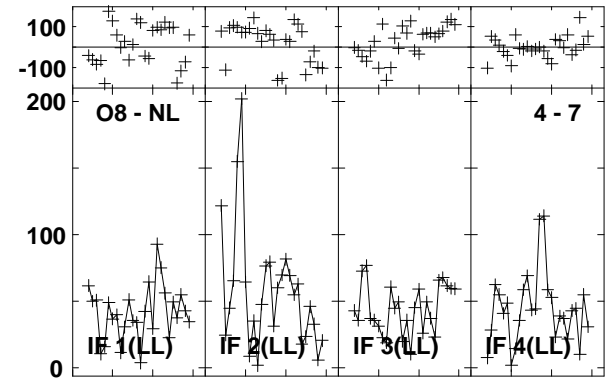
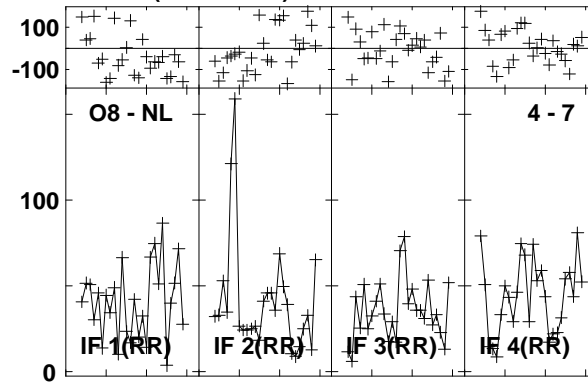
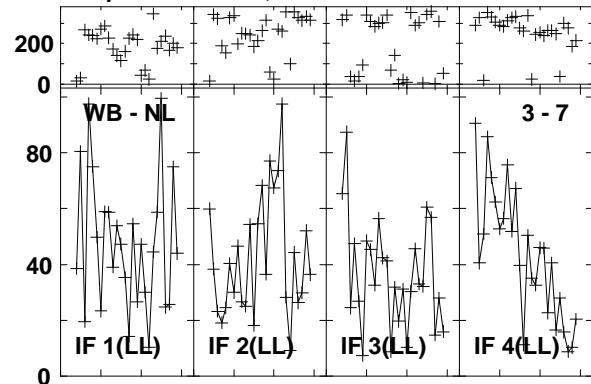

Lower frame: Milli Ampl Jy Top frame: Phas deg
Vector averaged cross-power spectrum Baseline: WB (03) - NL (07)
Timerange: 00/16:31:22 to 00/16:34:08

Plot file version 135 created 03-MAR-2016 01:12:20

4C52 GN002C 1.UVDATA.1

Freq = 1.2770 GHz, Bw = 16.000 MH Calibrated with CL # 3 and BP # 1 (BP mode 1)

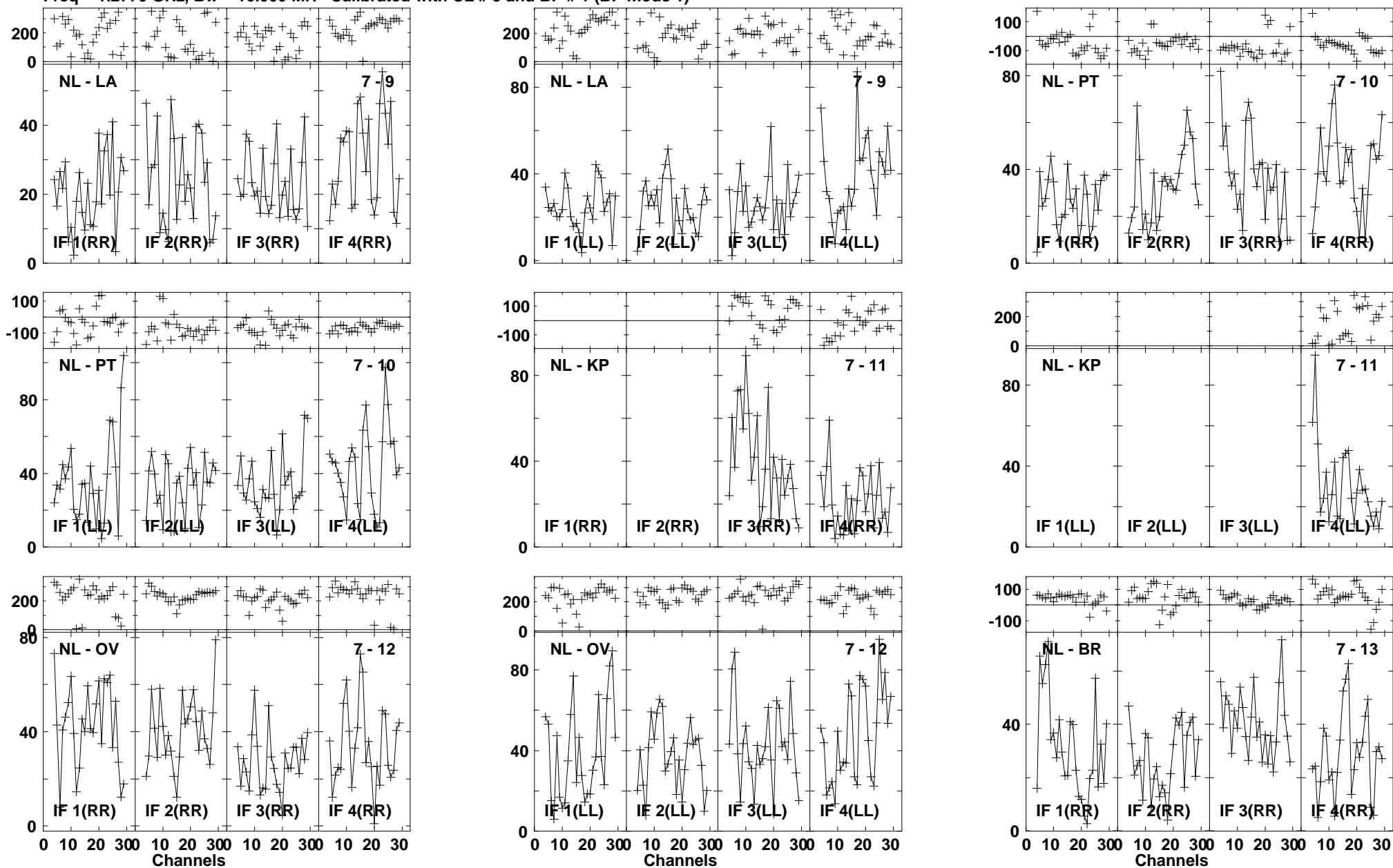

Lower frame: Milli Ampl Jy Top frame: Phas deg
Vector averaged cross-power spectrum Baseline: NL (07) - LA (09)
Timerange: 00/16:31:22 to 00/16:34:08

Plot file version 136 created 03-MAR-2016 01:12:20

4C52 GN002C 1.UVDATA.1

Freq = 1.2770 GHz, Bw = 16.000 MH Calibrated with CL # 3 and BP # 1 (BP mode 1)

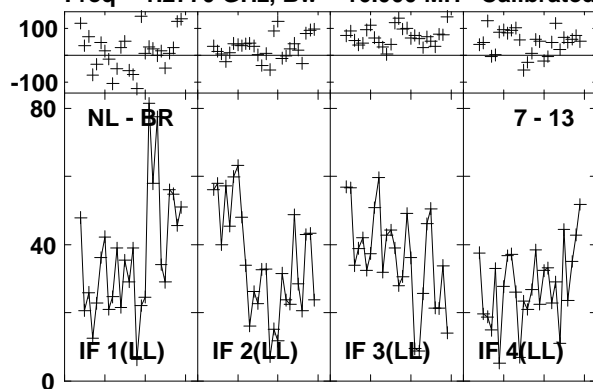

Lower frame: Milli Ampl Jy Top frame: Phas deg

Vector averaged cross-power spectrum Baseline: NL (07) - BR (13)

Timerange: 00/16:31:22 to 00/16:34:08

Plot file version 137 created 03-MAR-2016 01:12:20
 J1545+5400 GN002C 1.UVDATA.1
 Freq = 1.2770 GHz, Bw = 16.000 MH Calibrated with CL # 3 and BP # 1 (BP mode 1)

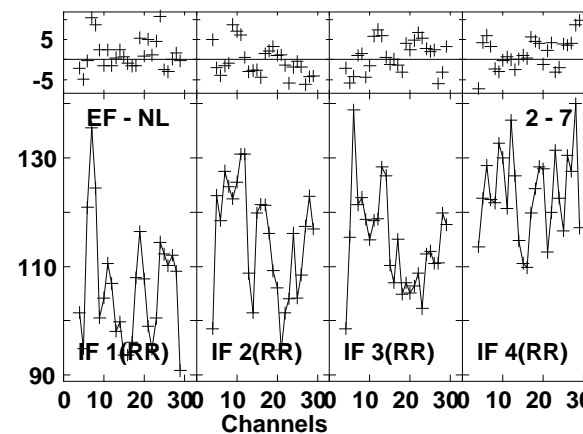
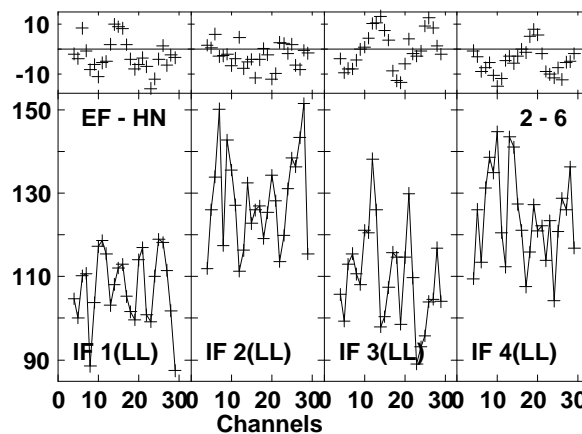
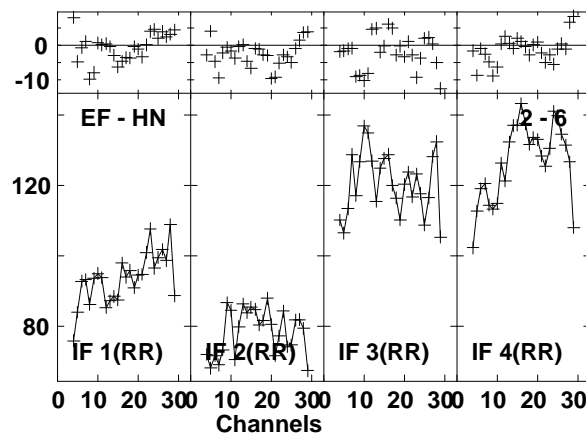
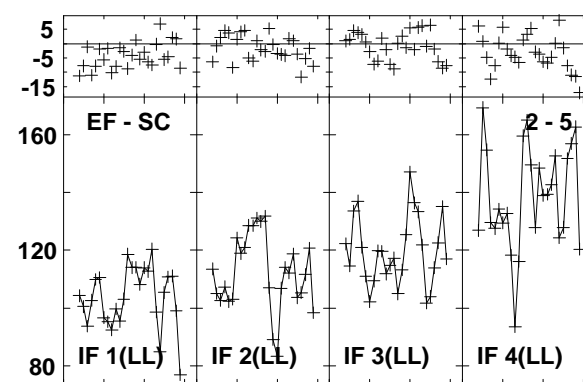
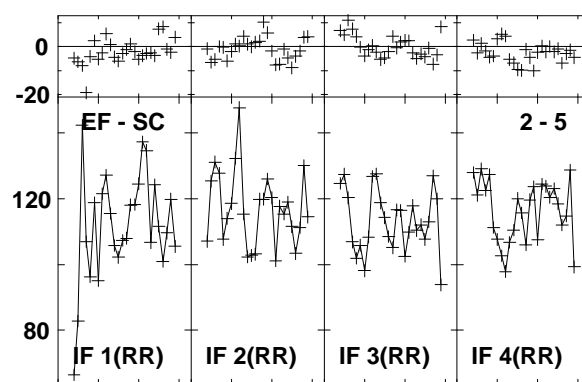
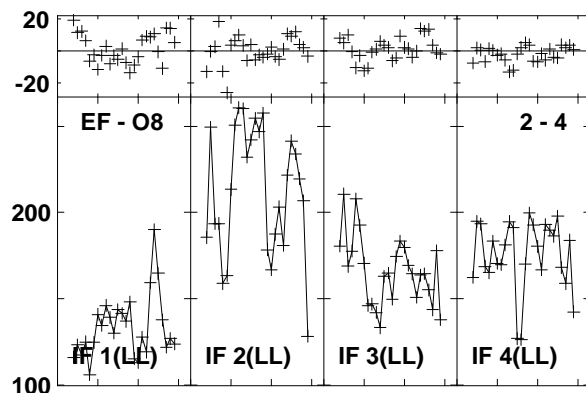
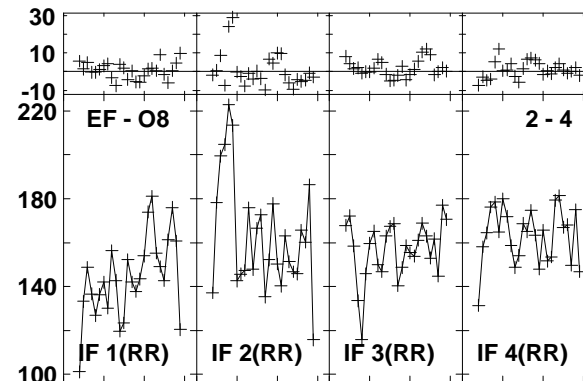
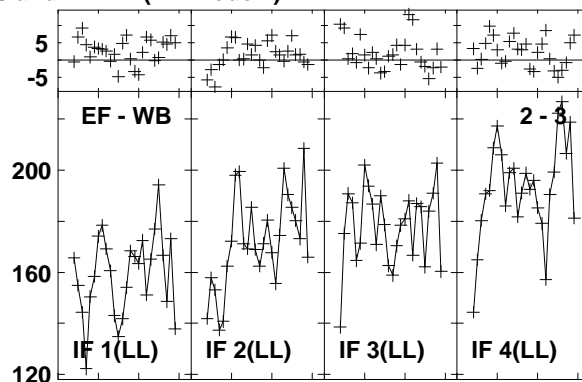
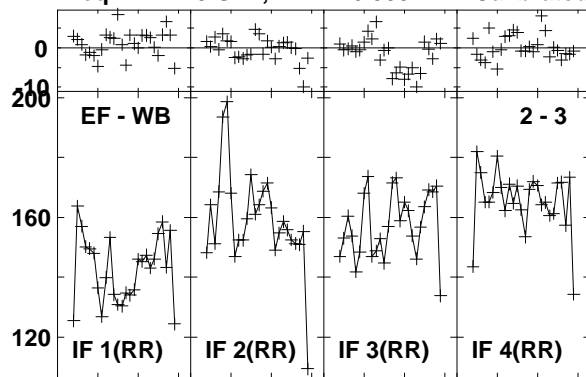

Lower frame: Milli Ampl Jy Top frame: Phas deg
 Vector averaged cross-power spectrum Baseline: EF (02) - WB (03)
 Timerange: 00/16:35:01 to 00/16:35:59

Plot file version 138 created 03-MAR-2016 01:12:20

J1545+5400 GN002C 1.UVDATA.1

Freq = 1.2770 GHz, Bw = 16.000 MH Calibrated with CL # 3 and BP # 1 (BP mode 1)

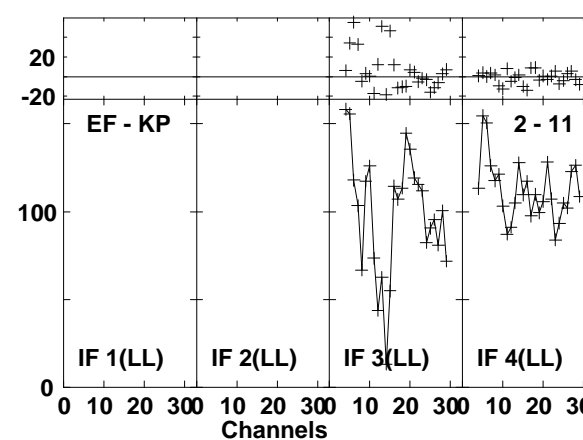
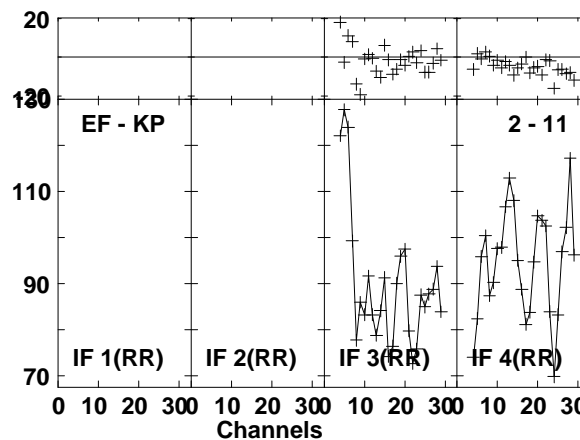
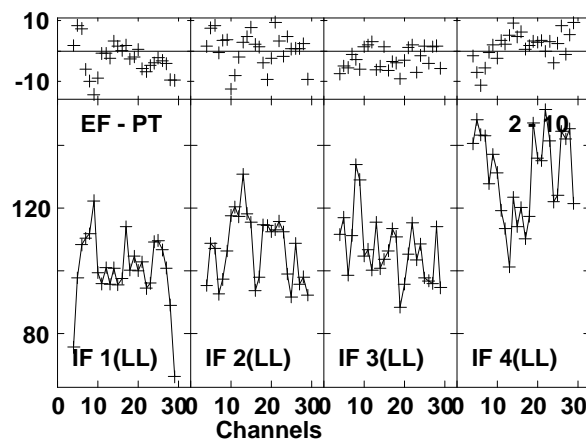
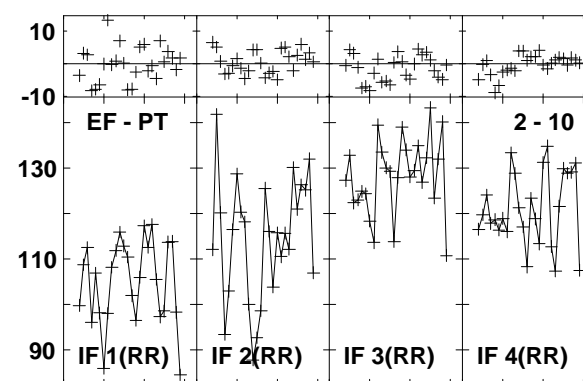
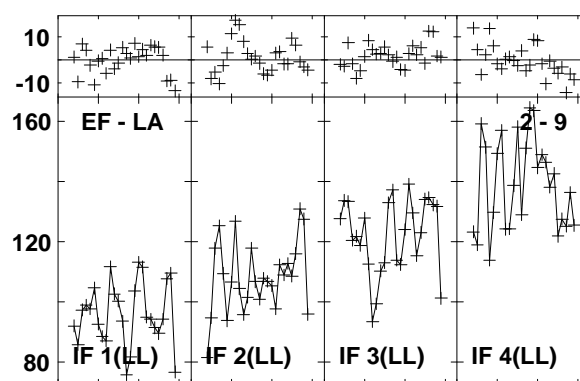
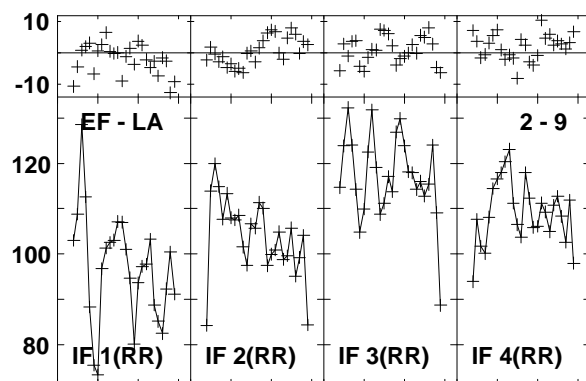
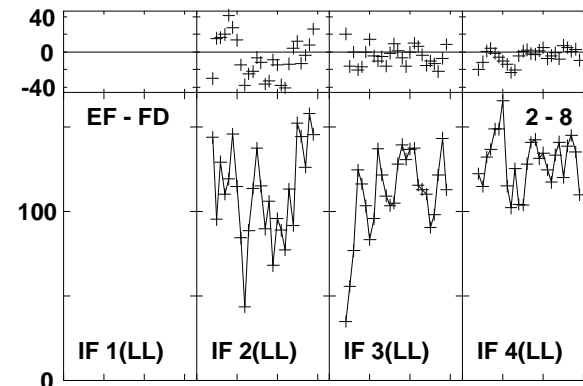
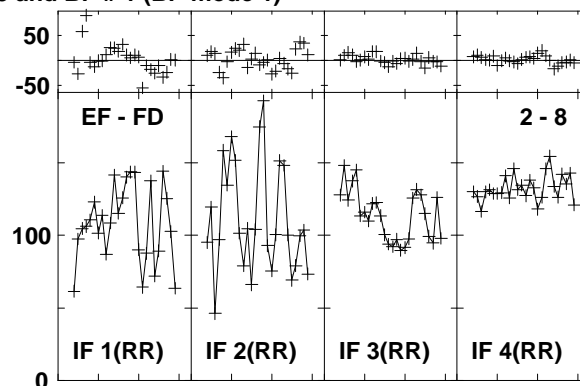
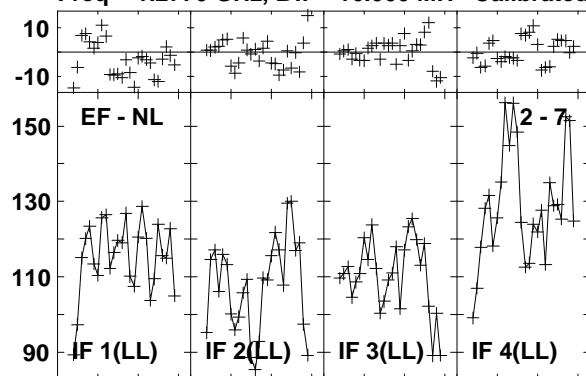

Lower frame: Milli Ampl Jy Top frame: Phas deg
Vector averaged cross-power spectrum Baseline: EF (02) - NL (07)
Timerange: 00/16:35:01 to 00/16:35:59

Plot file version 139 created 03-MAR-2016 01:12:21

J1545+5400 GN002C 1.UVDATA.1

Freq = 1.2770 GHz, Bw = 16.000 MH Calibrated with CL # 3 and BP # 1 (BP mode 1)

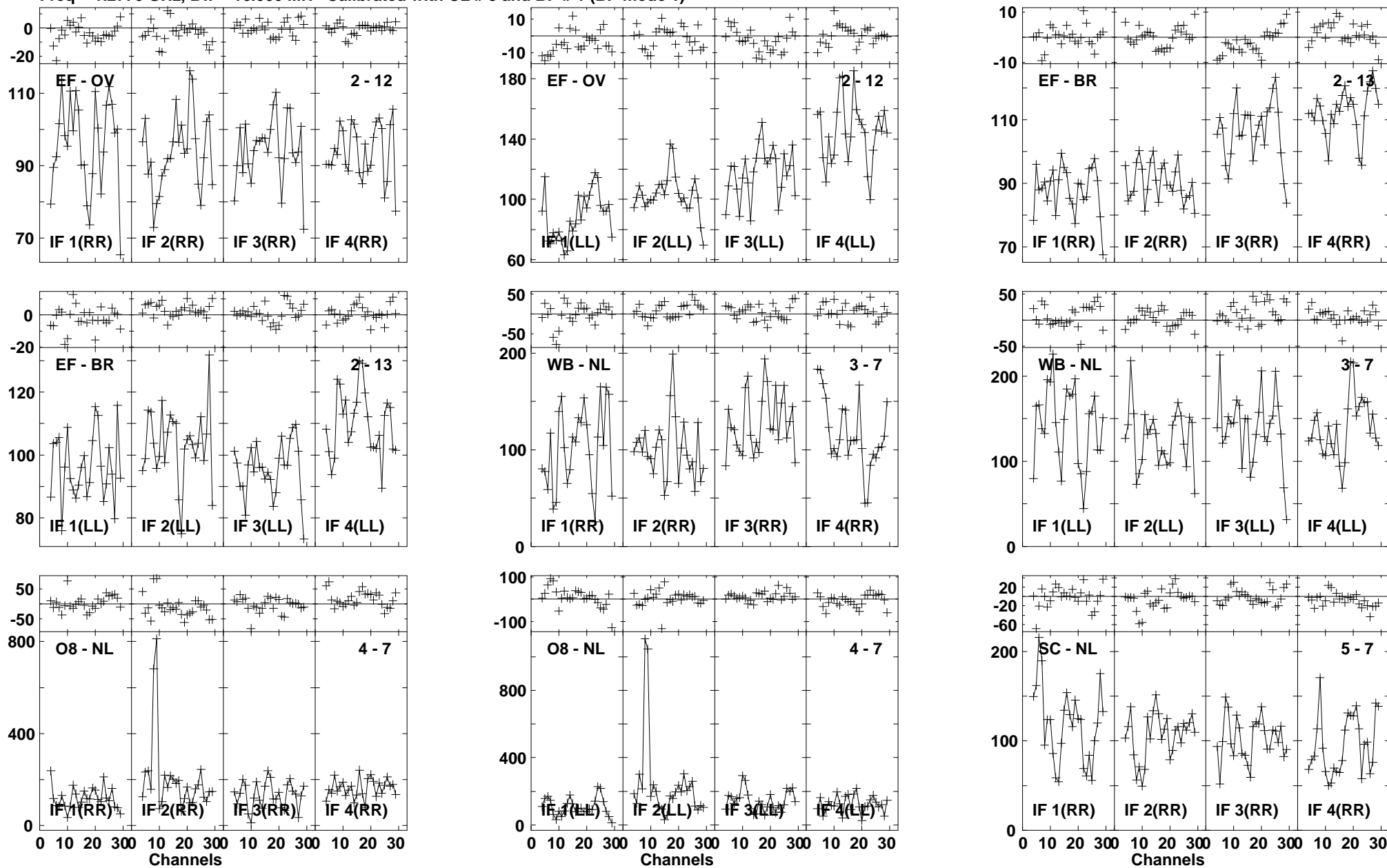

Lower frame: Milli Ampl Jy Top frame: Phas deg
Vector averaged cross-power spectrum Baseline: EF (02) - OV (12)
Timerange: 00/16:35:01 to 00/16:35:59

Plot file version 140 created 03-MAR-2016 01:12:21

J1545+5400 GN002C 1.UVDATA.1

Freq = 1.2770 GHz, Bw = 16.000 MH Calibrated with CL # 3 and BP # 1 (BP mode 1)

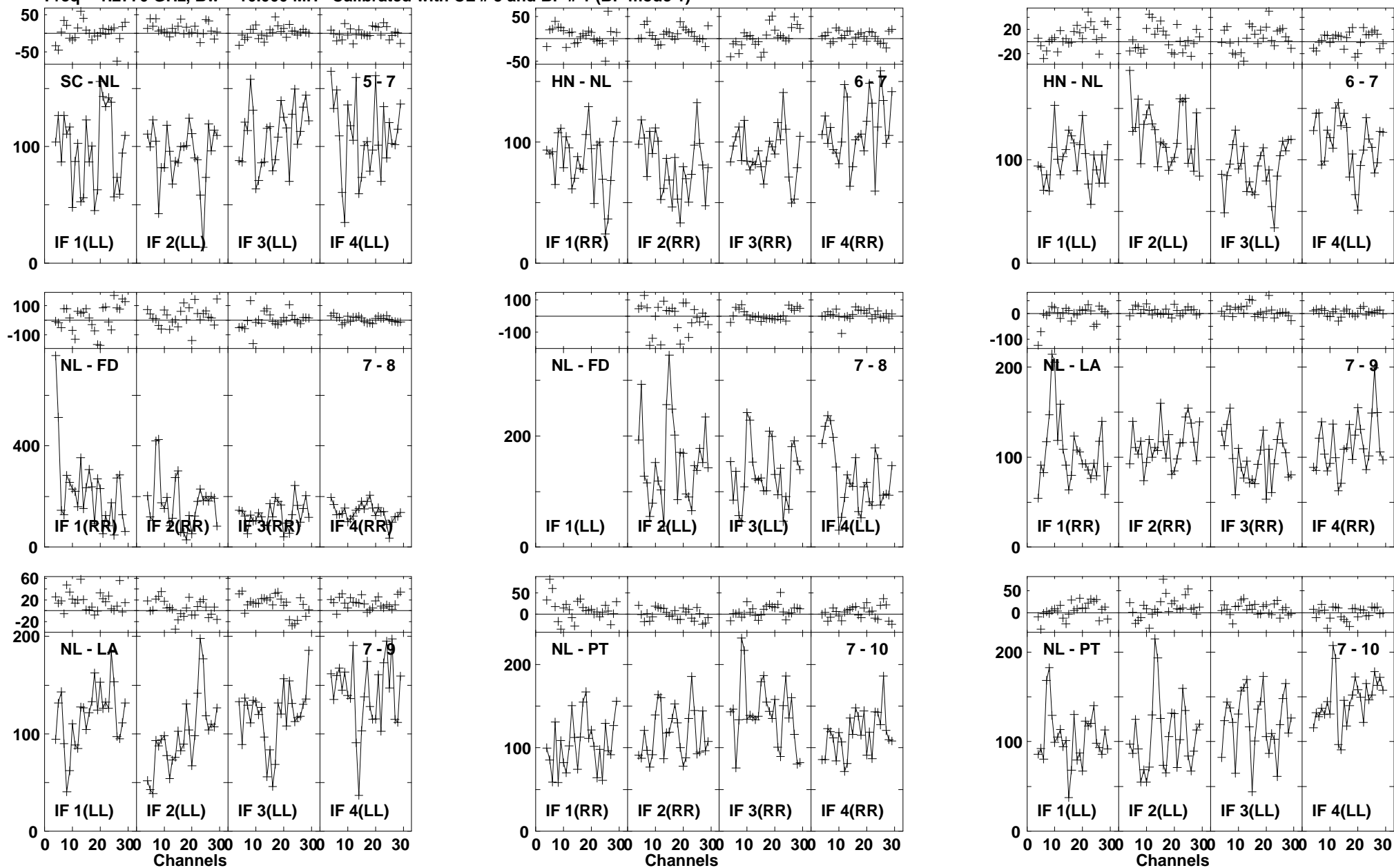

Lower frame: Milli Ampl Jy Top frame: Phas deg
Vector averaged cross-power spectrum Baseline: SC (05) - NL (07)
Timerange: 00/16:35:01 to 00/16:35:59

Plot file version 141 created 03-MAR-2016 01:12:21
 J1545+5400 GN002C 1.UVDATA.1
 Freq = 1.2770 GHz, Bw = 16.000 MH Calibrated with CL # 3 and BP # 1 (BP mode 1)

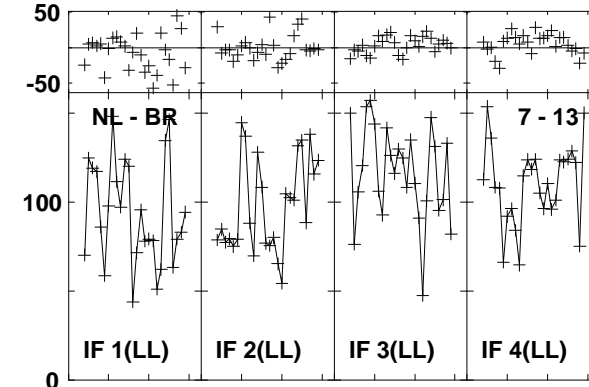
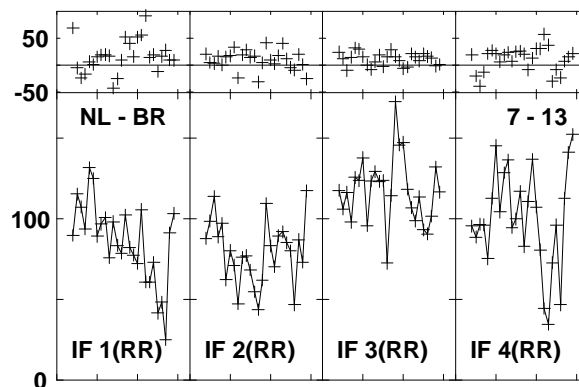
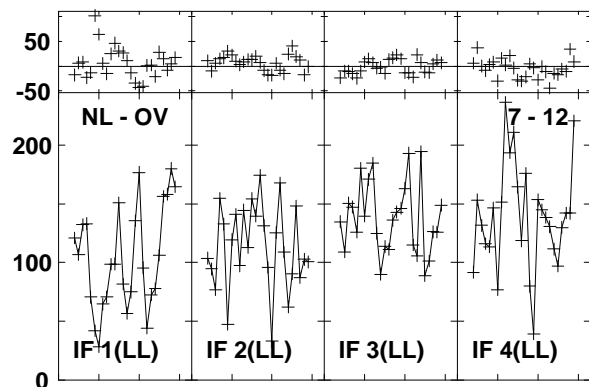
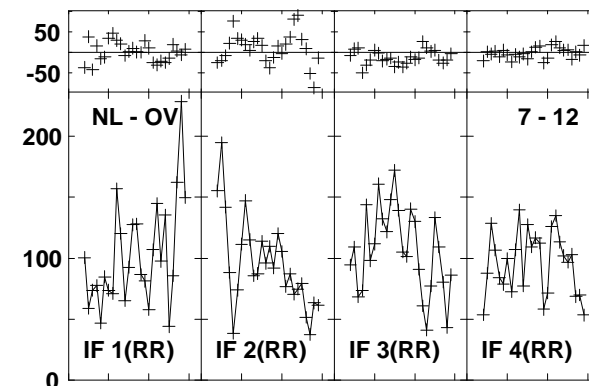
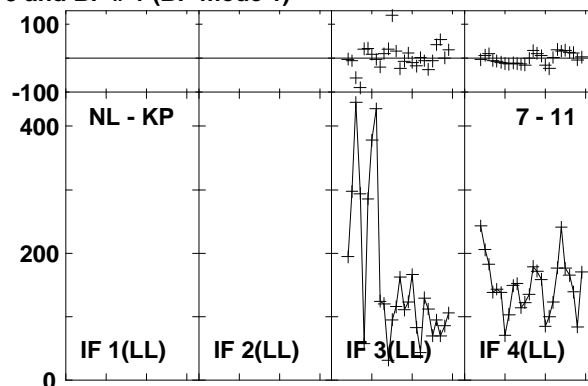
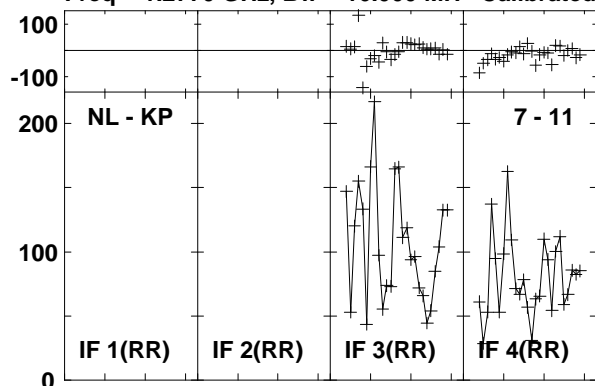

Lower frame: Milli Ampl Jy Top frame: Phas deg
 Vector averaged cross-power spectrum Baseline: NL (07) - KP (11)
 Timerange: 00/16:35:01 to 00/16:35:59

Plot file version 142 created 03-MAR-2016 01:12:21
 4C52 GN002C 1.UVDATA.1
 Freq = 1.2770 GHz, Bw = 16.000 MH Calibrated with CL # 3 and BP # 1 (BP mode 1)

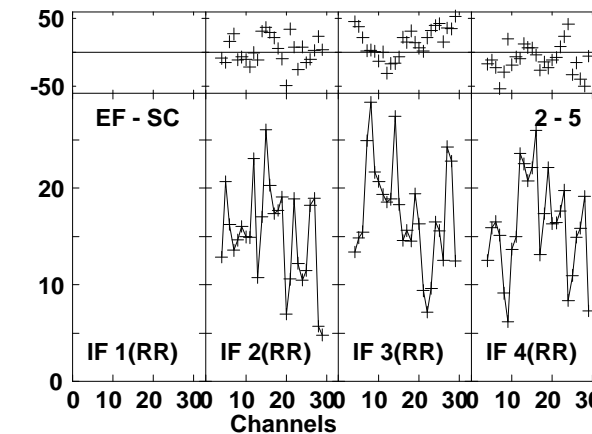
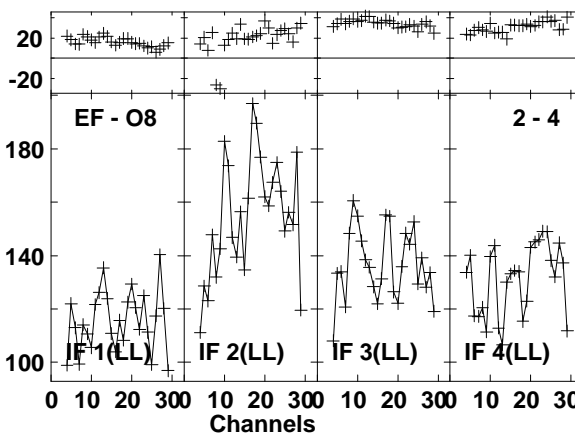
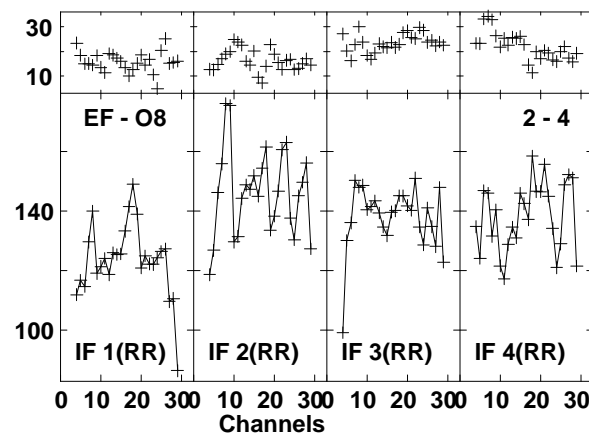
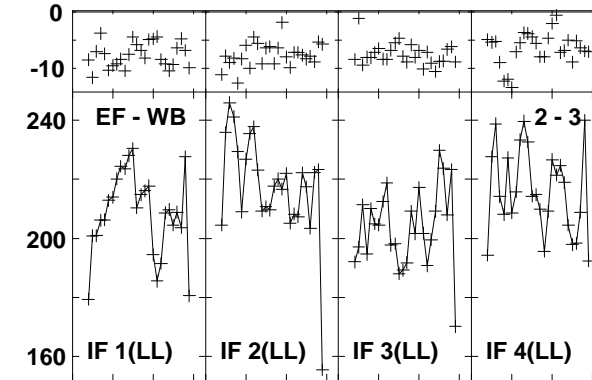
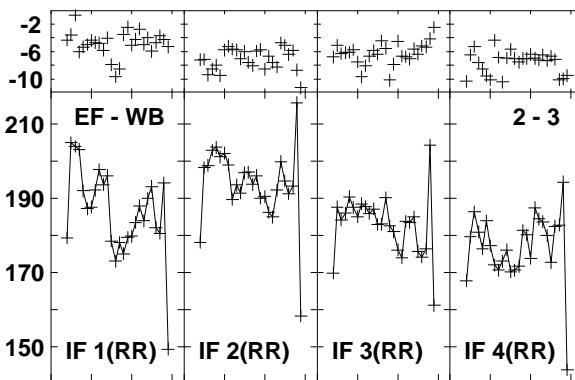
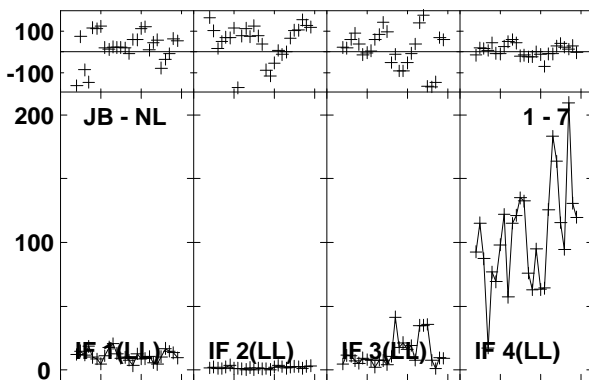
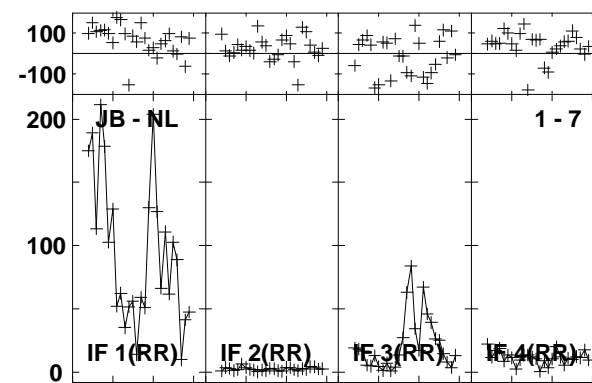
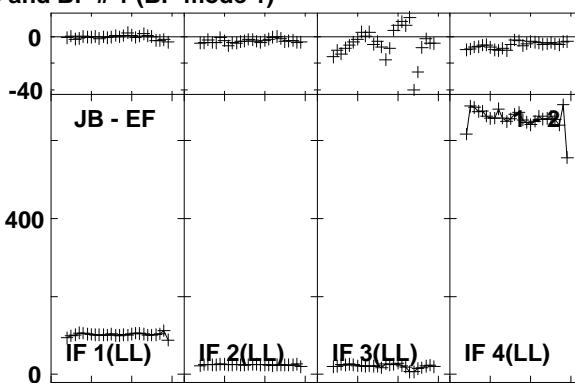
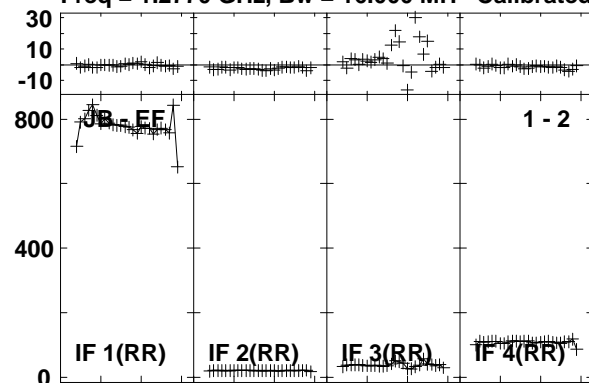

Lower frame: Milli Ampl Jy Top frame: Phas deg
 Vector averaged cross-power spectrum Baseline: JB (01) - EF (02)
 Timerange: 00/16:36:04 to 00/16:38:58

Plot file version 143 created 03-MAR-2016 01:12:21

4C52 GN002C 1.UVDATA.1

Freq = 1.2770 GHz, Bw = 16.000 MH Calibrated with CL # 3 and BP # 1 (BP mode 1)

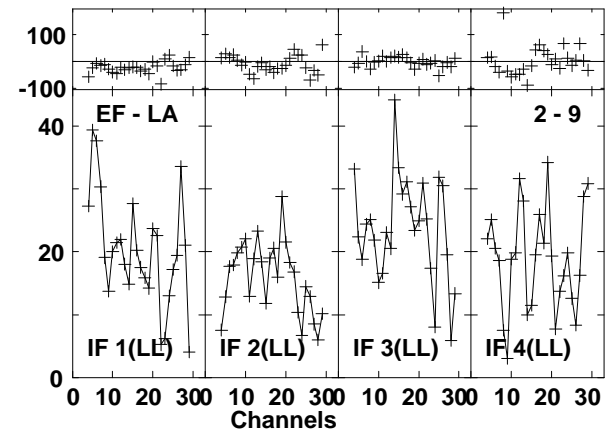
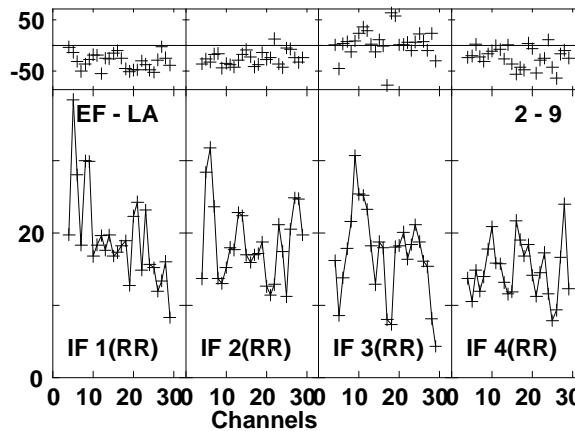
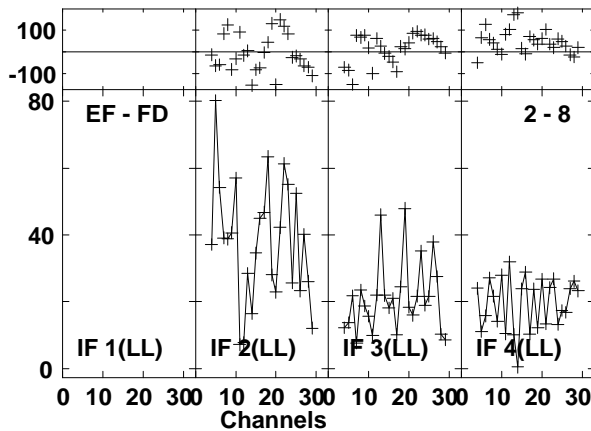
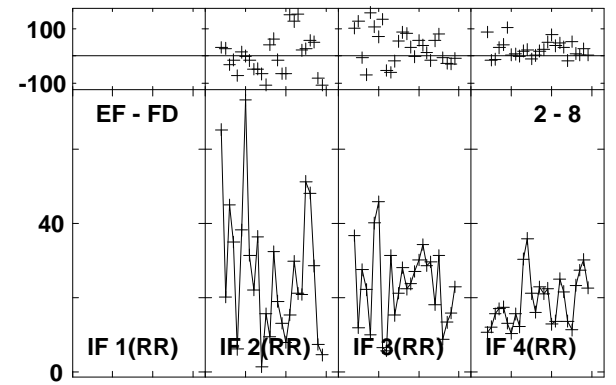
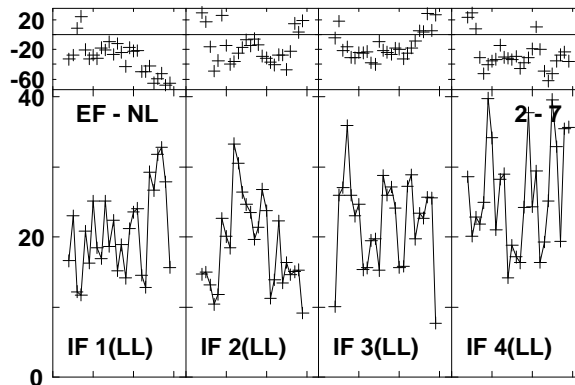
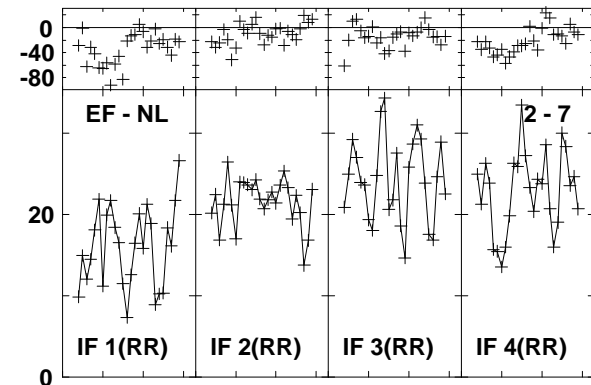
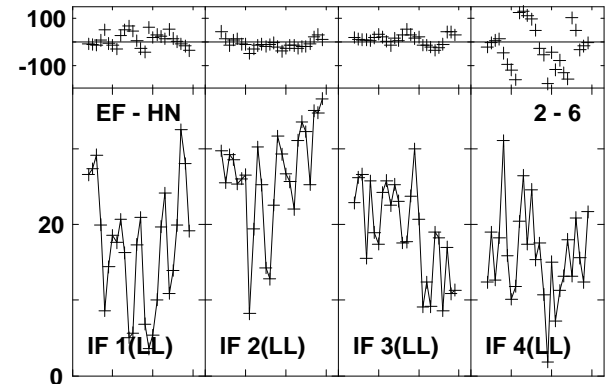
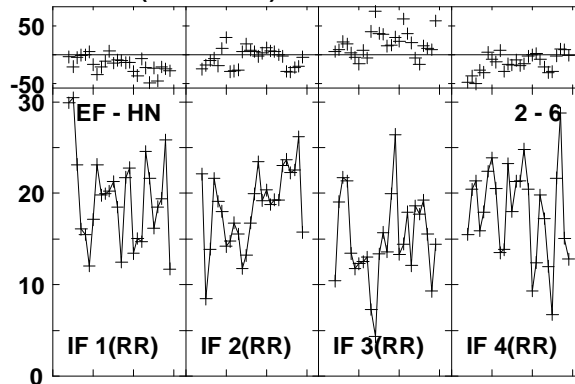
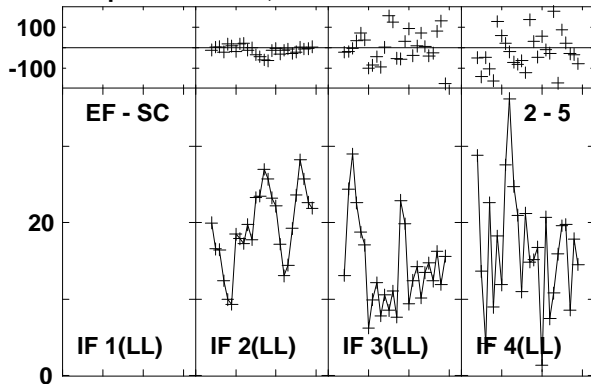

Lower frame: Milli Ampl Jy Top frame: Phas deg

Vector averaged cross-power spectrum Baseline: EF (02) - SC (05)

Timerange: 00/16:36:04 to 00/16:38:58

Plot file version 144 created 03-MAR-2016 01:12:22

4C52 GN002C 1.UVDATA.1

Freq = 1.2770 GHz, Bw = 16.000 MH Calibrated with CL # 3 and BP # 1 (BP mode 1)

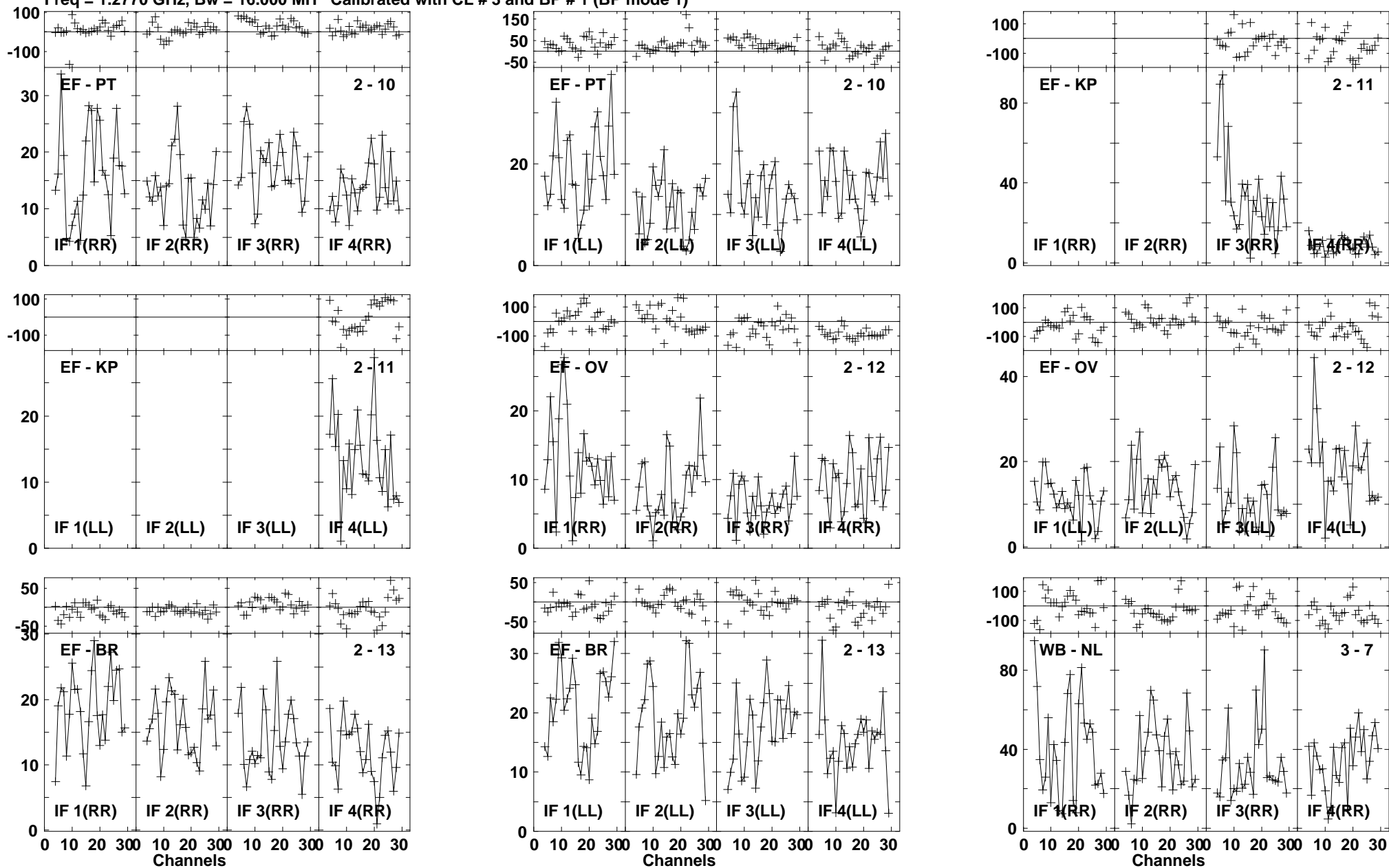

Lower frame: Milli Ampl Jy Top frame: Phas deg
Vector averaged cross-power spectrum Baseline: EF (02) - PT (10)
Timerange: 00/16:36:04 to 00/16:38:58

Plot file version 145 created 03-MAR-2016 01:12:22

4C52 GN002C 1.UVDATA.1

Freq = 1.2770 GHz, Bw = 16.000 MH Calibrated with CL # 3 and BP # 1 (BP mode 1)

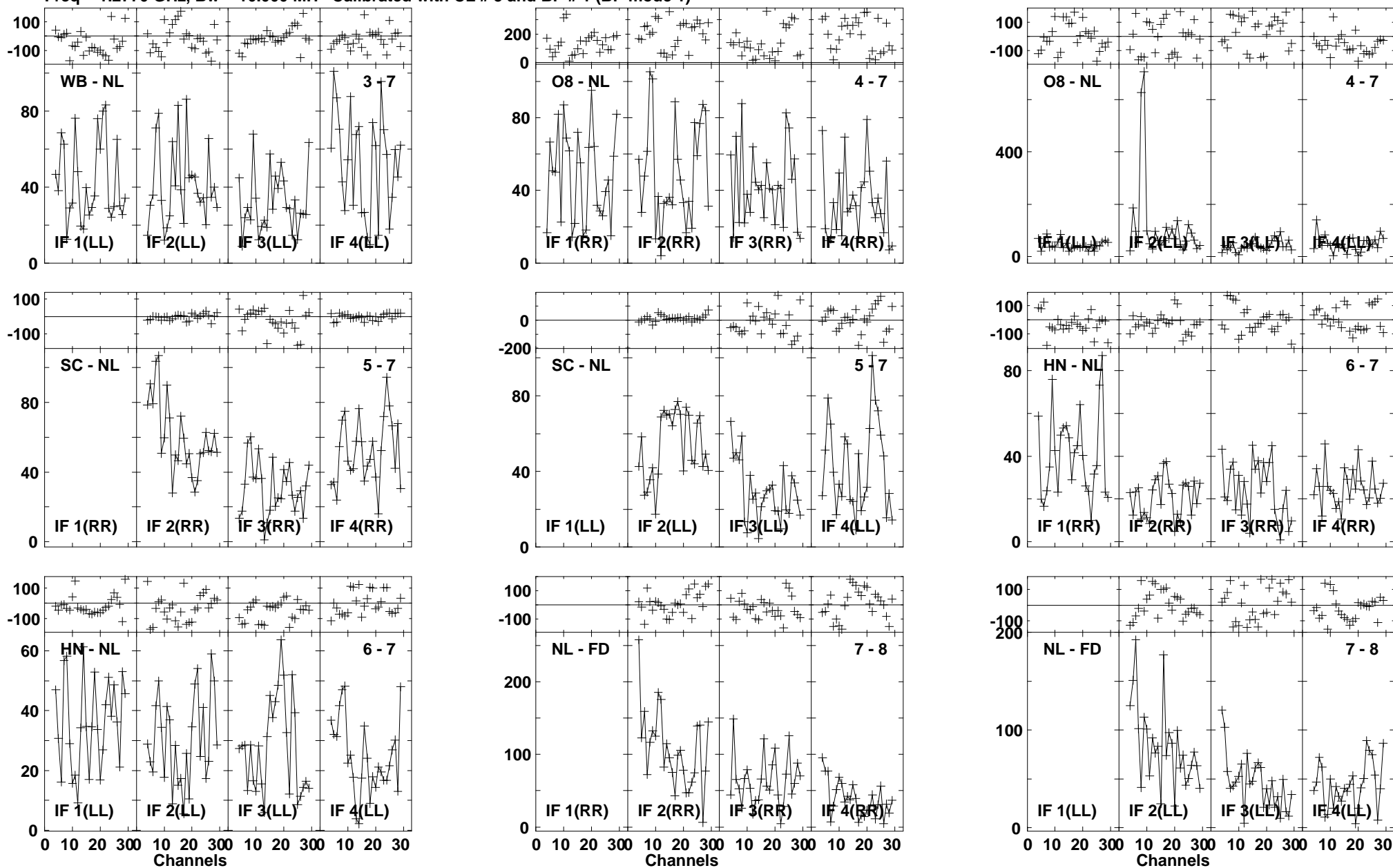

Lower frame: Milli Ampl Jy Top frame: Phas deg
Vector averaged cross-power spectrum Baseline: WB (03) - NL (07)
Timerange: 00/16:36:04 to 00/16:38:58

Plot file version 146 created 03-MAR-2016 01:12:22

4C52 GN002C 1.UVDATA.1

Freq = 1.2770 GHz, Bw = 16.000 MH Calibrated with CL # 3 and BP # 1 (BP mode 1)

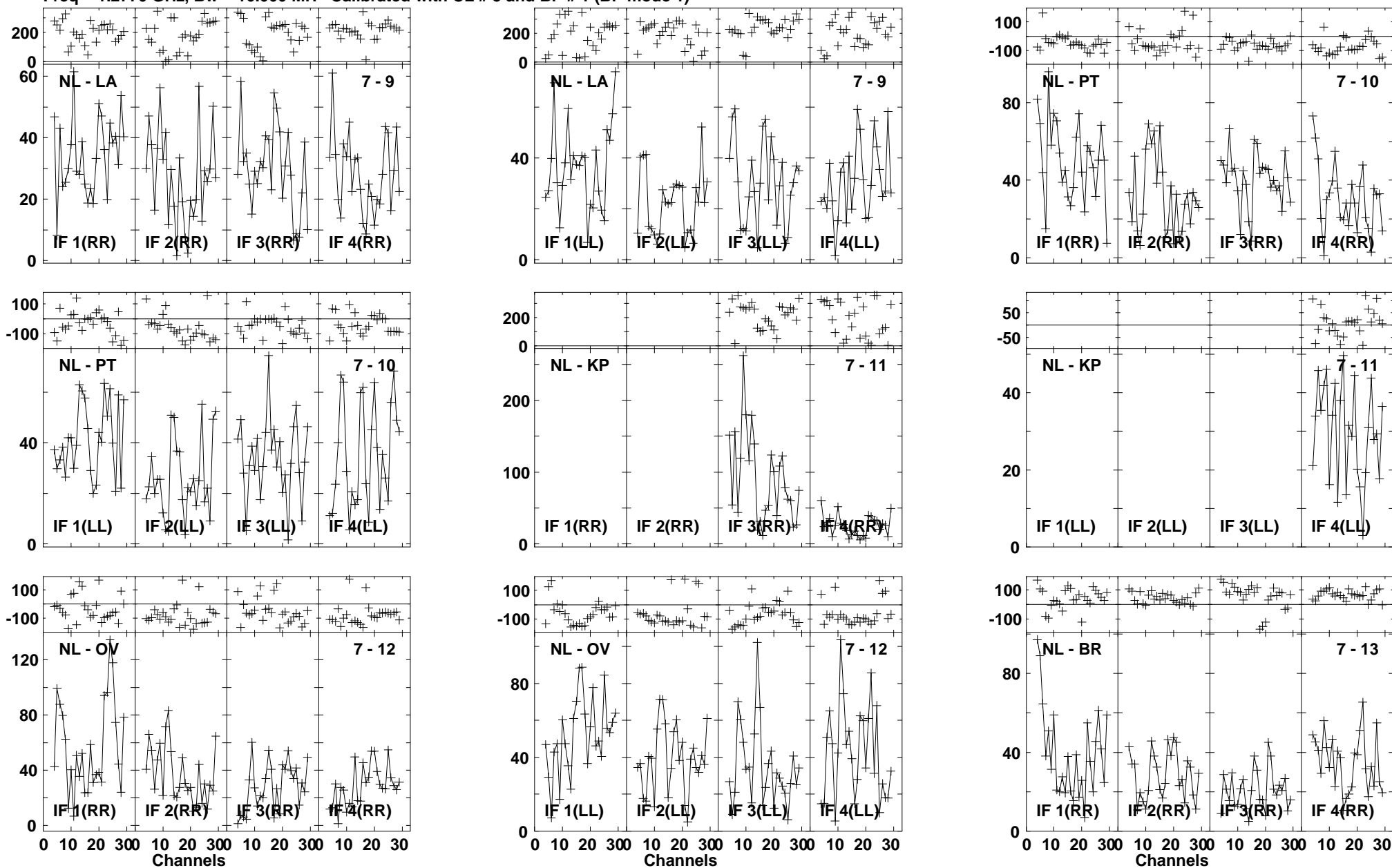

Lower frame: Milli Ampl Jy Top frame: Phas deg
Vector averaged cross-power spectrum Baseline: NL (07) - LA (09)
Timerange: 00/16:36:04 to 00/16:38:58

Plot file version 147 created 03-MAR-2016 01:12:22

4C52 GN002C 1.UVDATA.1

Freq = 1.2770 GHz, Bw = 16.000 MH Calibrated with CL # 3 and BP # 1 (BP mode 1)

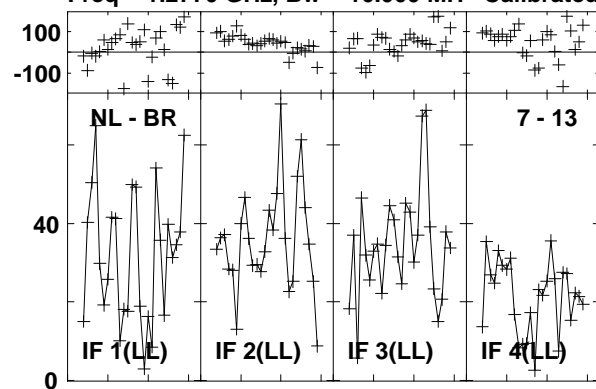

Lower frame: Milli Ampl Jy Top frame: Phas deg

Vector averaged cross-power spectrum Baseline: NL (07) - BR (13)

Timerange: 00/16:36:04 to 00/16:38:58

Plot file version 148 created 03-MAR-2016 01:12:22

J1545+5400 GN002C 1.UVDATA.1

Freq = 1.2770 GHz, Bw = 16.000 MH Calibrated with CL # 3 and BP # 1 (BP mode 1)

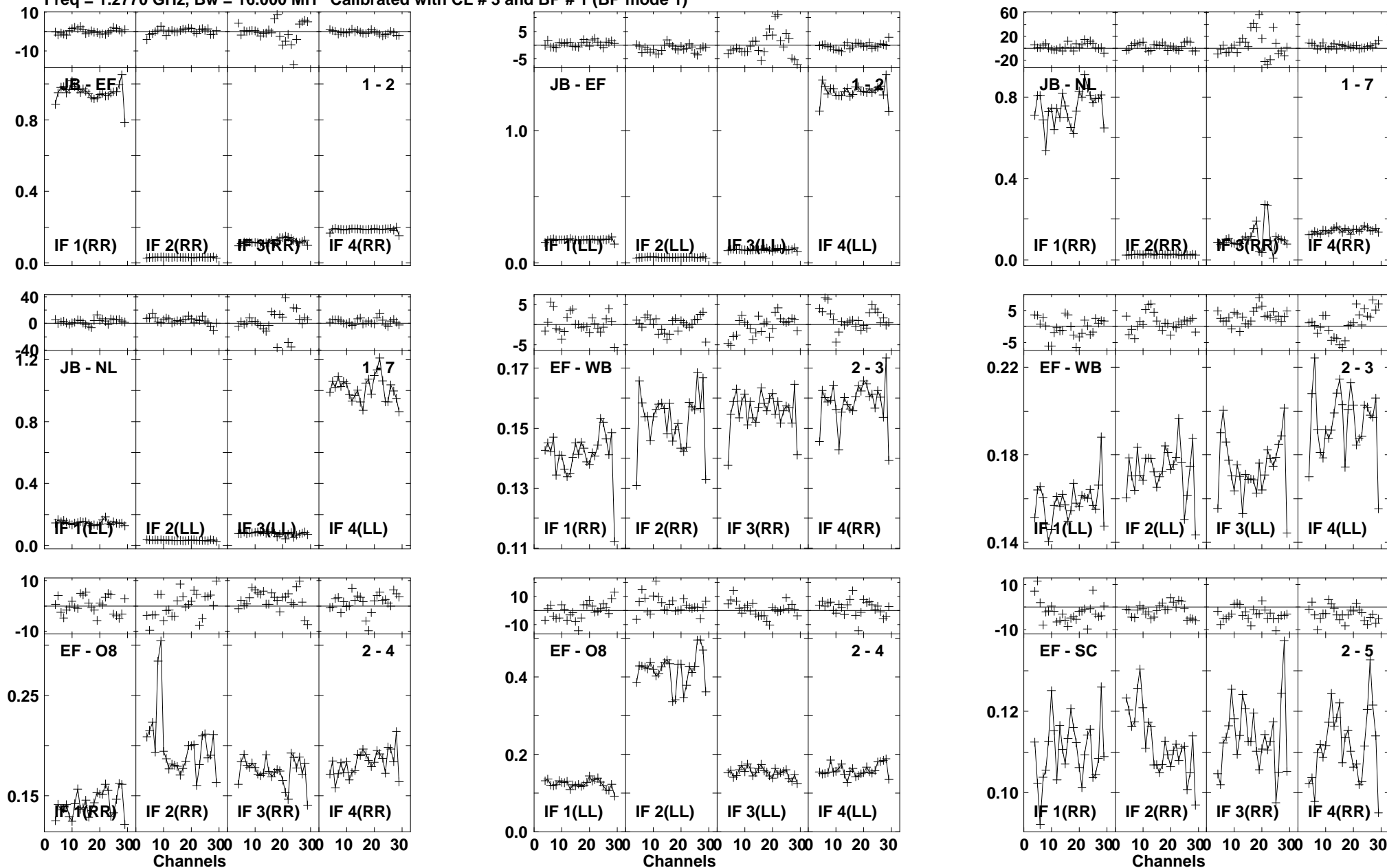

Lower frame: Ampl Jy Top frame: Phas deg
Vector averaged cross-power spectrum Baseline: JB (01) - EF (02)
Timerange: 00/16:39:51 to 00/16:41:49

Plot file version 149 created 03-MAR-2016 01:12:23

J1545+5400 GN002C 1.UVDATA.1

Freq = 1.2770 GHz, Bw = 16.000 MH Calibrated with CL # 3 and BP # 1 (BP mode 1)

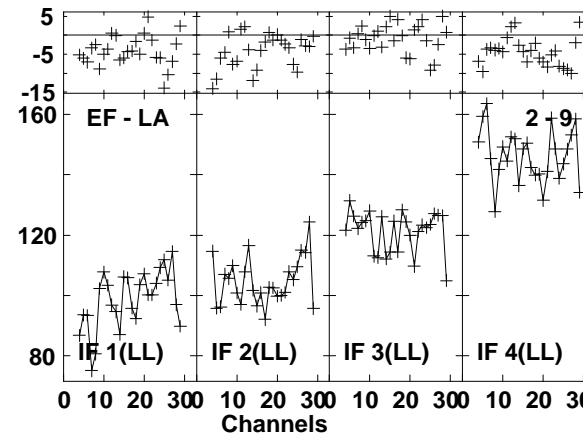
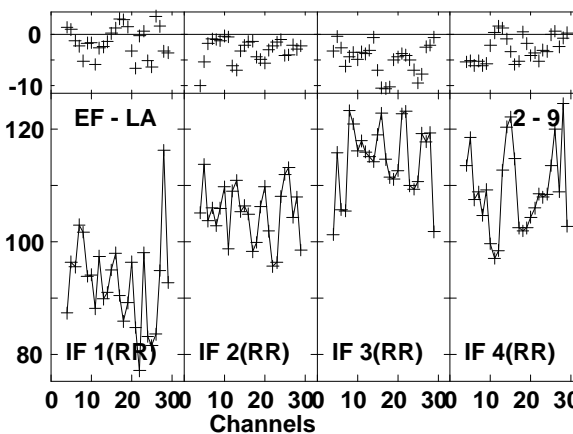
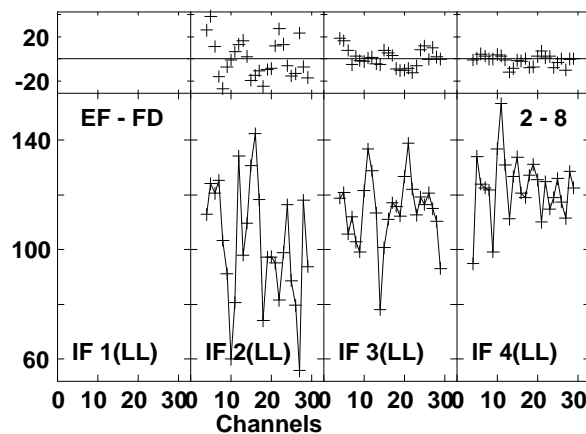
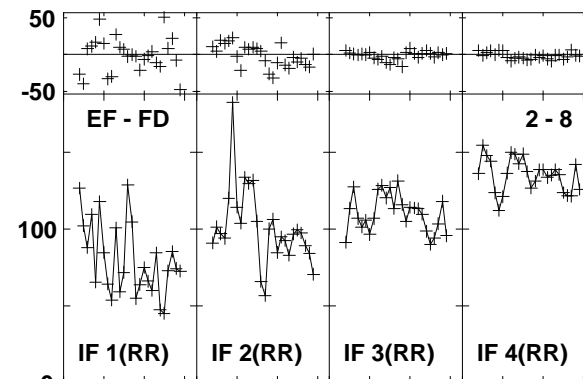
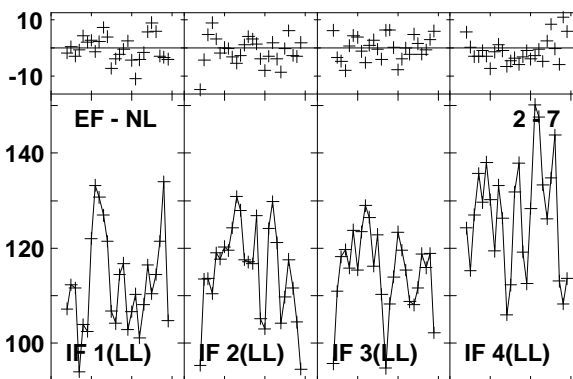
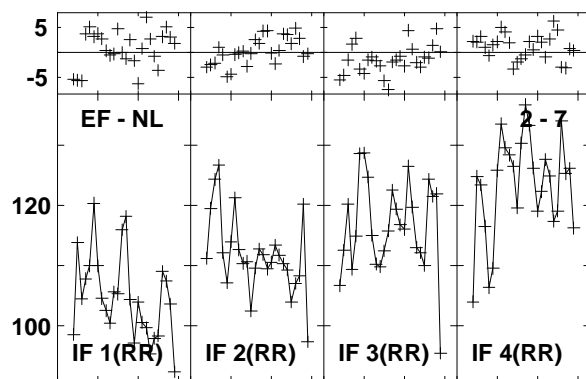
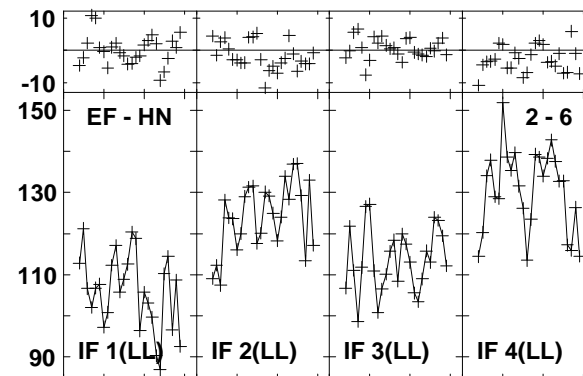
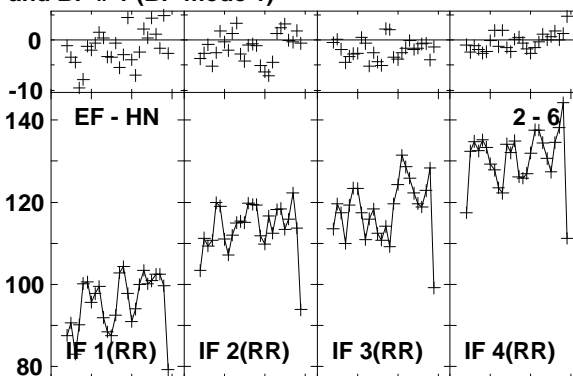
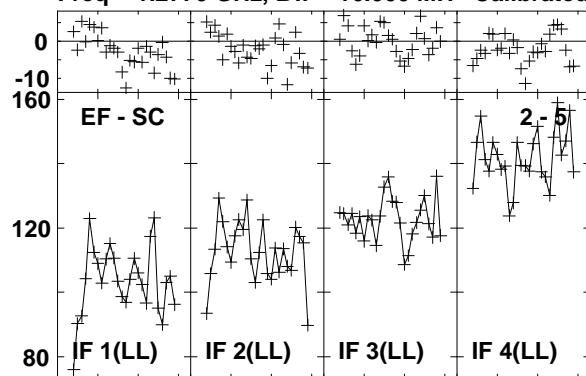

Lower frame: Milli Ampl Jy Top frame: Phas deg
Vector averaged cross-power spectrum Baseline: EF (02) - SC (05)
Timerange: 00/16:39:51 to 00/16:41:49

Plot file version 150 created 03-MAR-2016 01:12:23

J1545+5400 GN002C 1.UVDATA.1

Freq = 1.2770 GHz, Bw = 16.000 MH Calibrated with CL # 3 and BP # 1 (BP mode 1)

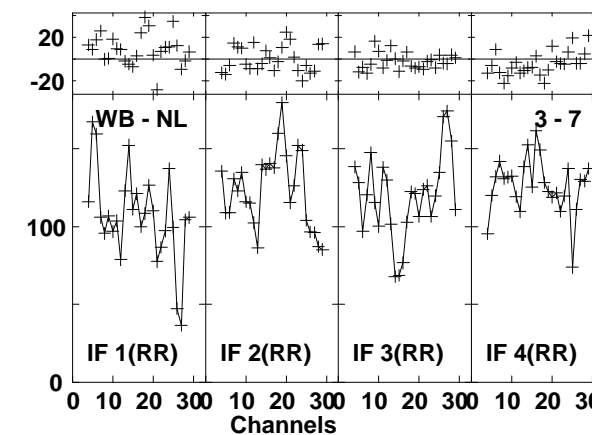
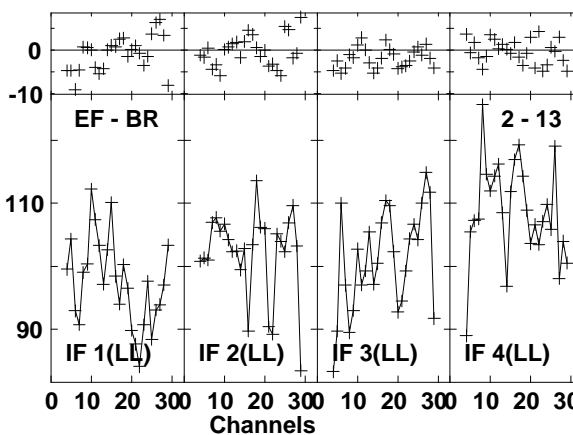
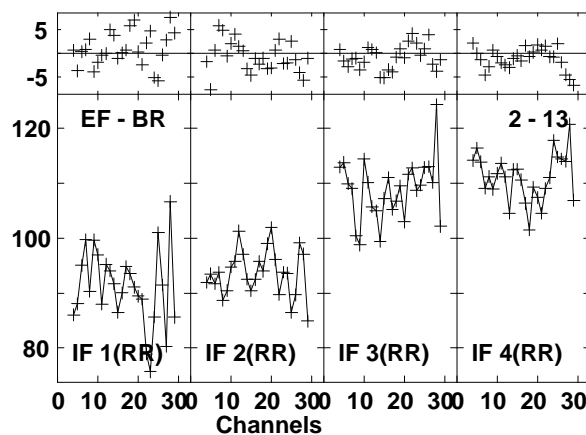
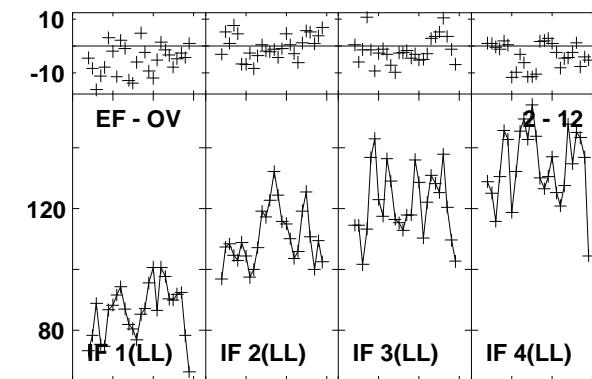
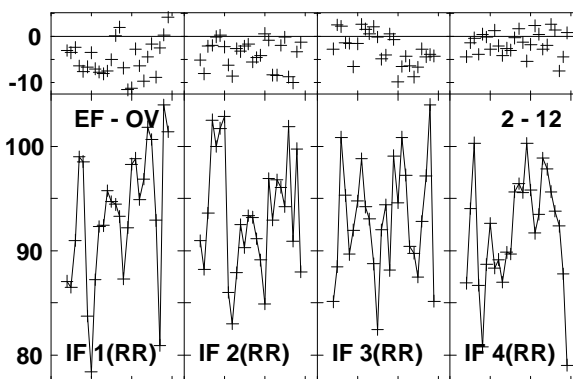
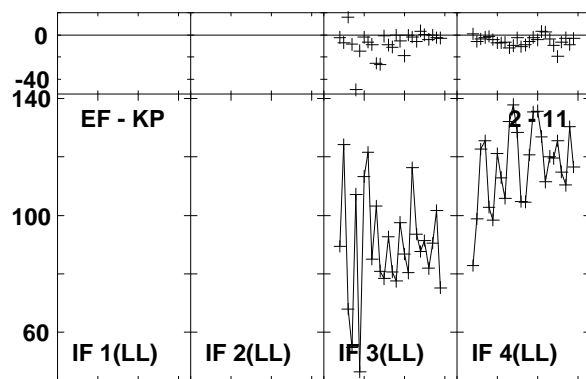
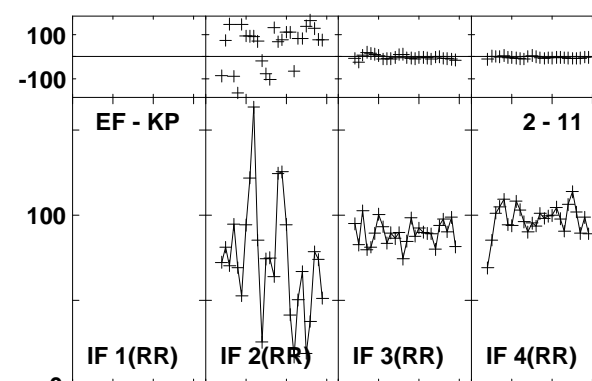
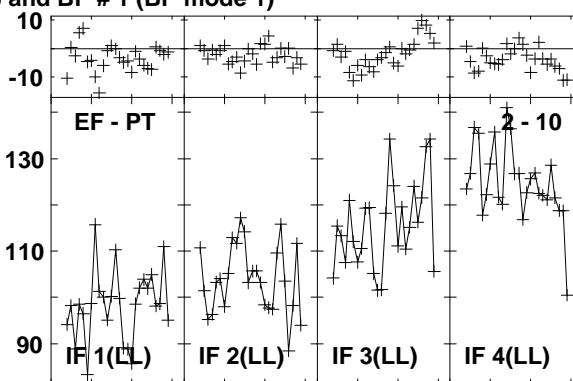
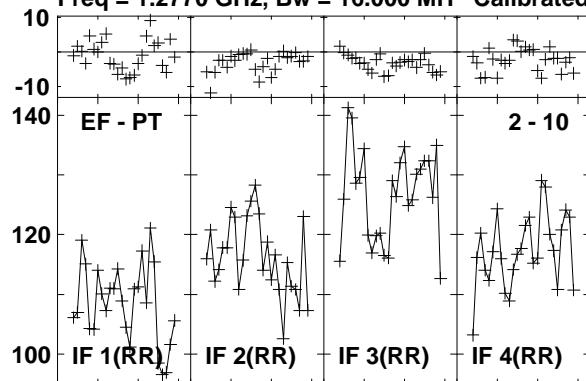

Lower frame: Milli Ampl Jy Top frame: Phas deg
Vector averaged cross-power spectrum Baseline: EF (02) - PT (10)
Timerange: 00/16:39:51 to 00/16:41:49

Plot file version 151 created 03-MAR-2016 01:12:23

J1545+5400 GN002C 1.UVDATA.1

Freq = 1.2770 GHz, Bw = 16.000 MH Calibrated with CL # 3 and BP # 1 (BP mode 1)

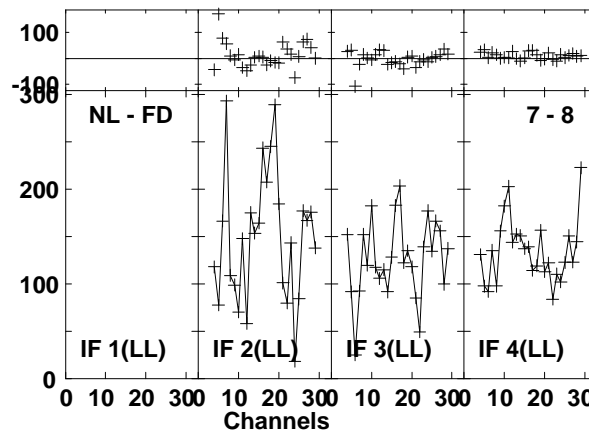
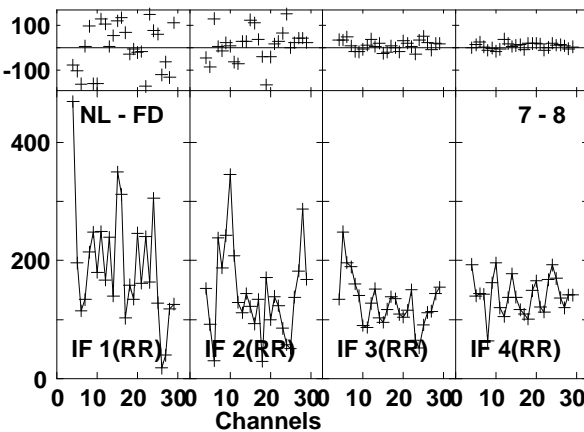
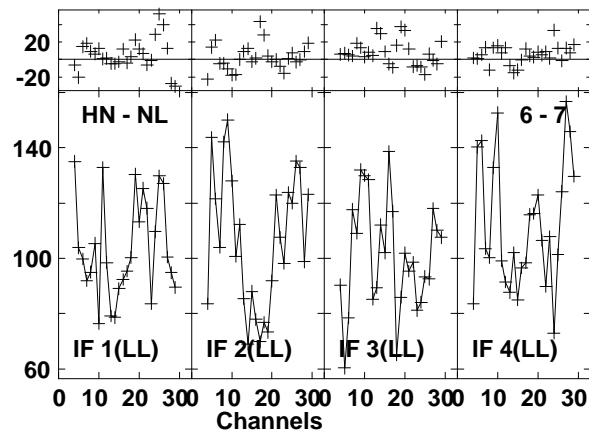
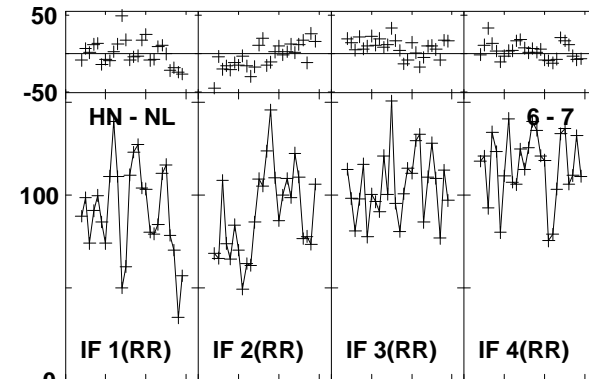
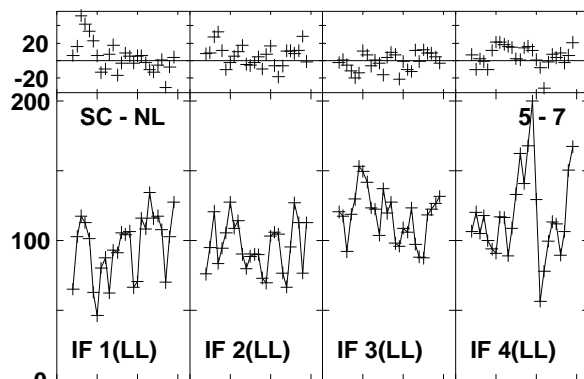
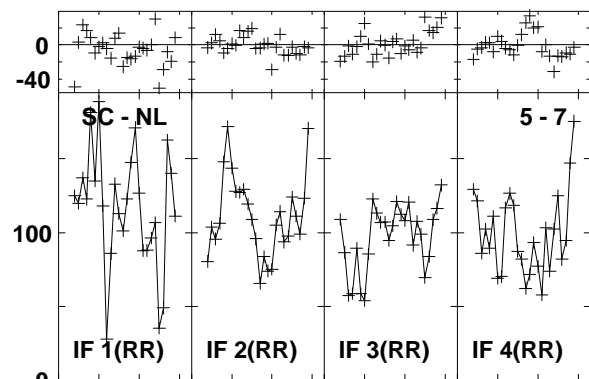
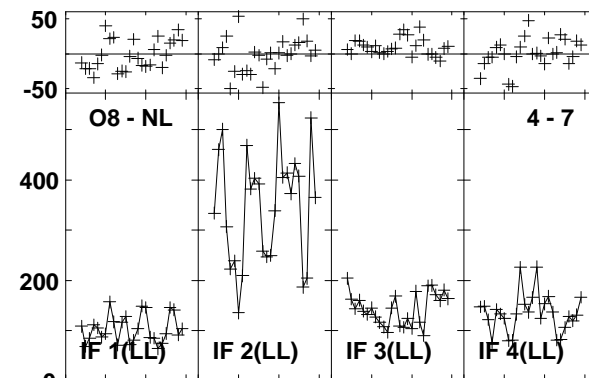
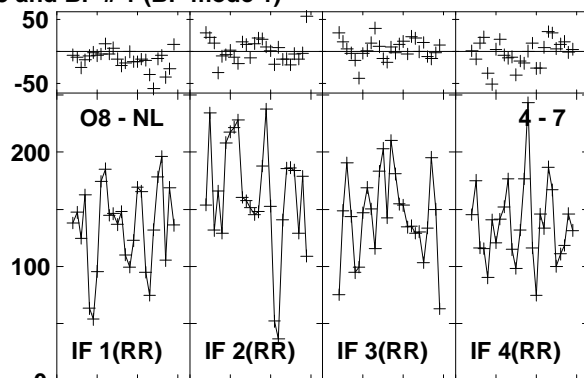
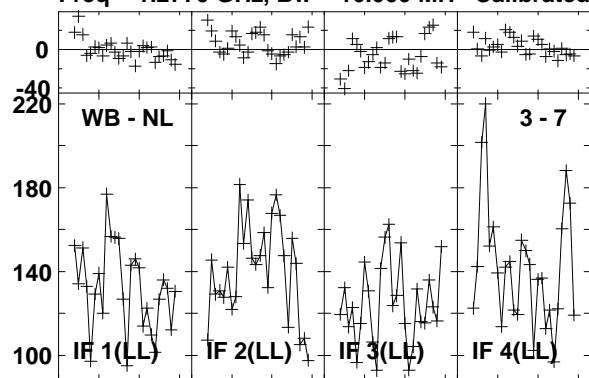

Lower frame: Milli Ampl Jy Top frame: Phas deg
Vector averaged cross-power spectrum Baseline: WB (03) - NL (07)
Timerange: 00/16:39:51 to 00/16:41:49

Plot file version 152 created 03-MAR-2016 01:12:23

J1545+5400 GN002C 1.UVDATA.1

Freq = 1.2770 GHz, Bw = 16.000 MH Calibrated with CL # 3 and BP # 1 (BP mode 1)

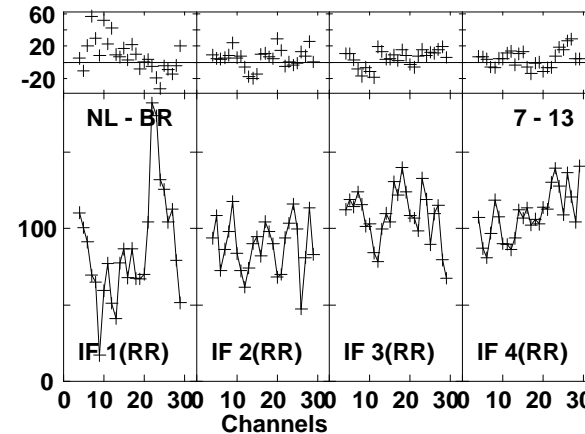
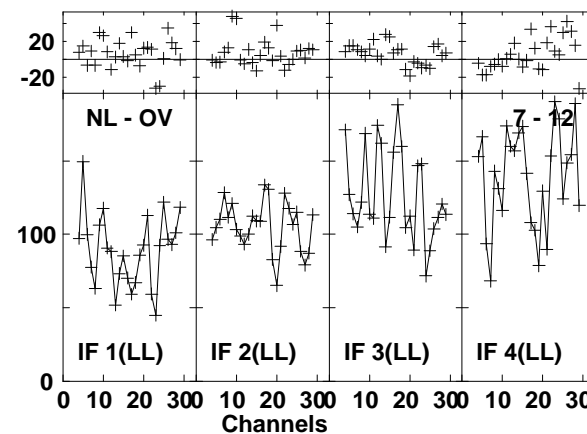
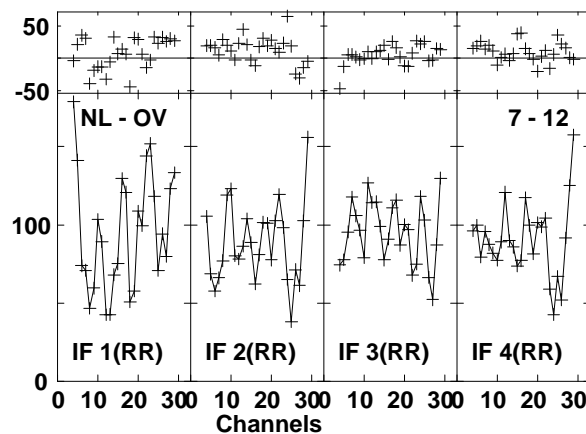
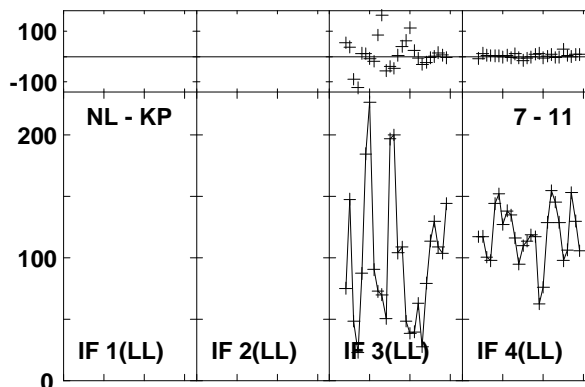
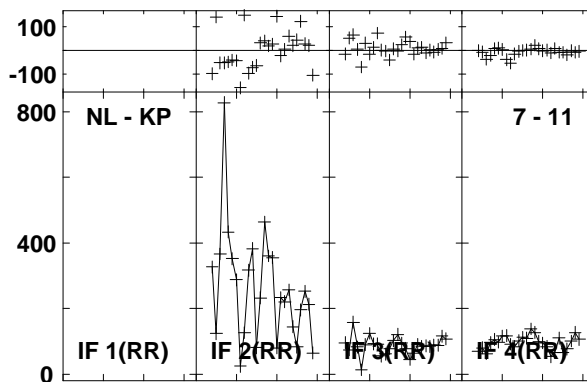
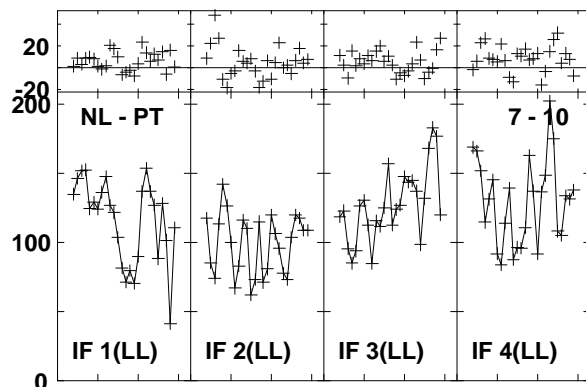
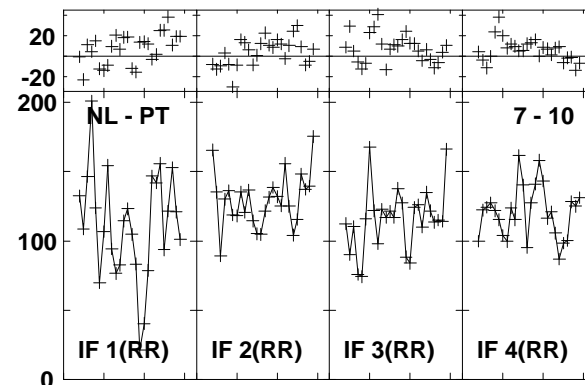
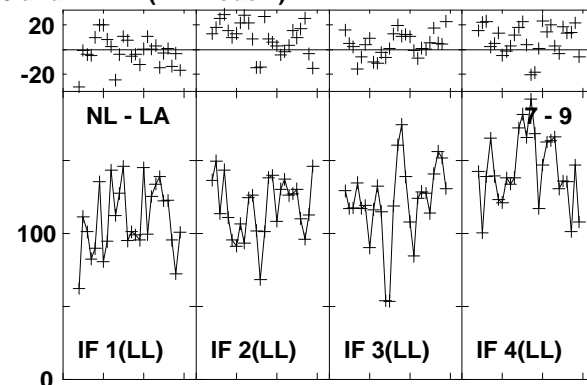
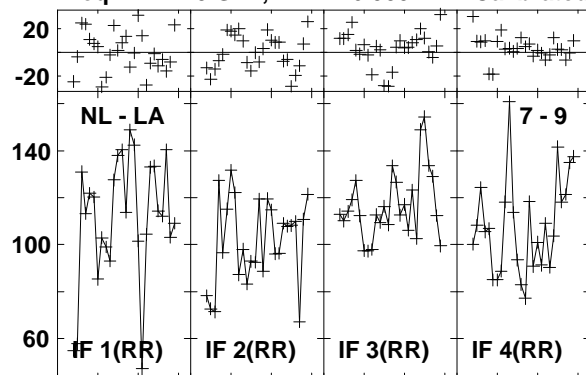

Lower frame: Milli Ampl Jy Top frame: Phas deg
Vector averaged cross-power spectrum Baseline: NL (07) - LA (09)
Timerange: 00/16:39:51 to 00/16:41:49

Plot file version 153 created 03-MAR-2016 01:12:23
J1545+5400 GN002C 1.UVDATA.1
Freq = 1.2770 GHz, Bw = 16.000 MH Calibrated with CL # 3 and BP # 1 (BP mode 1)

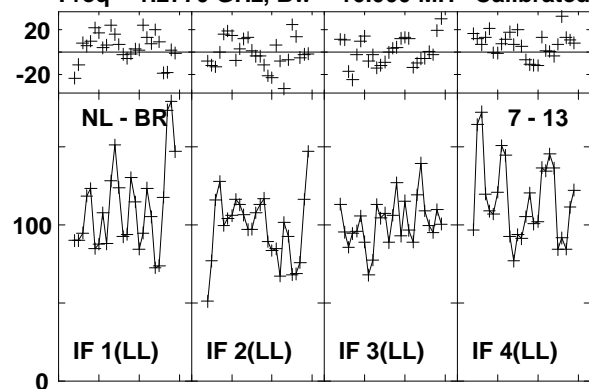

Lower frame: Milli Ampl Jy Top frame: Phas deg
Vector averaged cross-power spectrum Baseline: NL (07) - BR (13)
Timerange: 00/16:39:51 to 00/16:41:49

Plot file version 154 created 03-MAR-2016 01:12:23

J1638+5720 GN002C 1.UVDATA.1

Freq = 1.2770 GHz, Bw = 16.000 MH Calibrated with CL # 3 and BP # 1 (BP mode 1)

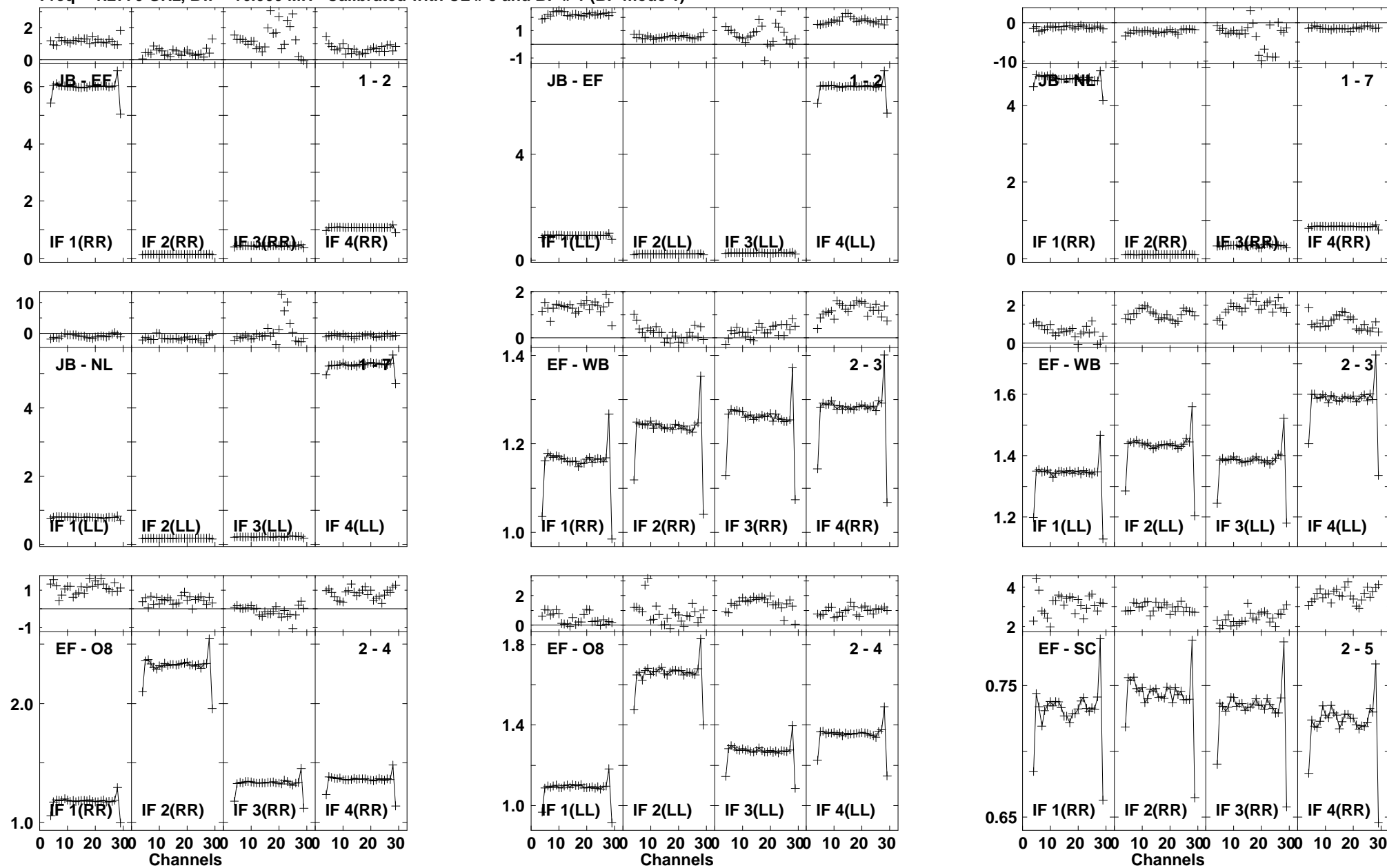

Lower frame: Ampl Jy Top frame: Phas deg
Vector averaged cross-power spectrum Baseline: JB (01) - EF (02)
Timerange: 00/16:43:08 to 00/16:46:56

Plot file version 155 created 03-MAR-2016 01:12:24

J1638+5720 GN002C 1.UVDATA.1

Freq = 1.2770 GHz, Bw = 16.000 MH Calibrated with CL # 3 and BP # 1 (BP mode 1)

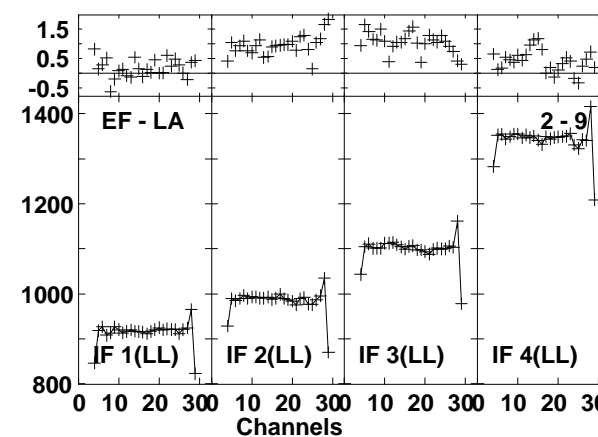
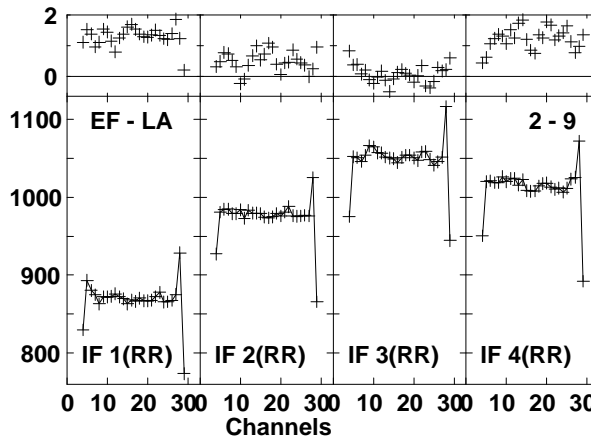
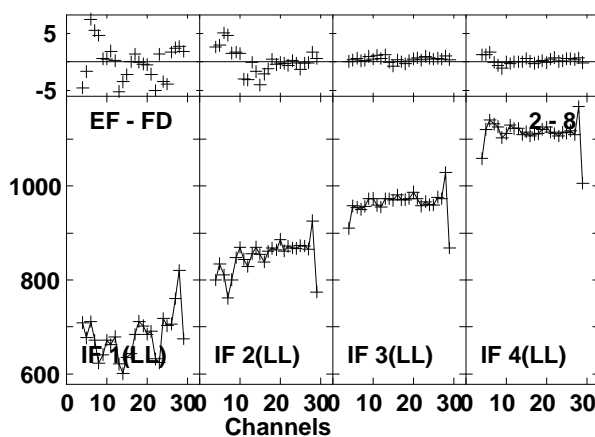
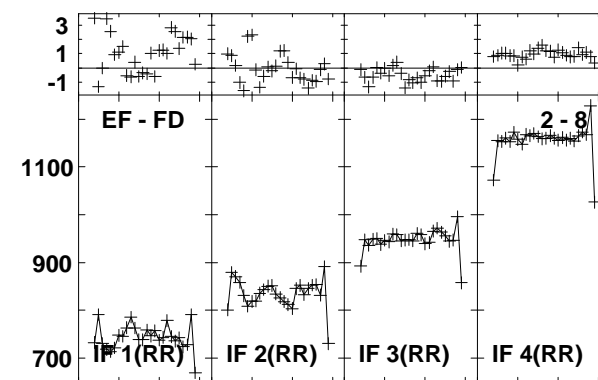
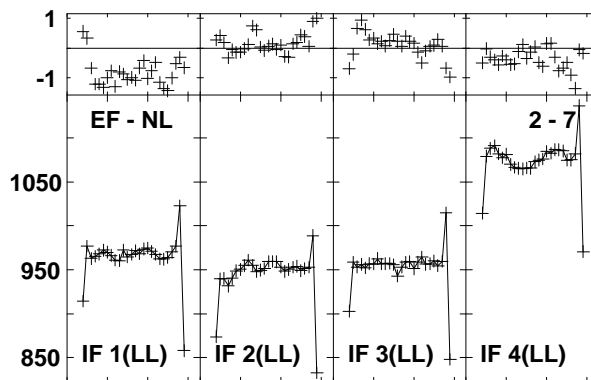
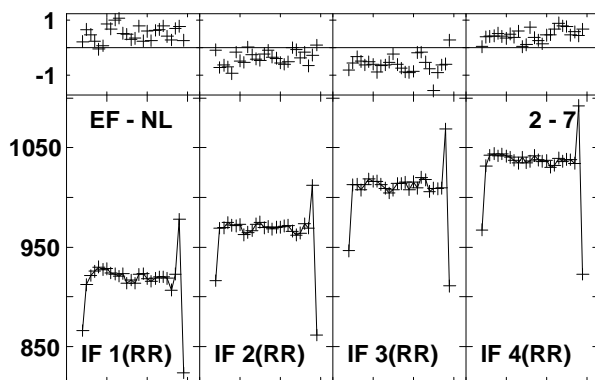
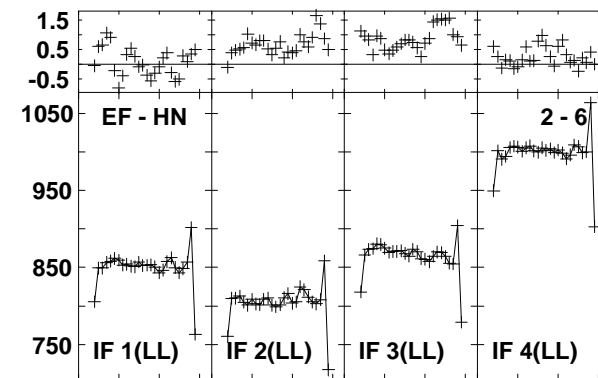
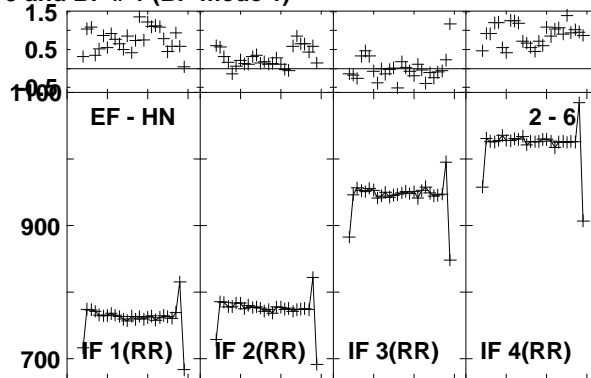
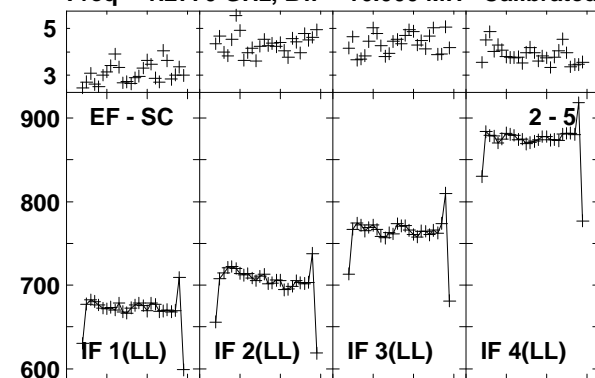

Lower frame: Milli Ampl Jy Top frame: Phas deg
Vector averaged cross-power spectrum Baseline: EF (02) - SC (05)
Timerange: 00/16:43:08 to 00/16:46:56

Plot file version 156 created 03-MAR-2016 01:12:24

J1638+5720 GN002C 1.UVDATA.1

Freq = 1.2770 GHz, Bw = 16.000 MH Calibrated with CL # 3 and BP # 1 (BP mode 1)

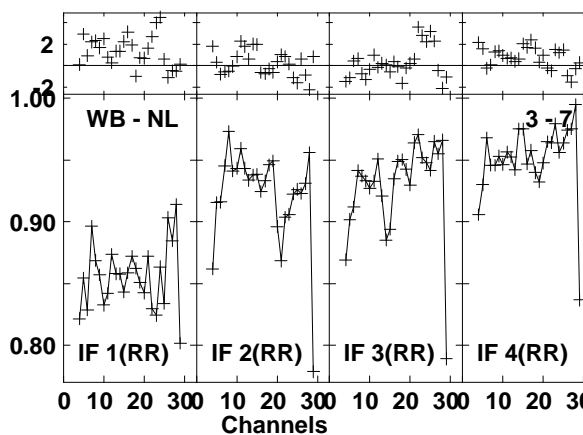
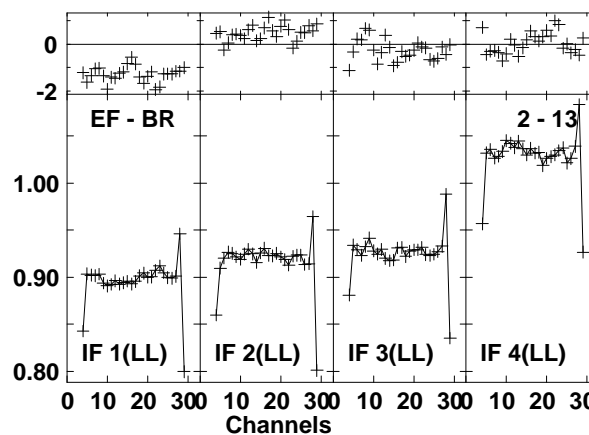
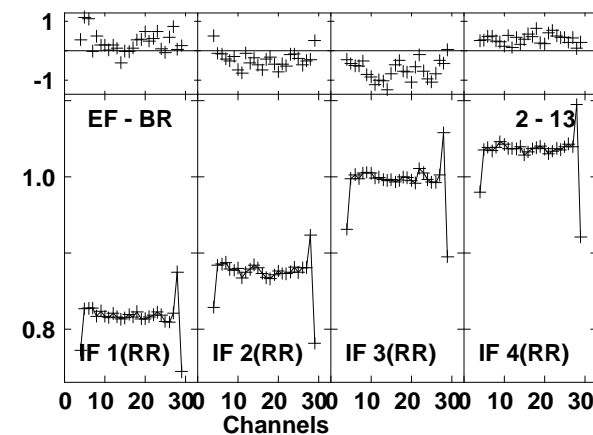
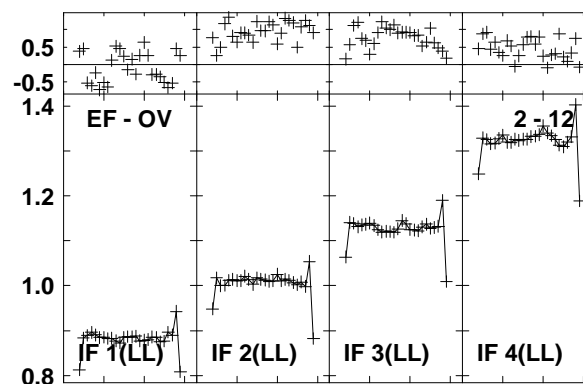
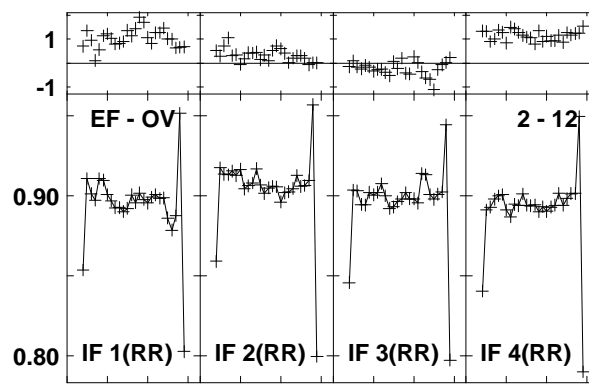
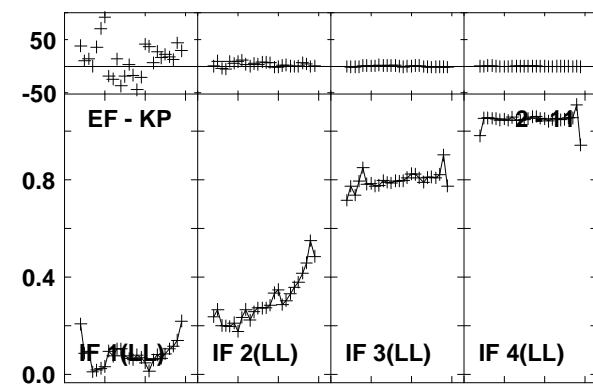
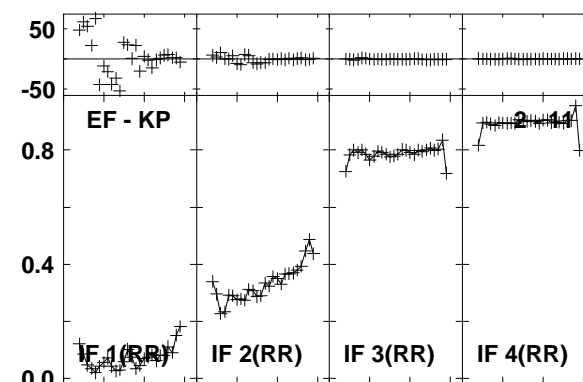
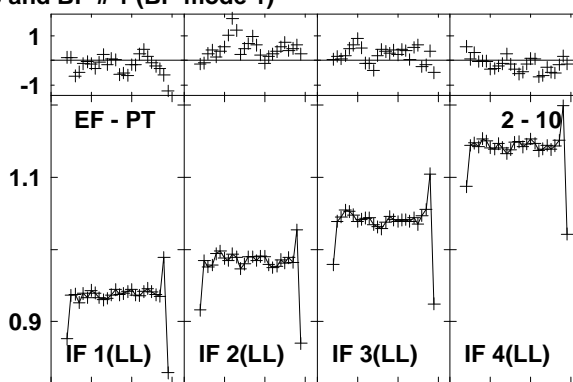
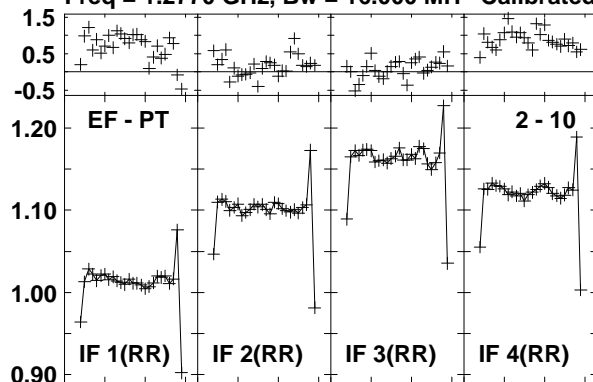

Lower frame: Ampl Jy Top frame: Phas deg
Vector averaged cross-power spectrum Baseline: EF (02) - PT (10)
Timerange: 00/16:43:08 to 00/16:46:56

Plot file version 157 created 03-MAR-2016 01:12:24

J1638+5720 GN002C 1.UVDATA.1

Freq = 1.2770 GHz, Bw = 16.000 MH Calibrated with CL # 3 and BP # 1 (BP mode 1)

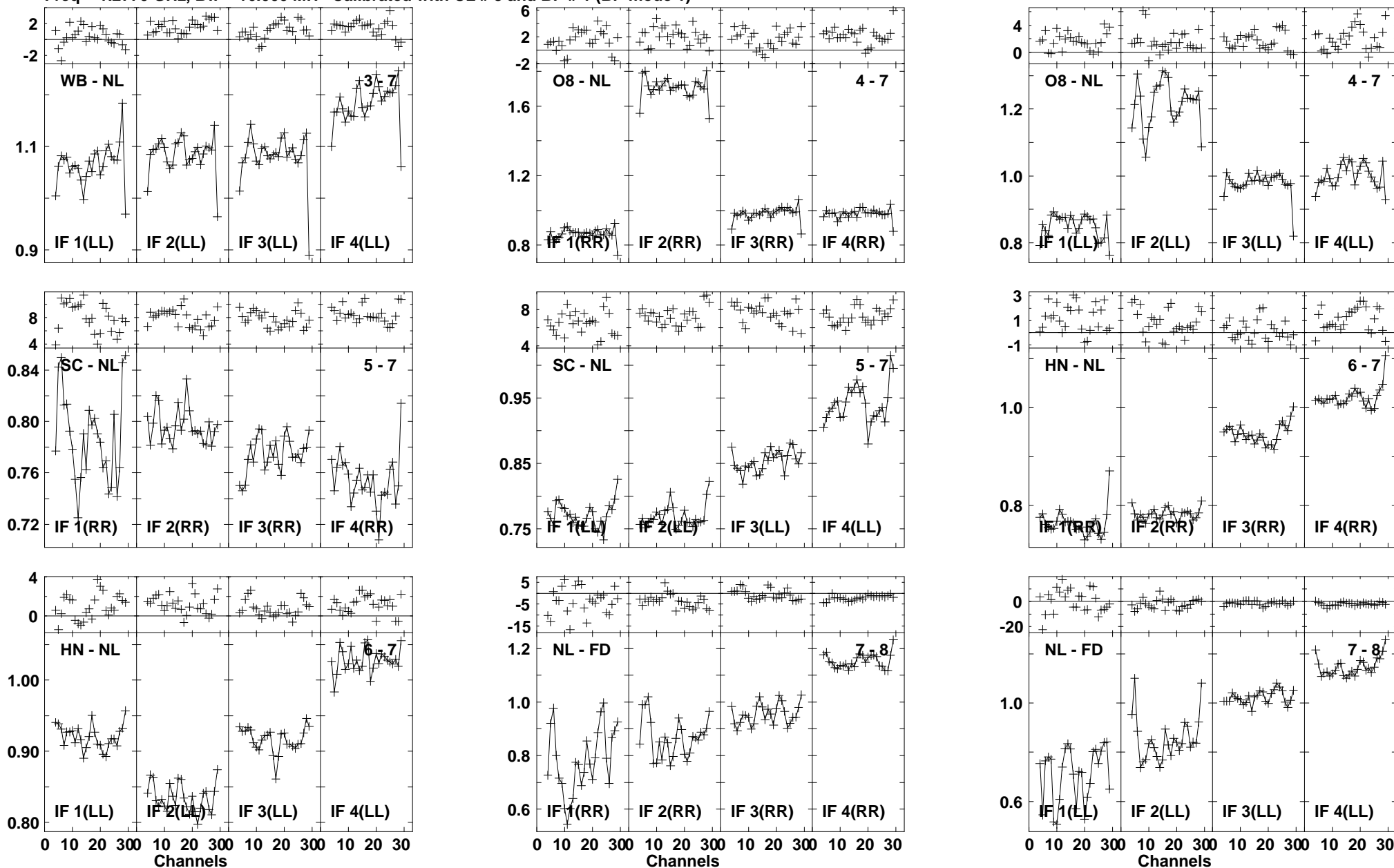

Lower frame: Ampl Jy Top frame: Phas deg
Vector averaged cross-power spectrum Baseline: WB (03) - NL (07)
Timerange: 00/16:43:08 to 00/16:46:56

Plot file version 158 created 03-MAR-2016 01:12:24

J1638+5720 GN002C 1.UVDATA.1

Freq = 1.2770 GHz, Bw = 16.000 MH Calibrated with CL # 3 and BP # 1 (BP mode 1)

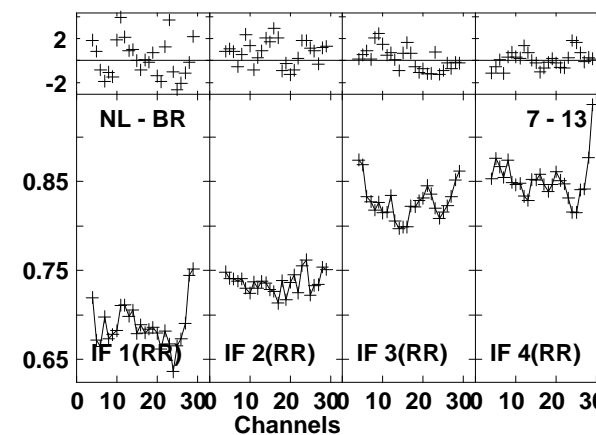
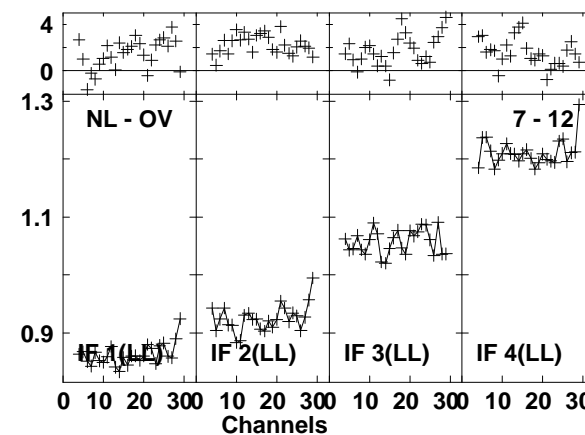
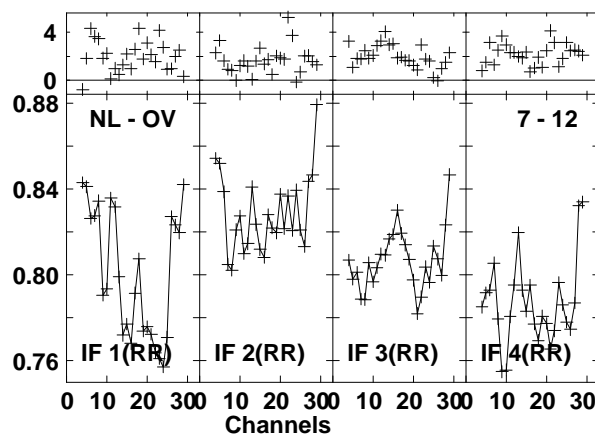
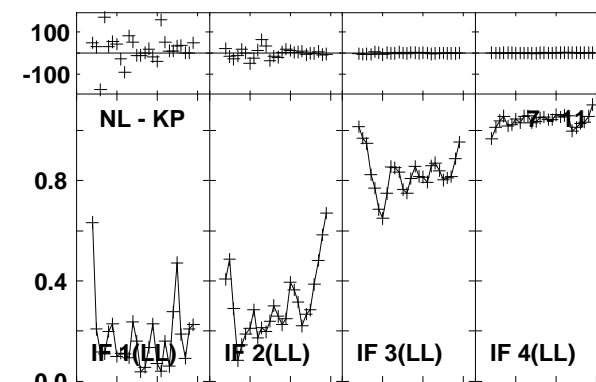
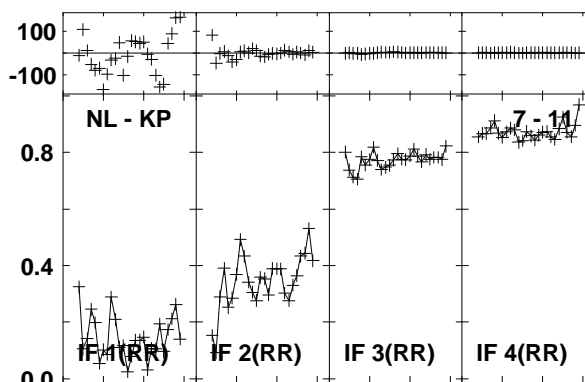
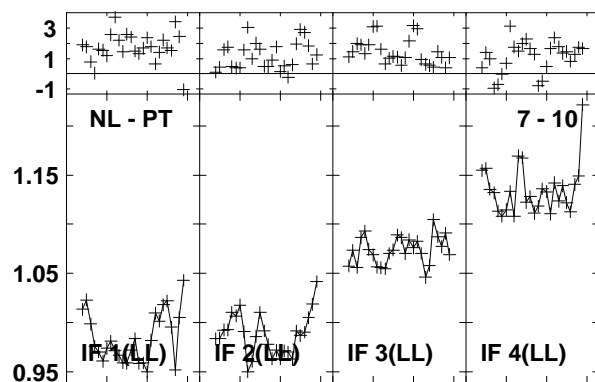
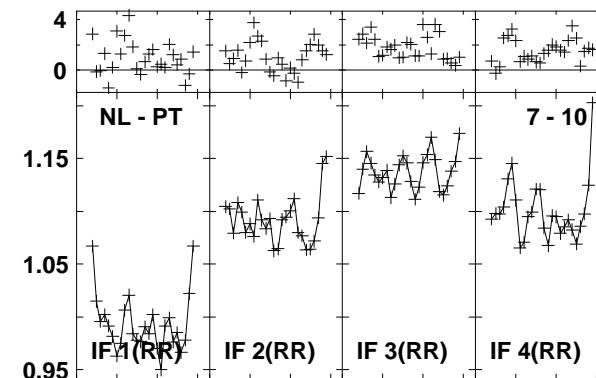
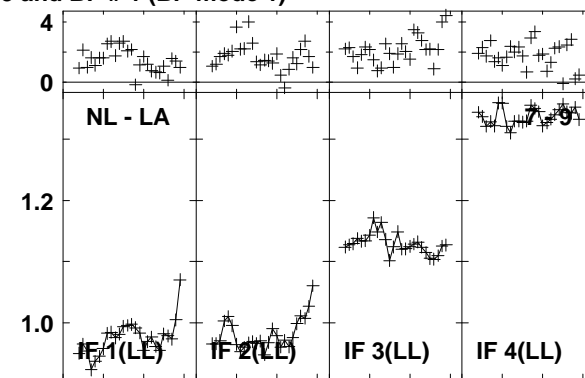
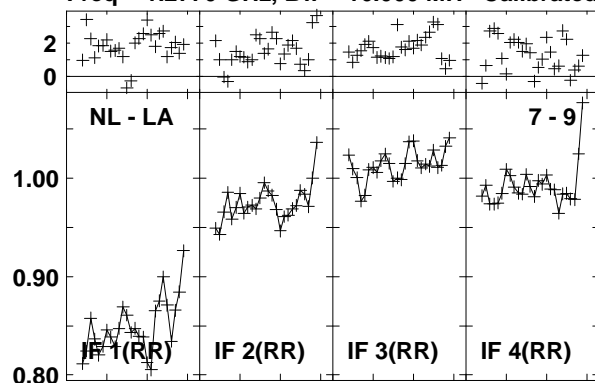

Lower frame: Ampl Jy Top frame: Phas deg
Vector averaged cross-power spectrum Baseline: NL (07) - LA (09)
Timerange: 00/16:43:08 to 00/16:46:56

Plot file version 159 created 03-MAR-2016 01:12:24

J1638+5720 GN002C 1.UVDATA.1

Freq = 1.2770 GHz, Bw = 16.000 MH Calibrated with CL # 3 and BP # 1 (BP mode 1)

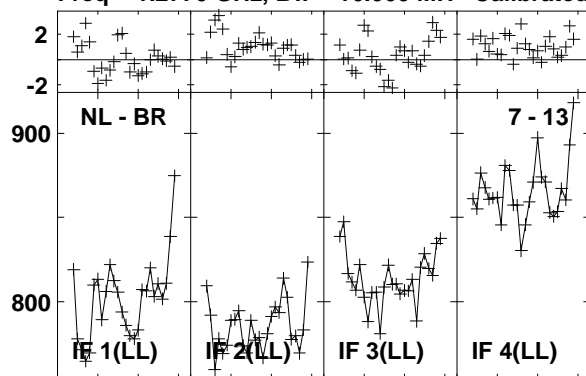

Lower frame: Milli Ampl Jy Top frame: Phas deg
Vector averaged cross-power spectrum Baseline: NL (07) - BR (13)
Timerange: 00/16:43:08 to 00/16:46:56

Plot file version 160 created 03-MAR-2016 01:12:24

J1545+5400 GN002C 1.UVDATA.1

Freq = 1.2770 GHz, Bw = 16.000 MH Calibrated with CL # 3 and BP # 1 (BP mode 1)

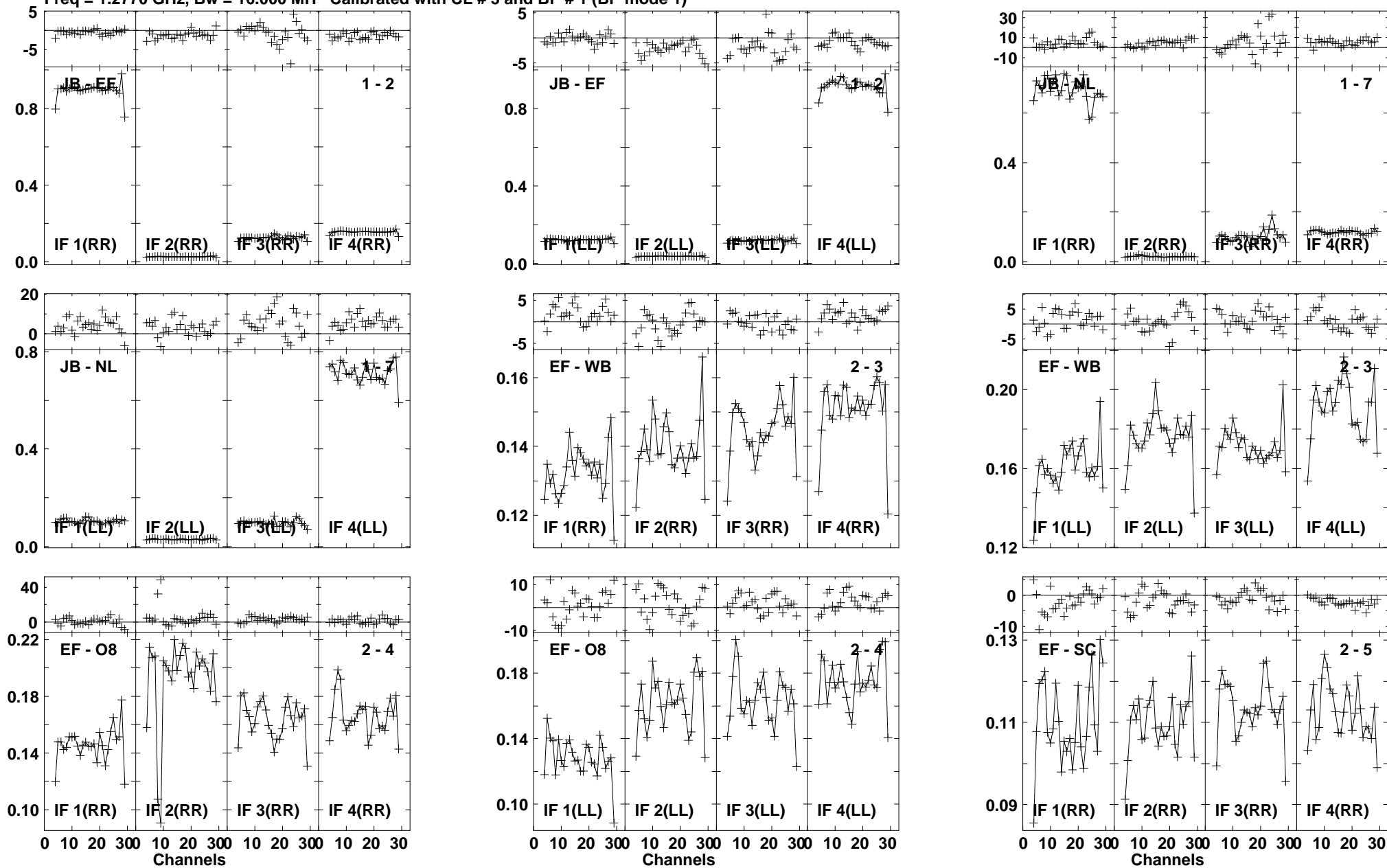

Lower frame: Ampl Jy Top frame: Phas deg
Vector averaged cross-power spectrum Baseline: JB (01) - EF (02)
Timerange: 00/16:48:18 to 00/16:51:06

Plot file version 161 created 03-MAR-2016 01:12:25

J1545+5400 GN002C 1.UVDATA.1

Freq = 1.2770 GHz, Bw = 16.000 MH Calibrated with CL # 3 and BP # 1 (BP mode 1)

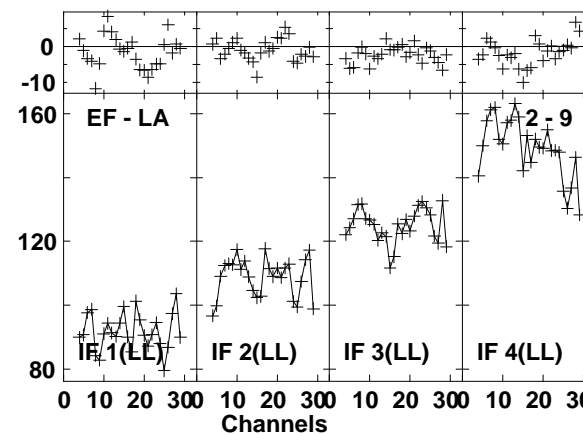
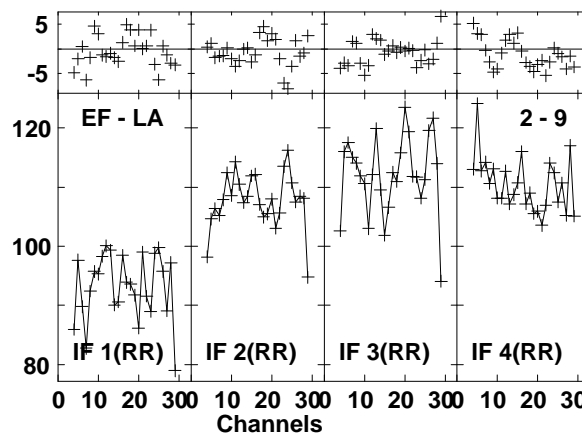
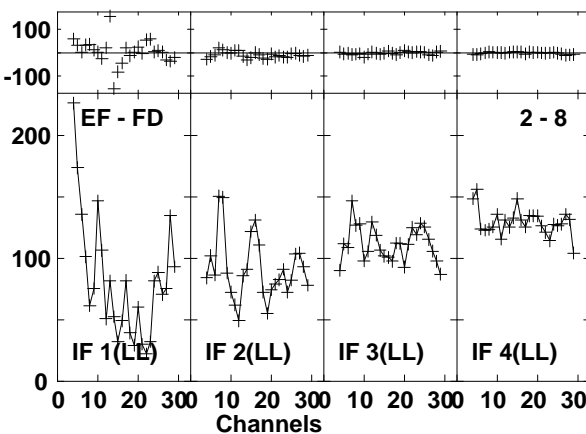
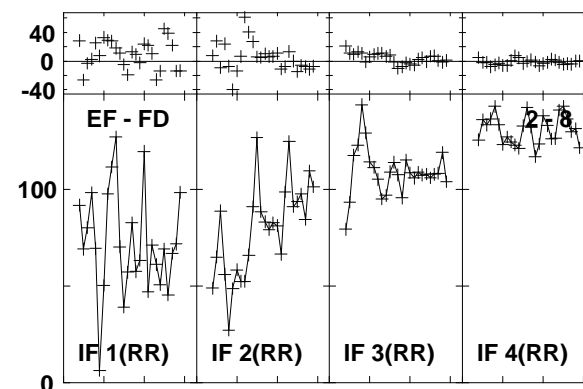
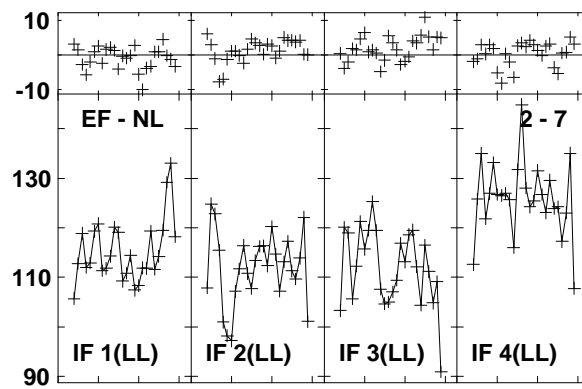
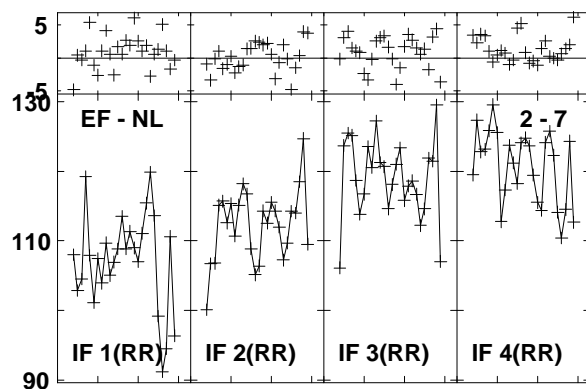
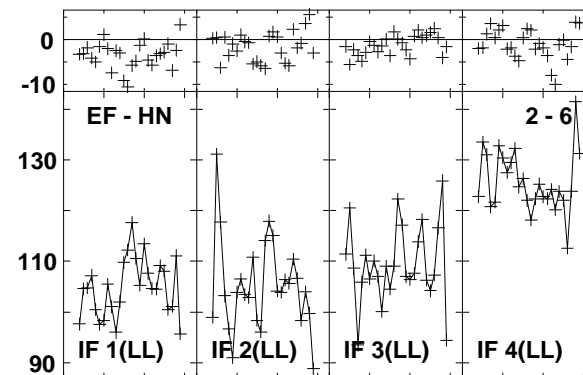
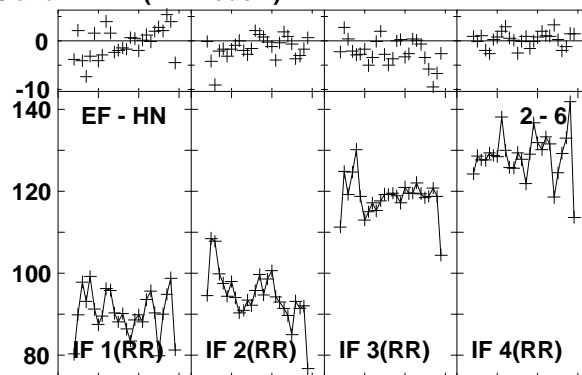
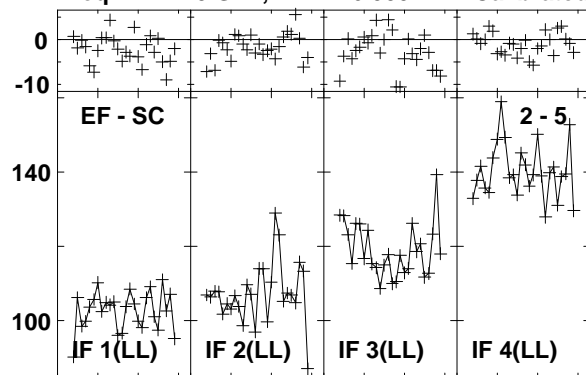

Lower frame: Milli Ampl Jy Top frame: Phas deg
Vector averaged cross-power spectrum Baseline: EF (02) - SC (05)
Timerange: 00/16:48:18 to 00/16:51:06

Plot file version 162 created 03-MAR-2016 01:12:25

J1545+5400 GN002C 1.UVDATA.1

Freq = 1.2770 GHz, Bw = 16.000 MH Calibrated with CL # 3 and BP # 1 (BP mode 1)

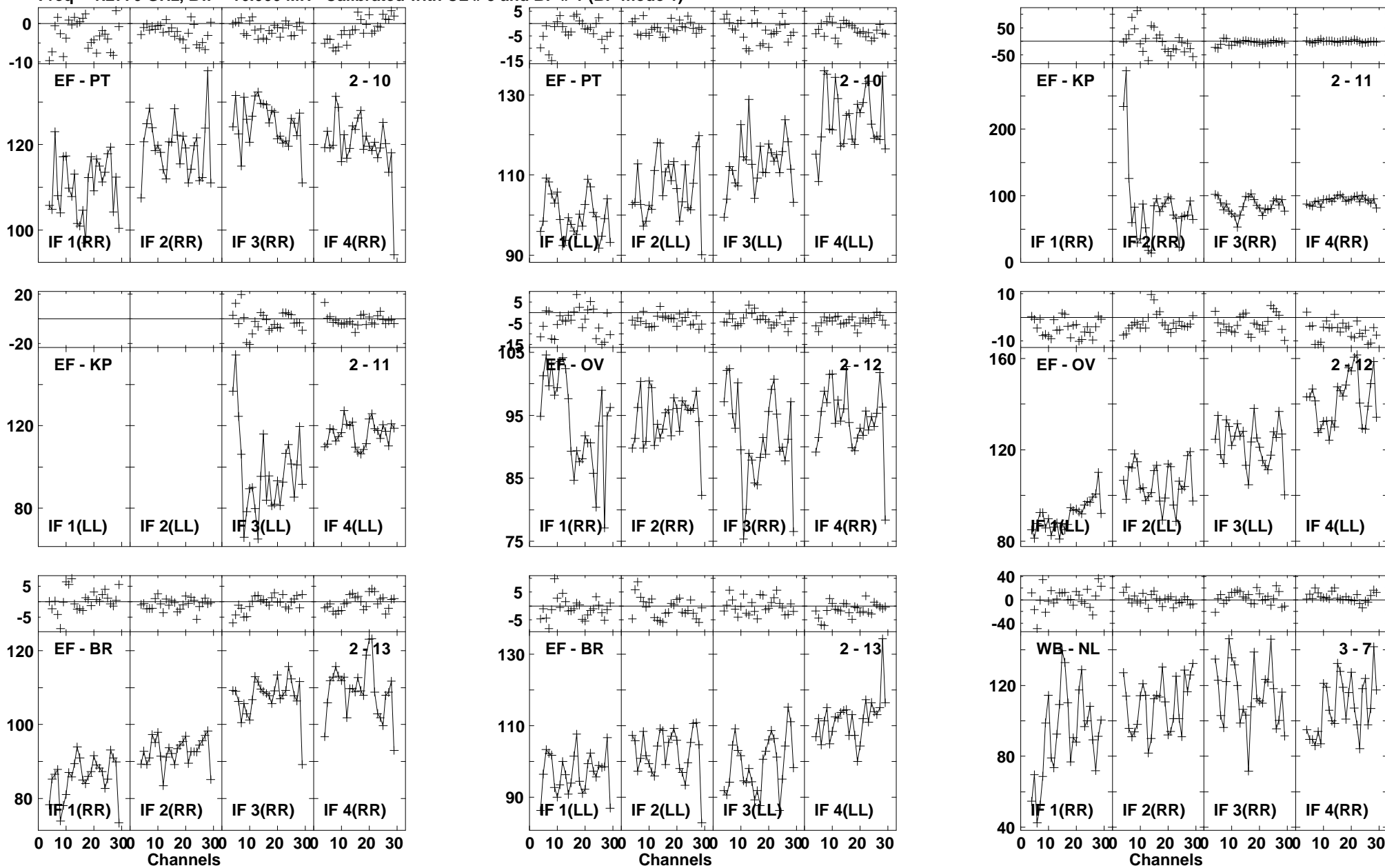

Lower frame: Milli Ampl Jy Top frame: Phas deg
Vector averaged cross-power spectrum Baseline: EF (02) - PT (10)
Timerange: 00/16:48:18 to 00/16:51:06

Plot file version 163 created 03-MAR-2016 01:12:25

J1545+5400 GN002C 1.UVDATA.1

Freq = 1.2770 GHz, Bw = 16.000 MH Calibrated with CL # 3 and BP # 1 (BP mode 1)

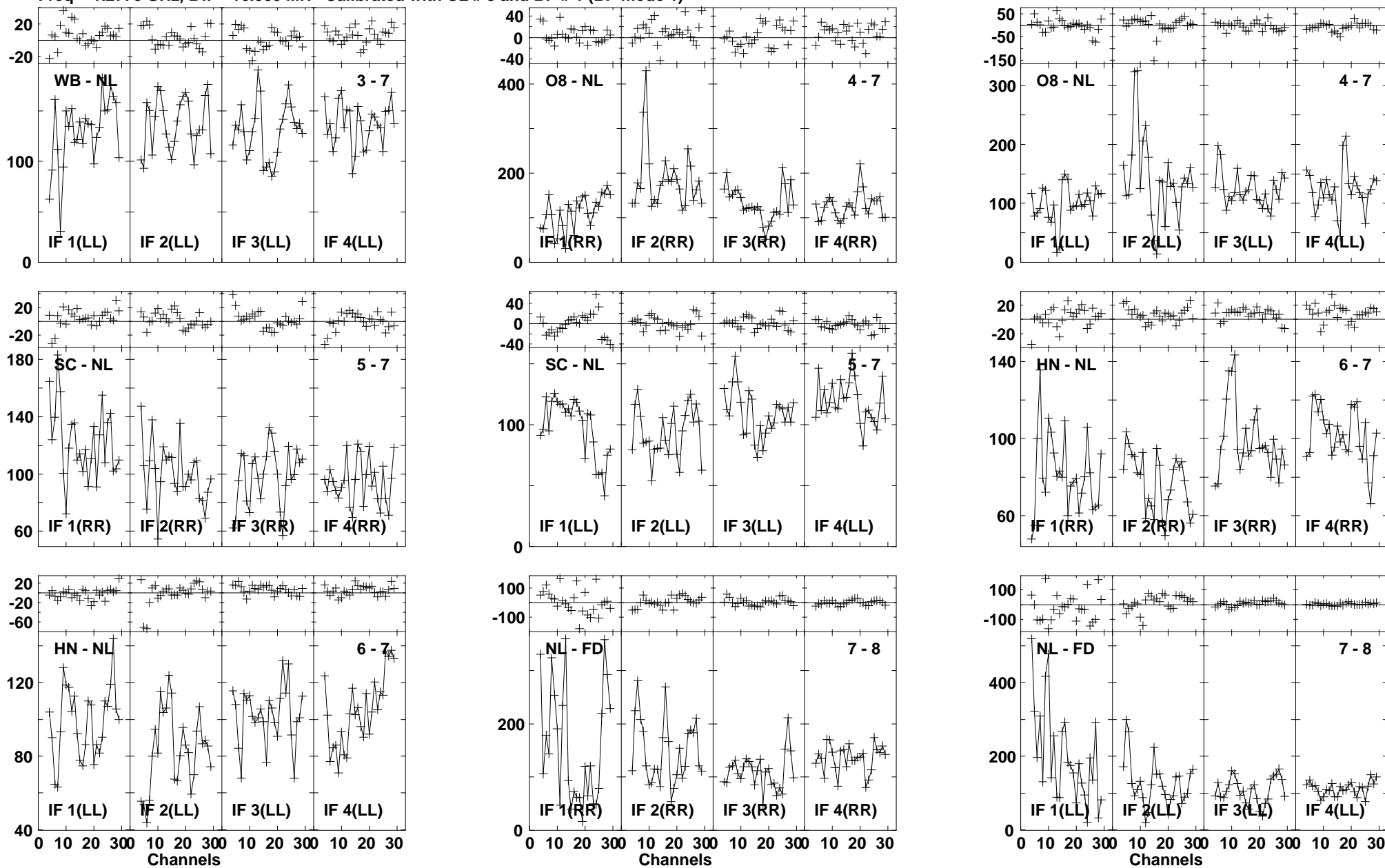

Lower frame: Milli Ampl Jy Top frame: Phas deg
Vector averaged cross-power spectrum Baseline: WB (03) - NL (07)
Timerange: 00/16:48:18 to 00/16:51:06

Plot file version 164 created 03-MAR-2016 01:12:25

J1545+5400 GN002C 1.UVDATA.1

Freq = 1.2770 GHz, Bw = 16.000 MH Calibrated with CL # 3 and BP # 1 (BP mode 1)

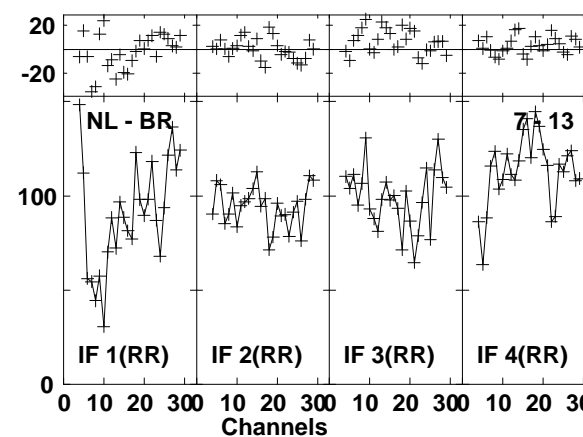
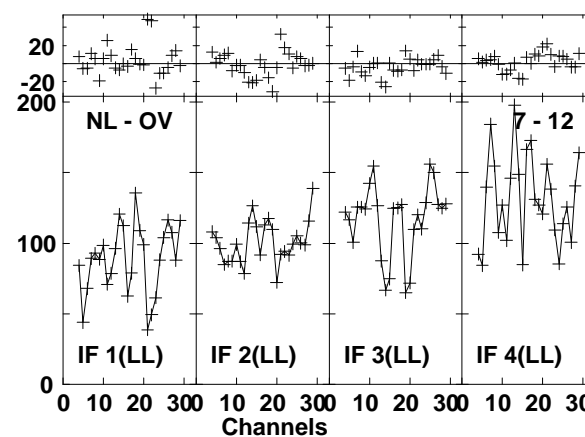
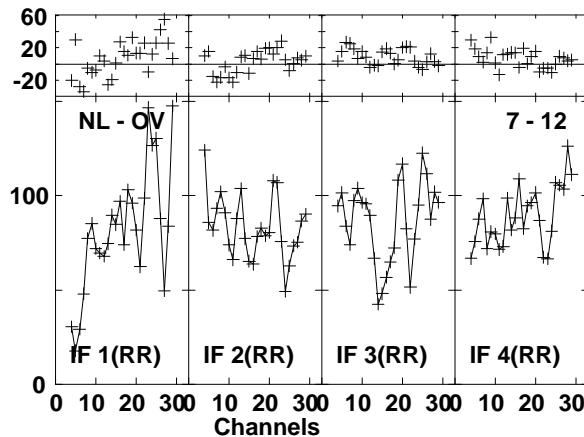
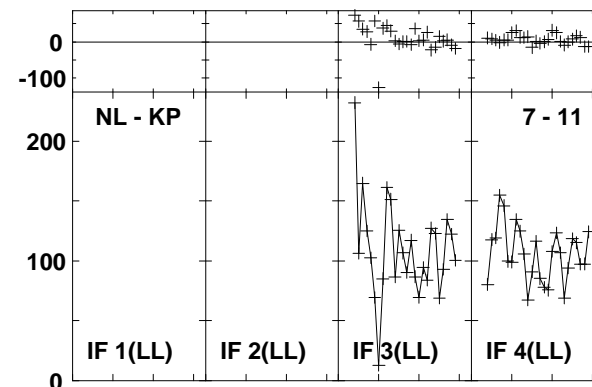
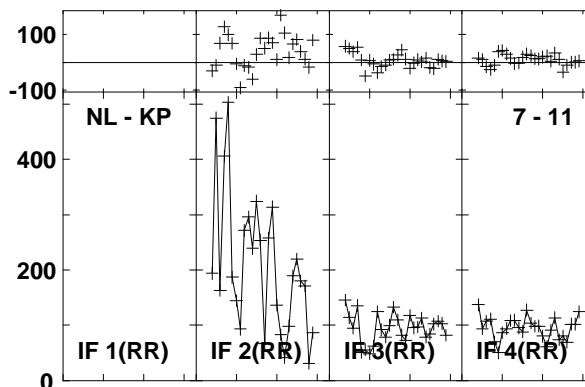
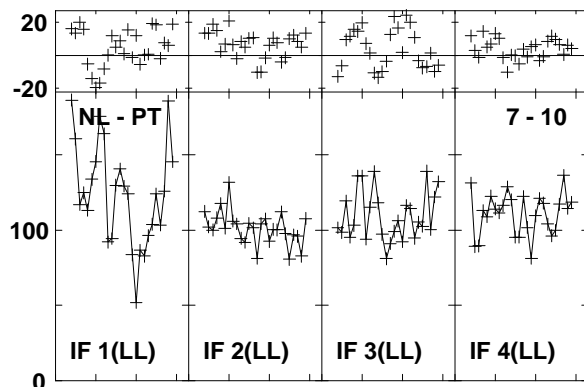
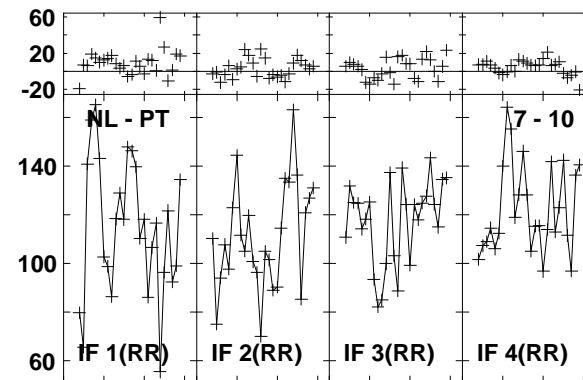
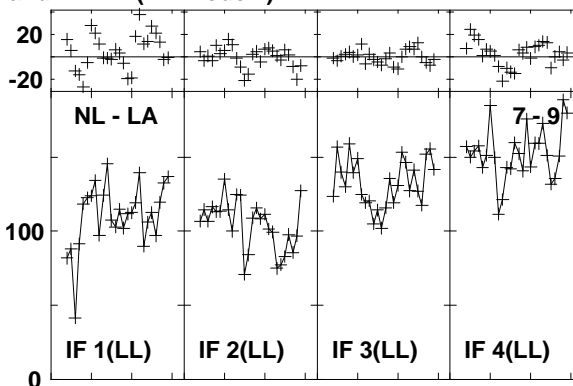
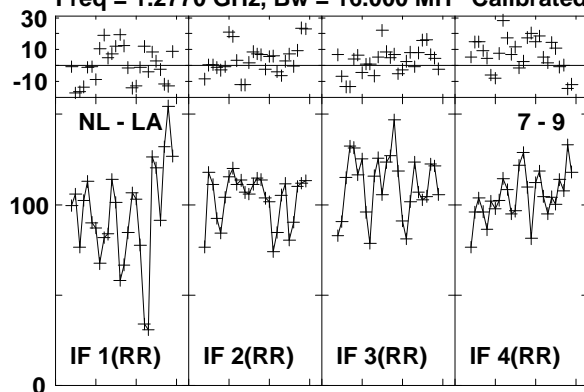

Lower frame: Milli Ampl Jy Top frame: Phas deg
Vector averaged cross-power spectrum Baseline: NL (07) - LA (09)
Timerange: 00/16:48:18 to 00/16:51:06

Plot file version 165 created 03-MAR-2016 01:12:25
J1545+5400 GN002C 1.UVDATA.1
Freq = 1.2770 GHz, Bw = 16.000 MH Calibrated with CL # 3 and BP # 1 (BP mode 1)

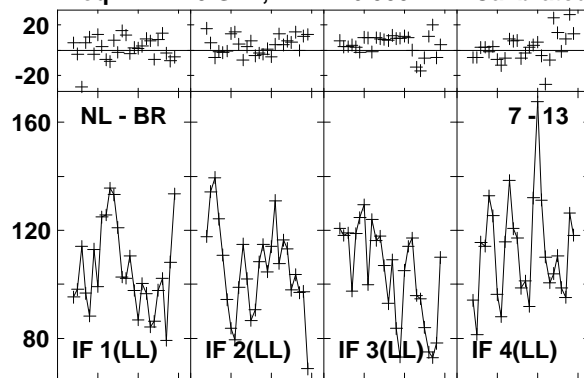

Lower frame: Milli Ampl Jy Top frame: Phas deg
Vector averaged cross-power spectrum Baseline: NL (07) - BR (13)
Timerange: 00/16:48:18 to 00/16:51:06

Plot file version 166 created 03-MAR-2016 01:12:25

4C52 GN002C 1.UVDATA.1

Freq = 1.2770 GHz, Bw = 16.000 MH Calibrated with CL # 3 and BP # 1 (BP mode 1)

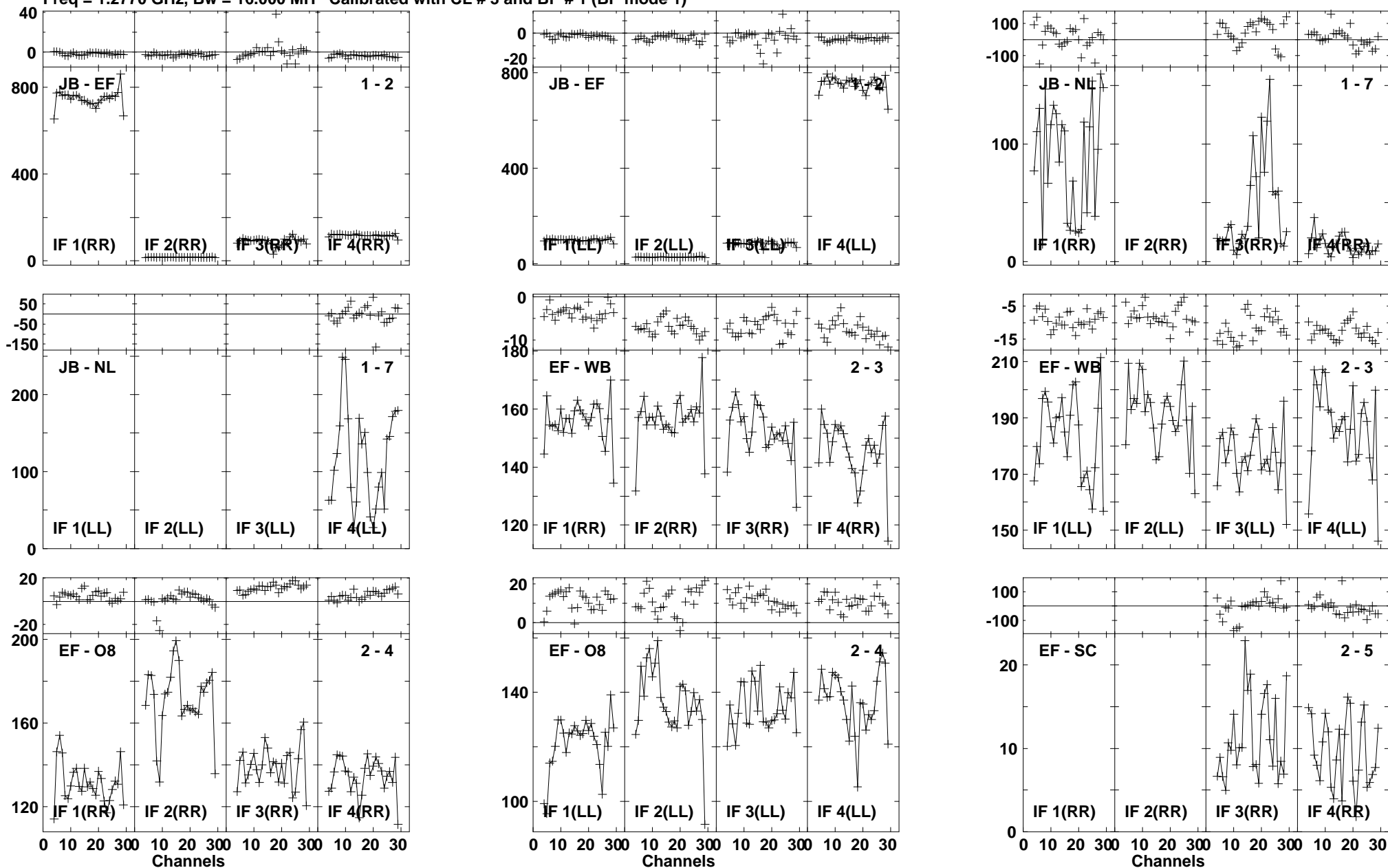

Lower frame: Milli Ampl Jy Top frame: Phas deg
Vector averaged cross-power spectrum Baseline: JB (01) - EF (02)
Timerange: 00/16:51:19 to 00/16:54:05

Plot file version 167 created 03-MAR-2016 01:12:26

4C52 GN002C 1.UVDATA.1

Freq = 1.2770 GHz, Bw = 16.000 MH Calibrated with CL # 3 and BP # 1 (BP mode 1)

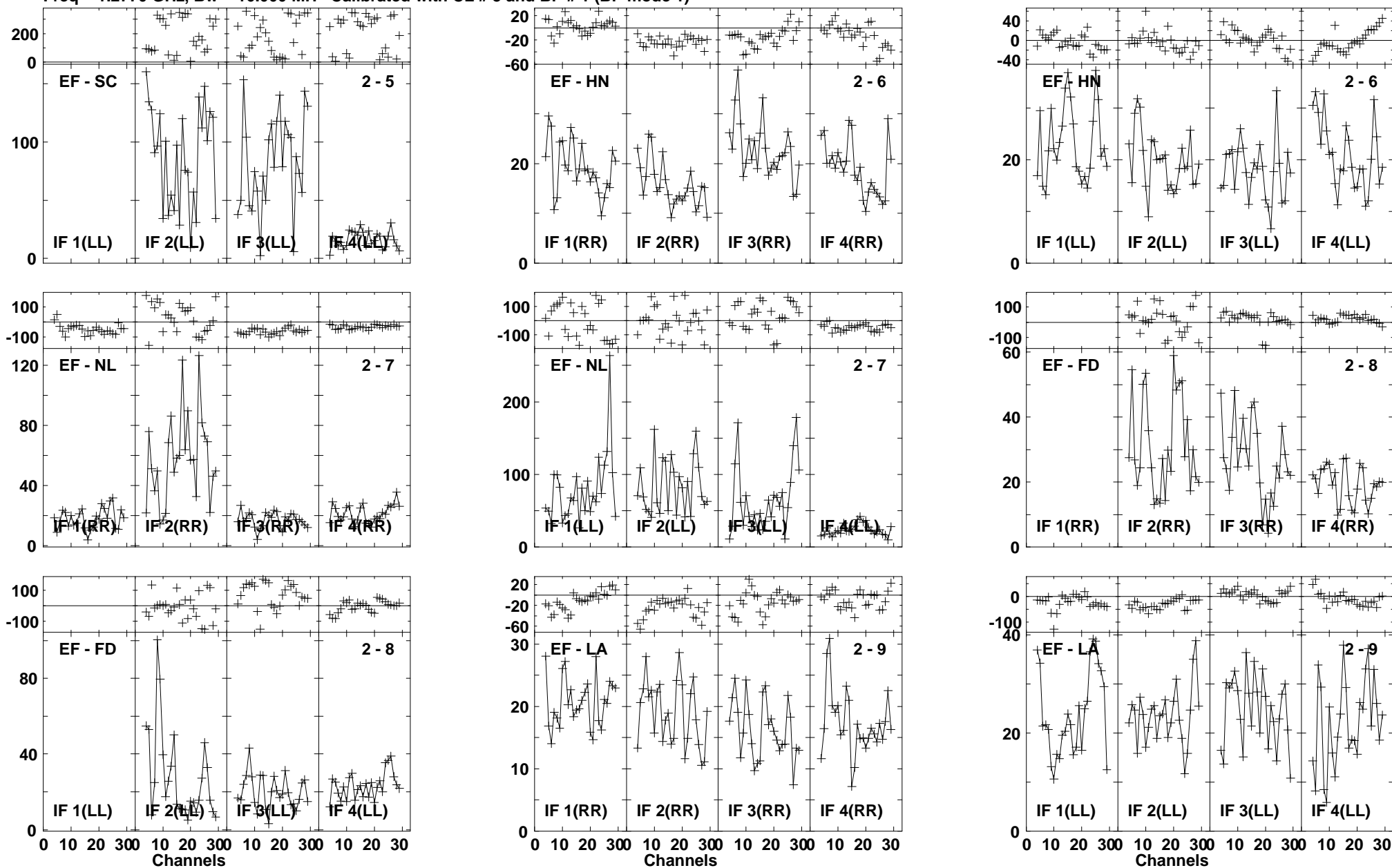

Lower frame: Milli Ampl Jy Top frame: Phas deg
Vector averaged cross-power spectrum Baseline: EF (02) - SC (05)
Timerange: 00/16:51:19 to 00/16:54:05

Plot file version 168 created 03-MAR-2016 01:12:26

4C52 GN002C 1.UVDATA.1

Freq = 1.2770 GHz, Bw = 16.000 MH Calibrated with CL # 3 and BP # 1 (BP mode 1)

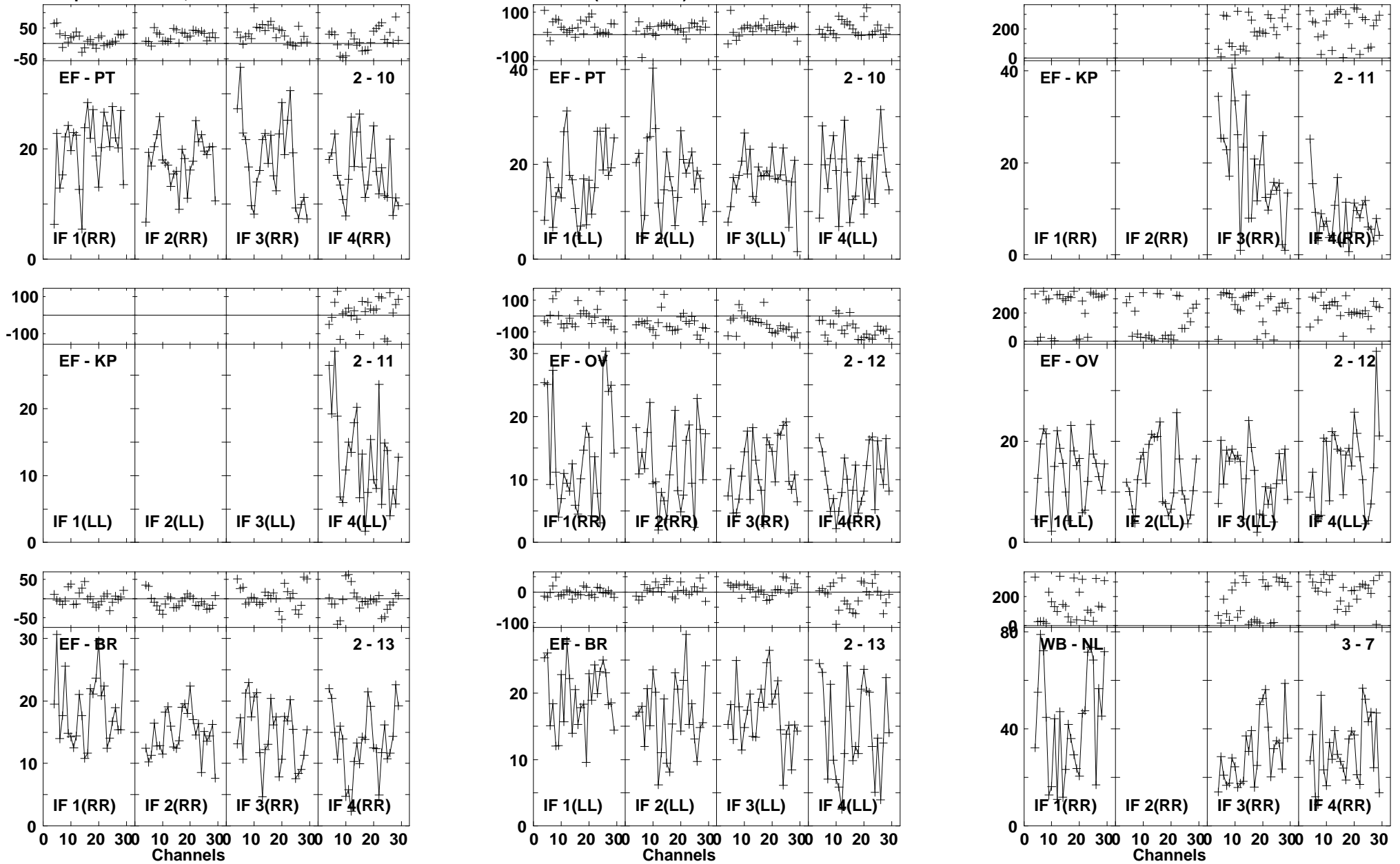

Lower frame: Milli Ampl Jy Top frame: Phas deg
Vector averaged cross-power spectrum Baseline: EF (02) - PT (10)
Timerange: 00/16:51:19 to 00/16:54:05

Plot file version 169 created 03-MAR-2016 01:12:26

4C52 GN002C 1.UVDATA.1

Freq = 1.2770 GHz, Bw = 16.000 MH Calibrated with CL # 3 and BP # 1 (BP mode 1)

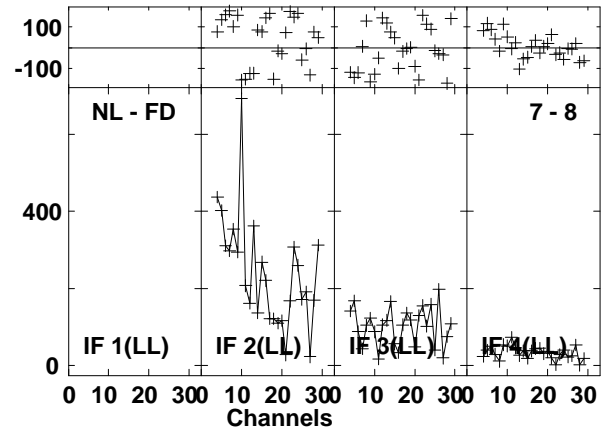
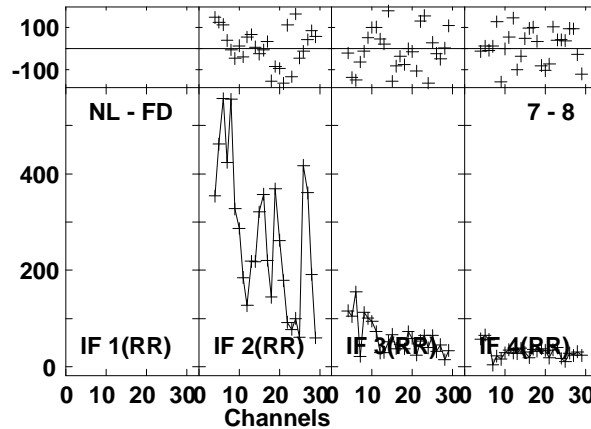
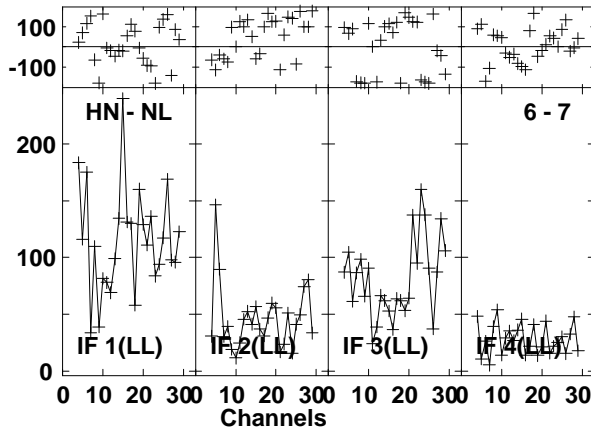
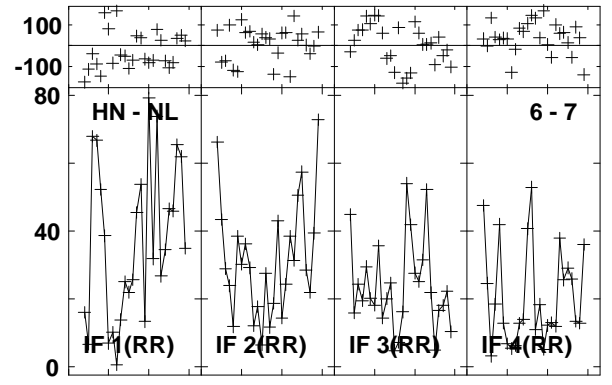
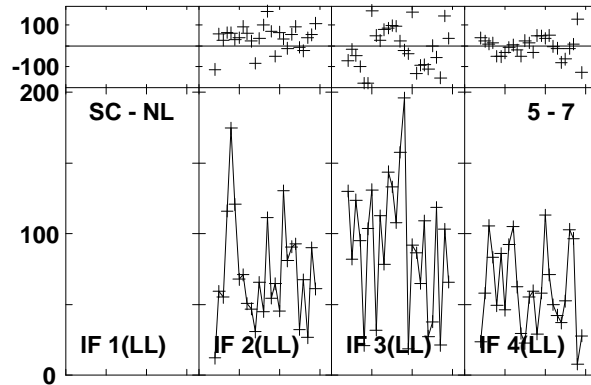
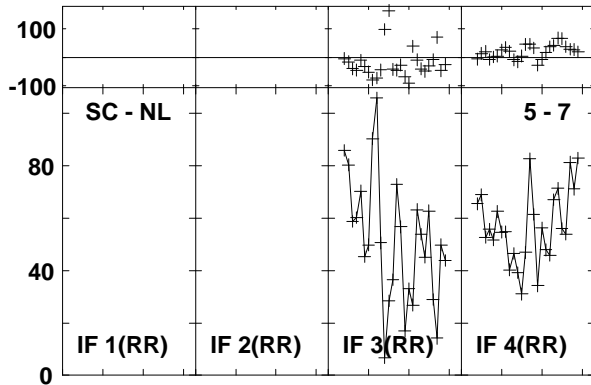
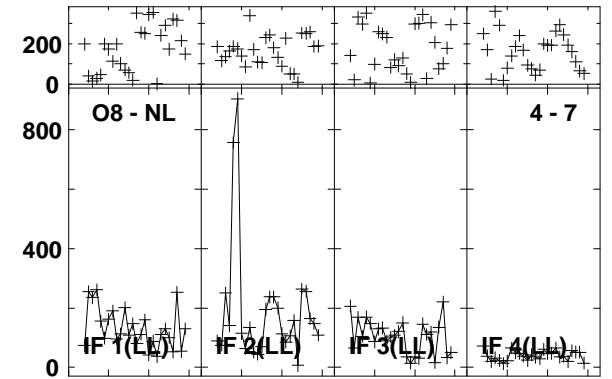
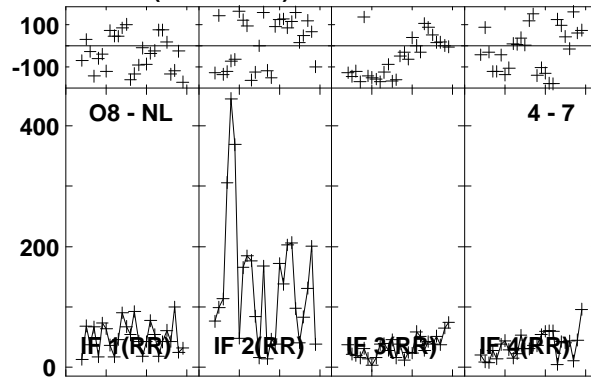
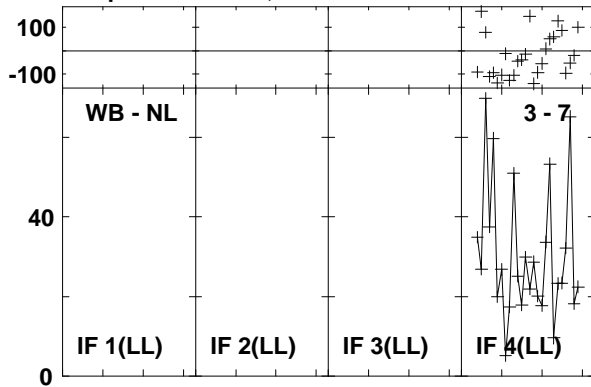

Lower frame: Milli Ampl Jy Top frame: Phas deg
Vector averaged cross-power spectrum Baseline: WB (03) - NL (07)
Timerange: 00/16:51:19 to 00/16:54:05

Plot file version 170 created 03-MAR-2016 01:12:26

4C52 GN002C 1.UVDATA.1

Freq = 1.2770 GHz, Bw = 16.000 MH Calibrated with CL # 3 and BP # 1 (BP mode 1)

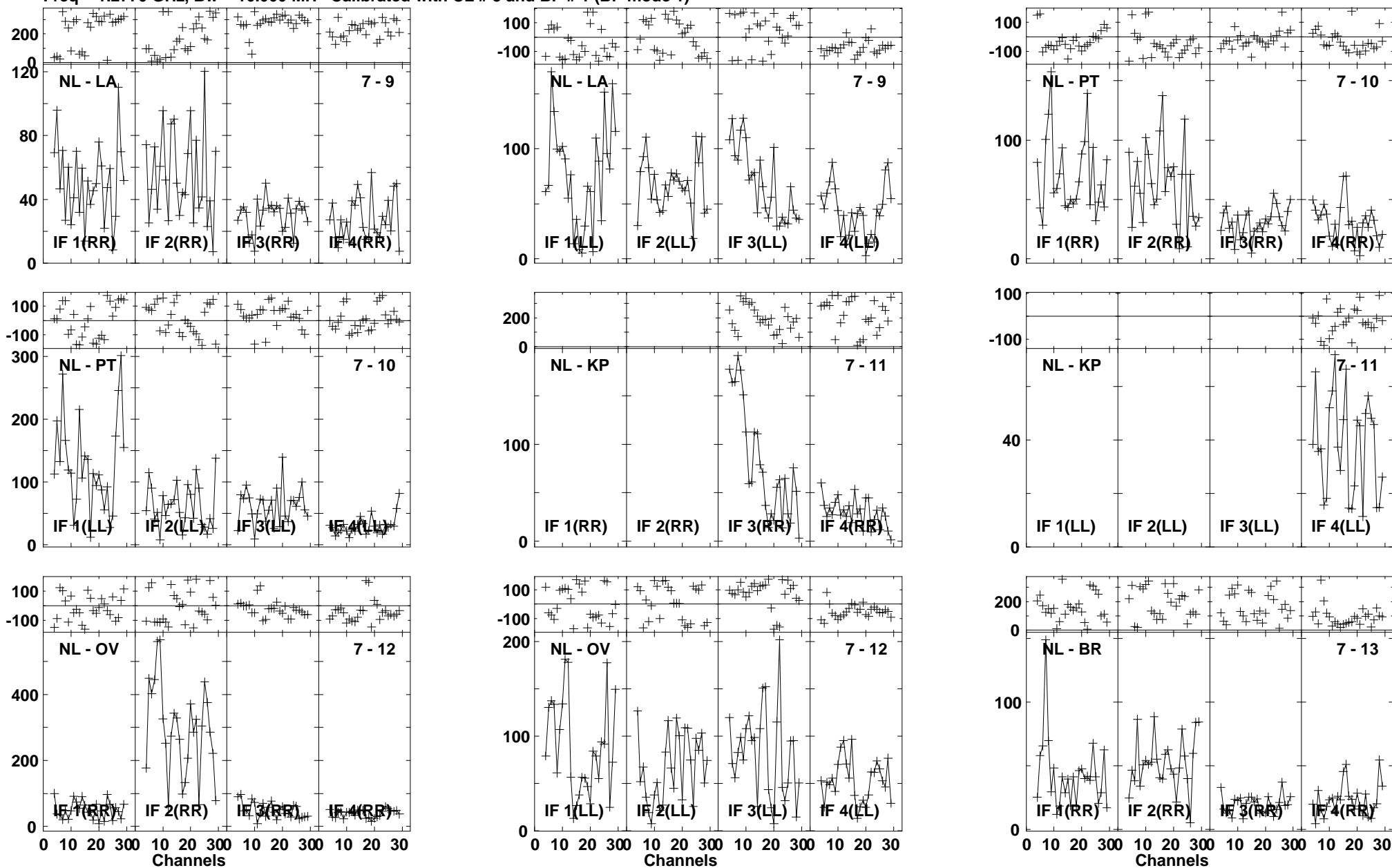

Lower frame: Milli Ampl Jy Top frame: Phas deg
Vector averaged cross-power spectrum Baseline: NL (07) - LA (09)
Timerange: 00/16:51:19 to 00/16:54:05

Plot file version 171 created 03-MAR-2016 01:12:26

4C52 GN002C 1.UVDATA.1

Freq = 1.2770 GHz, Bw = 16.000 MH Calibrated with CL # 3 and BP # 1 (BP mode 1)

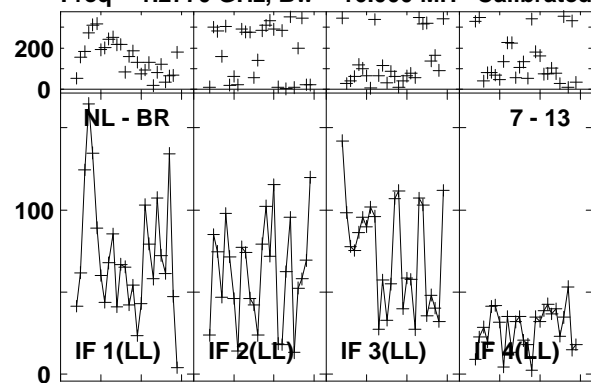

Lower frame: Milli Ampl Jy Top frame: Phas deg

Vector averaged cross-power spectrum Baseline: NL (07) - BR (13)

Timerange: 00/16:51:19 to 00/16:54:05

Plot file version 172 created 03-MAR-2016 01:12:27

J1545+5400 GN002C 1.UVDATA.1

Freq = 1.2770 GHz, Bw = 16.000 MH Calibrated with CL # 3 and BP # 1 (BP mode 1)

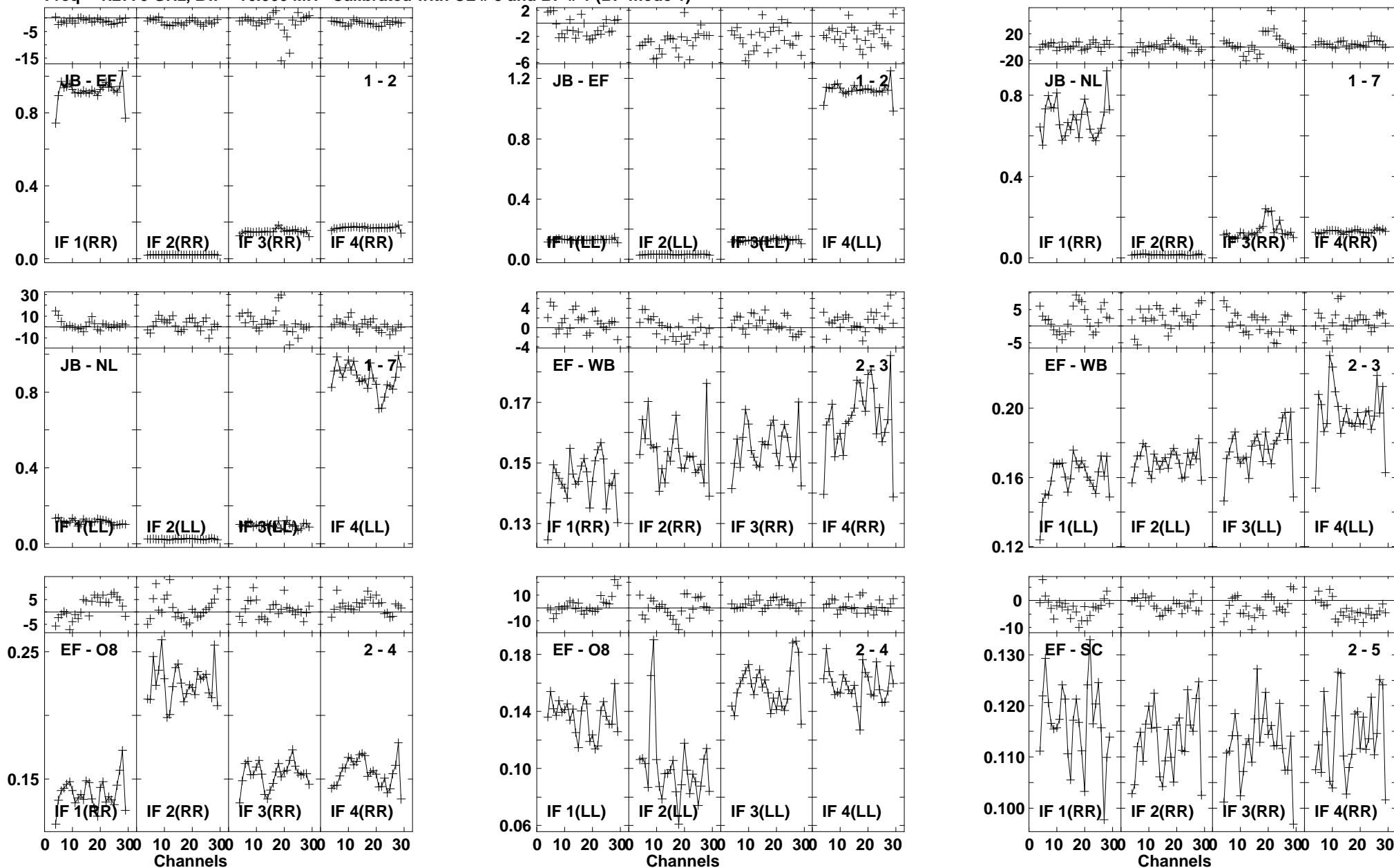

Lower frame: Ampl Jy Top frame: Phas deg
Vector averaged cross-power spectrum Baseline: JB (01) - EF (02)
Timerange: 00/16:54:58 to 00/16:56:56

Plot file version 173 created 03-MAR-2016 01:12:27

J1545+5400 GN002C 1.UVDATA.1

Freq = 1.2770 GHz, Bw = 16.000 MH Calibrated with CL # 3 and BP # 1 (BP mode 1)

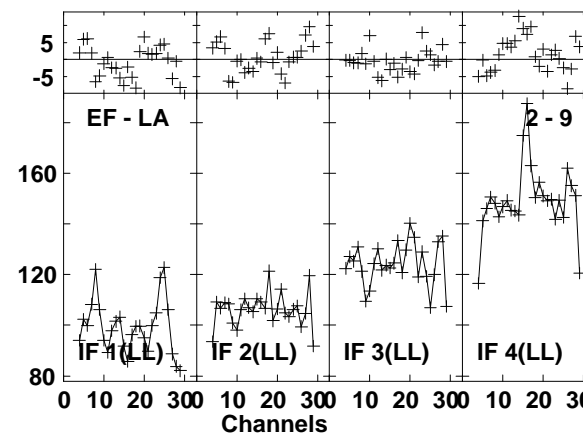
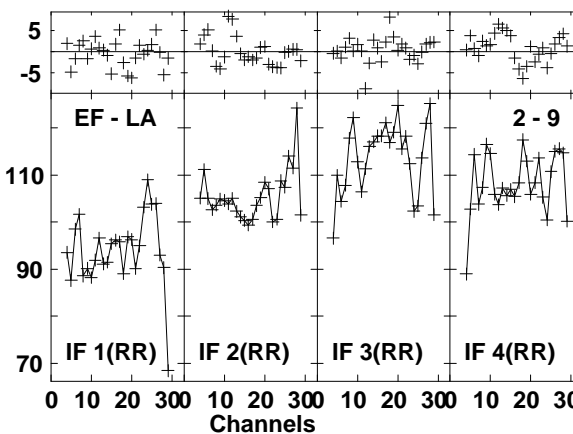
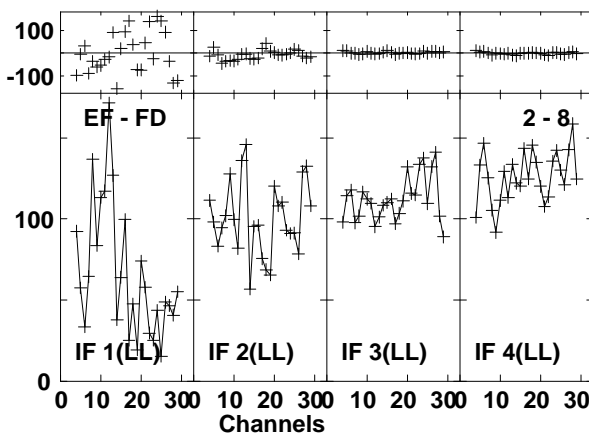
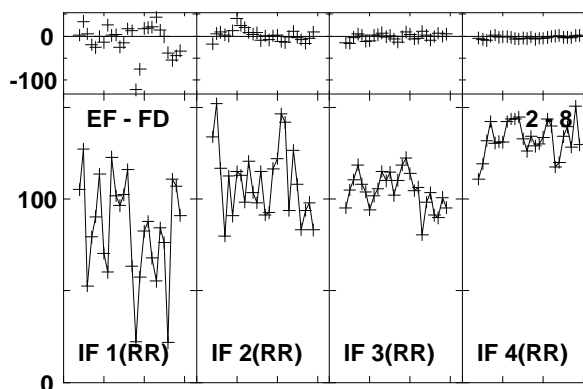
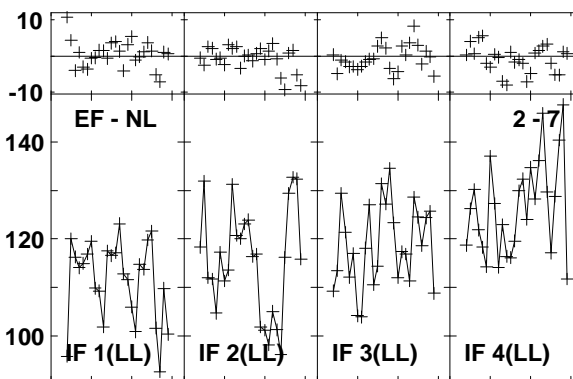
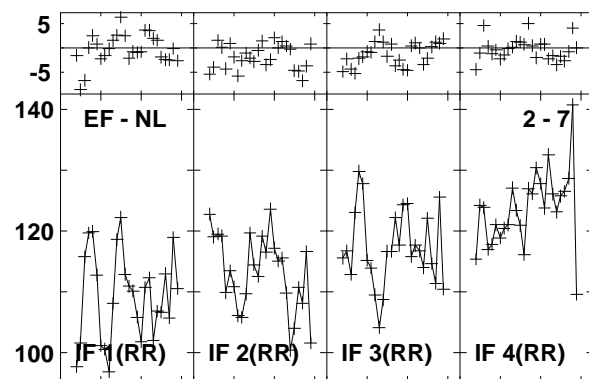
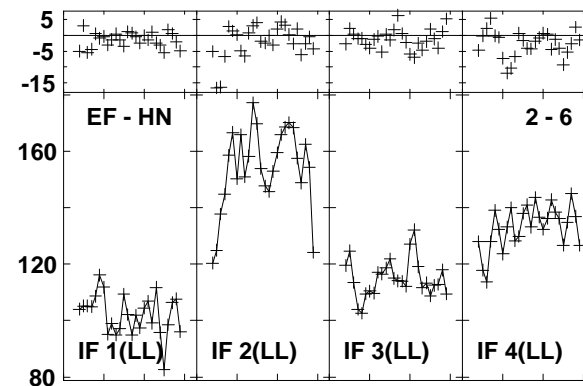
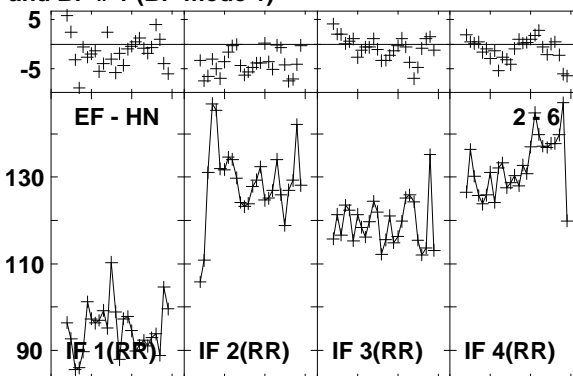
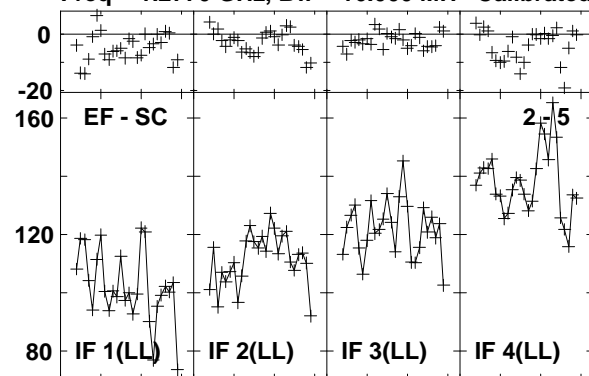

Lower frame: Milli Ampl Jy Top frame: Phas deg
Vector averaged cross-power spectrum Baseline: EF (02) - SC (05)
Timerange: 00/16:54:58 to 00/16:56:56

Plot file version 174 created 03-MAR-2016 01:12:27

J1545+5400 GN002C 1.UVDATA.1

Freq = 1.2770 GHz, Bw = 16.000 MH Calibrated with CL # 3 and BP # 1 (BP mode 1)

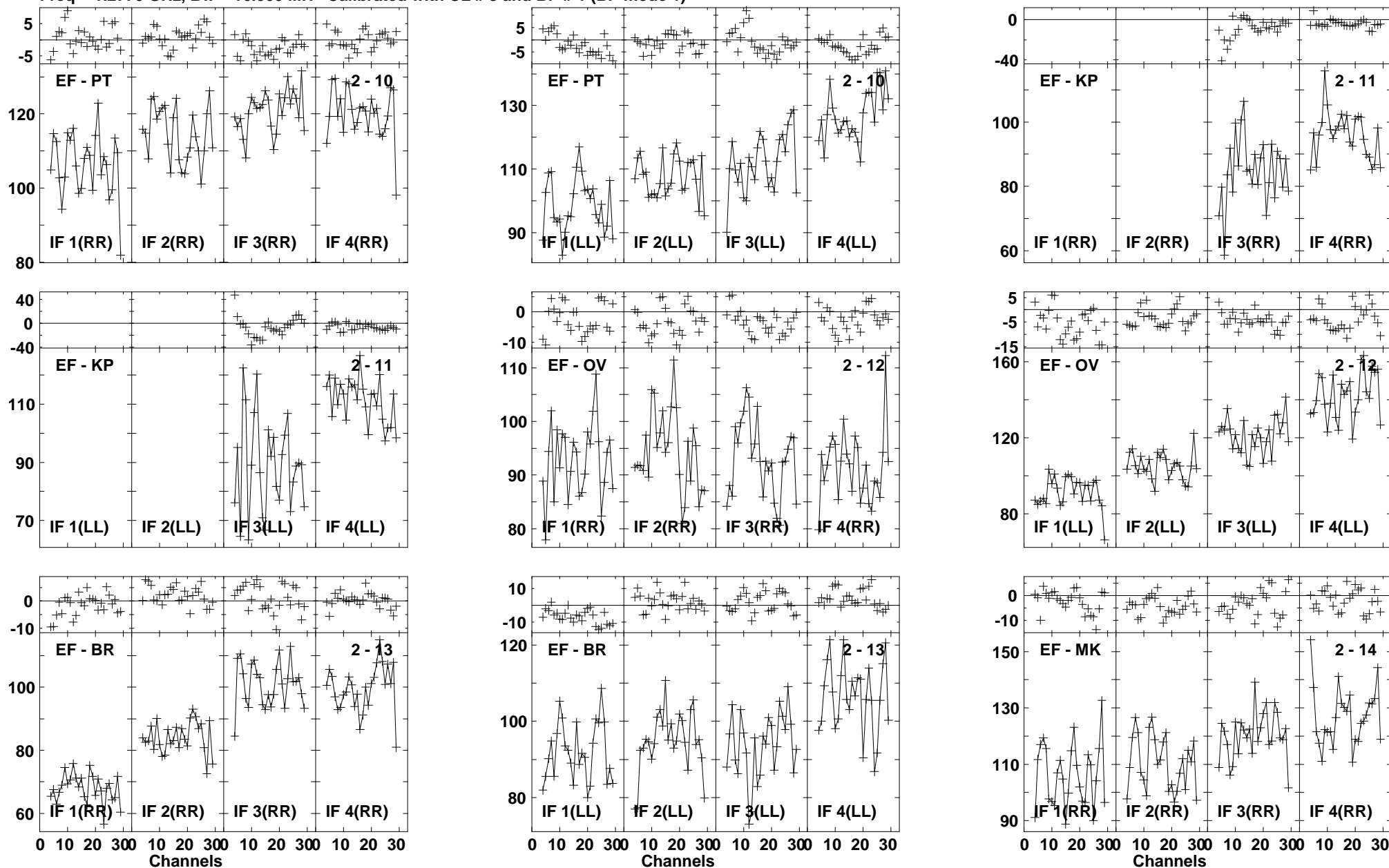

Lower frame: Milli Ampl Jy Top frame: Phas deg
Vector averaged cross-power spectrum Baseline: EF (02) - PT (10)
Timerange: 00/16:54:58 to 00/16:56:56

Plot file version 175 created 03-MAR-2016 01:12:27

J1545+5400 GN002C 1.UVDATA.1

Freq = 1.2770 GHz, Bw = 16.000 MH Calibrated with CL # 3 and BP # 1 (BP mode 1)

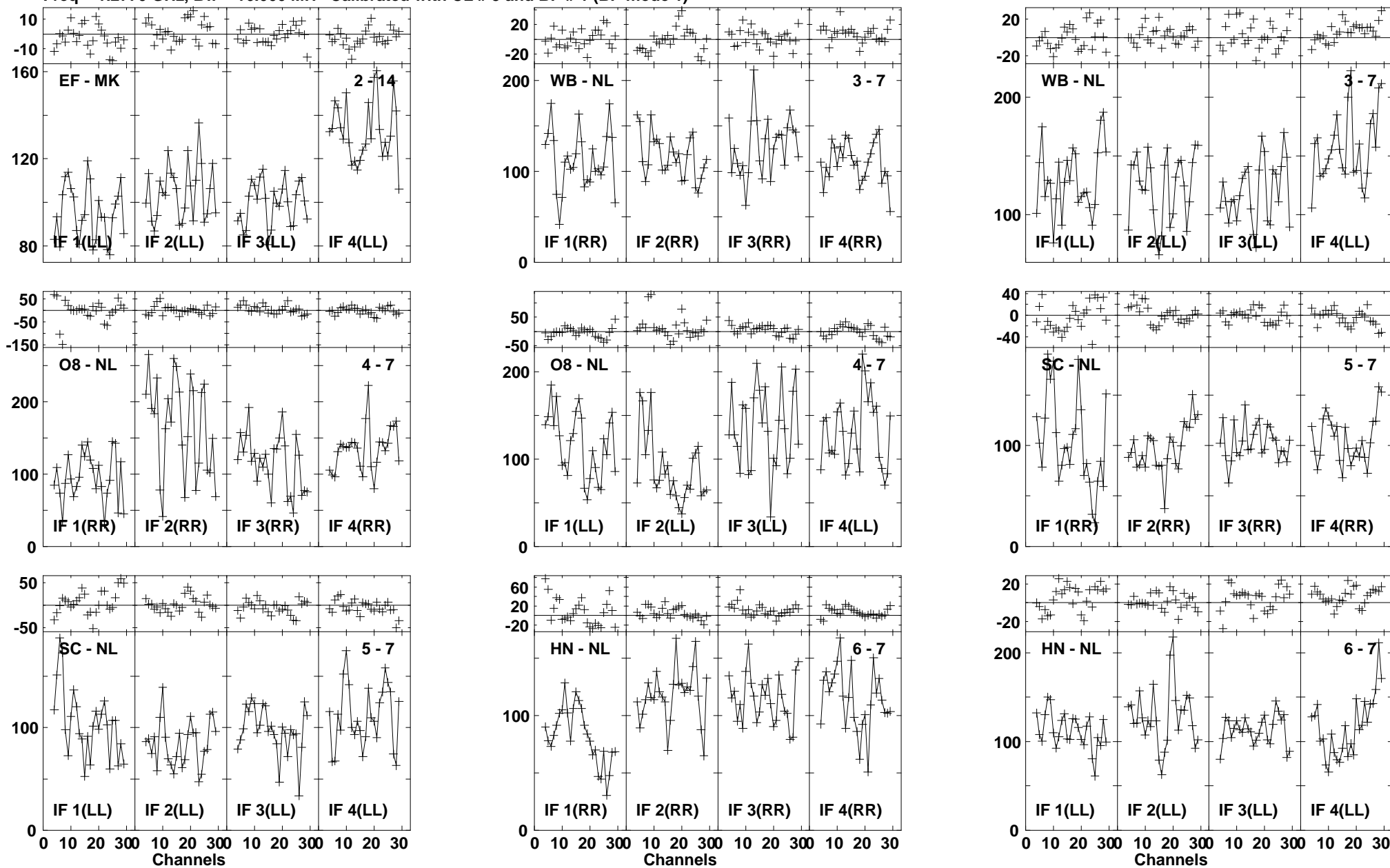

Lower frame: Milli Ampl Jy Top frame: Phas deg
Vector averaged cross-power spectrum Baseline: EF (02) - MK (14)
Timerange: 00/16:54:58 to 00/16:56:56

Plot file version 176 created 03-MAR-2016 01:12:27

J1545+5400 GN002C 1.UVDATA.1

Freq = 1.2770 GHz, Bw = 16.000 MH Calibrated with CL # 3 and BP # 1 (BP mode 1)

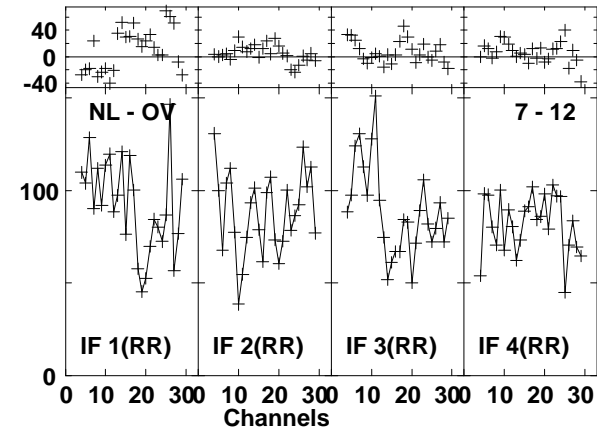
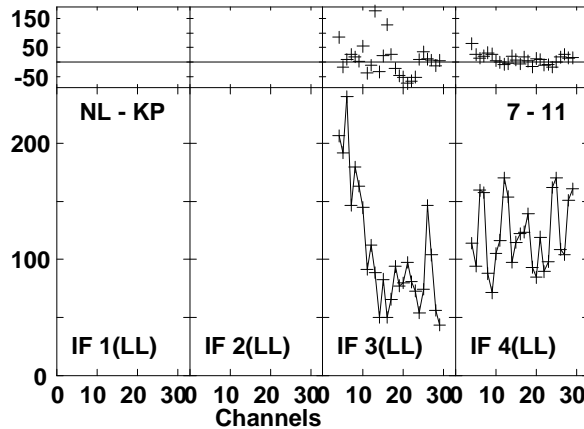
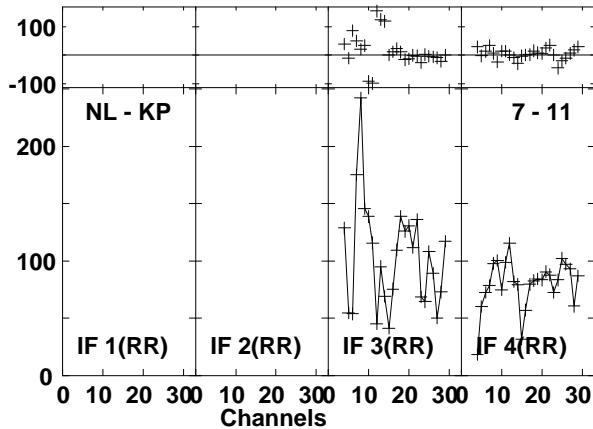
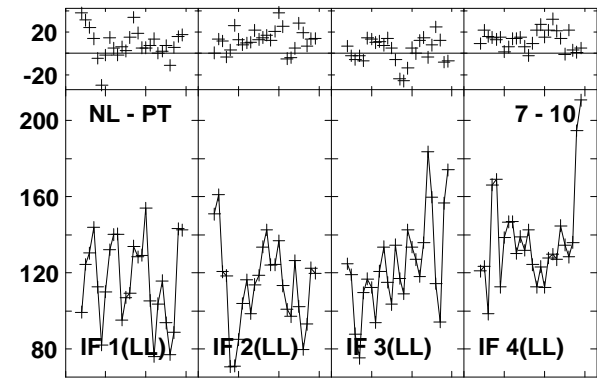
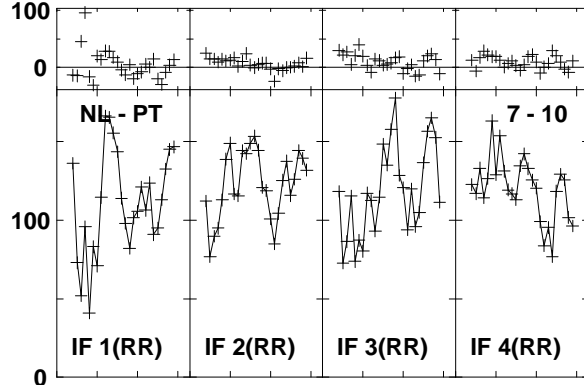
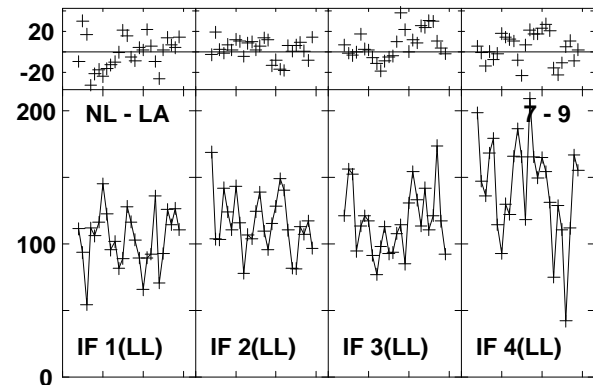
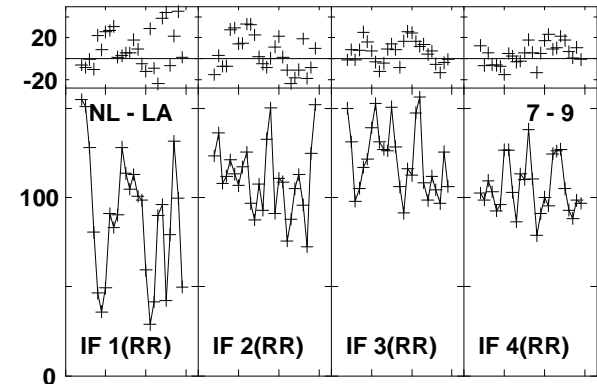
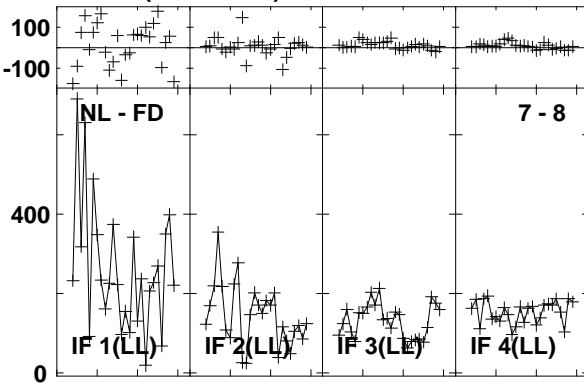
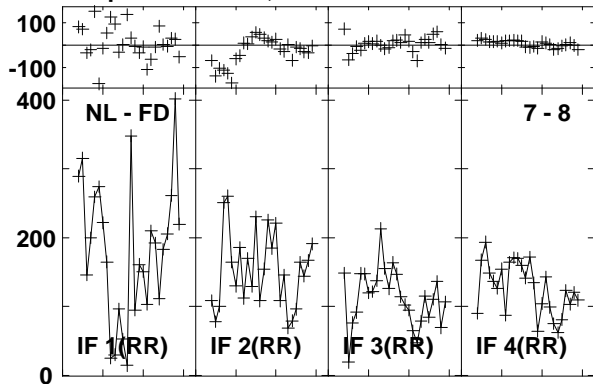

Lower frame: Milli Ampl Jy Top frame: Phas deg
Vector averaged cross-power spectrum Baseline: NL (07) - FD (08)
Timerange: 00/16:54:58 to 00/16:56:56

Plot file version 177 created 03-MAR-2016 01:12:27

J1545+5400 GN002C 1.UVDATA.1

Freq = 1.2770 GHz, Bw = 16.000 MH Calibrated with CL # 3 and BP # 1 (BP mode 1)

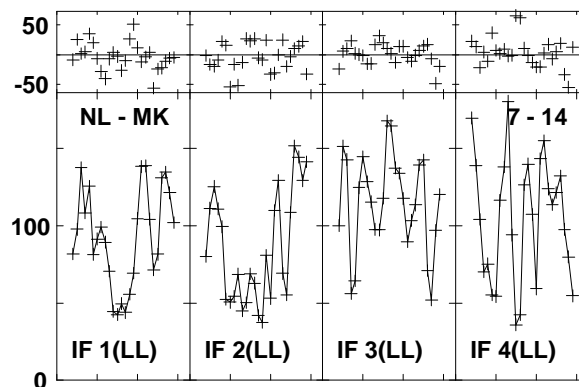
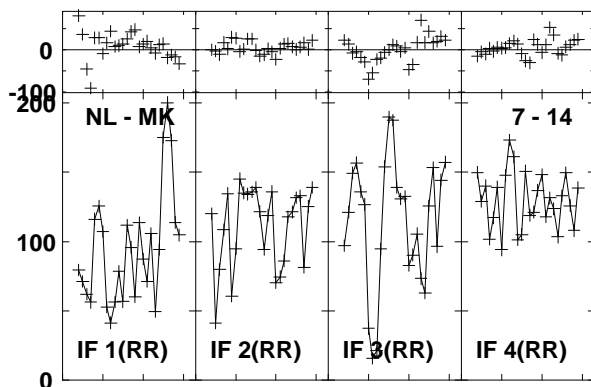
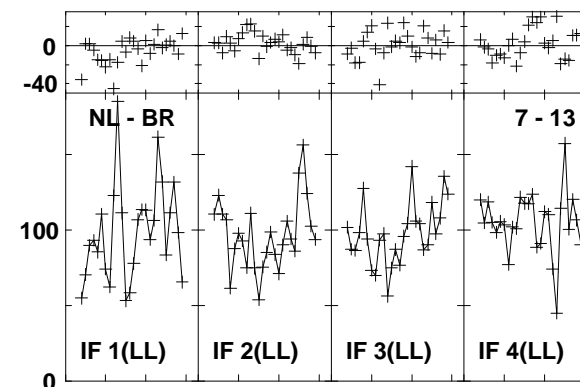
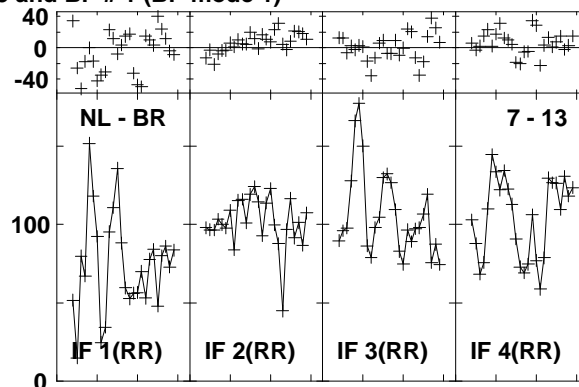
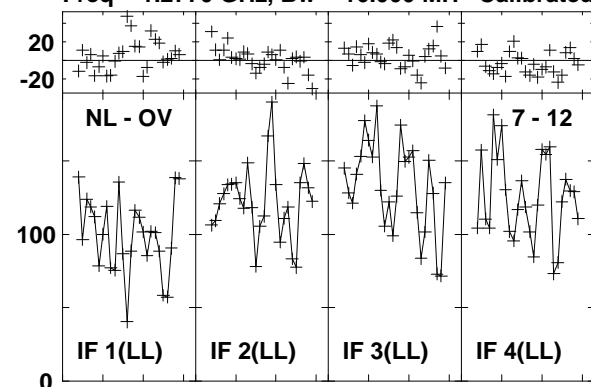

Lower frame: Milli Ampl Jy Top frame: Phas deg
Vector averaged cross-power spectrum Baseline: NL (07) - OV (12)
Timerange: 00/16:54:58 to 00/16:56:56

Plot file version 178 created 03-MAR-2016 01:12:28

4C52 GN002C 1.UVDATA.1

Freq = 1.2770 GHz, Bw = 16.000 MH Calibrated with CL # 3 and BP # 1 (BP mode 1)

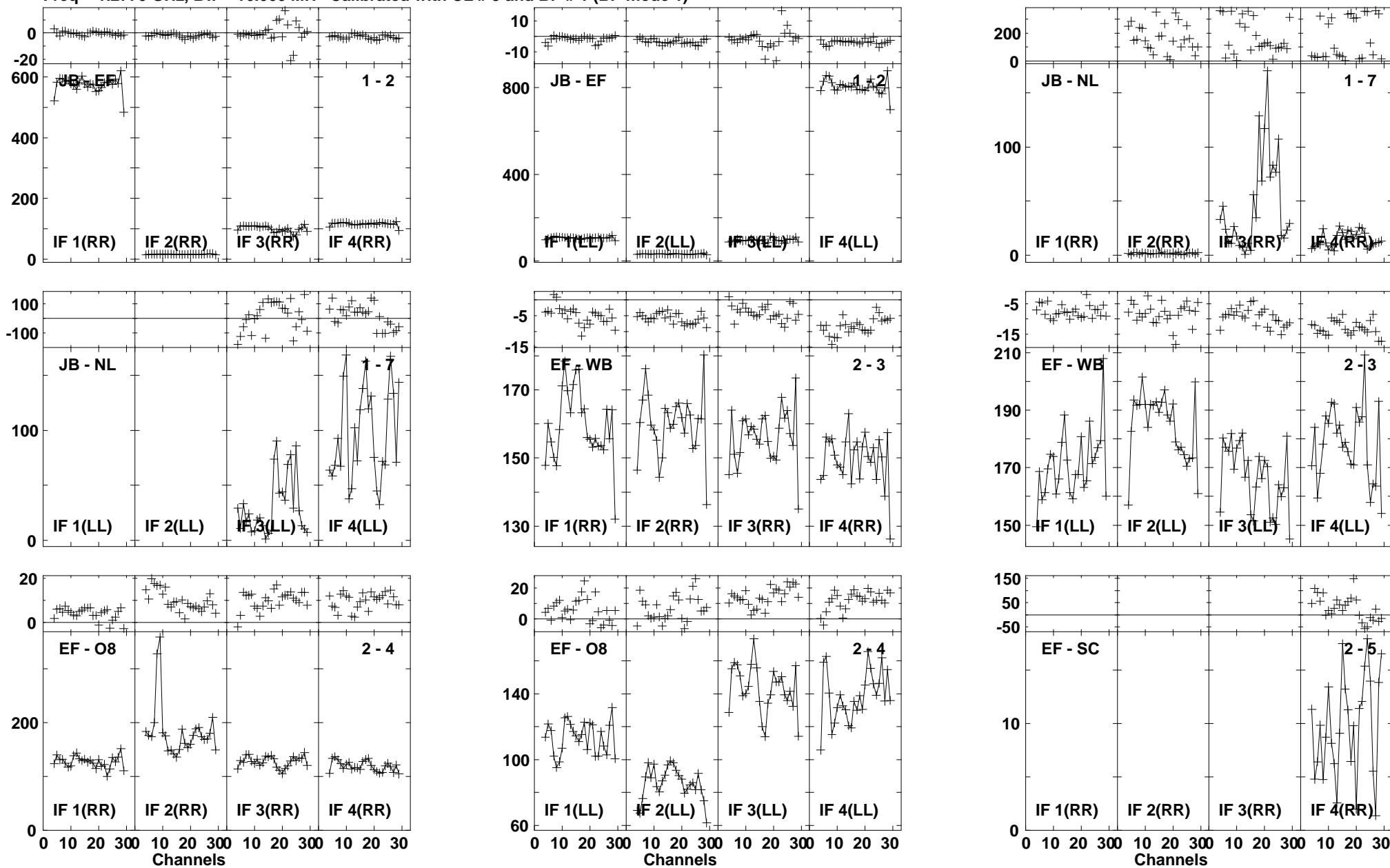

Lower frame: Milli Ampl Jy Top frame: Phas deg
Vector averaged cross-power spectrum Baseline: JB (01) - EF (02)
Timerange: 00/16:57:09 to 00/16:59:55

Plot file version 179 created 03-MAR-2016 01:12:28

4C52 GN002C 1.UVDATA.1

Freq = 1.2770 GHz, Bw = 16.000 MH Calibrated with CL # 3 and BP # 1 (BP mode 1)

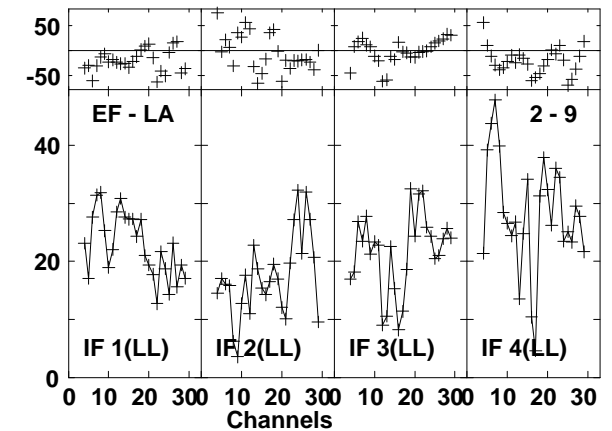
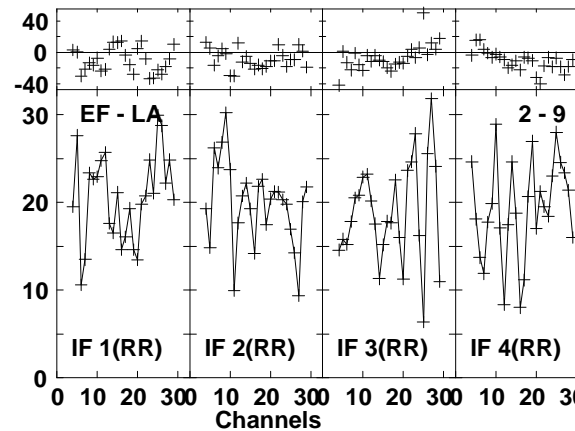
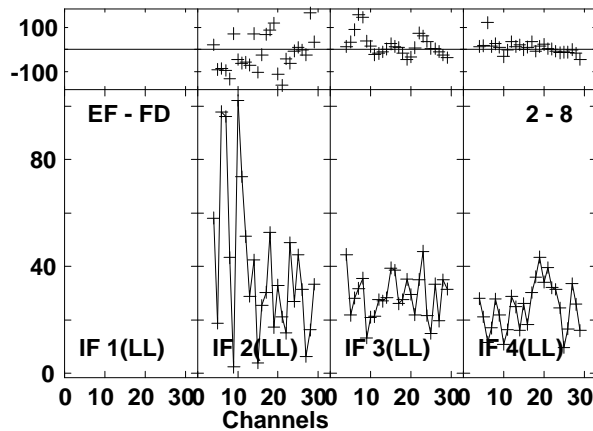
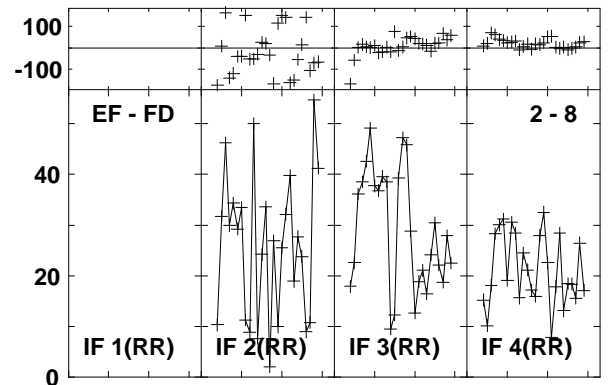
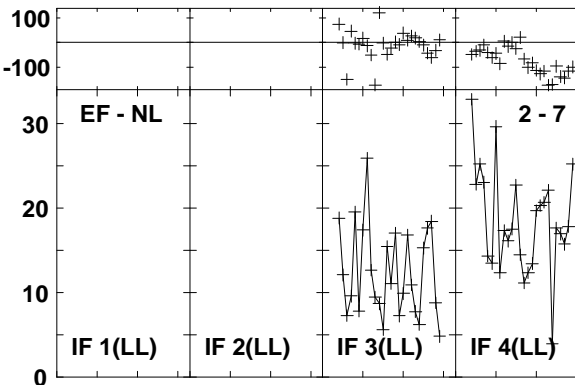
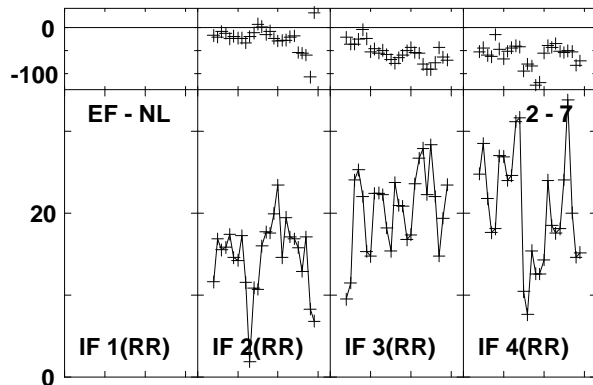
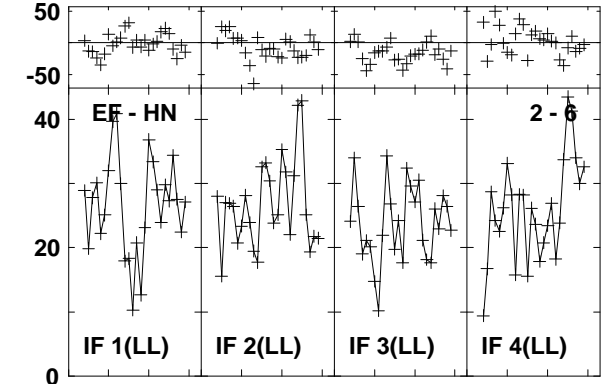
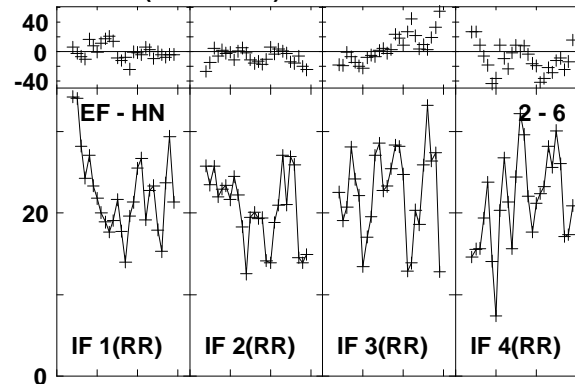
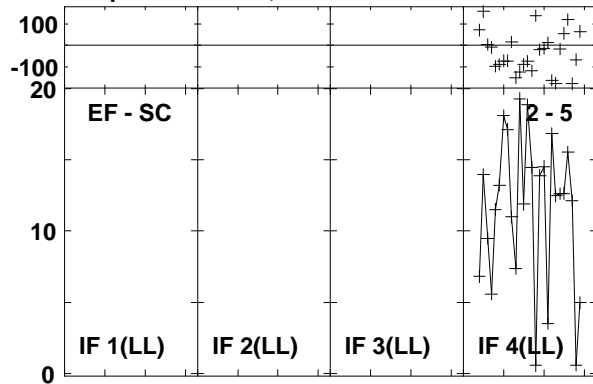

Lower frame: Milli Ampl Jy Top frame: Phas deg

Vector averaged cross-power spectrum Baseline: EF (02) - SC (05)

Timerange: 00/16:57:09 to 00/16:59:55

Plot file version 180 created 03-MAR-2016 01:12:28

4C52 GN002C 1.UVDATA.1

Freq = 1.2770 GHz, Bw = 16.000 MH Calibrated with CL # 3 and BP # 1 (BP mode 1)

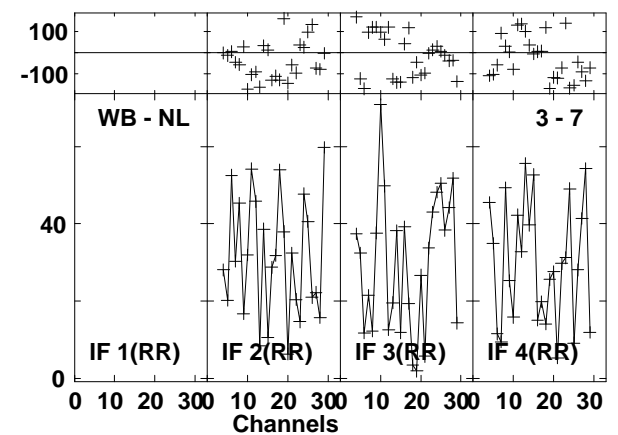
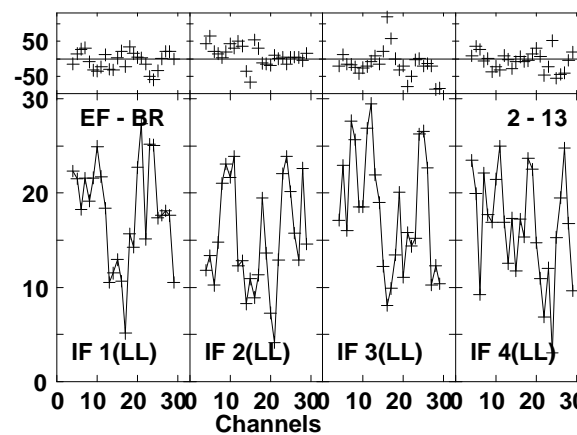
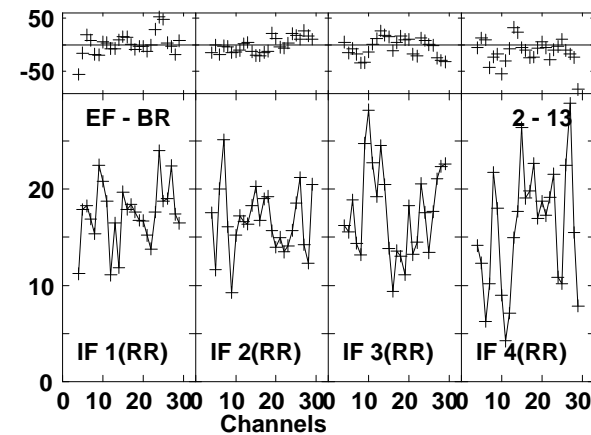
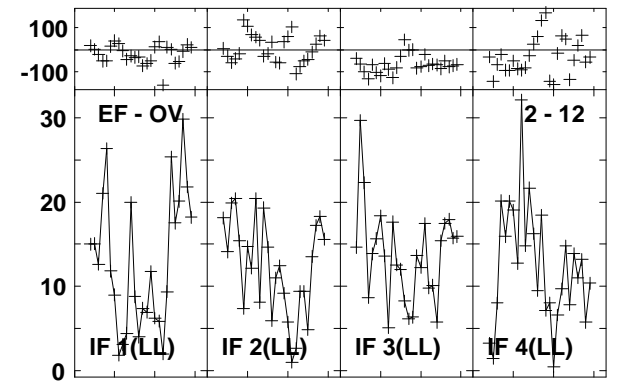
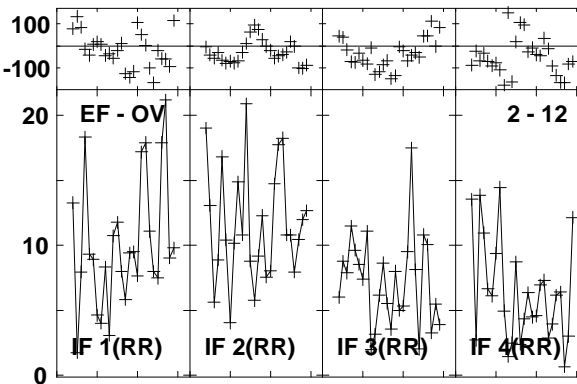
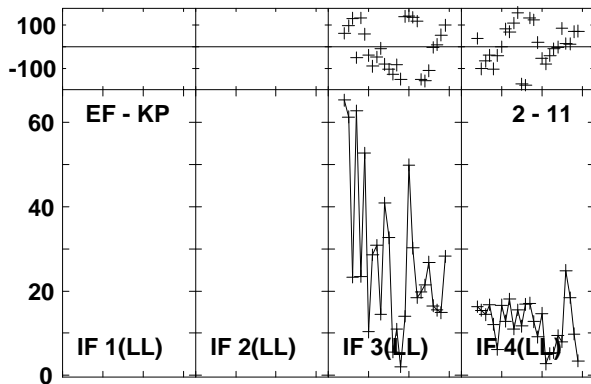
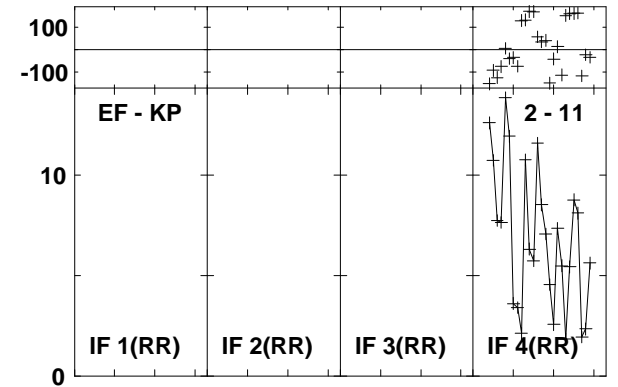
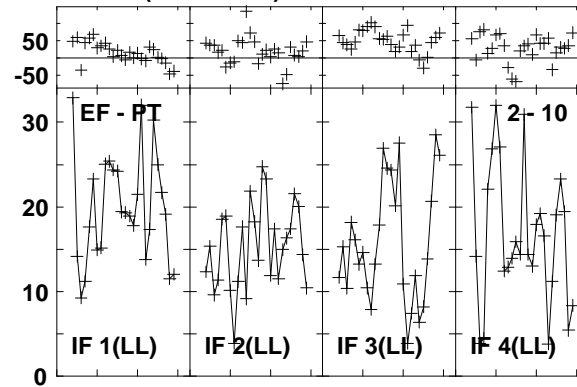
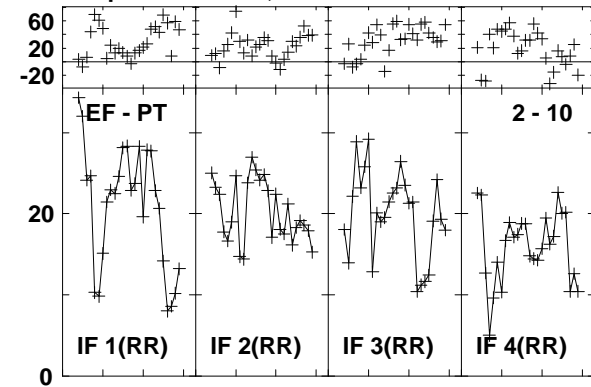

Lower frame: Milli Ampl Jy Top frame: Phas deg

Vector averaged cross-power spectrum Baseline: EF (02) - PT (10)

Timerange: 00/16:57:09 to 00/16:59:55

Plot file version 181 created 03-MAR-2016 01:12:28
 4C52 GN002C 1.UVDATA.1
 Freq = 1.2770 GHz, Bw = 16.000 MH Calibrated with CL # 3 and BP # 1 (BP mode 1)

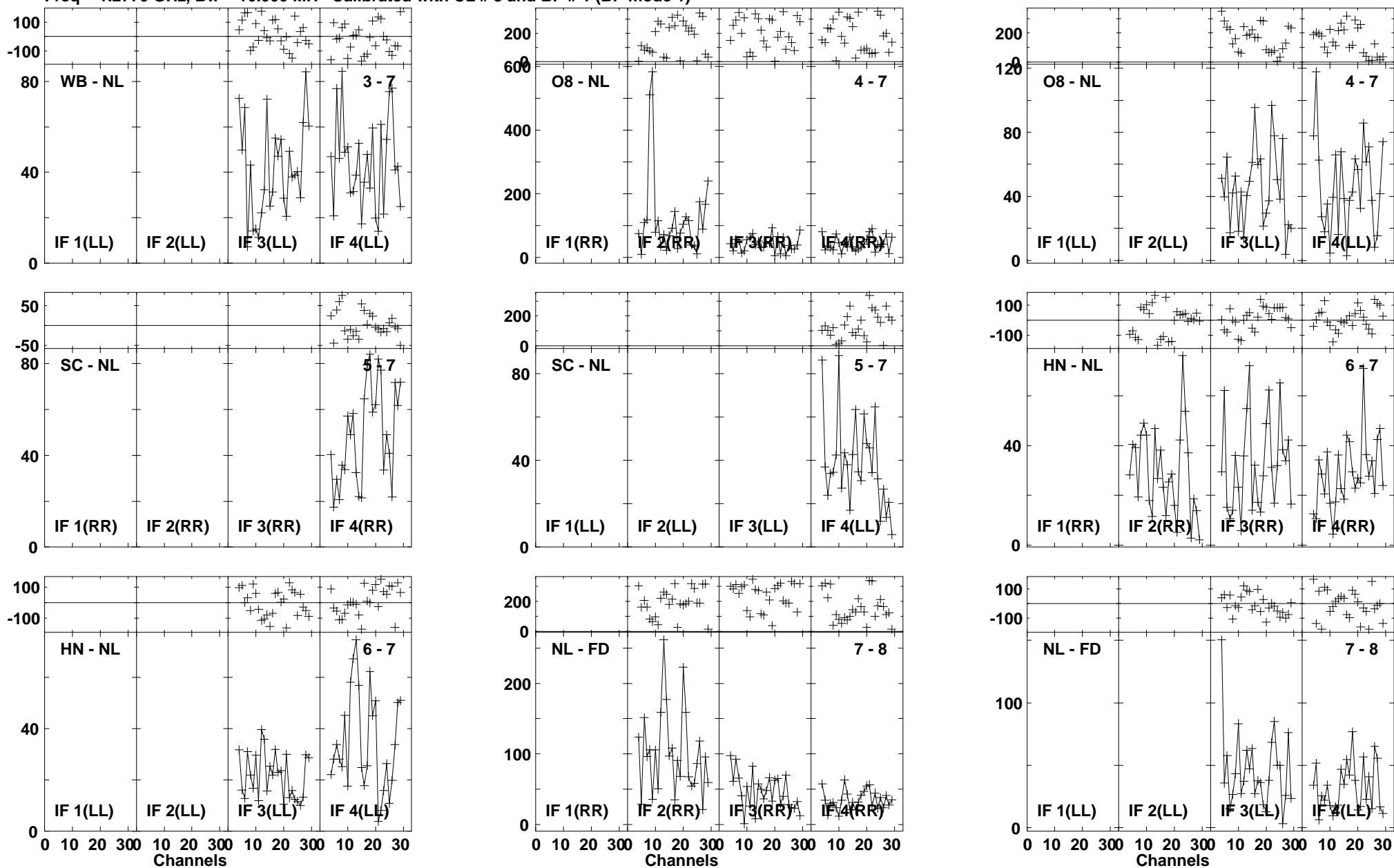

Lower frame: Milli Ampl Jy Top frame: Phas deg
 Vector averaged cross-power spectrum Baseline: WB (03) - NL (07)
 Timerange: 00/16:57:09 to 00/16:59:55

Plot file version 182 created 03-MAR-2016 01:12:28
 4C52 GN002C 1.UVDATA.1
 Freq = 1.2770 GHz, Bw = 16.000 MH Calibrated with CL # 3 and BP # 1 (BP mode 1)

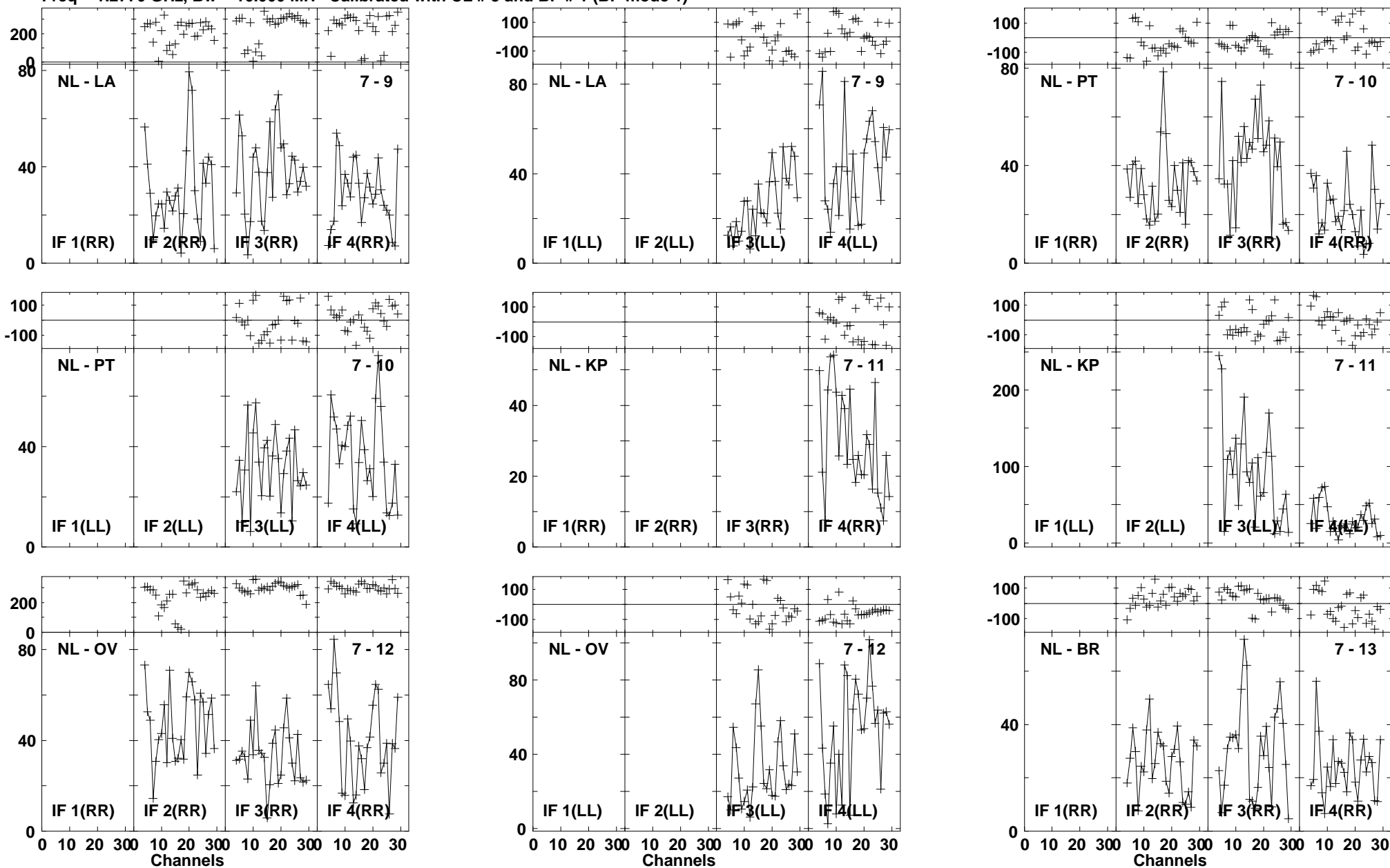

Lower frame: Milli Ampl Jy Top frame: Phas deg
 Vector averaged cross-power spectrum Baseline: NL (07) - LA (09)
 Timerange: 00/16:57:09 to 00/16:59:55

Plot file version 183 created 03-MAR-2016 01:12:28
4C52 GN002C 1.UVDATA.1
Freq = 1.2770 GHz, Bw = 16.000 MH Calibrated with CL # 3 and BP # 1 (BP mode 1)

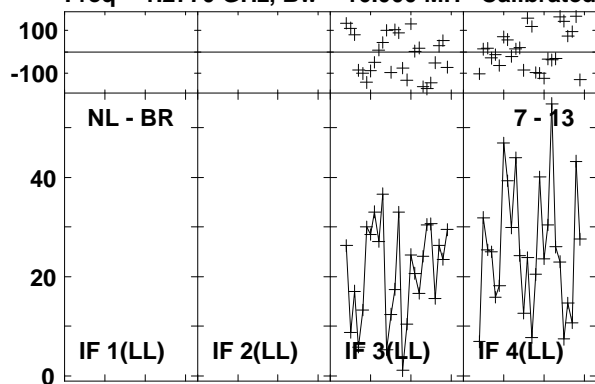

Lower frame: Milli Ampl Jy Top frame: Phas deg
Vector averaged cross-power spectrum Baseline: NL (07) - BR (13)
Timerange: 00/16:57:09 to 00/16:59:55

Plot file version 184 created 03-MAR-2016 01:12:29

J1545+5400 GN002C 1.UVDATA.1

Freq = 1.2770 GHz, Bw = 16.000 MH Calibrated with CL # 3 and BP # 1 (BP mode 1)

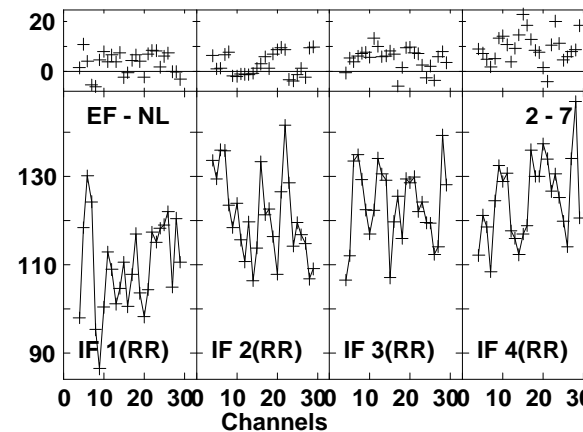
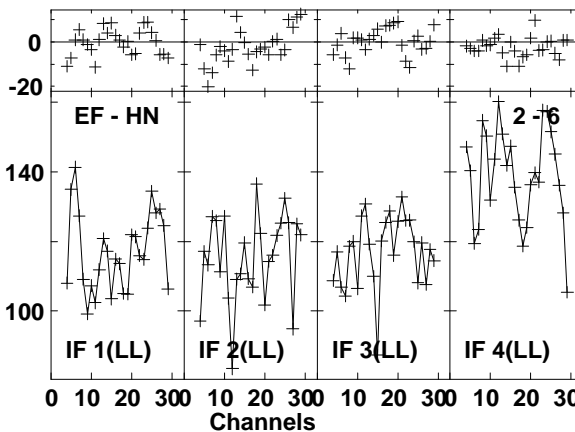
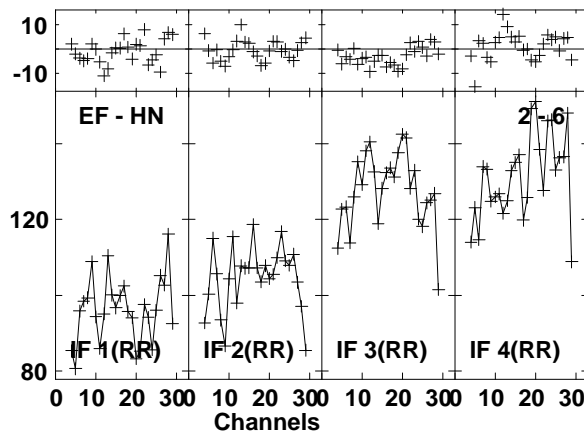
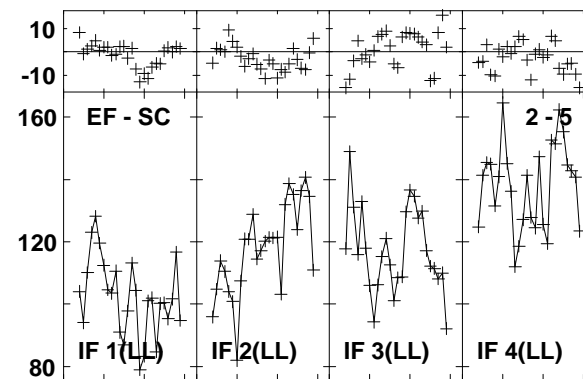
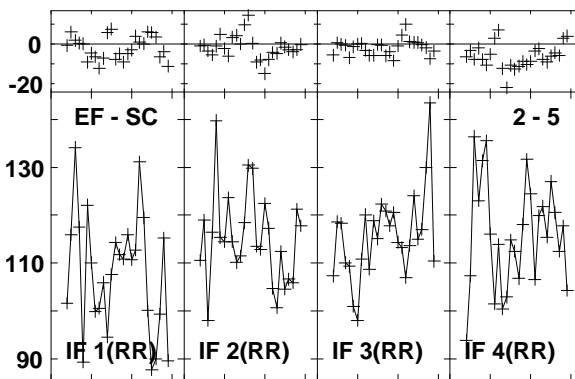
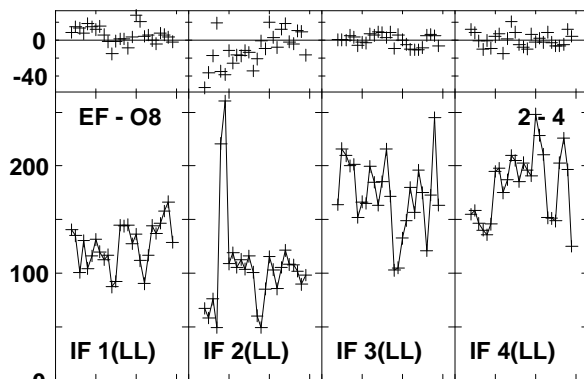
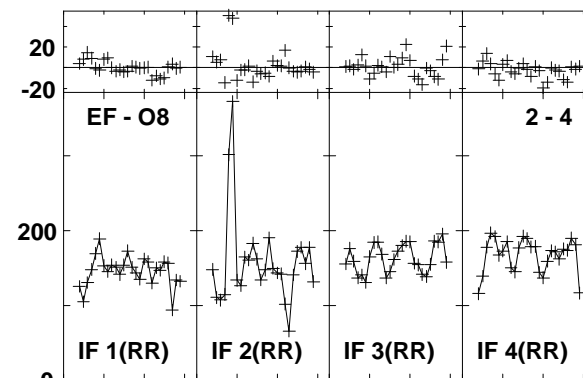
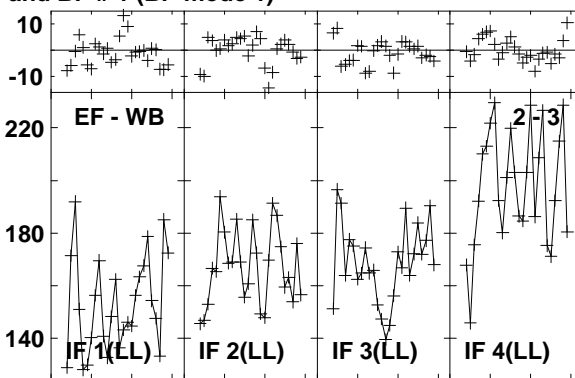
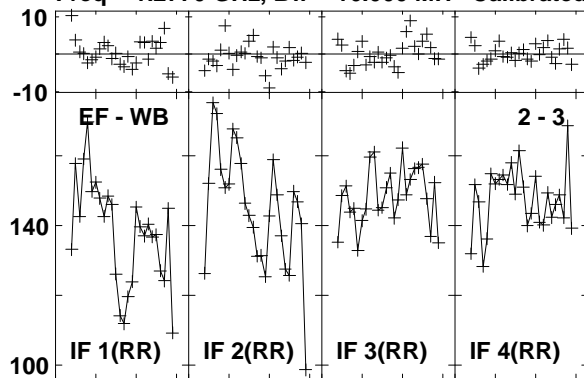

Lower frame: Milli Ampl Jy Top frame: Phas deg
Vector averaged cross-power spectrum Baseline: EF (02) - WB (03)
Timerange: 00/17:00:48 to 00/17:01:46

Plot file version 185 created 03-MAR-2016 01:12:29

J1545+5400 GN002C 1.UVDATA.1

Freq = 1.2770 GHz, Bw = 16.000 MH Calibrated with CL # 3 and BP # 1 (BP mode 1)

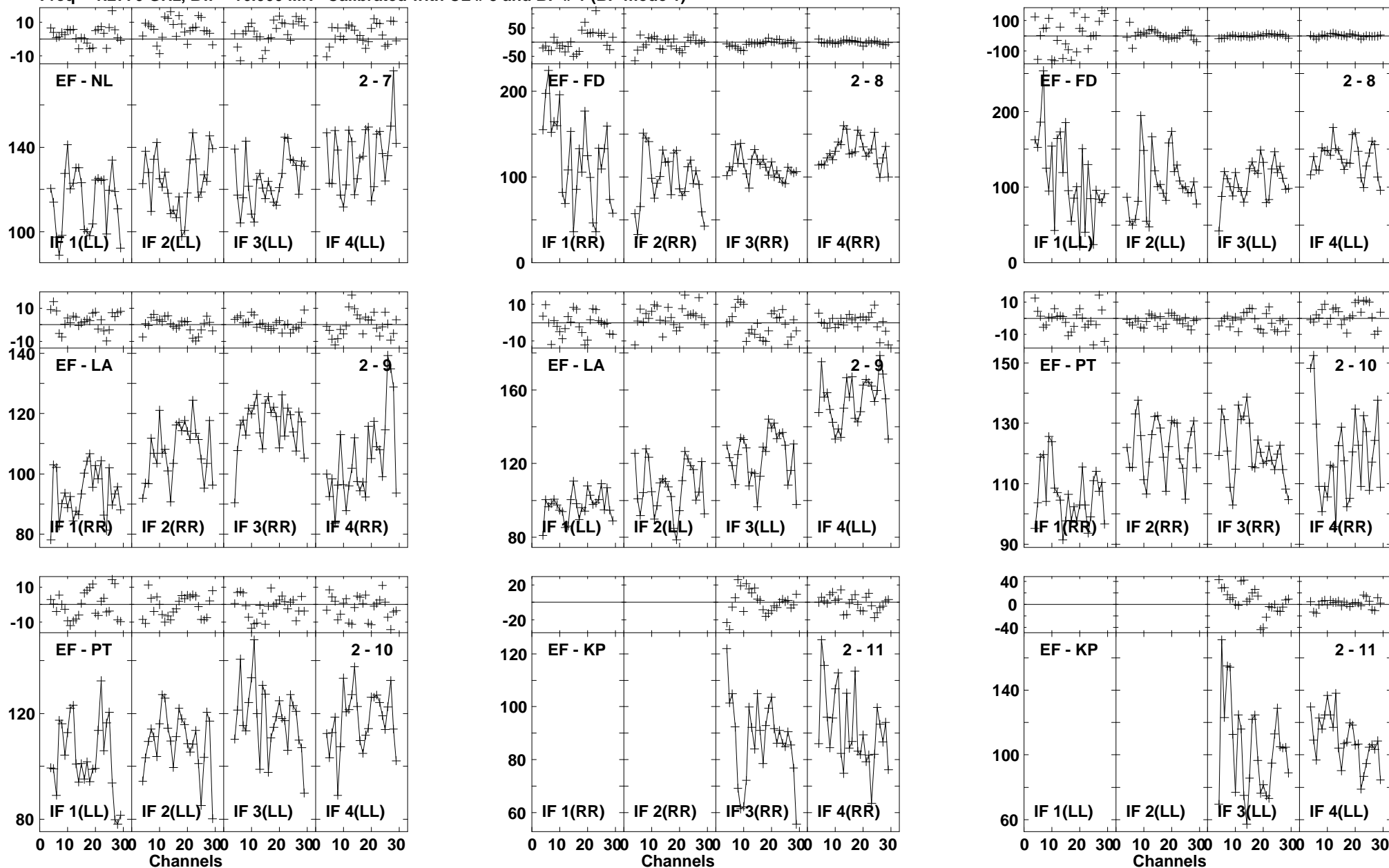

Lower frame: Milli Ampl Jy Top frame: Phas deg
Vector averaged cross-power spectrum Baseline: EF (02) - NL (07)
Timerange: 00/17:00:48 to 00/17:01:46

Plot file version 186 created 03-MAR-2016 01:12:29

J1545+5400 GN002C 1.UVDATA.1

Freq = 1.2770 GHz, Bw = 16.000 MH Calibrated with CL # 3 and BP # 1 (BP mode 1)

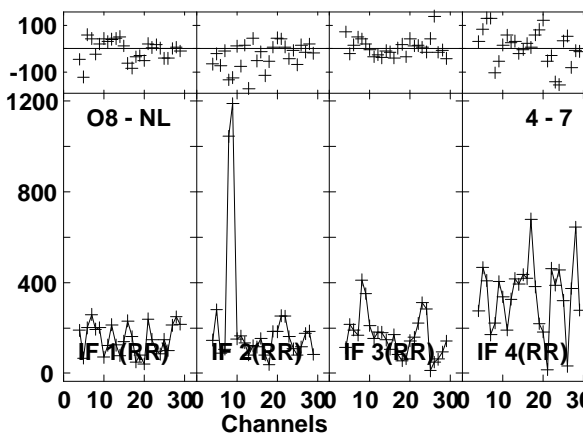
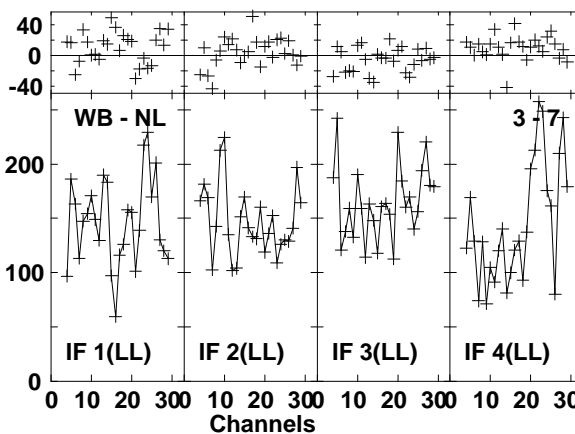
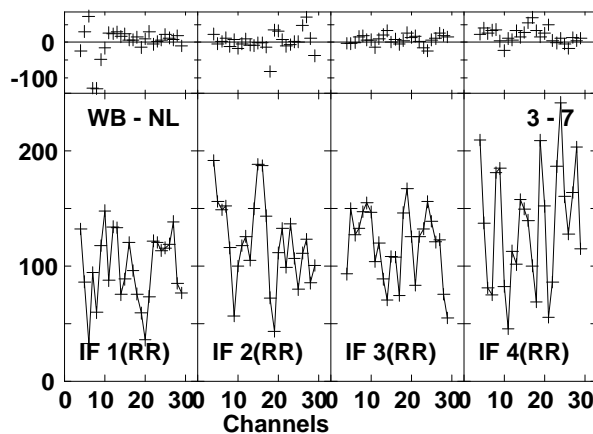
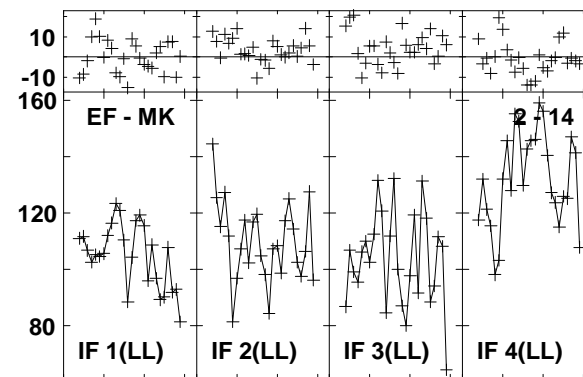
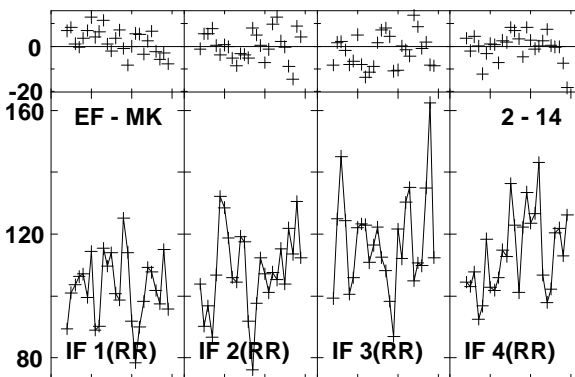
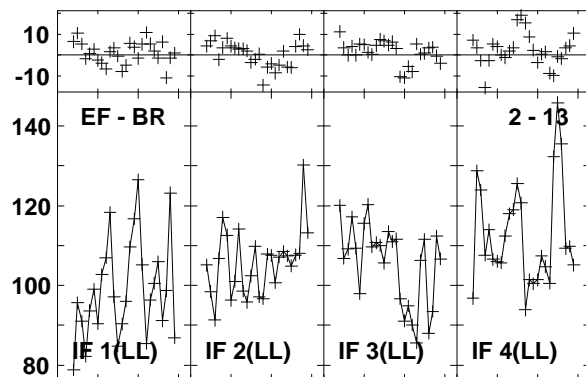
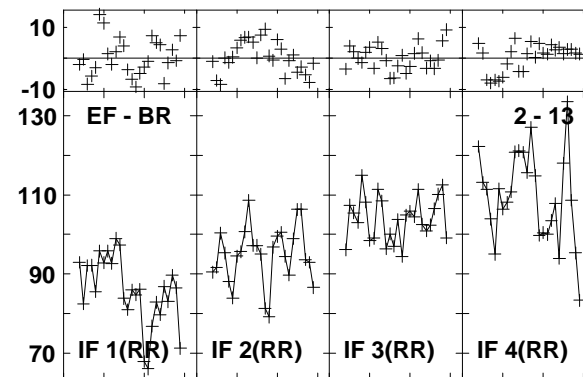
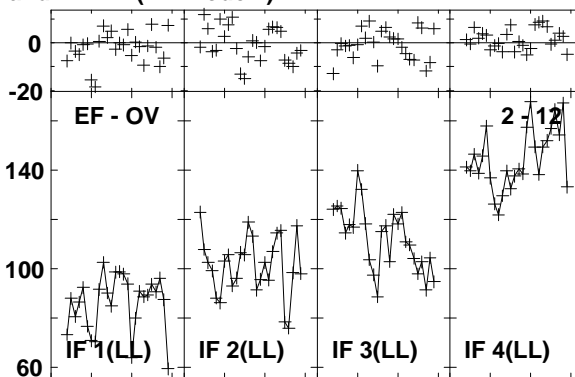
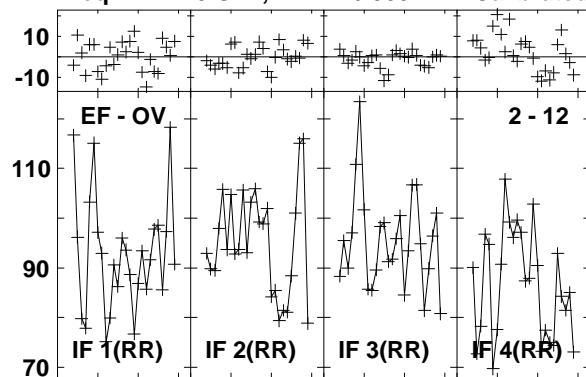

Lower frame: Milli Ampl Jy Top frame: Phas deg
Vector averaged cross-power spectrum Baseline: EF (02) - OV (12)
Timerange: 00/17:00:48 to 00/17:01:46

Plot file version 187 created 03-MAR-2016 01:12:29

J1545+5400 GN002C 1.UVDATA.1

Freq = 1.2770 GHz, Bw = 16.000 MH Calibrated with CL # 3 and BP # 1 (BP mode 1)

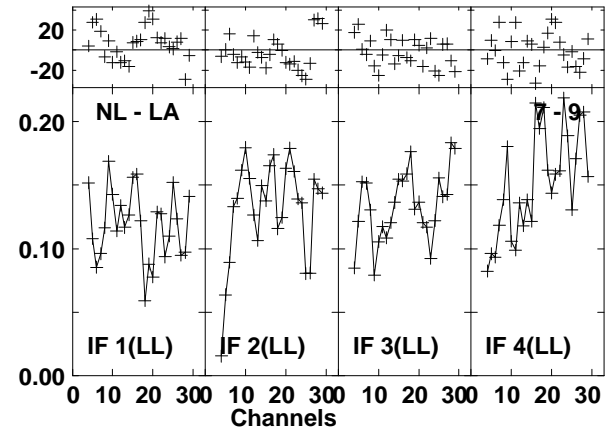
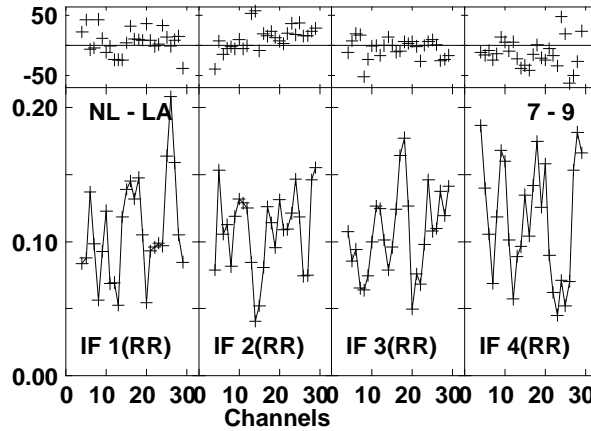
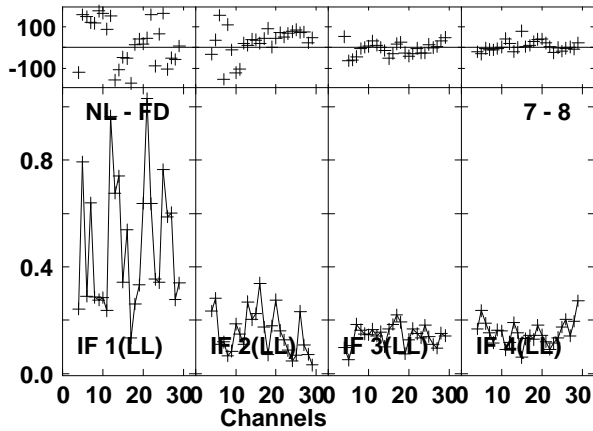
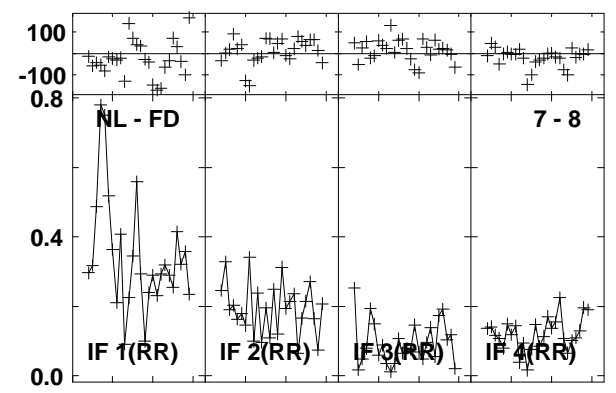
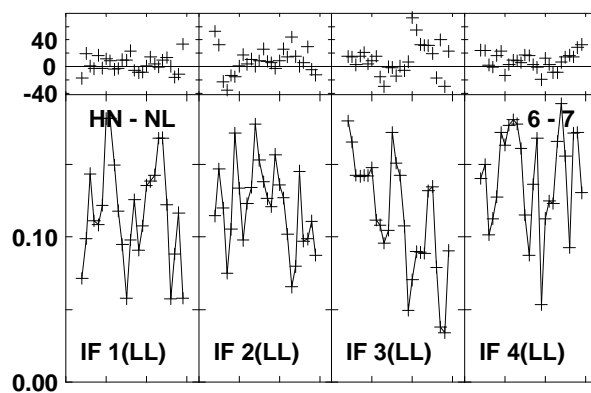
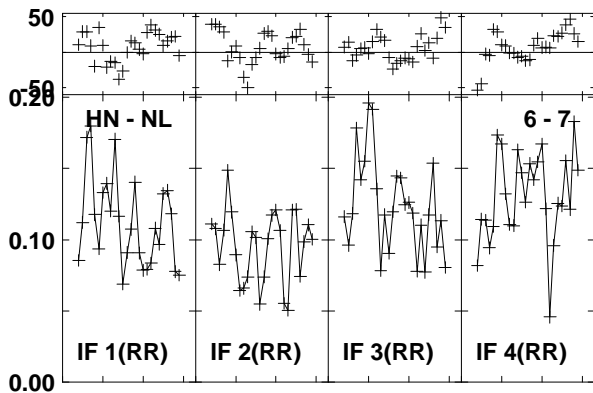
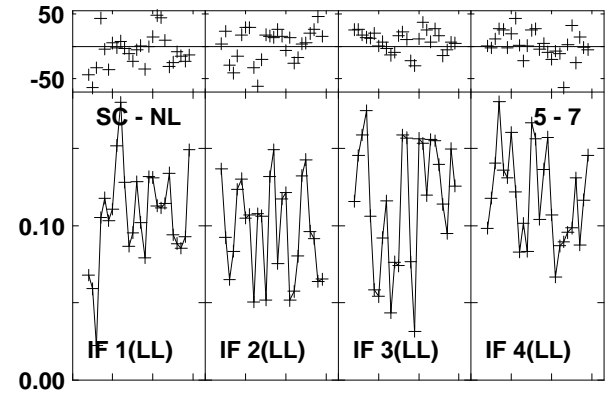
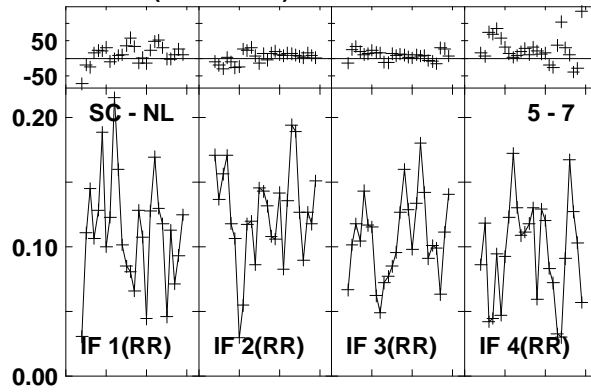
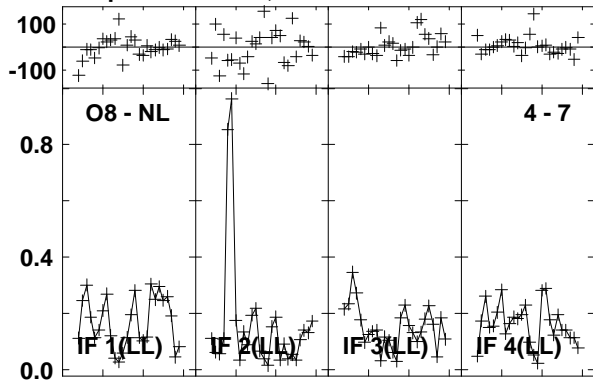

Lower frame: Ampl Jy Top frame: Phas deg
Vector averaged cross-power spectrum Baseline: O8 (04) - NL (07)
Timerange: 00/17:00:48 to 00/17:01:46

Plot file version 188 created 03-MAR-2016 01:12:29

J1545+5400 GN002C 1.UVDATA.1

Freq = 1.2770 GHz, Bw = 16.000 MH Calibrated with CL # 3 and BP # 1 (BP mode 1)

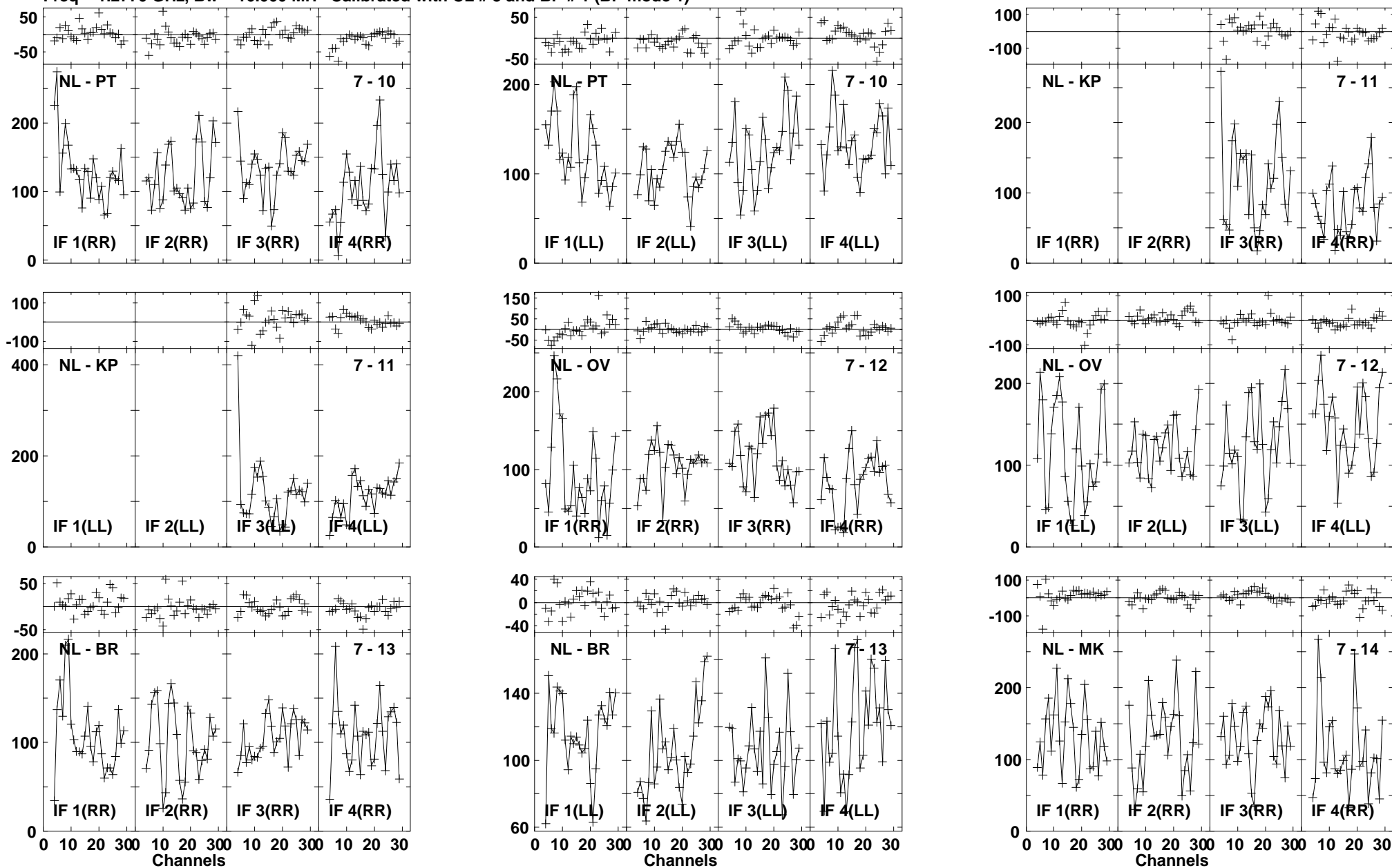

Lower frame: Milli Ampl Jy Top frame: Phas deg
Vector averaged cross-power spectrum Baseline: NL (07) - PT (10)
Timerange: 00/17:00:48 to 00/17:01:46

Plot file version 189 created 03-MAR-2016 01:12:29
J1545+5400 GN002C 1.UVDATA.1
Freq = 1.2770 GHz, Bw = 16.000 MH Calibrated with CL # 3 and BP # 1 (BP mode 1)

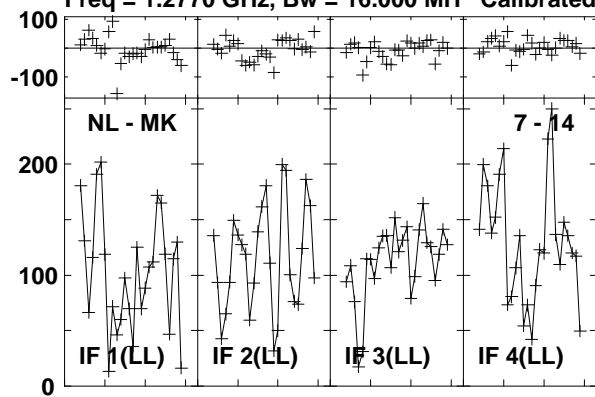

Lower frame: Milli Ampl Jy Top frame: Phas deg
Vector averaged cross-power spectrum Baseline: NL (07) - MK (14)
Timerange: 00/17:00:48 to 00/17:01:46

Plot file version 190 created 03-MAR-2016 01:12:29

4C52 GN002C 1.UVDATA.1

Freq = 1.2770 GHz, Bw = 16.000 MH Calibrated with CL # 3 and BP # 1 (BP mode 1)

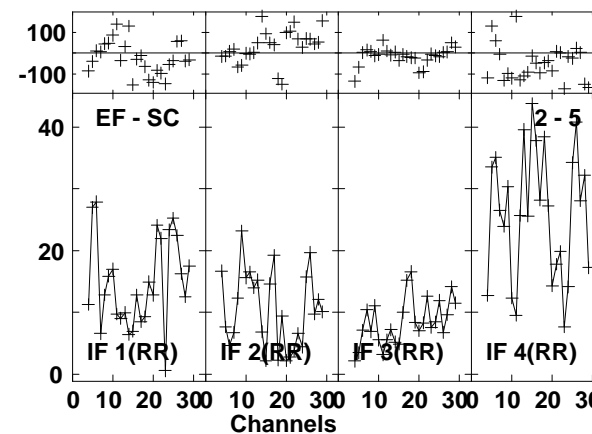
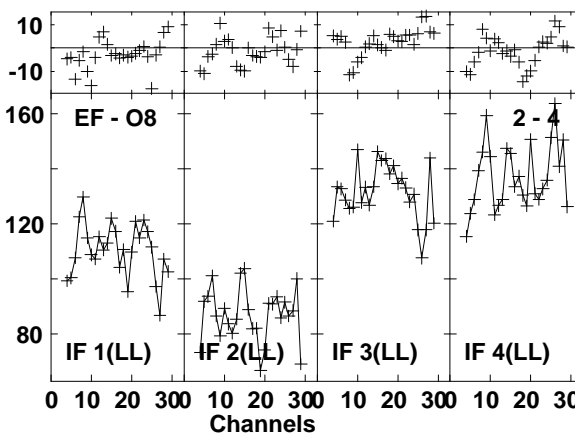
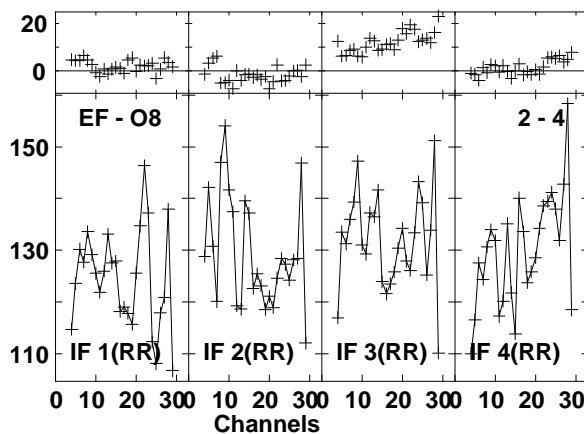
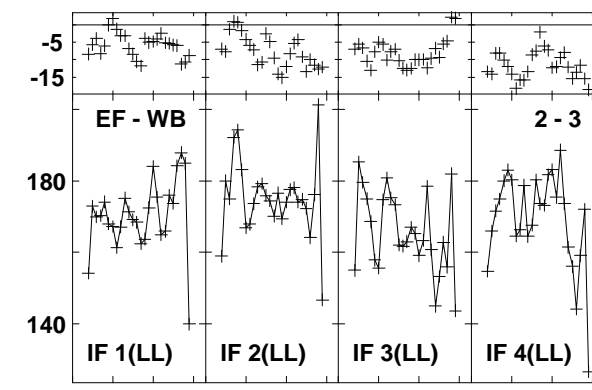
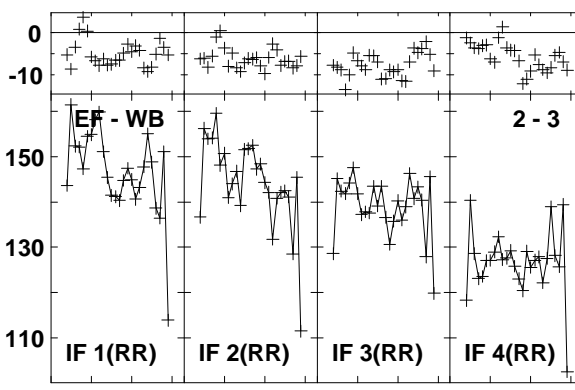
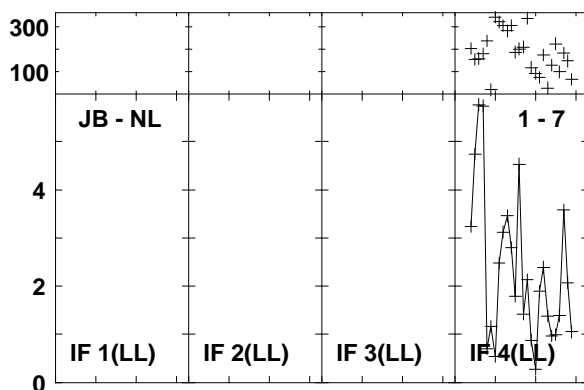
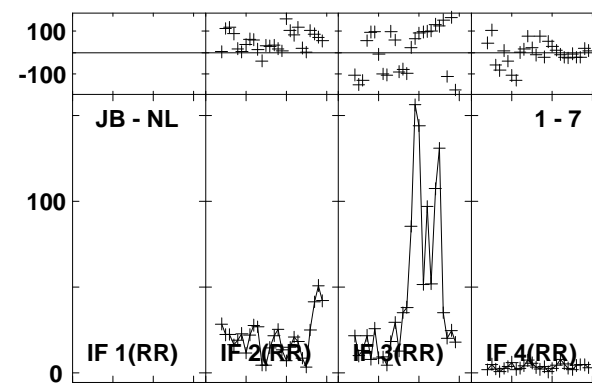
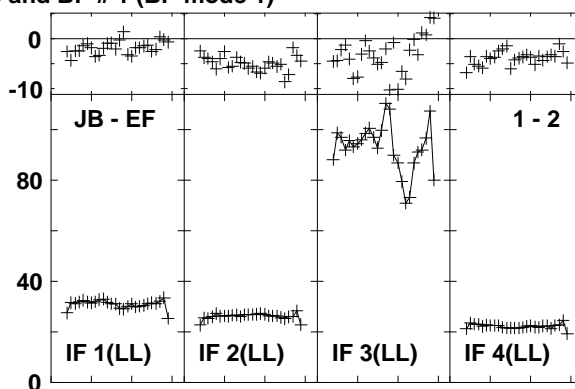
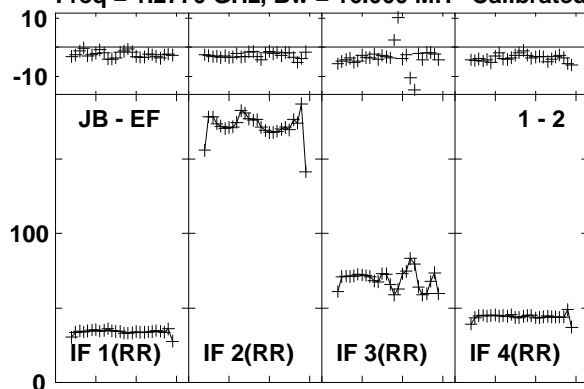

Lower frame: Milli Ampl Jy Top frame: Phas deg
Vector averaged cross-power spectrum Baseline: JB (01) - EF (02)
Timerange: 00/17:01:51 to 00/17:04:45

Plot file version 191 created 03-MAR-2016 01:12:30

4C52 GN002C 1.UVDATA.1

Freq = 1.2770 GHz, Bw = 16.000 MH Calibrated with CL # 3 and BP # 1 (BP mode 1)

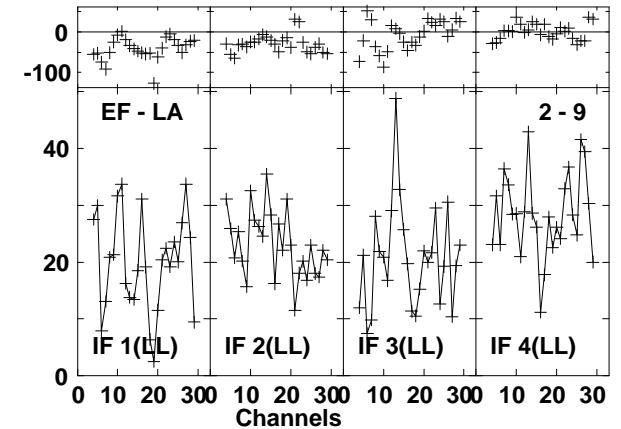
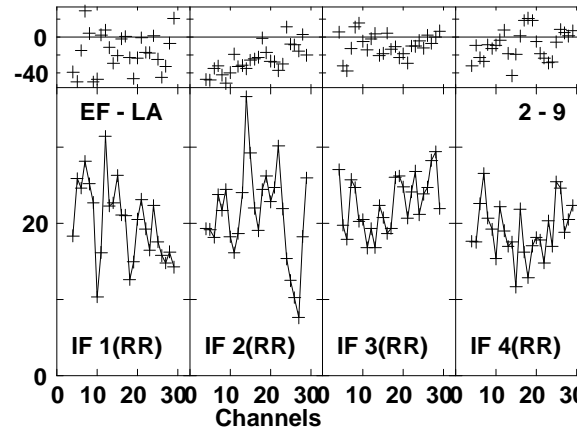
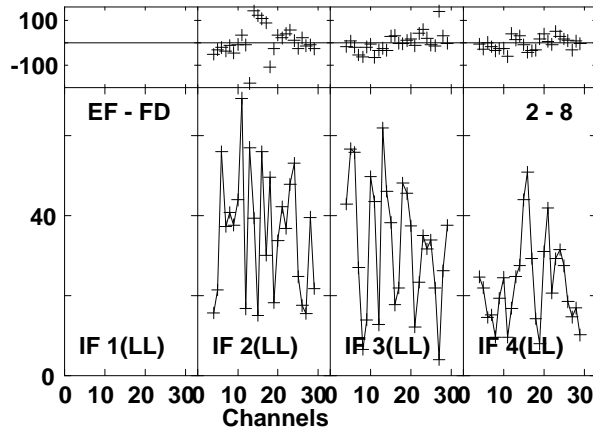
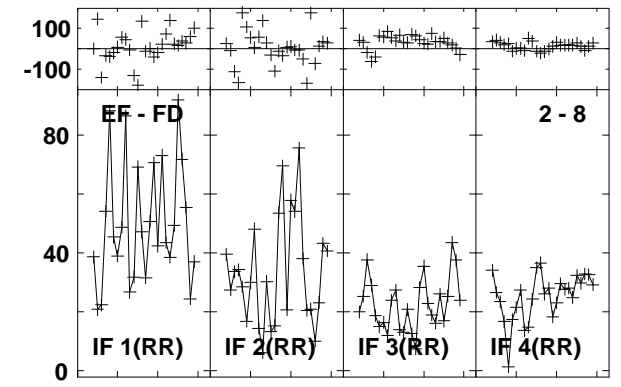
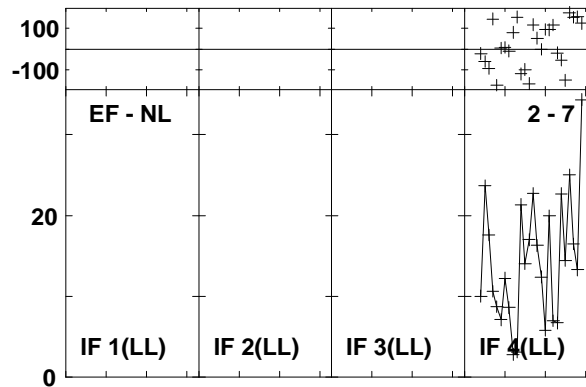
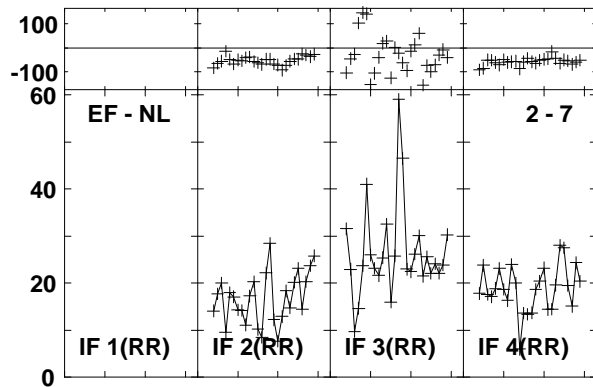
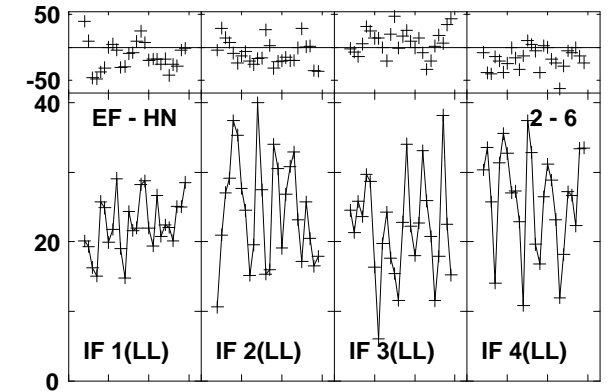
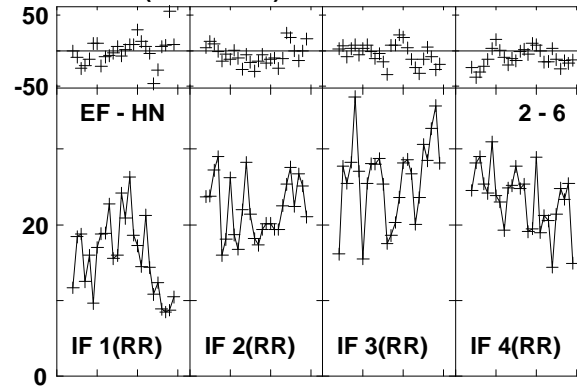
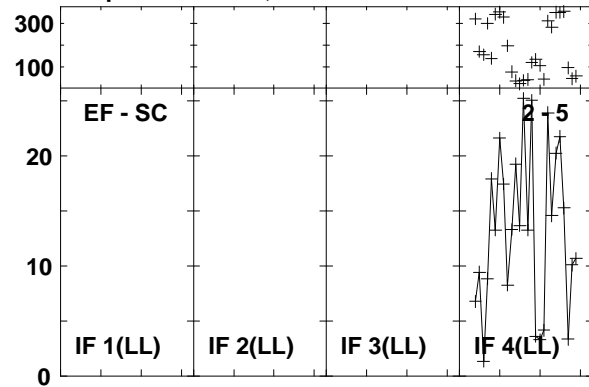

Lower frame: Milli Ampl Jy Top frame: Phas deg
Vector averaged cross-power spectrum Baseline: EF (02) - SC (05)
Timerange: 00/17:01:51 to 00/17:04:45

Plot file version 192 created 03-MAR-2016 01:12:30

4C52 GN002C 1.UVDATA.1

Freq = 1.2770 GHz, Bw = 16.000 MH Calibrated with CL # 3 and BP # 1 (BP mode 1)

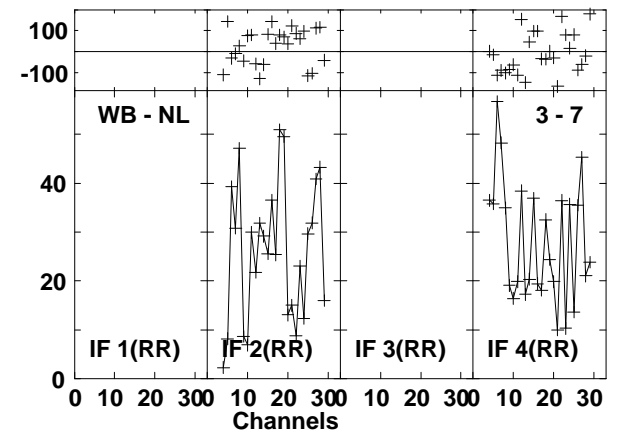
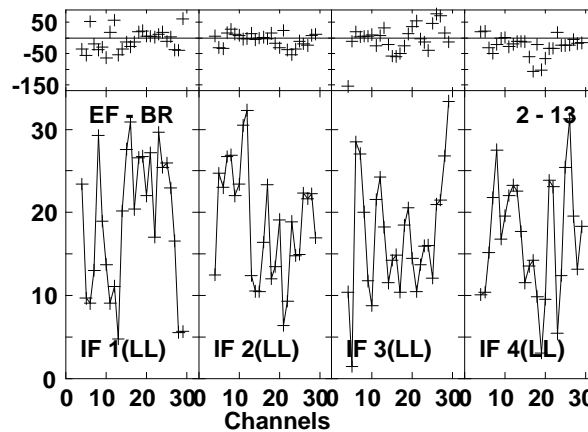
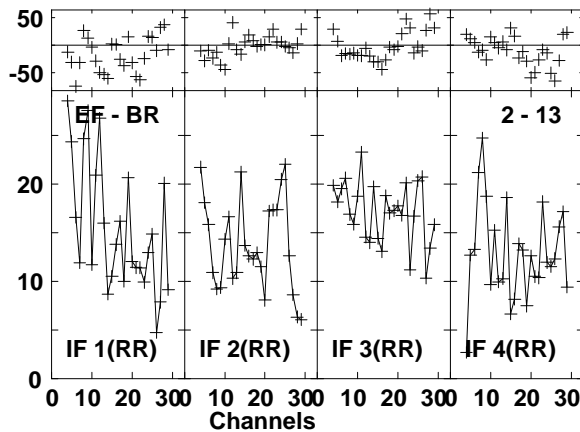
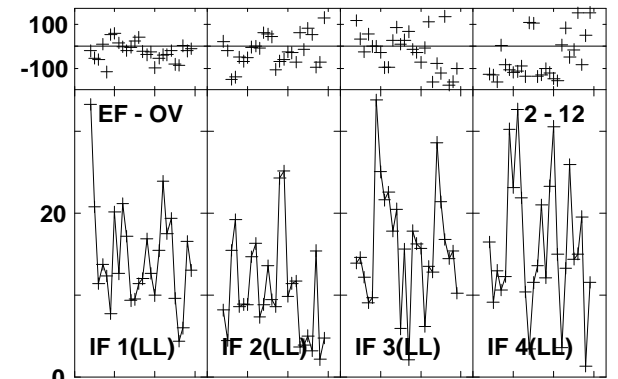
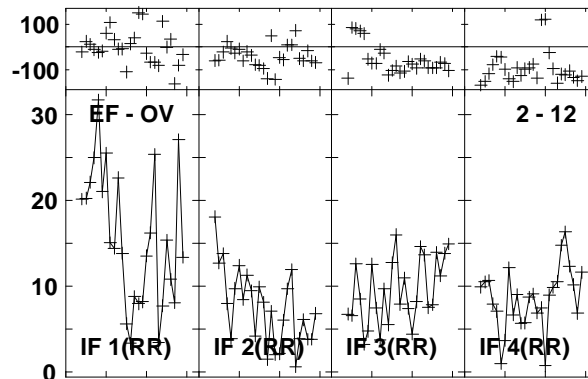
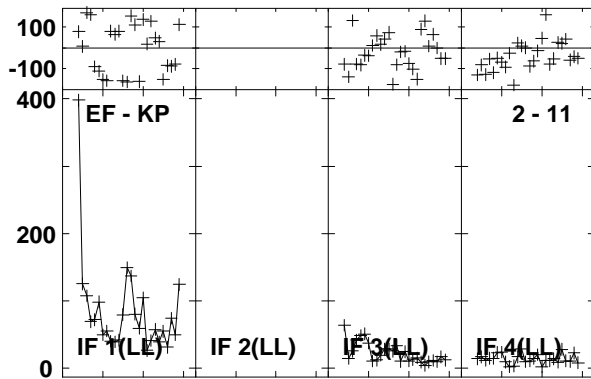
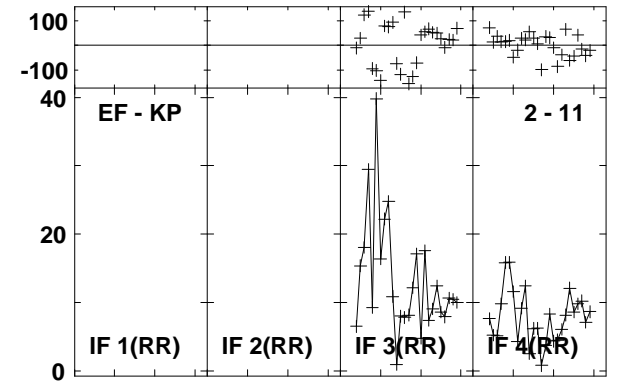
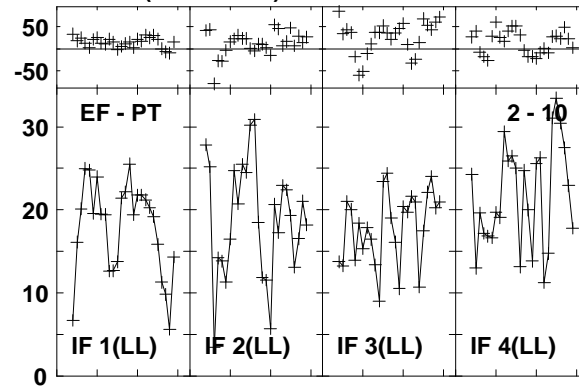
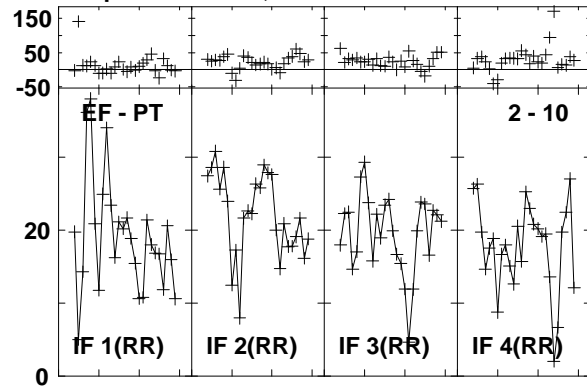

Lower frame: Milli Ampl Jy Top frame: Phas deg
Vector averaged cross-power spectrum Baseline: EF (02) - PT (10)
Timerange: 00/17:01:51 to 00/17:04:45

Plot file version 193 created 03-MAR-2016 01:12:30

4C52 GN002C 1.UVDATA.1

Freq = 1.2770 GHz, Bw = 16.000 MH Calibrated with CL # 3 and BP # 1 (BP mode 1)

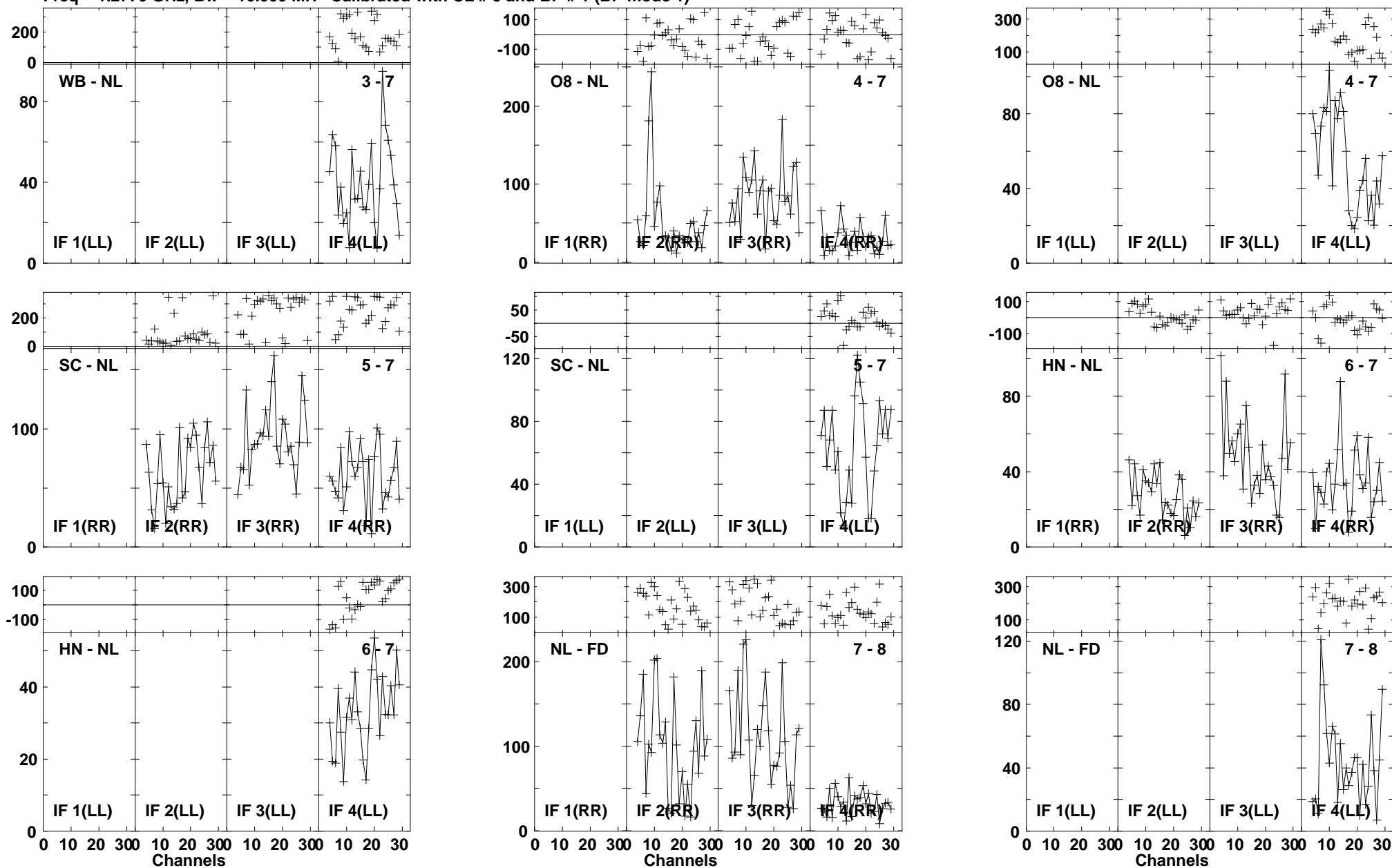

Lower frame: Milli Ampl Jy Top frame: Phas deg
Vector averaged cross-power spectrum Baseline: WB (03) - NL (07)
Timerange: 00/17:01:51 to 00/17:04:45

Plot file version 194 created 03-MAR-2016 01:12:30
 4C52 GN002C 1.UVDATA.1
 Freq = 1.2770 GHz, Bw = 16.000 MH Calibrated with CL # 3 and BP # 1 (BP mode 1)

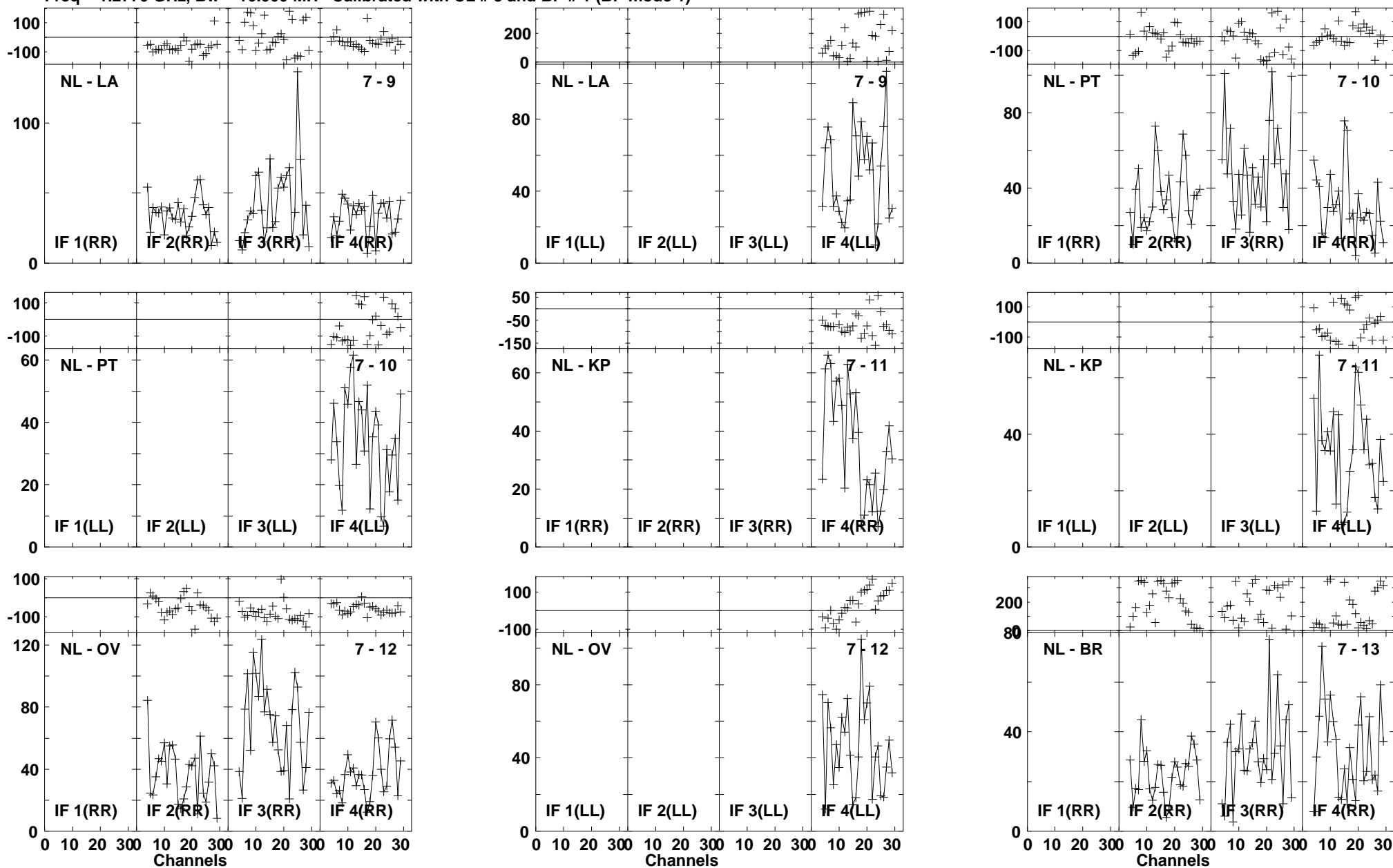

Lower frame: Milli Ampl Jy Top frame: Phas deg
 Vector averaged cross-power spectrum Baseline: NL (07) - LA (09)
 Timerange: 00/17:01:51 to 00/17:04:45

Plot file version 195 created 03-MAR-2016 01:12:30
4C52 GN002C 1.UVDATA.1
Freq = 1.2770 GHz, Bw = 16.000 MH Calibrated with CL # 3 and BP # 1 (BP mode 1)

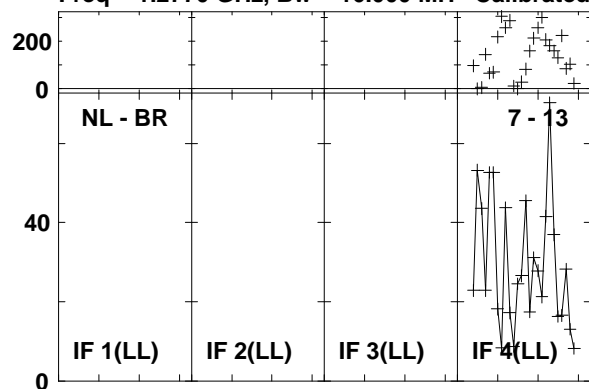

Lower frame: Milli Ampl Jy Top frame: Phas deg
Vector averaged cross-power spectrum Baseline: NL (07) - BR (13)
Timerange: 00/17:01:51 to 00/17:04:45

Plot file version 196 created 03-MAR-2016 01:12:31

J1545+5400 GN002C 1.UVDATA.1

Freq = 1.2770 GHz, Bw = 16.000 MH Calibrated with CL # 3 and BP # 1 (BP mode 1)

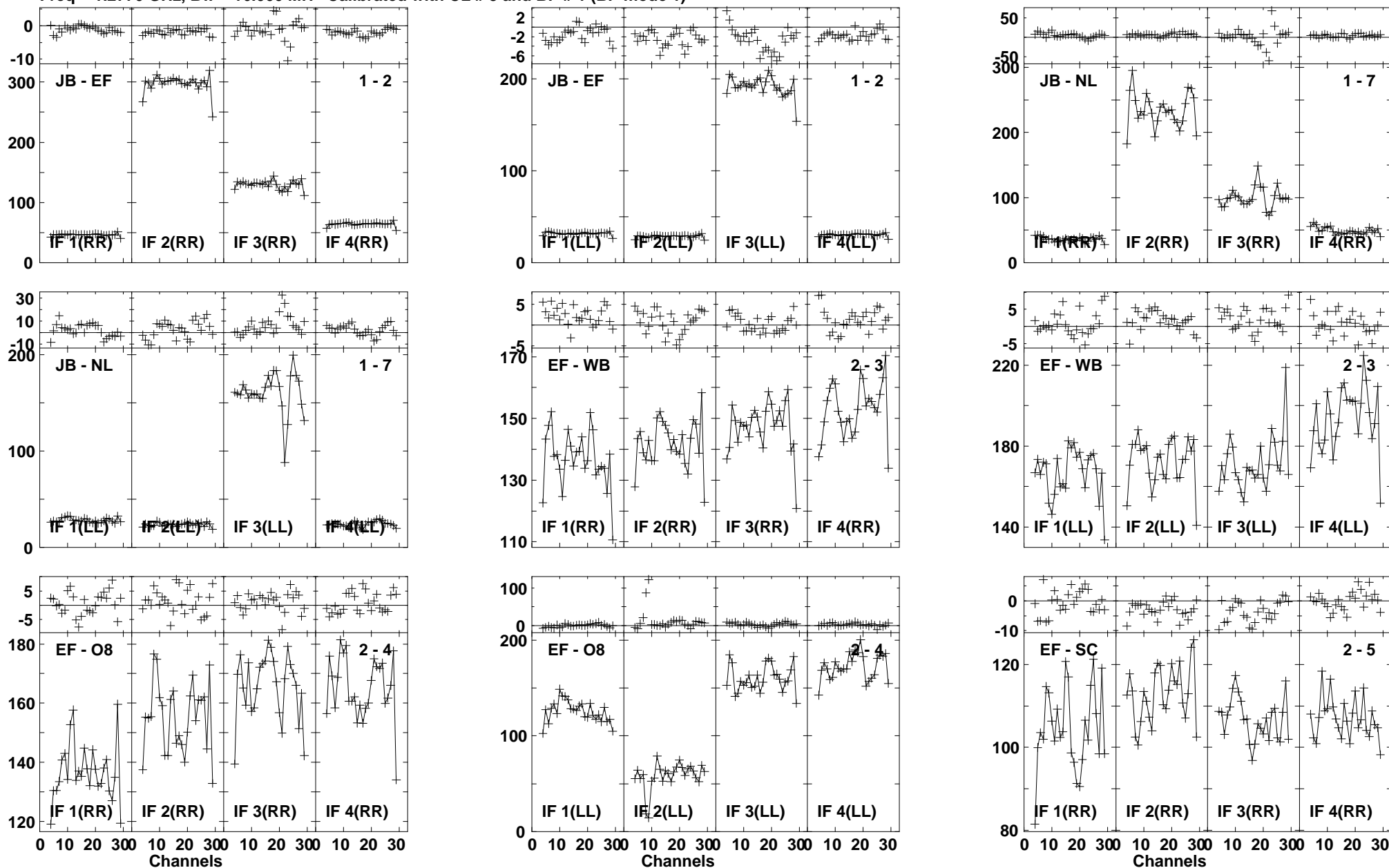

Lower frame: Milli Ampl Jy Top frame: Phas deg
Vector averaged cross-power spectrum Baseline: JB (01) - EF (02)
Timerange: 00/17:05:38 to 00/17:07:36

Plot file version 197 created 03-MAR-2016 01:12:31

J1545+5400 GN002C 1.UVDATA.1

Freq = 1.2770 GHz, Bw = 16.000 MH Calibrated with CL # 3 and BP # 1 (BP mode 1)

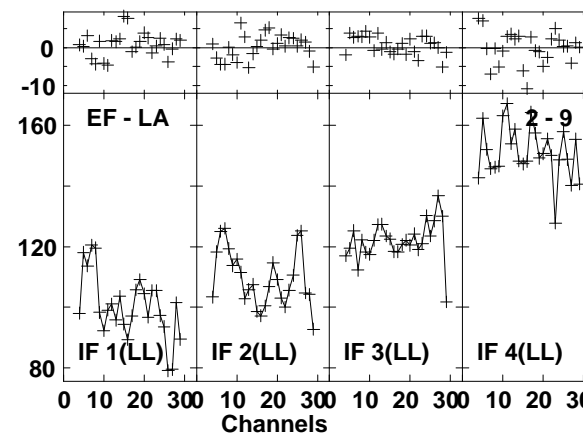
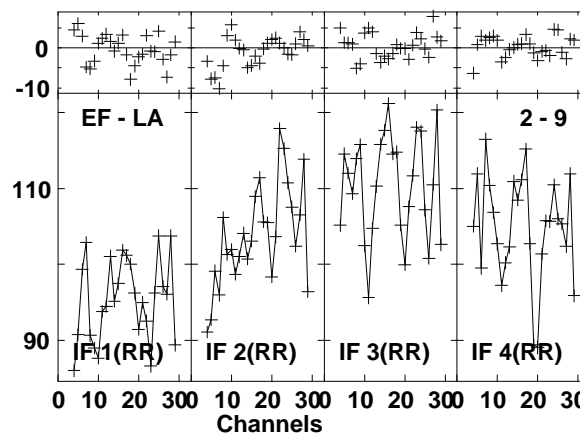
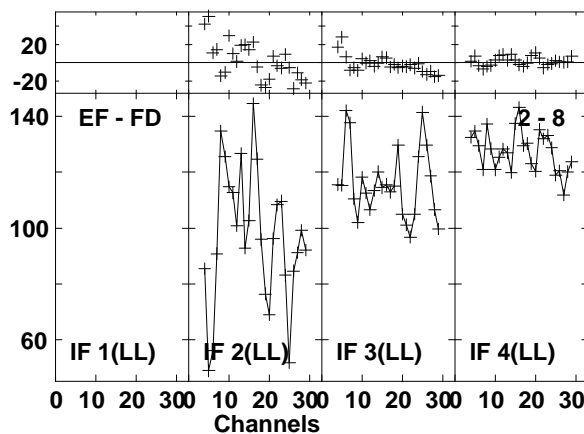
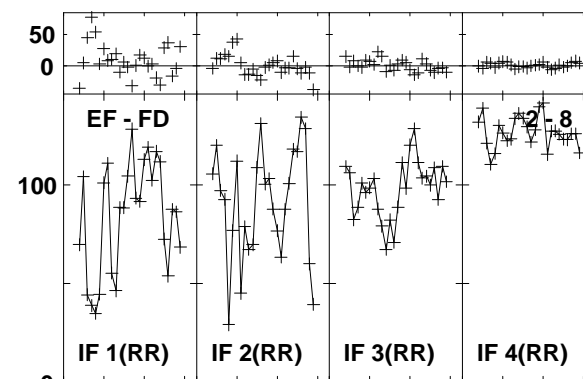
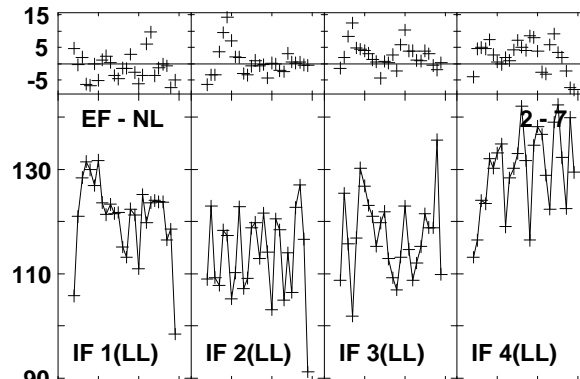
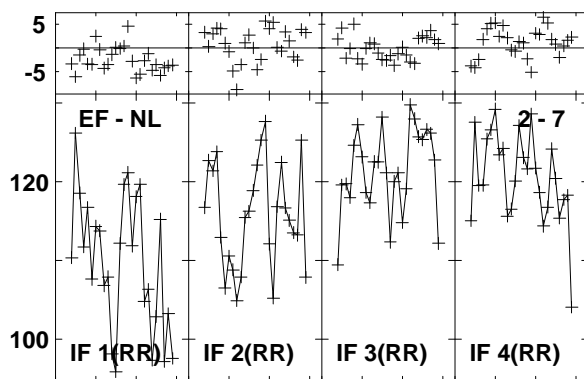
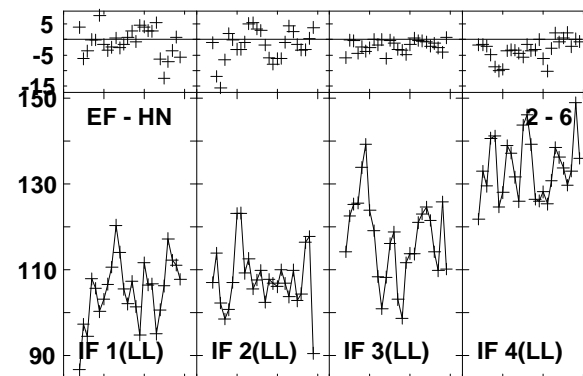
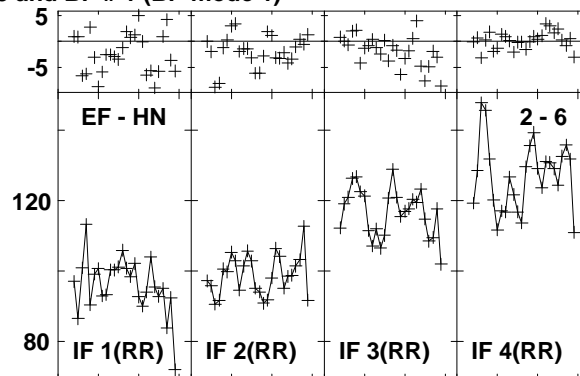
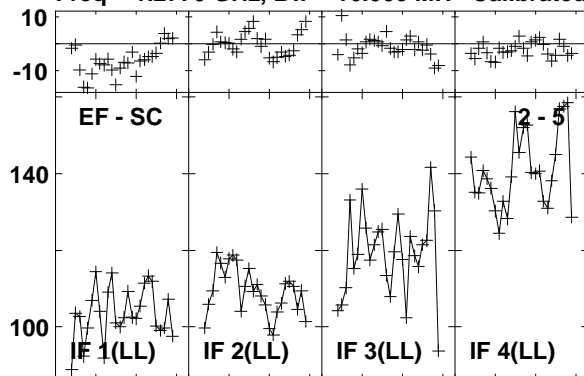

Lower frame: Milli Ampl Jy Top frame: Phas deg
Vector averaged cross-power spectrum Baseline: EF (02) - SC (05)
Timerange: 00/17:05:38 to 00/17:07:36

Plot file version 198 created 03-MAR-2016 01:12:31
 J1545+5400 GN002C 1.UVDATA.1
 Freq = 1.2770 GHz, Bw = 16.000 MH Calibrated with CL # 3 and BP # 1 (BP mode 1)

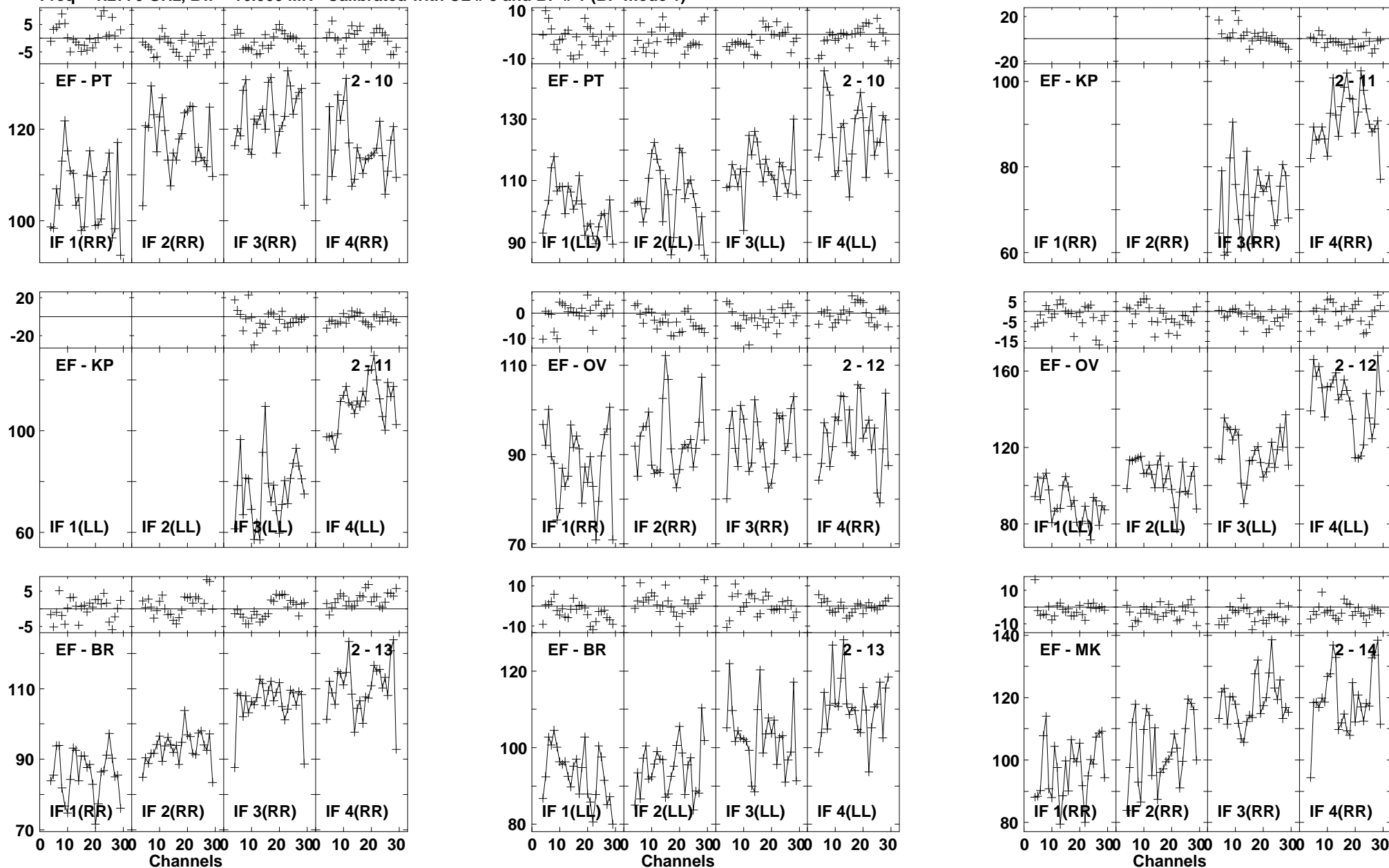

Lower frame: Milli Ampl Jy Top frame: Phas deg
 Vector averaged cross-power spectrum Baseline: EF (02) - PT (10)
 Timerange: 00/17:05:38 to 00/17:07:36

Plot file version 199 created 03-MAR-2016 01:12:31

J1545+5400 GN002C 1.UVDATA.1

Freq = 1.2770 GHz, Bw = 16.000 MH Calibrated with CL # 3 and BP # 1 (BP mode 1)

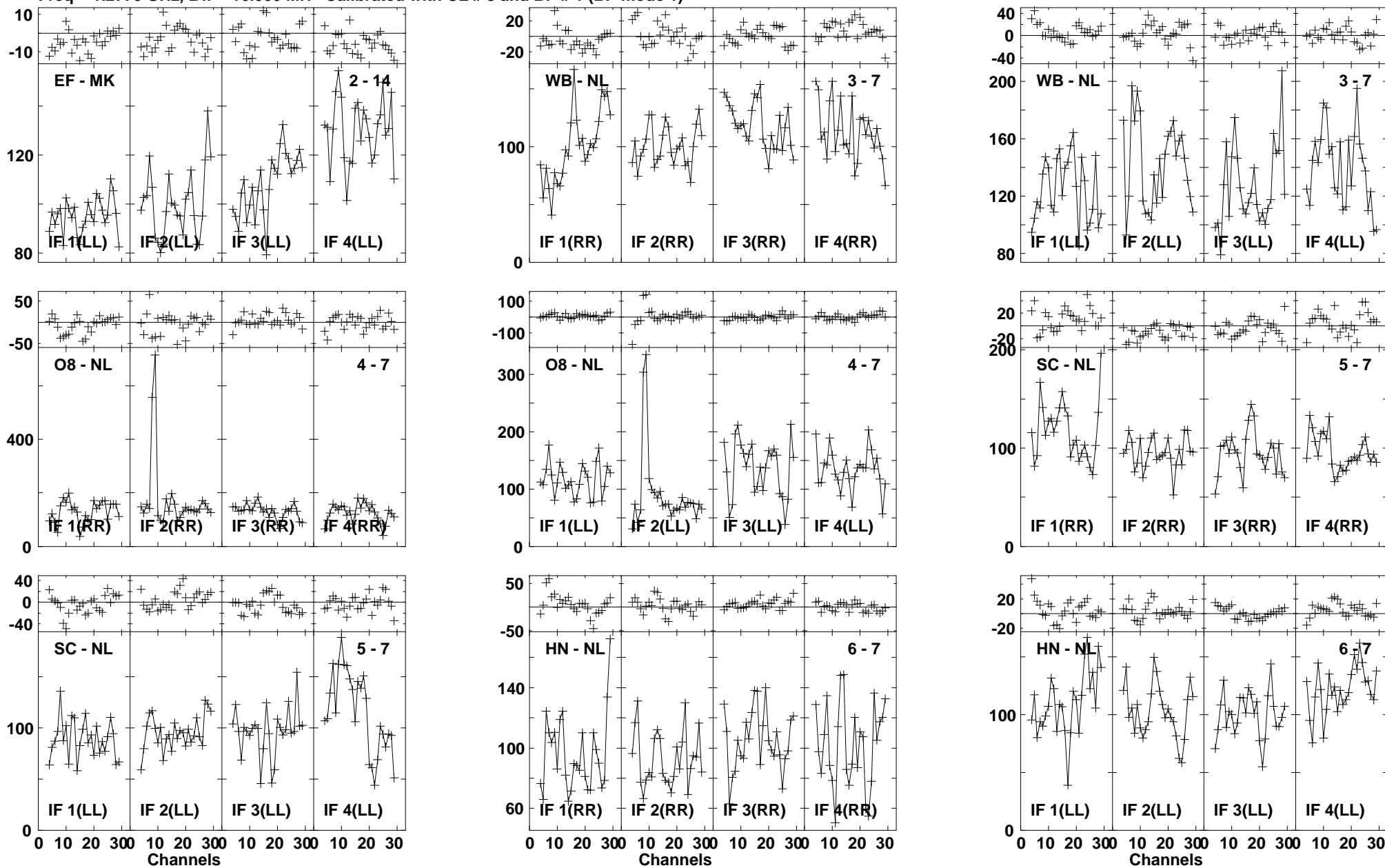

Lower frame: Milli Ampl Jy Top frame: Phas deg
Vector averaged cross-power spectrum Baseline: EF (02) - MK (14)
Timerange: 00:17:05:38 to 00:17:07:36

Plot file version 200 created 03-MAR-2016 01:12:31

J1545+5400 GN002C 1.UVDATA.1

Freq = 1.2770 GHz, Bw = 16.000 MH Calibrated with CL # 3 and BP # 1 (BP mode 1)

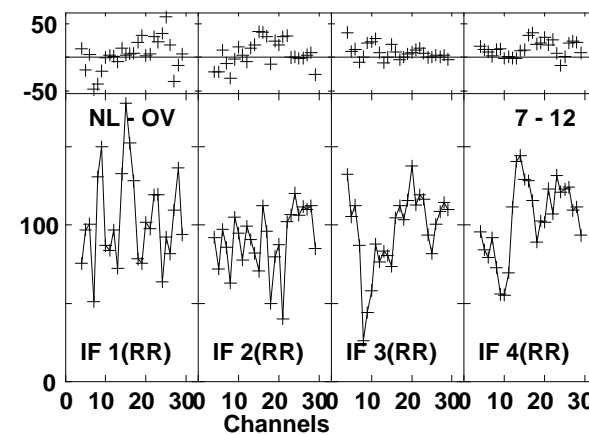
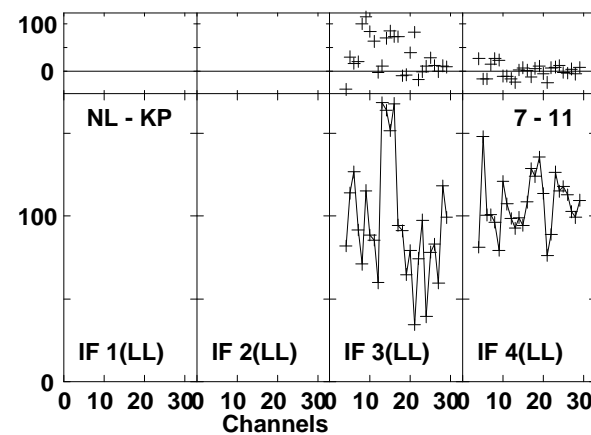
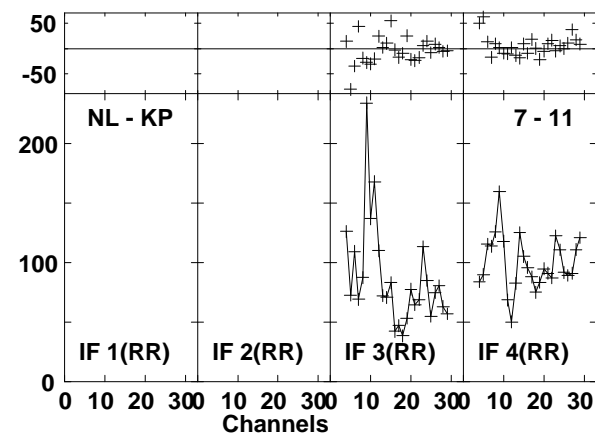
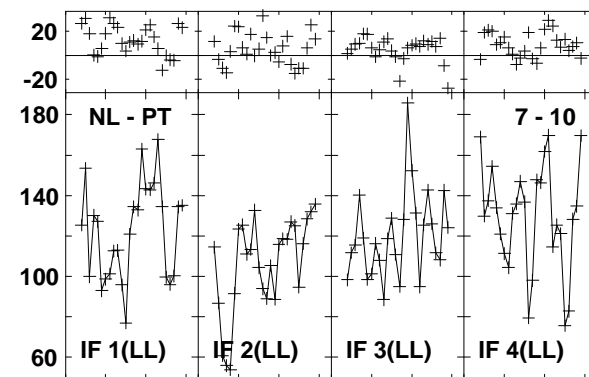
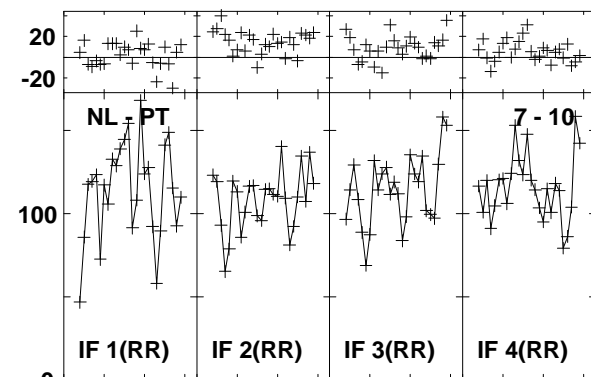
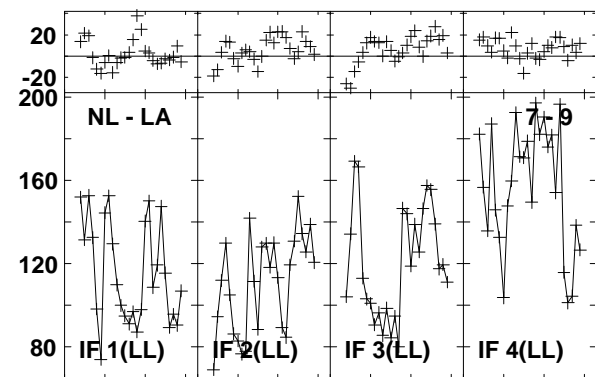
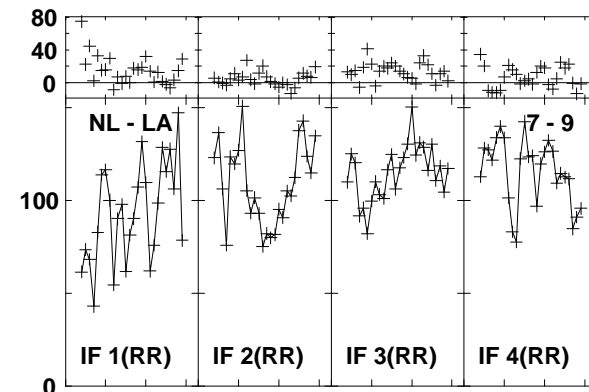
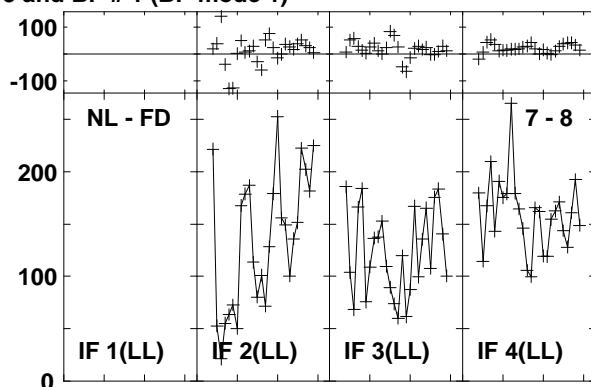
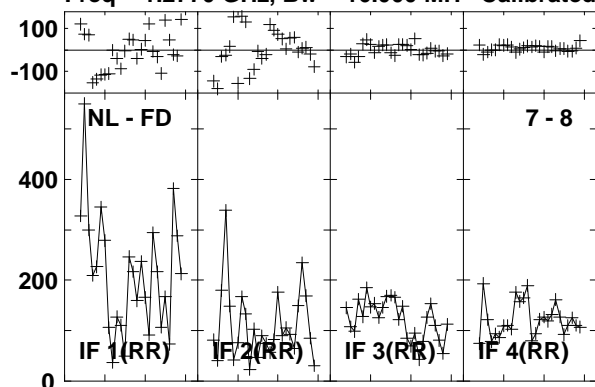

Lower frame: Milli Ampl Jy Top frame: Phas deg
Vector averaged cross-power spectrum Baseline: NL (07) - FD (08)
Timerange: 00/17:05:38 to 00/17:07:36

Plot file version 201 created 03-MAR-2016 01:12:31
 J1545+5400 GN002C 1.UVDATA.1
 Freq = 1.2770 GHz, Bw = 16.000 MH Calibrated with CL # 3 and BP # 1 (BP mode 1)

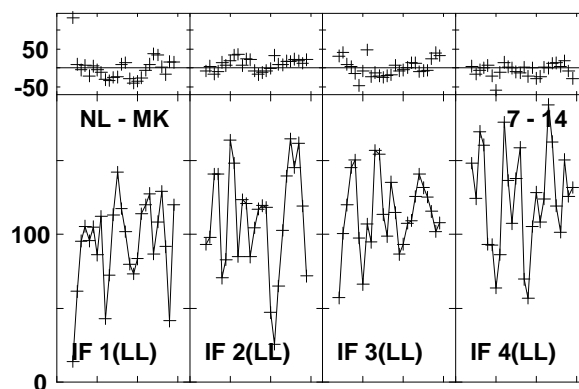
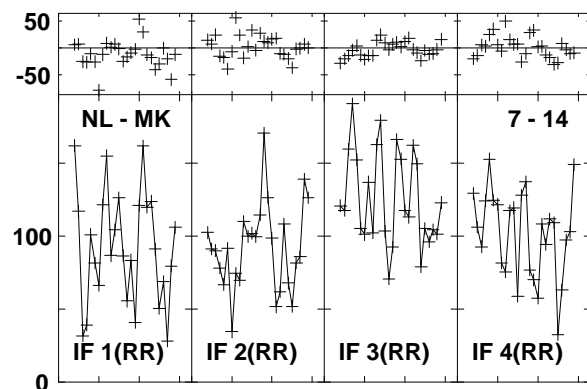
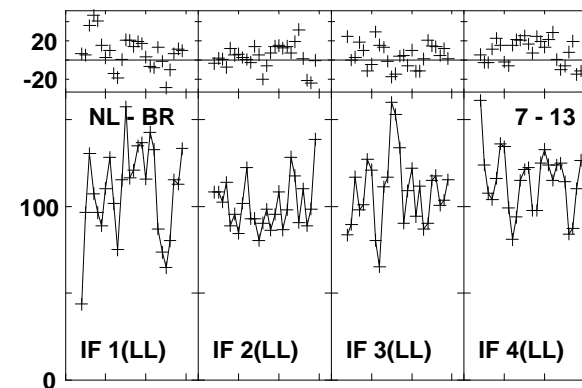
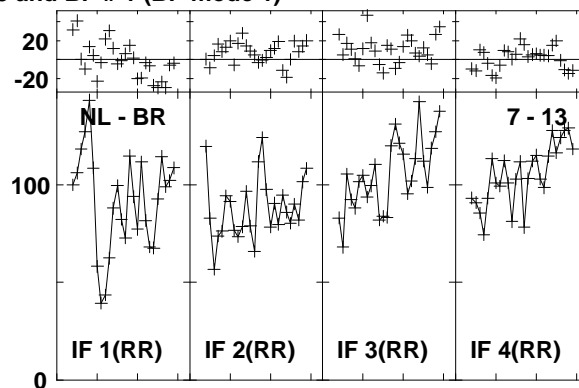
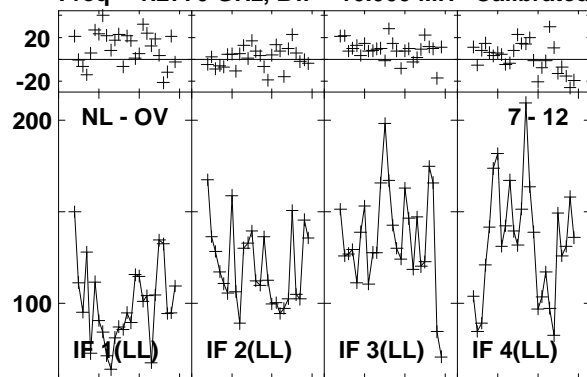

Lower frame: Milli Ampl Jy Top frame: Phas deg
 Vector averaged cross-power spectrum Baseline: NL (07) - OV (12)
 Timerange: 00/17:05:38 to 00/17:07:36

Plot file version 202 created 03-MAR-2016 01:12:32

4C52 GN002C 1.UVDATA.1

Freq = 1.2770 GHz, Bw = 16.000 MH Calibrated with CL # 3 and BP # 1 (BP mode 1)

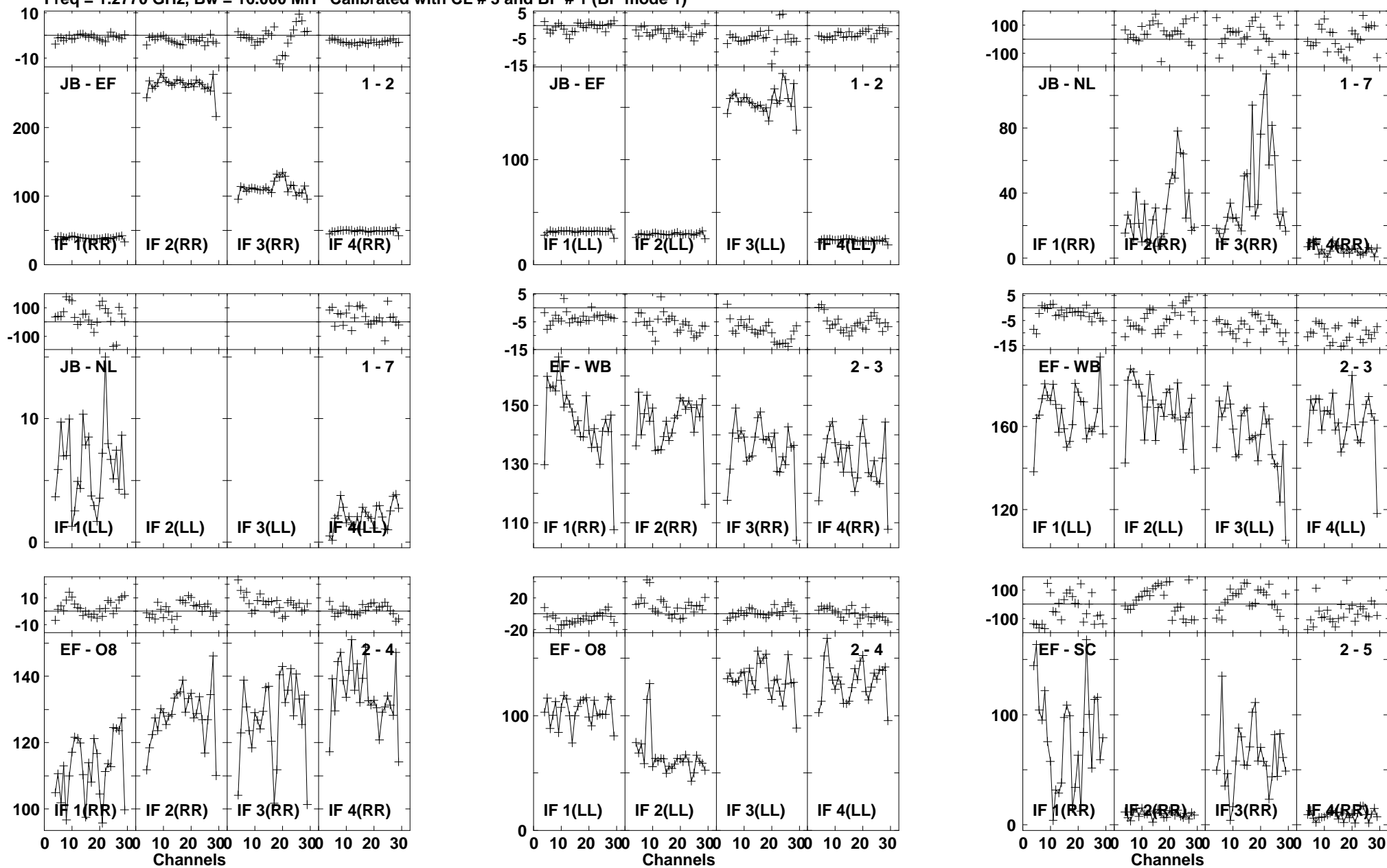

Lower frame: Milli Ampl Jy Top frame: Phas deg
Vector averaged cross-power spectrum Baseline: JB (01) - EF (02)
Timerange: 00/17:07:49 to 00/17:10:35

Plot file version 203 created 03-MAR-2016 01:12:32

4C52 GN002C 1.UVDATA.1

Freq = 1.2770 GHz, Bw = 16.000 MH Calibrated with CL # 3 and BP # 1 (BP mode 1)

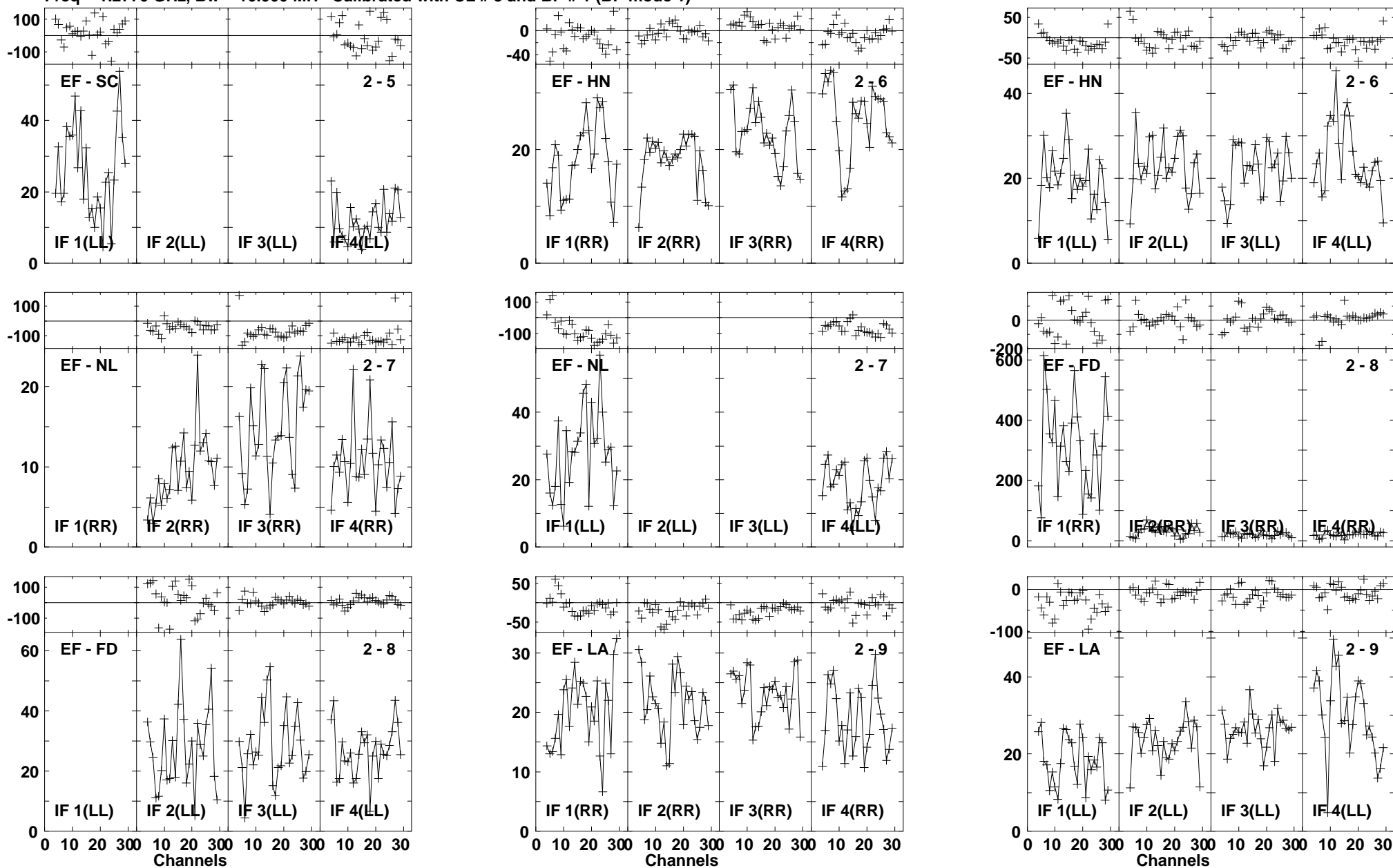

Lower frame: Milli Ampl Jy Top frame: Phas deg
Vector averaged cross-power spectrum Baseline: EF (02) - SC (05)
Timerange: 00/17:07:49 to 00/17:10:35

Plot file version 204 created 03-MAR-2016 01:12:32

4C52 GN002C 1.UVDATA.1

Freq = 1.2770 GHz, Bw = 16.000 MH Calibrated with CL # 3 and BP # 1 (BP mode 1)

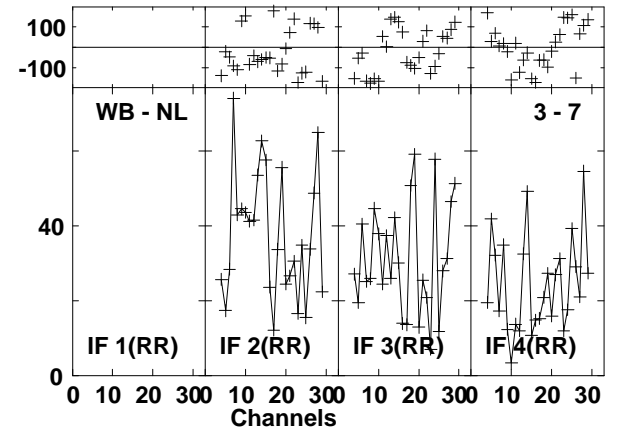
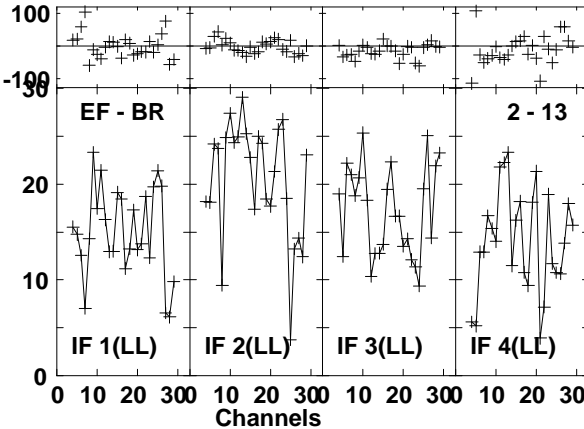
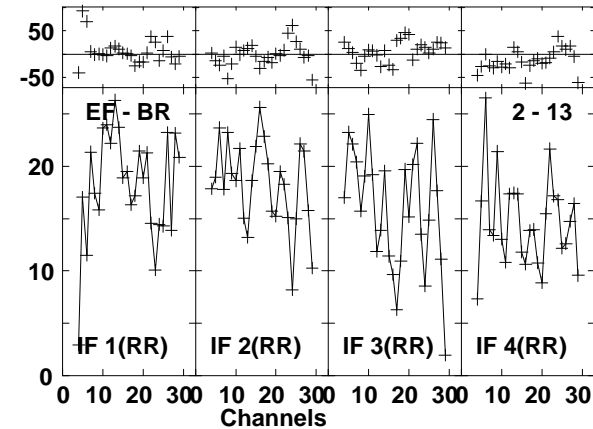
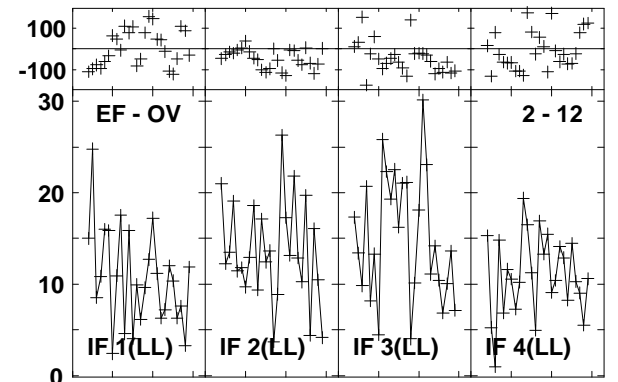
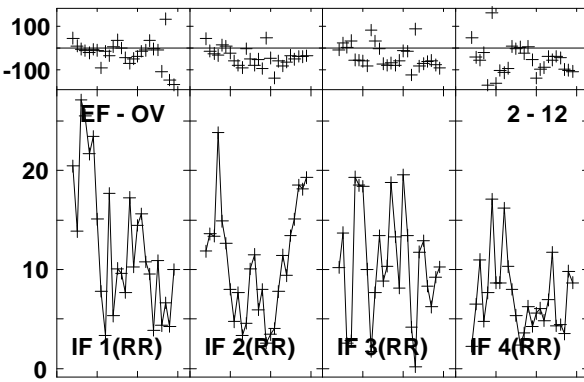
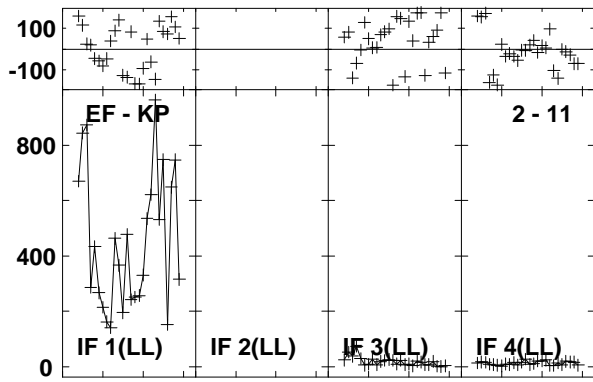
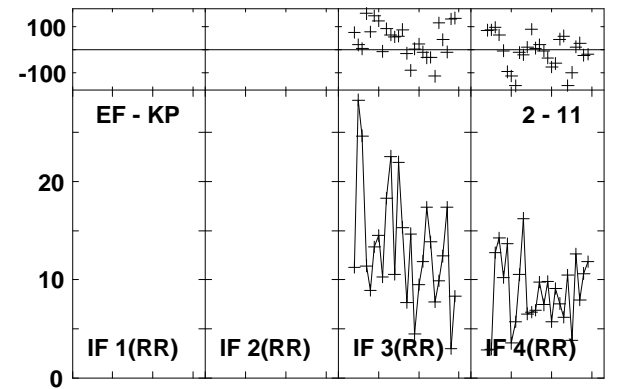
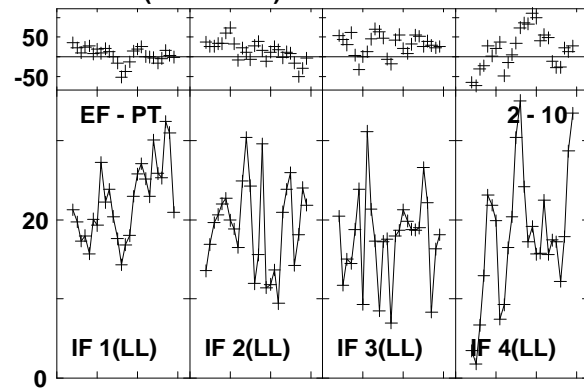
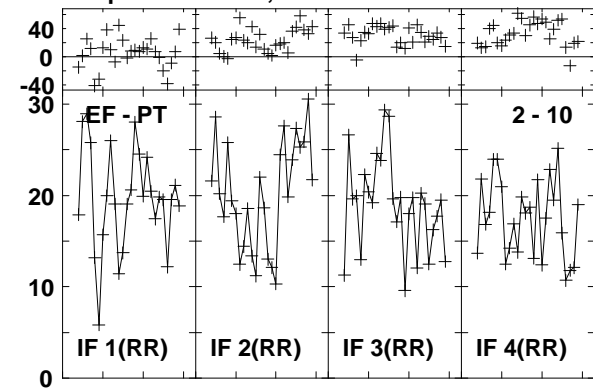

Lower frame: Milli Ampl Jy Top frame: Phas deg
Vector averaged cross-power spectrum Baseline: EF (02) - PT (10)
Timerange: 00/17:07:49 to 00/17:10:35

Plot file version 205 created 03-MAR-2016 01:12:32

4C52 GN002C 1.UVDATA.1

Freq = 1.2770 GHz, Bw = 16.000 MH Calibrated with CL # 3 and BP # 1 (BP mode 1)

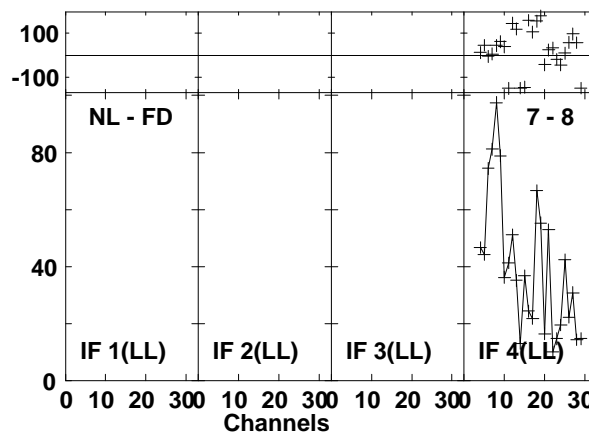
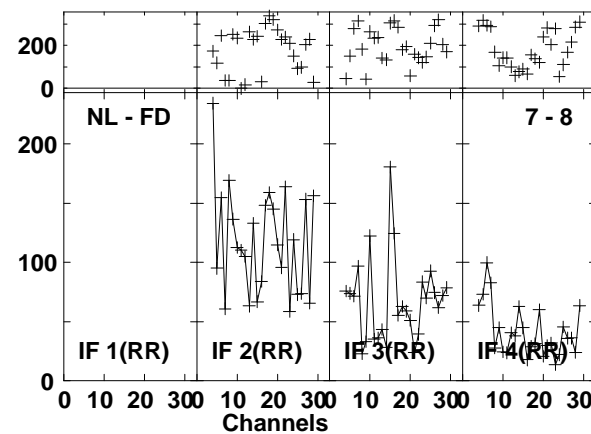
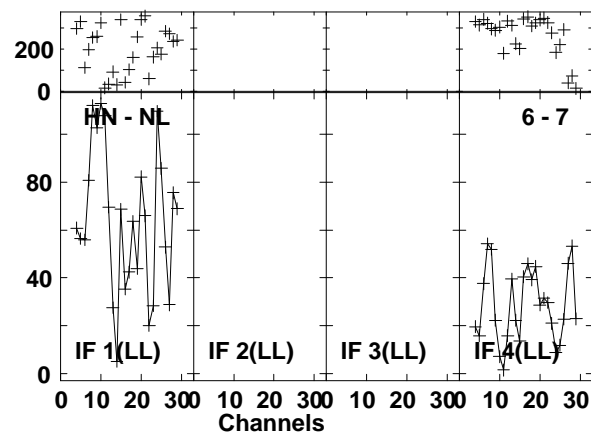
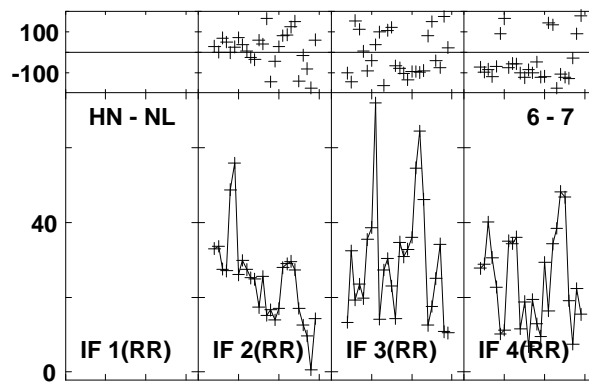
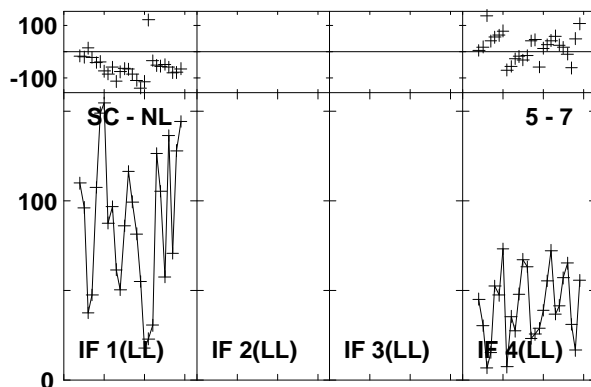
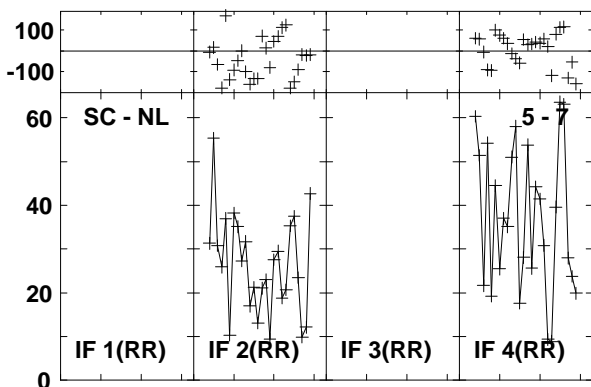
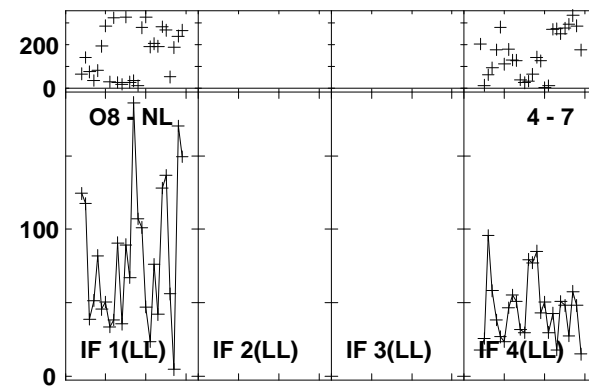
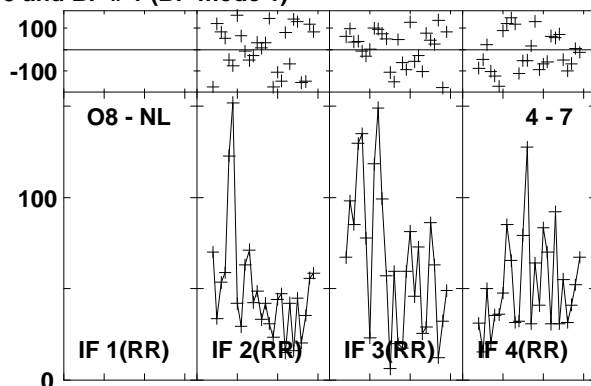
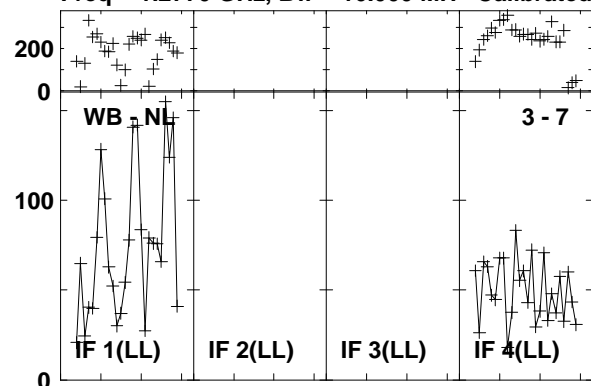

Lower frame: Milli Ampl Jy Top frame: Phas deg
Vector averaged cross-power spectrum Baseline: WB (03) - NL (07)
Timerange: 00/17:07:49 to 00/17:10:35

Plot file version 206 created 03-MAR-2016 01:12:32
 4C52 GN002C 1.UVDATA.1
 Freq = 1.2770 GHz, Bw = 16.000 MH Calibrated with CL # 3 and BP # 1 (BP mode 1)

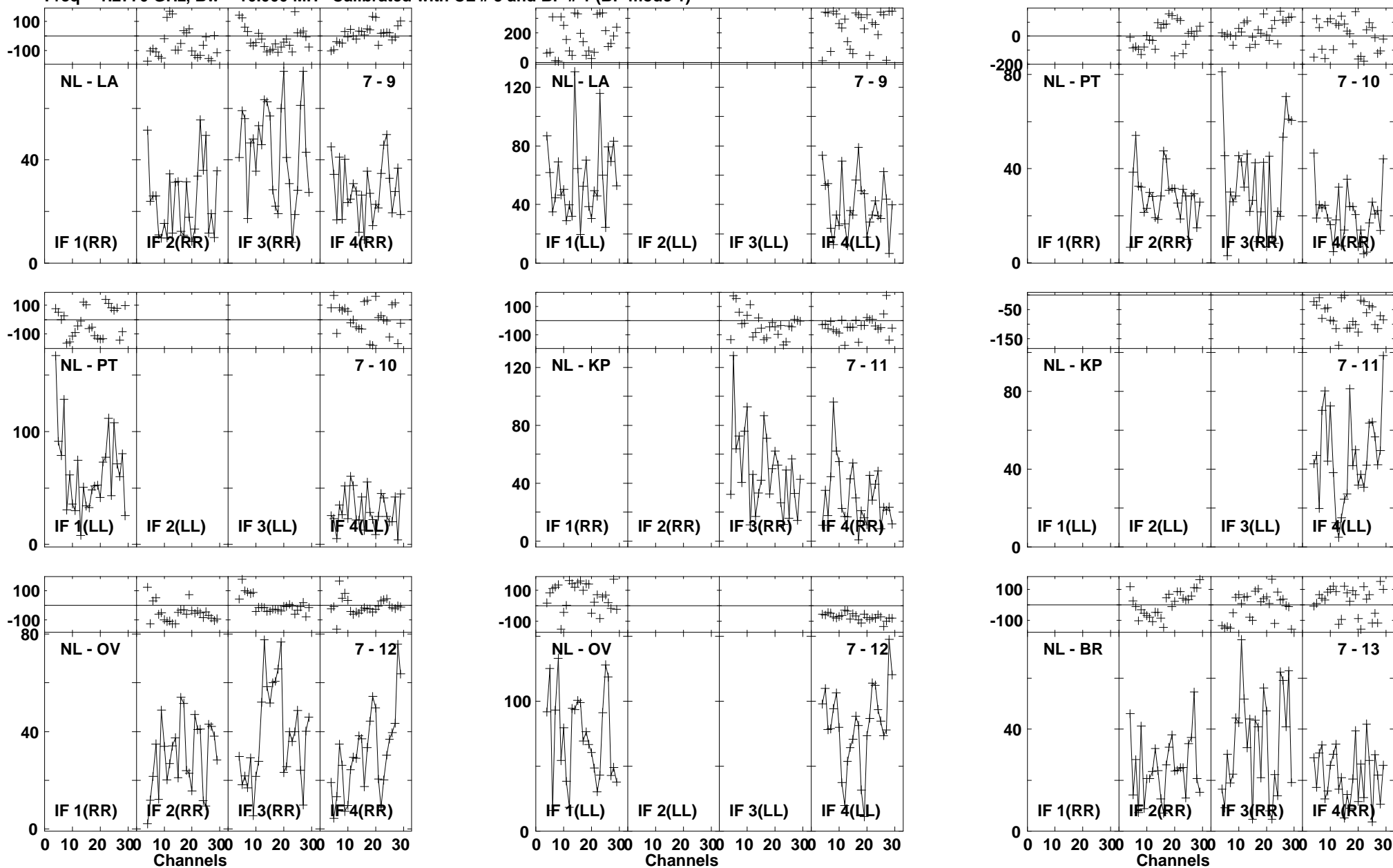

Lower frame: Milli Ampl Jy Top frame: Phas deg
 Vector averaged cross-power spectrum Baseline: NL (07) - LA (09)
 Timerange: 00/17:07:49 to 00/17:10:35

Plot file version 207 created 03-MAR-2016 01:12:32

4C52 GN002C 1.UVDATA.1

Freq = 1.2770 GHz, Bw = 16.000 MH Calibrated with CL # 3 and BP # 1 (BP mode 1)

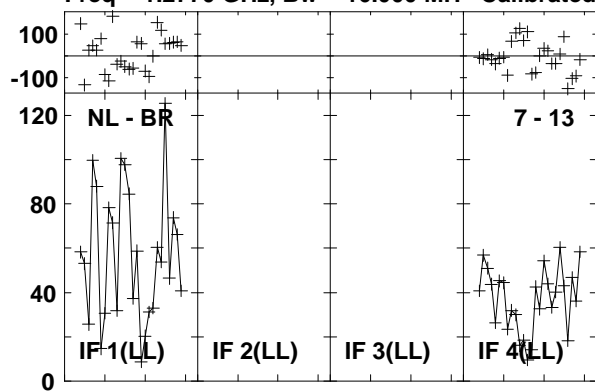

Lower frame: Milli Ampl Jy Top frame: Phas deg

Vector averaged cross-power spectrum Baseline: NL (07) - BR (13)

Timerange: 00/17:07:49 to 00/17:10:35

Plot file version 208 created 03-MAR-2016 01:12:33

J1545+5400 GN002C 1.UVDATA.1

Freq = 1.2770 GHz, Bw = 16.000 MH Calibrated with CL # 3 and BP # 1 (BP mode 1)

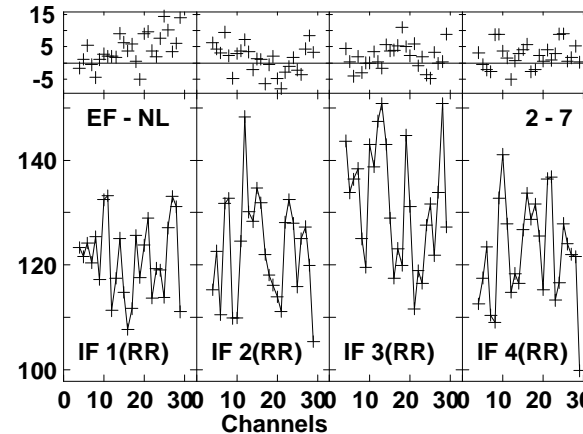
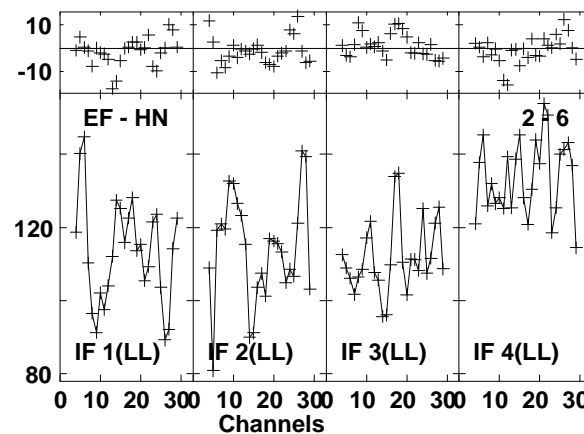
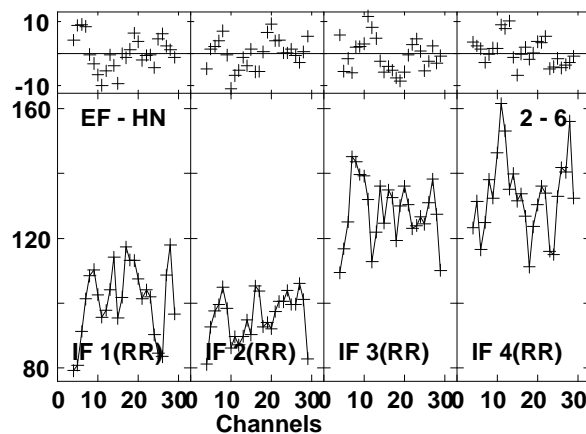
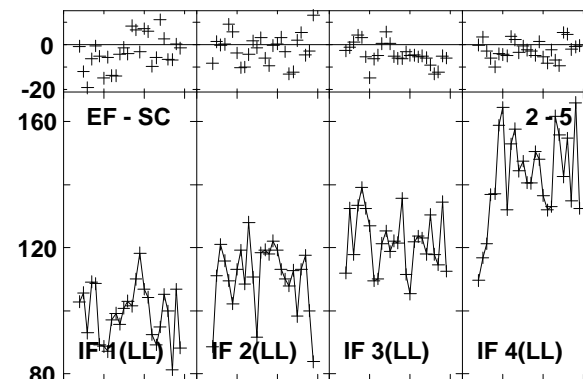
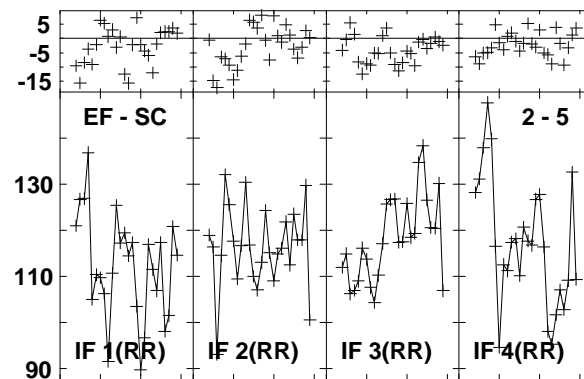
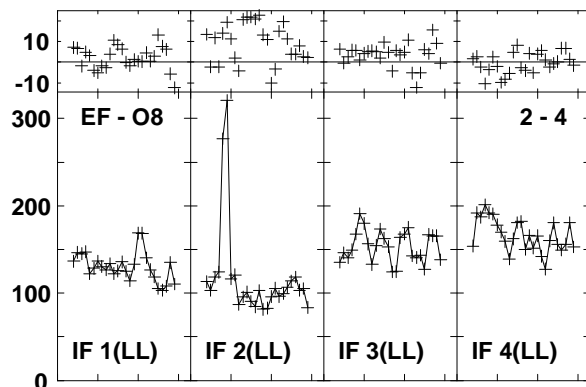
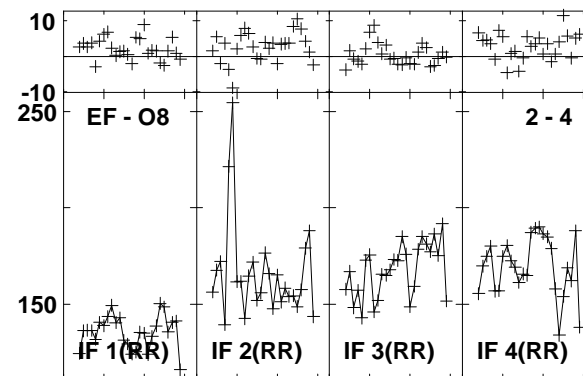
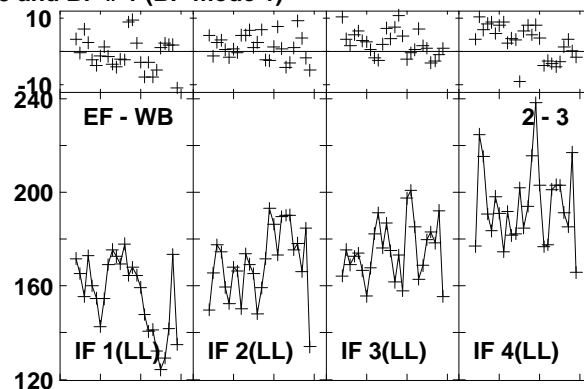
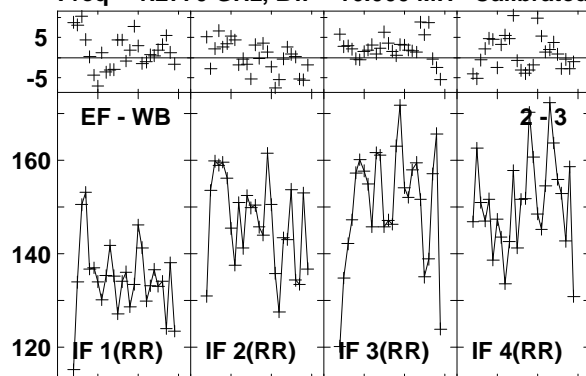

Lower frame: Milli Ampl Jy Top frame: Phas deg
Vector averaged cross-power spectrum Baseline: EF (02) - WB (03)
Timerange: 00/17:11:28 to 00/17:12:26

Plot file version 209 created 03-MAR-2016 01:12:33

J1545+5400 GN002C 1.UVDATA.1

Freq = 1.2770 GHz, Bw = 16.000 MH Calibrated with CL # 3 and BP # 1 (BP mode 1)

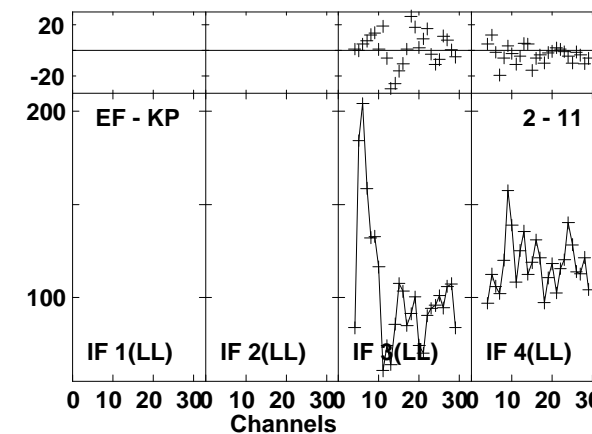
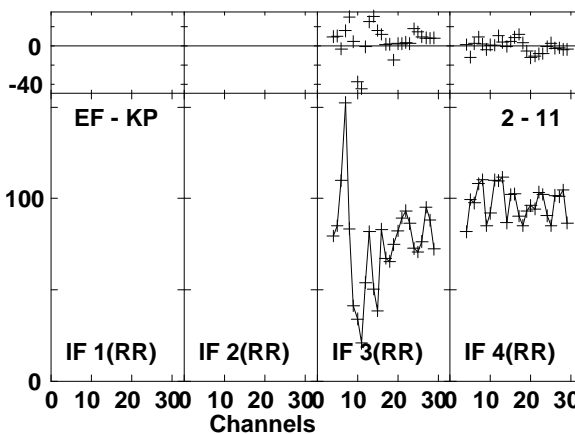
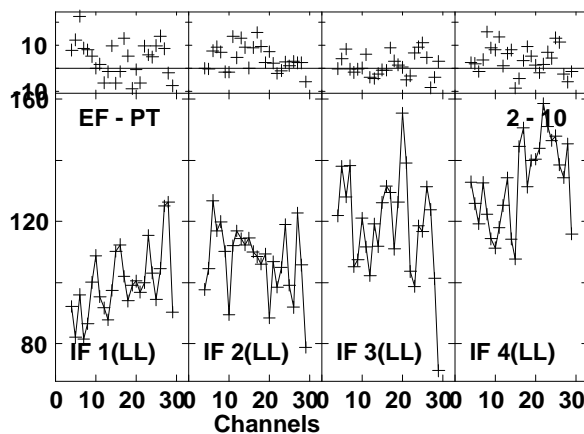
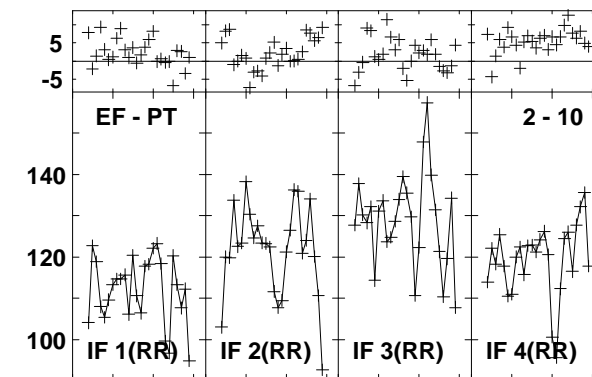
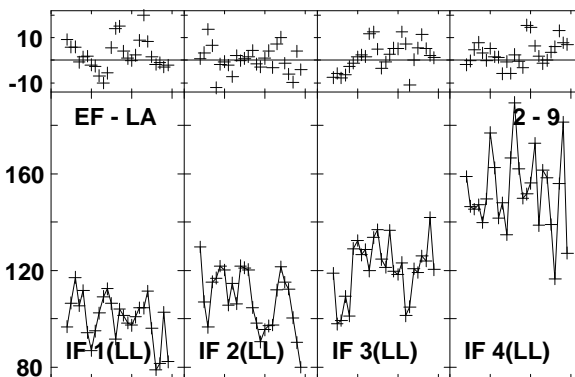
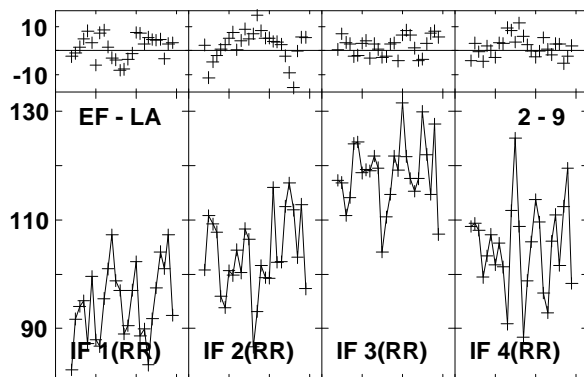
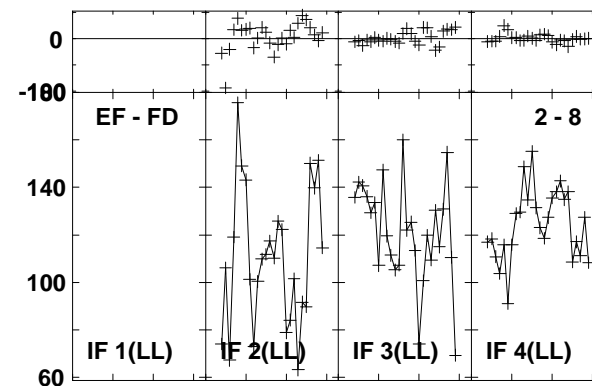
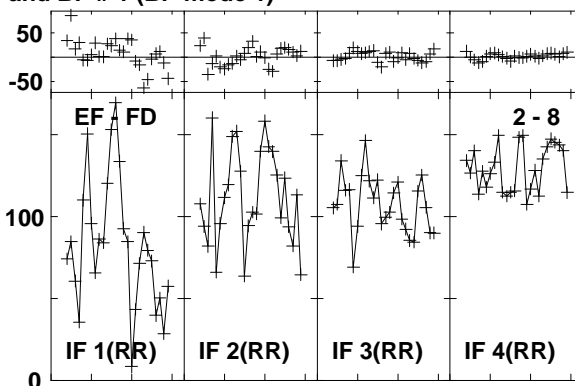
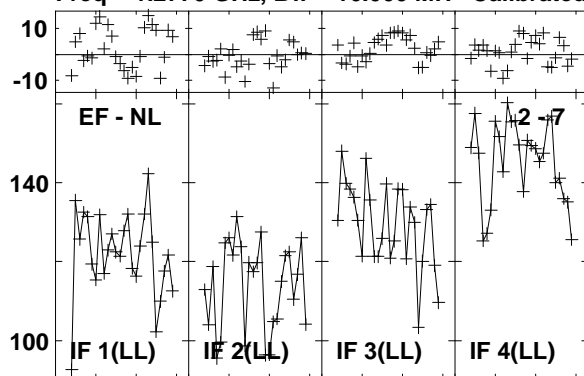

Lower frame: Milli Ampl Jy Top frame: Phas deg
Vector averaged cross-power spectrum Baseline: EF (02) - NL (07)
Timerange: 00/17:11:28 to 00/17:12:26

Plot file version 210 created 03-MAR-2016 01:12:33
 J1545+5400 GN002C 1.UVDATA.1
 Freq = 1.2770 GHz, Bw = 16.000 MH Calibrated with CL # 3 and BP # 1 (BP mode 1)

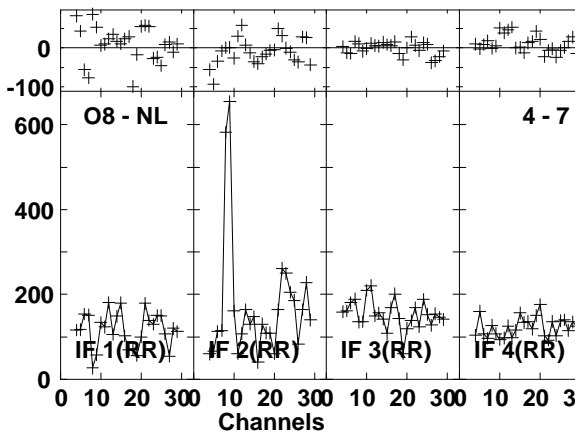
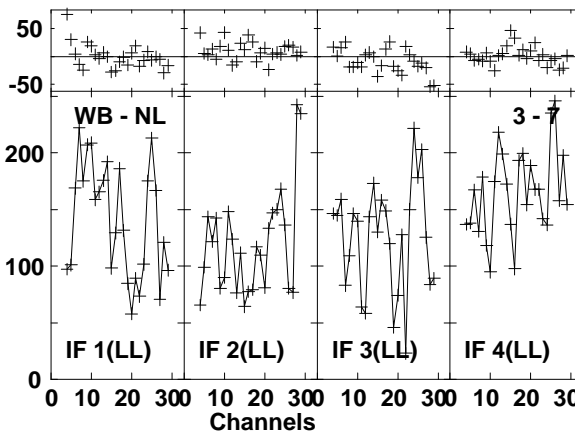
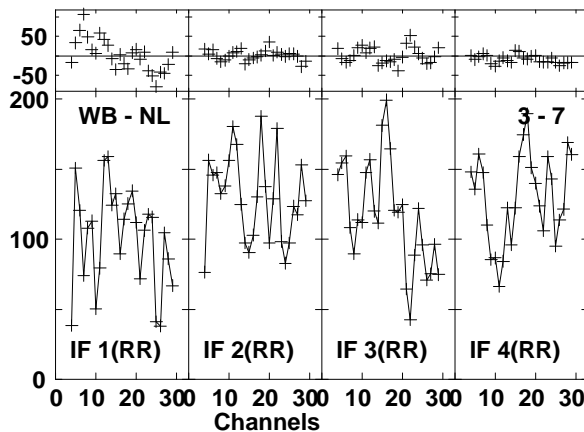
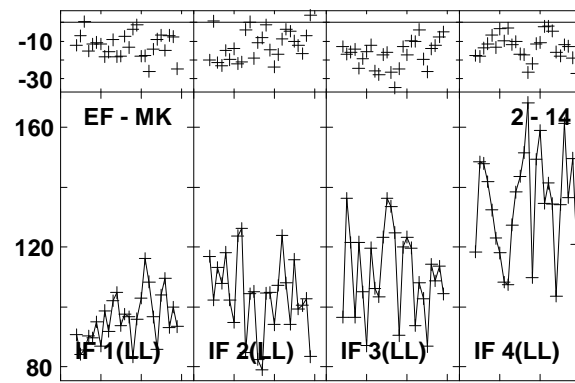
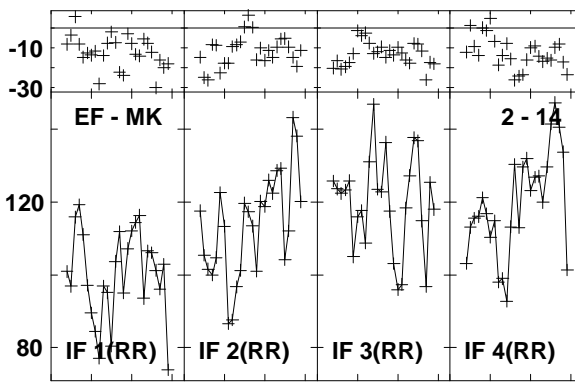
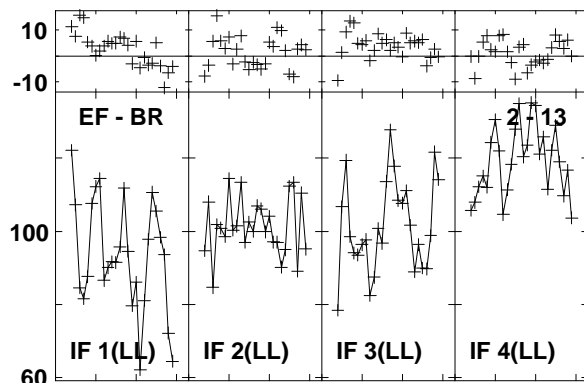
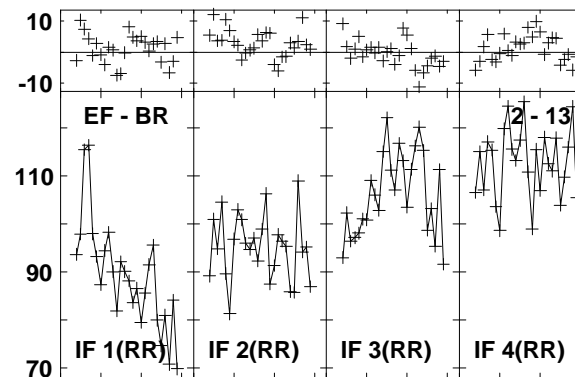
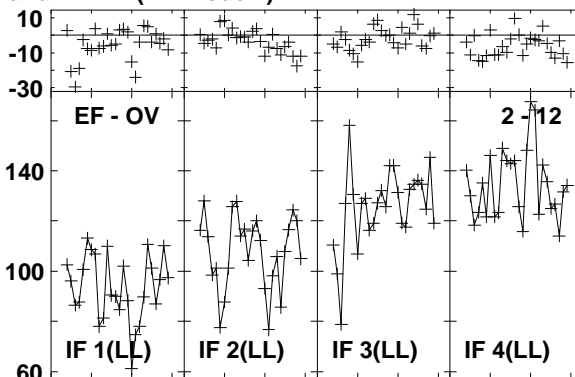
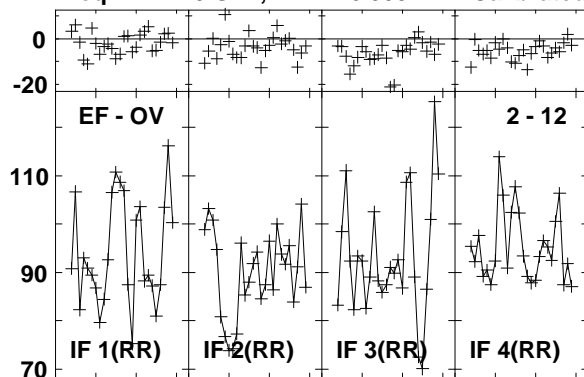

Lower frame: Milli Ampl Jy Top frame: Phas deg
 Vector averaged cross-power spectrum Baseline: EF (02) - OV (12)
 Timerange: 00/17:11:28 to 00/17:12:26

Plot file version 211 created 03-MAR-2016 01:12:33

J1545+5400 GN002C 1.UVDATA.1

Freq = 1.2770 GHz, Bw = 16.000 MH Calibrated with CL # 3 and BP # 1 (BP mode 1)

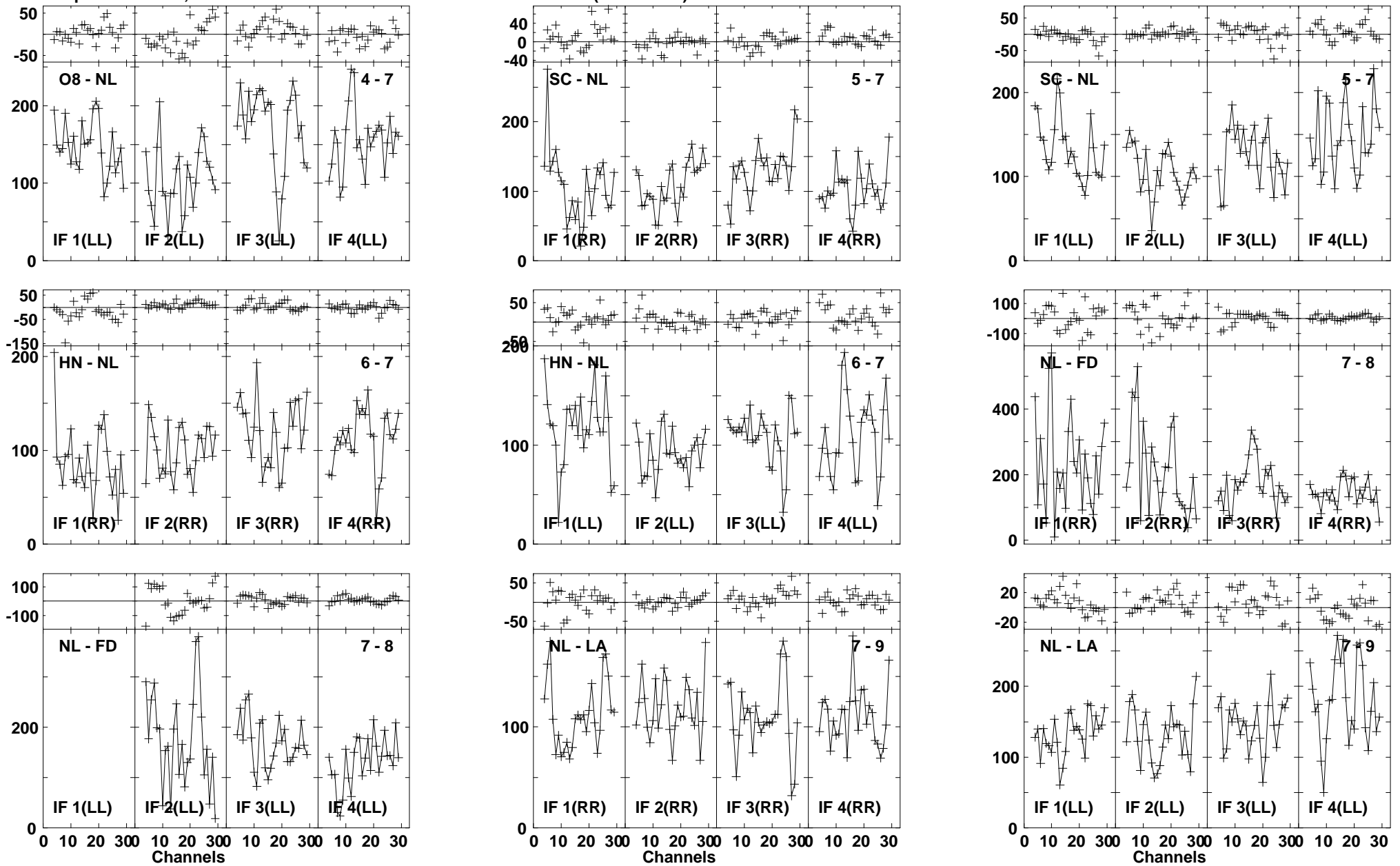

Lower frame: Milli Ampl Jy Top frame: Phas deg
Vector averaged cross-power spectrum Baseline: O8 (04) - NL (07)
Timerange: 00/17:11:28 to 00/17:12:26

Plot file version 212 created 03-MAR-2016 01:12:33

J1545+5400 GN002C 1.UVDATA.1

Freq = 1.2770 GHz, Bw = 16.000 MH Calibrated with CL # 3 and BP # 1 (BP mode 1)

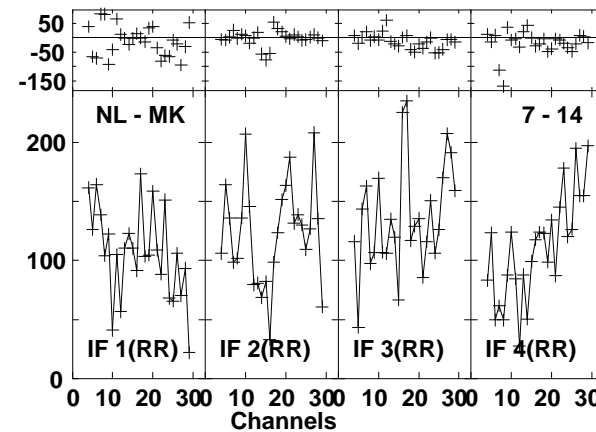
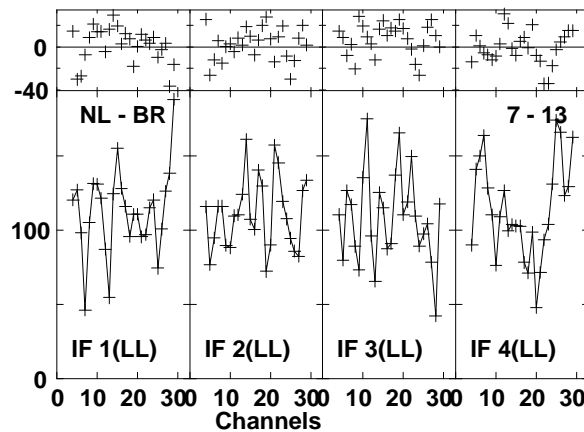
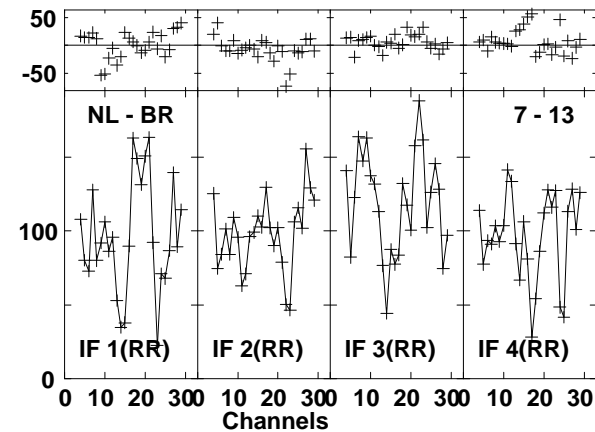
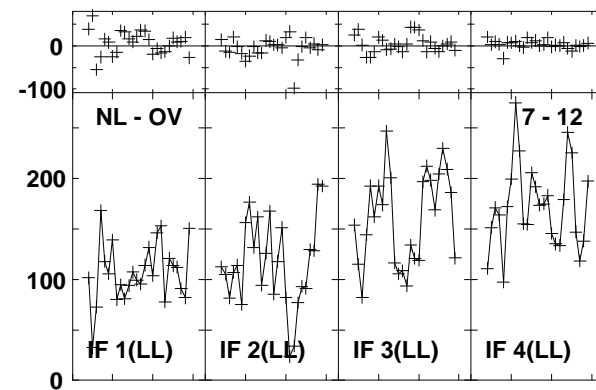
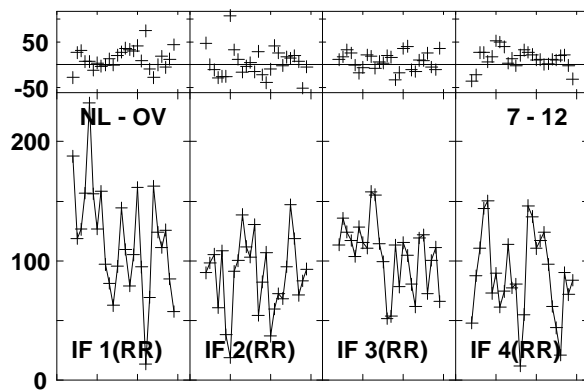
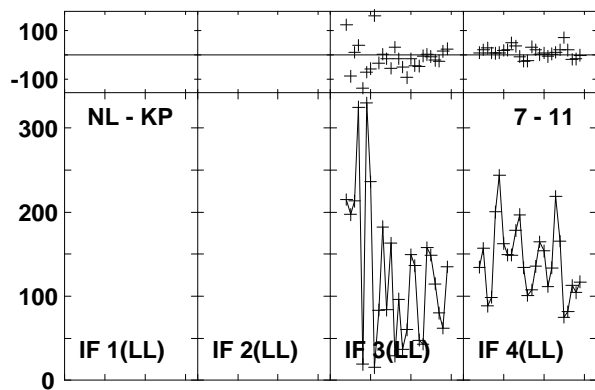
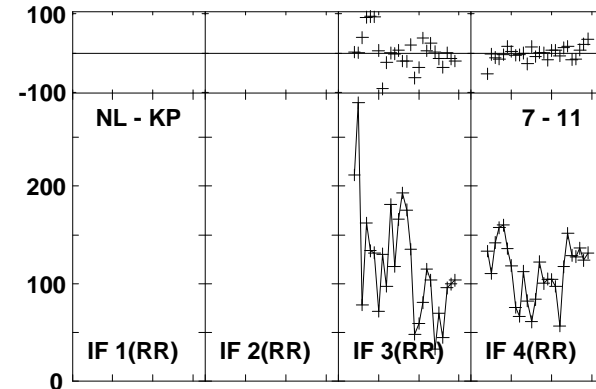
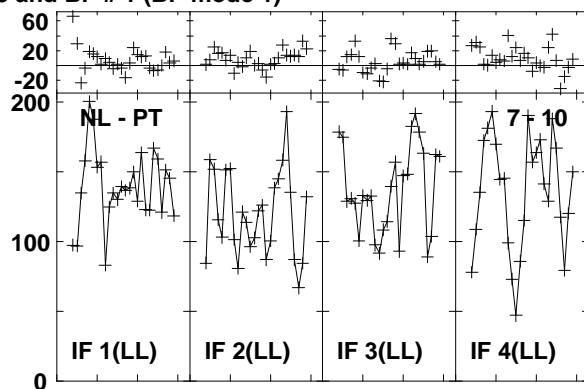
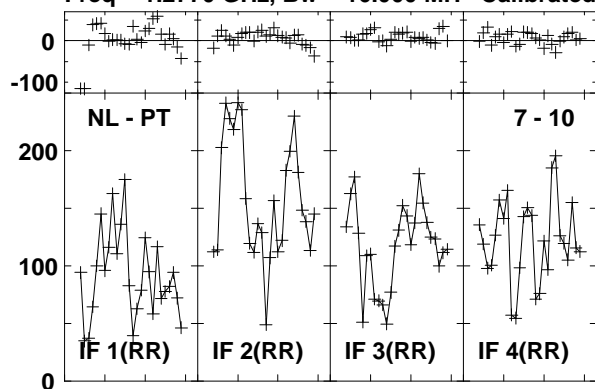

Lower frame: Milli Ampl Jy Top frame: Phas deg
Vector averaged cross-power spectrum Baseline: NL (07) - PT (10)
Timerange: 00/17:11:28 to 00/17:12:26

Plot file version 213 created 03-MAR-2016 01:12:33
J1545+5400 GN002C 1.UVDATA.1
Freq = 1.2770 GHz, Bw = 16.000 MH Calibrated with CL # 3 and BP # 1 (BP mode 1)

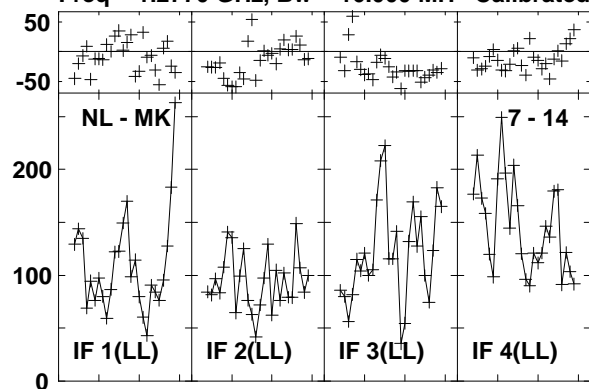

Lower frame: Milli Ampl Jy Top frame: Phas deg
Vector averaged cross-power spectrum Baseline: NL (07) - MK (14)
Timerange: 00/17:11:28 to 00/17:12:26

Plot file version 214 created 03-MAR-2016 01:12:33

4C52 GN002C 1.UVDATA.1

Freq = 1.2770 GHz, Bw = 16.000 MH Calibrated with CL # 3 and BP # 1 (BP mode 1)

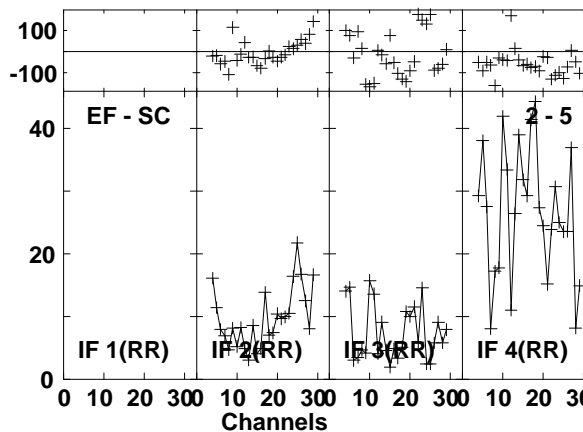
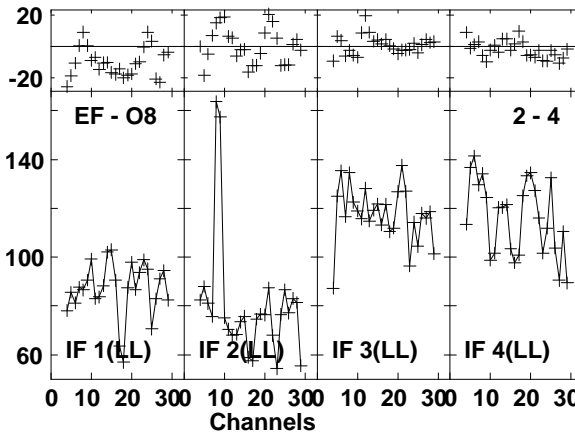
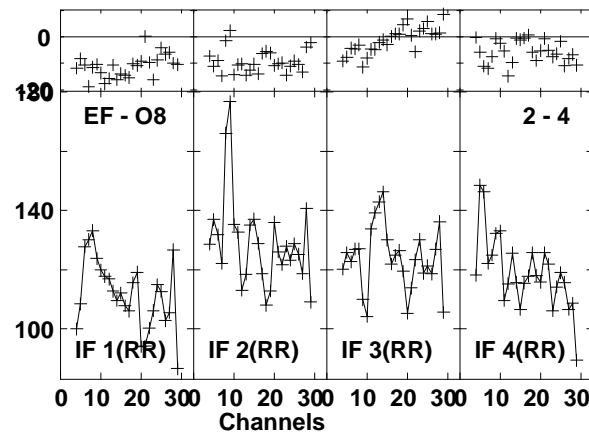
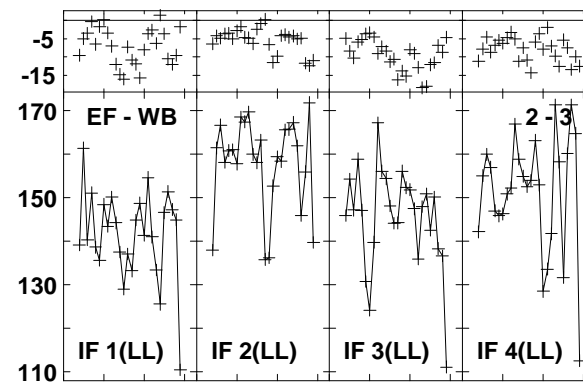
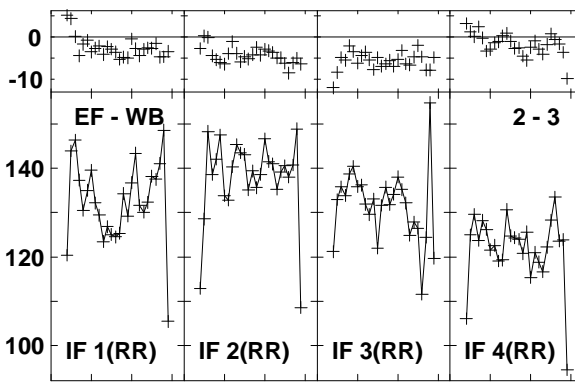
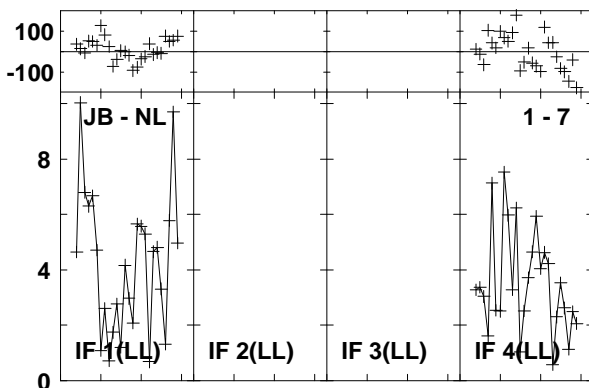
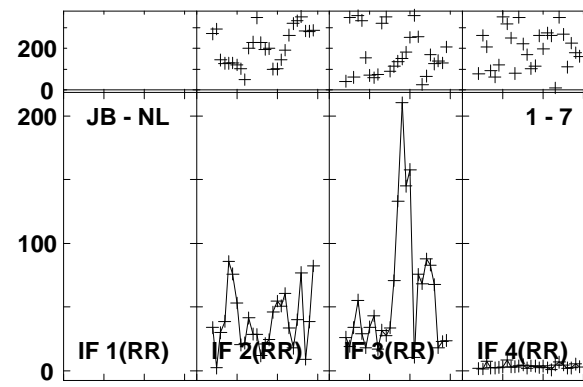
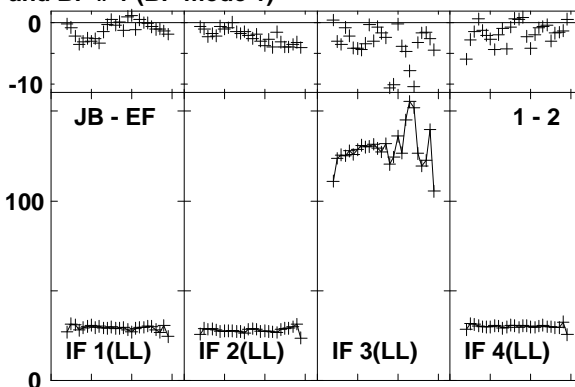
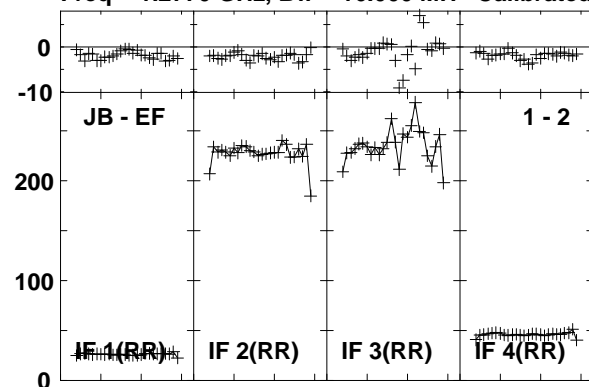

Lower frame: Milli Ampl Jy Top frame: Phas deg
Vector averaged cross-power spectrum Baseline: JB (01) - EF (02)
Timerange: 00/17:12:31 to 00/17:15:25

Plot file version 215 created 03-MAR-2016 01:12:34

4C52 GN002C 1.UVDATA.1

Freq = 1.2770 GHz, Bw = 16.000 MH Calibrated with CL # 3 and BP # 1 (BP mode 1)

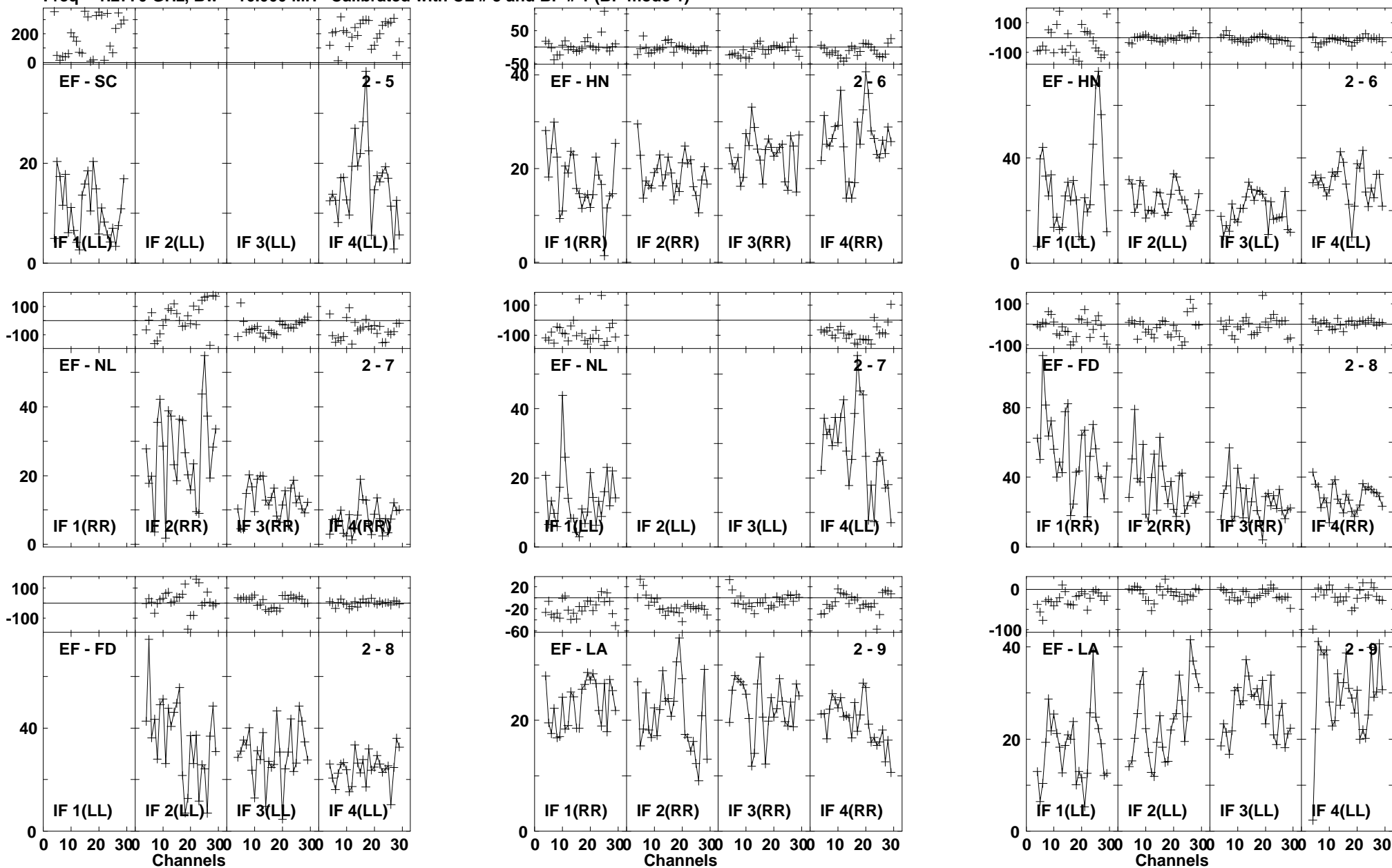

Lower frame: Milli Ampl Jy Top frame: Phas deg
Vector averaged cross-power spectrum Baseline: EF (02) - SC (05)
Timerange: 00/17:12:31 to 00/17:15:25

Plot file version 216 created 03-MAR-2016 01:12:34

4C52 GN002C 1.UVDATA.1

Freq = 1.2770 GHz, Bw = 16.000 MH Calibrated with CL # 3 and BP # 1 (BP mode 1)

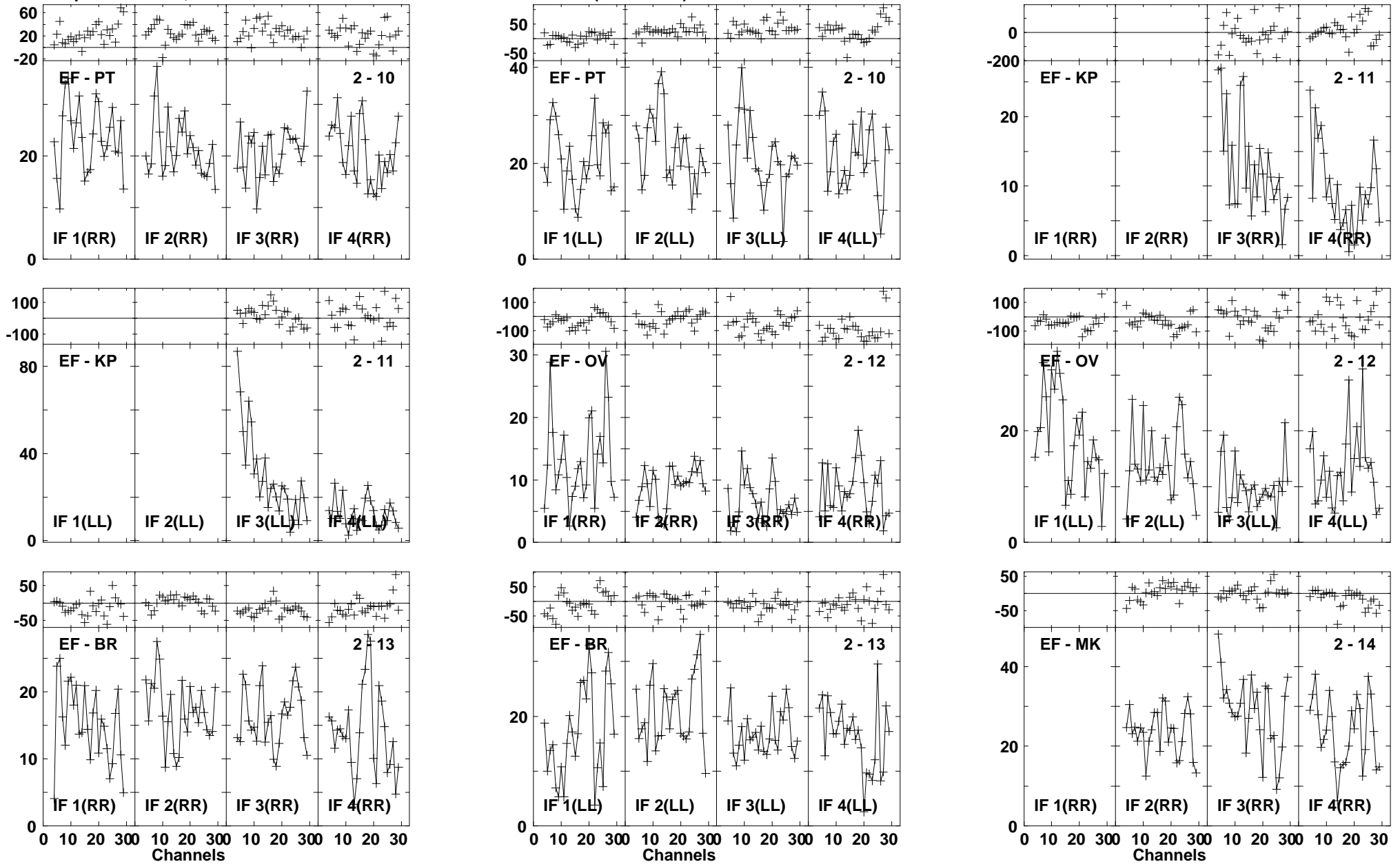

Lower frame: Milli Ampl Jy Top frame: Phas deg
Vector averaged cross-power spectrum Baseline: EF (02) - PT (10)
Timerange: 00/17:12:31 to 00/17:15:25

Plot file version 217 created 03-MAR-2016 01:12:34

4C52 GN002C 1.UVDATA.1

Freq = 1.2770 GHz, Bw = 16.000 MH Calibrated with CL # 3 and BP # 1 (BP mode 1)

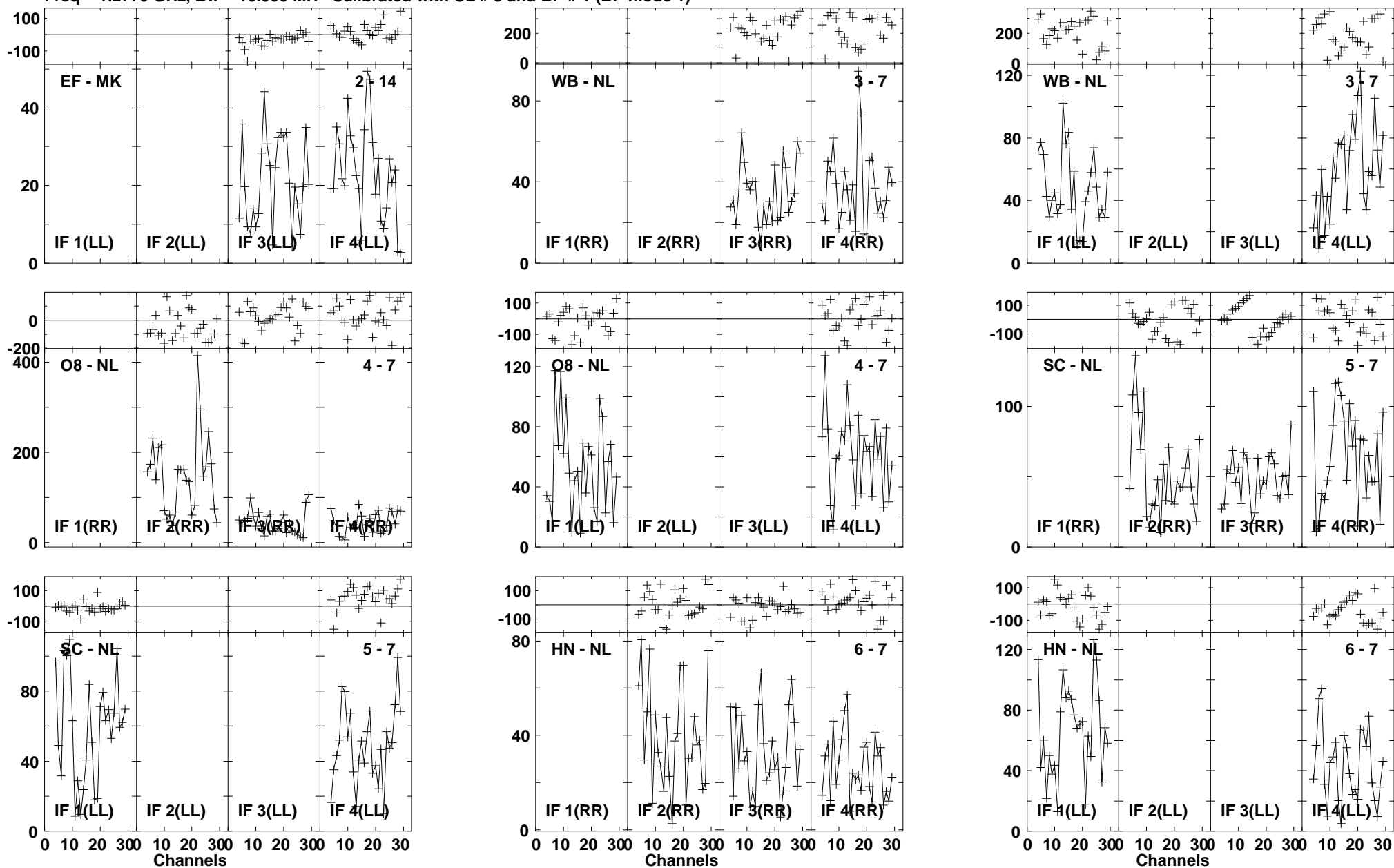

Lower frame: Milli Ampl Jy Top frame: Phas deg
Vector averaged cross-power spectrum Baseline: EF (02) - MK (14)
Timerange: 00/17:12:31 to 00/17:15:25

Plot file version 218 created 03-MAR-2016 01:12:34
 4C52 GN002C 1.UVDATA.1
 Freq = 1.2770 GHz, Bw = 16.000 MH Calibrated with CL # 3 and BP # 1 (BP mode 1)

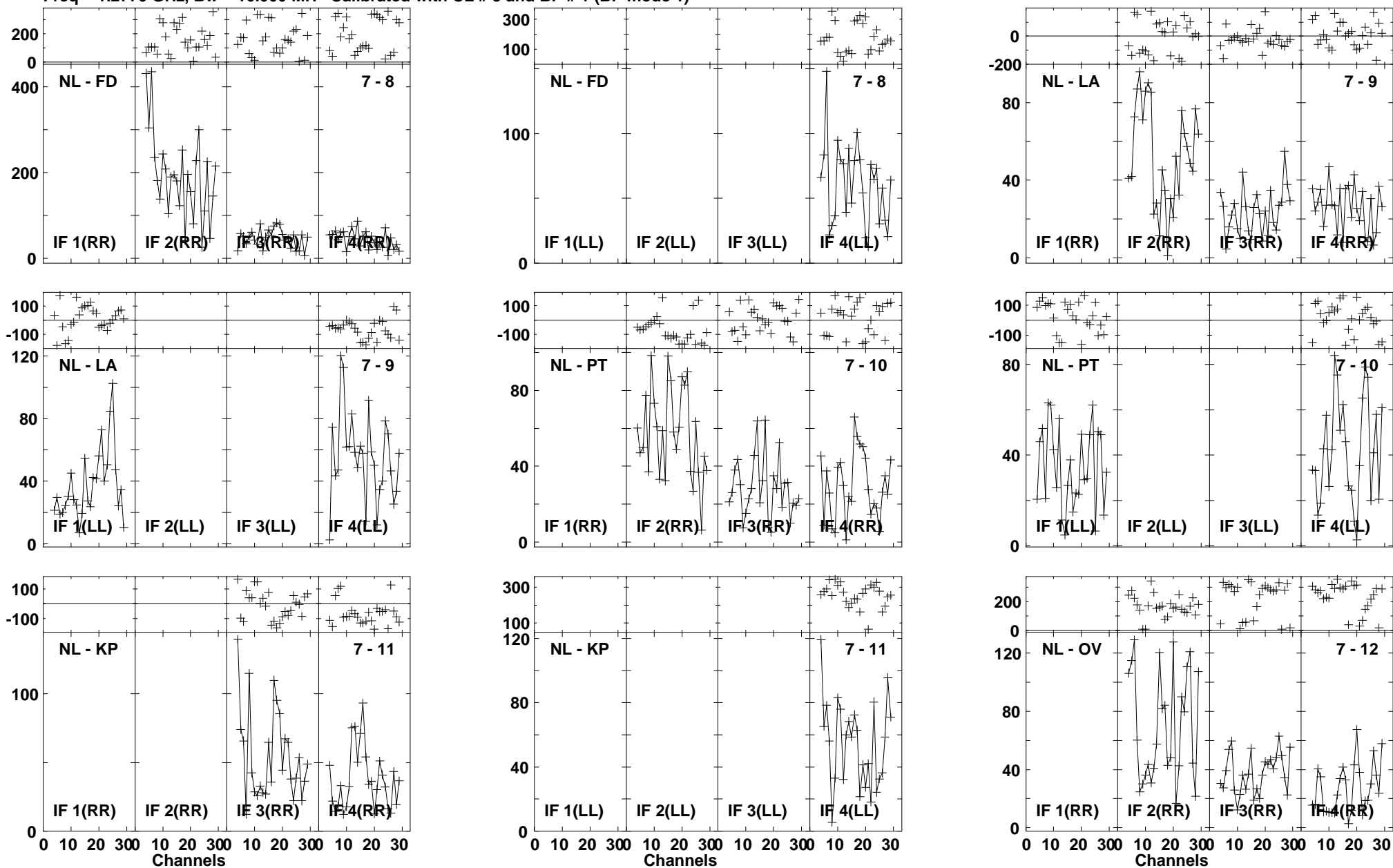

Lower frame: Milli Ampl Jy Top frame: Phas deg
 Vector averaged cross-power spectrum Baseline: NL (07) - FD (08)
 Timerange: 00/17:12:31 to 00/17:15:25

Plot file version 219 created 03-MAR-2016 01:12:34

4C52 GN002C 1.UVDATA.1

Freq = 1.2770 GHz, Bw = 16.000 MH Calibrated with CL # 3 and BP # 1 (BP mode 1)

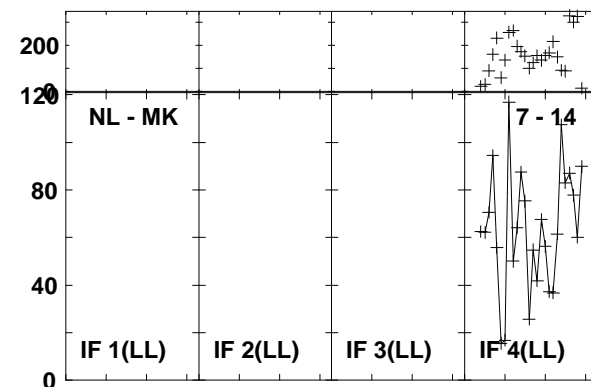
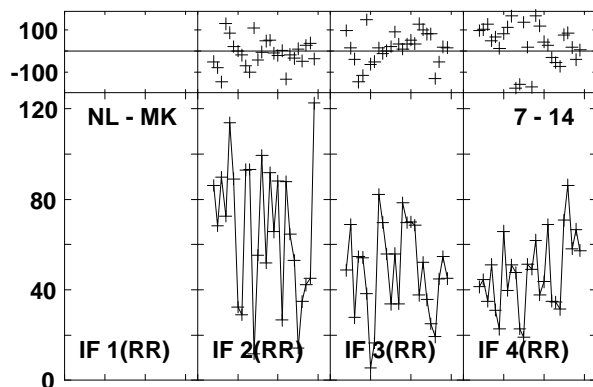
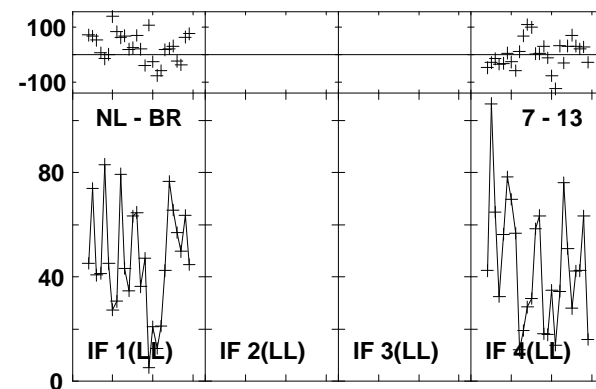
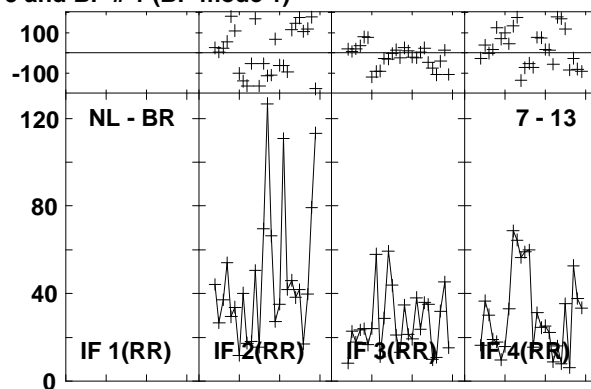
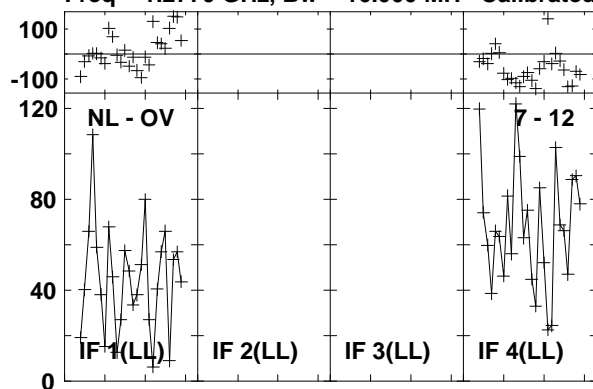

Lower frame: Milli Ampl Jy Top frame: Phas deg

Vector averaged cross-power spectrum Baseline: NL (07) - OV (12)

Timerange: 00/17:12:31 to 00/17:15:25

Plot file version 220 created 03-MAR-2016 01:12:35
 J1545+5400 GN002C 1.UVDATA.1
 Freq = 1.2770 GHz, Bw = 16.000 MH Calibrated with CL # 3 and BP # 1 (BP mode 1)

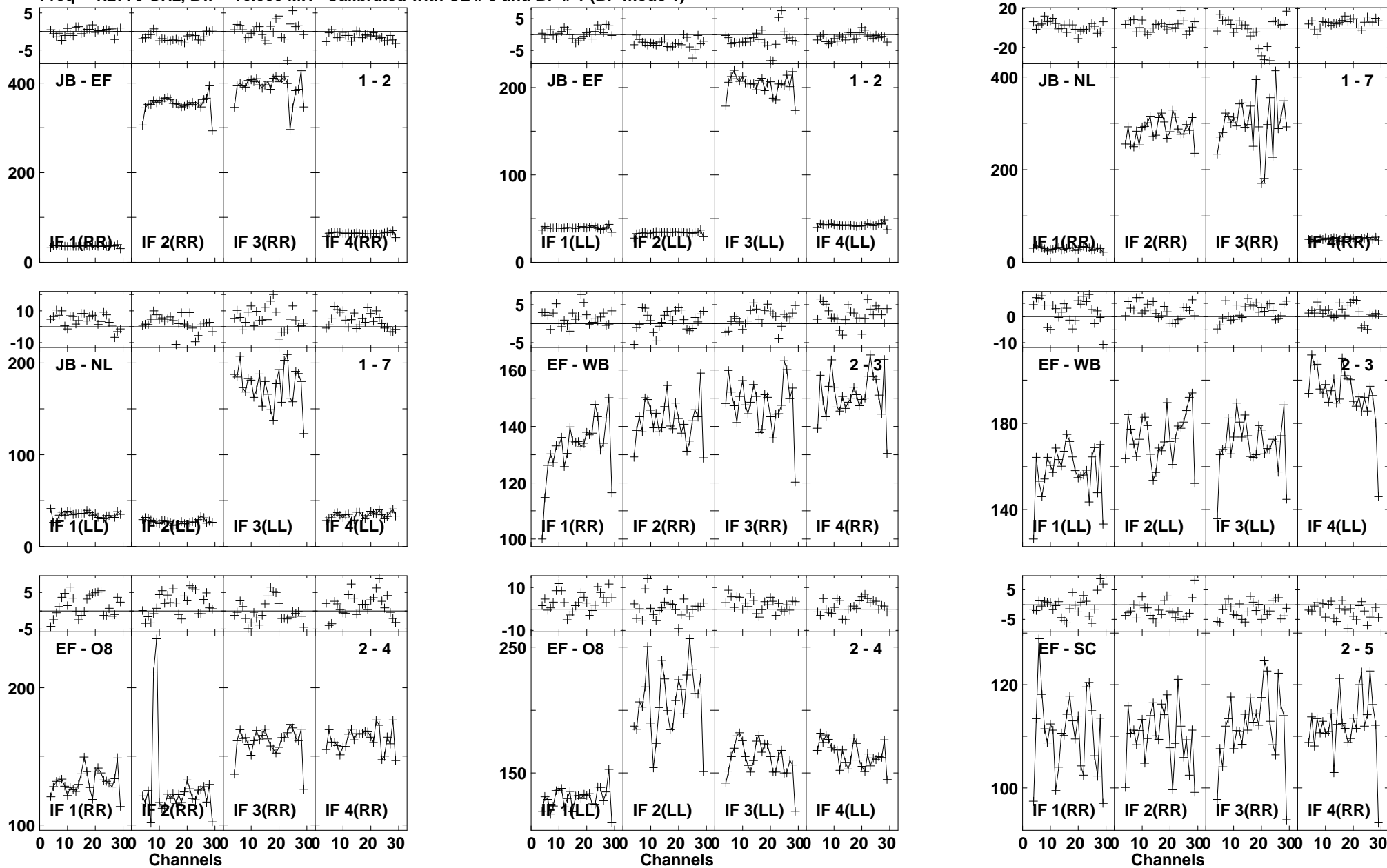

Lower frame: Milli Ampl Jy Top frame: Phas deg
 Vector averaged cross-power spectrum Baseline: JB (01) - EF (02)
 Timerange: 00/17:16:18 to 00/17:18:16

Plot file version 221 created 03-MAR-2016 01:12:35

J1545+5400 GN002C 1.UVDATA.1

Freq = 1.2770 GHz, Bw = 16.000 MH Calibrated with CL # 3 and BP # 1 (BP mode 1)

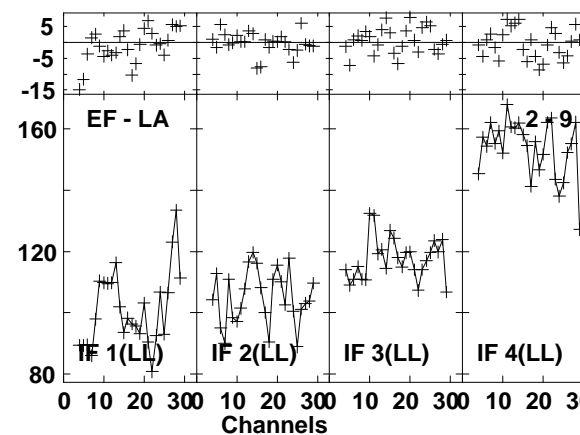
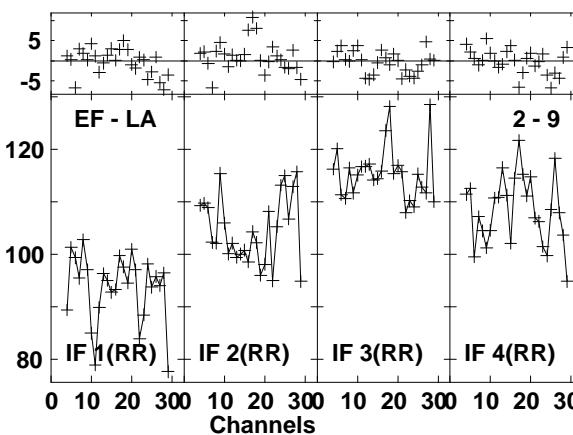
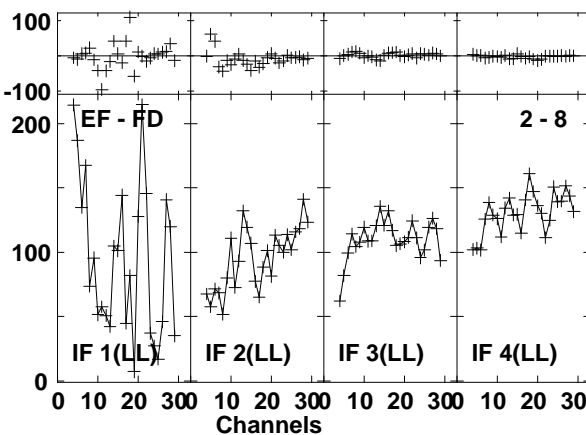
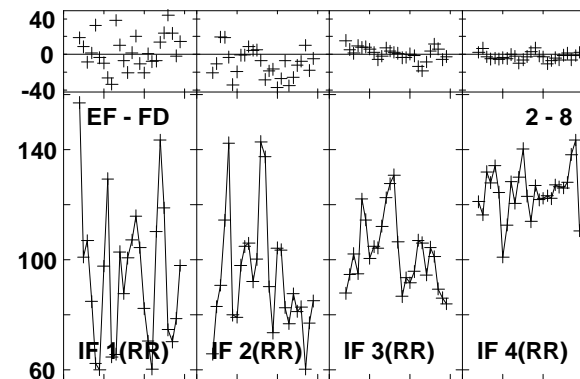
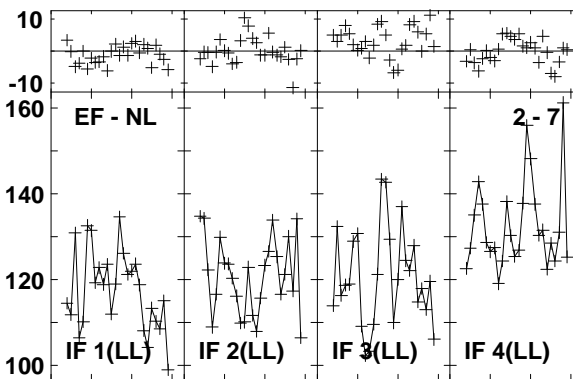
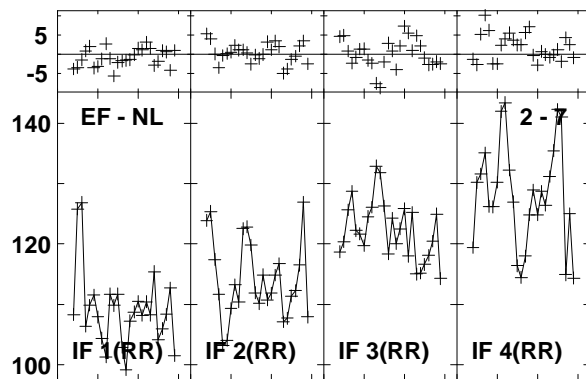
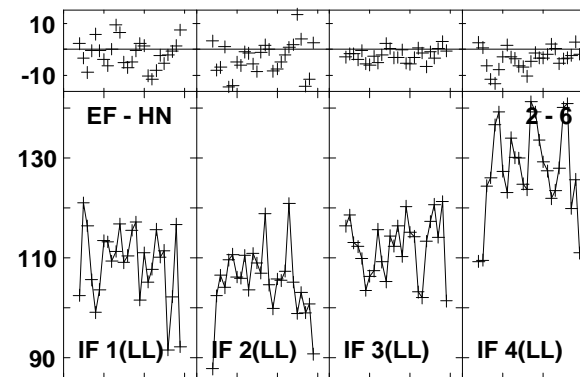
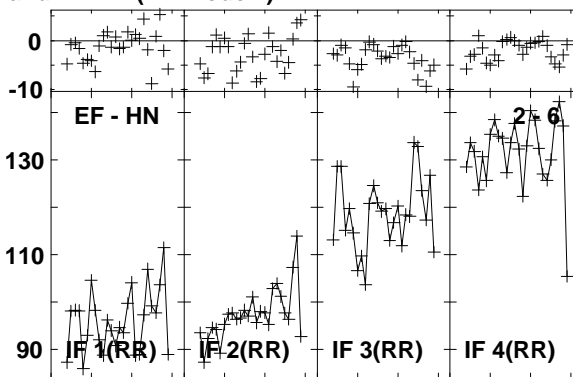
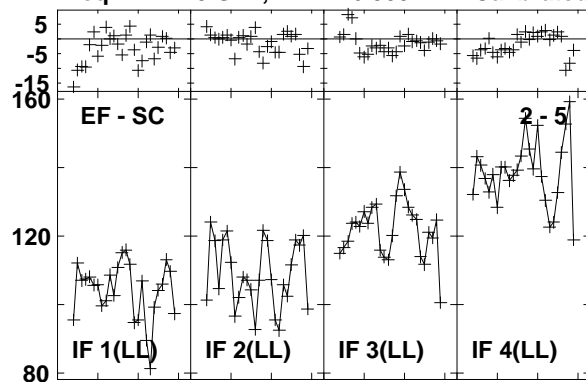

Lower frame: Milli Ampl Jy Top frame: Phas deg
Vector averaged cross-power spectrum Baseline: EF (02) - SC (05)
Timerange: 00/17:16:18 to 00/17:18:16

Plot file version 222 created 03-MAR-2016 01:12:35

J1545+5400 GN002C 1.UVDATA.1

Freq = 1.2770 GHz, Bw = 16.000 MH Calibrated with CL # 3 and BP # 1 (BP mode 1)

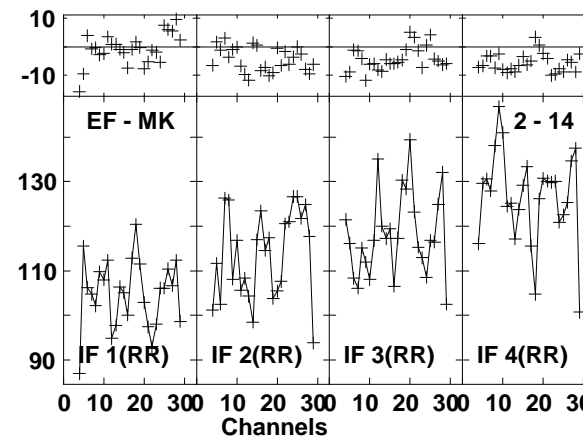
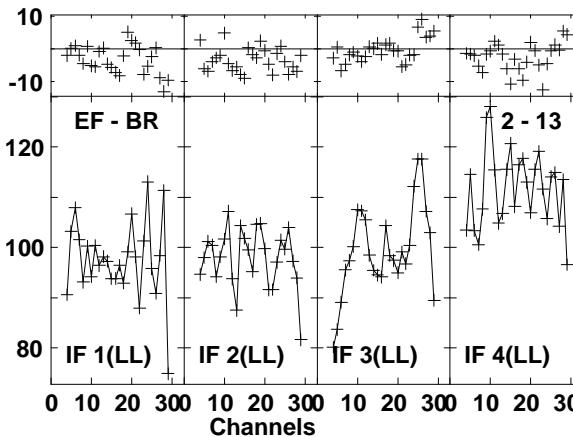
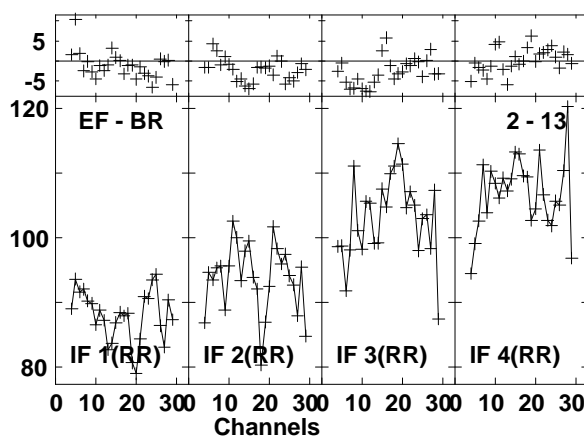
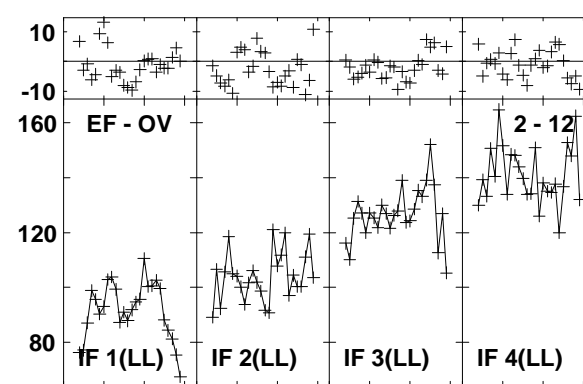
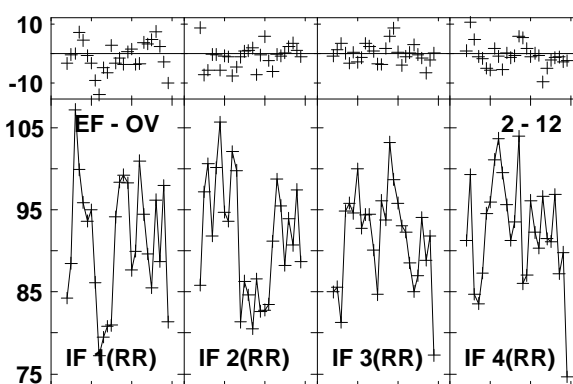
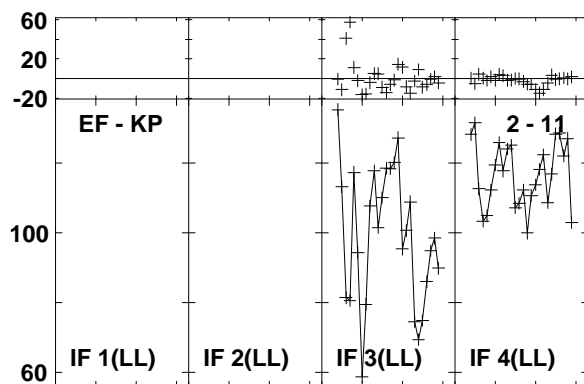
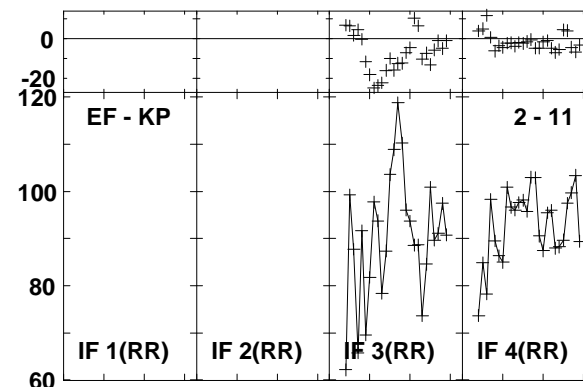
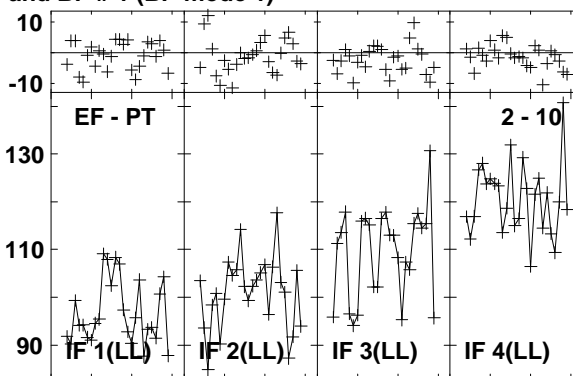
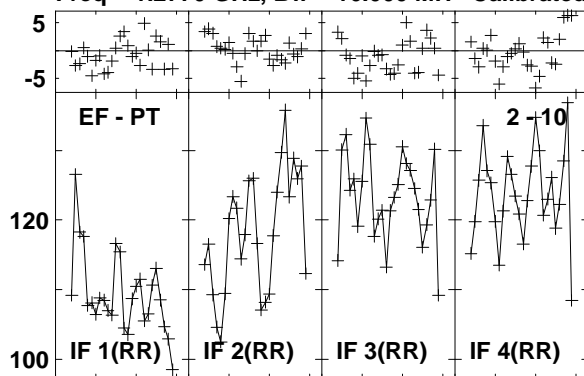

Lower frame: Milli Ampl Jy Top frame: Phas deg
Vector averaged cross-power spectrum Baseline: EF (02) - PT (10)
Timerange: 00/17:16:18 to 00/17:18:16

Plot file version 223 created 03-MAR-2016 01:12:35

J1545+5400 GN002C 1.UVDATA.1

Freq = 1.2770 GHz, Bw = 16.000 MH Calibrated with CL # 3 and BP # 1 (BP mode 1)

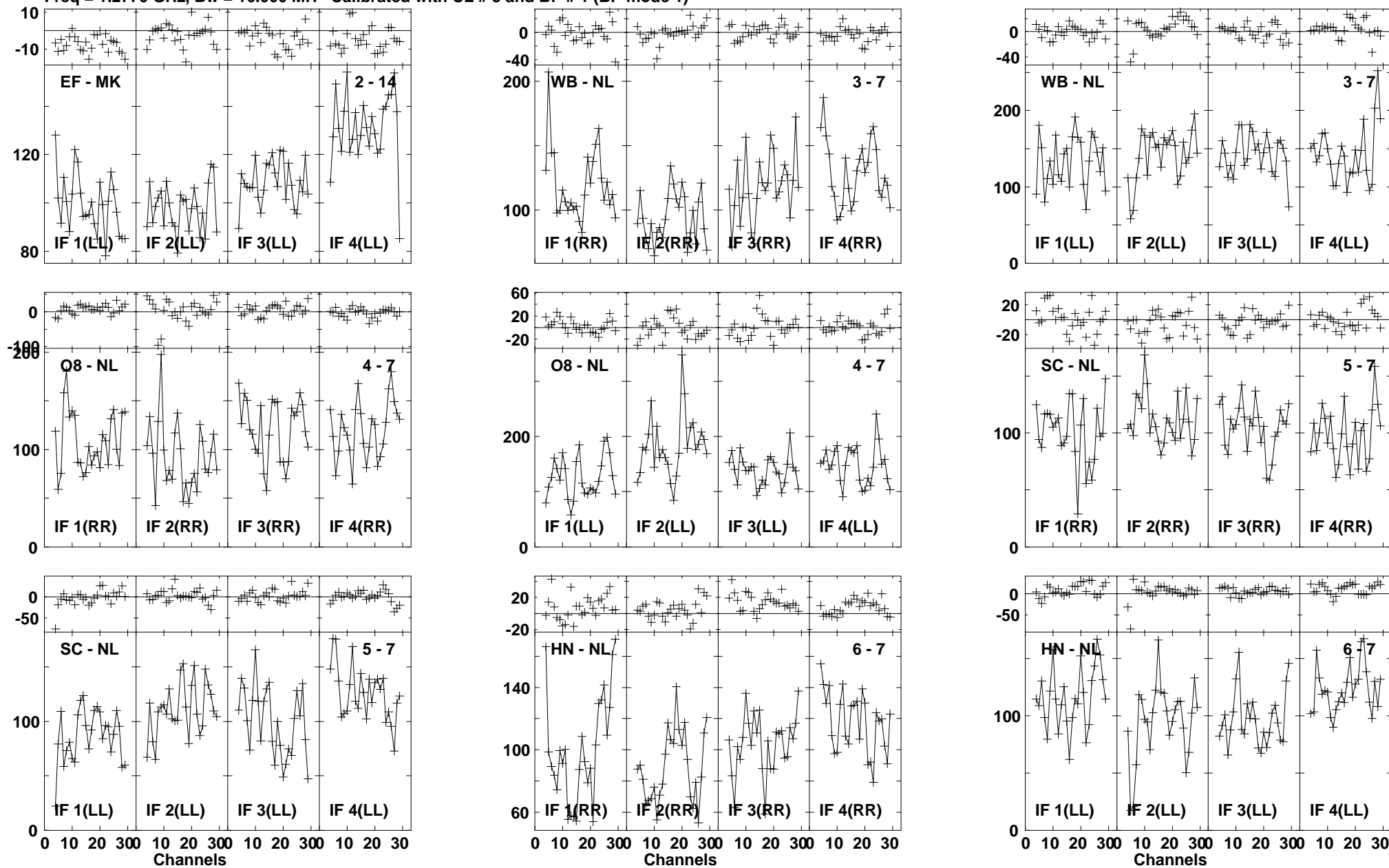

Lower frame: Milli Amp Jy Top frame: Phas deg
Vector averaged cross-power spectrum Baseline: EF (02) - MK (14)
Timerange: 00/17:16:18 to 00/17:18:16

Plot file version 224 created 03-MAR-2016 01:12:35
 J1545+5400 GN002C 1.UVDATA.1
 Freq = 1.2770 GHz, Bw = 16.000 MH Calibrated with CL # 3 and BP # 1 (BP mode 1)

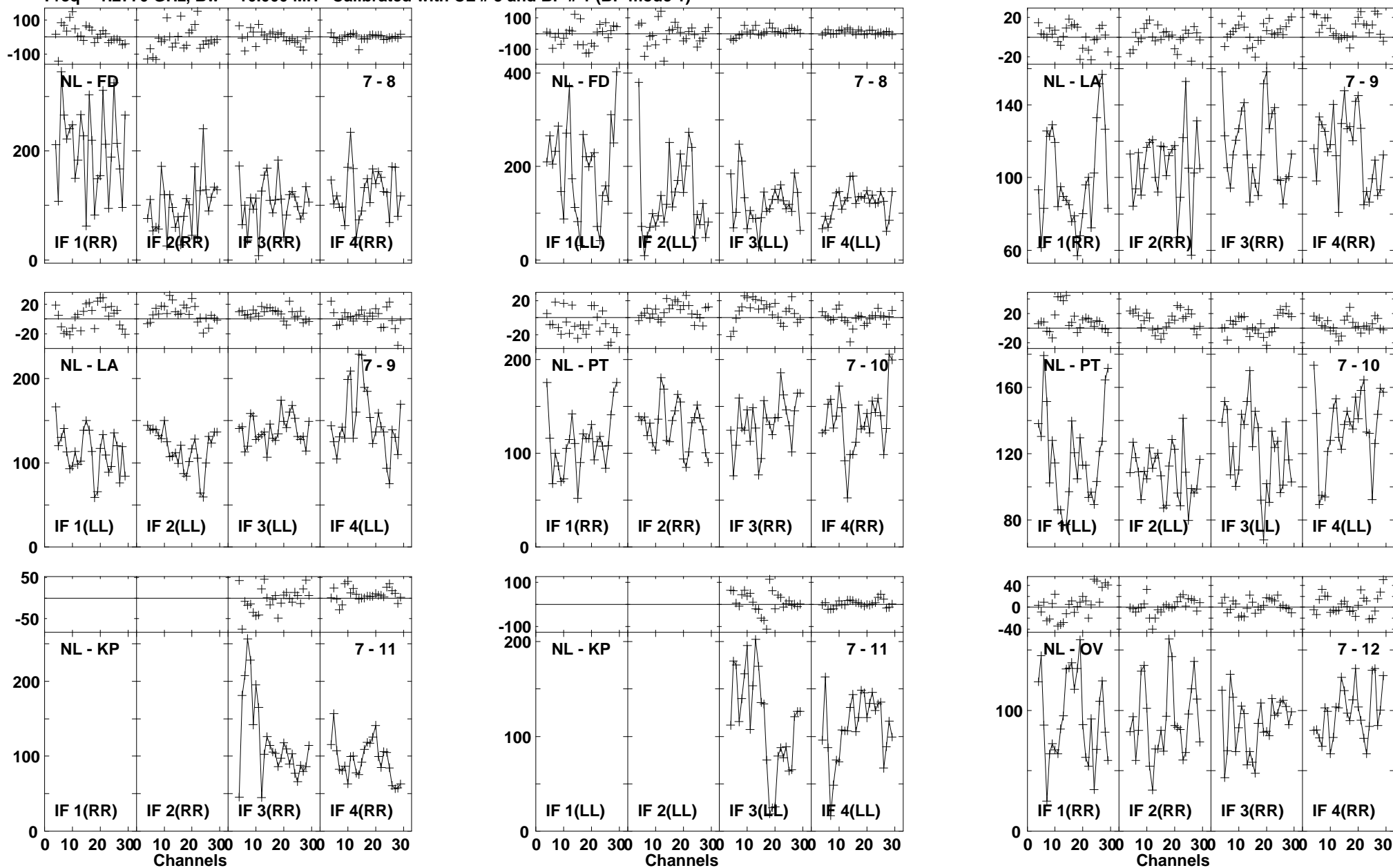

Lower frame: Milli Ampl Jy Top frame: Phas deg
 Vector averaged cross-power spectrum Baseline: NL (07) - FD (08)
 Timerange: 00/17:16:18 to 00/17:18:16

Plot file version 225 created 03-MAR-2016 01:12:35

J1545+5400 GN002C 1.UVDATA.1

Freq = 1.2770 GHz, Bw = 16.000 MH Calibrated with CL # 3 and BP # 1 (BP mode 1)

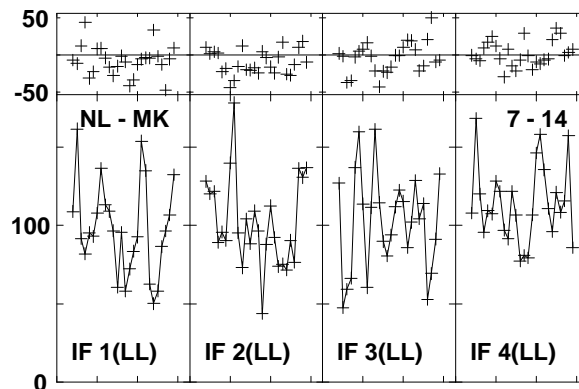
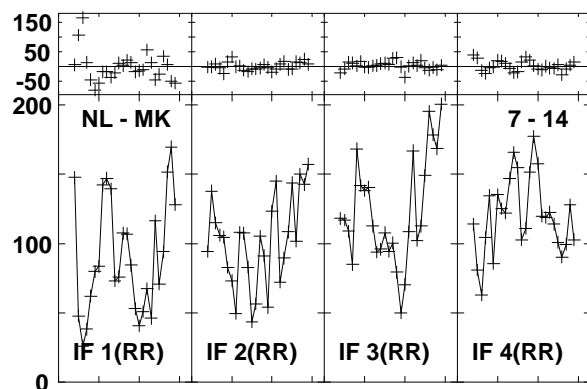
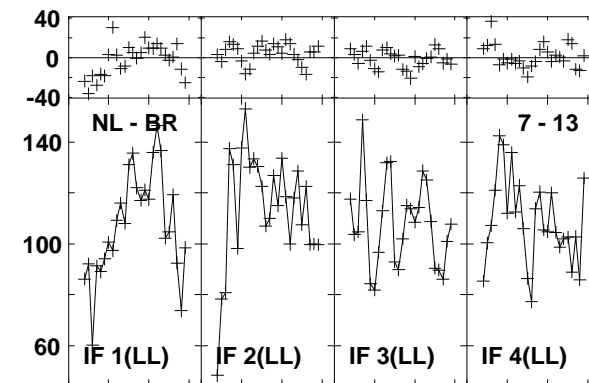
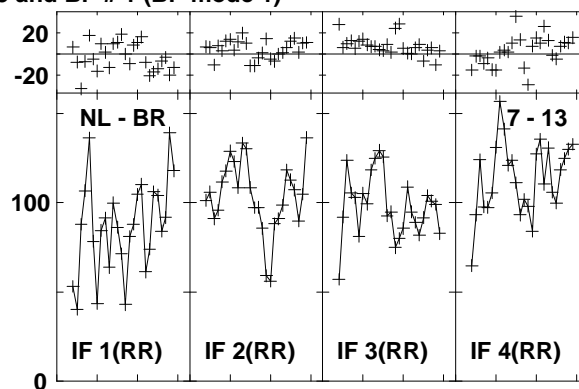
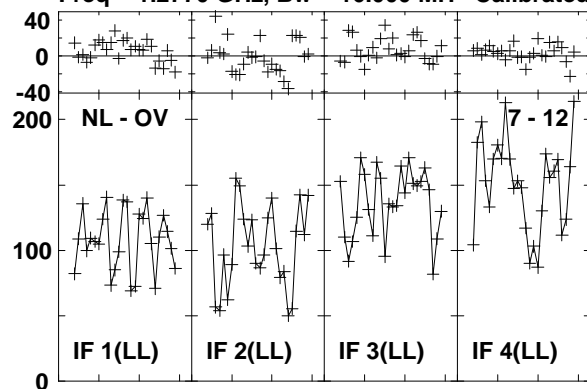

Lower frame: Milli Ampl Jy Top frame: Phas deg
Vector averaged cross-power spectrum Baseline: NL (07) - OV (12)
Timerange: 00/17:16:18 to 00/17:18:16

Plot file version 226 created 03-MAR-2016 01:12:36

4C52 GN002C 1.UVDATA.1

Freq = 1.2770 GHz, Bw = 16.000 MH Calibrated with CL # 3 and BP # 1 (BP mode 1)

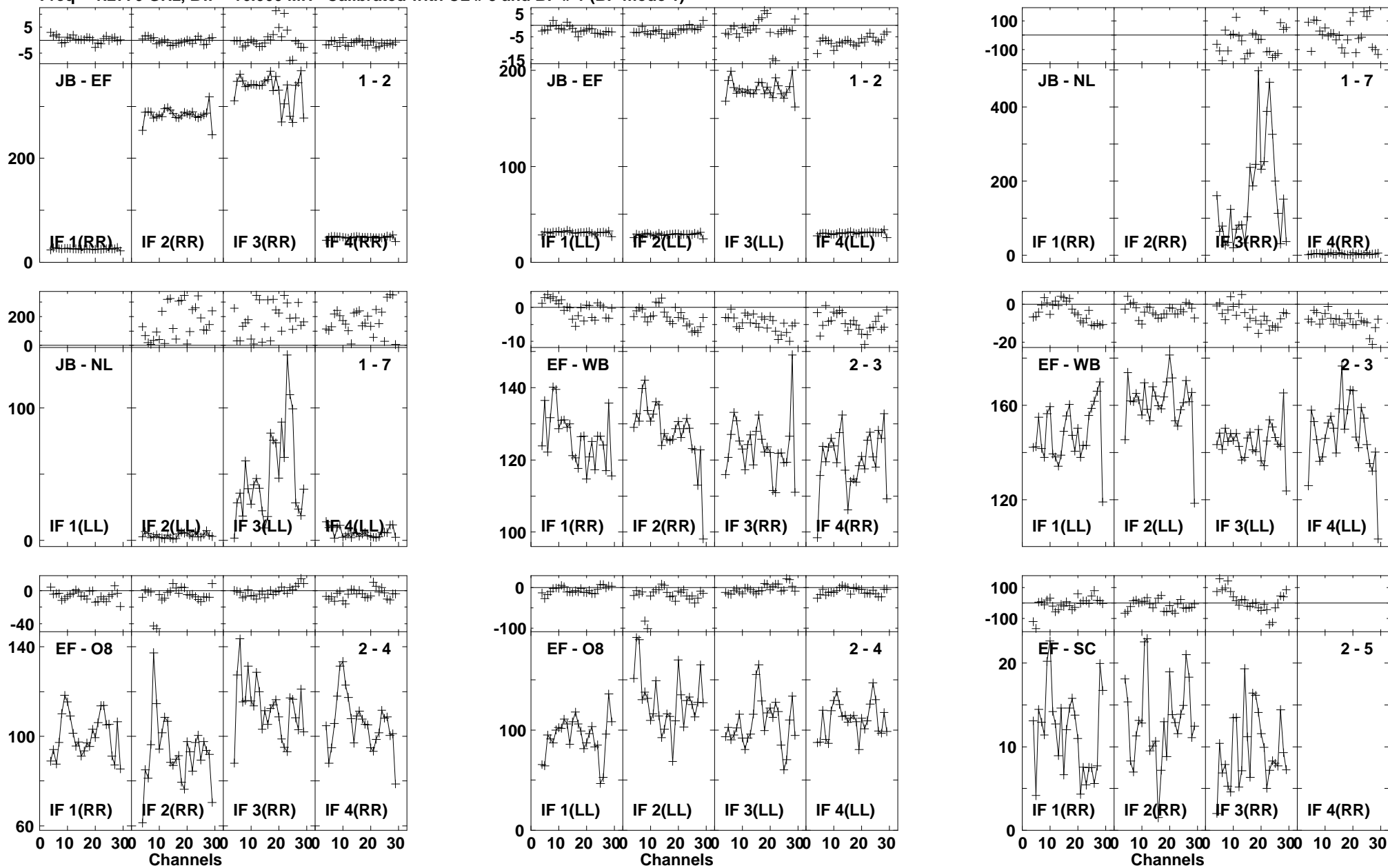

Lower frame: Milli Ampl Jy Top frame: Phas deg
Vector averaged cross-power spectrum Baseline: JB (01) - EF (02)
Timerange: 00/17:18:29 to 00/17:21:15

Plot file version 227 created 03-MAR-2016 01:12:36

4C52 GN002C 1.UVDATA.1

Freq = 1.2770 GHz, Bw = 16.000 MH Calibrated with CL # 3 and BP # 1 (BP mode 1)

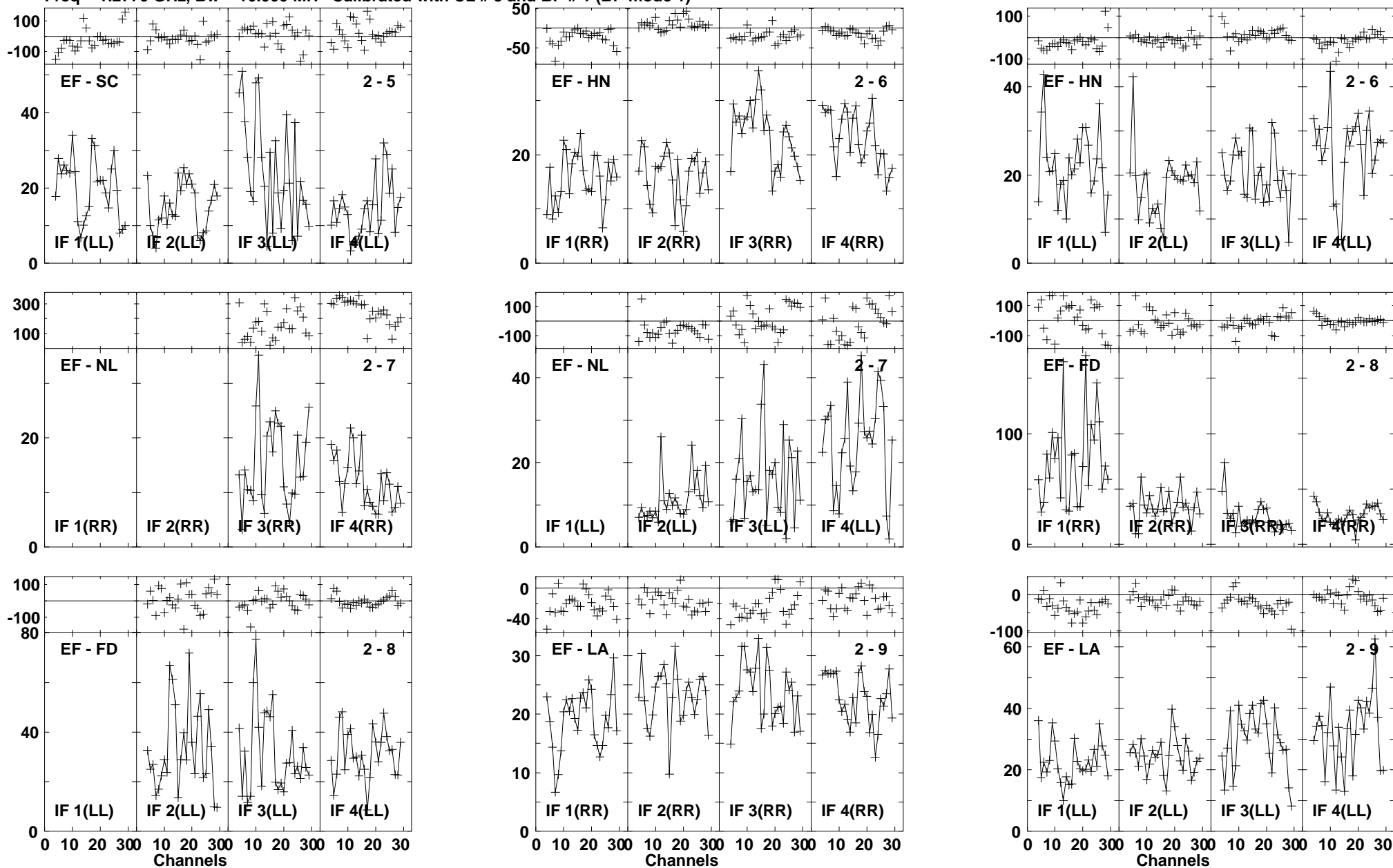

Lower frame: Milli Ampl Jy Top frame: Phas deg
Vector averaged cross-power spectrum Baseline: EF (02) - SC (05)
Timerange: 00/17:18:29 to 00/17:21:15

Plot file version 228 created 03-MAR-2016 01:12:36

4C52 GN002C 1.UVDATA.1

Freq = 1.2770 GHz, Bw = 16.000 MH Calibrated with CL # 3 and BP # 1 (BP mode 1)

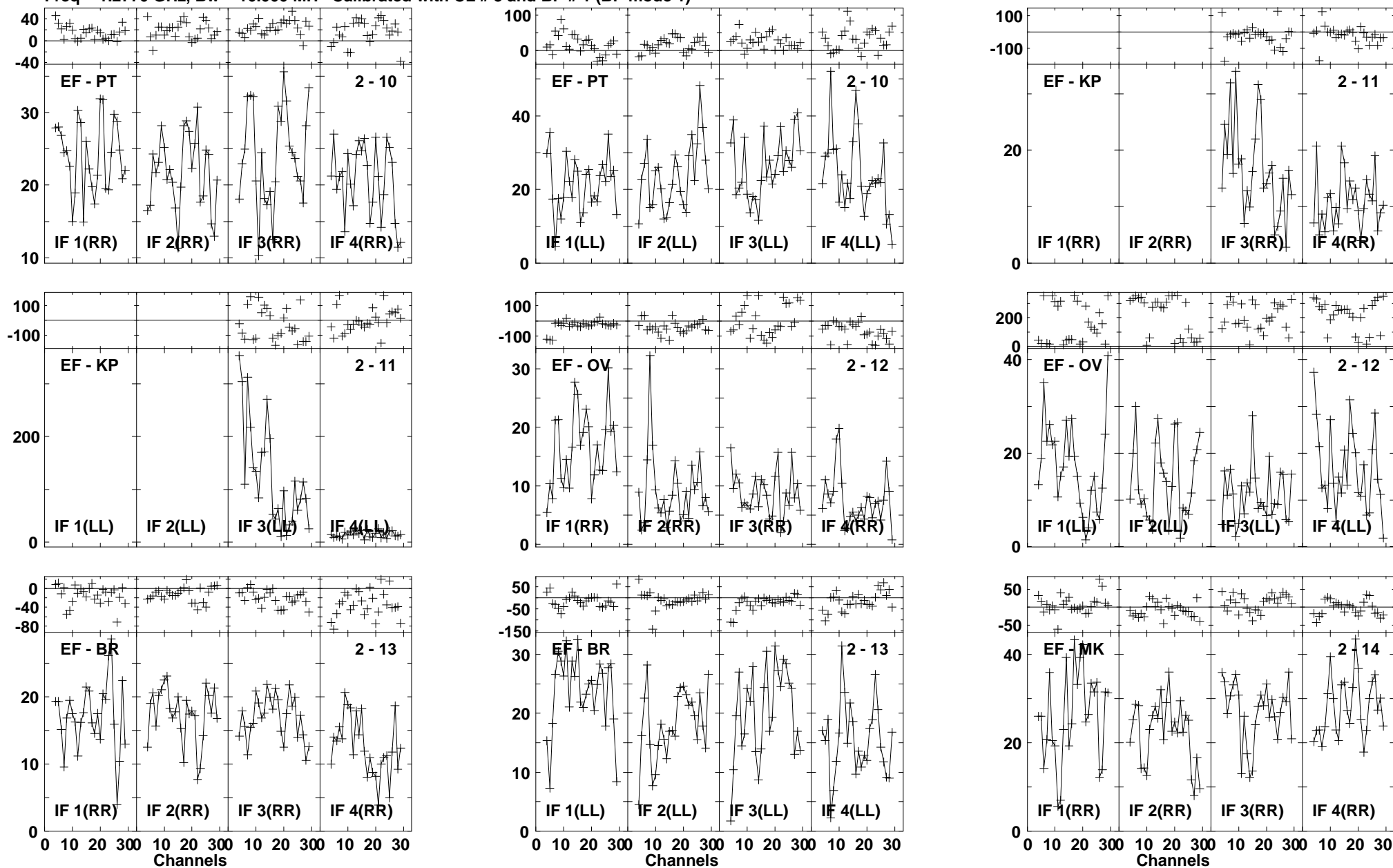

Lower frame: Milli Ampl Jy Top frame: Phas deg
Vector averaged cross-power spectrum Baseline: EF (02) - PT (10)
Timerange: 00/17:18:29 to 00/17:21:15

Plot file version 229 created 03-MAR-2016 01:12:36

4C52 GN002C 1.UVDATA.1

Freq = 1.2770 GHz, Bw = 16.000 MH Calibrated with CL # 3 and BP # 1 (BP mode 1)

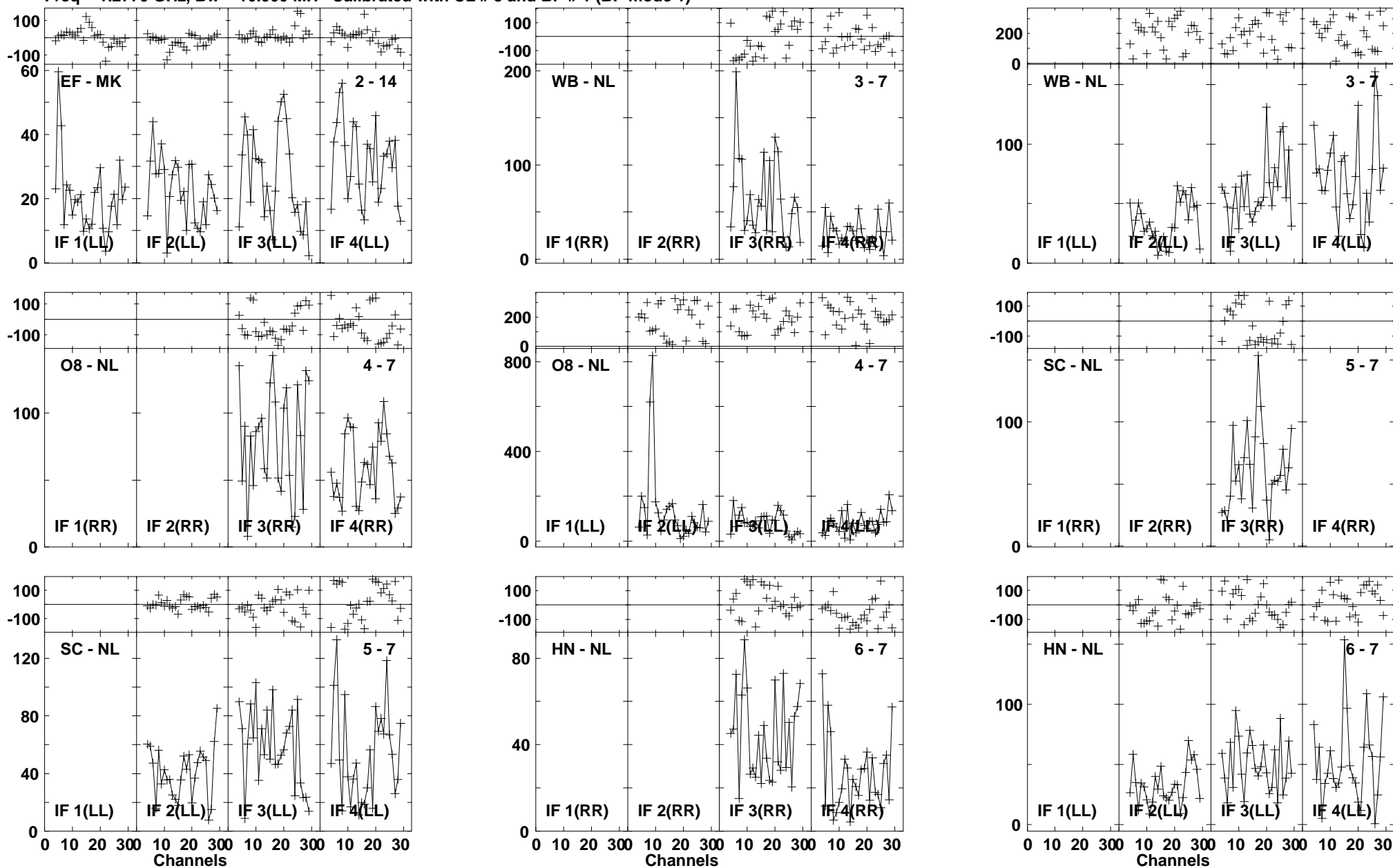

Lower frame: Milli Ampl Jy Top frame: Phas deg
Vector averaged cross-power spectrum Baseline: EF (02) - MK (14)
Timerange: 00/17:18:29 to 00/17:21:15

Plot file version 230 created 03-MAR-2016 01:12:36

4C52 GN002C 1.UVDATA.1

Freq = 1.2770 GHz, Bw = 16.000 MH Calibrated with CL # 3 and BP # 1 (BP mode 1)

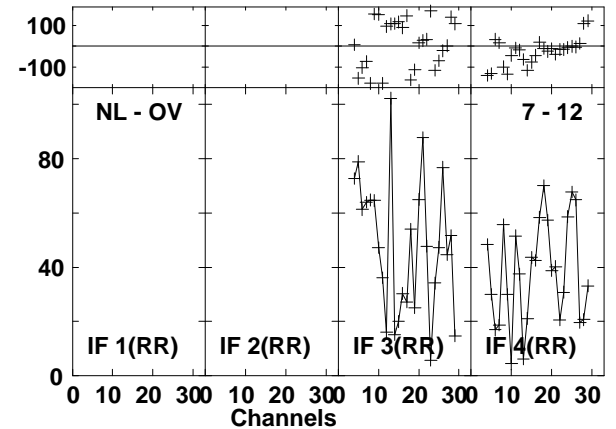
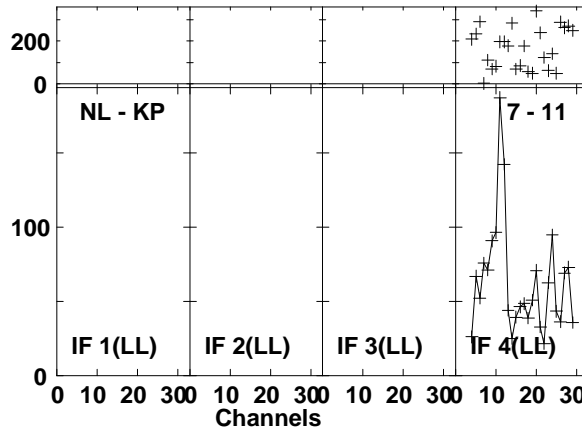
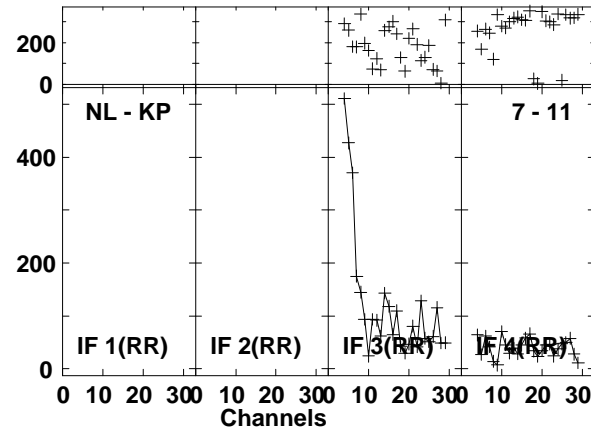
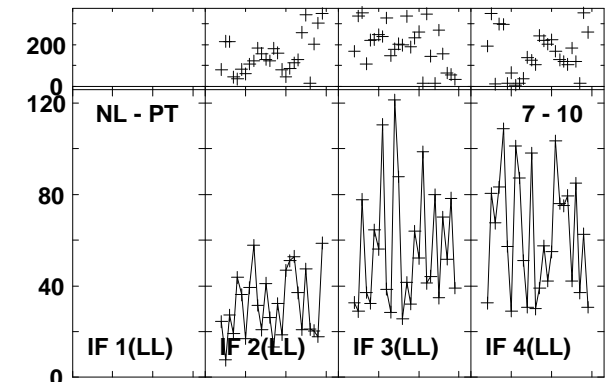
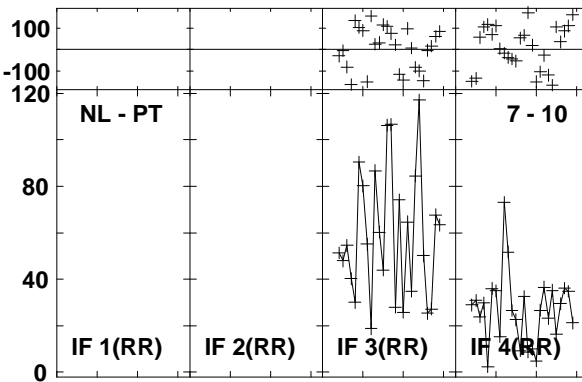
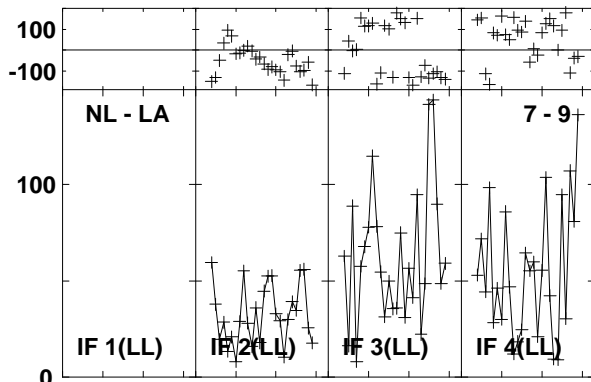
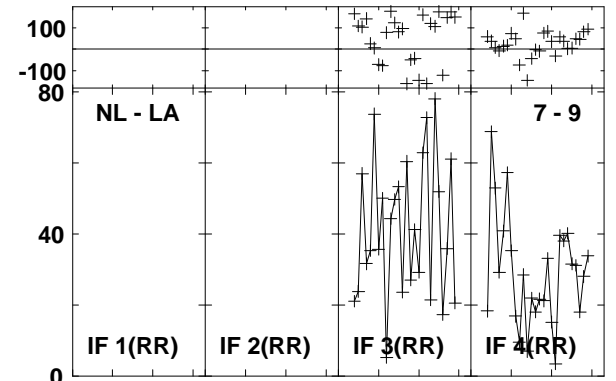
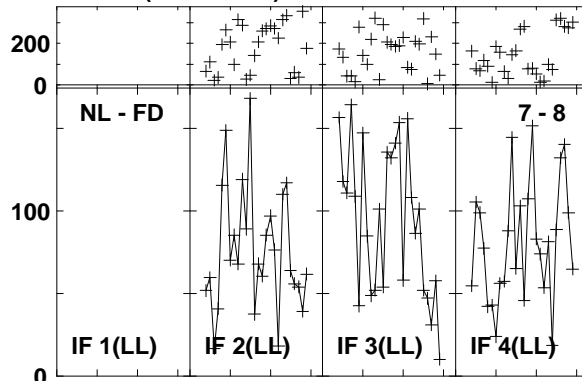
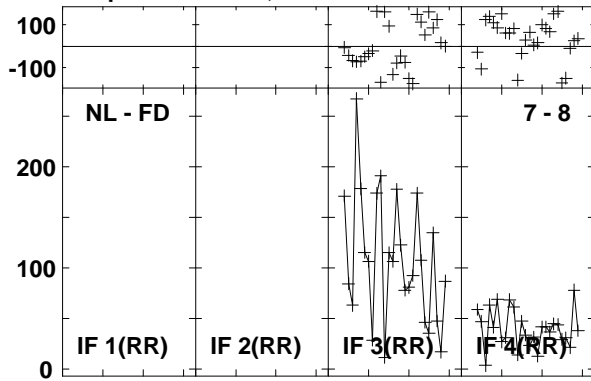

Lower frame: Milli Ampl Jy Top frame: Phas deg
Vector averaged cross-power spectrum Baseline: NL (07) - FD (08)
Timerange: 00/17:18:29 to 00/17:21:15

Plot file version 231 created 03-MAR-2016 01:12:37
 4C52 GN002C 1.UVDATA.1
 Freq = 1.2770 GHz, Bw = 16.000 MH Calibrated with CL # 3 and BP # 1 (BP mode 1)

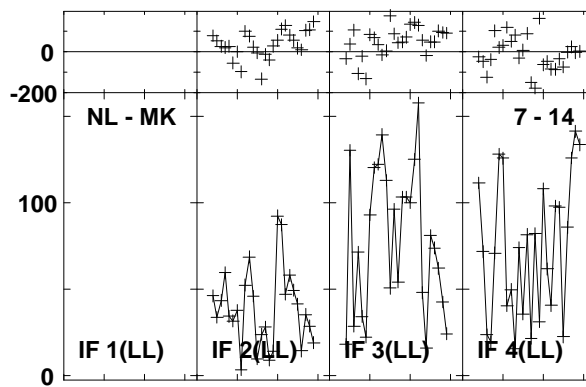
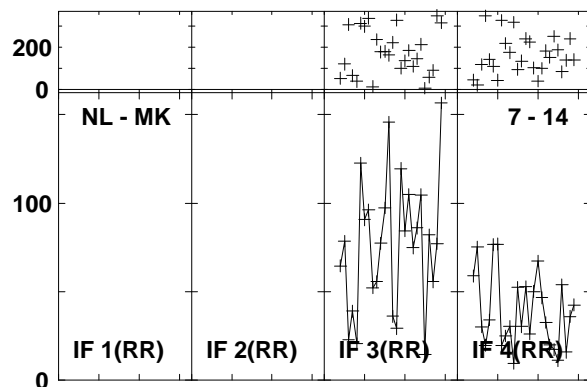
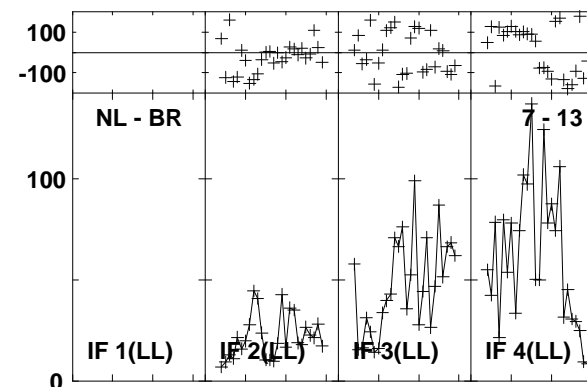
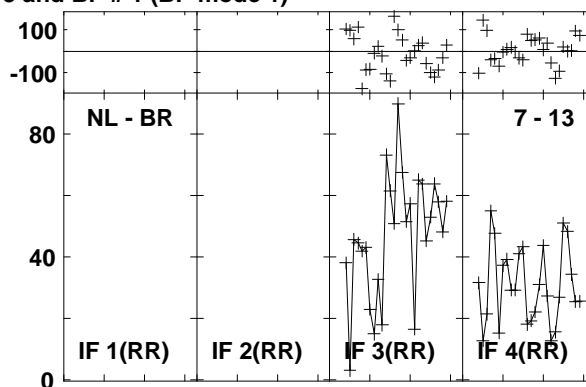
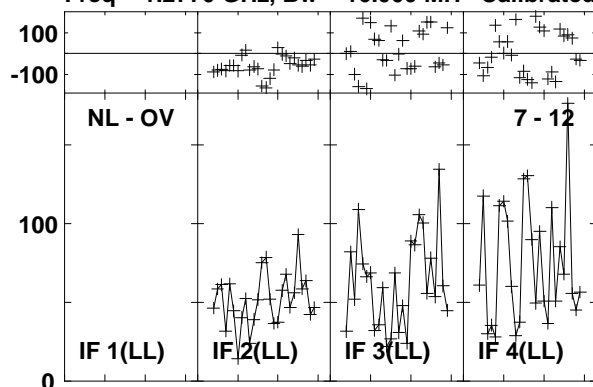

Lower frame: Milli Ampl Jy Top frame: Phas deg
 Vector averaged cross-power spectrum Baseline: NL (07) - OV (12)
 Timerange: 00/17:18:29 to 00/17:21:15

Plot file version 232 created 03-MAR-2016 01:12:37

J1545+5400 GN002C 1.UVDATA.1

Freq = 1.2770 GHz, Bw = 16.000 MH Calibrated with CL # 3 and BP # 1 (BP mode 1)

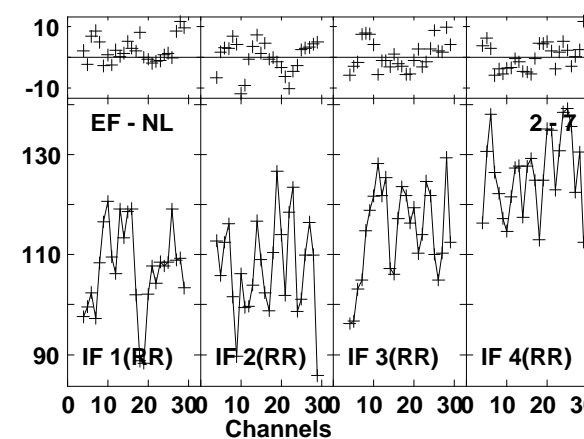
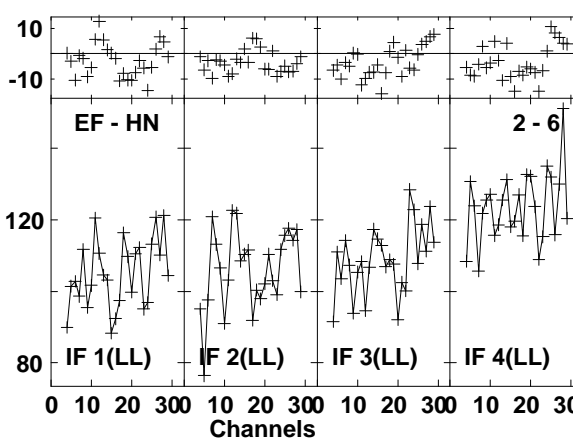
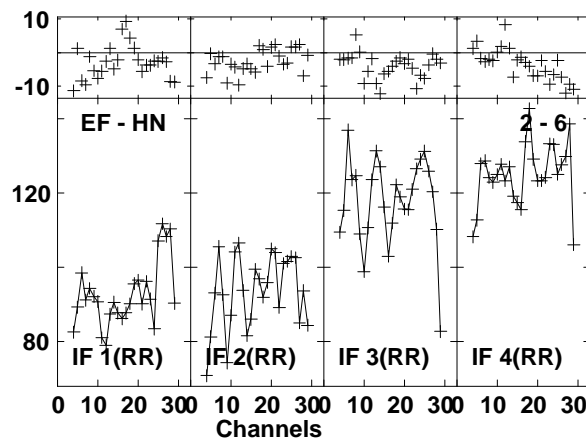
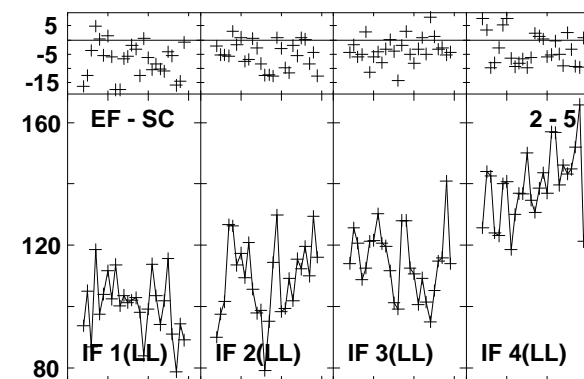
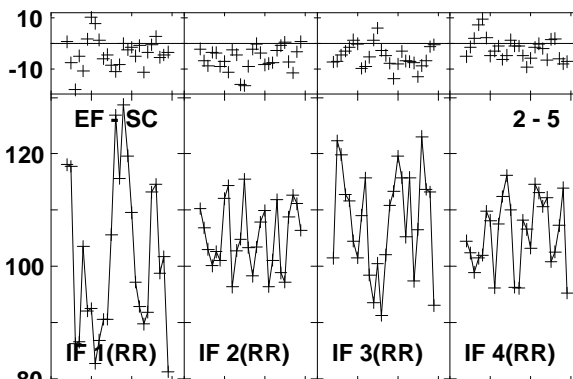
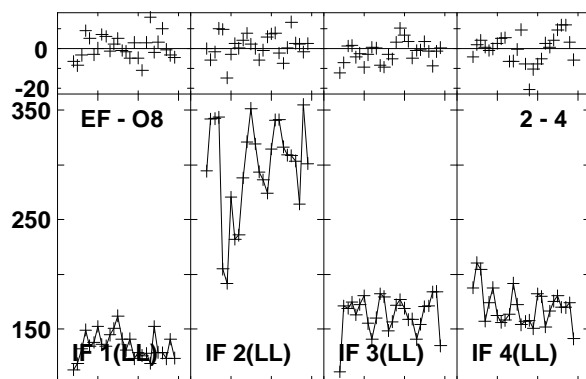
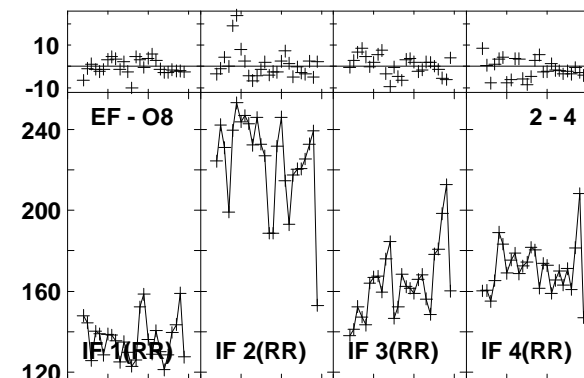
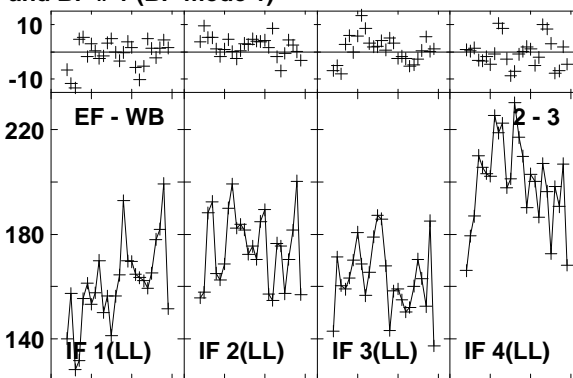
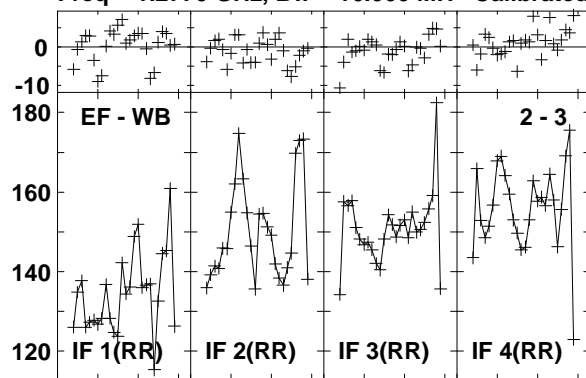

Lower frame: Milli Ampl Jy Top frame: Phas deg
Vector averaged cross-power spectrum Baseline: EF (02) - WB (03)
Timerange: 00/17:22:08 to 00/17:23:06

Plot file version 233 created 03-MAR-2016 01:12:37

J1545+5400 GN002C 1.UVDATA.1

Freq = 1.2770 GHz, Bw = 16.000 MH Calibrated with CL # 3 and BP # 1 (BP mode 1)

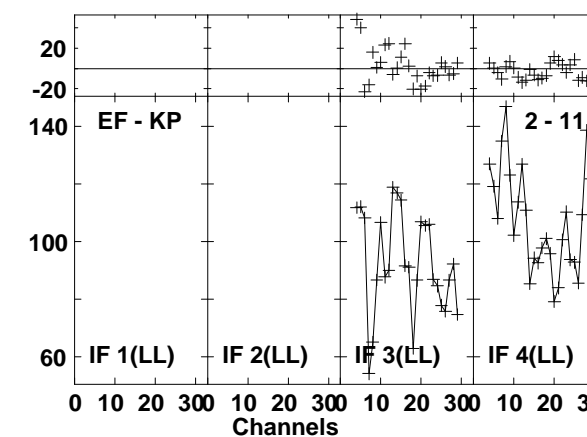
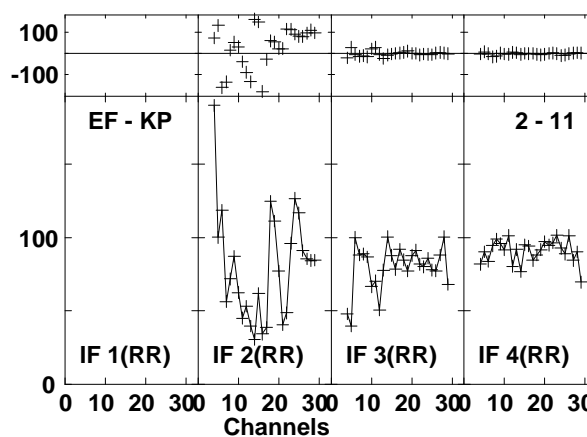
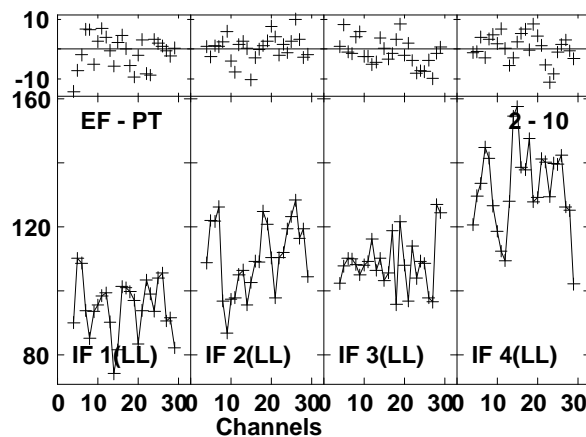
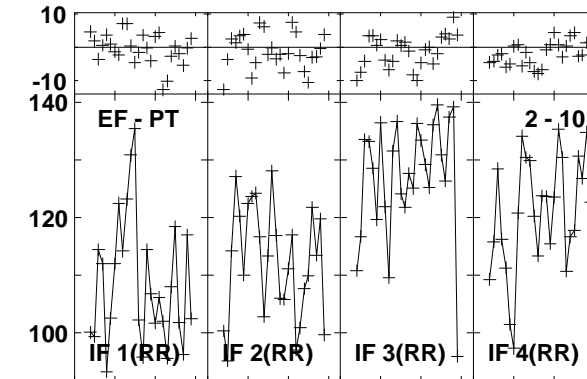
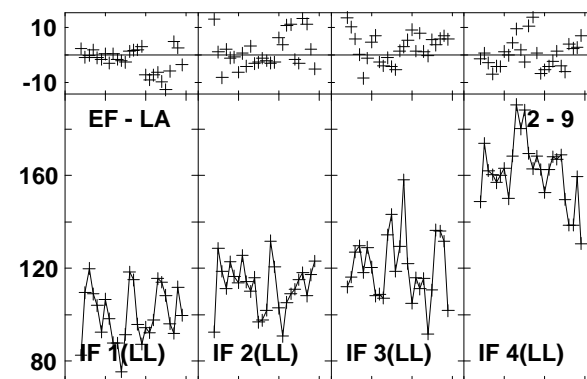
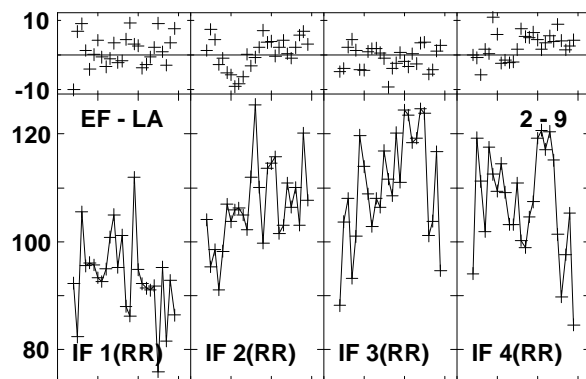
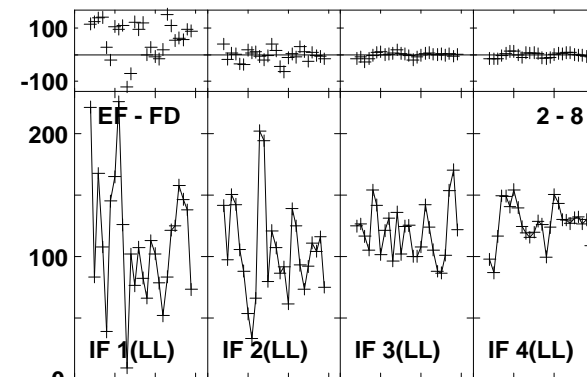
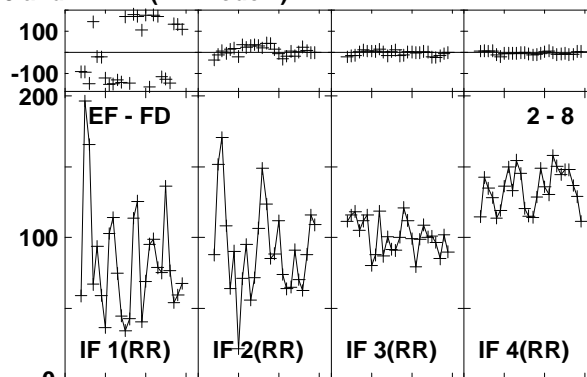
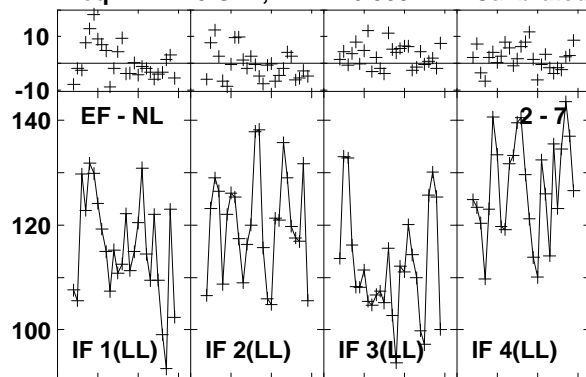

Lower frame: Milli Ampl Jy Top frame: Phas deg
Vector averaged cross-power spectrum Baseline: EF (02) - NL (07)
Timerange: 00/17:22:08 to 00/17:23:06

Plot file version 234 created 03-MAR-2016 01:12:37

J1545+5400 GN002C 1.UVDATA.1

Freq = 1.2770 GHz, Bw = 16.000 MH Calibrated with CL # 3 and BP # 1 (BP mode 1)

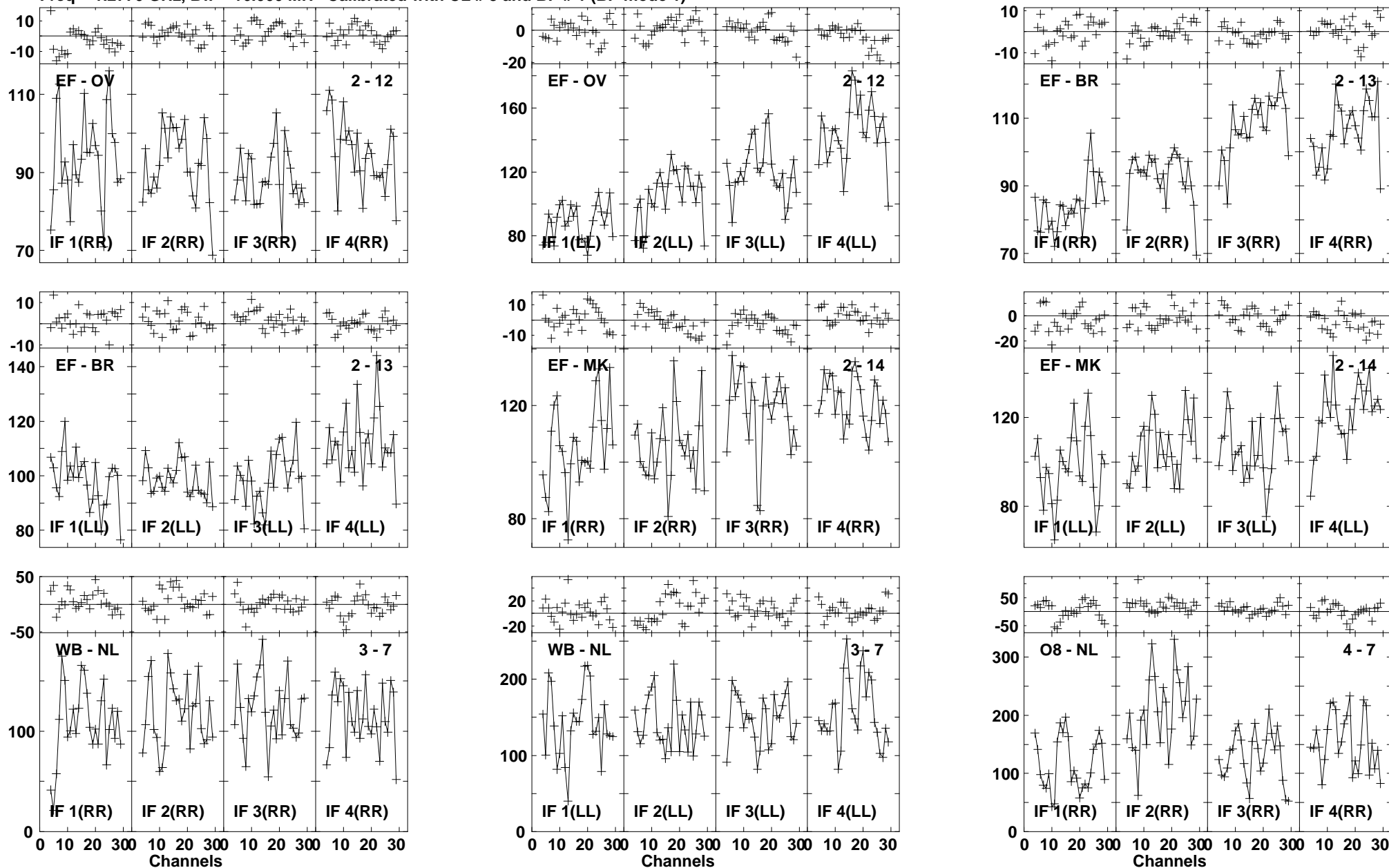

Lower frame: Milli Ampl Jy Top frame: Phas deg
Vector averaged cross-power spectrum Baseline: EF (02) - OV (12)
Timerange: 00/17:22:08 to 00/17:23:06

Plot file version 235 created 03-MAR-2016 01:12:37

J1545+5400 GN002C 1.UVDATA.1

Freq = 1.2770 GHz, Bw = 16.000 MH Calibrated with CL # 3 and BP # 1 (BP mode 1)

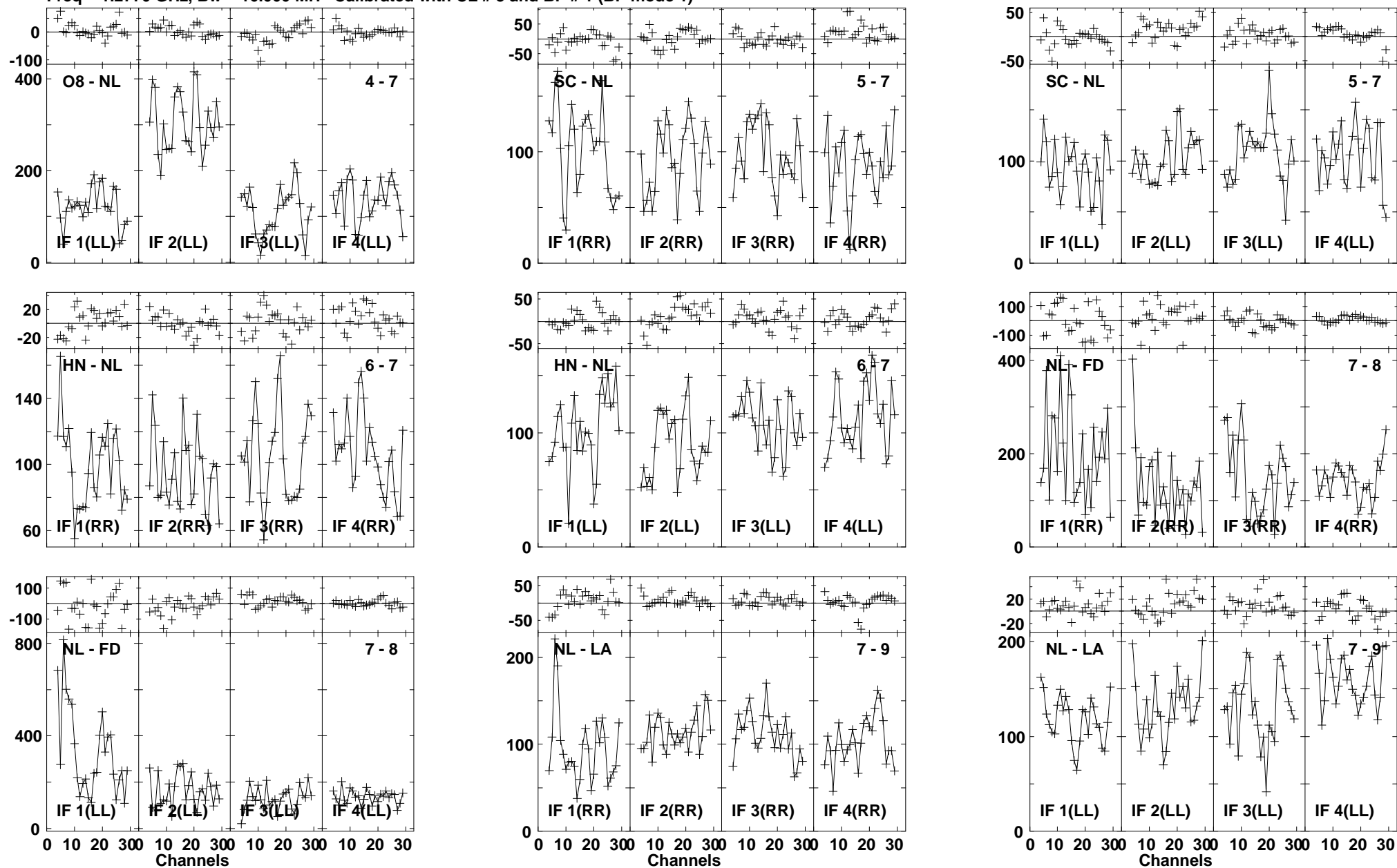

Lower frame: Milli Ampl Jy Top frame: Phas deg
Vector averaged cross-power spectrum Baseline: O8 (04) - NL (07)
Timerange: 00/17:22:08 to 00/17:23:06

Plot file version 236 created 03-MAR-2016 01:12:37
 J1545+5400 GN002C 1.UVDATA.1
 Freq = 1.2770 GHz, Bw = 16.000 MH Calibrated with CL # 3 and BP # 1 (BP mode 1)

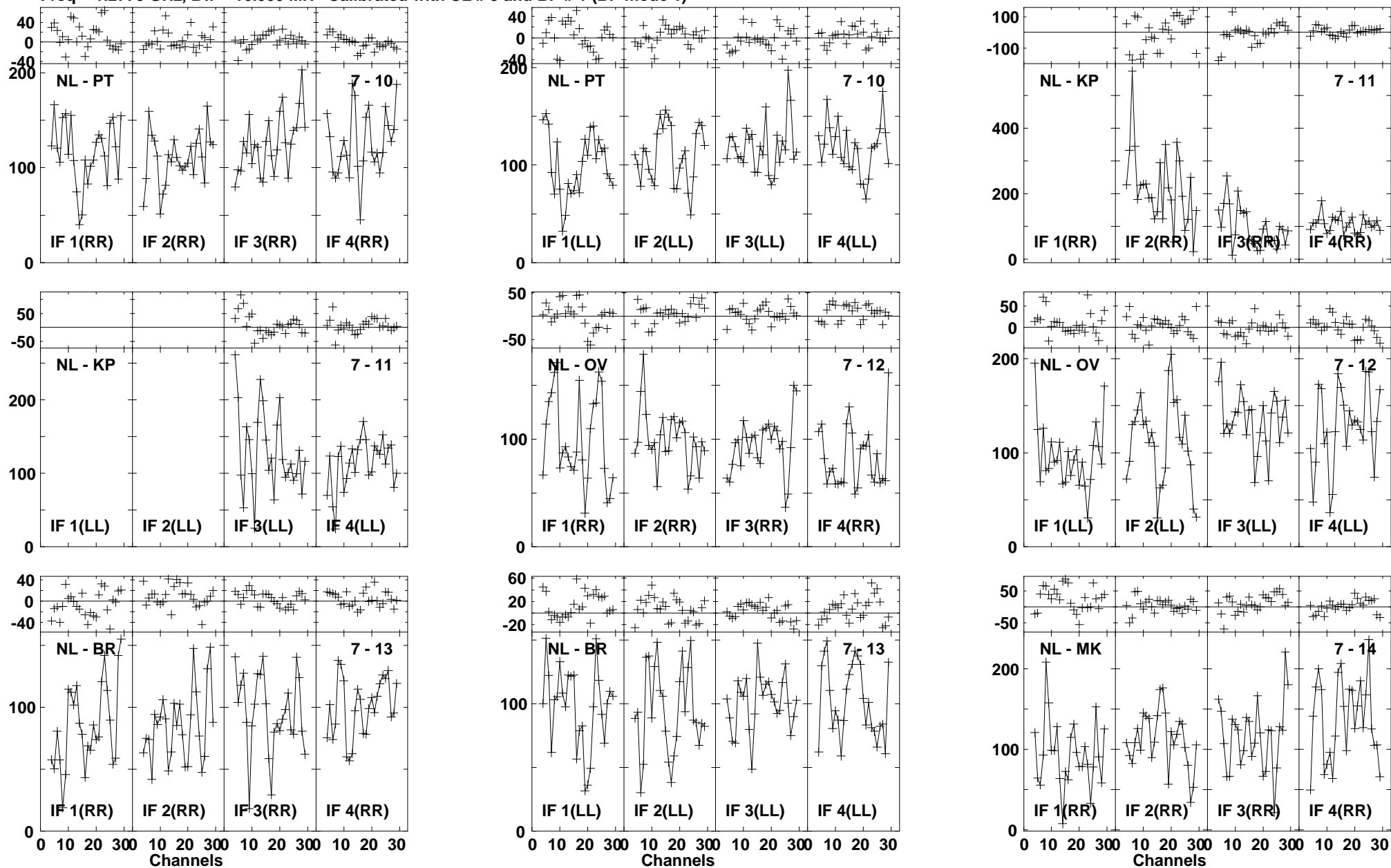

Lower frame: Milli Ampl Jy Top frame: Phas deg
 Vector averaged cross-power spectrum Baseline: NL (07) - PT (10)
 Timerange: 00/17:22:08 to 00/17:23:06

Plot file version 237 created 03-MAR-2016 01:12:38
J1545+5400 GN002C 1.UVDATA.1
Freq = 1.2770 GHz, Bw = 16.000 MH Calibrated with CL # 3 and BP # 1 (BP mode 1)

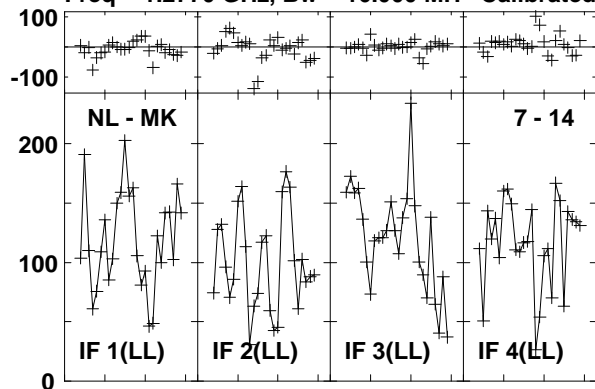

Lower frame: Milli Ampl Jy Top frame: Phas deg
Vector averaged cross-power spectrum Baseline: NL (07) - MK (14)
Timerange: 00/17:22:08 to 00/17:23:06

Plot file version 238 created 03-MAR-2016 01:12:38

4C52 GN002C 1.UVDATA.1

Freq = 1.2770 GHz, Bw = 16.000 MH Calibrated with CL # 3 and BP # 1 (BP mode 1)

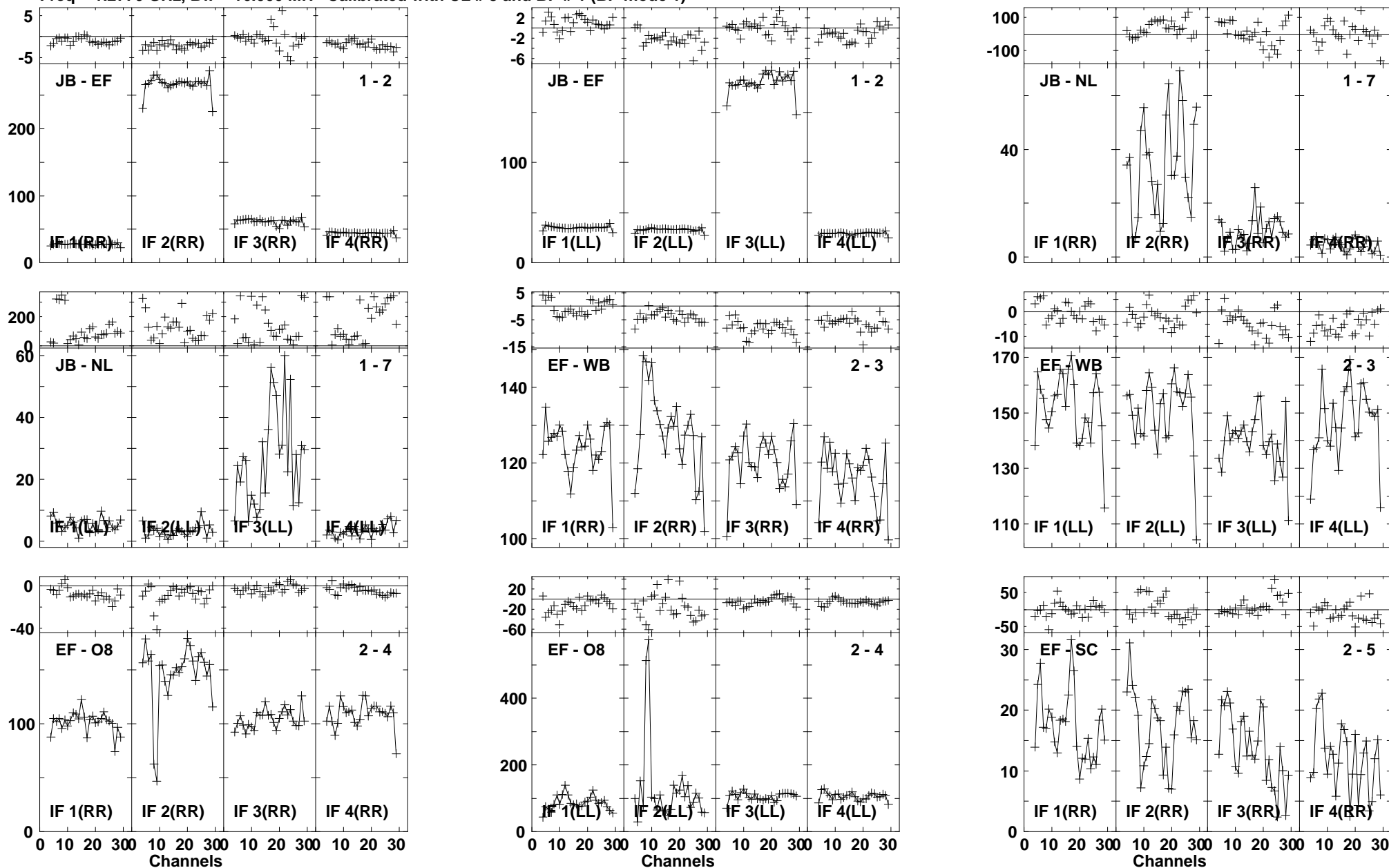

Lower frame: Milli Ampl Jy Top frame: Phas deg
Vector averaged cross-power spectrum Baseline: JB (01) - EF (02)
Timerange: 00/17:23:11 to 00/17:26:05

Plot file version 239 created 03-MAR-2016 01:12:38

4C52 GN002C 1.UVDATA.1

Freq = 1.2770 GHz, Bw = 16.000 MH Calibrated with CL # 3 and BP # 1 (BP mode 1)

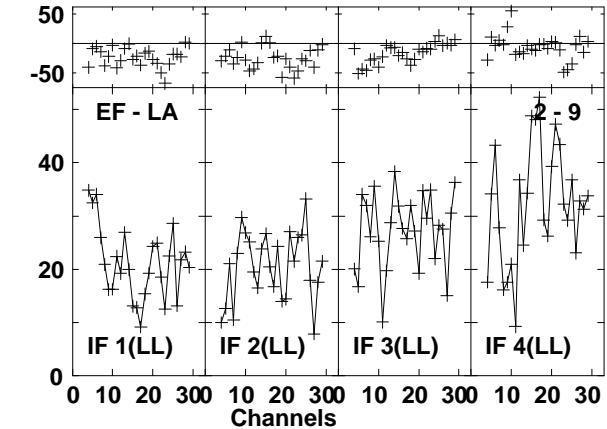
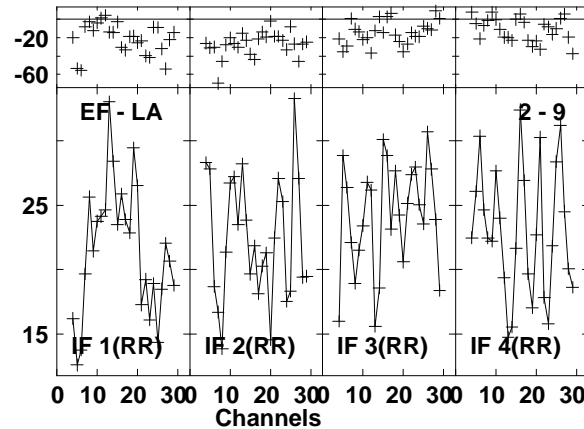
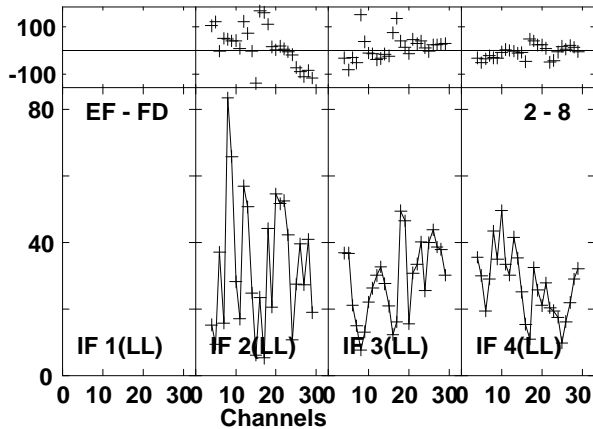
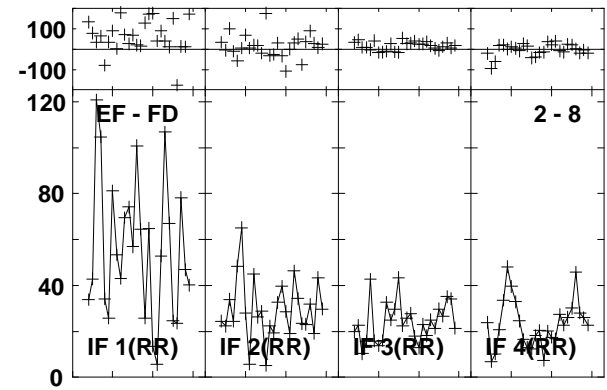
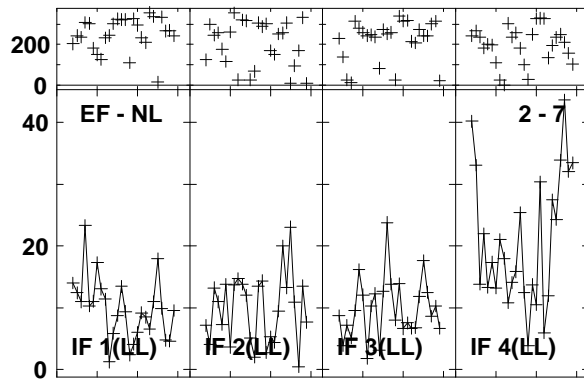
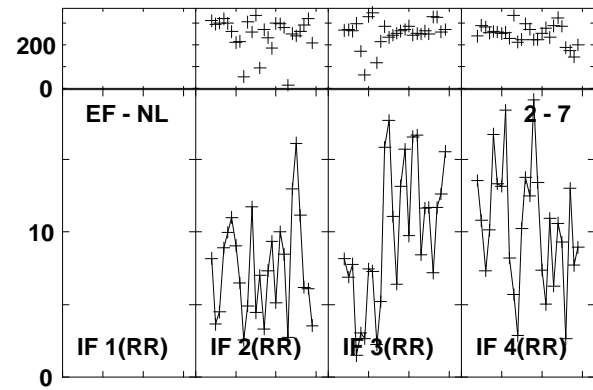
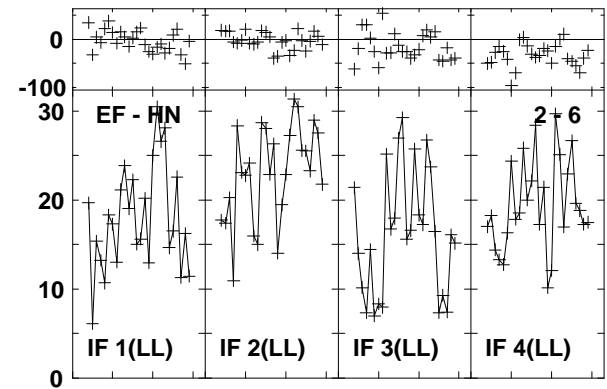
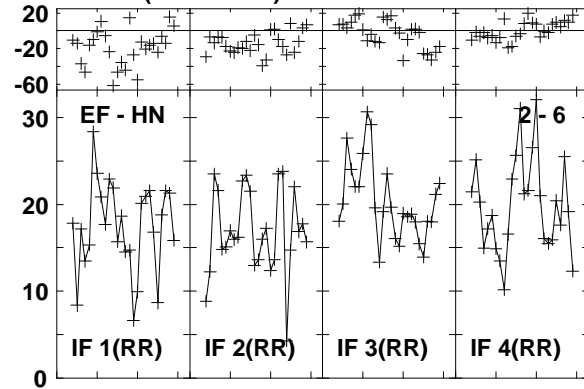
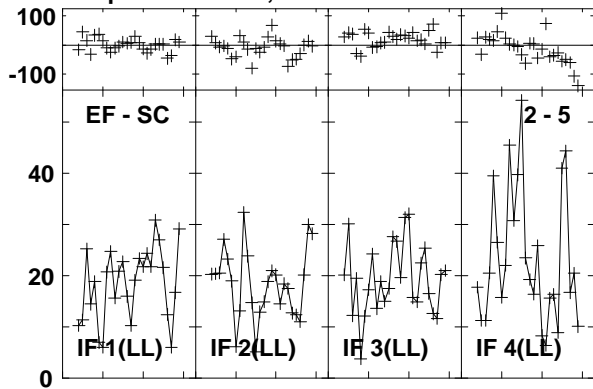

Lower frame: Milli Ampl Jy Top frame: Phas deg
Vector averaged cross-power spectrum Baseline: EF (02) - SC (05)
Timerange: 00/17:23:11 to 00/17:26:05

Plot file version 240 created 03-MAR-2016 01:12:38

4C52 GN002C 1.UVDATA.1

Freq = 1.2770 GHz, Bw = 16.000 MH Calibrated with CL # 3 and BP # 1 (BP mode 1)

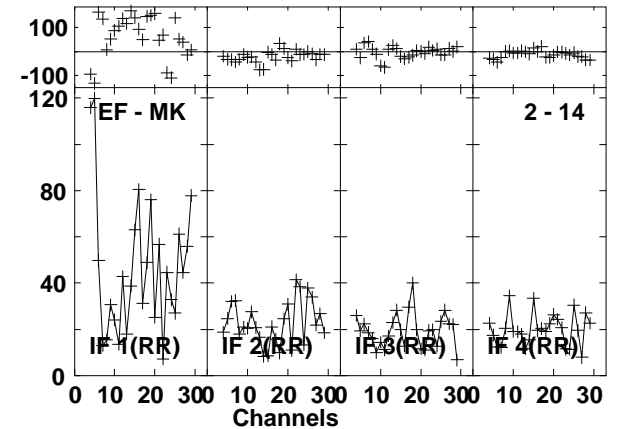
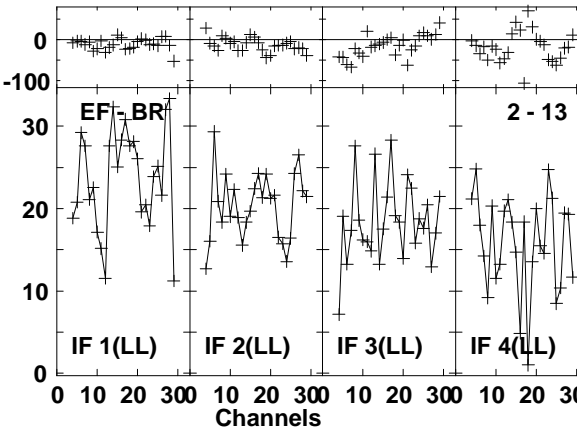
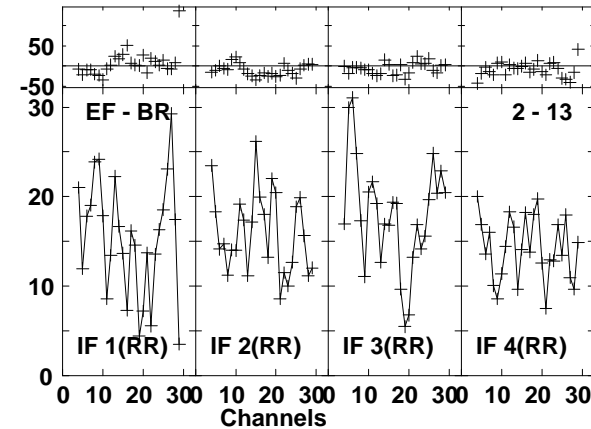
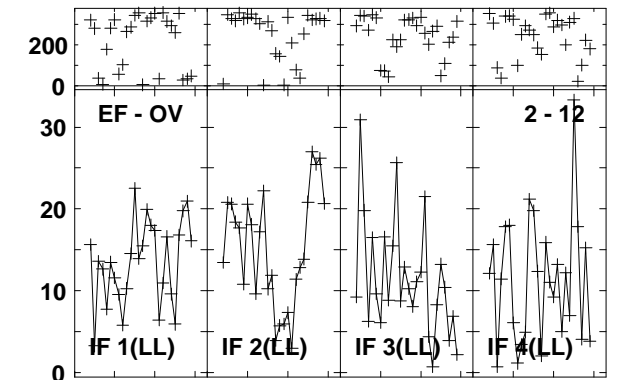
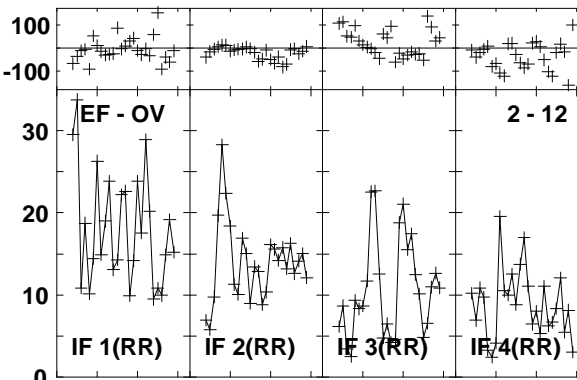
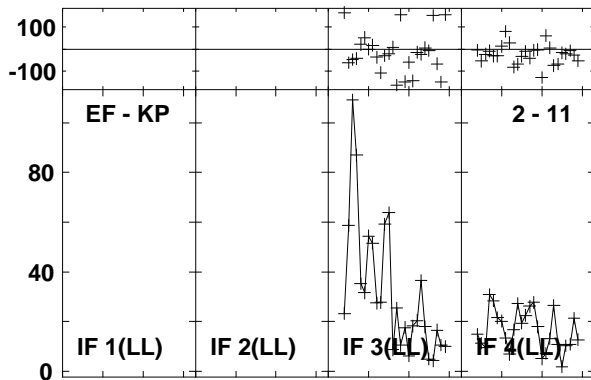
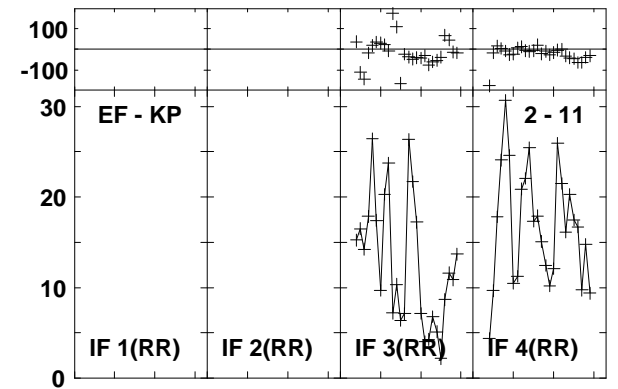
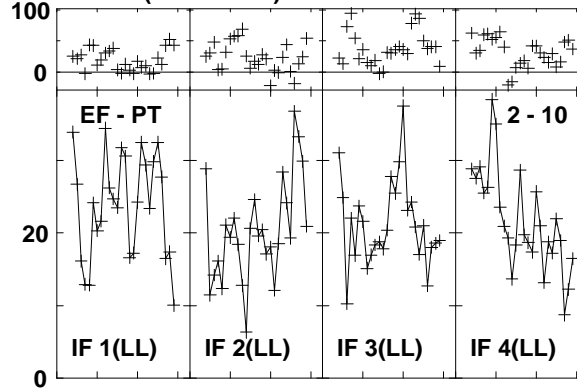
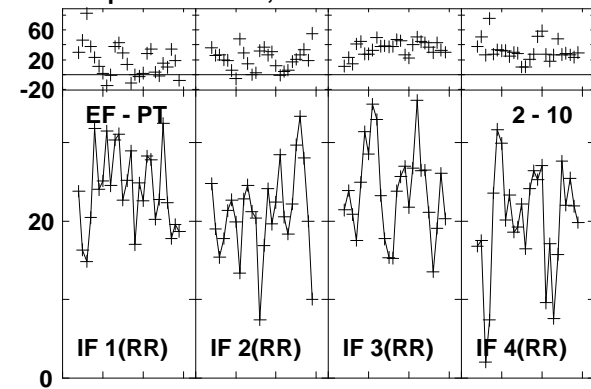

Lower frame: Milli Ampl Jy Top frame: Phas deg

Vector averaged cross-power spectrum Baseline: EF (02) - PT (10)

Timerange: 00/17:23:11 to 00/17:26:05

Plot file version 241 created 03-MAR-2016 01:12:38
 4C52 GN002C 1.UVDATA.1
 Freq = 1.2770 GHz, Bw = 16.000 MH Calibrated with CL # 3 and BP # 1 (BP mode 1)

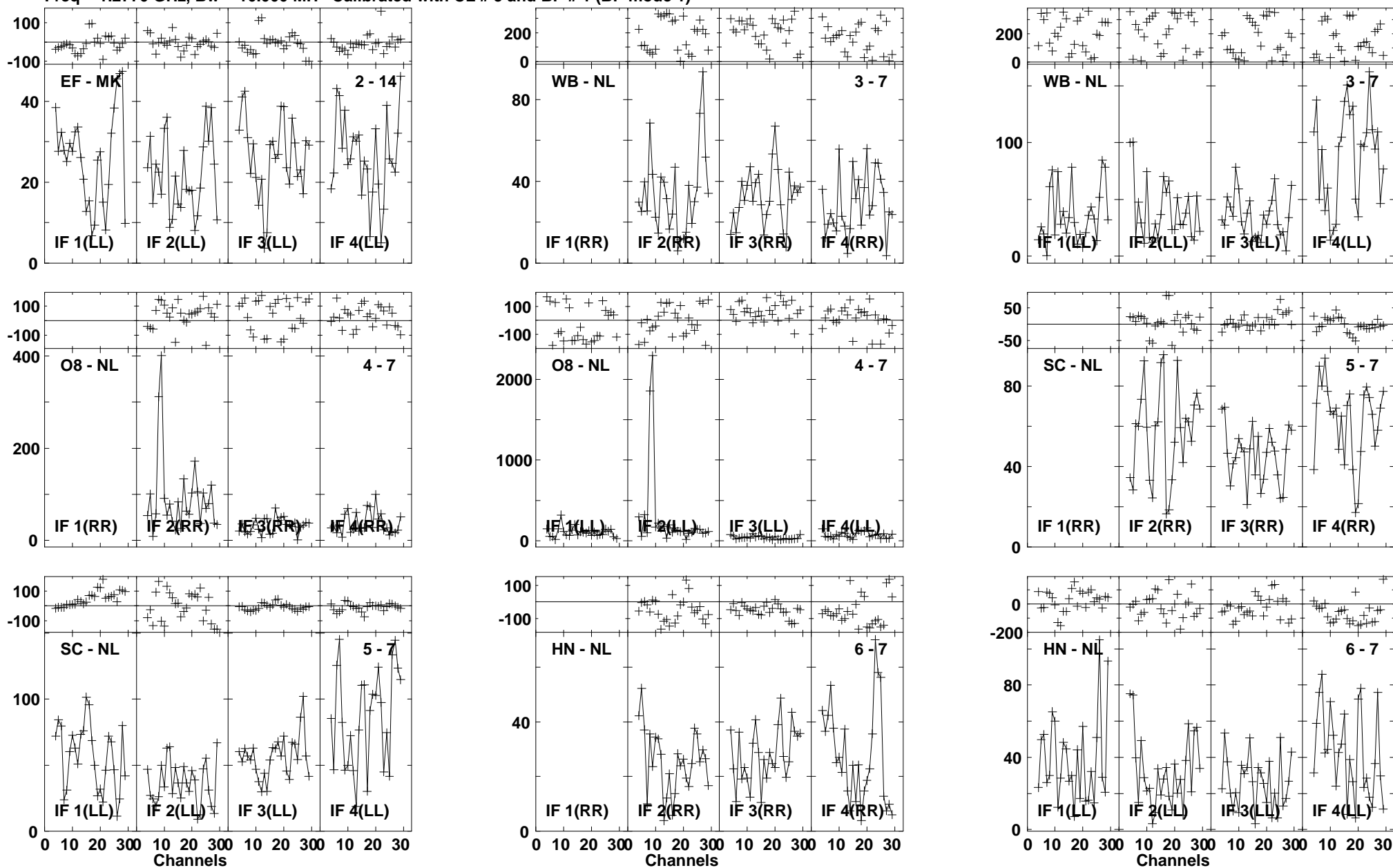

Lower frame: Milli Ampl Jy Top frame: Phas deg
 Vector averaged cross-power spectrum Baseline: EF (02) - MK (14)
 Timerange: 00/17:23:11 to 00/17:26:05

Plot file version 242 created 03-MAR-2016 01:12:38

4C52 GN002C 1.UVDATA.1

Freq = 1.2770 GHz, Bw = 16.000 MH Calibrated with CL # 3 and BP # 1 (BP mode 1)

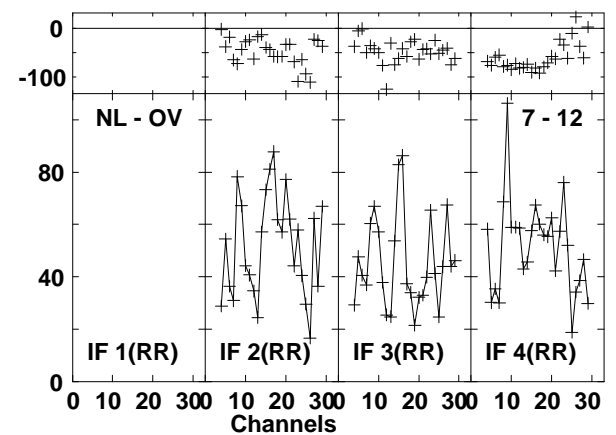
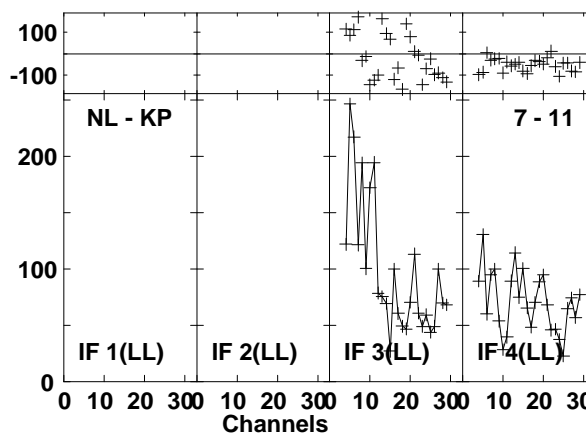
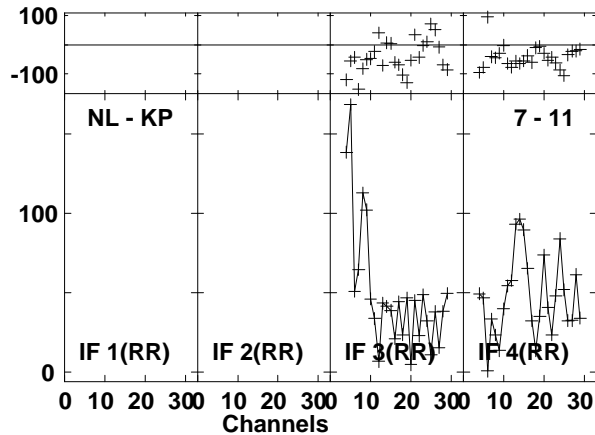
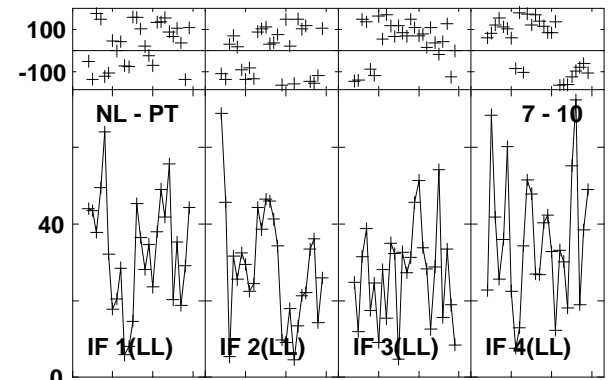
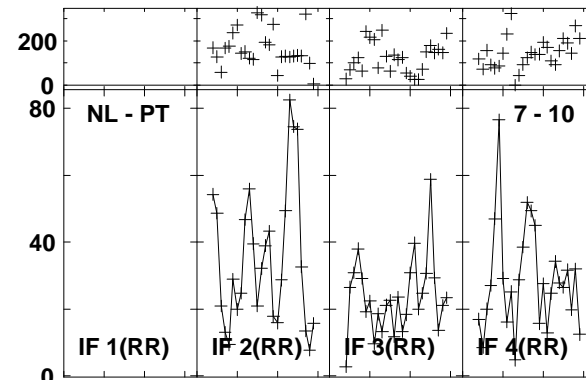
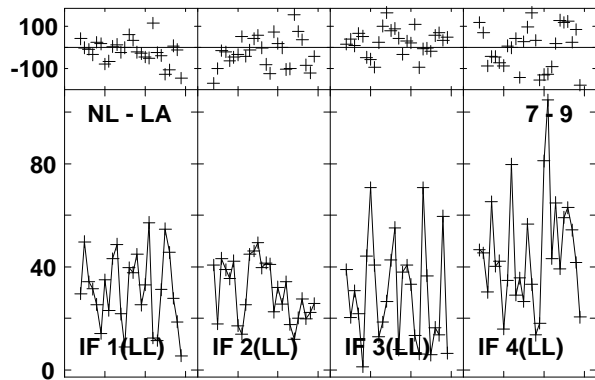
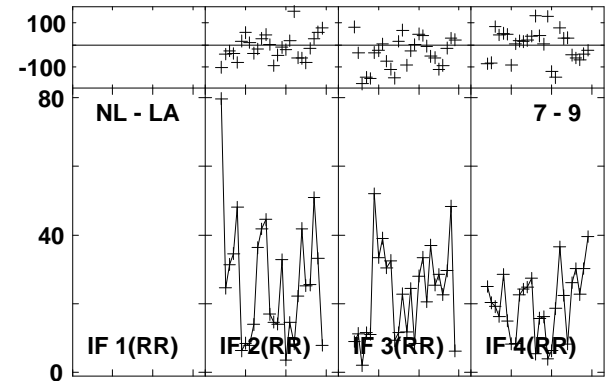
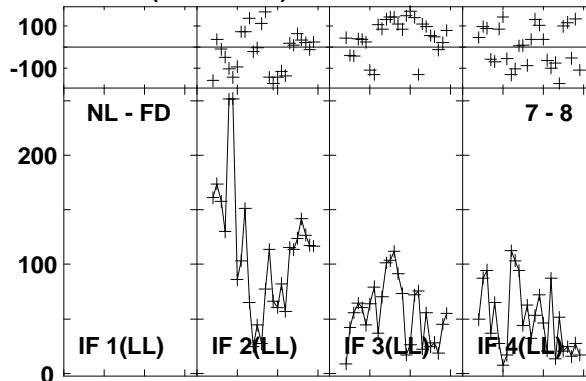
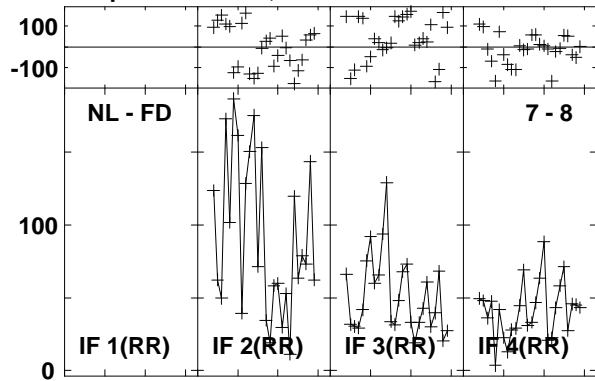

Lower frame: Milli Ampl Jy Top frame: Phas deg
Vector averaged cross-power spectrum Baseline: NL (07) - FD (08)
Timerange: 00/17:23:11 to 00/17:26:05

Plot file version 243 created 03-MAR-2016 01:12:39

4C52 GN002C 1.UVDATA.1

Freq = 1.2770 GHz, Bw = 16.000 MH Calibrated with CL # 3 and BP # 1 (BP mode 1)

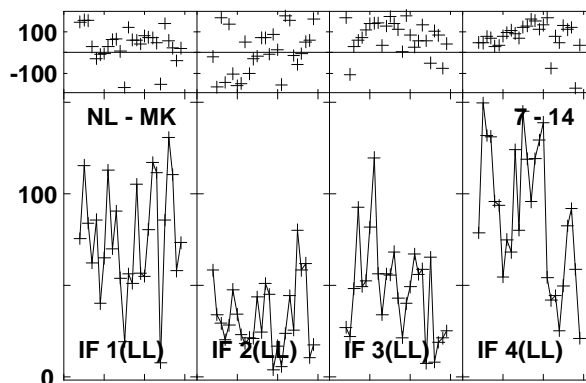
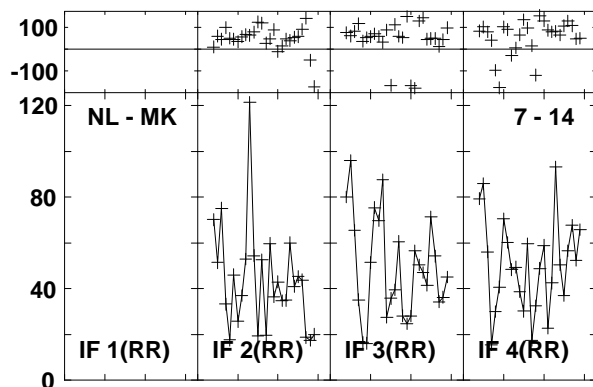
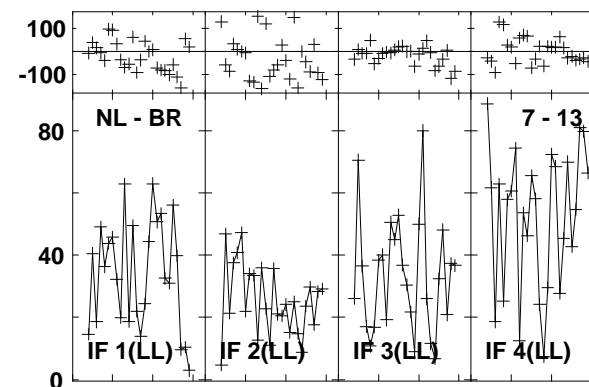
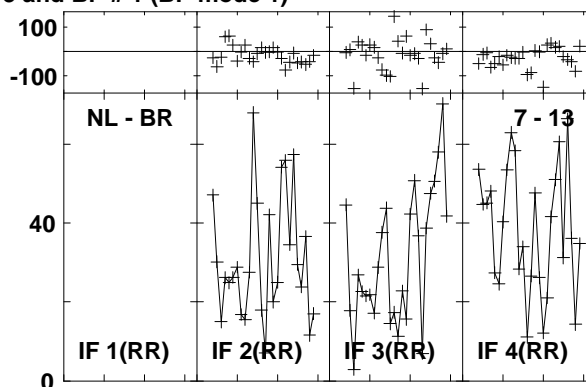
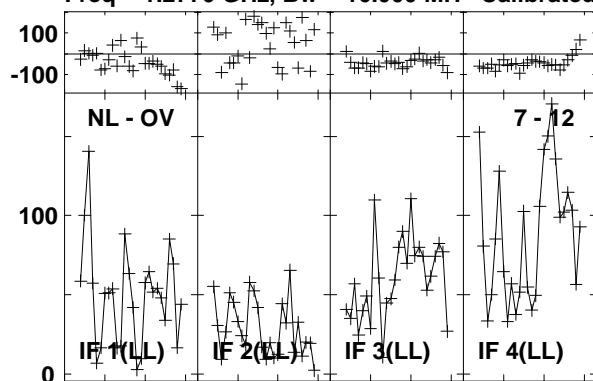

Lower frame: Milli Ampl Jy Top frame: Phas deg

Vector averaged cross-power spectrum Baseline: NL (07) - OV (12)

Timerange: 00/17:23:11 to 00/17:26:05

Plot file version 244 created 03-MAR-2016 01:12:39

J1545+5400 GN002C 1.UVDATA.1

Freq = 1.2770 GHz, Bw = 16.000 MH Calibrated with CL # 3 and BP # 1 (BP mode 1)

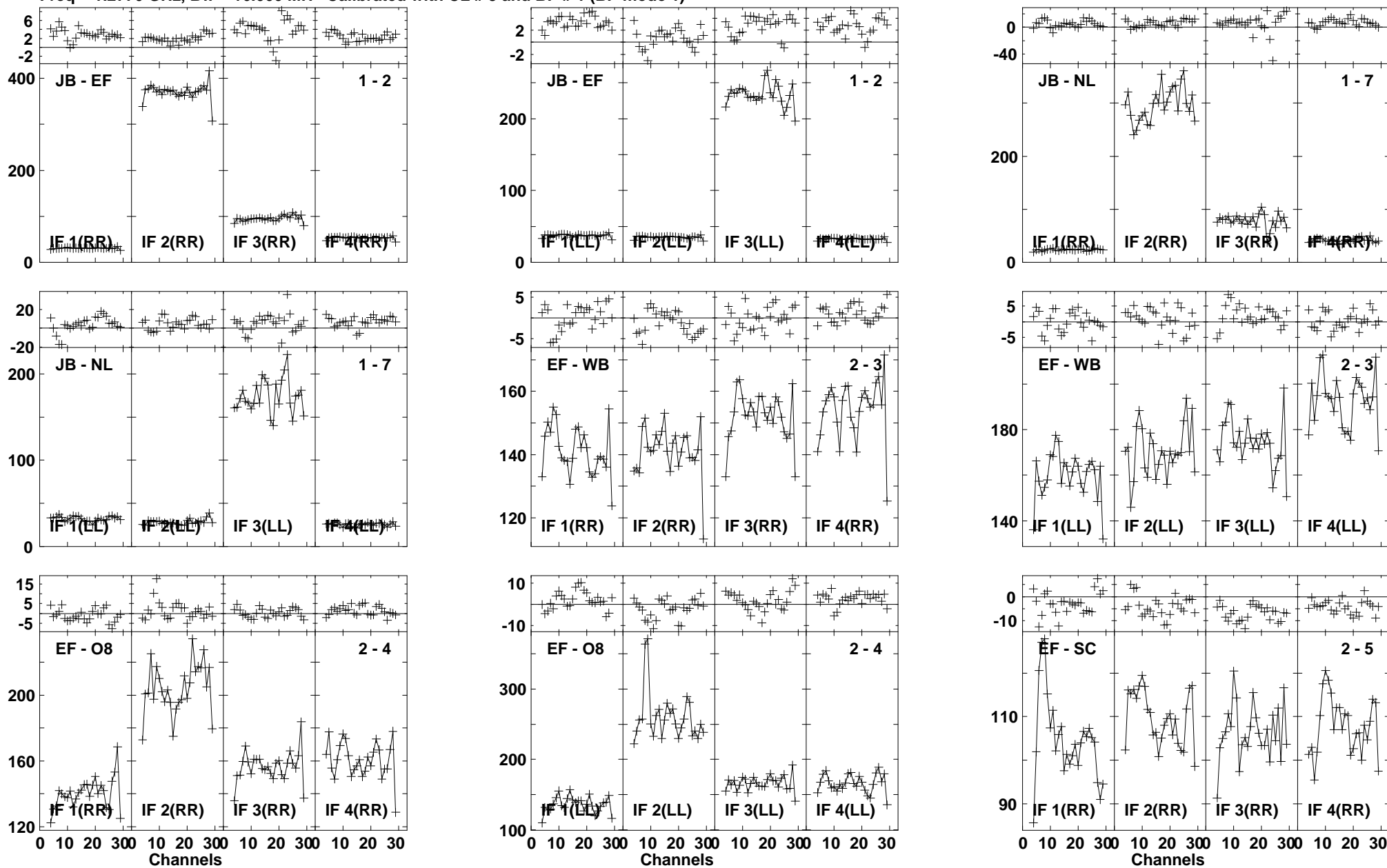

Lower frame: Milli Ampl Jy Top frame: Phas deg
Vector averaged cross-power spectrum Baseline: JB (01) - EF (02)
Timerange: 00/17:26:58 to 00/17:28:56

Plot file version 245 created 03-MAR-2016 01:12:39

J1545+5400 GN002C 1.UVDATA.1

Freq = 1.2770 GHz, Bw = 16.000 MH Calibrated with CL # 3 and BP # 1 (BP mode 1)

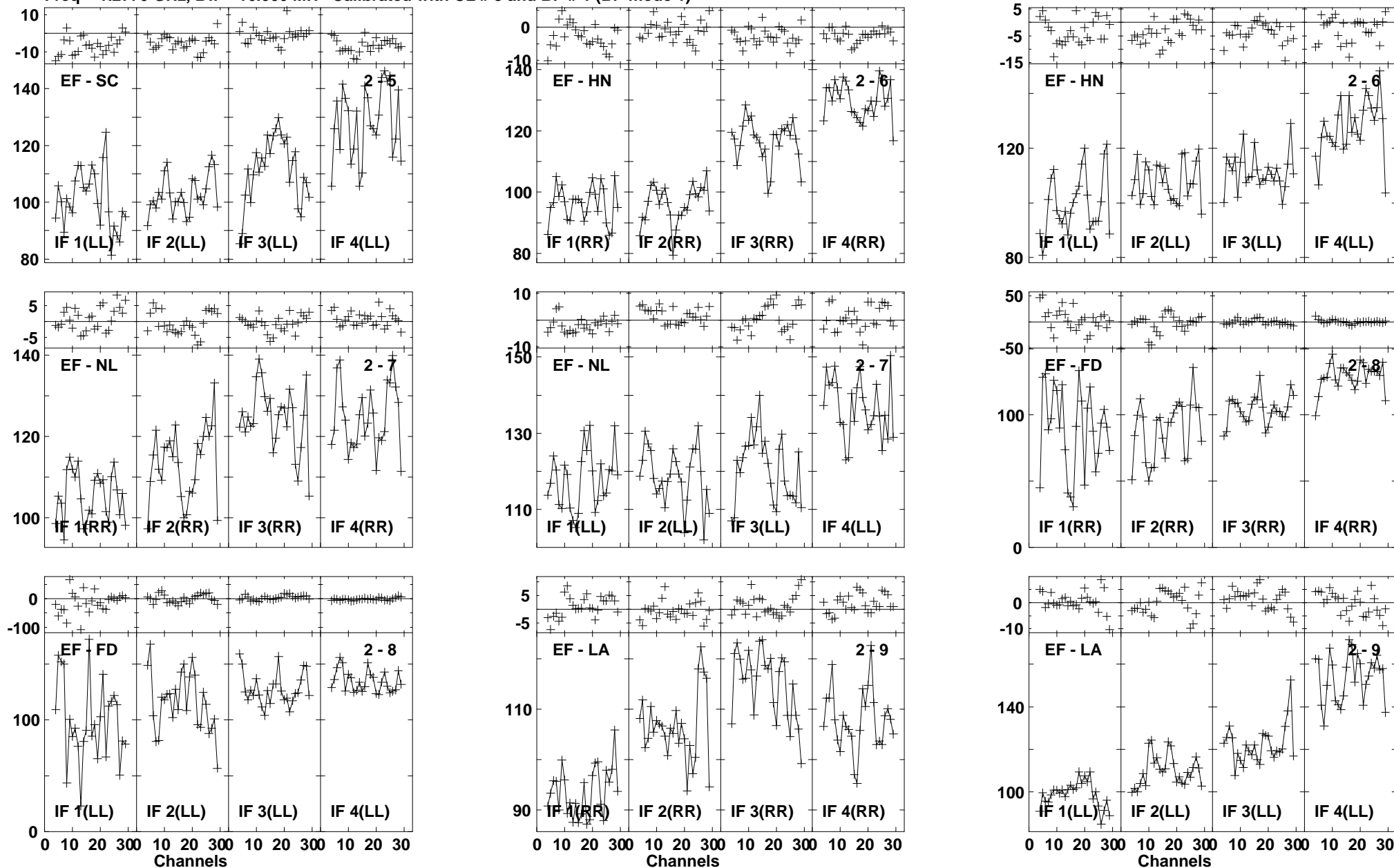

Lower frame: Milli Ampl Jy Top frame: Phas deg
Vector averaged cross-power spectrum Baseline: EF (02) - SC (05)
Timerange: 00/17:26:58 to 00/17:28:56

Plot file version 246 created 03-MAR-2016 01:12:39

J1545+5400 GN002C 1.UVDATA.1

Freq = 1.2770 GHz, Bw = 16.000 MH Calibrated with CL # 3 and BP # 1 (BP mode 1)

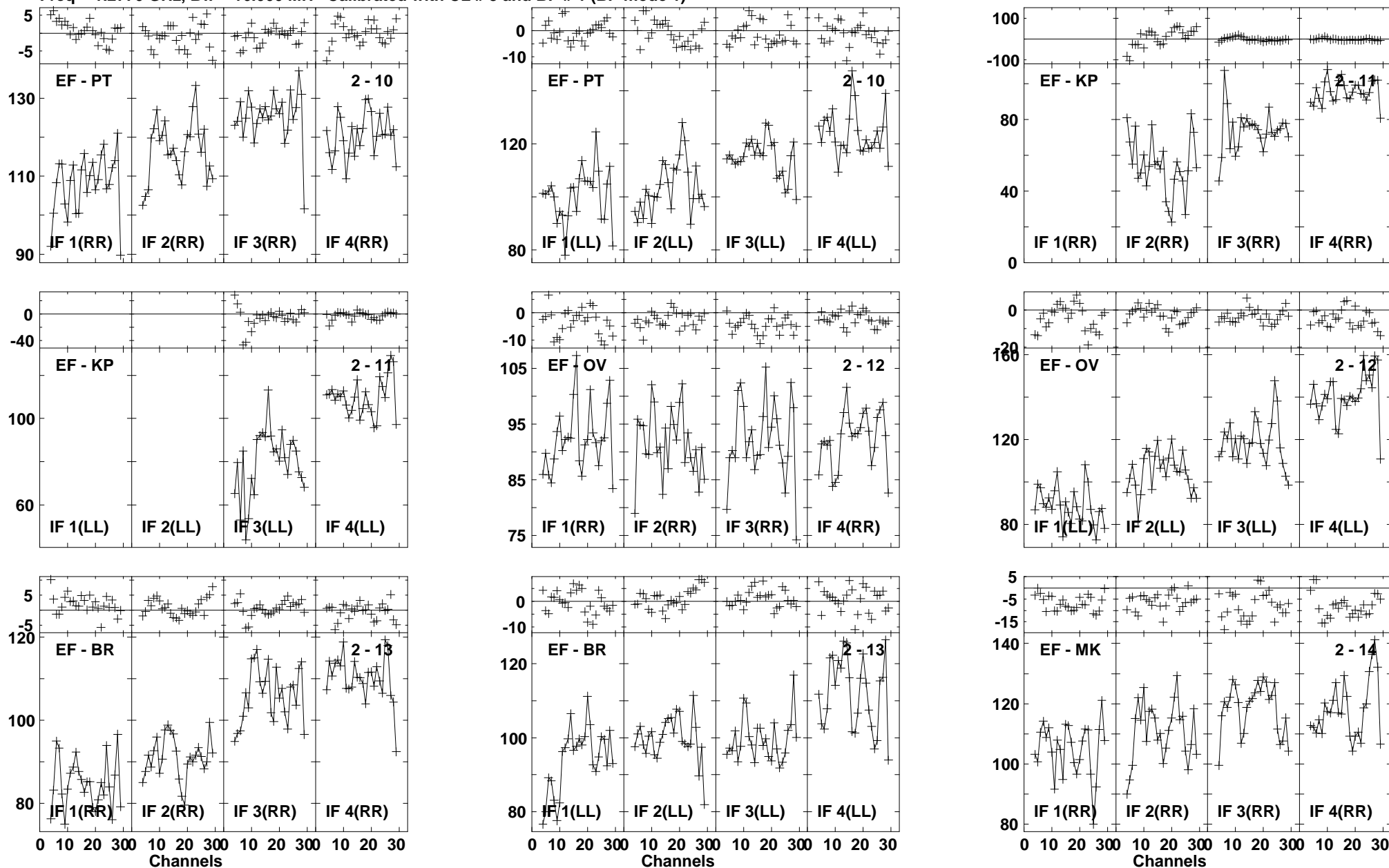

Lower frame: Milli Ampl Jy Top frame: Phas deg
Vector averaged cross-power spectrum Baseline: EF (02) - PT (10)
Timerange: 00/17:26:58 to 00/17:28:56

Plot file version 247 created 03-MAR-2016 01:12:39

J1545+5400 GN002C 1.UVDATA.1

Freq = 1.2770 GHz, Bw = 16.000 MH Calibrated with CL # 3 and BP # 1 (BP mode 1)

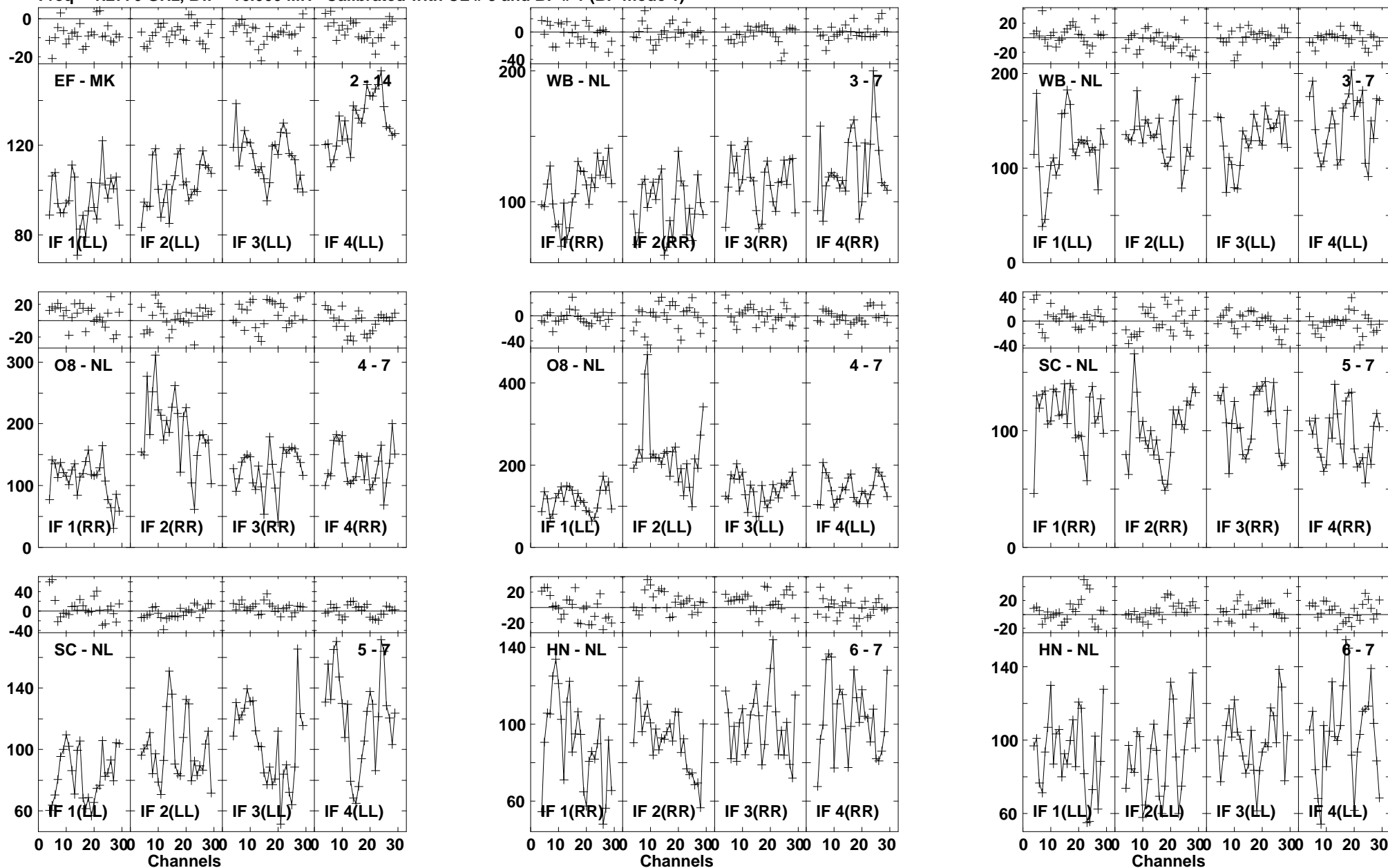

Lower frame: Milli Ampl Jy Top frame: Phas deg
Vector averaged cross-power spectrum Baseline: EF (02) - MK (14)
Timerange: 00/17:26:58 to 00/17:28:56

Plot file version 248 created 03-MAR-2016 01:12:39

J1545+5400 GN002C 1.UVDATA.1

Freq = 1.2770 GHz, Bw = 16.000 MH Calibrated with CL # 3 and BP # 1 (BP mode 1)

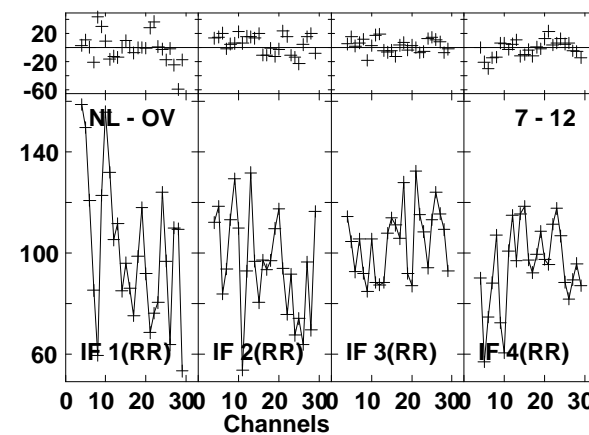
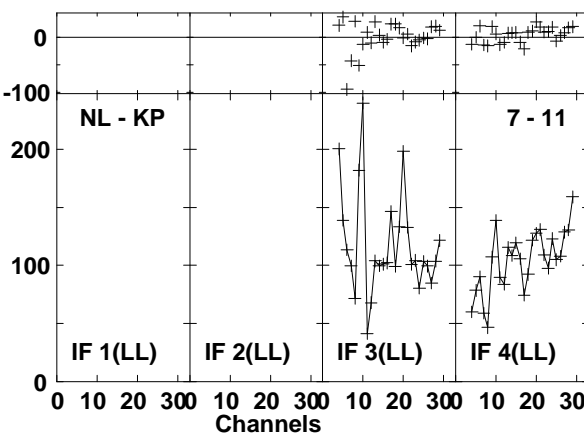
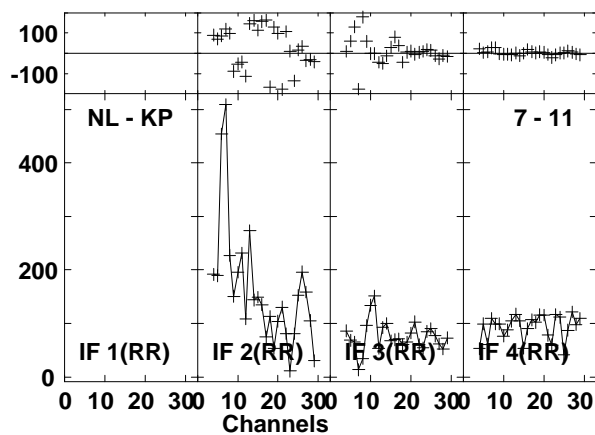
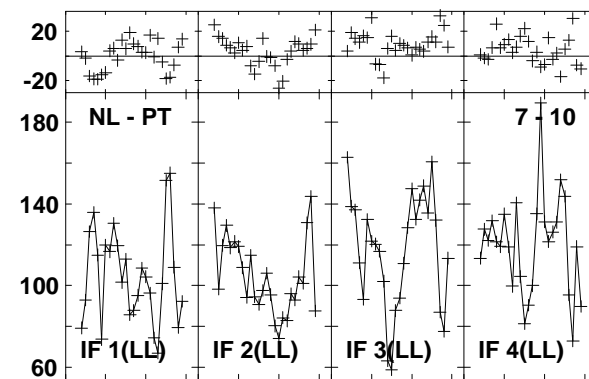
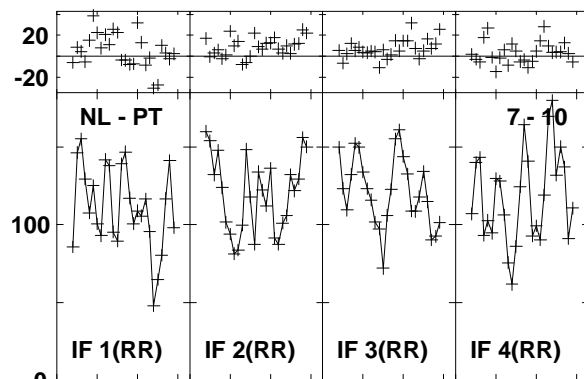
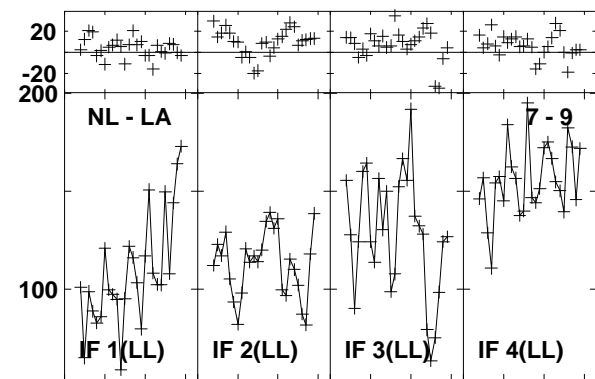
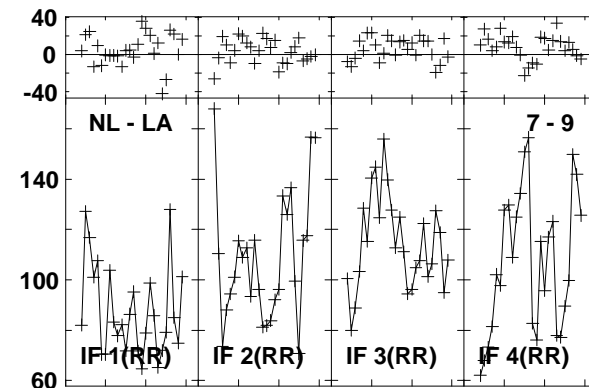
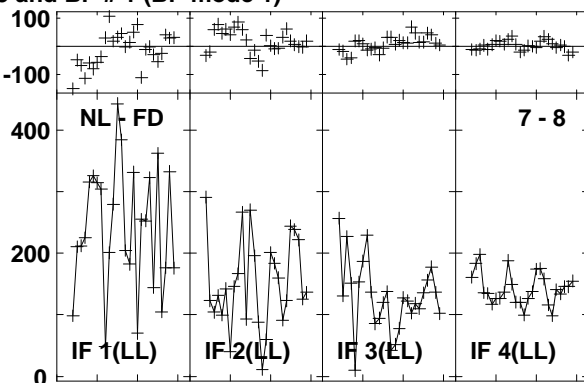
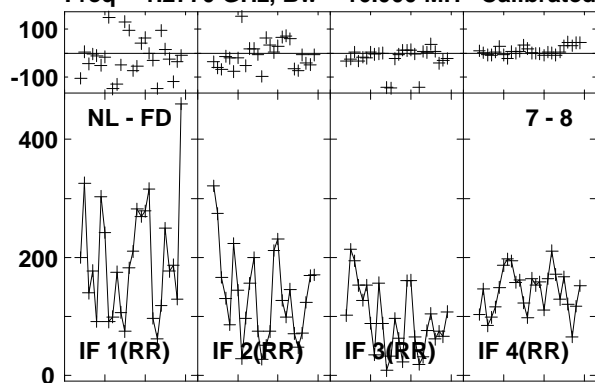

Lower frame: Milli Ampl Jy Top frame: Phas deg
Vector averaged cross-power spectrum Baseline: NL (07) - FD (08)
Timerange: 00/17:26:58 to 00/17:28:56

Plot file version 249 created 03-MAR-2016 01:12:40
 J1545+5400 GN002C 1.UVDATA.1
 Freq = 1.2770 GHz, Bw = 16.000 MH Calibrated with CL # 3 and BP # 1 (BP mode 1)

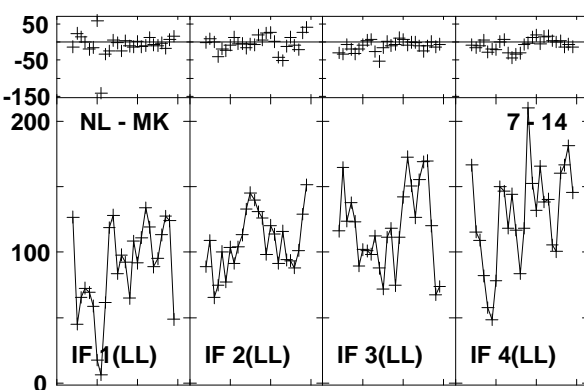
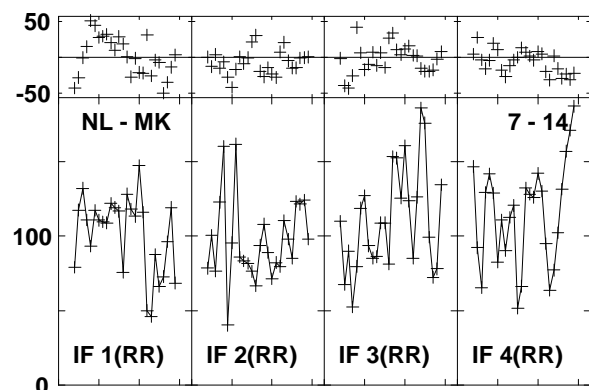
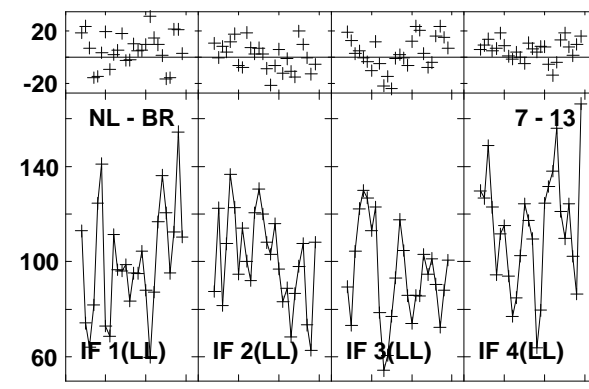
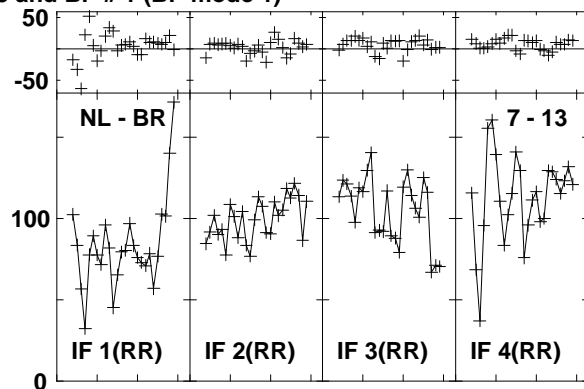
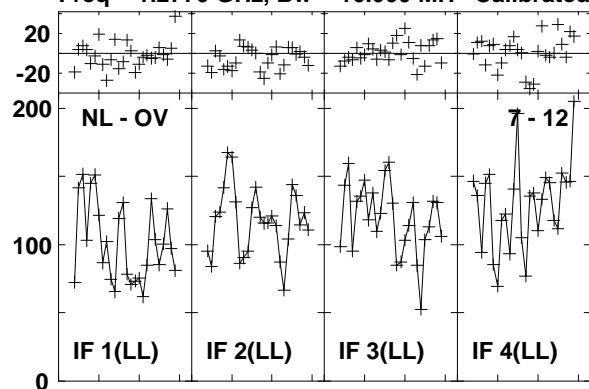

Lower frame: Milli Ampl Jy Top frame: Phas deg
 Vector averaged cross-power spectrum Baseline: NL (07) - OV (12)
 Timerange: 00/17:26:58 to 00/17:28:56

Plot file version 250 created 03-MAR-2016 01:12:40

4C52 GN002C 1.UVDATA.1

Freq = 1.2770 GHz, Bw = 16.000 MH Calibrated with CL # 3 and BP # 1 (BP mode 1)

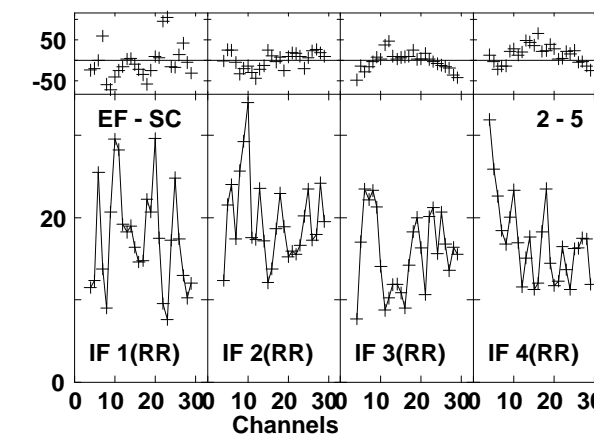
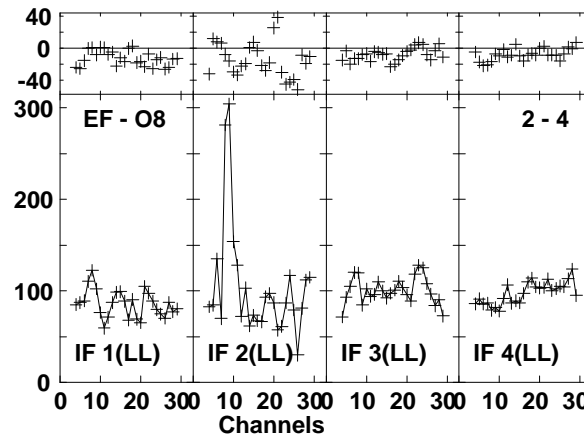
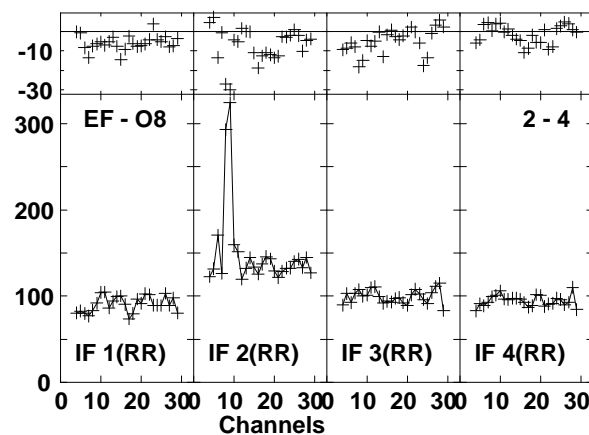
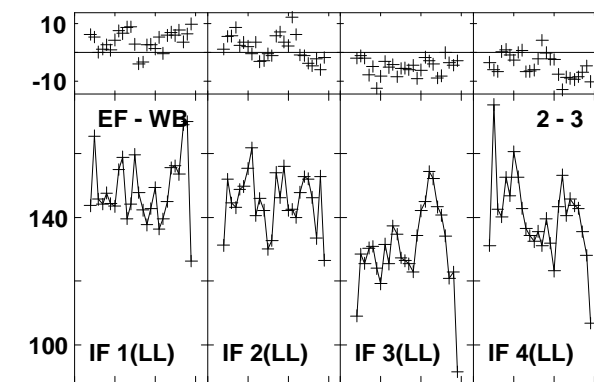
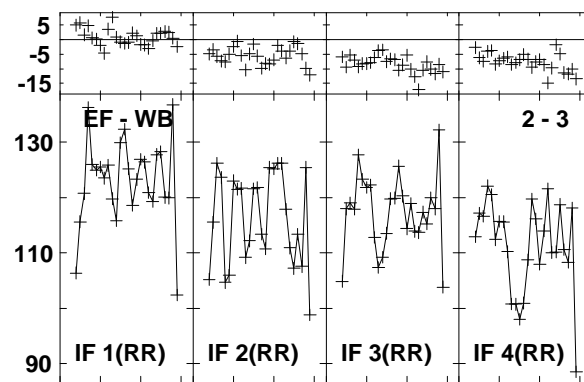
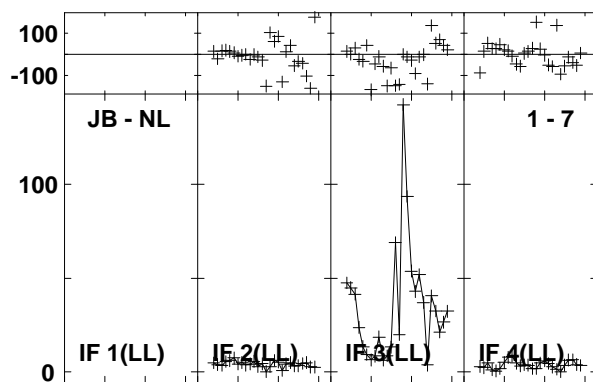
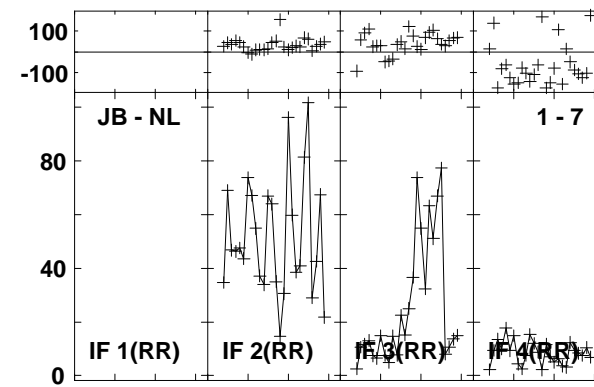
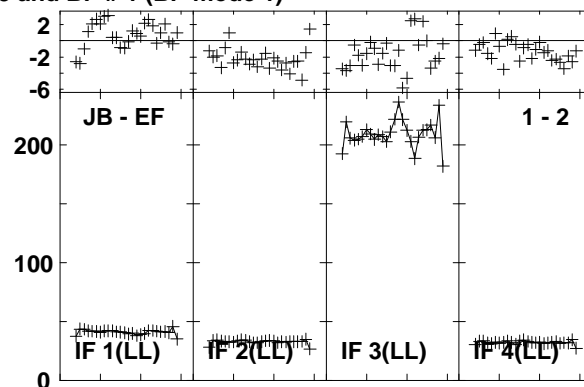
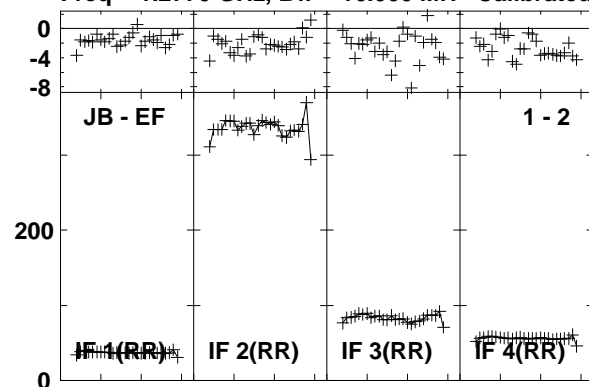

Lower frame: Milli Ampl Jy Top frame: Phas deg
Vector averaged cross-power spectrum Baseline: JB (01) - EF (02)
Timerange: 00/17:29:09 to 00/17:31:55

Plot file version 251 created 03-MAR-2016 01:12:40

4C52 GN002C 1.UVDATA.1

Freq = 1.2770 GHz, Bw = 16.000 MH Calibrated with CL # 3 and BP # 1 (BP mode 1)

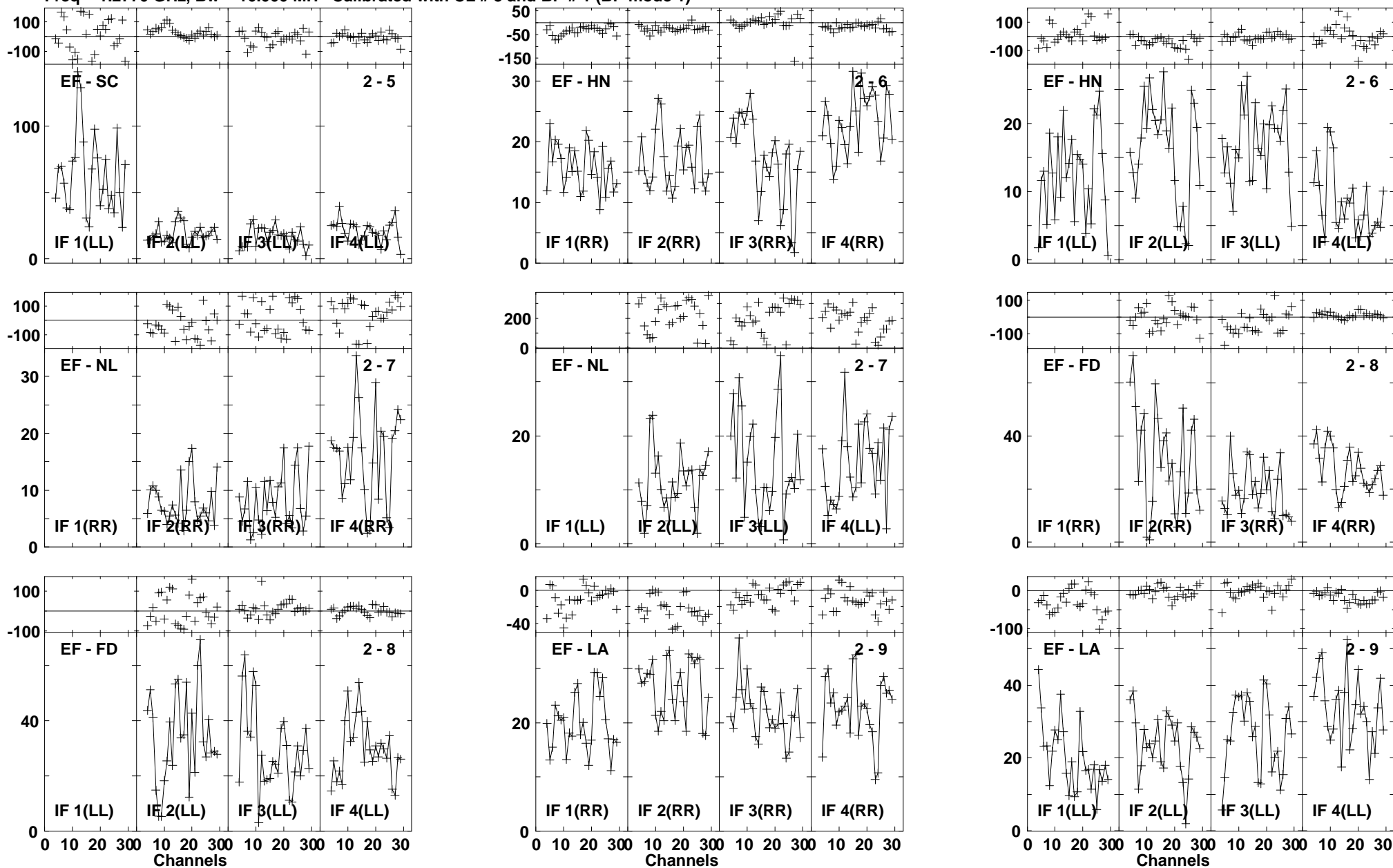

Lower frame: Milli Ampl Jy Top frame: Phas deg
Vector averaged cross-power spectrum Baseline: EF (02) - SC (05)
Timerange: 00/17:29:09 to 00/17:31:55

Plot file version 252 created 03-MAR-2016 01:12:40

4C52 GN002C 1.UVDATA.1

Freq = 1.2770 GHz, Bw = 16.000 MH Calibrated with CL # 3 and BP # 1 (BP mode 1)

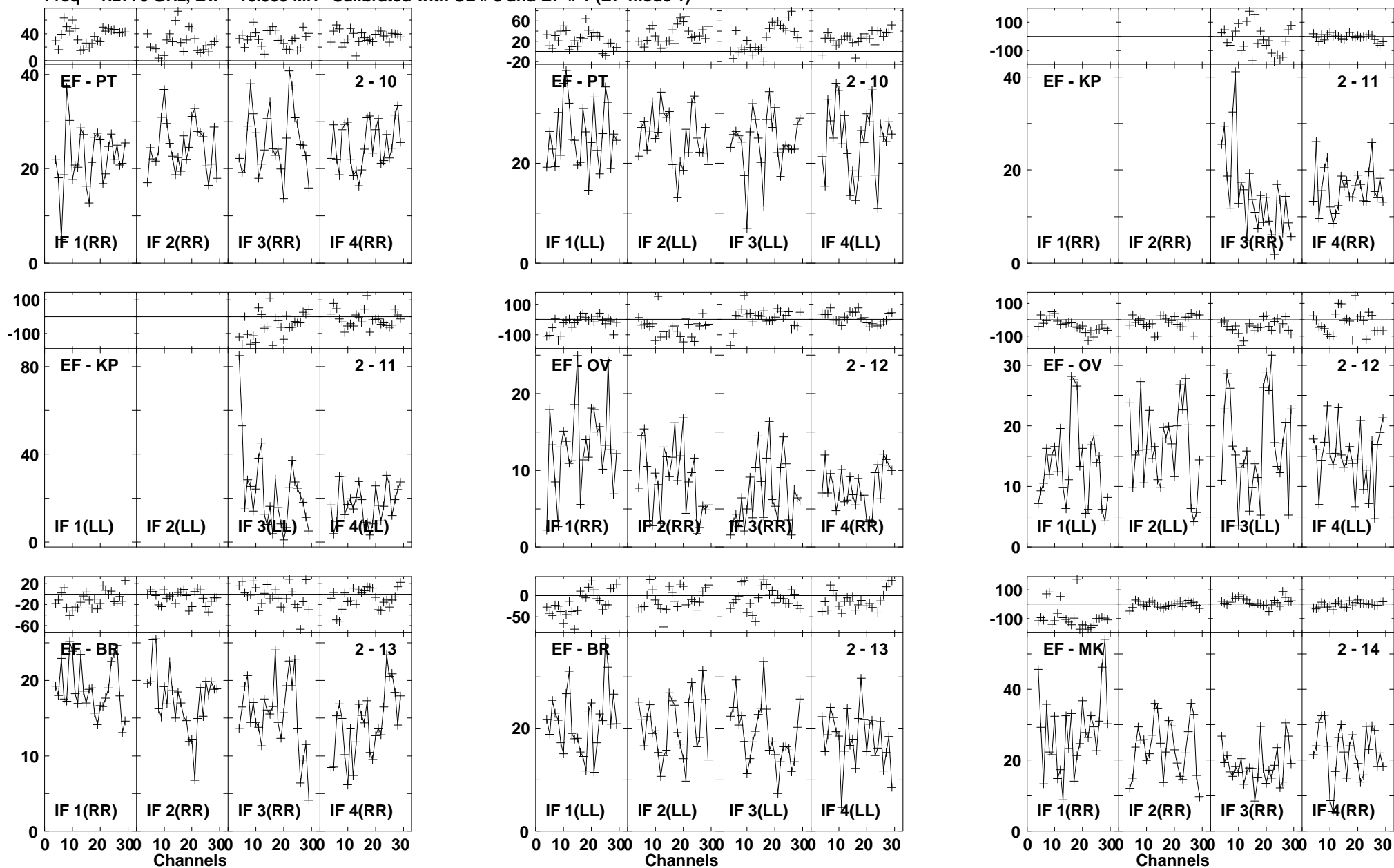

Lower frame: Milli Ampl Jy Top frame: Phas deg
Vector averaged cross-power spectrum Baseline: EF (02) - PT (10)
Timerange: 00/17:29:09 to 00/17:31:55

Plot file version 253 created 03-MAR-2016 01:12:40

4C52 GN002C 1.UVDATA.1

Freq = 1.2770 GHz, Bw = 16.000 MH Calibrated with CL # 3 and BP # 1 (BP mode 1)

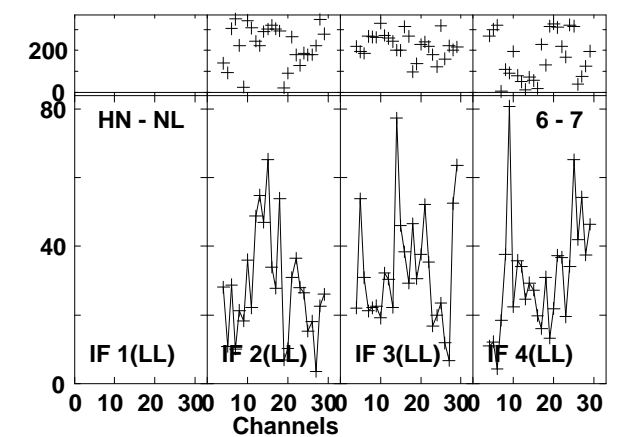
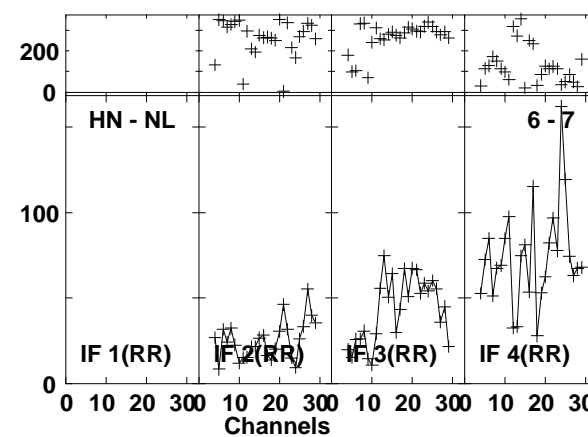
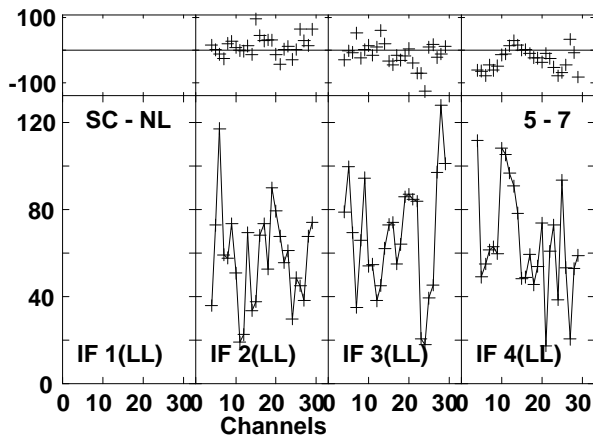
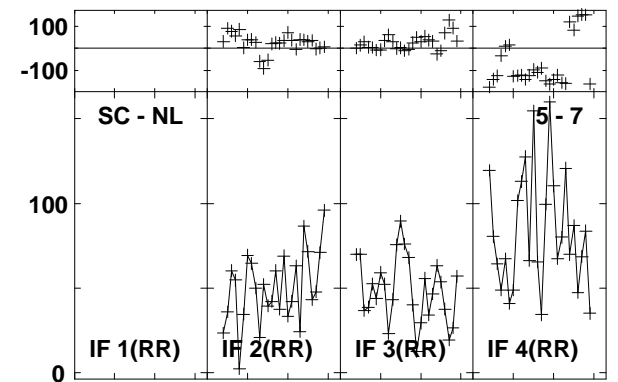
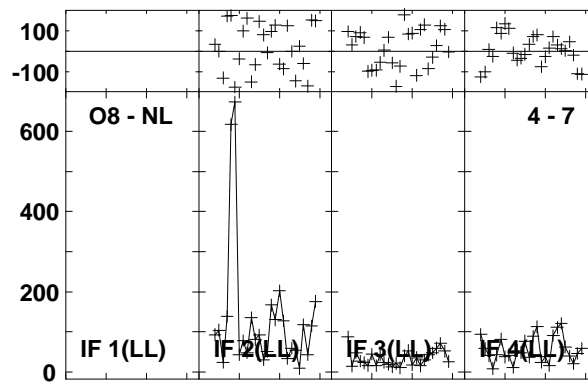
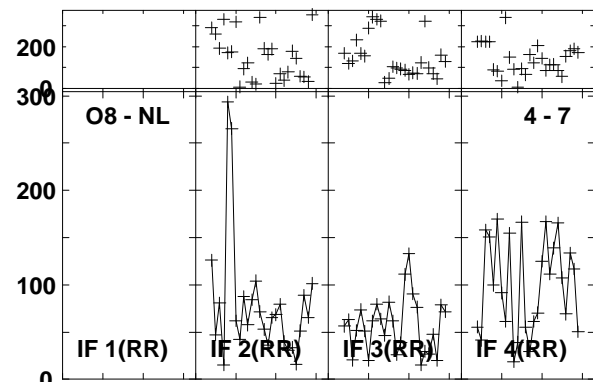
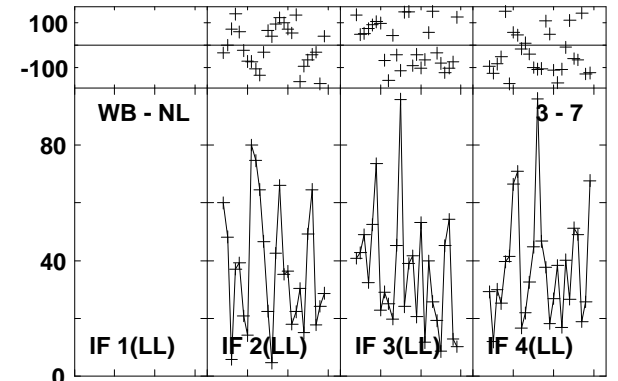
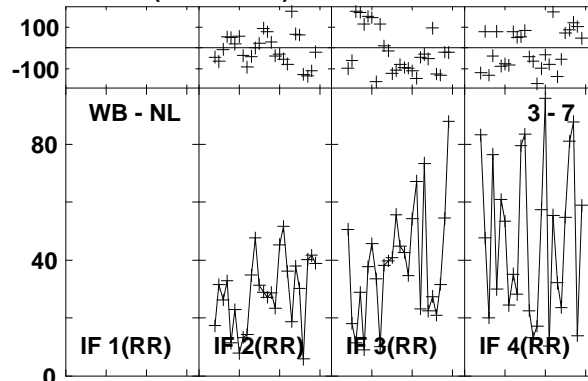
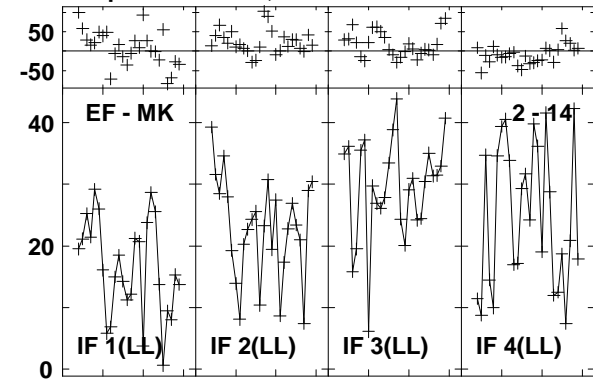

Lower frame: Milli Ampl Jy Top frame: Phas deg
Vector averaged cross-power spectrum Baseline: EF (02) - MK (14)
Timerange: 00/17:29:09 to 00/17:31:55

Plot file version 254 created 03-MAR-2016 01:12:40

4C52 GN002C 1.UVDATA.1

Freq = 1.2770 GHz, Bw = 16.000 MH Calibrated with CL # 3 and BP # 1 (BP mode 1)

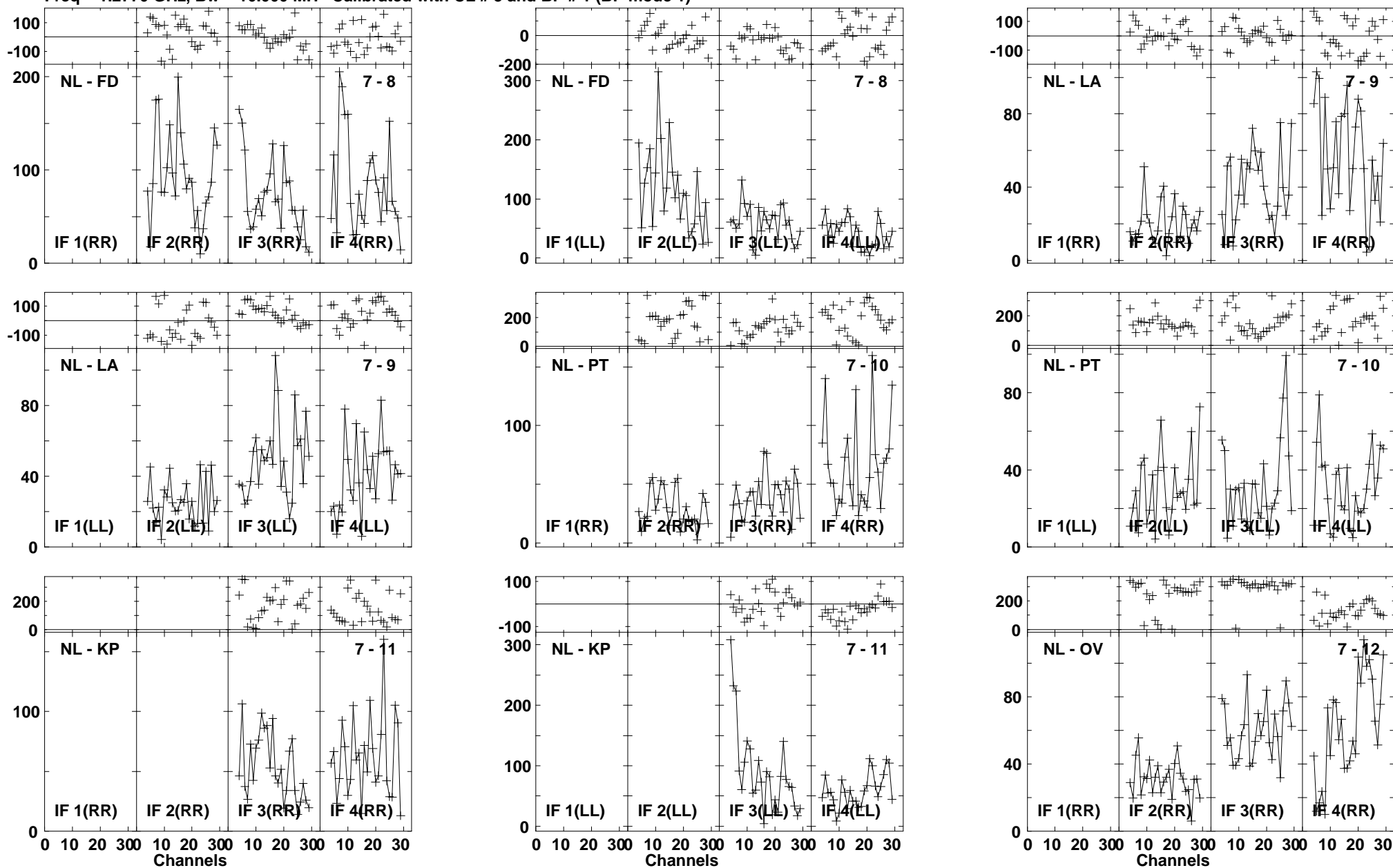

Lower frame: Milli Ampl Jy Top frame: Phas deg
Vector averaged cross-power spectrum Baseline: NL (07) - FD (08)
Timerange: 00/17:29:09 to 00/17:31:55

Plot file version 255 created 03-MAR-2016 01:12:41
 4C52 GN002C 1.UVDATA.1
 Freq = 1.2770 GHz, Bw = 16.000 MH Calibrated with CL # 3 and BP # 1 (BP mode 1)

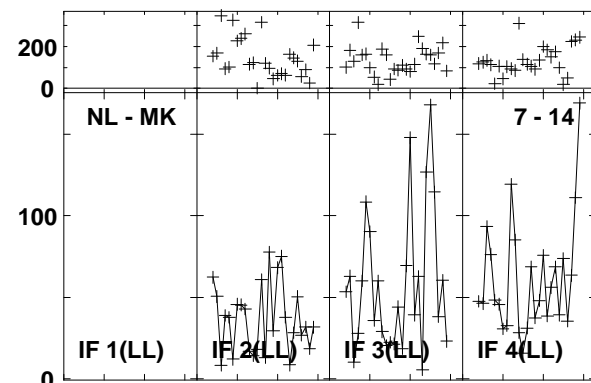
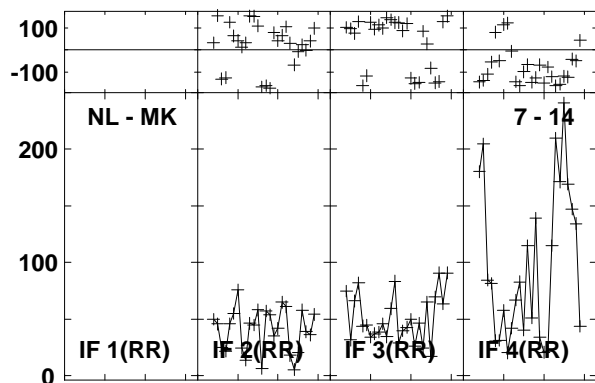
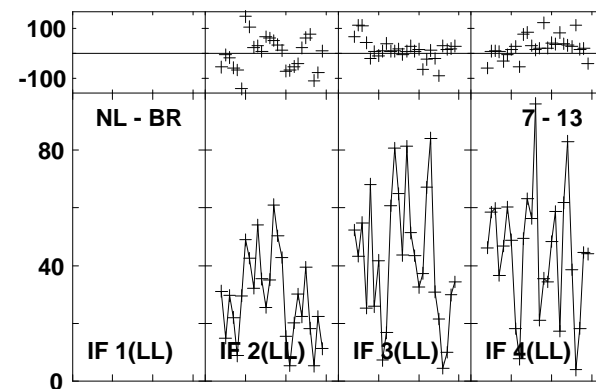
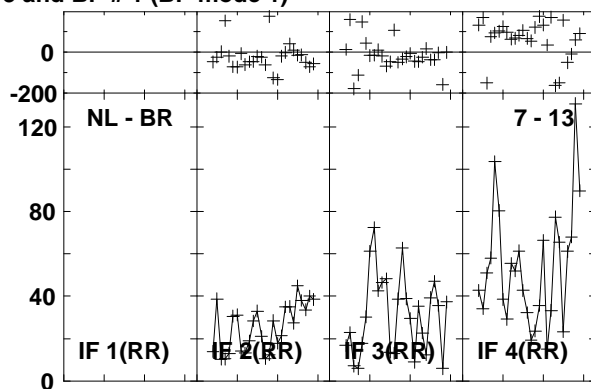
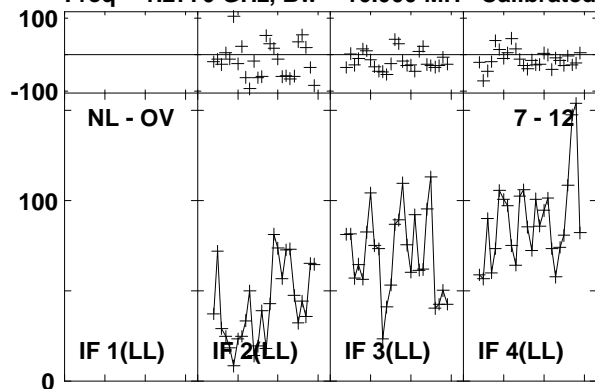

Lower frame: Milli Ampl Jy Top frame: Phas deg
 Vector averaged cross-power spectrum Baseline: NL (07) - OV (12)
 Timerange: 00/17:29:09 to 00/17:31:55

Plot file version 256 created 03-MAR-2016 01:12:41

J1545+5400 GN002C 1.UVDATA.1

Freq = 1.2770 GHz, Bw = 16.000 MH Calibrated with CL # 3 and BP # 1 (BP mode 1)

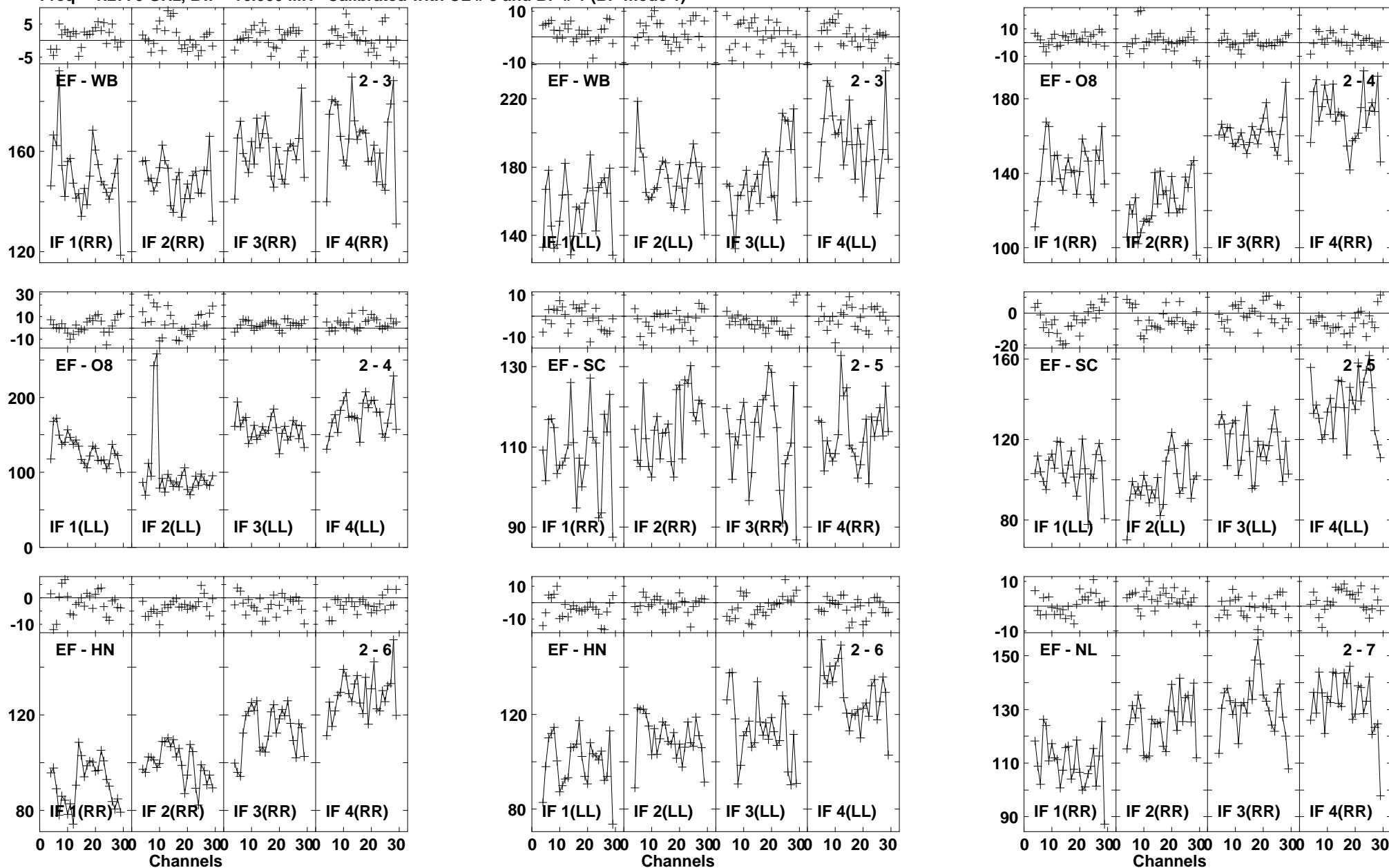

Lower frame: Milli Ampl Jy Top frame: Phas deg
Vector averaged cross-power spectrum Baseline: EF (02) - WB (03)
Timerange: 00/17:32:48 to 00/17:33:46

Plot file version 257 created 03-MAR-2016 01:12:41

J1545+5400 GN002C 1.UVDATA.1

Freq = 1.2770 GHz, Bw = 16.000 MH Calibrated with CL # 3 and BP # 1 (BP mode 1)

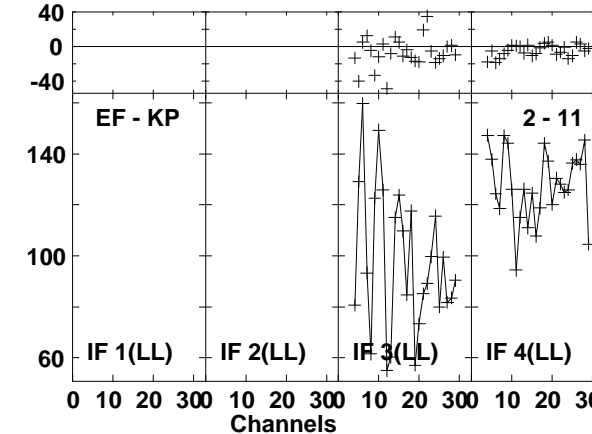
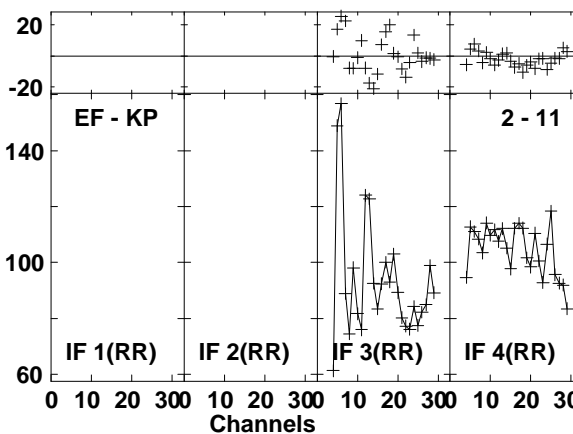
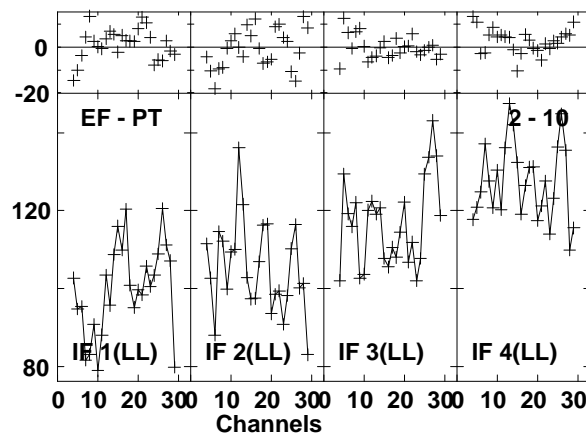
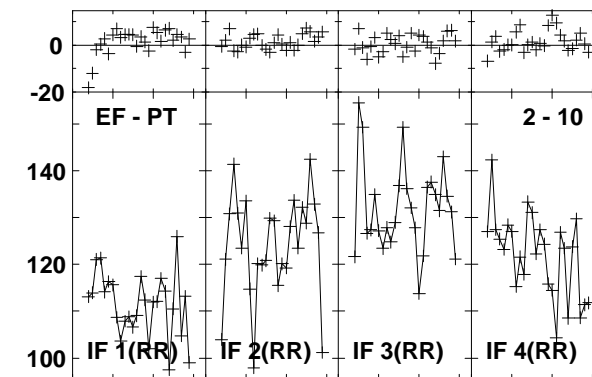
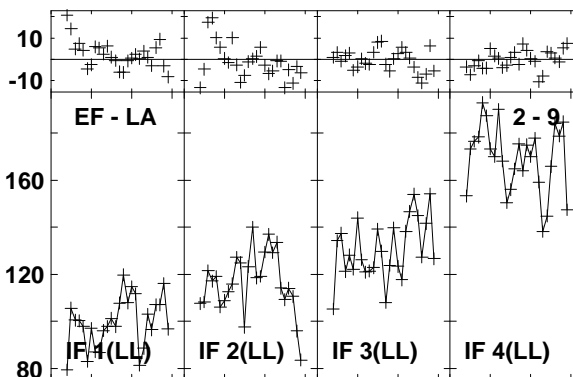
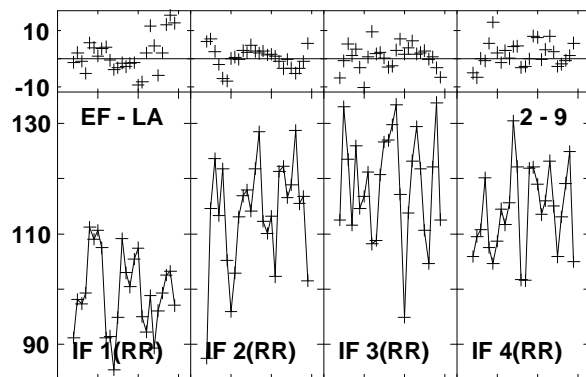
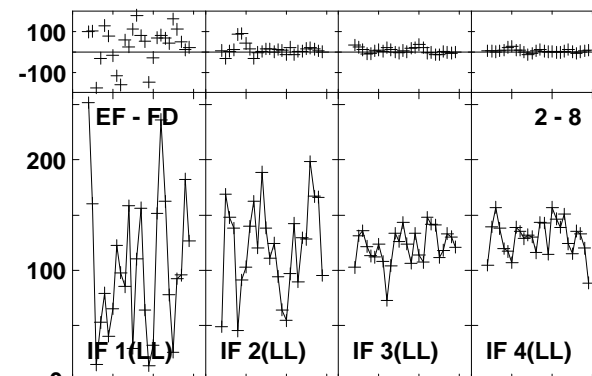
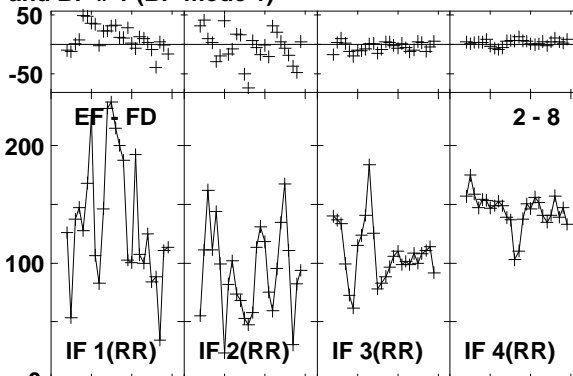
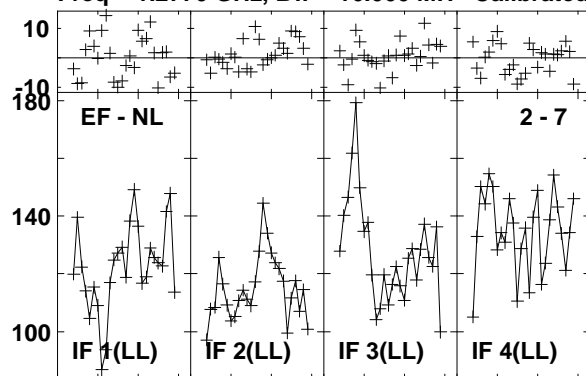

Lower frame: Milli Ampl Jy Top frame: Phas deg
Vector averaged cross-power spectrum Baseline: EF (02) - NL (07)
Timerange: 00/17:32:48 to 00/17:33:46

Plot file version 258 created 03-MAR-2016 01:12:41

J1545+5400 GN002C 1.UVDATA.1

Freq = 1.2770 GHz, Bw = 16.000 MH Calibrated with CL # 3 and BP # 1 (BP mode 1)

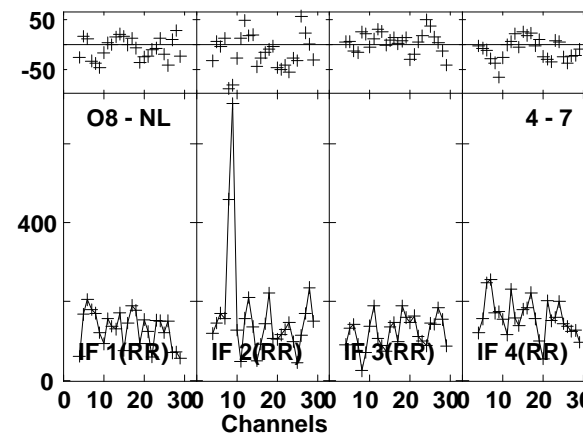
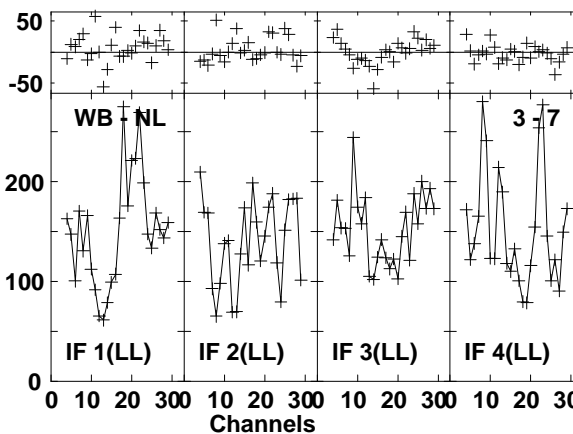
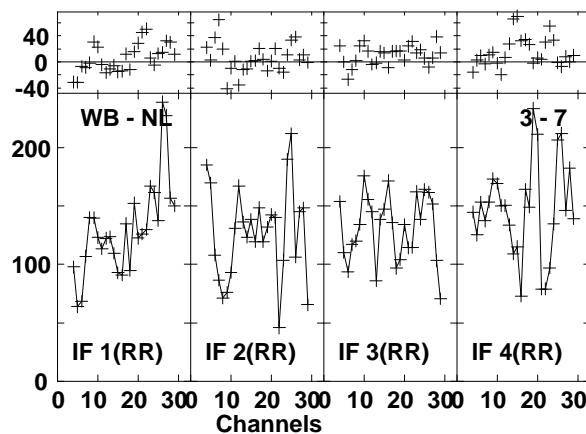
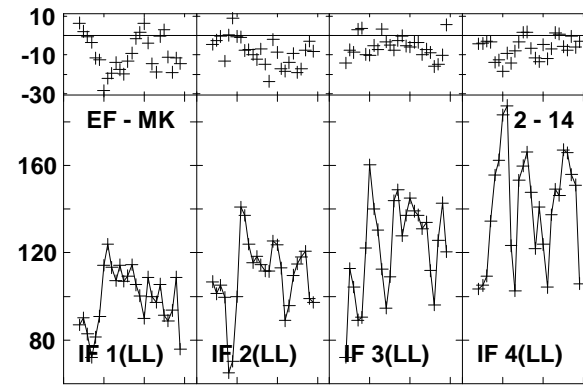
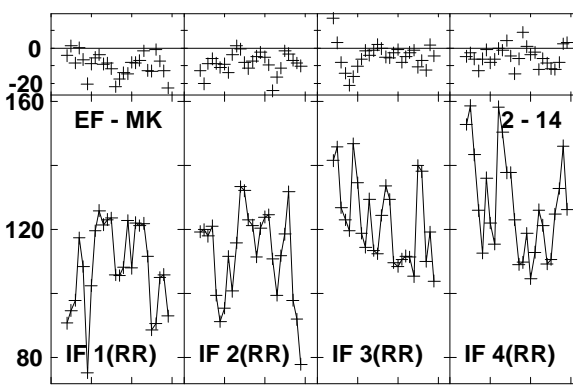
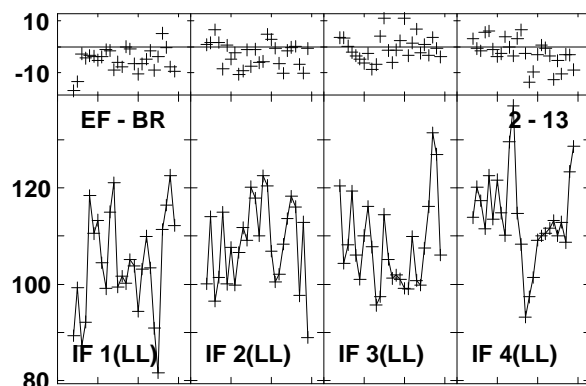
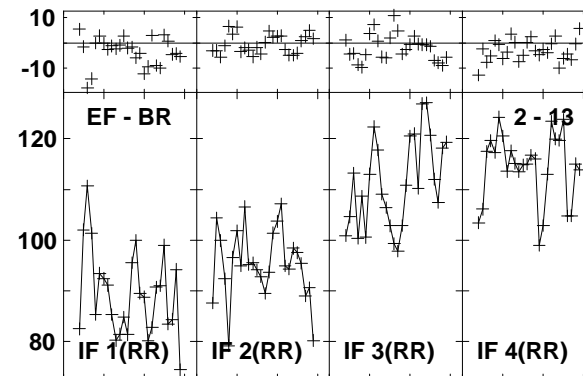
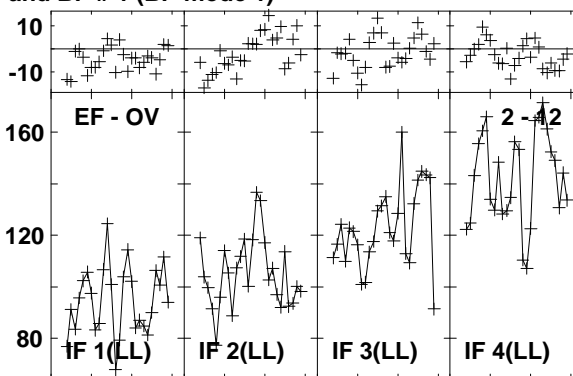
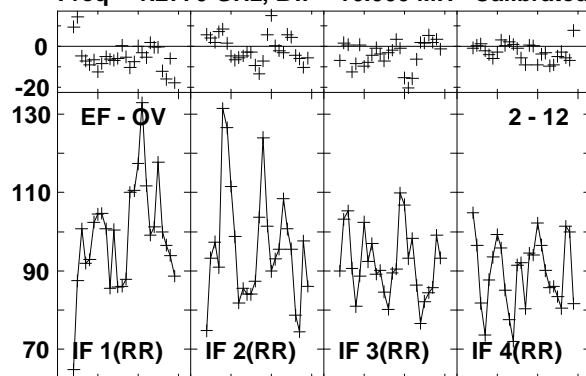

Lower frame: Milli Ampl Jy Top frame: Phas deg
Vector averaged cross-power spectrum Baseline: EF (02) - OV (12)
Timerange: 00/17:32:48 to 00/17:33:46

Plot file version 259 created 03-MAR-2016 01:12:41

J1545+5400 GN002C 1.UVDATA.1

Freq = 1.2770 GHz, Bw = 16.000 MH Calibrated with CL # 3 and BP # 1 (BP mode 1)

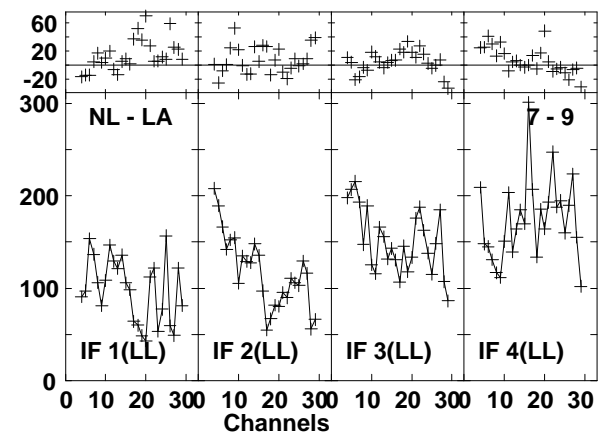
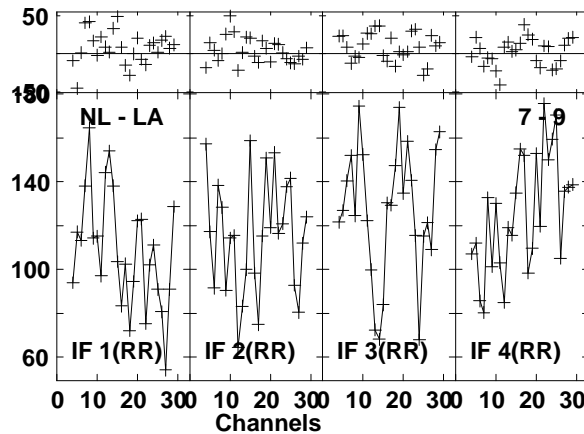
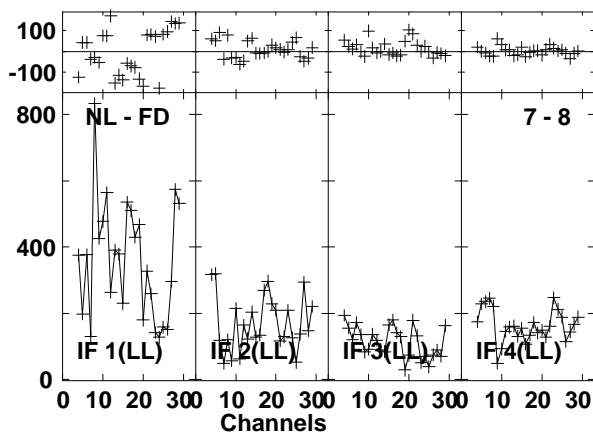
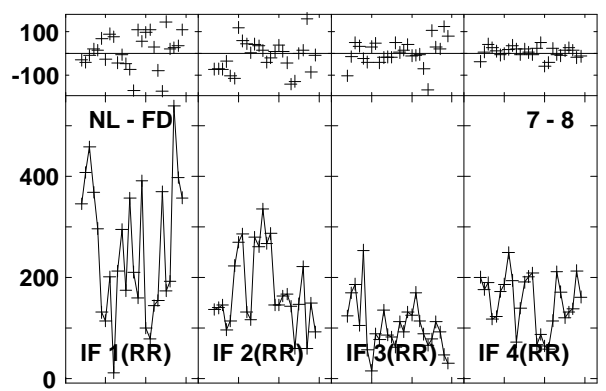
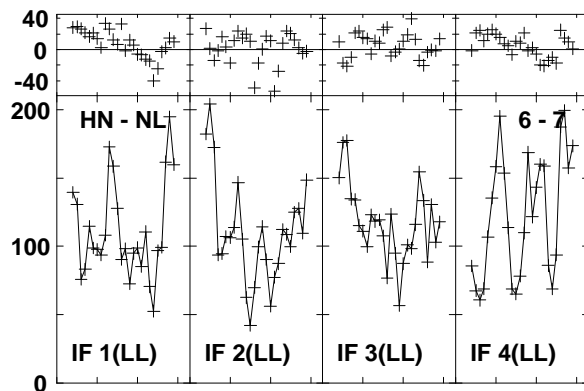
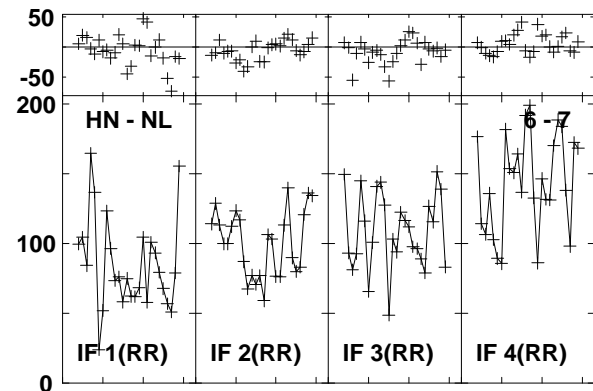
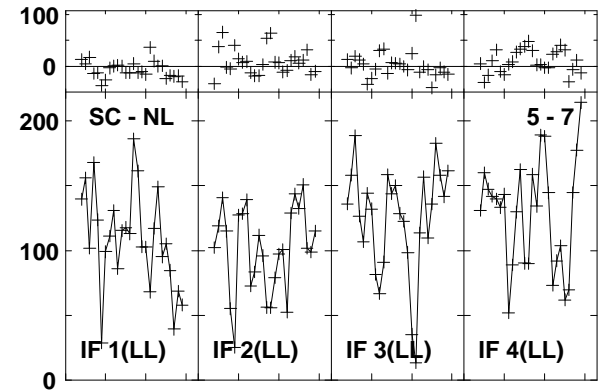
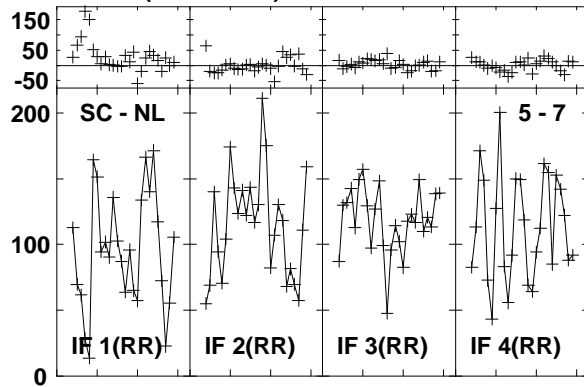
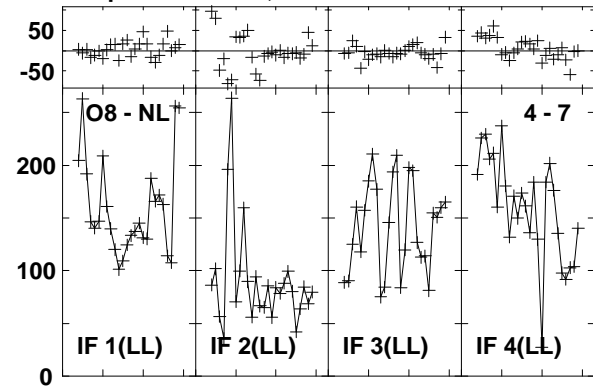

Lower frame: Milli Ampl Jy Top frame: Phas deg
Vector averaged cross-power spectrum Baseline: O8 (04) - NL (07)
Timerange: 00/17:32:48 to 00/17:33:46

Plot file version 260 created 03-MAR-2016 01:12:41

J1545+5400 GN002C 1.UVDATA.1

Freq = 1.2770 GHz, Bw = 16.000 MH Calibrated with CL # 3 and BP # 1 (BP mode 1)

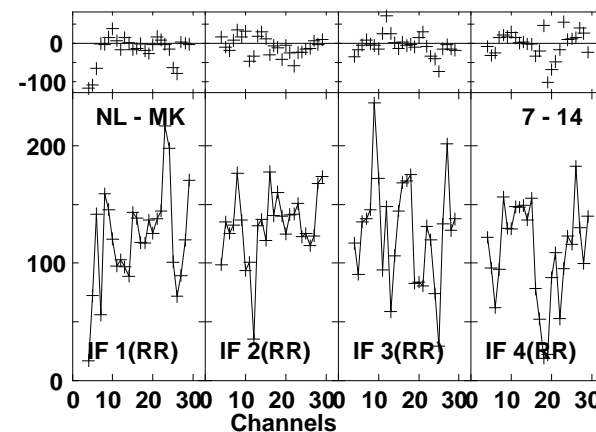
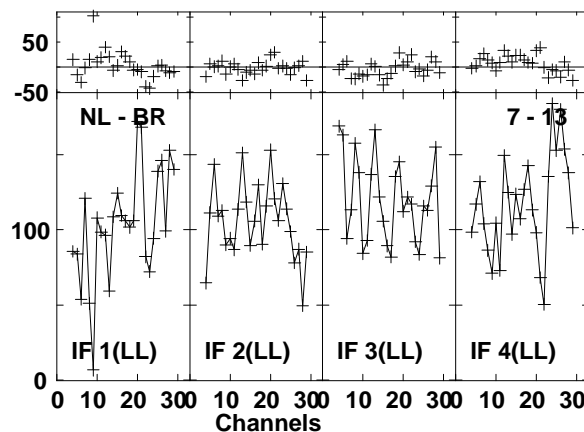
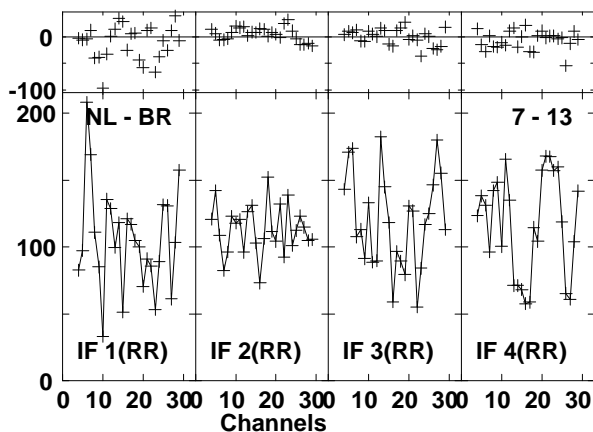
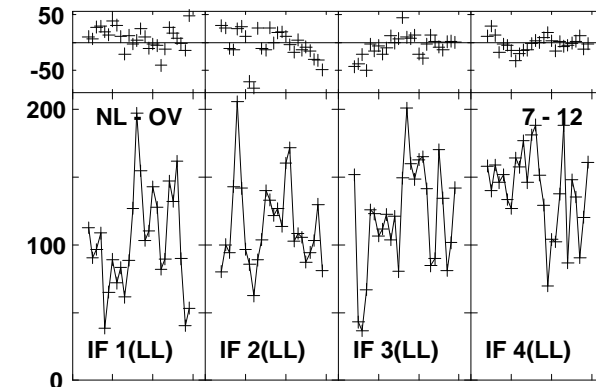
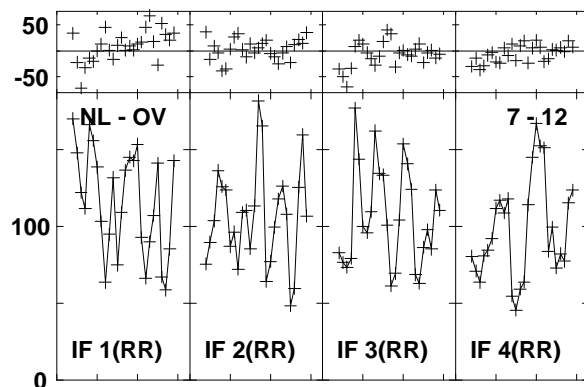
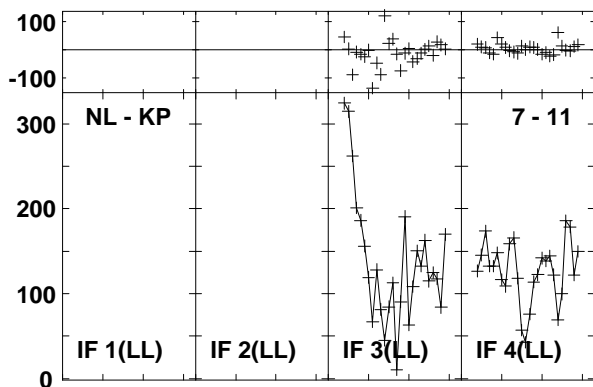
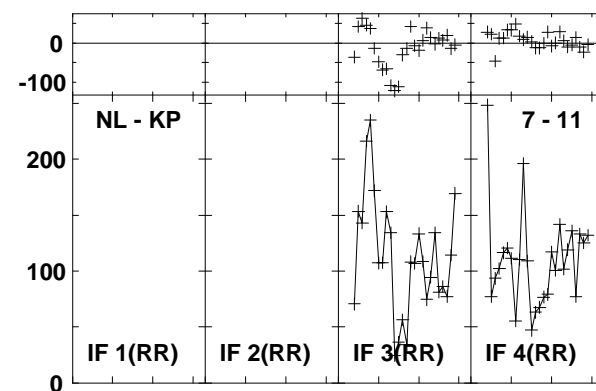
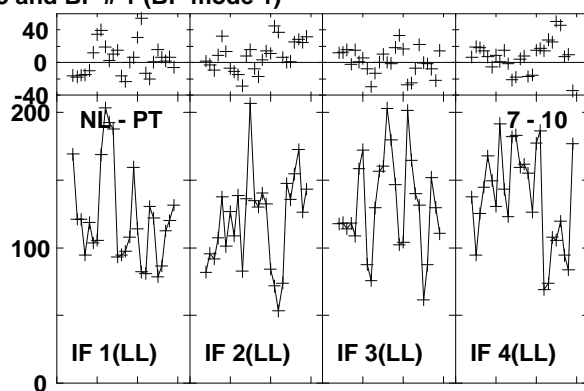
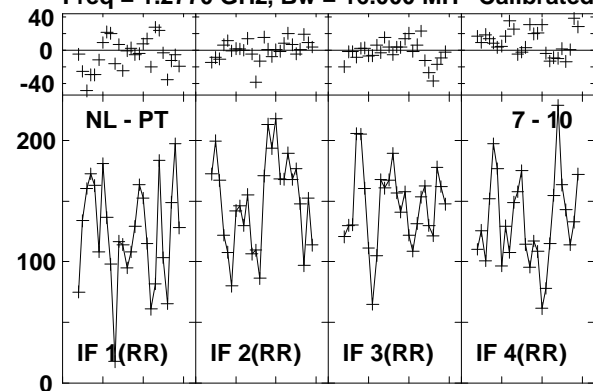

Lower frame: Milli Ampl Jy Top frame: Phas deg
Vector averaged cross-power spectrum Baseline: NL (07) - PT (10)
Timerange: 00/17:32:48 to 00/17:33:46

Plot file version 261 created 03-MAR-2016 01:12:41
J1545+5400 GN002C 1.UVDATA.1
Freq = 1.2770 GHz, Bw = 16.000 MH Calibrated with CL # 3 and BP # 1 (BP mode 1)

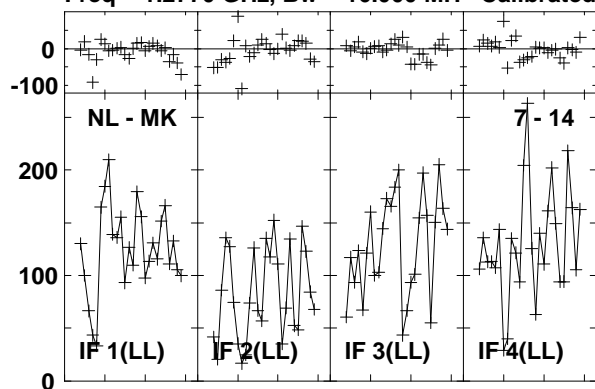

Lower frame: Milli Ampl Jy Top frame: Phas deg
Vector averaged cross-power spectrum Baseline: NL (07) - MK (14)
Timerange: 00/17:32:48 to 00/17:33:46

Plot file version 262 created 03-MAR-2016 01:12:42

4C52 GN002C 1.UVDATA.1

Freq = 1.2770 GHz, Bw = 16.000 MH Calibrated with CL # 3 and BP # 1 (BP mode 1)

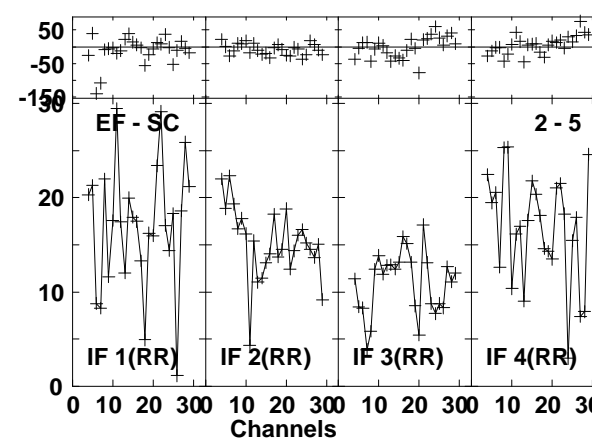
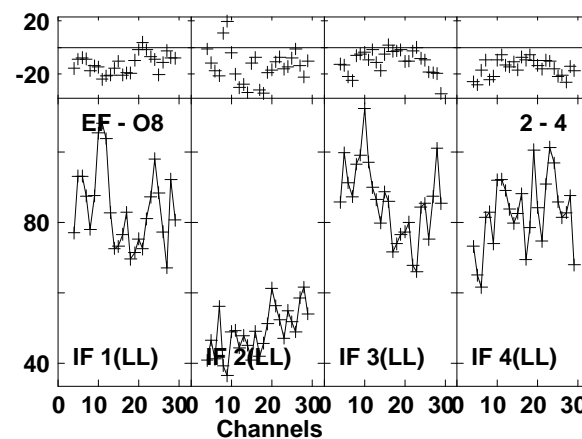
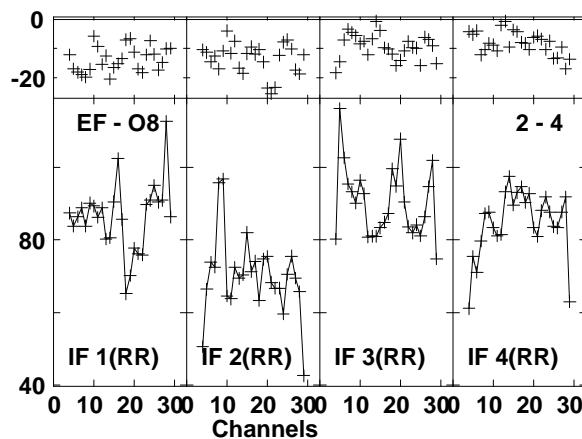
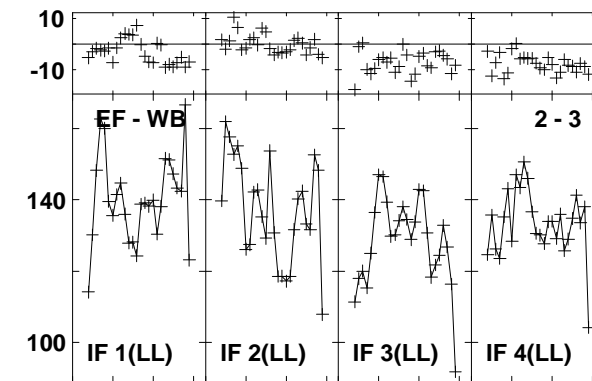
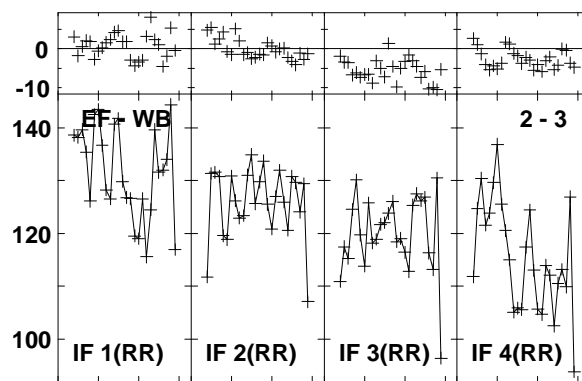
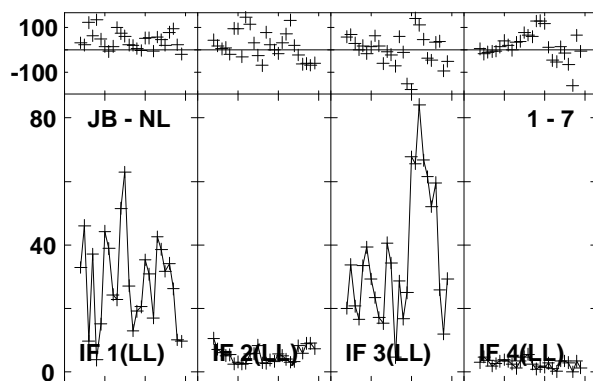
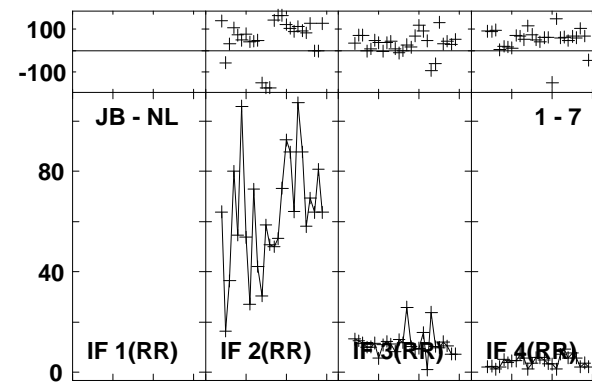
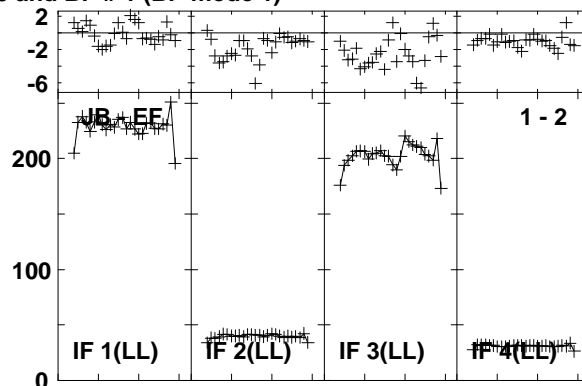
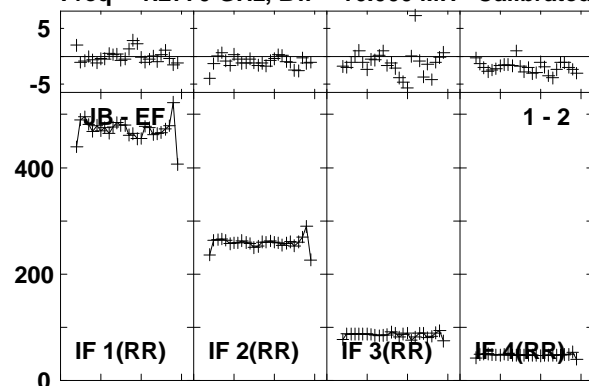

Lower frame: Milli Ampl Jy Top frame: Phas deg
Vector averaged cross-power spectrum Baseline: JB (01) - EF (02)
Timerange: 00/17:33:51 to 00/17:36:45

Plot file version 263 created 03-MAR-2016 01:12:42

4C52 GN002C 1.UVDATA.1

Freq = 1.2770 GHz, Bw = 16.000 MH Calibrated with CL # 3 and BP # 1 (BP mode 1)

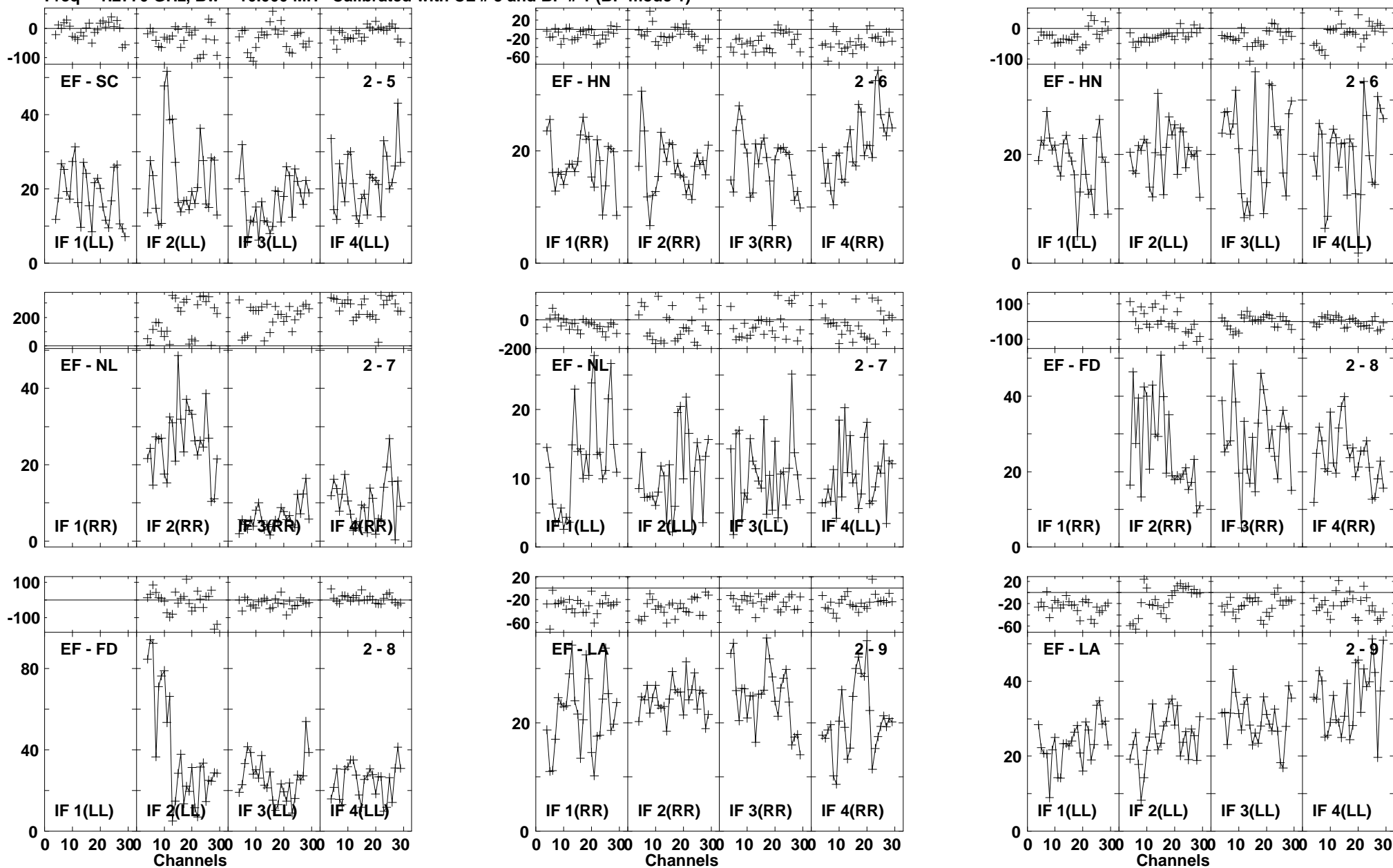

Lower frame: Milli Ampl Jy Top frame: Phas deg
Vector averaged cross-power spectrum Baseline: EF (02) - SC (05)
Timerange: 00/17:33:51 to 00/17:36:45

Plot file version 264 created 03-MAR-2016 01:12:42

4C52 GN002C 1.UVDATA.1

Freq = 1.2770 GHz, Bw = 16.000 MH Calibrated with CL # 3 and BP # 1 (BP mode 1)

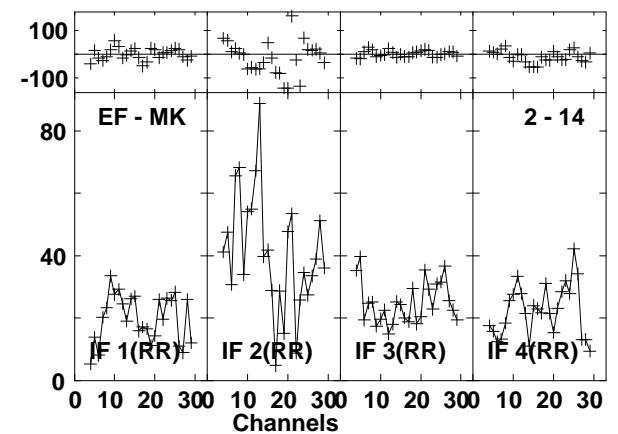
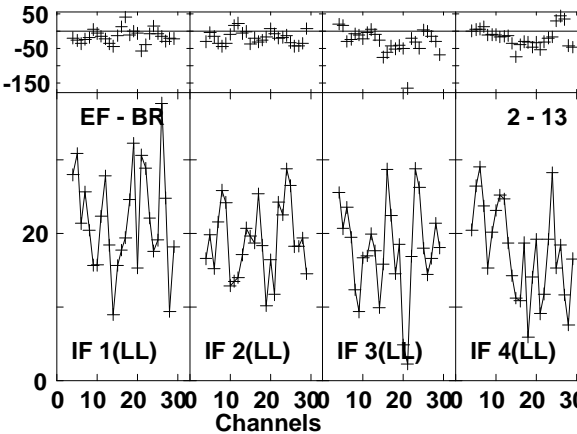
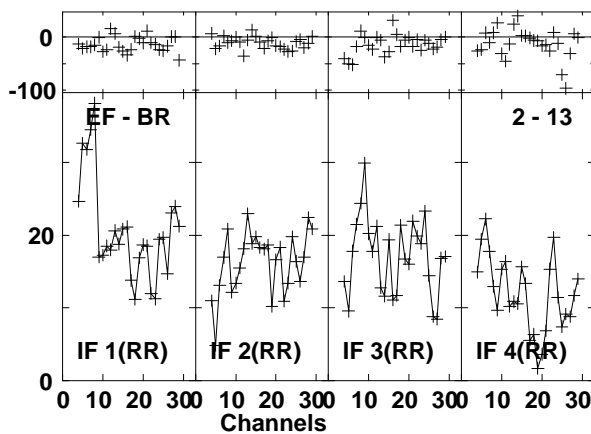
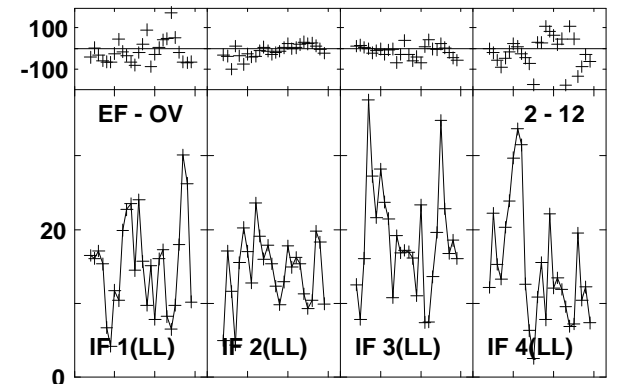
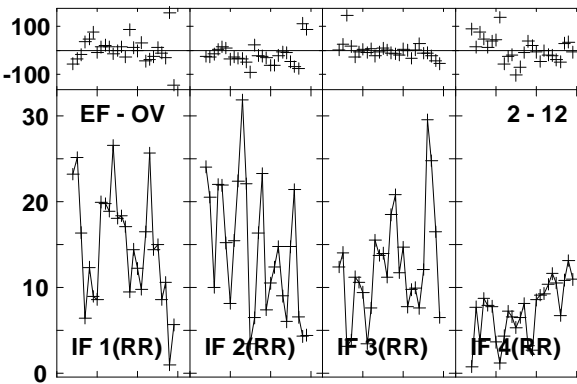
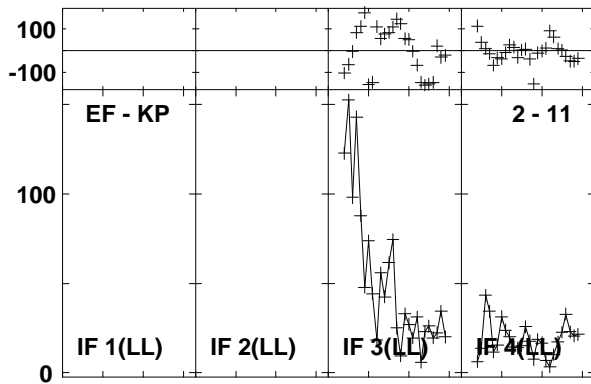
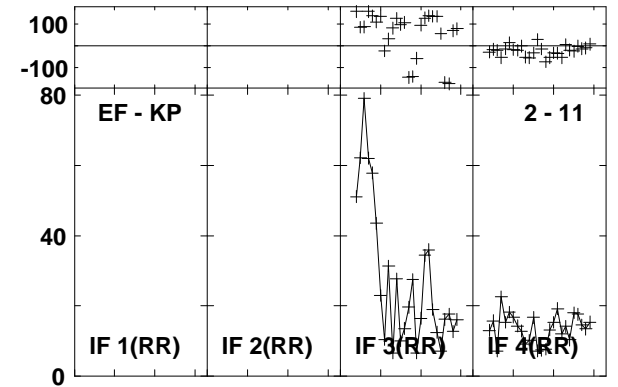
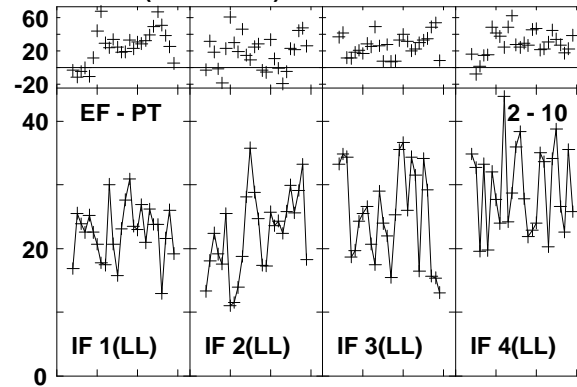
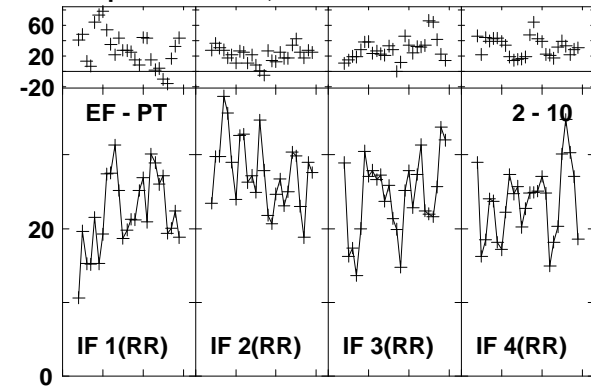

Lower frame: Milli Ampl Jy Top frame: Phas deg
Vector averaged cross-power spectrum Baseline: EF (02) - PT (10)
Timerange: 00/17:33:51 to 00/17:36:45

Plot file version 265 created 03-MAR-2016 01:12:42

4C52 GN002C 1.UVDATA.1

Freq = 1.2770 GHz, Bw = 16.000 MH Calibrated with CL # 3 and BP # 1 (BP mode 1)

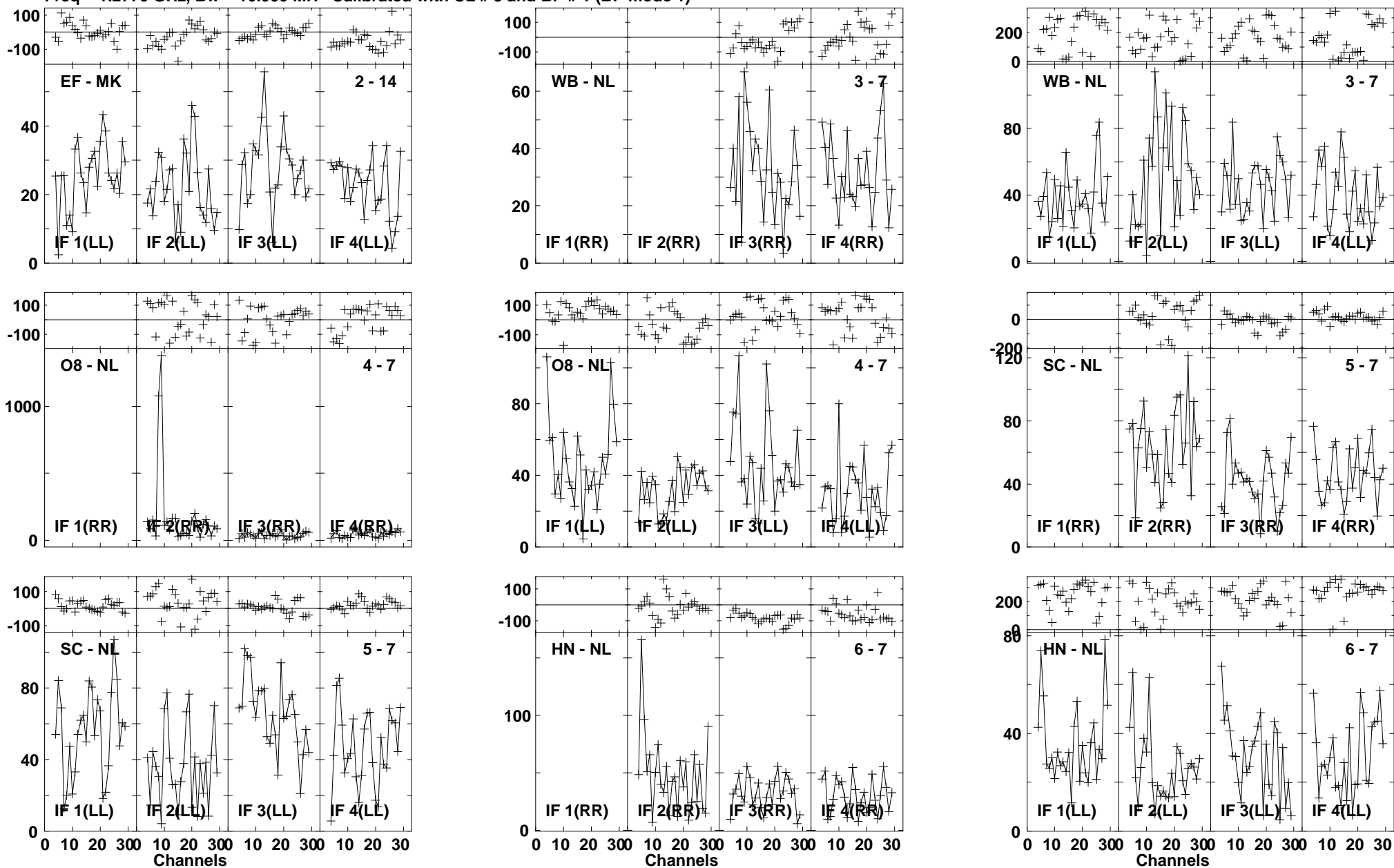

Lower frame: Milli Ampl Jy Top frame: Phas deg
Vector averaged cross-power spectrum Baseline: EF (02) - MK (14)
Timerange: 00/17:33:51 to 00/17:36:45

Plot file version 266 created 03-MAR-2016 01:12:42

4C52 GN002C 1.UVDATA.1

Freq = 1.2770 GHz, Bw = 16.000 MH Calibrated with CL # 3 and BP # 1 (BP mode 1)

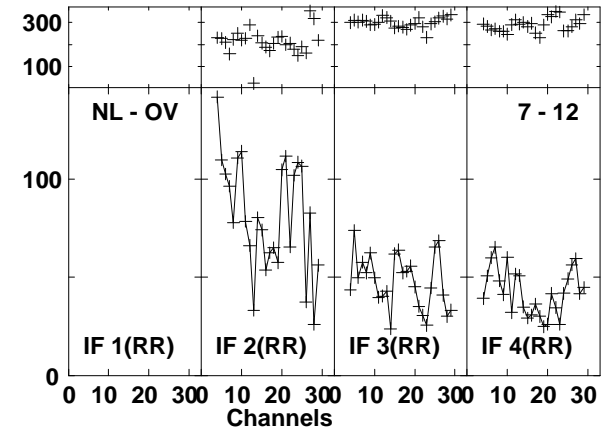
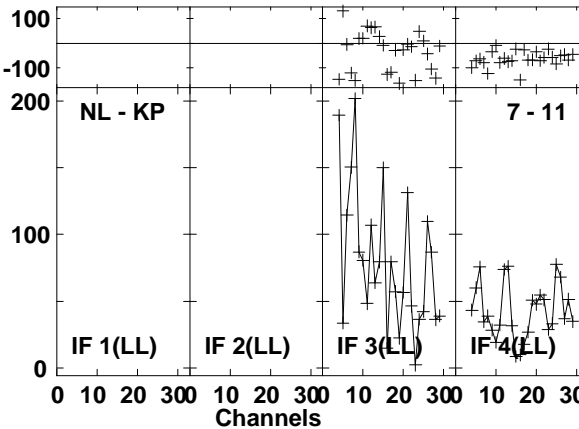
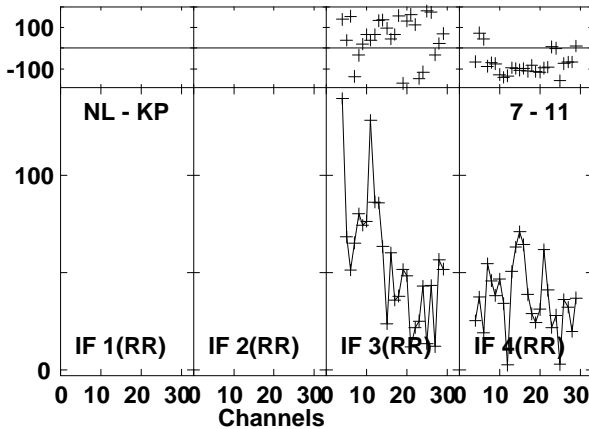
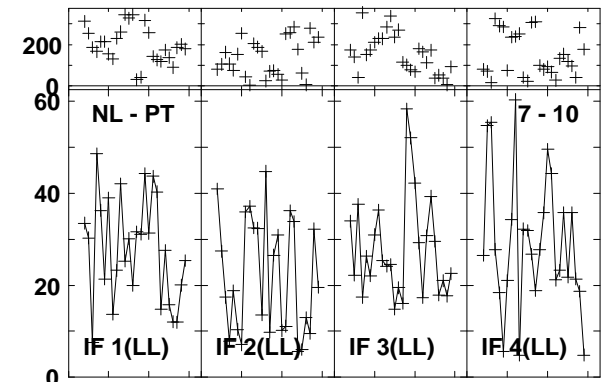
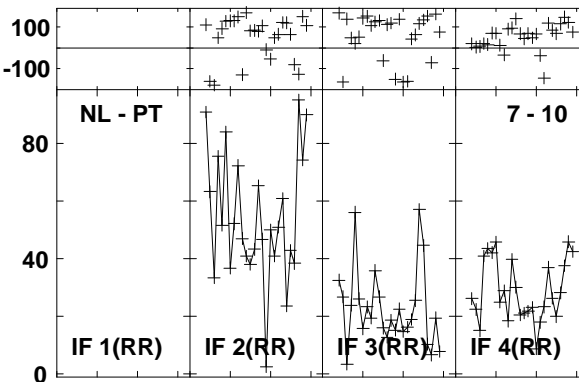
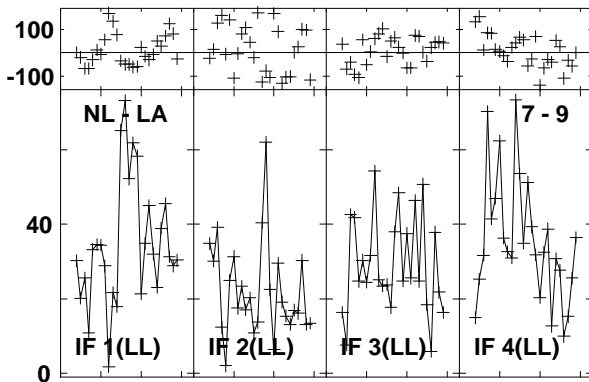
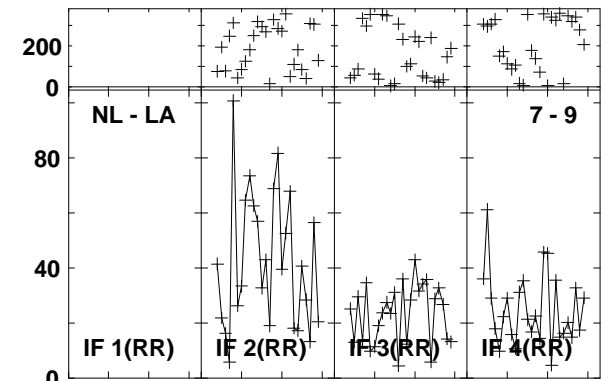
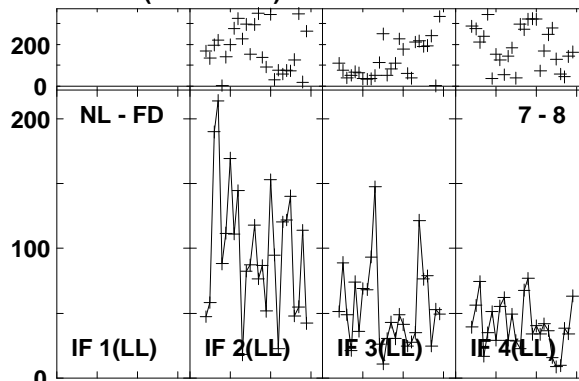
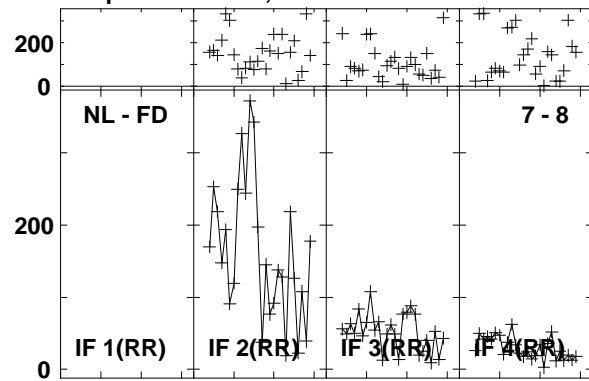

Lower frame: Milli Ampl Jy Top frame: Phas deg
Vector averaged cross-power spectrum Baseline: NL (07) - FD (08)
Timerange: 00/17:33:51 to 00/17:36:45

Plot file version 267 created 03-MAR-2016 01:12:42
 4C52 GN002C 1.UVDATA.1
 Freq = 1.2770 GHz, Bw = 16.000 MH Calibrated with CL # 3 and BP # 1 (BP mode 1)

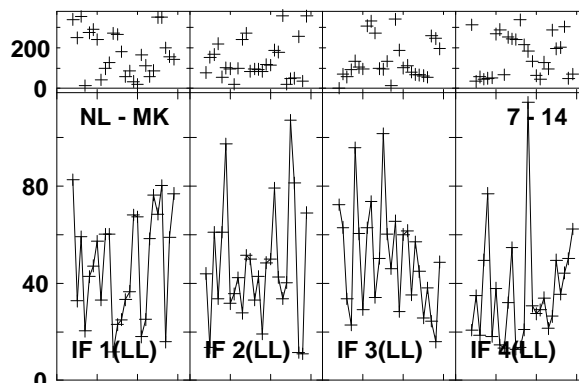
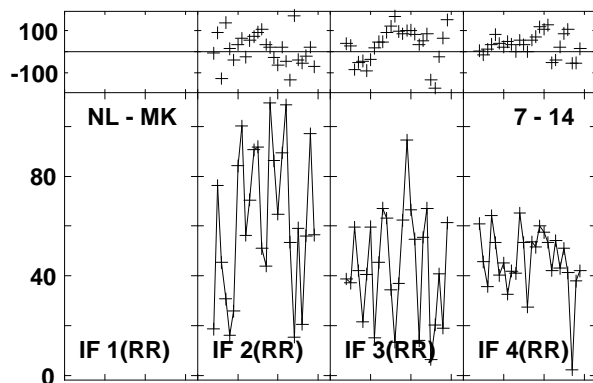
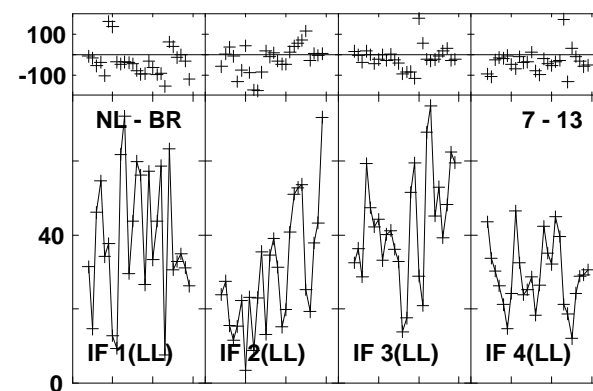
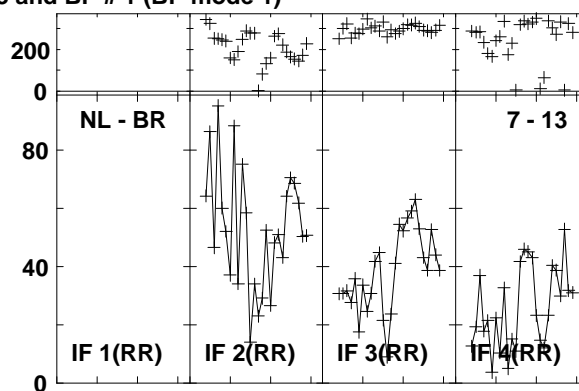
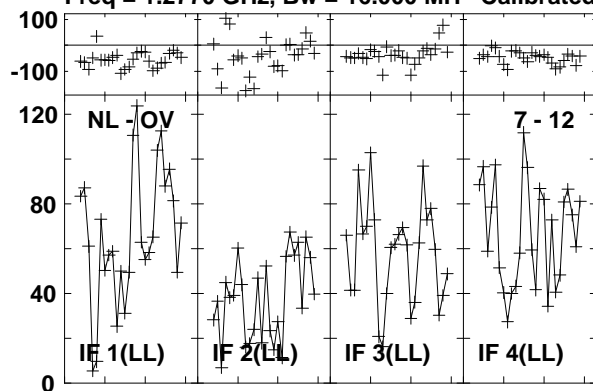

Lower frame: Milli Ampl Jy Top frame: Phas deg
 Vector averaged cross-power spectrum Baseline: NL (07) - OV (12)
 Timerange: 00/17:33:51 to 00/17:36:45

Plot file version 268 created 03-MAR-2016 01:12:43

J1545+5400 GN002C 1.UVDATA.1

Freq = 1.2770 GHz, Bw = 16.000 MH Calibrated with CL # 3 and BP # 1 (BP mode 1)

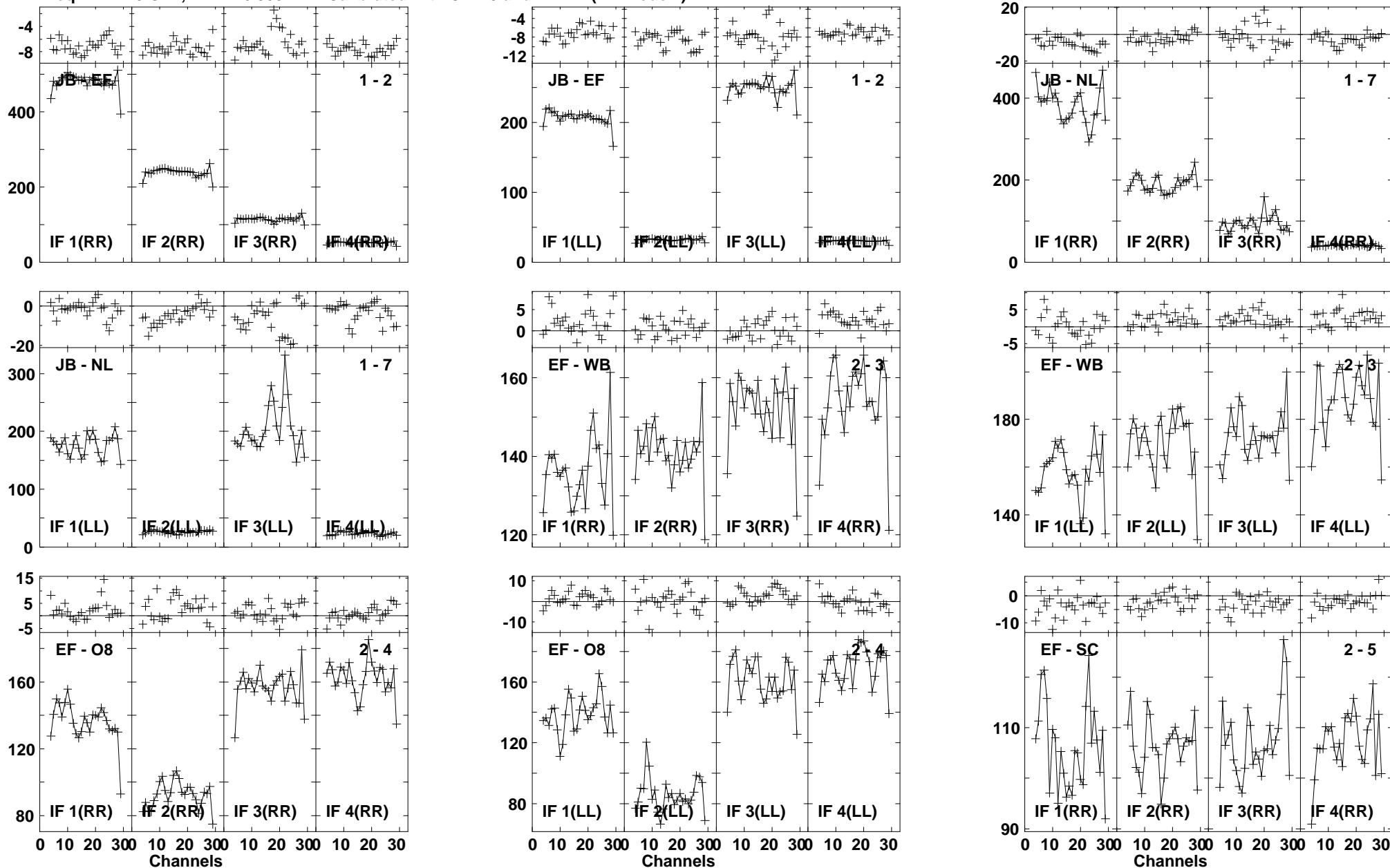

Lower frame: Milli Ampl Jy Top frame: Phas deg
Vector averaged cross-power spectrum Baseline: JB (01) - EF (02)
Timerange: 00/17:37:38 to 00/17:39:36

Plot file version 269 created 03-MAR-2016 01:12:43

J1545+5400 GN002C 1.UVDATA.1

Freq = 1.2770 GHz, Bw = 16.000 MH Calibrated with CL # 3 and BP # 1 (BP mode 1)

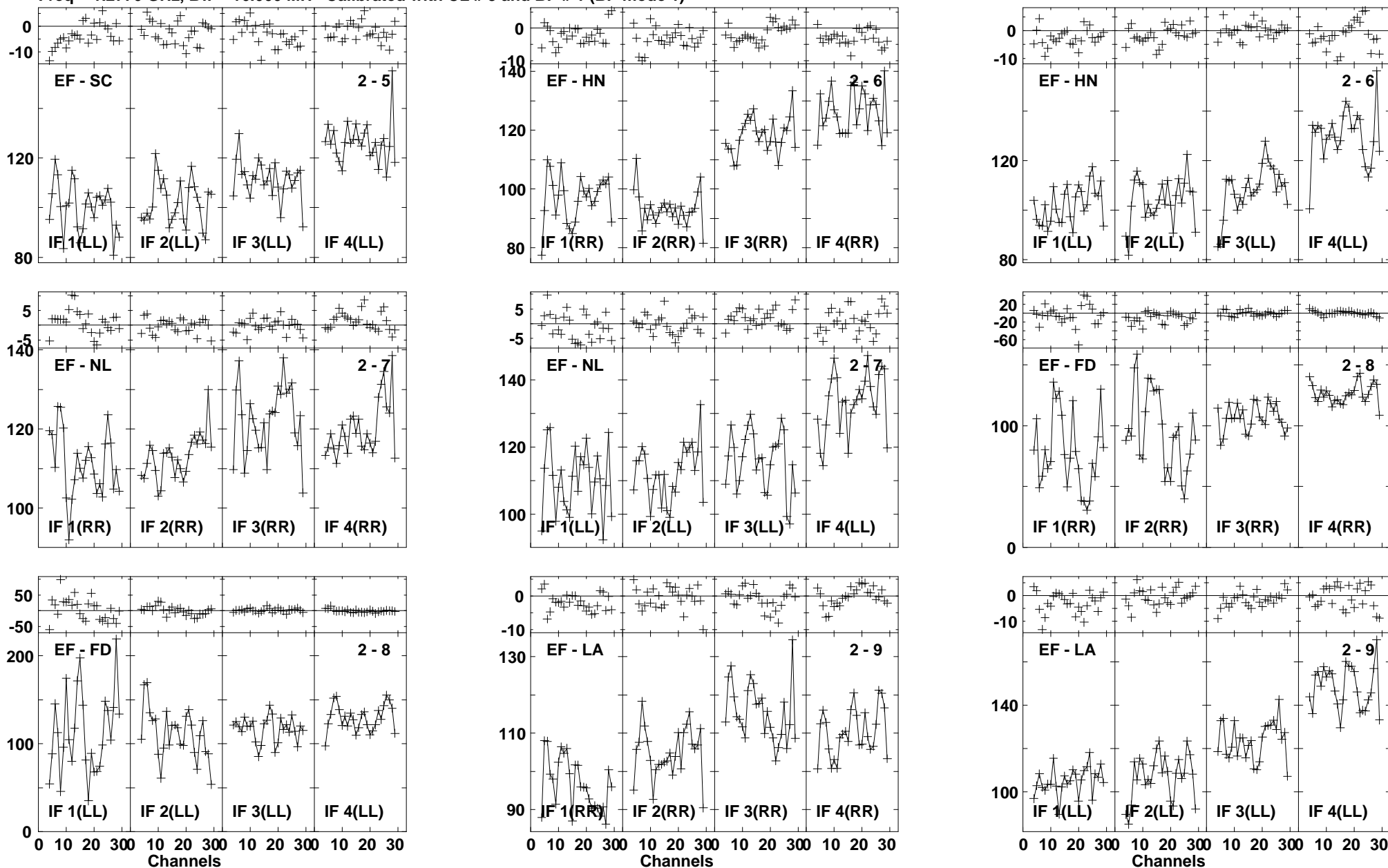

Lower frame: Milli Ampl Jy Top frame: Phas deg
Vector averaged cross-power spectrum Baseline: EF (02) - SC (05)
Timerange: 00/17:37:38 to 00/17:39:36

Plot file version 270 created 03-MAR-2016 01:12:43

J1545+5400 GN002C 1.UVDATA.1

Freq = 1.2770 GHz, Bw = 16.000 MH Calibrated with CL # 3 and BP # 1 (BP mode 1)

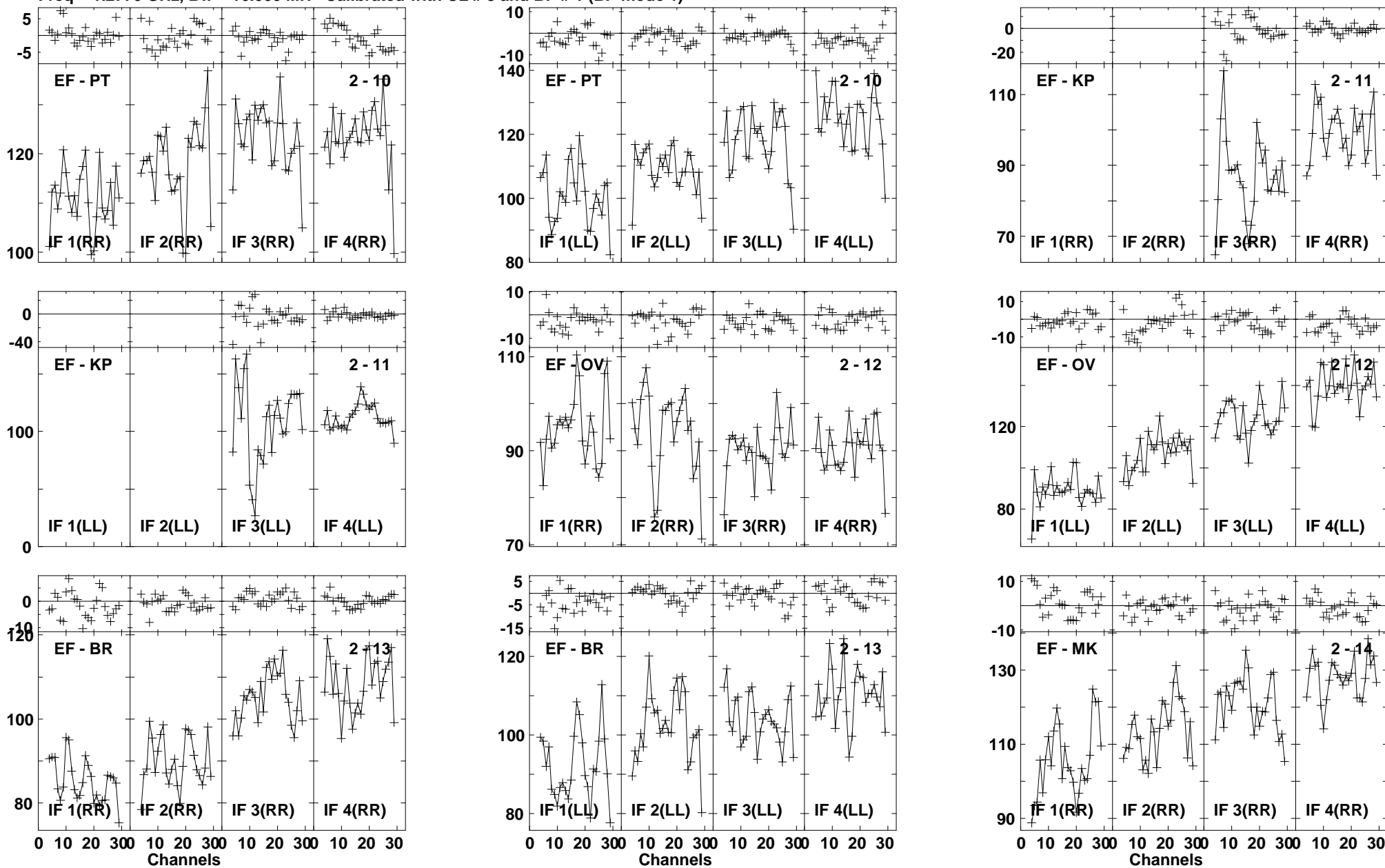

Lower frame: Milli Ampl Jy Top frame: Phas deg
Vector averaged cross-power spectrum Baseline: EF (02) - PT (10)
Timerange: 00/17:37:38 to 00/17:39:36

Plot file version 271 created 03-MAR-2016 01:12:43

J1545+5400 GN002C 1.UVDATA.1

Freq = 1.2770 GHz, Bw = 16.000 MH Calibrated with CL # 3 and BP # 1 (BP mode 1)

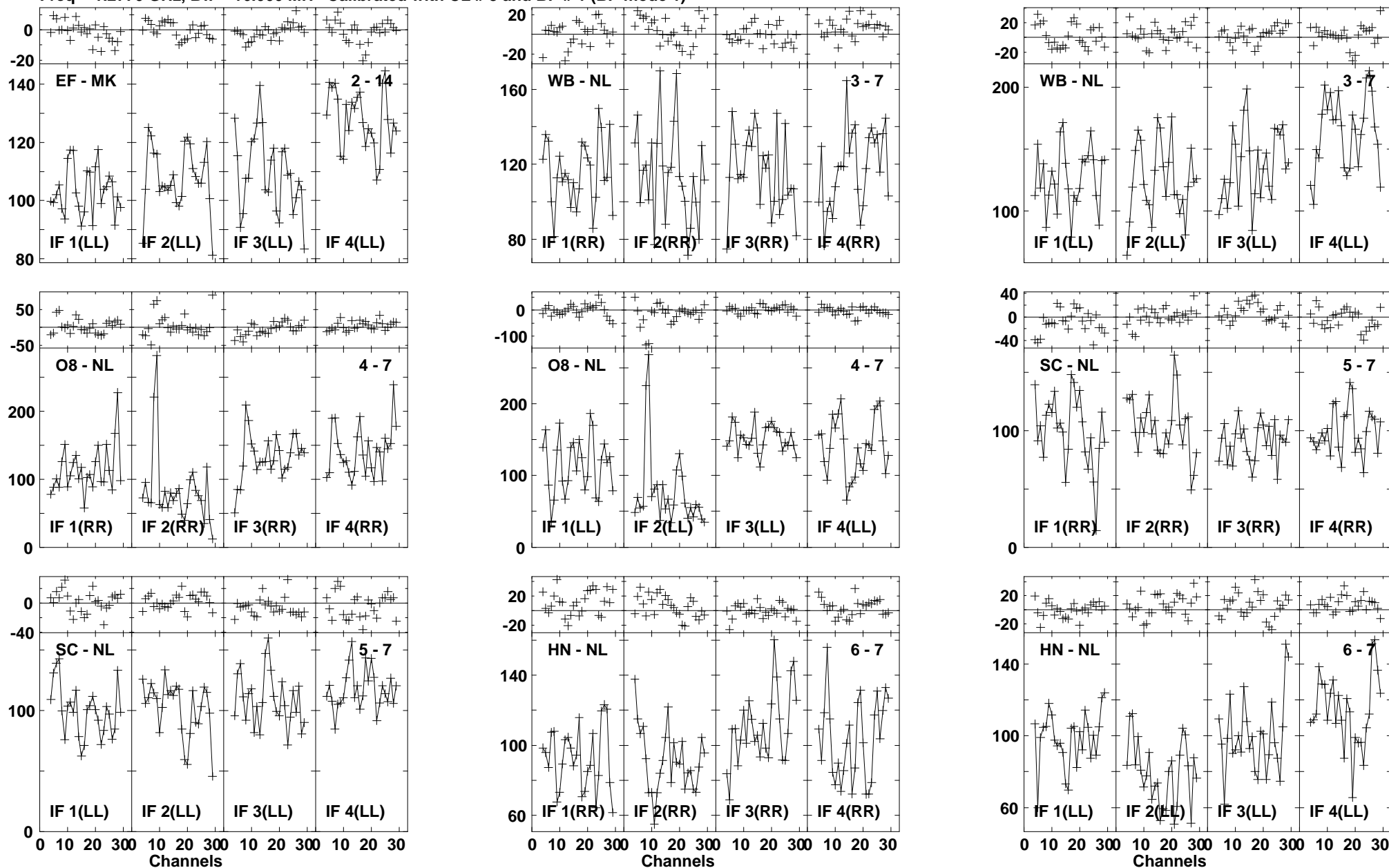

Lower frame: Milli Ampl Jy Top frame: Phas deg
Vector averaged cross-power spectrum Baseline: EF (02) - MK (14)
Timerange: 00/17:37:38 to 00/17:39:36

Plot file version 272 created 03-MAR-2016 01:12:43

J1545+5400 GN002C 1.UVDATA.1

Freq = 1.2770 GHz, Bw = 16.000 MH Calibrated with CL # 3 and BP # 1 (BP mode 1)

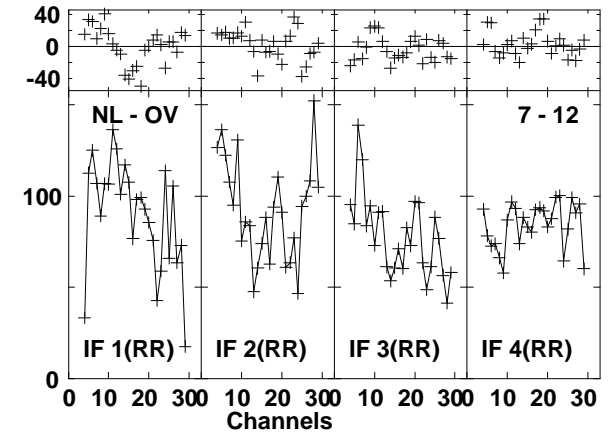
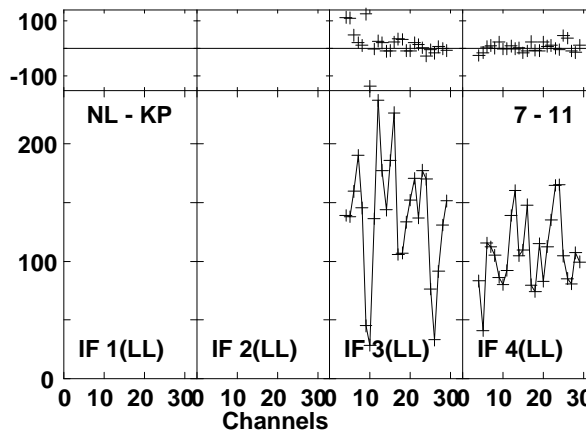
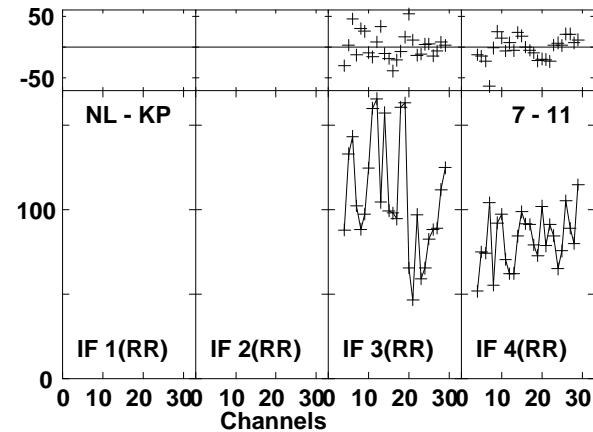
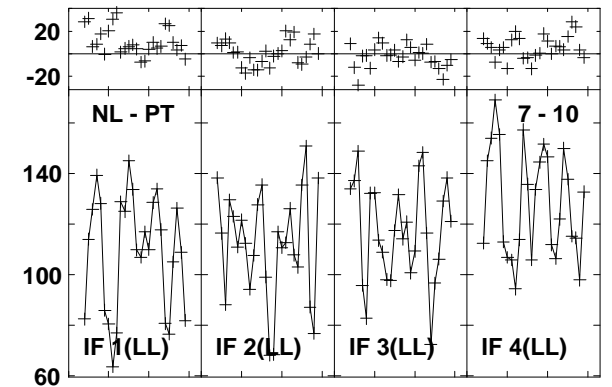
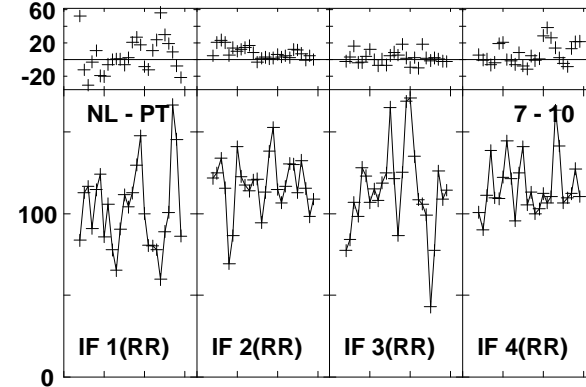
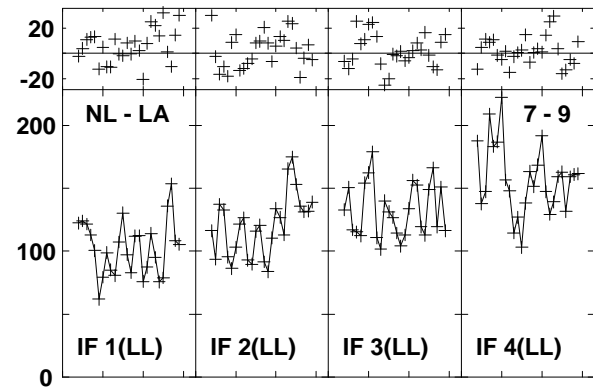
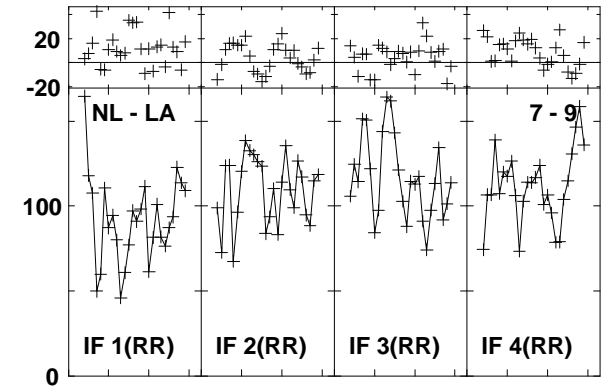
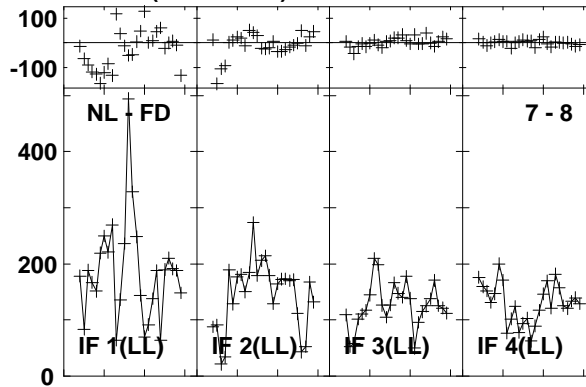
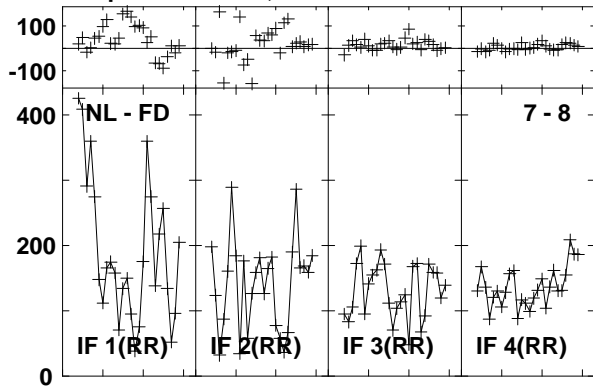

Lower frame: Milli Ampl Jy Top frame: Phas deg
Vector averaged cross-power spectrum Baseline: NL (07) - FD (08)
Timerange: 00/17:37:38 to 00/17:39:36

Plot file version 273 created 03-MAR-2016 01:12:43

J1545+5400 GN002C 1.UVDATA.1

Freq = 1.2770 GHz, Bw = 16.000 MH Calibrated with CL # 3 and BP # 1 (BP mode 1)

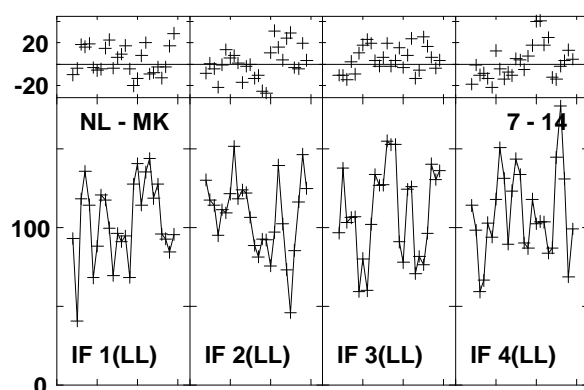
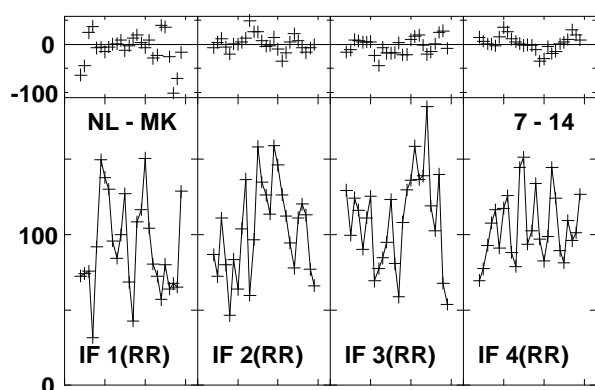
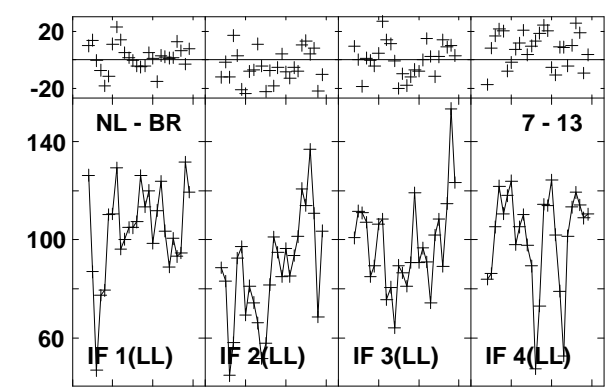
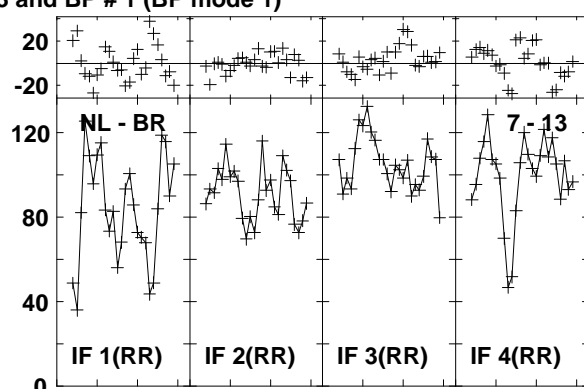
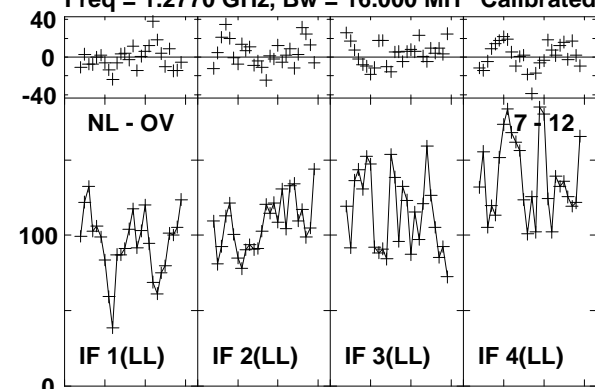

Lower frame: Milli Ampl Jy Top frame: Phas deg
Vector averaged cross-power spectrum Baseline: NL (07) - OV (12)
Timerange: 00/17:37:38 to 00/17:39:36

Plot file version 274 created 03-MAR-2016 01:12:43

4C52 GN002C 1.UVDATA.1

Freq = 1.2770 GHz, Bw = 16.000 MH Calibrated with CL # 3 and BP # 1 (BP mode 1)

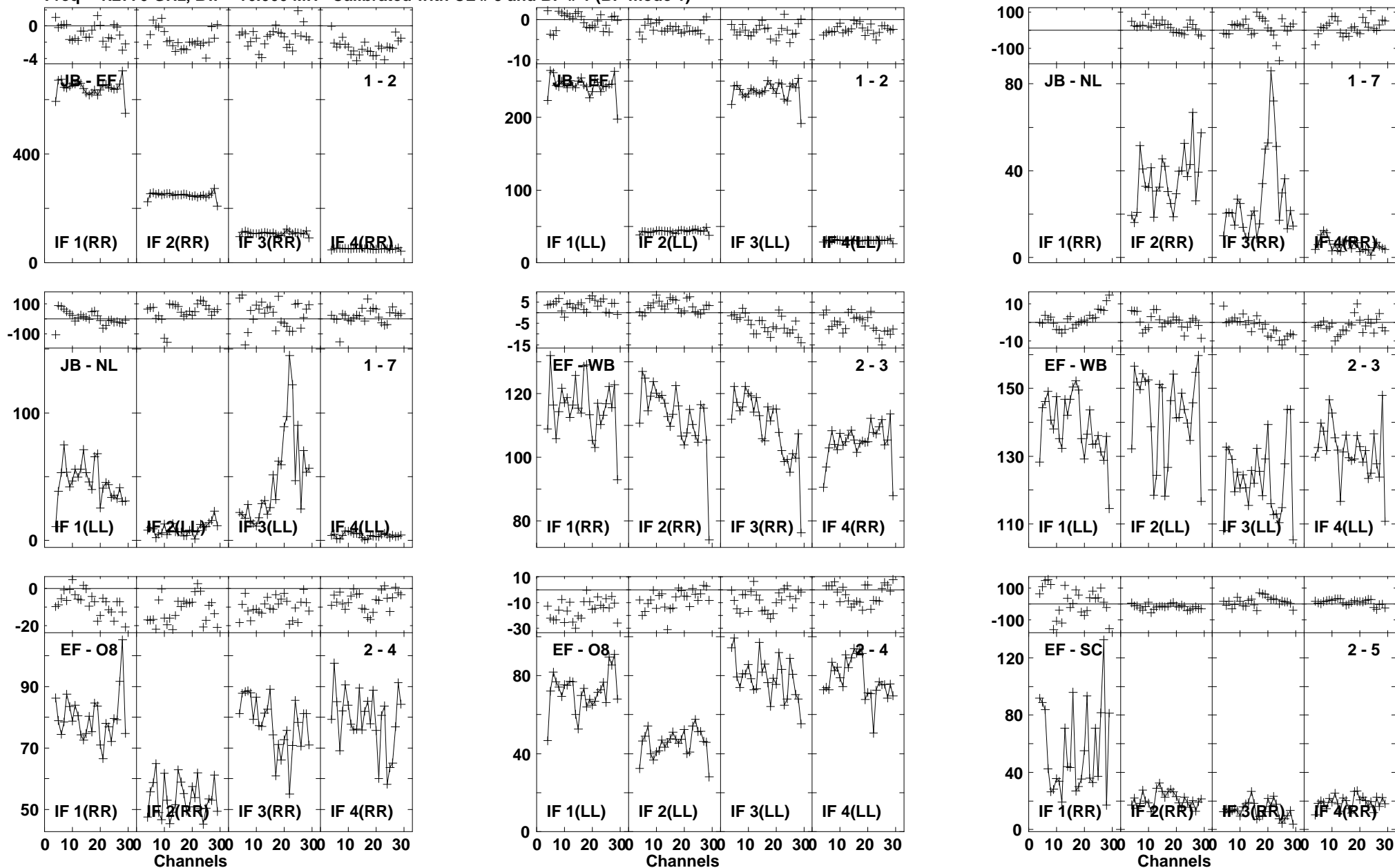

Lower frame: Milli Ampl Jy Top frame: Phas deg
Vector averaged cross-power spectrum Baseline: JB (01) - EF (02)
Timerange: 00/17:39:49 to 00/17:42:35

Plot file version 275 created 03-MAR-2016 01:12:44

4C52 GN002C 1.UVDATA.1

Freq = 1.2770 GHz, Bw = 16.000 MH Calibrated with CL # 3 and BP # 1 (BP mode 1)

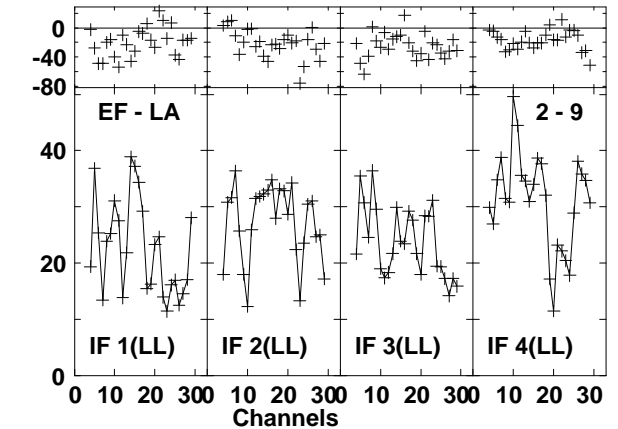
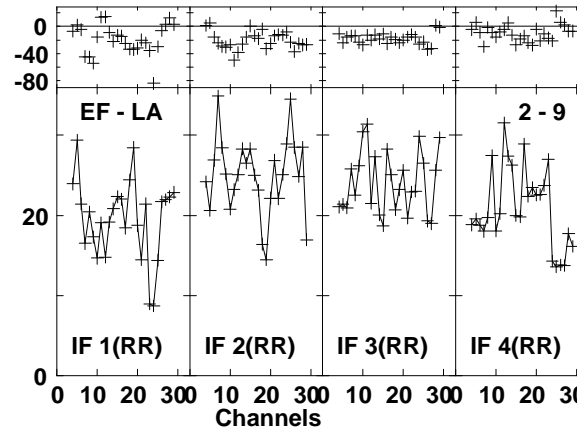
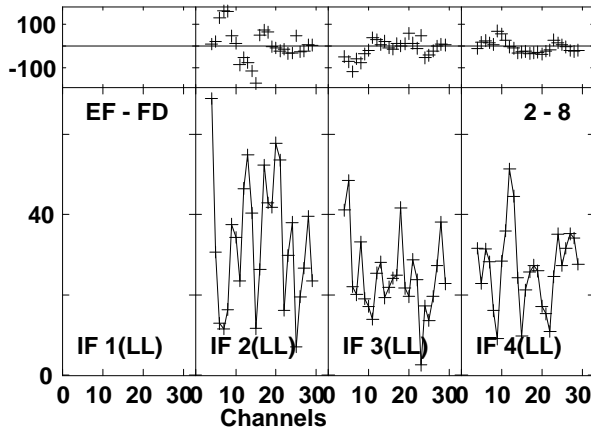
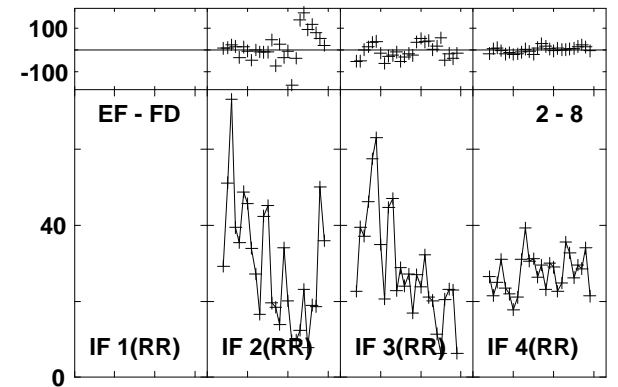
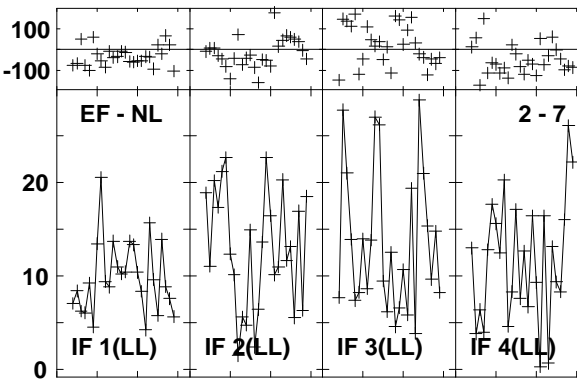
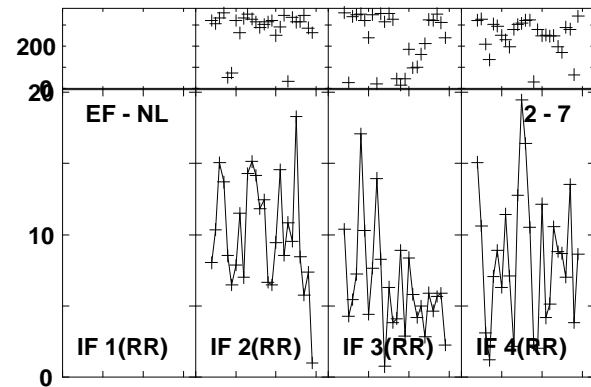
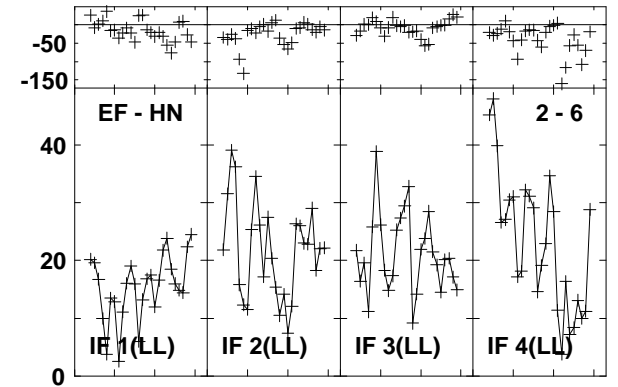
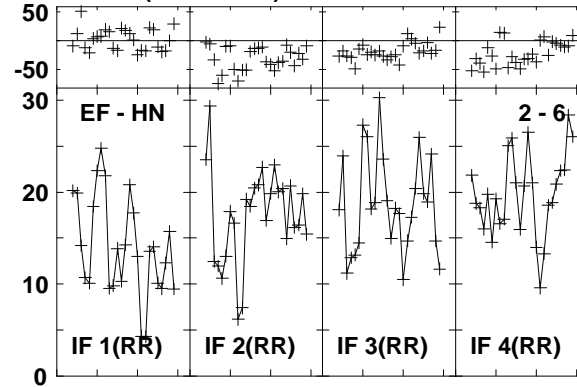
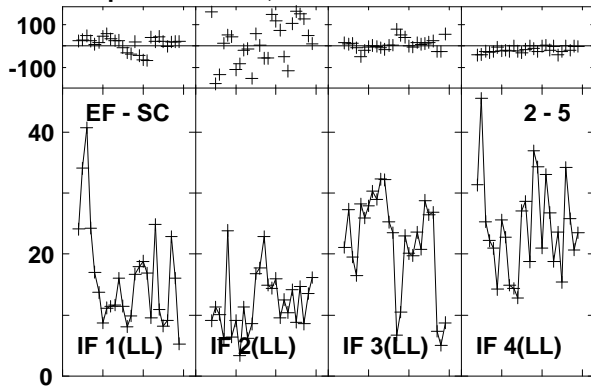

Lower frame: Milli Ampl Jy Top frame: Phas deg
Vector averaged cross-power spectrum Baseline: EF (02) - SC (05)
Timerange: 00/17:39:49 to 00/17:42:35

Plot file version 276 created 03-MAR-2016 01:12:44

4C52 GN002C 1.UVDATA.1

Freq = 1.2770 GHz, Bw = 16.000 MH Calibrated with CL # 3 and BP # 1 (BP mode 1)

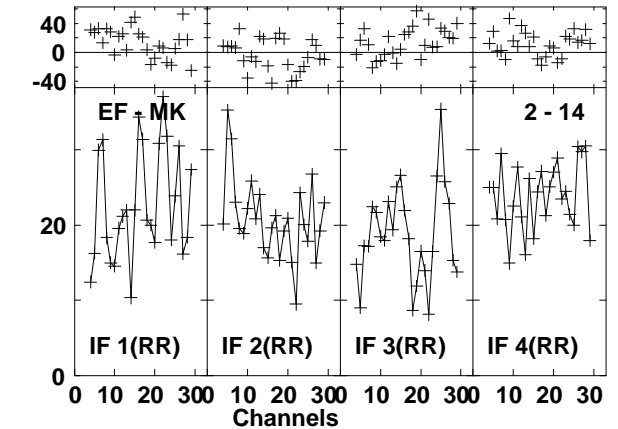
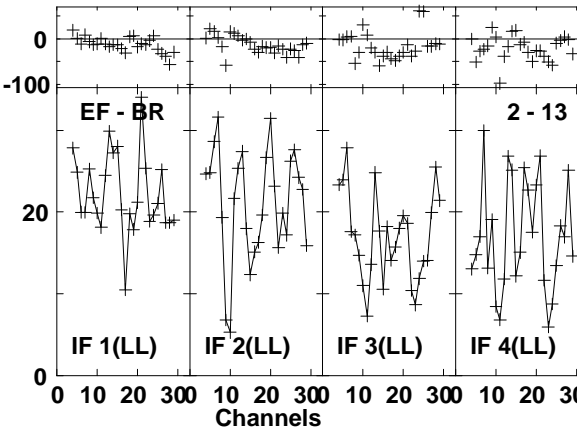
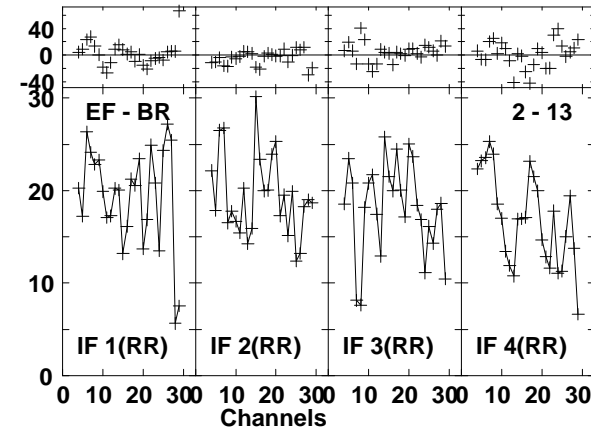
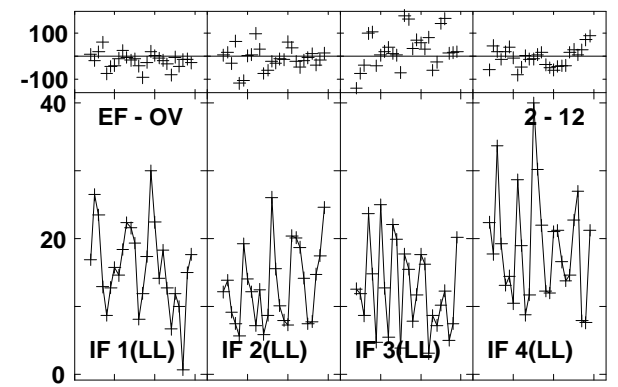
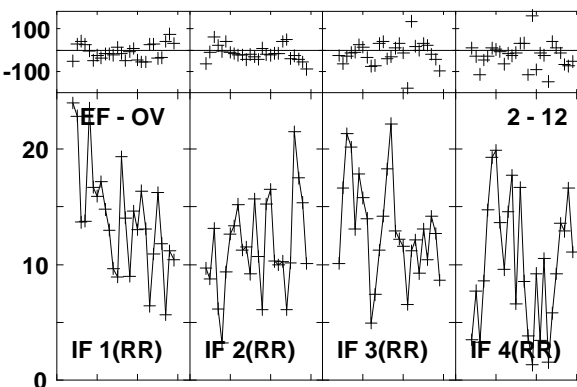
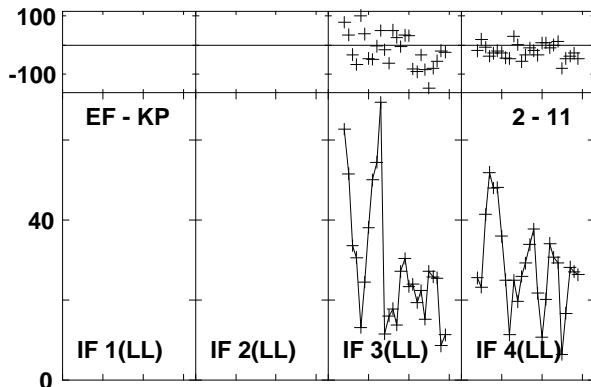
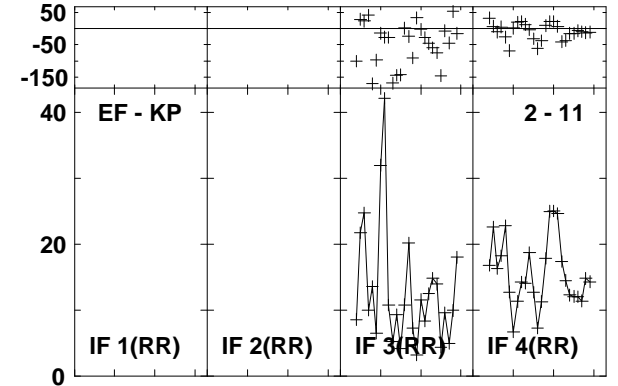
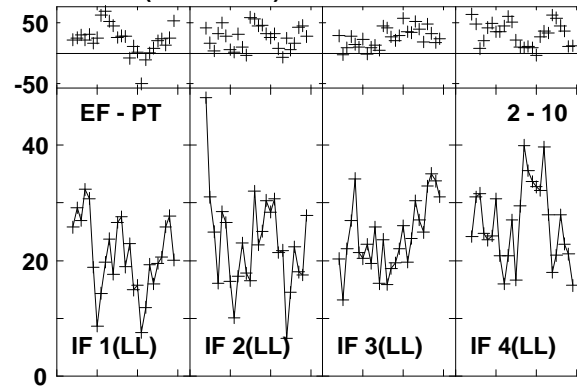
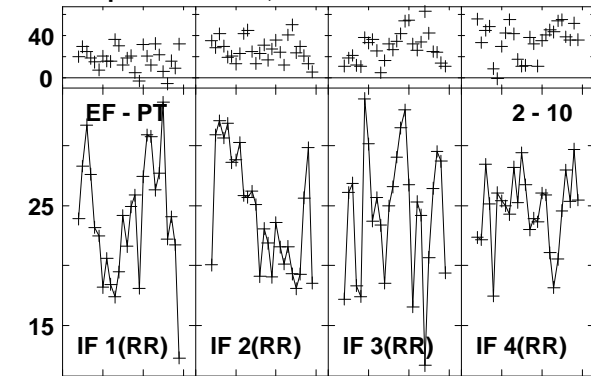

Lower frame: Milli Ampl Jy Top frame: Phas deg
Vector averaged cross-power spectrum Baseline: EF (02) - PT (10)
Timerange: 00/17:39:49 to 00/17:42:35

Plot file version 277 created 03-MAR-2016 01:12:44

4C52 GN002C 1.UVDATA.1

Freq = 1.2770 GHz, Bw = 16.000 MH Calibrated with CL # 3 and BP # 1 (BP mode 1)

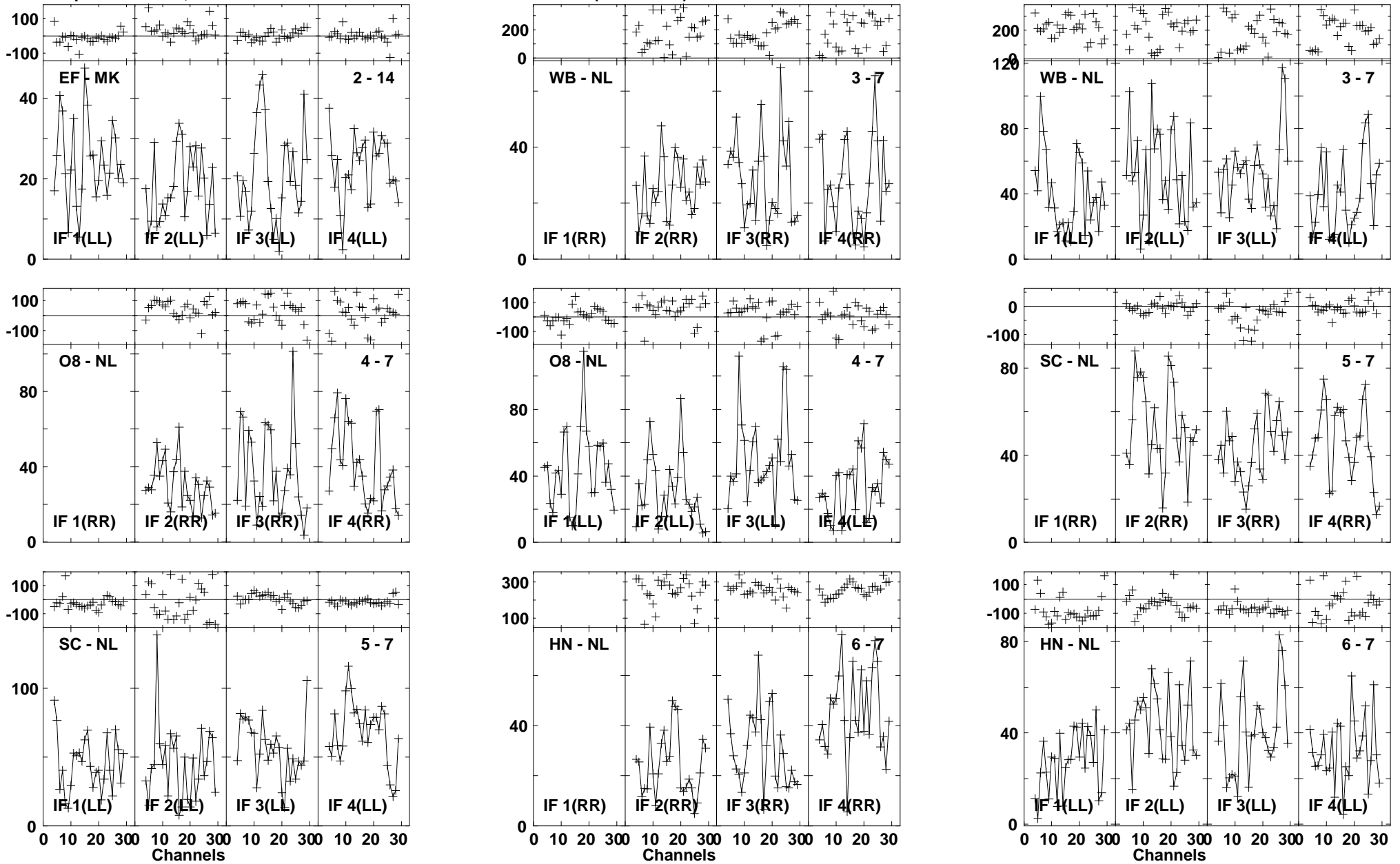

Lower frame: Milli Ampl Jy Top frame: Phas deg
Vector averaged cross-power spectrum Baseline: EF (02) - MK (14)
Timerange: 00/17:39:49 to 00/17:42:35

Plot file version 278 created 03-MAR-2016 01:12:44

4C52 GN002C 1.UVDATA.1

Freq = 1.2770 GHz, Bw = 16.000 MH Calibrated with CL # 3 and BP # 1 (BP mode 1)

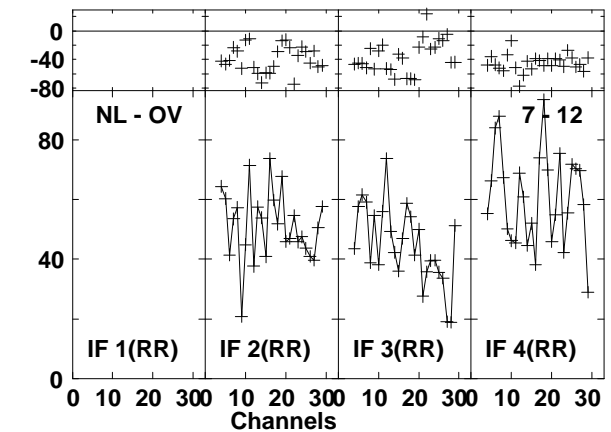
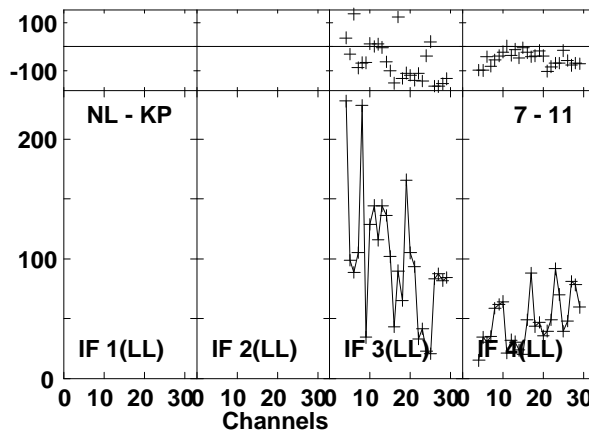
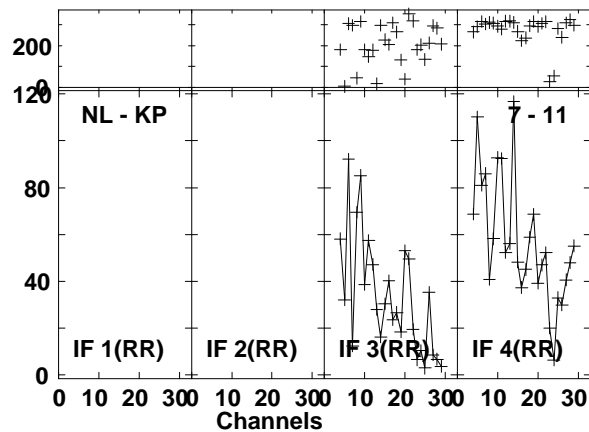
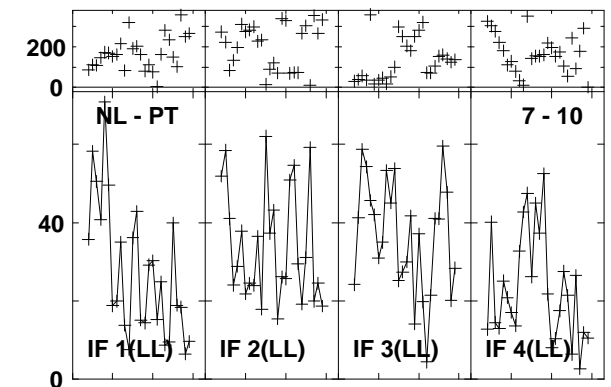
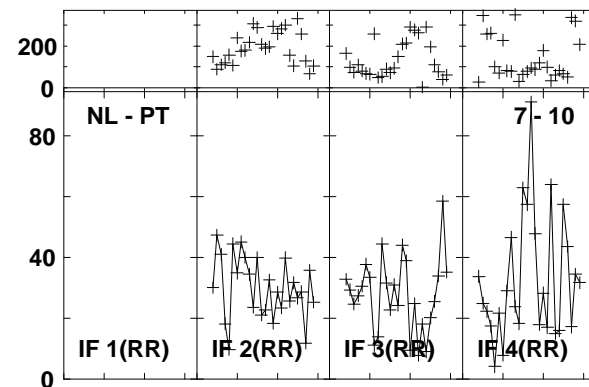
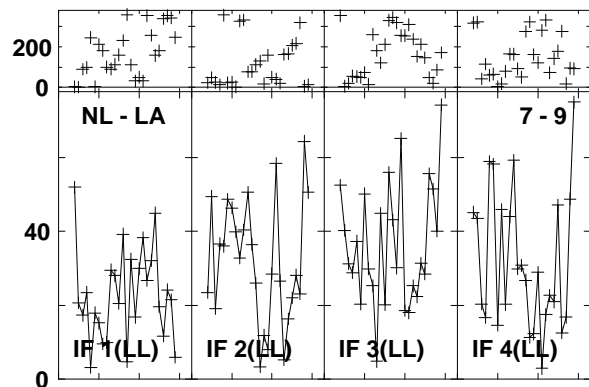
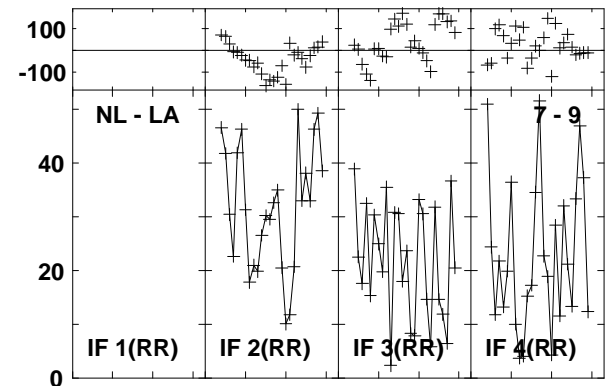
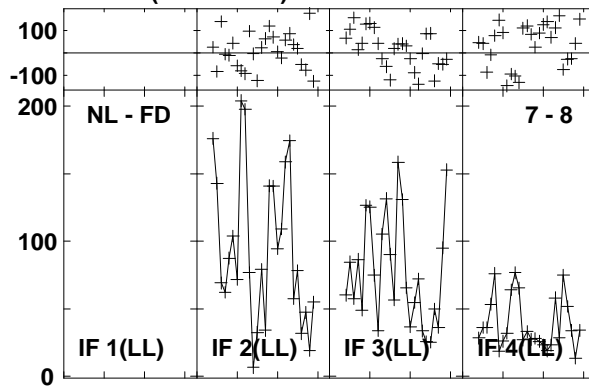
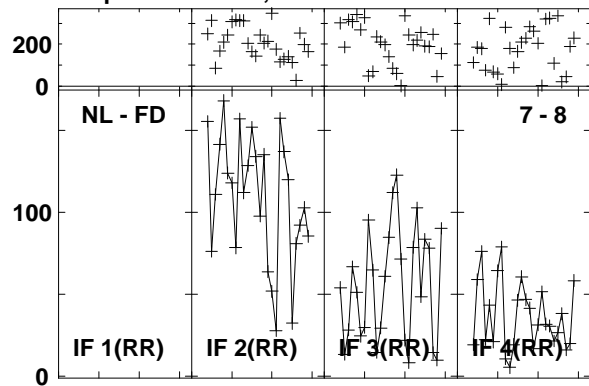

Lower frame: Milli Ampl Jy Top frame: Phas deg
Vector averaged cross-power spectrum Baseline: NL (07) - FD (08)
Timerange: 00/17:39:49 to 00/17:42:35

Plot file version 279 created 03-MAR-2016 01:12:44
 4C52 GN002C 1.UVDATA.1
 Freq = 1.2770 GHz, Bw = 16.000 MH Calibrated with CL # 3 and BP # 1 (BP mode 1)

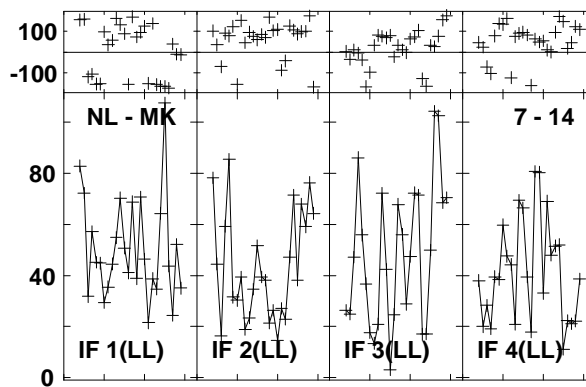
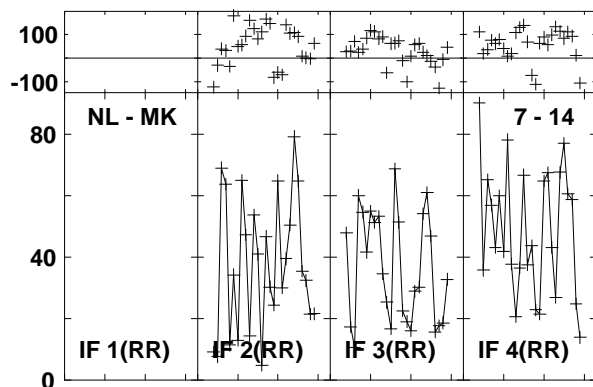
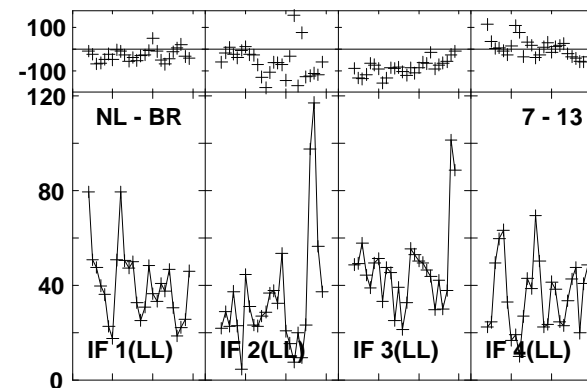
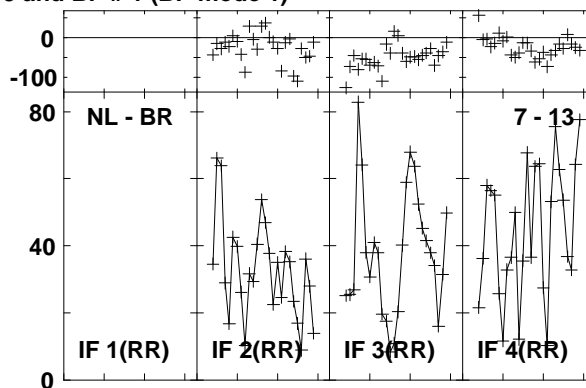
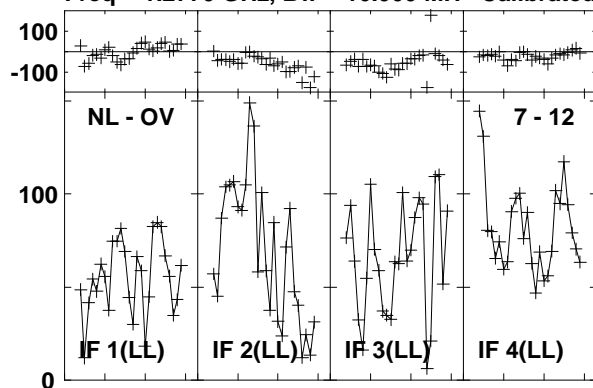

Lower frame: Milli Ampl Jy Top frame: Phas deg
 Vector averaged cross-power spectrum Baseline: NL (07) - OV (12)
 Timerange: 00/17:39:49 to 00/17:42:35

Plot file version 280 created 03-MAR-2016 01:12:44

J1545+5400 GN002C 1.UVDATA.1

Freq = 1.2770 GHz, Bw = 16.000 MH Calibrated with CL # 3 and BP # 1 (BP mode 1)

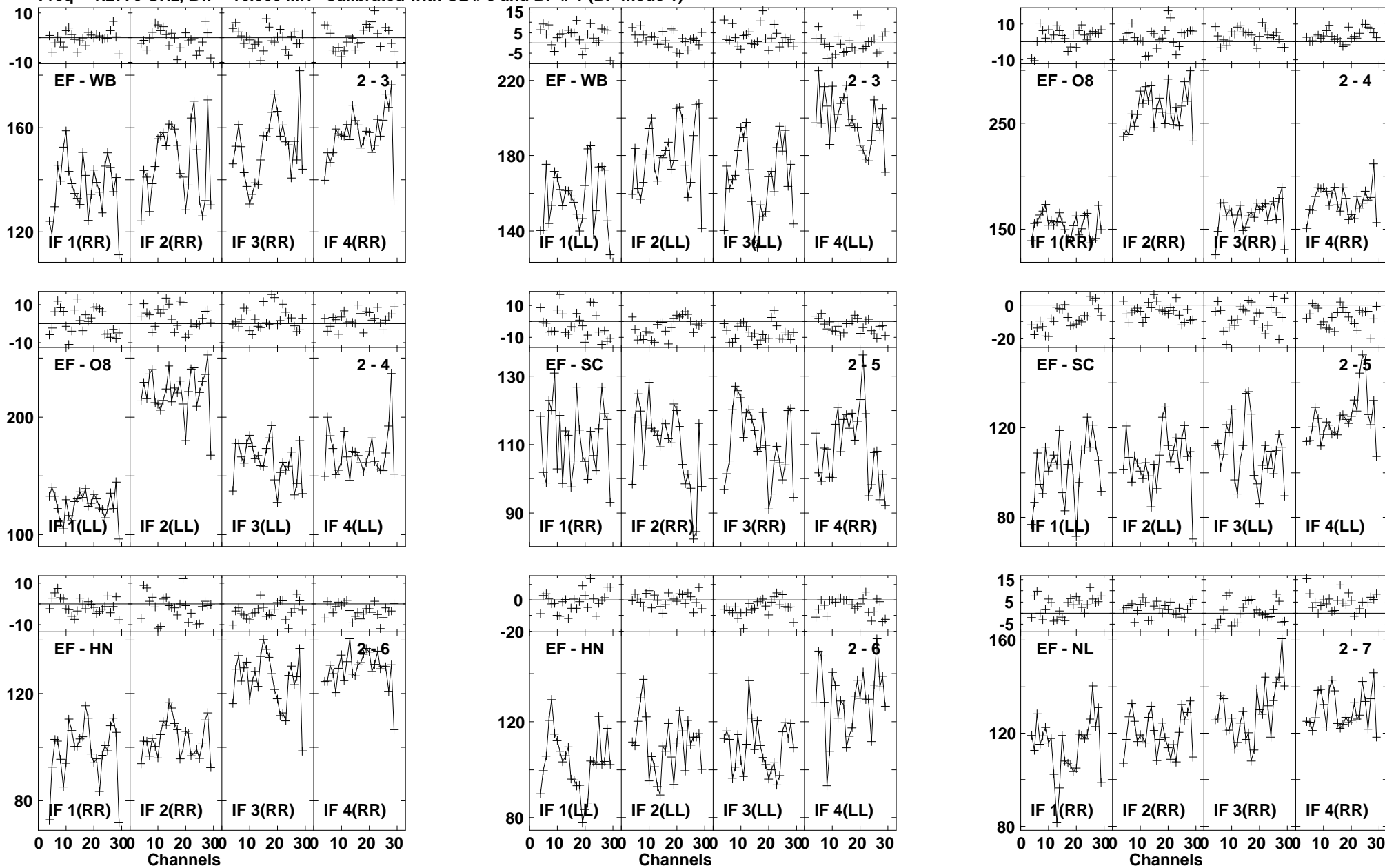

Lower frame: Milli Ampl Jy Top frame: Phas deg
Vector averaged cross-power spectrum Baseline: EF (02) - WB (03)
Timerange: 00/17:43:28 to 00/17:44:26

Plot file version 281 created 03-MAR-2016 01:12:45

J1545+5400 GN002C 1.UVDATA.1

Freq = 1.2770 GHz, Bw = 16.000 MH Calibrated with CL # 3 and BP # 1 (BP mode 1)

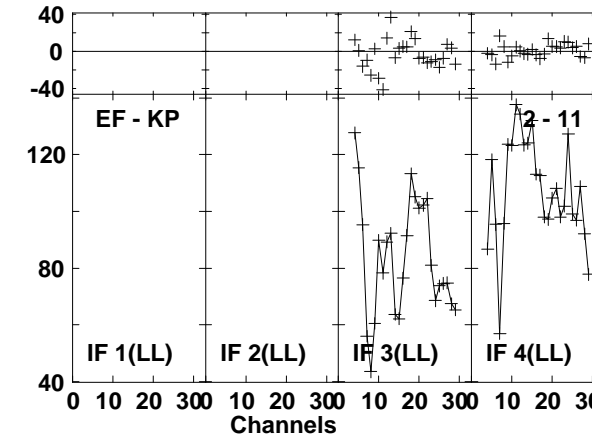
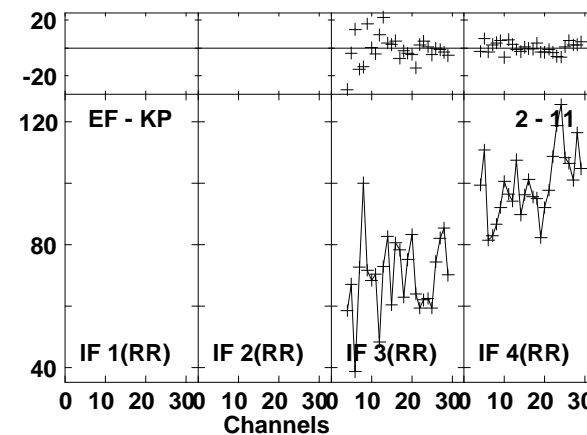
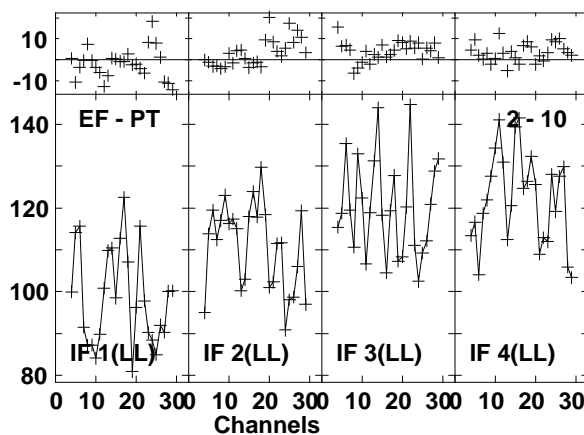
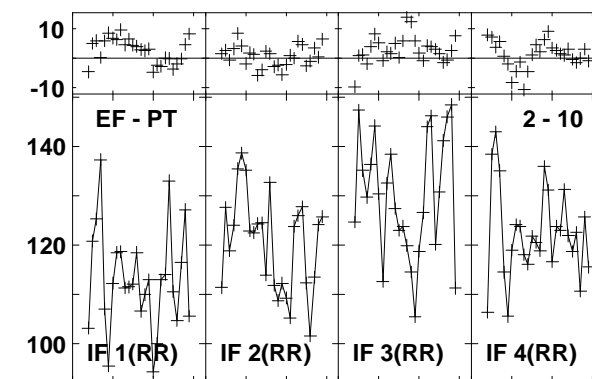
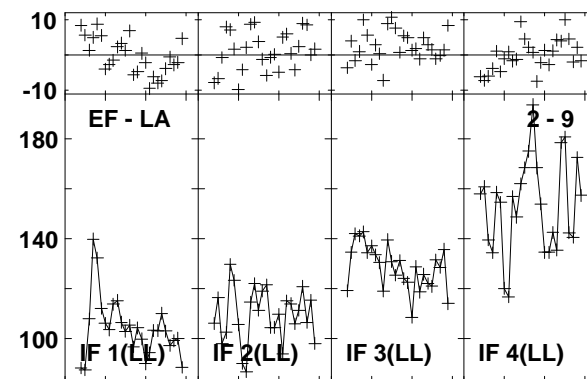
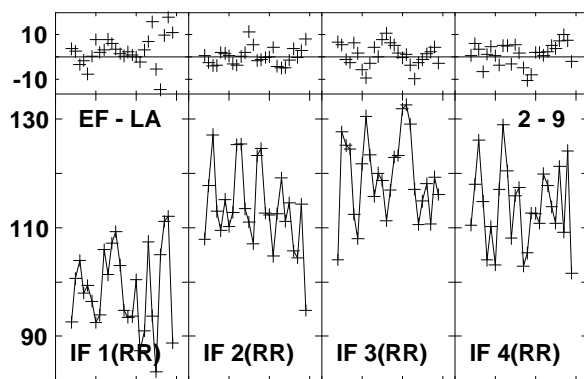
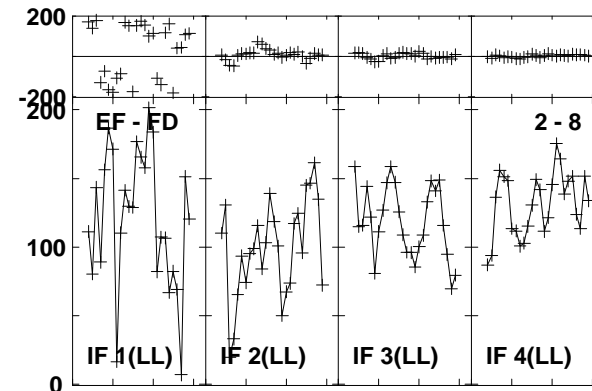
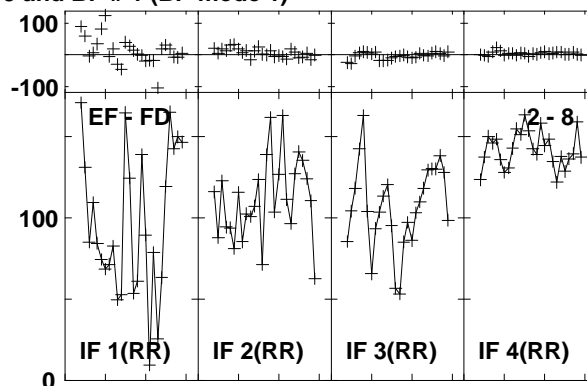
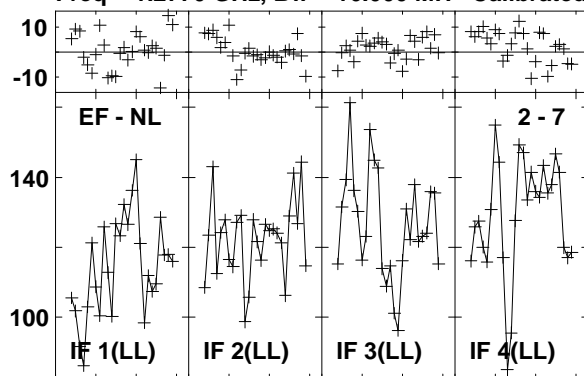

Lower frame: Milli Ampl Jy Top frame: Phas deg
Vector averaged cross-power spectrum Baseline: EF (02) - NL (07)
Timerange: 00/17:43:28 to 00/17:44:26

Plot file version 282 created 03-MAR-2016 01:12:45

J1545+5400 GN002C 1.UVDATA.1

Freq = 1.2770 GHz, Bw = 16.000 MH Calibrated with CL # 3 and BP # 1 (BP mode 1)

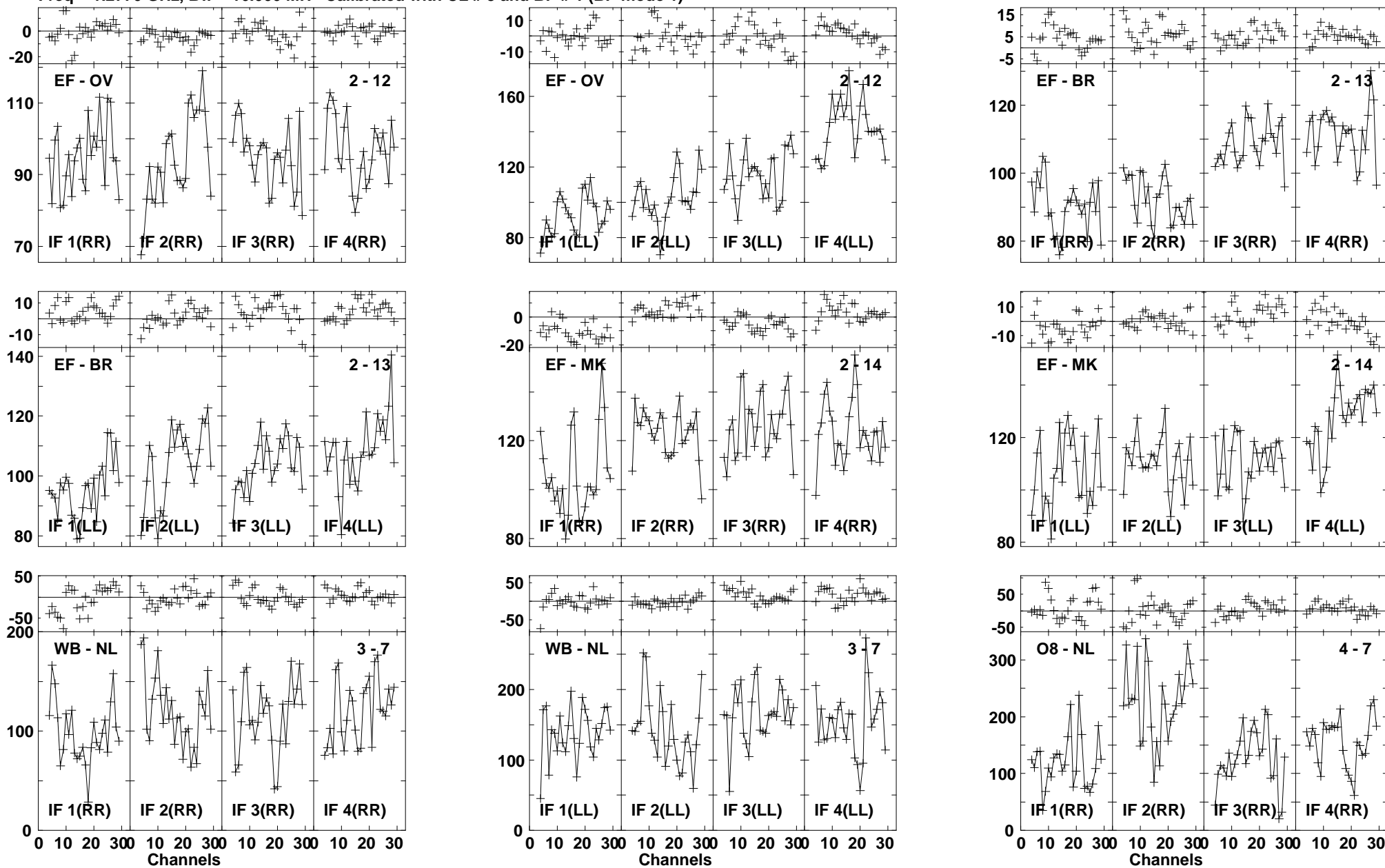

Lower frame: Milli Ampl Jy Top frame: Phas deg
Vector averaged cross-power spectrum Baseline: EF (02) - OV (12)
Timerange: 00/17:43:28 to 00/17:44:26

Plot file version 283 created 03-MAR-2016 01:12:45
 J1545+5400 GN002C 1.UVDATA.1
 Freq = 1.2770 GHz, Bw = 16.000 MH Calibrated with CL # 3 and BP # 1 (BP mode 1)

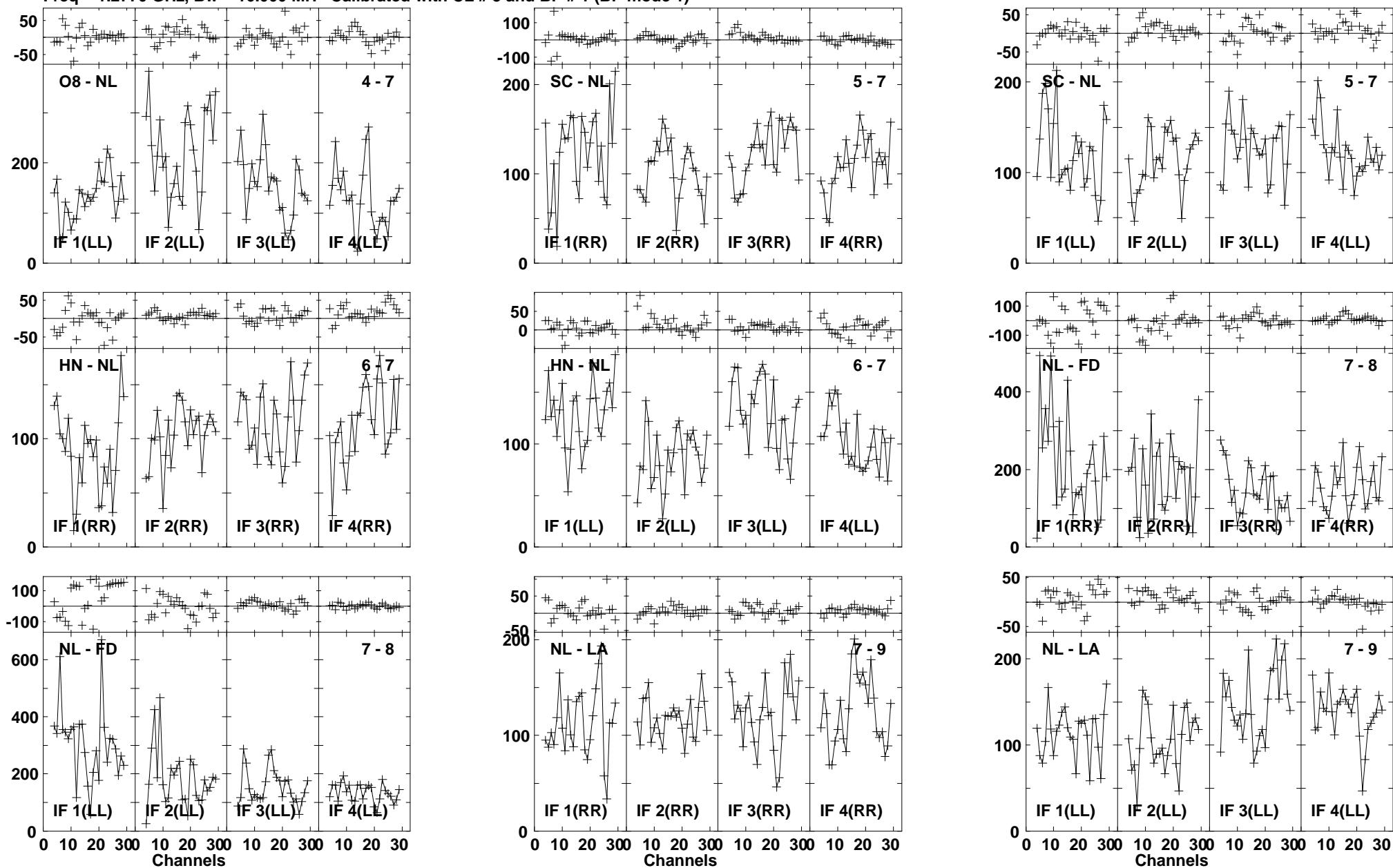

Lower frame: Milli Ampl Jy Top frame: Phas deg
 Vector averaged cross-power spectrum Baseline: O8 (04) - NL (07)
 Timerange: 00/17:43:28 to 00/17:44:26

Plot file version 284 created 03-MAR-2016 01:12:45

J1545+5400 GN002C 1.UVDATA.1

Freq = 1.2770 GHz, Bw = 16.000 MH Calibrated with CL # 3 and BP # 1 (BP mode 1)

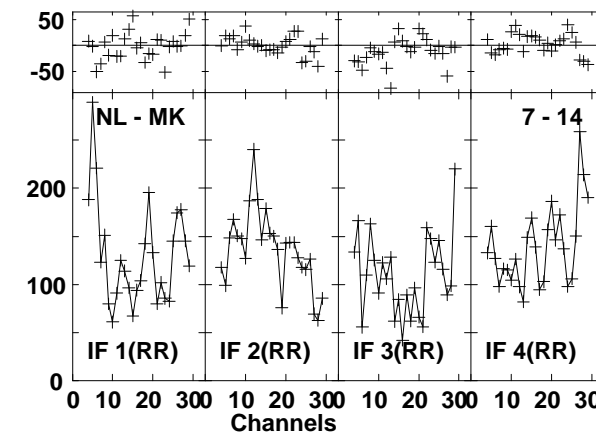
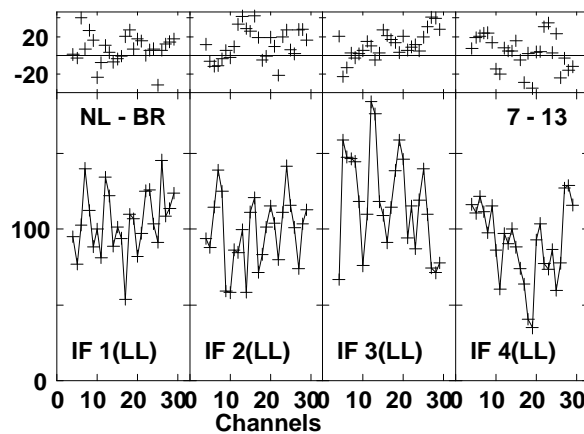
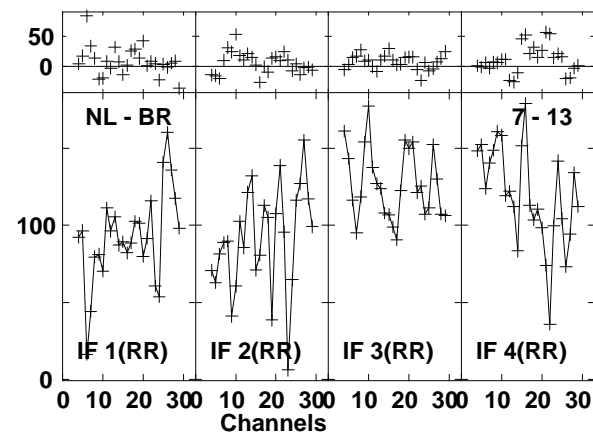
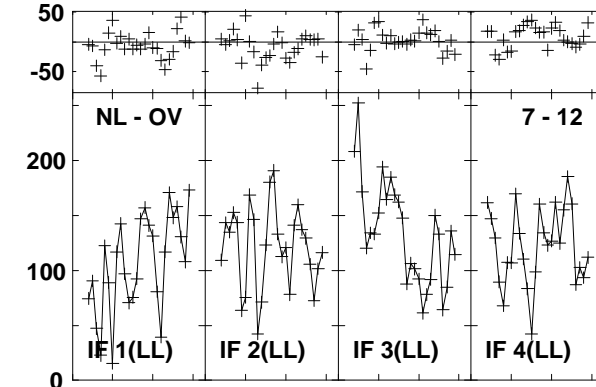
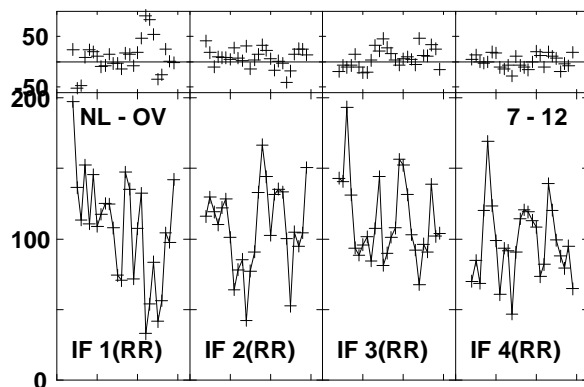
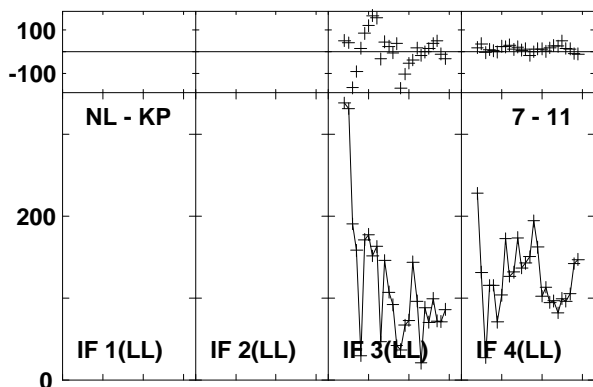
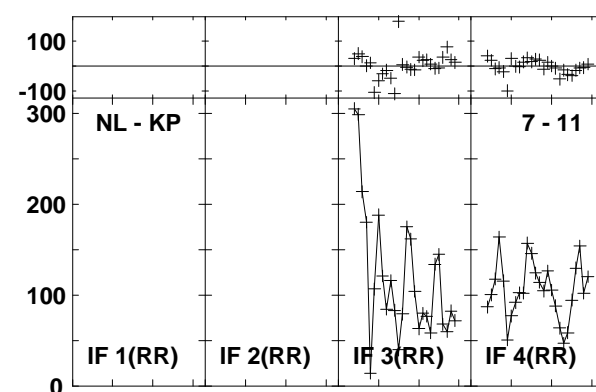
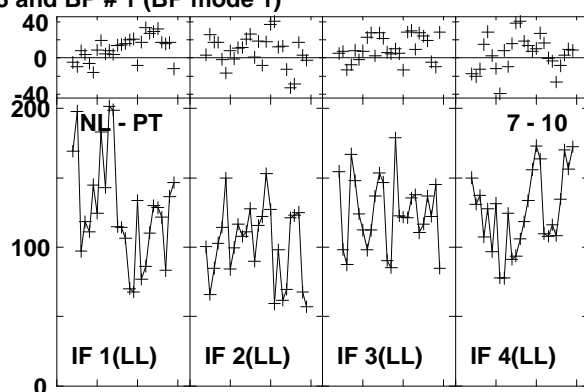
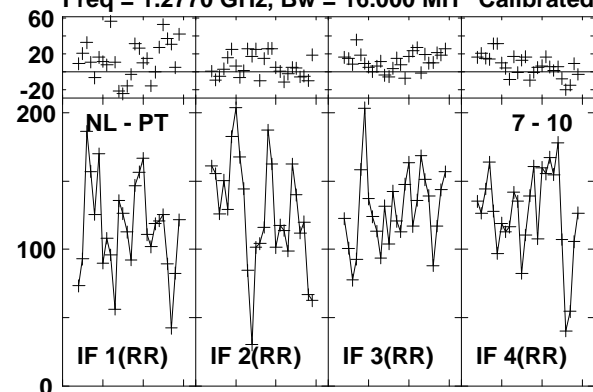

Lower frame: Milli Ampl Jy Top frame: Phas deg
Vector averaged cross-power spectrum Baseline: NL (07) - PT (10)
Timerange: 00/17:43:28 to 00/17:44:26

Plot file version 285 created 03-MAR-2016 01:12:45
J1545+5400 GN002C 1.UVDATA.1
Freq = 1.2770 GHz, Bw = 16.000 MH Calibrated with CL # 3 and BP # 1 (BP mode 1)

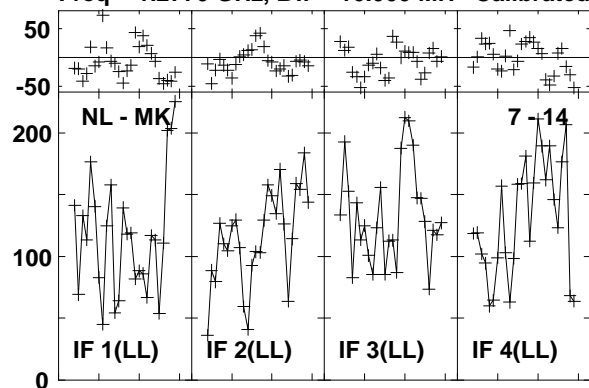

Lower frame: Milli Ampl Jy Top frame: Phas deg
Vector averaged cross-power spectrum Baseline: NL (07) - MK (14)
Timerange: 00/17:43:28 to 00/17:44:26

Plot file version 286 created 03-MAR-2016 01:12:45

4C52 GN002C 1.UVDATA.1

Freq = 1.2770 GHz, Bw = 16.000 MH Calibrated with CL # 3 and BP # 1 (BP mode 1)

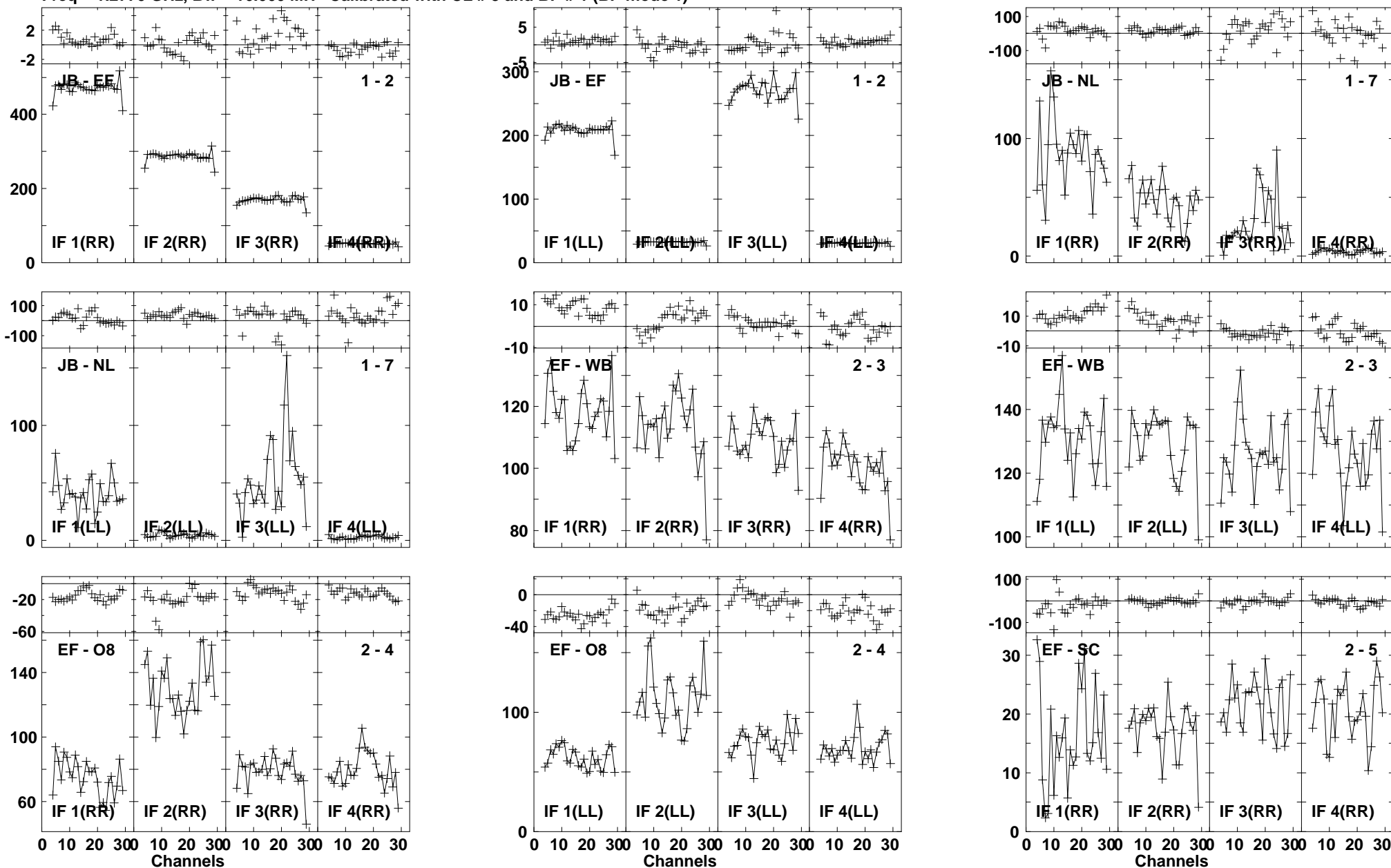

Lower frame: Milli Ampl Jy Top frame: Phas deg
Vector averaged cross-power spectrum Baseline: JB (01) - EF (02)
Timerange: 00/17:44:31 to 00/17:47:25

Plot file version 287 created 03-MAR-2016 01:12:46

4C52 GN002C 1.UVDATA.1

Freq = 1.2770 GHz, Bw = 16.000 MH Calibrated with CL # 3 and BP # 1 (BP mode 1)

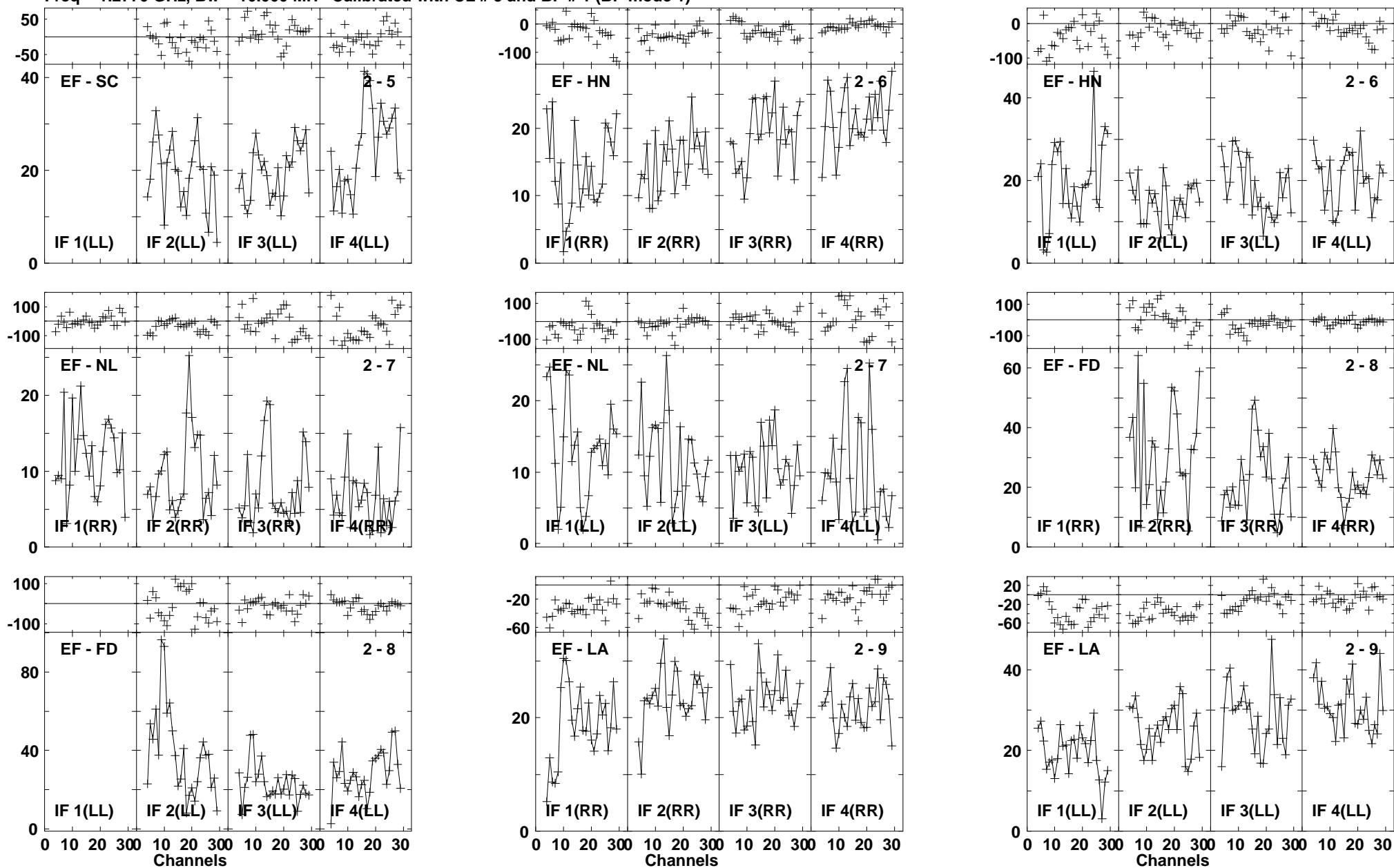

Lower frame: Milli Ampl Jy Top frame: Phas deg
Vector averaged cross-power spectrum Baseline: EF (02) - SC (05)
Timerange: 00/17:44:31 to 00/17:47:25

Plot file version 288 created 03-MAR-2016 01:12:46

4C52 GN002C 1.UVDATA.1

Freq = 1.2770 GHz, Bw = 16.000 MH Calibrated with CL # 3 and BP # 1 (BP mode 1)

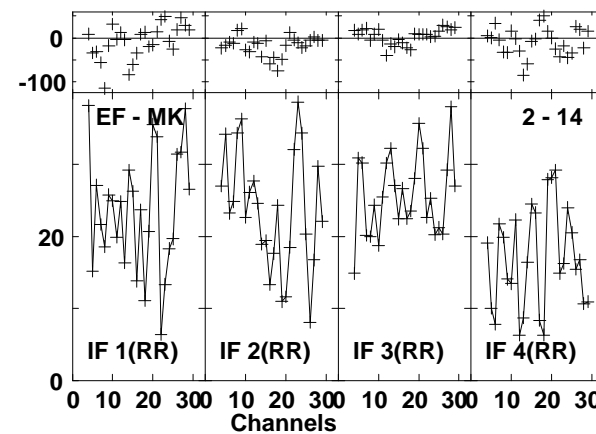
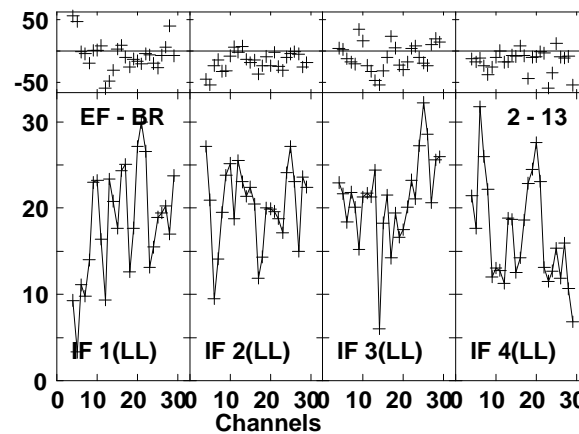
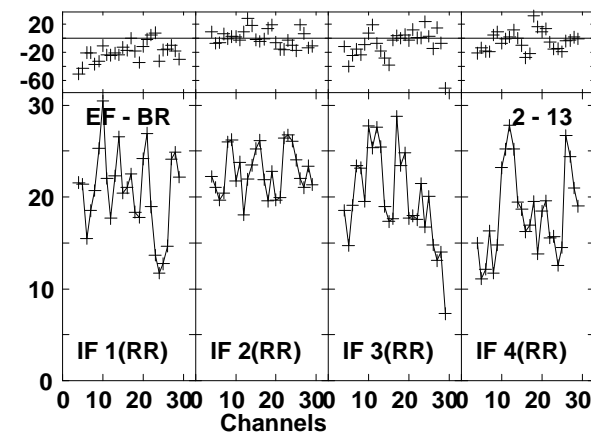
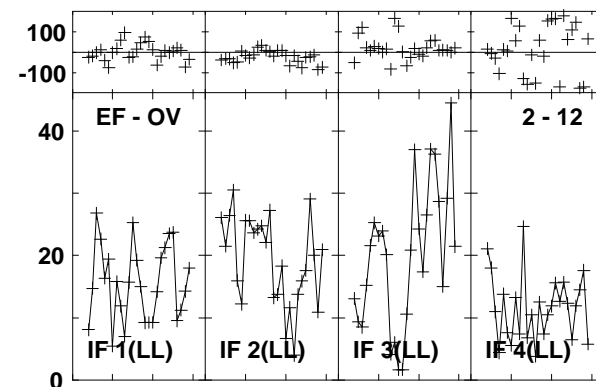
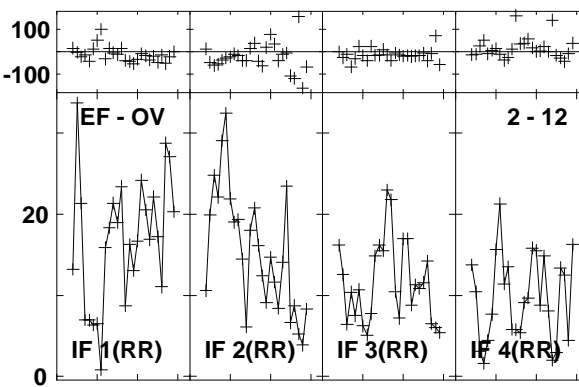
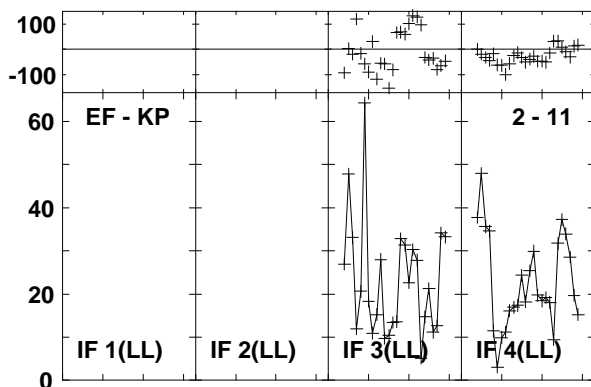
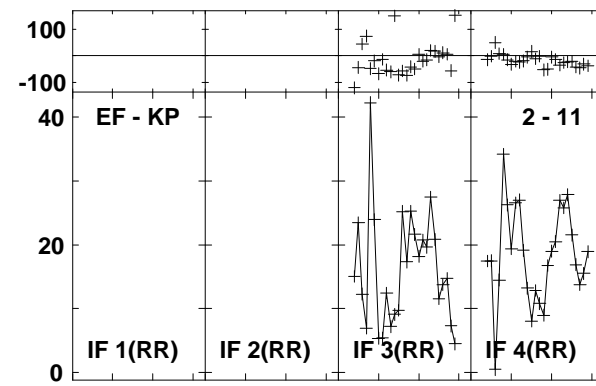
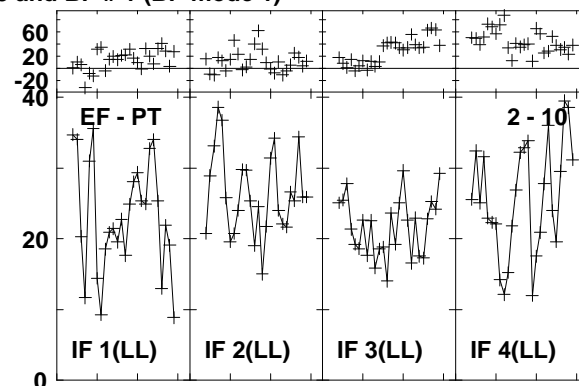
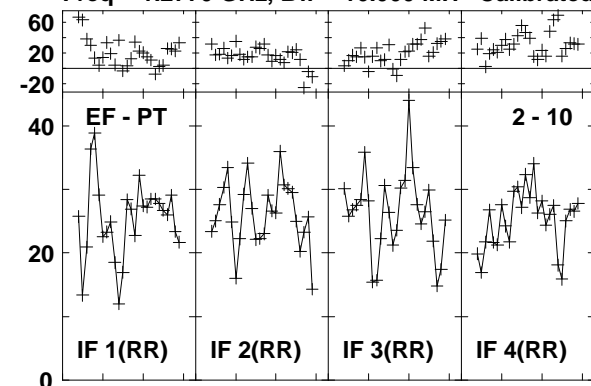

Lower frame: Milli Ampl Jy Top frame: Phas deg
Vector averaged cross-power spectrum Baseline: EF (02) - PT (10)
Timerange: 00/17:44:31 to 00/17:47:25

Plot file version 289 created 03-MAR-2016 01:12:46

4C52 GN002C 1.UVDATA.1

Freq = 1.2770 GHz, Bw = 16.000 MH Calibrated with CL # 3 and BP # 1 (BP mode 1)

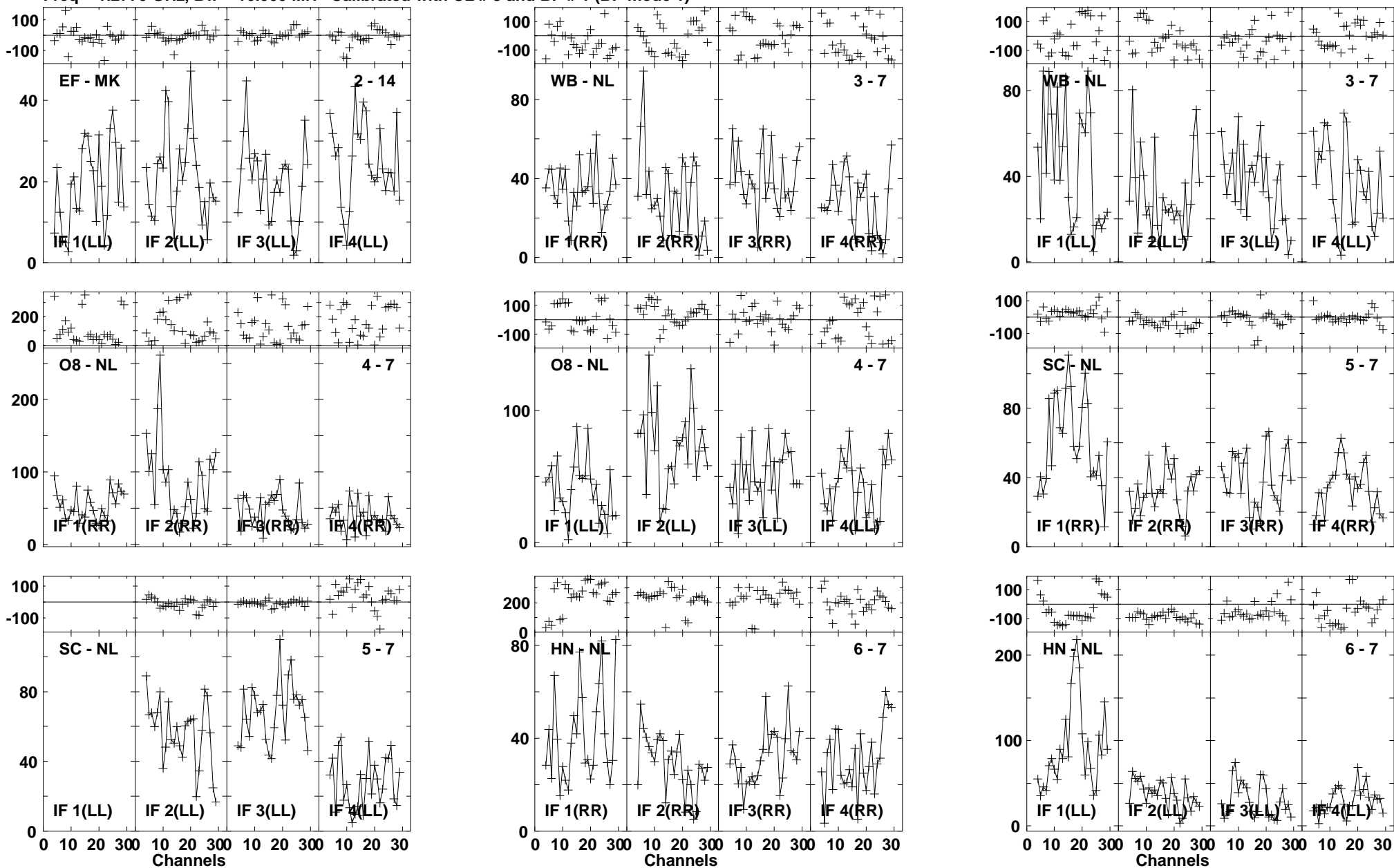

Lower frame: Milli Ampl Jy Top frame: Phas deg
Vector averaged cross-power spectrum Baseline: EF (02) - MK (14)
Timerange: 00:17:44:31 to 00:17:47:25

Plot file version 290 created 03-MAR-2016 01:12:46

4C52 GN002C 1.UVDATA.1

Freq = 1.2770 GHz, Bw = 16.000 MH Calibrated with CL # 3 and BP # 1 (BP mode 1)

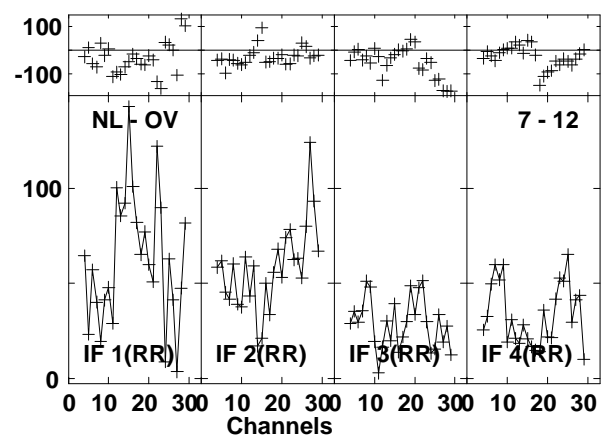
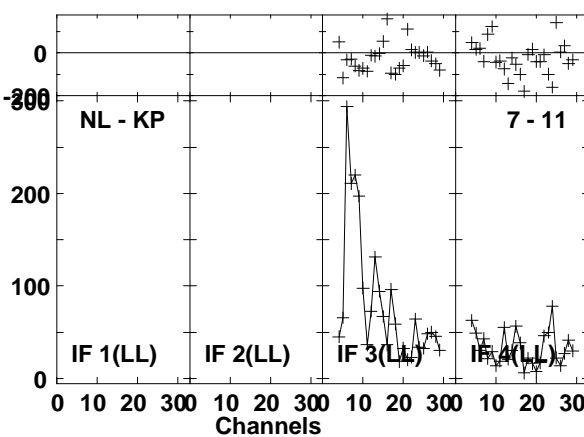
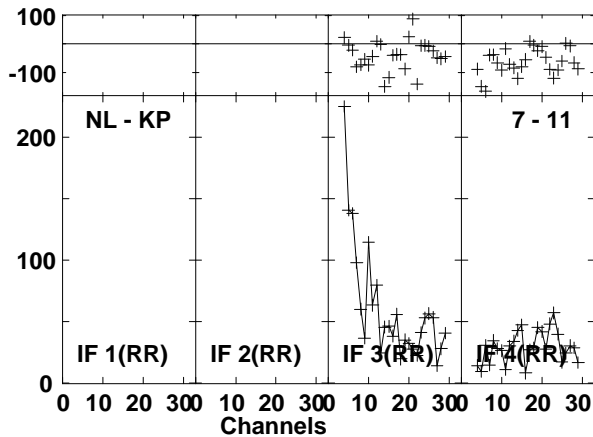
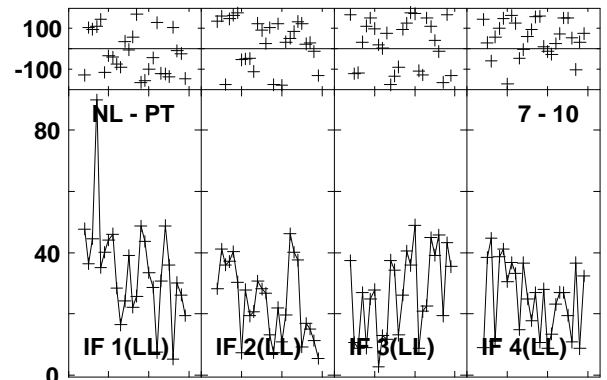
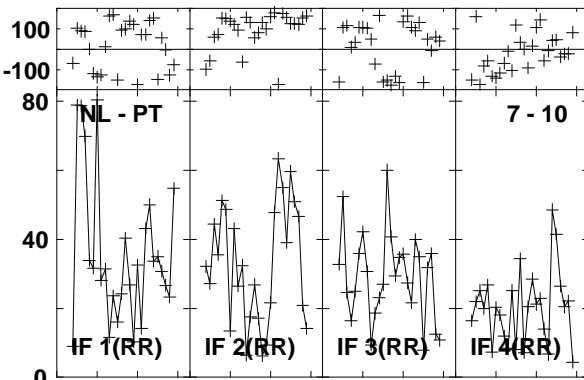
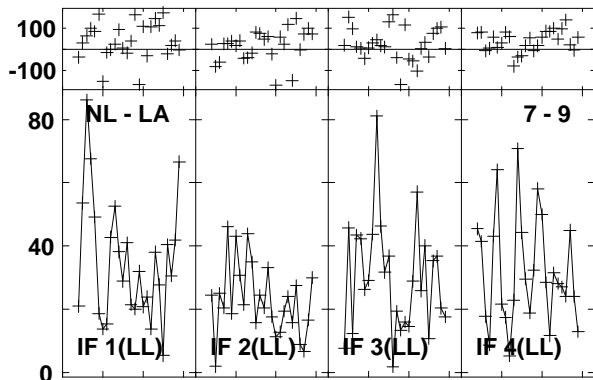
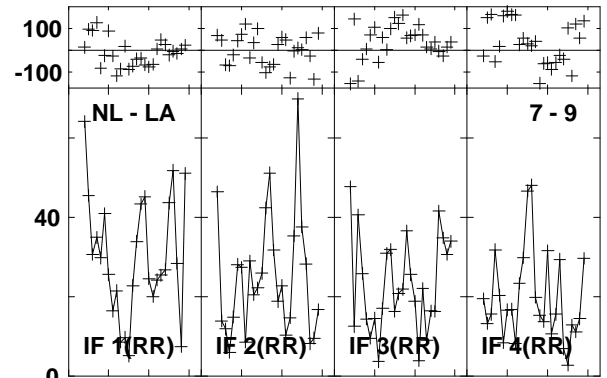
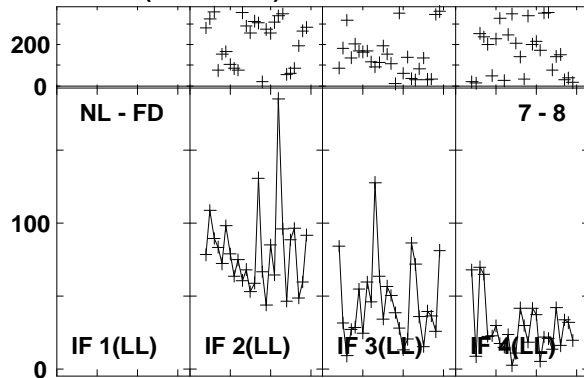
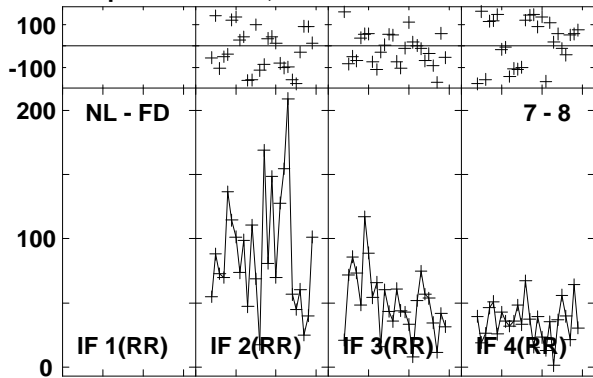

Lower frame: Milli Ampl Jy Top frame: Phas deg
Vector averaged cross-power spectrum Baseline: NL (07) - FD (08)
Timerange: 00/17:44:31 to 00/17:47:25

Plot file version 291 created 03-MAR-2016 01:12:46
 4C52 GN002C 1.UVDATA.1
 Freq = 1.2770 GHz, Bw = 16.000 MH Calibrated with CL # 3 and BP # 1 (BP mode 1)

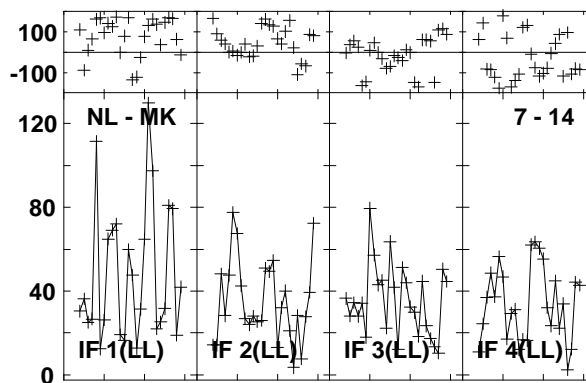
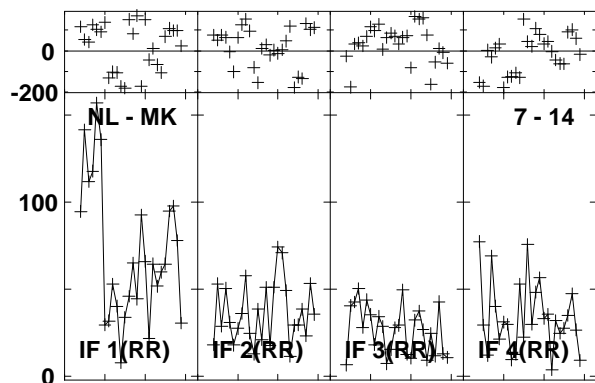
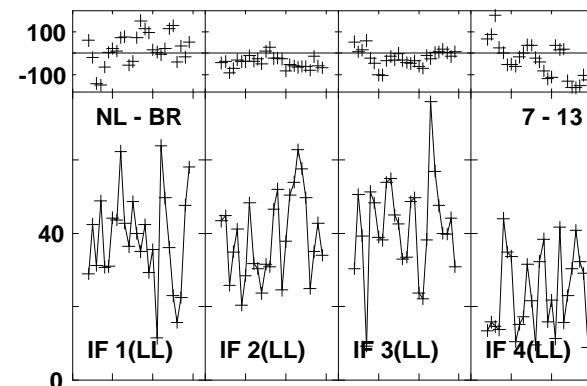
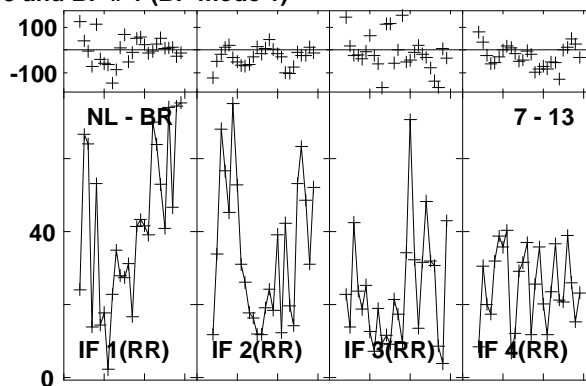
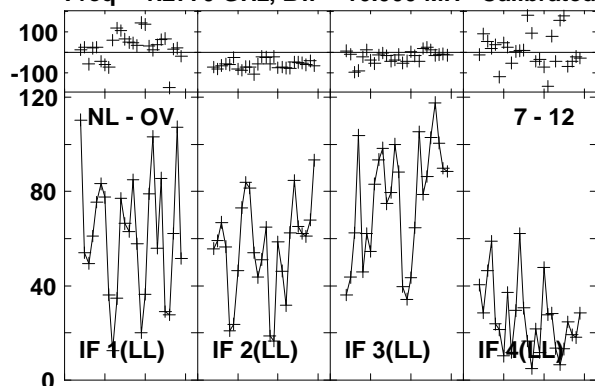

Lower frame: Milli Ampl Jy Top frame: Phas deg
 Vector averaged cross-power spectrum Baseline: NL (07) - OV (12)
 Timerange: 00/17:44:31 to 00/17:47:25

Plot file version 292 created 03-MAR-2016 01:12:46

J1545+5400 GN002C 1.UVDATA.1

Freq = 1.2770 GHz, Bw = 16.000 MH Calibrated with CL # 3 and BP # 1 (BP mode 1)

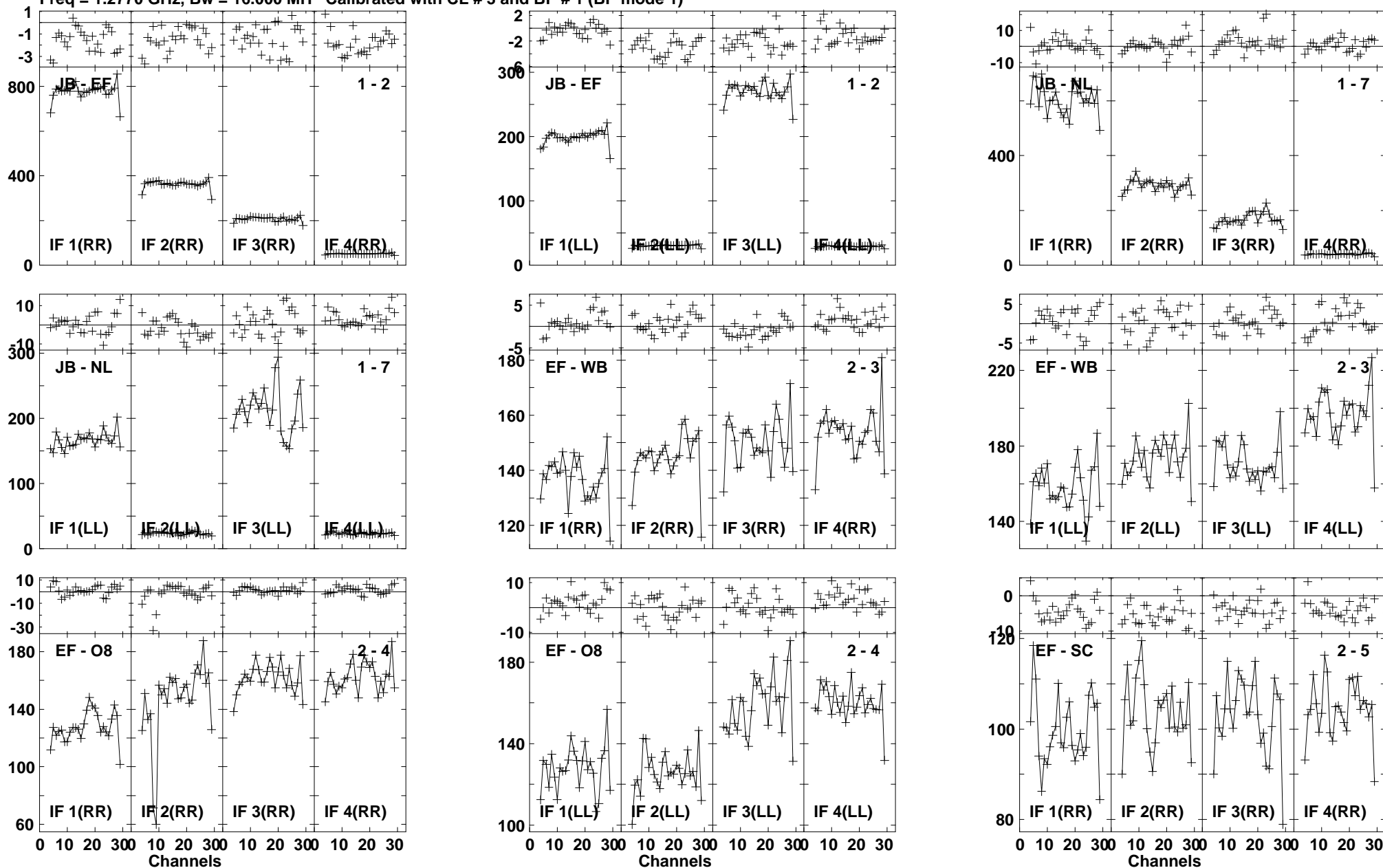

Lower frame: Milli Ampl Jy Top frame: Phas deg
Vector averaged cross-power spectrum Baseline: JB (01) - EF (02)
Timerange: 00/17:48:18 to 00/17:50:16

Plot file version 293 created 03-MAR-2016 01:12:47

J1545+5400 GN002C 1.UVDATA.1

Freq = 1.2770 GHz, Bw = 16.000 MH Calibrated with CL # 3 and BP # 1 (BP mode 1)

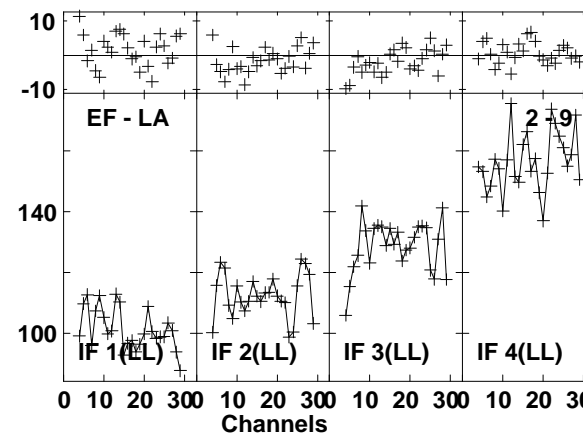
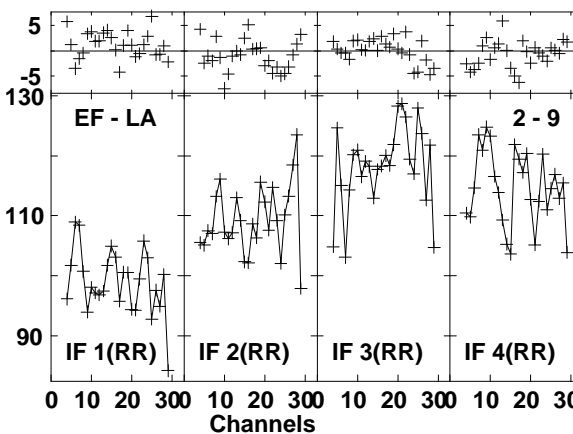
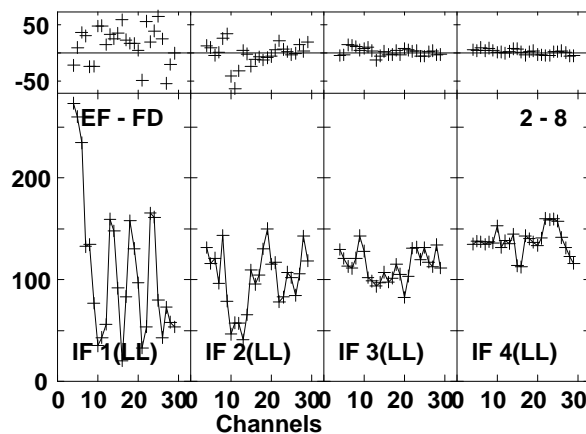
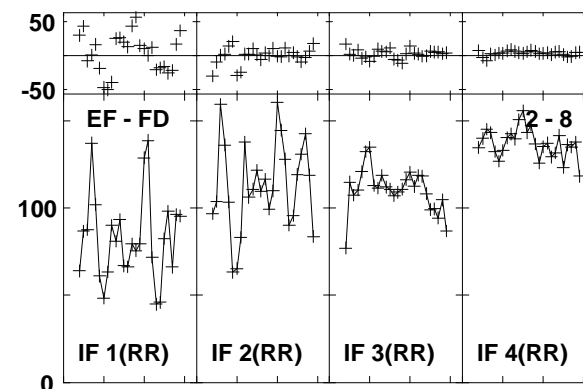
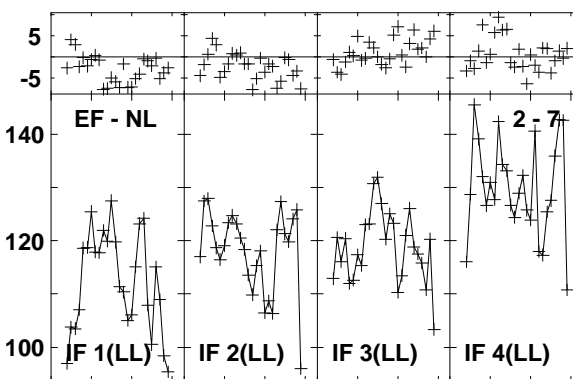
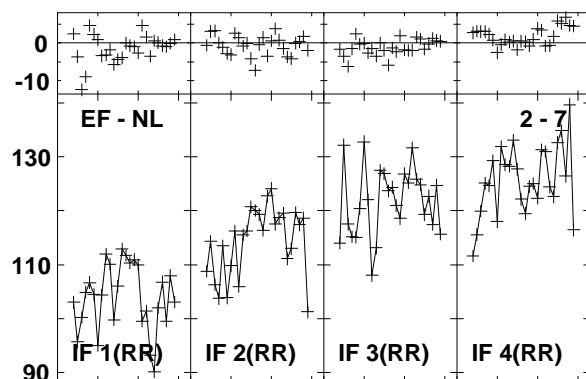
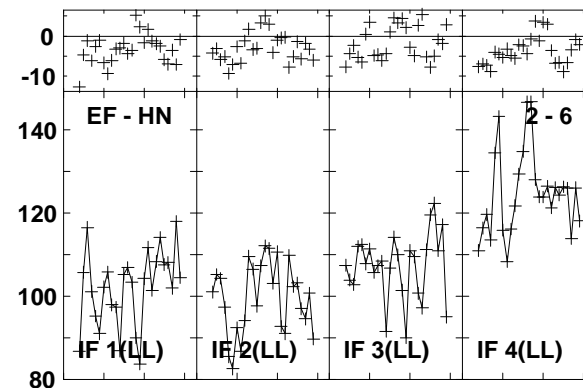
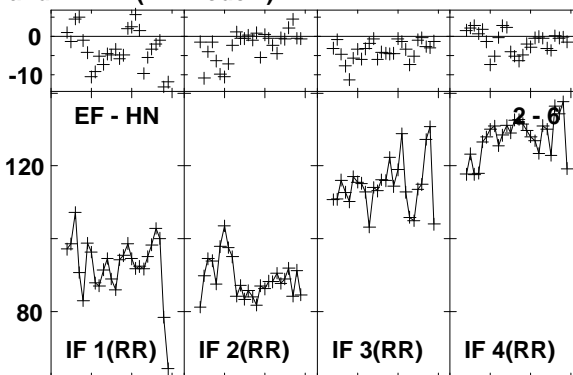
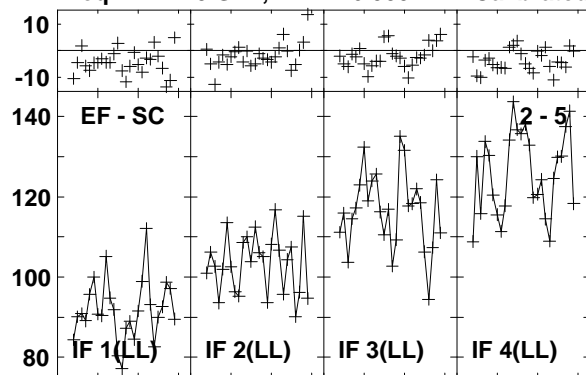

Lower frame: Milli Ampl Jy Top frame: Phas deg
Vector averaged cross-power spectrum Baseline: EF (02) - SC (05)
Timerange: 00/17:48:18 to 00/17:50:16

Plot file version 294 created 03-MAR-2016 01:12:47

J1545+5400 GN002C 1.UVDATA.1

Freq = 1.2770 GHz, Bw = 16.000 MH Calibrated with CL # 3 and BP # 1 (BP mode 1)

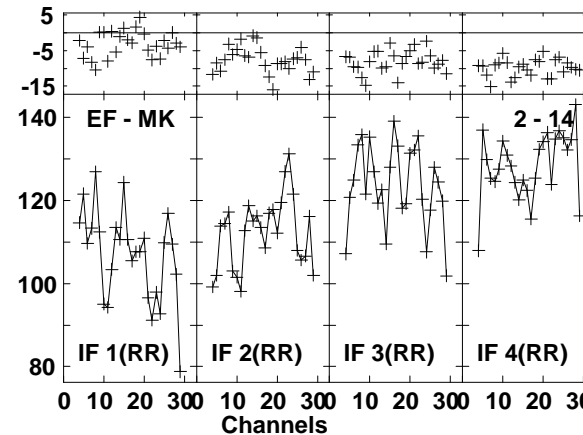
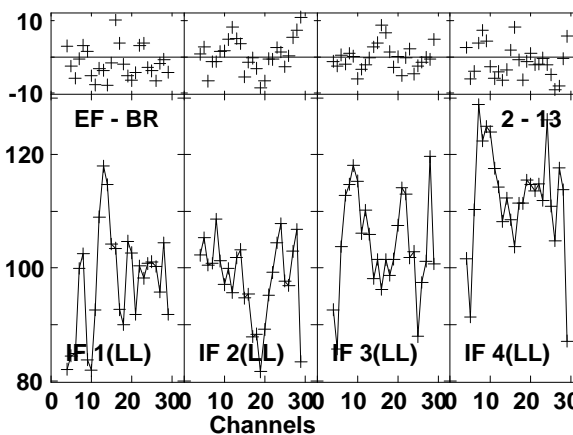
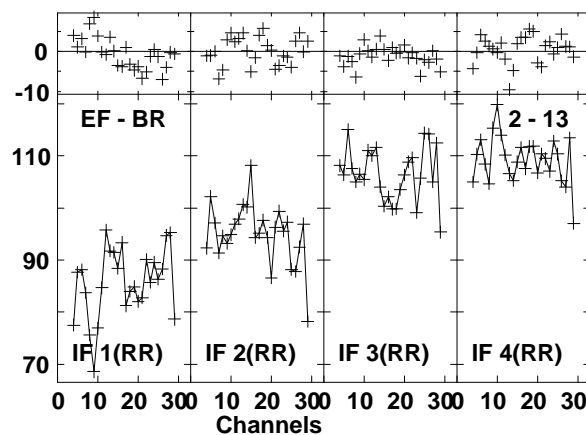
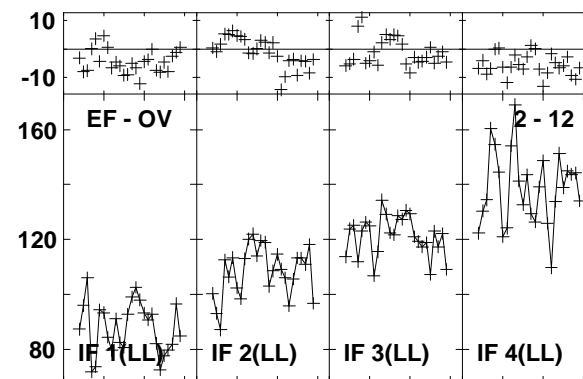
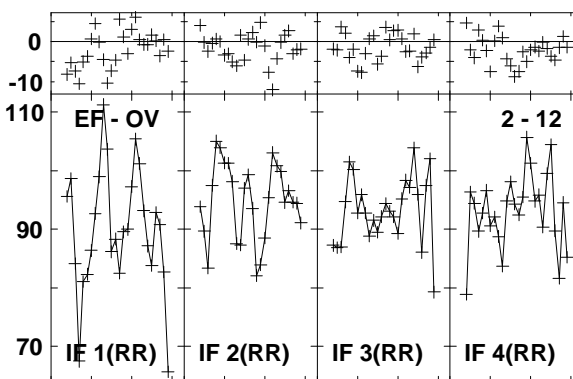
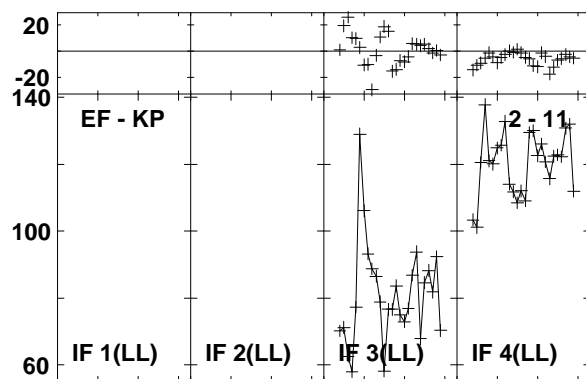
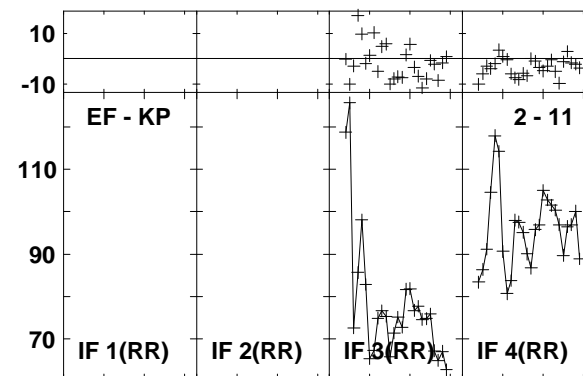
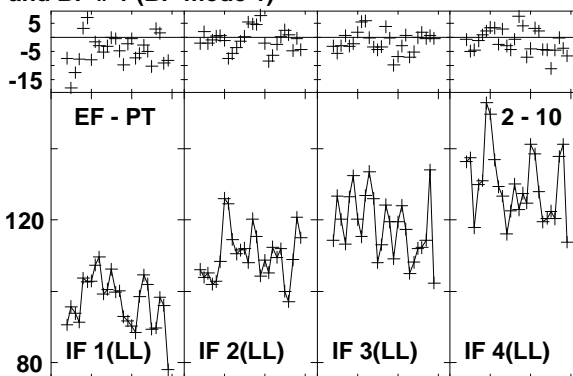
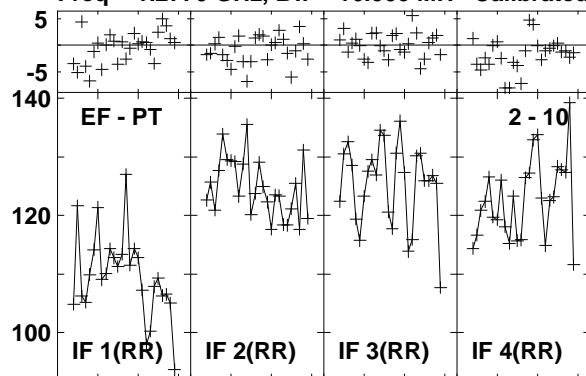

Lower frame: Milli Ampl Jy Top frame: Phas deg
Vector averaged cross-power spectrum Baseline: EF (02) - PT (10)
Timerange: 00/17:48:18 to 00/17:50:16

Plot file version 295 created 03-MAR-2016 01:12:47

J1545+5400 GN002C 1.UVDATA.1

Freq = 1.2770 GHz, Bw = 16.000 MH Calibrated with CL # 3 and BP # 1 (BP mode 1)

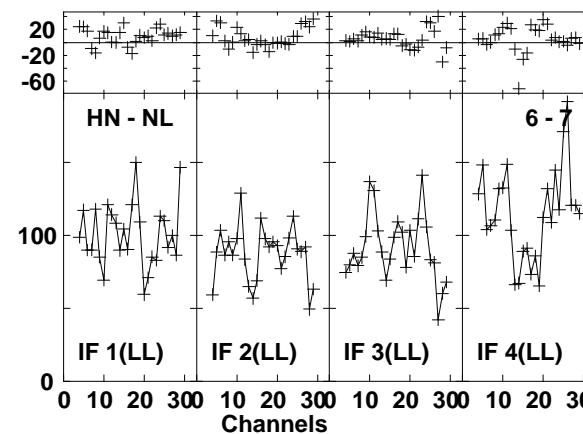
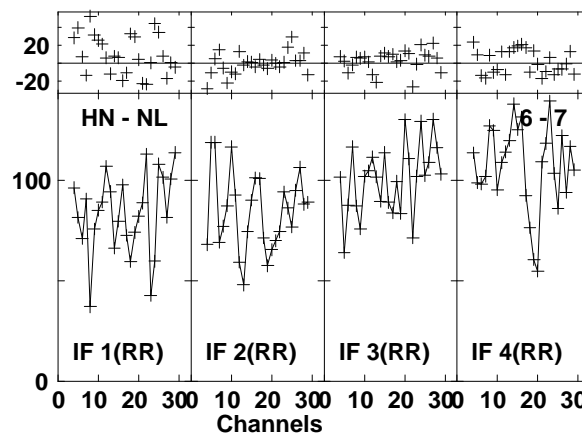
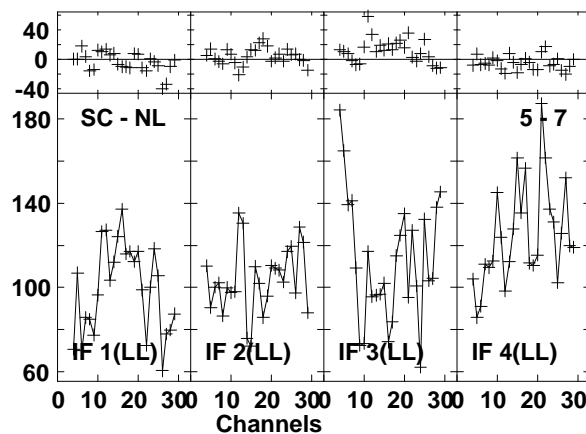
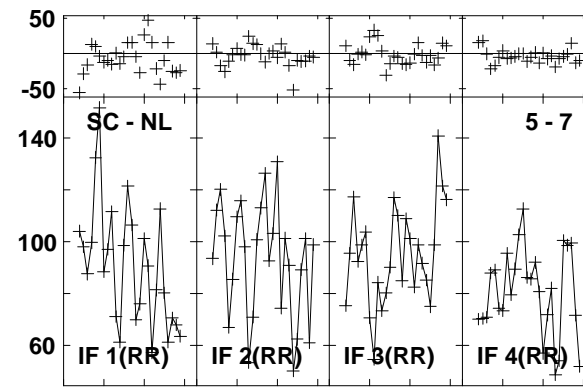
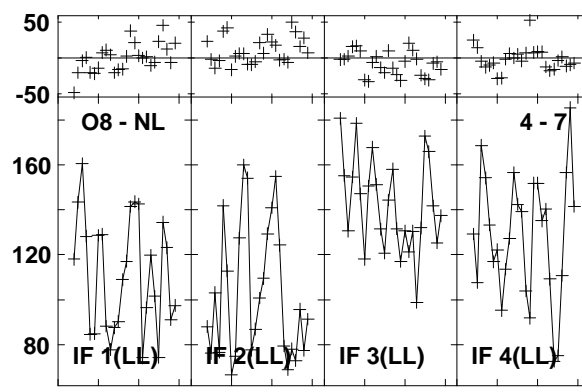
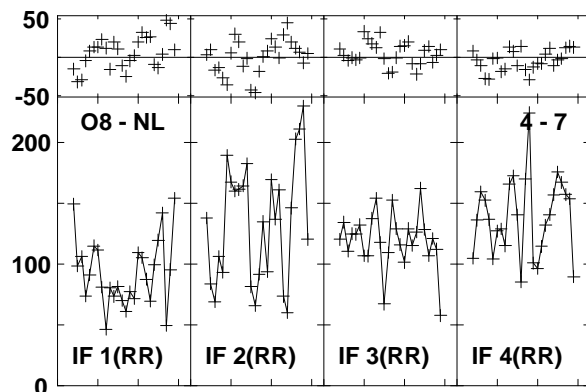
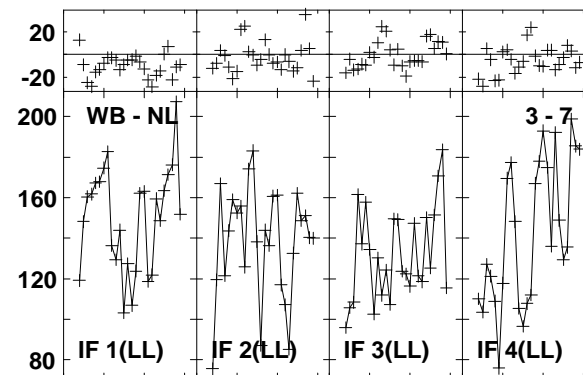
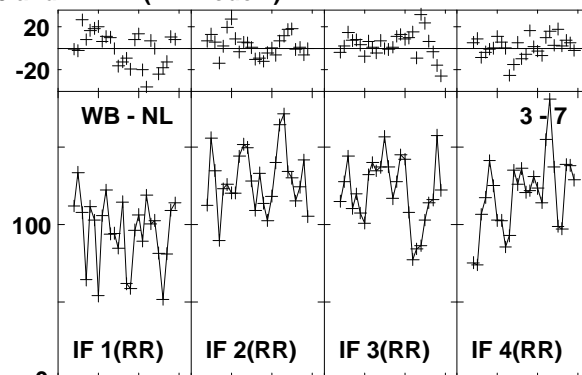
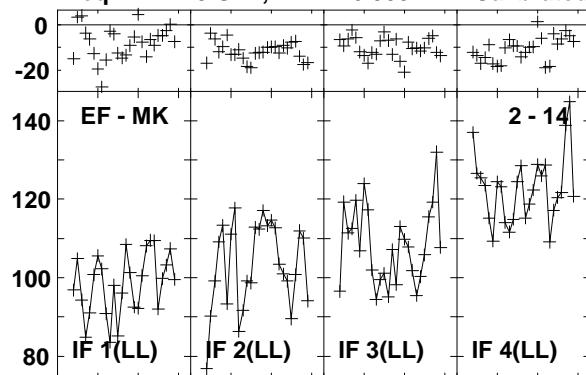

Lower frame: Milli Ampl Jy Top frame: Phas deg
Vector averaged cross-power spectrum Baseline: EF (02) - MK (14)
Timerange: 00/17:48:18 to 00/17:50:16

Plot file version 296 created 03-MAR-2016 01:12:47

J1545+5400 GN002C 1.UVDATA.1

Freq = 1.2770 GHz, Bw = 16.000 MH Calibrated with CL # 3 and BP # 1 (BP mode 1)

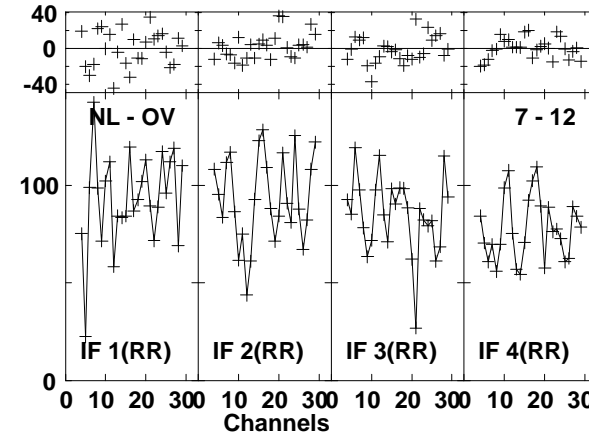
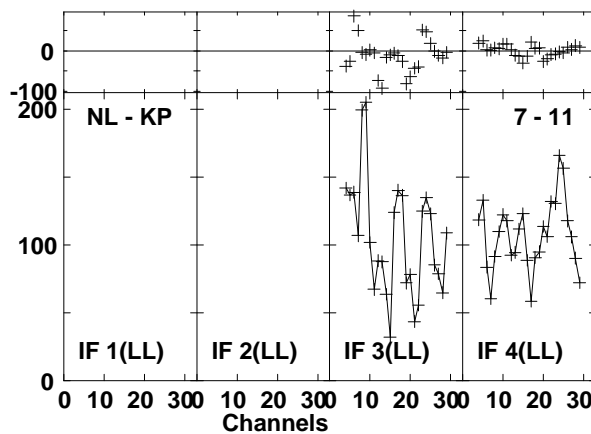
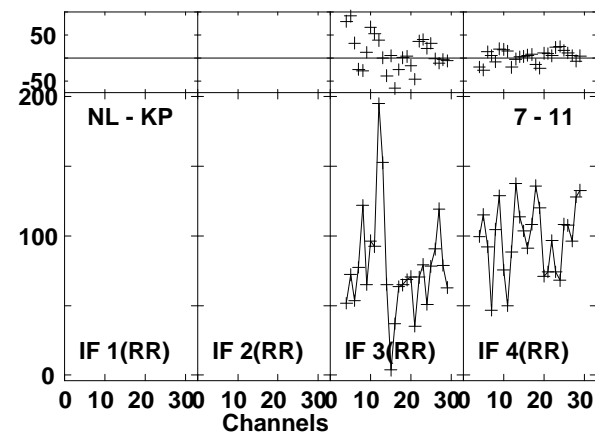
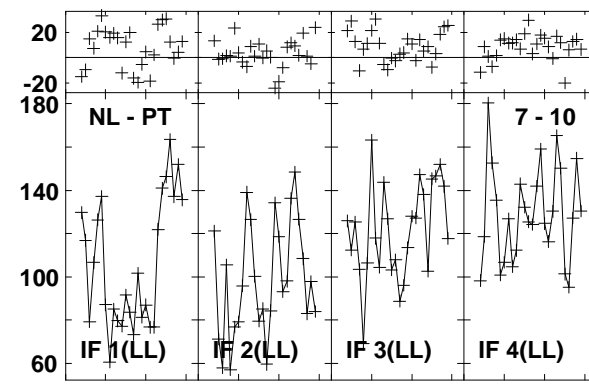
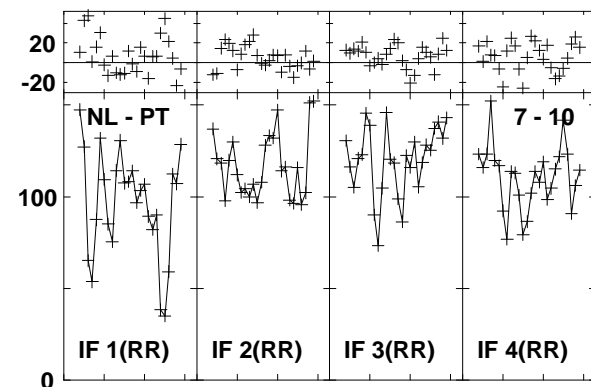
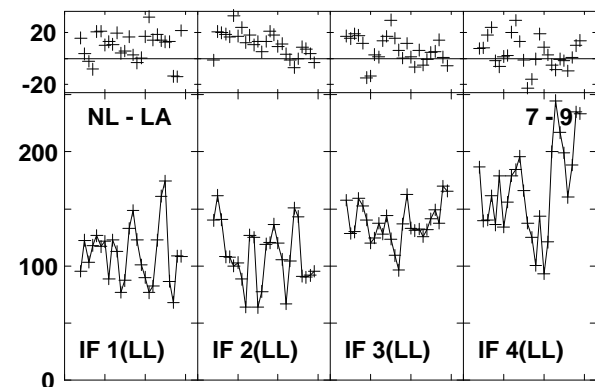
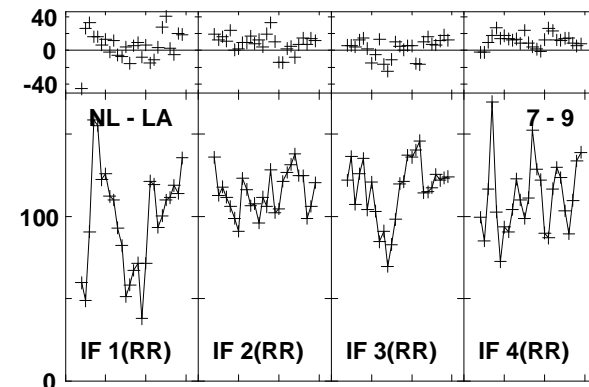
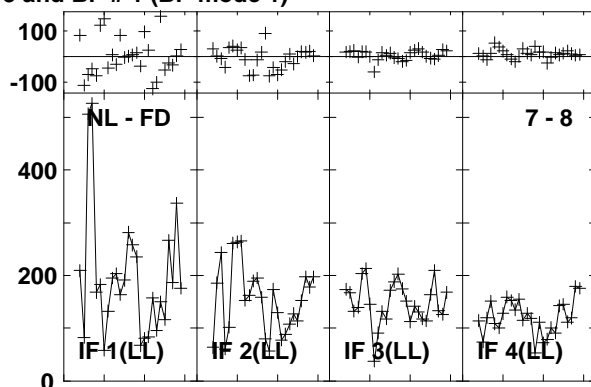
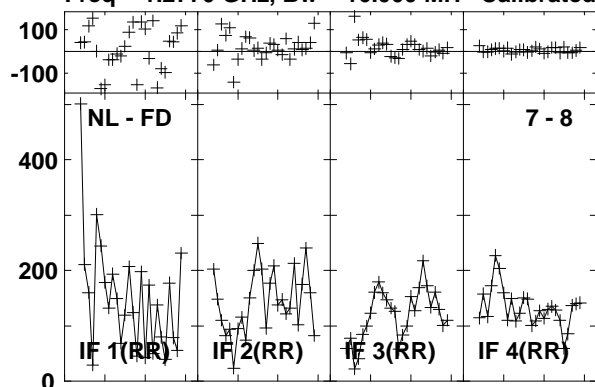

Lower frame: Milli Ampl Jy Top frame: Phas deg
Vector averaged cross-power spectrum Baseline: NL (07) - FD (08)
Timerange: 00/17:48:18 to 00/17:50:16

Plot file version 297 created 03-MAR-2016 01:12:47
 J1545+5400 GN002C 1.UVDATA.1
 Freq = 1.2770 GHz, Bw = 16.000 MH Calibrated with CL # 3 and BP # 1 (BP mode 1)

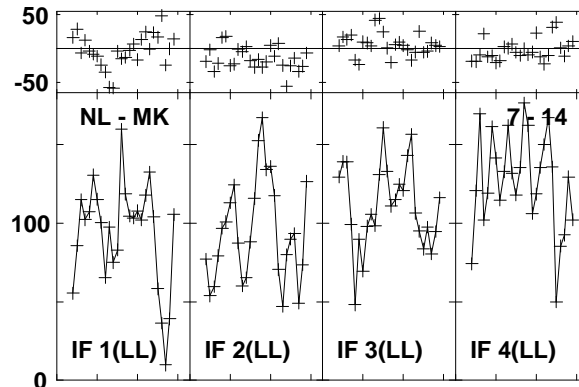
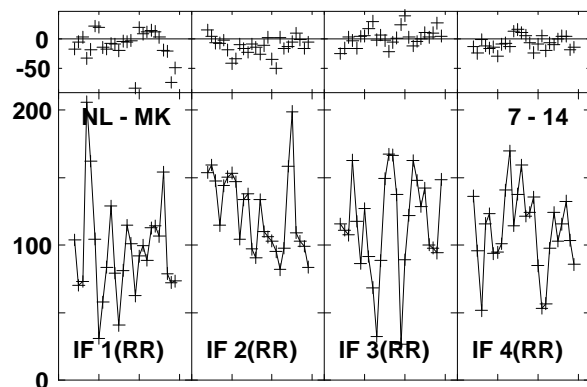
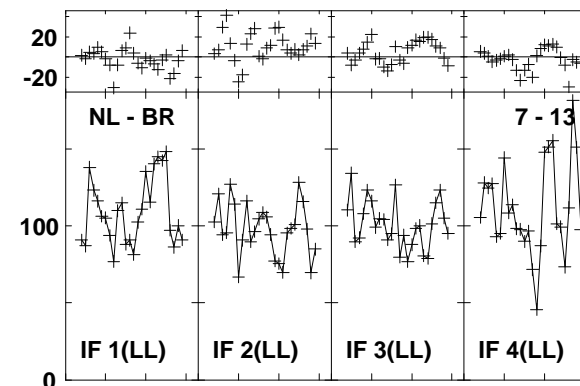
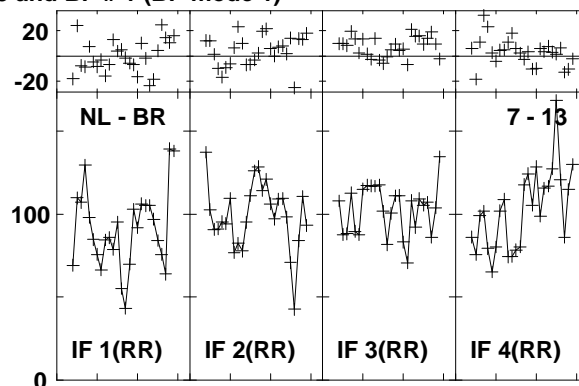
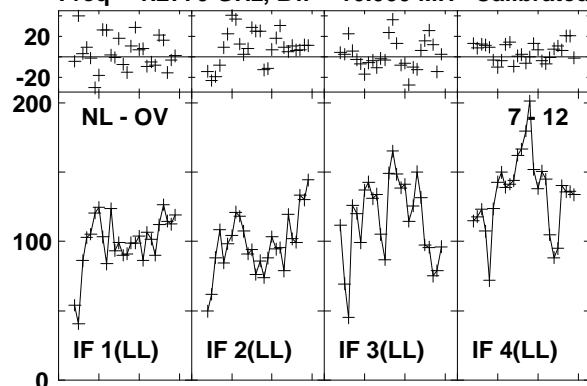

Lower frame: Milli Ampl Jy Top frame: Phas deg
 Vector averaged cross-power spectrum Baseline: NL (07) - OV (12)
 Timerange: 00/17:48:18 to 00/17:50:16

Plot file version 298 created 03-MAR-2016 01:12:47

4C52 GN002C 1.UVDATA.1

Freq = 1.2770 GHz, Bw = 16.000 MH Calibrated with CL # 3 and BP # 1 (BP mode 1)

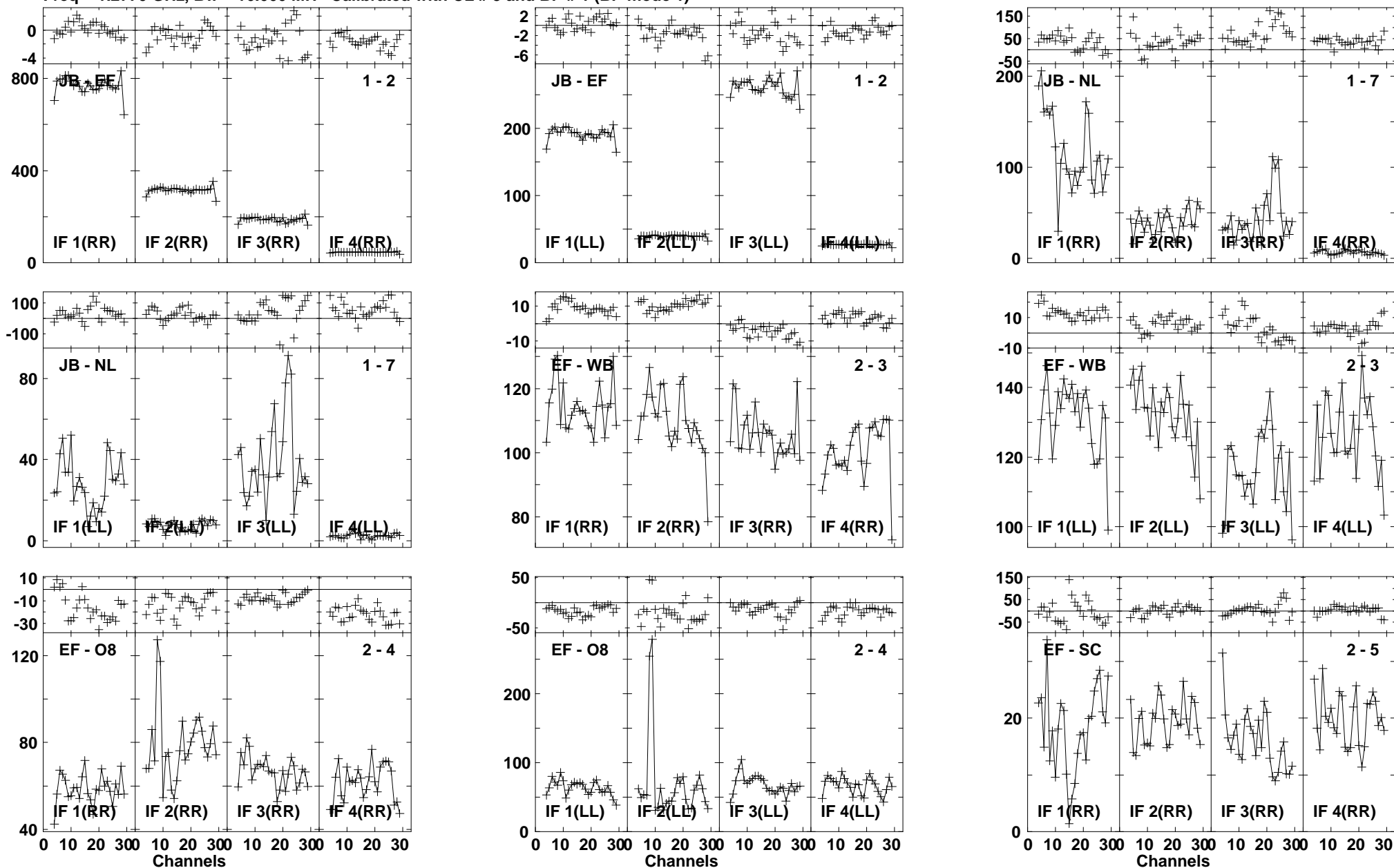

Lower frame: Milli Ampl Jy Top frame: Phas deg
Vector averaged cross-power spectrum Baseline: JB (01) - EF (02)
Timerange: 00/17:50:29 to 00/17:53:15

Plot file version 299 created 03-MAR-2016 01:12:48

4C52 GN002C 1.UVDATA.1

Freq = 1.2770 GHz, Bw = 16.000 MH Calibrated with CL # 3 and BP # 1 (BP mode 1)

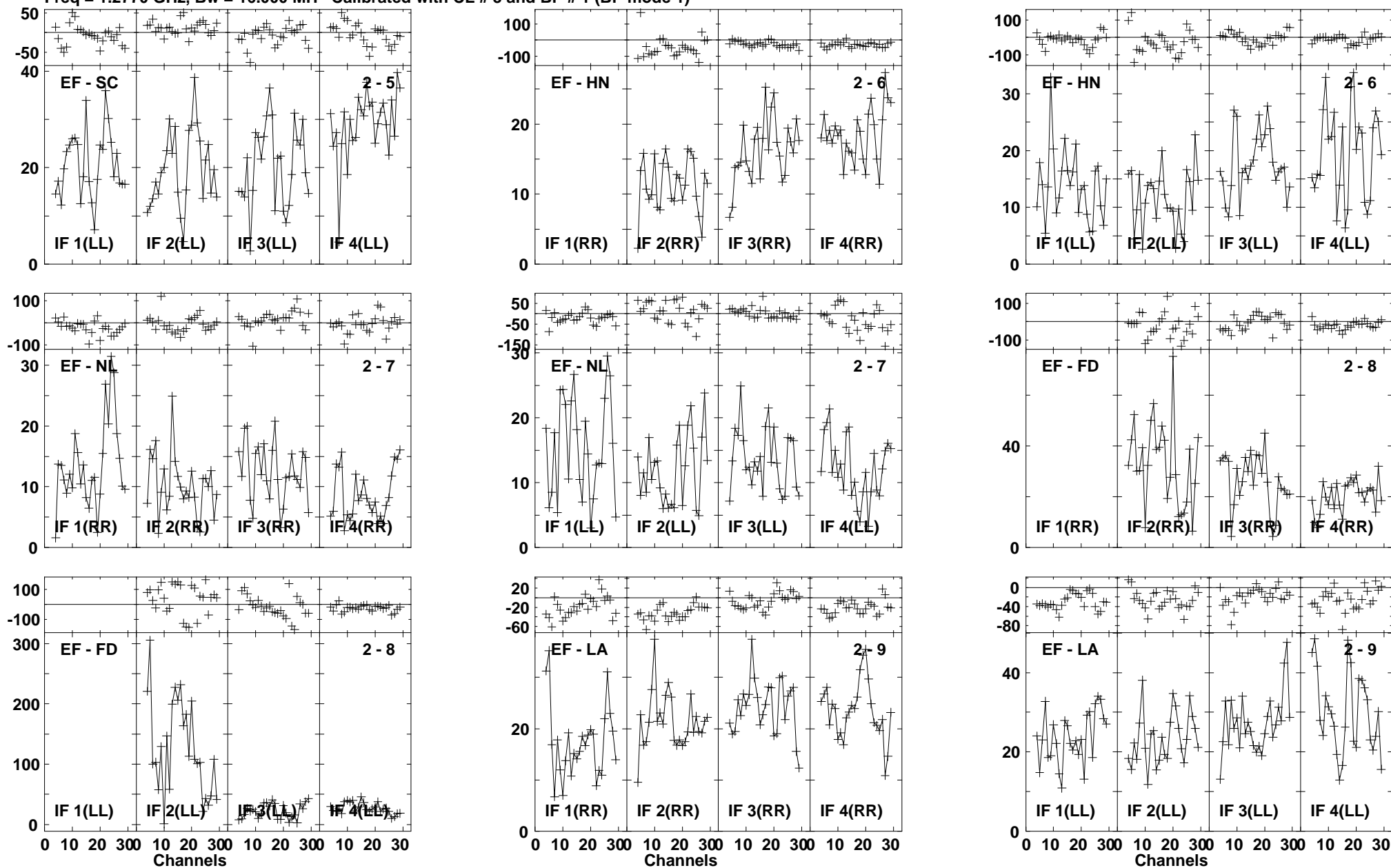

Lower frame: Milli Ampl Jy Top frame: Phas deg
Vector averaged cross-power spectrum Baseline: EF (02) - SC (05)
Timerange: 00/17:50:29 to 00/17:53:15

Plot file version 300 created 03-MAR-2016 01:12:48

4C52 GN002C 1.UVDATA.1

Freq = 1.2770 GHz, Bw = 16.000 MH Calibrated with CL # 3 and BP # 1 (BP mode 1)

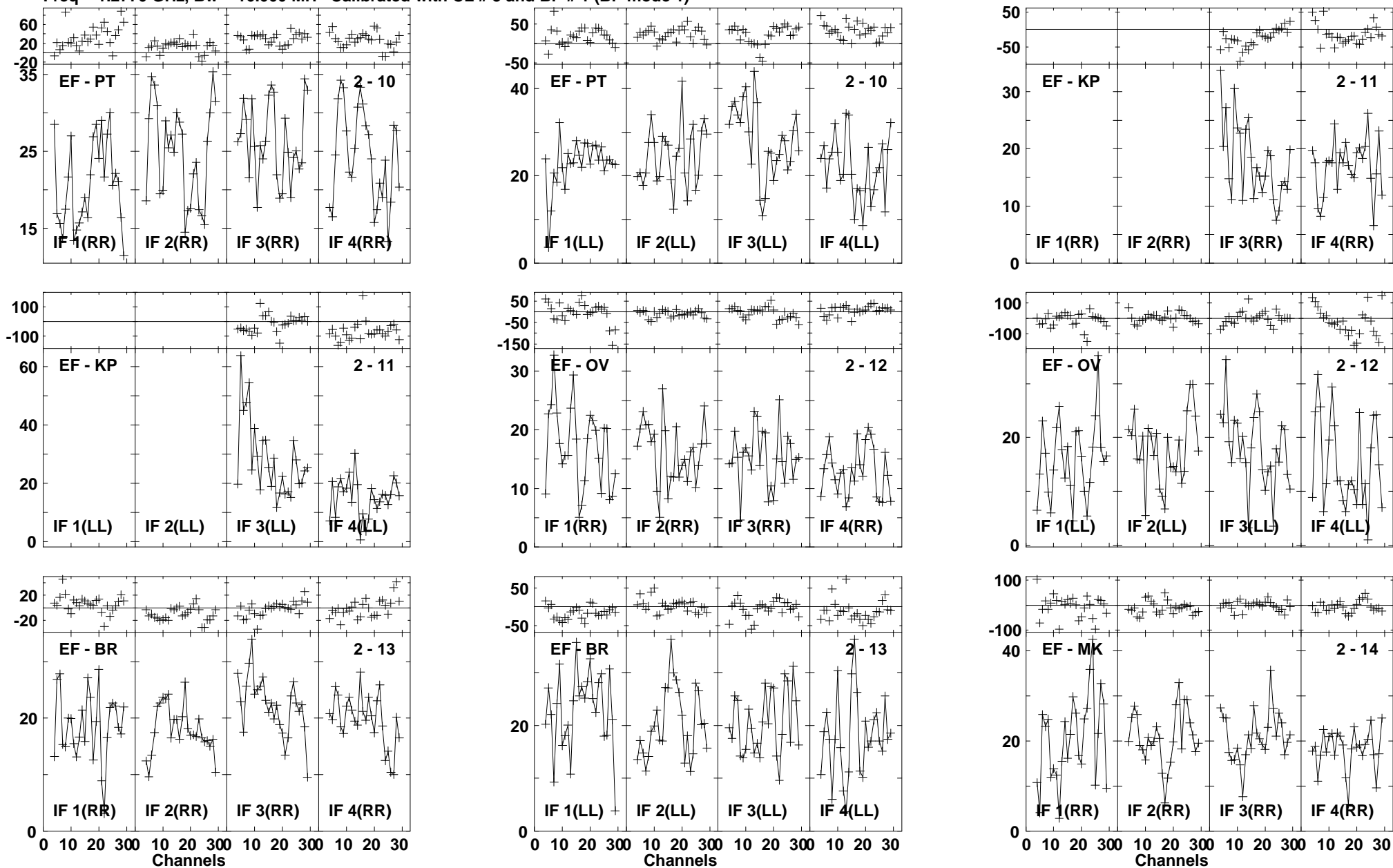

Lower frame: Milli Ampl Jy Top frame: Phas deg
Vector averaged cross-power spectrum Baseline: EF (02) - PT (10)
Timerange: 00/17:50:29 to 00/17:53:15

Plot file version 301 created 03-MAR-2016 01:12:48

4C52 GN002C 1.UVDATA.1

Freq = 1.2770 GHz, Bw = 16.000 MH Calibrated with CL # 3 and BP # 1 (BP mode 1)

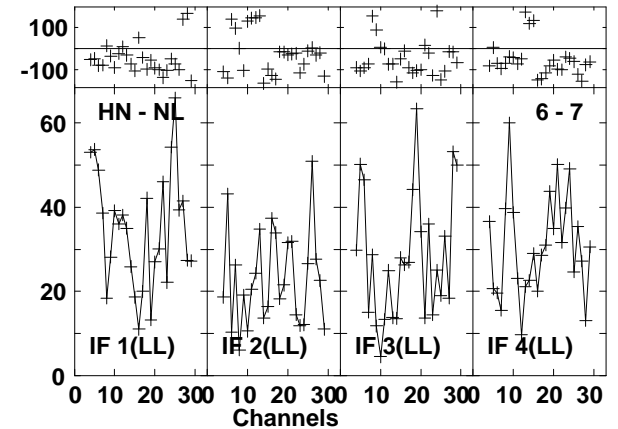
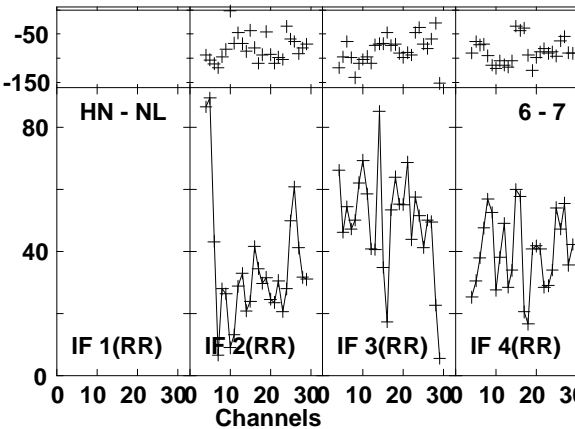
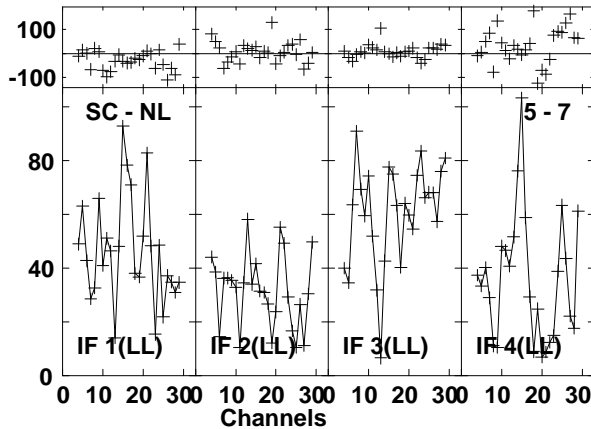
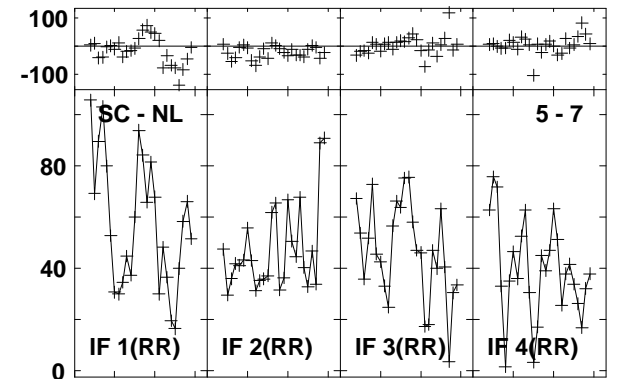
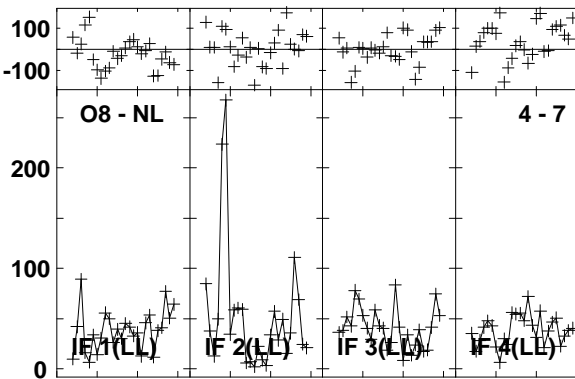
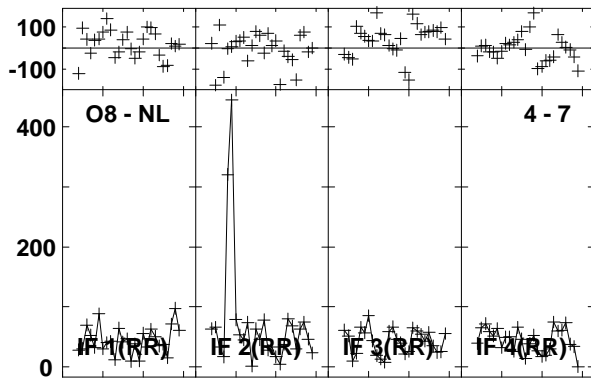
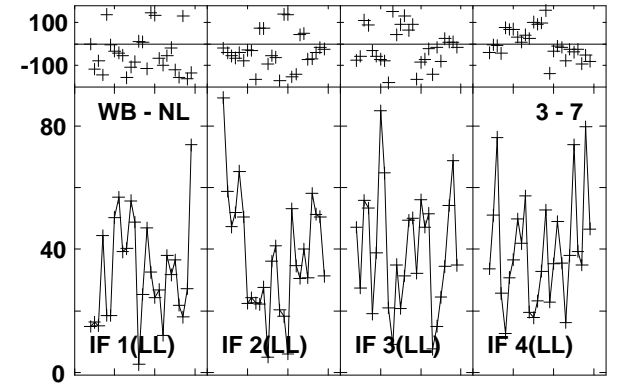
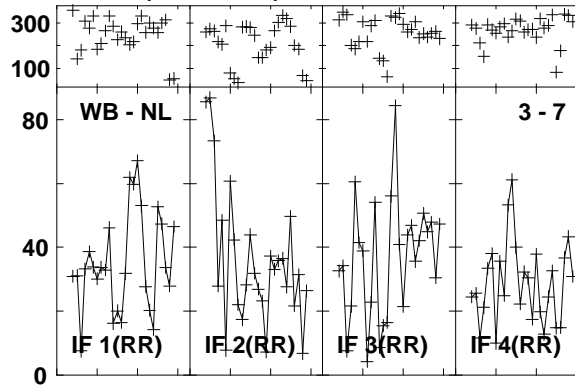
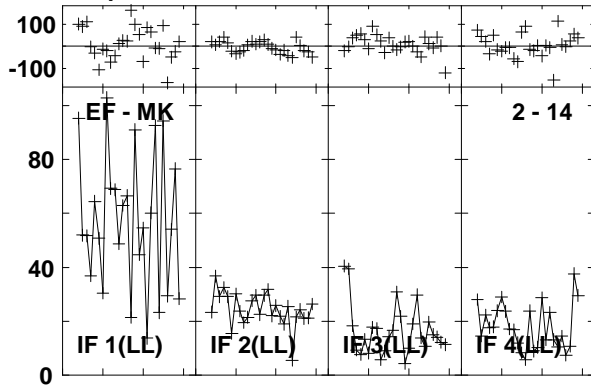

Lower frame: Milli Ampl Jy Top frame: Phas deg
Vector averaged cross-power spectrum Baseline: EF (02) - MK (14)
Timerange: 00/17:50:29 to 00/17:53:15

Plot file version 302 created 03-MAR-2016 01:12:48

4C52 GN002C 1.UVDATA.1

Freq = 1.2770 GHz, Bw = 16.000 MH Calibrated with CL # 3 and BP # 1 (BP mode 1)

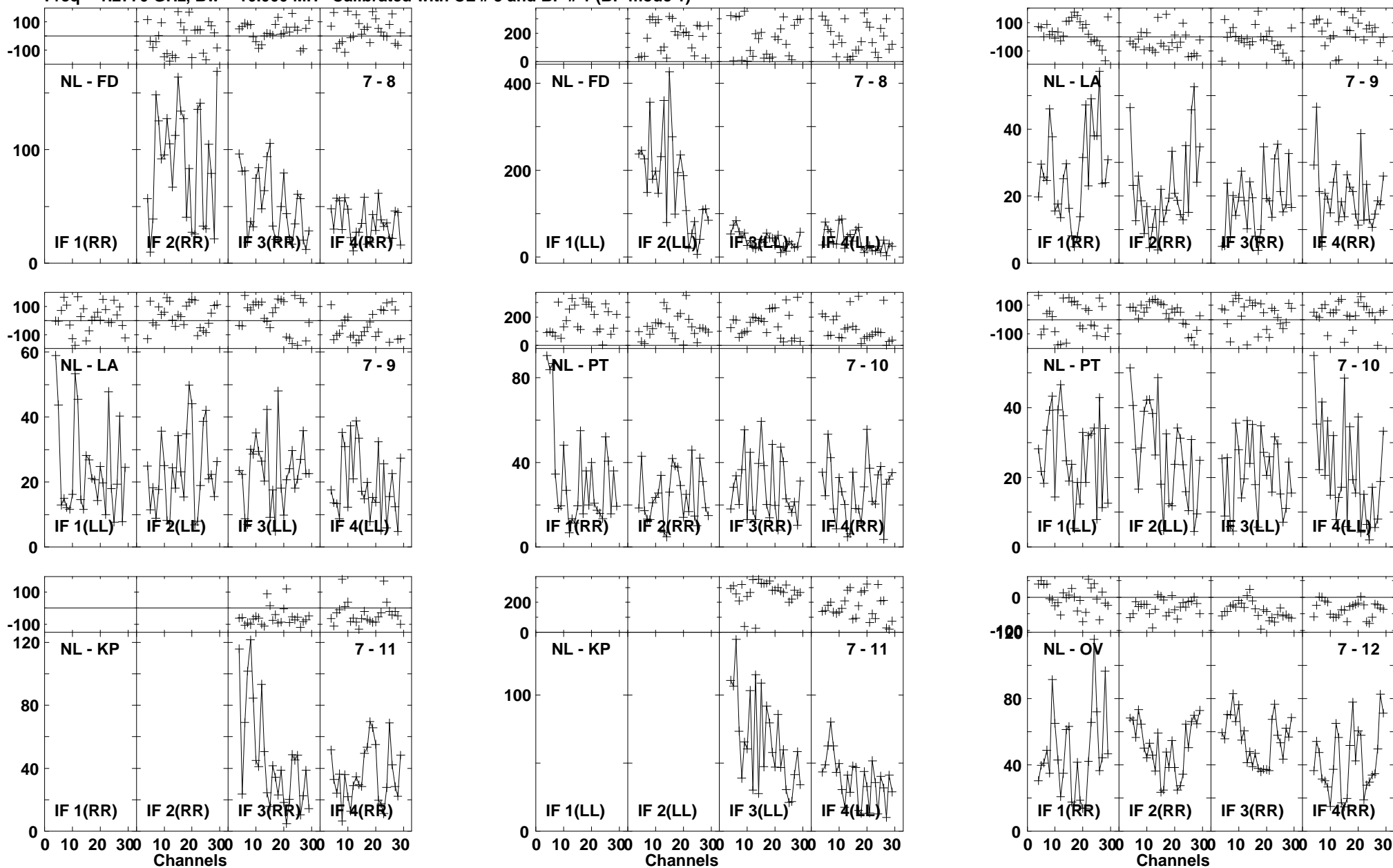

Lower frame: Milli Ampl Jy Top frame: Phas deg
Vector averaged cross-power spectrum Baseline: NL (07) - FD (08)
Timerange: 00/17:50:29 to 00/17:53:15

Plot file version 303 created 03-MAR-2016 01:12:48

4C52 GN002C 1.UVDATA.1

Freq = 1.2770 GHz, Bw = 16.000 MH Calibrated with CL # 3 and BP # 1 (BP mode 1)

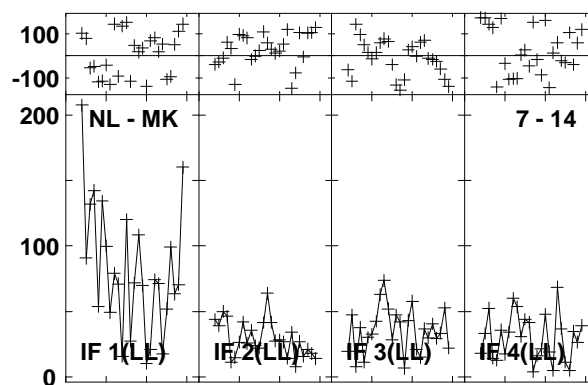
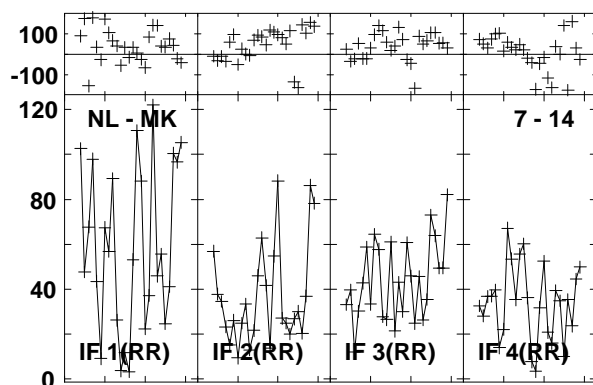
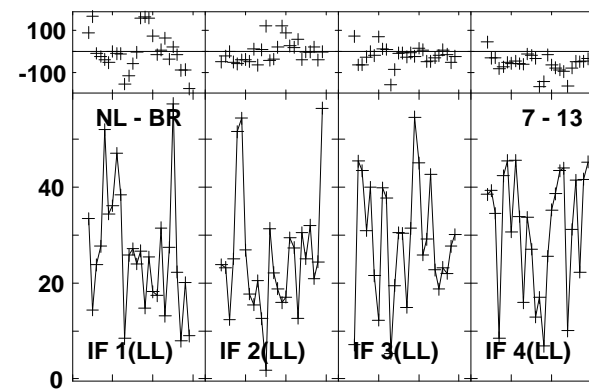
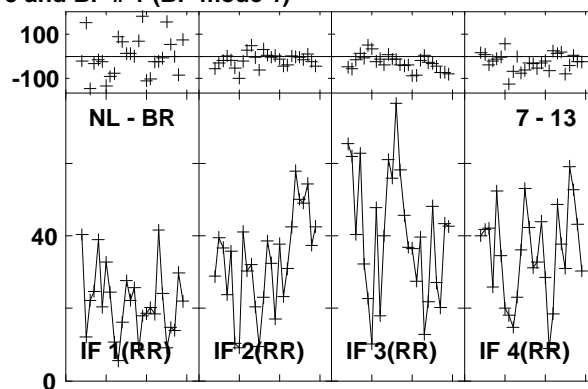
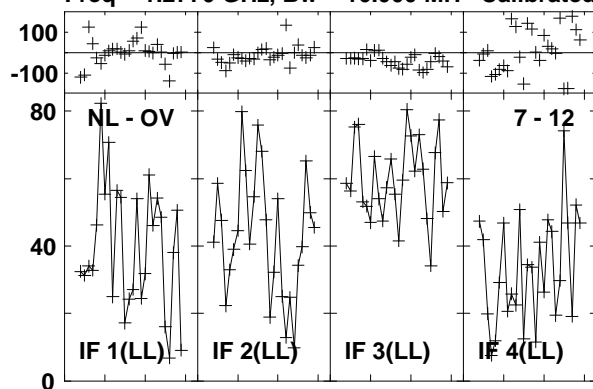

Lower frame: Milli Ampl Jy Top frame: Phas deg
Vector averaged cross-power spectrum Baseline: NL (07) - OV (12)
Timerange: 00/17:50:29 to 00/17:53:15

Plot file version 304 created 03-MAR-2016 01:12:49

J1545+5400 GN002C 1.UVDATA.1

Freq = 1.2770 GHz, Bw = 16.000 MH Calibrated with CL # 3 and BP # 1 (BP mode 1)

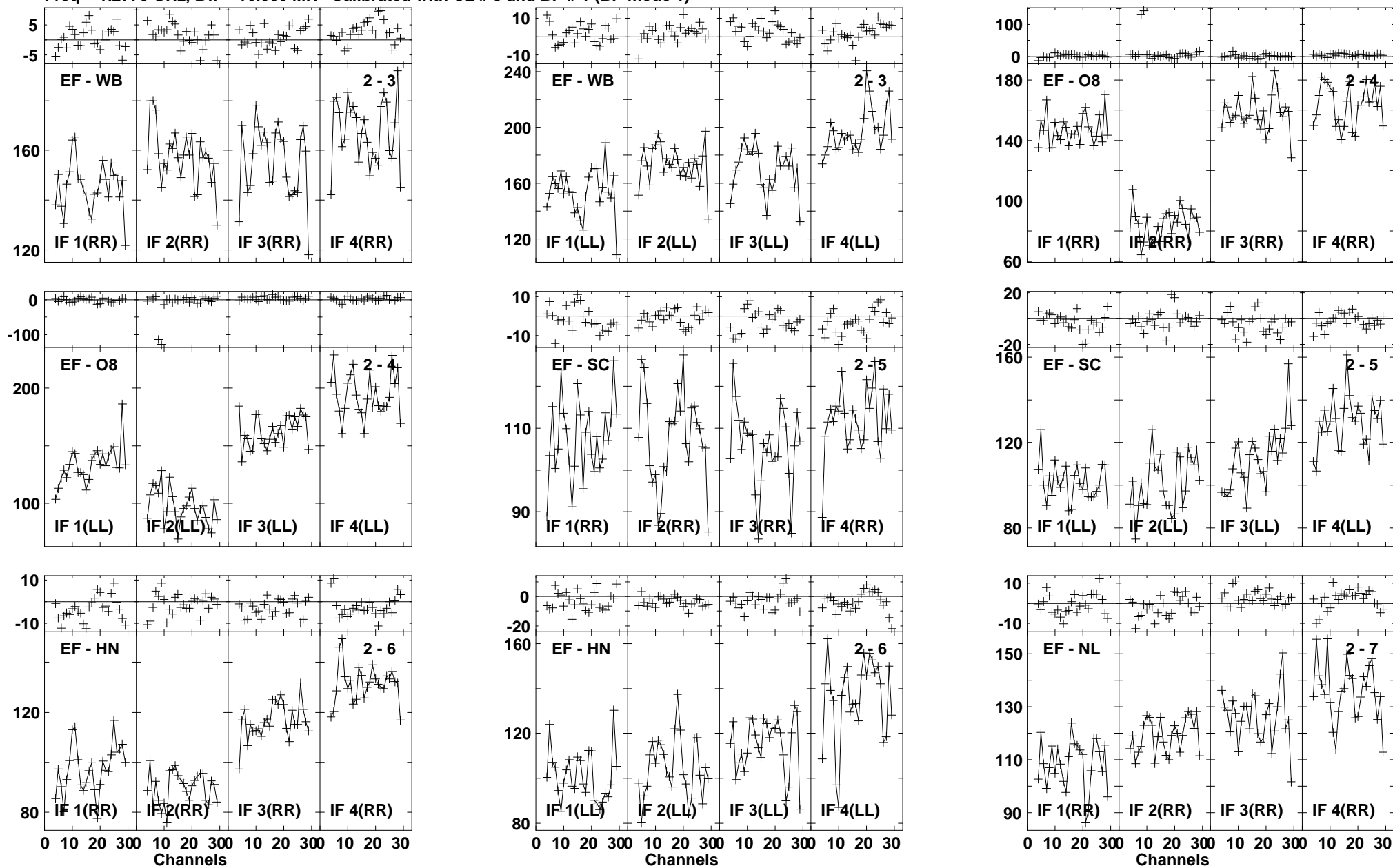

Lower frame: Milli Ampl Jy Top frame: Phas deg
Vector averaged cross-power spectrum Baseline: EF (02) - WB (03)
Timerange: 00/17:54:08 to 00/17:55:06

Plot file version 305 created 03-MAR-2016 01:12:49

J1545+5400 GN002C 1.UVDATA.1

Freq = 1.2770 GHz, Bw = 16.000 MH Calibrated with CL # 3 and BP # 1 (BP mode 1)

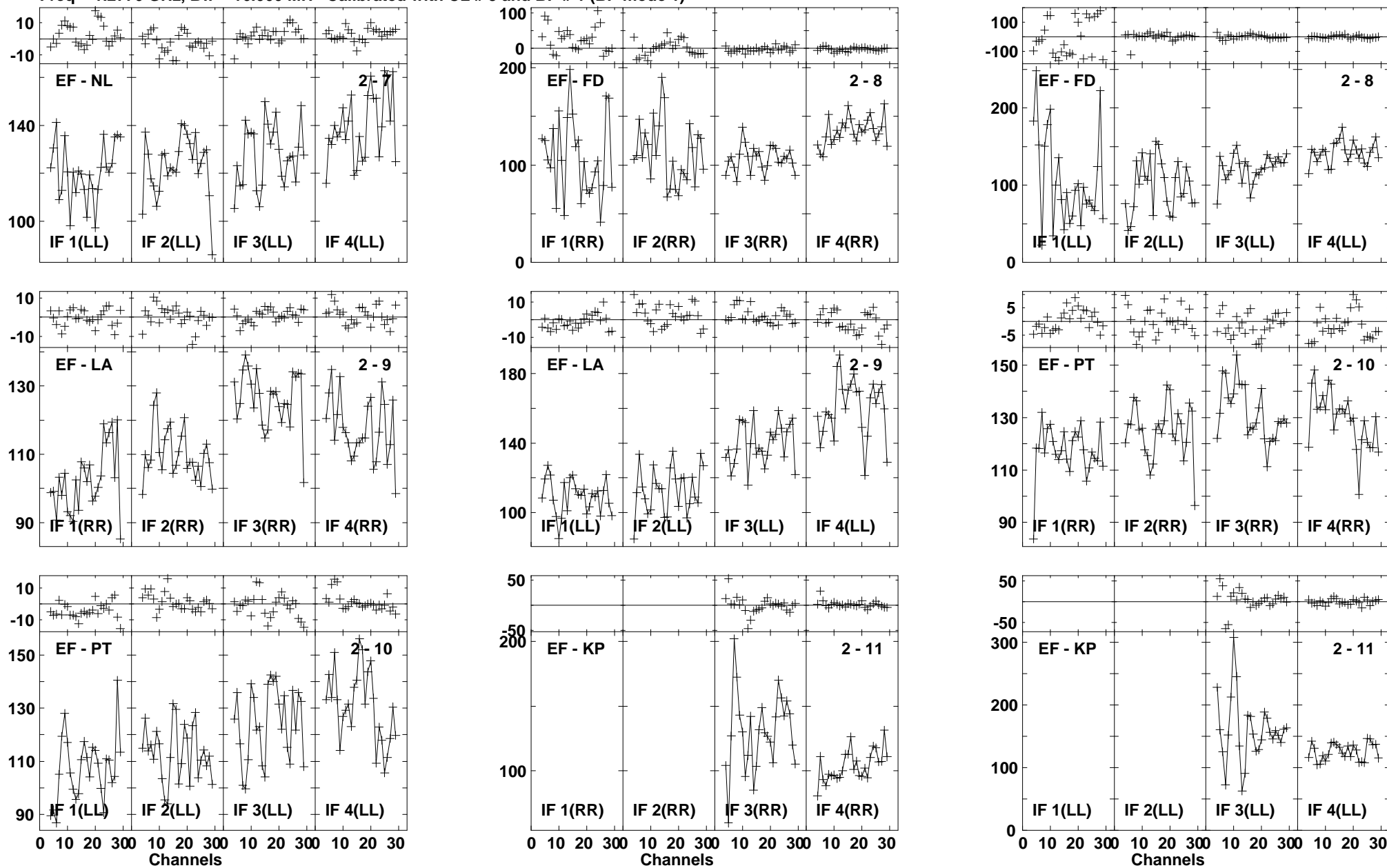

Lower frame: Milli Ampl Jy Top frame: Phas deg
Vector averaged cross-power spectrum Baseline: EF (02) - NL (07)
Timerange: 00/17:54:08 to 00/17:55:06

Plot file version 306 created 03-MAR-2016 01:12:49

J1545+5400 GN002C 1.UVDATA.1

Freq = 1.2770 GHz, Bw = 16.000 MH Calibrated with CL # 3 and BP # 1 (BP mode 1)

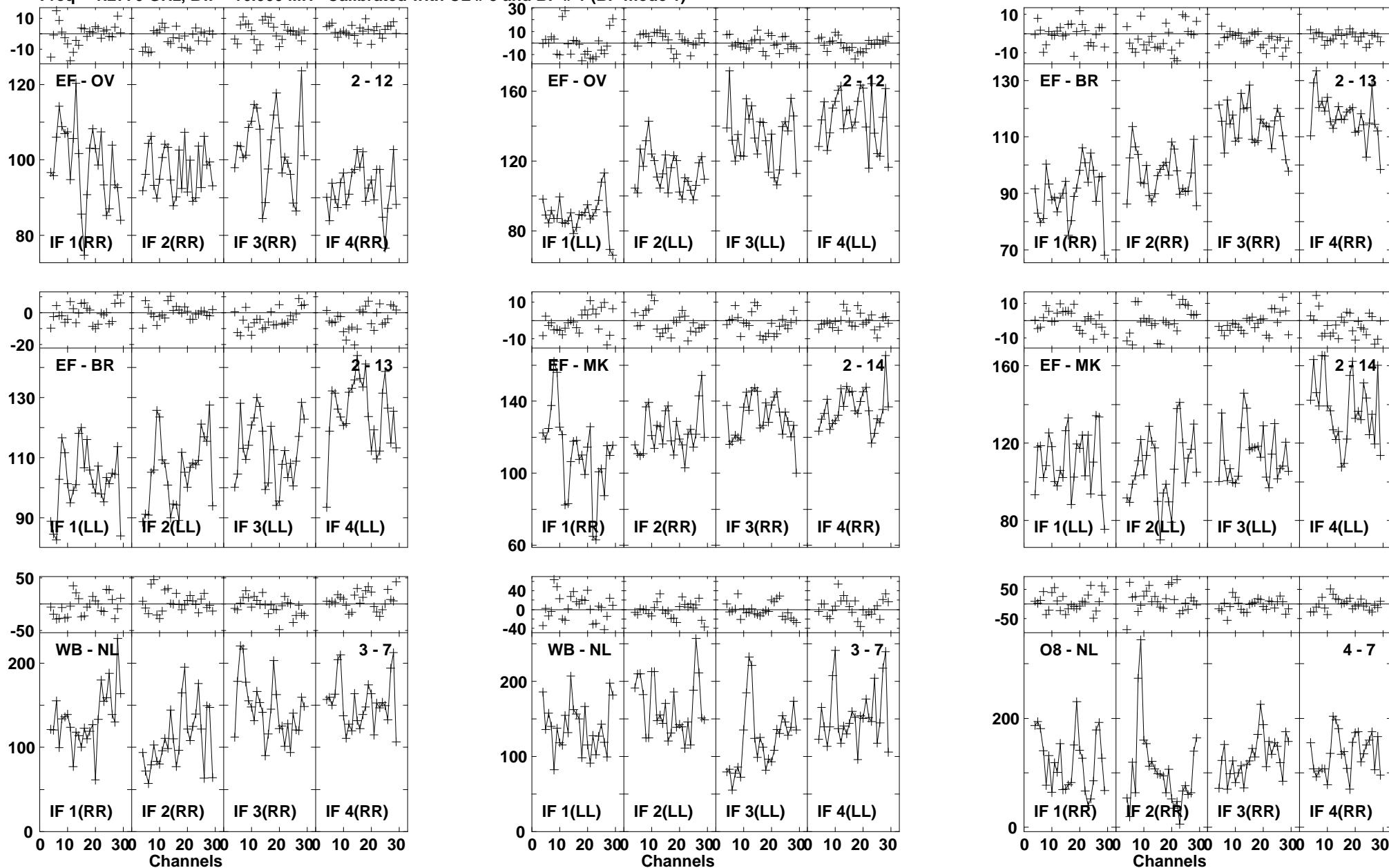

Lower frame: Milli Ampl Jy Top frame: Phas deg
Vector averaged cross-power spectrum Baseline: EF (02) - OV (12)
Timerange: 00/17:54:08 to 00/17:55:06

Plot file version 307 created 03-MAR-2016 01:12:49

J1545+5400 GN002C 1.UVDATA.1

Freq = 1.2770 GHz, Bw = 16.000 MH Calibrated with CL # 3 and BP # 1 (BP mode 1)

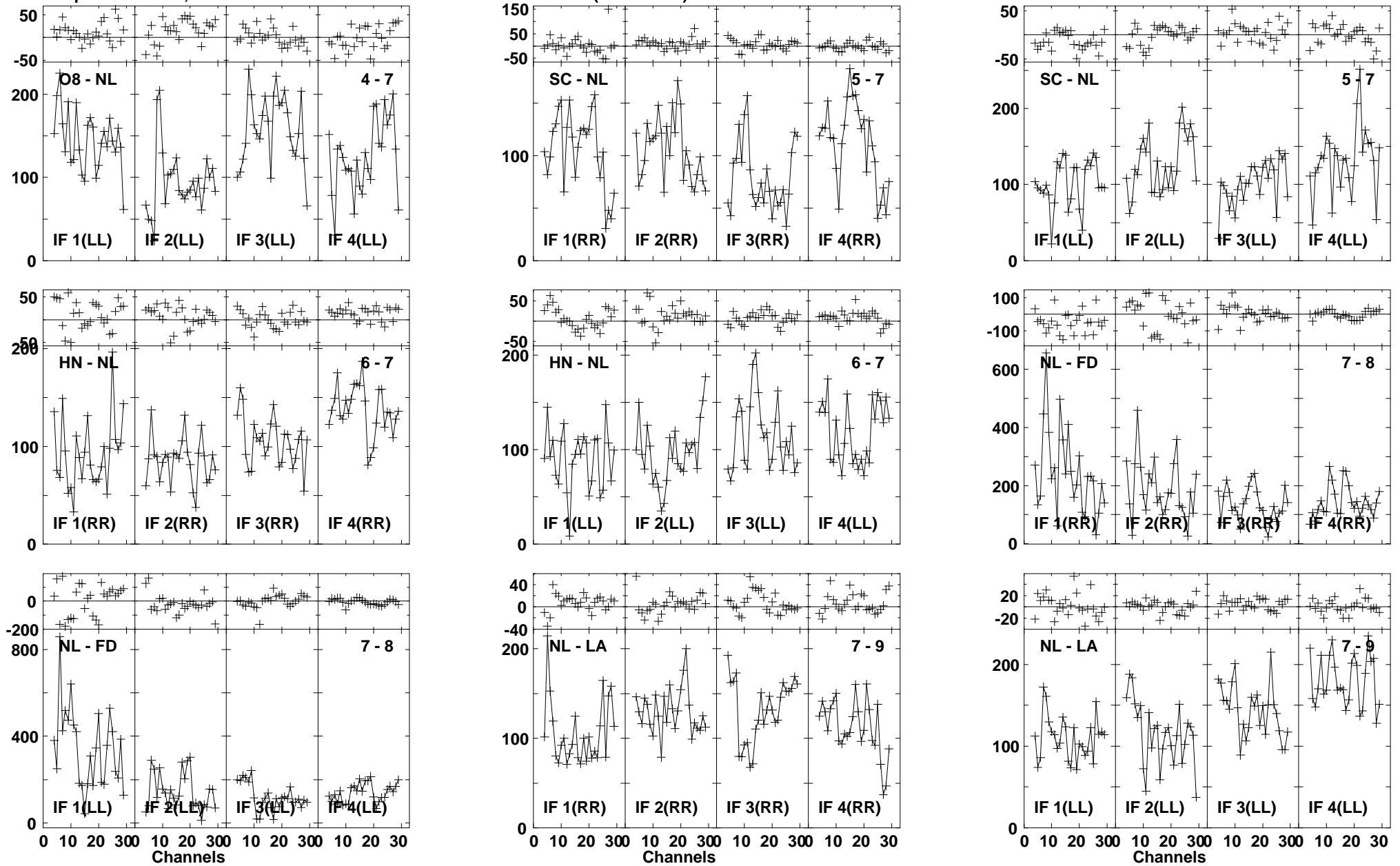

Lower frame: Milli Ampl Jy Top frame: Phas deg
Vector averaged cross-power spectrum Baseline: O8 (04) - NL (07)
Timerange: 00/17:54:08 to 00/17:55:06

Plot file version 308 created 03-MAR-2016 01:12:49

J1545+5400 GN002C 1.UVDATA.1

Freq = 1.2770 GHz, Bw = 16.000 MH Calibrated with CL # 3 and BP # 1 (BP mode 1)

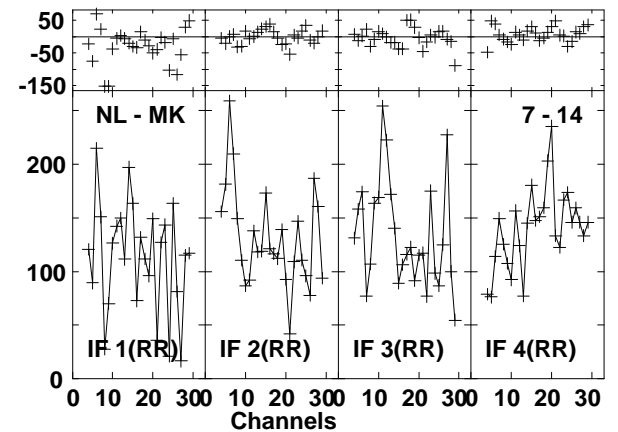
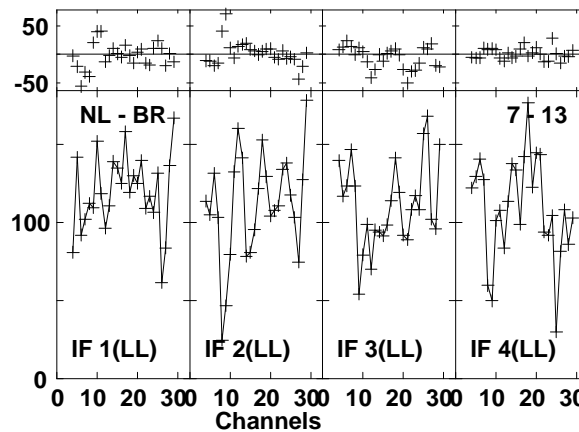
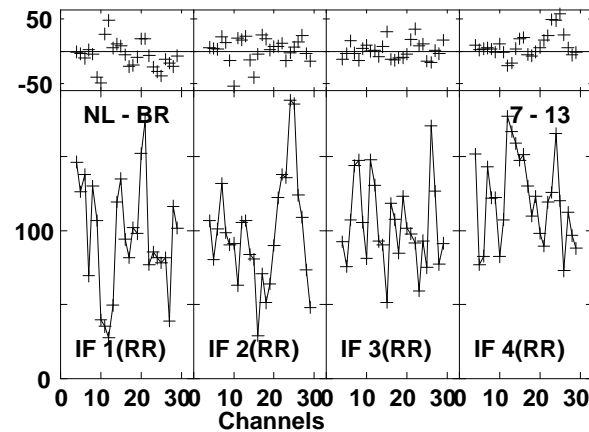
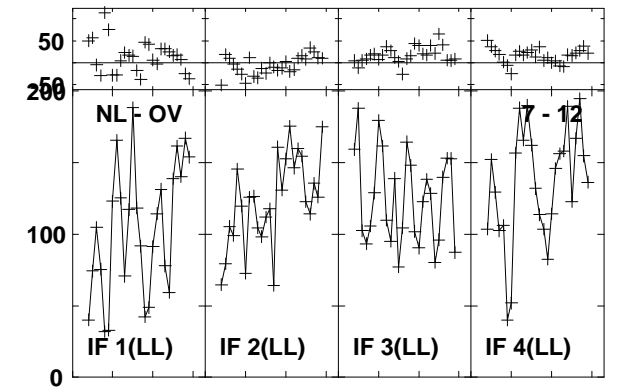
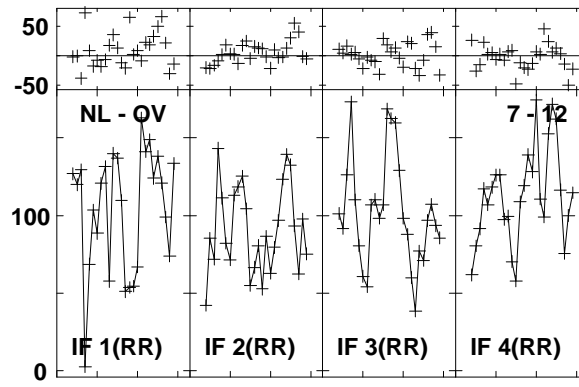
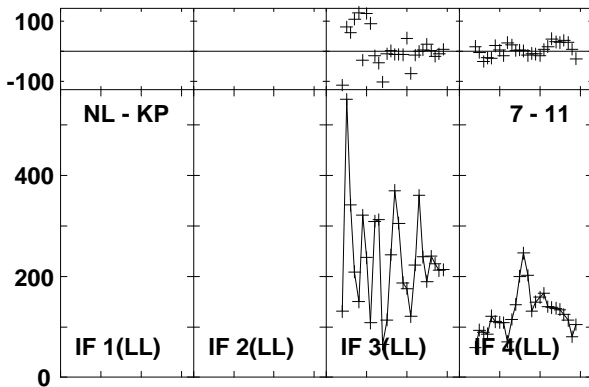
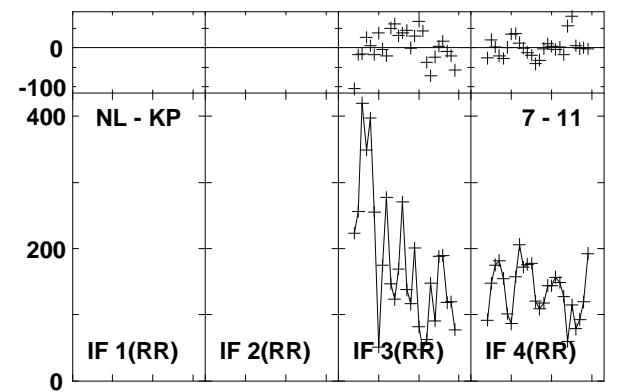
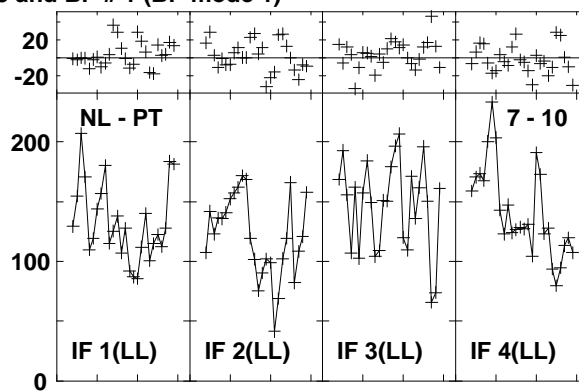
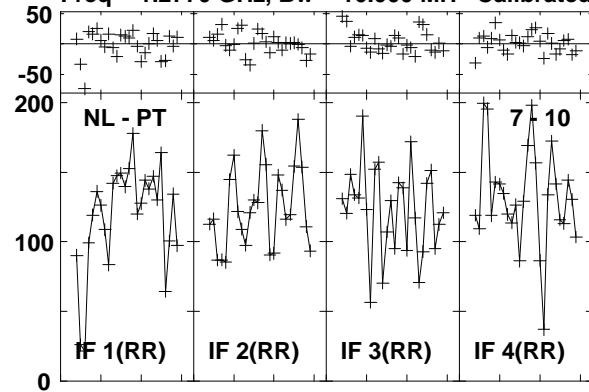

Lower frame: Milli Ampl Jy Top frame: Phas deg
Vector averaged cross-power spectrum Baseline: NL (07) - PT (10)
Timerange: 00/17:54:08 to 00/17:55:06

Plot file version 309 created 03-MAR-2016 01:12:49
J1545+5400 GN002C 1.UVDATA.1
Freq = 1.2770 GHz, Bw = 16.000 MH Calibrated with CL # 3 and BP # 1 (BP mode 1)

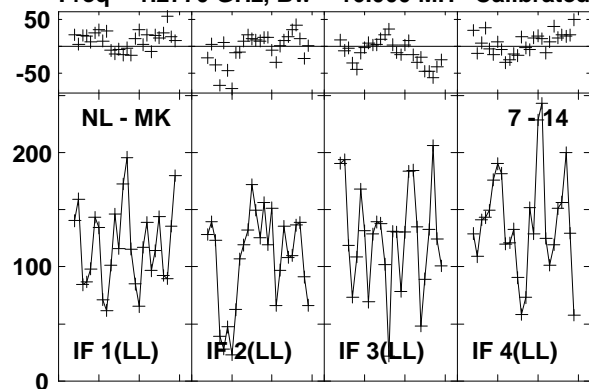

Lower frame: Milli Ampl Jy Top frame: Phas deg
Vector averaged cross-power spectrum Baseline: NL (07) - MK (14)
Timerange: 00/17:54:08 to 00/17:55:06

Plot file version 310 created 03-MAR-2016 01:12:49

4C52 GN002C 1.UVDATA.1

Freq = 1.2770 GHz, Bw = 16.000 MH Calibrated with CL # 3 and BP # 1 (BP mode 1)

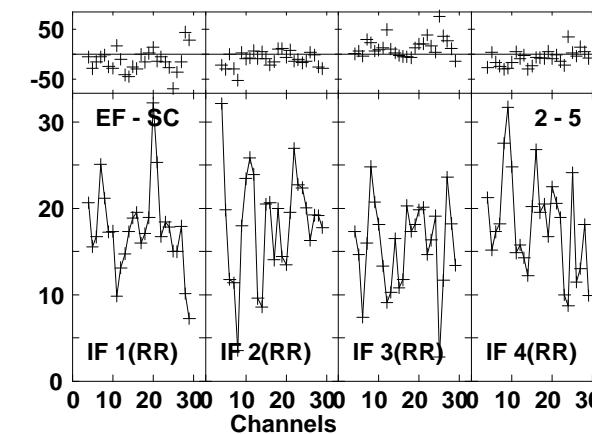
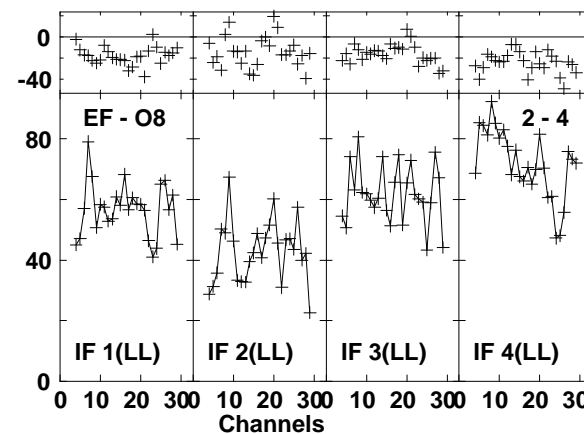
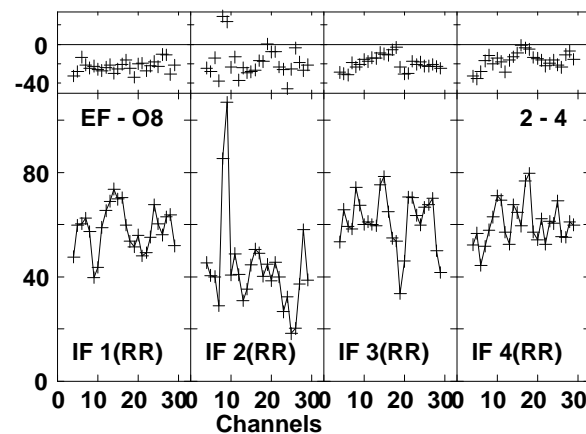
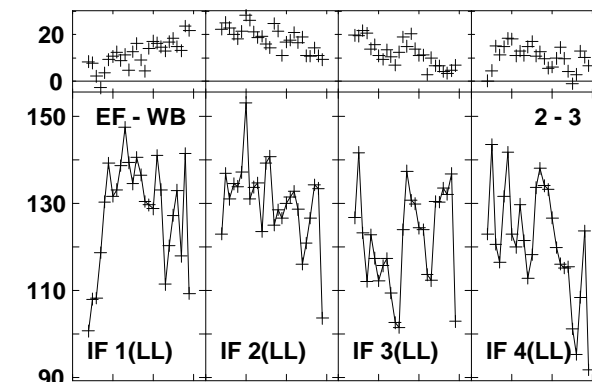
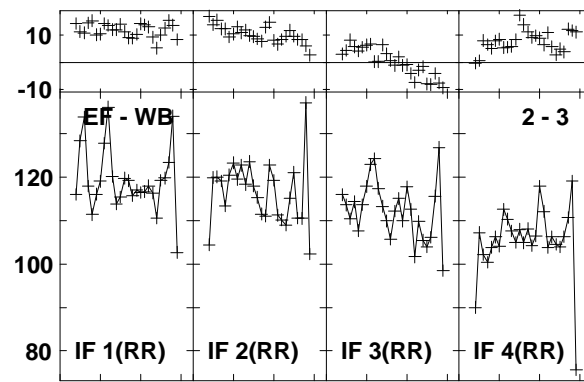
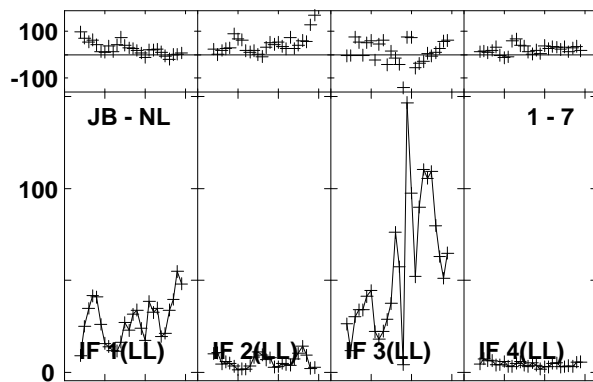
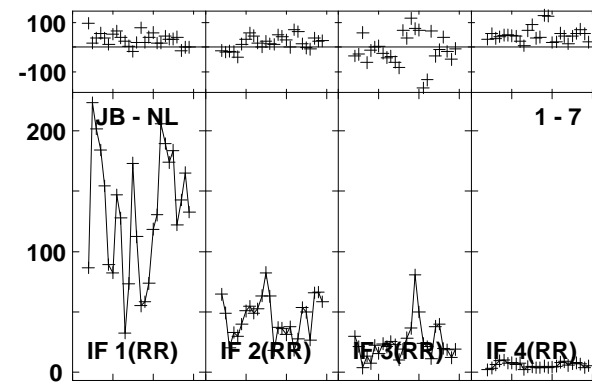
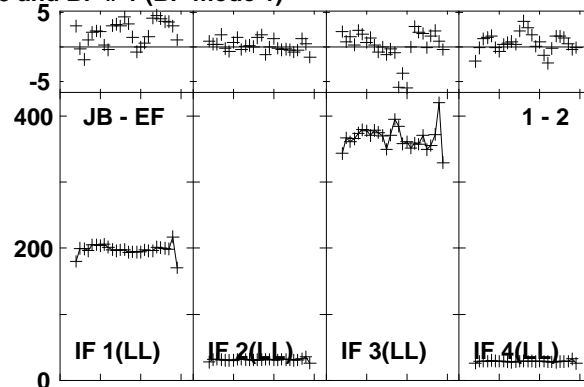
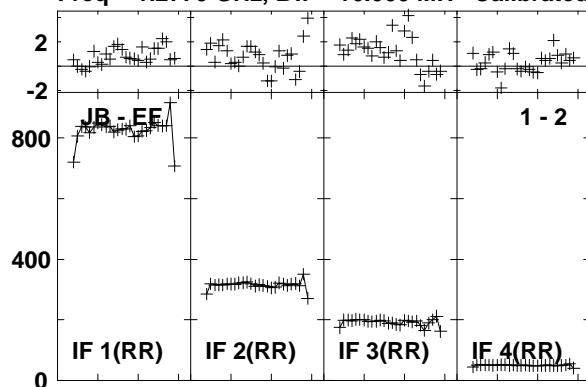

Lower frame: Milli Ampl Jy Top frame: Phas deg
Vector averaged cross-power spectrum Baseline: JB (01) - EF (02)
Timerange: 00/17:55:11 to 00/17:58:05

Plot file version 311 created 03-MAR-2016 01:12:50
 4C52 GN002C 1.UVDATA.1
 Freq = 1.2770 GHz, Bw = 16.000 MH Calibrated with CL # 3 and BP # 1 (BP mode 1)

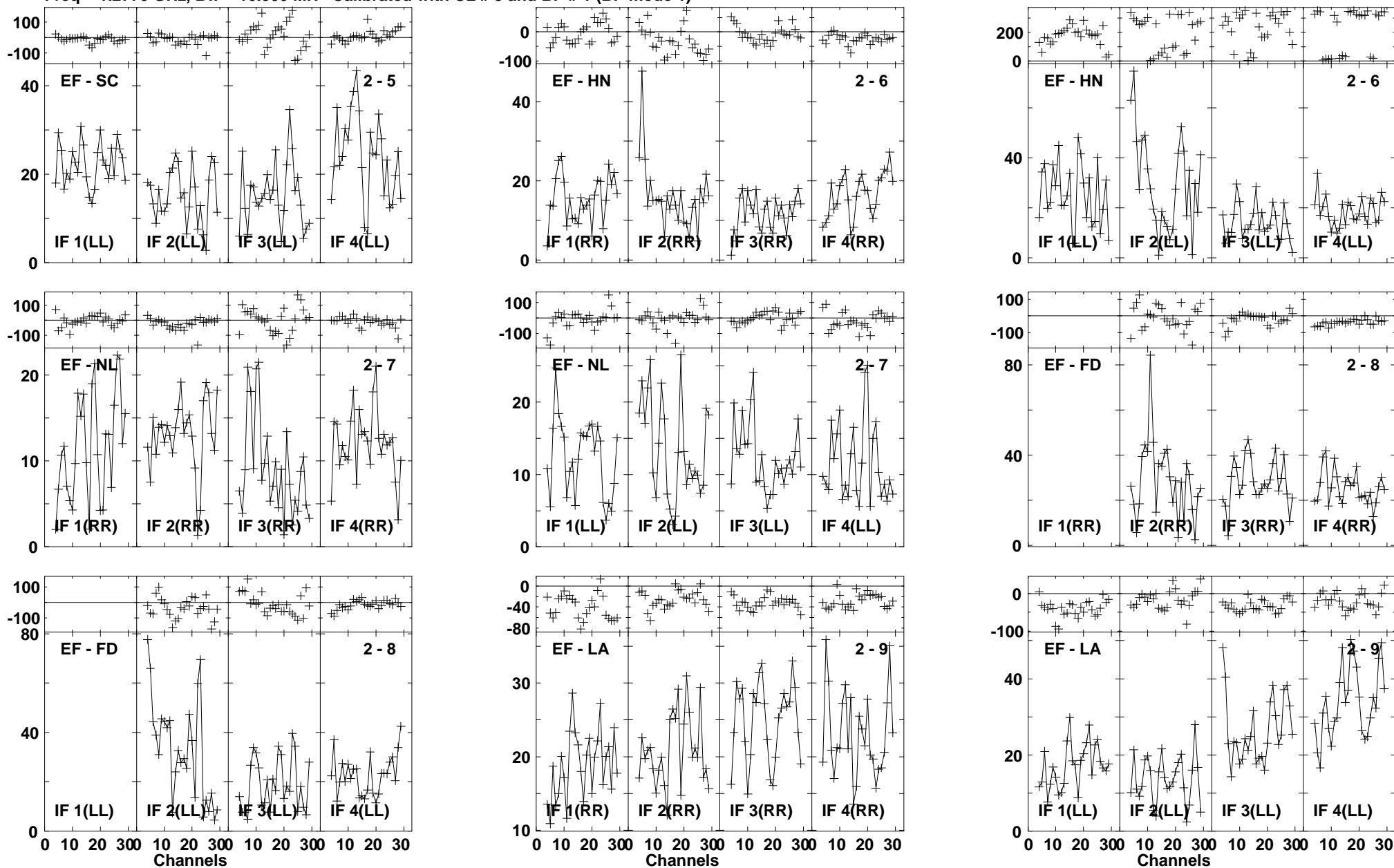

Lower frame: Milli Ampl Jy Top frame: Phas deg
 Vector averaged cross-power spectrum Baseline: EF (02) - SC (05)
 Timerange: 00/17:55:11 to 00/17:58:05

Plot file version 312 created 03-MAR-2016 01:12:50

4C52 GN002C 1.UVDATA.1

Freq = 1.2770 GHz, Bw = 16.000 MH Calibrated with CL # 3 and BP # 1 (BP mode 1)

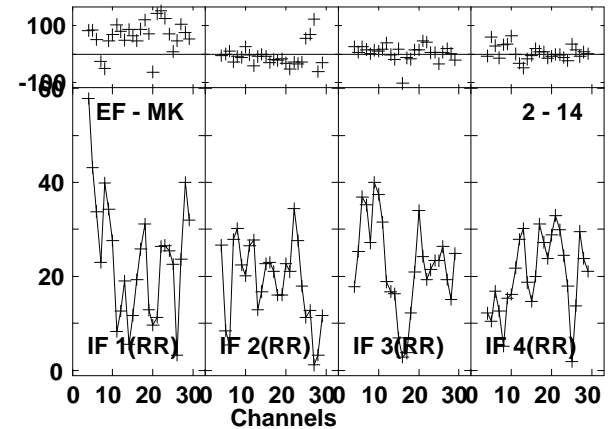
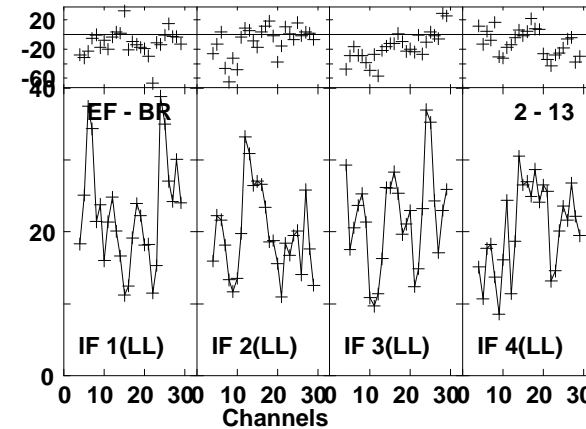
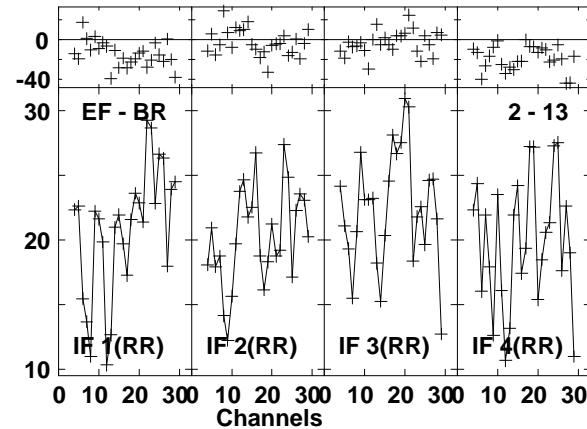
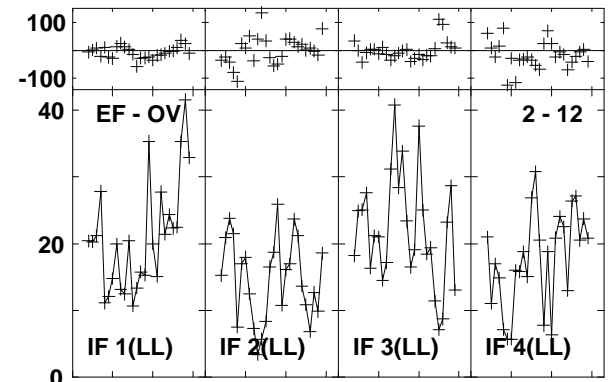
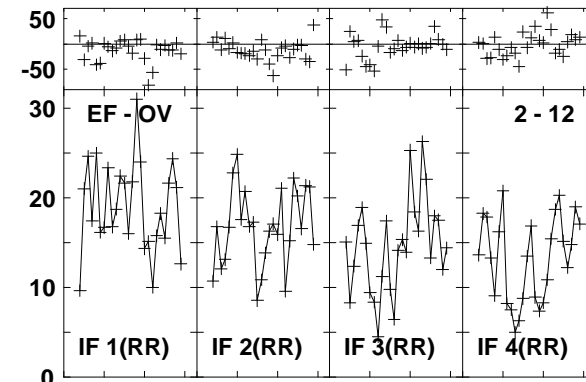
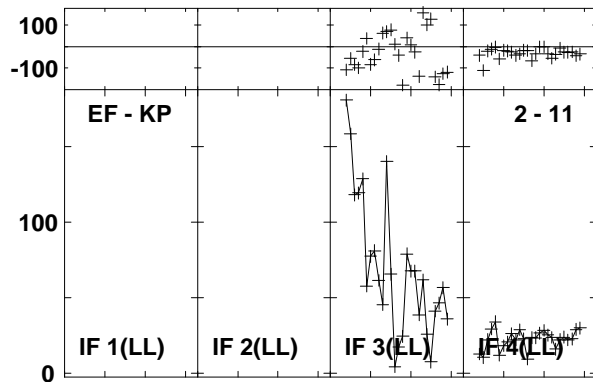
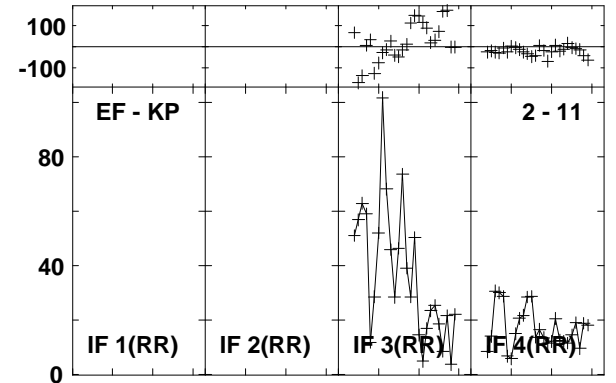
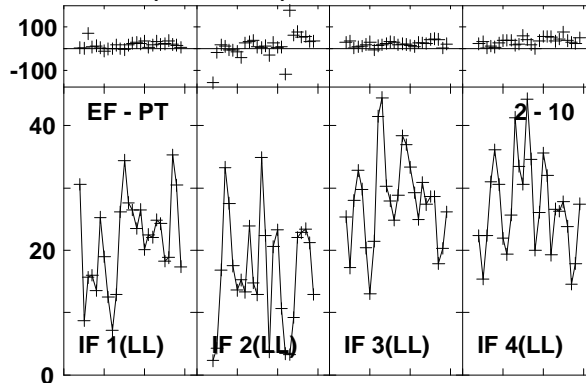
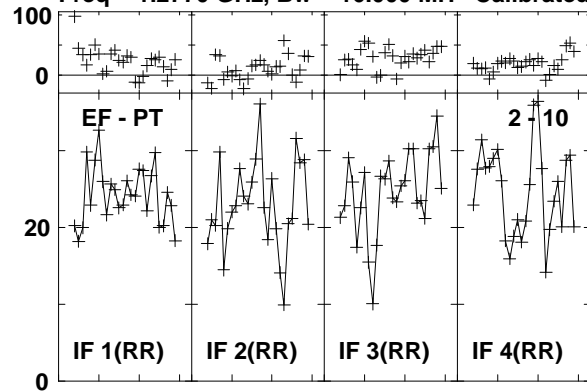

Lower frame: Milli Ampl Jy Top frame: Phas deg
Vector averaged cross-power spectrum Baseline: EF (02) - PT (10)
Timerange: 00/17:55:11 to 00/17:58:05

Plot file version 313 created 03-MAR-2016 01:12:50

4C52 GN002C 1.UVDATA.1

Freq = 1.2770 GHz, Bw = 16.000 MH Calibrated with CL # 3 and BP # 1 (BP mode 1)

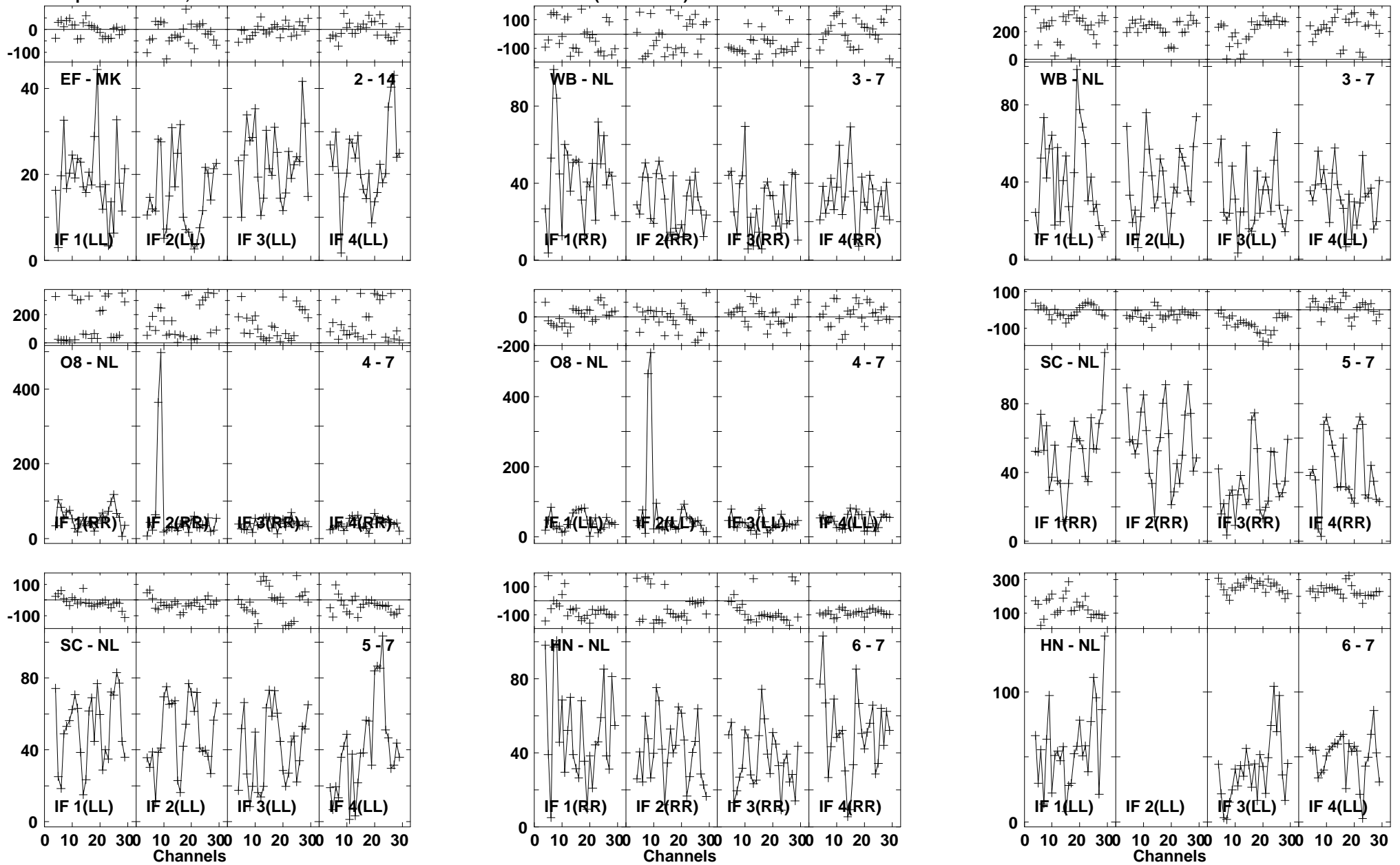

Lower frame: Milli Ampl Jy Top frame: Phas deg
Vector averaged cross-power spectrum Baseline: EF (02) - MK (14)
Timerange: 00/17:55:11 to 00/17:58:05

Plot file version 314 created 03-MAR-2016 01:12:50

4C52 GN002C 1.UVDATA.1

Freq = 1.2770 GHz, Bw = 16.000 MH Calibrated with CL # 3 and BP # 1 (BP mode 1)

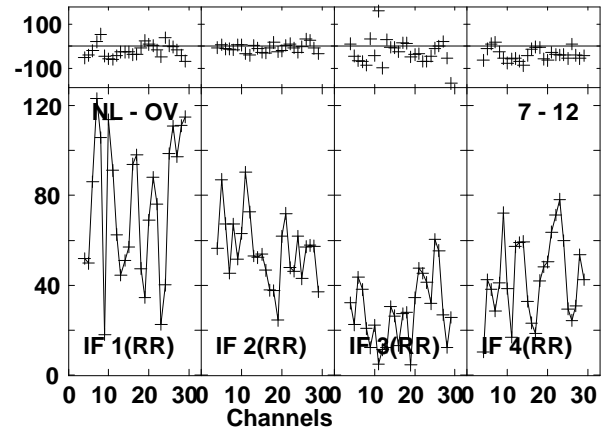
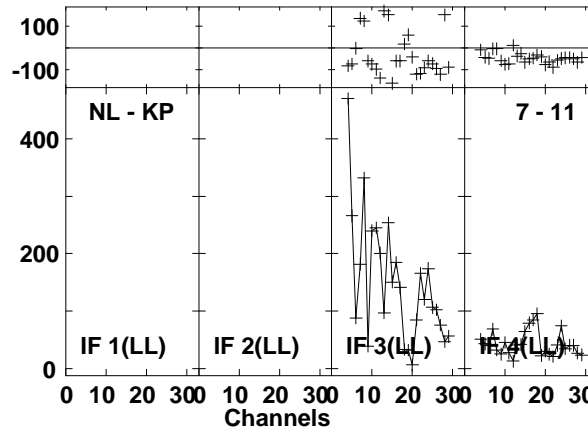
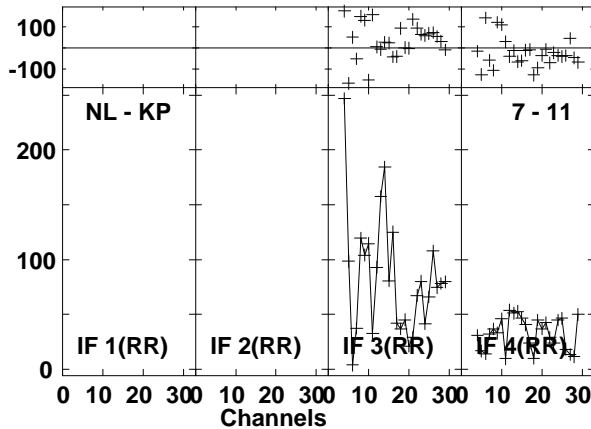
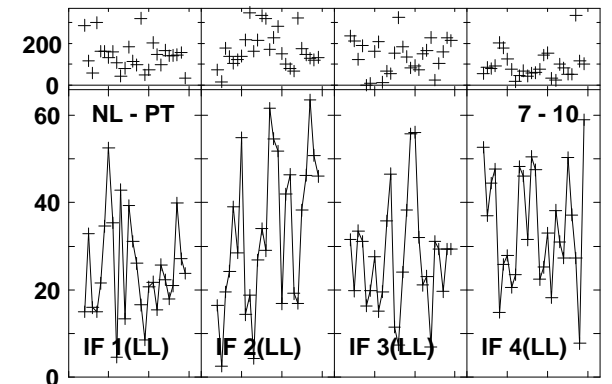
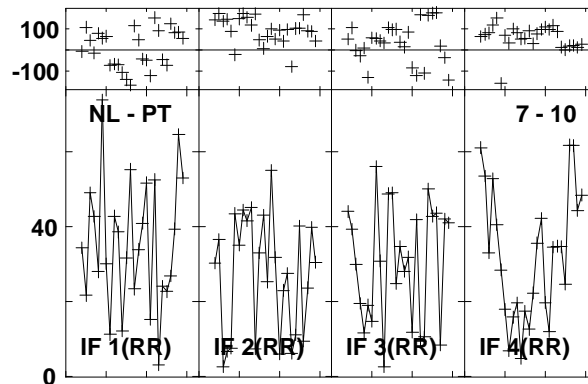
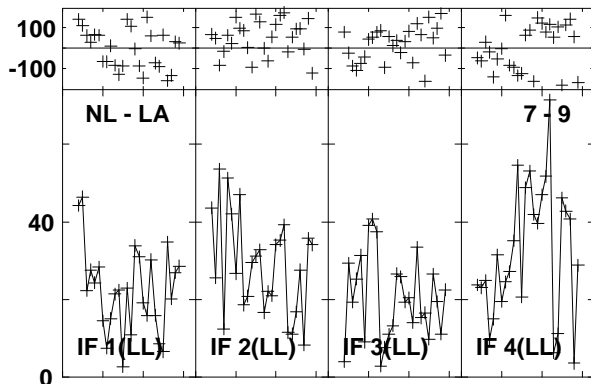
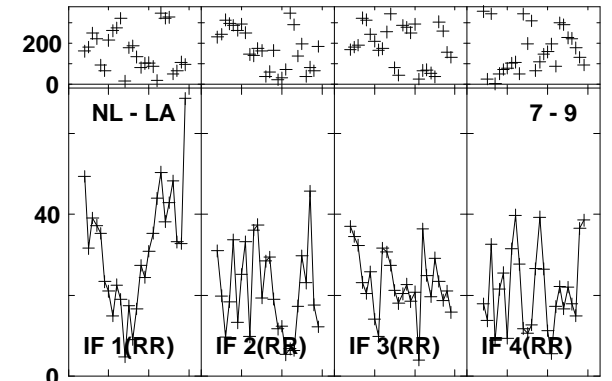
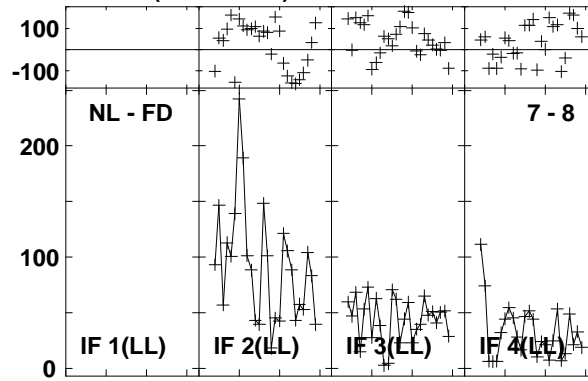
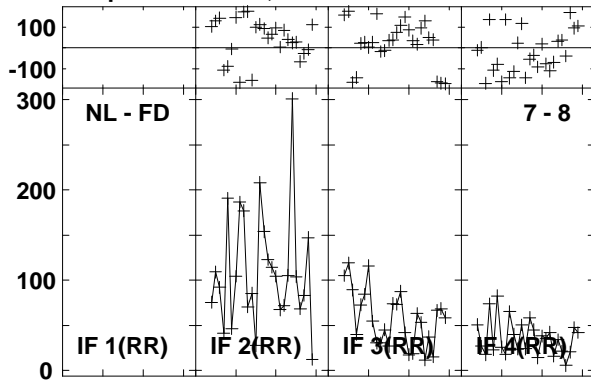

Lower frame: Milli Ampl Jy Top frame: Phas deg
Vector averaged cross-power spectrum Baseline: NL (07) - FD (08)
Timerange: 00/17:55:11 to 00/17:58:05

Plot file version 315 created 03-MAR-2016 01:12:50

4C52 GN002C 1.UVDATA.1

Freq = 1.2770 GHz, Bw = 16.000 MH Calibrated with CL # 3 and BP # 1 (BP mode 1)

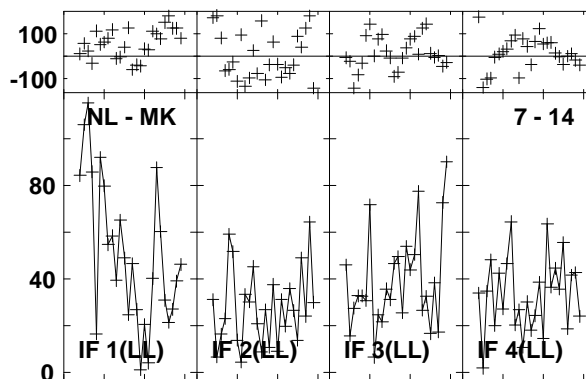
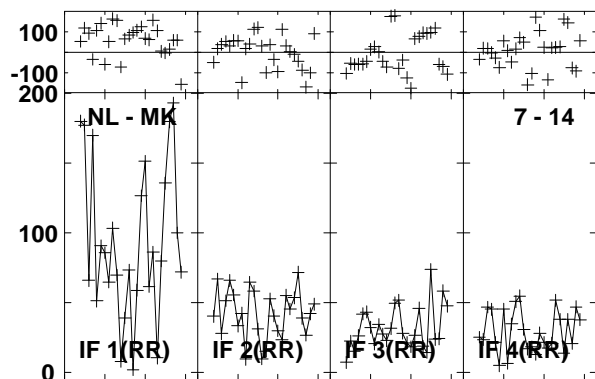
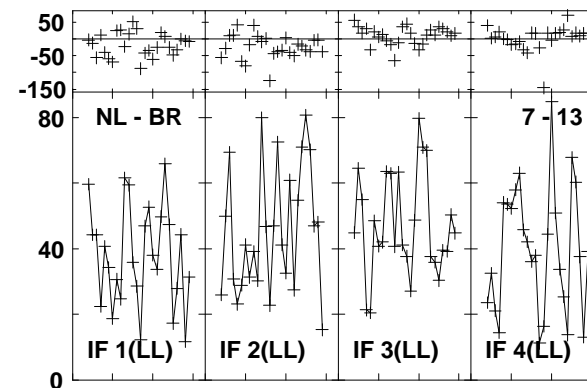
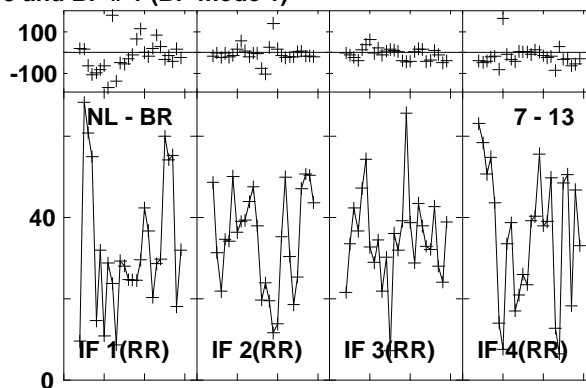
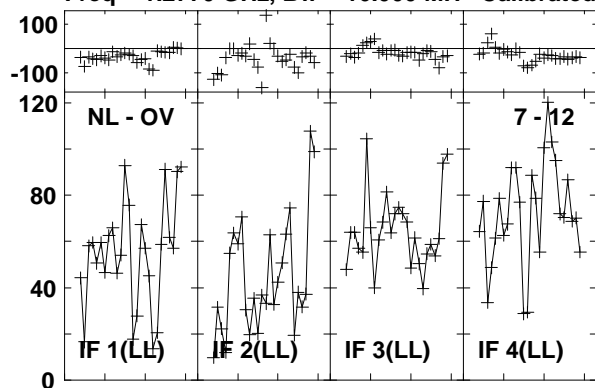

Lower frame: Milli Ampl Jy Top frame: Phas deg
Vector averaged cross-power spectrum Baseline: NL (07) - OV (12)
Timerange: 00/17:55:11 to 00/17:58:05

Plot file version 316 created 03-MAR-2016 01:12:51

J1545+5400 GN002C 1.UVDATA.1

Freq = 1.2770 GHz, Bw = 16.000 MH Calibrated with CL # 3 and BP # 1 (BP mode 1)

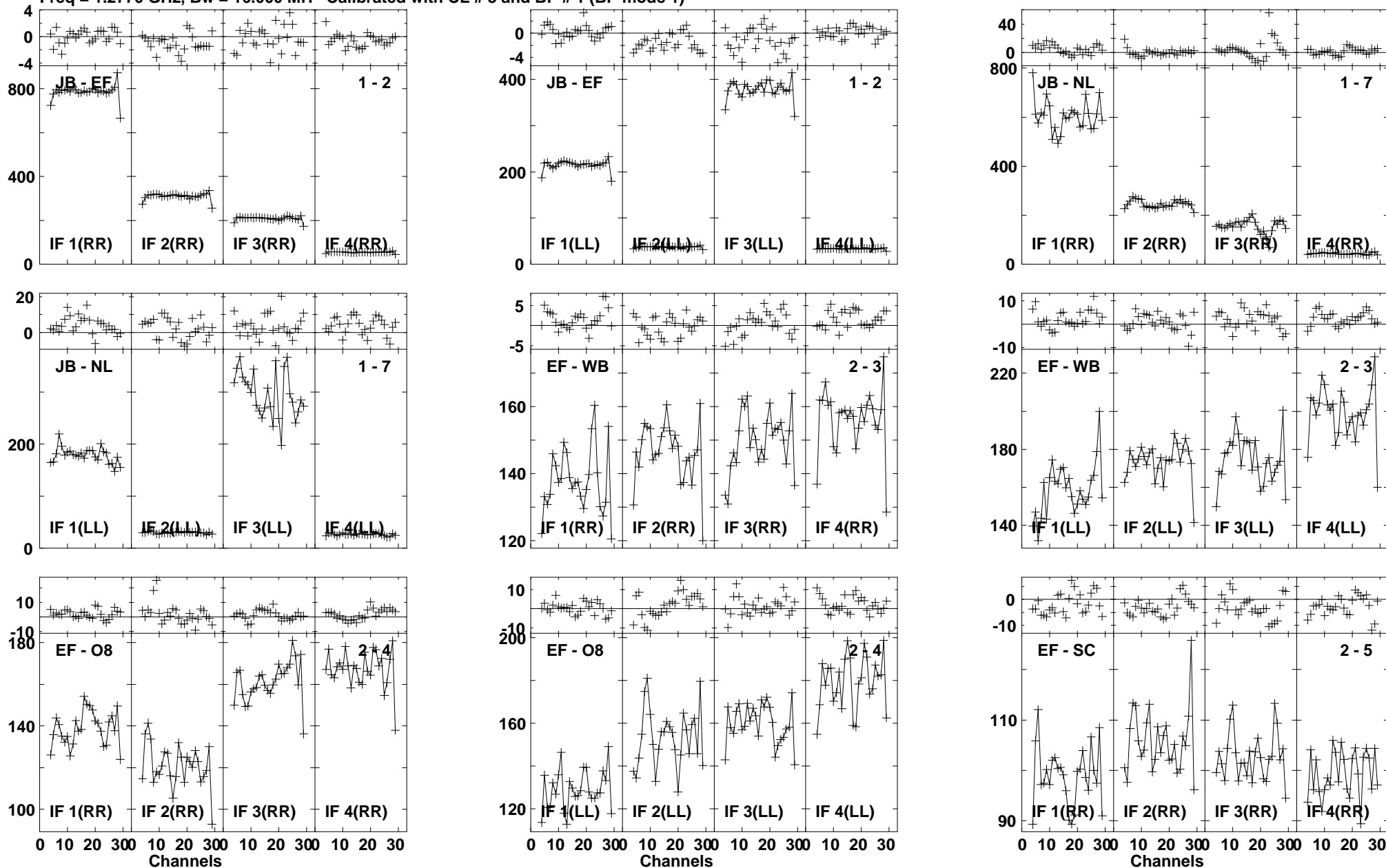

Lower frame: Milli Ampl Jy Top frame: Phas deg
Vector averaged cross-power spectrum Baseline: JB (01) - EF (02)
Timerange: 00/17:58:58 to 00/18:00:56

Plot file version 317 created 03-MAR-2016 01:12:51
 J1545+5400 GN002C 1.UVDATA.1
 Freq = 1.2770 GHz, Bw = 16.000 MH Calibrated with CL # 3 and BP # 1 (BP mode 1)

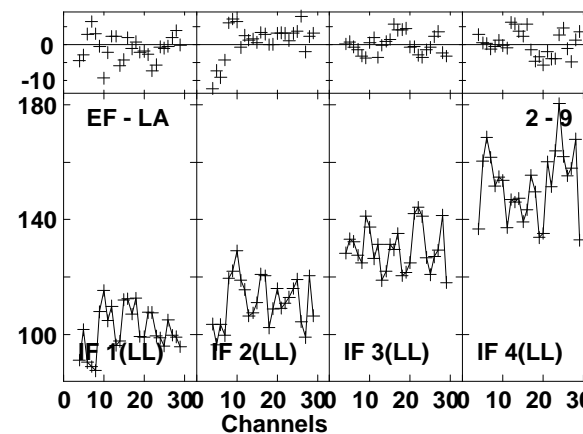
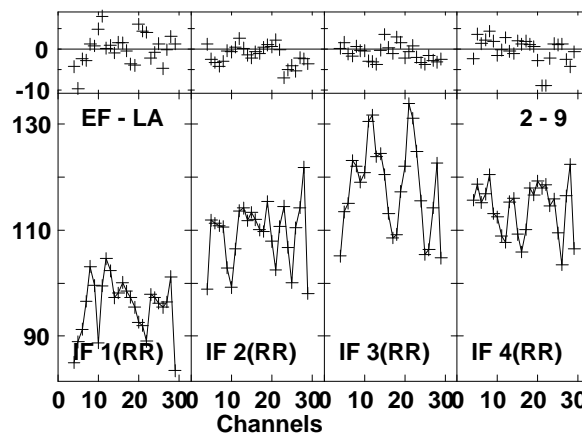
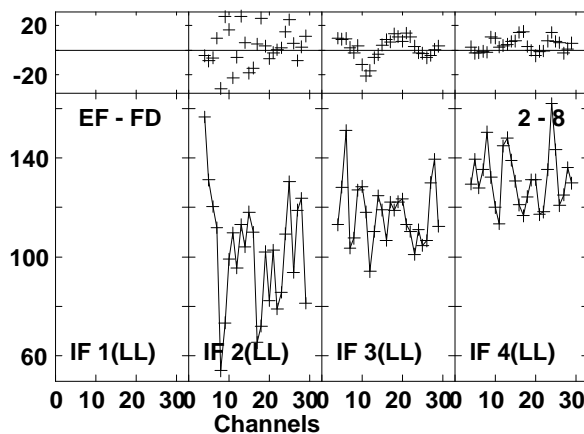
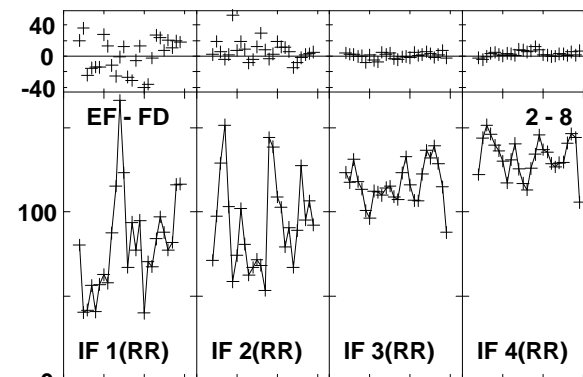
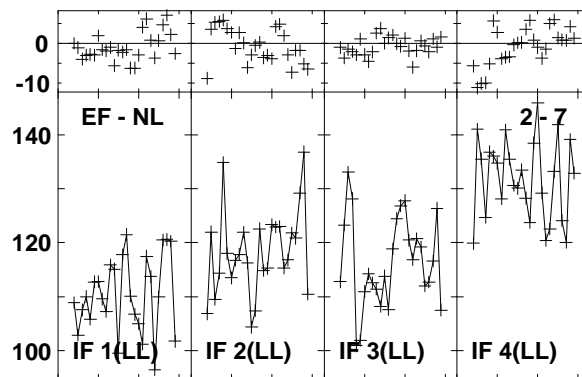
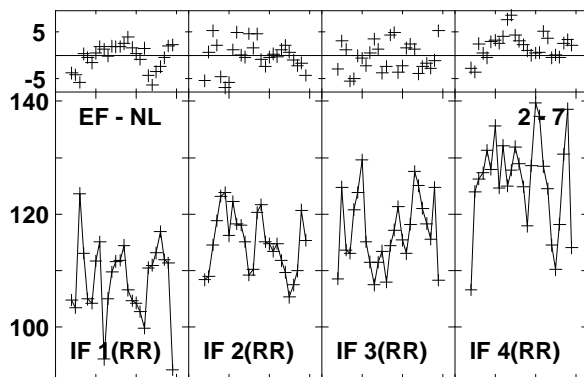
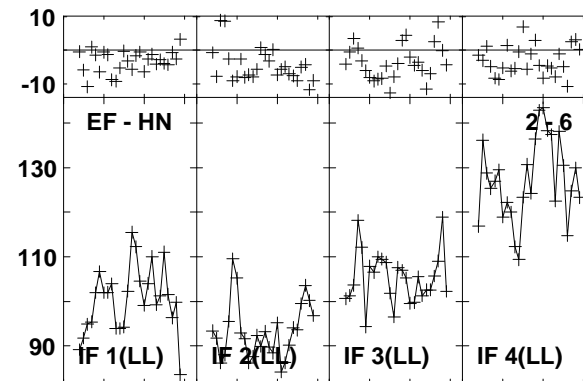
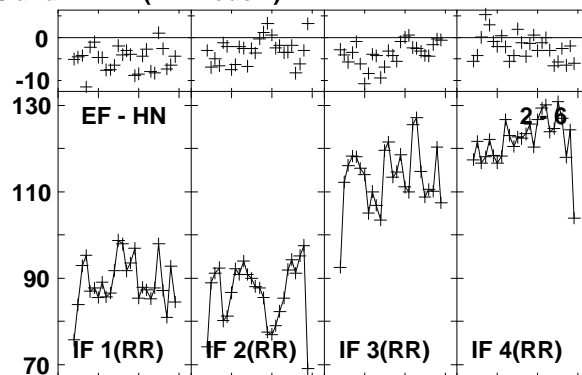
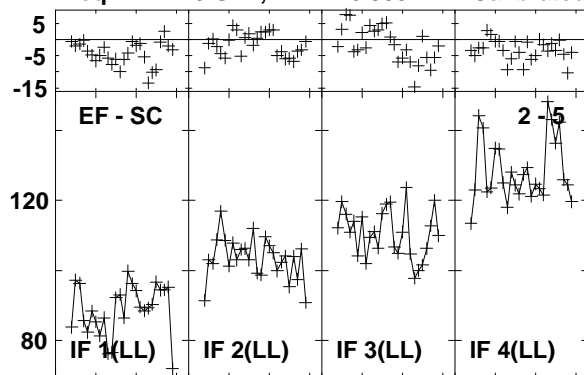

Lower frame: Milli Ampl Jy Top frame: Phas deg
 Vector averaged cross-power spectrum Baseline: EF (02) - SC (05)
 Timerange: 00/17:58:58 to 00/18:00:56

Plot file version 318 created 03-MAR-2016 01:12:51

J1545+5400 GN002C 1.UVDATA.1

Freq = 1.2770 GHz, Bw = 16.000 MH Calibrated with CL # 3 and BP # 1 (BP mode 1)

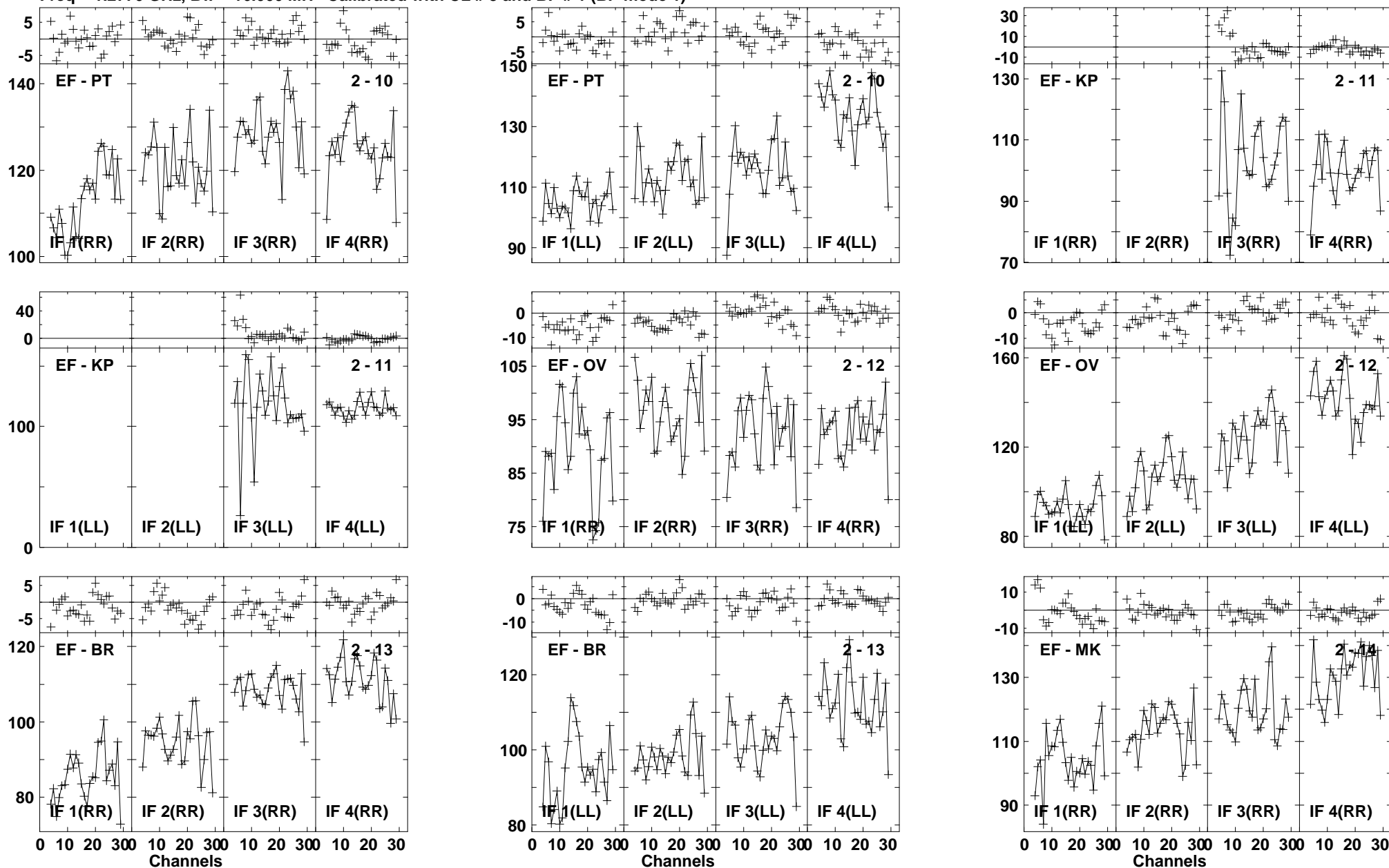

Lower frame: Milli Ampl Jy Top frame: Phas deg
Vector averaged cross-power spectrum Baseline: EF (02) - PT (10)
Timerange: 00/17:58:58 to 00/18:00:56

Plot file version 319 created 03-MAR-2016 01:12:51

J1545+5400 GN002C 1.UVDATA.1

Freq = 1.2770 GHz, Bw = 16.000 MH Calibrated with CL # 3 and BP # 1 (BP mode 1)

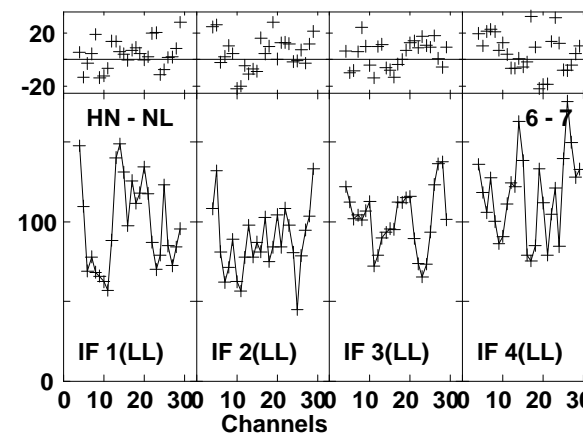
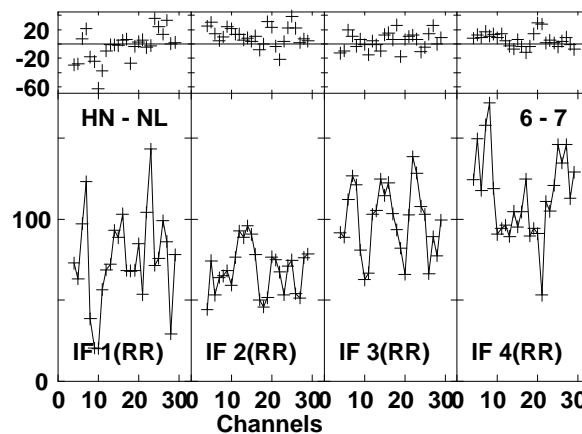
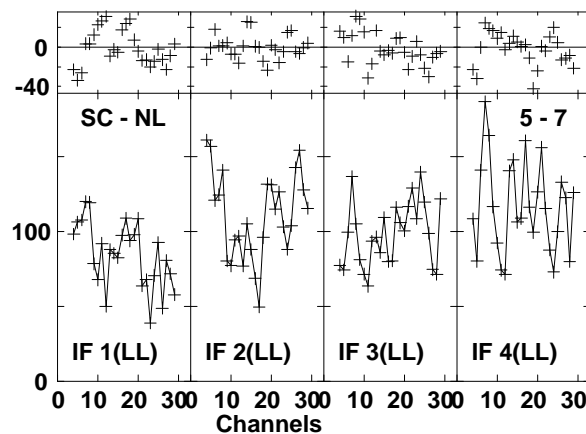
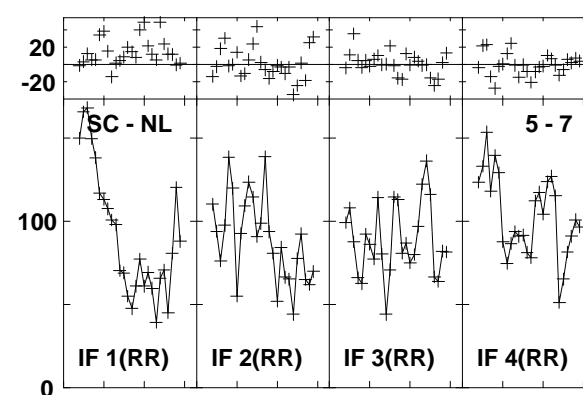
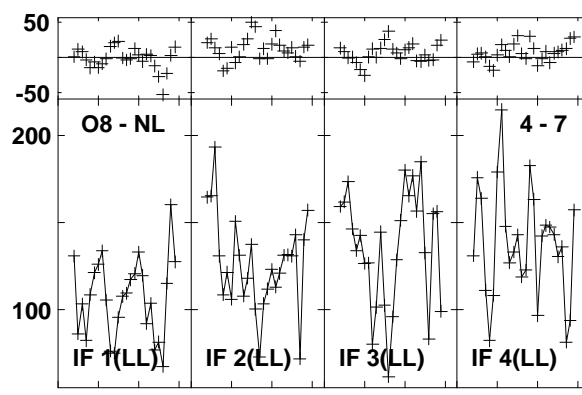
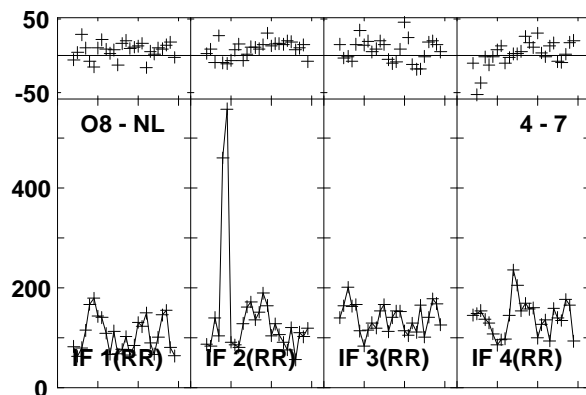
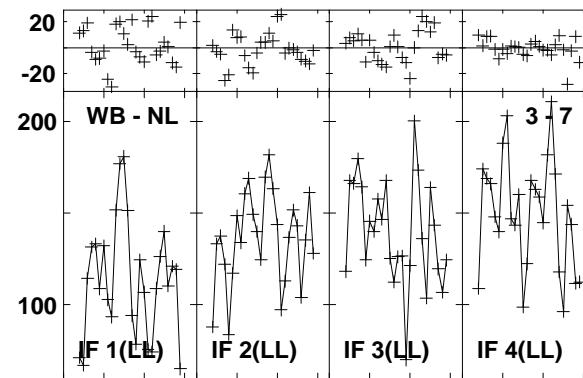
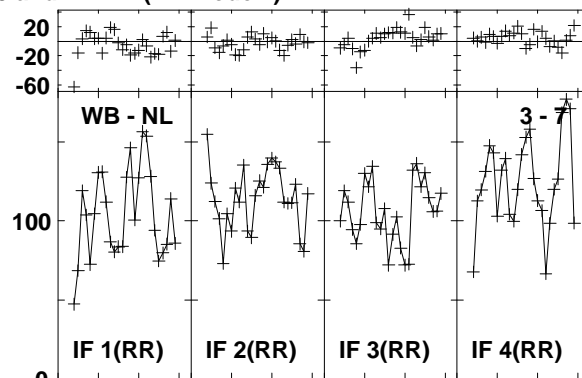
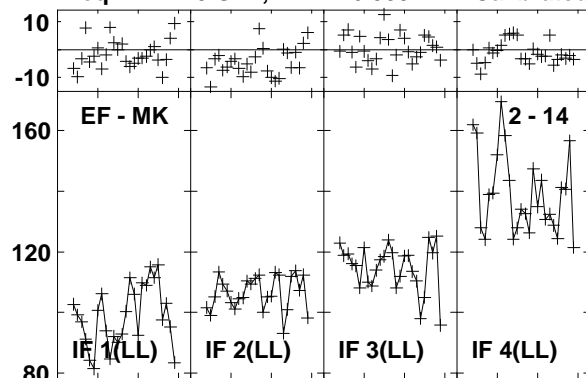

Lower frame: Milli Ampl Jy Top frame: Phas deg
Vector averaged cross-power spectrum Baseline: EF (02) - MK (14)
Timerange: 00/17:58:58 to 00/18:00:56

Plot file version 320 created 03-MAR-2016 01:12:51
 J1545+5400 GN002C 1.UVDATA.1
 Freq = 1.2770 GHz, Bw = 16.000 MH Calibrated with CL # 3 and BP # 1 (BP mode 1)

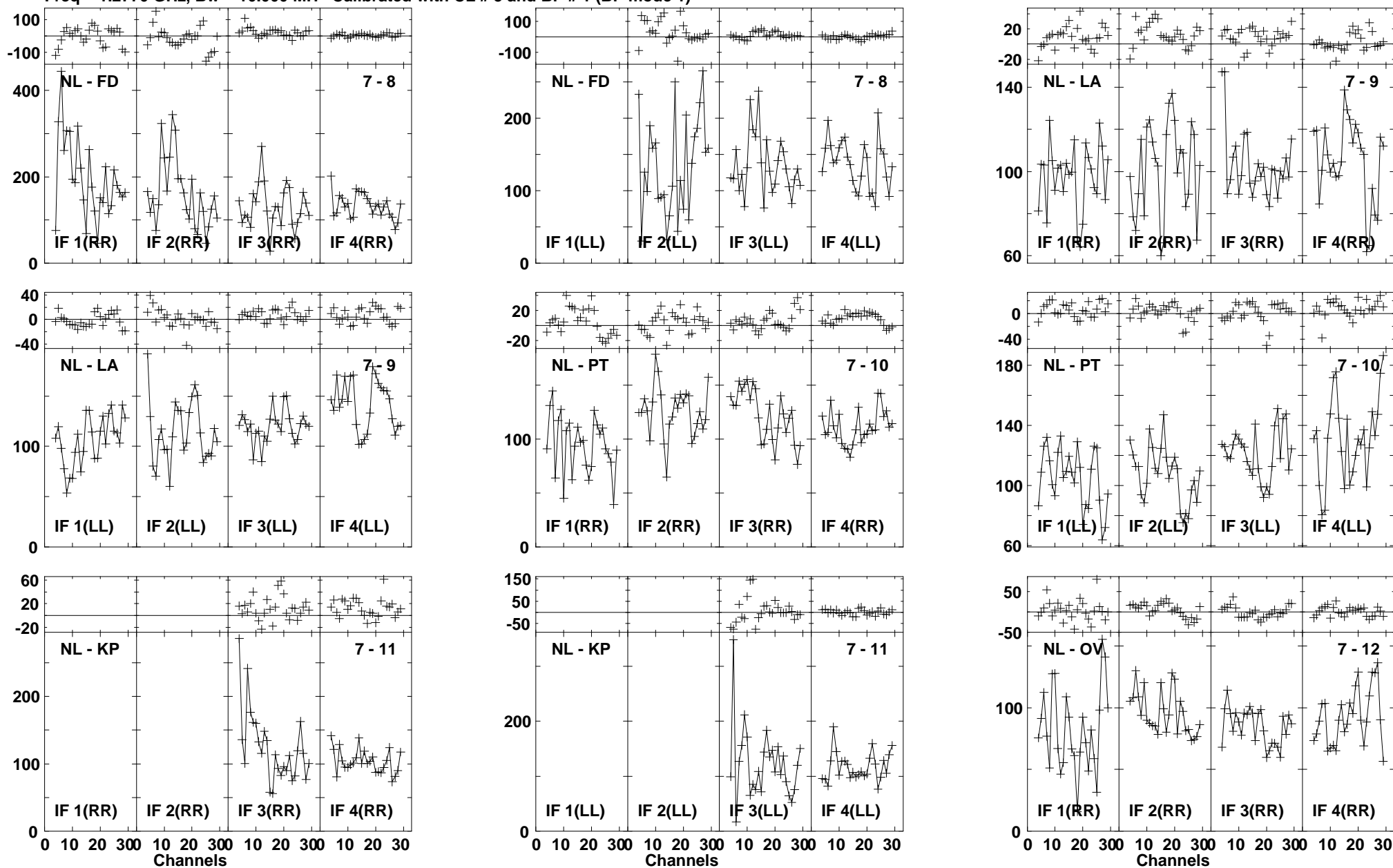

Lower frame: Milli Ampl Jy Top frame: Phas deg
 Vector averaged cross-power spectrum Baseline: NL (07) - FD (08)
 Timerange: 00/17:58:58 to 00/18:00:56

Plot file version 321 created 03-MAR-2016 01:12:51

J1545+5400 GN002C 1.UVDATA.1

Freq = 1.2770 GHz, Bw = 16.000 MH Calibrated with CL # 3 and BP # 1 (BP mode 1)

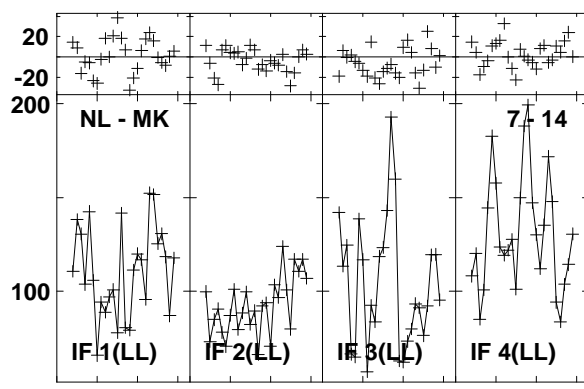
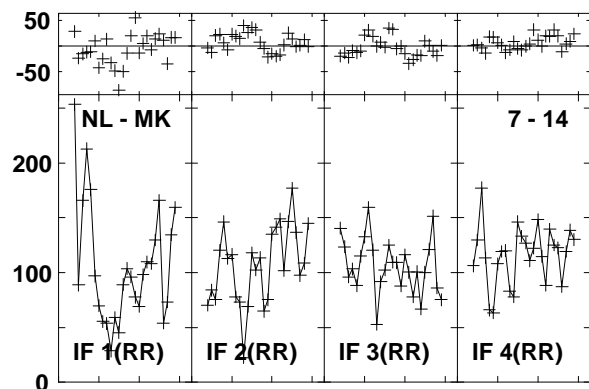
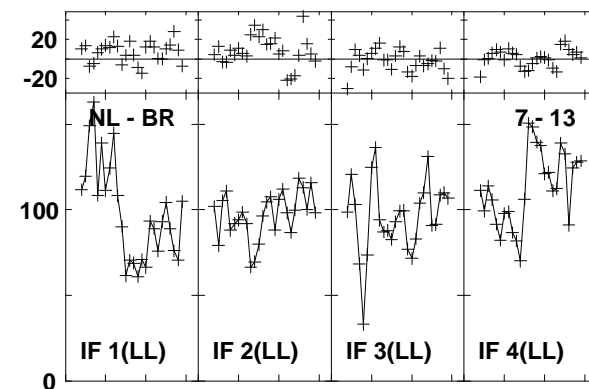
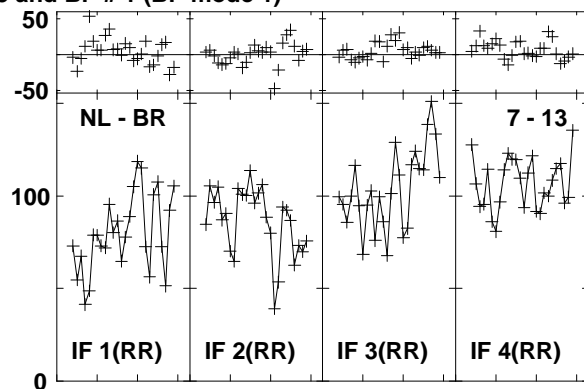
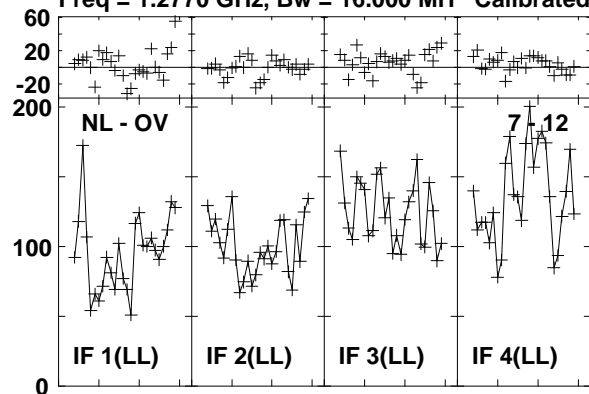

Lower frame: Milli Ampl Jy Top frame: Phas deg
Vector averaged cross-power spectrum Baseline: NL (07) - OV (12)
Timerange: 00:17:58:58 to 00:18:00:56

Plot file version 322 created 03-MAR-2016 01:12:52

J1638+5720 GN002C 1.UVDATA.1

Freq = 1.2770 GHz, Bw = 16.000 MH Calibrated with CL # 3 and BP # 1 (BP mode 1)

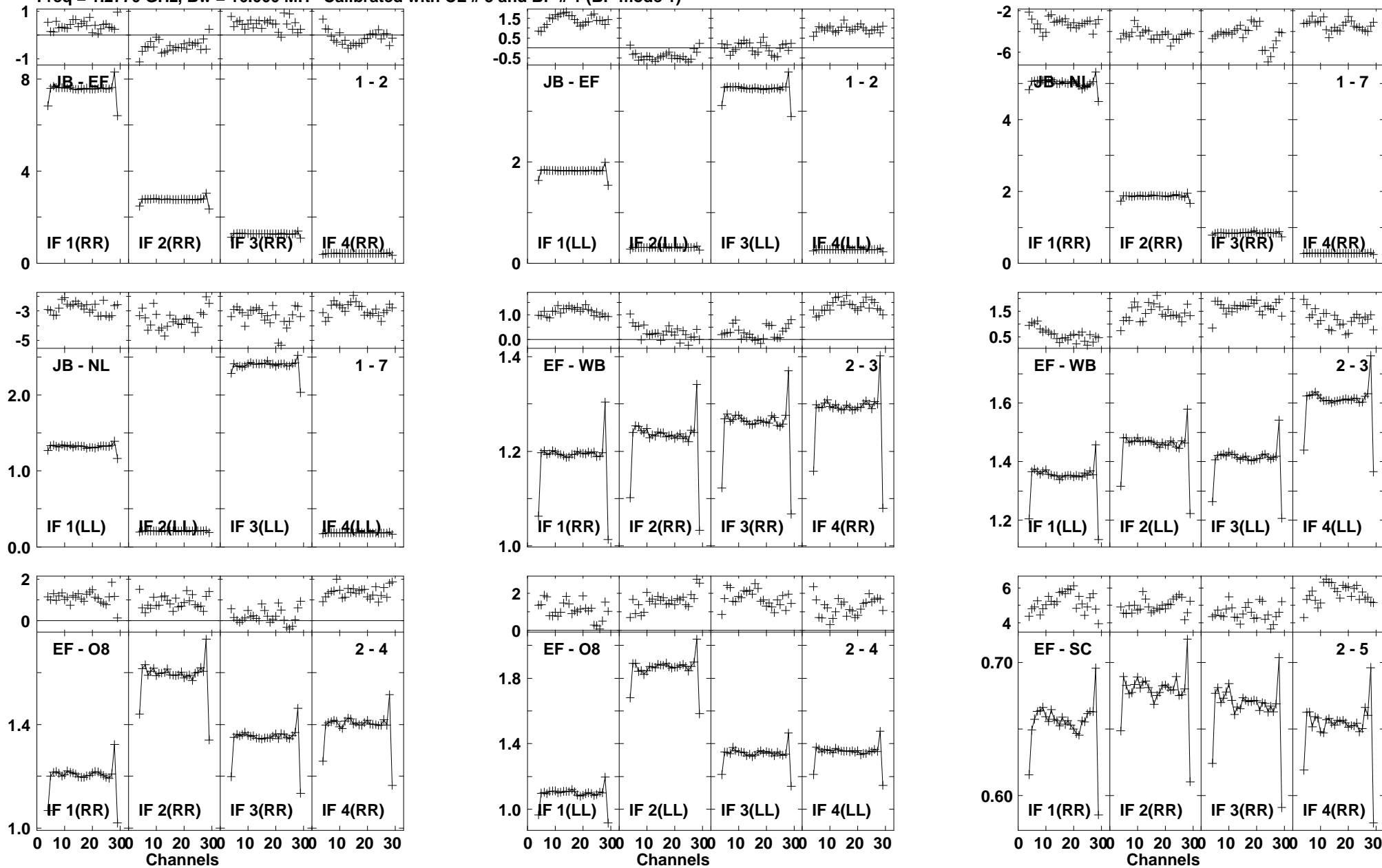

Lower frame: Ampl Jy Top frame: Phas deg
Vector averaged cross-power spectrum Baseline: JB (01) - EF (02)
Timerange: 00/18:02:19 to 00/18:06:07

Plot file version 323 created 03-MAR-2016 01:12:52

J1638+5720 GN002C 1.UVDATA.1

Freq = 1.2770 GHz, Bw = 16.000 MH Calibrated with CL # 3 and BP # 1 (BP mode 1)

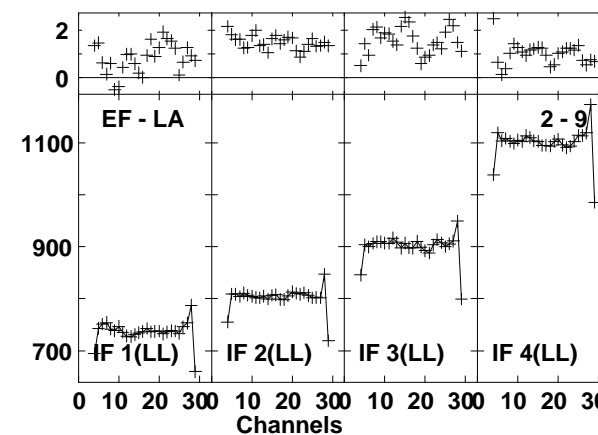
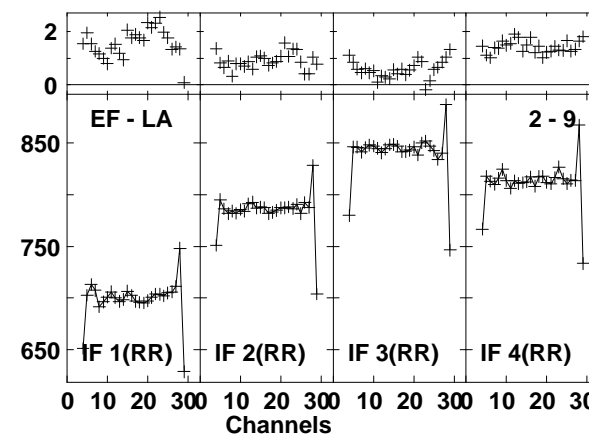
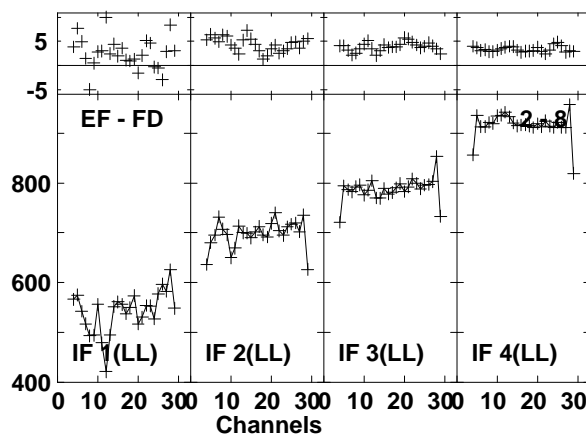
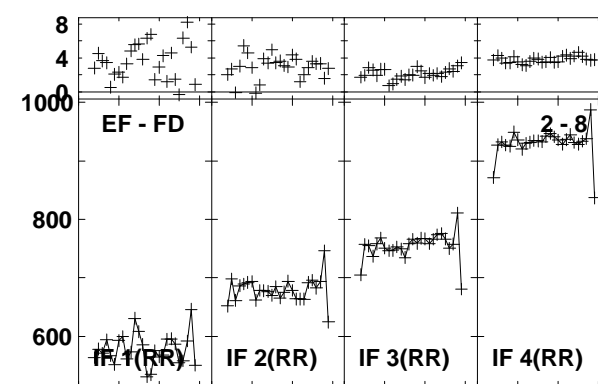
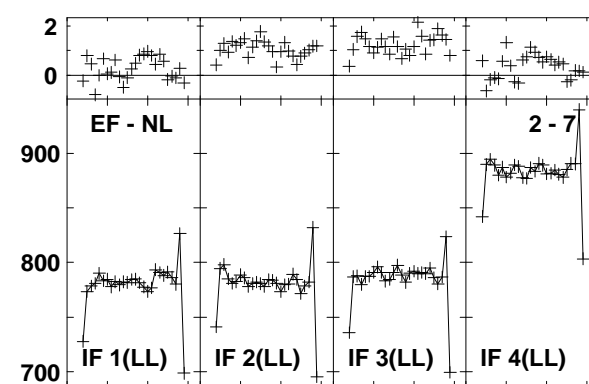
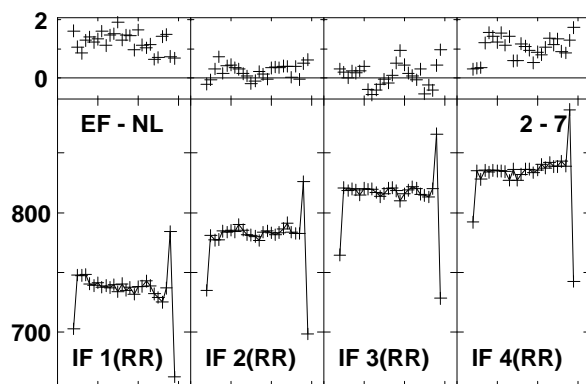
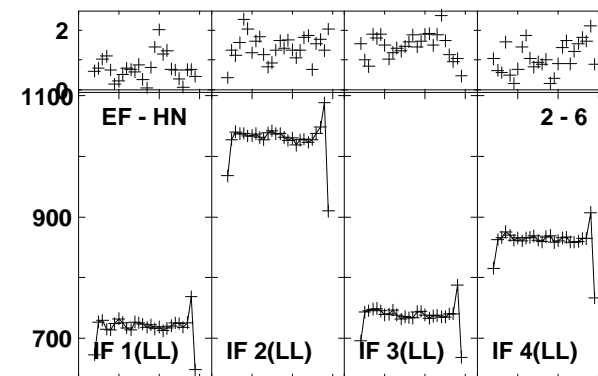
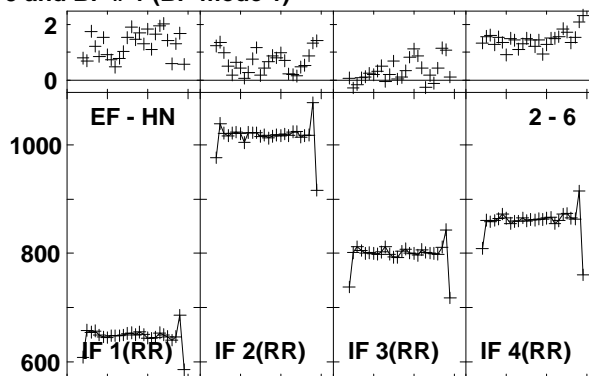
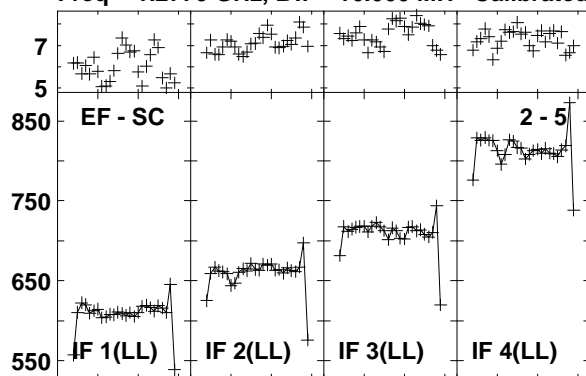

Lower frame: Milli Ampl Jy Top frame: Phas deg
Vector averaged cross-power spectrum Baseline: EF (02) - SC (05)
Timerange: 00/18:02:19 to 00/18:06:07

Plot file version 324 created 03-MAR-2016 01:12:52

J1638+5720 GN002C 1.UVDATA.1

Freq = 1.2770 GHz, Bw = 16.000 MH Calibrated with CL # 3 and BP # 1 (BP mode 1)

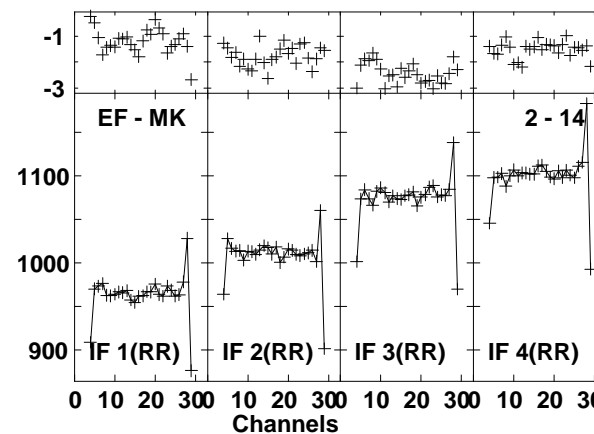
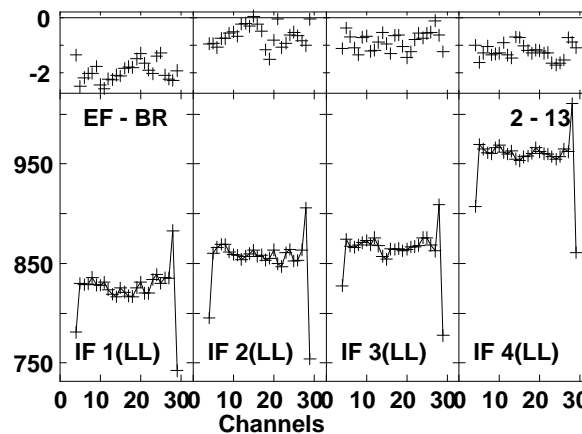
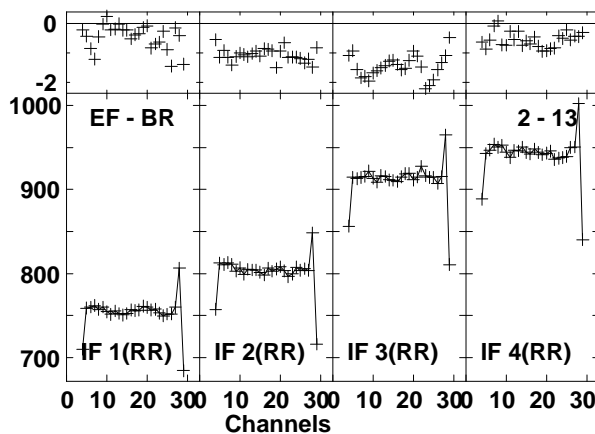
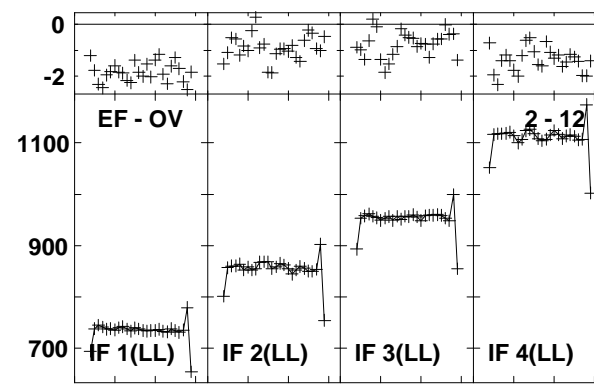
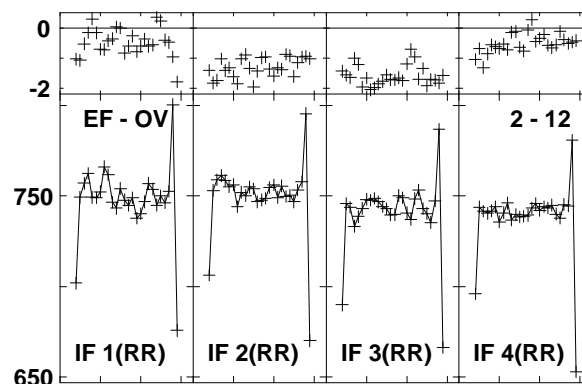
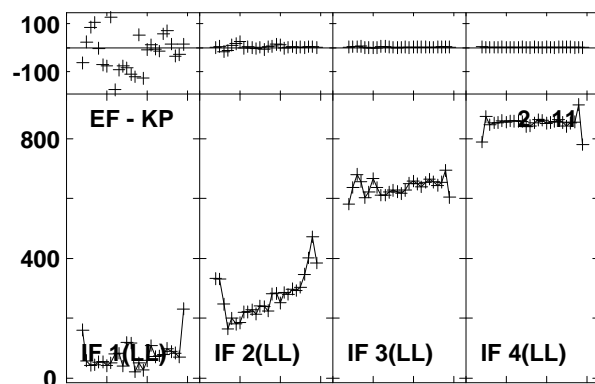
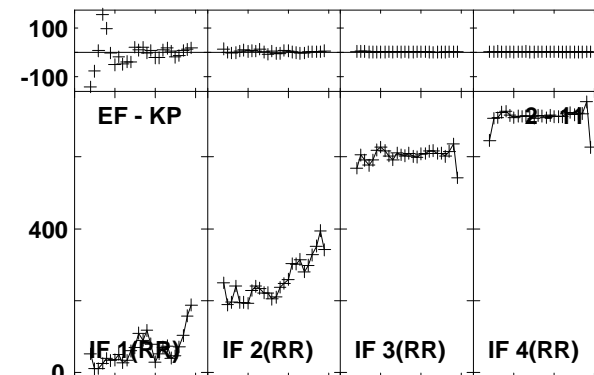
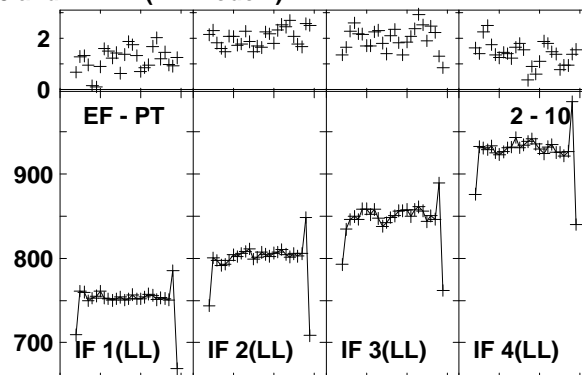
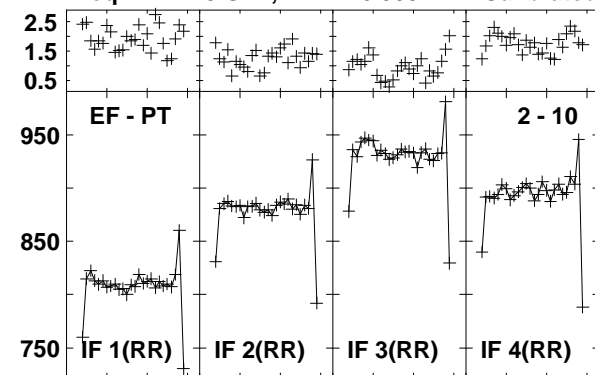

Lower frame: Milli Ampl Jy Top frame: Phas deg
Vector averaged cross-power spectrum Baseline: EF (02) - PT (10)
Timerange: 00/18:02:19 to 00/18:06:07

Plot file version 325 created 03-MAR-2016 01:12:52

J1638+5720 GN002C 1.UVDATA.1

Freq = 1.2770 GHz, Bw = 16.000 MH Calibrated with CL # 3 and BP # 1 (BP mode 1)

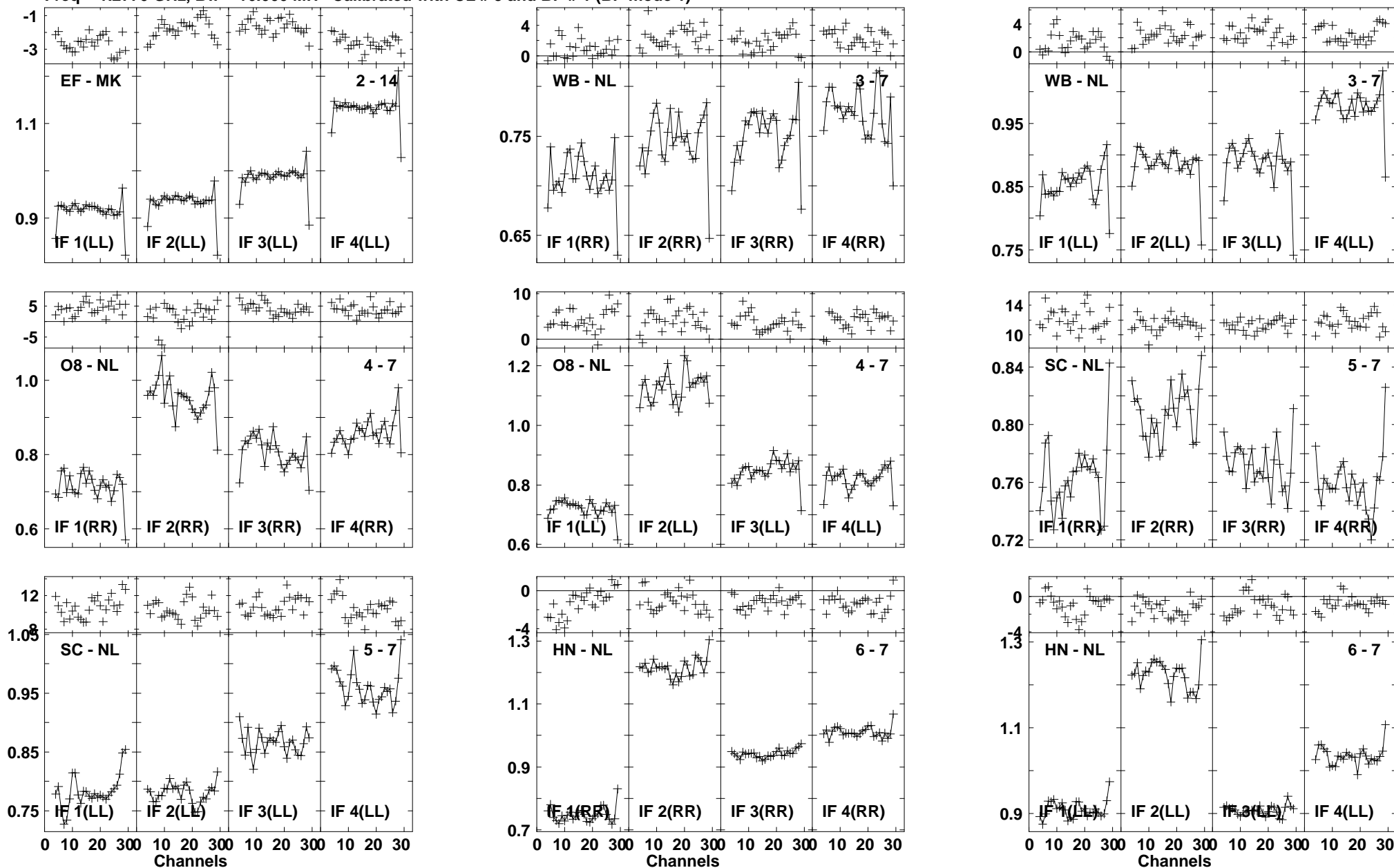

Lower frame: Ampl Jy Top frame: Phas deg
Vector averaged cross-power spectrum Baseline: EF (02) - MK (14)
Timerange: 00:18:02:19 to 00:18:06:07

Plot file version 326 created 03-MAR-2016 01:12:52

J1638+5720 GN002C 1.UVDATA.1

Freq = 1.2770 GHz, Bw = 16.000 MH Calibrated with CL # 3 and BP # 1 (BP mode 1)

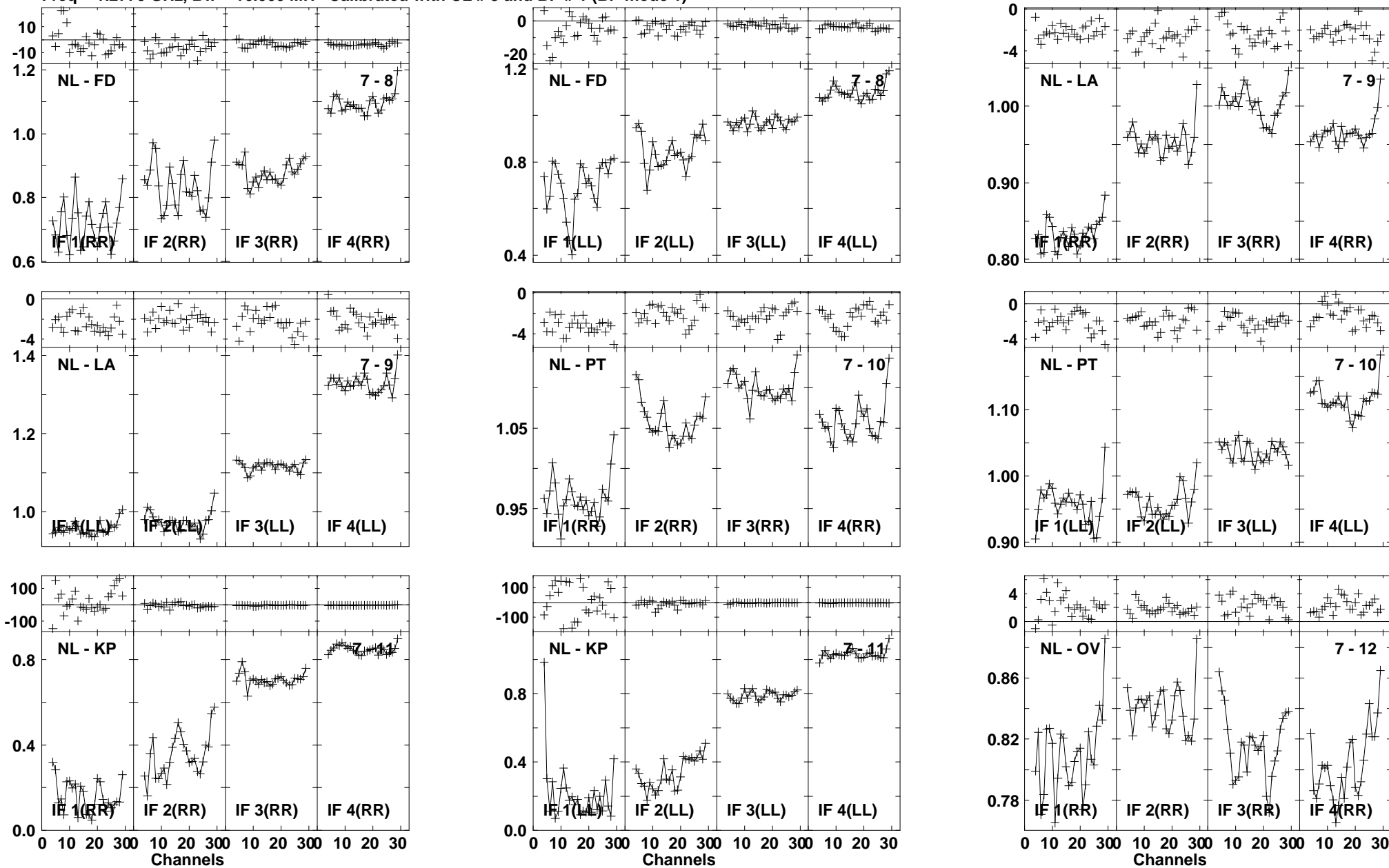

Lower frame: Ampl Jy Top frame: Phas deg
Vector averaged cross-power spectrum Baseline: NL (07) - FD (08)
Timerange: 00:18:02:19 to 00:18:06:07

Plot file version 327 created 03-MAR-2016 01:12:53

J1638+5720 GN002C 1.UVDATA.1

Freq = 1.2770 GHz, Bw = 16.000 MH Calibrated with CL # 3 and BP # 1 (BP mode 1)

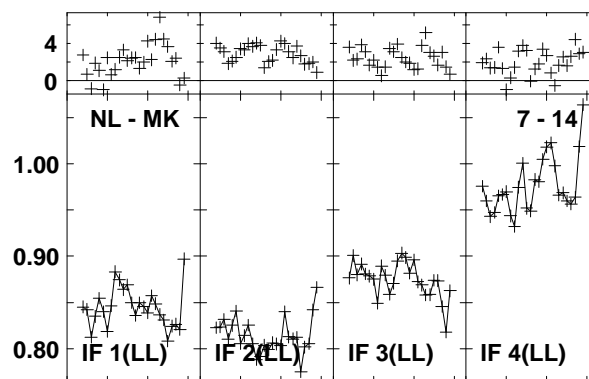
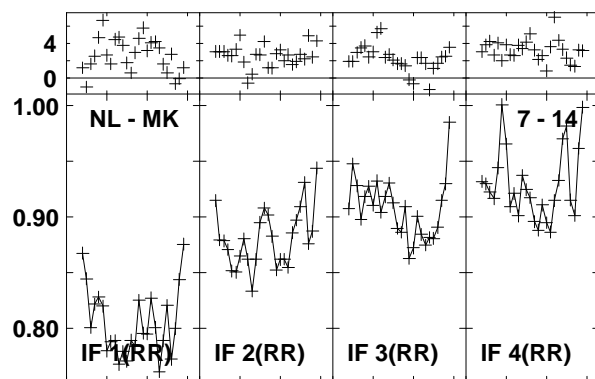
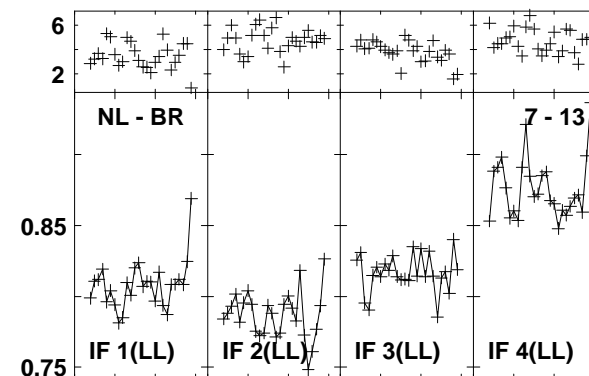
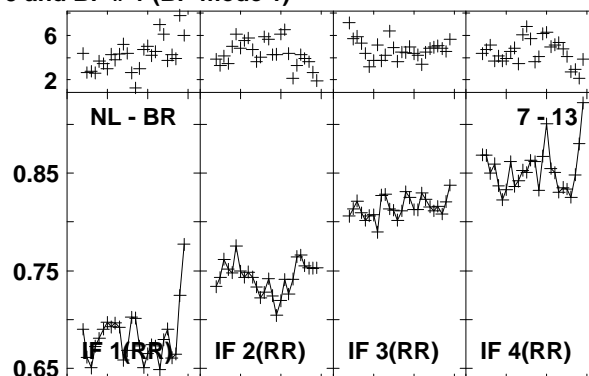
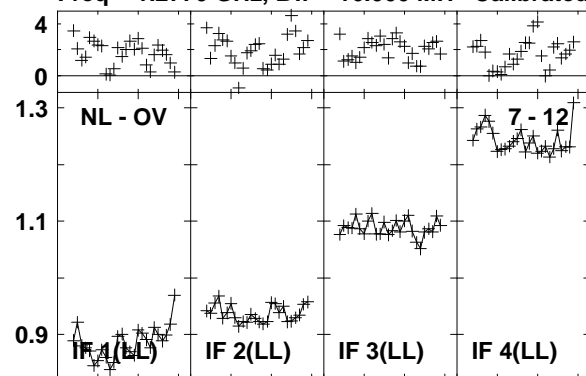

Lower frame: Ampl Jy Top frame: Phas deg
Vector averaged cross-power spectrum Baseline: NL (07) - OV (12)
Timerange: 00/18:02:19 to 00/18:06:07

Plot file version 328 created 03-MAR-2016 01:12:53

J1545+5400 GN002C 1.UVDATA.1

Freq = 1.2770 GHz, Bw = 16.000 MH Calibrated with CL # 3 and BP # 1 (BP mode 1)

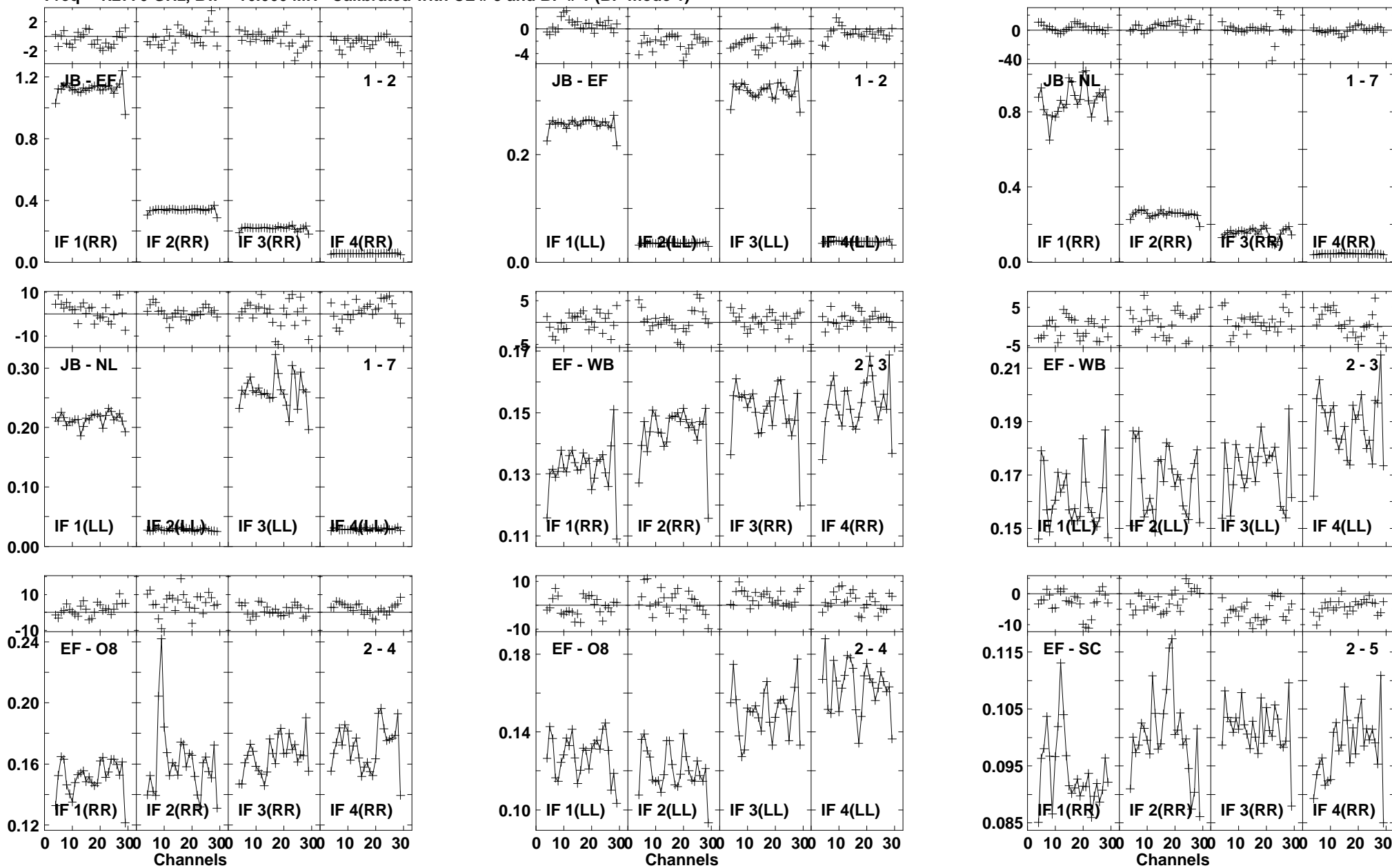

Plot file version 329 created 03-MAR-2016 01:12:53

J1545+5400 GN002C 1.UVDATA.1

Freq = 1.2770 GHz, Bw = 16.000 MH Calibrated with CL # 3 and BP # 1 (BP mode 1)

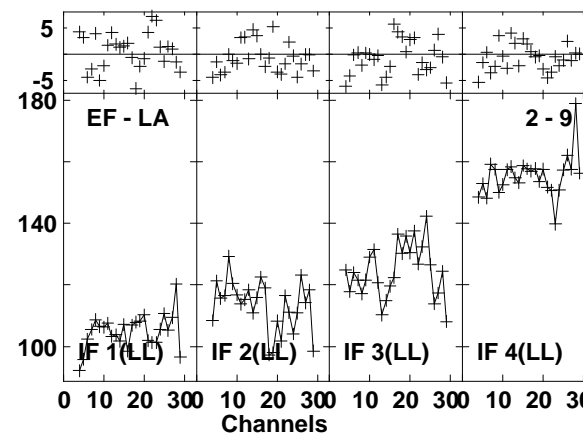
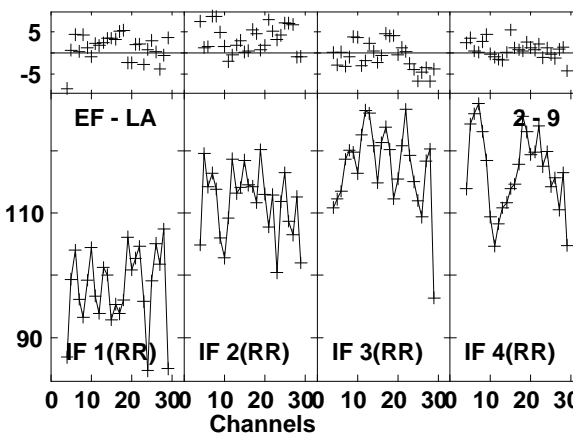
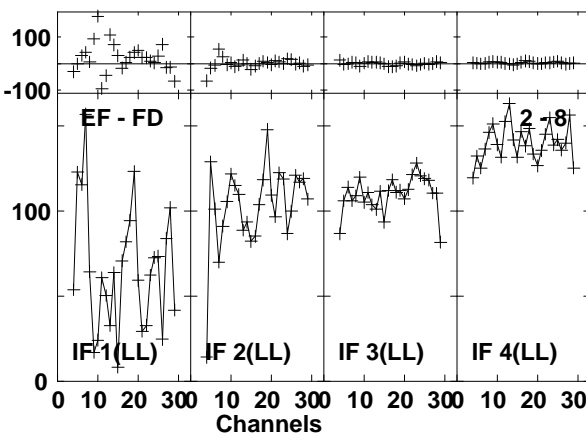
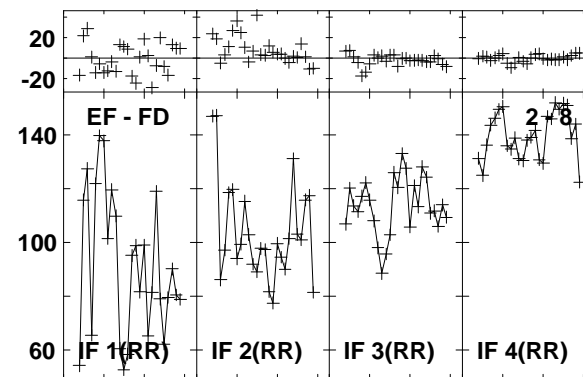
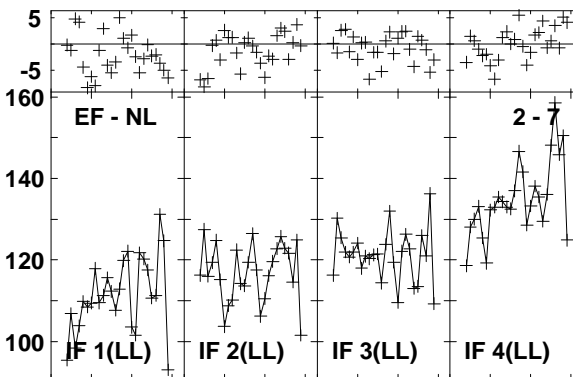
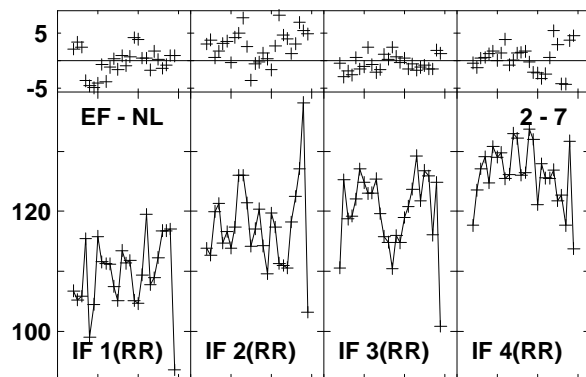
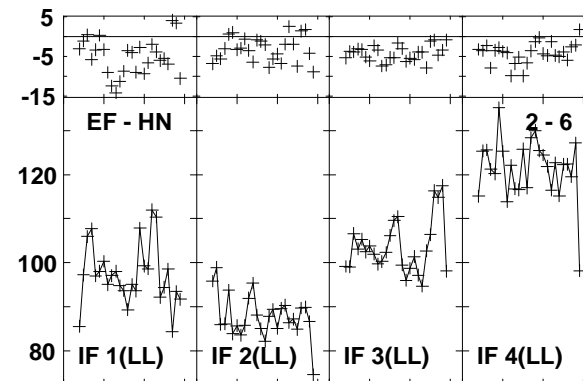
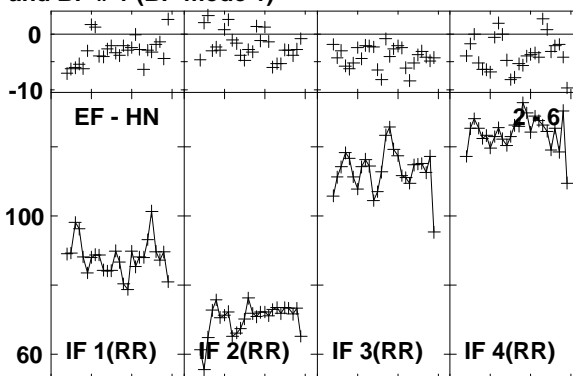
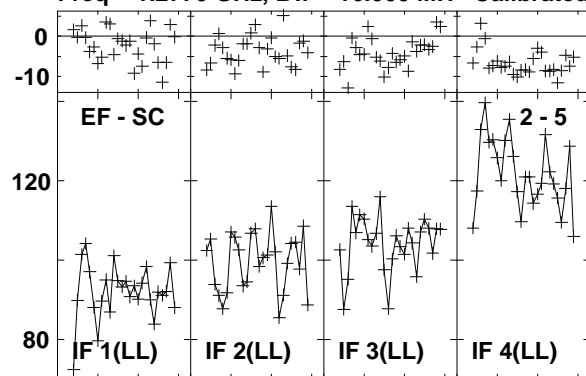

Lower frame: Milli Ampl Jy Top frame: Phas deg
Vector averaged cross-power spectrum Baseline: EF (02) - SC (05)
Timerange: 00:18:07:31 to 00:18:10:19

Plot file version 330 created 03-MAR-2016 01:12:53

J1545+5400 GN002C 1.UVDATA.1

Freq = 1.2770 GHz, Bw = 16.000 MH Calibrated with CL # 3 and BP # 1 (BP mode 1)

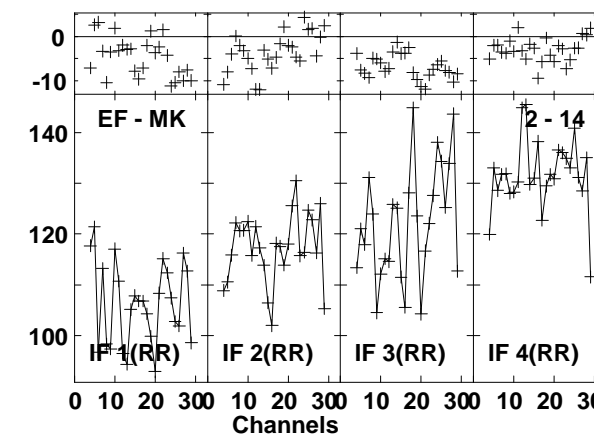
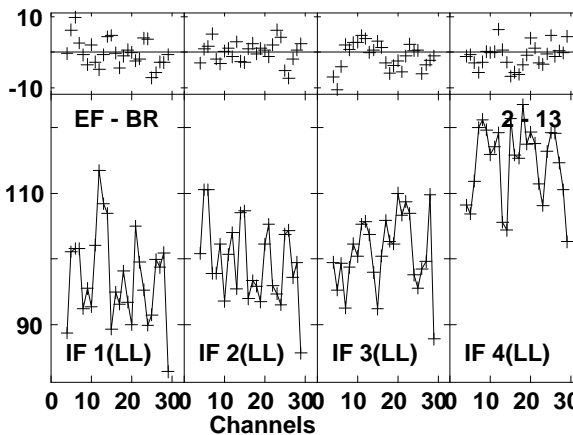
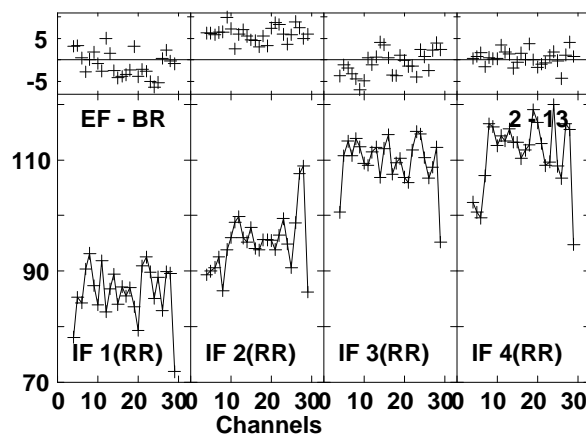
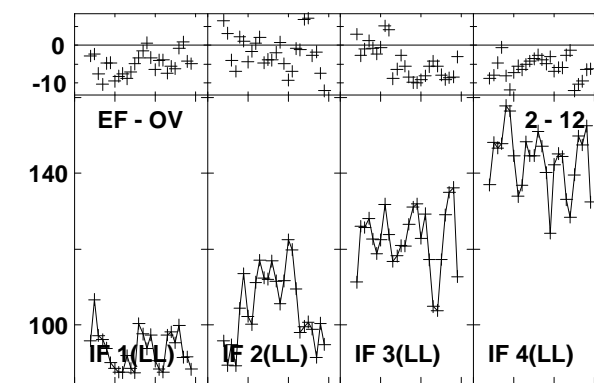
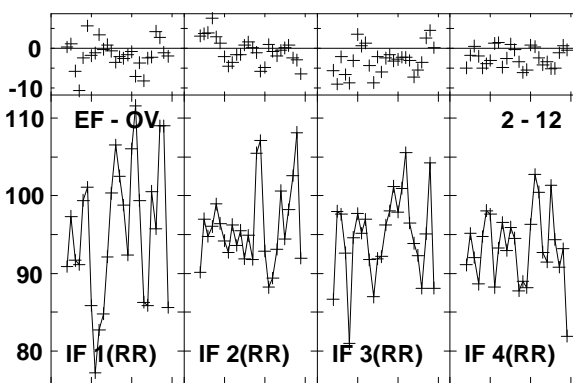
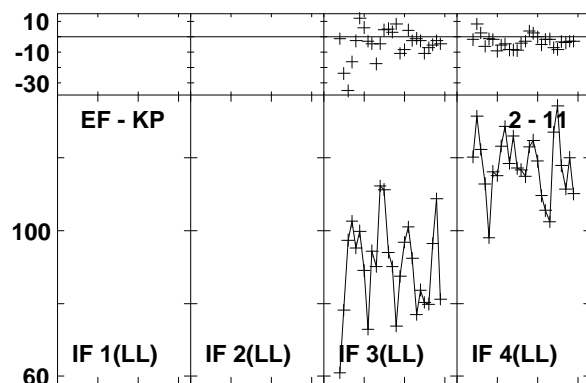
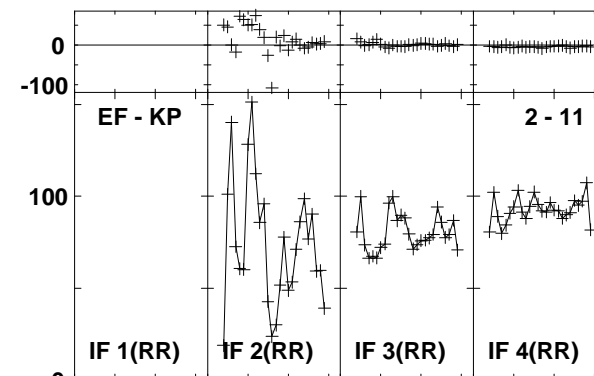
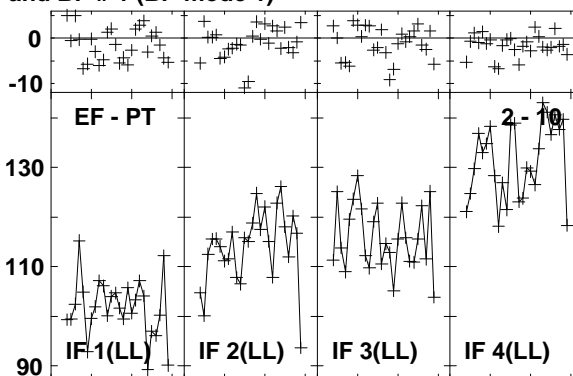
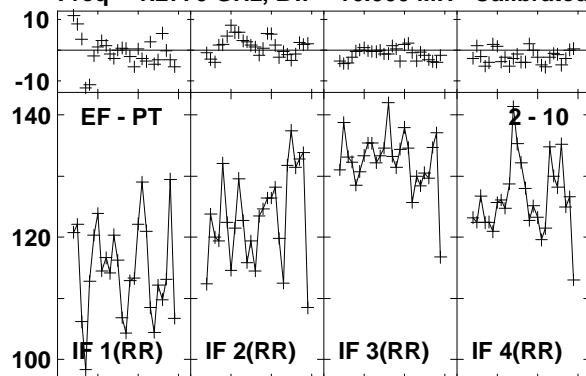

Lower frame: Milli Ampl Jy Top frame: Phas deg
Vector averaged cross-power spectrum Baseline: EF (02) - PT (10)
Timerange: 00/18:07:31 to 00/18:10:19

Plot file version 331 created 03-MAR-2016 01:12:53

J1545+5400 GN002C 1.UVDATA.1

Freq = 1.2770 GHz, Bw = 16.000 MH Calibrated with CL # 3 and BP # 1 (BP mode 1)

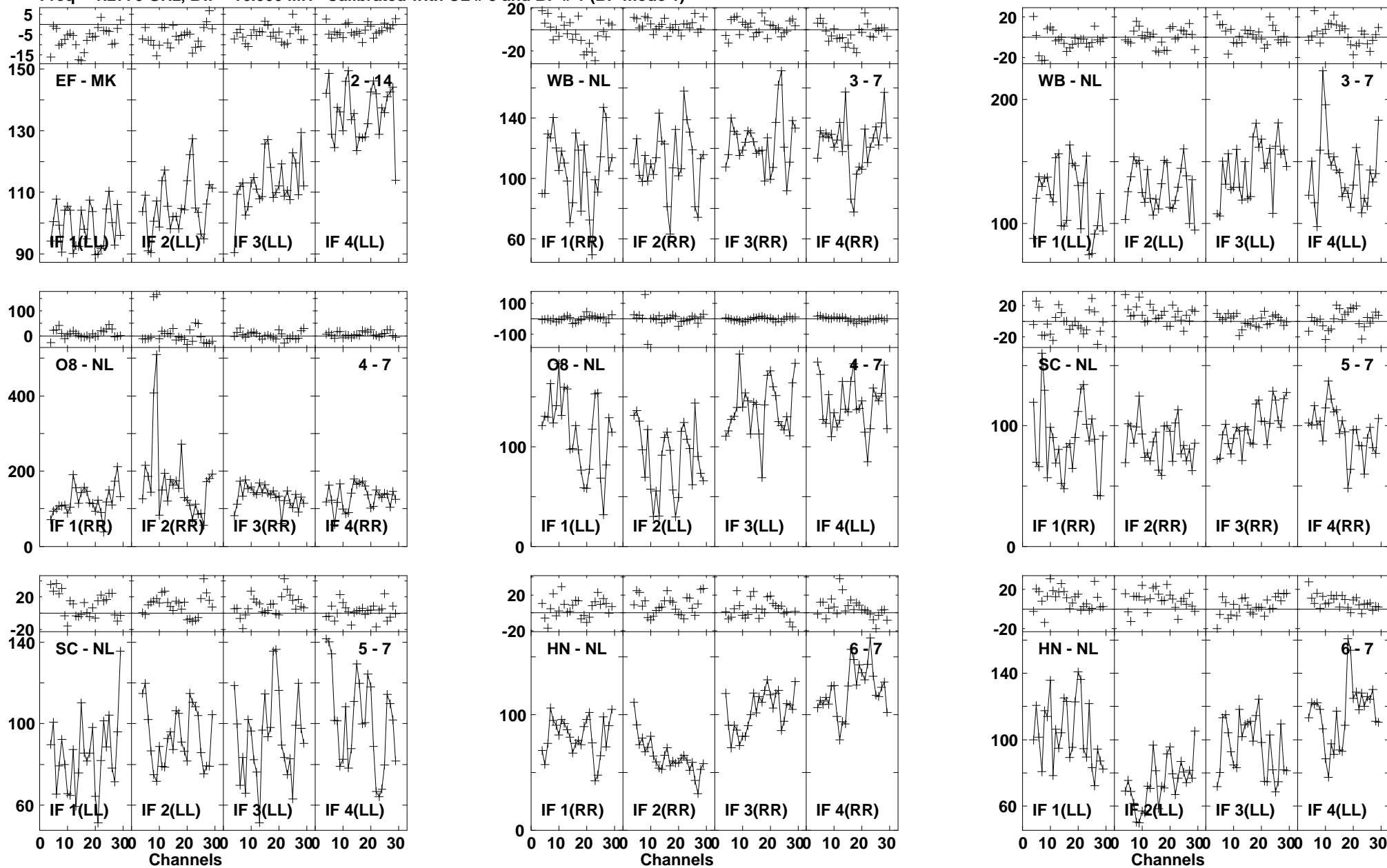

Lower frame: Milli Ampl Jy Top frame: Phas deg
Vector averaged cross-power spectrum Baseline: EF (02) - MK (14)
Timerange: 00/18:07:31 to 00/18:10:19

Plot file version 332 created 03-MAR-2016 01:12:54

J1545+5400 GN002C 1.UVDATA.1

Freq = 1.2770 GHz, Bw = 16.000 MH Calibrated with CL # 3 and BP # 1 (BP mode 1)

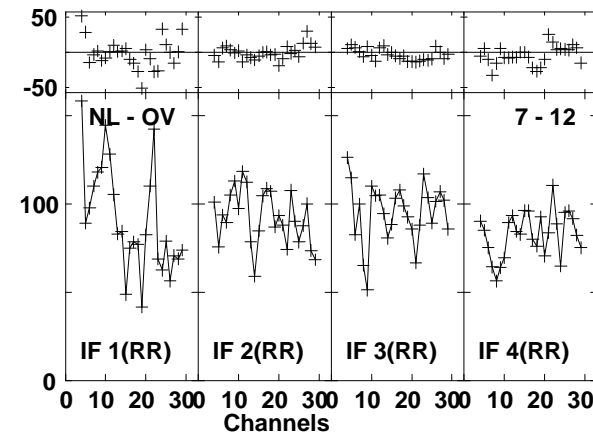
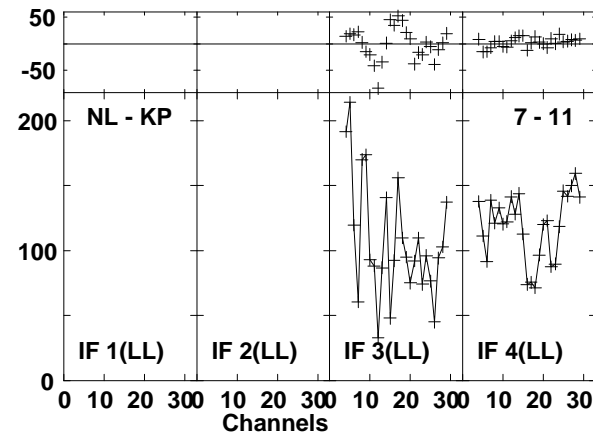
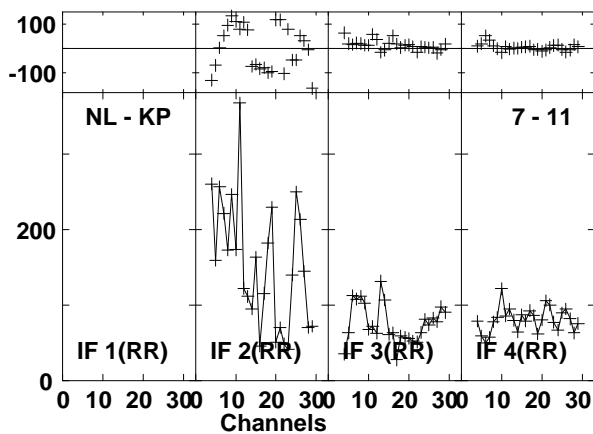
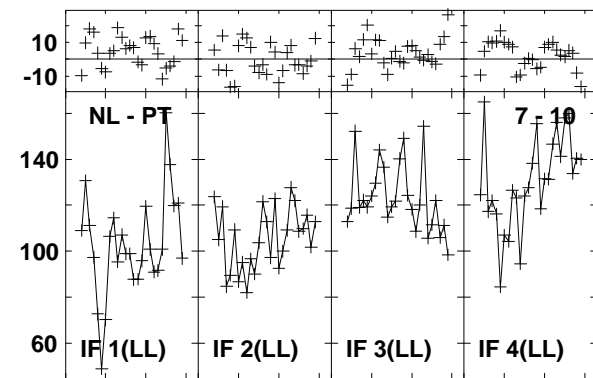
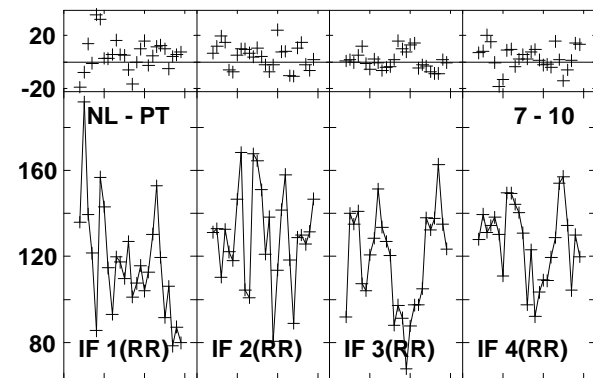
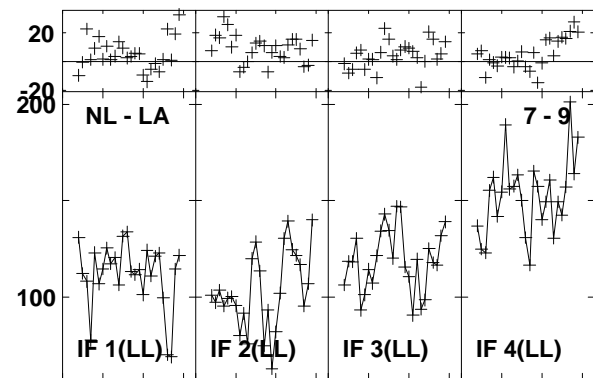
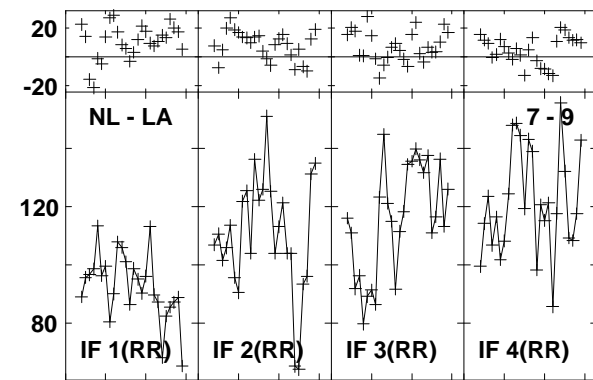
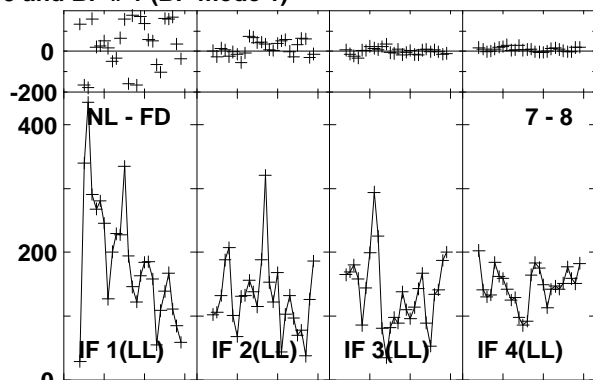
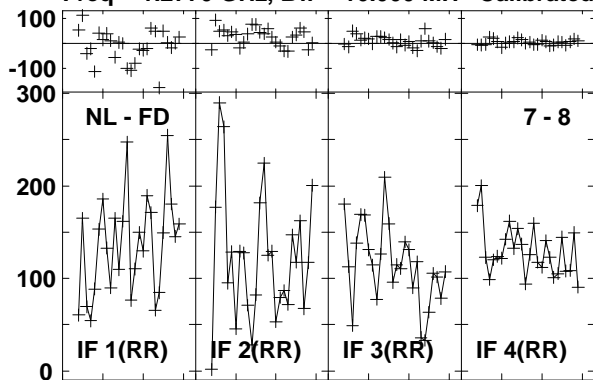

Lower frame: Milli Ampl Jy Top frame: Phas deg
Vector averaged cross-power spectrum Baseline: NL (07) - FD (08)
Timerange: 00/18:07:31 to 00/18:10:19

Plot file version 333 created 03-MAR-2016 01:12:54

J1545+5400 GN002C 1.UVDATA.1

Freq = 1.2770 GHz, Bw = 16.000 MH Calibrated with CL # 3 and BP # 1 (BP mode 1)

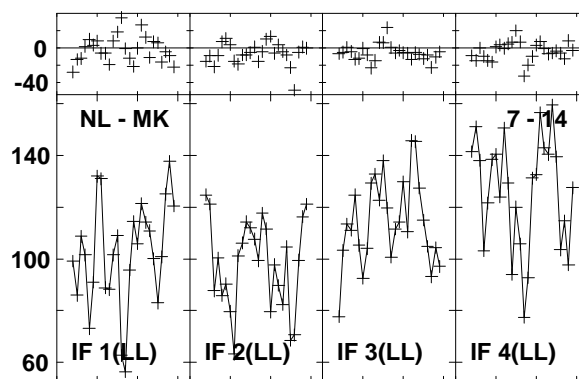
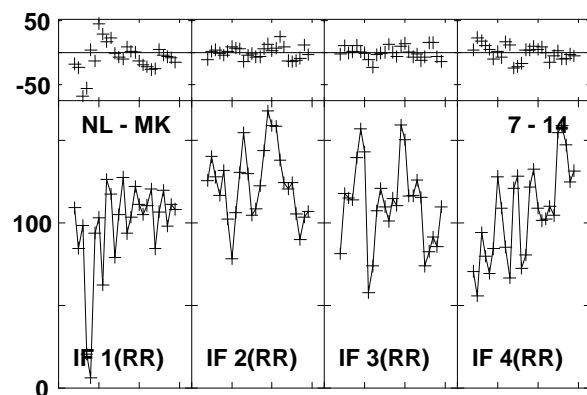
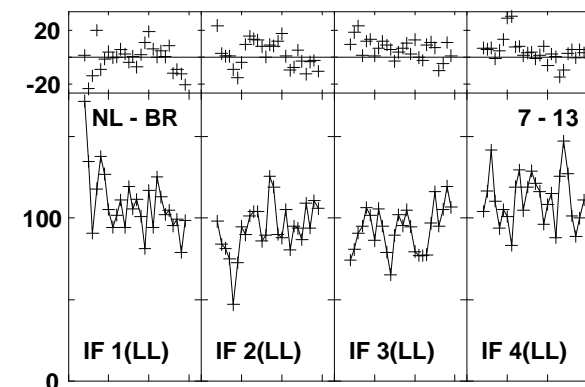
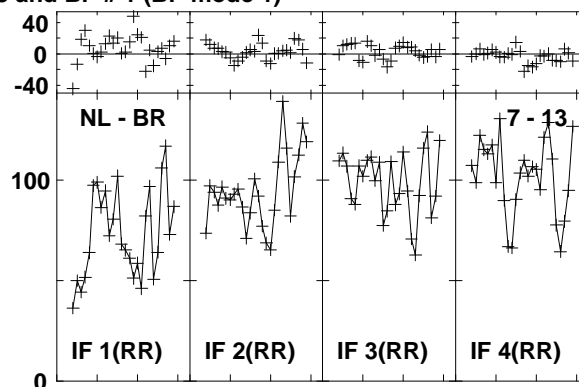
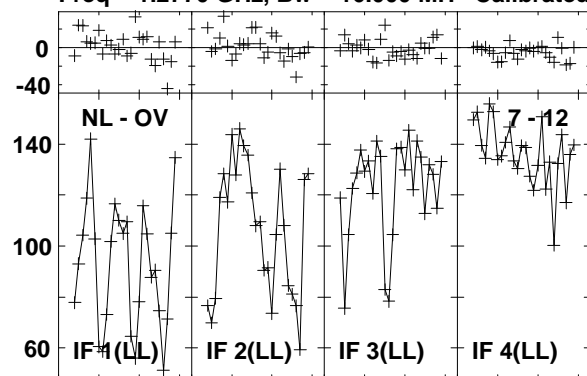

Lower frame: Milli Ampl Jy Top frame: Phas deg
Vector averaged cross-power spectrum Baseline: NL (07) - OV (12)
Timerange: 00:18:07:31 to 00:18:10:19

Plot file version 334 created 03-MAR-2016 01:12:54

4C52 GN002C 1.UVDATA.1

Freq = 1.2770 GHz, Bw = 16.000 MH Calibrated with CL # 3 and BP # 1 (BP mode 1)

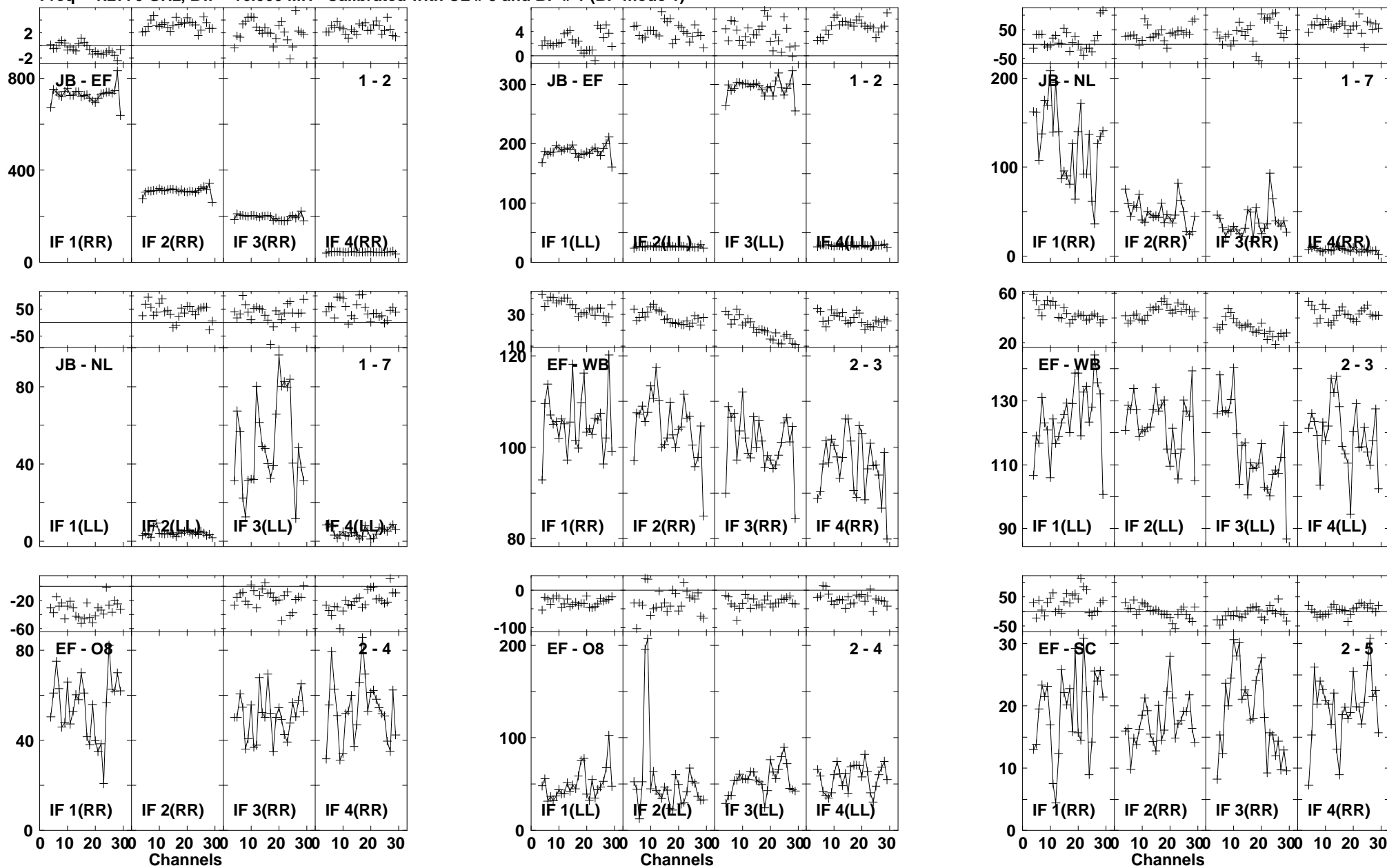

Lower frame: Milli Ampl Jy Top frame: Phas deg
Vector averaged cross-power spectrum Baseline: JB (01) - EF (02)
Timerange: 00/18:10:32 to 00/18:13:18

Plot file version 335 created 03-MAR-2016 01:12:54

4C52 GN002C 1.UVDATA.1

Freq = 1.2770 GHz, Bw = 16.000 MH Calibrated with CL # 3 and BP # 1 (BP mode 1)

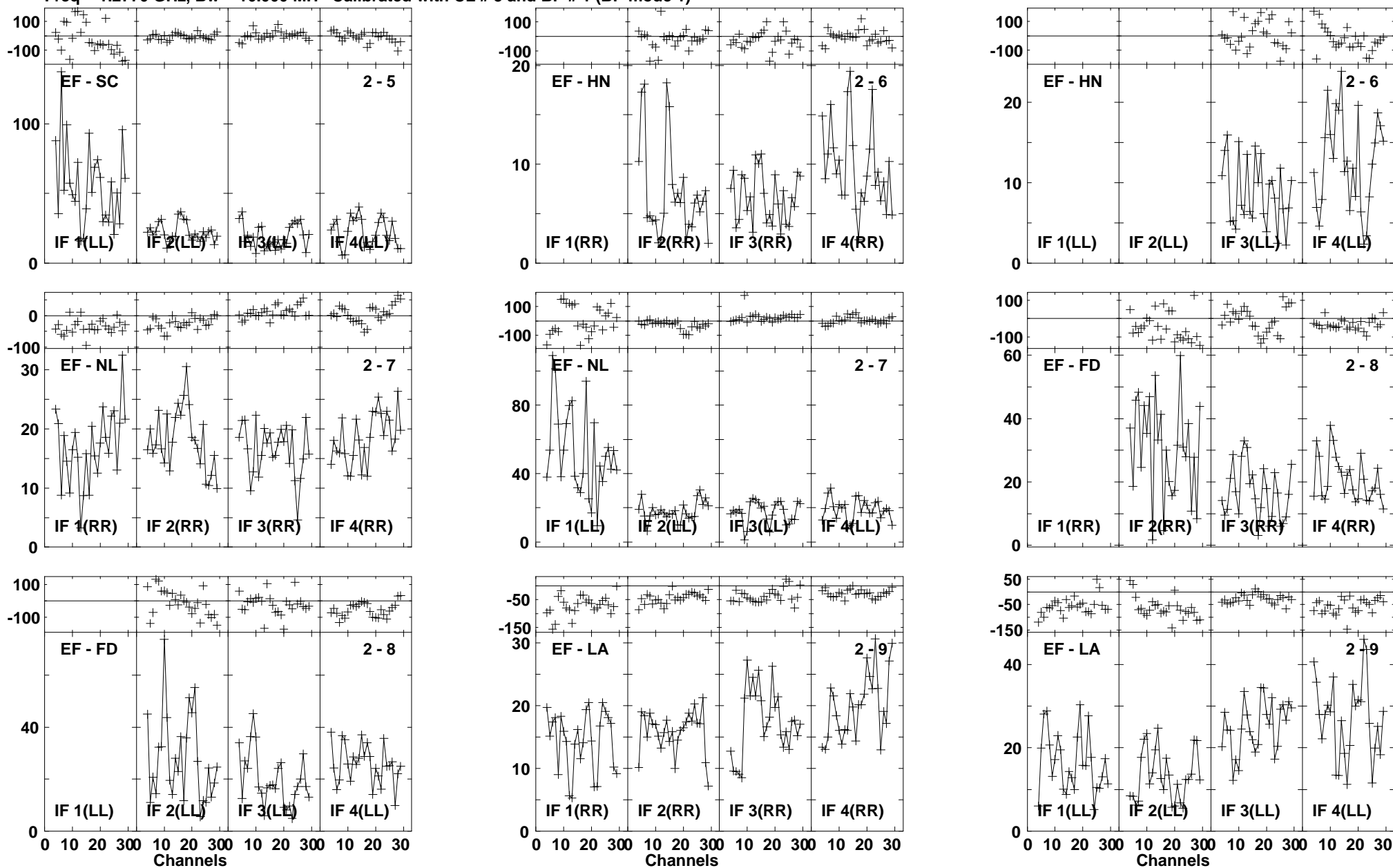

Lower frame: Milli Ampl Jy Top frame: Phas deg
Vector averaged cross-power spectrum Baseline: EF (02) - SC (05)
Timerange: 00/18:10:32 to 00/18:13:18

Plot file version 336 created 03-MAR-2016 01:12:54
 4C52 GN002C 1.UVDATA.1

Freq = 1.2770 GHz, Bw = 16.000 MH Calibrated with CL # 3 and BP # 1 (BP mode 1)

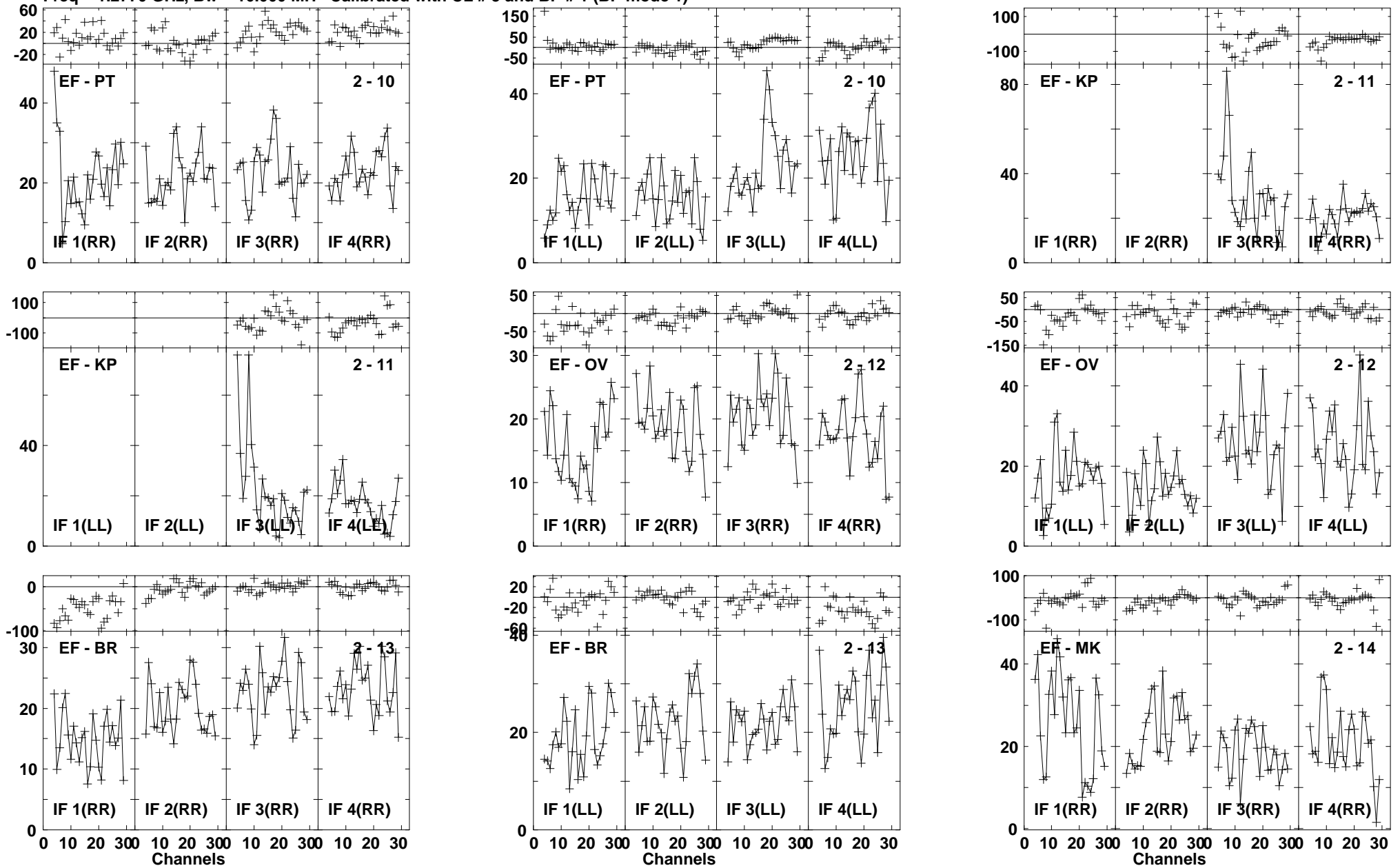

Lower frame: Milli Ampl Jy Top frame: Phas deg
 Vector averaged cross-power spectrum Baseline: EF (02) - PT (10)
 Timerange: 00/18:10:32 to 00/18:13:18

Plot file version 337 created 03-MAR-2016 01:12:54

4C52 GN002C 1.UVDATA.1

Freq = 1.2770 GHz, Bw = 16.000 MH Calibrated with CL # 3 and BP # 1 (BP mode 1)

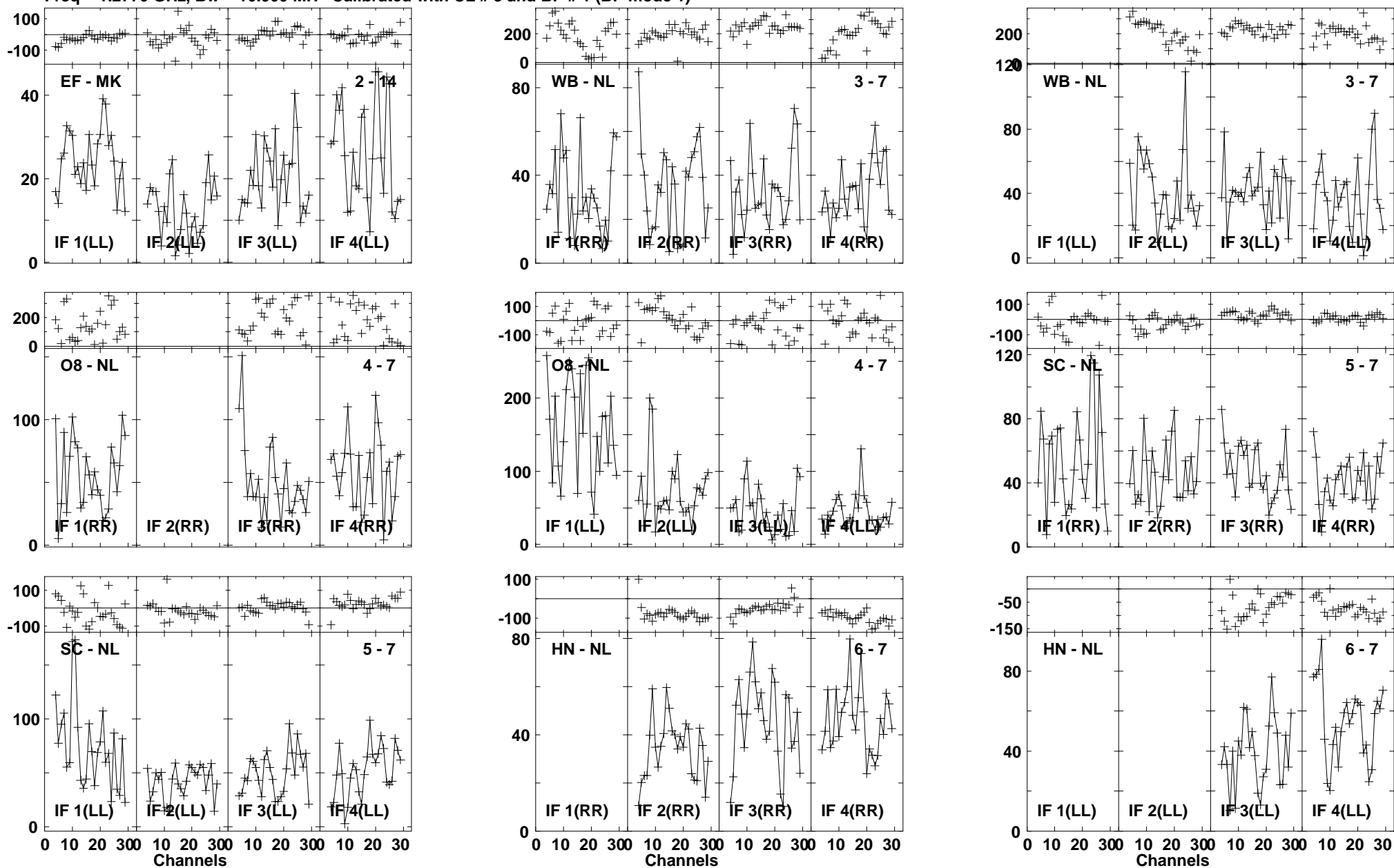

Lower frame: Milli Ampl Jy Top frame: Phas deg
Vector averaged cross-power spectrum Baseline: EF (02) - MK (14)
Timerange: 00/18:10:32 to 00/18:13:18

Plot file version 338 created 03-MAR-2016 01:12:55
 4C52 GN002C 1.UVDATA.1
 Freq = 1.2770 GHz, Bw = 16.000 MH Calibrated with CL # 3 and BP # 1 (BP mode 1)

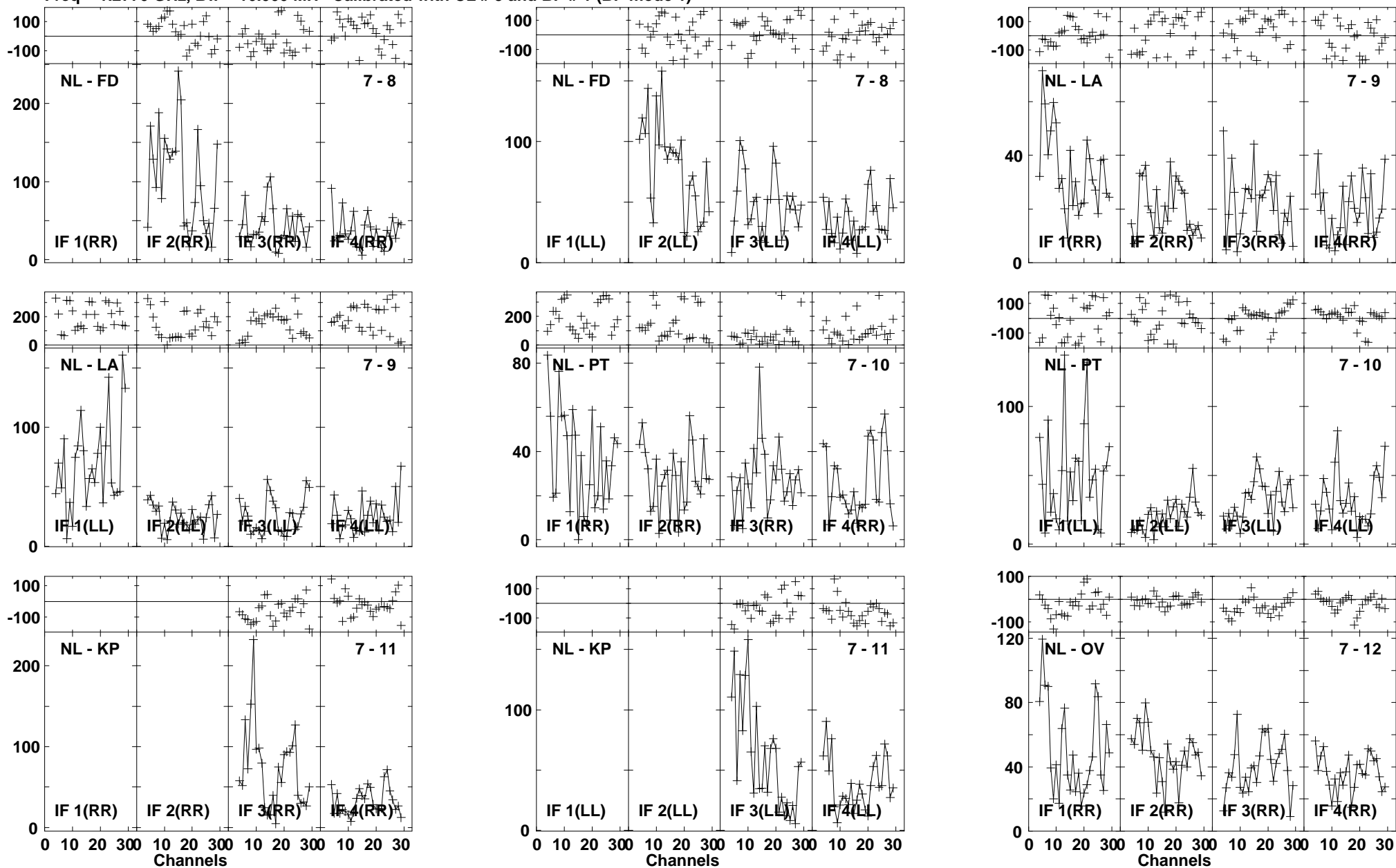

Lower frame: Milli Ampl Jy Top frame: Phas deg
 Vector averaged cross-power spectrum Baseline: NL (07) - FD (08)
 Timerange: 00/18:10:32 to 00/18:13:18

Plot file version 339 created 03-MAR-2016 01:12:55

4C52 GN002C 1.UVDATA.1

Freq = 1.2770 GHz, Bw = 16.000 MH Calibrated with CL # 3 and BP # 1 (BP mode 1)

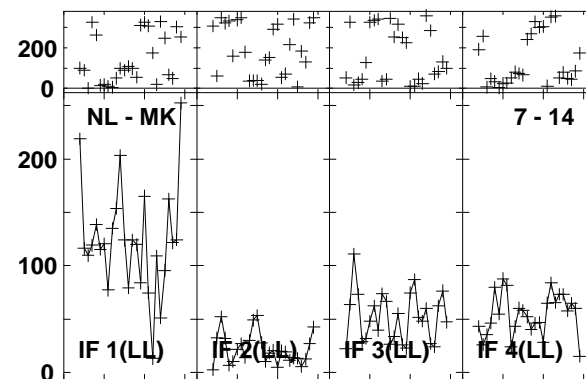
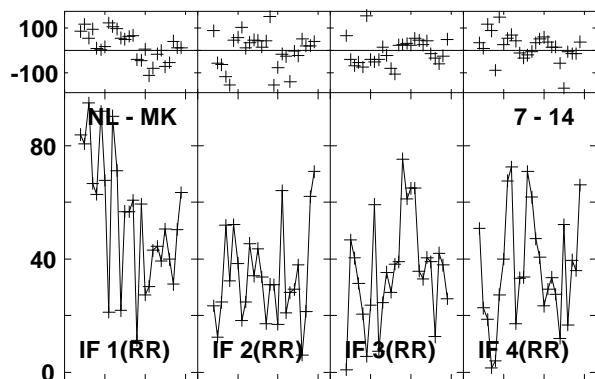
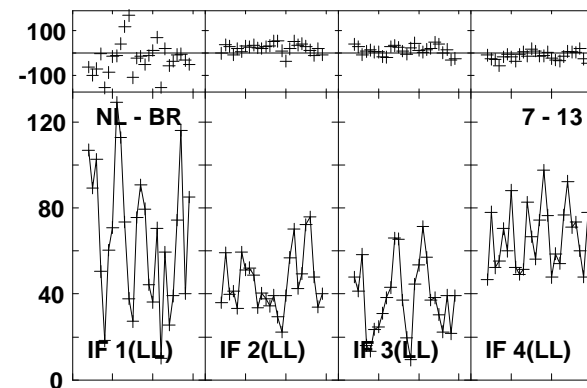
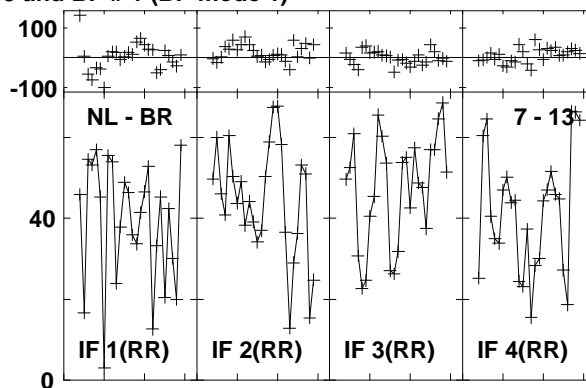
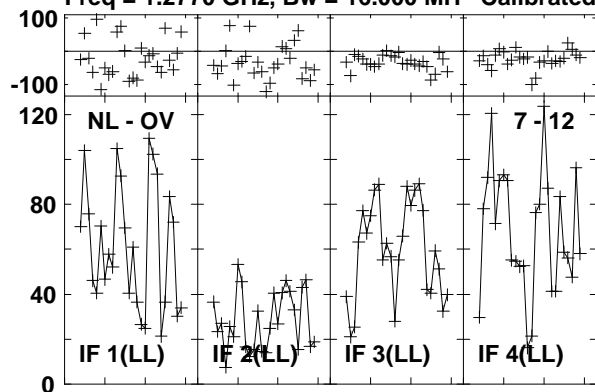

Lower frame: Milli Ampl Jy Top frame: Phas deg
Vector averaged cross-power spectrum Baseline: NL (07) - OV (12)
Timerange: 00:18:10:32 to 00:18:13:18

Plot file version 340 created 03-MAR-2016 01:12:55

J1545+5400 GN002C 1.UVDATA.1

Freq = 1.2770 GHz, Bw = 16.000 MH Calibrated with CL # 3 and BP # 1 (BP mode 1)

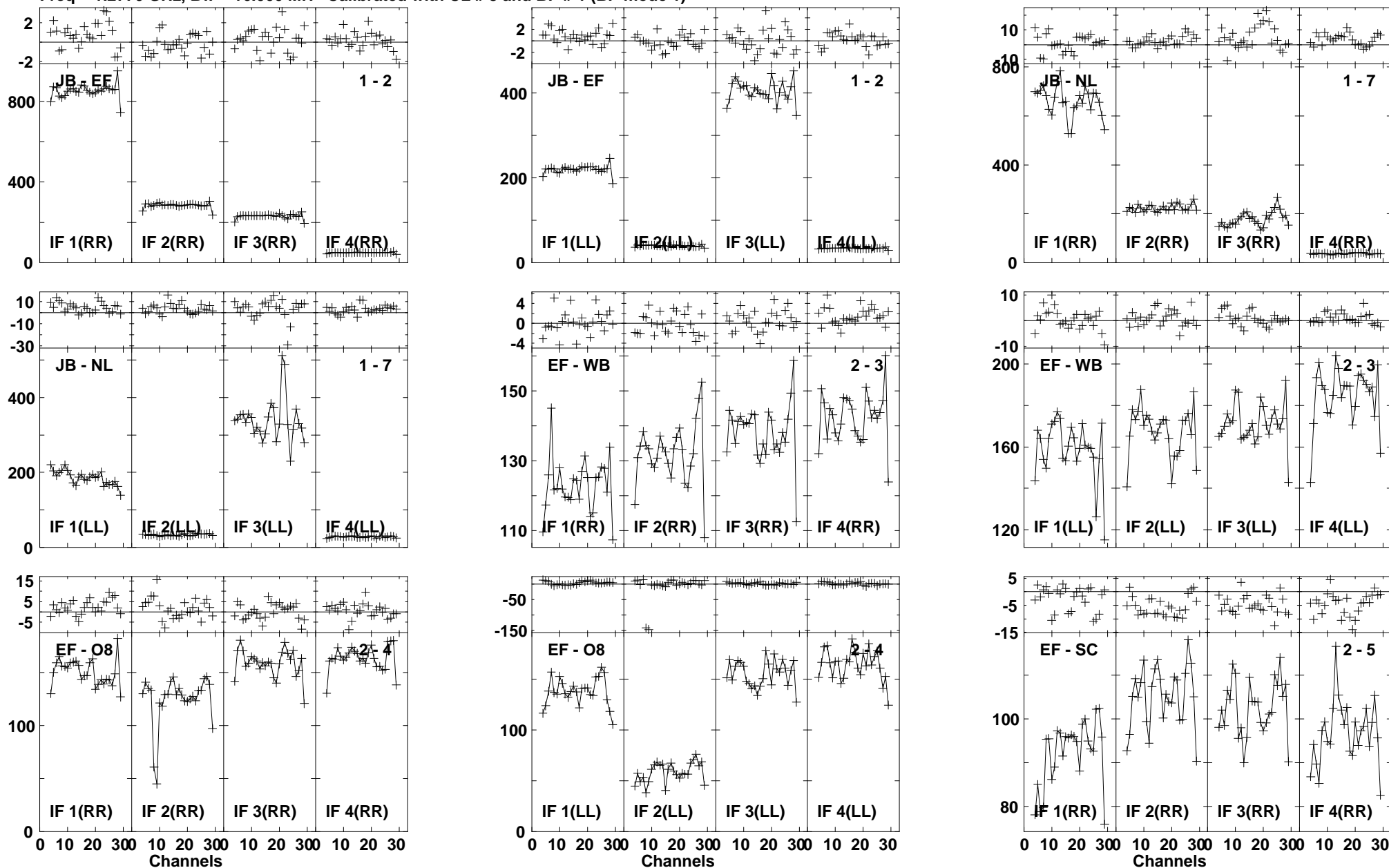

Lower frame: Milli Ampl Jy Top frame: Phas deg
Vector averaged cross-power spectrum Baseline: JB (01) - EF (02)
Timerange: 00/18:14:11 to 00/18:16:09

Plot file version 341 created 03-MAR-2016 01:12:55

J1545+5400 GN002C 1.UVDATA.1

Freq = 1.2770 GHz, Bw = 16.000 MH Calibrated with CL # 3 and BP # 1 (BP mode 1)

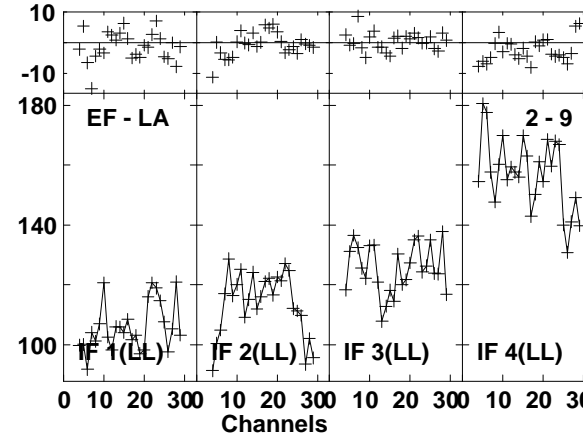
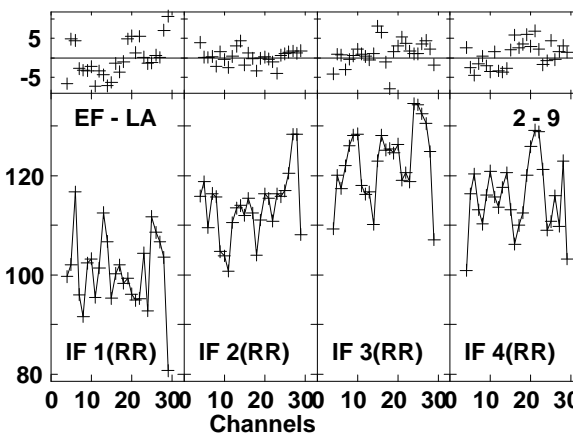
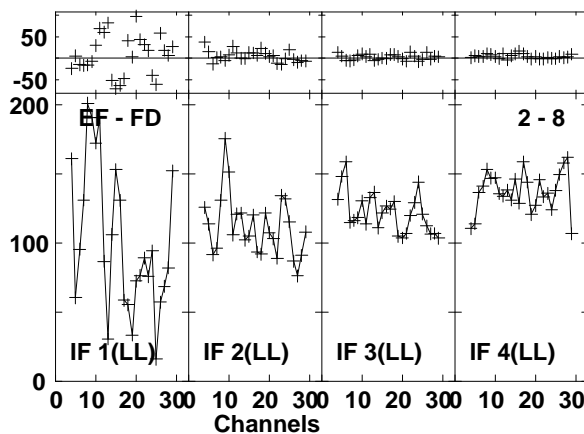
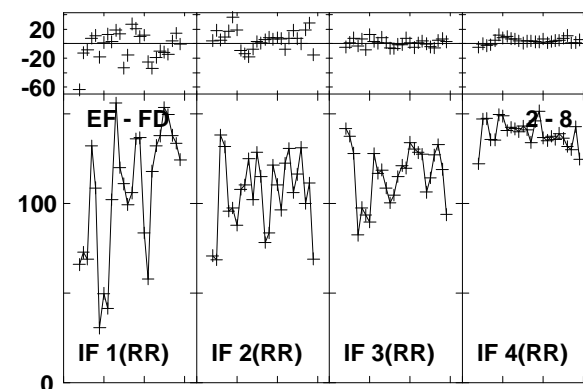
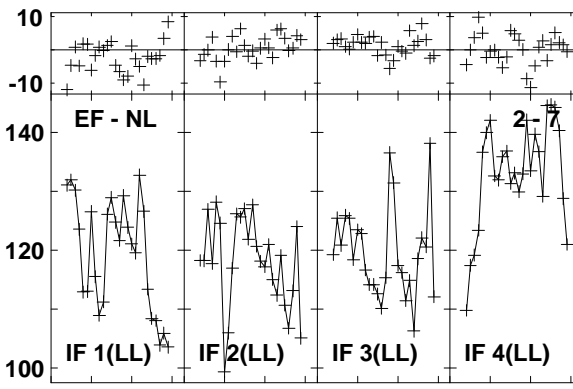
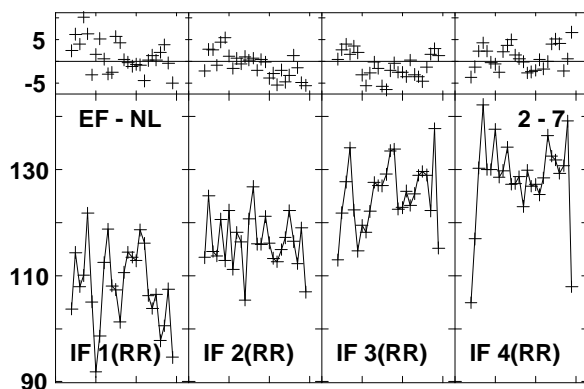
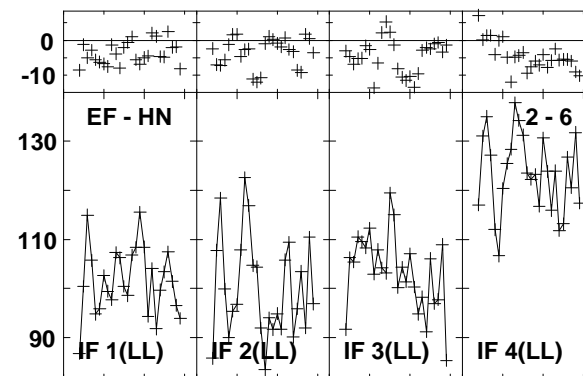
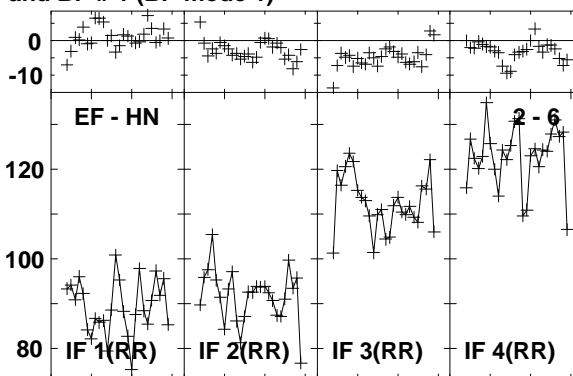
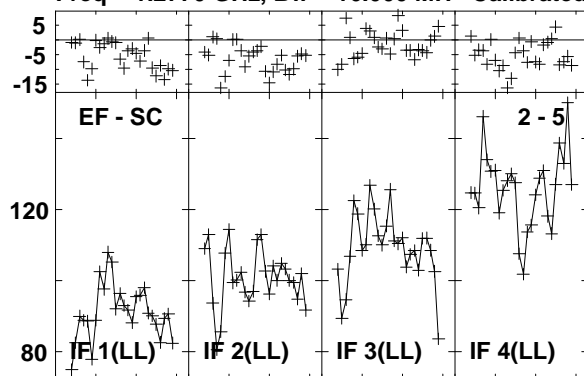

Lower frame: Milli Ampl Jy Top frame: Phas deg
Vector averaged cross-power spectrum Baseline: EF (02) - SC (05)
Timerange: 00/18:14:11 to 00/18:16:09

Plot file version 342 created 03-MAR-2016 01:12:55

J1545+5400 GN002C 1.UVDATA.1

Freq = 1.2770 GHz, Bw = 16.000 MH Calibrated with CL # 3 and BP # 1 (BP mode 1)

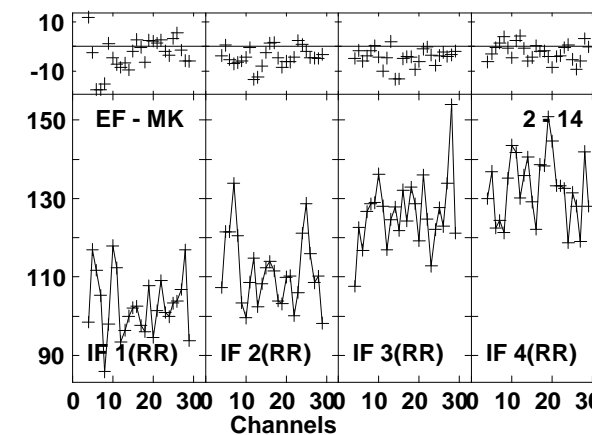
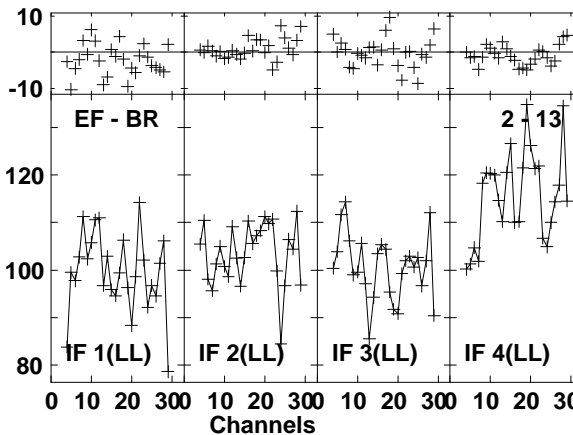
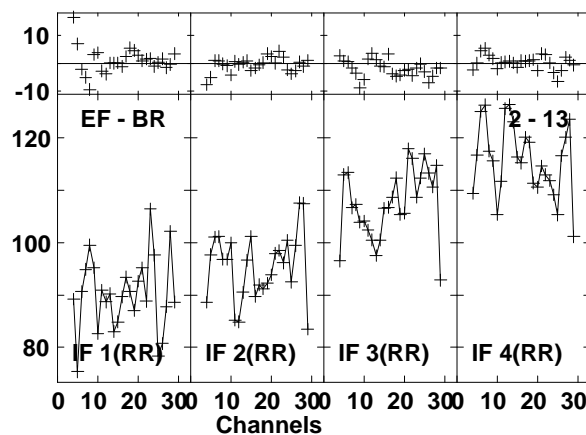
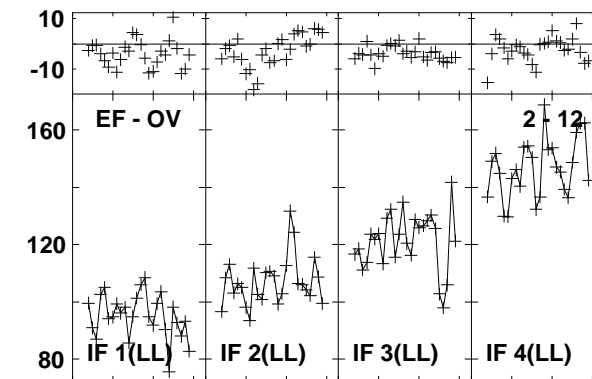
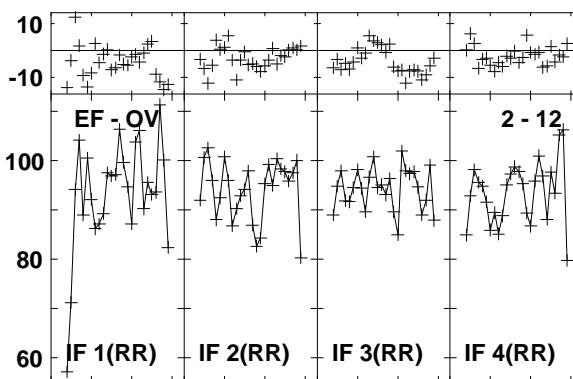
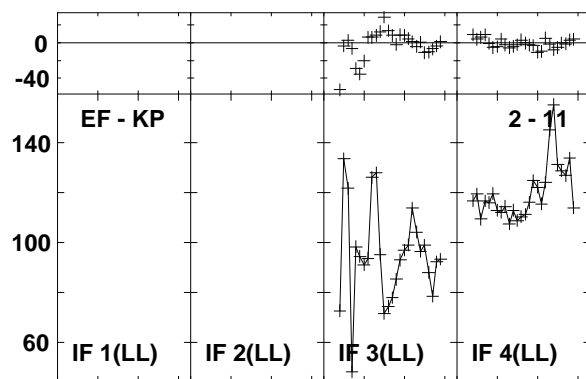
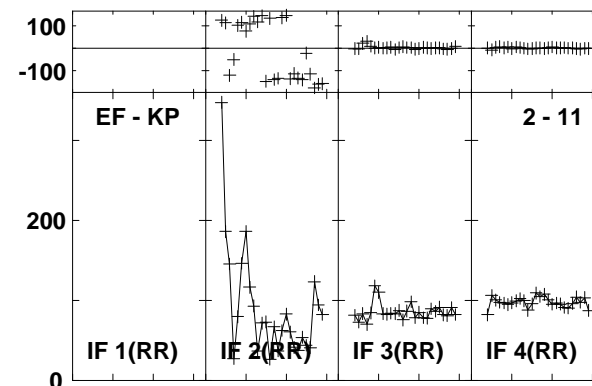
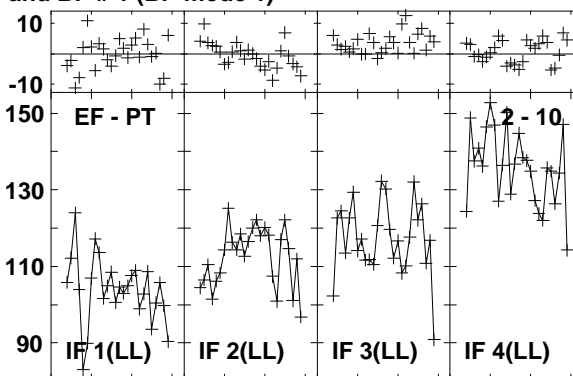
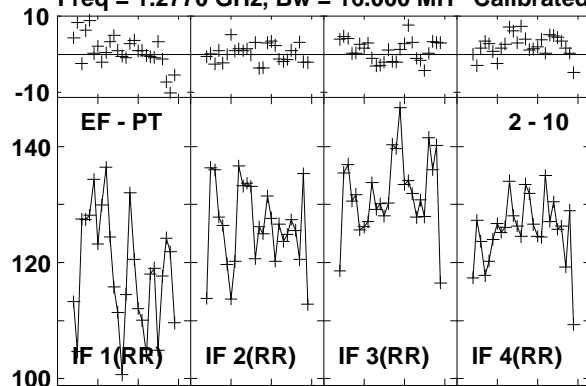

Lower frame: Milli Ampl Jy Top frame: Phas deg
Vector averaged cross-power spectrum Baseline: EF (02) - PT (10)
Timerange: 00/18:14:11 to 00/18:16:09

Plot file version 343 created 03-MAR-2016 01:12:55

J1545+5400 GN002C 1.UVDATA.1

Freq = 1.2770 GHz, Bw = 16.000 MH Calibrated with CL # 3 and BP # 1 (BP mode 1)

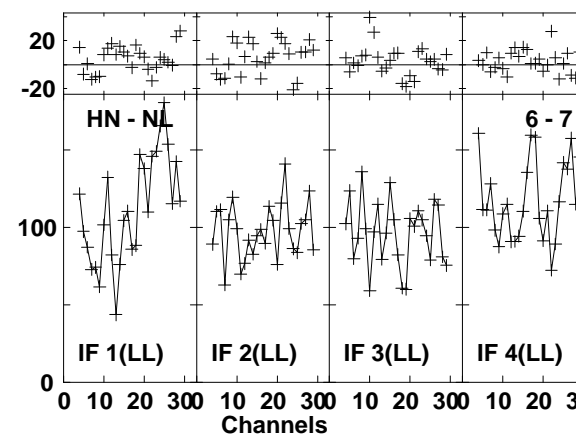
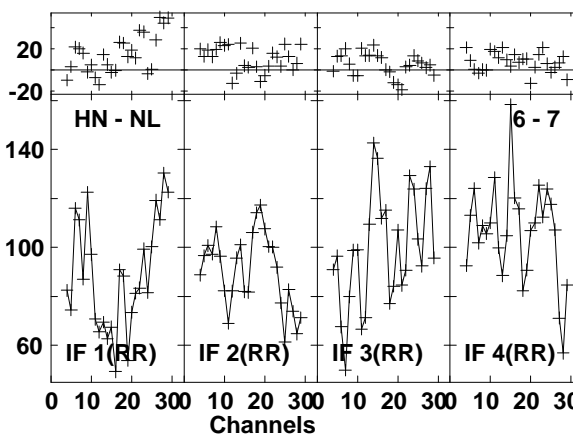
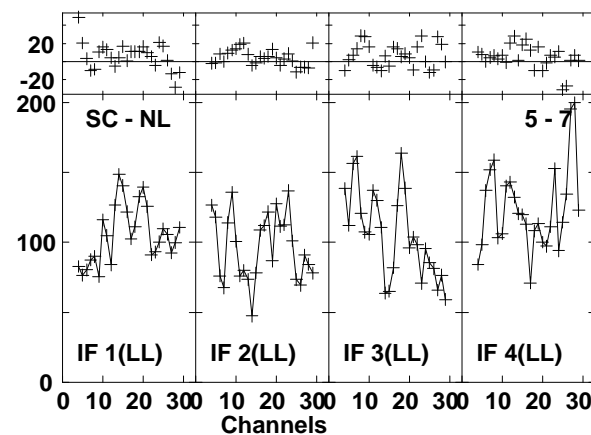
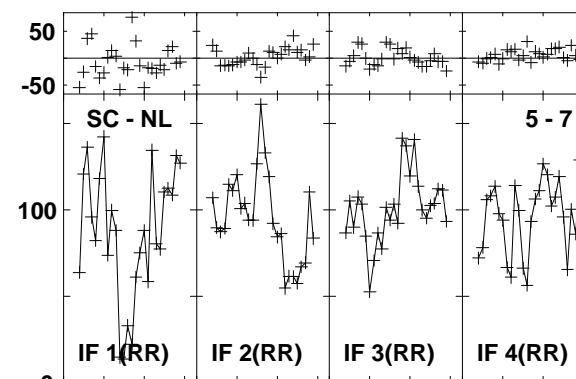
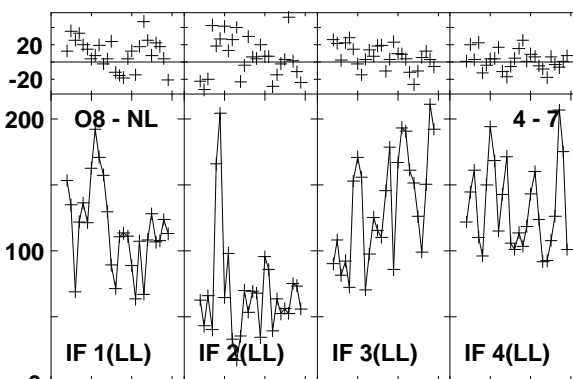
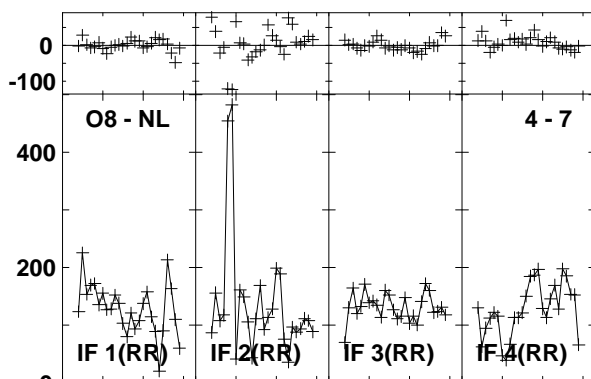
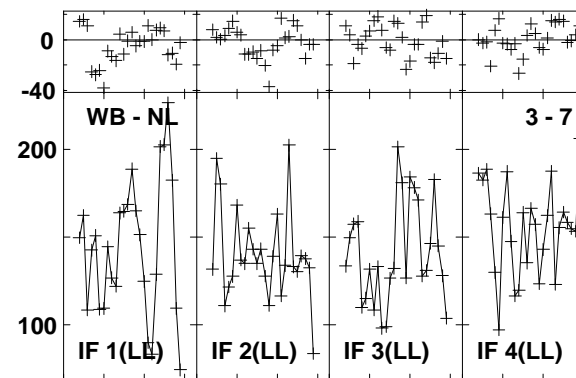
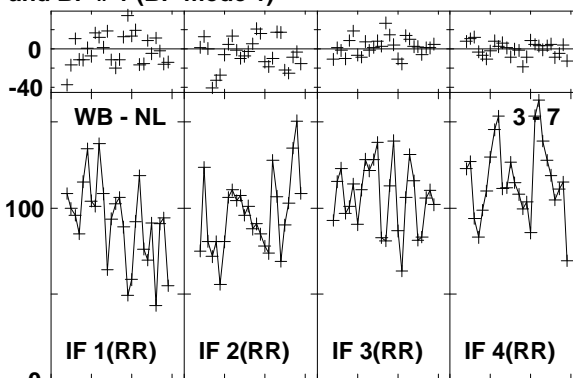
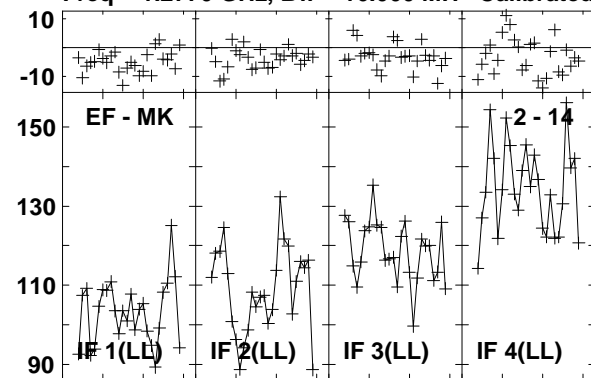

Lower frame: Milli Ampl Jy Top frame: Phas deg
Vector averaged cross-power spectrum Baseline: EF (02) - MK (14)
Timerange: 00/18:14:11 to 00/18:16:09

Plot file version 344 created 03-MAR-2016 01:12:56
 J1545+5400 GN002C 1.UVDATA.1
 Freq = 1.2770 GHz, Bw = 16.000 MH Calibrated with CL # 3 and BP # 1 (BP mode 1)

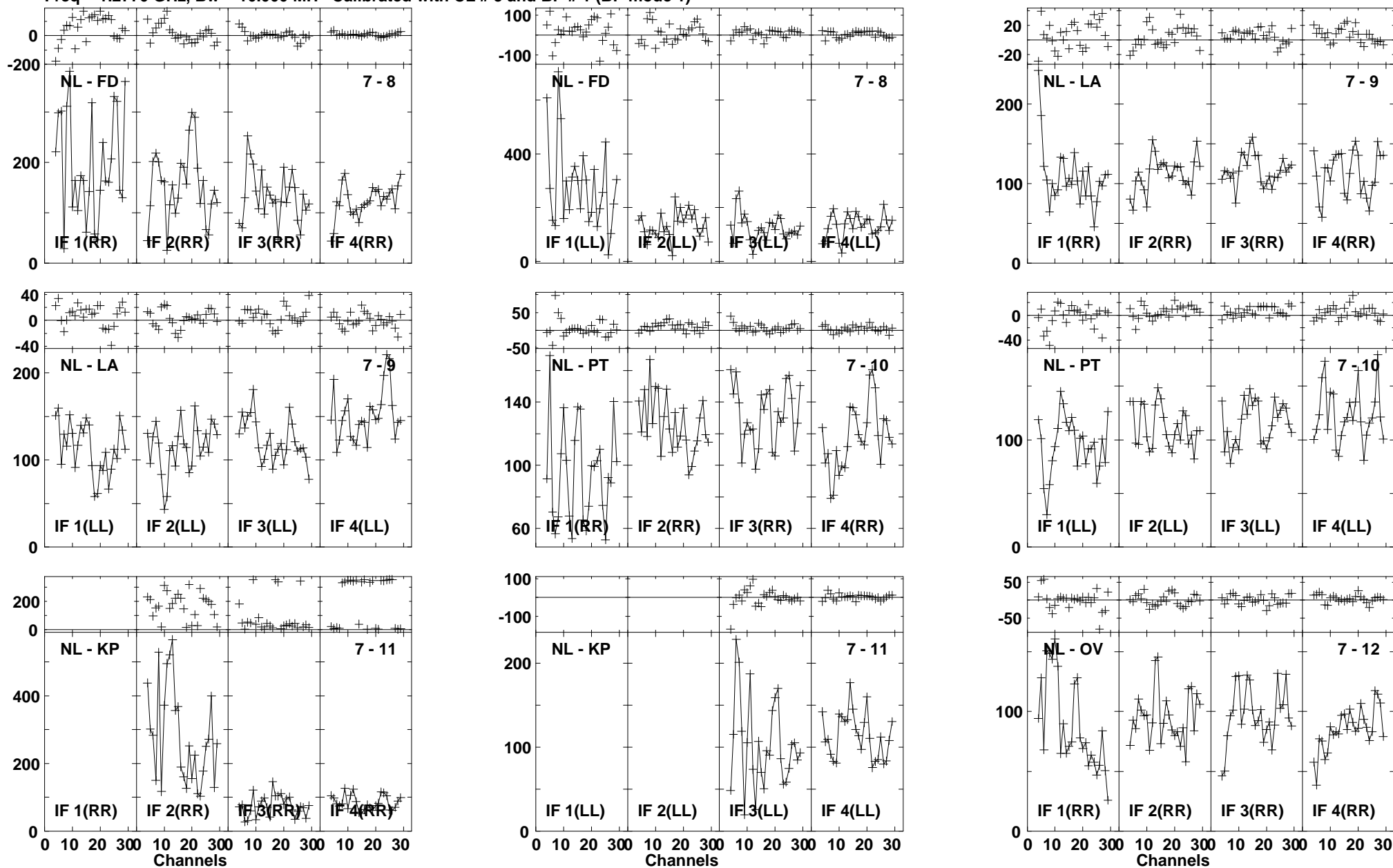

Lower frame: Milli Ampl Jy Top frame: Phas deg
 Vector averaged cross-power spectrum Baseline: NL (07) - FD (08)
 Timerange: 00/18:14:11 to 00/18:16:09

Plot file version 345 created 03-MAR-2016 01:12:56

J1545+5400 GN002C 1.UVDATA.1

Freq = 1.2770 GHz, Bw = 16.000 MH Calibrated with CL # 3 and BP # 1 (BP mode 1)

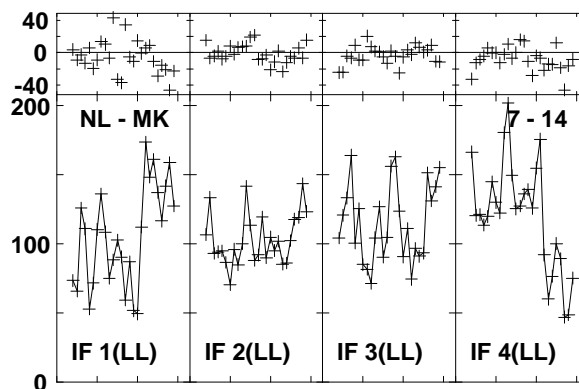
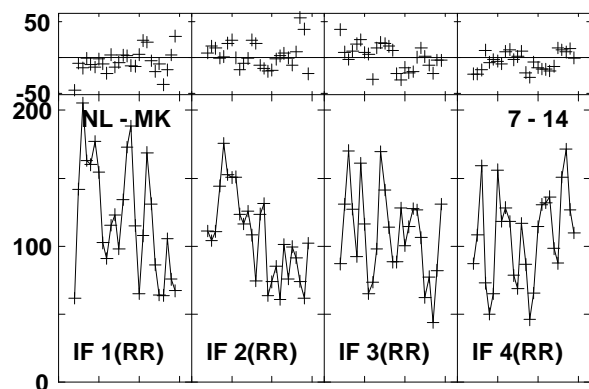
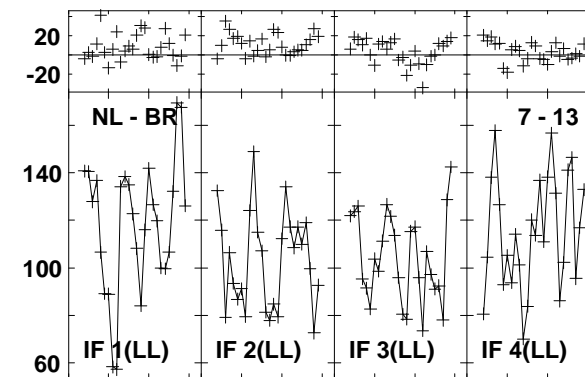
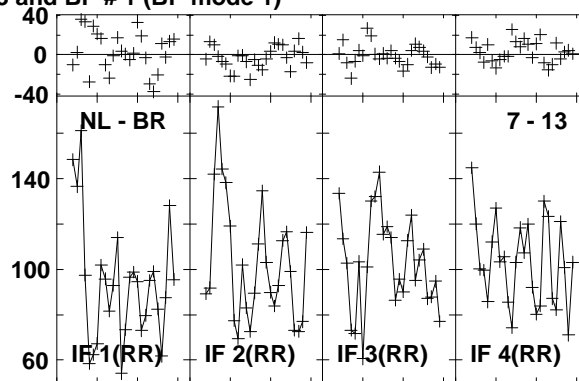
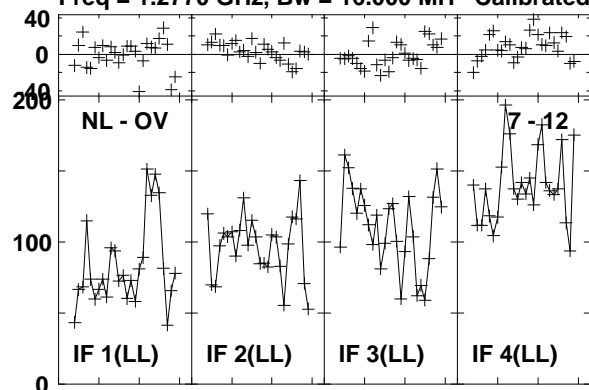

Lower frame: Milli Ampl Jy Top frame: Phas deg
Vector averaged cross-power spectrum Baseline: NL (07) - OV (12)
Timerange: 00/18:14:11 to 00/18:16:09

Plot file version 346 created 03-MAR-2016 01:12:56

4C52 GN002C 1.UVDATA.1

Freq = 1.2770 GHz, Bw = 16.000 MH Calibrated with CL # 3 and BP # 1 (BP mode 1)

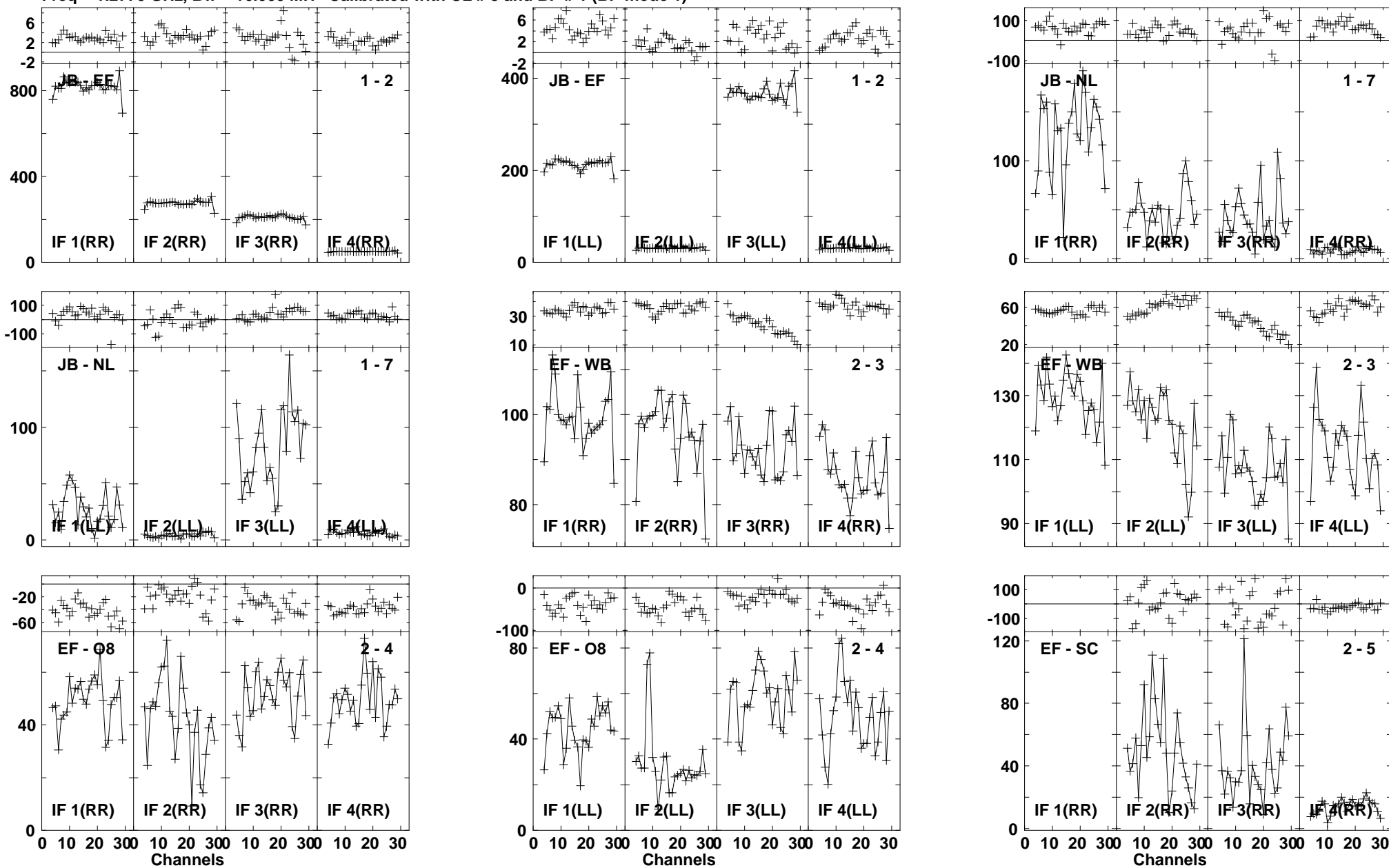

Lower frame: Milli Ampl Jy Top frame: Phas deg
Vector averaged cross-power spectrum Baseline: JB (01) - EF (02)
Timerange: 00/18:16:22 to 00/18:19:08

Plot file version 347 created 03-MAR-2016 01:12:56

4C52 GN002C 1.UVDATA.1

Freq = 1.2770 GHz, Bw = 16.000 MH Calibrated with CL # 3 and BP # 1 (BP mode 1)

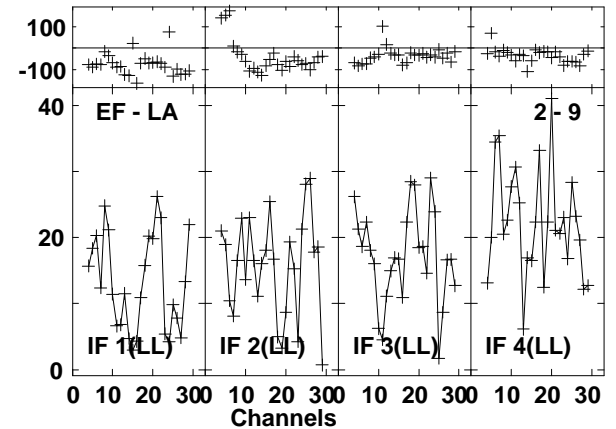
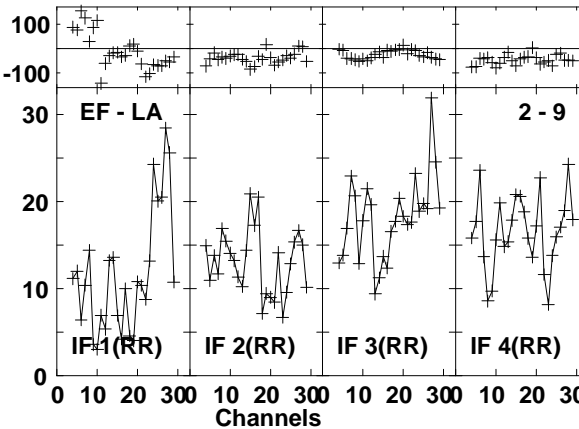
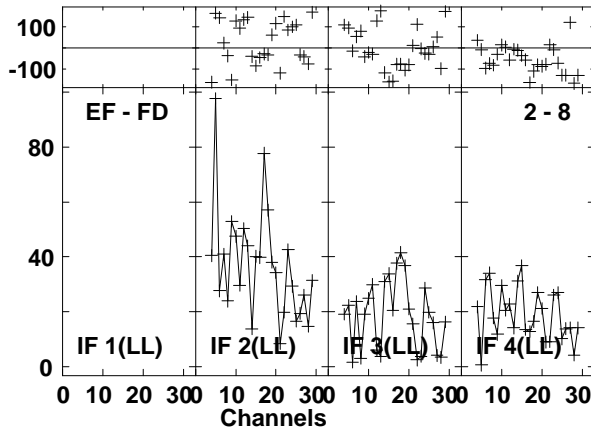
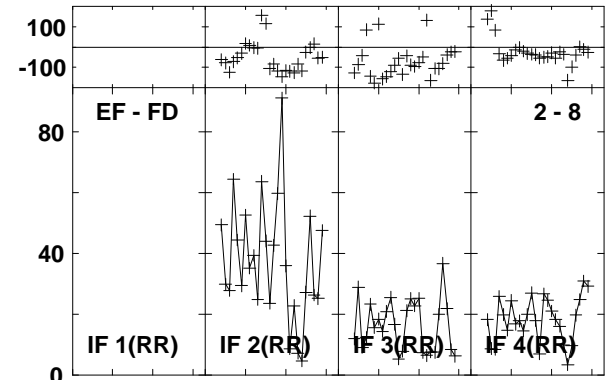
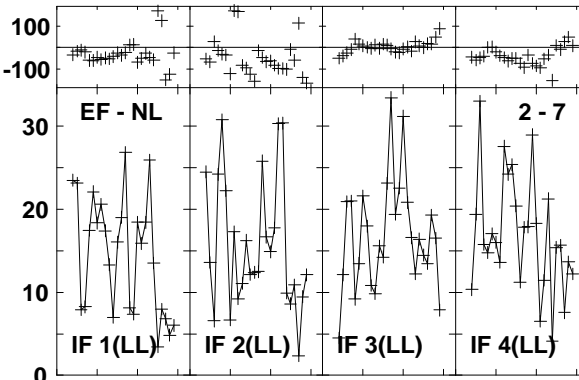
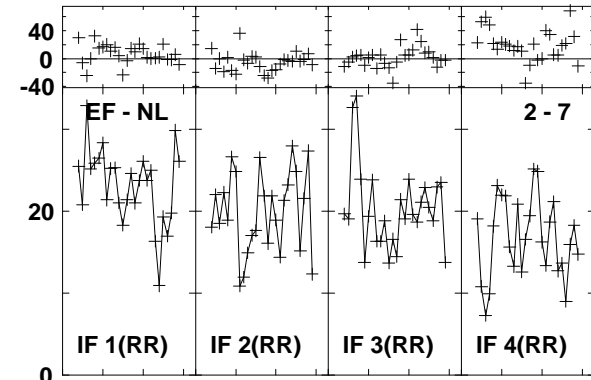
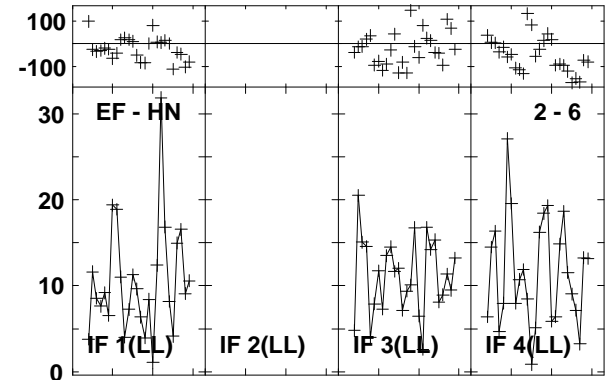
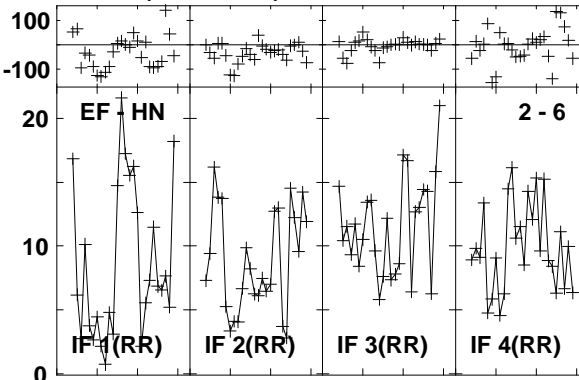
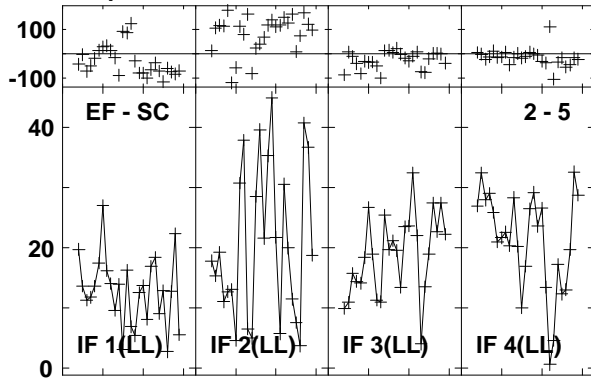

Lower frame: Milli Ampl Jy Top frame: Phas deg
Vector averaged cross-power spectrum Baseline: EF (02) - SC (05)
Timerange: 00/18:16:22 to 00/18:19:08

Plot file version 348 created 03-MAR-2016 01:12:56

4C52 GN002C 1.UVDATA.1

Freq = 1.2770 GHz, Bw = 16.000 MH Calibrated with CL # 3 and BP # 1 (BP mode 1)

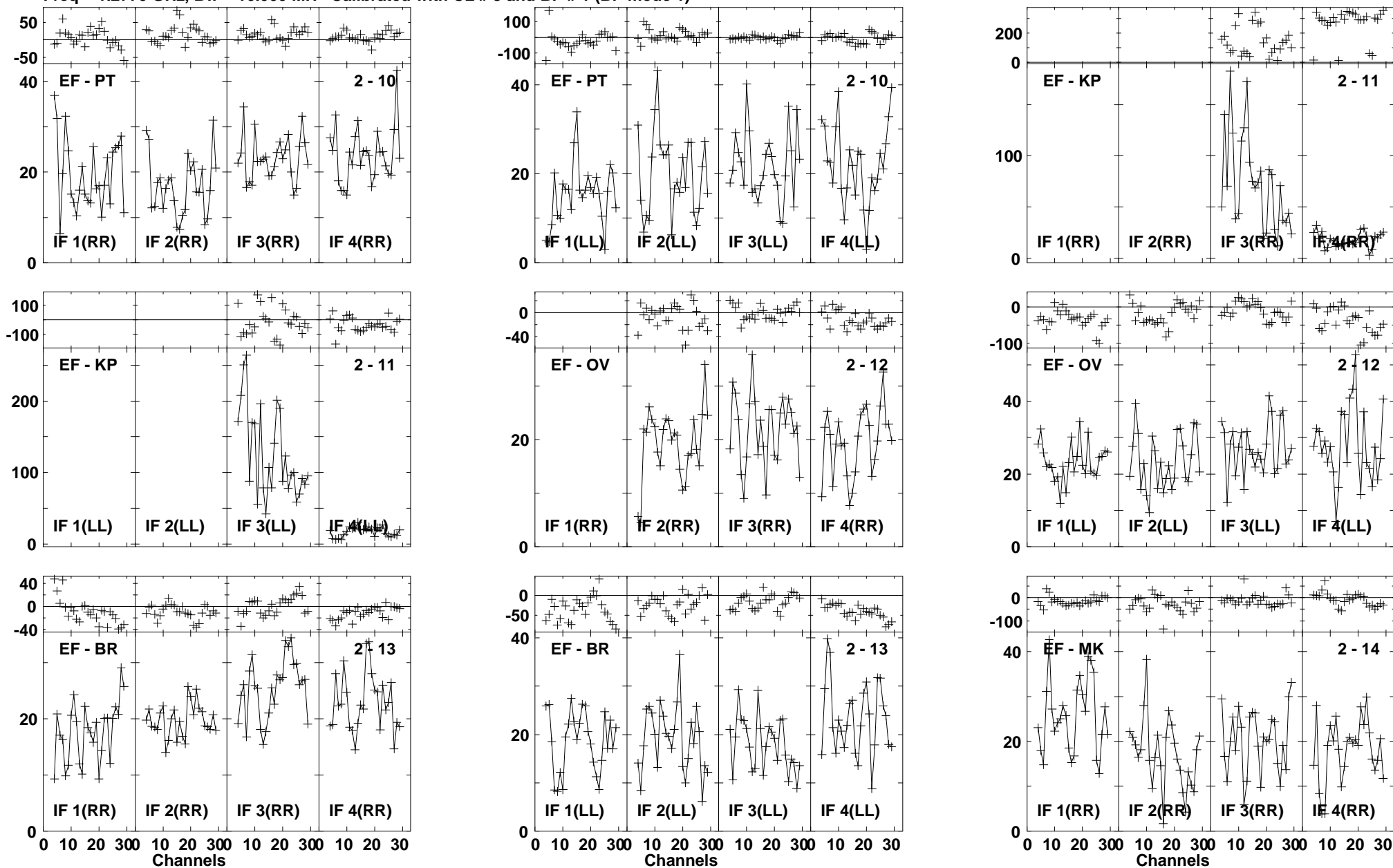

Lower frame: Milli Ampl Jy Top frame: Phas deg
Vector averaged cross-power spectrum Baseline: EF (02) - PT (10)
Timerange: 00/18:16:22 to 00/18:19:08

Plot file version 349 created 03-MAR-2016 01:12:56

4C52 GN002C 1.UVDATA.1

Freq = 1.2770 GHz, Bw = 16.000 MH Calibrated with CL # 3 and BP # 1 (BP mode 1)

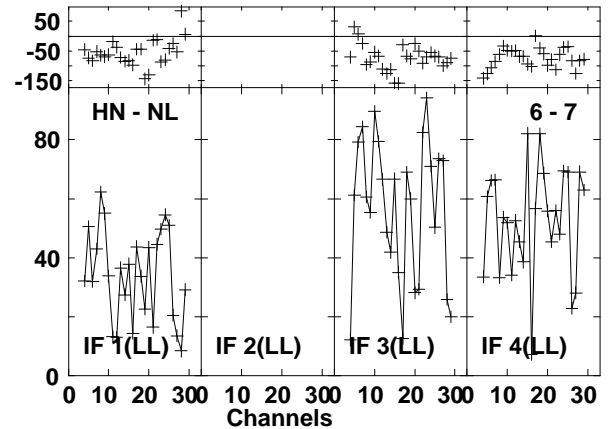
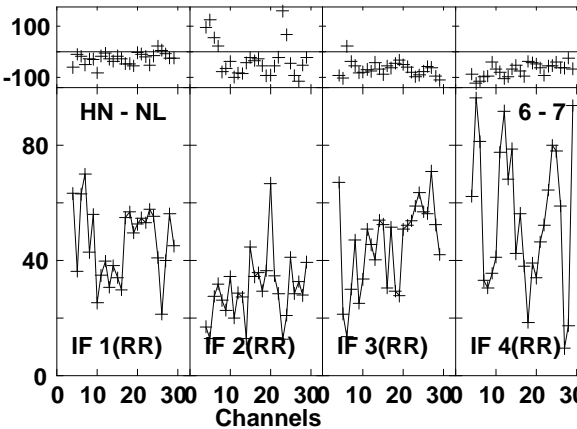
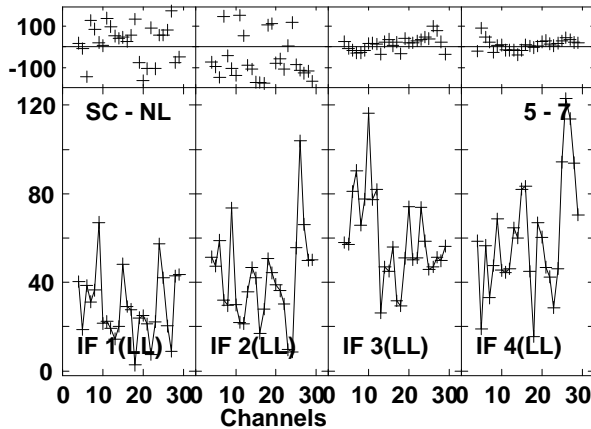
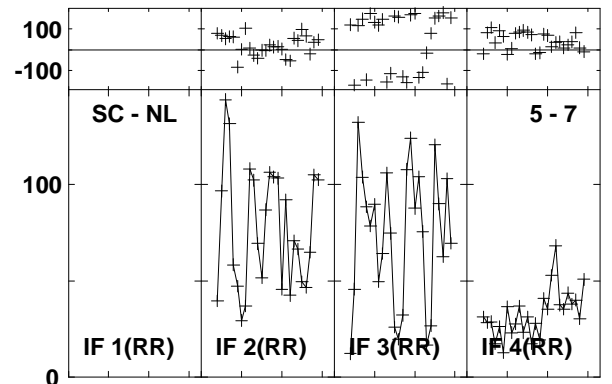
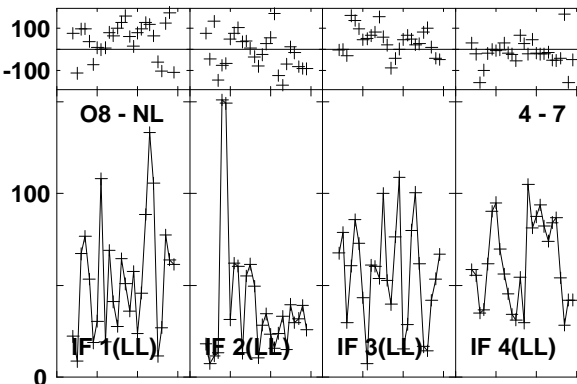
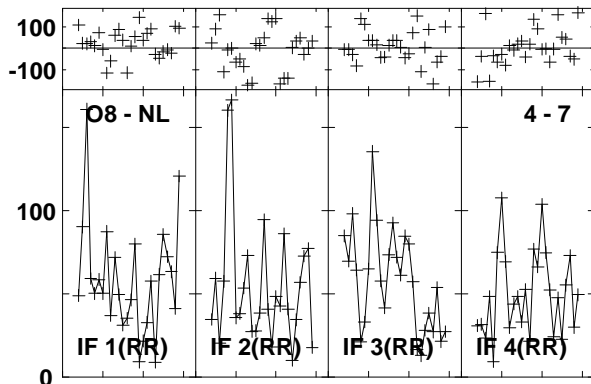
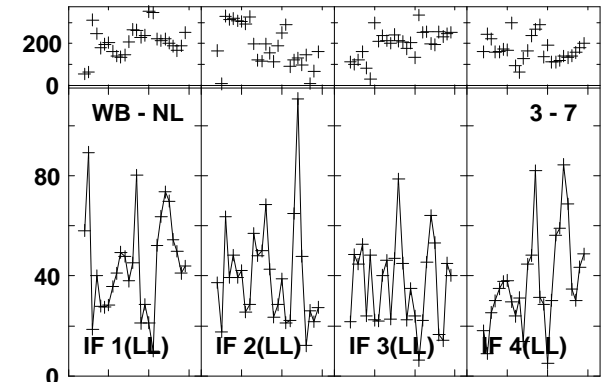
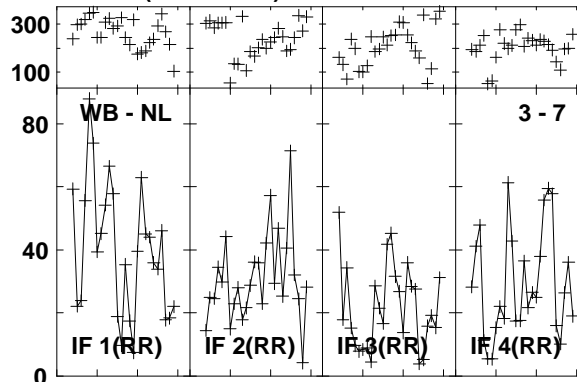
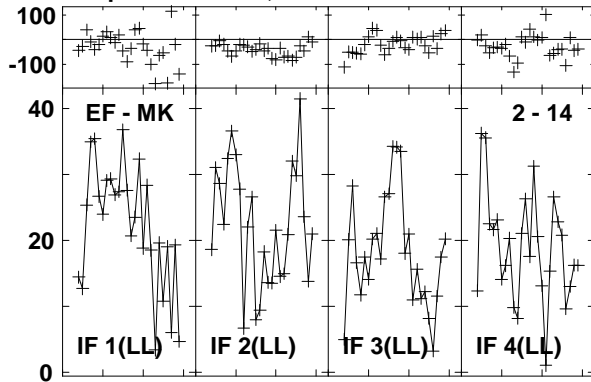

Lower frame: Milli Ampl Jy Top frame: Phas deg
Vector averaged cross-power spectrum Baseline: EF (02) - MK (14)
Timerange: 00/18:16:22 to 00/18:19:08

Plot file version 350 created 03-MAR-2016 01:12:57

4C52 GN002C 1.UVDATA.1

Freq = 1.2770 GHz, Bw = 16.000 MH Calibrated with CL # 3 and BP # 1 (BP mode 1)

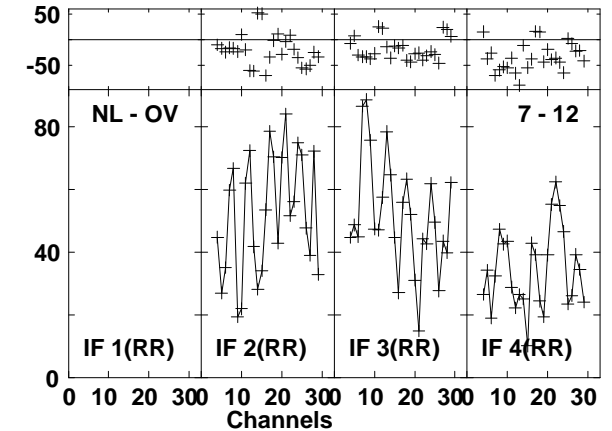
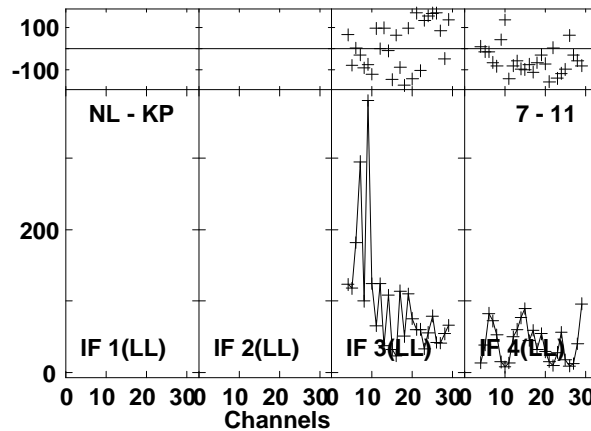
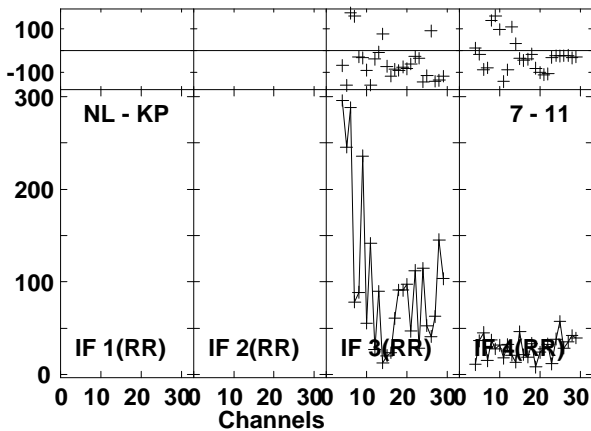
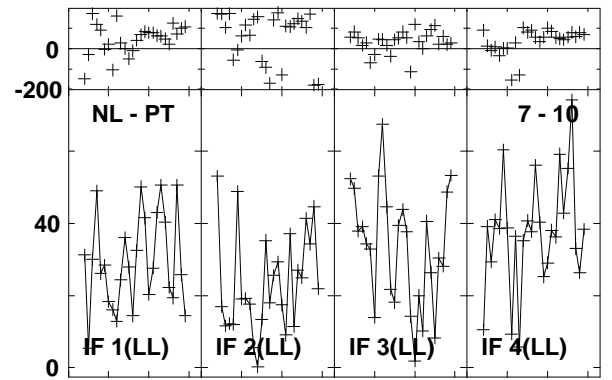
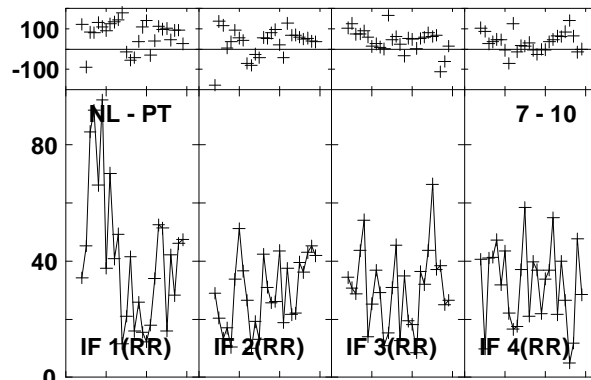
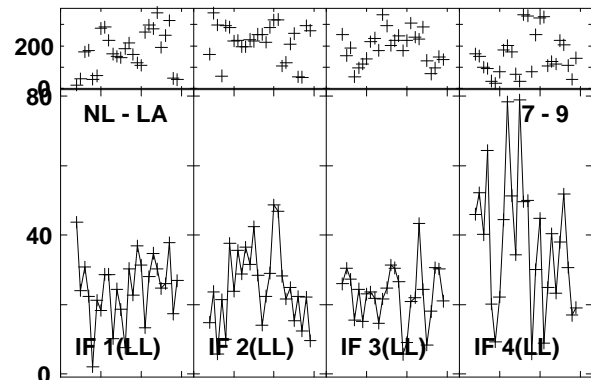
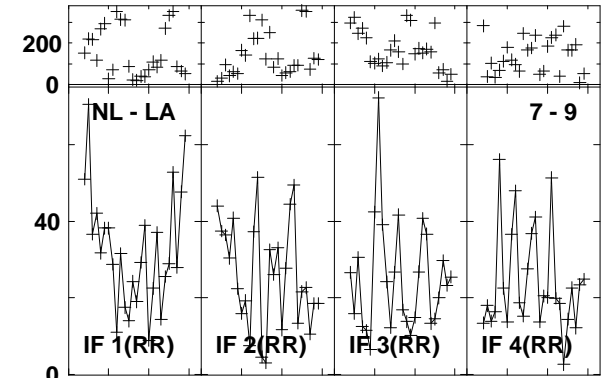
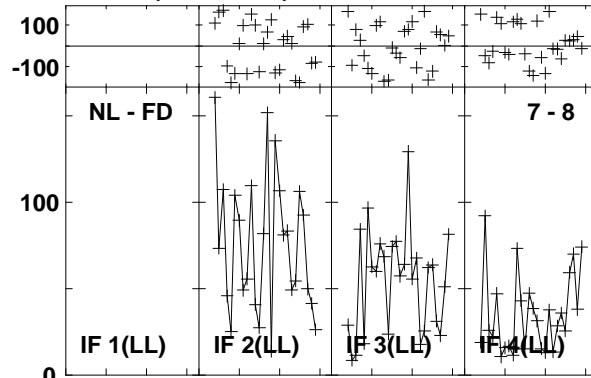
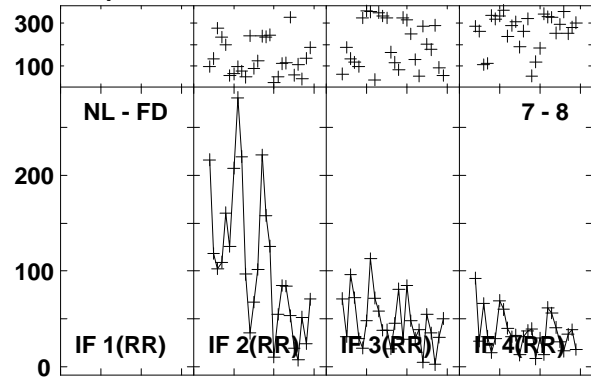

Lower frame: Milli Ampl Jy Top frame: Phas deg
Vector averaged cross-power spectrum Baseline: NL (07) - FD (08)
Timerange: 00/18:16:22 to 00/18:19:08

Plot file version 351 created 03-MAR-2016 01:12:57

4C52 GN002C 1.UVDATA.1

Freq = 1.2770 GHz, Bw = 16.000 MH Calibrated with CL # 3 and BP # 1 (BP mode 1)

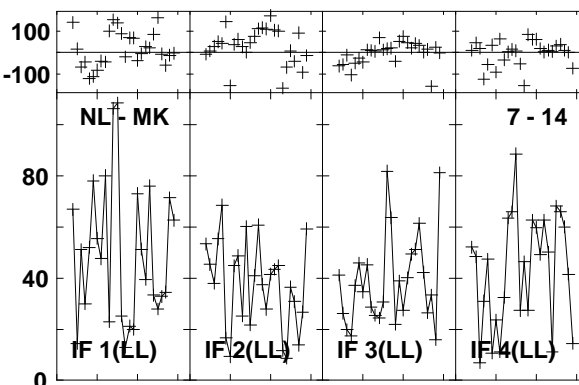
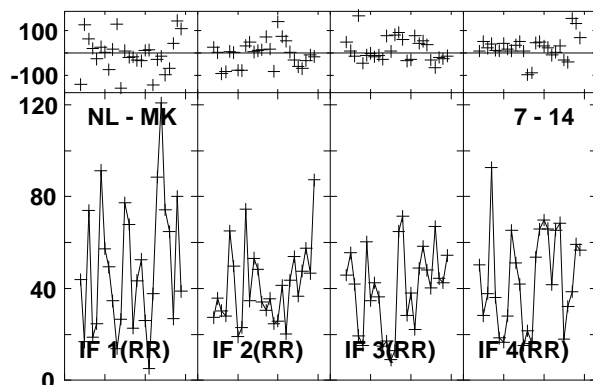
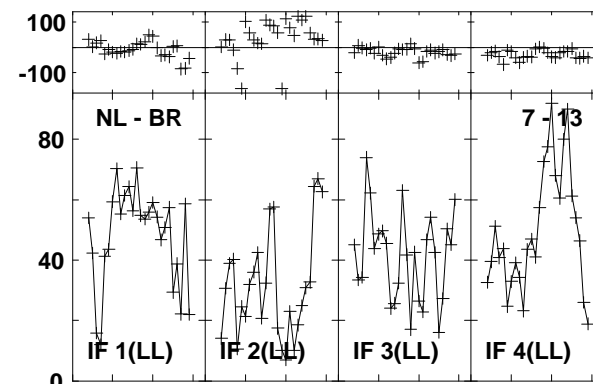
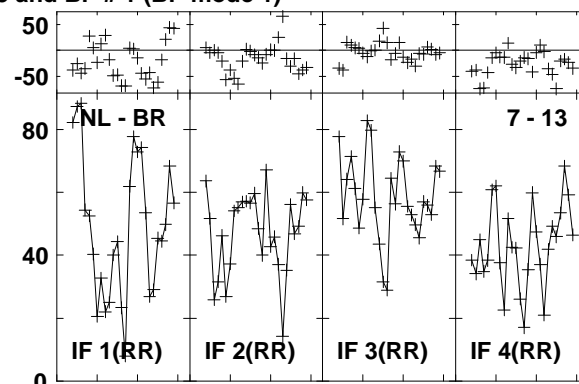
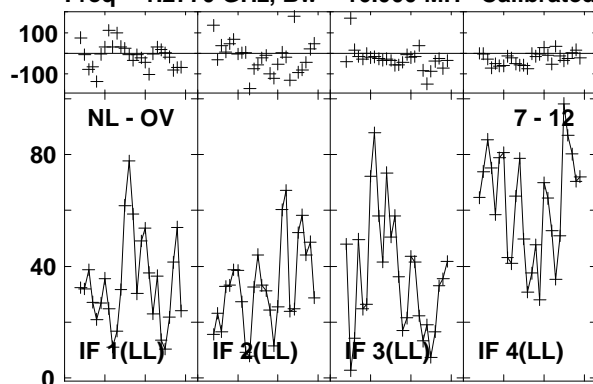

Lower frame: Milli Ampl Jy Top frame: Phas deg
Vector averaged cross-power spectrum Baseline: NL (07) - OV (12)
Timerange: 00:18:16:22 to 00:18:19:08

Plot file version 352 created 03-MAR-2016 01:12:57

J1545+5400 GN002C 1.UVDATA.1

Freq = 1.2770 GHz, Bw = 16.000 MH Calibrated with CL # 3 and BP # 1 (BP mode 1)

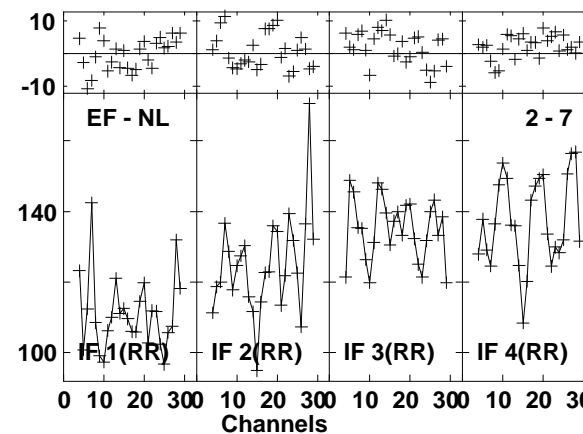
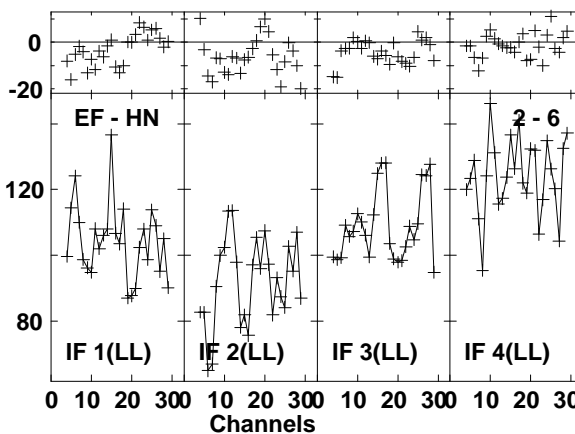
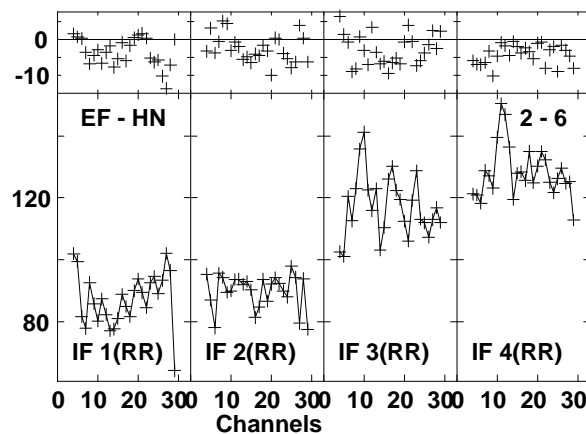
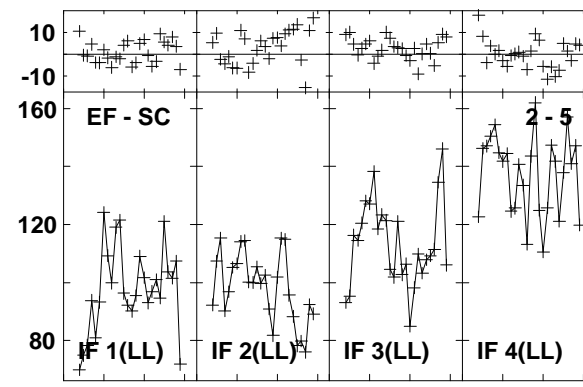
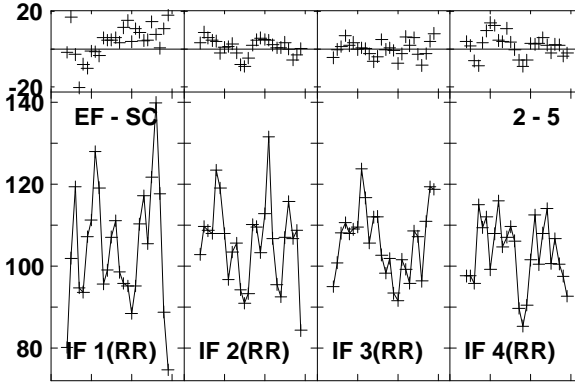
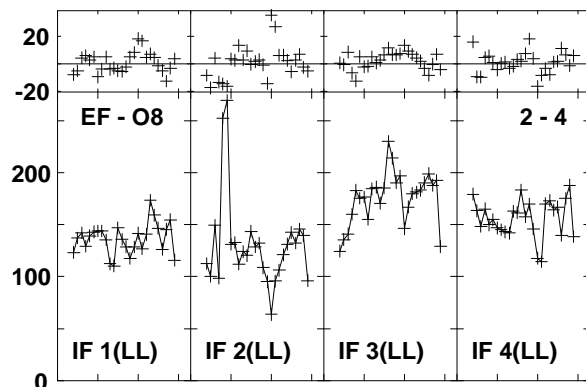
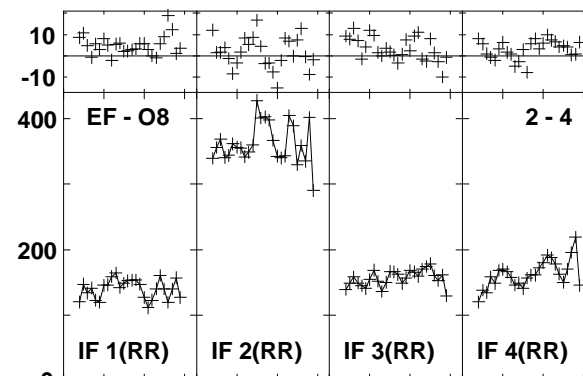
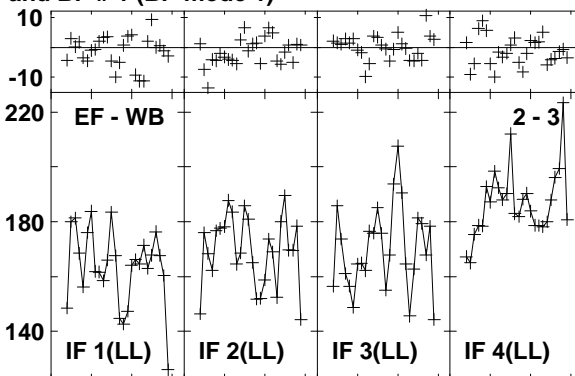
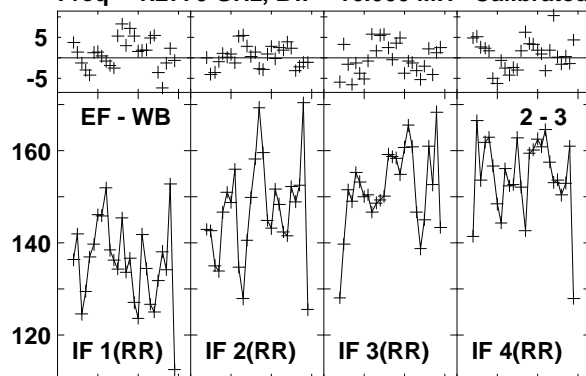

Lower frame: Milli Ampl Jy Top frame: Phas deg
Vector averaged cross-power spectrum Baseline: EF (02) - WB (03)
Timerange: 00/18:20:01 to 00/18:20:59

Plot file version 353 created 03-MAR-2016 01:12:57

J1545+5400 GN002C 1.UVDATA.1

Freq = 1.2770 GHz, Bw = 16.000 MH Calibrated with CL # 3 and BP # 1 (BP mode 1)

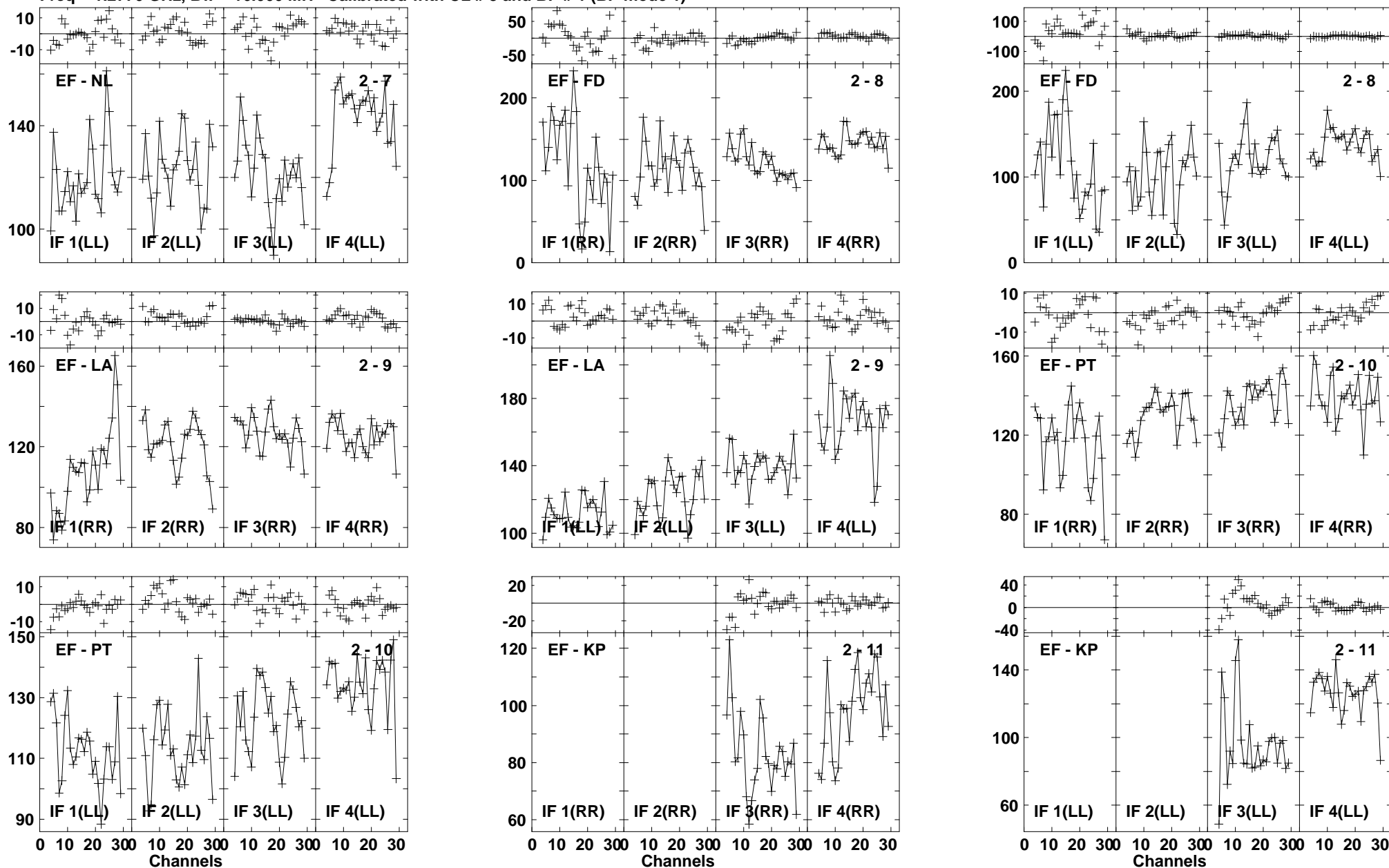

Lower frame: Milli Ampl Jy Top frame: Phas deg
Vector averaged cross-power spectrum Baseline: EF (02) - NL (07)
Timerange: 00/18:20:01 to 00/18:20:59

Plot file version 354 created 03-MAR-2016 01:12:57

J1545+5400 GN002C 1.UVDATA.1

Freq = 1.2770 GHz, Bw = 16.000 MH Calibrated with CL # 3 and BP # 1 (BP mode 1)

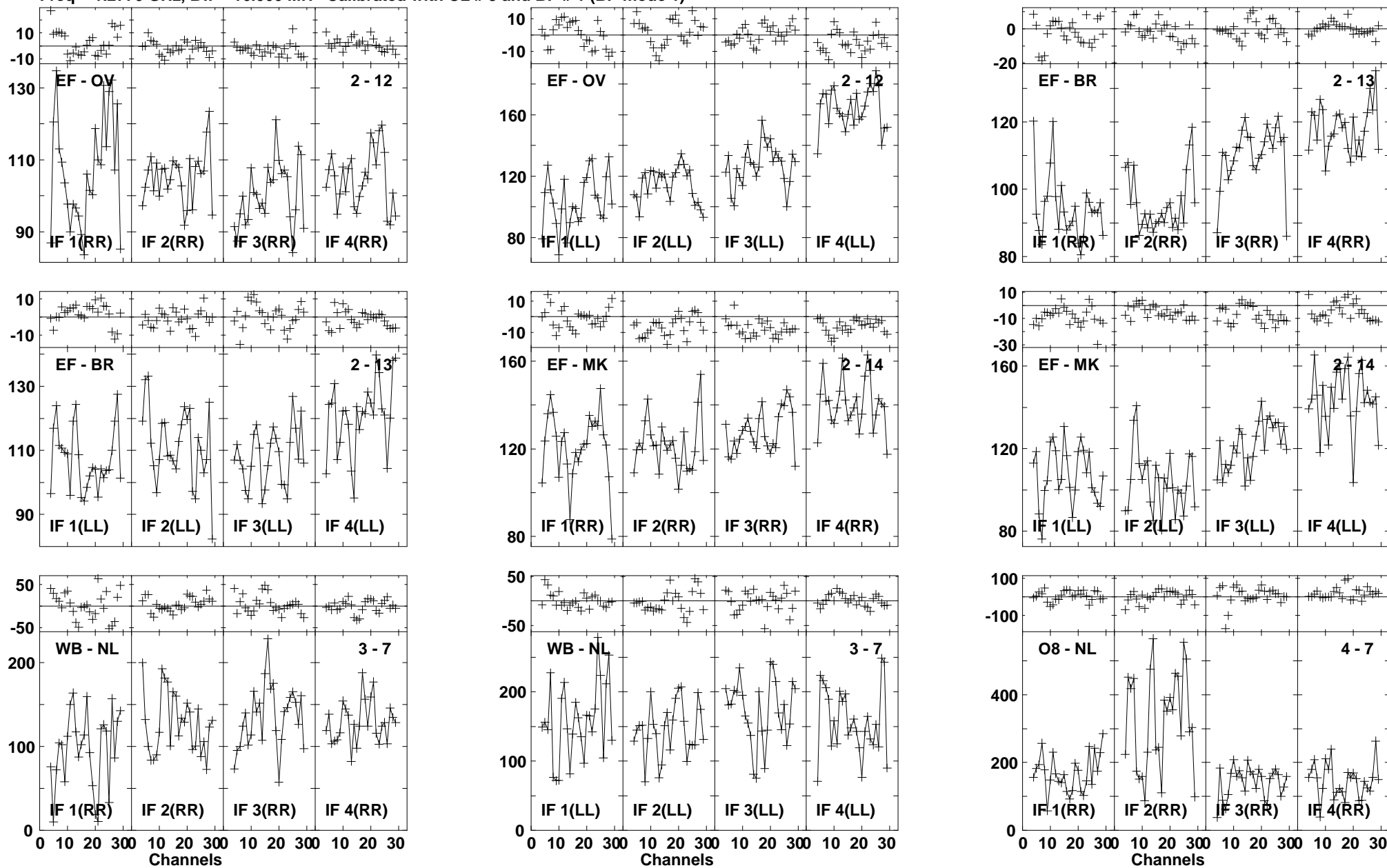

Lower frame: Milli Ampl Jy Top frame: Phas deg
Vector averaged cross-power spectrum Baseline: EF (02) - OV (12)
Timerange: 00/18:20:01 to 00/18:20:59

Plot file version 355 created 03-MAR-2016 01:12:57
 J1545+5400 GN002C 1.UVDATA.1
 Freq = 1.2770 GHz, Bw = 16.000 MH Calibrated with CL # 3 and BP # 1 (BP mode 1)

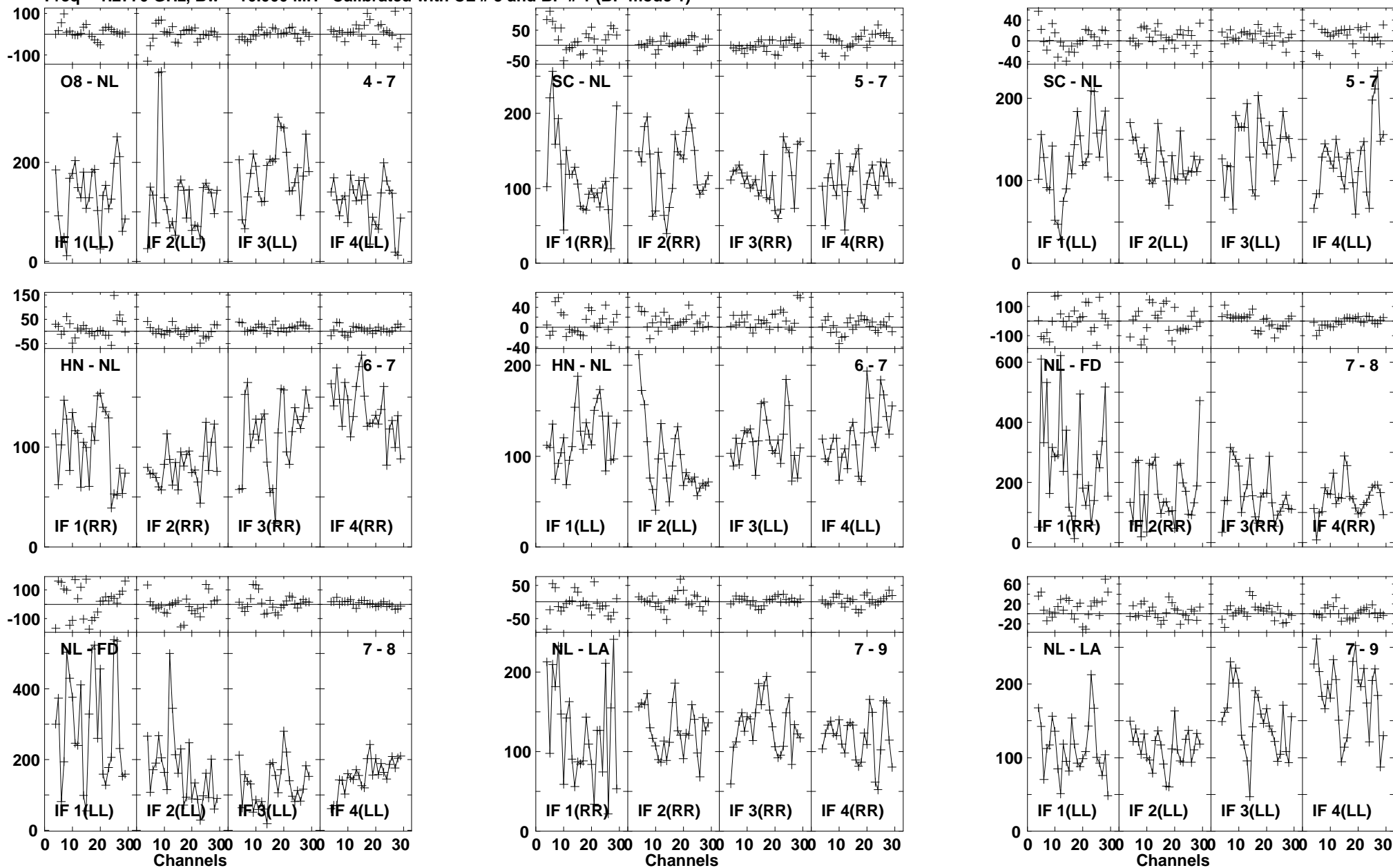

Lower frame: Milli Ampl Jy Top frame: Phas deg
 Vector averaged cross-power spectrum Baseline: O8 (04) - NL (07)
 Timerange: 00:18:20:01 to 00:18:20:59

Plot file version 356 created 03-MAR-2016 01:12:57
 J1545+5400 GN002C 1.UVDATA.1
 Freq = 1.2770 GHz, Bw = 16.000 MH Calibrated with CL # 3 and BP # 1 (BP mode 1)

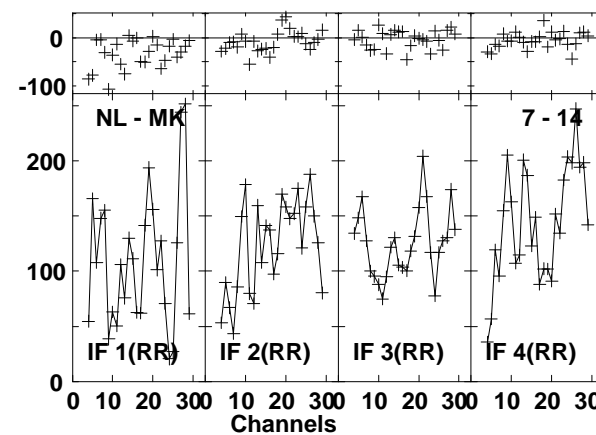
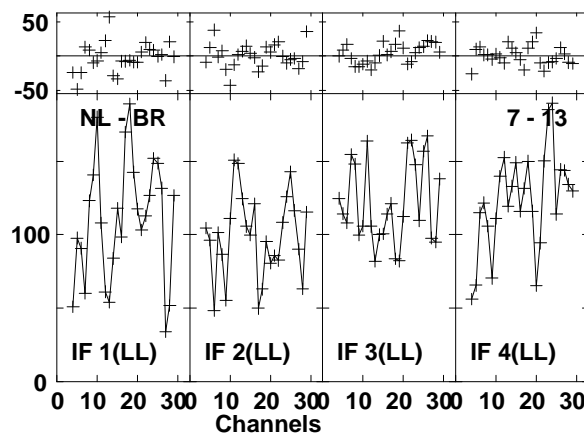
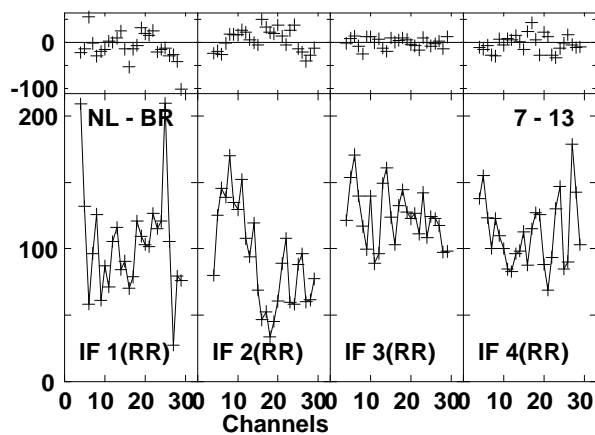
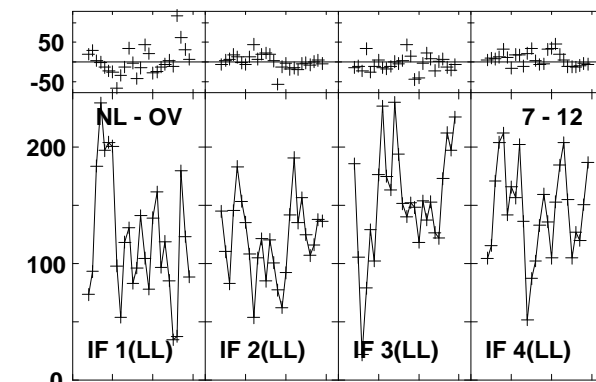
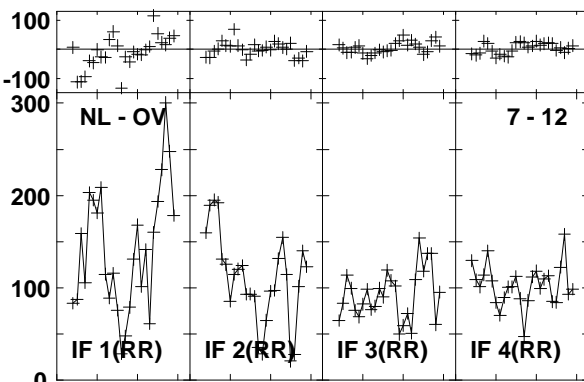
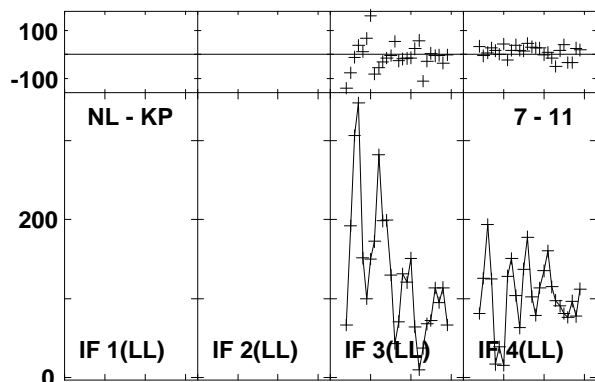
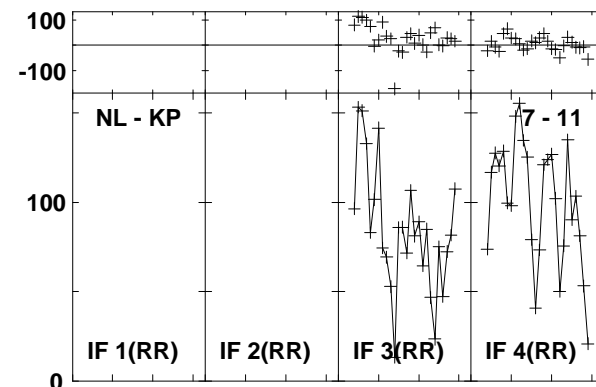
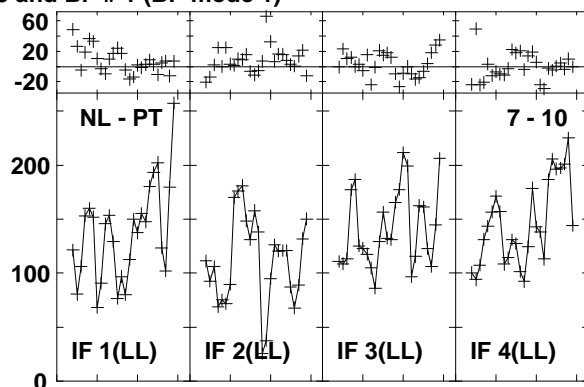
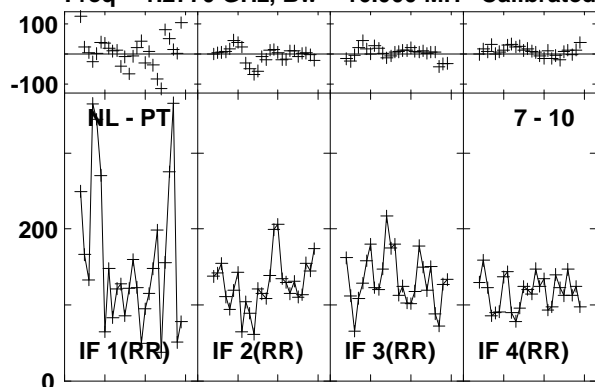

Lower frame: Milli Ampl Jy Top frame: Phas deg
 Vector averaged cross-power spectrum Baseline: NL (07) - PT (10)
 Timerange: 00/18:20:01 to 00/18:20:59

Plot file version 357 created 03-MAR-2016 01:12:58
J1545+5400 GN002C 1.UVDATA.1
Freq = 1.2770 GHz, Bw = 16.000 MH Calibrated with CL # 3 and BP # 1 (BP mode 1)

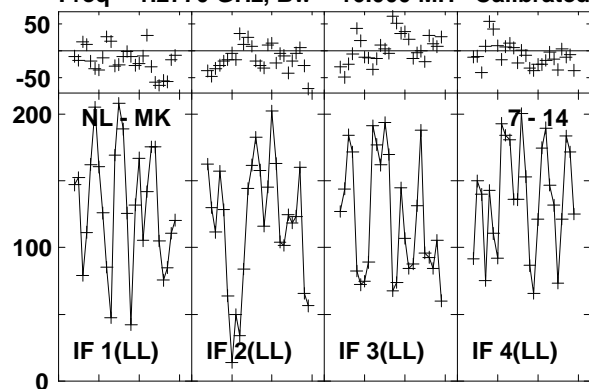

Lower frame: Milli Ampl Jy Top frame: Phas deg
Vector averaged cross-power spectrum Baseline: NL (07) - MK (14)
Timerange: 00/18:20:01 to 00/18:20:59

Plot file version 358 created 03-MAR-2016 01:12:58

4C52 GN002C 1.UVDATA.1

Freq = 1.2770 GHz, Bw = 16.000 MH Calibrated with CL # 3 and BP # 1 (BP mode 1)

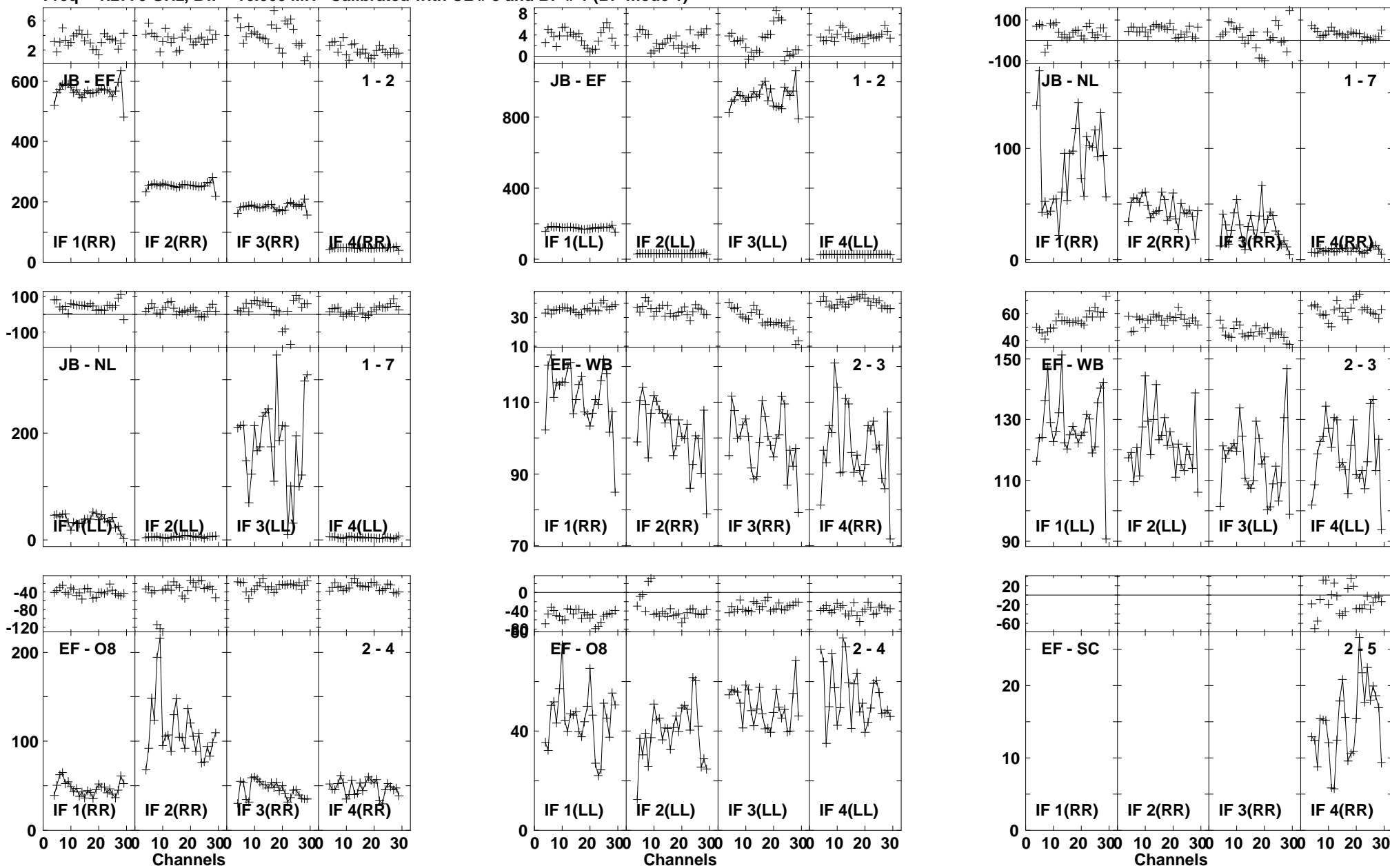

Lower frame: Milli Ampl Jy Top frame: Phas deg
Vector averaged cross-power spectrum Baseline: JB (01) - EF (02)
Timerange: 00/18:21:04 to 00/18:23:58

Plot file version 359 created 03-MAR-2016 01:12:58

4C52 GN002C 1.UVDATA.1

Freq = 1.2770 GHz, Bw = 16.000 MH Calibrated with CL # 3 and BP # 1 (BP mode 1)

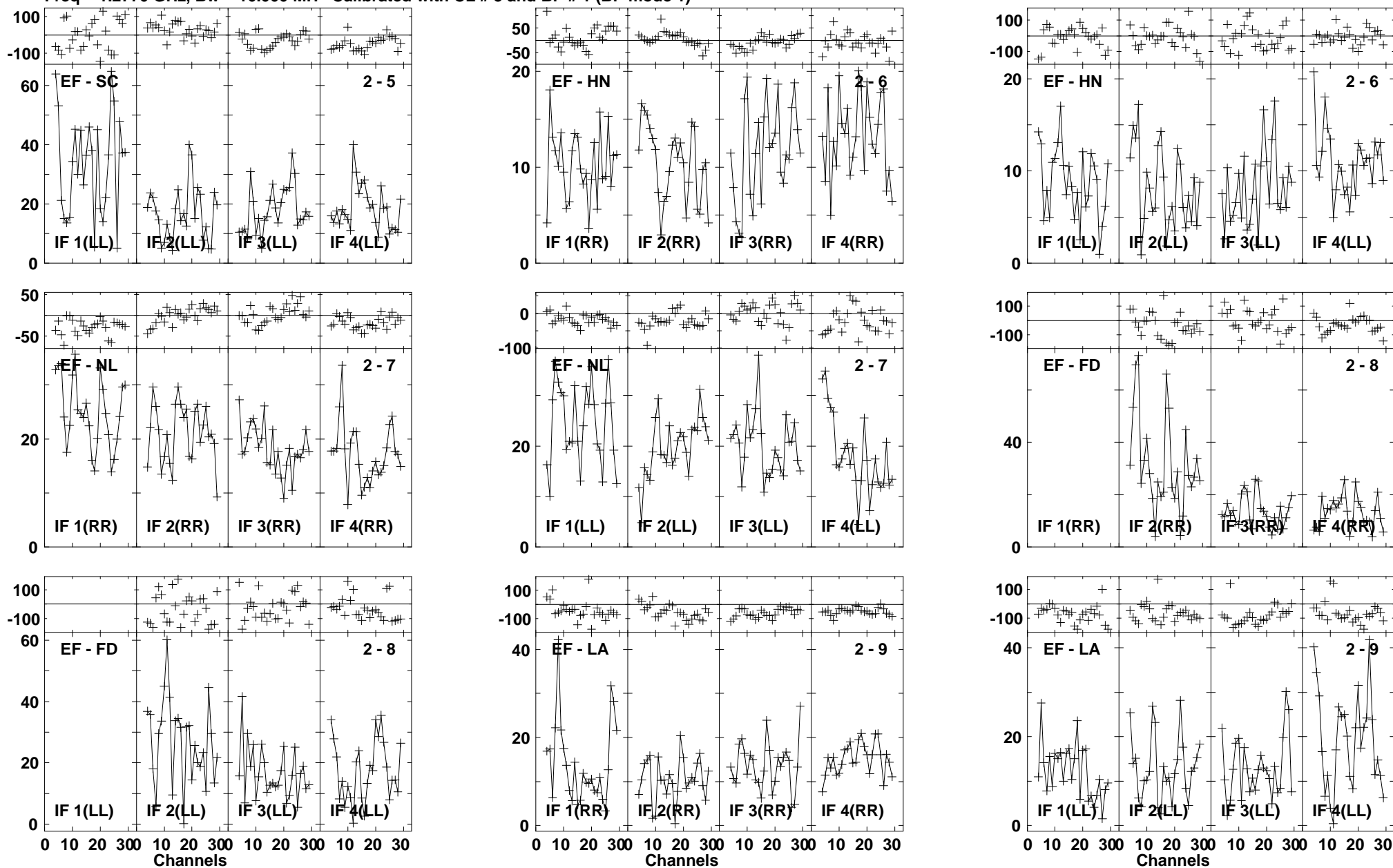

Lower frame: Milli Ampl Jy Top frame: Phas deg
Vector averaged cross-power spectrum Baseline: EF (02) - SC (05)
Timerange: 00/18:21:04 to 00/18:23:58

Plot file version 360 created 03-MAR-2016 01:12:58

4C52 GN002C 1.UVDATA.1

Freq = 1.2770 GHz, Bw = 16.000 MH Calibrated with CL # 3 and BP # 1 (BP mode 1)

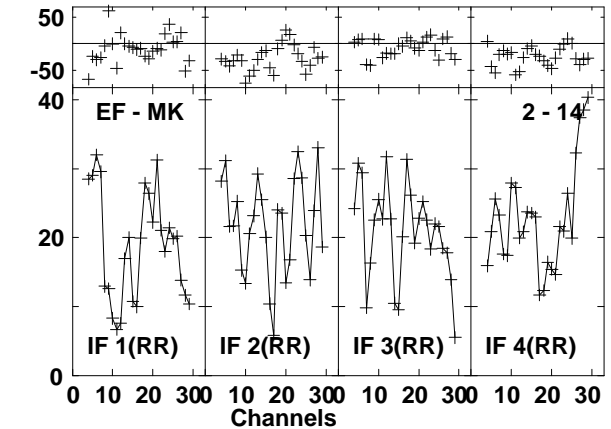
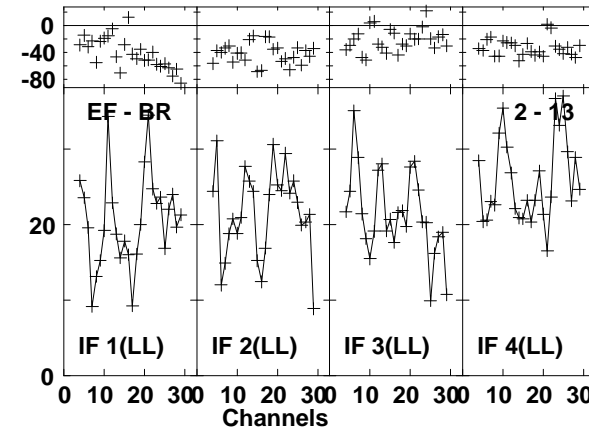
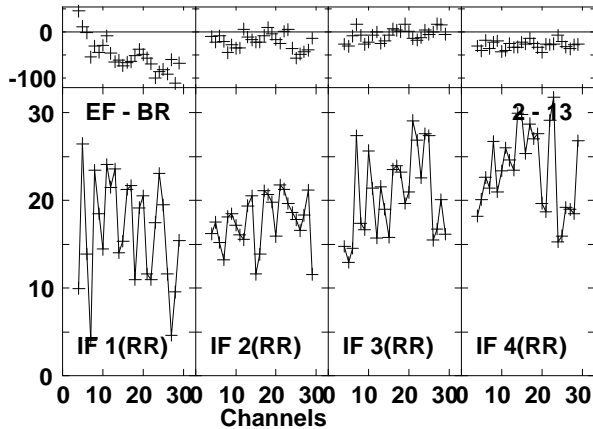
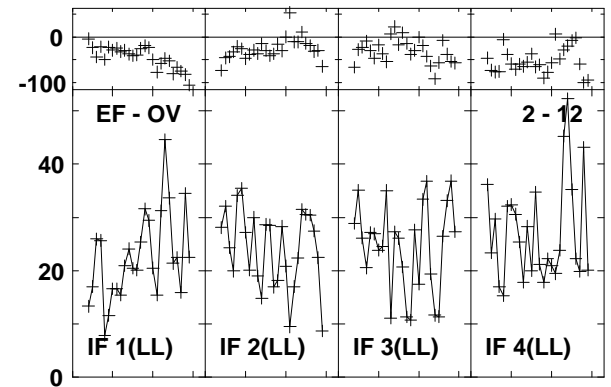
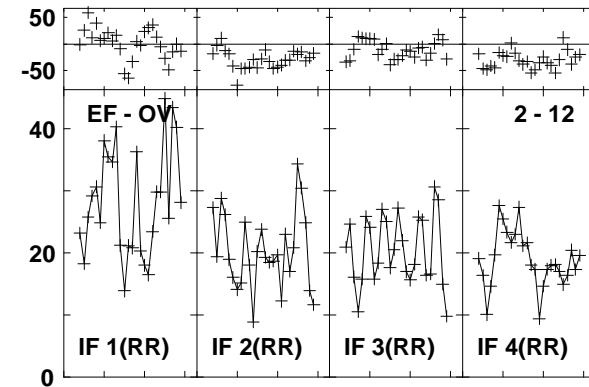
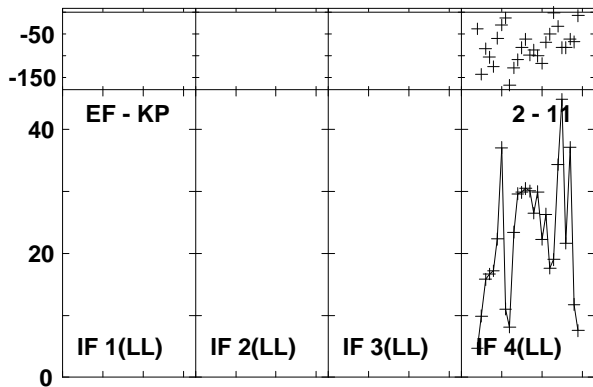
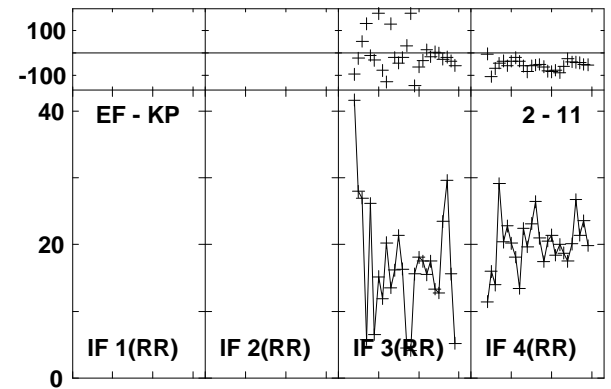
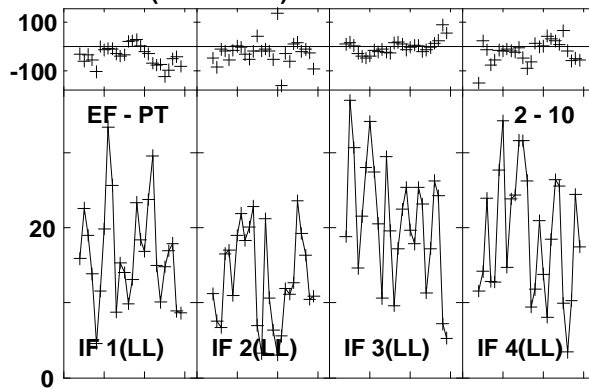
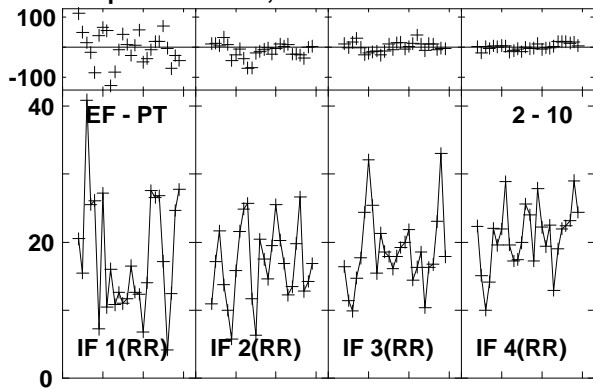

Lower frame: Milli Ampl Jy Top frame: Phas deg
Vector averaged cross-power spectrum Baseline: EF (02) - PT (10)
Timerange: 00/18:21:04 to 00/18:23:58

Plot file version 361 created 03-MAR-2016 01:12:58

4C52 GN002C 1.UVDATA.1

Freq = 1.2770 GHz, Bw = 16.000 MH Calibrated with CL # 3 and BP # 1 (BP mode 1)

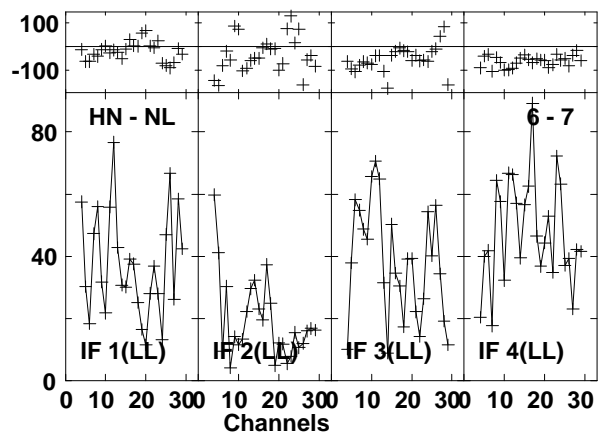
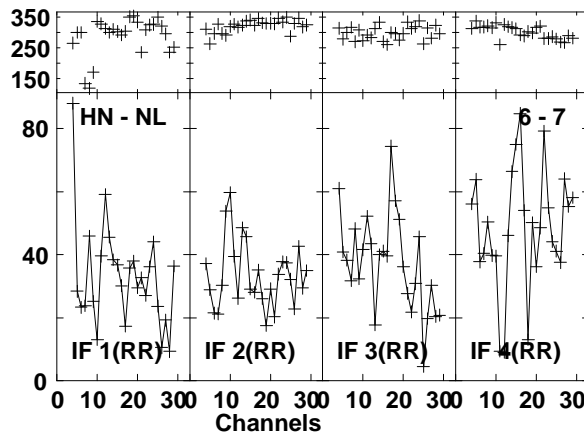
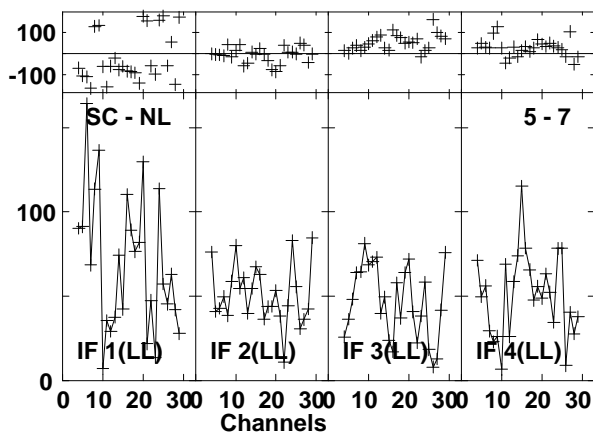
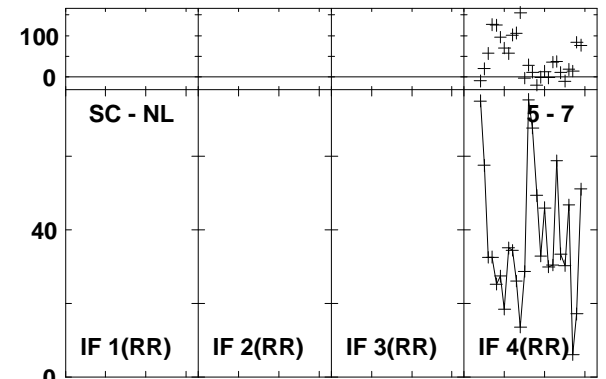
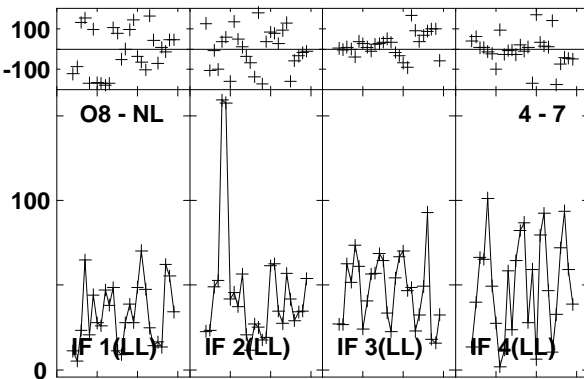
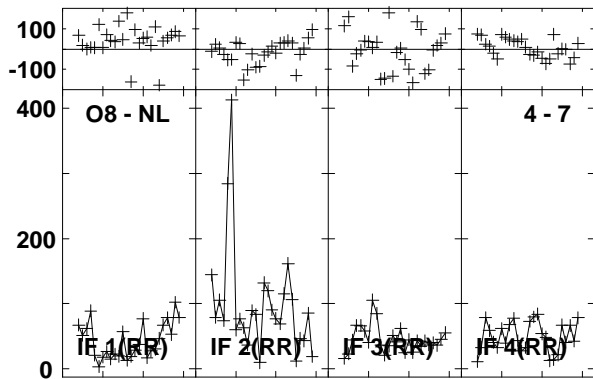
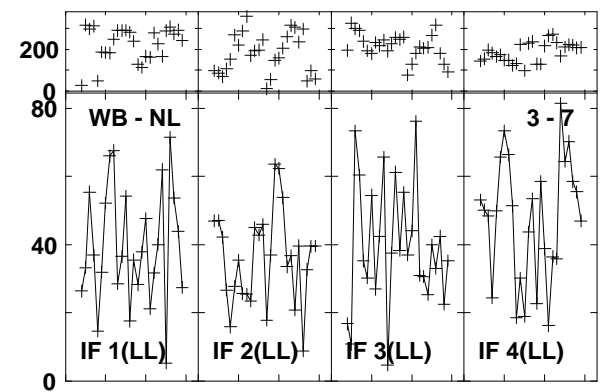
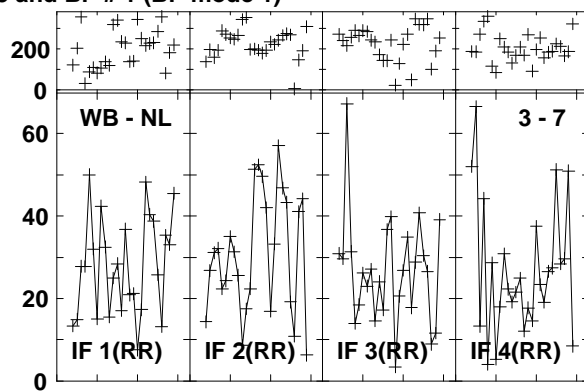
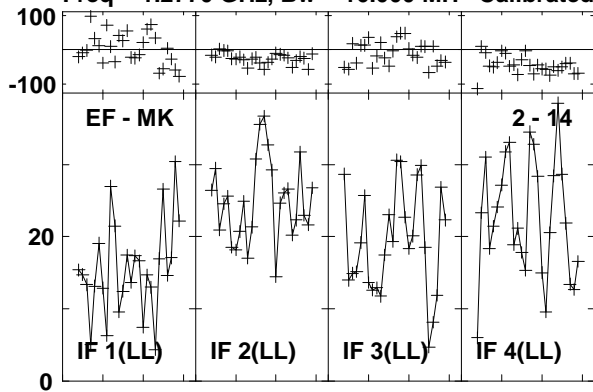

Lower frame: Milli Ampl Jy Top frame: Phas deg
Vector averaged cross-power spectrum Baseline: EF (02) - MK (14)
Timerange: 00/18:21:04 to 00/18:23:58

Plot file version 362 created 03-MAR-2016 01:12:58

4C52 GN002C 1.UVDATA.1

Freq = 1.2770 GHz, Bw = 16.000 MH Calibrated with CL # 3 and BP # 1 (BP mode 1)

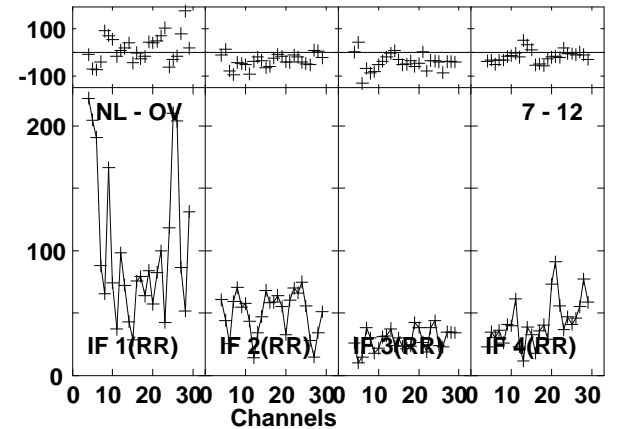
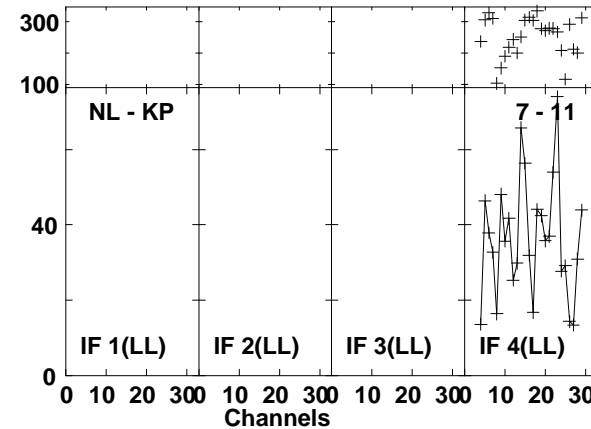
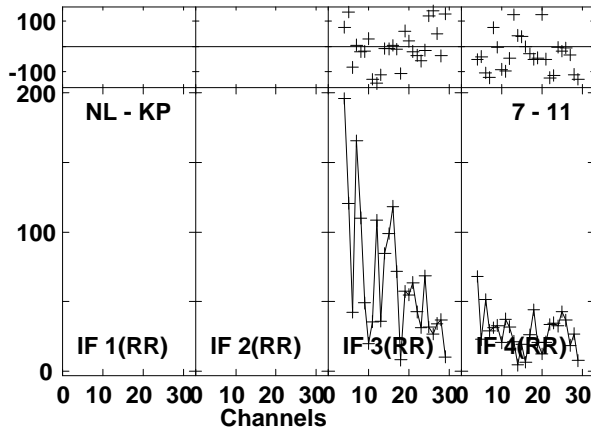
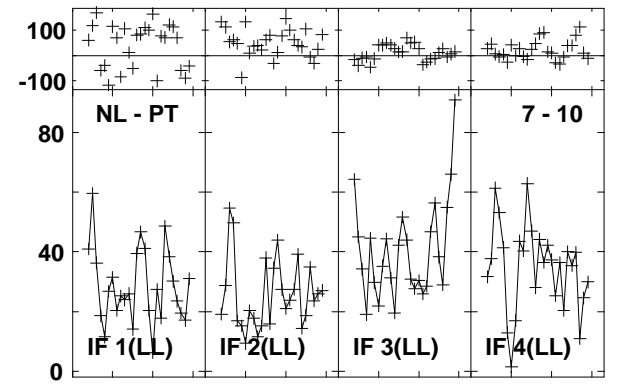
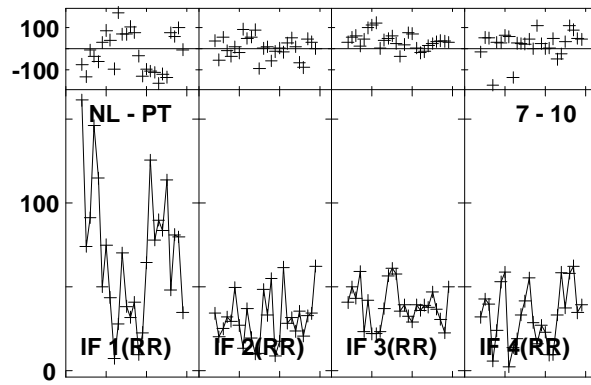
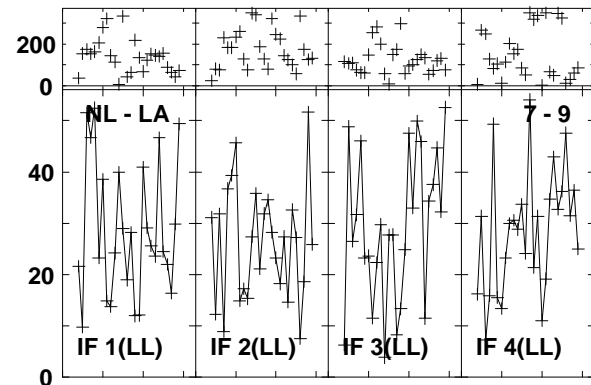
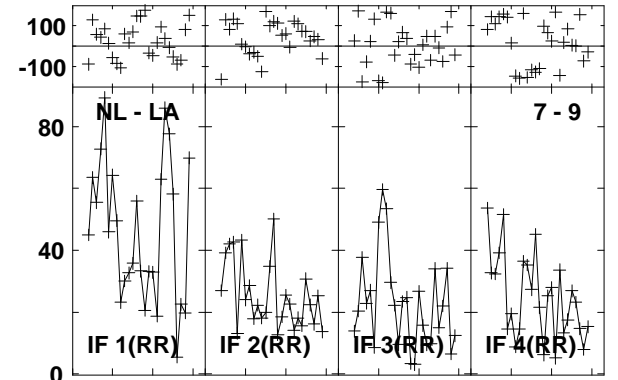
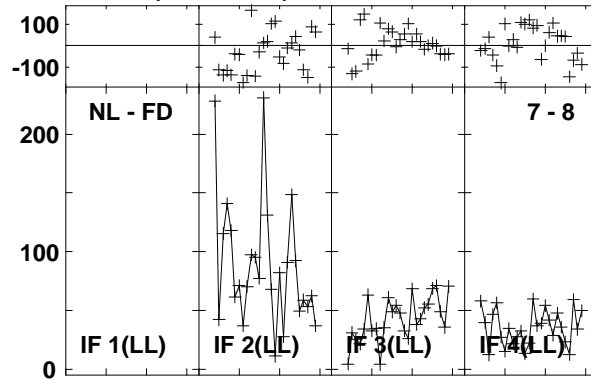
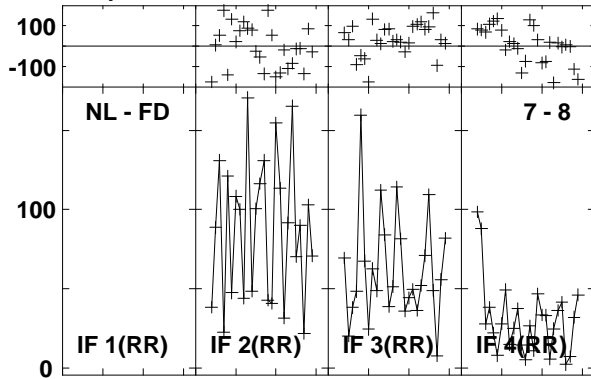

Lower frame: Milli Ampl Jy Top frame: Phas deg
Vector averaged cross-power spectrum Baseline: NL (07) - FD (08)
Timerange: 00/18:21:04 to 00/18:23:58

Plot file version 363 created 03-MAR-2016 01:12:59

4C52 GN002C 1.UVDATA.1

Freq = 1.2770 GHz, Bw = 16.000 MH Calibrated with CL # 3 and BP # 1 (BP mode 1)

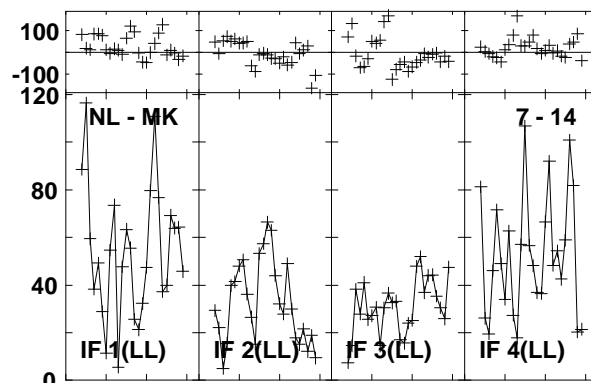
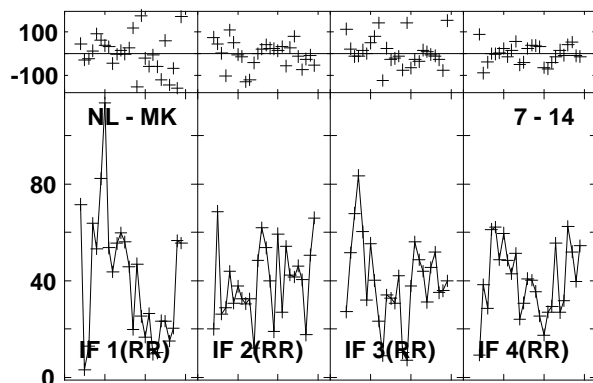
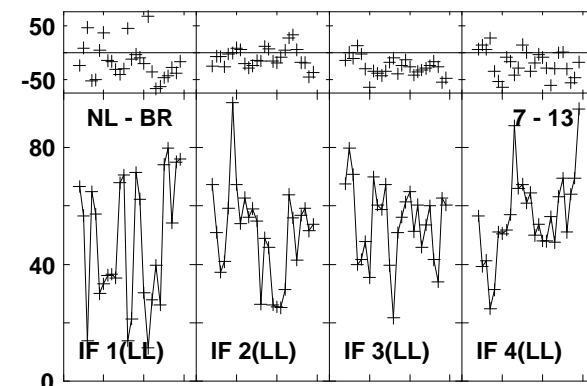
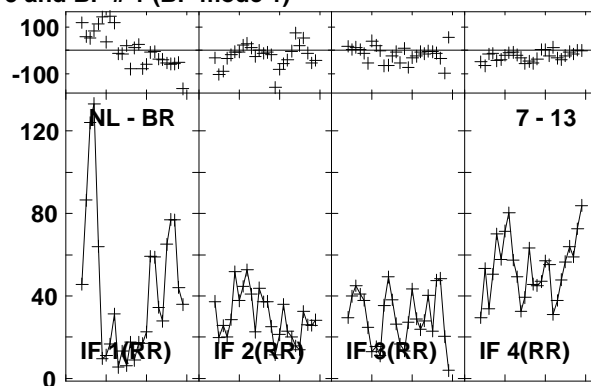
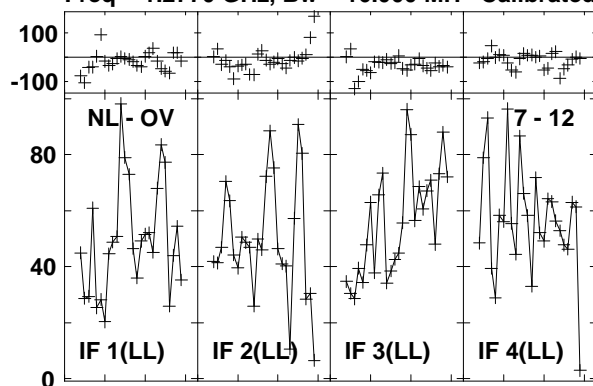

Lower frame: Milli Ampl Jy Top frame: Phas deg
Vector averaged cross-power spectrum Baseline: NL (07) - OV (12)
Timerange: 00:18:21:04 to 00:18:23:58

Plot file version 364 created 03-MAR-2016 01:12:59

J1545+5400 GN002C 1.UVDATA.1

Freq = 1.2770 GHz, Bw = 16.000 MH Calibrated with CL # 3 and BP # 1 (BP mode 1)

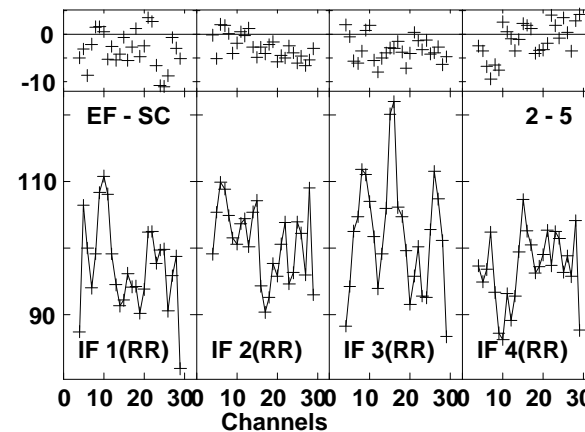
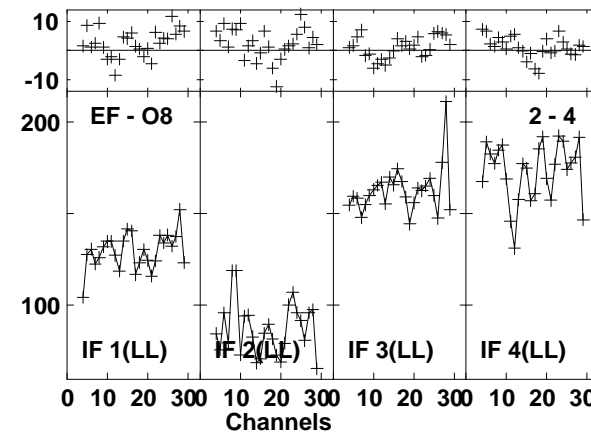
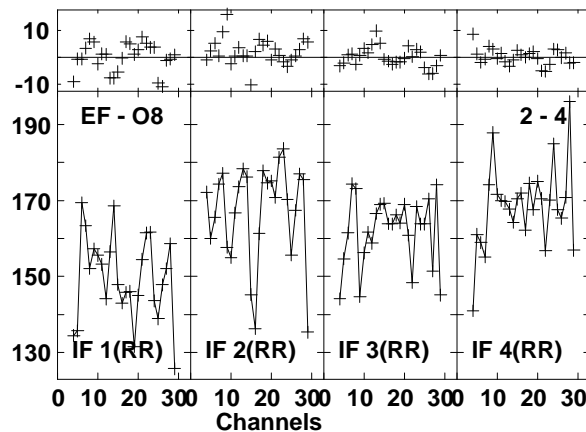
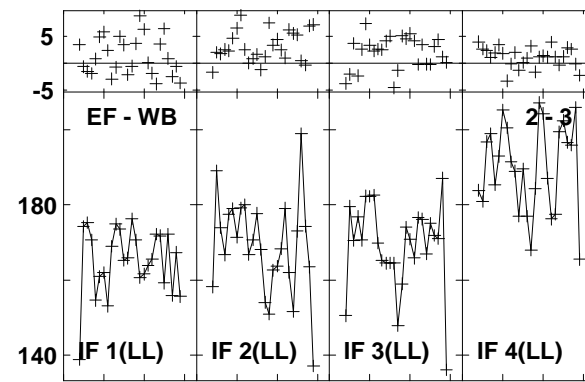
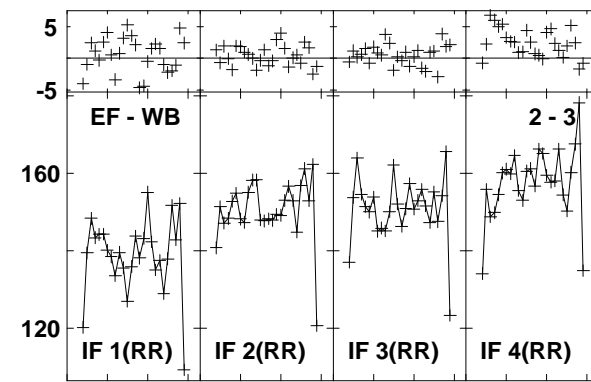
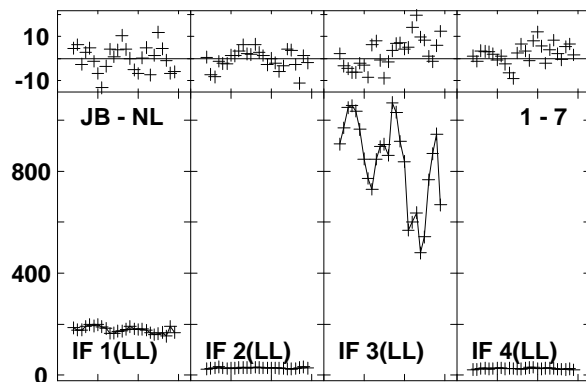
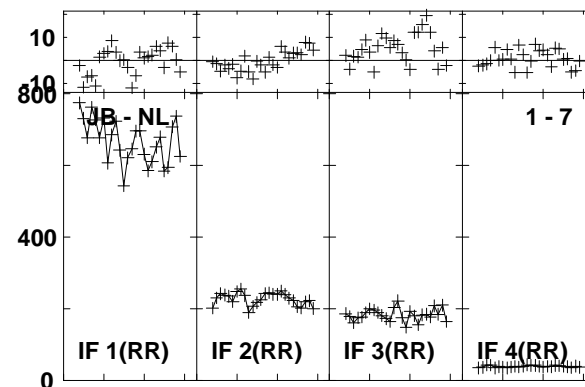
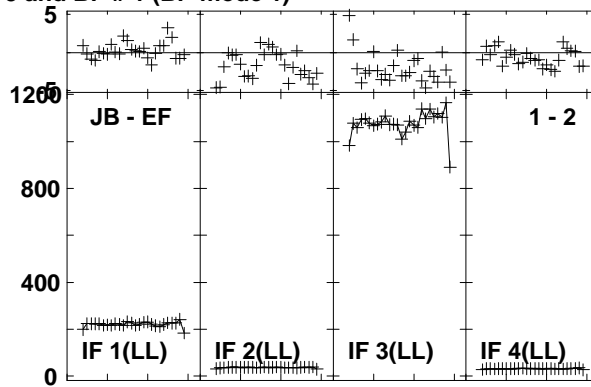
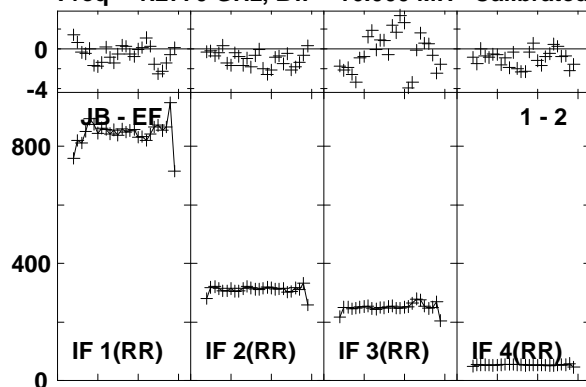

Lower frame: Milli Ampl Jy Top frame: Phas deg
Vector averaged cross-power spectrum Baseline: JB (01) - EF (02)
Timerange: 00/18:24:51 to 00/18:26:49

Plot file version 365 created 03-MAR-2016 01:12:59

J1545+5400 GN002C 1.UVDATA.1

Freq = 1.2770 GHz, Bw = 16.000 MH Calibrated with CL # 3 and BP # 1 (BP mode 1)

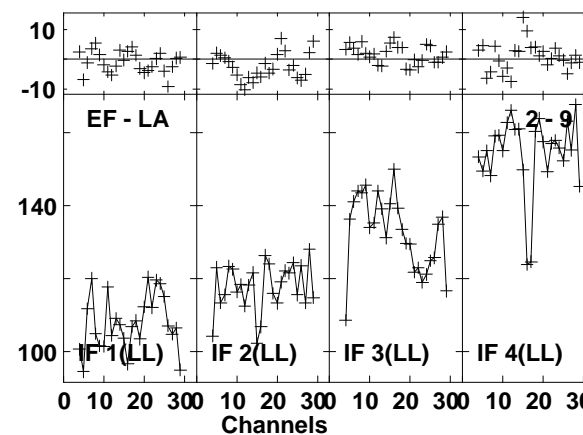
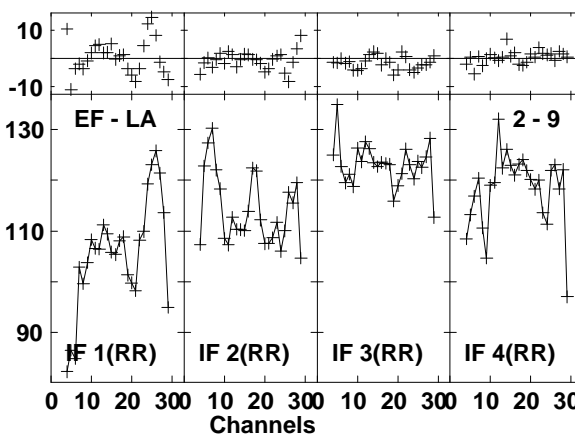
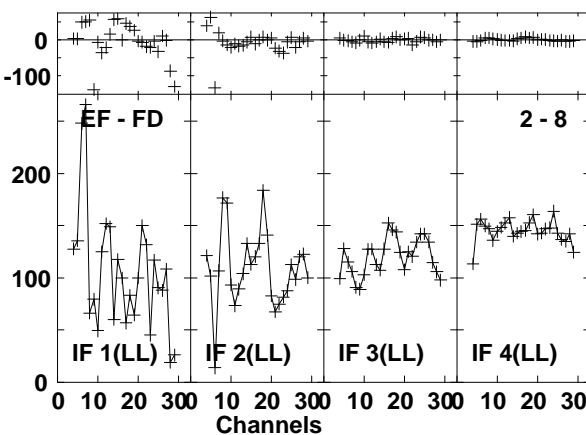
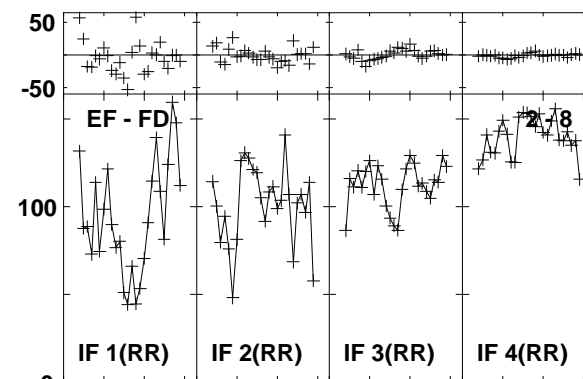
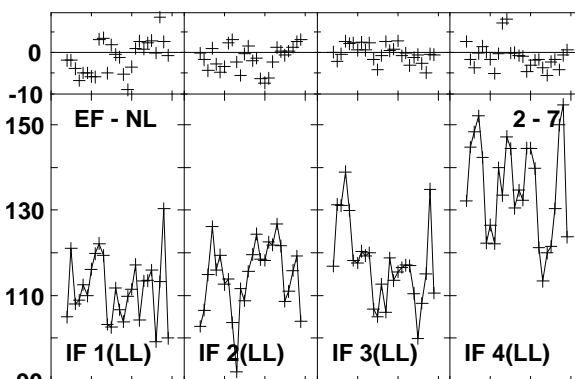
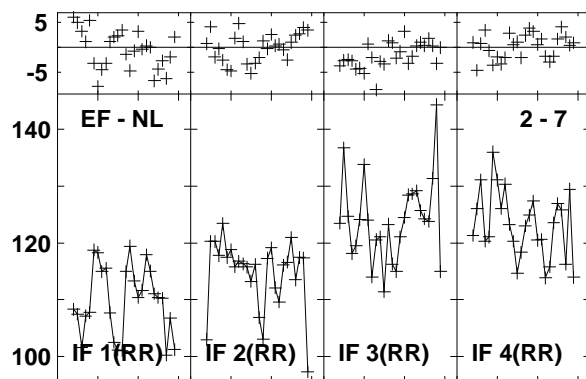
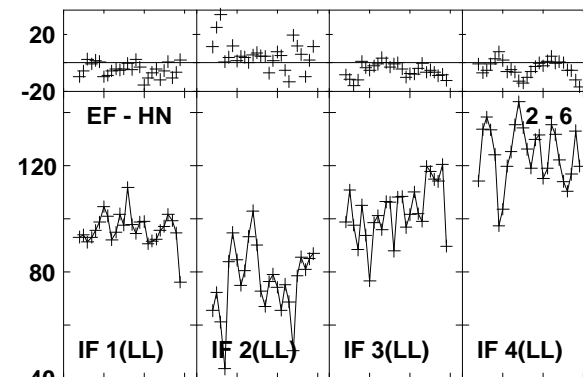
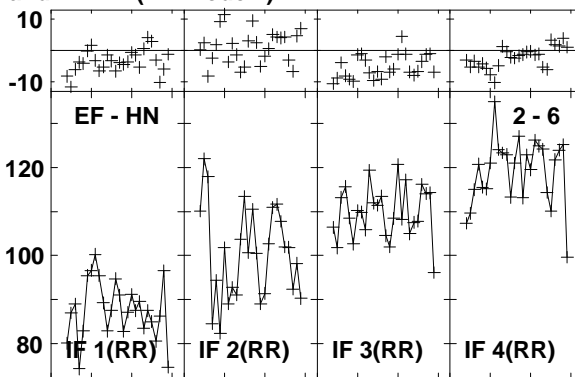
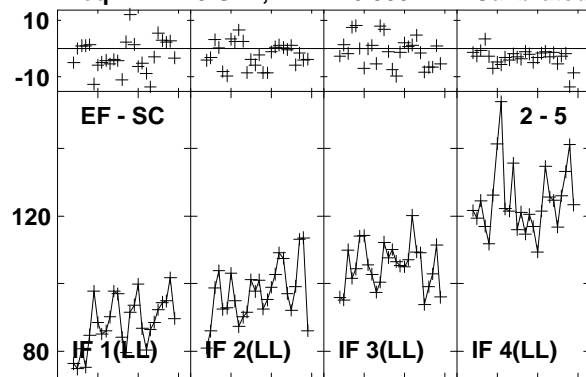

Lower frame: Milli Ampl Jy Top frame: Phas deg
Vector averaged cross-power spectrum Baseline: EF (02) - SC (05)
Timerange: 00/18:24:51 to 00/18:26:49

Plot file version 366 created 03-MAR-2016 01:12:59

J1545+5400 GN002C 1.UVDATA.1

Freq = 1.2770 GHz, Bw = 16.000 MH Calibrated with CL # 3 and BP # 1 (BP mode 1)

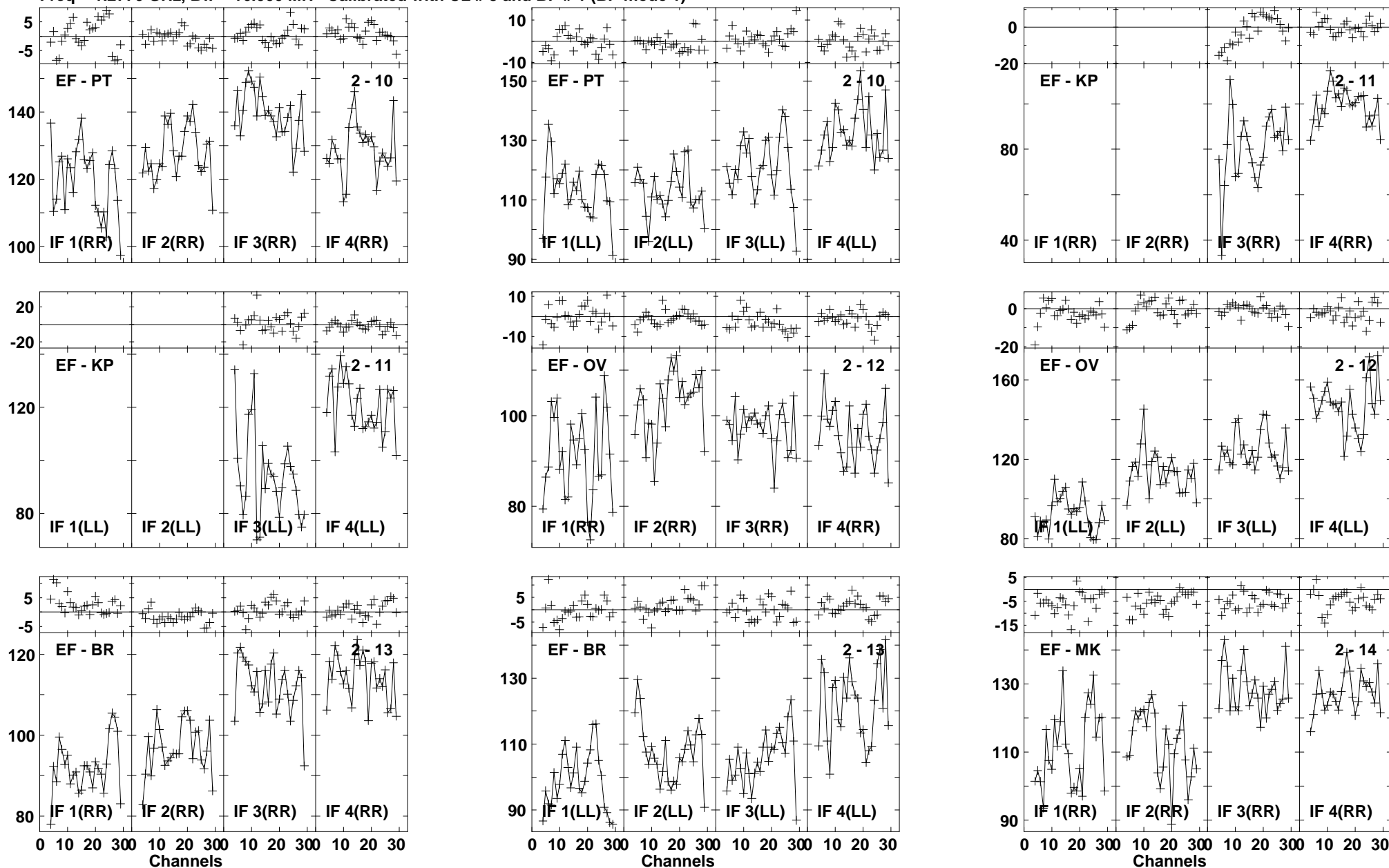

Lower frame: Milli Ampl Jy Top frame: Phas deg
Vector averaged cross-power spectrum Baseline: EF (02) - PT (10)
Timerange: 00/18:24:51 to 00/18:26:49

Plot file version 367 created 03-MAR-2016 01:12:59

J1545+5400 GN002C 1.UVDATA.1

Freq = 1.2770 GHz, Bw = 16.000 MH Calibrated with CL # 3 and BP # 1 (BP mode 1)

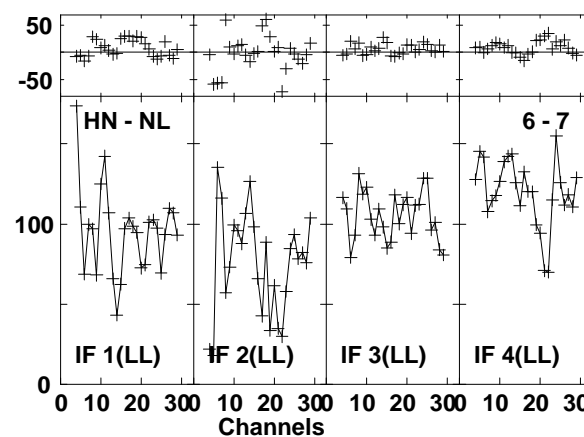
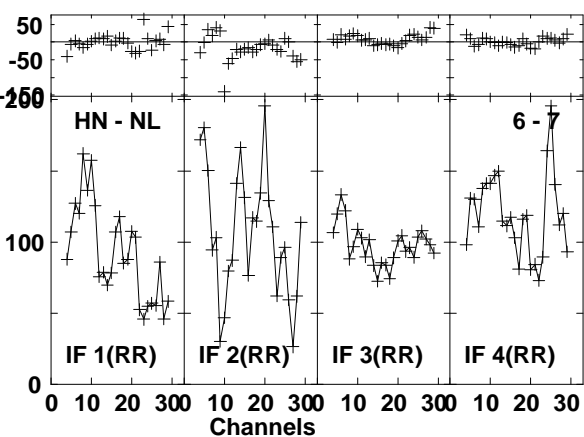
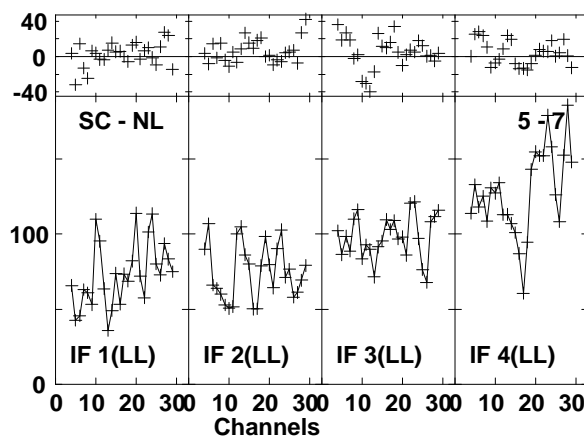
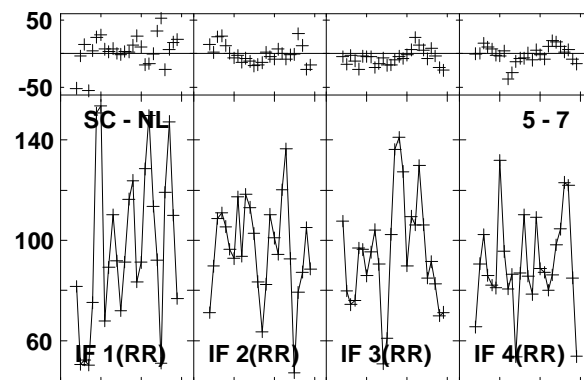
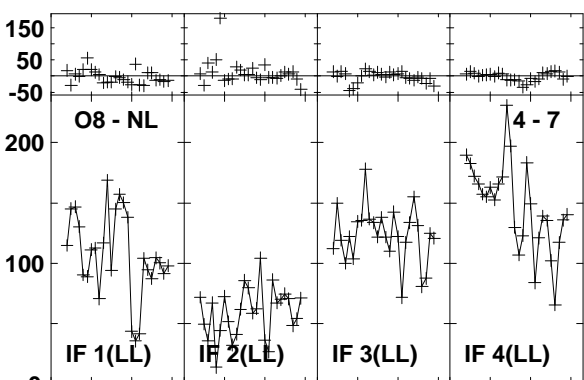
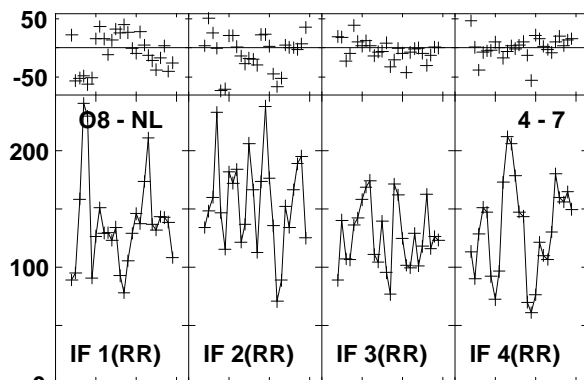
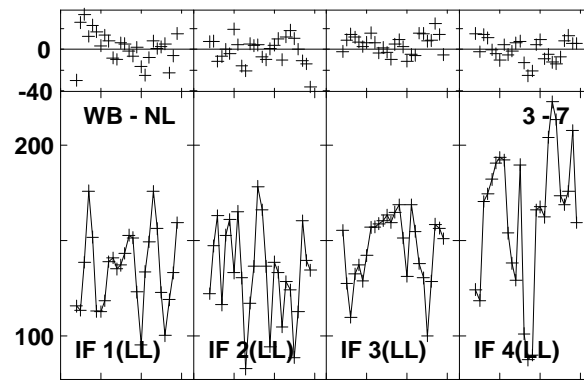
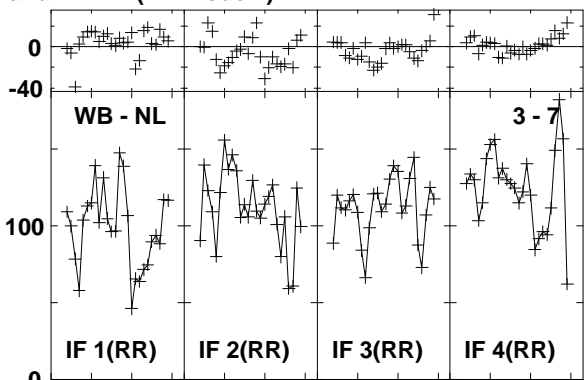
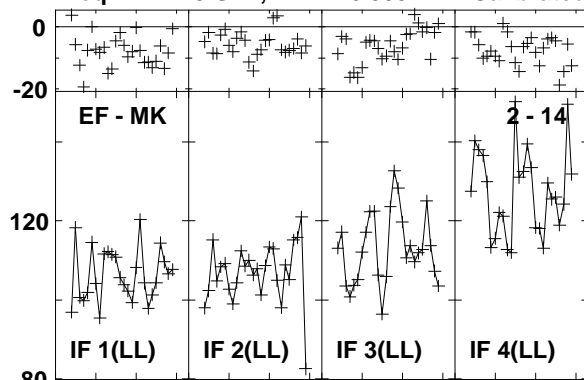

Lower frame: Milli Ampl Jy Top frame: Phas deg
Vector averaged cross-power spectrum Baseline: EF (02) - MK (14)
Timerange: 00/18:24:51 to 00/18:26:49

Plot file version 368 created 03-MAR-2016 01:12:59

J1545+5400 GN002C 1.UVDATA.1

Freq = 1.2770 GHz, Bw = 16.000 MH Calibrated with CL # 3 and BP # 1 (BP mode 1)

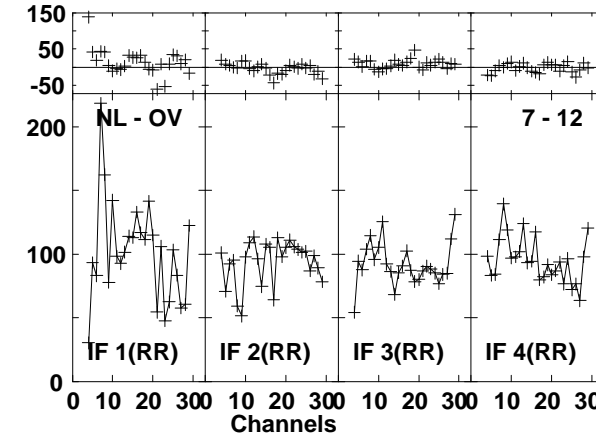
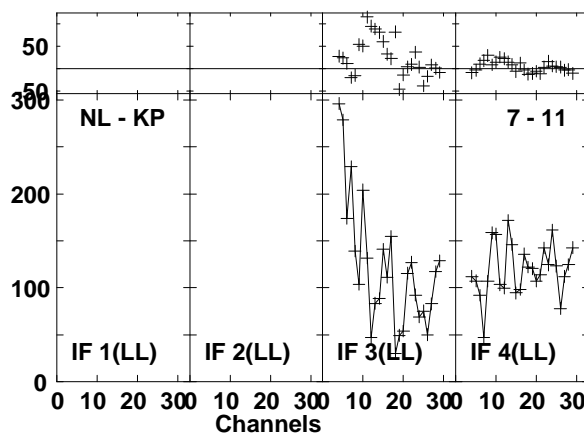
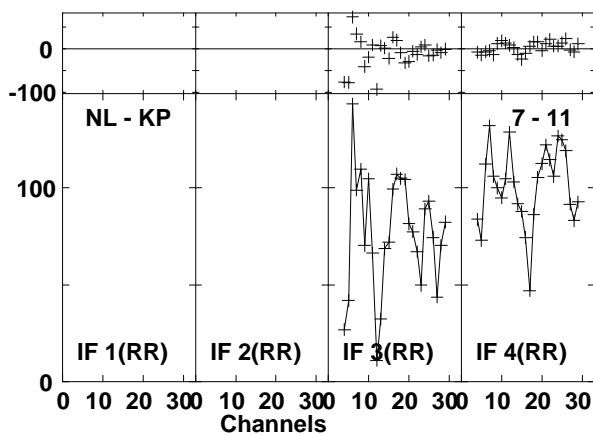
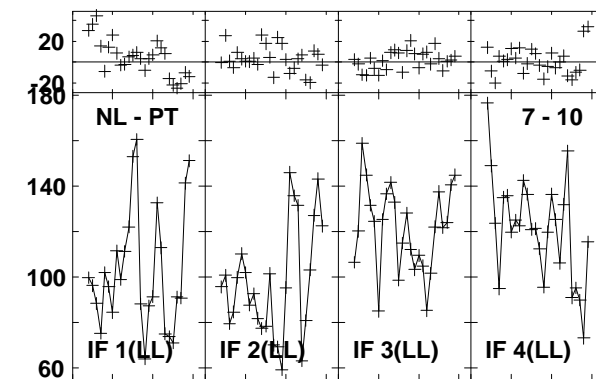
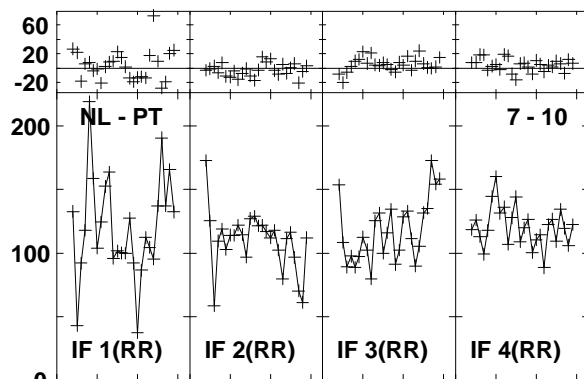
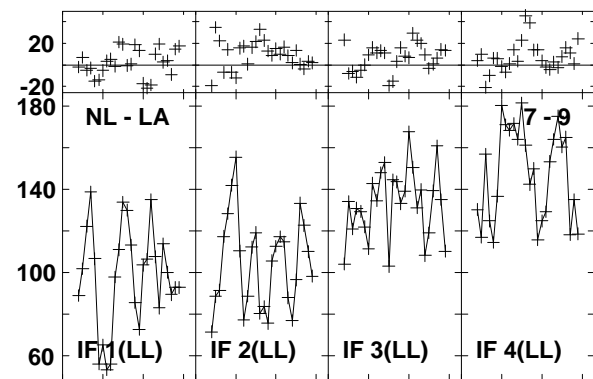
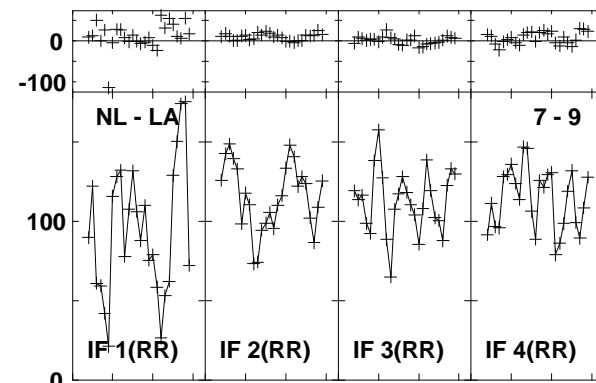
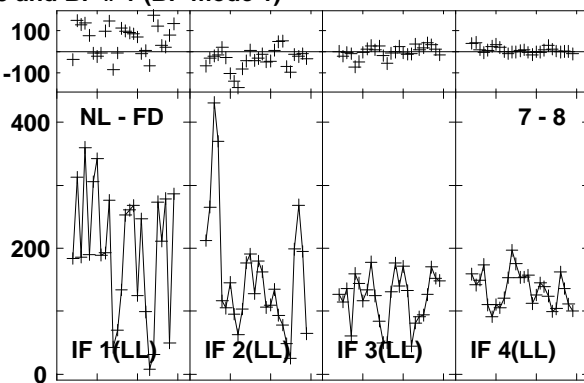
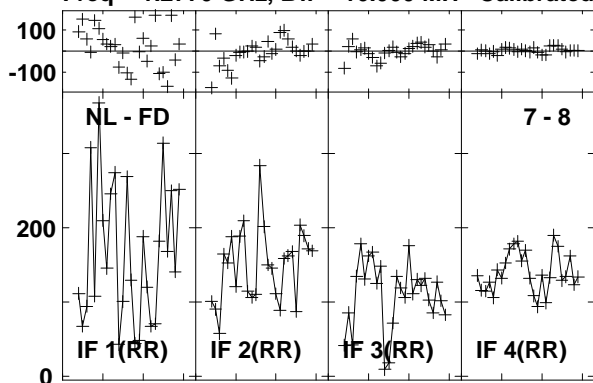

Lower frame: Milli Ampl Jy Top frame: Phas deg
Vector averaged cross-power spectrum Baseline: NL (07) - FD (08)
Timerange: 00:18:24:51 to 00:18:26:49

Plot file version 369 created 03-MAR-2016 01:12:59

J1545+5400 GN002C 1.UVDATA.1

Freq = 1.2770 GHz, Bw = 16.000 MH Calibrated with CL # 3 and BP # 1 (BP mode 1)

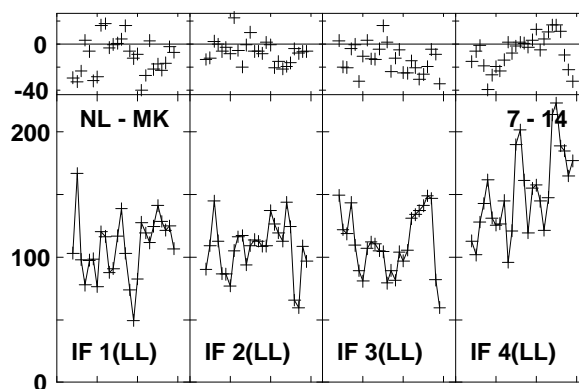
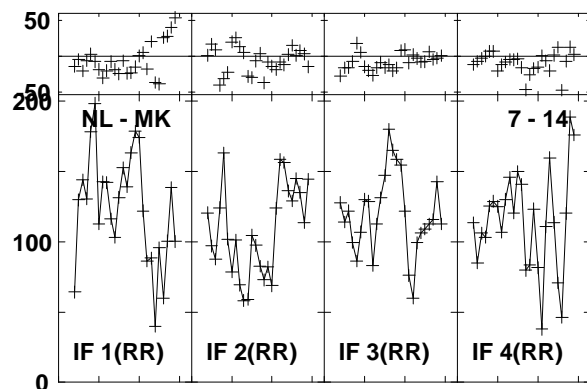
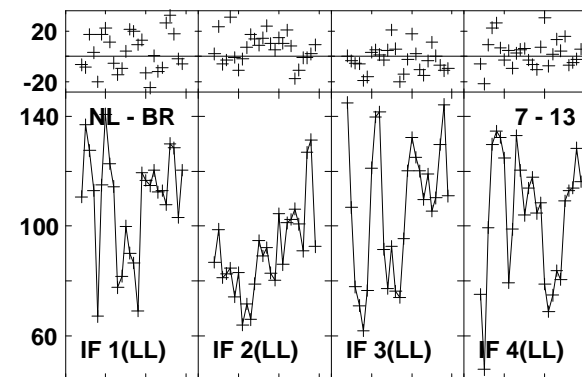
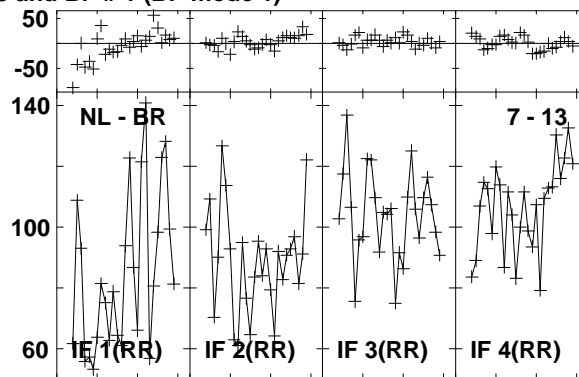
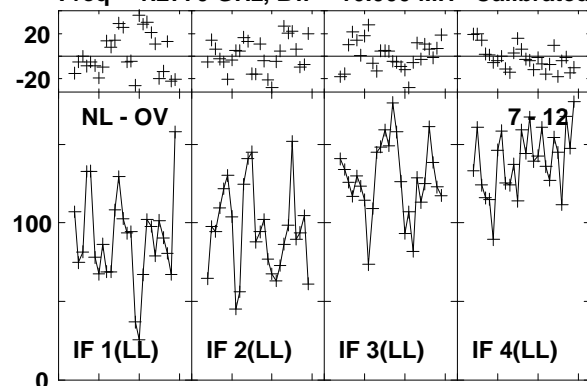

Lower frame: Milli Ampl Jy Top frame: Phas deg
Vector averaged cross-power spectrum Baseline: NL (07) - OV (12)
Timerange: 00:18:24:51 to 00:18:26:49

Plot file version 370 created 03-MAR-2016 01:13:00

4C52 GN002C 1.UVDATA.1

Freq = 1.2770 GHz, Bw = 16.000 MH Calibrated with CL # 3 and BP # 1 (BP mode 1)

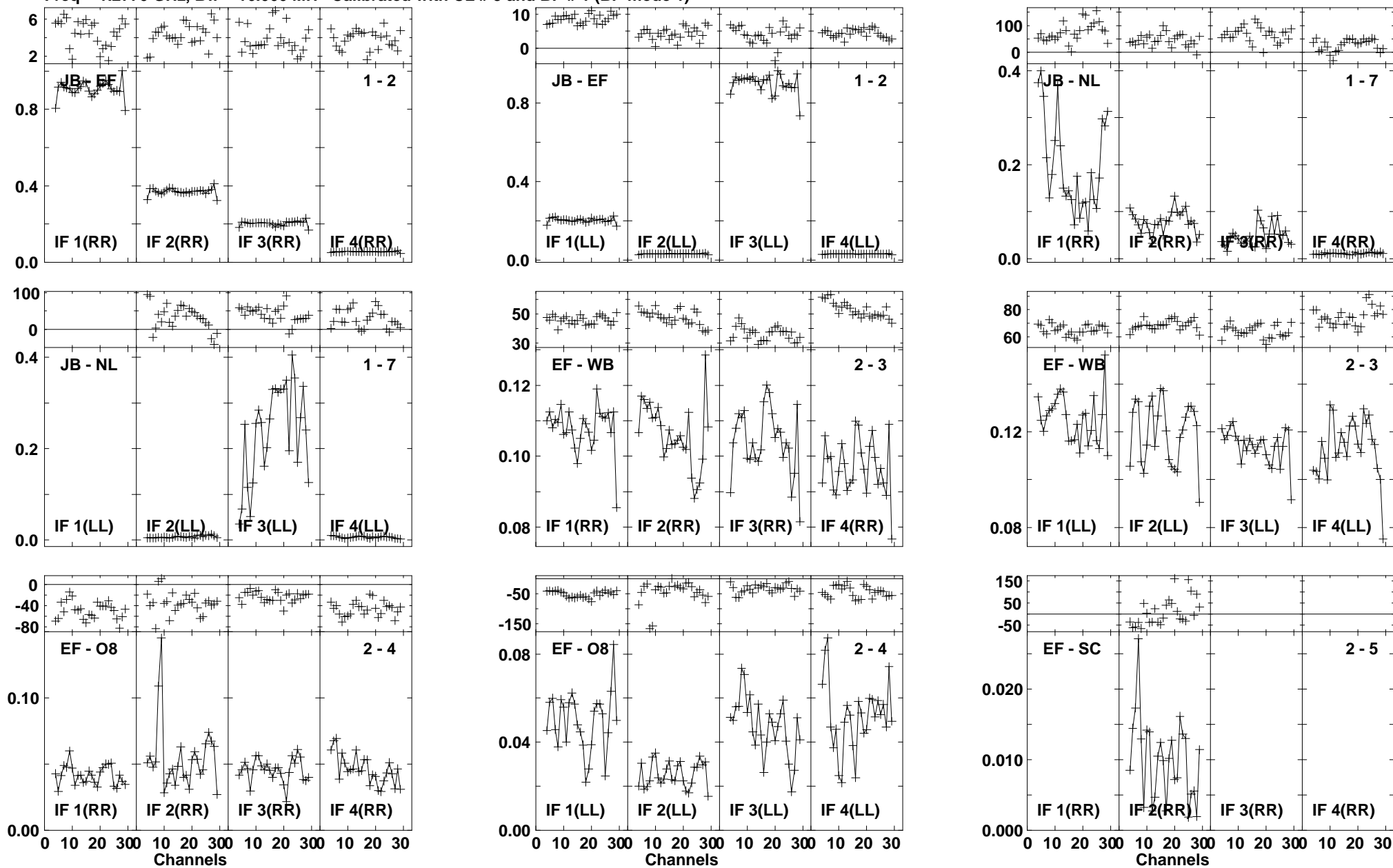

Lower frame: Ampl Jy Top frame: Phas deg
Vector averaged cross-power spectrum Baseline: JB (01) - EF (02)
Timerange: 00/18:27:02 to 00/18:29:48

Plot file version 371 created 03-MAR-2016 01:13:00

4C52 GN002C 1.UVDATA.1

Freq = 1.2770 GHz, Bw = 16.000 MH Calibrated with CL # 3 and BP # 1 (BP mode 1)

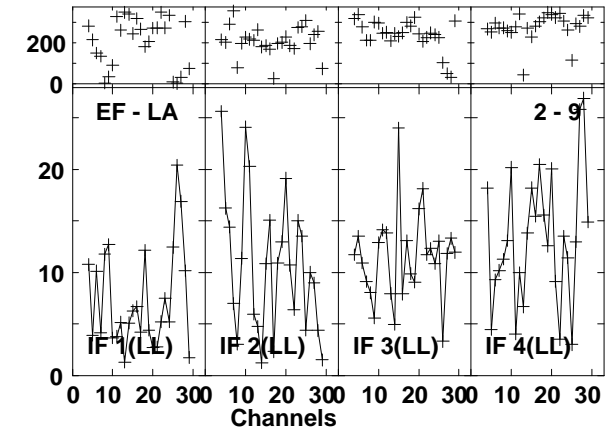
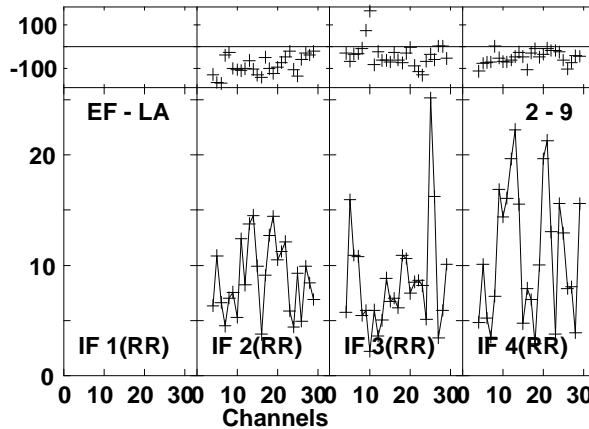
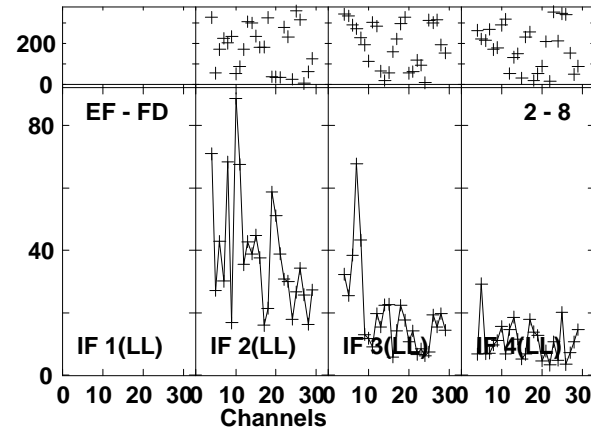
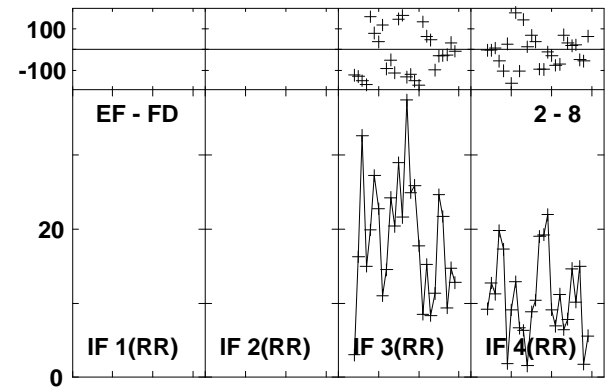
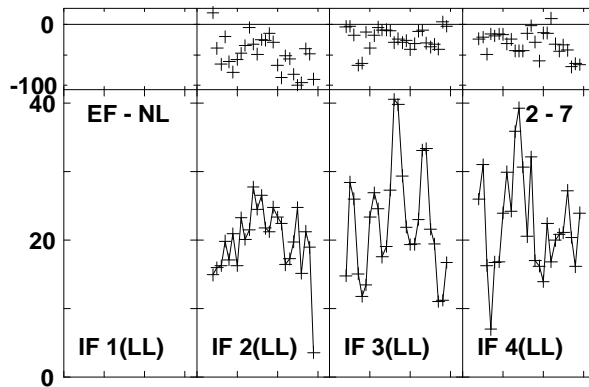
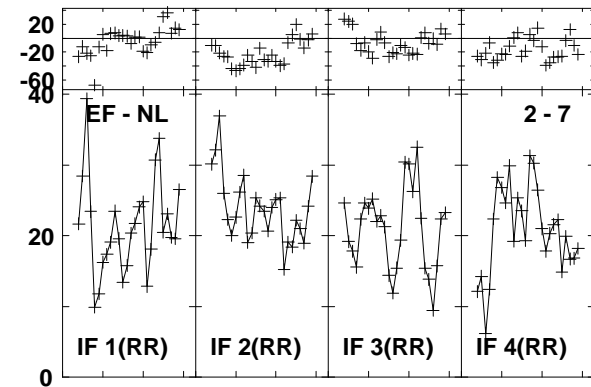
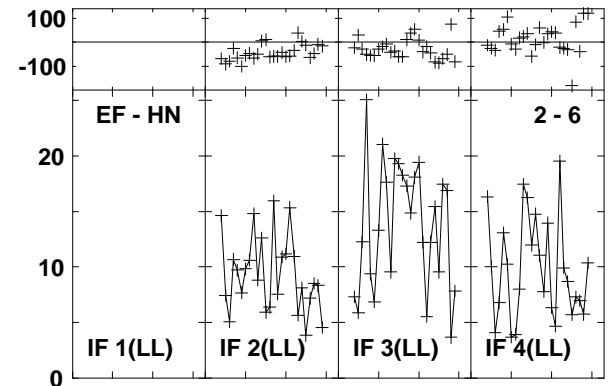
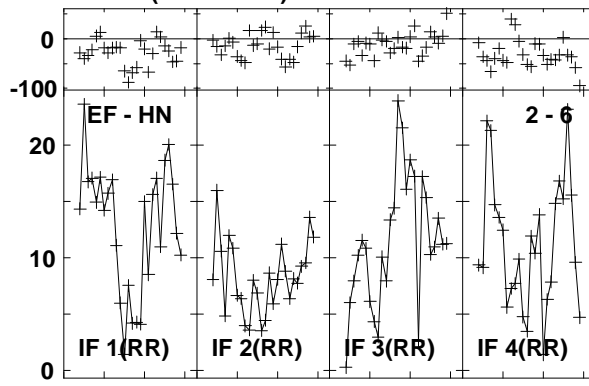
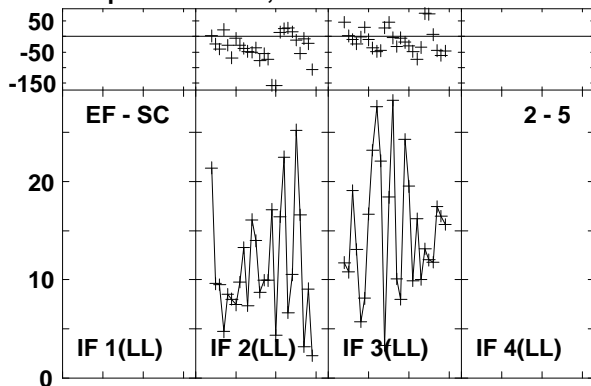

Lower frame: Milli Ampl Jy Top frame: Phas deg
Vector averaged cross-power spectrum Baseline: EF (02) - SC (05)
Timerange: 00/18:27:02 to 00/18:29:48

Plot file version 372 created 03-MAR-2016 01:13:00

4C52 GN002C 1.UVDATA.1

Freq = 1.2770 GHz, Bw = 16.000 MH Calibrated with CL # 3 and BP # 1 (BP mode 1)

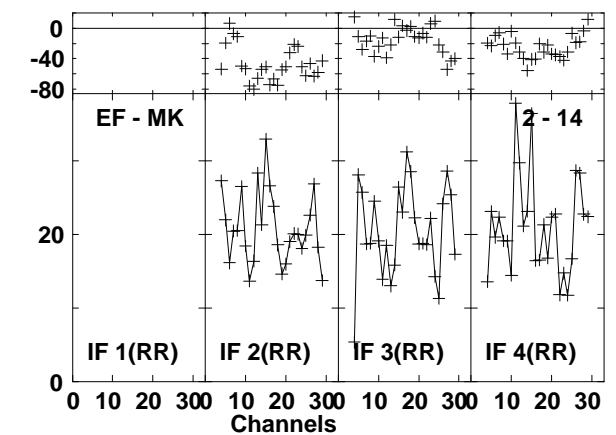
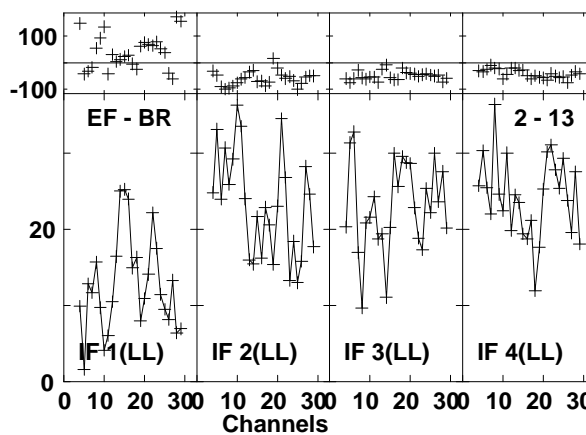
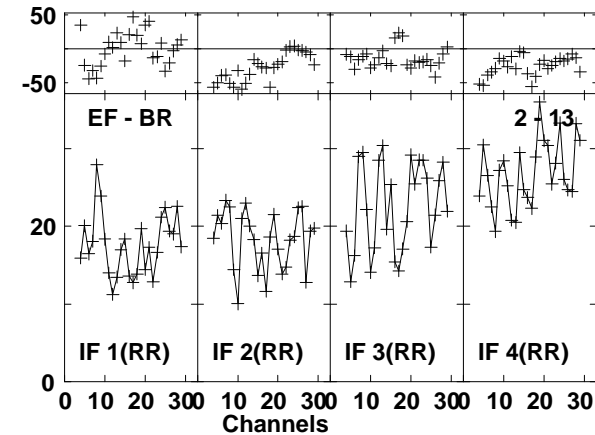
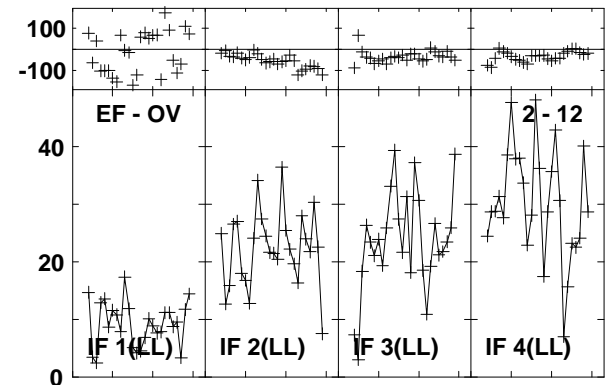
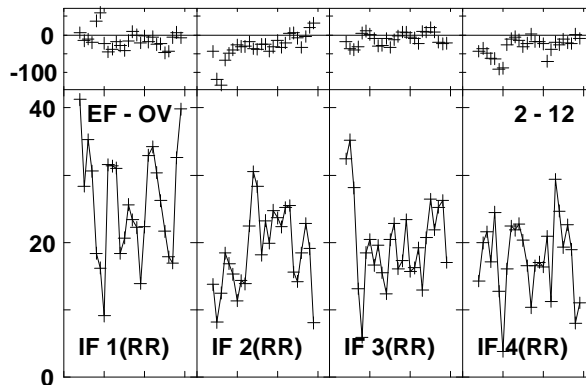
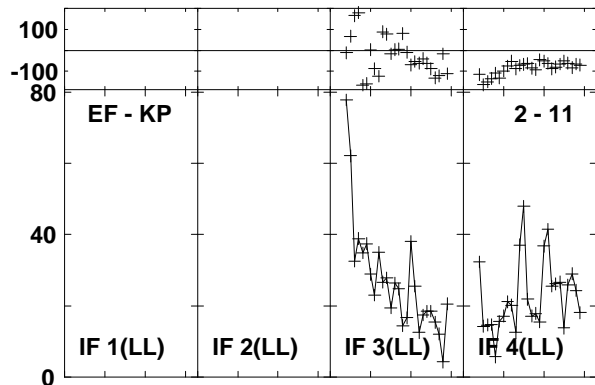
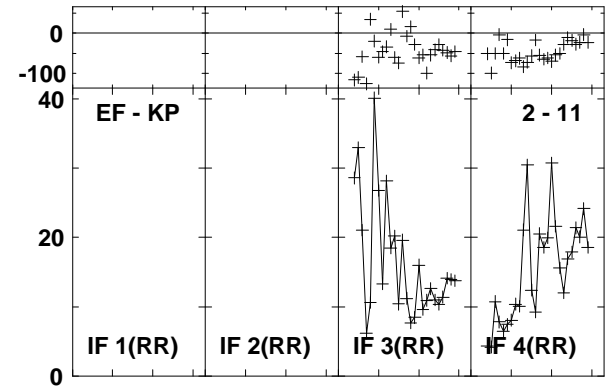
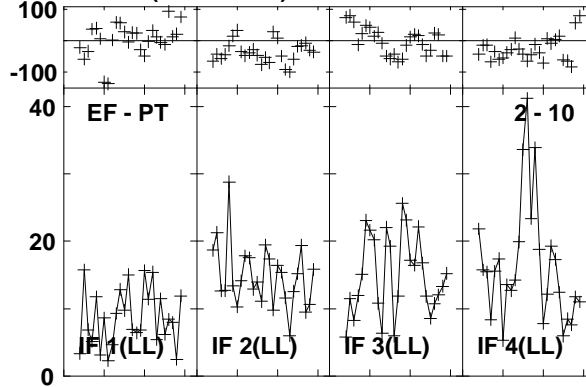
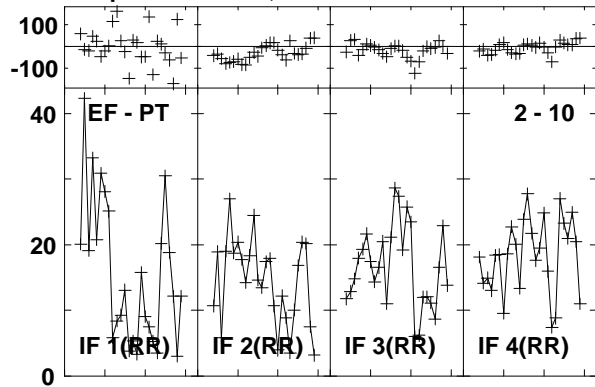

Lower frame: Milli Ampl Jy Top frame: Phas deg

Vector averaged cross-power spectrum Baseline: EF (02) - PT (10)

Timerange: 00/18:27:02 to 00/18:29:48

Plot file version 373 created 03-MAR-2016 01:13:00

4C52 GN002C 1.UVDATA.1

Freq = 1.2770 GHz, Bw = 16.000 MH Calibrated with CL # 3 and BP # 1 (BP mode 1)

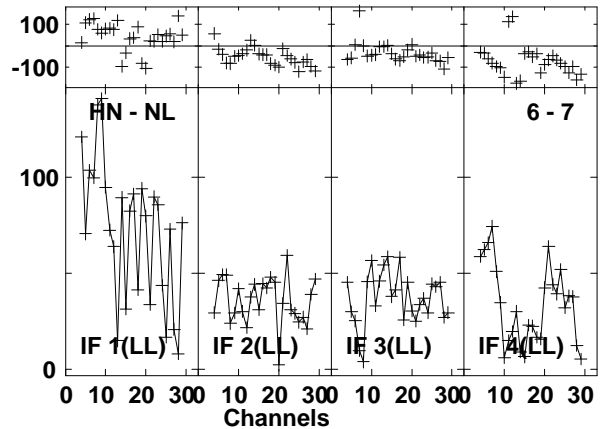
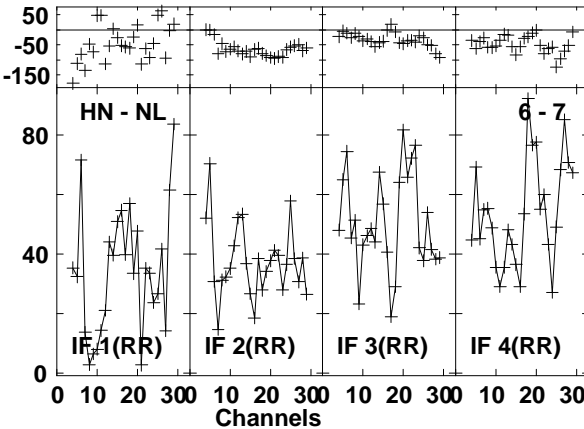
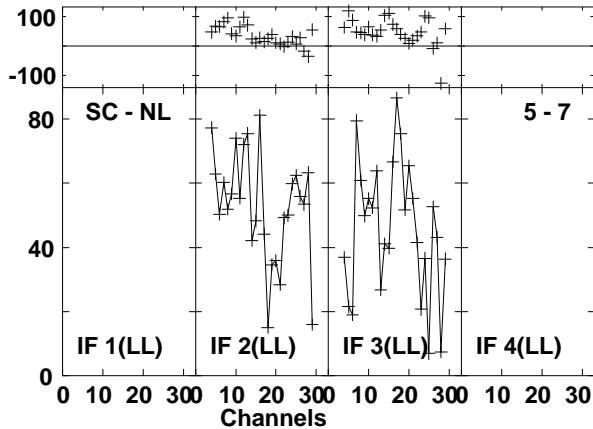
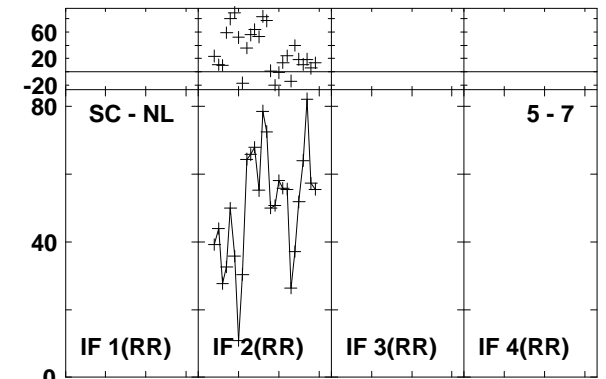
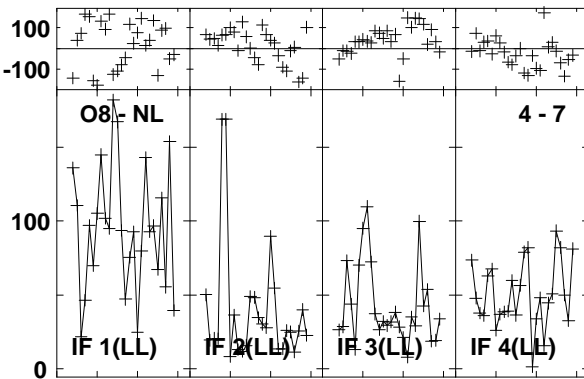
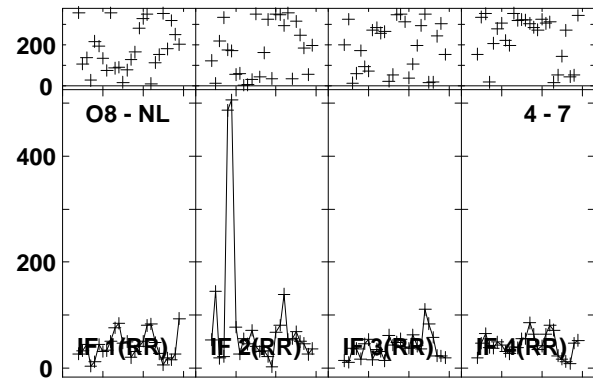
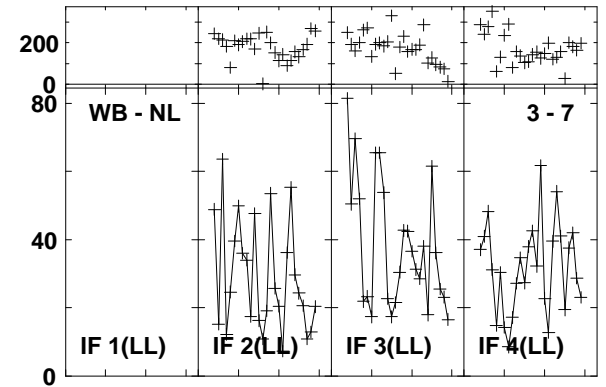
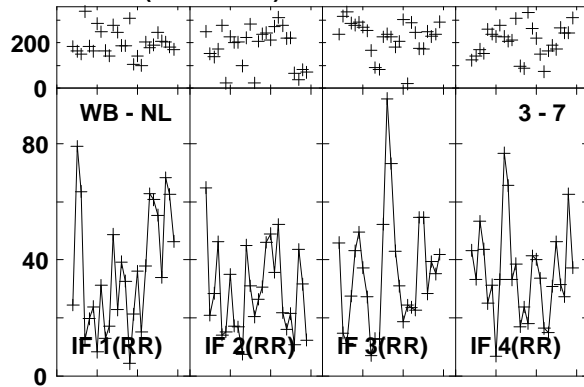
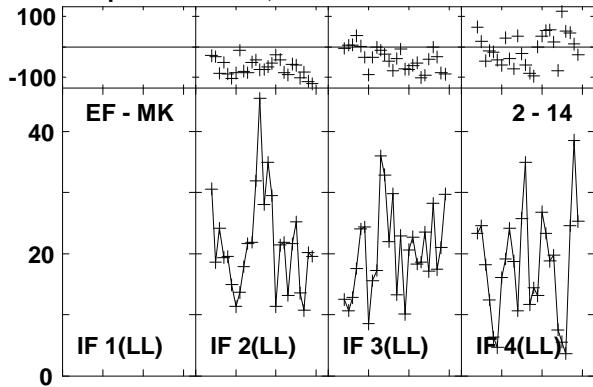

Lower frame: Milli Ampl Jy Top frame: Phas deg
Vector averaged cross-power spectrum Baseline: EF (02) - MK (14)
Timerange: 00/18:27:02 to 00/18:29:48

Plot file version 374 created 03-MAR-2016 01:13:00

4C52 GN002C 1.UVDATA.1

Freq = 1.2770 GHz, Bw = 16.000 MH Calibrated with CL # 3 and BP # 1 (BP mode 1)

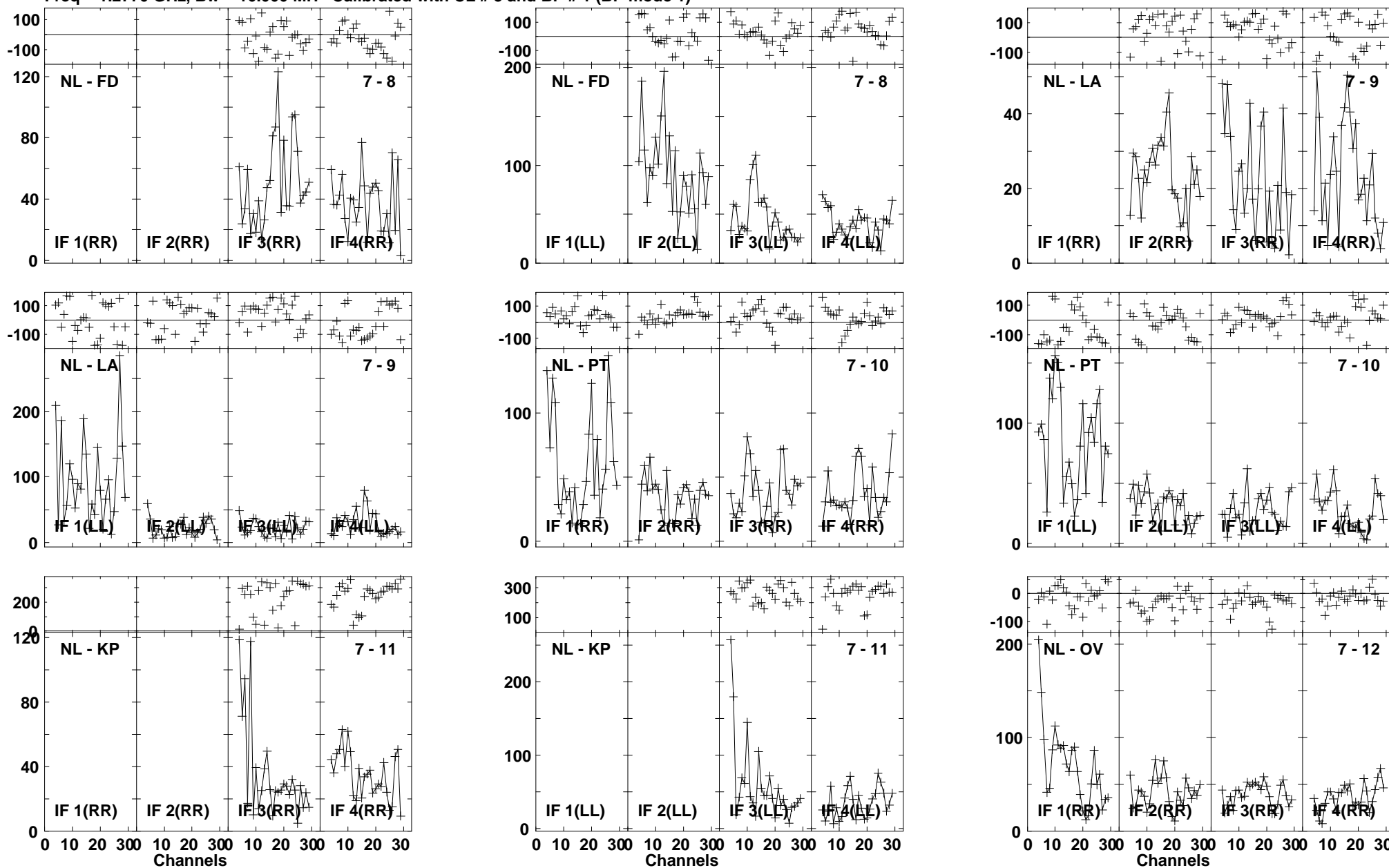

Lower frame: Milli Ampl Jy Top frame: Phas deg
Vector averaged cross-power spectrum Baseline: NL (07) - FD (08)
Timerange: 00/18:27:02 to 00/18:29:48

Plot file version 375 created 03-MAR-2016 01:13:00

4C52 GN002C 1.UVDATA.1

Freq = 1.2770 GHz, Bw = 16.000 MH Calibrated with CL # 3 and BP # 1 (BP mode 1)

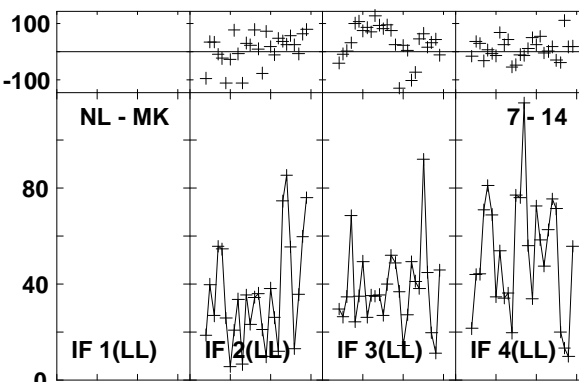
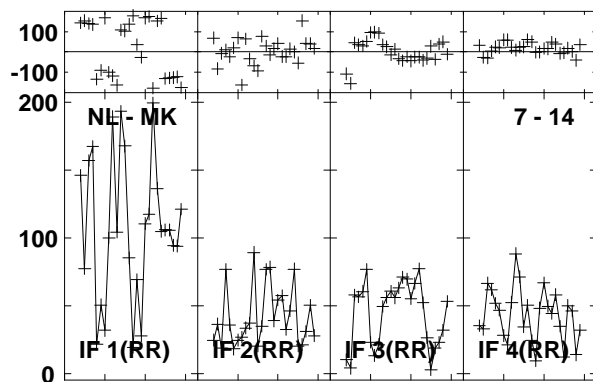
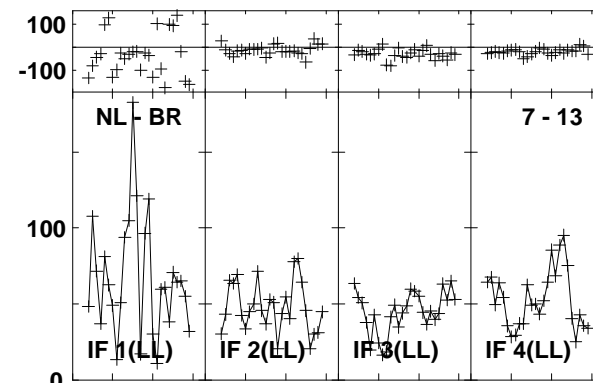
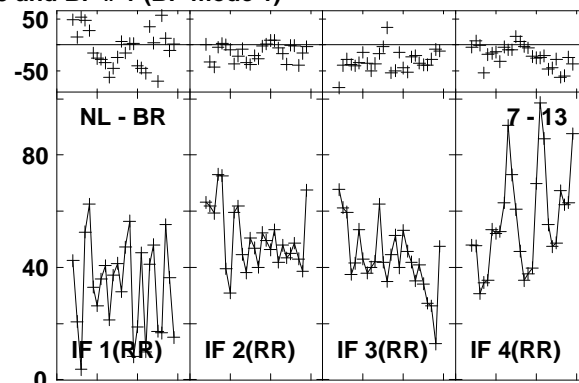
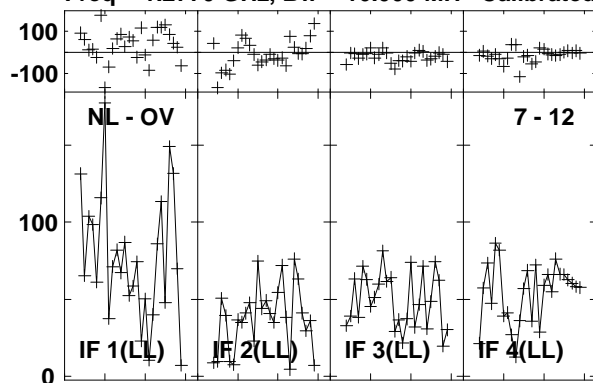

Lower frame: Milli Ampl Jy Top frame: Phas deg
Vector averaged cross-power spectrum Baseline: NL (07) - OV (12)
Timerange: 00/18:27:02 to 00/18:29:48

Plot file version 376 created 03-MAR-2016 01:13:01
 J1545+5400 GN002C 1.UVDATA.1
 Freq = 1.2770 GHz, Bw = 16.000 MH Calibrated with CL # 3 and BP # 1 (BP mode 1)

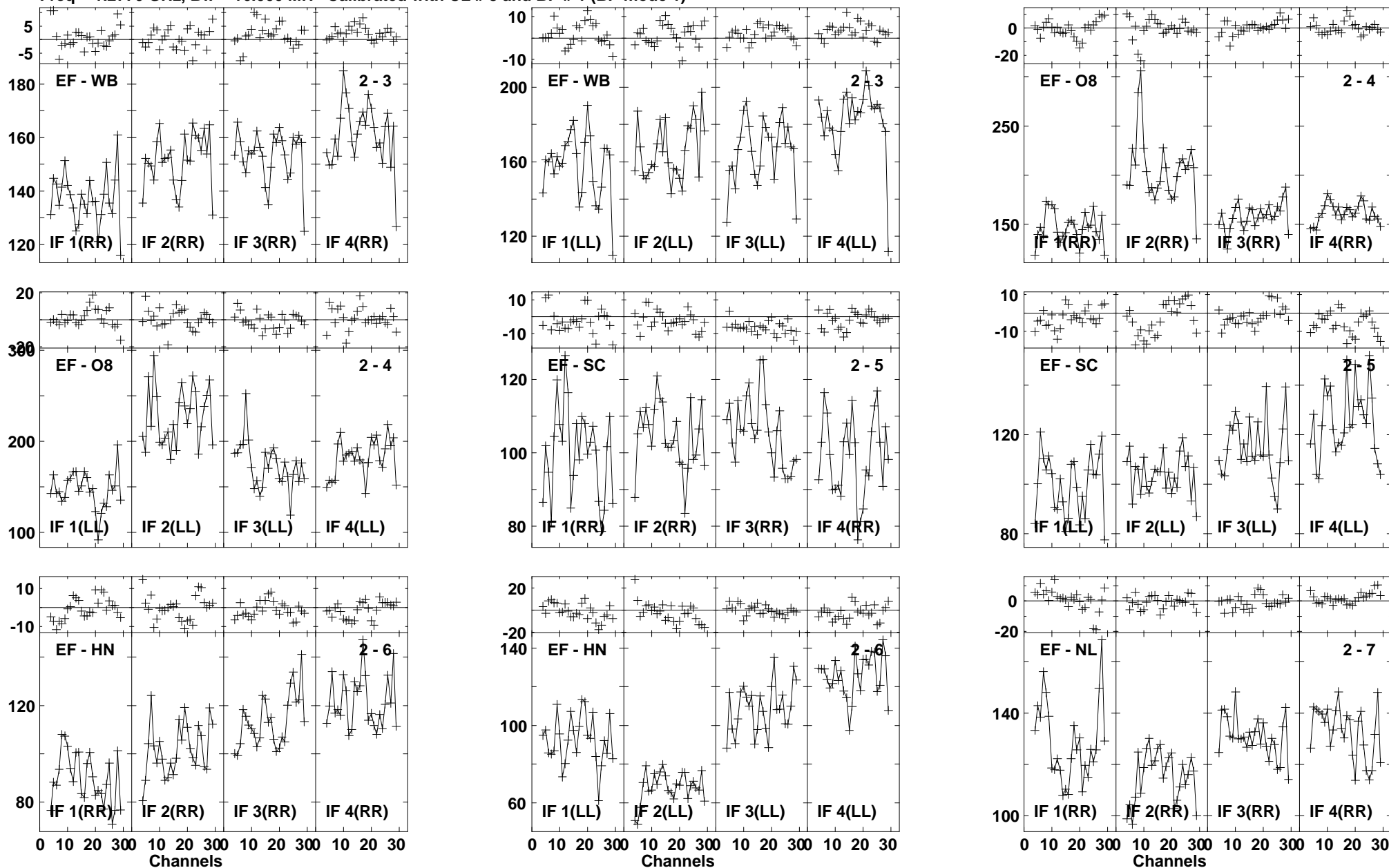

Lower frame: Milli Ampl Jy Top frame: Phas deg
 Vector averaged cross-power spectrum Baseline: EF (02) - WB (03)
 Timerange: 00/18:30:41 to 00/18:31:39

Plot file version 377 created 03-MAR-2016 01:13:01

J1545+5400 GN002C 1.UVDATA.1

Freq = 1.2770 GHz, Bw = 16.000 MH Calibrated with CL # 3 and BP # 1 (BP mode 1)

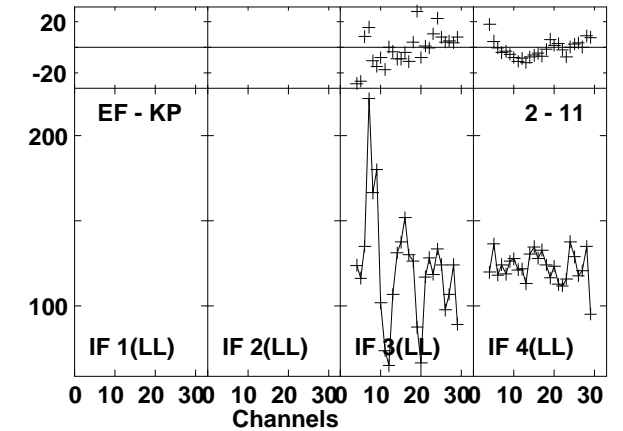
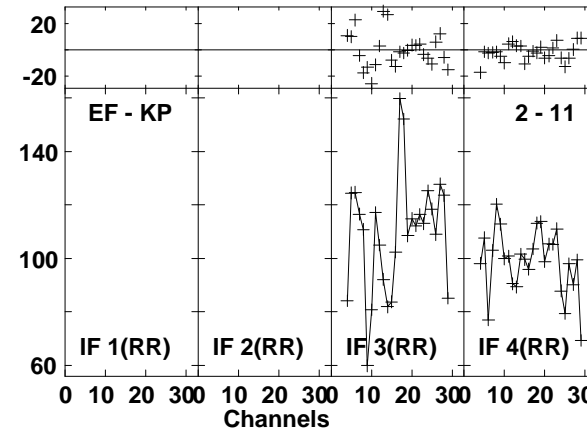
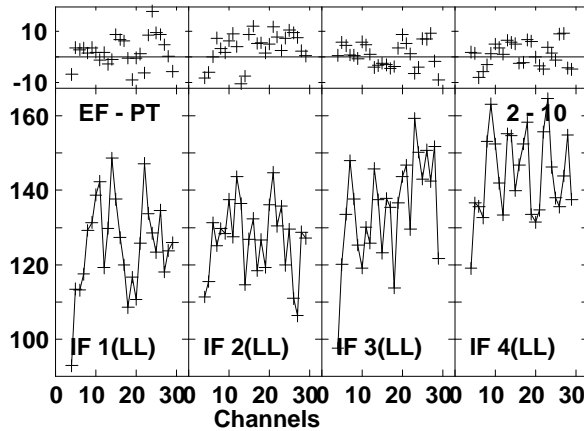
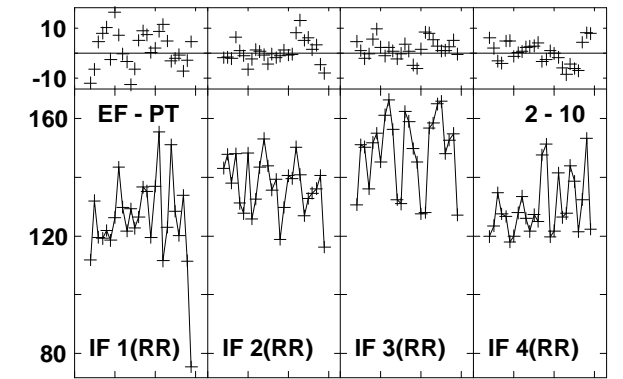
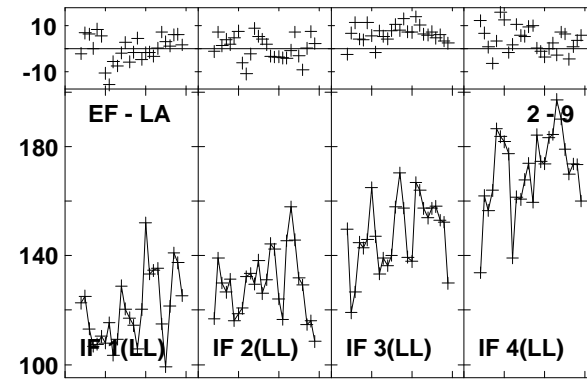
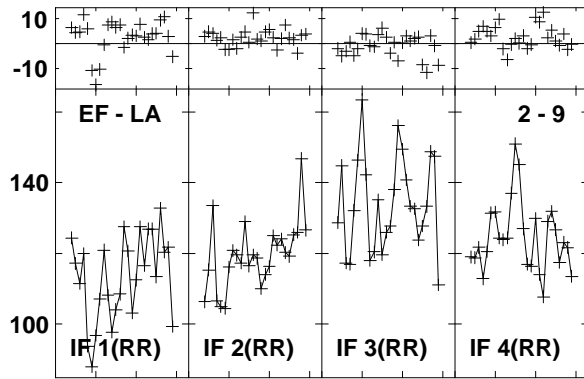
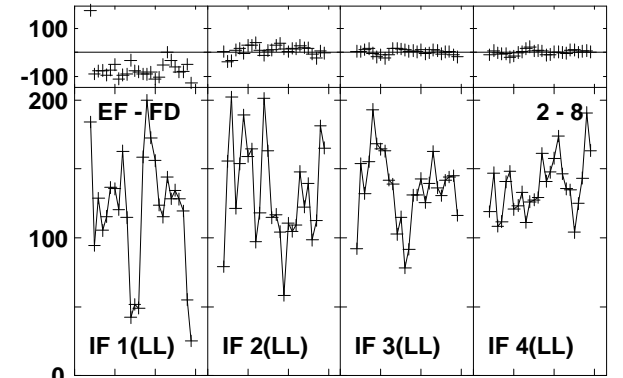
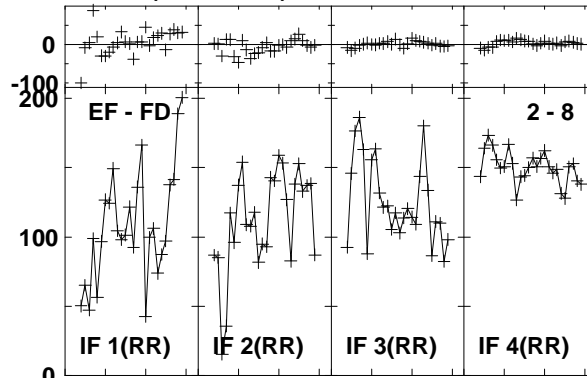
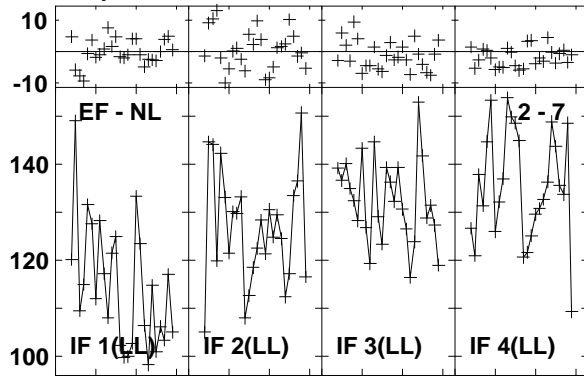

Lower frame: Milli Ampl Jy Top frame: Phas deg
Vector averaged cross-power spectrum Baseline: EF (02) - NL (07)
Timerange: 00/18:30:41 to 00/18:31:39

Plot file version 378 created 03-MAR-2016 01:13:01

J1545+5400 GN002C 1.UVDATA.1

Freq = 1.2770 GHz, Bw = 16.000 MH Calibrated with CL # 3 and BP # 1 (BP mode 1)

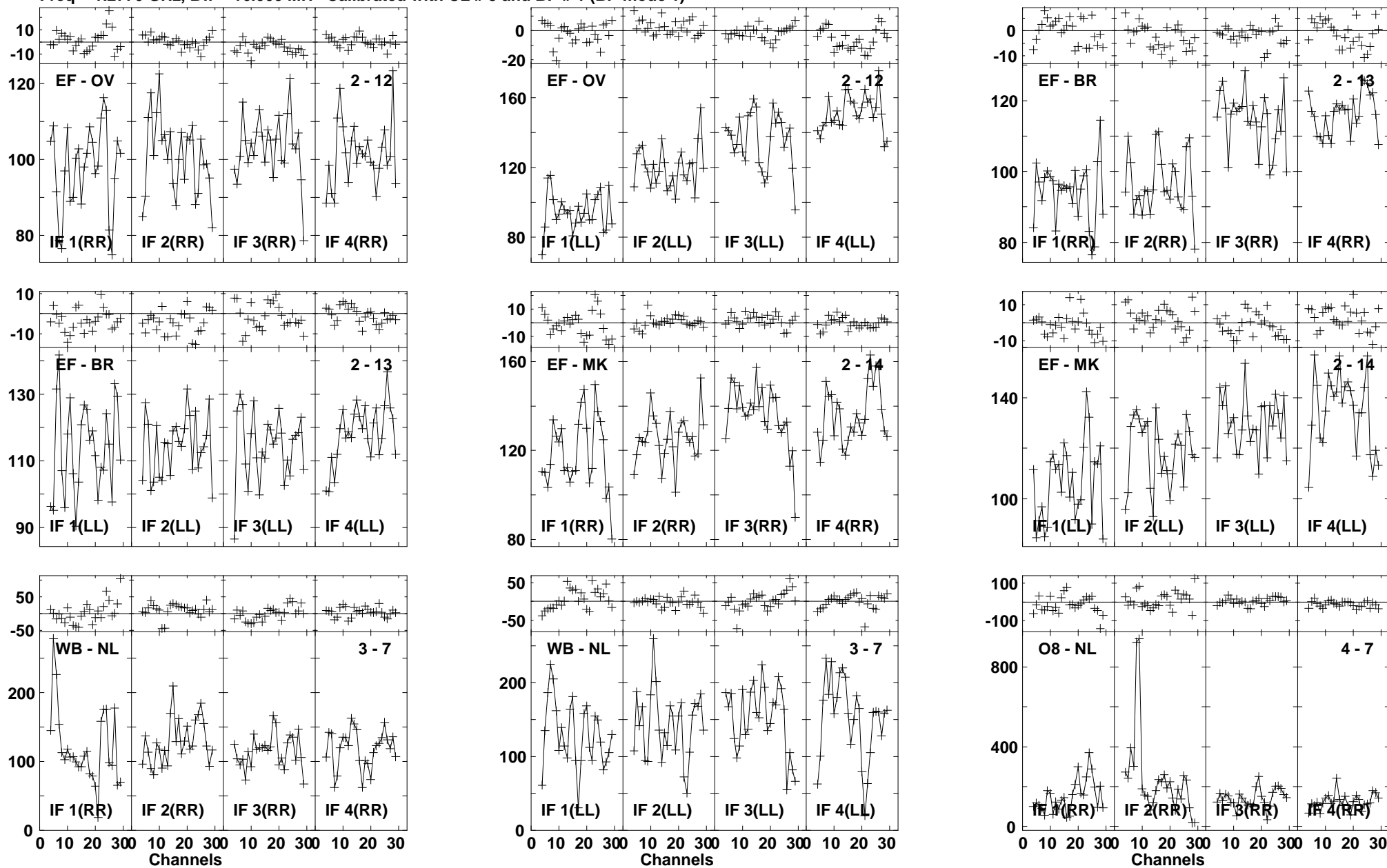

Lower frame: Milli Ampl Jy Top frame: Phas deg
Vector averaged cross-power spectrum Baseline: EF (02) - OV (12)
Timerange: 00/18:30:41 to 00/18:31:39

Plot file version 379 created 03-MAR-2016 01:13:01
 J1545+5400 GN002C 1.UVDATA.1
 Freq = 1.2770 GHz, Bw = 16.000 MH Calibrated with CL # 3 and BP # 1 (BP mode 1)

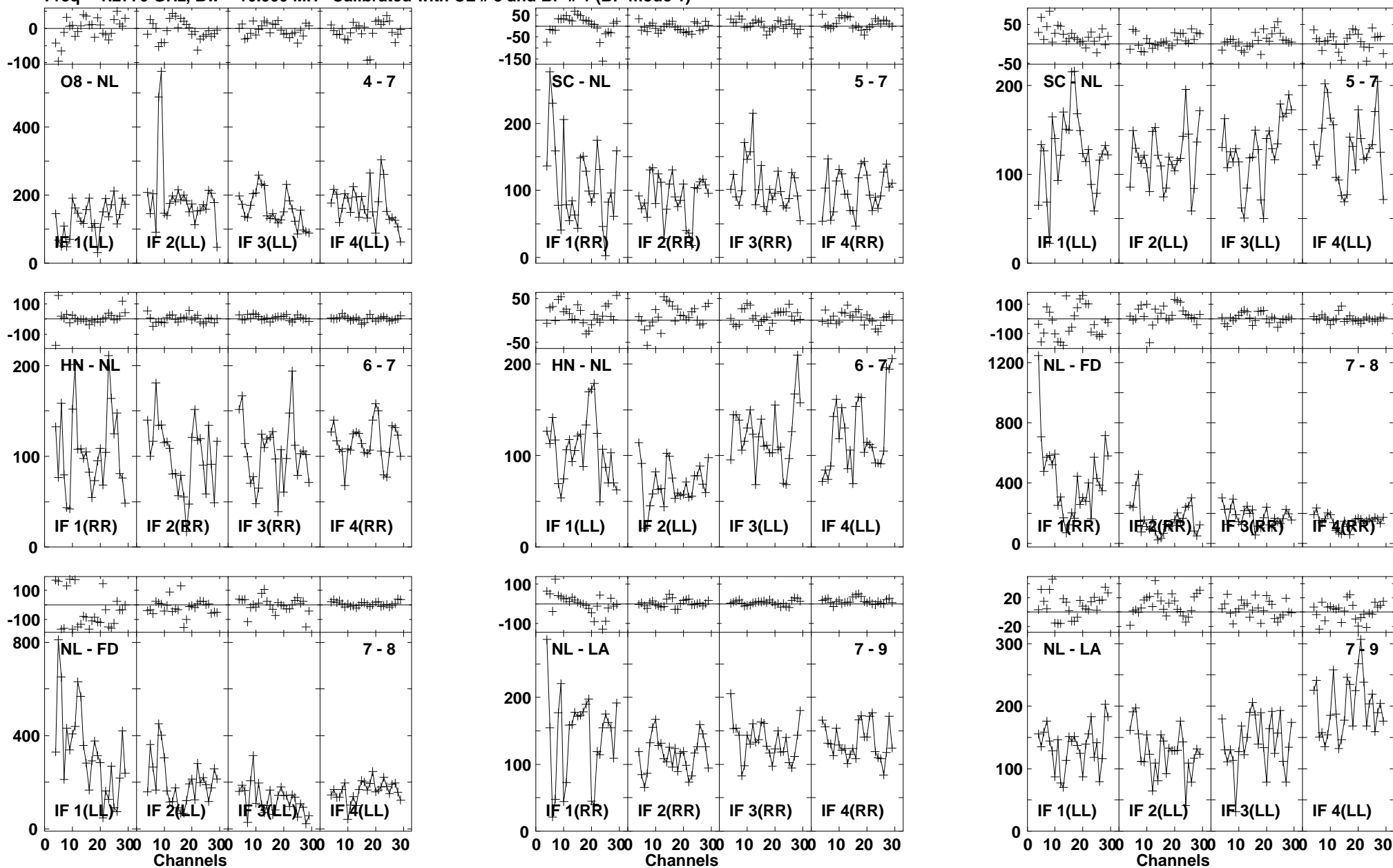

Lower frame: Milli Ampl Jy Top frame: Phas deg
 Vector averaged cross-power spectrum Baseline: O8 (04) - NL (07)
 Timerange: 00/18:30:41 to 00/18:31:39

Plot file version 380 created 03-MAR-2016 01:13:01

J1545+5400 GN002C 1.UVDATA.1

Freq = 1.2770 GHz, Bw = 16.000 MH Calibrated with CL # 3 and BP # 1 (BP mode 1)

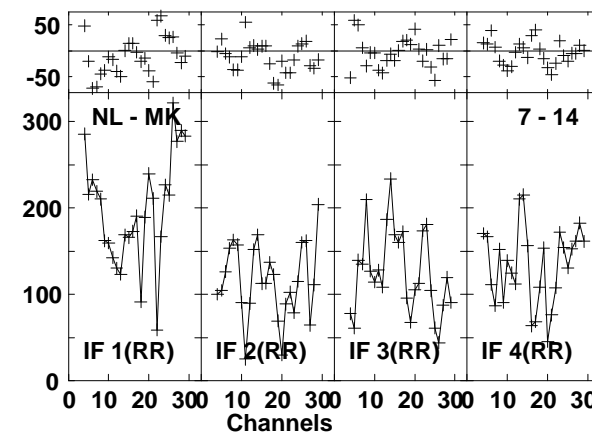
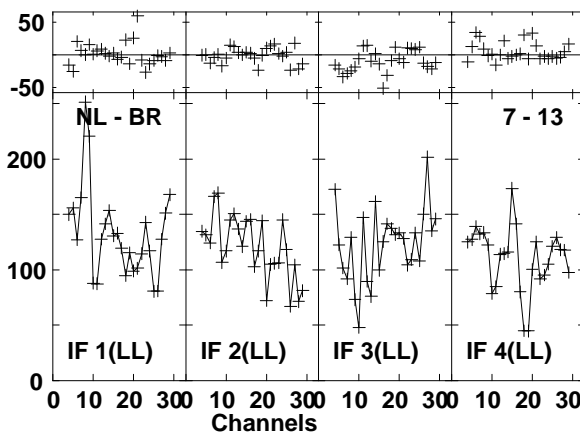
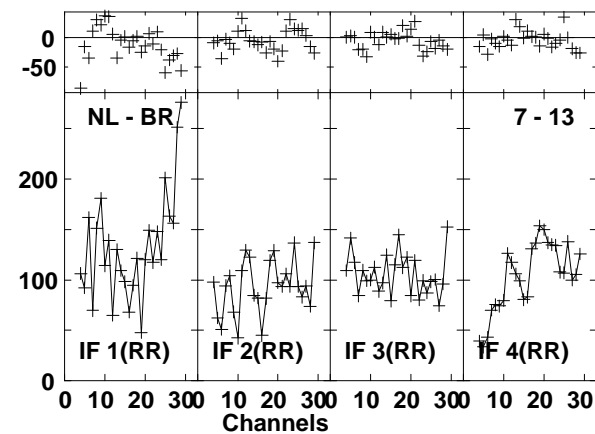
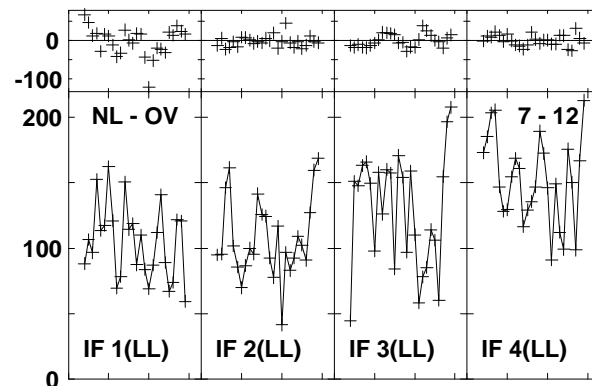
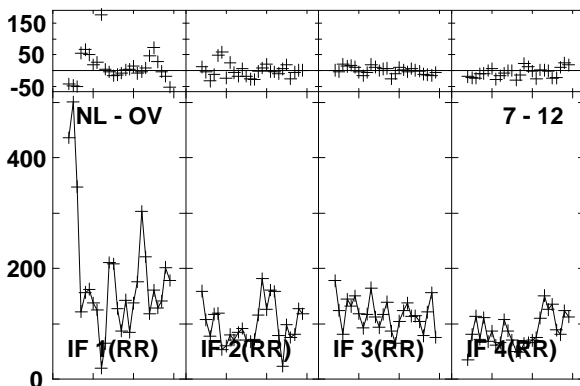
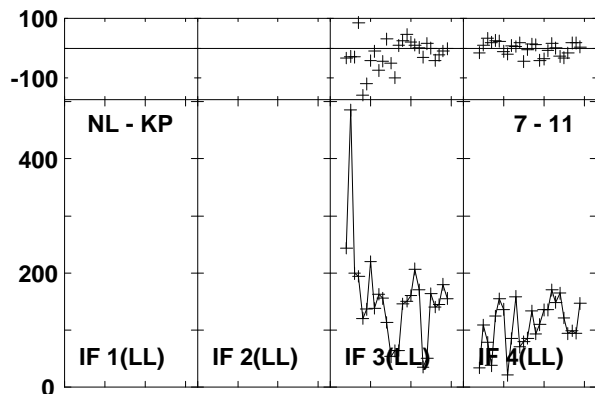
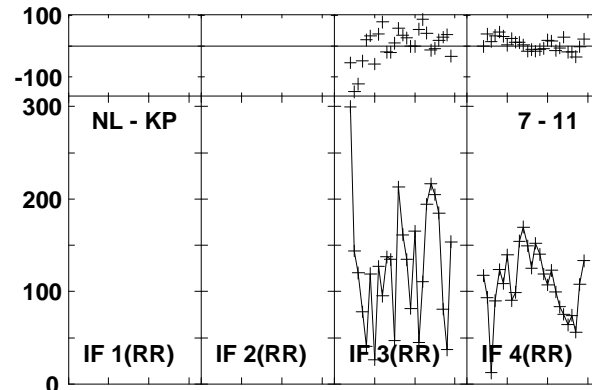
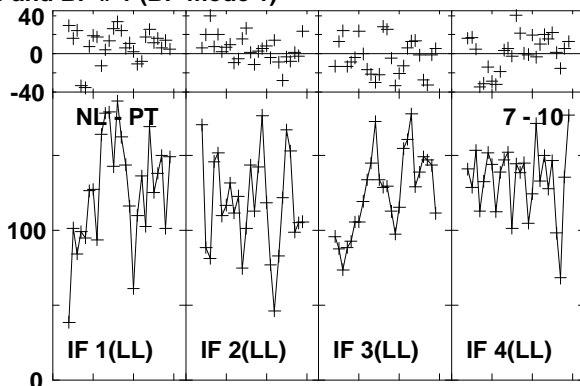
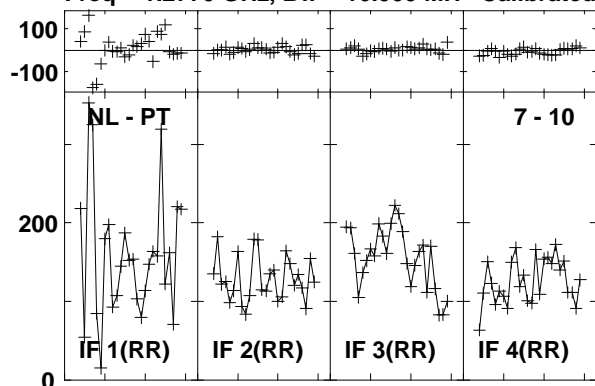

Lower frame: Milli Ampl Jy Top frame: Phas deg
Vector averaged cross-power spectrum Baseline: NL (07) - PT (10)
Timerange: 00:18:30:41 to 00:18:31:39

Plot file version 381 created 03-MAR-2016 01:13:02
J1545+5400 GN002C 1.UVDATA.1
Freq = 1.2770 GHz, Bw = 16.000 MH Calibrated with CL # 3 and BP # 1 (BP mode 1)

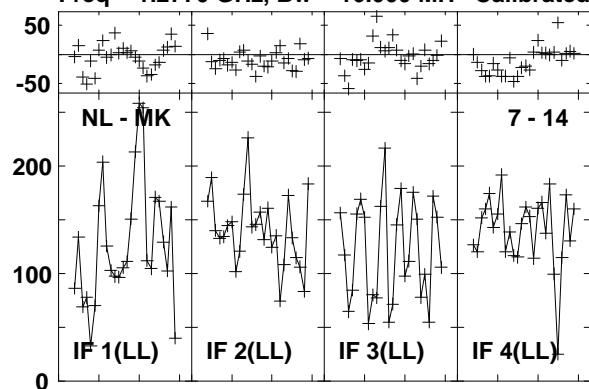

Lower frame: Milli Ampl Jy Top frame: Phas deg
Vector averaged cross-power spectrum Baseline: NL (07) - MK (14)
Timerange: 00/18:30:41 to 00/18:31:39

Plot file version 382 created 03-MAR-2016 01:13:02

4C52 GN002C 1.UVDATA.1

Freq = 1.2770 GHz, Bw = 16.000 MH Calibrated with CL # 3 and BP # 1 (BP mode 1)

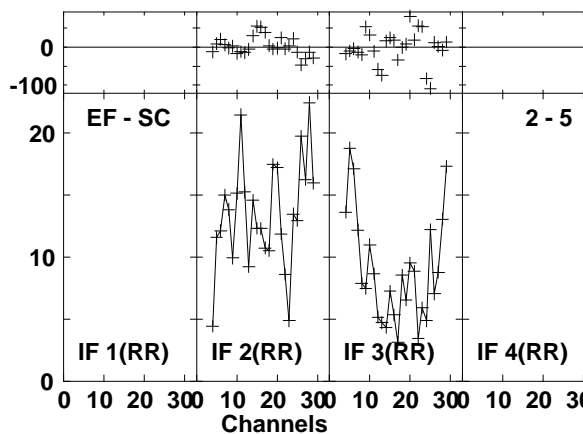
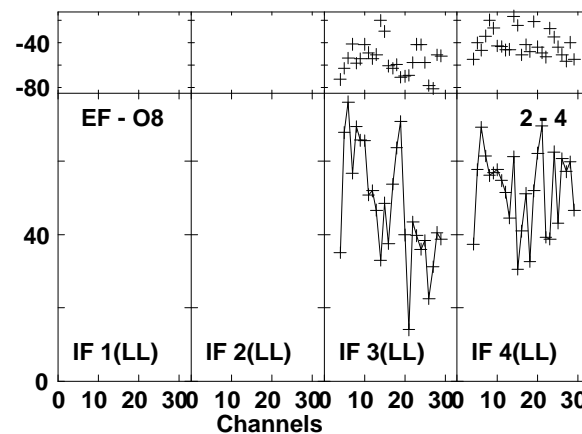
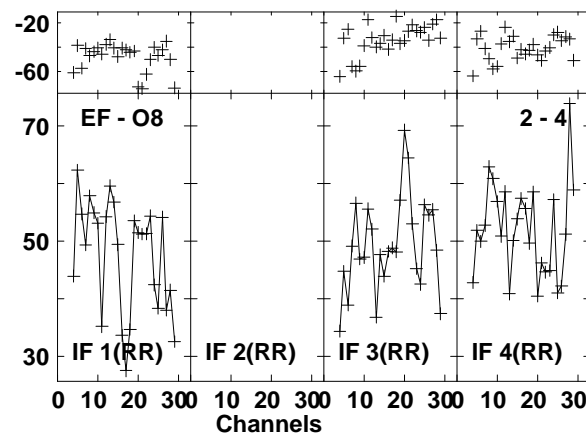
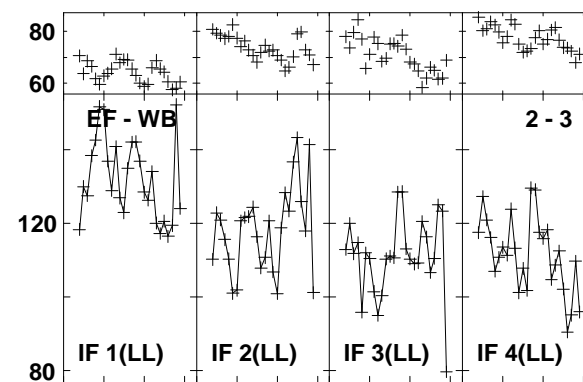
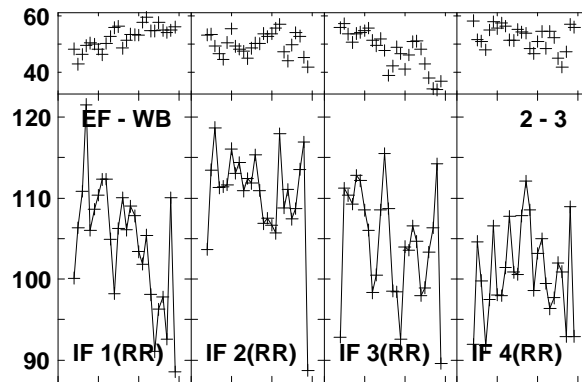
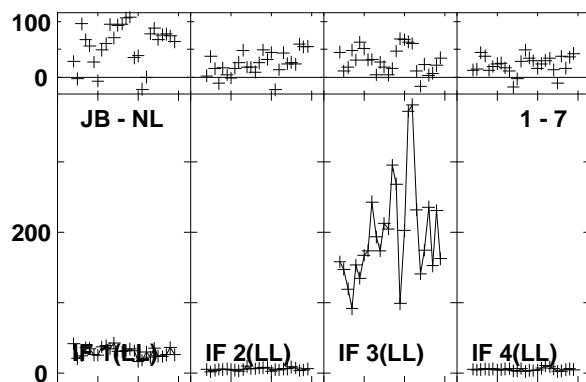
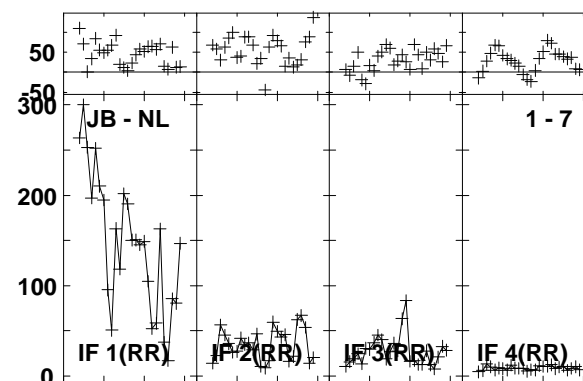
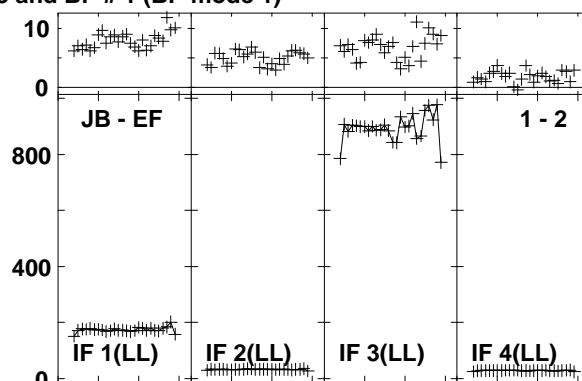
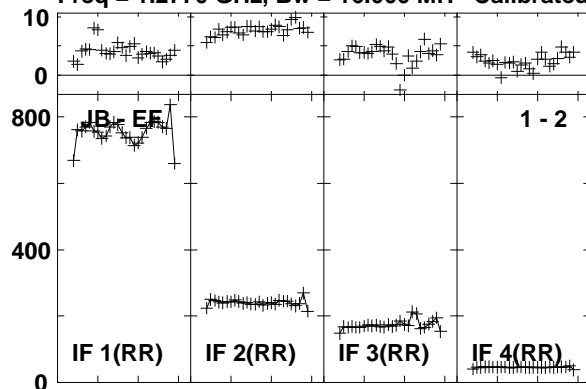

Lower frame: Milli Ampl Jy Top frame: Phas deg
Vector averaged cross-power spectrum Baseline: JB (01) - EF (02)
Timerange: 00/18:31:45 to 00/18:34:39

Plot file version 383 created 03-MAR-2016 01:13:02

4C52 GN002C 1.UVDATA.1

Freq = 1.2770 GHz, Bw = 16.000 MH Calibrated with CL # 3 and BP # 1 (BP mode 1)

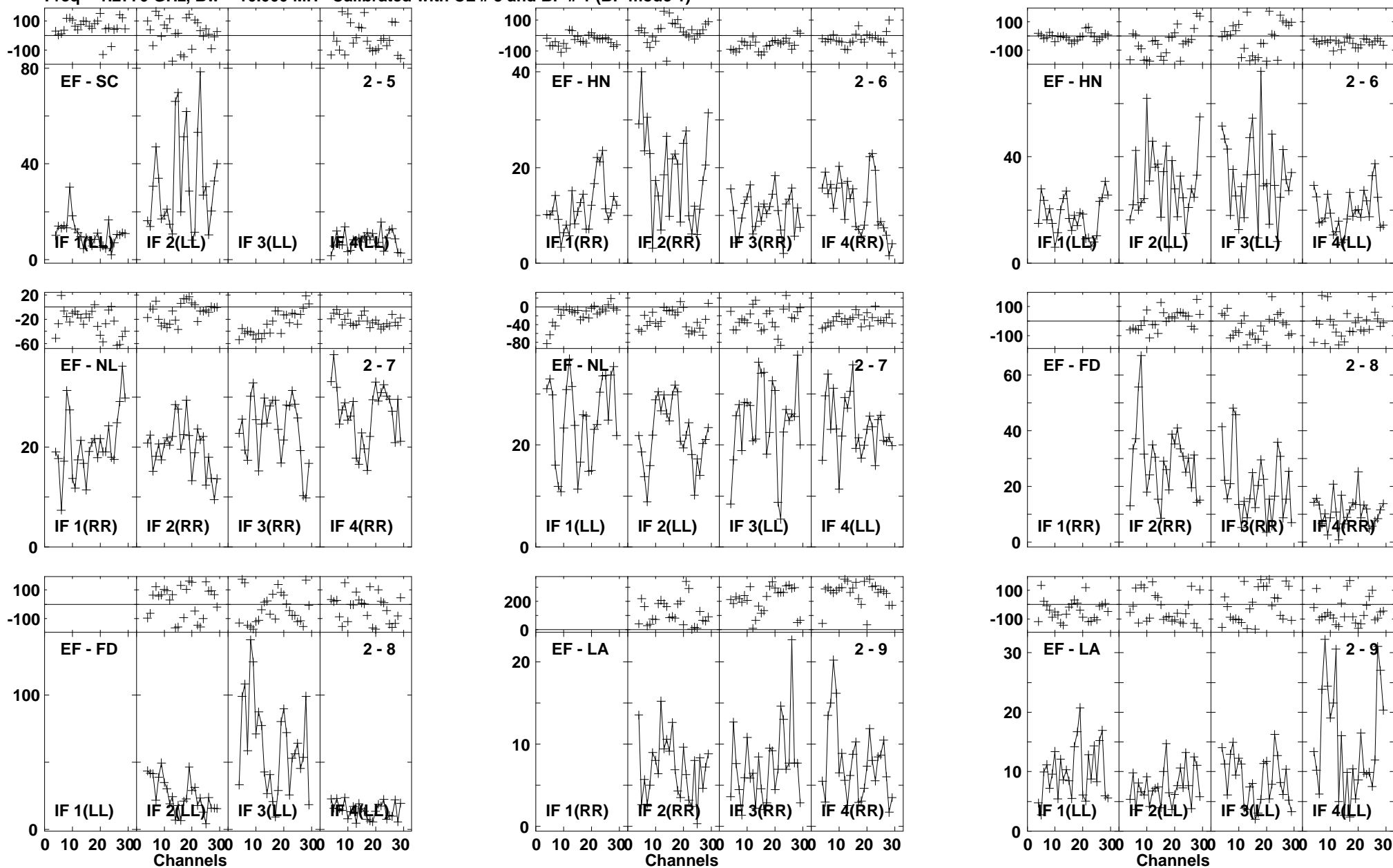

Lower frame: Milli Ampl Jy Top frame: Phas deg
Vector averaged cross-power spectrum Baseline: EF (02) - SC (05)
Timerange: 00/18:31:45 to 00/18:34:39

Plot file version 384 created 03-MAR-2016 01:13:02

4C52 GN002C 1.UVDATA.1

Freq = 1.2770 GHz, Bw = 16.000 MH Calibrated with CL # 3 and BP # 1 (BP mode 1)

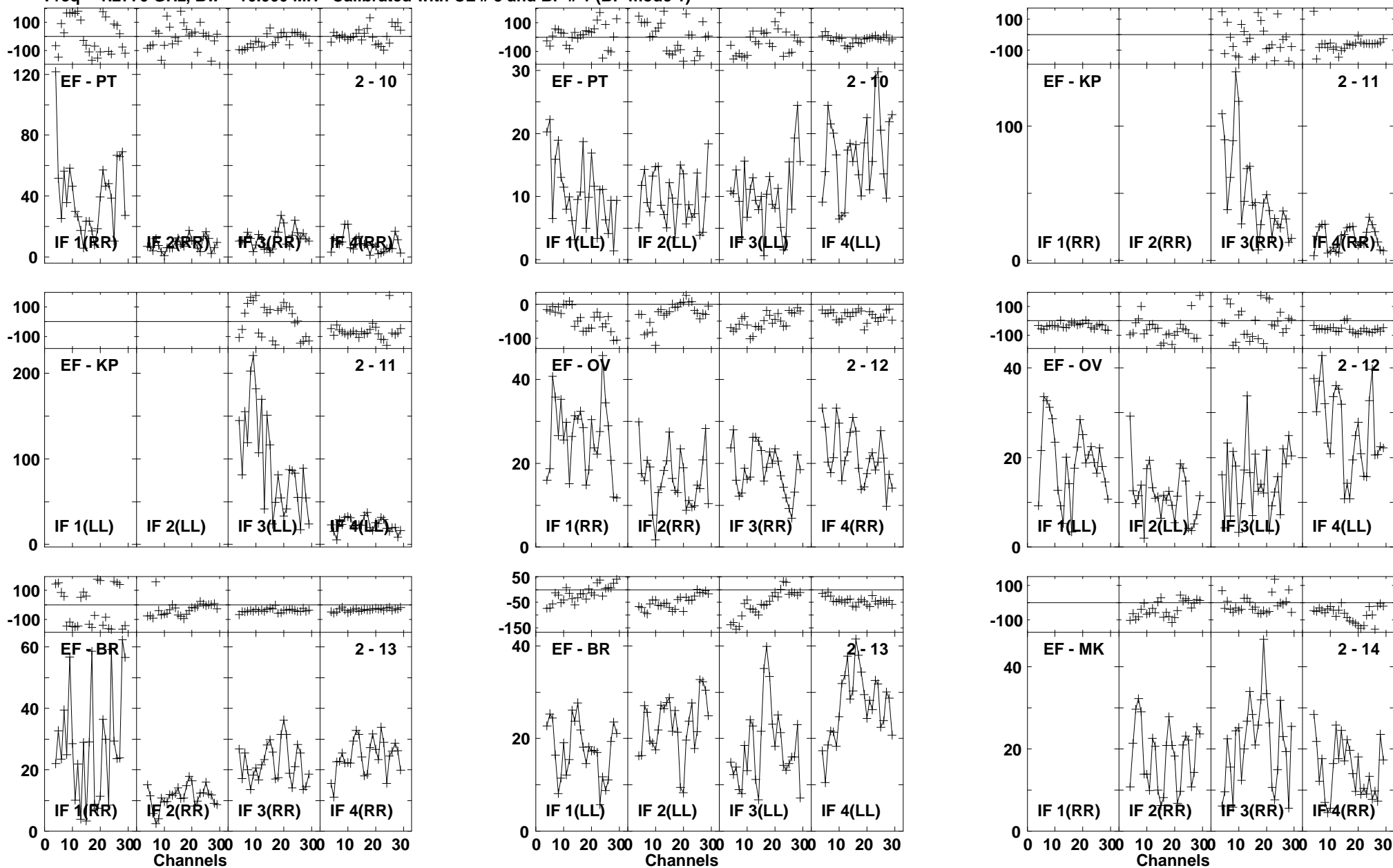

Plot file version 385 created 03-MAR-2016 01:13:02

4C52 GN002C 1.UVDATA.1

Freq = 1.2770 GHz, Bw = 16.000 MH Calibrated with CL # 3 and BP # 1 (BP mode 1)

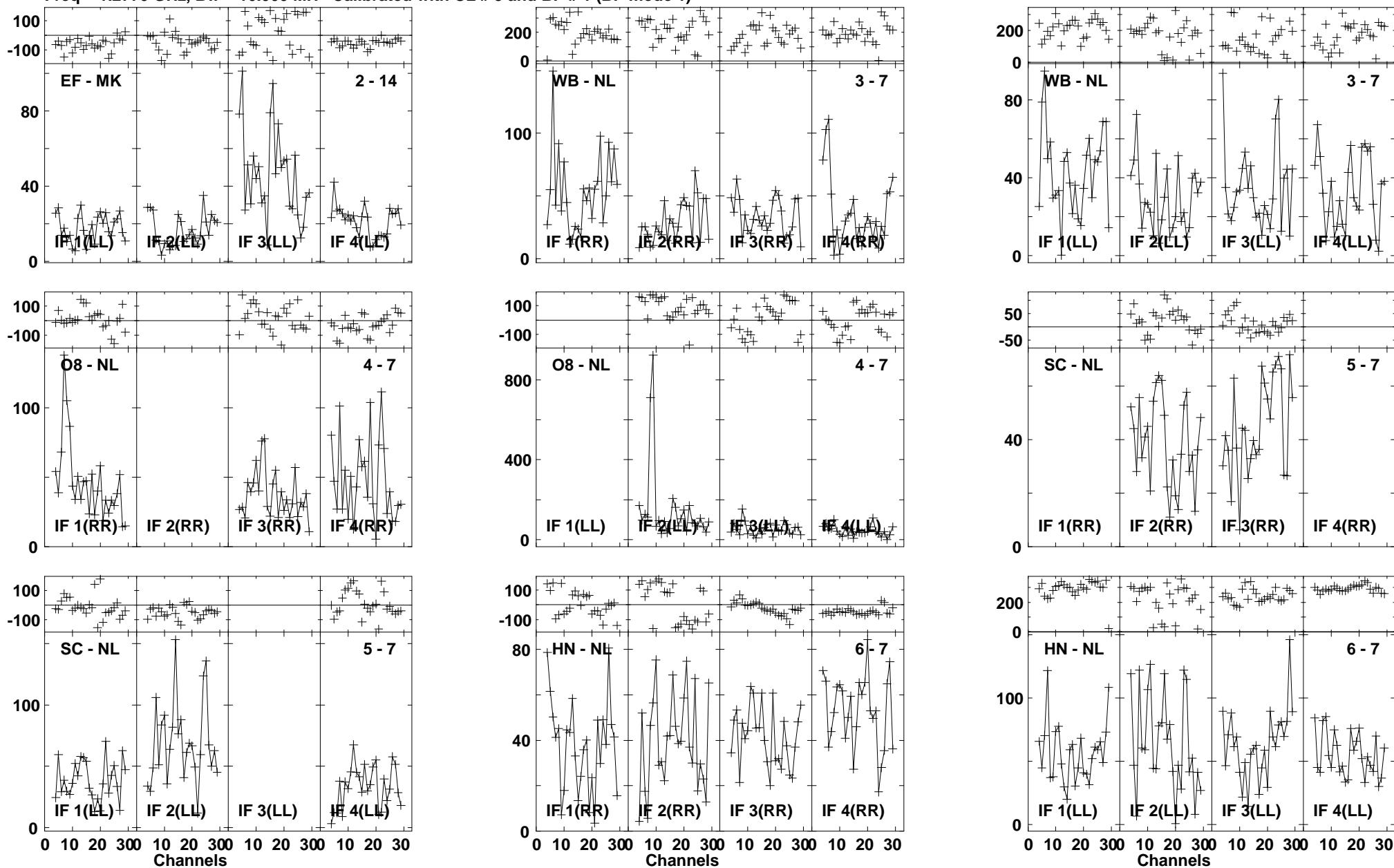

Lower frame: Milli Ampl Jy Top frame: Phas deg
Vector averaged cross-power spectrum Baseline: EF (02) - MK (14)
Timerange: 00/18:31:45 to 00/18:34:39

Plot file version 386 created 03-MAR-2016 01:13:02

4C52 GN002C 1.UVDATA.1

Freq = 1.2770 GHz, Bw = 16.000 MH Calibrated with CL # 3 and BP # 1 (BP mode 1)

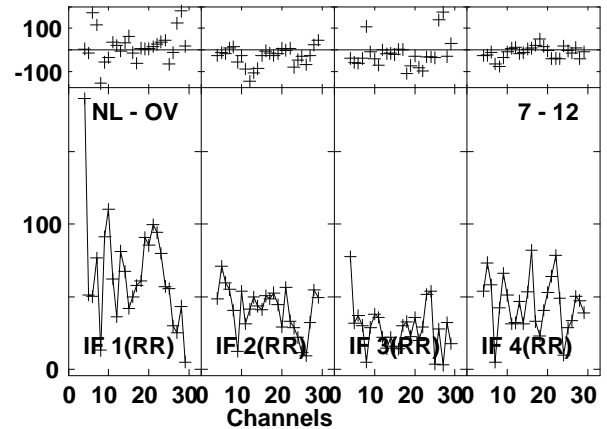
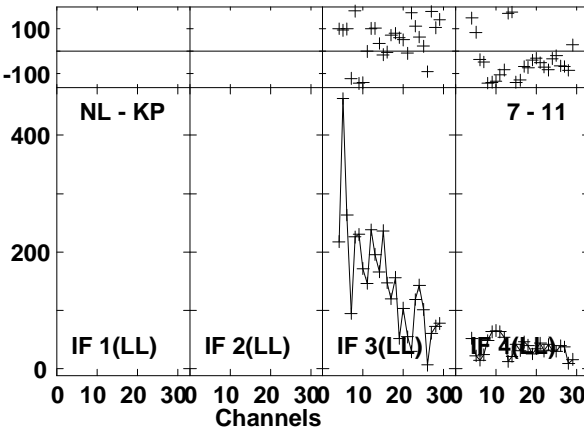
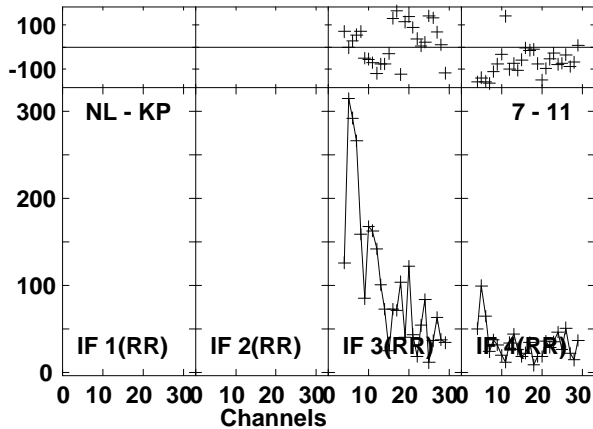
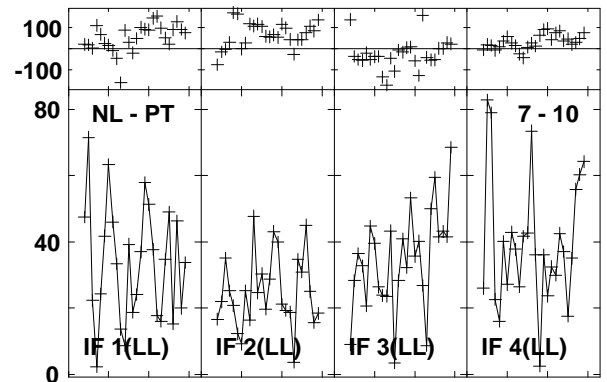
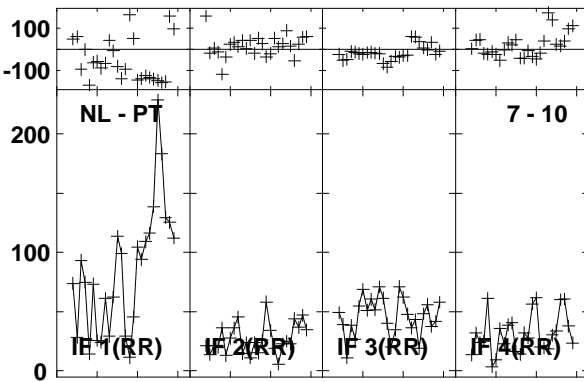
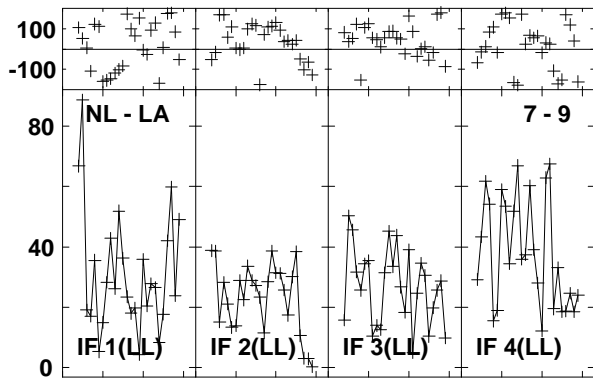
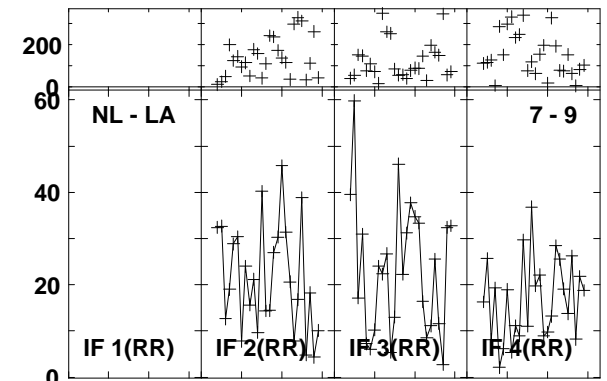
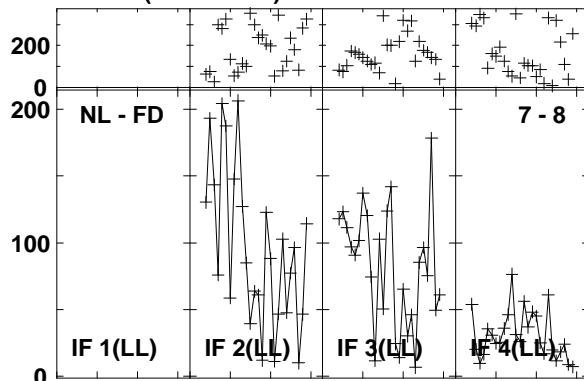
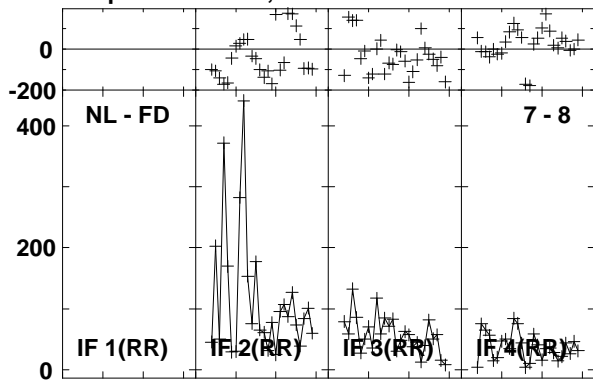

Lower frame: Milli Ampl Jy Top frame: Phas deg
Vector averaged cross-power spectrum Baseline: NL (07) - FD (08)
Timerange: 00/18:31:45 to 00/18:34:39

Plot file version 387 created 03-MAR-2016 01:13:03
 4C52 GN002C 1.UVDATA.1
 Freq = 1.2770 GHz, Bw = 16.000 MH Calibrated with CL # 3 and BP # 1 (BP mode 1)

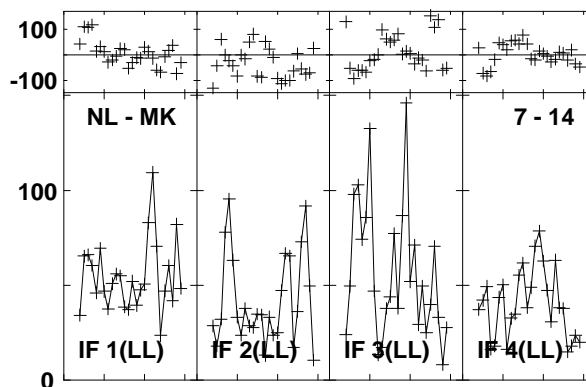
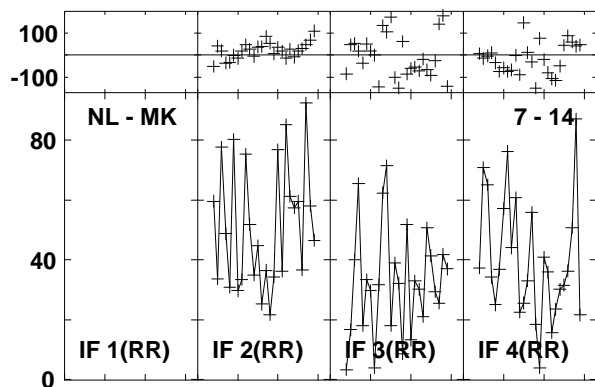
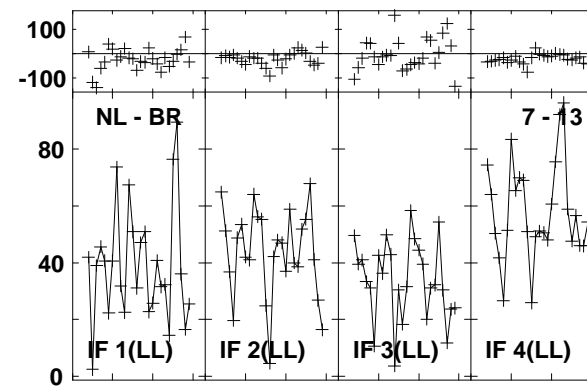
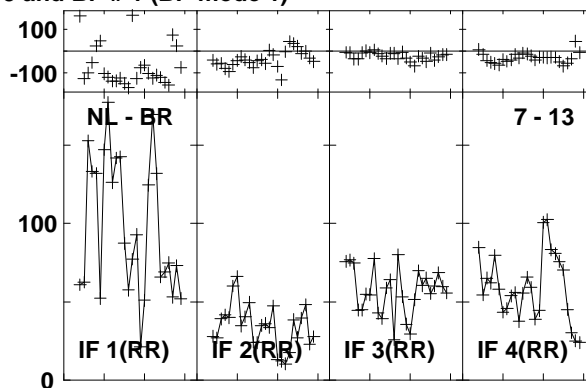
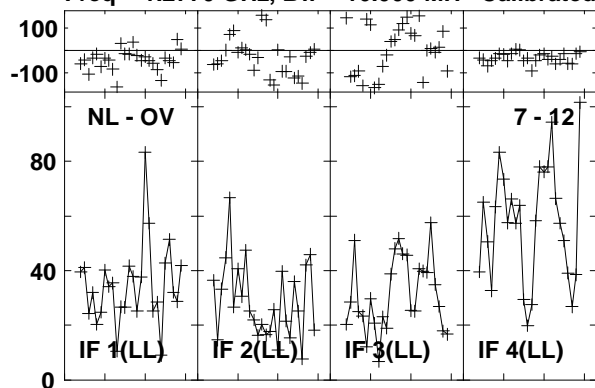

Lower frame: Milli Ampl Jy Top frame: Phas deg
 Vector averaged cross-power spectrum Baseline: NL (07) - OV (12)
 Timerange: 00:18:31:45 to 00:18:34:39

Plot file version 388 created 03-MAR-2016 01:13:03

J1545+5400 GN002C 1.UVDATA.1

Freq = 1.2770 GHz, Bw = 16.000 MH Calibrated with CL # 3 and BP # 1 (BP mode 1)

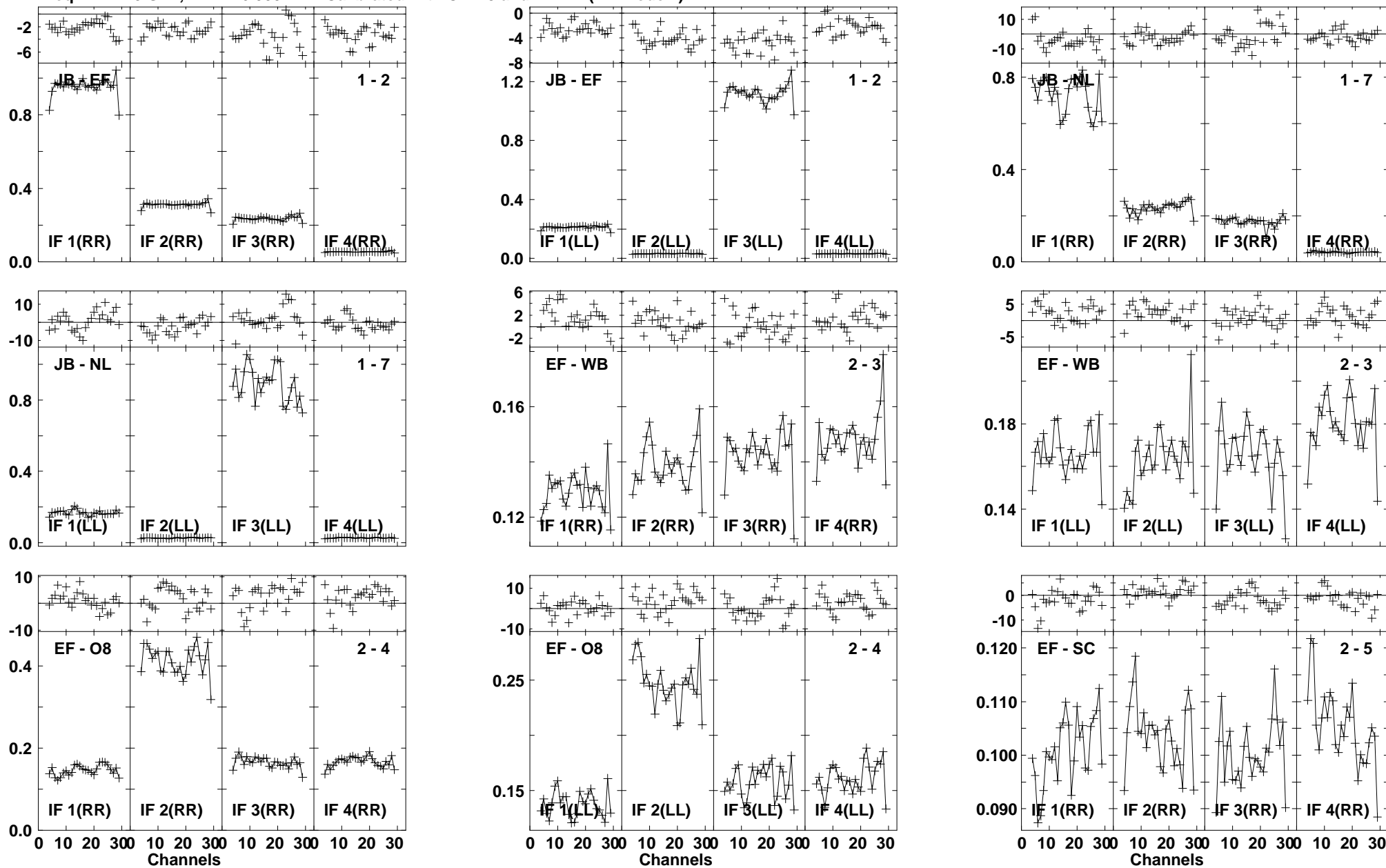

Lower frame: Ampl Jy Top frame: Phas deg
Vector averaged cross-power spectrum Baseline: JB (01) - EF (02)
Timerange: 00/18:35:31 to 00/18:37:29

Plot file version 389 created 03-MAR-2016 01:13:03

J1545+5400 GN002C 1.UVDATA.1

Freq = 1.2770 GHz, Bw = 16.000 MH Calibrated with CL # 3 and BP # 1 (BP mode 1)

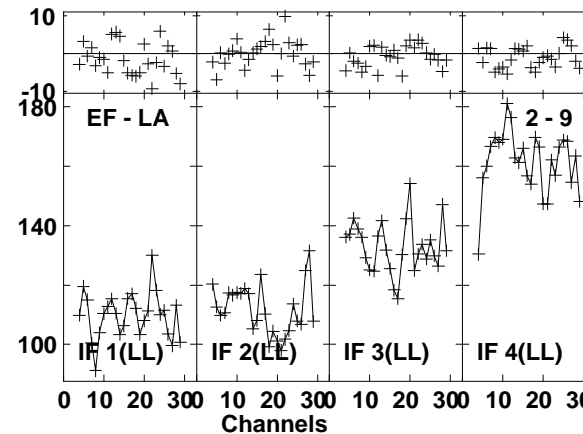
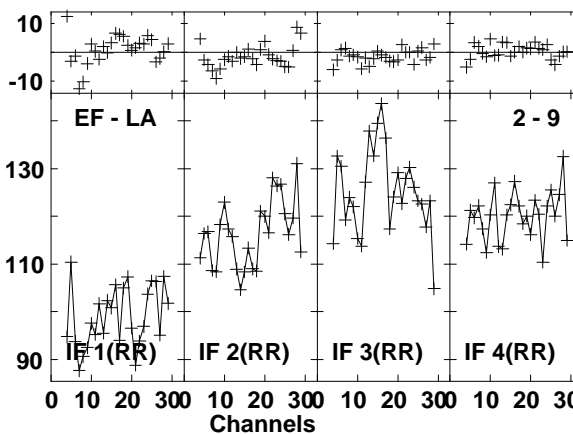
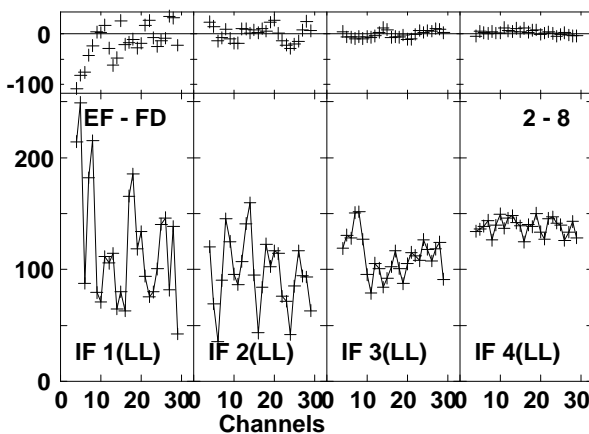
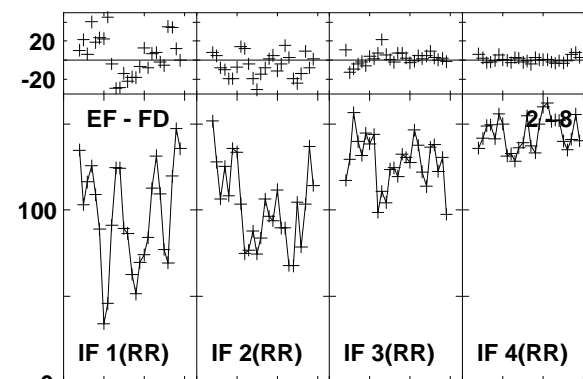
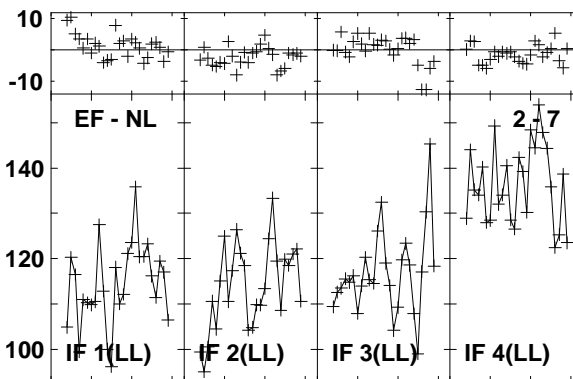
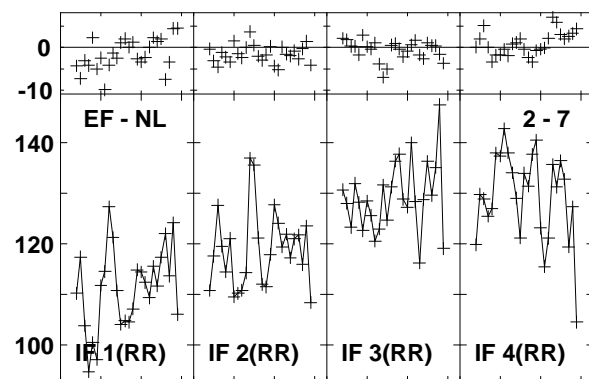
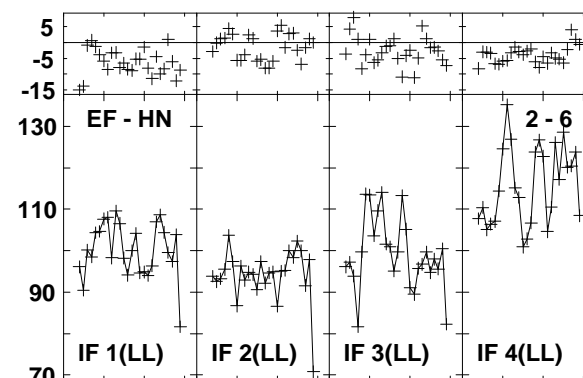
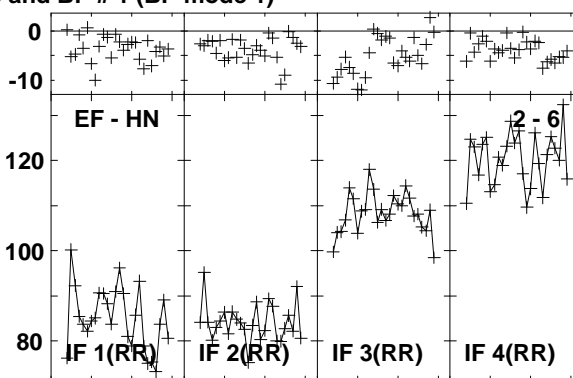
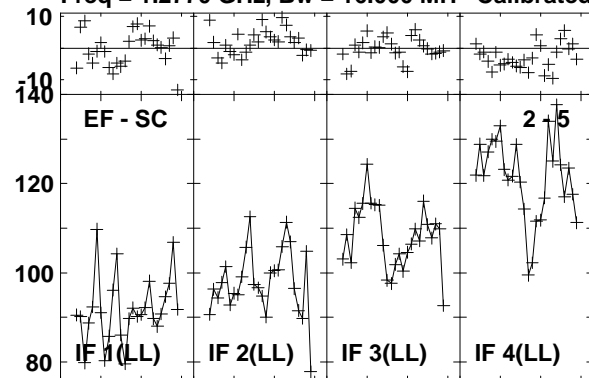

Lower frame: Milli Ampl Jy Top frame: Phas deg
Vector averaged cross-power spectrum Baseline: EF (02) - SC (05)
Timerange: 00/18:35:31 to 00/18:37:29

Plot file version 390 created 03-MAR-2016 01:13:03

J1545+5400 GN002C 1.UVDATA.1

Freq = 1.2770 GHz, Bw = 16.000 MH Calibrated with CL # 3 and BP # 1 (BP mode 1)

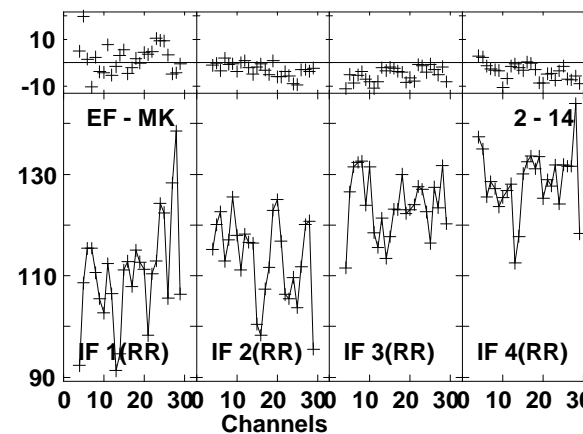
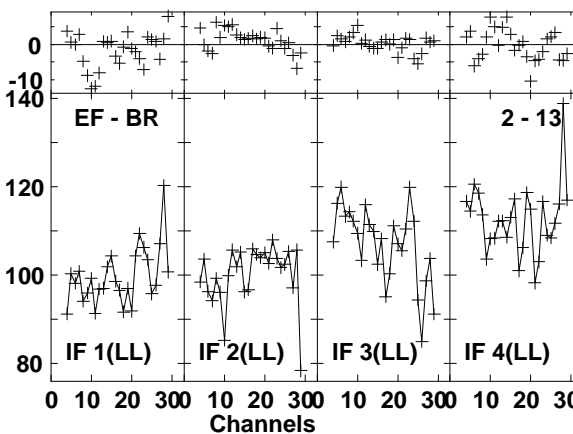
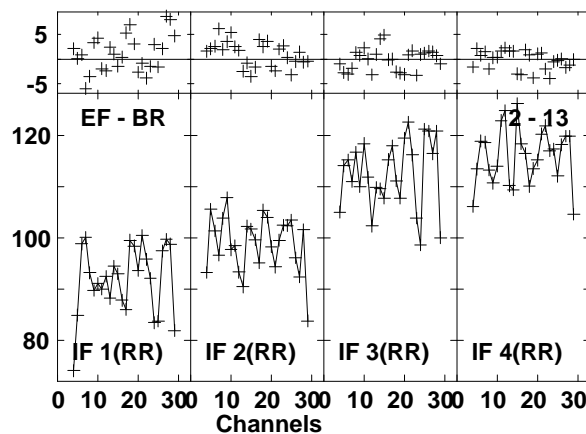
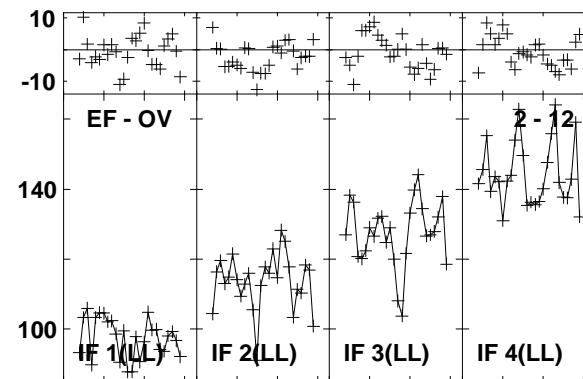
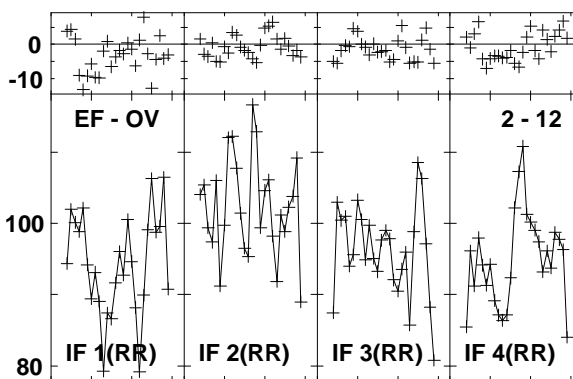
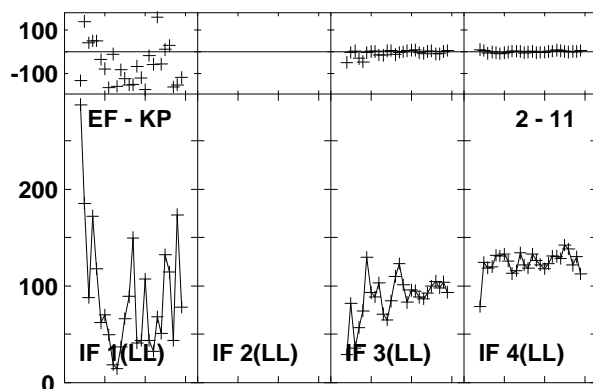
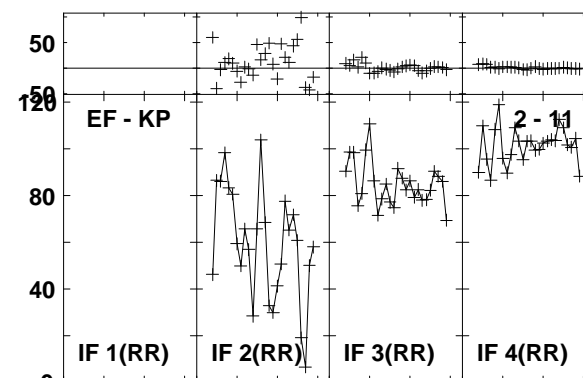
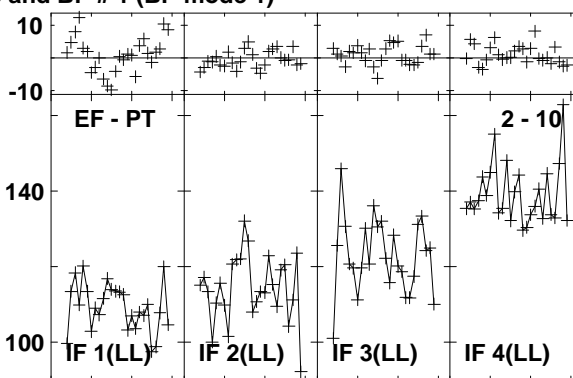
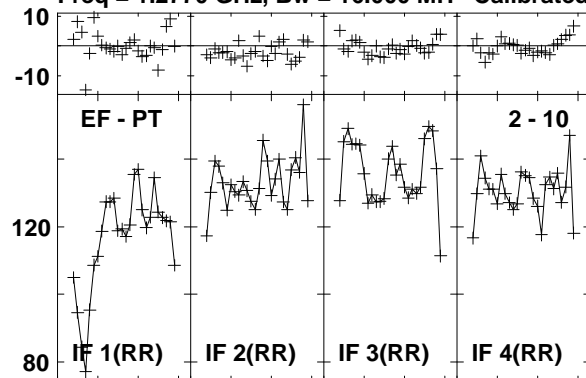

Lower frame: Milli Ampl Jy Top frame: Phas deg
Vector averaged cross-power spectrum Baseline: EF (02) - PT (10)
Timerange: 00/18:35:31 to 00/18:37:29

Plot file version 391 created 03-MAR-2016 01:13:03

J1545+5400 GN002C 1.UVDATA.1

Freq = 1.2770 GHz, Bw = 16.000 MH Calibrated with CL # 3 and BP # 1 (BP mode 1)

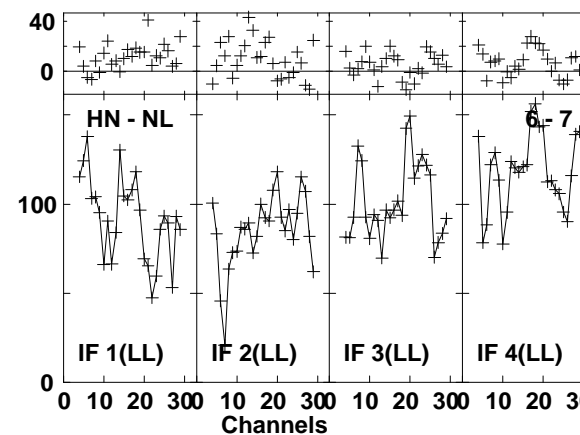
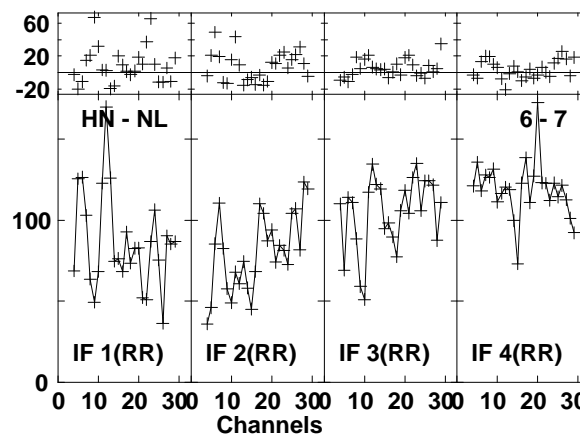
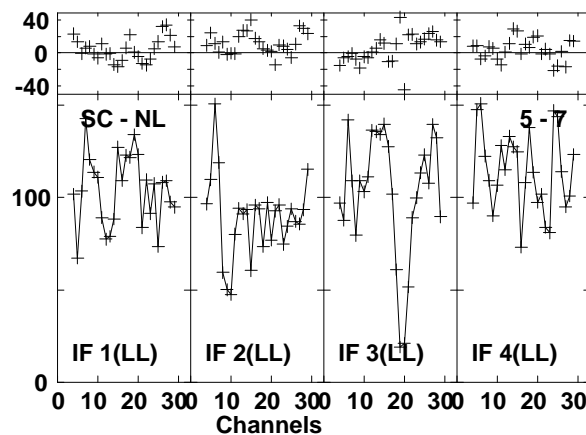
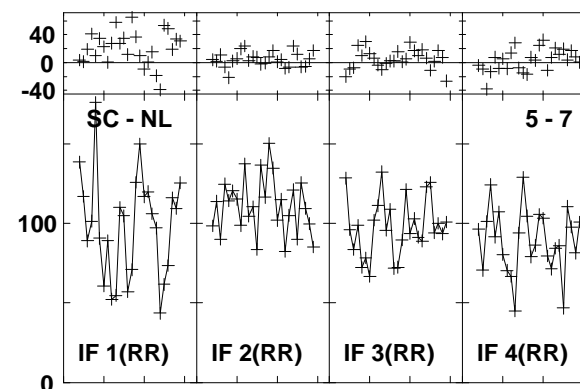
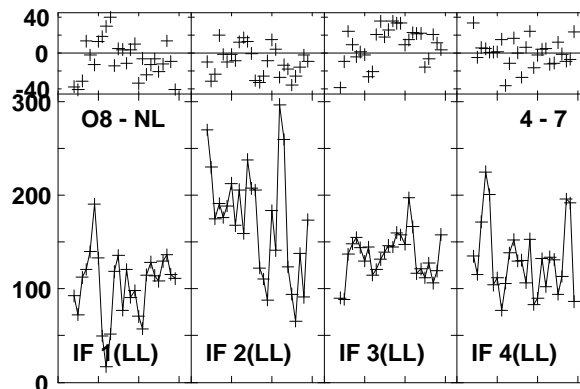
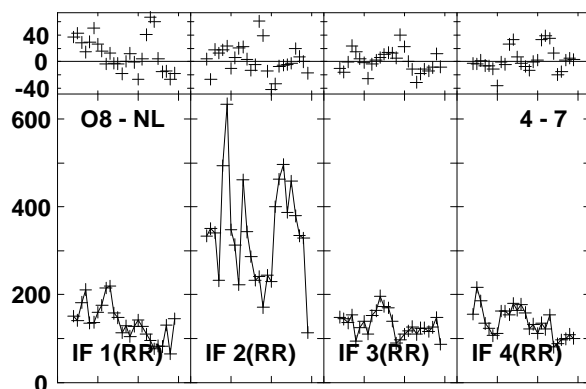
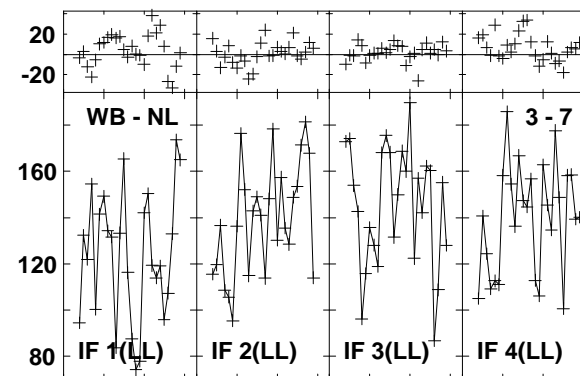
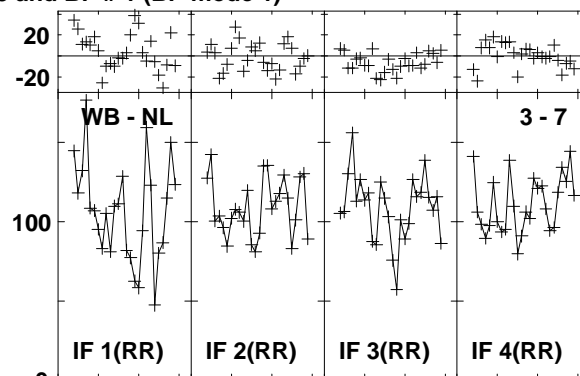
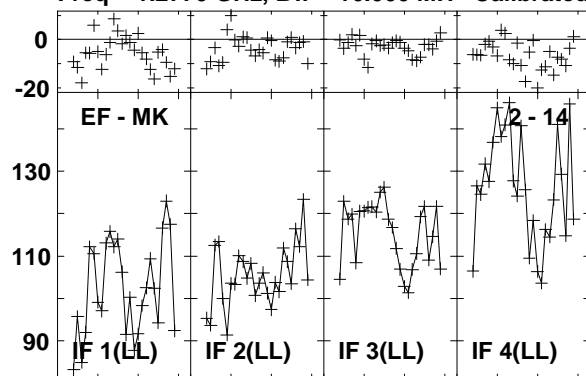

Lower frame: Milli Ampl Jy Top frame: Phas deg
Vector averaged cross-power spectrum Baseline: EF (02) - MK (14)
Timerange: 00/18:35:31 to 00/18:37:29

Plot file version 392 created 03-MAR-2016 01:13:03

J1545+5400 GN002C 1.UVDATA.1

Freq = 1.2770 GHz, Bw = 16.000 MH Calibrated with CL # 3 and BP # 1 (BP mode 1)

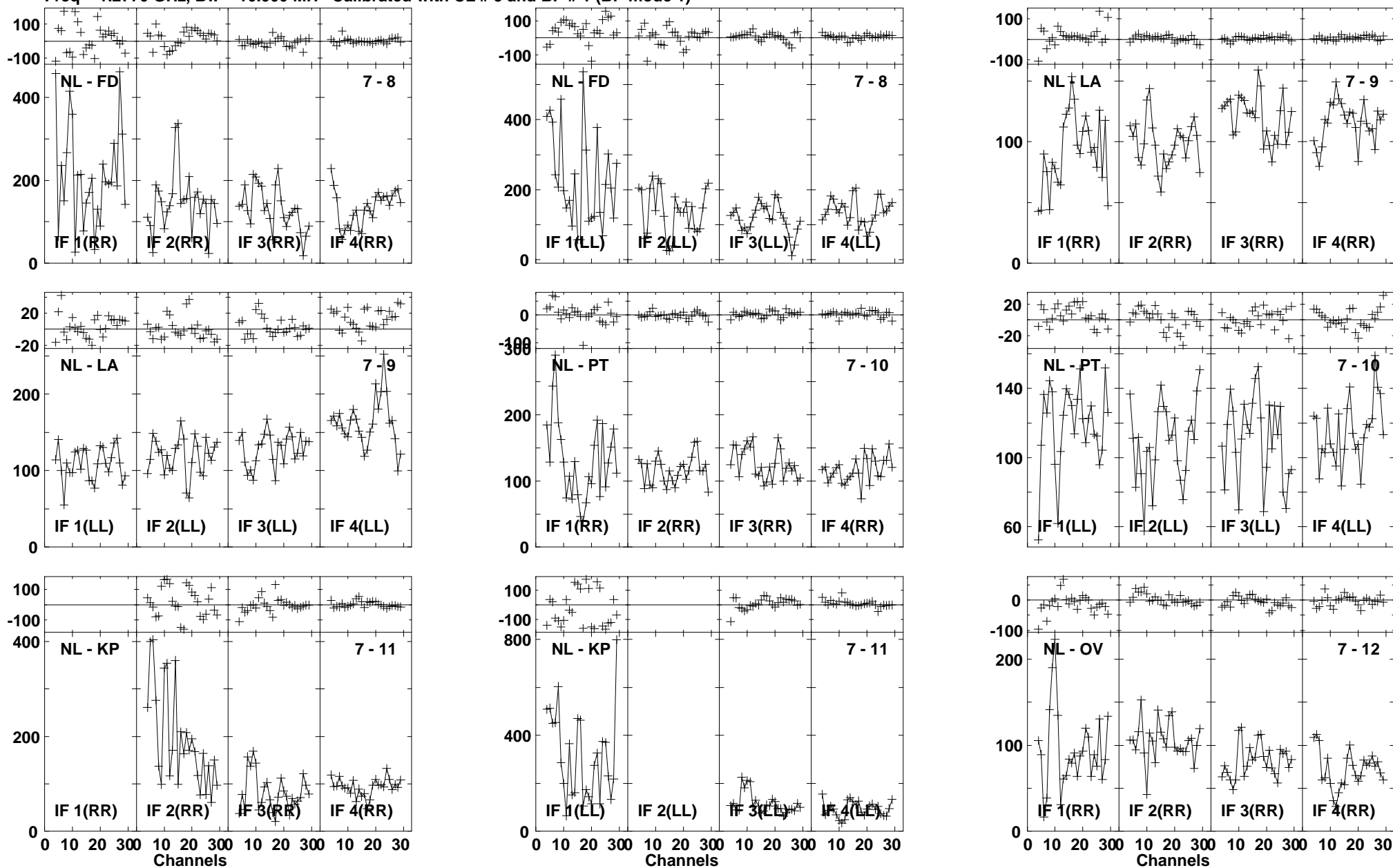

Lower frame: Milli Ampl Jy Top frame: Phas deg
Vector averaged cross-power spectrum Baseline: NL (07) - FD (08)
Timerange: 00/18:35:31 to 00/18:37:29

Plot file version 393 created 03-MAR-2016 01:13:04
 J1545+5400 GN002C 1.UVDATA.1
 Freq = 1.2770 GHz, Bw = 16.000 MH Calibrated with CL # 3 and BP # 1 (BP mode 1)

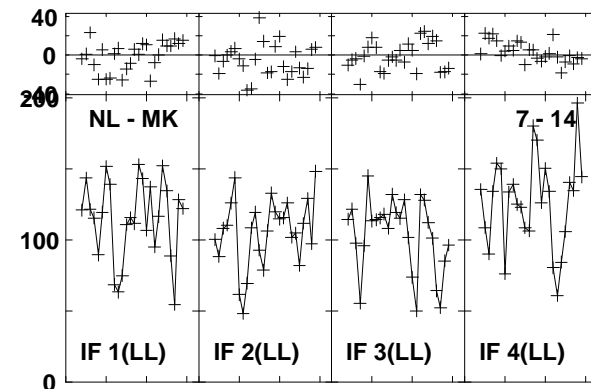
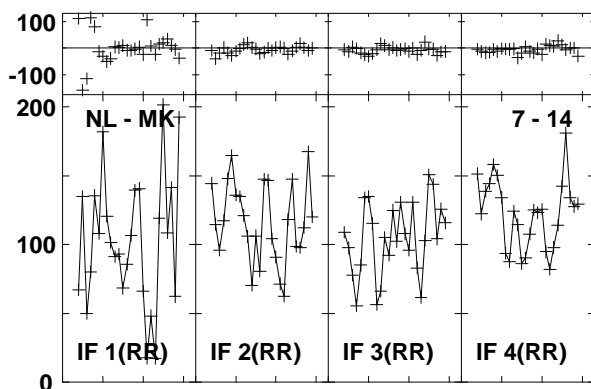
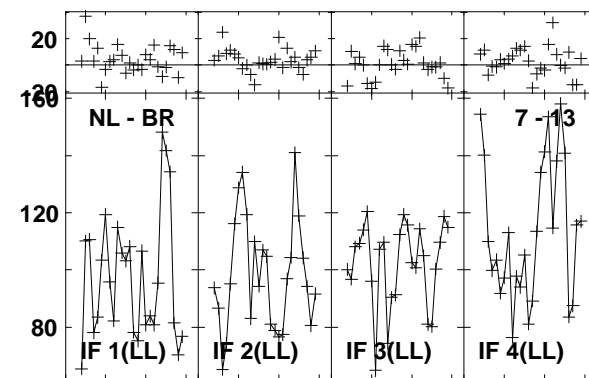
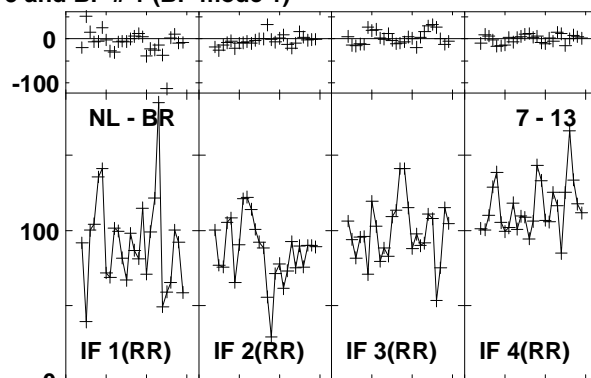
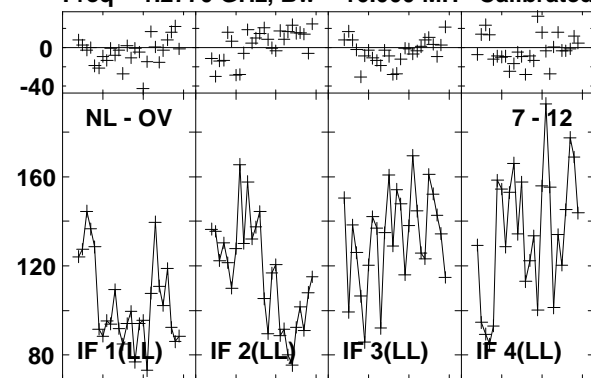

Lower frame: Milli Ampl Jy Top frame: Phas deg
 Vector averaged cross-power spectrum Baseline: NL (07) - OV (12)
 Timerange: 00:18:35:31 to 00:18:37:29

Plot file version 394 created 03-MAR-2016 01:13:04

4C52 GN002C 1.UVDATA.1

Freq = 1.2770 GHz, Bw = 16.000 MH Calibrated with CL # 3 and BP # 1 (BP mode 1)

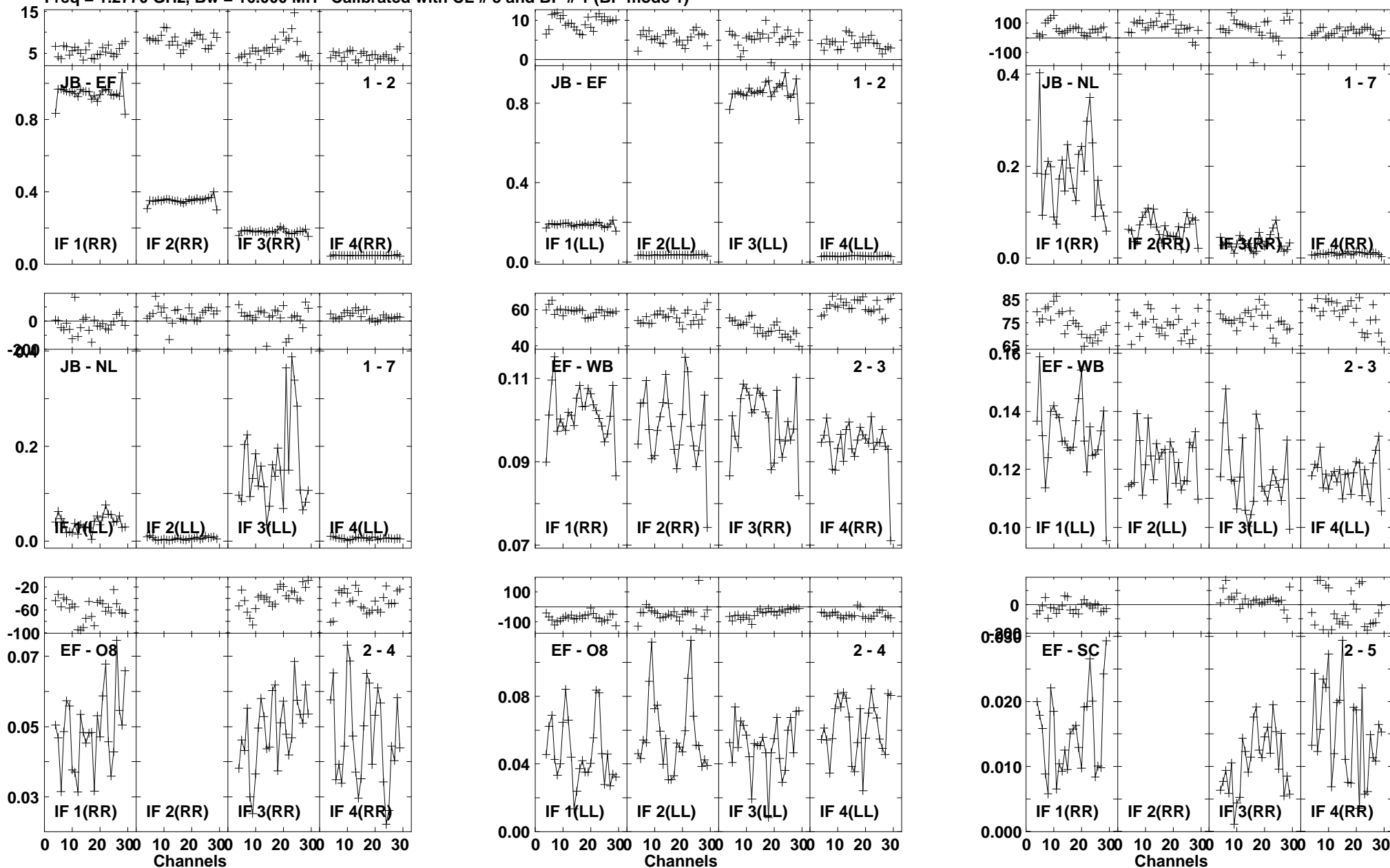

Lower frame: Ampl Jy Top frame: Phas deg
Vector averaged cross-power spectrum Baseline: JB (01) - EF (02)
Timerange: 00/18:37:42 to 00/18:40:28

Plot file version 395 created 03-MAR-2016 01:13:04

4C52 GN002C 1.UVDATA.1

Freq = 1.2770 GHz, Bw = 16.000 MH Calibrated with CL # 3 and BP # 1 (BP mode 1)

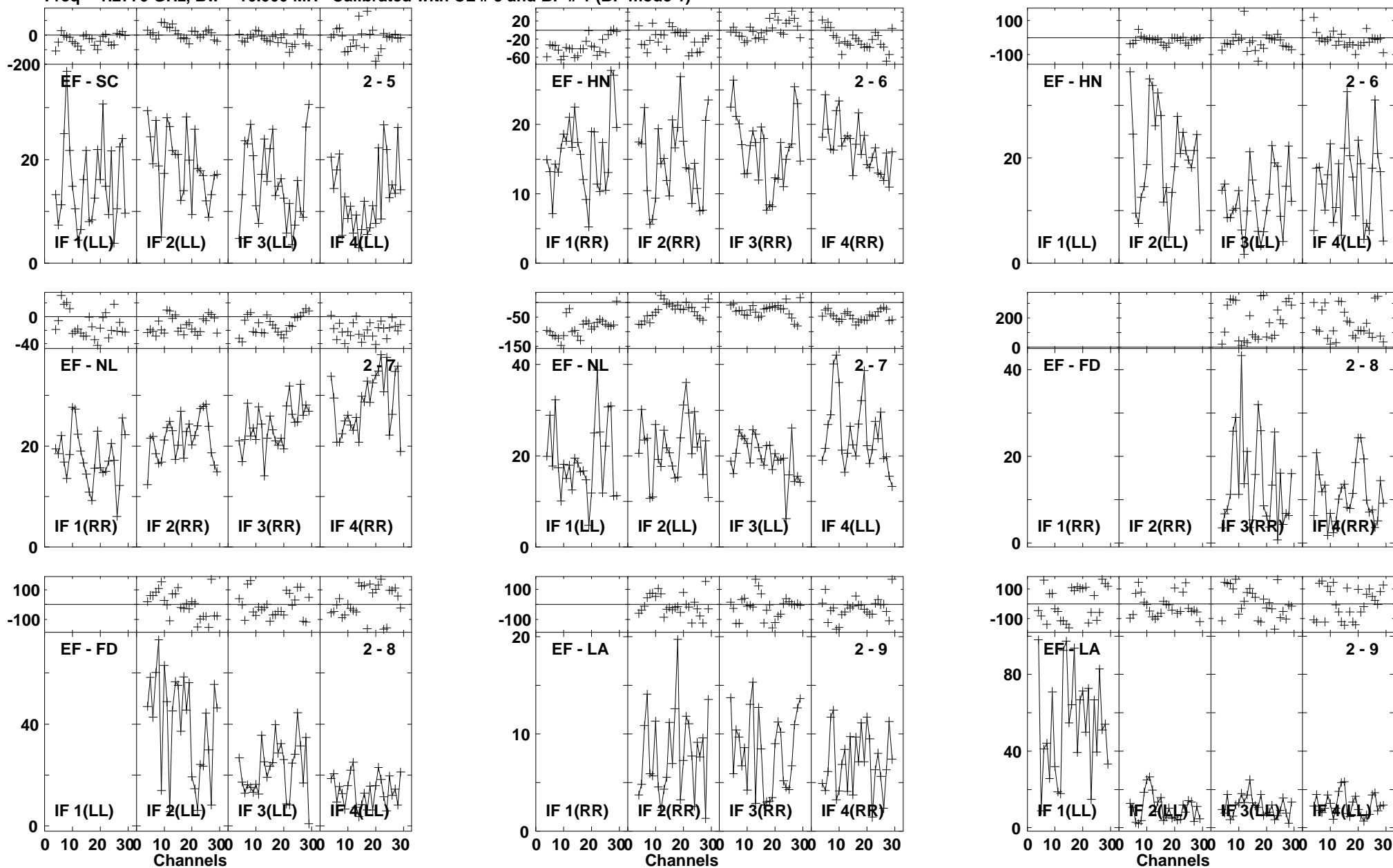

Lower frame: Milli Ampl Jy Top frame: Phas deg
Vector averaged cross-power spectrum Baseline: EF (02) - SC (05)
Timerange: 00/18:37:42 to 00/18:40:28

Plot file version 396 created 03-MAR-2016 01:13:04

4C52 GN002C 1.UVDATA.1

Freq = 1.2770 GHz, Bw = 16.000 MH Calibrated with CL # 3 and BP # 1 (BP mode 1)

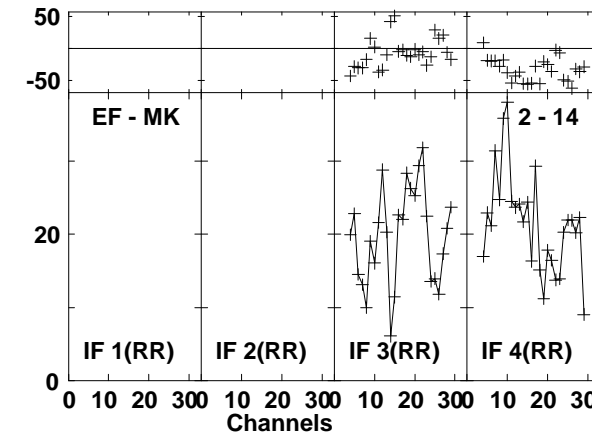
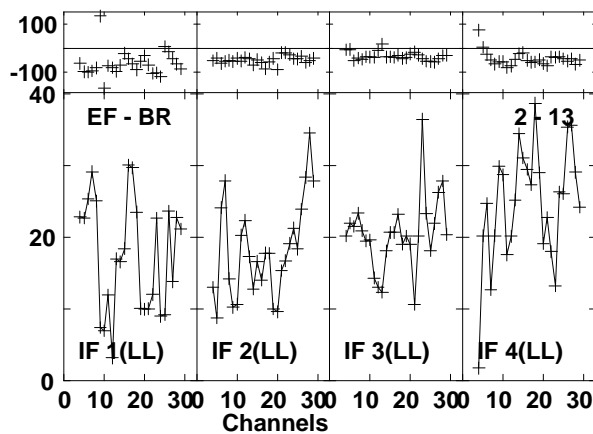
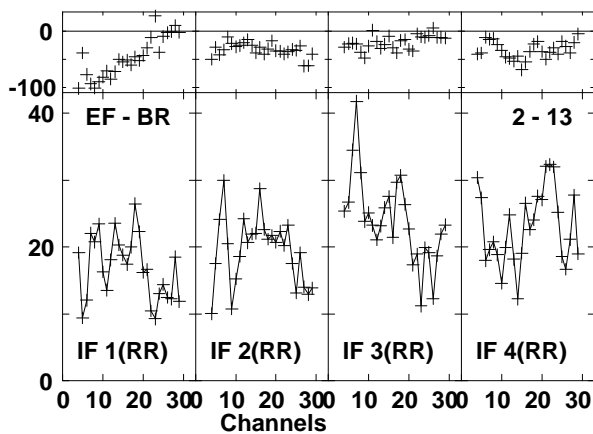
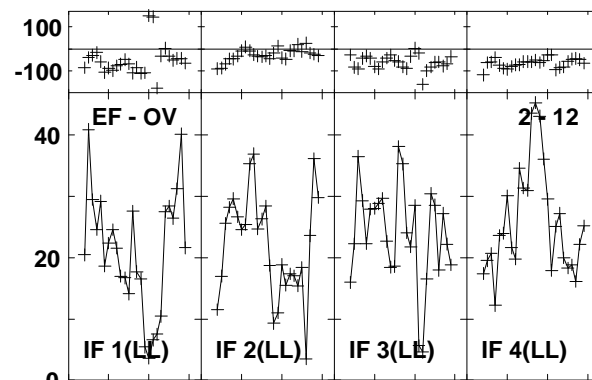
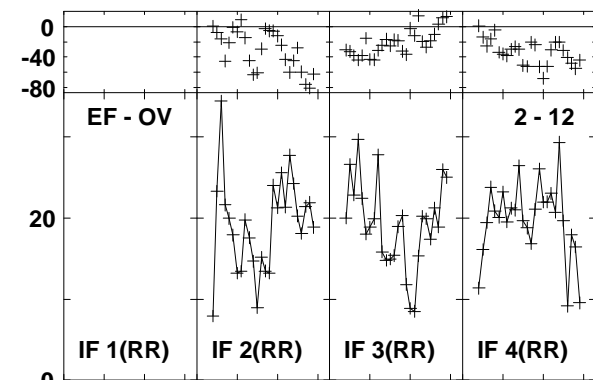
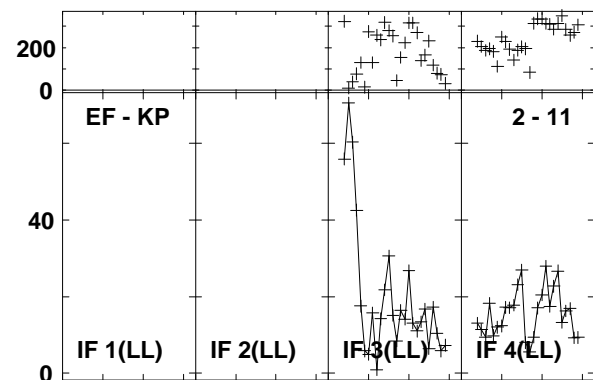
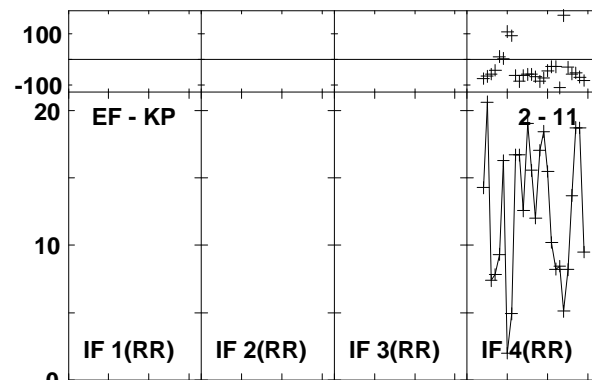
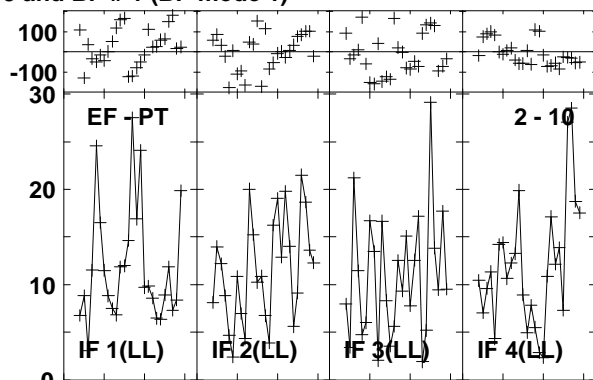
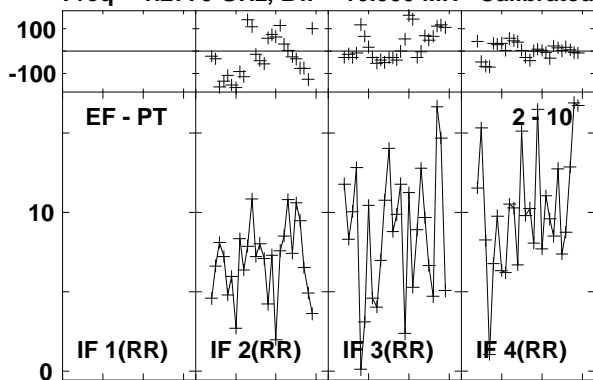

Lower frame: Milli Ampl Jy Top frame: Phas deg

Vector averaged cross-power spectrum Baseline: EF (02) - PT (10)

Timerange: 00/18:37:42 to 00/18:40:28

Plot file version 397 created 03-MAR-2016 01:13:04

4C52 GN002C 1.UVDATA.1

Freq = 1.2770 GHz, Bw = 16.000 MH Calibrated with CL # 3 and BP # 1 (BP mode 1)

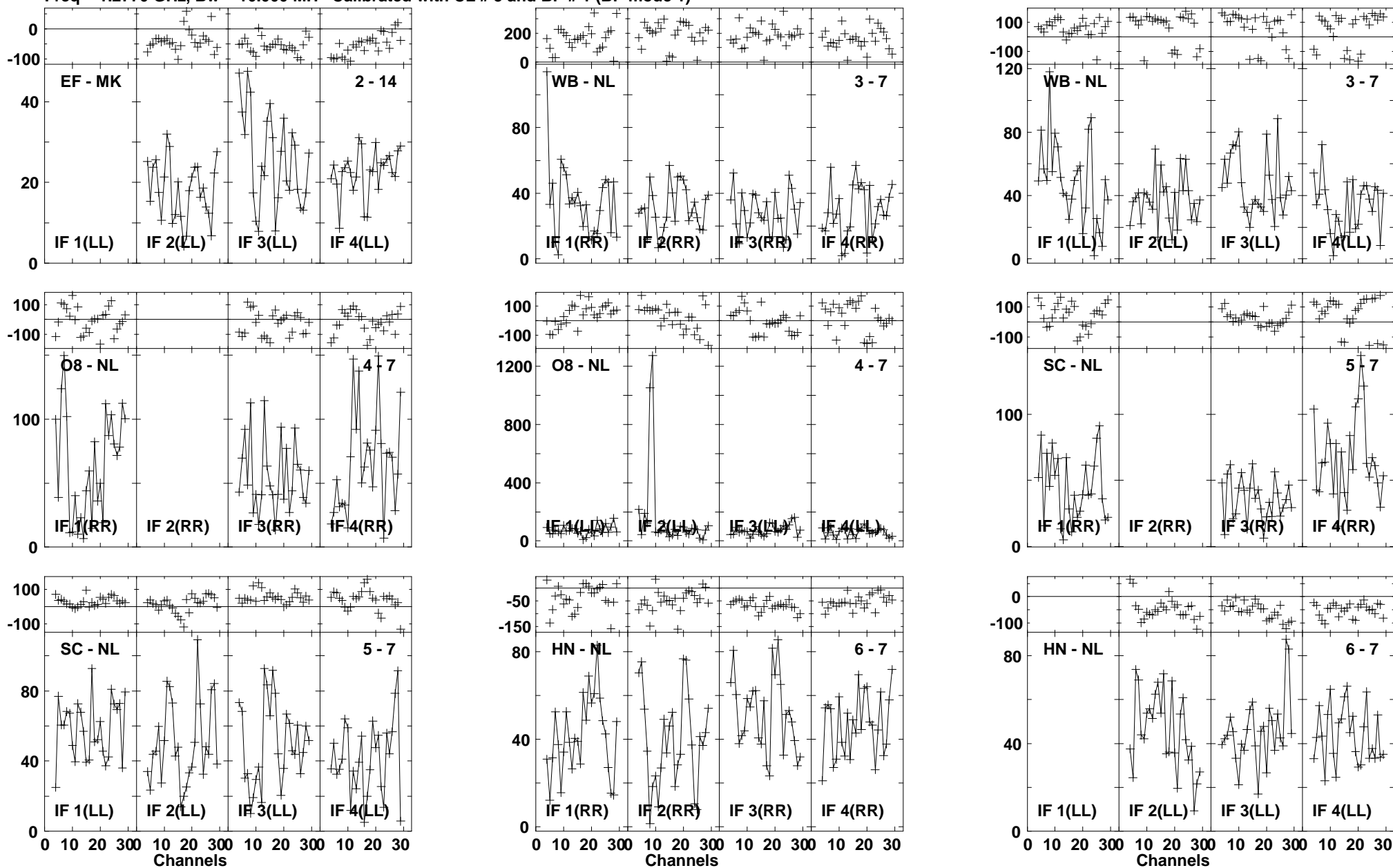

Lower frame: Milli Ampl Jy Top frame: Phas deg
Vector averaged cross-power spectrum Baseline: EF (02) - MK (14)
Timerange: 00/18:37:42 to 00/18:40:28

Plot file version 398 created 03-MAR-2016 01:13:04

4C52 GN002C 1.UVDATA.1

Freq = 1.2770 GHz, Bw = 16.000 MH Calibrated with CL # 3 and BP # 1 (BP mode 1)

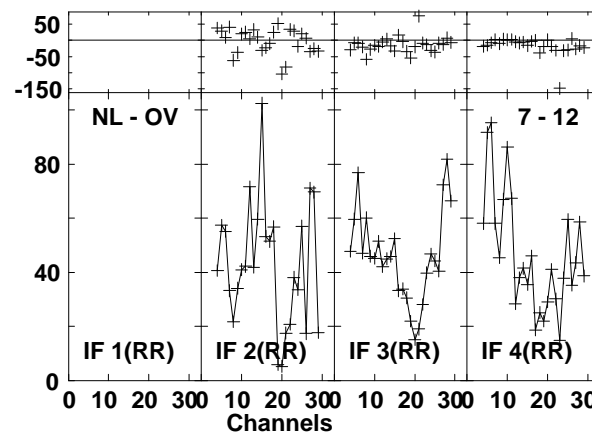
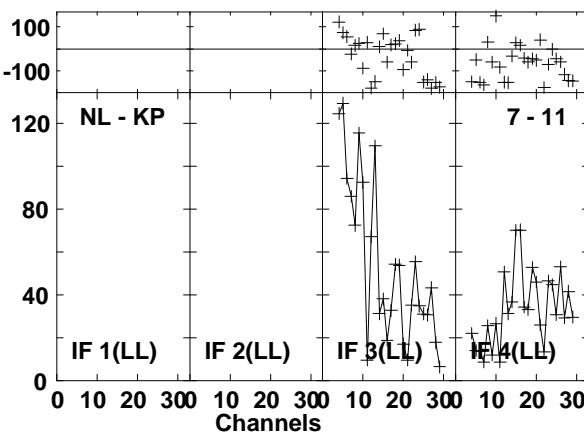
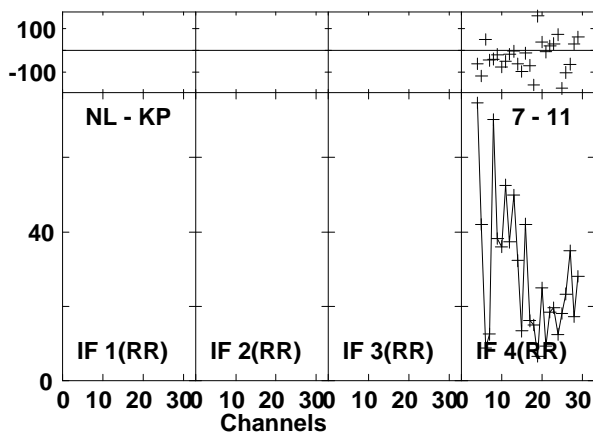
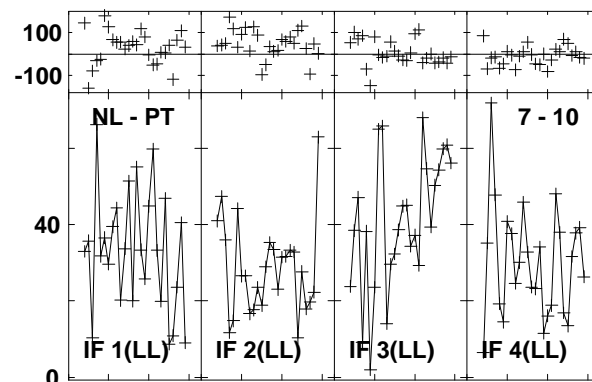
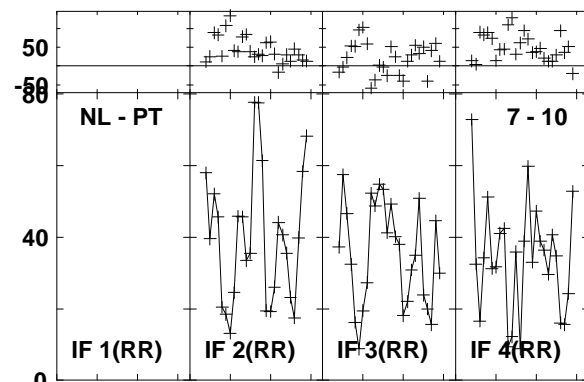
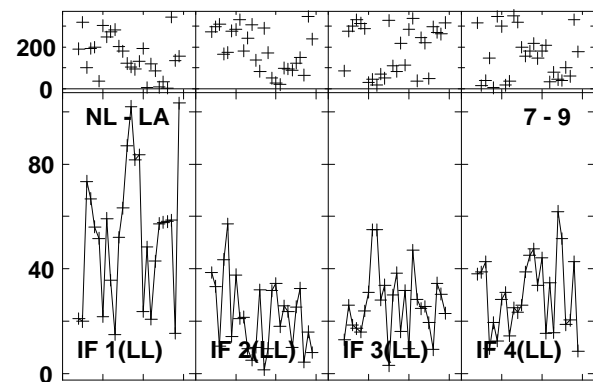
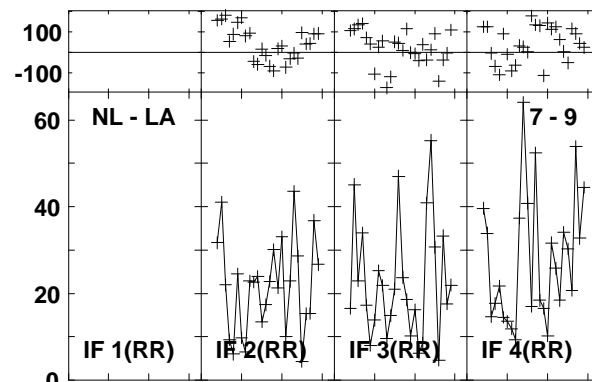
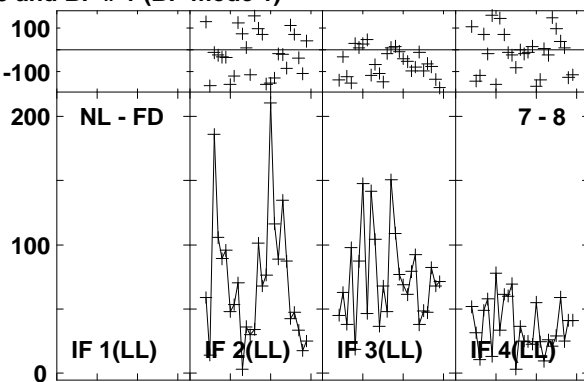
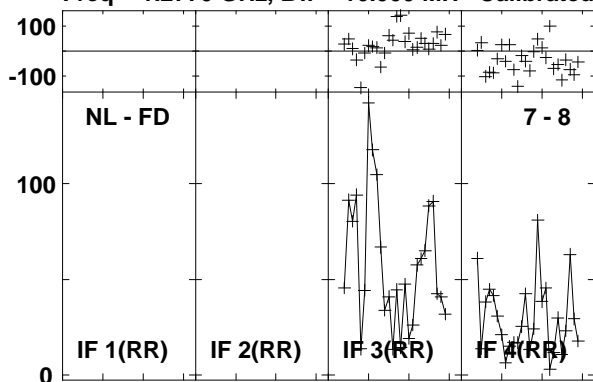

Lower frame: Milli Ampl Jy Top frame: Phas deg
Vector averaged cross-power spectrum Baseline: NL (07) - FD (08)
Timerange: 00/18:37:42 to 00/18:40:28

Plot file version 399 created 03-MAR-2016 01:13:05

4C52 GN002C 1.UVDATA.1

Freq = 1.2770 GHz, Bw = 16.000 MH Calibrated with CL # 3 and BP # 1 (BP mode 1)

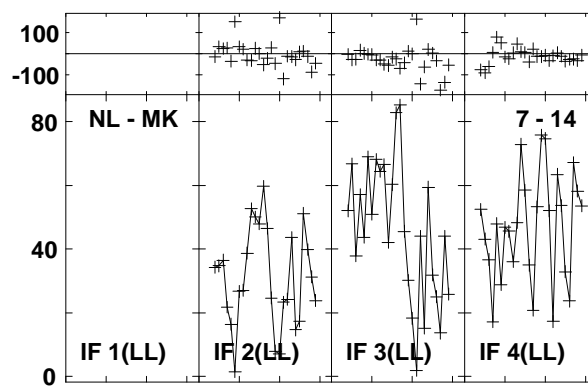
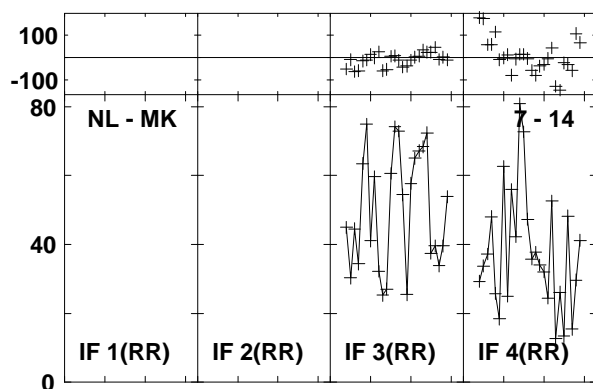
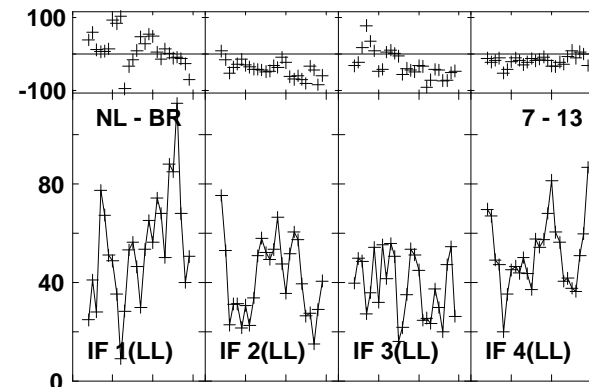
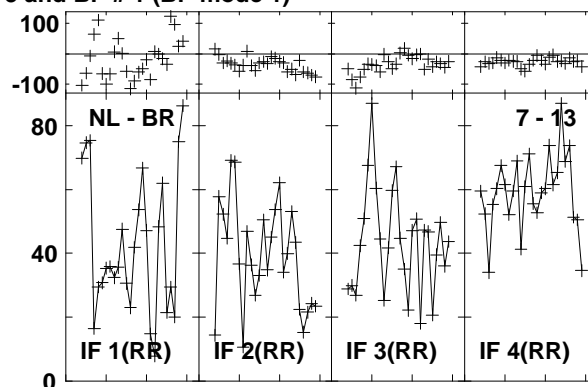
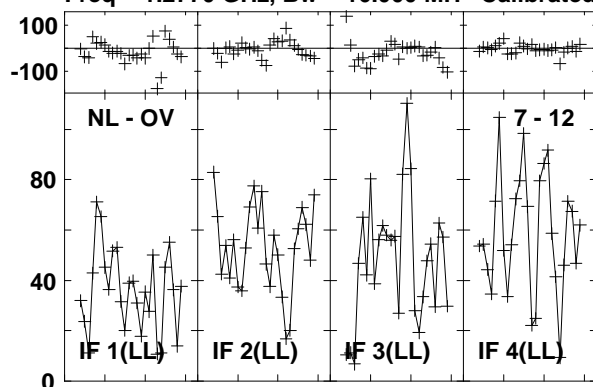

Lower frame: Milli Ampl Jy Top frame: Phas deg
Vector averaged cross-power spectrum Baseline: NL (07) - OV (12)
Timerange: 00/18:37:42 to 00/18:40:28

Plot file version 400 created 03-MAR-2016 01:13:05

J1545+5400 GN002C 1.UVDATA.1

Freq = 1.2770 GHz, Bw = 16.000 MH Calibrated with CL # 3 and BP # 1 (BP mode 1)

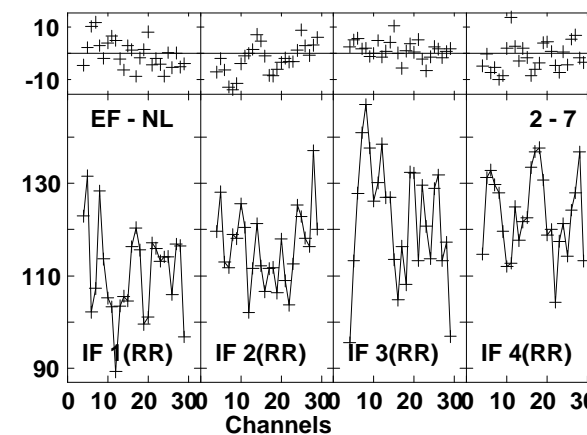
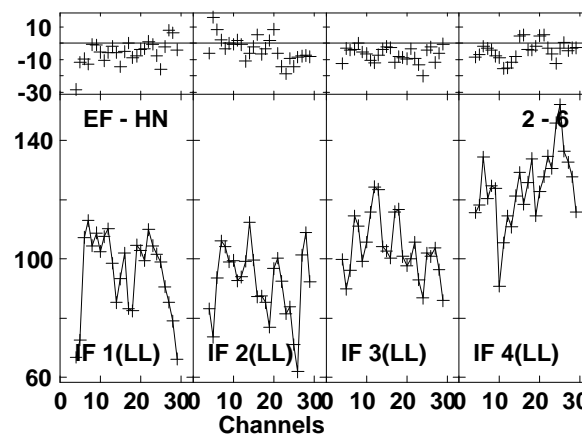
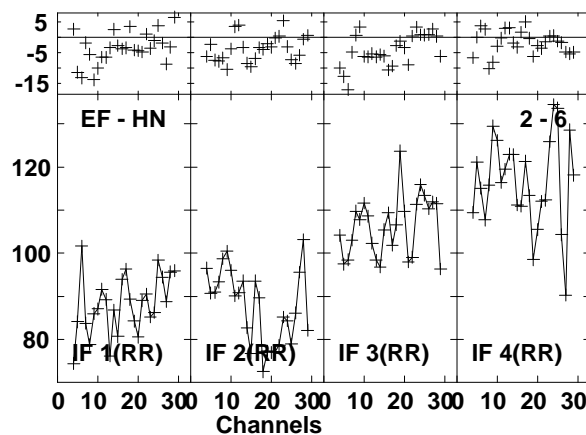
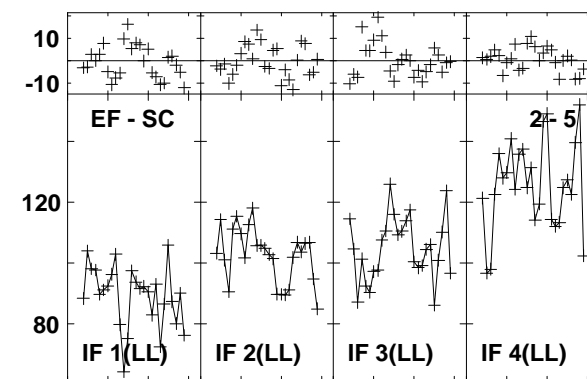
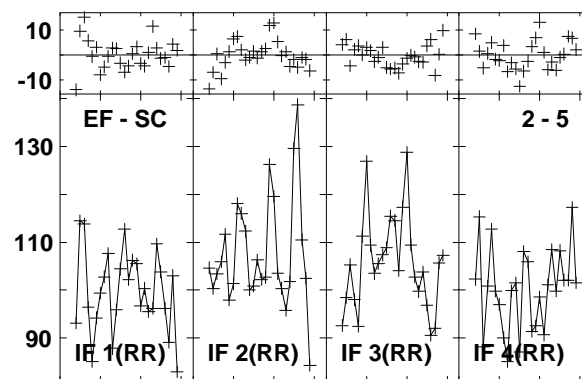
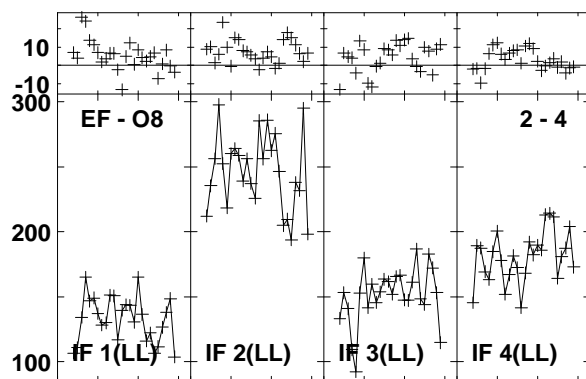
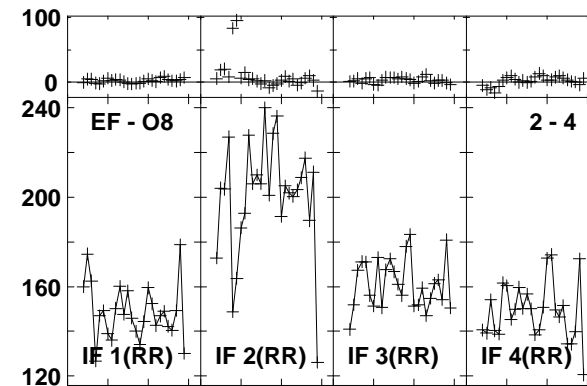
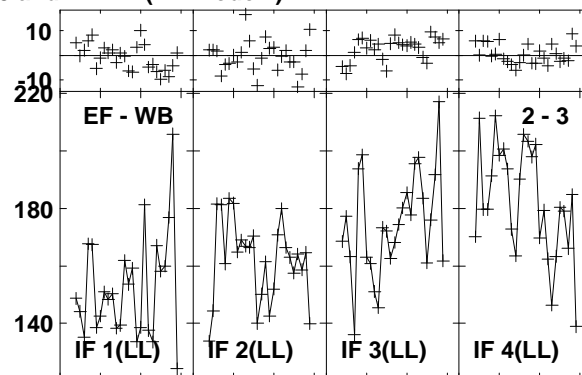
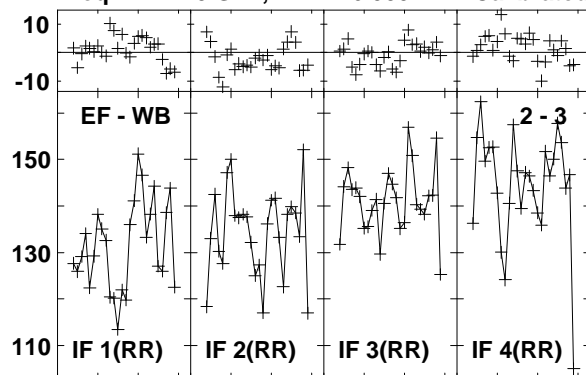

Lower frame: Milli Ampl Jy Top frame: Phas deg
Vector averaged cross-power spectrum Baseline: EF (02) - WB (03)
Timerange: 00/18:41:21 to 00/18:42:19

Plot file version 401 created 03-MAR-2016 01:13:05

J1545+5400 GN002C 1.UVDATA.1

Freq = 1.2770 GHz, Bw = 16.000 MH Calibrated with CL # 3 and BP # 1 (BP mode 1)

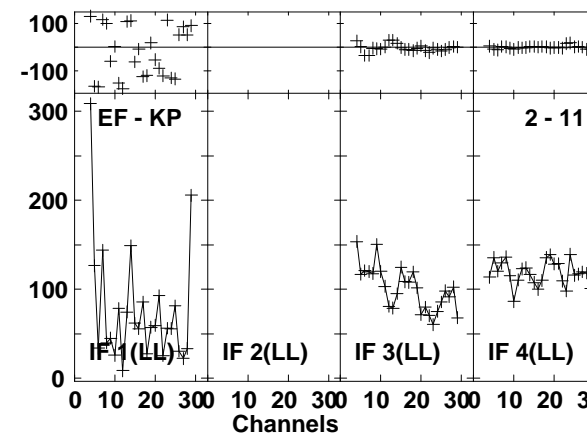
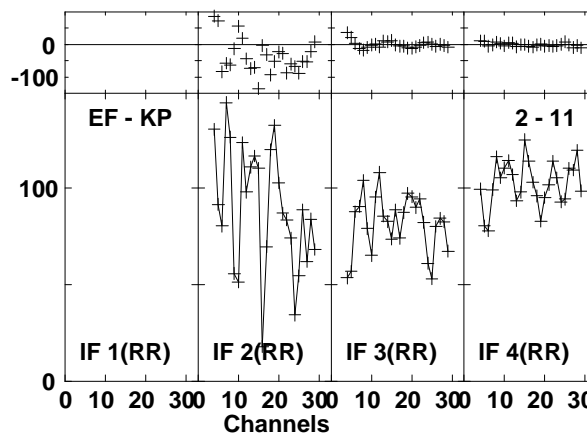
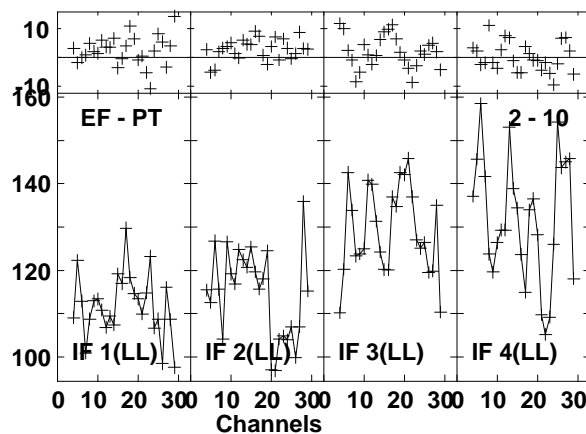
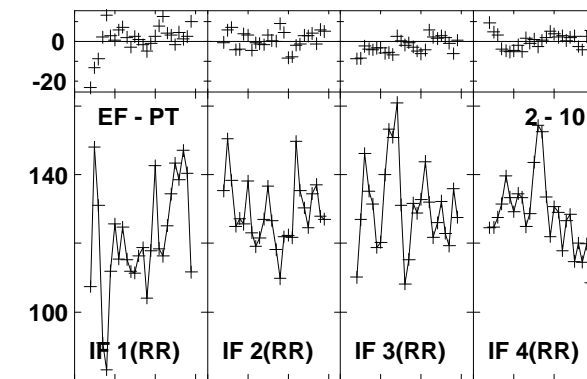
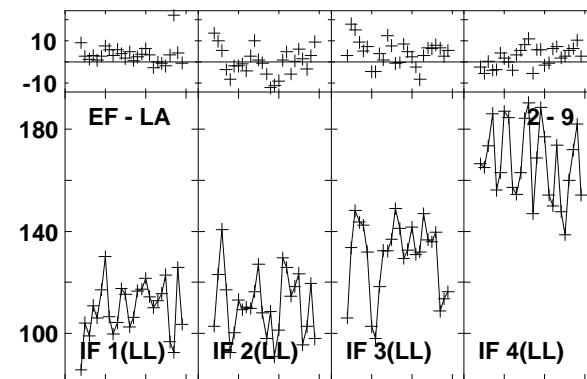
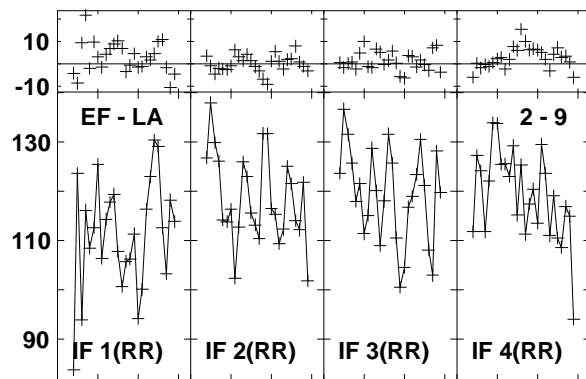
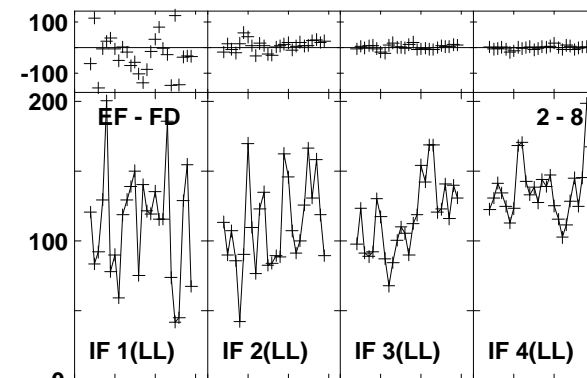
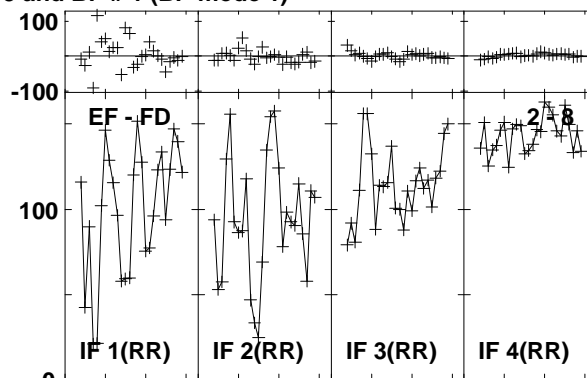
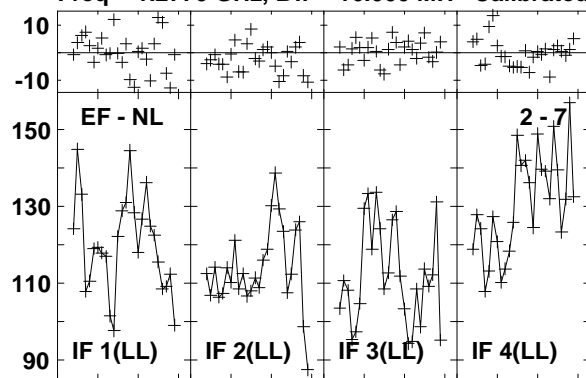

Lower frame: Milli Ampl Jy Top frame: Phas deg
Vector averaged cross-power spectrum Baseline: EF (02) - NL (07)
Timerange: 00/18:41:21 to 00/18:42:19

Plot file version 402 created 03-MAR-2016 01:13:05

J1545+5400 GN002C 1.UVDATA.1

Freq = 1.2770 GHz, Bw = 16.000 MH Calibrated with CL # 3 and BP # 1 (BP mode 1)

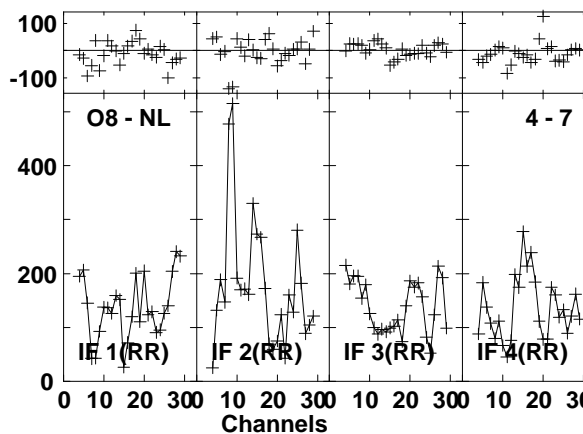
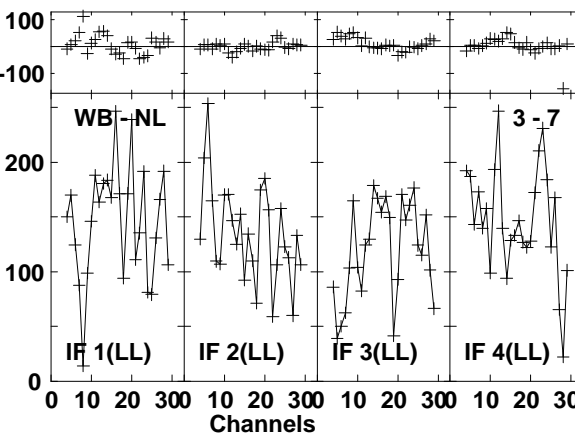
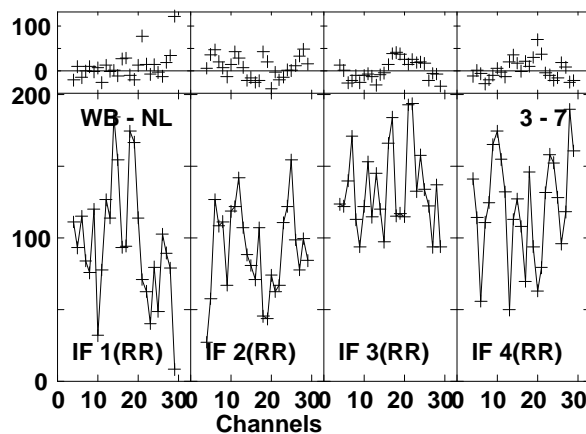
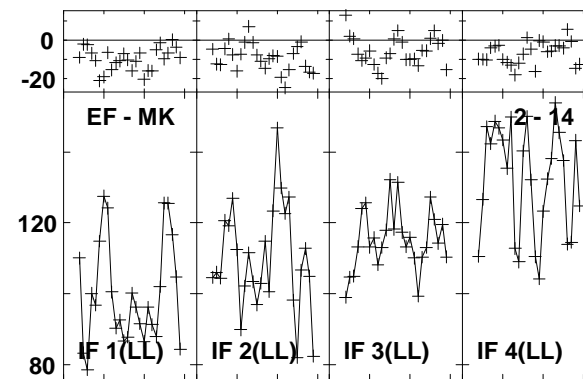
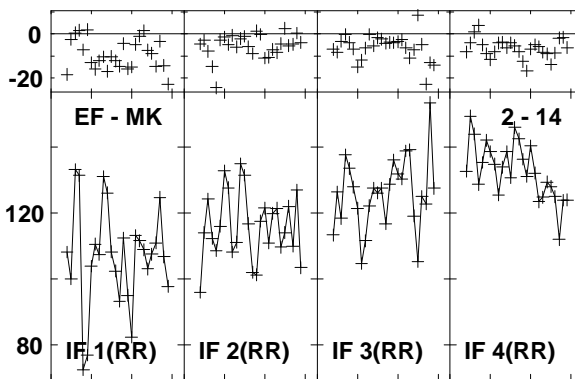
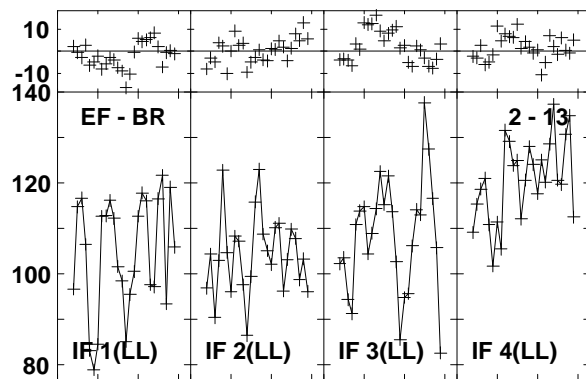
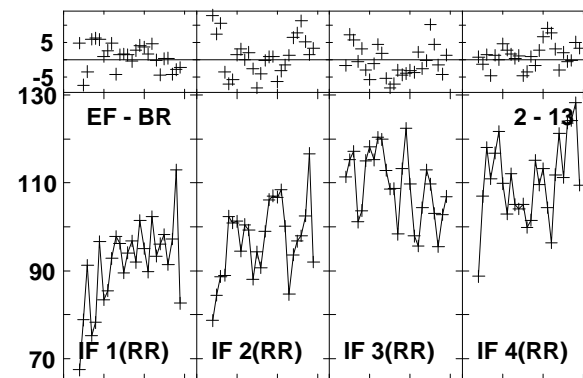
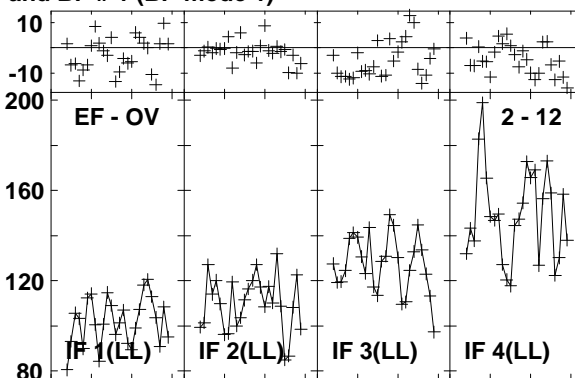
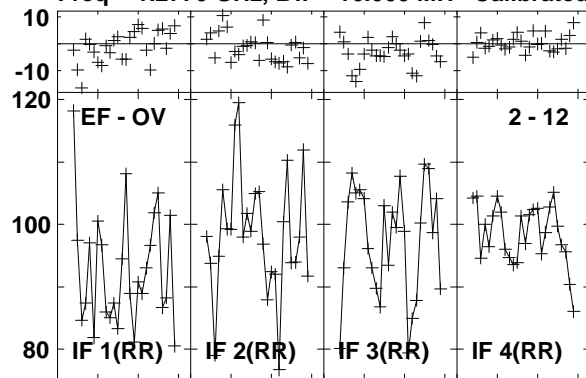

Lower frame: Milli Ampl Jy Top frame: Phas deg
Vector averaged cross-power spectrum Baseline: EF (02) - OV (12)
Timerange: 00/18:41:21 to 00/18:42:19

Plot file version 403 created 03-MAR-2016 01:13:05
 J1545+5400 GN002C 1.UVDATA.1
 Freq = 1.2770 GHz, Bw = 16.000 MH Calibrated with CL # 3 and BP # 1 (BP mode 1)

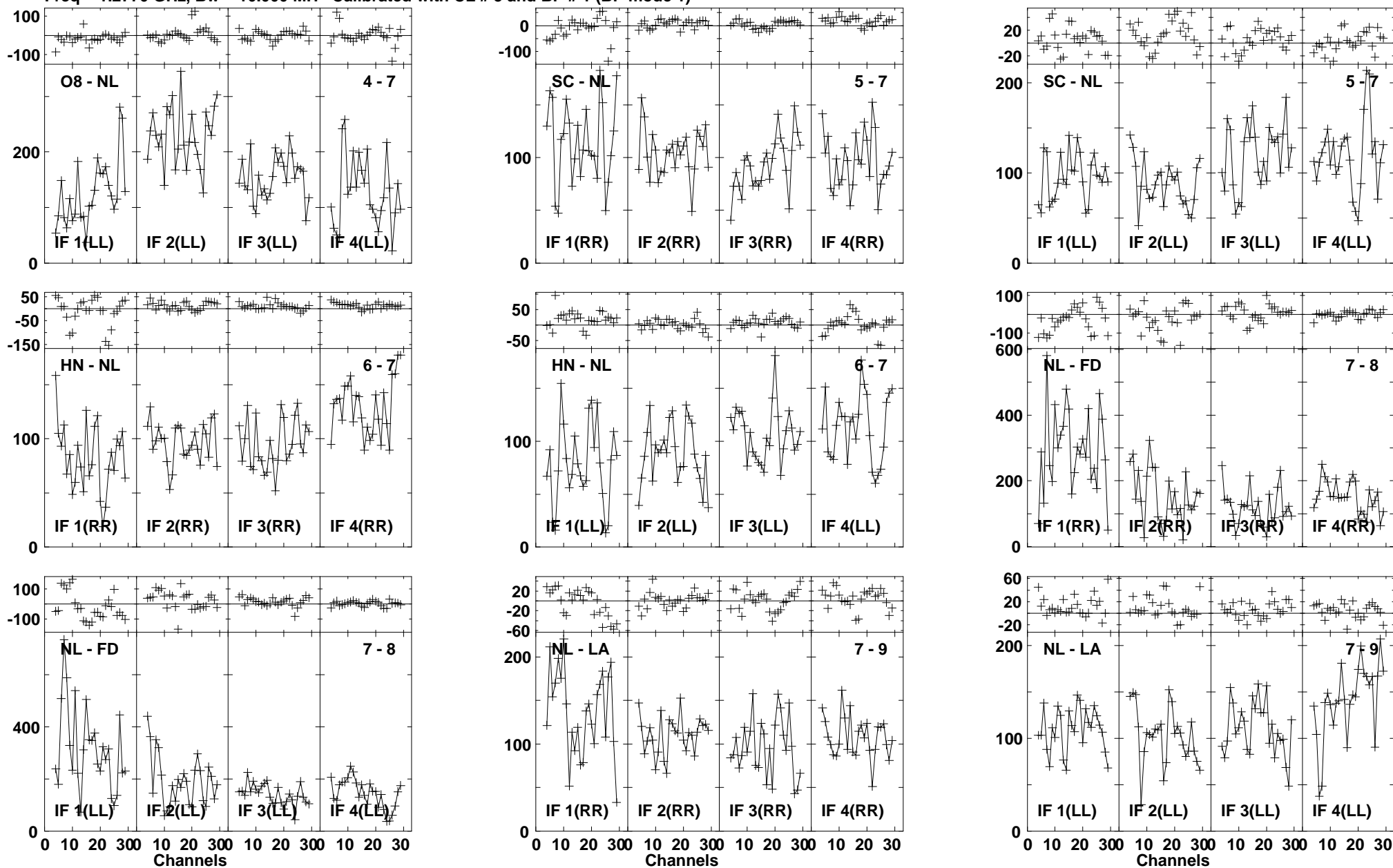

Lower frame: Milli Ampl Jy Top frame: Phas deg
 Vector averaged cross-power spectrum Baseline: O8 (04) - NL (07)
 Timerange: 00/18:41:21 to 00/18:42:19

Plot file version 404 created 03-MAR-2016 01:13:05
 J1545+5400 GN002C 1.UVDATA.1
 Freq = 1.2770 GHz, Bw = 16.000 MH Calibrated with CL # 3 and BP # 1 (BP mode 1)

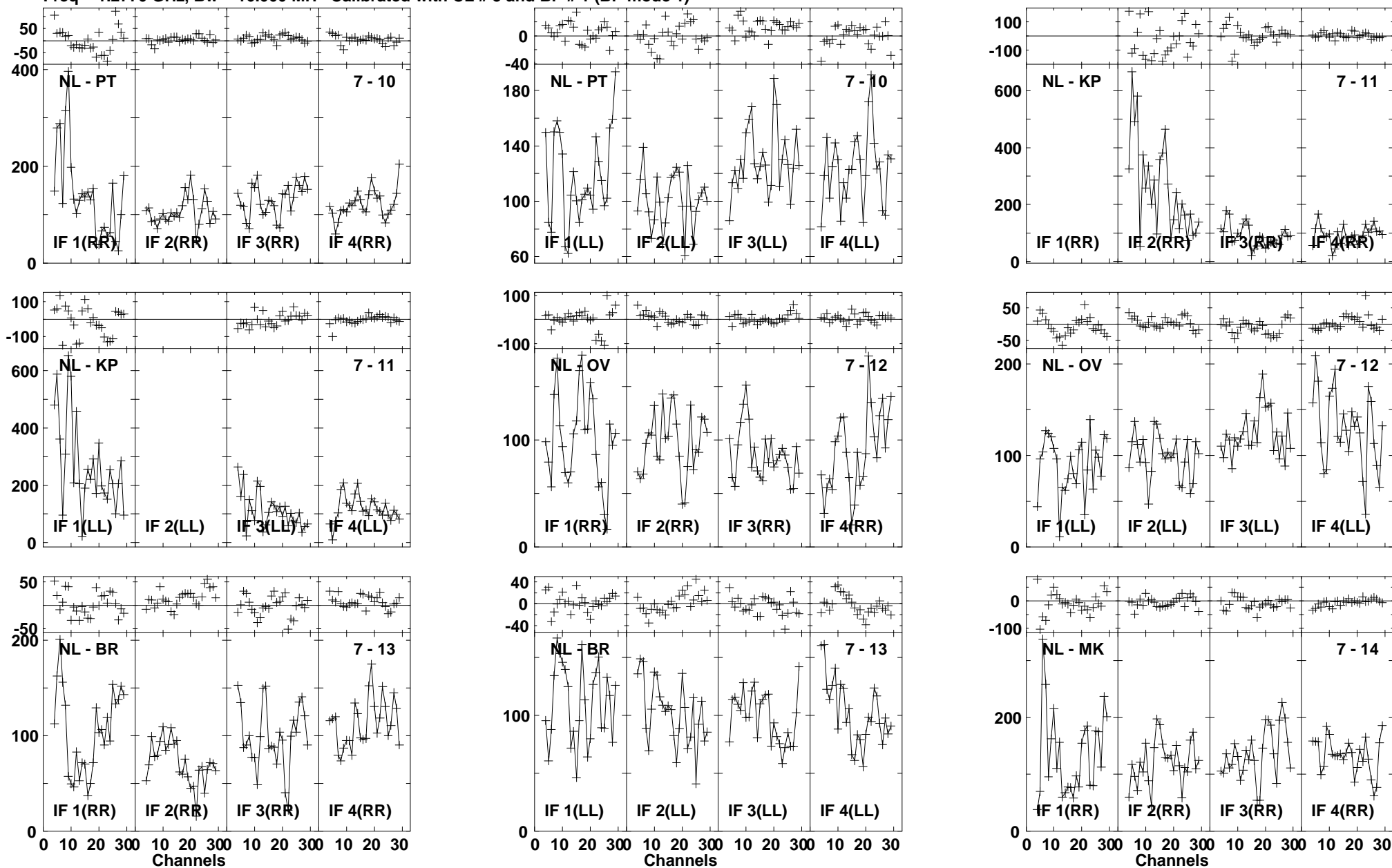

Lower frame: Milli Ampl Jy Top frame: Phas deg
 Vector averaged cross-power spectrum Baseline: NL (07) - PT (10)
 Timerange: 00/18:41:21 to 00/18:42:19

Plot file version 405 created 03-MAR-2016 01:13:06
J1545+5400 GN002C 1.UVDATA.1
Freq = 1.2770 GHz, Bw = 16.000 MH Calibrated with CL # 3 and BP # 1 (BP mode 1)

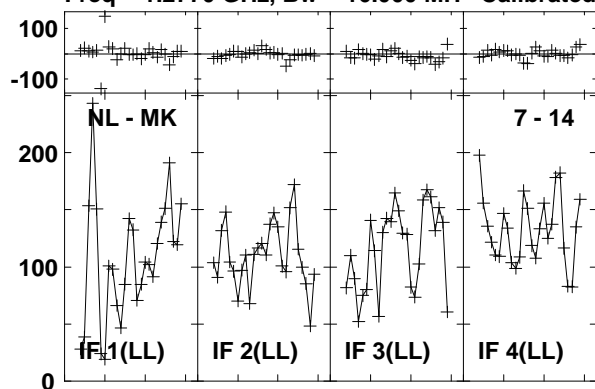

Lower frame: Milli Ampl Jy Top frame: Phas deg
Vector averaged cross-power spectrum Baseline: NL (07) - MK (14)
Timerange: 00/18:41:21 to 00/18:42:19

Plot file version 406 created 03-MAR-2016 01:13:06

4C52 GN002C 1.UVDATA.1

Freq = 1.2770 GHz, Bw = 16.000 MH Calibrated with CL # 3 and BP # 1 (BP mode 1)

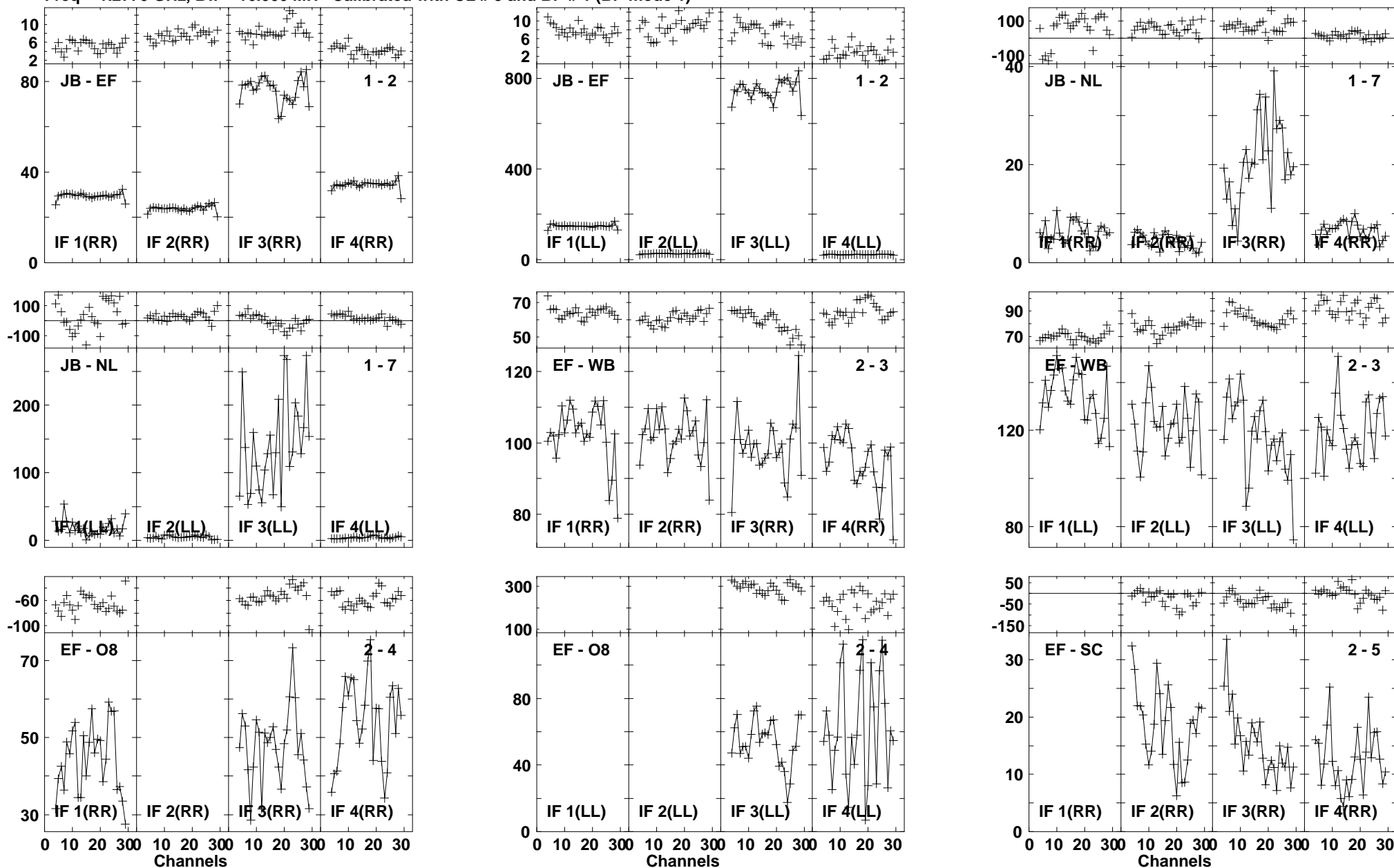

Lower frame: Milli Ampl Jy Top frame: Phas deg
Vector averaged cross-power spectrum Baseline: JB (01) - EF (02)
Timerange: 00/18:42:24 to 00/18:45:18

Plot file version 407 created 03-MAR-2016 01:13:06

4C52 GN002C 1.UVDATA.1

Freq = 1.2770 GHz, Bw = 16.000 MH Calibrated with CL # 3 and BP # 1 (BP mode 1)

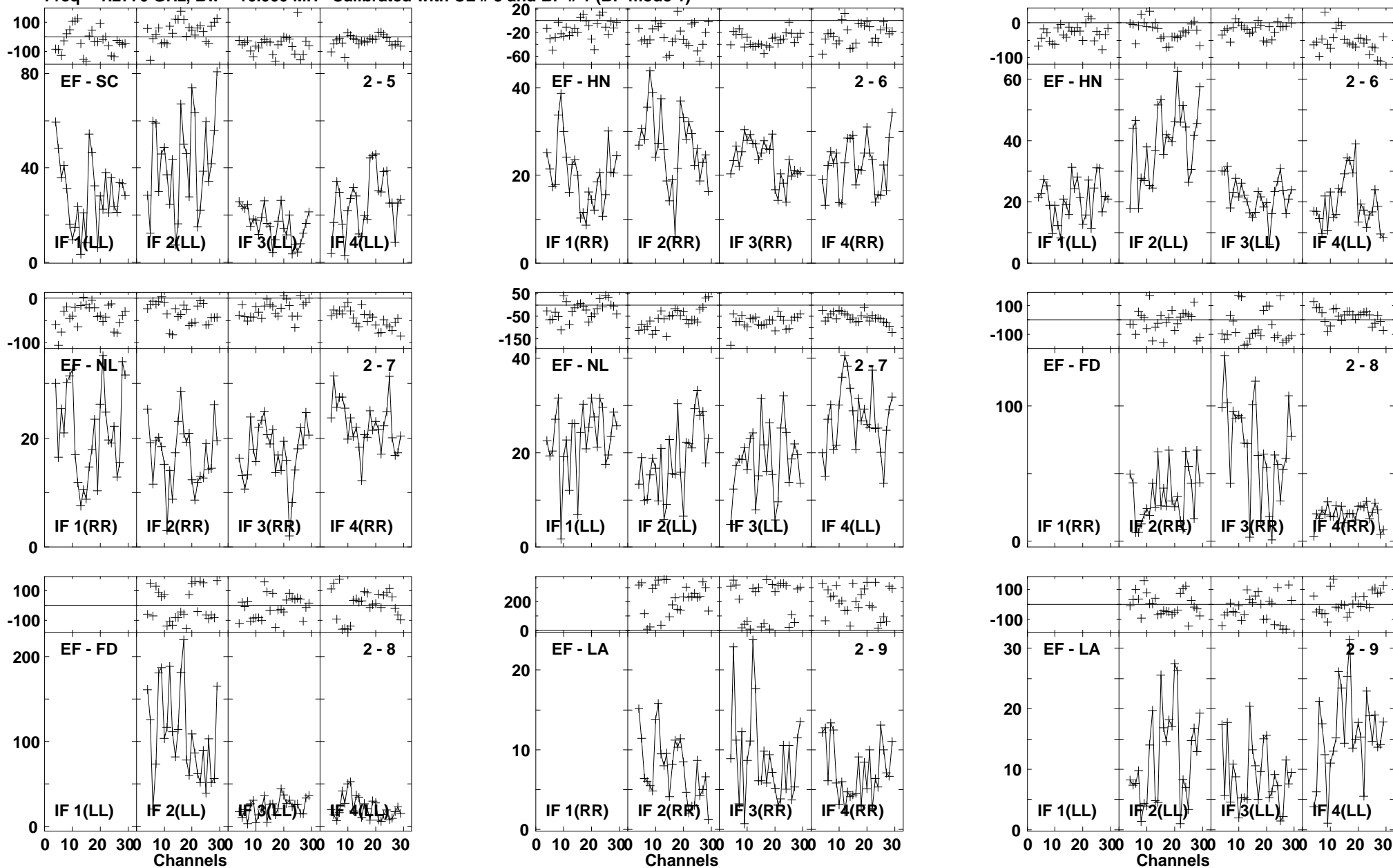

Lower frame: Milli Ampl Jy Top frame: Phas deg
Vector averaged cross-power spectrum Baseline: EF (02) - SC (05)
Timerange: 00/18:42:24 to 00/18:45:18

Plot file version 408 created 03-MAR-2016 01:13:06

4C52 GN002C 1.UVDATA.1

Freq = 1.2770 GHz, Bw = 16.000 MH Calibrated with CL # 3 and BP # 1 (BP mode 1)

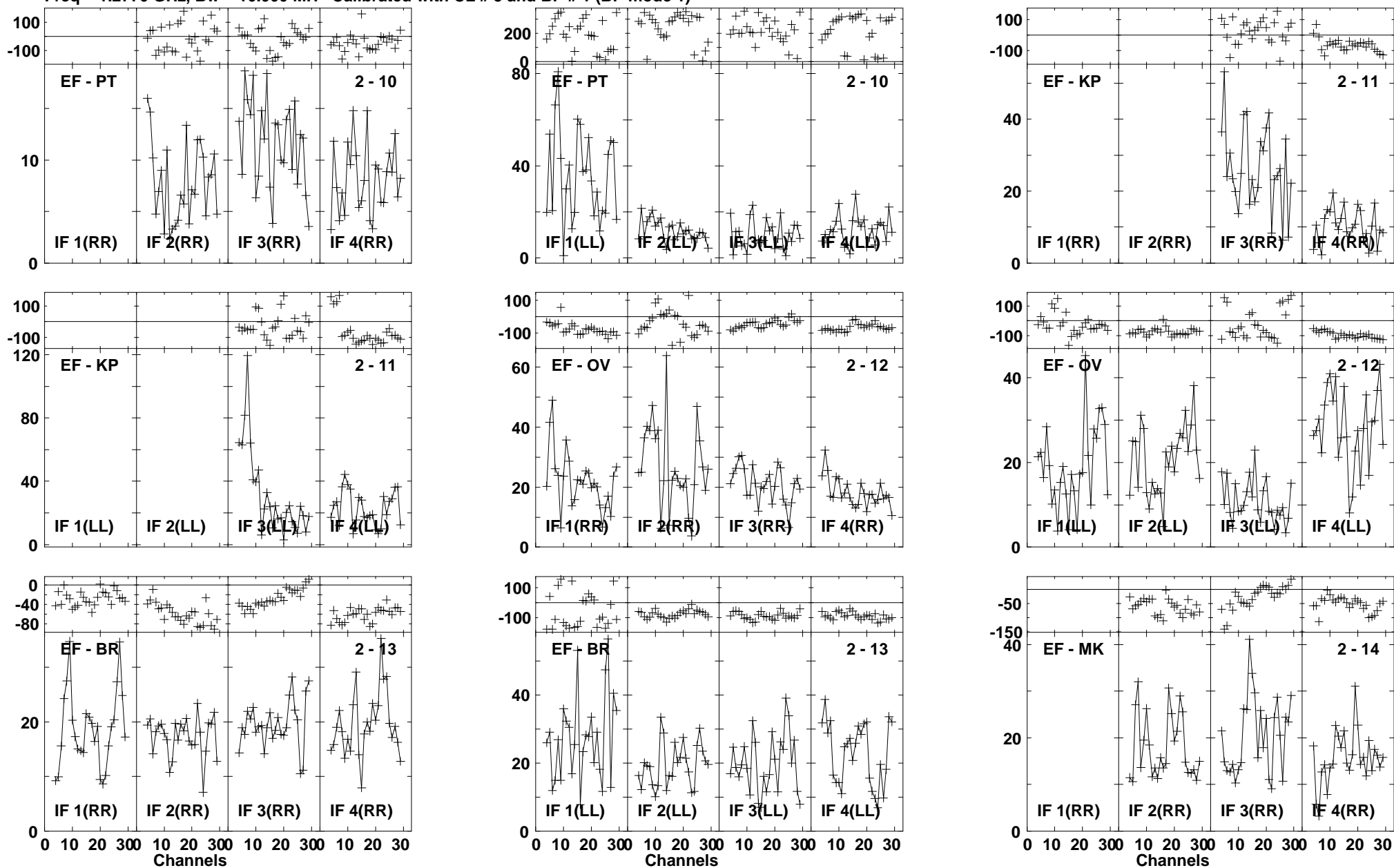

Lower frame: Milli Ampl Jy Top frame: Phas deg
Vector averaged cross-power spectrum Baseline: EF (02) - PT (10)
Timerange: 00/18:42:24 to 00/18:45:18

Plot file version 409 created 03-MAR-2016 01:13:06

4C52 GN002C 1.UVDATA.1

Freq = 1.2770 GHz, Bw = 16.000 MH Calibrated with CL # 3 and BP # 1 (BP mode 1)

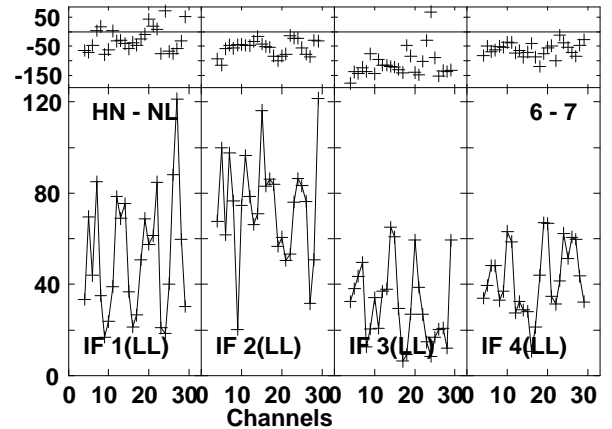
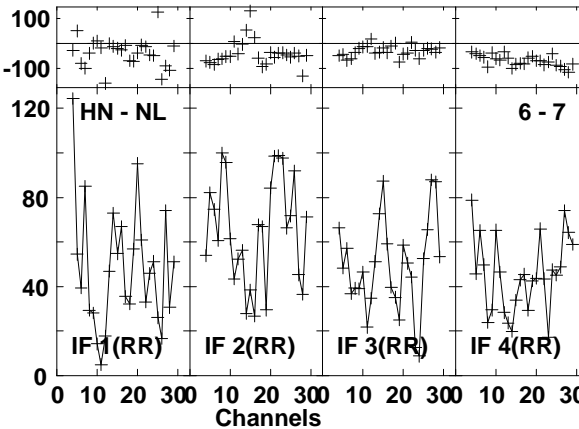
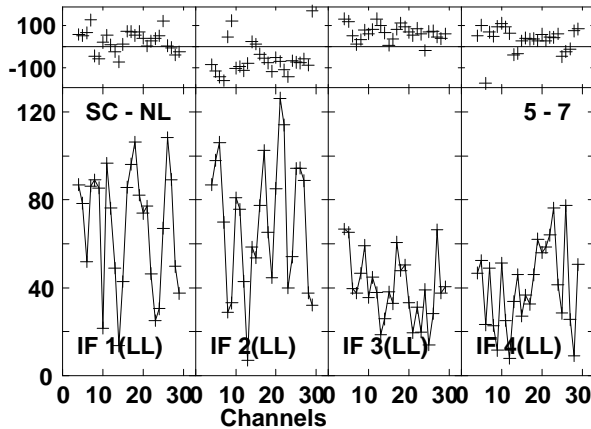
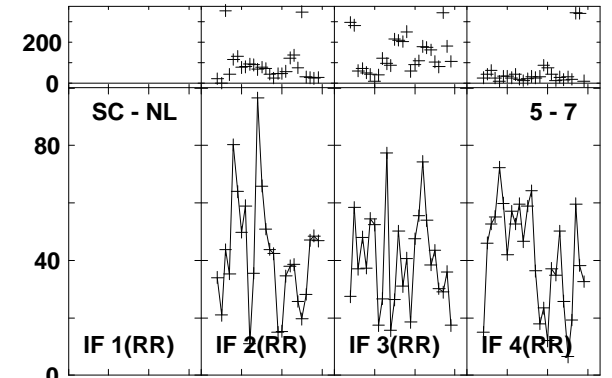
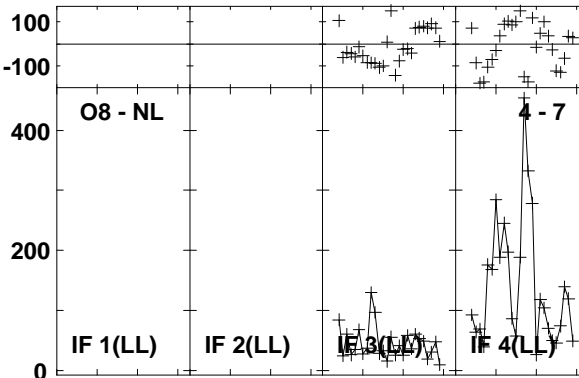
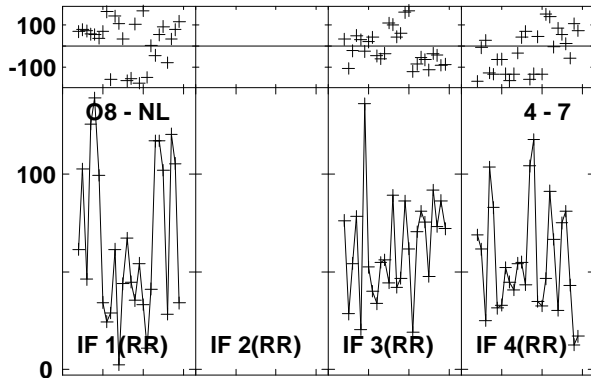
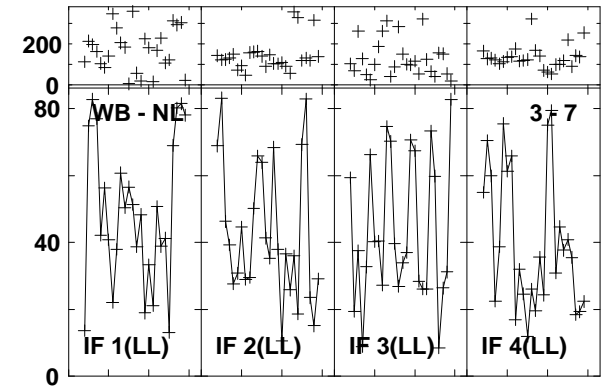
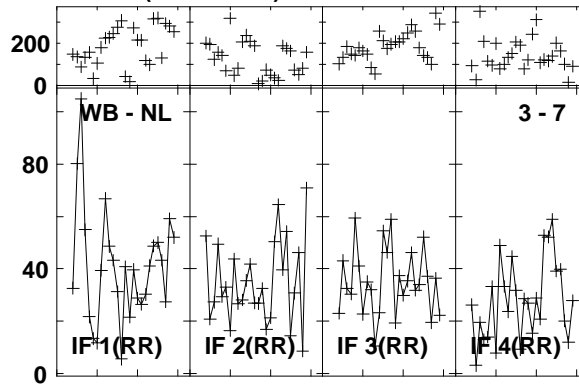
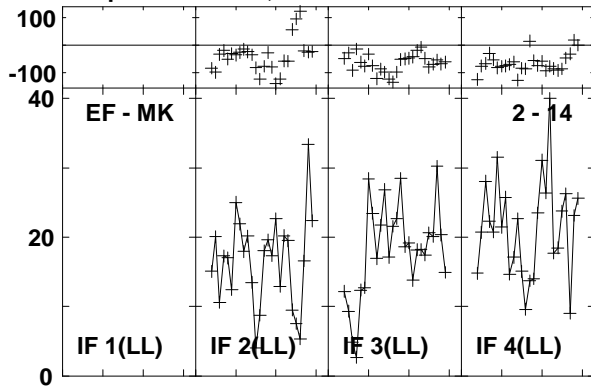

Lower frame: Milli Ampl Jy Top frame: Phas deg
Vector averaged cross-power spectrum Baseline: EF (02) - MK (14)
Timerange: 00/18:42:24 to 00/18:45:18

Plot file version 410 created 03-MAR-2016 01:13:06

4C52 GN002C 1.UVDATA.1

Freq = 1.2770 GHz, Bw = 16.000 MH Calibrated with CL # 3 and BP # 1 (BP mode 1)

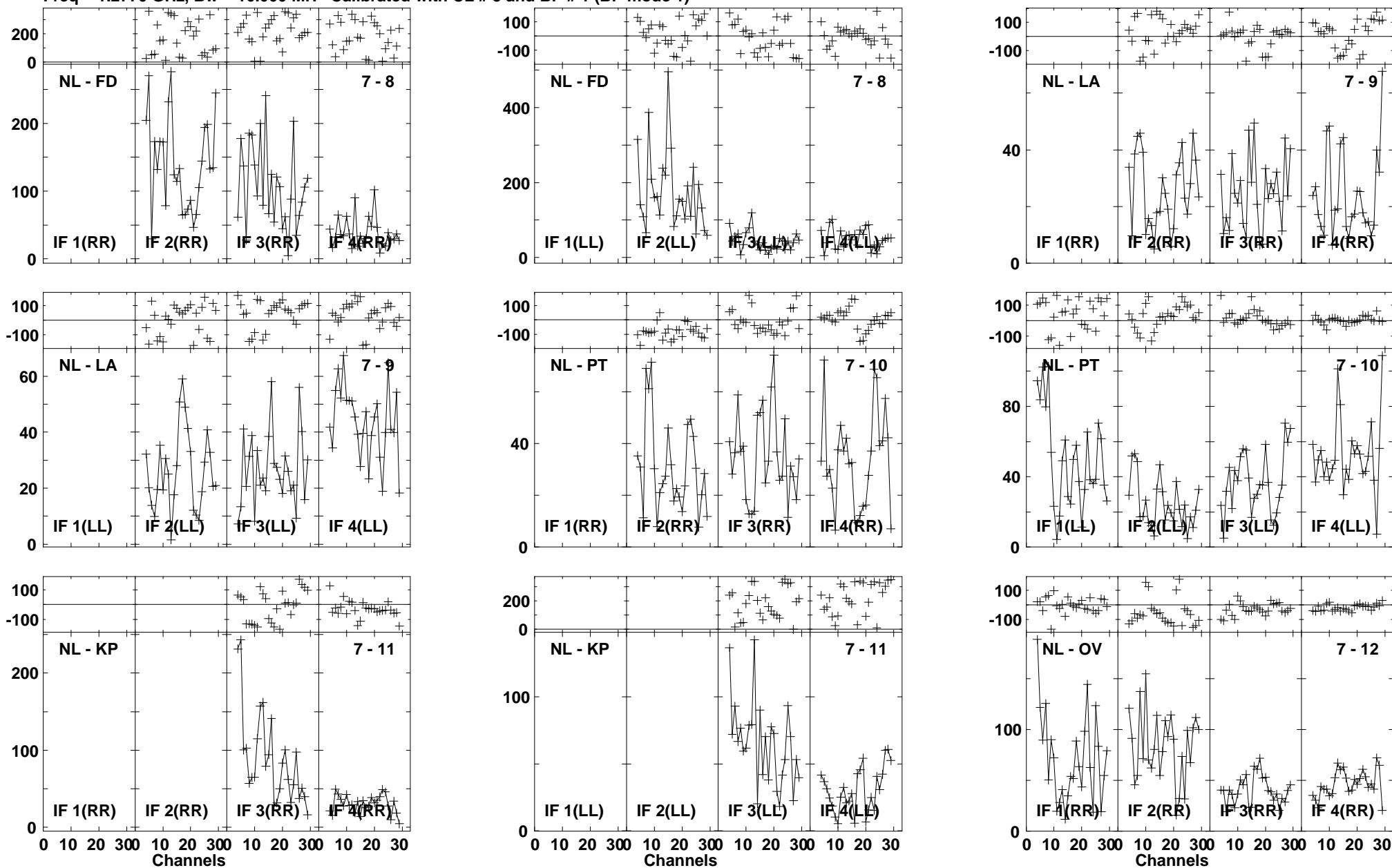

Lower frame: Milli Ampl Jy Top frame: Phas deg
Vector averaged cross-power spectrum Baseline: NL (07) - FD (08)
Timerange: 00/18:42:24 to 00/18:45:18

Plot file version 411 created 03-MAR-2016 01:13:06

4C52 GN002C 1.UVDATA.1

Freq = 1.2770 GHz, Bw = 16.000 MH Calibrated with CL # 3 and BP # 1 (BP mode 1)

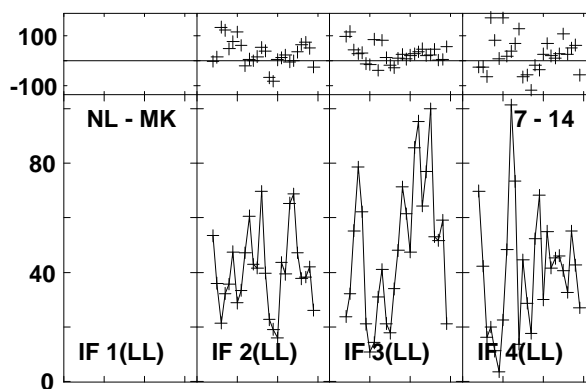
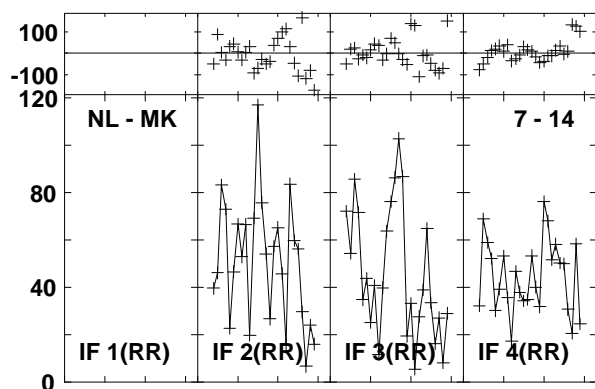
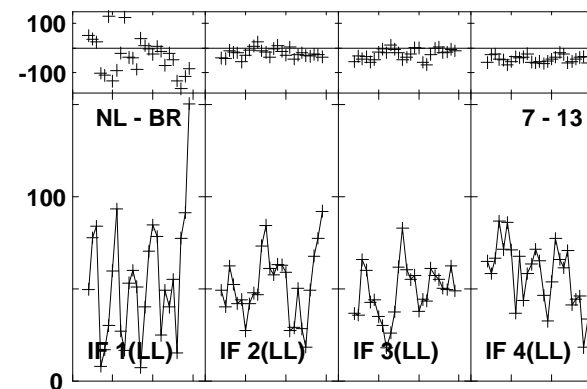
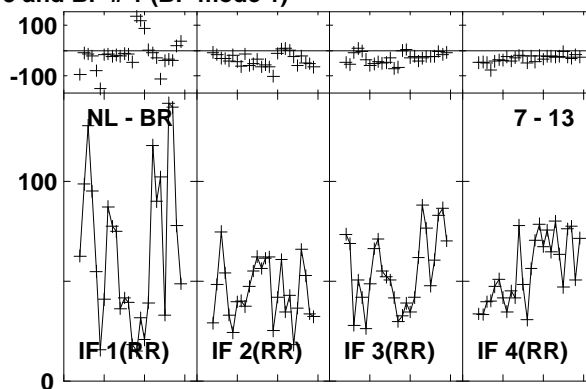
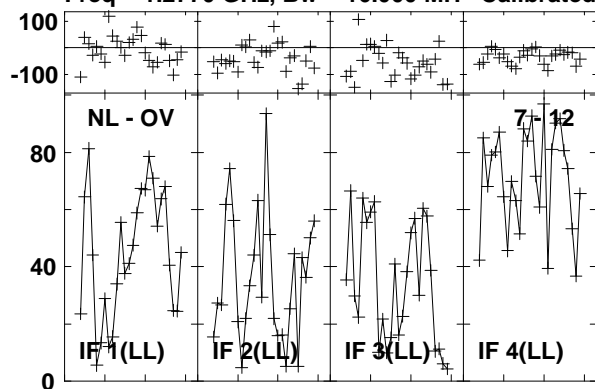

Lower frame: Milli Ampl Jy Top frame: Phas deg
Vector averaged cross-power spectrum Baseline: NL (07) - OV (12)
Timerange: 00:18:42:24 to 00:18:45:18

Plot file version 412 created 03-MAR-2016 01:13:07

J1545+5400 GN002C 1.UVDATA.1

Freq = 1.2770 GHz, Bw = 16.000 MH Calibrated with CL # 3 and BP # 1 (BP mode 1)

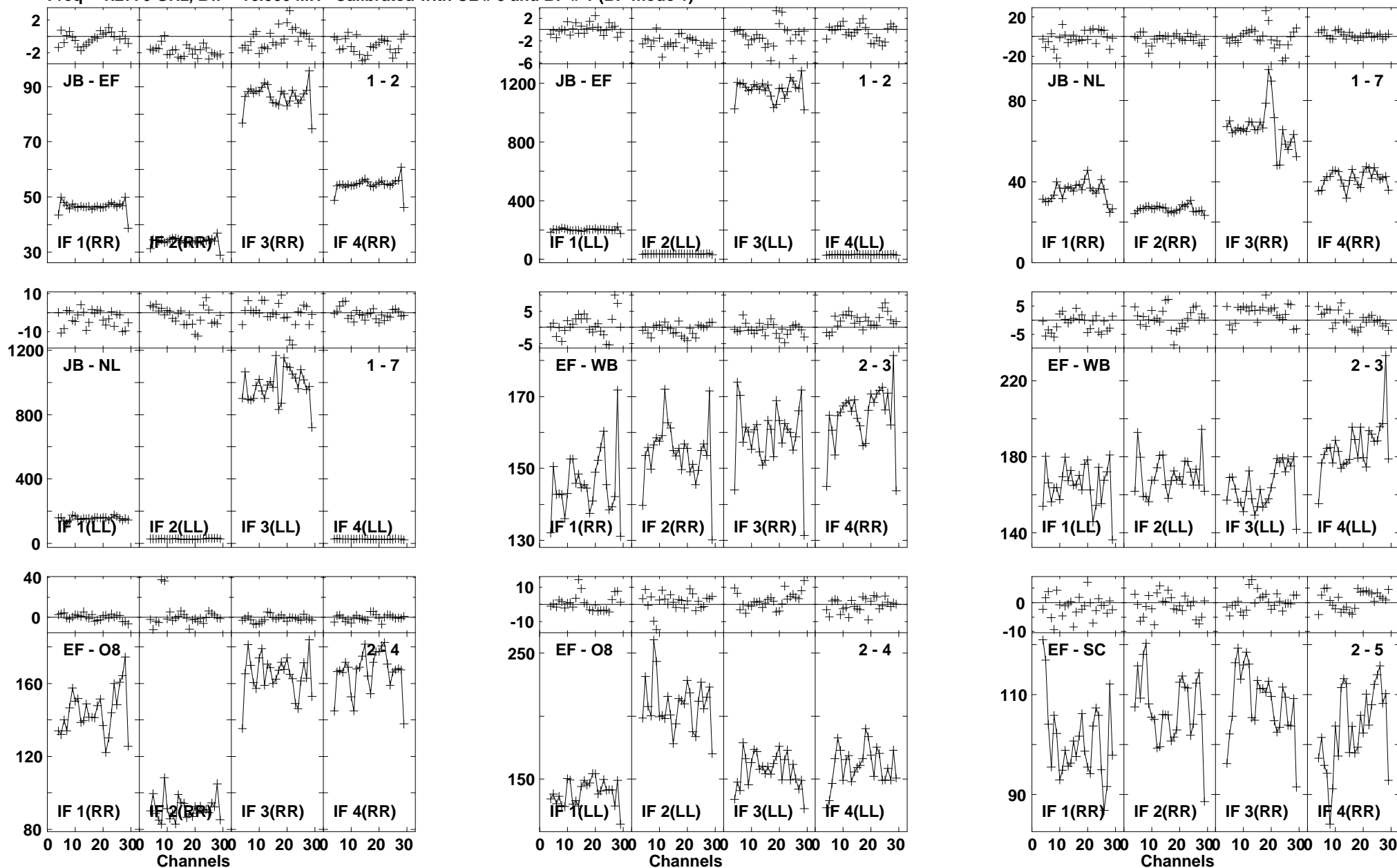

Plot file version 413 created 03-MAR-2016 01:13:07

J1545+5400 GN002C 1.UVDATA.1

Freq = 1.2770 GHz, Bw = 16.000 MH Calibrated with CL # 3 and BP # 1 (BP mode 1)

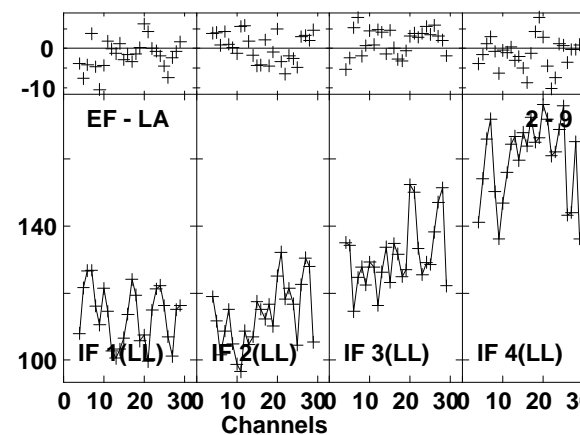
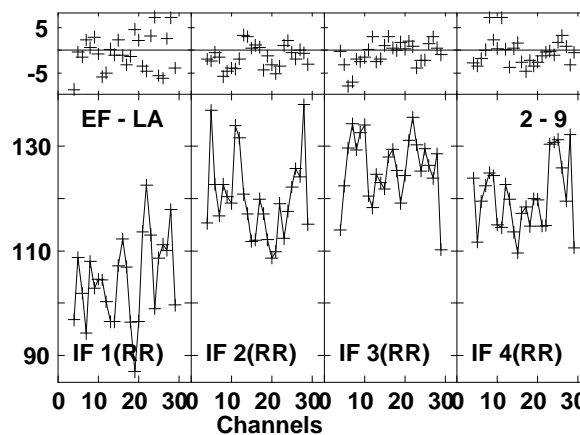
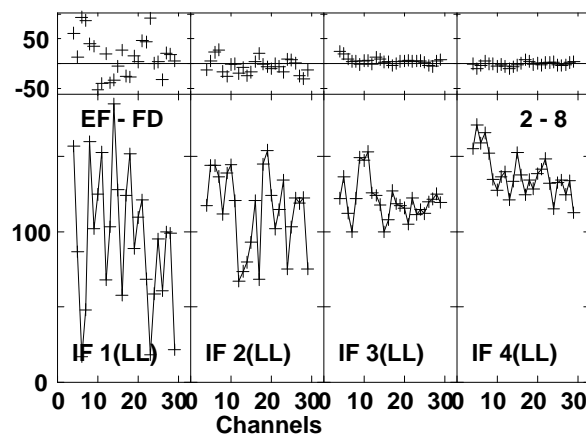
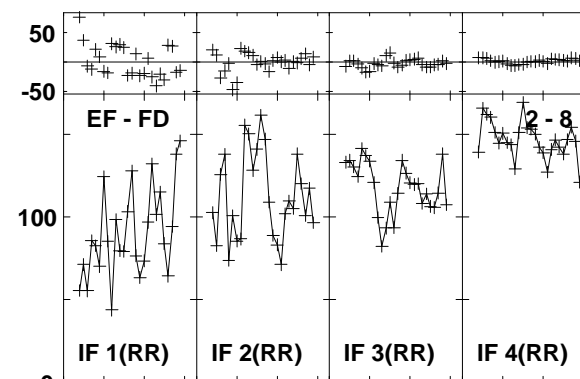
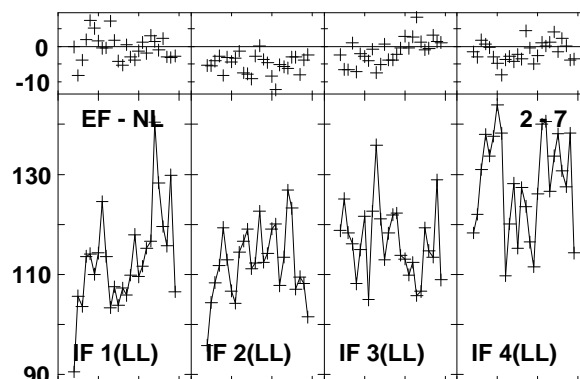
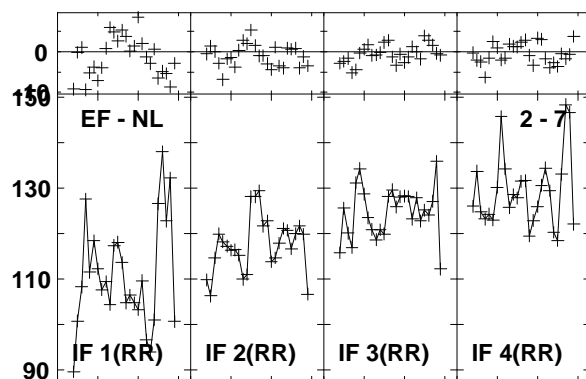
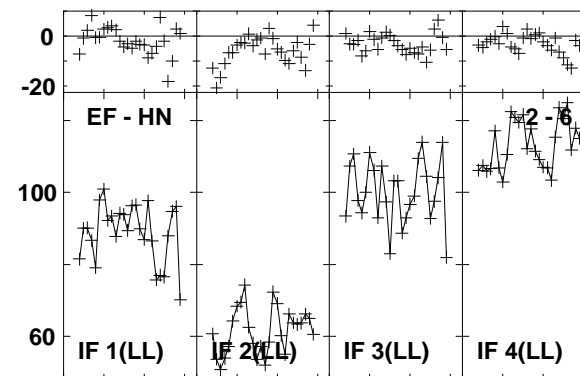
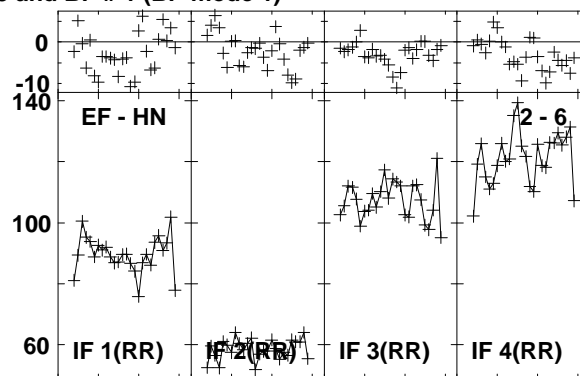
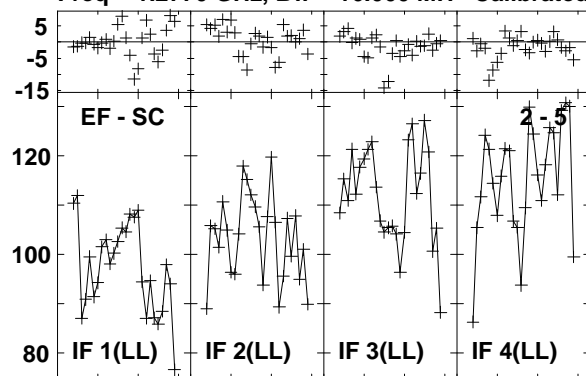

Lower frame: Milli Ampl Jy Top frame: Phas deg
Vector averaged cross-power spectrum Baseline: EF (02) - SC (05)
Timerange: 00/18:46:11 to 00/18:48:09

Plot file version 414 created 03-MAR-2016 01:13:07
 J1545+5400 GN002C 1.UVDATA.1
 Freq = 1.2770 GHz, Bw = 16.000 MH Calibrated with CL # 3 and BP # 1 (BP mode 1)

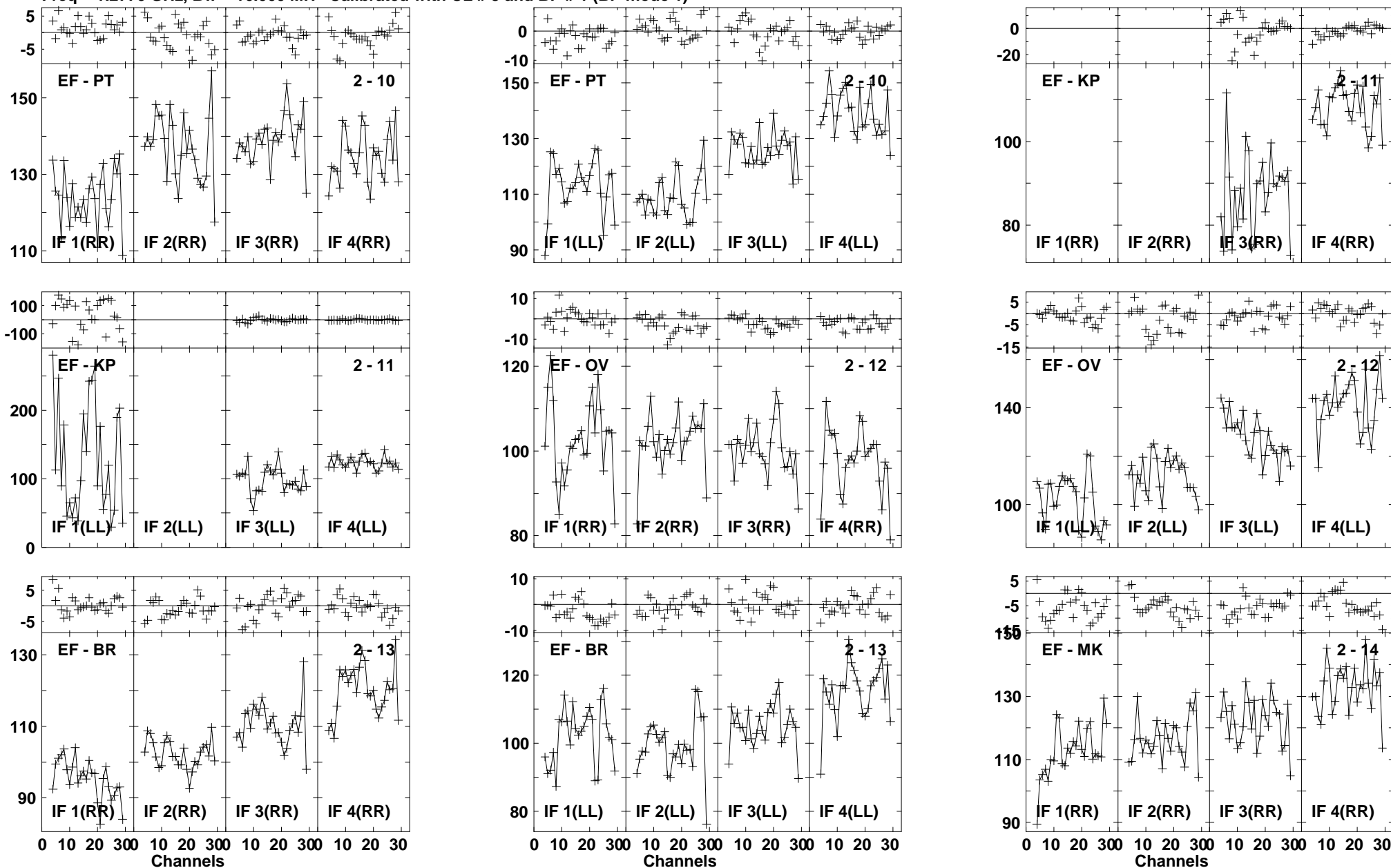

Lower frame: Milli Ampl Jy Top frame: Phas deg
 Vector averaged cross-power spectrum Baseline: EF (02) - PT (10)
 Timerange: 00/18:46:11 to 00/18:48:09

Plot file version 415 created 03-MAR-2016 01:13:07

J1545+5400 GN002C 1.UVDATA.1

Freq = 1.2770 GHz, Bw = 16.000 MH Calibrated with CL # 3 and BP # 1 (BP mode 1)

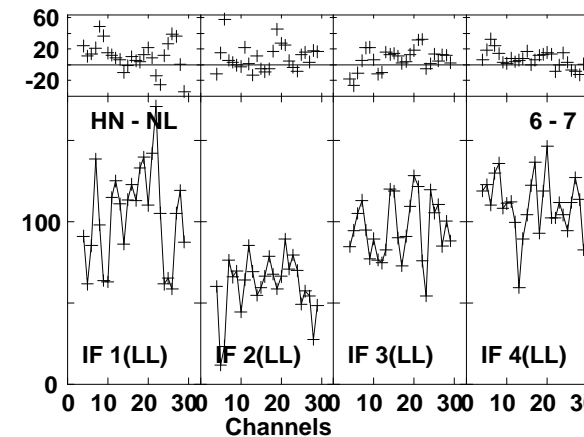
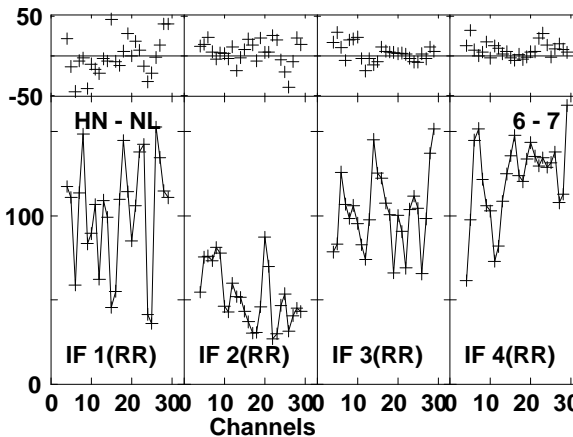
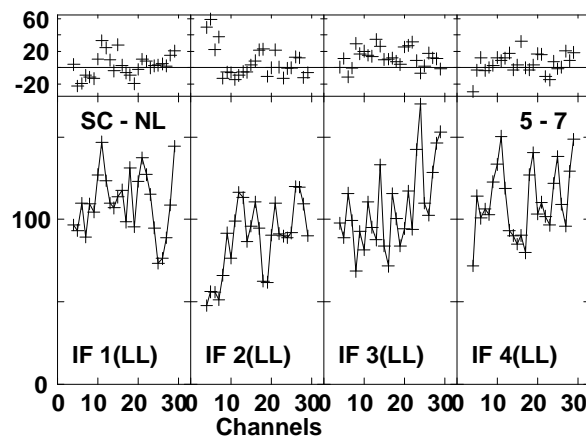
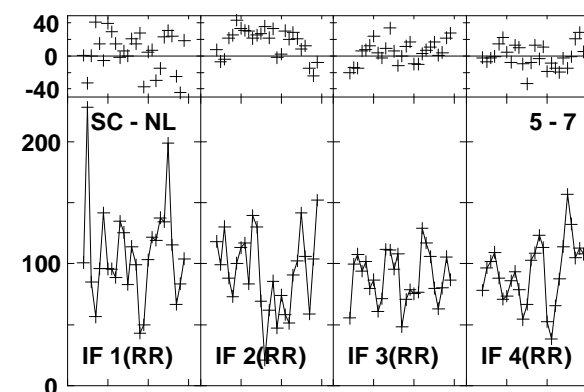
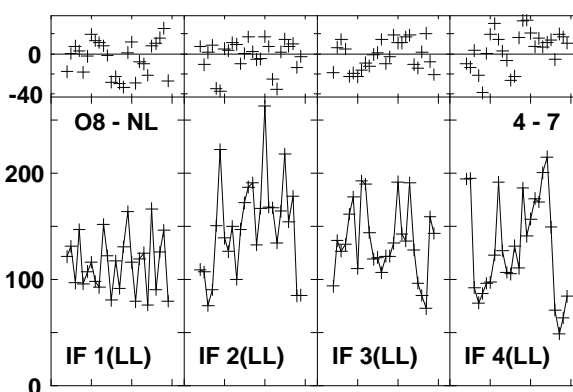
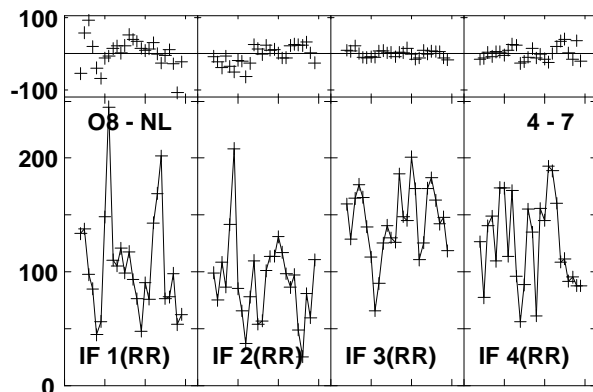
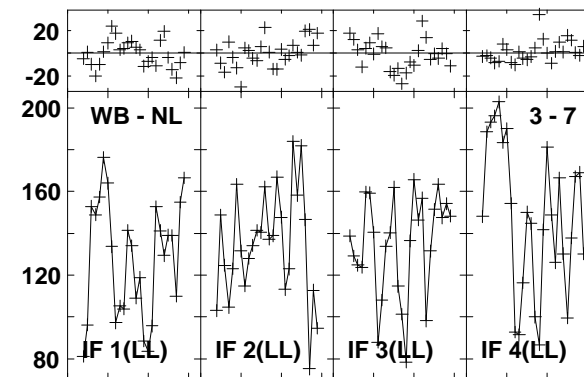
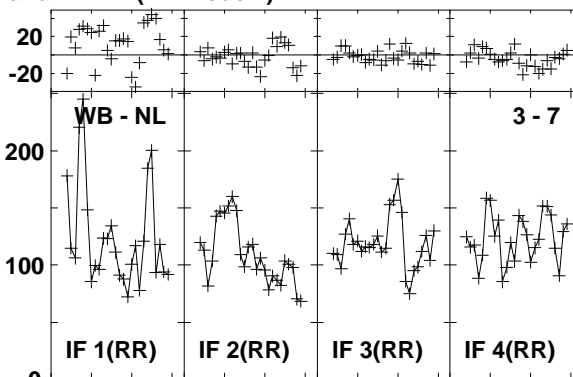
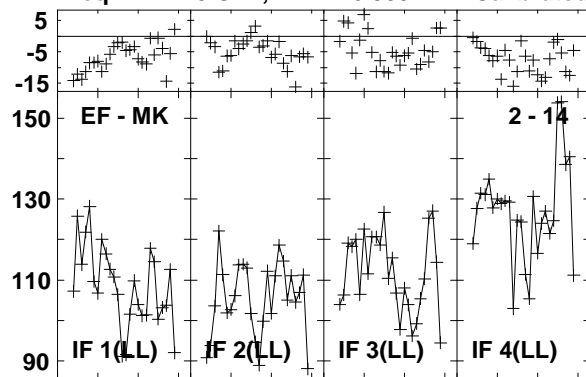

Lower frame: Milli Ampl Jy Top frame: Phas deg
Vector averaged cross-power spectrum Baseline: EF (02) - MK (14)
Timerange: 00/18:46:11 to 00/18:48:09

Plot file version 416 created 03-MAR-2016 01:13:07
 J1545+5400 GN002C 1.UVDATA.1
 Freq = 1.2770 GHz, Bw = 16.000 MH Calibrated with CL # 3 and BP # 1 (BP mode 1)

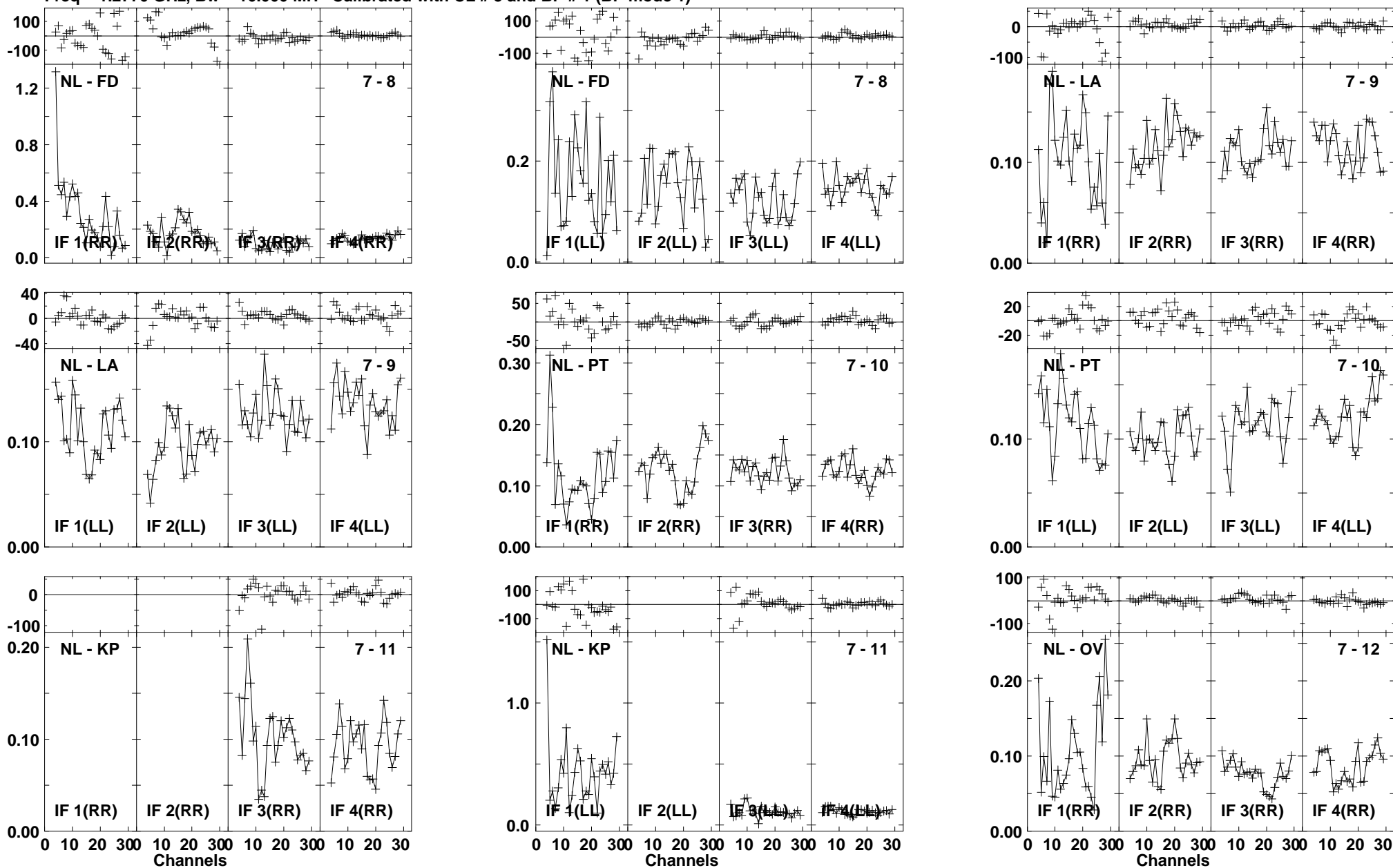

Lower frame: Ampl Jy Top frame: Phas deg
 Vector averaged cross-power spectrum Baseline: NL (07) - FD (08)
 Timerange: 00/18:46:11 to 00/18:48:09

Plot file version 417 created 03-MAR-2016 01:13:07
 J1545+5400 GN002C 1.UVDATA.1
 Freq = 1.2770 GHz, Bw = 16.000 MH Calibrated with CL # 3 and BP # 1 (BP mode 1)

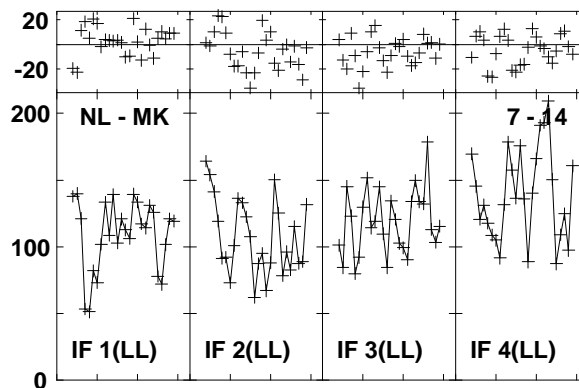
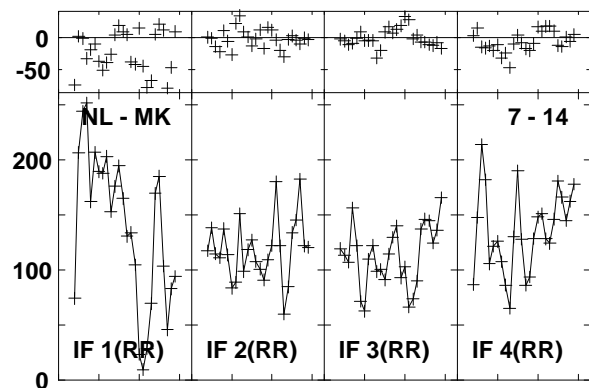
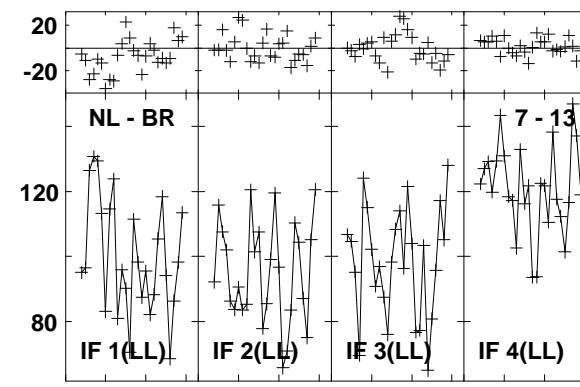
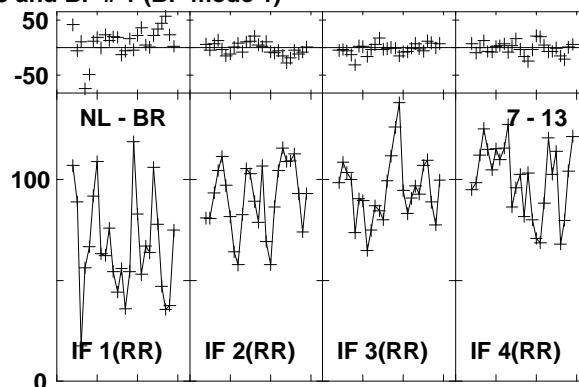
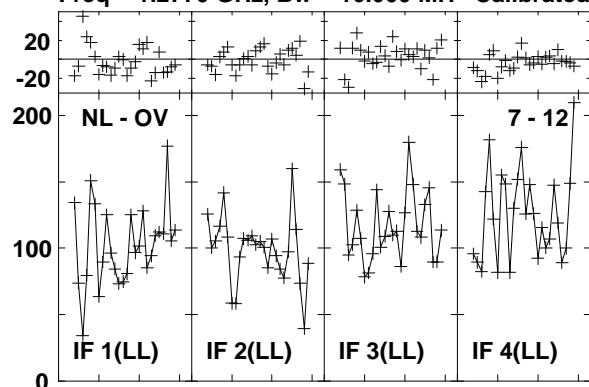

Lower frame: Milli Ampl Jy Top frame: Phas deg
 Vector averaged cross-power spectrum Baseline: NL (07) - OV (12)
 Timerange: 00:18:46:11 to 00:18:48:09

Plot file version 418 created 03-MAR-2016 01:13:08

4C52 GN002C 1.UVDATA.1

Freq = 1.2770 GHz, Bw = 16.000 MH Calibrated with CL # 3 and BP # 1 (BP mode 1)

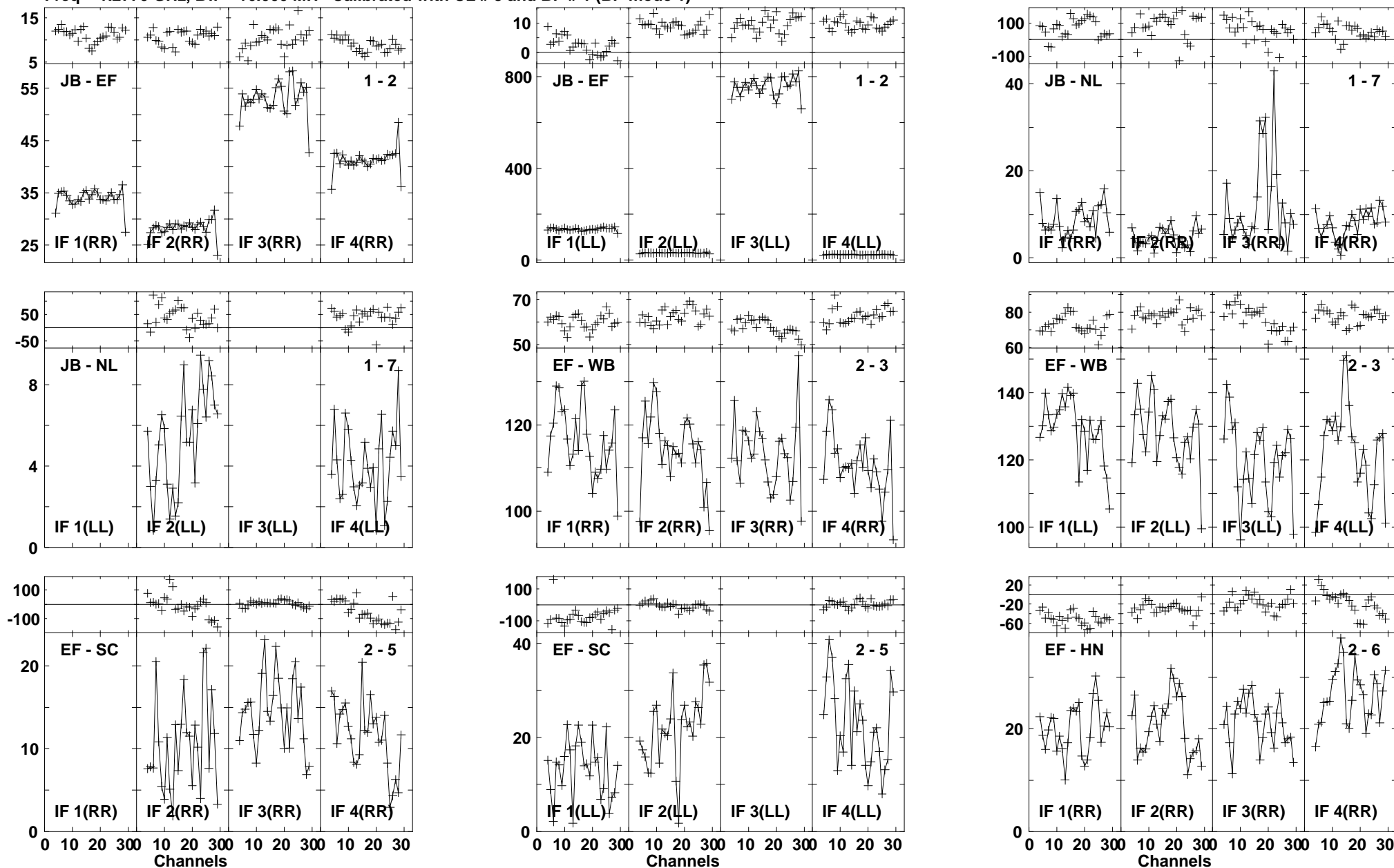

Plot file version 419 created 03-MAR-2016 01:13:08

4C52 GN002C 1.UVDATA.1

Freq = 1.2770 GHz, Bw = 16.000 MH Calibrated with CL # 3 and BP # 1 (BP mode 1)

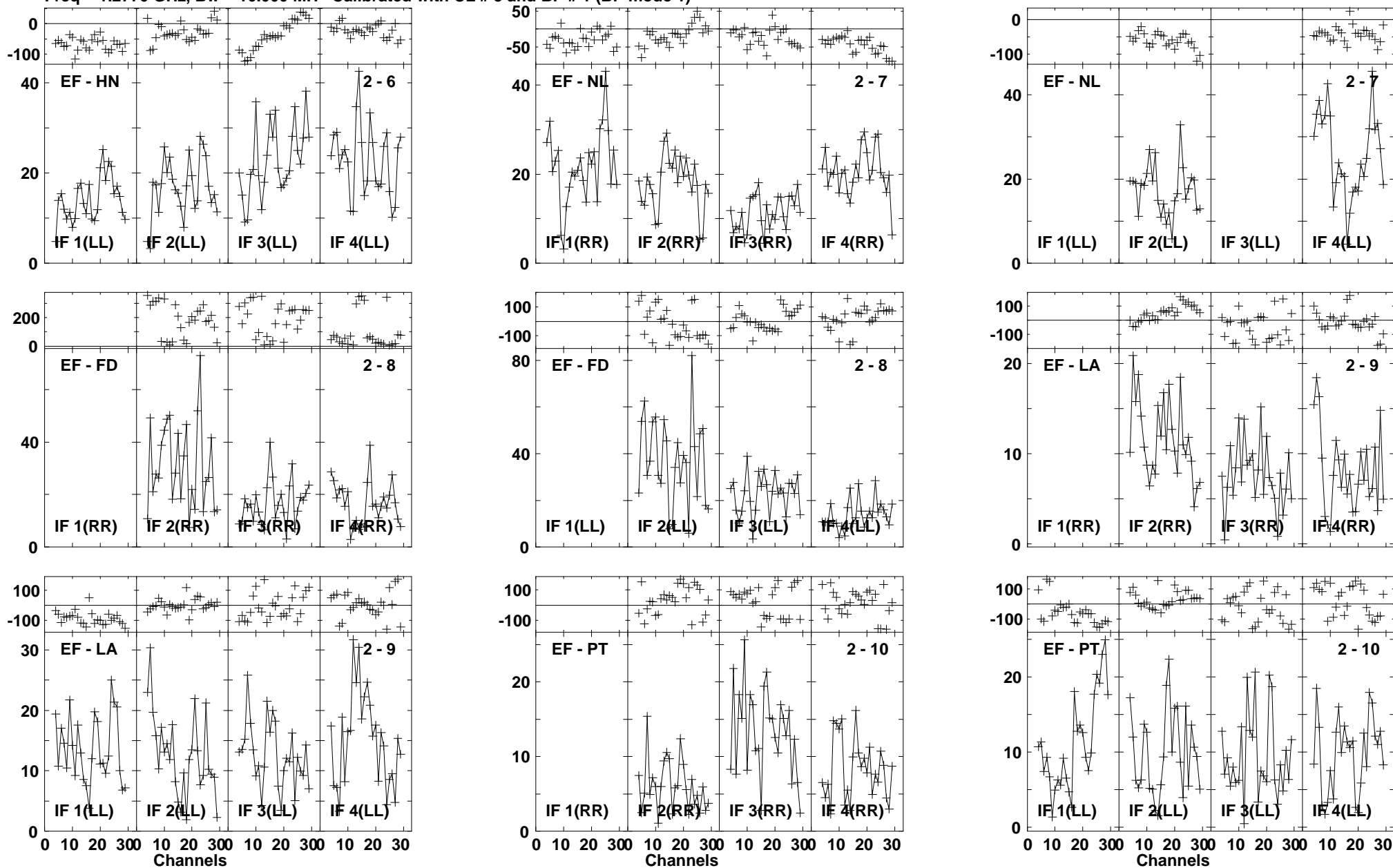

Lower frame: Milli Ampl Jy Top frame: Phas deg
Vector averaged cross-power spectrum Baseline: EF (02) - HN (06)
Timerange: 00/18:48:22 to 00/18:51:08

Plot file version 420 created 03-MAR-2016 01:13:08
 4C52 GN002C 1.UVDATA.1
 Freq = 1.2770 GHz, Bw = 16.000 MH Calibrated with CL # 3 and BP # 1 (BP mode 1)

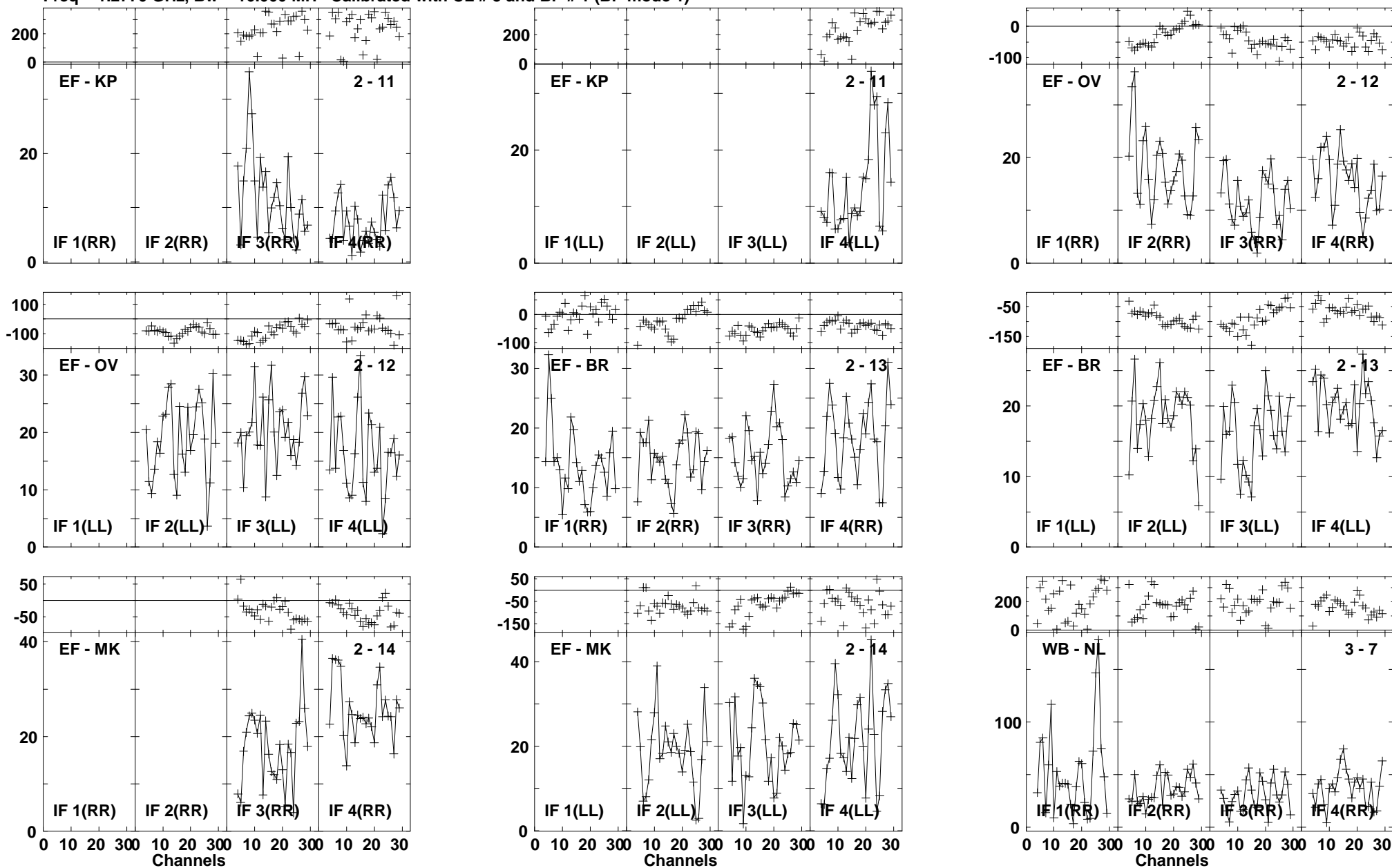

Lower frame: Milli Ampl Jy Top frame: Phas deg
 Vector averaged cross-power spectrum Baseline: EF (02) - KP (11)
 Timerange: 00:18:48:22 to 00:18:51:08

Plot file version 421 created 03-MAR-2016 01:13:08

4C52 GN002C 1.UVDATA.1

Freq = 1.2770 GHz, Bw = 16.000 MH Calibrated with CL # 3 and BP # 1 (BP mode 1)

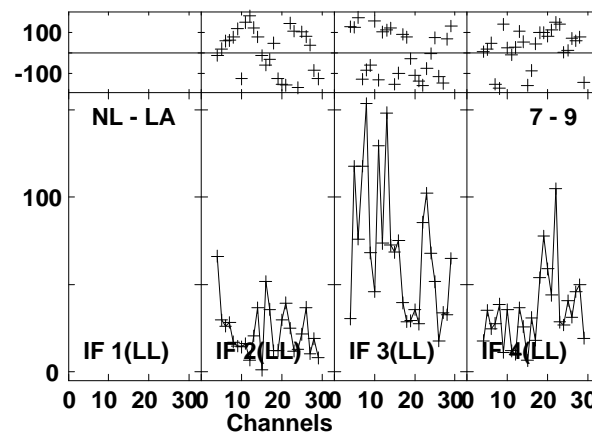
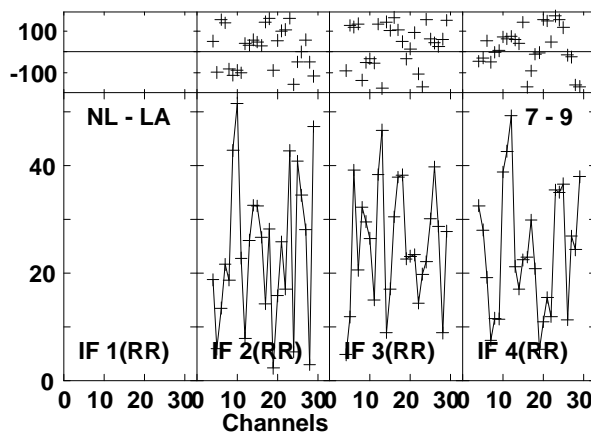
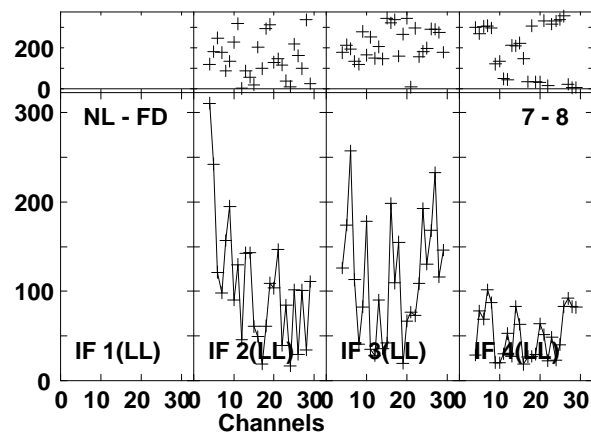
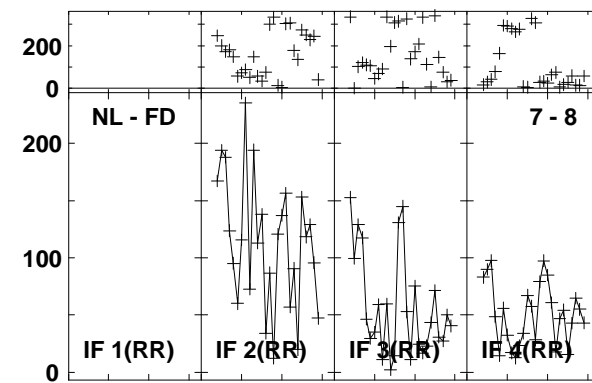
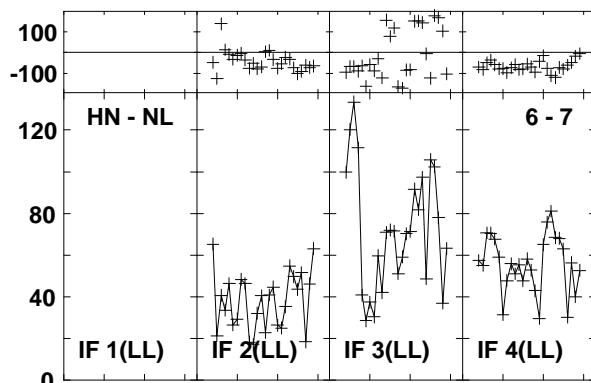
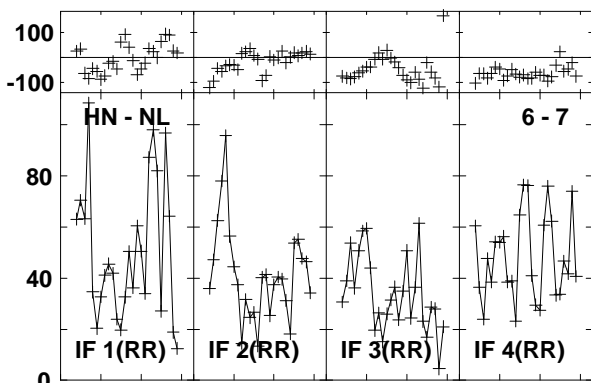
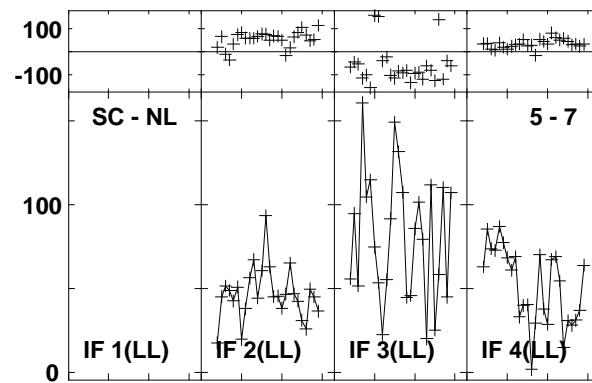
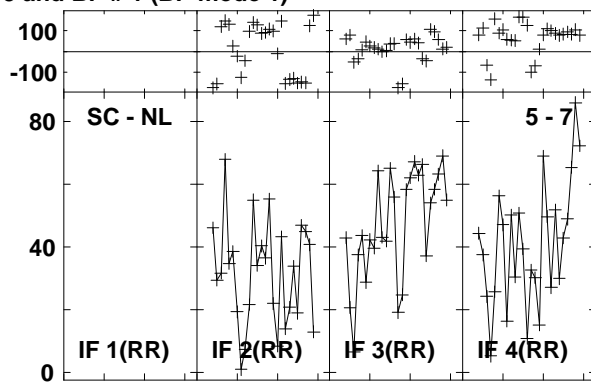
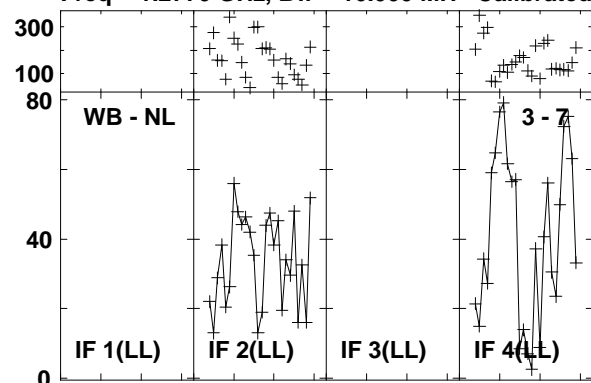

Lower frame: Milli Ampl Jy Top frame: Phas deg
Vector averaged cross-power spectrum Baseline: WB (03) - NL (07)
Timerange: 00/18:48:22 to 00/18:51:08

Plot file version 422 created 03-MAR-2016 01:13:08

4C52 GN002C 1.UVDATA.1

Freq = 1.2770 GHz, Bw = 16.000 MH Calibrated with CL # 3 and BP # 1 (BP mode 1)

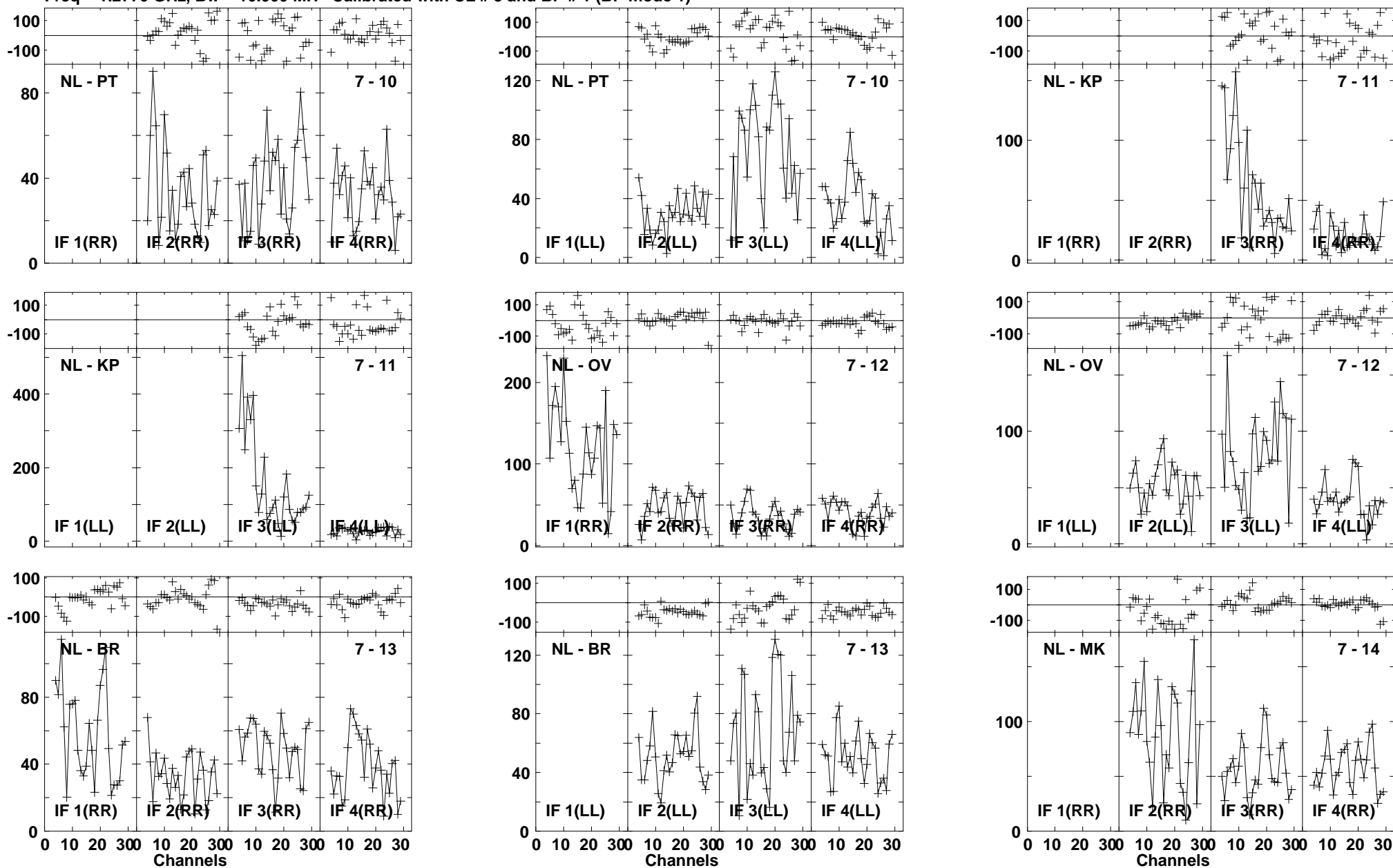

Lower frame: Milli Ampl Jy Top frame: Phas deg
Vector averaged cross-power spectrum Baseline: NL (07) - PT (10)
Timerange: 00/18:48:22 to 00/18:51:08

Plot file version 423 created 03-MAR-2016 01:13:08
4C52 GN002C 1.UVDATA.1
Freq = 1.2770 GHz, Bw = 16.000 MH Calibrated with CL # 3 and BP # 1 (BP mode 1)

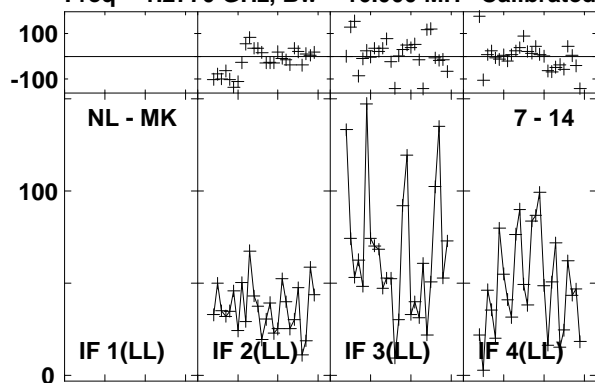

Lower frame: Milli Ampl Jy Top frame: Phas deg
Vector averaged cross-power spectrum Baseline: NL (07) - MK (14)
Timerange: 00/18:48:22 to 00/18:51:08

Plot file version 424 created 03-MAR-2016 01:13:09

J1545+5400 GN002C 1.UVDATA.1

Freq = 1.2770 GHz, Bw = 16.000 MH Calibrated with CL # 3 and BP # 1 (BP mode 1)

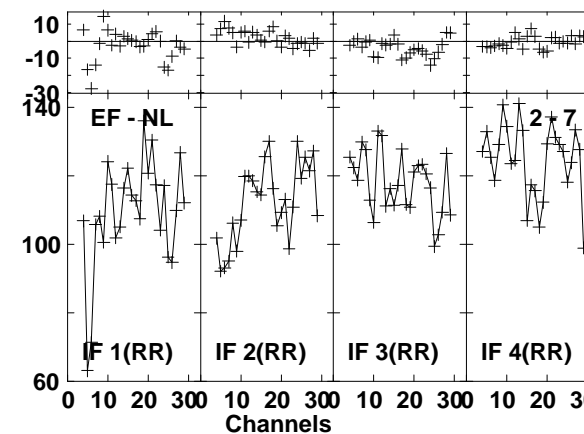
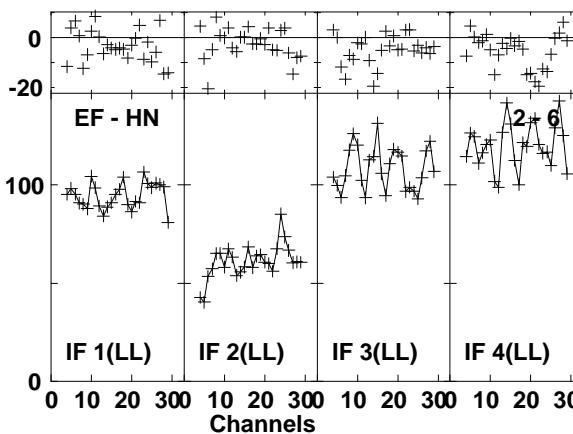
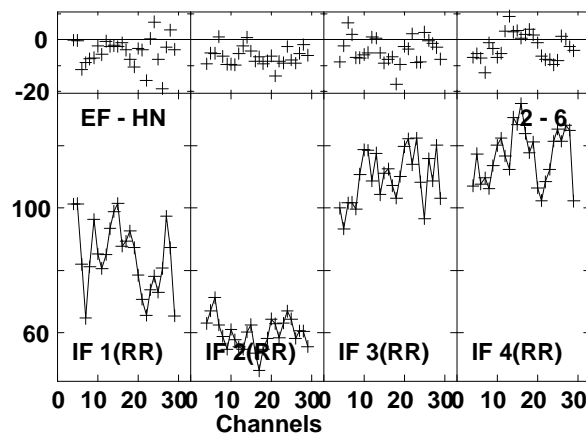
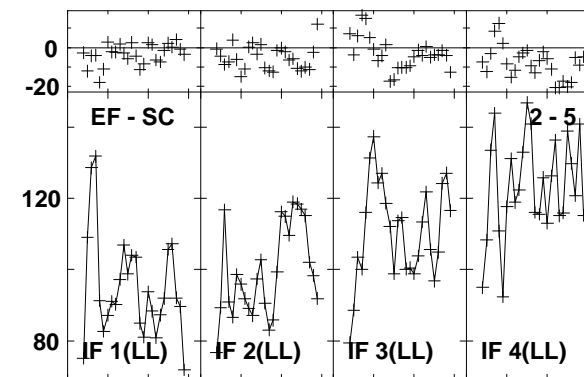
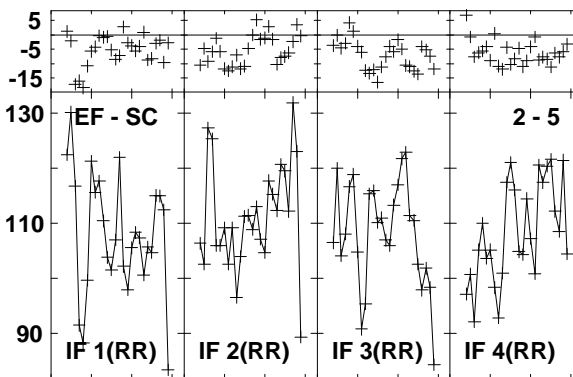
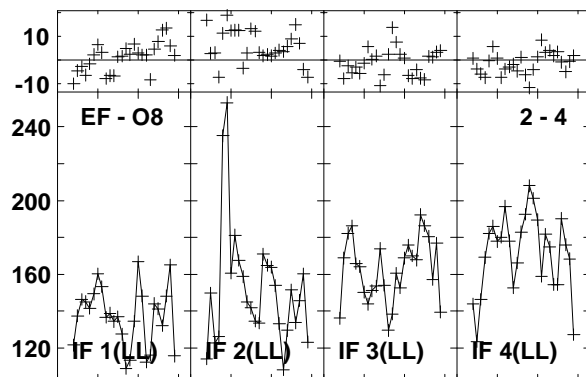
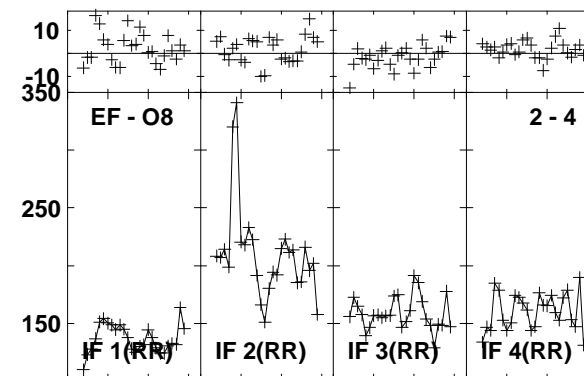
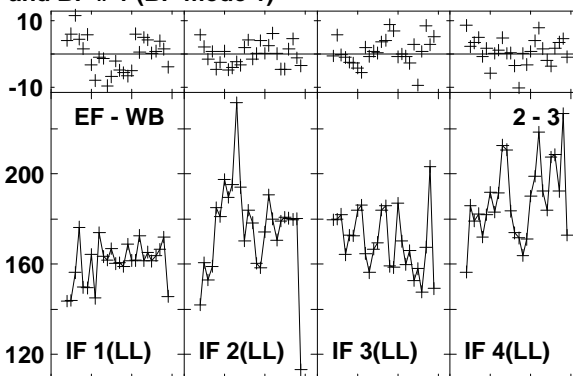
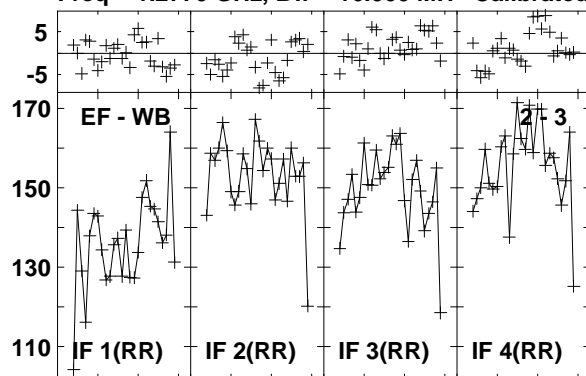

Lower frame: Milli Ampl Jy Top frame: Phas deg
Vector averaged cross-power spectrum Baseline: EF (02) - WB (03)
Timerange: 00/18:52:01 to 00/18:52:59

Plot file version 425 created 03-MAR-2016 01:13:09

J1545+5400 GN002C 1.UVDATA.1

Freq = 1.2770 GHz, Bw = 16.000 MH Calibrated with CL # 3 and BP # 1 (BP mode 1)

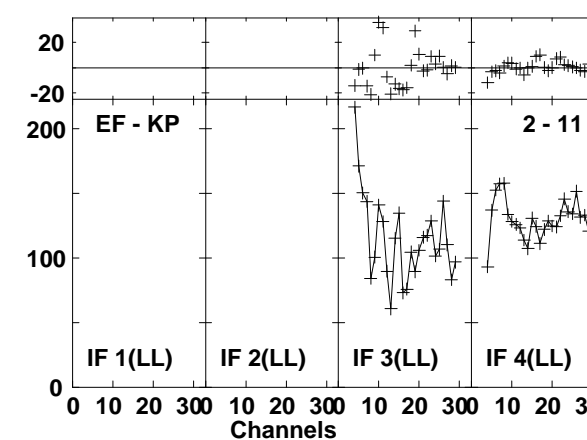
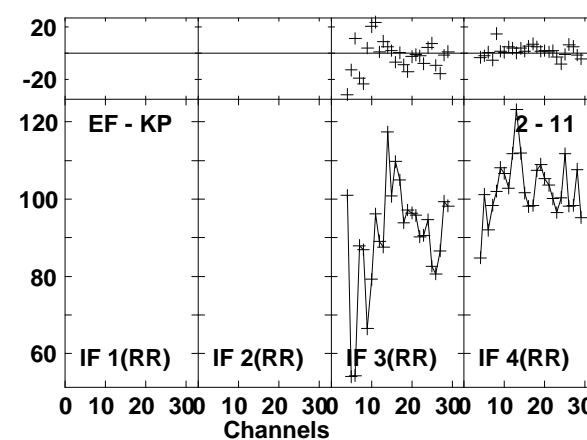
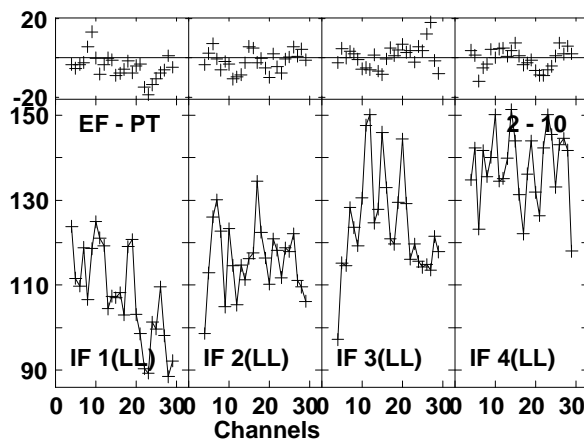
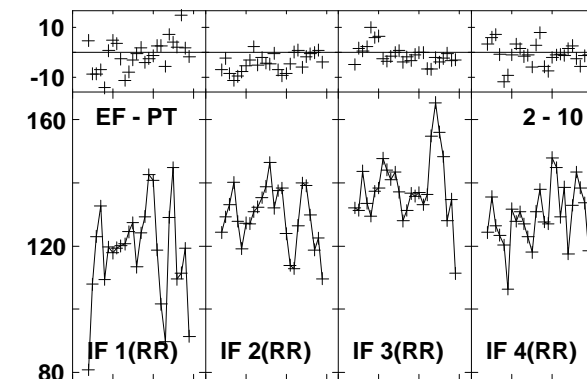
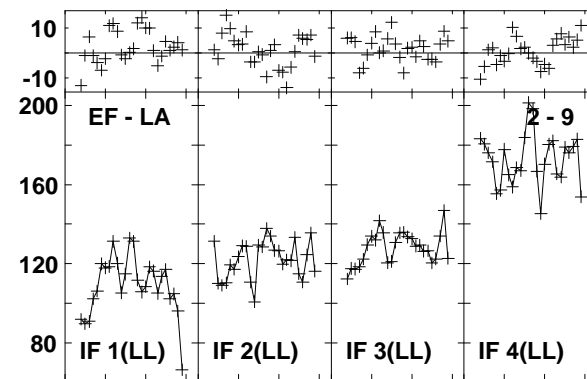
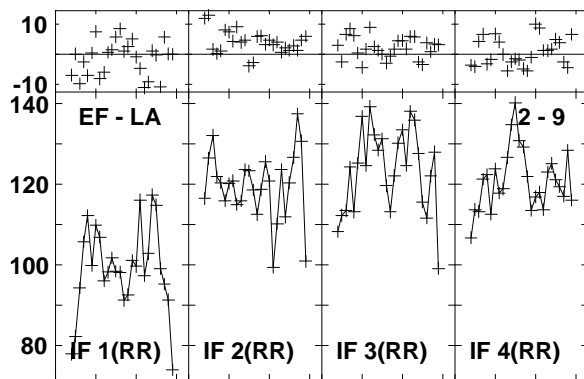
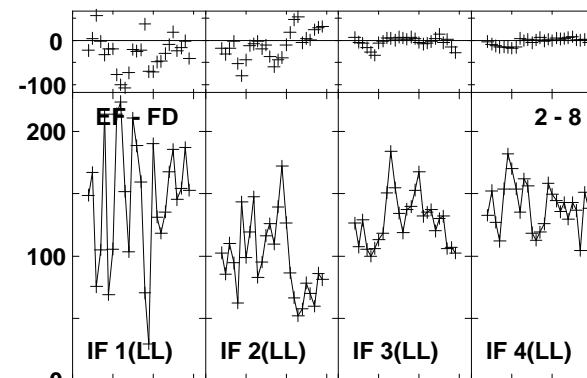
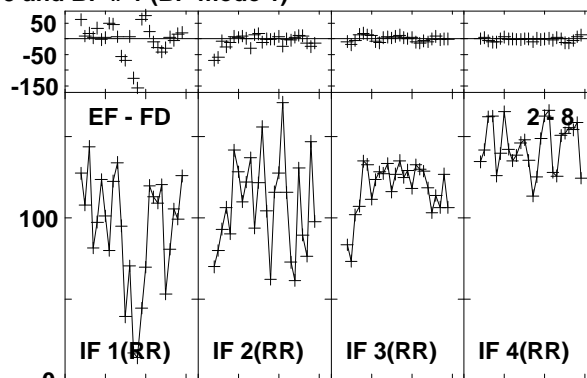
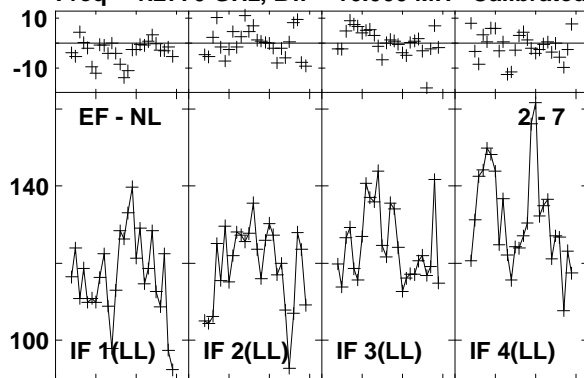

Lower frame: Milli Ampl Jy Top frame: Phas deg
Vector averaged cross-power spectrum Baseline: EF (02) - NL (07)
Timerange: 00/18:52:01 to 00/18:52:59

Plot file version 426 created 03-MAR-2016 01:13:09

J1545+5400 GN002C 1.UVDATA.1

Freq = 1.2770 GHz, Bw = 16.000 MH Calibrated with CL # 3 and BP # 1 (BP mode 1)

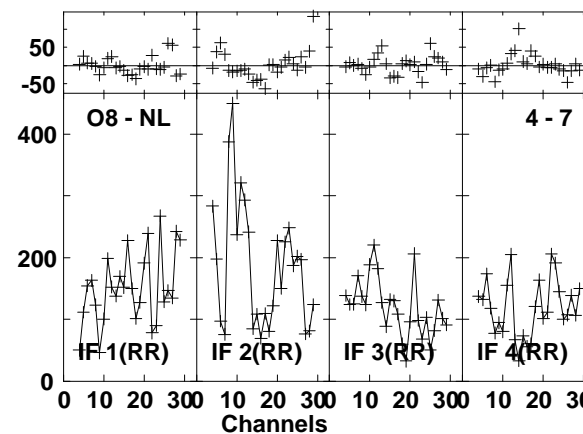
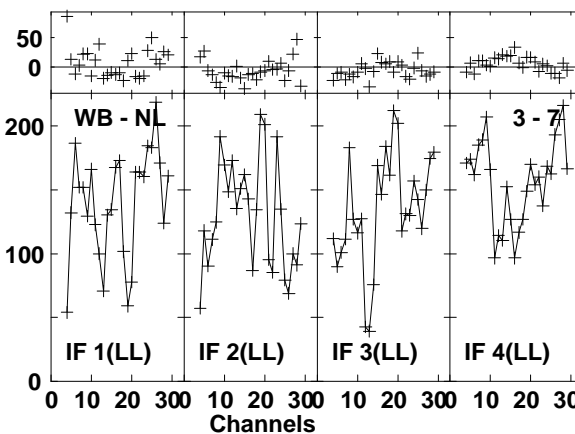
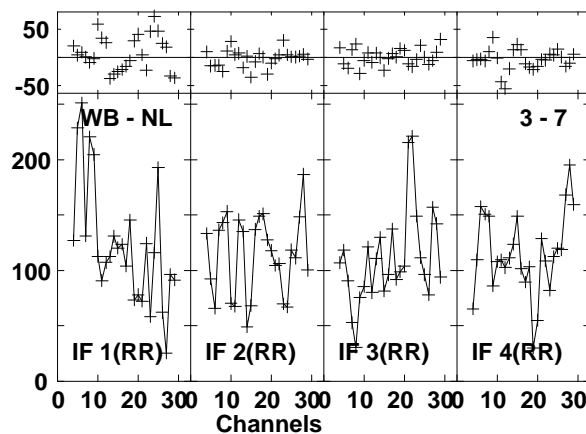
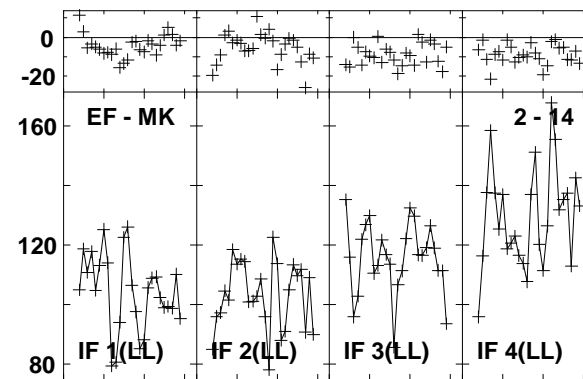
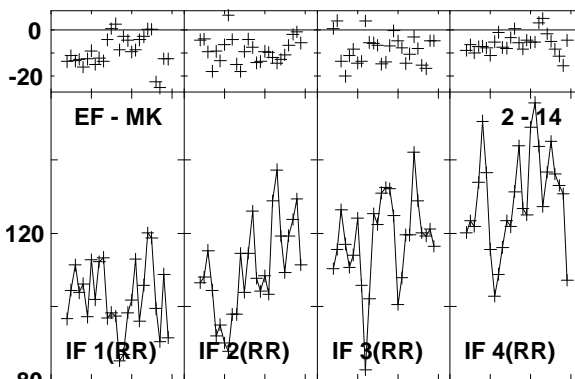
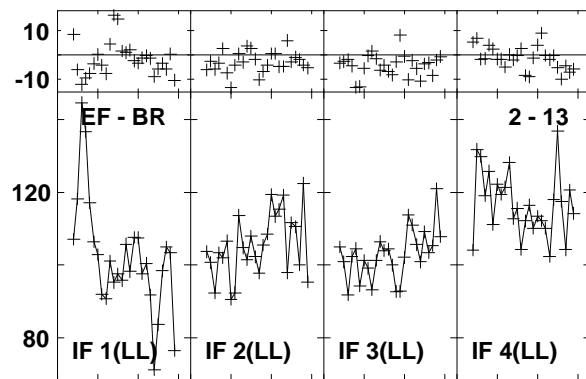
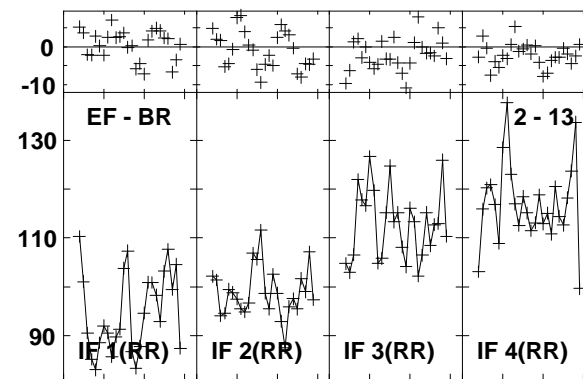
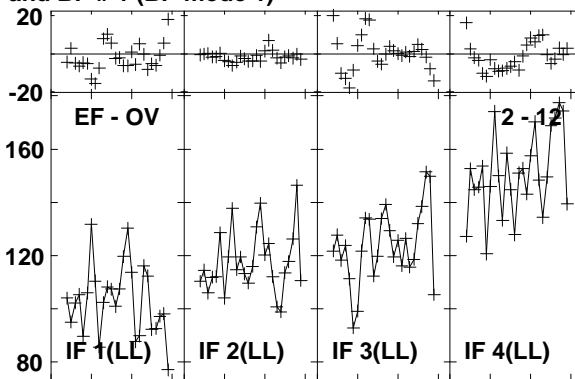
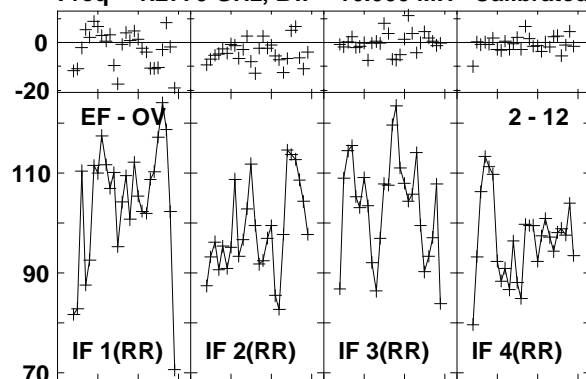

Lower frame: Milli Ampl Jy Top frame: Phas deg
Vector averaged cross-power spectrum Baseline: EF (02) - OV (12)
Timerange: 00/18:52:01 to 00/18:52:59

Plot file version 427 created 03-MAR-2016 01:13:09

J1545+5400 GN002C 1.UVDATA.1

Freq = 1.2770 GHz, Bw = 16.000 MH Calibrated with CL # 3 and BP # 1 (BP mode 1)

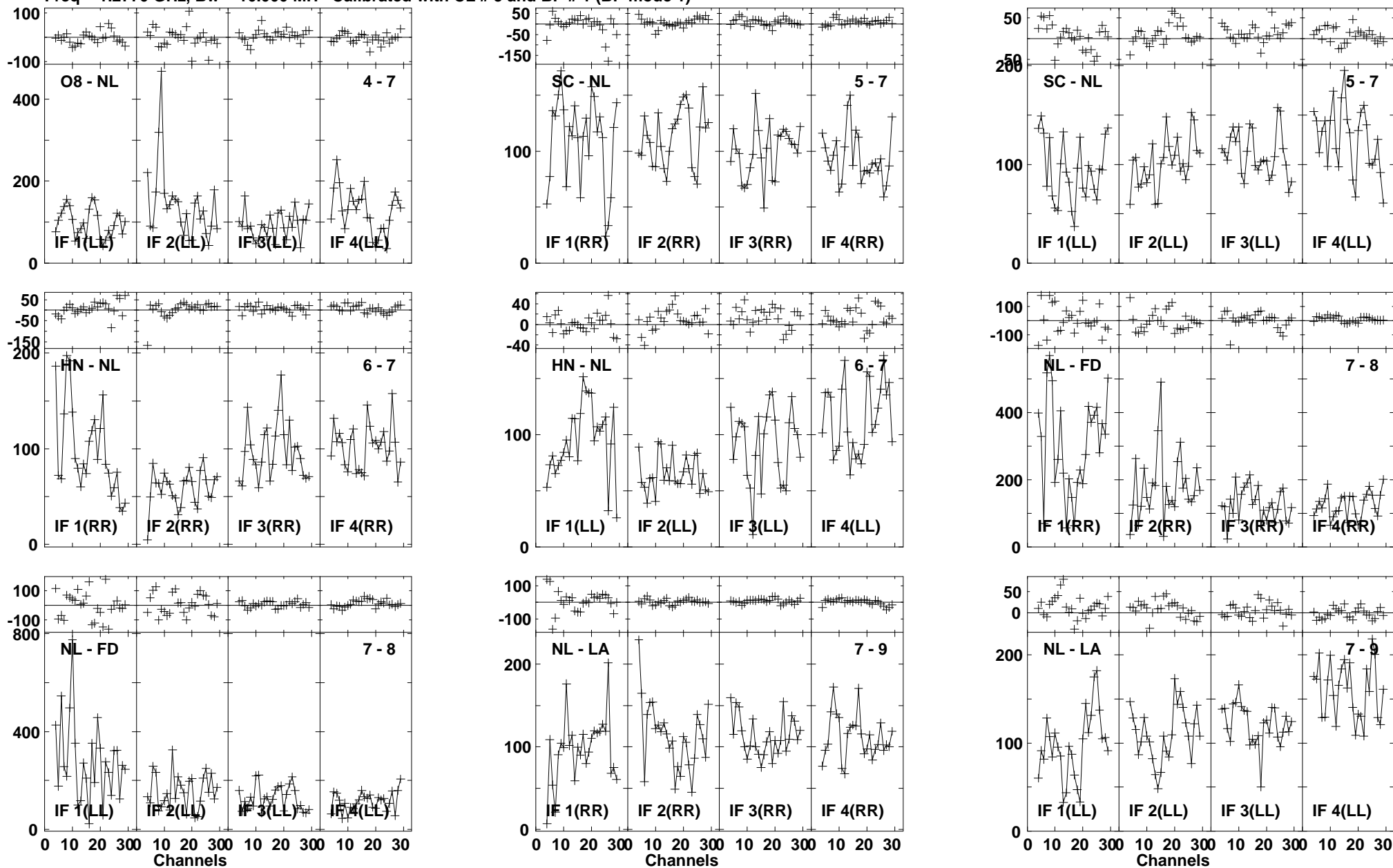

Lower frame: Milli Ampl Jy Top frame: Phas deg
Vector averaged cross-power spectrum Baseline: O8 (04) - NL (07)
Timerange: 00/18:52:01 to 00/18:52:59

Plot file version 428 created 03-MAR-2016 01:13:09

J1545+5400 GN002C 1.UVDATA.1

Freq = 1.2770 GHz, Bw = 16.000 MH Calibrated with CL # 3 and BP # 1 (BP mode 1)

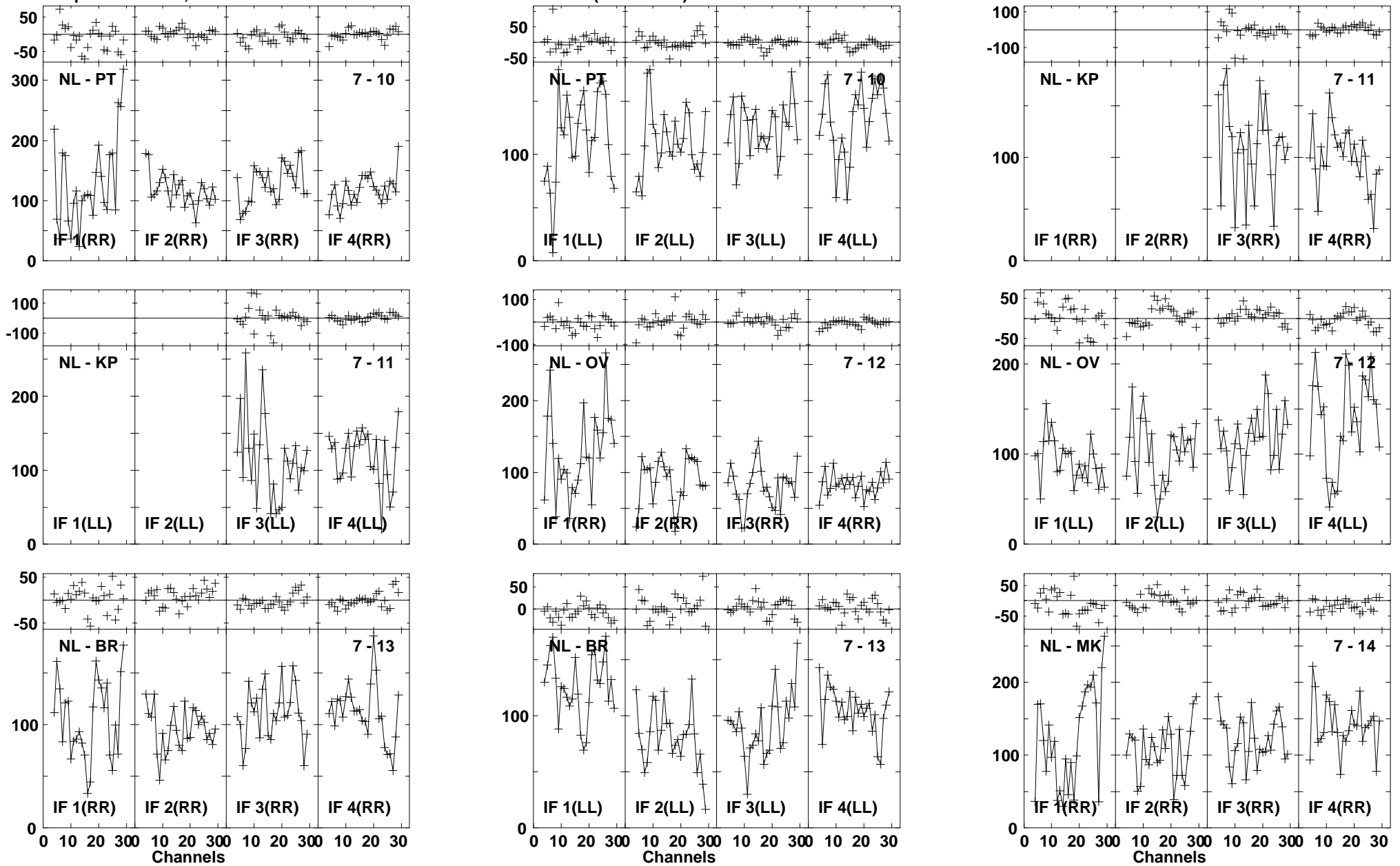

Lower frame: Milli Ampl Jy Top frame: Phas deg
Vector averaged cross-power spectrum Baseline: NL (07) - PT (10)
Timerange: 00:18:52:01 to 00:18:52:59

Plot file version 429 created 03-MAR-2016 01:13:09
J1545+5400 GN002C 1.UVDATA.1
Freq = 1.2770 GHz, Bw = 16.000 MH Calibrated with CL # 3 and BP # 1 (BP mode 1)

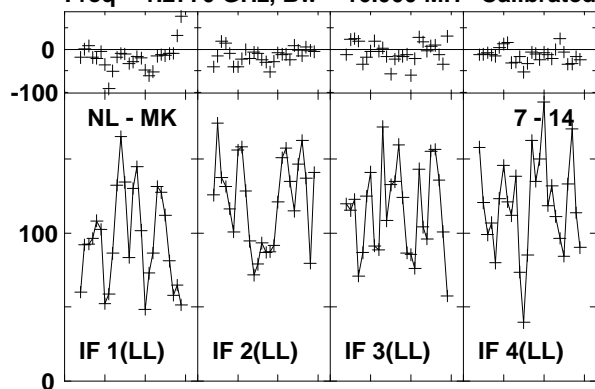

Lower frame: Milli Ampl Jy Top frame: Phas deg
Vector averaged cross-power spectrum Baseline: NL (07) - MK (14)
Timerange: 00/18:52:01 to 00/18:52:59

Plot file version 430 created 03-MAR-2016 01:13:09

4C52 GN002C 1.UVDATA.1

Freq = 1.2770 GHz, Bw = 16.000 MH Calibrated with CL # 3 and BP # 1 (BP mode 1)

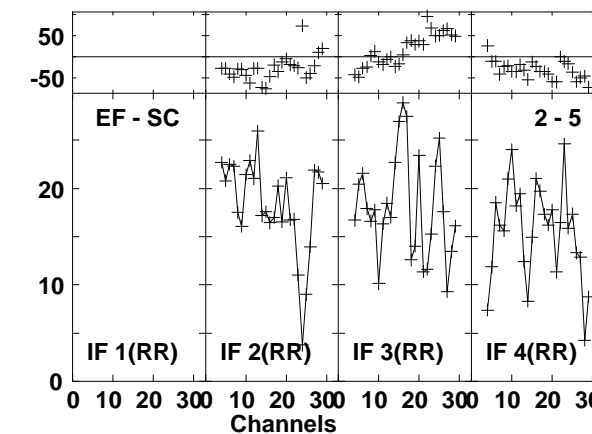
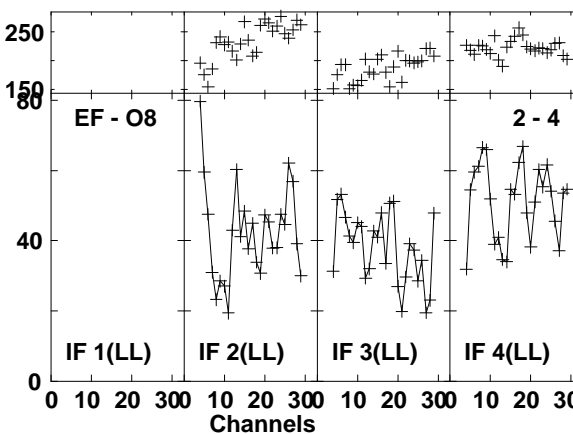
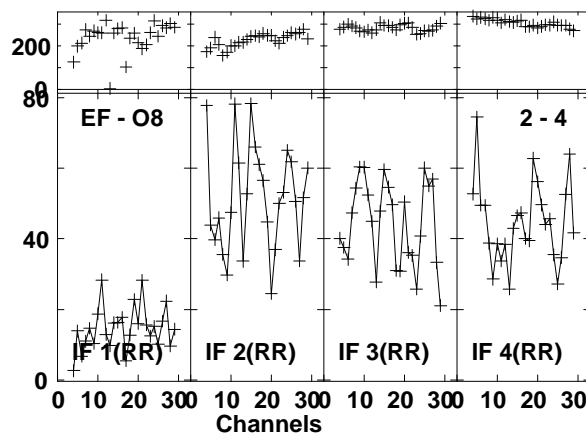
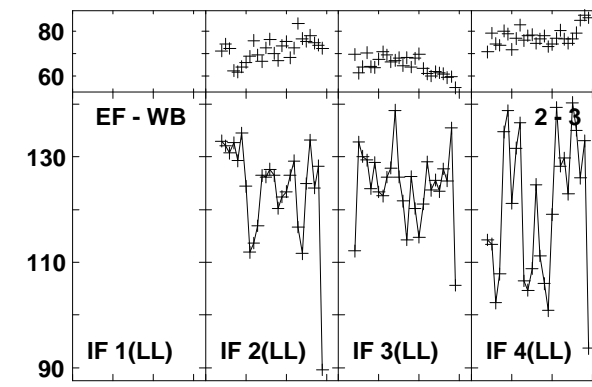
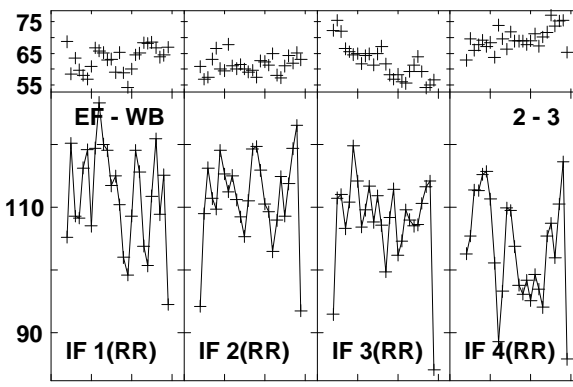
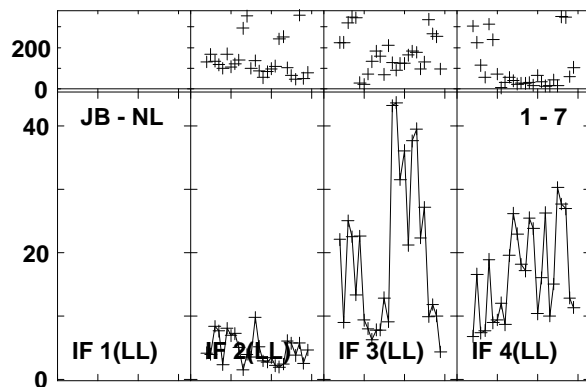
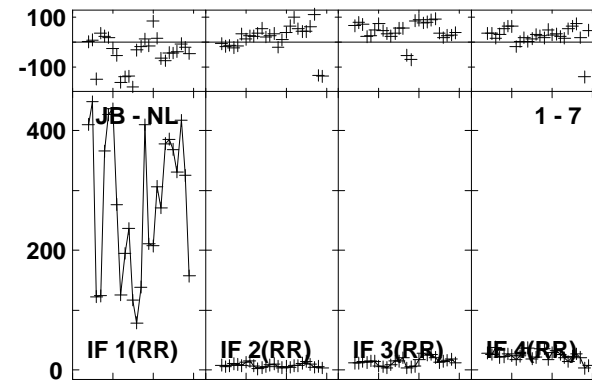
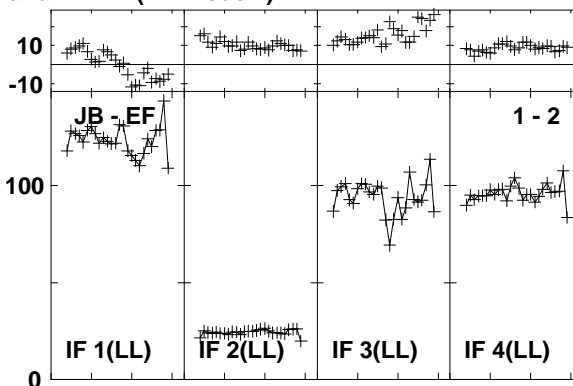
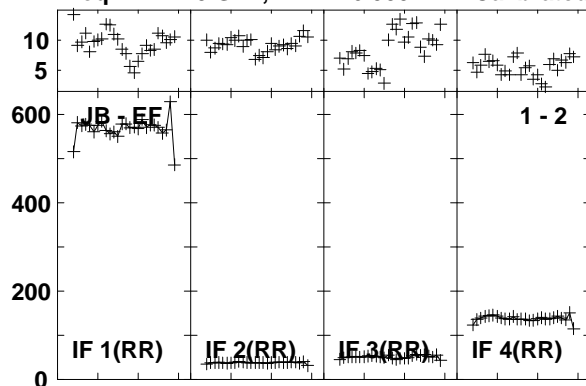

Lower frame: Milli Ampl Jy Top frame: Phas deg
Vector averaged cross-power spectrum Baseline: JB (01) - EF (02)
Timerange: 00/18:53:04 to 00/18:55:58

Plot file version 431 created 03-MAR-2016 01:13:10

4C52 GN002C 1.UVDATA.1

Freq = 1.2770 GHz, Bw = 16.000 MH Calibrated with CL # 3 and BP # 1 (BP mode 1)

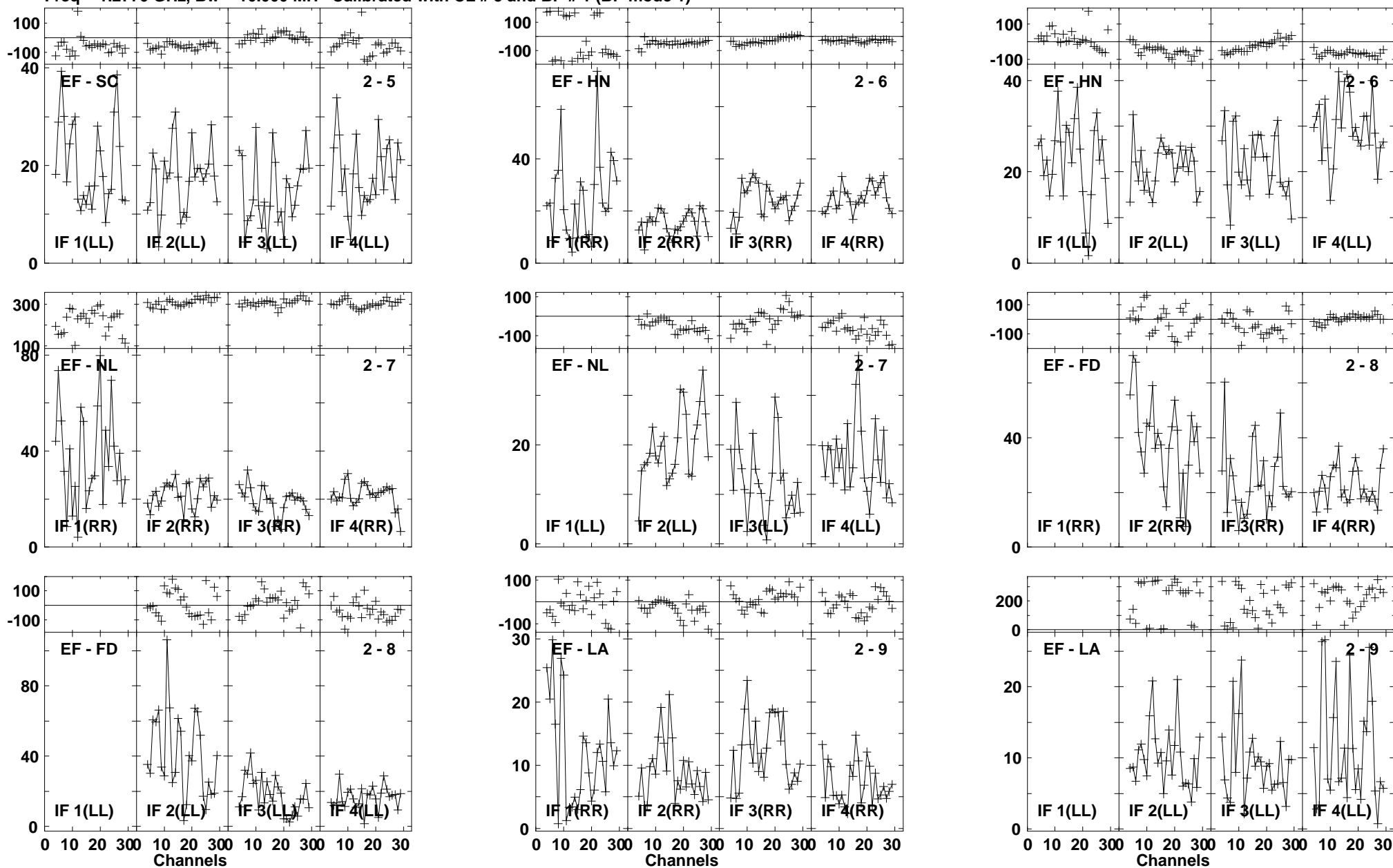

Lower frame: Milli Ampl Jy Top frame: Phas deg
Vector averaged cross-power spectrum Baseline: EF (02) - SC (05)
Timerange: 00/18:53:04 to 00/18:55:58

Plot file version 432 created 03-MAR-2016 01:13:10

4C52 GN002C 1.UVDATA.1

Freq = 1.2770 GHz, Bw = 16.000 MH Calibrated with CL # 3 and BP # 1 (BP mode 1)

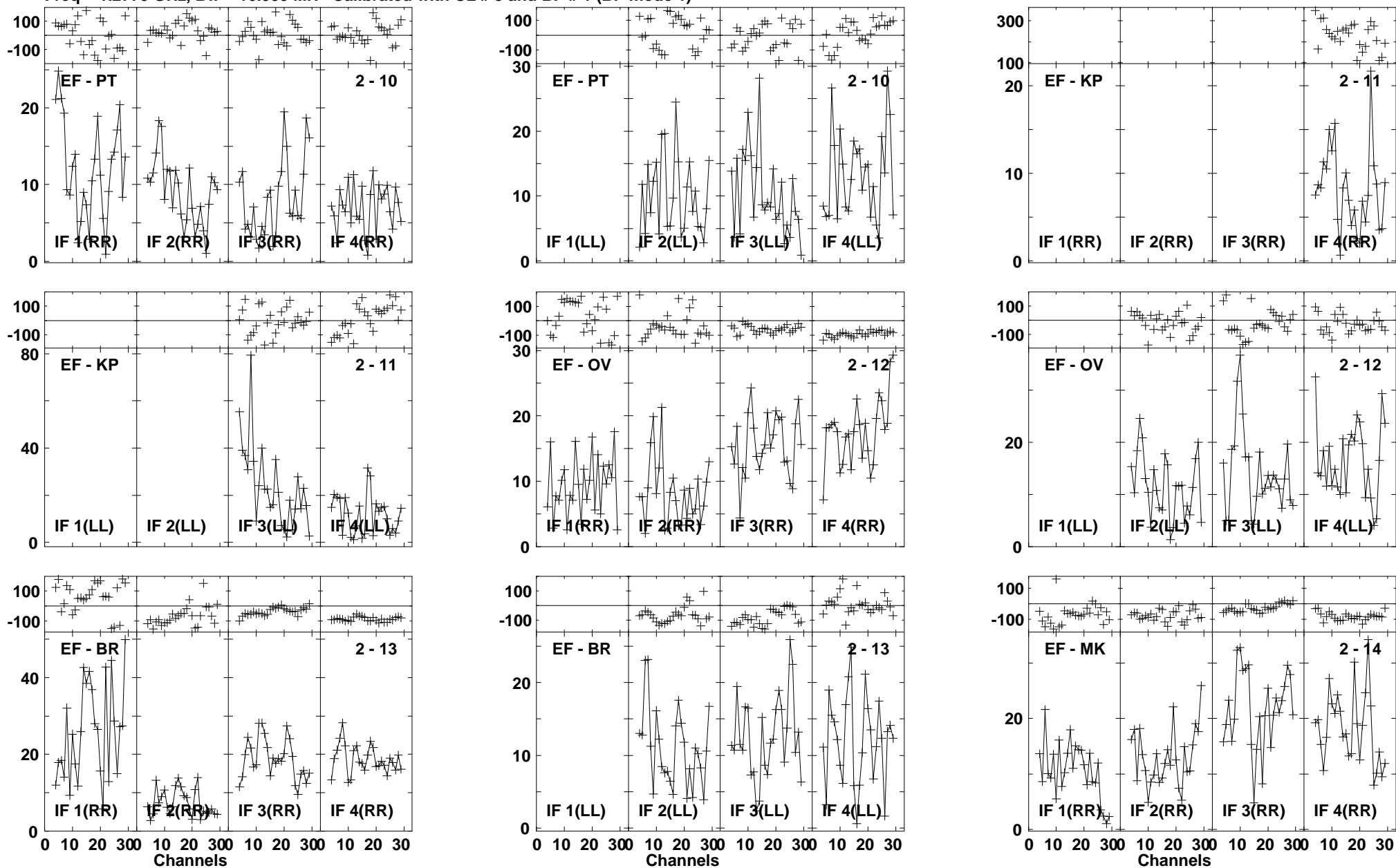

Lower frame: Milli Ampl Jy Top frame: Phas deg
Vector averaged cross-power spectrum Baseline: EF (02) - PT (10)
Timerange: 00/18:53:04 to 00/18:55:58

Plot file version 433 created 03-MAR-2016 01:13:10

4C52 GN002C 1.UVDATA.1

Freq = 1.2770 GHz, Bw = 16.000 MH Calibrated with CL # 3 and BP # 1 (BP mode 1)

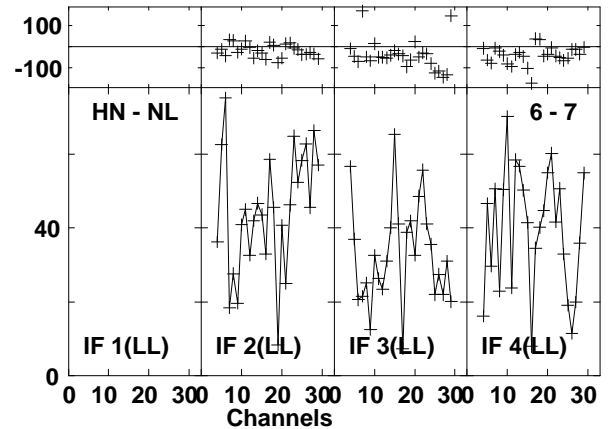
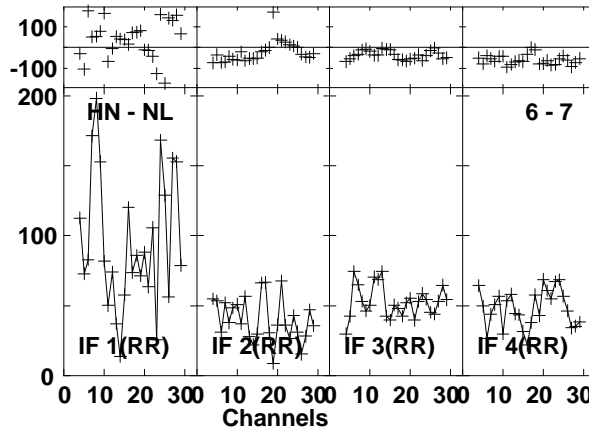
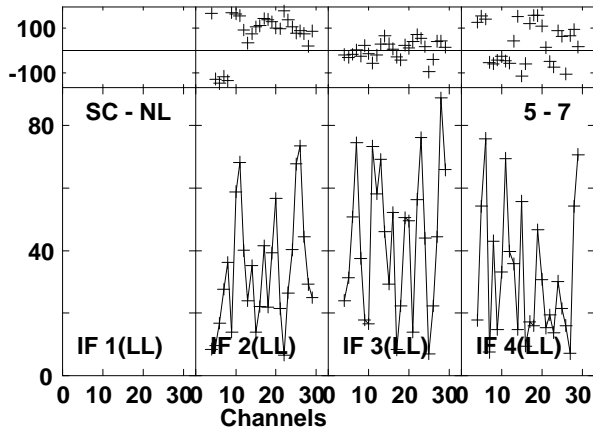
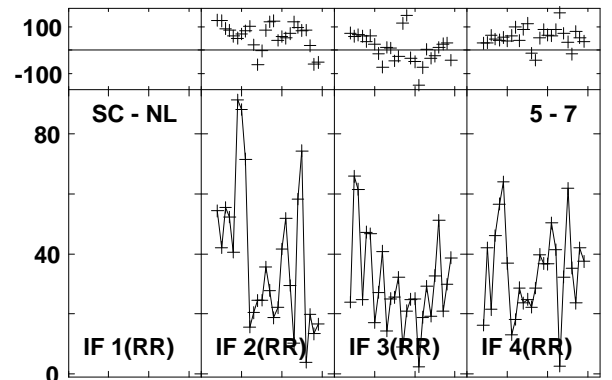
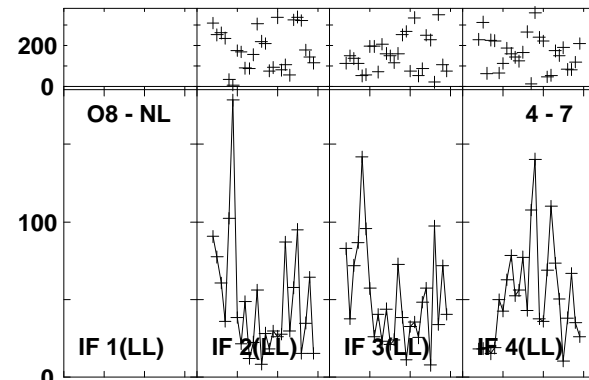
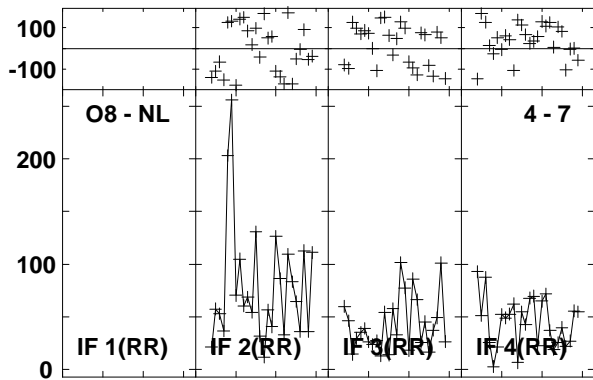
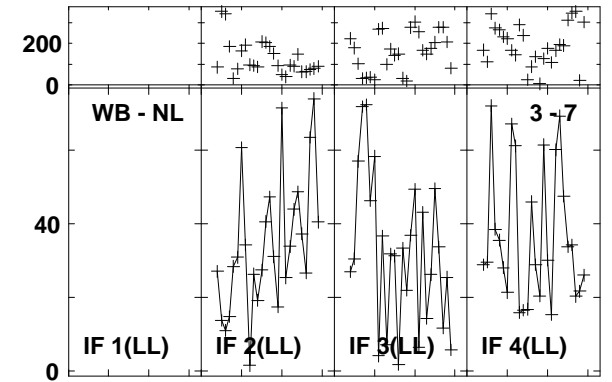
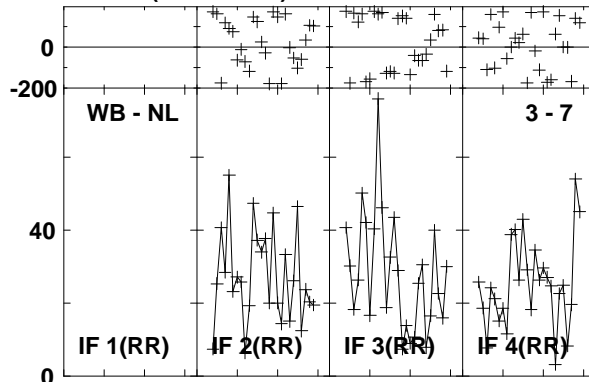
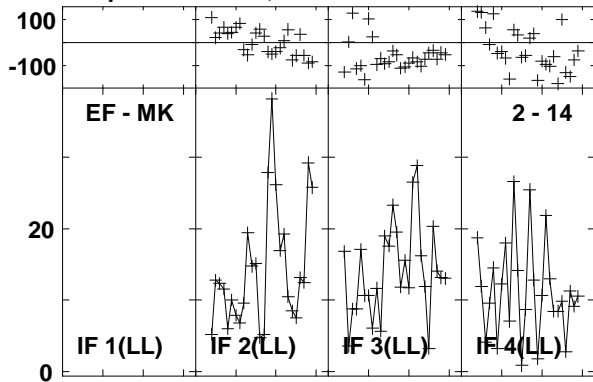

Lower frame: Milli Ampl Jy Top frame: Phas deg
Vector averaged cross-power spectrum Baseline: EF (02) - MK (14)
Timerange: 00/18:53:04 to 00/18:55:58

Plot file version 434 created 03-MAR-2016 01:13:10

4C52 GN002C 1.UVDATA.1

Freq = 1.2770 GHz, Bw = 16.000 MH Calibrated with CL # 3 and BP # 1 (BP mode 1)

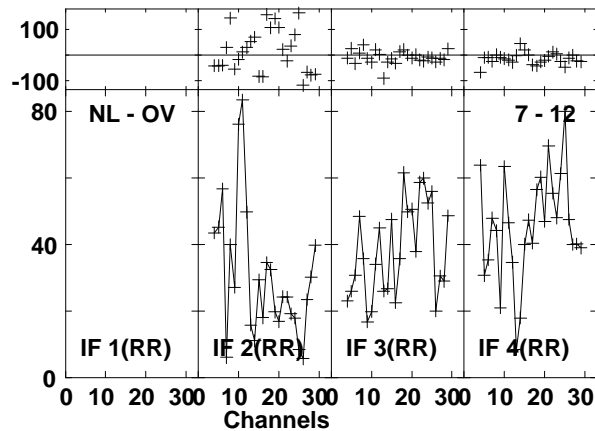
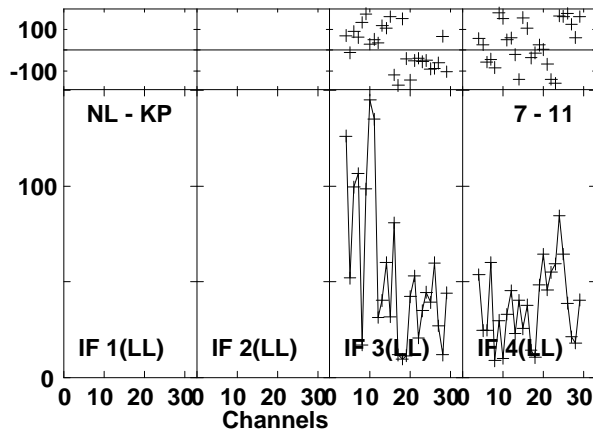
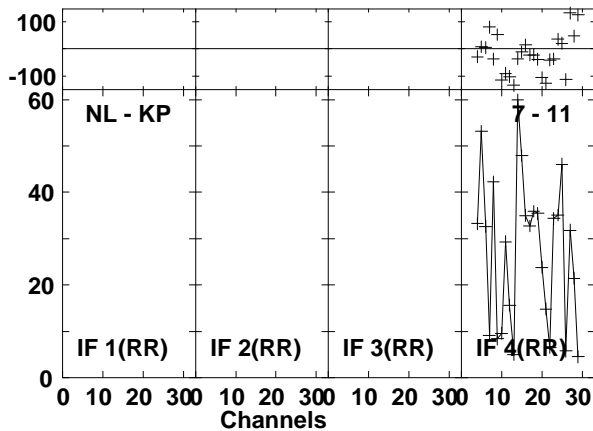
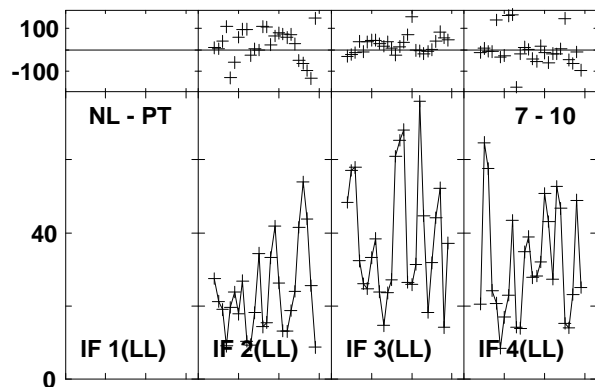
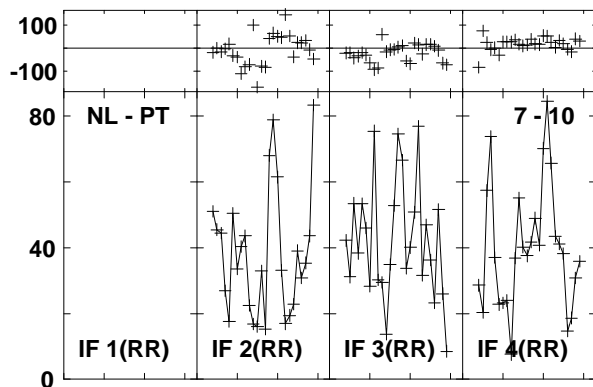
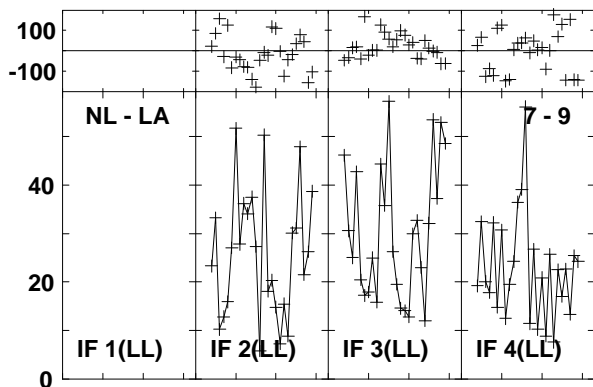
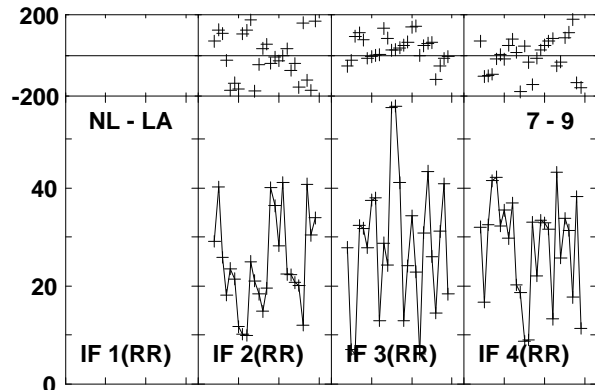
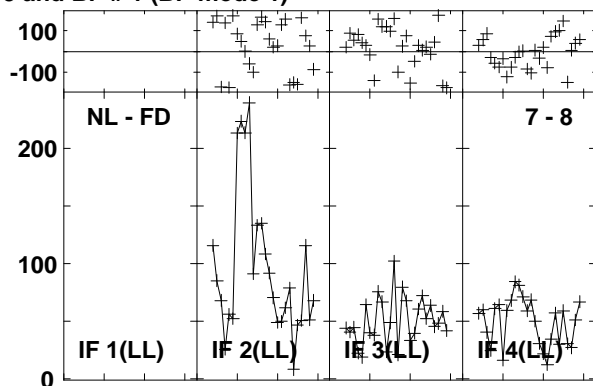
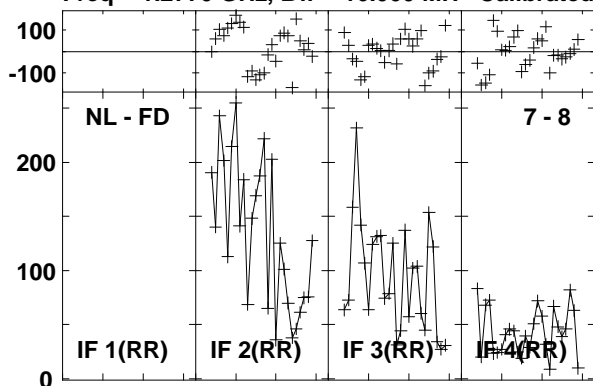

Lower frame: Milli Ampl Jy Top frame: Phas deg
Vector averaged cross-power spectrum Baseline: NL (07) - FD (08)
Timerange: 00/18:53:04 to 00/18:55:58

Plot file version 435 created 03-MAR-2016 01:13:10

4C52 GN002C 1.UVDATA.1

Freq = 1.2770 GHz, Bw = 16.000 MH Calibrated with CL # 3 and BP # 1 (BP mode 1)

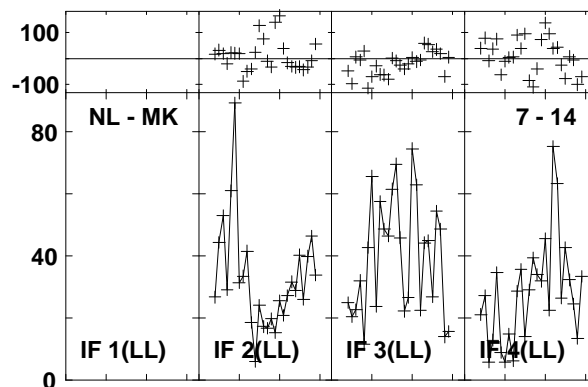
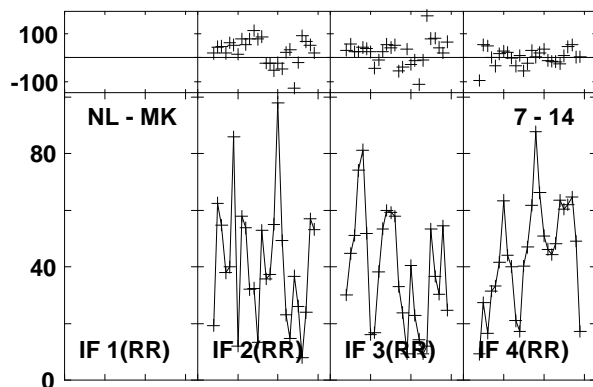
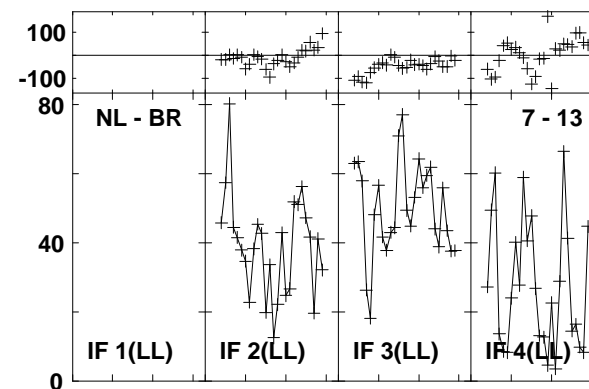
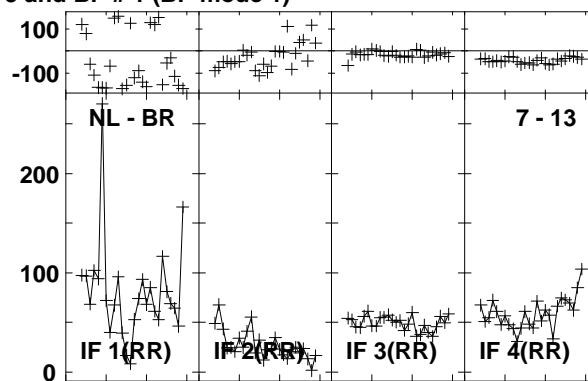
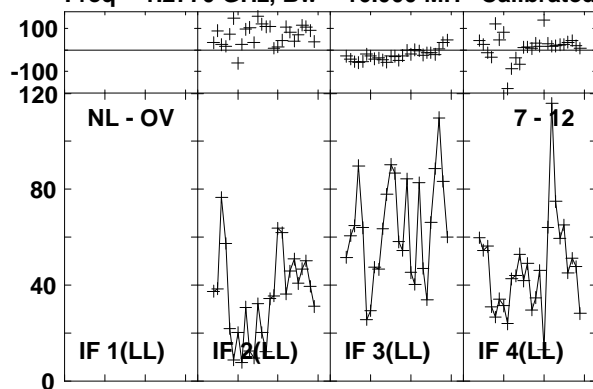

Lower frame: Milli Ampl Jy Top frame: Phas deg
Vector averaged cross-power spectrum Baseline: NL (07) - OV (12)
Timerange: 00/18:53:04 to 00/18:55:58

Plot file version 436 created 03-MAR-2016 01:13:10

J1545+5400 GN002C 1.UVDATA.1

Freq = 1.2770 GHz, Bw = 16.000 MH Calibrated with CL # 3 and BP # 1 (BP mode 1)

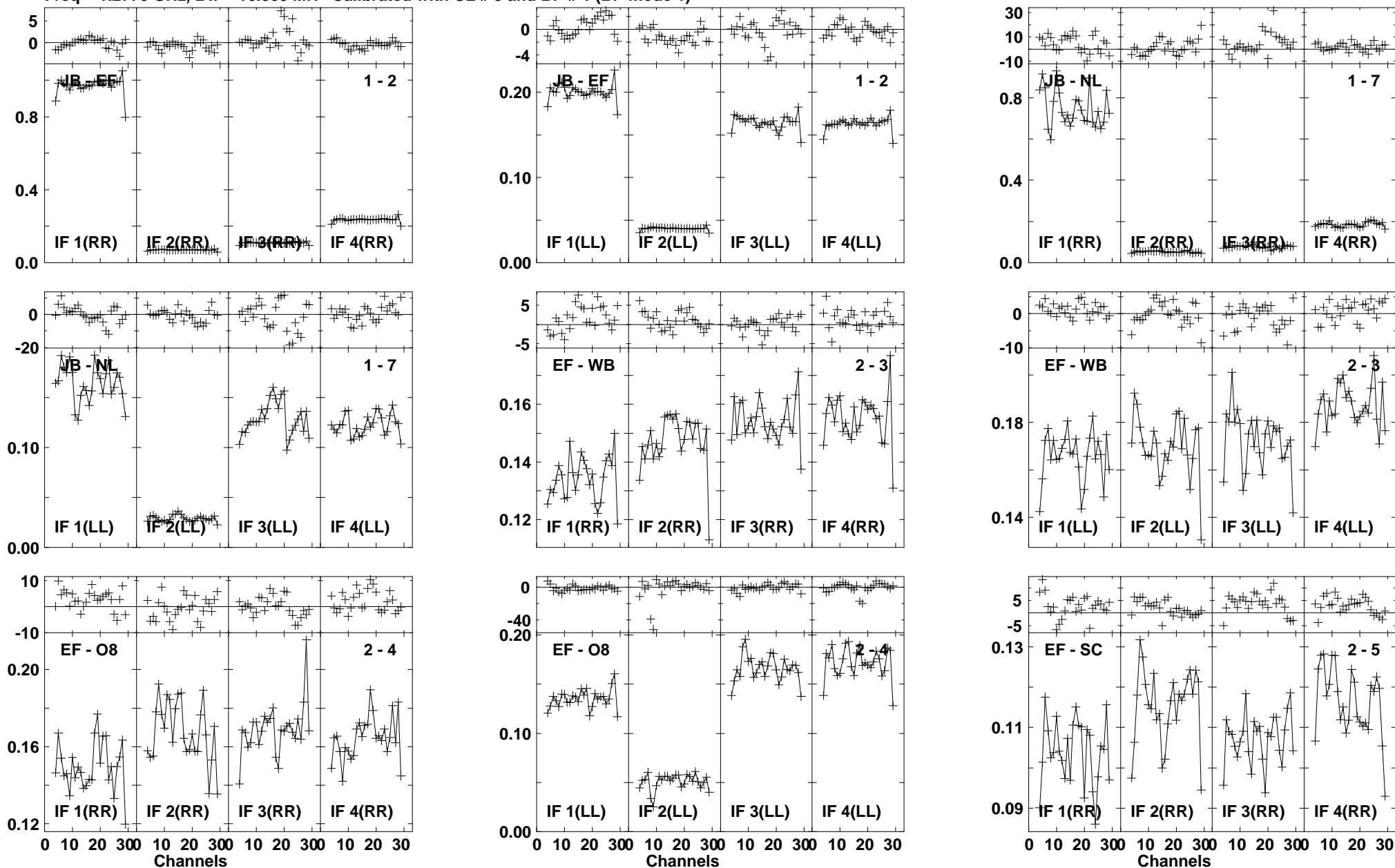

Lower frame: Ampl Jy Top frame: Phas deg
Vector averaged cross-power spectrum Baseline: JB (01) - EF (02)
Timerange: 00/18:56:51 to 00/18:58:49

Plot file version 437 created 03-MAR-2016 01:13:11

J1545+5400 GN002C 1.UVDATA.1

Freq = 1.2770 GHz, Bw = 16.000 MH Calibrated with CL # 3 and BP # 1 (BP mode 1)

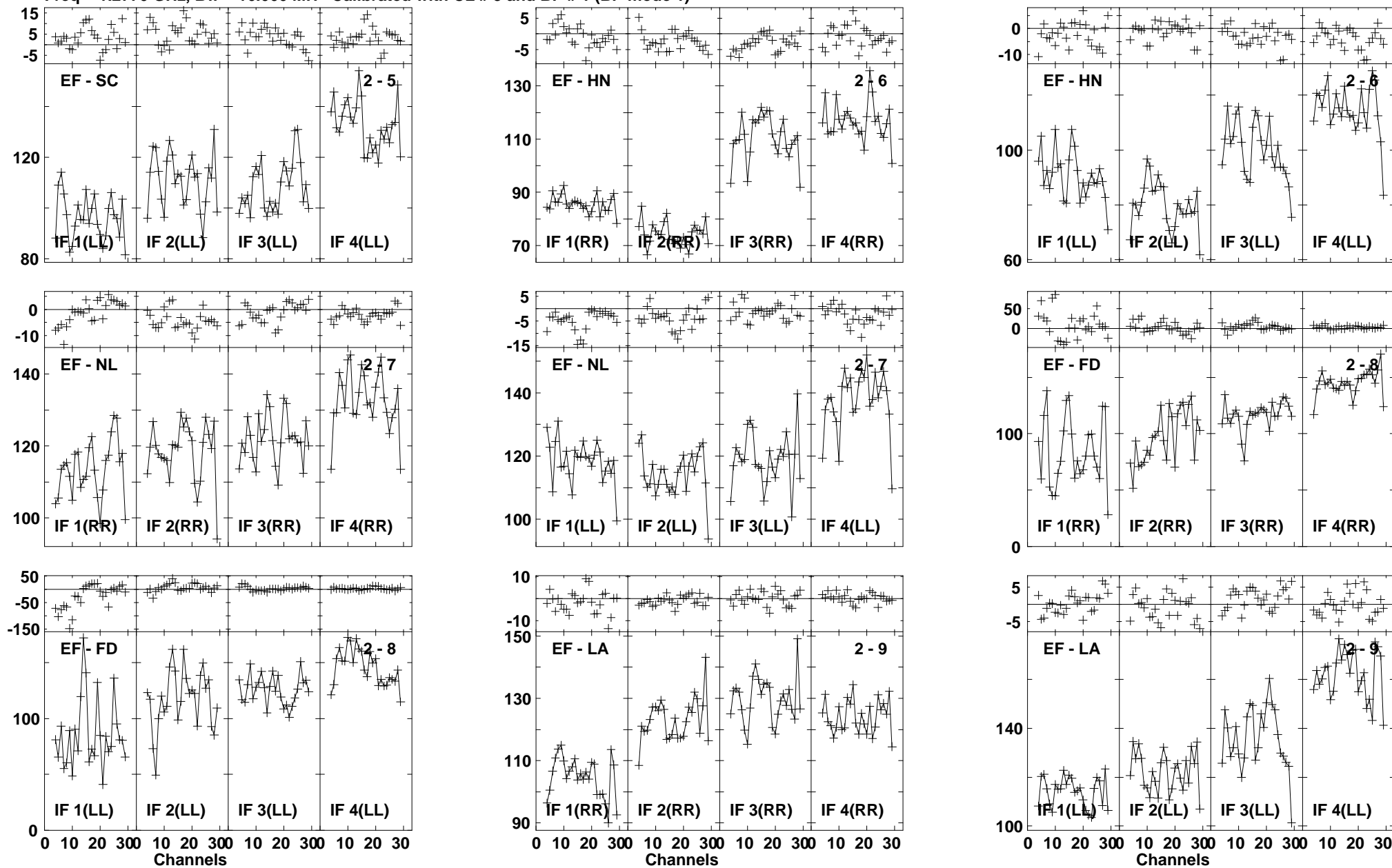

Lower frame: Milli Ampl Jy Top frame: Phas deg
Vector averaged cross-power spectrum Baseline: EF (02) - SC (05)
Timerange: 00/18:56:51 to 00/18:58:49

Plot file version 438 created 03-MAR-2016 01:13:11

J1545+5400 GN002C 1.UVDATA.1

Freq = 1.2770 GHz, Bw = 16.000 MH Calibrated with CL # 3 and BP # 1 (BP mode 1)

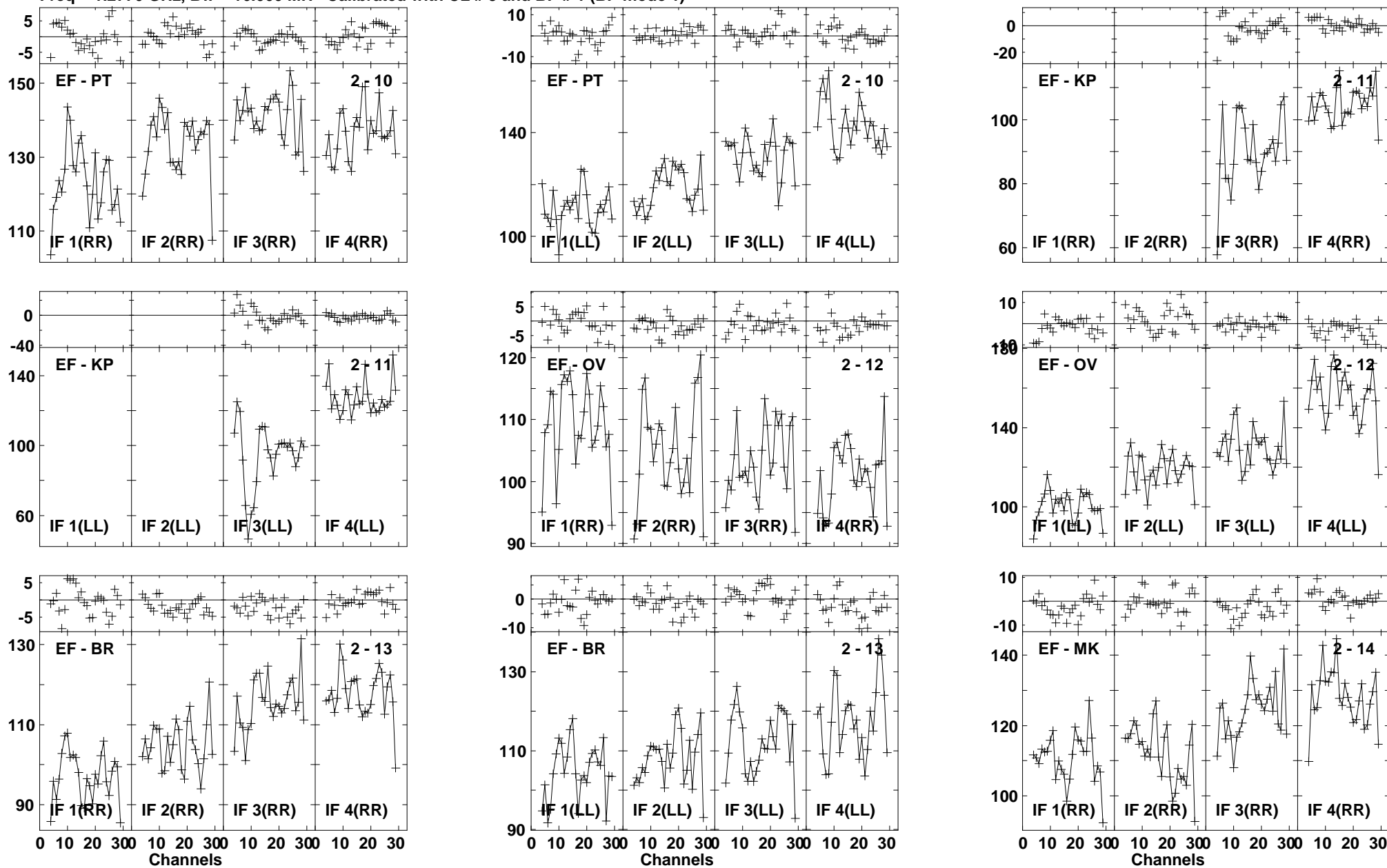

Plot file version 439 created 03-MAR-2016 01:13:11

J1545+5400 GN002C 1.UVDATA.1

Freq = 1.2770 GHz, Bw = 16.000 MH Calibrated with CL # 3 and BP # 1 (BP mode 1)

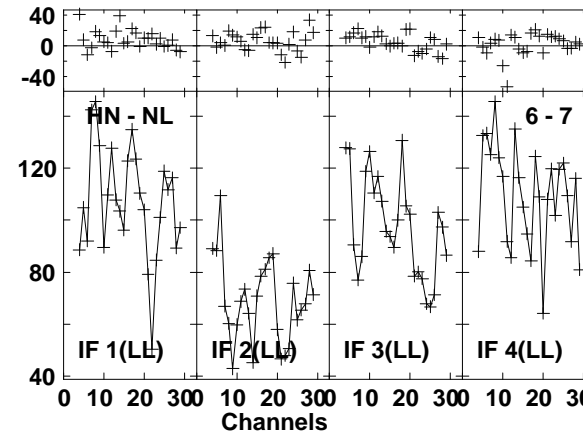
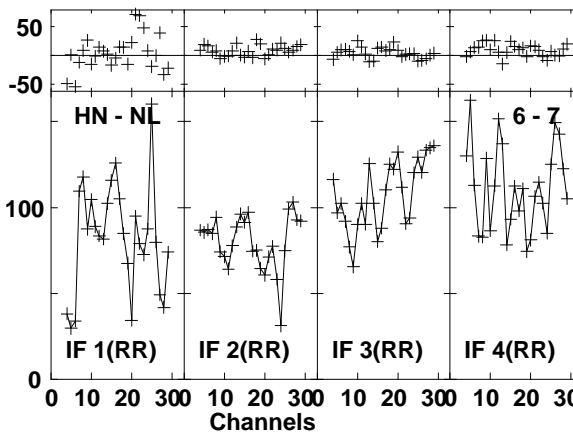
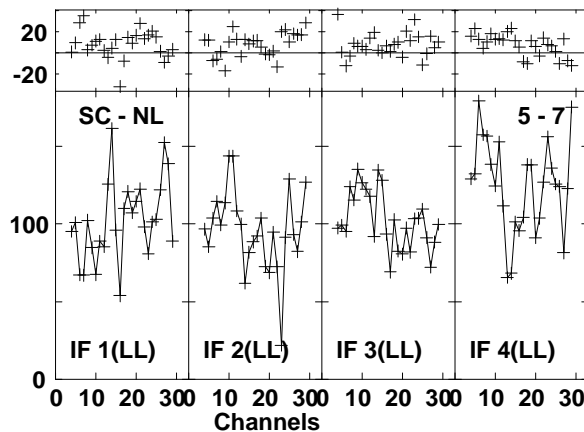
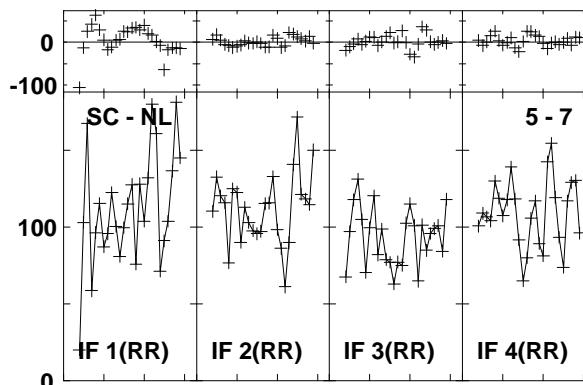
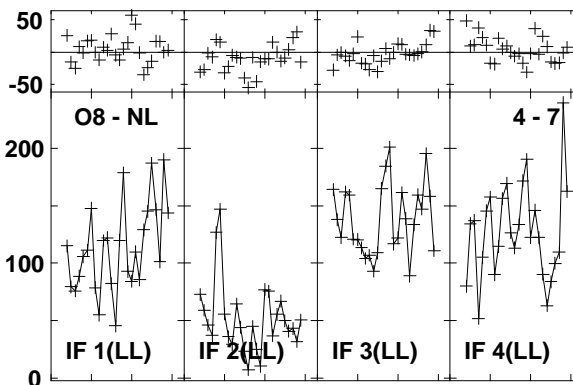
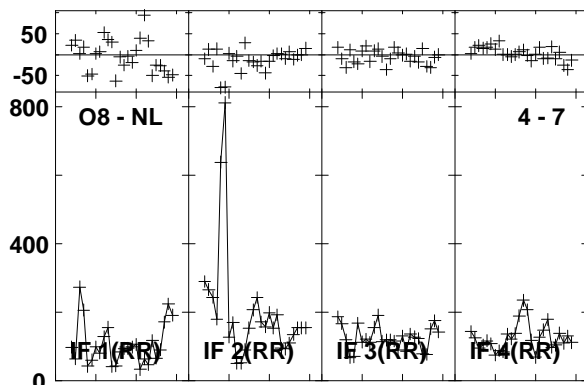
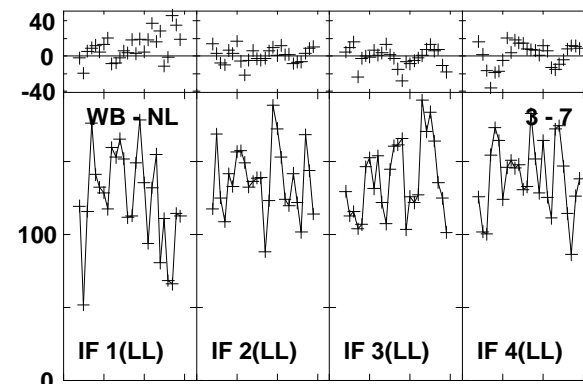
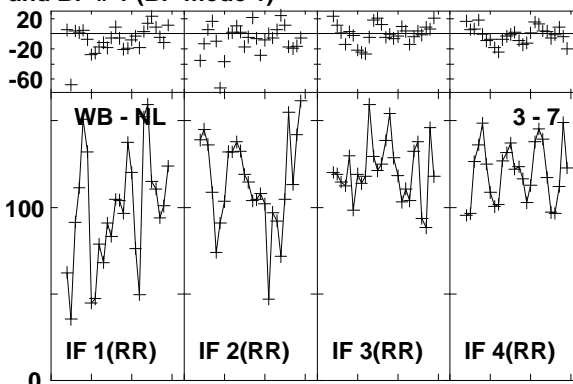
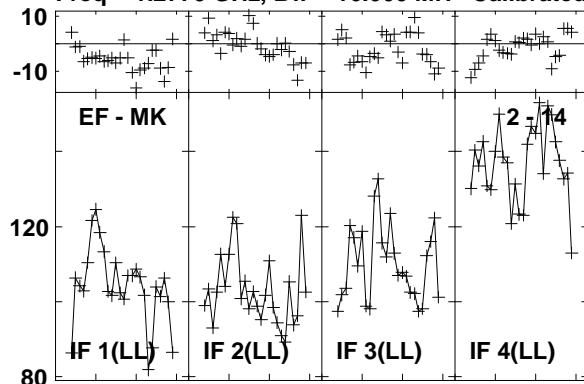

Lower frame: Milli Ampl Jy Top frame: Phas deg
Vector averaged cross-power spectrum Baseline: EF (02) - MK (14)
Timerange: 00/18:56:51 to 00/18:58:49

Plot file version 440 created 03-MAR-2016 01:13:11

J1545+5400 GN002C 1.UVDATA.1

Freq = 1.2770 GHz, Bw = 16.000 MH Calibrated with CL # 3 and BP # 1 (BP mode 1)

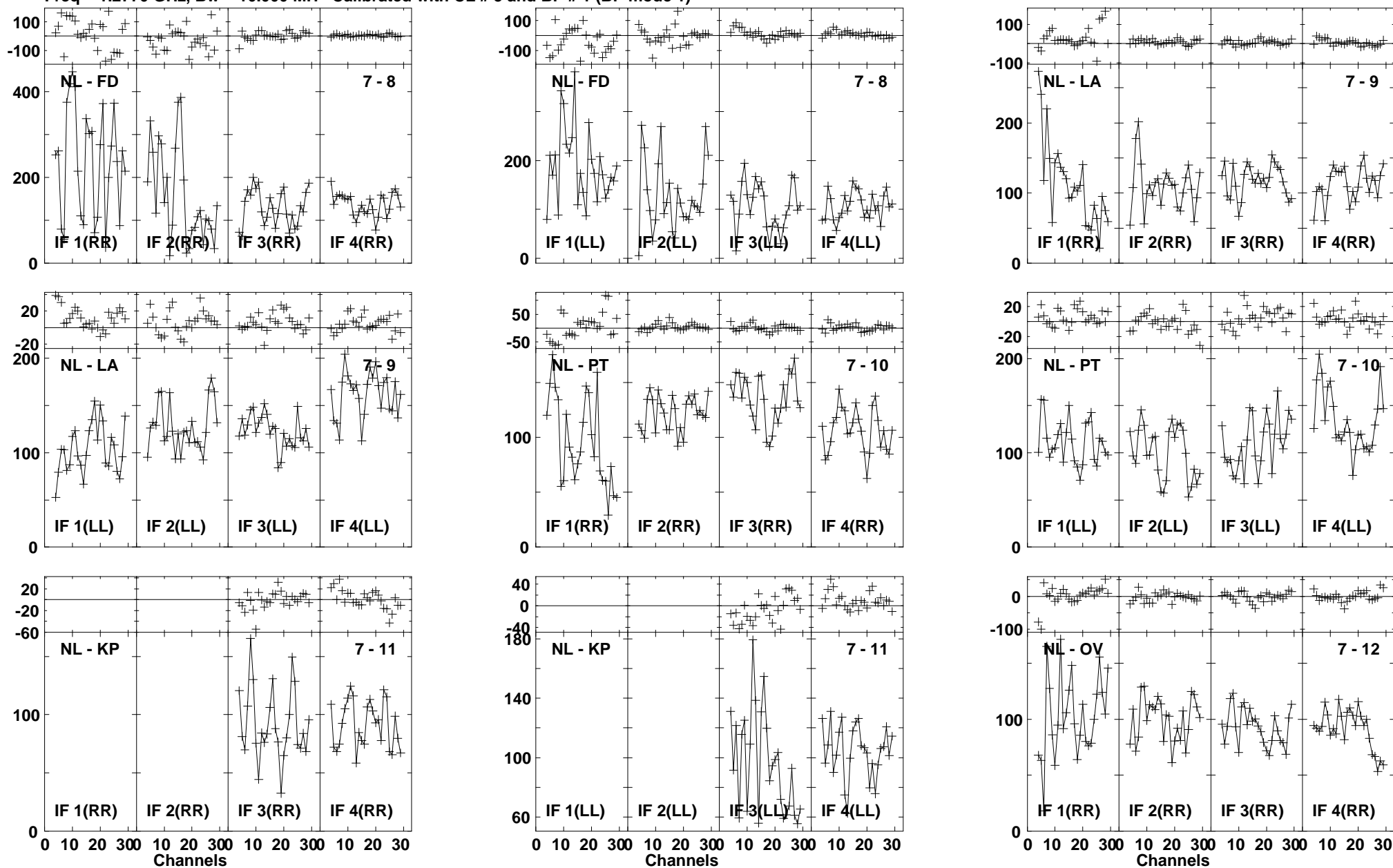

Lower frame: Milli Ampl Jy Top frame: Phas deg
Vector averaged cross-power spectrum Baseline: NL (07) - FD (08)
Timerange: 00/18:56:51 to 00/18:58:49

Plot file version 441 created 03-MAR-2016 01:13:11

J1545+5400 GN002C 1.UVDATA.1

Freq = 1.2770 GHz, Bw = 16.000 MH Calibrated with CL # 3 and BP # 1 (BP mode 1)

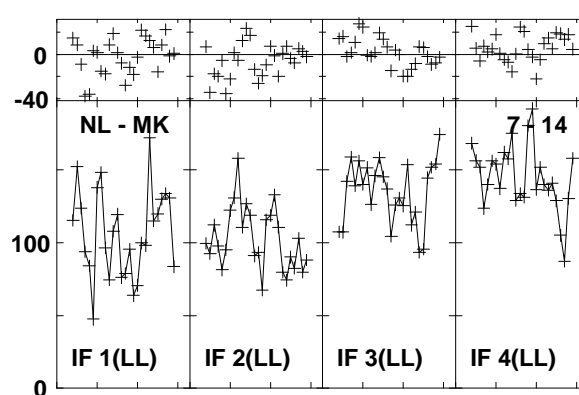
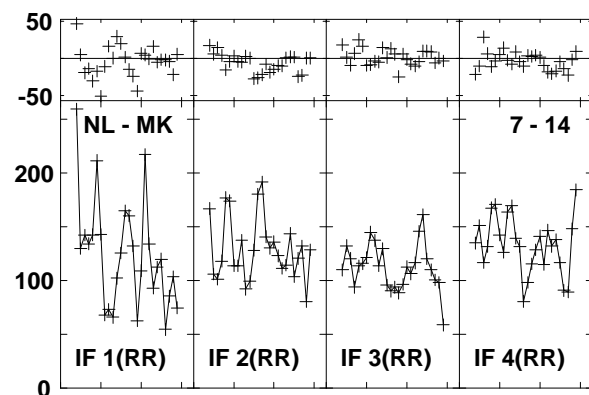
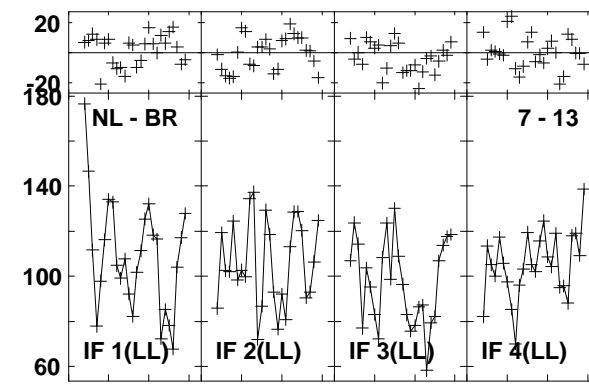
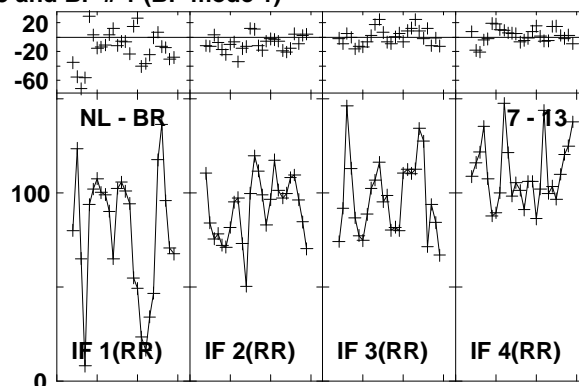
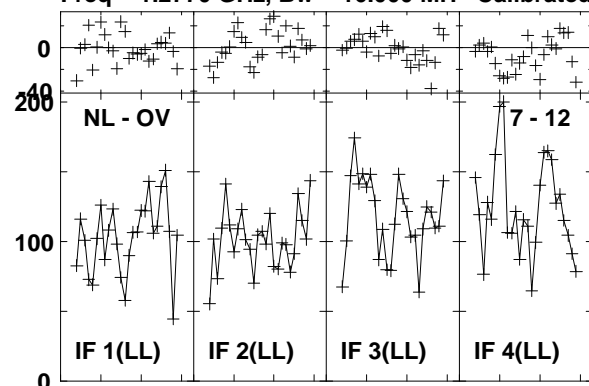

Lower frame: Milli Ampl Jy Top frame: Phas deg
Vector averaged cross-power spectrum Baseline: NL (07) - OV (12)
Timerange: 00/18:56:51 to 00/18:58:49

Plot file version 442 created 03-MAR-2016 01:13:11

4C52 GN002C 1.UVDATA.1

Freq = 1.2770 GHz, Bw = 16.000 MH Calibrated with CL # 3 and BP # 1 (BP mode 1)

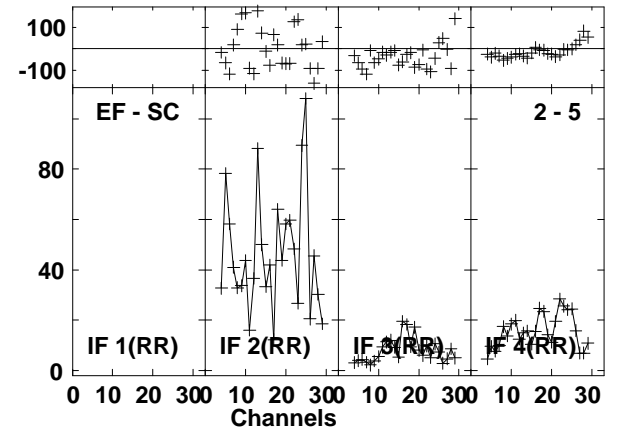
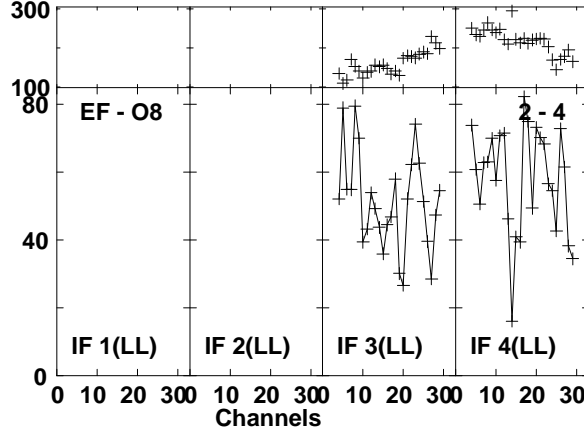
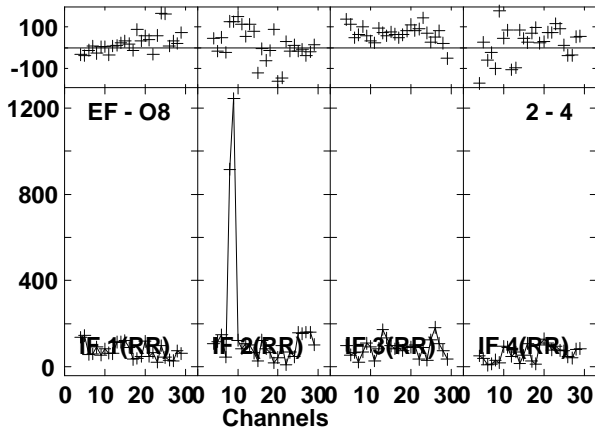
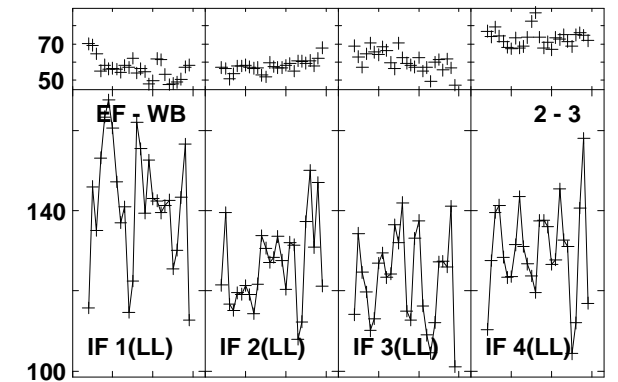
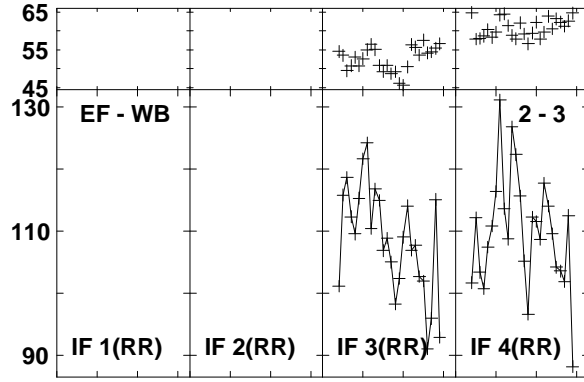
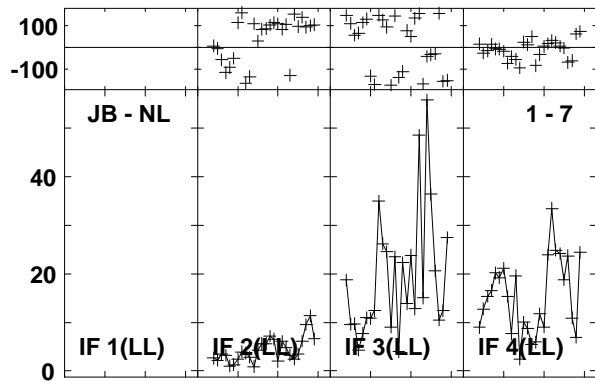
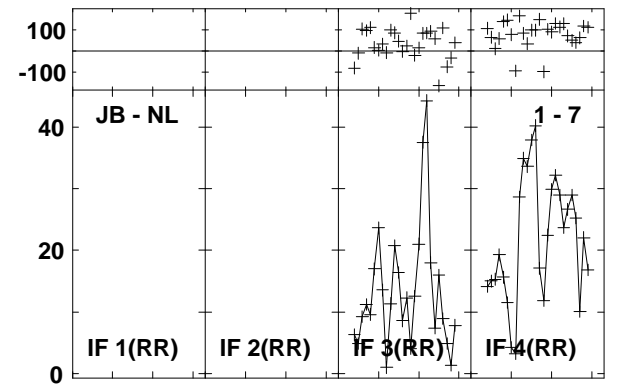
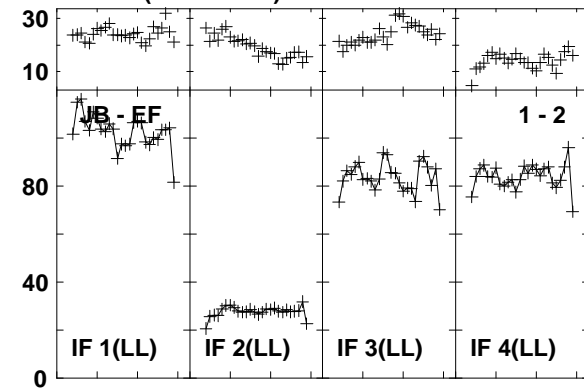
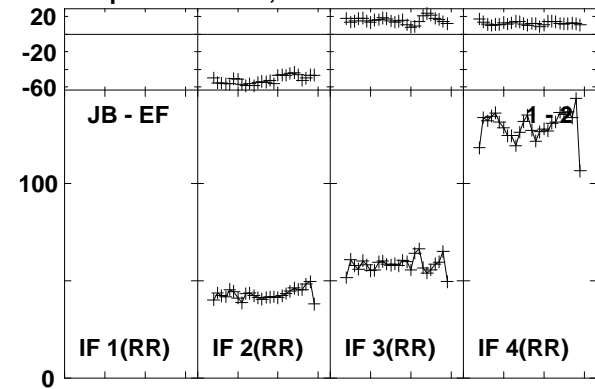

Lower frame: Milli Ampl Jy Top frame: Phas deg
Vector averaged cross-power spectrum Baseline: JB (01) - EF (02)
Timerange: 00/18:59:02 to 00/19:01:48

Plot file version 443 created 03-MAR-2016 01:13:11

4C52 GN002C 1.UVDATA.1

Freq = 1.2770 GHz, Bw = 16.000 MH Calibrated with CL # 3 and BP # 1 (BP mode 1)

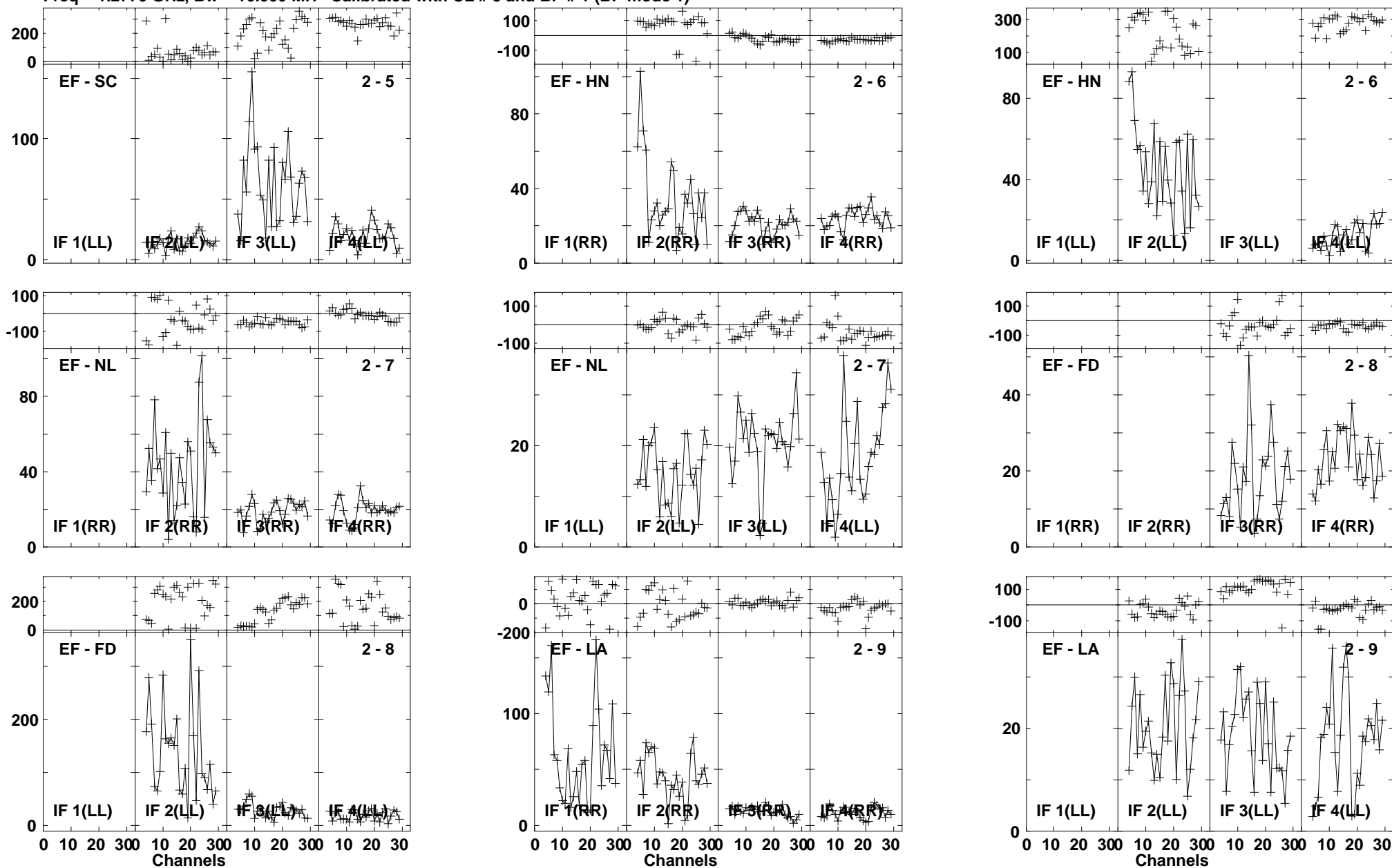

Lower frame: Milli Ampl Jy Top frame: Phas deg
Vector averaged cross-power spectrum Baseline: EF (02) - SC (05)
Timerange: 00/18:59:02 to 00/19:01:48

Plot file version 444 created 03-MAR-2016 01:13:12

4C52 GN002C 1.UVDATA.1

Freq = 1.2770 GHz, Bw = 16.000 MH Calibrated with CL # 3 and BP # 1 (BP mode 1)

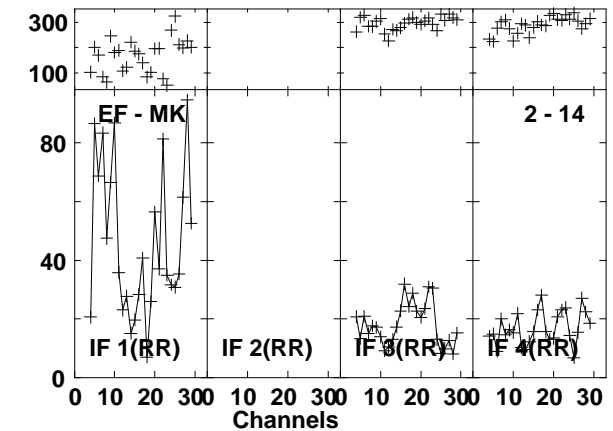
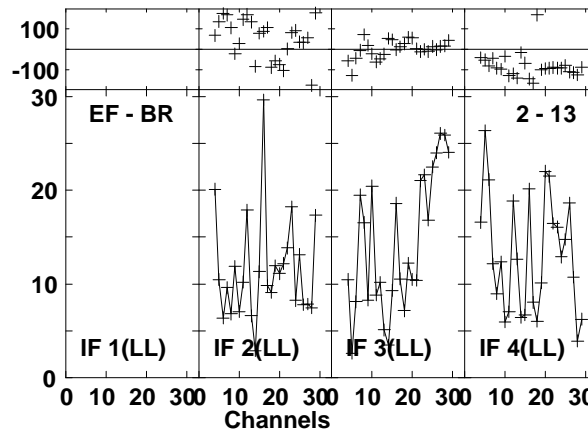
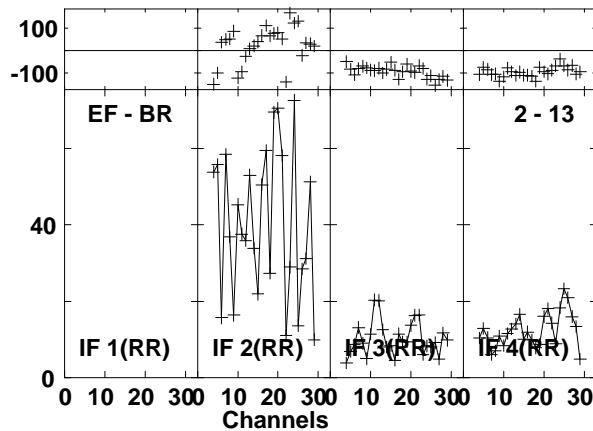
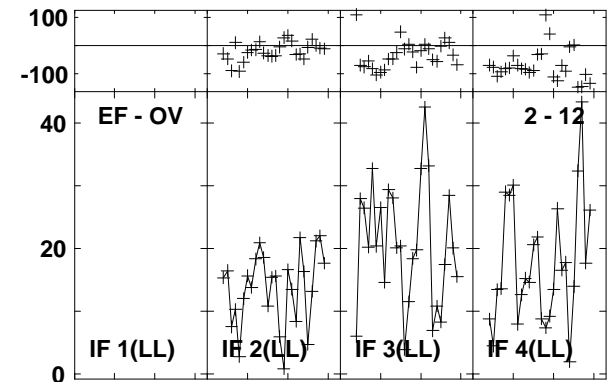
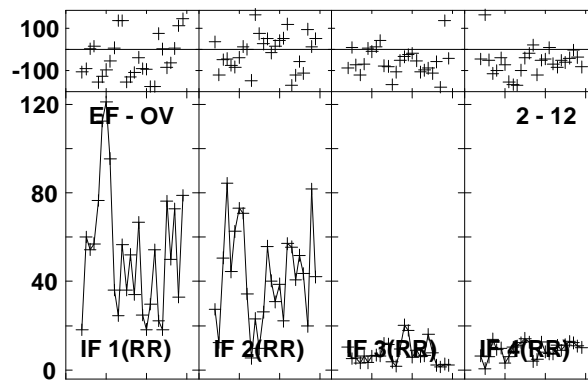
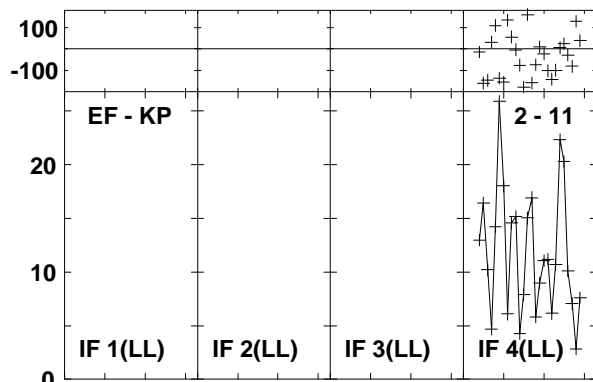
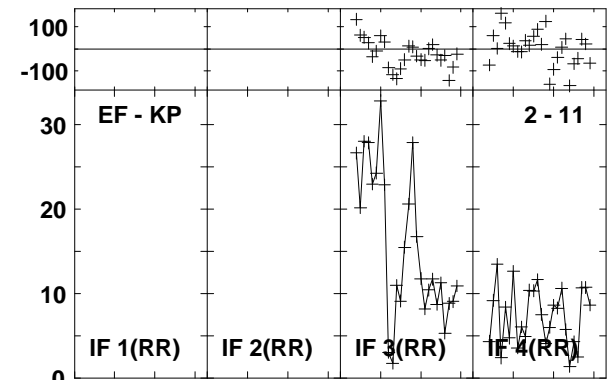
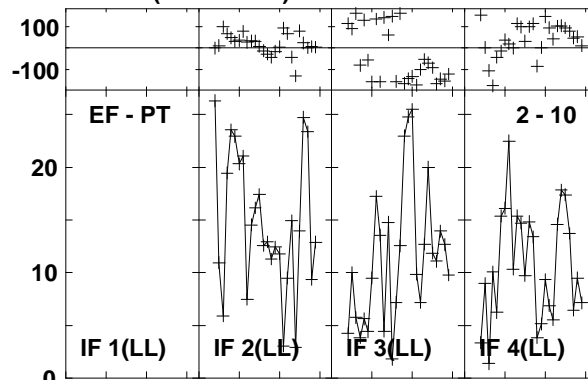
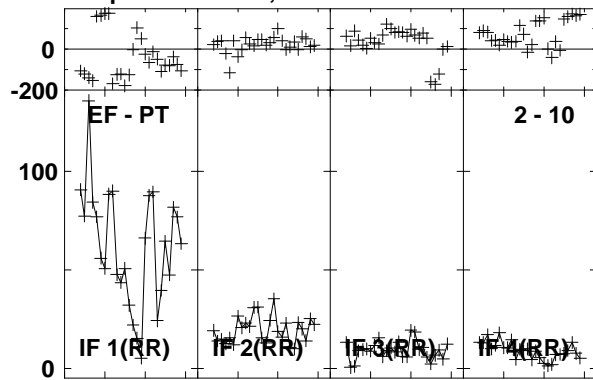

Lower frame: Milli Ampl Jy Top frame: Phas deg
Vector averaged cross-power spectrum Baseline: EF (02) - PT (10)
Timerange: 00/18:59:02 to 00/19:01:48

Plot file version 445 created 03-MAR-2016 01:13:12

4C52 GN002C 1.UVDATA.1

Freq = 1.2770 GHz, Bw = 16.000 MH Calibrated with CL # 3 and BP # 1 (BP mode 1)

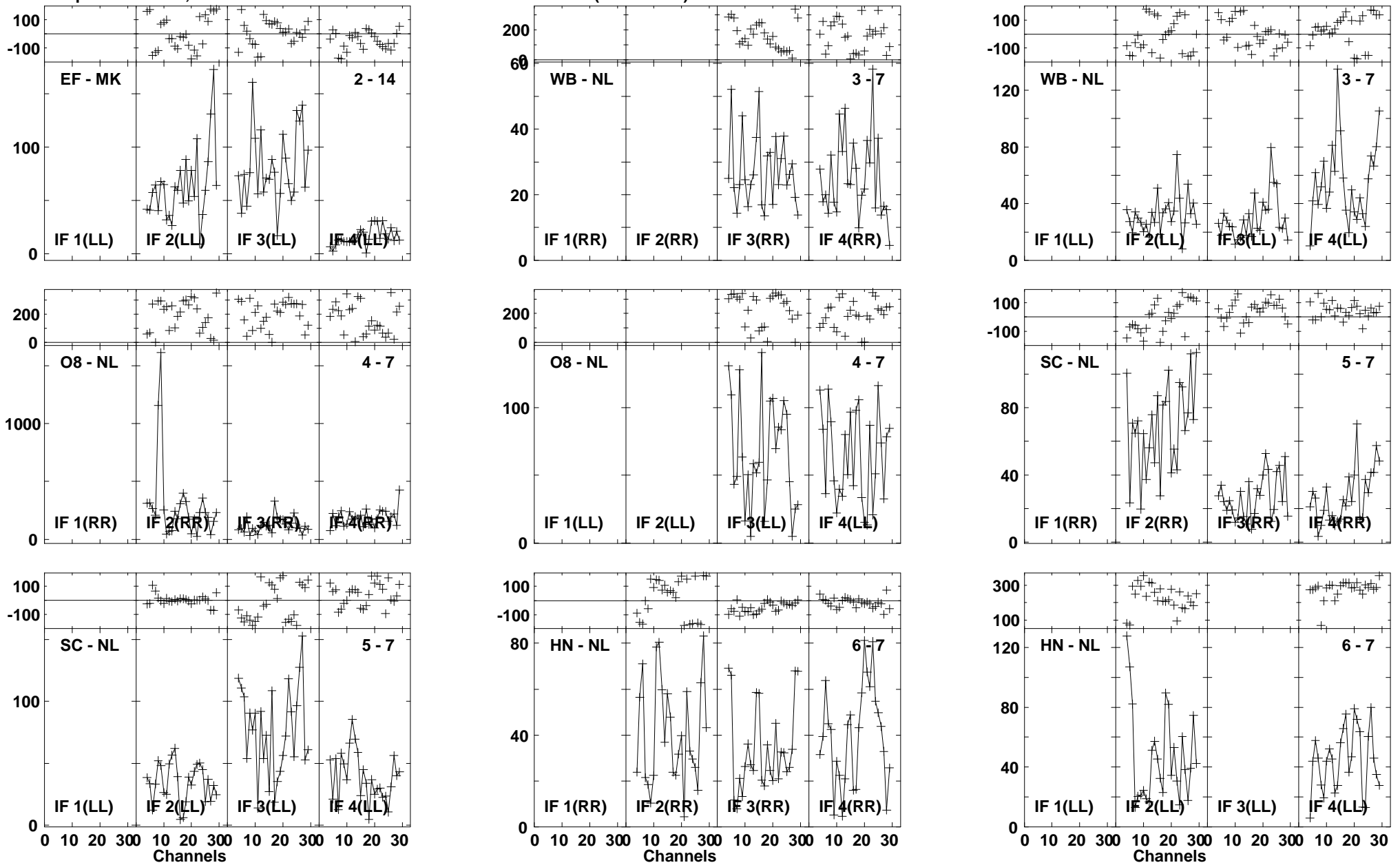

Lower frame: Milli Ampl Jy Top frame: Phas deg
Vector averaged cross-power spectrum Baseline: EF (02) - MK (14)
Timerange: 00/18:59:02 to 00/19:01:48

Plot file version 446 created 03-MAR-2016 01:13:12

4C52 GN002C 1.UVDATA.1

Freq = 1.2770 GHz, Bw = 16.000 MH Calibrated with CL # 3 and BP # 1 (BP mode 1)

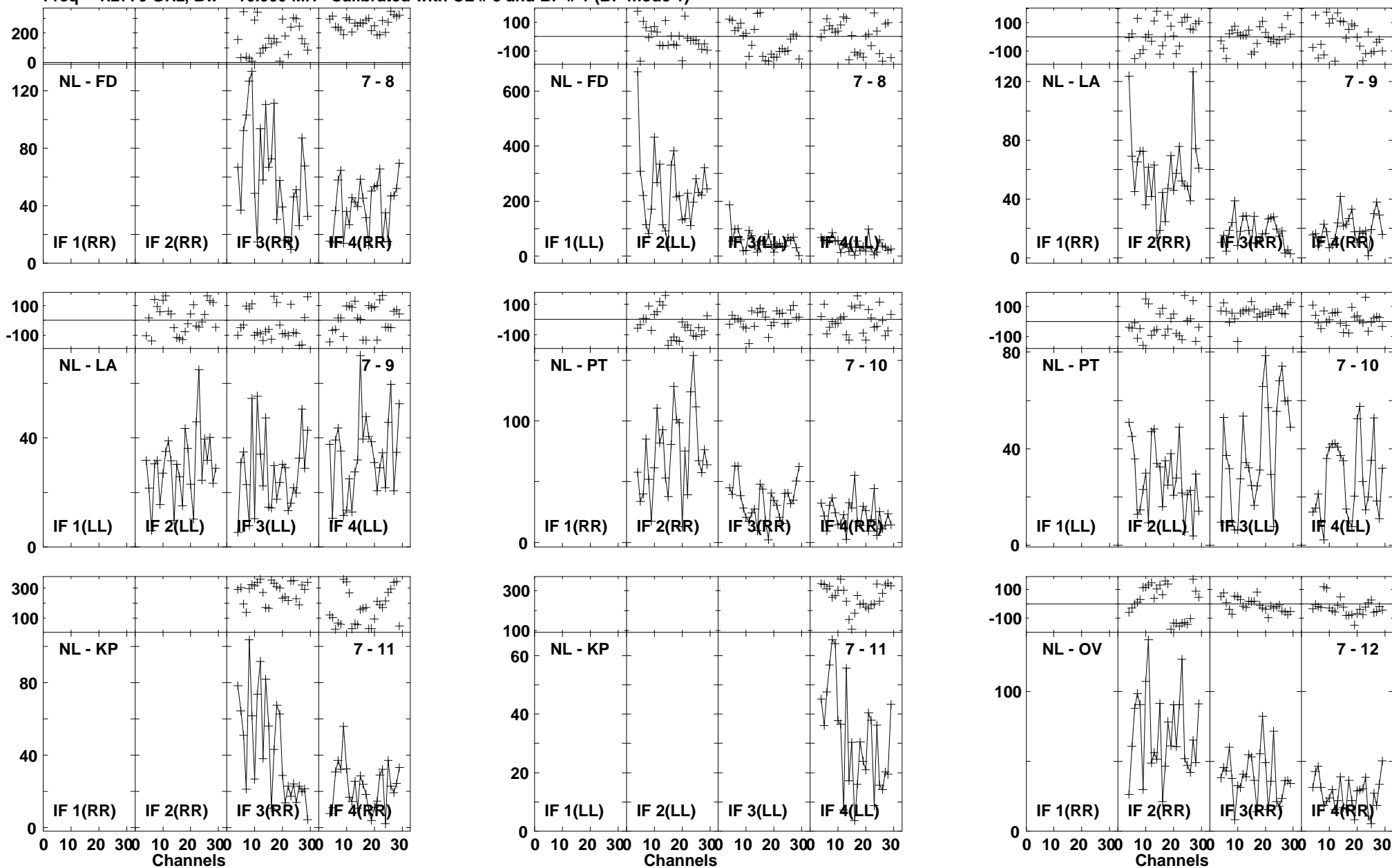

Lower frame: Milli Ampl Jy Top frame: Phas deg
Vector averaged cross-power spectrum Baseline: NL (07) - FD (08)
Timerange: 00/18:59:02 to 00/19:01:48

Plot file version 447 created 03-MAR-2016 01:13:12

4C52 GN002C 1.UVDATA.1

Freq = 1.2770 GHz, Bw = 16.000 MH Calibrated with CL # 3 and BP # 1 (BP mode 1)

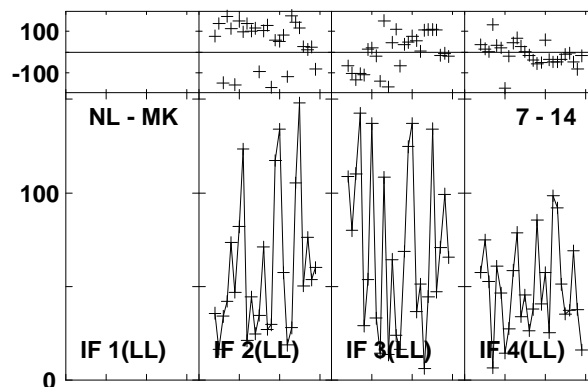
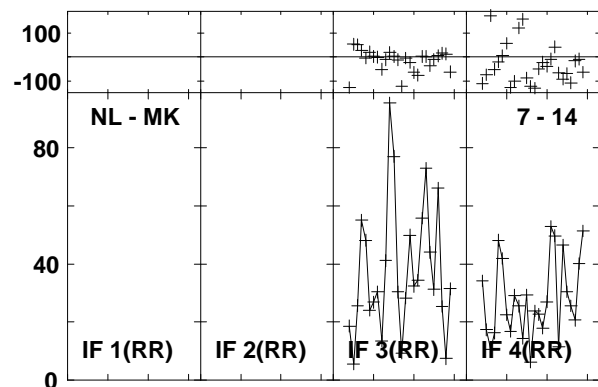
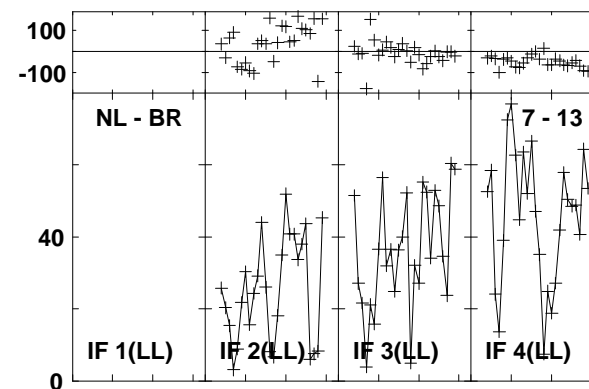
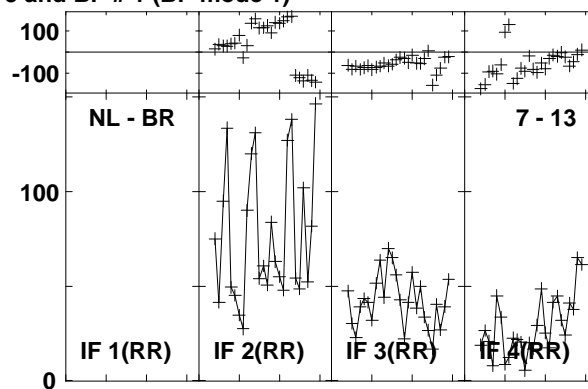
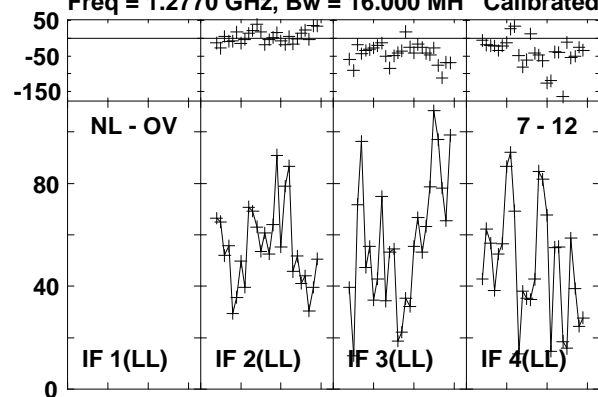

Lower frame: Milli Ampl Jy Top frame: Phas deg
Vector averaged cross-power spectrum Baseline: NL (07) - OV (12)
Timerange: 00:18:59:02 to 00:19:01:48

Plot file version 448 created 03-MAR-2016 01:13:12

J1545+5400 GN002C 1.UVDATA.1

Freq = 1.2770 GHz, Bw = 16.000 MH Calibrated with CL # 3 and BP # 1 (BP mode 1)

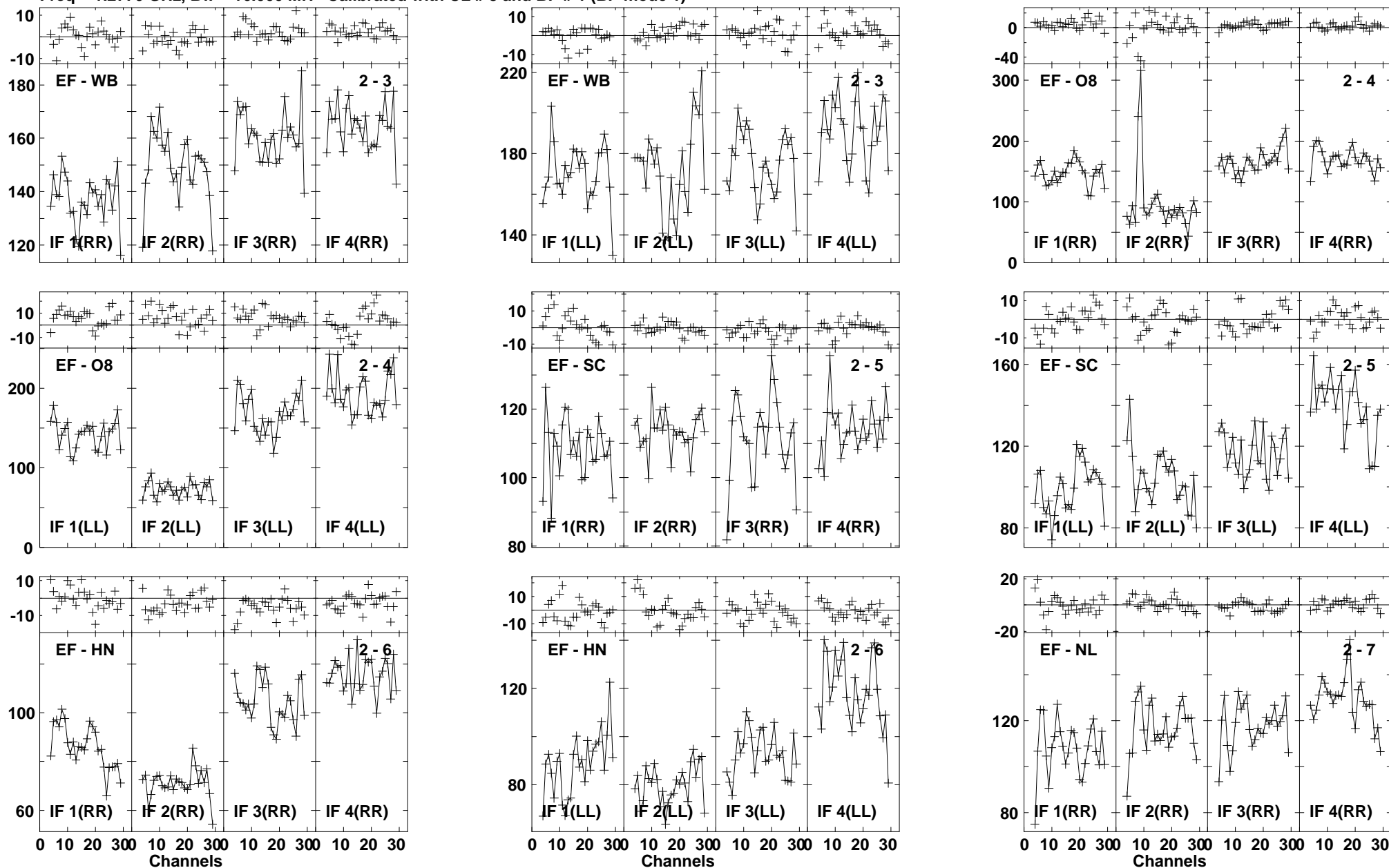

Lower frame: Milli Ampl Jy Top frame: Phas deg
Vector averaged cross-power spectrum Baseline: EF (02) - WB (03)
Timerange: 00/19:02:41 to 00/19:03:39

Plot file version 449 created 03-MAR-2016 01:13:12

J1545+5400 GN002C 1.UVDATA.1

Freq = 1.2770 GHz, Bw = 16.000 MH Calibrated with CL # 3 and BP # 1 (BP mode 1)

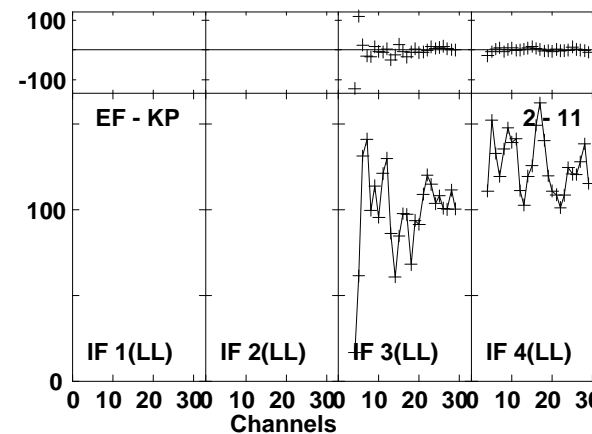
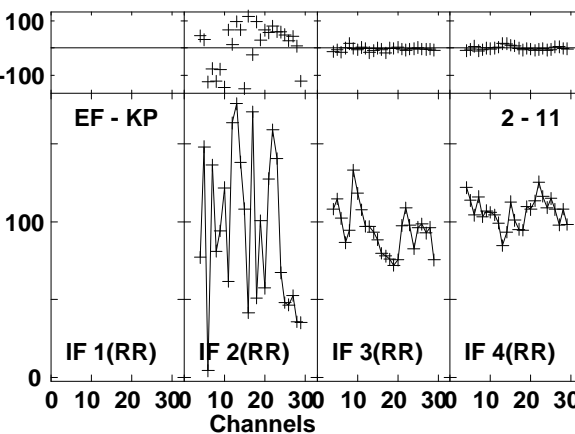
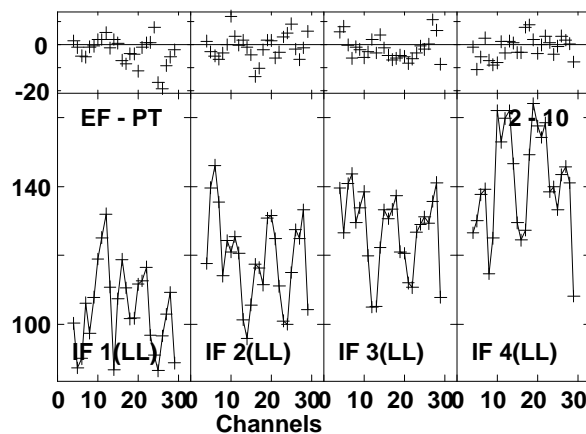
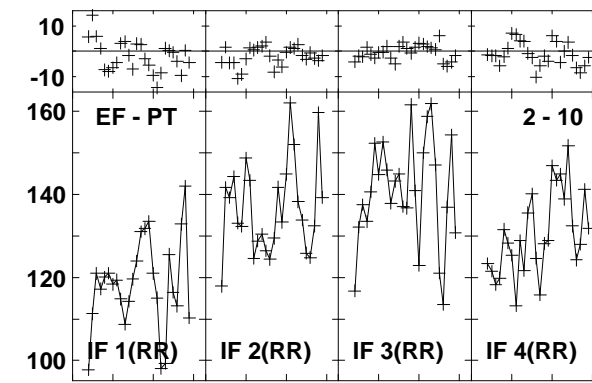
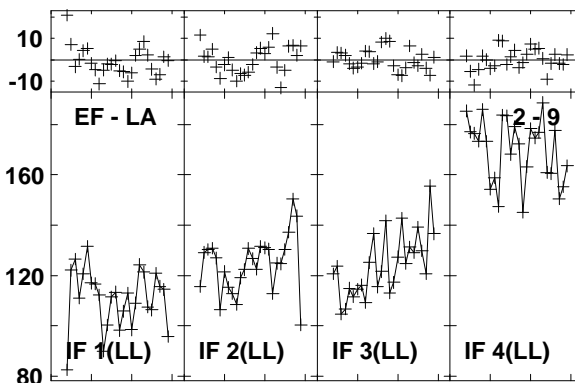
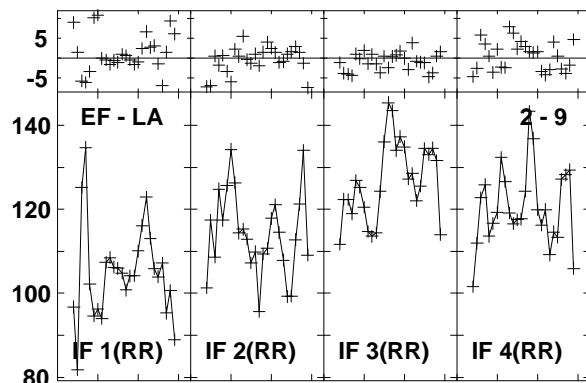
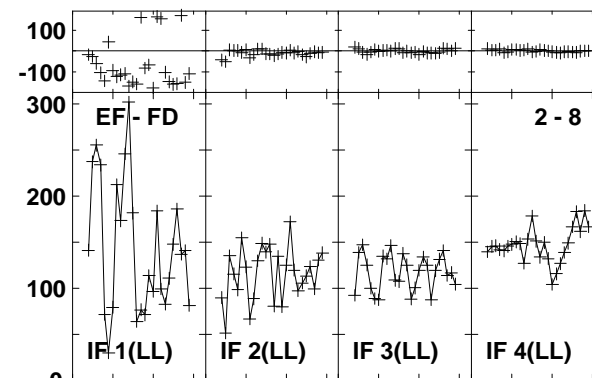
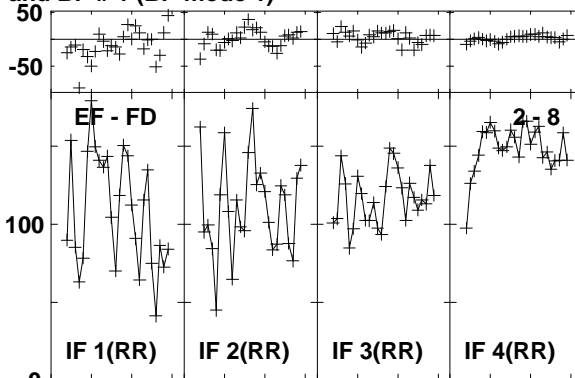
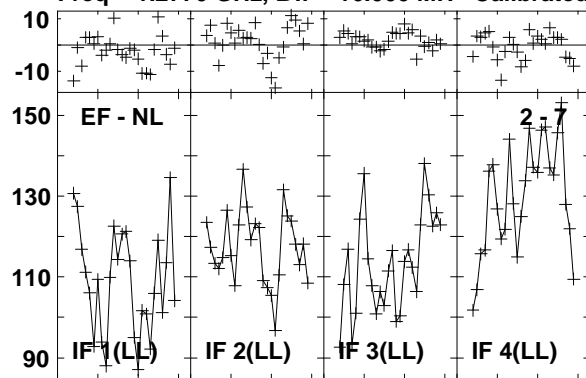

Lower frame: Milli Ampl Jy Top frame: Phas deg
Vector averaged cross-power spectrum Baseline: EF (02) - NL (07)
Timerange: 00/19:02:41 to 00/19:03:39

Plot file version 450 created 03-MAR-2016 01:13:13

J1545+5400 GN002C 1.UVDATA.1

Freq = 1.2770 GHz, Bw = 16.000 MH Calibrated with CL # 3 and BP # 1 (BP mode 1)

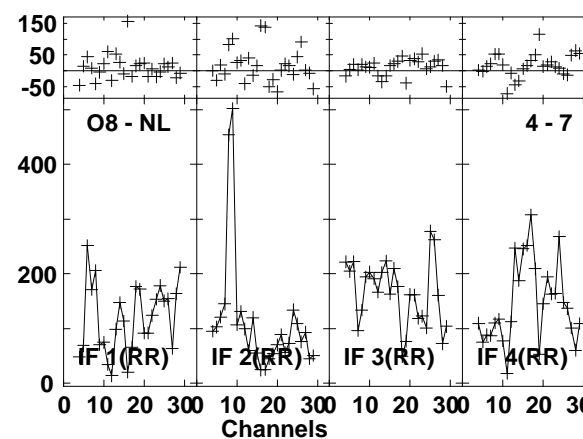
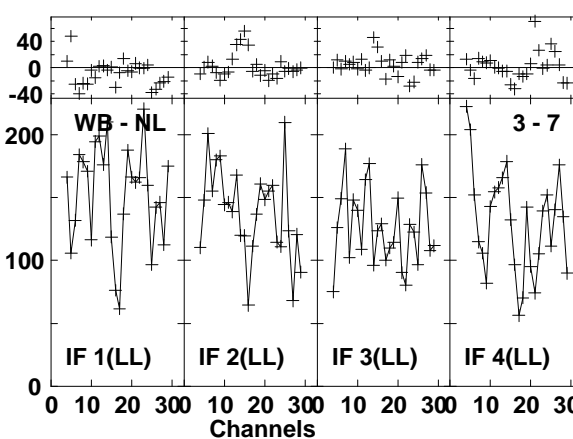
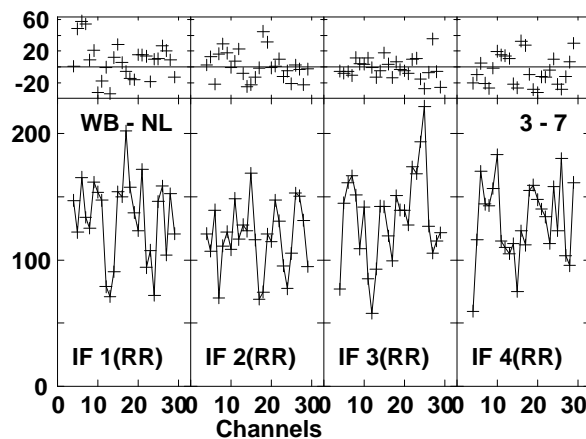
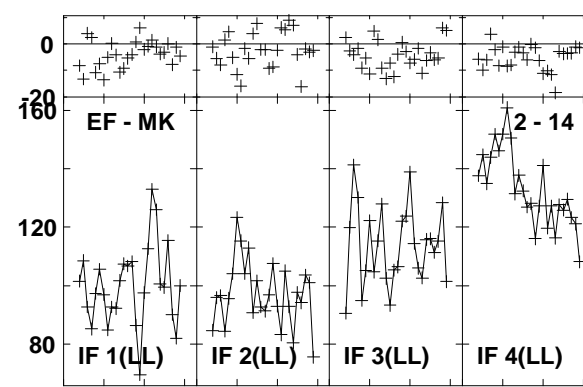
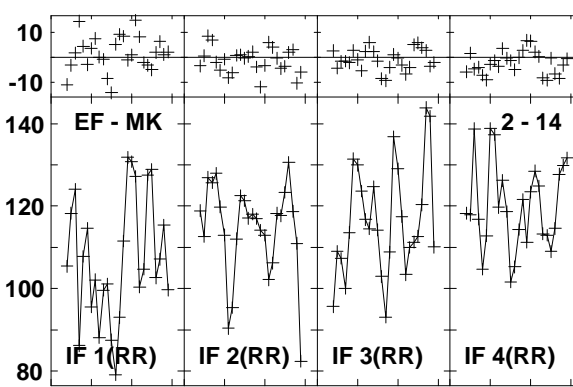
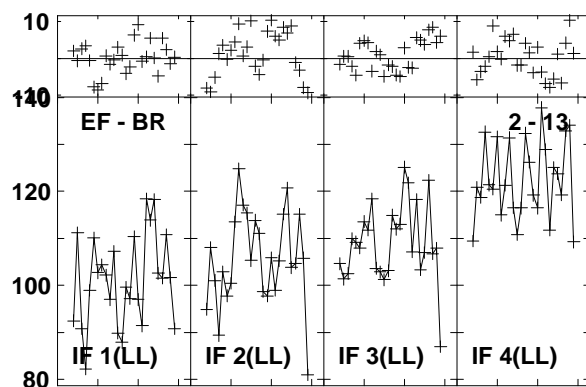
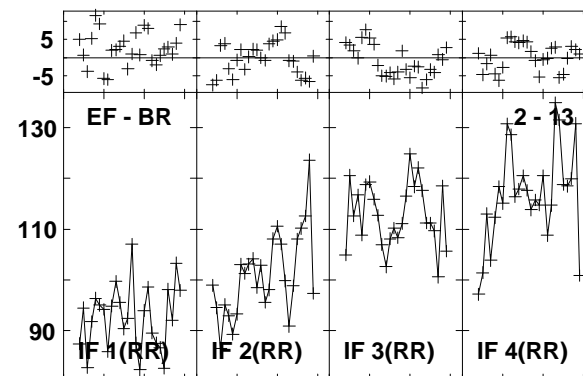
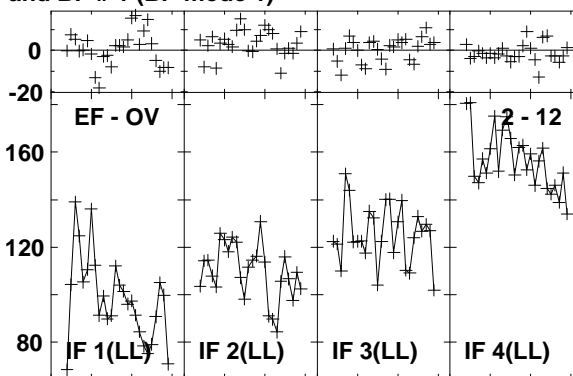
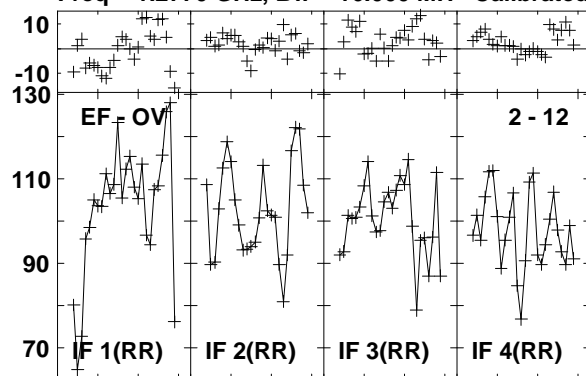

Lower frame: Milli Ampl Jy Top frame: Phas deg
Vector averaged cross-power spectrum Baseline: EF (02) - OV (12)
Timerange: 00/19:02:41 to 00/19:03:39

Plot file version 451 created 03-MAR-2016 01:13:13

J1545+5400 GN002C 1.UVDATA.1

Freq = 1.2770 GHz, Bw = 16.000 MH Calibrated with CL # 3 and BP # 1 (BP mode 1)

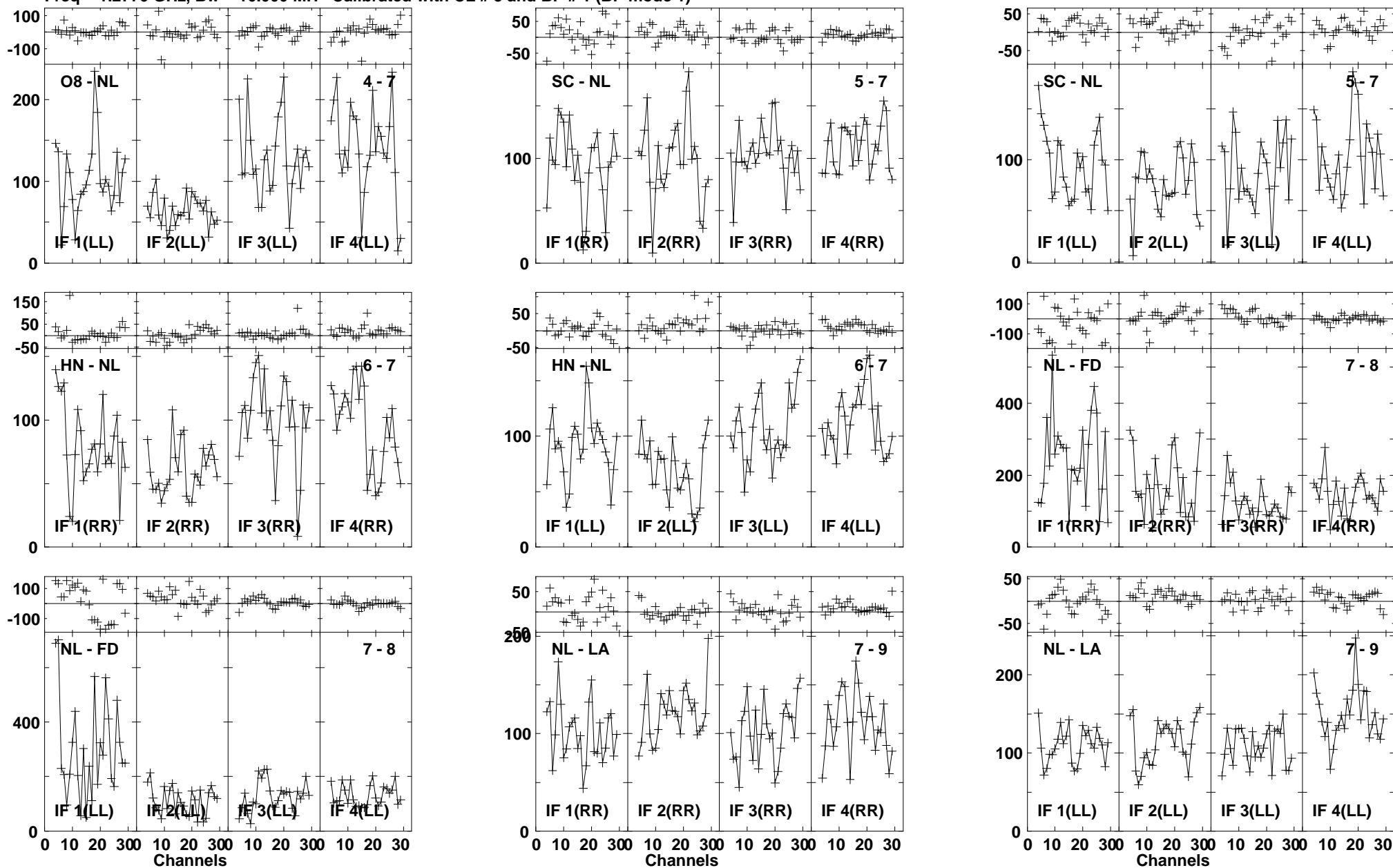

Lower frame: Milli Ampl Jy Top frame: Phas deg
Vector averaged cross-power spectrum Baseline: O8 (04) - NL (07)
Timerange: 00/19:02:41 to 00/19:03:39

Plot file version 452 created 03-MAR-2016 01:13:13

J1545+5400 GN002C 1.UVDATA.1

Freq = 1.2770 GHz, Bw = 16.000 MH Calibrated with CL # 3 and BP # 1 (BP mode 1)

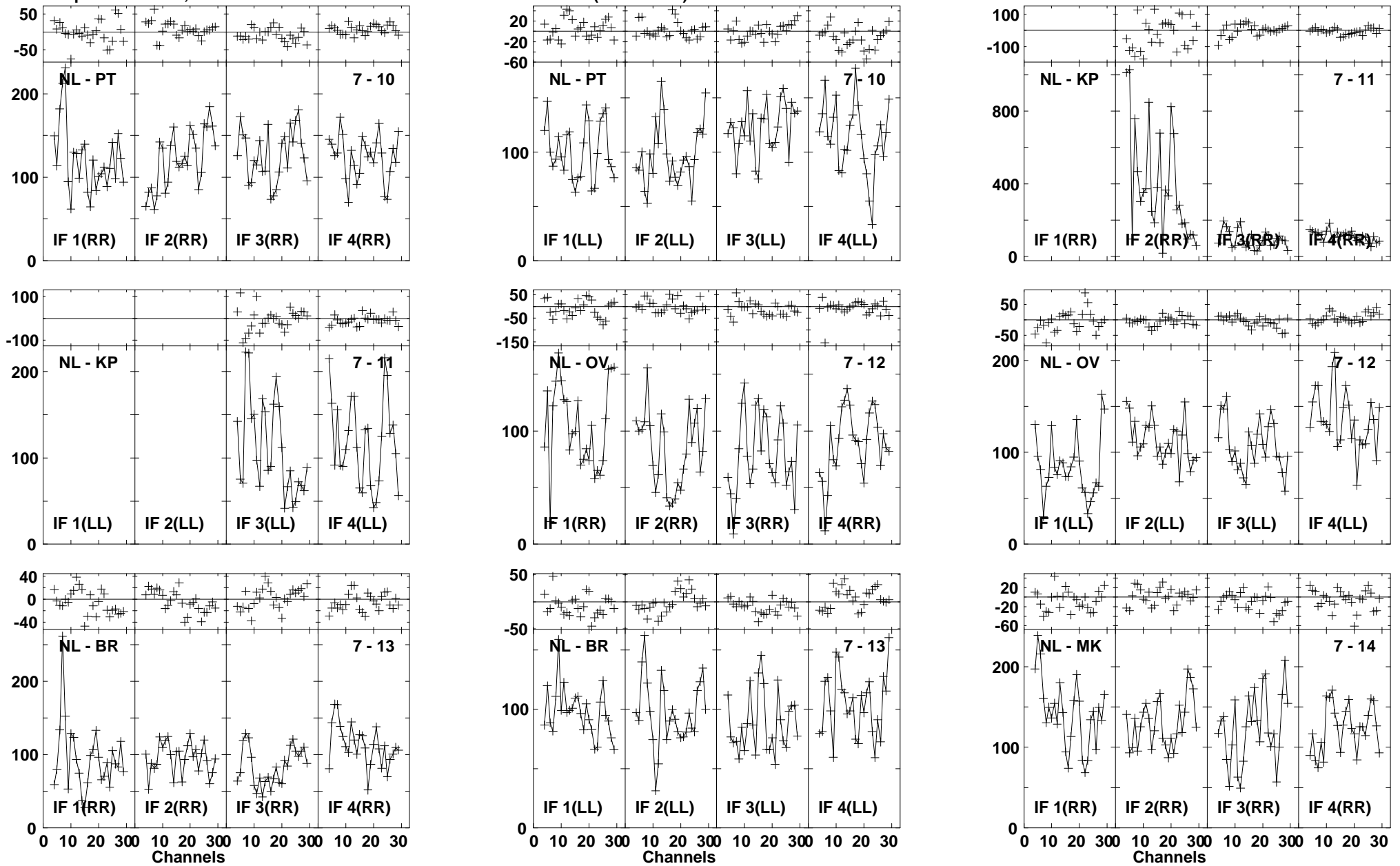

Lower frame: Milli Ampl Jy Top frame: Phas deg
Vector averaged cross-power spectrum Baseline: NL (07) - PT (10)
Timerange: 00/19:02:41 to 00/19:03:39

Plot file version 453 created 03-MAR-2016 01:13:13
J1545+5400 GN002C 1.UVDATA.1
Freq = 1.2770 GHz, Bw = 16.000 MH Calibrated with CL # 3 and BP # 1 (BP mode 1)

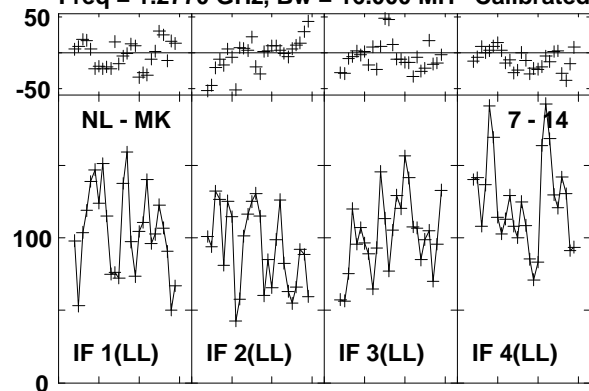

Lower frame: Milli Ampl Jy Top frame: Phas deg
Vector averaged cross-power spectrum Baseline: NL (07) - MK (14)
Timerange: 00/19:02:41 to 00/19:03:39

Plot file version 454 created 03-MAR-2016 01:13:13

4C52 GN002C 1.UVDATA.1

Freq = 1.2770 GHz, Bw = 16.000 MH Calibrated with CL # 3 and BP # 1 (BP mode 1)

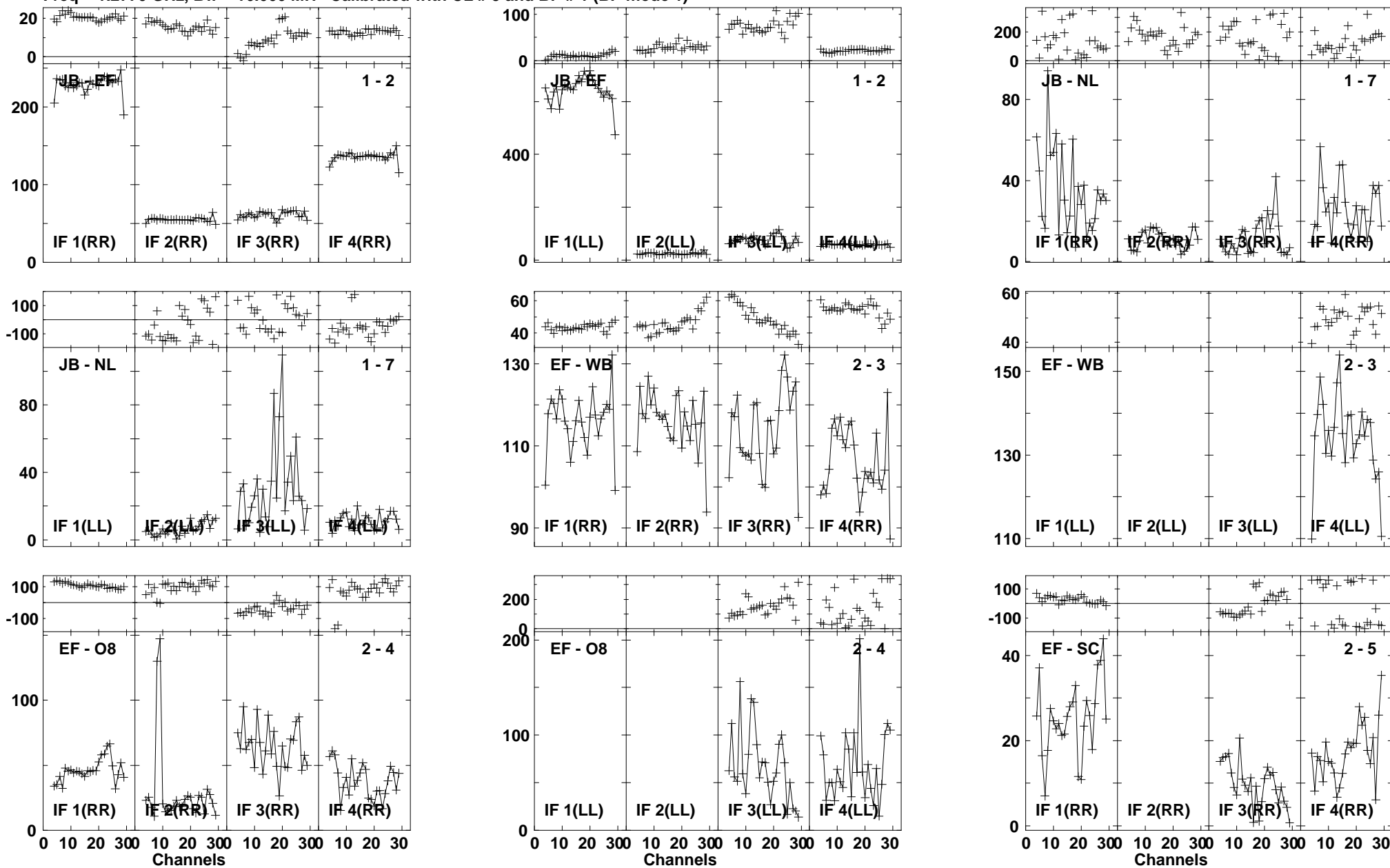

Lower frame: Milli Ampl Jy Top frame: Phas deg
Vector averaged cross-power spectrum Baseline: JB (01) - EF (02)
Timerange: 00/19:03:44 to 00/19:06:38

Plot file version 455 created 03-MAR-2016 01:13:13

4C52 GN002C 1.UVDATA.1

Freq = 1.2770 GHz, Bw = 16.000 MH Calibrated with CL # 3 and BP # 1 (BP mode 1)

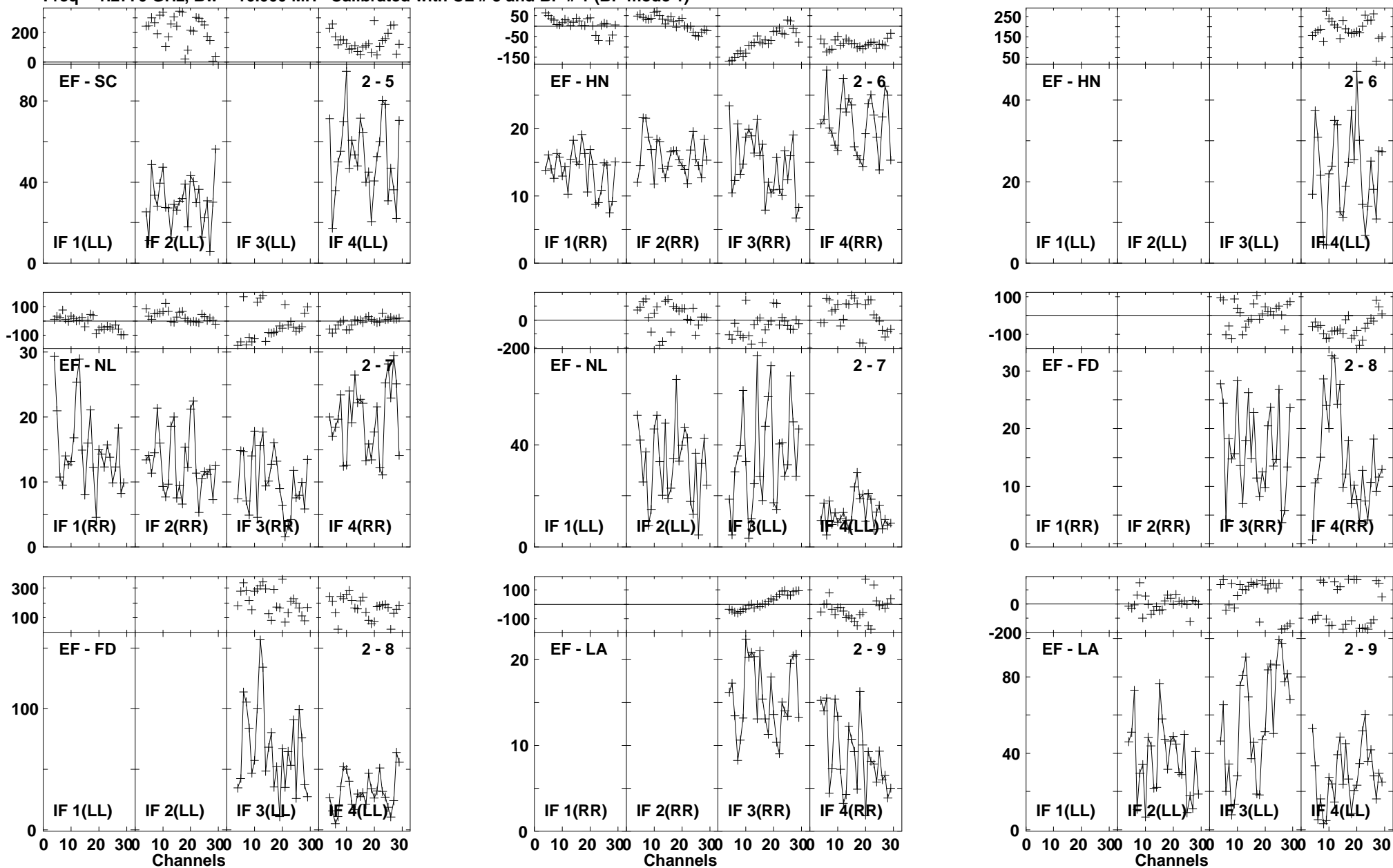

Lower frame: Milli Ampl Jy Top frame: Phas deg
Vector averaged cross-power spectrum Baseline: EF (02) - SC (05)
Timerange: 00/19:03:44 to 00/19:06:38

Plot file version 456 created 03-MAR-2016 01:13:13

4C52 GN002C 1.UVDATA.1

Freq = 1.2770 GHz, Bw = 16.000 MH Calibrated with CL # 3 and BP # 1 (BP mode 1)

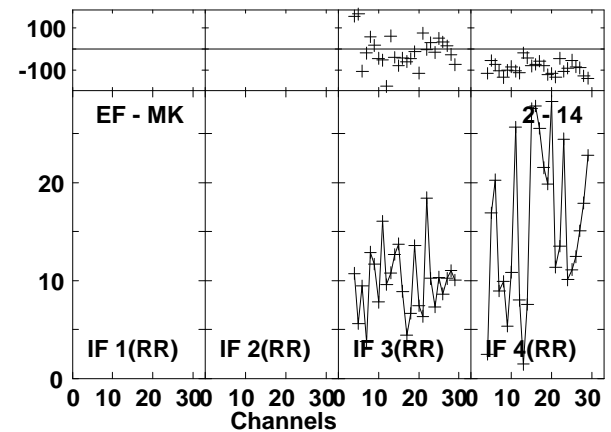
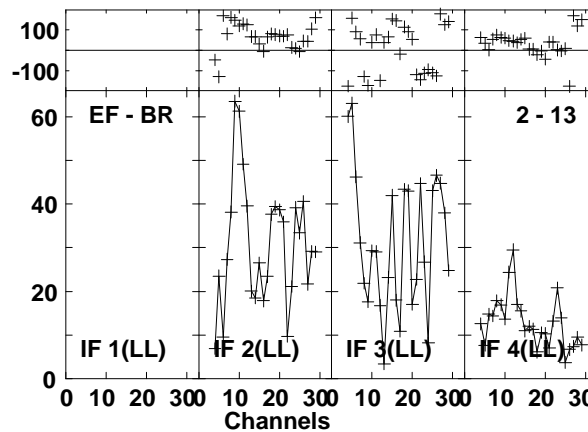
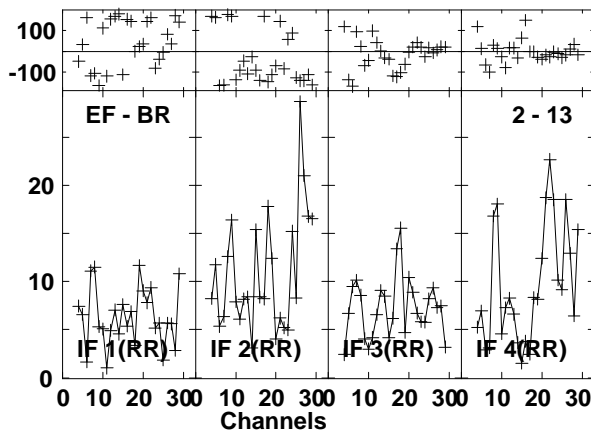
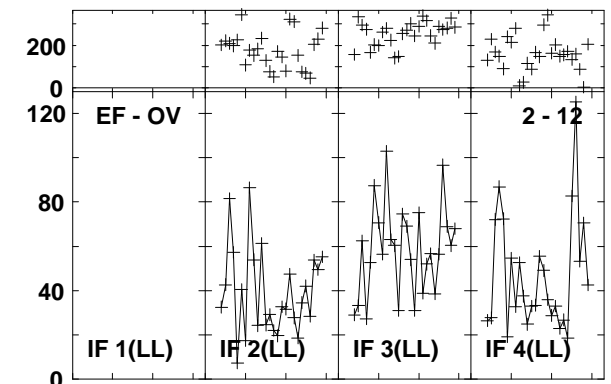
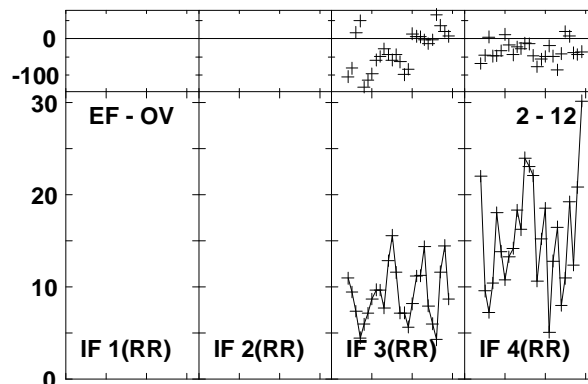
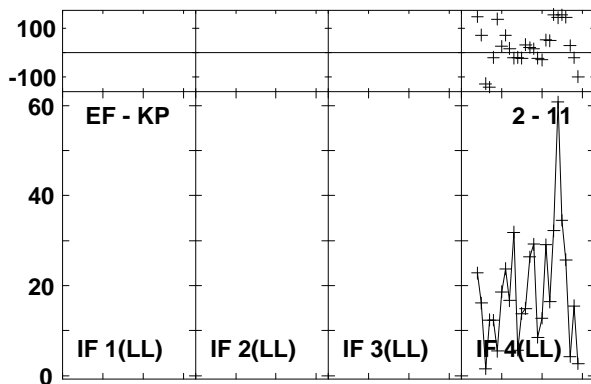
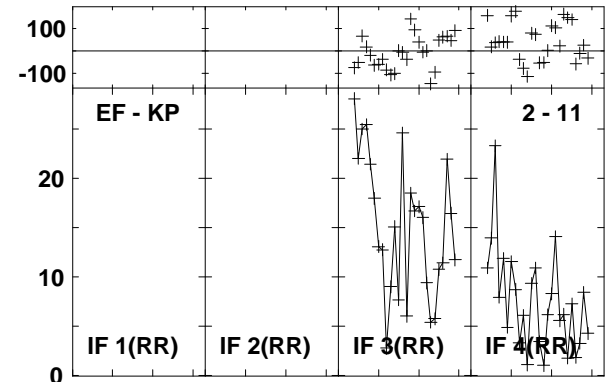
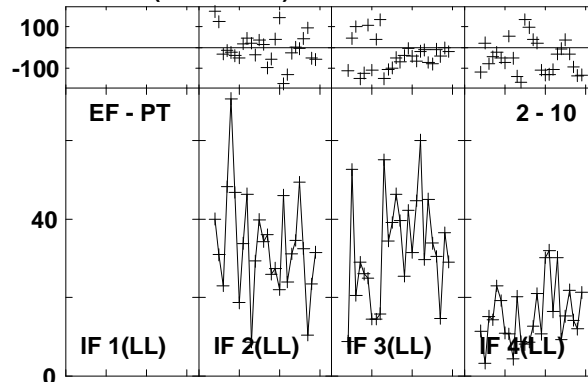
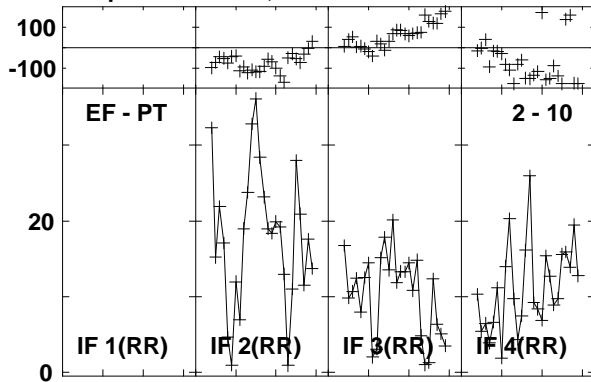

Lower frame: Milli Ampl Jy Top frame: Phas deg
Vector averaged cross-power spectrum Baseline: EF (02) - PT (10)
Timerange: 00/19:03:44 to 00/19:06:38

Plot file version 457 created 03-MAR-2016 01:13:14

4C52 GN002C 1.UVDATA.1

Freq = 1.2770 GHz, Bw = 16.000 MH Calibrated with CL # 3 and BP # 1 (BP mode 1)

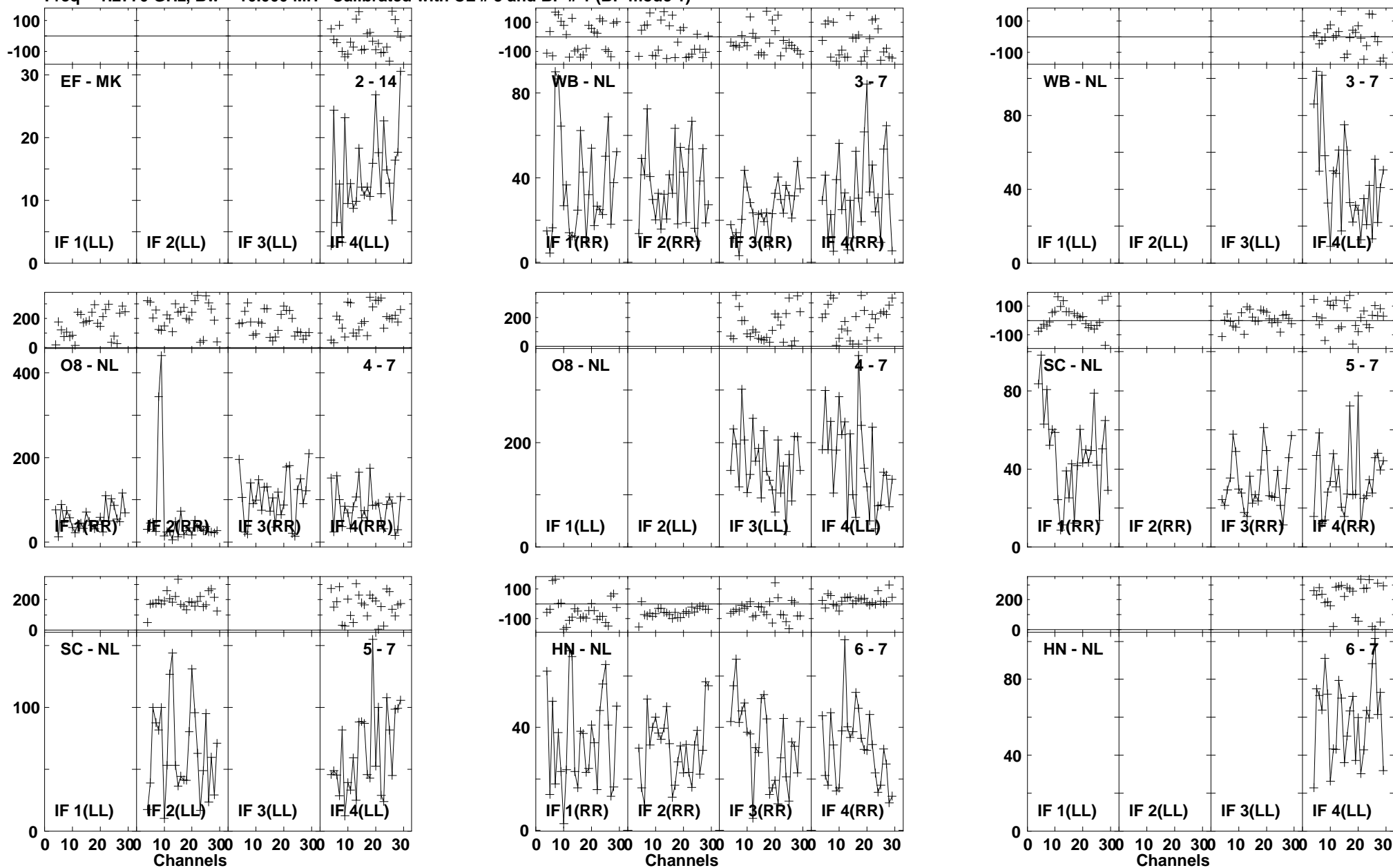

Lower frame: Milli Ampl Jy Top frame: Phas deg
Vector averaged cross-power spectrum Baseline: EF (02) - MK (14)
Timerange: 00/19:03:44 to 00/19:06:38

Plot file version 458 created 03-MAR-2016 01:13:14
 4C52 GN002C 1.UVDATA.1
 Freq = 1.2770 GHz, Bw = 16.000 MH Calibrated with CL # 3 and BP # 1 (BP mode 1)

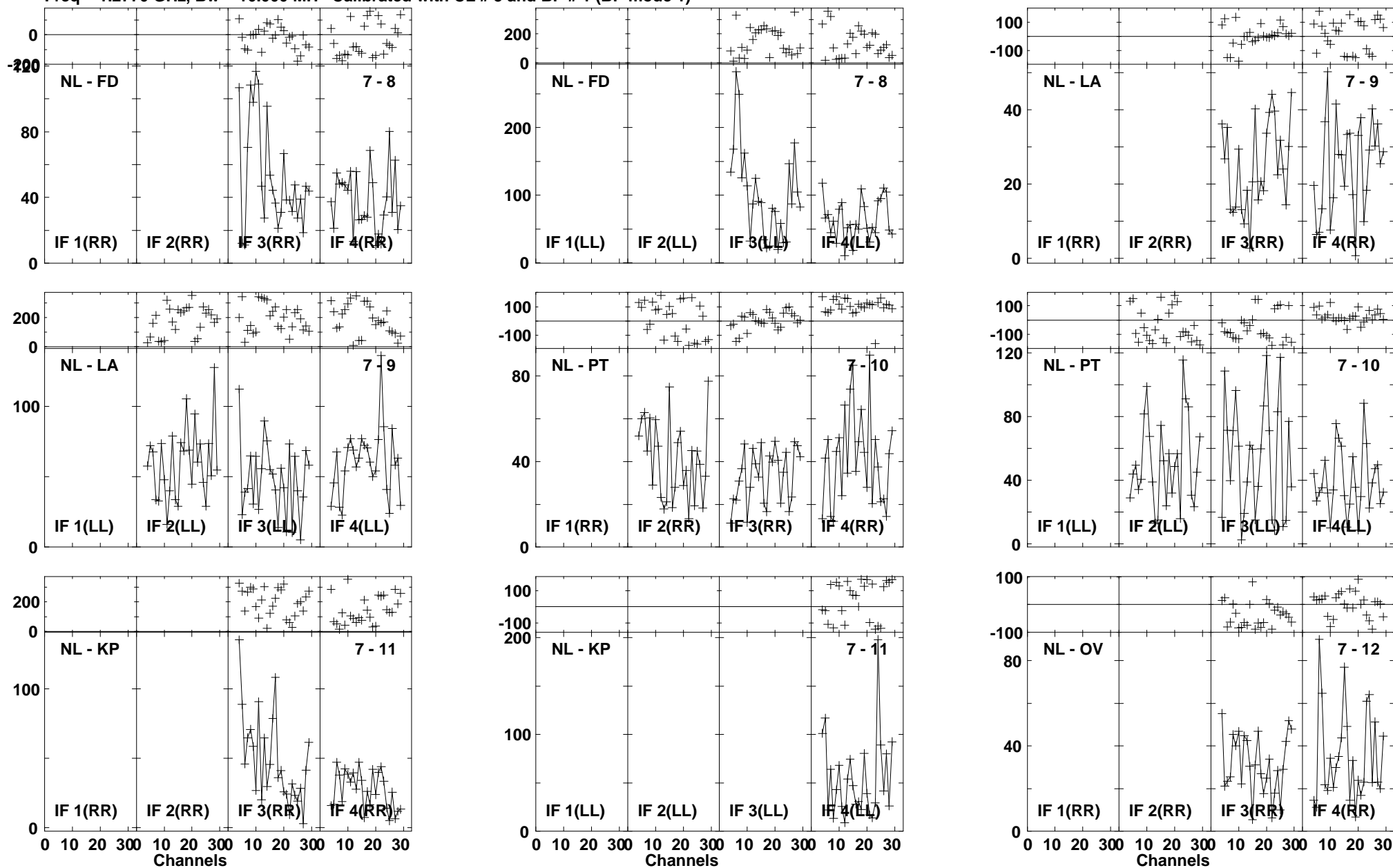

Lower frame: Milli Ampl Jy Top frame: Phas deg
 Vector averaged cross-power spectrum Baseline: NL (07) - FD (08)
 Timerange: 00/19:03:44 to 00/19:06:38

Plot file version 459 created 03-MAR-2016 01:13:14

4C52 GN002C 1.UVDATA.1

Freq = 1.2770 GHz, Bw = 16.000 MH Calibrated with CL # 3 and BP # 1 (BP mode 1)

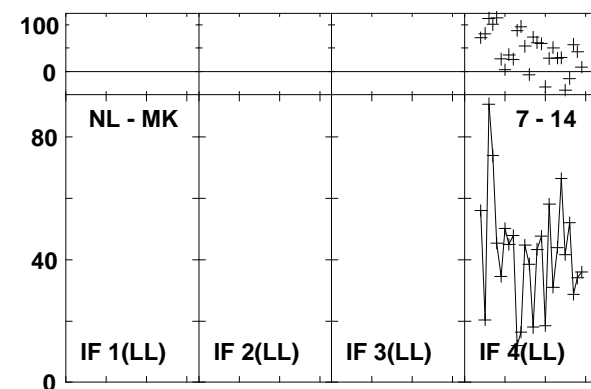
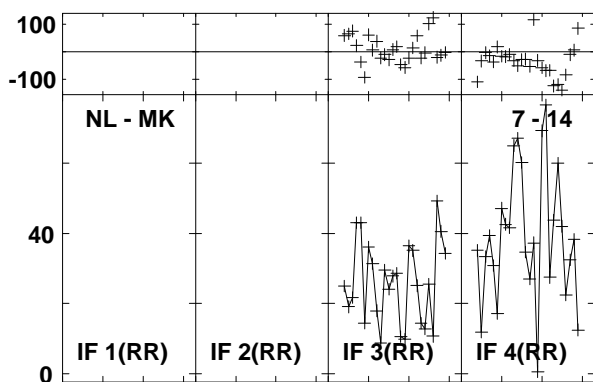
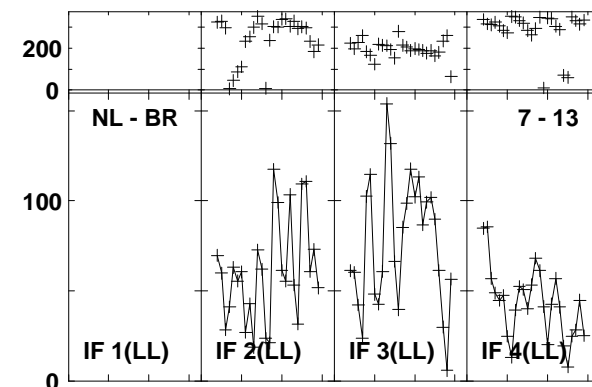
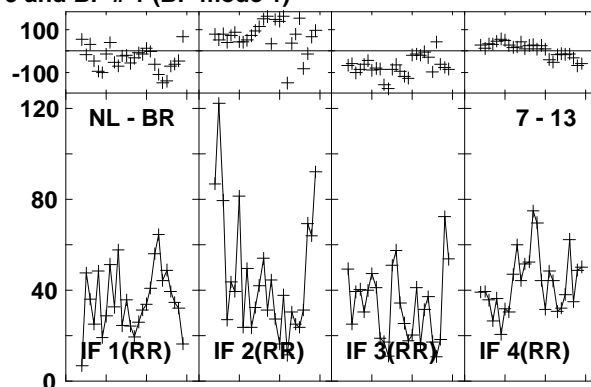
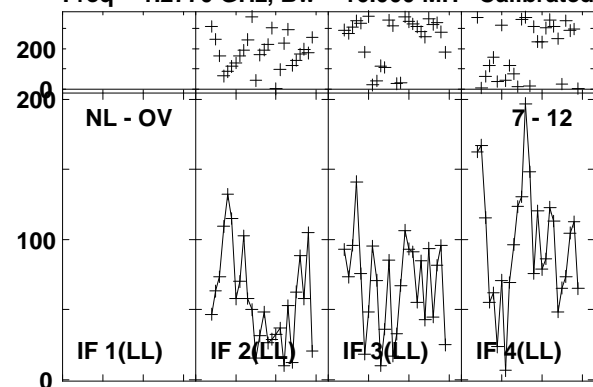

Lower frame: Milli Ampl Jy Top frame: Phas deg
Vector averaged cross-power spectrum Baseline: NL (07) - OV (12)
Timerange: 00/19:03:44 to 00/19:06:38

Plot file version 460 created 03-MAR-2016 01:13:14

J1545+5400 GN002C 1.UVDATA.1

Freq = 1.2770 GHz, Bw = 16.000 MH Calibrated with CL # 3 and BP # 1 (BP mode 1)

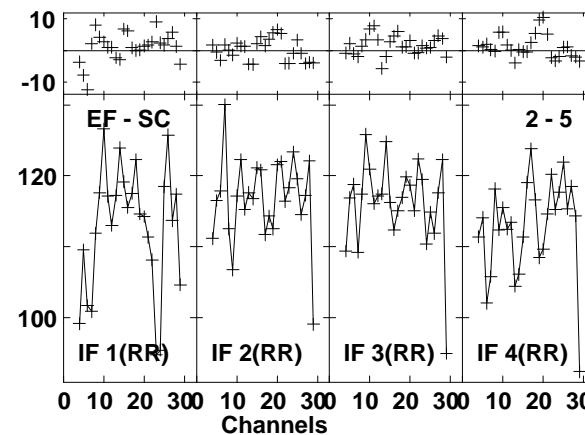
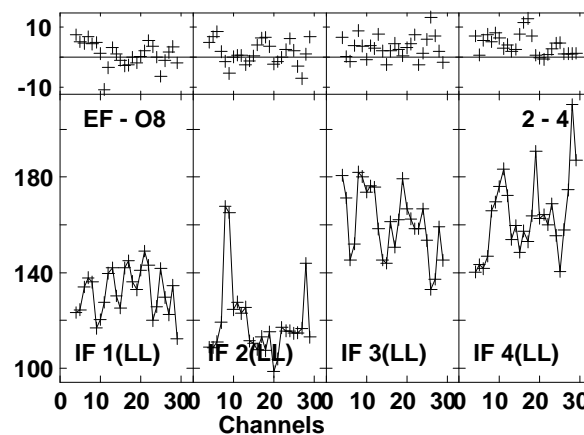
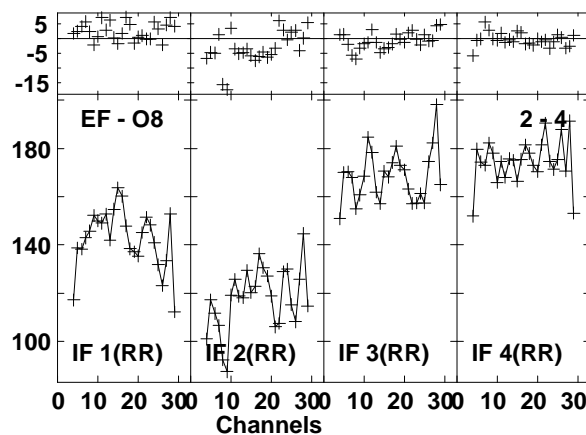
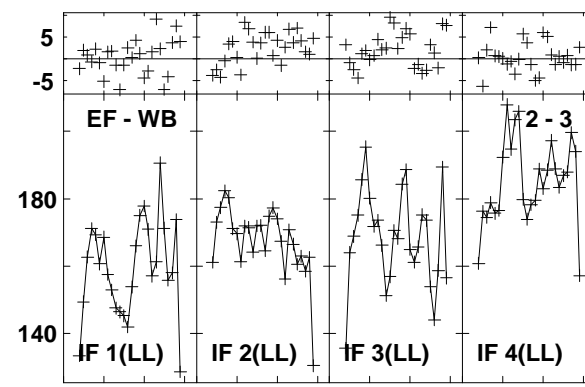
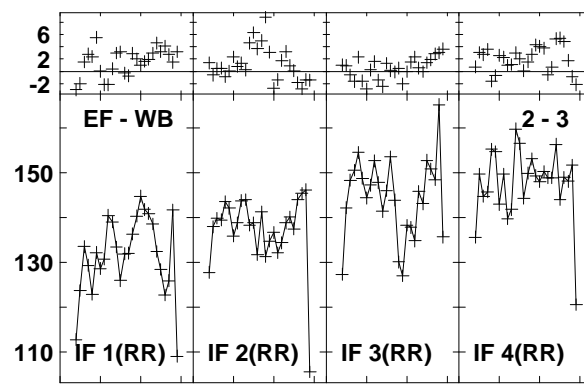
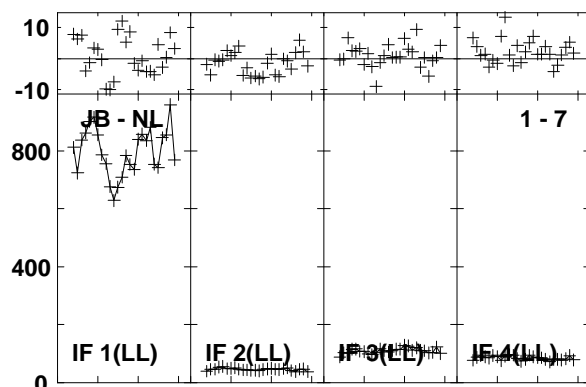
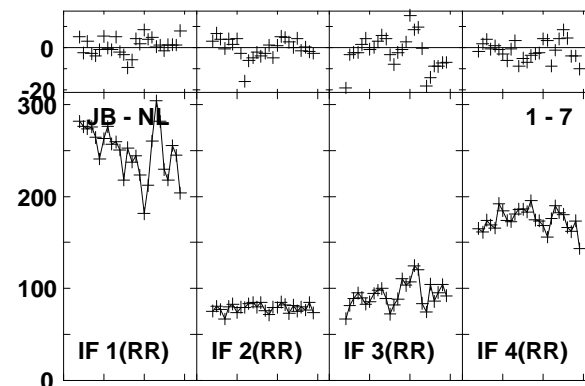
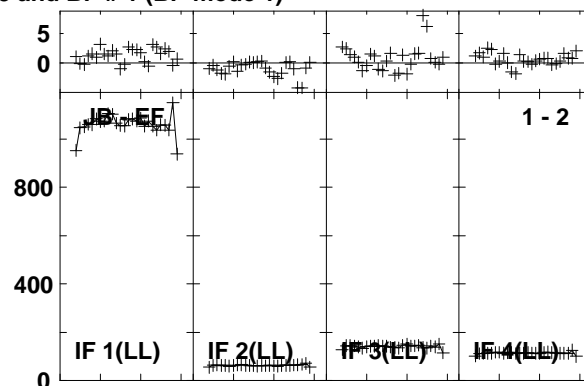
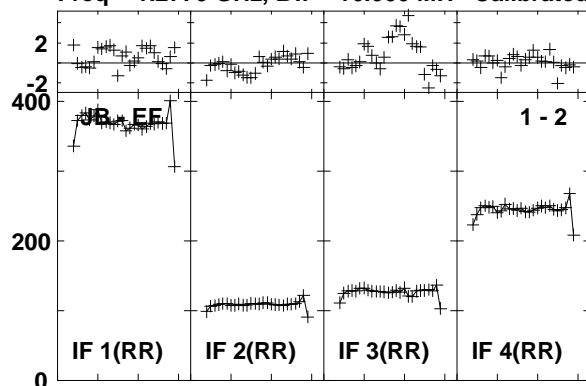

Lower frame: Milli Ampl Jy Top frame: Phas deg
Vector averaged cross-power spectrum Baseline: JB (01) - EF (02)
Timerange: 00/19:07:31 to 00/19:09:29

Plot file version 461 created 03-MAR-2016 01:13:14

J1545+5400 GN002C 1.UVDATA.1

Freq = 1.2770 GHz, Bw = 16.000 MH Calibrated with CL # 3 and BP # 1 (BP mode 1)

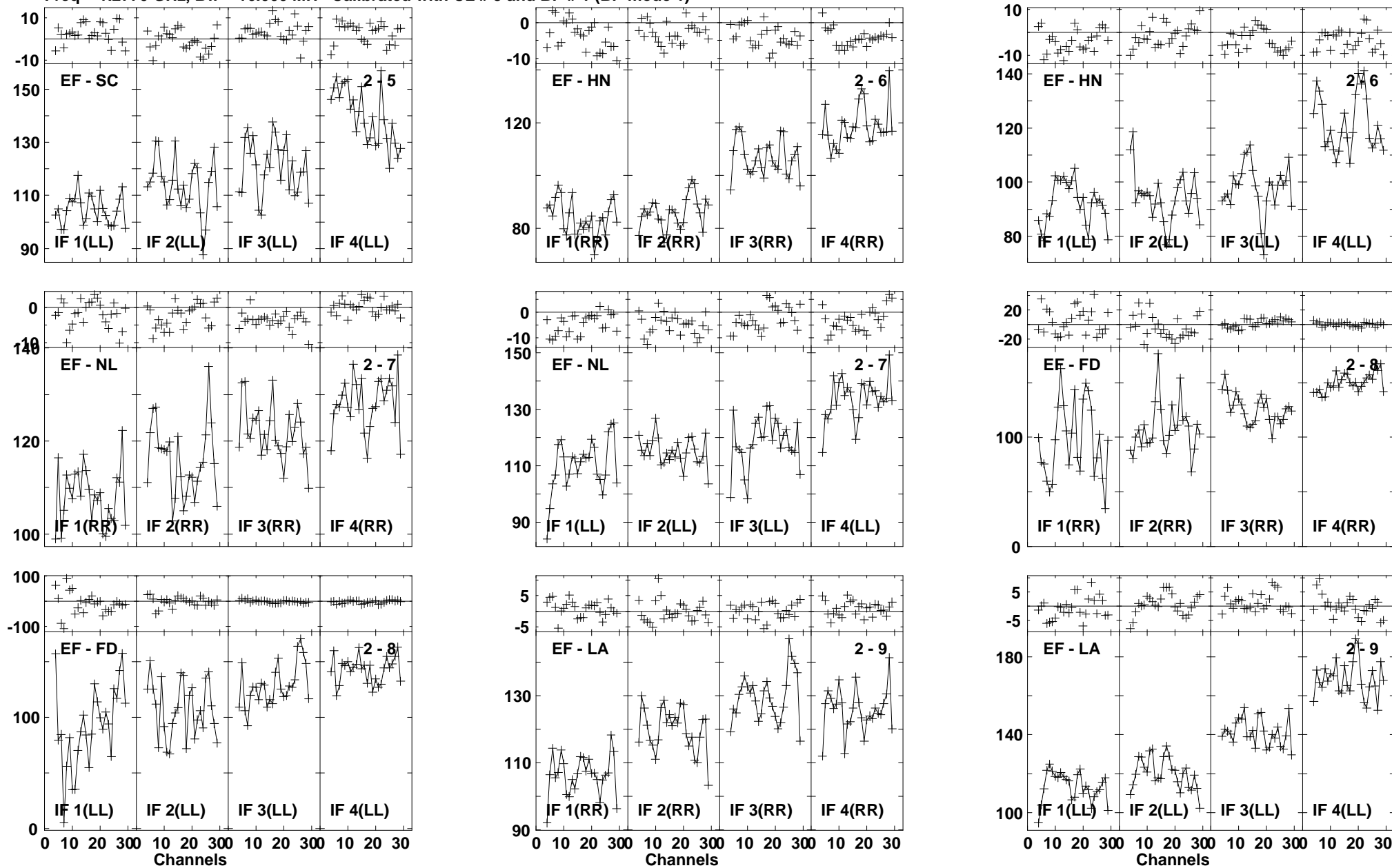

Lower frame: Milli Ampl Jy Top frame: Phas deg
Vector averaged cross-power spectrum Baseline: EF (02) - SC (05)
Timerange: 00/19:07:31 to 00/19:09:29

Plot file version 462 created 03-MAR-2016 01:13:14

J1545+5400 GN002C 1.UVDATA.1

Freq = 1.2770 GHz, Bw = 16.000 MH Calibrated with CL # 3 and BP # 1 (BP mode 1)

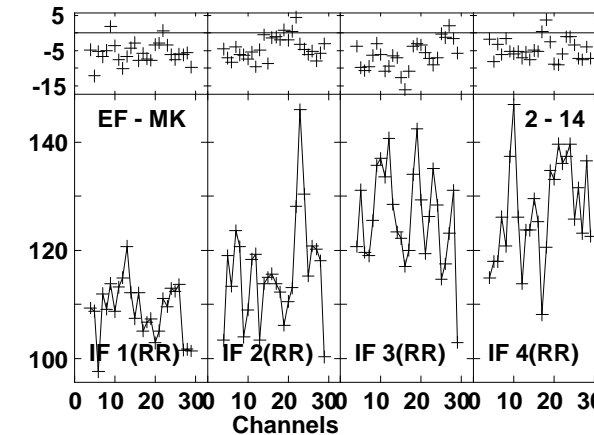
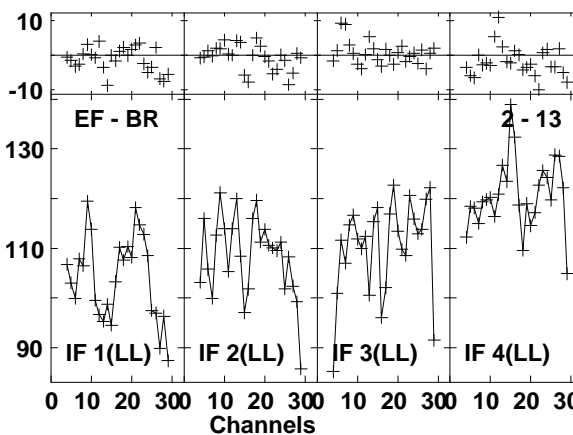
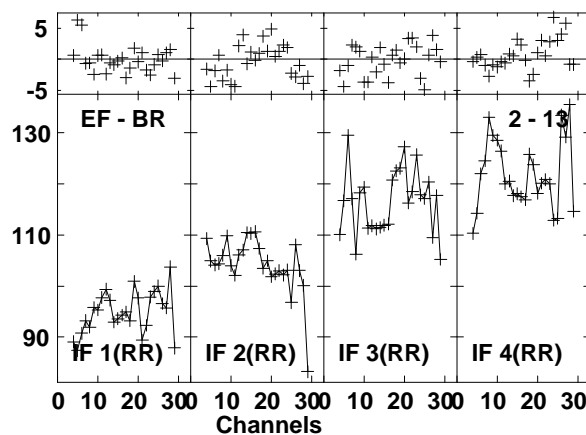
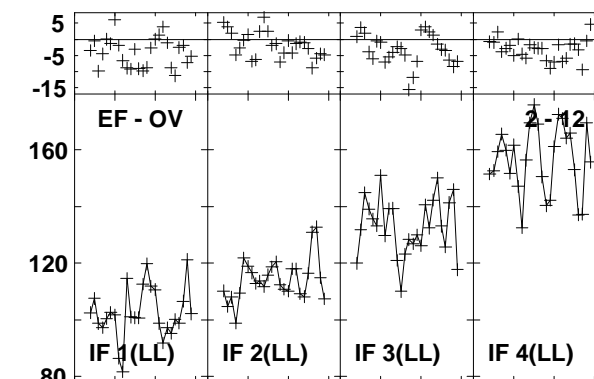
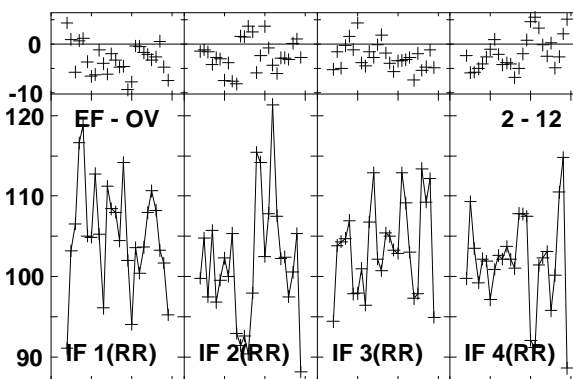
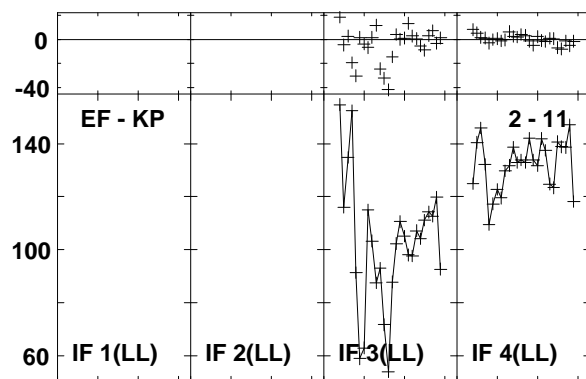
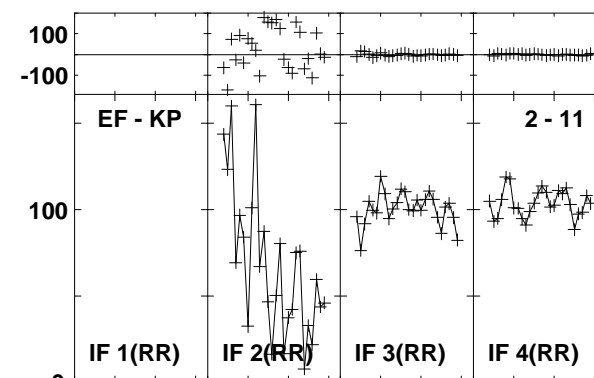
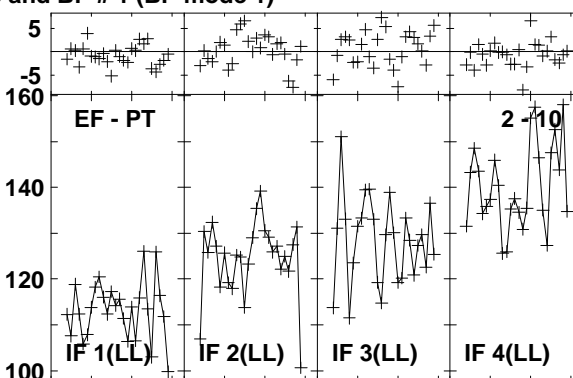
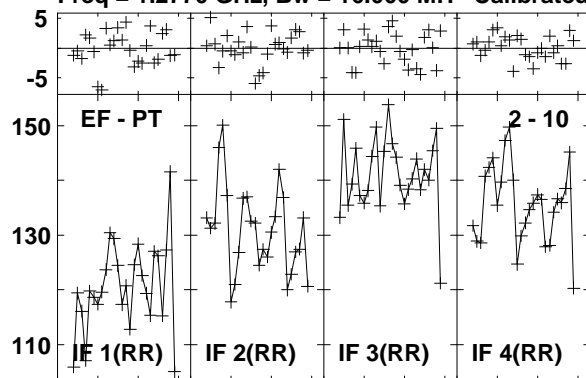

Lower frame: Milli Ampl Jy Top frame: Phas deg
Vector averaged cross-power spectrum Baseline: EF (02) - PT (10)
Timerange: 00/19:07:31 to 00/19:09:29

Plot file version 463 created 03-MAR-2016 01:13:15

J1545+5400 GN002C 1.UVDATA.1

Freq = 1.2770 GHz, Bw = 16.000 MH Calibrated with CL # 3 and BP # 1 (BP mode 1)

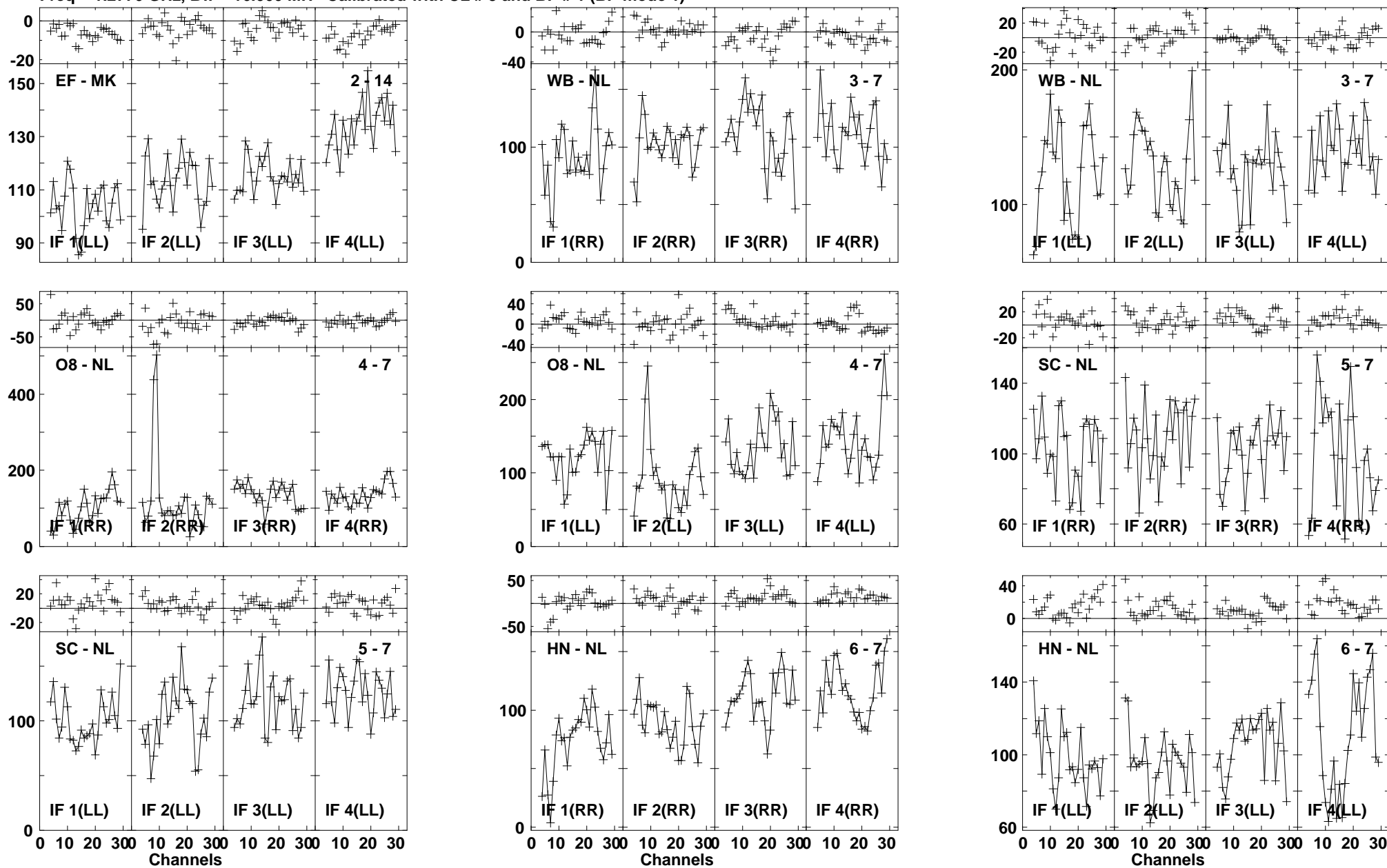

Lower frame: Milli Ampl Jy Top frame: Phas deg
Vector averaged cross-power spectrum Baseline: EF (02) - MK (14)
Timerange: 00/19:07:31 to 00/19:09:29

Plot file version 464 created 03-MAR-2016 01:13:15
 J1545+5400 GN002C 1.UVDATA.1
 Freq = 1.2770 GHz, Bw = 16.000 MH Calibrated with CL # 3 and BP # 1 (BP mode 1)

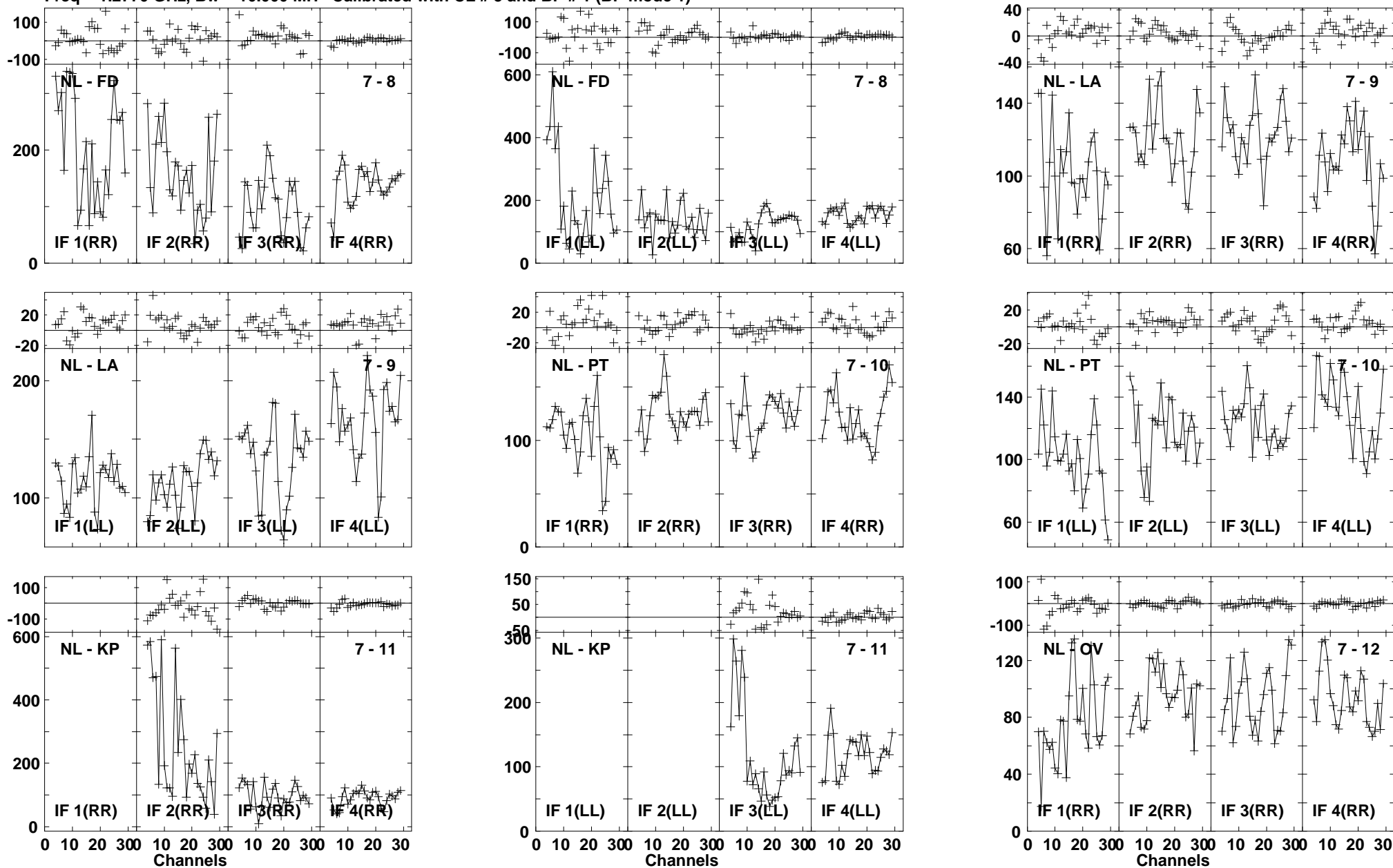

Lower frame: Milli Ampl Jy Top frame: Phas deg
 Vector averaged cross-power spectrum Baseline: NL (07) - FD (08)
 Timerange: 00/19:07:31 to 00/19:09:29

Plot file version 465 created 03-MAR-2016 01:13:15
 J1545+5400 GN002C 1.UVDATA.1
 Freq = 1.2770 GHz, Bw = 16.000 MH Calibrated with CL # 3 and BP # 1 (BP mode 1)

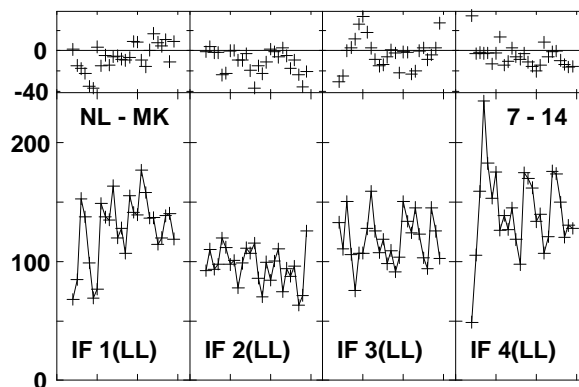
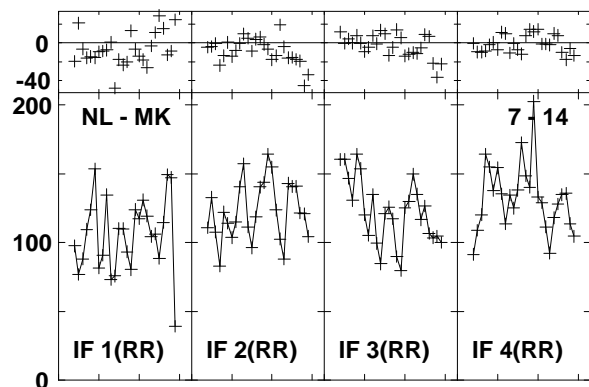
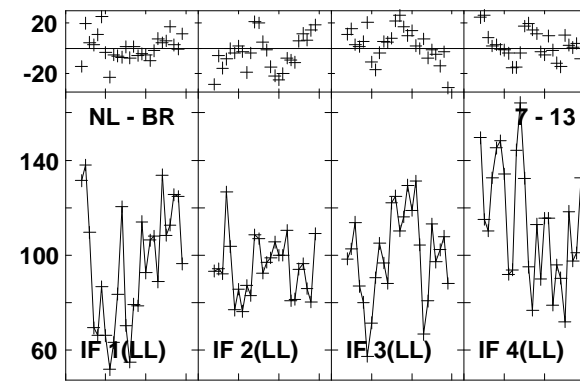
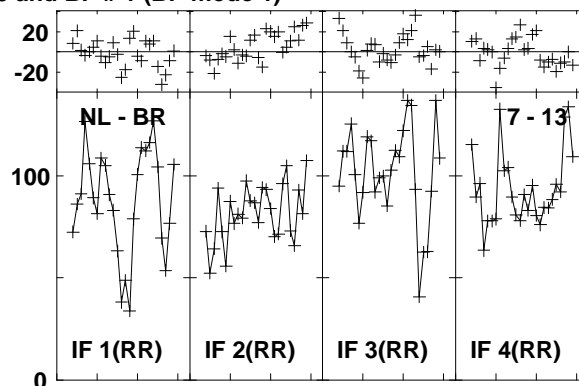
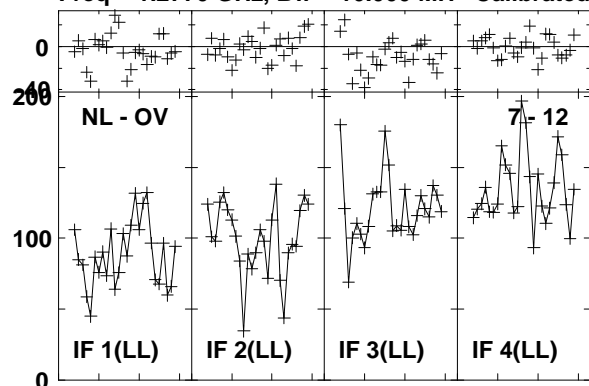

Lower frame: Milli Ampl Jy Top frame: Phas deg
 Vector averaged cross-power spectrum Baseline: NL (07) - OV (12)
 Timerange: 00/19:07:31 to 00/19:09:29

Plot file version 466 created 03-MAR-2016 01:13:15

4C52 GN002C 1.UVDATA.1

Freq = 1.2770 GHz, Bw = 16.000 MH Calibrated with CL # 3 and BP # 1 (BP mode 1)

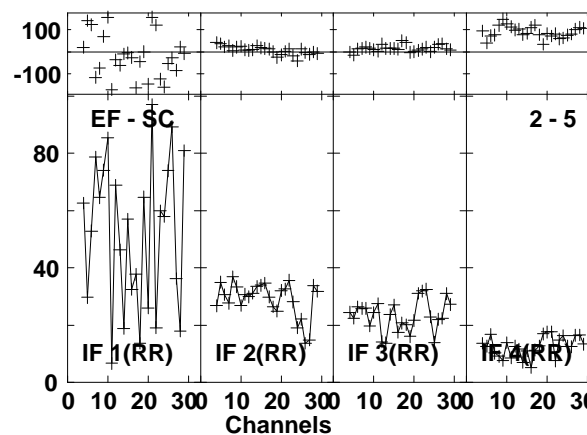
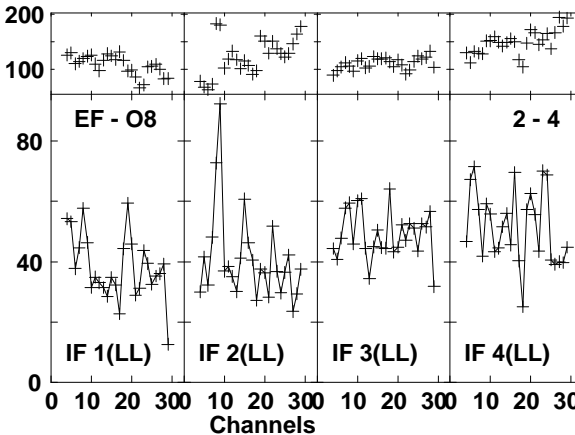
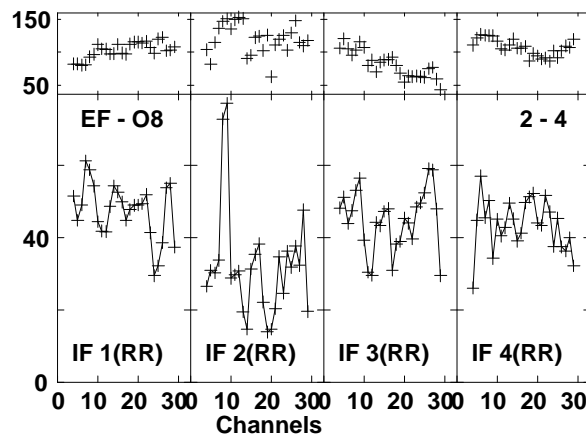
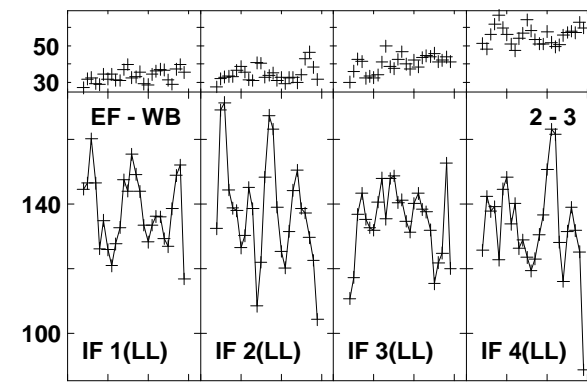
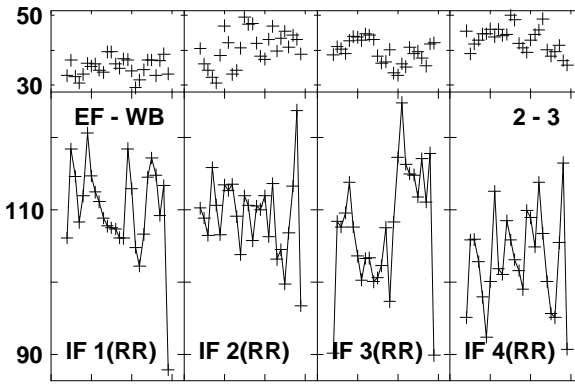
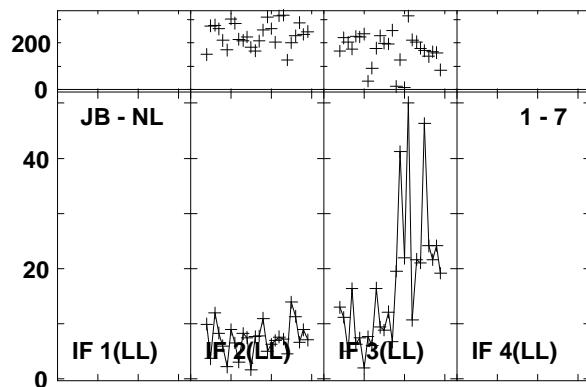
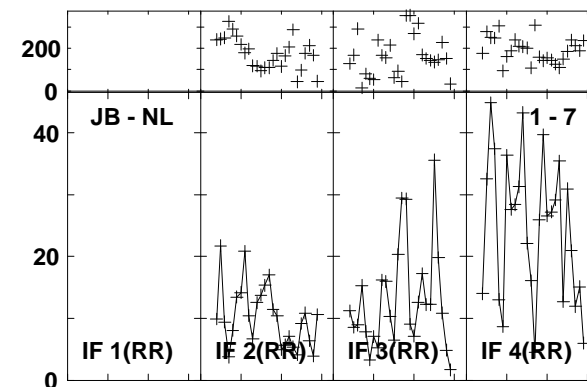
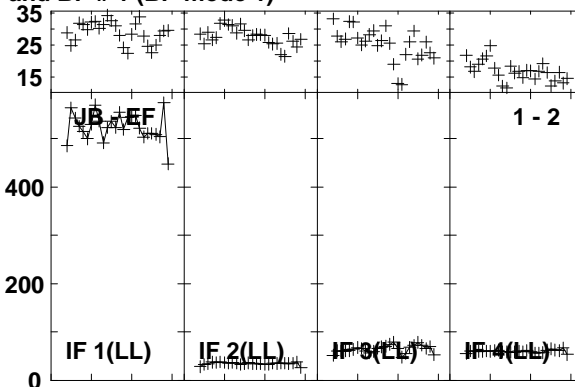
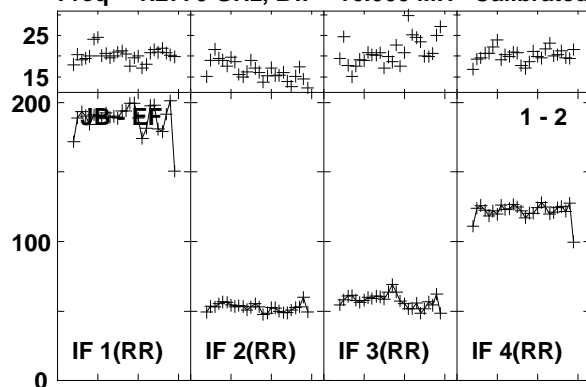

Lower frame: Milli Ampl Jy Top frame: Phas deg
Vector averaged cross-power spectrum Baseline: JB (01) - EF (02)
Timerange: 00/19:09:42 to 00/19:12:28

Plot file version 467 created 03-MAR-2016 01:13:15

4C52 GN002C 1.UVDATA.1

Freq = 1.2770 GHz, Bw = 16.000 MH Calibrated with CL # 3 and BP # 1 (BP mode 1)

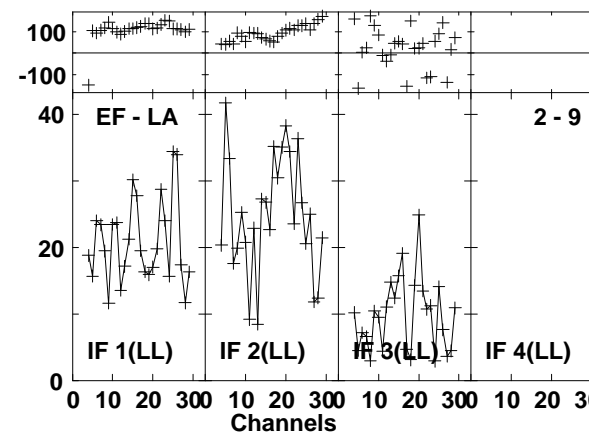
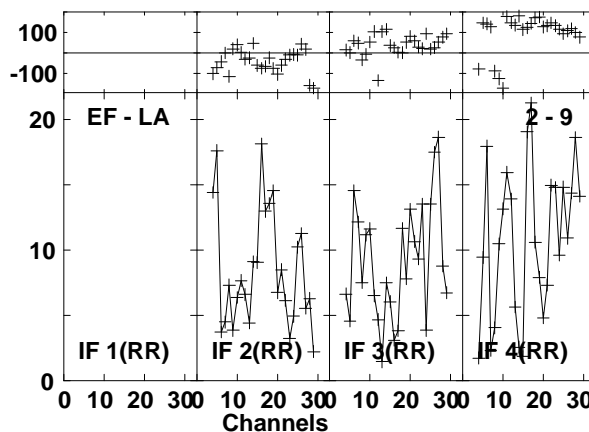
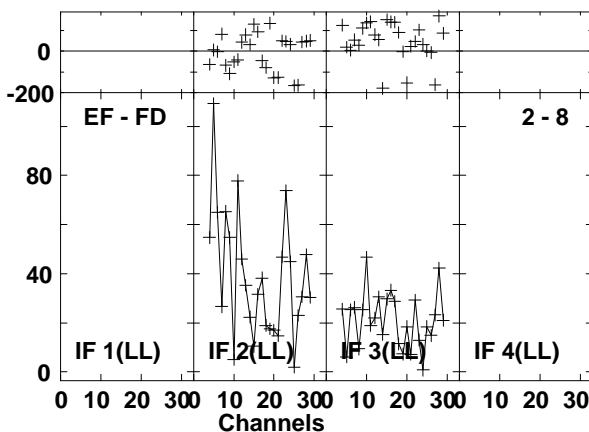
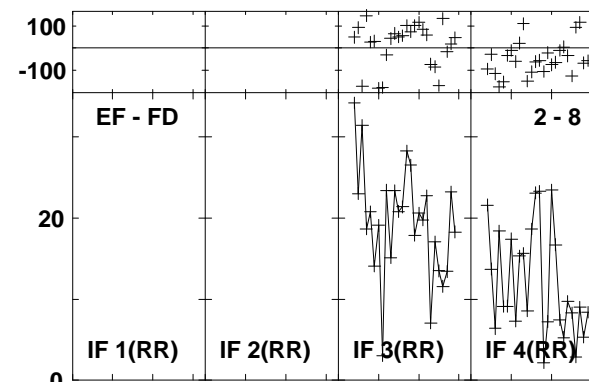
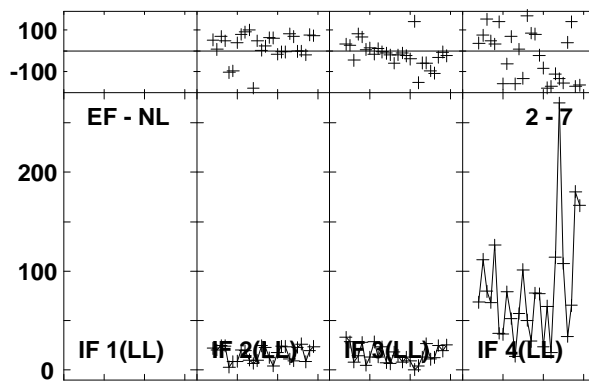
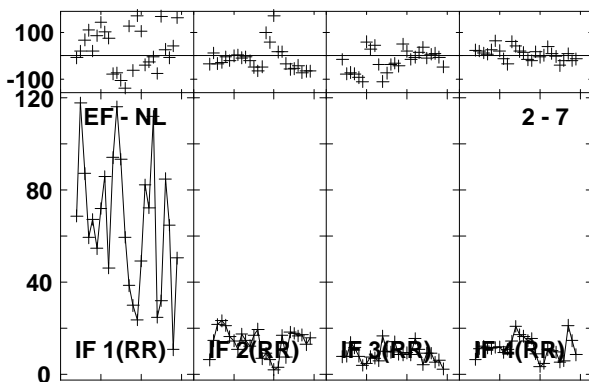
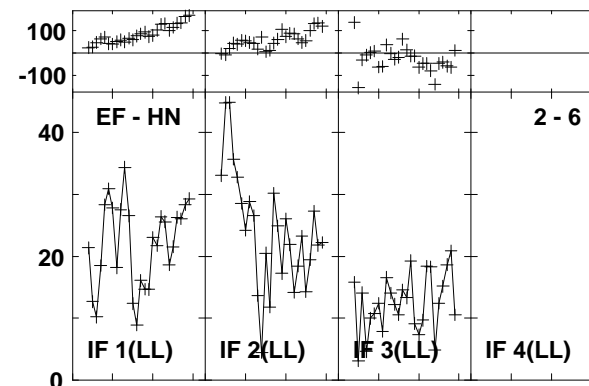
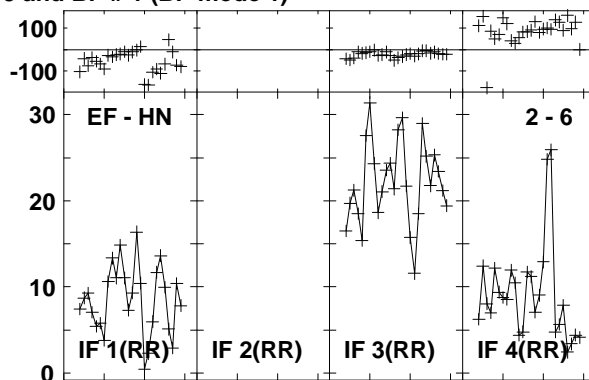
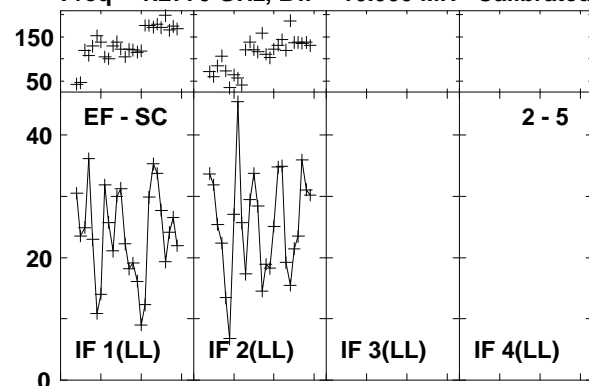

Lower frame: Milli Ampl Jy Top frame: Phas deg
Vector averaged cross-power spectrum Baseline: EF (02) - SC (05)
Timerange: 00/19:09:42 to 00/19:12:28

Plot file version 468 created 03-MAR-2016 01:13:15
 4C52 GN002C 1.UVDATA.1
 Freq = 1.2770 GHz, Bw = 16.000 MH Calibrated with CL # 3 and BP # 1 (BP mode 1)

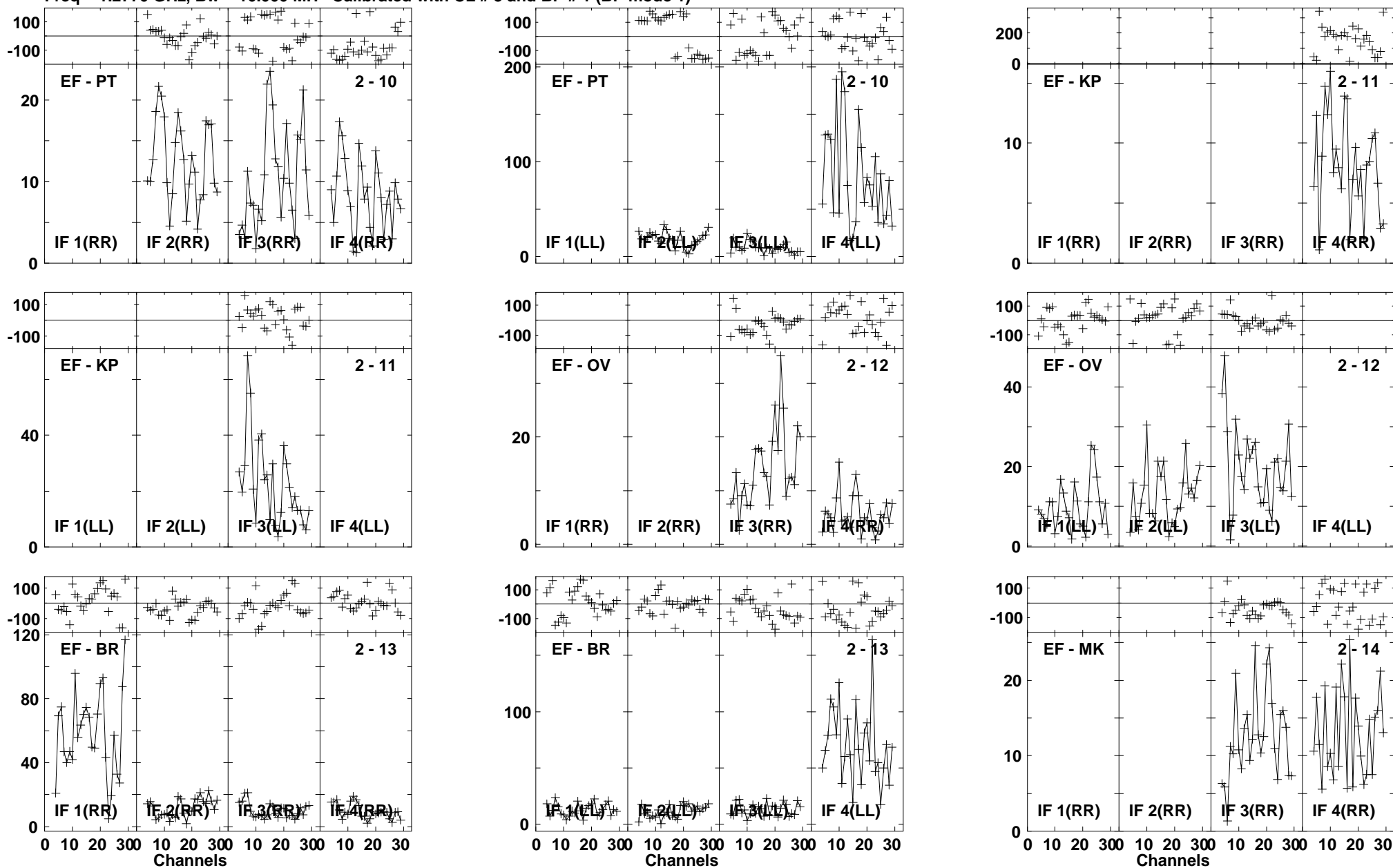

Lower frame: Milli Ampl Jy Top frame: Phas deg
 Vector averaged cross-power spectrum Baseline: EF (02) - PT (10)
 Timerange: 00/19:09:42 to 00/19:12:28

Plot file version 469 created 03-MAR-2016 01:13:16

4C52 GN002C 1.UVDATA.1

Freq = 1.2770 GHz, Bw = 16.000 MH Calibrated with CL # 3 and BP # 1 (BP mode 1)

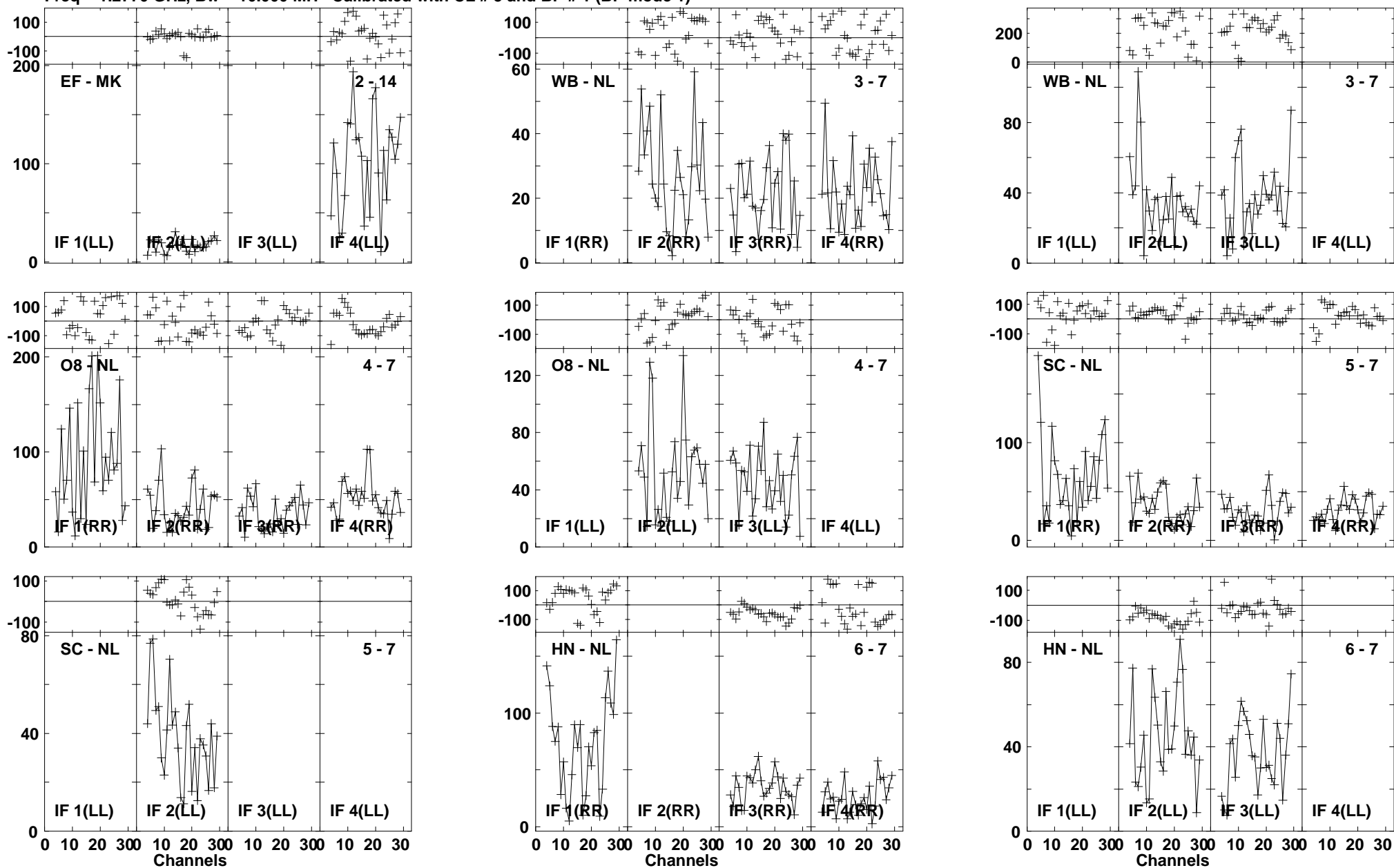

Lower frame: Milli Ampl Jy Top frame: Phas deg
Vector averaged cross-power spectrum Baseline: EF (02) - MK (14)
Timerange: 00/19:09:42 to 00/19:12:28

Plot file version 470 created 03-MAR-2016 01:13:16

4C52 GN002C 1.UVDATA.1

Freq = 1.2770 GHz, Bw = 16.000 MH Calibrated with CL # 3 and BP # 1 (BP mode 1)

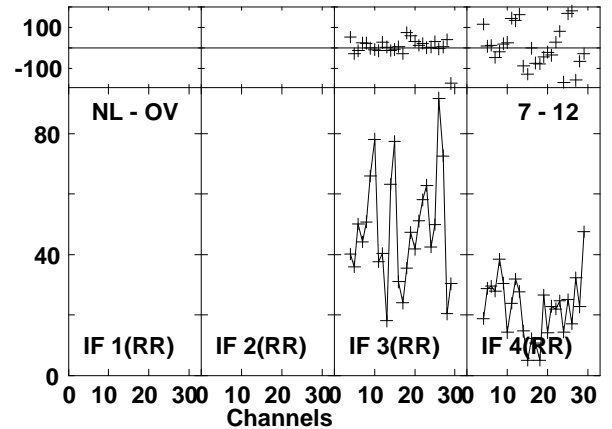
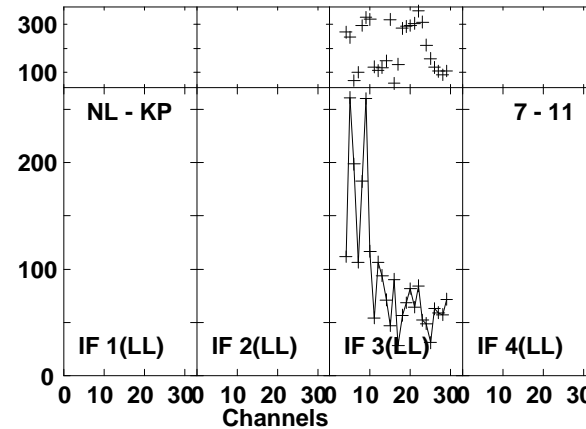
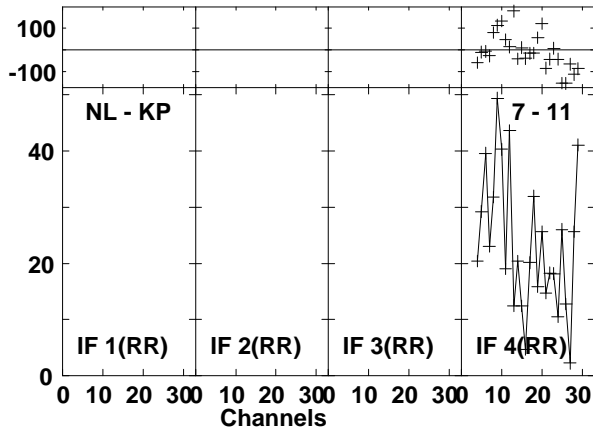
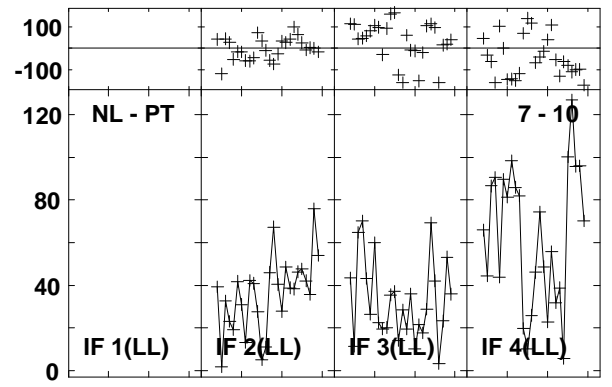
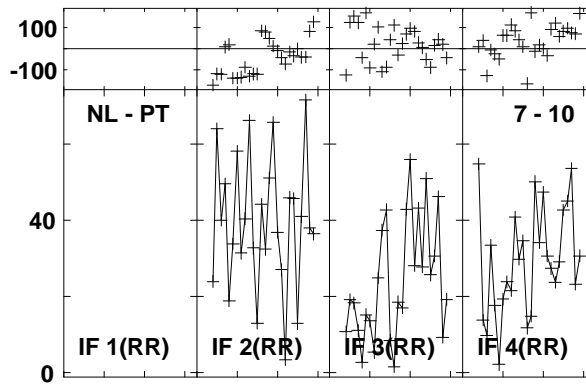
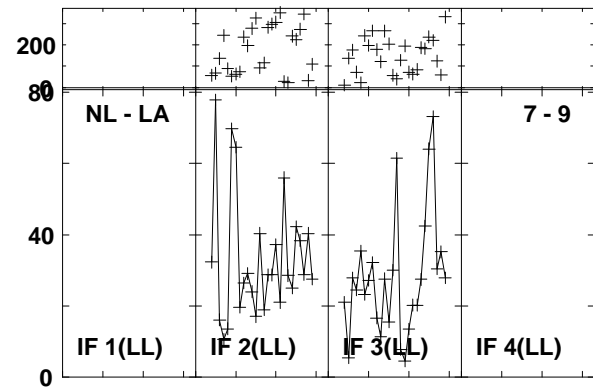
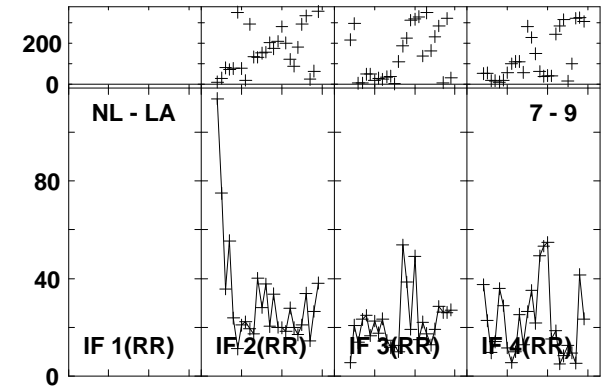
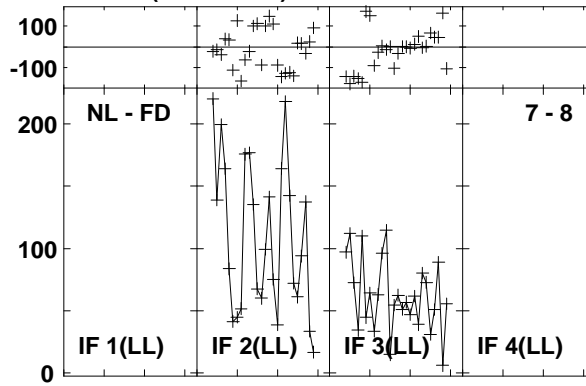
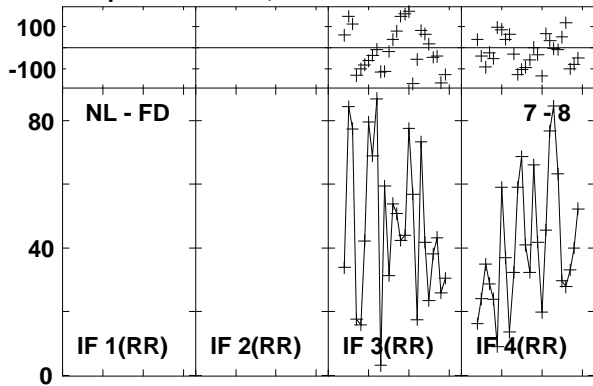

Lower frame: Milli Ampl Jy Top frame: Phas deg
Vector averaged cross-power spectrum Baseline: NL (07) - FD (08)
Timerange: 00/19:09:42 to 00/19:12:28

Plot file version 471 created 03-MAR-2016 01:13:16
 4C52 GN002C 1.UVDATA.1
 Freq = 1.2770 GHz, Bw = 16.000 MH Calibrated with CL # 3 and BP # 1 (BP mode 1)

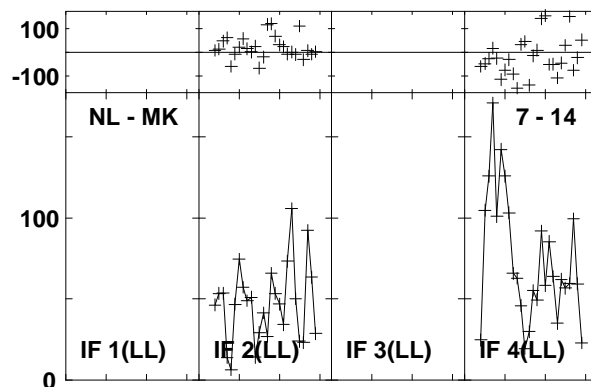
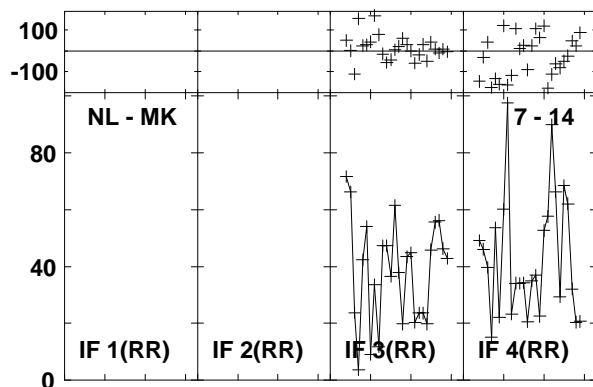
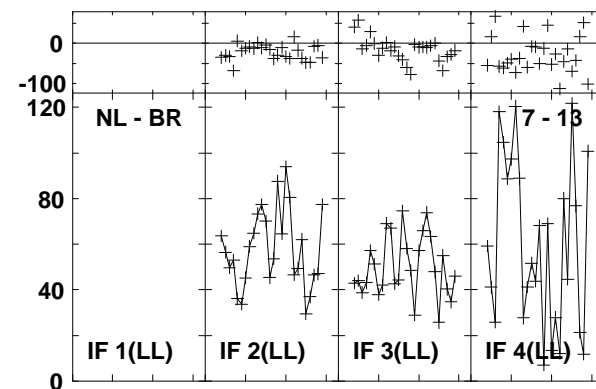
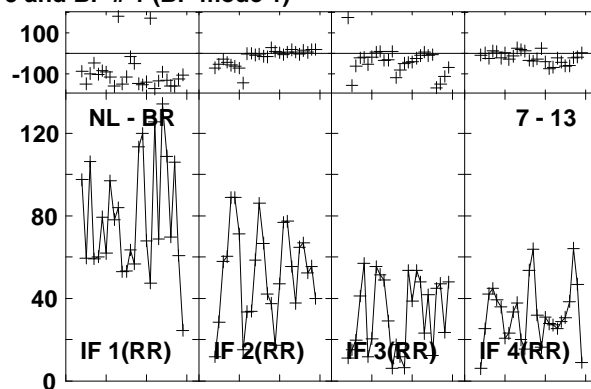
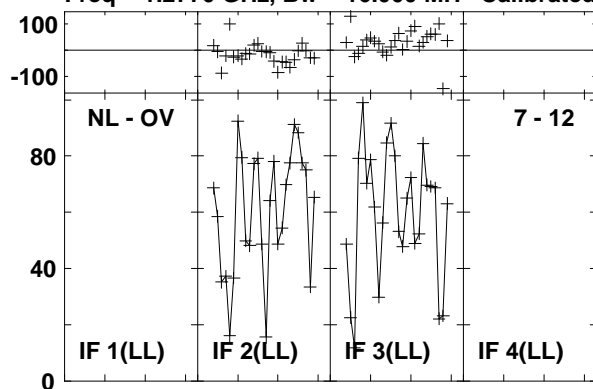

Lower frame: Milli Ampl Jy Top frame: Phas deg
 Vector averaged cross-power spectrum Baseline: NL (07) - OV (12)
 Timerange: 00:19:09:42 to 00:19:12:28

Plot file version 472 created 03-MAR-2016 01:13:16

J1545+5400 GN002C 1.UVDATA.1

Freq = 1.2770 GHz, Bw = 16.000 MH Calibrated with CL # 3 and BP # 1 (BP mode 1)

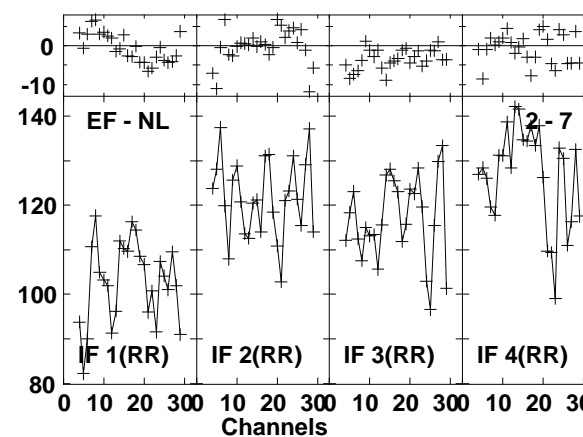
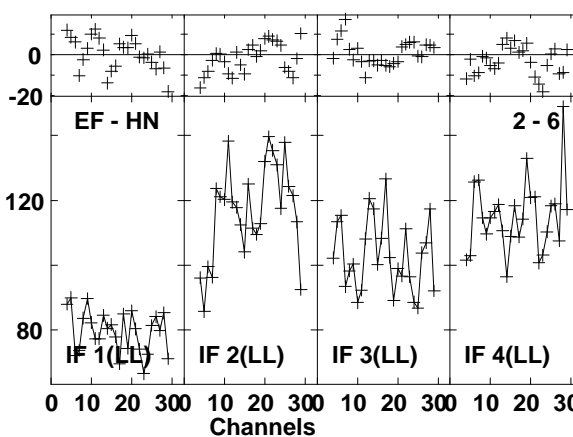
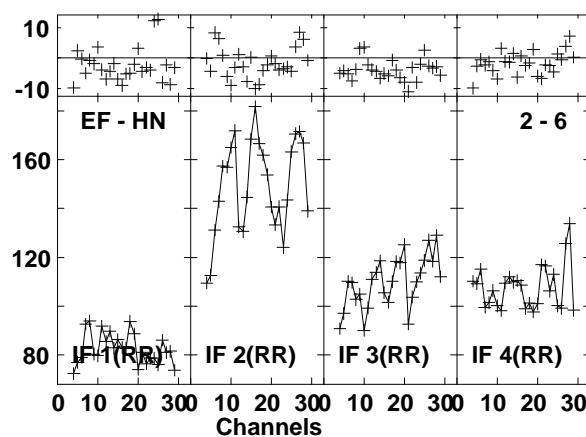
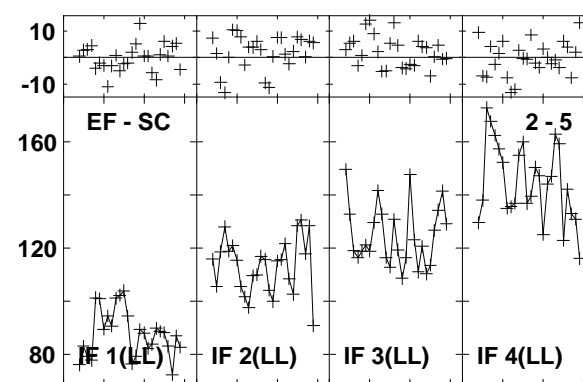
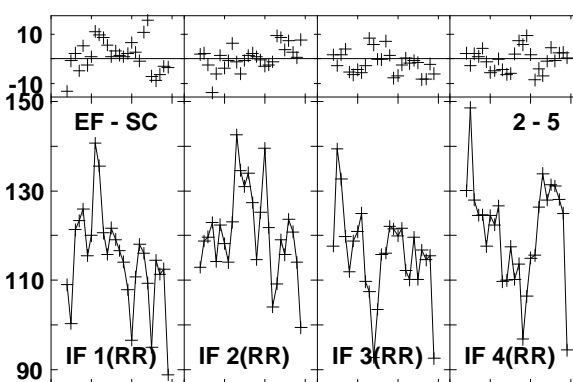
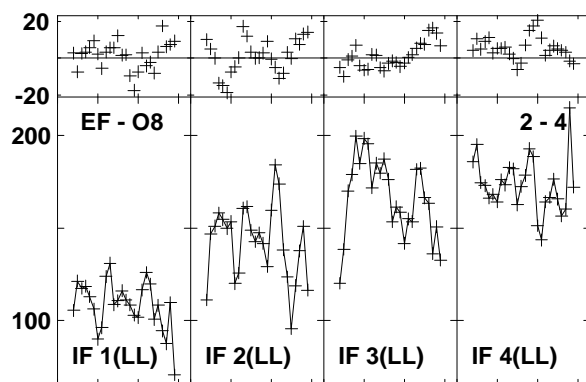
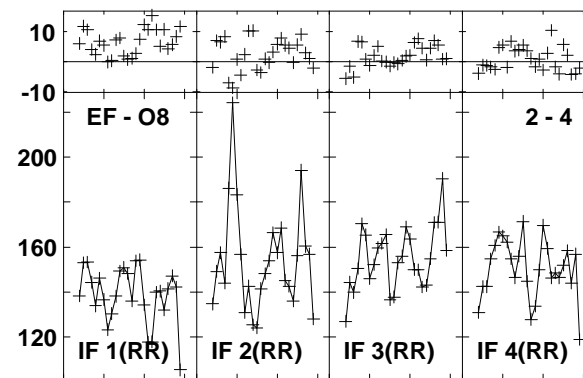
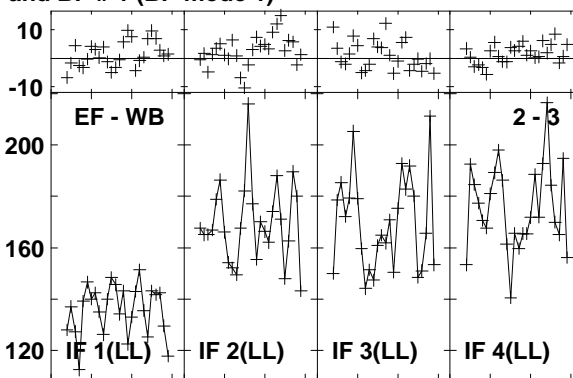
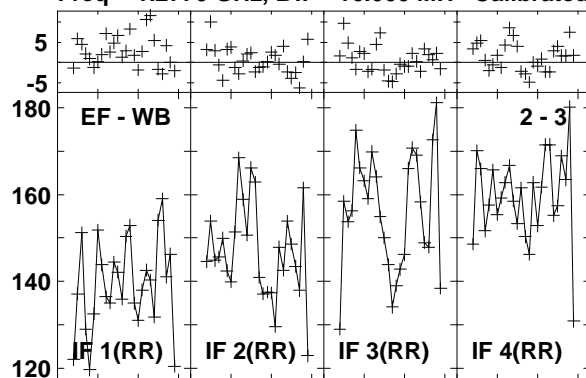

Lower frame: Milli Ampl Jy Top frame: Phas deg
Vector averaged cross-power spectrum Baseline: EF (02) - WB (03)
Timerange: 00/19:13:21 to 00/19:14:19

Plot file version 473 created 03-MAR-2016 01:13:16

J1545+5400 GN002C 1.UVDATA.1

Freq = 1.2770 GHz, Bw = 16.000 MH Calibrated with CL # 3 and BP # 1 (BP mode 1)

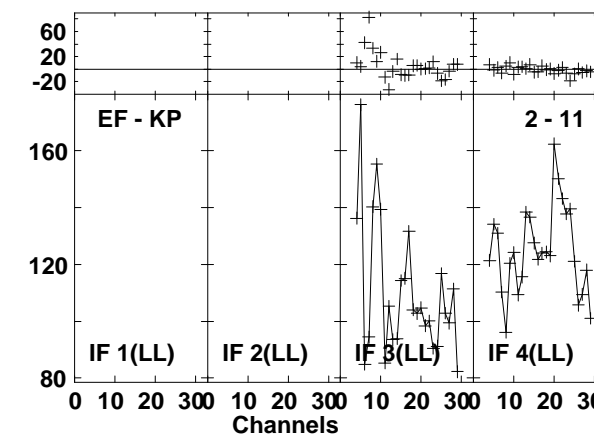
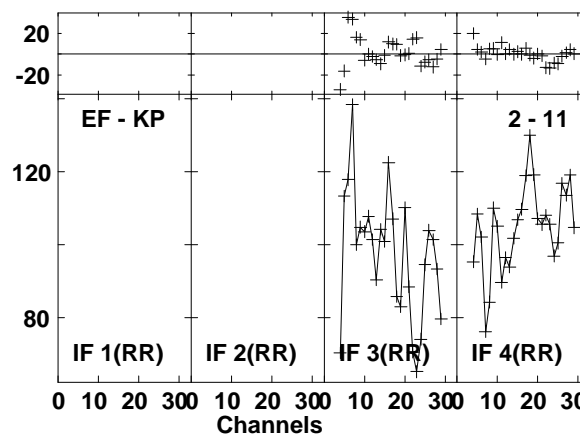
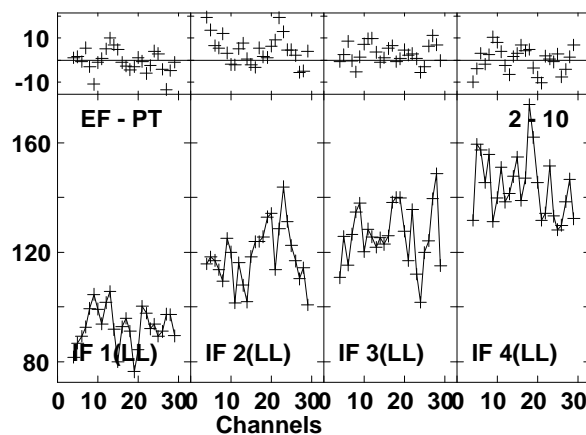
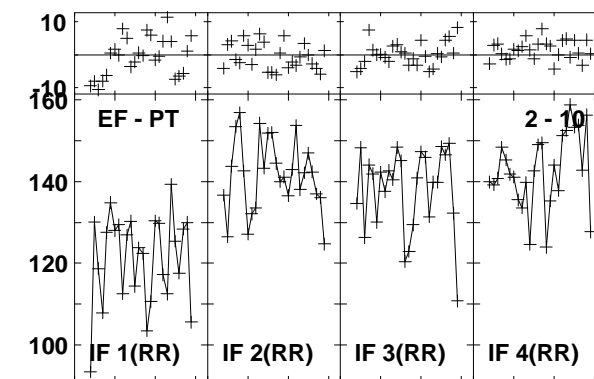
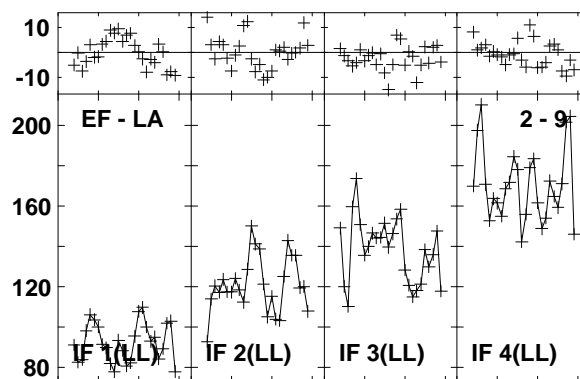
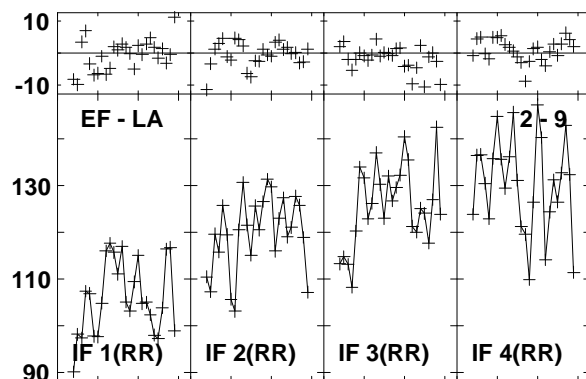
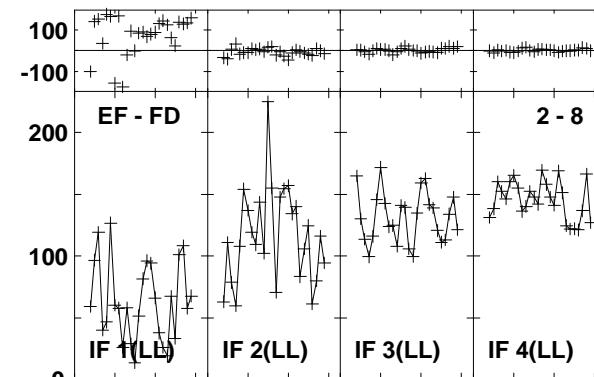
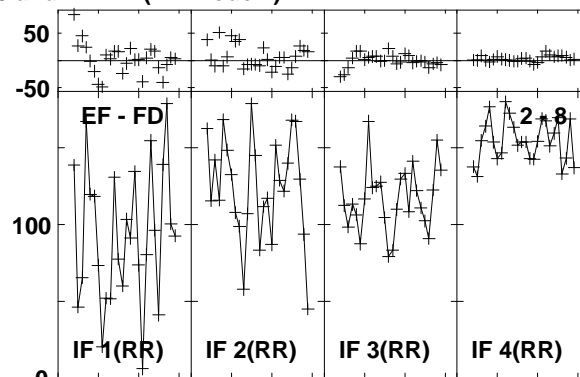
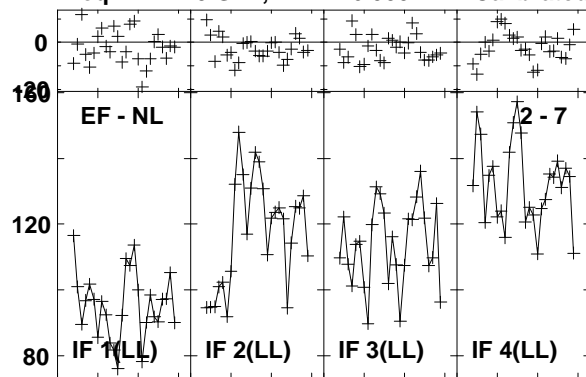

Lower frame: Milli Ampl Jy Top frame: Phas deg
Vector averaged cross-power spectrum Baseline: EF (02) - NL (07)
Timerange: 00/19:13:21 to 00/19:14:19

Plot file version 474 created 03-MAR-2016 01:13:17

J1545+5400 GN002C 1.UVDATA.1

Freq = 1.2770 GHz, Bw = 16.000 MH Calibrated with CL # 3 and BP # 1 (BP mode 1)

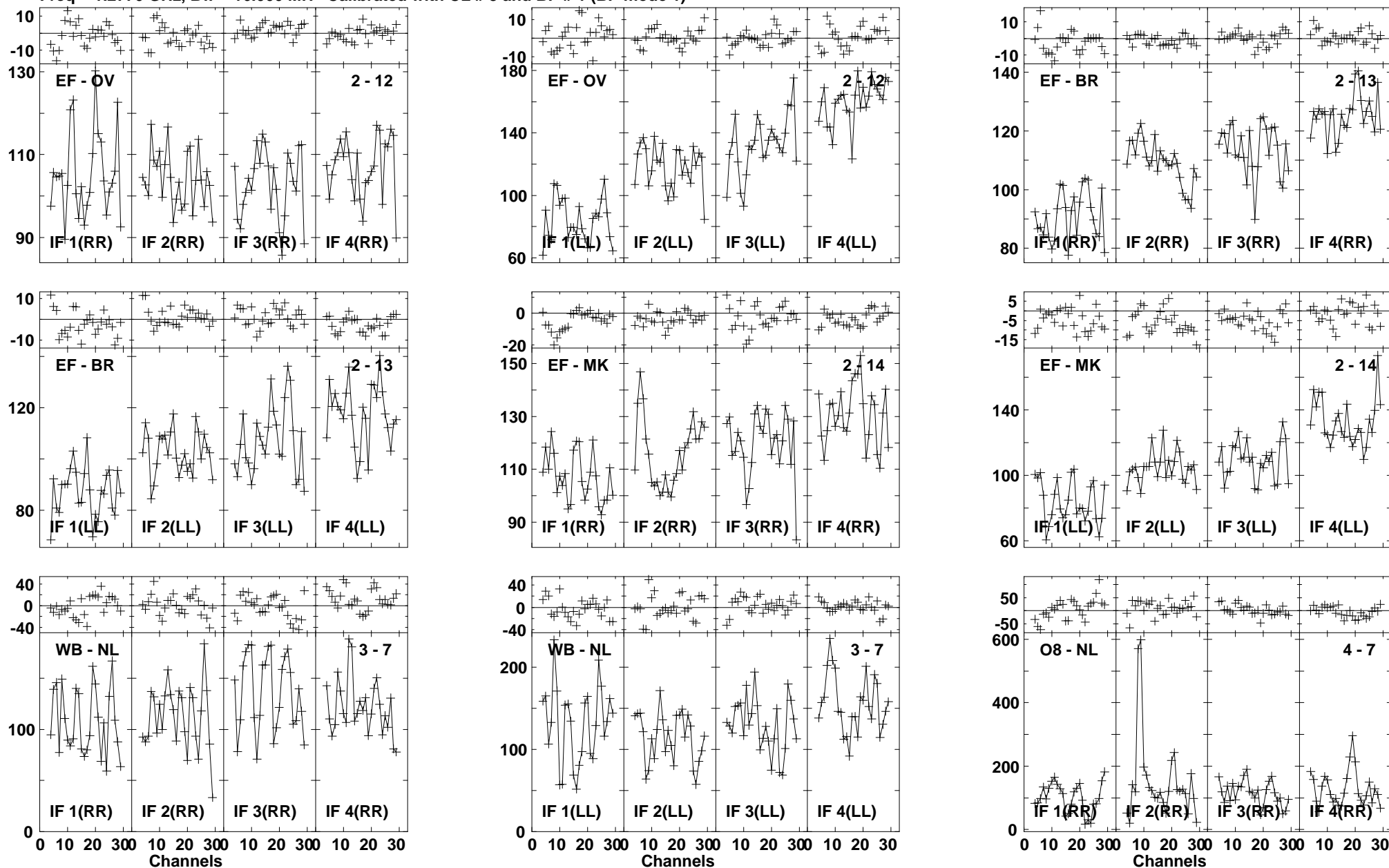

Lower frame: Milli Ampl Jy Top frame: Phas deg
Vector averaged cross-power spectrum Baseline: EF (02) - OV (12)
Timerange: 00/19:13:21 to 00/19:14:19

Plot file version 475 created 03-MAR-2016 01:13:17

J1545+5400 GN002C 1.UVDATA.1

Freq = 1.2770 GHz, Bw = 16.000 MH Calibrated with CL # 3 and BP # 1 (BP mode 1)

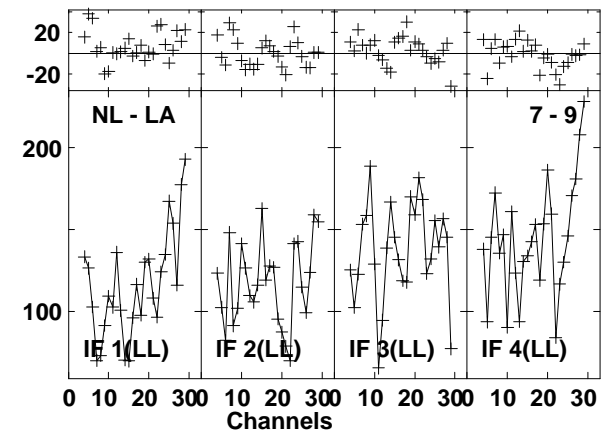
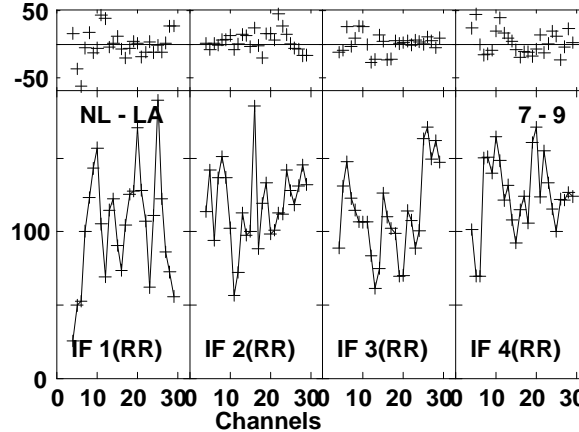
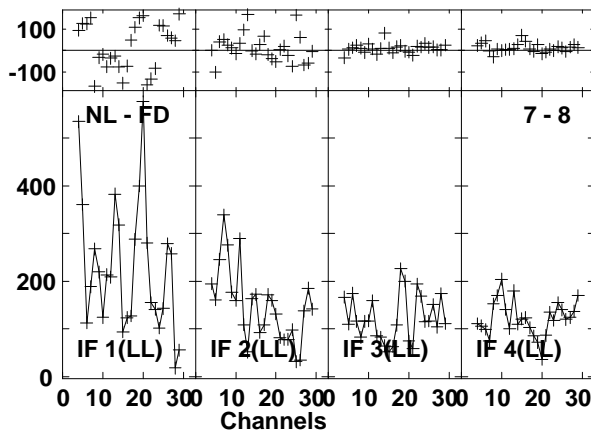
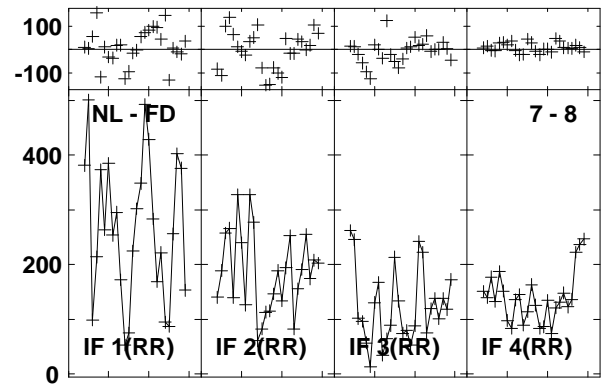
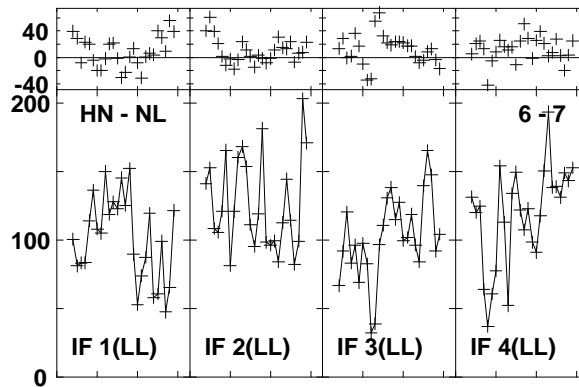
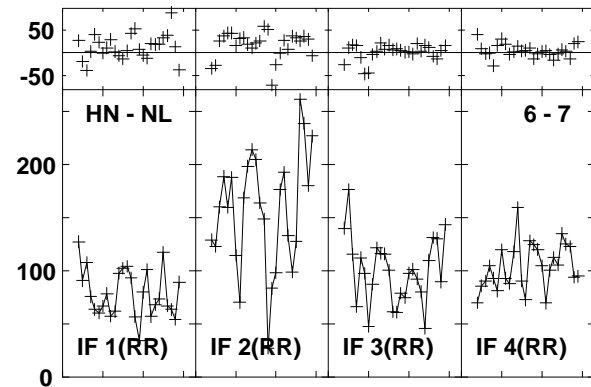
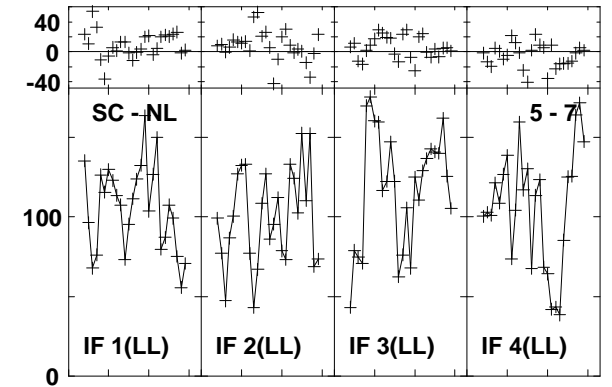
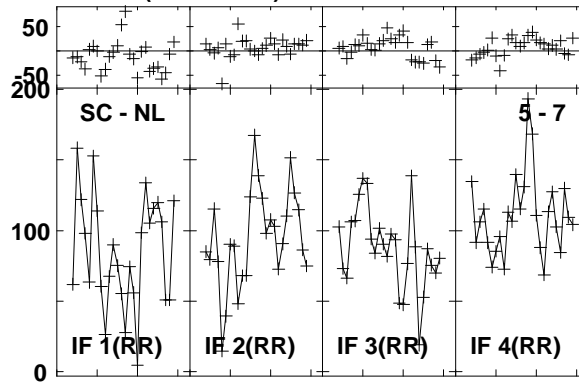
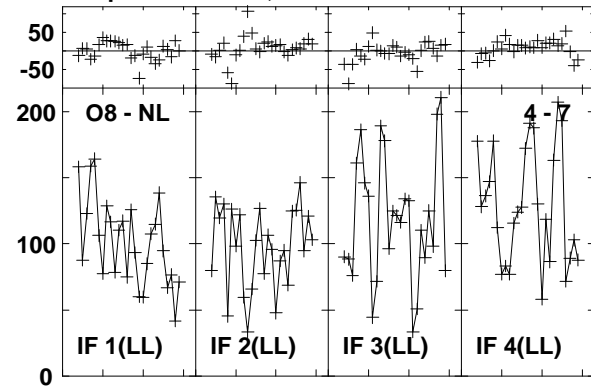

Lower frame: Milli Ampl Jy Top frame: Phas deg

Vector averaged cross-power spectrum Baseline: O8 (04) - NL (07)

Timerange: 00/19:13:21 to 00/19:14:19

Plot file version 476 created 03-MAR-2016 01:13:17

J1545+5400 GN002C 1.UVDATA.1

Freq = 1.2770 GHz, Bw = 16.000 MH Calibrated with CL # 3 and BP # 1 (BP mode 1)

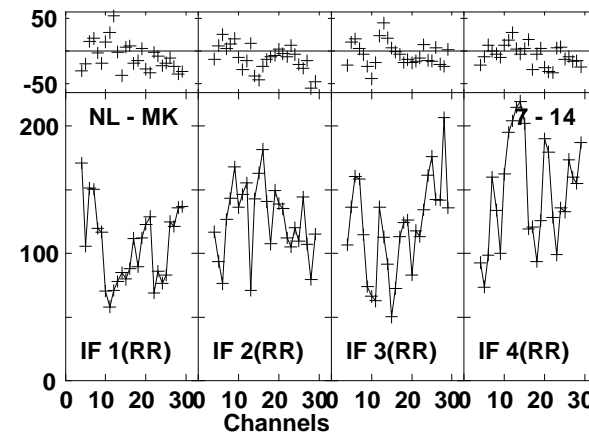
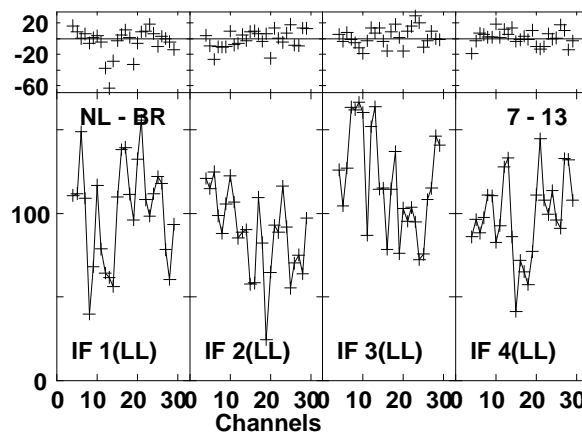
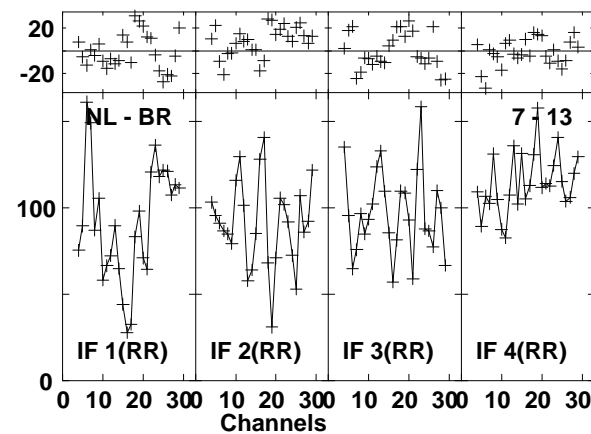
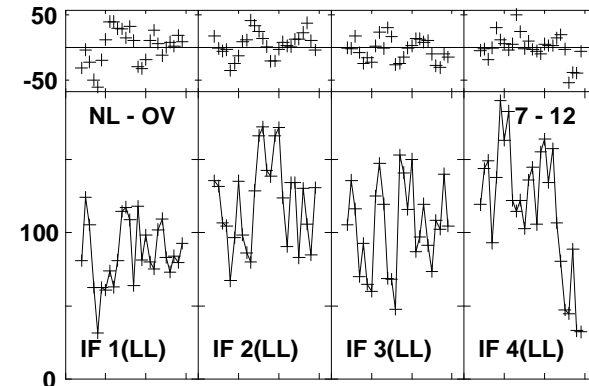
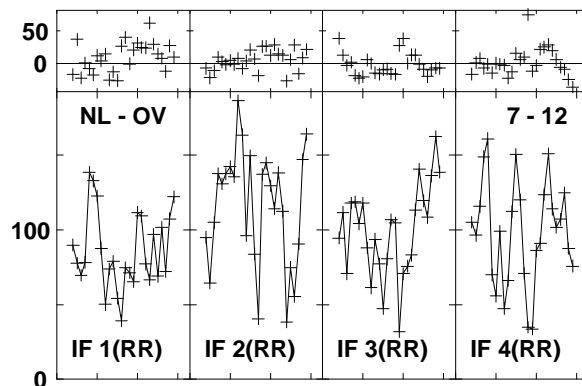
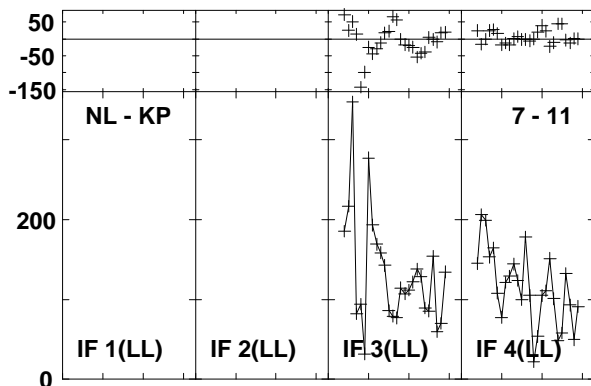
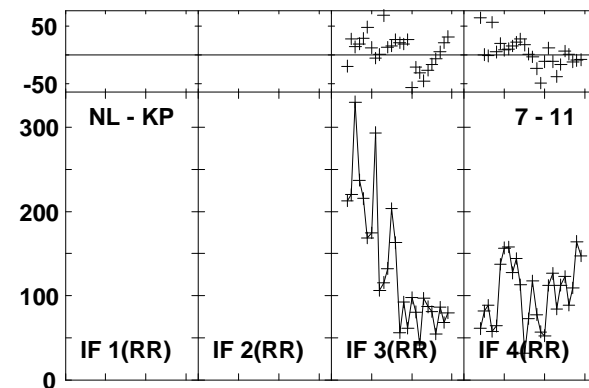
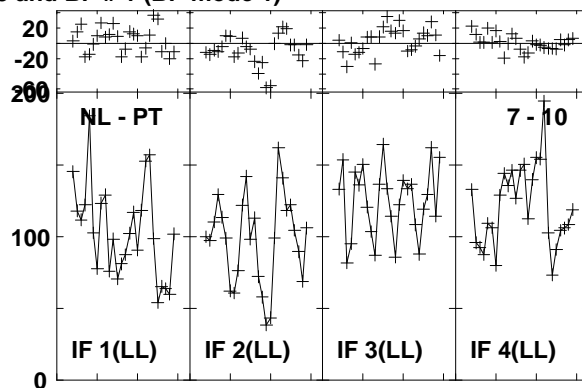
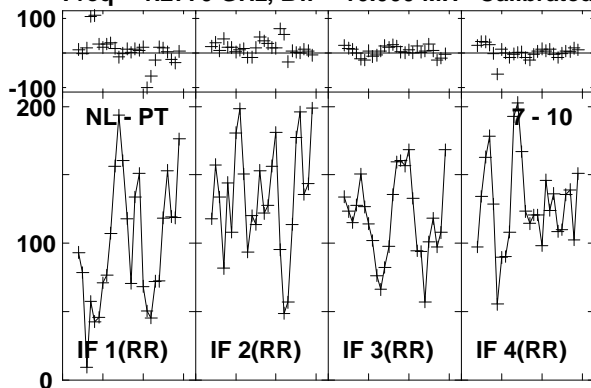

Lower frame: Milli Ampl Jy Top frame: Phas deg
Vector averaged cross-power spectrum Baseline: NL (07) - PT (10)
Timerange: 00/19:13:21 to 00/19:14:19

Plot file version 477 created 03-MAR-2016 01:13:17
J1545+5400 GN002C 1.UVDATA.1
Freq = 1.2770 GHz, Bw = 16.000 MH Calibrated with CL # 3 and BP # 1 (BP mode 1)

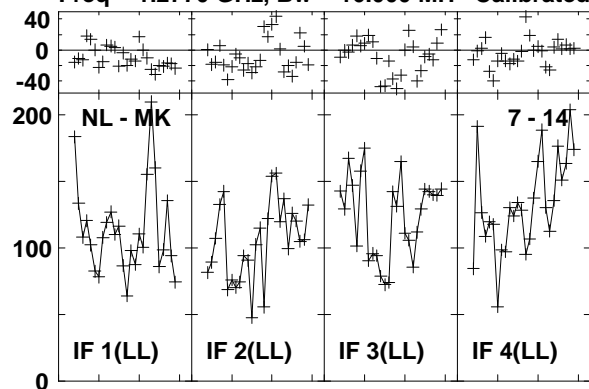

Lower frame: Milli Ampl Jy Top frame: Phas deg
Vector averaged cross-power spectrum Baseline: NL (07) - MK (14)
Timerange: 00/19:13:21 to 00/19:14:19

Plot file version 478 created 03-MAR-2016 01:13:17

4C52 GN002C 1.UVDATA.1

Freq = 1.2770 GHz, Bw = 16.000 MH Calibrated with CL # 3 and BP # 1 (BP mode 1)

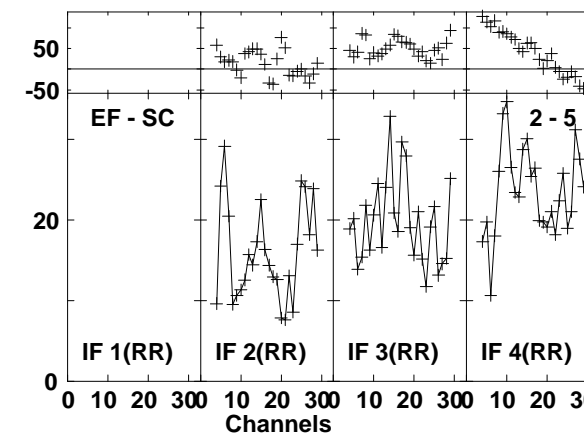
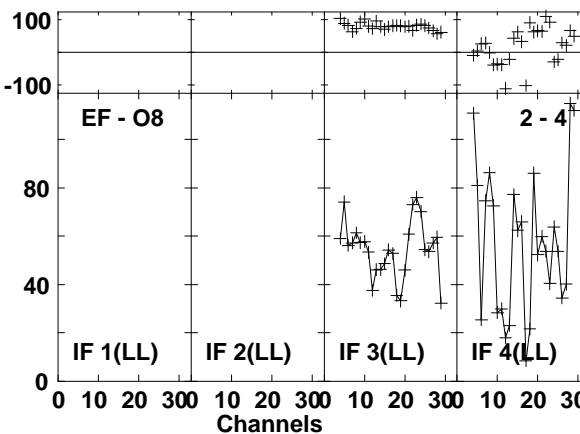
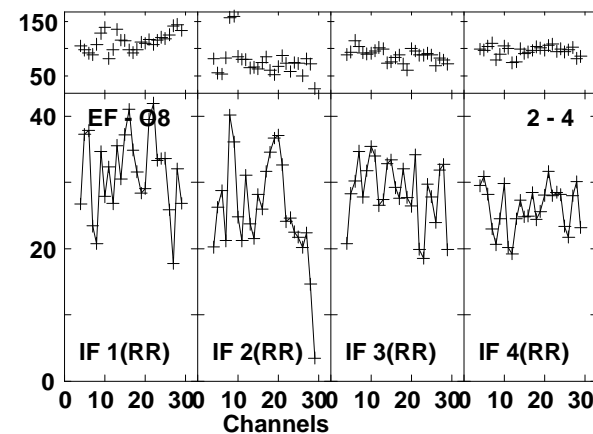
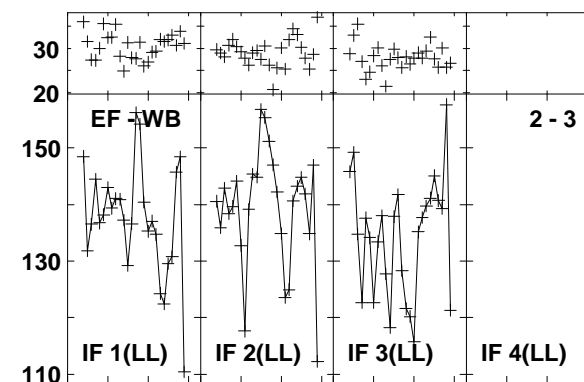
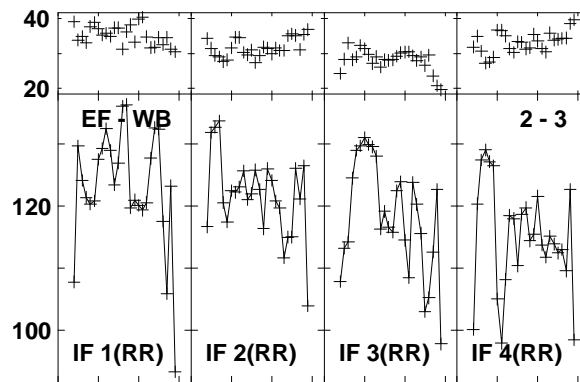
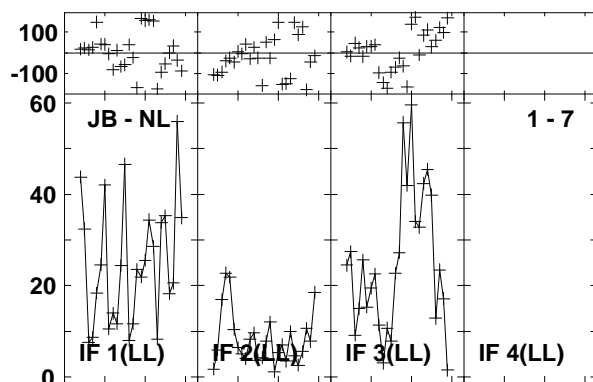
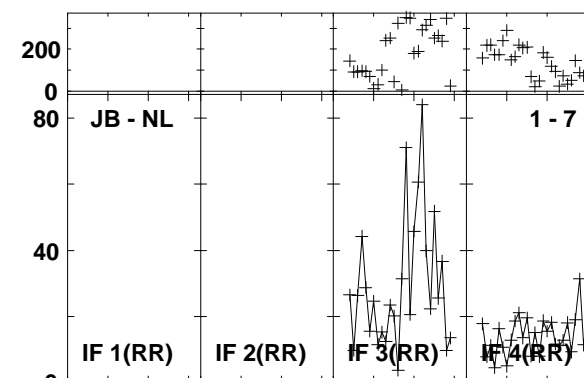
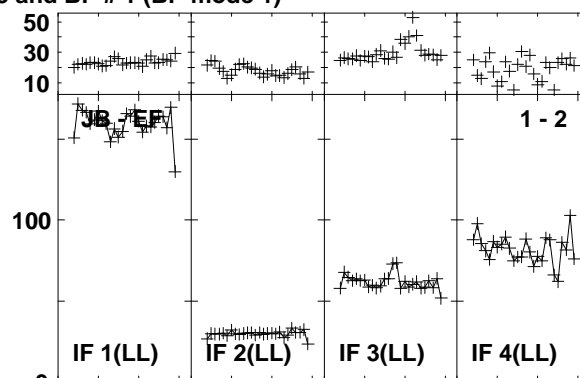
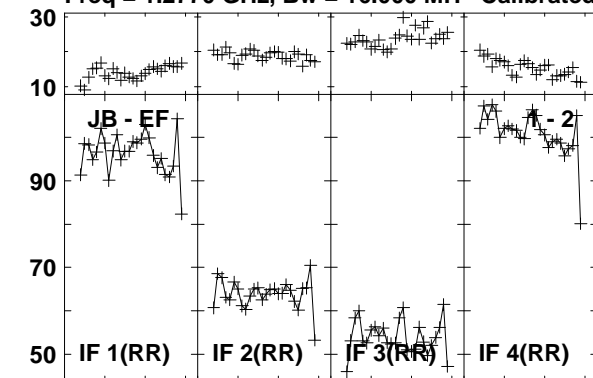

Lower frame: Milli Ampl Jy Top frame: Phas deg
Vector averaged cross-power spectrum Baseline: JB (01) - EF (02)
Timerange: 00/19:14:24 to 00/19:17:18

Plot file version 479 created 03-MAR-2016 01:13:17

4C52 GN002C 1.UVDATA.1

Freq = 1.2770 GHz, Bw = 16.000 MH Calibrated with CL # 3 and BP # 1 (BP mode 1)

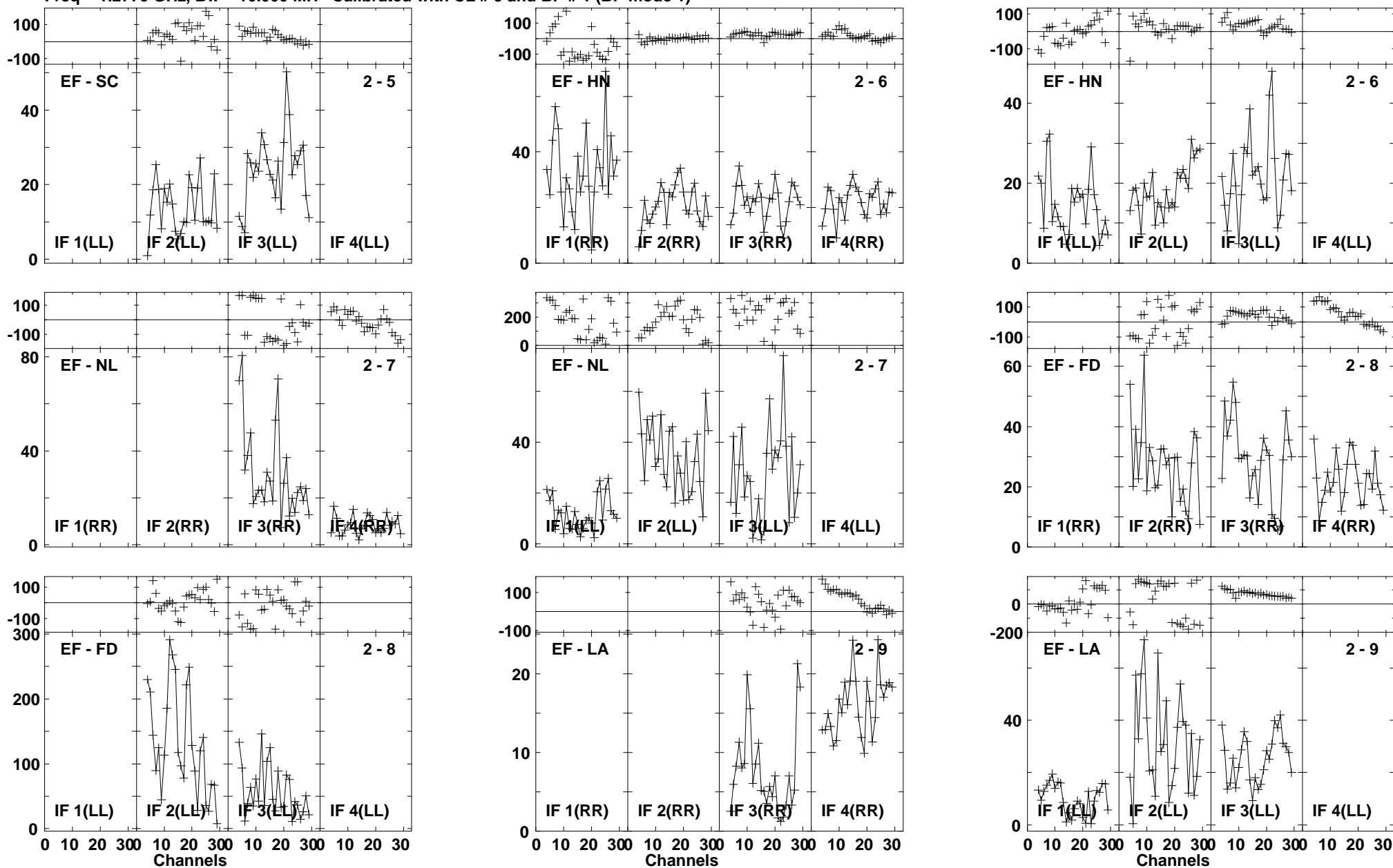

Lower frame: Milli Ampl Jy Top frame: Phas deg
Vector averaged cross-power spectrum Baseline: EF (02) - SC (05)
Timerange: 00/19:14:24 to 00/19:17:18

Plot file version 480 created 03-MAR-2016 01:13:17

4C52 GN002C 1.UVDATA.1

Freq = 1.2770 GHz, Bw = 16.000 MH Calibrated with CL # 3 and BP # 1 (BP mode 1)

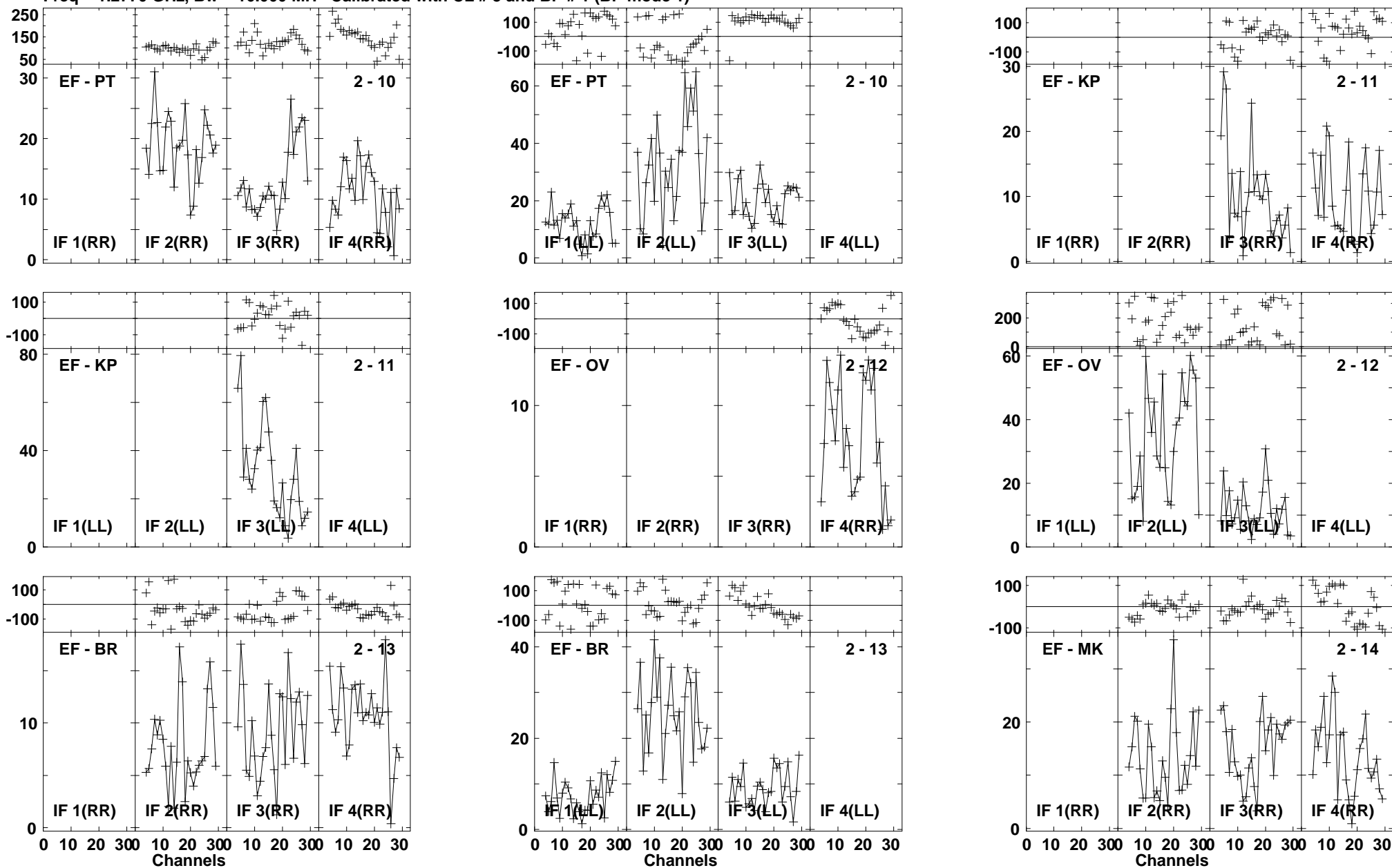

Lower frame: Milli Ampl Jy Top frame: Phas deg
Vector averaged cross-power spectrum Baseline: EF (02) - PT (10)
Timerange: 00/19:14:24 to 00/19:17:18

Plot file version 481 created 03-MAR-2016 01:13:18

4C52 GN002C 1.UVDATA.1

Freq = 1.2770 GHz, Bw = 16.000 MH Calibrated with CL # 3 and BP # 1 (BP mode 1)

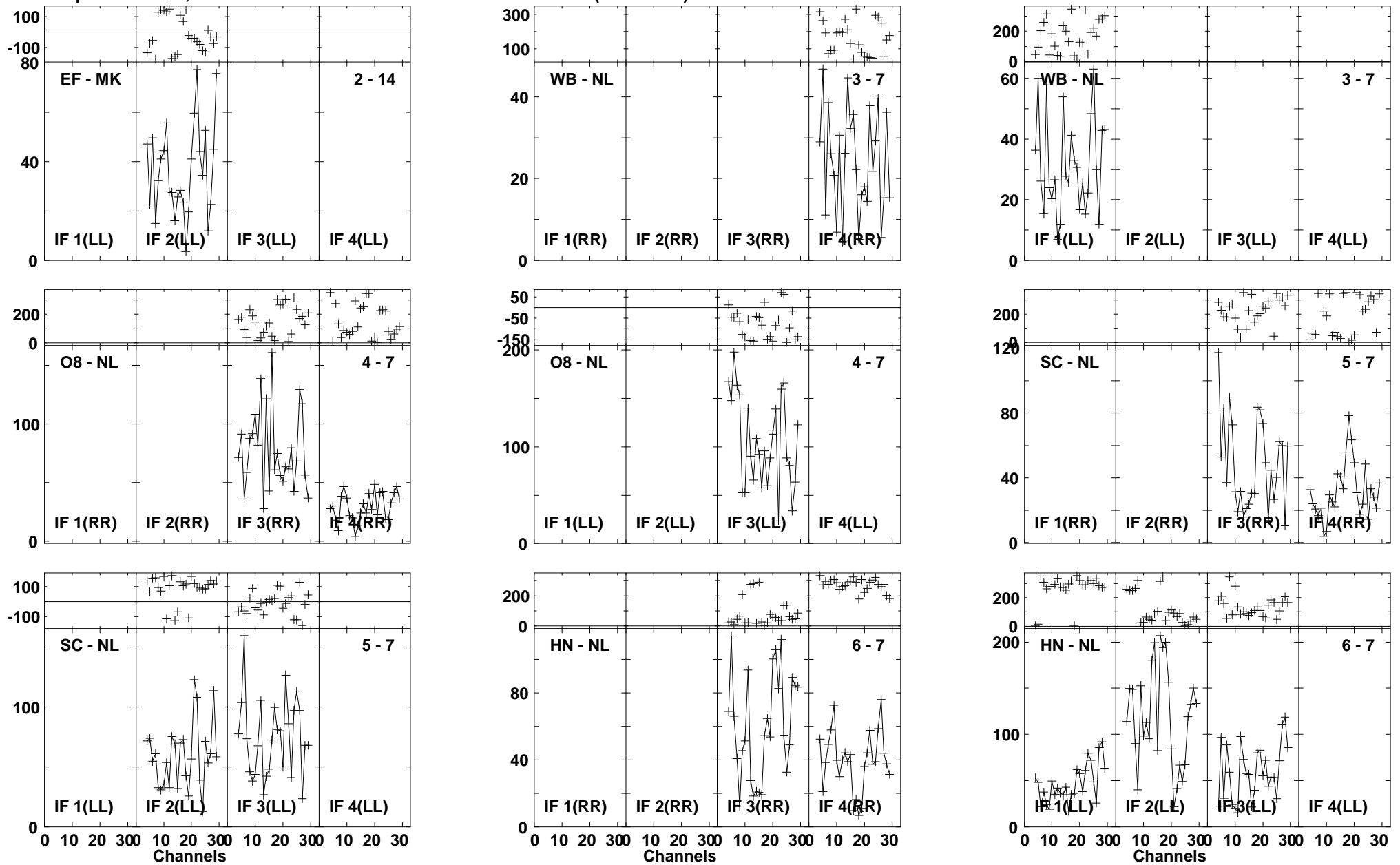

Lower frame: Milli Ampl Jy Top frame: Phas deg
Vector averaged cross-power spectrum Baseline: EF (02) - MK (14)
Timerange: 00/19:14:24 to 00/19:17:18

Plot file version 482 created 03-MAR-2016 01:13:18

4C52 GN002C 1.UVDATA.1

Freq = 1.2770 GHz, Bw = 16.000 MH Calibrated with CL # 3 and BP # 1 (BP mode 1)

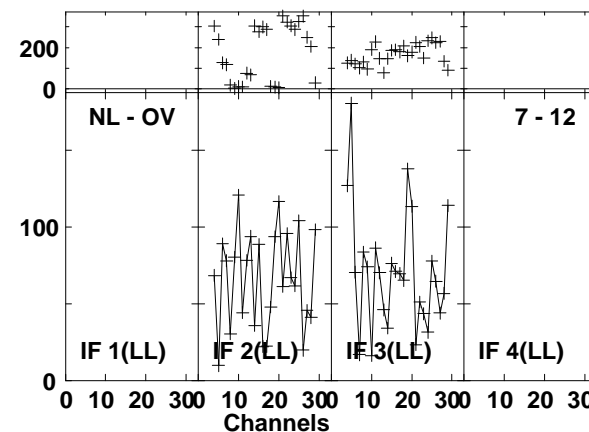
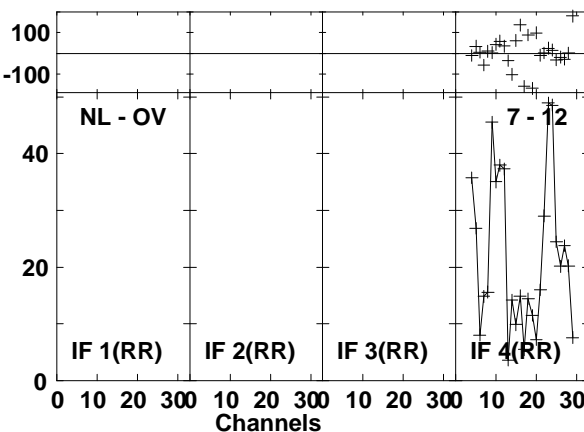
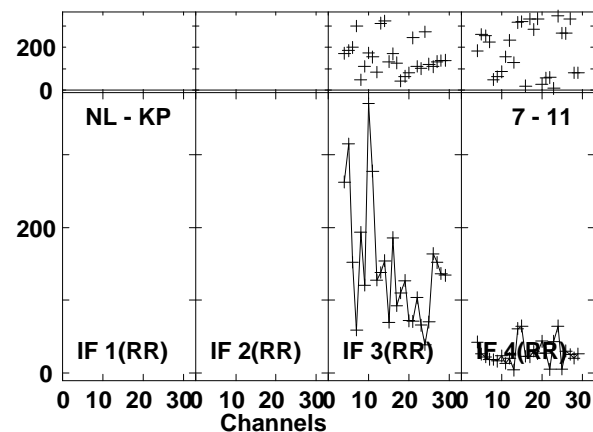
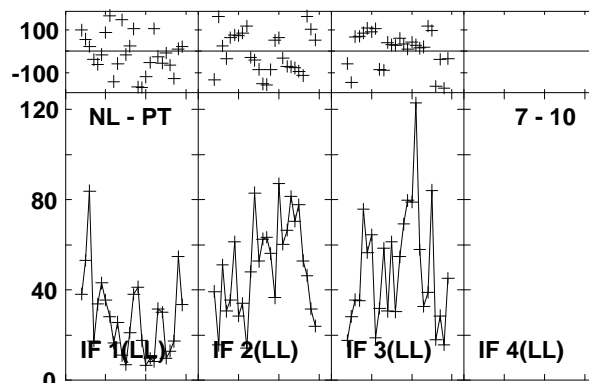
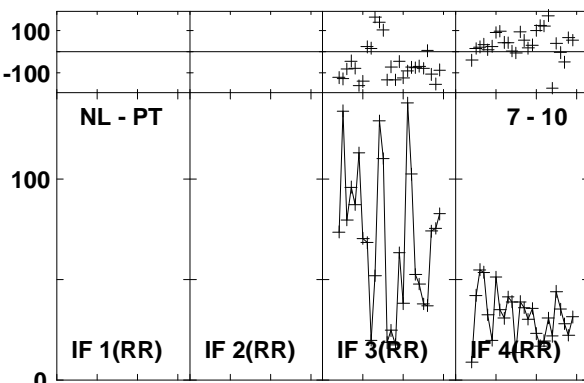
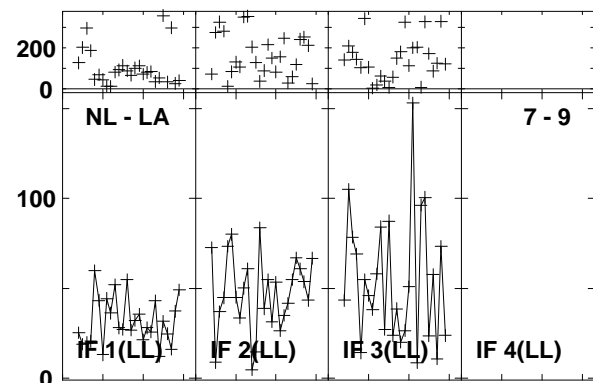
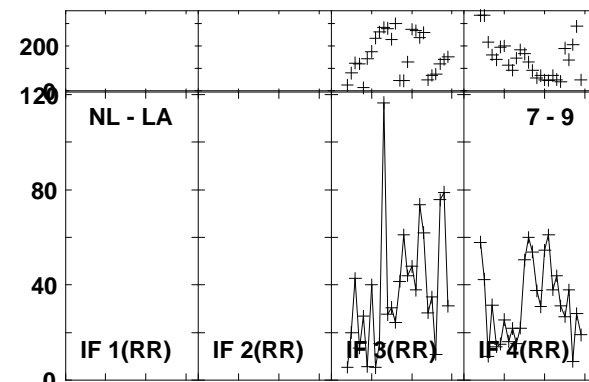
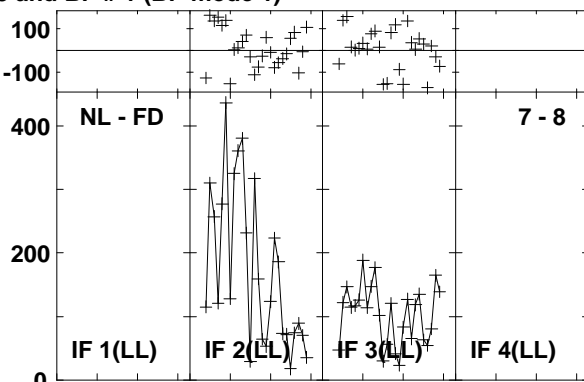
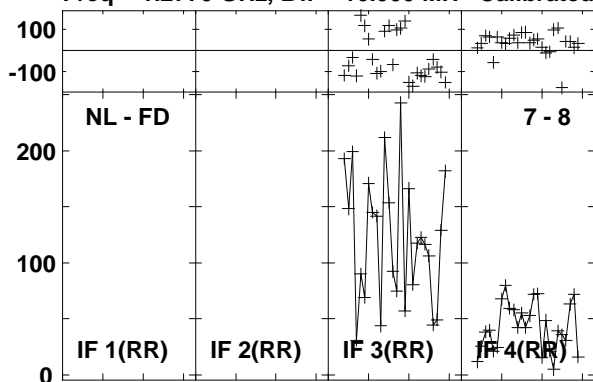

Lower frame: Milli Ampl Jy Top frame: Phas deg
Vector averaged cross-power spectrum Baseline: NL (07) - FD (08)
Timerange: 00/19:14:24 to 00/19:17:18

Plot file version 483 created 03-MAR-2016 01:13:18
 4C52 GN002C 1.UVDATA.1
 Freq = 1.2770 GHz, Bw = 16.000 MH Calibrated with CL # 3 and BP # 1 (BP mode 1)

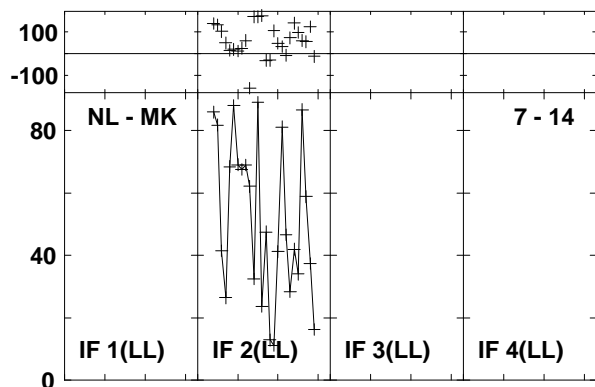
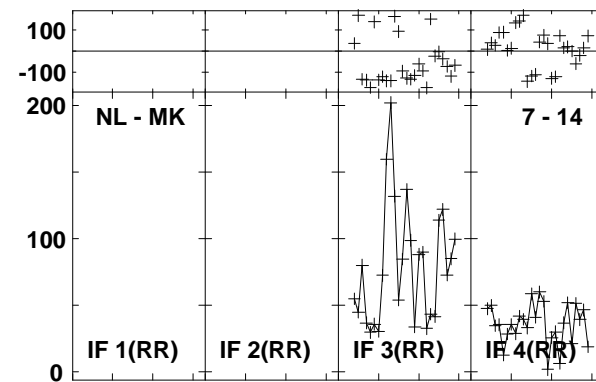
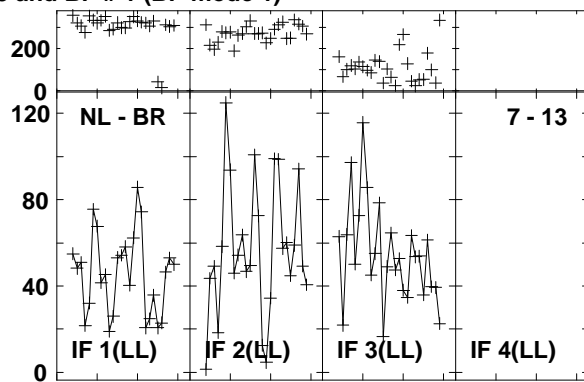
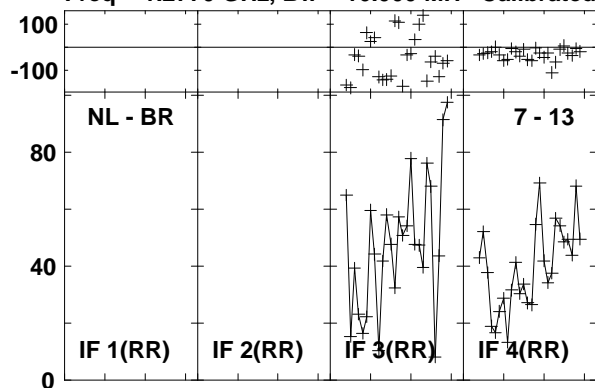

Lower frame: Milli Ampl Jy Top frame: Phas deg
 Vector averaged cross-power spectrum Baseline: NL (07) - BR (13)
 Timerange: 00/19:14:24 to 00/19:17:18

Plot file version 484 created 03-MAR-2016 01:13:18

J1545+5400 GN002C 1.UVDATA.1

Freq = 1.2770 GHz, Bw = 16.000 MH Calibrated with CL # 3 and BP # 1 (BP mode 1)

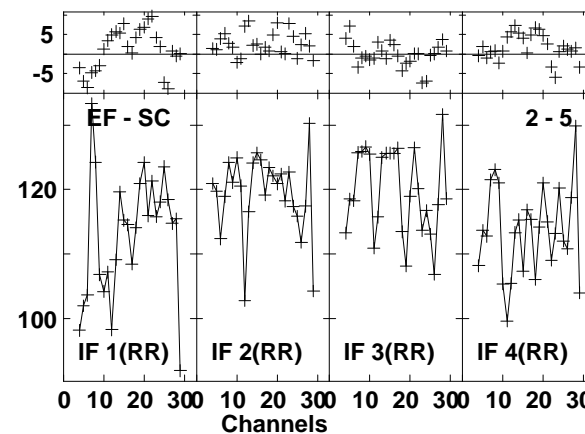
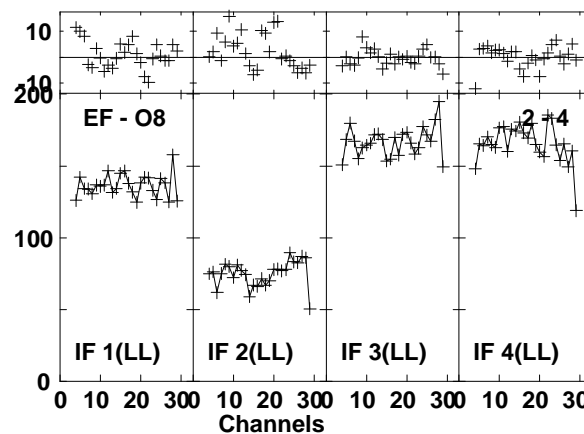
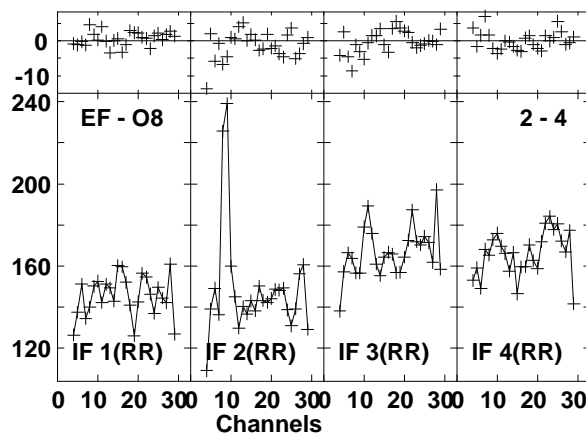
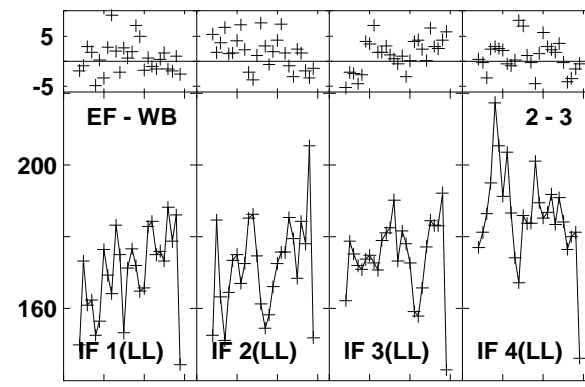
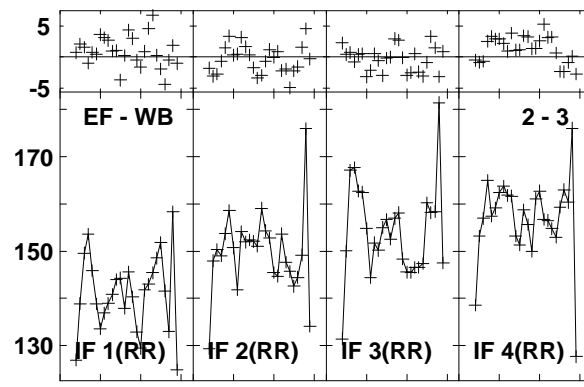
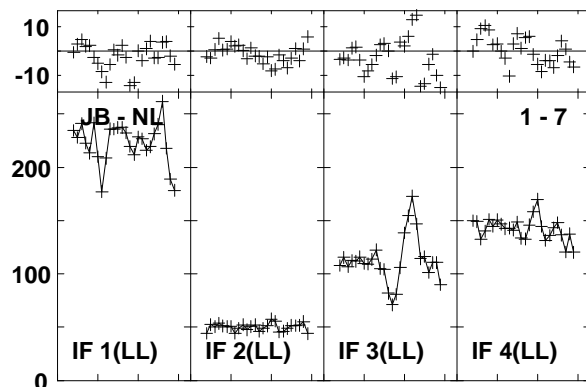
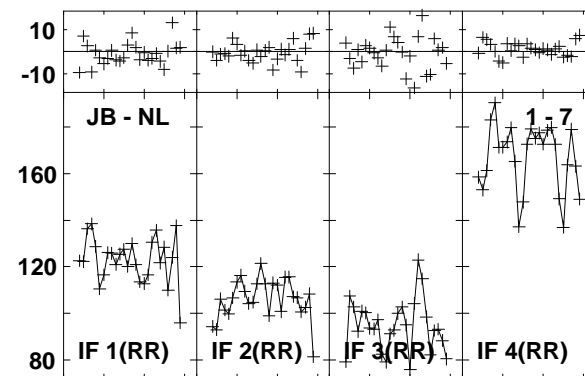
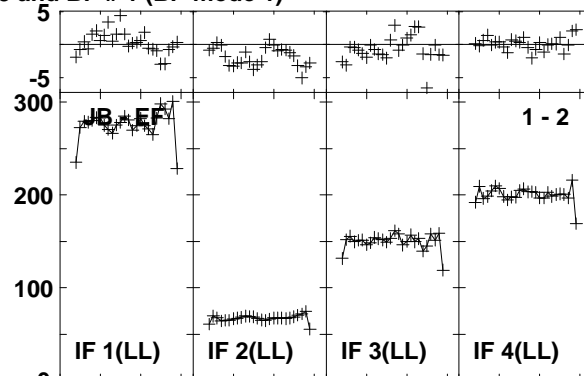
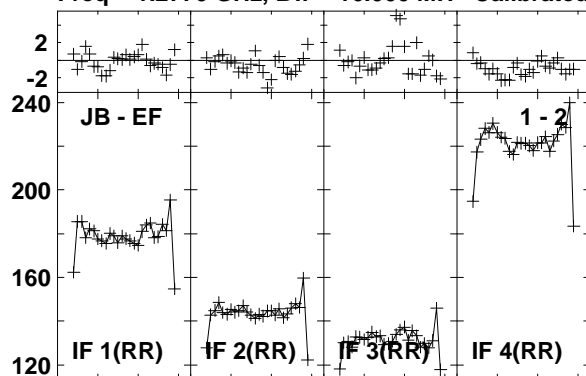

Lower frame: Milli Ampl Jy Top frame: Phas deg
Vector averaged cross-power spectrum Baseline: JB (01) - EF (02)
Timerange: 00/19:18:11 to 00/19:20:09

Plot file version 485 created 03-MAR-2016 01:13:18

J1545+5400 GN002C 1.UVDATA.1

Freq = 1.2770 GHz, Bw = 16.000 MH Calibrated with CL # 3 and BP # 1 (BP mode 1)

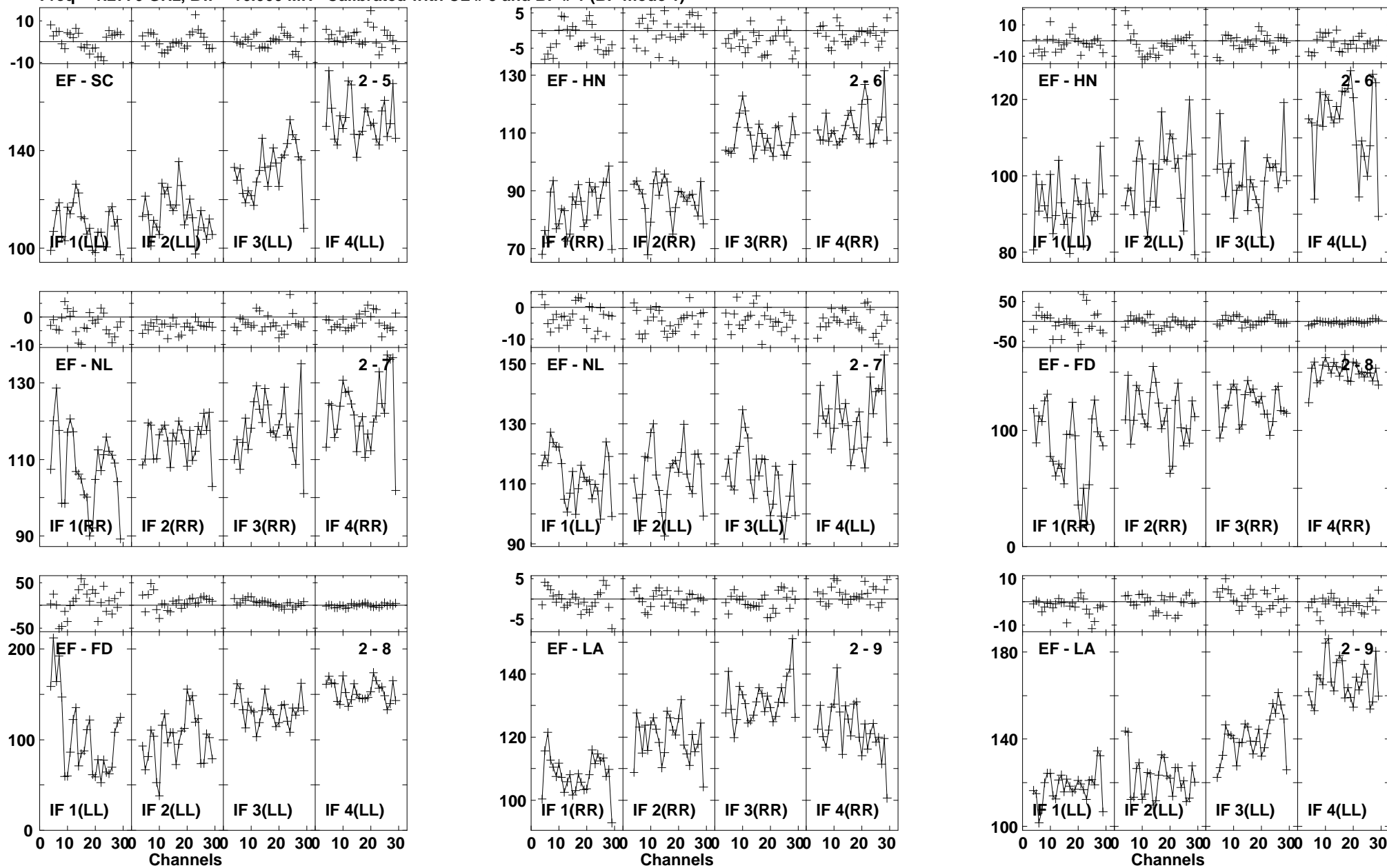

Lower frame: Milli Ampl Jy Top frame: Phas deg
Vector averaged cross-power spectrum Baseline: EF (02) - SC (05)
Timerange: 00/19:18:11 to 00/19:20:09

Plot file version 486 created 03-MAR-2016 01:13:18

J1545+5400 GN002C 1.UVDATA.1

Freq = 1.2770 GHz, Bw = 16.000 MH Calibrated with CL # 3 and BP # 1 (BP mode 1)

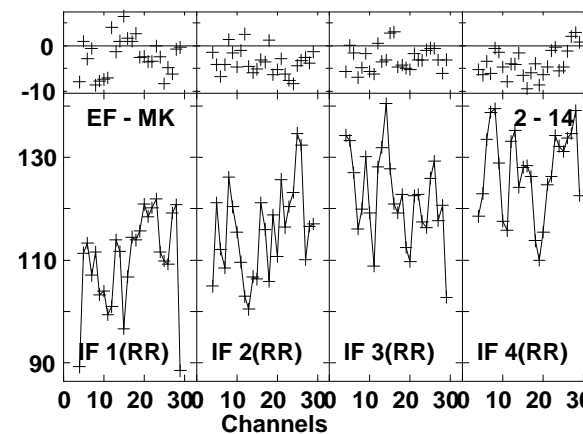
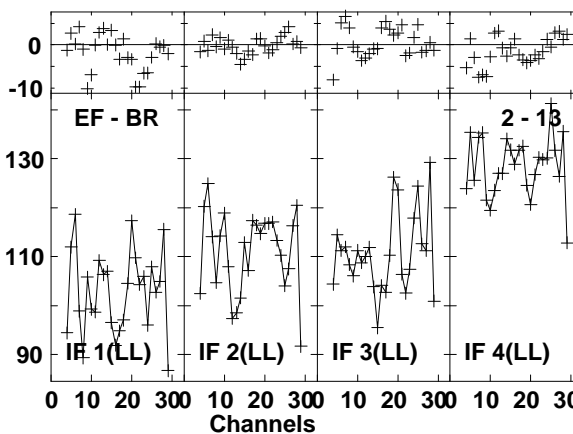
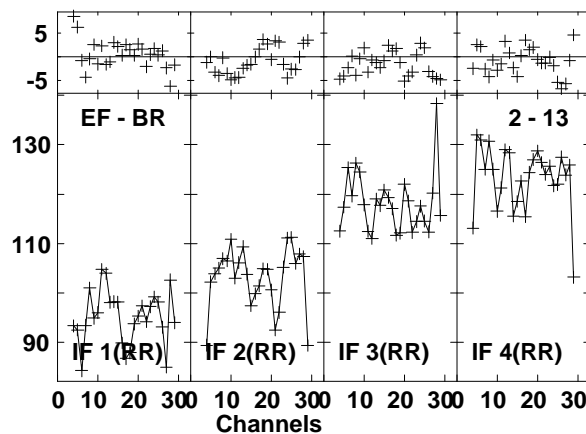
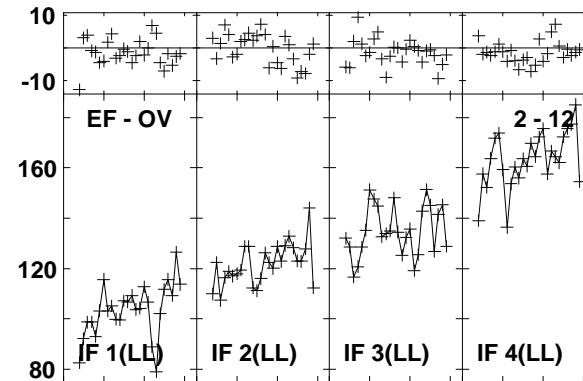
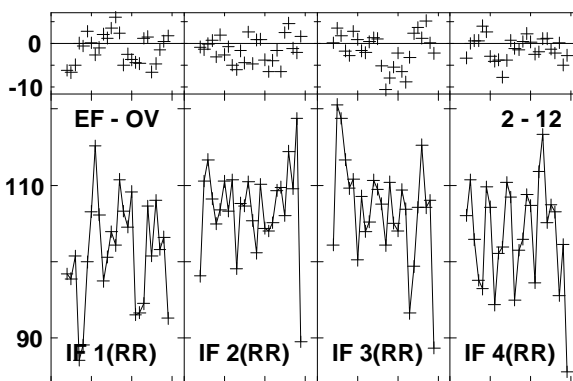
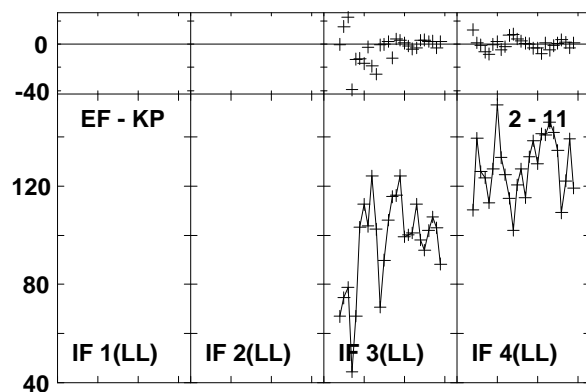
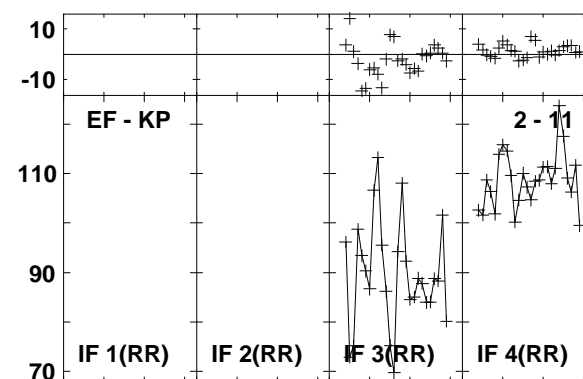
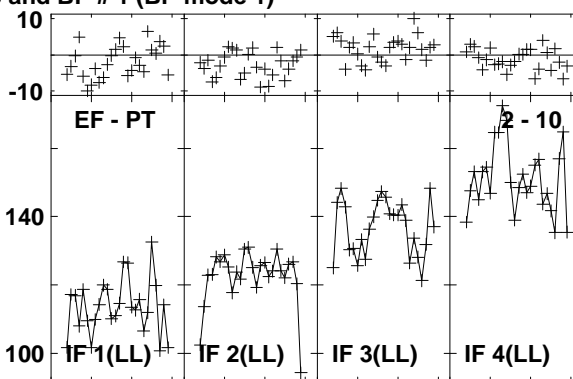
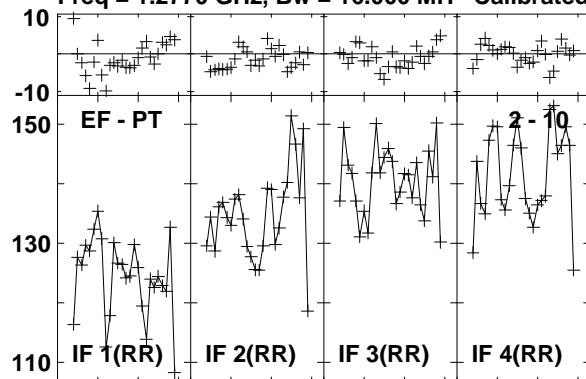

Lower frame: Milli Ampl Jy Top frame: Phas deg
Vector averaged cross-power spectrum Baseline: EF (02) - PT (10)
Timerange: 00/19:18:11 to 00/19:20:09

Plot file version 487 created 03-MAR-2016 01:13:19
 J1545+5400 GN002C 1.UVDATA.1
 Freq = 1.2770 GHz, Bw = 16.000 MH Calibrated with CL # 3 and BP # 1 (BP mode 1)

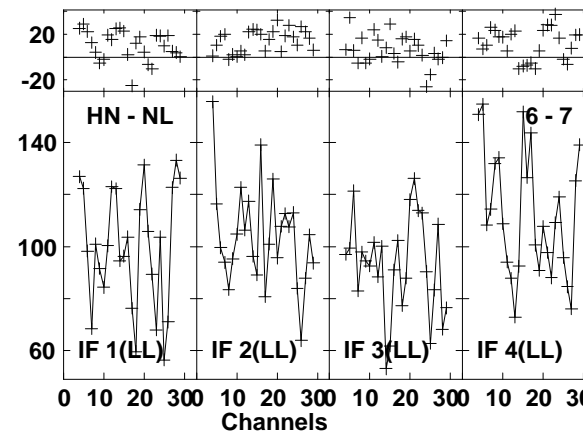
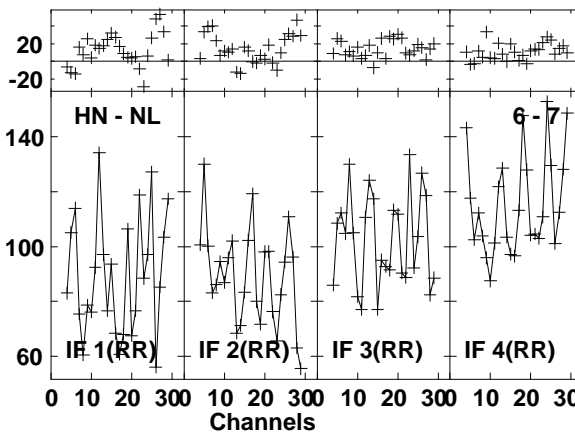
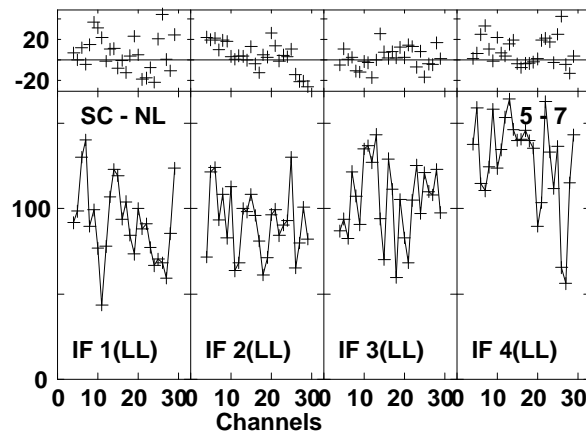
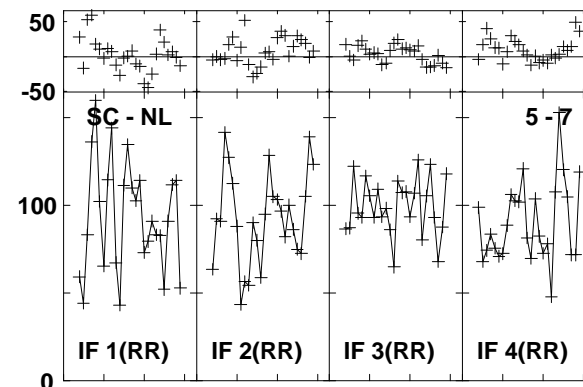
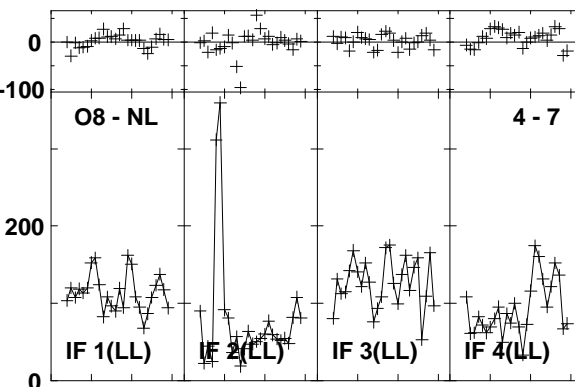
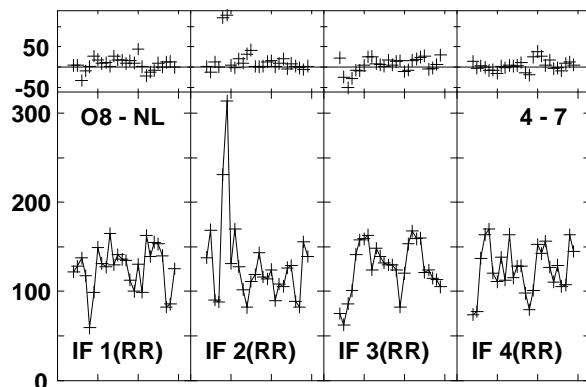
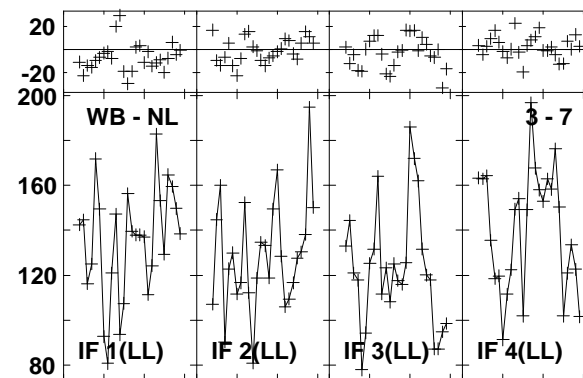
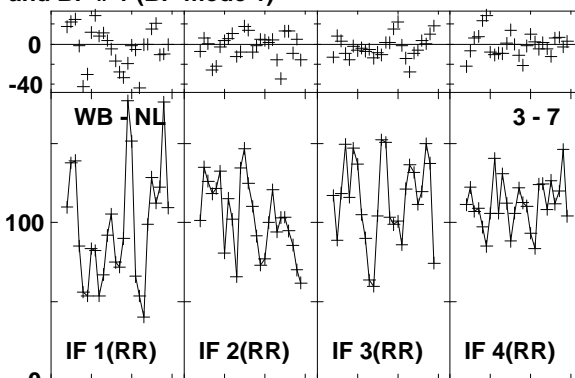
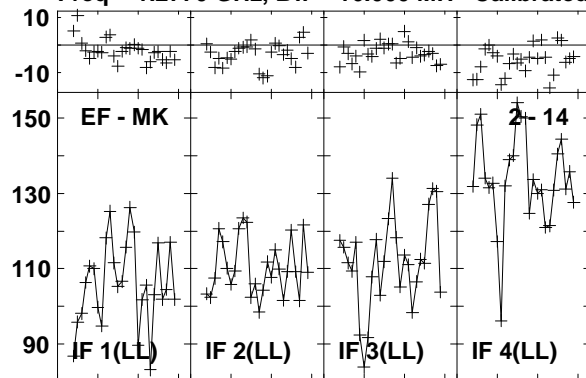

Lower frame: Milli Ampl Jy Top frame: Phas deg
 Vector averaged cross-power spectrum Baseline: EF (02) - MK (14)
 Timerange: 00/19:18:11 to 00/19:20:09

Plot file version 488 created 03-MAR-2016 01:13:19

J1545+5400 GN002C 1.UVDATA.1

Freq = 1.2770 GHz, Bw = 16.000 MH Calibrated with CL # 3 and BP # 1 (BP mode 1)

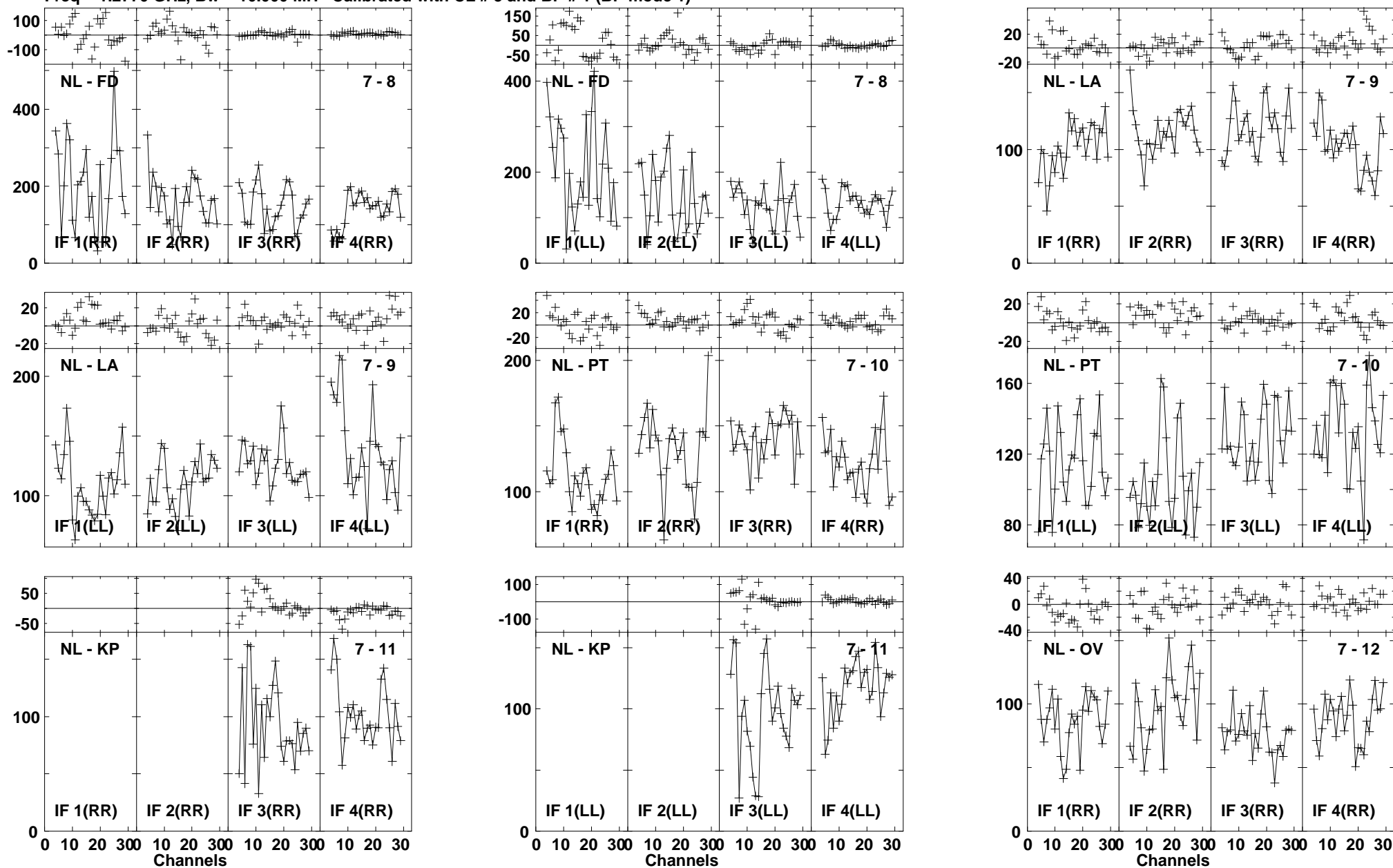

Plot file version 489 created 03-MAR-2016 01:13:19

J1545+5400 GN002C 1.UVDATA.1

Freq = 1.2770 GHz, Bw = 16.000 MH Calibrated with CL # 3 and BP # 1 (BP mode 1)

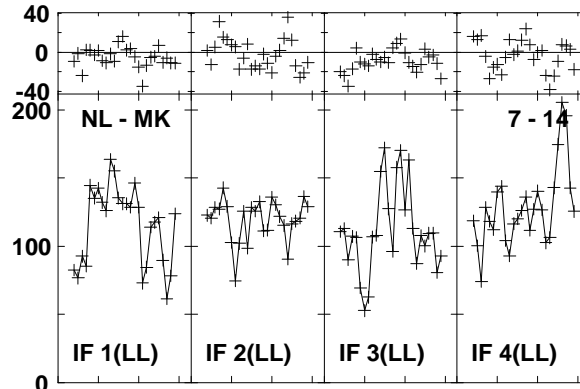
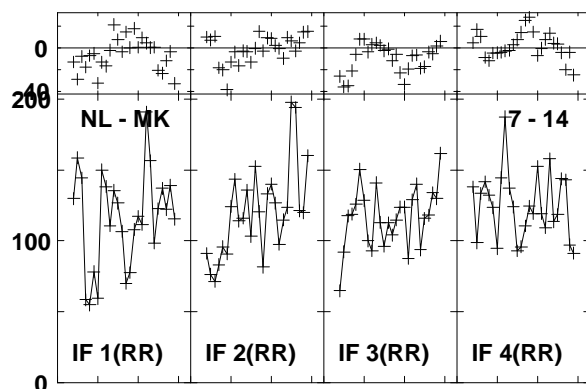
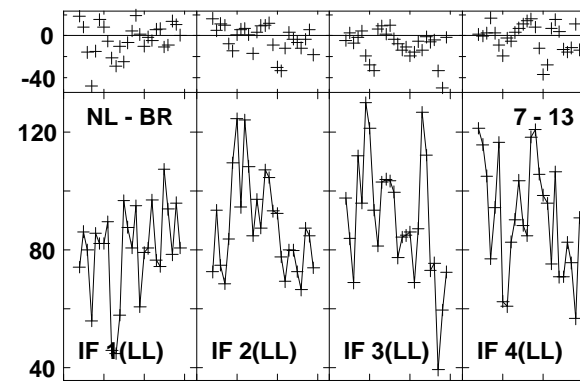
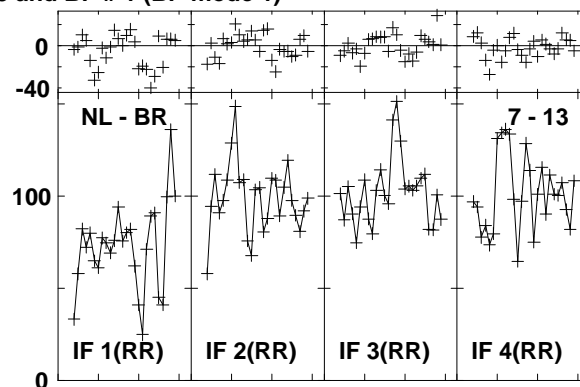
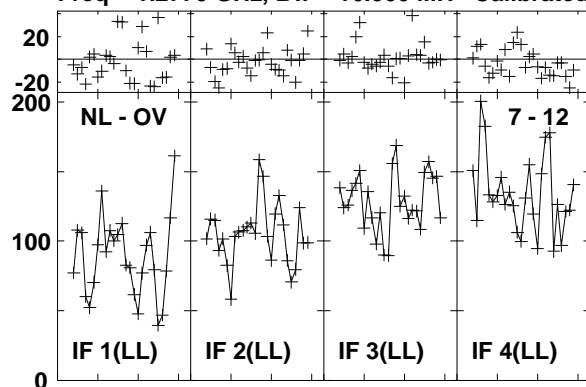

Lower frame: Milli Ampl Jy Top frame: Phas deg
Vector averaged cross-power spectrum Baseline: NL (07) - OV (12)
Timerange: 00/19:18:11 to 00/19:20:09

Plot file version 490 created 03-MAR-2016 01:13:19

J1638+5720 GN002C 1.UVDATA.1

Freq = 1.2770 GHz, Bw = 16.000 MH Calibrated with CL # 3 and BP # 1 (BP mode 1)

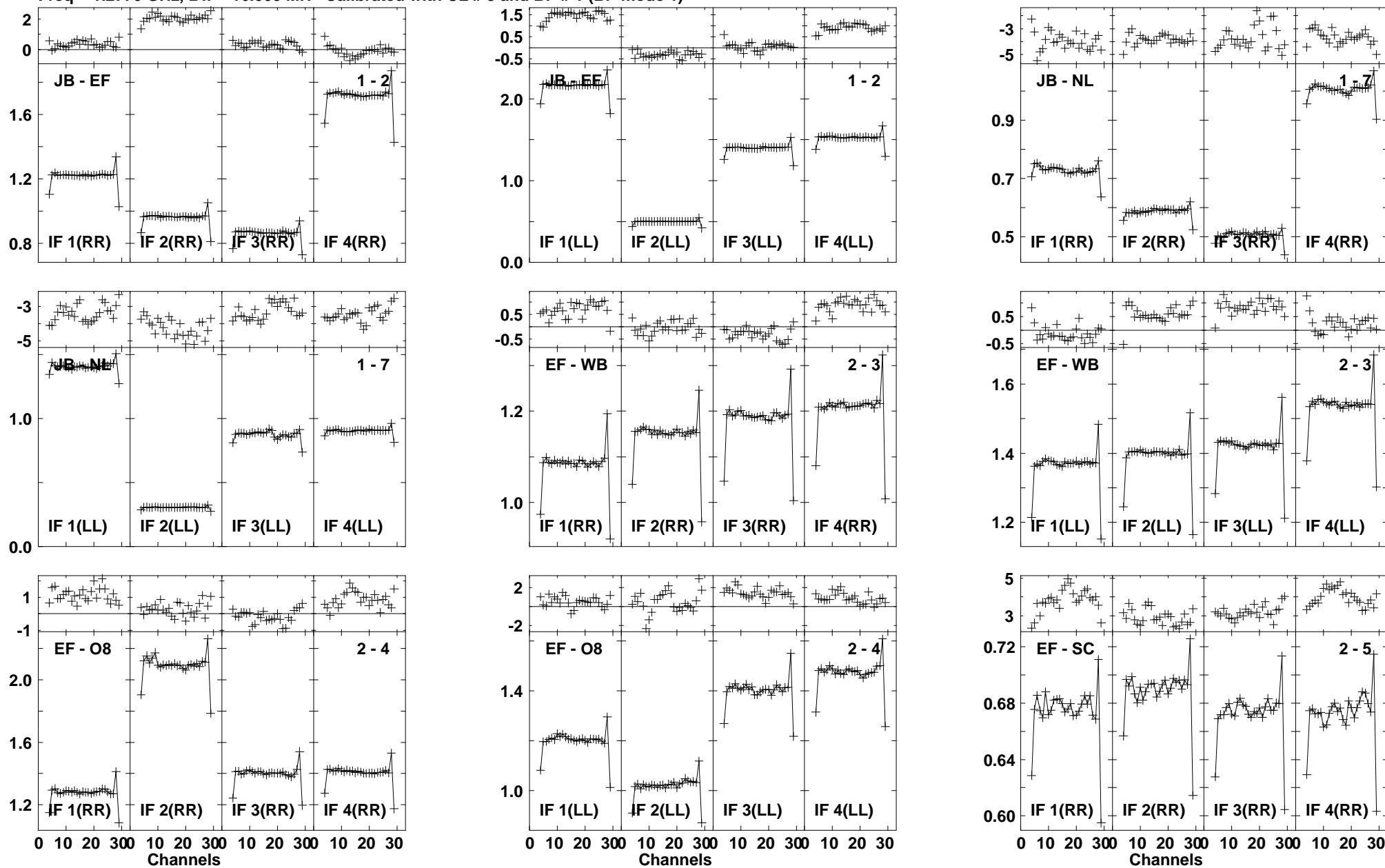

Lower frame: Ampl Jy Top frame: Phas deg
Vector averaged cross-power spectrum Baseline: JB (01) - EF (02)
Timerange: 00/19:21:33 to 00/19:25:21

Plot file version 491 created 03-MAR-2016 01:13:19

J1638+5720 GN002C 1.UVDATA.1

Freq = 1.2770 GHz, Bw = 16.000 MH Calibrated with CL # 3 and BP # 1 (BP mode 1)

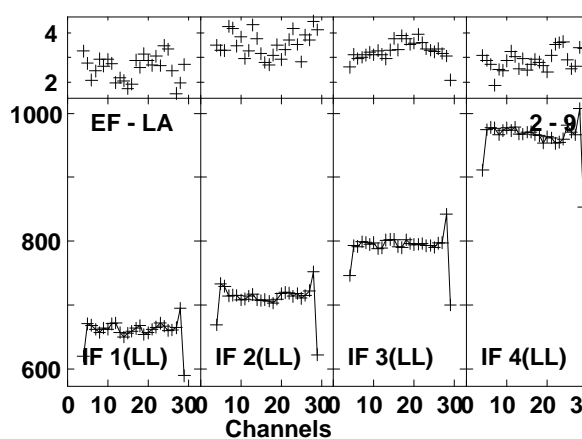
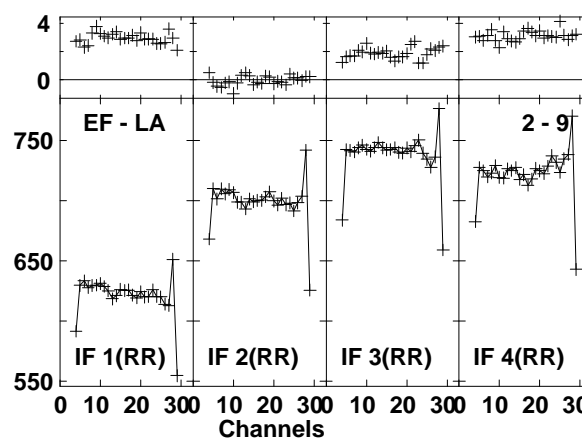
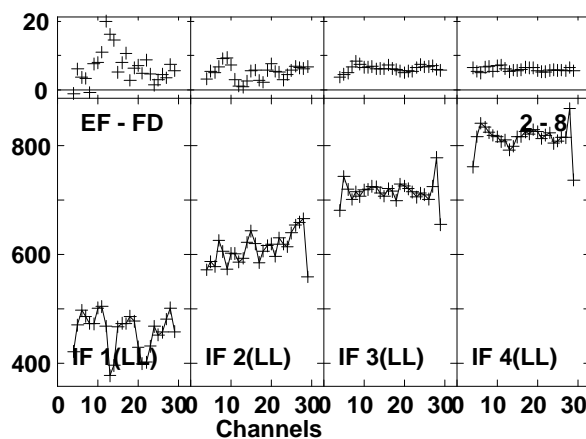
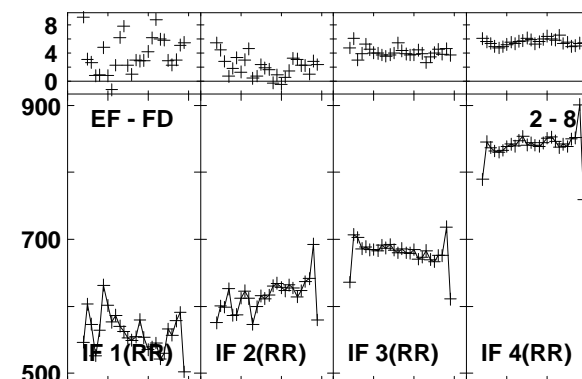
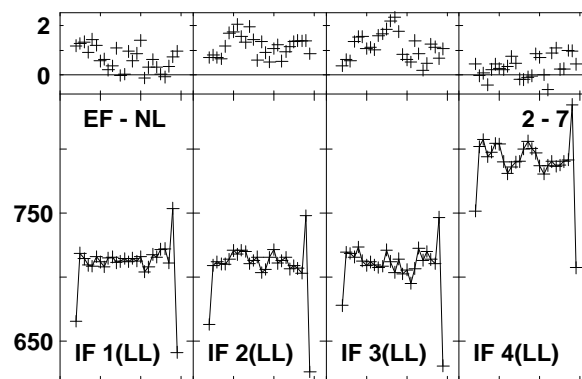
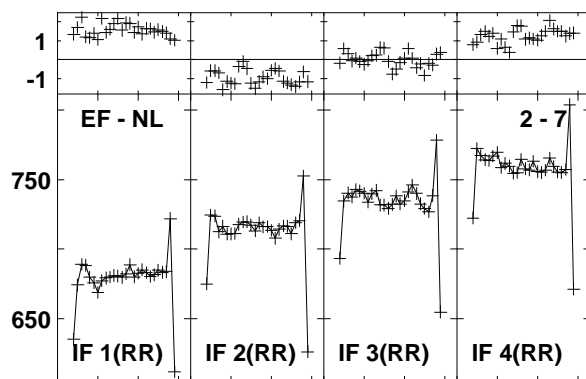
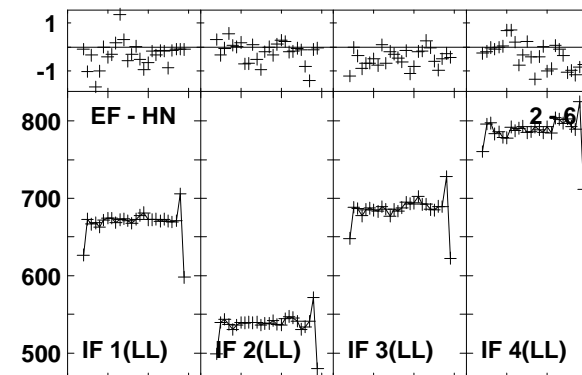
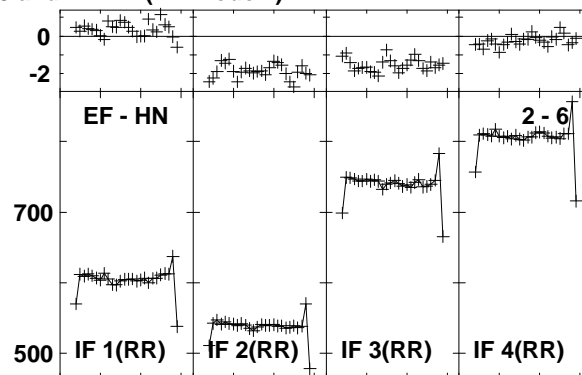
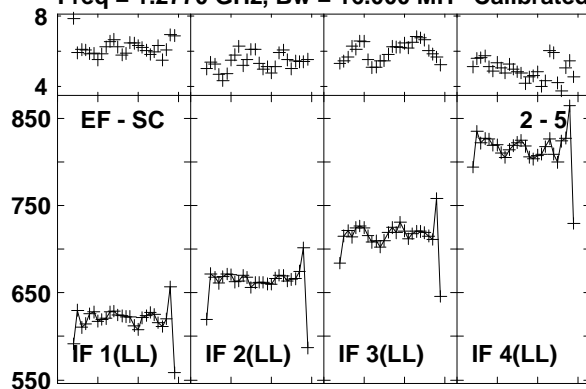

Lower frame: Milli Ampl Jy Top frame: Phas deg
Vector averaged cross-power spectrum Baseline: EF (02) - SC (05)
Timerange: 00/19:21:33 to 00/19:25:21

Plot file version 492 created 03-MAR-2016 01:13:20

J1638+5720 GN002C 1.UVDATA.1

Freq = 1.2770 GHz, Bw = 16.000 MH Calibrated with CL # 3 and BP # 1 (BP mode 1)

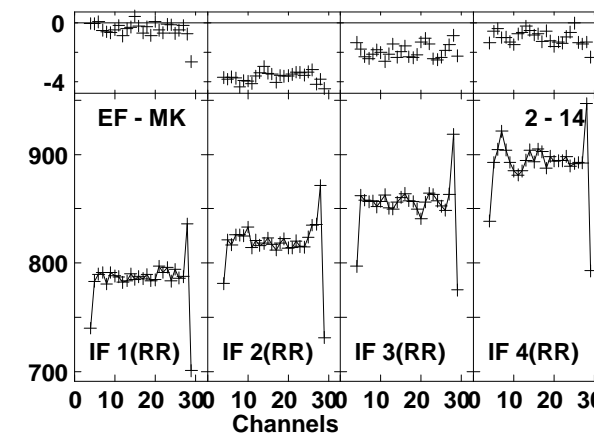
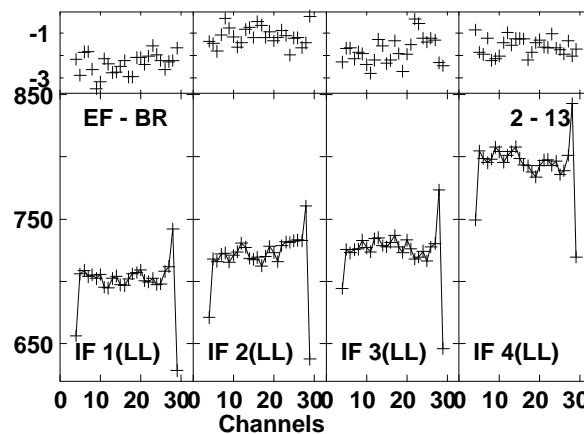
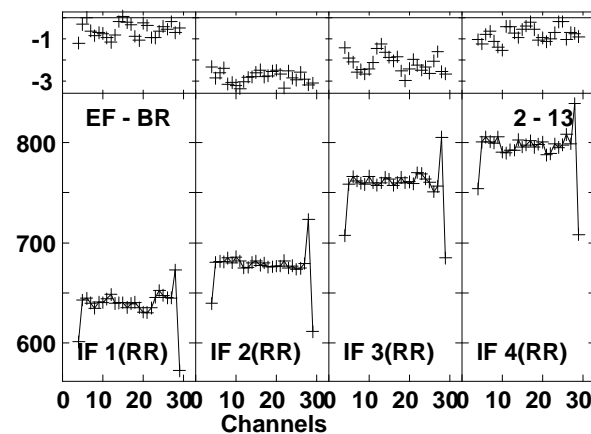
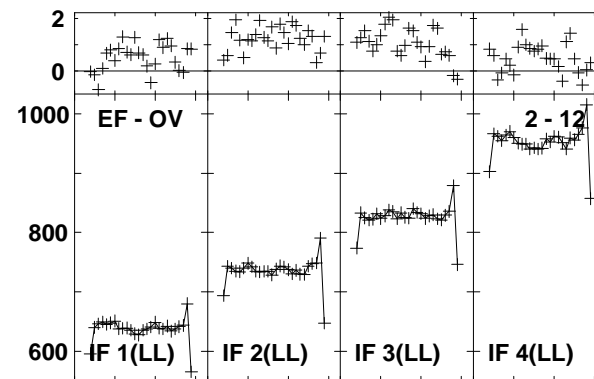
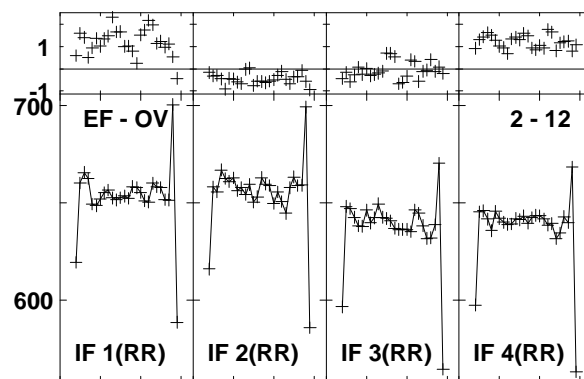
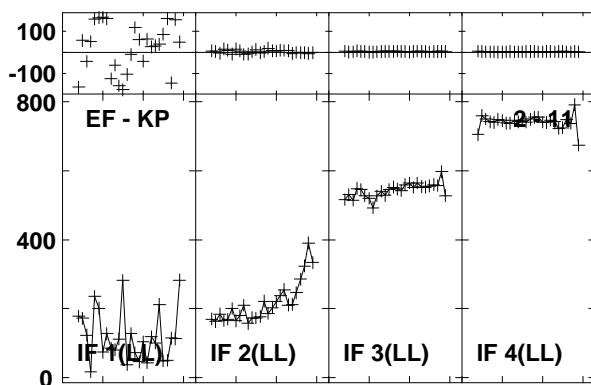
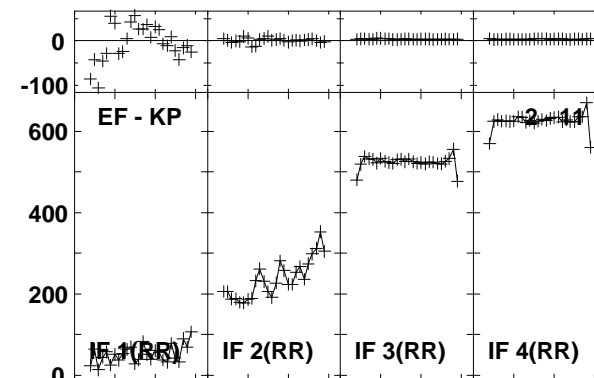
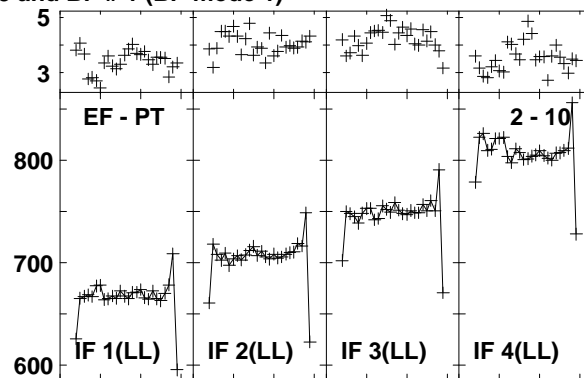
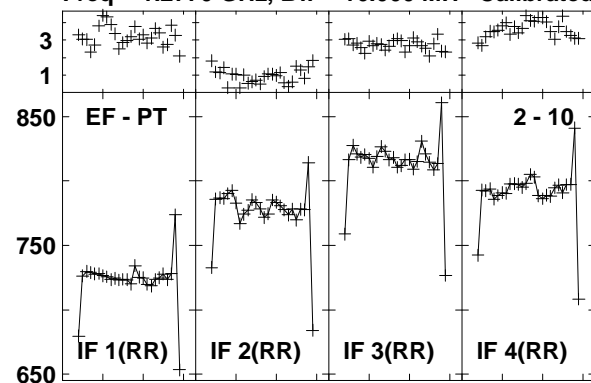

Lower frame: Milli Ampl Jy Top frame: Phas deg
Vector averaged cross-power spectrum Baseline: EF (02) - PT (10)
Timerange: 00/19:21:33 to 00/19:25:21

Plot file version 493 created 03-MAR-2016 01:13:20
 J1638+5720 GN002C 1.UVDATA.1
 Freq = 1.2770 GHz, Bw = 16.000 MH Calibrated with CL # 3 and BP # 1 (BP mode 1)

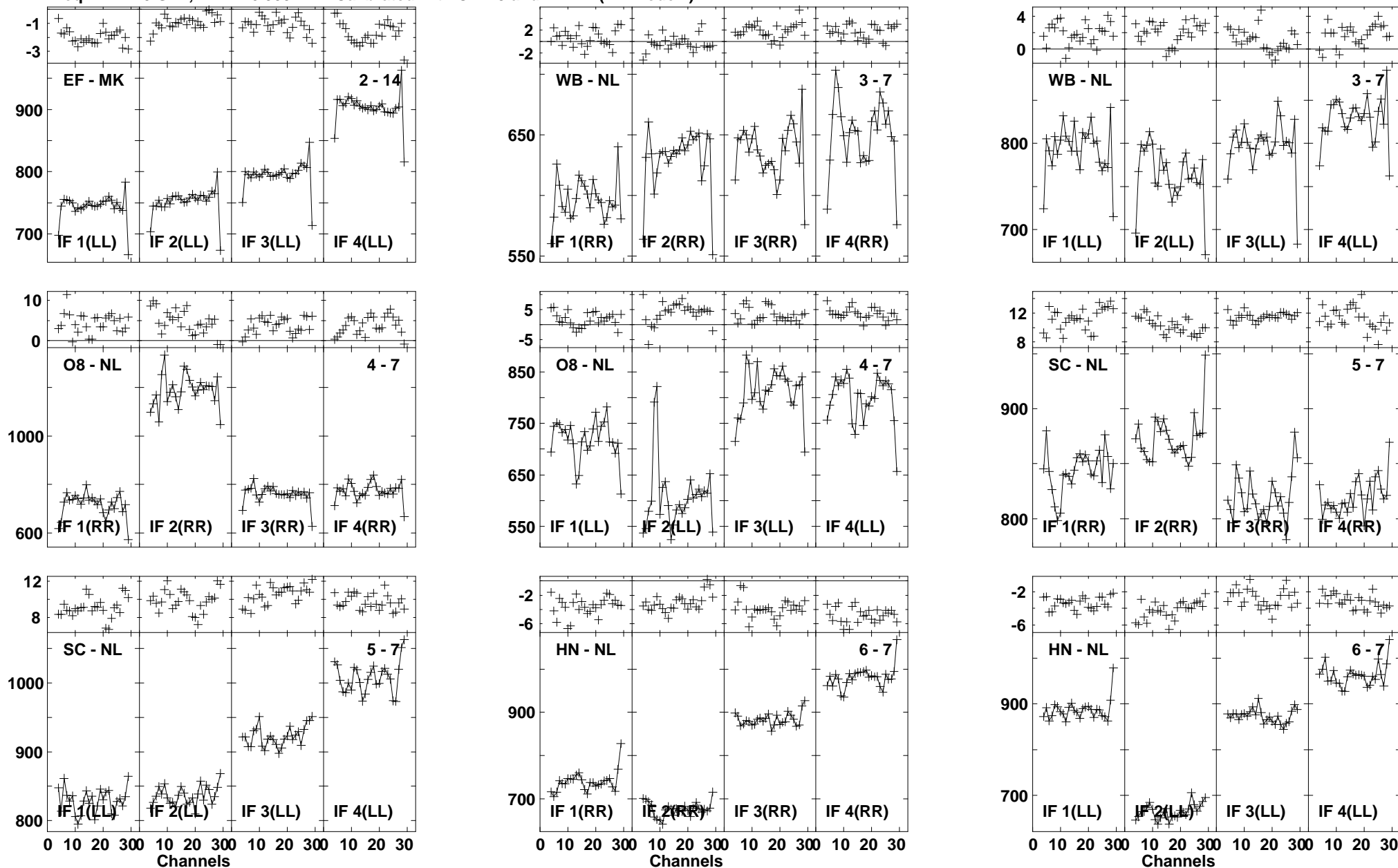

Lower frame: Milli Ampl Jy Top frame: Phas deg
 Vector averaged cross-power spectrum Baseline: EF (02) - MK (14)
 Timerange: 00/19:21:33 to 00/19:25:21

Plot file version 494 created 03-MAR-2016 01:13:20
 J1638+5720 GN002C 1.UVDATA.1
 Freq = 1.2770 GHz, Bw = 16.000 MH Calibrated with CL # 3 and BP # 1 (BP mode 1)

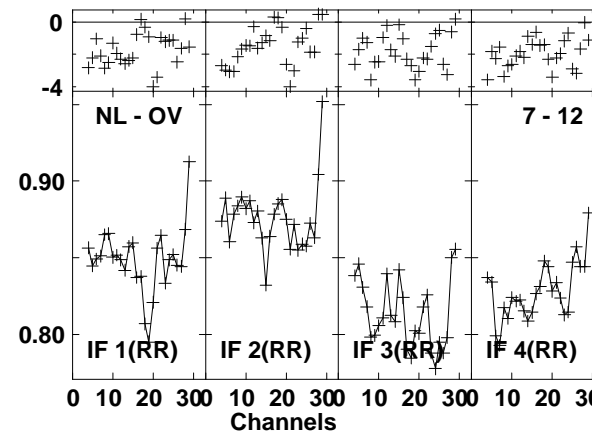
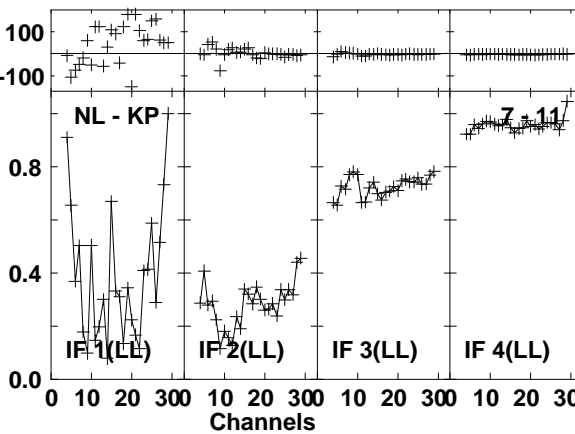
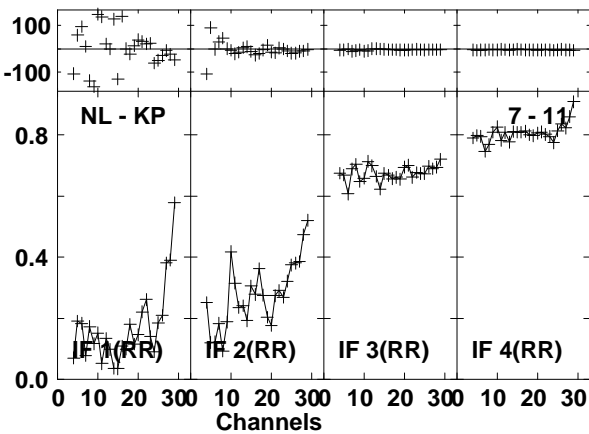
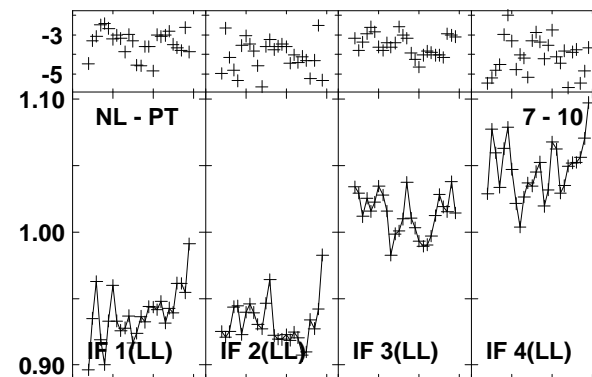
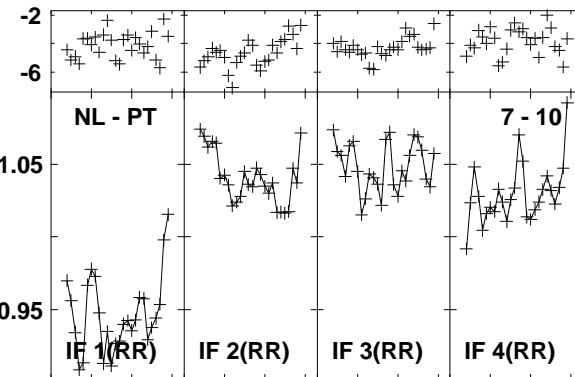
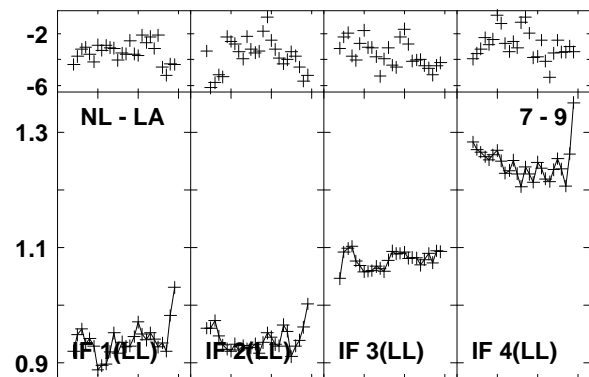
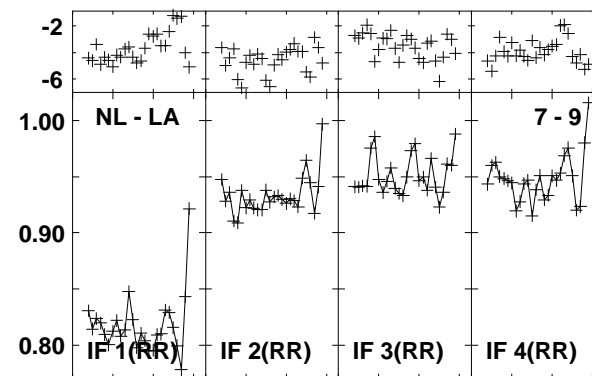
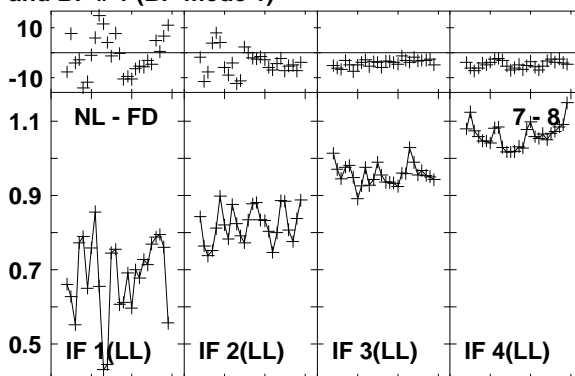
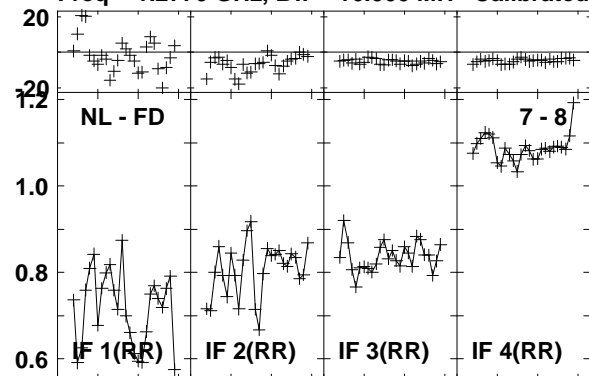

Lower frame: Ampl Jy Top frame: Phas deg
 Vector averaged cross-power spectrum Baseline: NL (07) - FD (08)
 Timerange: 00/19:21:33 to 00/19:25:21

Plot file version 495 created 03-MAR-2016 01:13:20

J1638+5720 GN002C 1.UVDATA.1

Freq = 1.2770 GHz, Bw = 16.000 MH Calibrated with CL # 3 and BP # 1 (BP mode 1)

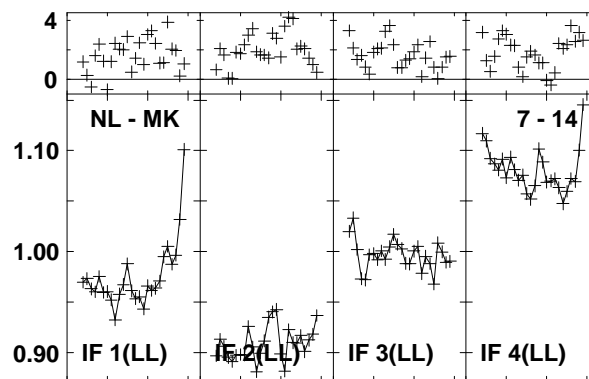
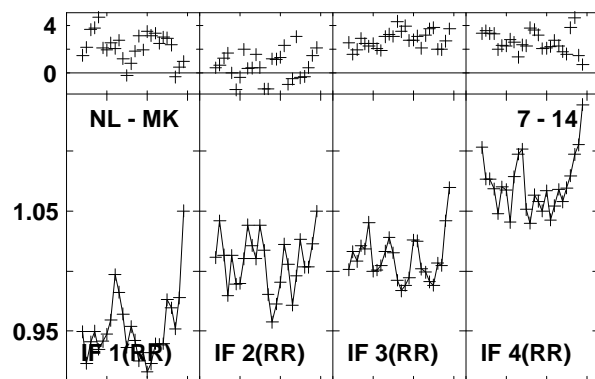
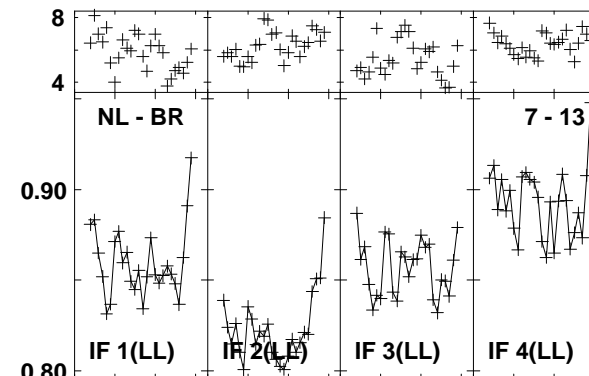
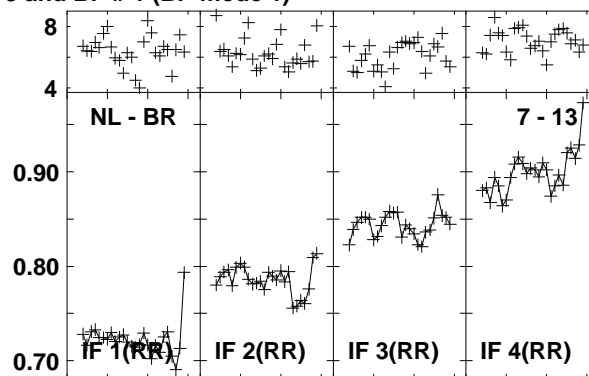
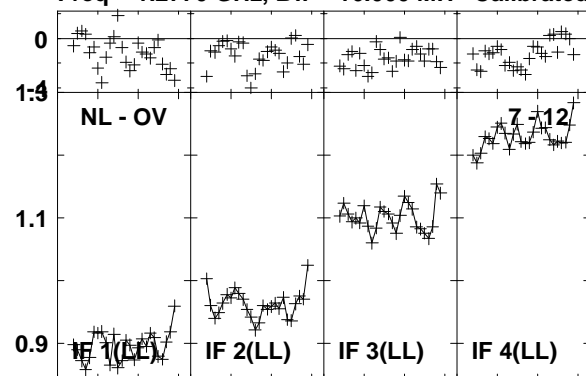

Lower frame: Ampl Jy Top frame: Phas deg

Vector averaged cross-power spectrum Baseline: NL (07) - OV (12)

Timerange: 00/19:21:33 to 00/19:25:21

Plot file version 496 created 03-MAR-2016 01:13:20

J1545+5400 GN002C 1.UVDATA.1

Freq = 1.2770 GHz, Bw = 16.000 MH Calibrated with CL # 3 and BP # 1 (BP mode 1)

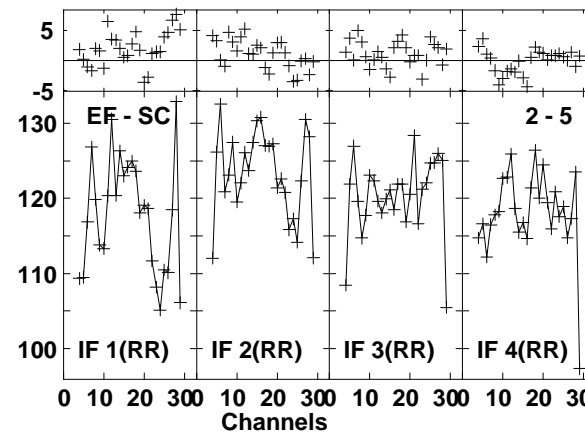
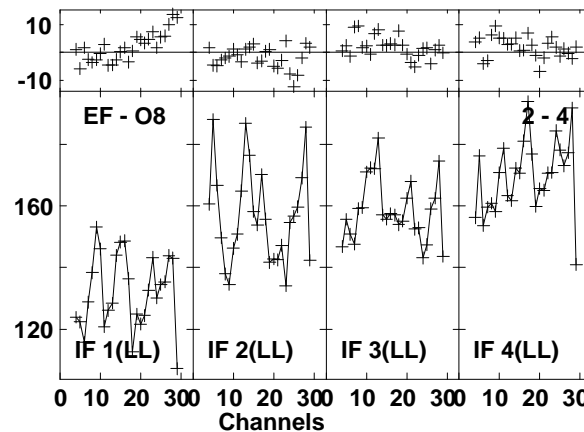
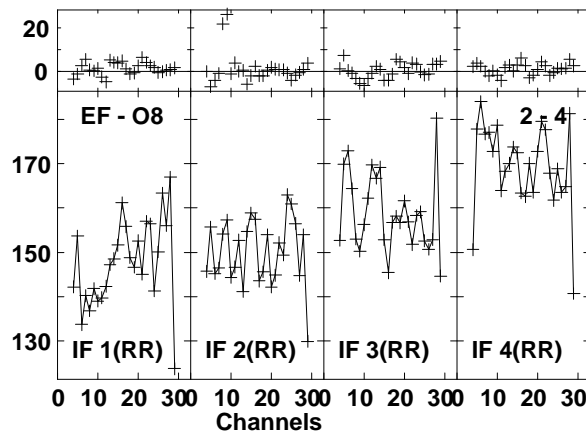
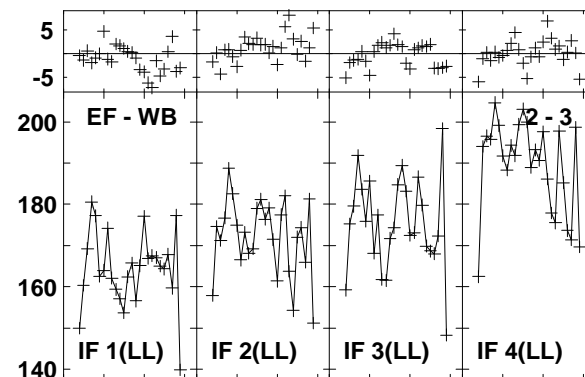
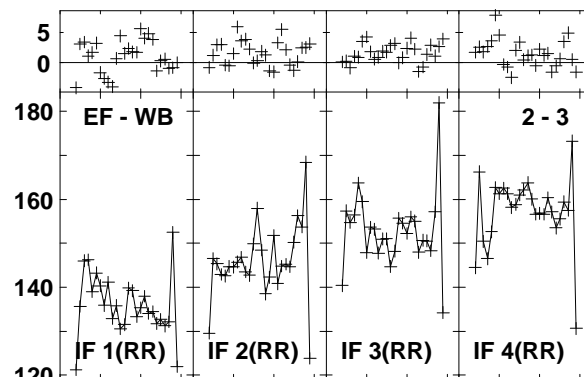
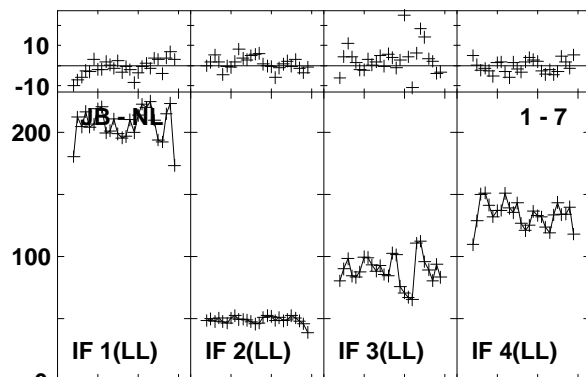
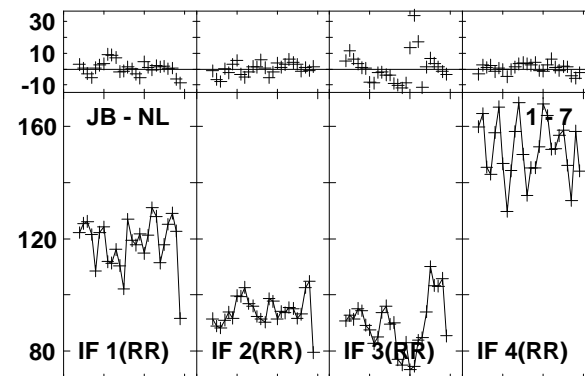
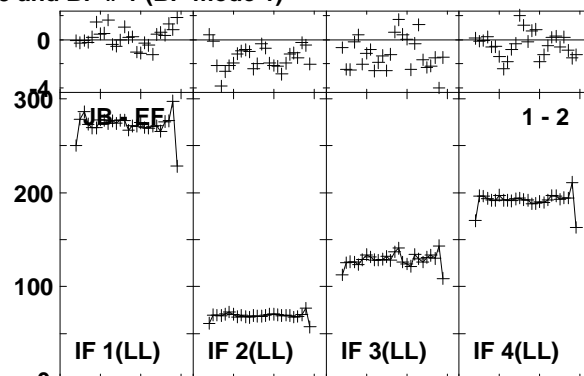
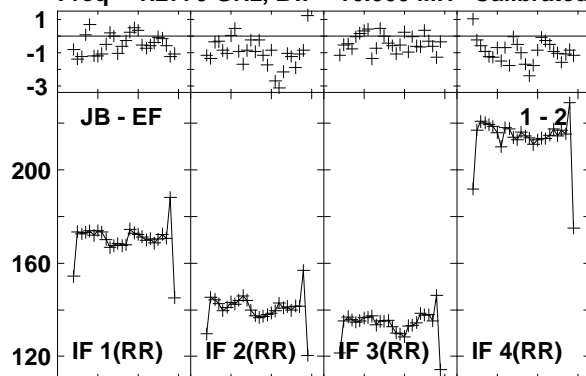

Lower frame: Milli Ampl Jy Top frame: Phas deg
Vector averaged cross-power spectrum Baseline: JB (01) - EF (02)
Timerange: 00/19:26:46 to 00/19:29:34

Plot file version 497 created 03-MAR-2016 01:13:20

J1545+5400 GN002C 1.UVDATA.1

Freq = 1.2770 GHz, Bw = 16.000 MH Calibrated with CL # 3 and BP # 1 (BP mode 1)

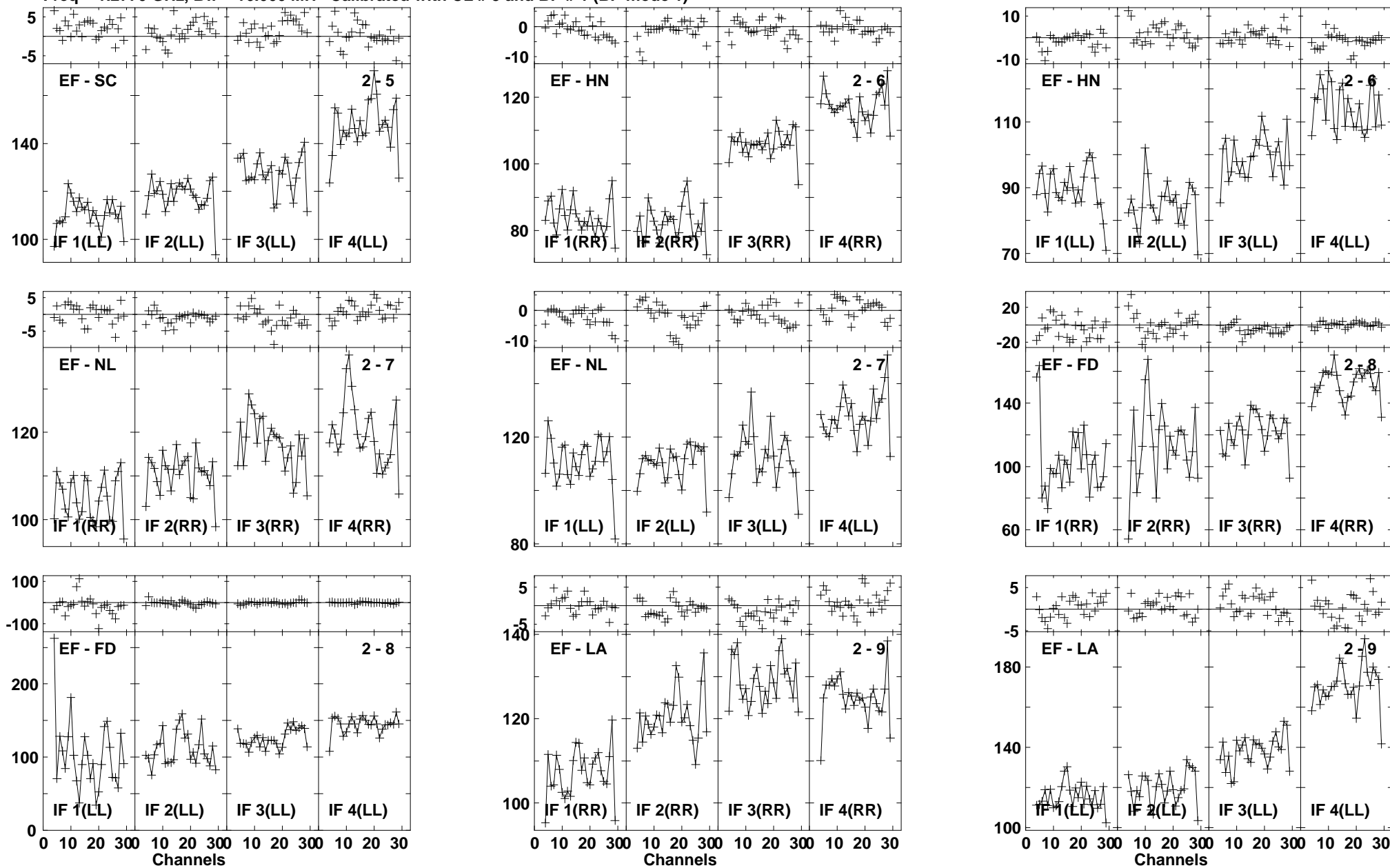

Lower frame: Milli Ampl Jy Top frame: Phas deg
Vector averaged cross-power spectrum Baseline: EF (02) - SC (05)
Timerange: 00/19:26:46 to 00/19:29:34

Plot file version 498 created 03-MAR-2016 01:13:21

J1545+5400 GN002C 1.UVDATA.1

Freq = 1.2770 GHz, Bw = 16.000 MH Calibrated with CL # 3 and BP # 1 (BP mode 1)

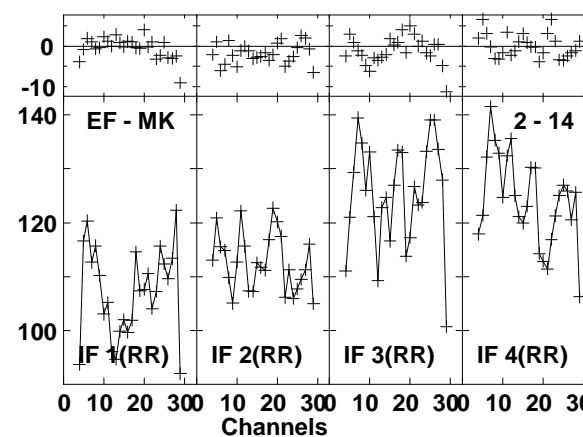
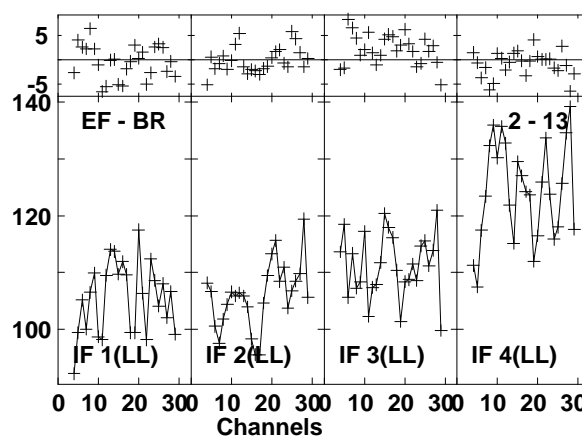
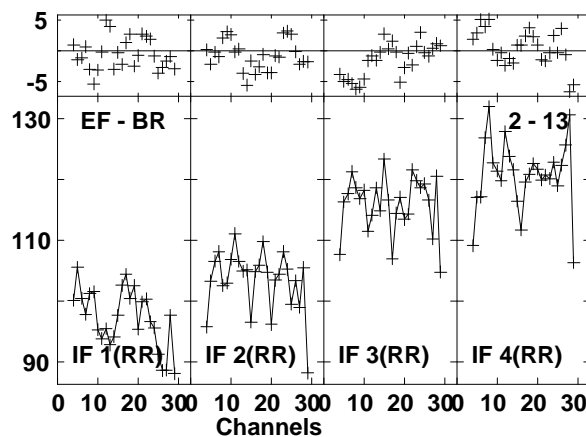
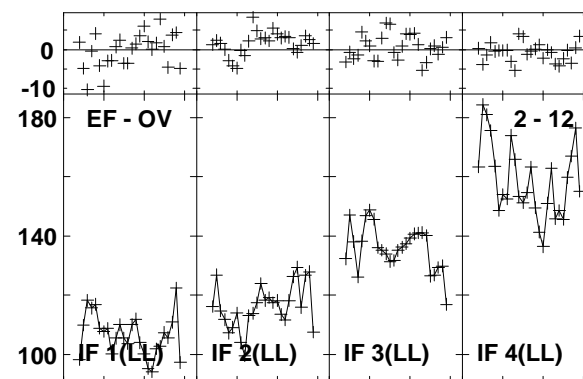
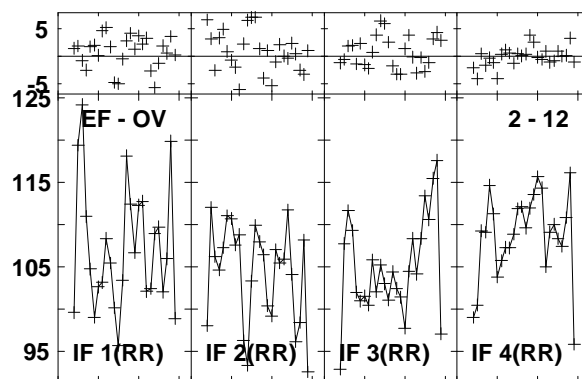
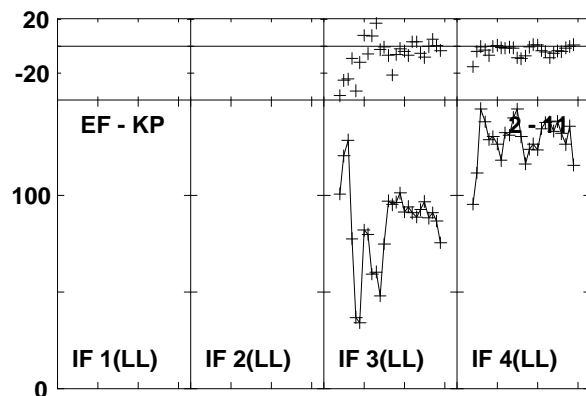
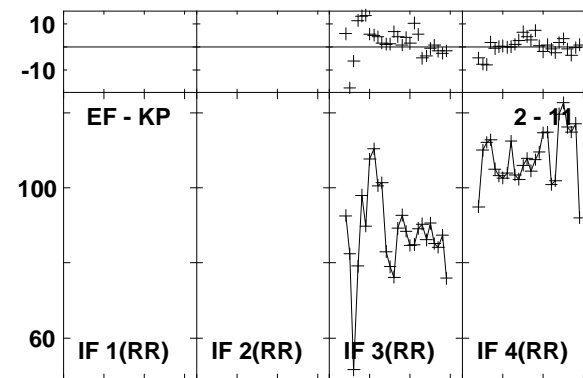
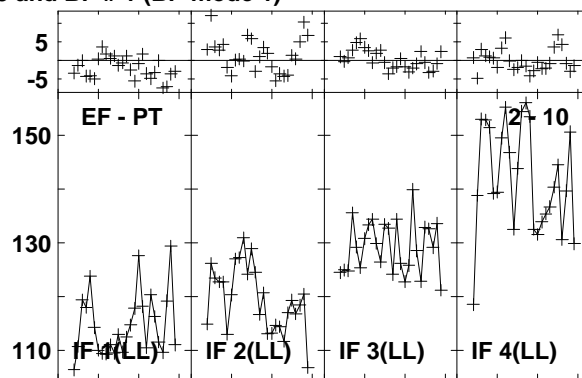
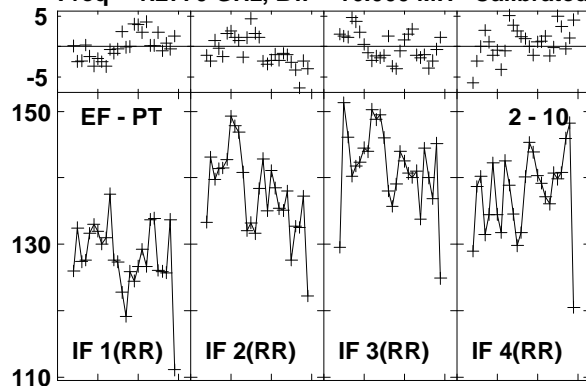

Lower frame: Milli Ampl Jy Top frame: Phas deg
Vector averaged cross-power spectrum Baseline: EF (02) - PT (10)
Timerange: 00/19:26:46 to 00/19:29:34

Plot file version 499 created 03-MAR-2016 01:13:21

J1545+5400 GN002C 1.UVDATA.1

Freq = 1.2770 GHz, Bw = 16.000 MH Calibrated with CL # 3 and BP # 1 (BP mode 1)

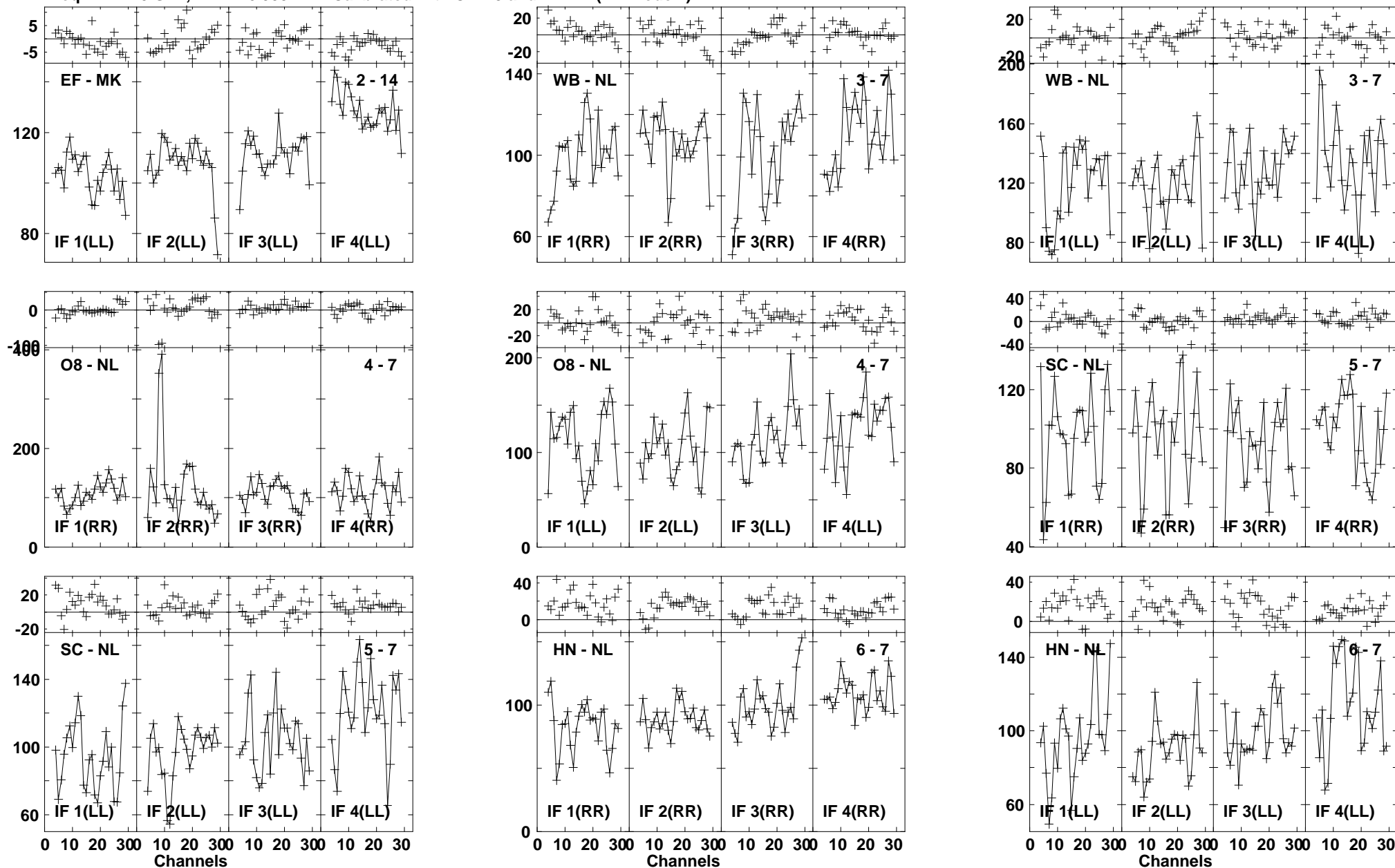

Lower frame: Milli Ampl Jy Top frame: Phas deg
Vector averaged cross-power spectrum Baseline: EF (02) - MK (14)
Timerange: 00/19:26:46 to 00/19:29:34

Plot file version 500 created 03-MAR-2016 01:13:21

J1545+5400 GN002C 1.UVDATA.1

Freq = 1.2770 GHz, Bw = 16.000 MH Calibrated with CL # 3 and BP # 1 (BP mode 1)

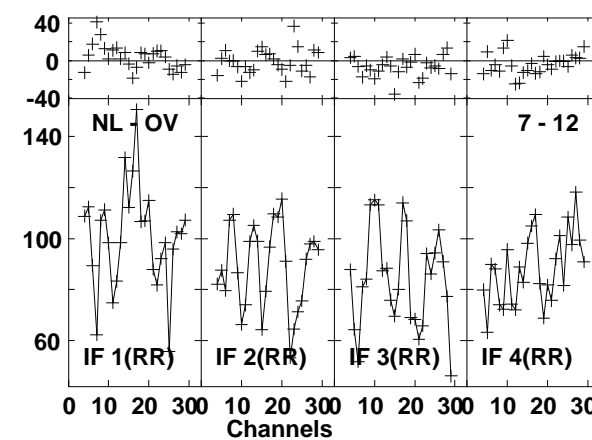
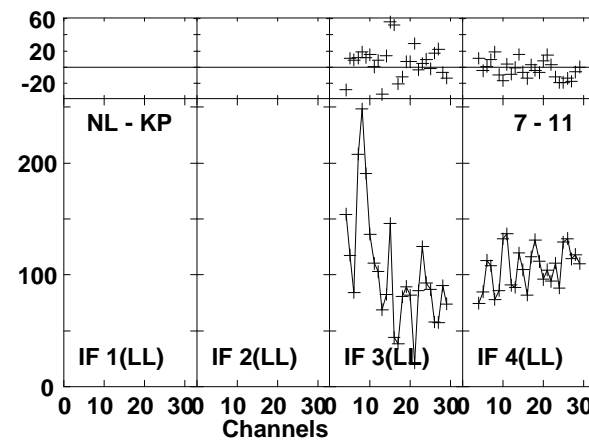
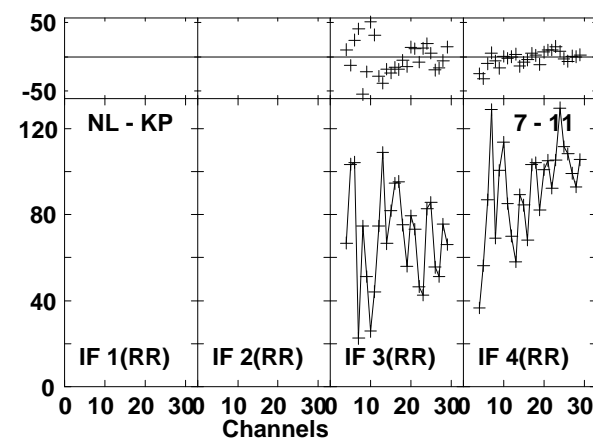
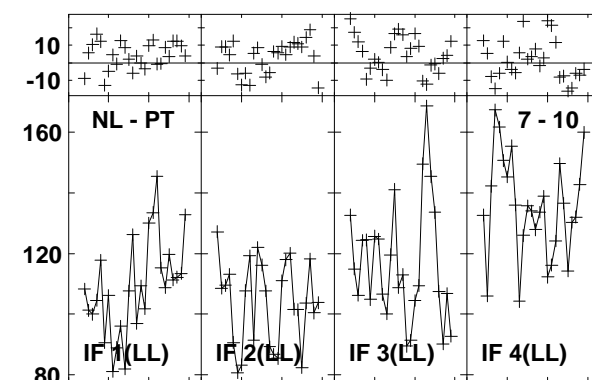
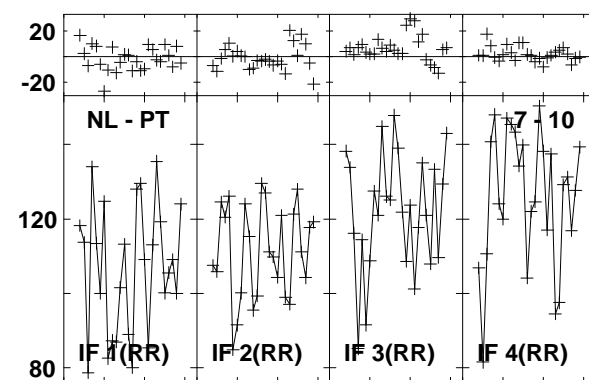
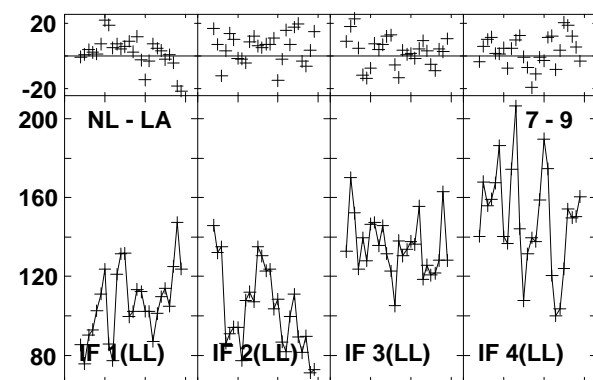
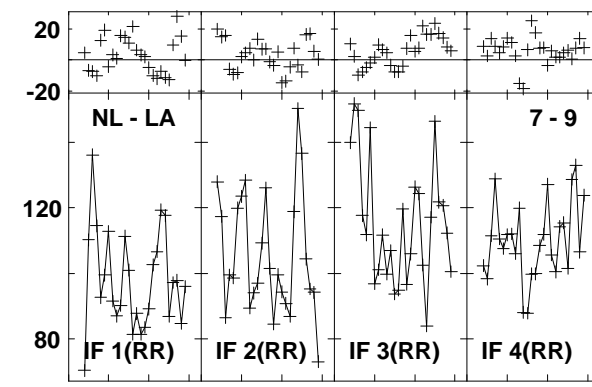
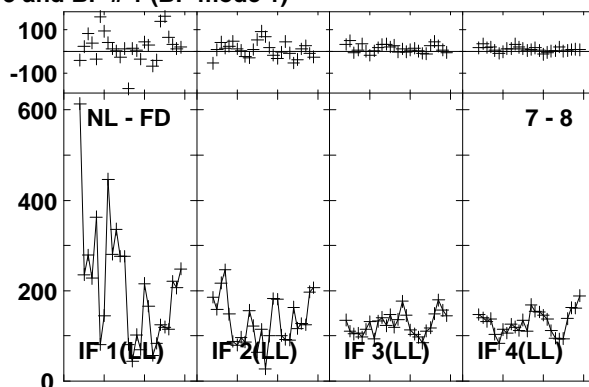
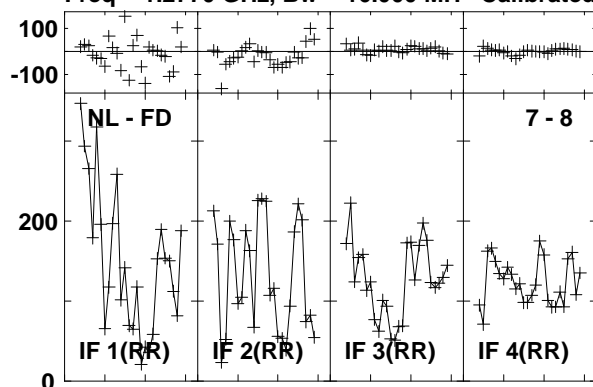

Lower frame: Milli Ampl Jy Top frame: Phas deg
Vector averaged cross-power spectrum Baseline: NL (07) - FD (08)
Timerange: 00/19:26:46 to 00/19:29:34

Plot file version 501 created 03-MAR-2016 01:13:21

J1545+5400 GN002C 1.UVDATA.1

Freq = 1.2770 GHz, Bw = 16.000 MH Calibrated with CL # 3 and BP # 1 (BP mode 1)

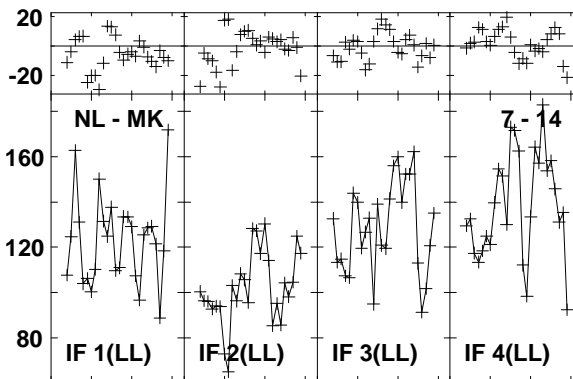
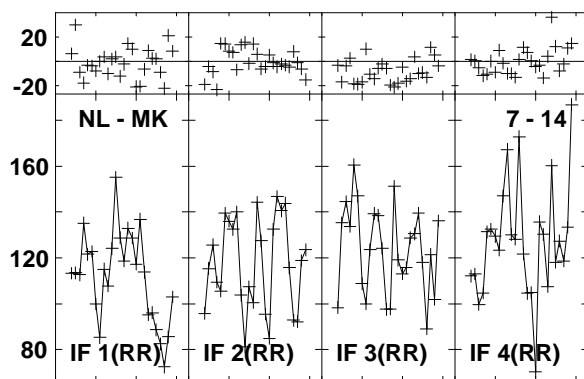
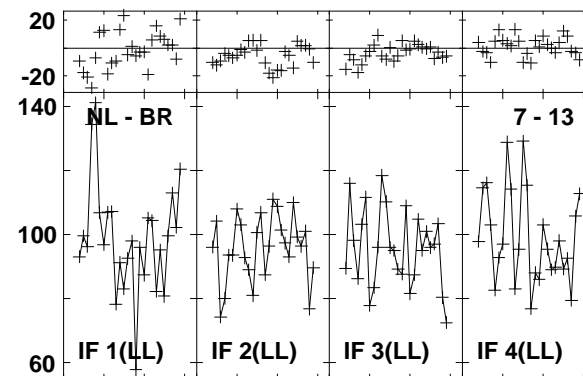
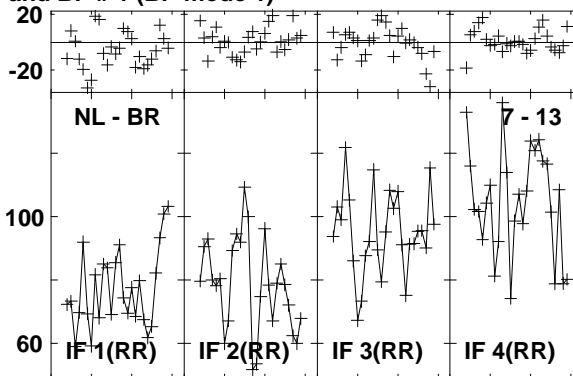
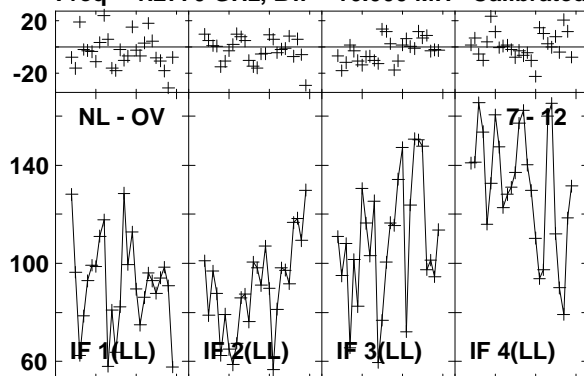

Lower frame: Milli Ampl Jy Top frame: Phas deg
Vector averaged cross-power spectrum Baseline: NL (07) - OV (12)
Timerange: 00/19:26:46 to 00/19:29:34

Plot file version 502 created 03-MAR-2016 01:13:21

4C52 GN002C 1.UVDATA.1

Freq = 1.2770 GHz, Bw = 16.000 MH Calibrated with CL # 3 and BP # 1 (BP mode 1)

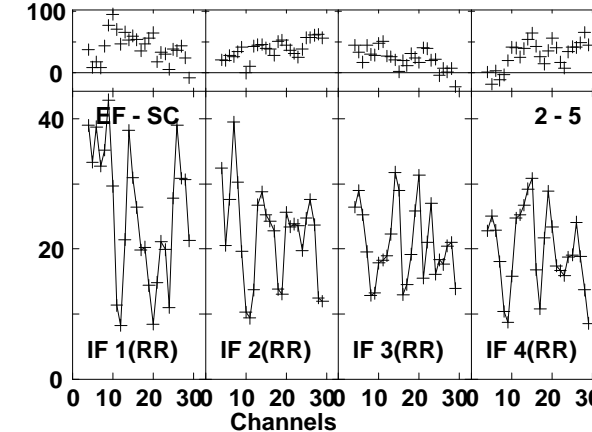
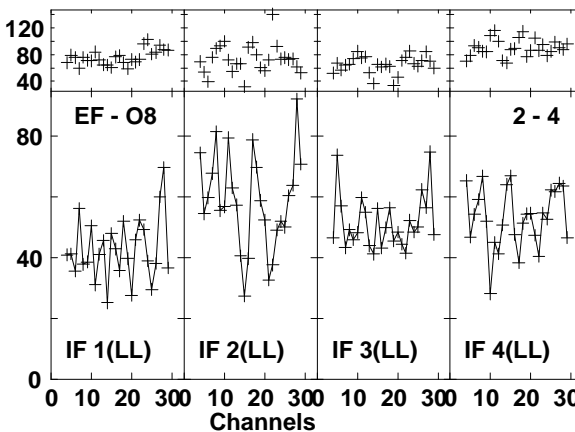
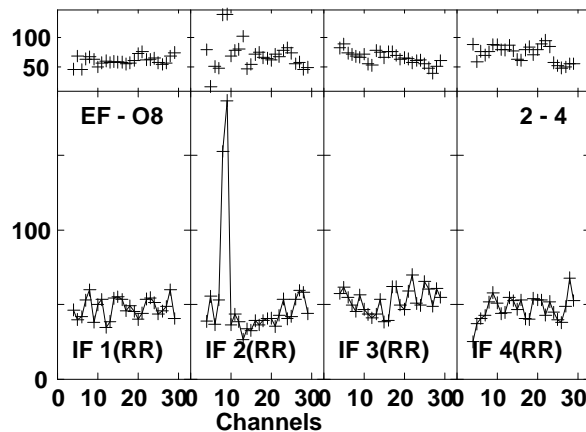
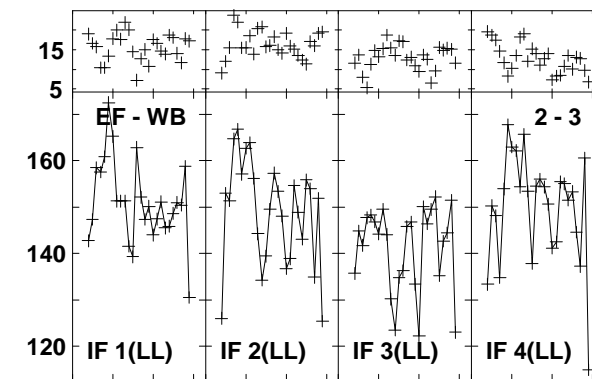
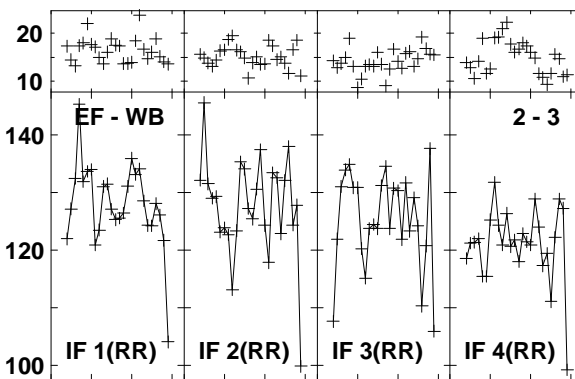
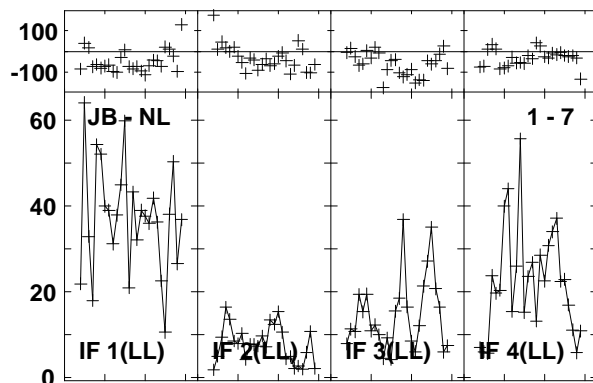
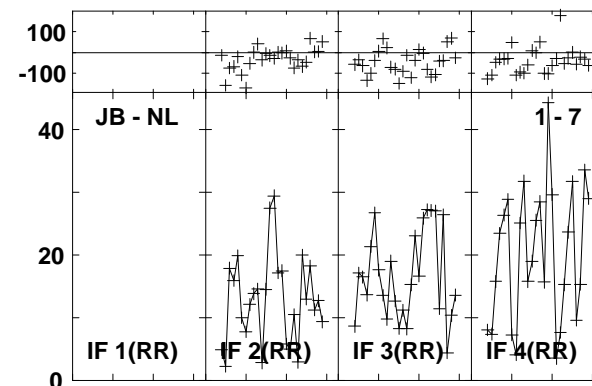
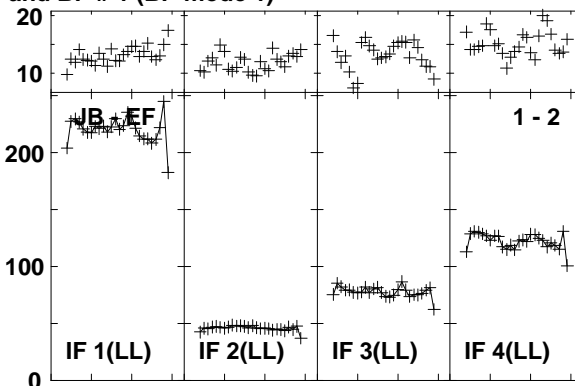
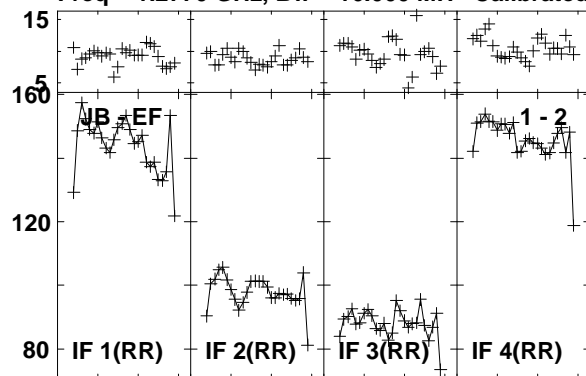

Lower frame: Milli Ampl Jy Top frame: Phas deg
Vector averaged cross-power spectrum Baseline: JB (01) - EF (02)
Timerange: 00/19:29:47 to 00/19:32:33

Plot file version 503 created 03-MAR-2016 01:13:21

4C52 GN002C 1.UVDATA.1

Freq = 1.2770 GHz, Bw = 16.000 MH Calibrated with CL # 3 and BP # 1 (BP mode 1)

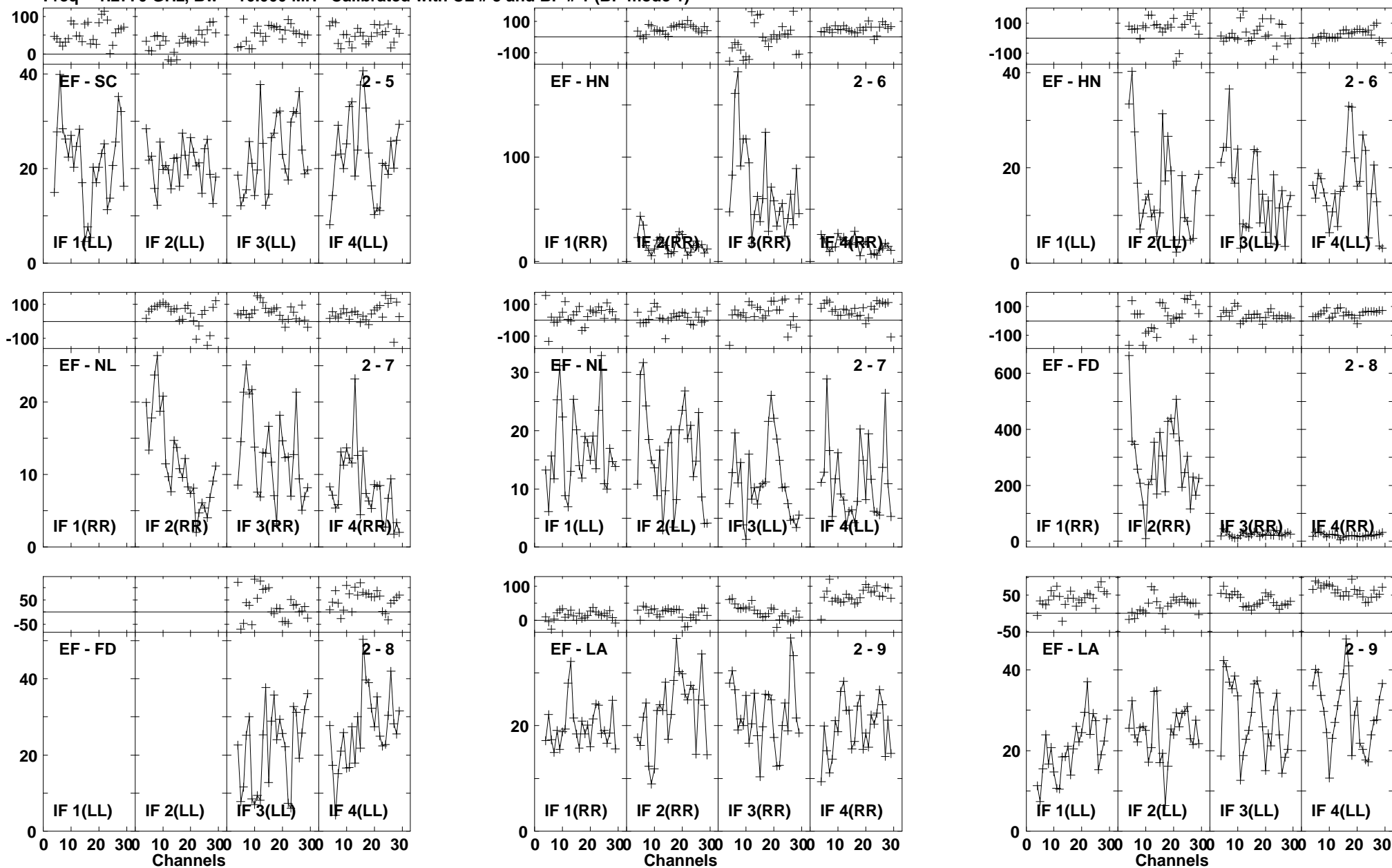

Lower frame: Milli Ampl Jy Top frame: Phas deg
Vector averaged cross-power spectrum Baseline: EF (02) - SC (05)
Timerange: 00/19:29:47 to 00/19:32:33

Plot file version 504 created 03-MAR-2016 01:13:22

4C52 GN002C 1.UVDATA.1

Freq = 1.2770 GHz, Bw = 16.000 MH Calibrated with CL # 3 and BP # 1 (BP mode 1)

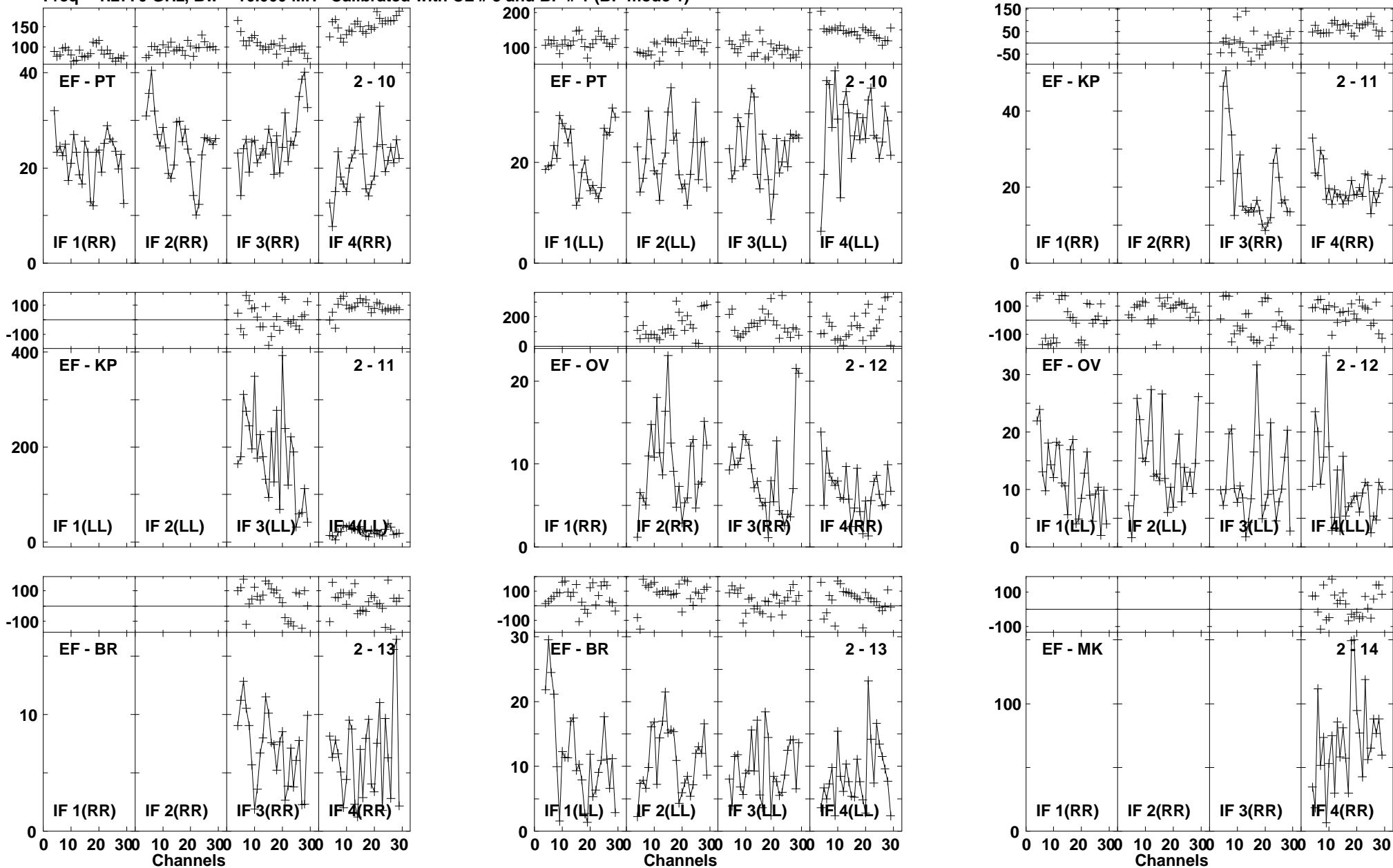

Lower frame: Milli Ampl Jy Top frame: Phas deg
Vector averaged cross-power spectrum Baseline: EF (02) - PT (10)
Timerange: 00/19:29:47 to 00/19:32:33

Plot file version 505 created 03-MAR-2016 01:13:22

4C52 GN002C 1.UVDATA.1

Freq = 1.2770 GHz, Bw = 16.000 MH Calibrated with CL # 3 and BP # 1 (BP mode 1)

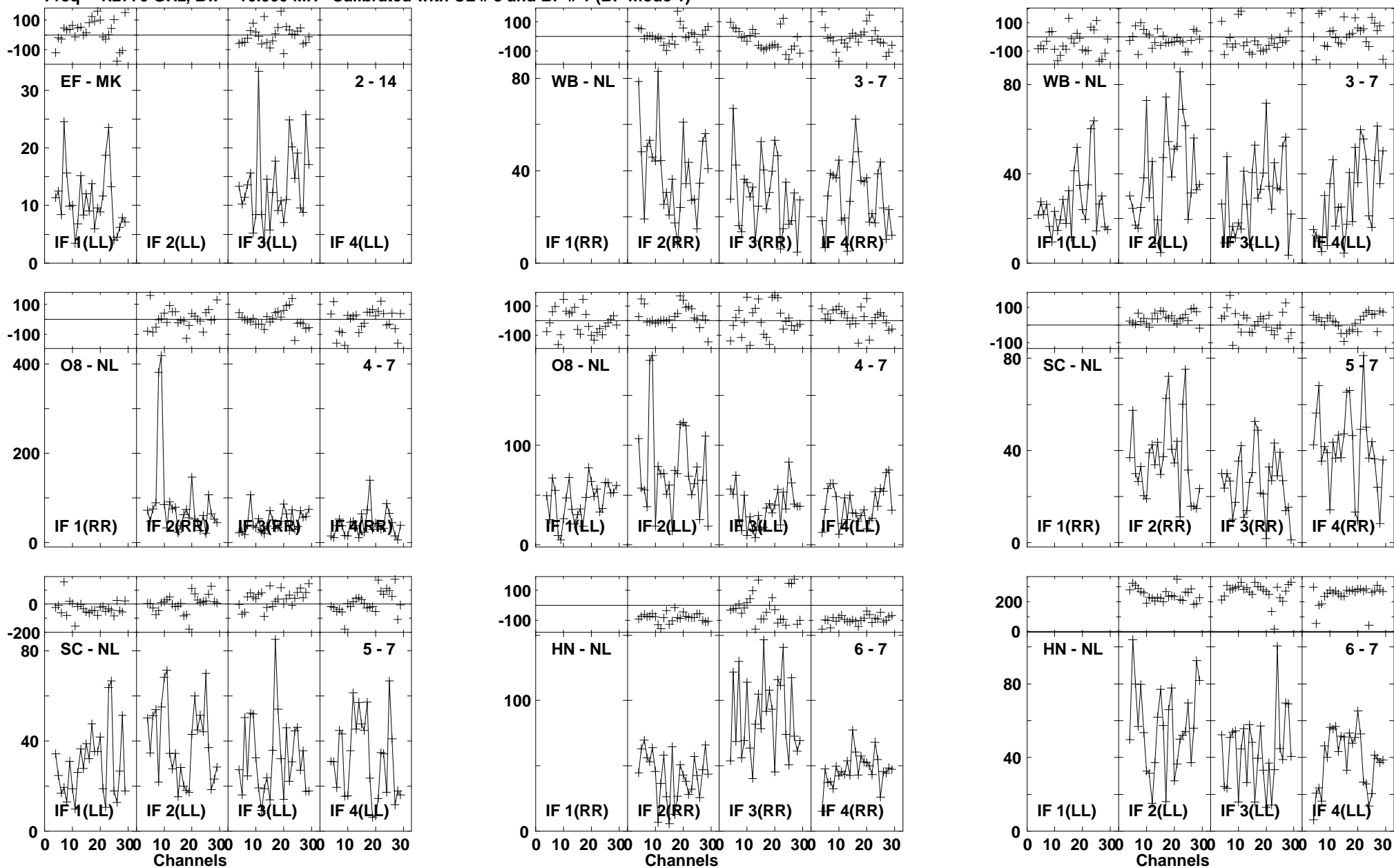

Lower frame: Milli Ampl Jy Top frame: Phas deg
Vector averaged cross-power spectrum Baseline: EF (02) - MK (14)
Timerange: 00/19:29:47 to 00/19:32:33

Plot file version 506 created 03-MAR-2016 01:13:22

4C52 GN002C 1.UVDATA.1

Freq = 1.2770 GHz, Bw = 16.000 MH Calibrated with CL # 3 and BP # 1 (BP mode 1)

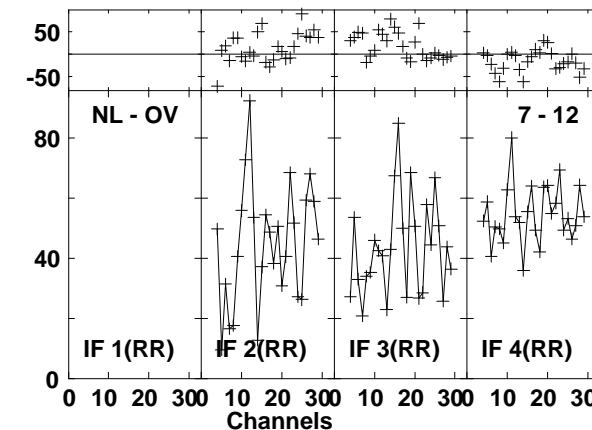
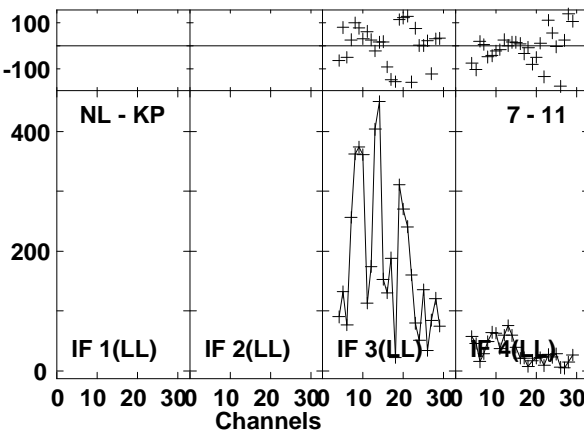
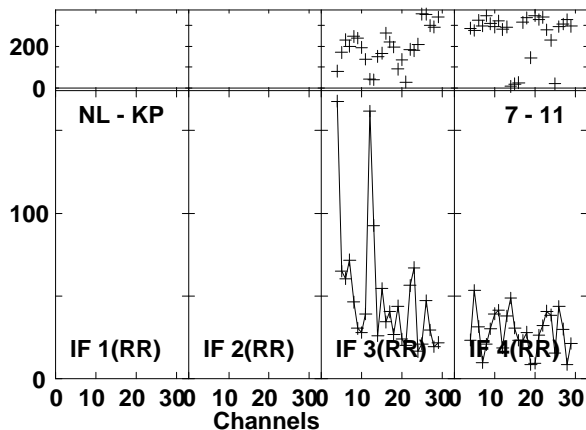
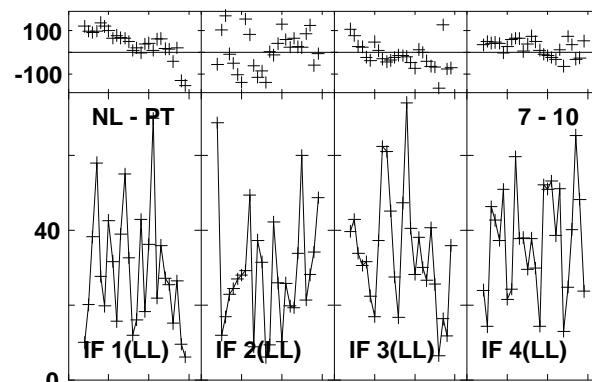
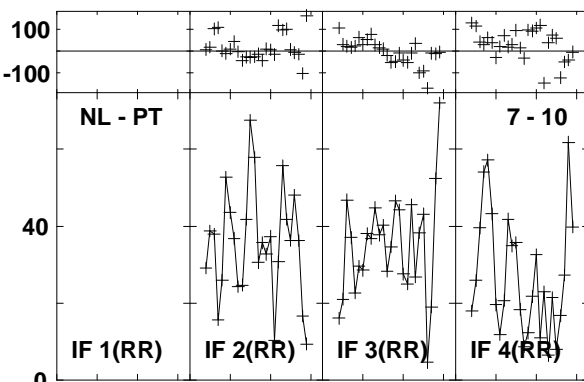
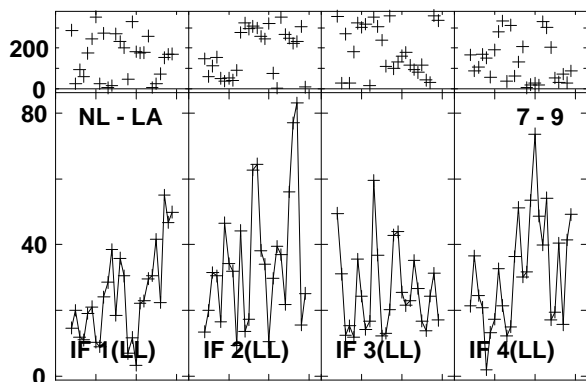
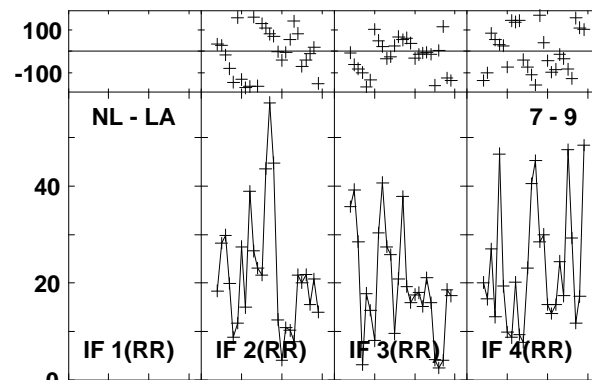
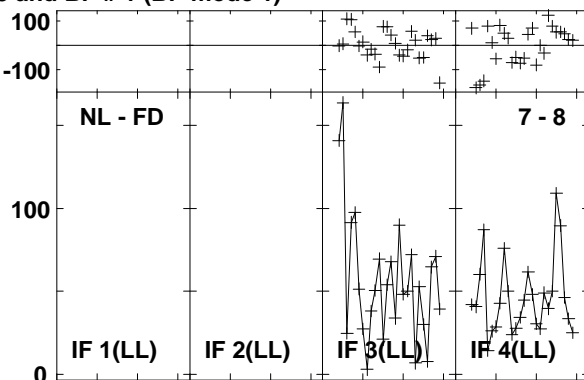
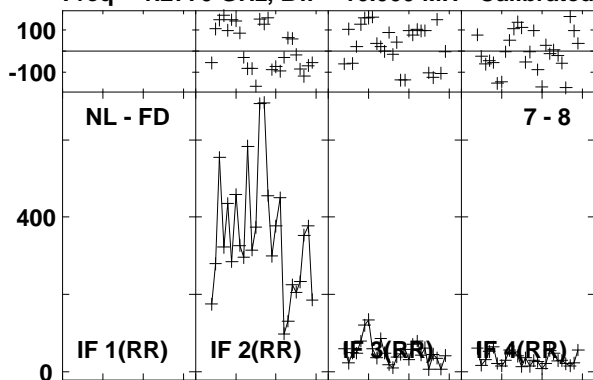

Lower frame: Milli Ampl Jy Top frame: Phas deg
Vector averaged cross-power spectrum Baseline: NL (07) - FD (08)
Timerange: 00:19:29:47 to 00:19:32:33

Plot file version 507 created 03-MAR-2016 01:13:22

4C52 GN002C 1.UVDATA.1

Freq = 1.2770 GHz, Bw = 16.000 MH Calibrated with CL # 3 and BP # 1 (BP mode 1)

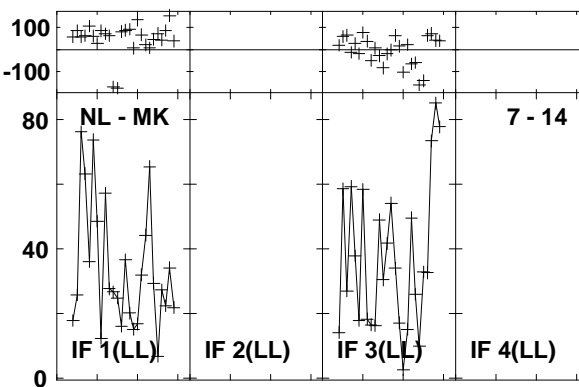
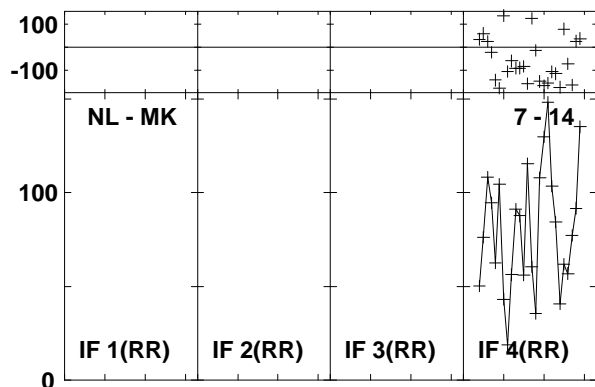
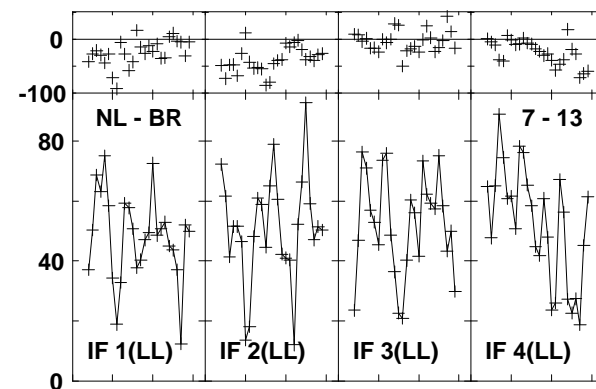
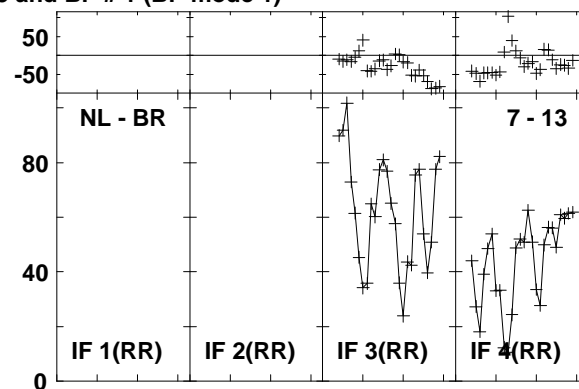
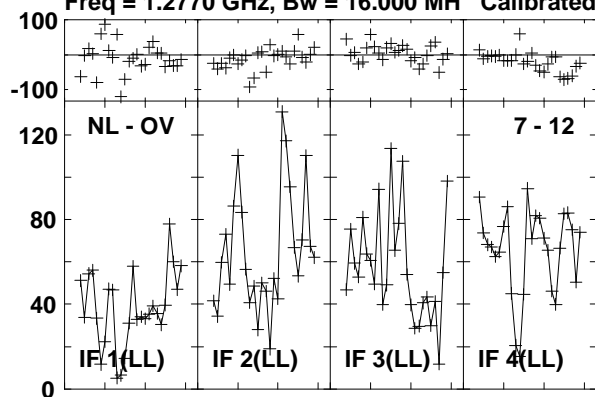

Lower frame: Milli Ampl Jy Top frame: Phas deg
Vector averaged cross-power spectrum Baseline: NL (07) - OV (12)
Timerange: 00/19:29:47 to 00/19:32:33

Plot file version 508 created 03-MAR-2016 01:13:22

J1545+5400 GN002C 1.UVDATA.1

Freq = 1.2770 GHz, Bw = 16.000 MH Calibrated with CL # 3 and BP # 1 (BP mode 1)

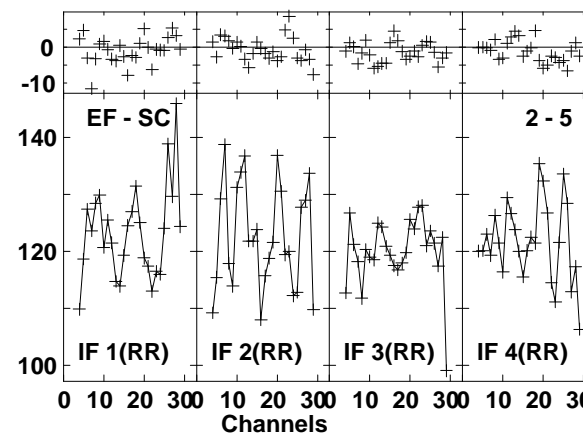
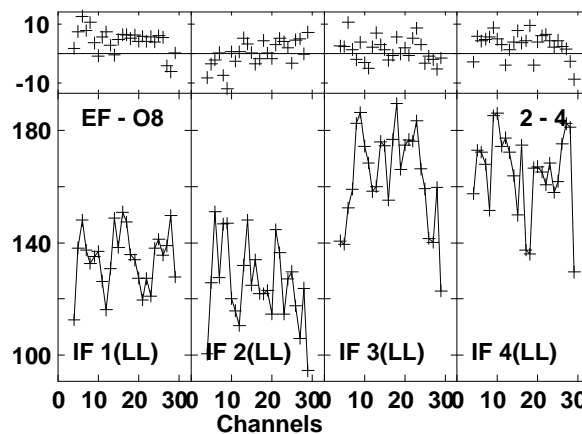
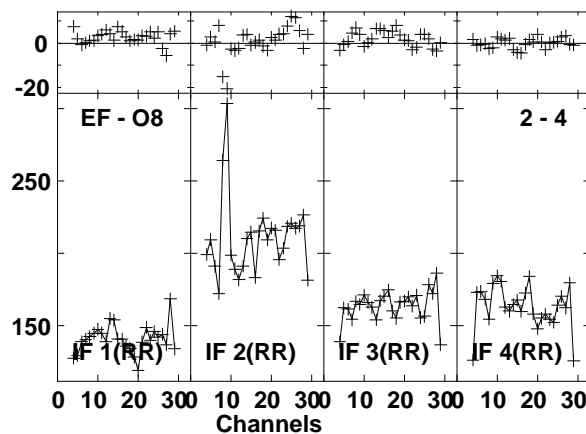
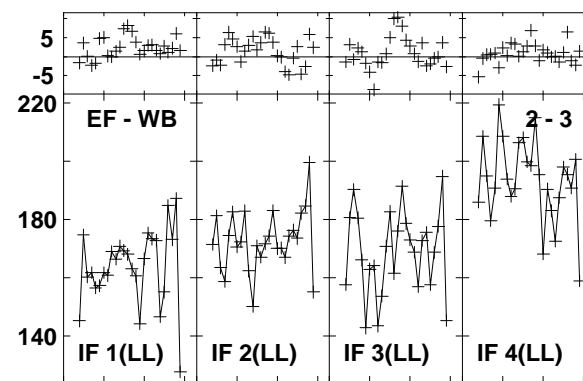
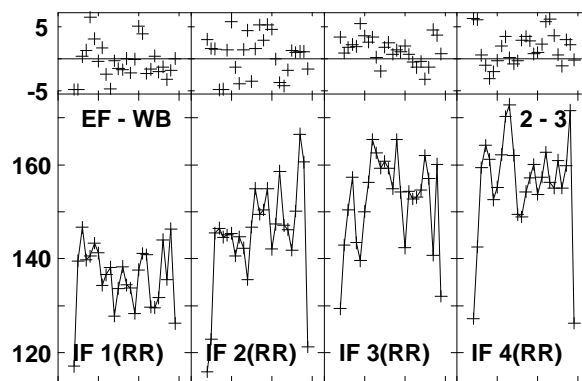
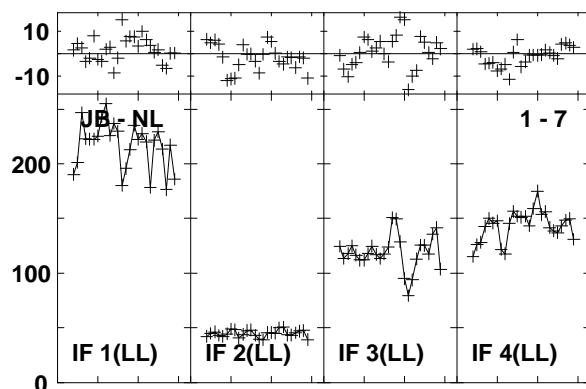
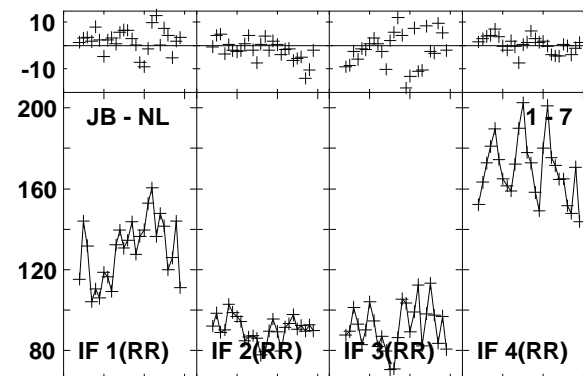
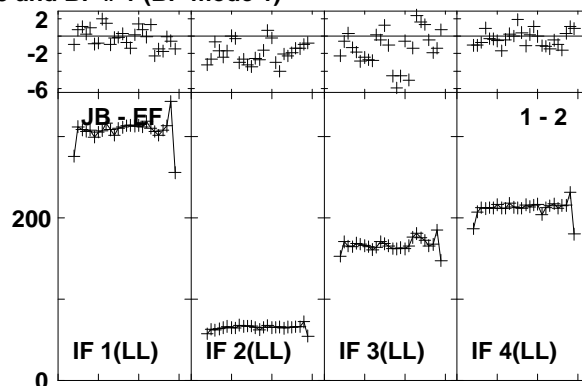
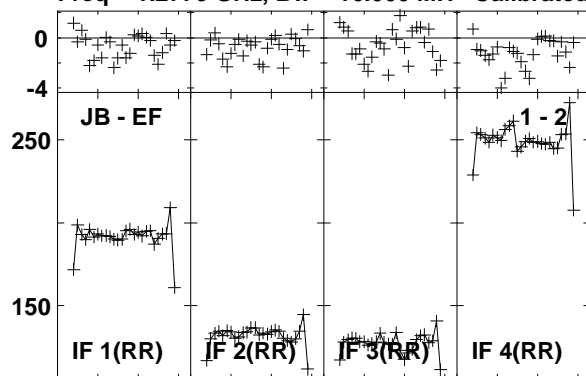

Lower frame: Milli Ampl Jy Top frame: Phas deg
Vector averaged cross-power spectrum Baseline: JB (01) - EF (02)
Timerange: 00/19:33:26 to 00/19:35:24

Plot file version 509 created 03-MAR-2016 01:13:22

J1545+5400 GN002C 1.UVDATA.1

Freq = 1.2770 GHz, Bw = 16.000 MH Calibrated with CL # 3 and BP # 1 (BP mode 1)

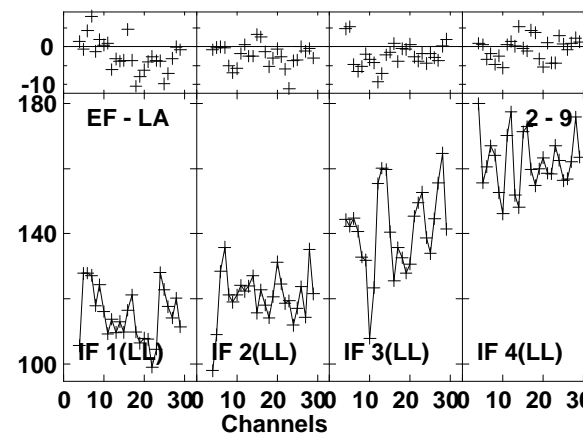
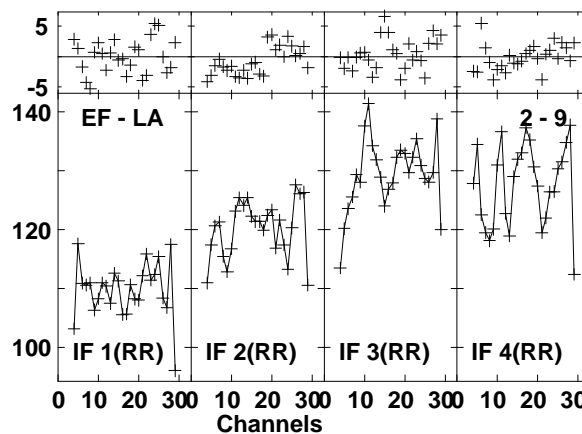
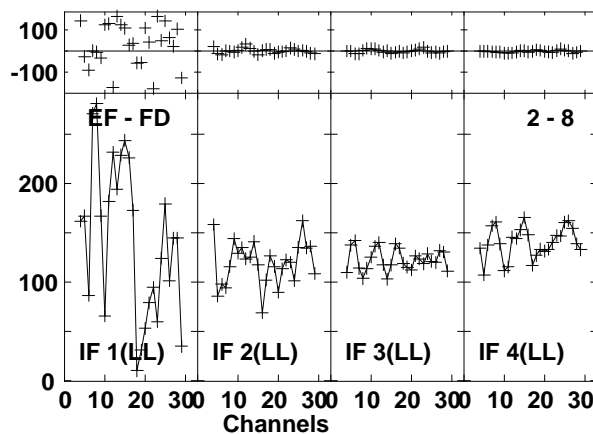
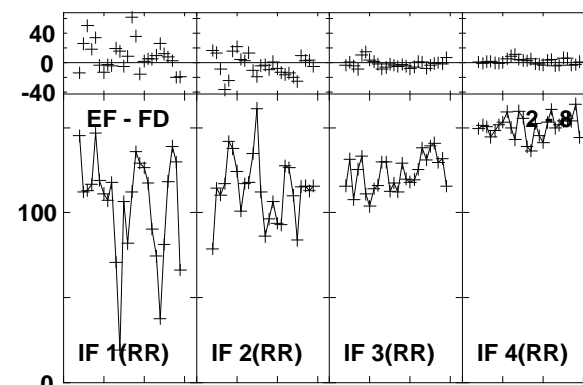
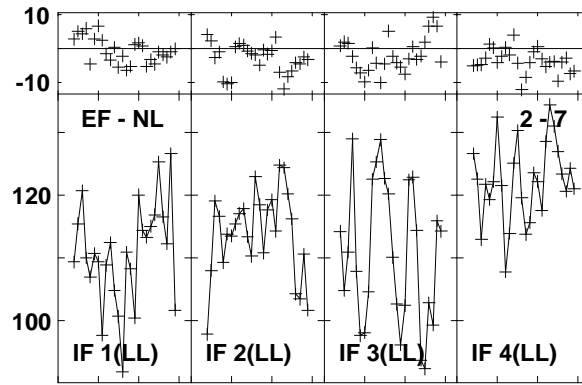
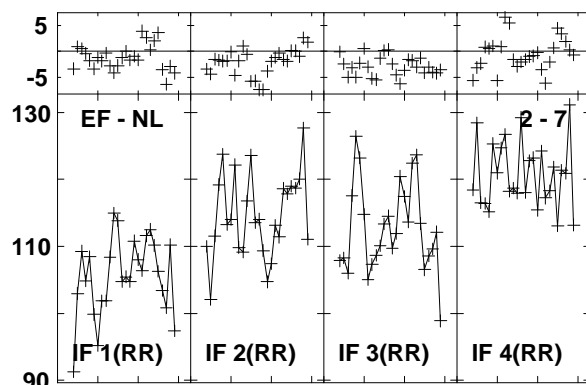
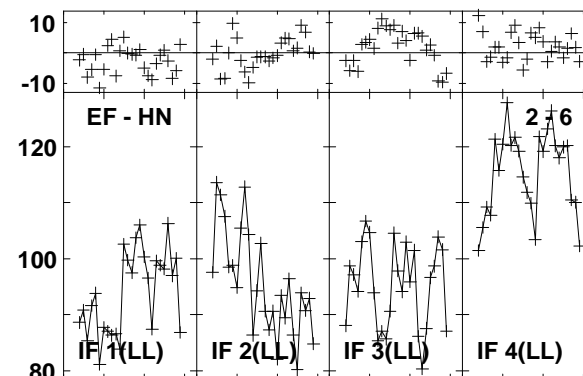
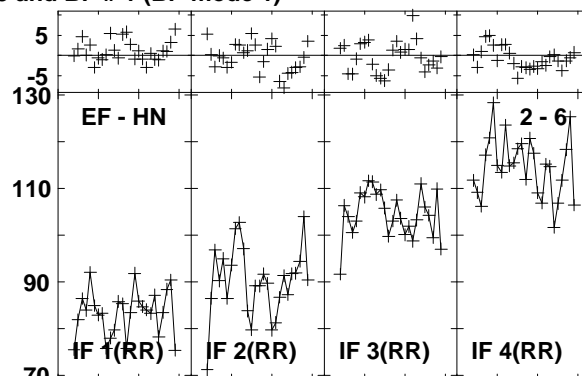
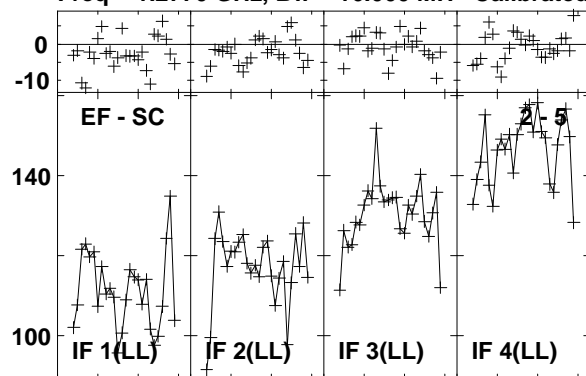

Lower frame: Milli Ampl Jy Top frame: Phas deg
Vector averaged cross-power spectrum Baseline: EF (02) - SC (05)
Timerange: 00/19:33:26 to 00/19:35:24

Plot file version 510 created 03-MAR-2016 01:13:23

J1545+5400 GN002C 1.UVDATA.1

Freq = 1.2770 GHz, Bw = 16.000 MH Calibrated with CL # 3 and BP # 1 (BP mode 1)

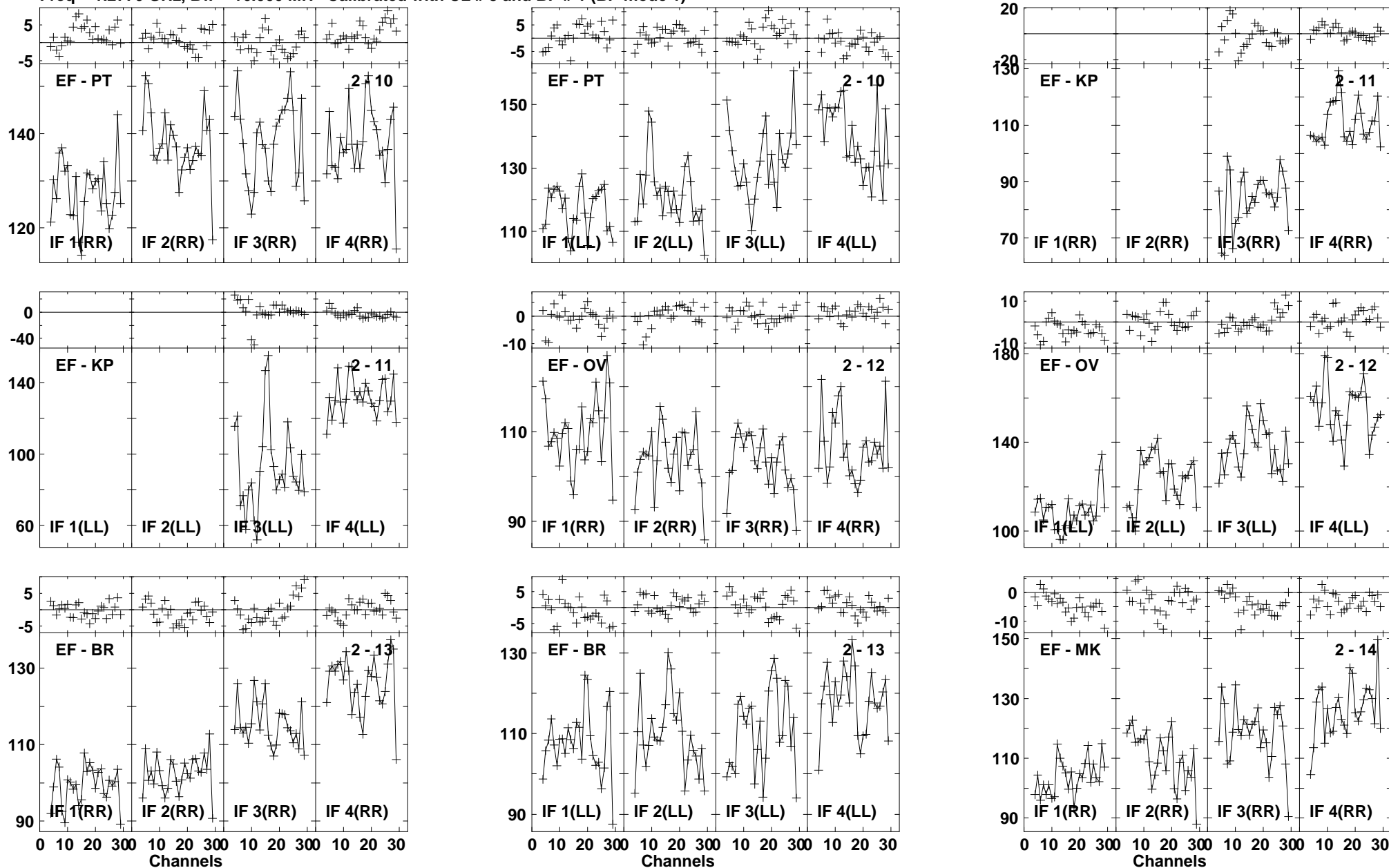

Lower frame: Milli Ampl Jy Top frame: Phas deg
Vector averaged cross-power spectrum Baseline: EF (02) - PT (10)
Timerange: 00/19:33:26 to 00/19:35:24

Plot file version 511 created 03-MAR-2016 01:13:23

J1545+5400 GN002C 1.UVDATA.1

Freq = 1.2770 GHz, Bw = 16.000 MH Calibrated with CL # 3 and BP # 1 (BP mode 1)

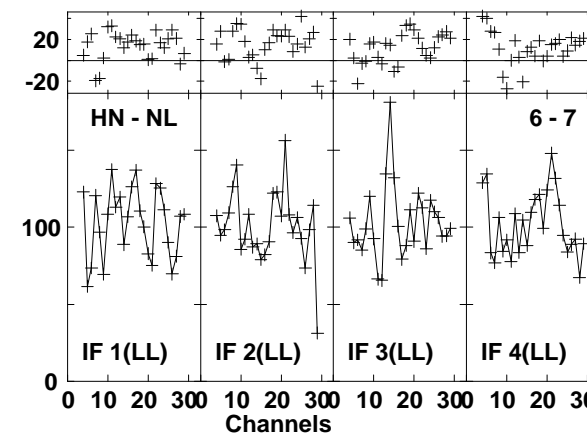
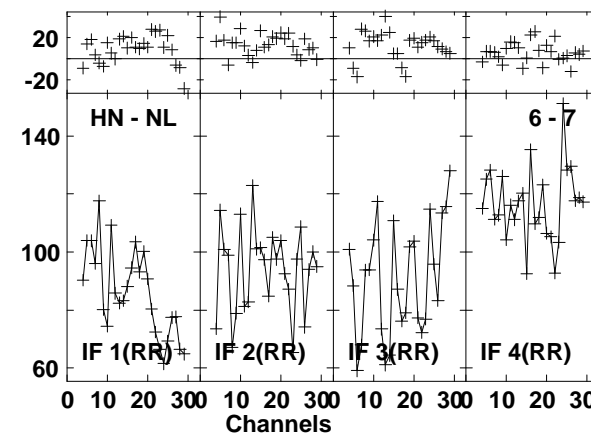
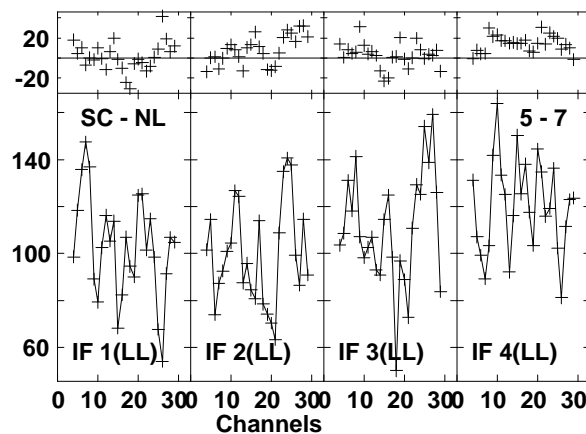
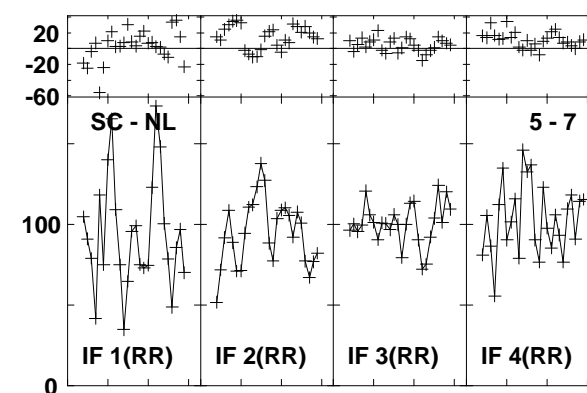
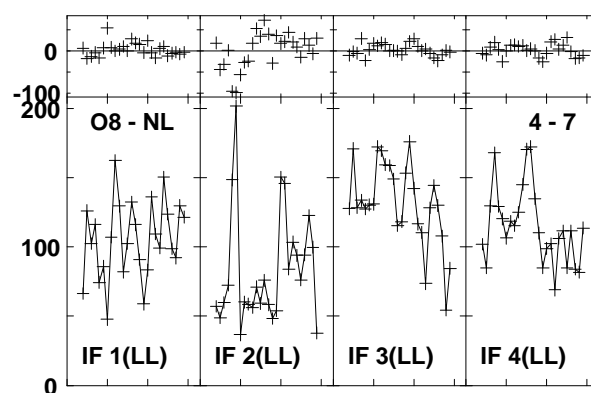
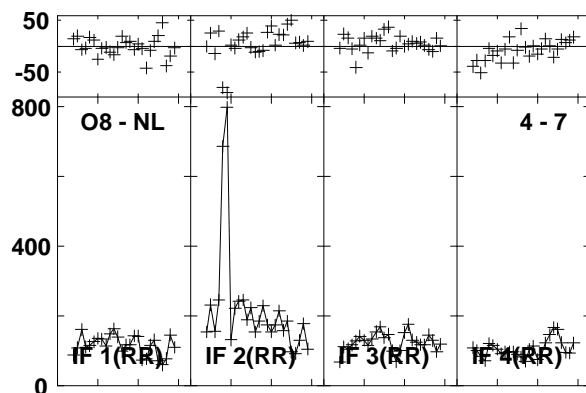
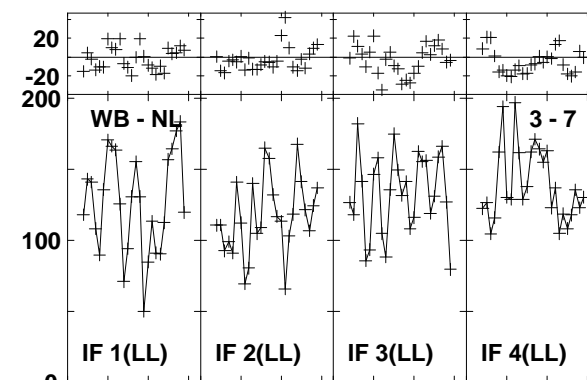
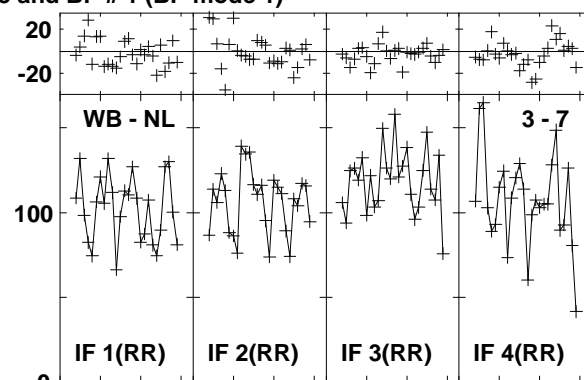
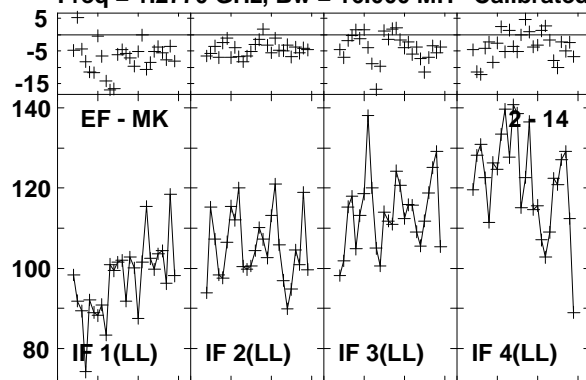

Lower frame: Milli Ampl Jy Top frame: Phas deg
Vector averaged cross-power spectrum Baseline: EF (02) - MK (14)
Timerange: 00/19:33:26 to 00/19:35:24

Plot file version 512 created 03-MAR-2016 01:13:23

J1545+5400 GN002C 1.UVDATA.1

Freq = 1.2770 GHz, Bw = 16.000 MH Calibrated with CL # 3 and BP # 1 (BP mode 1)

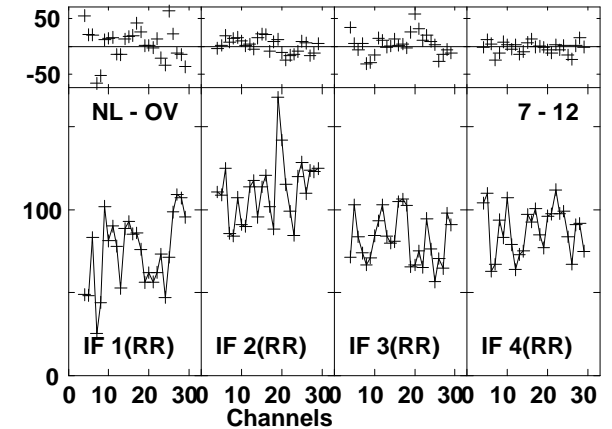
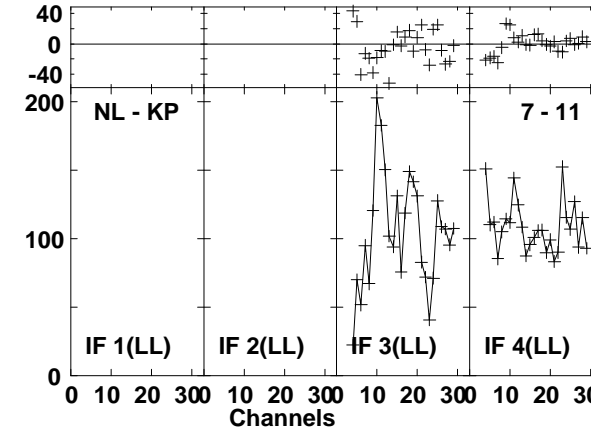
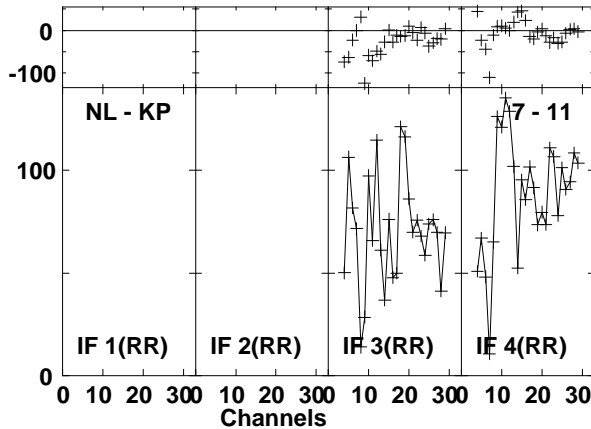
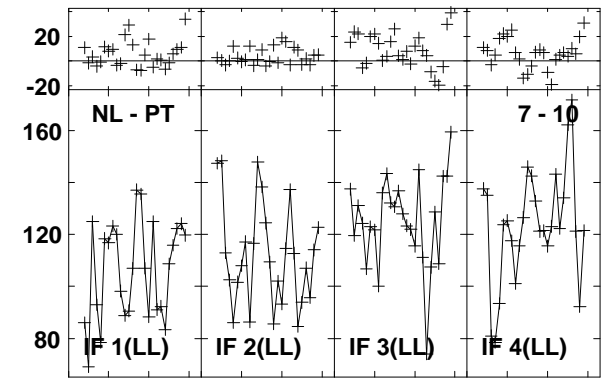
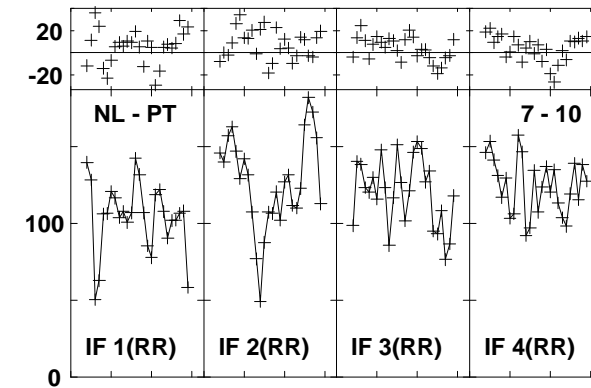
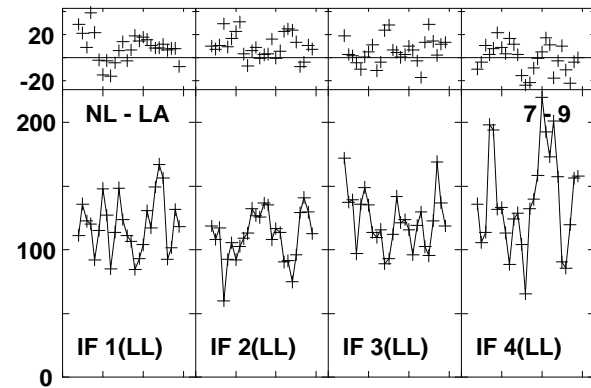
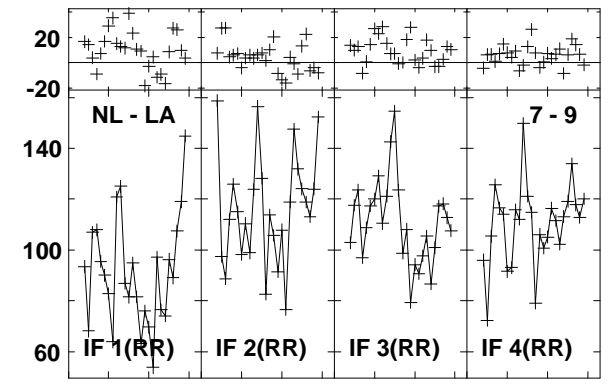
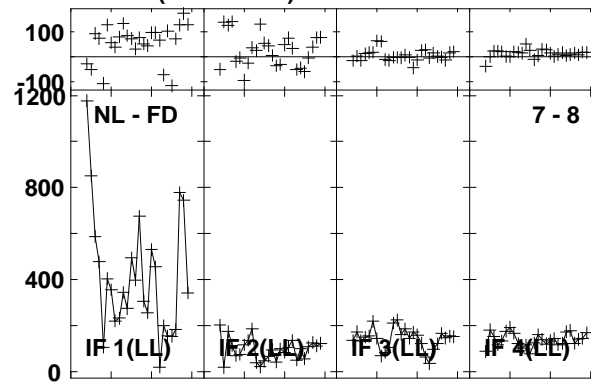
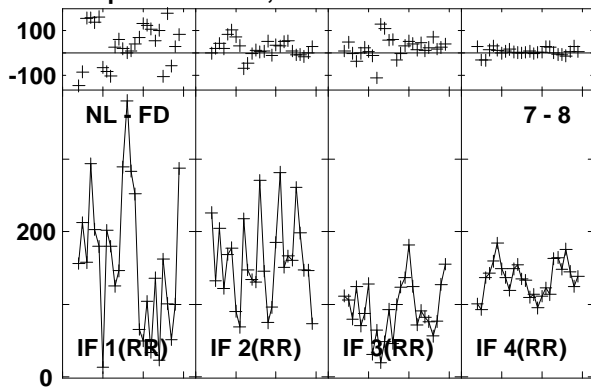

Lower frame: Milli Ampl Jy Top frame: Phas deg
Vector averaged cross-power spectrum Baseline: NL (07) - FD (08)
Timerange: 00/19:33:26 to 00/19:35:24

Plot file version 513 created 03-MAR-2016 01:13:23

J1545+5400 GN002C 1.UVDATA.1

Freq = 1.2770 GHz, Bw = 16.000 MH Calibrated with CL # 3 and BP # 1 (BP mode 1)

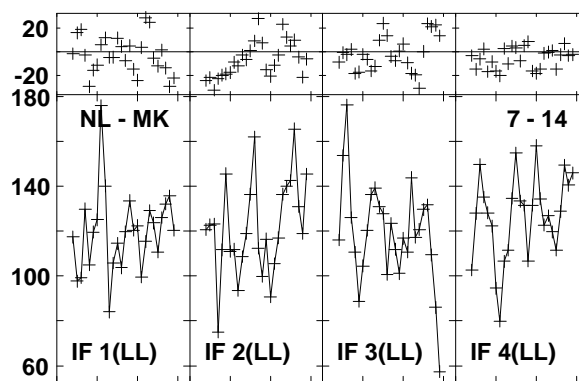
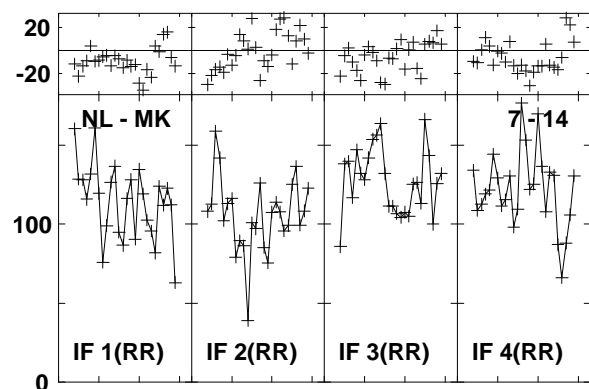
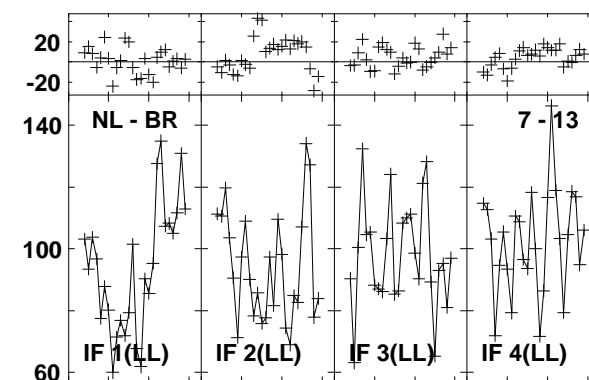
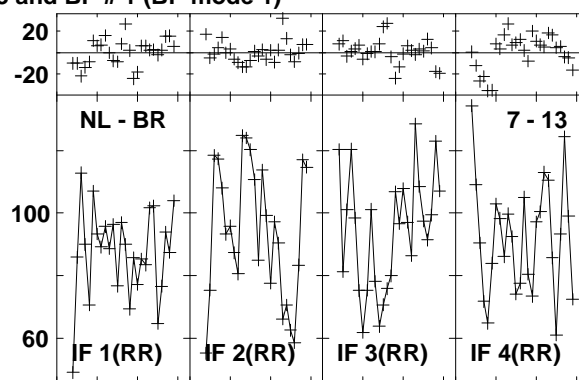
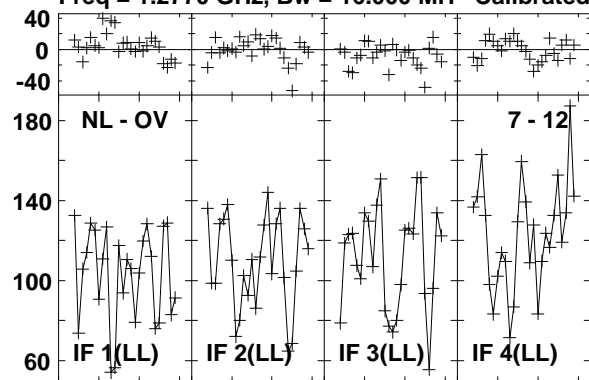

Lower frame: Milli Ampl Jy Top frame: Phas deg
Vector averaged cross-power spectrum Baseline: NL (07) - OV (12)
Timerange: 00/19:33:26 to 00/19:35:24

Plot file version 514 created 03-MAR-2016 01:13:23

4C52 GN002C 1.UVDATA.1

Freq = 1.2770 GHz, Bw = 16.000 MH Calibrated with CL # 3 and BP # 1 (BP mode 1)

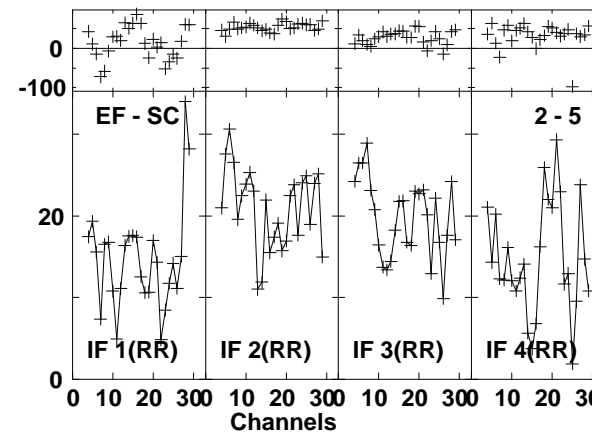
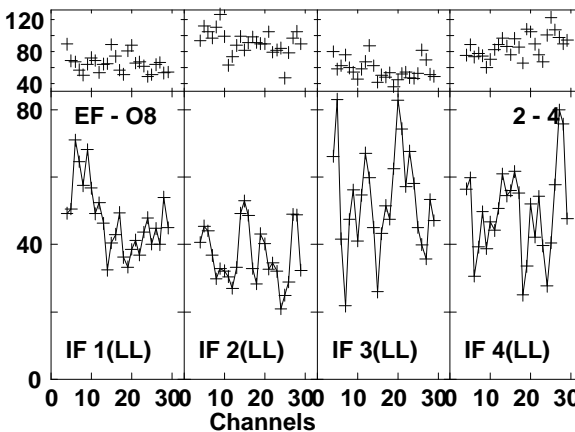
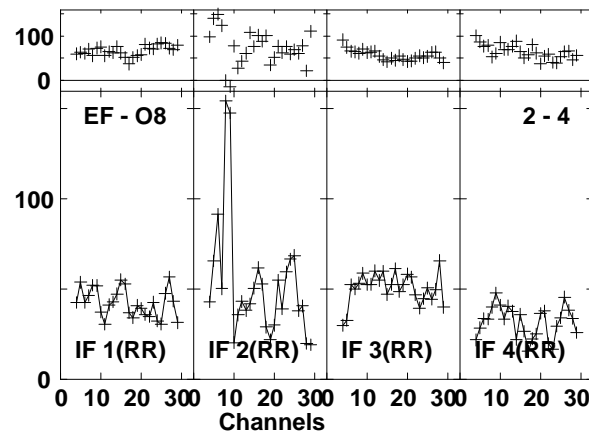
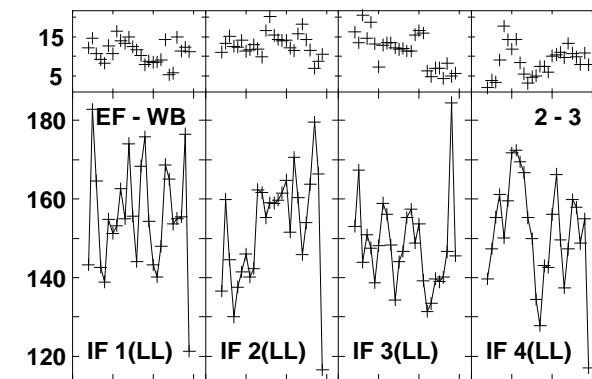
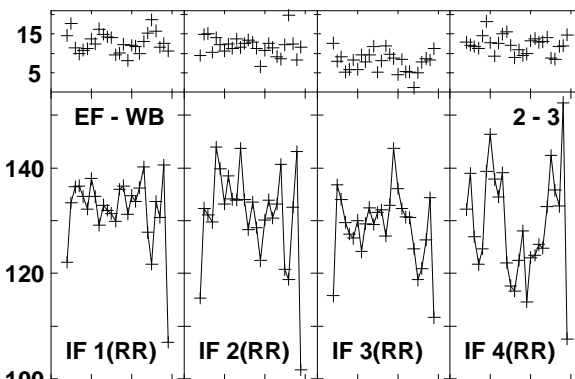
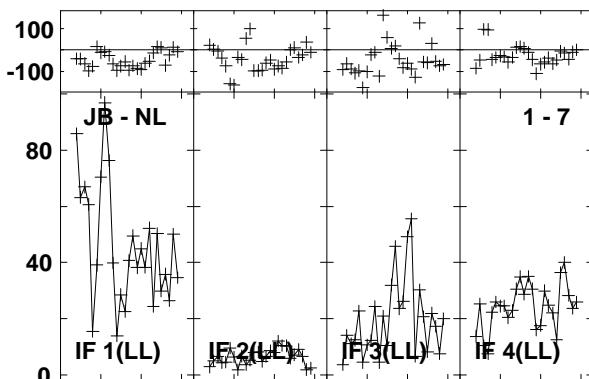
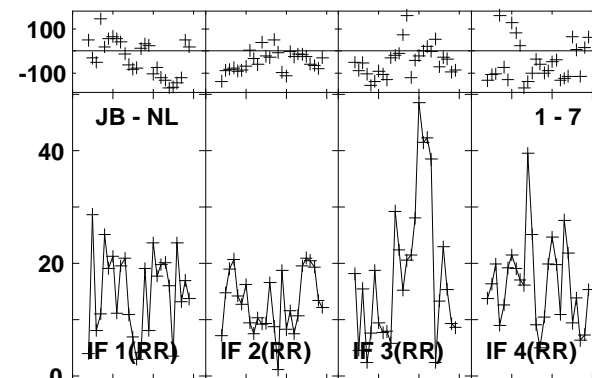
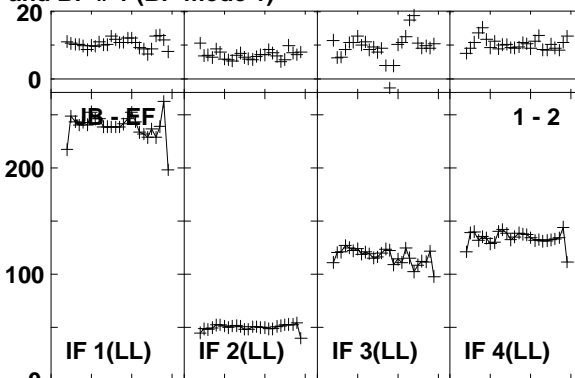
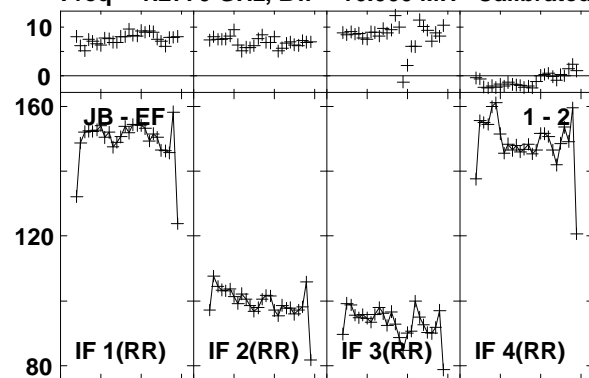

Lower frame: Milli Ampl Jy Top frame: Phas deg
Vector averaged cross-power spectrum Baseline: JB (01) - EF (02)
Timerange: 00/19:35:37 to 00/19:38:23

Plot file version 515 created 03-MAR-2016 01:13:23

4C52 GN002C 1.UVDATA.1

Freq = 1.2770 GHz, Bw = 16.000 MH Calibrated with CL # 3 and BP # 1 (BP mode 1)

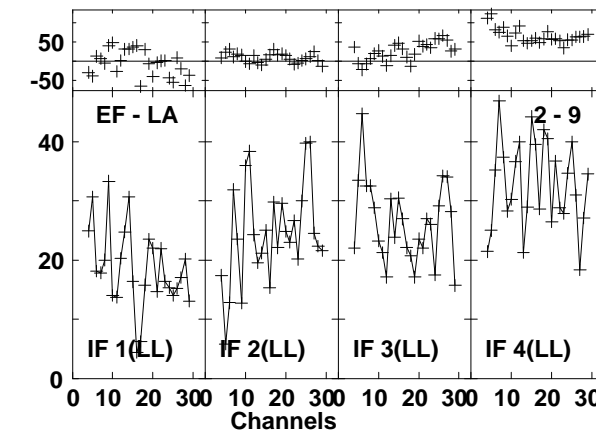
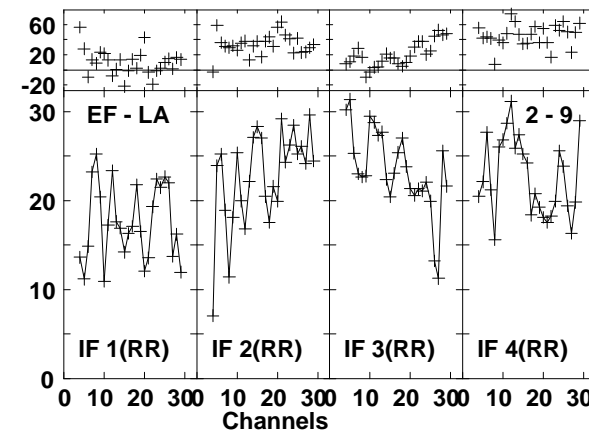
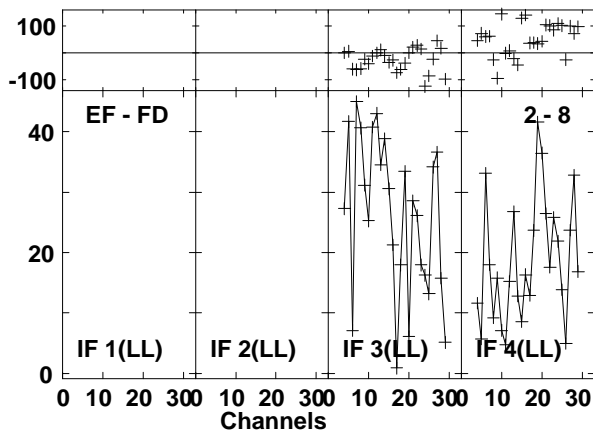
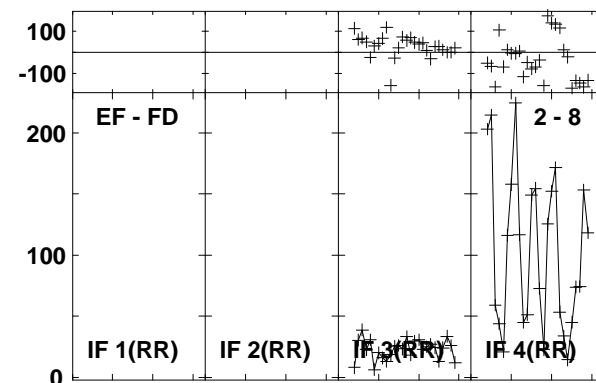
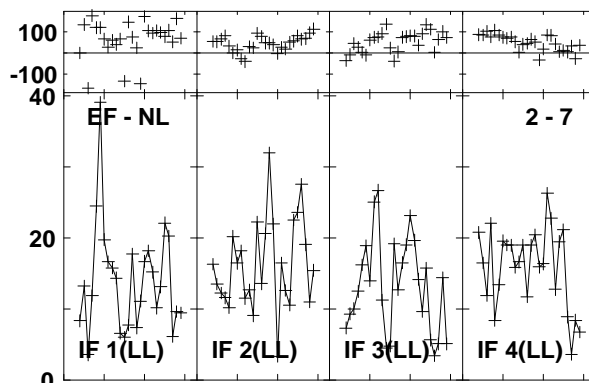
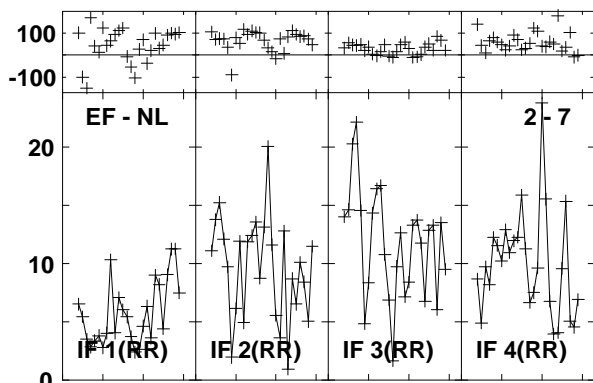
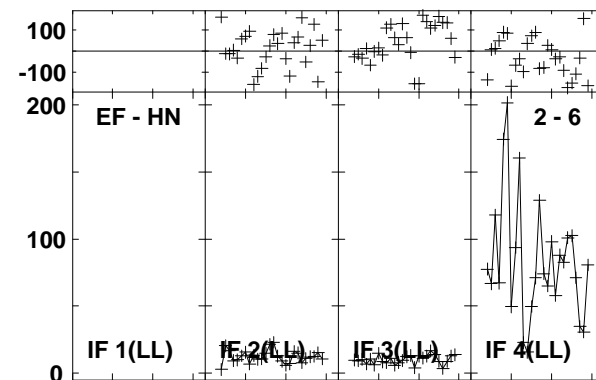
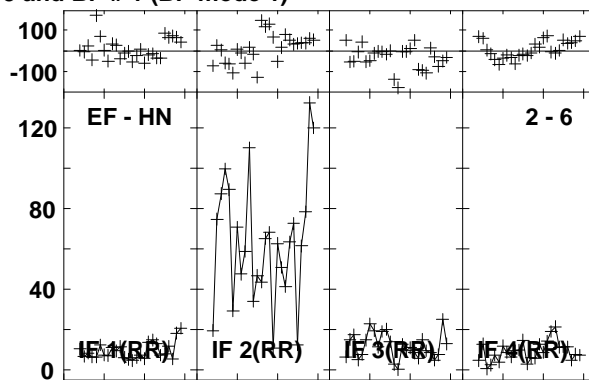
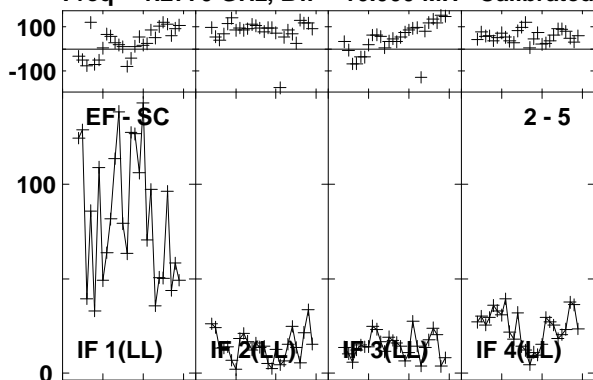

Lower frame: Milli Ampl Jy Top frame: Phas deg
Vector averaged cross-power spectrum Baseline: EF (02) - SC (05)
Timerange: 00/19:35:37 to 00/19:38:23

Plot file version 516 created 03-MAR-2016 01:13:24

4C52 GN002C 1.UVDATA.1

Freq = 1.2770 GHz, Bw = 16.000 MH Calibrated with CL # 3 and BP # 1 (BP mode 1)

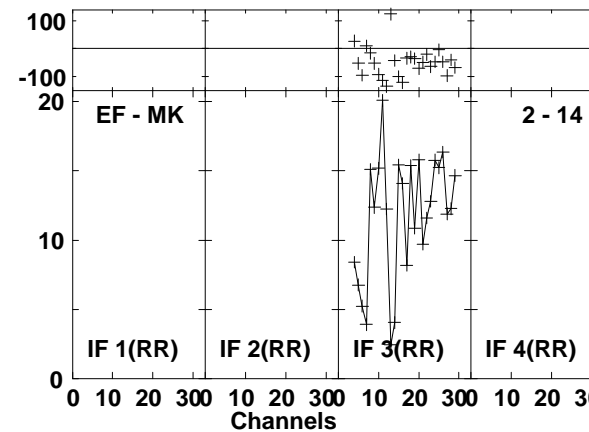
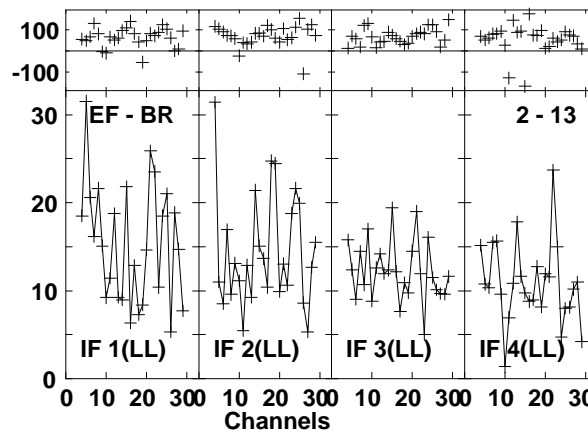
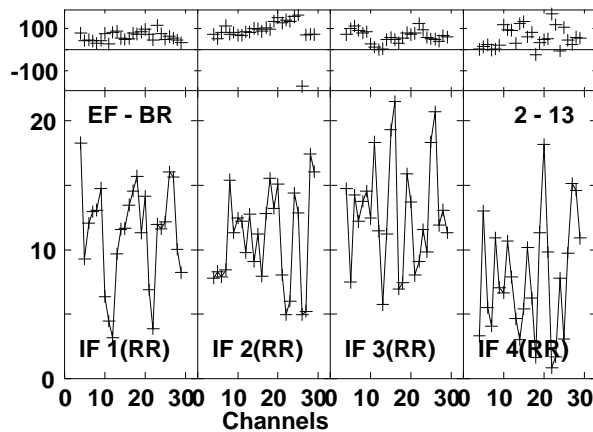
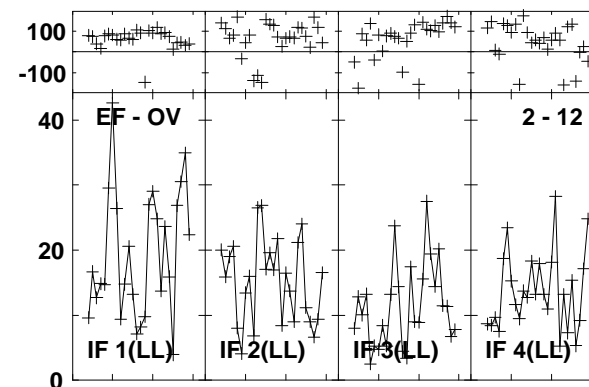
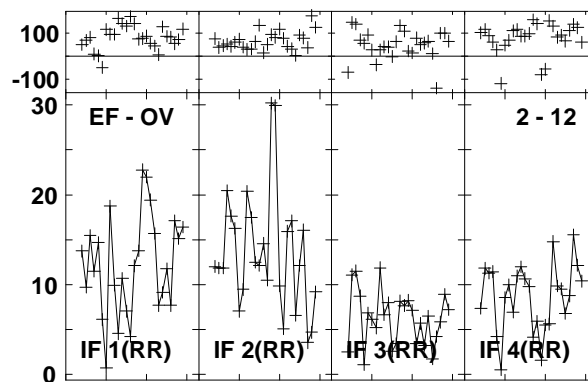
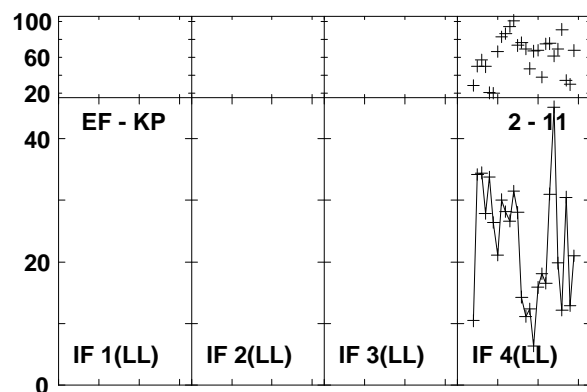
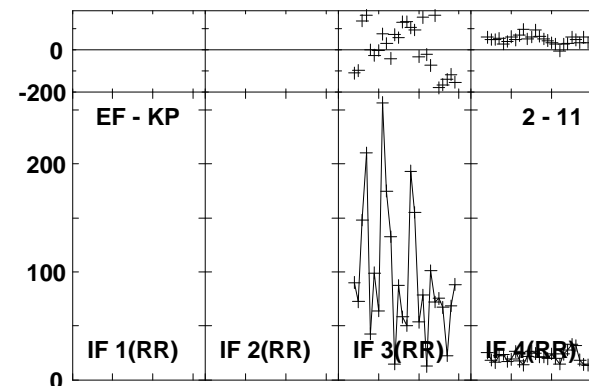
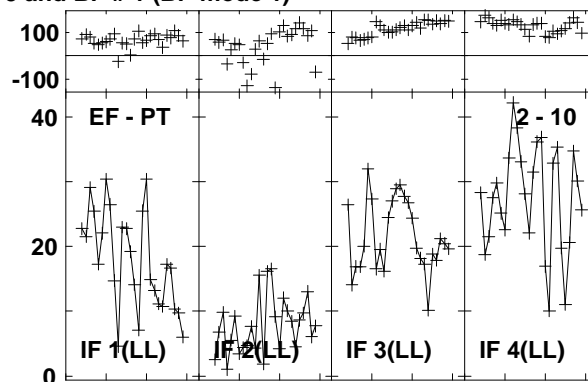
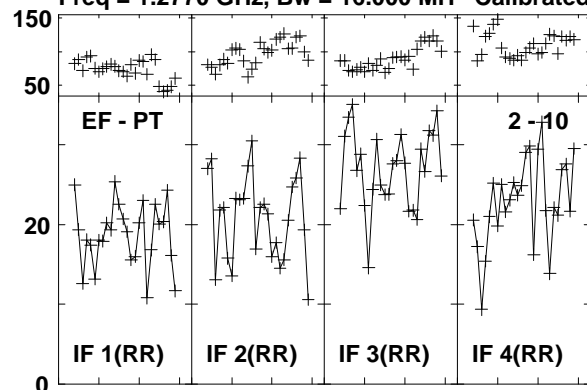

Lower frame: Milli Ampl Jy Top frame: Phas deg
Vector averaged cross-power spectrum Baseline: EF (02) - PT (10)
Timerange: 00/19:35:37 to 00/19:38:23

Plot file version 517 created 03-MAR-2016 01:13:24

4C52 GN002C 1.UVDATA.1

Freq = 1.2770 GHz, Bw = 16.000 MH Calibrated with CL # 3 and BP # 1 (BP mode 1)

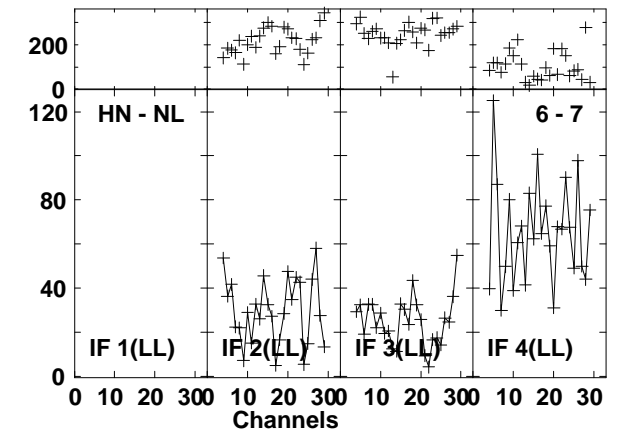
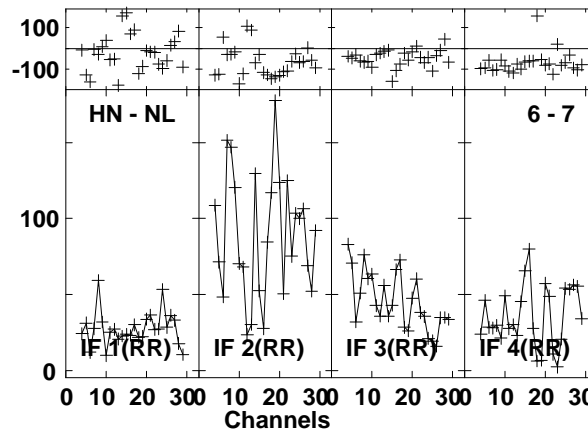
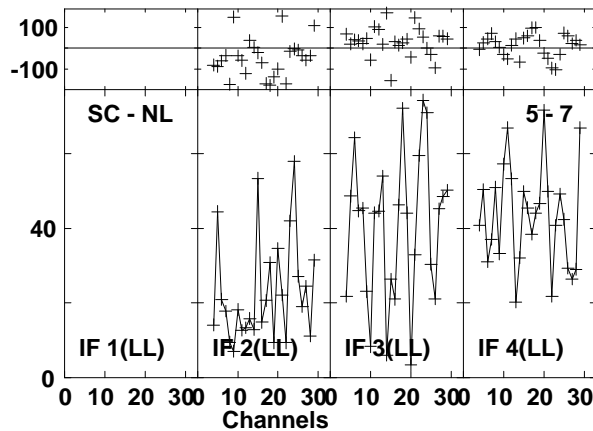
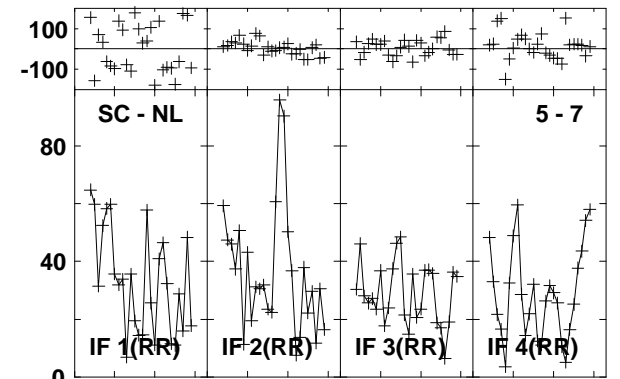
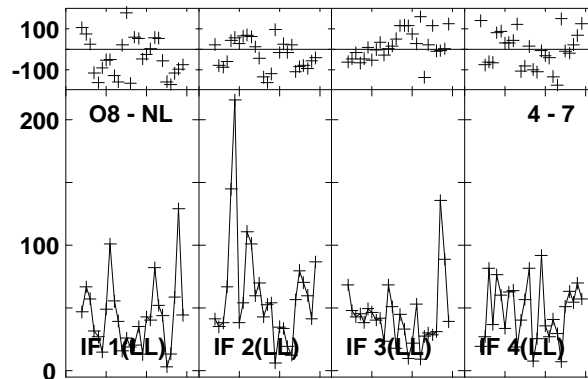
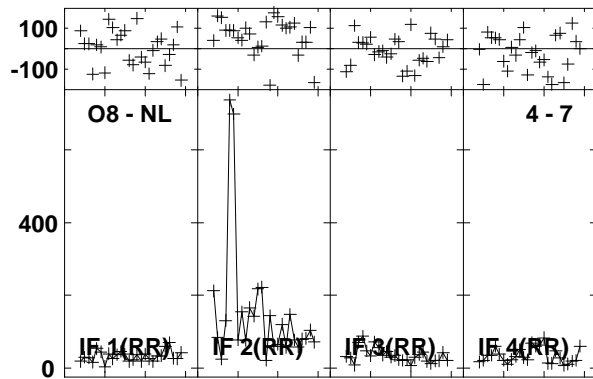
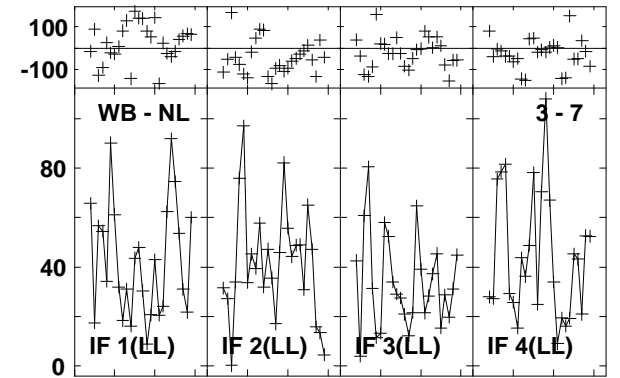
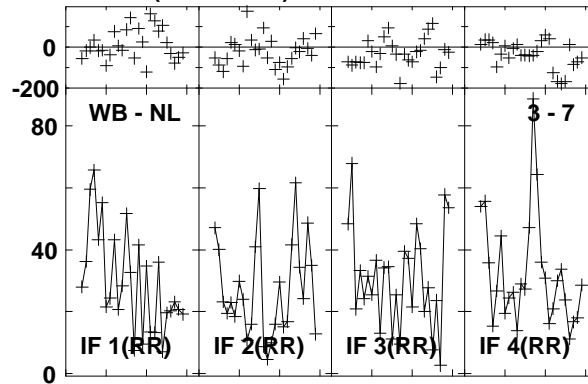
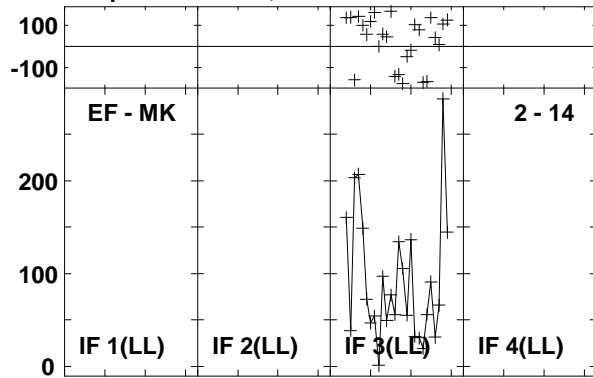

Lower frame: Milli Ampl Jy Top frame: Phas deg

Vector averaged cross-power spectrum Baseline: EF (02) - MK (14)

Timerange: 00/19:35:37 to 00/19:38:23

Plot file version 518 created 03-MAR-2016 01:13:24

4C52 GN002C 1.UVDATA.1

Freq = 1.2770 GHz, Bw = 16.000 MH Calibrated with CL # 3 and BP # 1 (BP mode 1)

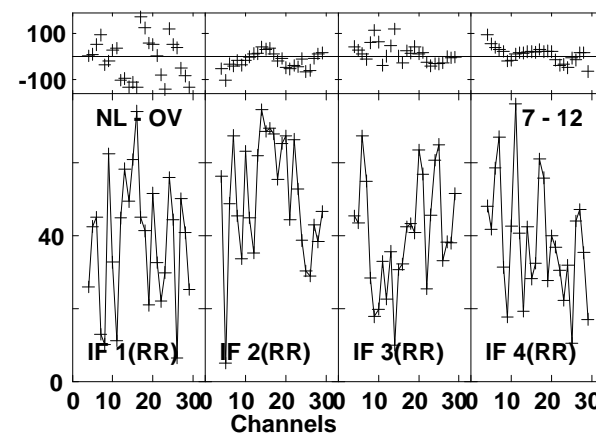
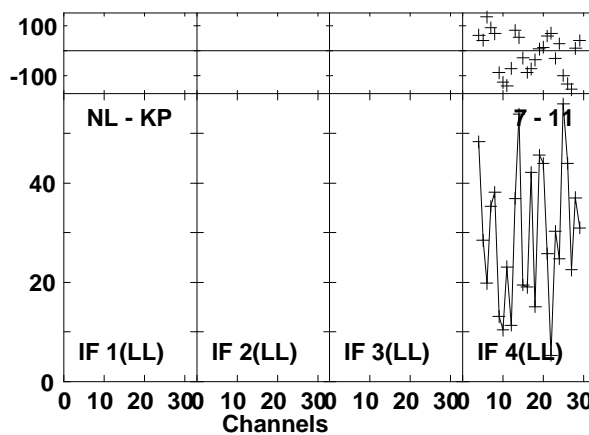
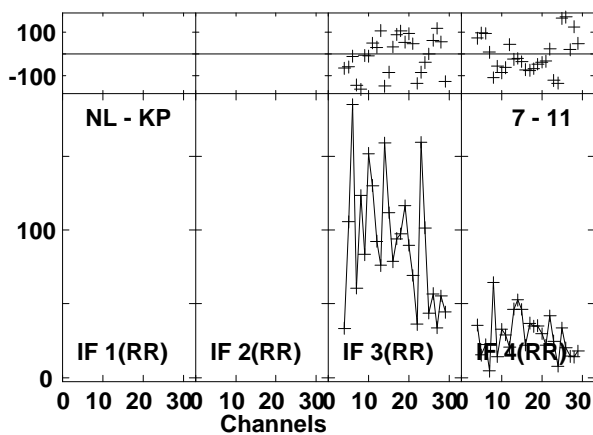
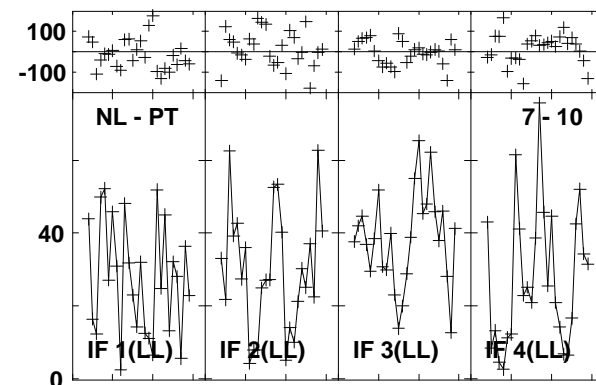
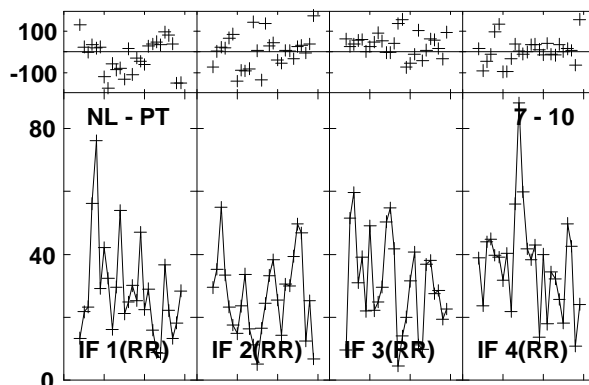
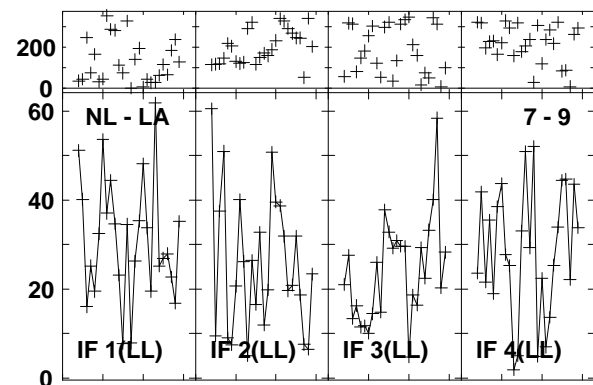
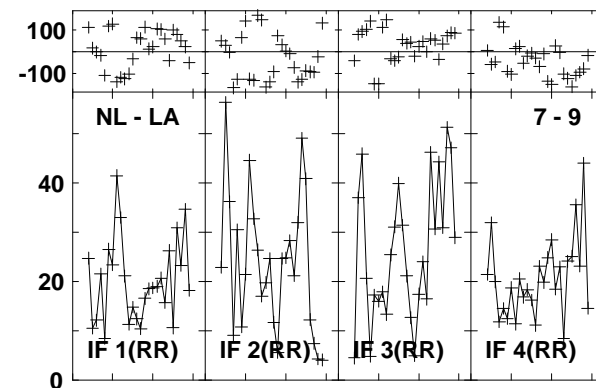
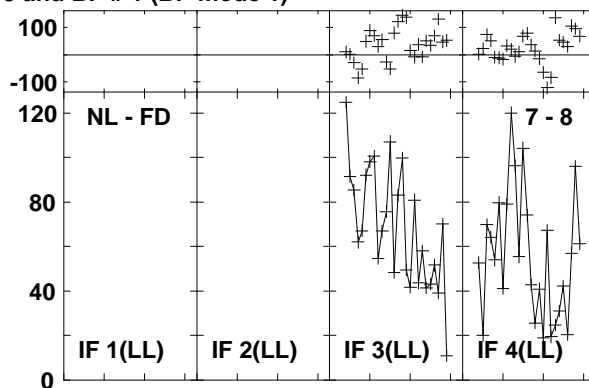
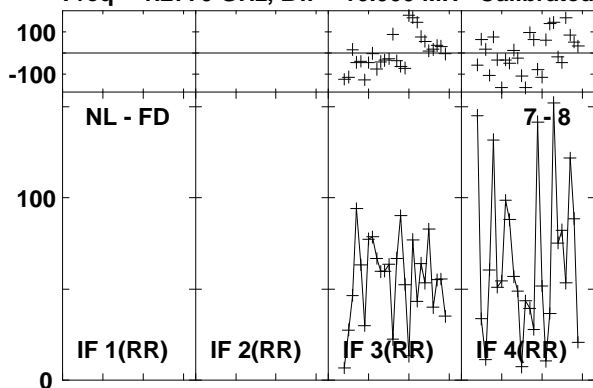

Lower frame: Milli Ampl Jy Top frame: Phas deg
Vector averaged cross-power spectrum Baseline: NL (07) - FD (08)
Timerange: 00/19:35:37 to 00/19:38:23

Plot file version 519 created 03-MAR-2016 01:13:24

4C52 GN002C 1.UVDATA.1

Freq = 1.2770 GHz, Bw = 16.000 MH Calibrated with CL # 3 and BP # 1 (BP mode 1)

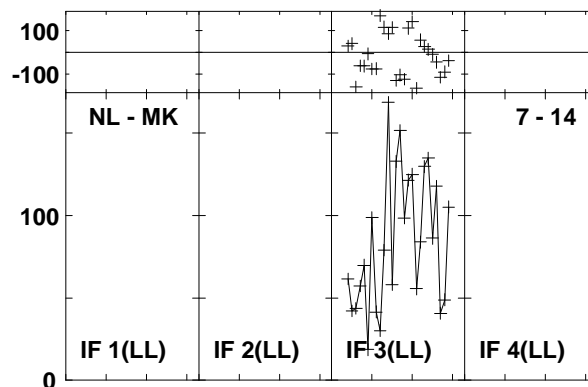
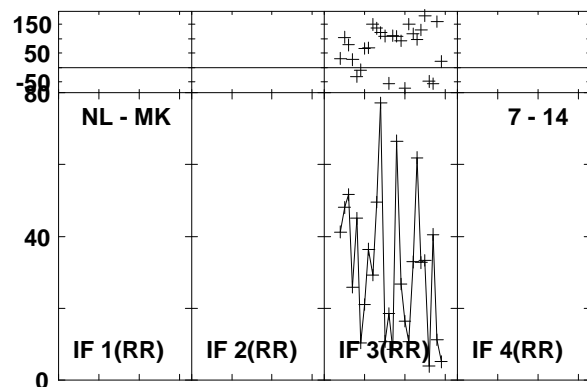
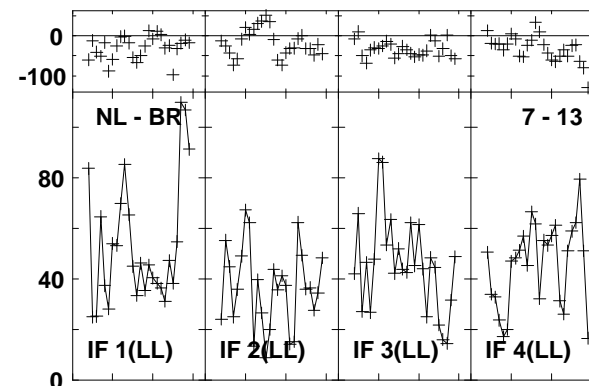
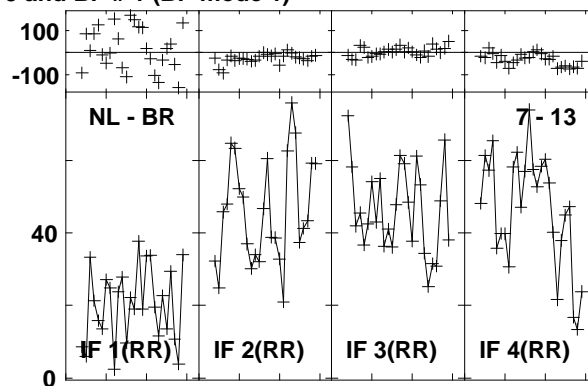
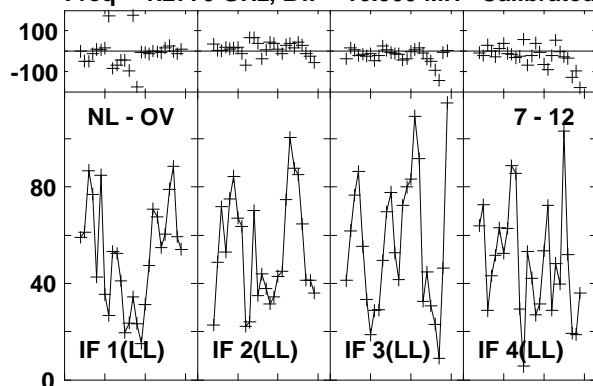

Lower frame: Milli Ampl Jy Top frame: Phas deg
Vector averaged cross-power spectrum Baseline: NL (07) - OV (12)
Timerange: 00/19:35:37 to 00/19:38:23

Plot file version 520 created 03-MAR-2016 01:13:24

J1545+5400 GN002C 1.UVDATA.1

Freq = 1.2770 GHz, Bw = 16.000 MH Calibrated with CL # 3 and BP # 1 (BP mode 1)

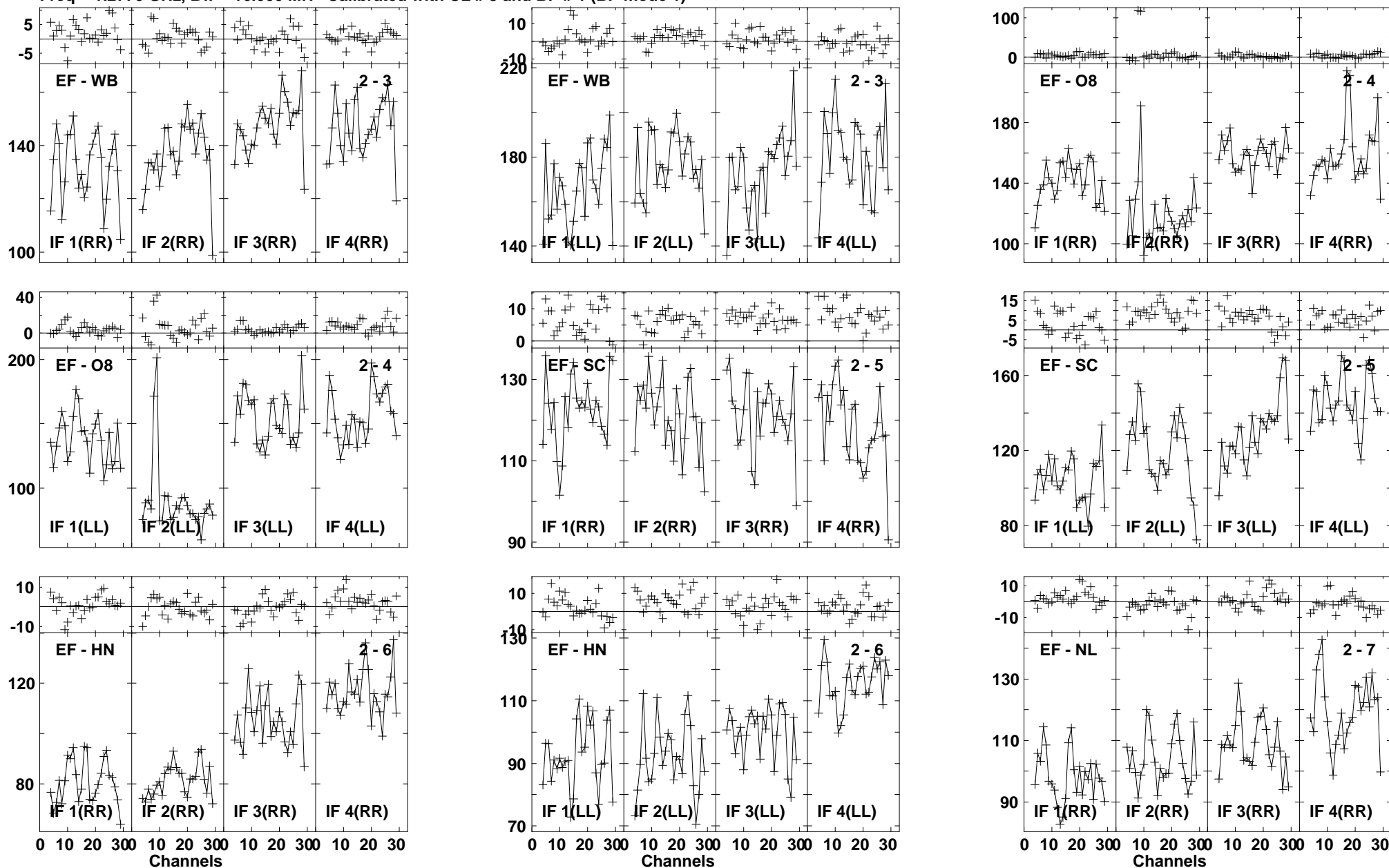

Lower frame: Milli Ampl Jy Top frame: Phas deg
Vector averaged cross-power spectrum Baseline: EF (02) - WB (03)
Timerange: 00/19:39:16 to 00/19:40:14

Plot file version 521 created 03-MAR-2016 01:13:24

J1545+5400 GN002C 1.UVDATA.1

Freq = 1.2770 GHz, Bw = 16.000 MH Calibrated with CL # 3 and BP # 1 (BP mode 1)

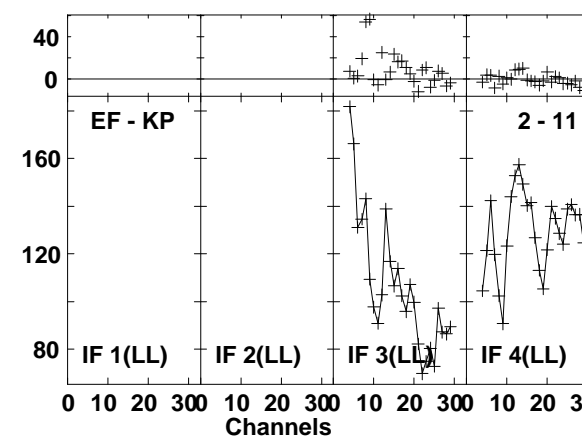
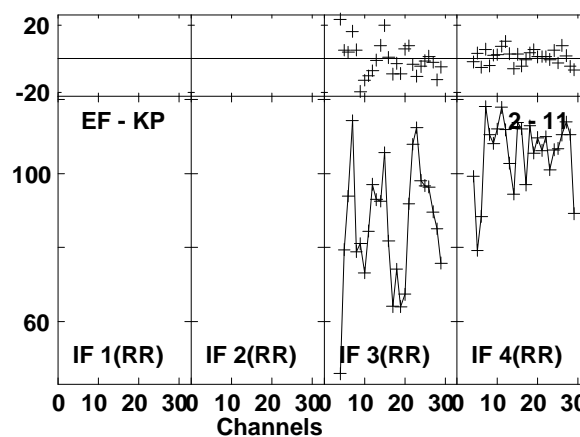
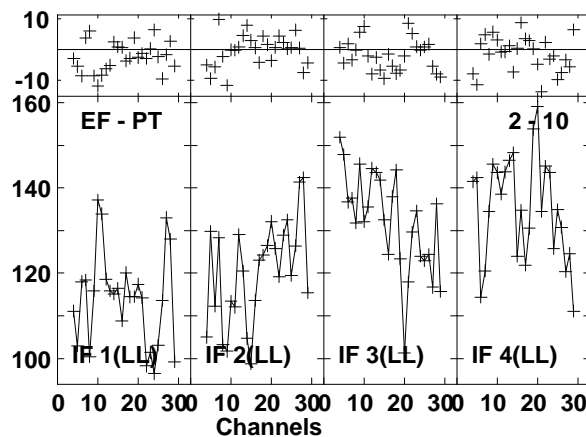
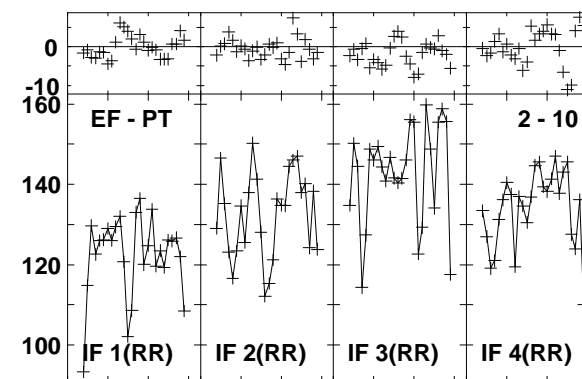
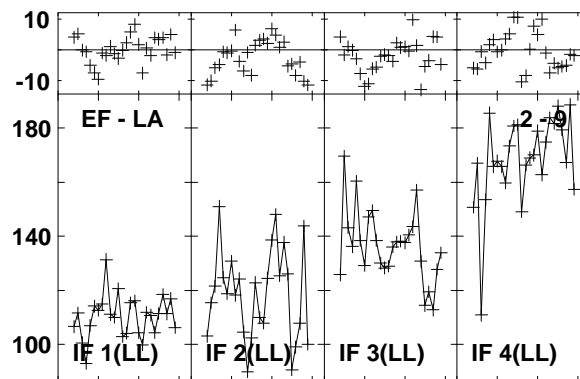
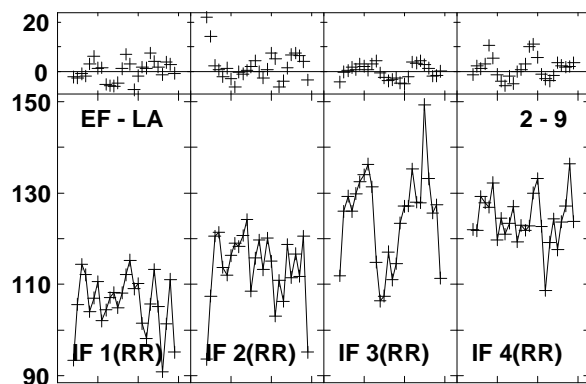
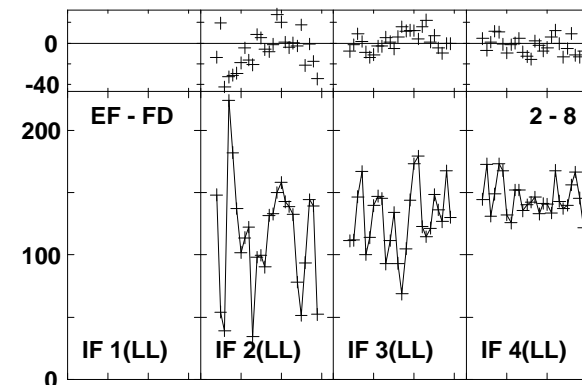
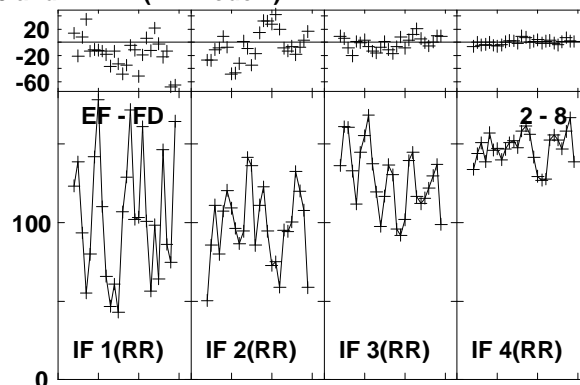
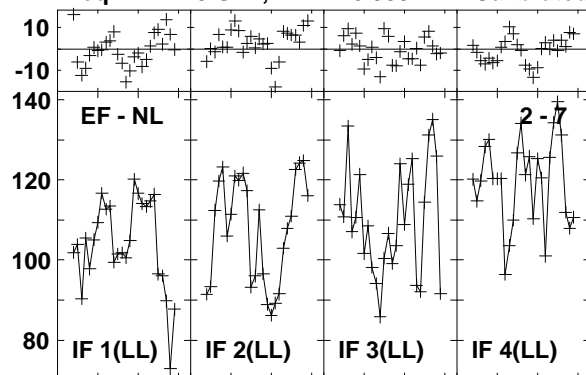

Lower frame: Milli Ampl Jy Top frame: Phas deg
Vector averaged cross-power spectrum Baseline: EF (02) - NL (07)
Timerange: 00/19:39:16 to 00/19:40:14

Plot file version 522 created 03-MAR-2016 01:13:25

J1545+5400 GN002C 1.UVDATA.1

Freq = 1.2770 GHz, Bw = 16.000 MH Calibrated with CL # 3 and BP # 1 (BP mode 1)

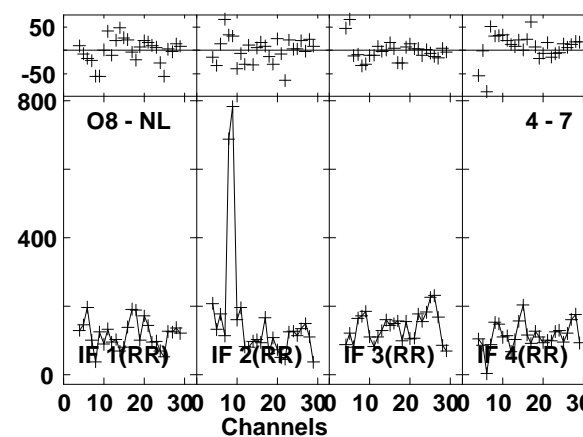
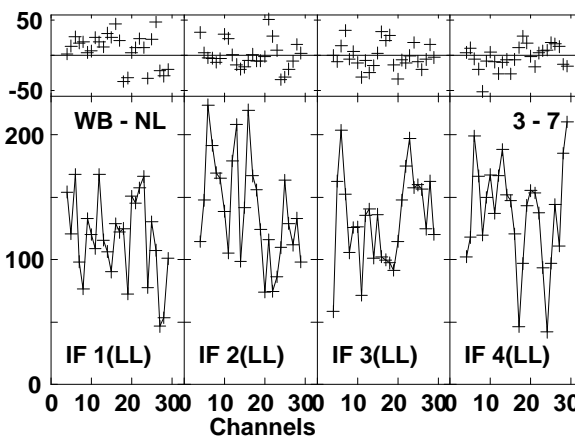
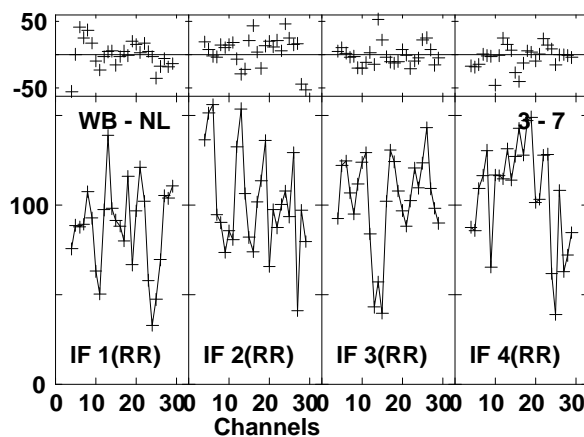
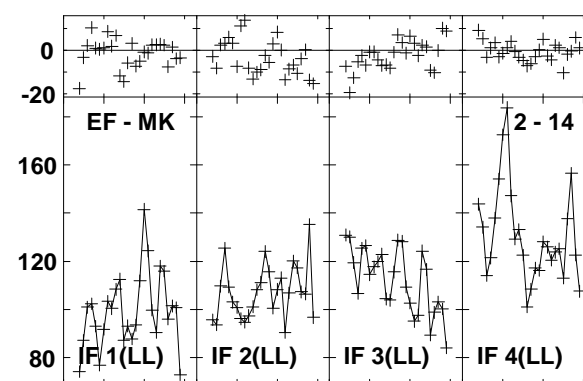
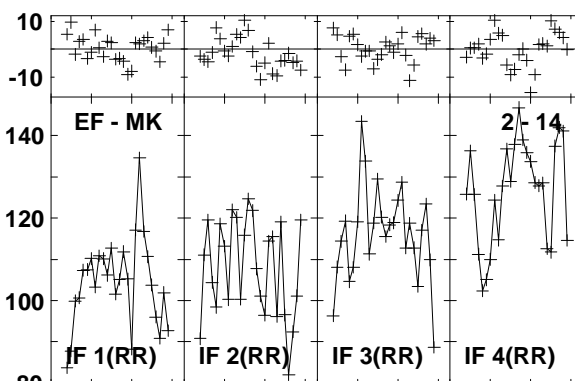
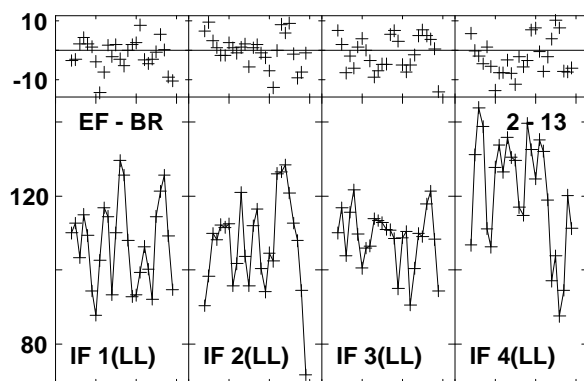
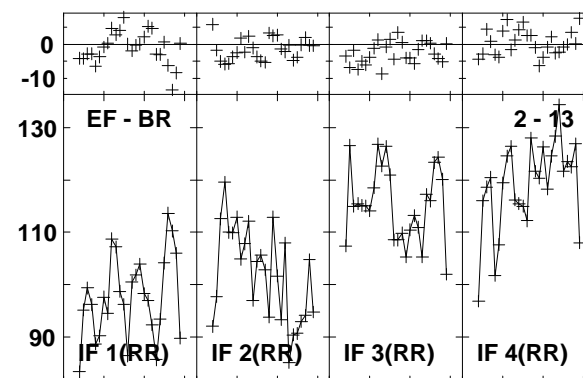
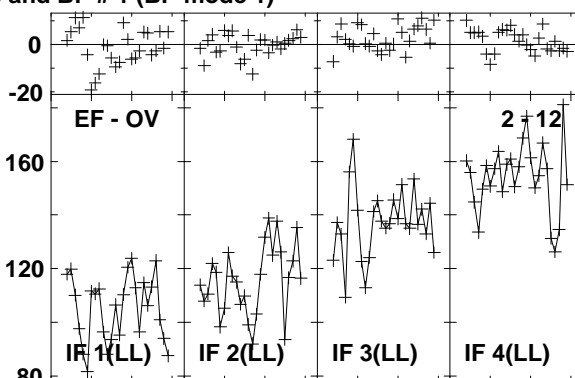
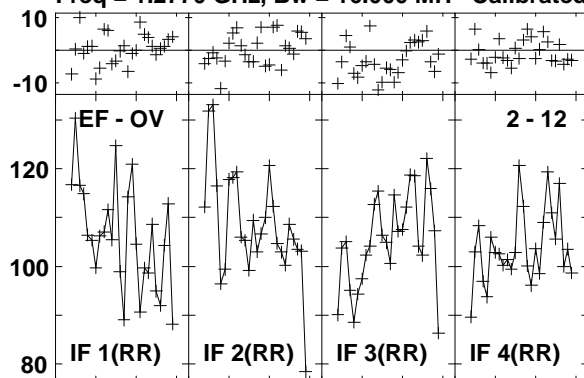

Lower frame: Milli Ampl Jy Top frame: Phas deg
Vector averaged cross-power spectrum Baseline: EF (02) - OV (12)
Timerange: 00/19:39:16 to 00/19:40:14

Plot file version 523 created 03-MAR-2016 01:13:25

J1545+5400 GN002C 1.UVDATA.1

Freq = 1.2770 GHz, Bw = 16.000 MH Calibrated with CL # 3 and BP # 1 (BP mode 1)

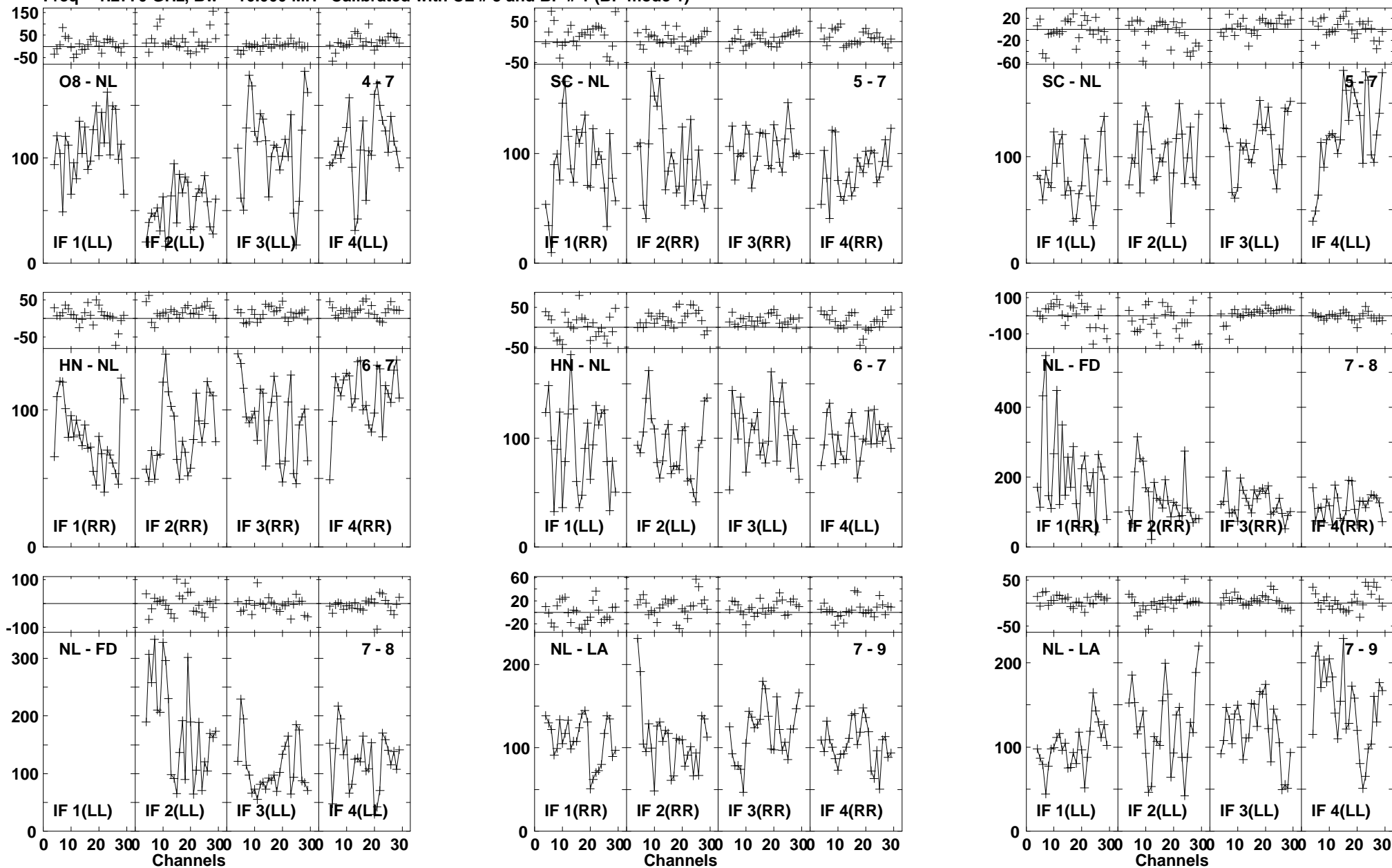

Lower frame: Milli Ampl Jy Top frame: Phas deg
Vector averaged cross-power spectrum Baseline: O8 (04) - NL (07)
Timerange: 00/19:39:16 to 00/19:40:14

Plot file version 524 created 03-MAR-2016 01:13:25

J1545+5400 GN002C 1.UVDATA.1

Freq = 1.2770 GHz, Bw = 16.000 MH Calibrated with CL # 3 and BP # 1 (BP mode 1)

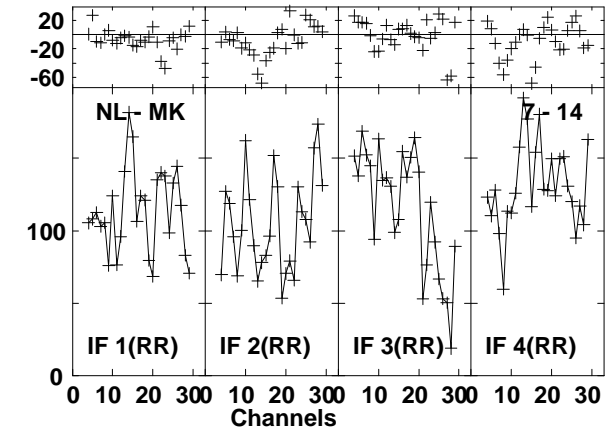
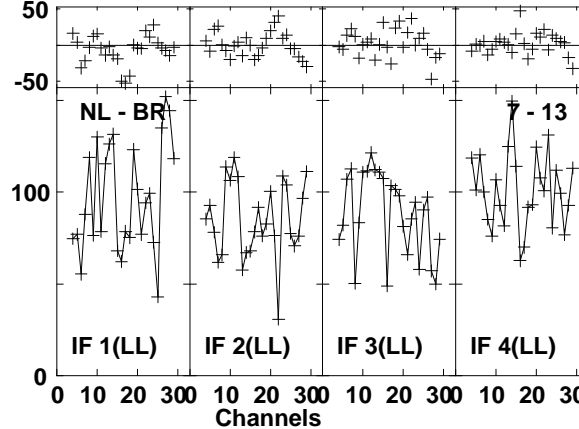
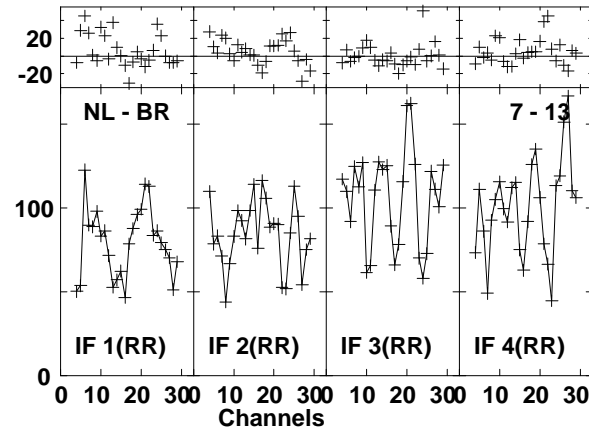
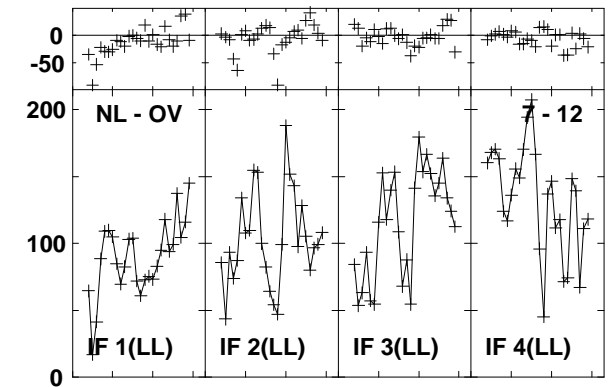
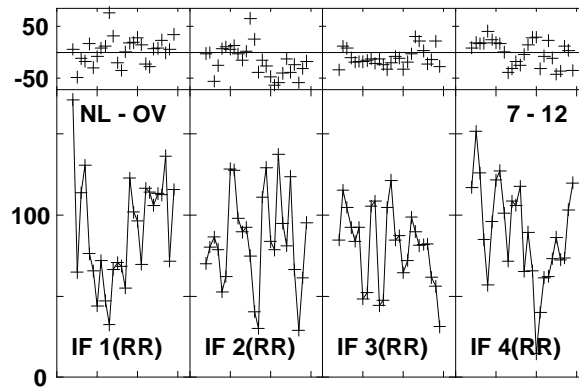
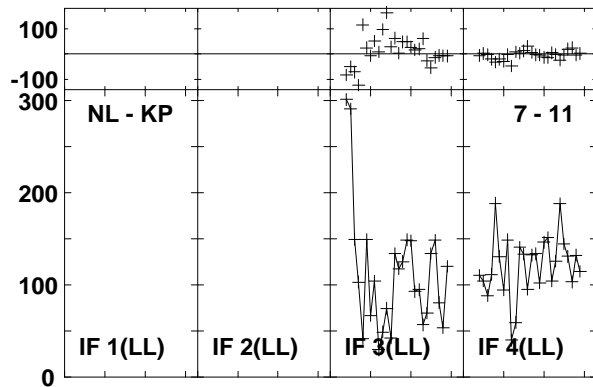
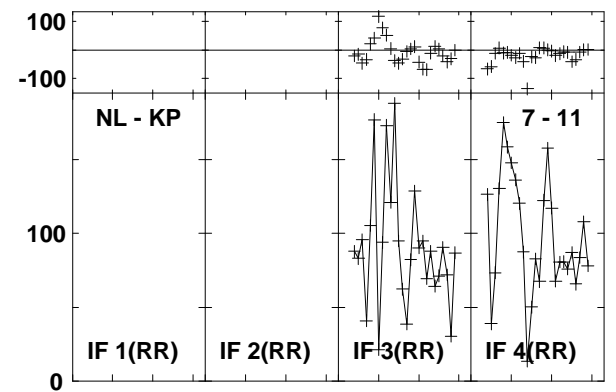
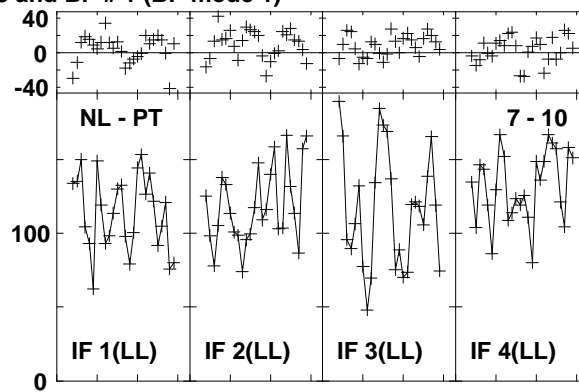
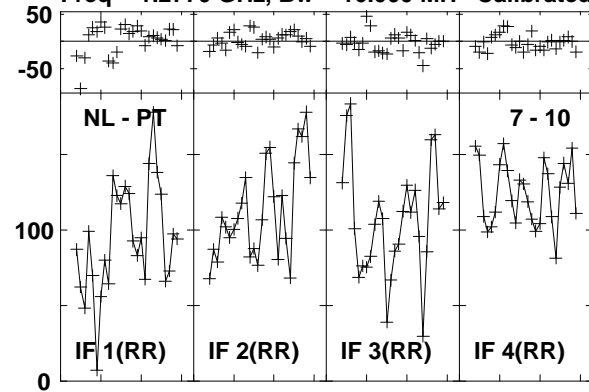

Lower frame: Milli Ampl Jy Top frame: Phas deg
Vector averaged cross-power spectrum Baseline: NL (07) - PT (10)
Timerange: 00/19:39:16 to 00/19:40:14

Plot file version 525 created 03-MAR-2016 01:13:25
J1545+5400 GN002C 1.UVDATA.1
Freq = 1.2770 GHz, Bw = 16.000 MH Calibrated with CL # 3 and BP # 1 (BP mode 1)

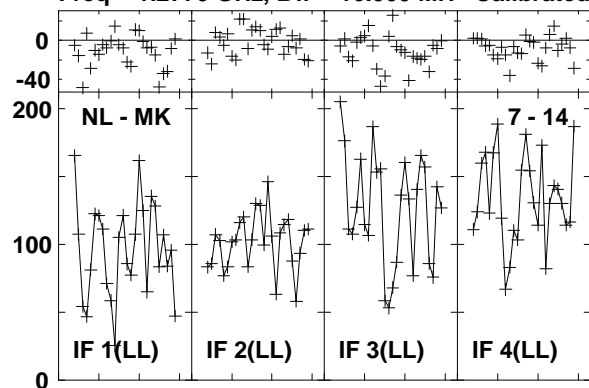

Lower frame: Milli Ampl Jy Top frame: Phas deg
Vector averaged cross-power spectrum Baseline: NL (07) - MK (14)
Timerange: 00/19:39:16 to 00/19:40:14

Plot file version 526 created 03-MAR-2016 01:13:25

4C52 GN002C 1.UVDATA.1

Freq = 1.2770 GHz, Bw = 16.000 MH Calibrated with CL # 3 and BP # 1 (BP mode 1)

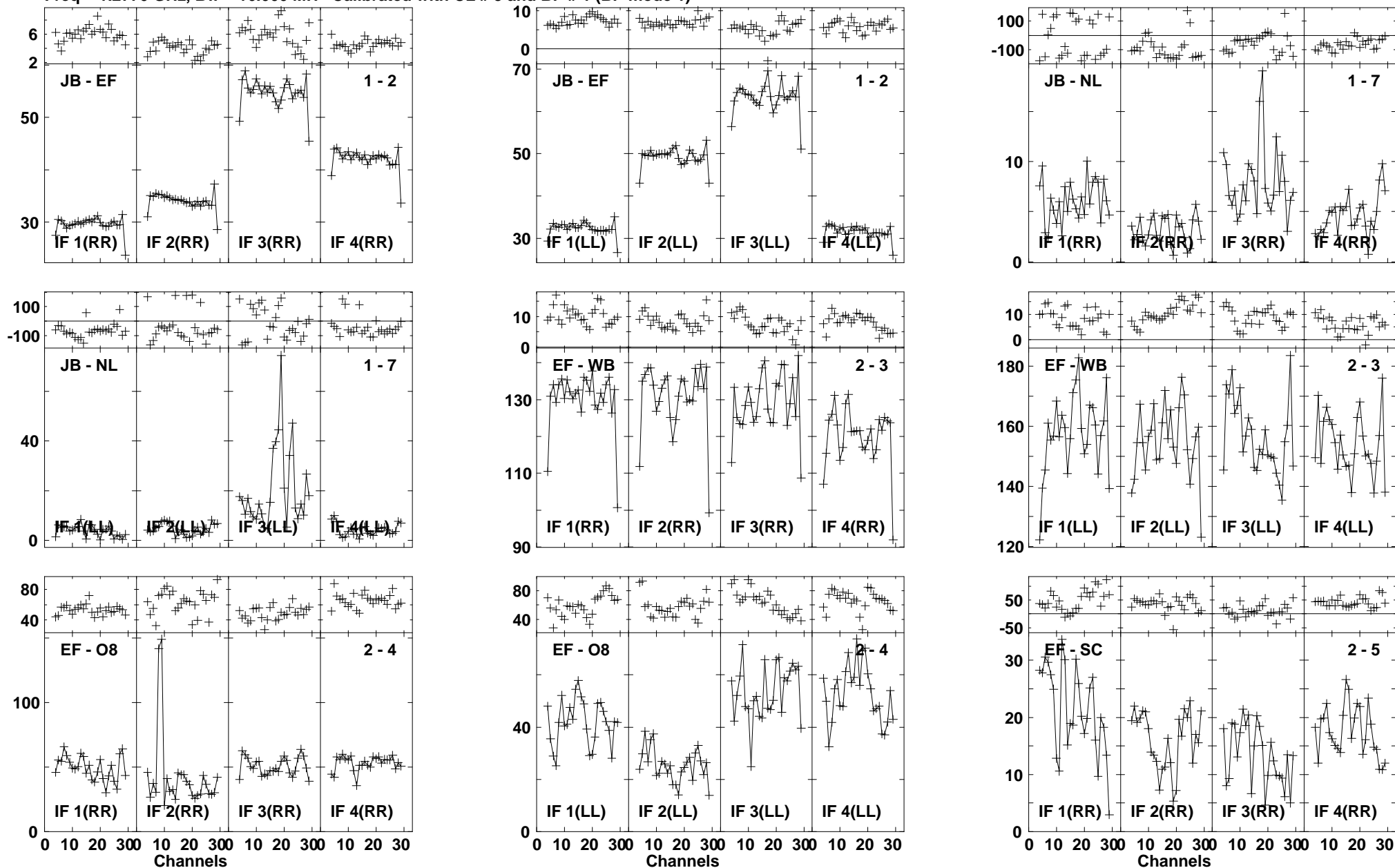

Lower frame: Milli Ampl Jy Top frame: Phas deg
Vector averaged cross-power spectrum Baseline: JB (01) - EF (02)
Timerange: 00/19:40:19 to 00/19:43:13

Plot file version 527 created 03-MAR-2016 01:13:25

4C52 GN002C 1.UVDATA.1

Freq = 1.2770 GHz, Bw = 16.000 MH Calibrated with CL # 3 and BP # 1 (BP mode 1)

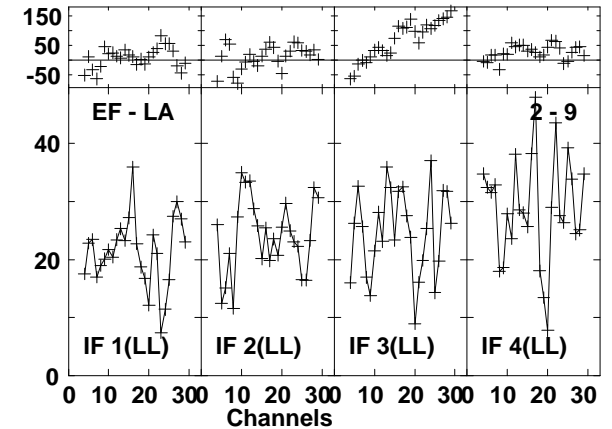
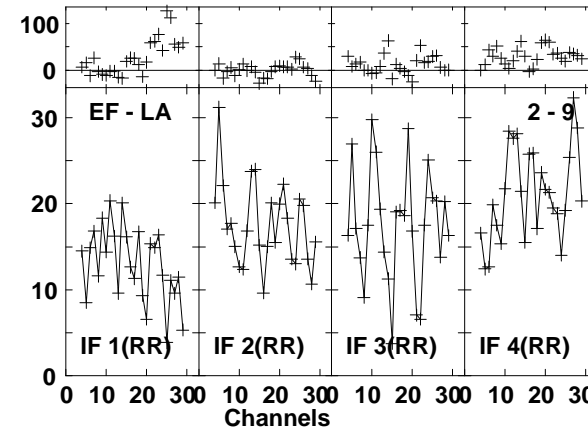
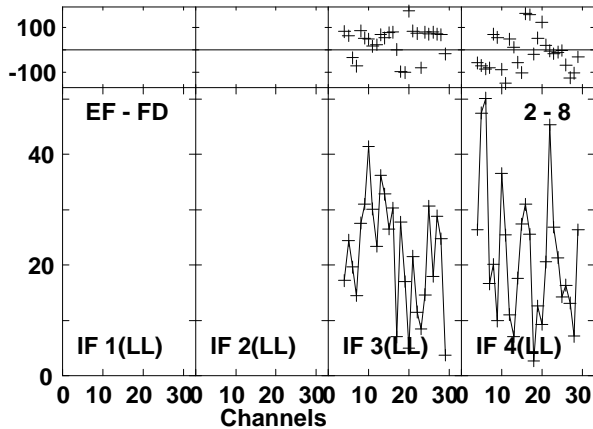
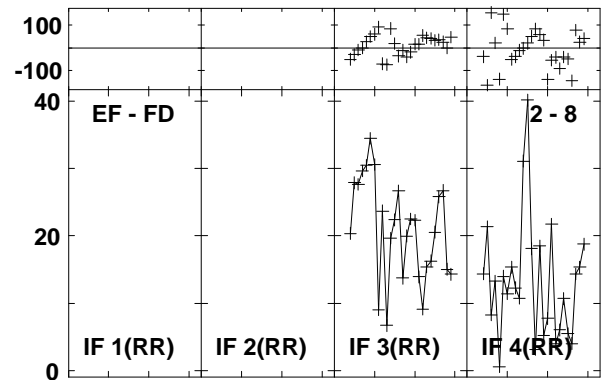
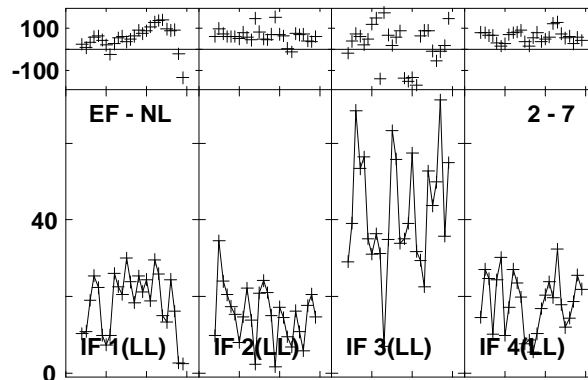
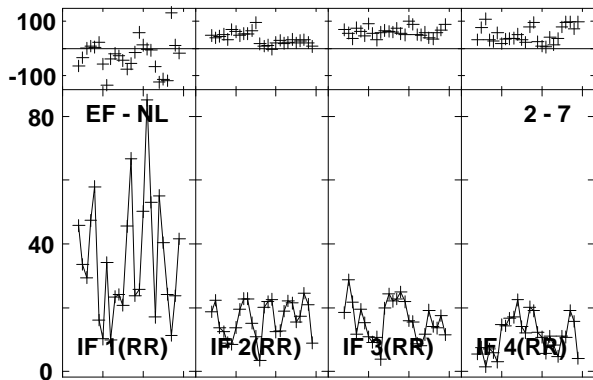
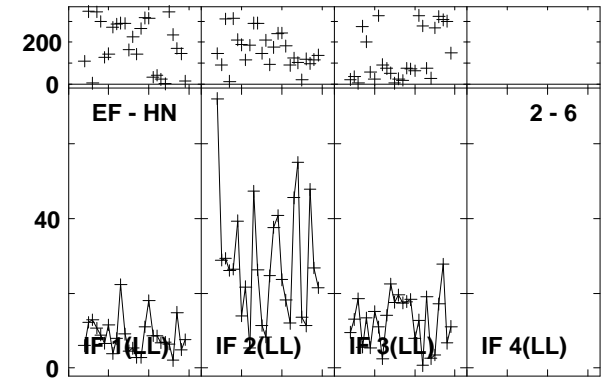
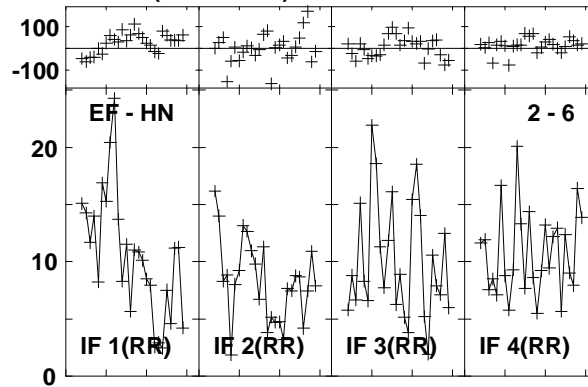
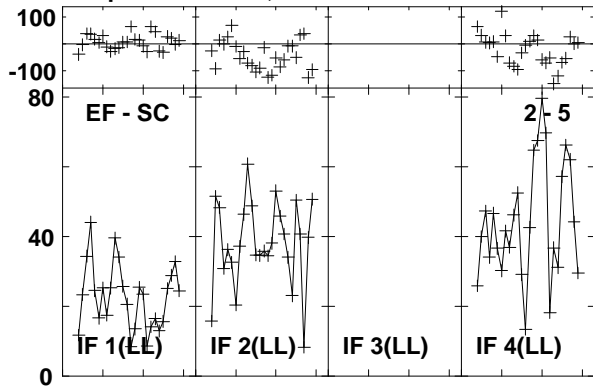

Lower frame: Milli Ampl Jy Top frame: Phas deg

Vector averaged cross-power spectrum Baseline: EF (02) - SC (05)

Timerange: 00/19:40:19 to 00/19:43:13

Plot file version 528 created 03-MAR-2016 01:13:26

4C52 GN002C 1.UVDATA.1

Freq = 1.2770 GHz, Bw = 16.000 MH Calibrated with CL # 3 and BP # 1 (BP mode 1)

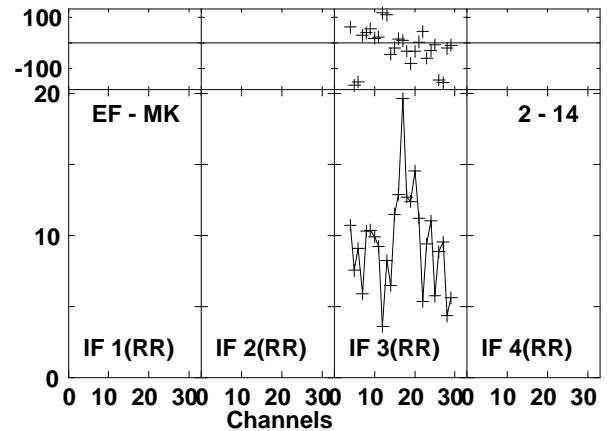
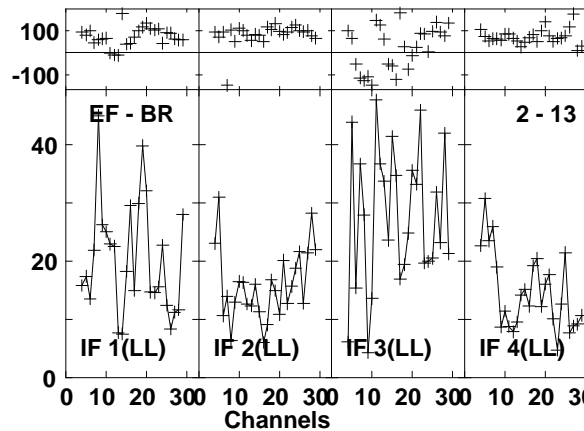
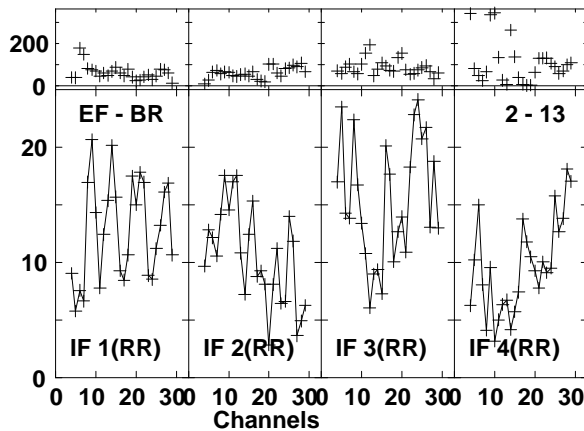
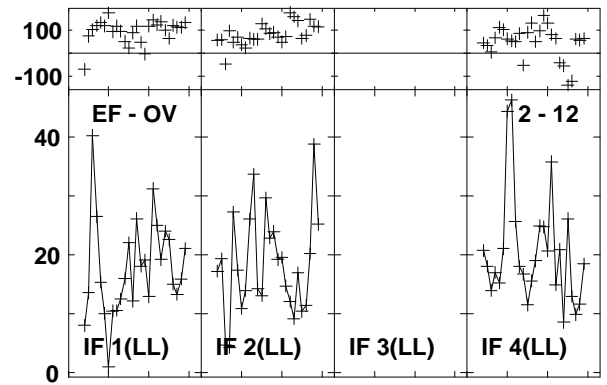
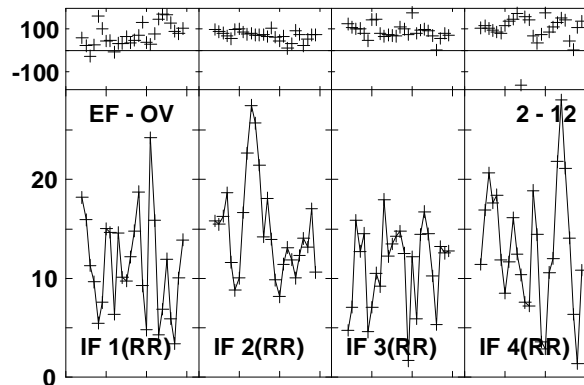
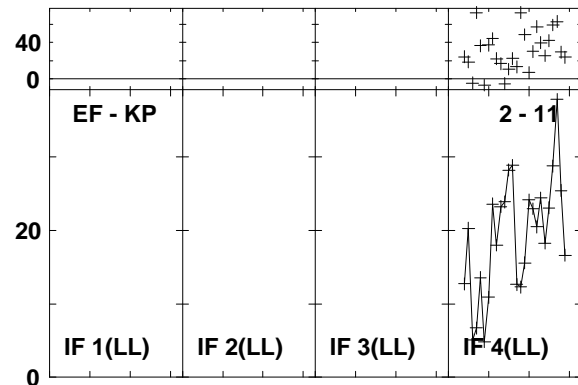
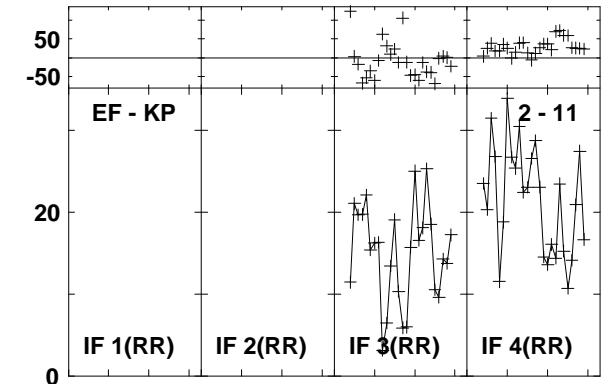
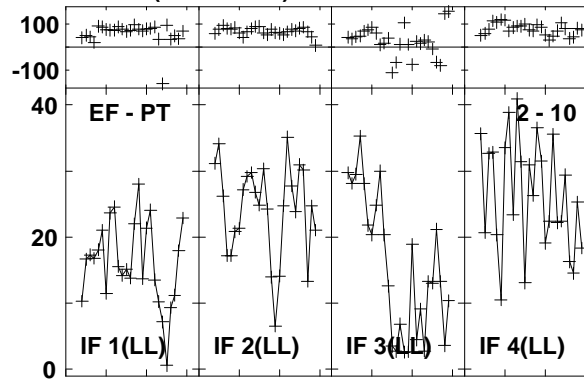
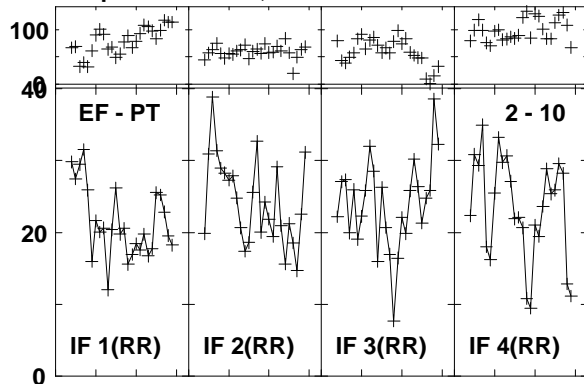

Lower frame: Milli Ampl Jy Top frame: Phas deg
Vector averaged cross-power spectrum Baseline: EF (02) - PT (10)
Timerange: 00/19:40:19 to 00/19:43:13

Plot file version 529 created 03-MAR-2016 01:13:26

4C52 GN002C 1.UVDATA.1

Freq = 1.2770 GHz, Bw = 16.000 MH Calibrated with CL # 3 and BP # 1 (BP mode 1)

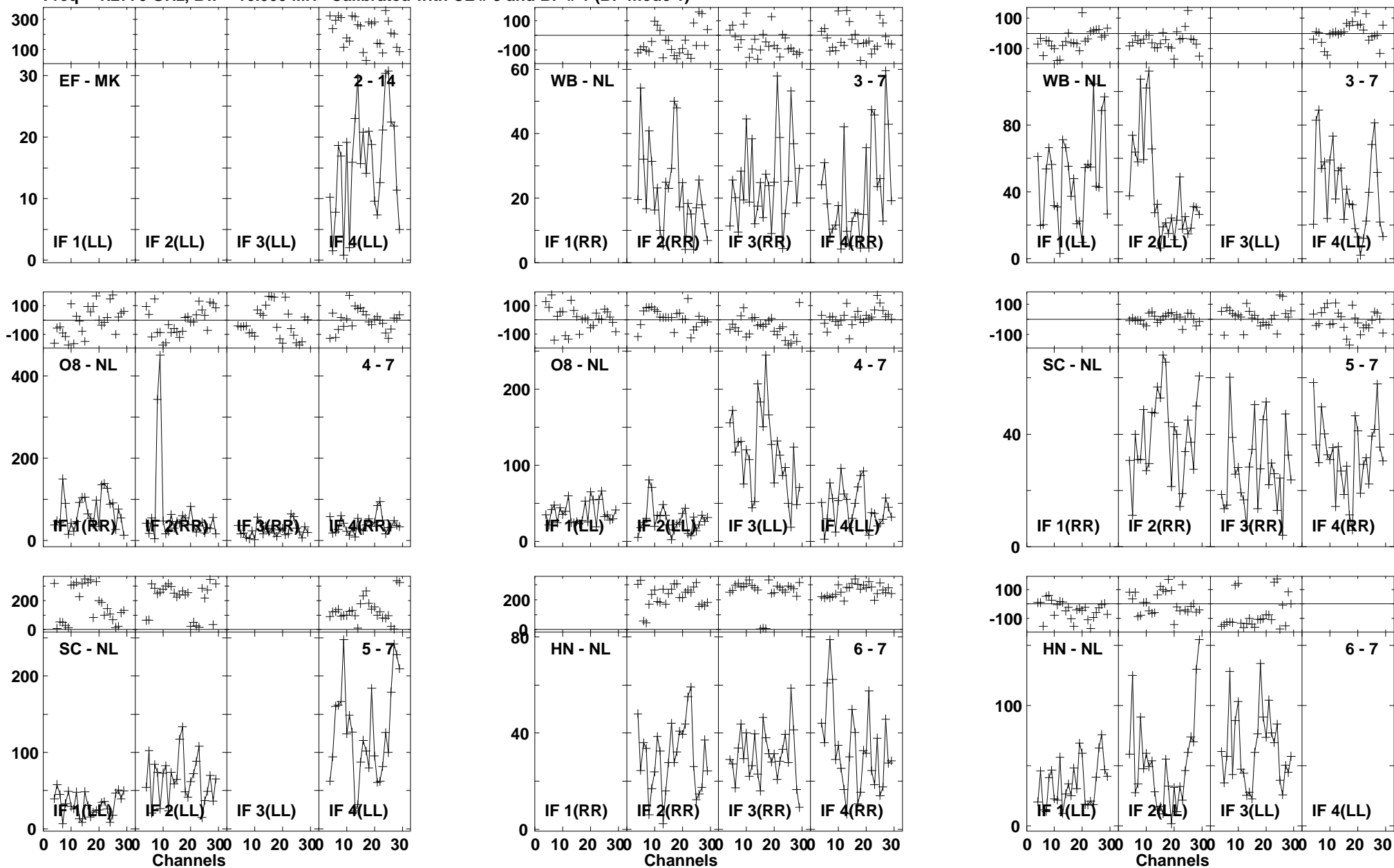

Plot file version 530 created 03-MAR-2016 01:13:26

4C52 GN002C 1.UVDATA.1

Freq = 1.2770 GHz, Bw = 16.000 MH Calibrated with CL # 3 and BP # 1 (BP mode 1)

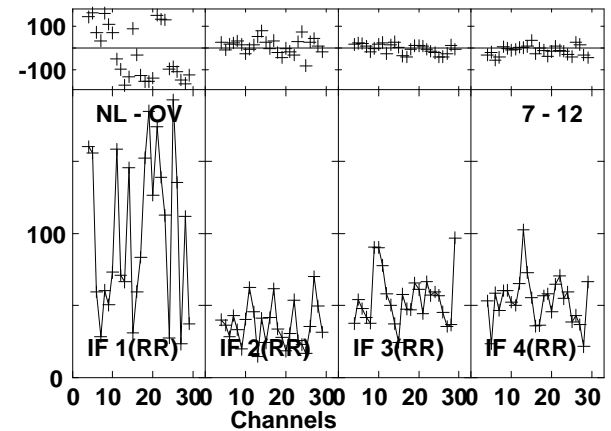
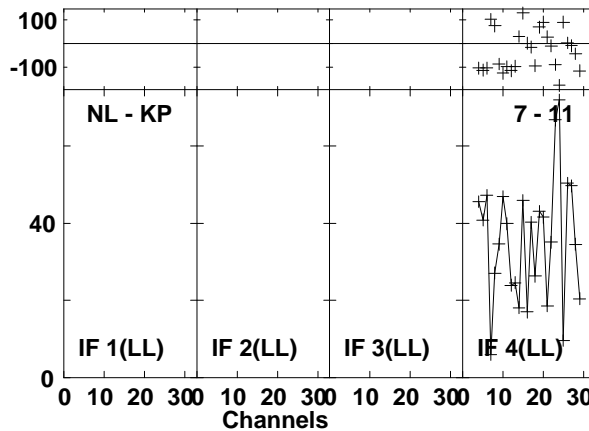
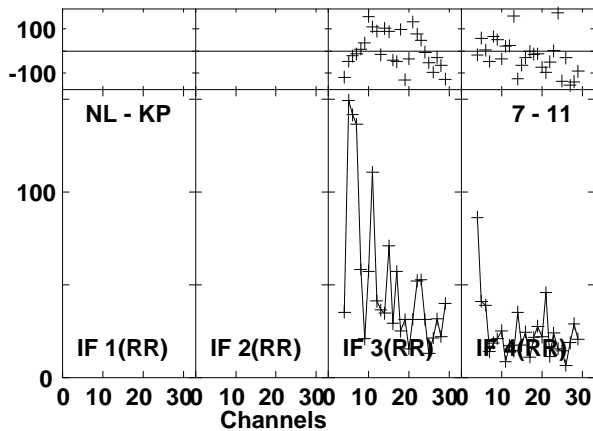
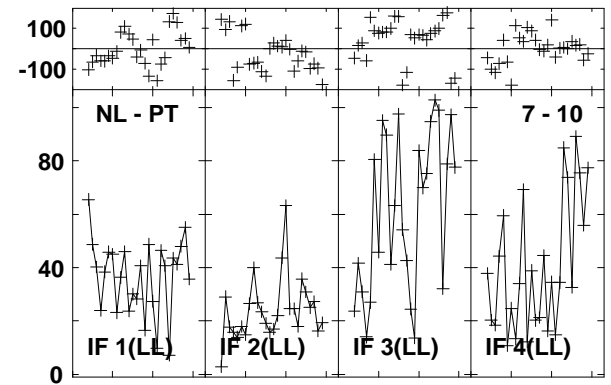
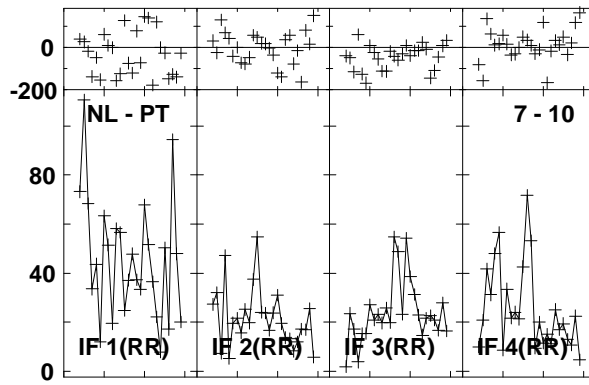
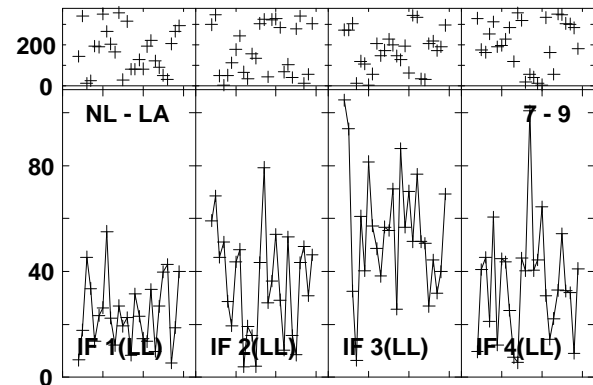
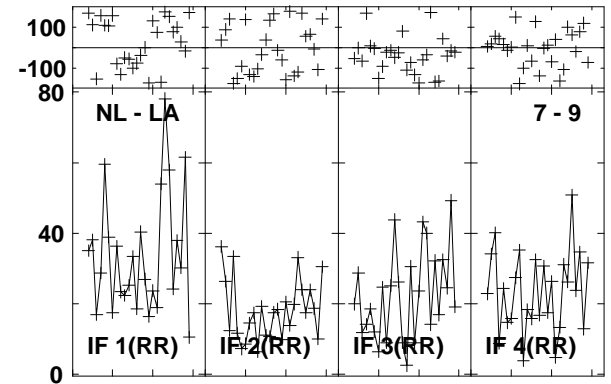
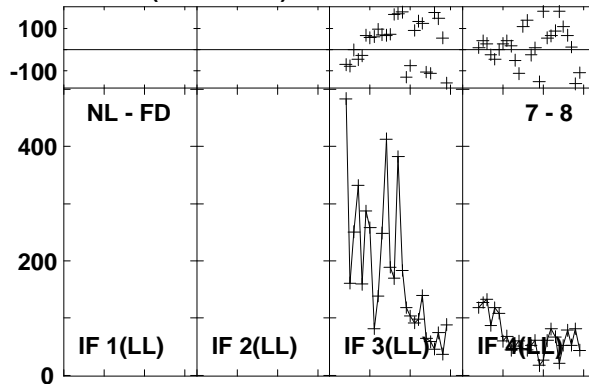
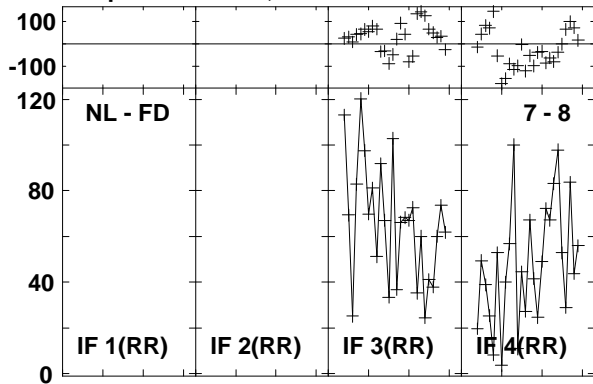

Lower frame: Milli Ampl Jy Top frame: Phas deg
Vector averaged cross-power spectrum Baseline: NL (07) - FD (08)
Timerange: 00/19:40:19 to 00/19:43:13

Plot file version 531 created 03-MAR-2016 01:13:26

4C52 GN002C 1.UVDATA.1

Freq = 1.2770 GHz, Bw = 16.000 MH Calibrated with CL # 3 and BP # 1 (BP mode 1)

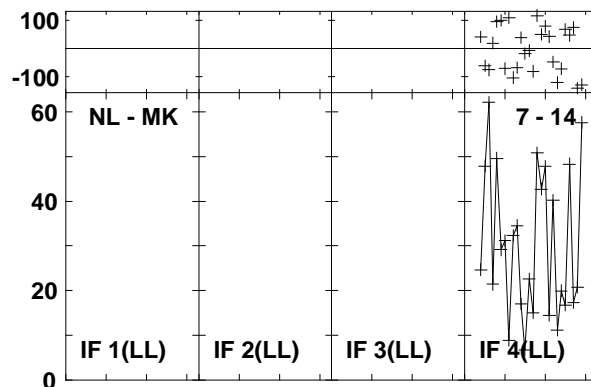
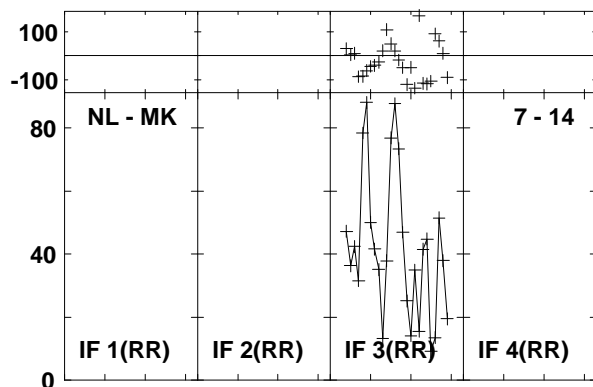
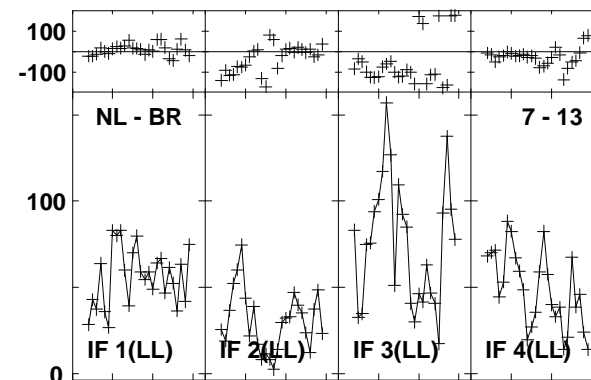
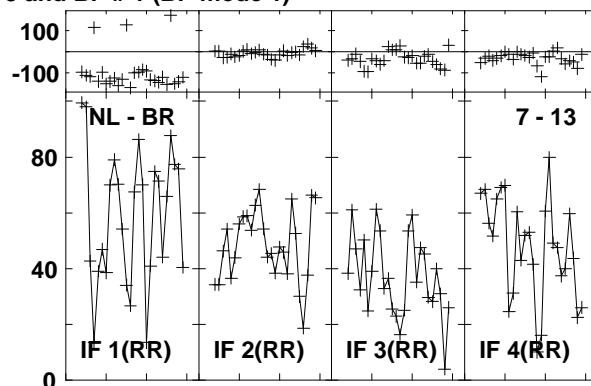
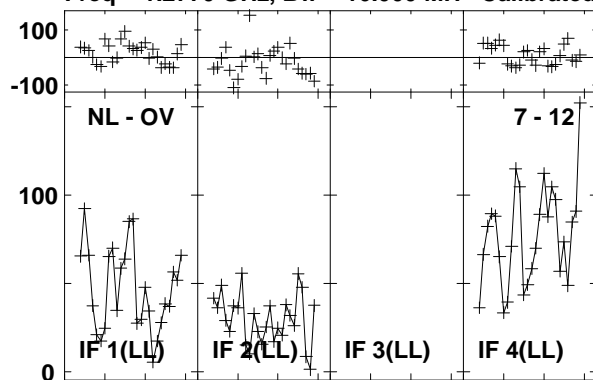

Lower frame: Milli Ampl Jy Top frame: Phas deg

Vector averaged cross-power spectrum Baseline: NL (07) - OV (12)

Timerange: 00/19:40:19 to 00/19:43:13

Plot file version 532 created 03-MAR-2016 01:13:26

J1545+5400 GN002C 1.UVDATA.1

Freq = 1.2770 GHz, Bw = 16.000 MH Calibrated with CL # 3 and BP # 1 (BP mode 1)

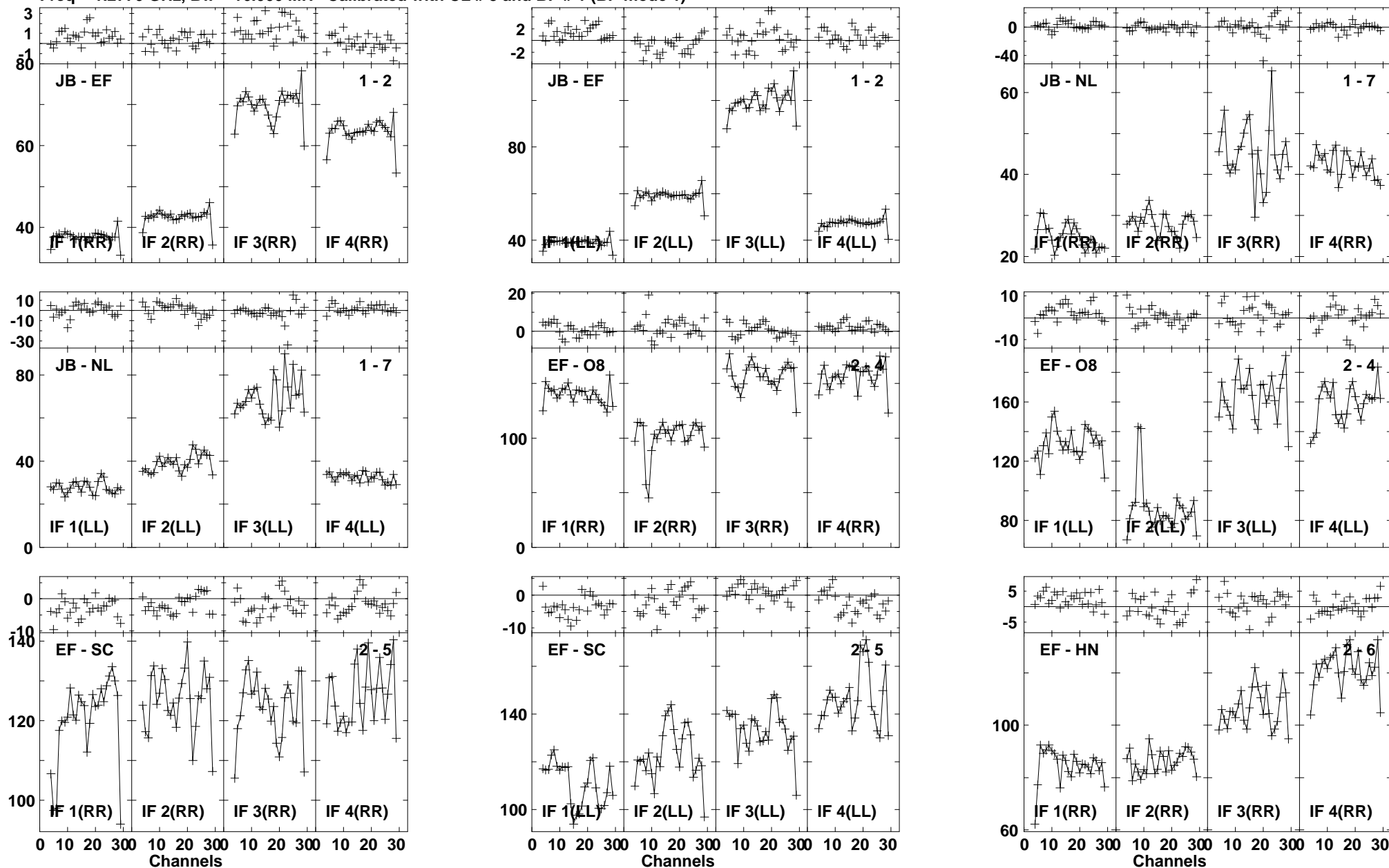

Lower frame: Milli Ampl Jy Top frame: Phas deg
Vector averaged cross-power spectrum Baseline: JB (01) - EF (02)
Timerange: 00/19:44:06 to 00/19:46:04

Plot file version 533 created 03-MAR-2016 01:13:27

J1545+5400 GN002C 1.UVDATA.1

Freq = 1.2770 GHz, Bw = 16.000 MH Calibrated with CL # 3 and BP # 1 (BP mode 1)

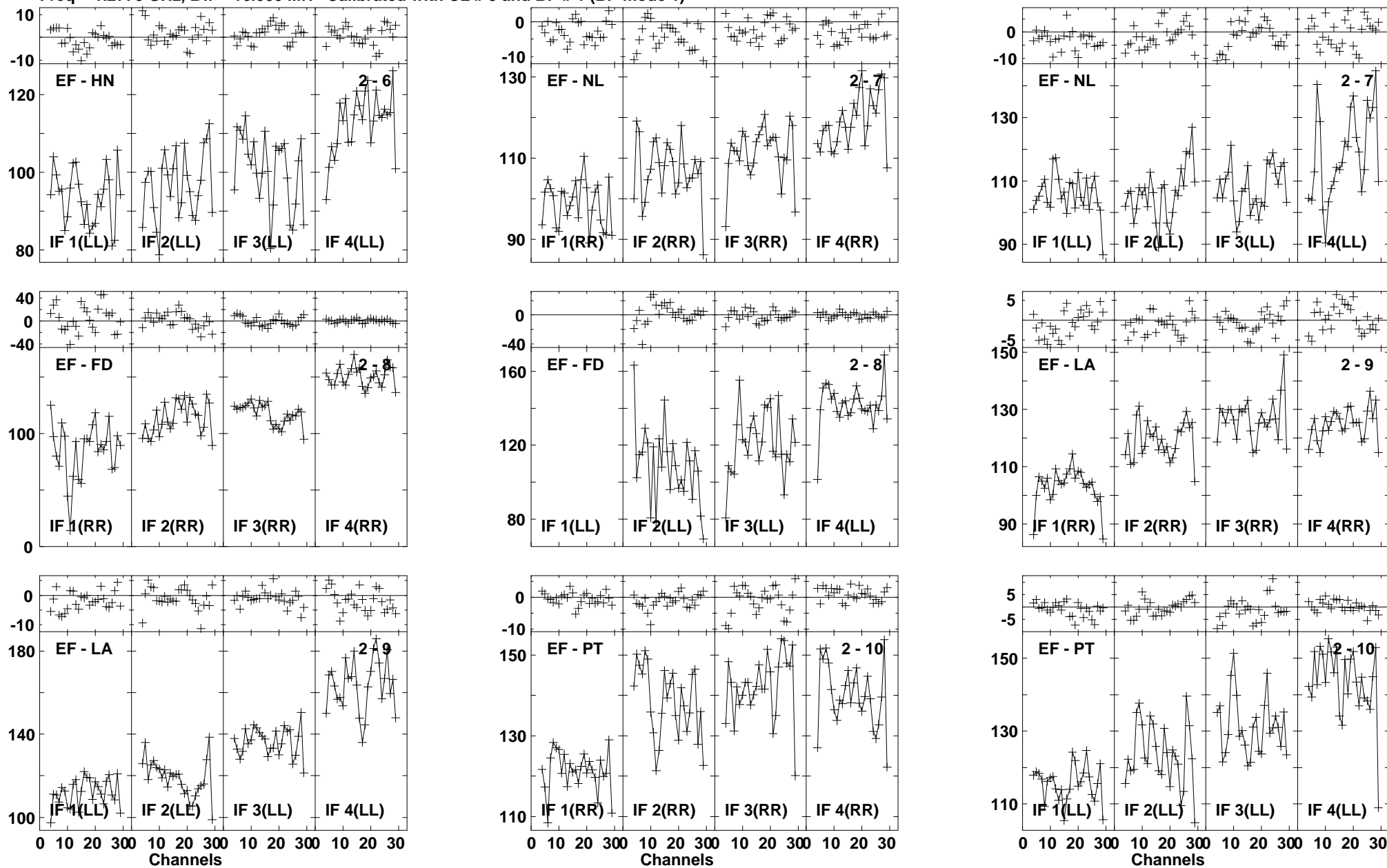

Lower frame: Milli Ampl Jy Top frame: Phas deg
Vector averaged cross-power spectrum Baseline: EF (02) - HN (06)
Timerange: 00/19:44:06 to 00/19:46:04

Plot file version 534 created 03-MAR-2016 01:13:27

J1545+5400 GN002C 1.UVDATA.1

Freq = 1.2770 GHz, Bw = 16.000 MH Calibrated with CL # 3 and BP # 1 (BP mode 1)

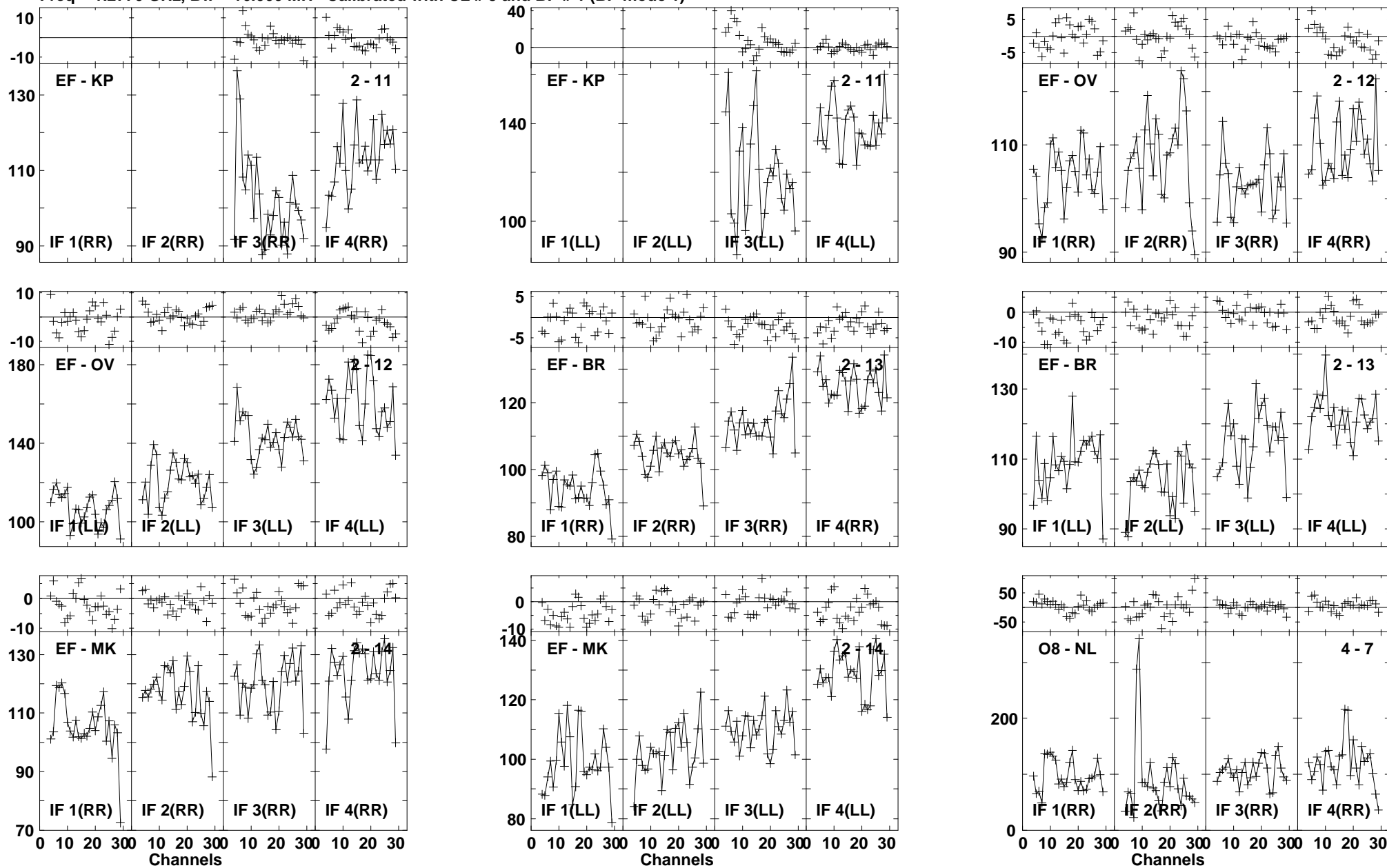

Lower frame: Milli Ampl Jy Top frame: Phas deg
Vector averaged cross-power spectrum Baseline: EF (02) - KP (11)
Timerange: 00/19:44:06 to 00/19:46:04

Plot file version 535 created 03-MAR-2016 01:13:27

J1545+5400 GN002C 1.UVDATA.1

Freq = 1.2770 GHz, Bw = 16.000 MH Calibrated with CL # 3 and BP # 1 (BP mode 1)

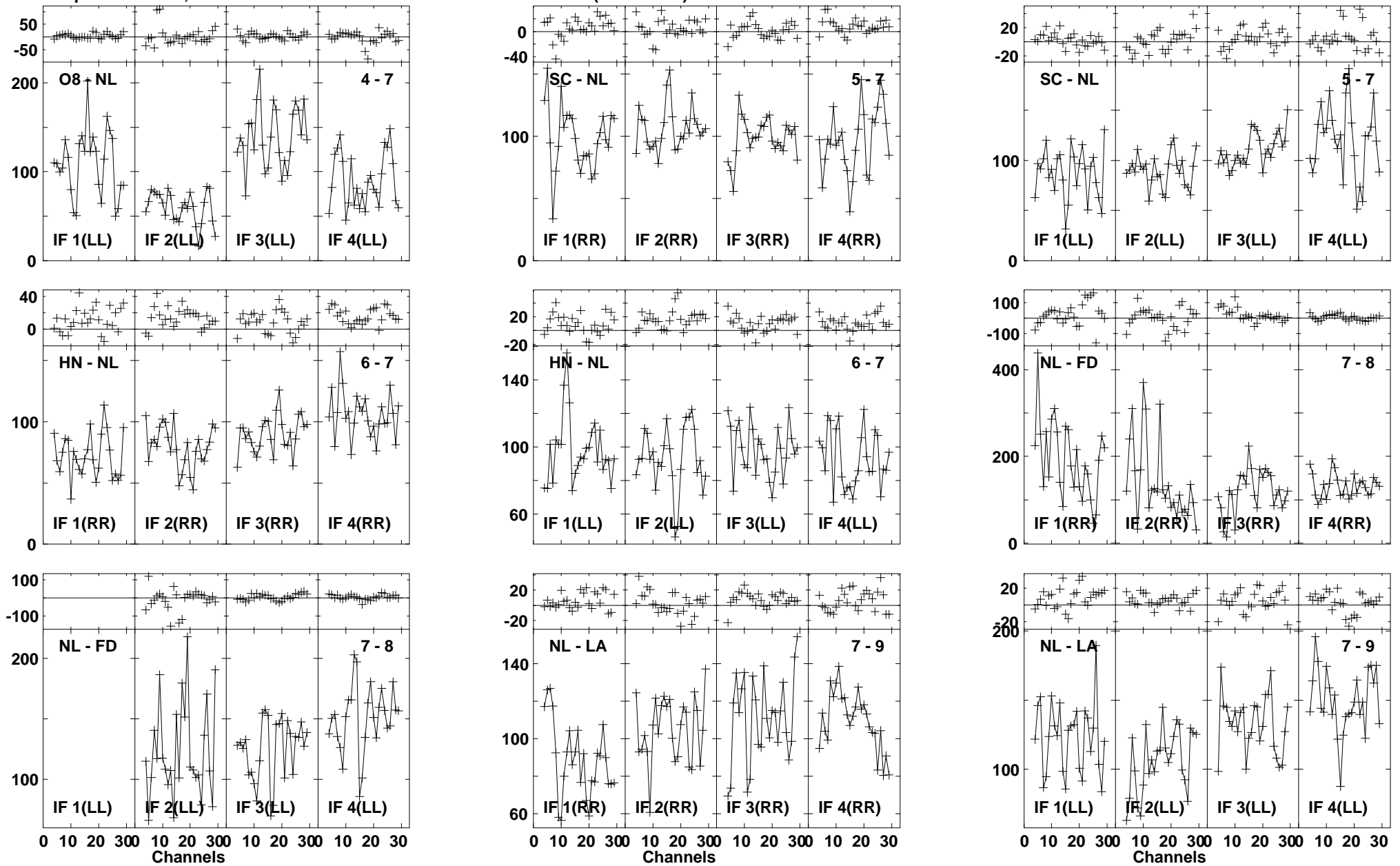

Lower frame: Milli Ampl Jy Top frame: Phas deg
Vector averaged cross-power spectrum Baseline: O8 (04) - NL (07)
Timerange: 00/19:44:06 to 00/19:46:04

Plot file version 536 created 03-MAR-2016 01:13:27
 J1545+5400 GN002C 1.UVDATA.1
 Freq = 1.2770 GHz, Bw = 16.000 MH Calibrated with CL # 3 and BP # 1 (BP mode 1)

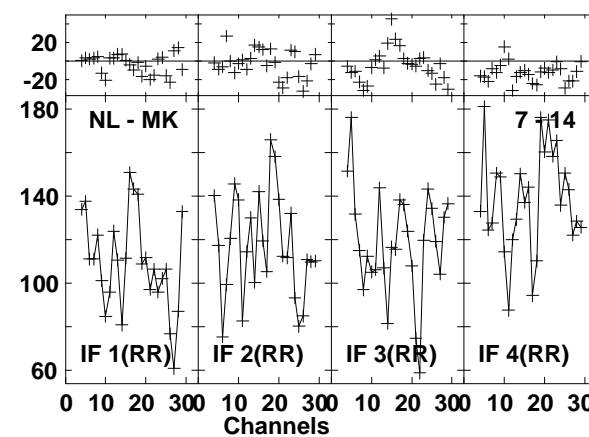
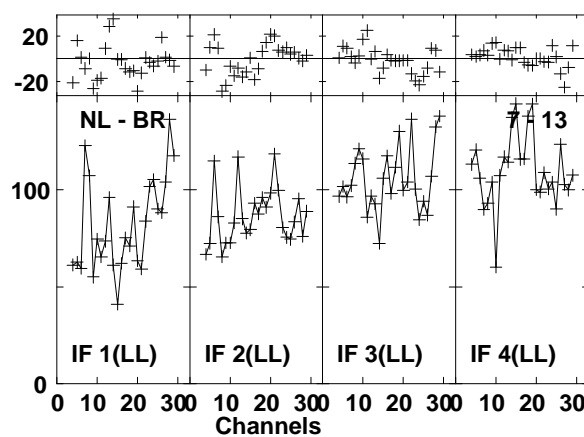
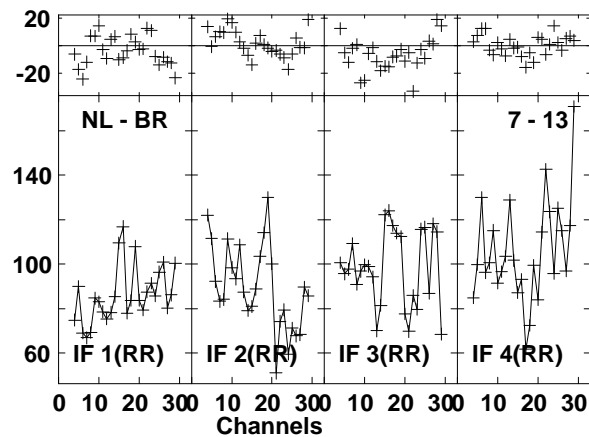
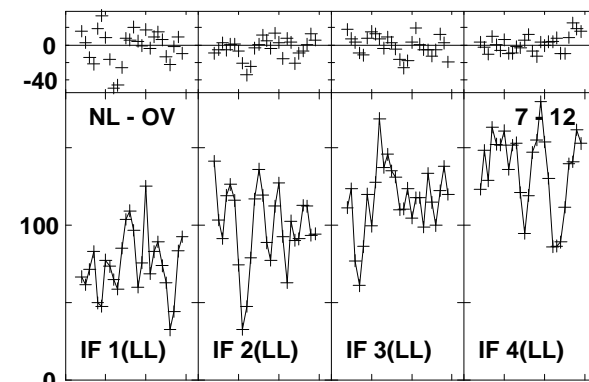
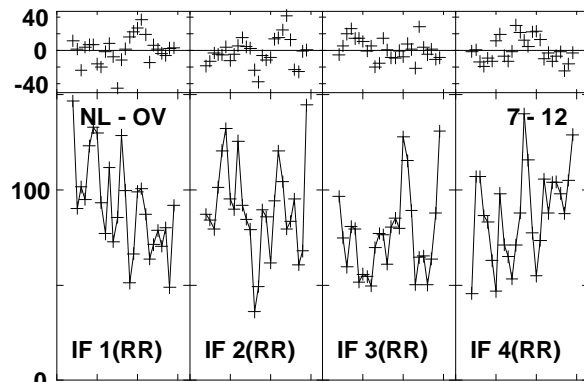
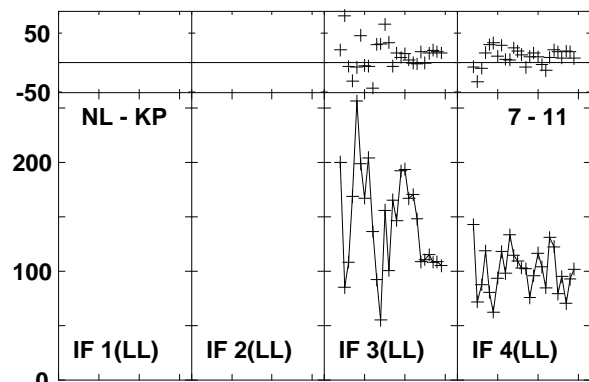
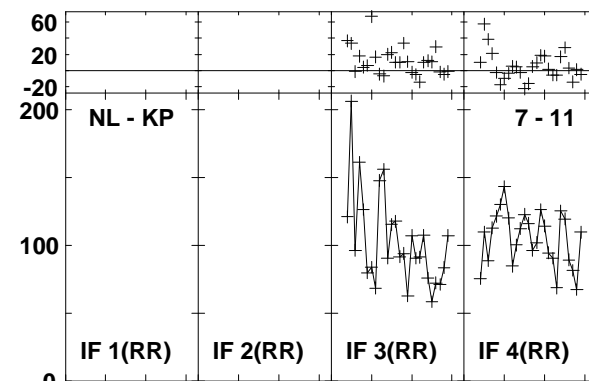
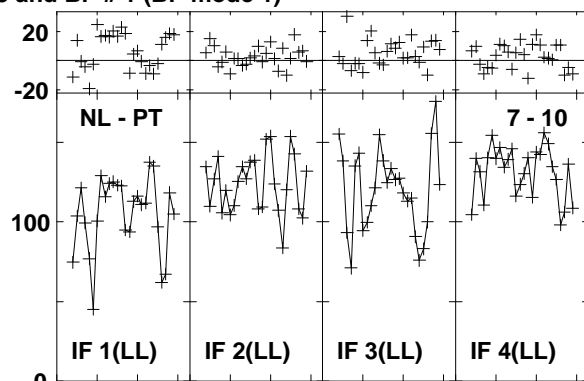
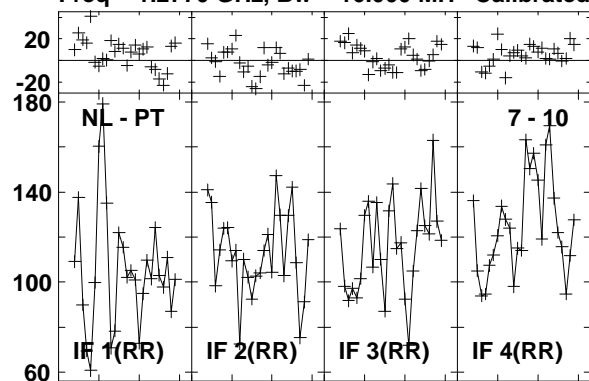

Lower frame: Milli Ampl Jy Top frame: Phas deg
 Vector averaged cross-power spectrum Baseline: NL (07) - PT (10)
 Timerange: 00/19:44:06 to 00/19:46:04

Plot file version 537 created 03-MAR-2016 01:13:27
J1545+5400 GN002C 1.UVDATA.1
Freq = 1.2770 GHz, Bw = 16.000 MH Calibrated with CL # 3 and BP # 1 (BP mode 1)

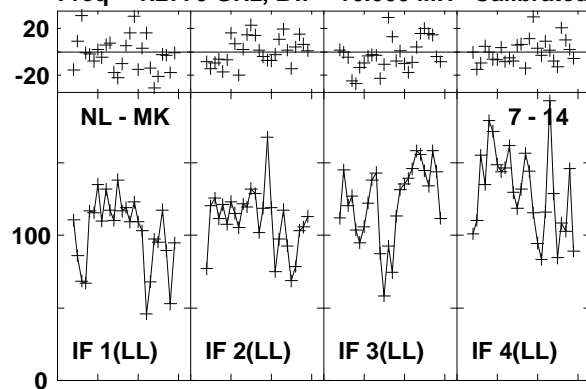

Lower frame: Milli Ampl Jy Top frame: Phas deg
Vector averaged cross-power spectrum Baseline: NL (07) - MK (14)
Timerange: 00/19:44:06 to 00/19:46:04

Plot file version 538 created 03-MAR-2016 01:13:27

4C52 GN002C 1.UVDATA.1

Freq = 1.2770 GHz, Bw = 16.000 MH Calibrated with CL # 3 and BP # 1 (BP mode 1)

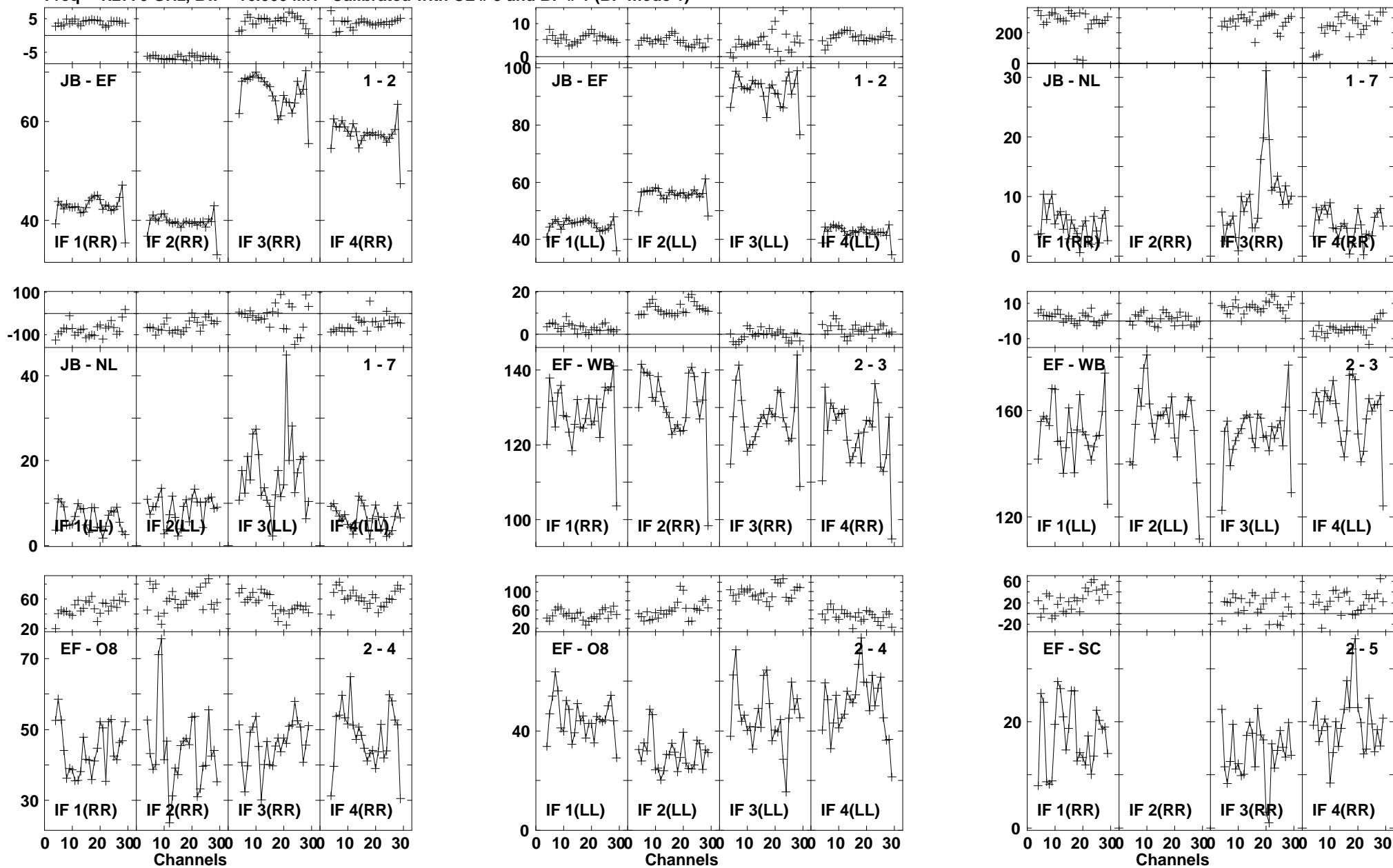

Lower frame: Milli Ampl Jy Top frame: Phas deg
Vector averaged cross-power spectrum Baseline: JB (01) - EF (02)
Timerange: 00/19:46:09 to 00/19:49:03

Plot file version 539 created 03-MAR-2016 01:13:28

4C52 GN002C 1.UVDATA.1

Freq = 1.2770 GHz, Bw = 16.000 MH Calibrated with CL # 3 and BP # 1 (BP mode 1)

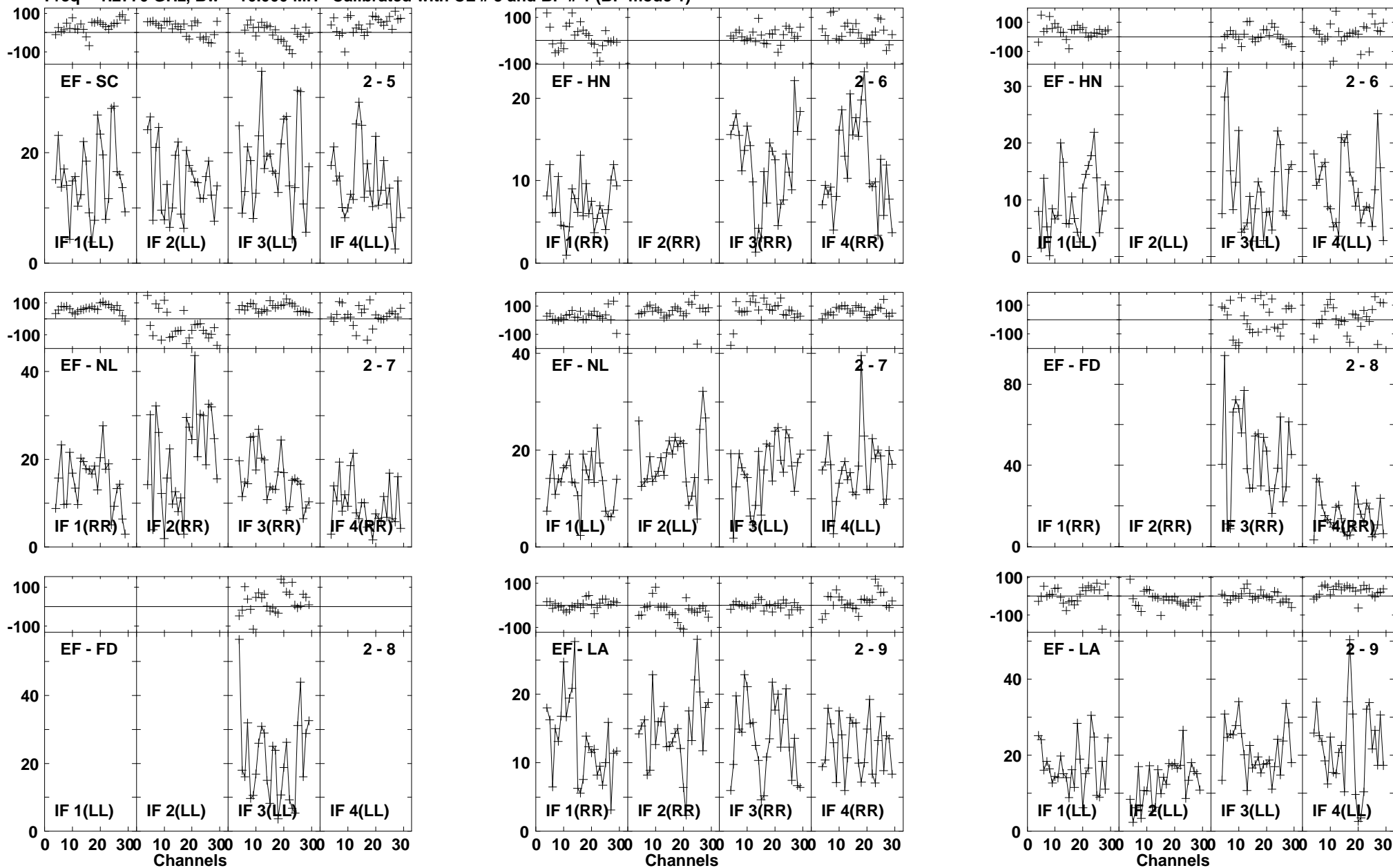

Lower frame: Milli Ampl Jy Top frame: Phas deg
Vector averaged cross-power spectrum Baseline: EF (02) - SC (05)
Timerange: 00/19:46:09 to 00/19:49:03

Plot file version 540 created 03-MAR-2016 01:13:28

4C52 GN002C 1.UVDATA.1

Freq = 1.2770 GHz, Bw = 16.000 MH Calibrated with CL # 3 and BP # 1 (BP mode 1)

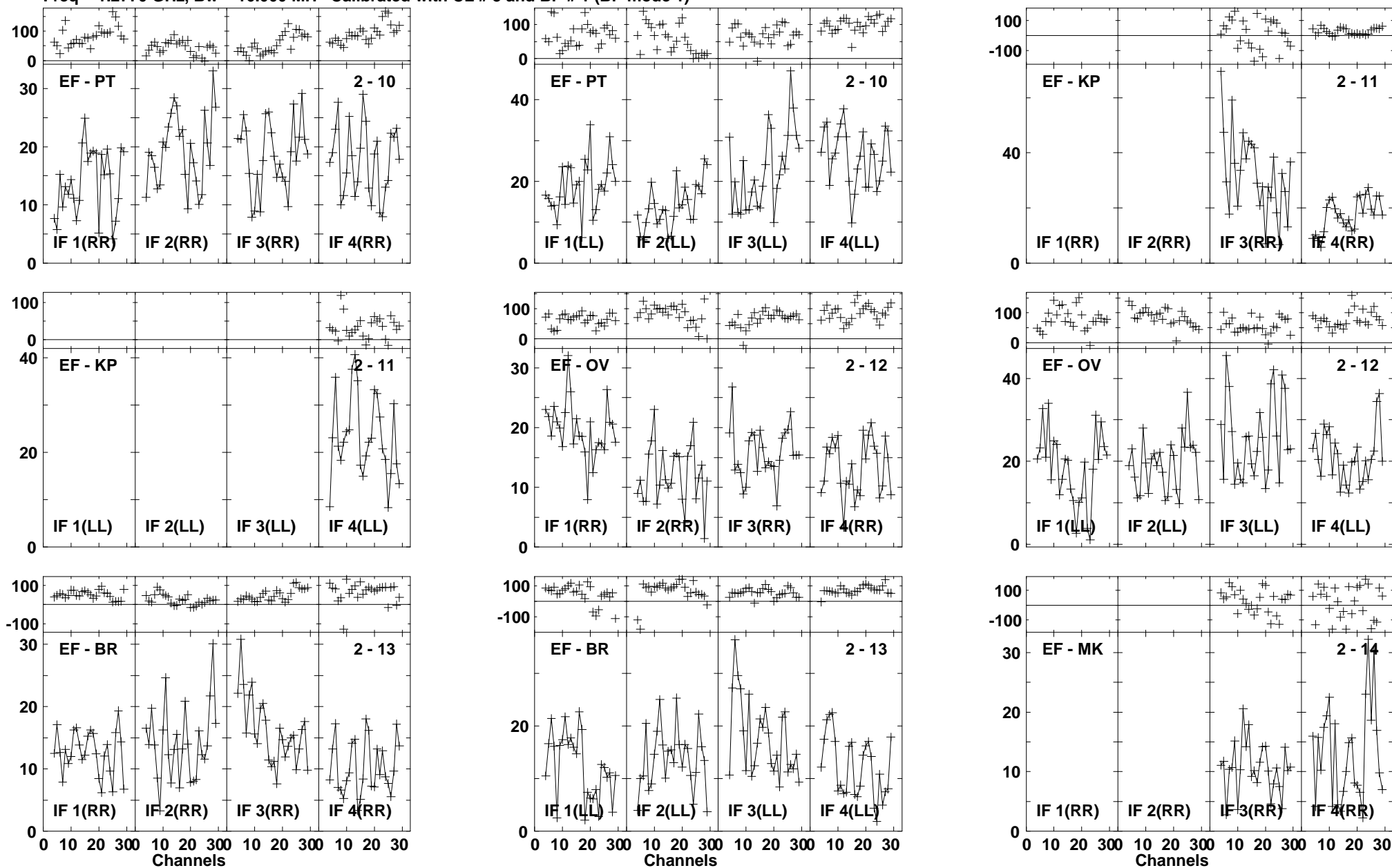

Lower frame: Milli Ampl Jy Top frame: Phas deg
Vector averaged cross-power spectrum Baseline: EF (02) - PT (10)
Timerange: 00/19:46:09 to 00/19:49:03

Plot file version 541 created 03-MAR-2016 01:13:28

4C52 GN002C 1.UVDATA.1

Freq = 1.2770 GHz, Bw = 16.000 MH Calibrated with CL # 3 and BP # 1 (BP mode 1)

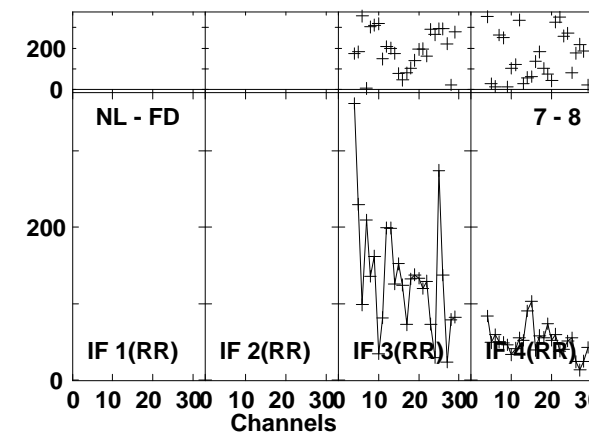
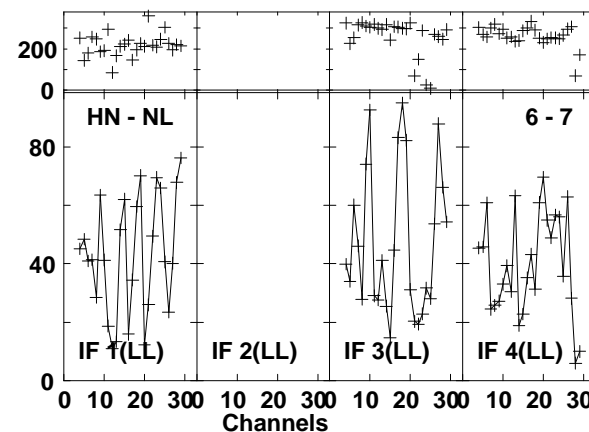
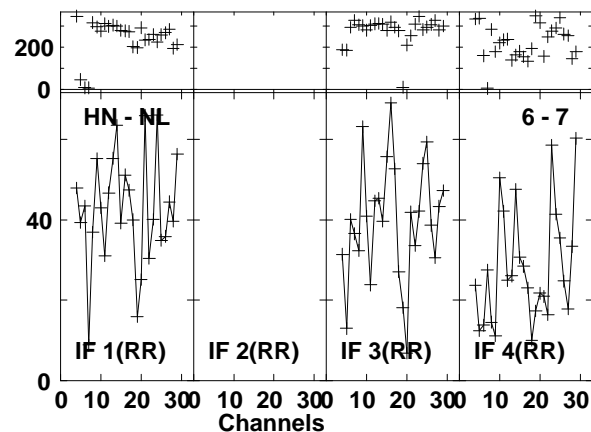
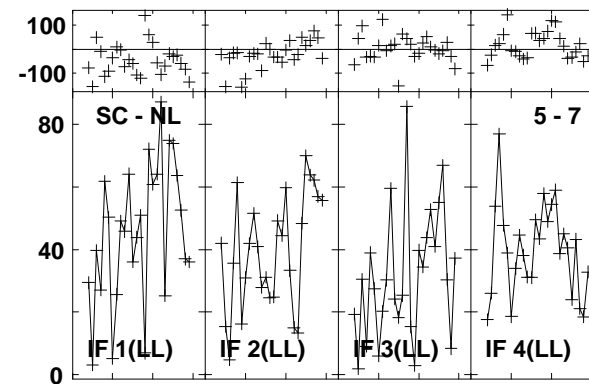
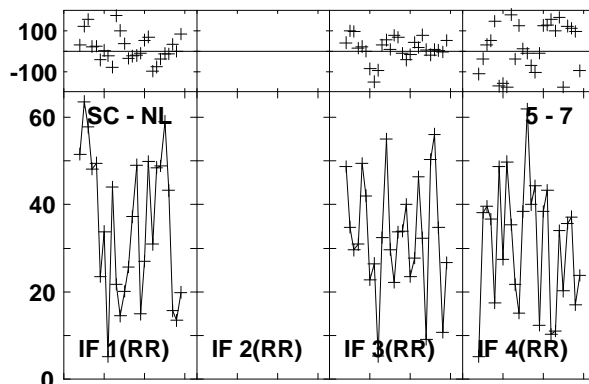
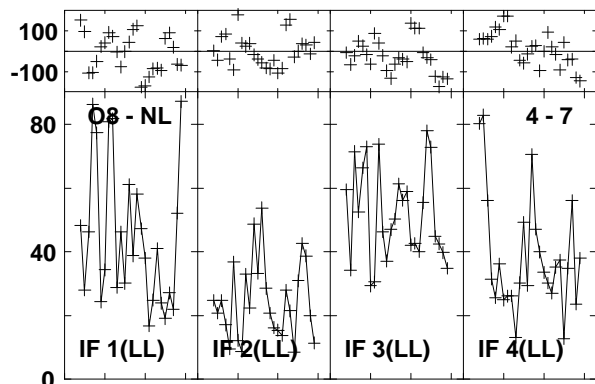
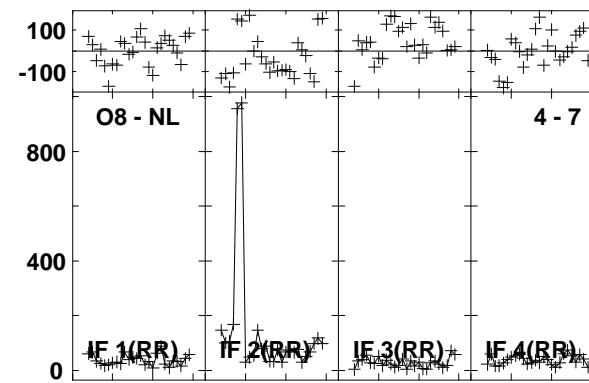
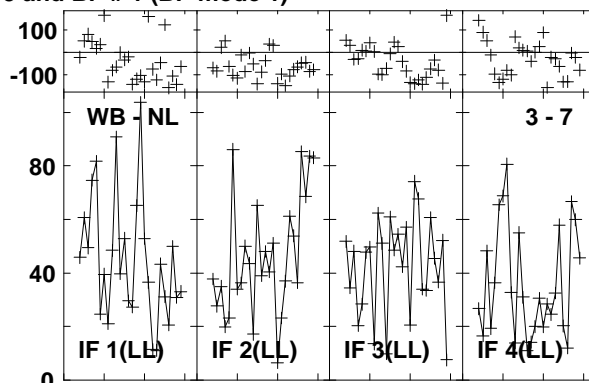
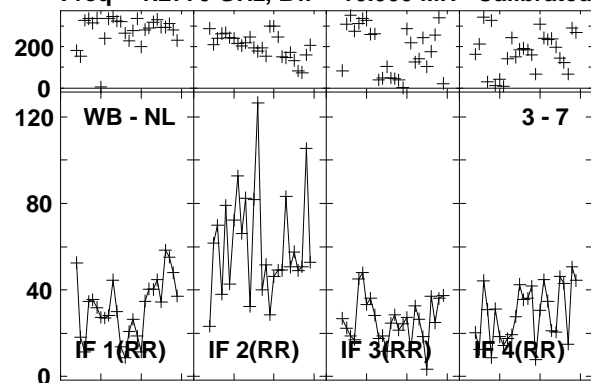

Lower frame: Milli Ampl Jy Top frame: Phas deg

Vector averaged cross-power spectrum Baseline: WB (03) - NL (07)

Timerange: 00/19:46:09 to 00/19:49:03

Plot file version 542 created 03-MAR-2016 01:13:28

4C52 GN002C 1.UVDATA.1

Freq = 1.2770 GHz, Bw = 16.000 MH Calibrated with CL # 3 and BP # 1 (BP mode 1)

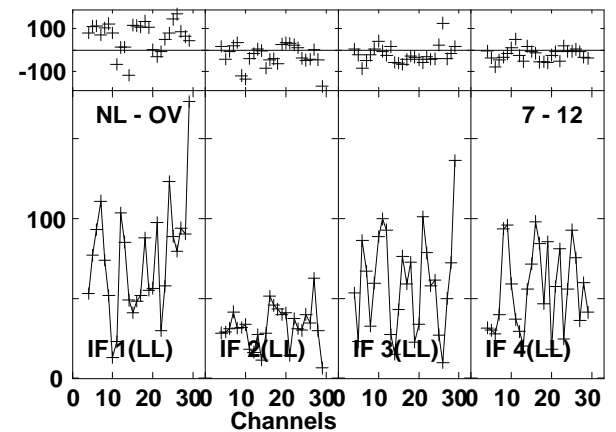
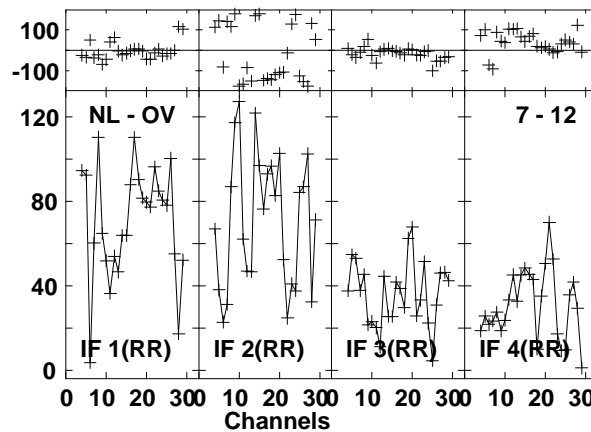
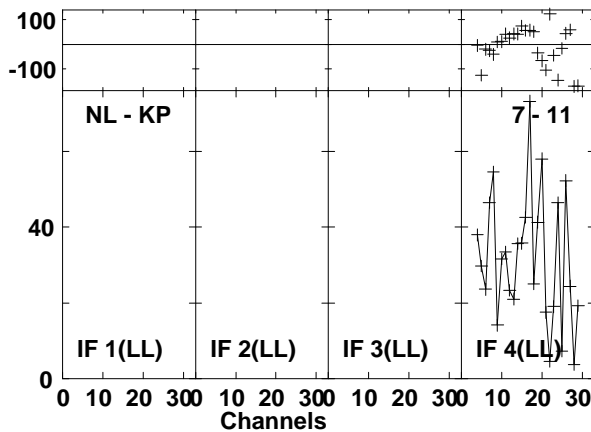
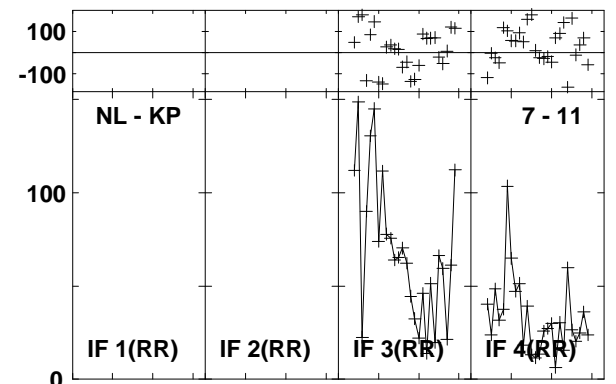
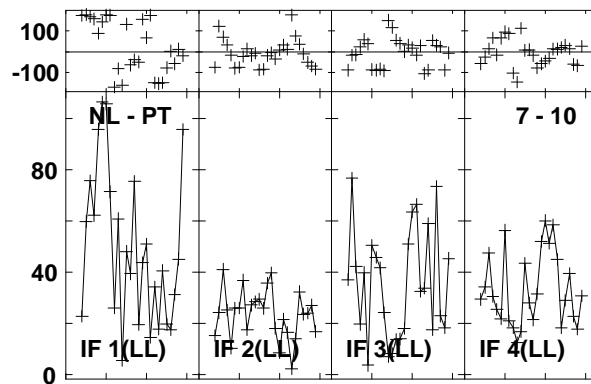
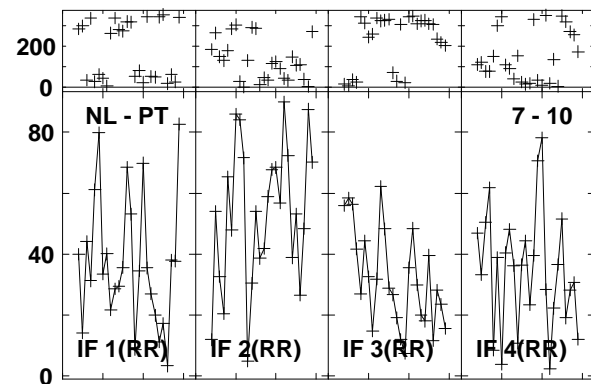
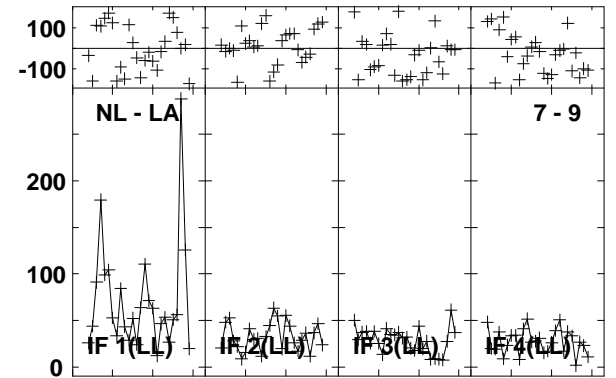
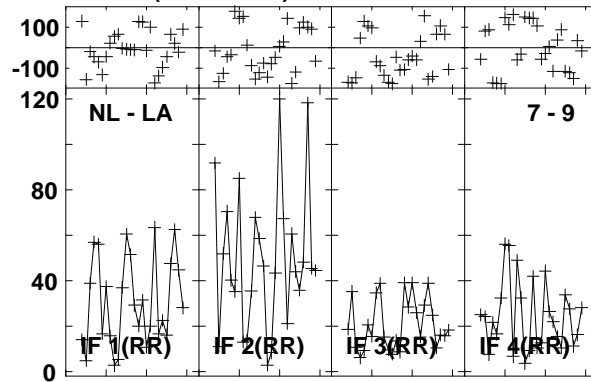
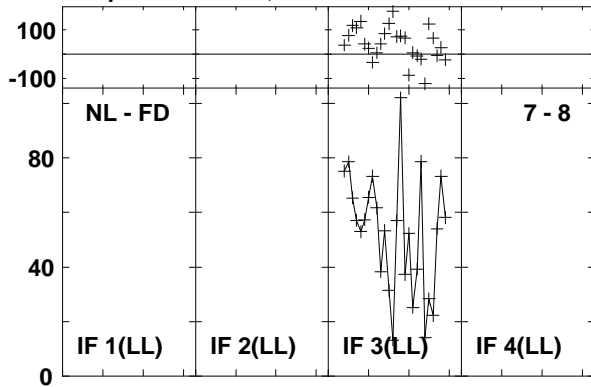

Lower frame: Milli Ampl Jy Top frame: Phas deg
Vector averaged cross-power spectrum Baseline: NL (07) - FD (08)
Timerange: 00/19:46:09 to 00/19:49:03

Plot file version 543 created 03-MAR-2016 01:13:28

4C52 GN002C 1.UVDATA.1

Freq = 1.2770 GHz, Bw = 16.000 MH Calibrated with CL # 3 and BP # 1 (BP mode 1)

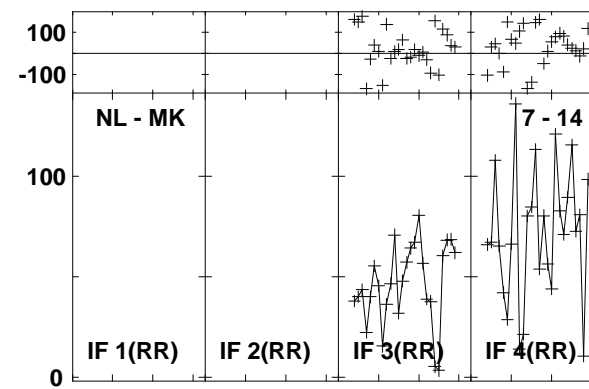
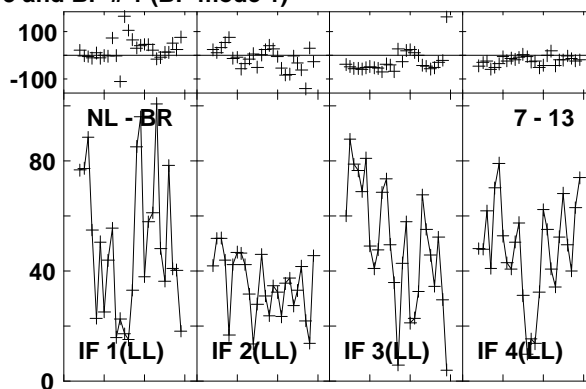
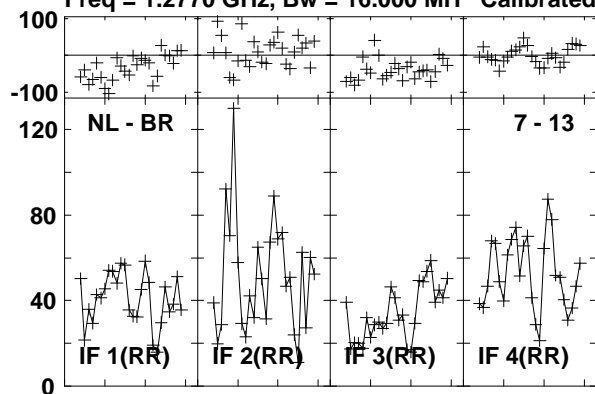

Lower frame: Milli Ampl Jy Top frame: Phas deg
Vector averaged cross-power spectrum Baseline: NL (07) - BR (13)
Timerange: 00/19:46:09 to 00/19:49:03

Plot file version 544 created 03-MAR-2016 01:13:29

J1545+5400 GN002C 1.UVDATA.1

Freq = 1.2770 GHz, Bw = 16.000 MH Calibrated with CL # 3 and BP # 1 (BP mode 1)

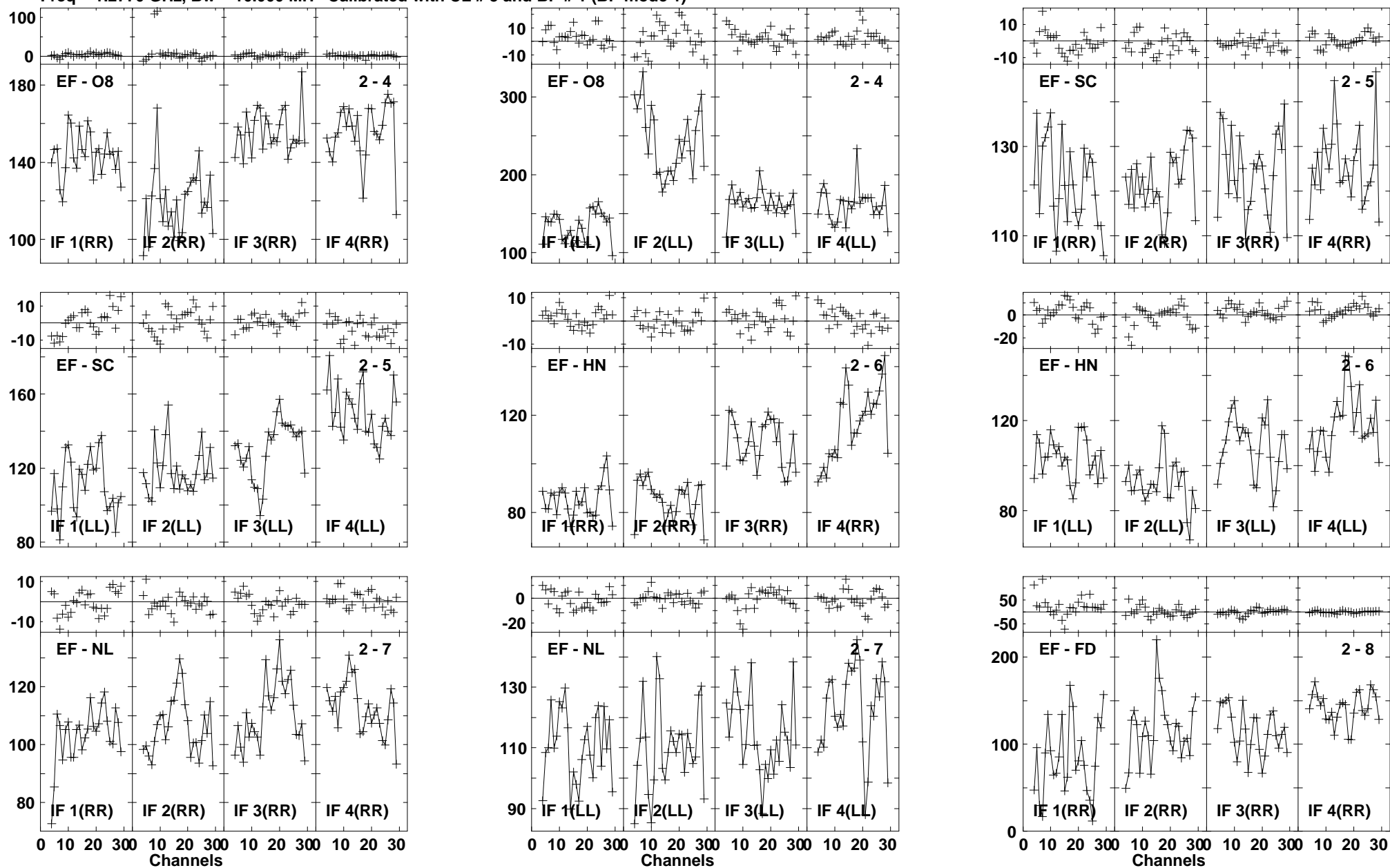

Lower frame: Milli Ampl Jy Top frame: Phas deg
Vector averaged cross-power spectrum Baseline: EF (02) - O8 (04)
Timerange: 00/19:49:56 to 00/19:50:54

Plot file version 545 created 03-MAR-2016 01:13:29

J1545+5400 GN002C 1.UVDATA.1

Freq = 1.2770 GHz, Bw = 16.000 MH Calibrated with CL # 3 and BP # 1 (BP mode 1)

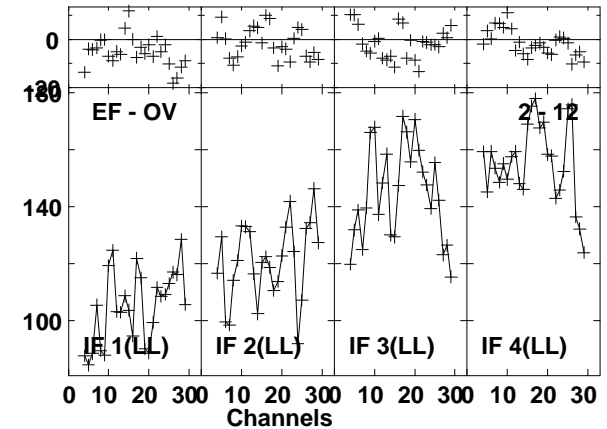
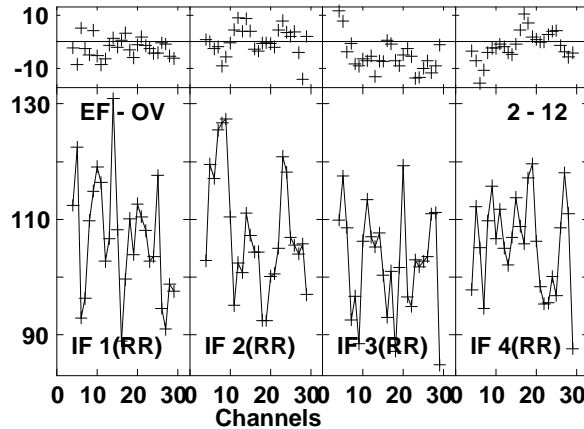
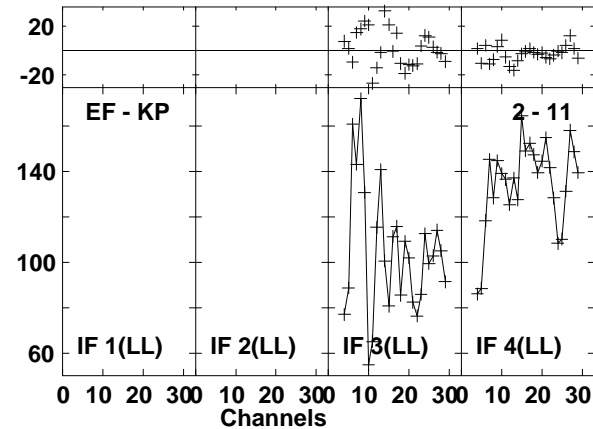
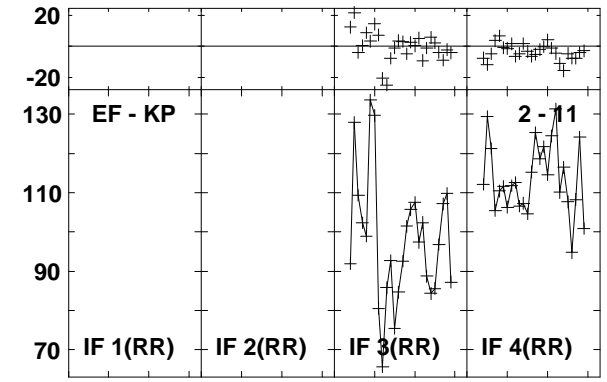
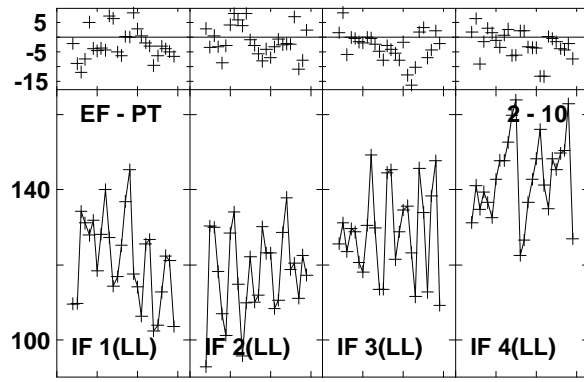
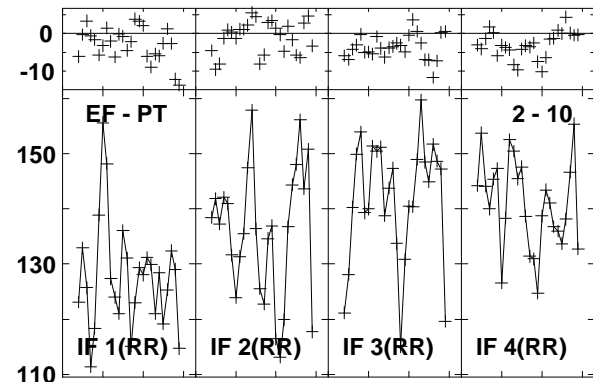
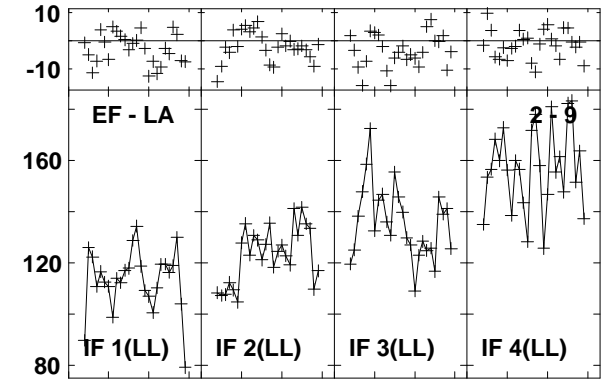
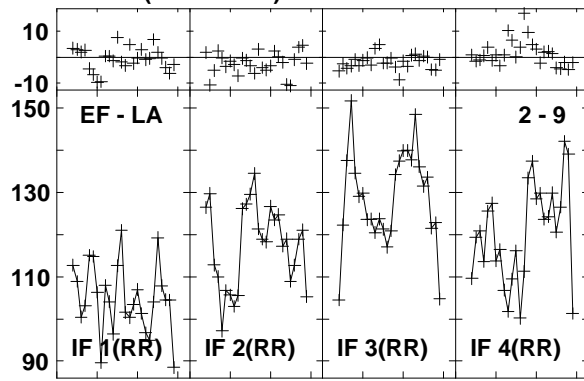
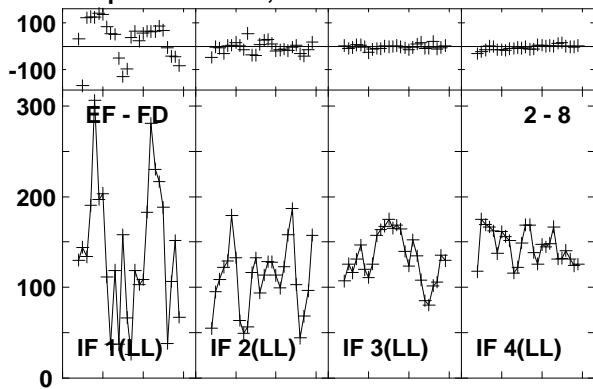

Lower frame: Milli Ampl Jy Top frame: Phas deg
Vector averaged cross-power spectrum Baseline: EF (02) - FD (08)
Timerange: 00/19:49:56 to 00/19:50:54

Plot file version 546 created 03-MAR-2016 01:13:29

J1545+5400 GN002C 1.UVDATA.1

Freq = 1.2770 GHz, Bw = 16.000 MH Calibrated with CL # 3 and BP # 1 (BP mode 1)

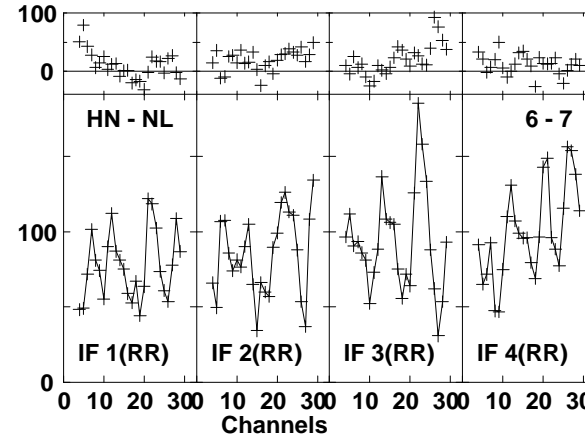
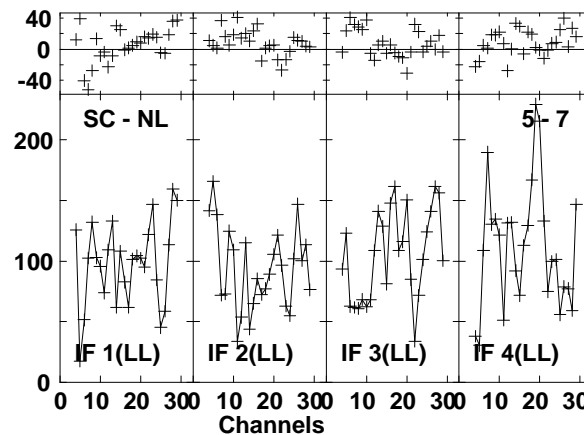
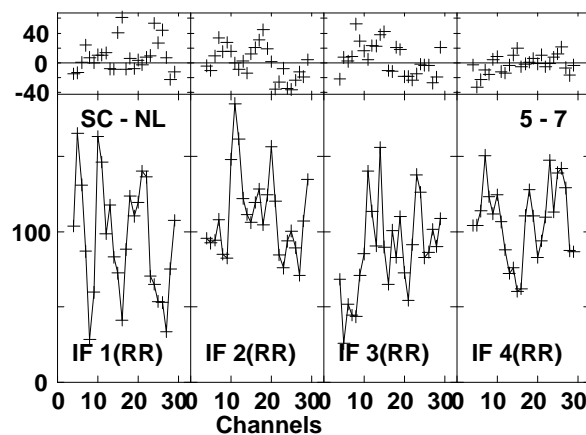
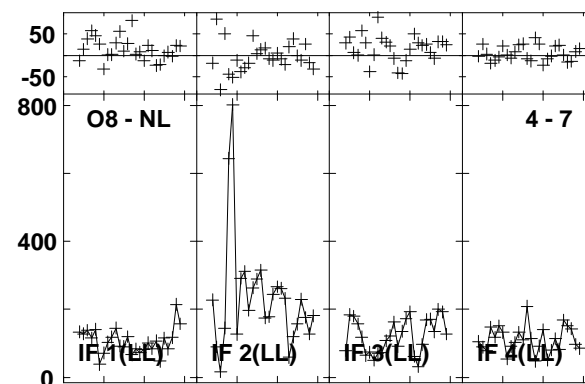
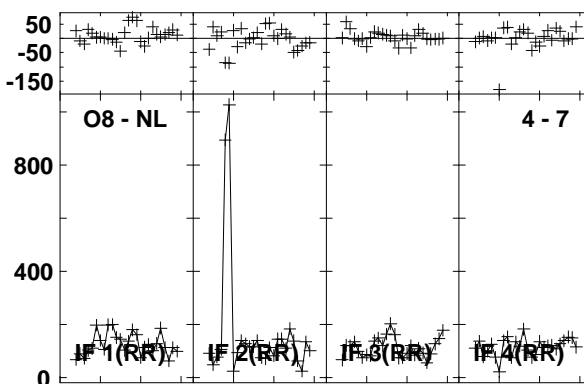
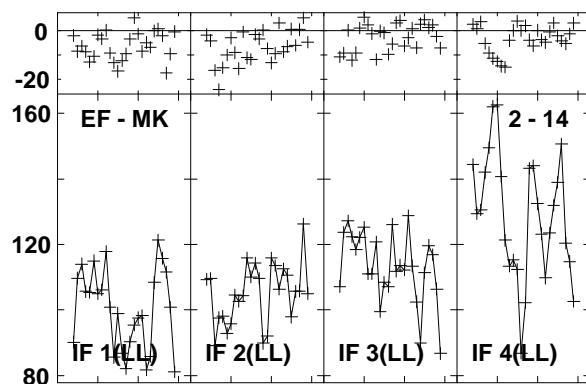
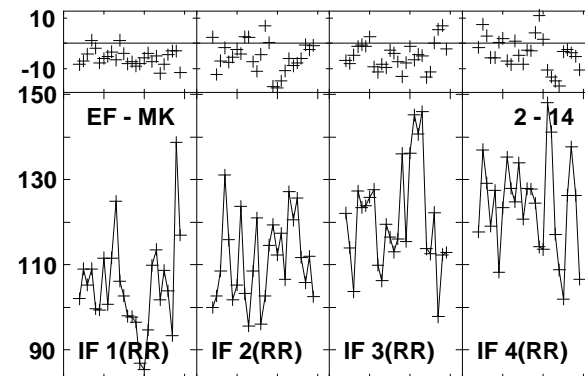
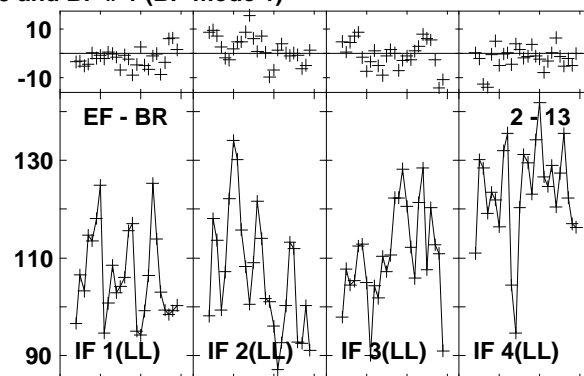
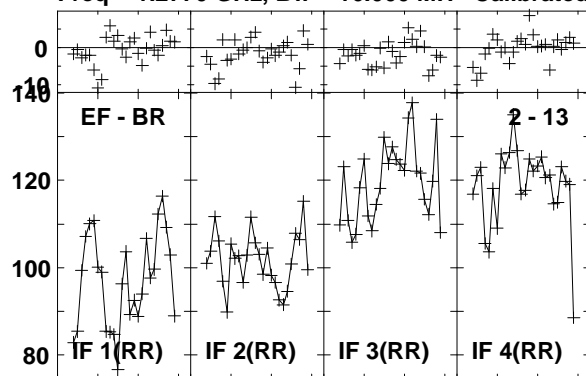

Lower frame: Milli Ampl Jy Top frame: Phas deg
Vector averaged cross-power spectrum Baseline: EF (02) - BR (13)
Timerange: 00/19:49:56 to 00/19:50:54

Plot file version 547 created 03-MAR-2016 01:13:29

J1545+5400 GN002C 1.UVDATA.1

Freq = 1.2770 GHz, Bw = 16.000 MH Calibrated with CL # 3 and BP # 1 (BP mode 1)

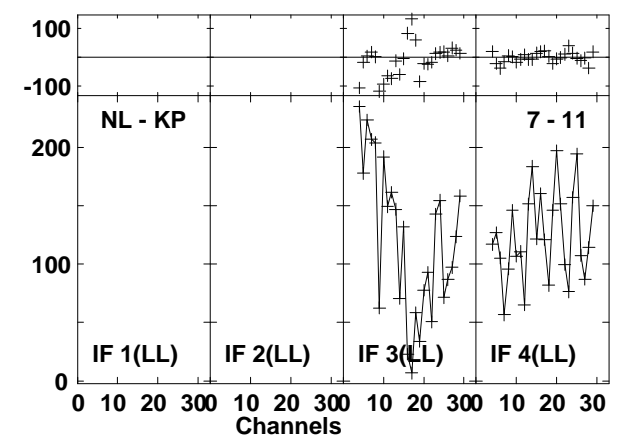
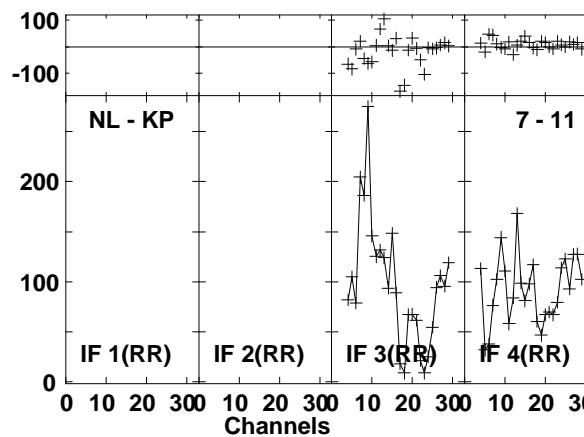
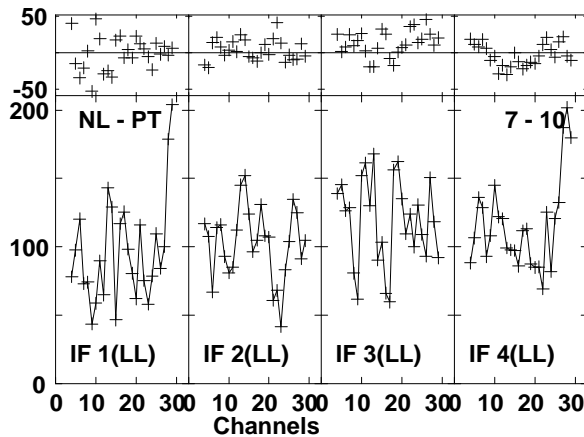
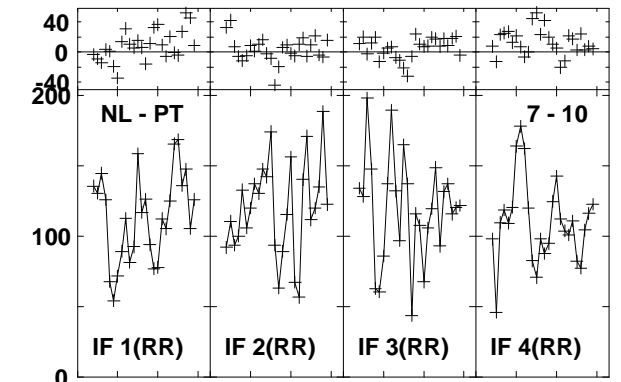
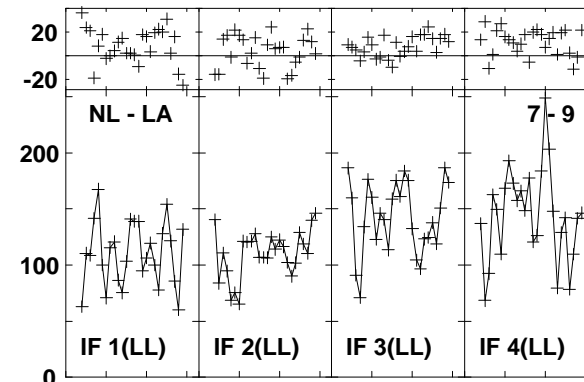
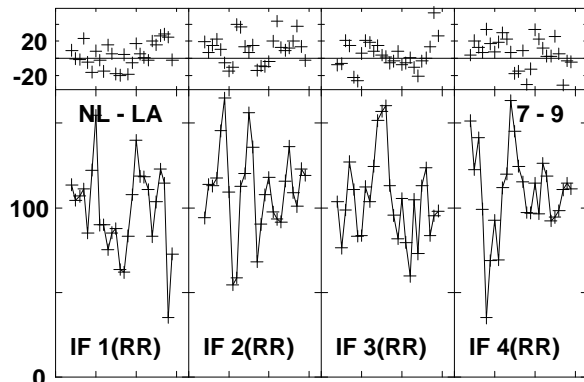
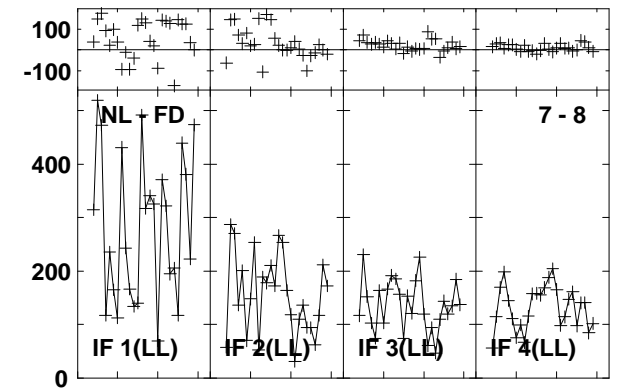
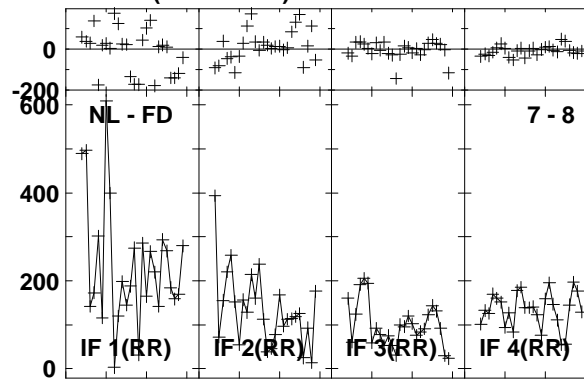
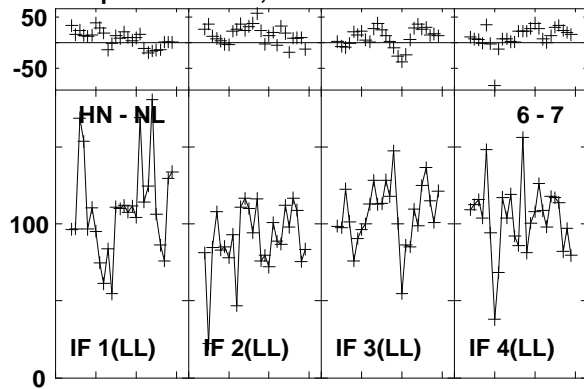

Lower frame: Milli Ampl Jy Top frame: Phas deg
Vector averaged cross-power spectrum Baseline: HN (06) - NL (07)
Timerange: 00/19:49:56 to 00/19:50:54

Plot file version 548 created 03-MAR-2016 01:13:29
 J1545+5400 GN002C 1.UVDATA.1
 Freq = 1.2770 GHz, Bw = 16.000 MH Calibrated with CL # 3 and BP # 1 (BP mode 1)

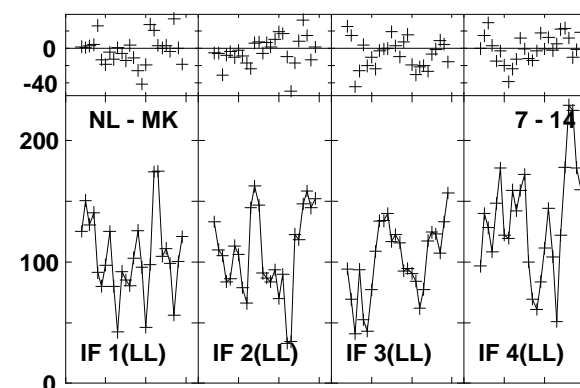
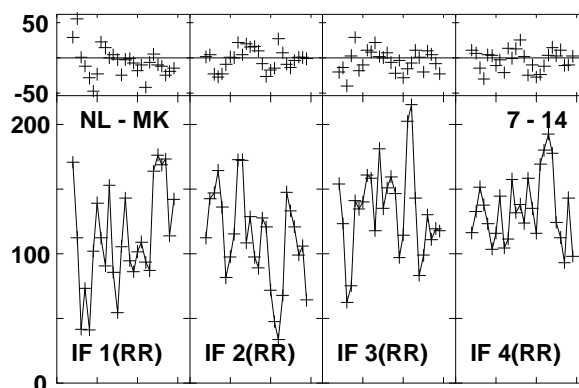
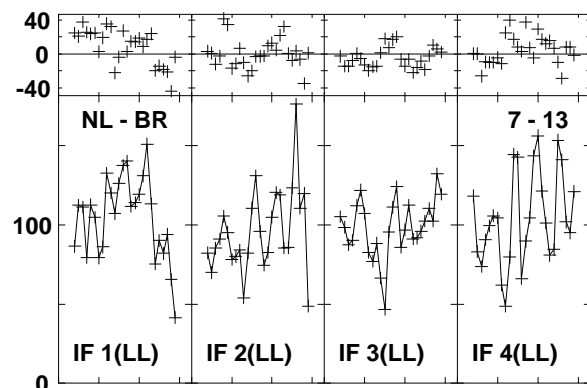
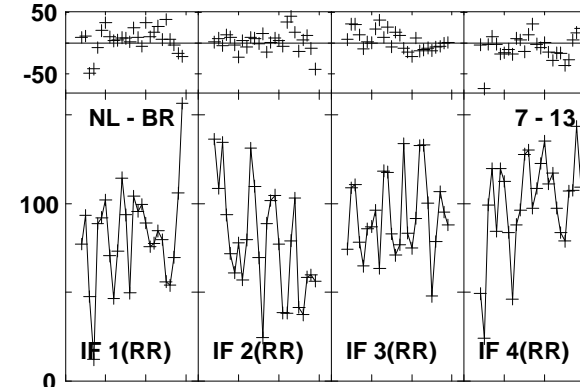
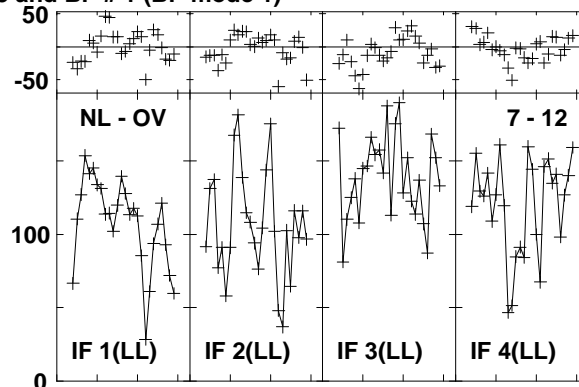
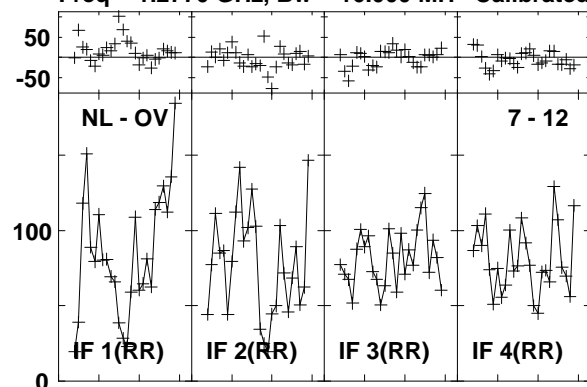

Lower frame: Milli Ampl Jy Top frame: Phas deg
 Vector averaged cross-power spectrum Baseline: NL (07) - OV (12)
 Timerange: 00/19:49:56 to 00/19:50:54

Plot file version 549 created 03-MAR-2016 01:13:29

4C52 GN002C 1.UVDATA.1

Freq = 1.2770 GHz, Bw = 16.000 MH Calibrated with CL # 3 and BP # 1 (BP mode 1)

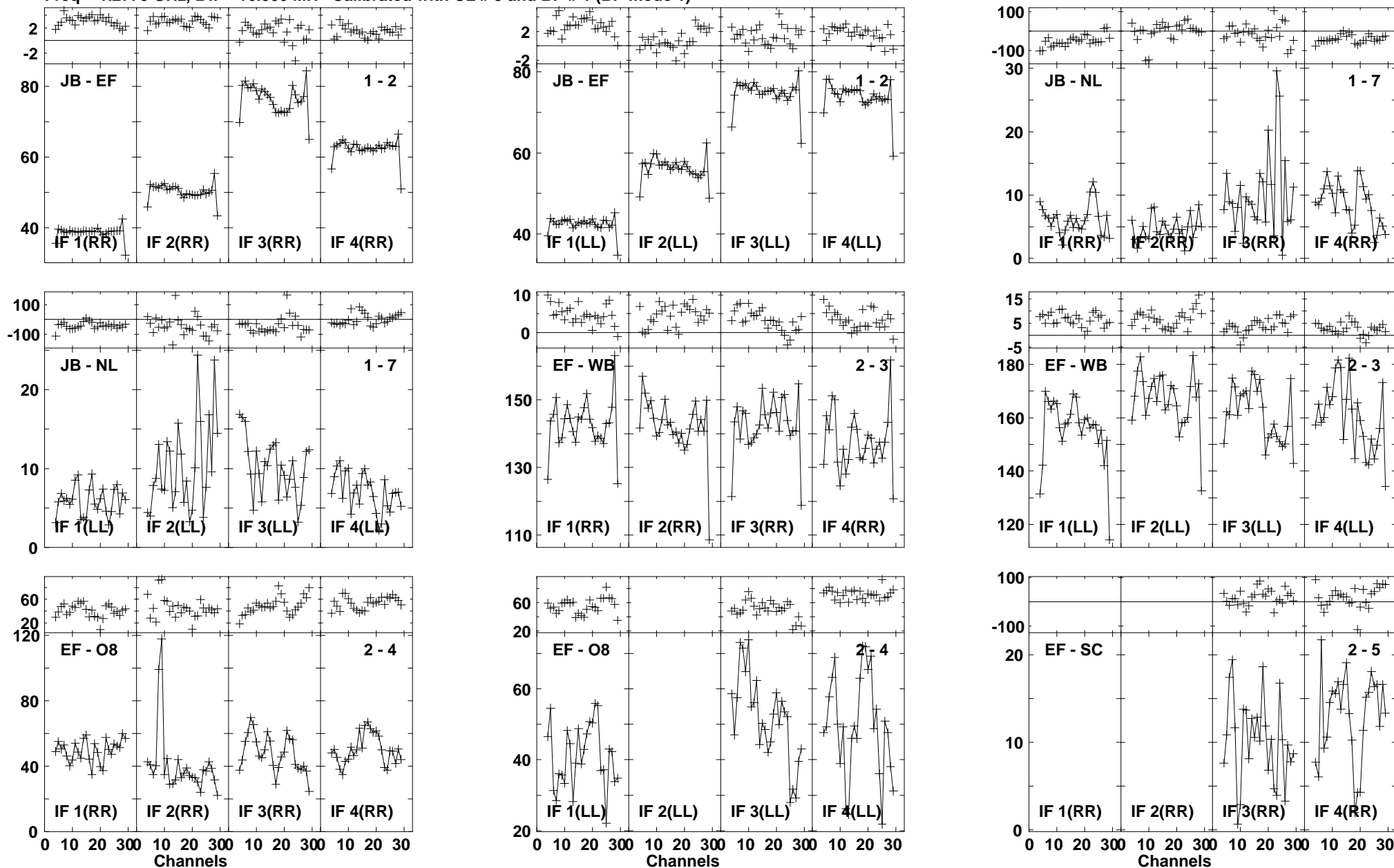

Lower frame: Milli Ampl Jy Top frame: Phas deg
Vector averaged cross-power spectrum Baseline: JB (01) - EF (02)
Timerange: 00/19:50:59 to 00/19:53:53

Plot file version 550 created 03-MAR-2016 01:13:30

4C52 GN002C 1.UVDATA.1

Freq = 1.2770 GHz, Bw = 16.000 MH Calibrated with CL # 3 and BP # 1 (BP mode 1)

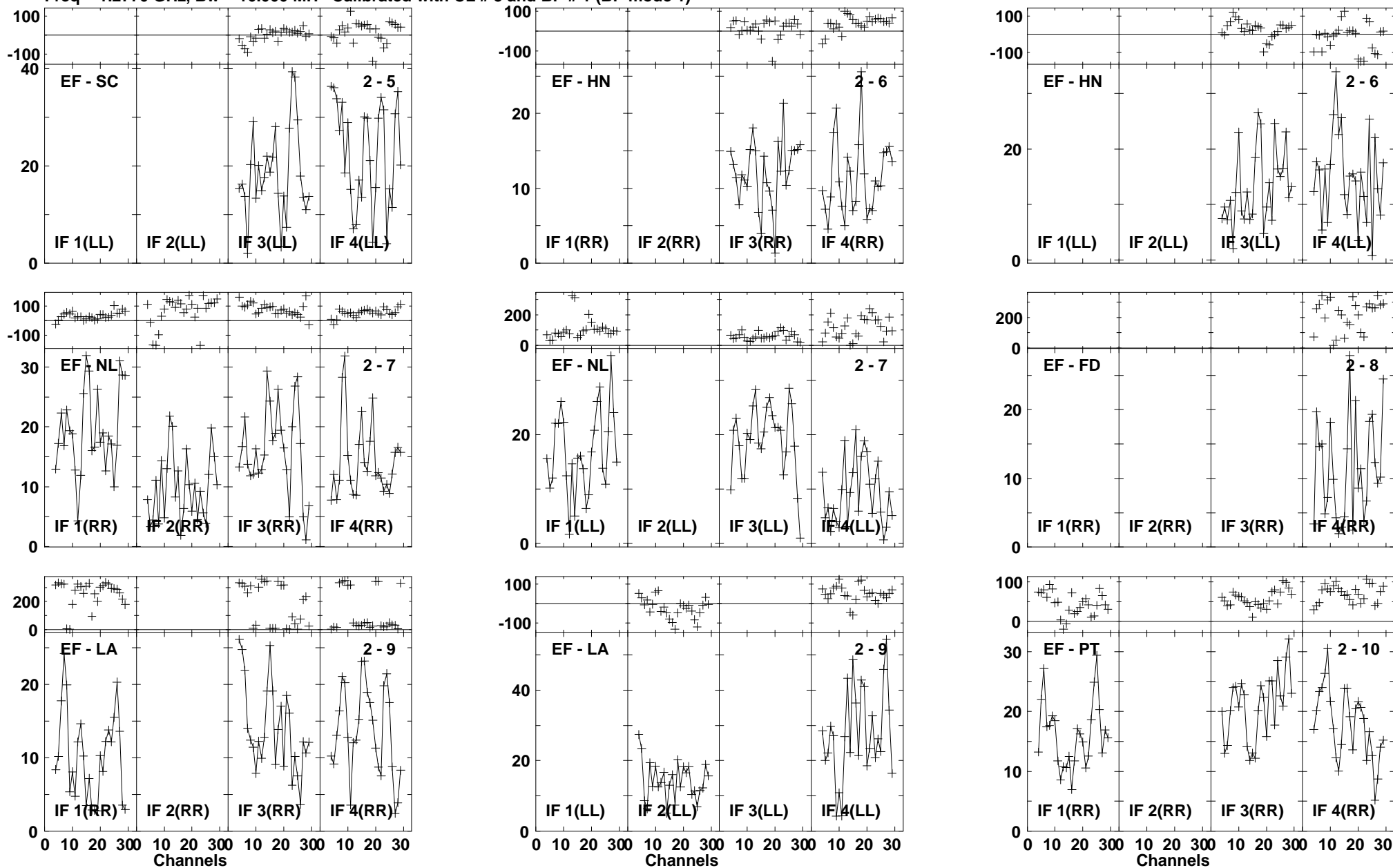

Lower frame: Milli Ampl Jy Top frame: Phas deg
Vector averaged cross-power spectrum Baseline: EF (02) - SC (05)
Timerange: 00/19:50:59 to 00/19:53:53

Plot file version 551 created 03-MAR-2016 01:13:30

4C52 GN002C 1.UVDATA.1

Freq = 1.2770 GHz, Bw = 16.000 MH Calibrated with CL # 3 and BP # 1 (BP mode 1)

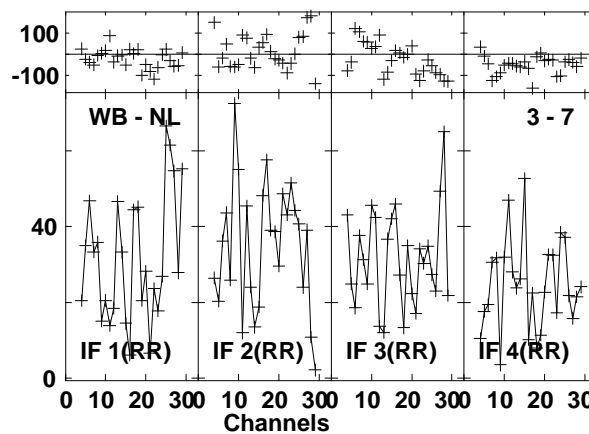
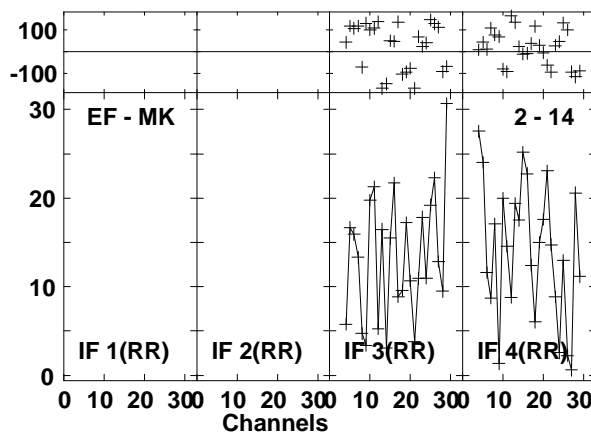
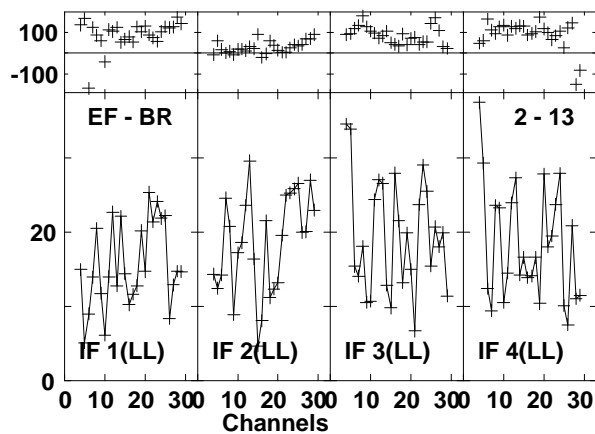
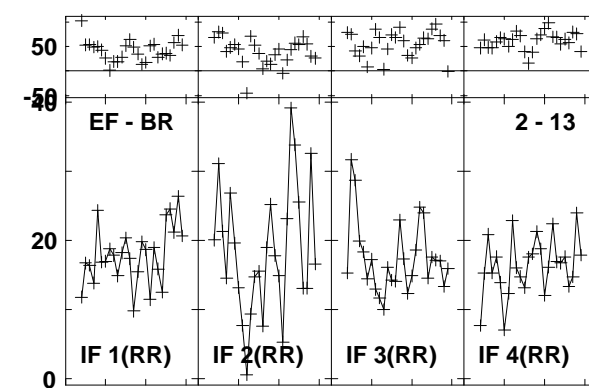
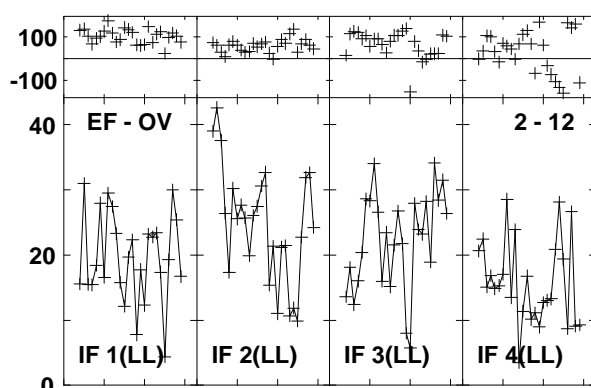
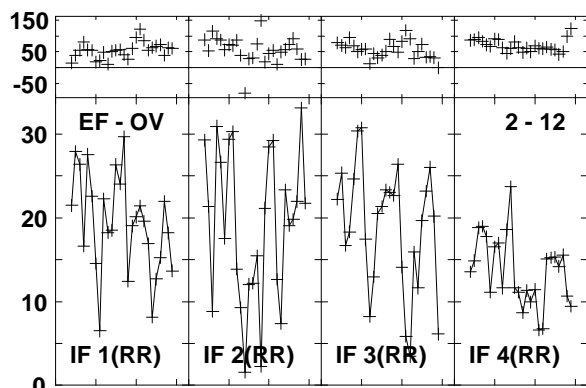
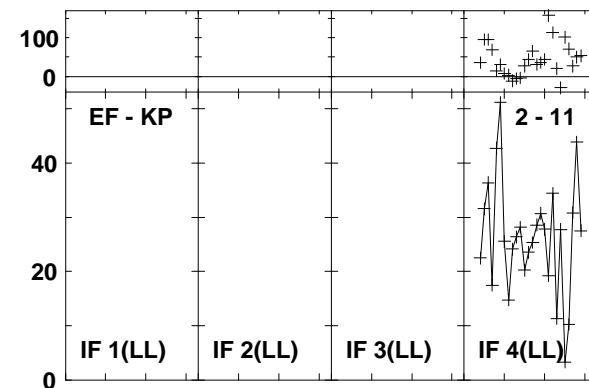
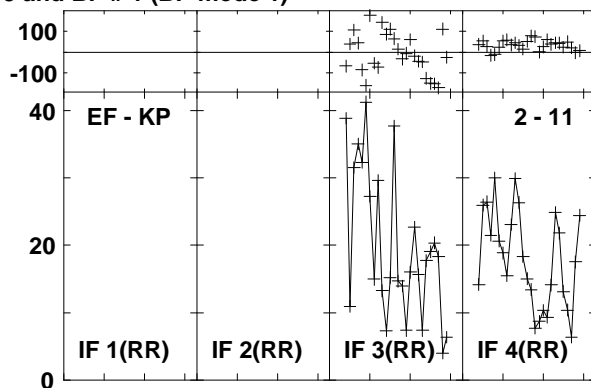
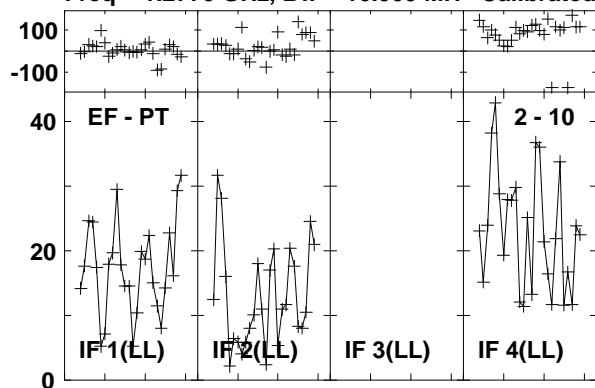

Lower frame: Milli Ampl Jy Top frame: Phas deg
Vector averaged cross-power spectrum Baseline: EF (02) - PT (10)
Timerange: 00/19:50:59 to 00/19:53:53

Plot file version 552 created 03-MAR-2016 01:13:30

4C52 GN002C 1.UVDATA.1

Freq = 1.2770 GHz, Bw = 16.000 MH Calibrated with CL # 3 and BP # 1 (BP mode 1)

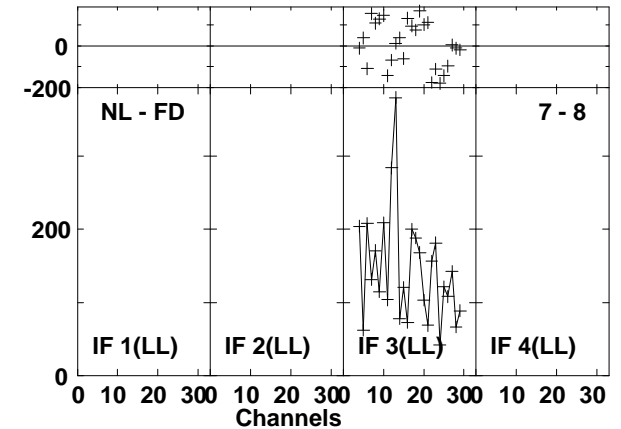
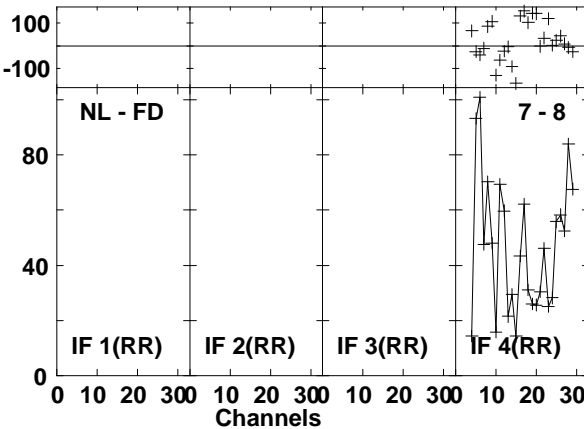
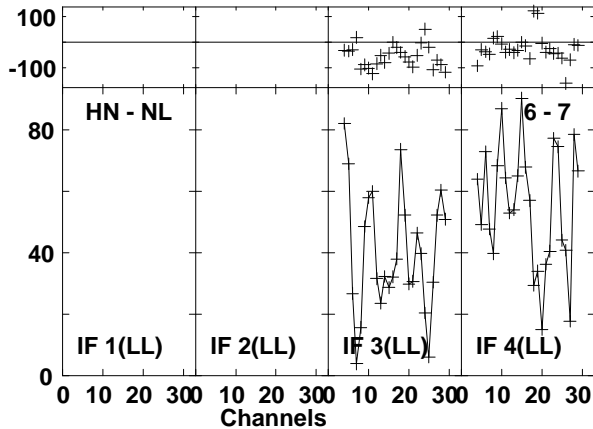
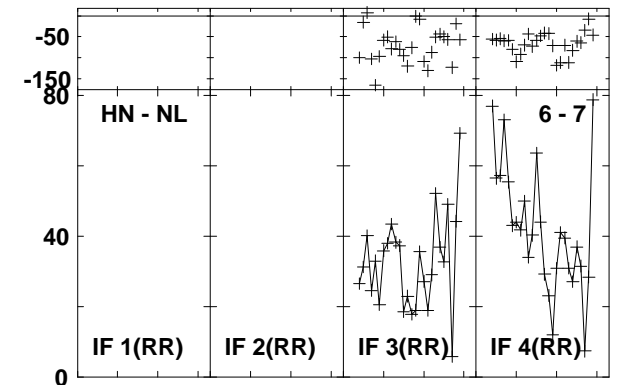
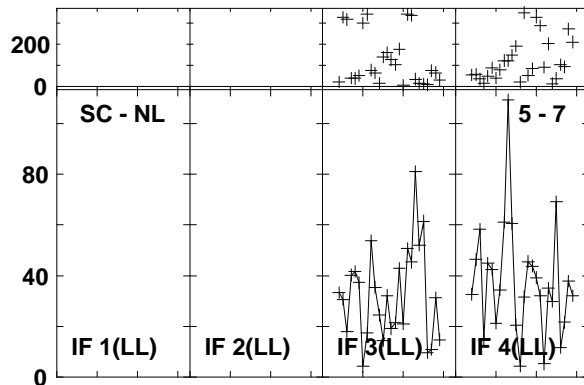
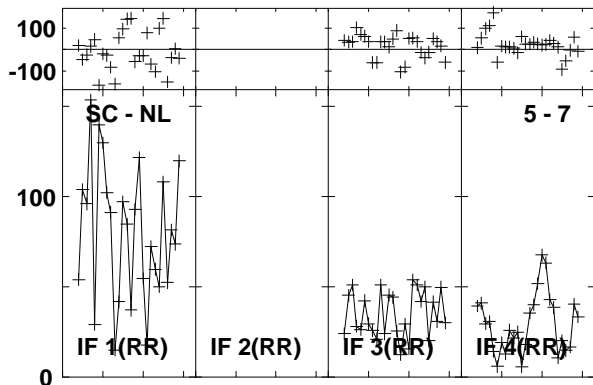
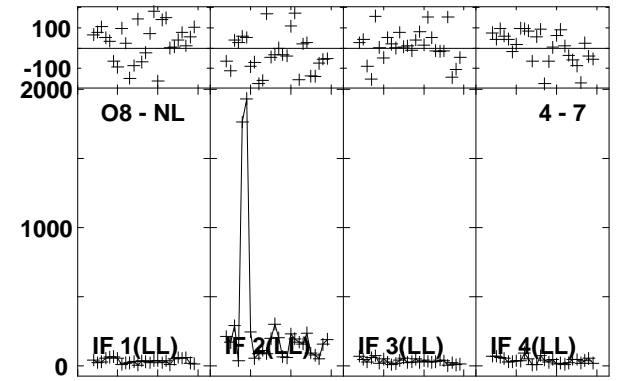
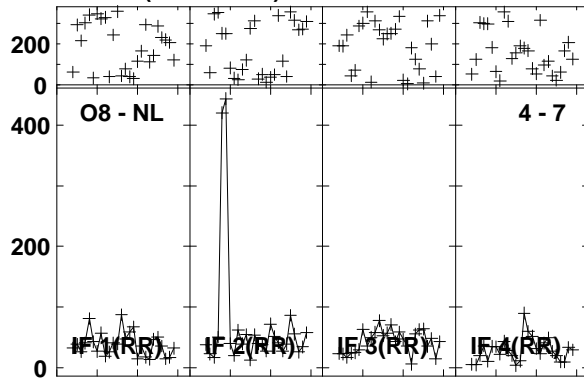
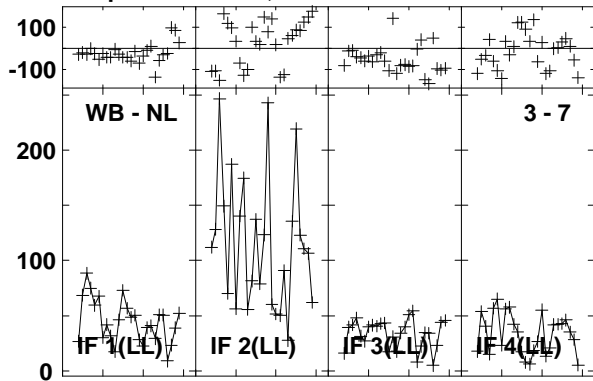

Lower frame: Milli Ampl Jy Top frame: Phas deg
Vector averaged cross-power spectrum Baseline: WB (03) - NL (07)
Timerange: 00/19:50:59 to 00/19:53:53

Plot file version 553 created 03-MAR-2016 01:13:30

4C52 GN002C 1.UVDATA.1

Freq = 1.2770 GHz, Bw = 16.000 MH Calibrated with CL # 3 and BP # 1 (BP mode 1)

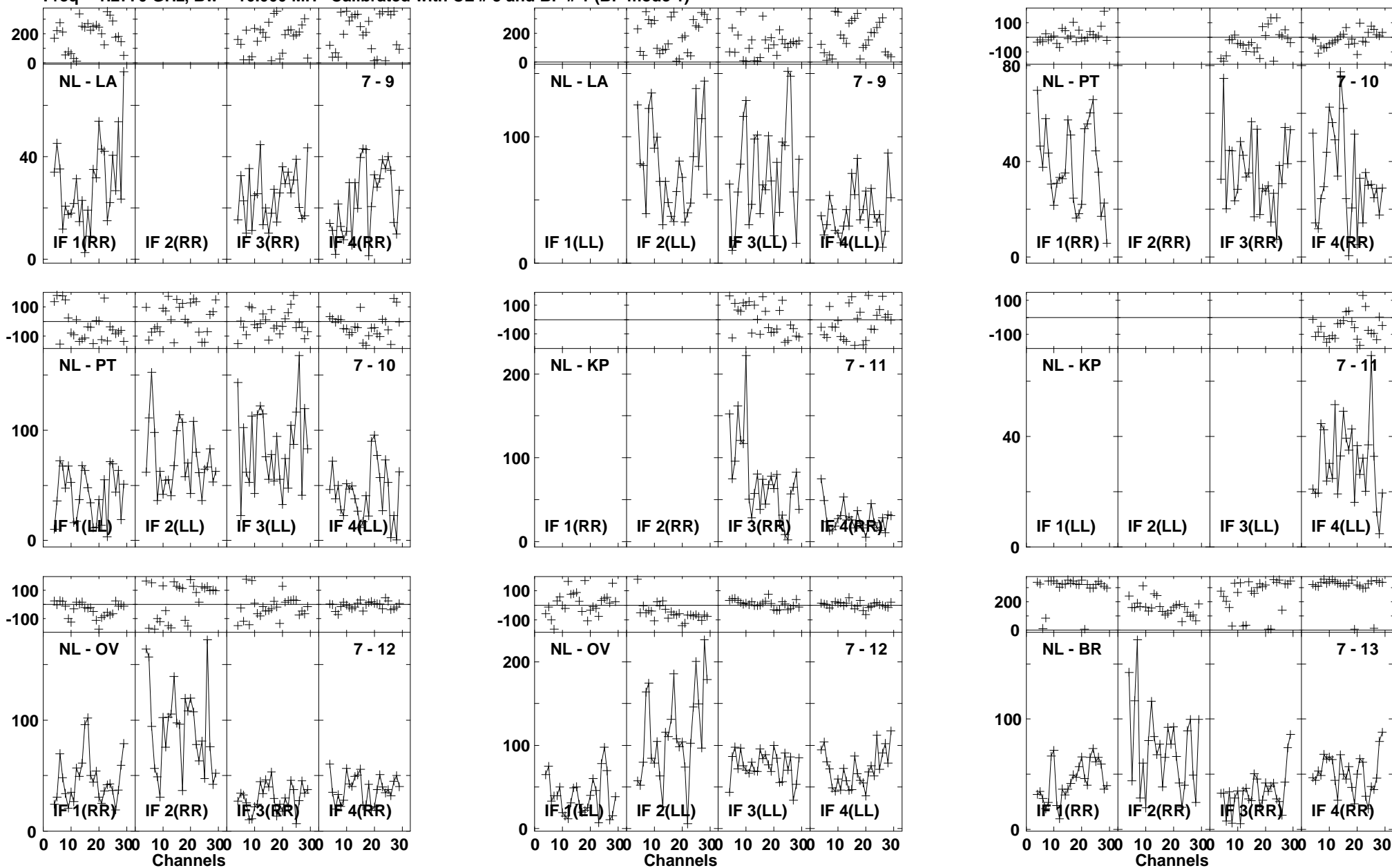

Lower frame: Milli Ampl Jy Top frame: Phas deg
Vector averaged cross-power spectrum Baseline: NL (07) - LA (09)
Timerange: 00/19:50:59 to 00/19:53:53

Plot file version 554 created 03-MAR-2016 01:13:30

4C52 GN002C 1.UVDATA.1

Freq = 1.2770 GHz, Bw = 16.000 MH Calibrated with CL # 3 and BP # 1 (BP mode 1)

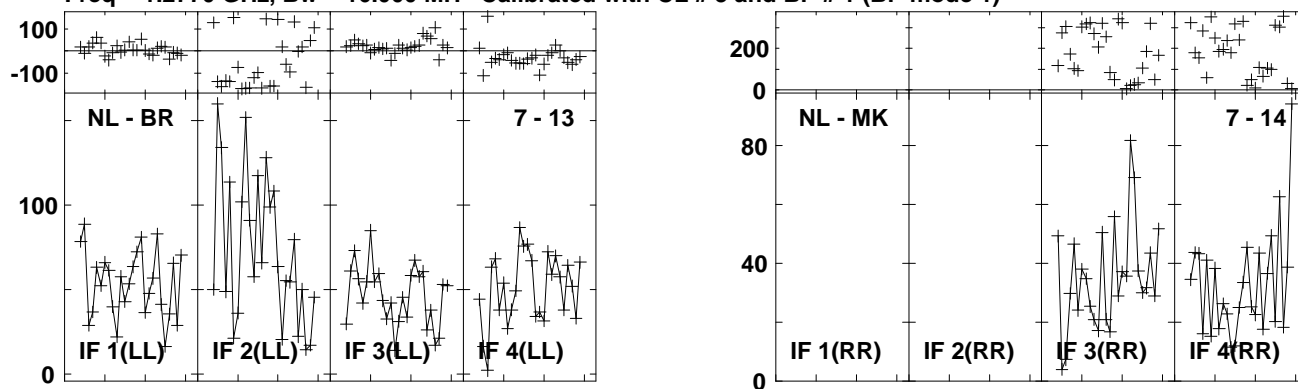

Lower frame: Milli Ampl Jy Top frame: Phas deg
Vector averaged cross-power spectrum Baseline: NL (07) - BR (13)
Timerange: 00/19:50:59 to 00/19:53:53

Plot file version 555 created 03-MAR-2016 01:13:30

J1545+5400 GN002C 1.UVDATA.1

Freq = 1.2770 GHz, Bw = 16.000 MH Calibrated with CL # 3 and BP # 1 (BP mode 1)

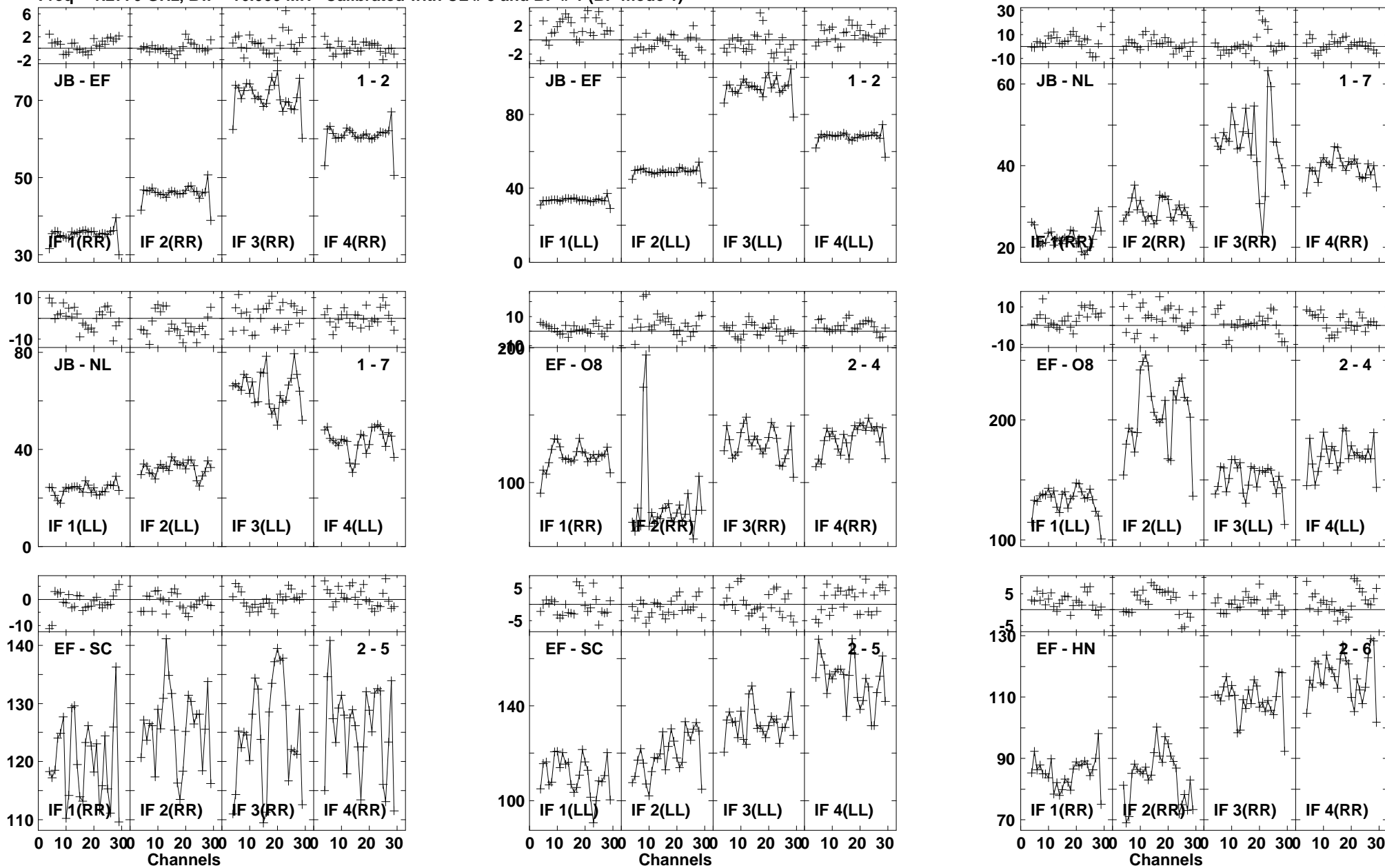

Lower frame: Milli Ampl Jy Top frame: Phas deg
Vector averaged cross-power spectrum Baseline: JB (01) - EF (02)
Timerange: 00/19:54:46 to 00/19:56:44

Plot file version 556 created 03-MAR-2016 01:13:31

J1545+5400 GN002C 1.UVDATA.1

Freq = 1.2770 GHz, Bw = 16.000 MH Calibrated with CL # 3 and BP # 1 (BP mode 1)

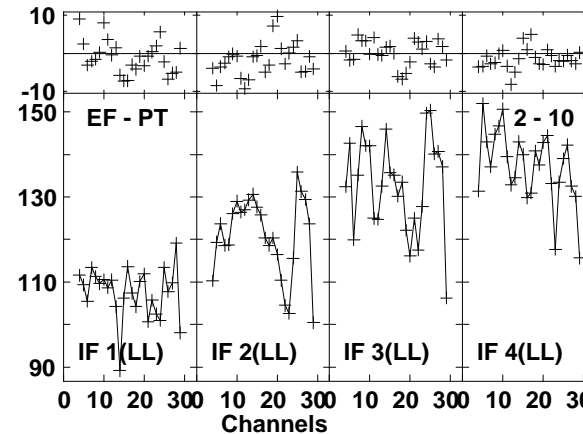
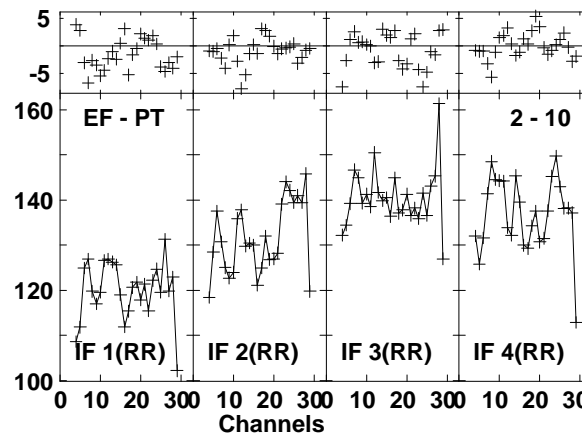
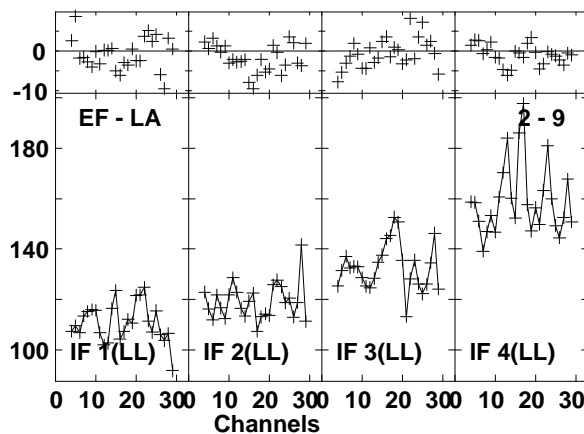
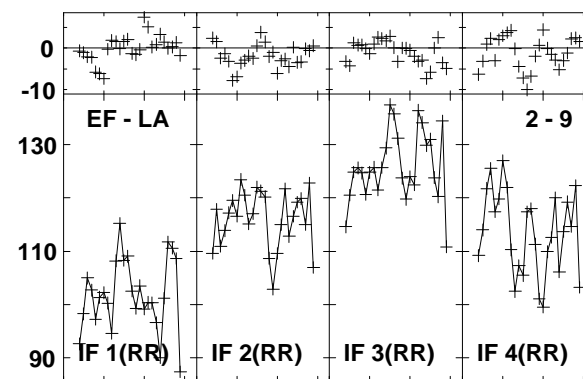
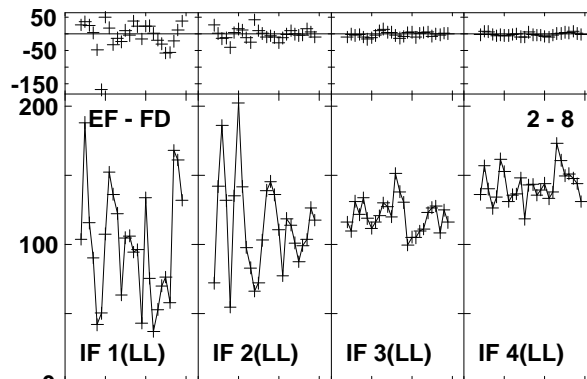
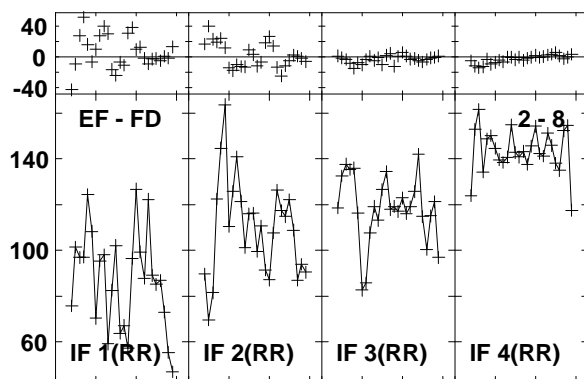
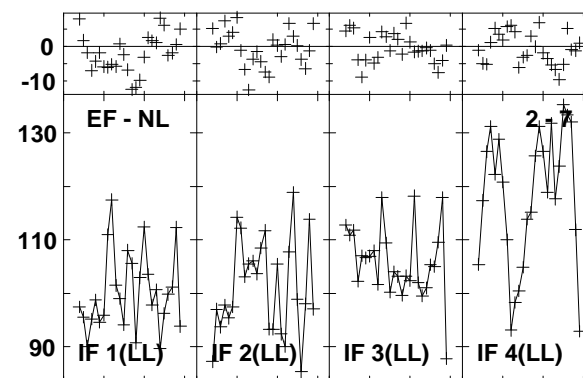
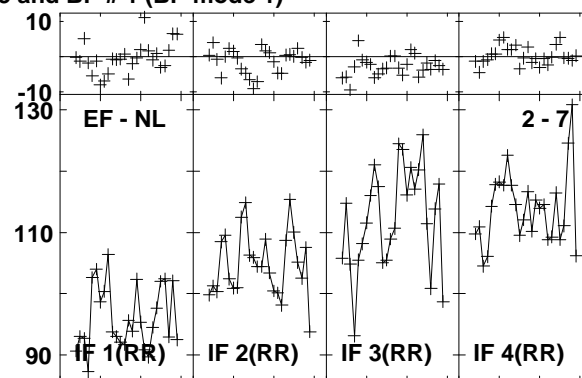
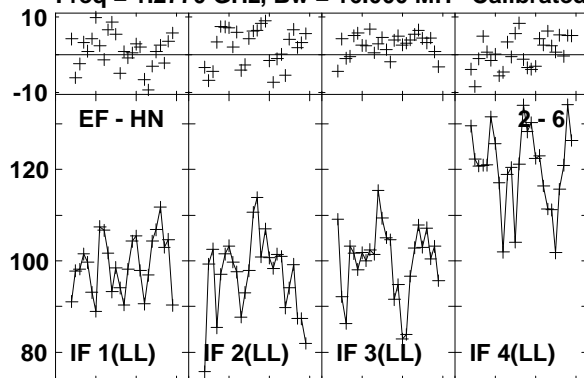

Lower frame: Milli Ampl Jy Top frame: Phas deg
Vector averaged cross-power spectrum Baseline: EF (02) - HN (06)
Timerange: 00/19:54:46 to 00/19:56:44

Plot file version 557 created 03-MAR-2016 01:13:31

J1545+5400 GN002C 1.UVDATA.1

Freq = 1.2770 GHz, Bw = 16.000 MH Calibrated with CL # 3 and BP # 1 (BP mode 1)

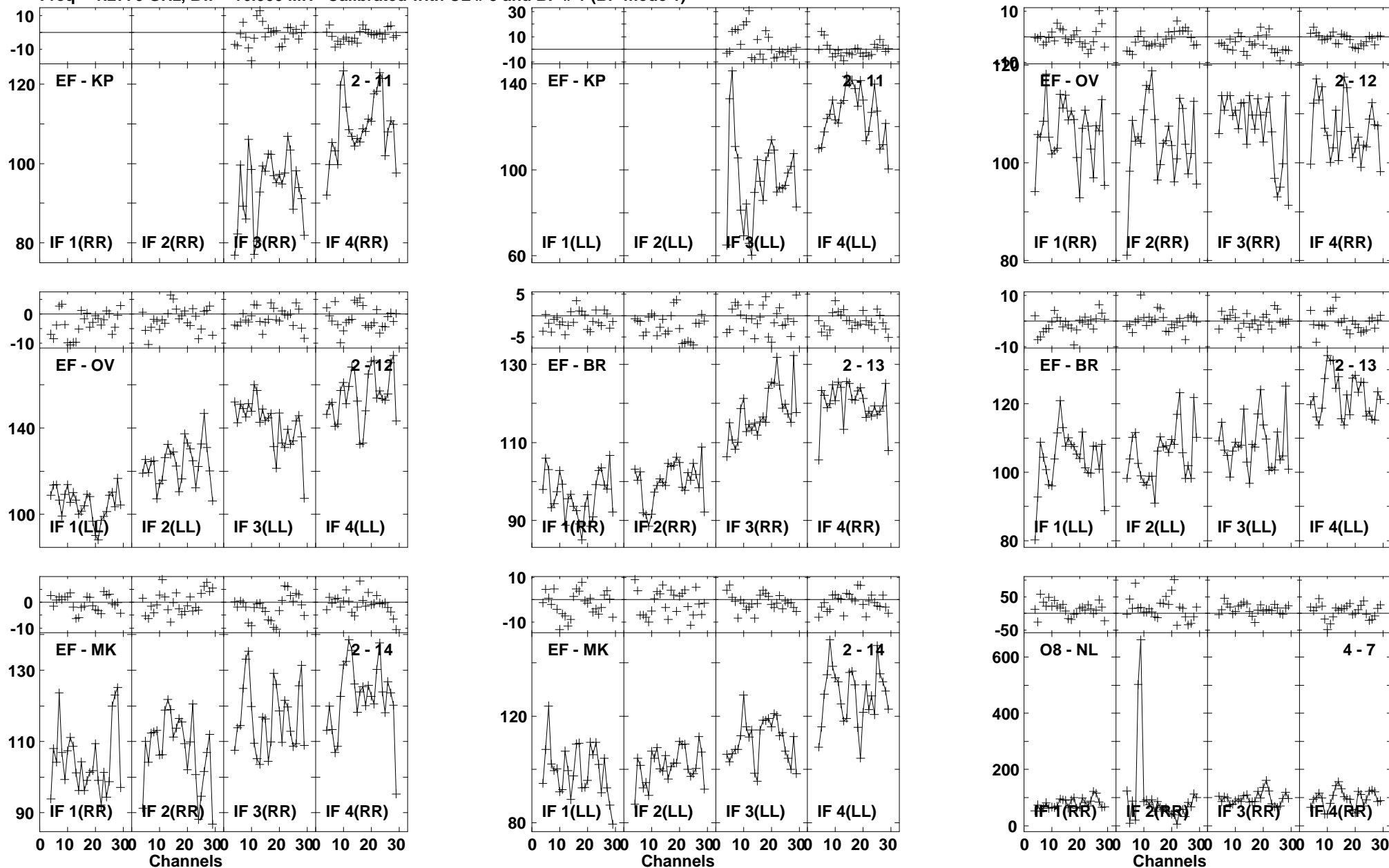

Lower frame: Milli Ampl Jy Top frame: Phas deg
Vector averaged cross-power spectrum Baseline: EF (02) - KP (11)
Timerange: 00/19:54:46 to 00/19:56:44

Plot file version 558 created 03-MAR-2016 01:13:31

J1545+5400 GN002C 1.UVDATA.1

Freq = 1.2770 GHz, Bw = 16.000 MH Calibrated with CL # 3 and BP # 1 (BP mode 1)

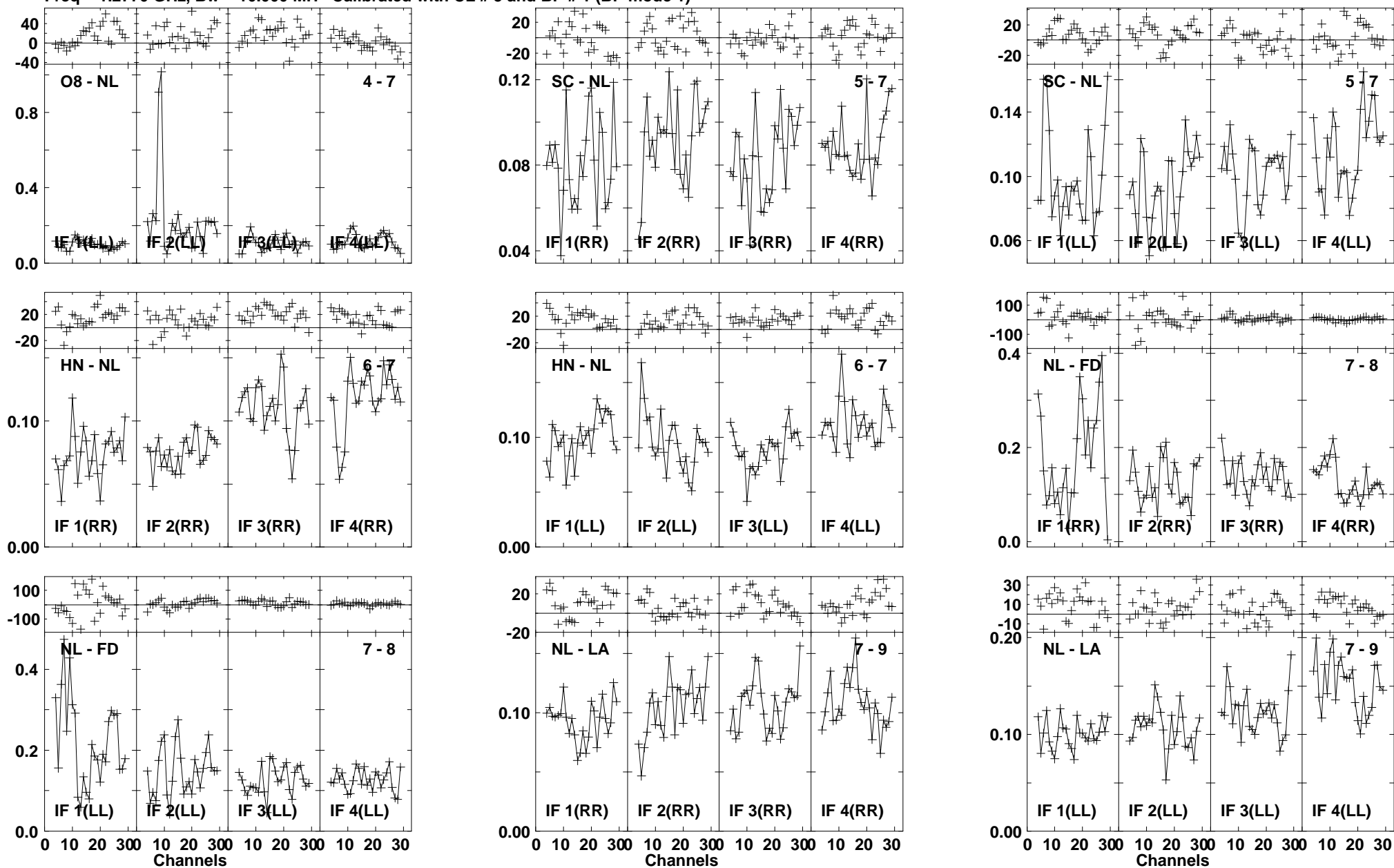

Lower frame: Ampl Jy Top frame: Phas deg
Vector averaged cross-power spectrum Baseline: O8 (04) - NL (07)
Timerange: 00/19:54:46 to 00/19:56:44

Plot file version 559 created 03-MAR-2016 01:13:31

J1545+5400 GN002C 1.UVDATA.1

Freq = 1.2770 GHz, Bw = 16.000 MH Calibrated with CL # 3 and BP # 1 (BP mode 1)

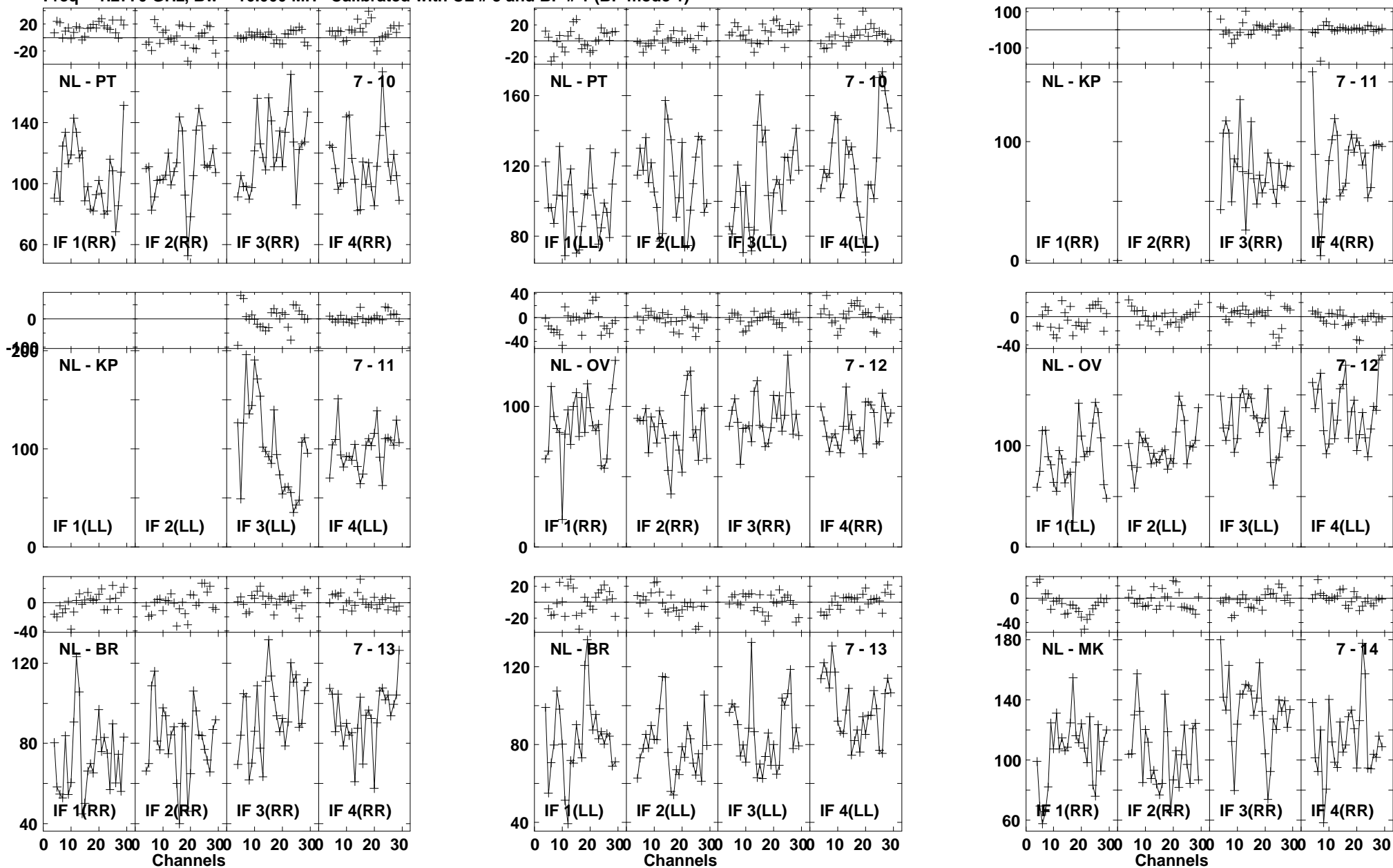

Lower frame: Milli Ampl Jy Top frame: Phas deg
Vector averaged cross-power spectrum Baseline: NL (07) - PT (10)
Timerange: 00/19:54:46 to 00/19:56:44

Plot file version 560 created 03-MAR-2016 01:13:31
J1545+5400 GN002C 1.UVDATA.1
Freq = 1.2770 GHz, Bw = 16.000 MH Calibrated with CL # 3 and BP # 1 (BP mode 1)

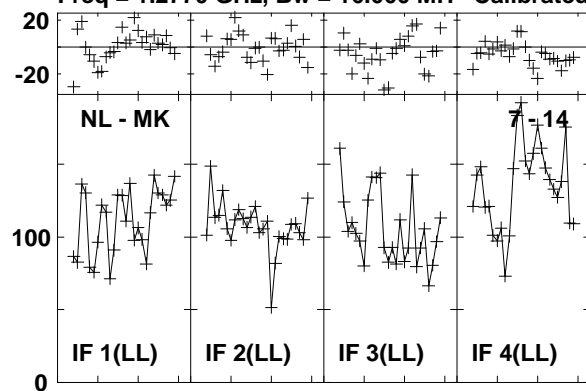

Lower frame: Milli Ampl Jy Top frame: Phas deg
Vector averaged cross-power spectrum Baseline: NL (07) - MK (14)
Timerange: 00/19:54:46 to 00/19:56:44

Plot file version 561 created 03-MAR-2016 01:13:32

4C52 GN002C 1.UVDATA.1

Freq = 1.2770 GHz, Bw = 16.000 MH Calibrated with CL # 3 and BP # 1 (BP mode 1)

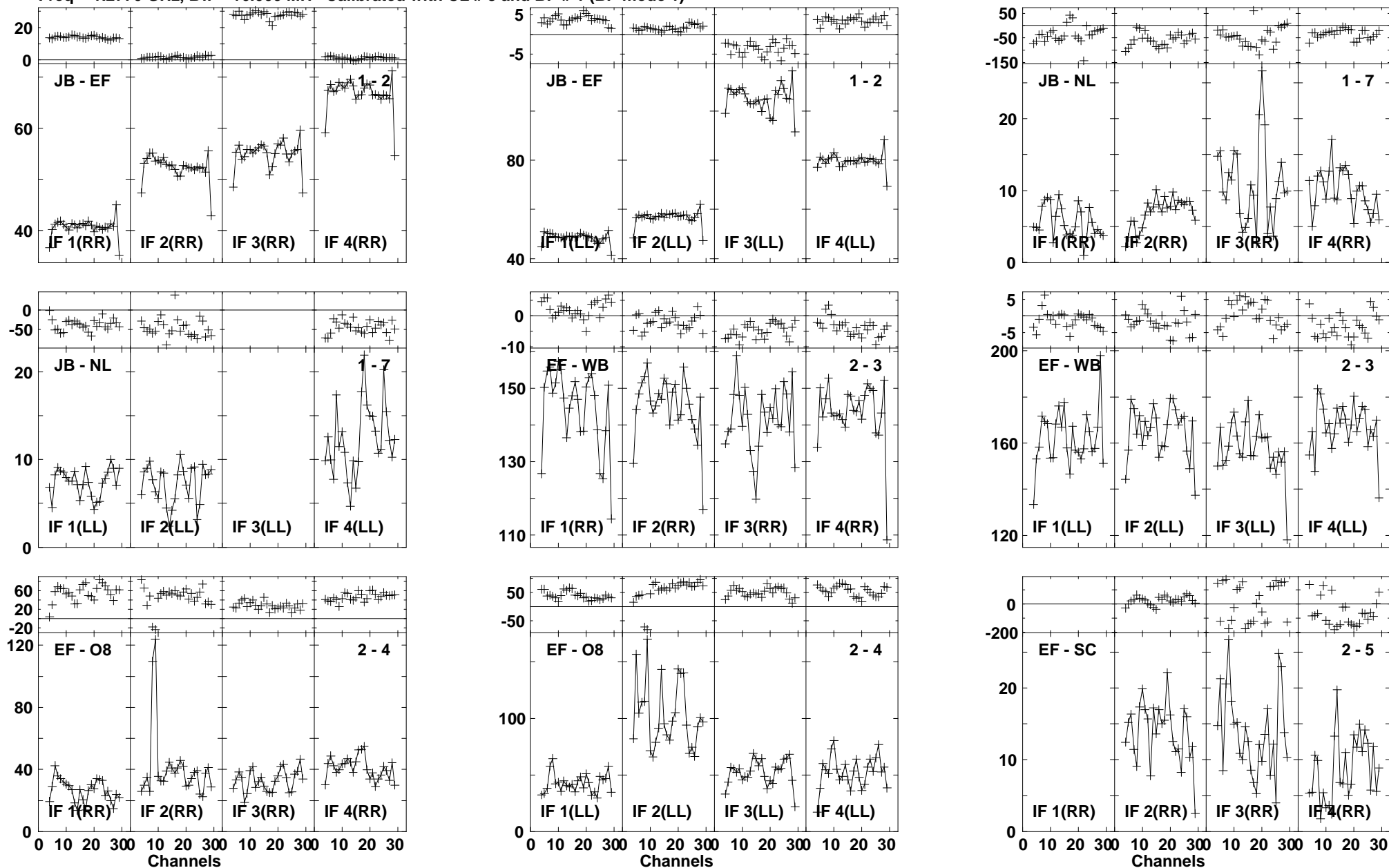

Lower frame: Milli Ampl Jy Top frame: Phas deg
Vector averaged cross-power spectrum Baseline: JB (01) - EF (02)
Timerange: 00/19:56:49 to 00/19:59:43

Plot file version 562 created 03-MAR-2016 01:13:32

4C52 GN002C 1.UVDATA.1

Freq = 1.2770 GHz, Bw = 16.000 MH Calibrated with CL # 3 and BP # 1 (BP mode 1)

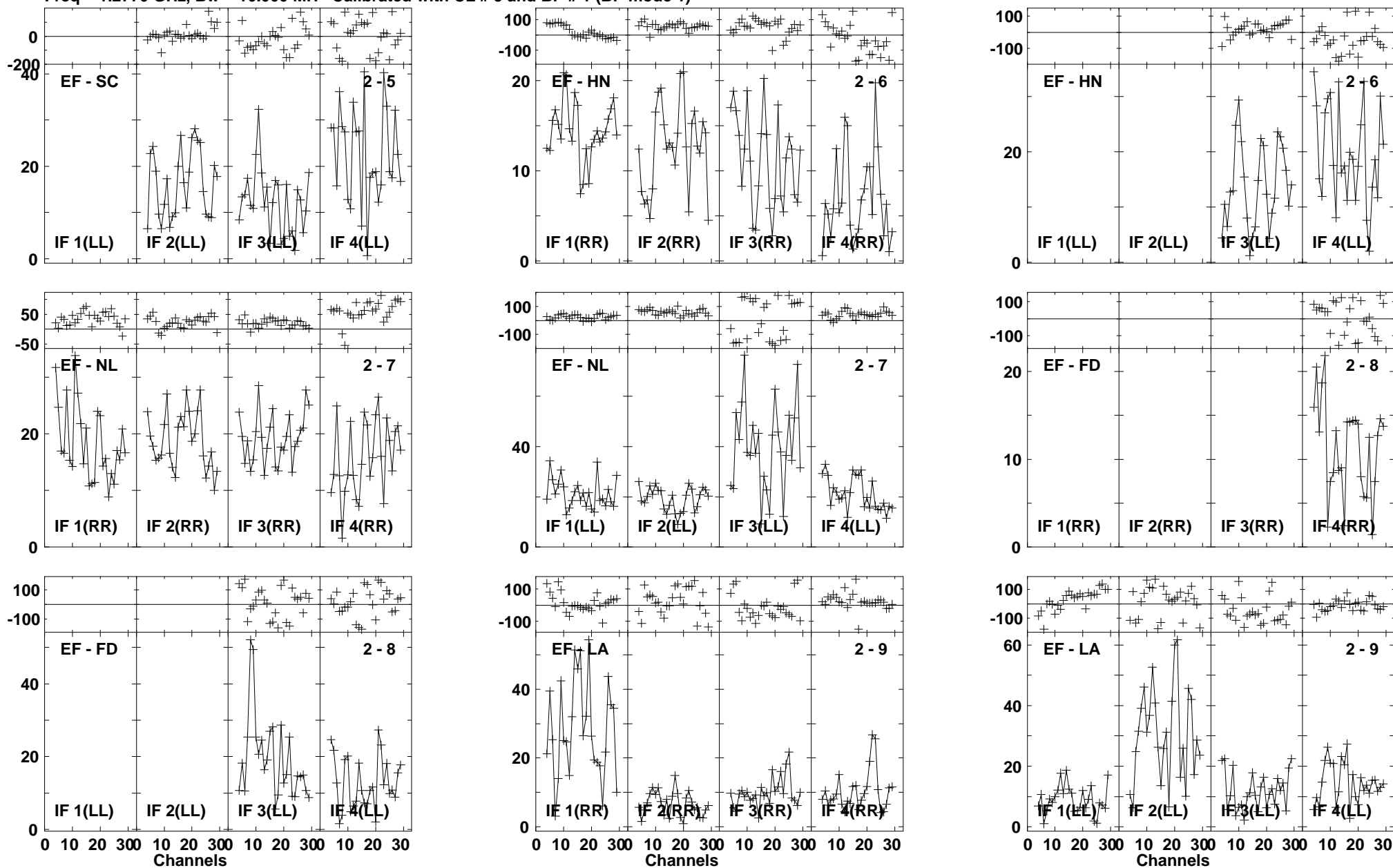

Lower frame: Milli Ampl Jy Top frame: Phas deg
Vector averaged cross-power spectrum Baseline: EF (02) - SC (05)
Timerange: 00/19:56:49 to 00/19:59:43

Plot file version 563 created 03-MAR-2016 01:13:32

4C52 GN002C 1.UVDATA.1

Freq = 1.2770 GHz, Bw = 16.000 MH Calibrated with CL # 3 and BP # 1 (BP mode 1)

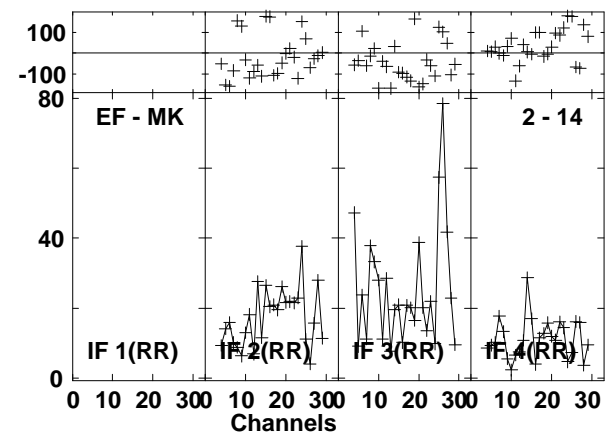
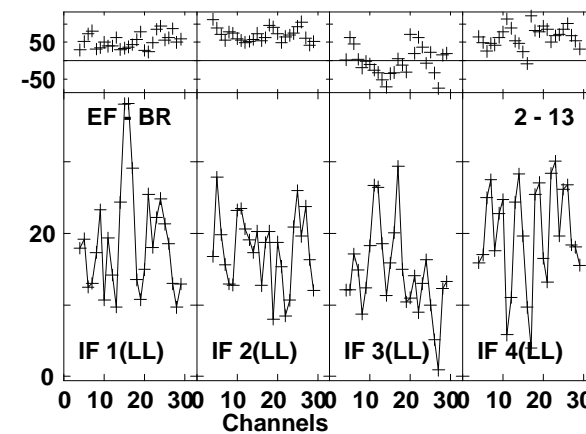
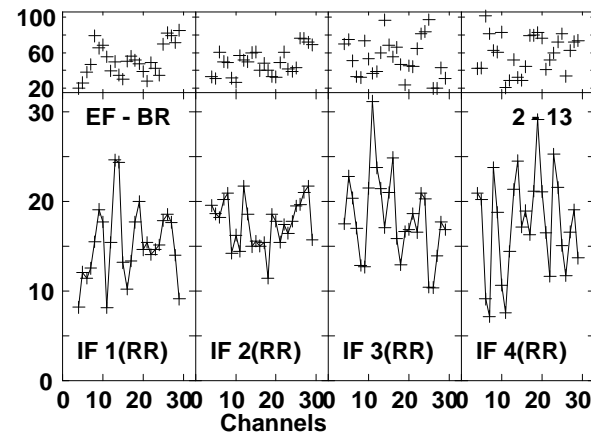
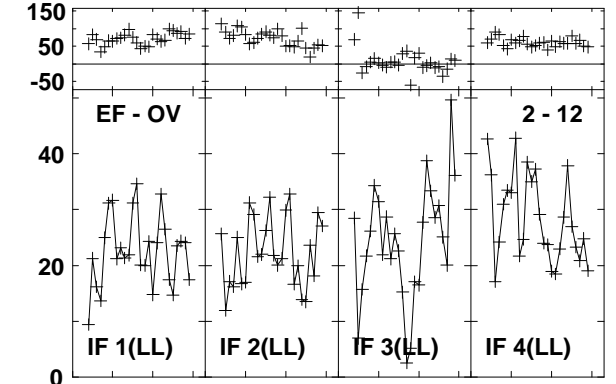
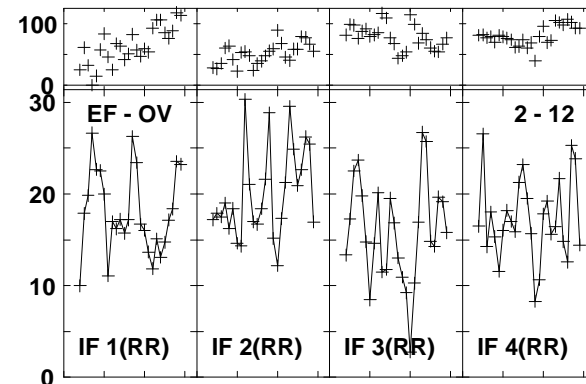
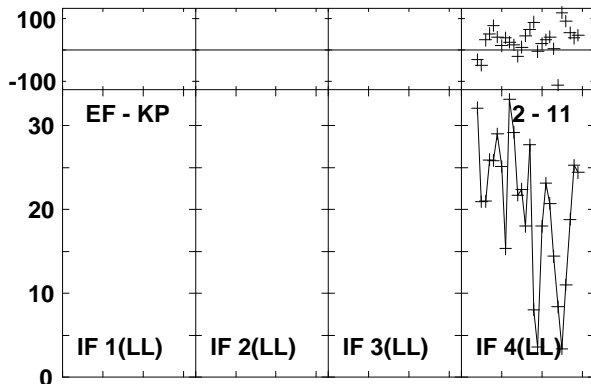
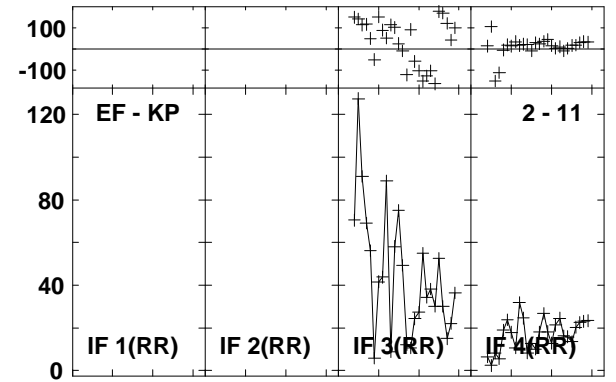
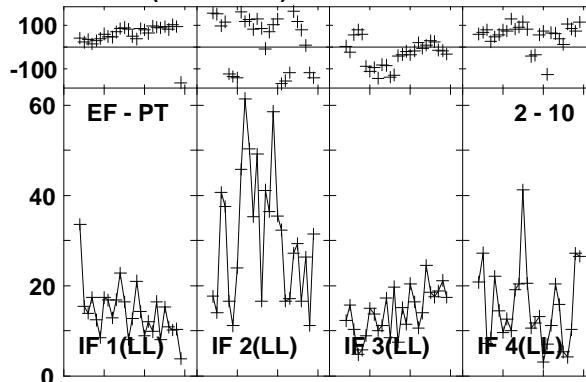
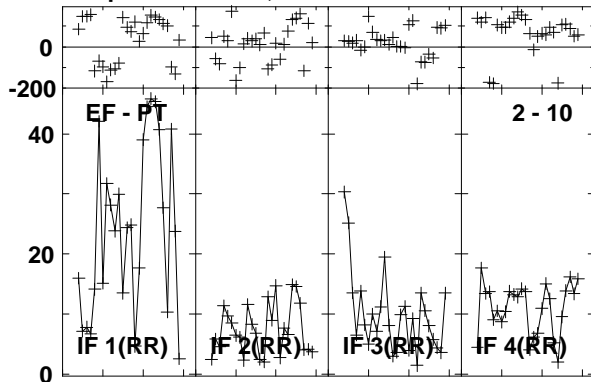

Lower frame: Milli Ampl Jy Top frame: Phas deg

Vector averaged cross-power spectrum Baseline: EF (02) - PT (10)

Timerange: 00/19:56:49 to 00/19:59:43

Plot file version 564 created 03-MAR-2016 01:13:32

4C52 GN002C 1.UVDATA.1

Freq = 1.2770 GHz, Bw = 16.000 MH Calibrated with CL # 3 and BP # 1 (BP mode 1)

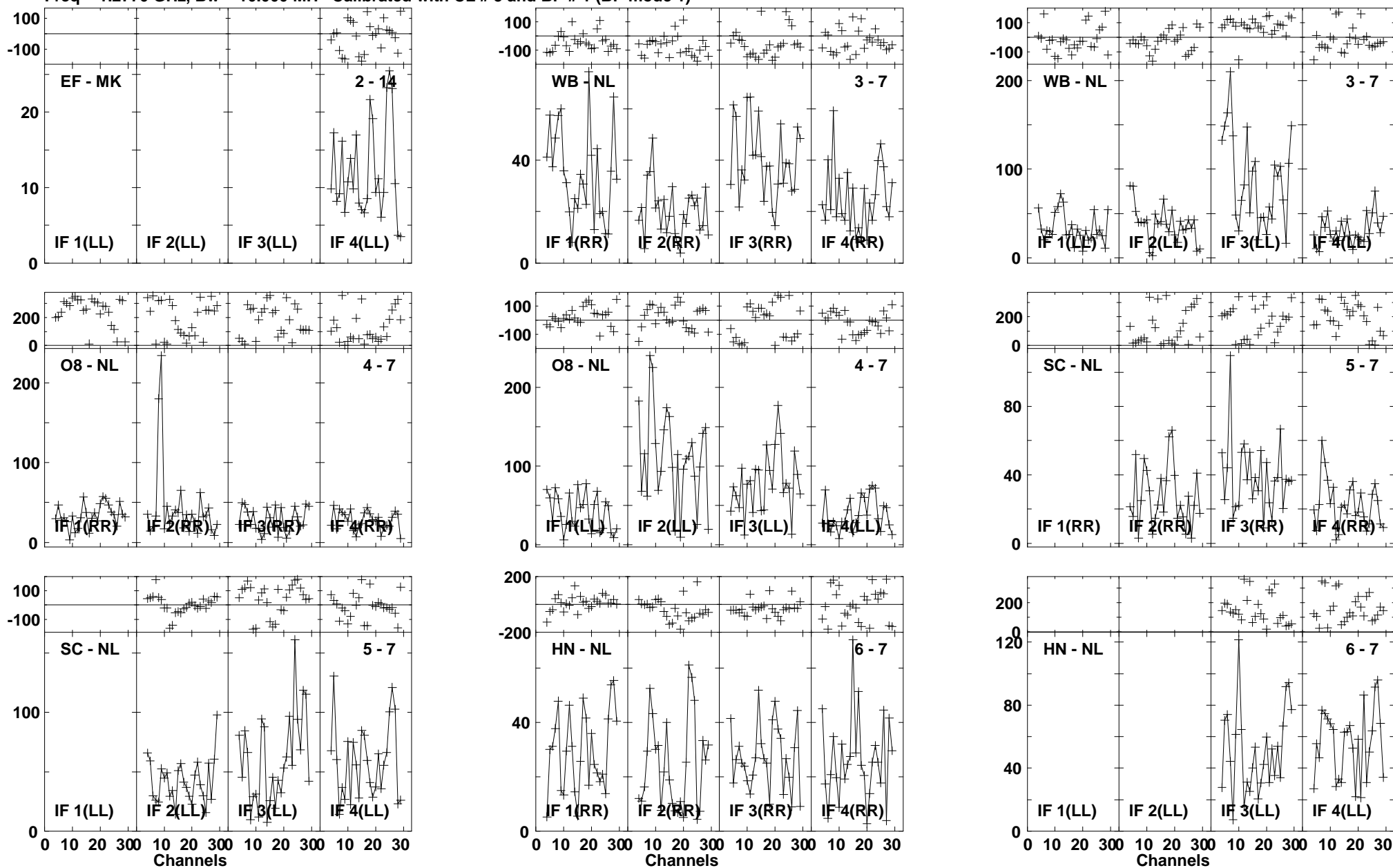

Lower frame: Milli Ampl Jy Top frame: Phas deg
Vector averaged cross-power spectrum Baseline: EF (02) - MK (14)
Timerange: 00/19:56:49 to 00/19:59:43

Plot file version 565 created 03-MAR-2016 01:13:32

4C52 GN002C 1.UVDATA.1

Freq = 1.2770 GHz, Bw = 16.000 MH Calibrated with CL # 3 and BP # 1 (BP mode 1)

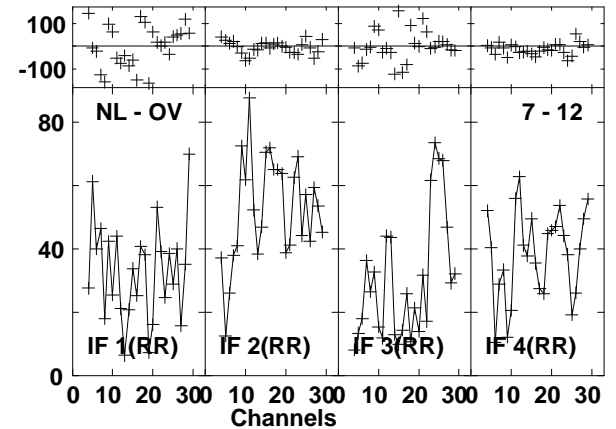
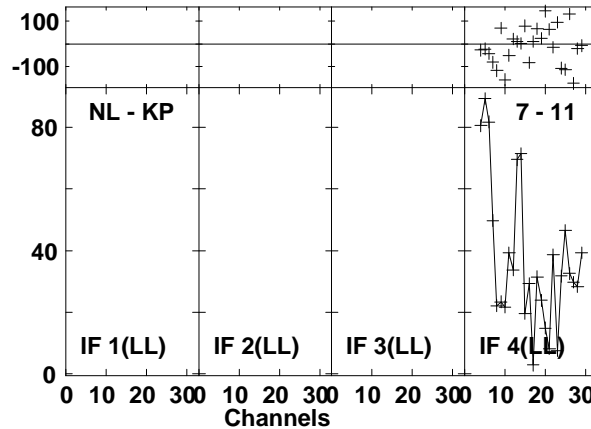
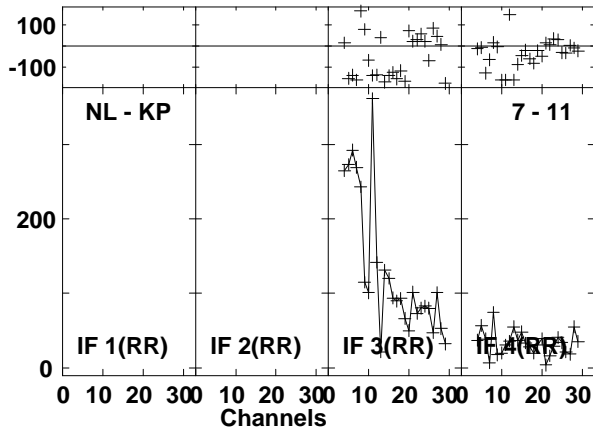
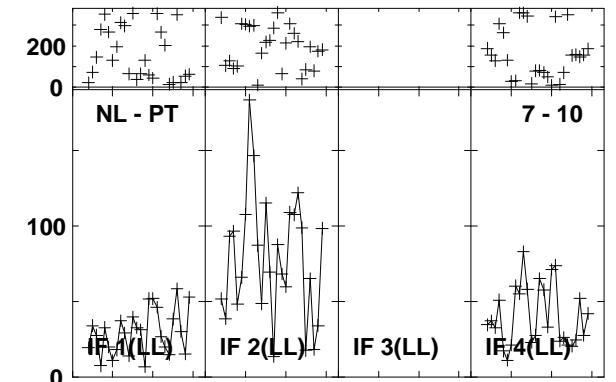
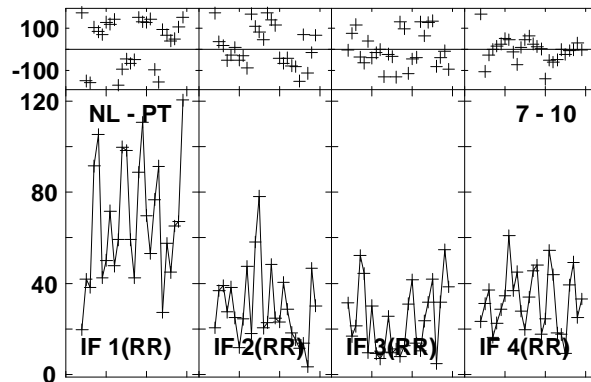
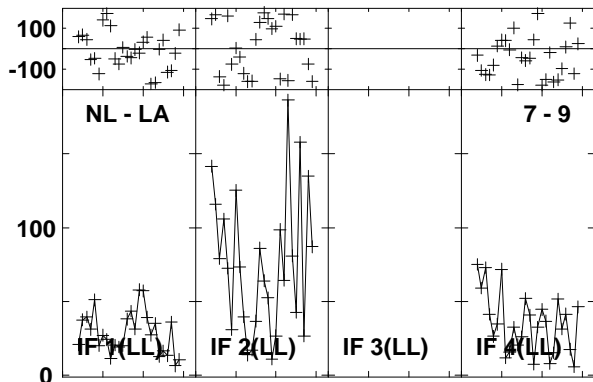
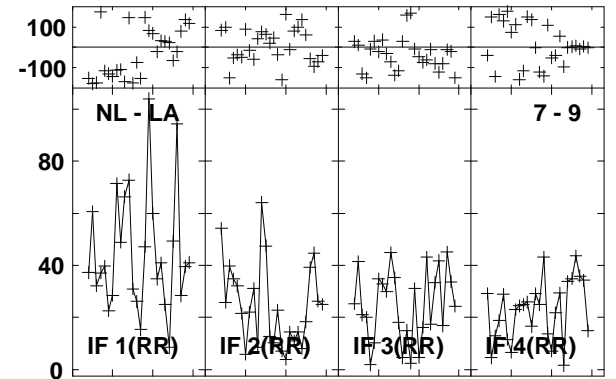
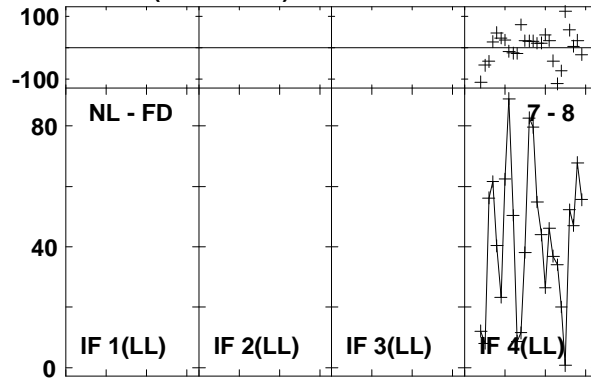
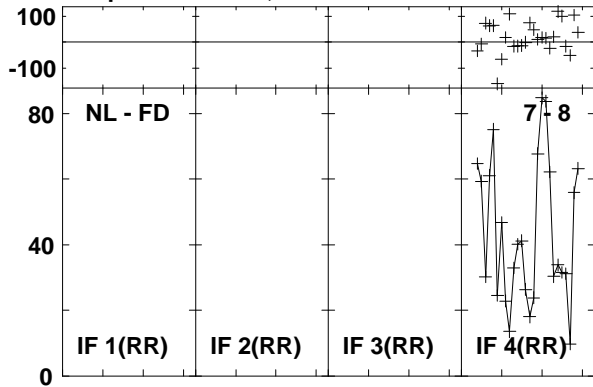

Lower frame: Milli Ampl Jy Top frame: Phas deg
Vector averaged cross-power spectrum Baseline: NL (07) - FD (08)
Timerange: 00/19:56:49 to 00/19:59:43

Plot file version 566 created 03-MAR-2016 01:13:32

4C52 GN002C 1.UVDATA.1

Freq = 1.2770 GHz, Bw = 16.000 MH Calibrated with CL # 3 and BP # 1 (BP mode 1)

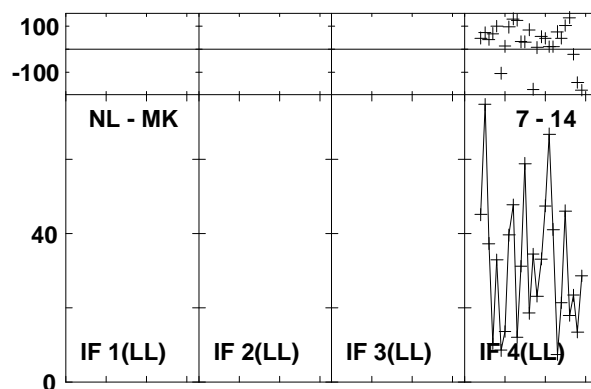
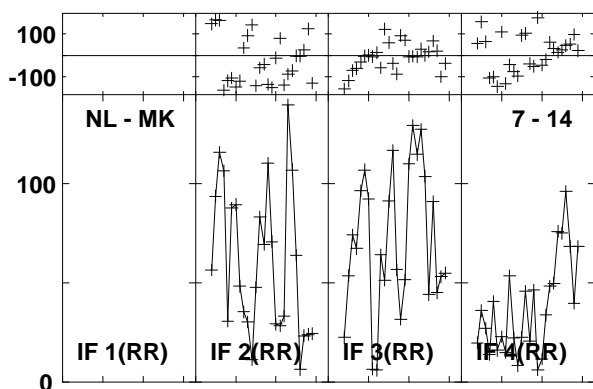
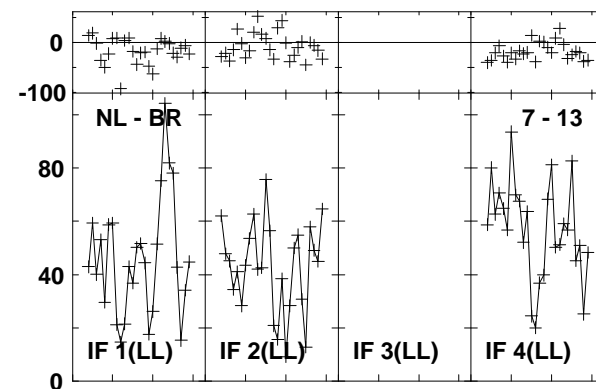
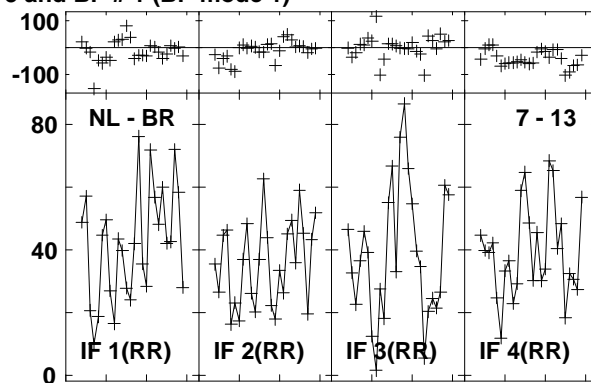
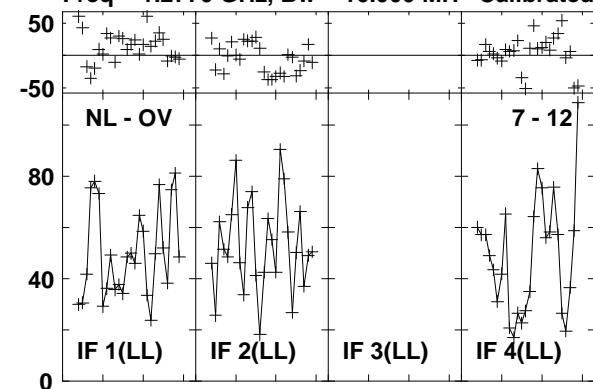

Lower frame: Milli Ampl Jy Top frame: Phas deg

Vector averaged cross-power spectrum Baseline: NL (07) - OV (12)

Timerange: 00/19:56:49 to 00/19:59:43

Plot file version 567 created 03-MAR-2016 01:13:33

J1545+5400 GN002C 1.UVDATA.1

Freq = 1.2770 GHz, Bw = 16.000 MH Calibrated with CL # 3 and BP # 1 (BP mode 1)

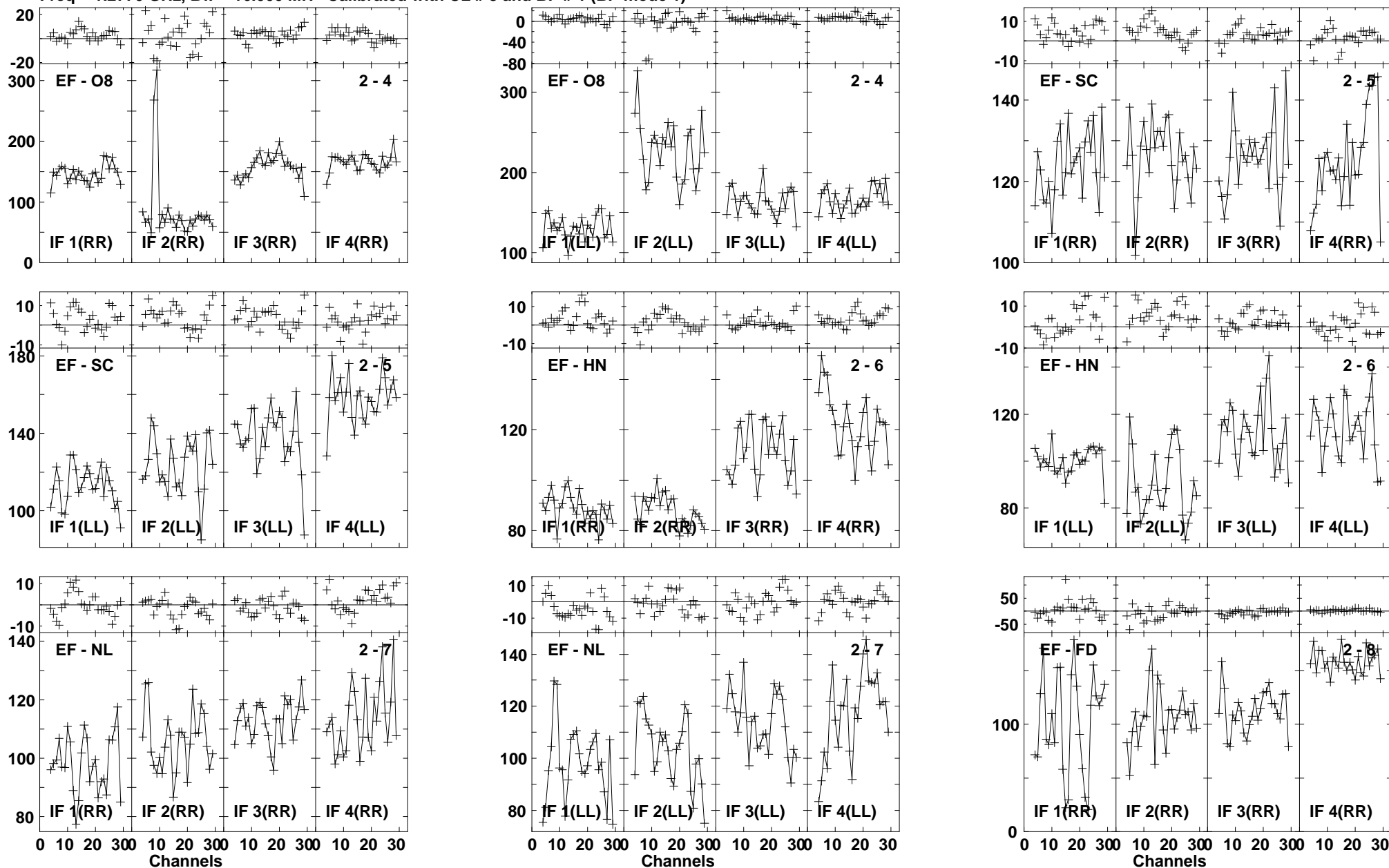

Lower frame: Milli Ampl Jy Top frame: Phas deg
Vector averaged cross-power spectrum Baseline: EF (02) - O8 (04)
Timerange: 00/20:00:36 to 00/20:01:34

Plot file version 568 created 03-MAR-2016 01:13:33

J1545+5400 GN002C 1.UVDATA.1

Freq = 1.2770 GHz, Bw = 16.000 MH Calibrated with CL # 3 and BP # 1 (BP mode 1)

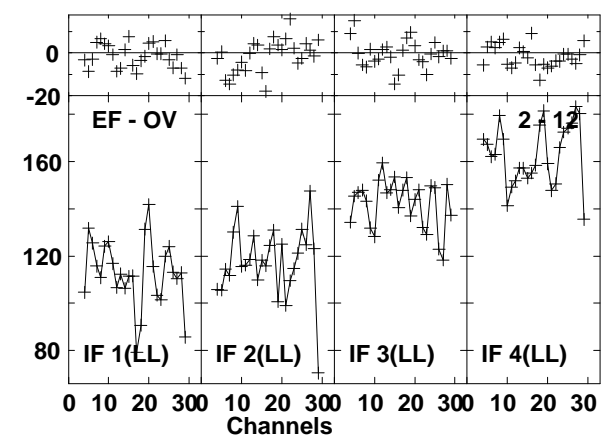
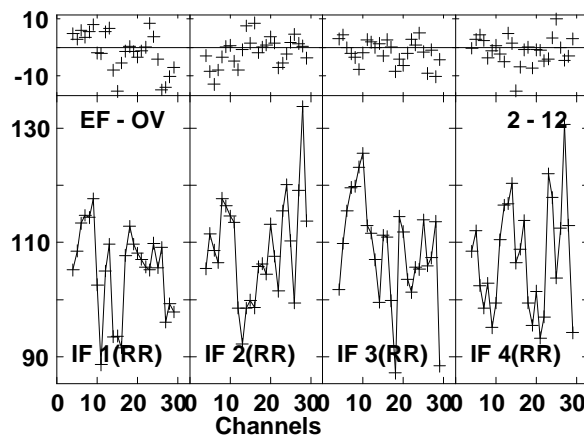
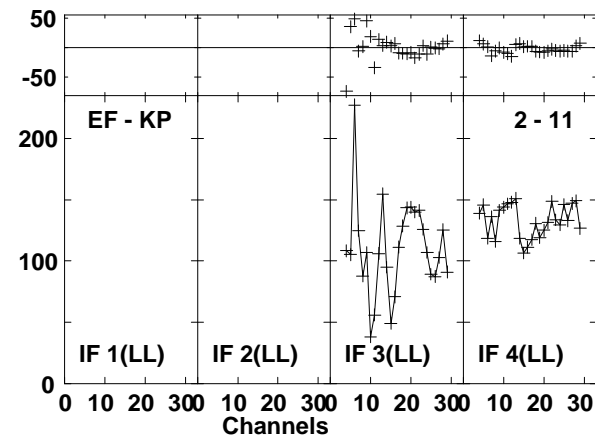
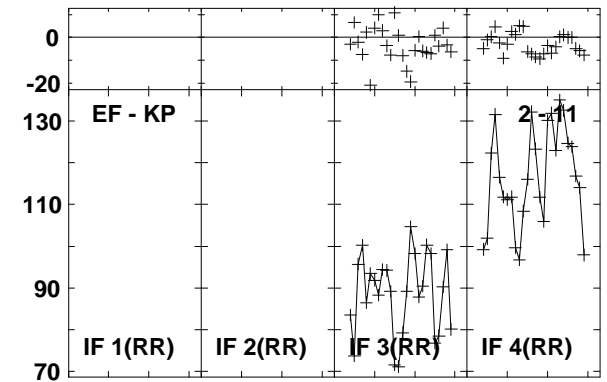
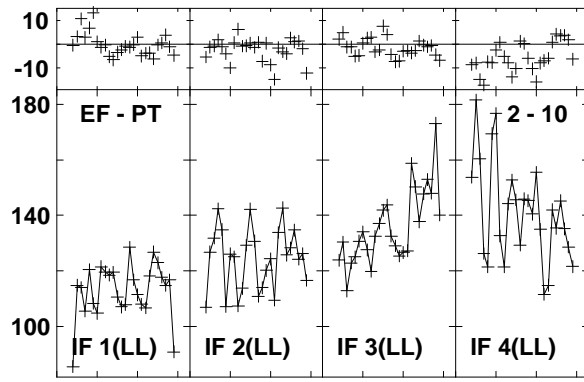
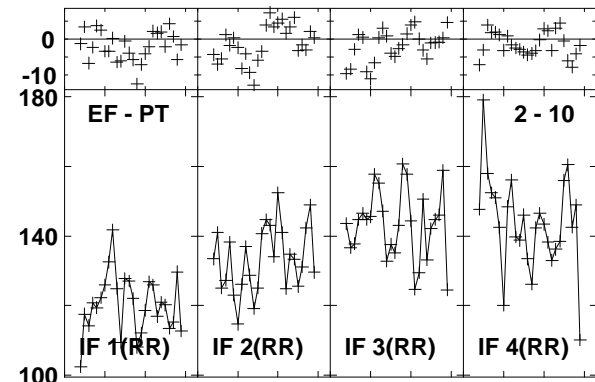
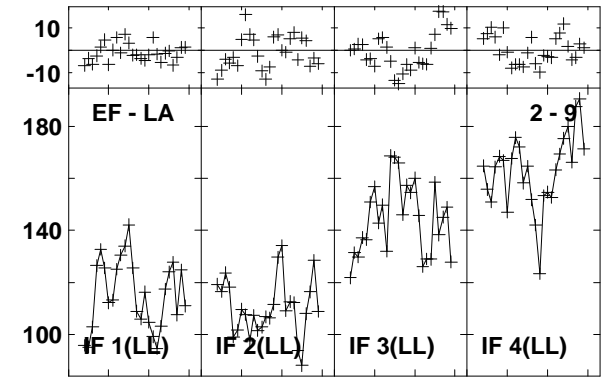
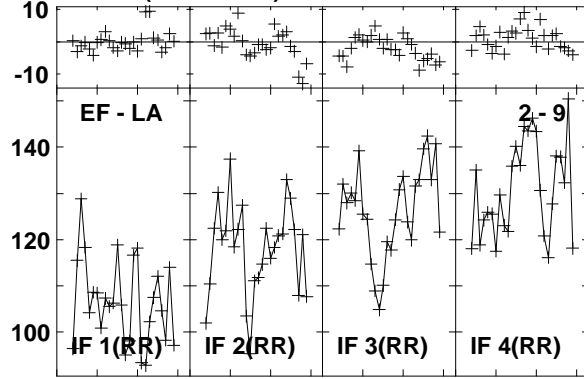
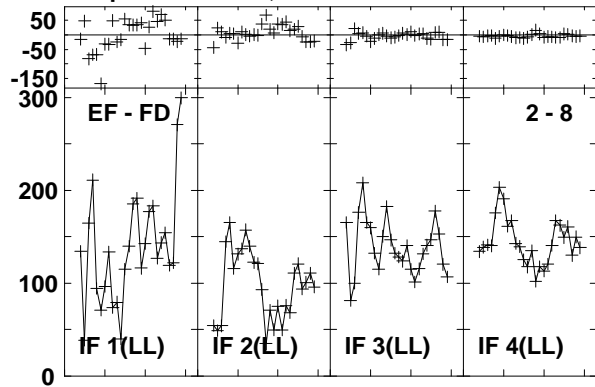

Lower frame: Milli Ampl Jy Top frame: Phas deg
Vector averaged cross-power spectrum Baseline: EF (02) - FD (08)
Timerange: 00/20:00:36 to 00/20:01:34

Plot file version 569 created 03-MAR-2016 01:13:33

J1545+5400 GN002C 1.UVDATA.1

Freq = 1.2770 GHz, Bw = 16.000 MH Calibrated with CL # 3 and BP # 1 (BP mode 1)

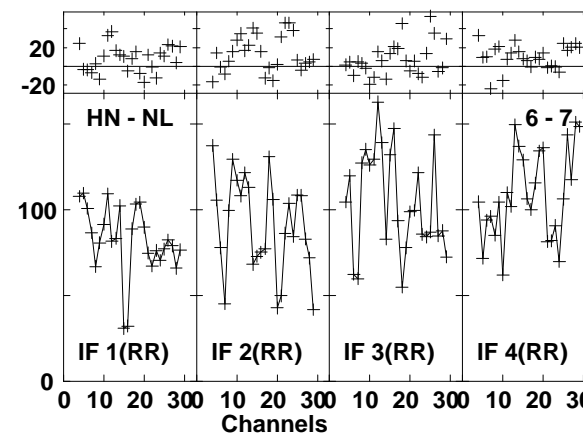
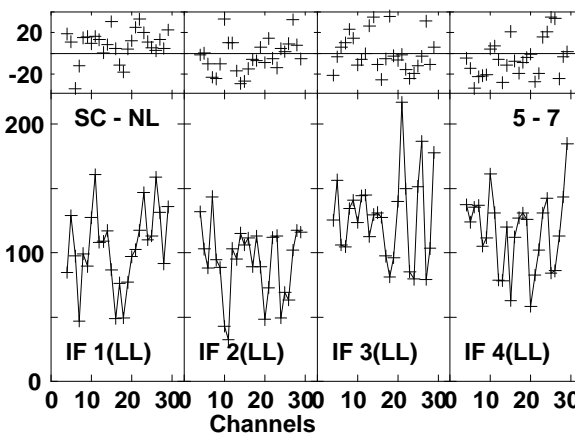
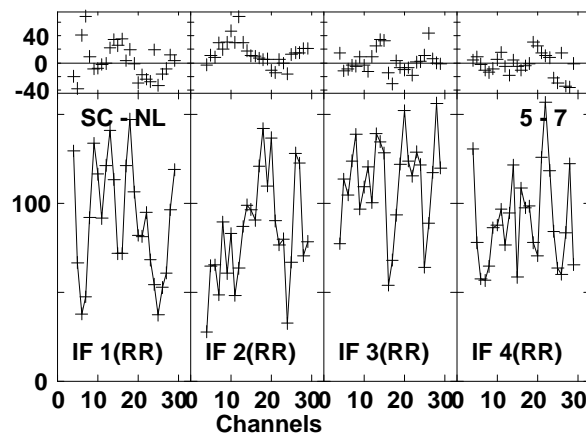
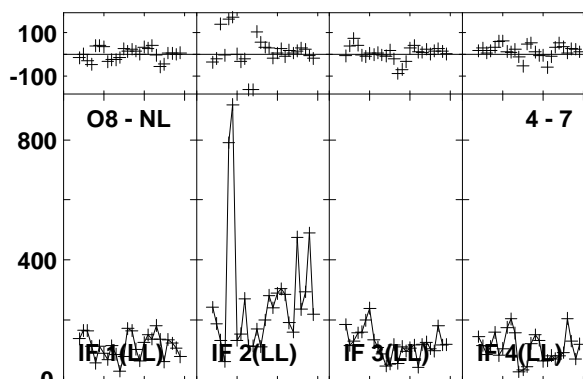
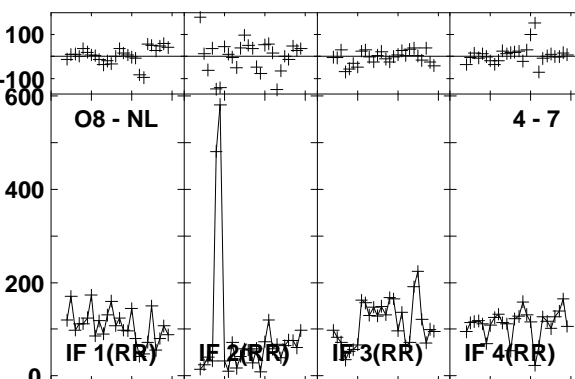
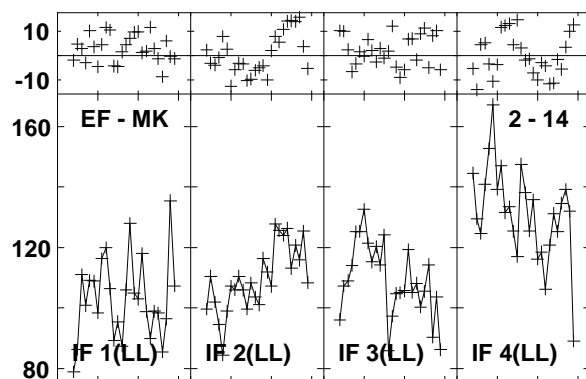
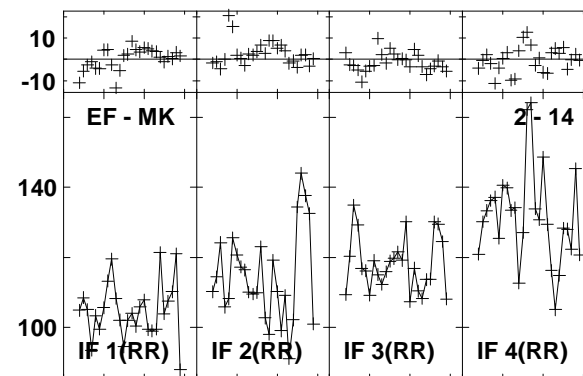
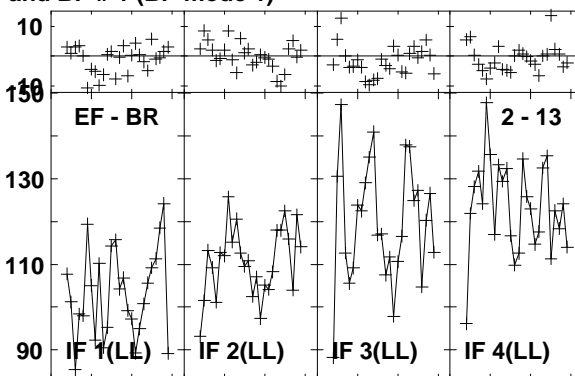
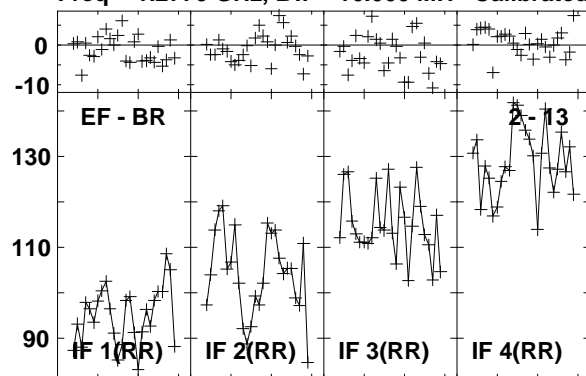

Lower frame: Milli Ampl Jy Top frame: Phas deg
Vector averaged cross-power spectrum Baseline: EF (02) - BR (13)
Timerange: 00/20/00:36 to 00/20/01:34

Plot file version 570 created 03-MAR-2016 01:13:33

J1545+5400 GN002C 1.UVDATA.1

Freq = 1.2770 GHz, Bw = 16.000 MH Calibrated with CL # 3 and BP # 1 (BP mode 1)

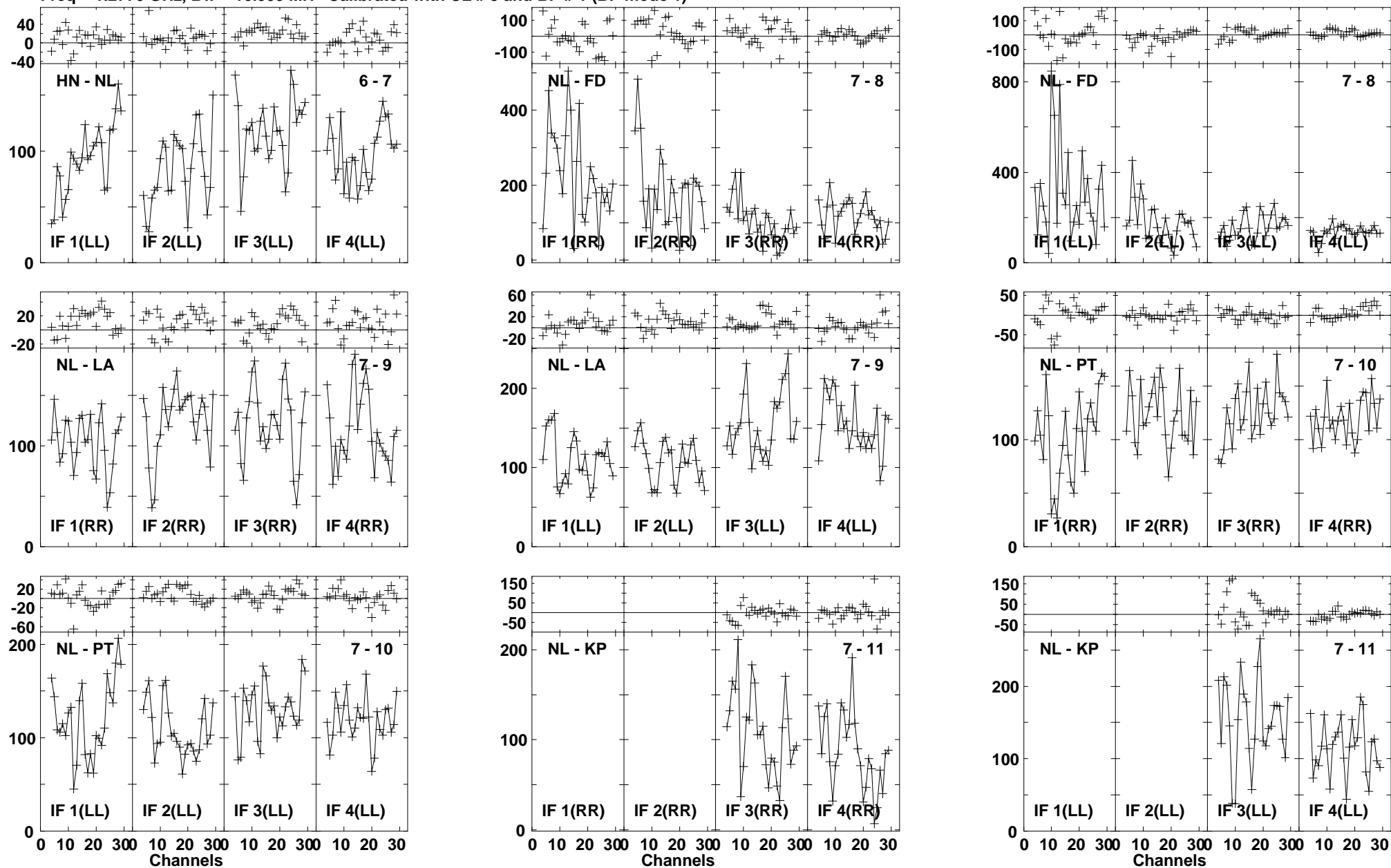

Lower frame: Milli Ampl Jy Top frame: Phas deg
Vector averaged cross-power spectrum Baseline: HN (06) - NL (07)
Timerange: 00/20:00:36 to 00/20:01:34

Plot file version 571 created 03-MAR-2016 01:13:33
 J1545+5400 GN002C 1.UVDATA.1
 Freq = 1.2770 GHz, Bw = 16.000 MH Calibrated with CL # 3 and BP # 1 (BP mode 1)

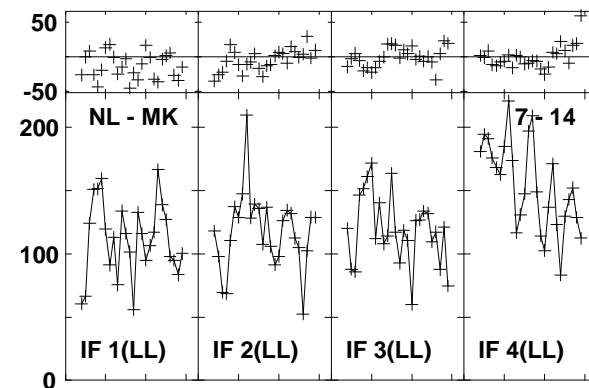
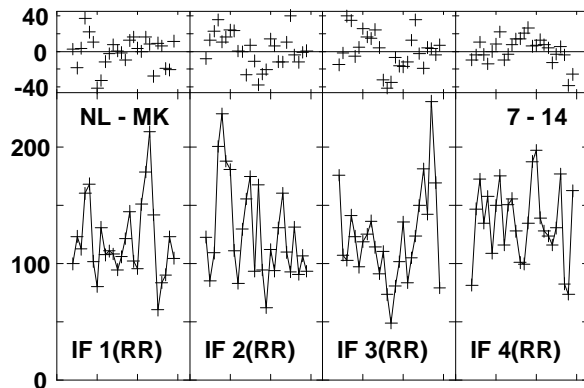
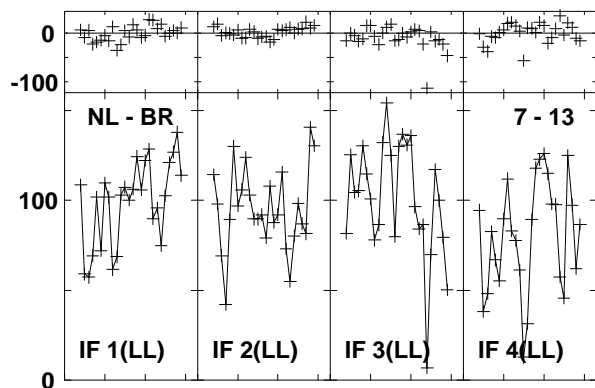
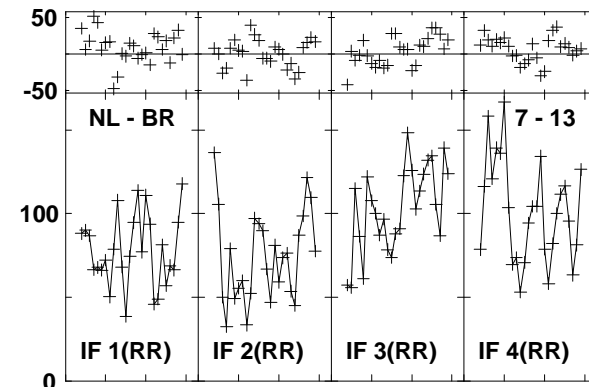
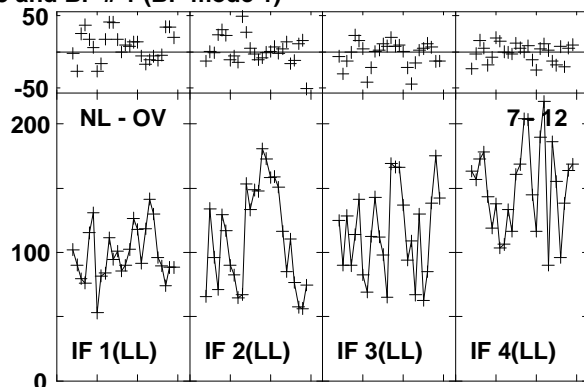
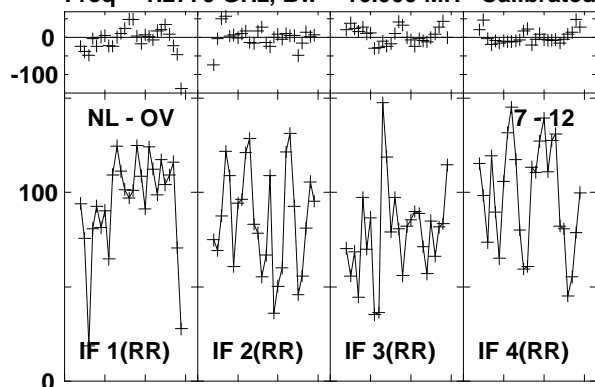

Lower frame: Milli Ampl Jy Top frame: Phas deg
 Vector averaged cross-power spectrum Baseline: NL (07) - OV (12)
 Timerange: 00/20:00:36 to 00/20:01:34

Plot file version 572 created 03-MAR-2016 01:13:33

4C52 GN002C 1.UVDATA.1

Freq = 1.2770 GHz, Bw = 16.000 MH Calibrated with CL # 3 and BP # 1 (BP mode 1)

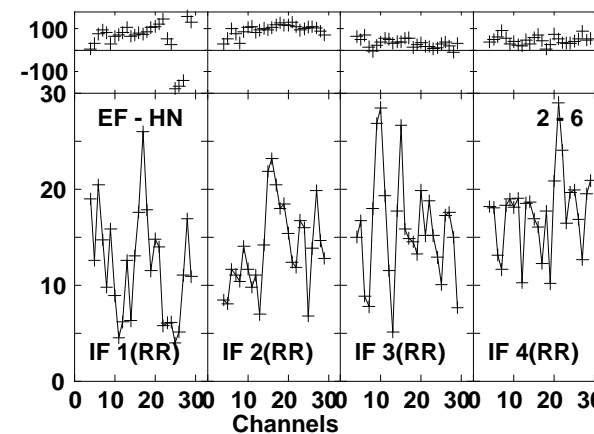
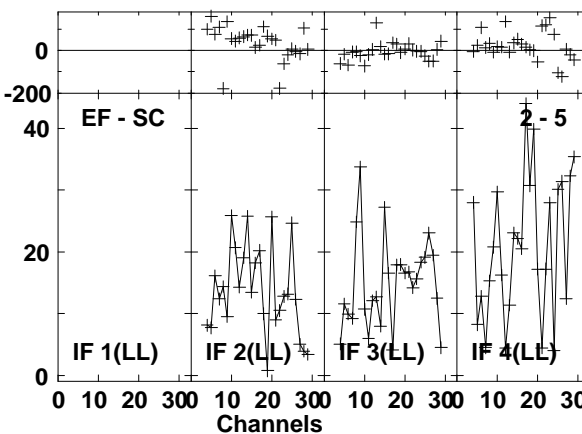
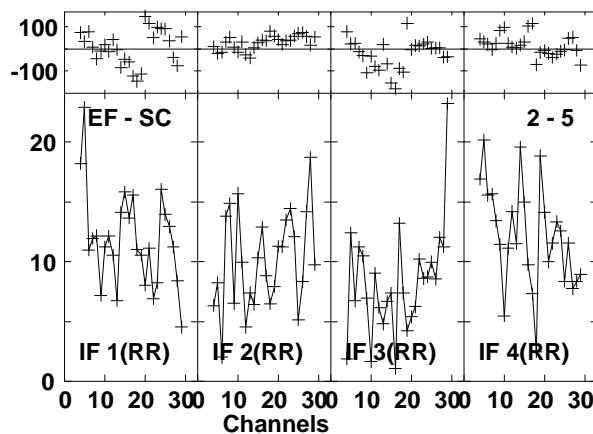
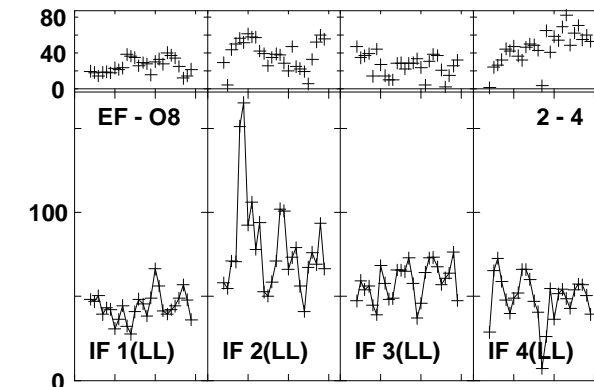
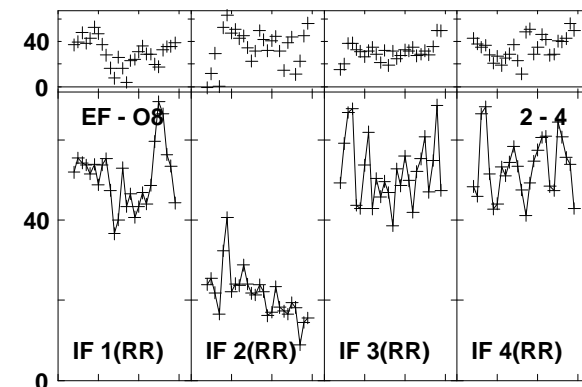
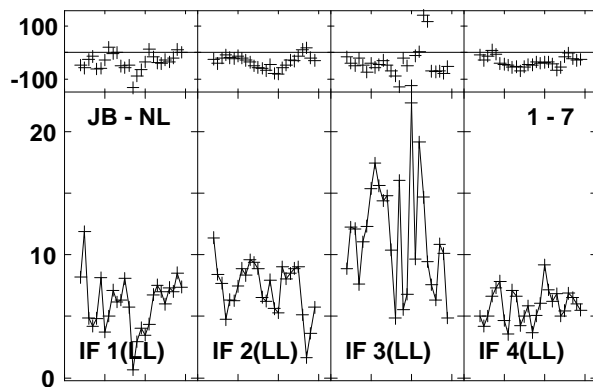
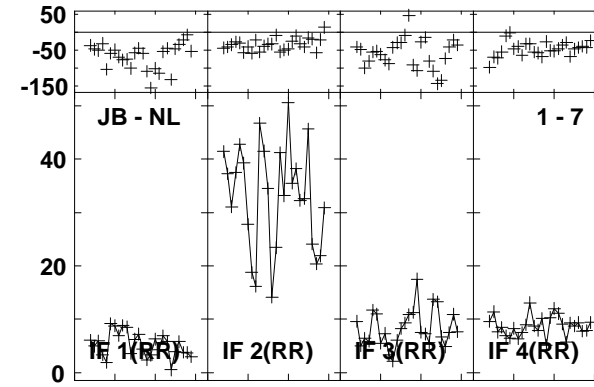
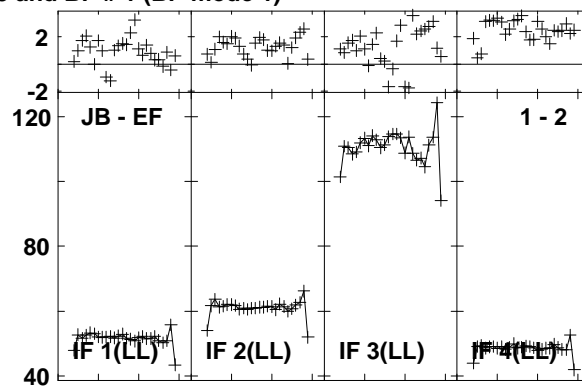
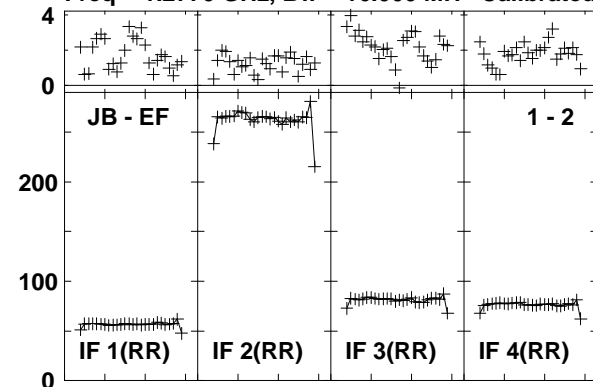

Lower frame: Milli Ampl Jy Top frame: Phas deg
Vector averaged cross-power spectrum Baseline: JB (01) - EF (02)
Timerange: 00/20:01:39 to 00/20:04:33

Plot file version 573 created 03-MAR-2016 01:13:34

4C52 GN002C 1.UVDATA.1

Freq = 1.2770 GHz, Bw = 16.000 MH Calibrated with CL # 3 and BP # 1 (BP mode 1)

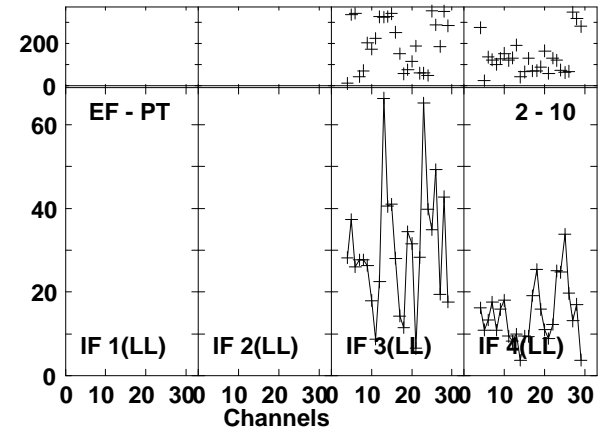
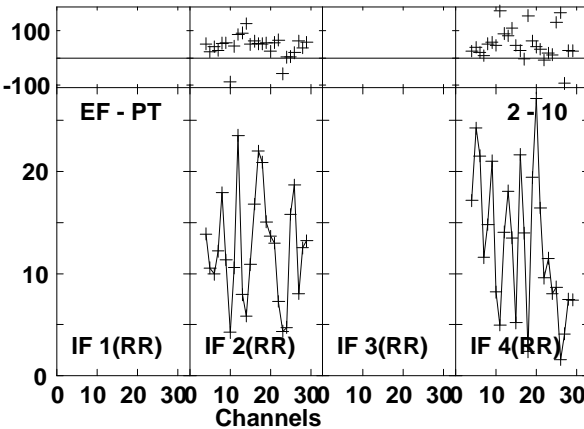
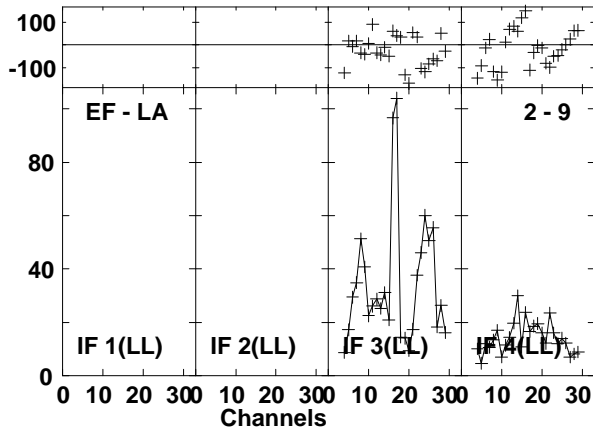
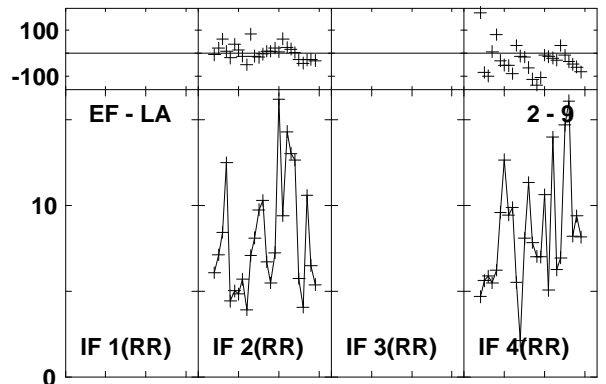
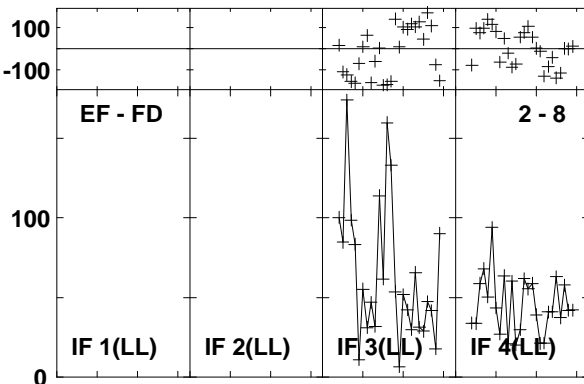
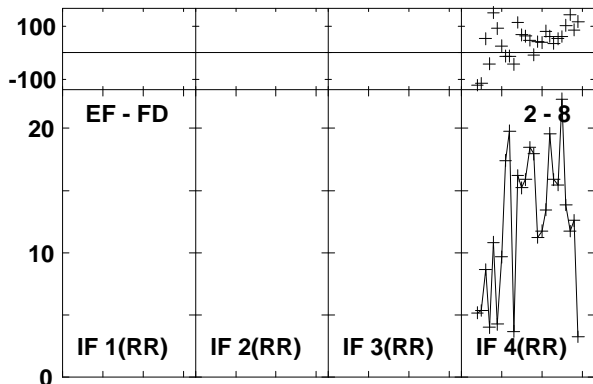
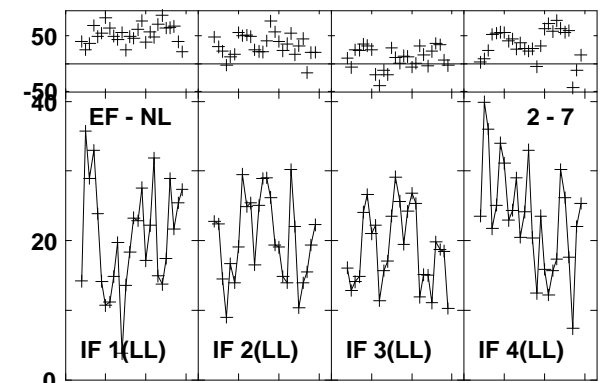
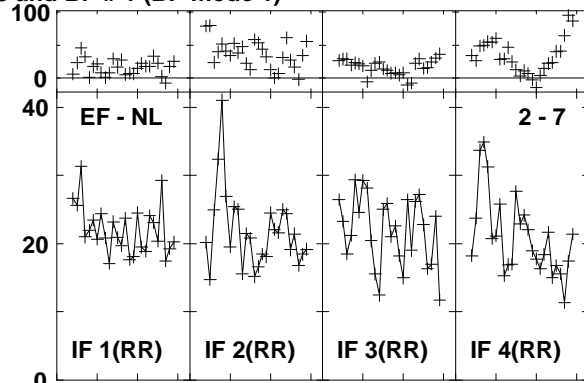
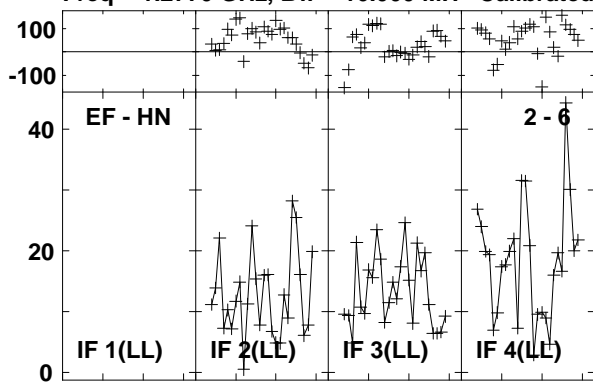

Lower frame: Milli Ampl Jy Top frame: Phas deg
Vector averaged cross-power spectrum Baseline: EF (02) - HN (06)
Timerange: 00/20:01:39 to 00/20:04:33

Plot file version 574 created 03-MAR-2016 01:13:34

4C52 GN002C 1.UVDATA.1

Freq = 1.2770 GHz, Bw = 16.000 MH Calibrated with CL # 3 and BP # 1 (BP mode 1)

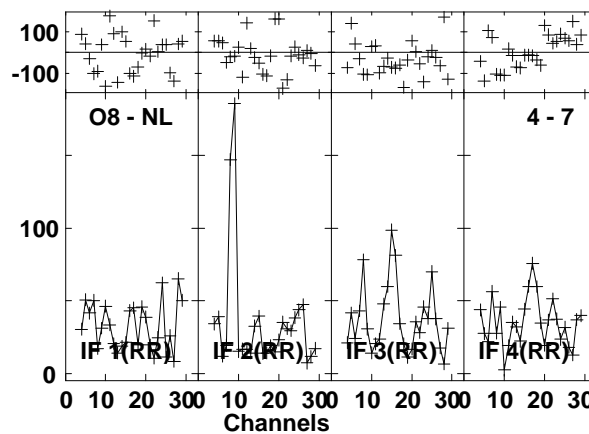
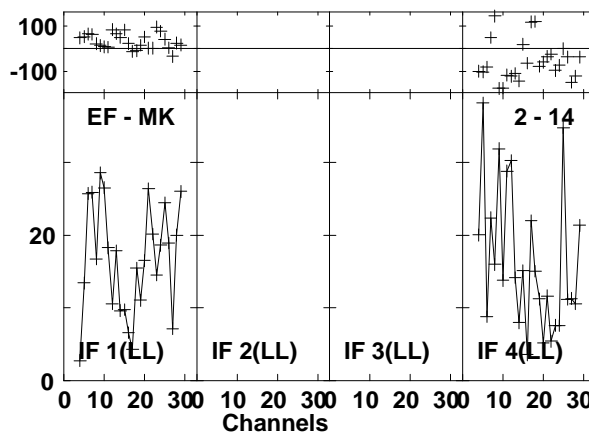
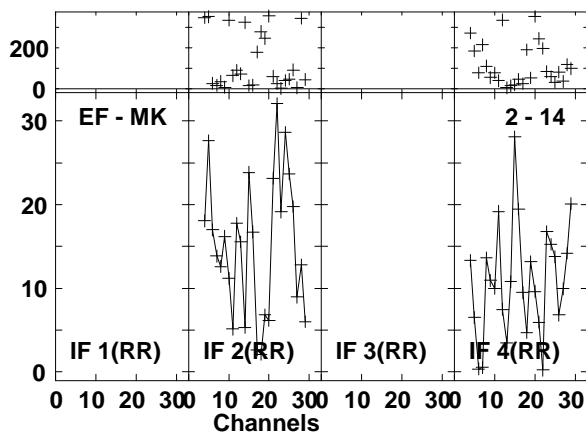
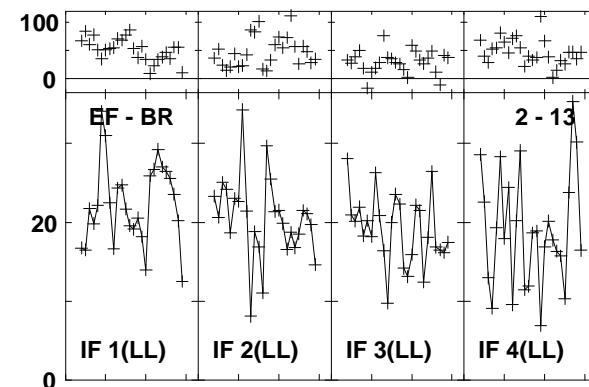
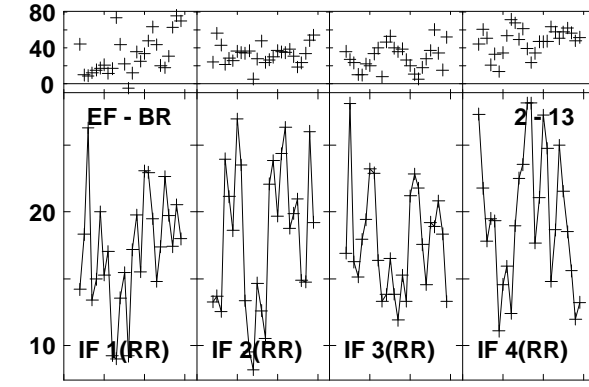
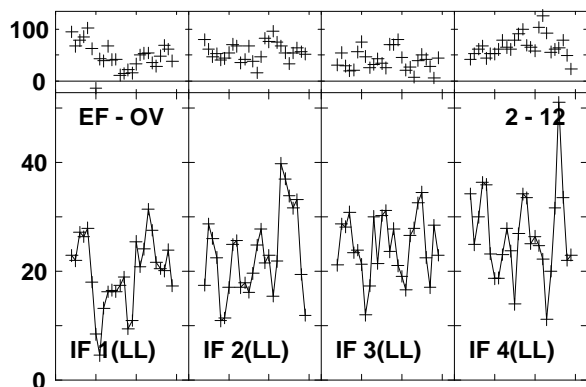
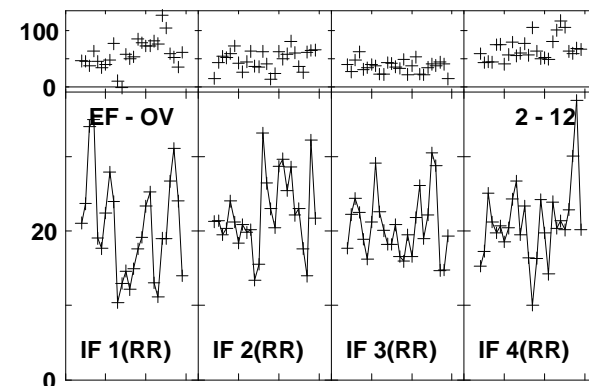
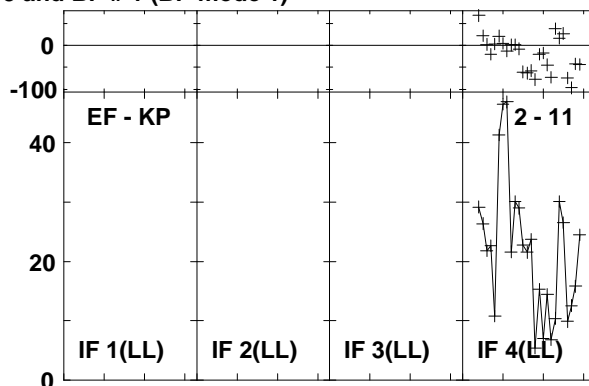
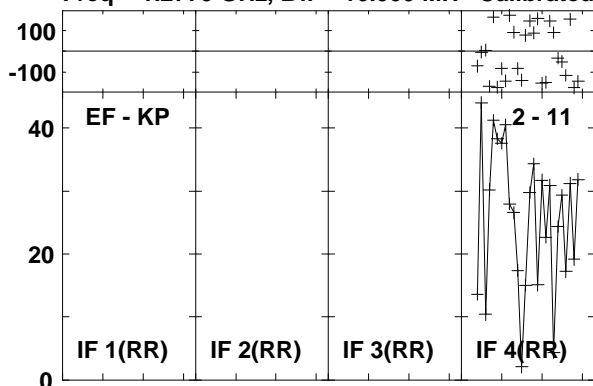

Lower frame: Milli Ampl Jy Top frame: Phas deg
Vector averaged cross-power spectrum Baseline: EF (02) - KP (11)
Timerange: 00/20:01:39 to 00/20:04:33

Plot file version 575 created 03-MAR-2016 01:13:34

4C52 GN002C 1.UVDATA.1

Freq = 1.2770 GHz, Bw = 16.000 MH Calibrated with CL # 3 and BP # 1 (BP mode 1)

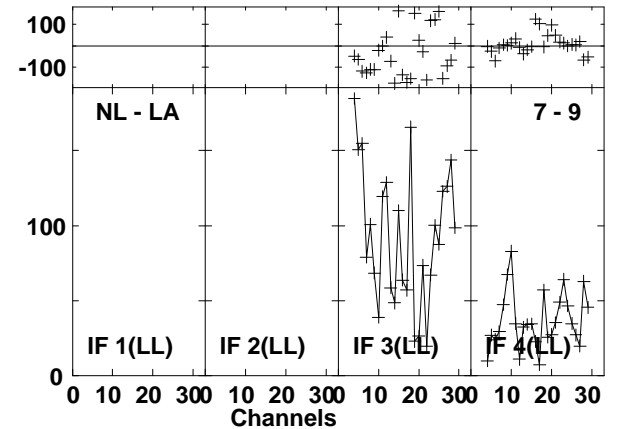
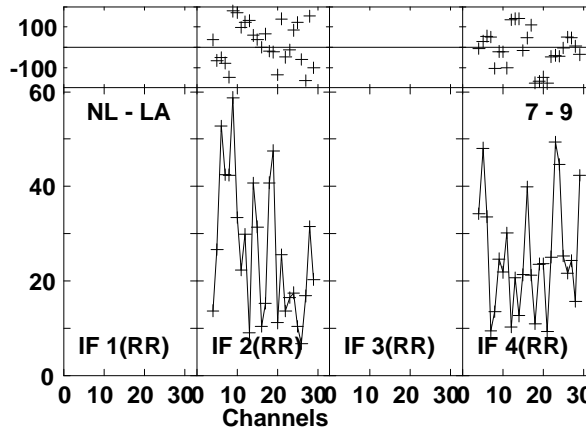
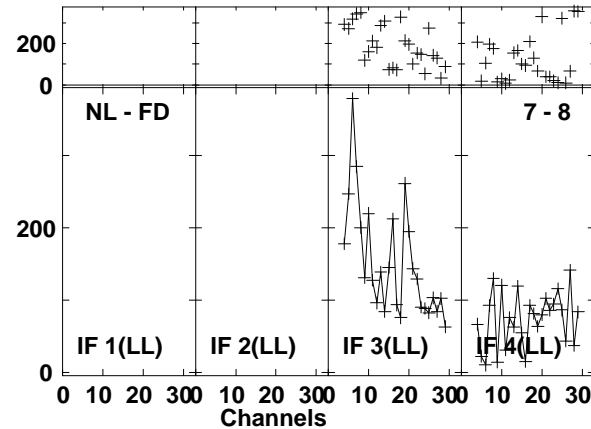
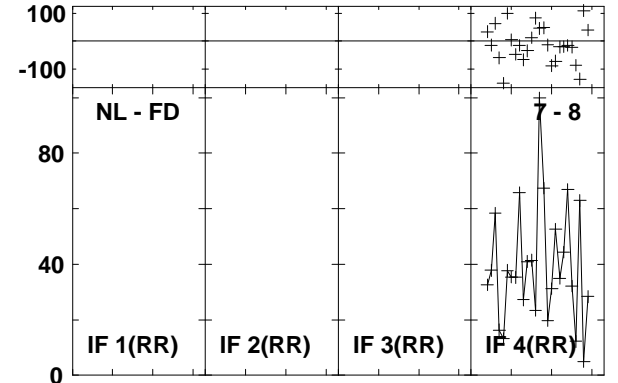
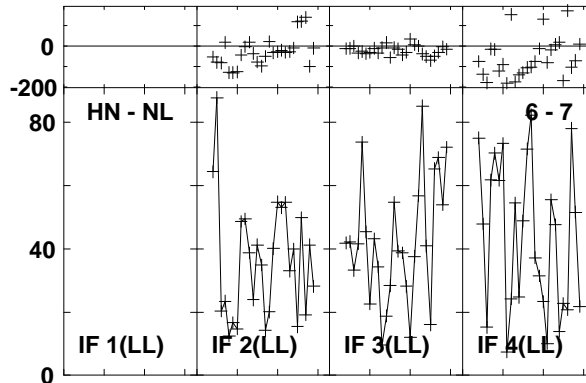
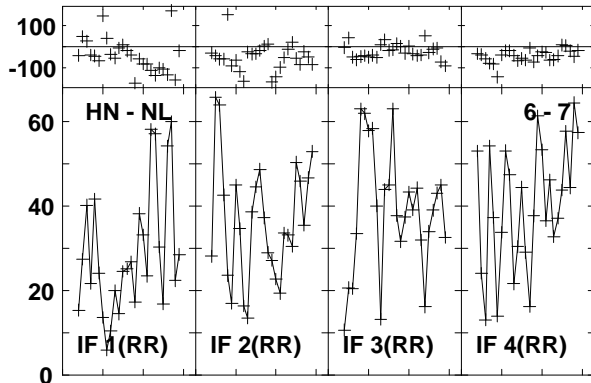
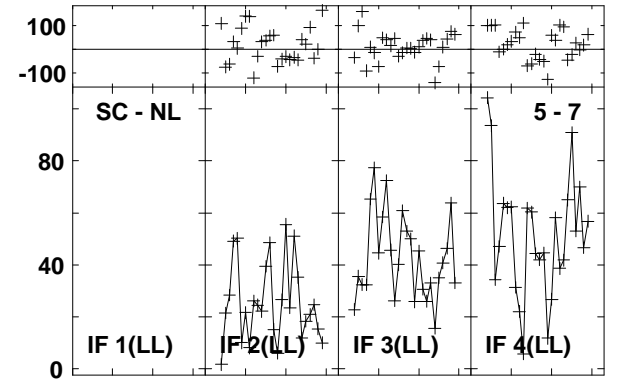
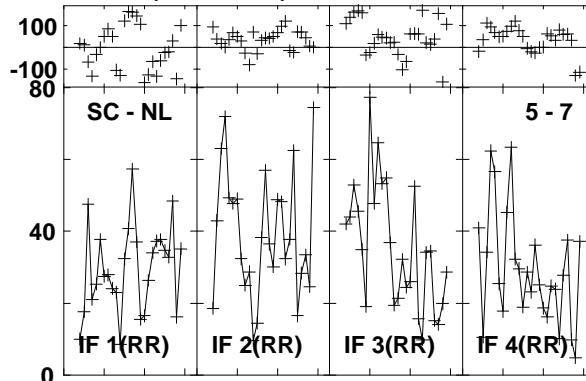
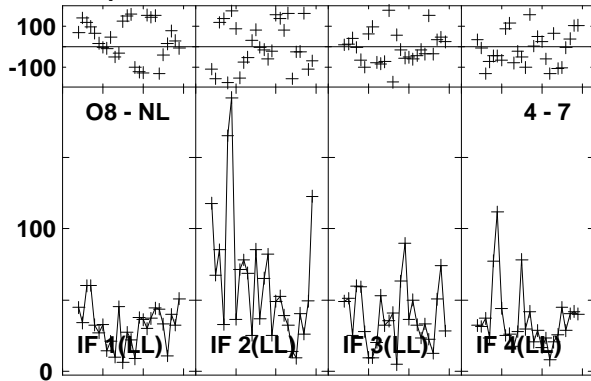

Lower frame: Milli Ampl Jy Top frame: Phas deg
Vector averaged cross-power spectrum Baseline: O8 (04) - NL (07)
Timerange: 00/20:01:39 to 00/20:04:33

Plot file version 576 created 03-MAR-2016 01:13:34

4C52 GN002C 1.UVDATA.1

Freq = 1.2770 GHz, Bw = 16.000 MH Calibrated with CL # 3 and BP # 1 (BP mode 1)

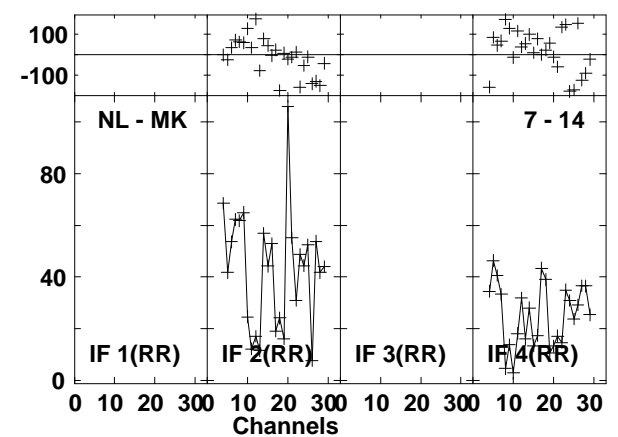
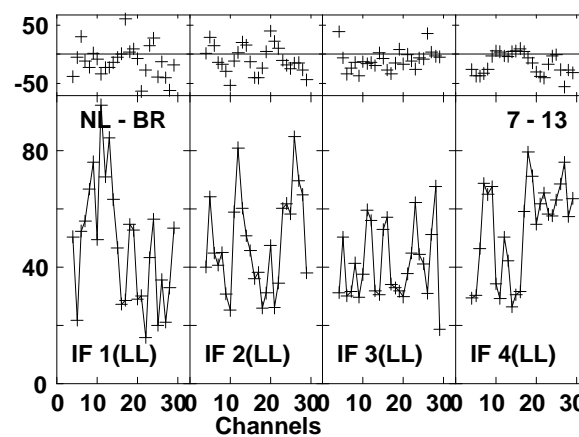
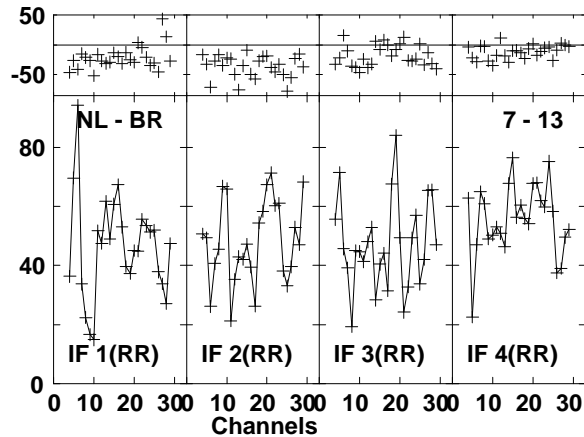
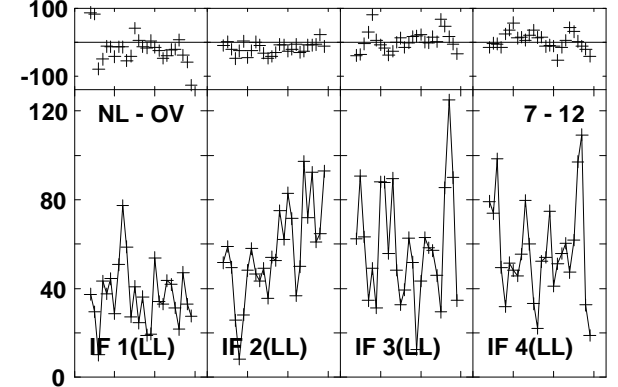
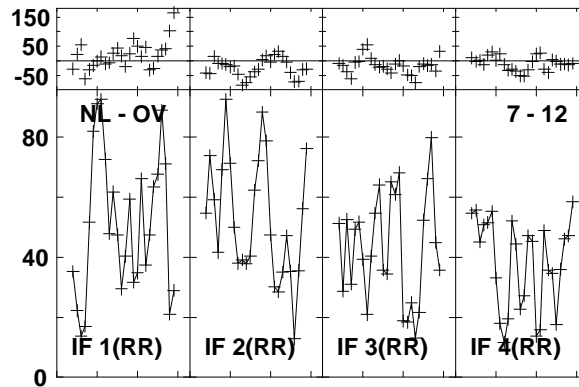
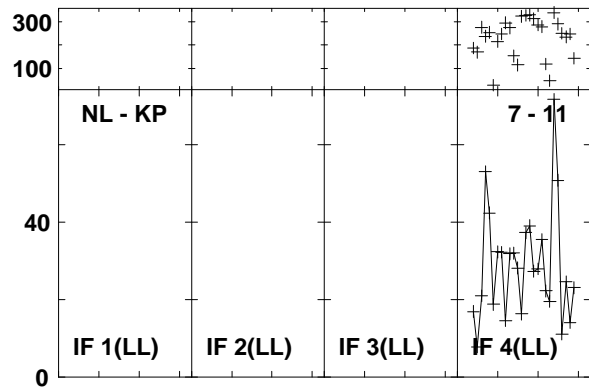
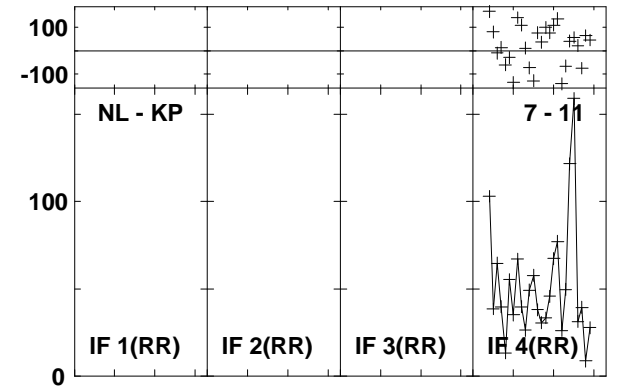
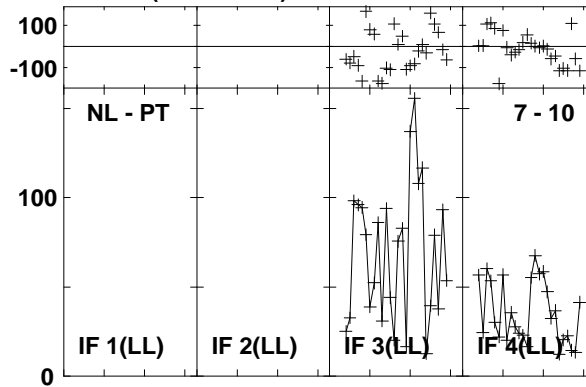
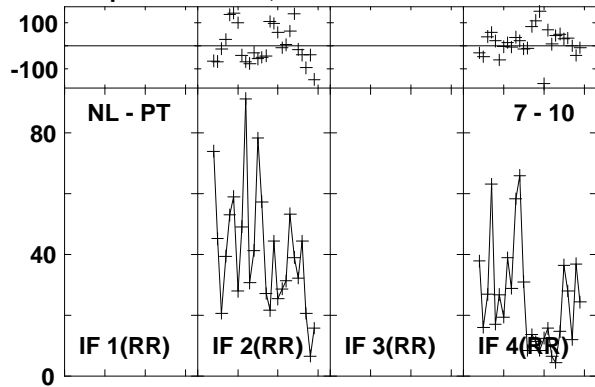

Lower frame: Milli Ampl Jy Top frame: Phas deg
Vector averaged cross-power spectrum Baseline: NL (07) - PT (10)
Timerange: 00/20:01:39 to 00/20:04:33

Plot file version 577 created 03-MAR-2016 01:13:34

4C52 GN002C 1.UVDATA.1

Freq = 1.2770 GHz, Bw = 16.000 MH Calibrated with CL # 3 and BP # 1 (BP mode 1)

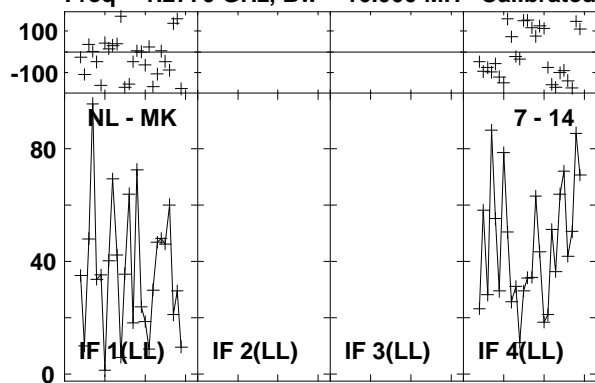

Lower frame: Milli Ampl Jy Top frame: Phas deg
Vector averaged cross-power spectrum Baseline: NL (07) - MK (14)
Timerange: 00/20:01:39 to 00/20:04:33

Plot file version 578 created 03-MAR-2016 01:13:35

J1545+5400 GN002C 1.UVDATA.1

Freq = 1.2770 GHz, Bw = 16.000 MH Calibrated with CL # 3 and BP # 1 (BP mode 1)

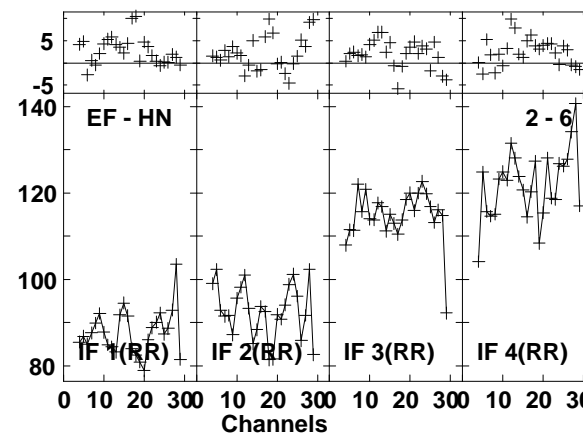
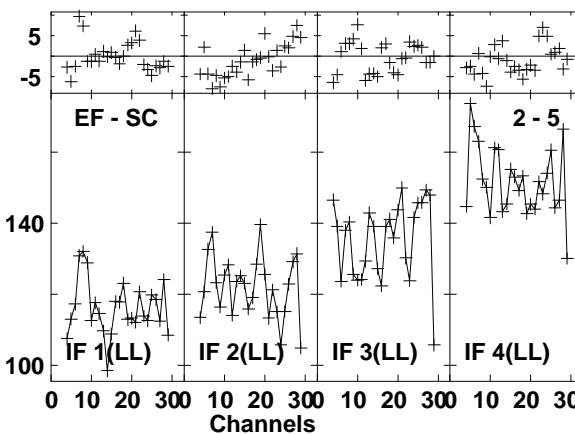
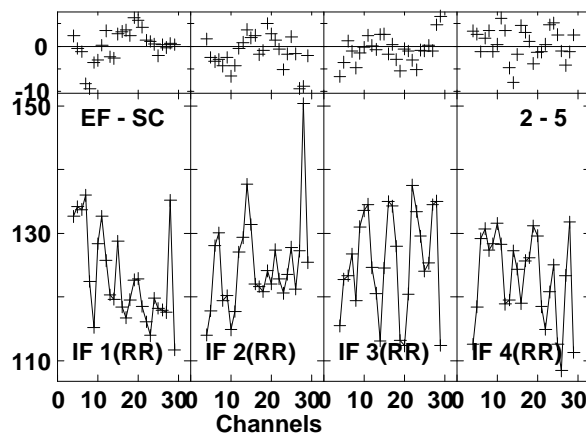
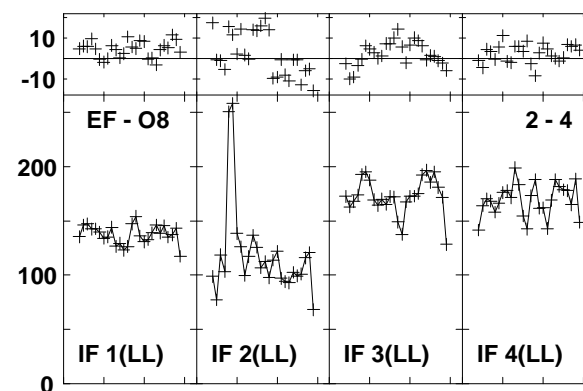
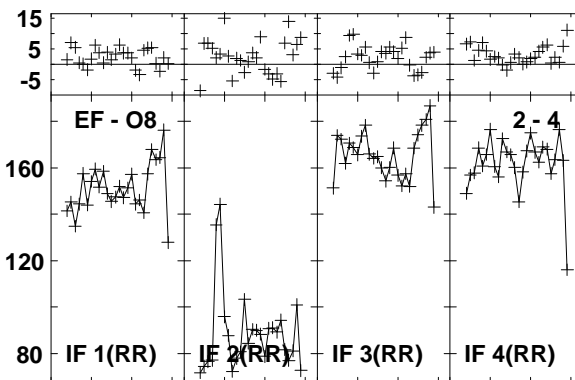
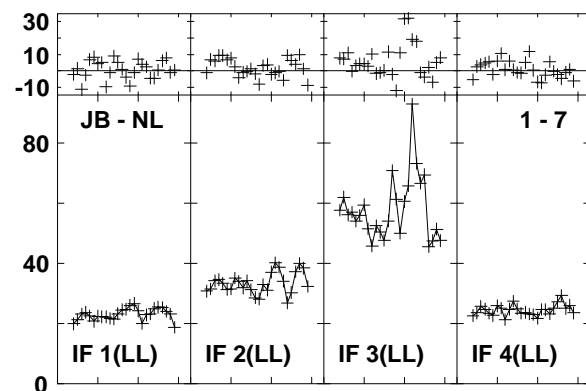
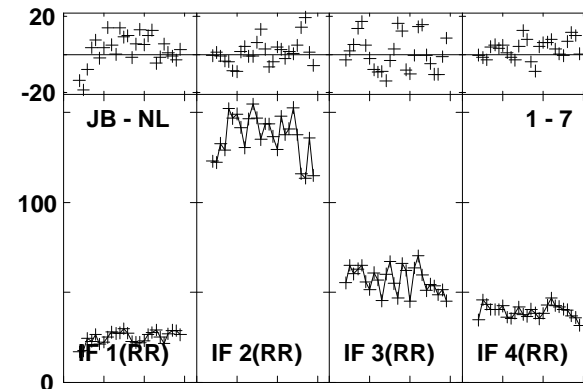
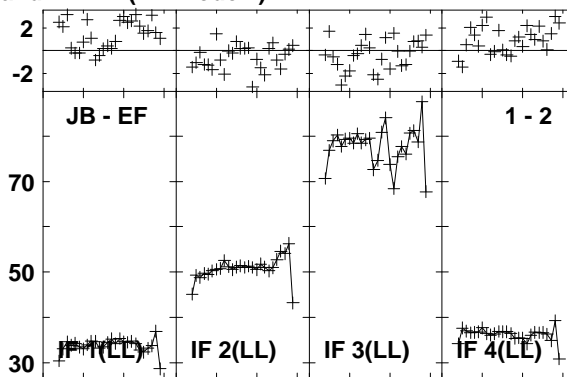
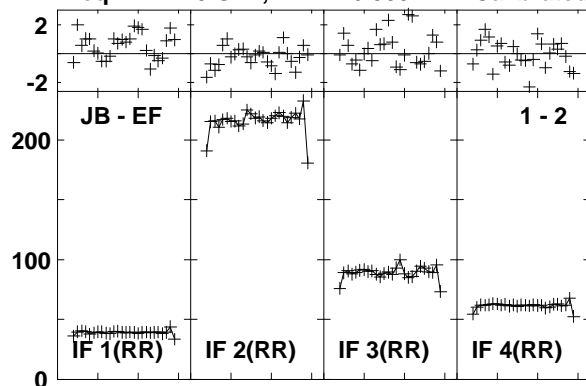

Lower frame: Milli Ampl Jy Top frame: Phas deg
Vector averaged cross-power spectrum Baseline: JB (01) - EF (02)
Timerange: 00/20:05:26 to 00/20:07:24

Plot file version 579 created 03-MAR-2016 01:13:35

J1545+5400 GN002C 1.UVDATA.1

Freq = 1.2770 GHz, Bw = 16.000 MH Calibrated with CL # 3 and BP # 1 (BP mode 1)

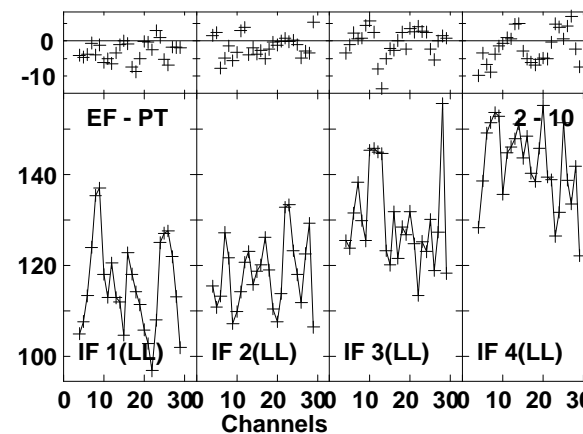
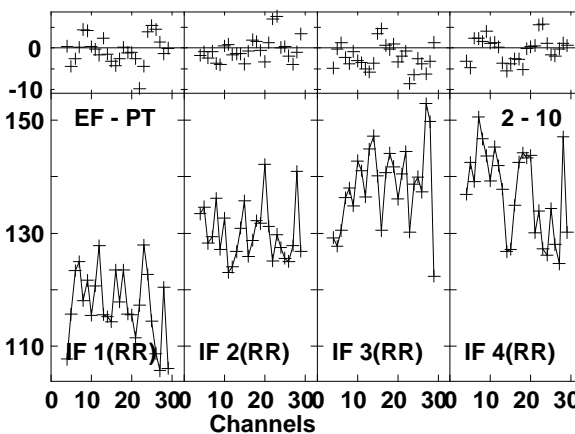
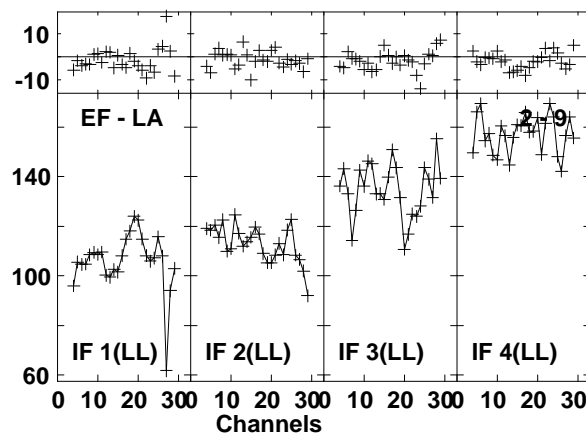
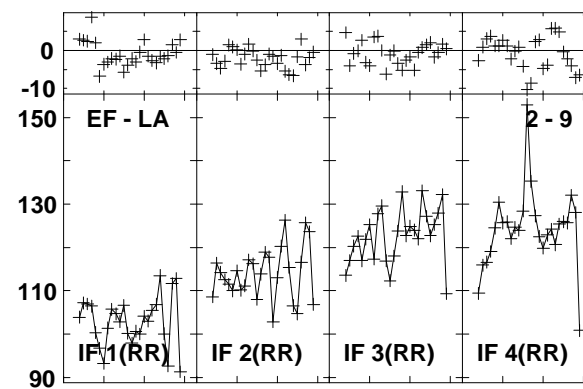
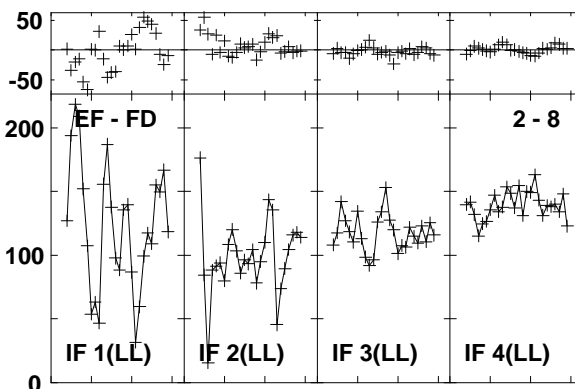
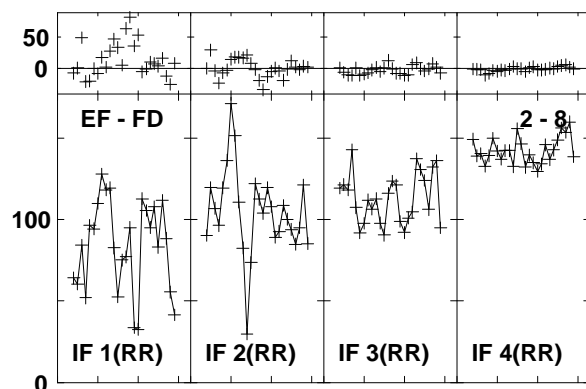
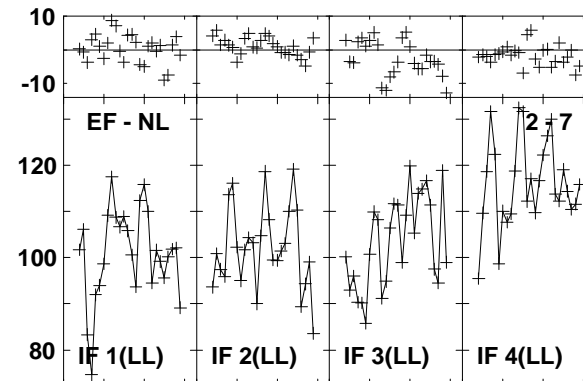
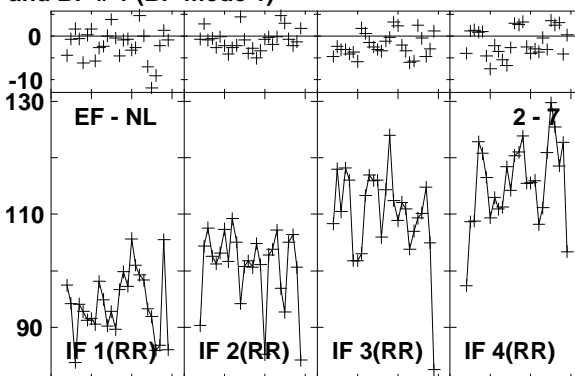
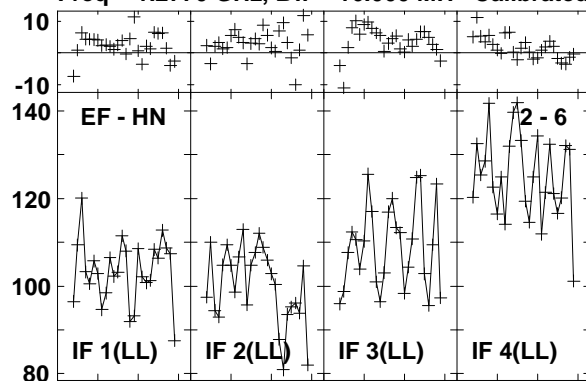

Lower frame: Milli Ampl Jy Top frame: Phas deg
Vector averaged cross-power spectrum Baseline: EF (02) - HN (06)
Timerange: 00/20:05:26 to 00/20:07:24

Plot file version 580 created 03-MAR-2016 01:13:35

J1545+5400 GN002C 1.UVDATA.1

Freq = 1.2770 GHz, Bw = 16.000 MH Calibrated with CL # 3 and BP # 1 (BP mode 1)

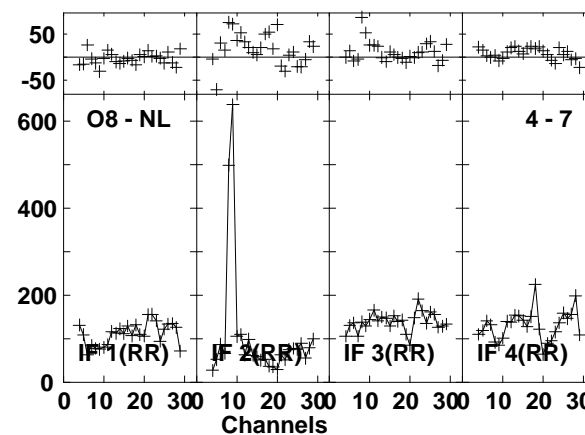
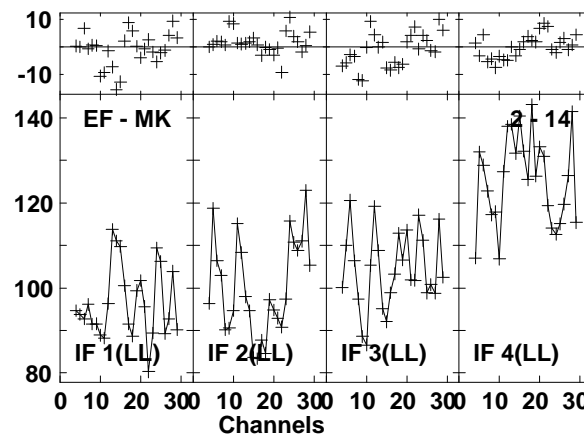
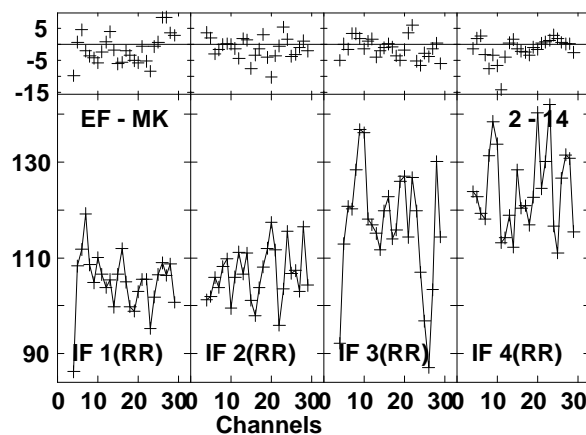
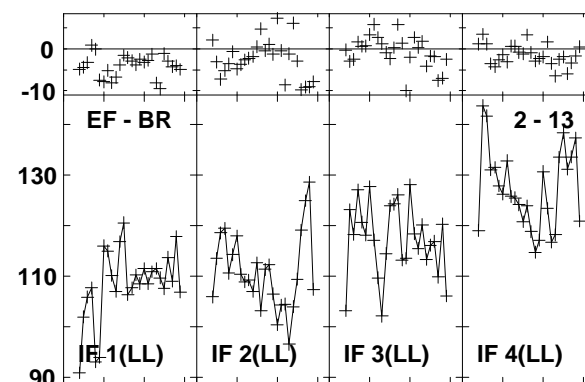
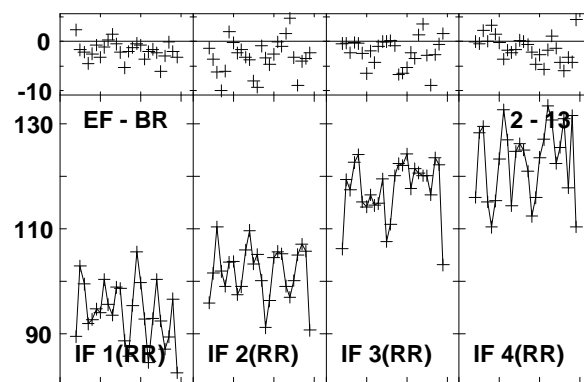
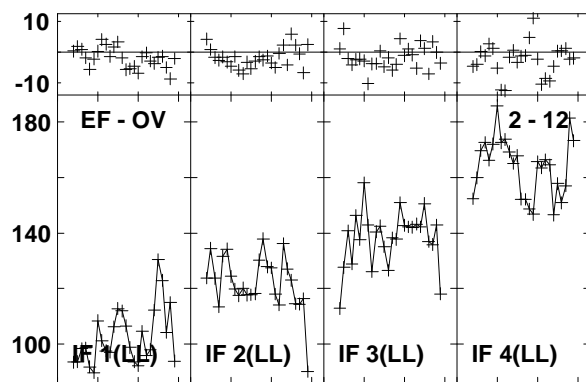
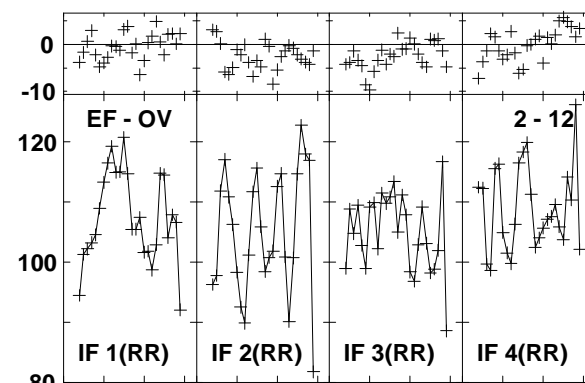
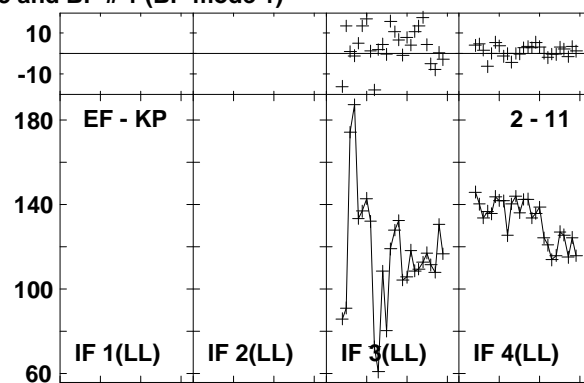
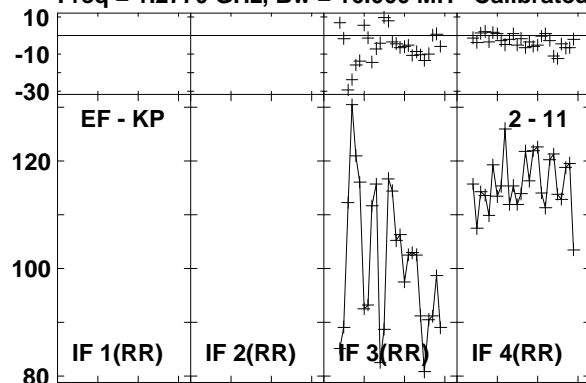

Lower frame: Milli Ampl Jy Top frame: Phas deg
Vector averaged cross-power spectrum Baseline: EF (02) - KP (11)
Timerange: 00/20:05:26 to 00/20:07:24

Plot file version 581 created 03-MAR-2016 01:13:35

J1545+5400 GN002C 1.UVDATA.1

Freq = 1.2770 GHz, Bw = 16.000 MH Calibrated with CL # 3 and BP # 1 (BP mode 1)

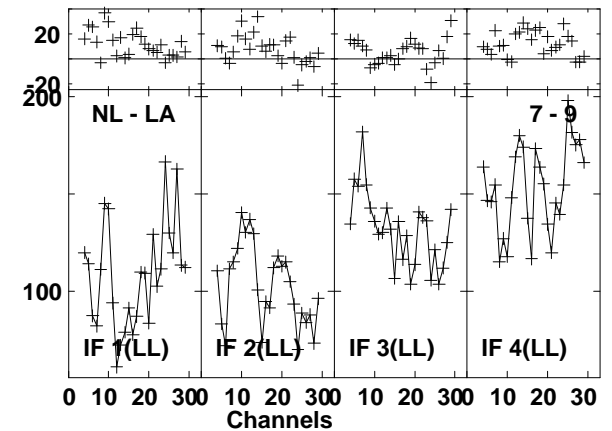
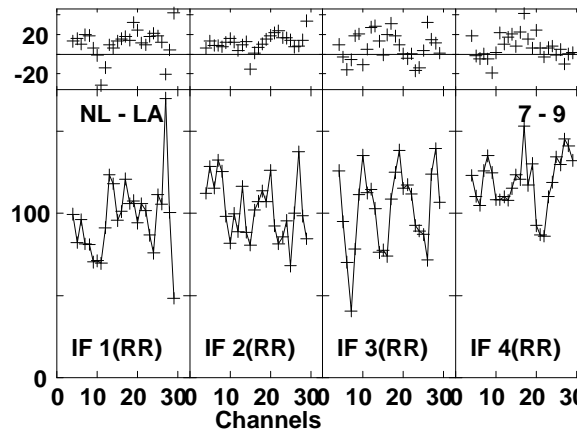
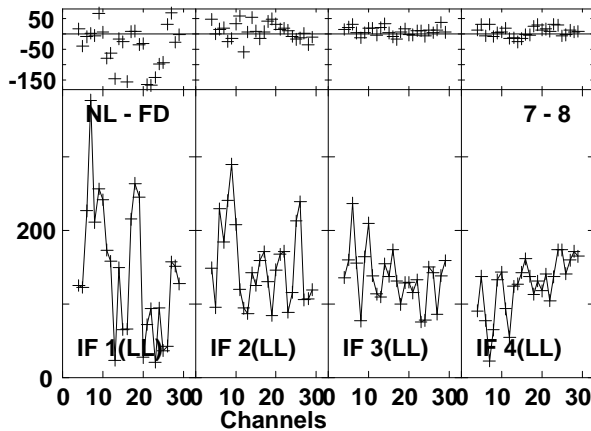
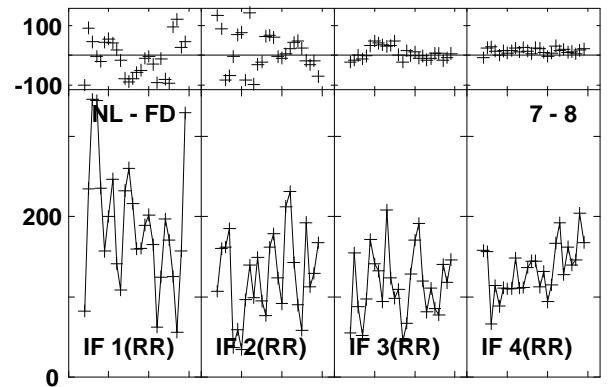
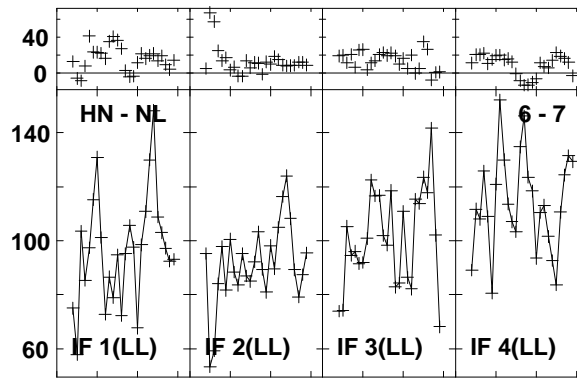
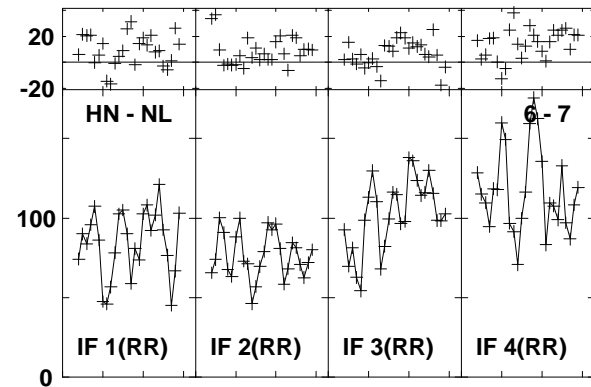
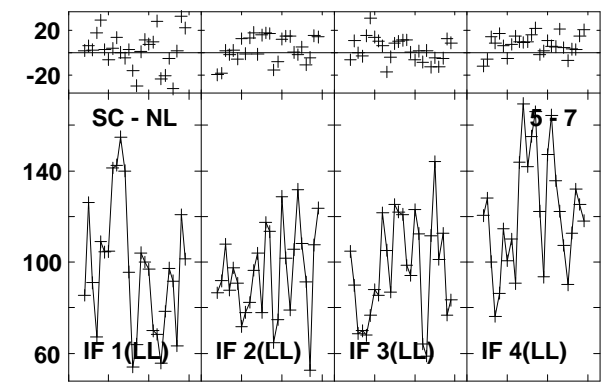
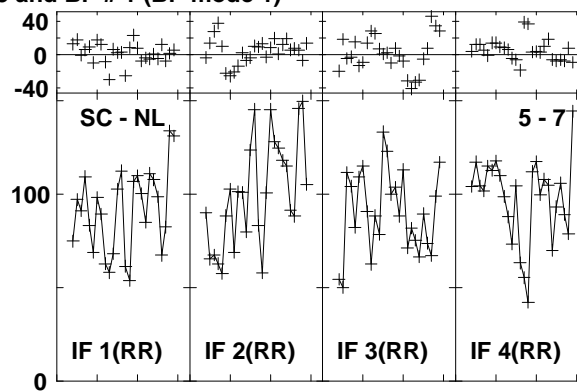
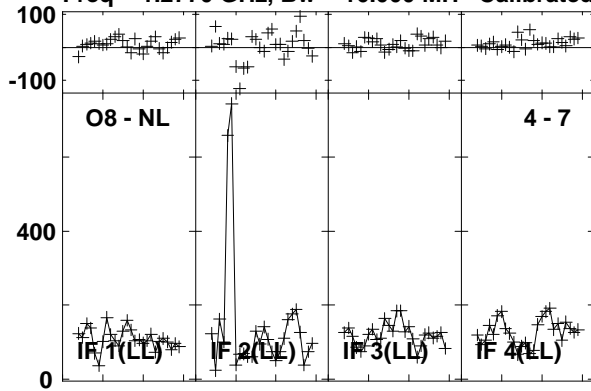

Lower frame: Milli Ampl Jy Top frame: Phas deg
Vector averaged cross-power spectrum Baseline: O8 (04) - NL (07)
Timerange: 00/20:05:26 to 00/20:07:24

Plot file version 582 created 03-MAR-2016 01:13:35

J1545+5400 GN002C 1.UVDATA.1

Freq = 1.2770 GHz, Bw = 16.000 MH Calibrated with CL # 3 and BP # 1 (BP mode 1)

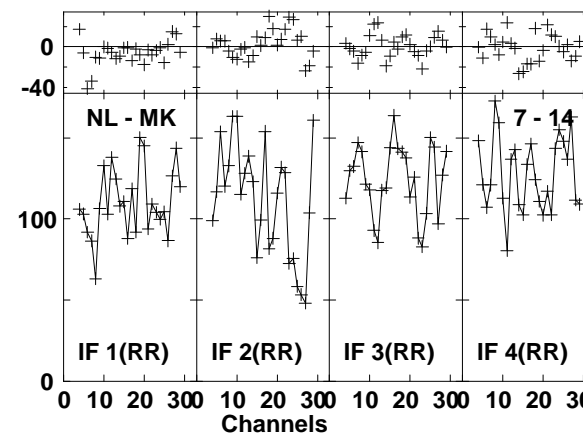
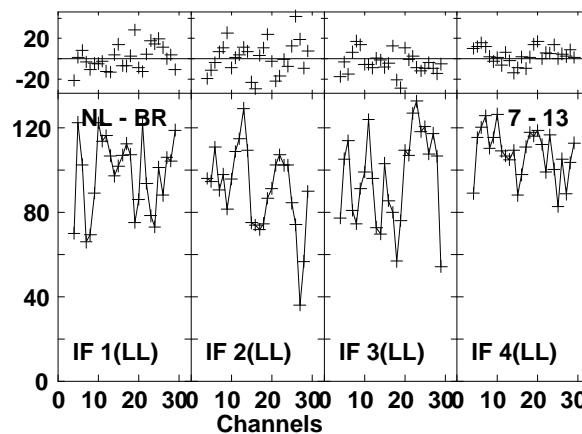
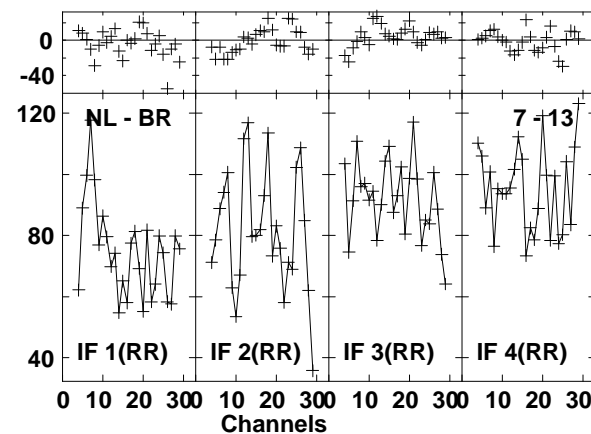
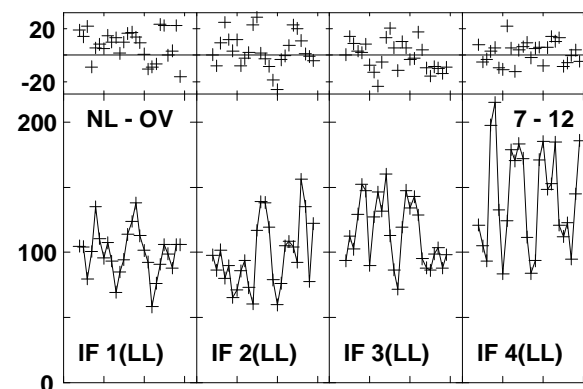
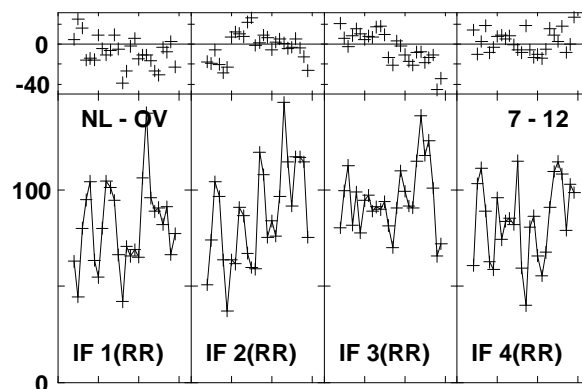
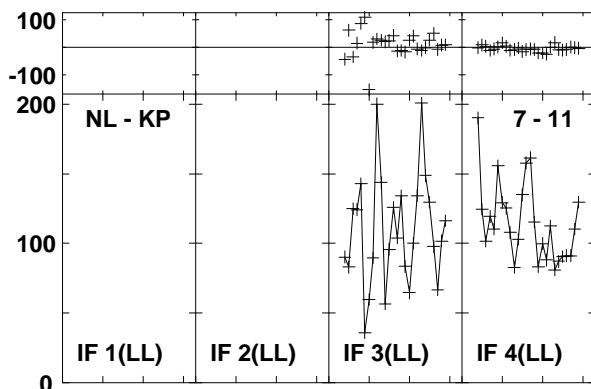
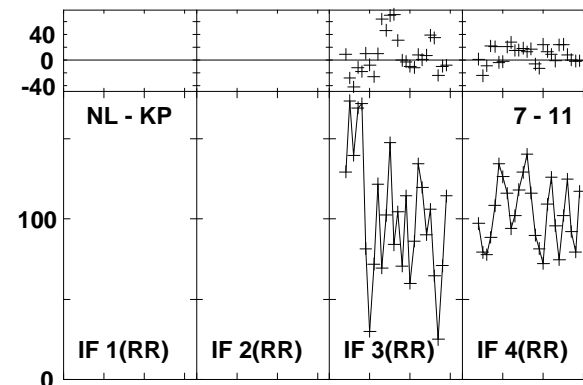
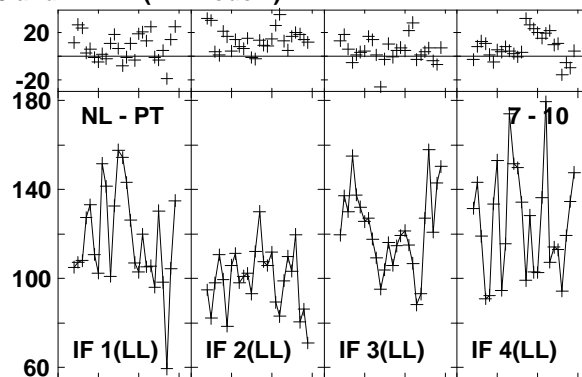
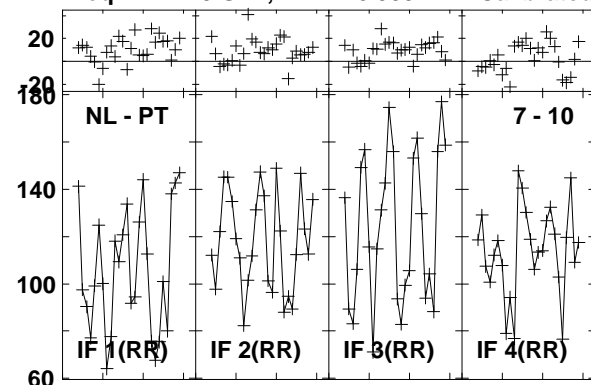

Lower frame: Milli Ampl Jy Top frame: Phas deg
Vector averaged cross-power spectrum Baseline: NL (07) - PT (10)
Timerange: 00/20:05:26 to 00/20:07:24

Plot file version 583 created 03-MAR-2016 01:13:35
J1545+5400 GN002C 1.UVDATA.1
Freq = 1.2770 GHz, Bw = 16.000 MH Calibrated with CL # 3 and BP # 1 (BP mode 1)

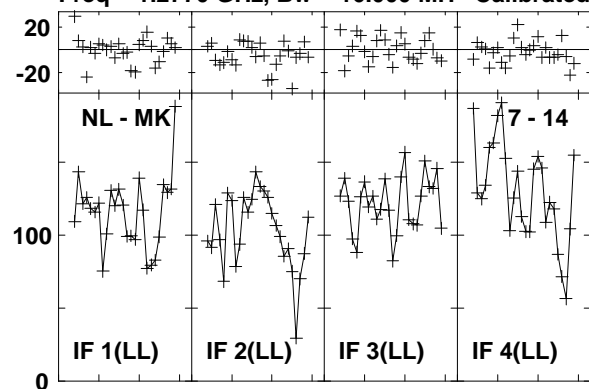

Lower frame: Milli Ampl Jy Top frame: Phas deg
Vector averaged cross-power spectrum Baseline: NL (07) - MK (14)
Timerange: 00/20:05:26 to 00/20:07:24

Plot file version 584 created 03-MAR-2016 01:13:35

4C52 GN002C 1.UVDATA.1

Freq = 1.2770 GHz, Bw = 16.000 MH Calibrated with CL # 3 and BP # 1 (BP mode 1)

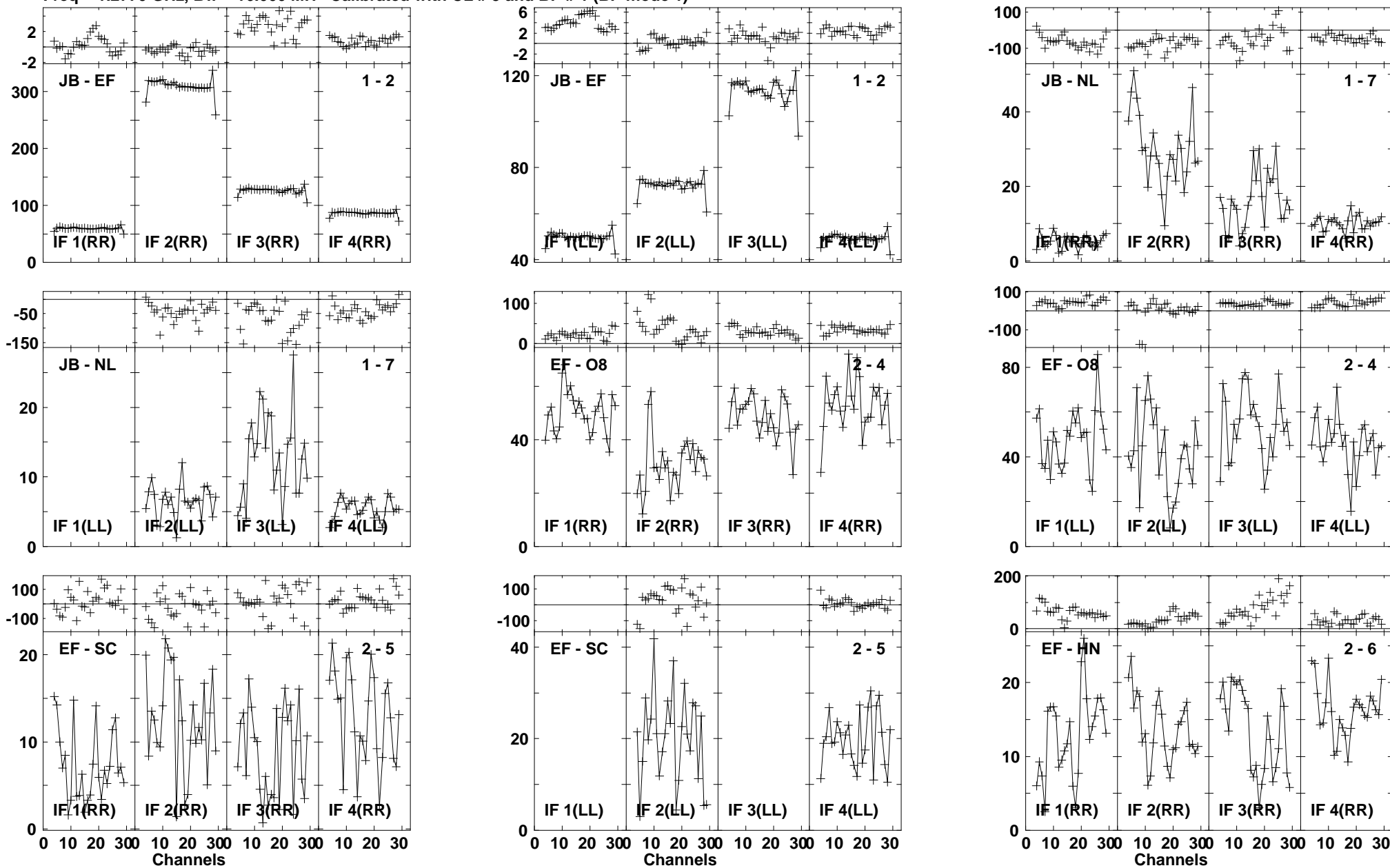

Lower frame: Milli Ampl Jy Top frame: Phas deg
Vector averaged cross-power spectrum Baseline: JB (01) - EF (02)
Timerange: 00/20/07:38 to 00/20/10:24

Plot file version 585 created 03-MAR-2016 01:13:36

4C52 GN002C 1.UVDATA.1

Freq = 1.2770 GHz, Bw = 16.000 MH Calibrated with CL # 3 and BP # 1 (BP mode 1)

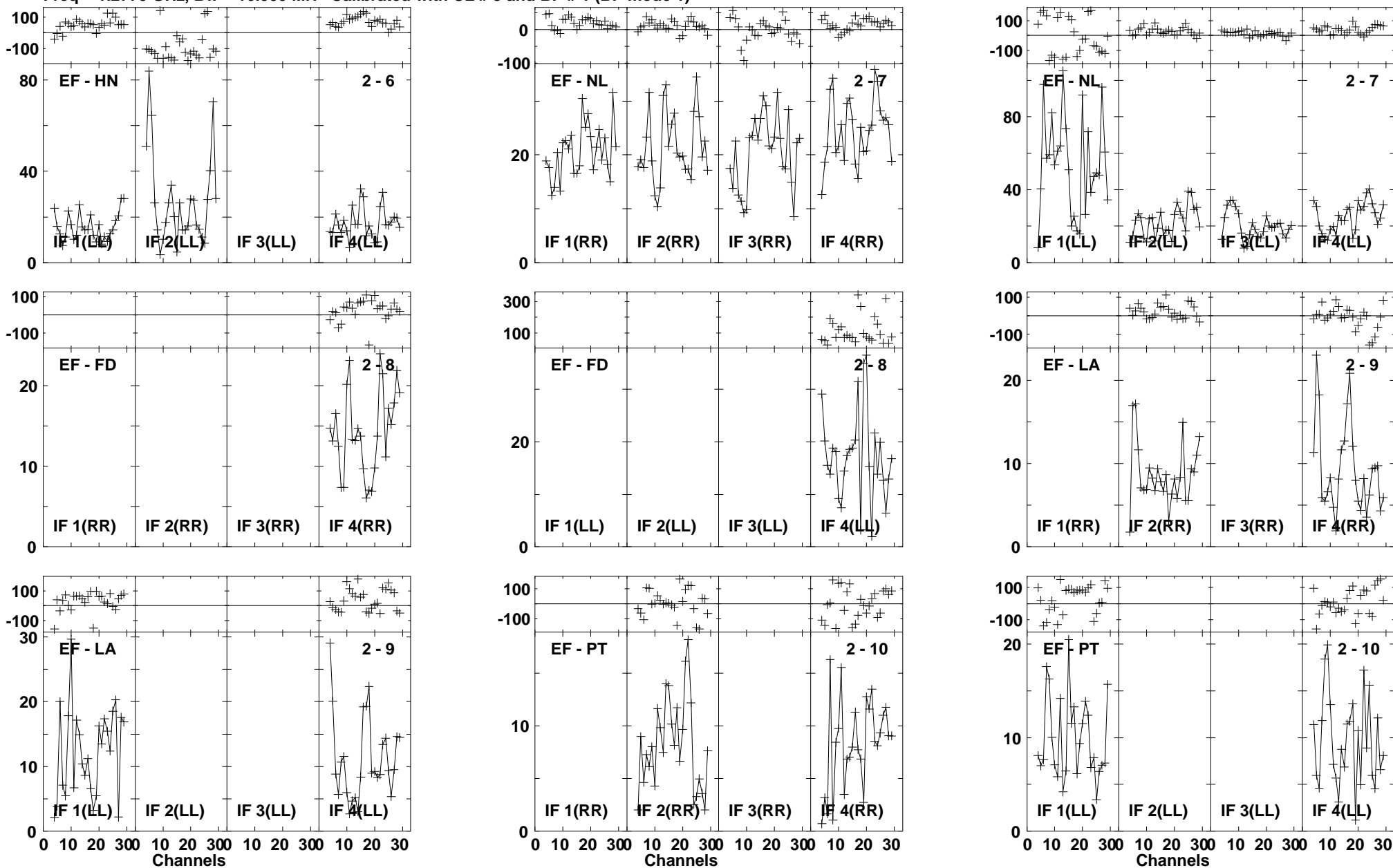

Lower frame: Milli Ampl Jy Top frame: Phas deg
Vector averaged cross-power spectrum Baseline: EF (02) - HN (06)
Timerange: 00/20:07:38 to 00/20:10:24

Plot file version 586 created 03-MAR-2016 01:13:36

4C52 GN002C 1.UVDATA.1

Freq = 1.2770 GHz, Bw = 16.000 MH Calibrated with CL # 3 and BP # 1 (BP mode 1)

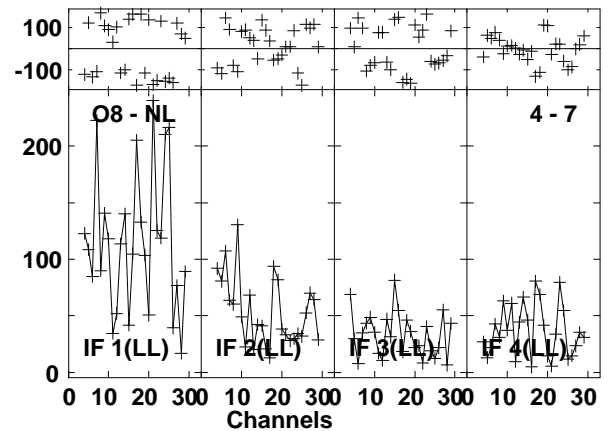
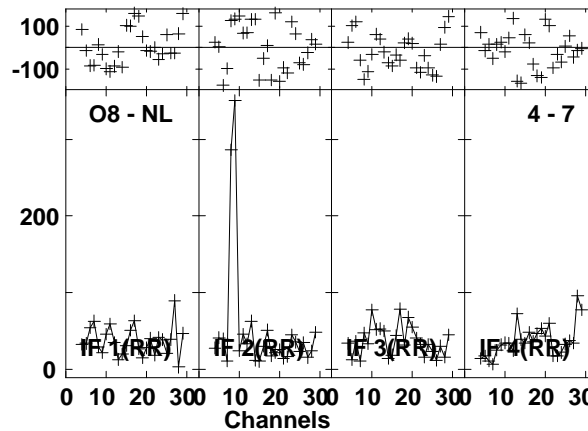
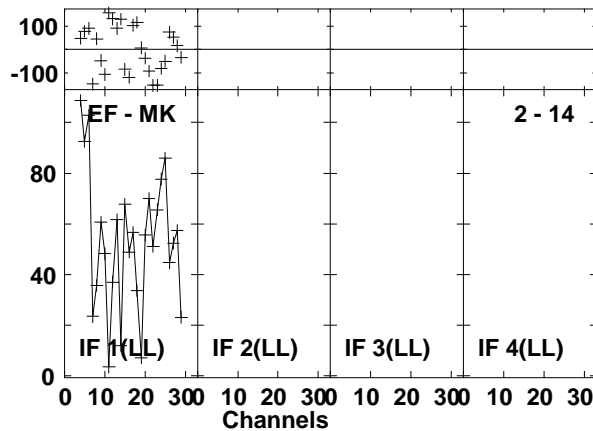
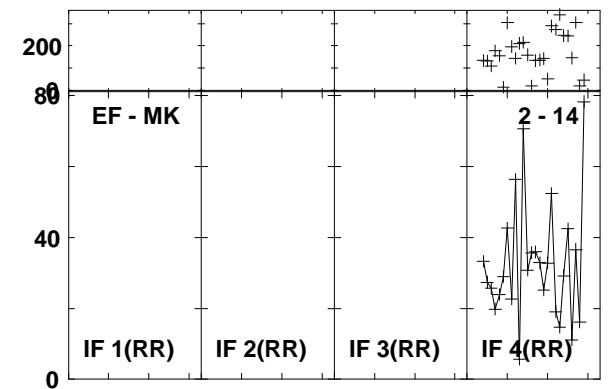
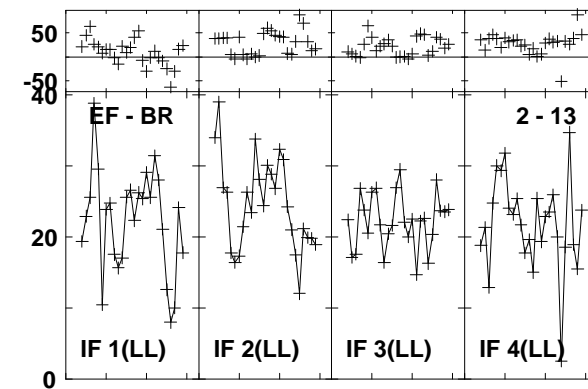
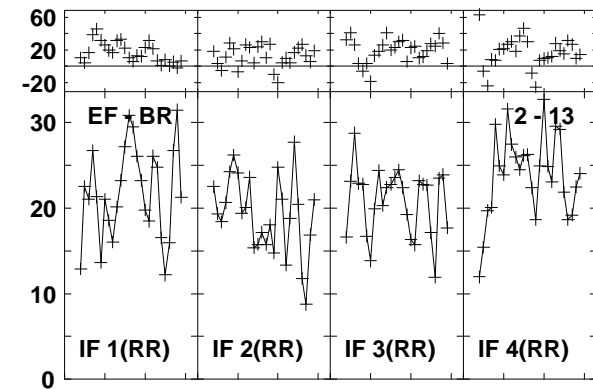
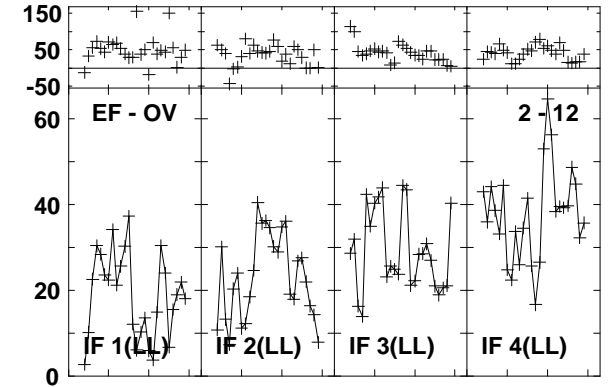
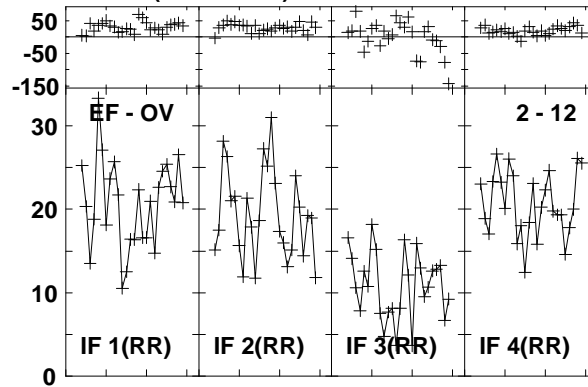
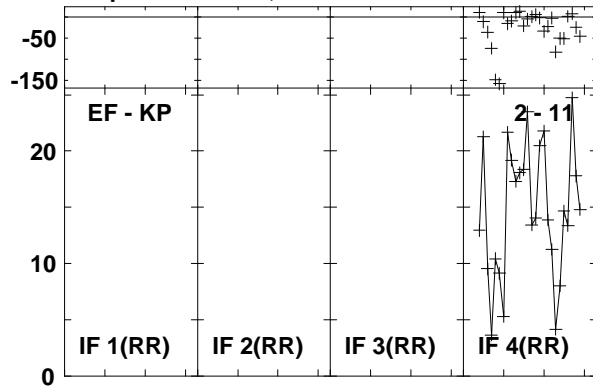

Lower frame: Milli Ampl Jy Top frame: Phas deg
Vector averaged cross-power spectrum Baseline: EF (02) - KP (11)
Timerange: 00/20:07:38 to 00/20:10:24

Plot file version 587 created 03-MAR-2016 01:13:36

4C52 GN002C 1.UVDATA.1

Freq = 1.2770 GHz, Bw = 16.000 MH Calibrated with CL # 3 and BP # 1 (BP mode 1)

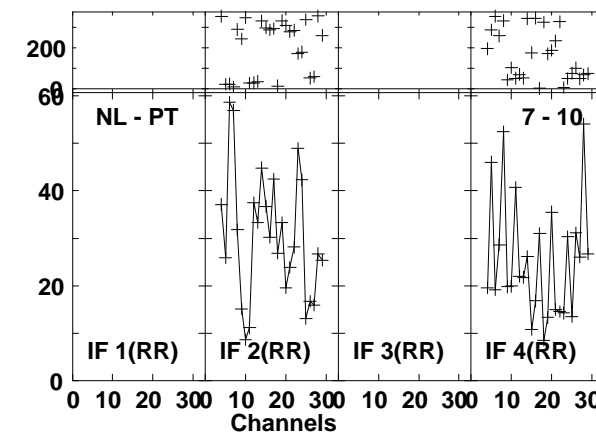
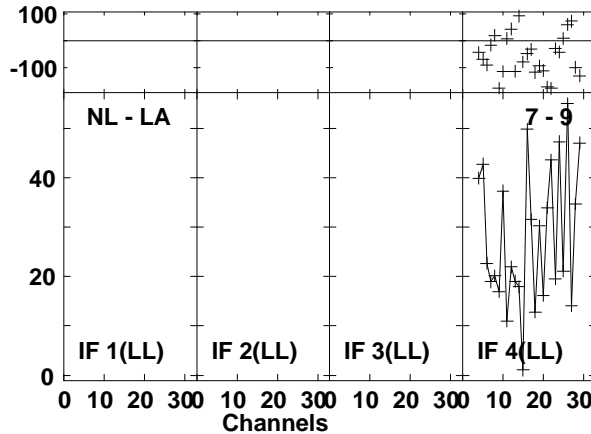
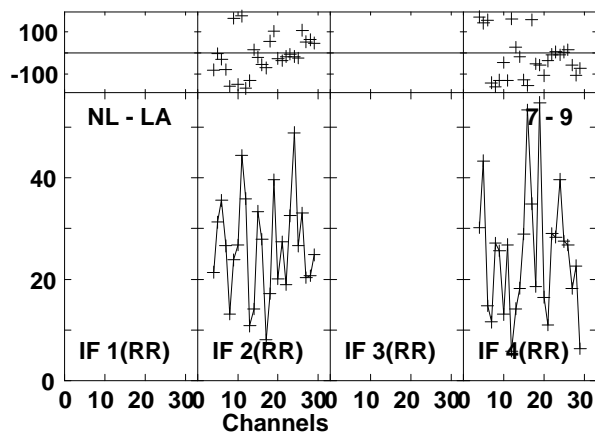
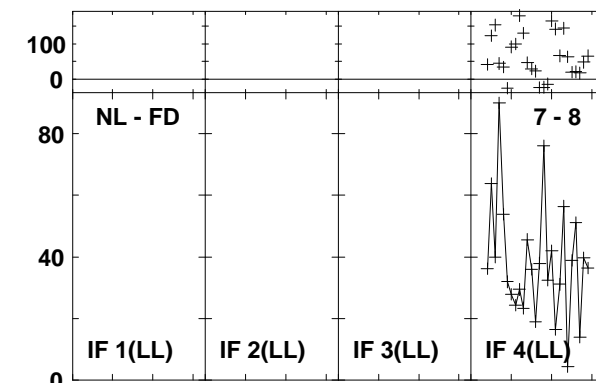
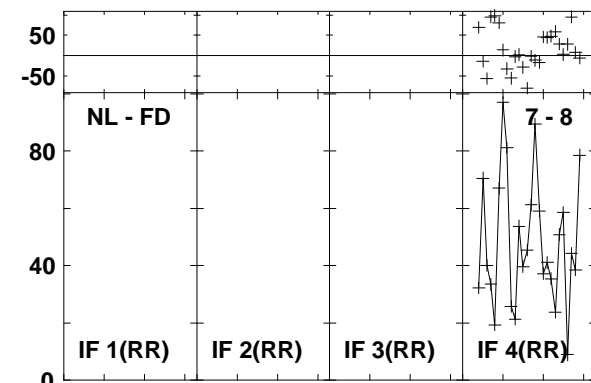
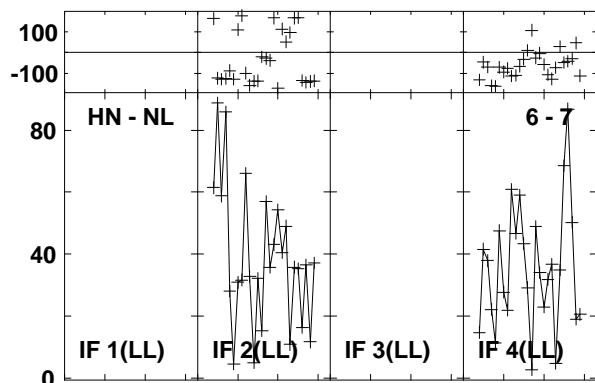
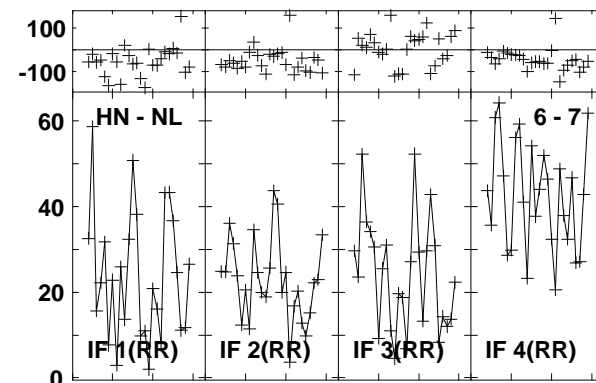
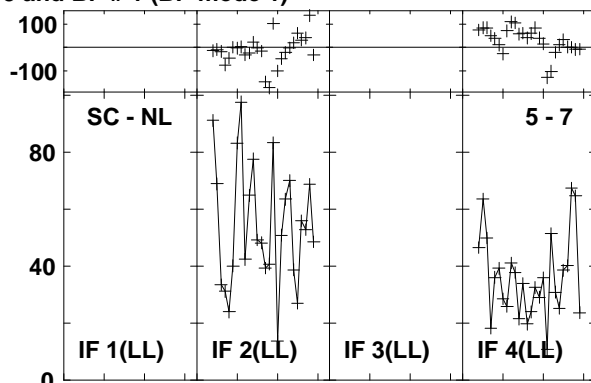
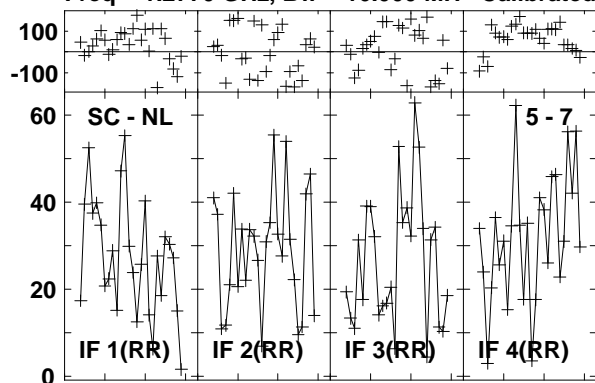

Lower frame: Milli Ampl Jy Top frame: Phas deg
Vector averaged cross-power spectrum Baseline: SC (05) - NL (07)
Timerange: 00/20:07:38 to 00/20:10:24

Plot file version 588 created 03-MAR-2016 01:13:36

4C52 GN002C 1.UVDATA.1

Freq = 1.2770 GHz, Bw = 16.000 MH Calibrated with CL # 3 and BP # 1 (BP mode 1)

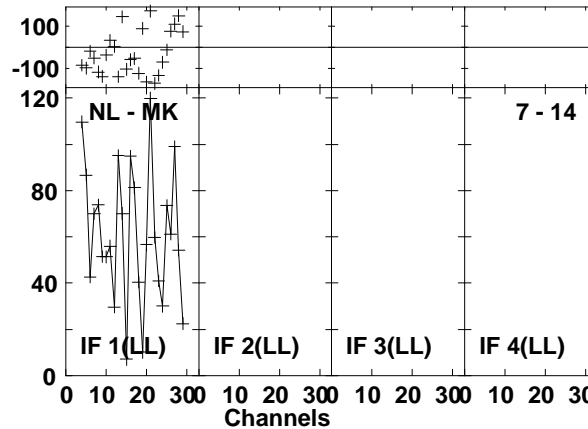
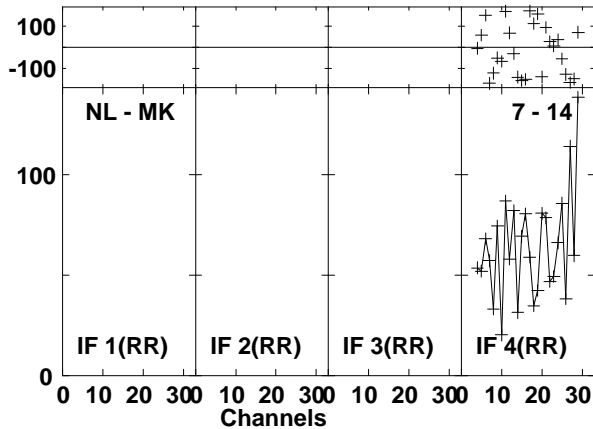
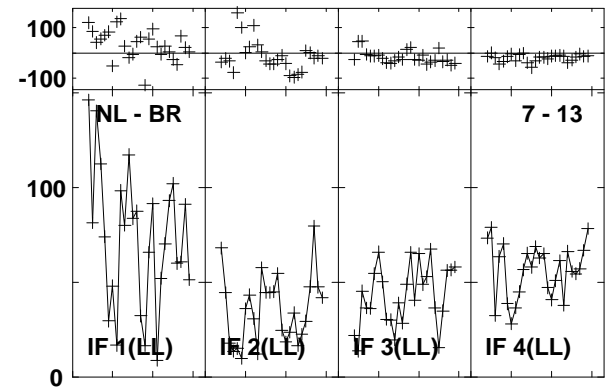
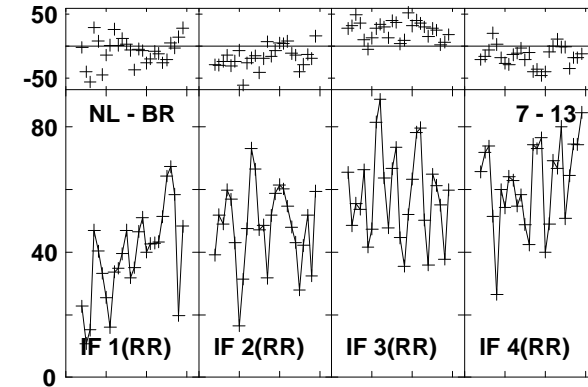
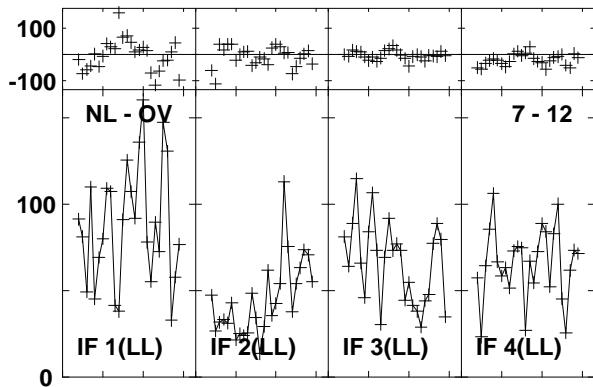
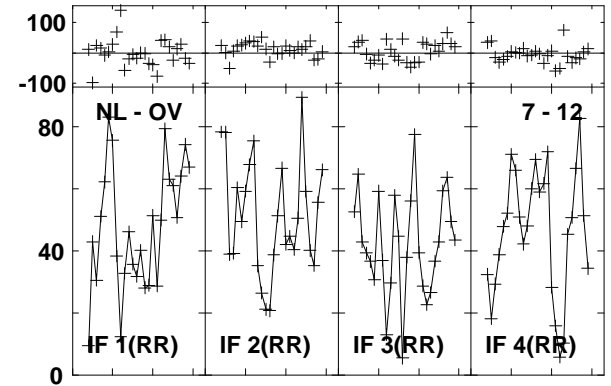
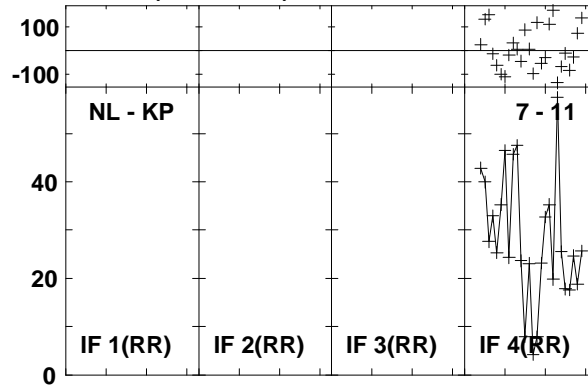
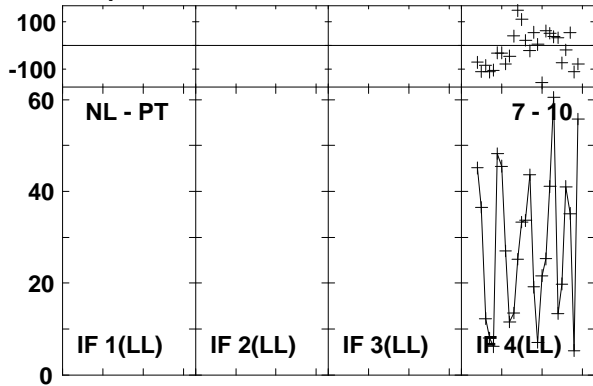

Lower frame: Milli Ampl Jy Top frame: Phas deg
Vector averaged cross-power spectrum Baseline: NL (07) - PT (10)
Timerange: 00/20:07:38 to 00/20:10:24

Plot file version 589 created 03-MAR-2016 01:13:36

J1545+5400 GN002C 1.UVDATA.1

Freq = 1.2770 GHz, Bw = 16.000 MH Calibrated with CL # 3 and BP # 1 (BP mode 1)

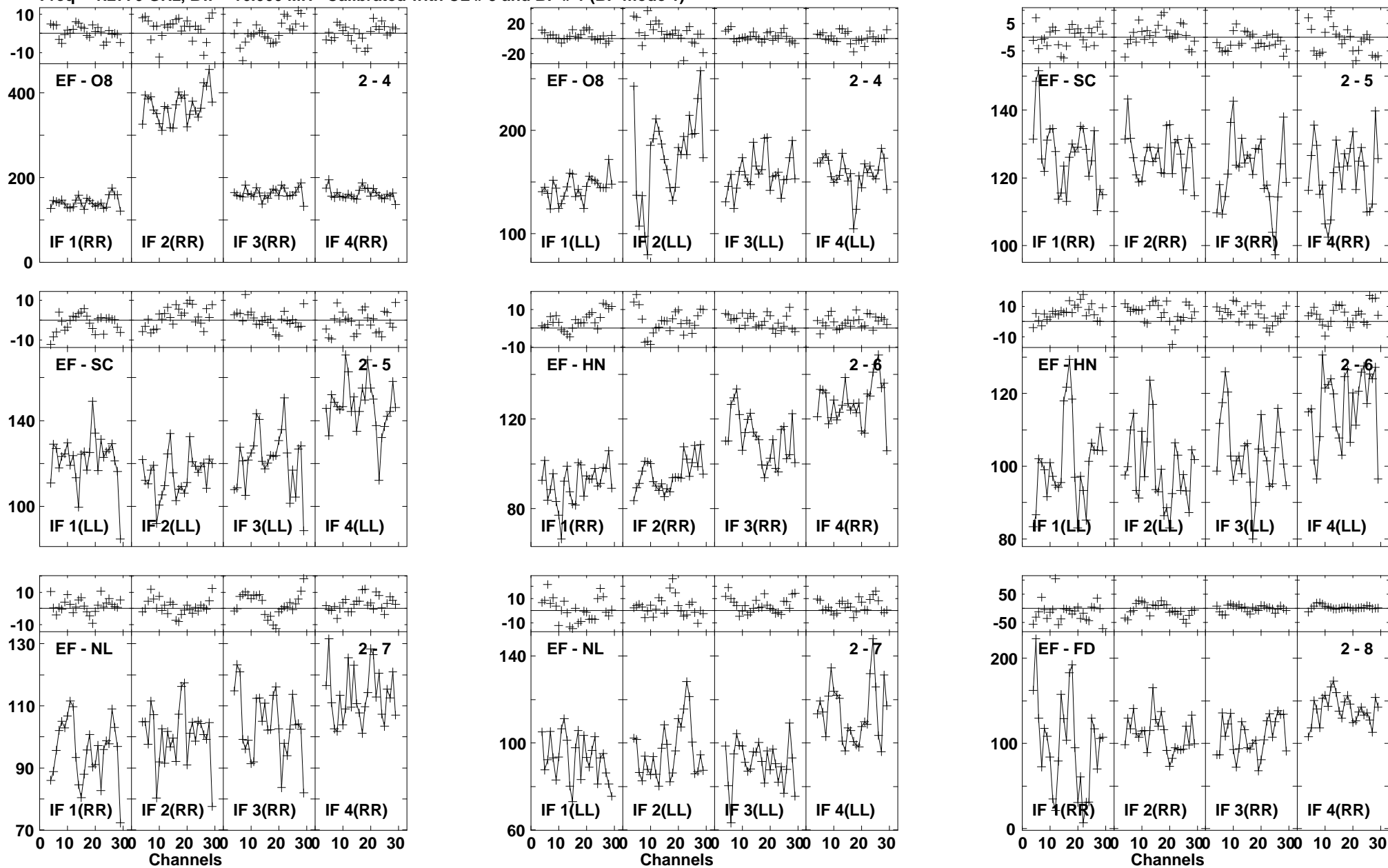

Plot file version 590 created 03-MAR-2016 01:13:37

J1545+5400 GN002C 1.UVDATA.1

Freq = 1.2770 GHz, Bw = 16.000 MH Calibrated with CL # 3 and BP # 1 (BP mode 1)

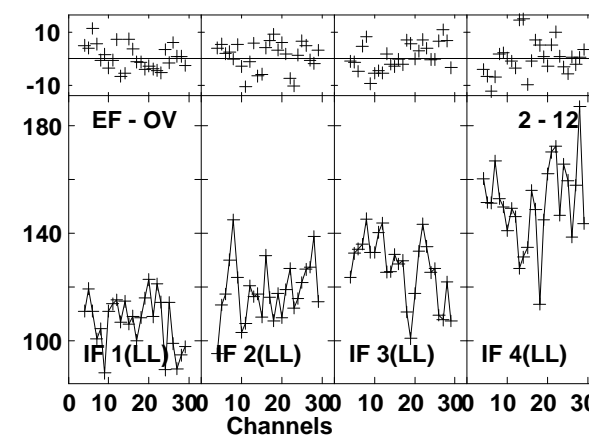
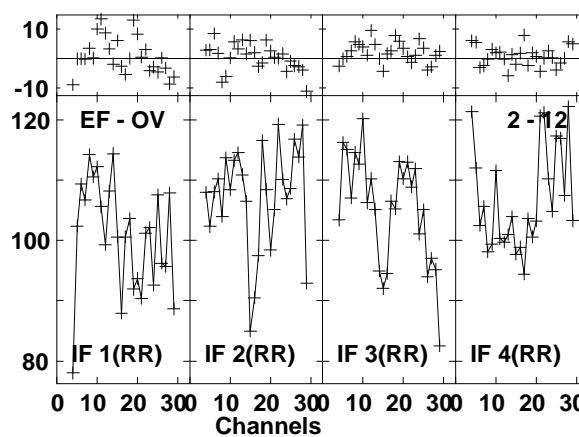
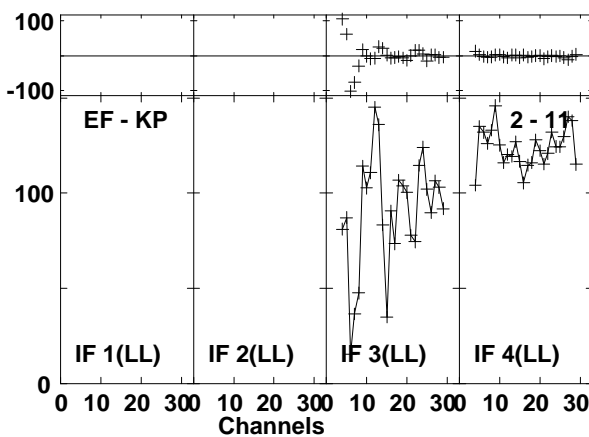
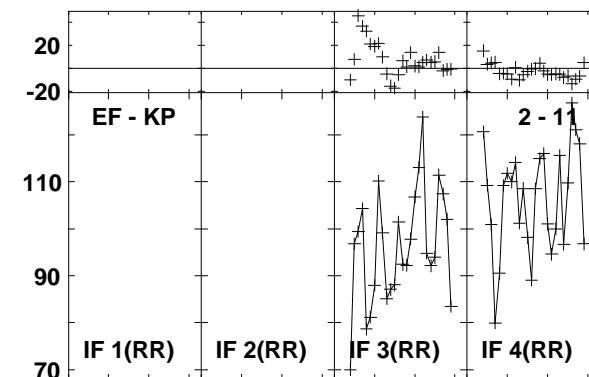
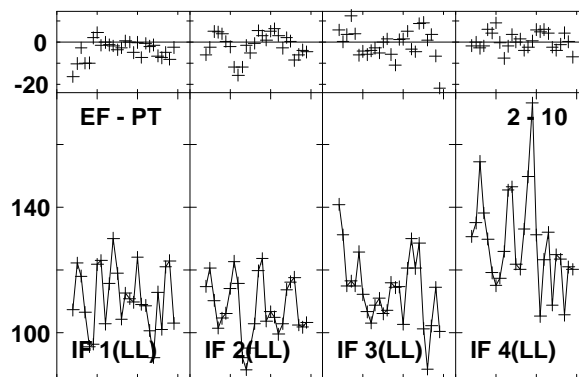
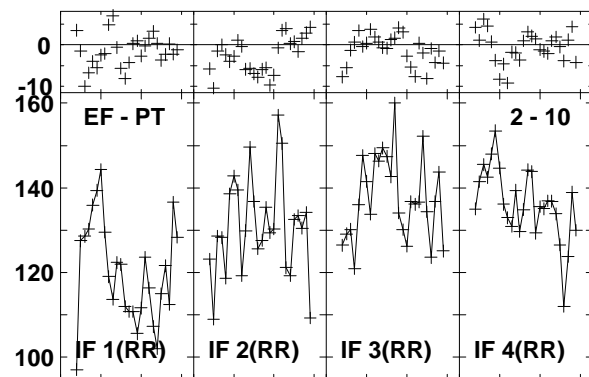
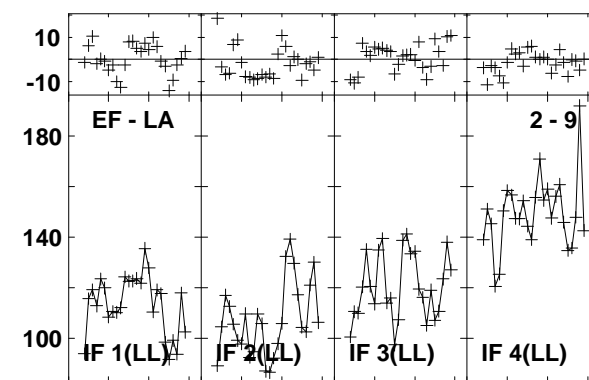
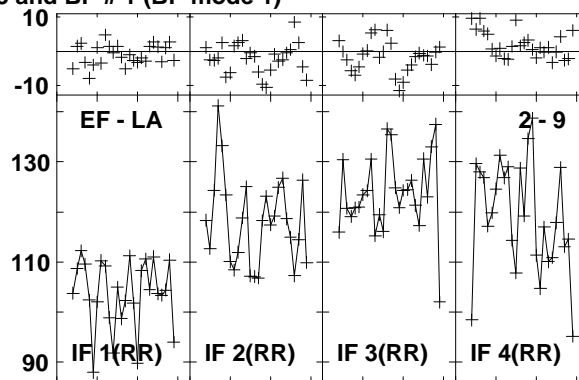
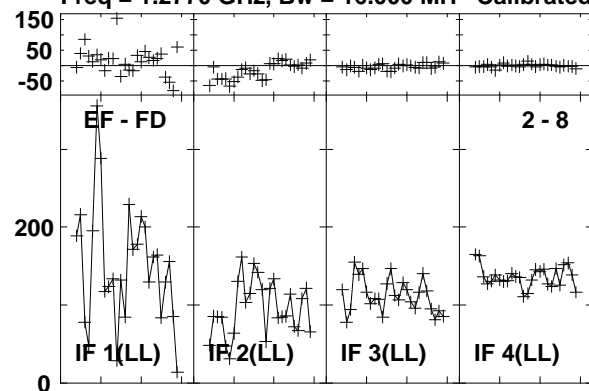

Lower frame: Milli Ampl Jy Top frame: Phas deg
Vector averaged cross-power spectrum Baseline: EF (02) - FD (08)
Timerange: 00/20:11:16 to 00/20:12:14

Plot file version 591 created 03-MAR-2016 01:13:37

J1545+5400 GN002C 1.UVDATA.1

Freq = 1.2770 GHz, Bw = 16.000 MH Calibrated with CL # 3 and BP # 1 (BP mode 1)

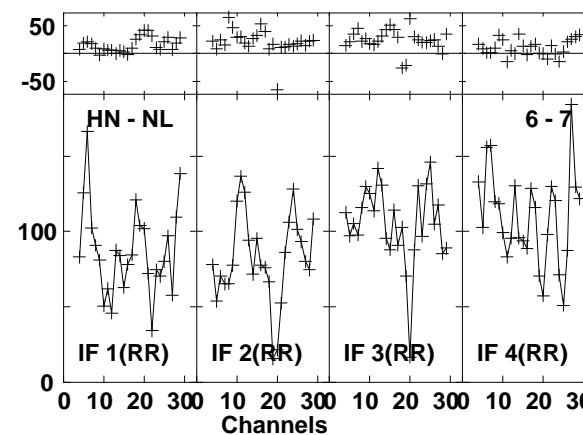
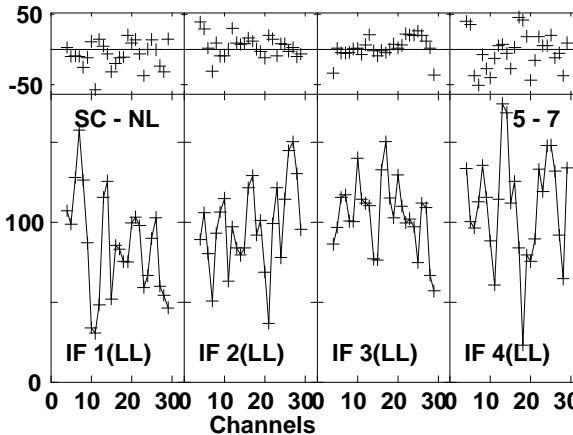
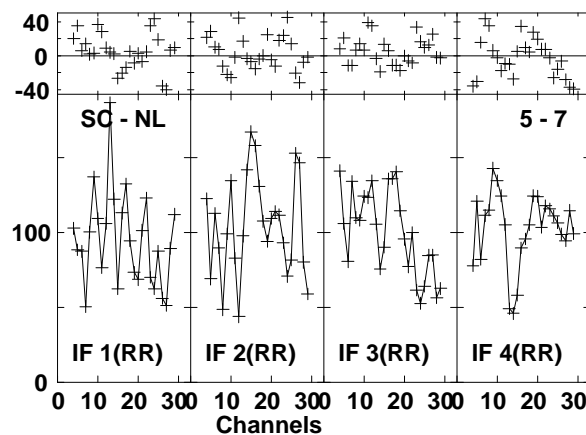
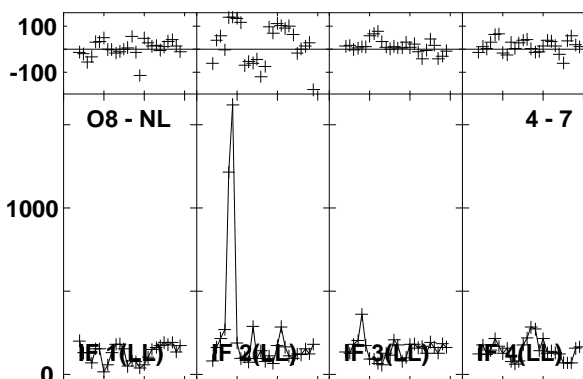
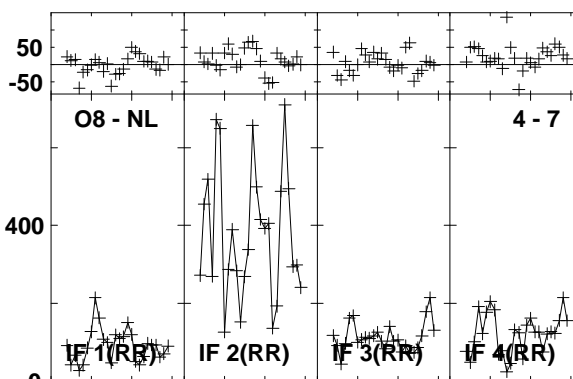
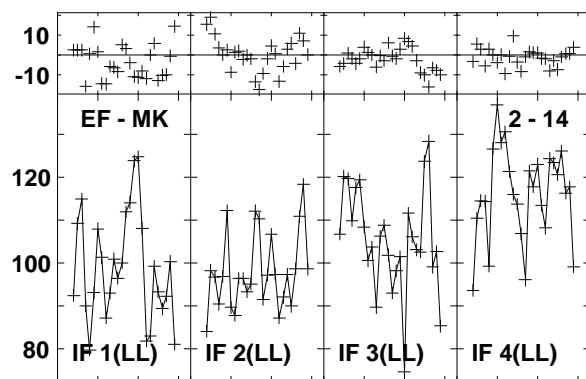
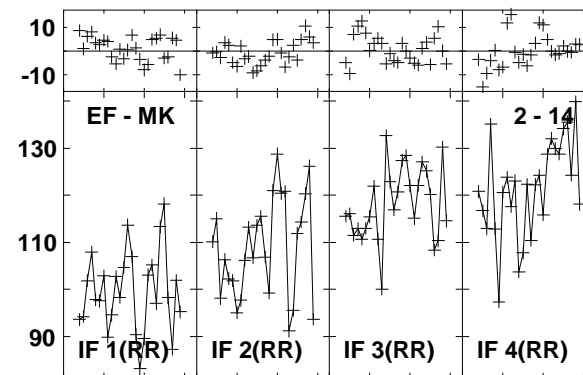
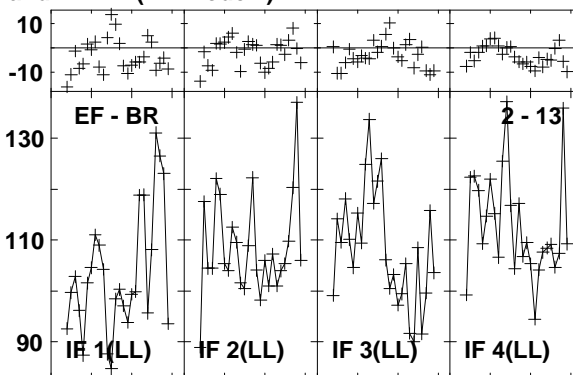
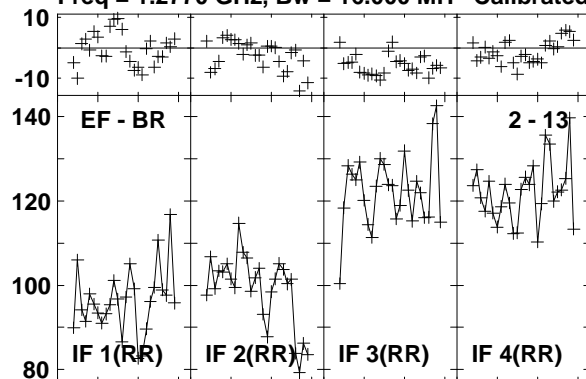

Lower frame: Milli Ampl Jy Top frame: Phas deg
Vector averaged cross-power spectrum Baseline: EF (02) - BR (13)
Timerange: 00/20:11:16 to 00/20:12:14

Plot file version 592 created 03-MAR-2016 01:13:37

J1545+5400 GN002C 1.UVDATA.1

Freq = 1.2770 GHz, Bw = 16.000 MH Calibrated with CL # 3 and BP # 1 (BP mode 1)

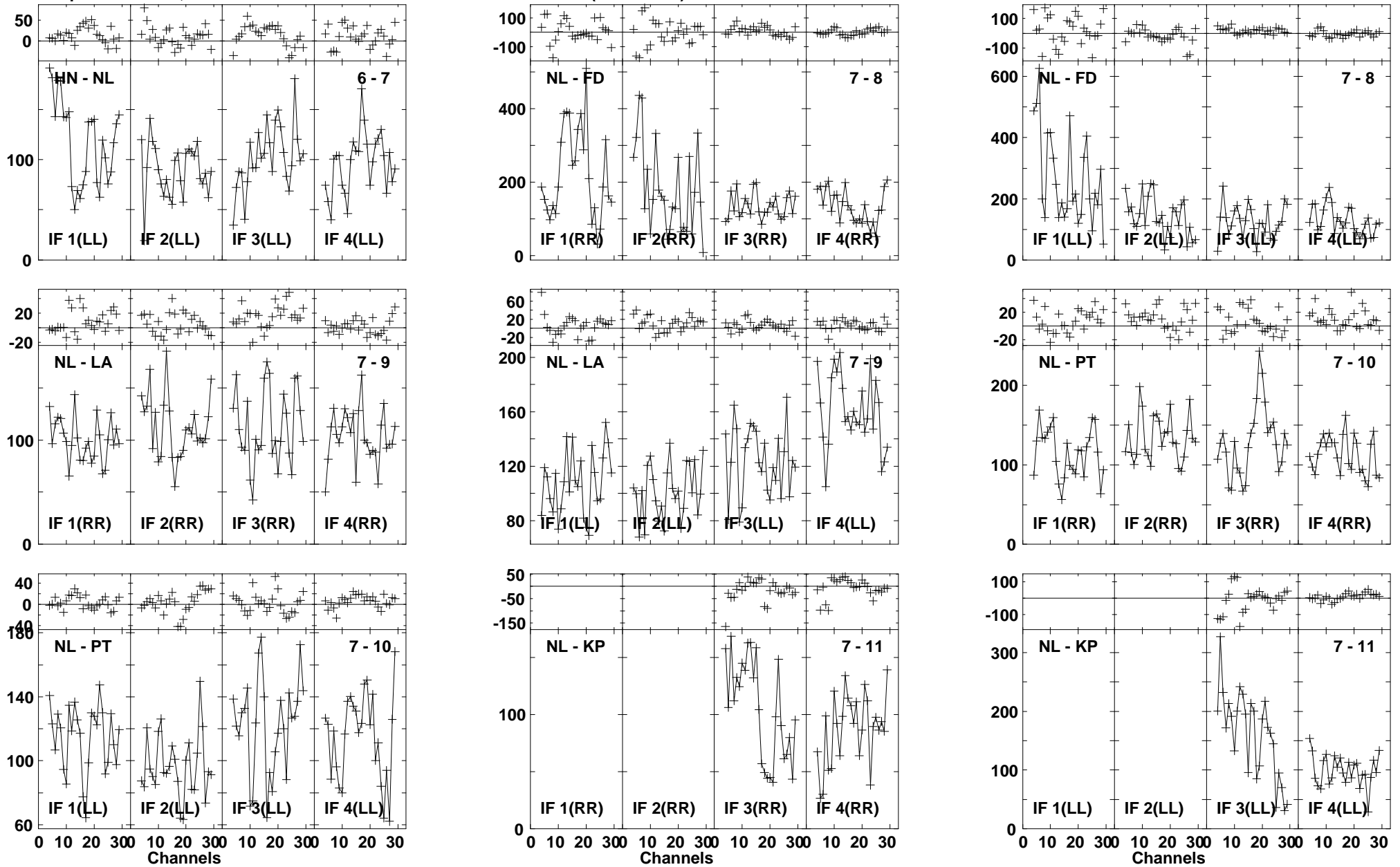

Lower frame: Milli Ampl Jy Top frame: Phas deg
Vector averaged cross-power spectrum Baseline: HN (06) - NL (07)
Timerange: 00/20:11:16 to 00/20:12:14

Plot file version 593 created 03-MAR-2016 01:13:37

J1545+5400 GN002C 1.UVDATA.1

Freq = 1.2770 GHz, Bw = 16.000 MH Calibrated with CL # 3 and BP # 1 (BP mode 1)

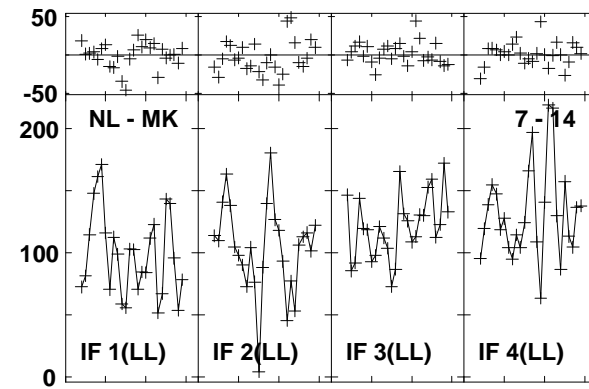
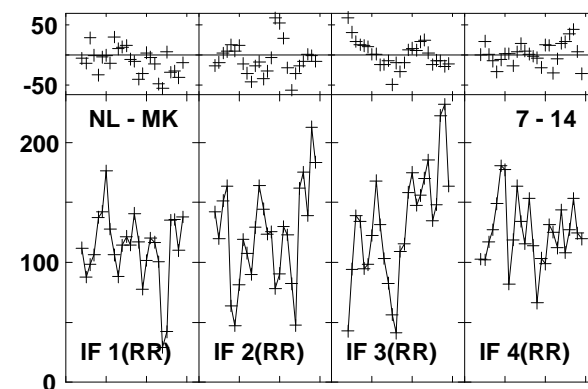
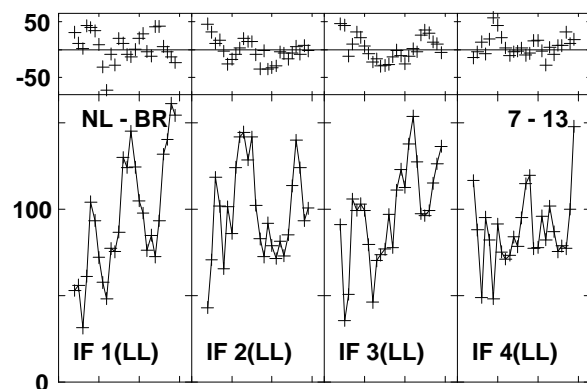
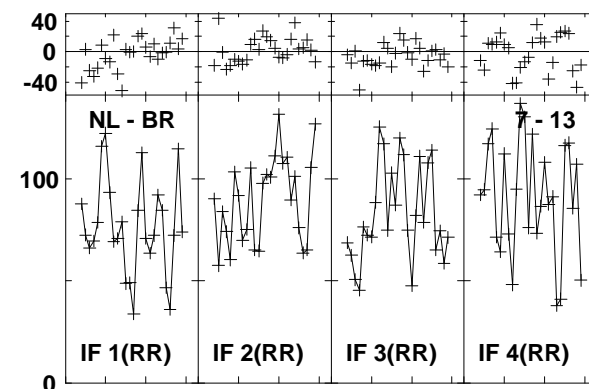
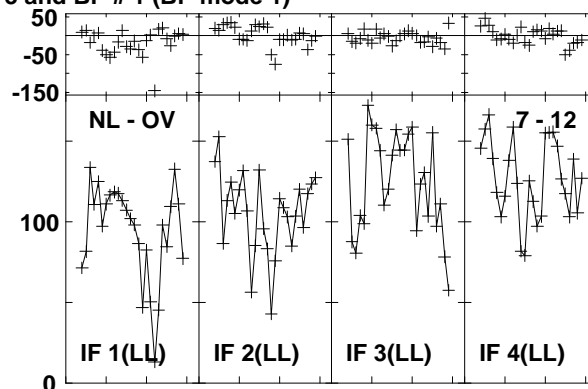
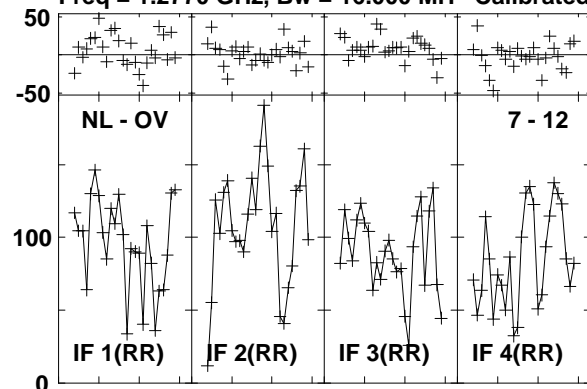

Lower frame: Milli Ampl Jy Top frame: Phas deg
Vector averaged cross-power spectrum Baseline: NL (07) - OV (12)
Timerange: 00/20:11:16 to 00/20:12:14

Plot file version 594 created 03-MAR-2016 01:13:37

4C52 GN002C 1.UVDATA.1

Freq = 1.2770 GHz, Bw = 16.000 MH Calibrated with CL # 3 and BP # 1 (BP mode 1)

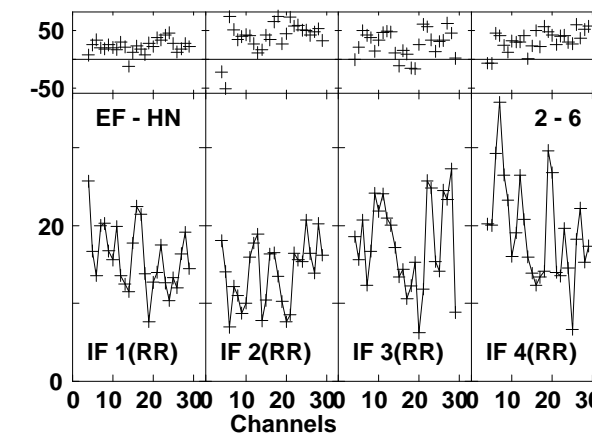
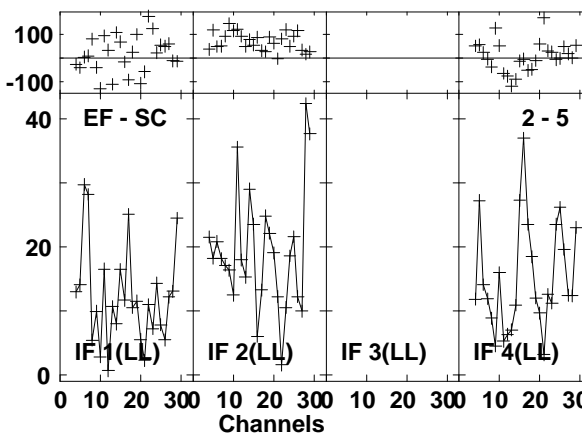
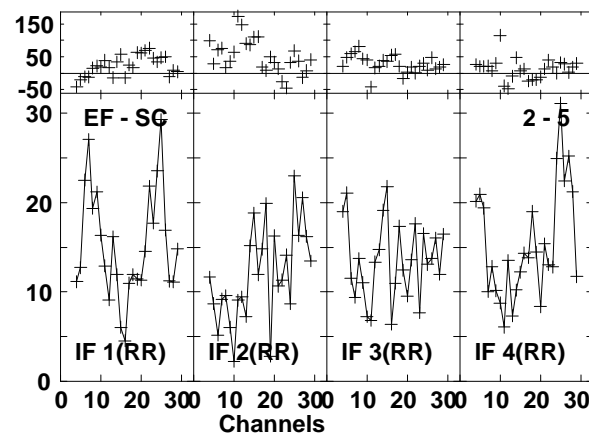
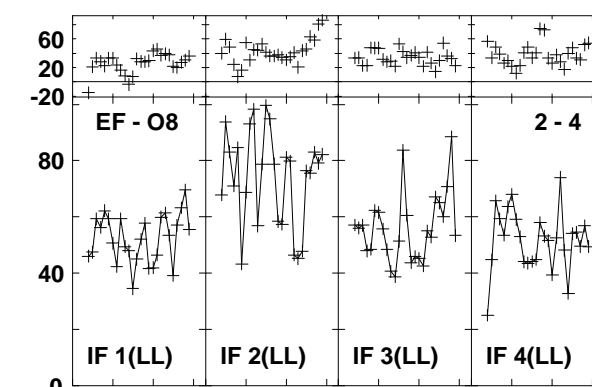
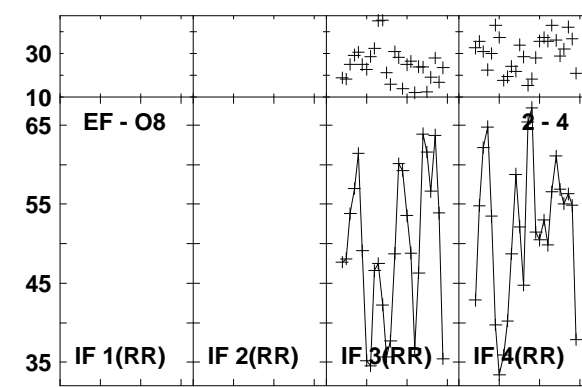
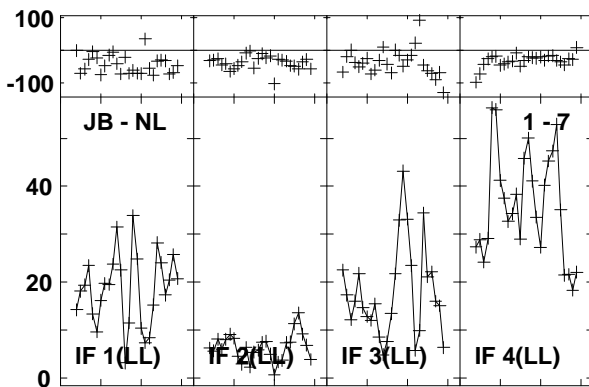
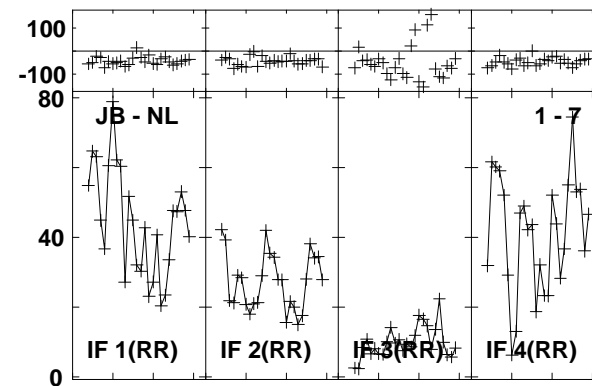
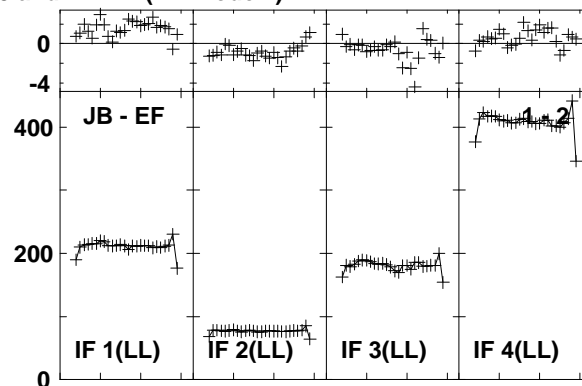
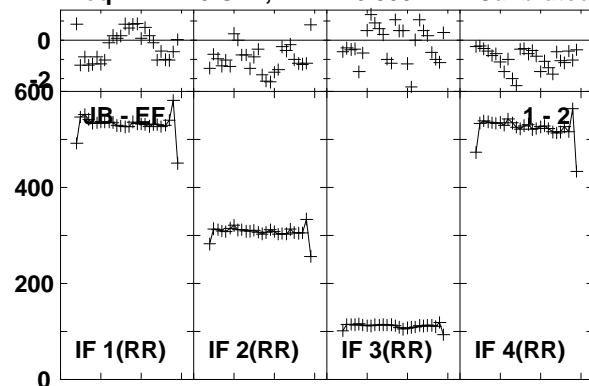

Lower frame: Milli Ampl Jy Top frame: Phas deg
Vector averaged cross-power spectrum Baseline: JB (01) - EF (02)
Timerange: 00/20:12:19 to 00/20:15:13

Plot file version 595 created 03-MAR-2016 01:13:37

4C52 GN002C 1.UVDATA.1

Freq = 1.2770 GHz, Bw = 16.000 MH Calibrated with CL # 3 and BP # 1 (BP mode 1)

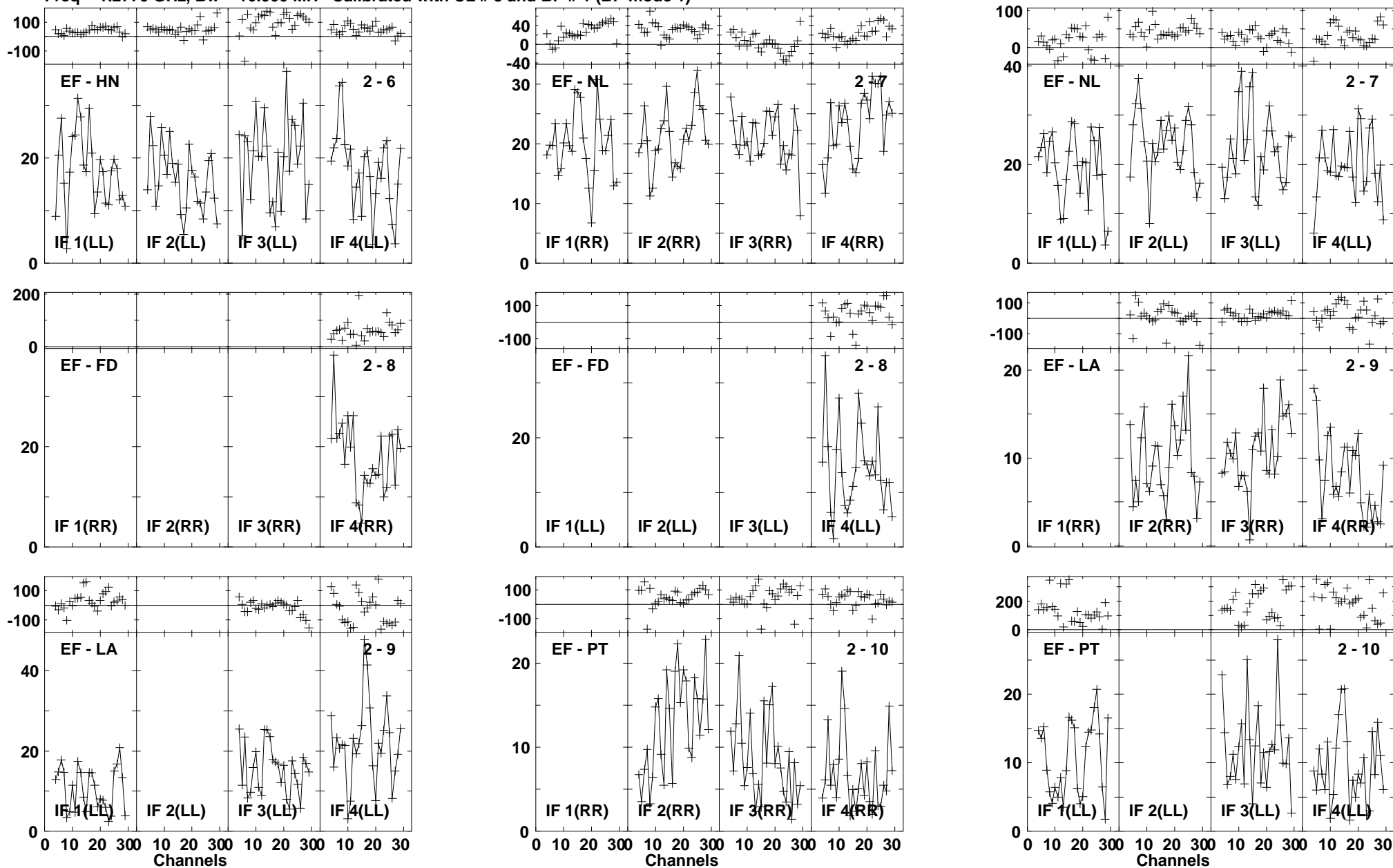

Lower frame: Milli Ampl Jy Top frame: Phas deg
Vector averaged cross-power spectrum Baseline: EF (02) - HN (06)
Timerange: 00/20:12:19 to 00/20:15:13

Plot file version 596 created 03-MAR-2016 01:13:38

4C52 GN002C 1.UVDATA.1

Freq = 1.2770 GHz, Bw = 16.000 MH Calibrated with CL # 3 and BP # 1 (BP mode 1)

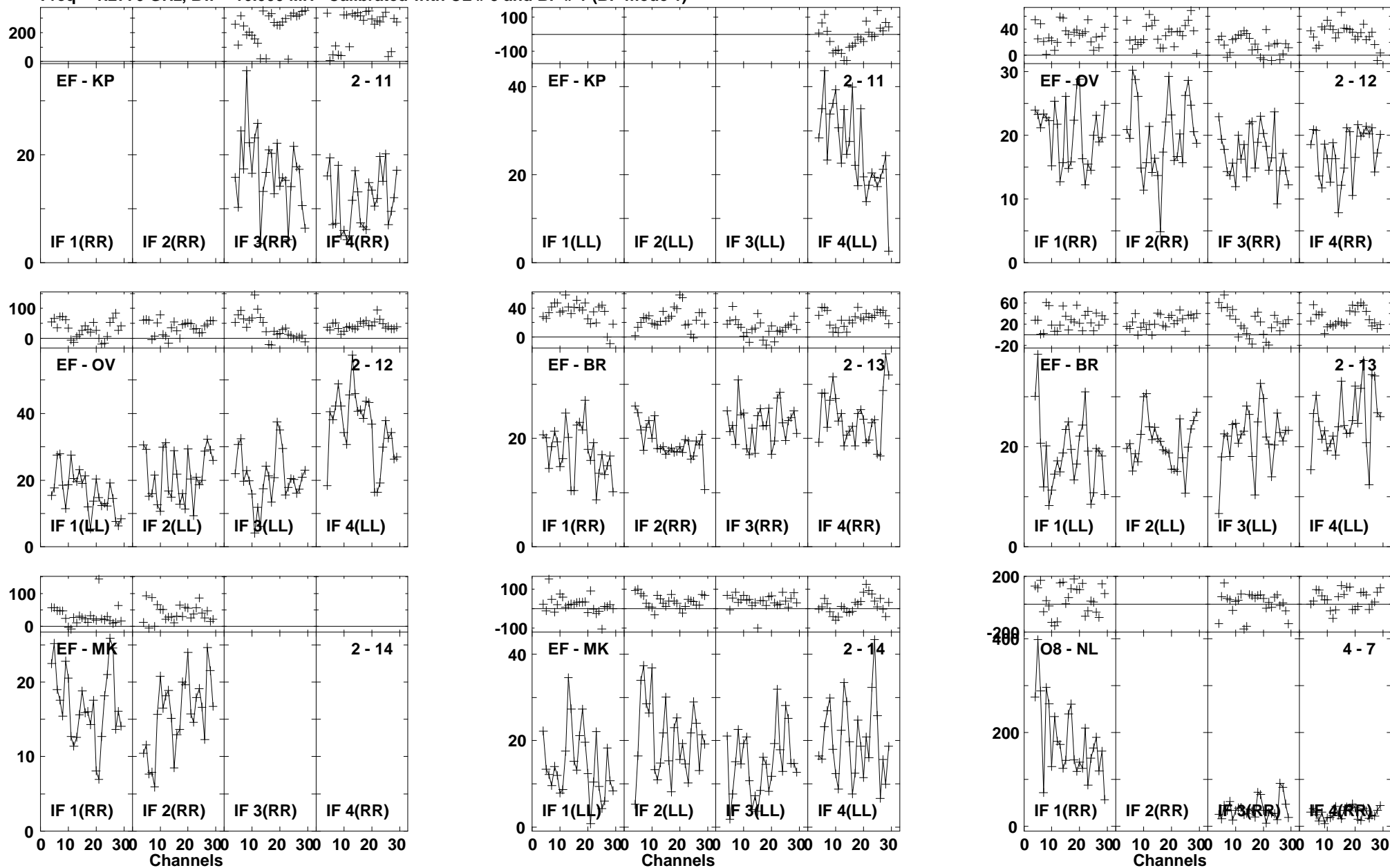

Lower frame: Milli Ampl Jy Top frame: Phas deg
Vector averaged cross-power spectrum Baseline: EF (02) - KP (11)
Timerange: 00/20:12:19 to 00/20:15:13

Plot file version 597 created 03-MAR-2016 01:13:38

4C52 GN002C 1.UVDATA.1

Freq = 1.2770 GHz, Bw = 16.000 MH Calibrated with CL # 3 and BP # 1 (BP mode 1)

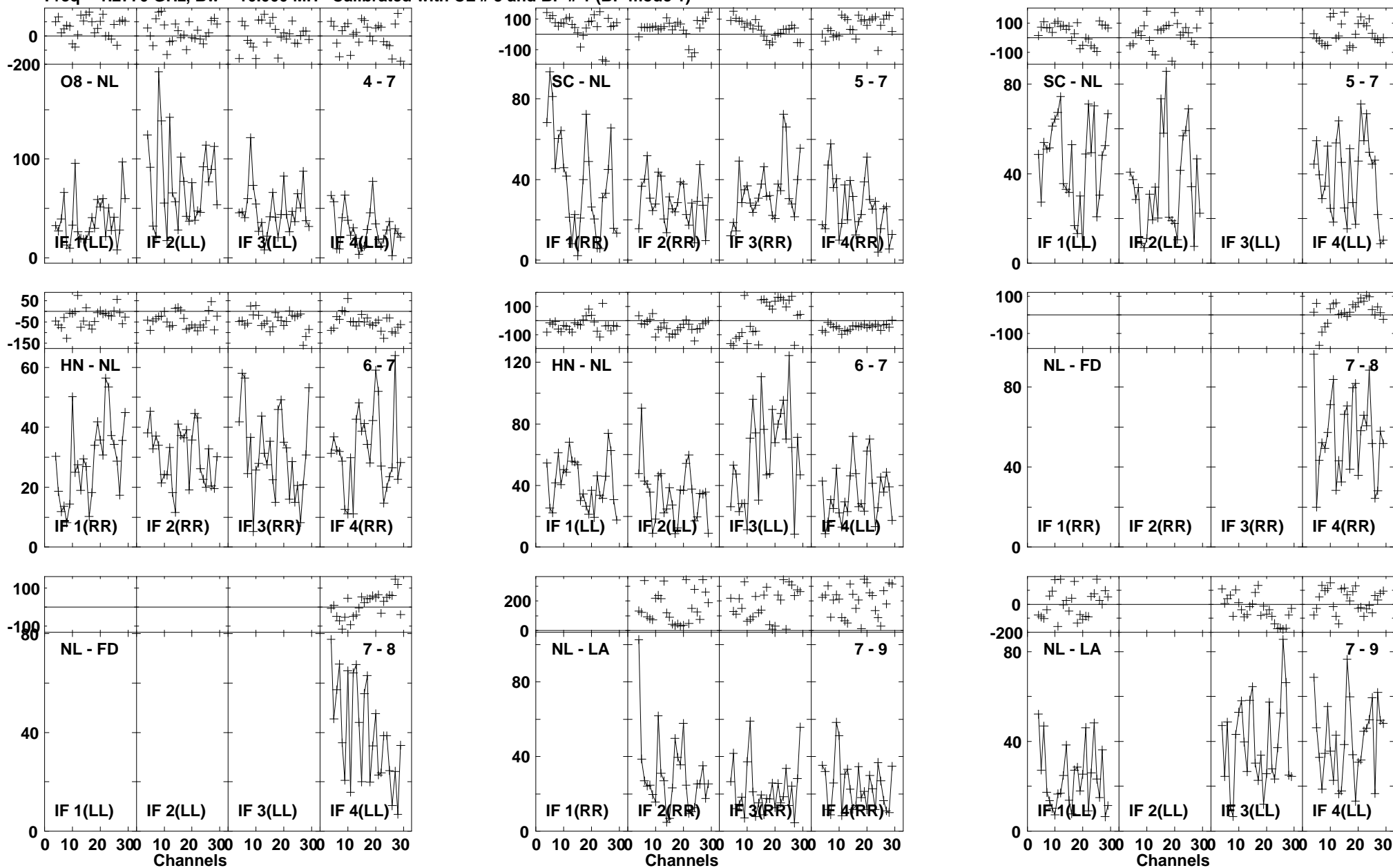

Lower frame: Milli Ampl Jy Top frame: Phas deg
Vector averaged cross-power spectrum Baseline: O8 (04) - NL (07)
Timerange: 00/20:12:19 to 00/20:15:13

Plot file version 598 created 03-MAR-2016 01:13:38

4C52 GN002C 1.UVDATA.1

Freq = 1.2770 GHz, Bw = 16.000 MH Calibrated with CL # 3 and BP # 1 (BP mode 1)

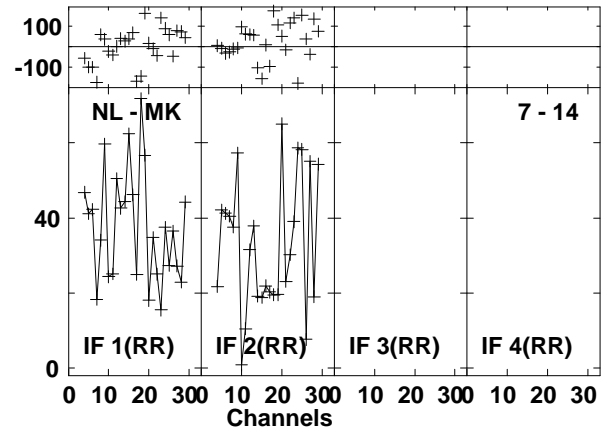
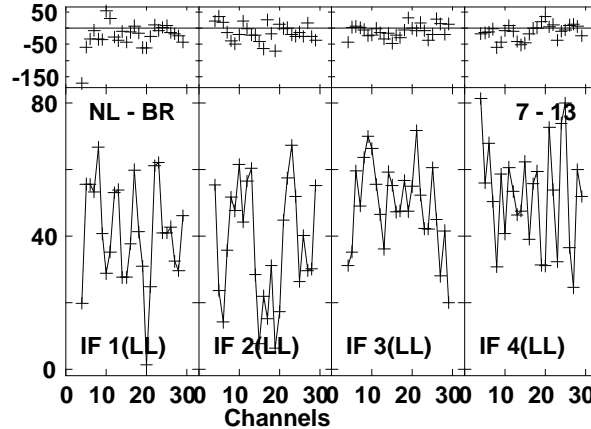
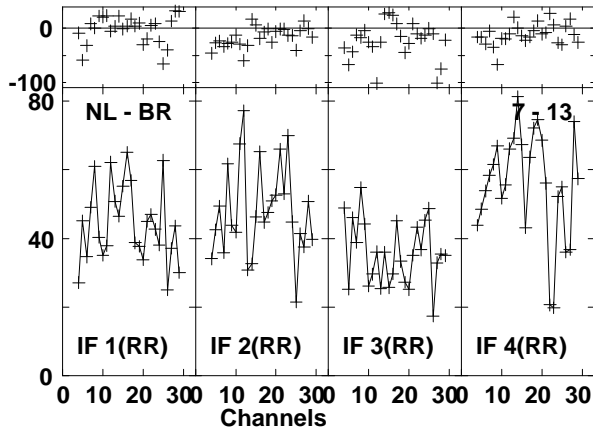
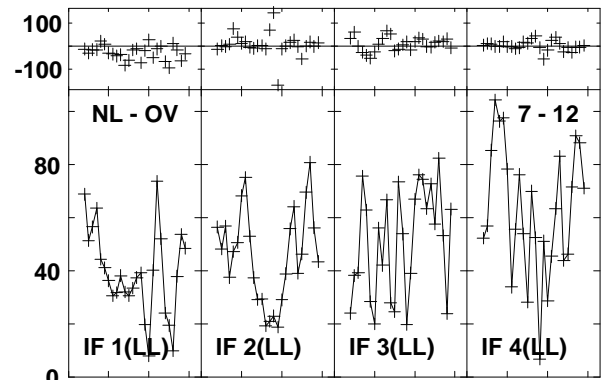
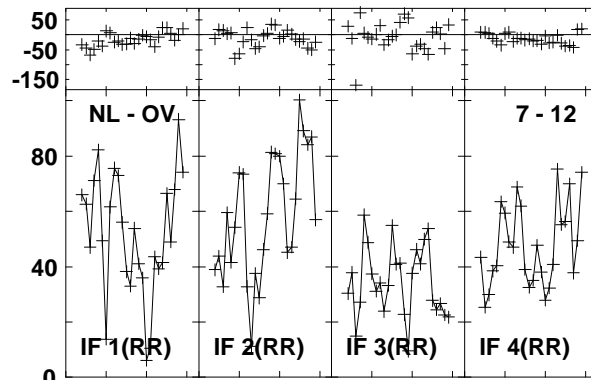
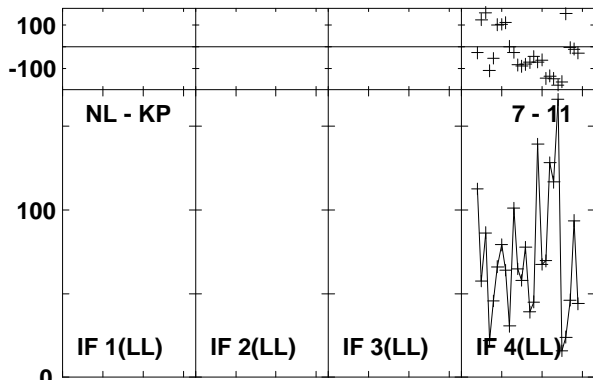
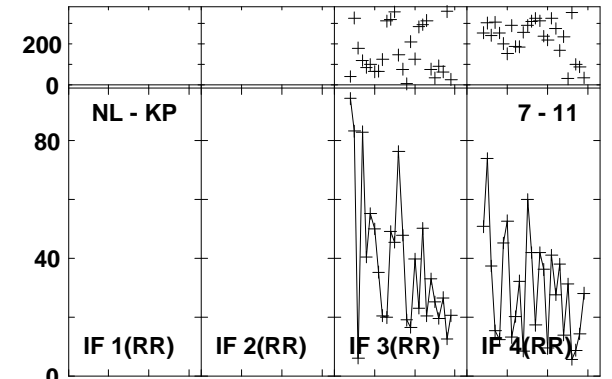
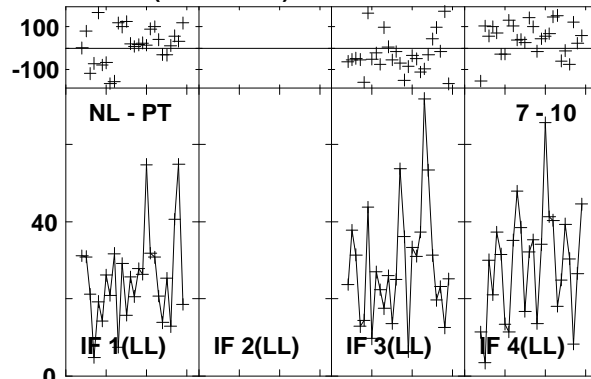
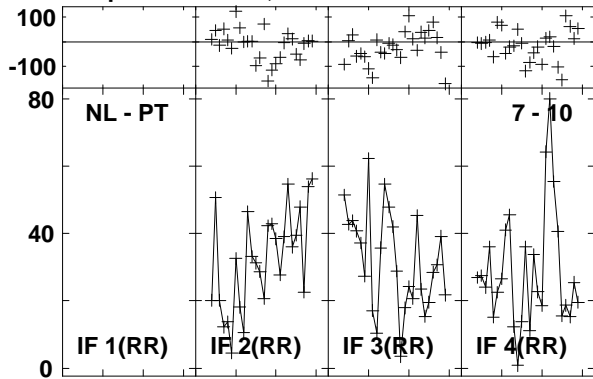

Lower frame: Milli Ampl Jy Top frame: Phas deg
Vector averaged cross-power spectrum Baseline: NL (07) - PT (10)
Timerange: 00/20:12:19 to 00/20:15:13

Plot file version 599 created 03-MAR-2016 01:13:38
4C52 GN002C 1.UVDATA.1
Freq = 1.2770 GHz, Bw = 16.000 MH Calibrated with CL # 3 and BP # 1 (BP mode 1)

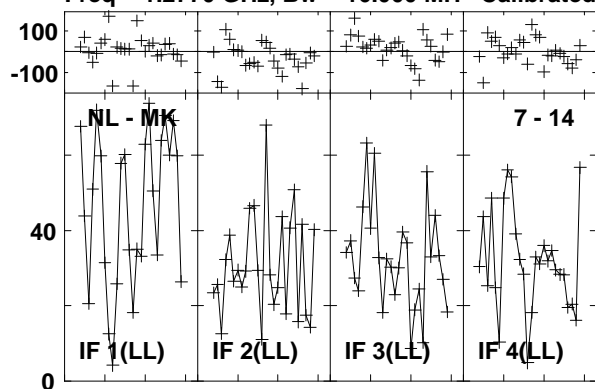

Lower frame: Milli Ampl Jy Top frame: Phas deg
Vector averaged cross-power spectrum Baseline: NL (07) - MK (14)
Timerange: 00/20:12:19 to 00/20:15:13

Plot file version 600 created 03-MAR-2016 01:13:38

J1545+5400 GN002C 1.UVDATA.1

Freq = 1.2770 GHz, Bw = 16.000 MH Calibrated with CL # 3 and BP # 1 (BP mode 1)

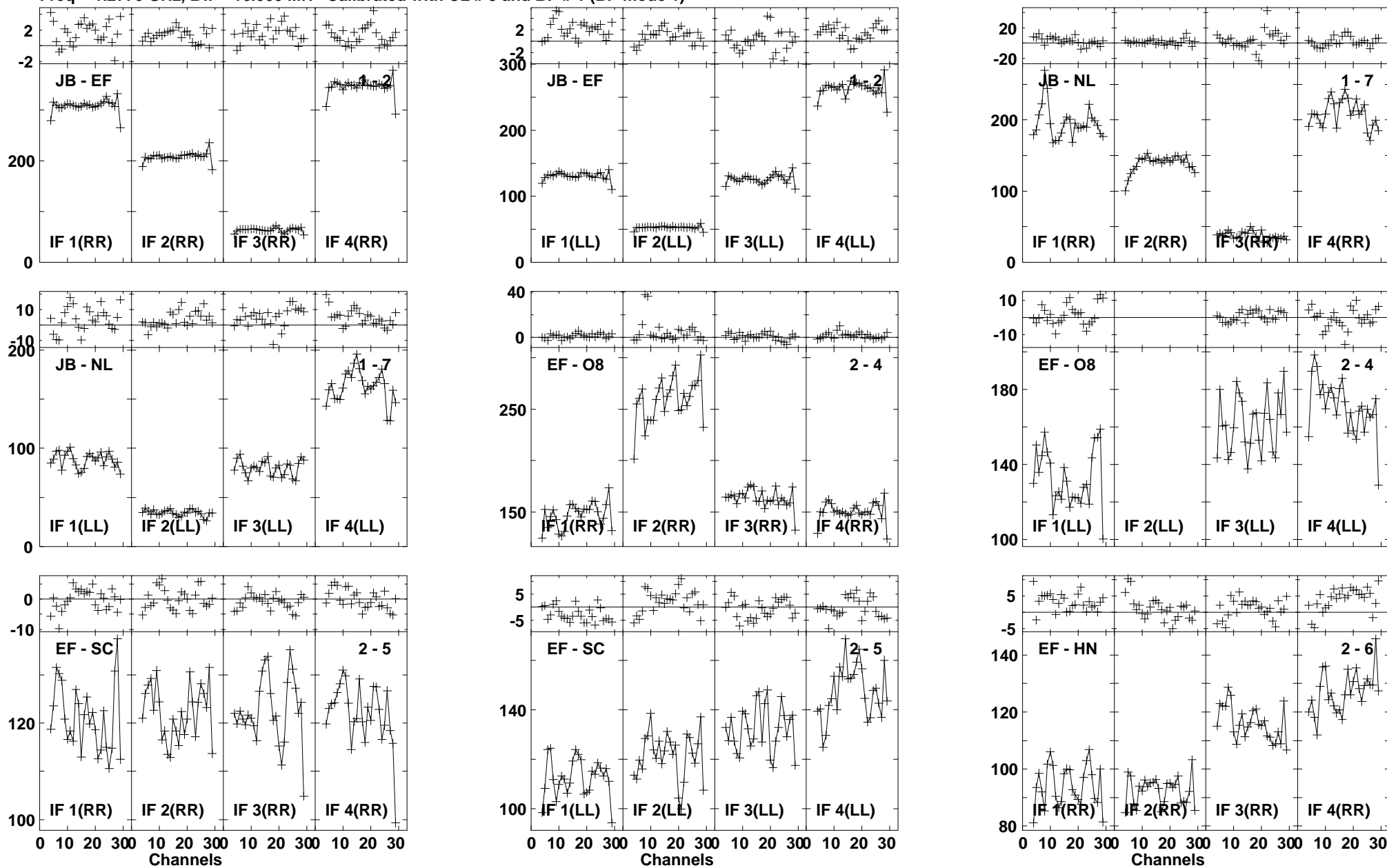

Lower frame: Milli Ampl Jy Top frame: Phas deg
Vector averaged cross-power spectrum Baseline: JB (01) - EF (02)
Timerange: 00/20:16:06 to 00/20:18:04

Plot file version 601 created 03-MAR-2016 01:13:38

J1545+5400 GN002C 1.UVDATA.1

Freq = 1.2770 GHz, Bw = 16.000 MH Calibrated with CL # 3 and BP # 1 (BP mode 1)

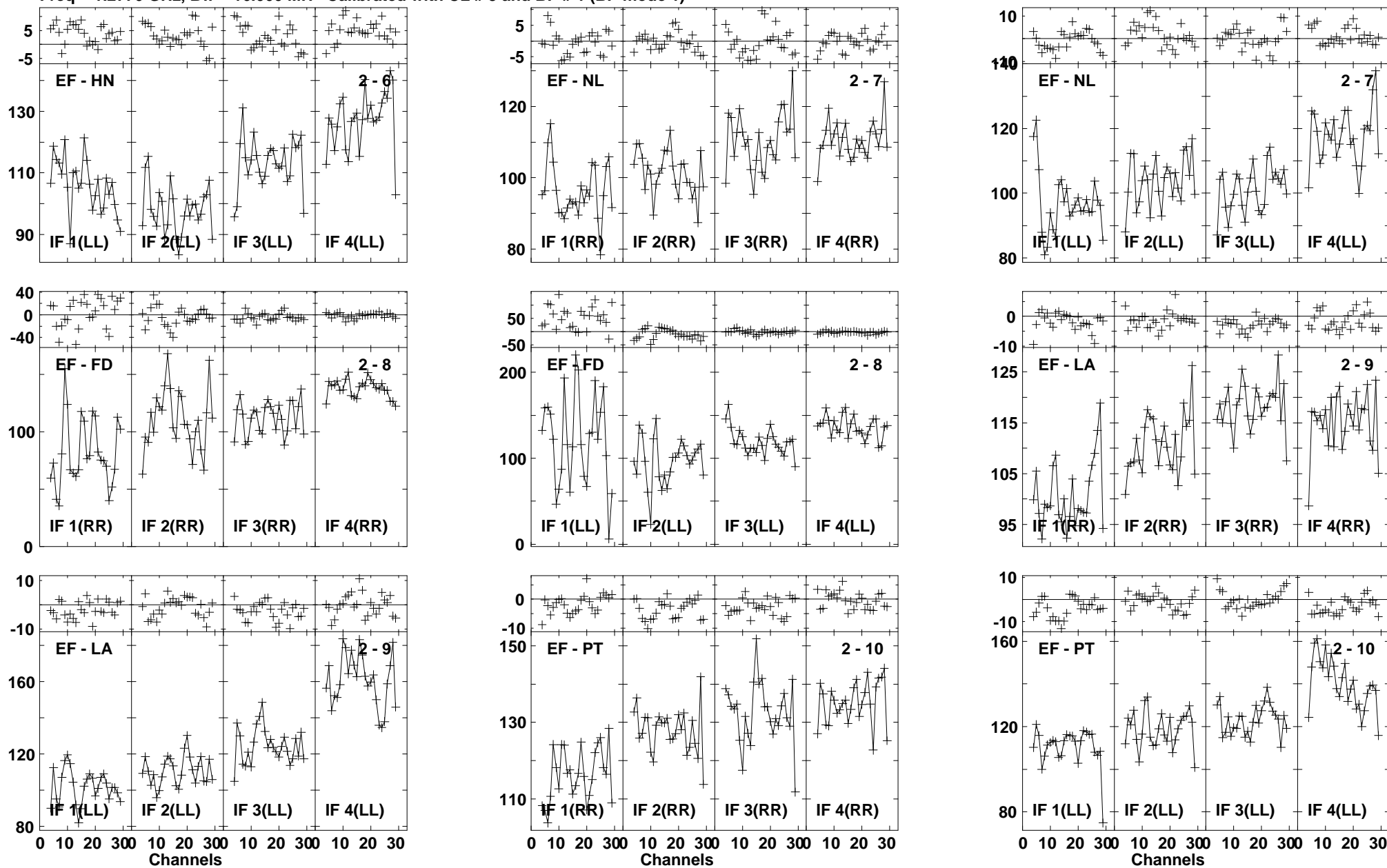

Lower frame: Milli Ampl Jy Top frame: Phas deg
Vector averaged cross-power spectrum Baseline: EF (02) - HN (06)
Timerange: 00/20:16:06 to 00/20:18:04

Plot file version 602 created 03-MAR-2016 01:13:39

J1545+5400 GN002C 1.UVDATA.1

Freq = 1.2770 GHz, Bw = 16.000 MH Calibrated with CL # 3 and BP # 1 (BP mode 1)

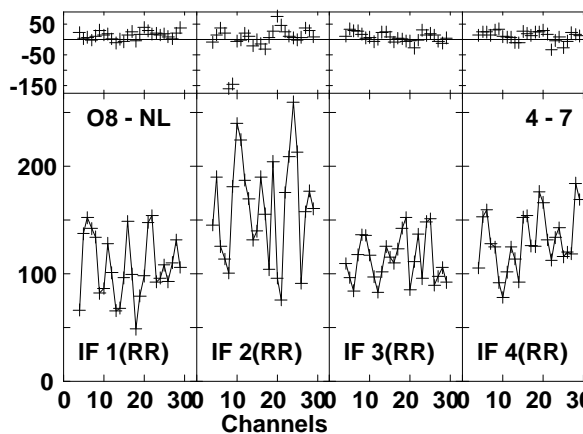
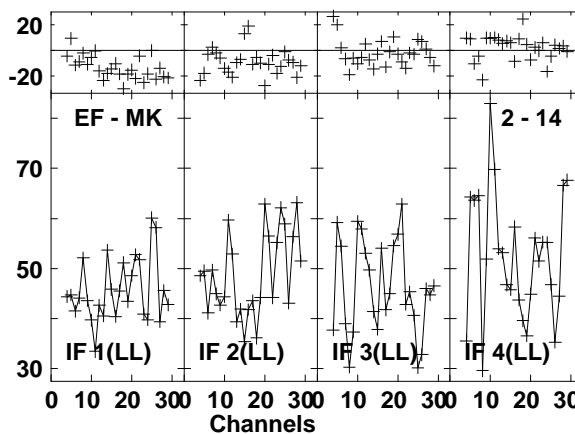
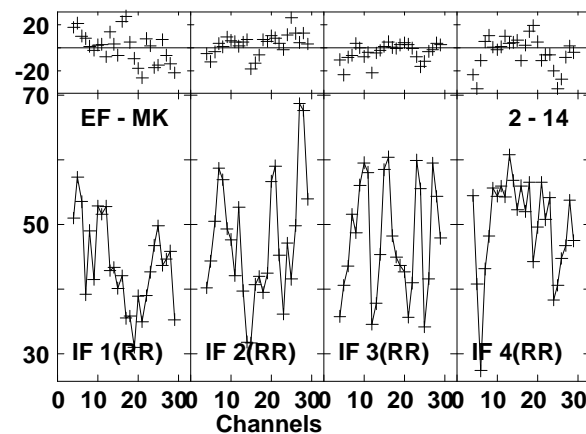
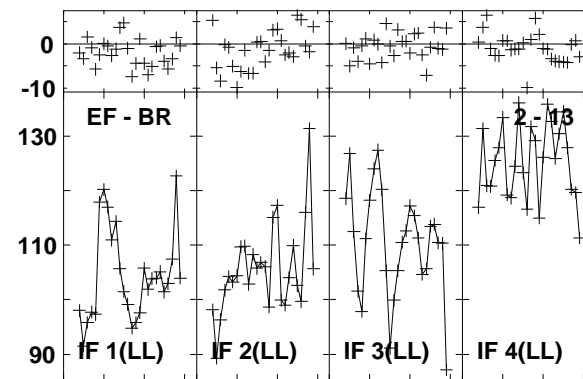
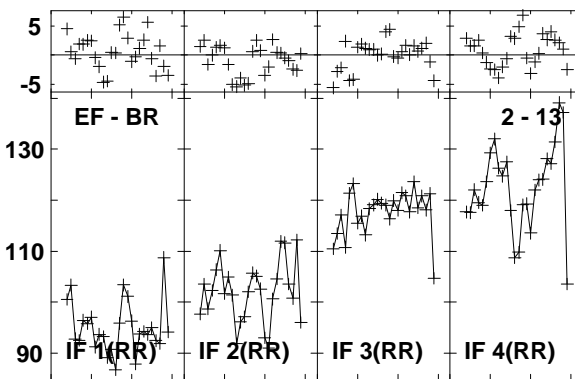
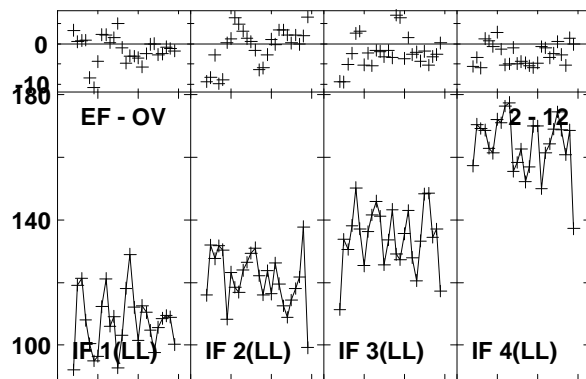
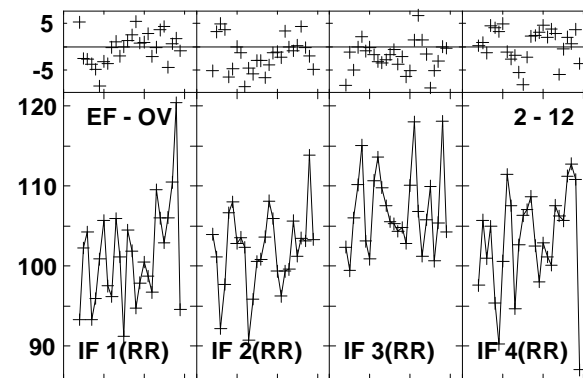
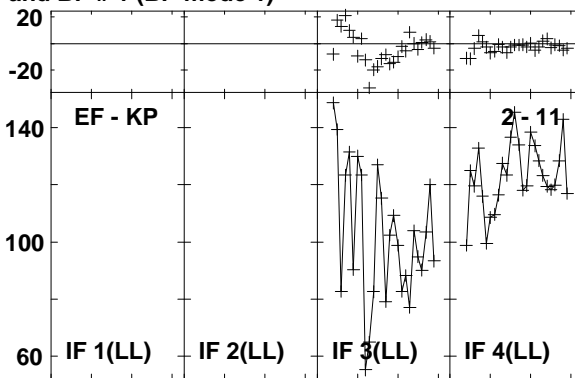
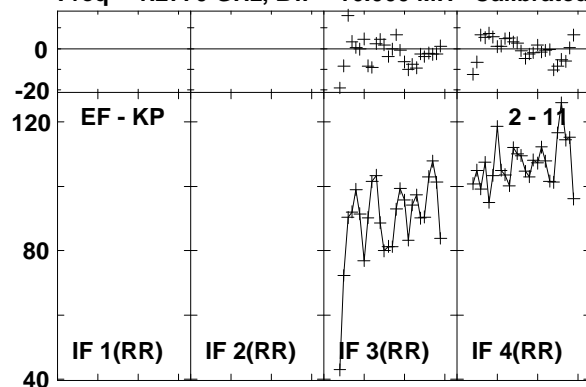

Lower frame: Milli Ampl Jy Top frame: Phas deg
Vector averaged cross-power spectrum Baseline: EF (02) - KP (11)
Timerange: 00/20:16:06 to 00/20:18:04

Plot file version 603 created 03-MAR-2016 01:13:39
 J1545+5400 GN002C 1.UVDATA.1
 Freq = 1.2770 GHz, Bw = 16.000 MH Calibrated with CL # 3 and BP # 1 (BP mode 1)

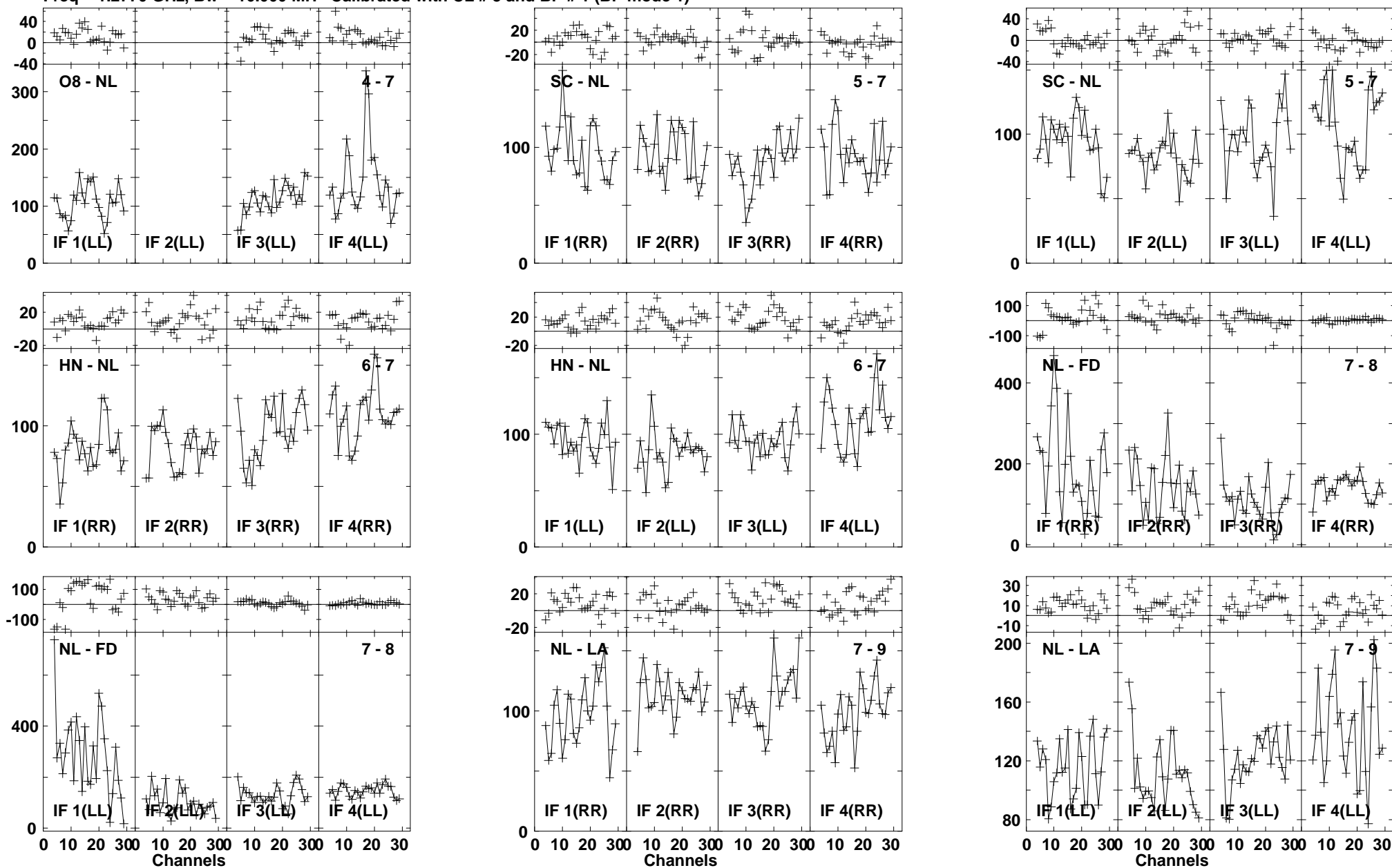

Lower frame: Milli Ampl Jy Top frame: Phas deg
 Vector averaged cross-power spectrum Baseline: O8 (04) - NL (07)
 Timerange: 00/20:16:06 to 00/20:18:04

Plot file version 604 created 03-MAR-2016 01:13:39

J1545+5400 GN002C 1.UVDATA.1

Freq = 1.2770 GHz, Bw = 16.000 MH Calibrated with CL # 3 and BP # 1 (BP mode 1)

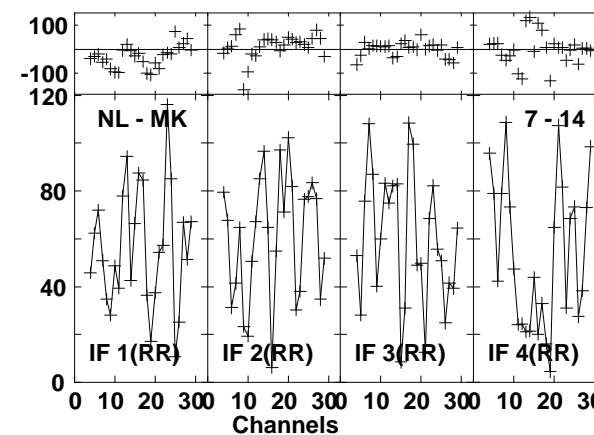
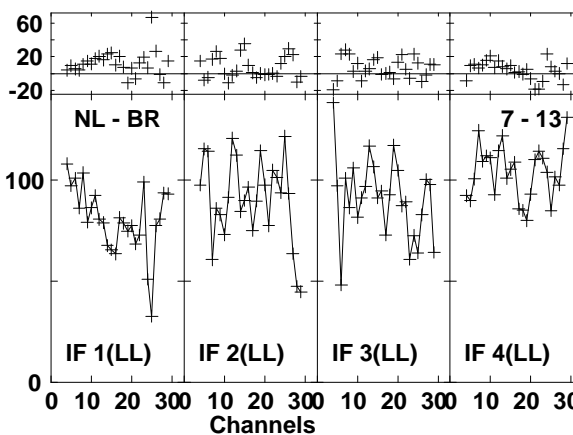
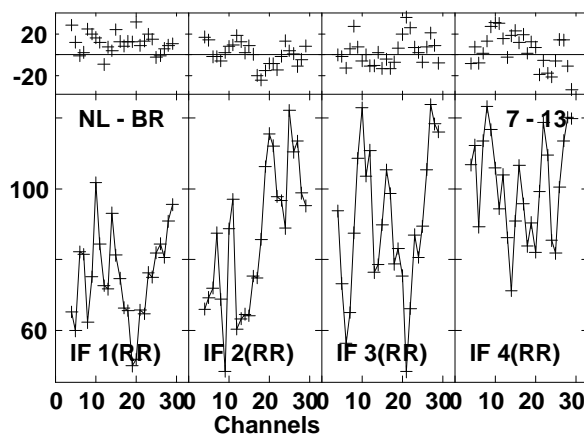
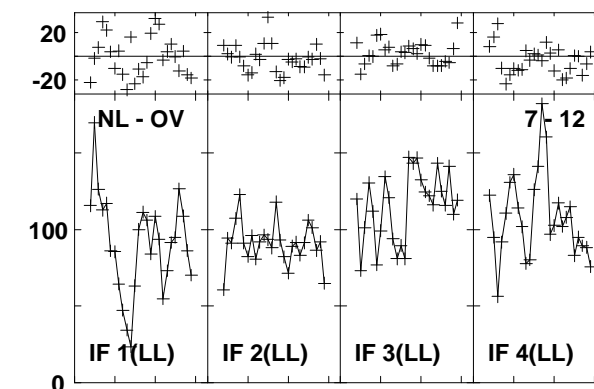
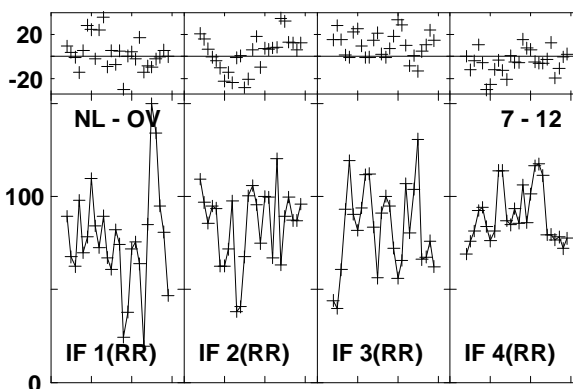
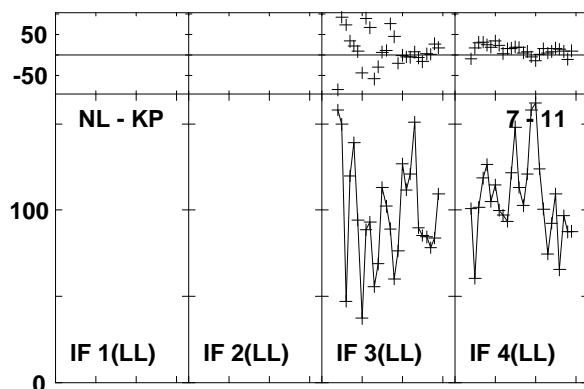
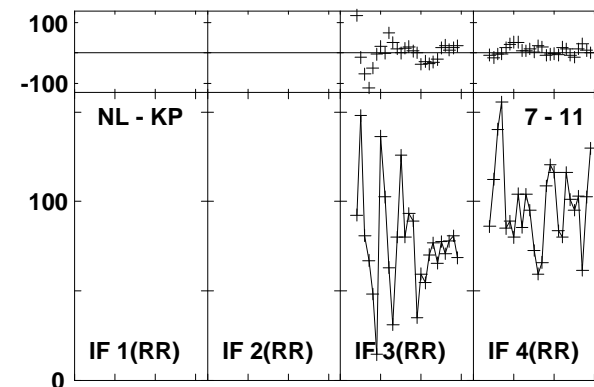
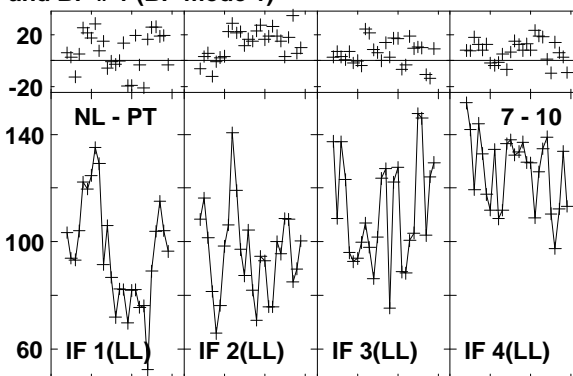
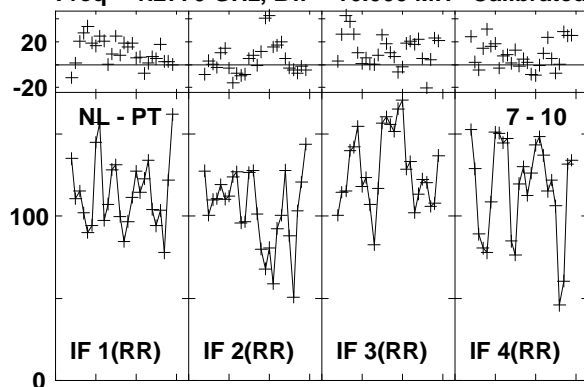

Lower frame: Milli Ampl Jy Top frame: Phas deg
Vector averaged cross-power spectrum Baseline: NL (07) - PT (10)
Timerange: 00/20:16:06 to 00/20:18:04

Plot file version 605 created 03-MAR-2016 01:13:39
J1545+5400 GN002C 1.UVDATA.1
Freq = 1.2770 GHz, Bw = 16.000 MH Calibrated with CL # 3 and BP # 1 (BP mode 1)

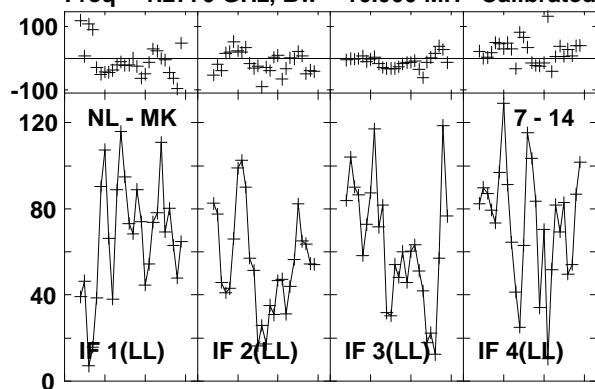

Lower frame: Milli Ampl Jy Top frame: Phas deg
Vector averaged cross-power spectrum Baseline: NL (07) - MK (14)
Timerange: 00/20:16:06 to 00/20:18:04

Plot file version 606 created 03-MAR-2016 01:13:39

4C52 GN002C 1.UVDATA.1

Freq = 1.2770 GHz, Bw = 16.000 MH Calibrated with CL # 3 and BP # 1 (BP mode 1)

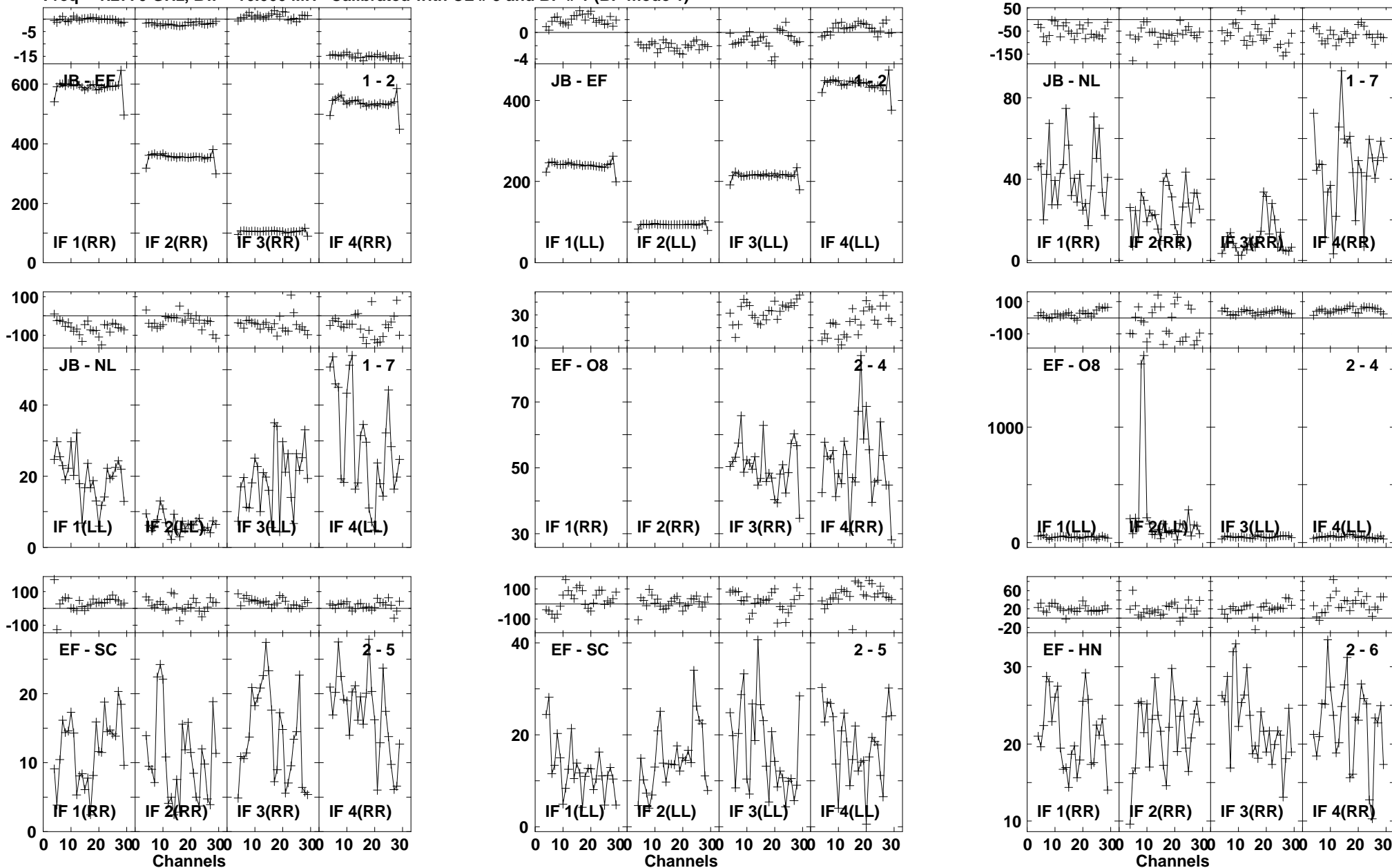

Lower frame: Milli Ampl Jy Top frame: Phas deg
Vector averaged cross-power spectrum Baseline: JB (01) - EF (02)
Timerange: 00/20:18:18 to 00/20:21:04

Plot file version 607 created 03-MAR-2016 01:13:39

4C52 GN002C 1.UVDATA.1

Freq = 1.2770 GHz, Bw = 16.000 MH Calibrated with CL # 3 and BP # 1 (BP mode 1)

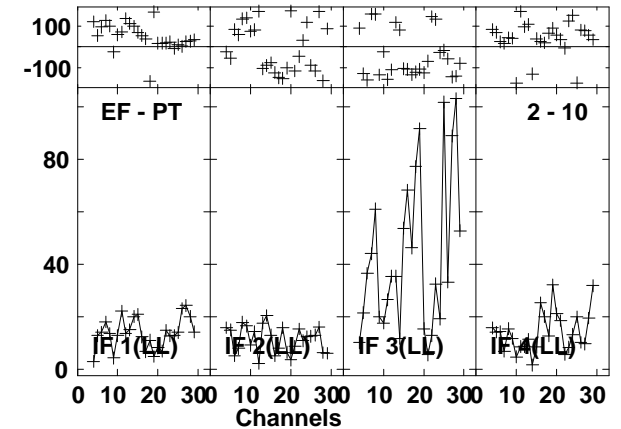
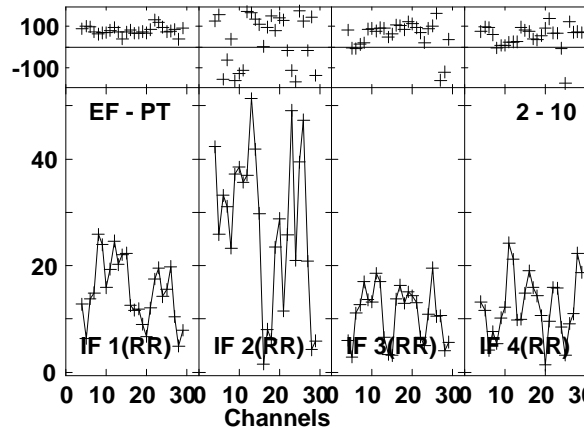
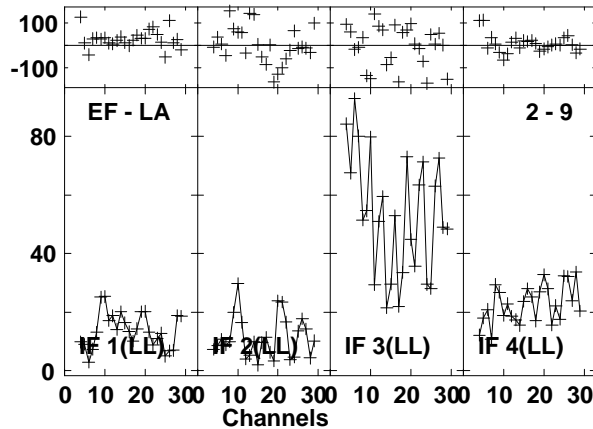
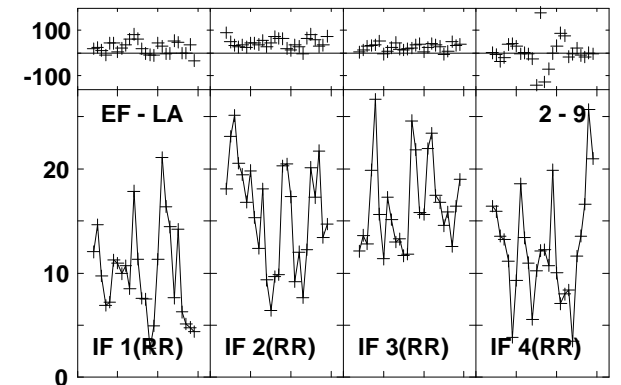
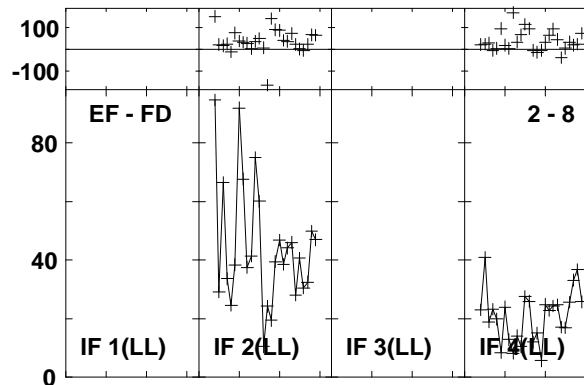
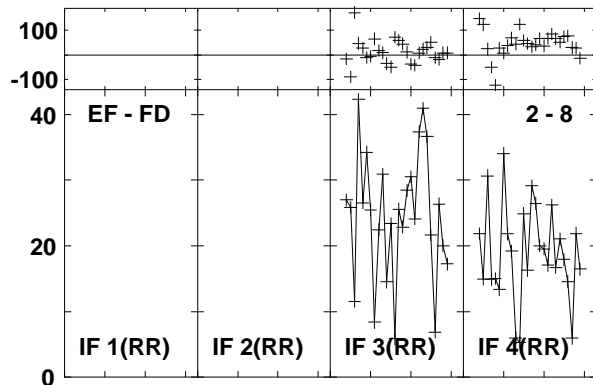
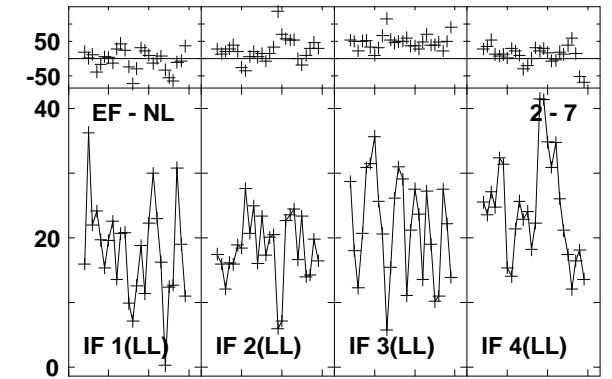
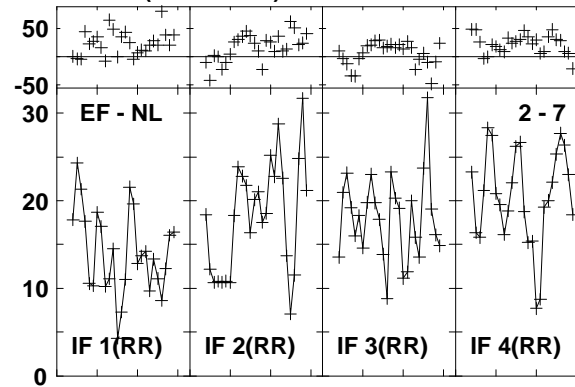
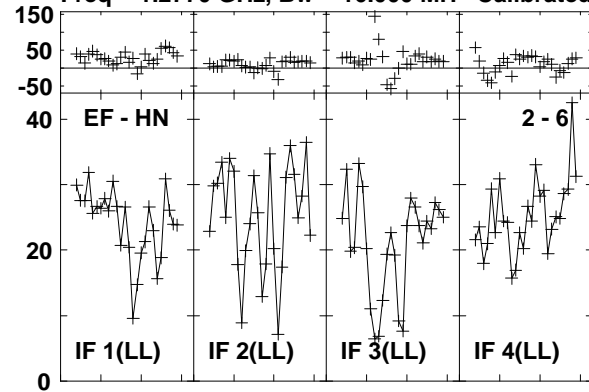

Lower frame: Milli Ampl Jy Top frame: Phas deg
Vector averaged cross-power spectrum Baseline: EF (02) - HN (06)
Timerange: 00/20:18:18 to 00/20:21:04

Plot file version 608 created 03-MAR-2016 01:13:39

4C52 GN002C 1.UVDATA.1

Freq = 1.2770 GHz, Bw = 16.000 MH Calibrated with CL # 3 and BP # 1 (BP mode 1)

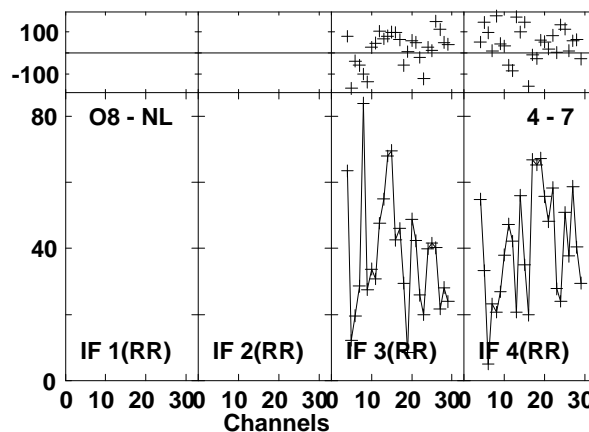
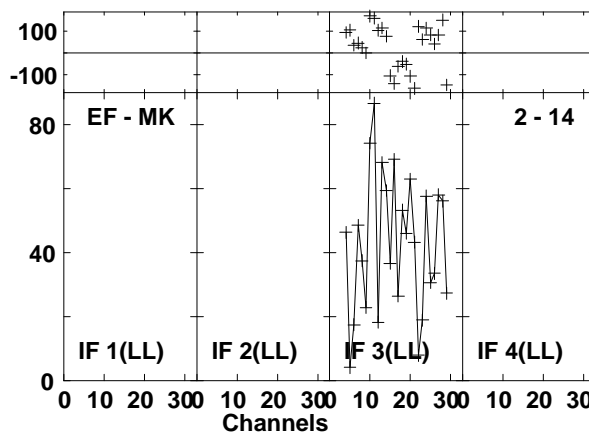
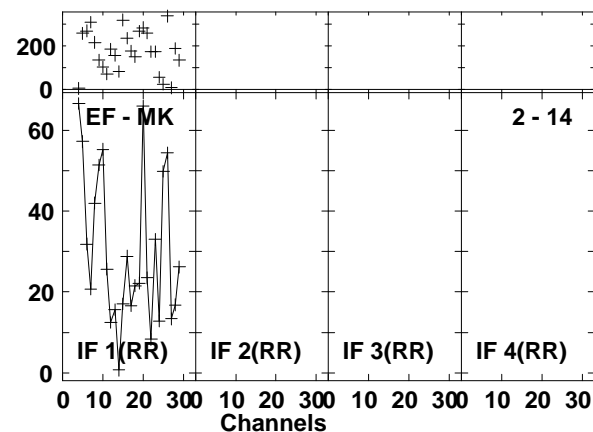
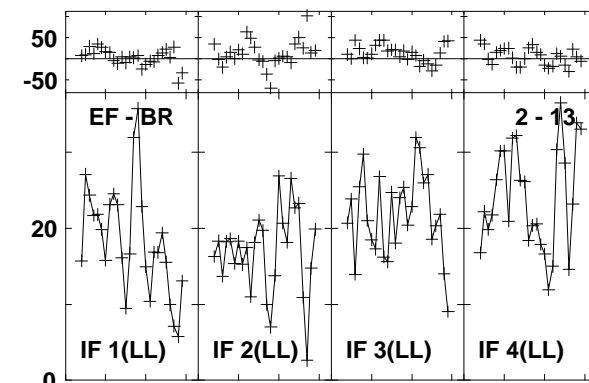
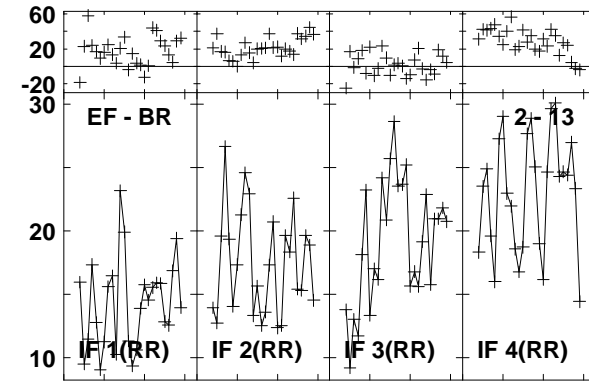
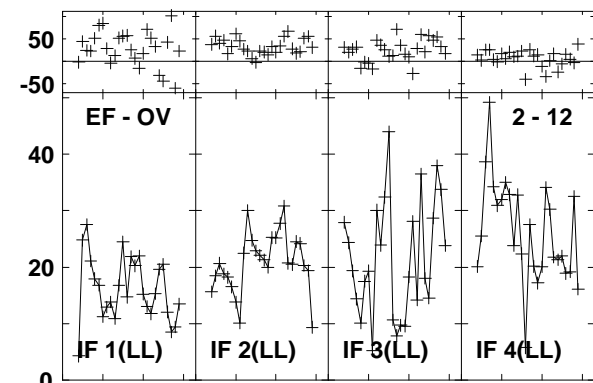
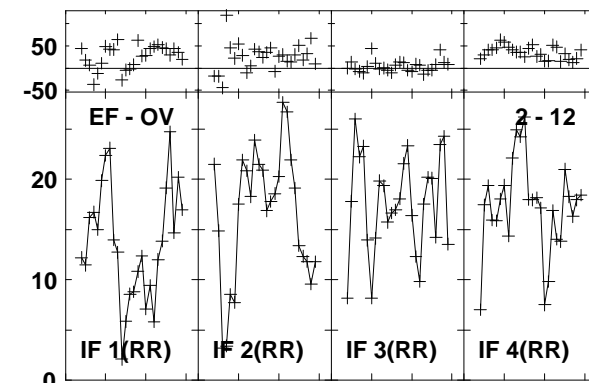
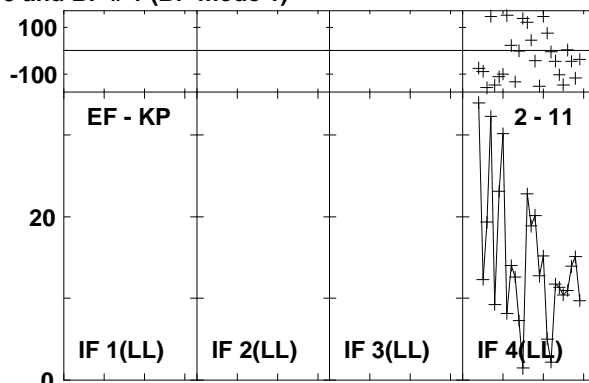
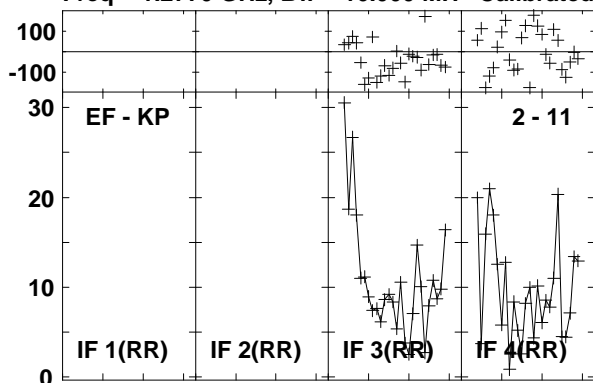

Lower frame: Milli Ampl Jy Top frame: Phas deg
Vector averaged cross-power spectrum Baseline: EF (02) - KP (11)
Timerange: 00/20:18:18 to 00/20:21:04

Plot file version 609 created 03-MAR-2016 01:13:40
 4C52 GN002C 1.UVDATA.1

Freq = 1.2770 GHz, Bw = 16.000 MH Calibrated with CL # 3 and BP # 1 (BP mode 1)

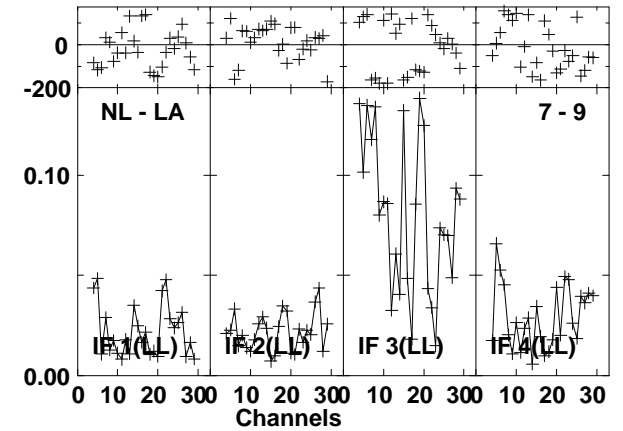
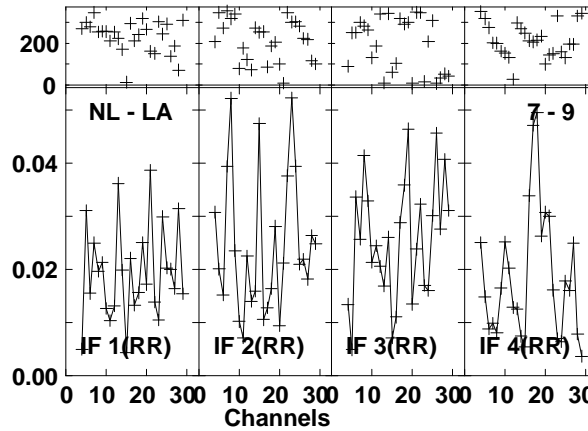
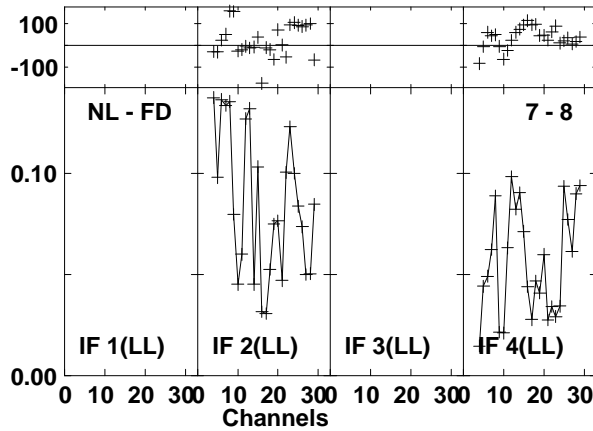
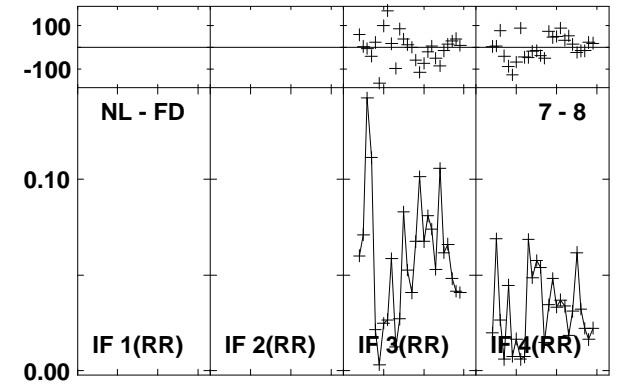
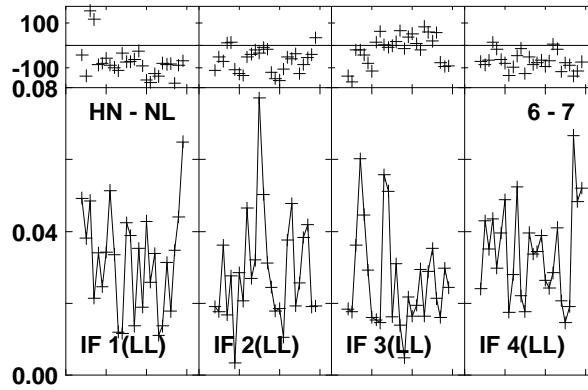
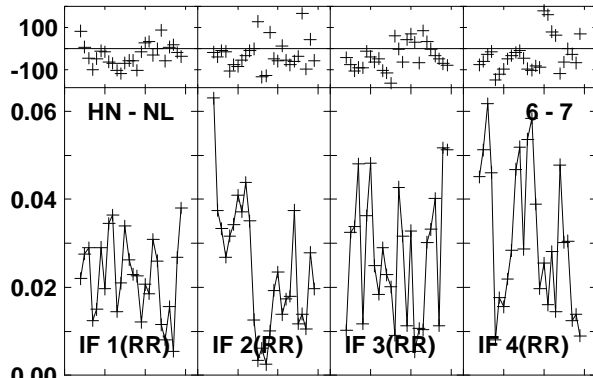
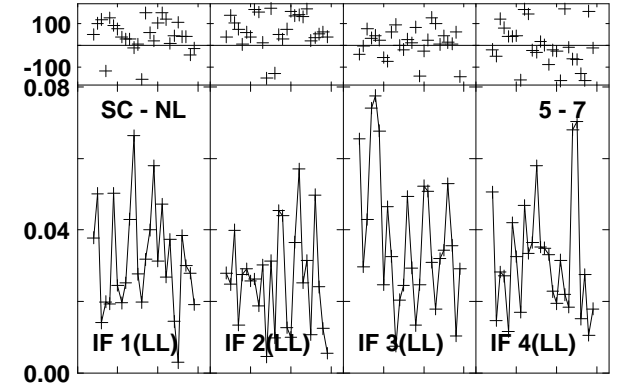
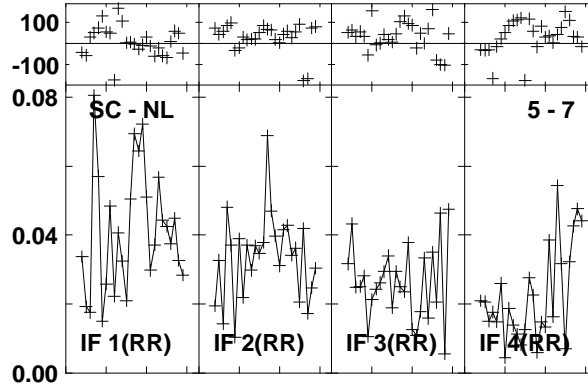
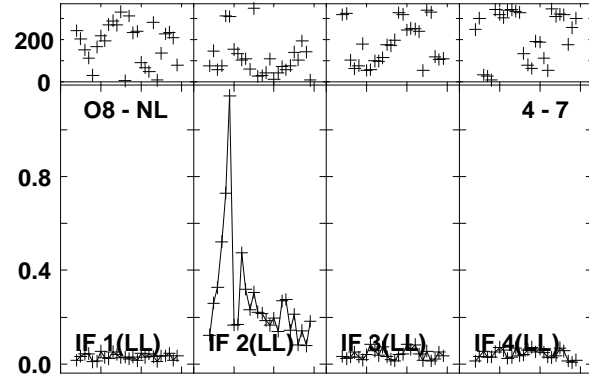

Lower frame: Ampl Jy Top frame: Phas deg
 Vector averaged cross-power spectrum Baseline: O8 (04) - NL (07)
 Timerange: 00/20:18:18 to 00/20:21:04

Plot file version 610 created 03-MAR-2016 01:13:40
 4C52 GN002C 1.UVDATA.1
 Freq = 1.2770 GHz, Bw = 16.000 MH Calibrated with CL # 3 and BP # 1 (BP mode 1)

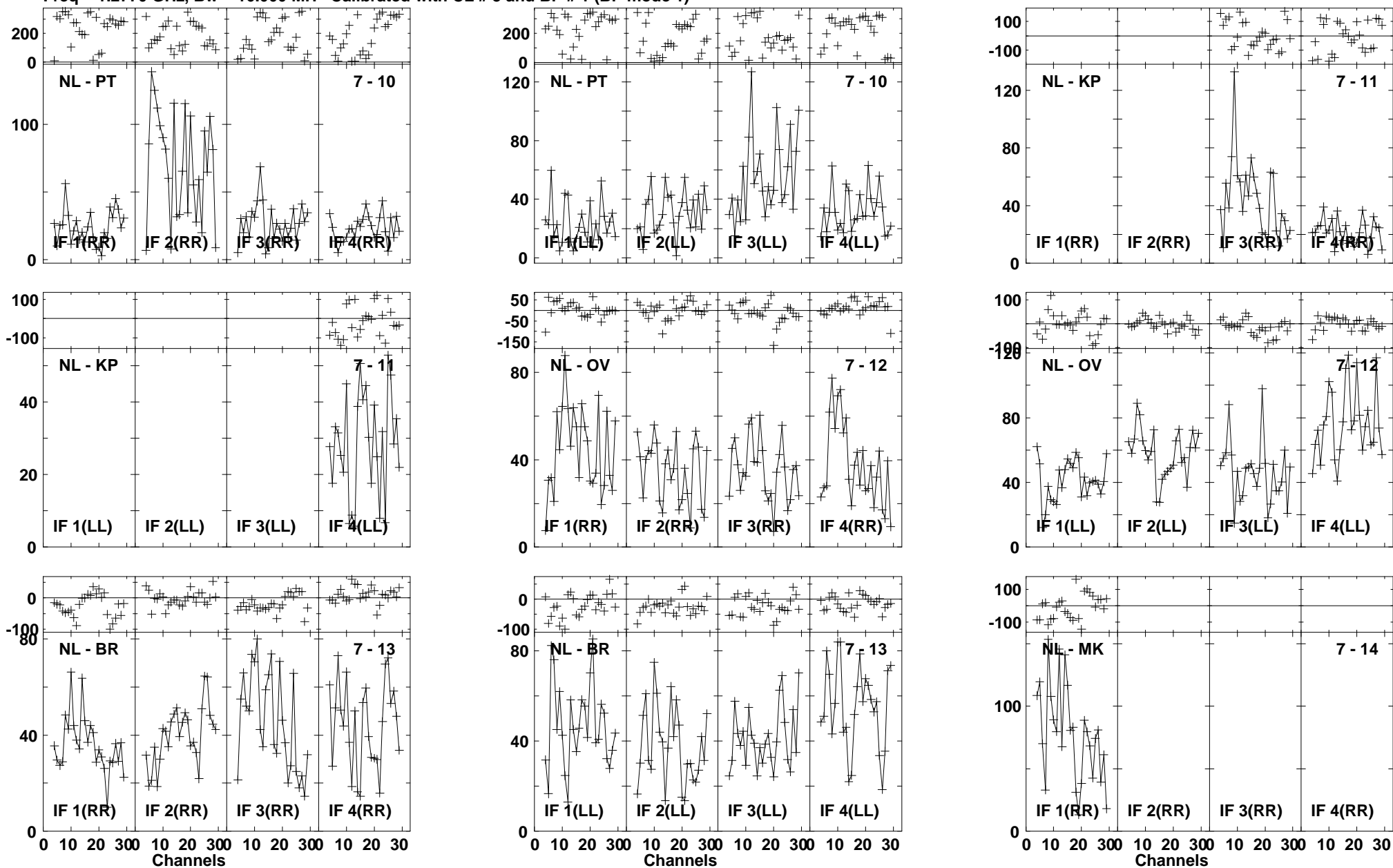

Lower frame: Milli Ampl Jy Top frame: Phas deg
 Vector averaged cross-power spectrum Baseline: NL (07) - PT (10)
 Timerange: 00/20:18:18 to 00/20:21:04

Plot file version 611 created 03-MAR-2016 01:13:40
4C52 GN002C 1.UVDATA.1
Freq = 1.2770 GHz, Bw = 16.000 MH Calibrated with CL # 3 and BP # 1 (BP mode 1)

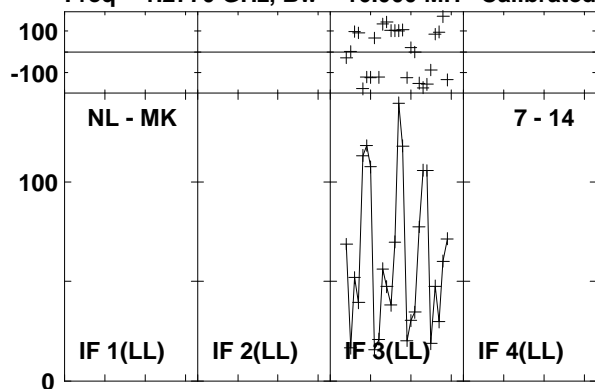

Lower frame: Milli Ampl Jy Top frame: Phas deg
Vector averaged cross-power spectrum Baseline: NL (07) - MK (14)
Timerange: 00/20:18:18 to 00/20:21:04

Plot file version 612 created 03-MAR-2016 01:13:40

J1545+5400 GN002C 1.UVDATA.1

Freq = 1.2770 GHz, Bw = 16.000 MH Calibrated with CL # 3 and BP # 1 (BP mode 1)

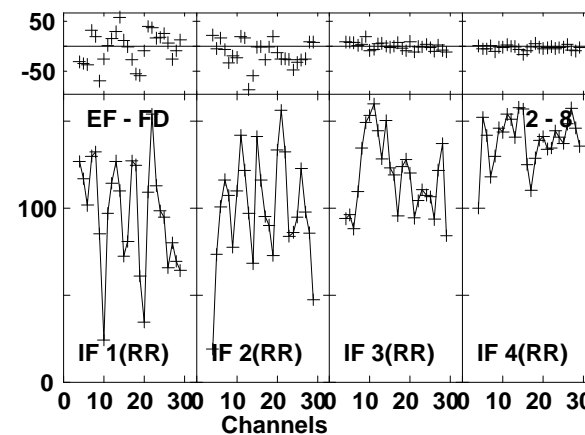
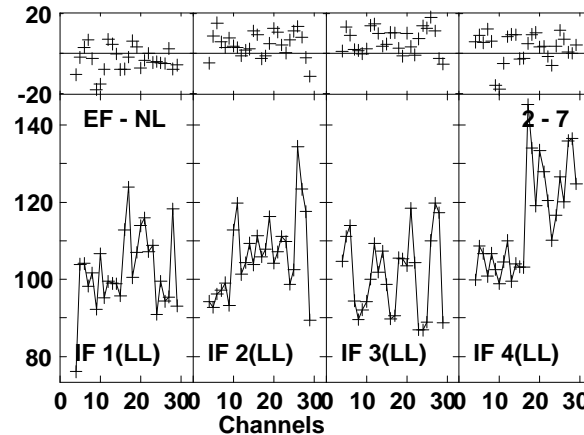
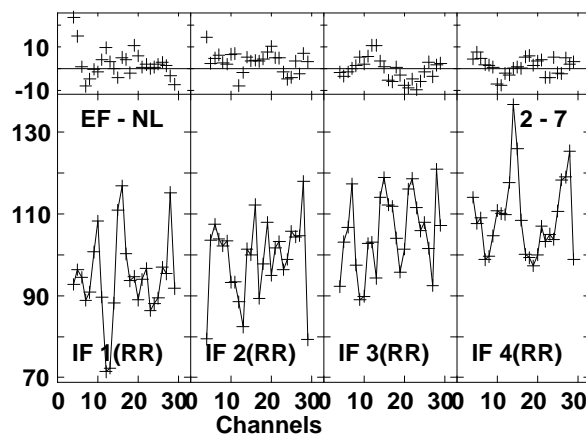
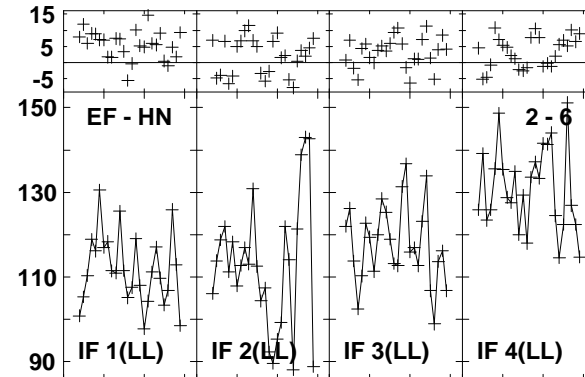
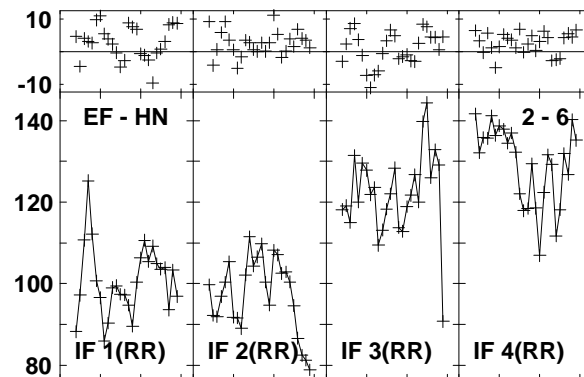
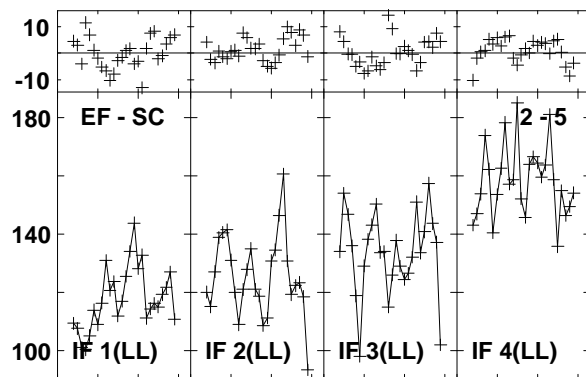
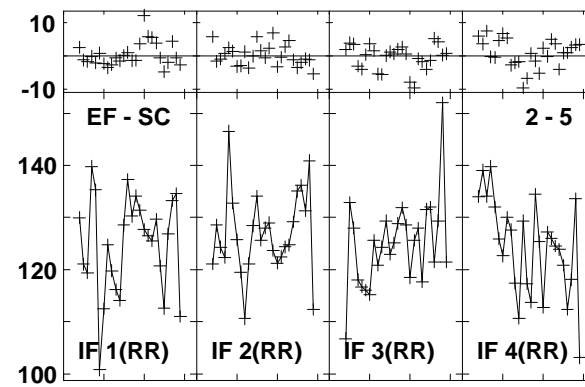
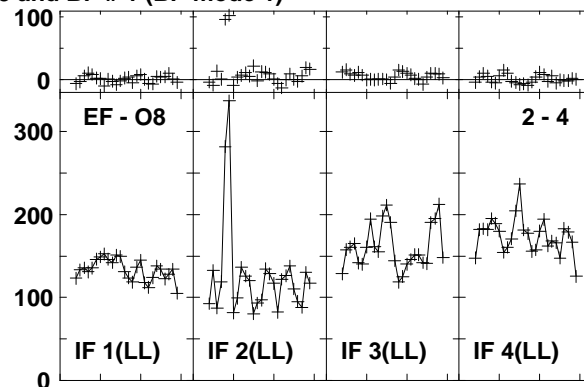
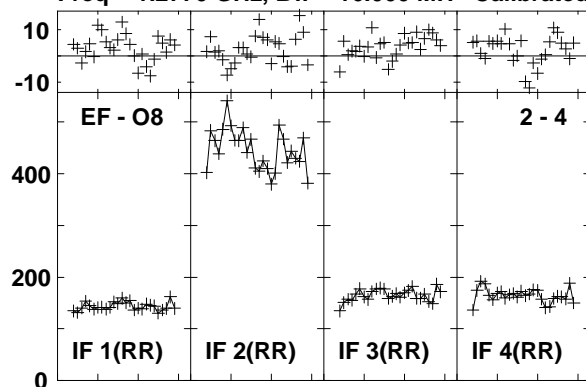

Lower frame: Milli Ampl Jy Top frame: Phas deg
Vector averaged cross-power spectrum Baseline: EF (02) - O8 (04)
Timerange: 00/20:21:56 to 00/20:22:54

Plot file version 613 created 03-MAR-2016 01:13:40
 J1545+5400 GN002C 1.UVDATA.1
 Freq = 1.2770 GHz, Bw = 16.000 MH Calibrated with CL # 3 and BP # 1 (BP mode 1)

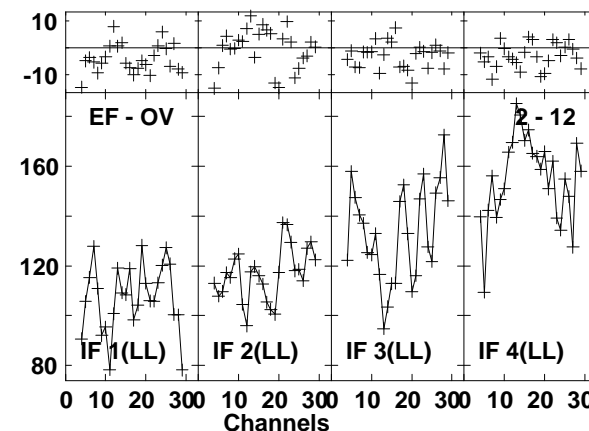
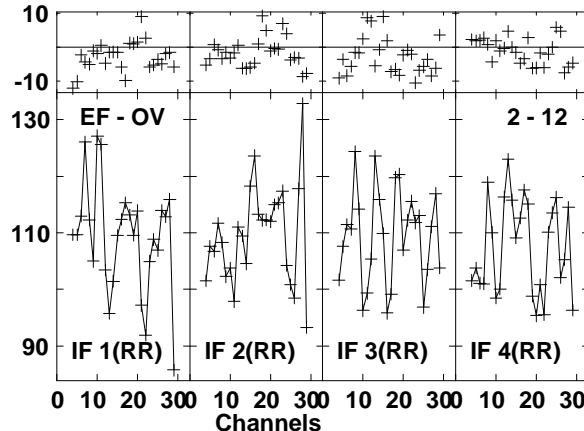
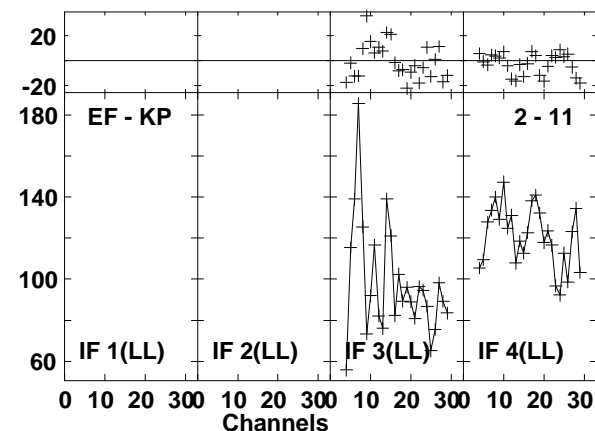
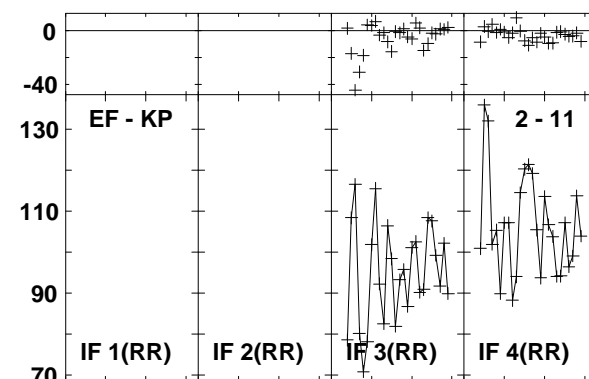
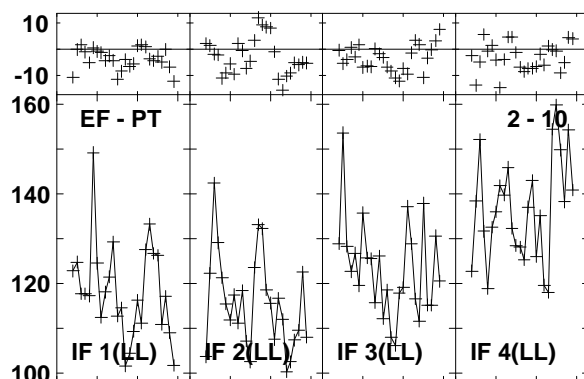
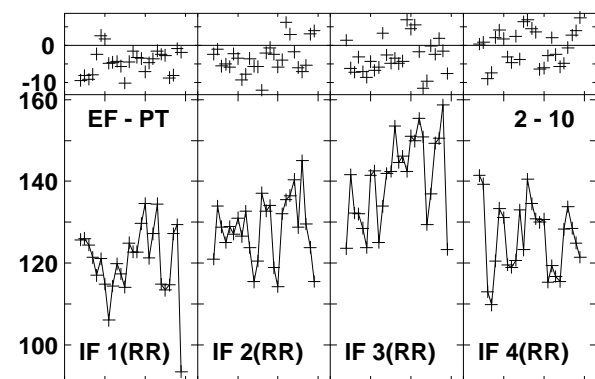
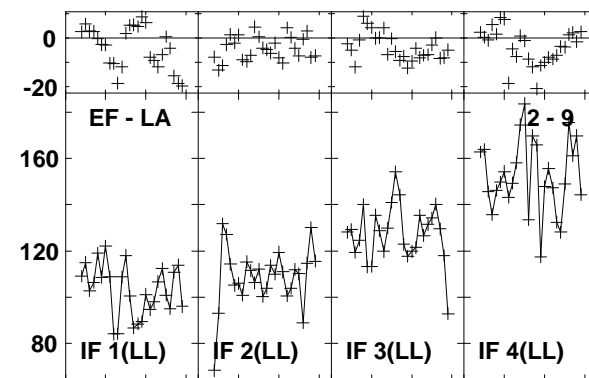
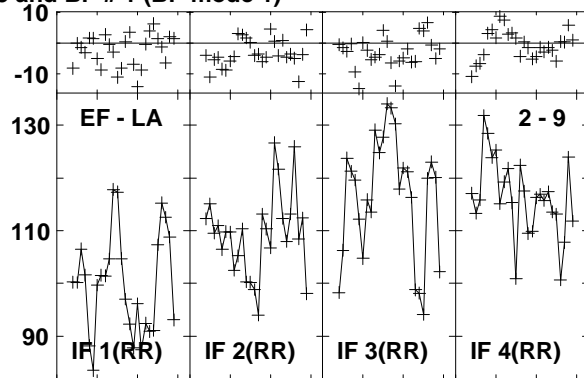
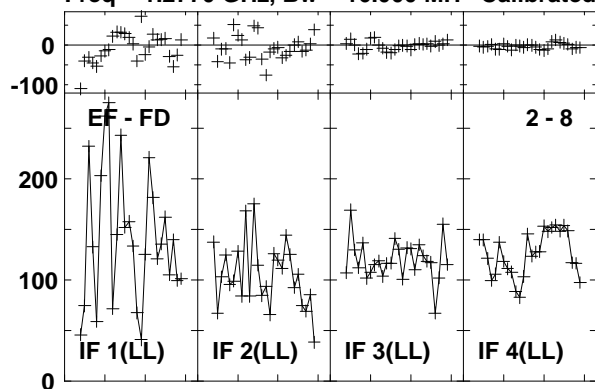

Lower frame: Milli Ampl Jy Top frame: Phas deg
 Vector averaged cross-power spectrum Baseline: EF (02) - FD (08)
 Timerange: 00/20:21:56 to 00/20:22:54

Plot file version 614 created 03-MAR-2016 01:13:40

J1545+5400 GN002C 1.UVDATA.1

Freq = 1.2770 GHz, Bw = 16.000 MH Calibrated with CL # 3 and BP # 1 (BP mode 1)

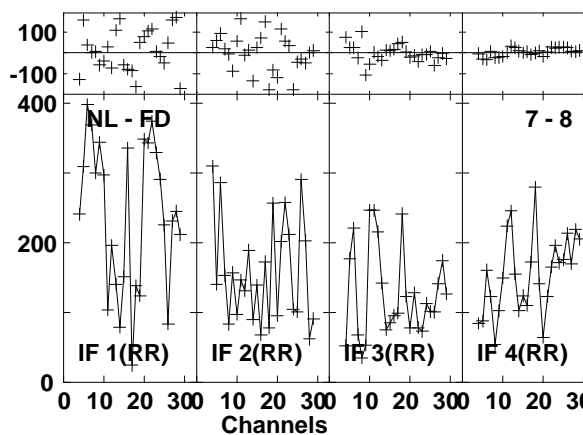
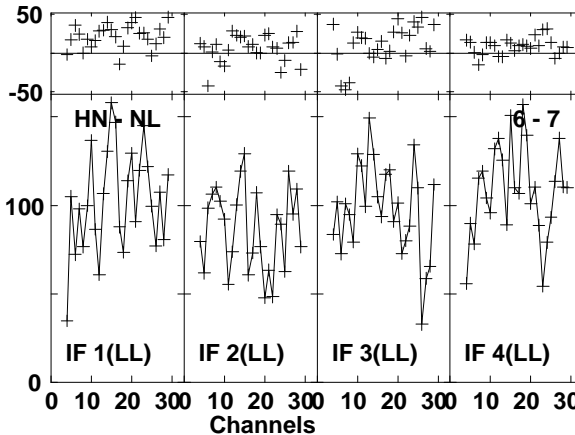
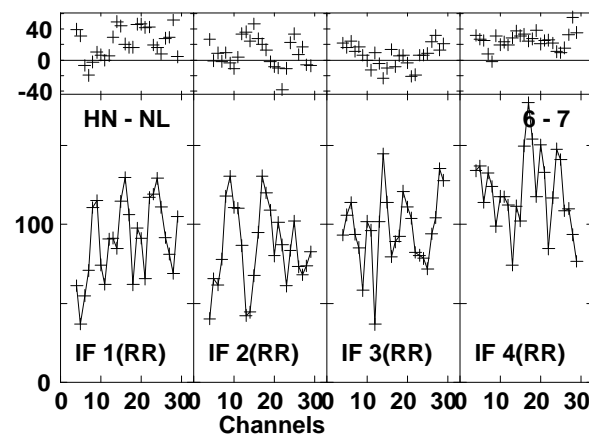
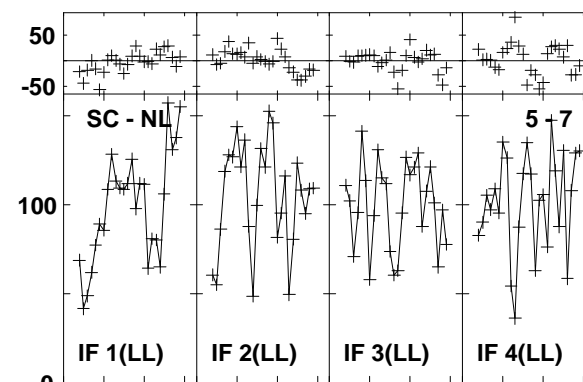
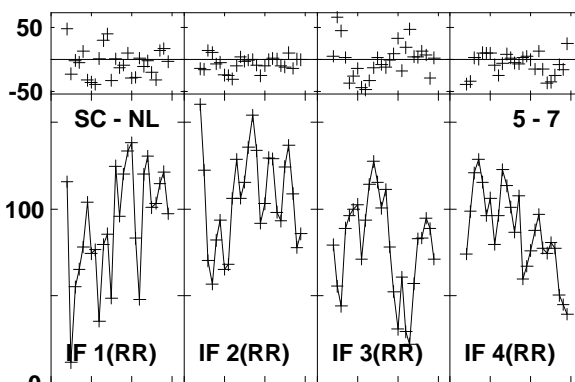
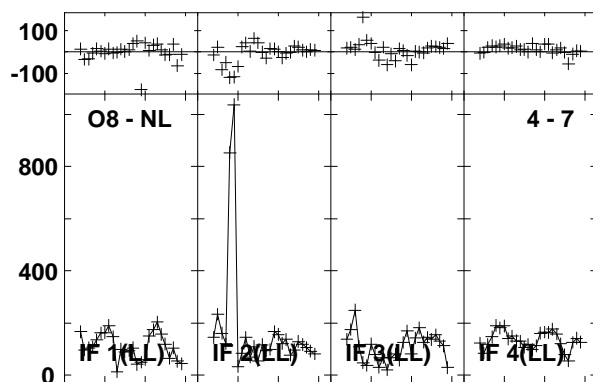
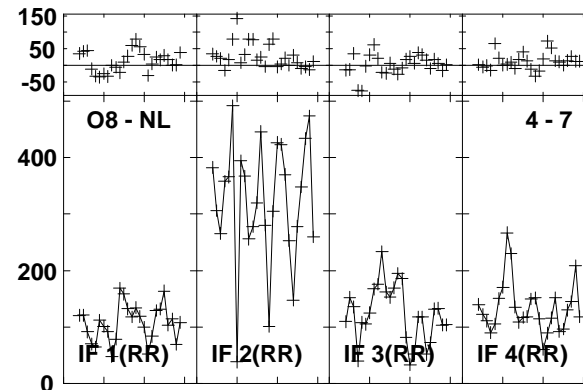
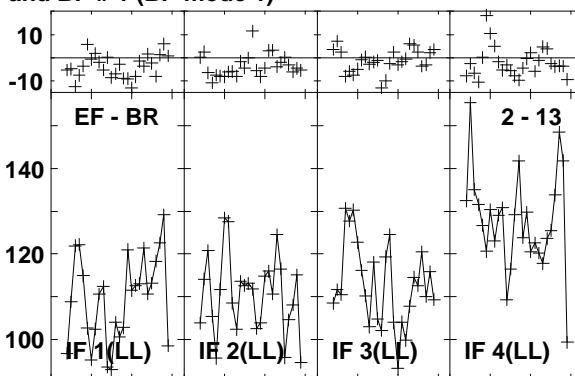
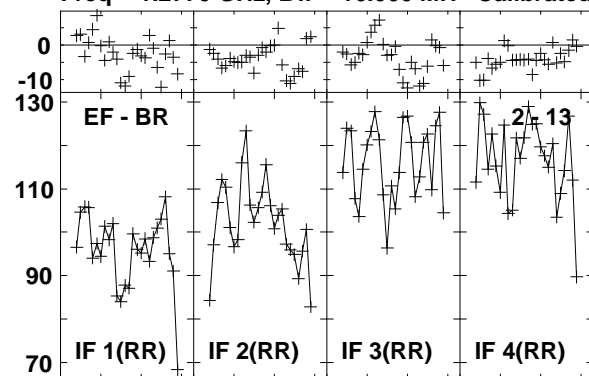

Lower frame: Milli Ampl Jy Top frame: Phas deg
Vector averaged cross-power spectrum Baseline: EF (02) - BR (13)
Timerange: 00/20:21:56 to 00/20:22:54

Plot file version 615 created 03-MAR-2016 01:13:41
 J1545+5400 GN002C 1.UVDATA.1
 Freq = 1.2770 GHz, Bw = 16.000 MH Calibrated with CL # 3 and BP # 1 (BP mode 1)

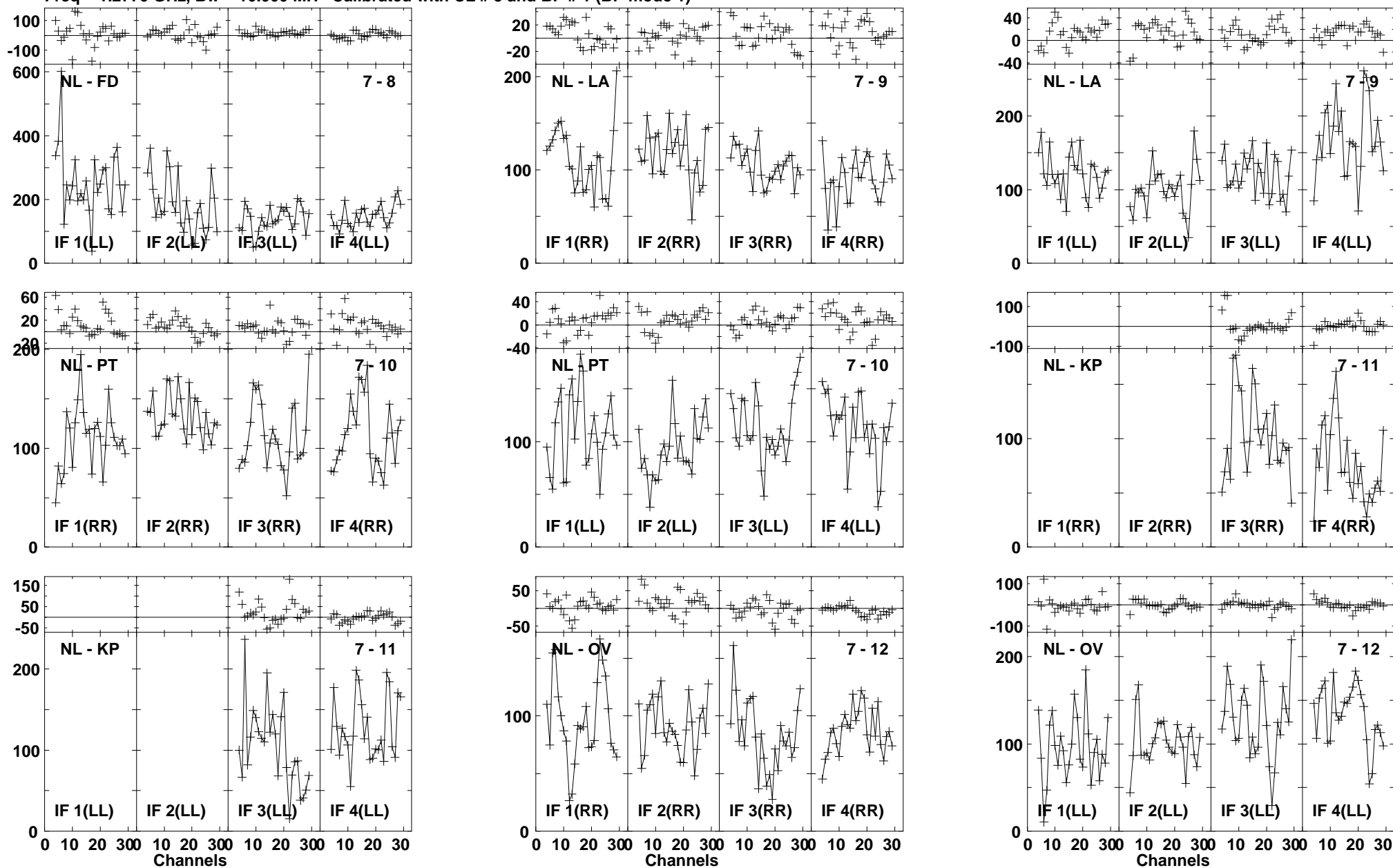

Lower frame: Milli Ampl Jy Top frame: Phas deg
 Vector averaged cross-power spectrum Baseline: NL (07) - FD (08)
 Timerange: 00/20:21:56 to 00/20:22:54

Plot file version 616 created 03-MAR-2016 01:13:41

J1545+5400 GN002C 1.UVDATA.1

Freq = 1.2770 GHz, Bw = 16.000 MH Calibrated with CL # 3 and BP # 1 (BP mode 1)

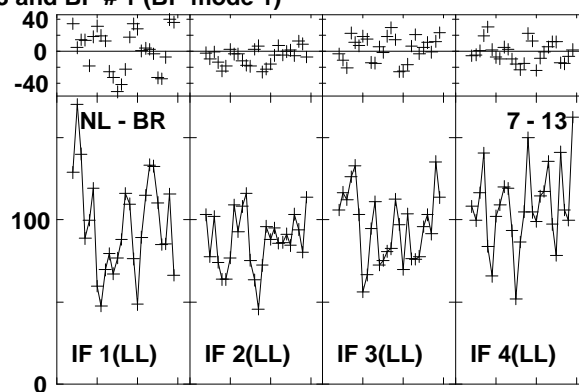
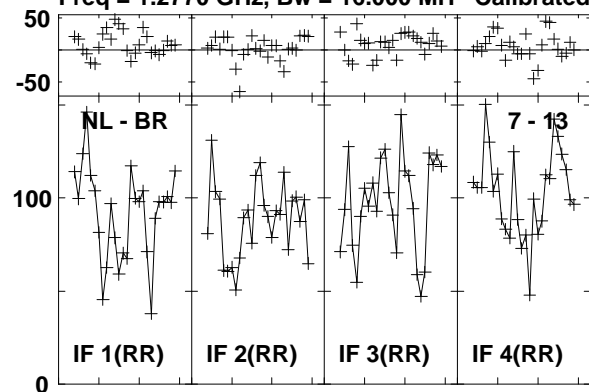

Lower frame: Milli Ampl Jy Top frame: Phas deg
Vector averaged cross-power spectrum Baseline: NL (07) - BR (13)
Timerange: 00/20:21:56 to 00/20:22:54

Plot file version 617 created 03-MAR-2016 01:13:41

4C52 GN002C 1.UVDATA.1

Freq = 1.2770 GHz, Bw = 16.000 MH Calibrated with CL # 3 and BP # 1 (BP mode 1)

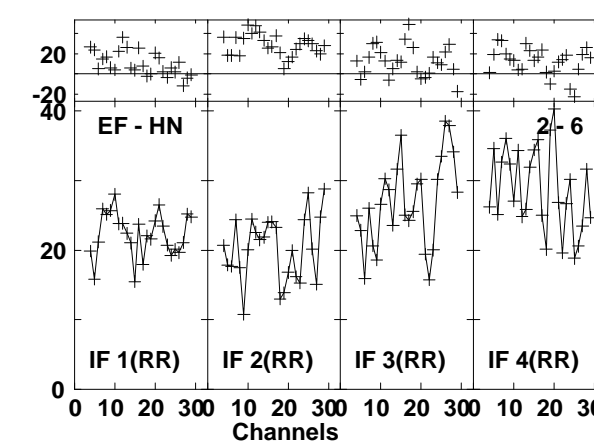
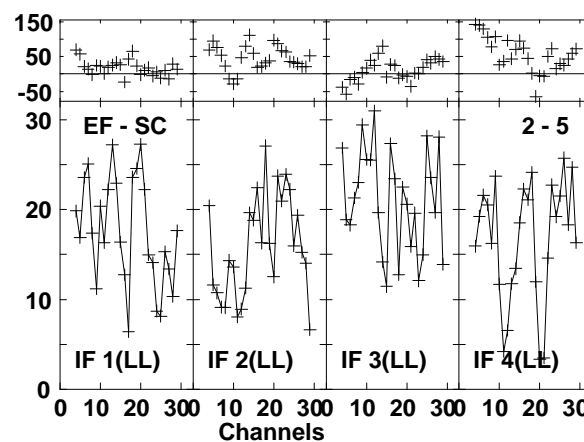
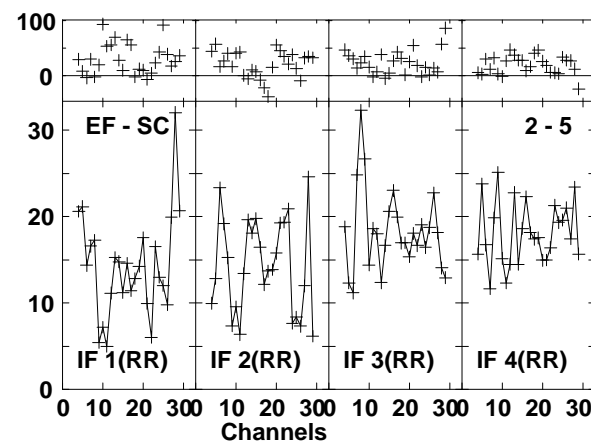
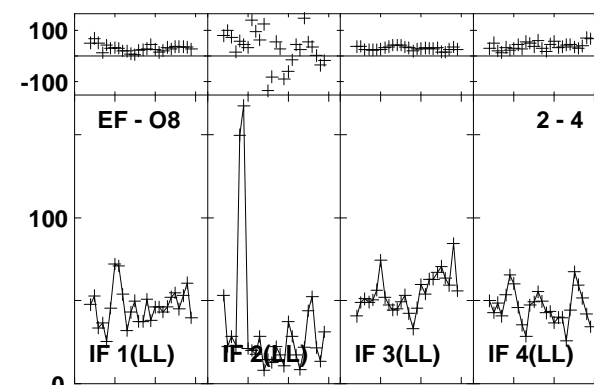
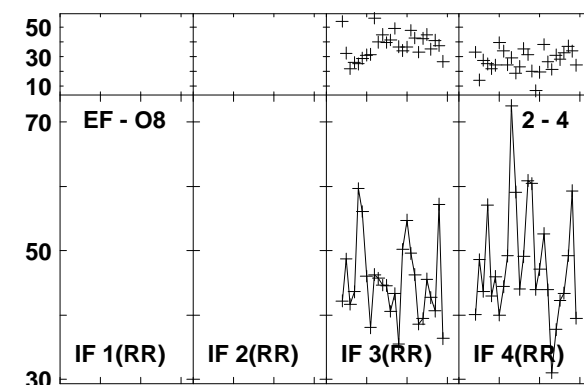
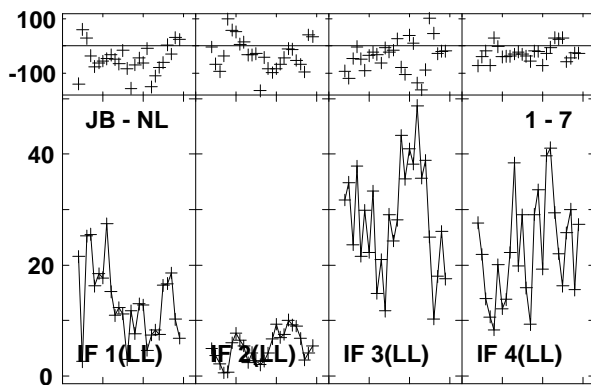
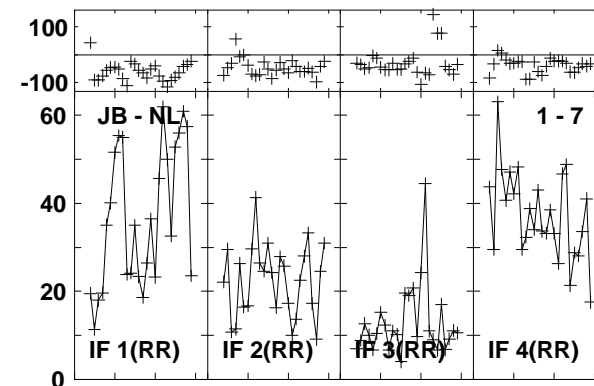
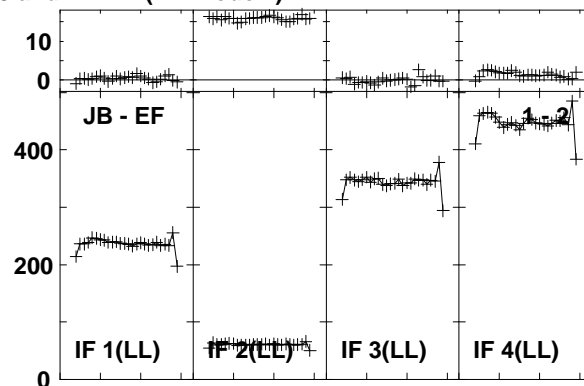
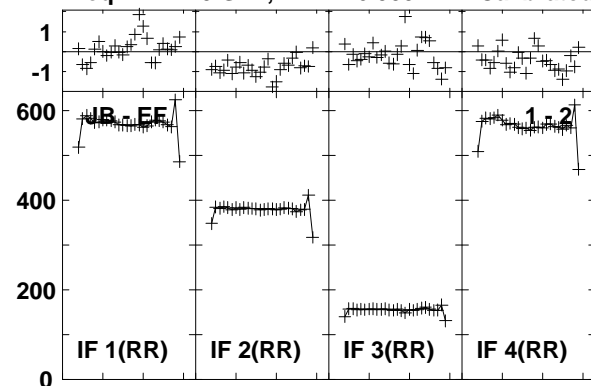

Lower frame: Milli Ampl Jy Top frame: Phas deg
Vector averaged cross-power spectrum Baseline: JB (01) - EF (02)
Timerange: 00/20:22:59 to 00/20:25:53

Plot file version 618 created 03-MAR-2016 01:13:41

4C52 GN002C 1.UVDATA.1

Freq = 1.2770 GHz, Bw = 16.000 MH Calibrated with CL # 3 and BP # 1 (BP mode 1)

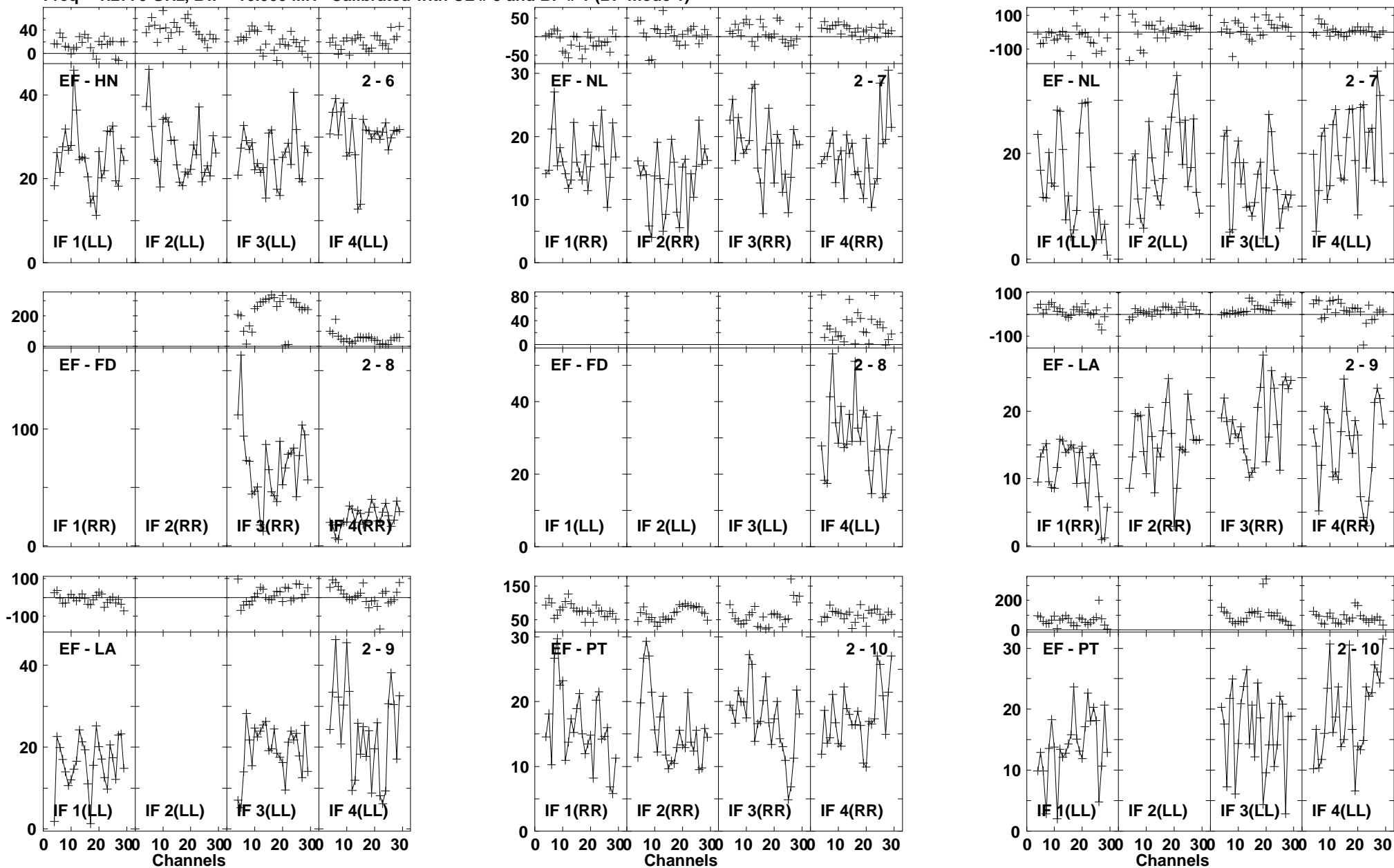

Lower frame: Milli Ampl Jy Top frame: Phas deg
Vector averaged cross-power spectrum Baseline: EF (02) - HN (06)
Timerange: 00/20:22:59 to 00/20:25:53

Plot file version 619 created 03-MAR-2016 01:13:41

4C52 GN002C 1.UVDATA.1

Freq = 1.2770 GHz, Bw = 16.000 MH Calibrated with CL # 3 and BP # 1 (BP mode 1)

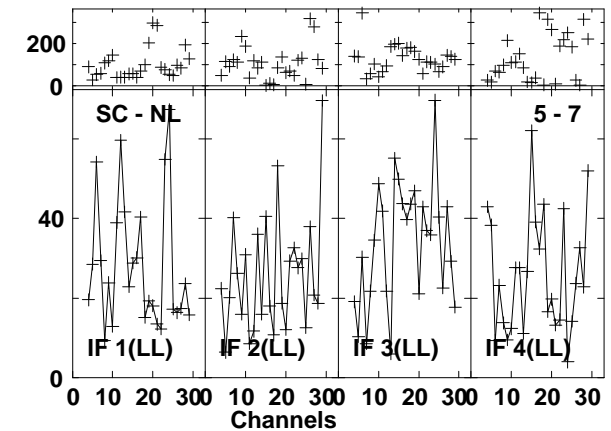
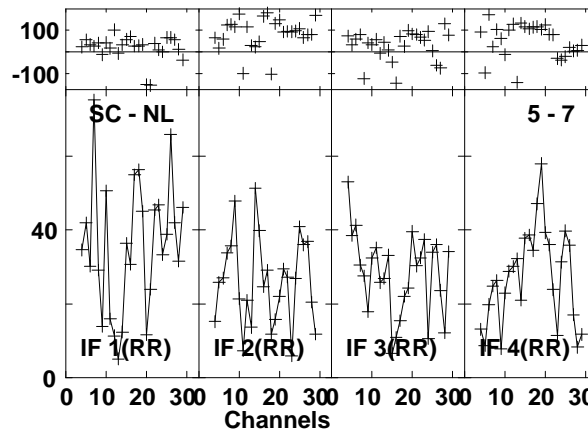
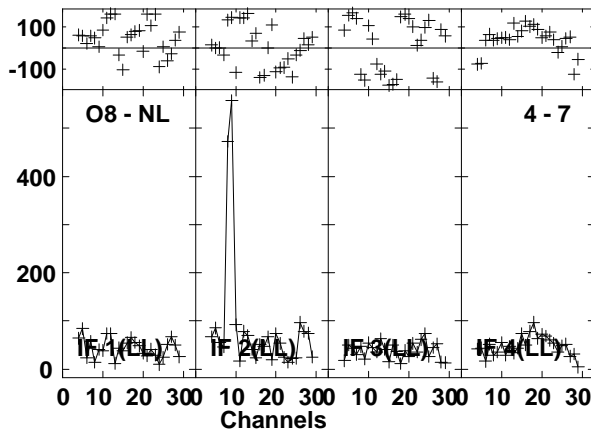
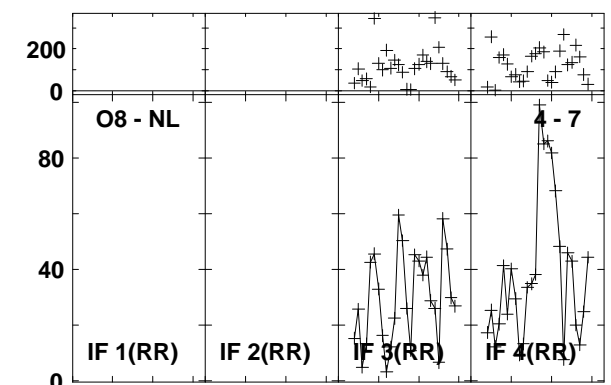
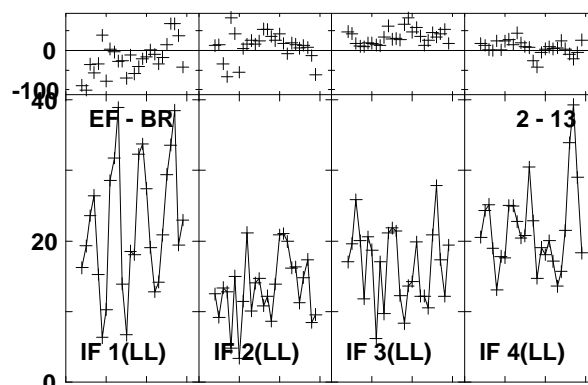
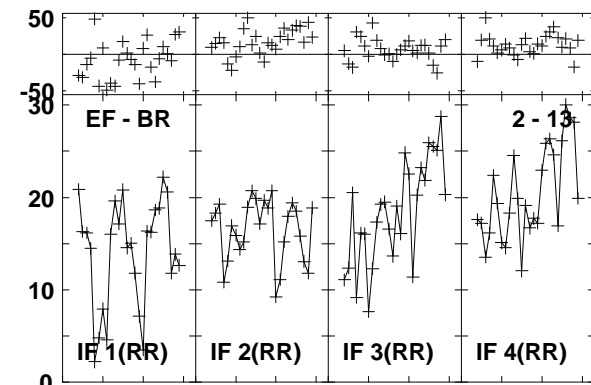
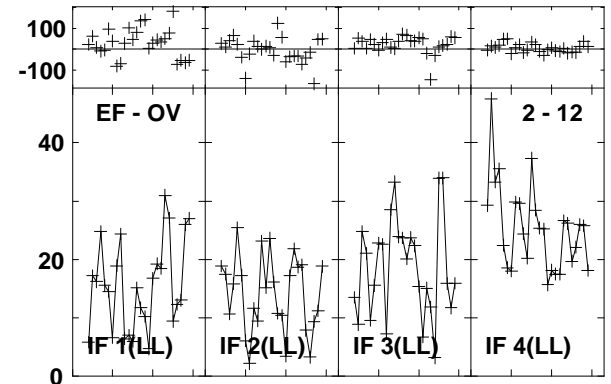
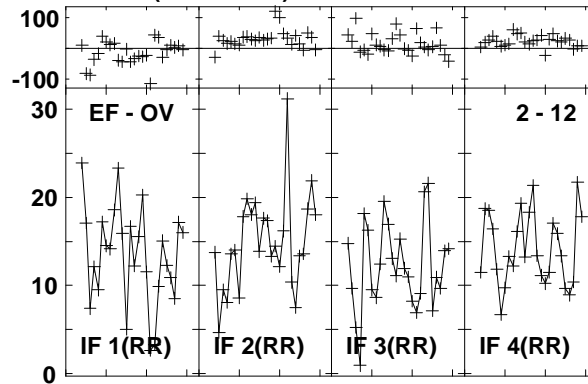
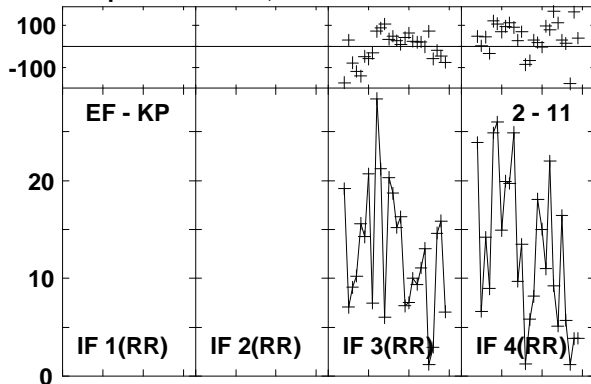

Lower frame: Milli Ampl Jy Top frame: Phas deg
Vector averaged cross-power spectrum Baseline: EF (02) - KP (11)
Timerange: 00/20:22:59 to 00/20:25:53

Plot file version 620 created 03-MAR-2016 01:13:42

4C52 GN002C 1.UVDATA.1

Freq = 1.2770 GHz, Bw = 16.000 MH Calibrated with CL # 3 and BP # 1 (BP mode 1)

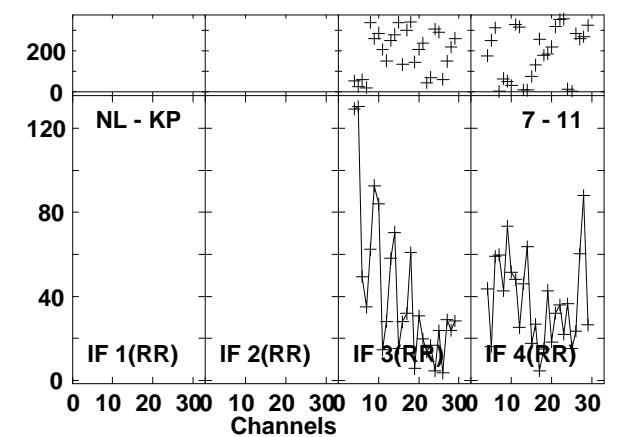
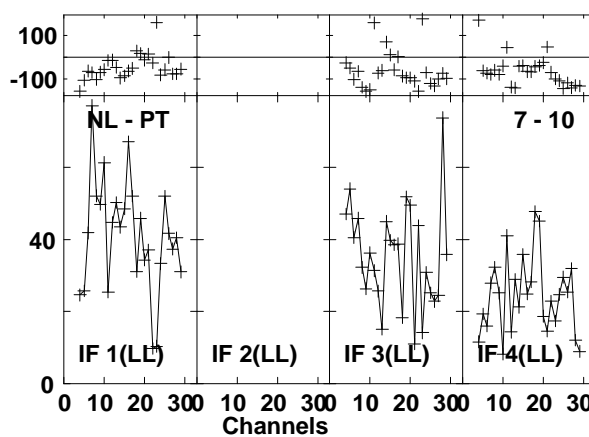
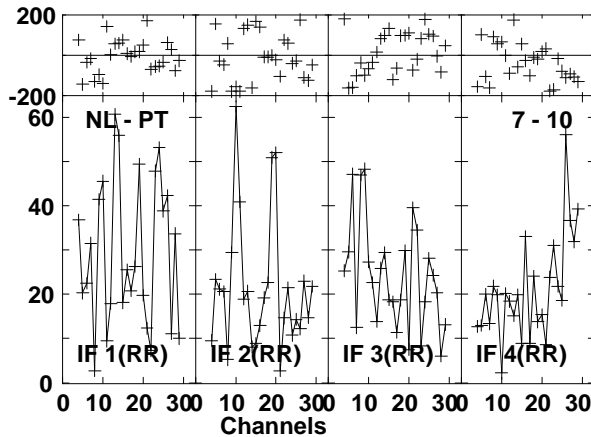
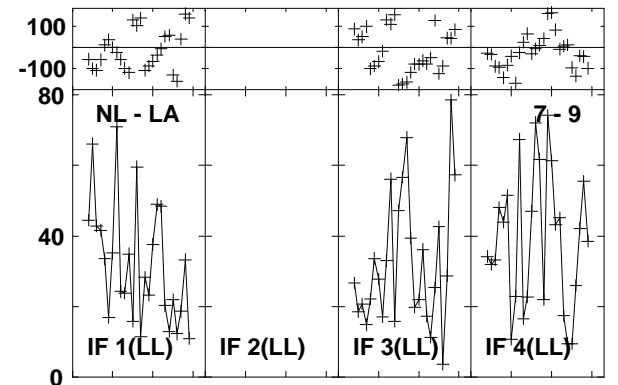
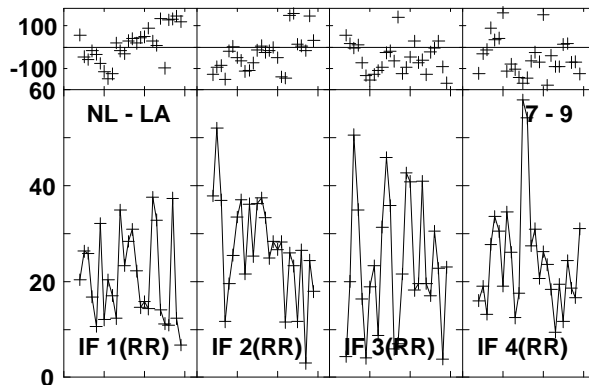
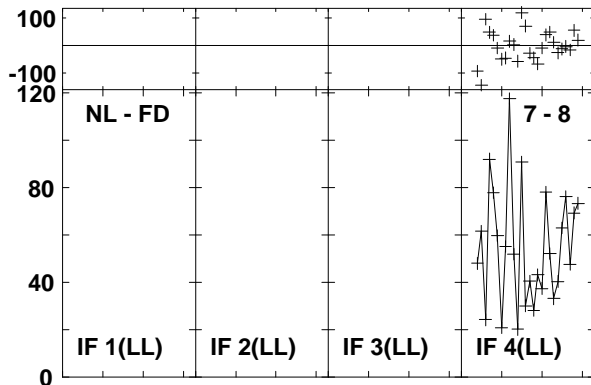
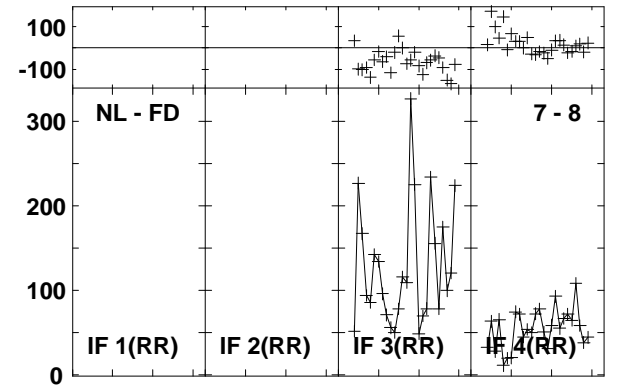
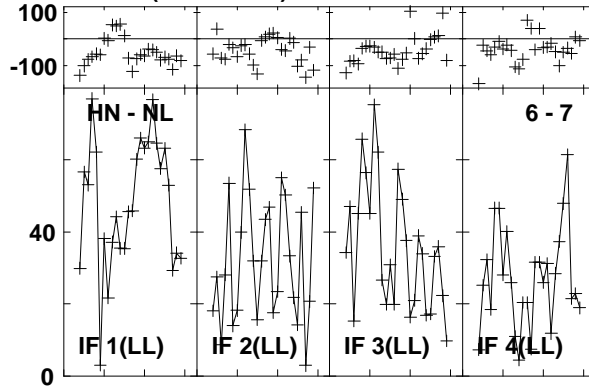
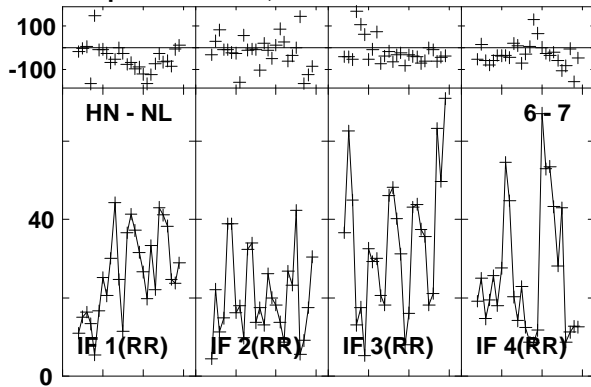

Lower frame: Milli Ampl Jy Top frame: Phas deg
Vector averaged cross-power spectrum Baseline: HN (06) - NL (07)
Timerange: 00/20:22:59 to 00/20:25:53

Plot file version 621 created 03-MAR-2016 01:13:42

4C52 GN002C 1.UVDATA.1

Freq = 1.2770 GHz, Bw = 16.000 MH Calibrated with CL # 3 and BP # 1 (BP mode 1)

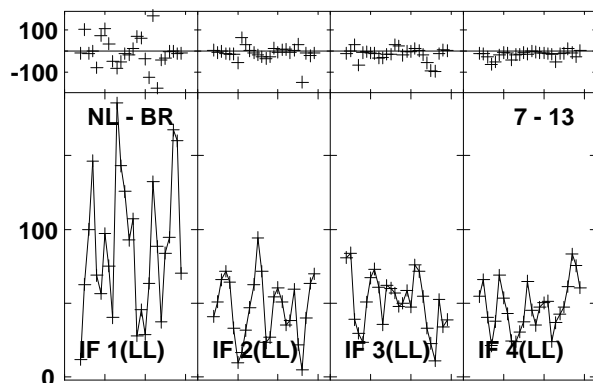
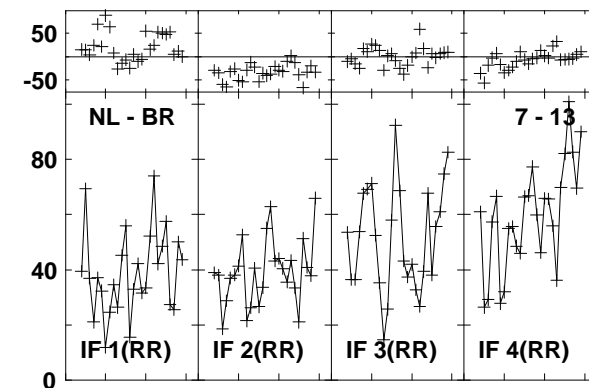
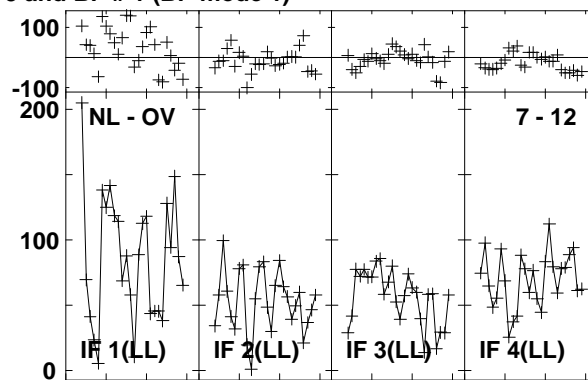
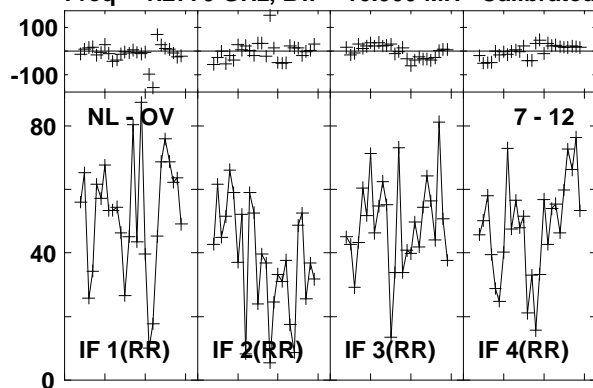

Lower frame: Milli Ampl Jy Top frame: Phas deg
Vector averaged cross-power spectrum Baseline: NL (07) - OV (12)
Timerange: 00/20:22:59 to 00/20:25:53

Plot file version 622 created 03-MAR-2016 01:13:42

J1545+5400 GN002C 1.UVDATA.1

Freq = 1.2770 GHz, Bw = 16.000 MH Calibrated with CL # 3 and BP # 1 (BP mode 1)

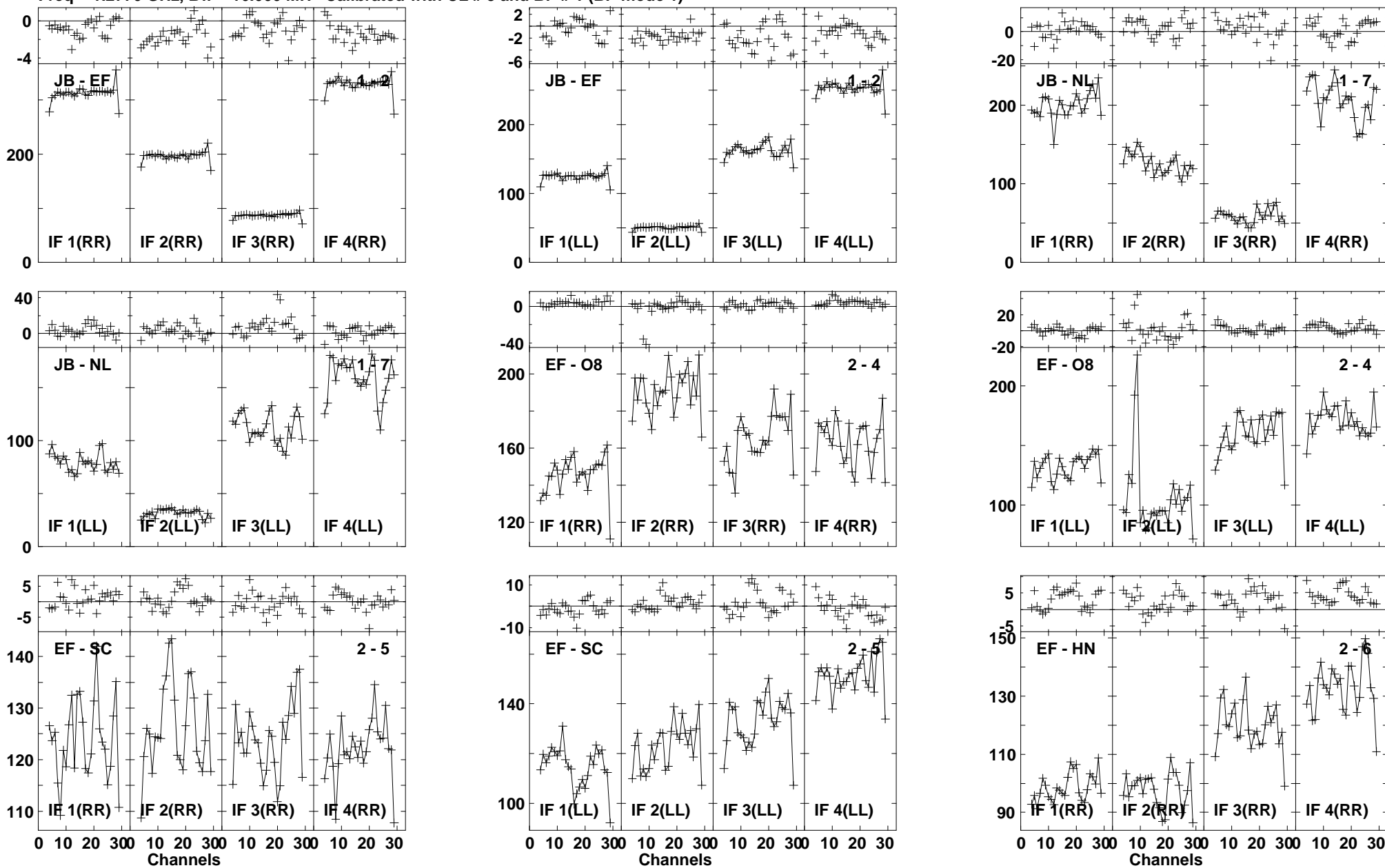

Plot file version 623 created 03-MAR-2016 01:13:42

J1545+5400 GN002C 1.UVDATA.1

Freq = 1.2770 GHz, Bw = 16.000 MH Calibrated with CL # 3 and BP # 1 (BP mode 1)

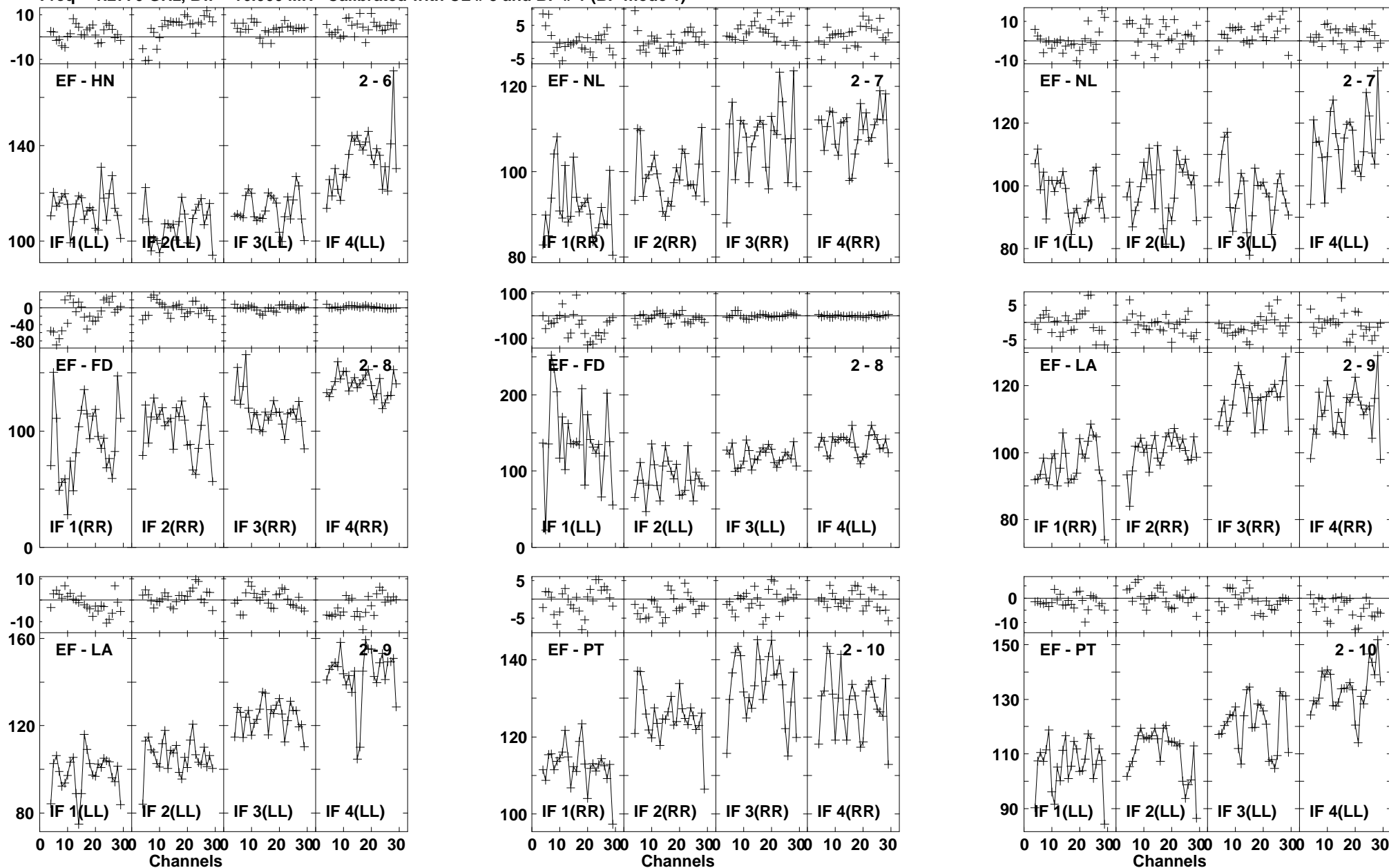

Lower frame: Milli Ampl Jy Top frame: Phas deg
Vector averaged cross-power spectrum Baseline: EF (02) - HN (06)
Timerange: 00/20:26:46 to 00/20:28:44

Plot file version 624 created 03-MAR-2016 01:13:42
 J1545+5400 GN002C 1.UVDATA.1
 Freq = 1.2770 GHz, Bw = 16.000 MH Calibrated with CL # 3 and BP # 1 (BP mode 1)

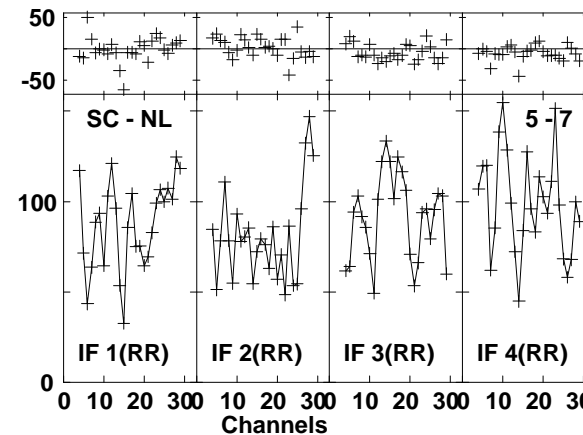
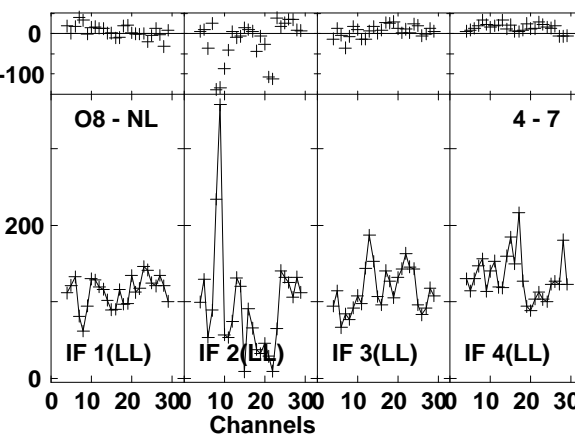
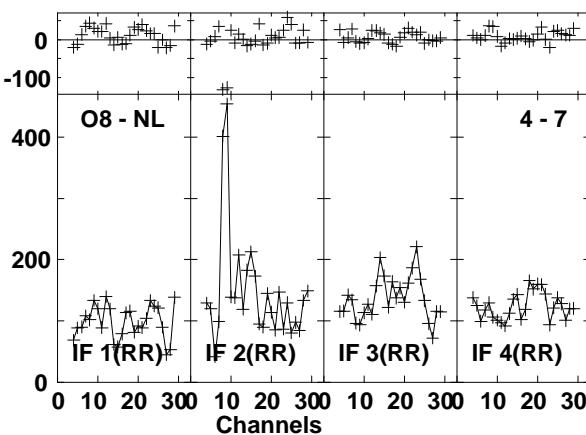
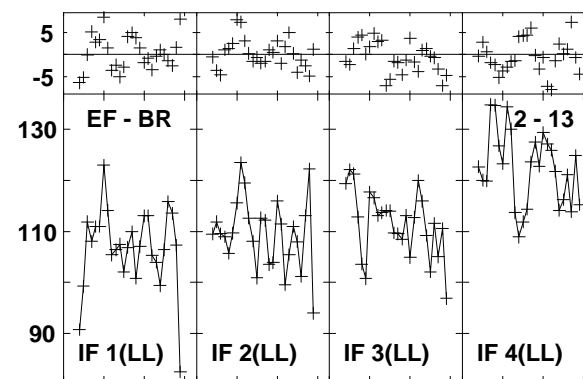
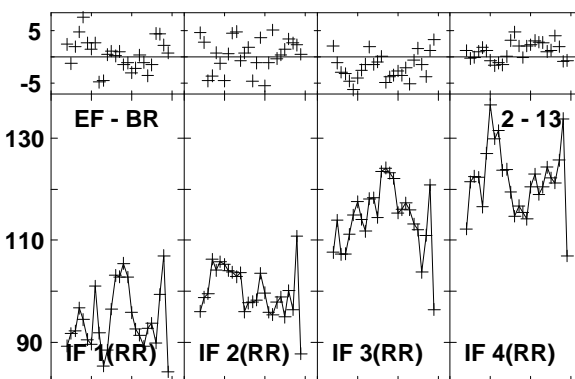
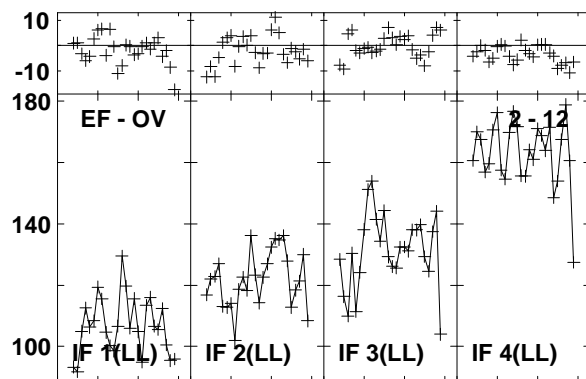
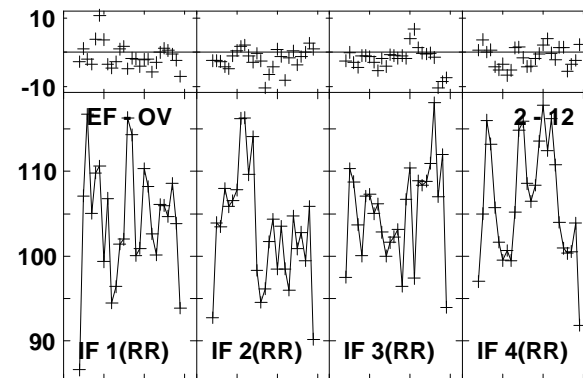
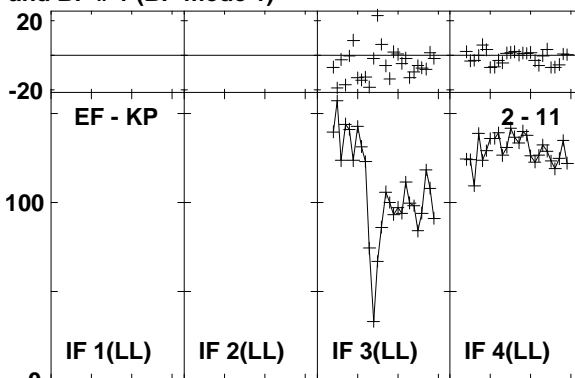
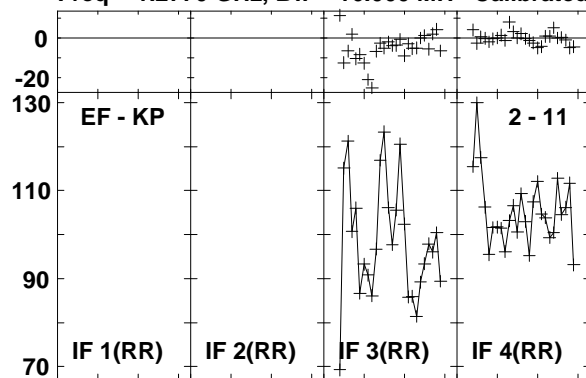

Lower frame: Milli Ampl Jy Top frame: Phas deg
 Vector averaged cross-power spectrum Baseline: EF (02) - KP (11)
 Timerange: 00/20:26:46 to 00/20:28:44

Plot file version 625 created 03-MAR-2016 01:13:43
 J1545+5400 GN002C 1.UVDATA.1
 Freq = 1.2770 GHz, Bw = 16.000 MH Calibrated with CL # 3 and BP # 1 (BP mode 1)

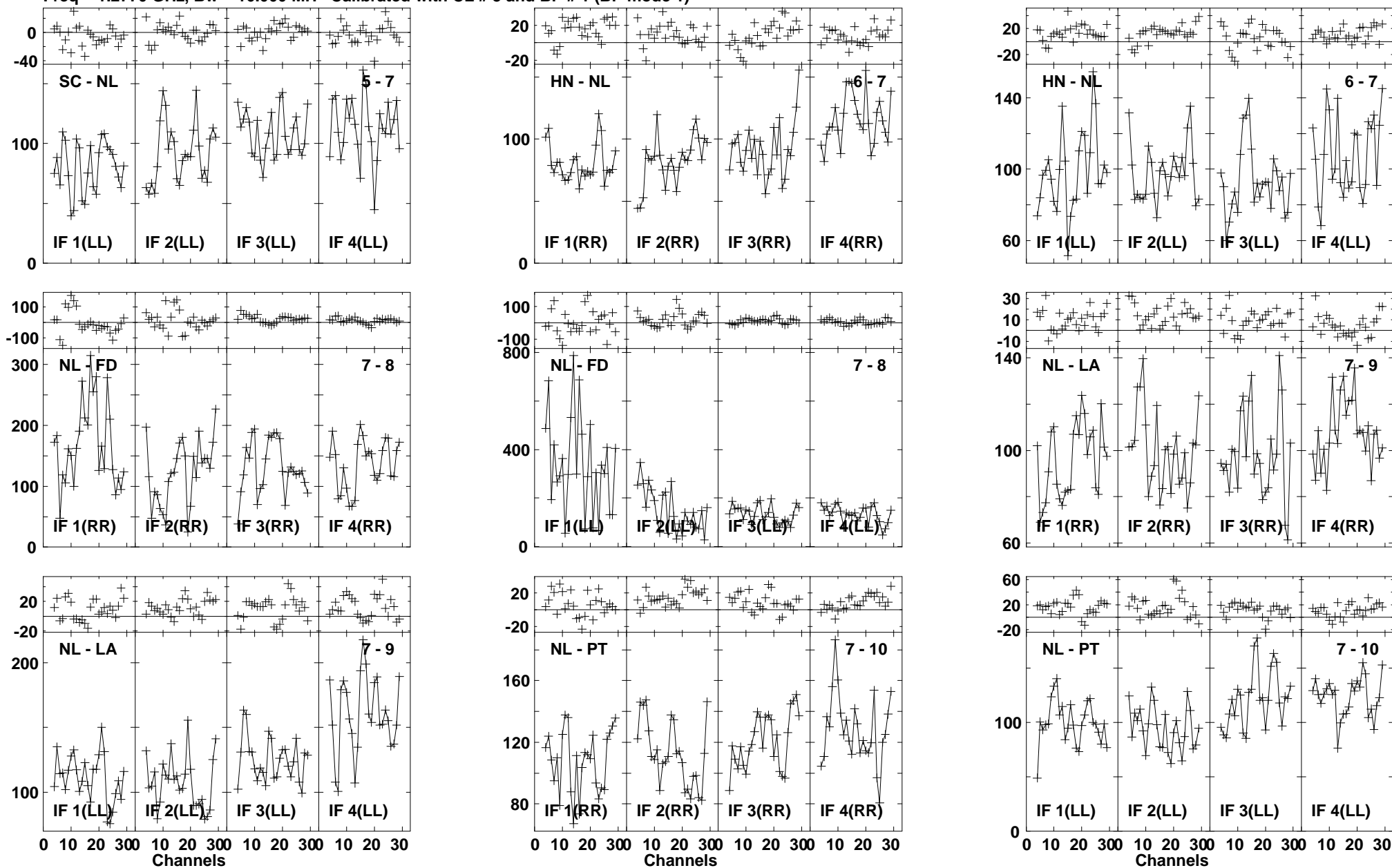

Lower frame: Milli Ampl Jy Top frame: Phas deg
 Vector averaged cross-power spectrum Baseline: SC (05) - NL (07)
 Timerange: 00/20:26:46 to 00/20:28:44

Plot file version 626 created 03-MAR-2016 01:13:43
 J1545+5400 GN002C 1.UVDATA.1
 Freq = 1.2770 GHz, Bw = 16.000 MH Calibrated with CL # 3 and BP # 1 (BP mode 1)

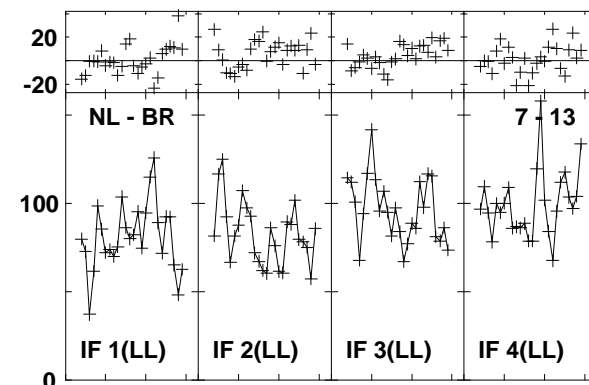
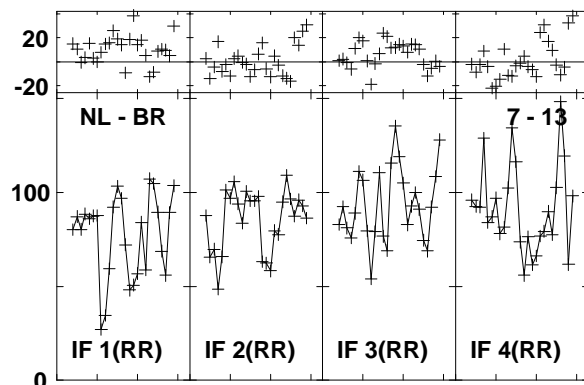
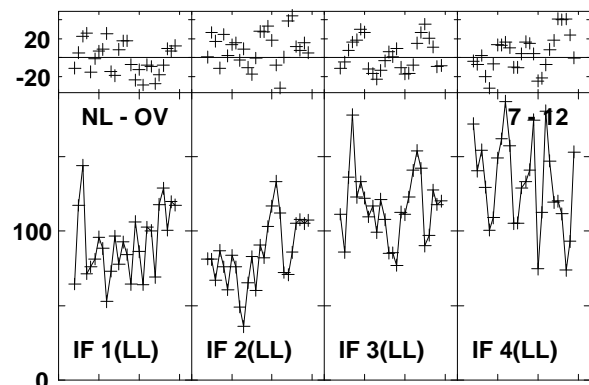
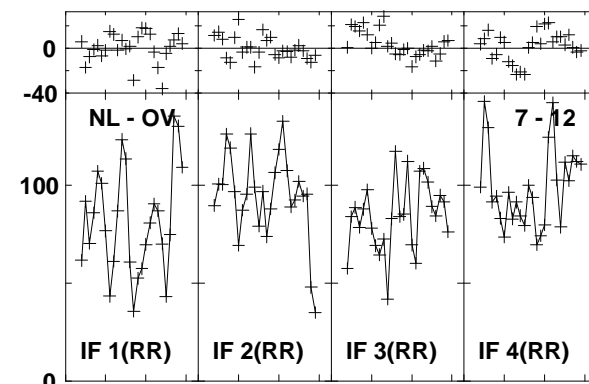
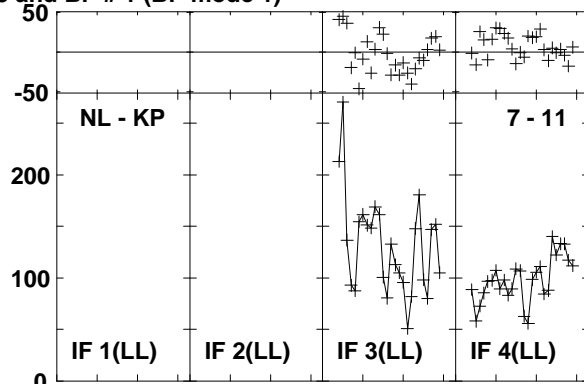
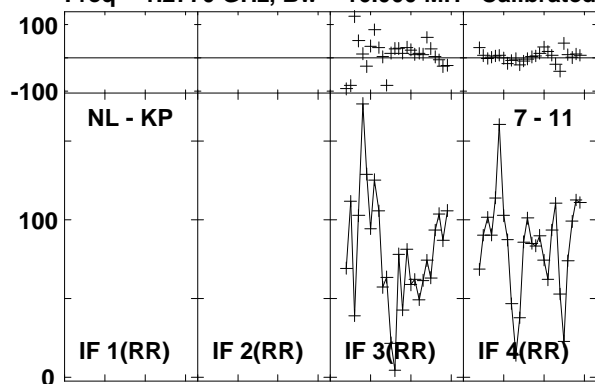

Lower frame: Milli Ampl Jy Top frame: Phas deg
 Vector averaged cross-power spectrum Baseline: NL (07) - KP (11)
 Timerange: 00/20:26:46 to 00/20:28:44

Plot file version 627 created 03-MAR-2016 01:13:43

4C52 GN002C 1.UVDATA.1

Freq = 1.2770 GHz, Bw = 16.000 MH Calibrated with CL # 3 and BP # 1 (BP mode 1)

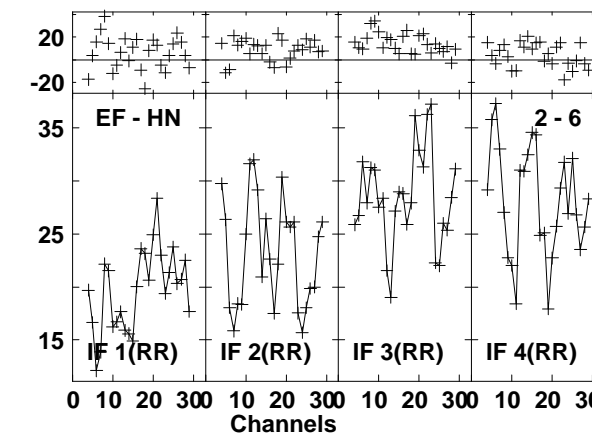
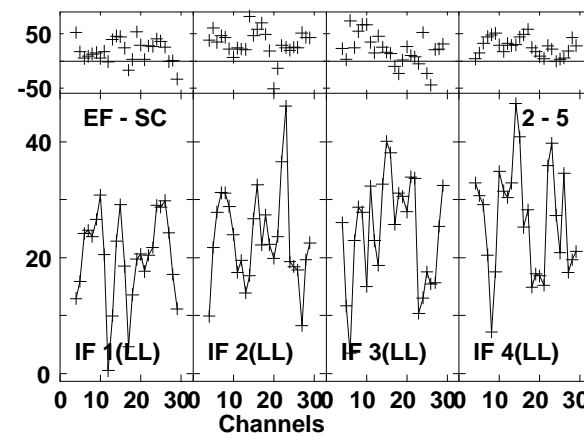
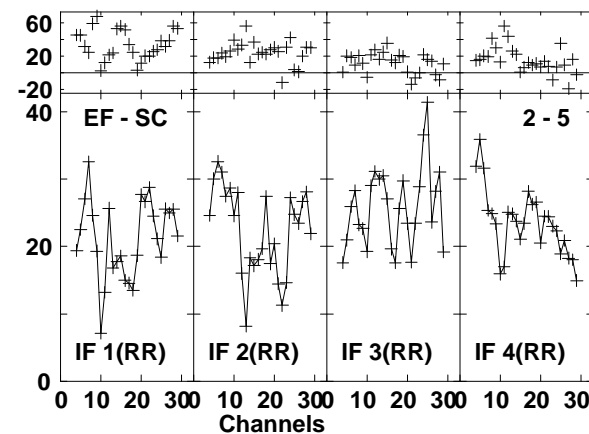
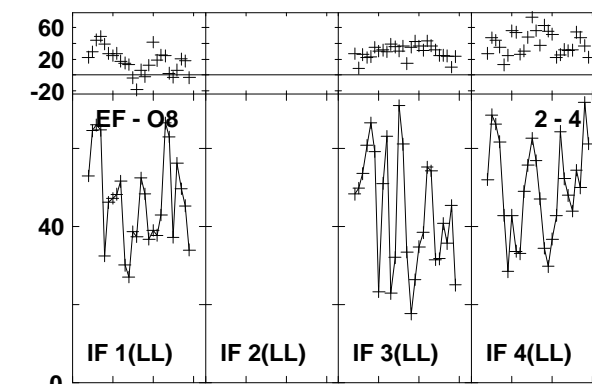
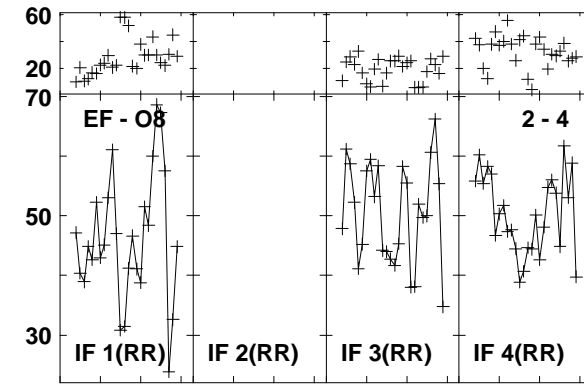
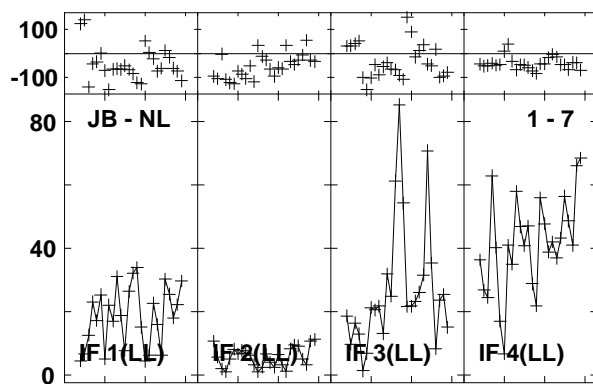
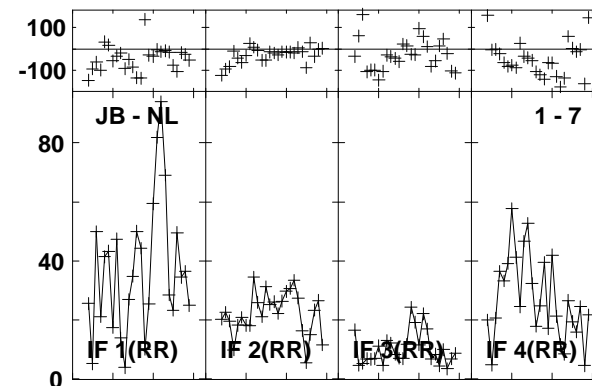
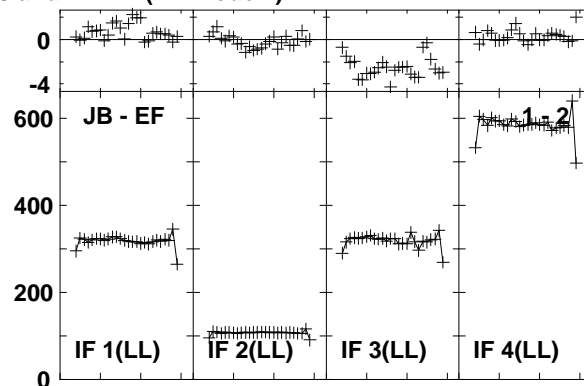
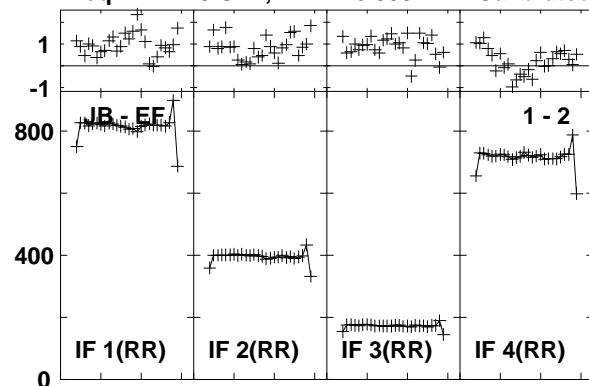

Lower frame: Milli Ampl Jy Top frame: Phas deg
Vector averaged cross-power spectrum Baseline: JB (01) - EF (02)
Timerange: 00/20:28:58 to 00/20:31:44

Plot file version 628 created 03-MAR-2016 01:13:43

4C52 GN002C 1.UVDATA.1

Freq = 1.2770 GHz, Bw = 16.000 MH Calibrated with CL # 3 and BP # 1 (BP mode 1)

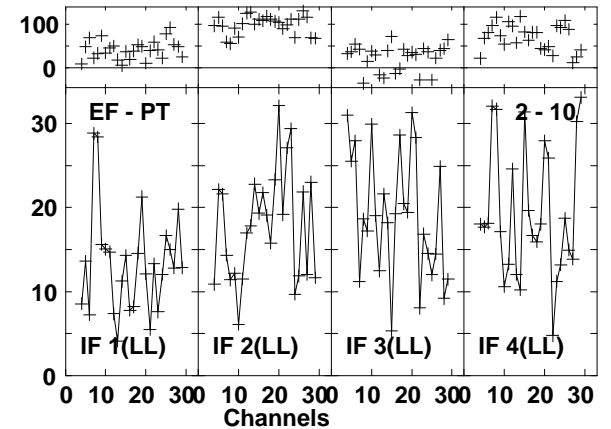
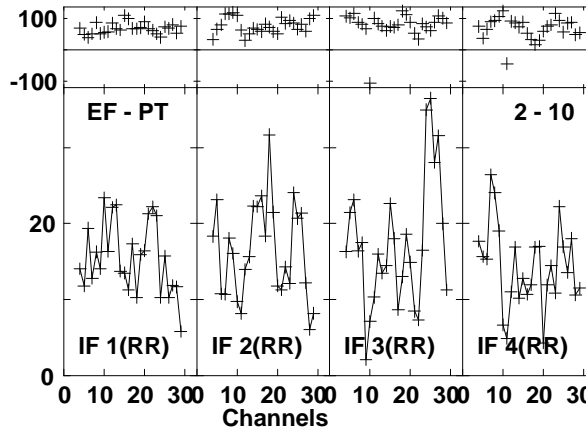
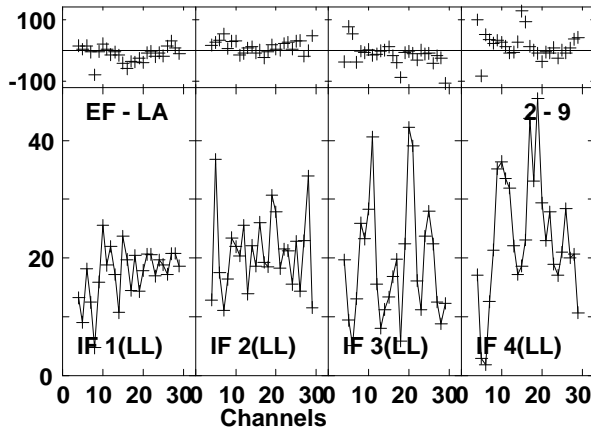
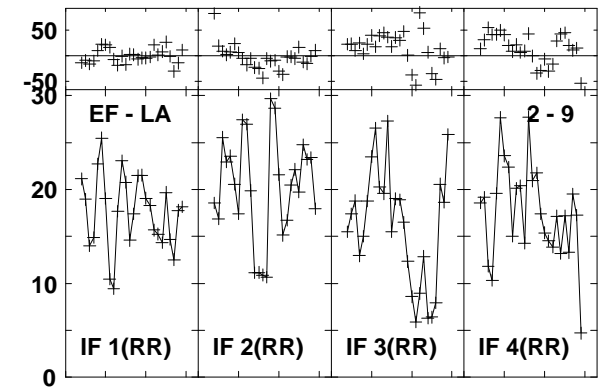
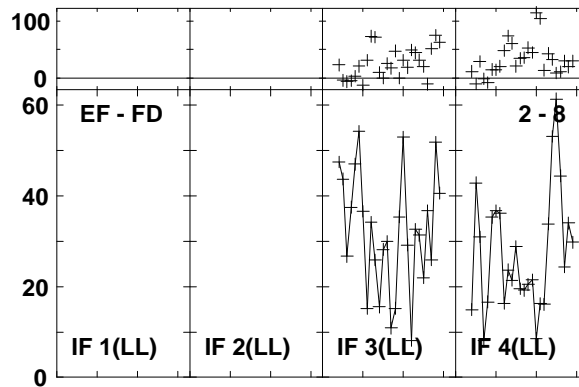
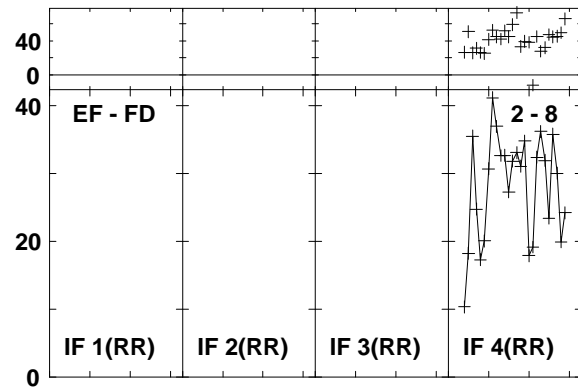
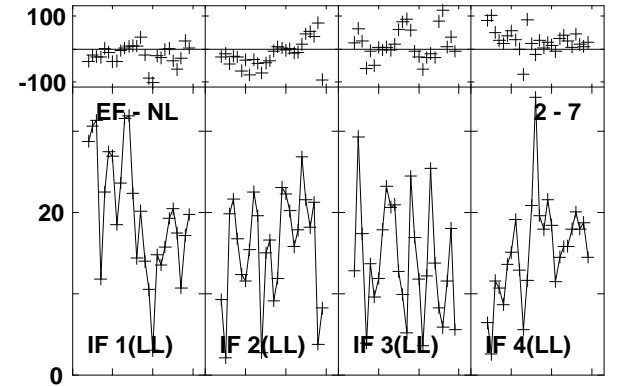
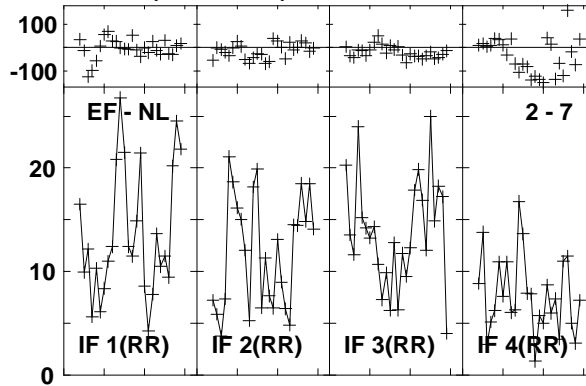
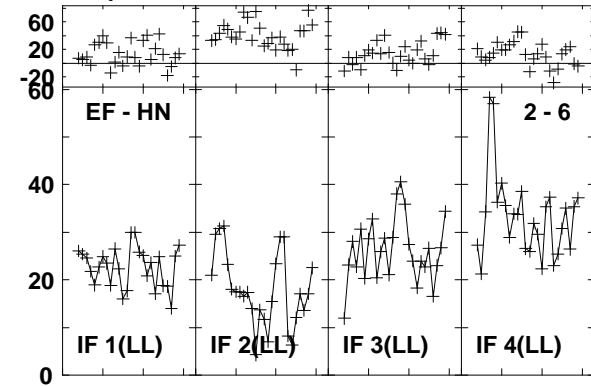

Lower frame: Milli Ampl Jy Top frame: Phas deg
Vector averaged cross-power spectrum Baseline: EF (02) - HN (06)
Timerange: 00/20:28:58 to 00/20:31:44

Plot file version 629 created 03-MAR-2016 01:13:43

4C52 GN002C 1.UVDATA.1

Freq = 1.2770 GHz, Bw = 16.000 MH Calibrated with CL # 3 and BP # 1 (BP mode 1)

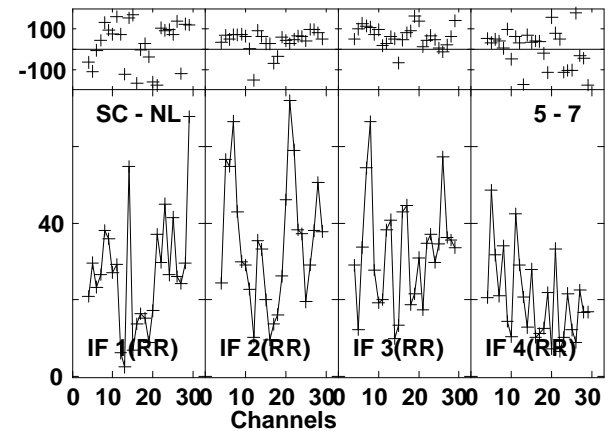
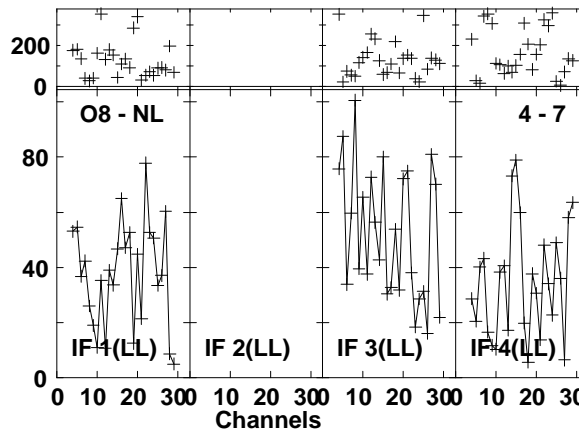
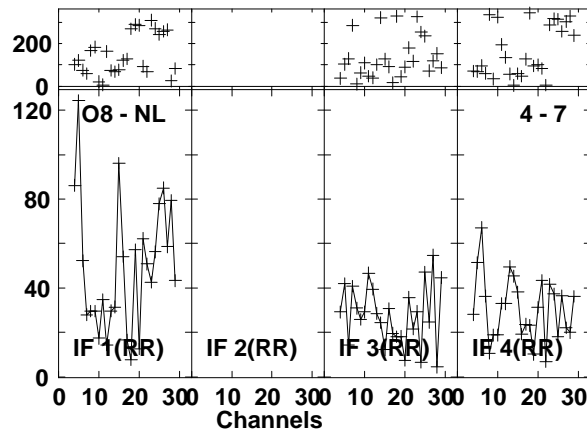
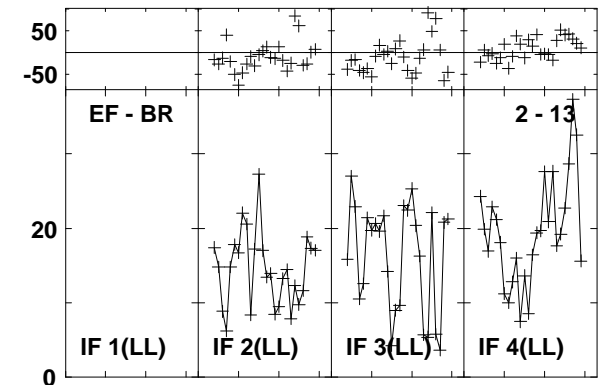
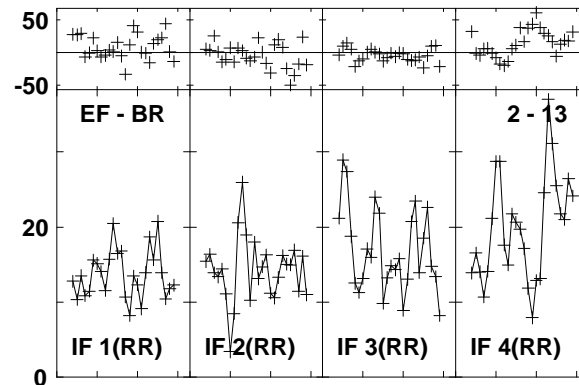
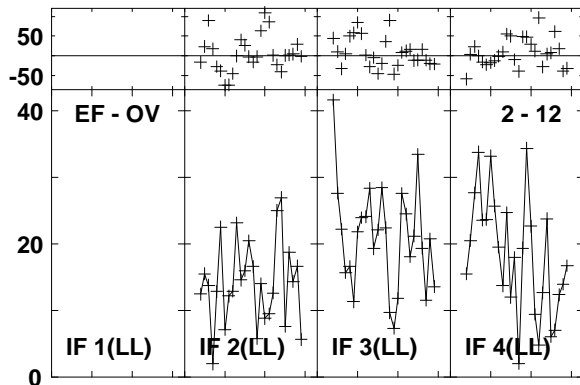
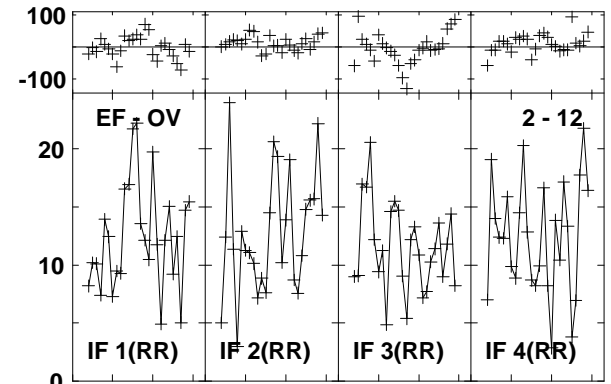
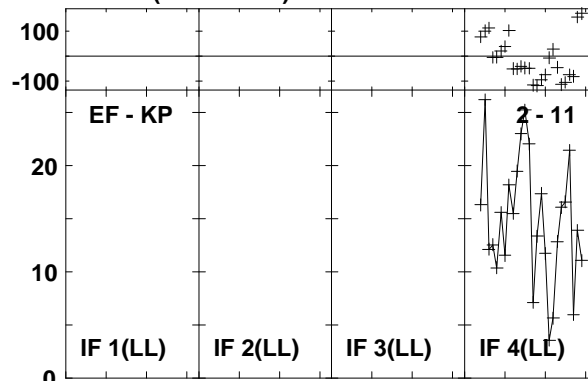
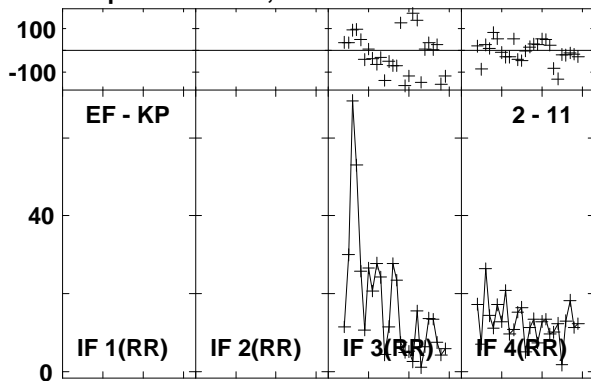

Lower frame: Milli Ampl Jy Top frame: Phas deg

Vector averaged cross-power spectrum Baseline: EF (02) - KP (11)

Timerange: 00/20:28:58 to 00/20:31:44

Plot file version 630 created 03-MAR-2016 01:13:44

4C52 GN002C 1.UVDATA.1

Freq = 1.2770 GHz, Bw = 16.000 MH Calibrated with CL # 3 and BP # 1 (BP mode 1)

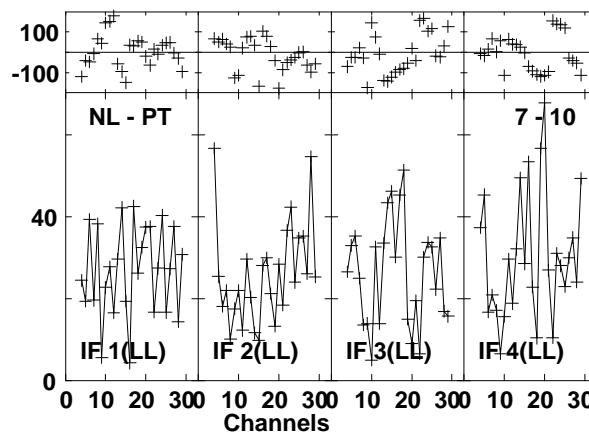
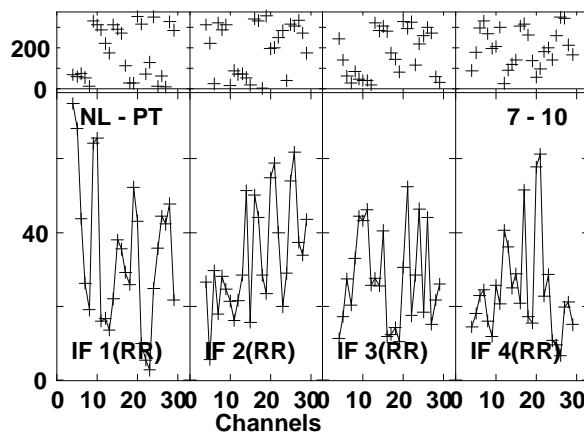
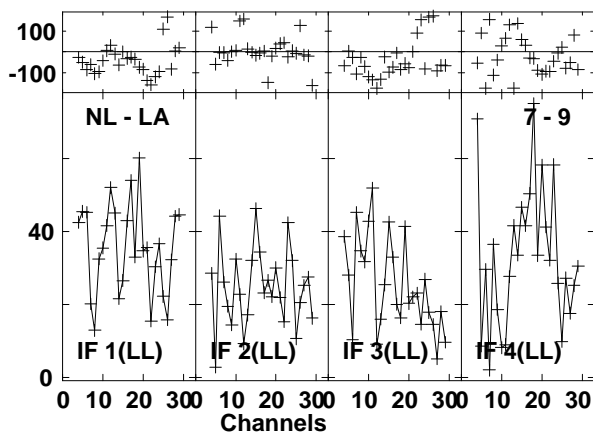
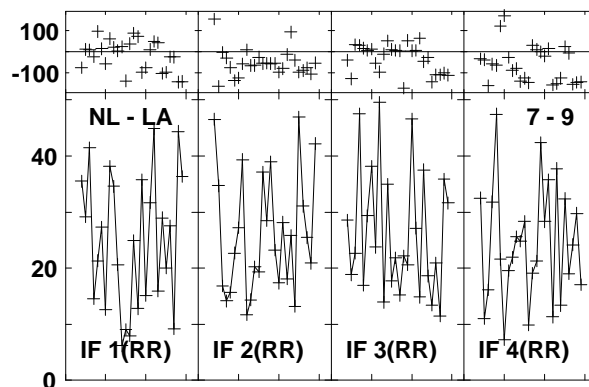
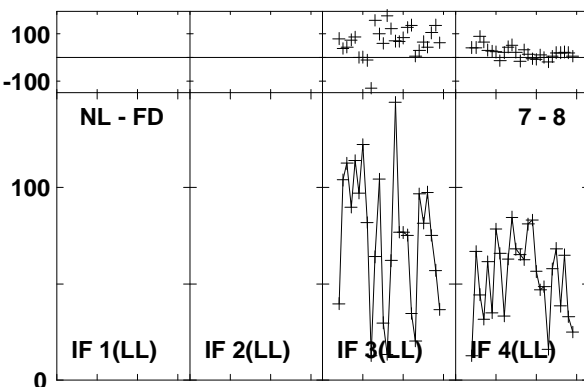
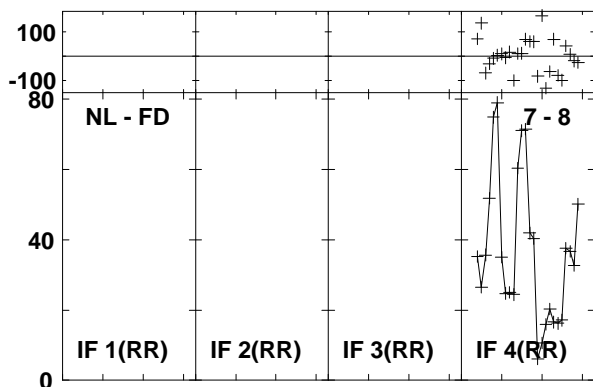
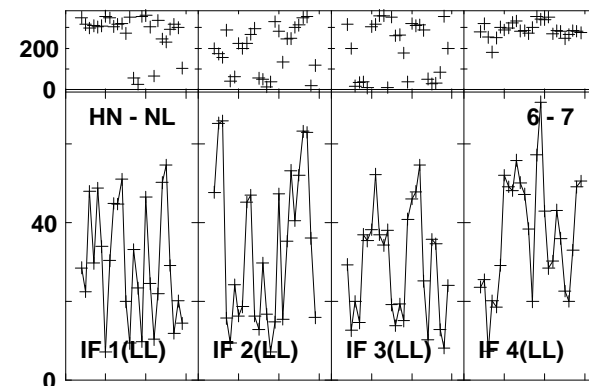
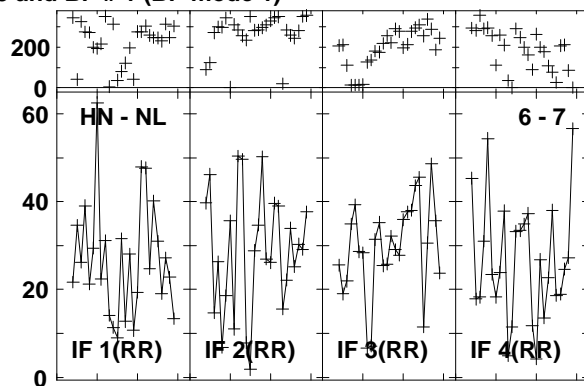
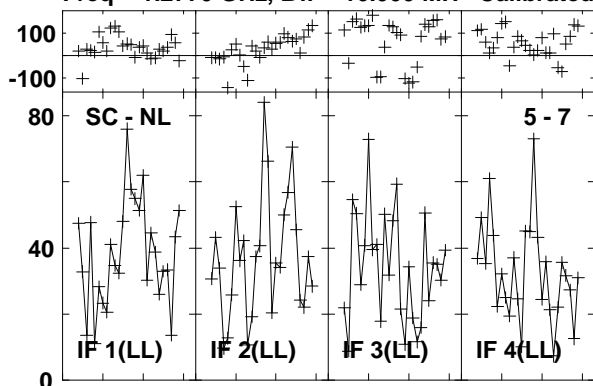

Lower frame: Milli Ampl Jy Top frame: Phas deg
Vector averaged cross-power spectrum Baseline: SC (05) - NL (07)
Timerange: 00/20:28:58 to 00/20:31:44

Plot file version 631 created 03-MAR-2016 01:13:44
 4C52 GN002C 1.UVDATA.1
 Freq = 1.2770 GHz, Bw = 16.000 MH Calibrated with CL # 3 and BP # 1 (BP mode 1)

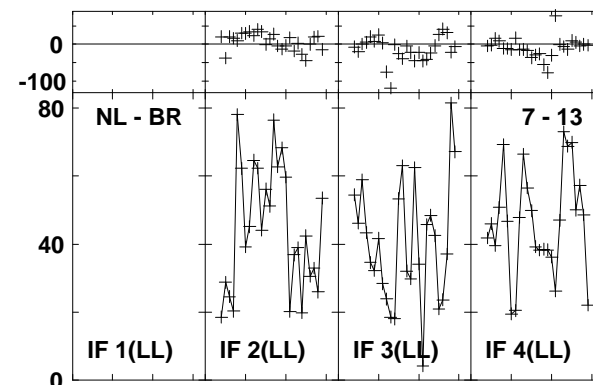
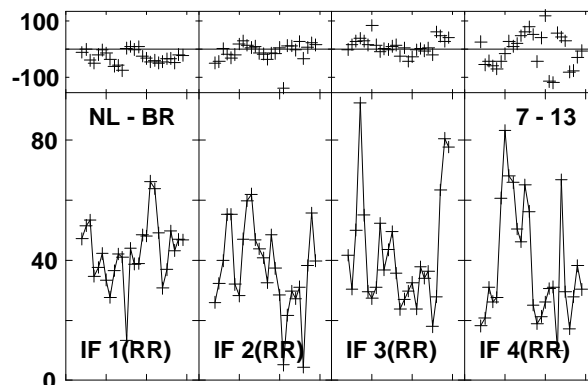
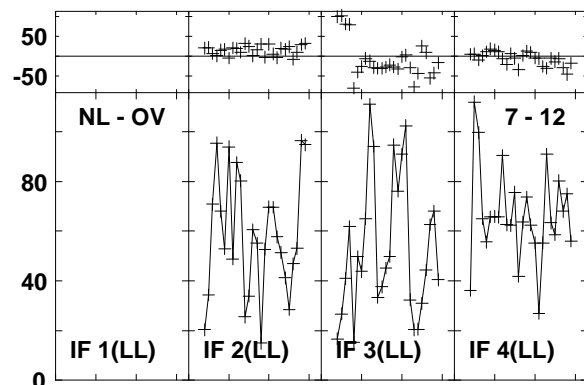
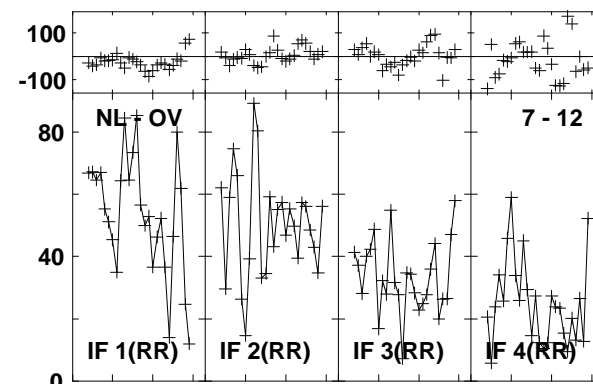
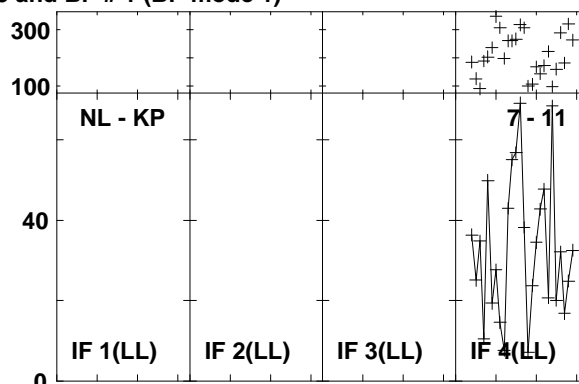
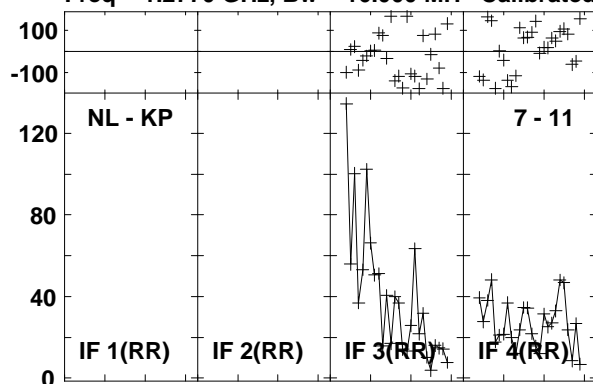

Lower frame: Milli Ampl Jy Top frame: Phas deg
 Vector averaged cross-power spectrum Baseline: NL (07) - KP (11)
 Timerange: 00/20:28:58 to 00/20:31:44

Plot file version 632 created 03-MAR-2016 01:13:44

J1545+5400 GN002C 1.UVDATA.1

Freq = 1.2770 GHz, Bw = 16.000 MH Calibrated with CL # 3 and BP # 1 (BP mode 1)

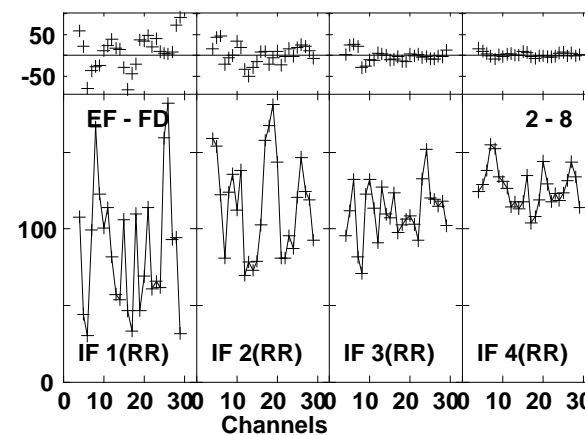
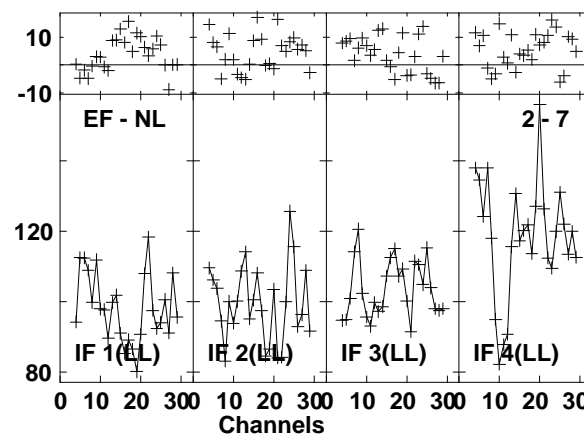
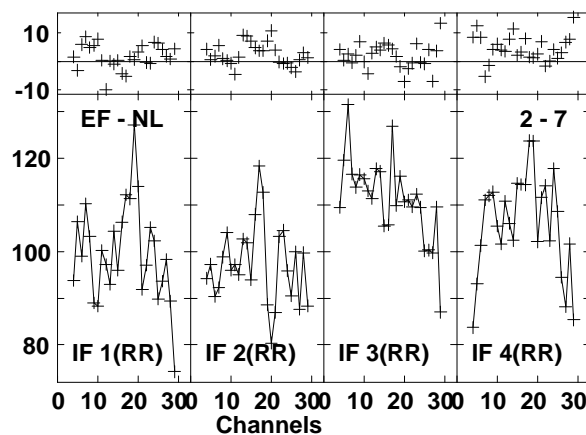
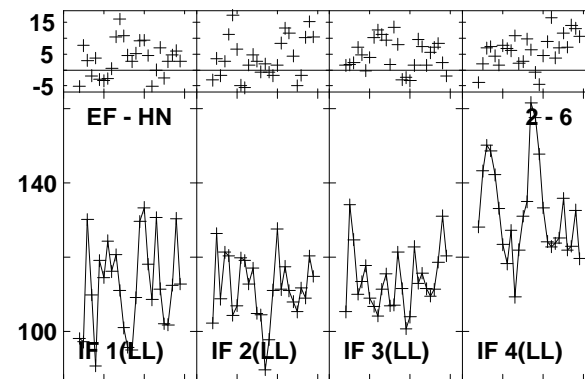
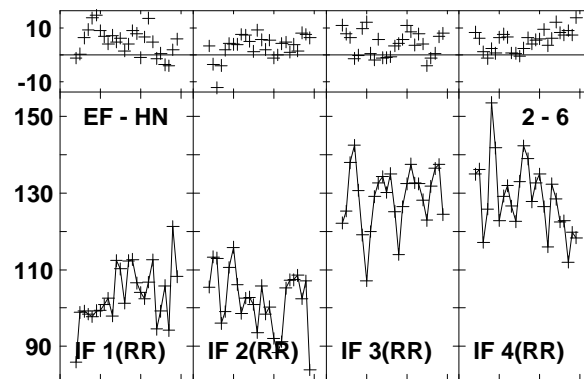
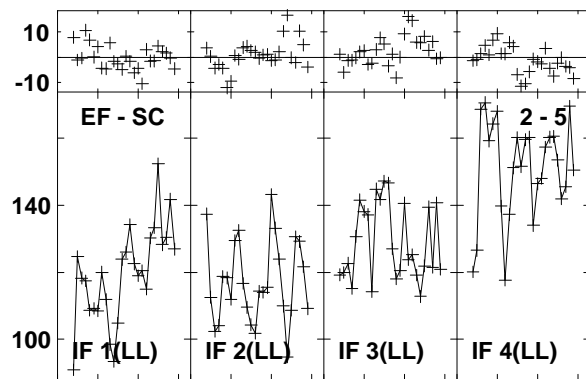
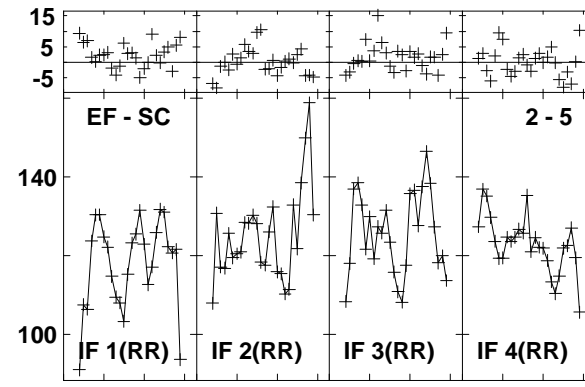
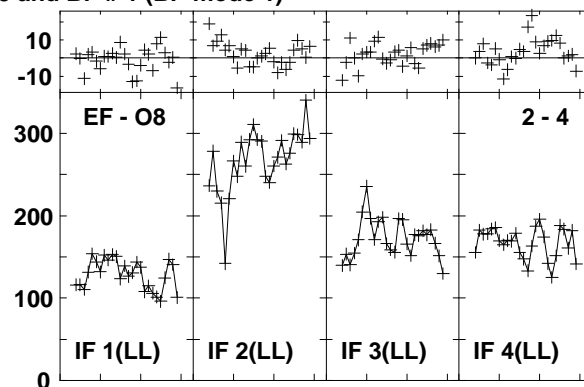
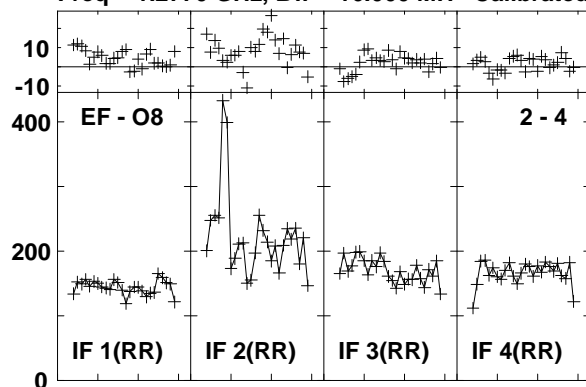

Lower frame: Milli Ampl Jy Top frame: Phas deg
Vector averaged cross-power spectrum Baseline: EF (02) - O8 (04)
Timerange: 00/20:32:36 to 00/20:33:34

Plot file version 633 created 03-MAR-2016 01:13:44
 J1545+5400 GN002C 1.UVDATA.1
 Freq = 1.2770 GHz, Bw = 16.000 MH Calibrated with CL # 3 and BP # 1 (BP mode 1)

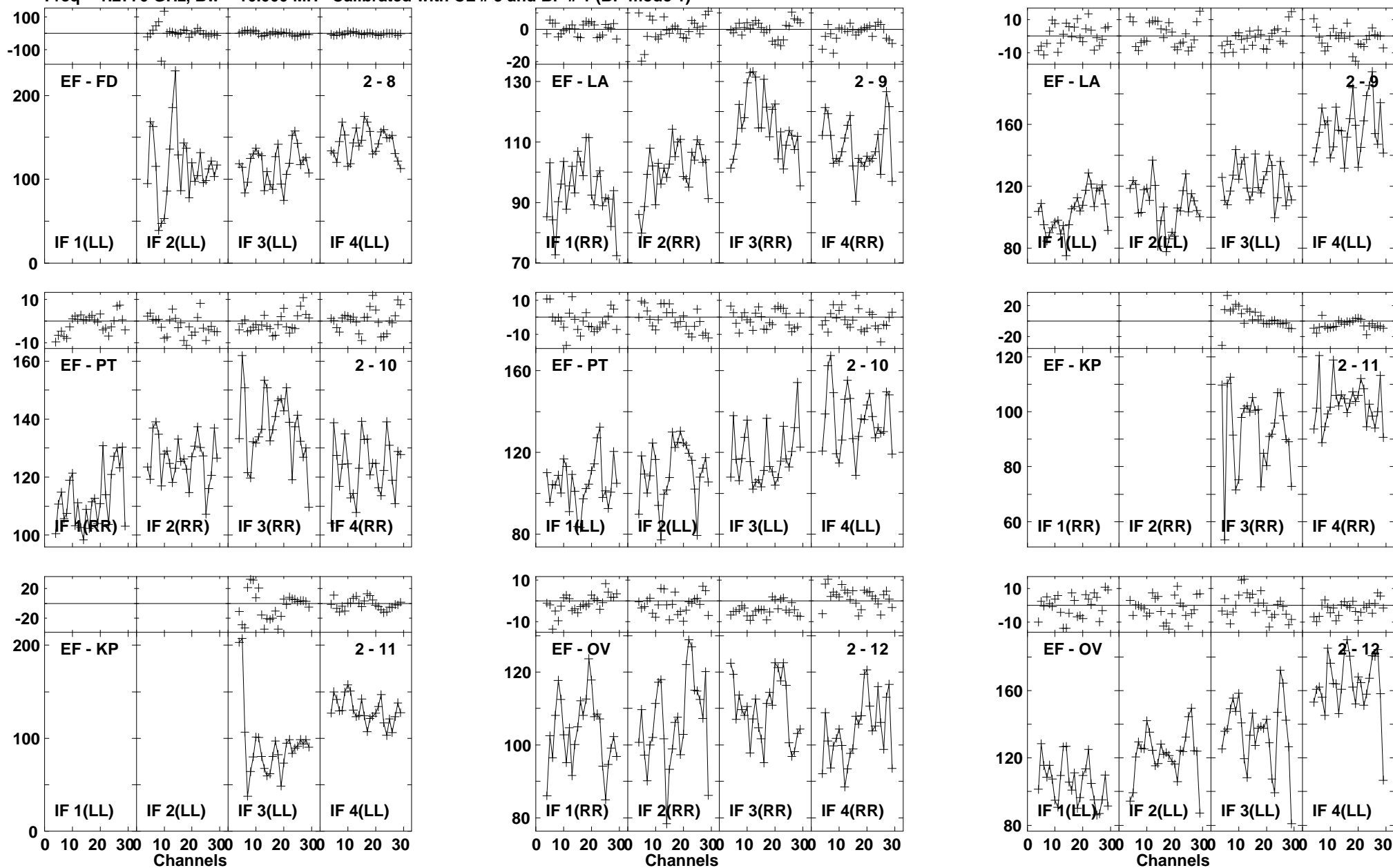

Lower frame: Milli Ampl Jy Top frame: Phas deg
 Vector averaged cross-power spectrum Baseline: EF (02) - FD (08)
 Timerange: 00/20:32:36 to 00/20:33:34

Plot file version 634 created 03-MAR-2016 01:13:44

J1545+5400 GN002C 1.UVDATA.1

Freq = 1.2770 GHz, Bw = 16.000 MH Calibrated with CL # 3 and BP # 1 (BP mode 1)

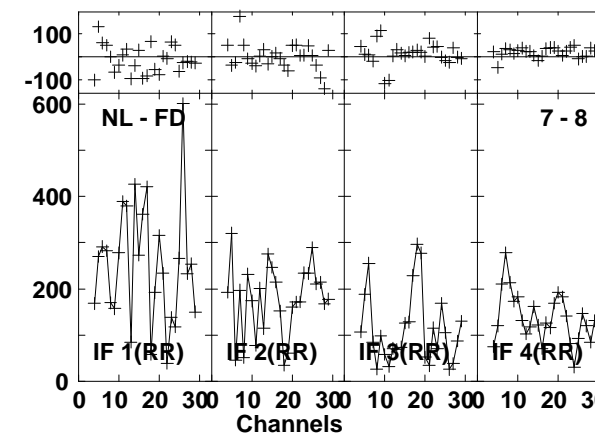
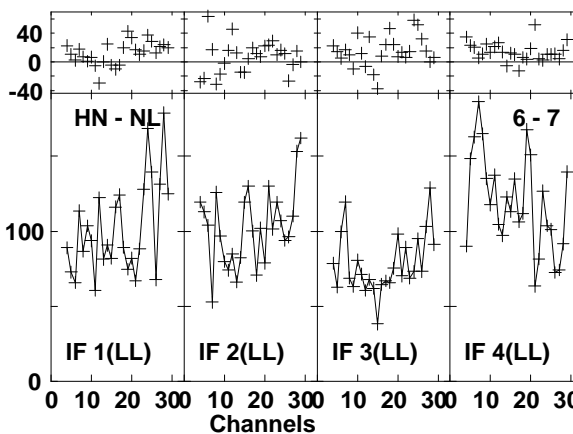
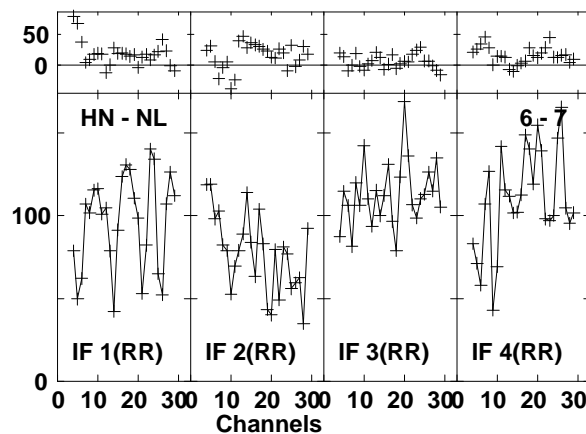
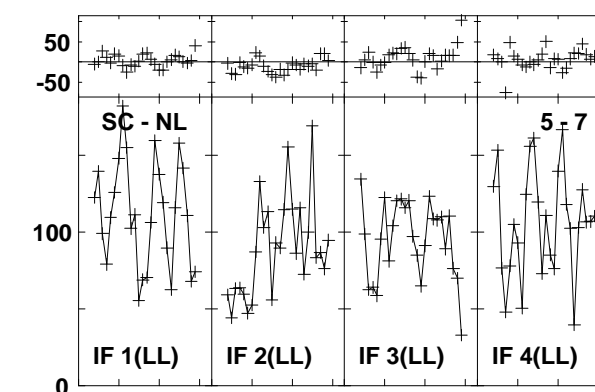
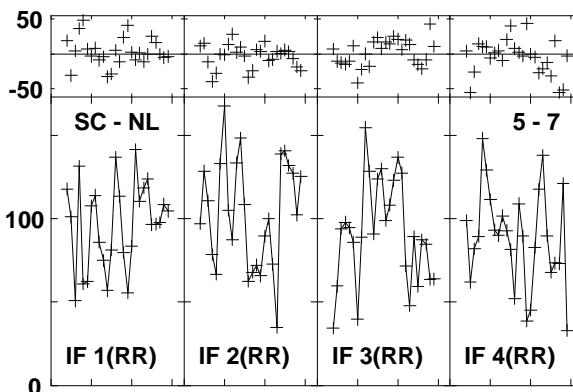
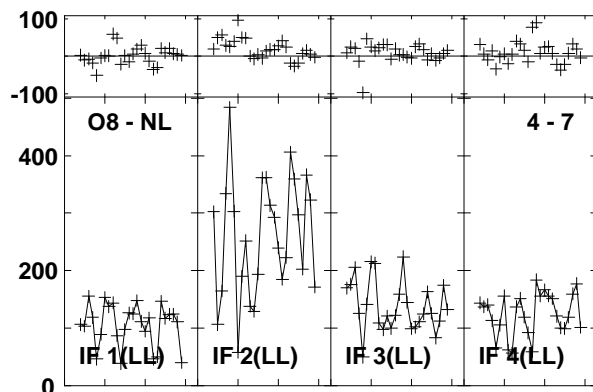
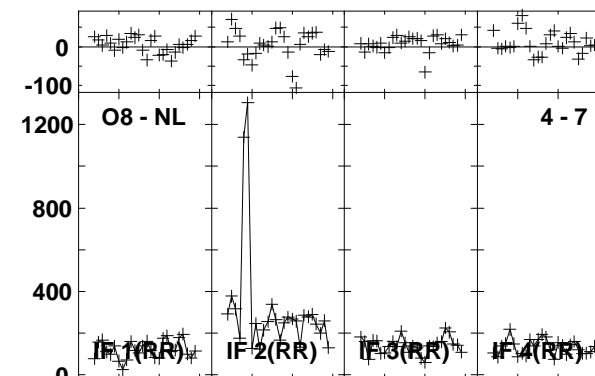
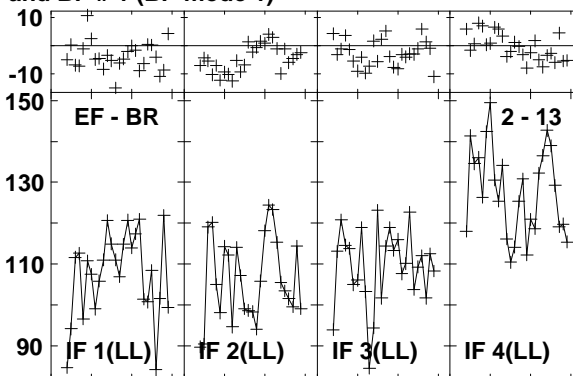
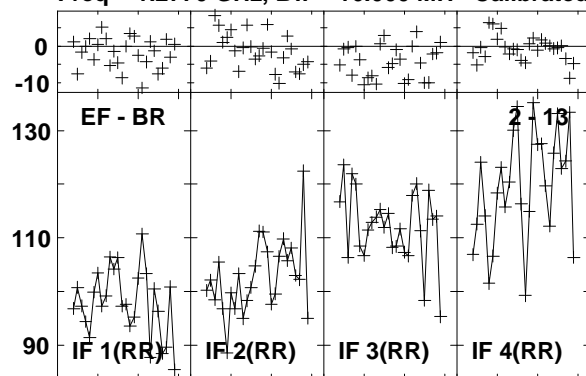

Lower frame: Milli Ampl Jy Top frame: Phas deg
Vector averaged cross-power spectrum Baseline: EF (02) - BR (13)
Timerange: 00/20:32:36 to 00/20:33:34

Plot file version 635 created 03-MAR-2016 01:13:45
 J1545+5400 GN002C 1.UVDATA.1
 Freq = 1.2770 GHz, Bw = 16.000 MH Calibrated with CL # 3 and BP # 1 (BP mode 1)

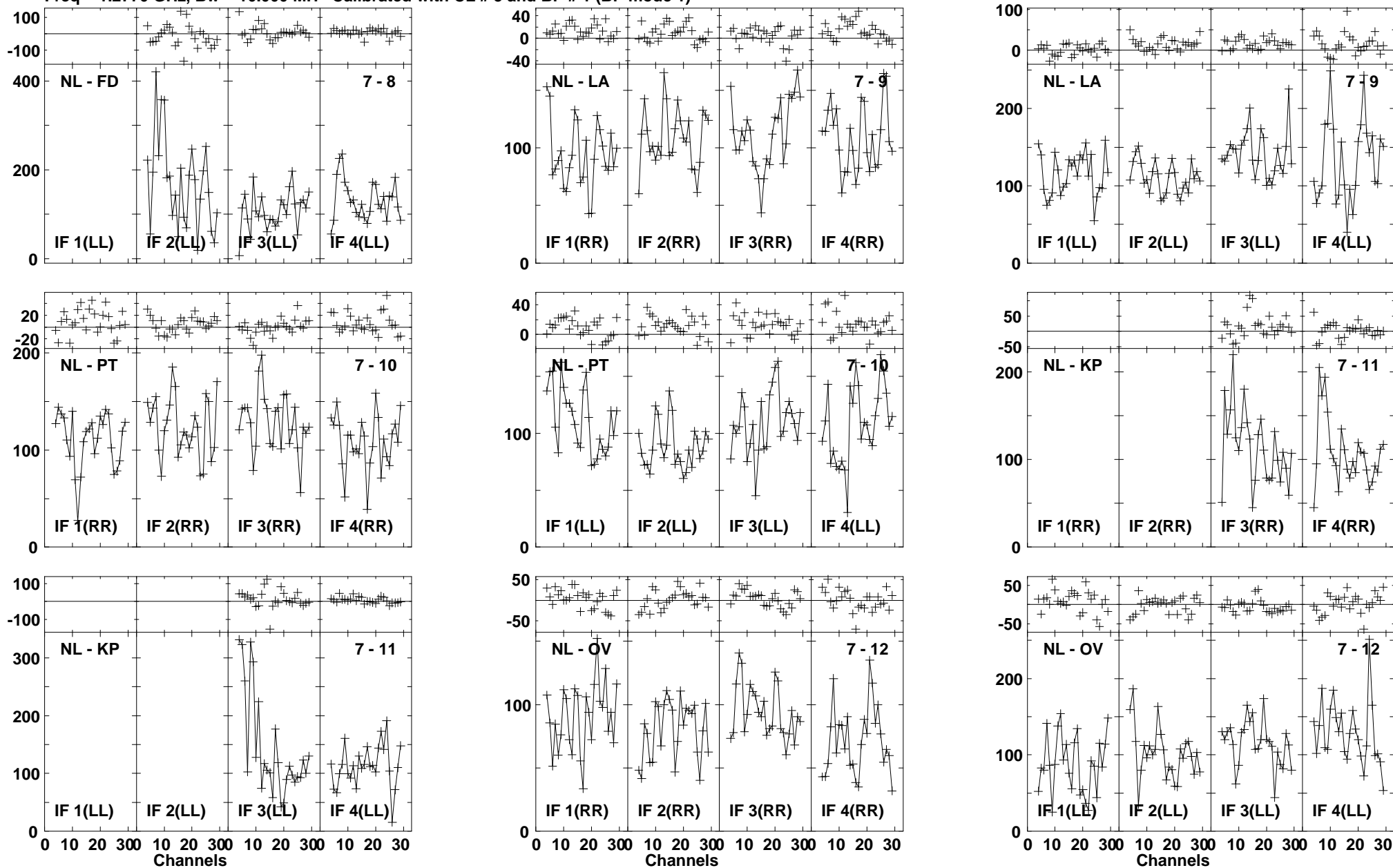

Lower frame: Milli Ampl Jy Top frame: Phas deg
 Vector averaged cross-power spectrum Baseline: NL (07) - FD (08)
 Timerange: 00/20:32:36 to 00/20:33:34

Plot file version 636 created 03-MAR-2016 01:13:45

J1545+5400 GN002C 1.UVDATA.1

Freq = 1.2770 GHz, Bw = 16.000 MH Calibrated with CL # 3 and BP # 1 (BP mode 1)

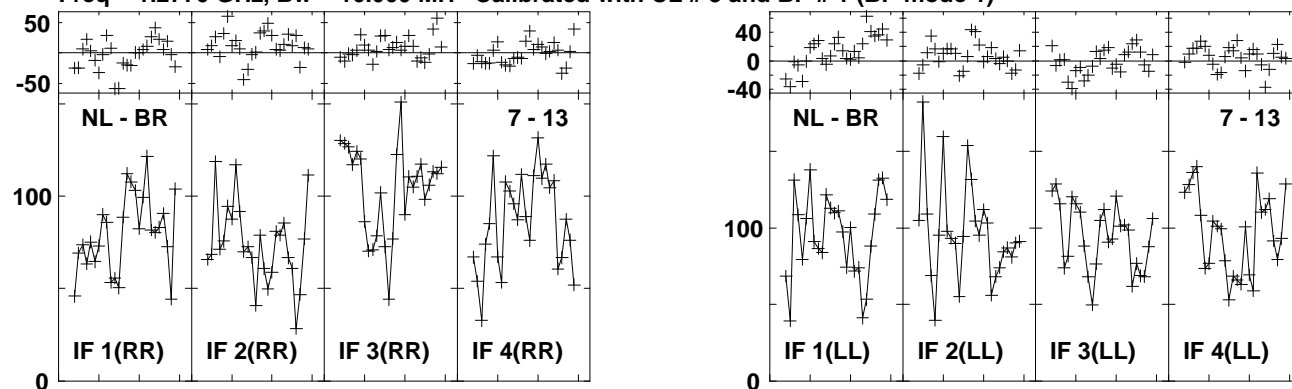

Lower frame: Milli Ampl Jy Top frame: Phas deg
Vector averaged cross-power spectrum Baseline: NL (07) - BR (13)
Timerange: 00/20:32:36 to 00/20:33:34

Plot file version 637 created 03-MAR-2016 01:13:45

4C52 GN002C 1.UVDATA.1

Freq = 1.2770 GHz, Bw = 16.000 MH Calibrated with CL # 3 and BP # 1 (BP mode 1)

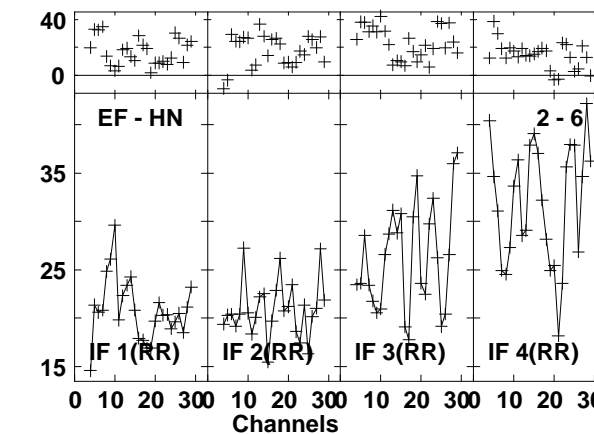
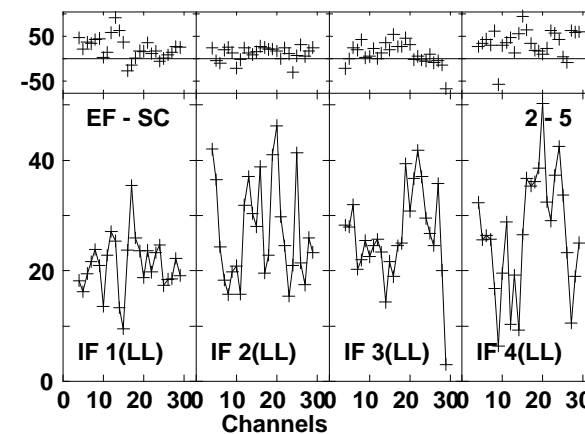
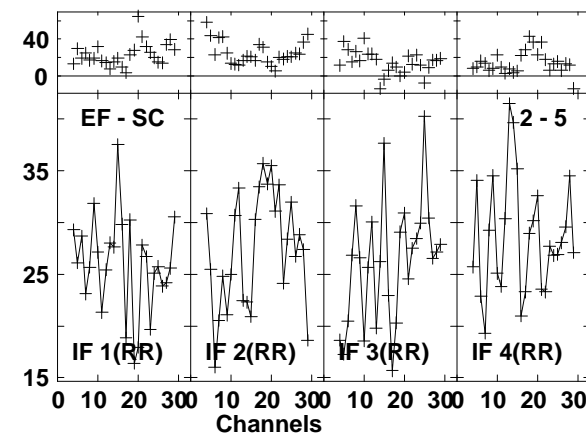
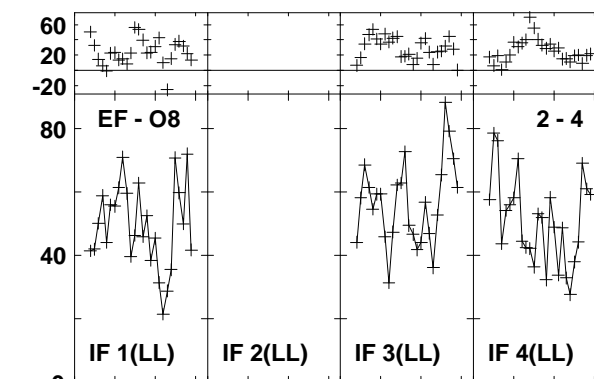
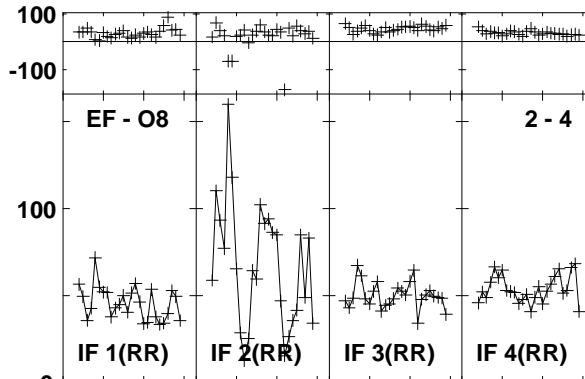
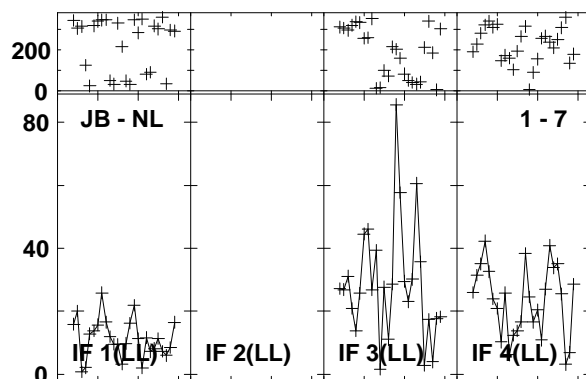
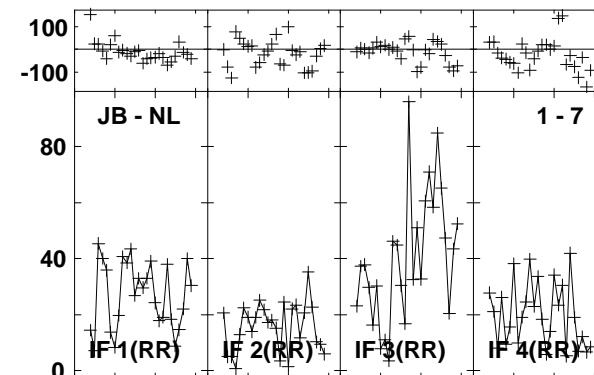
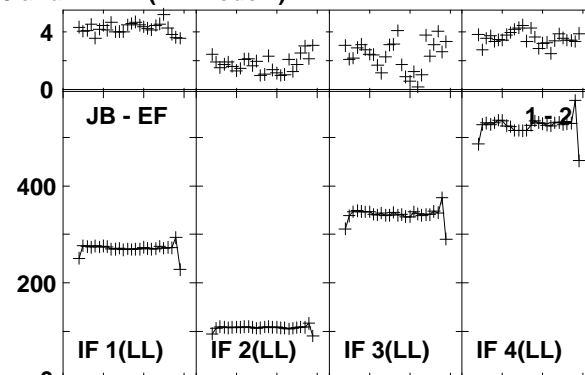
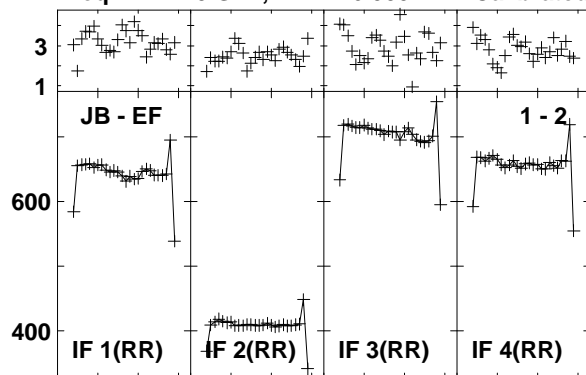

Lower frame: Milli Ampl Jy Top frame: Phas deg
Vector averaged cross-power spectrum Baseline: JB (01) - EF (02)
Timerange: 00/20:33:39 to 00/20:36:33

Plot file version 638 created 03-MAR-2016 01:13:45

4C52 GN002C 1.UVDATA.1

Freq = 1.2770 GHz, Bw = 16.000 MH Calibrated with CL # 3 and BP # 1 (BP mode 1)

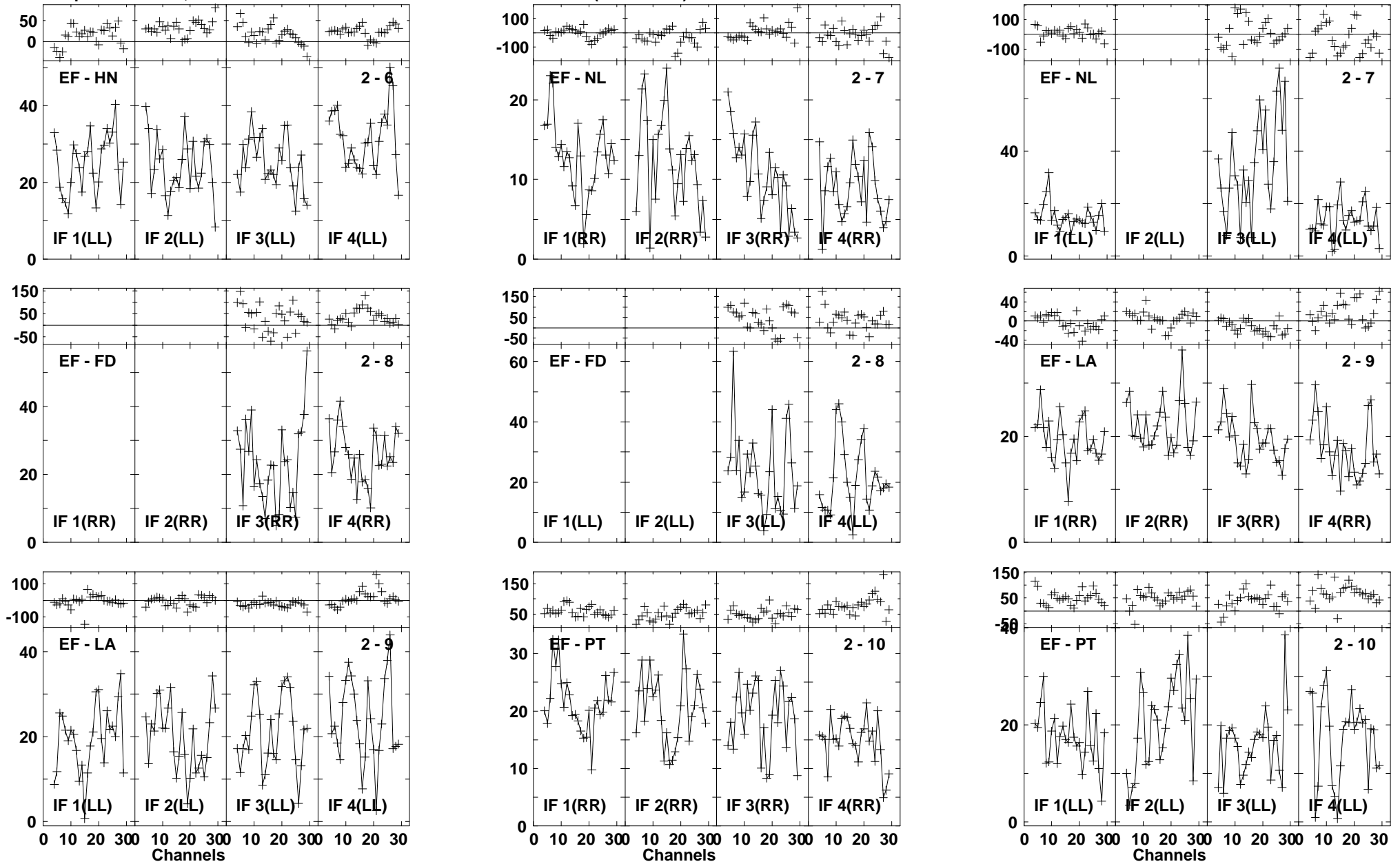

Lower frame: Milli Ampl Jy Top frame: Phas deg
Vector averaged cross-power spectrum Baseline: EF (02) - HN (06)
Timerange: 00/20:33:39 to 00/20:36:33

Plot file version 639 created 03-MAR-2016 01:13:45
 4C52 GN002C 1.UVDATA.1
 Freq = 1.2770 GHz, Bw = 16.000 MH Calibrated with CL # 3 and BP # 1 (BP mode 1)

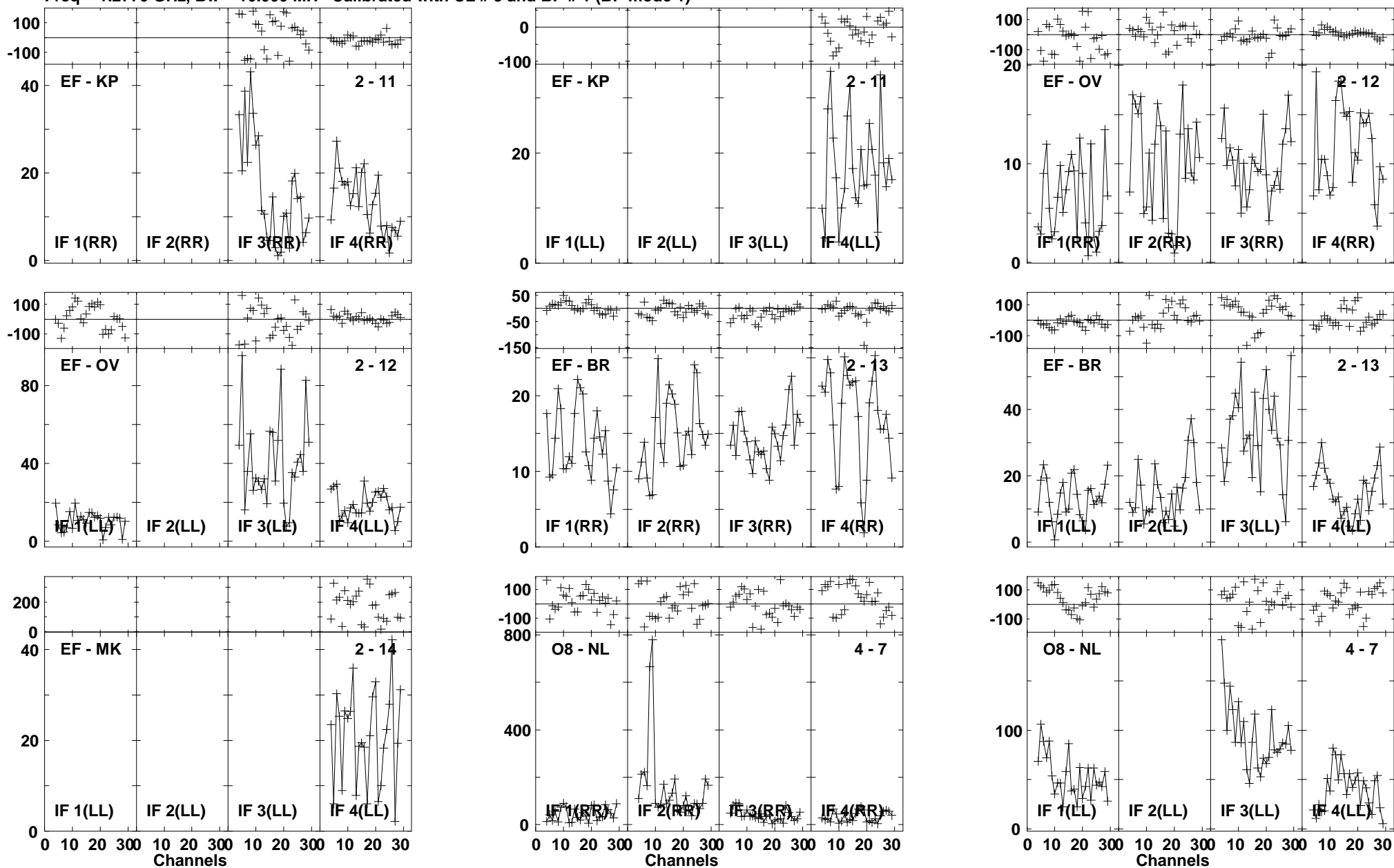

Lower frame: Milli Ampl Jy Top frame: Phas deg
 Vector averaged cross-power spectrum Baseline: EF (02) - KP (11)
 Timerange: 00/20:33:39 to 00/20:36:33

Plot file version 640 created 03-MAR-2016 01:13:46

4C52 GN002C 1.UVDATA.1

Freq = 1.2770 GHz, Bw = 16.000 MH Calibrated with CL # 3 and BP # 1 (BP mode 1)

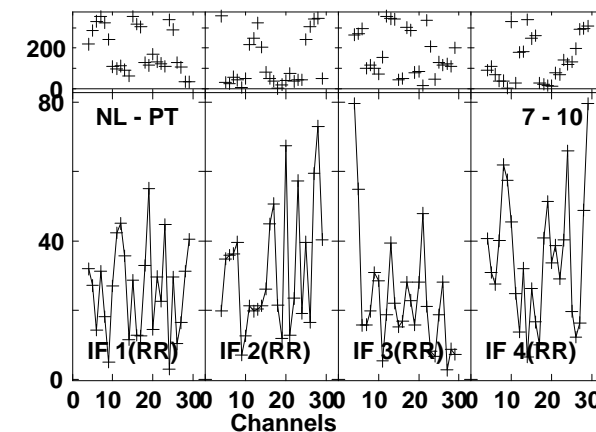
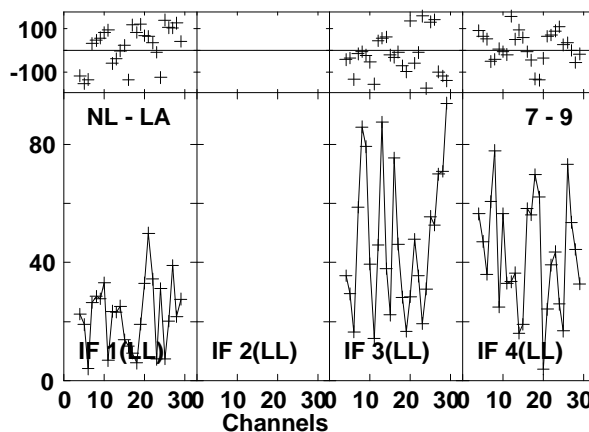
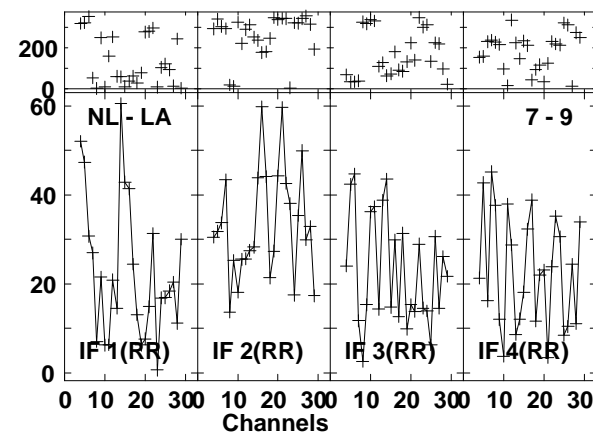
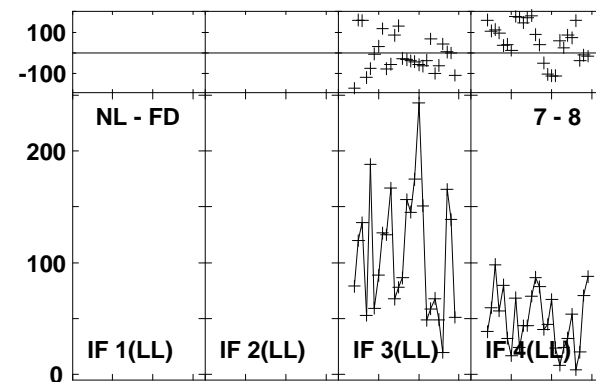
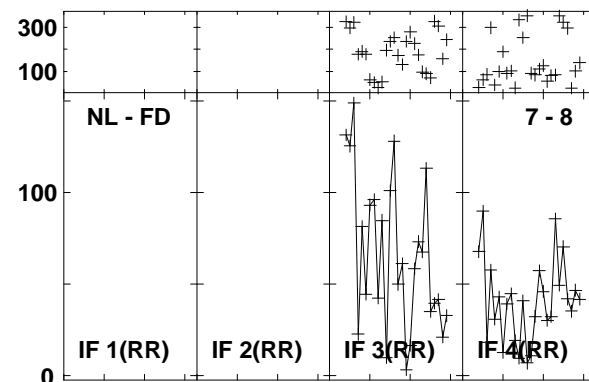
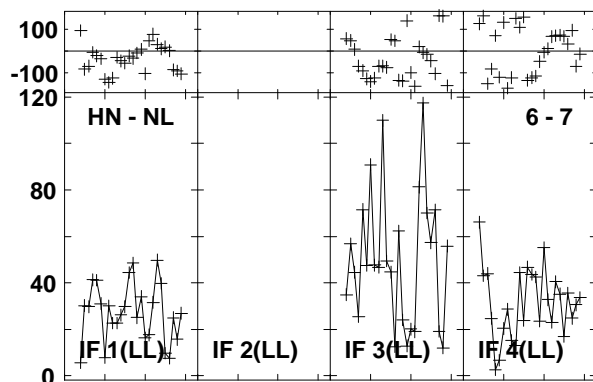
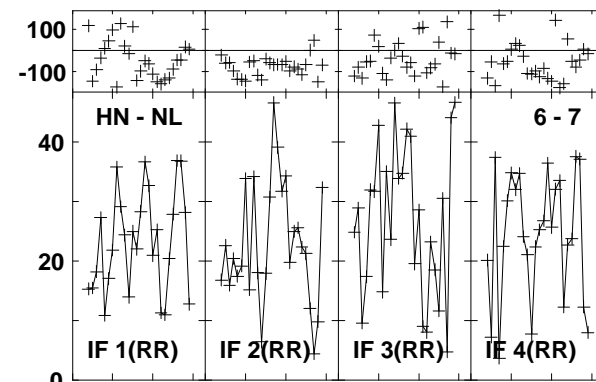
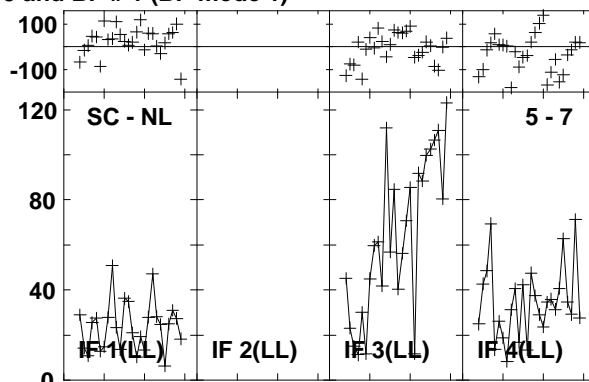
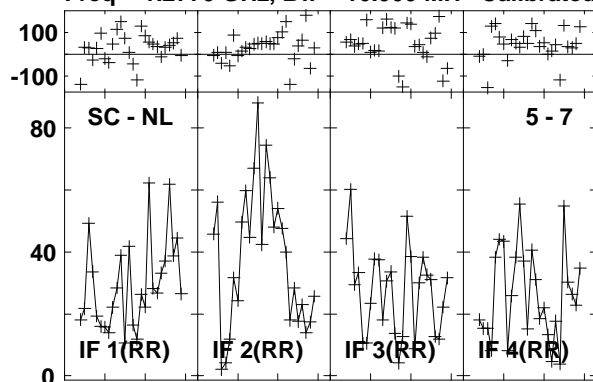

Lower frame: Milli Ampl Jy Top frame: Phas deg
Vector averaged cross-power spectrum Baseline: SC (05) - NL (07)
Timerange: 00/20:33:39 to 00/20:36:33

Plot file version 641 created 03-MAR-2016 01:13:46

4C52 GN002C 1.UVDATA.1

Freq = 1.2770 GHz, Bw = 16.000 MH Calibrated with CL # 3 and BP # 1 (BP mode 1)

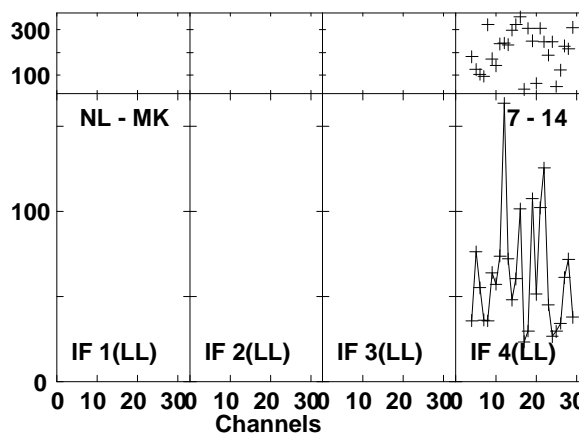
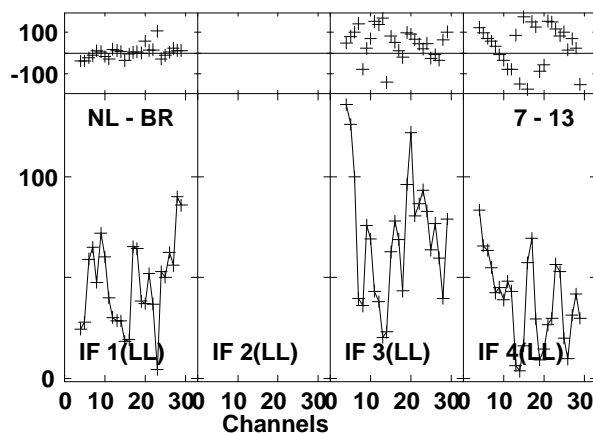
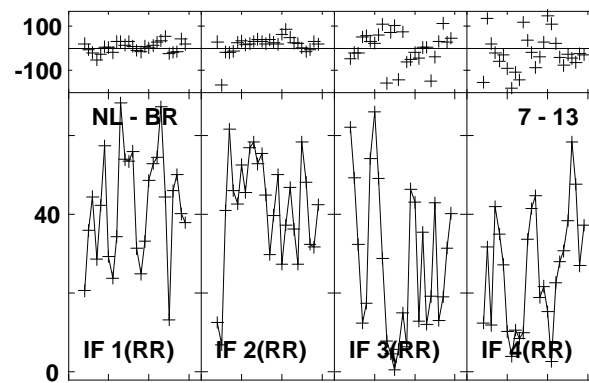
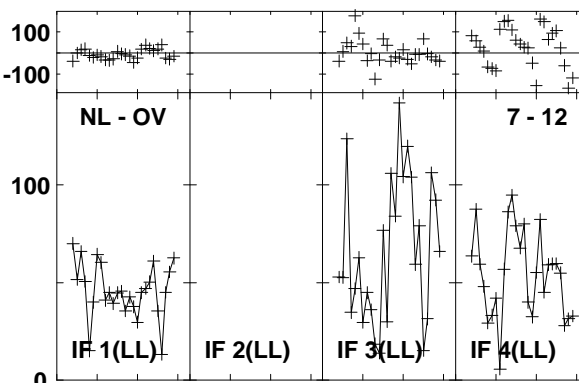
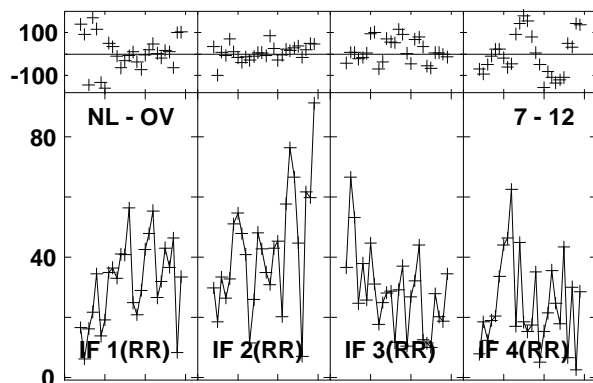
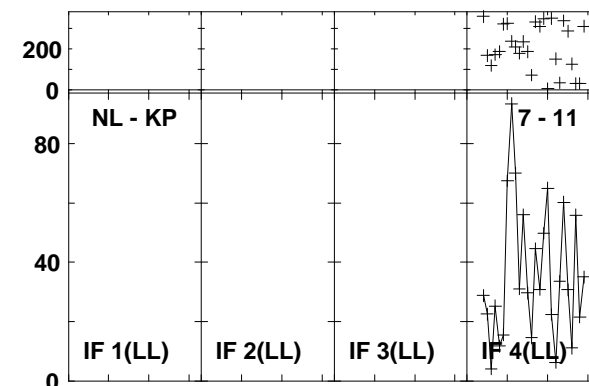
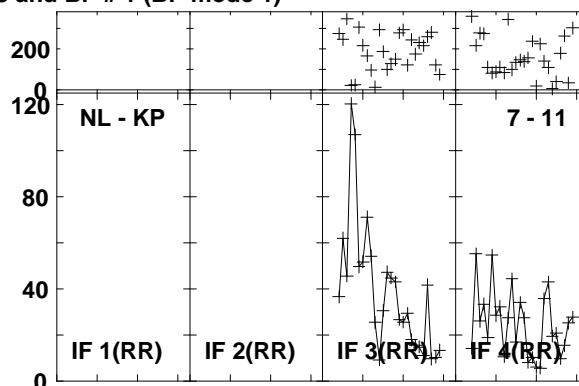
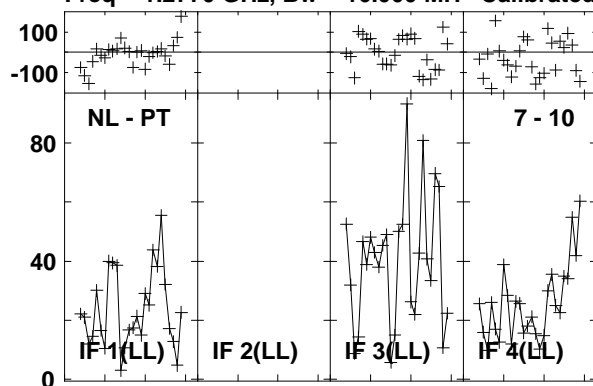

Lower frame: Milli Ampl Jy Top frame: Phas deg
Vector averaged cross-power spectrum Baseline: NL (07) - PT (10)
Timerange: 00/20:33:39 to 00/20:36:33

Plot file version 642 created 03-MAR-2016 01:13:46

J1545+5400 GN002C 1.UVDATA.1

Freq = 1.2770 GHz, Bw = 16.000 MH Calibrated with CL # 3 and BP # 1 (BP mode 1)

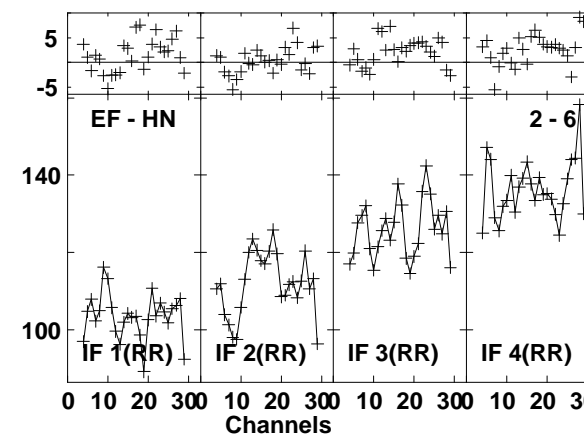
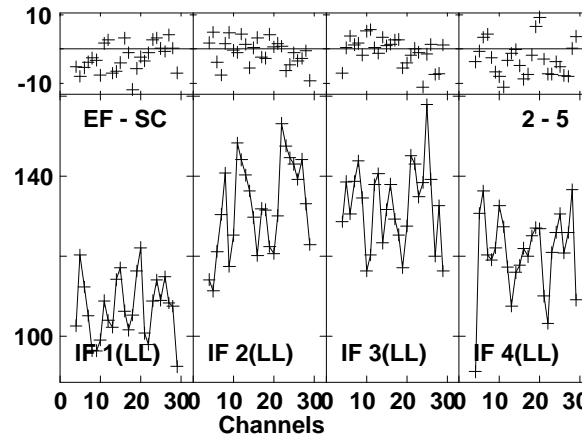
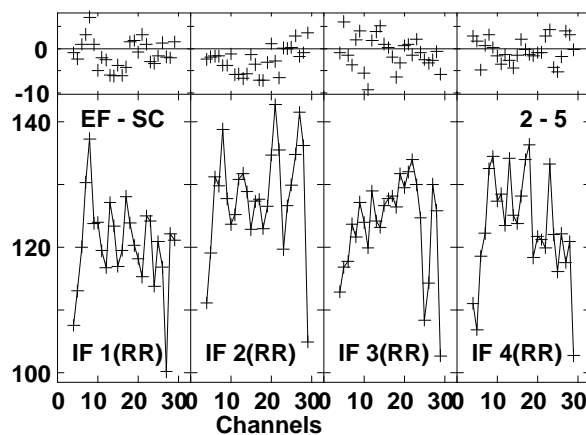
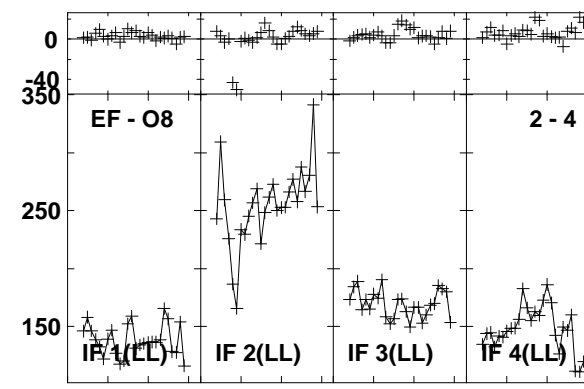
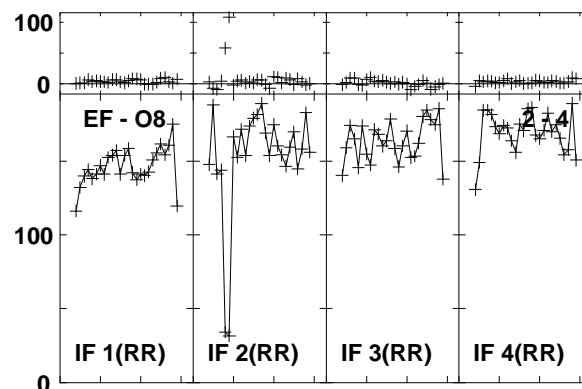
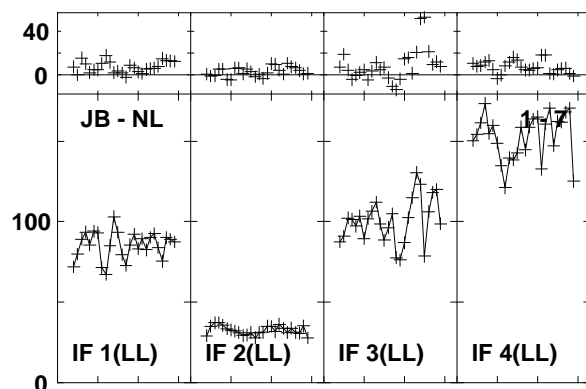
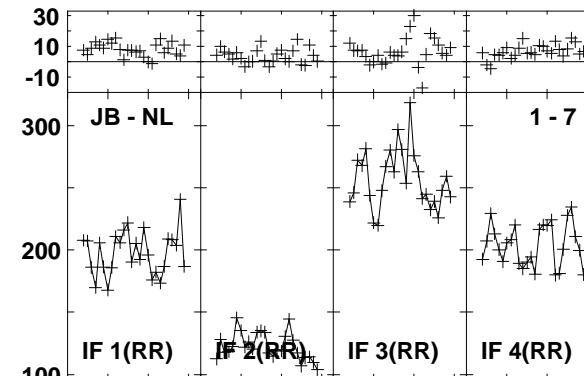
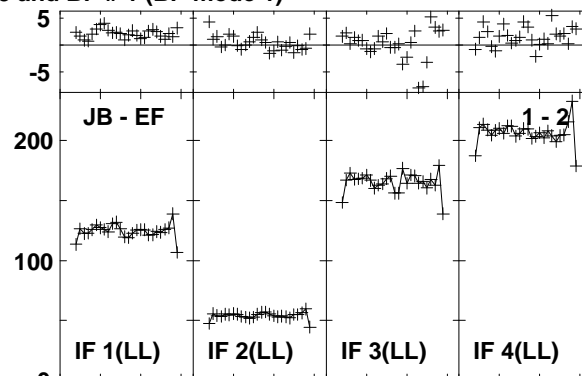
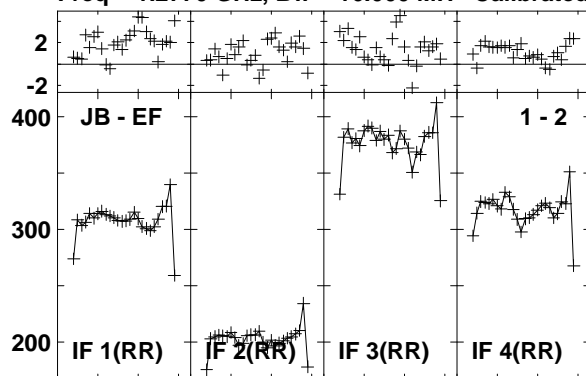

Lower frame: Milli Ampl Jy Top frame: Phas deg
Vector averaged cross-power spectrum Baseline: JB (01) - EF (02)
Timerange: 00/20:37:26 to 00/20:39:24

Plot file version 643 created 03-MAR-2016 01:13:46

J1545+5400 GN002C 1.UVDATA.1

Freq = 1.2770 GHz, Bw = 16.000 MH Calibrated with CL # 3 and BP # 1 (BP mode 1)

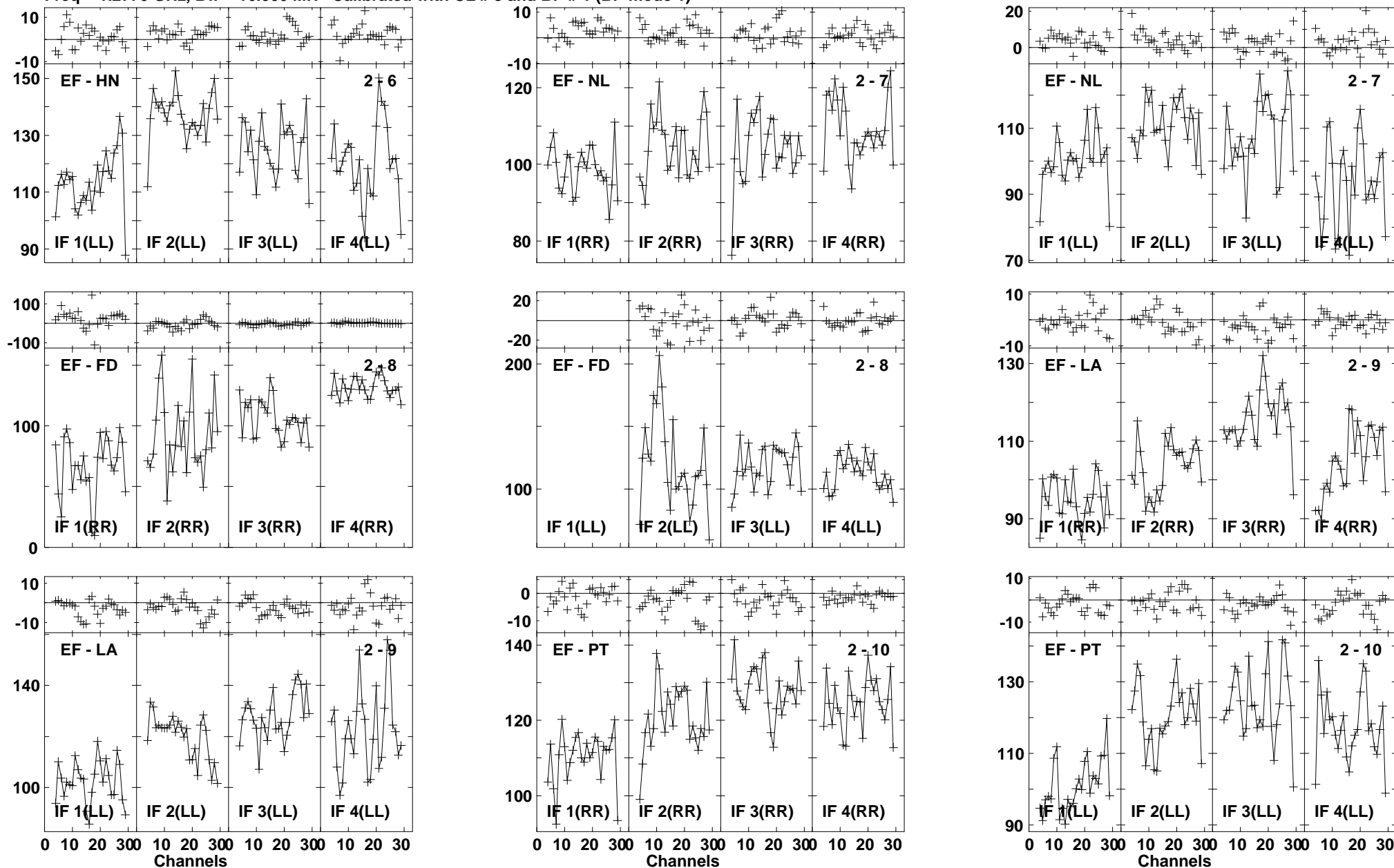

Lower frame: Milli Ampl Jy Top frame: Phas deg
Vector averaged cross-power spectrum Baseline: EF (02) - HN (06)
Timerange: 00/20:37:26 to 00/20:39:24

Plot file version 644 created 03-MAR-2016 01:13:46

J1545+5400 GN002C 1.UVDATA.1

Freq = 1.2770 GHz, Bw = 16.000 MH Calibrated with CL # 3 and BP # 1 (BP mode 1)

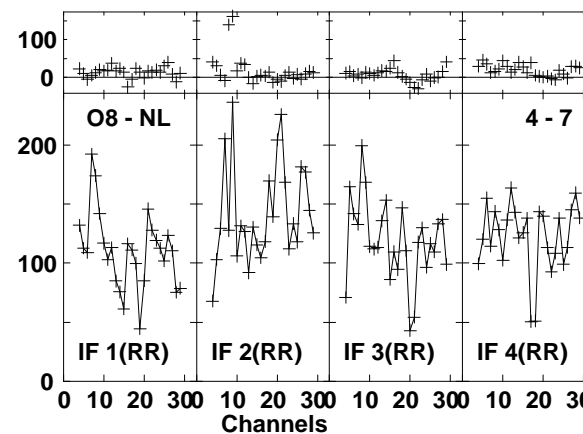
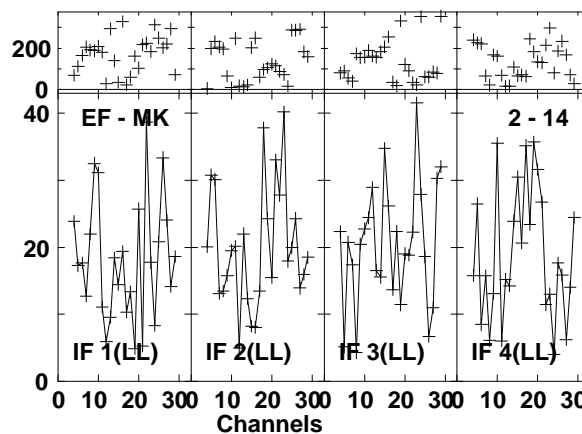
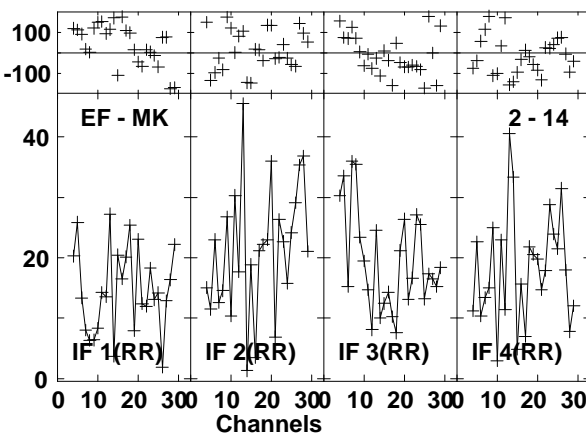
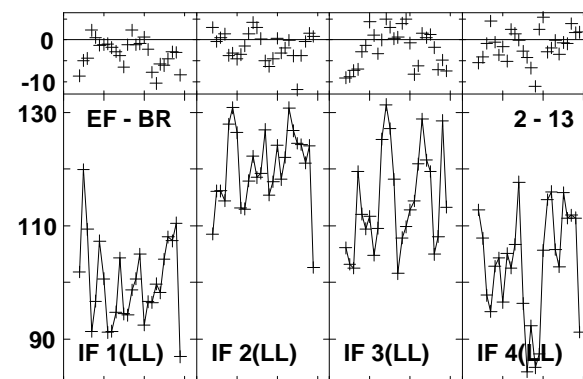
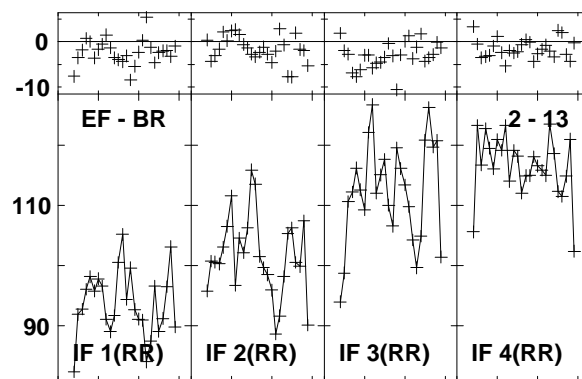
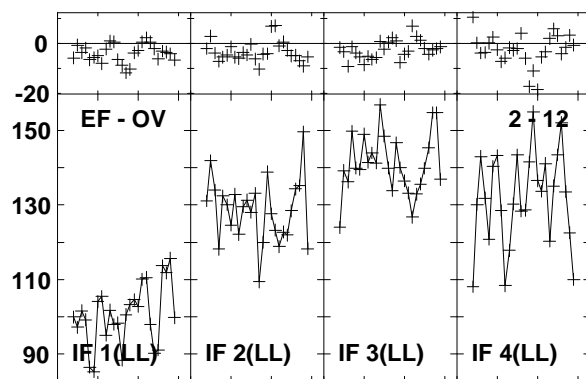
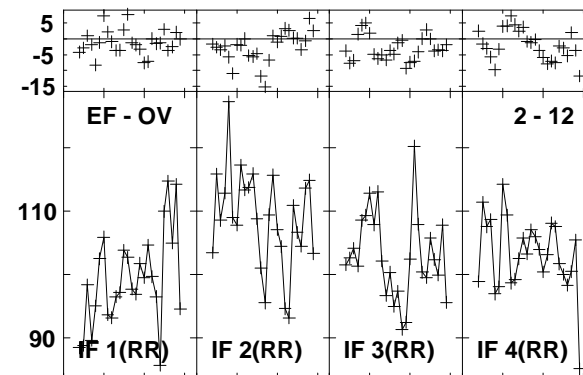
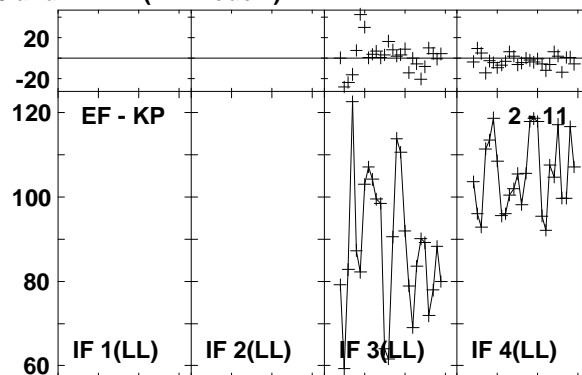
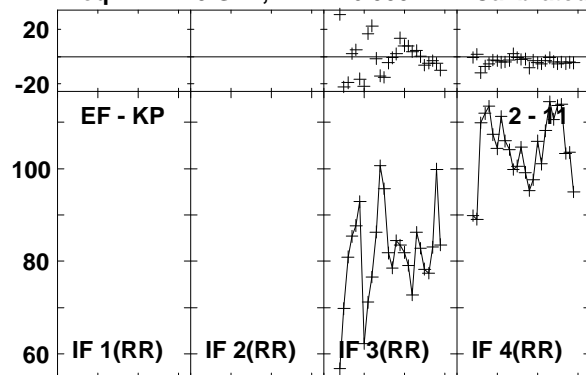

Lower frame: Milli Ampl Jy Top frame: Phas deg
Vector averaged cross-power spectrum Baseline: EF (02) - KP (11)
Timerange: 00/20:37:26 to 00/20:39:24

Plot file version 645 created 03-MAR-2016 01:13:47

J1545+5400 GN002C 1.UVDATA.1

Freq = 1.2770 GHz, Bw = 16.000 MH Calibrated with CL # 3 and BP # 1 (BP mode 1)

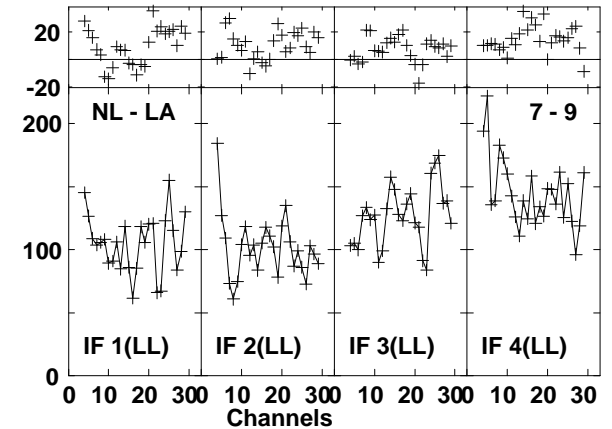
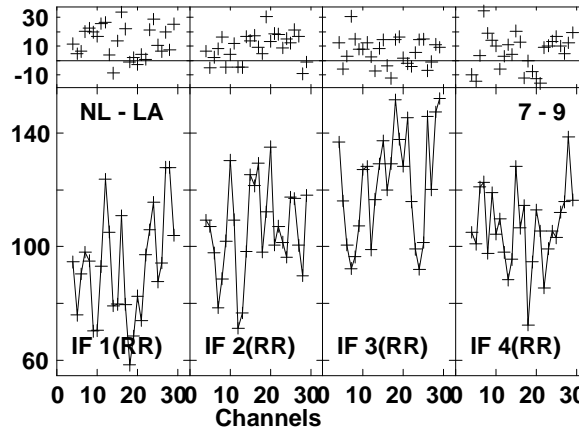
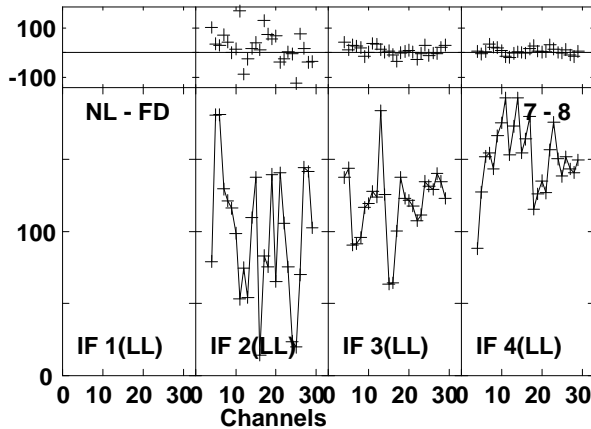
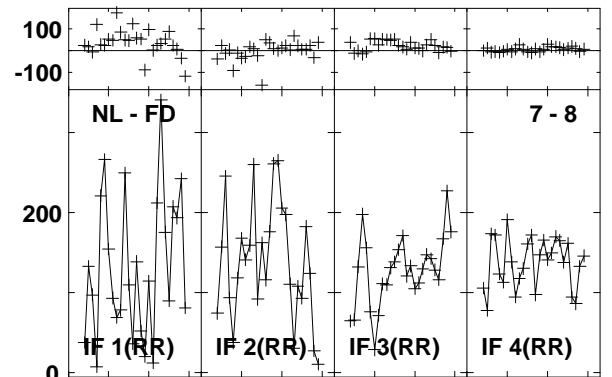
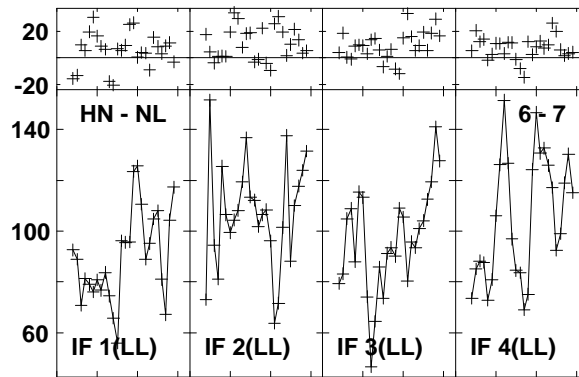
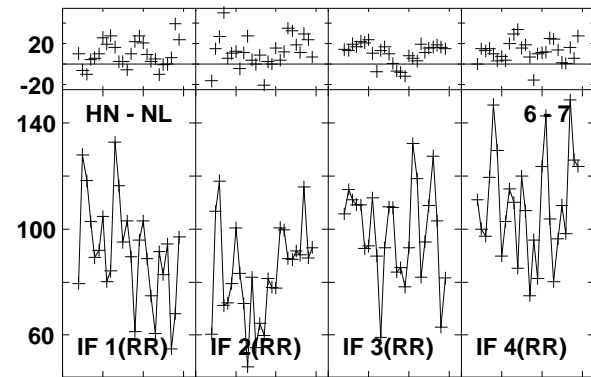
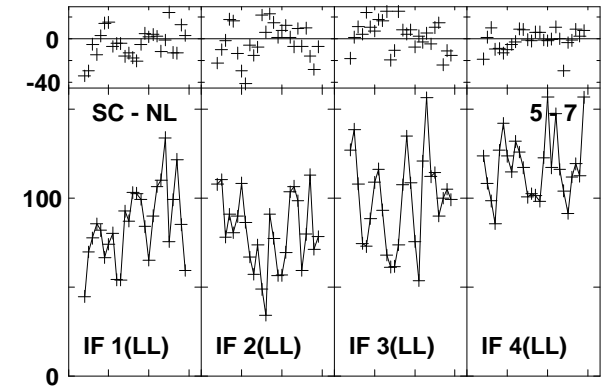
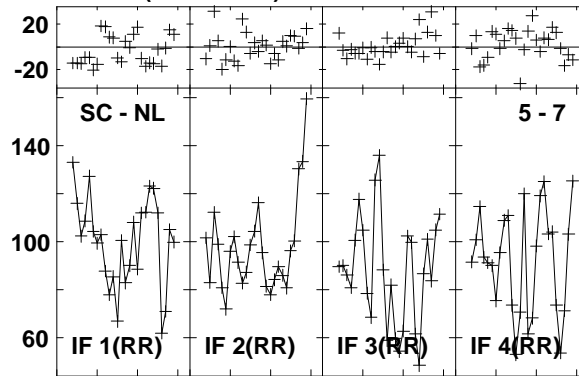
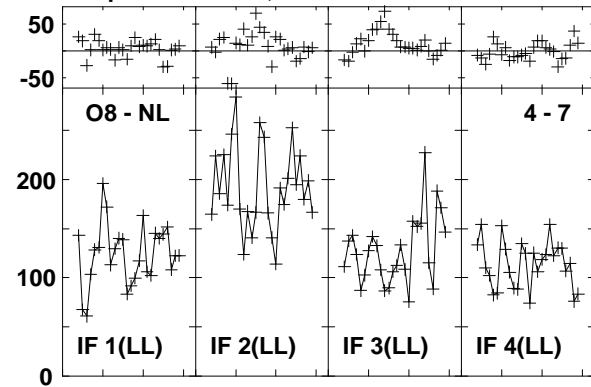

Lower frame: Milli Ampl Jy Top frame: Phas deg
Vector averaged cross-power spectrum Baseline: O8 (04) - NL (07)
Timerange: 00/20:37:26 to 00/20:39:24

Plot file version 646 created 03-MAR-2016 01:13:47

J1545+5400 GN002C 1.UVDATA.1

Freq = 1.2770 GHz, Bw = 16.000 MH Calibrated with CL # 3 and BP # 1 (BP mode 1)

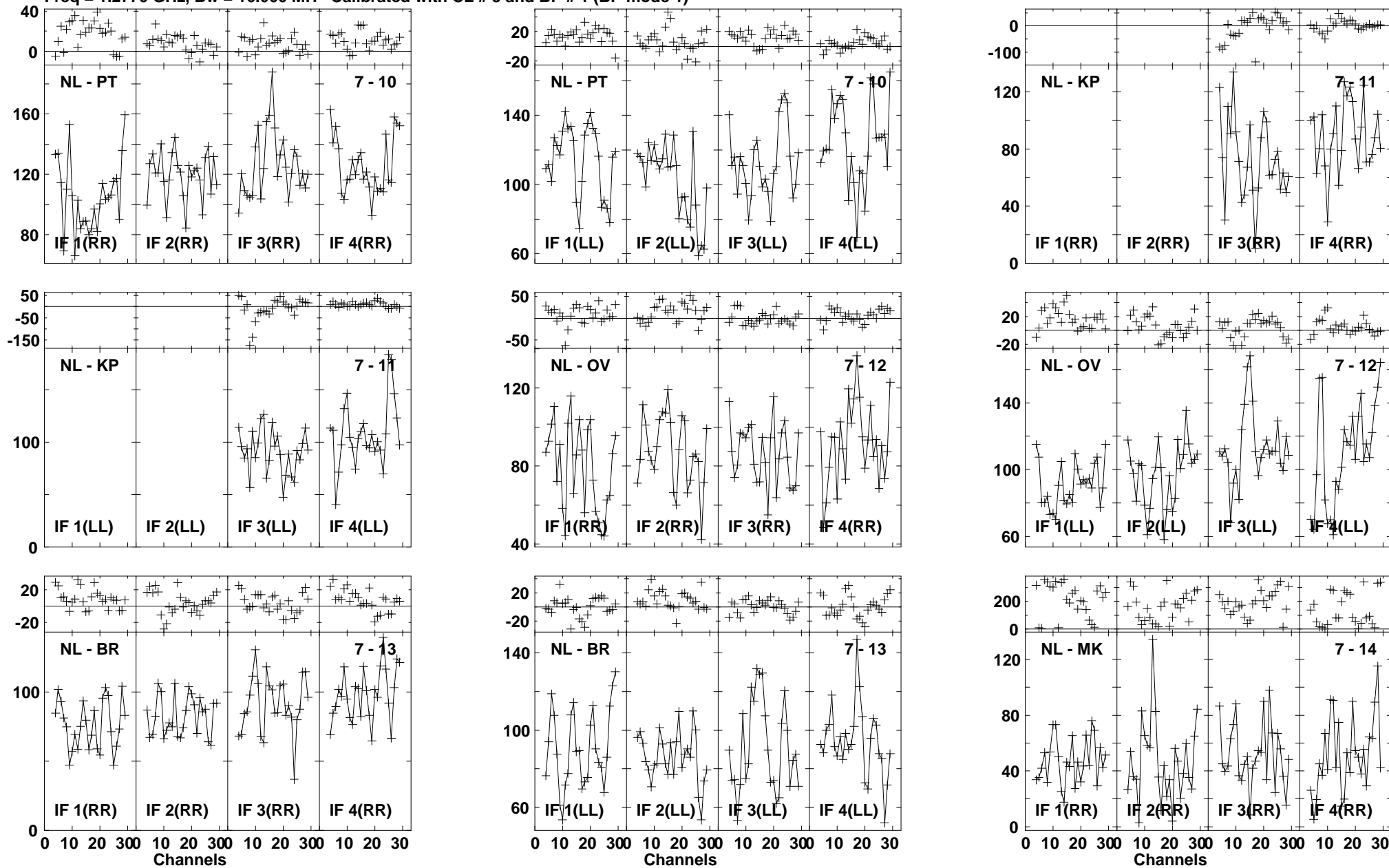

Lower frame: Milli Ampl Jy Top frame: Phas deg
Vector averaged cross-power spectrum Baseline: NL (07) - PT (10)
Timerange: 00/20:37:26 to 00/20:39:24

Plot file version 647 created 03-MAR-2016 01:13:47
J1545+5400 GN002C 1.UVDATA.1
Freq = 1.2770 GHz, Bw = 16.000 MH Calibrated with CL # 3 and BP # 1 (BP mode 1)

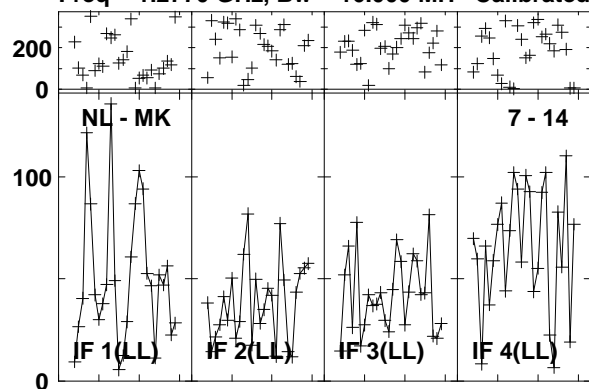

Lower frame: Milli Ampl Jy Top frame: Phas deg
Vector averaged cross-power spectrum Baseline: NL (07) - MK (14)
Timerange: 00/20:37:26 to 00/20:39:24

Plot file version 648 created 03-MAR-2016 01:13:47

J1638+5720 GN002C 1.UVDATA.1

Freq = 1.2770 GHz, Bw = 16.000 MH Calibrated with CL # 3 and BP # 1 (BP mode 1)

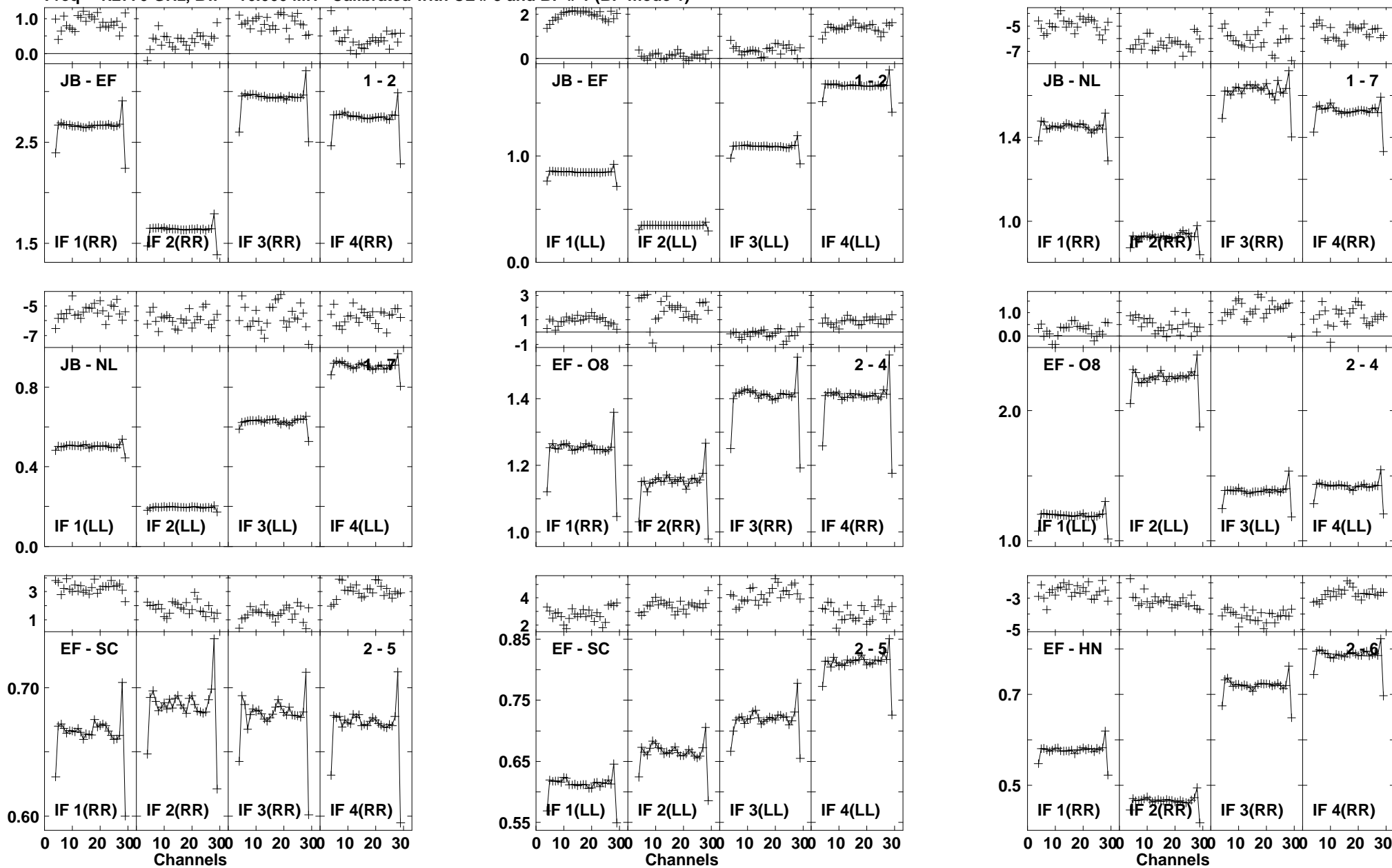

Plot file version 649 created 03-MAR-2016 01:13:47

J1638+5720 GN002C 1.UVDATA.1

Freq = 1.2770 GHz, Bw = 16.000 MH Calibrated with CL # 3 and BP # 1 (BP mode 1)

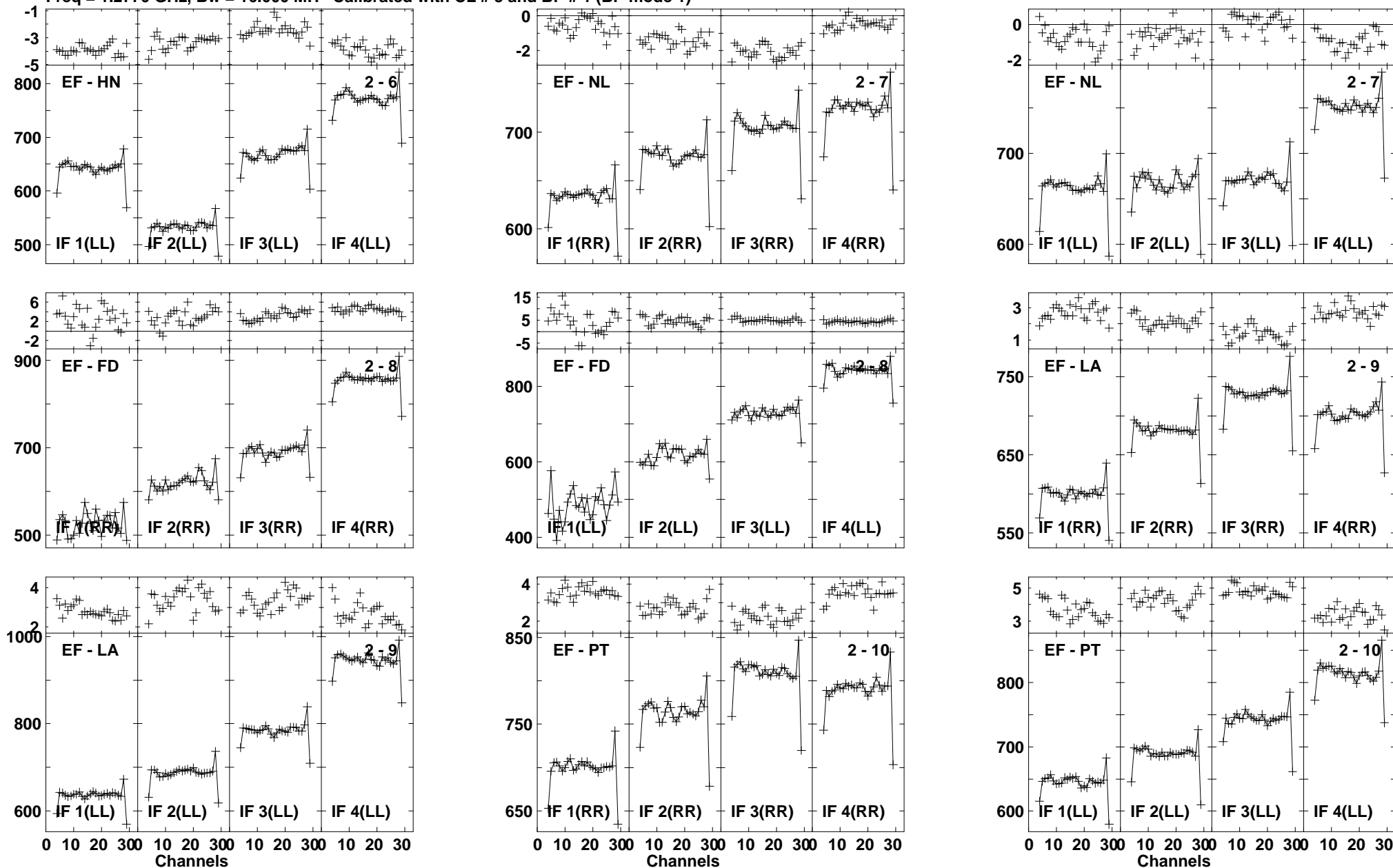

Lower frame: Milli Ampl Jy Top frame: Phas deg
Vector averaged cross-power spectrum Baseline: EF (02) - HN (06)
Timerange: 00/20:40:47 to 00/20:44:35

Plot file version 650 created 03-MAR-2016 01:13:47

J1638+5720 GN002C 1.UVDATA.1

Freq = 1.2770 GHz, Bw = 16.000 MH Calibrated with CL # 3 and BP # 1 (BP mode 1)

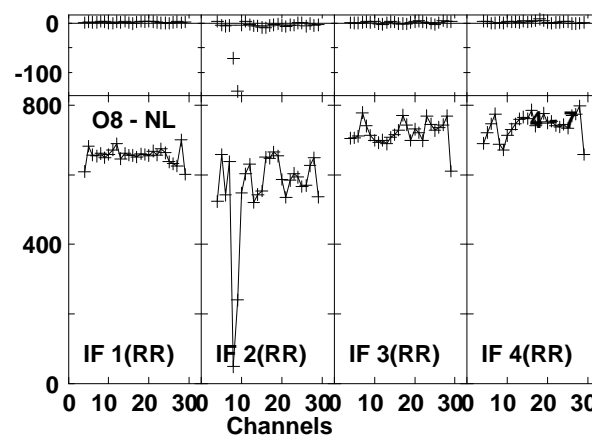
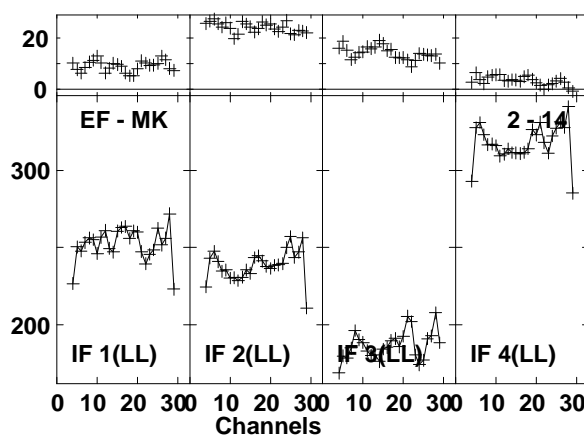
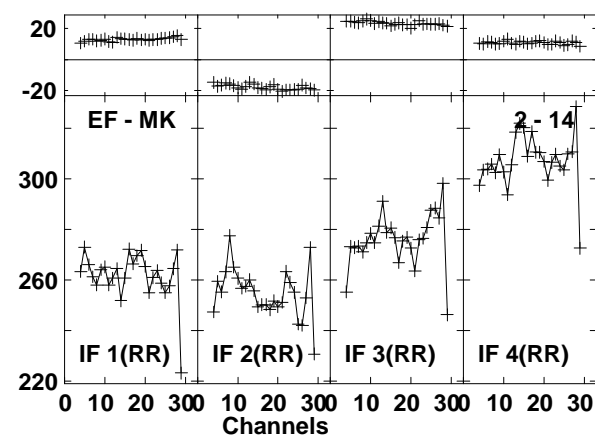
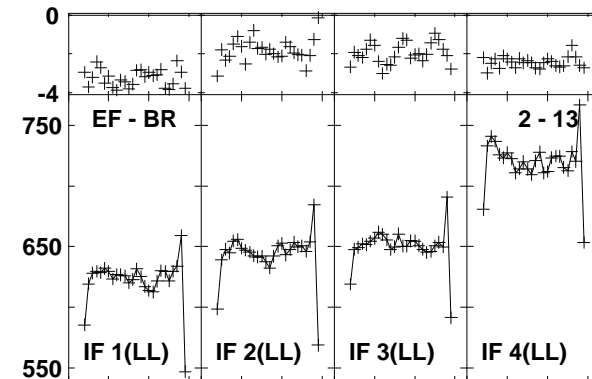
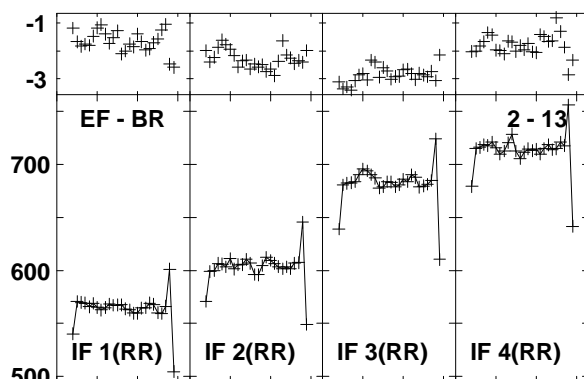
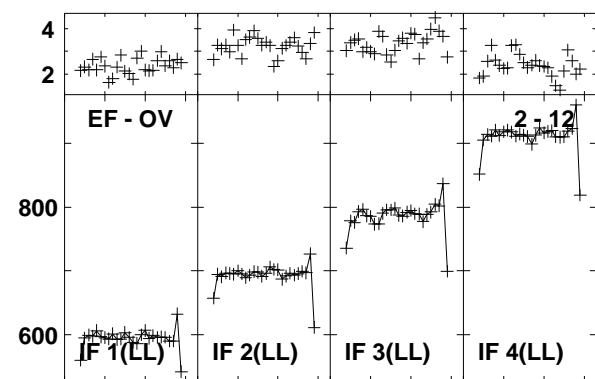
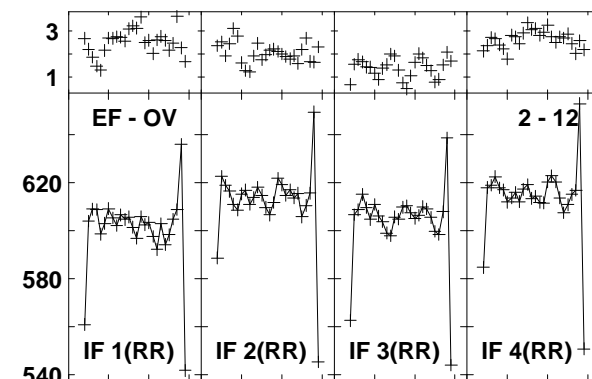
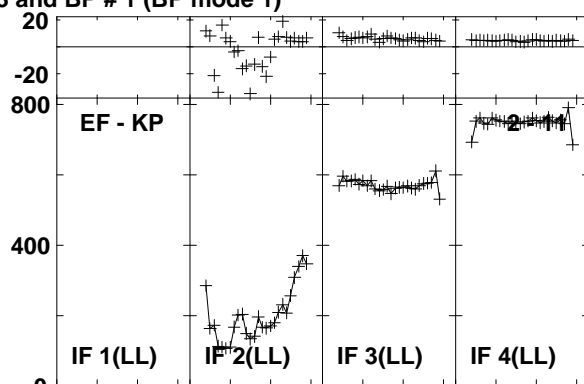
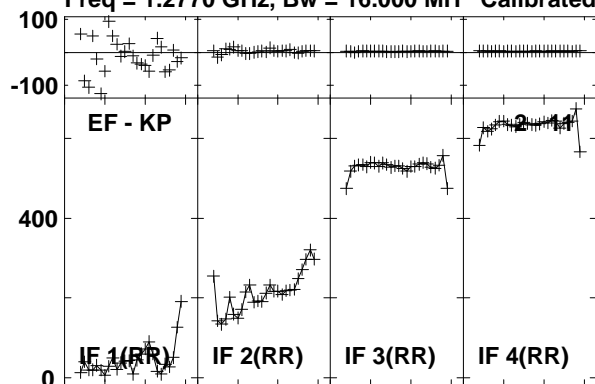

Lower frame: Milli Ampl Jy Top frame: Phas deg
Vector averaged cross-power spectrum Baseline: EF (02) - KP (11)
Timerange: 00/20:40:47 to 00/20:44:35

Plot file version 651 created 03-MAR-2016 01:13:48

J1638+5720 GN002C 1.UVDATA.1

Freq = 1.2770 GHz, Bw = 16.000 MH Calibrated with CL # 3 and BP # 1 (BP mode 1)

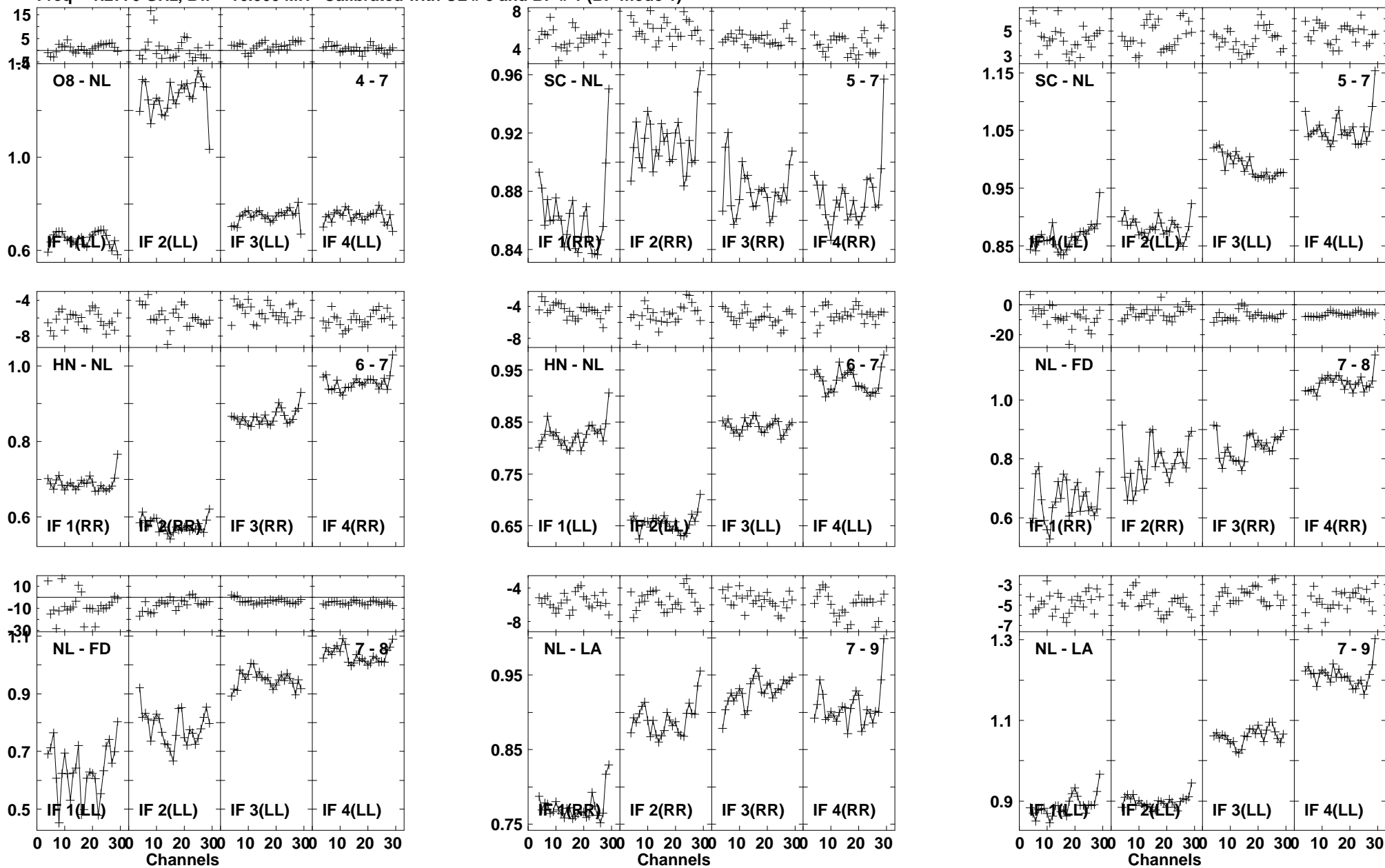

Lower frame: Ampl Jy Top frame: Phas deg
Vector averaged cross-power spectrum Baseline: O8 (04) - NL (07)
Timerange: 00/20:40:47 to 00/20:44:35

Plot file version 652 created 03-MAR-2016 01:13:48
 J1638+5720 GN002C 1.UVDATA.1
 Freq = 1.2770 GHz, Bw = 16.000 MH Calibrated with CL # 3 and BP # 1 (BP mode 1)

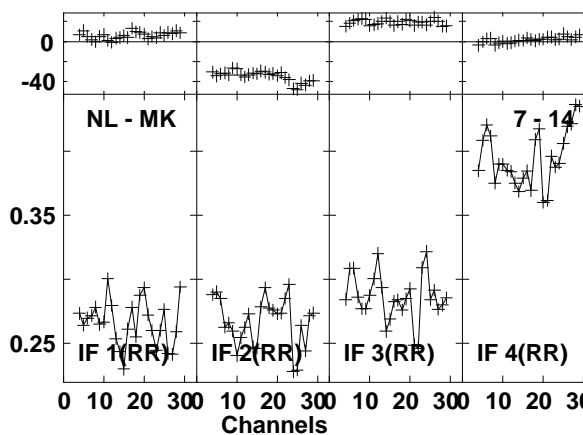
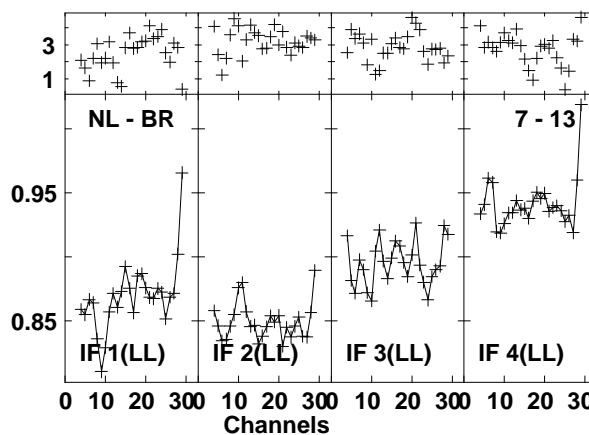
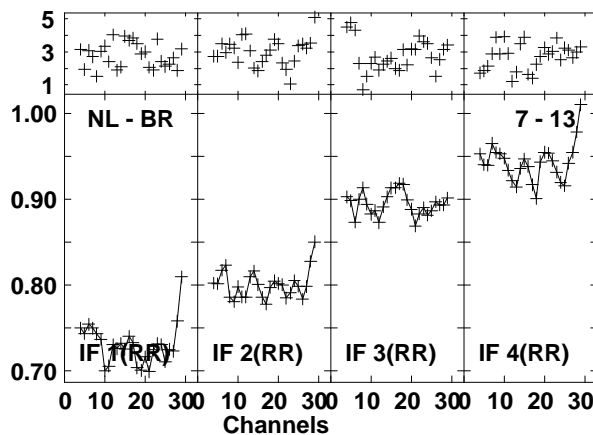
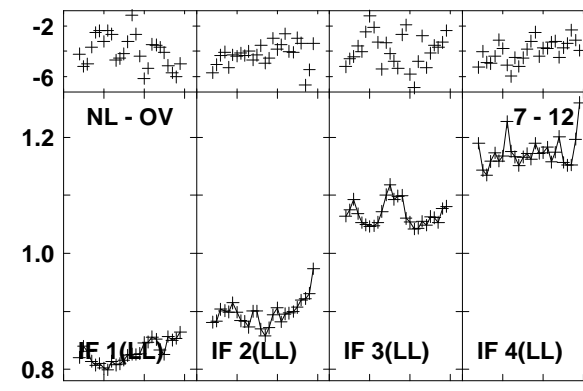
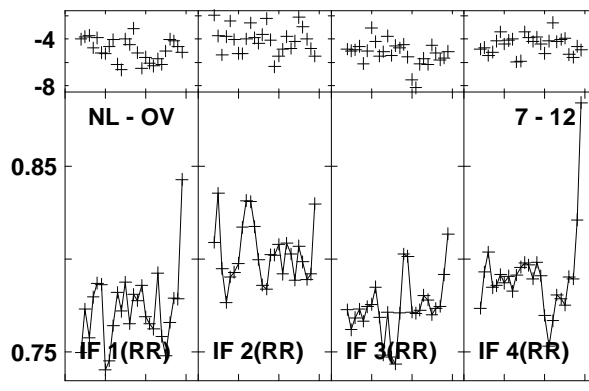
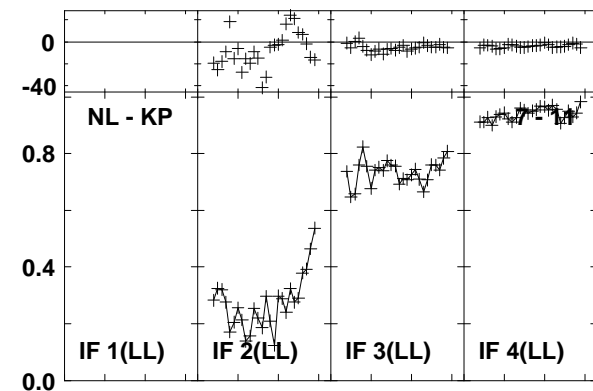
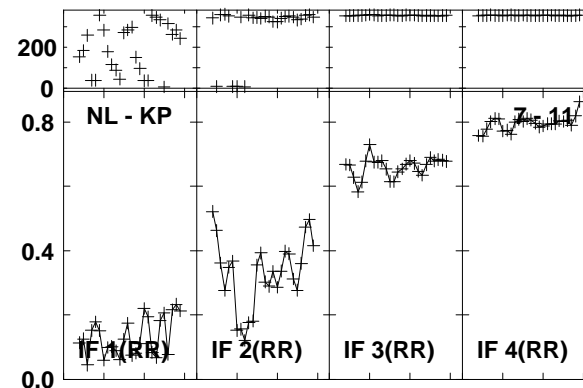
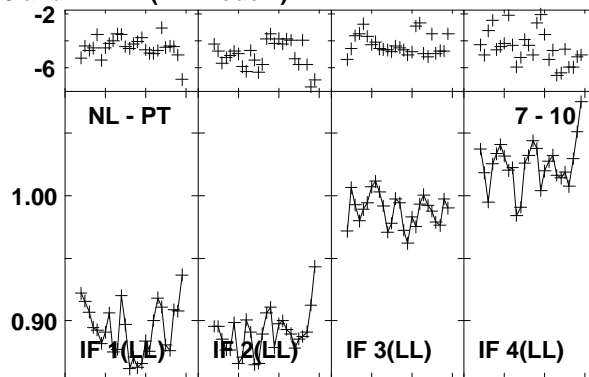
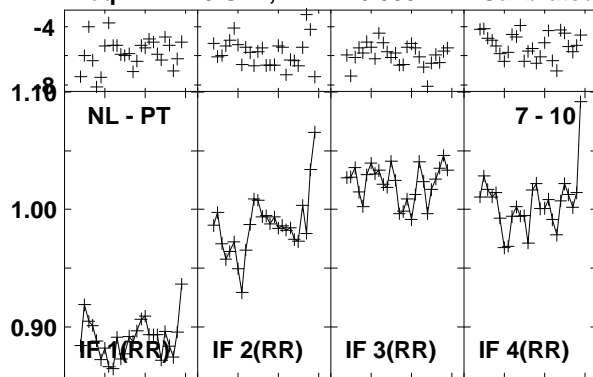

Lower frame: Ampl Jy Top frame: Phas deg
 Vector averaged cross-power spectrum Baseline: NL (07) - PT (10)
 Timerange: 00/20:40:47 to 00/20:44:35

Plot file version 653 created 03-MAR-2016 01:13:48
J1638+5720 GN002C 1.UVDATA.1
Freq = 1.2770 GHz, Bw = 16.000 MH Calibrated with CL # 3 and BP # 1 (BP mode 1)

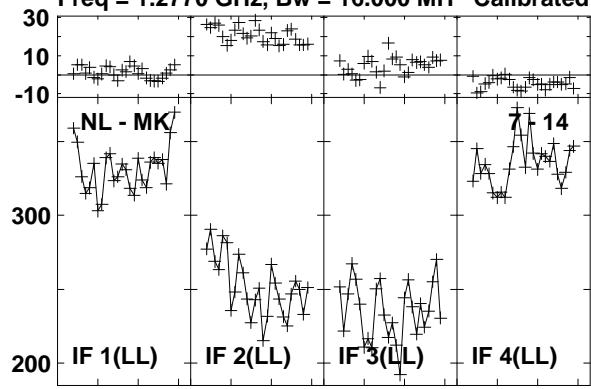

Lower frame: Milli Ampl Jy Top frame: Phas deg
Vector averaged cross-power spectrum Baseline: NL (07) - MK (14)
Timerange: 00/20:40:47 to 00/20:44:35

Plot file version 654 created 03-MAR-2016 01:13:48

J1545+5400 GN002C 1.UVDATA.1

Freq = 1.2770 GHz, Bw = 16.000 MH Calibrated with CL # 3 and BP # 1 (BP mode 1)

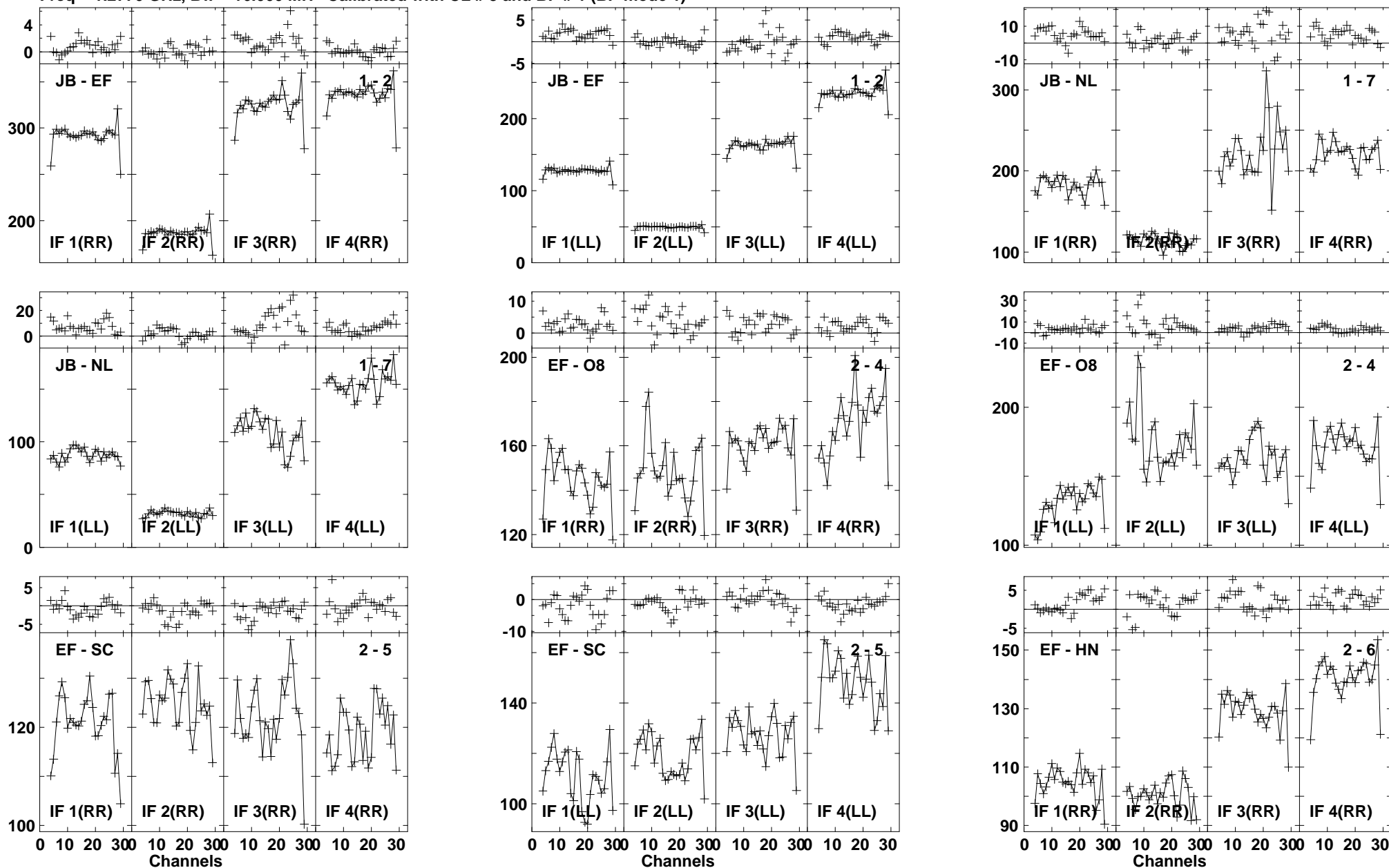

Lower frame: Milli Ampl Jy Top frame: Phas deg
Vector averaged cross-power spectrum Baseline: JB (01) - EF (02)
Timerange: 00/20:45:58 to 00/20:48:46

Plot file version 655 created 03-MAR-2016 01:13:48

J1545+5400 GN002C 1.UVDATA.1

Freq = 1.2770 GHz, Bw = 16.000 MH Calibrated with CL # 3 and BP # 1 (BP mode 1)

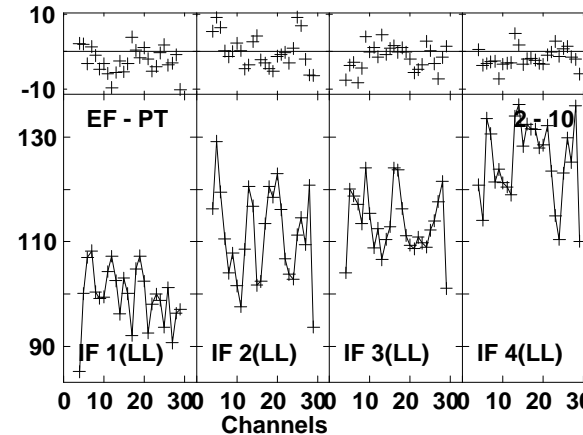
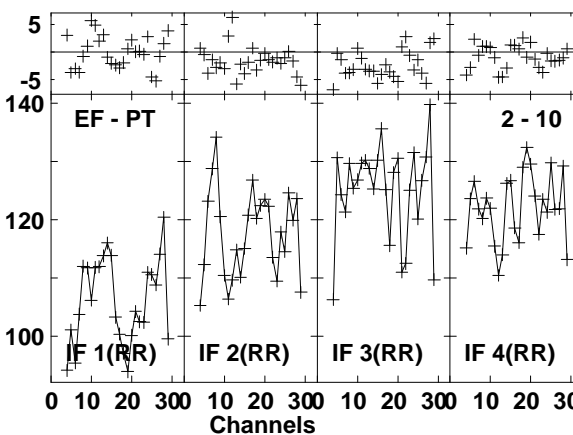
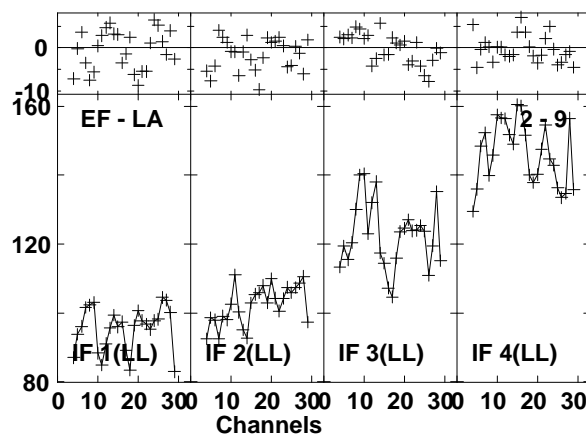
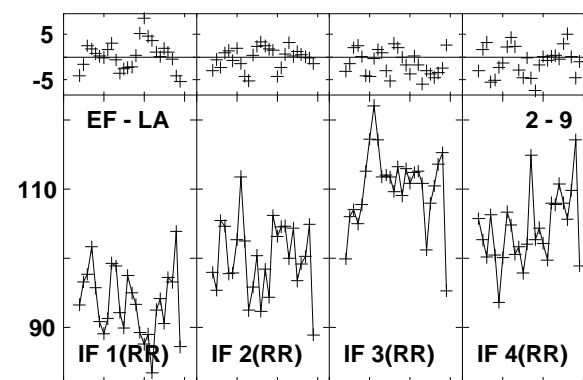
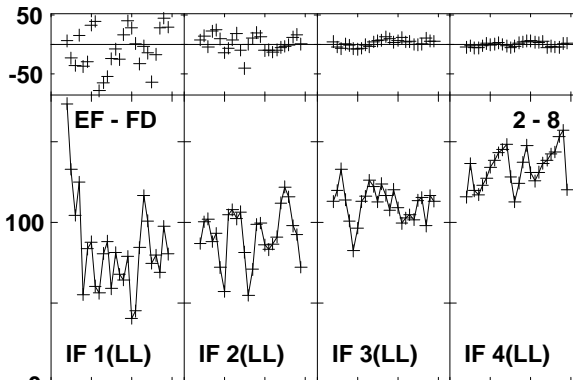
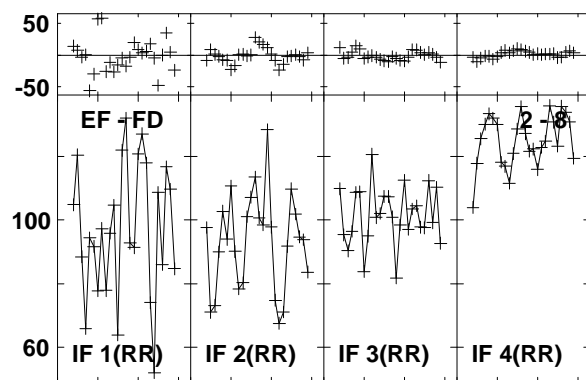
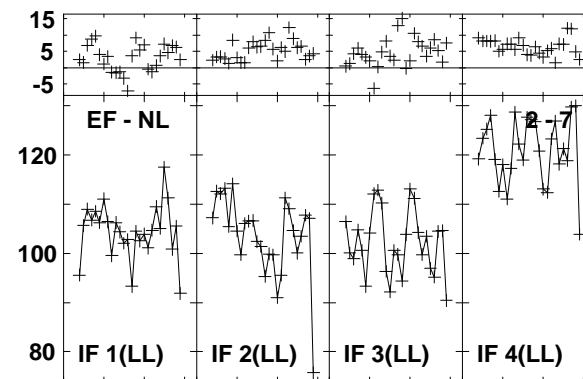
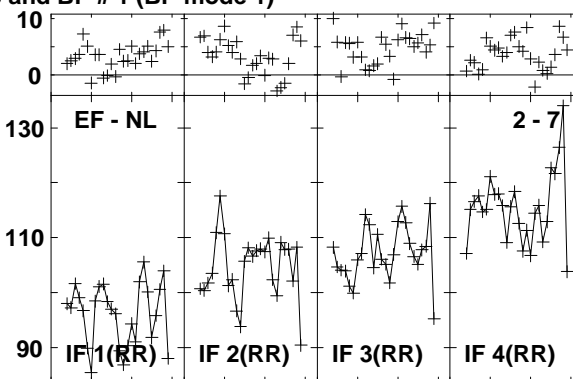
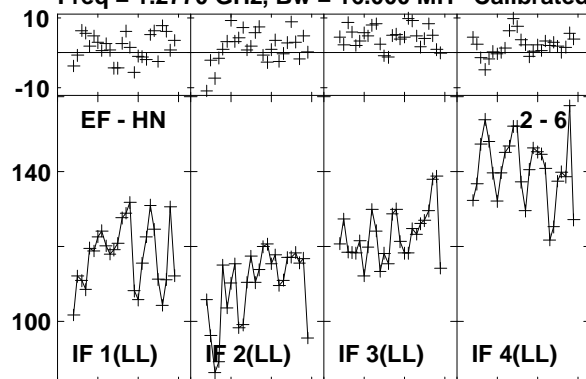

Lower frame: Milli Ampl Jy Top frame: Phas deg
Vector averaged cross-power spectrum Baseline: EF (02) - HN (06)
Timerange: 00/20:45:58 to 00/20:48:46

Plot file version 656 created 03-MAR-2016 01:13:48

J1545+5400 GN002C 1.UVDATA.1

Freq = 1.2770 GHz, Bw = 16.000 MH Calibrated with CL # 3 and BP # 1 (BP mode 1)

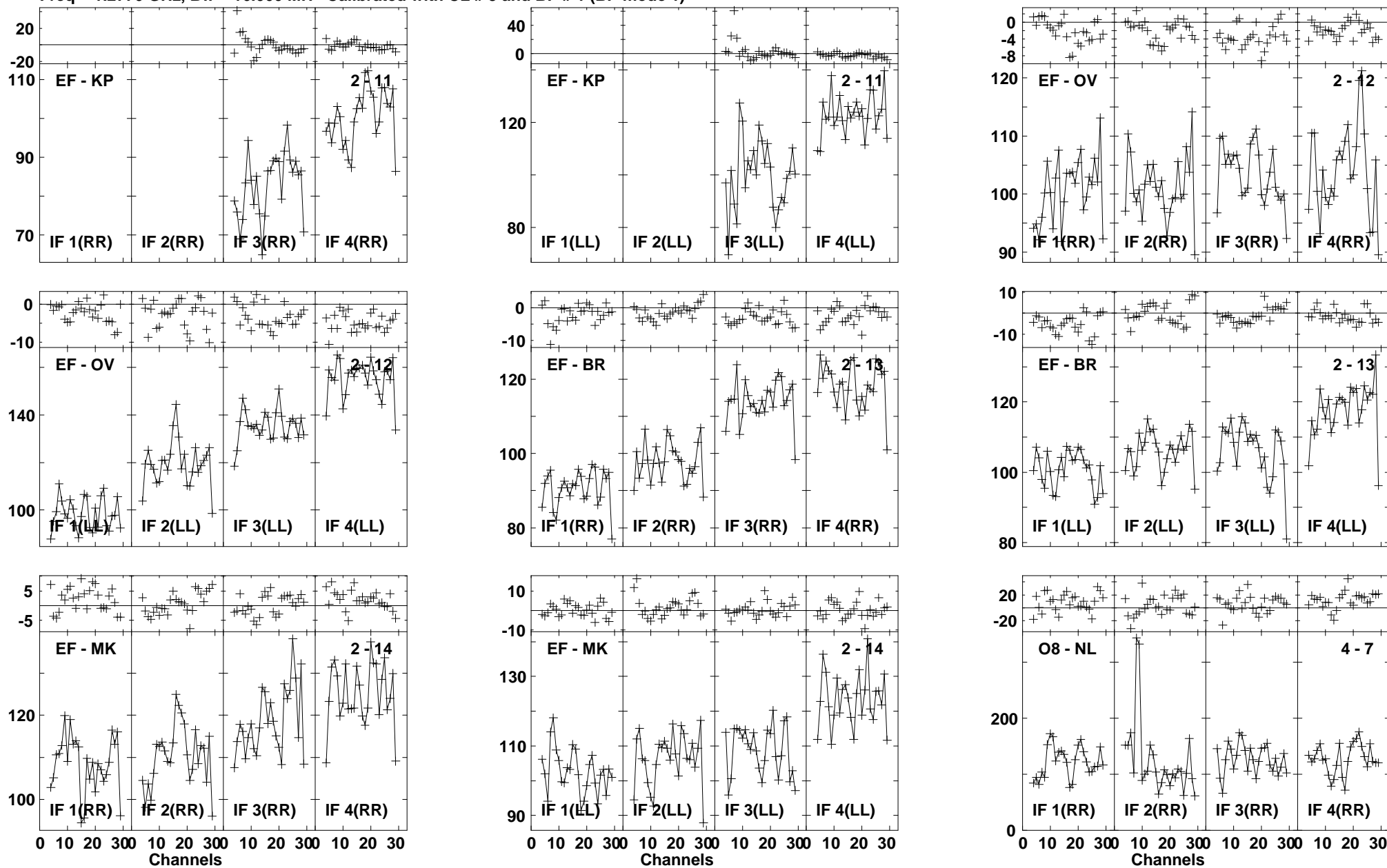

Lower frame: Milli Ampl Jy Top frame: Phas deg
Vector averaged cross-power spectrum Baseline: EF (02) - KP (11)
Timerange: 00/20:45:58 to 00/20:48:46

Plot file version 657 created 03-MAR-2016 01:13:49

J1545+5400 GN002C 1.UVDATA.1

Freq = 1.2770 GHz, Bw = 16.000 MH Calibrated with CL # 3 and BP # 1 (BP mode 1)

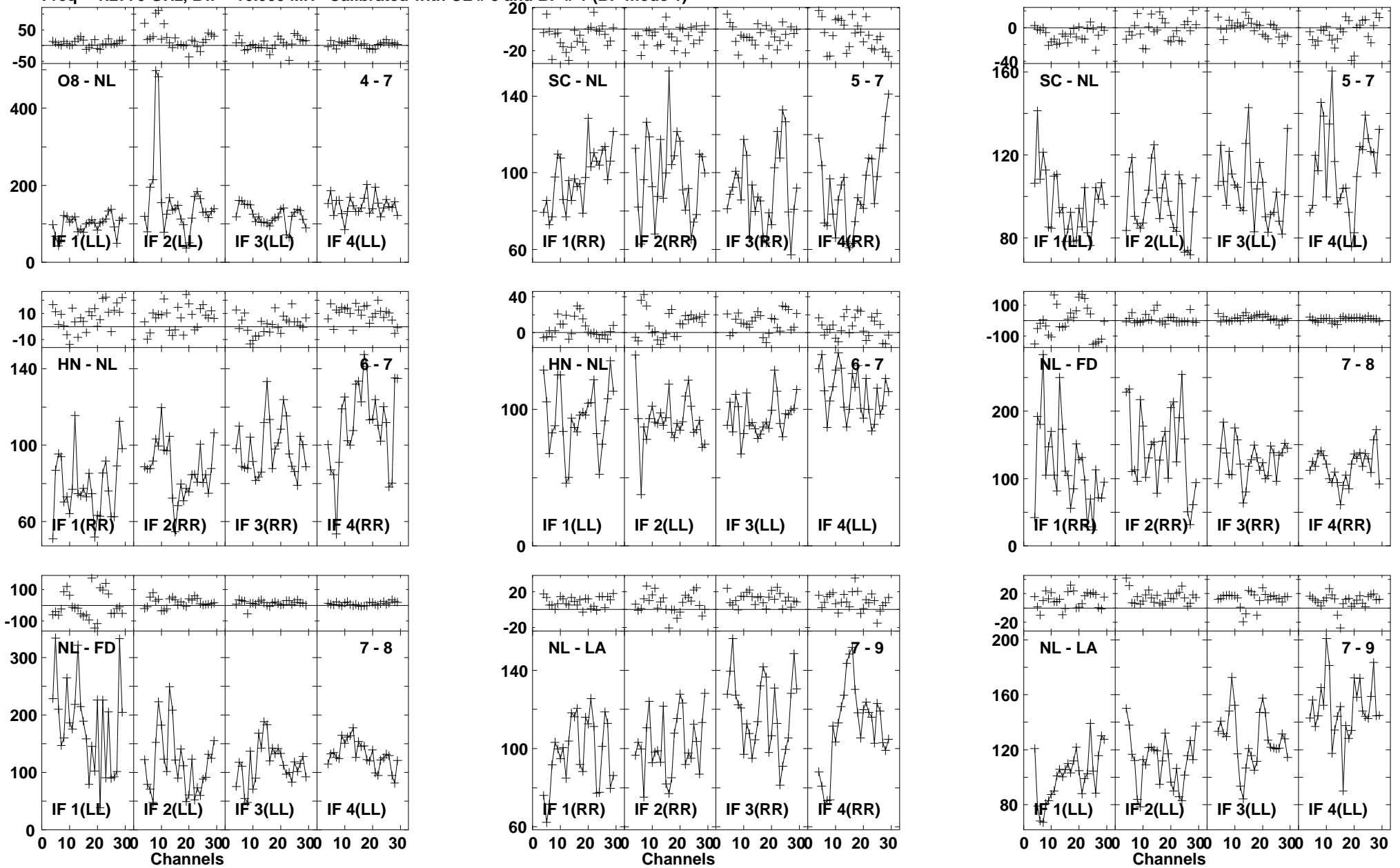

Lower frame: Milli Ampl Jy Top frame: Phas deg
Vector averaged cross-power spectrum Baseline: O8 (04) - NL (07)
Timerange: 00/20:45:58 to 00/20:48:46

Plot file version 658 created 03-MAR-2016 01:13:49

J1545+5400 GN002C 1.UVDATA.1

Freq = 1.2770 GHz, Bw = 16.000 MH Calibrated with CL # 3 and BP # 1 (BP mode 1)

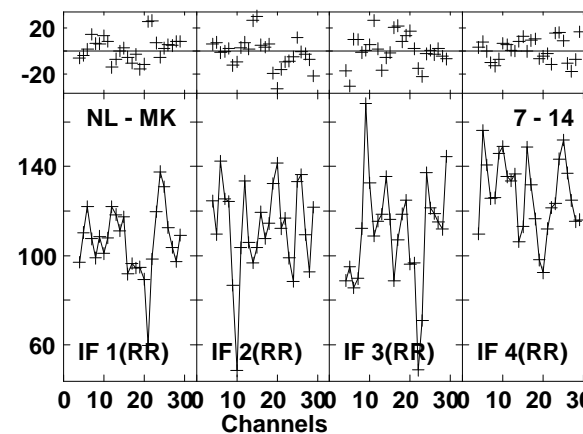
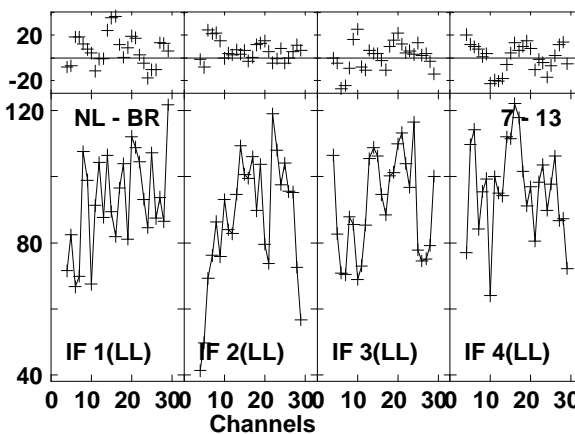
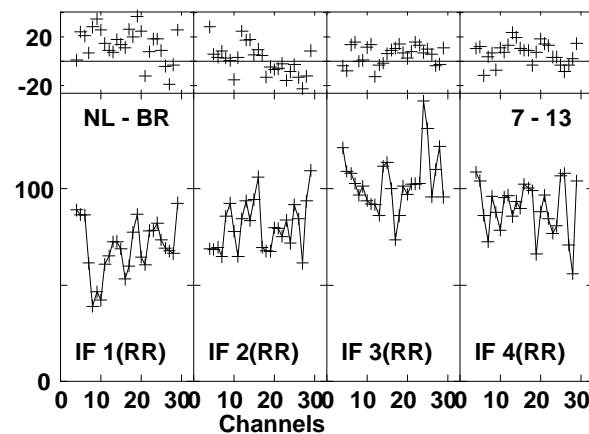
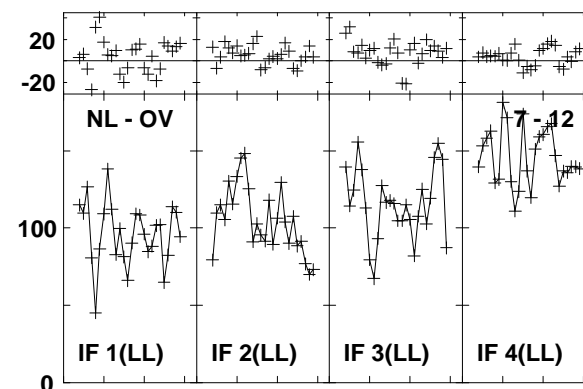
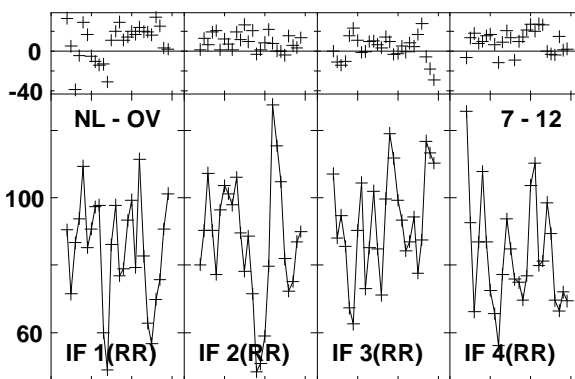
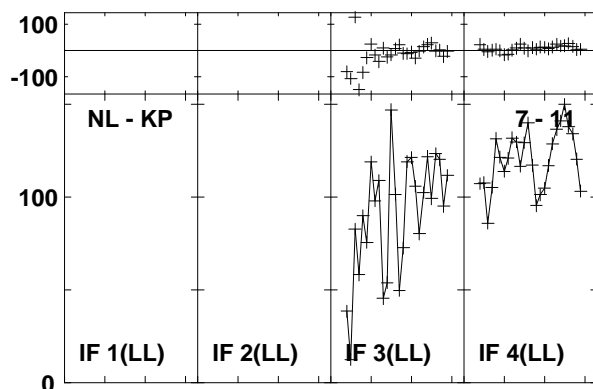
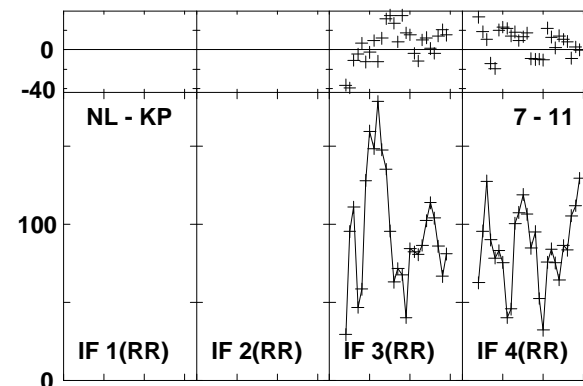
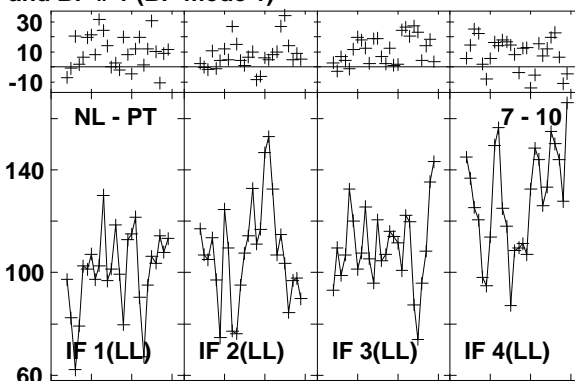
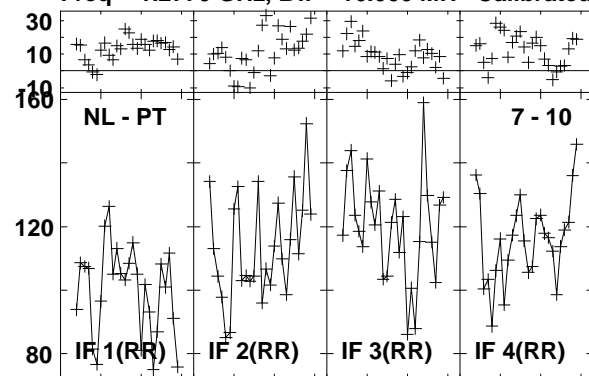

Lower frame: Milli Ampl Jy Top frame: Phas deg
Vector averaged cross-power spectrum Baseline: NL (07) - PT (10)
Timerange: 00/20:45:58 to 00/20:48:46

Plot file version 659 created 03-MAR-2016 01:13:49
J1545+5400 GN002C 1.UVDATA.1
Freq = 1.2770 GHz, Bw = 16.000 MH Calibrated with CL # 3 and BP # 1 (BP mode 1)

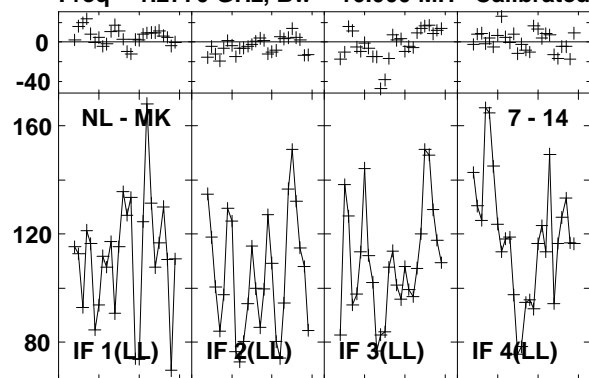

Lower frame: Milli Ampl Jy Top frame: Phas deg
Vector averaged cross-power spectrum Baseline: NL (07) - MK (14)
Timerange: 00/20:45:58 to 00/20:48:46

Plot file version 660 created 03-MAR-2016 01:13:49

4C52 GN002C 1.UVDATA.1

Freq = 1.2770 GHz, Bw = 16.000 MH Calibrated with CL # 3 and BP # 1 (BP mode 1)

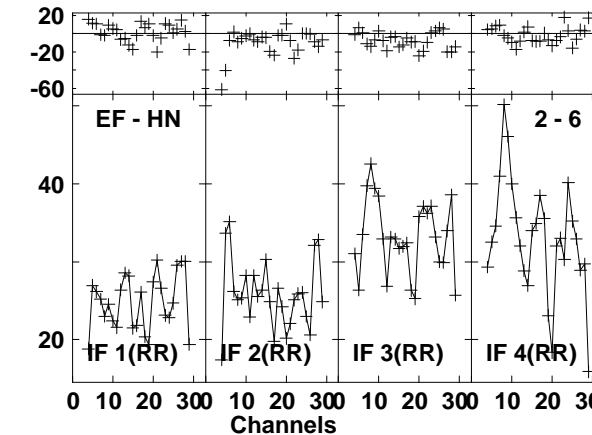
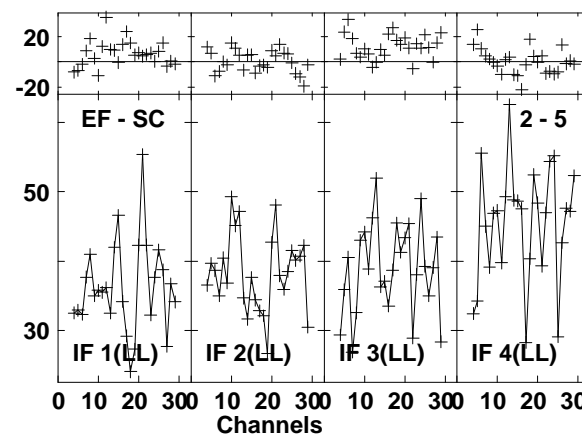
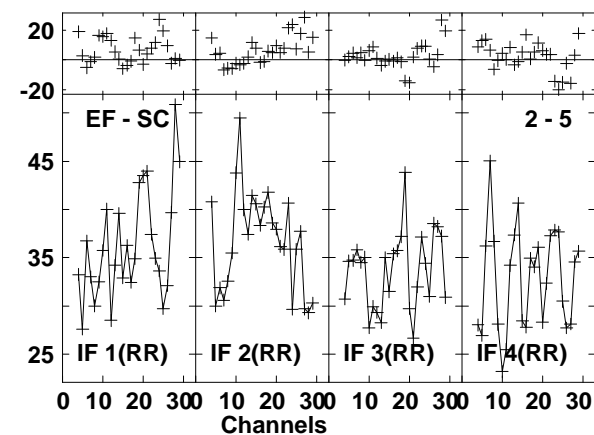
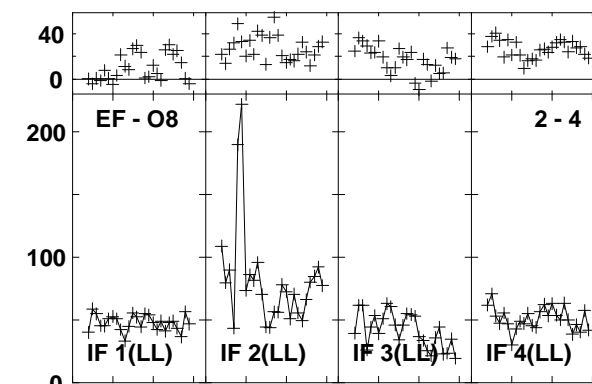
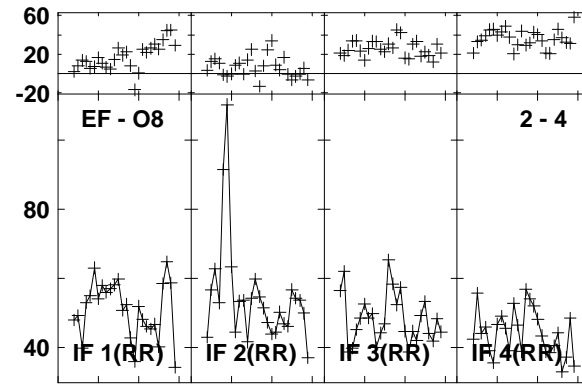
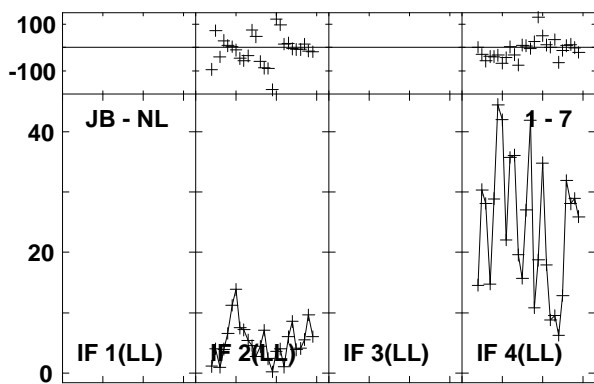
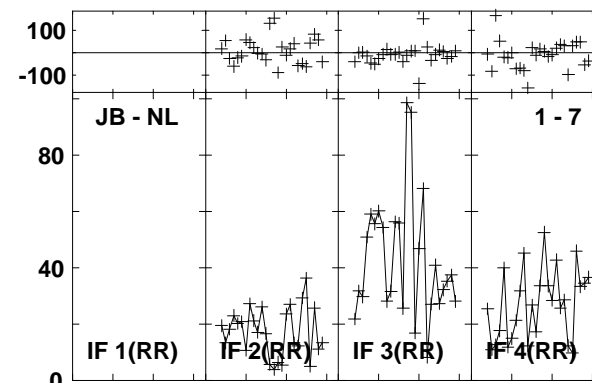
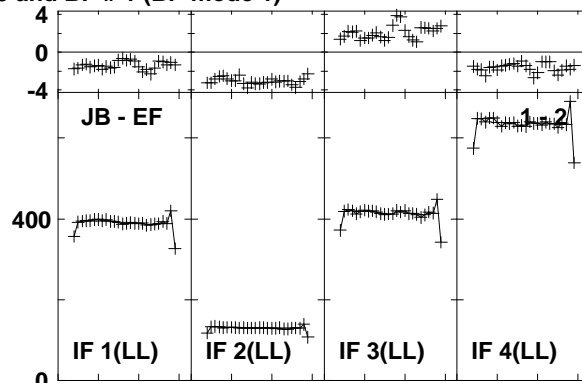
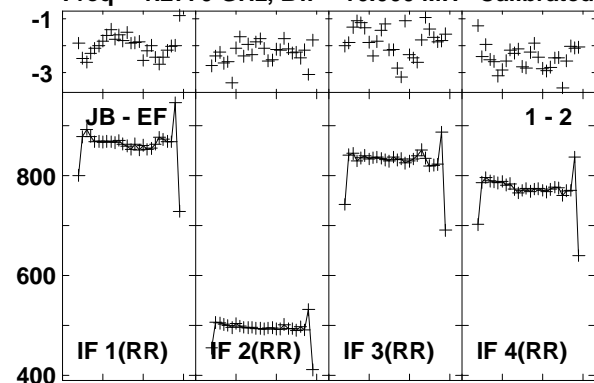

Lower frame: Milli Ampl Jy Top frame: Phas deg
Vector averaged cross-power spectrum Baseline: JB (01) - EF (02)
Timerange: 00/20:49:00 to 00/20:52:06

Plot file version 661 created 03-MAR-2016 01:13:49

4C52 GN002C 1.UVDATA.1

Freq = 1.2770 GHz, Bw = 16.000 MH Calibrated with CL # 3 and BP # 1 (BP mode 1)

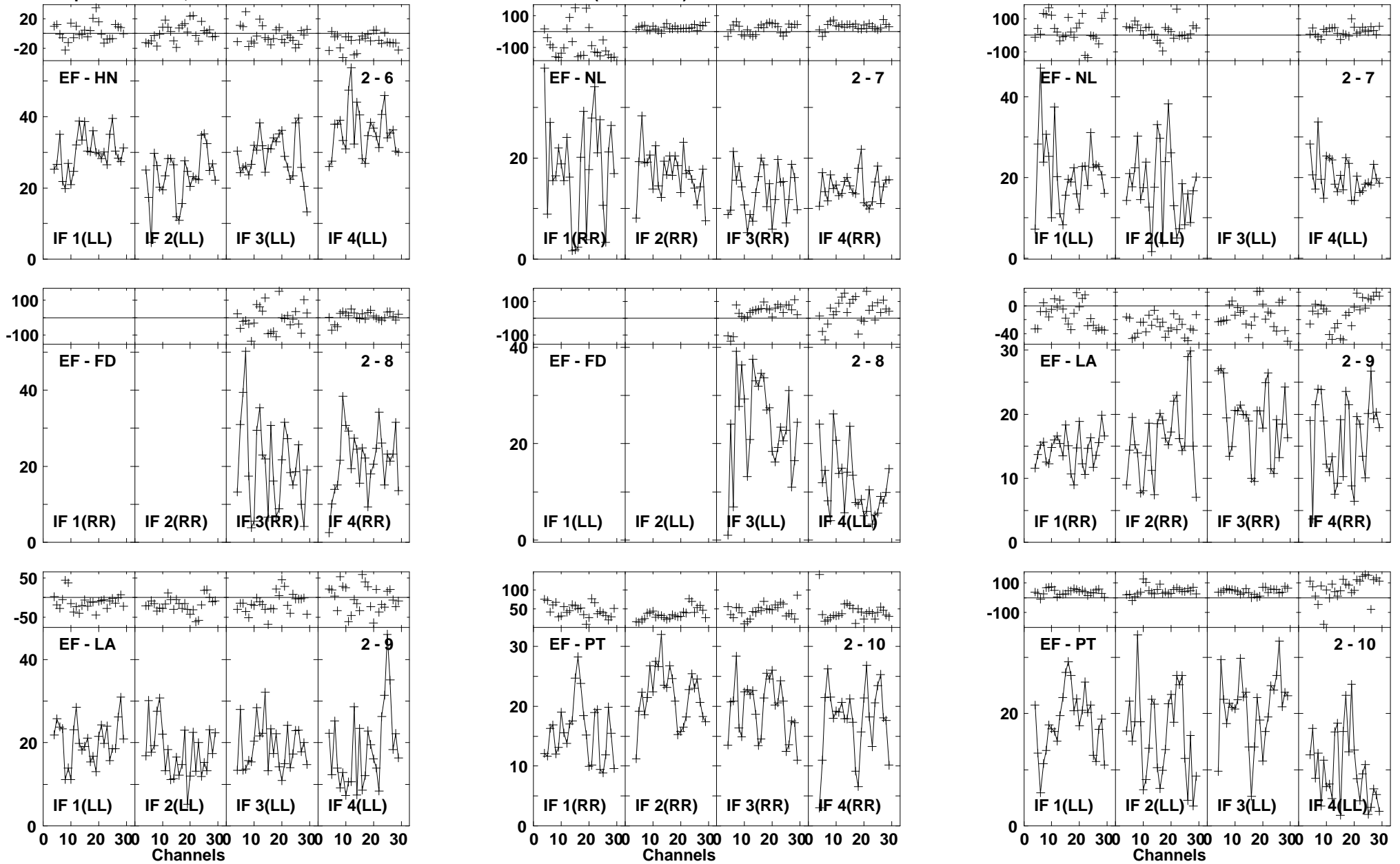

Lower frame: Milli Ampl Jy Top frame: Phas deg
Vector averaged cross-power spectrum Baseline: EF (02) - HN (06)
Timerange: 00/20:49:00 to 00/20:52:06

Plot file version 662 created 03-MAR-2016 01:13:49

4C52 GN002C 1.UVDATA.1

Freq = 1.2770 GHz, Bw = 16.000 MH Calibrated with CL # 3 and BP # 1 (BP mode 1)

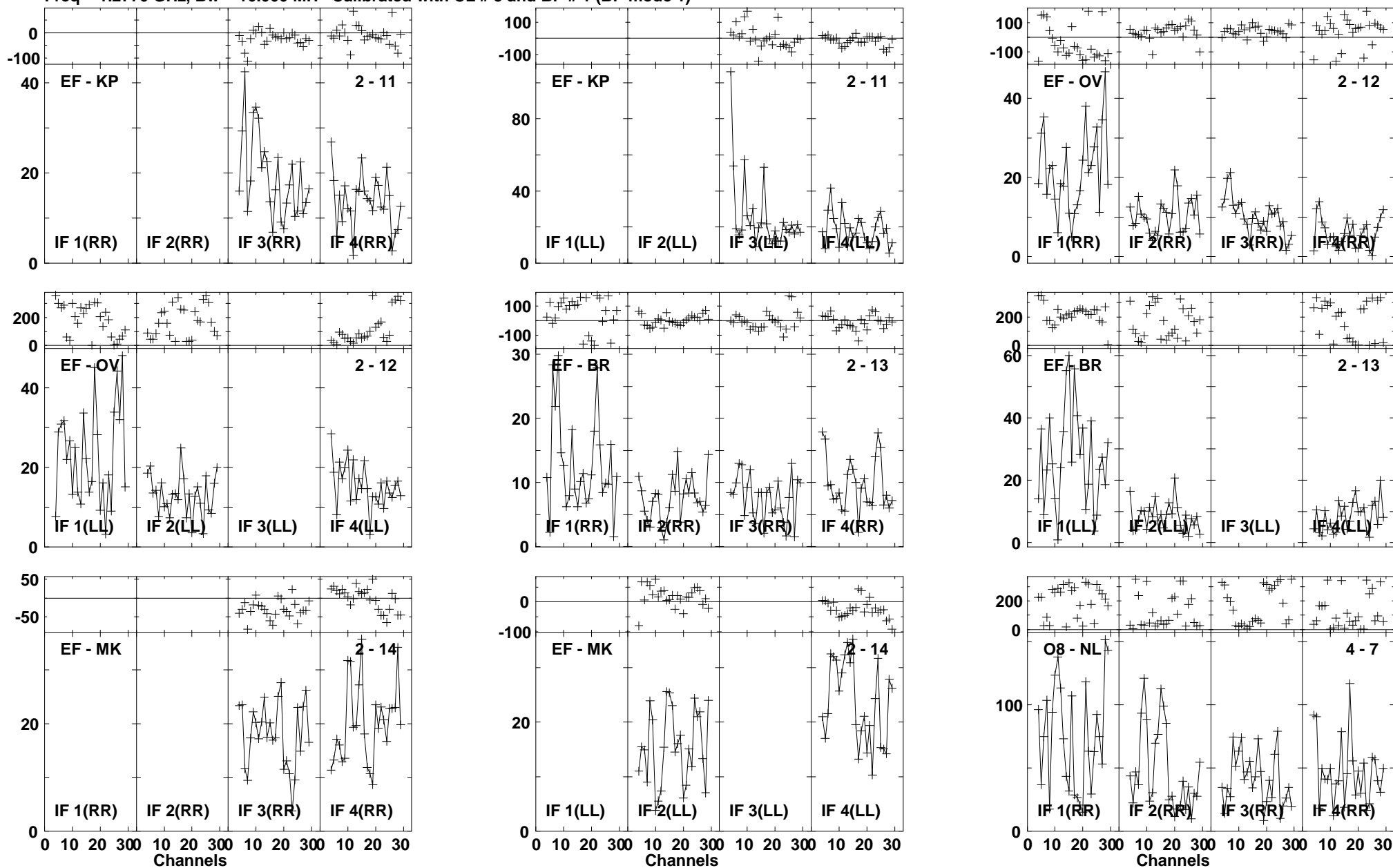

Lower frame: Milli Ampl Jy Top frame: Phas deg
Vector averaged cross-power spectrum Baseline: EF (02) - KP (11)
Timerange: 00/20:49:00 to 00/20:52:06

Plot file version 663 created 03-MAR-2016 01:13:50

4C52 GN002C 1.UVDATA.1

Freq = 1.2770 GHz, Bw = 16.000 MH Calibrated with CL # 3 and BP # 1 (BP mode 1)

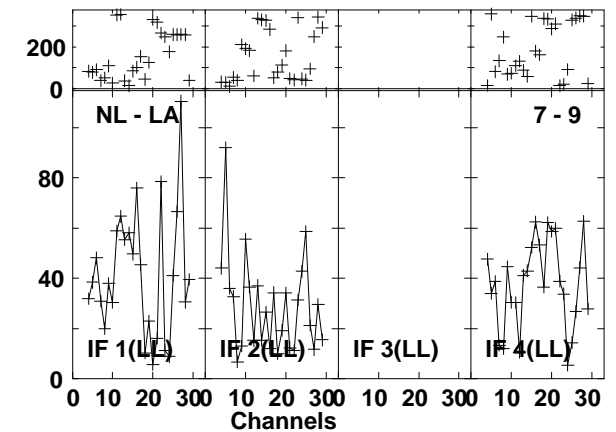
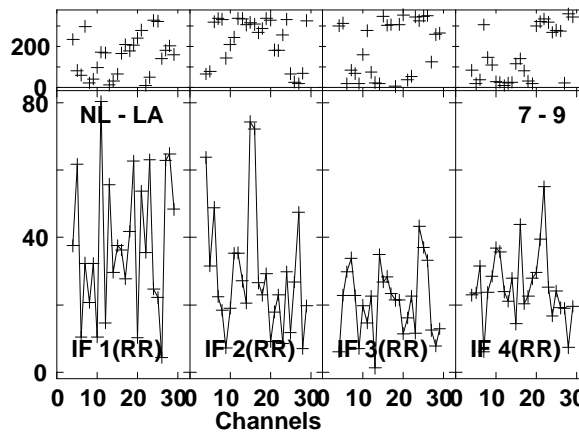
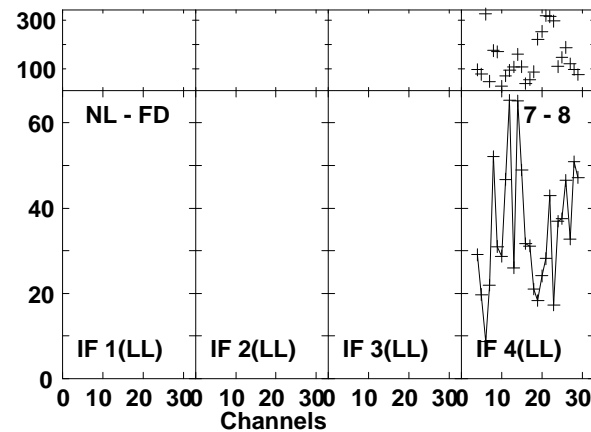
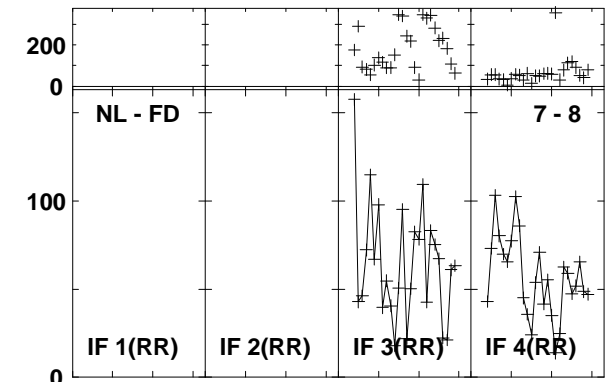
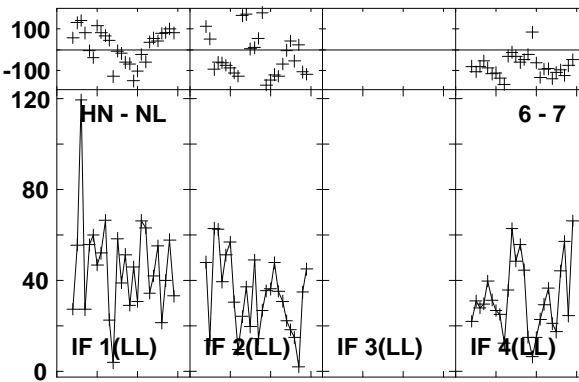
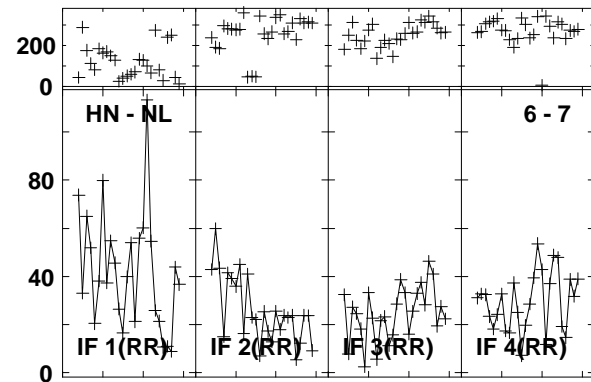
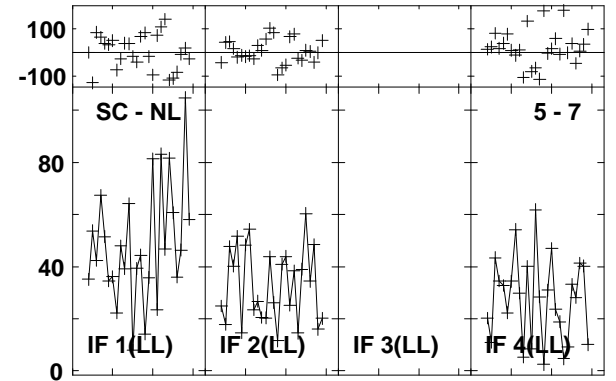
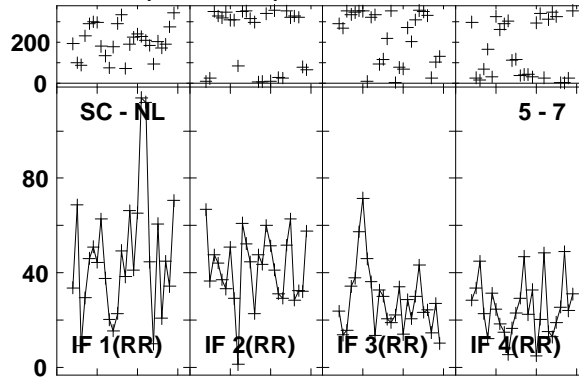
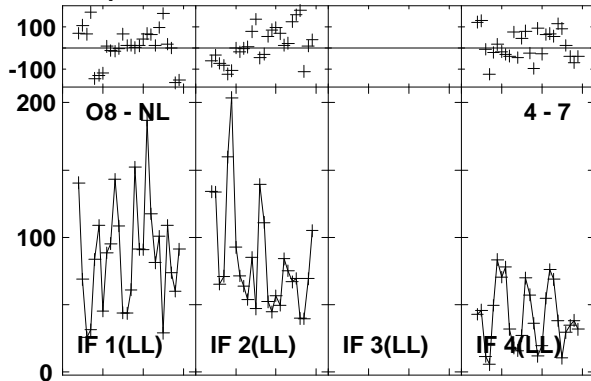

Lower frame: Milli Ampl Jy Top frame: Phas deg
Vector averaged cross-power spectrum Baseline: O8 (04) - NL (07)
Timerange: 00/20:49:00 to 00/20:52:06

Plot file version 664 created 03-MAR-2016 01:13:50

4C52 GN002C 1.UVDATA.1

Freq = 1.2770 GHz, Bw = 16.000 MH Calibrated with CL # 3 and BP # 1 (BP mode 1)

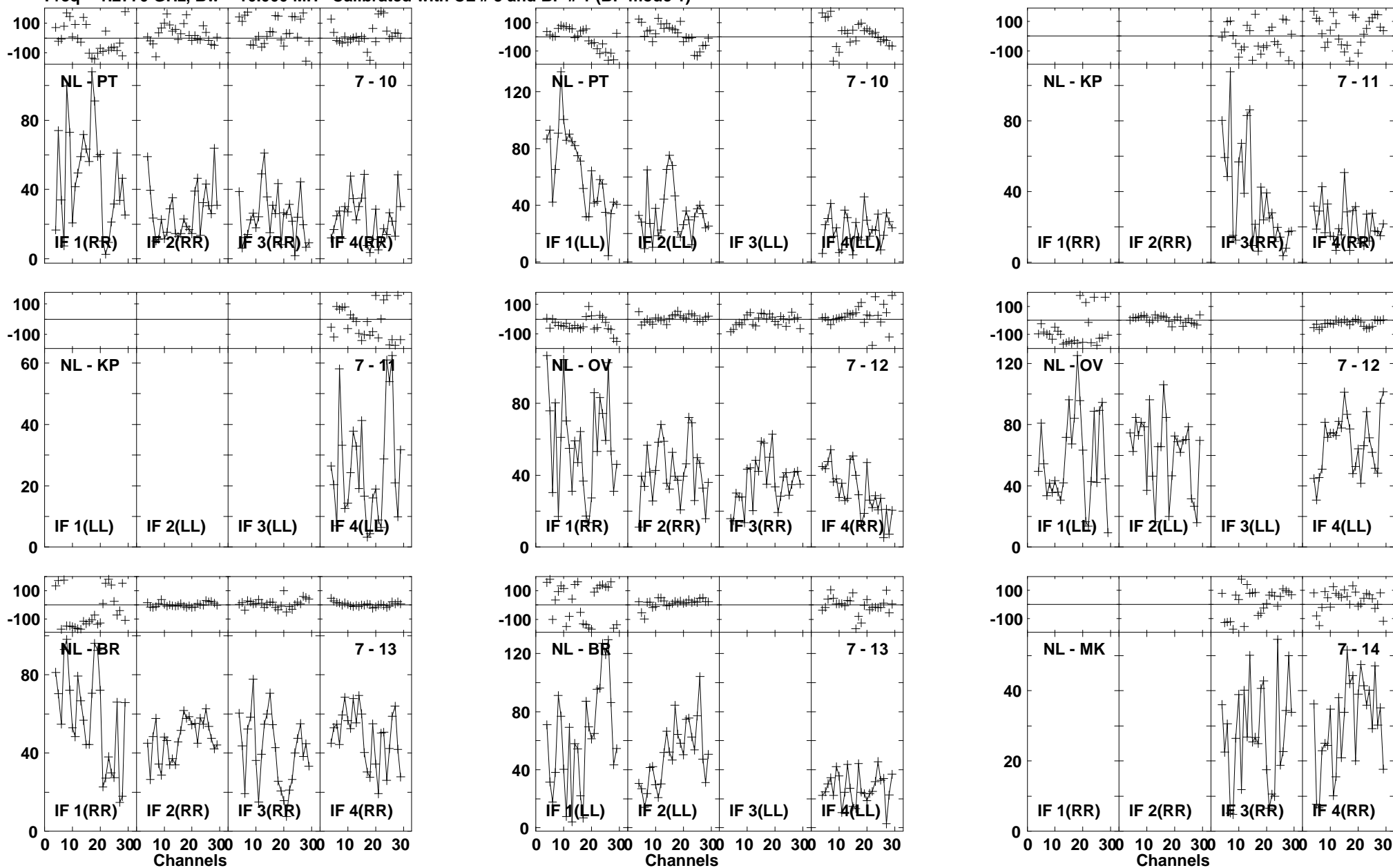

Lower frame: Milli Ampl Jy Top frame: Phas deg
Vector averaged cross-power spectrum Baseline: NL (07) - PT (10)
Timerange: 00/20:49:00 to 00/20:52:06

Plot file version 665 created 03-MAR-2016 01:13:50

4C52 GN002C 1.UVDATA.1

Freq = 1.2770 GHz, Bw = 16.000 MH Calibrated with CL # 3 and BP # 1 (BP mode 1)

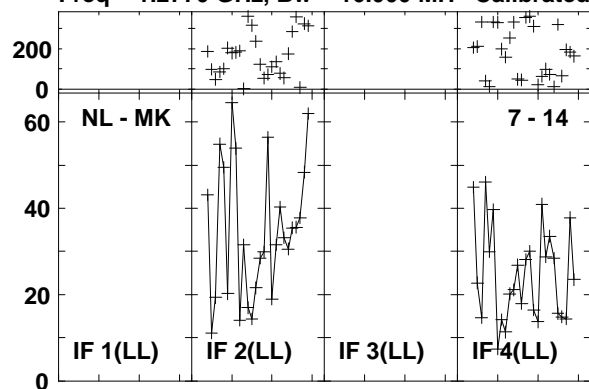

Lower frame: Milli Ampl Jy Top frame: Phas deg
Vector averaged cross-power spectrum Baseline: NL (07) - MK (14)
Timerange: 00/20:49:00 to 00/20:52:06

Plot file version 666 created 03-MAR-2016 01:13:50

J1545+5400 GN002C 1.UVDATA.1

Freq = 1.2770 GHz, Bw = 16.000 MH Calibrated with CL # 3 and BP # 1 (BP mode 1)

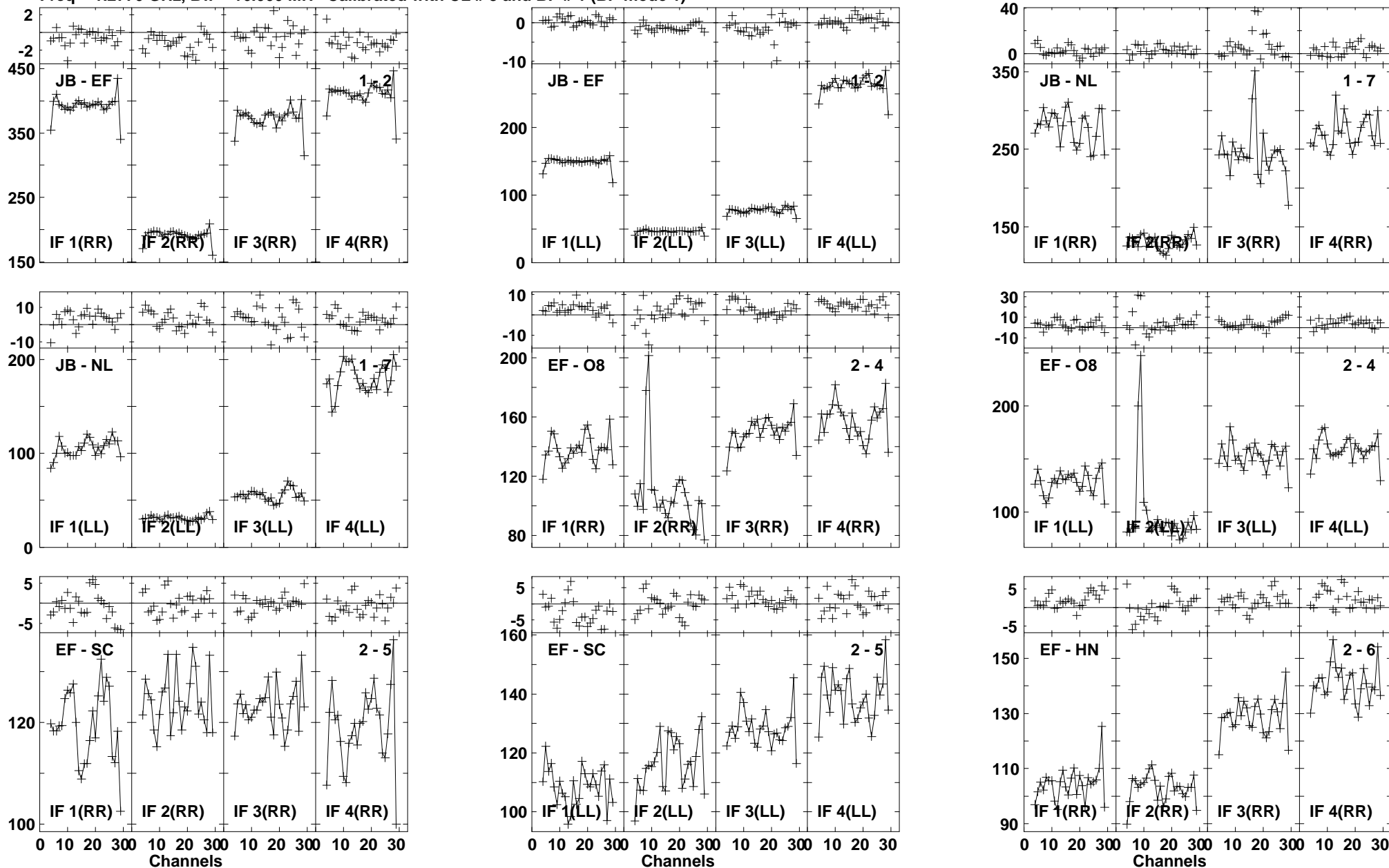

Lower frame: Milli Ampl Jy Top frame: Phas deg
Vector averaged cross-power spectrum Baseline: JB (01) - EF (02)
Timerange: 00/20:52:58 to 00/20:55:26

Plot file version 667 created 03-MAR-2016 01:13:50

J1545+5400 GN002C 1.UVDATA.1

Freq = 1.2770 GHz, Bw = 16.000 MH Calibrated with CL # 3 and BP # 1 (BP mode 1)

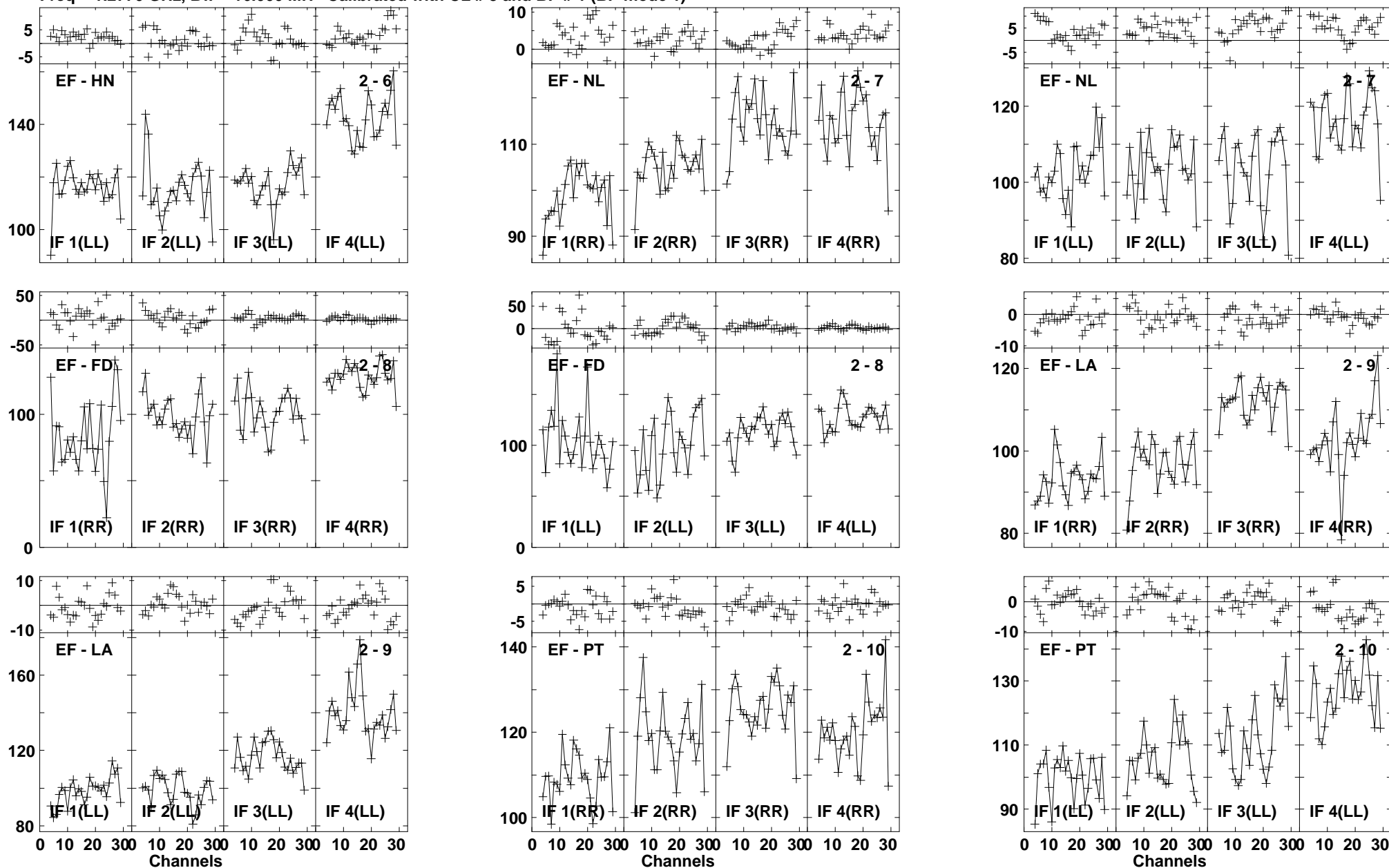

Lower frame: Milli Ampl Jy Top frame: Phas deg
Vector averaged cross-power spectrum Baseline: EF (02) - HN (06)
Timerange: 00/20:52:58 to 00/20:55:26

Plot file version 668 created 03-MAR-2016 01:13:50
 J1545+5400 GN002C 1.UVDATA.1
 Freq = 1.2770 GHz, Bw = 16.000 MH Calibrated with CL # 3 and BP # 1 (BP mode 1)

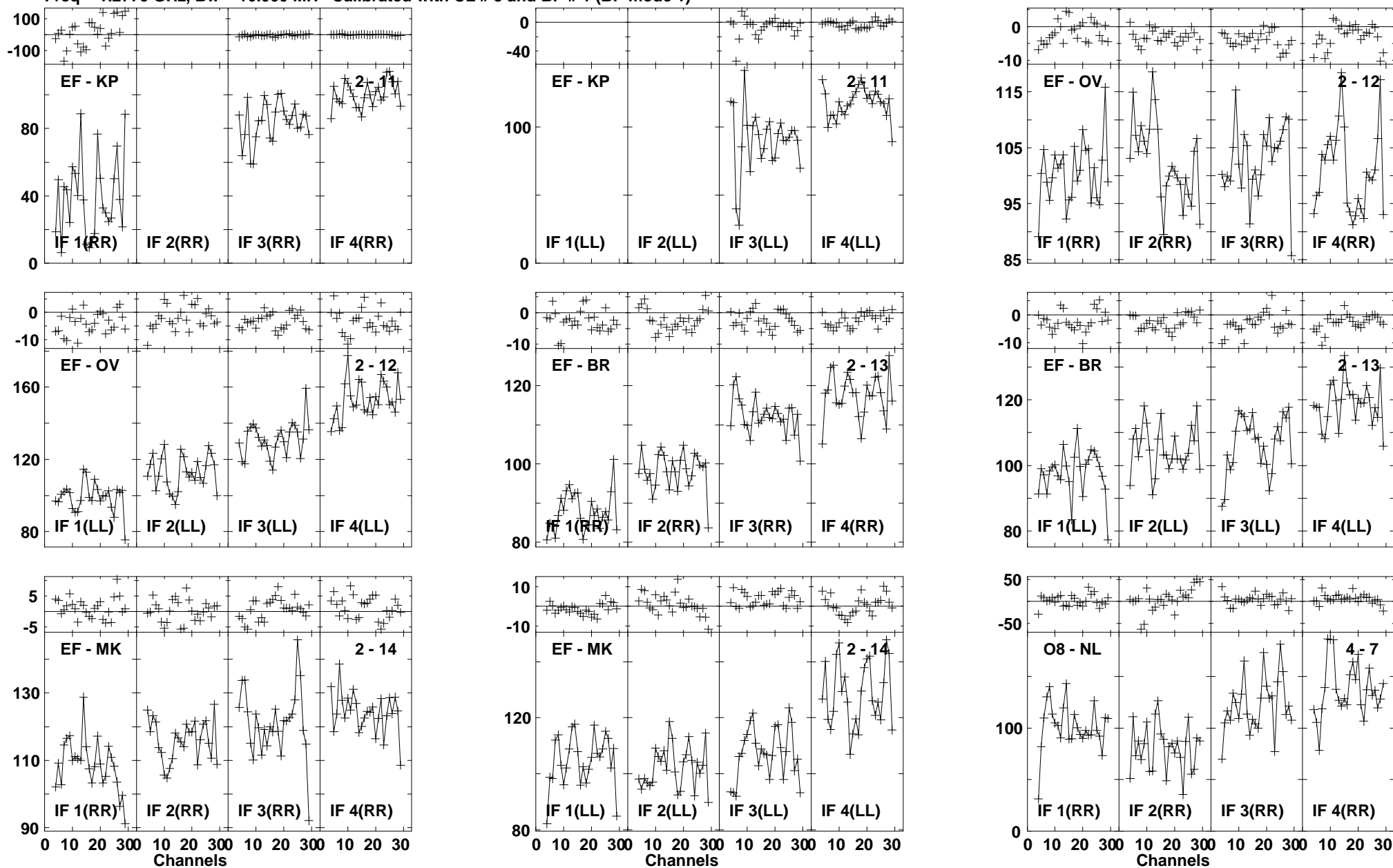

Lower frame: Milli Ampl Jy Top frame: Phas deg
 Vector averaged cross-power spectrum Baseline: EF (02) - KP (11)
 Timerange: 00/20:52:58 to 00/20:55:26

Plot file version 669 created 03-MAR-2016 01:13:51
 J1545+5400 GN002C 1.UVDATA.1
 Freq = 1.2770 GHz, Bw = 16.000 MH Calibrated with CL # 3 and BP # 1 (BP mode 1)

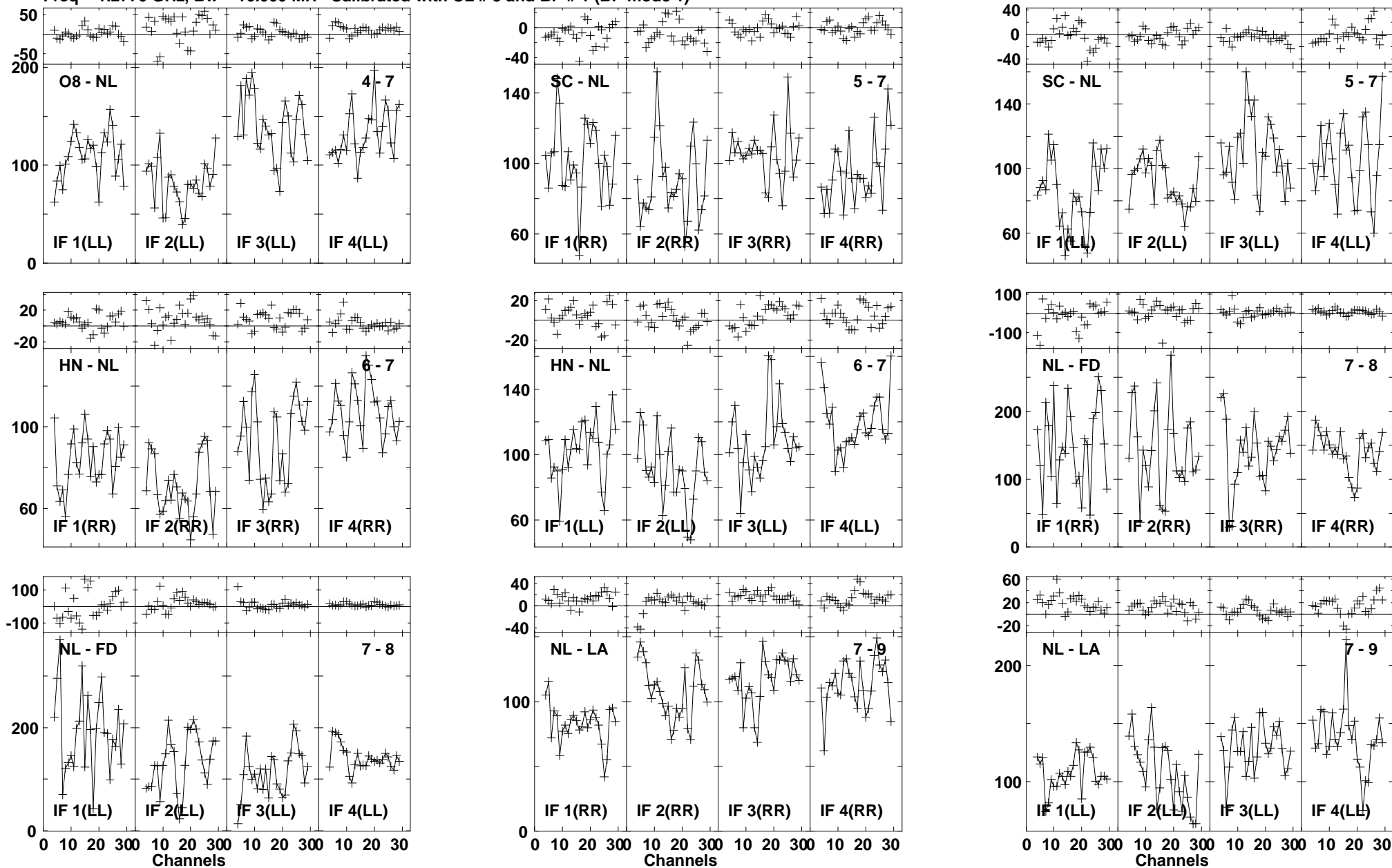

Lower frame: Milli Ampl Jy Top frame: Phas deg
 Vector averaged cross-power spectrum Baseline: O8 (04) - NL (07)
 Timerange: 00/20:52:58 to 00/20:55:26

Plot file version 670 created 03-MAR-2016 01:13:51

J1545+5400 GN002C 1.UVDATA.1

Freq = 1.2770 GHz, Bw = 16.000 MH Calibrated with CL # 3 and BP # 1 (BP mode 1)

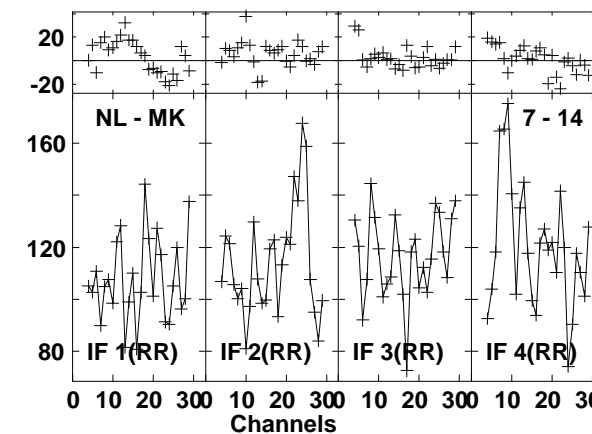
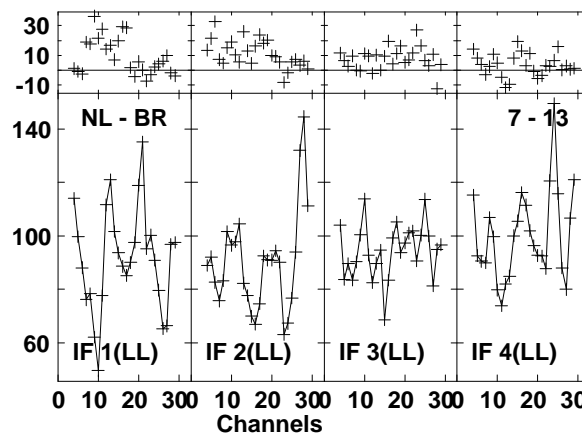
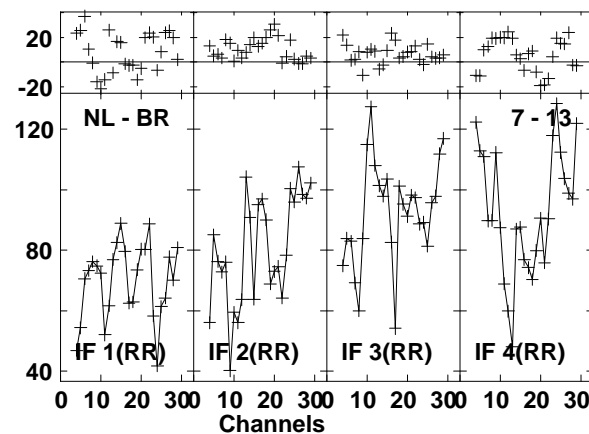
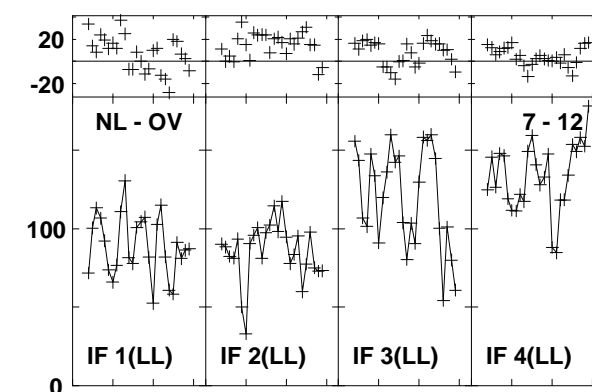
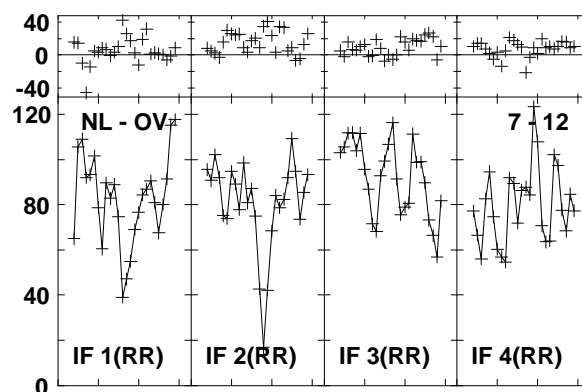
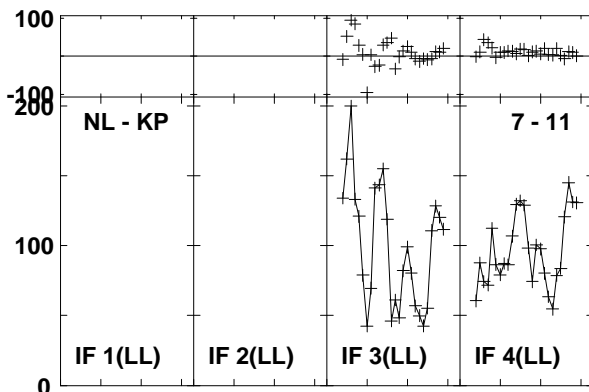
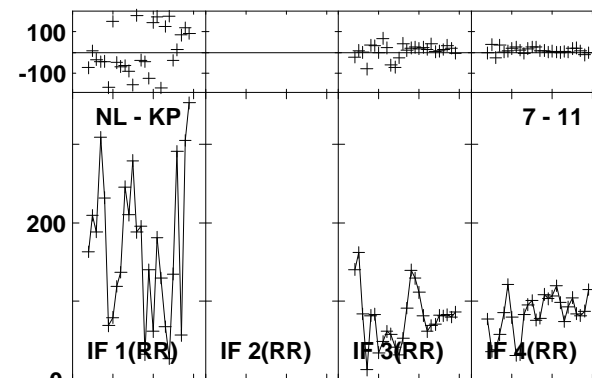
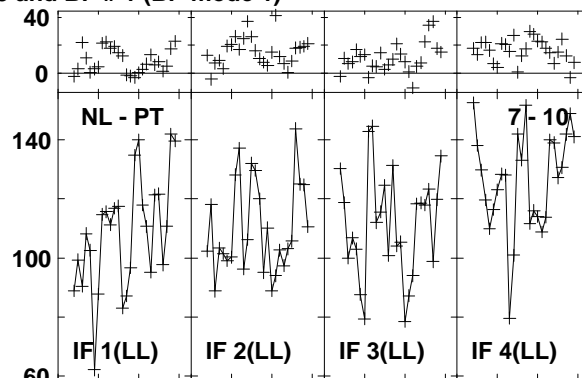
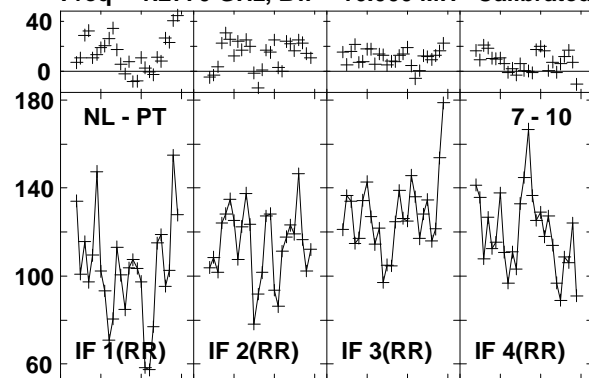

Lower frame: Milli Ampl Jy Top frame: Phas deg
Vector averaged cross-power spectrum Baseline: NL (07) - PT (10)
Timerange: 00/20:52:58 to 00/20:55:26

Plot file version 671 created 03-MAR-2016 01:13:51
J1545+5400 GN002C 1.UVDATA.1
Freq = 1.2770 GHz, Bw = 16.000 MH Calibrated with CL # 3 and BP # 1 (BP mode 1)

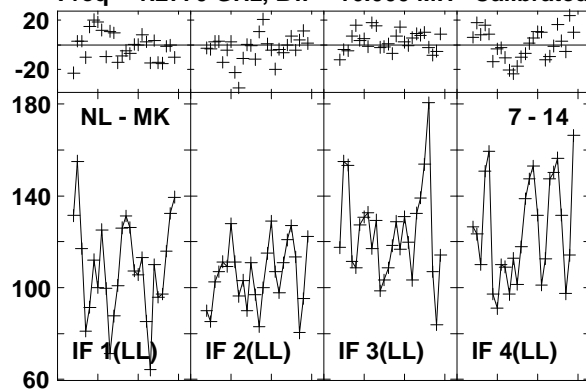

Lower frame: Milli Ampl Jy Top frame: Phas deg
Vector averaged cross-power spectrum Baseline: NL (07) - MK (14)
Timerange: 00/20:52:58 to 00/20:55:26

Plot file version 672 created 03-MAR-2016 01:13:51

4C52 GN002C 1.UVDATA.1

Freq = 1.2770 GHz, Bw = 16.000 MH Calibrated with CL # 3 and BP # 1 (BP mode 1)

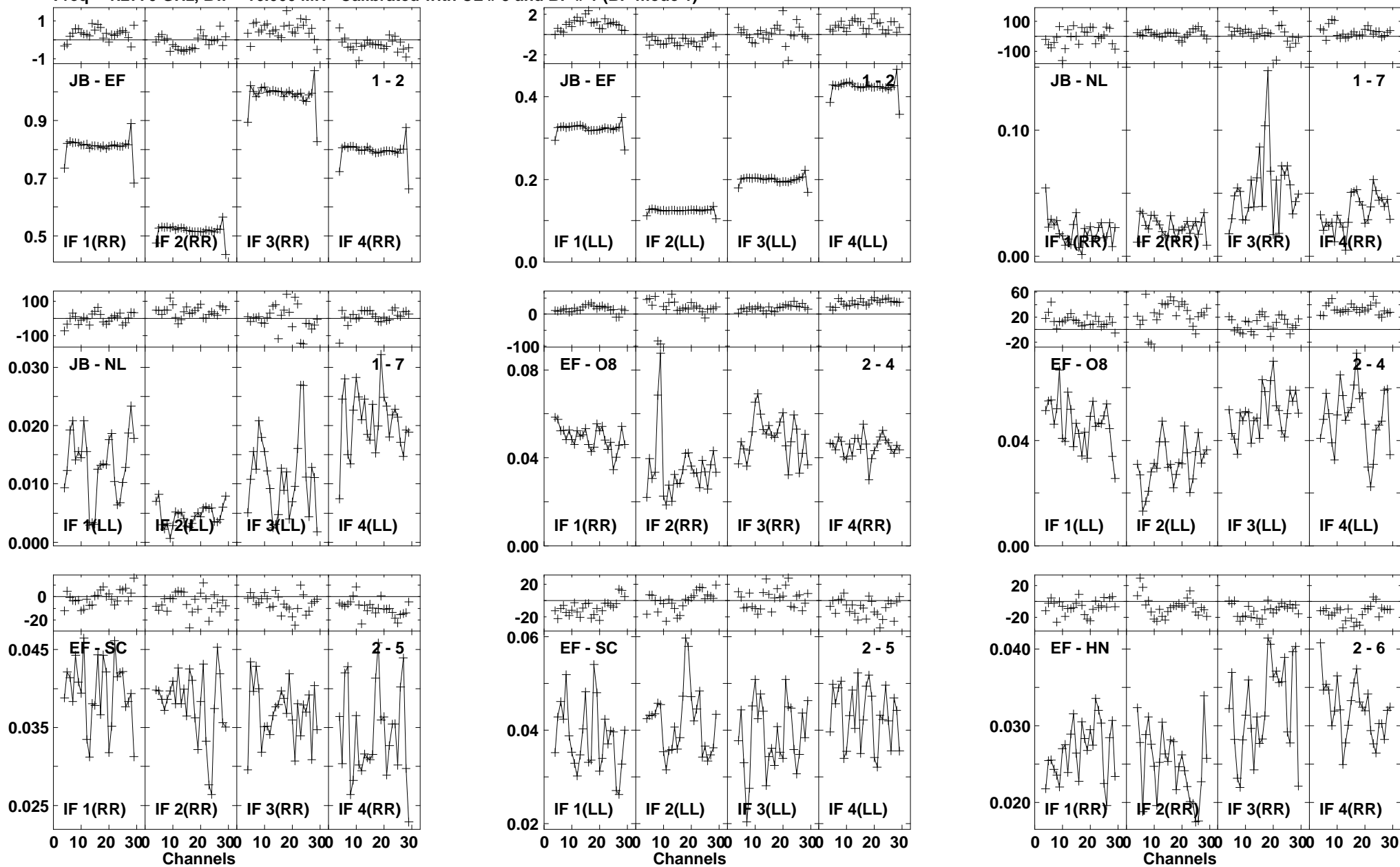

Plot file version 673 created 03-MAR-2016 01:13:51

4C52 GN002C 1.UVDATA.1

Freq = 1.2770 GHz, Bw = 16.000 MH Calibrated with CL # 3 and BP # 1 (BP mode 1)

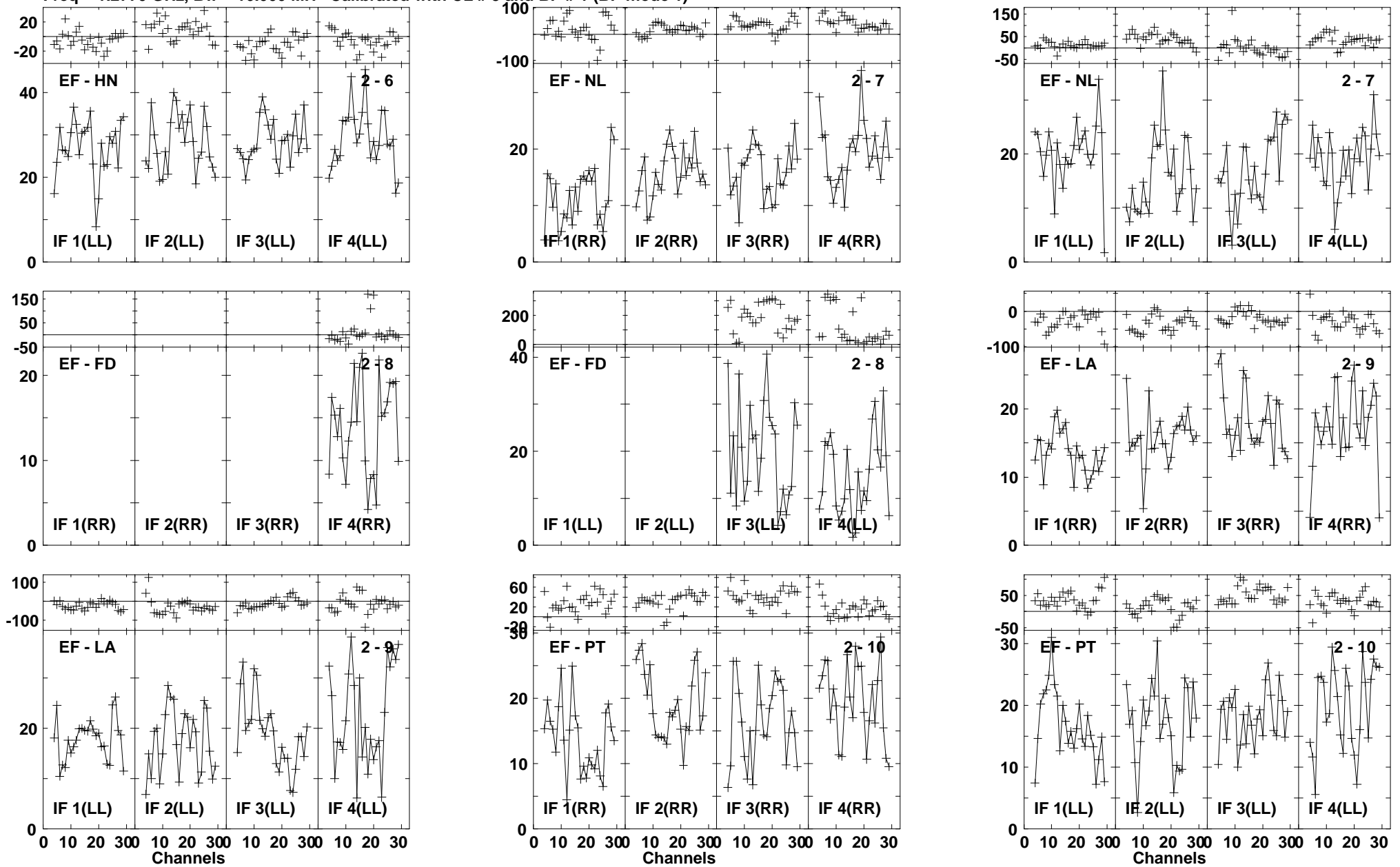

Lower frame: Milli Ampl Jy Top frame: Phas deg
Vector averaged cross-power spectrum Baseline: EF (02) - HN (06)
Timerange: 00/20:55:40 to 00/20:58:56

Plot file version 674 created 03-MAR-2016 01:13:51

4C52 GN002C 1.UVDATA.1

Freq = 1.2770 GHz, Bw = 16.000 MH Calibrated with CL # 3 and BP # 1 (BP mode 1)

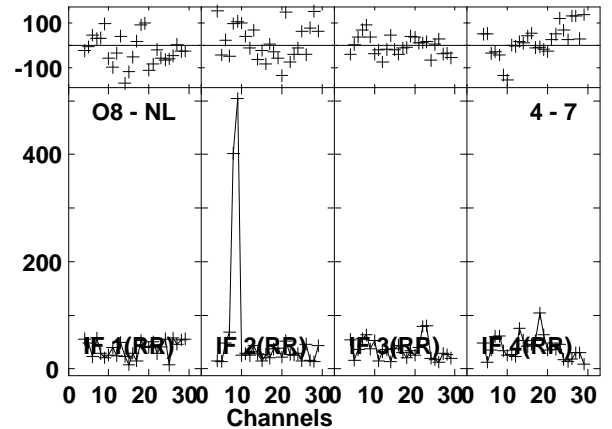
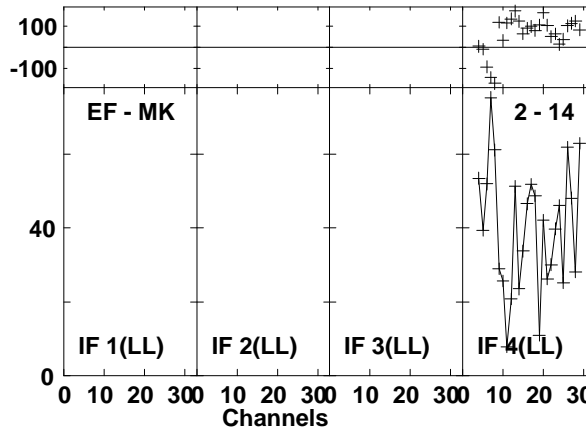
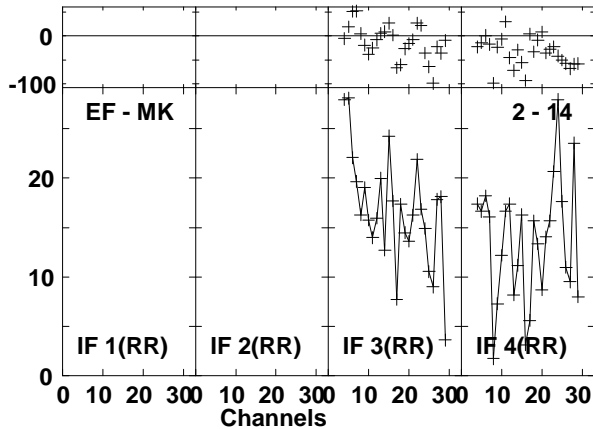
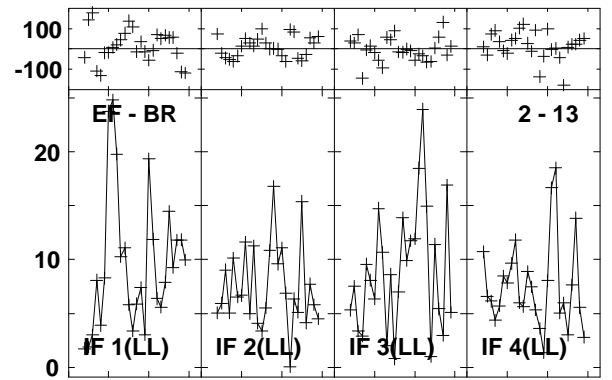
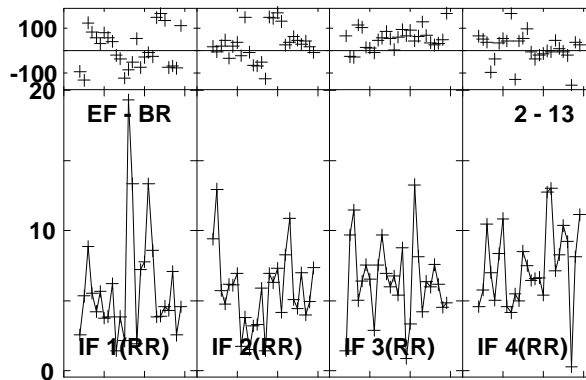
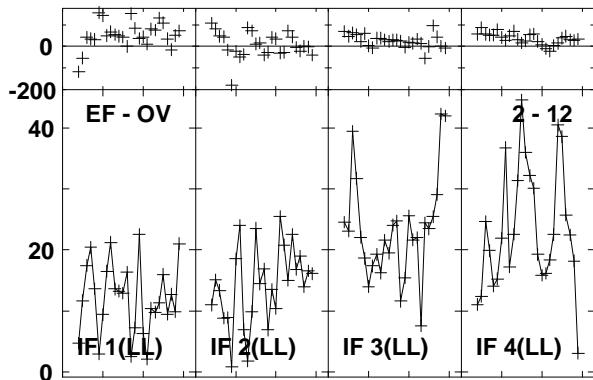
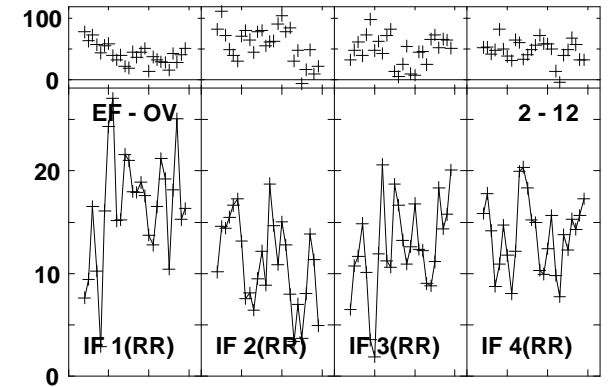
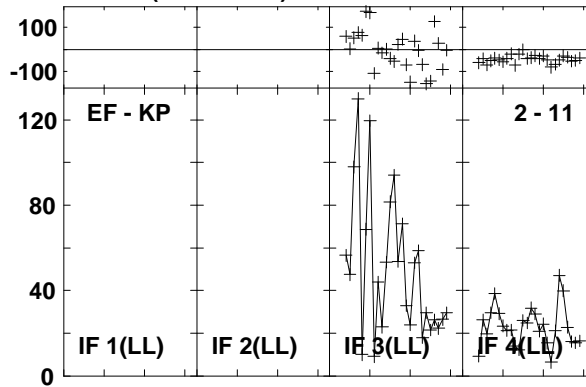
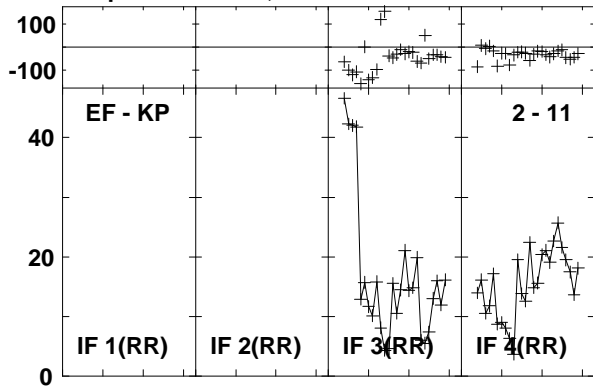

Lower frame: Milli Ampl Jy Top frame: Phas deg
Vector averaged cross-power spectrum Baseline: EF (02) - KP (11)
Timerange: 00/20:55:40 to 00/20:58:56

Plot file version 675 created 03-MAR-2016 01:13:52

4C52 GN002C 1.UVDATA.1

Freq = 1.2770 GHz, Bw = 16.000 MH Calibrated with CL # 3 and BP # 1 (BP mode 1)

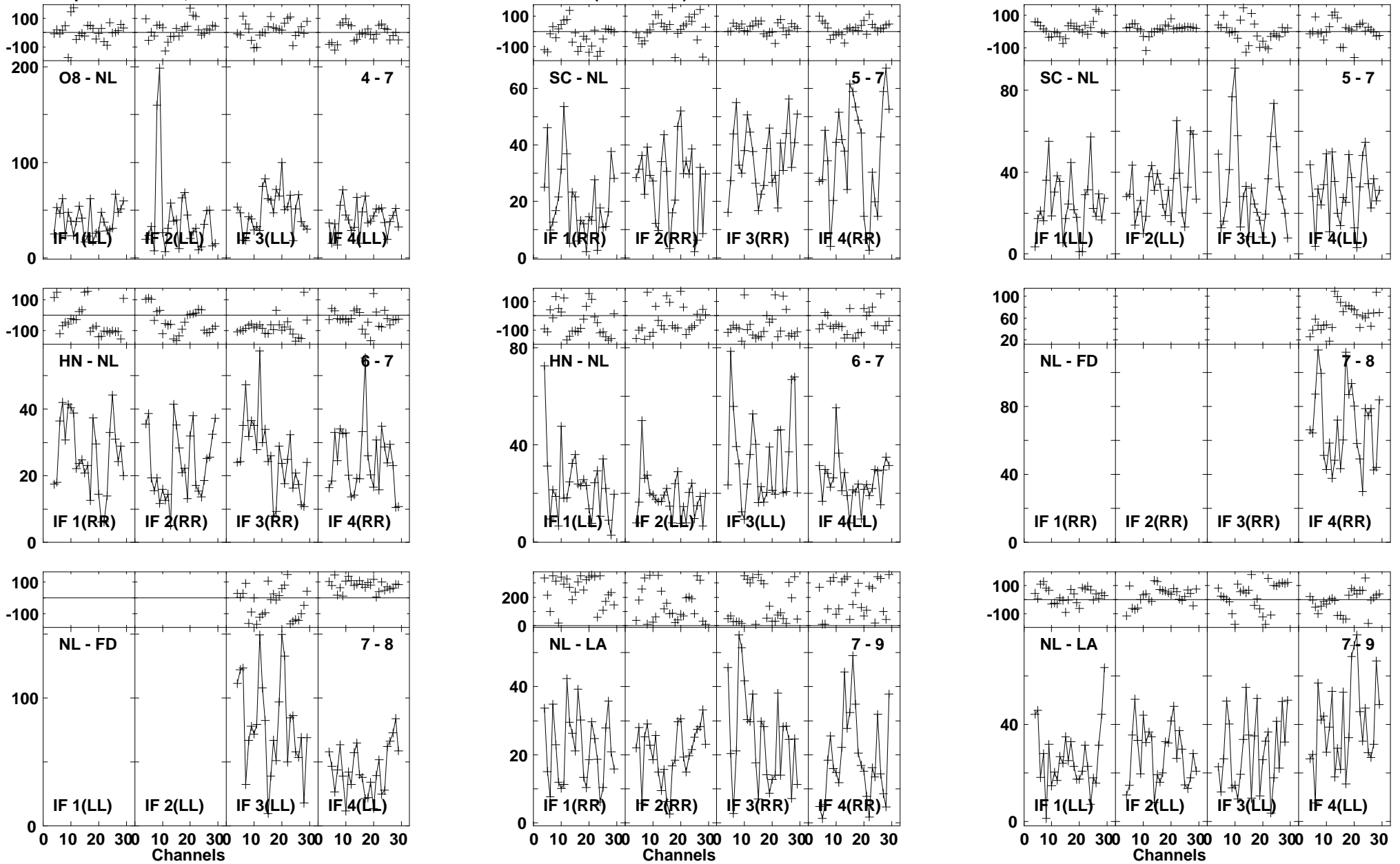

Lower frame: Milli Ampl Jy Top frame: Phas deg
Vector averaged cross-power spectrum Baseline: O8 (04) - NL (07)
Timerange: 00/20:55:40 to 00/20:58:56

Plot file version 676 created 03-MAR-2016 01:13:52

4C52 GN002C 1.UVDATA.1

Freq = 1.2770 GHz, Bw = 16.000 MH Calibrated with CL # 3 and BP # 1 (BP mode 1)

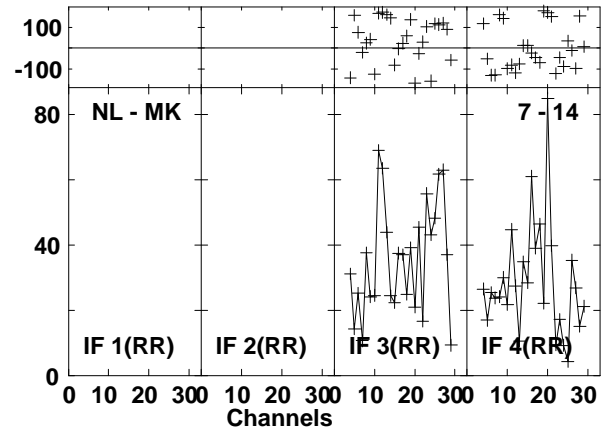
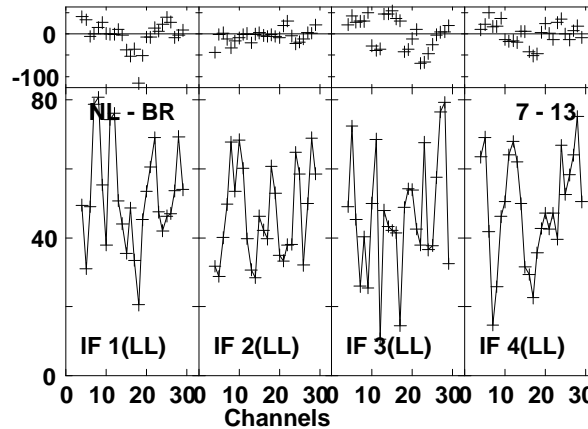
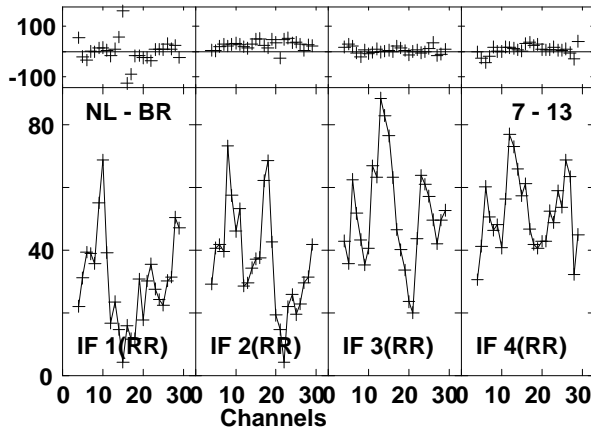
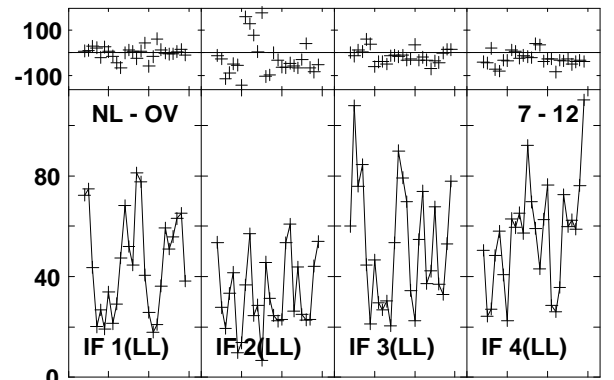
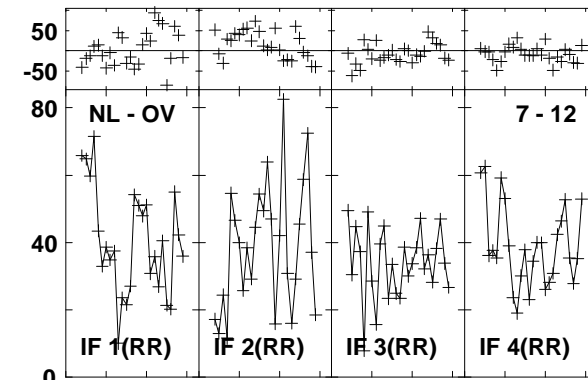
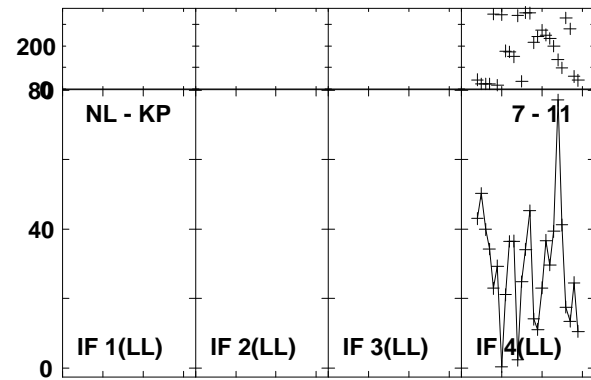
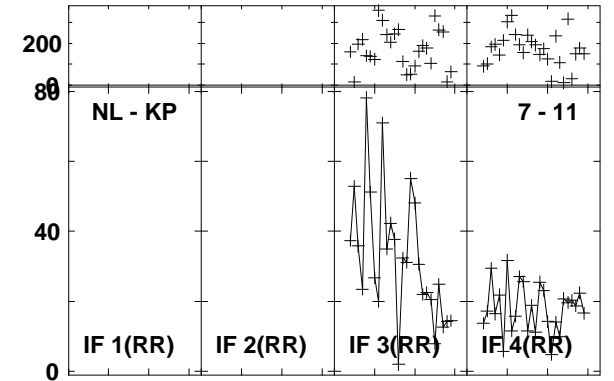
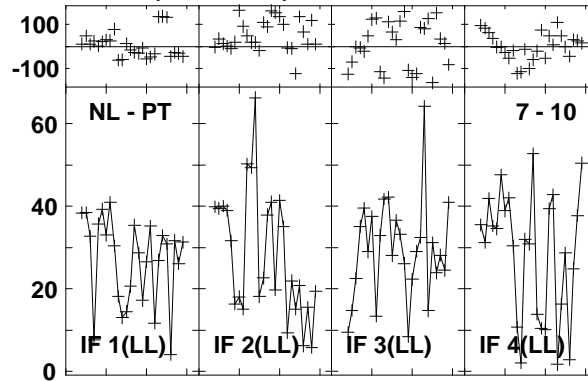
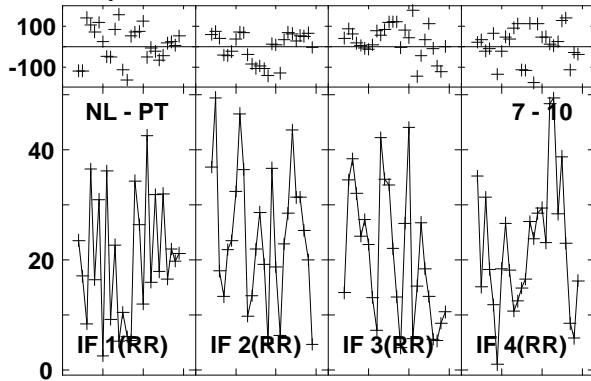

Lower frame: Milli Ampl Jy Top frame: Phas deg
Vector averaged cross-power spectrum Baseline: NL (07) - PT (10)
Timerange: 00/20:55:40 to 00/20:58:56

Plot file version 677 created 03-MAR-2016 01:13:52
4C52 GN002C 1.UVDATA.1
Freq = 1.2770 GHz, Bw = 16.000 MH Calibrated with CL # 3 and BP # 1 (BP mode 1)

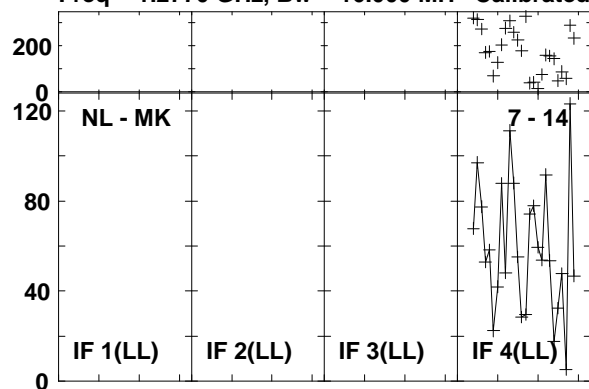

Lower frame: Milli Ampl Jy Top frame: Phas deg
Vector averaged cross-power spectrum Baseline: NL (07) - MK (14)
Timerange: 00/20:55:40 to 00/20:58:56

Plot file version 678 created 03-MAR-2016 01:13:52

J1545+5400 GN002C 1.UVDATA.1

Freq = 1.2770 GHz, Bw = 16.000 MH Calibrated with CL # 3 and BP # 1 (BP mode 1)

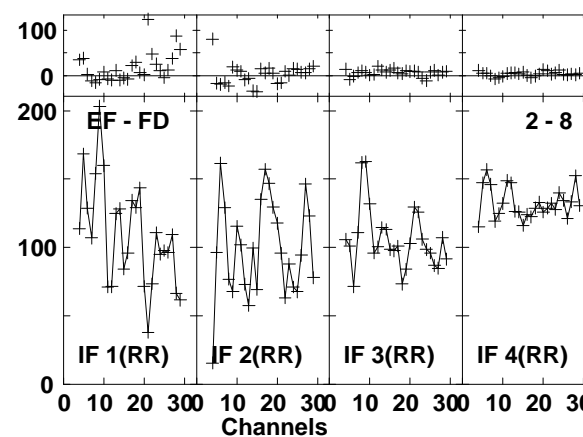
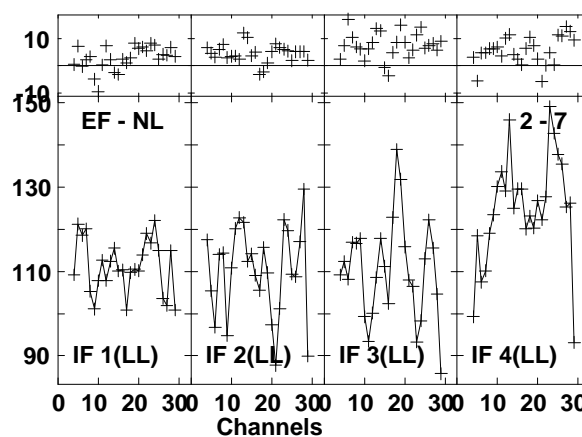
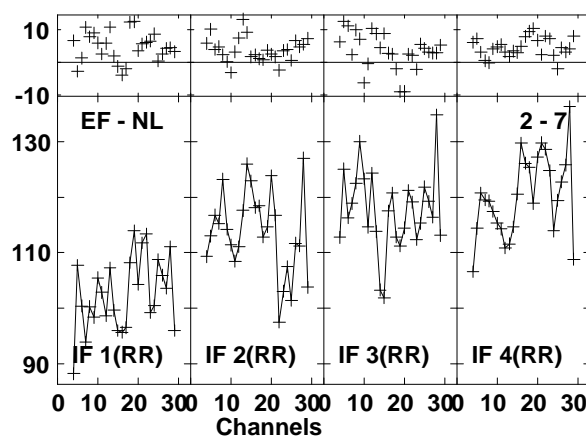
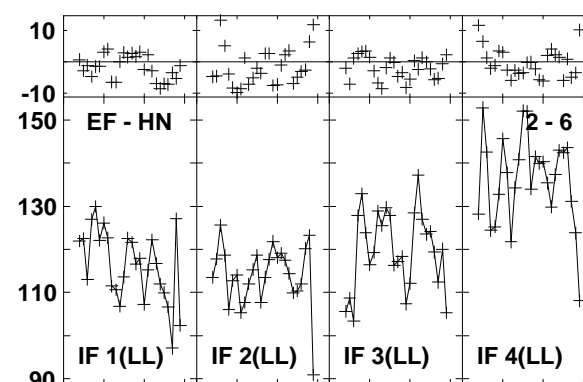
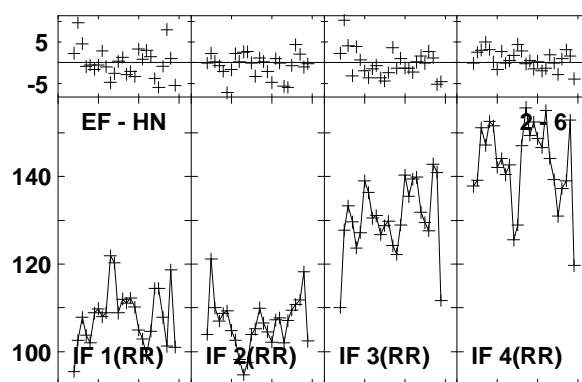
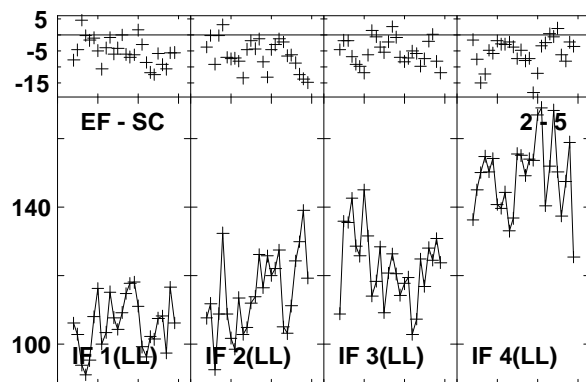
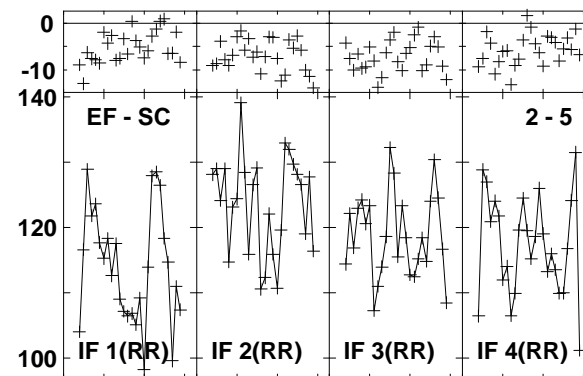
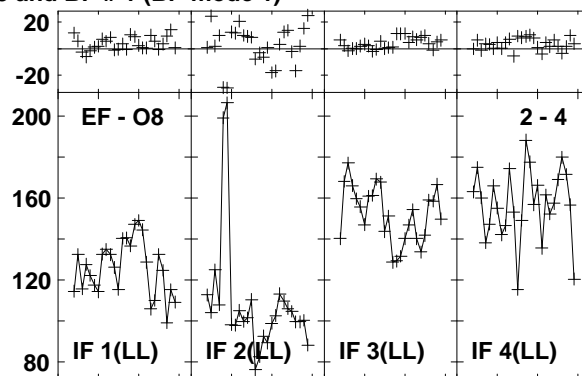
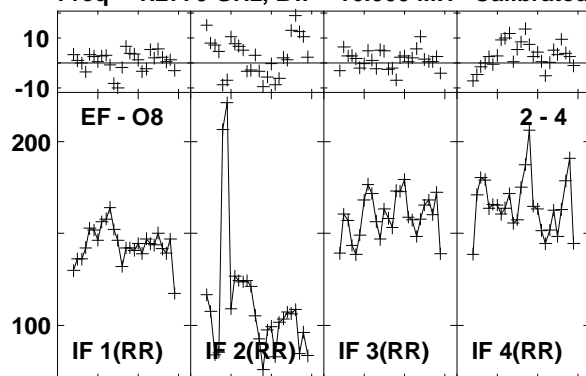

Lower frame: Milli Ampl Jy Top frame: Phas deg
Vector averaged cross-power spectrum Baseline: EF (02) - O8 (04)
Timerange: 00/20:59:48 to 00/21:01:16

Plot file version 679 created 03-MAR-2016 01:13:52
 J1545+5400 GN002C 1.UVDATA.1
 Freq = 1.2770 GHz, Bw = 16.000 MH Calibrated with CL # 3 and BP # 1 (BP mode 1)

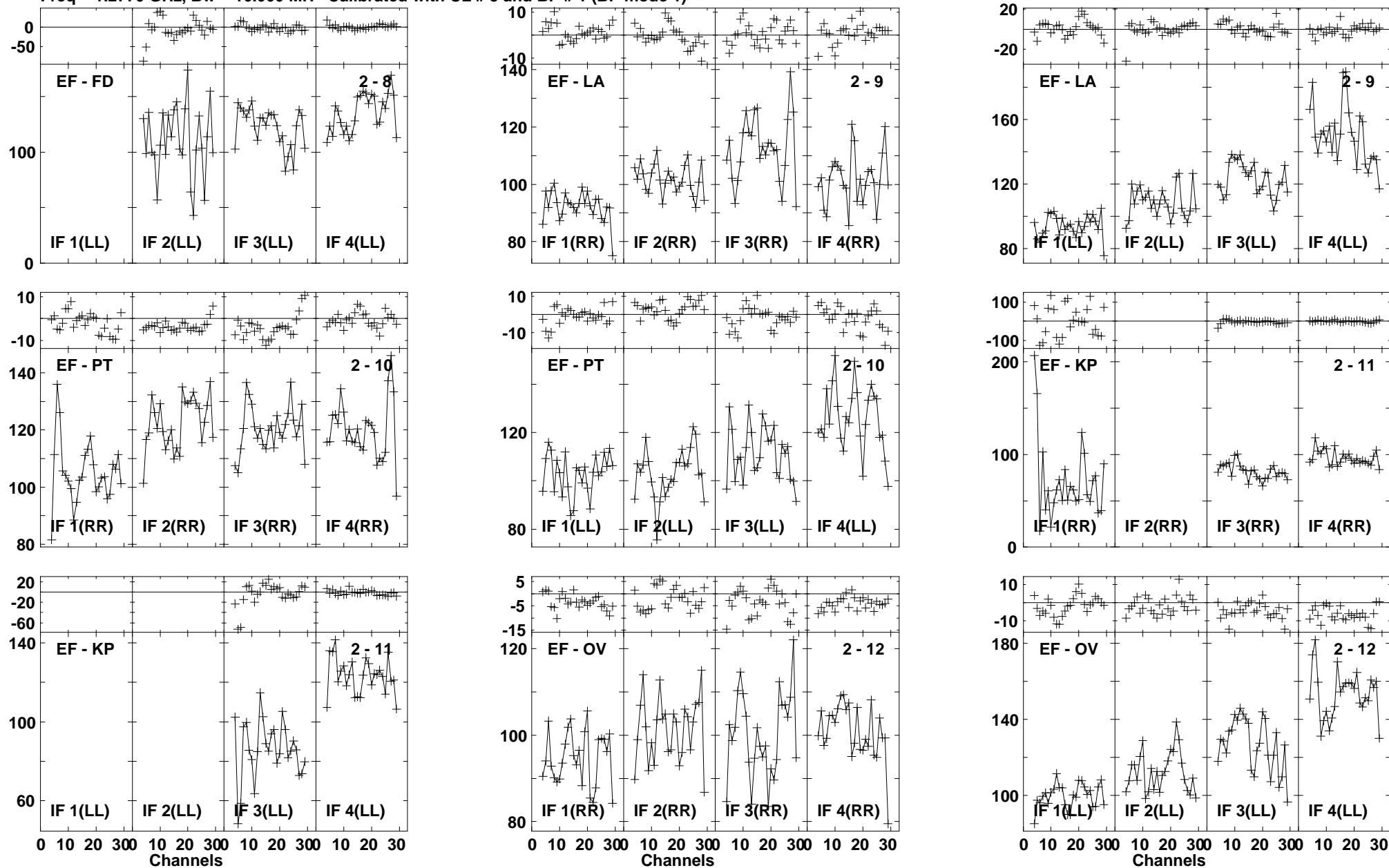

Lower frame: Milli Ampl Jy Top frame: Phas deg
 Vector averaged cross-power spectrum Baseline: EF (02) - FD (08)
 Timerange: 00/20:59:48 to 00/21:01:16

Plot file version 680 created 03-MAR-2016 01:13:52

J1545+5400 GN002C 1.UVDATA.1

Freq = 1.2770 GHz, Bw = 16.000 MH Calibrated with CL # 3 and BP # 1 (BP mode 1)

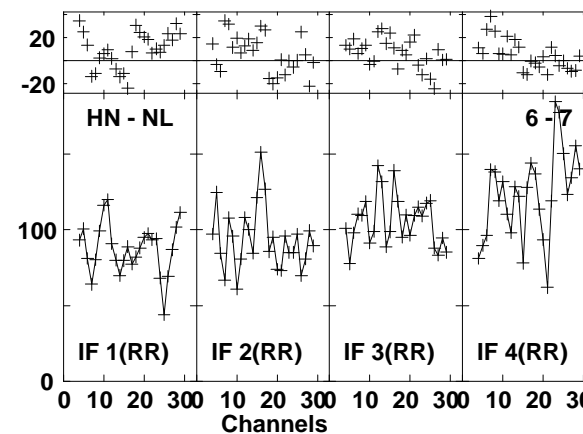
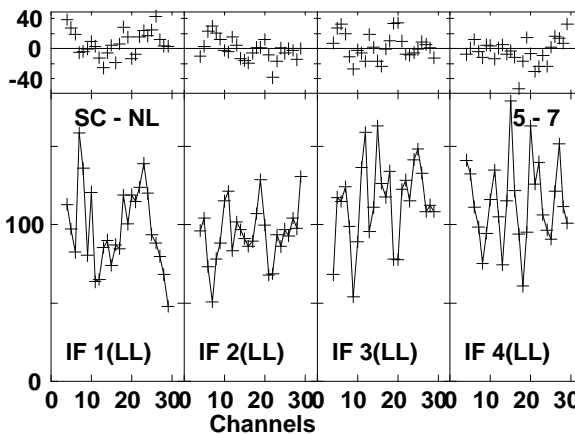
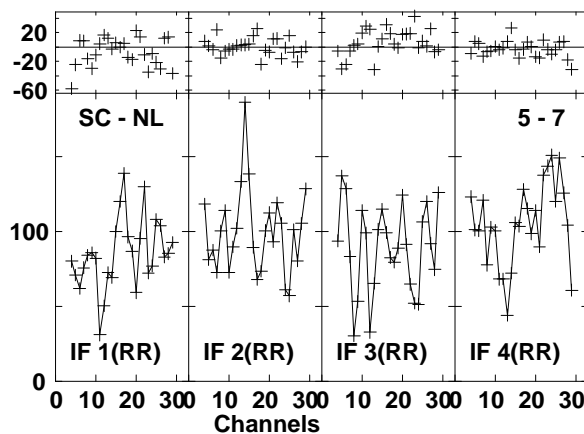
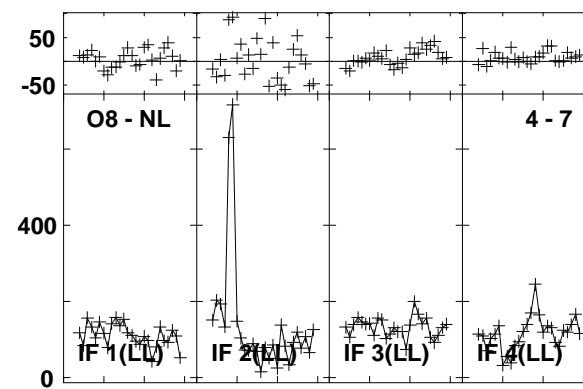
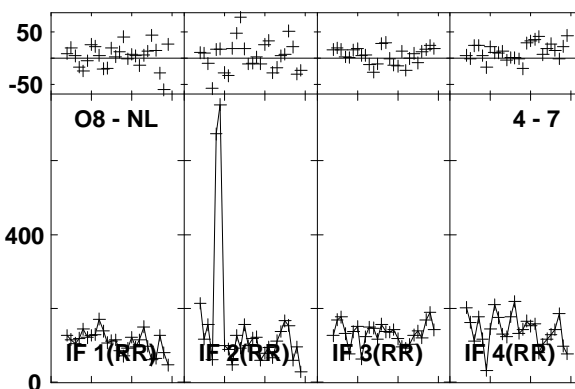
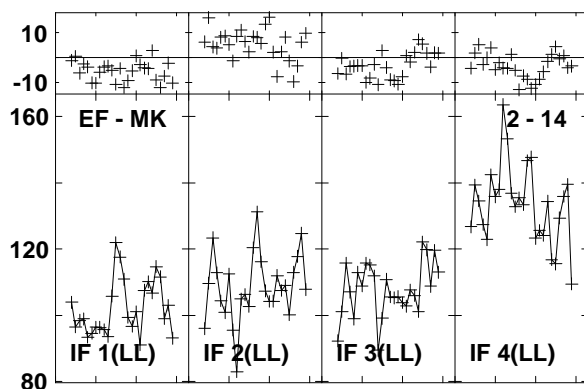
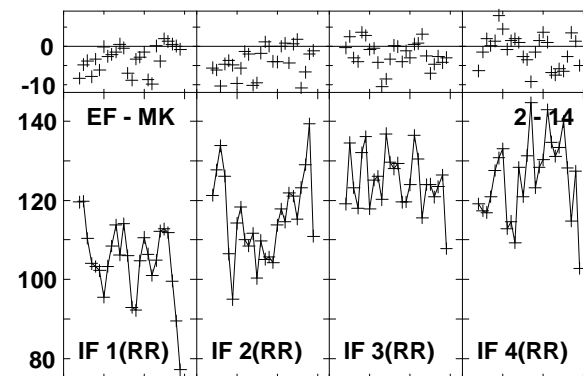
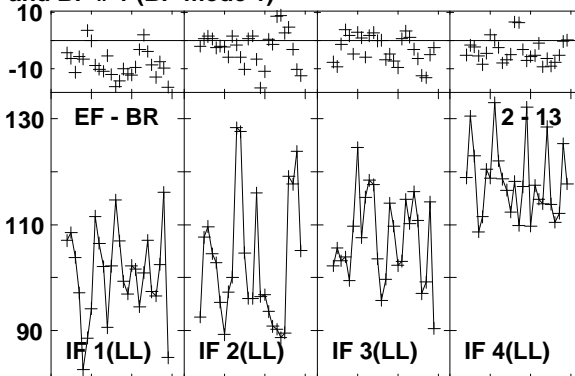
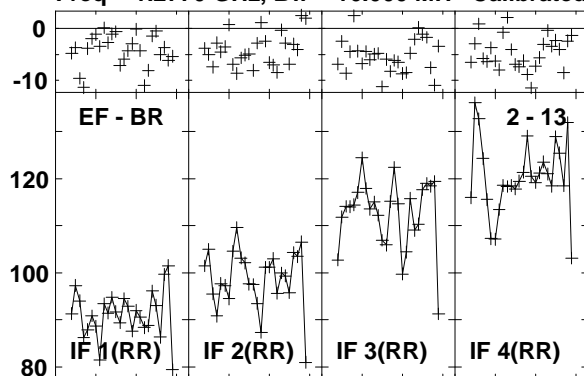

Lower frame: Milli Ampl Jy Top frame: Phas deg
Vector averaged cross-power spectrum Baseline: EF (02) - BR (13)
Timerange: 00/20:59:48 to 00/21:01:16

Plot file version 681 created 03-MAR-2016 01:13:53

J1545+5400 GN002C 1.UVDATA.1

Freq = 1.2770 GHz, Bw = 16.000 MH Calibrated with CL # 3 and BP # 1 (BP mode 1)

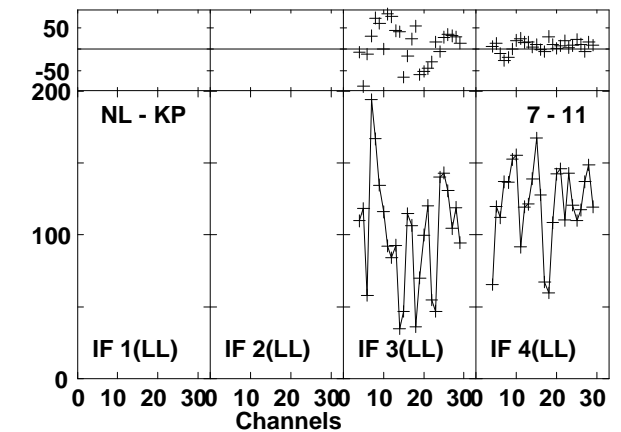
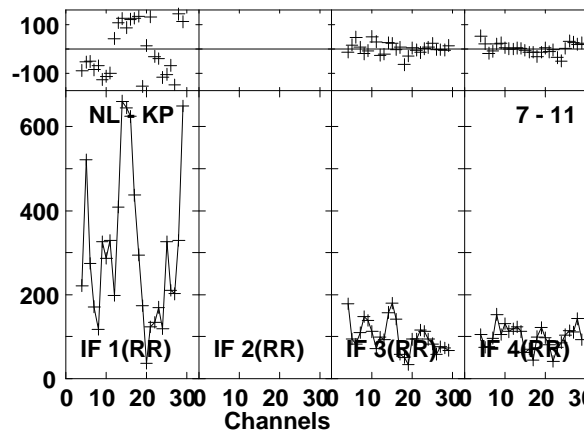
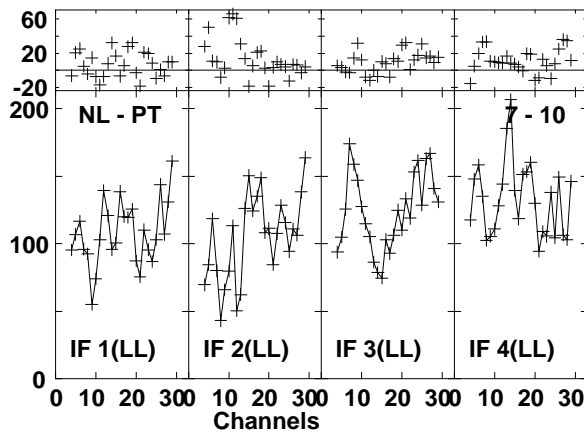
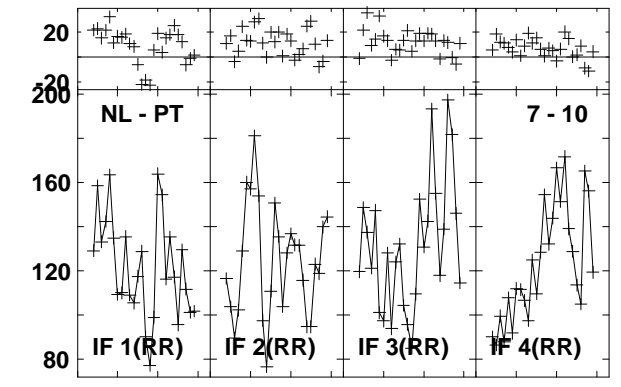
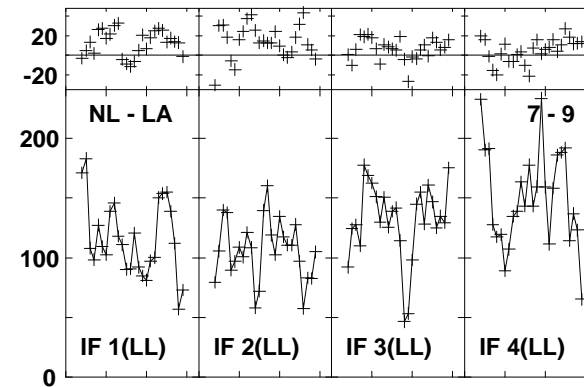
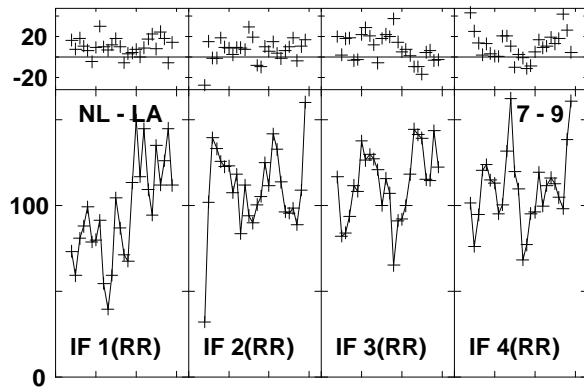
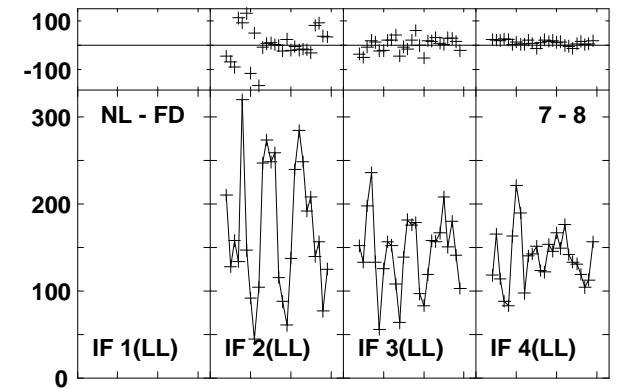
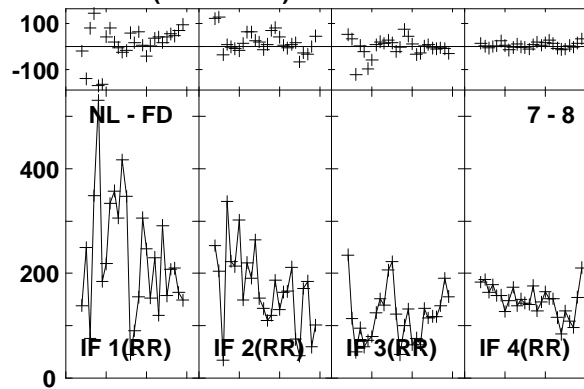
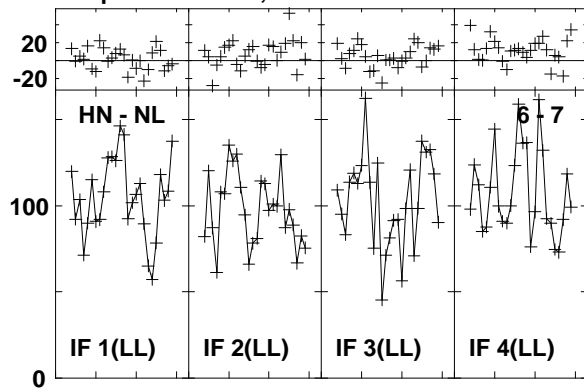

Lower frame: Milli Ampl Jy Top frame: Phas deg
Vector averaged cross-power spectrum Baseline: HN (06) - NL (07)
Timerange: 00/20:59:48 to 00/21:01:16

Plot file version 682 created 03-MAR-2016 01:13:53

J1545+5400 GN002C 1.UVDATA.1

Freq = 1.2770 GHz, Bw = 16.000 MH Calibrated with CL # 3 and BP # 1 (BP mode 1)

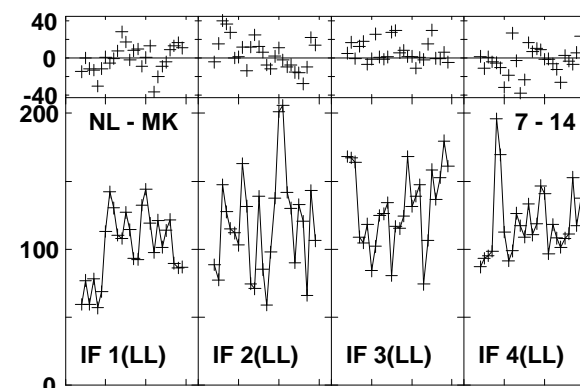
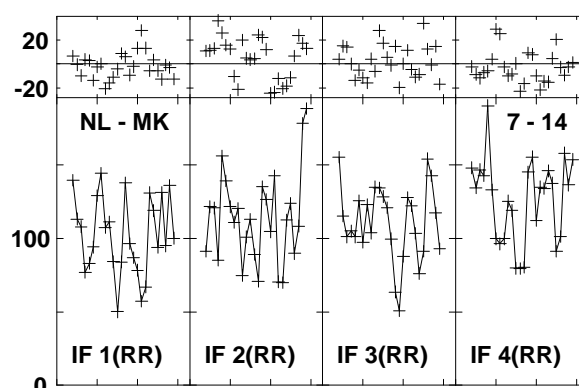
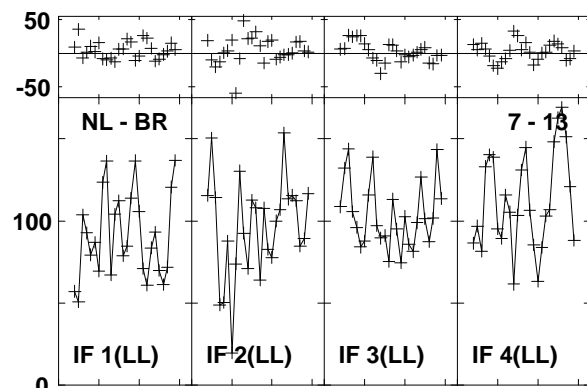
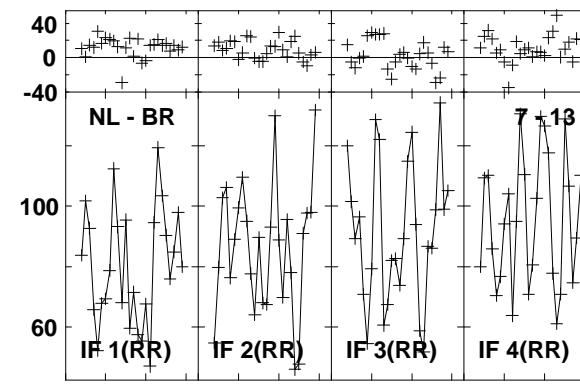
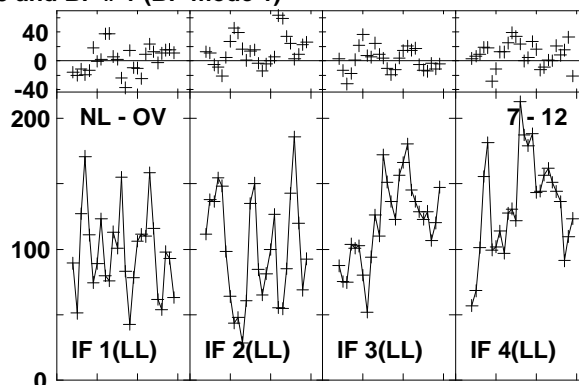
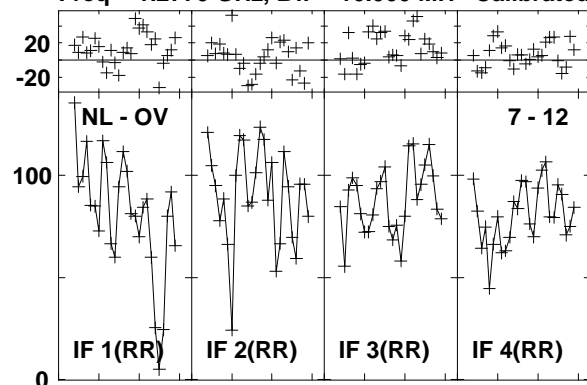

Lower frame: Milli Ampl Jy Top frame: Phas deg
Vector averaged cross-power spectrum Baseline: NL (07) - OV (12)
Timerange: 00/20:59:48 to 00/21:01:16

Plot file version 683 created 03-MAR-2016 01:13:53

4C52 GN002C 1.UVDATA.1

Freq = 1.2770 GHz, Bw = 16.000 MH Calibrated with CL # 3 and BP # 1 (BP mode 1)

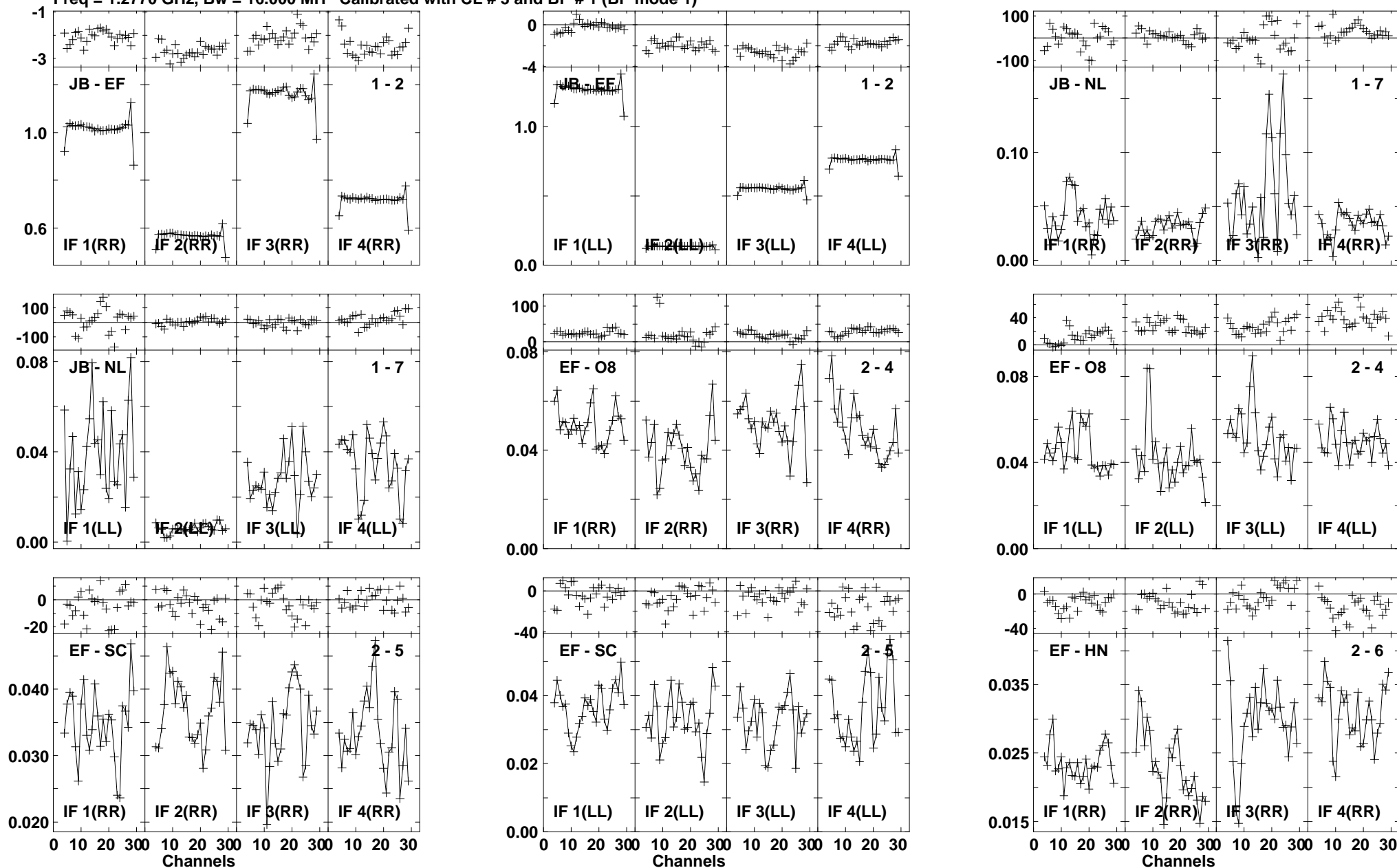

Lower frame: Ampl Jy Top frame: Phas deg
Vector averaged cross-power spectrum Baseline: JB (01) - EF (02)
Timerange: 00/21:01:21 to 00/21:04:35

Plot file version 684 created 03-MAR-2016 01:13:53

4C52 GN002C 1.UVDATA.1

Freq = 1.2770 GHz, Bw = 16.000 MH Calibrated with CL # 3 and BP # 1 (BP mode 1)

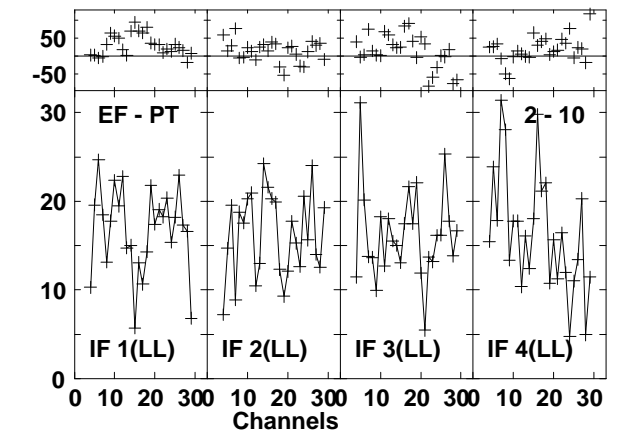
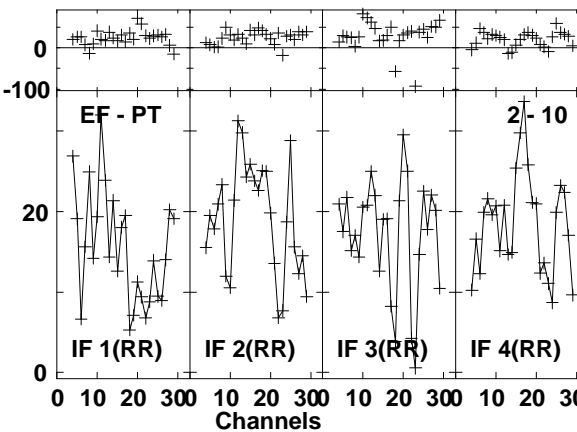
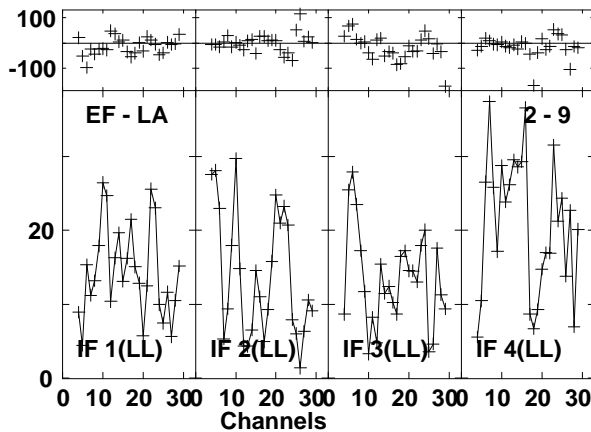
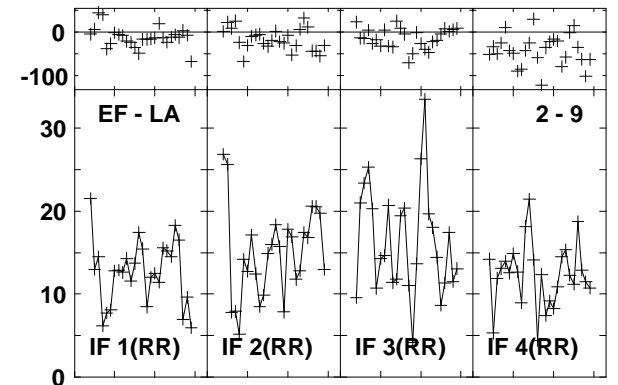
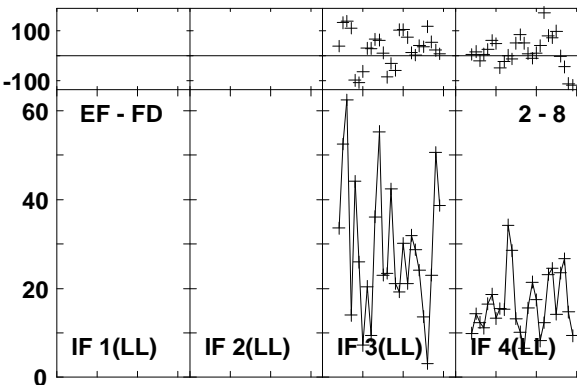
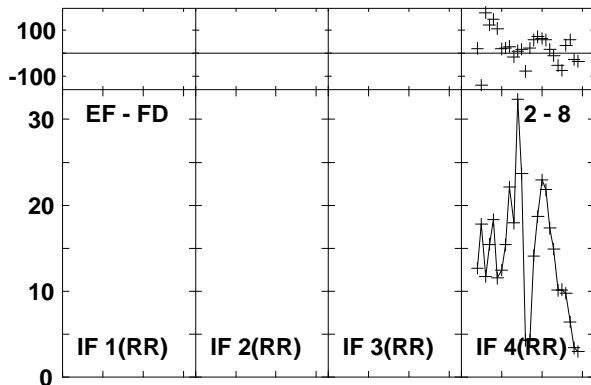
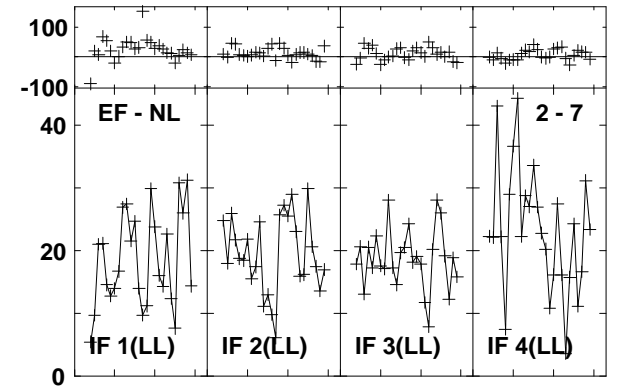
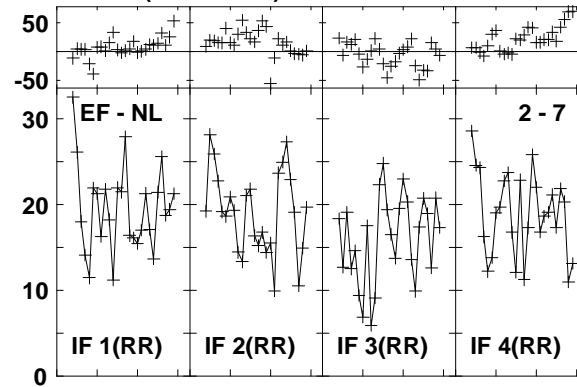
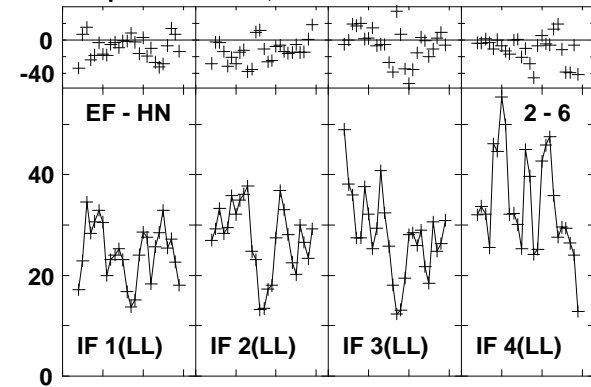

Lower frame: Milli Ampl Jy Top frame: Phas deg

Vector averaged cross-power spectrum Baseline: EF (02) - HN (06)

Timerange: 00/21:01:21 to 00/21:04:35

Plot file version 685 created 03-MAR-2016 01:13:53
 4C52 GN002C 1.UVDATA.1
 Freq = 1.2770 GHz, Bw = 16.000 MH Calibrated with CL # 3 and BP # 1 (BP mode 1)

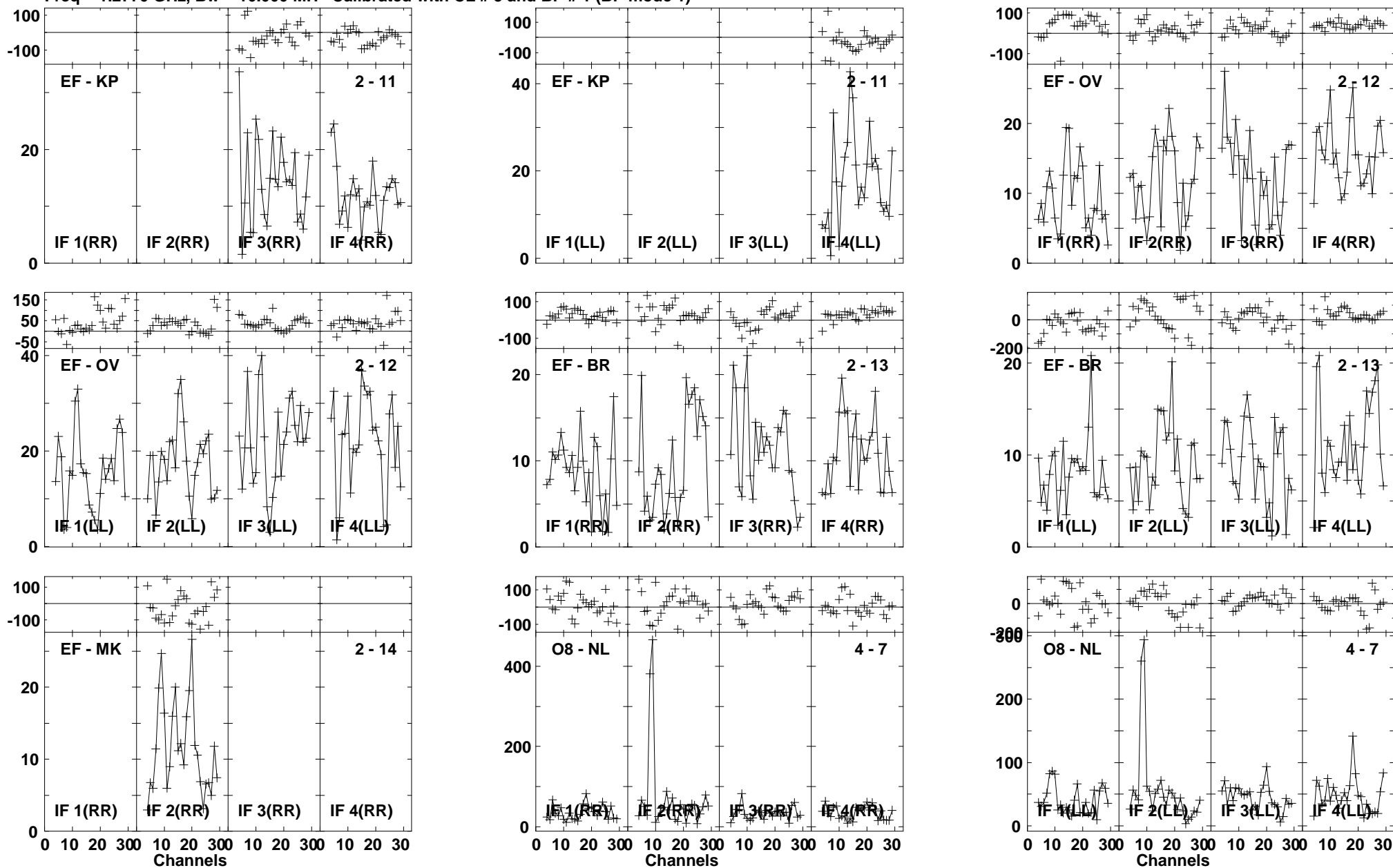

Lower frame: Milli Ampl Jy Top frame: Phas deg
 Vector averaged cross-power spectrum Baseline: EF (02) - KP (11)
 Timerange: 00/21:01:21 to 00/21:04:35

Plot file version 686 created 03-MAR-2016 01:13:54

4C52 GN002C 1.UVDATA.1

Freq = 1.2770 GHz, Bw = 16.000 MH Calibrated with CL # 3 and BP # 1 (BP mode 1)

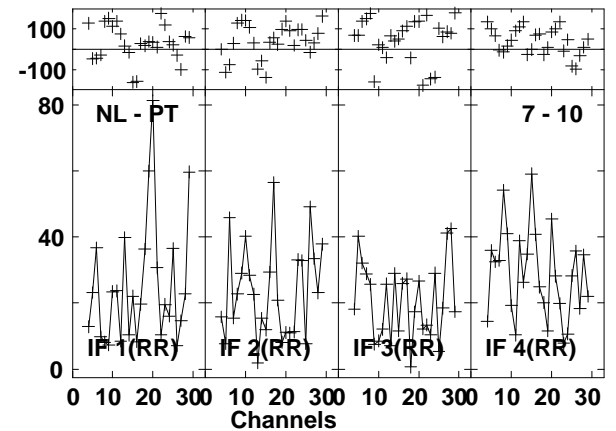
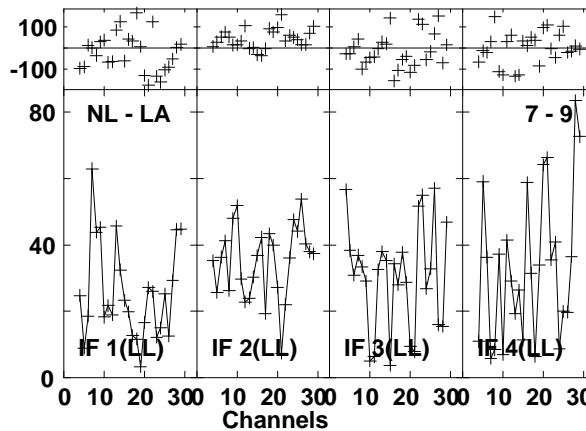
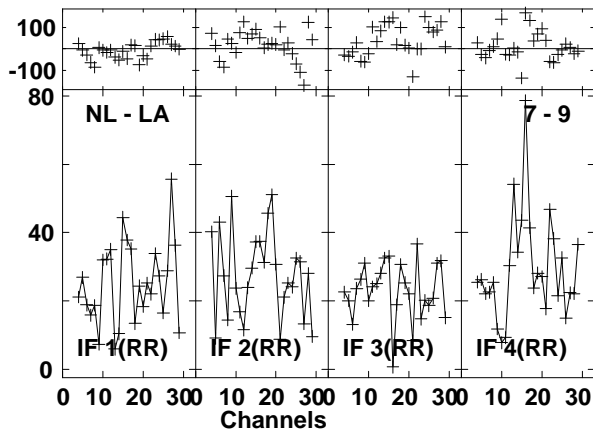
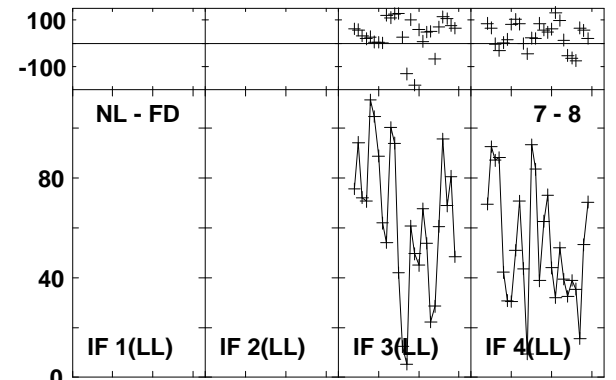
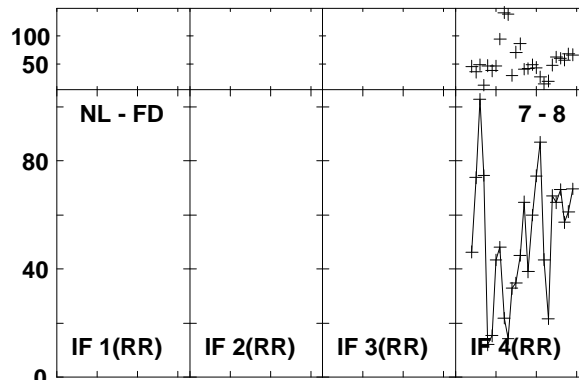
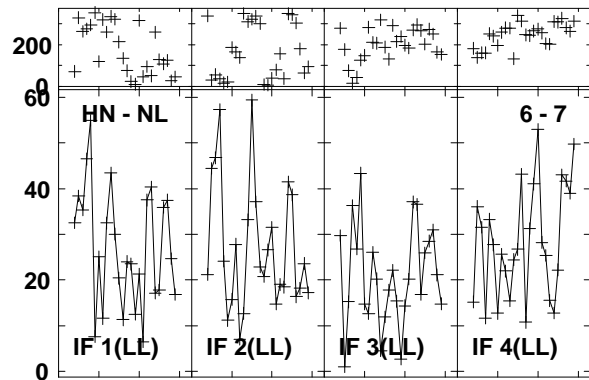
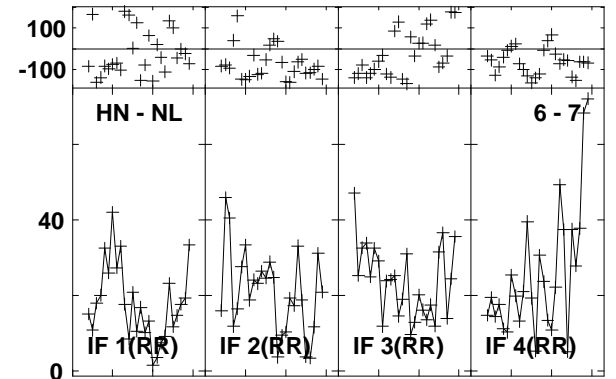
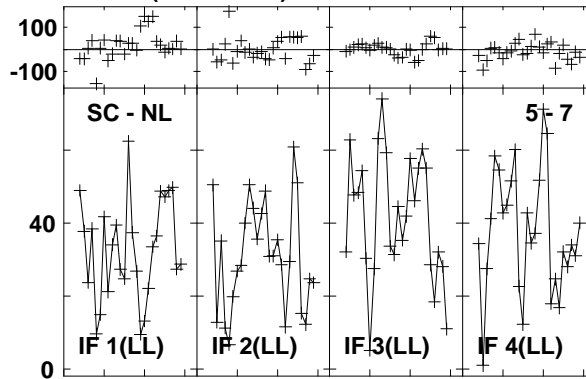
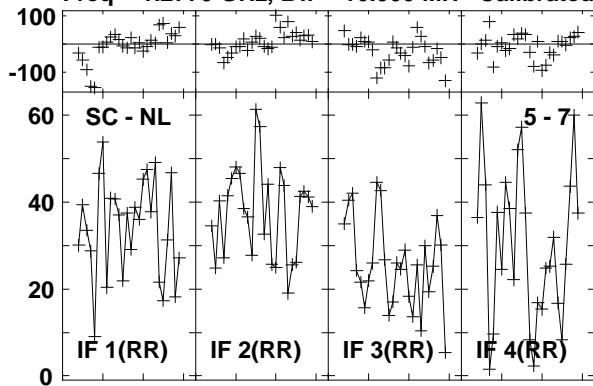

Lower frame: Milli Ampl Jy Top frame: Phas deg

Vector averaged cross-power spectrum Baseline: SC (05) - NL (07)

Timerange: 00/21:01:21 to 00/21:04:35

Plot file version 687 created 03-MAR-2016 01:13:54

4C52 GN002C 1.UVDATA.1

Freq = 1.2770 GHz, Bw = 16.000 MH Calibrated with CL # 3 and BP # 1 (BP mode 1)

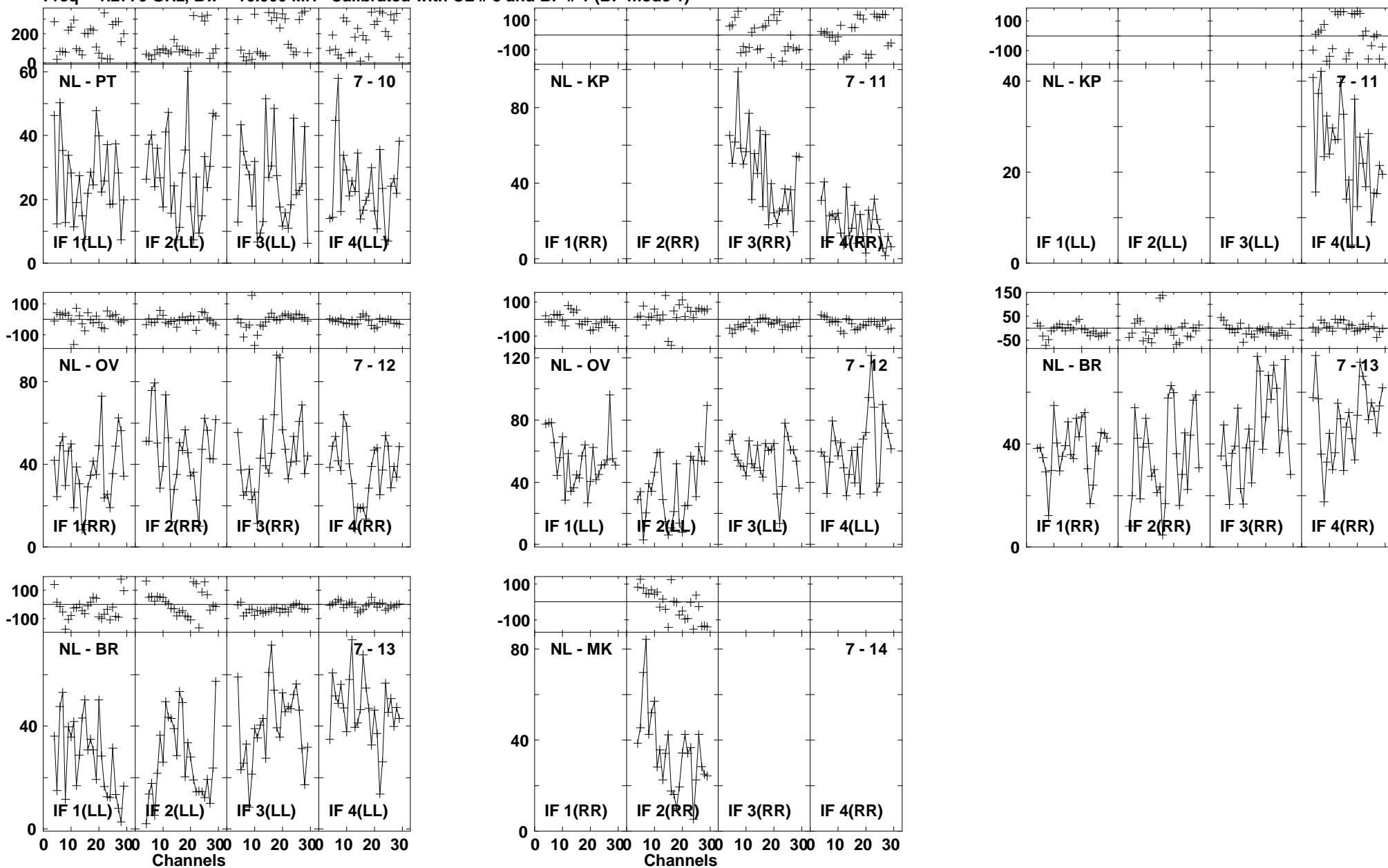

Lower frame: Milli Ampl Jy Top frame: Phas deg
Vector averaged cross-power spectrum Baseline: NL (07) - PT (10)
Timerange: 00/21:01:21 to 00/21:04:35

Plot file version 688 created 03-MAR-2016 01:13:54

J1545+5400 GN002C 1.UVDATA.1

Freq = 1.2770 GHz, Bw = 16.000 MH Calibrated with CL # 3 and BP # 1 (BP mode 1)

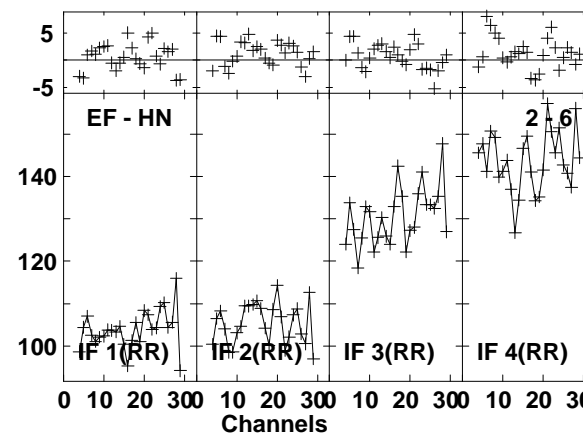
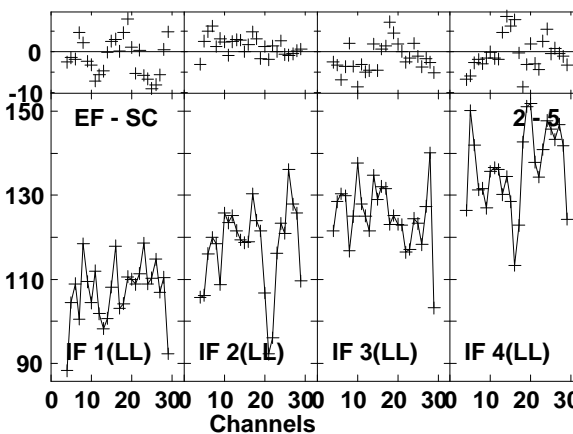
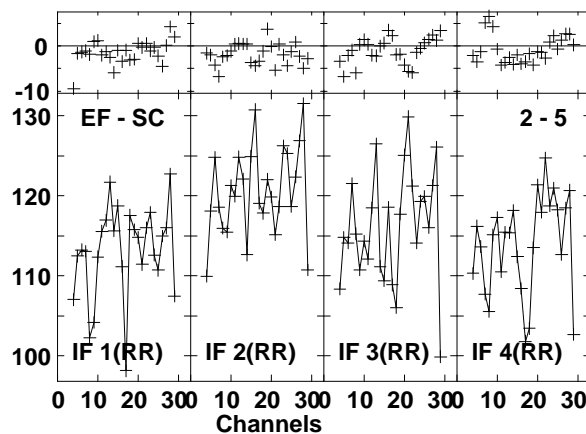
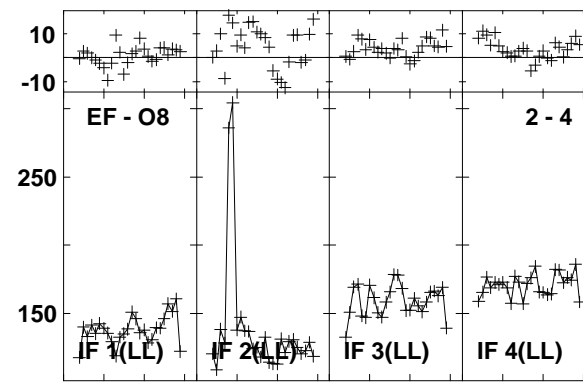
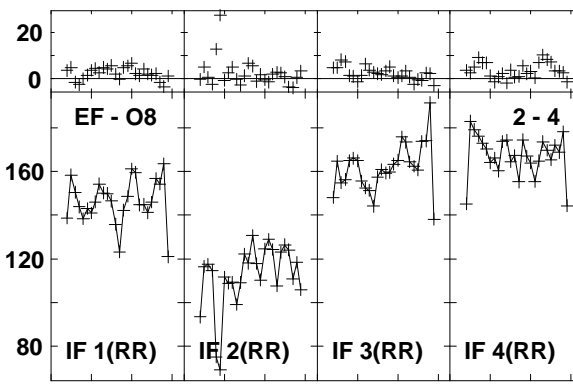
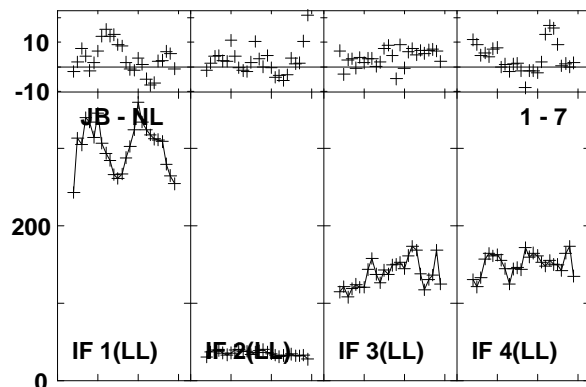
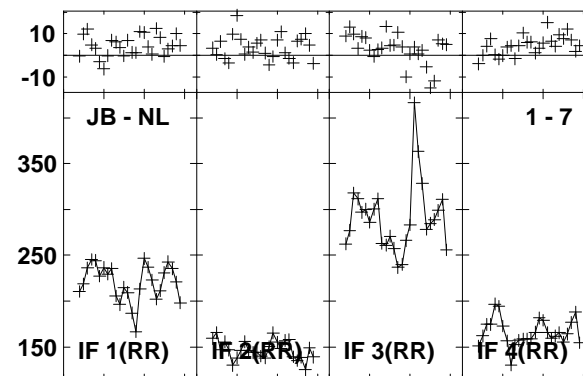
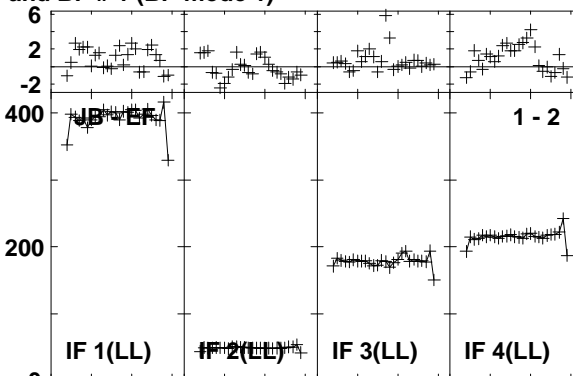
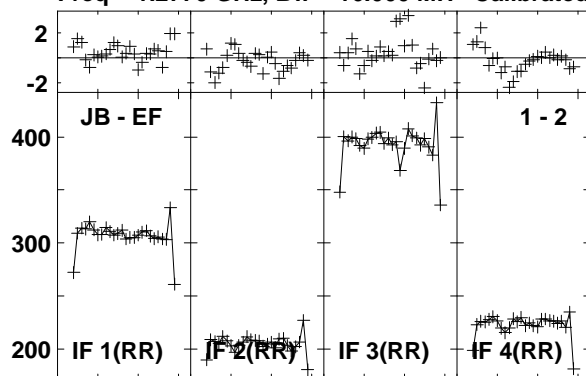

Lower frame: Milli Ampl Jy Top frame: Phas deg
Vector averaged cross-power spectrum Baseline: JB (01) - EF (02)
Timerange: 00/21:05:28 to 00/21:07:56

Plot file version 689 created 03-MAR-2016 01:13:54

J1545+5400 GN002C 1.UVDATA.1

Freq = 1.2770 GHz, Bw = 16.000 MH Calibrated with CL # 3 and BP # 1 (BP mode 1)

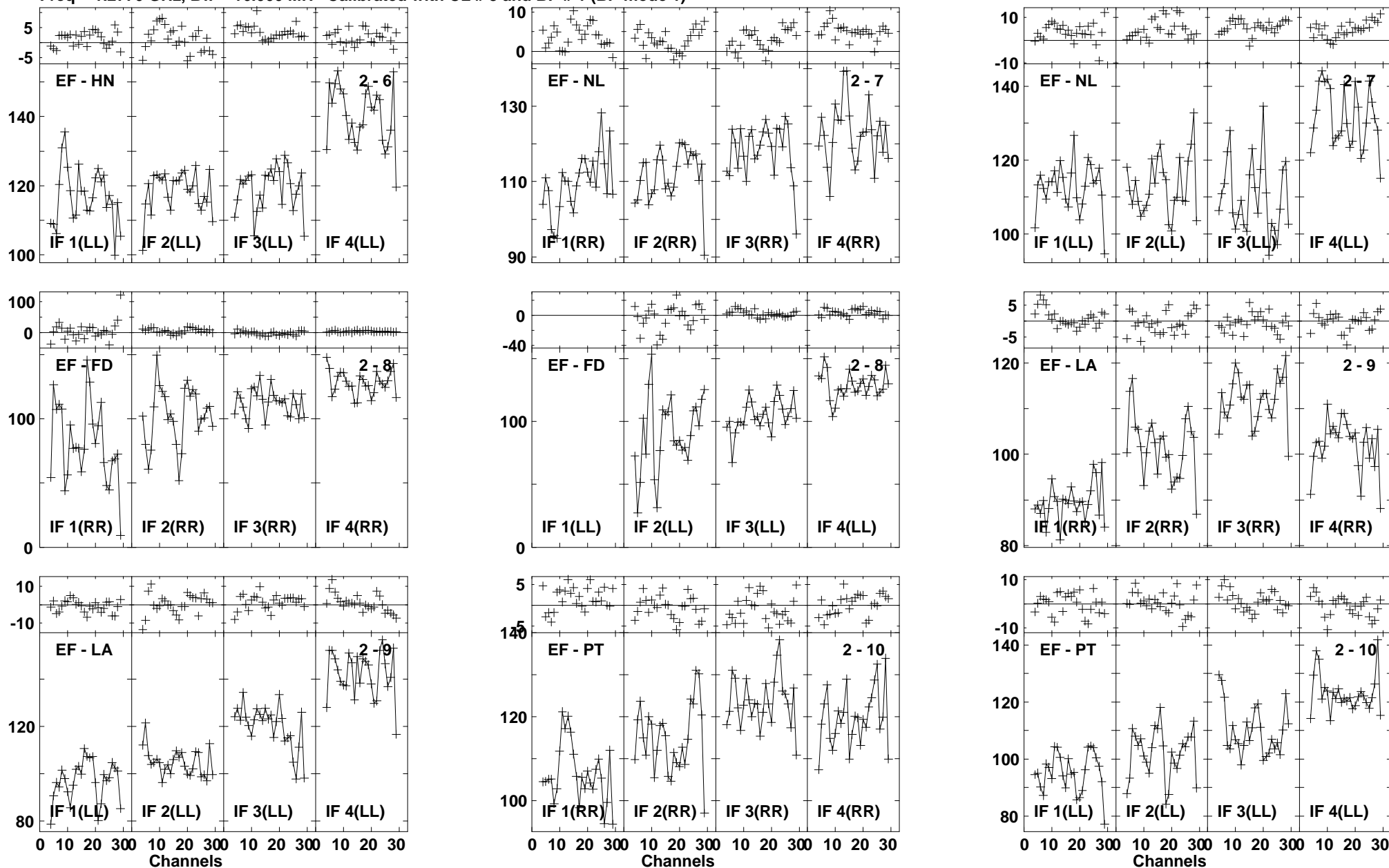

Lower frame: Milli Ampl Jy Top frame: Phas deg
Vector averaged cross-power spectrum Baseline: EF (02) - HN (06)
Timerange: 00/21:05:28 to 00/21:07:56

Plot file version 690 created 03-MAR-2016 01:13:54

J1545+5400 GN002C 1.UVDATA.1

Freq = 1.2770 GHz, Bw = 16.000 MH Calibrated with CL # 3 and BP # 1 (BP mode 1)

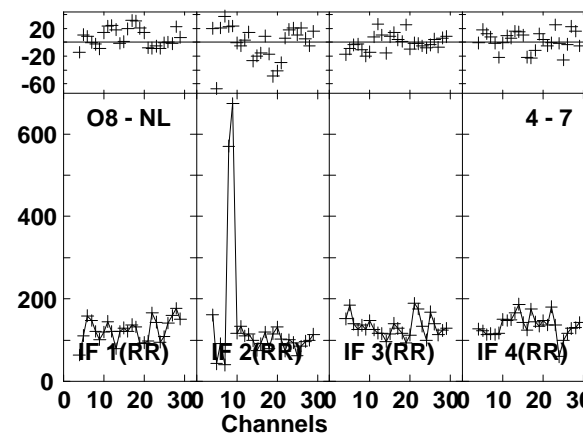
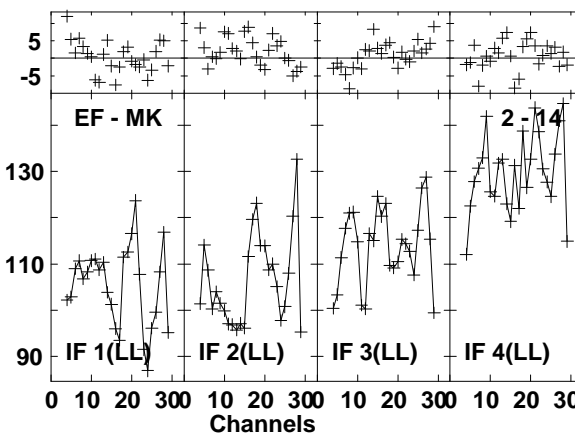
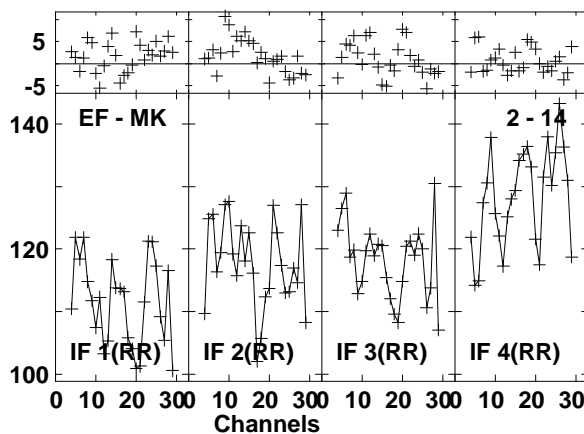
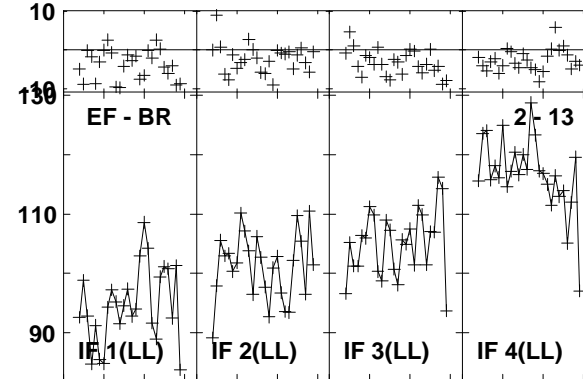
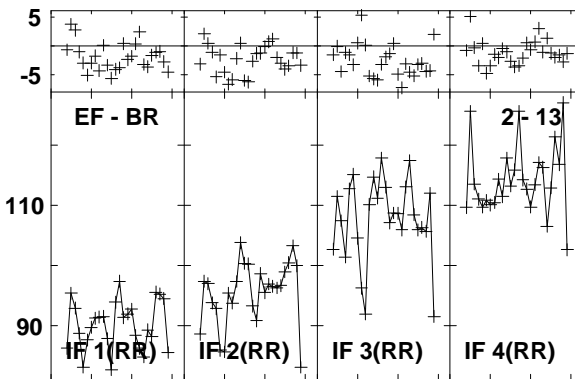
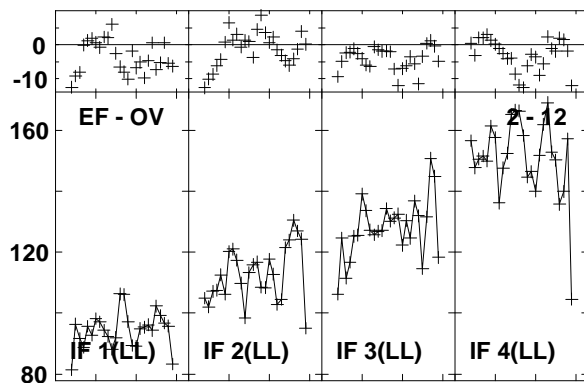
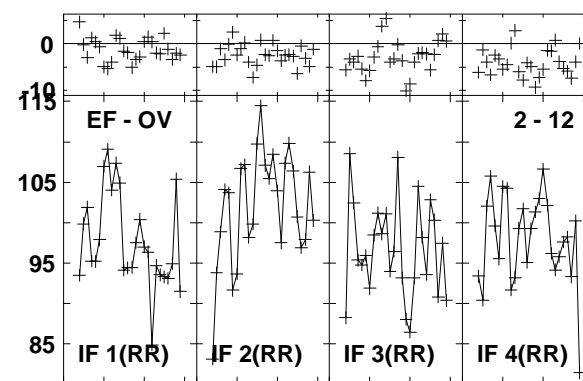
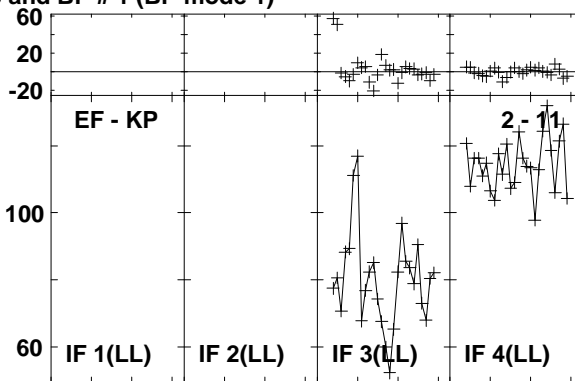
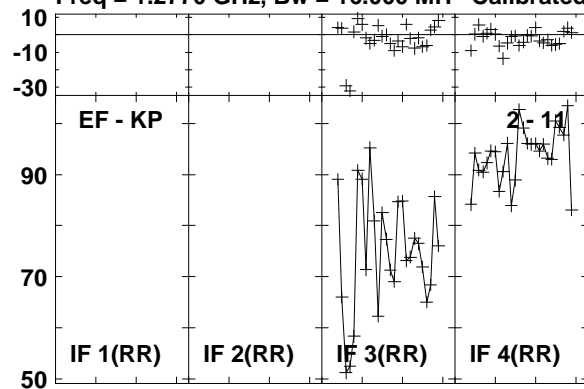

Lower frame: Milli Ampl Jy Top frame: Phas deg
Vector averaged cross-power spectrum Baseline: EF (02) - KP (11)
Timerange: 00/21:05:28 to 00/21:07:56

Plot file version 691 created 03-MAR-2016 01:13:55

J1545+5400 GN002C 1.UVDATA.1

Freq = 1.2770 GHz, Bw = 16.000 MH Calibrated with CL # 3 and BP # 1 (BP mode 1)

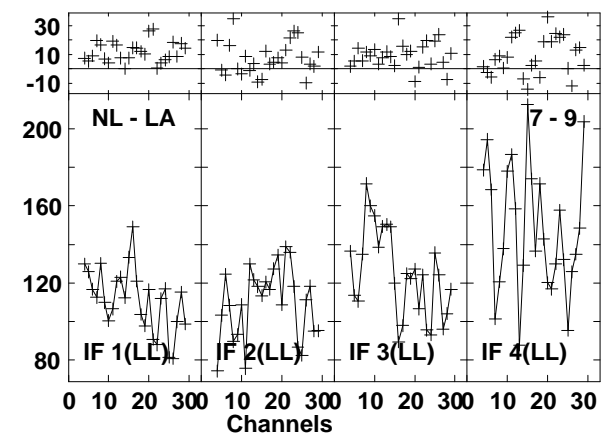
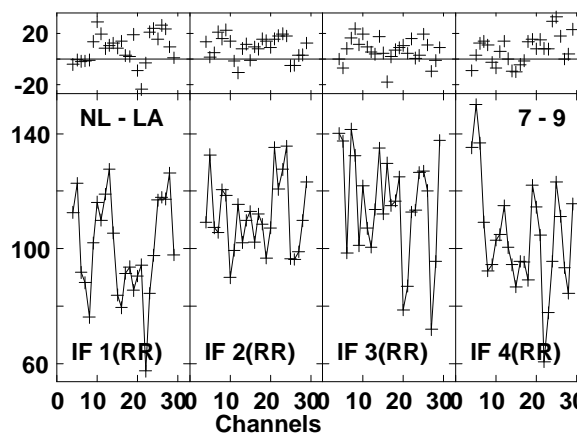
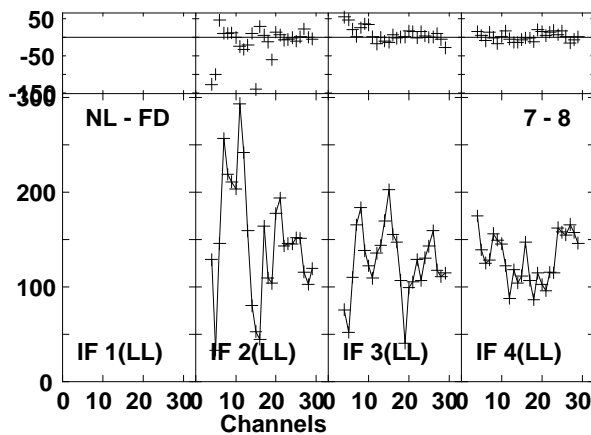
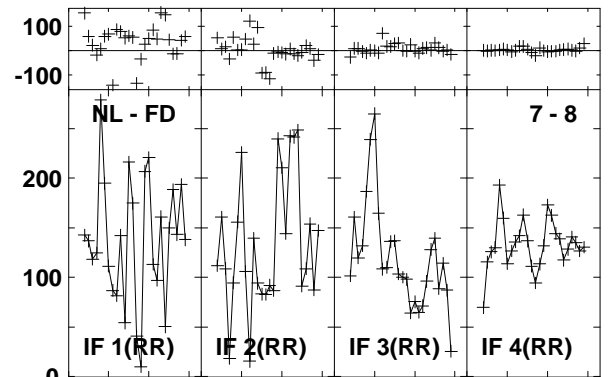
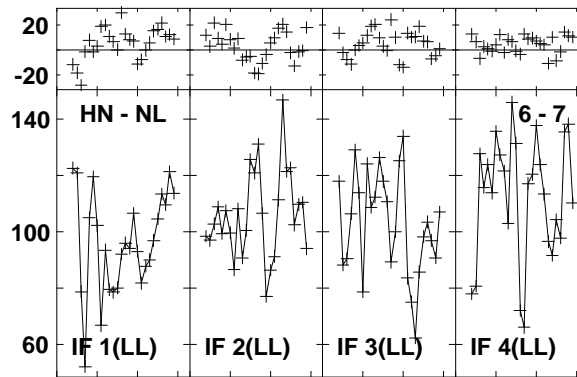
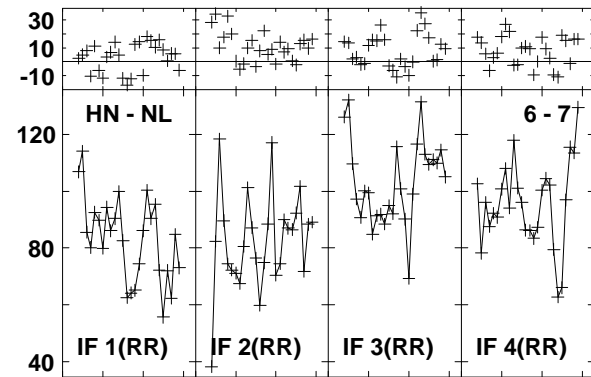
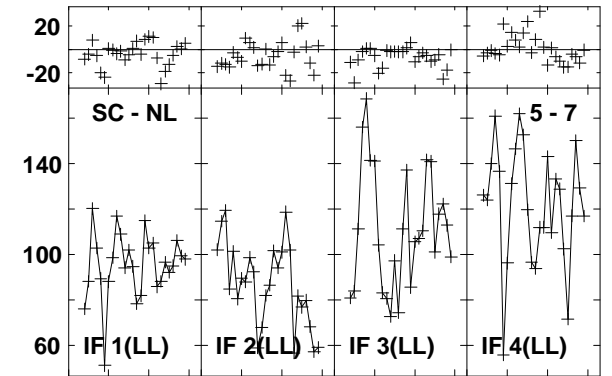
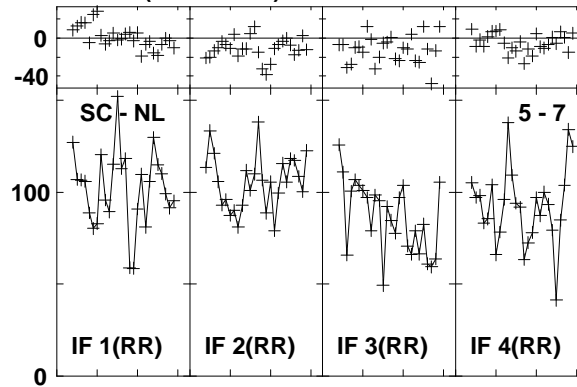
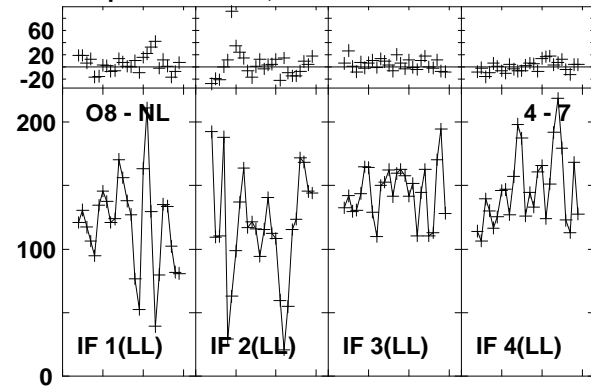

Lower frame: Milli Ampl Jy Top frame: Phas deg
Vector averaged cross-power spectrum Baseline: O8 (04) - NL (07)
Timerange: 00/21:05:28 to 00/21:07:56

Plot file version 692 created 03-MAR-2016 01:13:55

J1545+5400 GN002C 1.UVDATA.1

Freq = 1.2770 GHz, Bw = 16.000 MH Calibrated with CL # 3 and BP # 1 (BP mode 1)

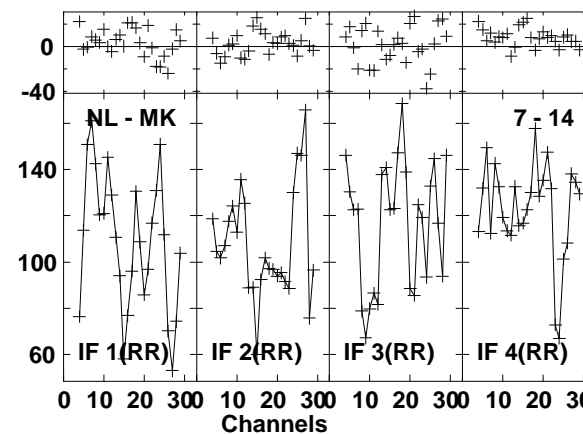
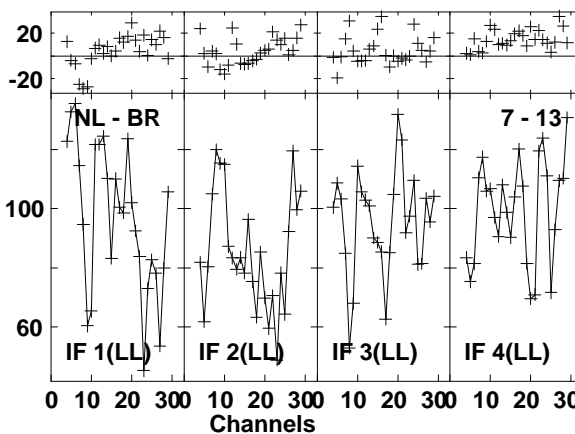
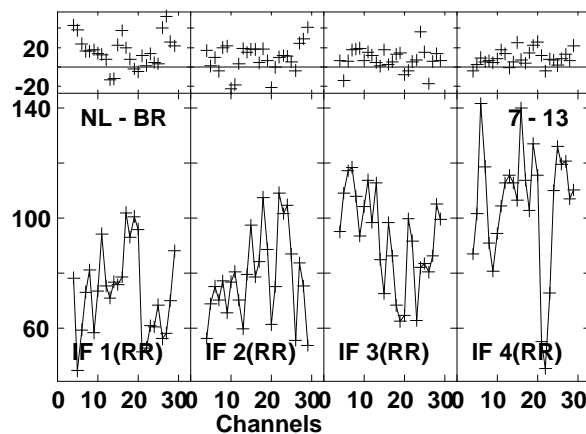
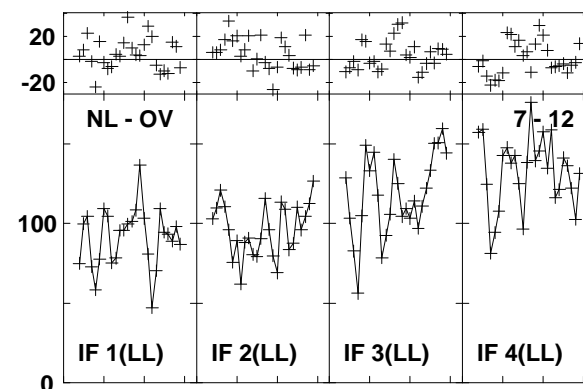
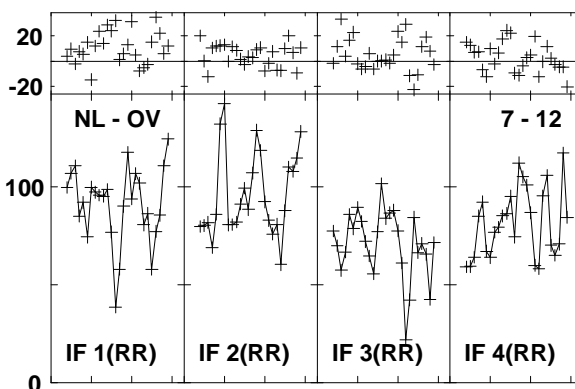
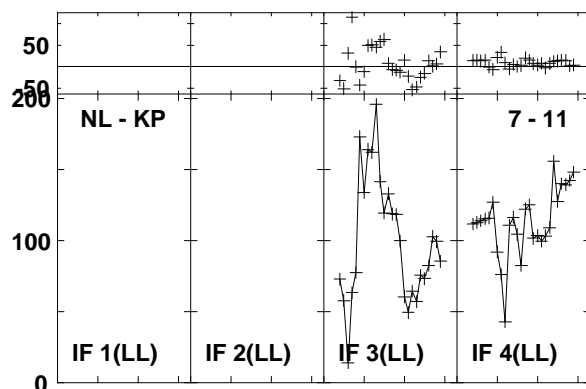
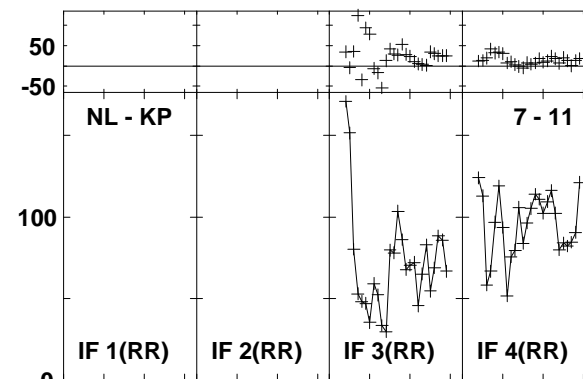
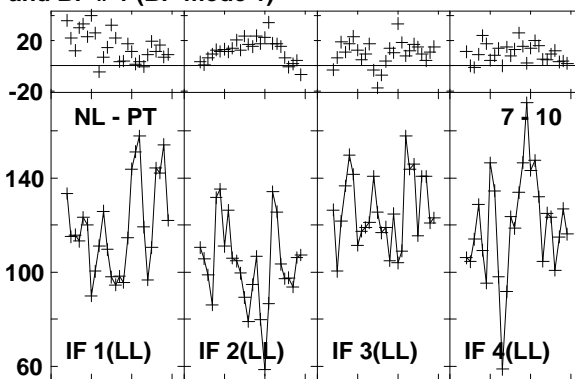
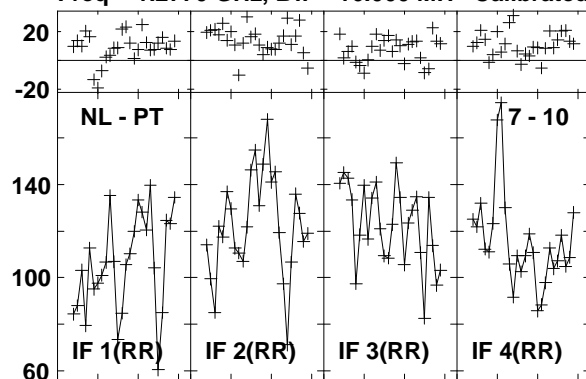

Lower frame: Milli Ampl Jy Top frame: Phas deg
Vector averaged cross-power spectrum Baseline: NL (07) - PT (10)
Timerange: 00/21:05:28 to 00/21:07:56

Plot file version 693 created 03-MAR-2016 01:13:55
J1545+5400 GN002C 1.UVDATA.1
Freq = 1.2770 GHz, Bw = 16.000 MH Calibrated with CL # 3 and BP # 1 (BP mode 1)

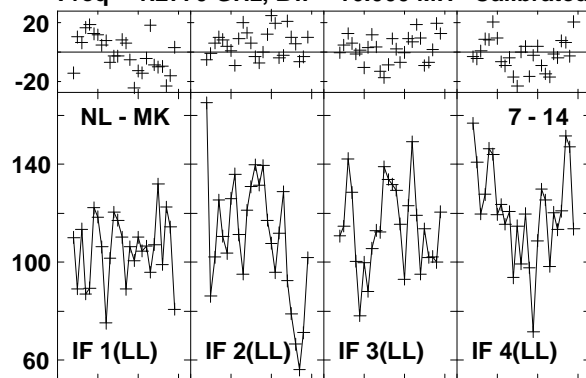

Lower frame: Milli Ampl Jy Top frame: Phas deg
Vector averaged cross-power spectrum Baseline: NL (07) - MK (14)
Timerange: 00/21:05:28 to 00/21:07:56

Plot file version 694 created 03-MAR-2016 01:13:55

4C52 GN002C 1.UVDATA.1

Freq = 1.2770 GHz, Bw = 16.000 MH Calibrated with CL # 3 and BP # 1 (BP mode 1)

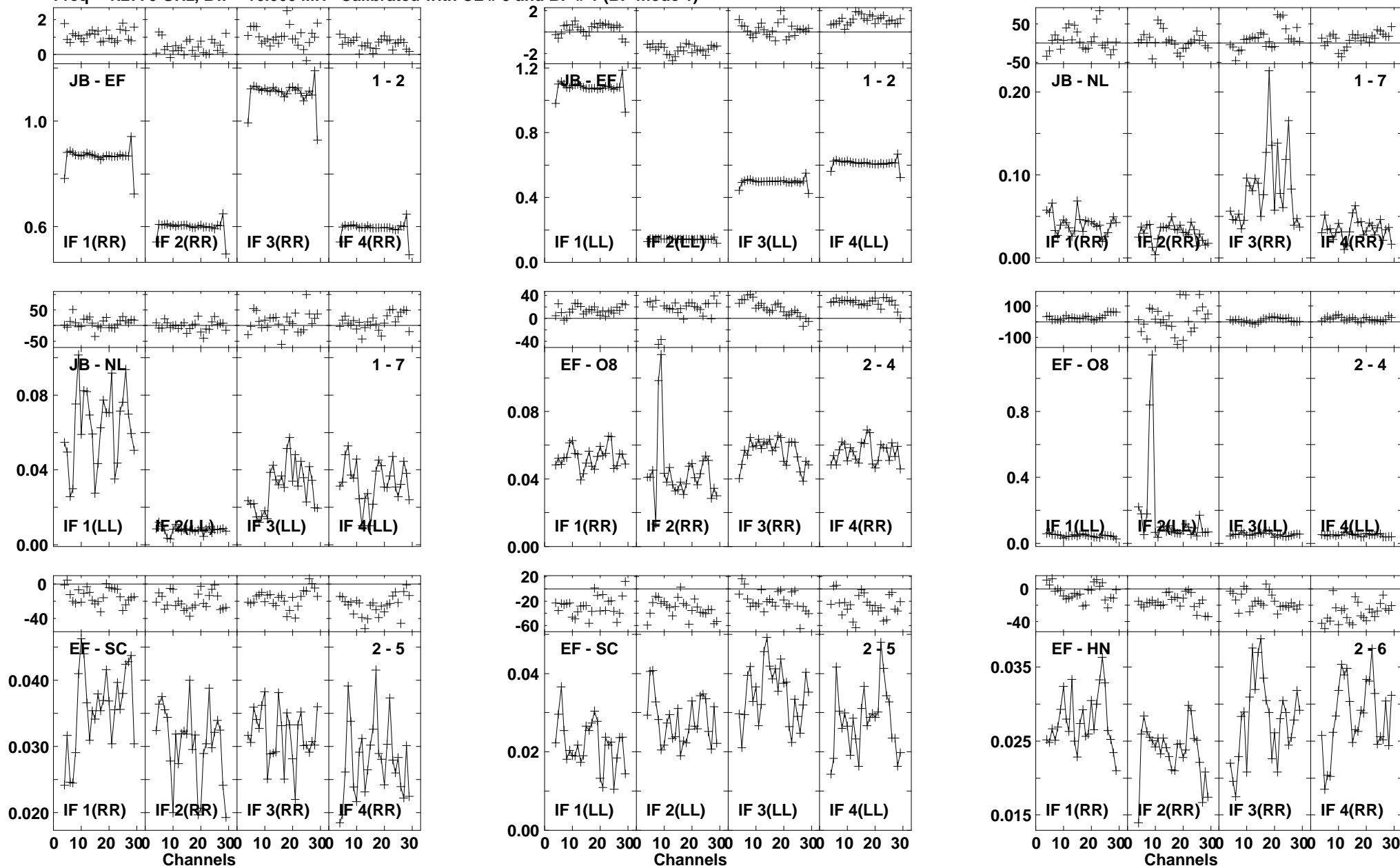

Plot file version 695 created 03-MAR-2016 01:13:55

4C52 GN002C 1.UVDATA.1

Freq = 1.2770 GHz, Bw = 16.000 MH Calibrated with CL # 3 and BP # 1 (BP mode 1)

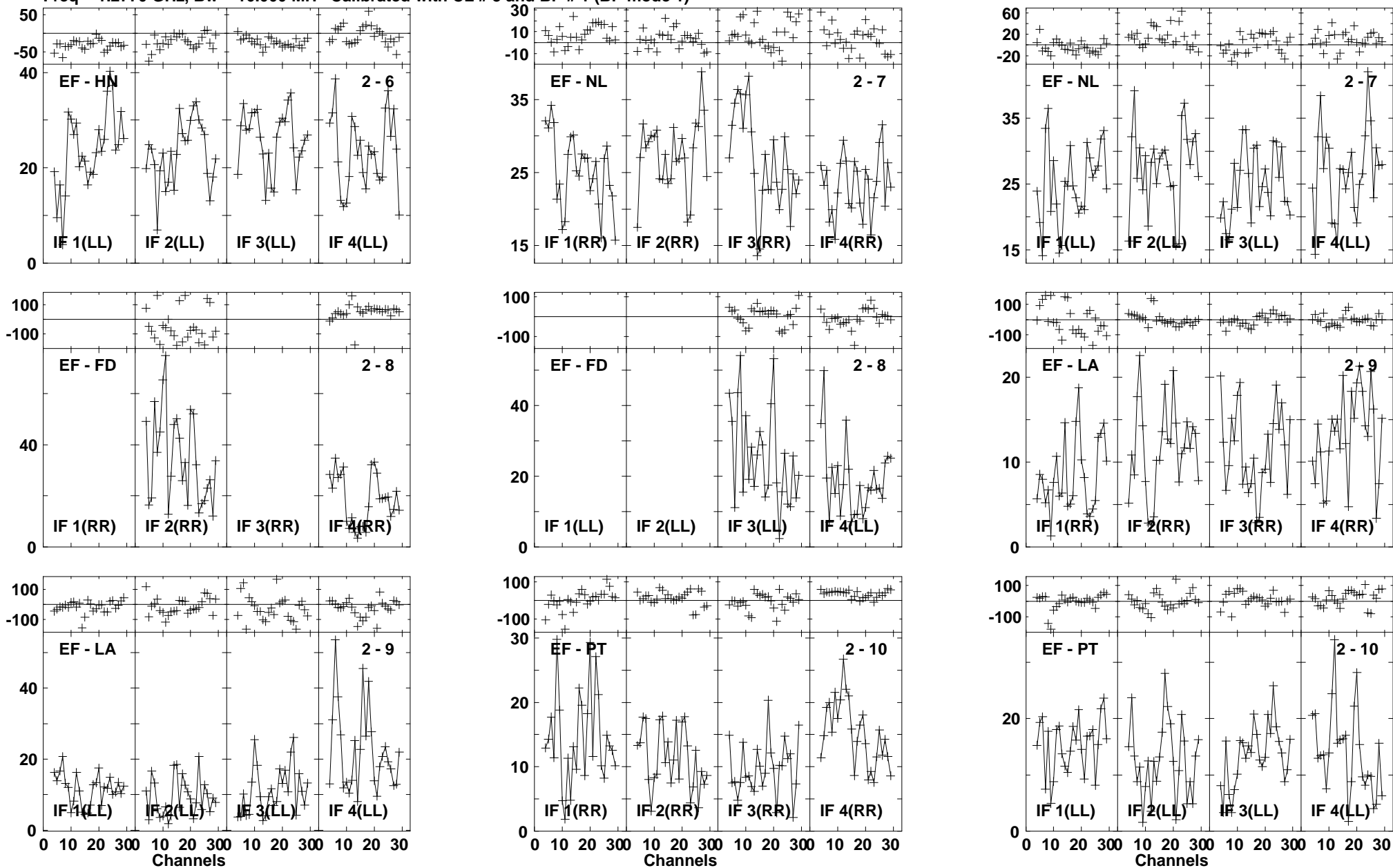

Lower frame: Milli Ampl Jy Top frame: Phas deg
Vector averaged cross-power spectrum Baseline: EF (02) - HN (06)
Timerange: 00/21:08:10 to 00/21:11:26

Plot file version 696 created 03-MAR-2016 01:13:55
 4C52 GN002C 1.UVDATA.1
 Freq = 1.2770 GHz, Bw = 16.000 MH Calibrated with CL # 3 and BP # 1 (BP mode 1)

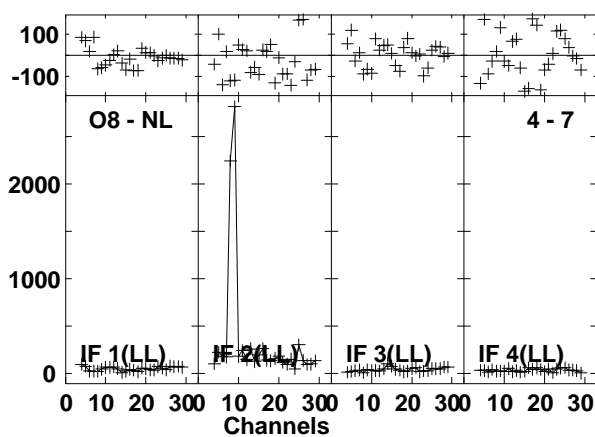
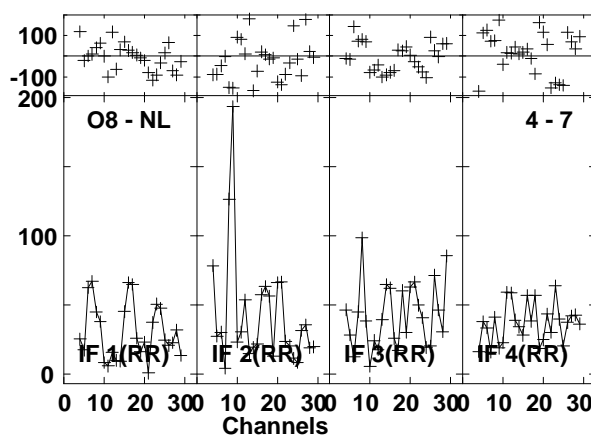
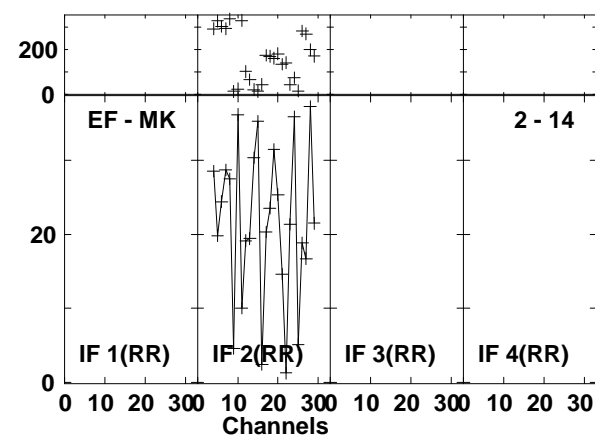
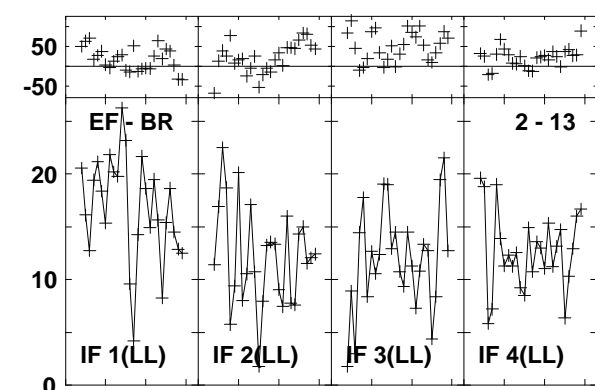
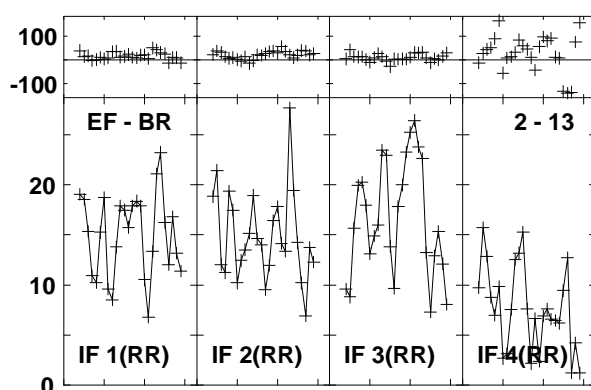
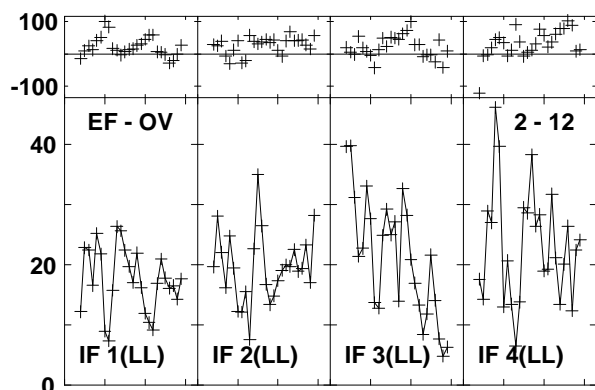
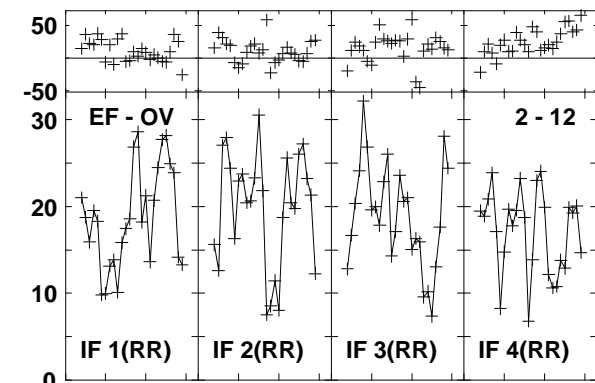
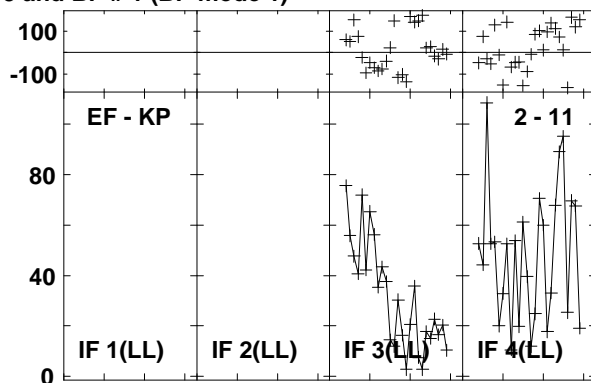
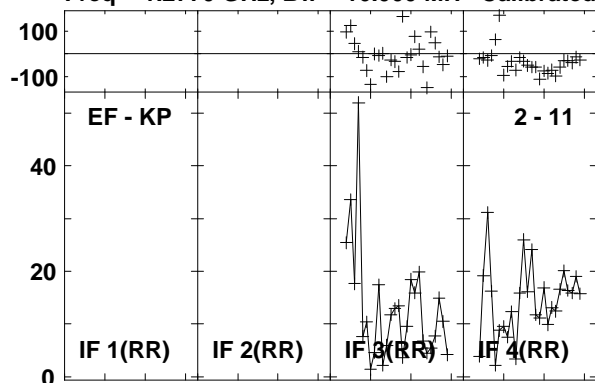

Lower frame: Milli Ampl Jy Top frame: Phas deg
 Vector averaged cross-power spectrum Baseline: EF (02) - KP (11)
 Timerange: 00/21:08:10 to 00/21:11:26

Plot file version 697 created 03-MAR-2016 01:13:56

4C52 GN002C 1.UVDATA.1

Freq = 1.2770 GHz, Bw = 16.000 MH Calibrated with CL # 3 and BP # 1 (BP mode 1)

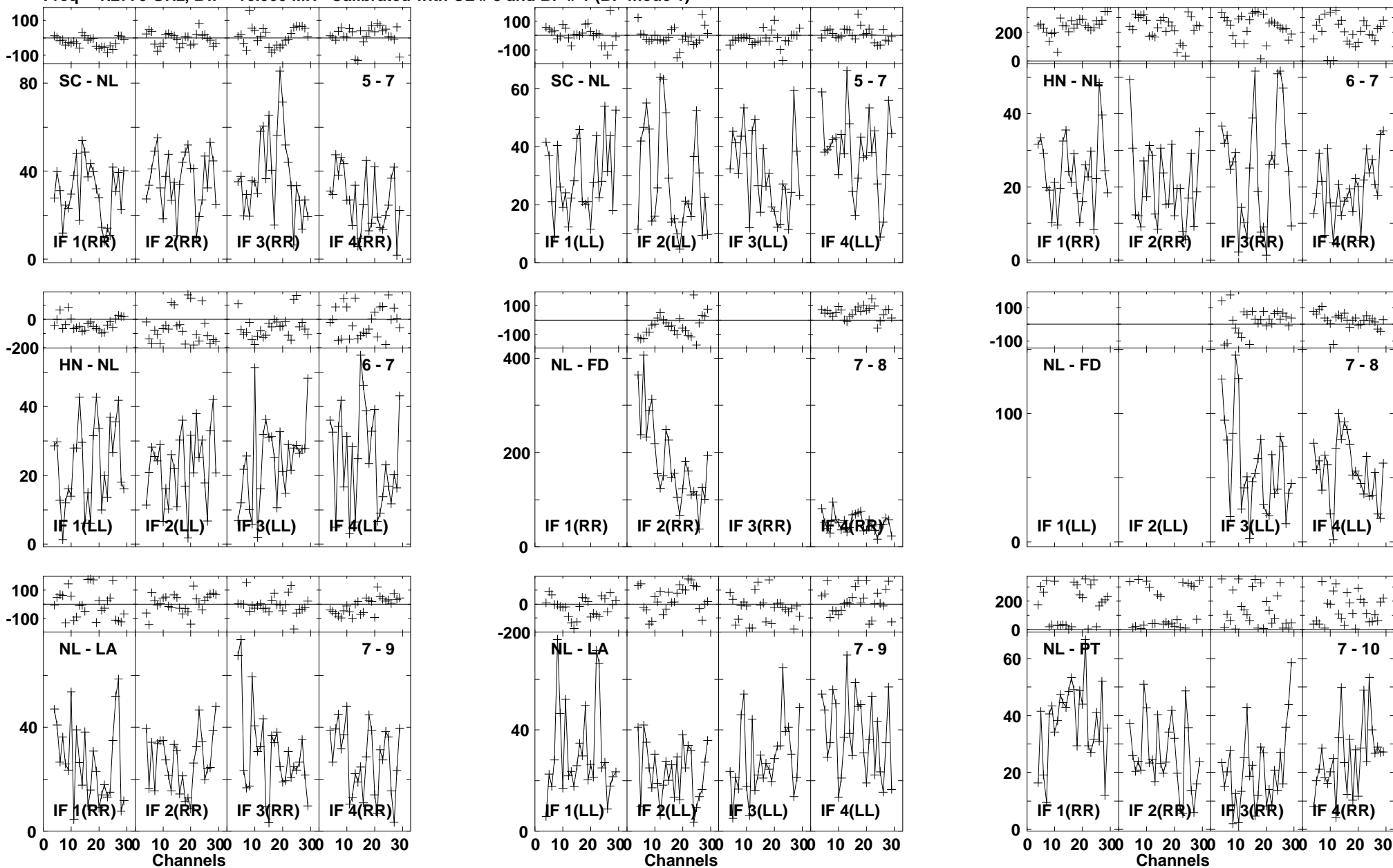

Lower frame: Milli Ampl Jy Top frame: Phas deg
Vector averaged cross-power spectrum Baseline: SC (05) - NL (07)
Timerange: 00/21:08:10 to 00/21:11:26

Plot file version 698 created 03-MAR-2016 01:13:56

4C52 GN002C 1.UVDATA.1

Freq = 1.2770 GHz, Bw = 16.000 MH Calibrated with CL # 3 and BP # 1 (BP mode 1)

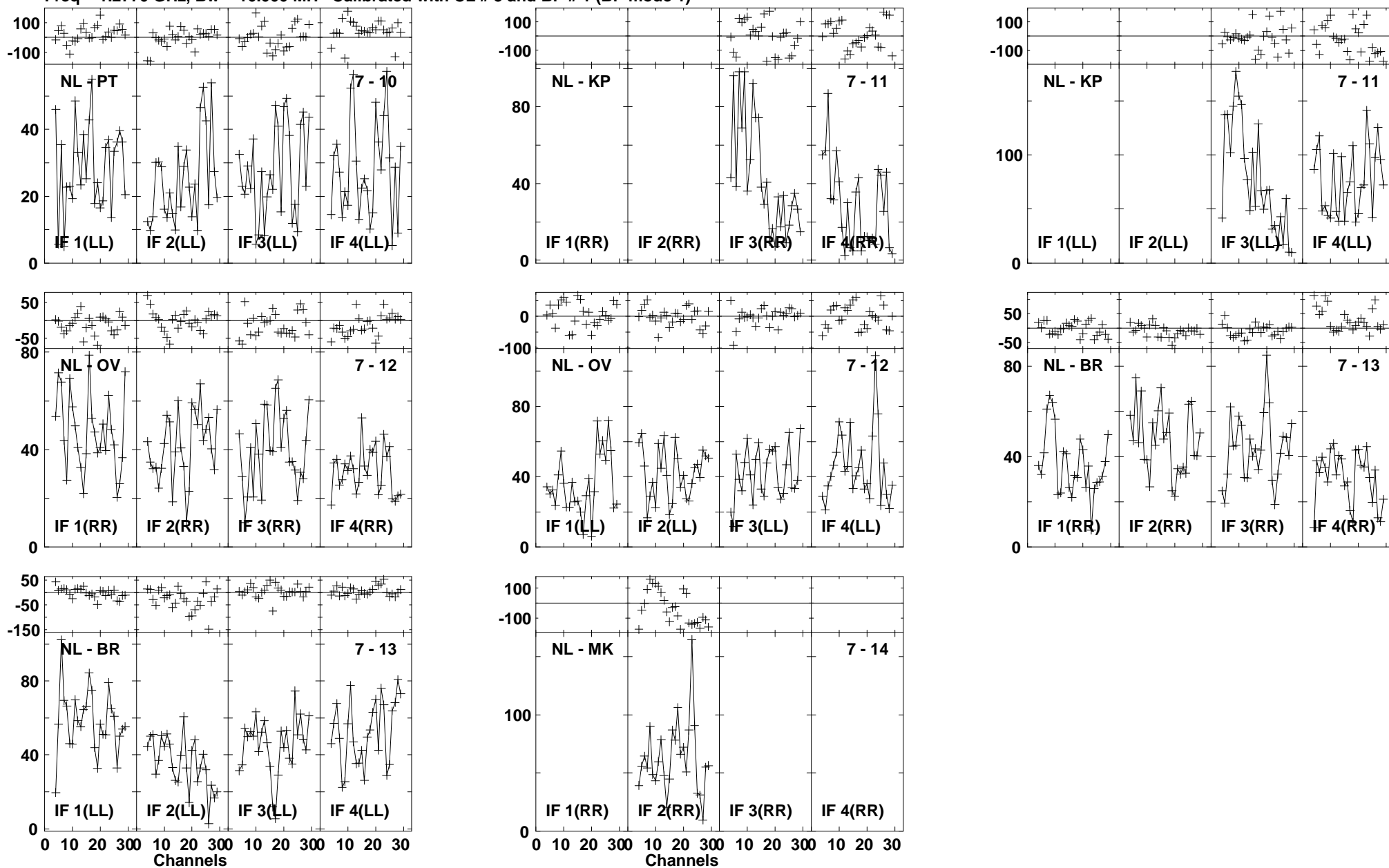

Lower frame: Milli Ampl Jy Top frame: Phas deg
Vector averaged cross-power spectrum Baseline: NL (07) - PT (10)
Timerange: 00/21:08:10 to 00/21:11:26

Plot file version 699 created 03-MAR-2016 01:13:56
 J1545+5400 GN002C 1.UVDATA.1
 Freq = 1.2770 GHz, Bw = 16.000 MH Calibrated with CL # 3 and BP # 1 (BP mode 1)

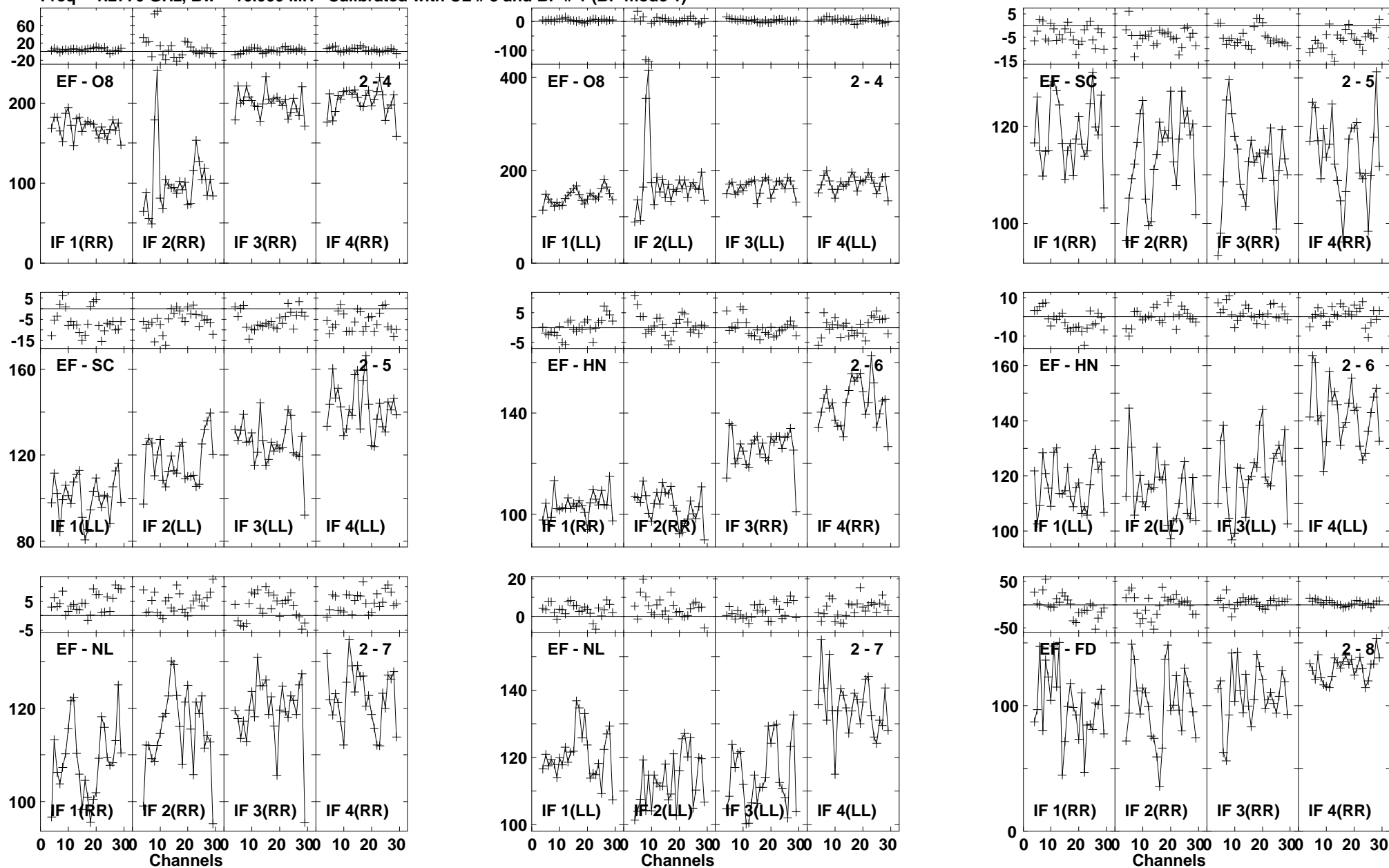

Lower frame: Milli Ampl Jy Top frame: Phas deg
 Vector averaged cross-power spectrum Baseline: EF (02) - O8 (04)
 Timerange: 00/21:12:18 to 00/21:13:46

Plot file version 700 created 03-MAR-2016 01:13:56
 J1545+5400 GN002C 1.UVDATA.1
 Freq = 1.2770 GHz, Bw = 16.000 MH Calibrated with CL # 3 and BP # 1 (BP mode 1)

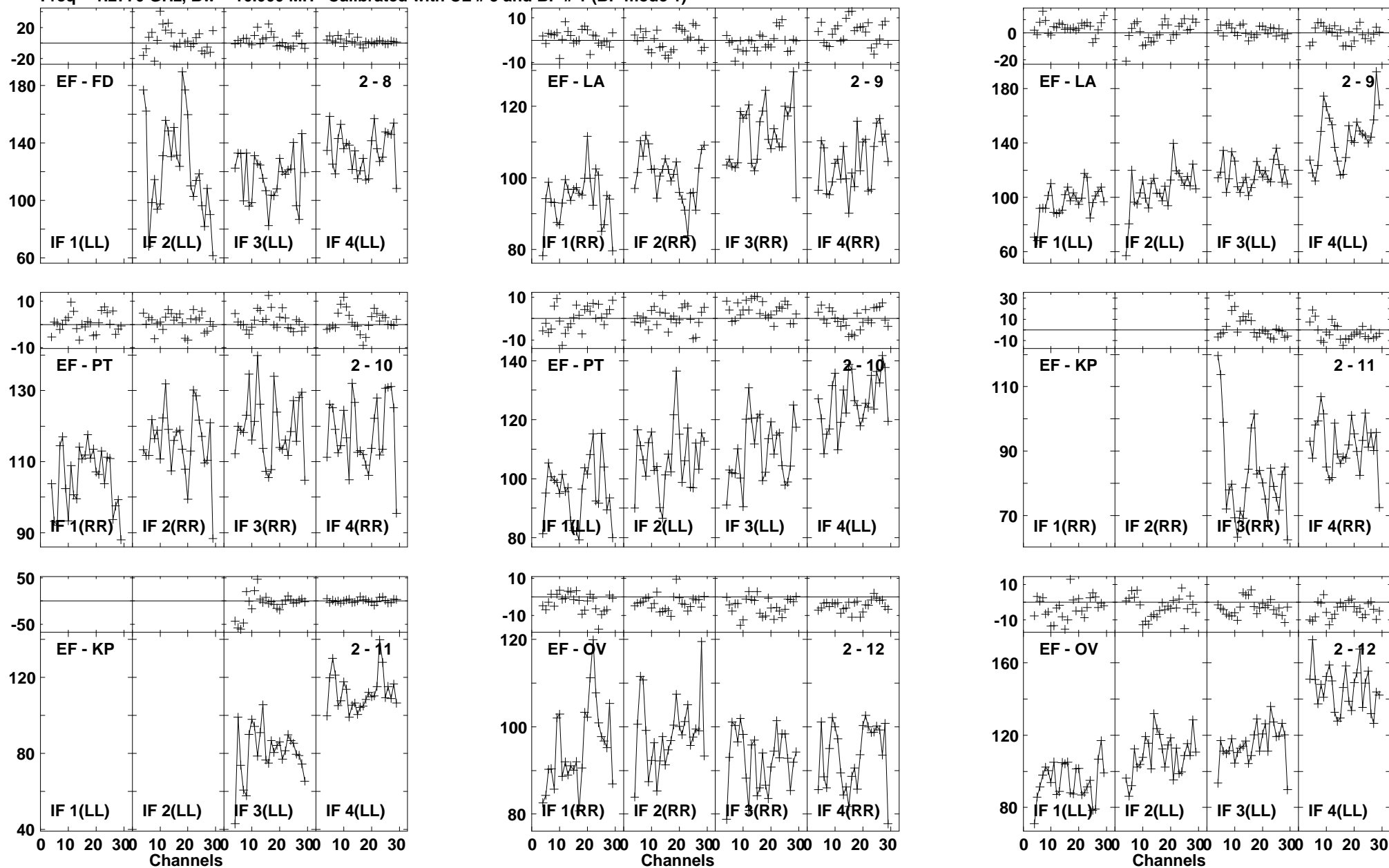

Lower frame: Milli Ampl Jy Top frame: Phas deg
 Vector averaged cross-power spectrum Baseline: EF (02) - FD (08)
 Timerange: 00/21:12:18 to 00/21:13:46

Plot file version 701 created 03-MAR-2016 01:13:57

J1545+5400 GN002C 1.UVDATA.1

Freq = 1.2770 GHz, Bw = 16.000 MH Calibrated with CL # 3 and BP # 1 (BP mode 1)

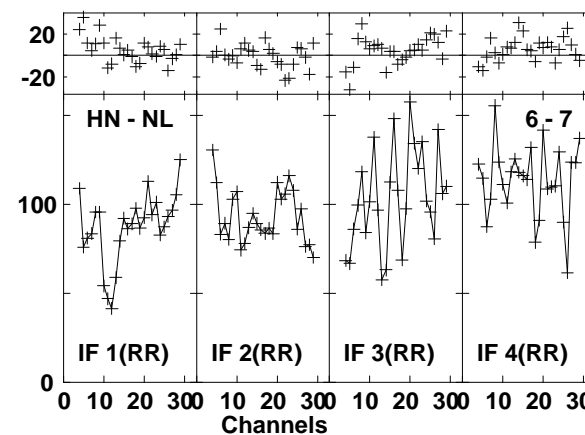
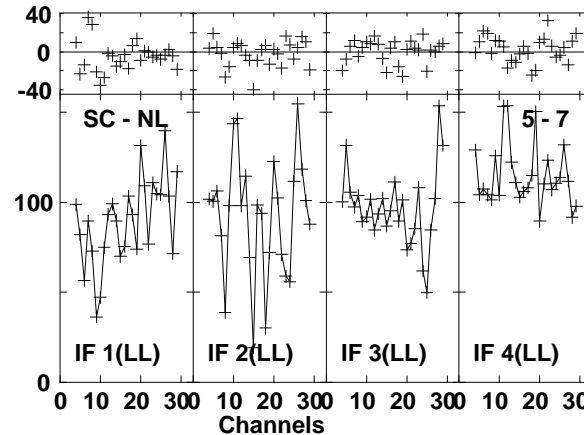
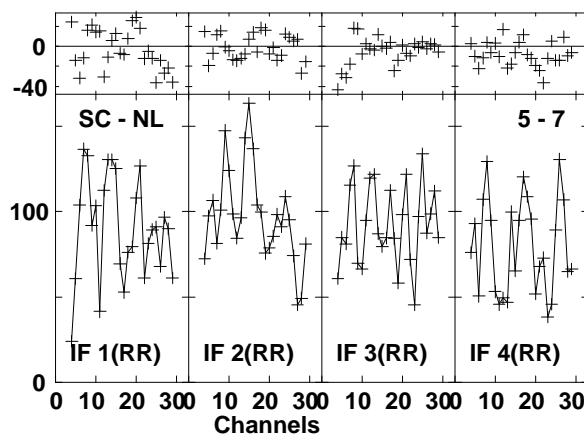
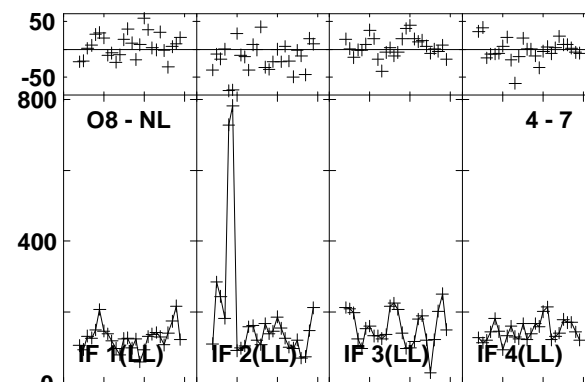
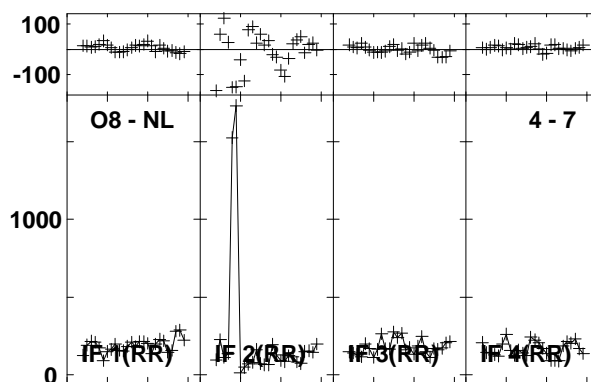
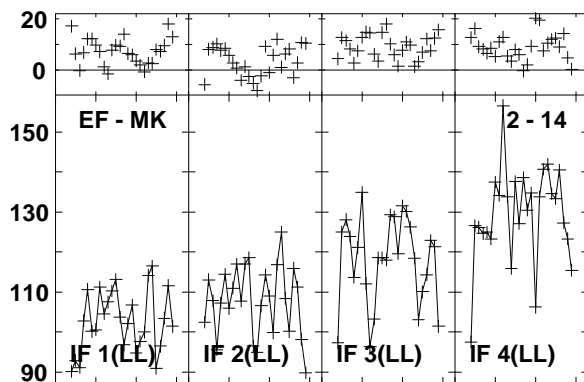
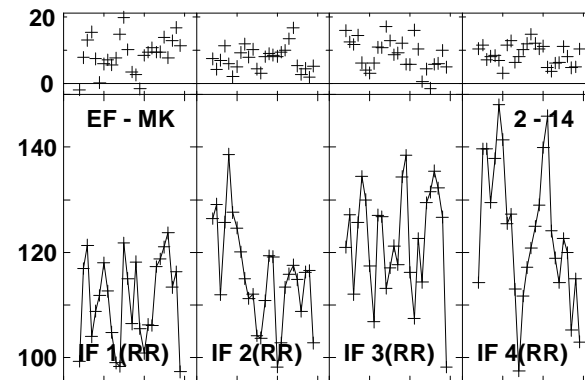
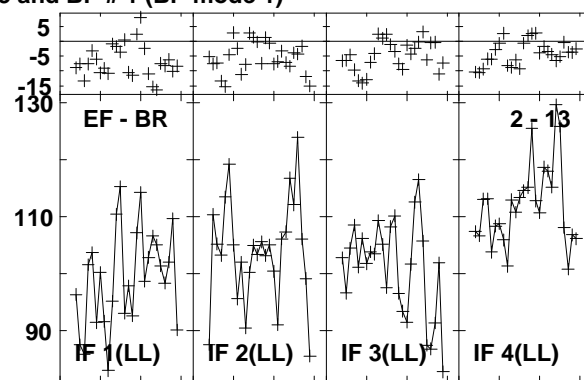
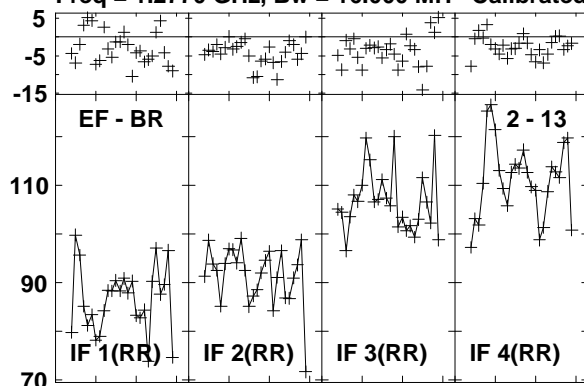

Lower frame: Milli Ampl Jy Top frame: Phas deg
Vector averaged cross-power spectrum Baseline: EF (02) - BR (13)
Timerange: 00/21:12:18 to 00/21:13:46

Plot file version 702 created 03-MAR-2016 01:13:57

J1545+5400 GN002C 1.UVDATA.1

Freq = 1.2770 GHz, Bw = 16.000 MH Calibrated with CL # 3 and BP # 1 (BP mode 1)

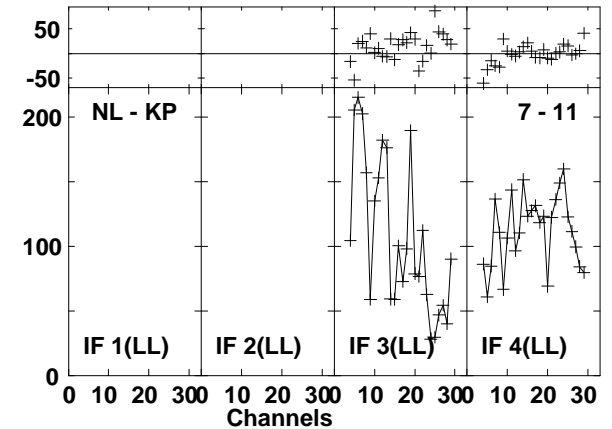
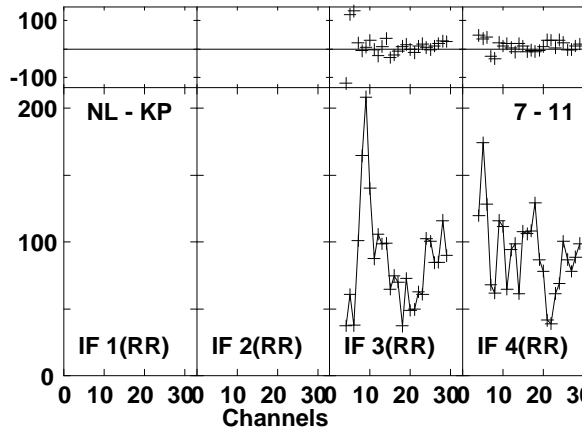
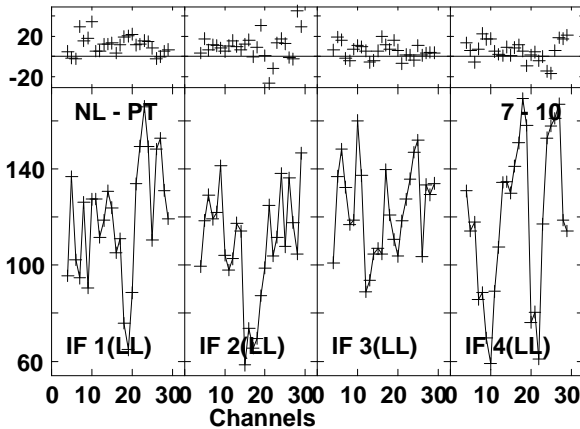
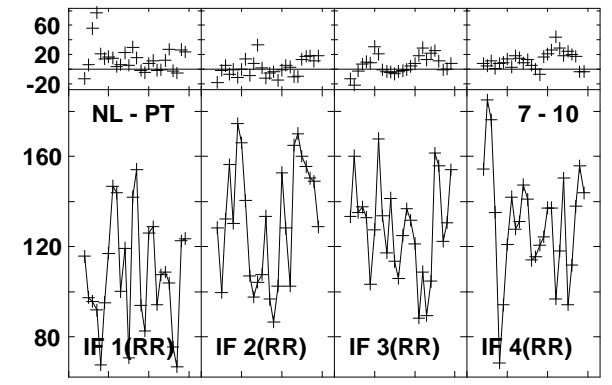
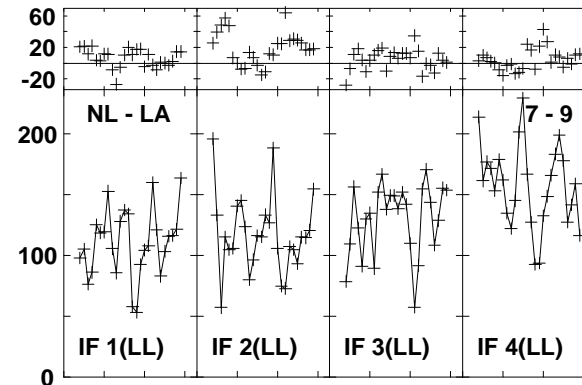
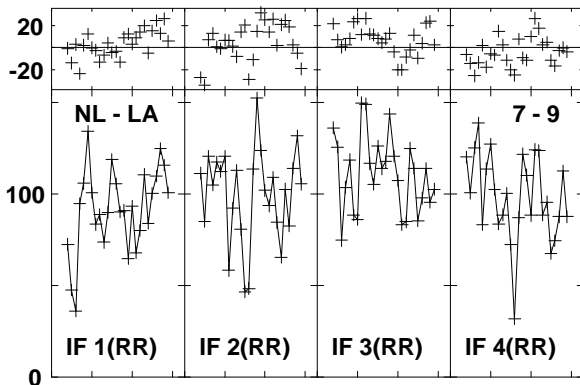
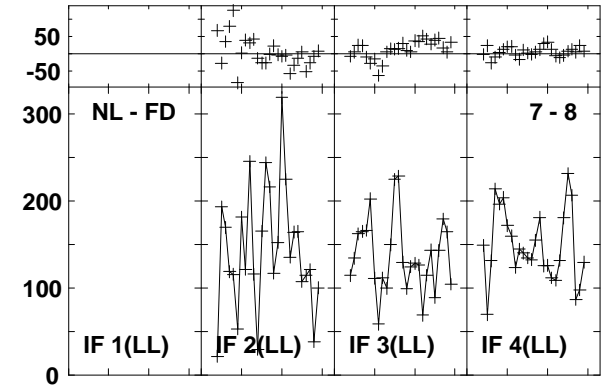
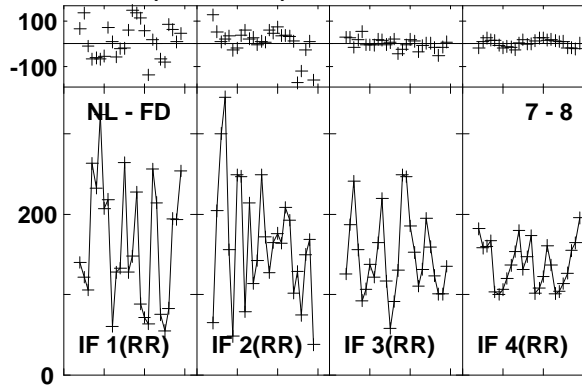
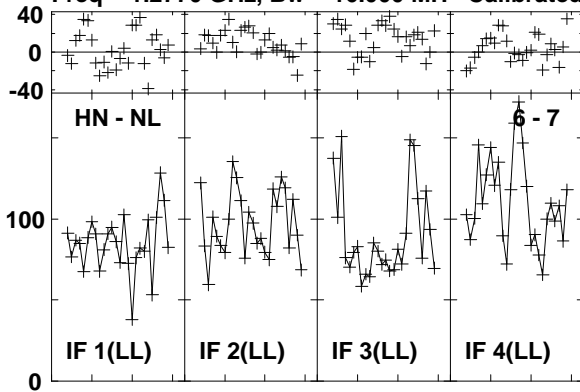

Lower frame: Milli Ampl Jy Top frame: Phas deg
Vector averaged cross-power spectrum Baseline: HN (06) - NL (07)
Timerange: 00/21:12:18 to 00/21:13:46

Plot file version 703 created 03-MAR-2016 01:13:57
 J1545+5400 GN002C 1.UVDATA.1
 Freq = 1.2770 GHz, Bw = 16.000 MH Calibrated with CL # 3 and BP # 1 (BP mode 1)

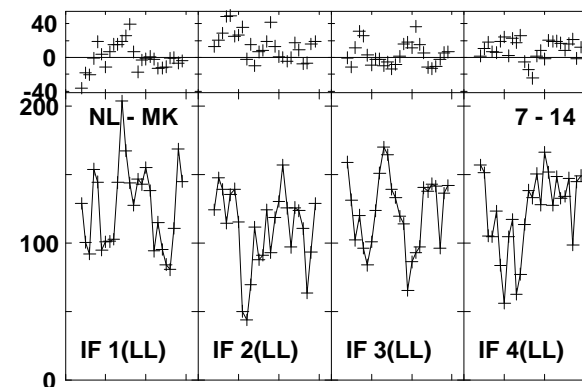
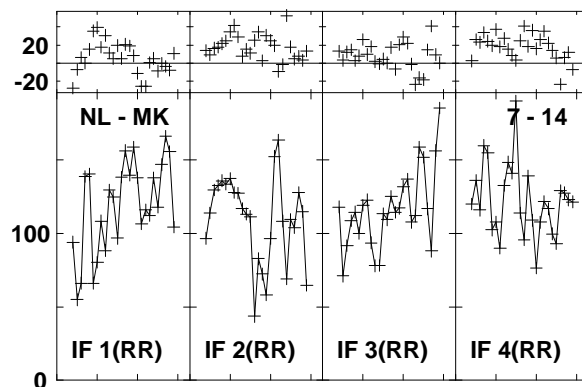
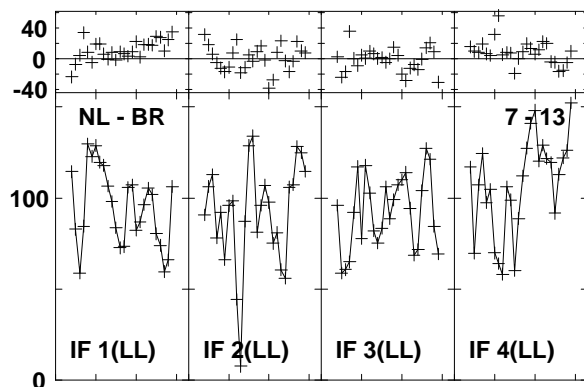
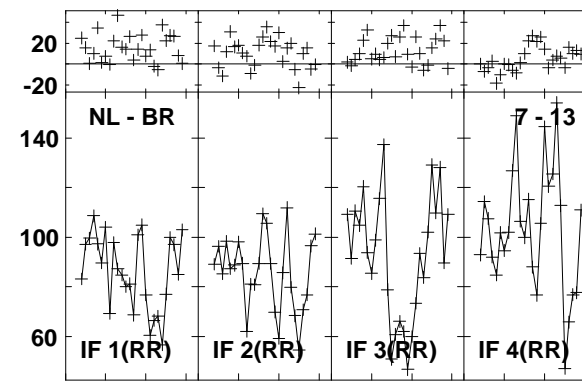
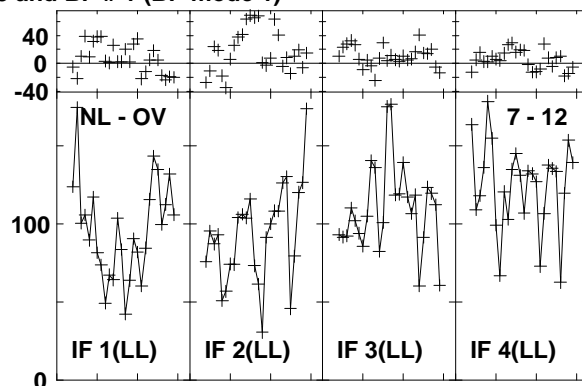
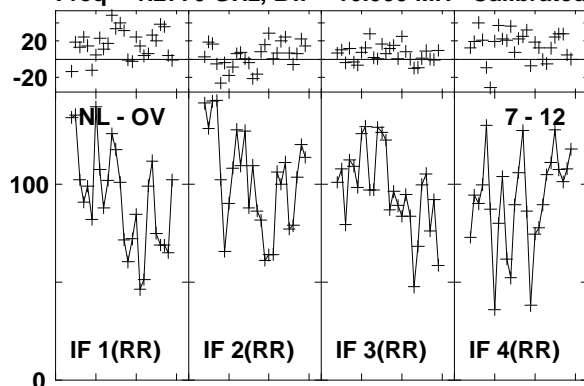

Lower frame: Milli Ampl Jy Top frame: Phas deg
 Vector averaged cross-power spectrum Baseline: NL (07) - OV (12)
 Timerange: 00/21:12:18 to 00/21:13:46

Plot file version 704 created 03-MAR-2016 01:13:57

4C52 GN002C 1.UVDATA.1

Freq = 1.2770 GHz, Bw = 16.000 MH Calibrated with CL # 3 and BP # 1 (BP mode 1)

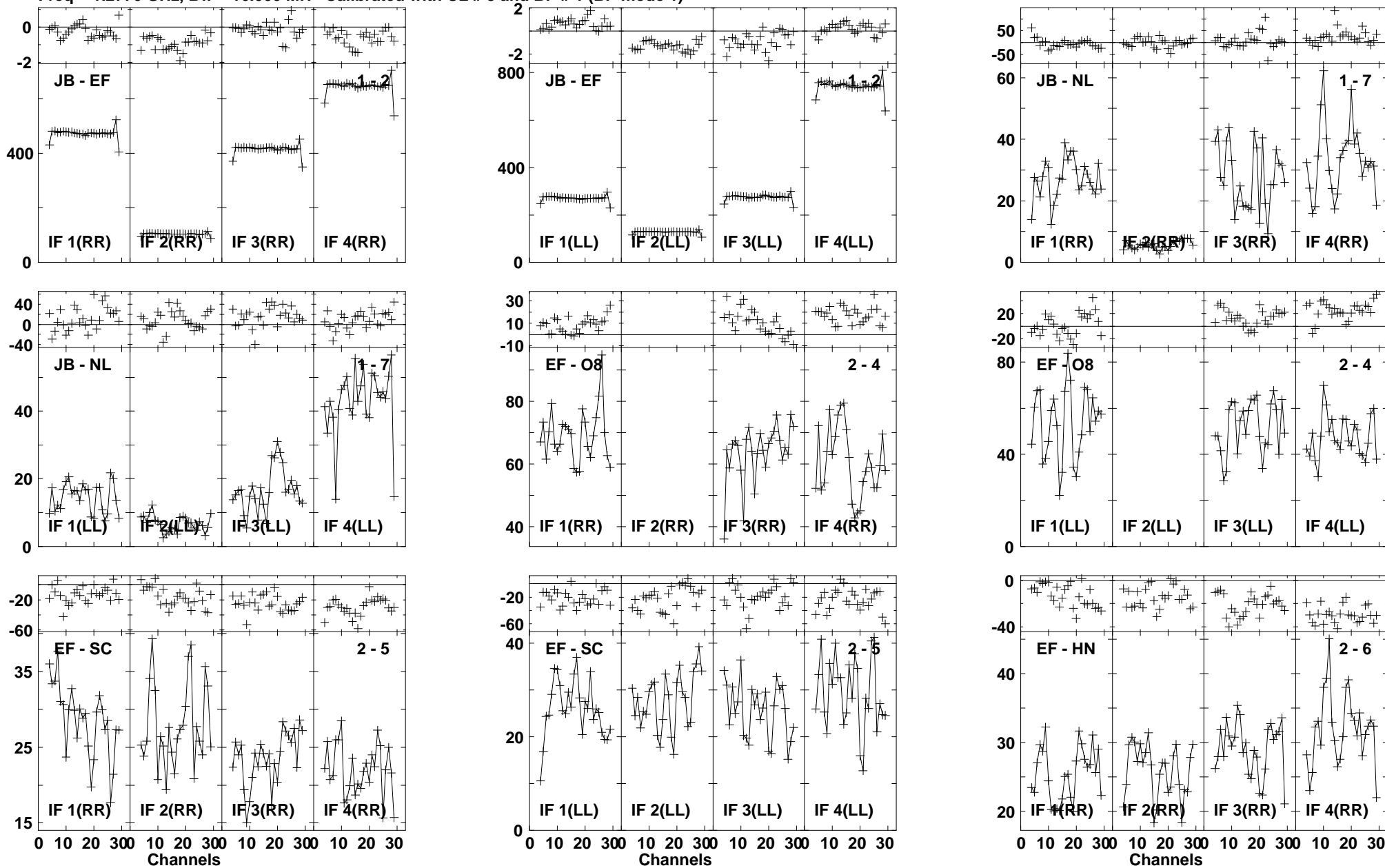

Lower frame: Milli Ampl Jy Top frame: Phas deg
Vector averaged cross-power spectrum Baseline: JB (01) - EF (02)
Timerange: 00/21:13:51 to 00/21:17:05

Plot file version 705 created 03-MAR-2016 01:13:57

4C52 GN002C 1.UVDATA.1

Freq = 1.2770 GHz, Bw = 16.000 MH Calibrated with CL # 3 and BP # 1 (BP mode 1)

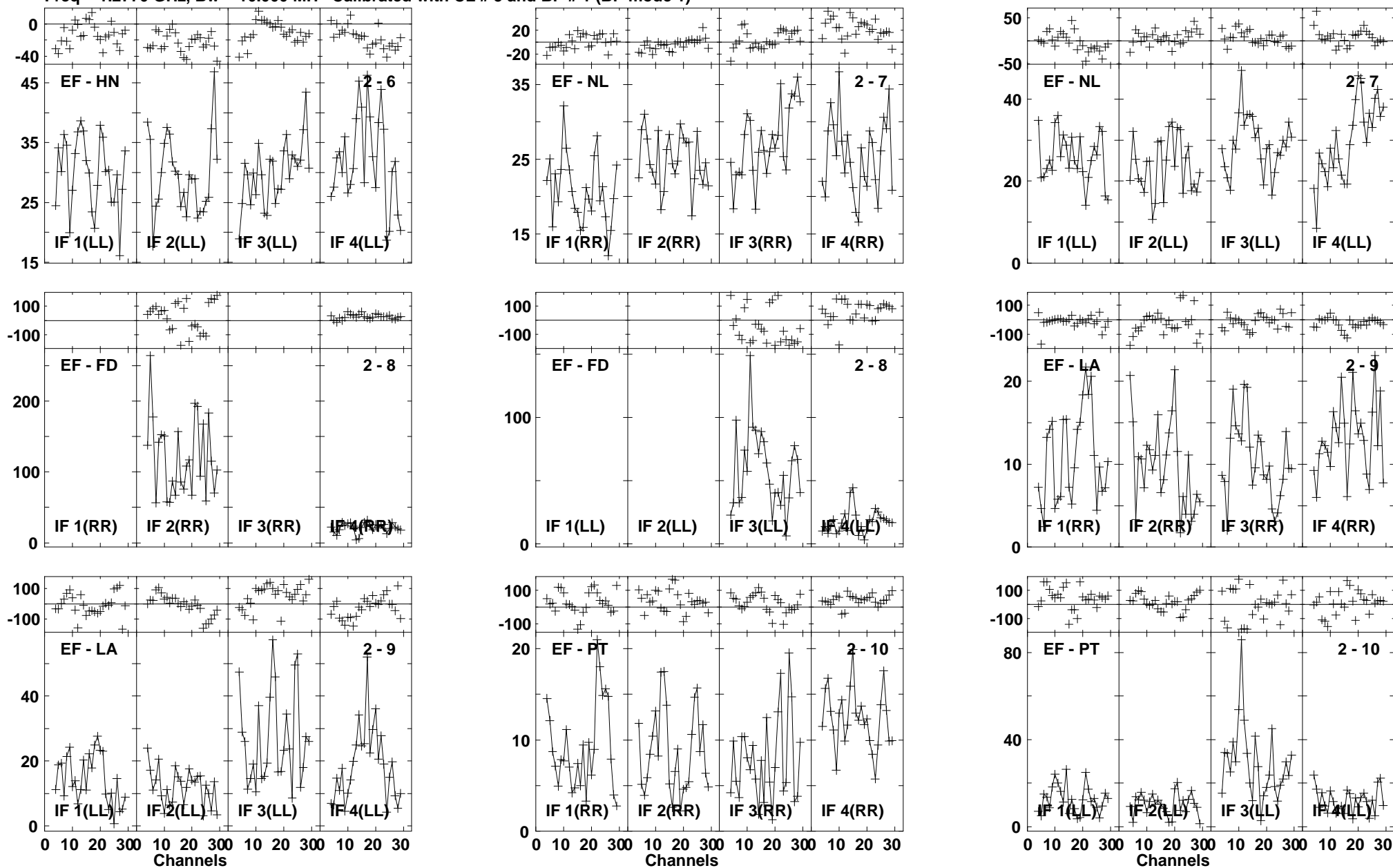

Lower frame: Milli Ampl Jy Top frame: Phas deg
Vector averaged cross-power spectrum Baseline: EF (02) - HN (06)
Timerange: 00/21:13:51 to 00/21:17:05

Plot file version 706 created 03-MAR-2016 01:13:58

4C52 GN002C 1.UVDATA.1

Freq = 1.2770 GHz, Bw = 16.000 MH Calibrated with CL # 3 and BP # 1 (BP mode 1)

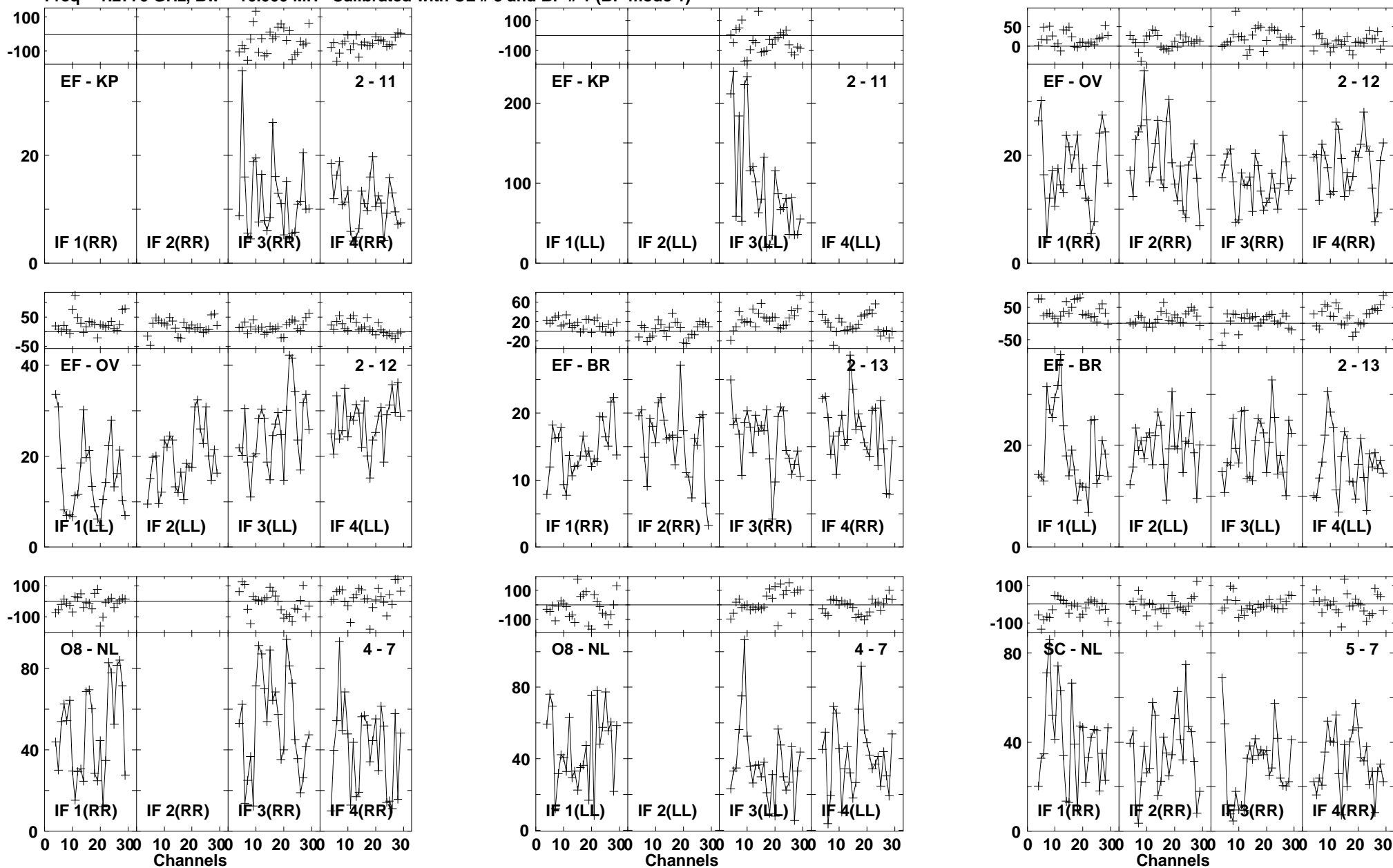

Lower frame: Milli Ampl Jy Top frame: Phas deg
Vector averaged cross-power spectrum Baseline: EF (02) - KP (11)
Timerange: 00/21:13:51 to 00/21:17:05

Plot file version 707 created 03-MAR-2016 01:13:58

4C52 GN002C 1.UVDATA.1

Freq = 1.2770 GHz, Bw = 16.000 MH Calibrated with CL # 3 and BP # 1 (BP mode 1)

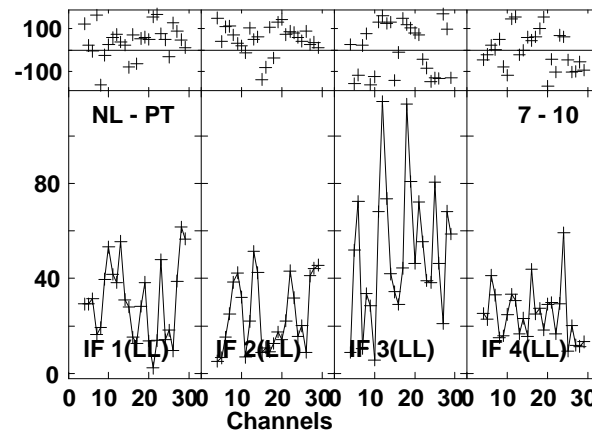
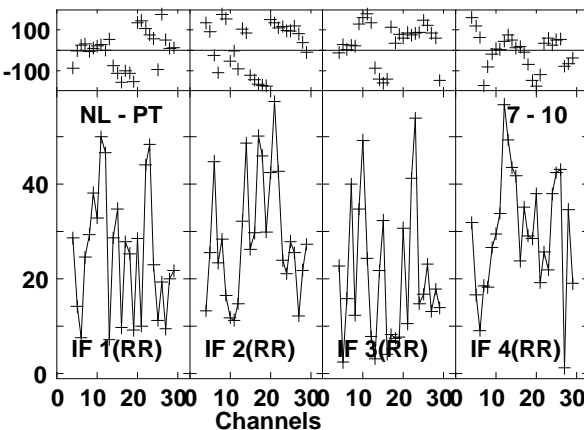
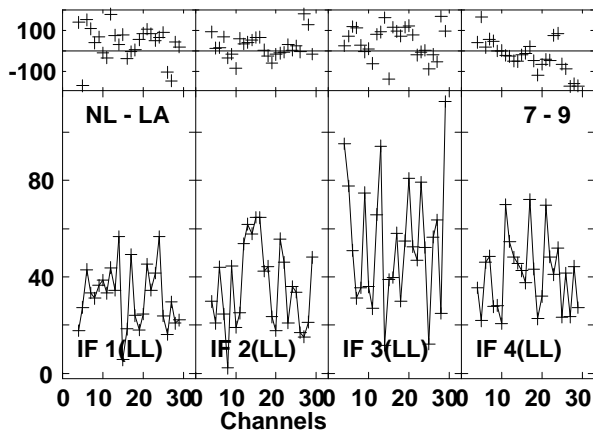
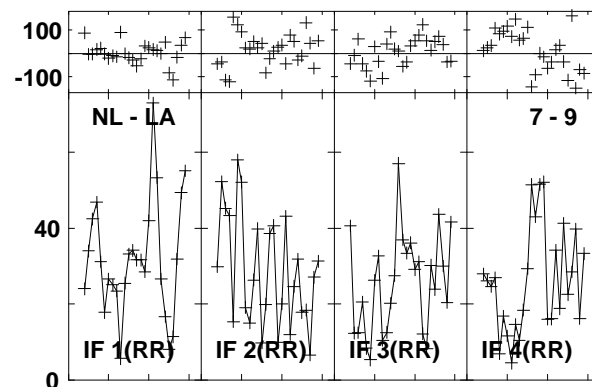
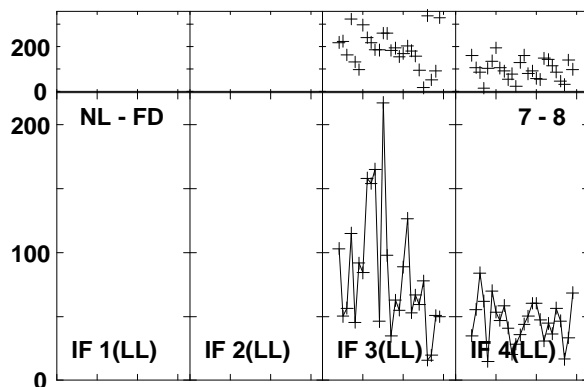
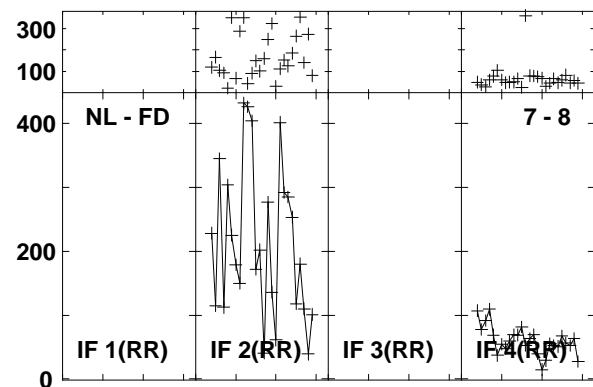
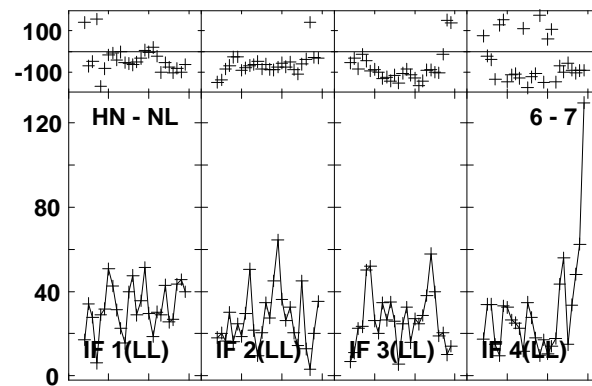
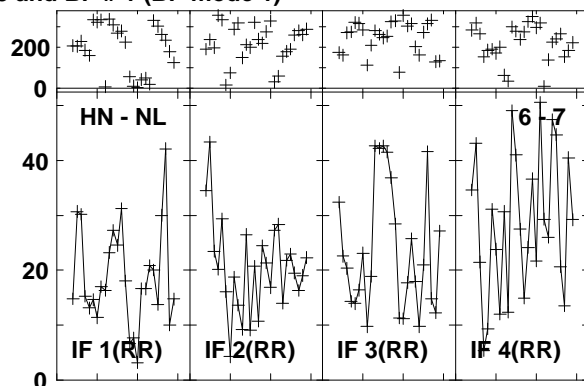
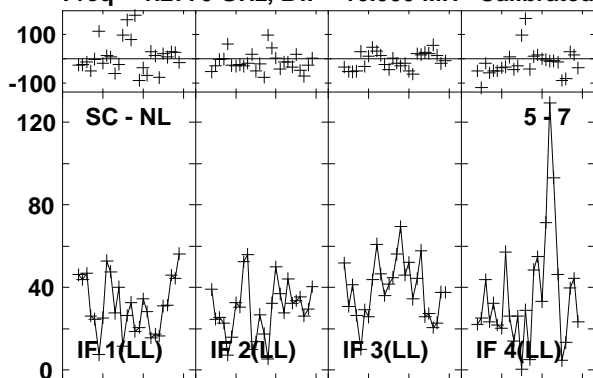

Lower frame: Milli Ampl Jy Top frame: Phas deg

Vector averaged cross-power spectrum Baseline: SC (05) - NL (07)

Timerange: 00/21:13:51 to 00/21:17:05

Plot file version 708 created 03-MAR-2016 01:13:58

4C52 GN002C 1.UVDATA.1

Freq = 1.2770 GHz, Bw = 16.000 MH Calibrated with CL # 3 and BP # 1 (BP mode 1)

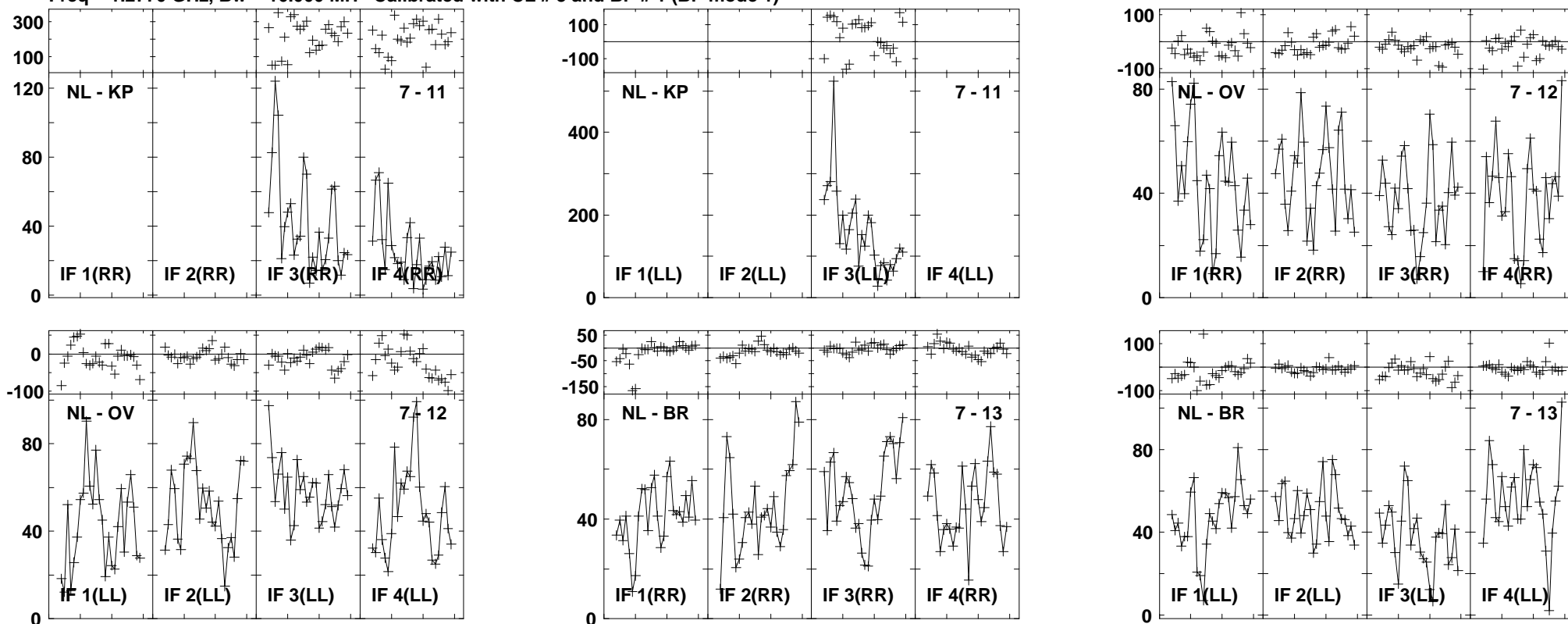

Lower frame: Milli Ampl Jy Top frame: Phas deg
Vector averaged cross-power spectrum Baseline: NL (07) - KP (11)
Timerange: 00/21:13:51 to 00/21:17:05

Plot file version 709 created 03-MAR-2016 01:13:58

J1545+5400 GN002C 1.UVDATA.1

Freq = 1.2770 GHz, Bw = 16.000 MH Calibrated with CL # 3 and BP # 1 (BP mode 1)

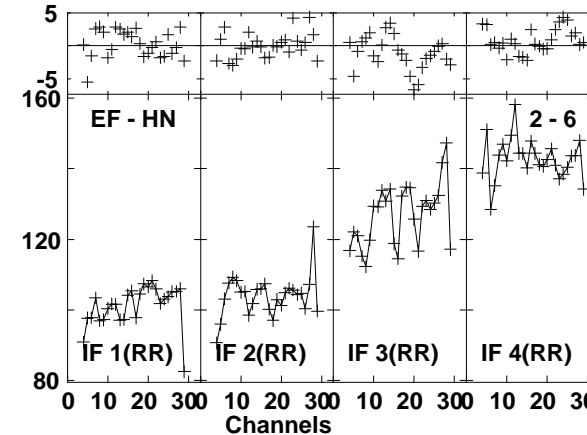
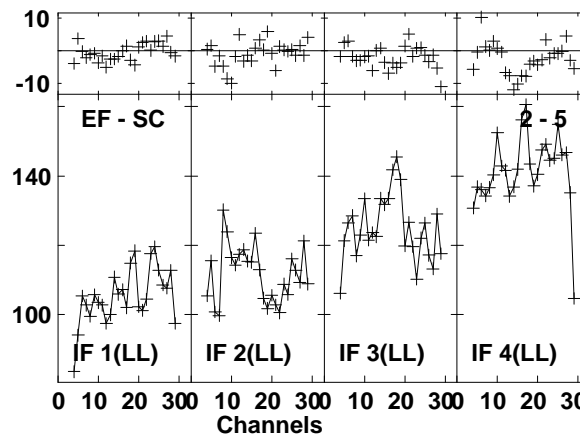
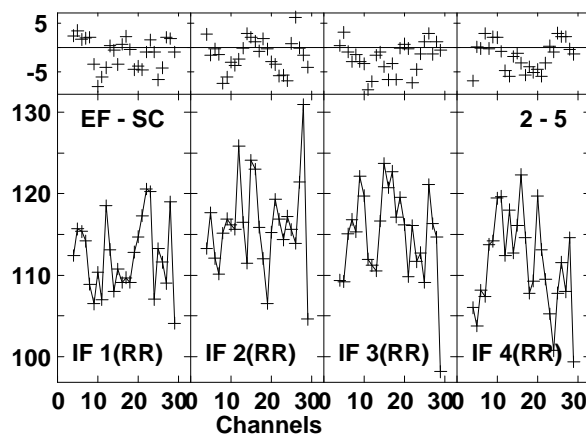
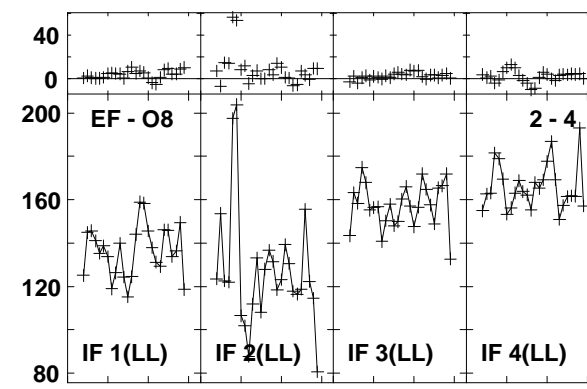
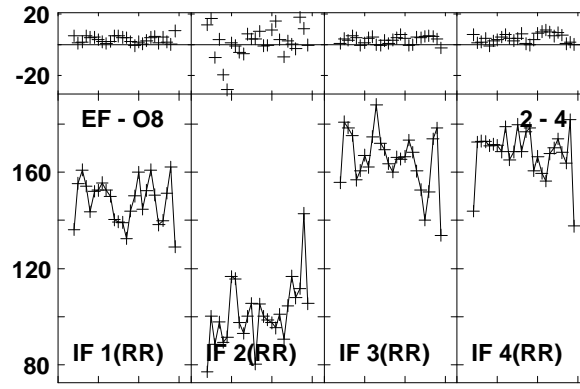
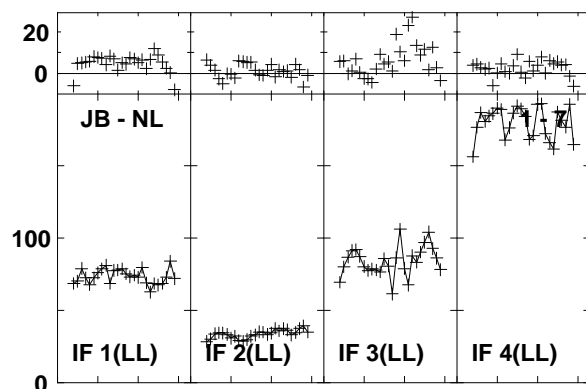
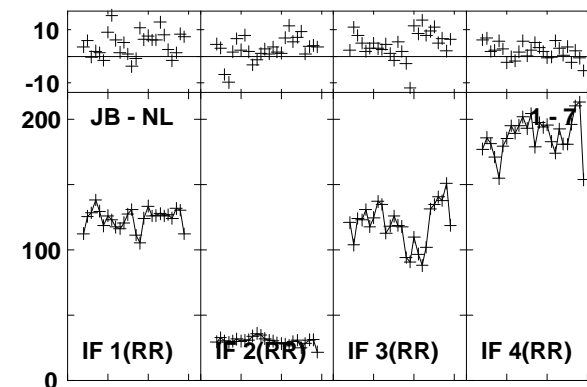
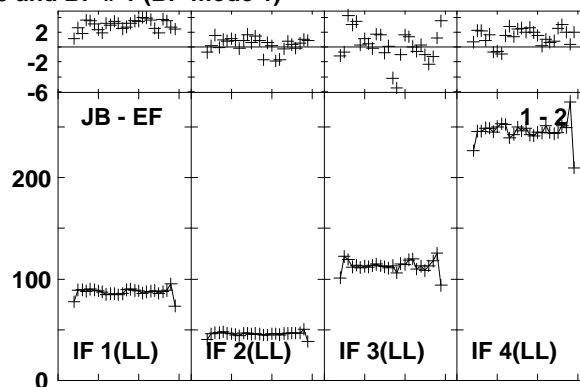
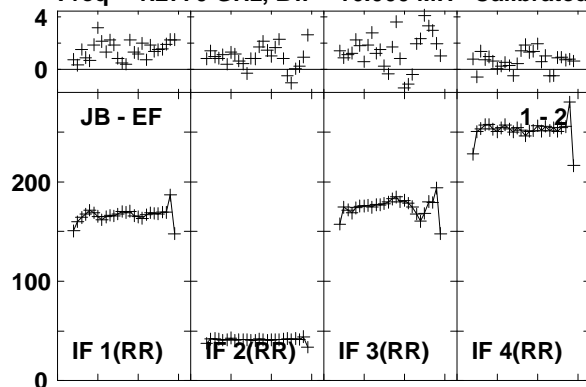

Lower frame: Milli Ampl Jy Top frame: Phas deg
Vector averaged cross-power spectrum Baseline: JB (01) - EF (02)
Timerange: 00/21:17:58 to 00/21:20:26

Plot file version 710 created 03-MAR-2016 01:13:58

J1545+5400 GN002C 1.UVDATA.1

Freq = 1.2770 GHz, Bw = 16.000 MH Calibrated with CL # 3 and BP # 1 (BP mode 1)

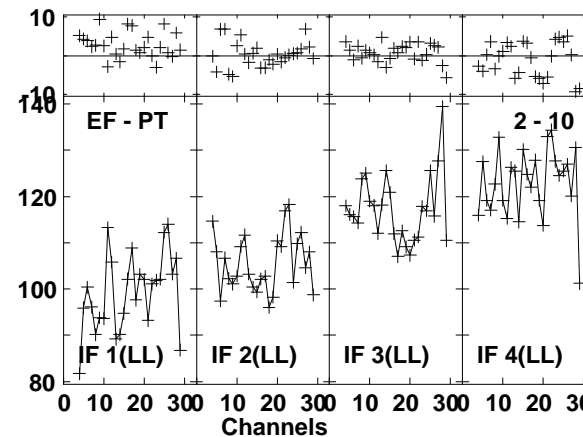
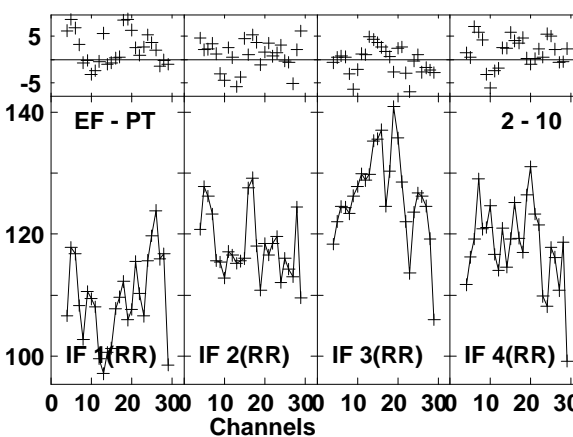
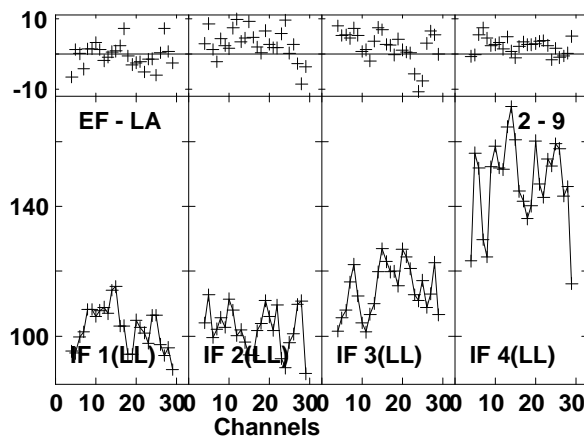
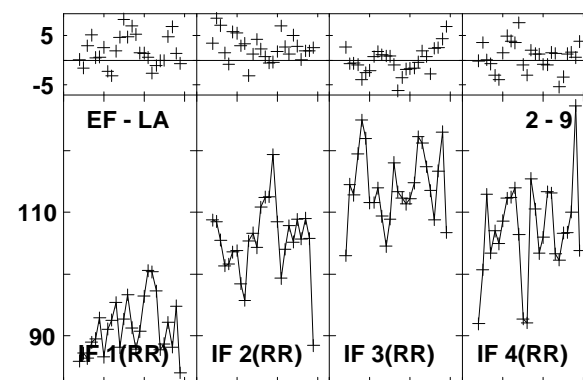
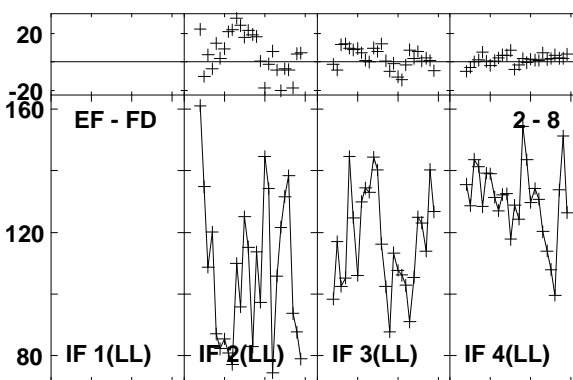
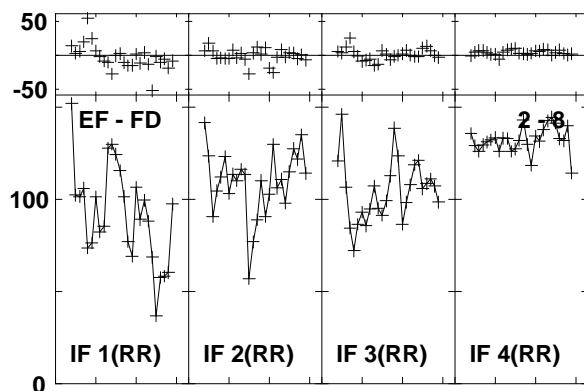
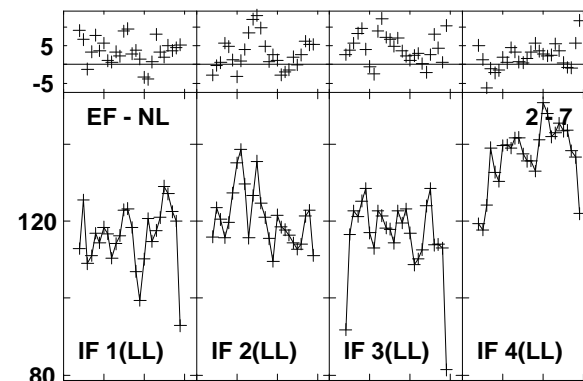
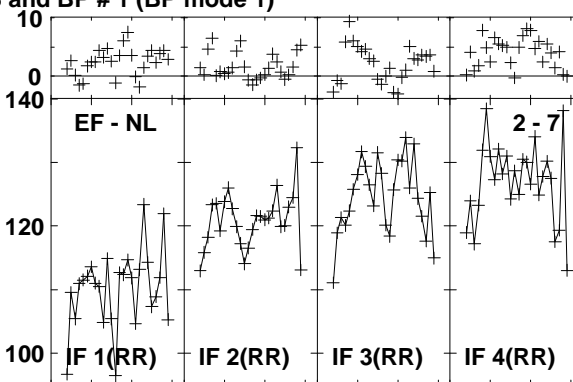
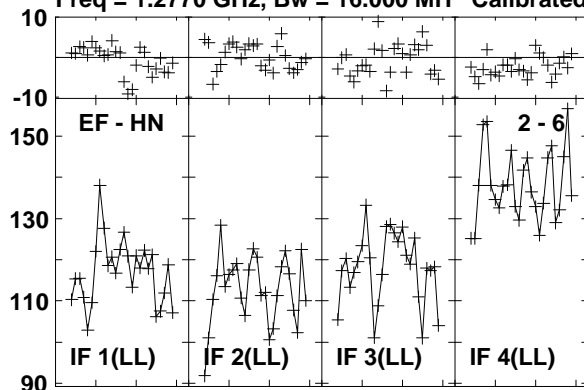

Lower frame: Milli Ampl Jy Top frame: Phas deg
Vector averaged cross-power spectrum Baseline: EF (02) - HN (06)
Timerange: 00/21:17:58 to 00/21:20:26

Plot file version 711 created 03-MAR-2016 01:13:59

J1545+5400 GN002C 1.UVDATA.1

Freq = 1.2770 GHz, Bw = 16.000 MH Calibrated with CL # 3 and BP # 1 (BP mode 1)

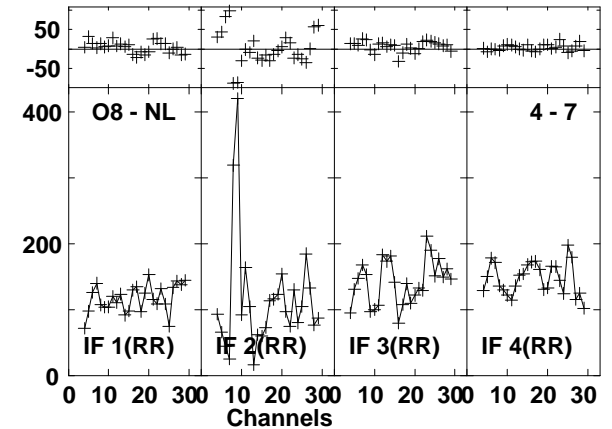
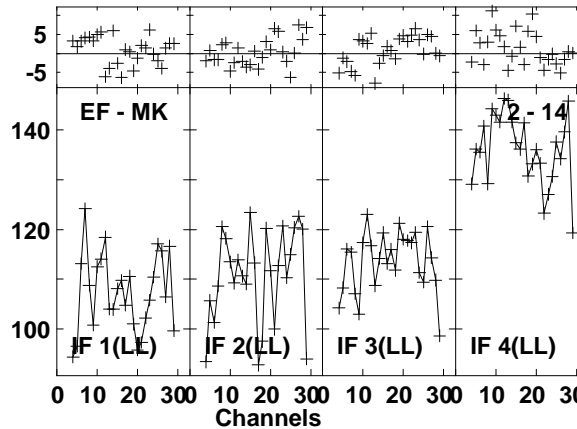
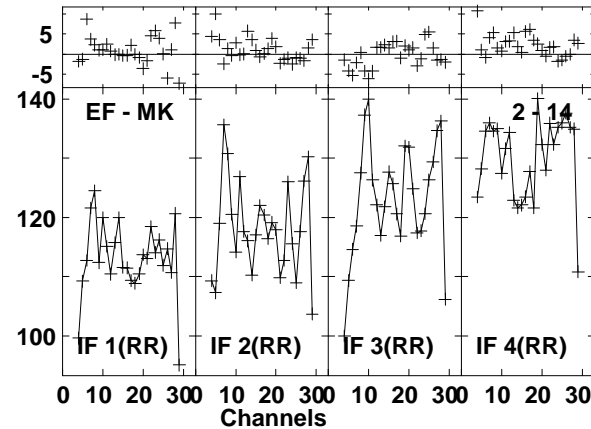
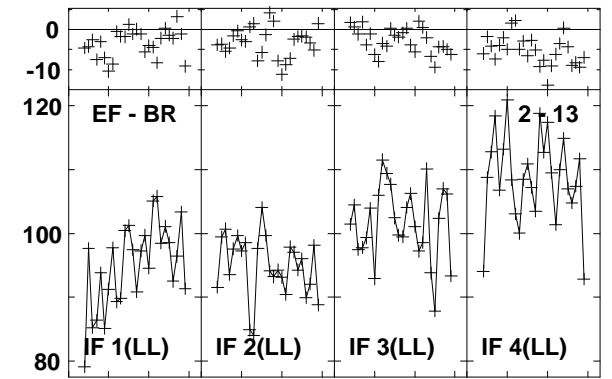
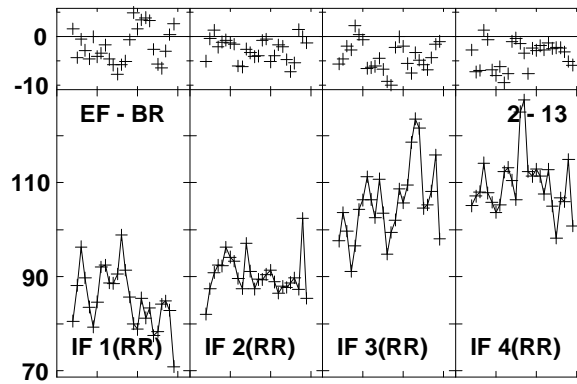
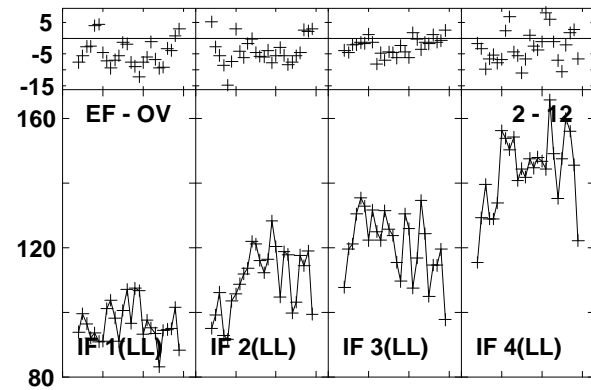
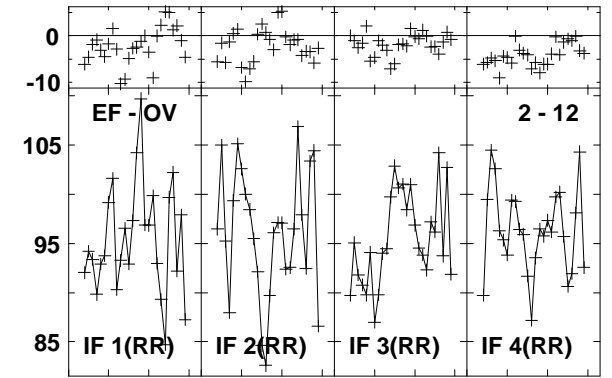
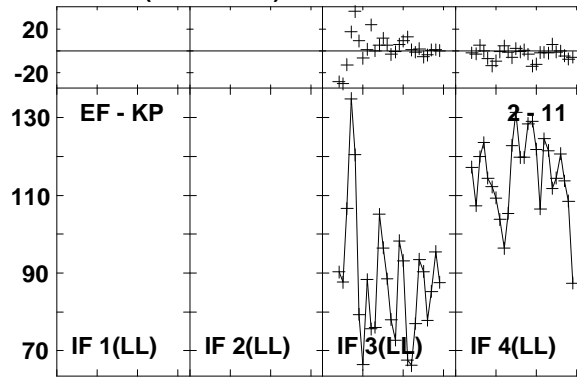
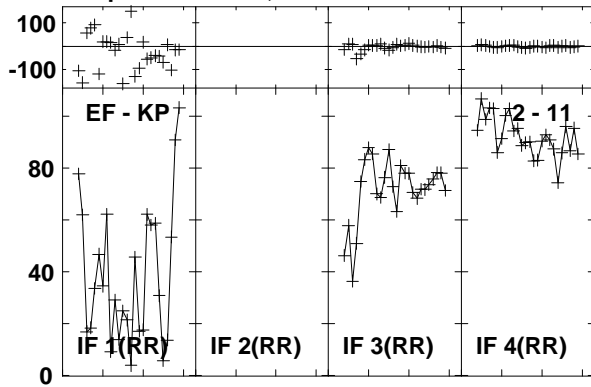

Lower frame: Milli Ampl Jy Top frame: Phas deg

Vector averaged cross-power spectrum Baseline: EF (02) - KP (11)

Timerange: 00/21:17:58 to 00/21:20:26

Plot file version 712 created 03-MAR-2016 01:13:59
 J1545+5400 GN002C 1.UVDATA.1
 Freq = 1.2770 GHz, Bw = 16.000 MH Calibrated with CL # 3 and BP # 1 (BP mode 1)

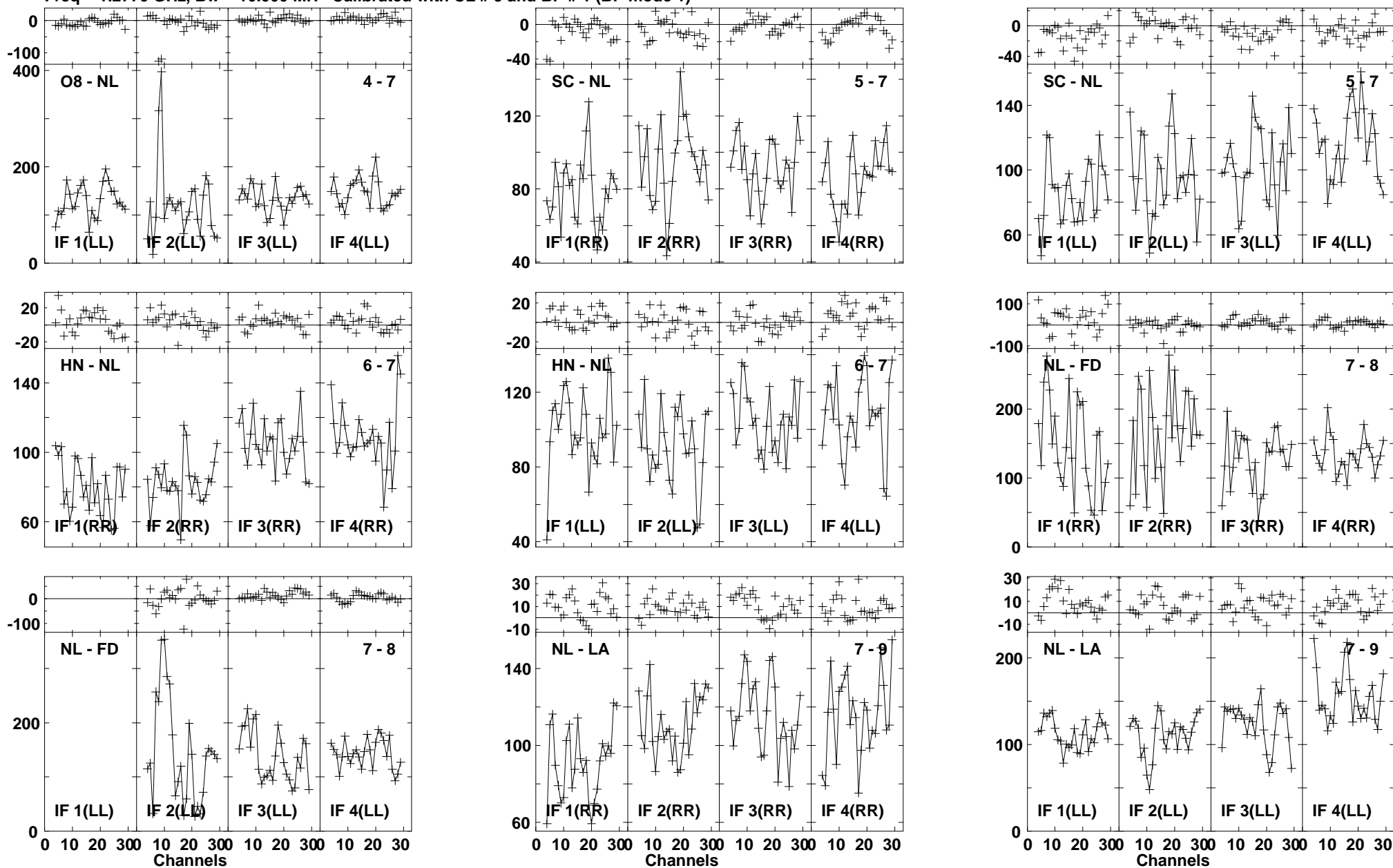

Lower frame: Milli Ampl Jy Top frame: Phas deg
 Vector averaged cross-power spectrum Baseline: O8 (04) - NL (07)
 Timerange: 00/21:17:58 to 00/21:20:26

Plot file version 713 created 03-MAR-2016 01:13:59

J1545+5400 GN002C 1.UVDATA.1

Freq = 1.2770 GHz, Bw = 16.000 MH Calibrated with CL # 3 and BP # 1 (BP mode 1)

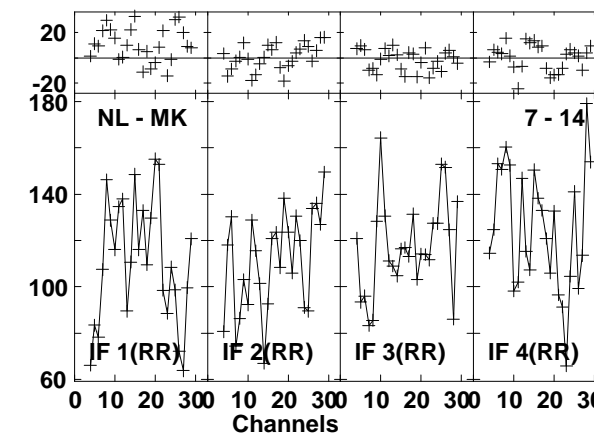
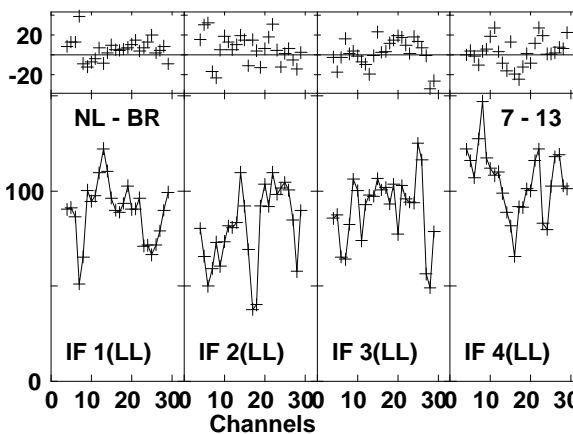
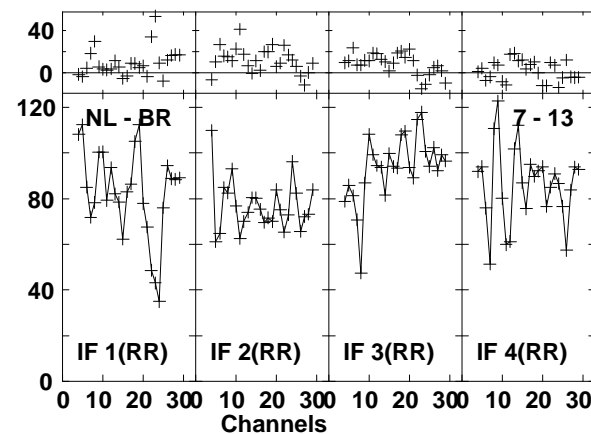
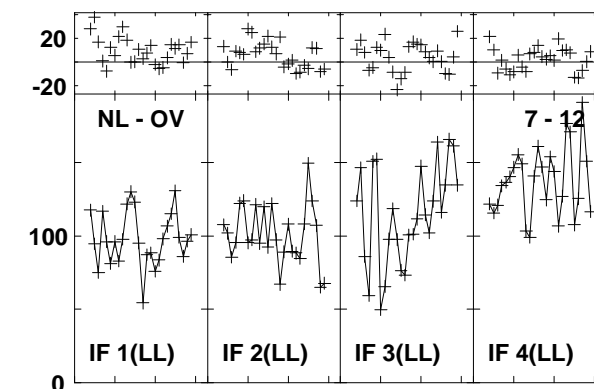
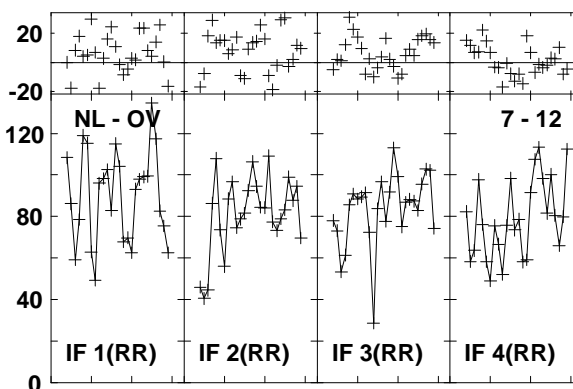
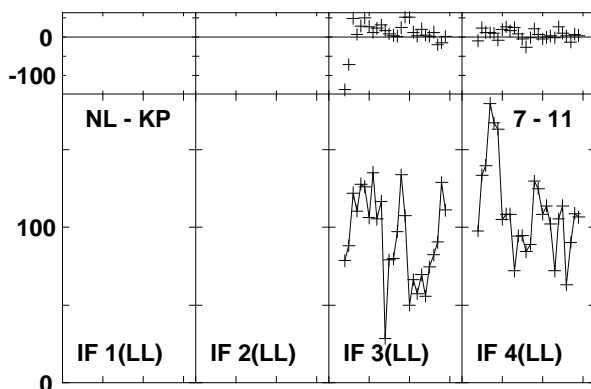
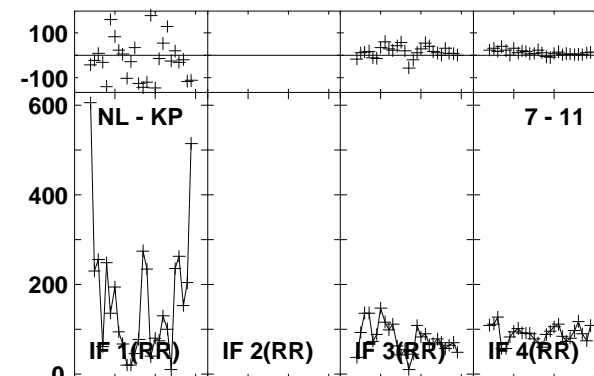
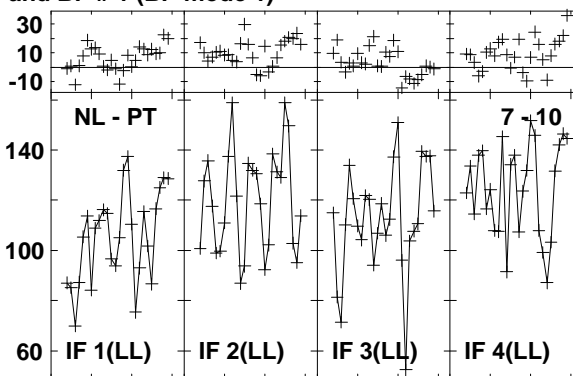
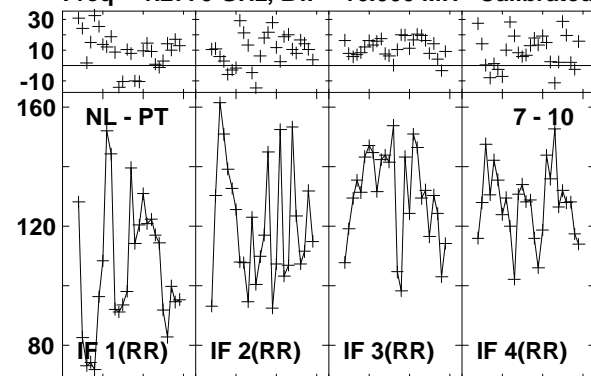

Lower frame: Milli Ampl Jy Top frame: Phas deg
Vector averaged cross-power spectrum Baseline: NL (07) - PT (10)
Timerange: 00/21:17:58 to 00/21:20:26

Plot file version 714 created 03-MAR-2016 01:13:59
J1545+5400 GN002C 1.UVDATA.1
Freq = 1.2770 GHz, Bw = 16.000 MH Calibrated with CL # 3 and BP # 1 (BP mode 1)

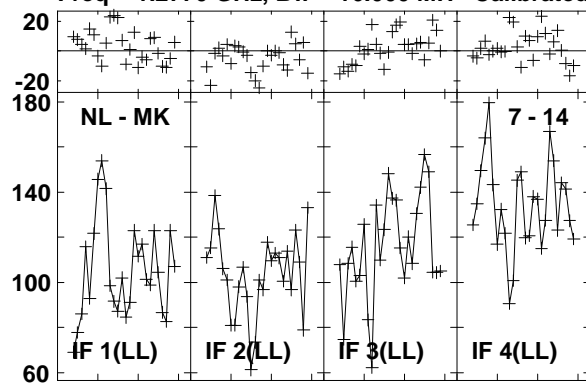

Lower frame: Milli Ampl Jy Top frame: Phas deg
Vector averaged cross-power spectrum Baseline: NL (07) - MK (14)
Timerange: 00/21:17:58 to 00/21:20:26

Plot file version 715 created 03-MAR-2016 01:13:59

4C52 GN002C 1.UVDATA.1

Freq = 1.2770 GHz, Bw = 16.000 MH Calibrated with CL # 3 and BP # 1 (BP mode 1)

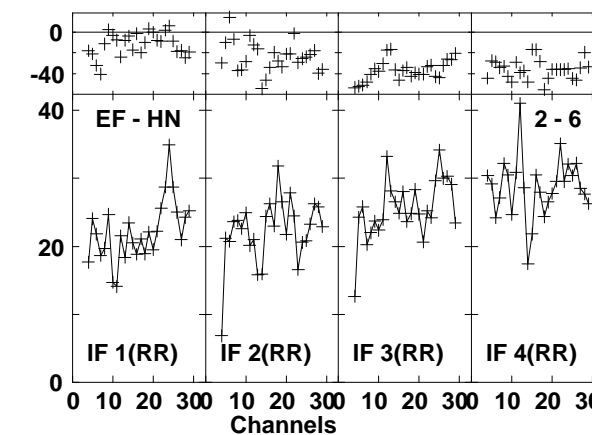
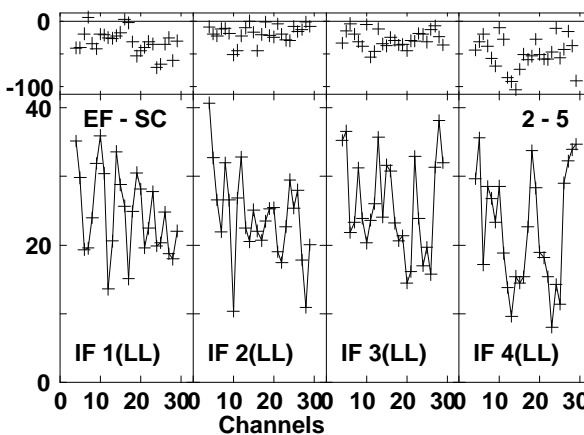
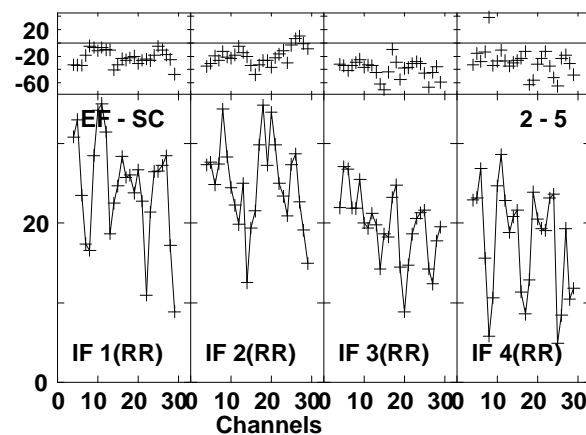
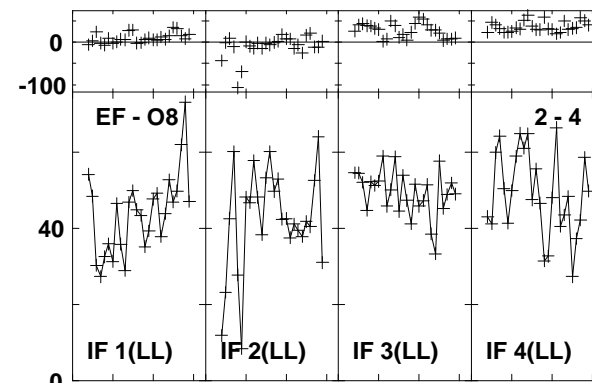
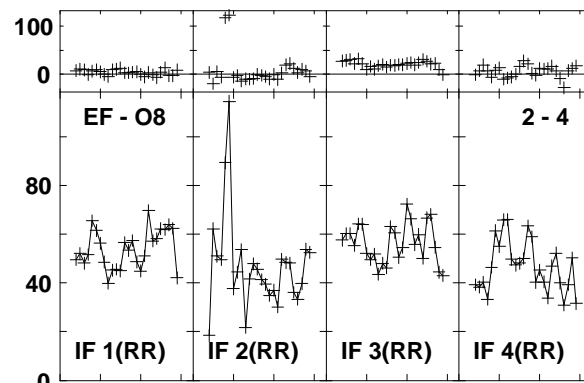
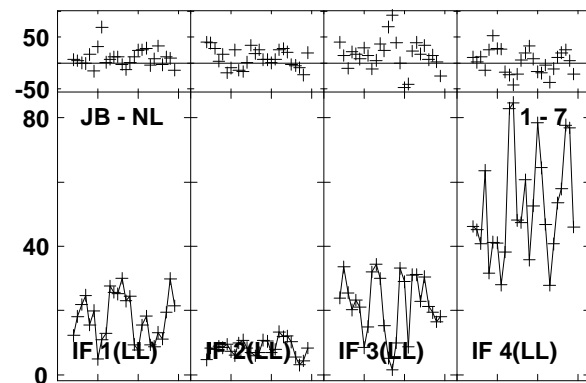
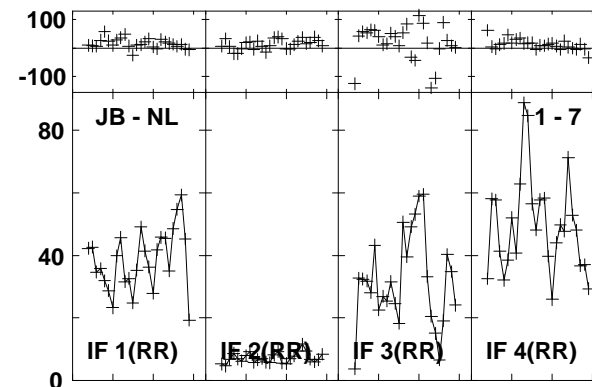
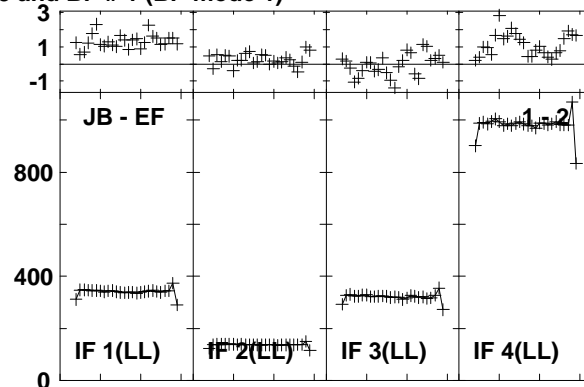
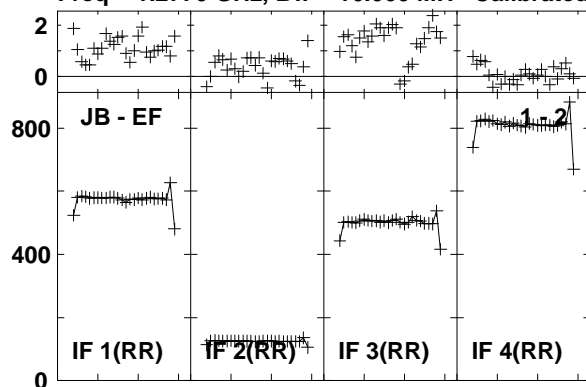

Lower frame: Milli Ampl Jy Top frame: Phas deg
Vector averaged cross-power spectrum Baseline: JB (01) - EF (02)
Timerange: 00/21:20:40 to 00/21:23:56

Plot file version 716 created 03-MAR-2016 01:13:59

4C52 GN002C 1.UVDATA.1

Freq = 1.2770 GHz, Bw = 16.000 MH Calibrated with CL # 3 and BP # 1 (BP mode 1)

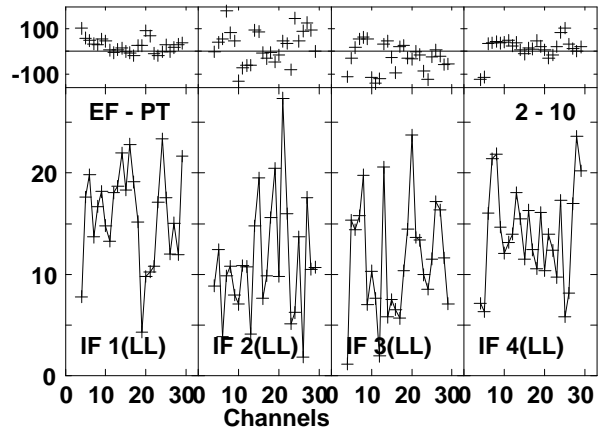
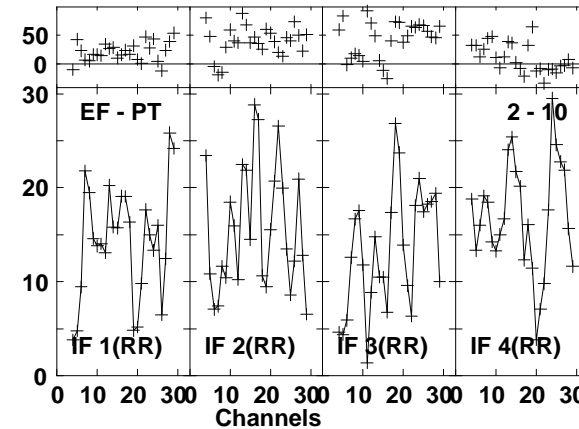
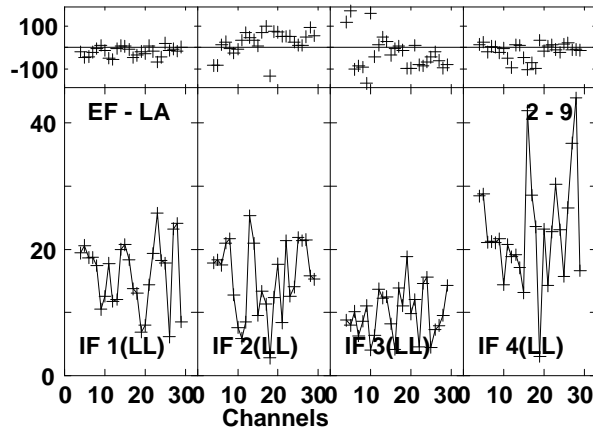
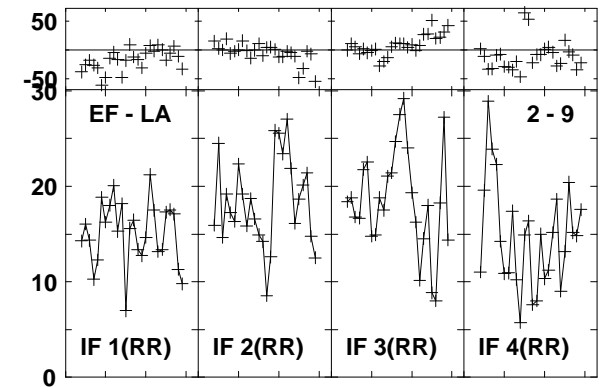
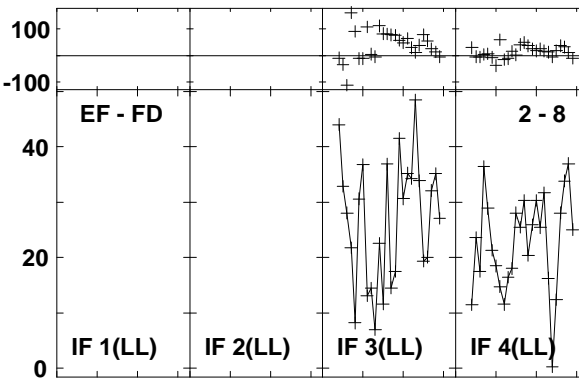
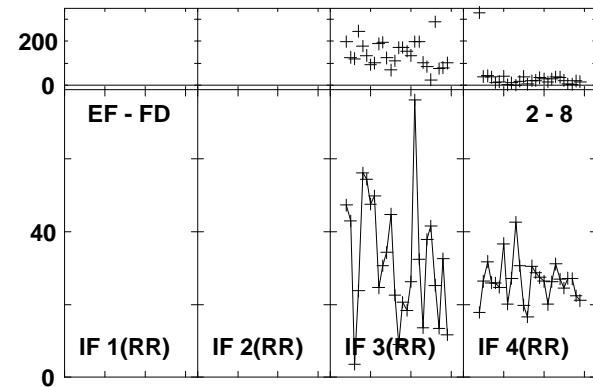
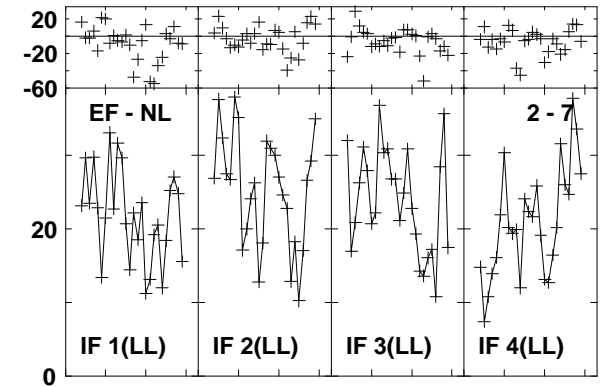
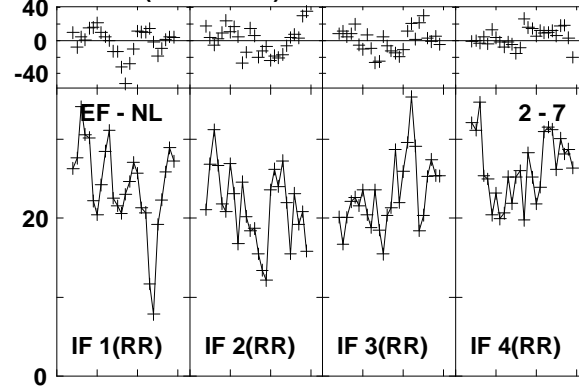
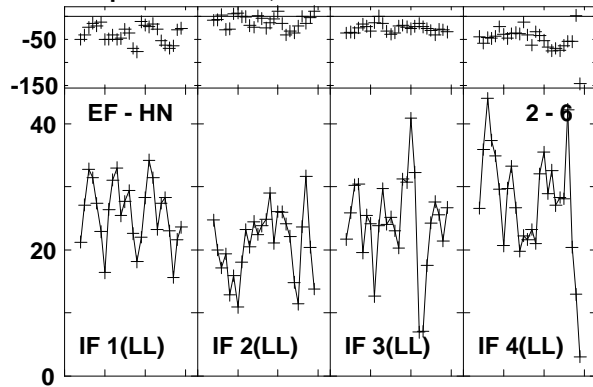

Lower frame: Milli Ampl Jy Top frame: Phas deg
Vector averaged cross-power spectrum Baseline: EF (02) - HN (06)
Timerange: 00/21:20:40 to 00/21:23:56

Plot file version 717 created 03-MAR-2016 01:14:00
 4C52 GN002C 1.UVDATA.1
 Freq = 1.2770 GHz, Bw = 16.000 MH Calibrated with CL # 3 and BP # 1 (BP mode 1)

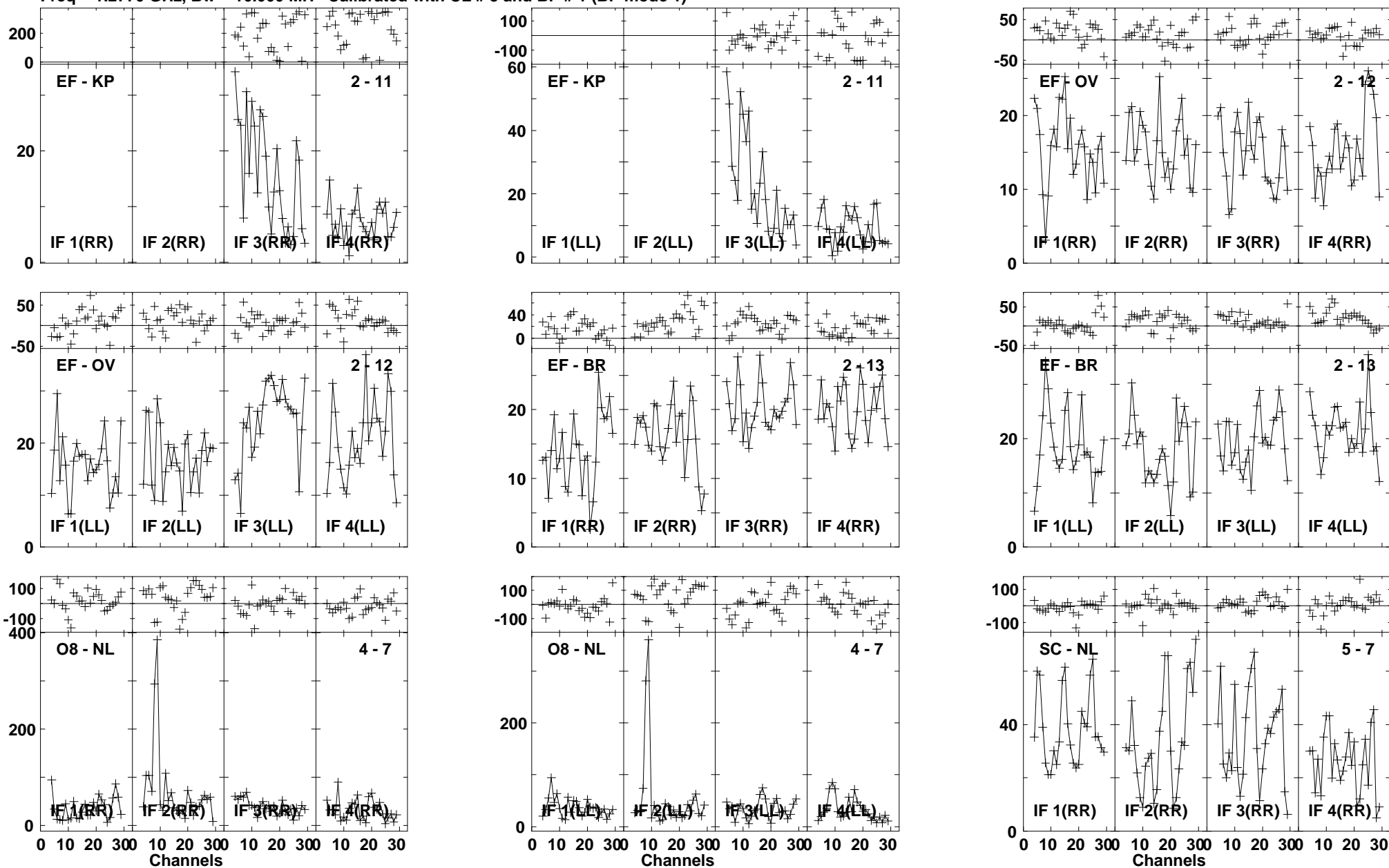

Lower frame: Milli Ampl Jy Top frame: Phas deg
 Vector averaged cross-power spectrum Baseline: EF (02) - KP (11)
 Timerange: 00/21:20:40 to 00/21:23:56

Plot file version 718 created 03-MAR-2016 01:14:00

4C52 GN002C 1.UVDATA.1

Freq = 1.2770 GHz, Bw = 16.000 MH Calibrated with CL # 3 and BP # 1 (BP mode 1)

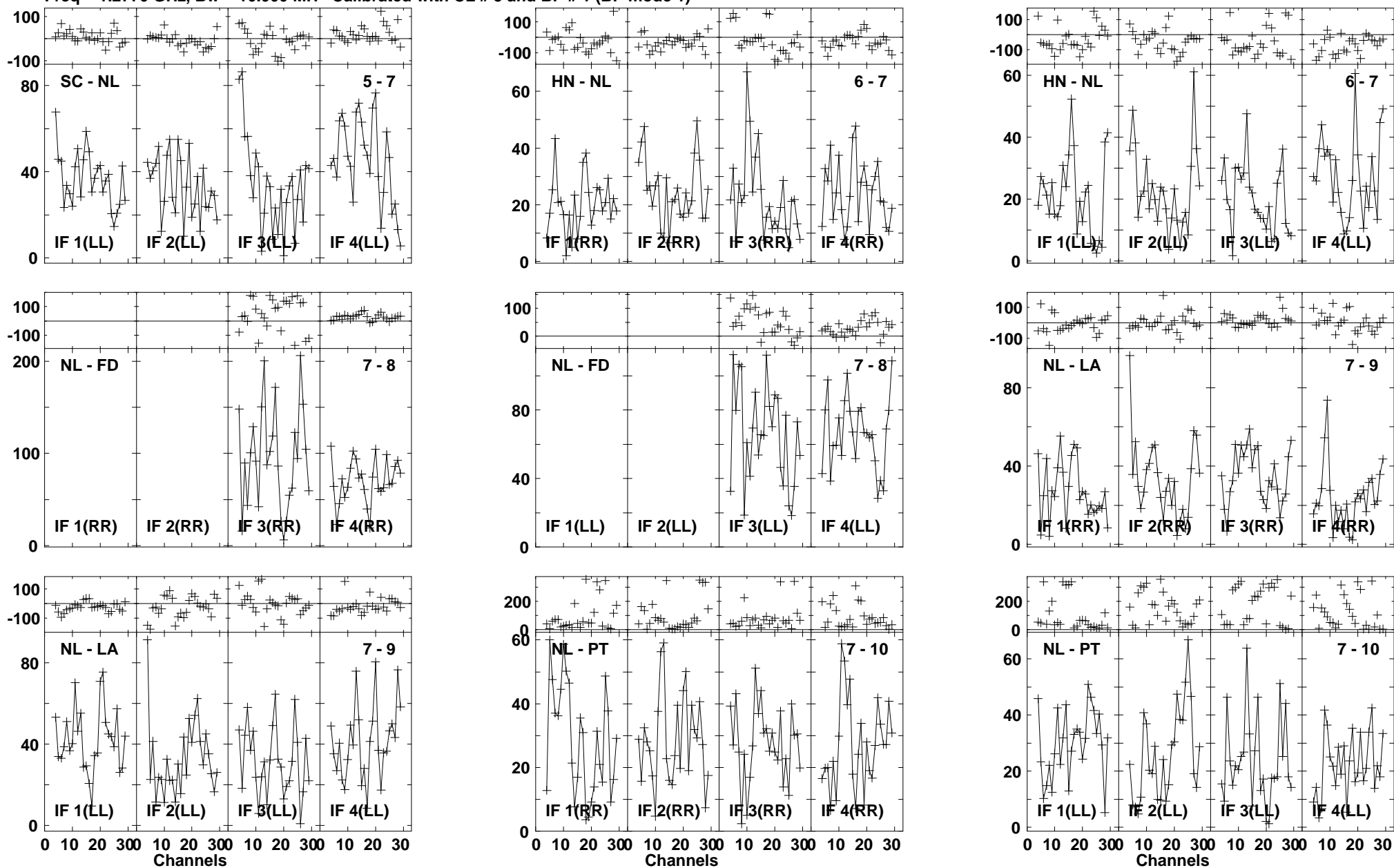

Lower frame: Milli Ampl Jy Top frame: Phas deg

Vector averaged cross-power spectrum Baseline: SC (05) - NL (07)

Timerange: 00/21:20:40 to 00/21:23:56

Plot file version 719 created 03-MAR-2016 01:14:00
 4C52 GN002C 1.UVDATA.1
 Freq = 1.2770 GHz, Bw = 16.000 MH Calibrated with CL # 3 and BP # 1 (BP mode 1)

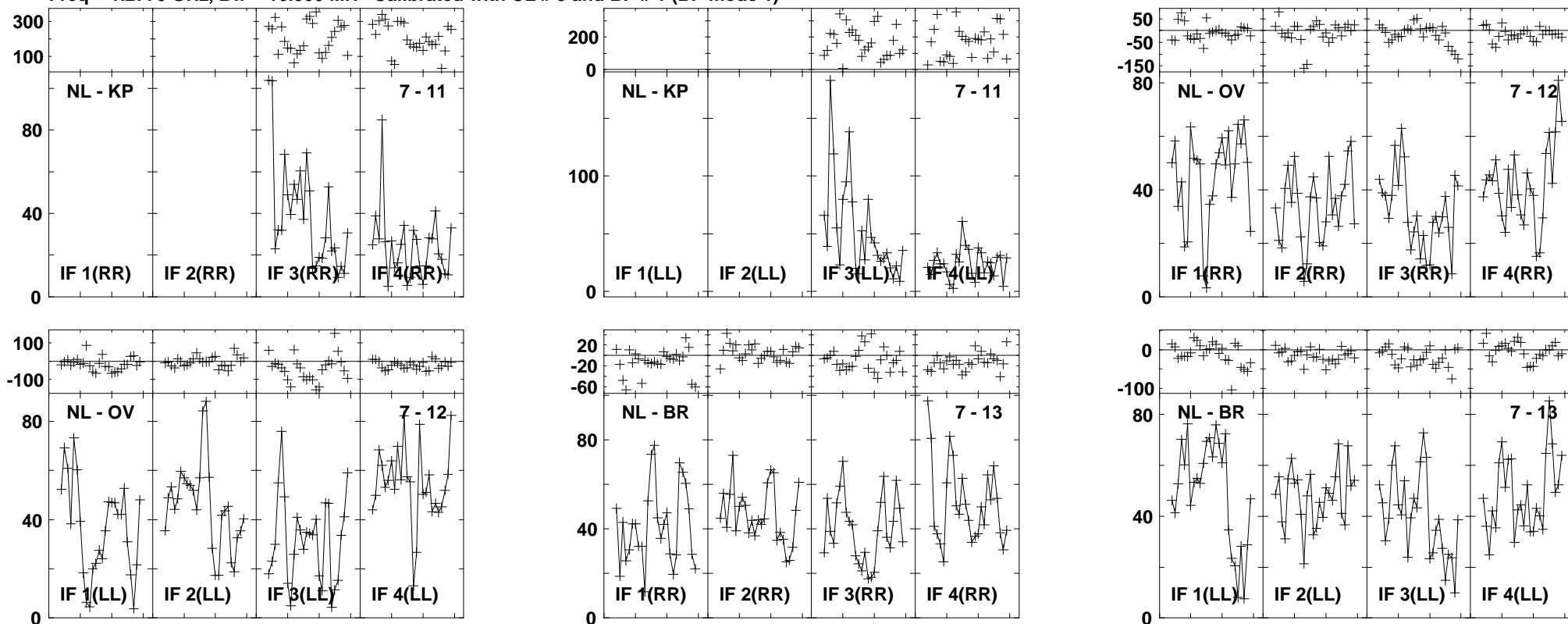

Lower frame: Milli Ampl Jy Top frame: Phas deg
 Vector averaged cross-power spectrum Baseline: NL (07) - KP (11)
 Timerange: 00/21:20:40 to 00/21:23:56

Plot file version 720 created 03-MAR-2016 01:14:00

J1545+5400 GN002C 1.UVDATA.1

Freq = 1.2770 GHz, Bw = 16.000 MH Calibrated with CL # 3 and BP # 1 (BP mode 1)

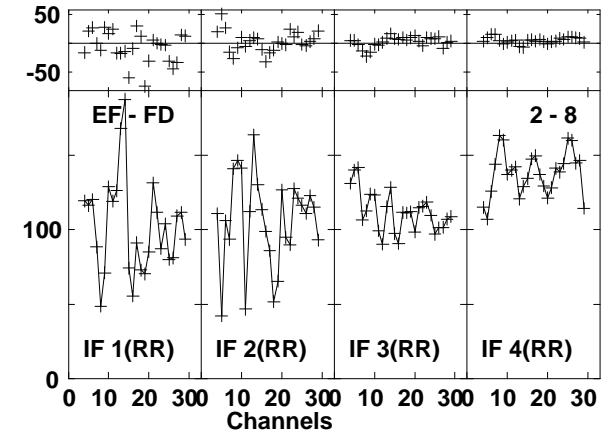
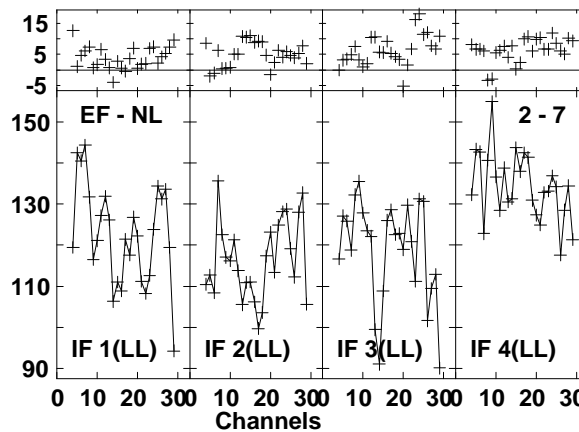
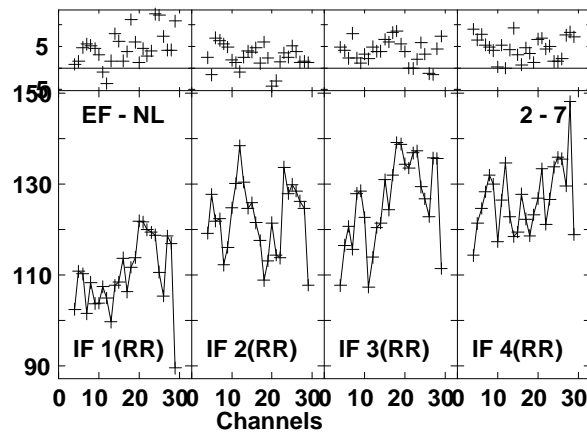
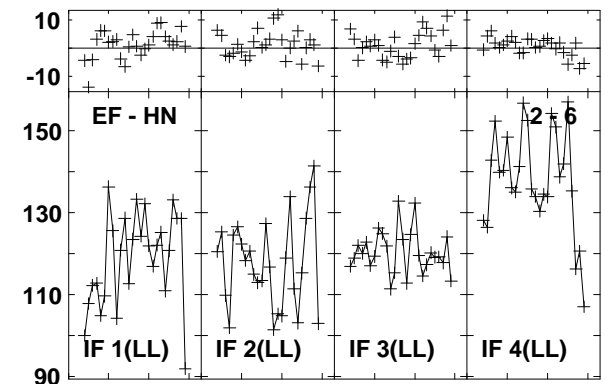
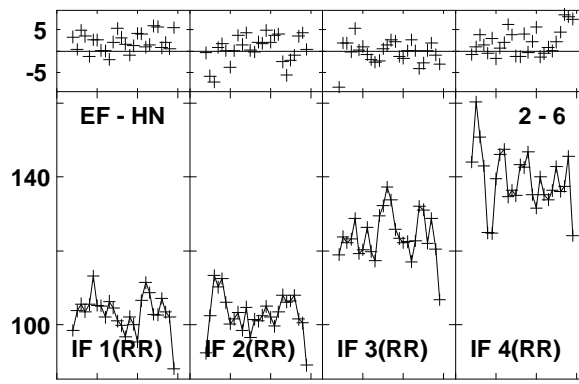
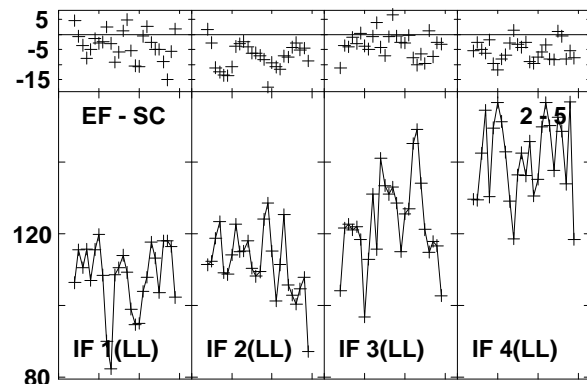
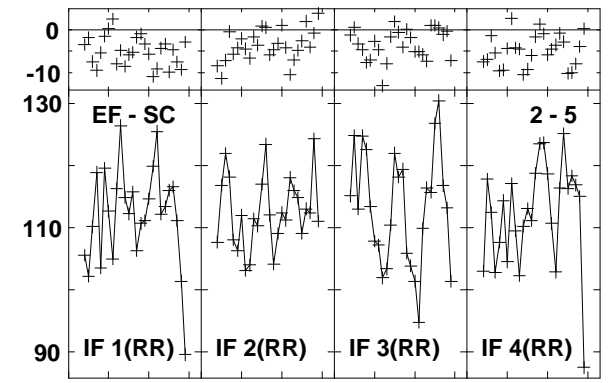
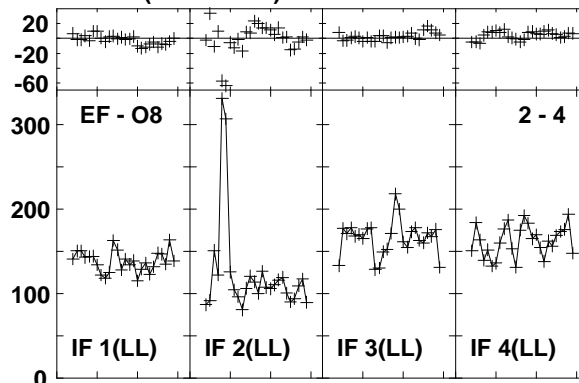
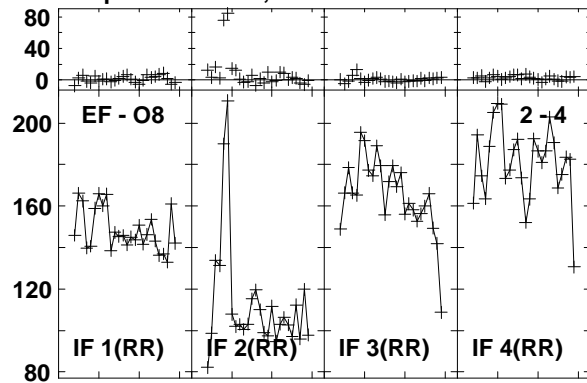

Lower frame: Milli Ampl Jy Top frame: Phas deg

Vector averaged cross-power spectrum Baseline: EF (02) - O8 (04)

Timerange: 00/21:24:48 to 00/21:26:16

Plot file version 721 created 03-MAR-2016 01:14:00
 J1545+5400 GN002C 1.UVDATA.1
 Freq = 1.2770 GHz, Bw = 16.000 MH Calibrated with CL # 3 and BP # 1 (BP mode 1)

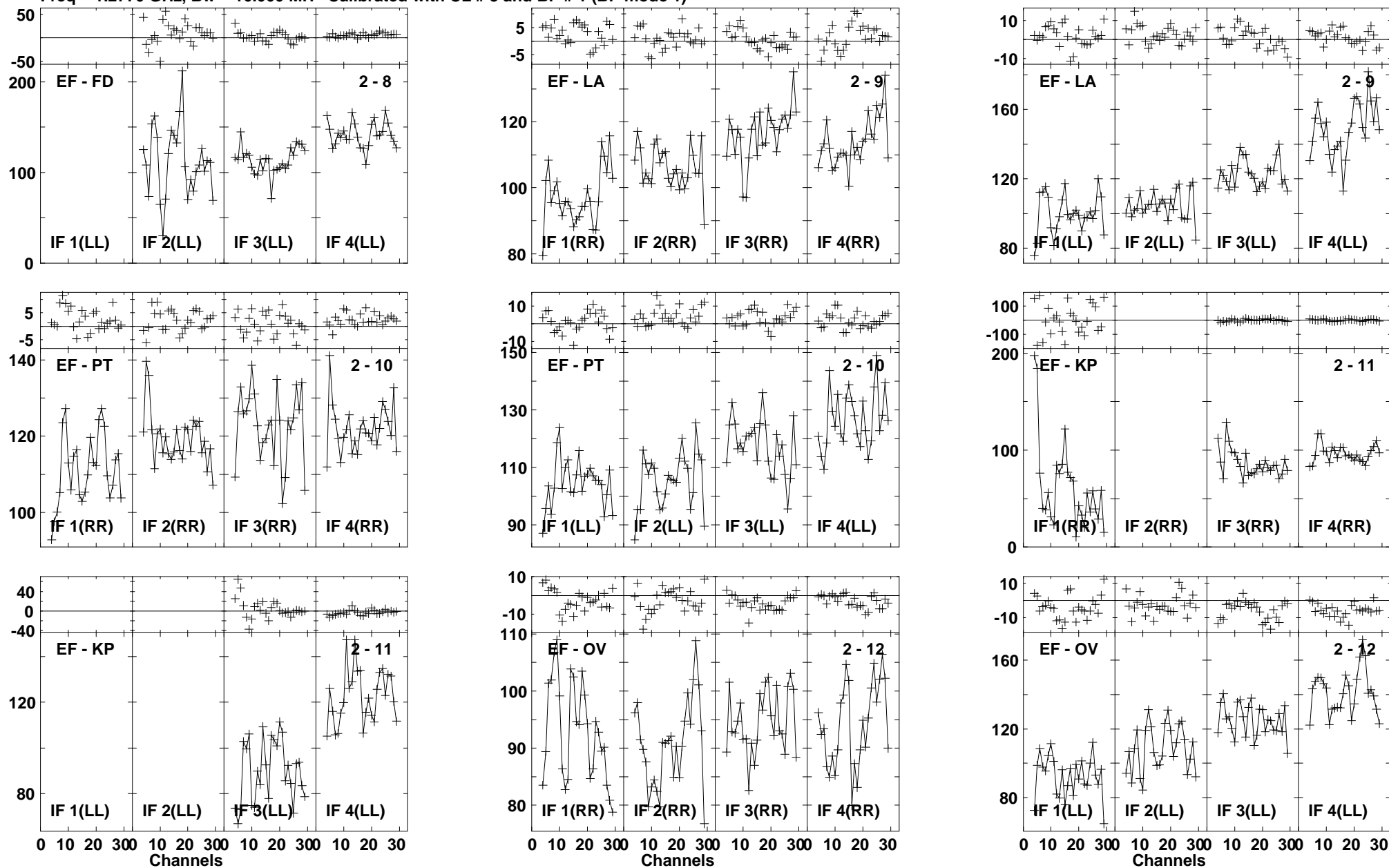

Lower frame: Milli Ampl Jy Top frame: Phas deg
 Vector averaged cross-power spectrum Baseline: EF (02) - FD (08)
 Timerange: 00/21:24:48 to 00/21:26:16

Plot file version 722 created 03-MAR-2016 01:14:01

J1545+5400 GN002C 1.UVDATA.1

Freq = 1.2770 GHz, Bw = 16.000 MH Calibrated with CL # 3 and BP # 1 (BP mode 1)

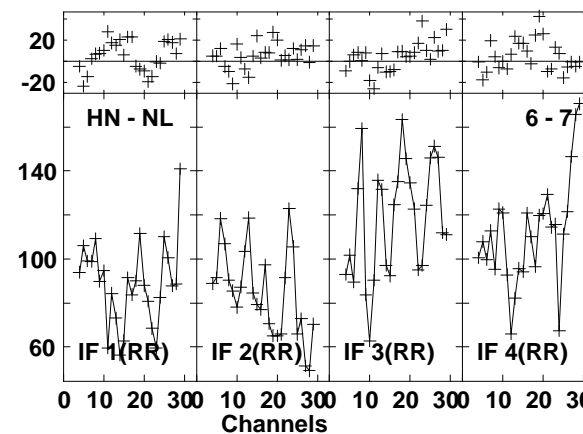
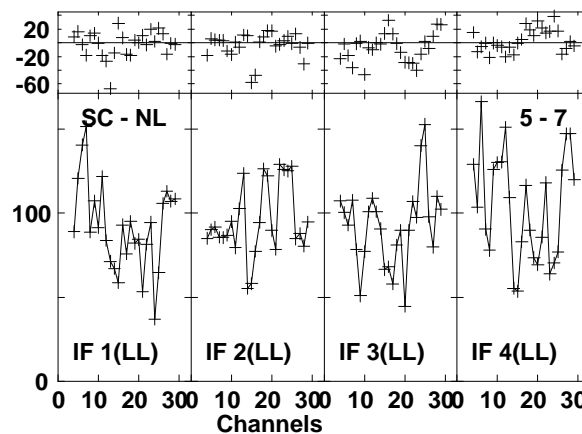
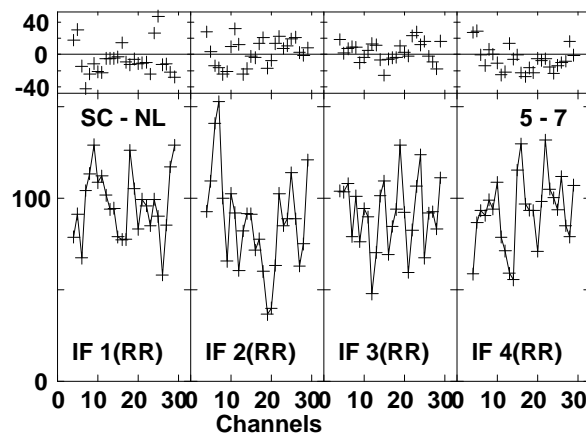
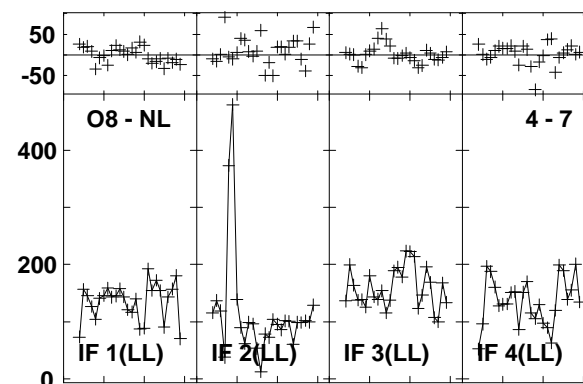
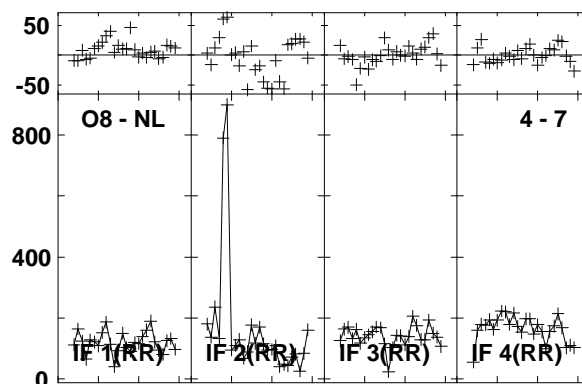
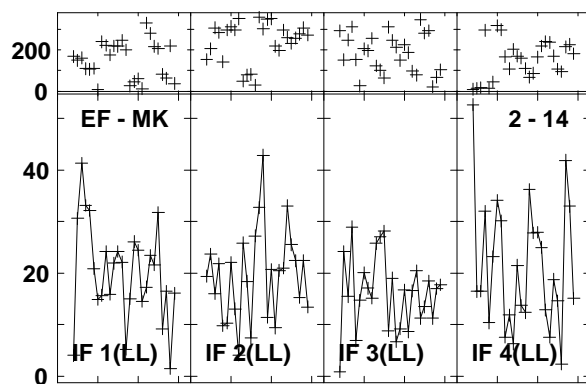
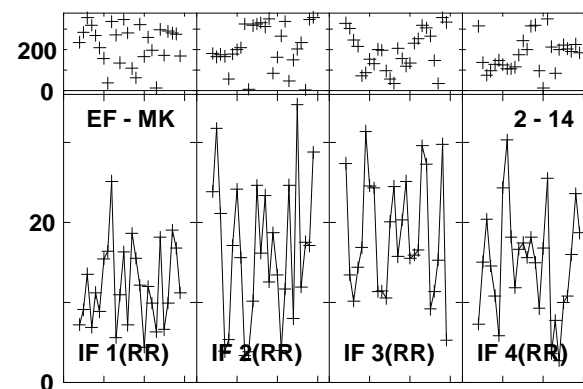
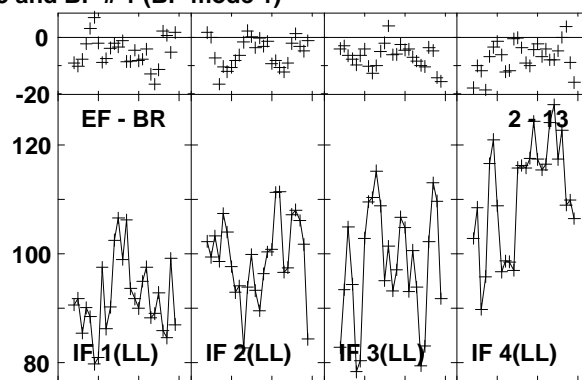
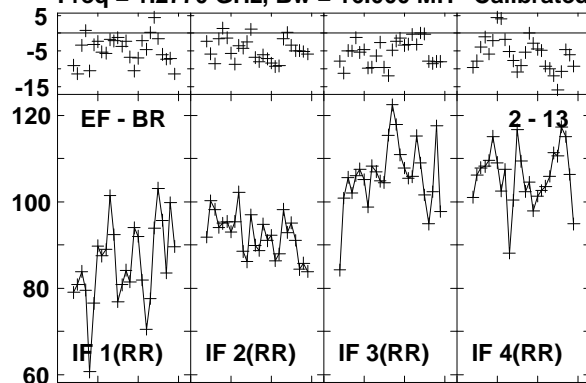

Lower frame: Milli Ampl Jy Top frame: Phas deg
Vector averaged cross-power spectrum Baseline: EF (02) - BR (13)
Timerange: 00/21:24:48 to 00/21:26:16

Plot file version 723 created 03-MAR-2016 01:14:01

J1545+5400 GN002C 1.UVDATA.1

Freq = 1.2770 GHz, Bw = 16.000 MH Calibrated with CL # 3 and BP # 1 (BP mode 1)

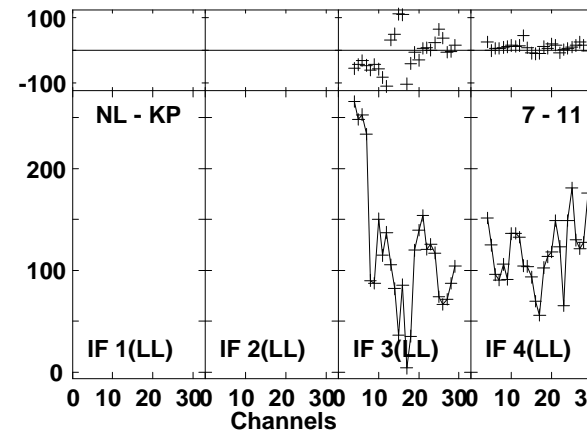
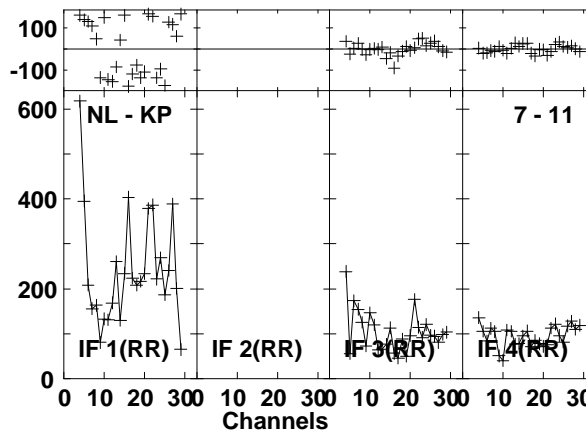
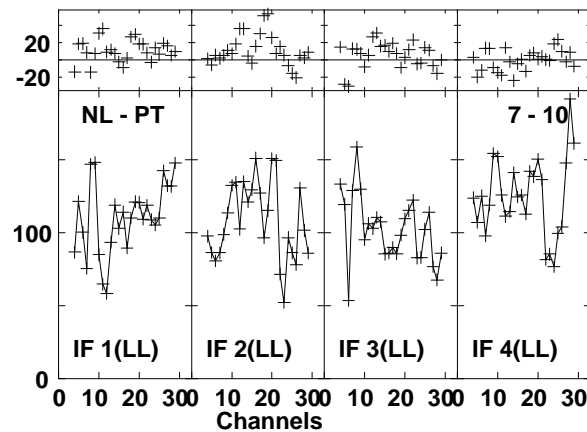
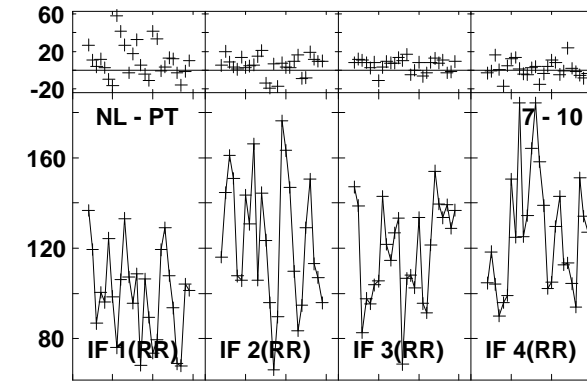
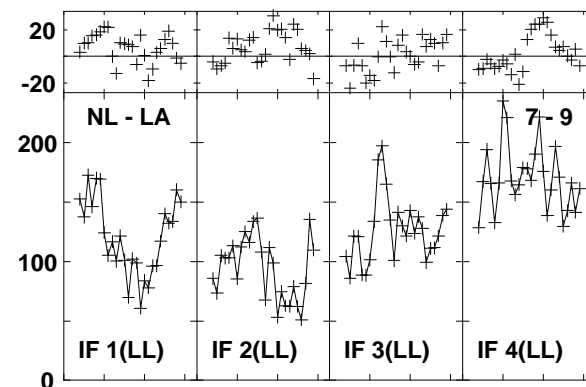
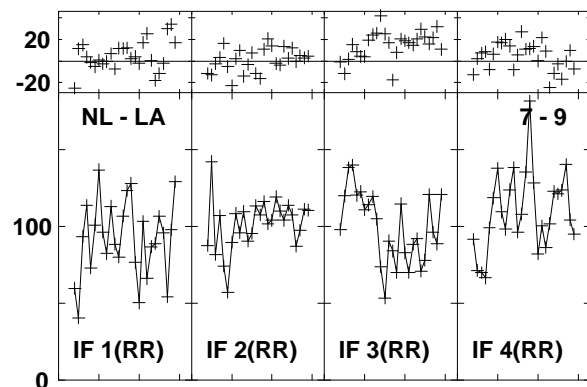
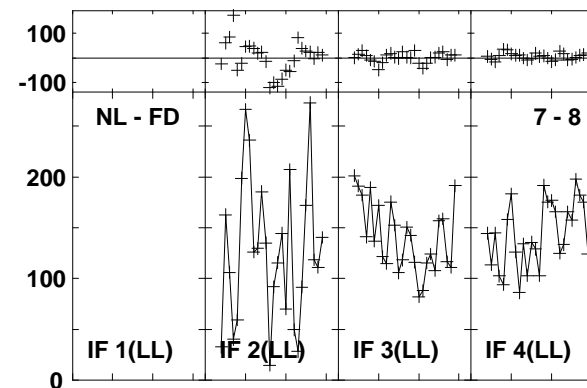
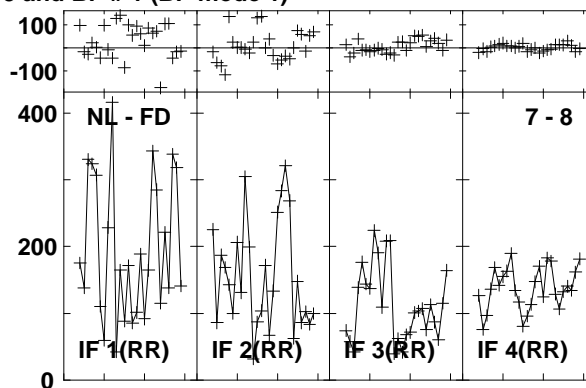
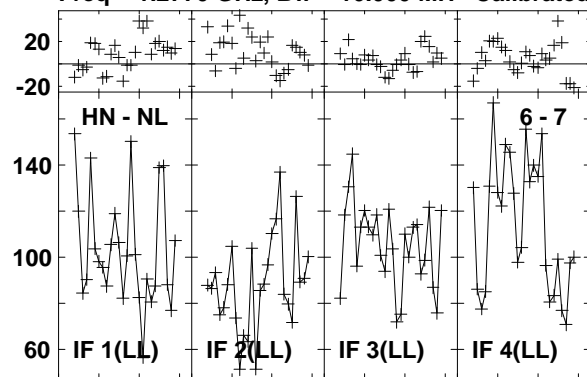

Lower frame: Milli Ampl Jy Top frame: Phas deg
Vector averaged cross-power spectrum Baseline: HN (06) - NL (07)
Timerange: 00/21:24:48 to 00/21:26:16

Plot file version 724 created 03-MAR-2016 01:14:01
 J1545+5400 GN002C 1.UVDATA.1
 Freq = 1.2770 GHz, Bw = 16.000 MH Calibrated with CL # 3 and BP # 1 (BP mode 1)

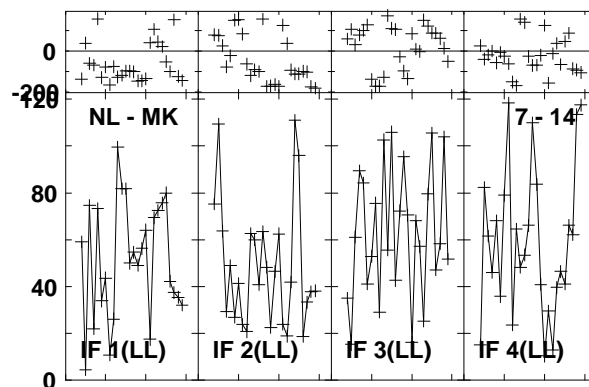
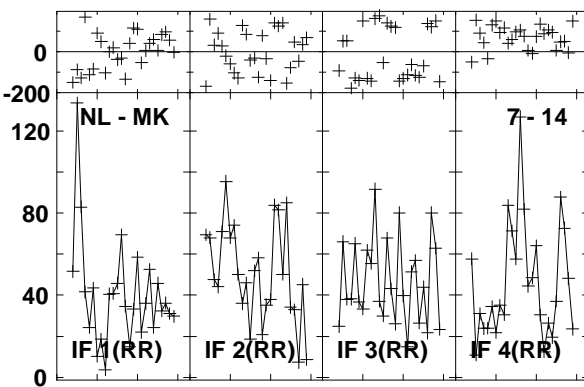
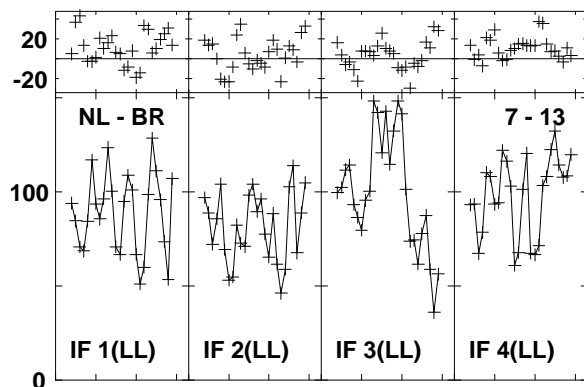
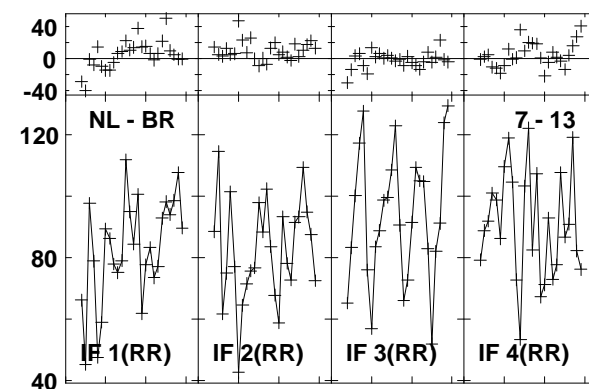
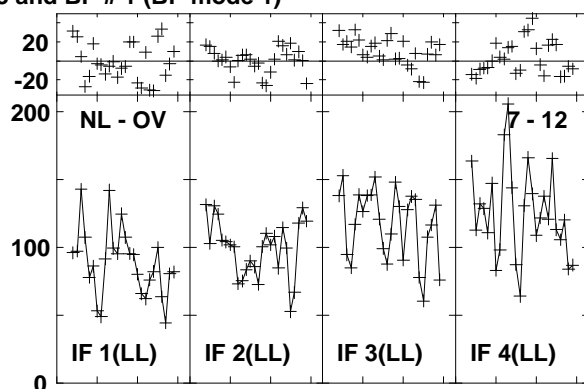
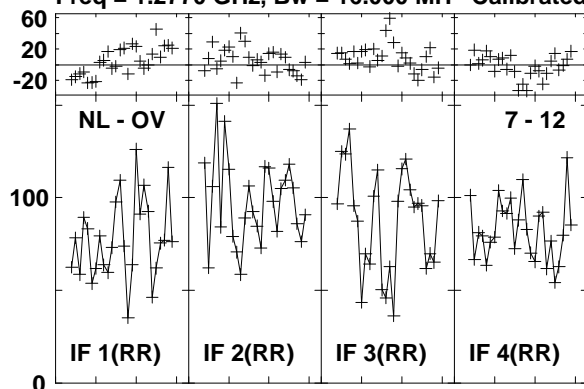

Lower frame: Milli Ampl Jy Top frame: Phas deg
 Vector averaged cross-power spectrum Baseline: NL (07) - OV (12)
 Timerange: 00/21:24:48 to 00/21:26:16

Plot file version 725 created 03-MAR-2016 01:14:01

4C52 GN002C 1.UVDATA.1

Freq = 1.2770 GHz, Bw = 16.000 MH Calibrated with CL # 3 and BP # 1 (BP mode 1)

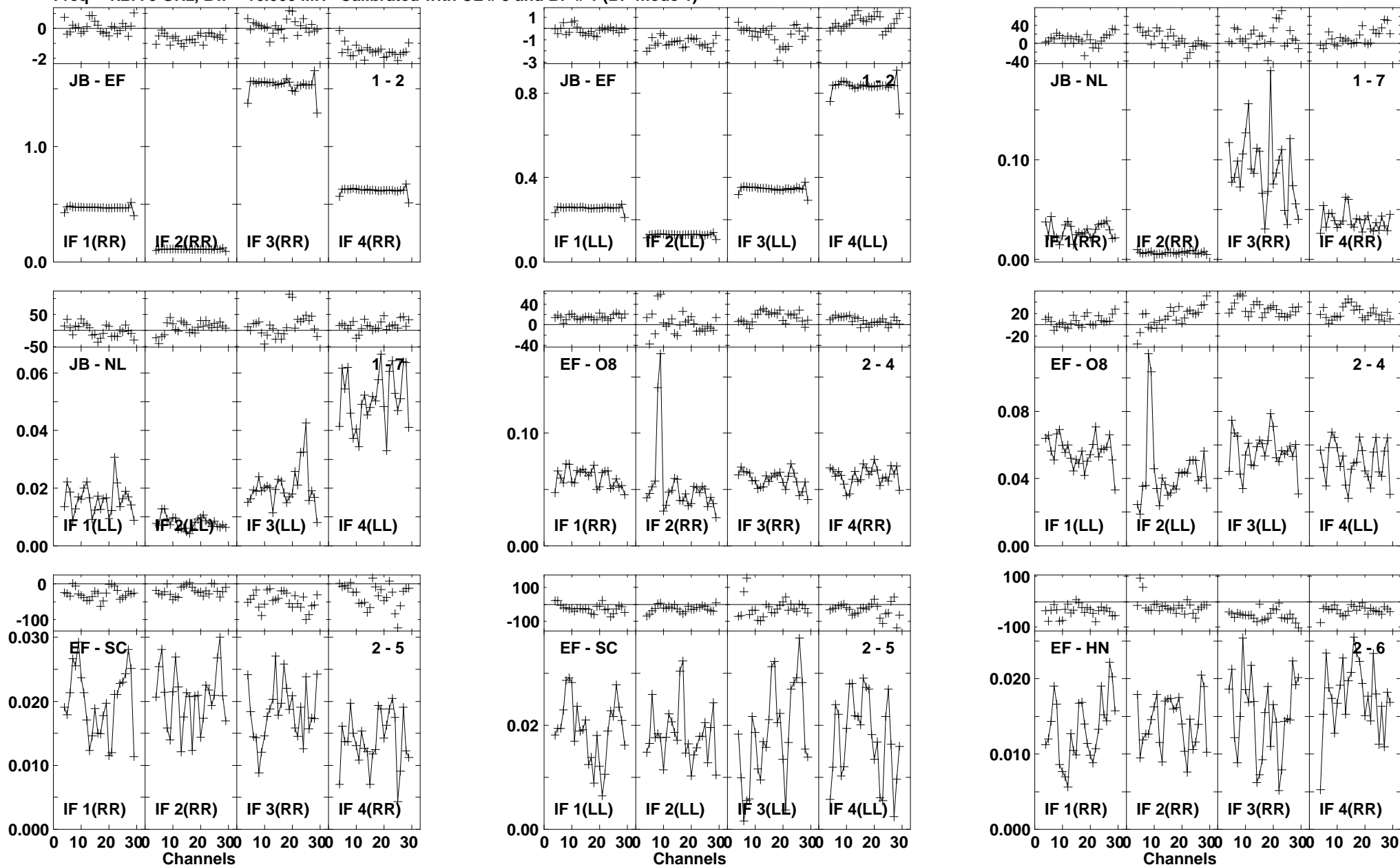

Lower frame: Ampl Jy Top frame: Phas deg
Vector averaged cross-power spectrum Baseline: JB (01) - EF (02)
Timerange: 00/21:26:21 to 00/21:29:35

Plot file version 726 created 03-MAR-2016 01:14:01

4C52 GN002C 1.UVDATA.1

Freq = 1.2770 GHz, Bw = 16.000 MH Calibrated with CL # 3 and BP # 1 (BP mode 1)

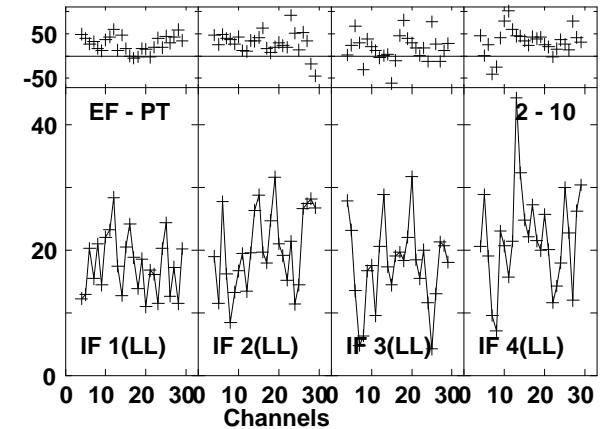
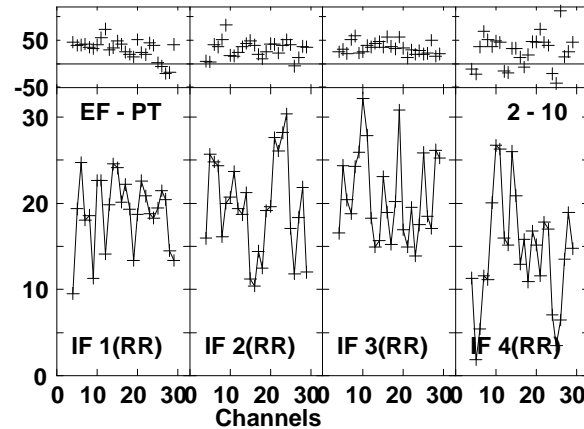
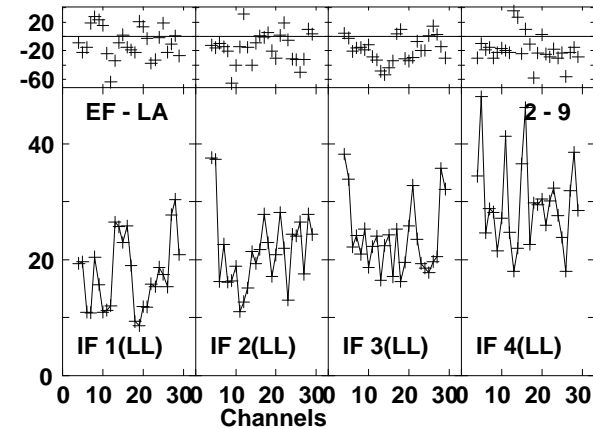
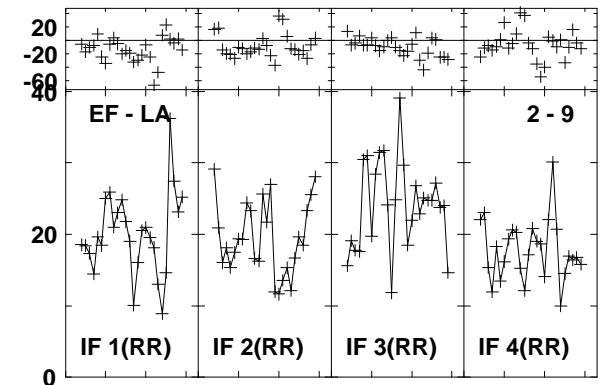
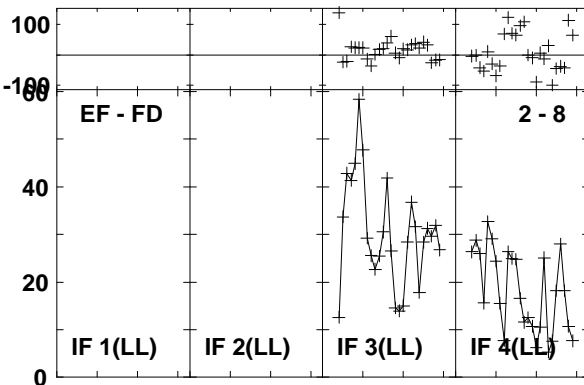
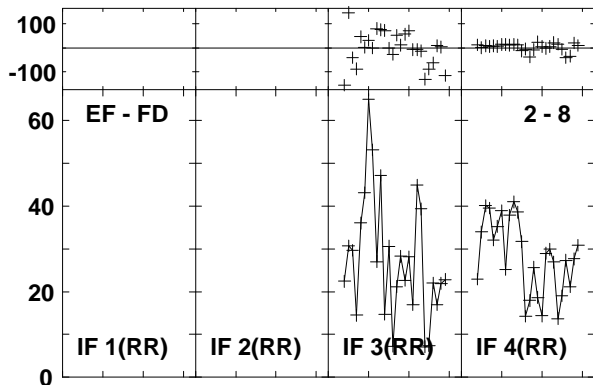
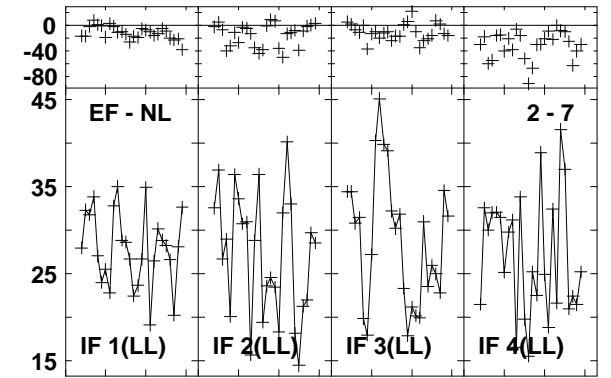
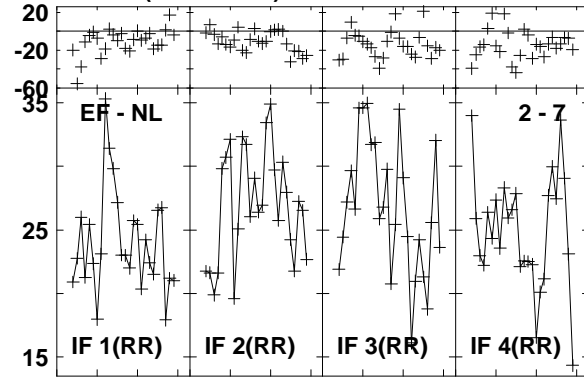
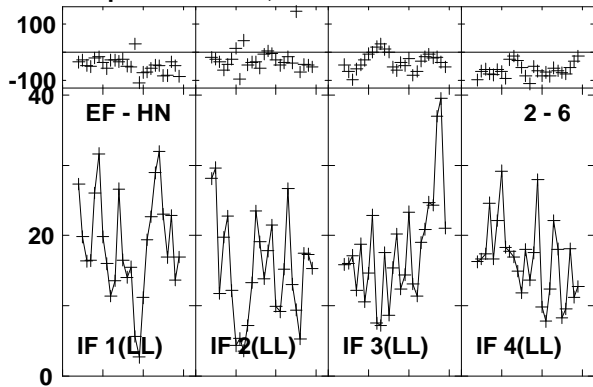

Lower frame: Milli Ampl Jy Top frame: Phas deg
Vector averaged cross-power spectrum Baseline: EF (02) - HN (06)
Timerange: 00/21:26:21 to 00/21:29:35

Plot file version 727 created 03-MAR-2016 01:14:01

4C52 GN002C 1.UVDATA.1

Freq = 1.2770 GHz, Bw = 16.000 MH Calibrated with CL # 3 and BP # 1 (BP mode 1)

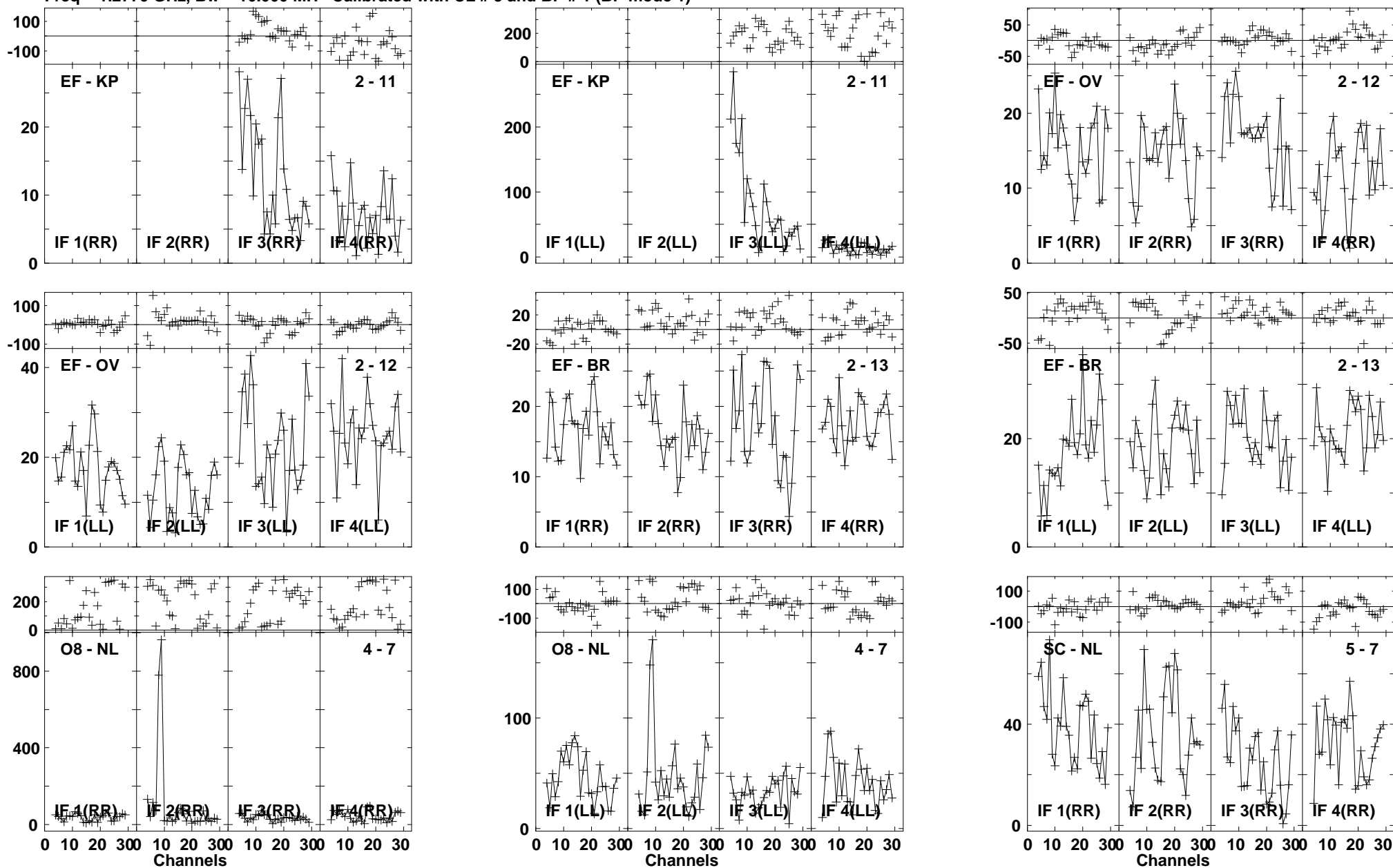

Lower frame: Milli Ampl Jy Top frame: Phas deg
Vector averaged cross-power spectrum Baseline: EF (02) - KP (11)
Timerange: 00/21:26:21 to 00/21:29:35

Plot file version 728 created 03-MAR-2016 01:14:02

4C52 GN002C 1.UVDATA.1

Freq = 1.2770 GHz, Bw = 16.000 MH Calibrated with CL # 3 and BP # 1 (BP mode 1)

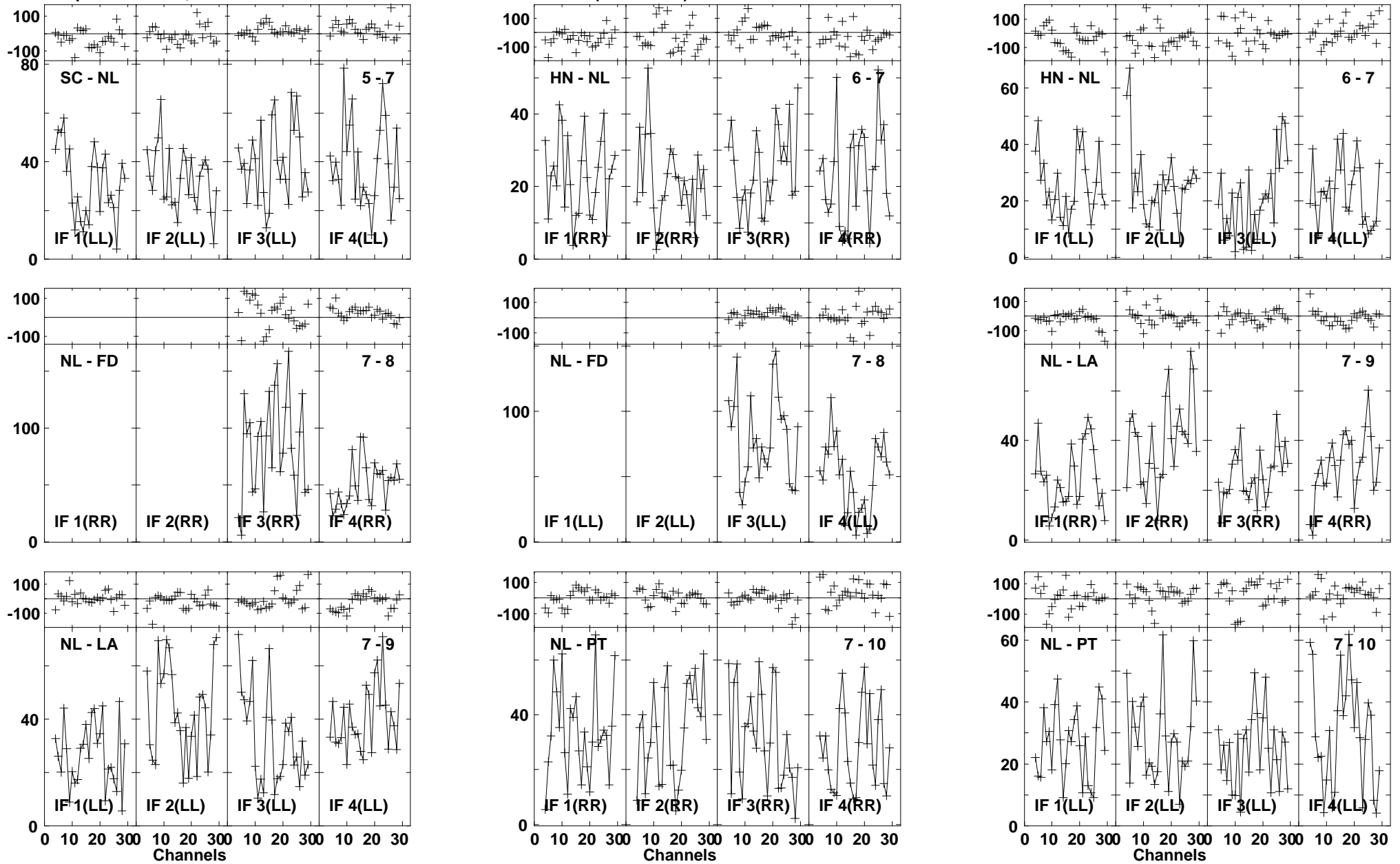

Lower frame: Milli Ampl Jy Top frame: Phas deg
Vector averaged cross-power spectrum Baseline: SC (05) - NL (07)
Timerange: 00/21:26:21 to 00/21:29:35

Plot file version 729 created 03-MAR-2016 01:14:02
 4C52 GN002C 1.UVDATA.1
 Freq = 1.2770 GHz, Bw = 16.000 MH Calibrated with CL # 3 and BP # 1 (BP mode 1)

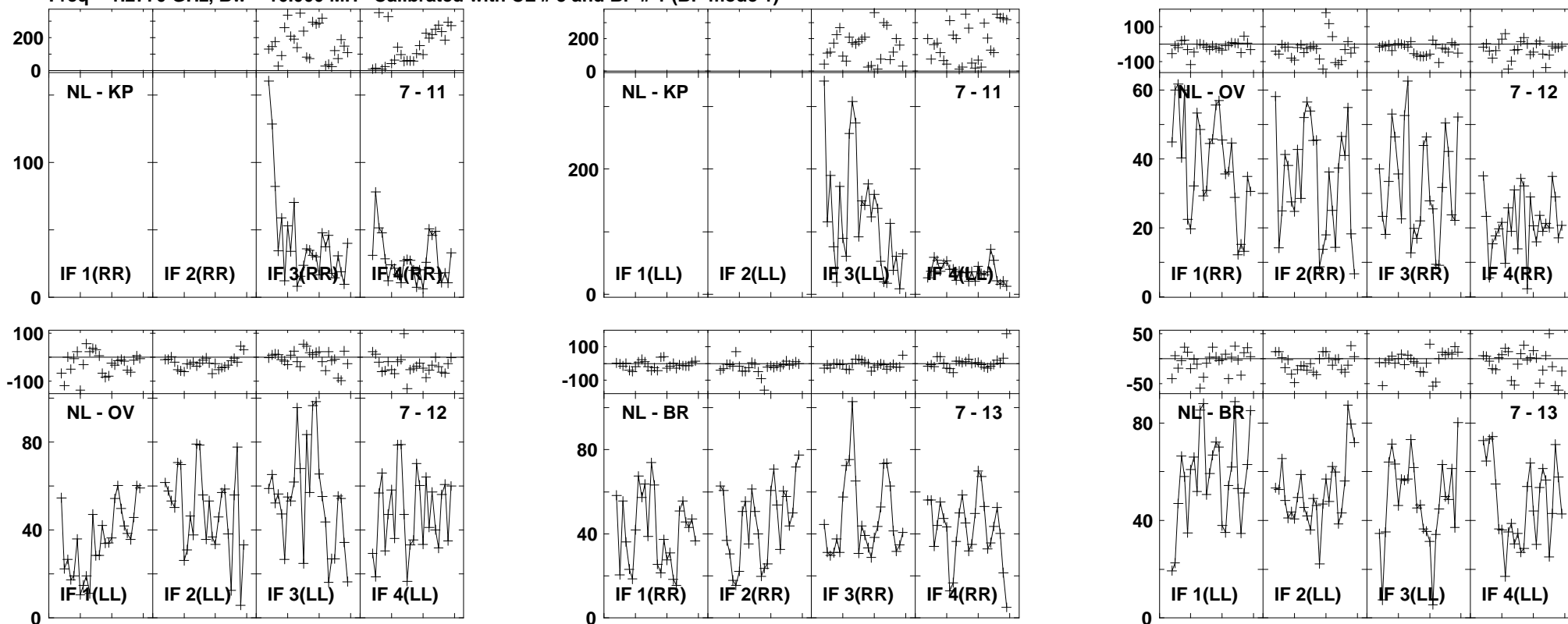

Lower frame: Milli Ampl Jy Top frame: Phas deg
 Vector averaged cross-power spectrum Baseline: NL (07) - KP (11)
 Timerange: 00/21:26:21 to 00/21:29:35

Plot file version 730 created 03-MAR-2016 01:14:02

J1545+5400 GN002C 1.UVDATA.1

Freq = 1.2770 GHz, Bw = 16.000 MH Calibrated with CL # 3 and BP # 1 (BP mode 1)

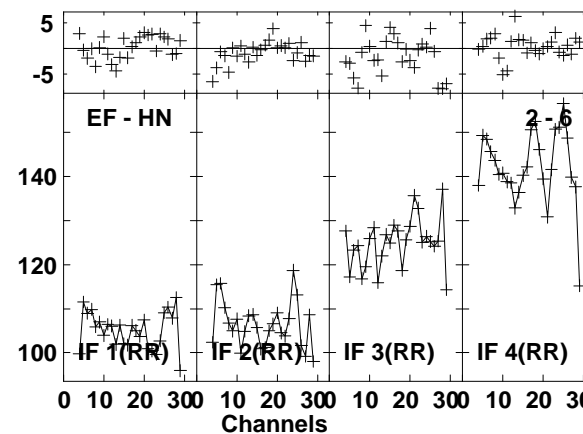
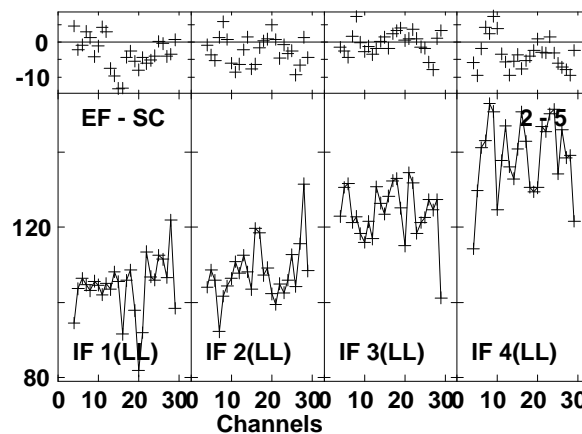
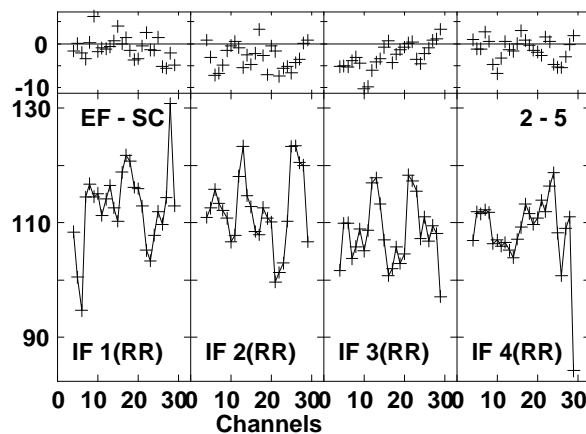
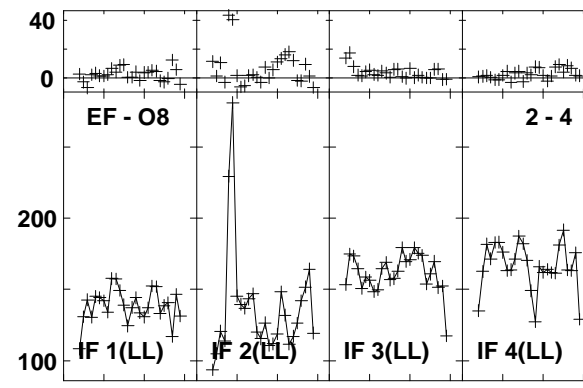
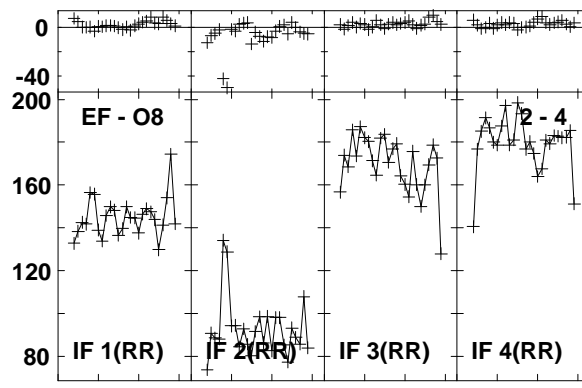
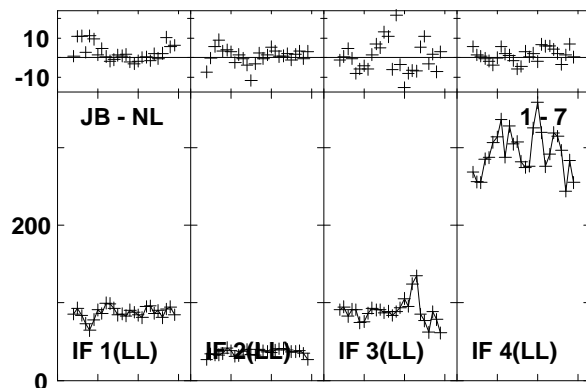
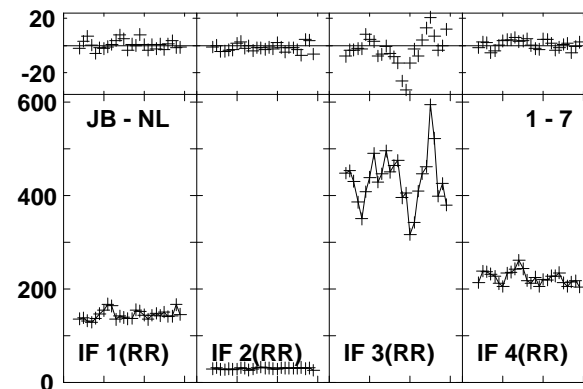
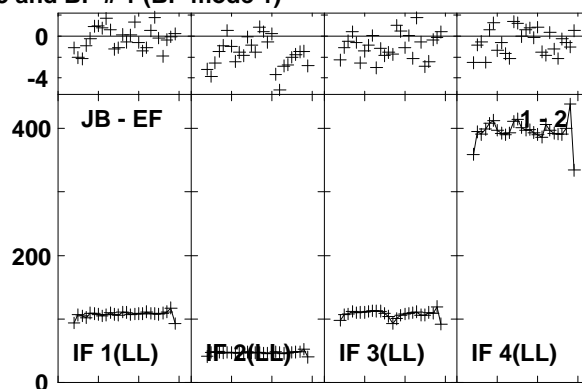
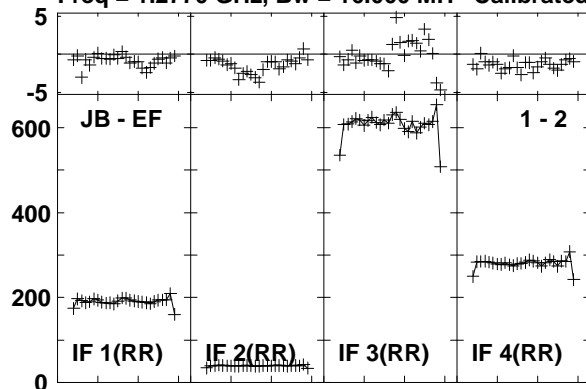

Lower frame: Milli Ampl Jy Top frame: Phas deg
Vector averaged cross-power spectrum Baseline: JB (01) - EF (02)
Timerange: 00/21:30:28 to 00/21:32:56

Plot file version 731 created 03-MAR-2016 01:14:02

J1545+5400 GN002C 1.UVDATA.1

Freq = 1.2770 GHz, Bw = 16.000 MH Calibrated with CL # 3 and BP # 1 (BP mode 1)

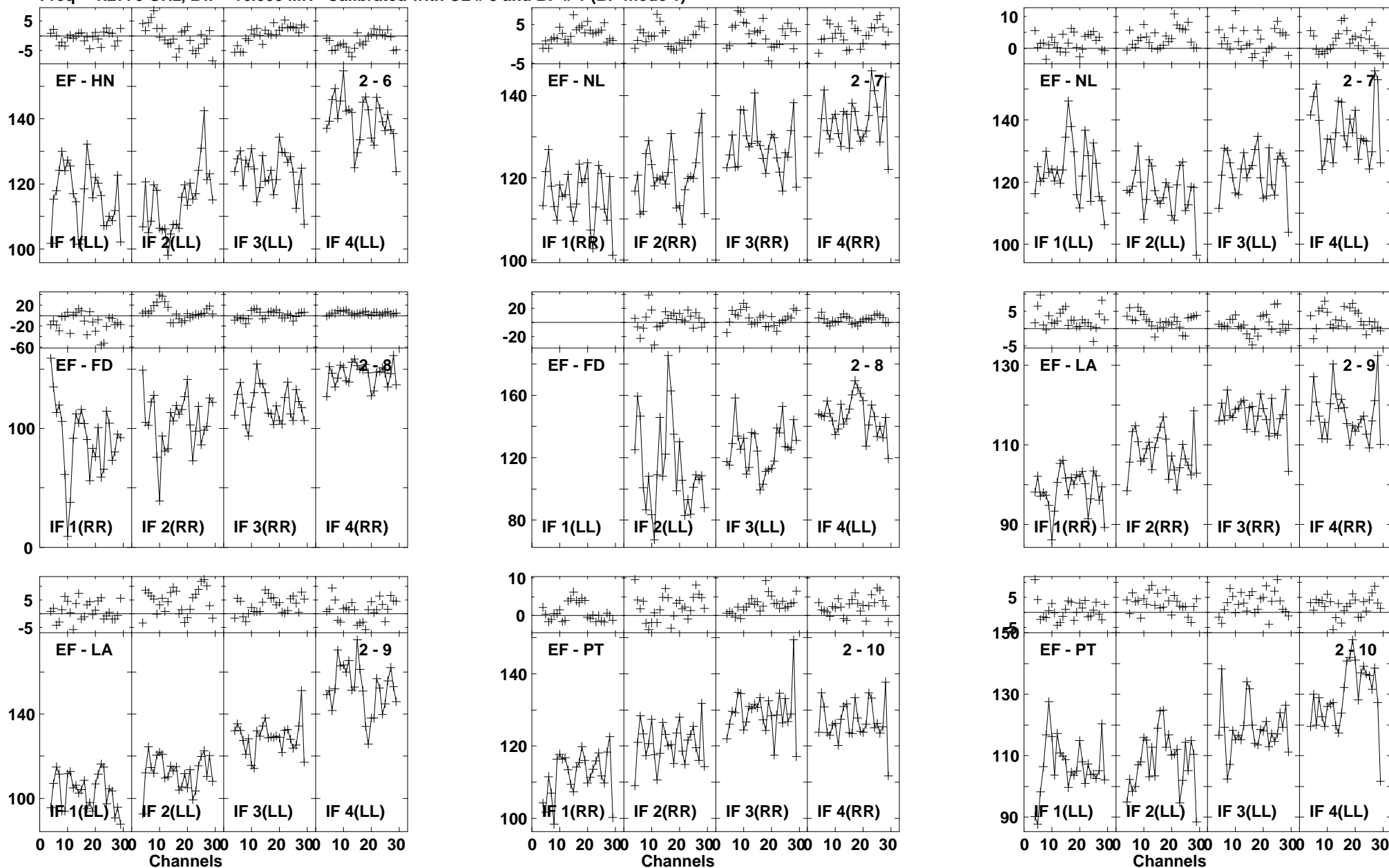

Plot file version 732 created 03-MAR-2016 01:14:02

J1545+5400 GN002C 1.UVDATA.1

Freq = 1.2770 GHz, Bw = 16.000 MH Calibrated with CL # 3 and BP # 1 (BP mode 1)

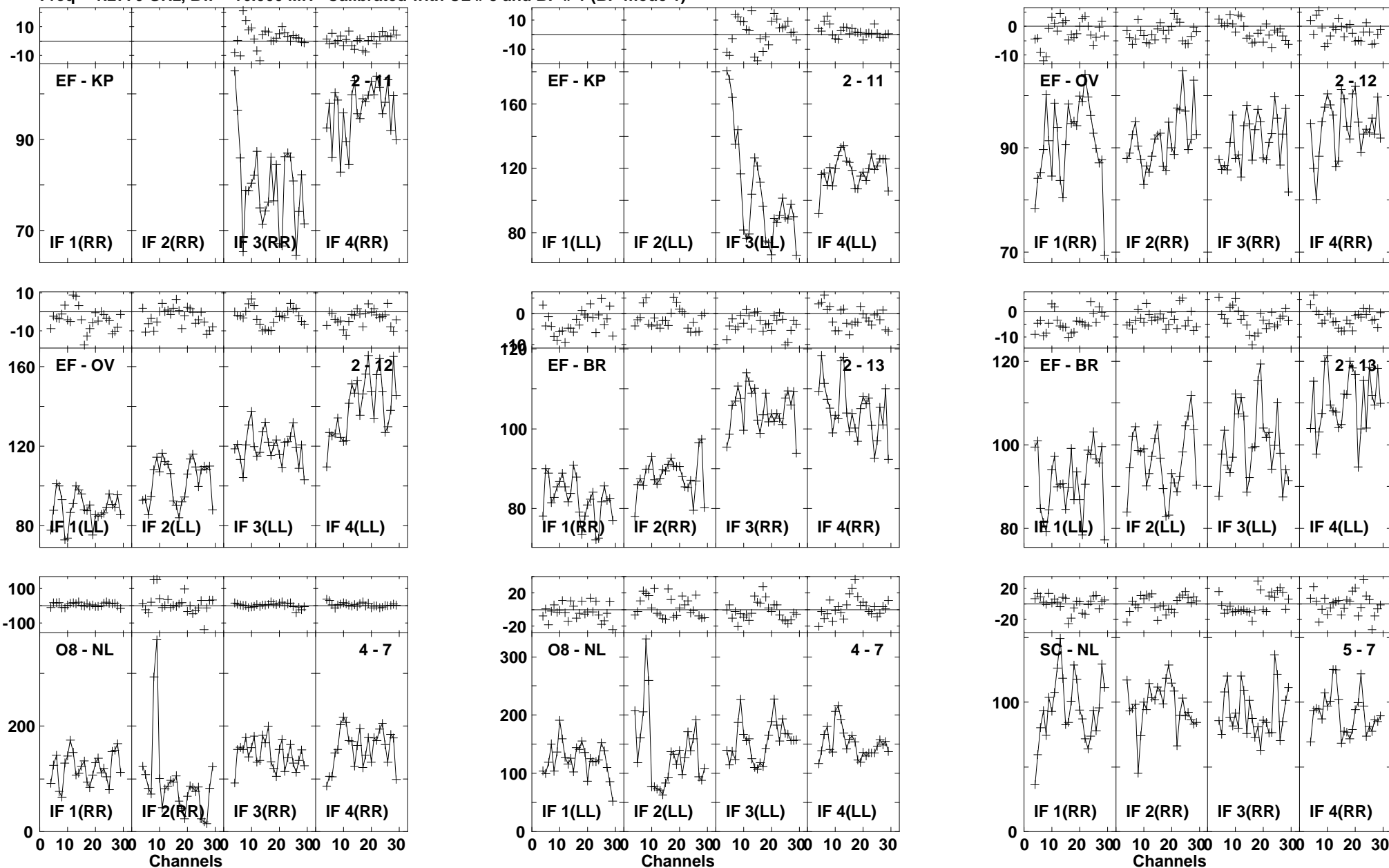

Lower frame: Milli Ampl Jy Top frame: Phas deg
Vector averaged cross-power spectrum Baseline: EF (02) - KP (11)
Timerange: 00/21:30:28 to 00/21:32:56

Plot file version 733 created 03-MAR-2016 01:14:03

J1545+5400 GN002C 1.UVDATA.1

Freq = 1.2770 GHz, Bw = 16.000 MH Calibrated with CL # 3 and BP # 1 (BP mode 1)

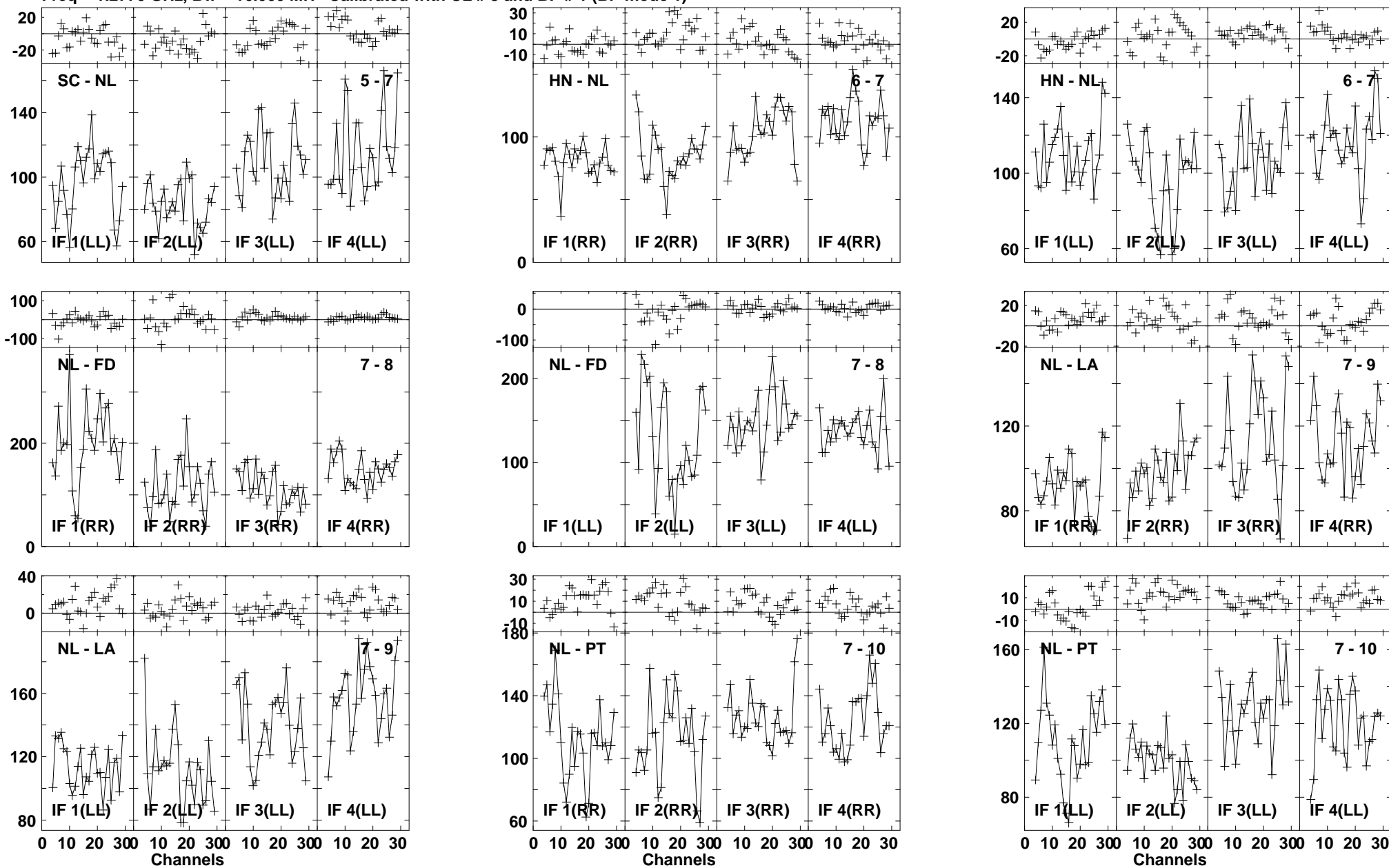

Plot file version 734 created 03-MAR-2016 01:14:03
 J1545+5400 GN002C 1.UVDATA.1
 Freq = 1.2770 GHz, Bw = 16.000 MH Calibrated with CL # 3 and BP # 1 (BP mode 1)

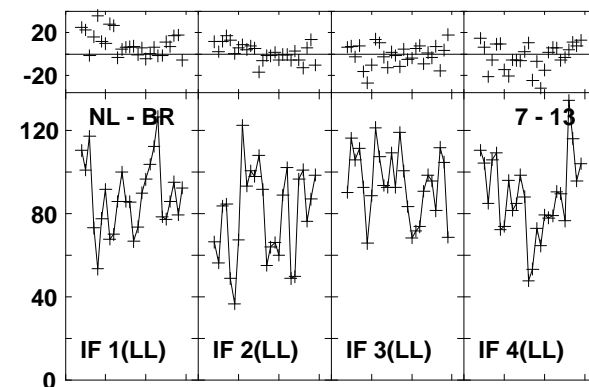
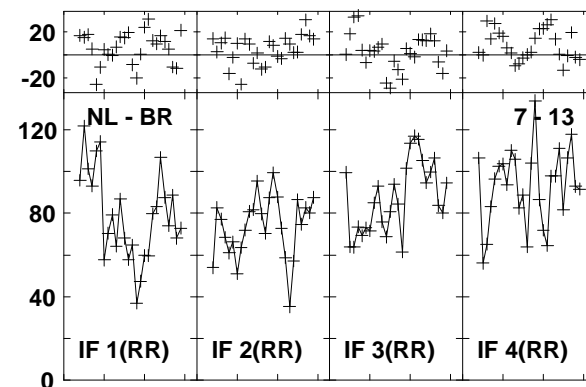
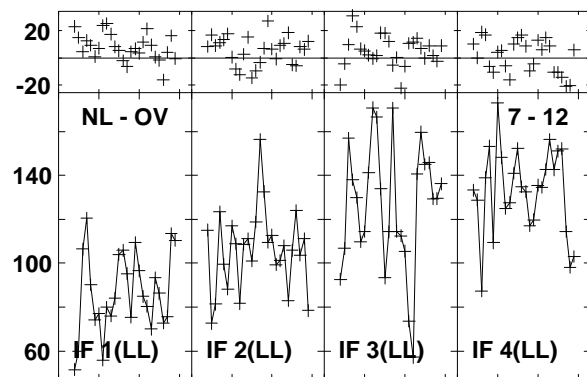
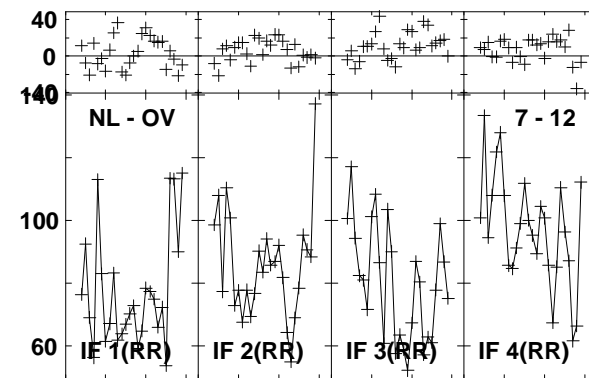
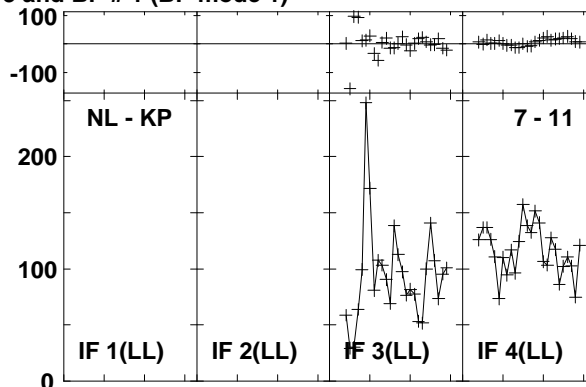
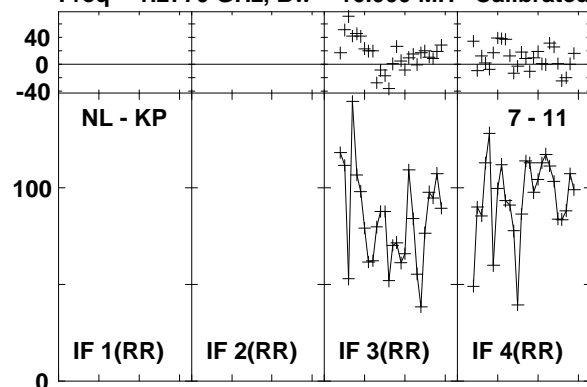

Lower frame: Milli Ampl Jy Top frame: Phas deg
 Vector averaged cross-power spectrum Baseline: NL (07) - KP (11)
 Timerange: 00/21:30:28 to 00/21:32:56

Plot file version 735 created 03-MAR-2016 01:14:03

4C52 GN002C 1.UVDATA.1

Freq = 1.2770 GHz, Bw = 16.000 MH Calibrated with CL # 3 and BP # 1 (BP mode 1)

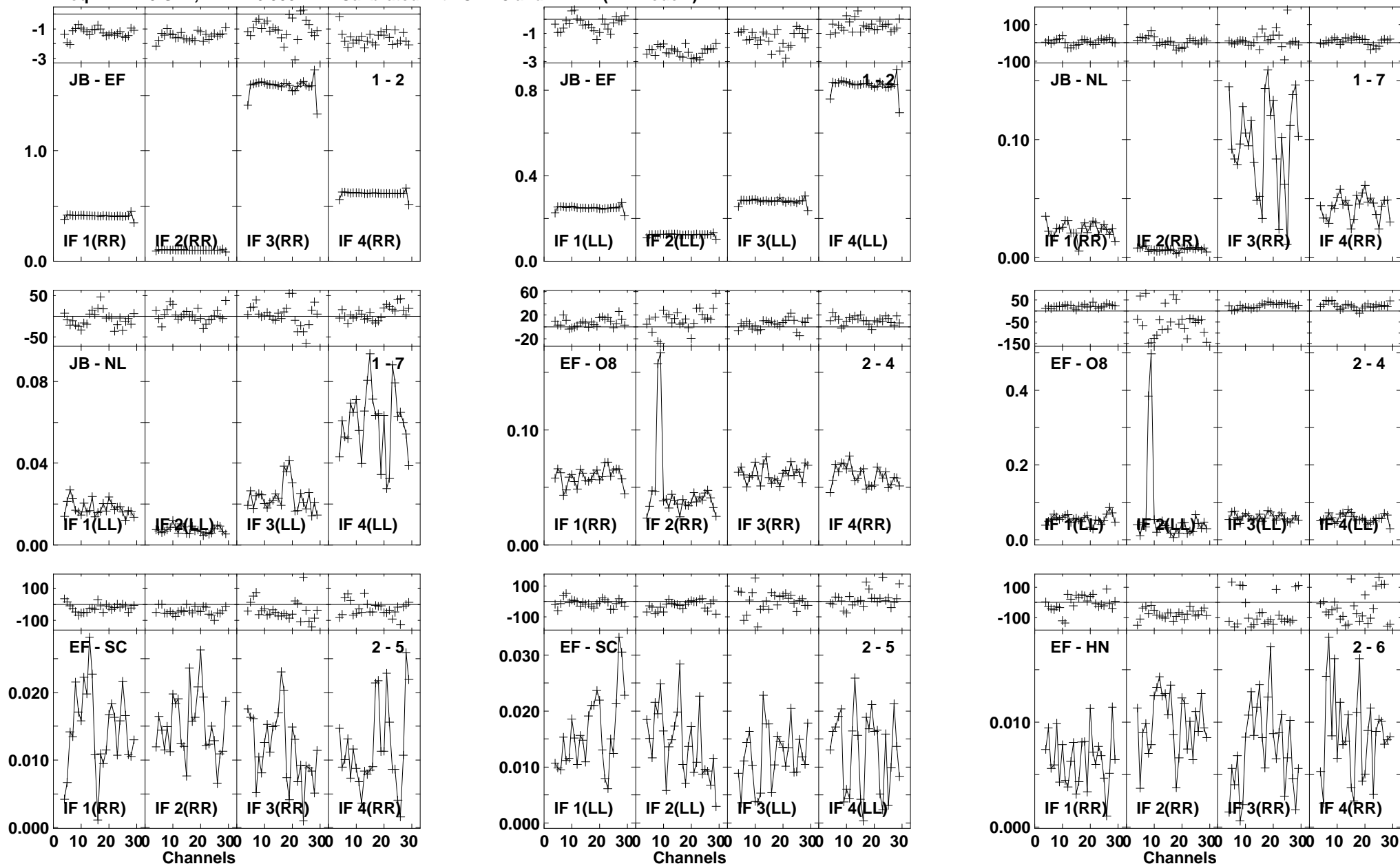

Lower frame: Ampl Jy Top frame: Phas deg
Vector averaged cross-power spectrum Baseline: JB (01) - EF (02)
Timerange: 00/21:33:10 to 00/21:36:26

Plot file version 736 created 03-MAR-2016 01:14:03

4C52 GN002C 1.UVDATA.1

Freq = 1.2770 GHz, Bw = 16.000 MH Calibrated with CL # 3 and BP # 1 (BP mode 1)

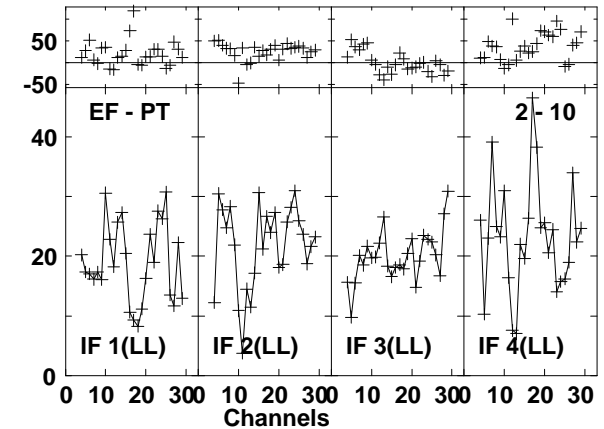
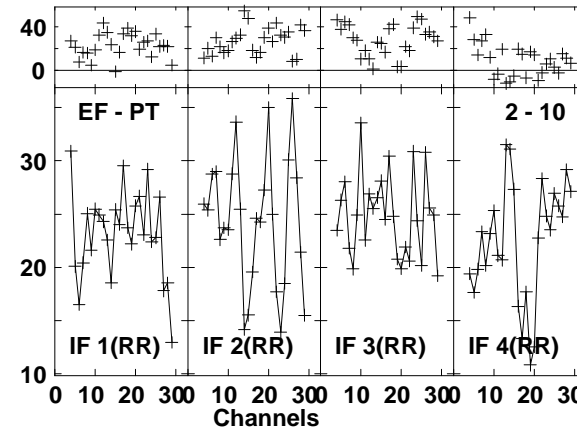
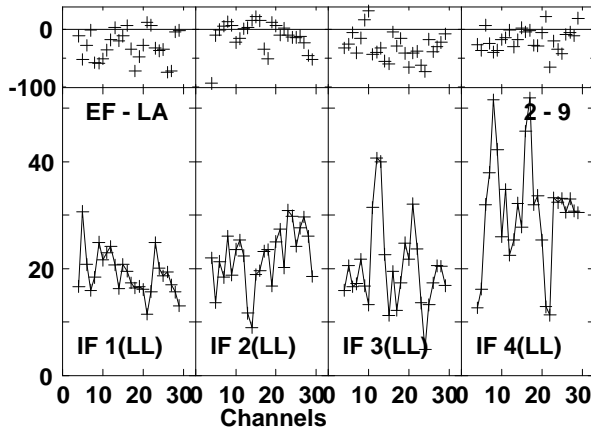
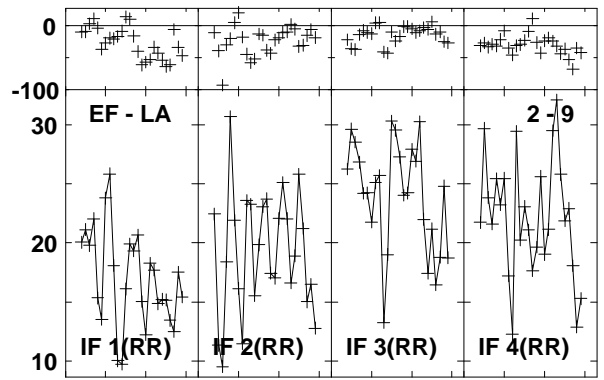
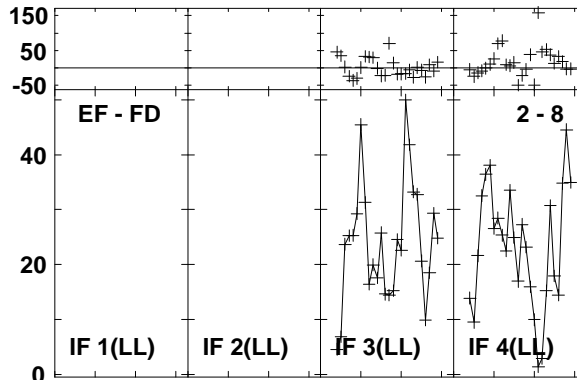
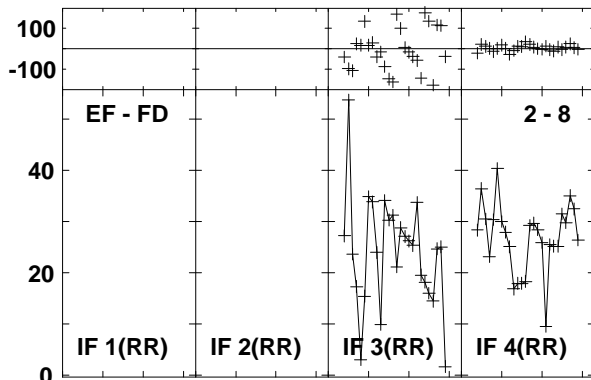
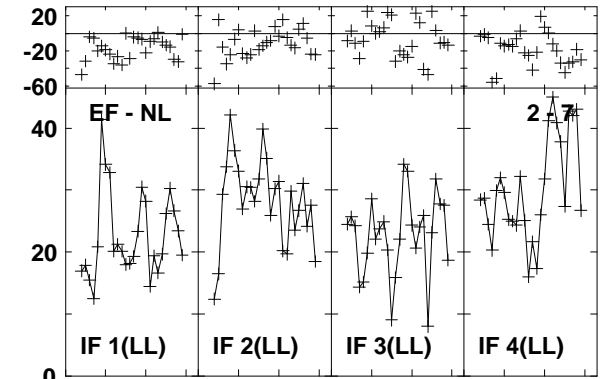
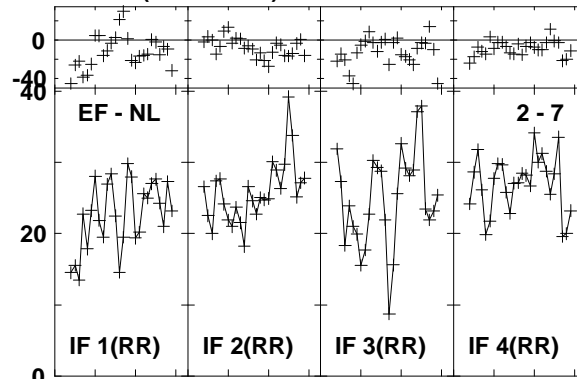
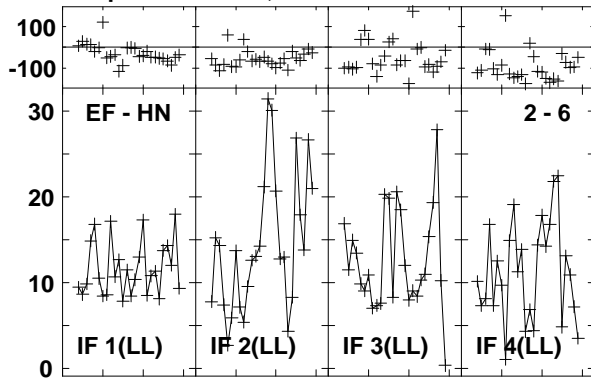

Lower frame: Milli Ampl Jy Top frame: Phas deg
Vector averaged cross-power spectrum Baseline: EF (02) - HN (06)
Timerange: 00/21:33:10 to 00/21:36:26

Plot file version 737 created 03-MAR-2016 01:14:03
 4C52 GN002C 1.UVDATA.1
 Freq = 1.2770 GHz, Bw = 16.000 MH Calibrated with CL # 3 and BP # 1 (BP mode 1)

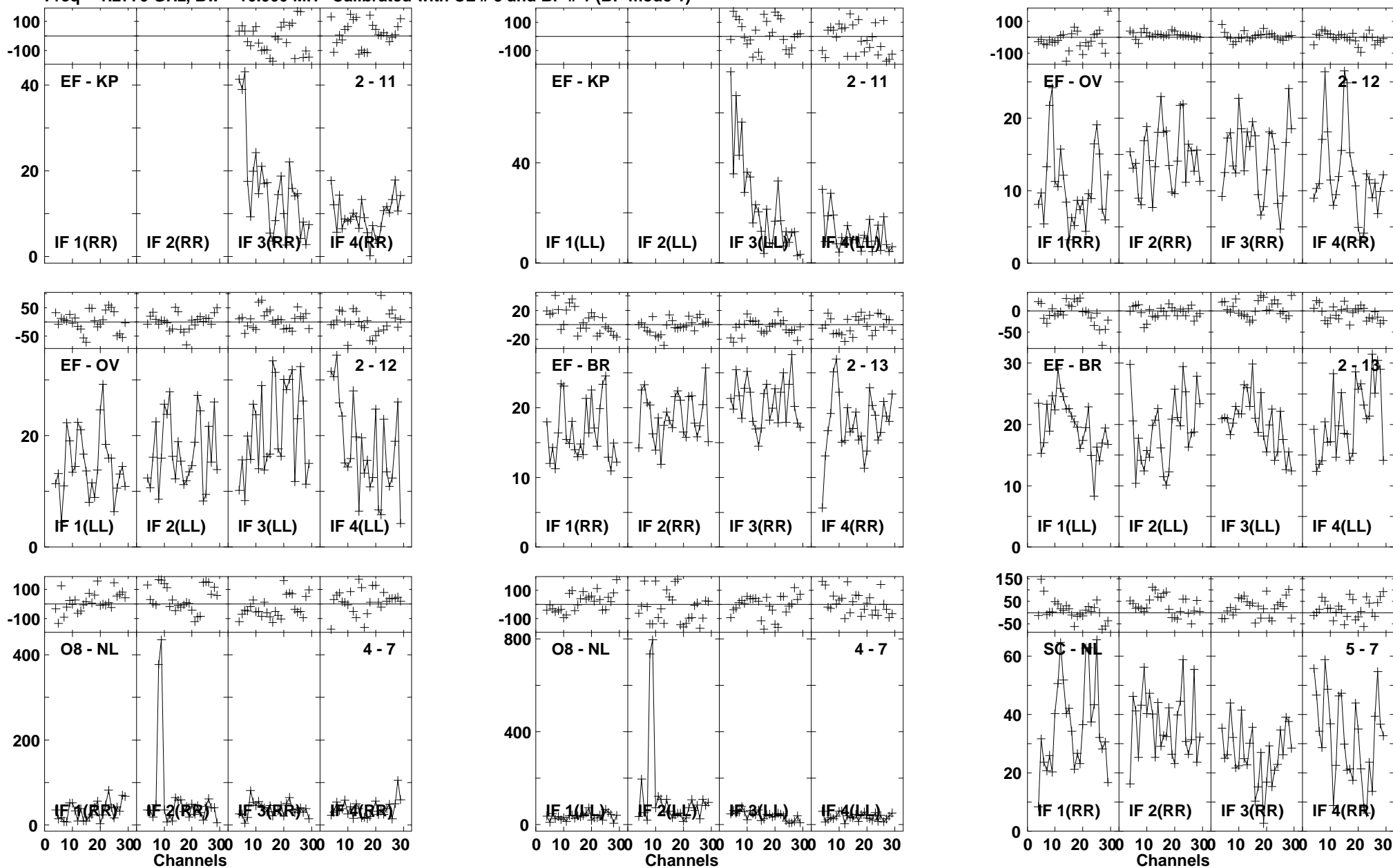

Lower frame: Milli Ampl Jy Top frame: Phas deg
 Vector averaged cross-power spectrum Baseline: EF (02) - KP (11)
 Timerange: 00/21:33:10 to 00/21:36:26

Plot file version 738 created 03-MAR-2016 01:14:04

4C52 GN002C 1.UVDATA.1

Freq = 1.2770 GHz, Bw = 16.000 MH Calibrated with CL # 3 and BP # 1 (BP mode 1)

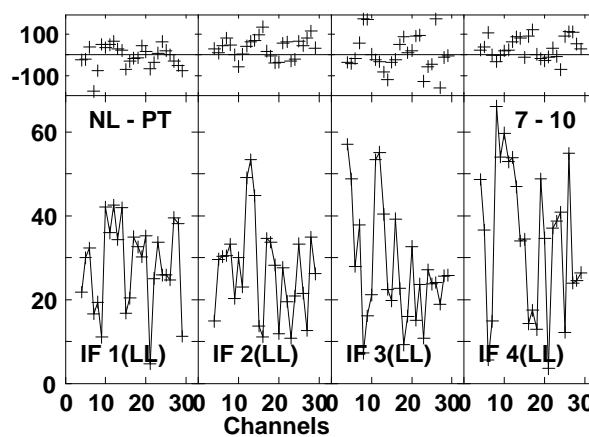
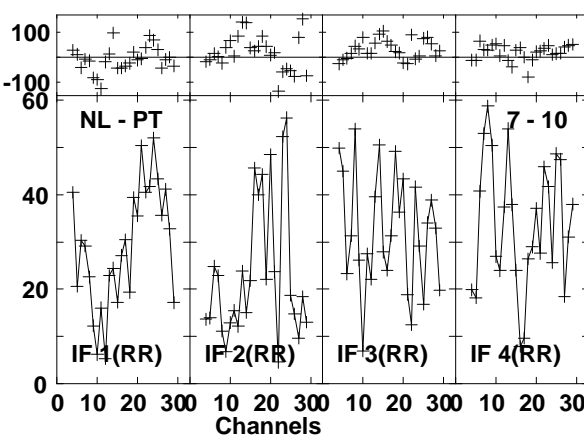
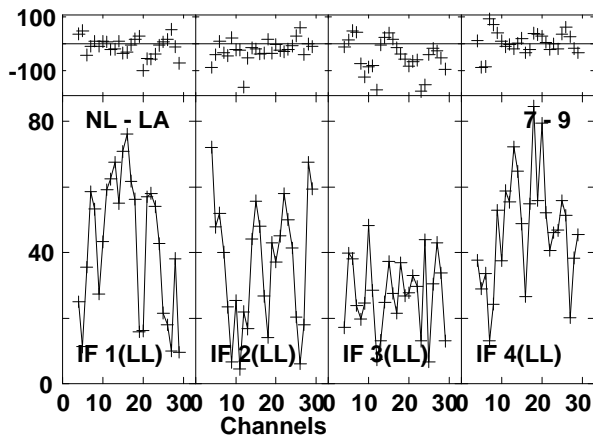
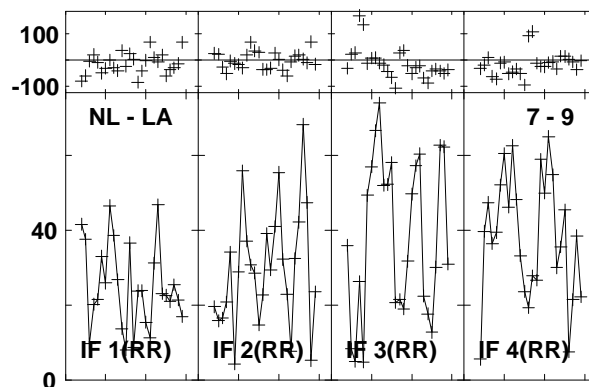
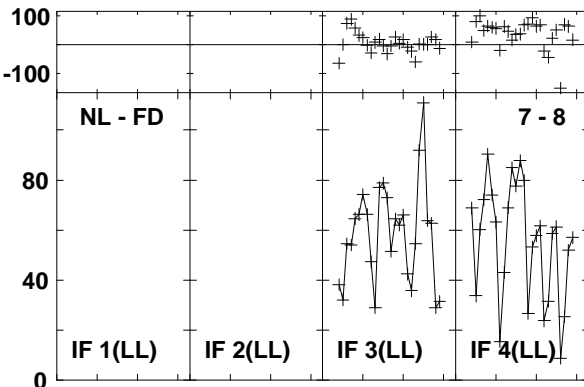
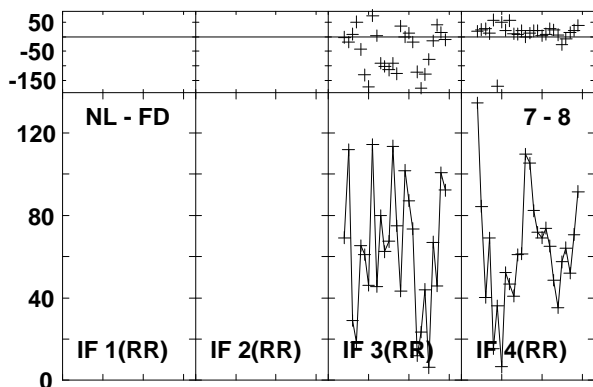
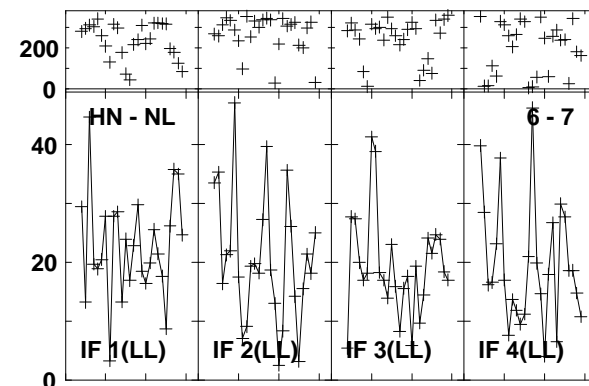
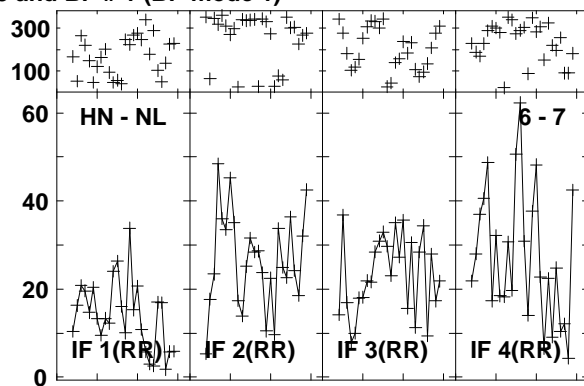
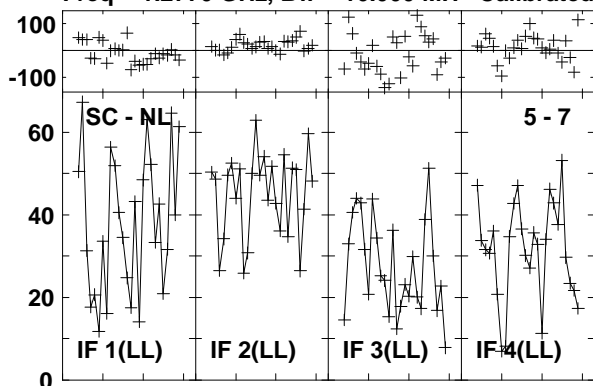

Lower frame: Milli Ampl Jy Top frame: Phas deg
Vector averaged cross-power spectrum Baseline: SC (05) - NL (07)
Timerange: 00/21:33:10 to 00/21:36:26

Plot file version 739 created 03-MAR-2016 01:14:04
 4C52 GN002C 1.UVDATA.1
 Freq = 1.2770 GHz, Bw = 16.000 MH Calibrated with CL # 3 and BP # 1 (BP mode 1)

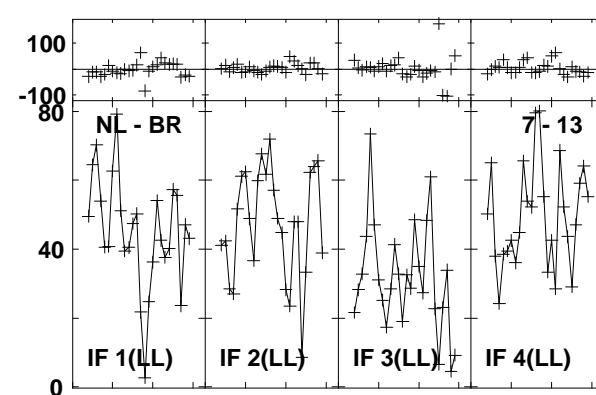
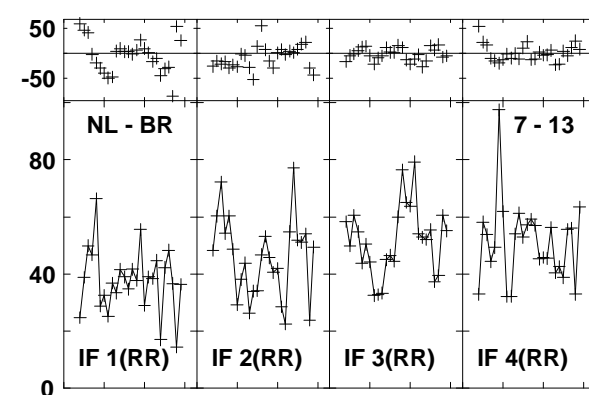
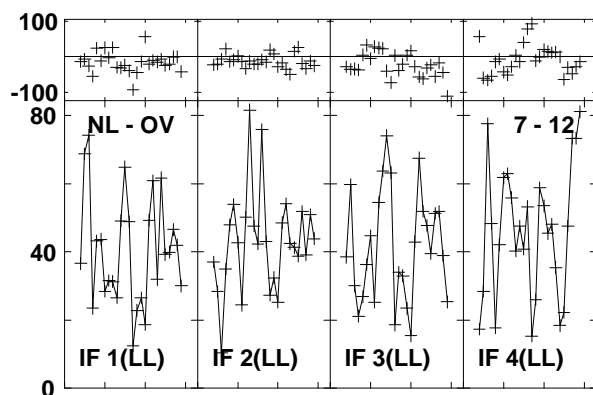
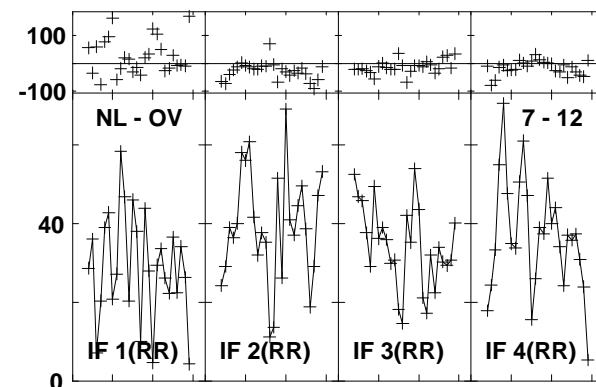
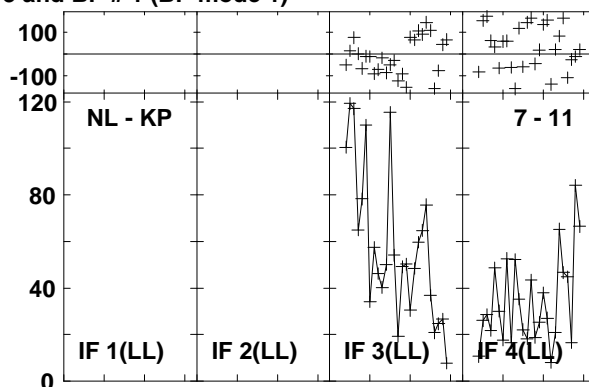
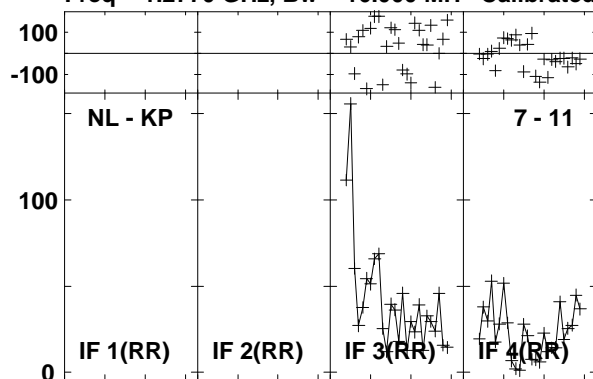

Lower frame: Milli Ampl Jy Top frame: Phas deg
 Vector averaged cross-power spectrum Baseline: NL (07) - KP (11)
 Timerange: 00/21:33:10 to 00/21:36:26

Plot file version 740 created 03-MAR-2016 01:14:04
 J1545+5400 GN002C 1.UVDATA.1
 Freq = 1.2770 GHz, Bw = 16.000 MH Calibrated with CL # 3 and BP # 1 (BP mode 1)

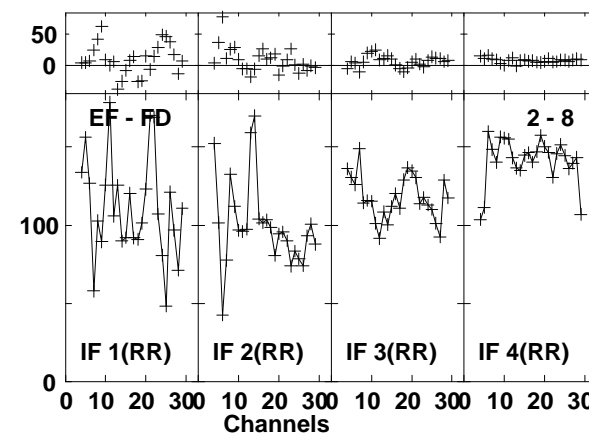
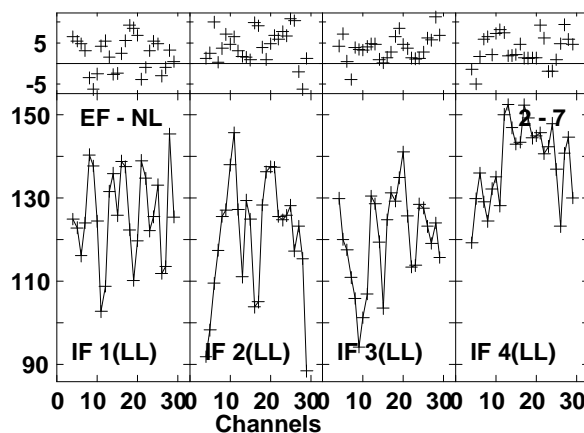
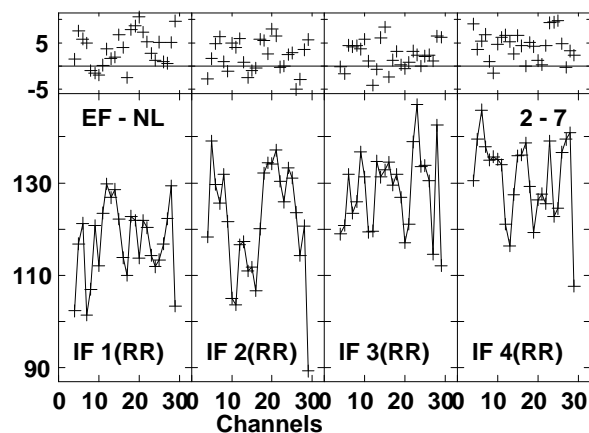
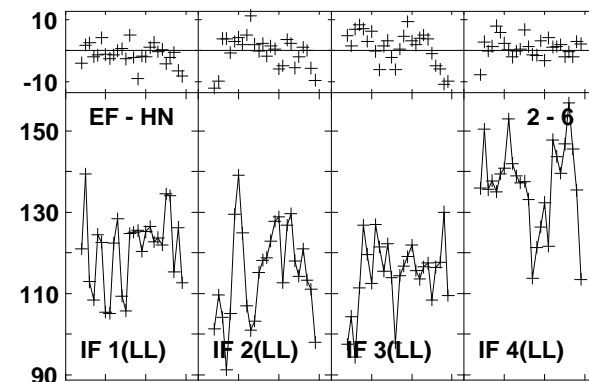
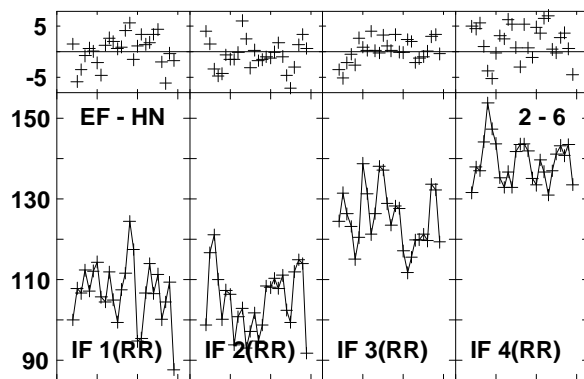
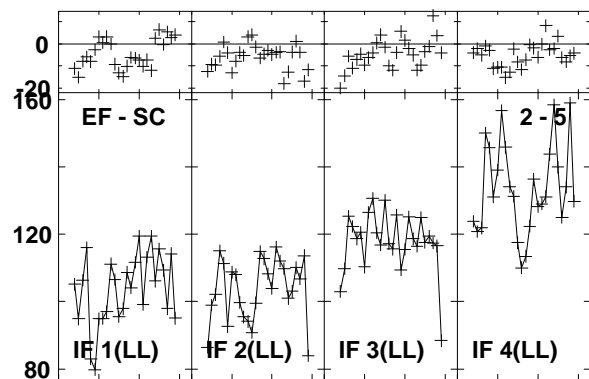
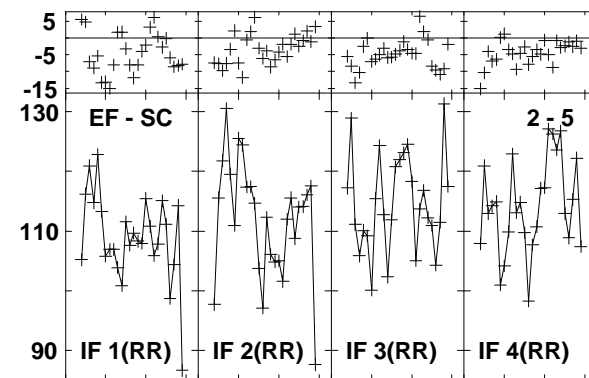
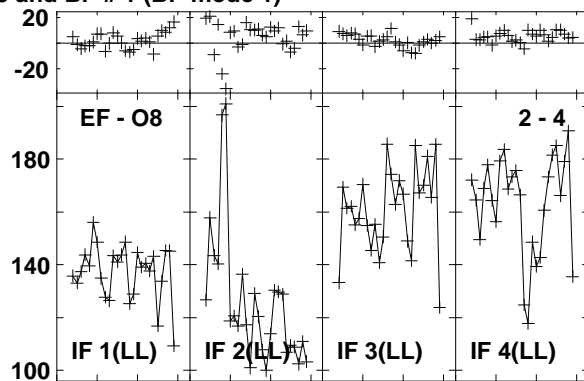
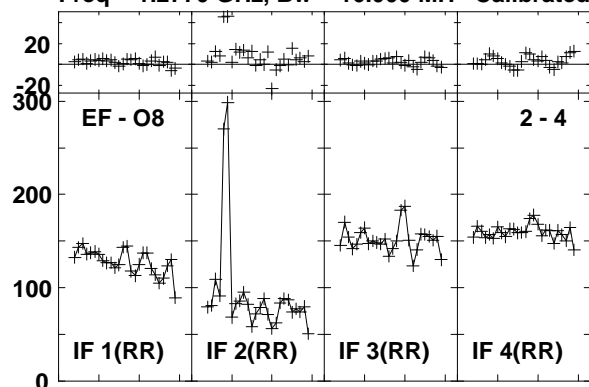

Lower frame: Milli Ampl Jy Top frame: Phas deg
 Vector averaged cross-power spectrum Baseline: EF (02) - O8 (04)
 Timerange: 00/21:37:18 to 00/21:38:46

Plot file version 741 created 03-MAR-2016 01:14:04

J1545+5400 GN002C 1.UVDATA.1

Freq = 1.2770 GHz, Bw = 16.000 MH Calibrated with CL # 3 and BP # 1 (BP mode 1)

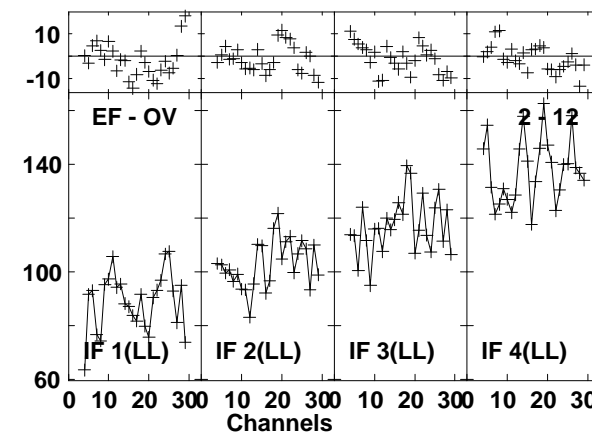
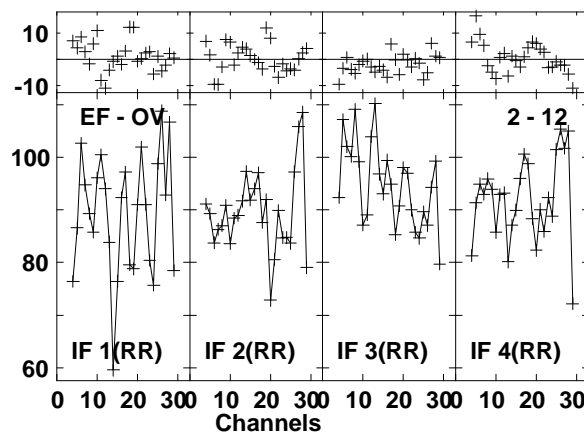
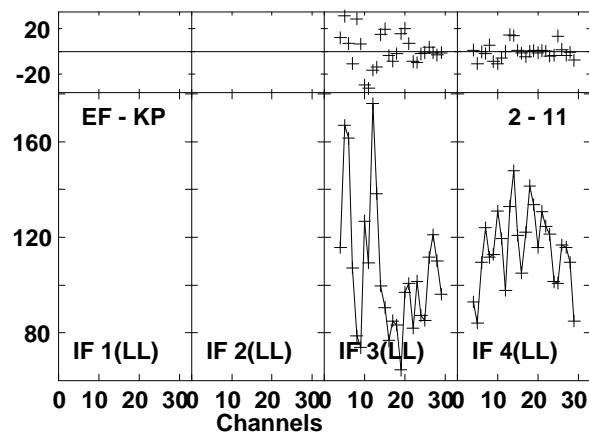
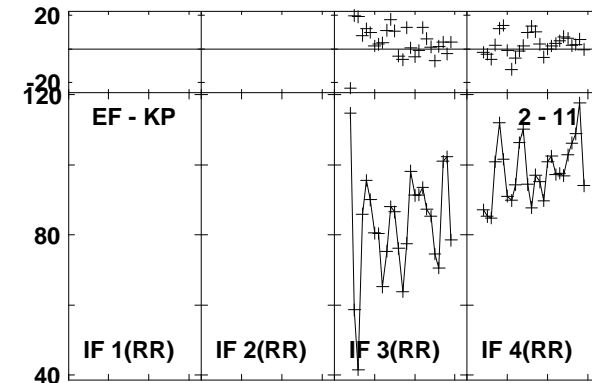
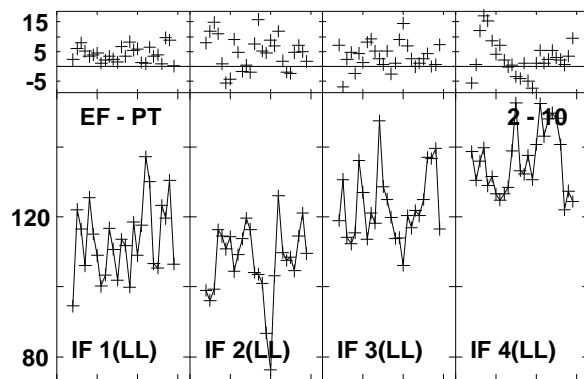
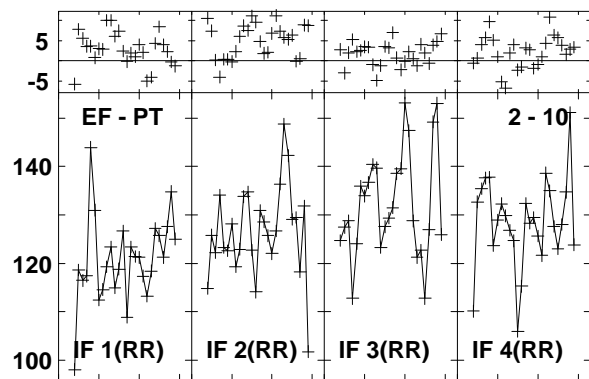
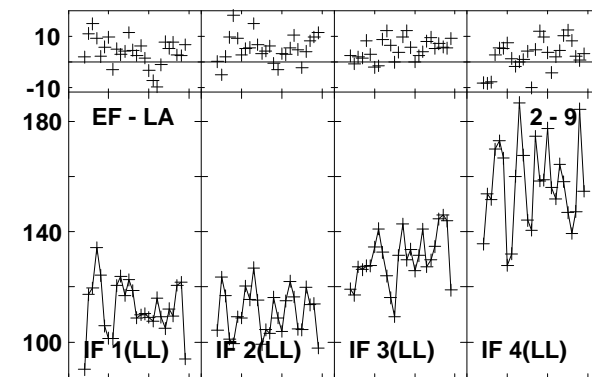
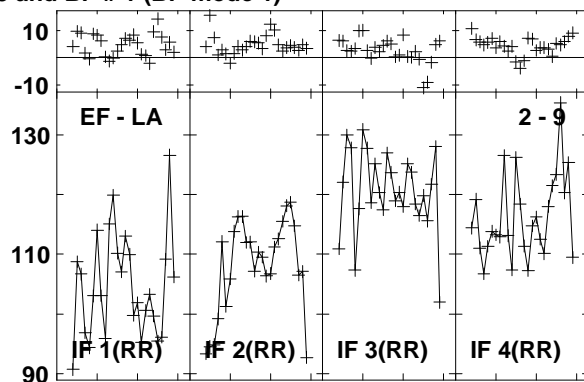
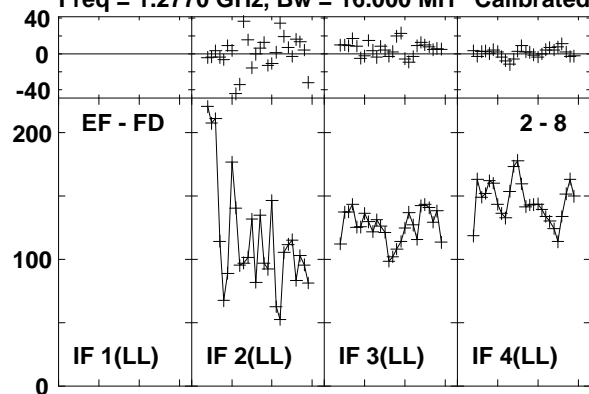

Lower frame: Milli Ampl Jy Top frame: Phas deg
Vector averaged cross-power spectrum Baseline: EF (02) - FD (08)
Timerange: 00/21:37:18 to 00/21:38:46

Plot file version 742 created 03-MAR-2016 01:14:04

J1545+5400 GN002C 1.UVDATA.1

Freq = 1.2770 GHz, Bw = 16.000 MH Calibrated with CL # 3 and BP # 1 (BP mode 1)

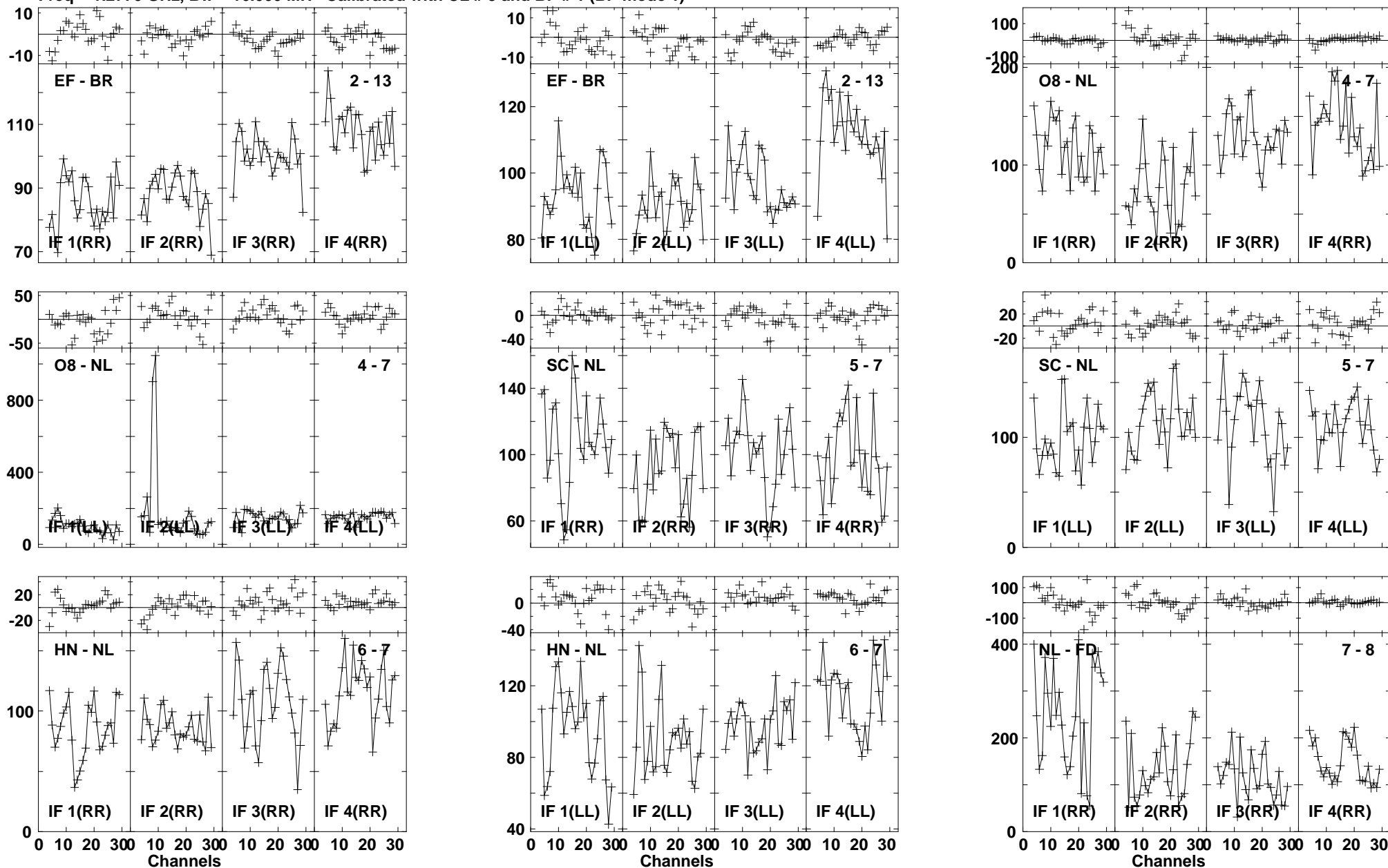

Lower frame: Milli Ampl Jy Top frame: Phas deg
Vector averaged cross-power spectrum Baseline: EF (02) - BR (13)
Timerange: 00/21:37:18 to 00/21:38:46

Plot file version 743 created 03-MAR-2016 01:14:05

J1545+5400 GN002C 1.UVDATA.1

Freq = 1.2770 GHz, Bw = 16.000 MH Calibrated with CL # 3 and BP # 1 (BP mode 1)

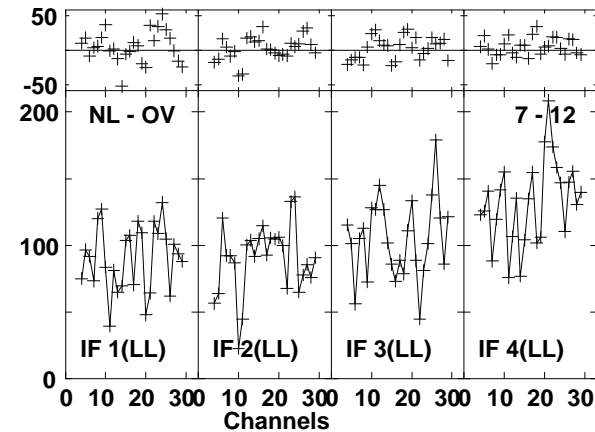
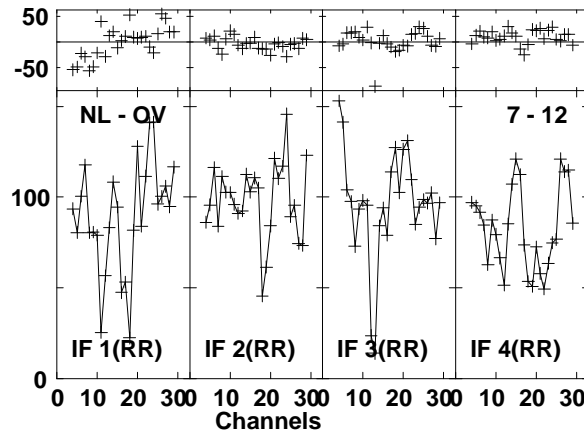
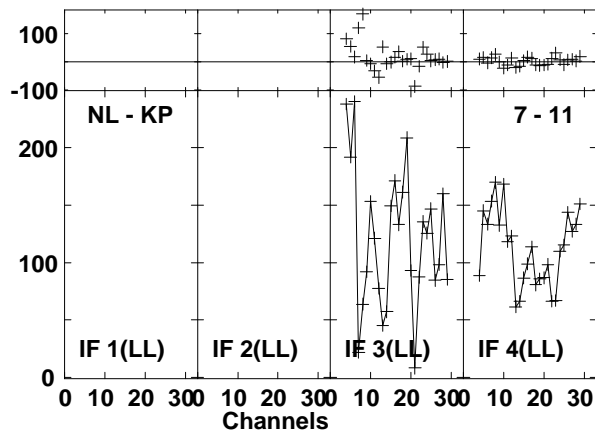
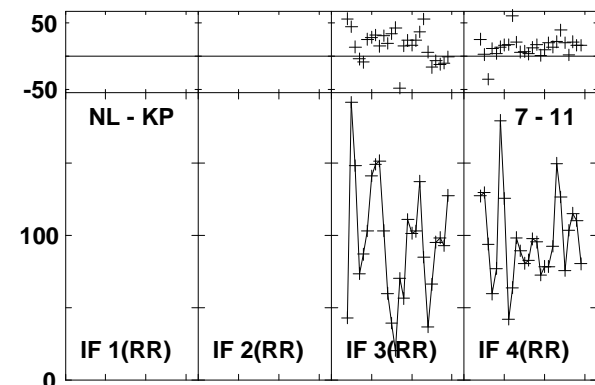
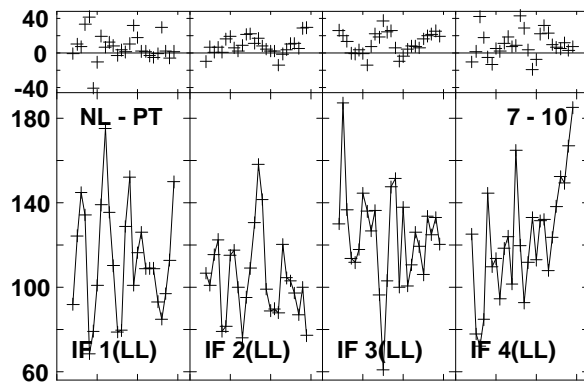
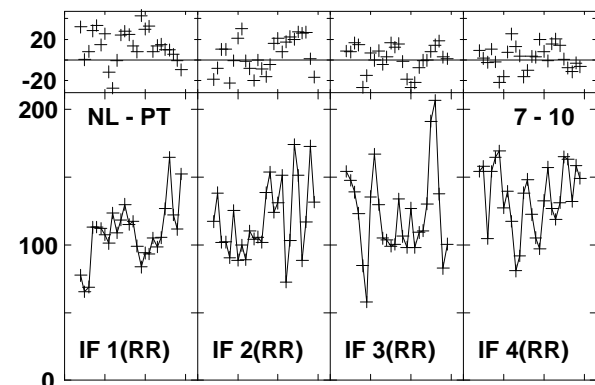
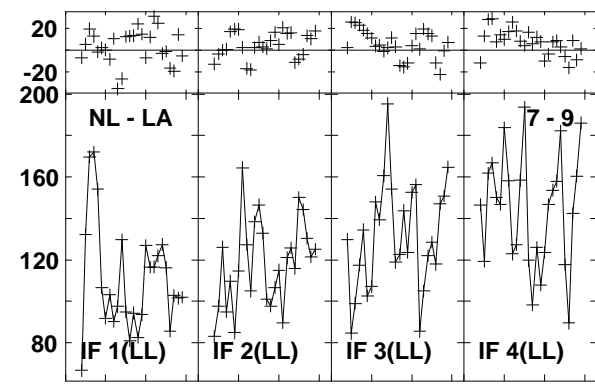
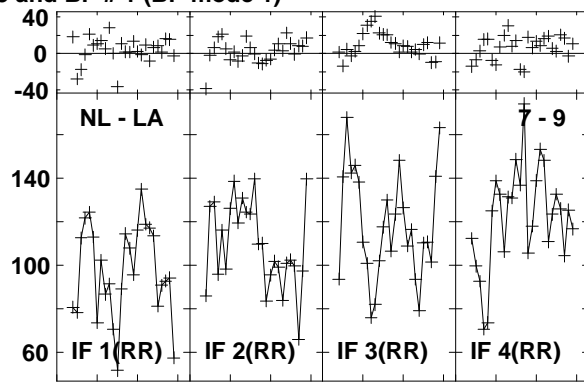
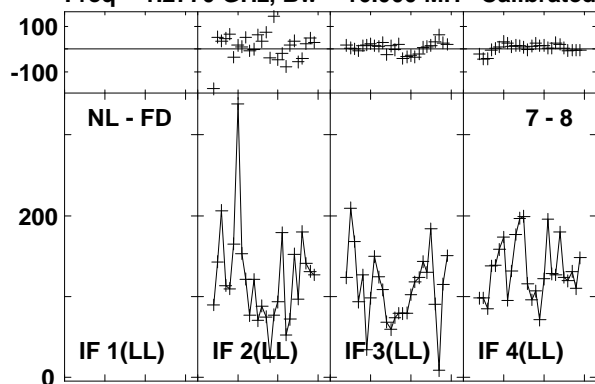

Lower frame: Milli Ampl Jy Top frame: Phas deg
Vector averaged cross-power spectrum Baseline: NL (07) - FD (08)
Timerange: 00/21:37:18 to 00/21:38:46

Plot file version 744 created 03-MAR-2016 01:14:05

J1545+5400 GN002C 1.UVDATA.1

Freq = 1.2770 GHz, Bw = 16.000 MH Calibrated with CL # 3 and BP # 1 (BP mode 1)

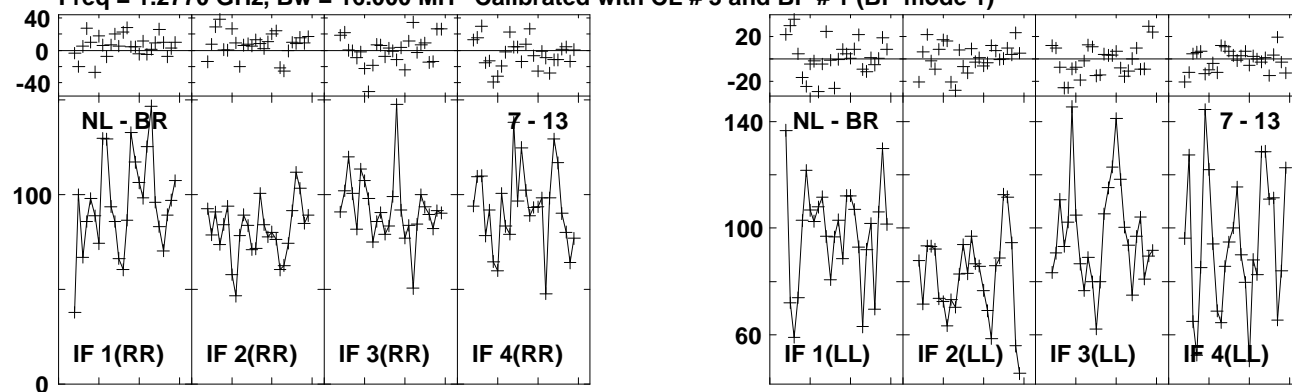

Lower frame: Milli Ampl Jy Top frame: Phas deg
Vector averaged cross-power spectrum Baseline: NL (07) - BR (13)
Timerange: 00/21:37:18 to 00/21:38:46

Plot file version 745 created 03-MAR-2016 01:14:05

4C52 GN002C 1.UVDATA.1

Freq = 1.2770 GHz, Bw = 16.000 MH Calibrated with CL # 3 and BP # 1 (BP mode 1)

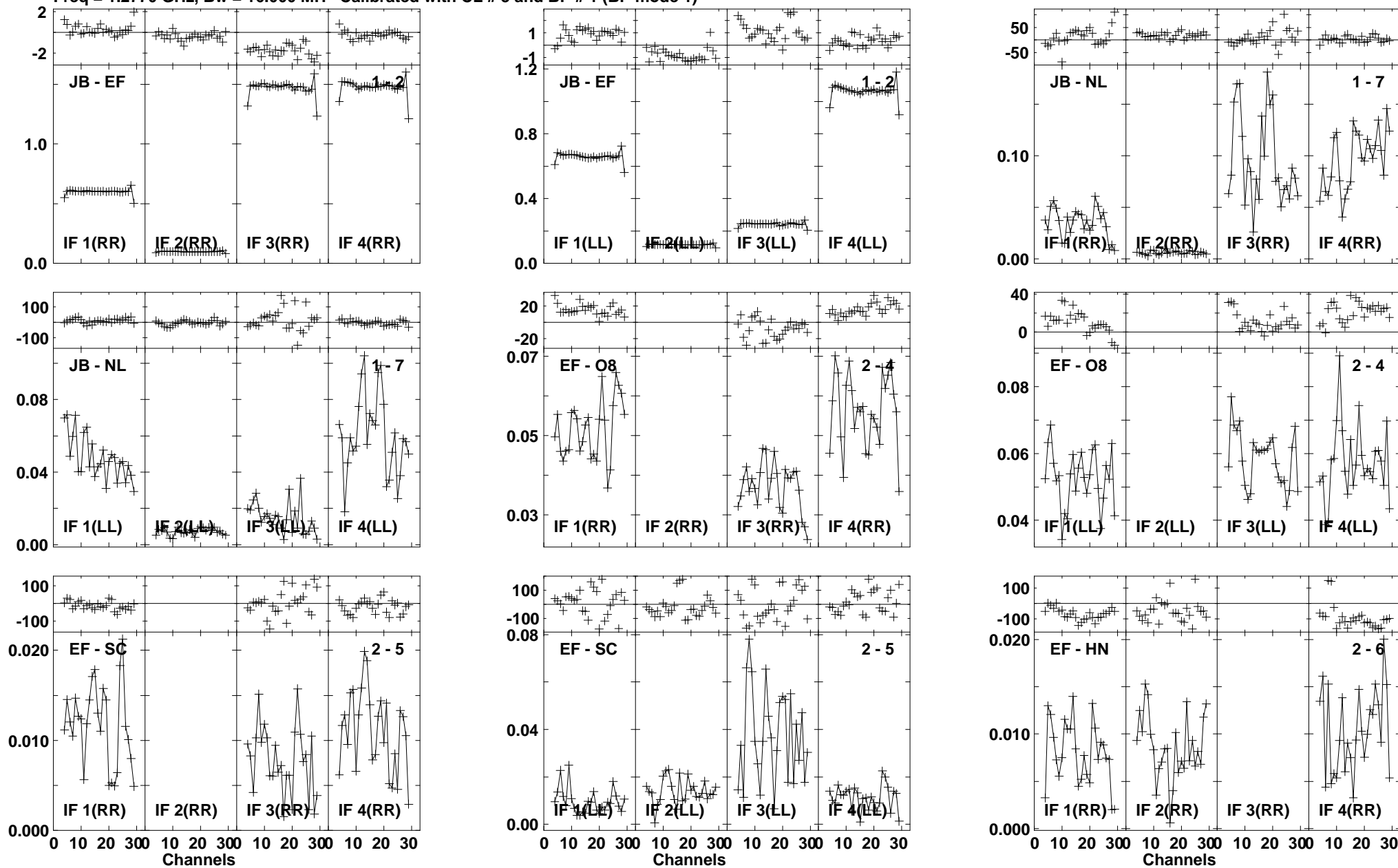

Plot file version 746 created 03-MAR-2016 01:14:05

4C52 GN002C 1.UVDATA.1

Freq = 1.2770 GHz, Bw = 16.000 MH Calibrated with CL # 3 and BP # 1 (BP mode 1)

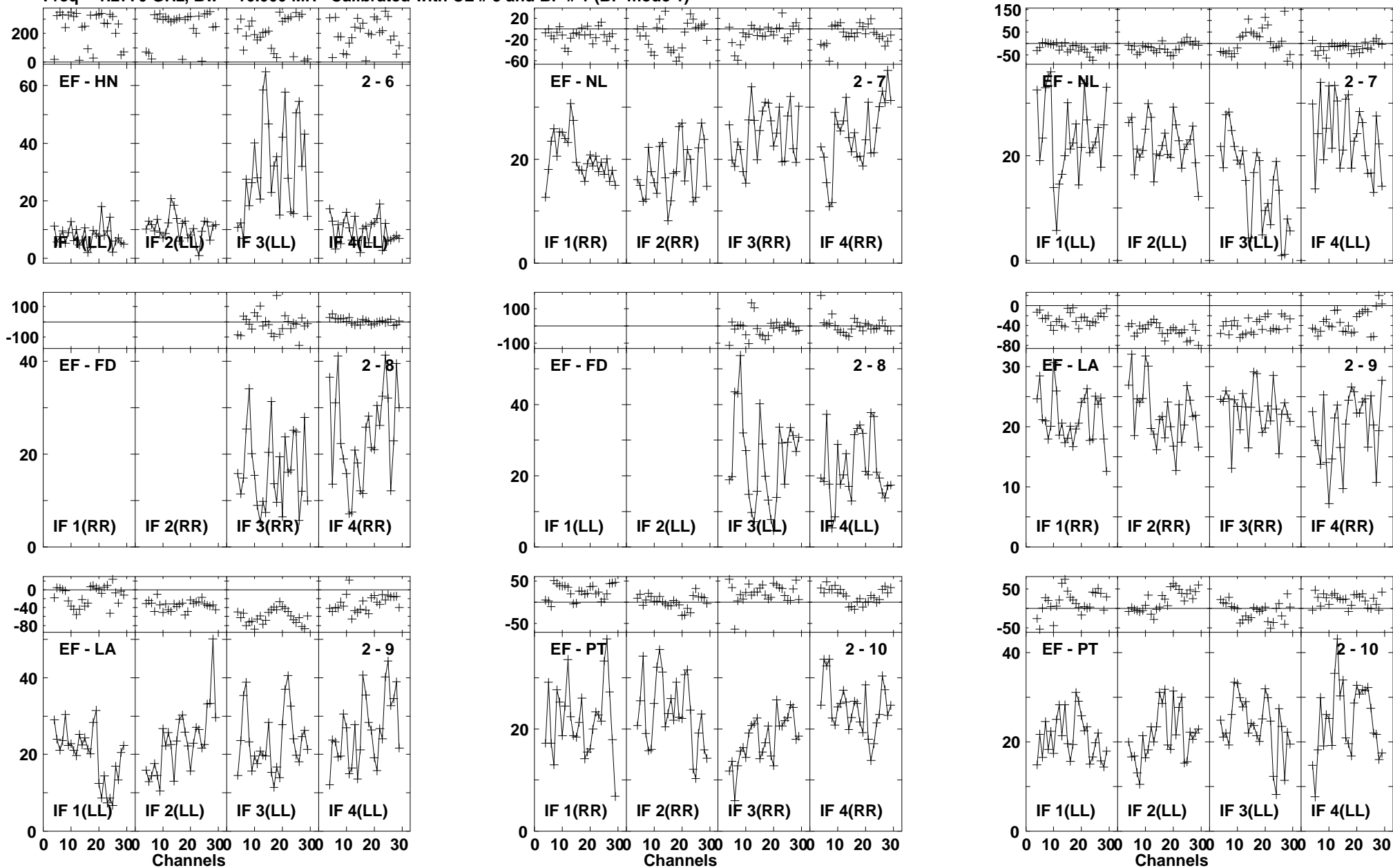

Lower frame: Milli Ampl Jy Top frame: Phas deg
Vector averaged cross-power spectrum Baseline: EF (02) - HN (06)
Timerange: 00/21:38:51 to 00/21:42:05

Plot file version 747 created 03-MAR-2016 01:14:05

4C52 GN002C 1.UVDATA.1

Freq = 1.2770 GHz, Bw = 16.000 MH Calibrated with CL # 3 and BP # 1 (BP mode 1)

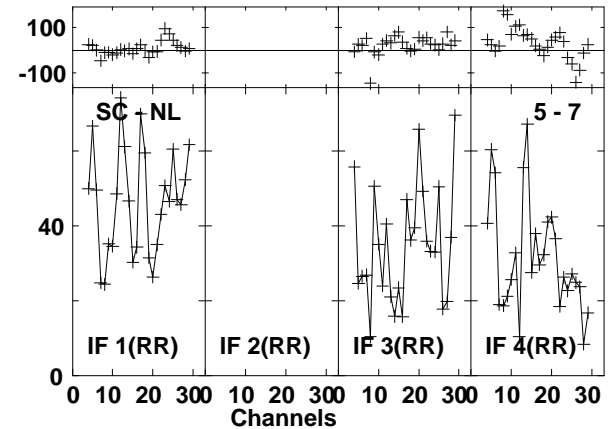
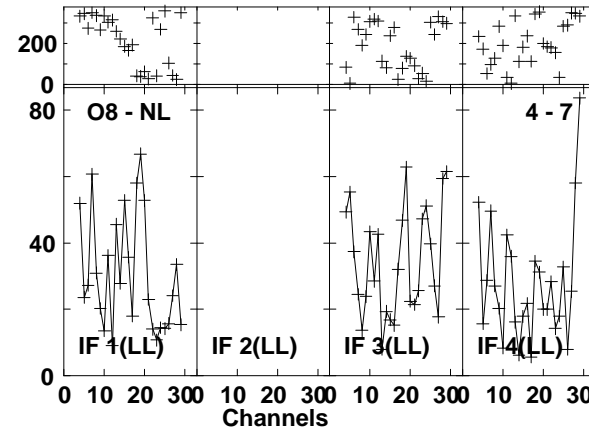
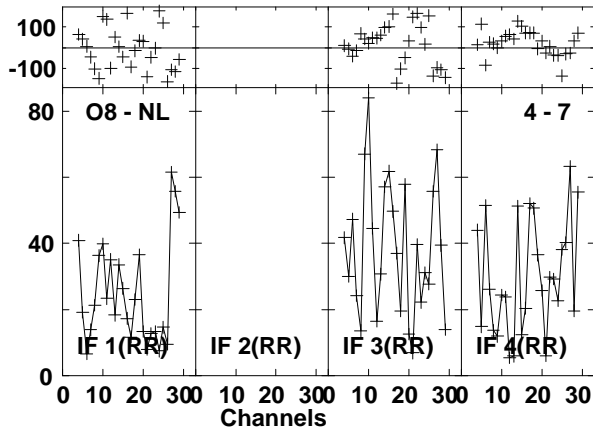
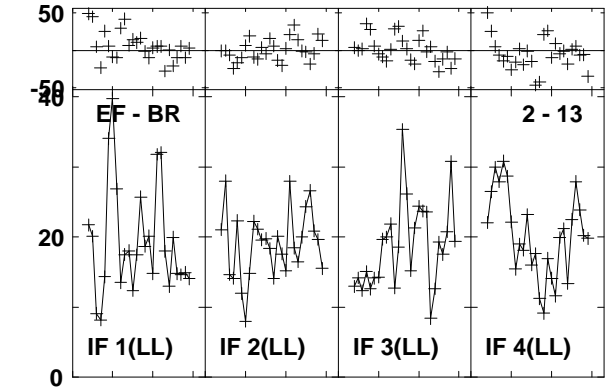
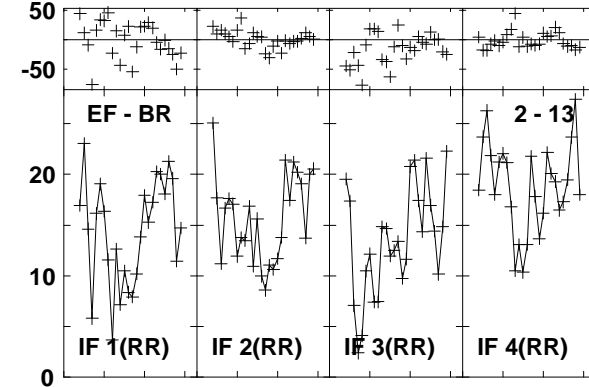
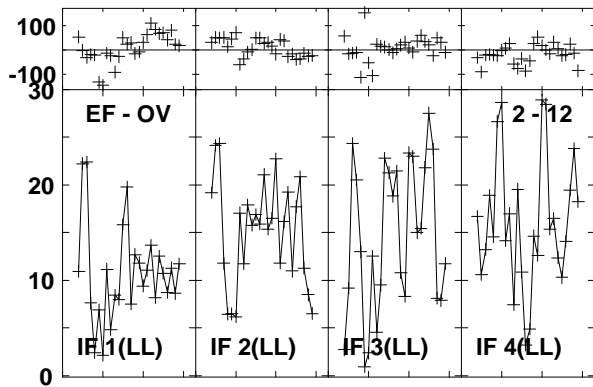
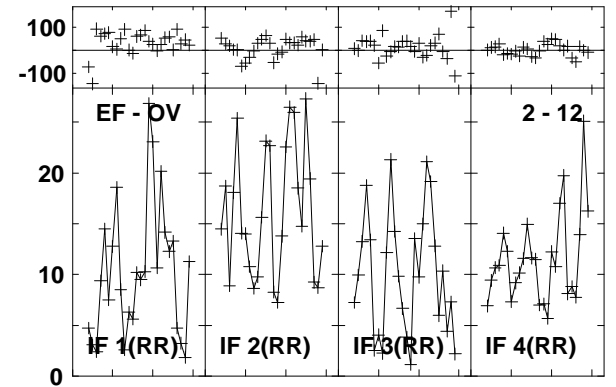
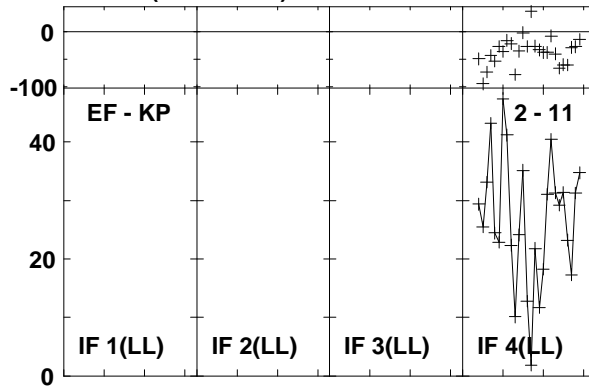
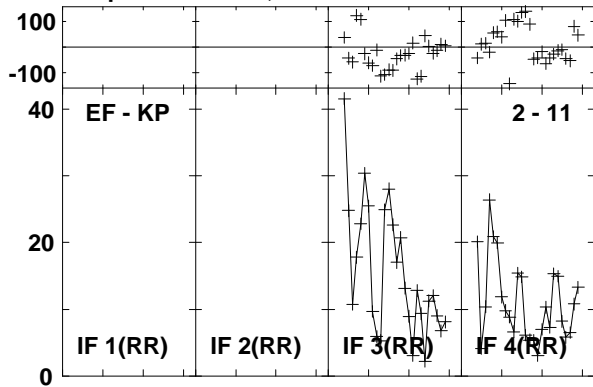

Lower frame: Milli Ampl Jy Top frame: Phas deg
Vector averaged cross-power spectrum Baseline: EF (02) - KP (11)
Timerange: 00/21:38:51 to 00/21:42:05

Plot file version 748 created 03-MAR-2016 01:14:05
 4C52 GN002C 1.UVDATA.1
 Freq = 1.2770 GHz, Bw = 16.000 MH Calibrated with CL # 3 and BP # 1 (BP mode 1)

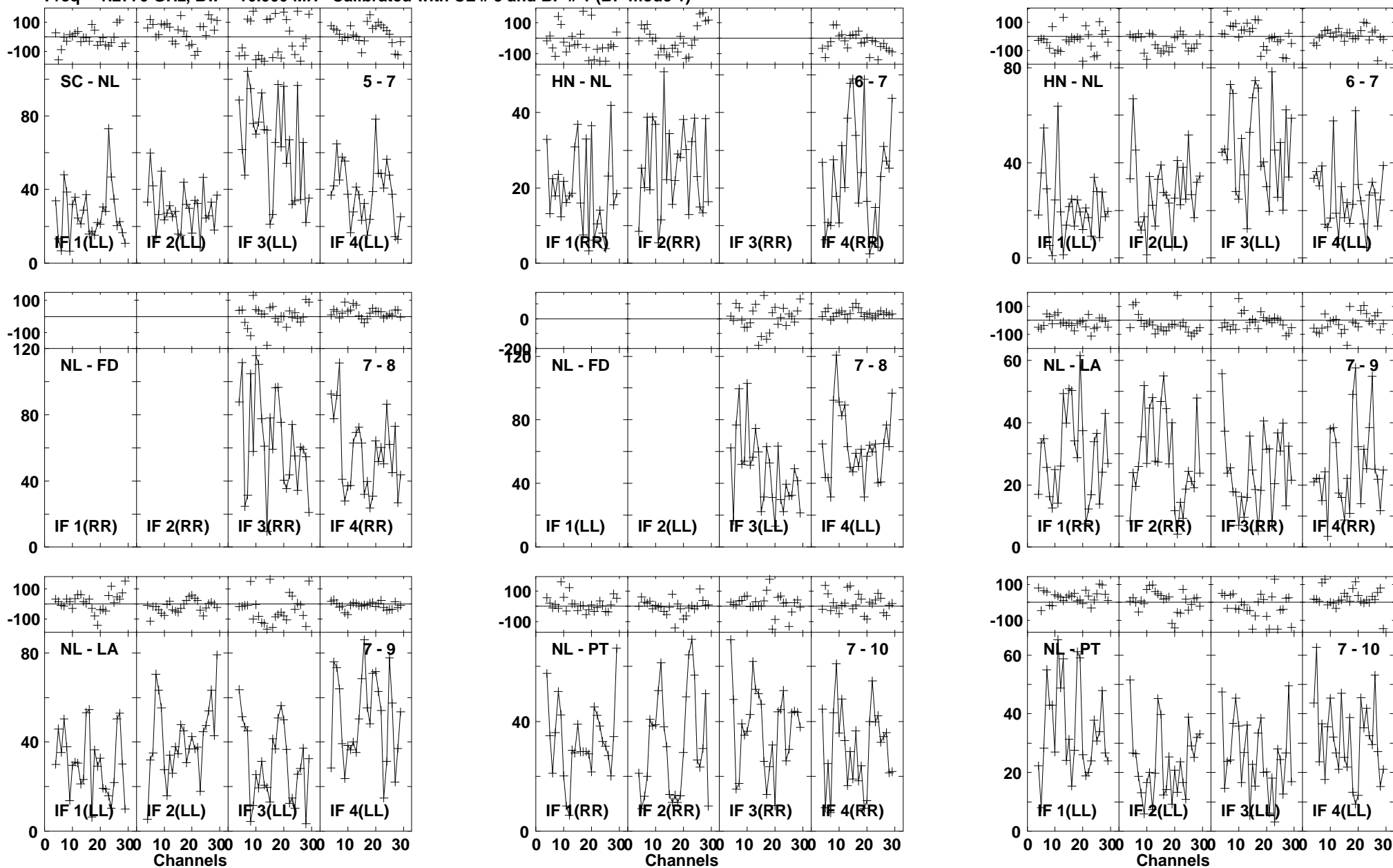

Lower frame: Milli Ampl Jy Top frame: Phas deg
 Vector averaged cross-power spectrum Baseline: SC (05) - NL (07)
 Timerange: 00/21:38:51 to 00/21:42:05

Plot file version 749 created 03-MAR-2016 01:14:06

4C52 GN002C 1.UVDATA.1

Freq = 1.2770 GHz, Bw = 16.000 MH Calibrated with CL # 3 and BP # 1 (BP mode 1)

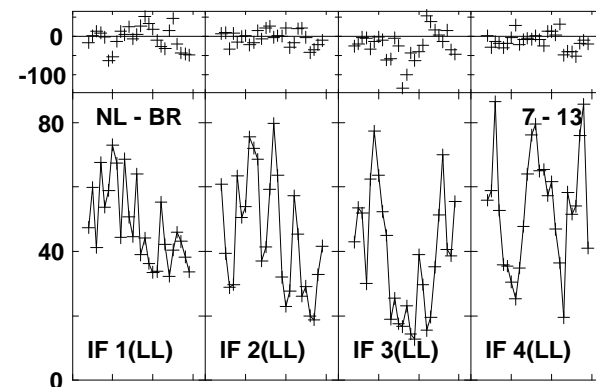
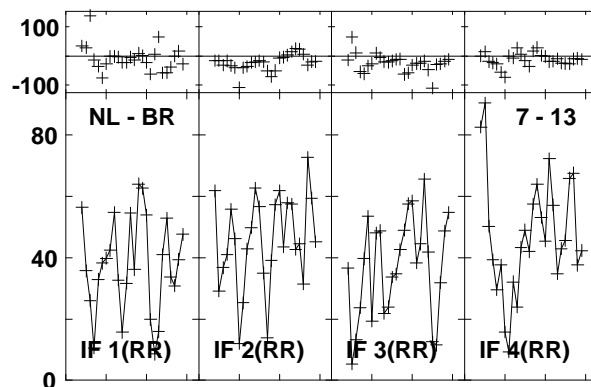
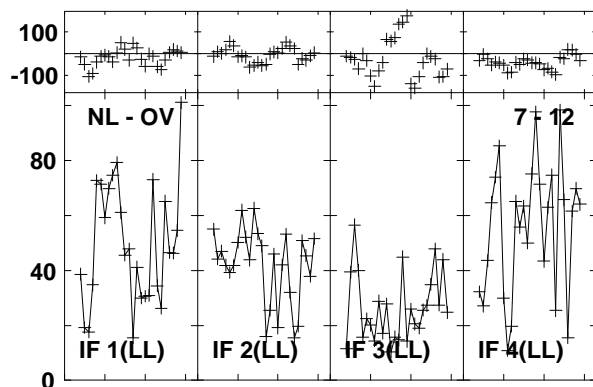
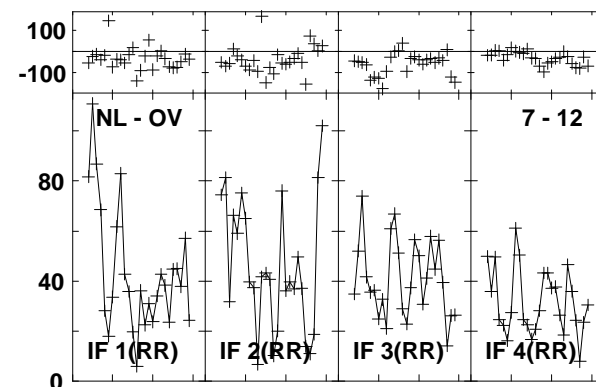
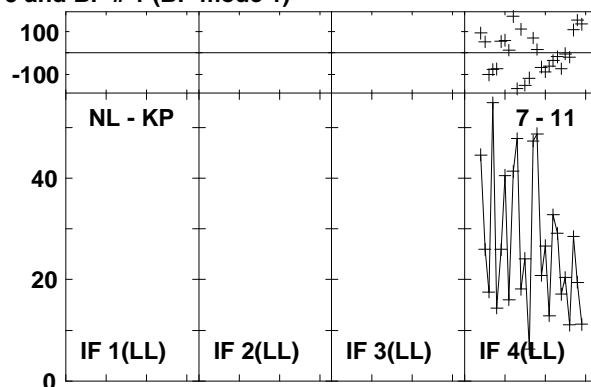
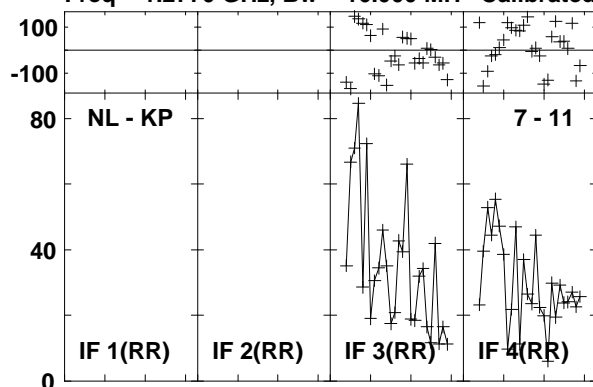

Lower frame: Milli Ampl Jy Top frame: Phas deg
Vector averaged cross-power spectrum Baseline: NL (07) - KP (11)
Timerange: 00/21:38:51 to 00/21:42:05

Plot file version 750 created 03-MAR-2016 01:14:06

J1545+5400 GN002C 1.UVDATA.1

Freq = 1.2770 GHz, Bw = 16.000 MH Calibrated with CL # 3 and BP # 1 (BP mode 1)

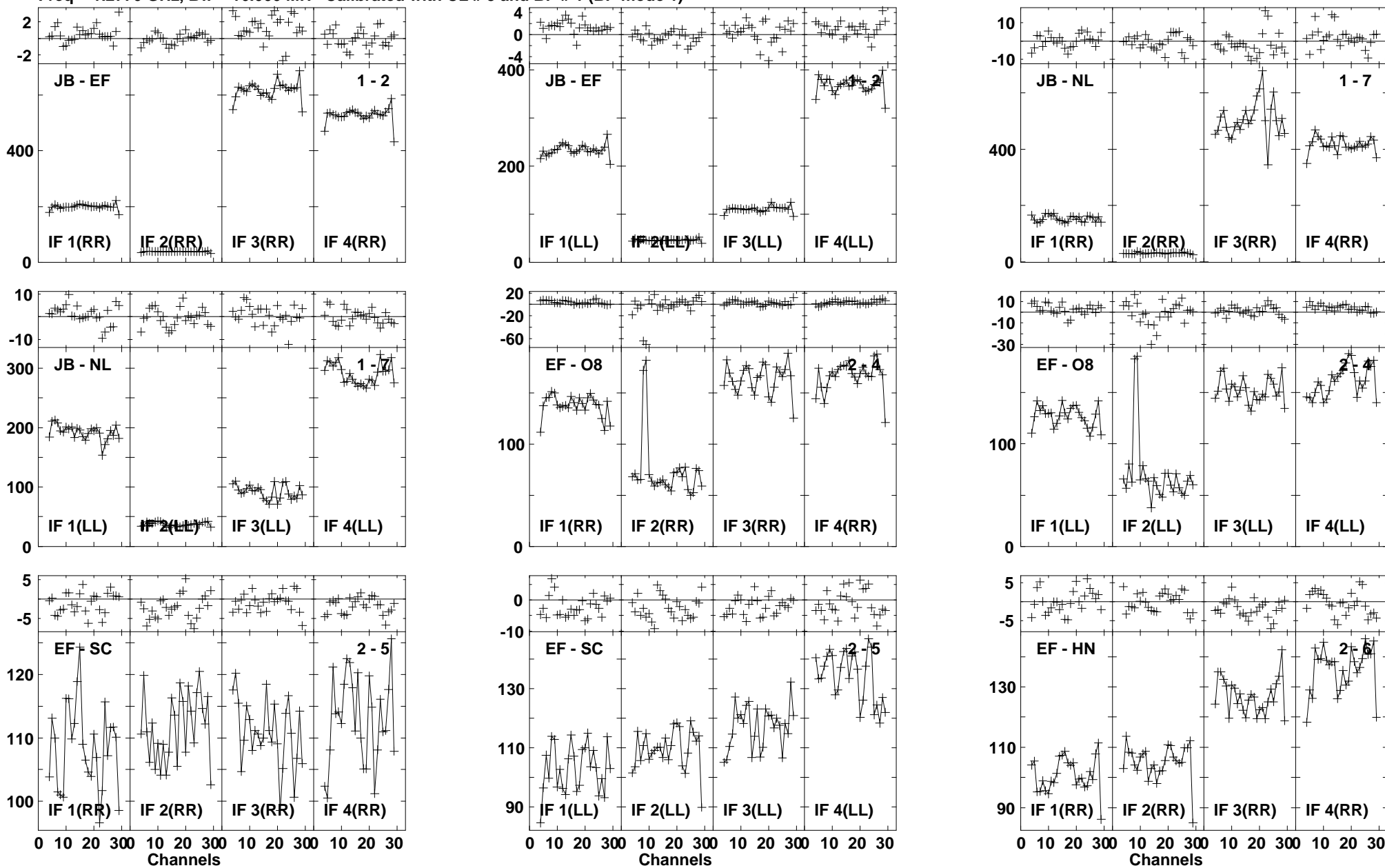

Lower frame: Milli Ampl Jy Top frame: Phas deg
Vector averaged cross-power spectrum Baseline: JB (01) - EF (02)
Timerange: 00/21:42:58 to 00/21:45:26

Plot file version 751 created 03-MAR-2016 01:14:06

J1545+5400 GN002C 1.UVDATA.1

Freq = 1.2770 GHz, Bw = 16.000 MH Calibrated with CL # 3 and BP # 1 (BP mode 1)

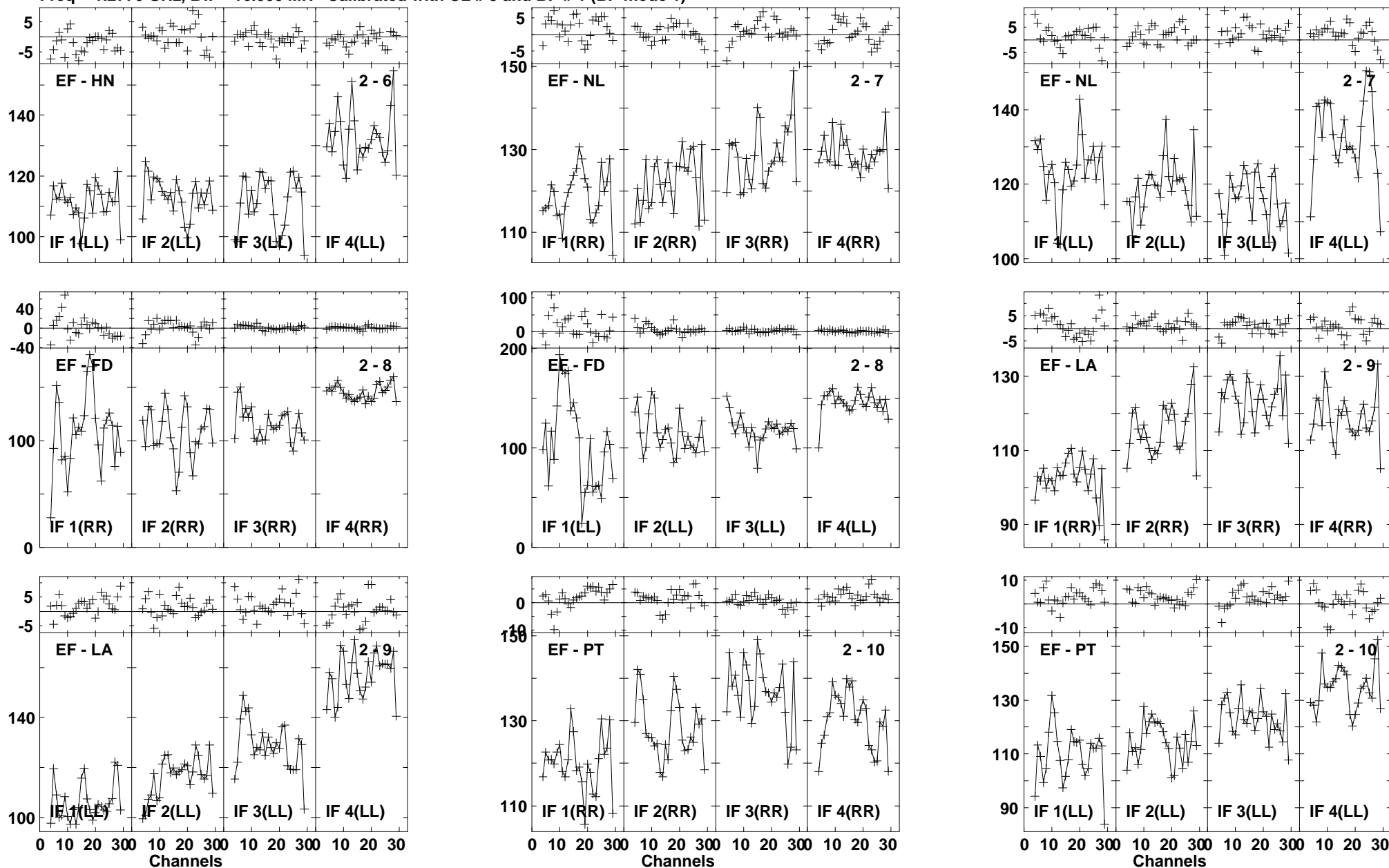

Lower frame: Milli Ampl Jy Top frame: Phas deg
Vector averaged cross-power spectrum Baseline: EF (02) - HN (06)
Timerange: 00/21:42:58 to 00/21:45:26

Plot file version 752 created 03-MAR-2016 01:14:06

J1545+5400 GN002C 1.UVDATA.1

Freq = 1.2770 GHz, Bw = 16.000 MH Calibrated with CL # 3 and BP # 1 (BP mode 1)

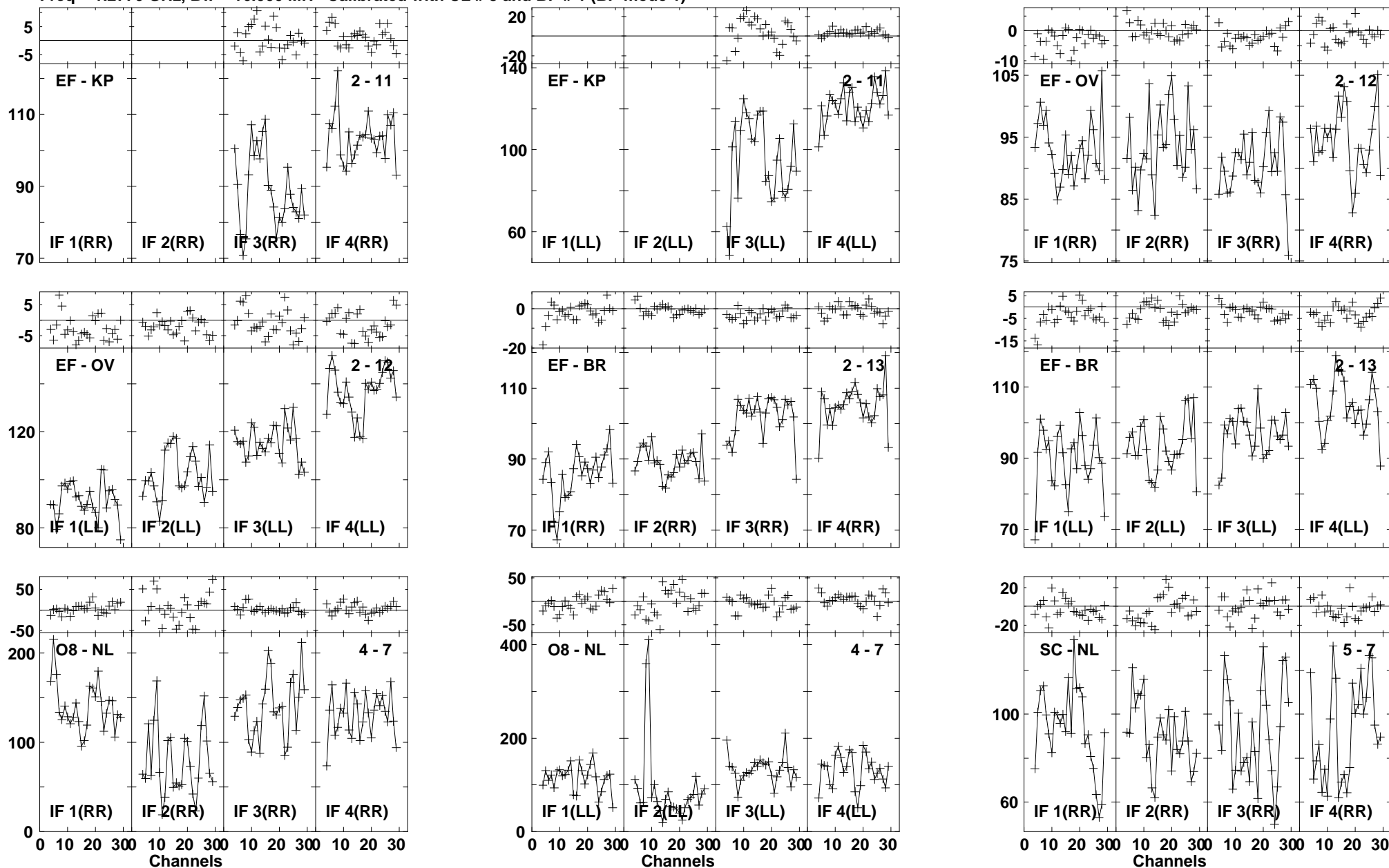

Lower frame: Milli Ampl Jy Top frame: Phas deg
Vector averaged cross-power spectrum Baseline: EF (02) - KP (11)
Timerange: 00/21:42:58 to 00/21:45:26

Plot file version 753 created 03-MAR-2016 01:14:07
 J1545+5400 GN002C 1.UVDATA.1
 Freq = 1.2770 GHz, Bw = 16.000 MH Calibrated with CL # 3 and BP # 1 (BP mode 1)

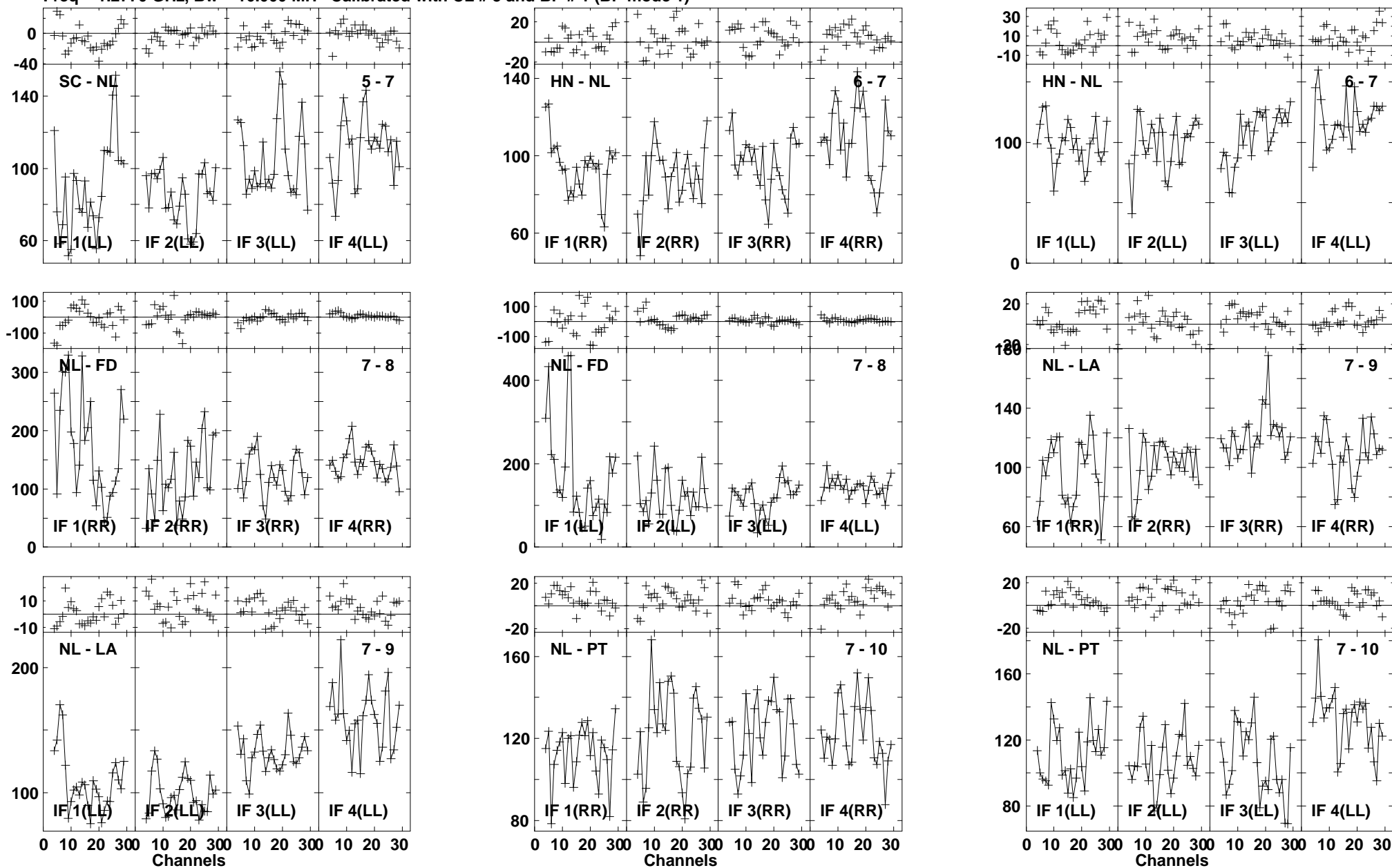

Lower frame: Milli Ampl Jy Top frame: Phas deg
 Vector averaged cross-power spectrum Baseline: SC (05) - NL (07)
 Timerange: 00/21:42:58 to 00/21:45:26

Plot file version 754 created 03-MAR-2016 01:14:07
 J1545+5400 GN002C 1.UVDATA.1
 Freq = 1.2770 GHz, Bw = 16.000 MH Calibrated with CL # 3 and BP # 1 (BP mode 1)

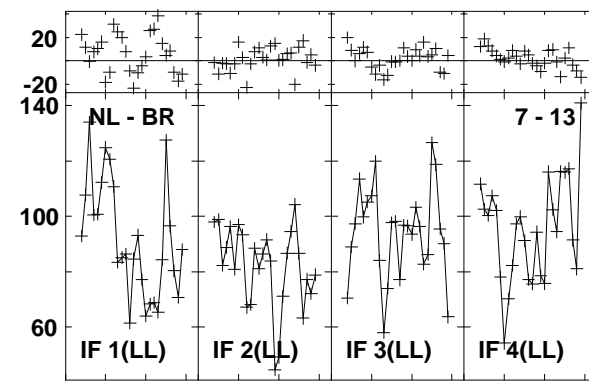
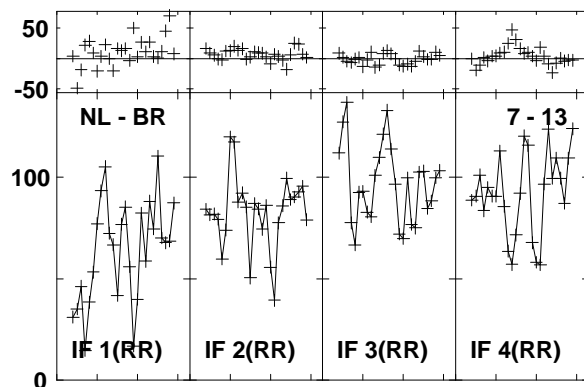
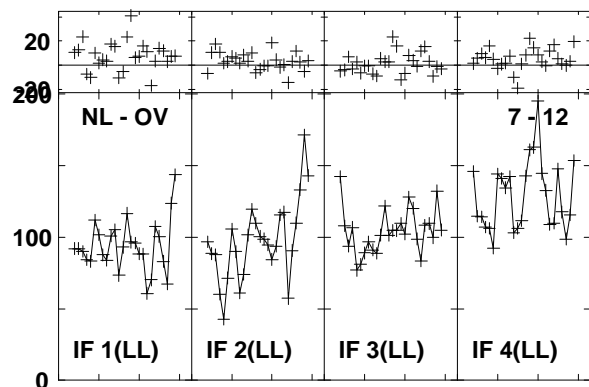
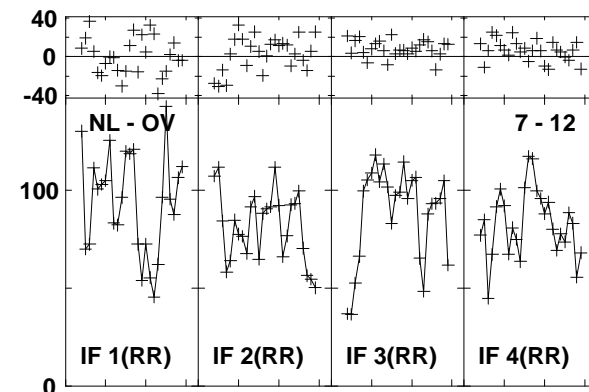
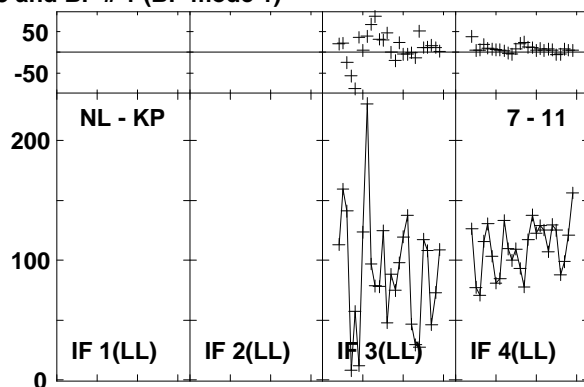
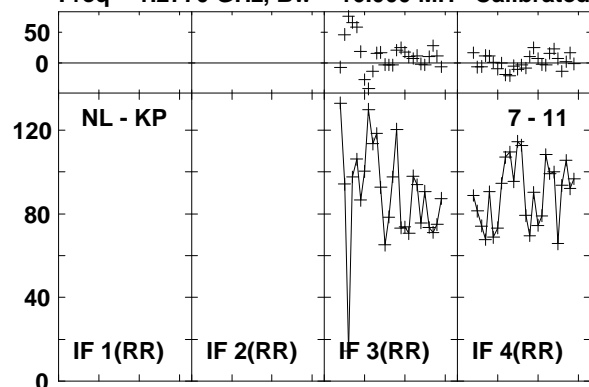

Lower frame: Milli Ampl Jy Top frame: Phas deg
 Vector averaged cross-power spectrum Baseline: NL (07) - KP (11)
 Timerange: 00/21:42:58 to 00/21:45:26

Plot file version 755 created 03-MAR-2016 01:14:07

4C52 GN002C 1.UVDATA.1

Freq = 1.2770 GHz, Bw = 16.000 MH Calibrated with CL # 3 and BP # 1 (BP mode 1)

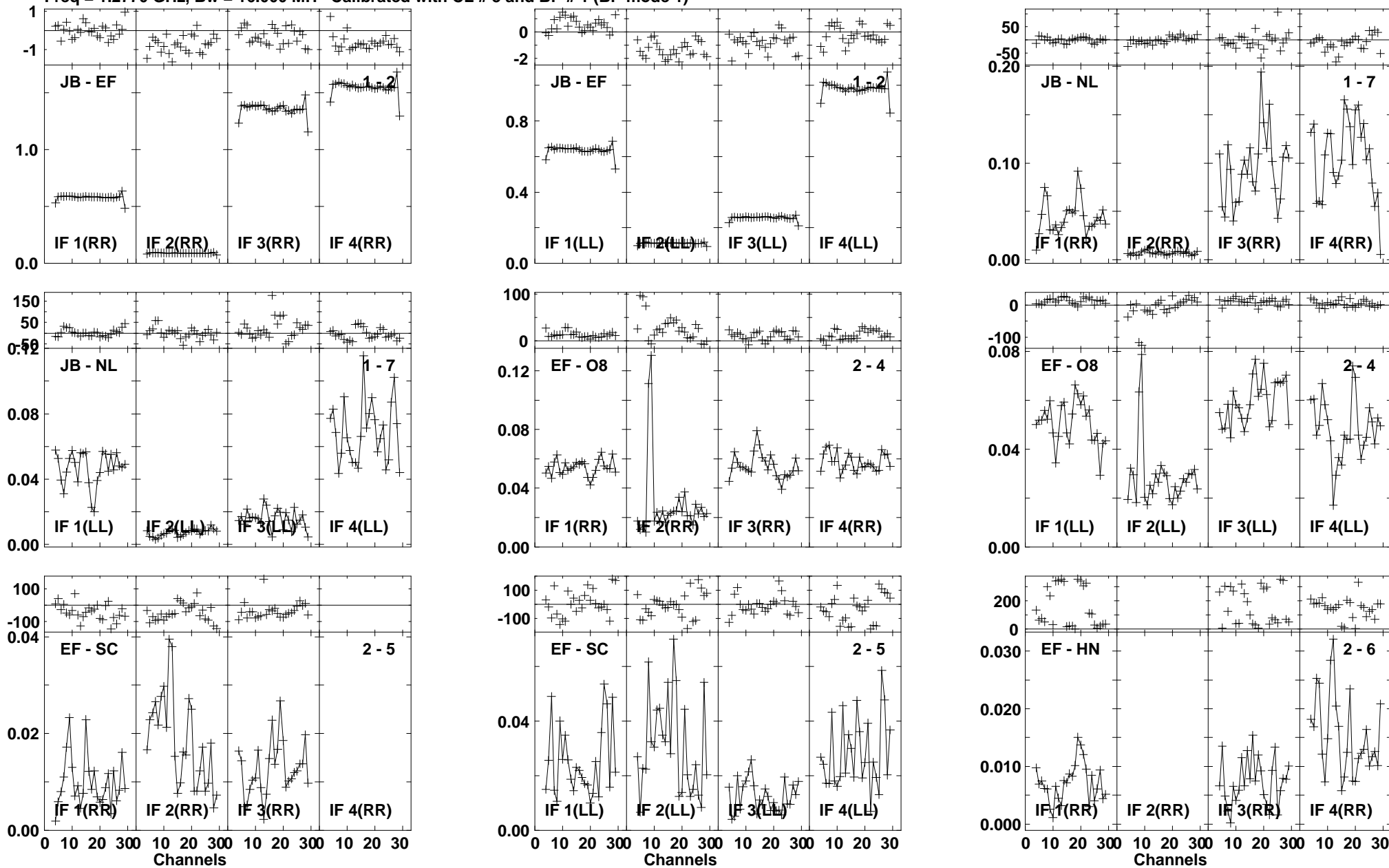

Lower frame: Ampl Jy Top frame: Phas deg
Vector averaged cross-power spectrum Baseline: JB (01) - EF (02)
Timerange: 00/21:45:39 to 00/21:48:55

Plot file version 756 created 03-MAR-2016 01:14:07

4C52 GN002C 1.UVDATA.1

Freq = 1.2770 GHz, Bw = 16.000 MH Calibrated with CL # 3 and BP # 1 (BP mode 1)

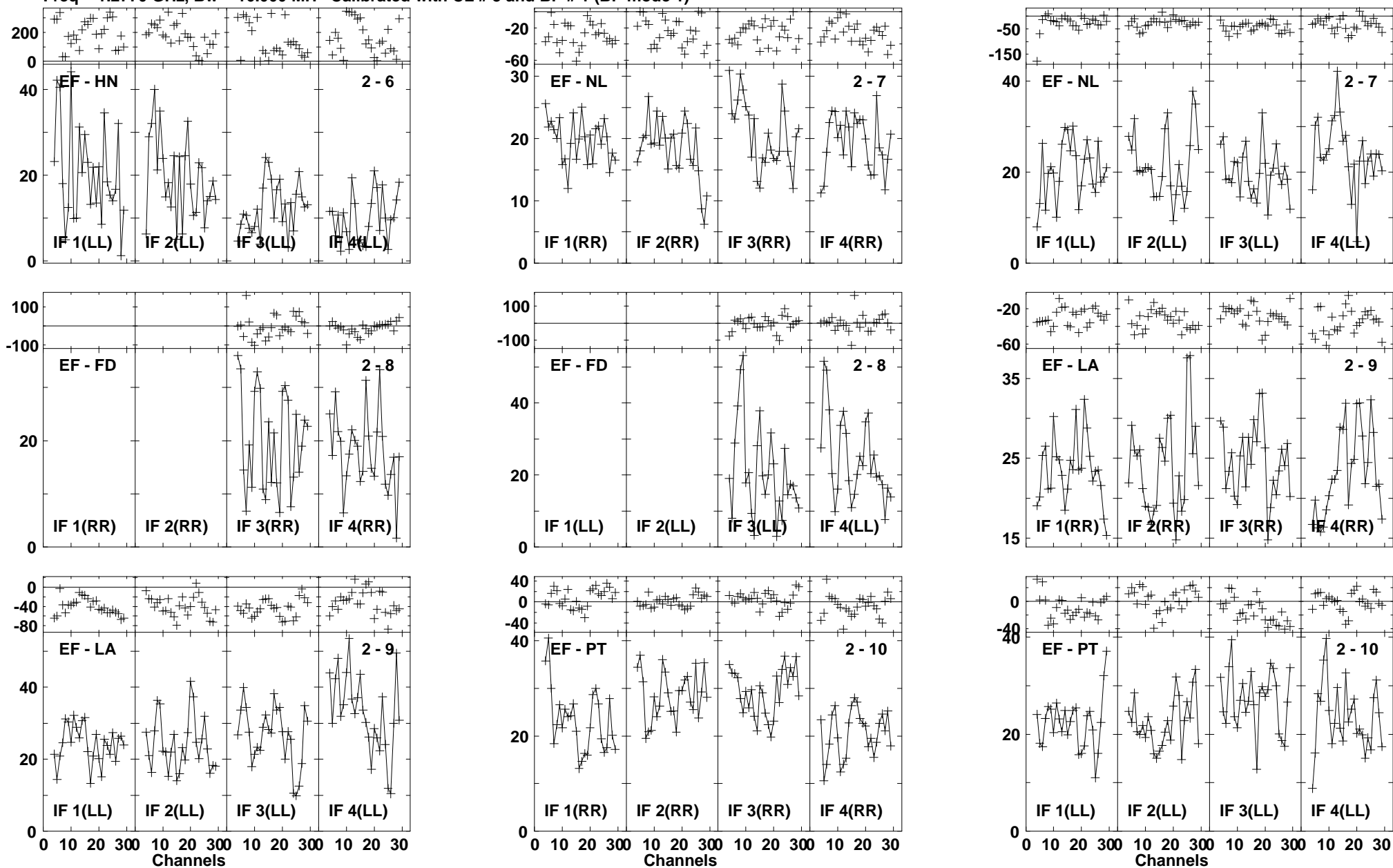

Lower frame: Milli Ampl Jy Top frame: Phas deg
Vector averaged cross-power spectrum Baseline: EF (02) - HN (06)
Timerange: 00/21:45:39 to 00/21:48:55

Plot file version 757 created 03-MAR-2016 01:14:07

4C52 GN002C 1.UVDATA.1

Freq = 1.2770 GHz, Bw = 16.000 MH Calibrated with CL # 3 and BP # 1 (BP mode 1)

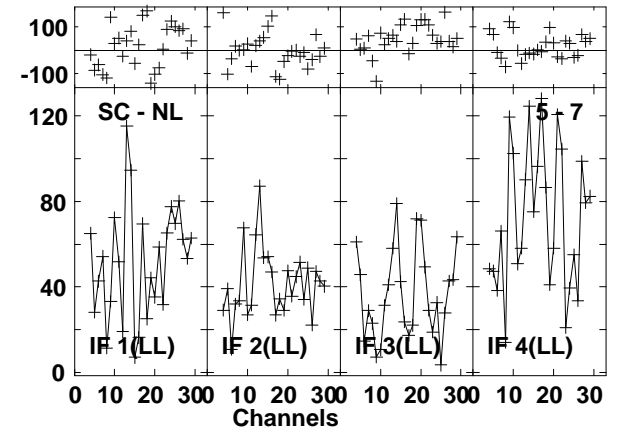
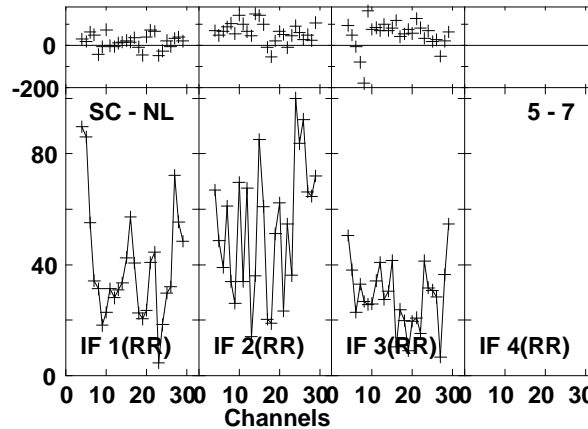
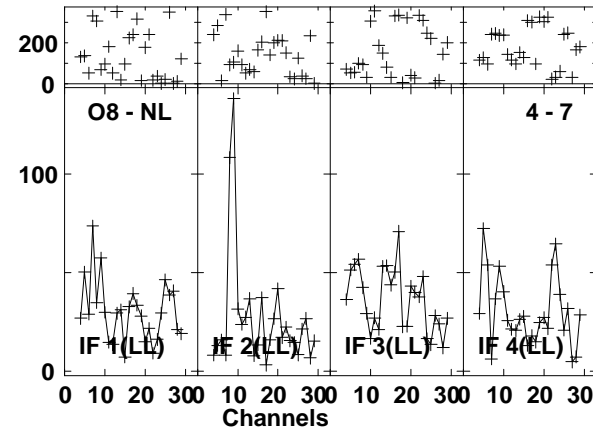
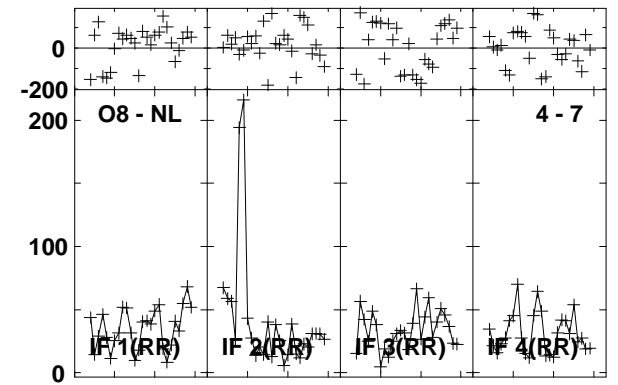
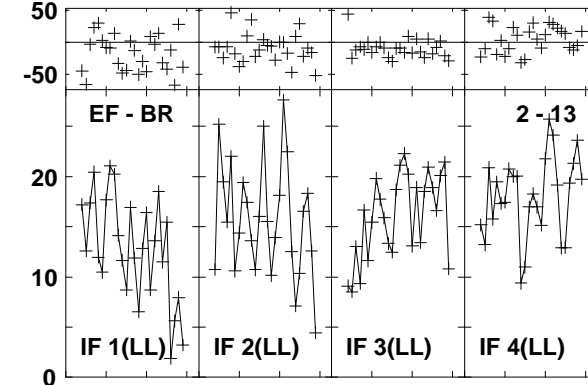
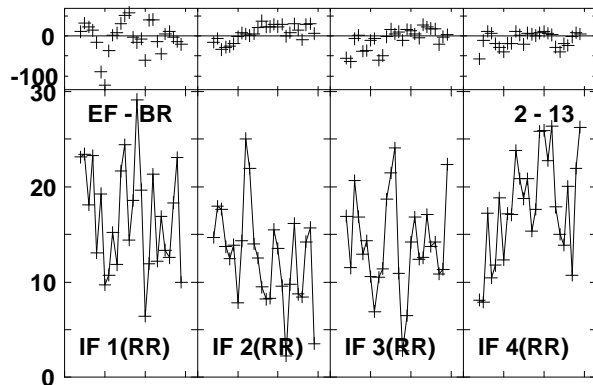
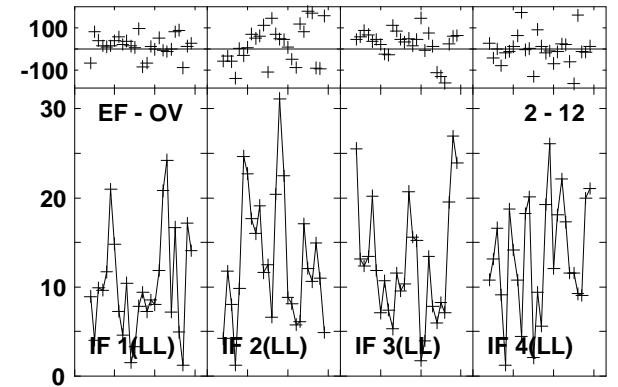
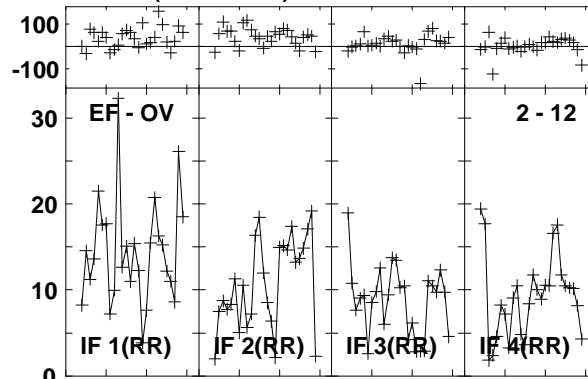
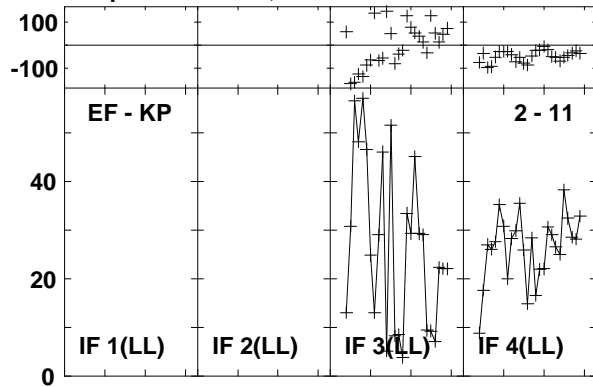

Lower frame: Milli Ampl Jy Top frame: Phas deg

Vector averaged cross-power spectrum Baseline: EF (02) - KP (11)

Timerange: 00/21:45:39 to 00/21:48:55

Plot file version 758 created 03-MAR-2016 01:14:08

4C52 GN002C 1.UVDATA.1

Freq = 1.2770 GHz, Bw = 16.000 MH Calibrated with CL # 3 and BP # 1 (BP mode 1)

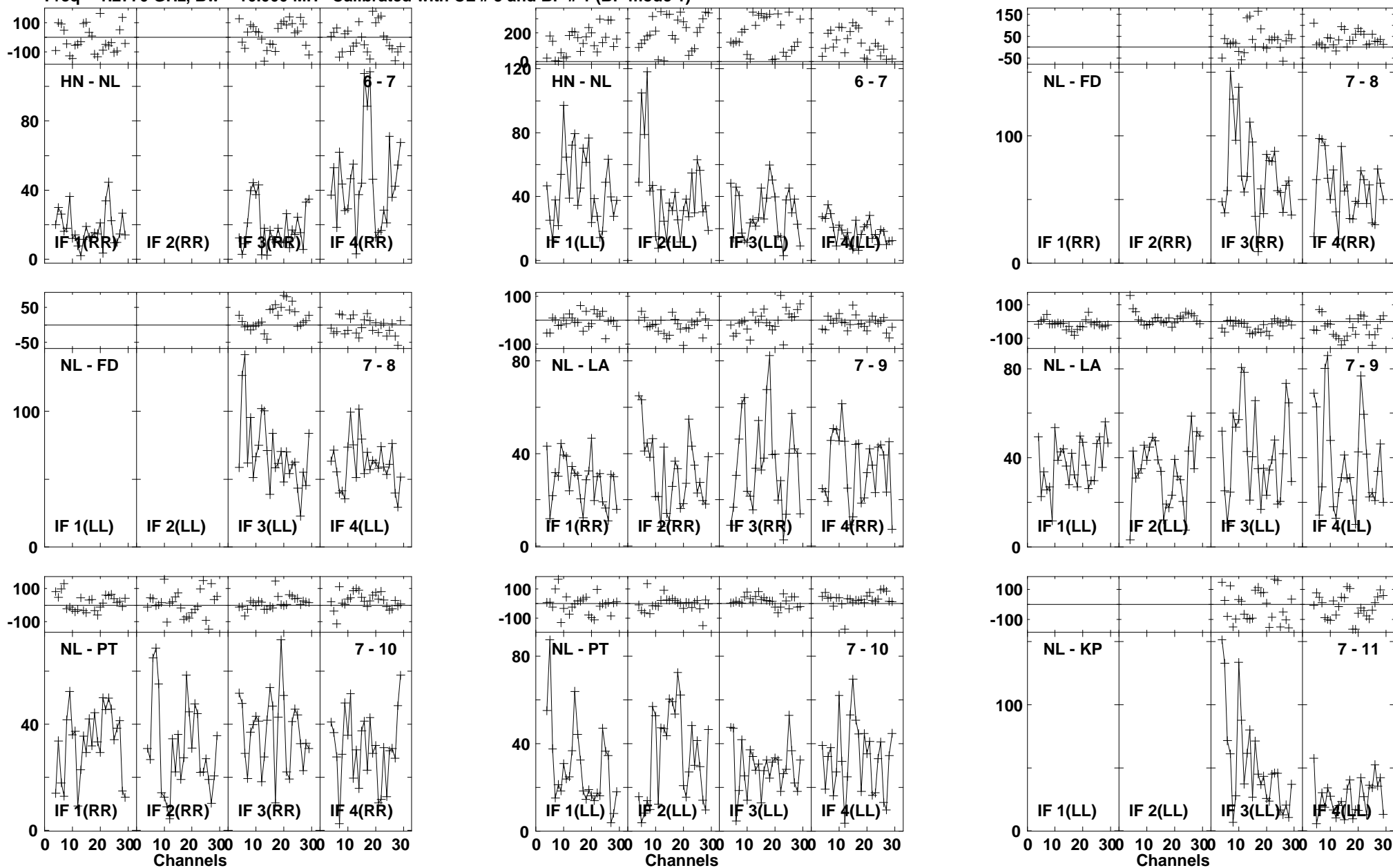

Lower frame: Milli Ampl Jy Top frame: Phas deg
Vector averaged cross-power spectrum Baseline: HN (06) - NL (07)
Timerange: 00/21:45:39 to 00/21:48:55

Plot file version 759 created 03-MAR-2016 01:14:08

4C52 GN002C 1.UVDATA.1

Freq = 1.2770 GHz, Bw = 16.000 MH Calibrated with CL # 3 and BP # 1 (BP mode 1)

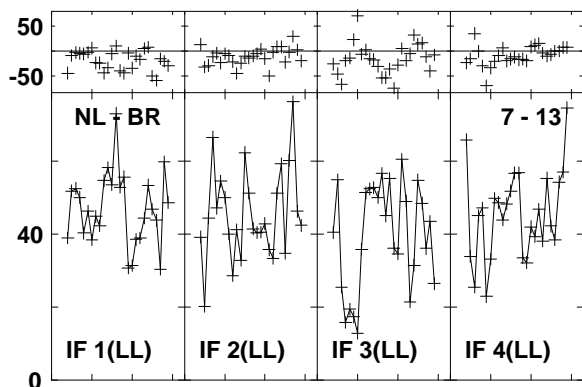
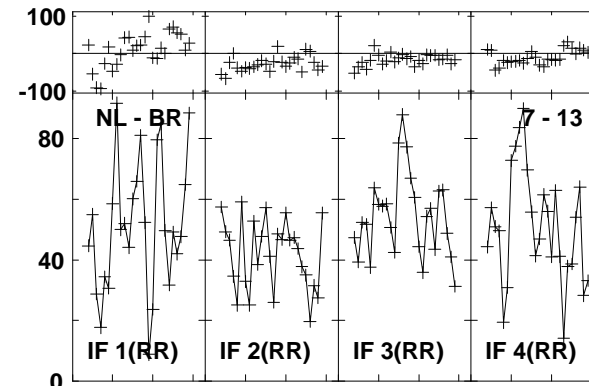
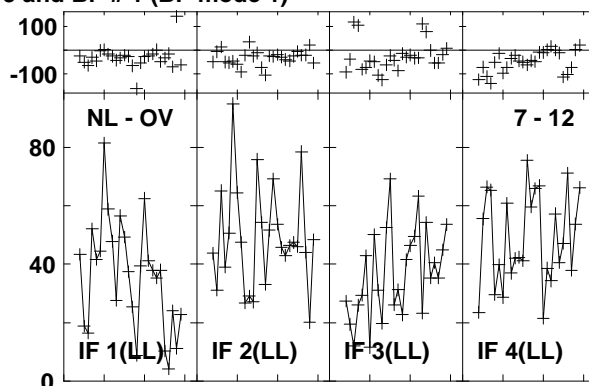
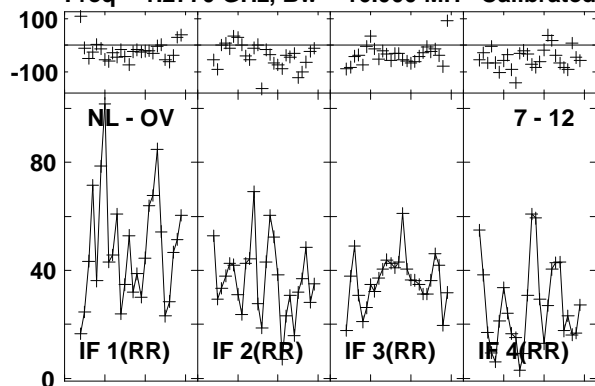

Lower frame: Milli Ampl Jy Top frame: Phas deg
Vector averaged cross-power spectrum Baseline: NL (07) - OV (12)
Timerange: 00/21:45:39 to 00/21:48:55

Plot file version 760 created 03-MAR-2016 01:14:08

J1545+5400 GN002C 1.UVDATA.1

Freq = 1.2770 GHz, Bw = 16.000 MH Calibrated with CL # 3 and BP # 1 (BP mode 1)

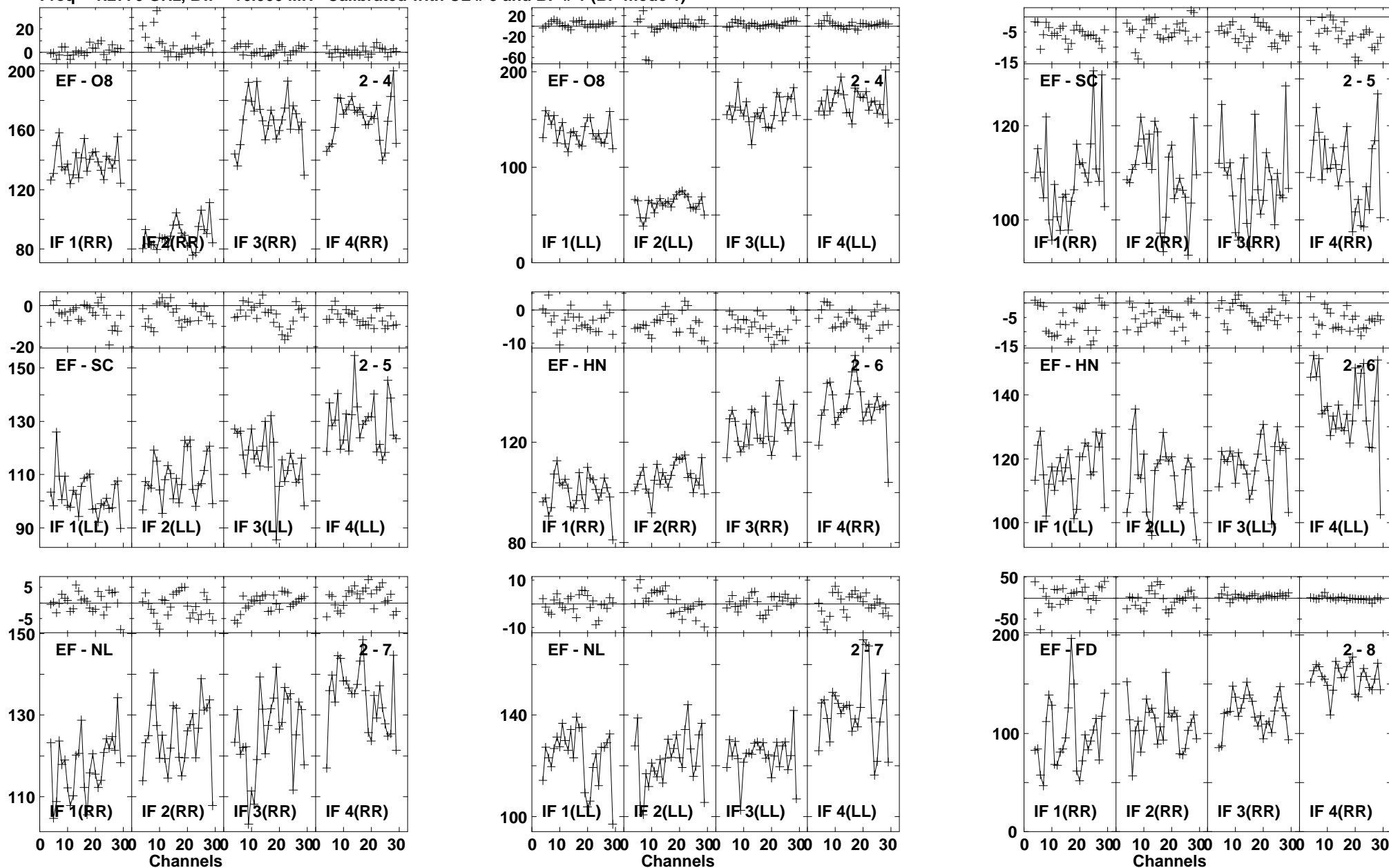

Lower frame: Milli Ampl Jy Top frame: Phas deg
Vector averaged cross-power spectrum Baseline: EF (02) - O8 (04)
Timerange: 00/21:49:48 to 00/21:51:16

Plot file version 761 created 03-MAR-2016 01:14:08

J1545+5400 GN002C 1.UVDATA.1

Freq = 1.2770 GHz, Bw = 16.000 MH Calibrated with CL # 3 and BP # 1 (BP mode 1)

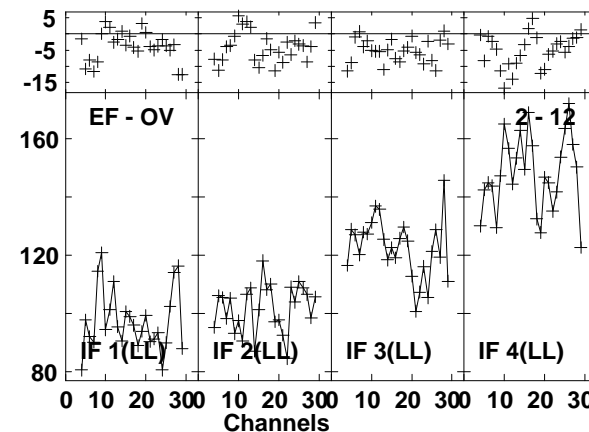
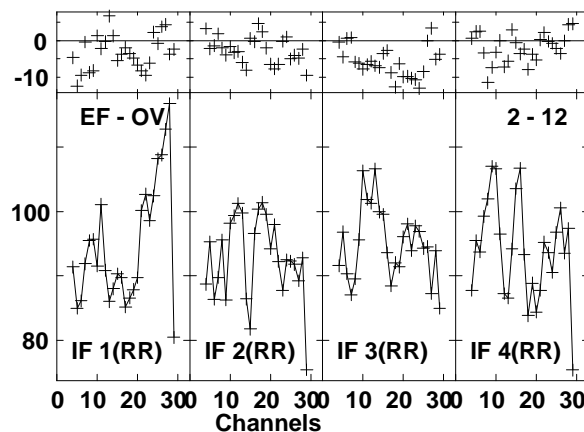
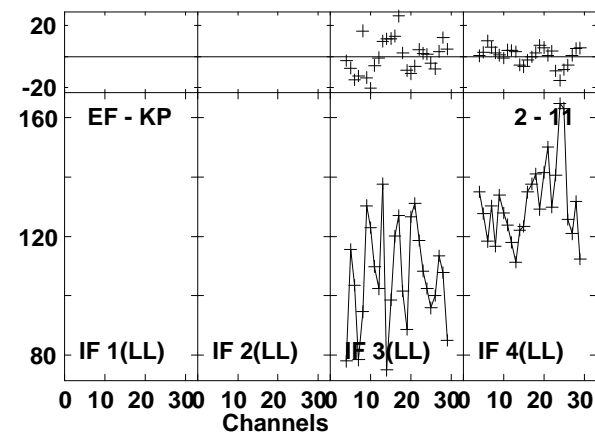
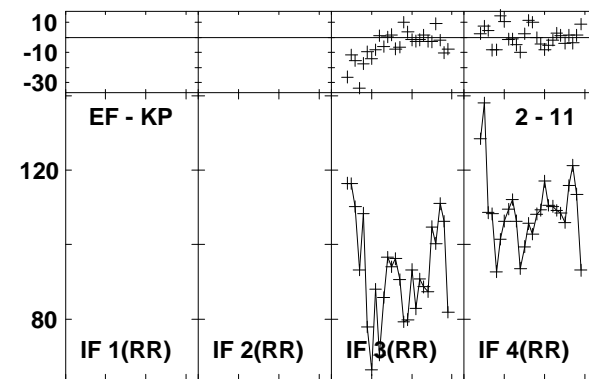
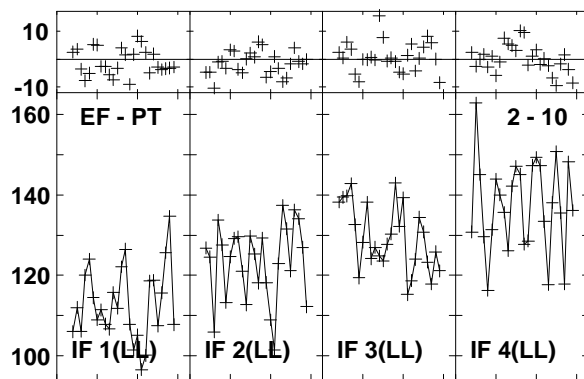
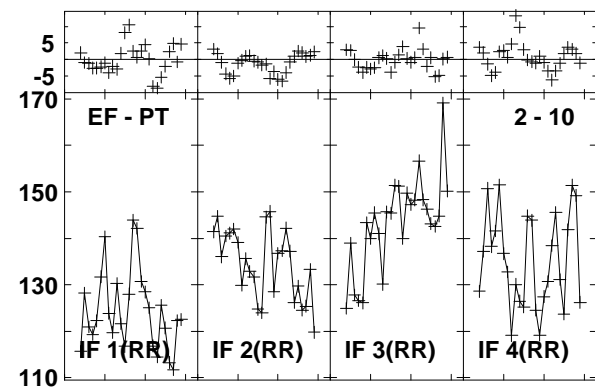
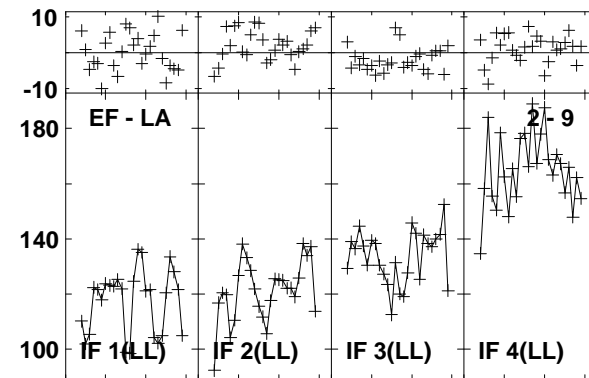
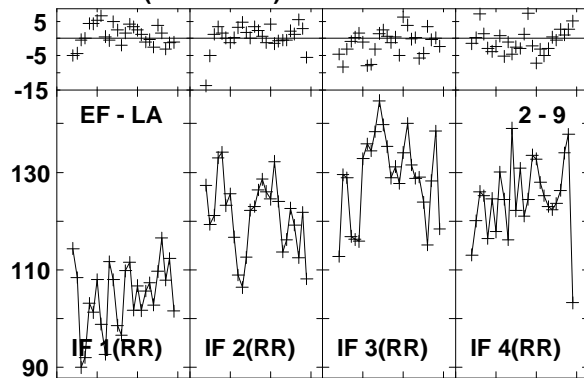
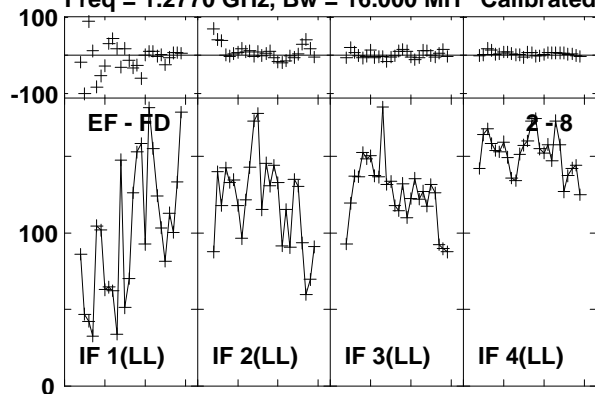

Lower frame: Milli Ampl Jy Top frame: Phas deg

Vector averaged cross-power spectrum Baseline: EF (02) - FD (08)

Timerange: 00/21:49:48 to 00/21:51:16

Plot file version 762 created 03-MAR-2016 01:14:08

J1545+5400 GN002C 1.UVDATA.1

Freq = 1.2770 GHz, Bw = 16.000 MH Calibrated with CL # 3 and BP # 1 (BP mode 1)

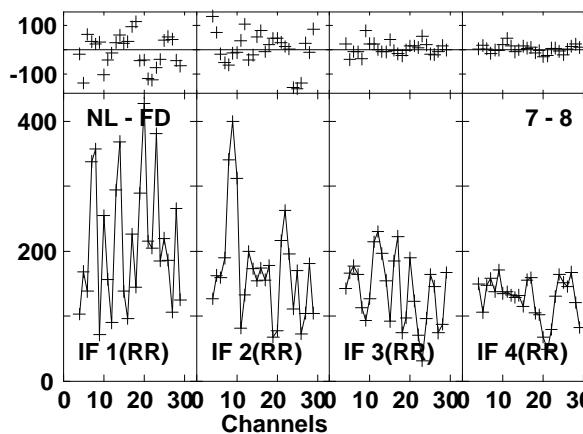
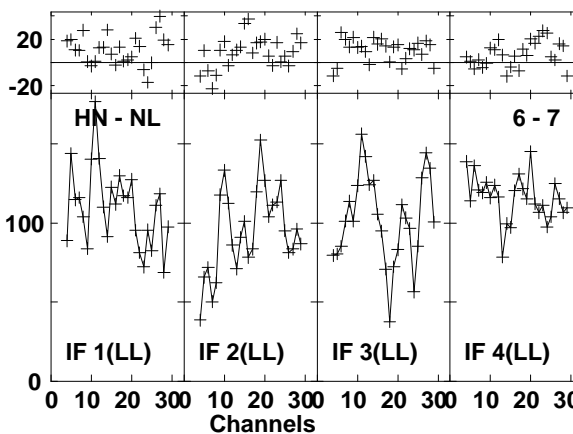
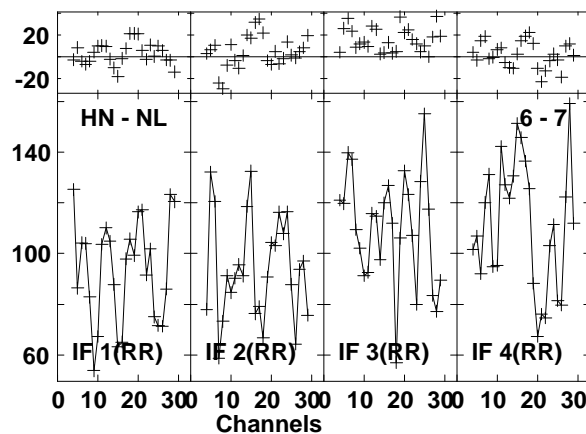
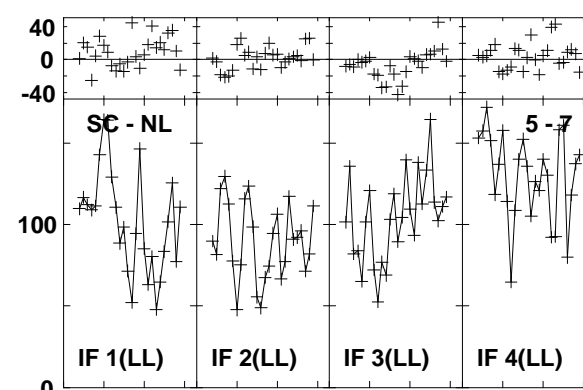
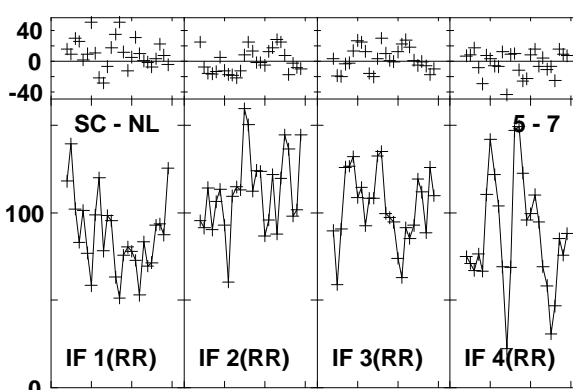
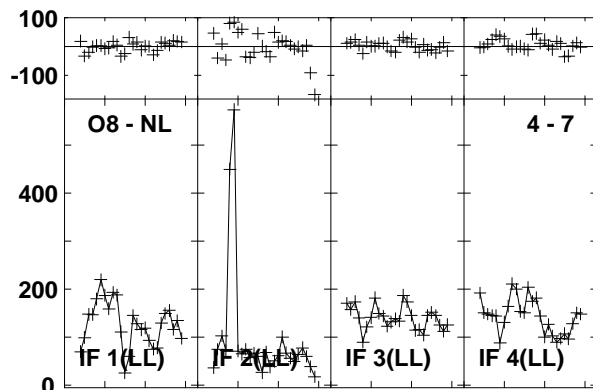
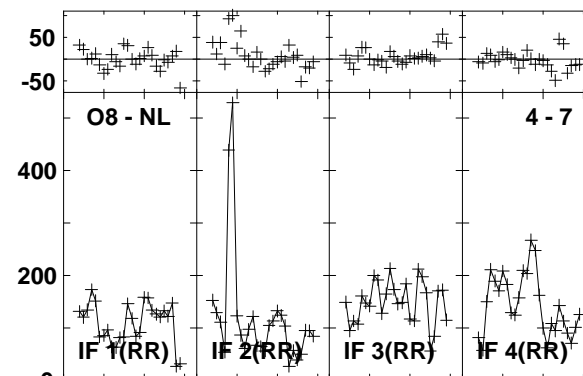
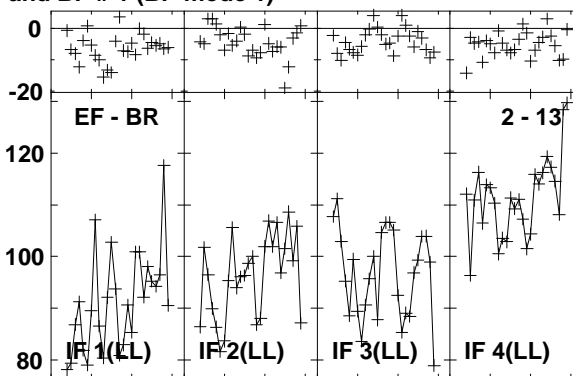
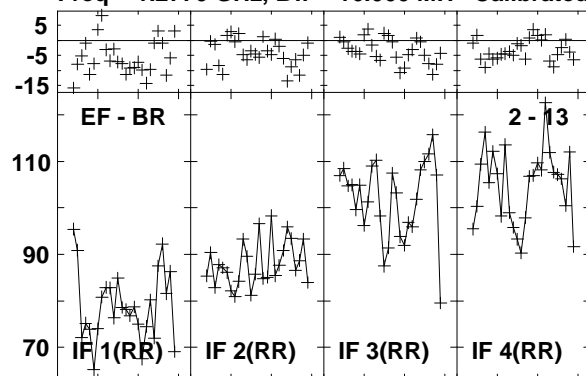

Lower frame: Milli Ampl Jy Top frame: Phas deg
Vector averaged cross-power spectrum Baseline: EF (02) - BR (13)
Timerange: 00/21:49:48 to 00/21:51:16

Plot file version 763 created 03-MAR-2016 01:14:09

J1545+5400 GN002C 1.UVDATA.1

Freq = 1.2770 GHz, Bw = 16.000 MH Calibrated with CL # 3 and BP # 1 (BP mode 1)

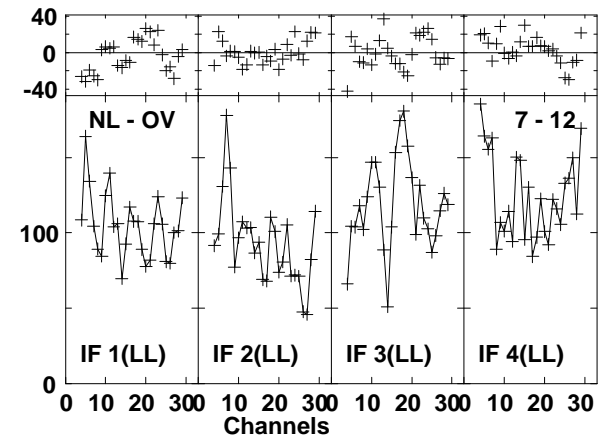
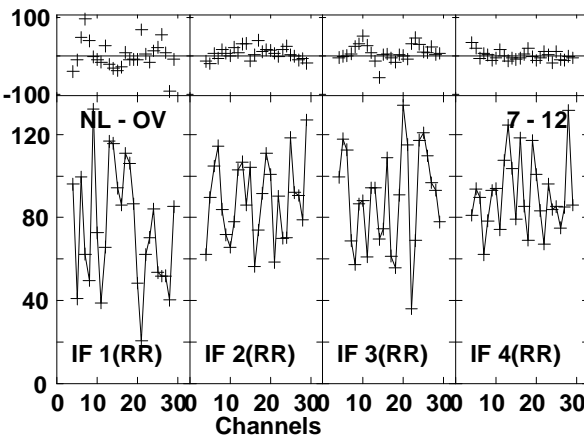
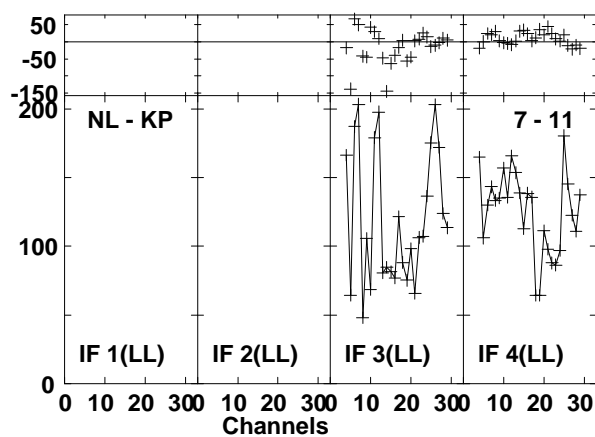
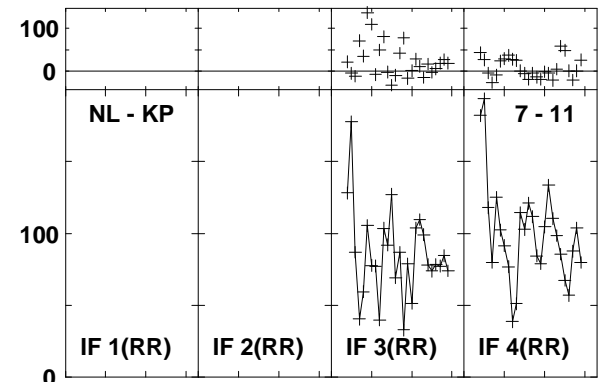
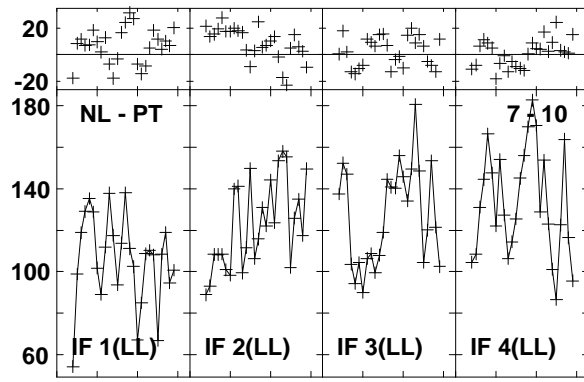
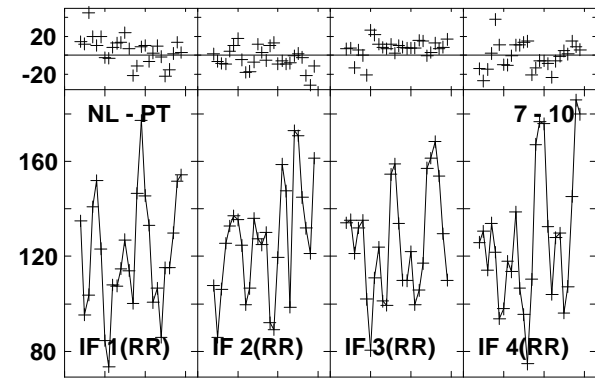
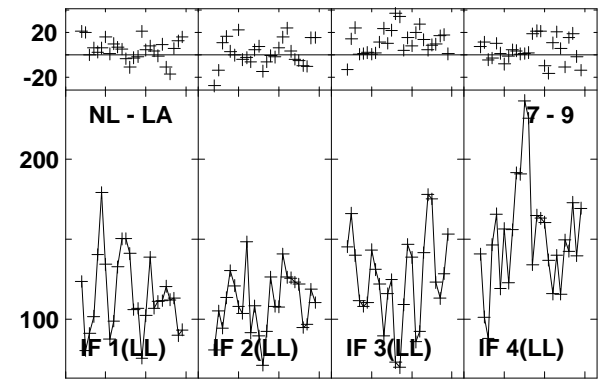
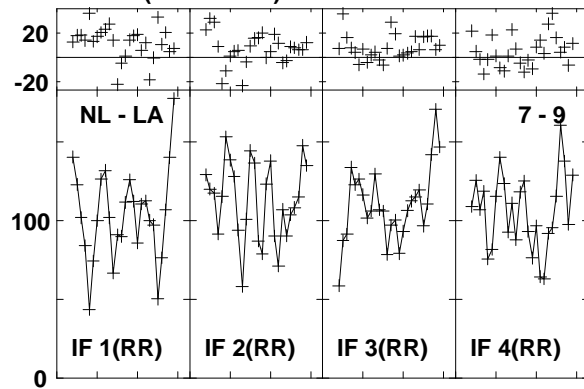
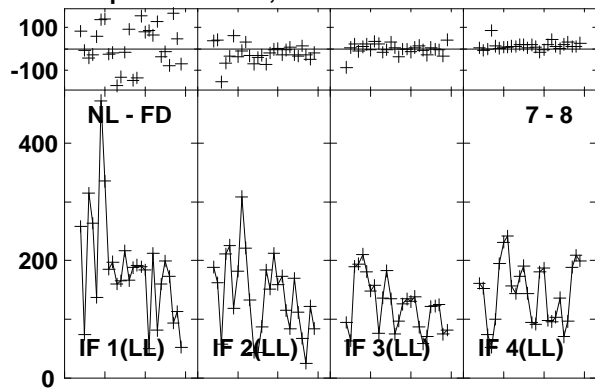

Lower frame: Milli Ampl Jy Top frame: Phas deg
Vector averaged cross-power spectrum Baseline: NL (07) - FD (08)
Timerange: 00/21:49:48 to 00/21:51:16

Plot file version 764 created 03-MAR-2016 01:14:09

J1545+5400 GN002C 1.UVDATA.1

Freq = 1.2770 GHz, Bw = 16.000 MH Calibrated with CL # 3 and BP # 1 (BP mode 1)

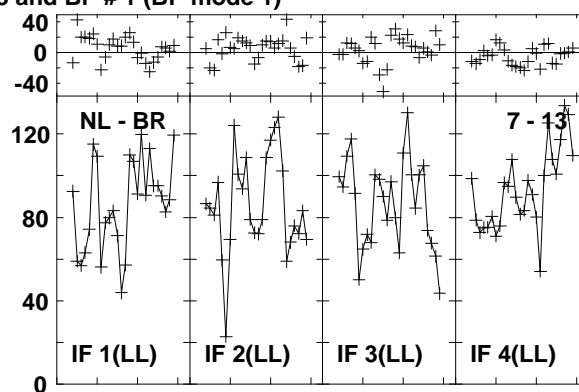
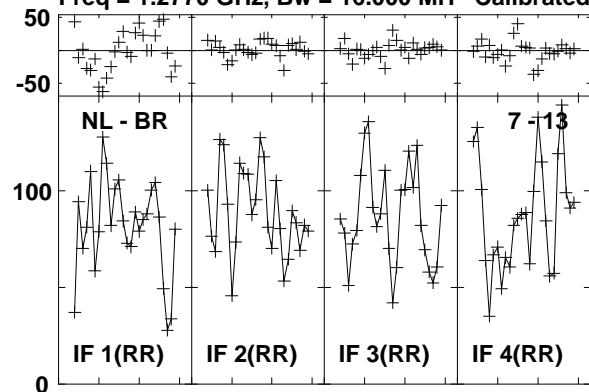

Lower frame: Milli Ampl Jy Top frame: Phas deg
Vector averaged cross-power spectrum Baseline: NL (07) - BR (13)
Timerange: 00/21:49:48 to 00/21:51:16

Plot file version 765 created 03-MAR-2016 01:14:09

4C52 GN002C 1.UVDATA.1

Freq = 1.2770 GHz, Bw = 16.000 MH Calibrated with CL # 3 and BP # 1 (BP mode 1)

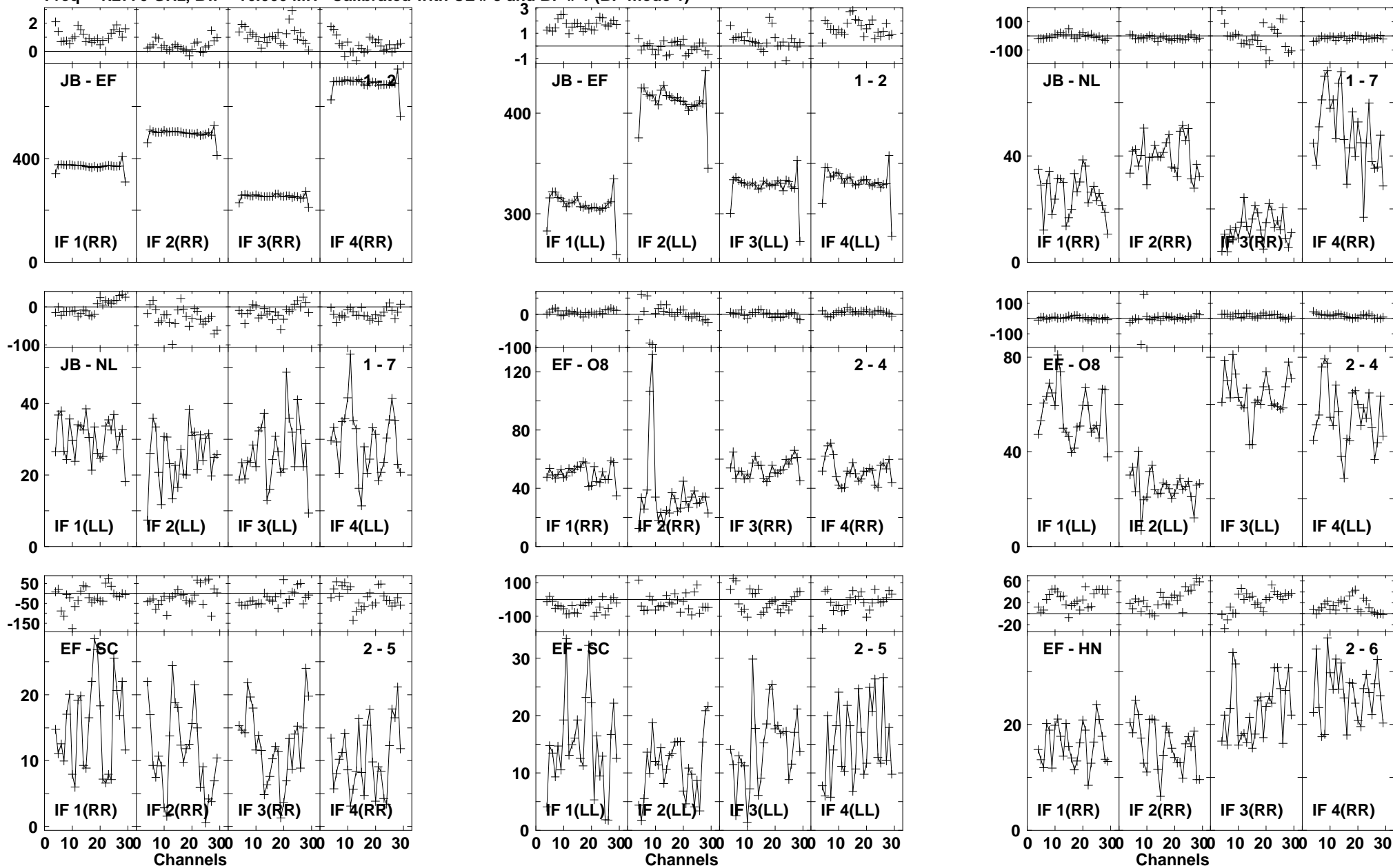

Lower frame: Milli Ampl Jy Top frame: Phas deg
Vector averaged cross-power spectrum Baseline: JB (01) - EF (02)
Timerange: 00/21:51:21 to 00/21:54:35

Plot file version 766 created 03-MAR-2016 01:14:09

4C52 GN002C 1.UVDATA.1

Freq = 1.2770 GHz, Bw = 16.000 MH Calibrated with CL # 3 and BP # 1 (BP mode 1)

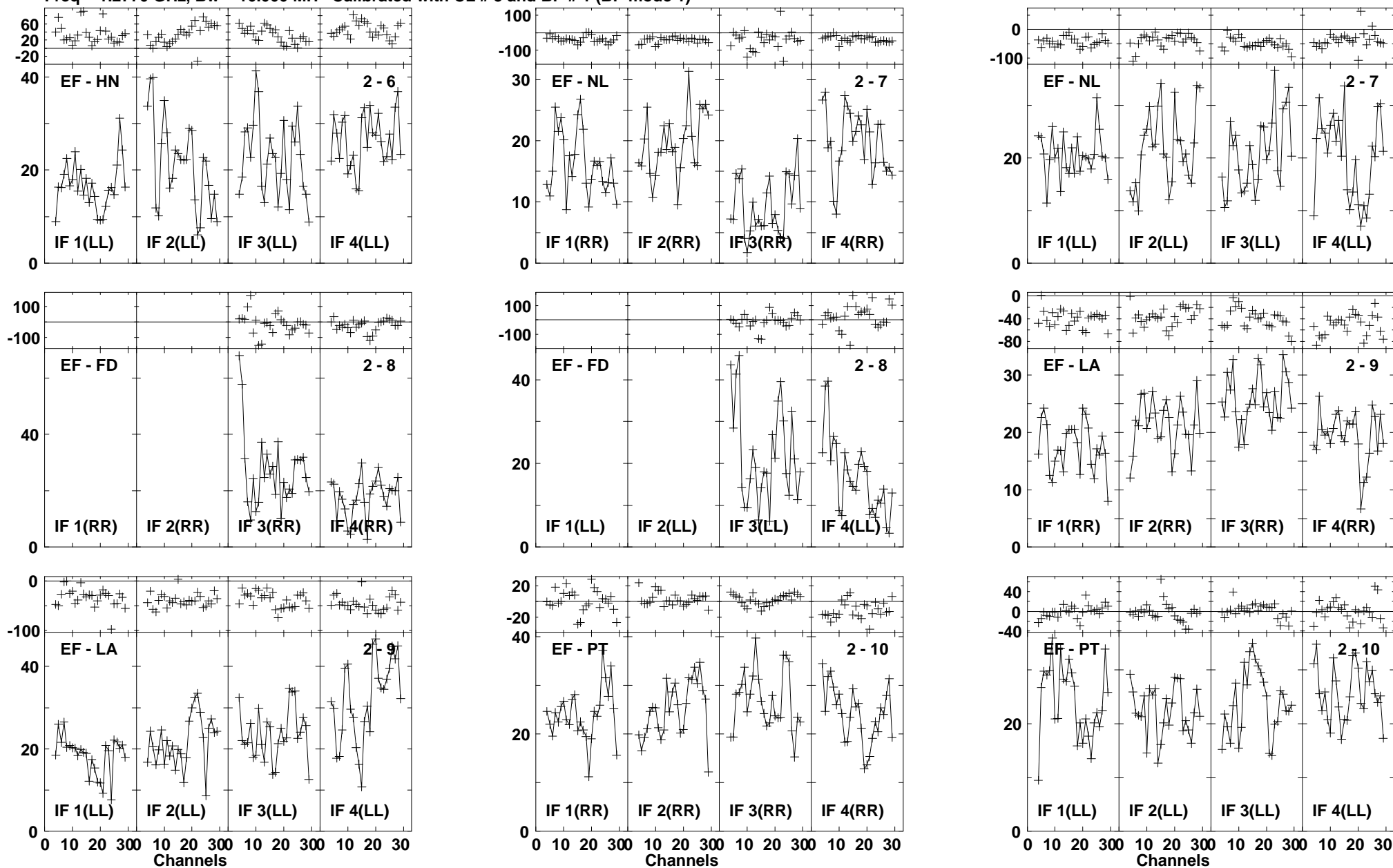

Lower frame: Milli Ampl Jy Top frame: Phas deg
Vector averaged cross-power spectrum Baseline: EF (02) - HN (06)
Timerange: 00/21:51:21 to 00/21:54:35

Plot file version 767 created 03-MAR-2016 01:14:09

4C52 GN002C 1.UVDATA.1

Freq = 1.2770 GHz, Bw = 16.000 MH Calibrated with CL # 3 and BP # 1 (BP mode 1)

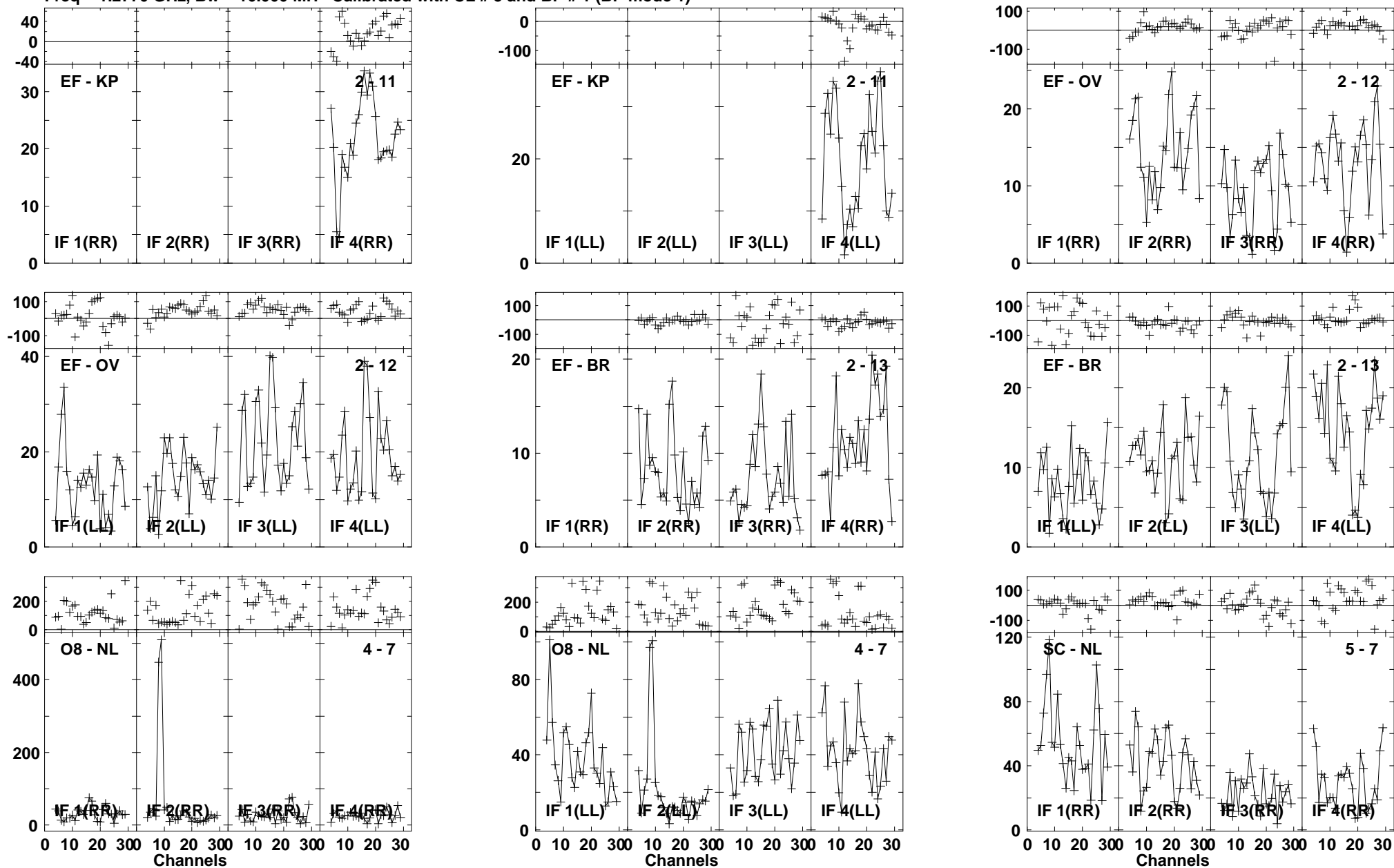

Lower frame: Milli Ampl Jy Top frame: Phas deg
Vector averaged cross-power spectrum Baseline: EF (02) - KP (11)
Timerange: 00/21:51:21 to 00/21:54:35

Plot file version 768 created 03-MAR-2016 01:14:10

4C52 GN002C 1.UVDATA.1

Freq = 1.2770 GHz, Bw = 16.000 MH Calibrated with CL # 3 and BP # 1 (BP mode 1)

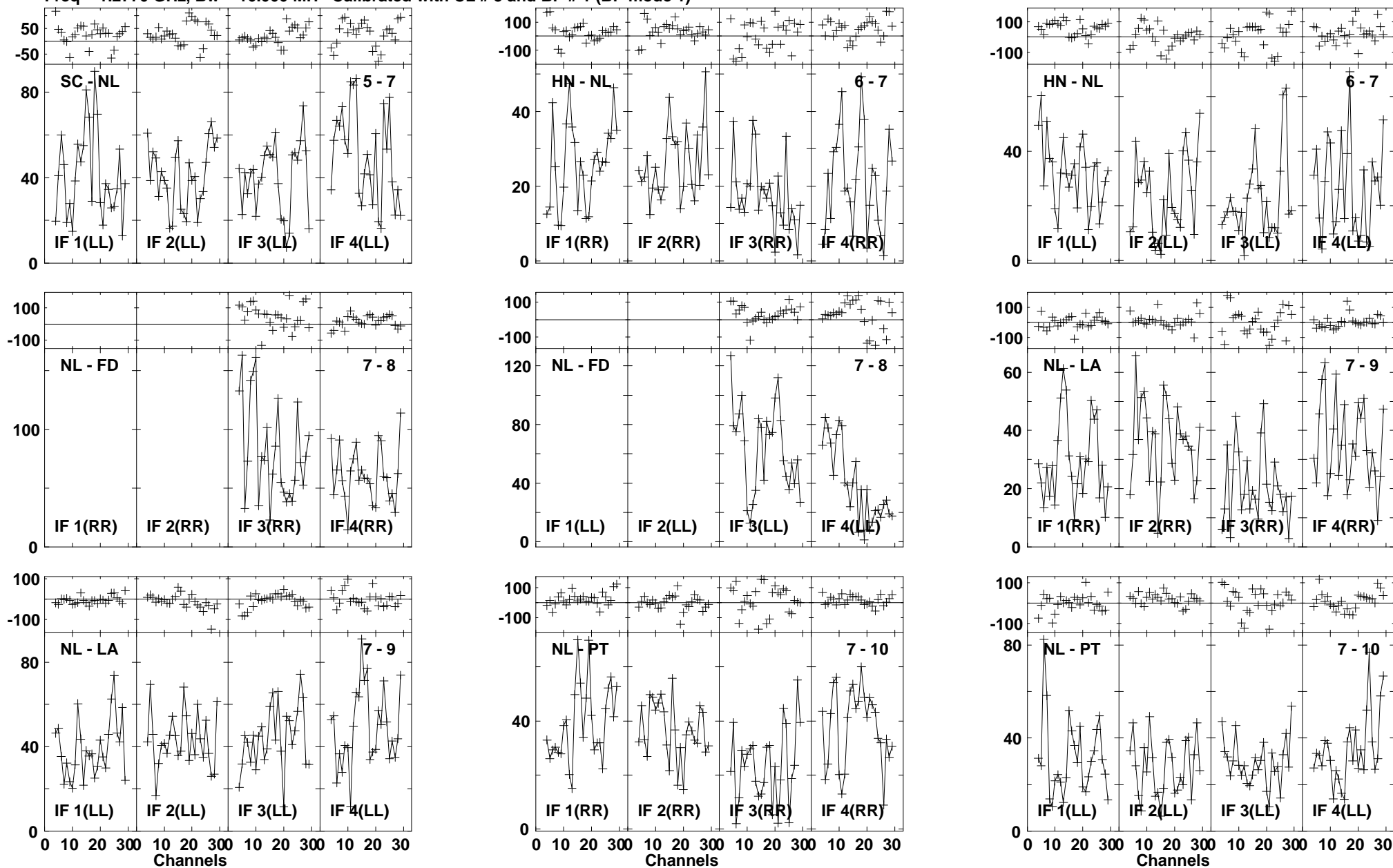

Lower frame: Milli Ampl Jy Top frame: Phas deg
Vector averaged cross-power spectrum Baseline: SC (05) - NL (07)
Timerange: 00/21:51:21 to 00/21:54:35

Plot file version 769 created 03-MAR-2016 01:14:10
 4C52 GN002C 1.UVDATA.1
 Freq = 1.2770 GHz, Bw = 16.000 MH Calibrated with CL # 3 and BP # 1 (BP mode 1)

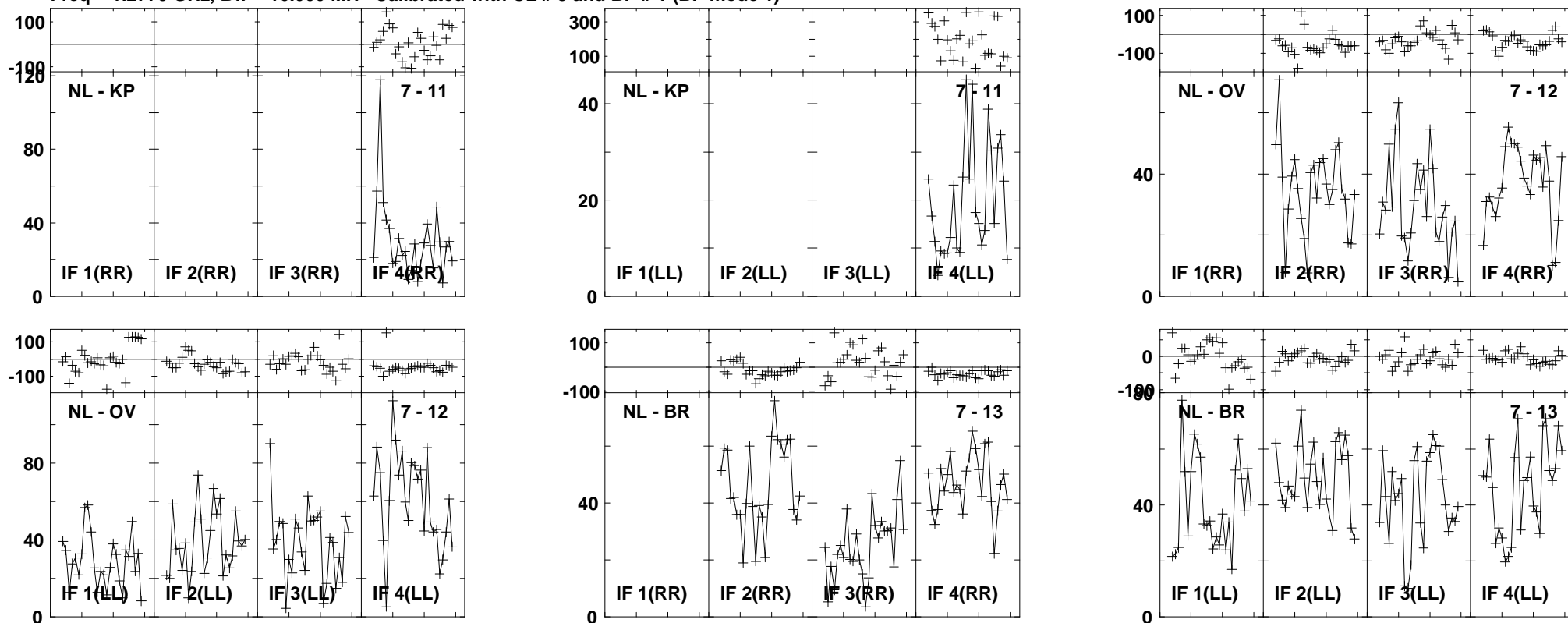

Lower frame: Milli Ampl Jy Top frame: Phas deg
 Vector averaged cross-power spectrum Baseline: NL (07) - KP (11)
 Timerange: 00/21:51:21 to 00/21:54:35

Plot file version 770 created 03-MAR-2016 01:14:10

J1545+5400 GN002C 1.UVDATA.1

Freq = 1.2770 GHz, Bw = 16.000 MH Calibrated with CL # 3 and BP # 1 (BP mode 1)

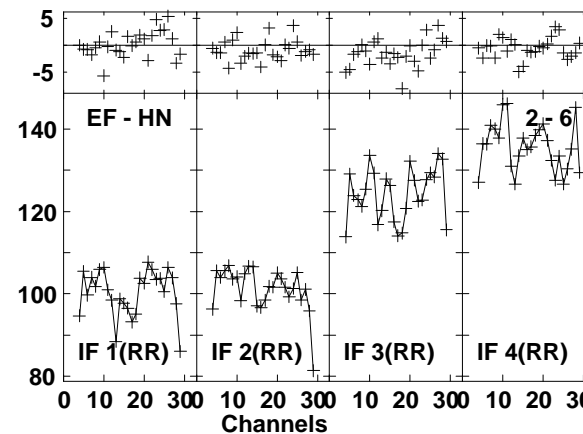
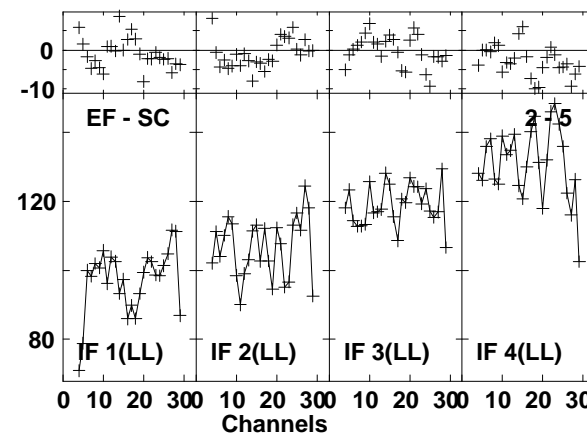
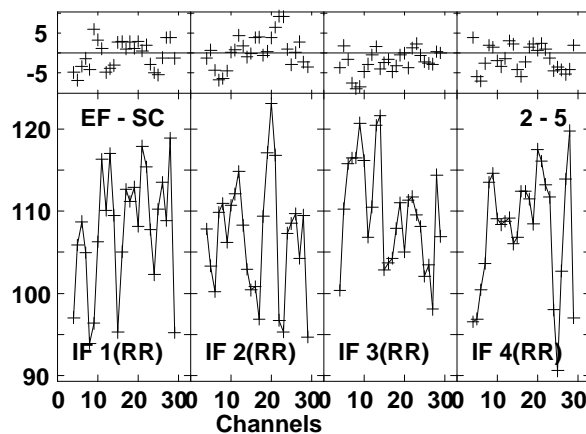
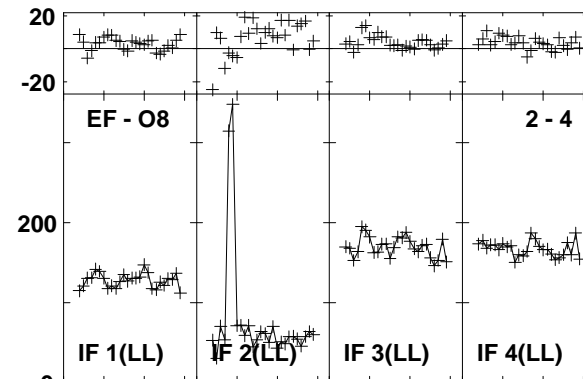
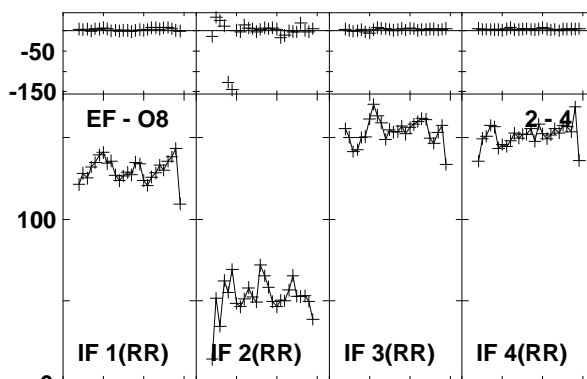
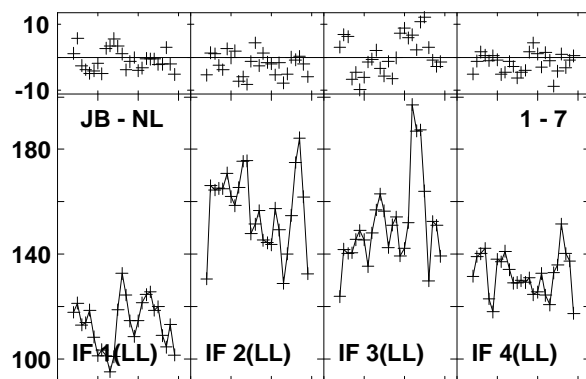
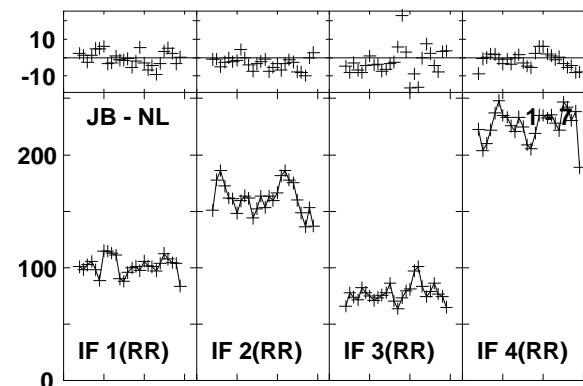
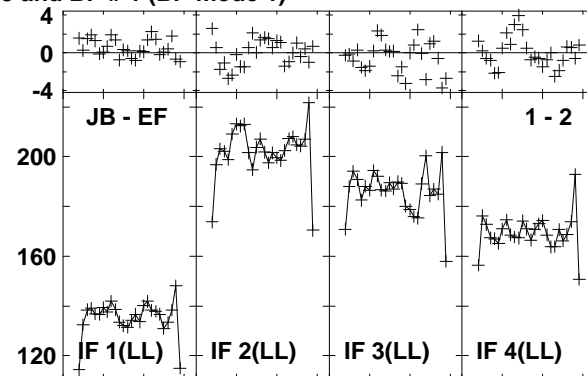
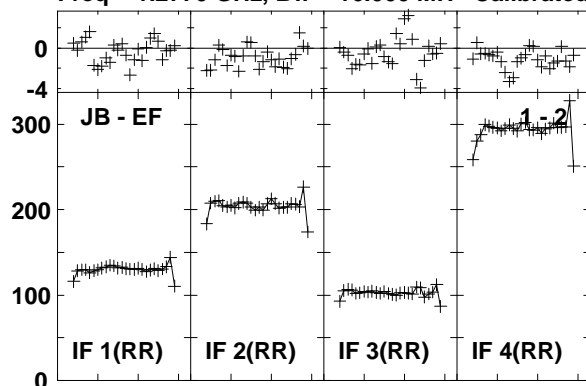

Lower frame: Milli Ampl Jy Top frame: Phas deg
Vector averaged cross-power spectrum Baseline: JB (01) - EF (02)
Timerange: 00/21:55:28 to 00/21:57:56

Plot file version 771 created 03-MAR-2016 01:14:10

J1545+5400 GN002C 1.UVDATA.1

Freq = 1.2770 GHz, Bw = 16.000 MH Calibrated with CL # 3 and BP # 1 (BP mode 1)

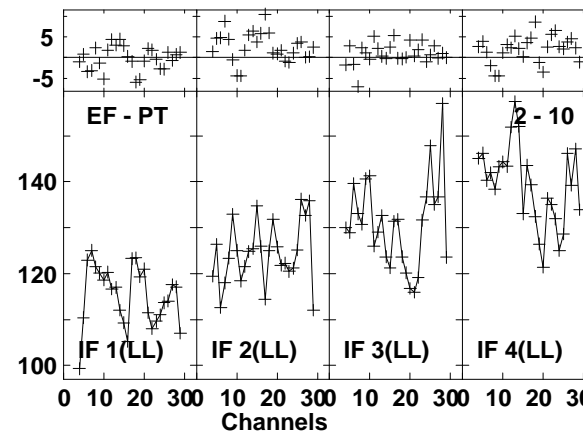
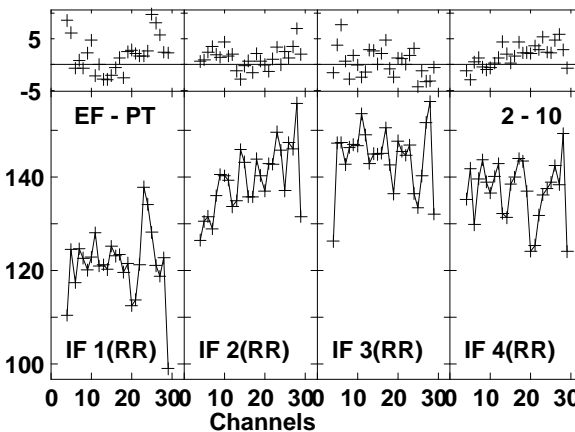
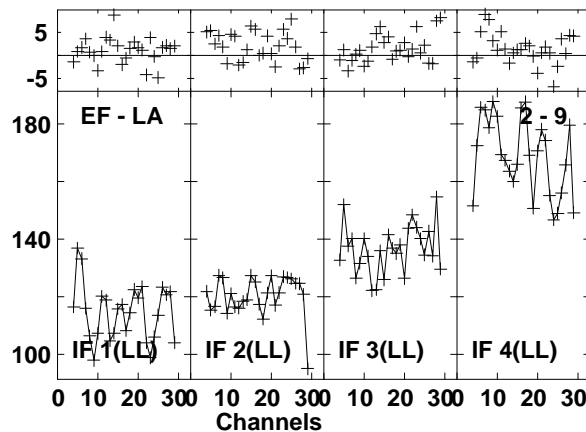
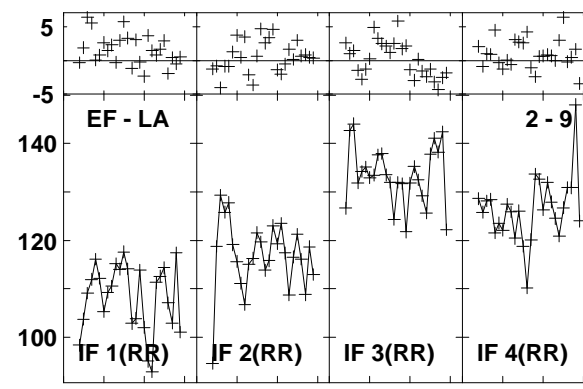
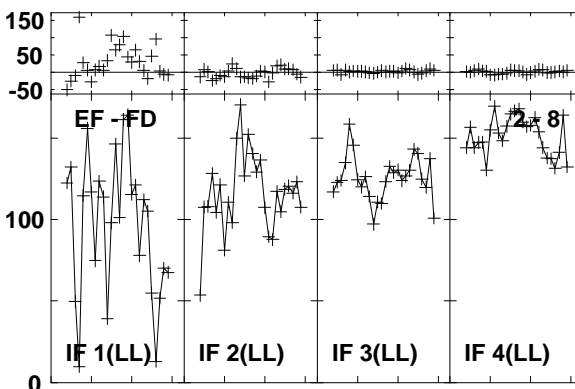
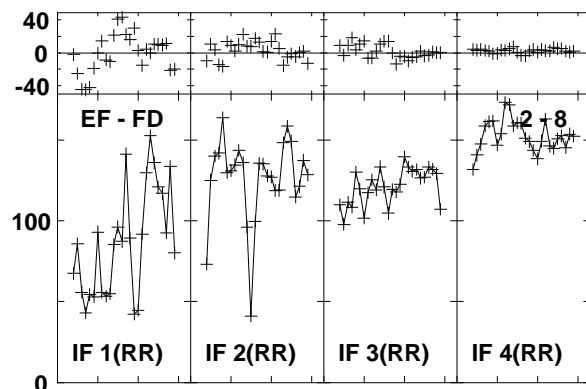
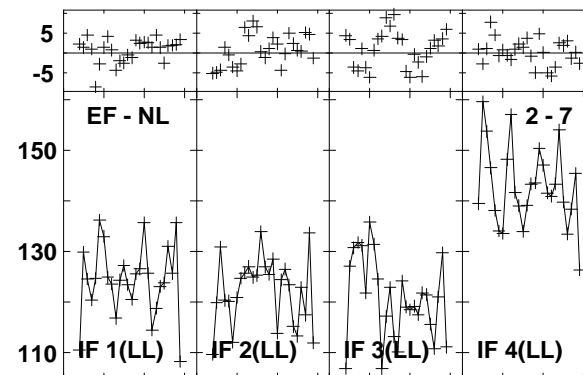
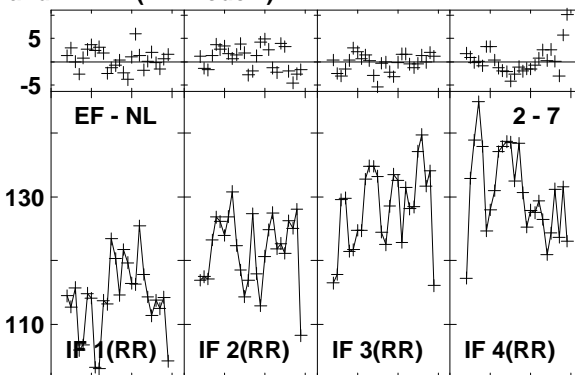
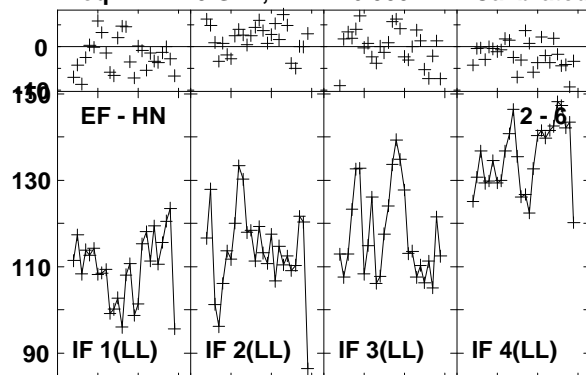

Lower frame: Milli Ampl Jy Top frame: Phas deg
 Vector averaged cross-power spectrum Baseline: EF (02) - HN (06)
 Timerange: 00/21:55:28 to 00/21:57:56

Plot file version 772 created 03-MAR-2016 01:14:10
 J1545+5400 GN002C 1.UVDATA.1
 Freq = 1.2770 GHz, Bw = 16.000 MH Calibrated with CL # 3 and BP # 1 (BP mode 1)

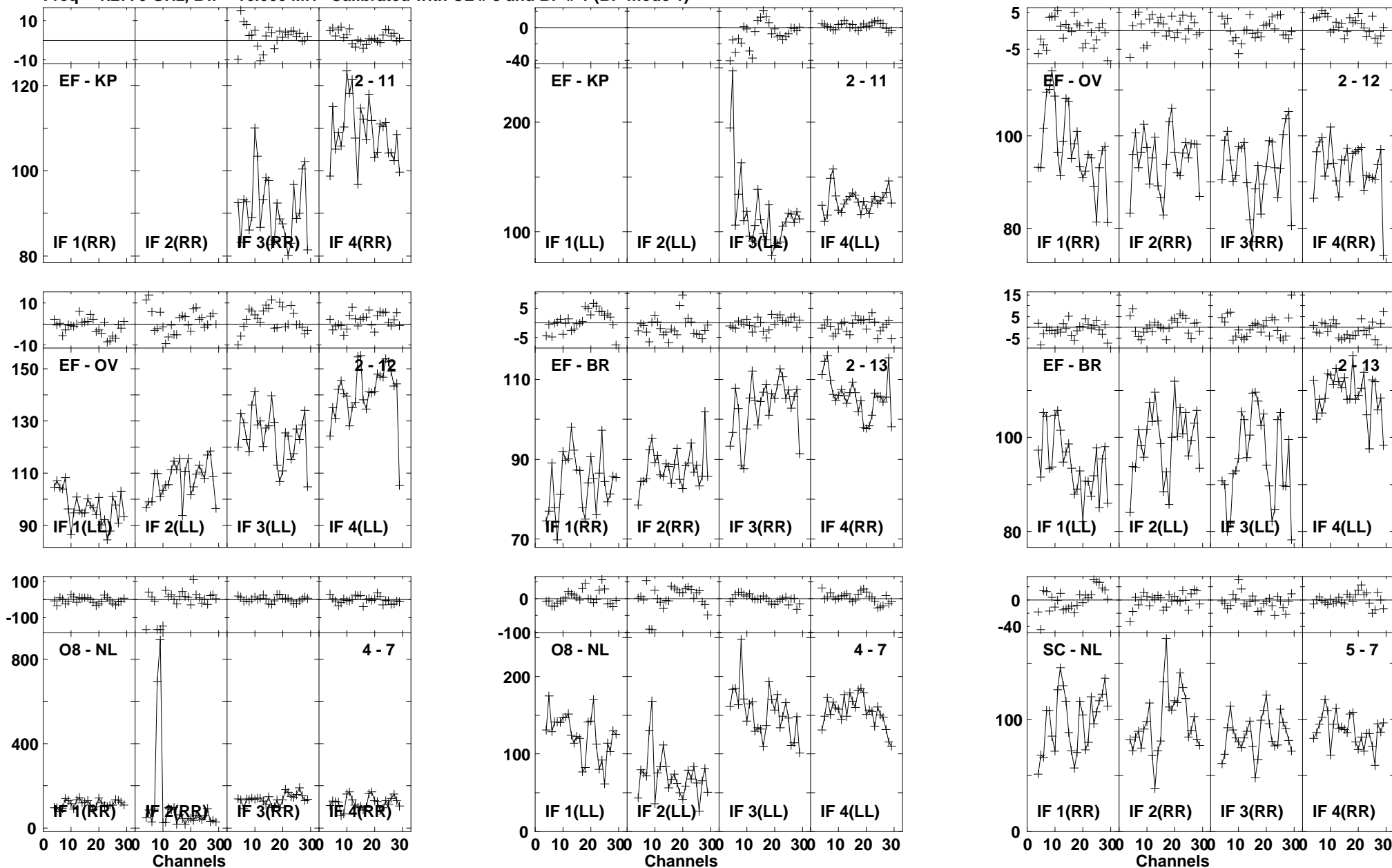

Lower frame: Milli Ampl Jy Top frame: Phas deg
 Vector averaged cross-power spectrum Baseline: EF (02) - KP (11)
 Timerange: 00/21:55:28 to 00/21:57:56

Plot file version 773 created 03-MAR-2016 01:14:10

J1545+5400 GN002C 1.UVDATA.1

Freq = 1.2770 GHz, Bw = 16.000 MH Calibrated with CL # 3 and BP # 1 (BP mode 1)

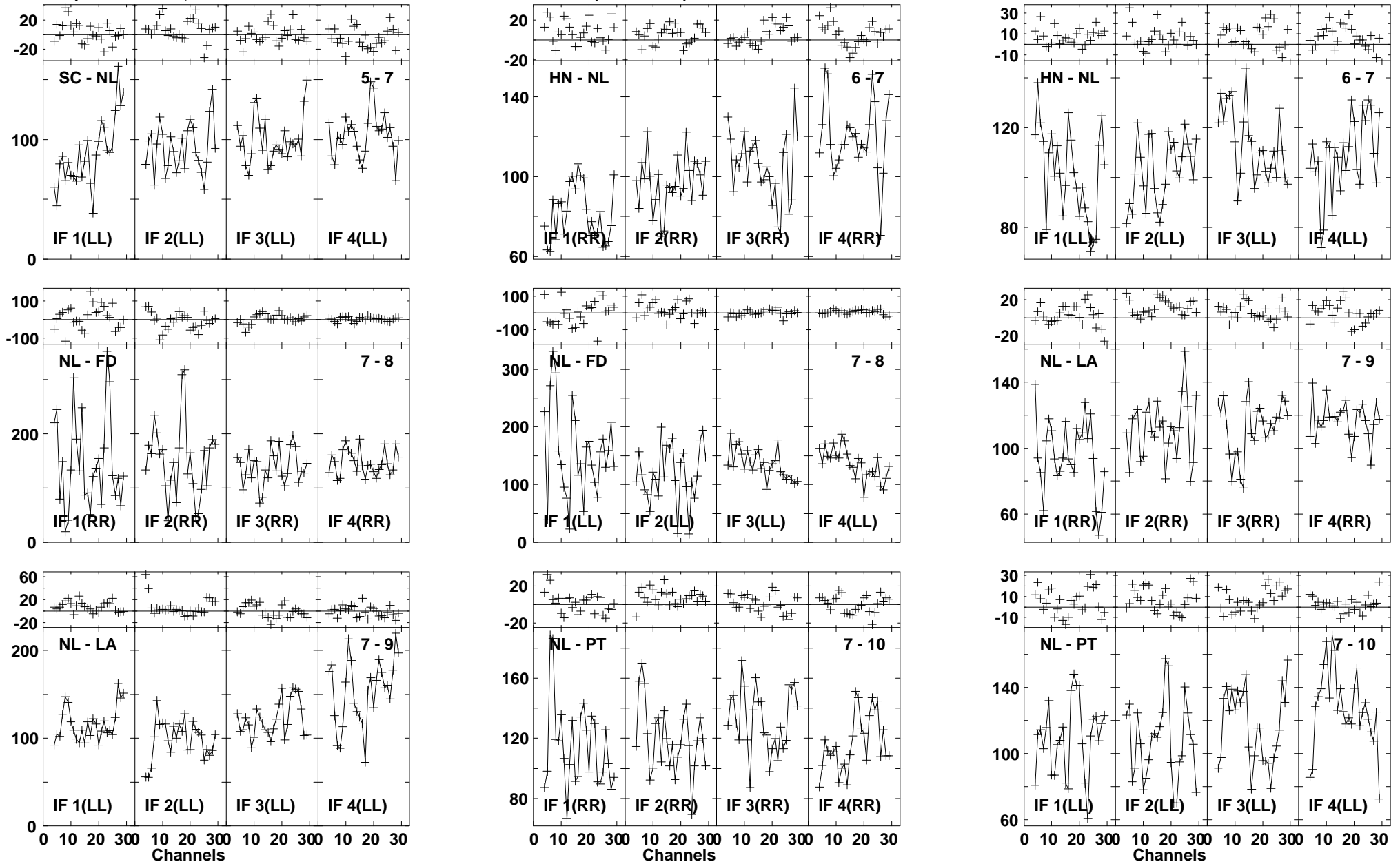

Lower frame: Milli Ampl Jy Top frame: Phas deg
Vector averaged cross-power spectrum Baseline: SC (05) - NL (07)
Timerange: 00/21:55:28 to 00/21:57:56

Plot file version 774 created 03-MAR-2016 01:14:11
 J1545+5400 GN002C 1.UVDATA.1
 Freq = 1.2770 GHz, Bw = 16.000 MH Calibrated with CL # 3 and BP # 1 (BP mode 1)

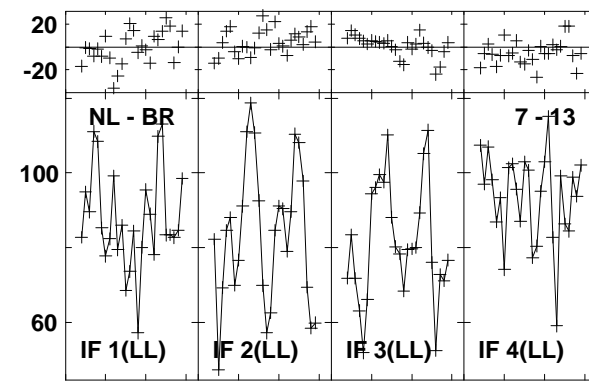
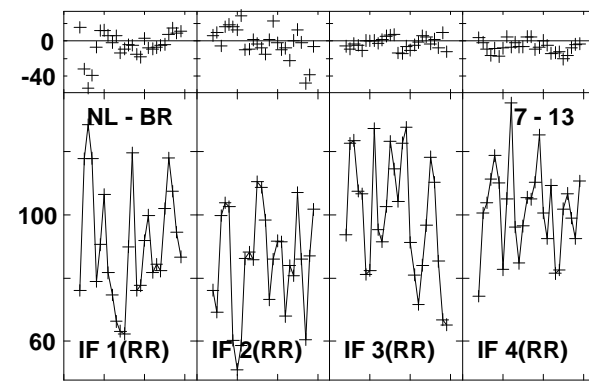
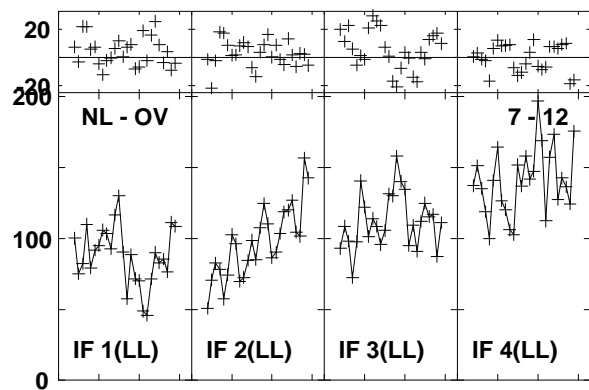
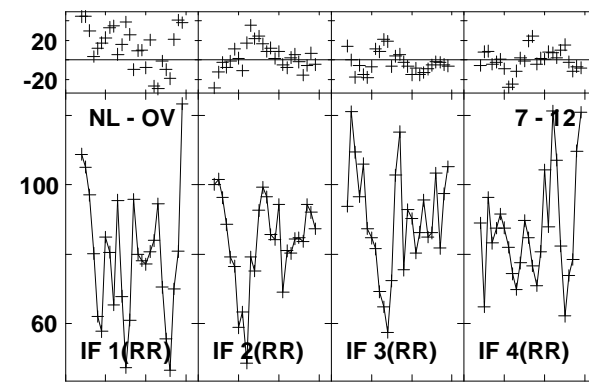
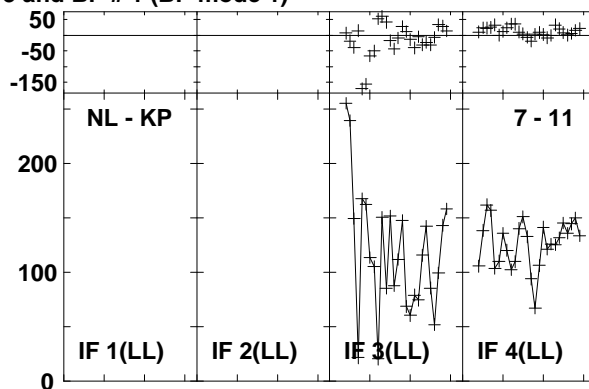
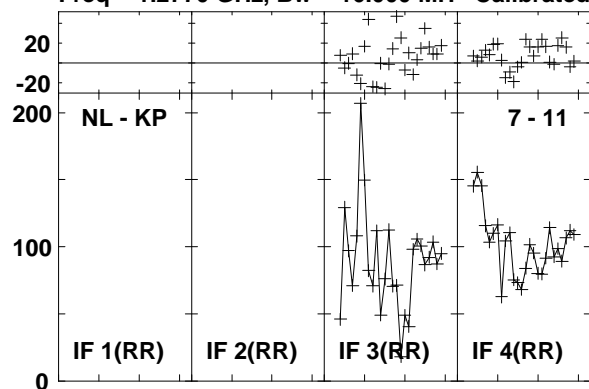

Lower frame: Milli Ampl Jy Top frame: Phas deg
 Vector averaged cross-power spectrum Baseline: NL (07) - KP (11)
 Timerange: 00/21:55:28 to 00/21:57:56

Plot file version 775 created 03-MAR-2016 01:14:11

4C52 GN002C 1.UVDATA.1

Freq = 1.2770 GHz, Bw = 16.000 MH Calibrated with CL # 3 and BP # 1 (BP mode 1)

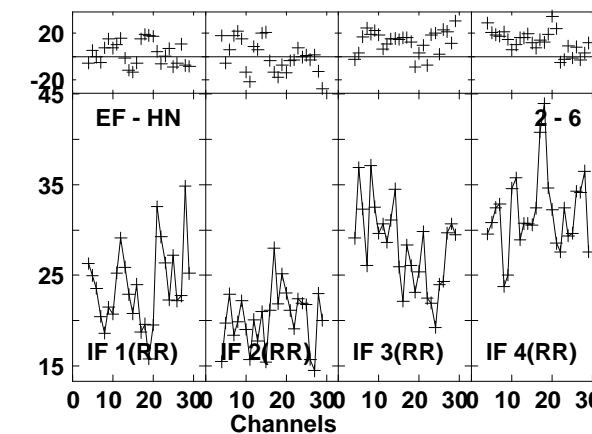
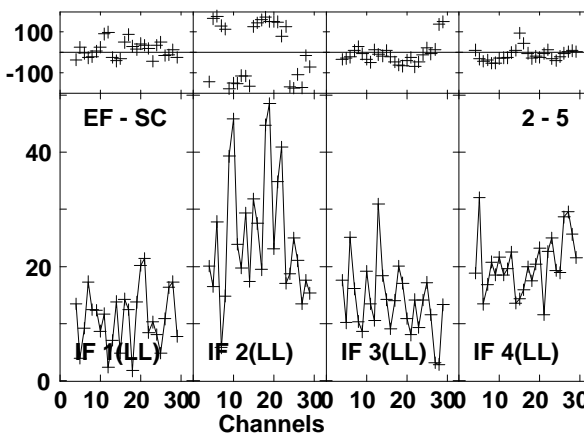
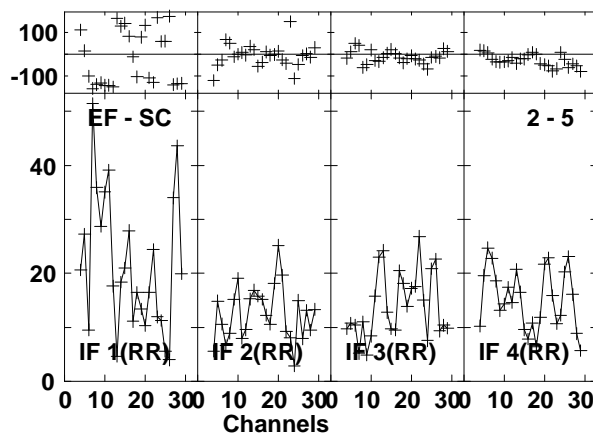
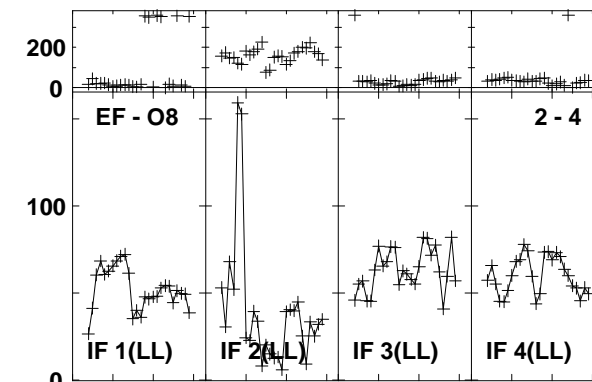
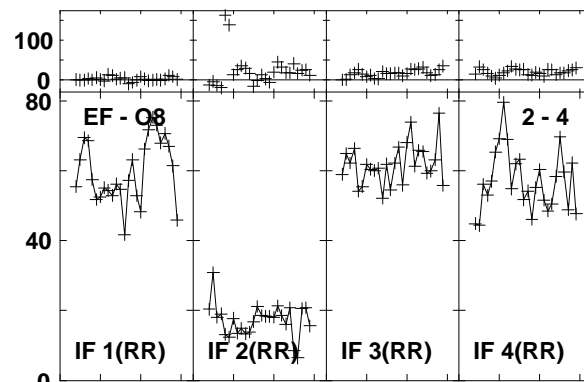
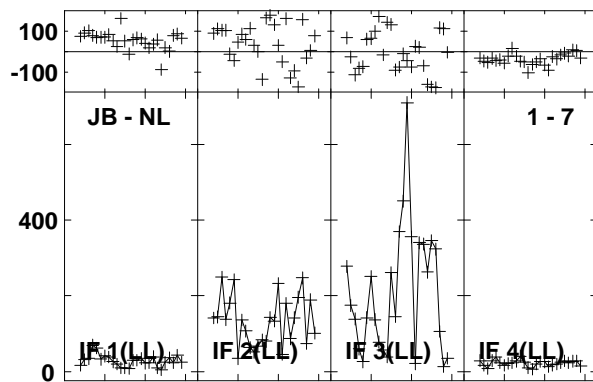
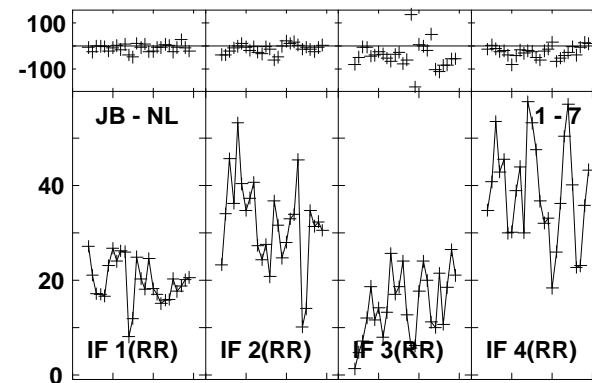
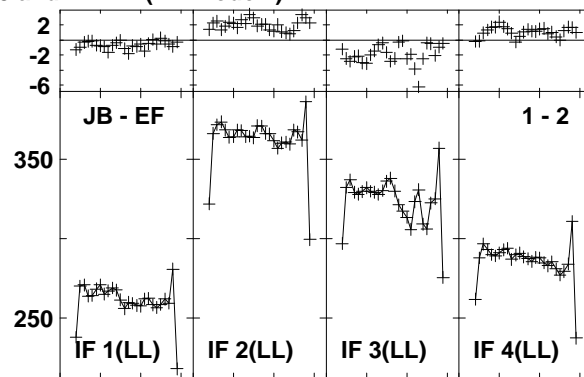
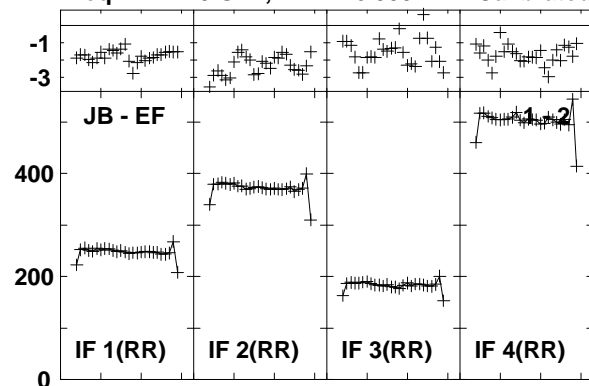

Lower frame: Milli Ampl Jy Top frame: Phas deg
Vector averaged cross-power spectrum Baseline: JB (01) - EF (02)
Timerange: 00/21:58:09 to 00/22:01:25

Plot file version 776 created 03-MAR-2016 01:14:11

4C52 GN002C 1.UVDATA.1

Freq = 1.2770 GHz, Bw = 16.000 MH Calibrated with CL # 3 and BP # 1 (BP mode 1)

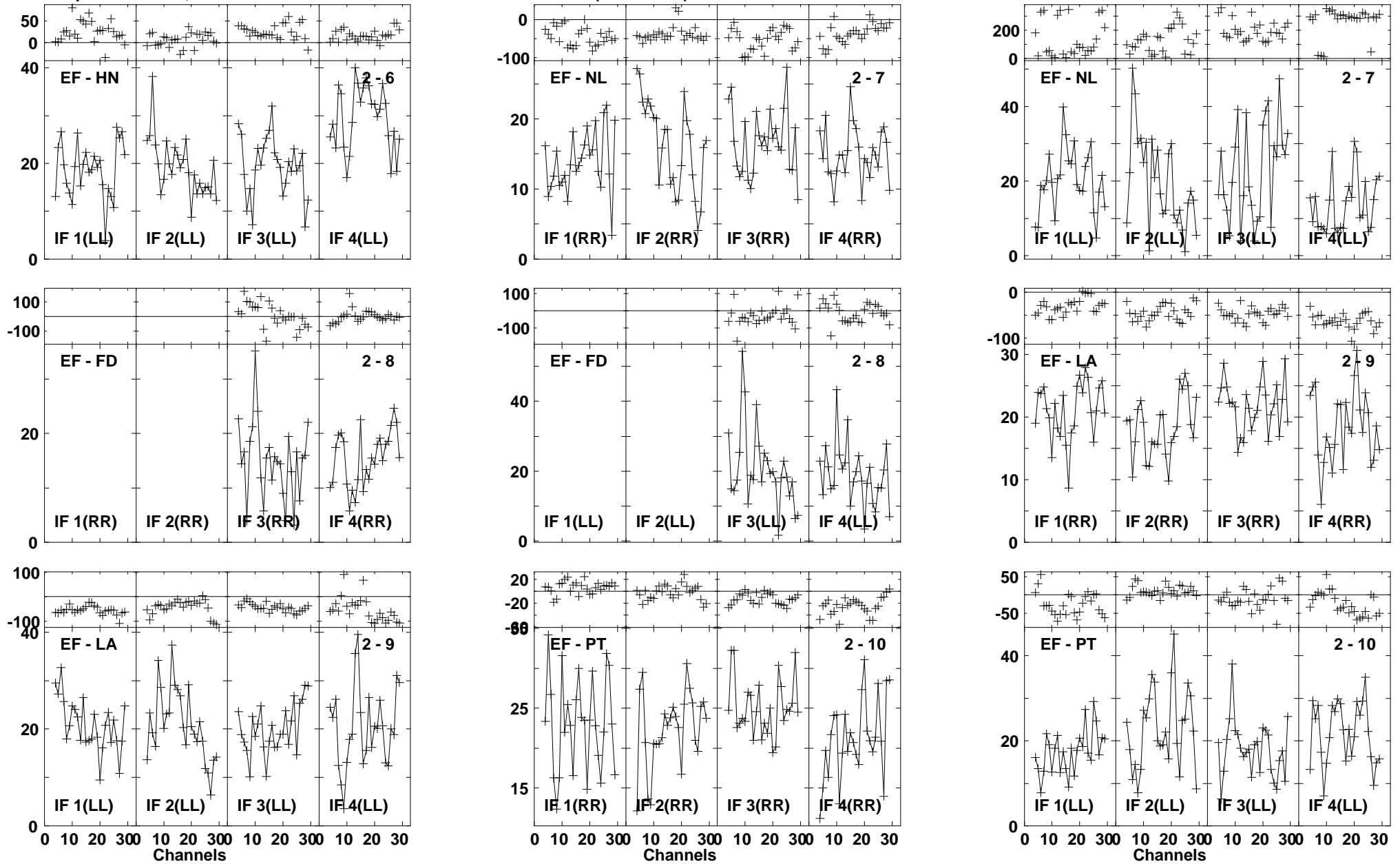

Lower frame: Milli Ampl Jy Top frame: Phas deg
Vector averaged cross-power spectrum Baseline: EF (02) - HN (06)
Timerange: 00/21:58:09 to 00/22:01:25

Plot file version 777 created 03-MAR-2016 01:14:11

4C52 GN002C 1.UVDATA.1

Freq = 1.2770 GHz, Bw = 16.000 MH Calibrated with CL # 3 and BP # 1 (BP mode 1)

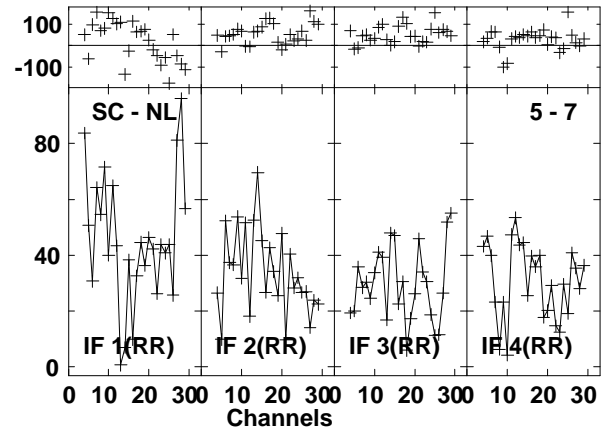
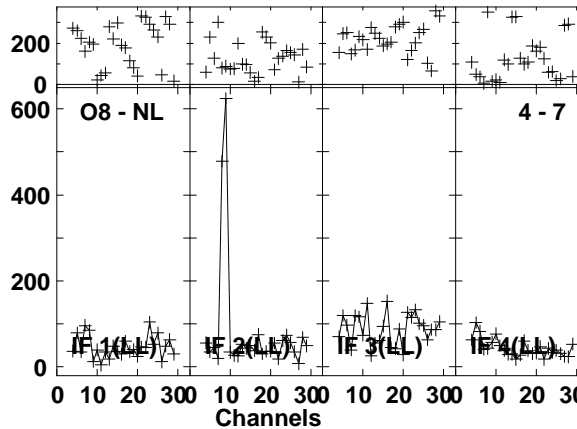
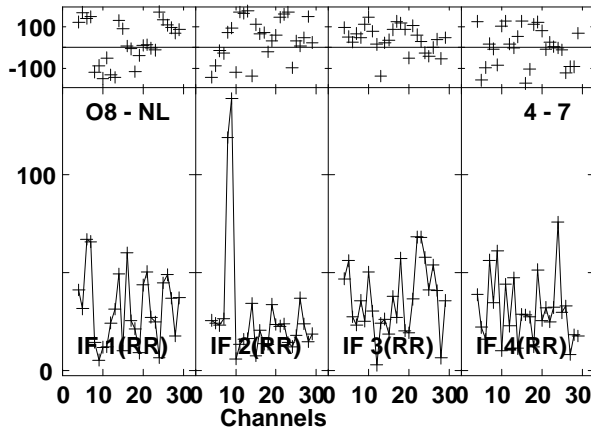
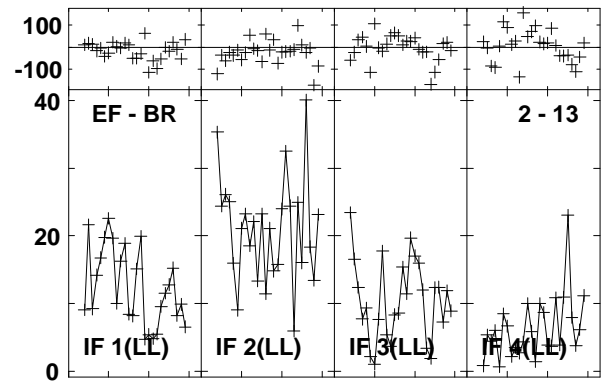
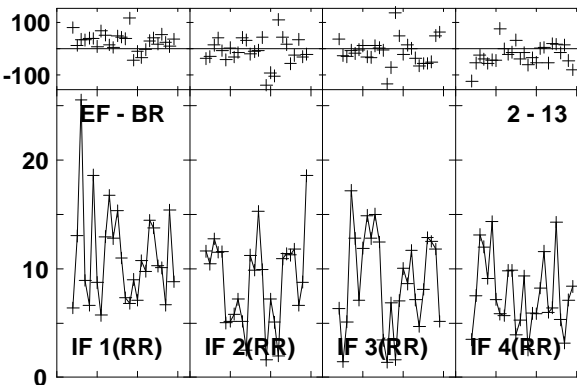
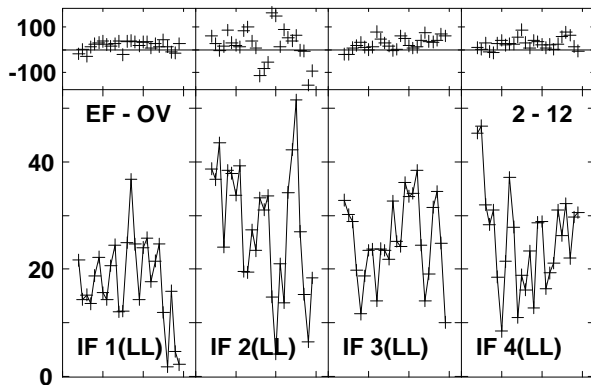
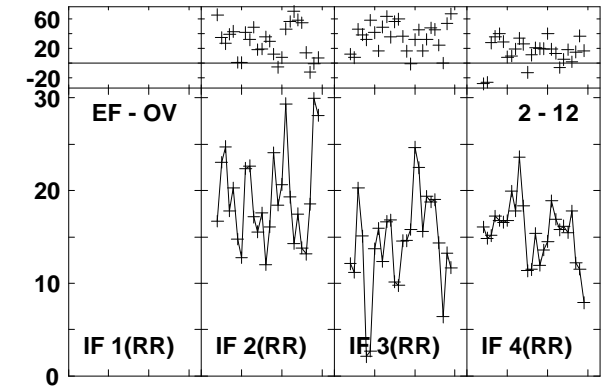
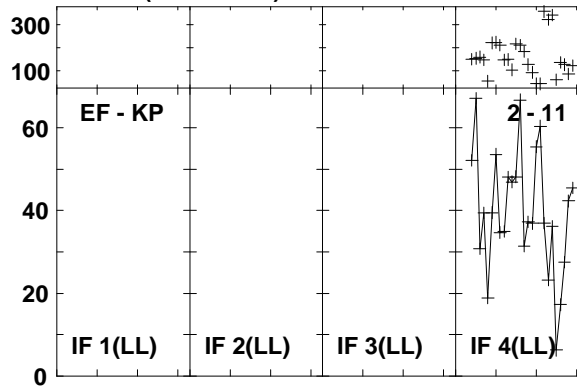
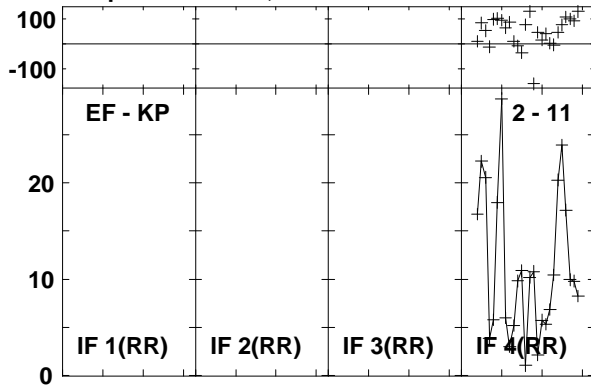

Lower frame: Milli Ampl Jy Top frame: Phas deg
Vector averaged cross-power spectrum Baseline: EF (02) - KP (11)
Timerange: 00/21:58:09 to 00/22:01:25

Plot file version 778 created 03-MAR-2016 01:14:11
 4C52 GN002C 1.UVDATA.1
 Freq = 1.2770 GHz, Bw = 16.000 MH Calibrated with CL # 3 and BP # 1 (BP mode 1)

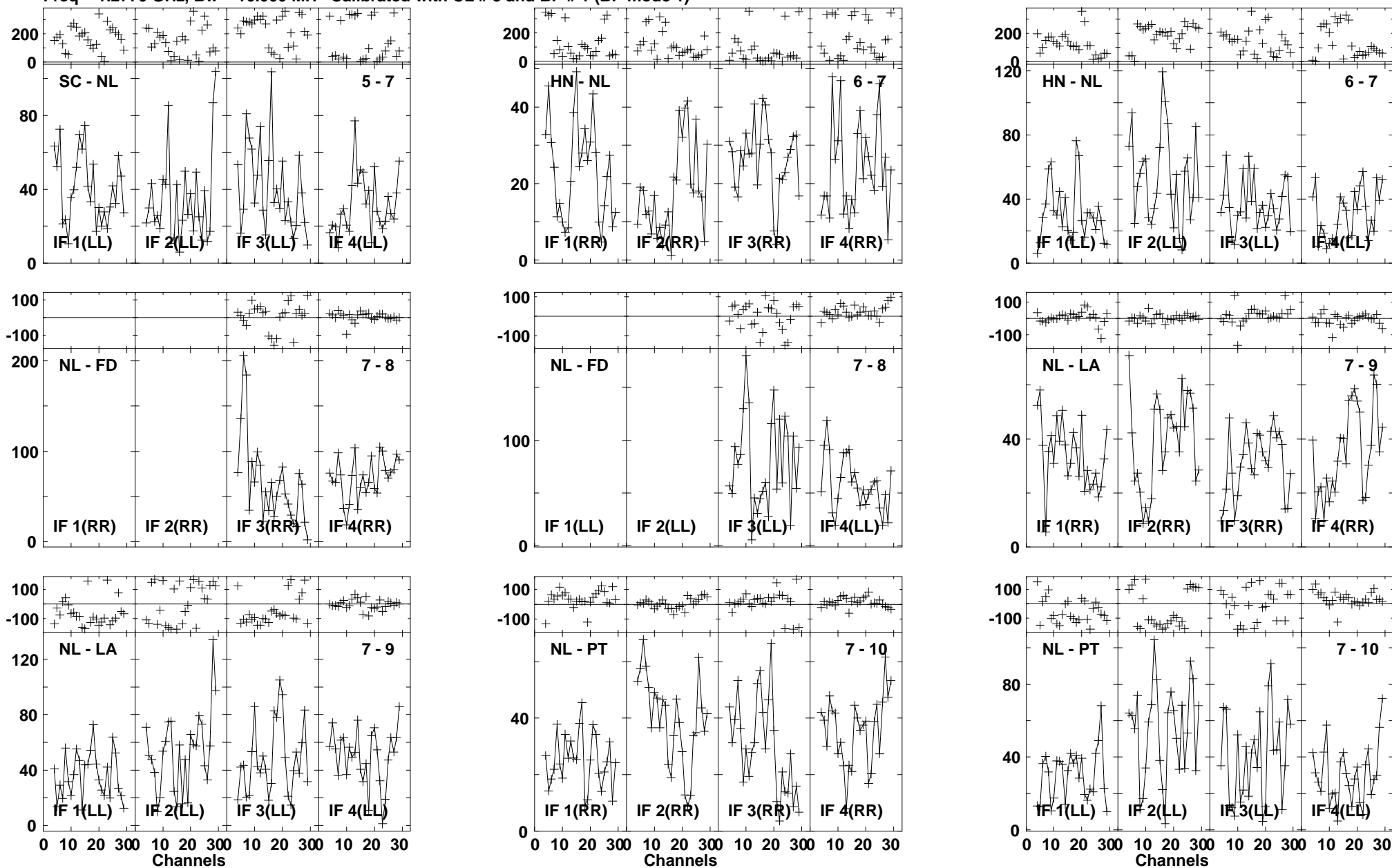

Lower frame: Milli Ampl Jy Top frame: Phas deg
 Vector averaged cross-power spectrum Baseline: SC (05) - NL (07)
 Timerange: 00/21:58:09 to 00/22:01:25

Plot file version 779 created 03-MAR-2016 01:14:12

4C52 GN002C 1.UVDATA.1

Freq = 1.2770 GHz, Bw = 16.000 MH Calibrated with CL # 3 and BP # 1 (BP mode 1)

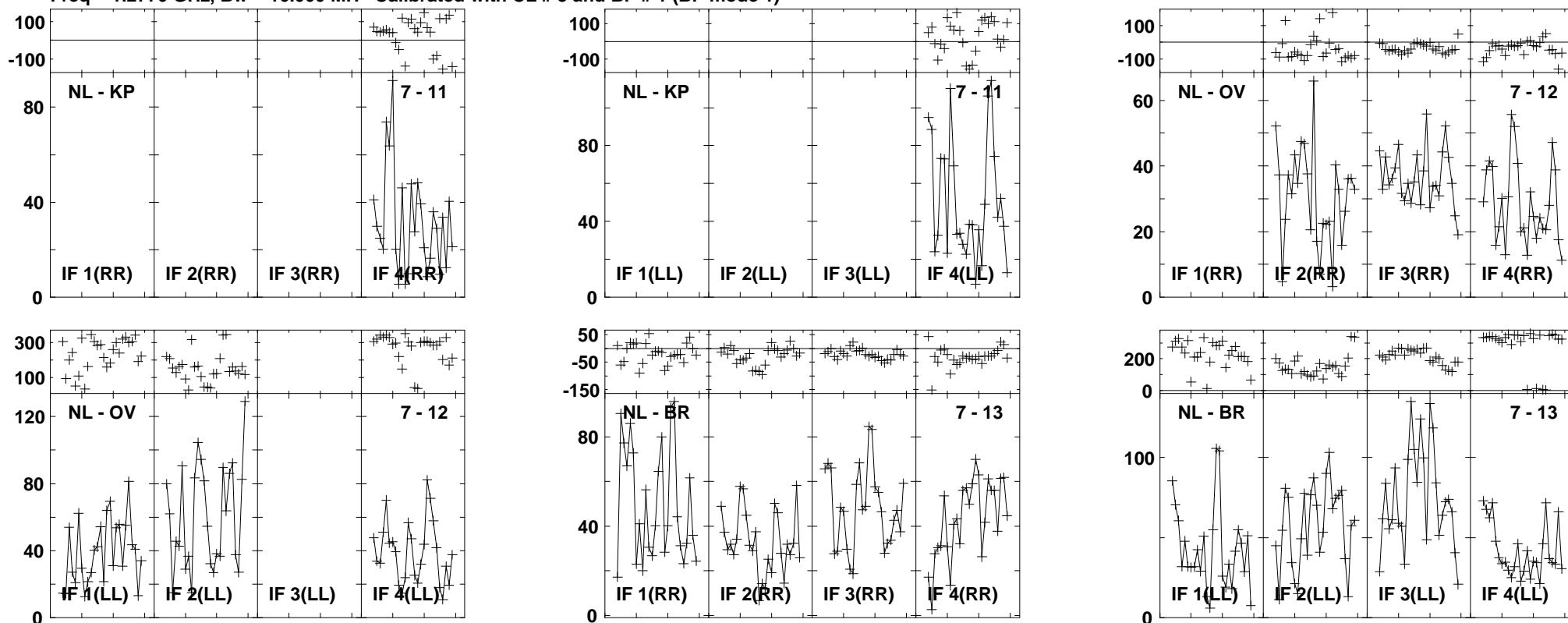

Lower frame: Milli Ampl Jy Top frame: Phas deg
Vector averaged cross-power spectrum Baseline: NL (07) - KP (11)
Timerange: 00/21:58:09 to 00/22:01:25

Plot file version 780 created 03-MAR-2016 01:14:12
 J1545+5400 GN002C 1.UVDATA.1
 Freq = 1.2770 GHz, Bw = 16.000 MH Calibrated with CL # 3 and BP # 1 (BP mode 1)

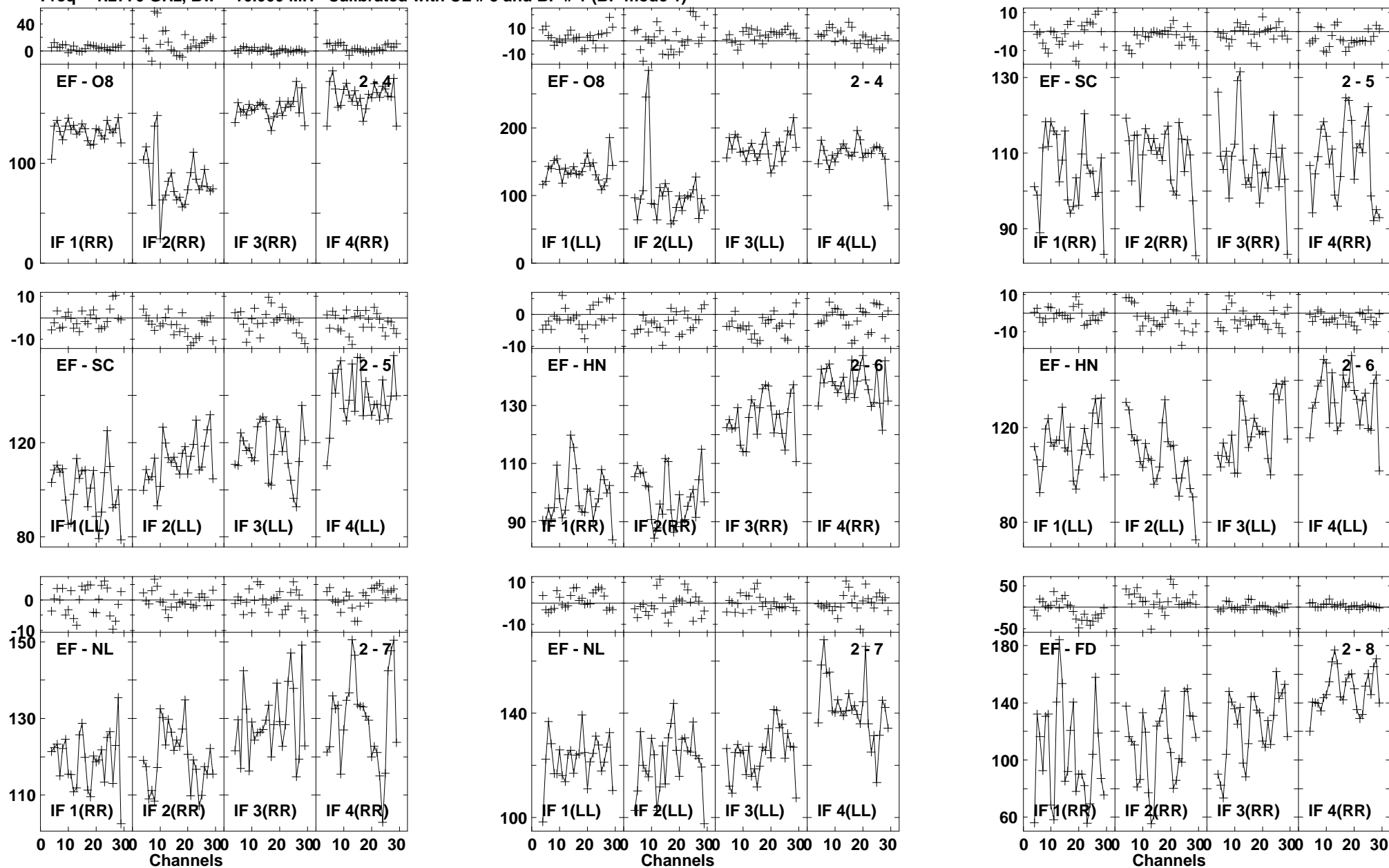

Lower frame: Milli Ampl Jy Top frame: Phas deg
 Vector averaged cross-power spectrum Baseline: EF (02) - O8 (04)
 Timerange: 00/22:02:18 to 00/22:03:46

Plot file version 781 created 03-MAR-2016 01:14:12

J1545+5400 GN002C 1.UVDATA.1

Freq = 1.2770 GHz, Bw = 16.000 MH Calibrated with CL # 3 and BP # 1 (BP mode 1)

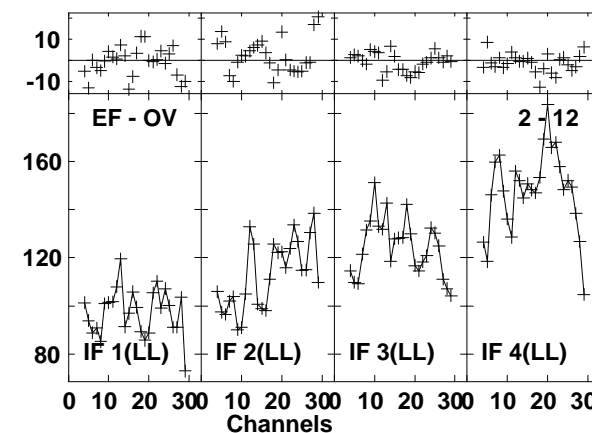
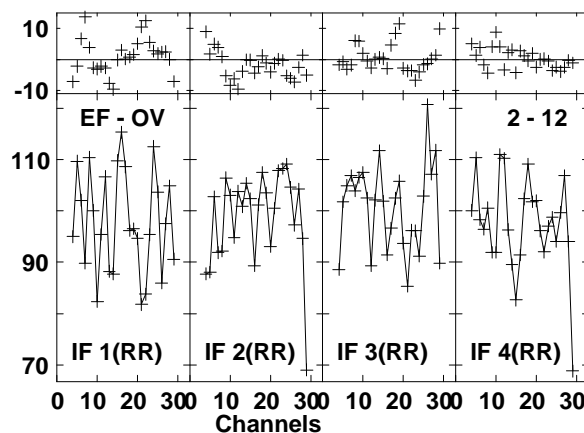
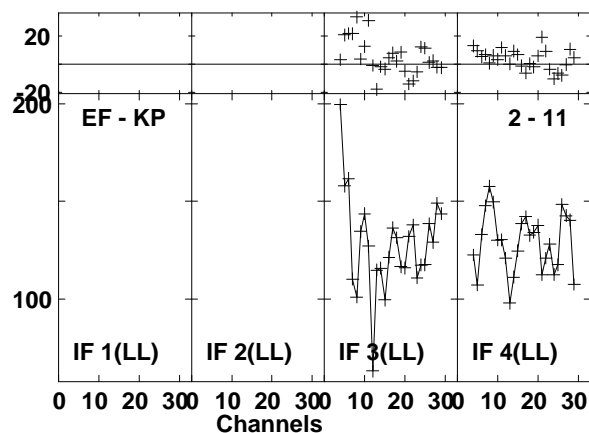
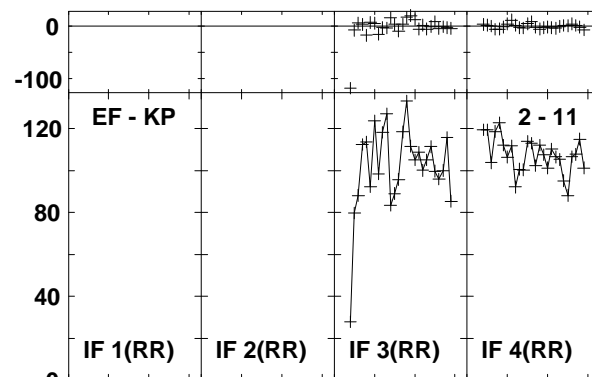
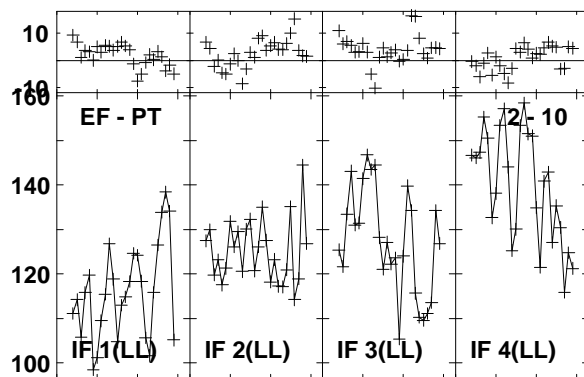
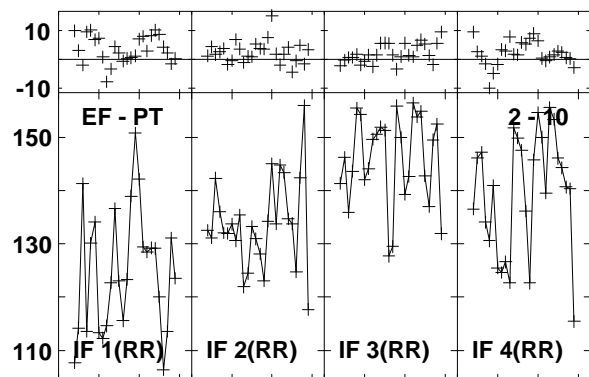
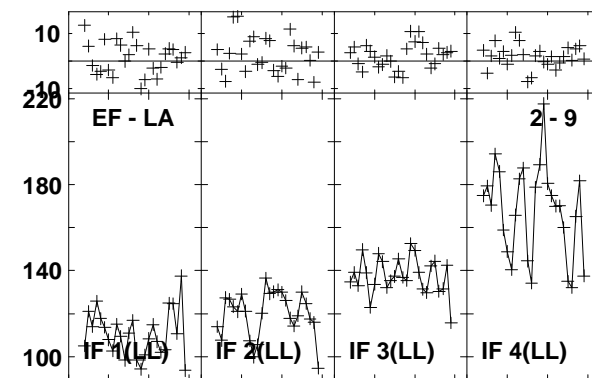
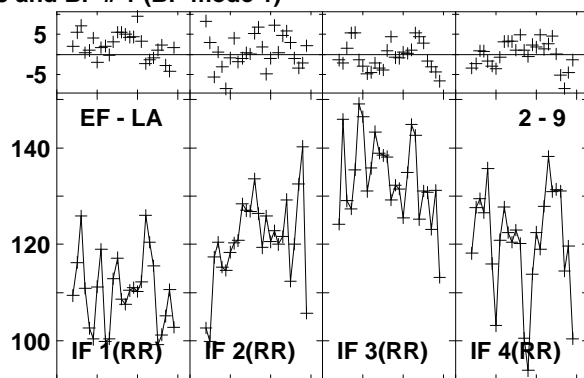
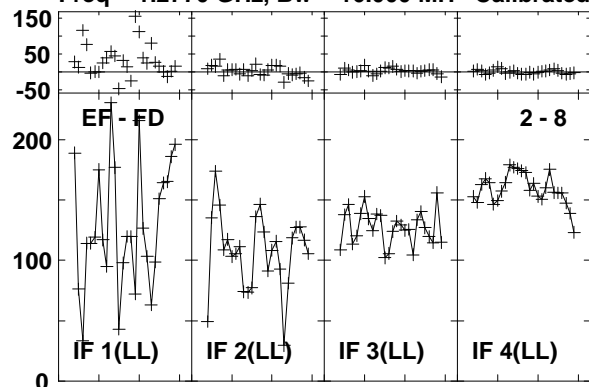

Lower frame: Milli Ampl Jy Top frame: Phas deg
Vector averaged cross-power spectrum Baseline: EF (02) - FD (08)
Timerange: 00/22:02:18 to 00/22:03:46

Plot file version 782 created 03-MAR-2016 01:14:12

J1545+5400 GN002C 1.UVDATA.1

Freq = 1.2770 GHz, Bw = 16.000 MH Calibrated with CL # 3 and BP # 1 (BP mode 1)

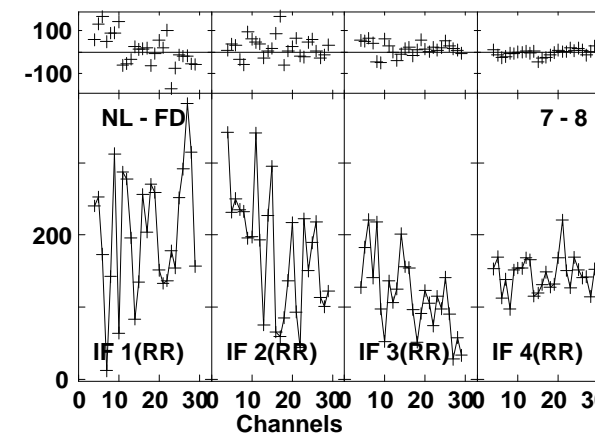
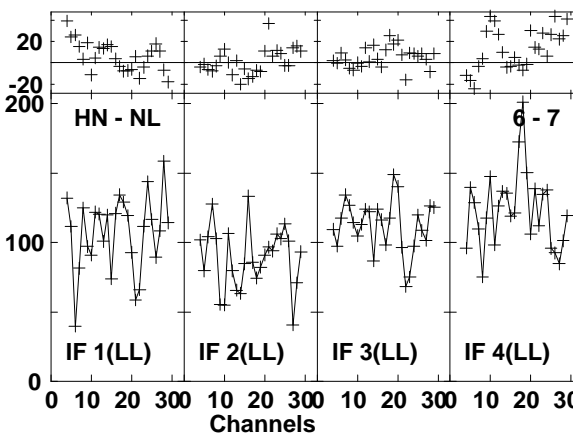
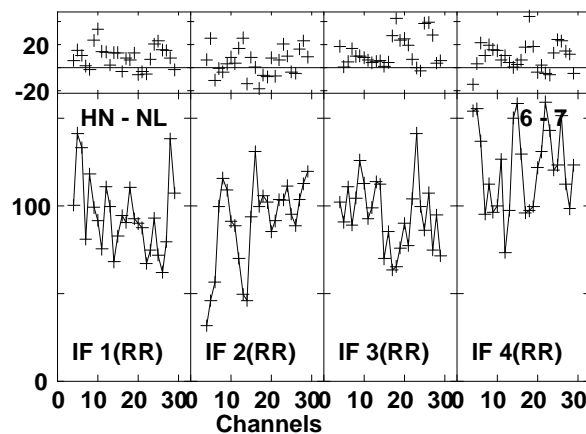
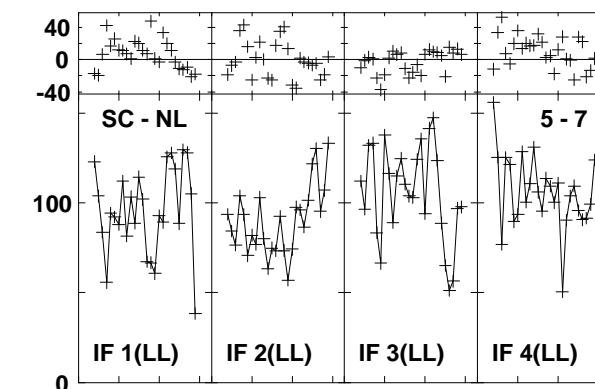
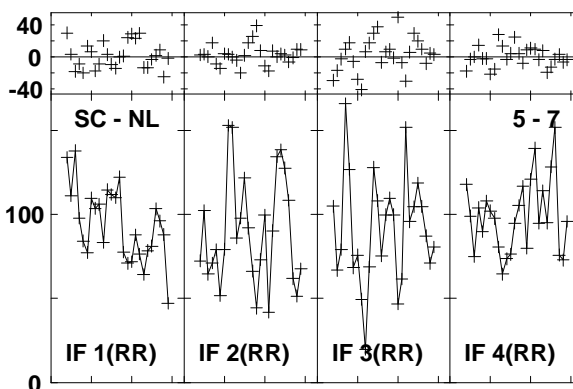
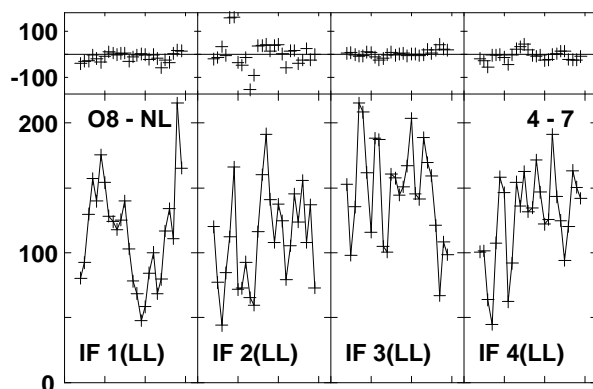
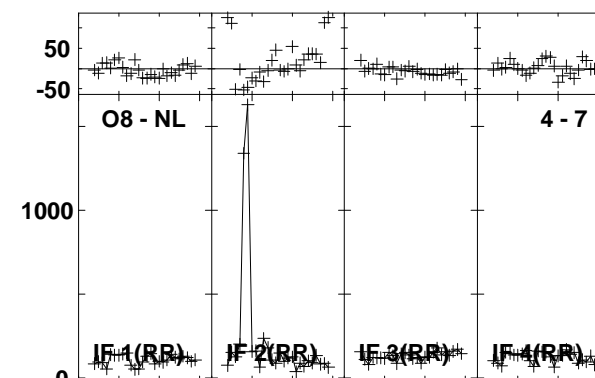
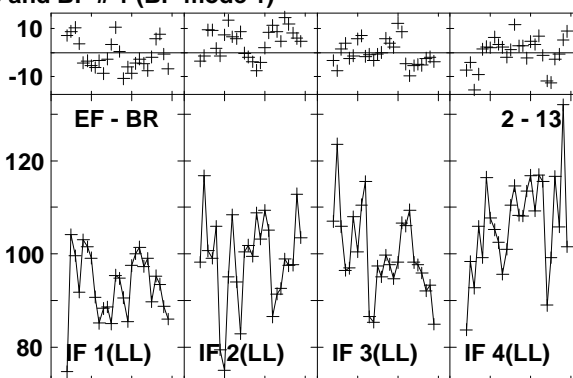
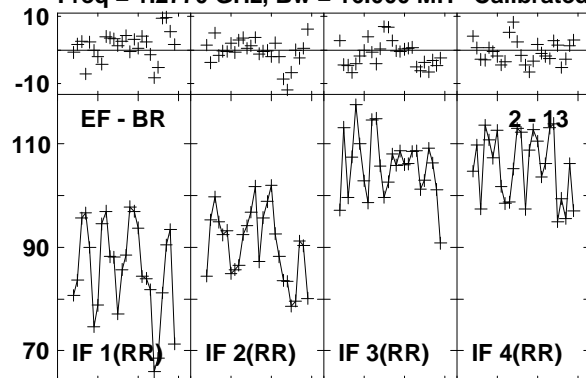

Lower frame: Milli Ampl Jy Top frame: Phas deg
Vector averaged cross-power spectrum Baseline: EF (02) - BR (13)
Timerange: 00/22:02:18 to 00/22:03:46

Plot file version 783 created 03-MAR-2016 01:14:12
 J1545+5400 GN002C 1.UVDATA.1
 Freq = 1.2770 GHz, Bw = 16.000 MH Calibrated with CL # 3 and BP # 1 (BP mode 1)

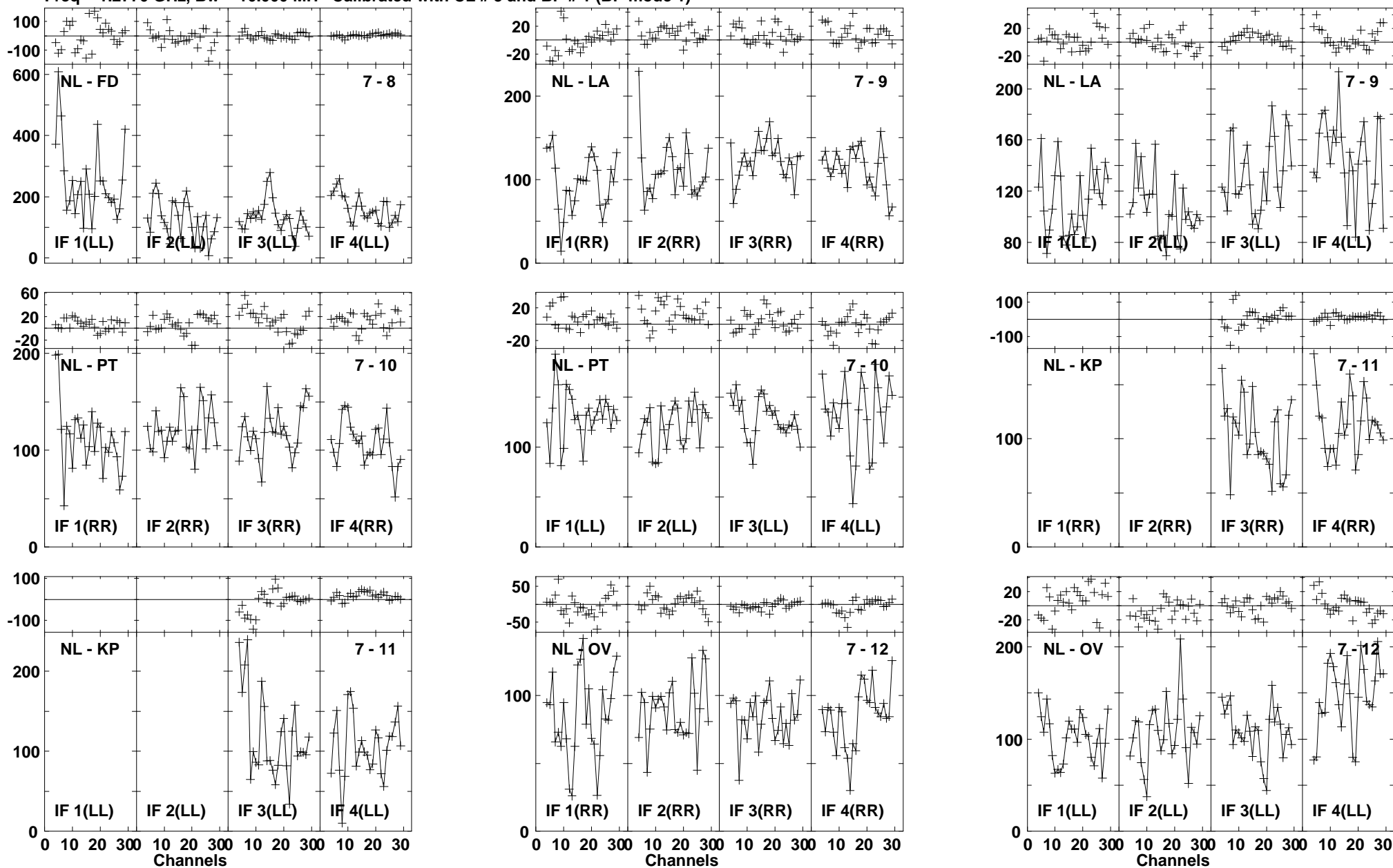

Lower frame: Milli Ampl Jy Top frame: Phas deg
 Vector averaged cross-power spectrum Baseline: NL (07) - FD (08)
 Timerange: 00/22:02:18 to 00/22:03:46

Plot file version 784 created 03-MAR-2016 01:14:13

J1545+5400 GN002C 1.UVDATA.1

Freq = 1.2770 GHz, Bw = 16.000 MH Calibrated with CL # 3 and BP # 1 (BP mode 1)

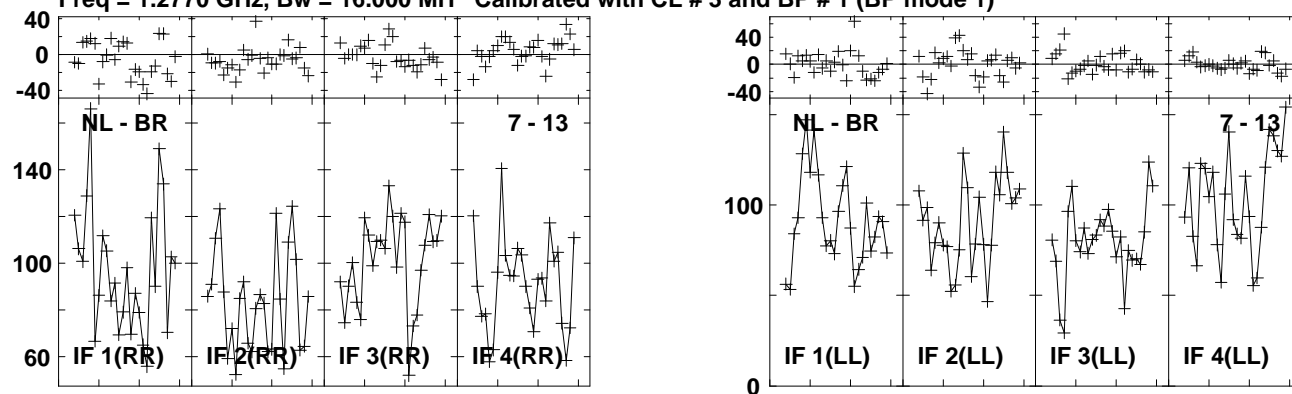

Lower frame: Milli Ampl Jy Top frame: Phas deg

Vector averaged cross-power spectrum Baseline: NL (07) - BR (13)

Timerange: 00/22:02:18 to 00/22:03:46

Plot file version 785 created 03-MAR-2016 01:14:13

4C52 GN002C 1.UVDATA.1

Freq = 1.2770 GHz, Bw = 16.000 MH Calibrated with CL # 3 and BP # 1 (BP mode 1)

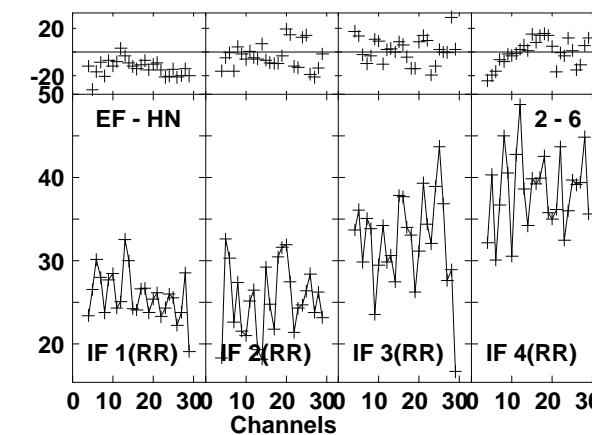
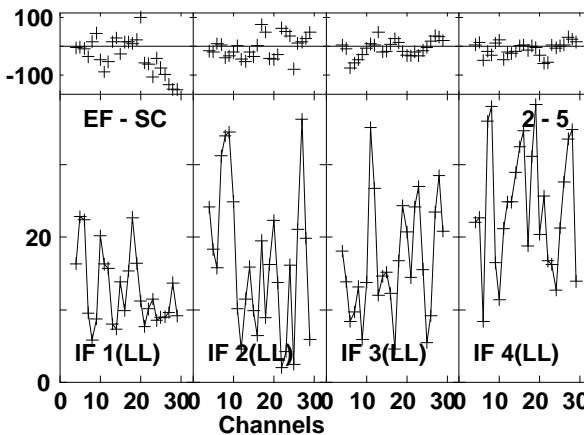
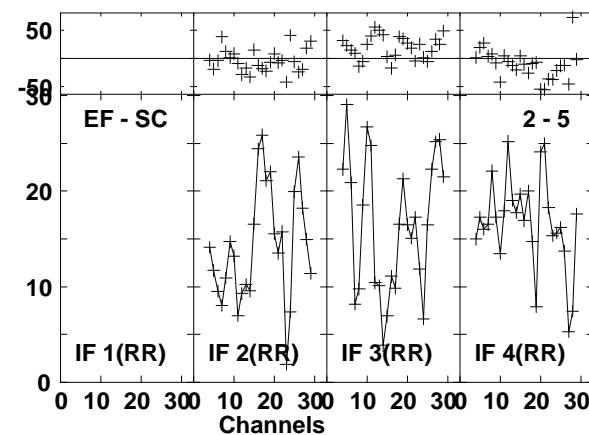
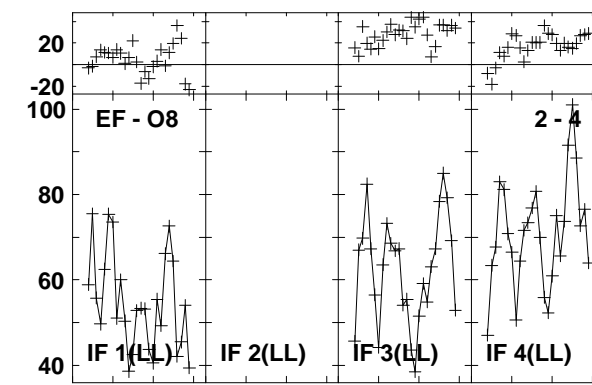
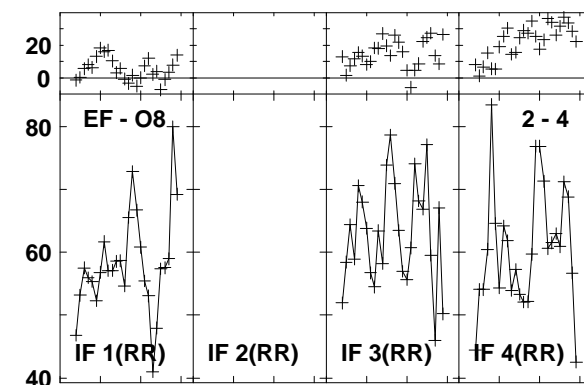
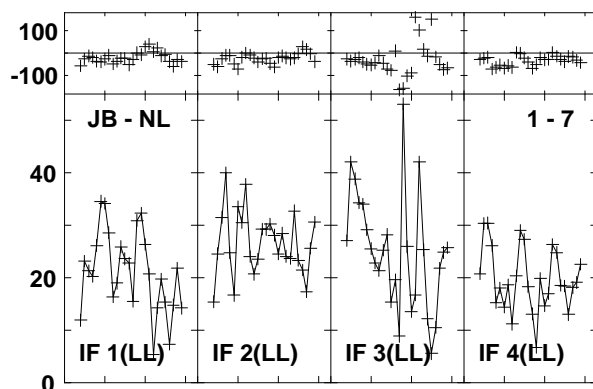
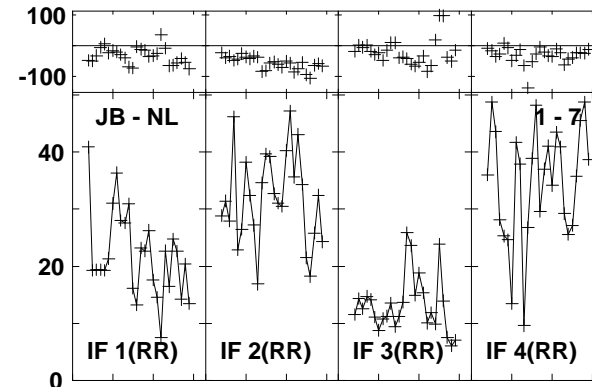
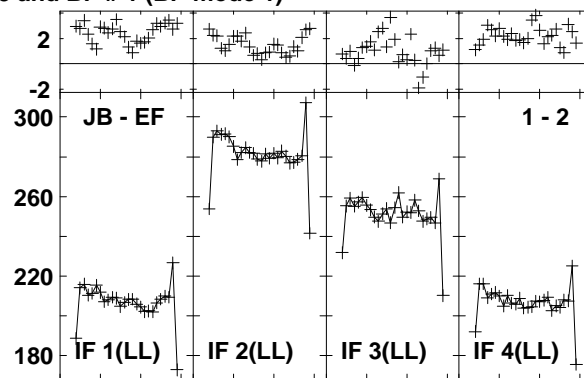
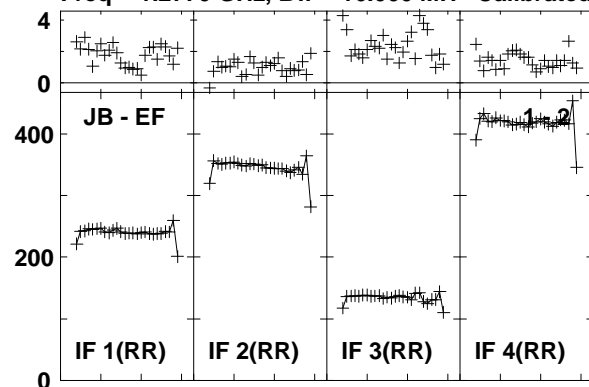

Lower frame: Milli Ampl Jy Top frame: Phas deg
Vector averaged cross-power spectrum Baseline: JB (01) - EF (02)
Timerange: 00/22:03:51 to 00/22:07:05

Plot file version 786 created 03-MAR-2016 01:14:13

4C52 GN002C 1.UVDATA.1

Freq = 1.2770 GHz, Bw = 16.000 MH Calibrated with CL # 3 and BP # 1 (BP mode 1)

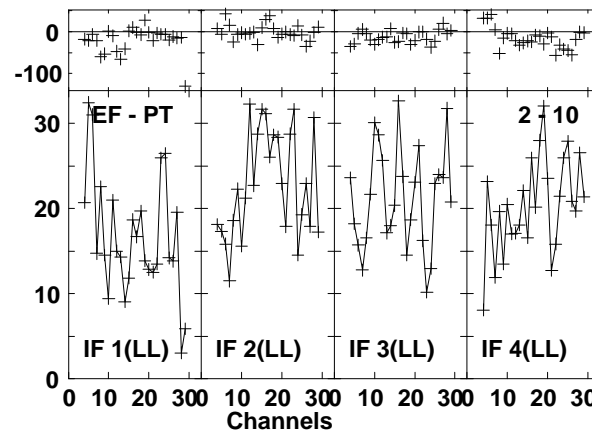
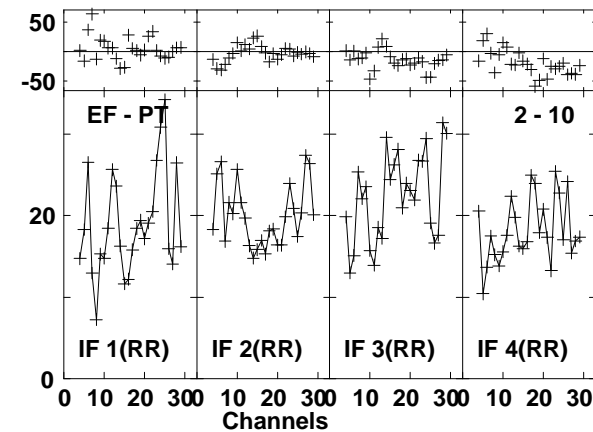
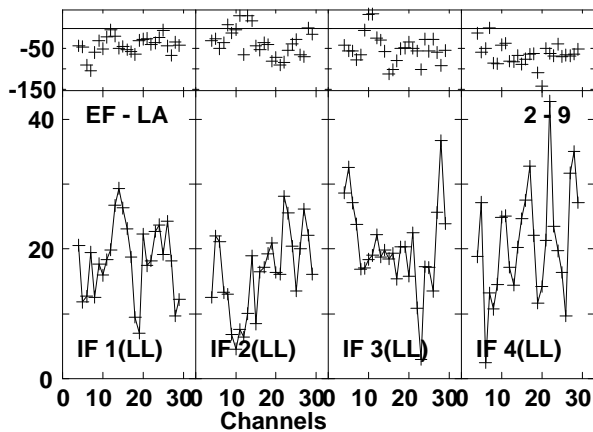
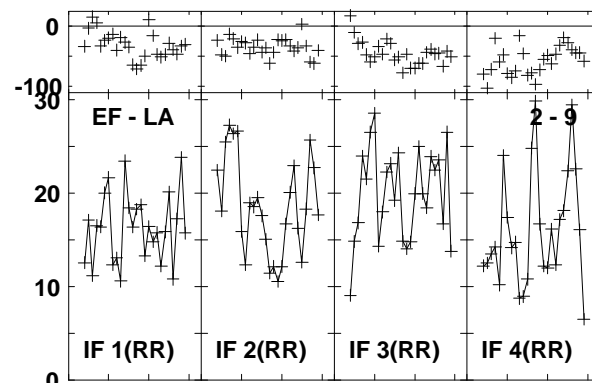
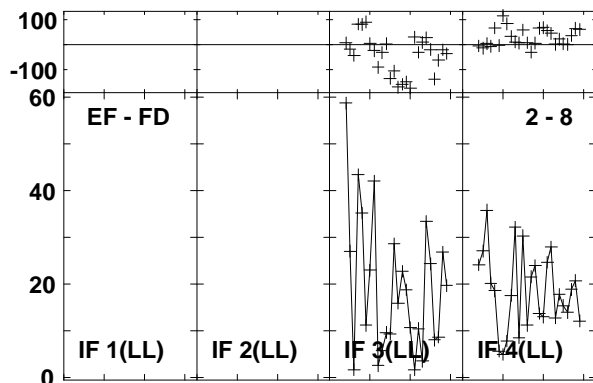
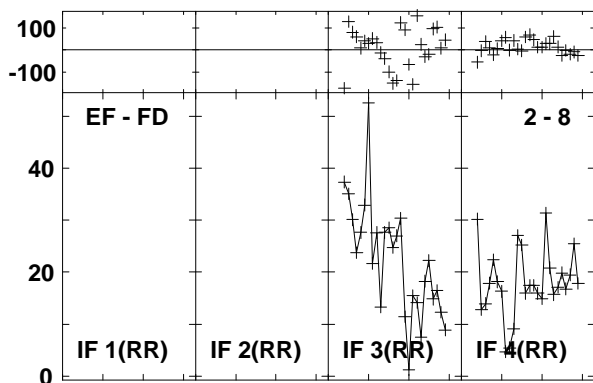
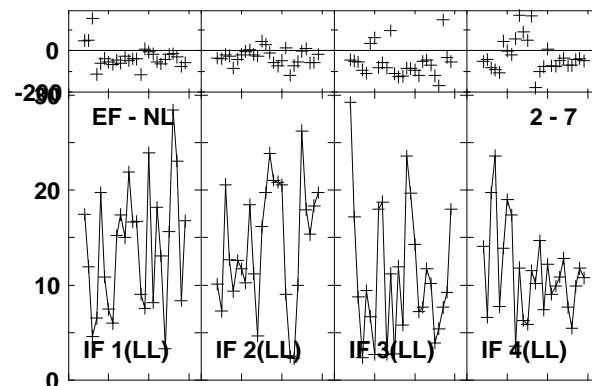
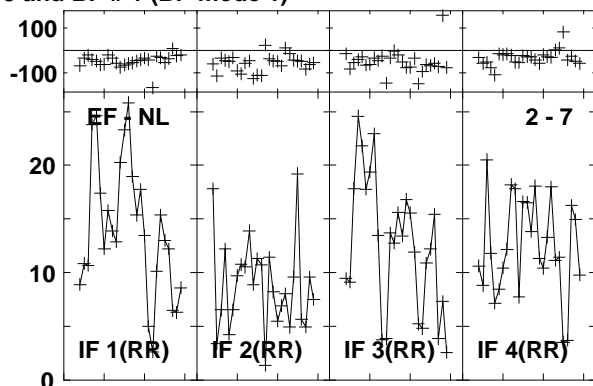
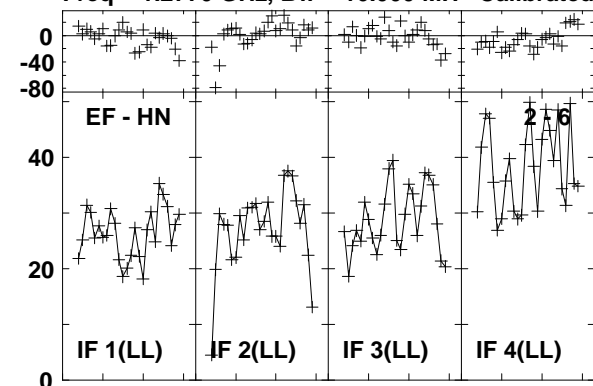

Lower frame: Milli Ampl Jy Top frame: Phas deg
Vector averaged cross-power spectrum Baseline: EF (02) - HN (06)
Timerange: 00/22:03:51 to 00/22:07:05

Plot file version 787 created 03-MAR-2016 01:14:13

4C52 GN002C 1.UVDATA.1

Freq = 1.2770 GHz, Bw = 16.000 MH Calibrated with CL # 3 and BP # 1 (BP mode 1)

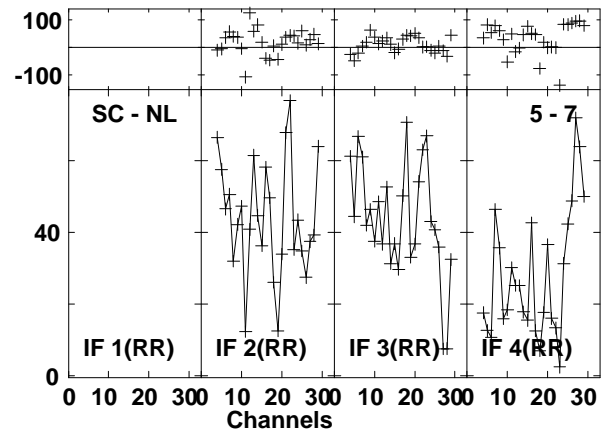
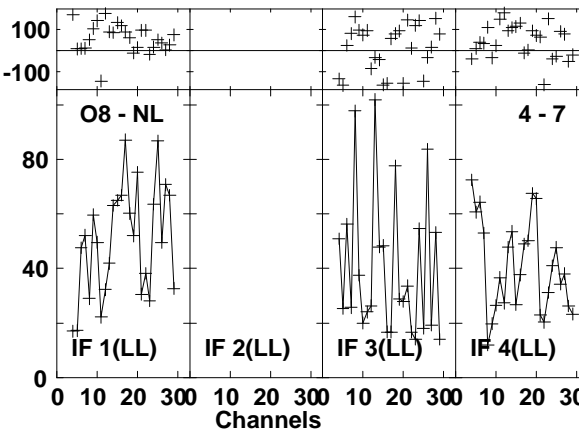
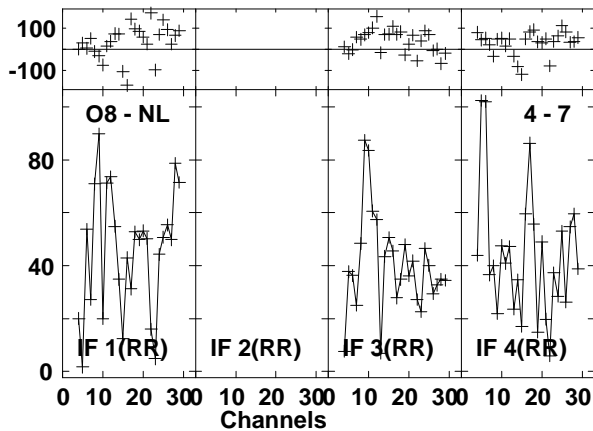
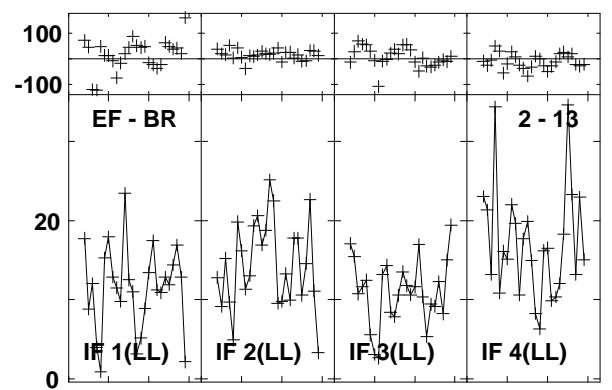
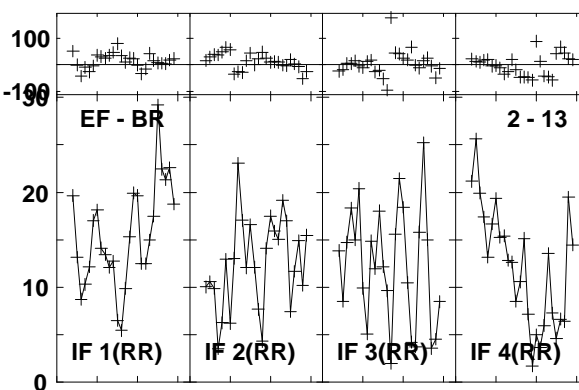
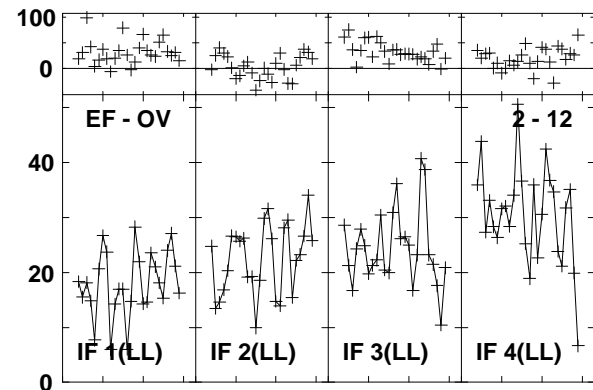
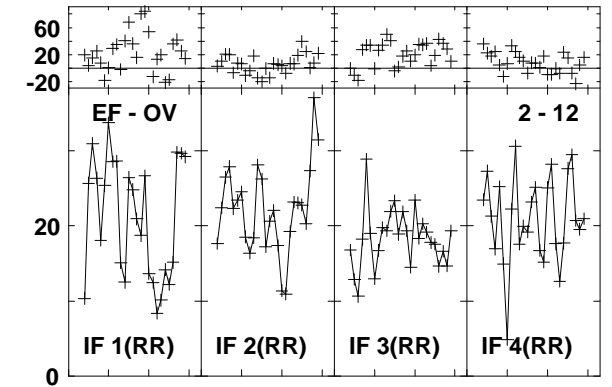
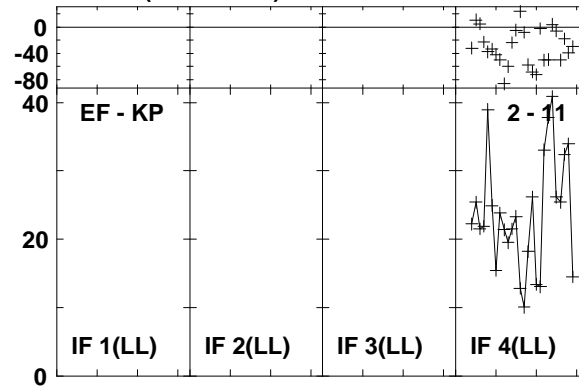
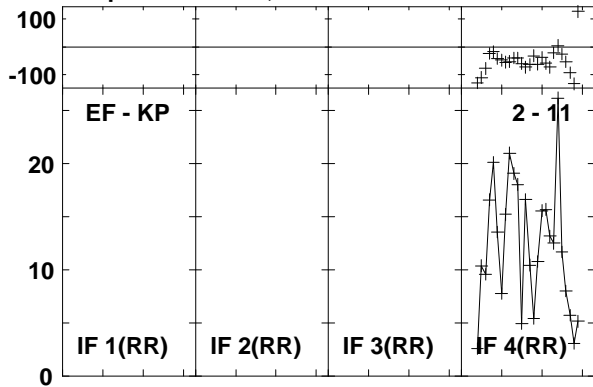

Lower frame: Milli Ampl Jy Top frame: Phas deg
Vector averaged cross-power spectrum Baseline: EF (02) - KP (11)
Timerange: 00/22:03:51 to 00/22:07:05

Plot file version 788 created 03-MAR-2016 01:14:13

4C52 GN002C 1.UVDATA.1

Freq = 1.2770 GHz, Bw = 16.000 MH Calibrated with CL # 3 and BP # 1 (BP mode 1)

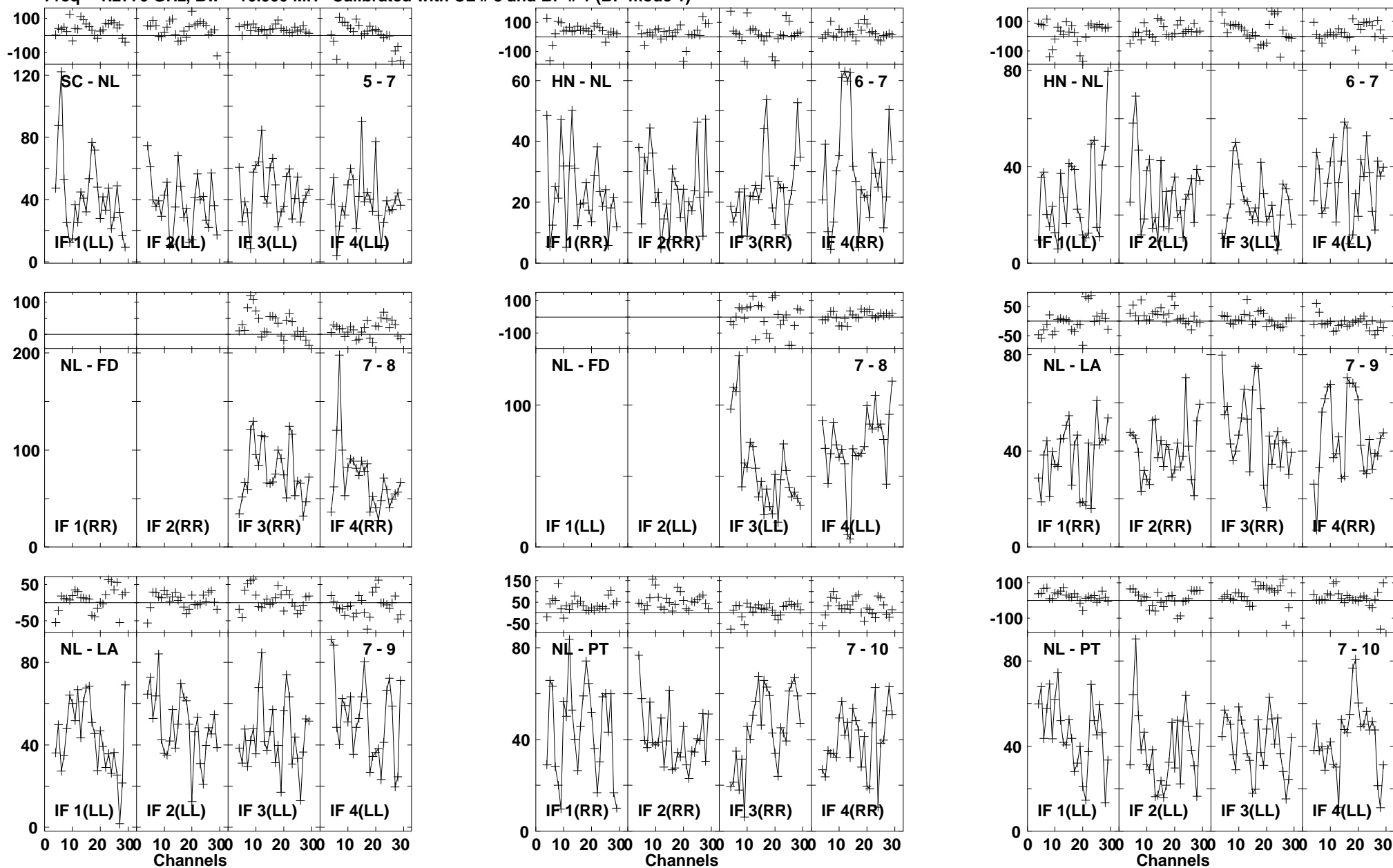

Lower frame: Milli Ampl Jy Top frame: Phas deg
Vector averaged cross-power spectrum Baseline: SC (05) - NL (07)
Timerange: 00/22:03:51 to 00/22:07:05

Plot file version 789 created 03-MAR-2016 01:14:13

4C52 GN002C 1.UVDATA.1

Freq = 1.2770 GHz, Bw = 16.000 MH Calibrated with CL # 3 and BP # 1 (BP mode 1)

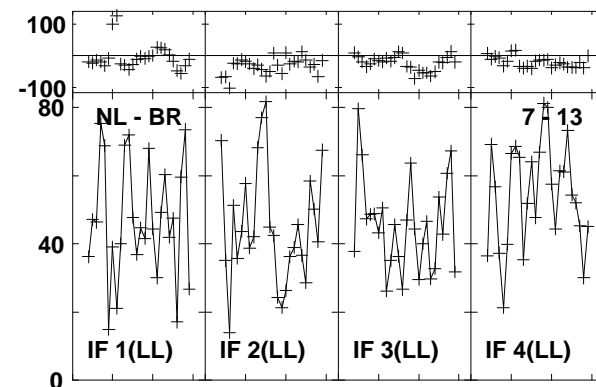
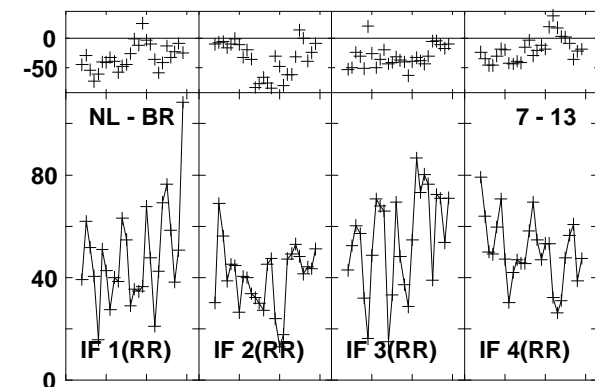
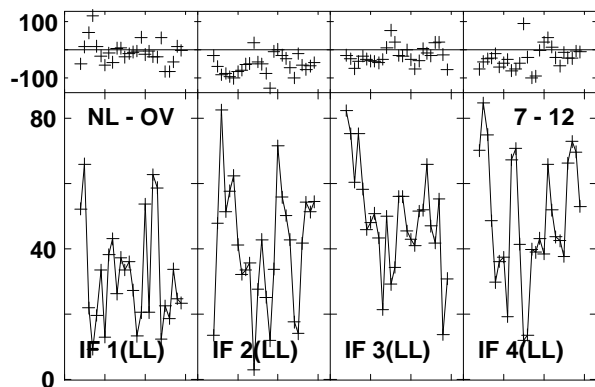
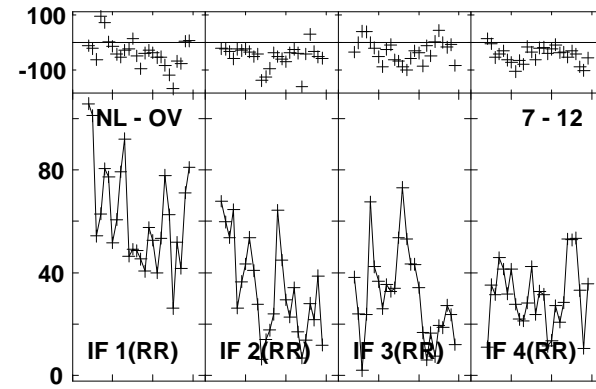
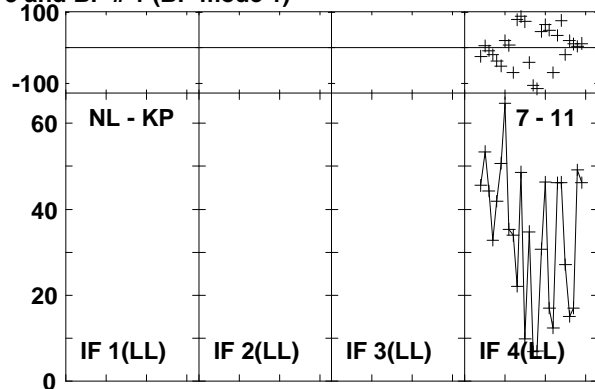
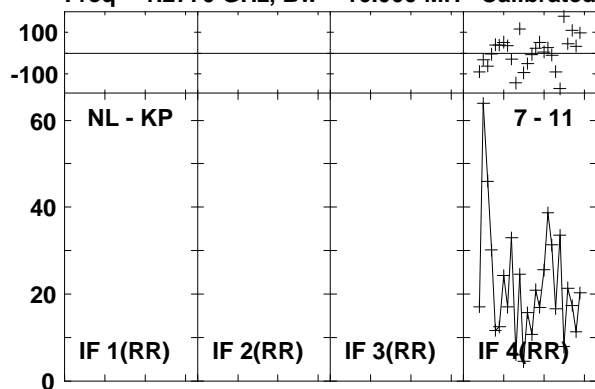

Lower frame: Milli Ampl Jy Top frame: Phas deg
Vector averaged cross-power spectrum Baseline: NL (07) - KP (11)
Timerange: 00/22:03:51 to 00/22:07:05

Plot file version 790 created 03-MAR-2016 01:14:14

J1545+5400 GN002C 1.UVDATA.1

Freq = 1.2770 GHz, Bw = 16.000 MH Calibrated with CL # 3 and BP # 1 (BP mode 1)

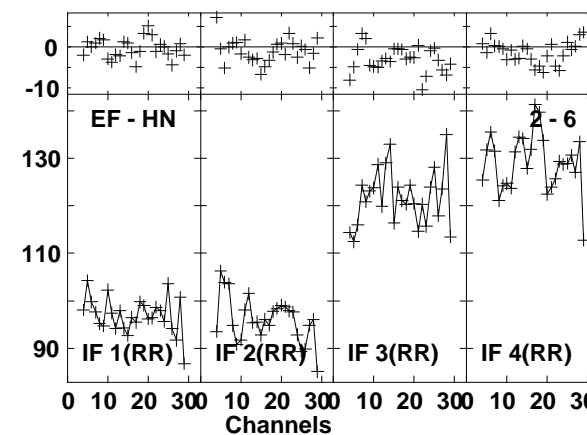
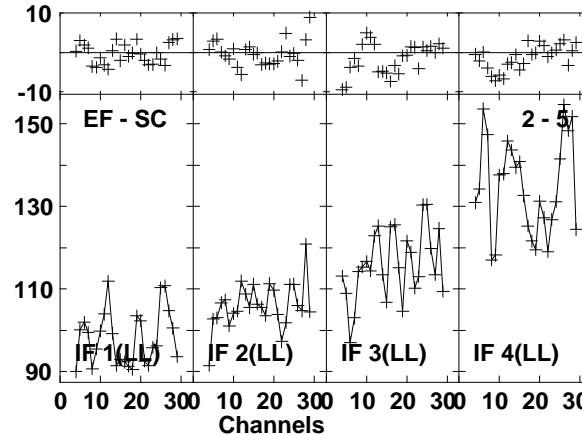
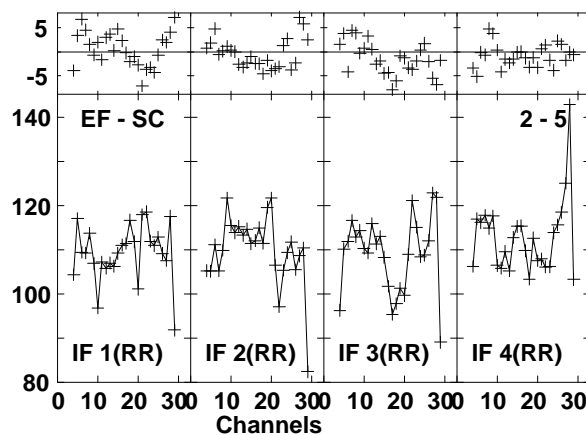
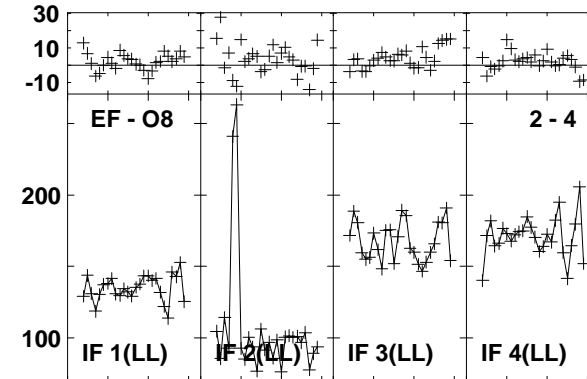
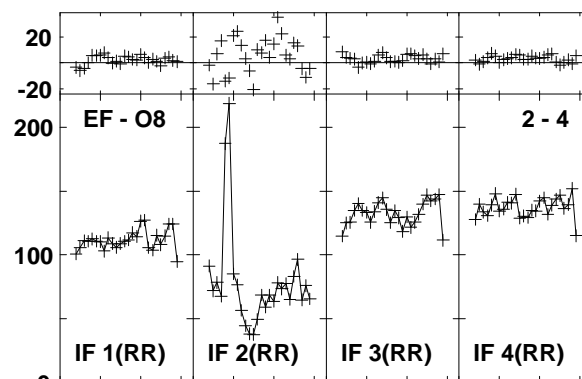
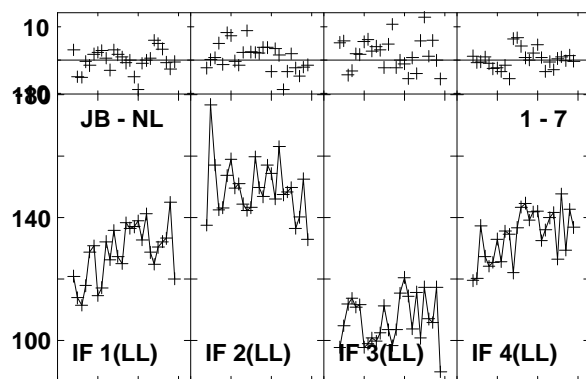
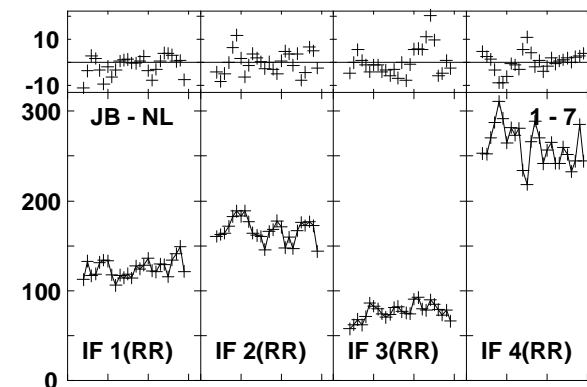
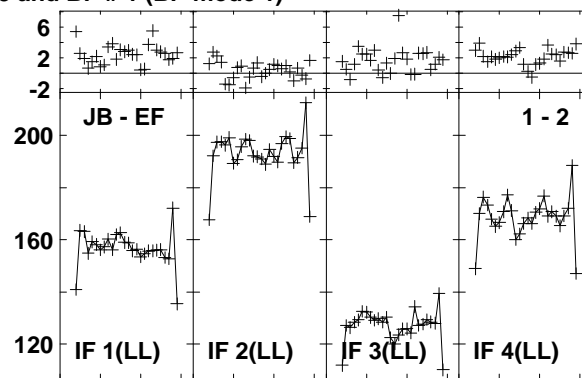
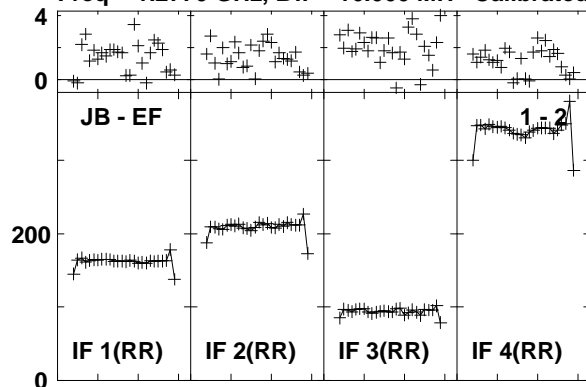

Lower frame: Milli Ampl Jy Top frame: Phas deg
Vector averaged cross-power spectrum Baseline: JB (01) - EF (02)
Timerange: 00/22:07:58 to 00/22:10:26

Plot file version 791 created 03-MAR-2016 01:14:14

J1545+5400 GN002C 1.UVDATA.1

Freq = 1.2770 GHz, Bw = 16.000 MH Calibrated with CL # 3 and BP # 1 (BP mode 1)

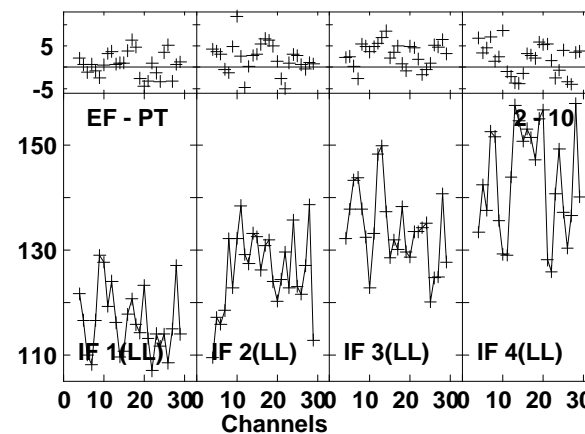
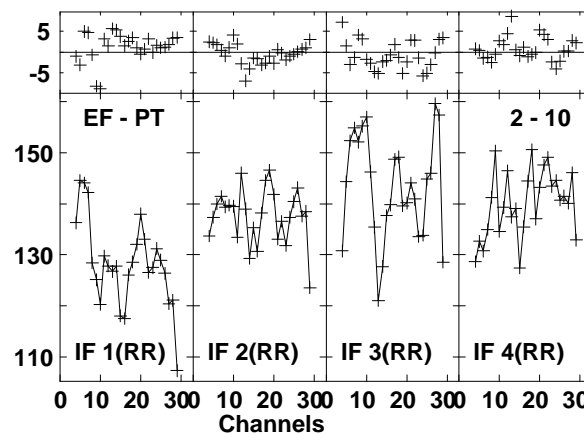
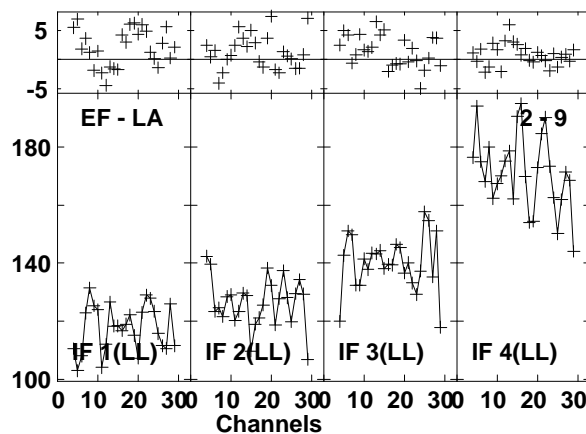
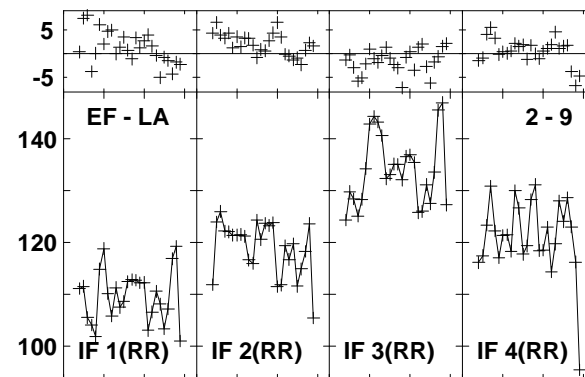
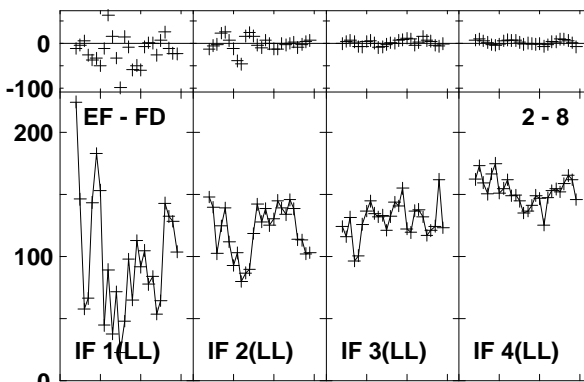
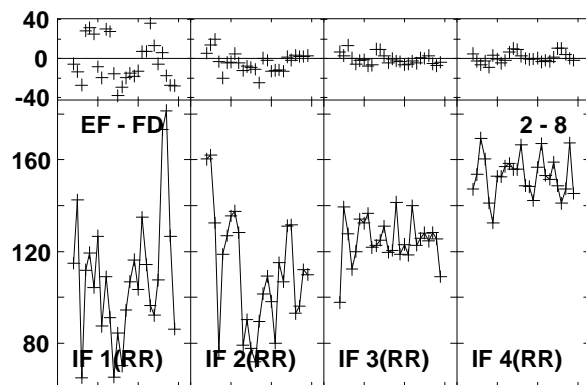
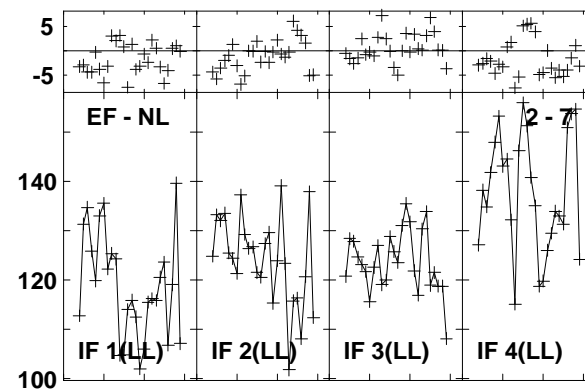
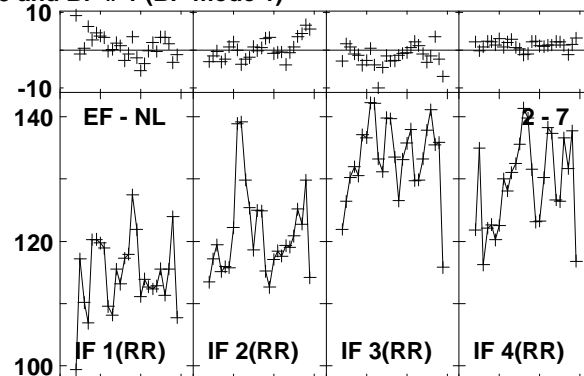
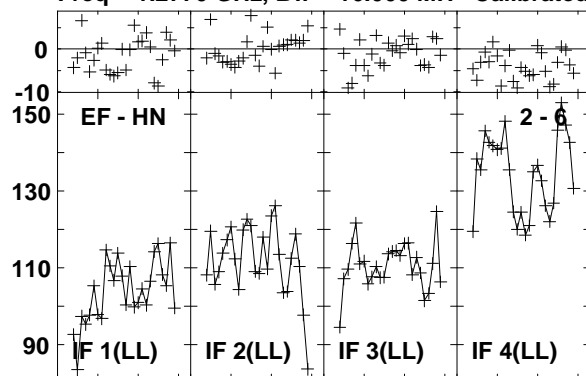

Lower frame: Milli Ampl Jy Top frame: Phas deg
Vector averaged cross-power spectrum Baseline: EF (02) - HN (06)
Timerange: 00/22:07:58 to 00/22:10:26

Plot file version 792 created 03-MAR-2016 01:14:14

J1545+5400 GN002C 1.UVDATA.1

Freq = 1.2770 GHz, Bw = 16.000 MH Calibrated with CL # 3 and BP # 1 (BP mode 1)

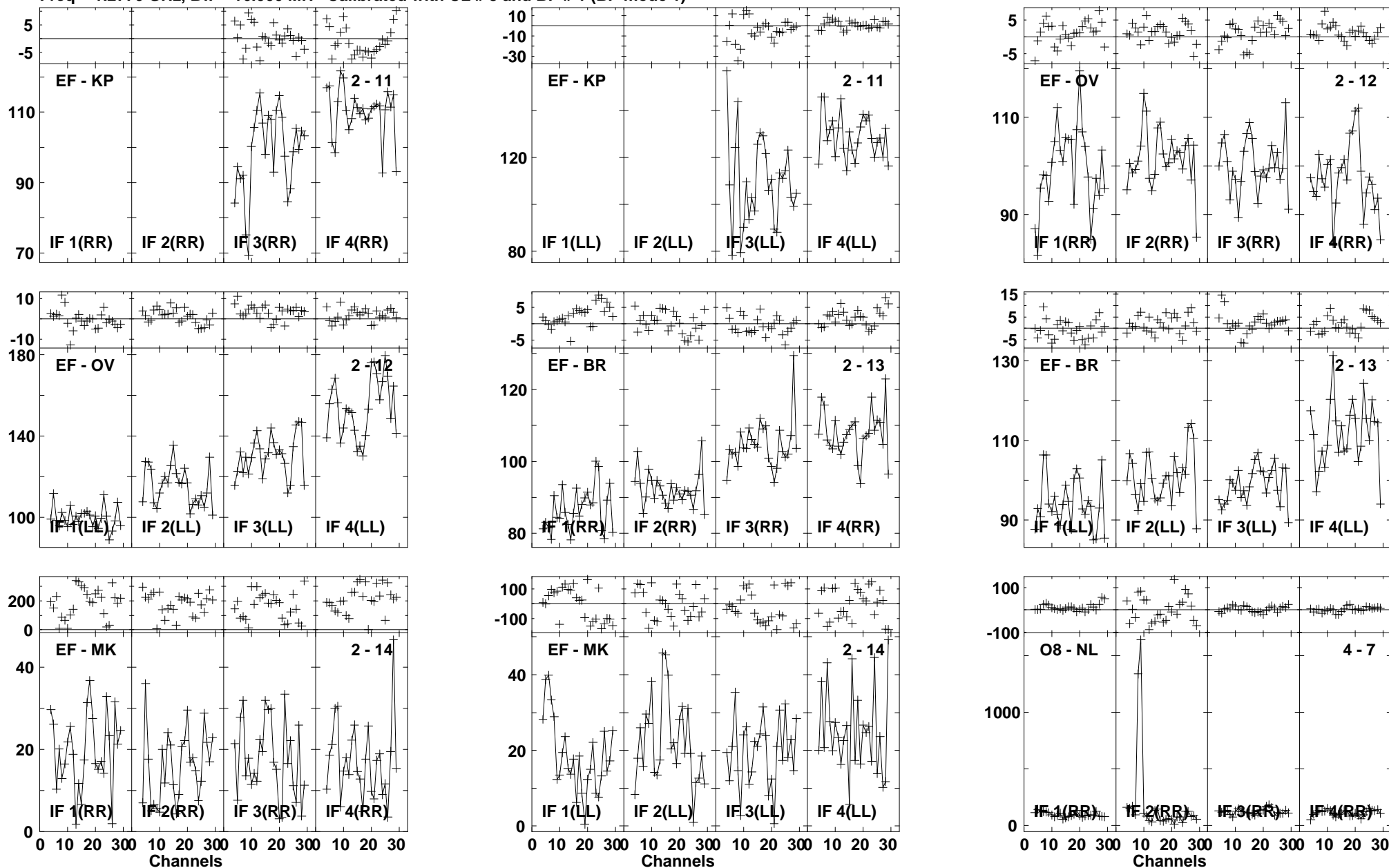

Lower frame: Milli Ampl Jy Top frame: Phas deg
Vector averaged cross-power spectrum Baseline: EF (02) - KP (11)
Timerange: 00/22:07:58 to 00/22:10:26

Plot file version 793 created 03-MAR-2016 01:14:14
 J1545+5400 GN002C 1.UVDATA.1
 Freq = 1.2770 GHz, Bw = 16.000 MH Calibrated with CL # 3 and BP # 1 (BP mode 1)

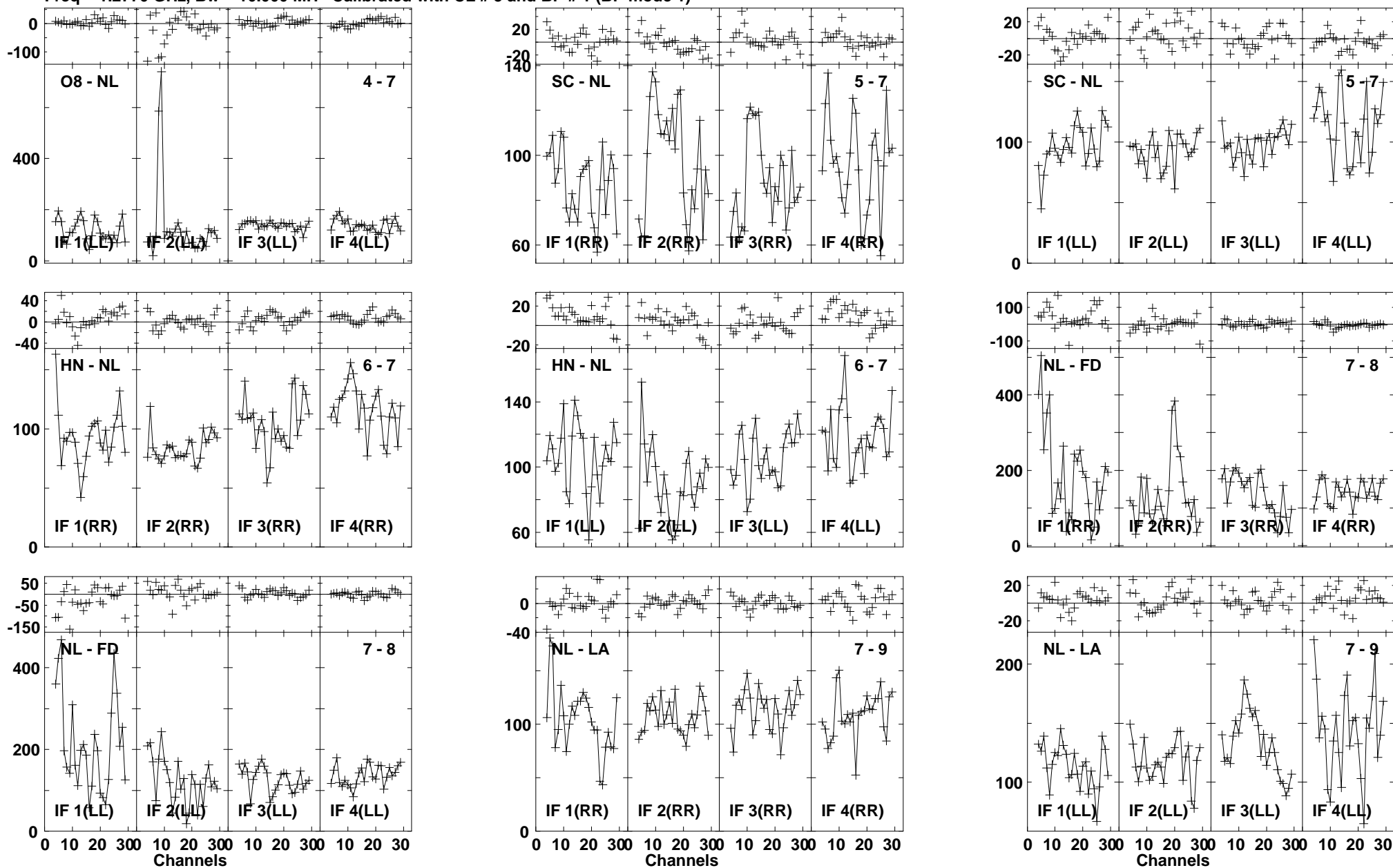

Lower frame: Milli Ampl Jy Top frame: Phas deg
 Vector averaged cross-power spectrum Baseline: O8 (04) - NL (07)
 Timerange: 00:22:07:58 to 00:22:10:26

Plot file version 794 created 03-MAR-2016 01:14:14

J1545+5400 GN002C 1.UVDATA.1

Freq = 1.2770 GHz, Bw = 16.000 MH Calibrated with CL # 3 and BP # 1 (BP mode 1)

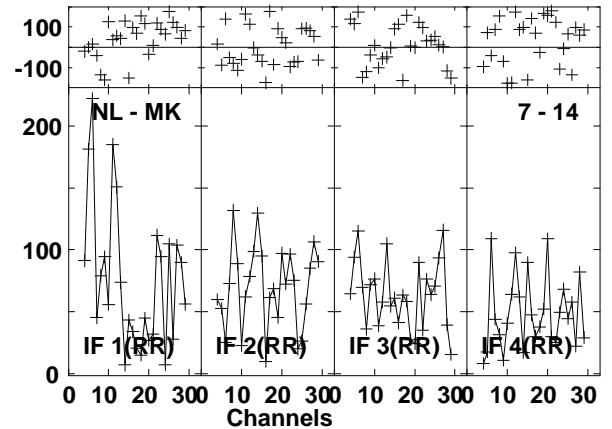
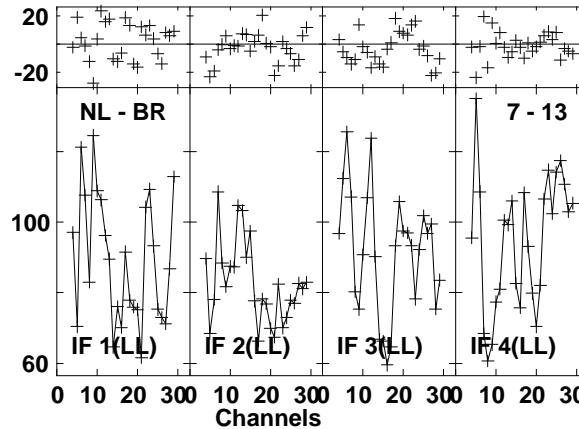
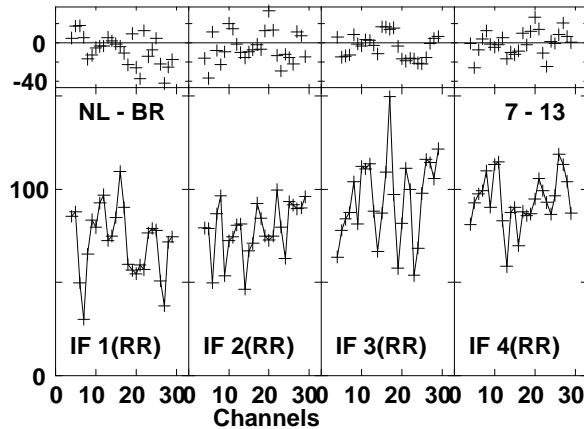
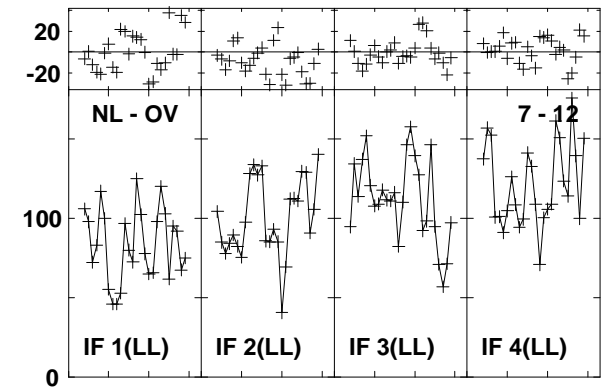
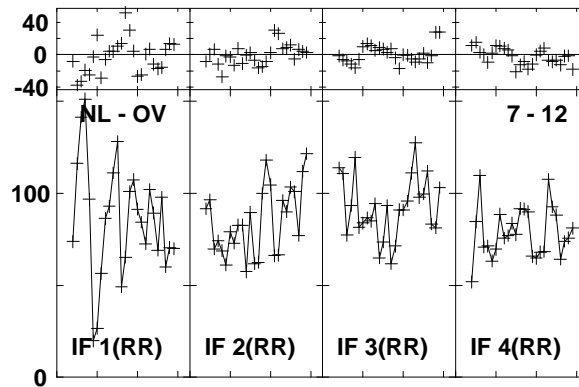
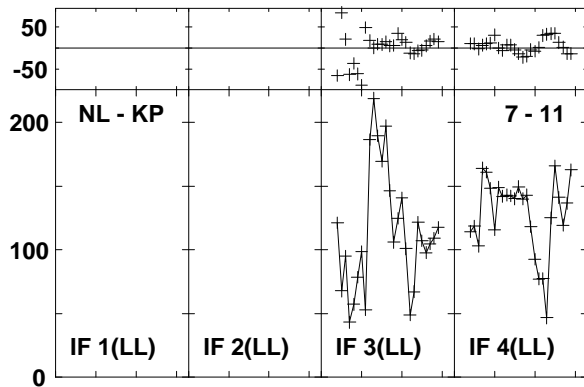
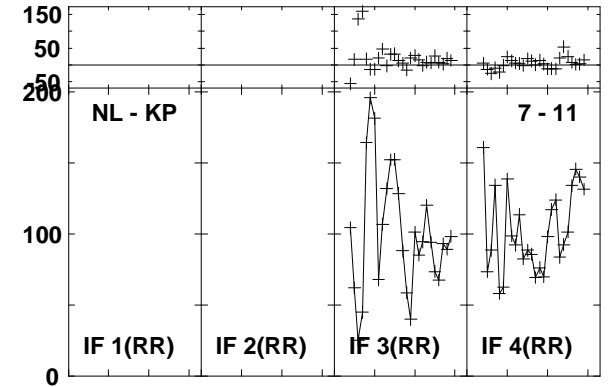
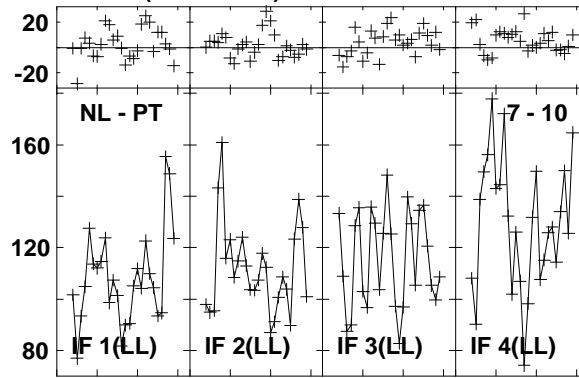
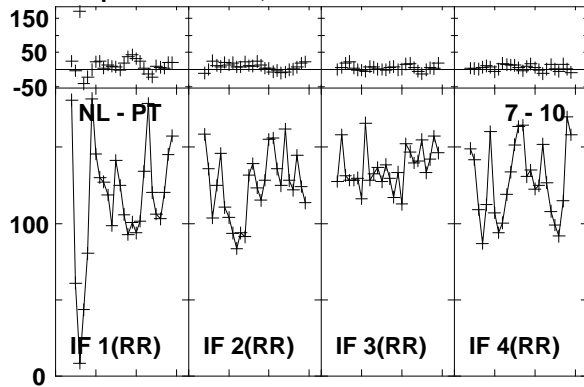

Lower frame: Milli Ampl Jy Top frame: Phas deg
Vector averaged cross-power spectrum Baseline: NL (07) - PT (10)
Timerange: 00/22:07:58 to 00/22:10:26

Plot file version 795 created 03-MAR-2016 01:14:15
J1545+5400 GN002C 1.UVDATA.1
Freq = 1.2770 GHz, Bw = 16.000 MH Calibrated with CL # 3 and BP # 1 (BP mode 1)

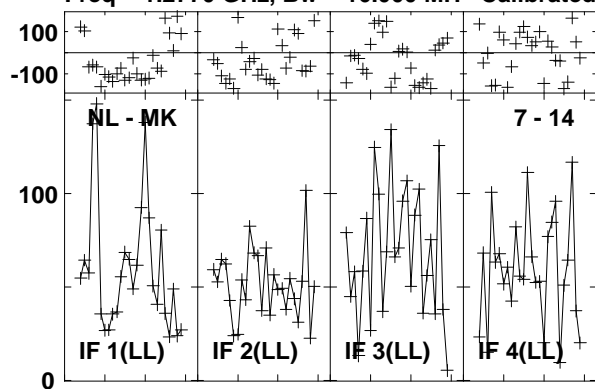

Lower frame: Milli Ampl Jy Top frame: Phas deg
Vector averaged cross-power spectrum Baseline: NL (07) - MK (14)
Timerange: 00/22:07:58 to 00/22:10:26

Plot file version 796 created 03-MAR-2016 01:14:15

J1638+5720 GN002C 1.UVDATA.1

Freq = 1.2770 GHz, Bw = 16.000 MH Calibrated with CL # 3 and BP # 1 (BP mode 1)

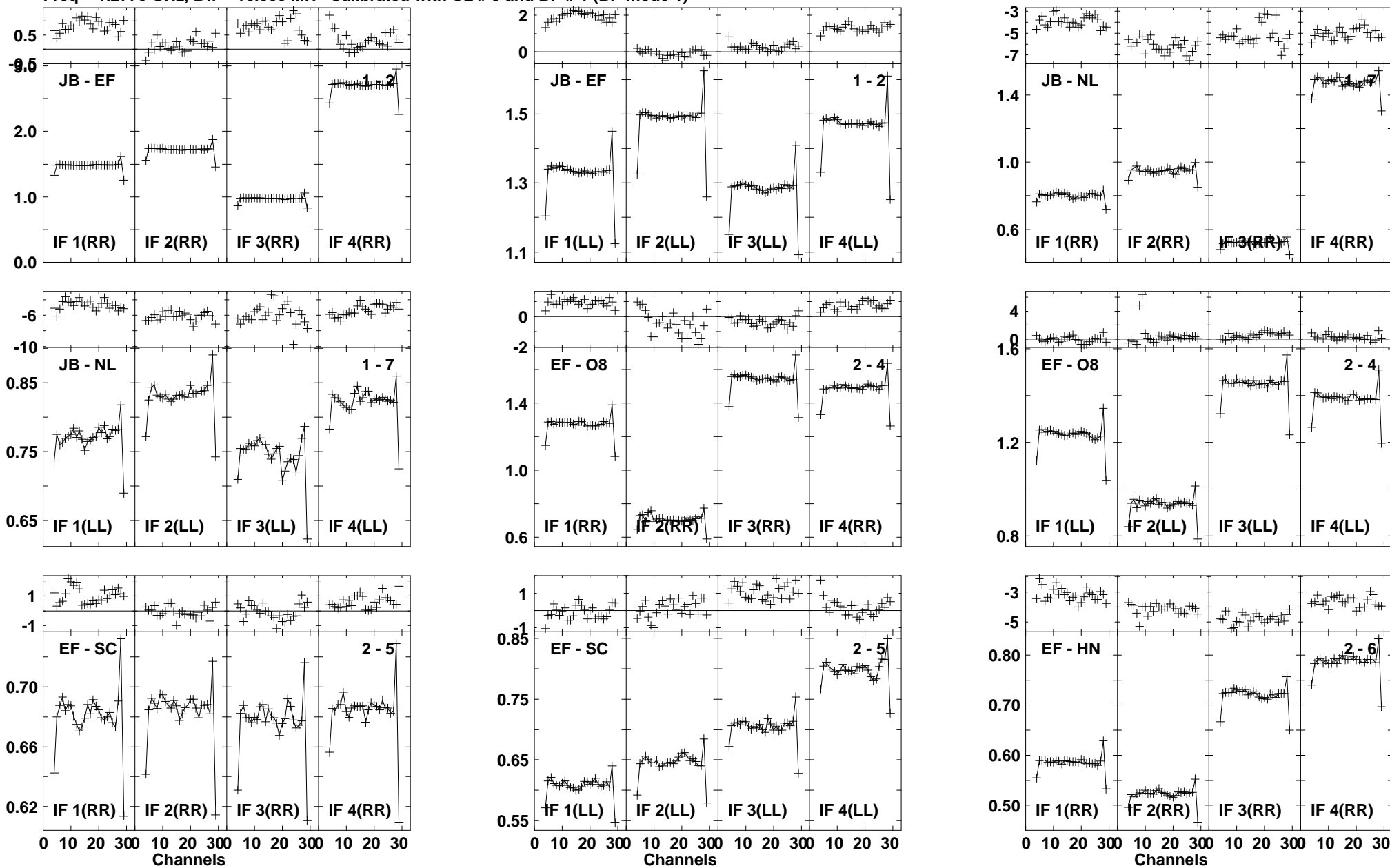

Lower frame: Ampl Jy Top frame: Phas deg
Vector averaged cross-power spectrum Baseline: JB (01) - EF (02)
Timerange: 00/22:11:45 to 00/22:15:33

Plot file version 797 created 03-MAR-2016 01:14:15

J1638+5720 GN002C 1.UVDATA.1

Freq = 1.2770 GHz, Bw = 16.000 MH Calibrated with CL # 3 and BP # 1 (BP mode 1)

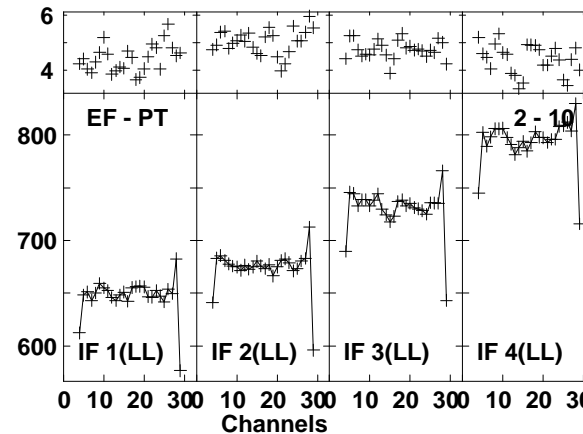
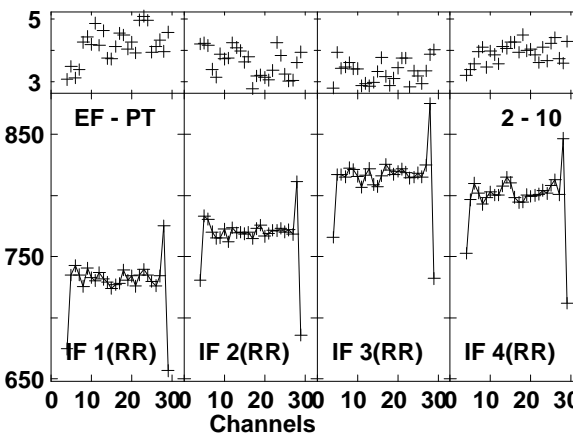
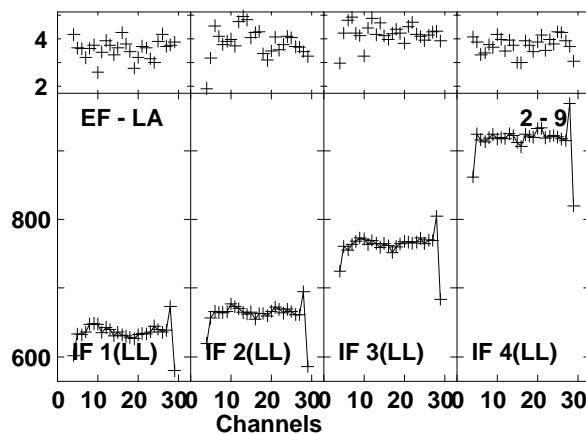
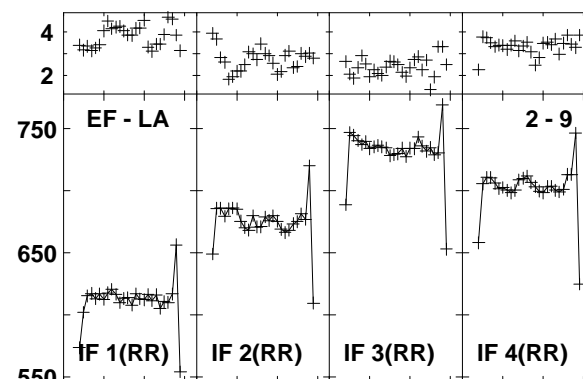
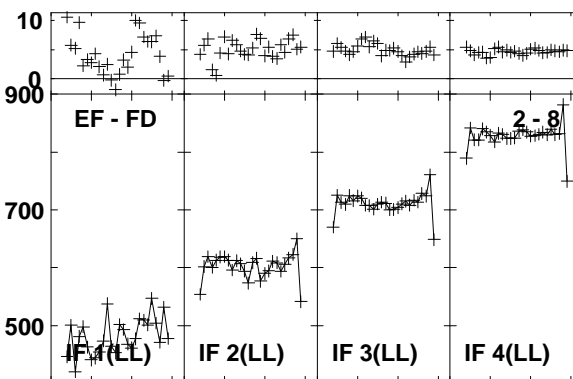
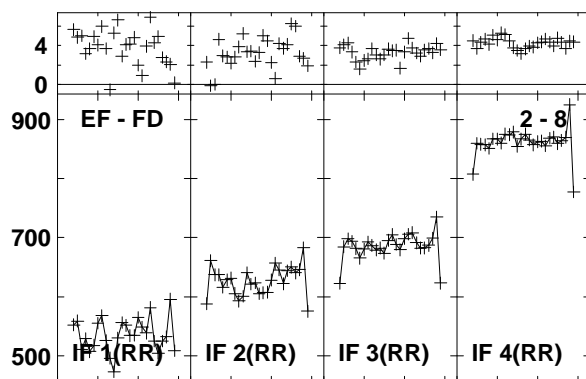
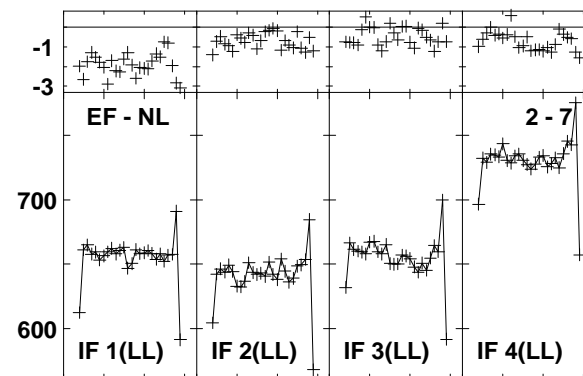
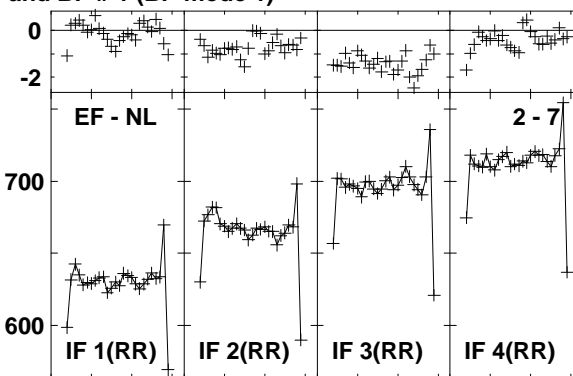
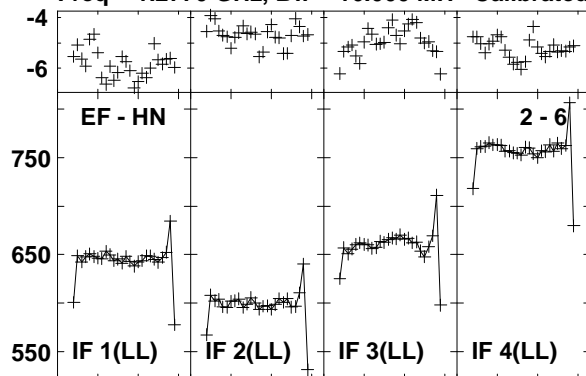

Lower frame: Milli Ampl Jy Top frame: Phas deg
Vector averaged cross-power spectrum Baseline: EF (02) - HN (06)
Timerange: 00/22:11:45 to 00/22:15:33

Plot file version 798 created 03-MAR-2016 01:14:15
 J1638+5720 GN002C 1.UVDATA.1
 Freq = 1.2770 GHz, Bw = 16.000 MH Calibrated with CL # 3 and BP # 1 (BP mode 1)

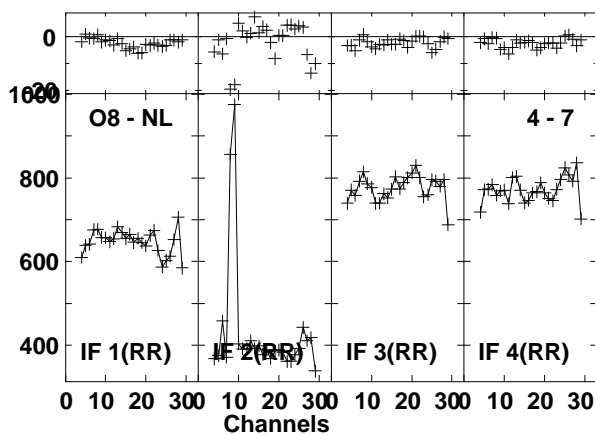
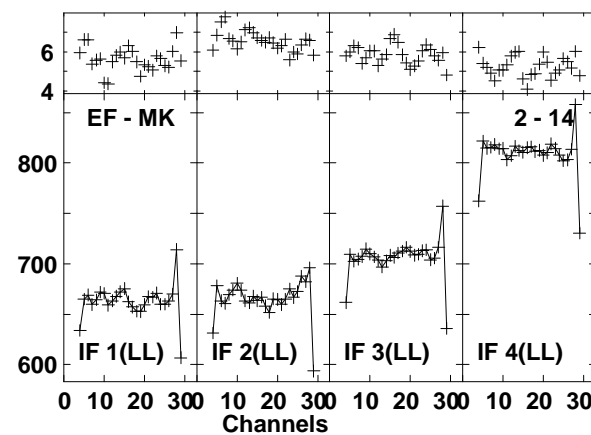
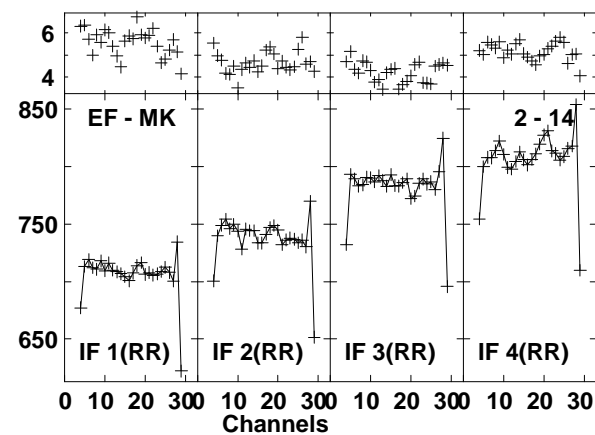
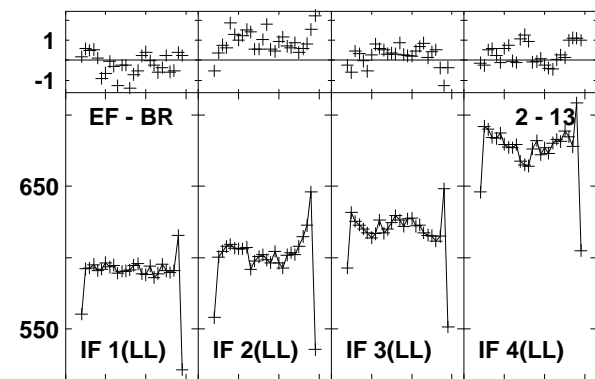
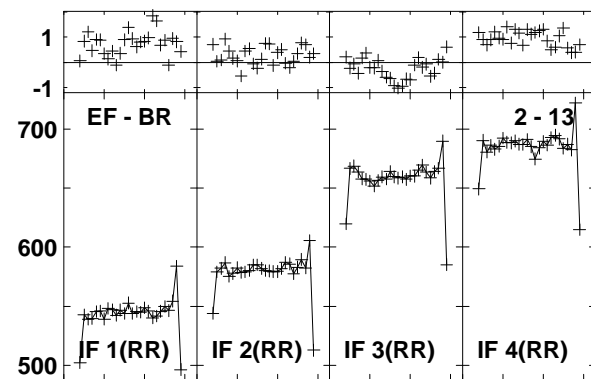
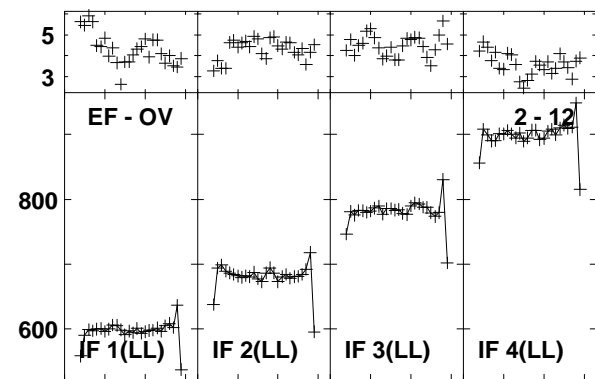
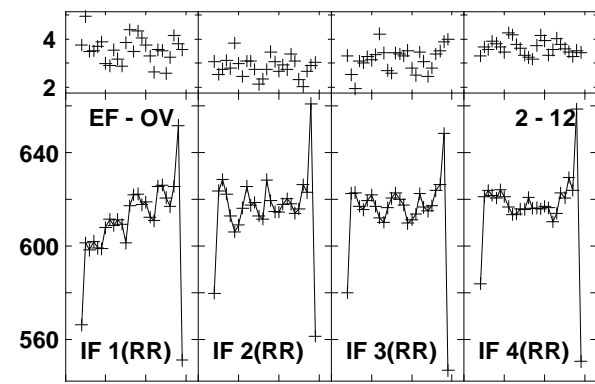
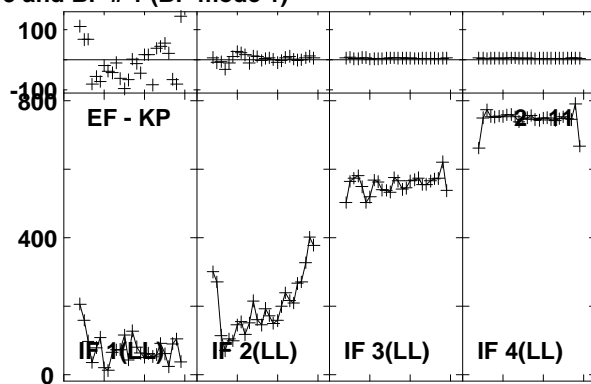
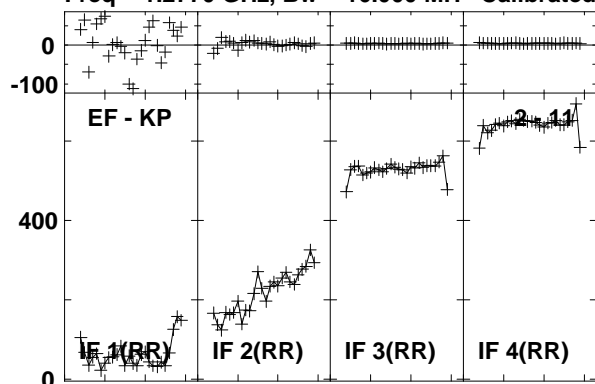

Lower frame: Milli Ampl Jy Top frame: Phas deg
 Vector averaged cross-power spectrum Baseline: EF (02) - KP (11)
 Timerange: 00/22:11:45 to 00/22:15:33

Plot file version 799 created 03-MAR-2016 01:14:15

J1638+5720 GN002C 1.UVDATA.1

Freq = 1.2770 GHz, Bw = 16.000 MH Calibrated with CL # 3 and BP # 1 (BP mode 1)

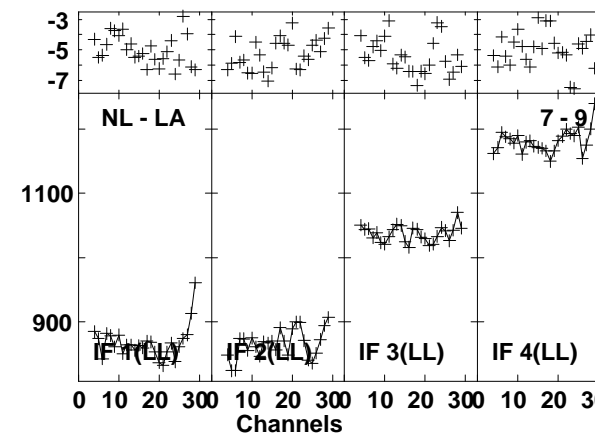
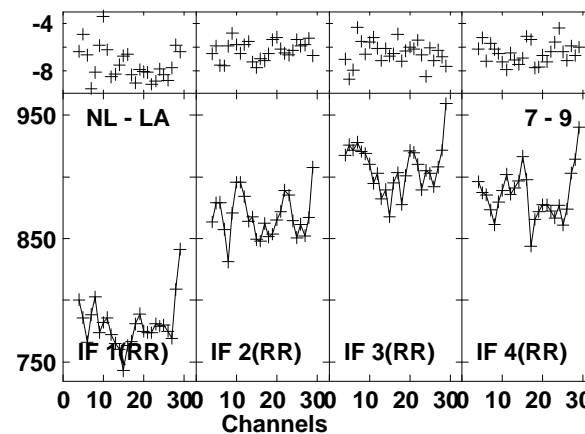
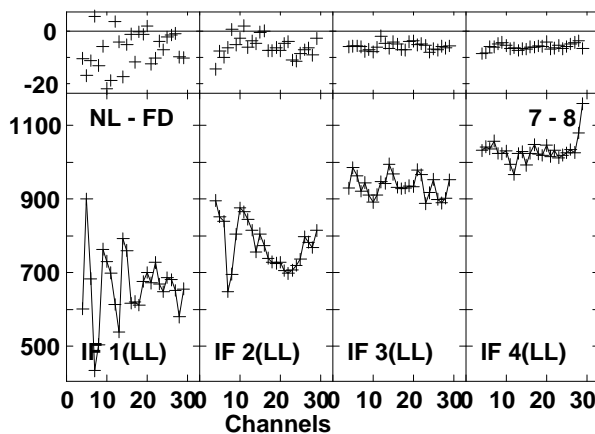
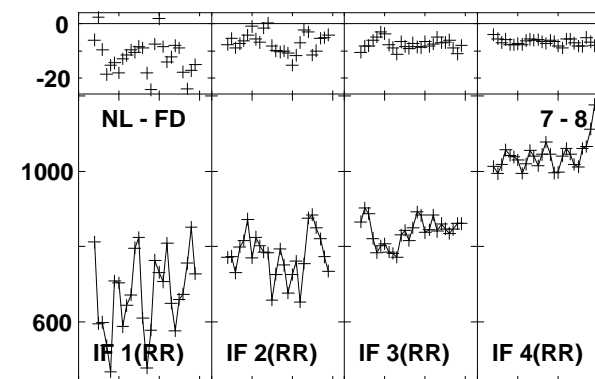
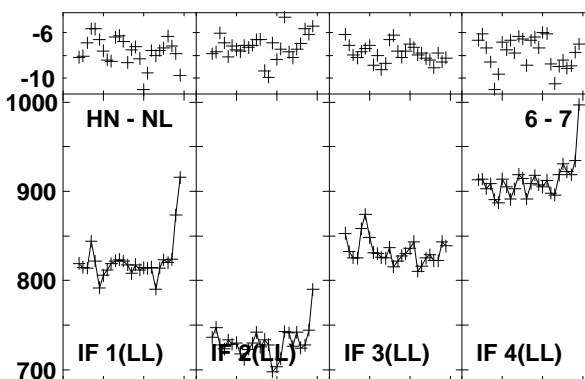
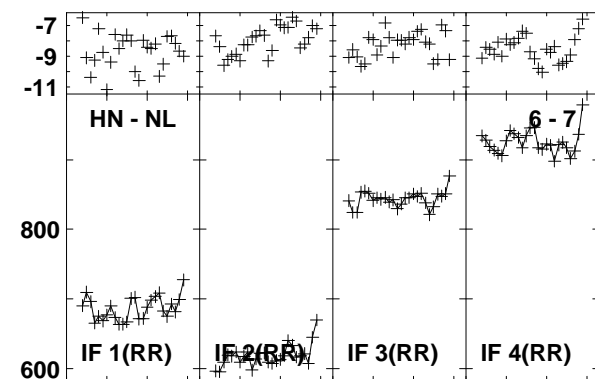
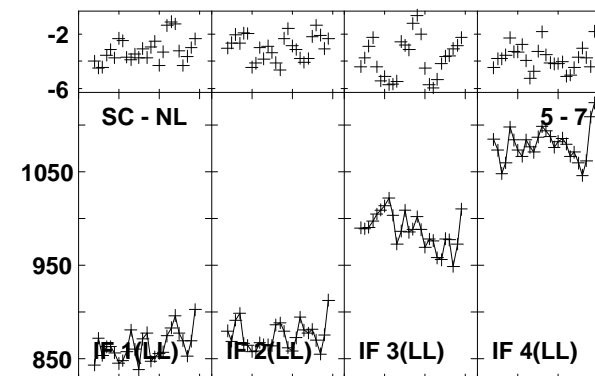
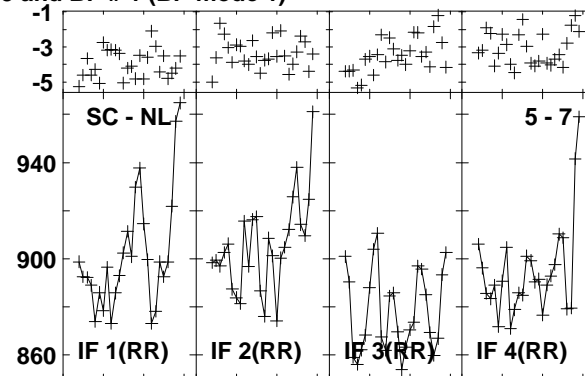
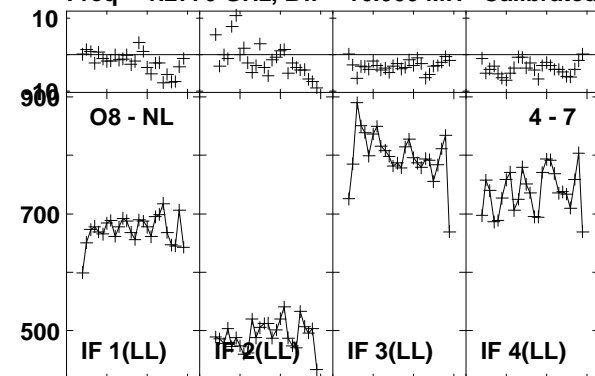

Lower frame: Milli Ampl Jy Top frame: Phas deg
Vector averaged cross-power spectrum Baseline: O8 (04) - NL (07)
Timerange: 00/22:11:45 to 00/22:15:33

Plot file version 800 created 03-MAR-2016 01:14:16

J1638+5720 GN002C 1.UVDATA.1

Freq = 1.2770 GHz, Bw = 16.000 MH Calibrated with CL # 3 and BP # 1 (BP mode 1)

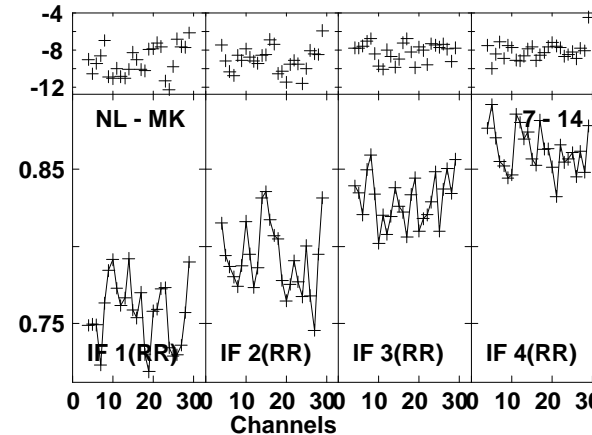
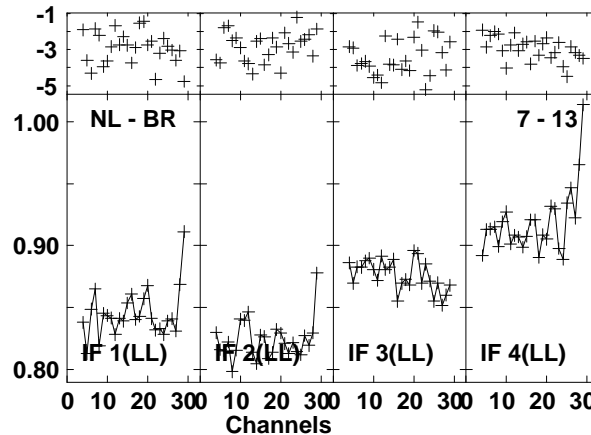
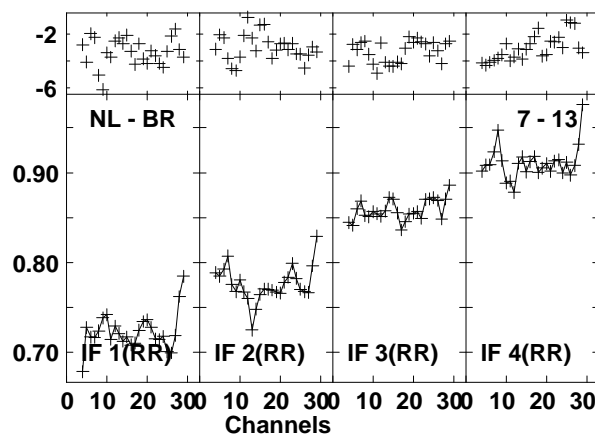
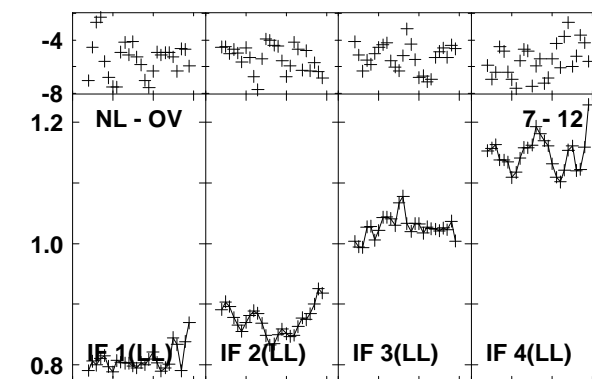
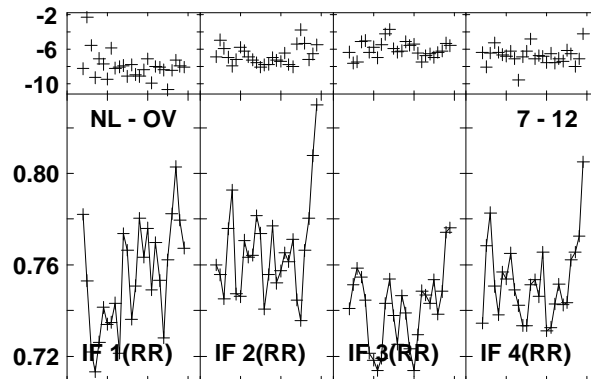
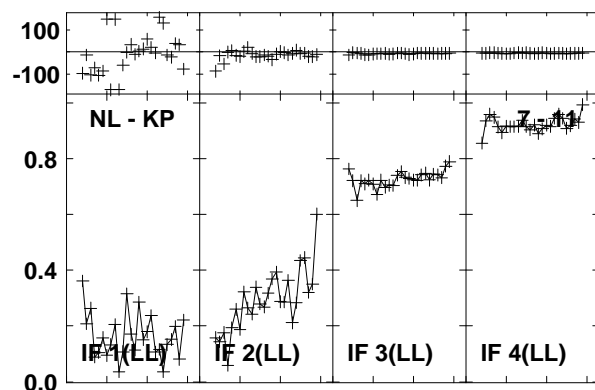
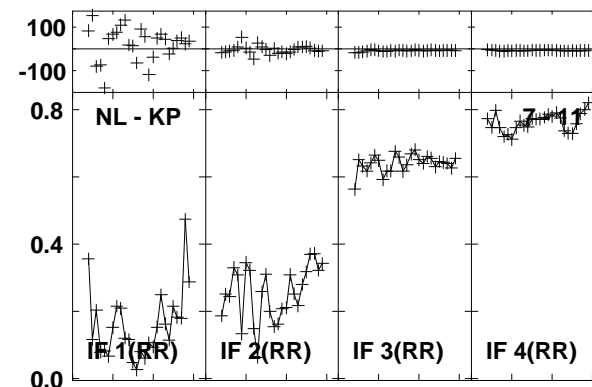
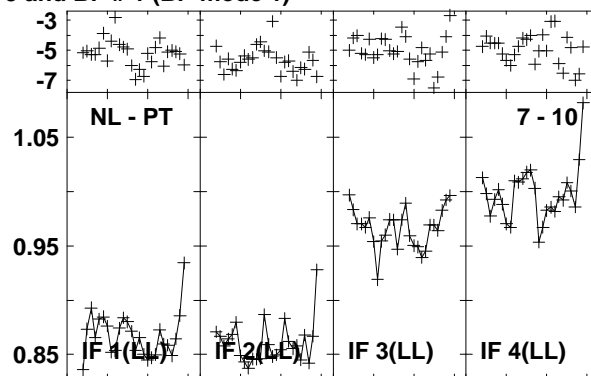
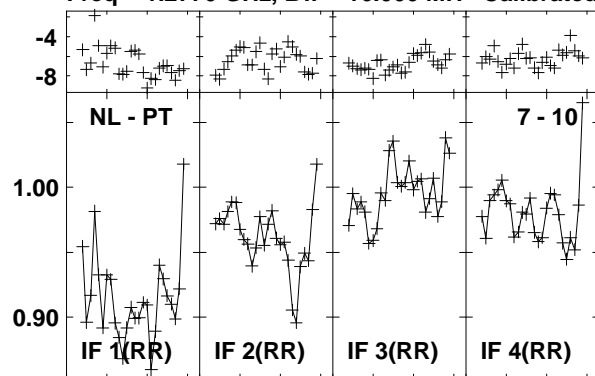

Lower frame: Ampl Jy Top frame: Phas deg
Vector averaged cross-power spectrum Baseline: NL (07) - PT (10)
Timerange: 00/22:11:45 to 00/22:15:33

Plot file version 801 created 03-MAR-2016 01:14:16
J1638+5720 GN002C 1.UVDATA.1
Freq = 1.2770 GHz, Bw = 16.000 MH Calibrated with CL # 3 and BP # 1 (BP mode 1)

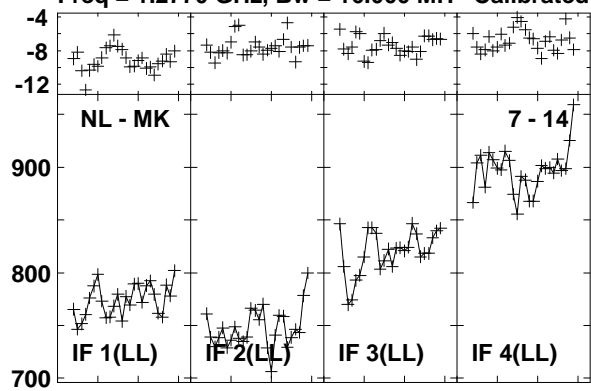

Lower frame: Milli Ampl Jy Top frame: Phas deg
Vector averaged cross-power spectrum Baseline: NL (07) - MK (14)
Timerange: 00/22:11:45 to 00/22:15:33

Plot file version 802 created 03-MAR-2016 01:14:16

J1545+5400 GN002C 1.UVDATA.1

Freq = 1.2770 GHz, Bw = 16.000 MH Calibrated with CL # 3 and BP # 1 (BP mode 1)

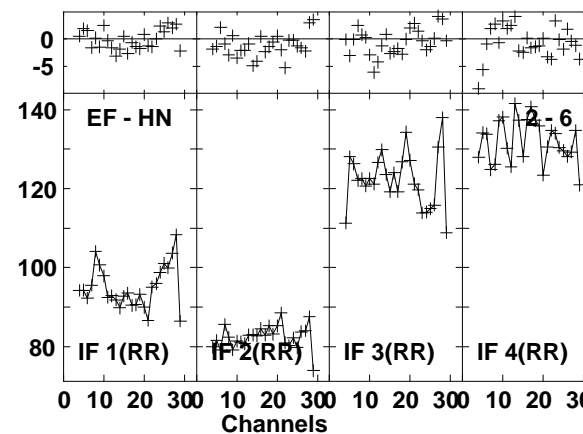
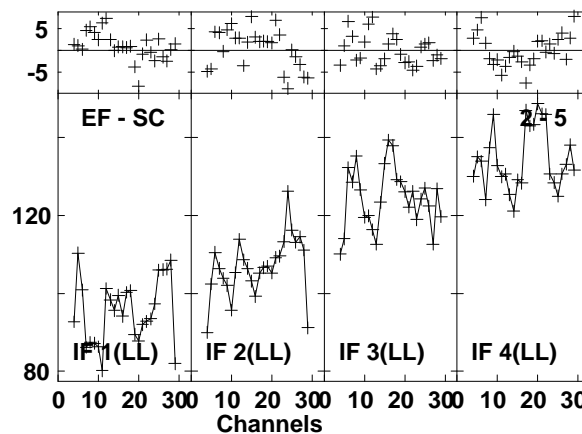
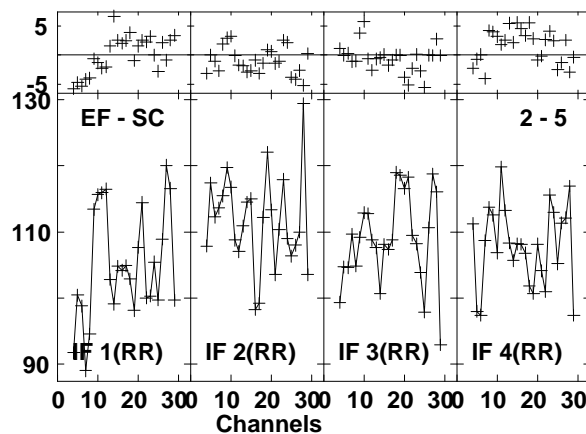
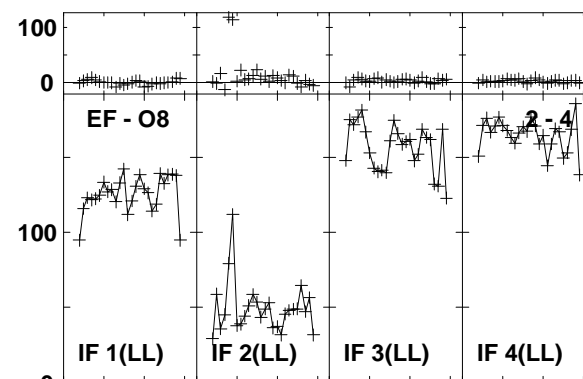
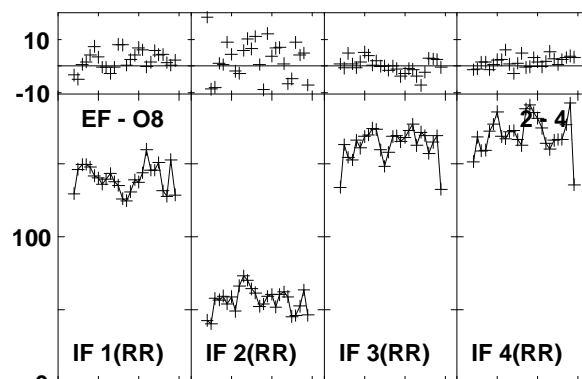
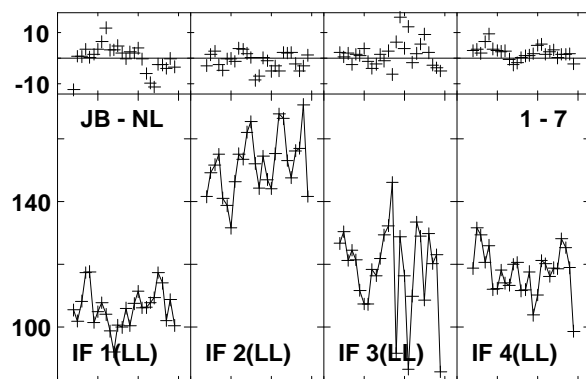
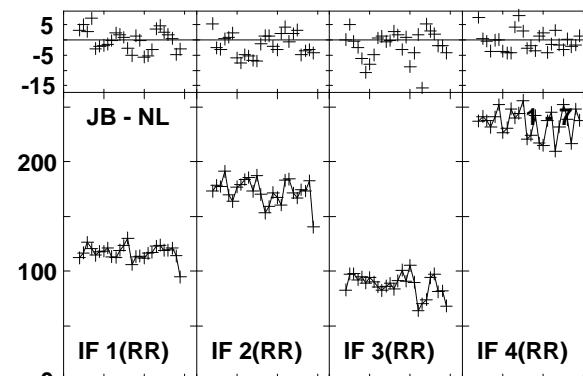
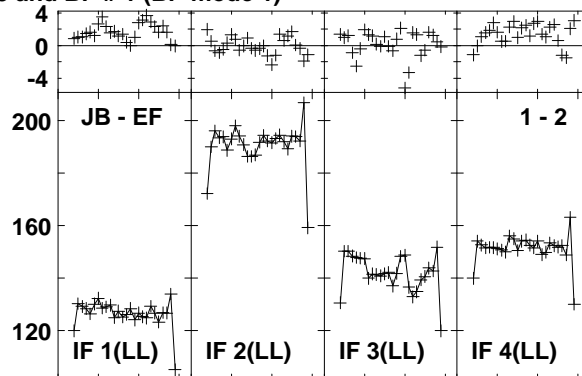
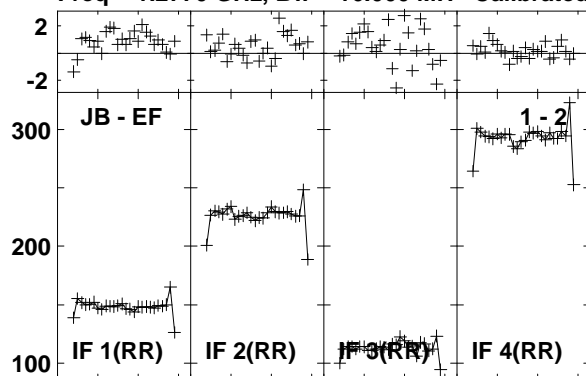

Lower frame: Milli Ampl Jy Top frame: Phas deg
Vector averaged cross-power spectrum Baseline: JB (01) - EF (02)
Timerange: 00/22:16:52 to 00/22:20:00

Plot file version 803 created 03-MAR-2016 01:14:16

J1545+5400 GN002C 1.UVDATA.1

Freq = 1.2770 GHz, Bw = 16.000 MH Calibrated with CL # 3 and BP # 1 (BP mode 1)

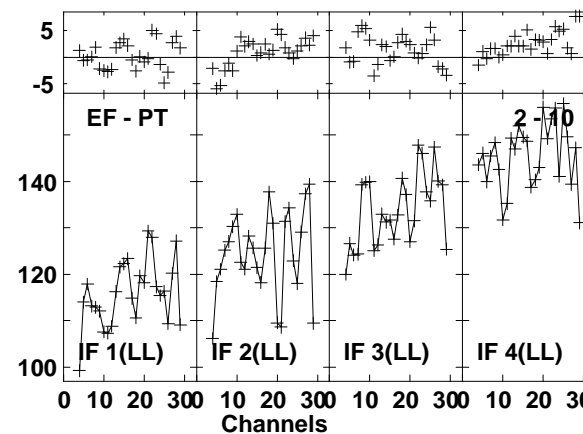
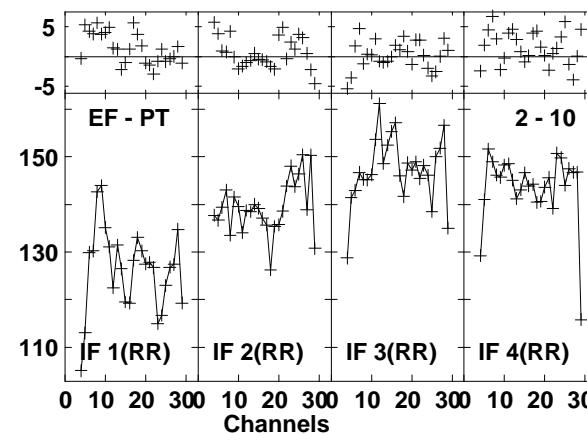
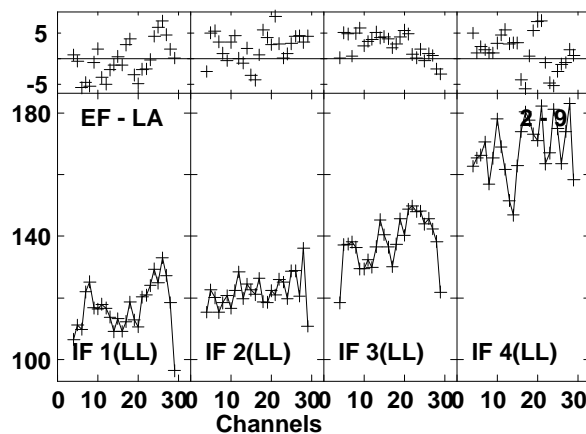
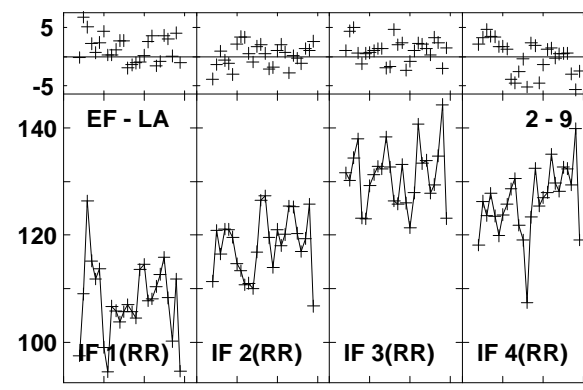
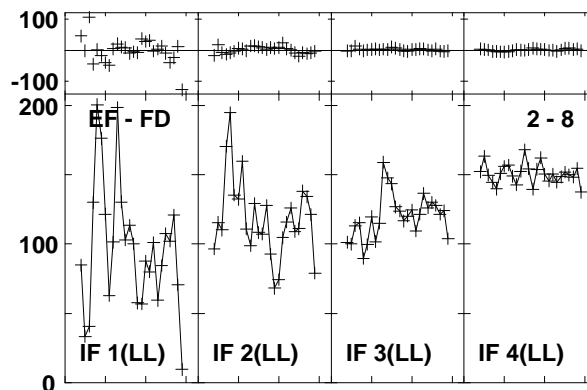
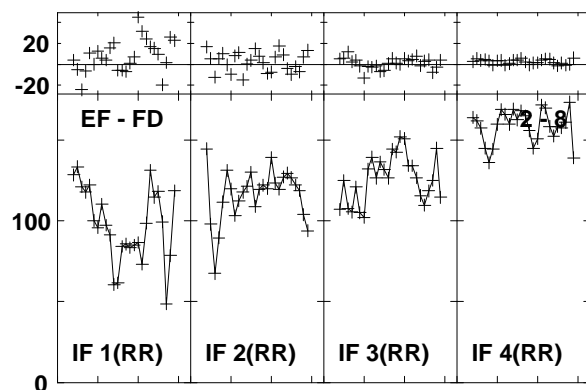
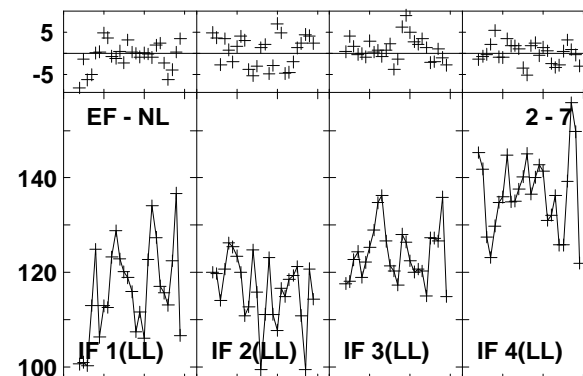
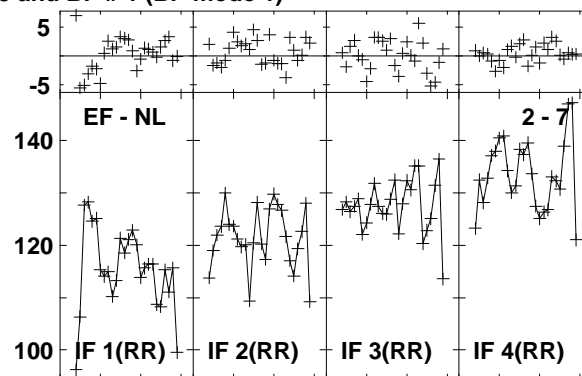
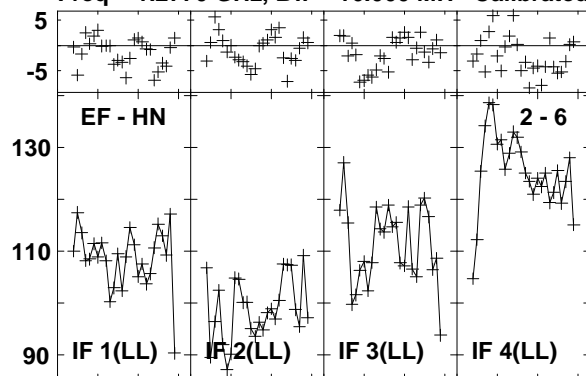

Lower frame: Milli Ampl Jy Top frame: Phas deg
Vector averaged cross-power spectrum Baseline: EF (02) - HN (06)
Timerange: 00/22:16:52 to 00/22:20:00

Plot file version 804 created 03-MAR-2016 01:14:16

J1545+5400 GN002C 1.UVDATA.1

Freq = 1.2770 GHz, Bw = 16.000 MH Calibrated with CL # 3 and BP # 1 (BP mode 1)

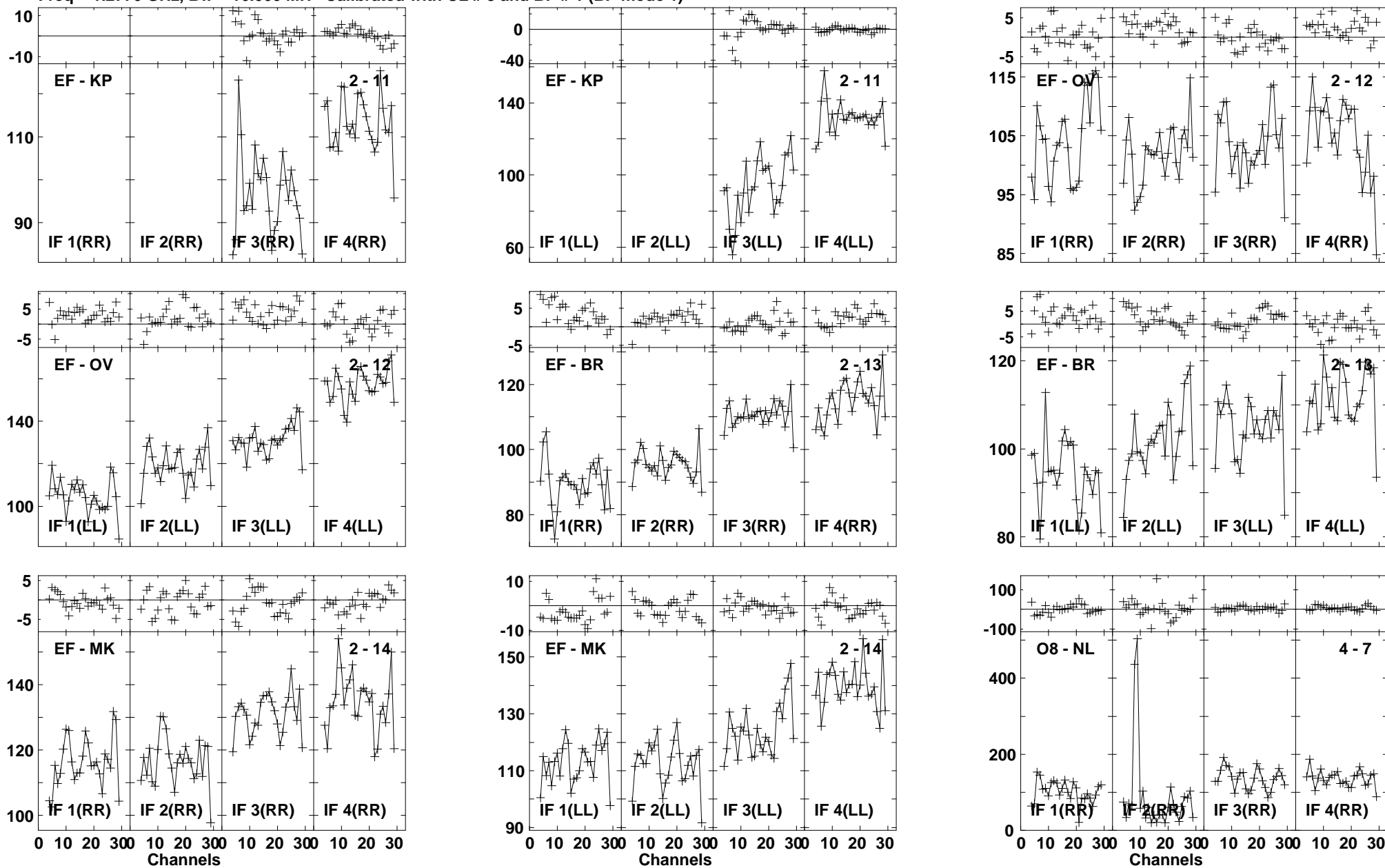

Lower frame: Milli Ampl Jy Top frame: Phas deg
Vector averaged cross-power spectrum Baseline: EF (02) - KP (11)
Timerange: 00/22:16:52 to 00/22:20:00

Plot file version 805 created 03-MAR-2016 01:14:16
 J1545+5400 GN002C 1.UVDATA.1
 Freq = 1.2770 GHz, Bw = 16.000 MH Calibrated with CL # 3 and BP # 1 (BP mode 1)

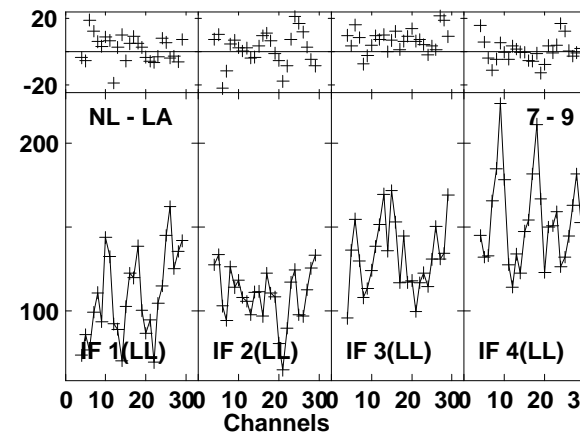
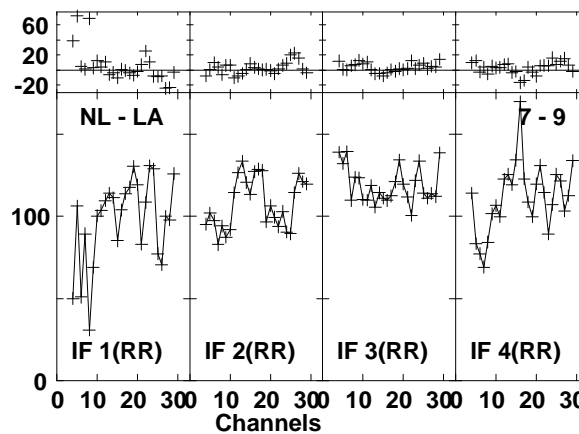
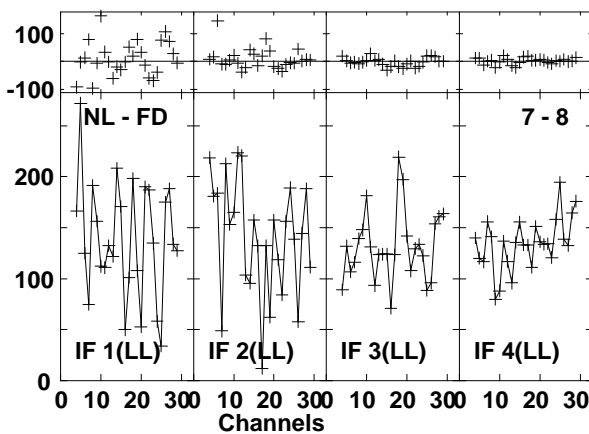
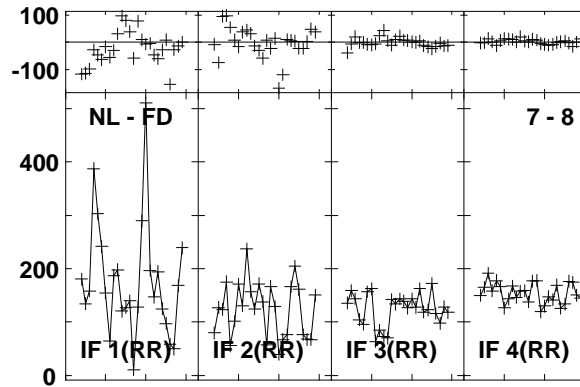
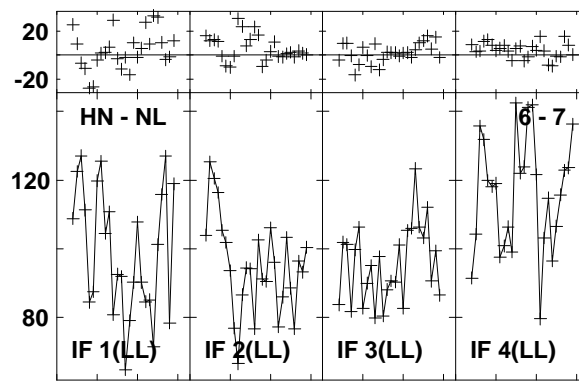
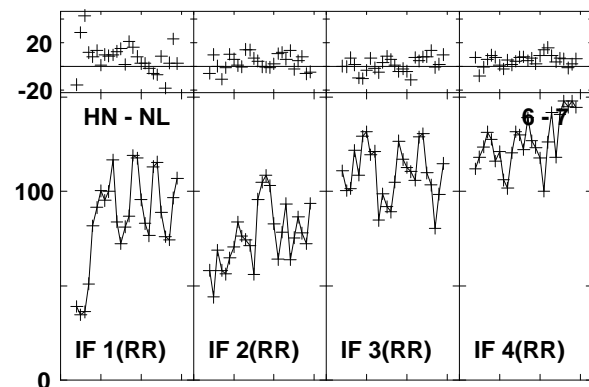
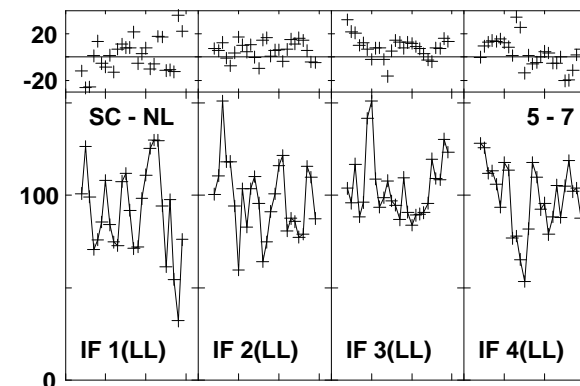
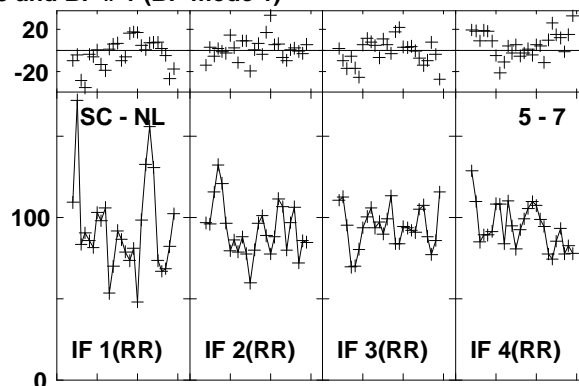
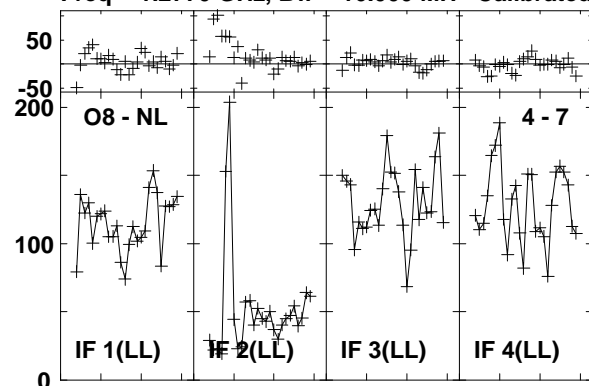

Lower frame: Milli Ampl Jy Top frame: Phas deg
 Vector averaged cross-power spectrum Baseline: O8 (04) - NL (07)
 Timerange: 00/22:16:52 to 00/22:20:00

Plot file version 806 created 03-MAR-2016 01:14:17

J1545+5400 GN002C 1.UVDATA.1

Freq = 1.2770 GHz, Bw = 16.000 MH Calibrated with CL # 3 and BP # 1 (BP mode 1)

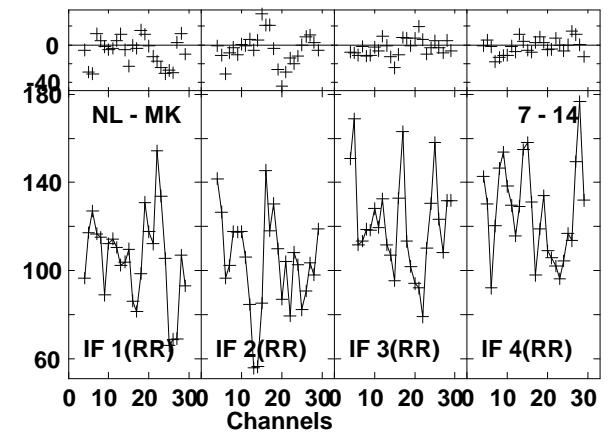
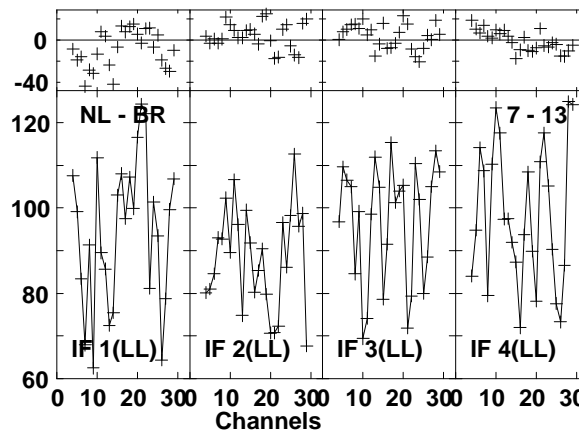
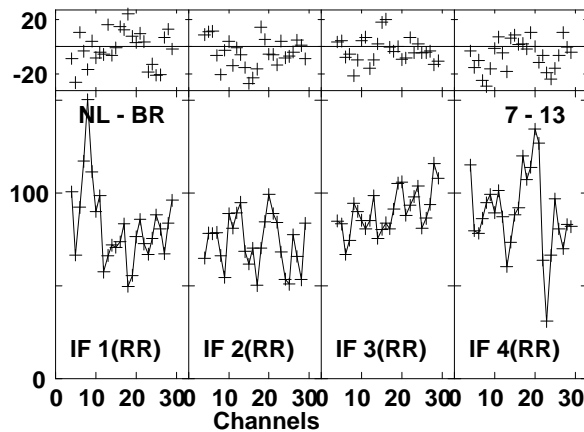
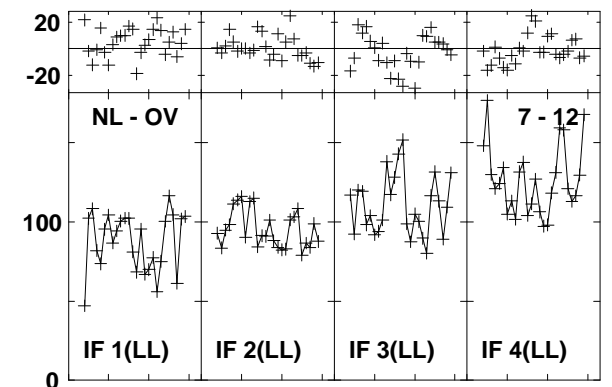
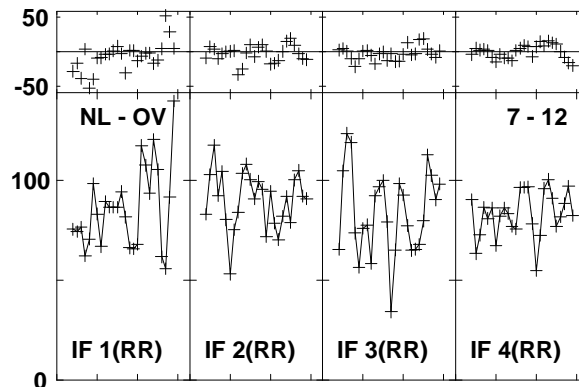
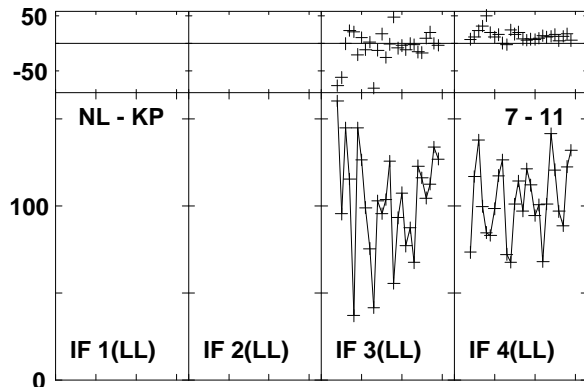
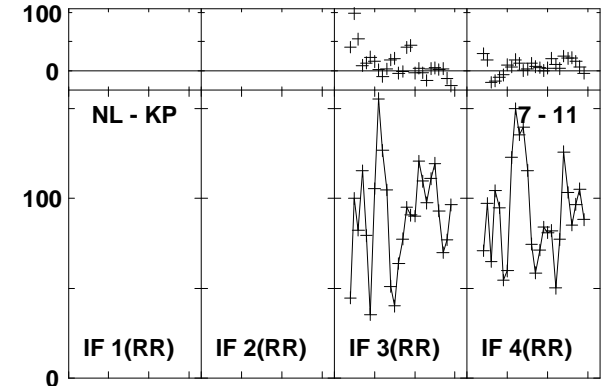
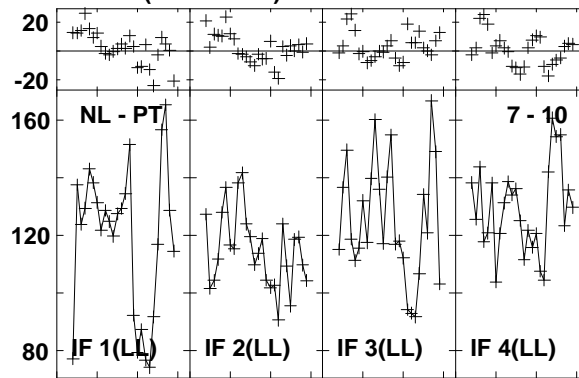
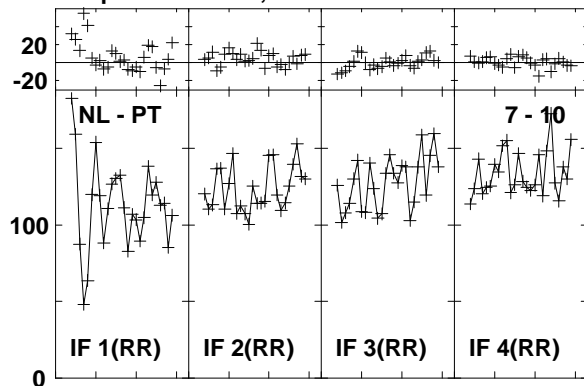

Lower frame: Milli Ampl Jy Top frame: Phas deg
Vector averaged cross-power spectrum Baseline: NL (07) - PT (10)
Timerange: 00:22:16:52 to 00:22:20:00

Plot file version 807 created 03-MAR-2016 01:14:17
J1545+5400 GN002C 1.UVDATA.1
Freq = 1.2770 GHz, Bw = 16.000 MH Calibrated with CL # 3 and BP # 1 (BP mode 1)

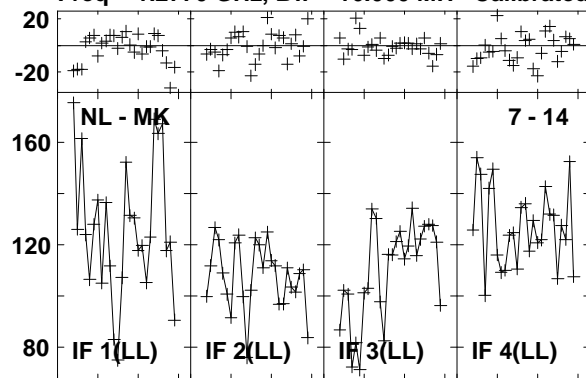

Lower frame: Milli Ampl Jy Top frame: Phas deg
Vector averaged cross-power spectrum Baseline: NL (07) - MK (14)
Timerange: 00/22:16:52 to 00/22:20:00

Plot file version 808 created 03-MAR-2016 01:14:17

4C52 GN002C 1.UVDATA.1

Freq = 1.2770 GHz, Bw = 16.000 MH Calibrated with CL # 3 and BP # 1 (BP mode 1)

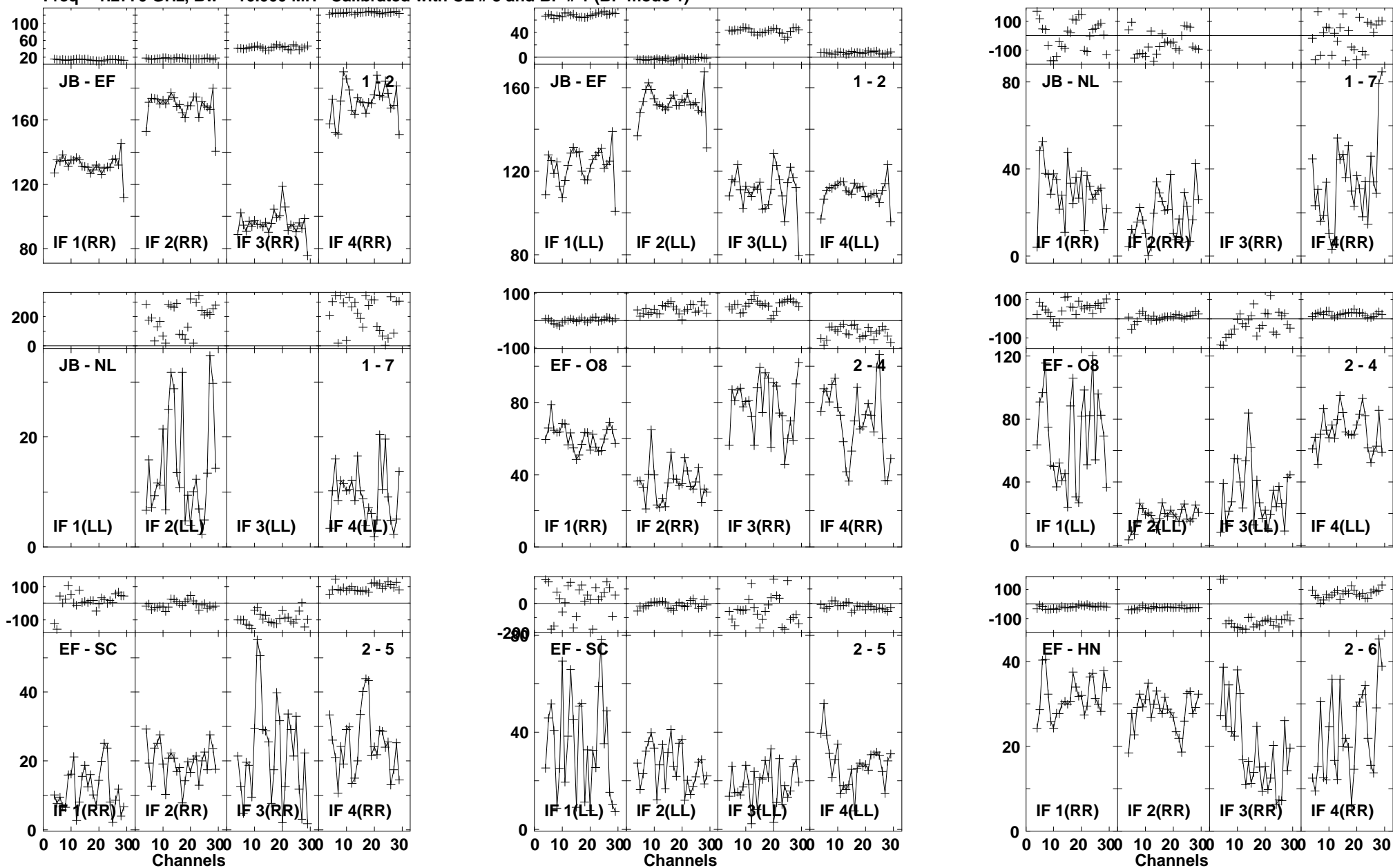

Lower frame: Milli Ampl Jy Top frame: Phas deg
Vector averaged cross-power spectrum Baseline: JB (01) - EF (02)
Timerange: 00/22:20:02 to 00/22:23:30

Plot file version 809 created 03-MAR-2016 01:14:17

4C52 GN002C 1.UVDATA.1

Freq = 1.2770 GHz, Bw = 16.000 MH Calibrated with CL # 3 and BP # 1 (BP mode 1)

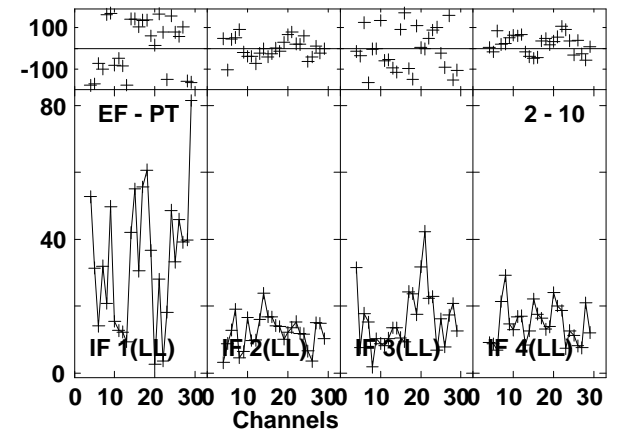
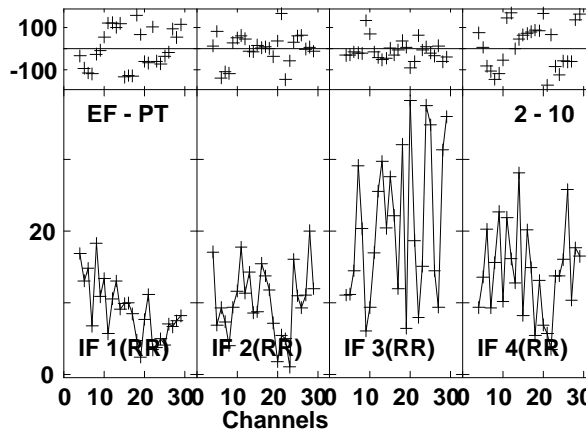
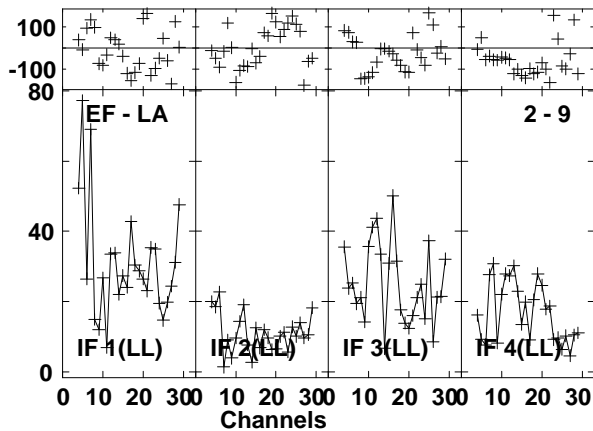
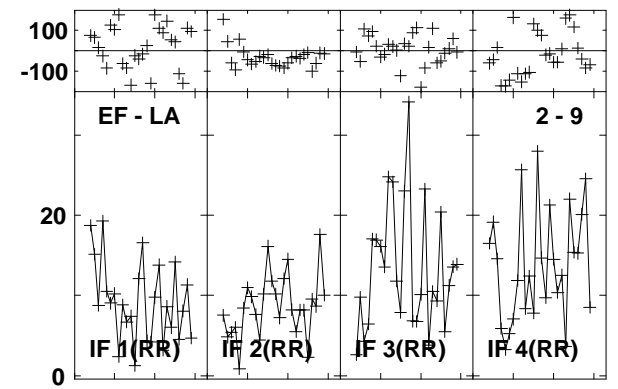
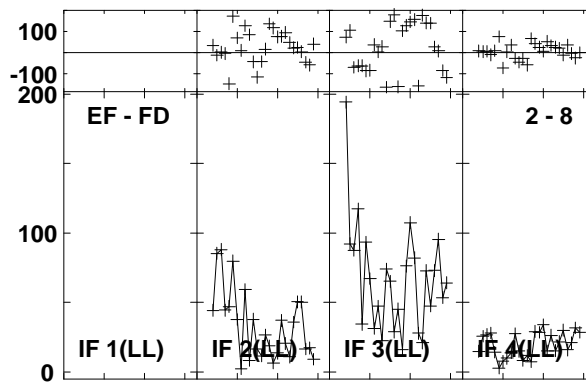
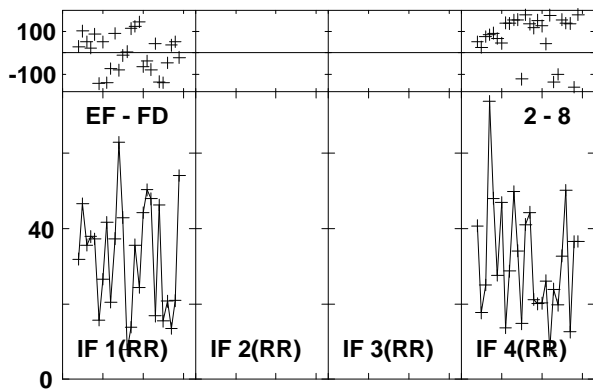
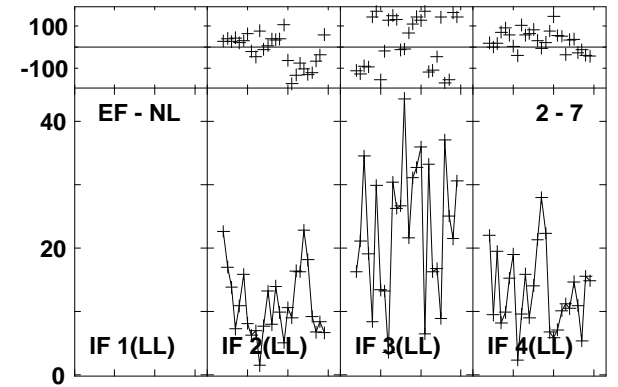
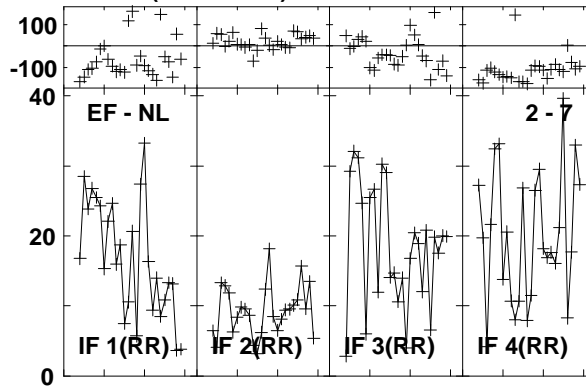
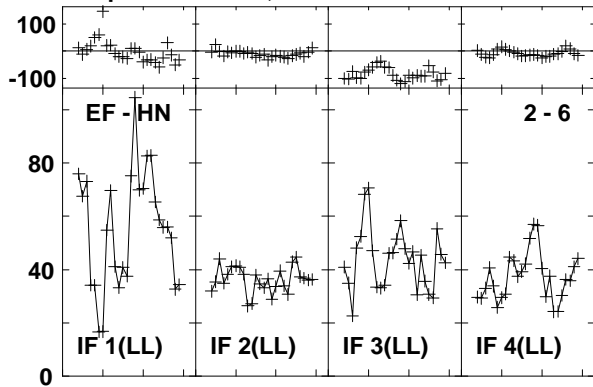

Lower frame: Milli Ampl Jy Top frame: Phas deg
Vector averaged cross-power spectrum Baseline: EF (02) - HN (06)
Timerange: 00/22:20:02 to 00/22:23:30

Plot file version 810 created 03-MAR-2016 01:14:17

4C52 GN002C 1.UVDATA.1

Freq = 1.2770 GHz, Bw = 16.000 MH Calibrated with CL # 3 and BP # 1 (BP mode 1)

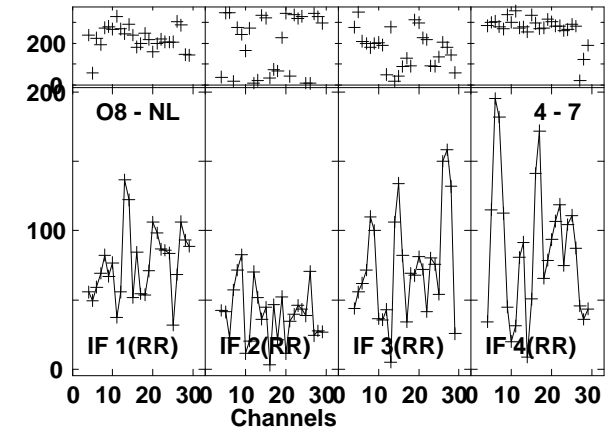
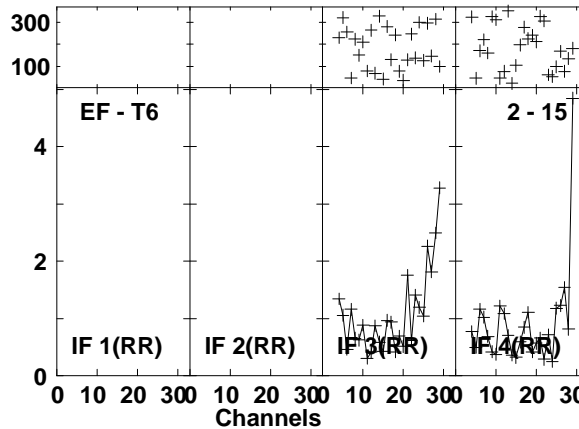
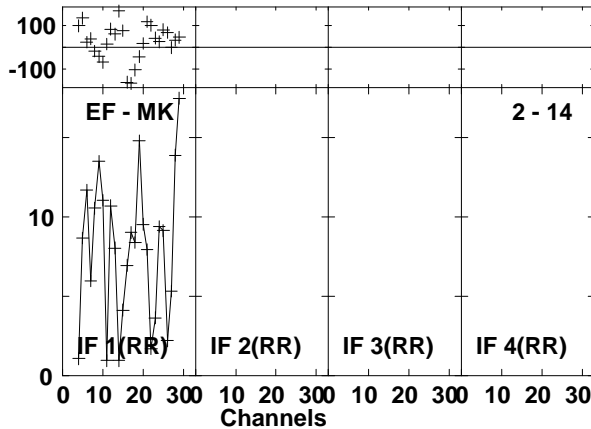
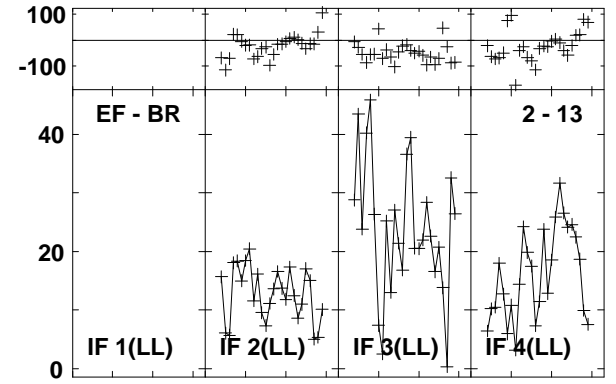
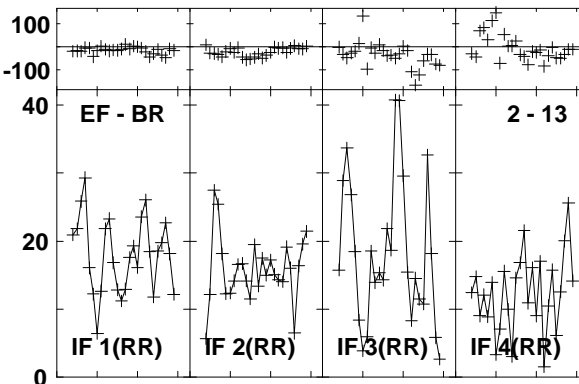
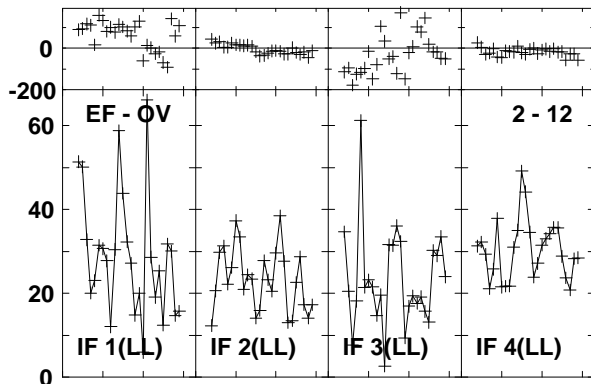
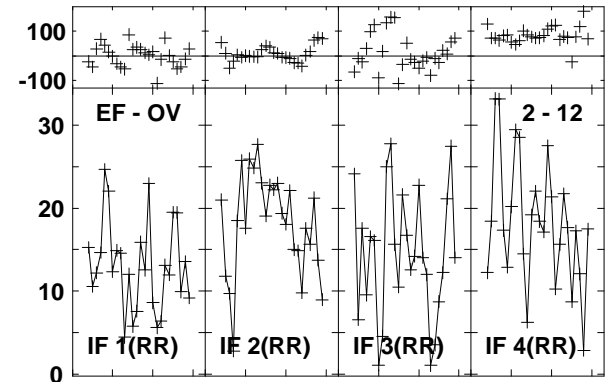
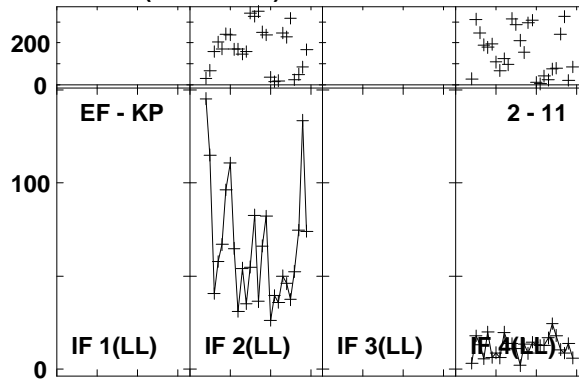
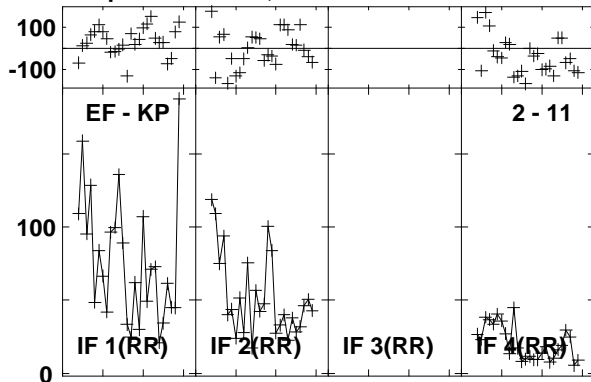

Lower frame: Milli Ampl Jy Top frame: Phas deg
Vector averaged cross-power spectrum Baseline: EF (02) - KP (11)
Timerange: 00/22:20:02 to 00/22:23:30

Plot file version 811 created 03-MAR-2016 01:14:17

4C52 GN002C 1.UVDATA.1

Freq = 1.2770 GHz, Bw = 16.000 MH Calibrated with CL # 3 and BP # 1 (BP mode 1)

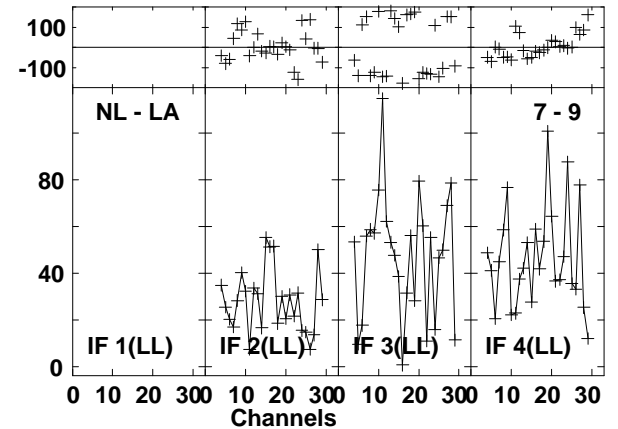
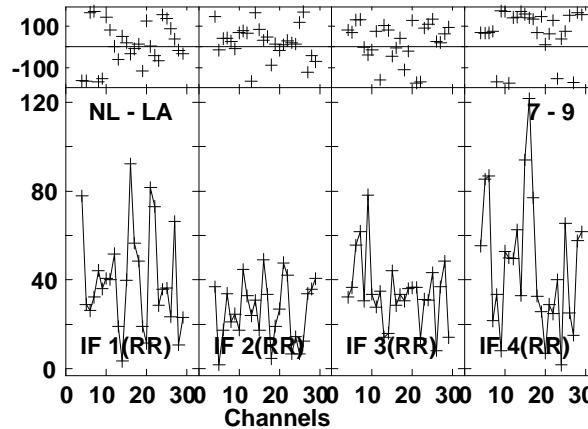
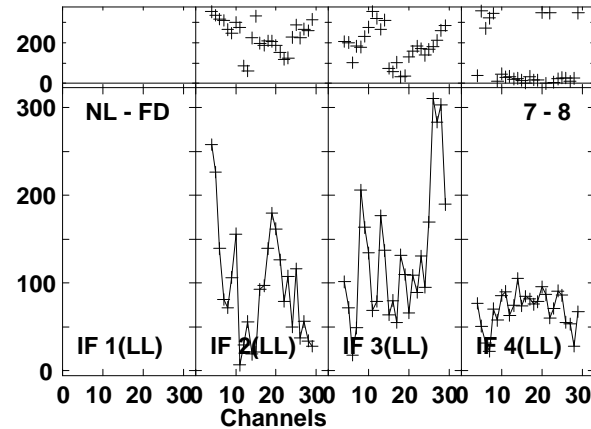
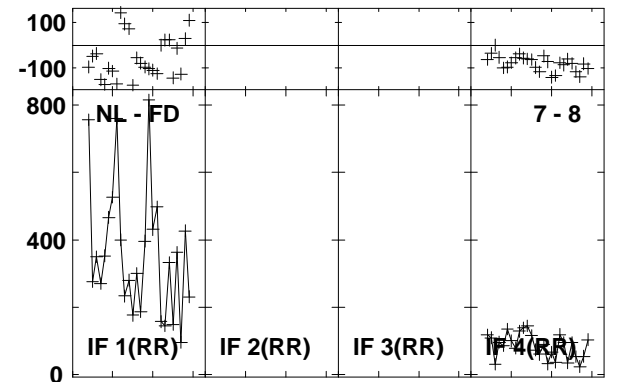
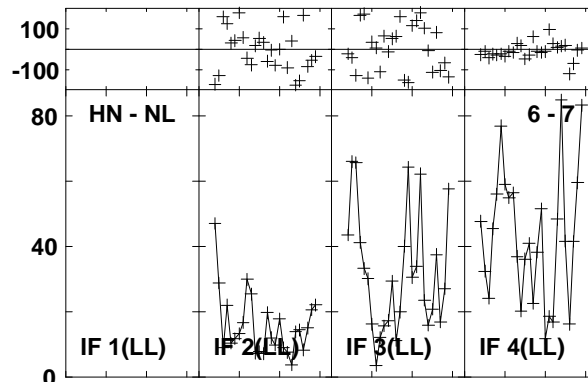
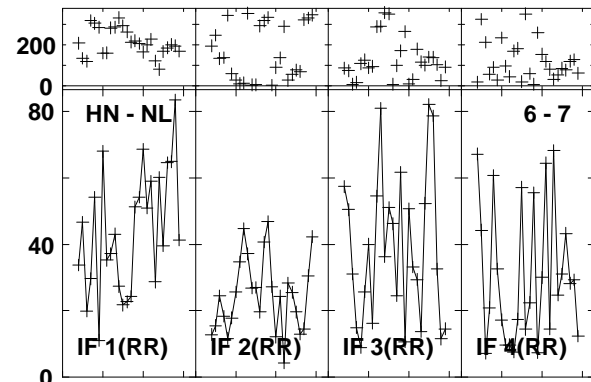
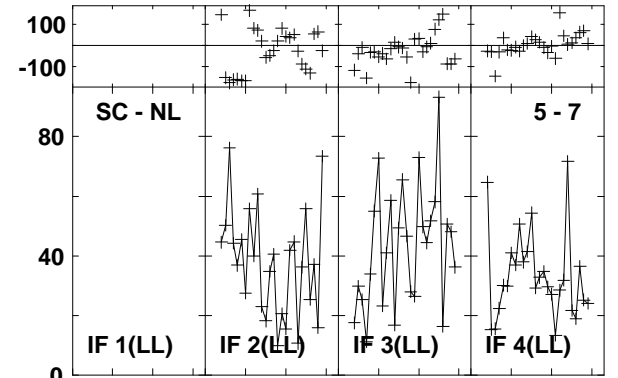
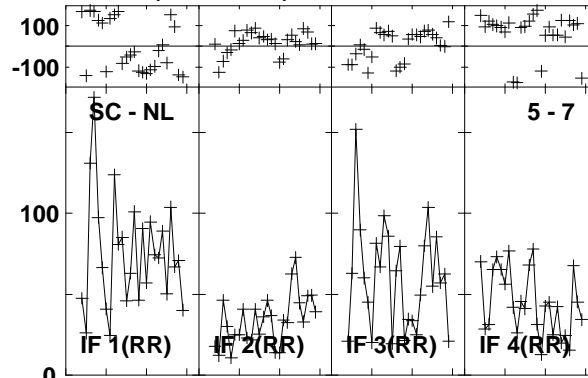
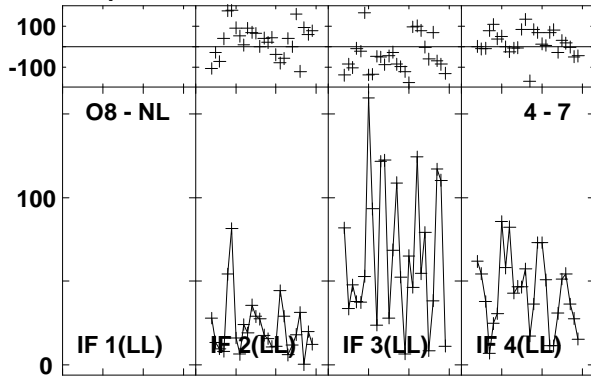

Lower frame: Milli Ampl Jy Top frame: Phas deg
Vector averaged cross-power spectrum Baseline: O8 (04) - NL (07)
Timerange: 00/22:20:02 to 00/22:23:30

Plot file version 812 created 03-MAR-2016 01:14:18

4C52 GN002C 1.UVDATA.1

Freq = 1.2770 GHz, Bw = 16.000 MH Calibrated with CL # 3 and BP # 1 (BP mode 1)

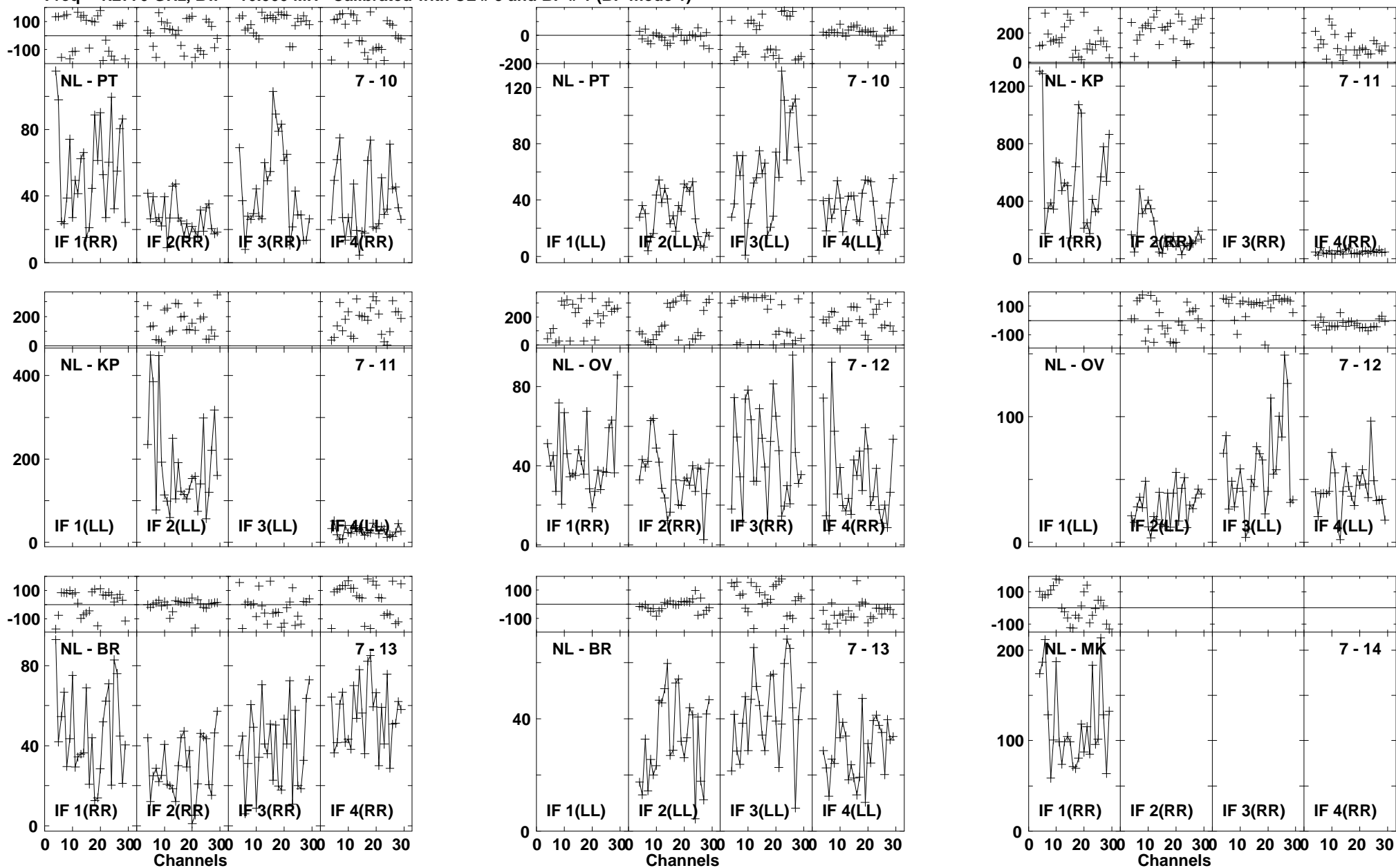

Lower frame: Milli Ampl Jy Top frame: Phas deg
Vector averaged cross-power spectrum Baseline: NL (07) - PT (10)
Timerange: 00/22:20:02 to 00/22:23:30

Plot file version 813 created 03-MAR-2016 01:14:18
4C52 GN002C 1.UVDATA.1
Freq = 1.2770 GHz, Bw = 16.000 MH Calibrated with CL # 3 and BP # 1 (BP mode 1)

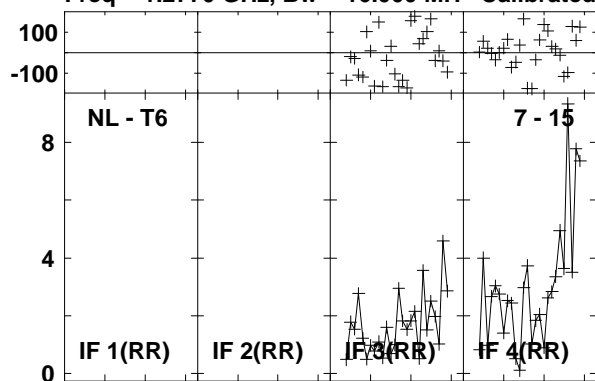

Lower frame: Milli Ampl Jy Top frame: Phas deg
Vector averaged cross-power spectrum Baseline: NL (07) - T6 (15)
Timerange: 00/22:20:02 to 00/22:23:30

Plot file version 814 created 03-MAR-2016 01:14:18

J1545+5400 GN002C 1.UVDATA.1

Freq = 1.2770 GHz, Bw = 16.000 MH Calibrated with CL # 3 and BP # 1 (BP mode 1)

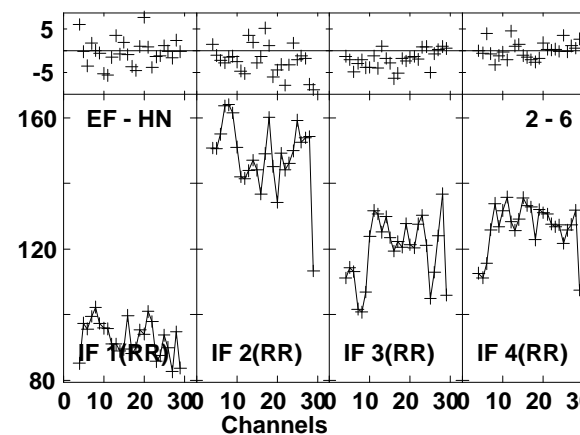
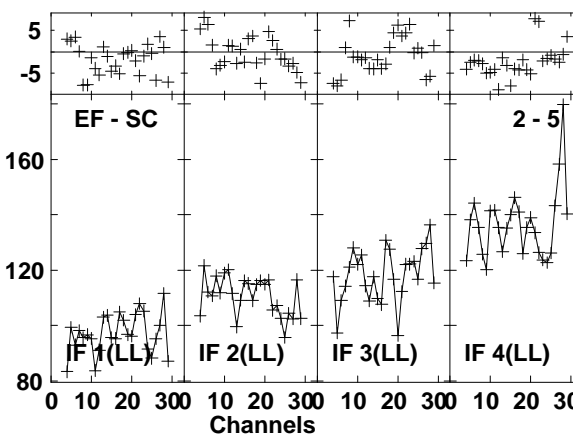
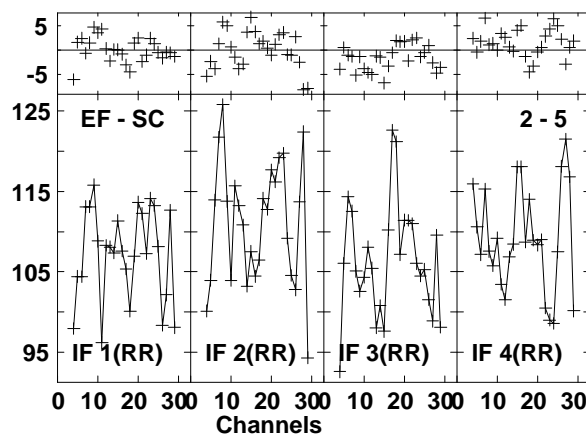
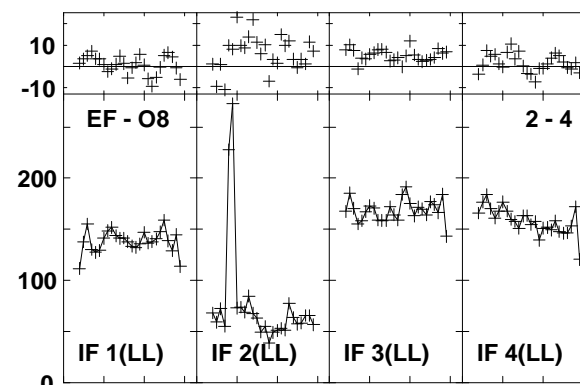
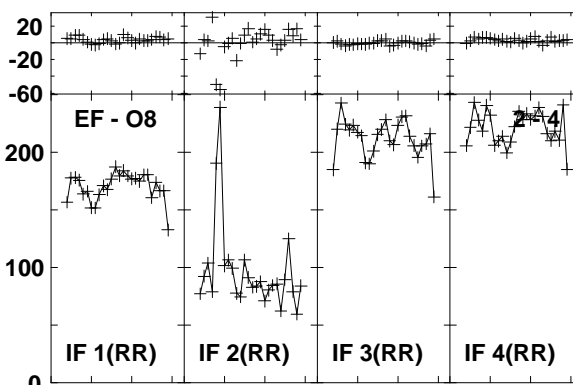
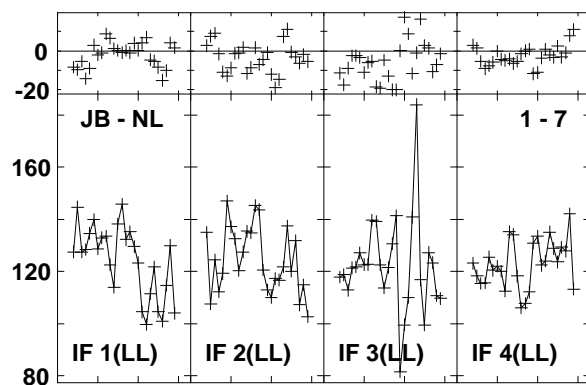
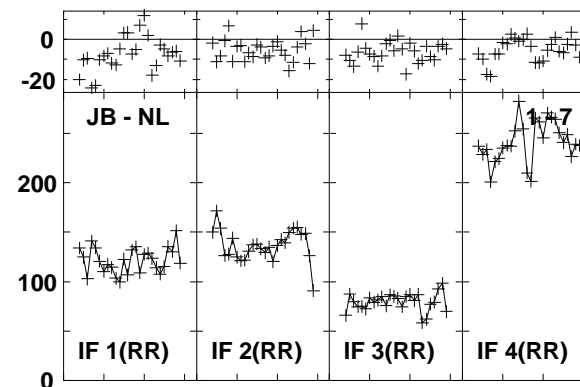
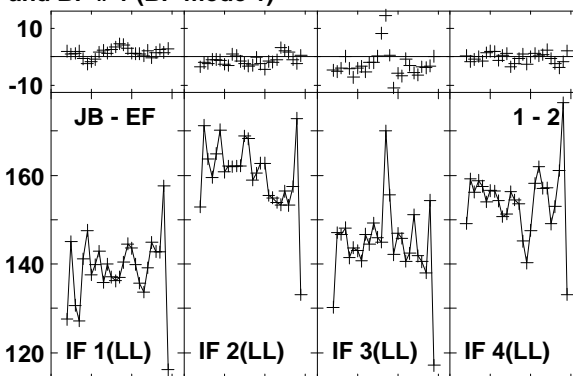
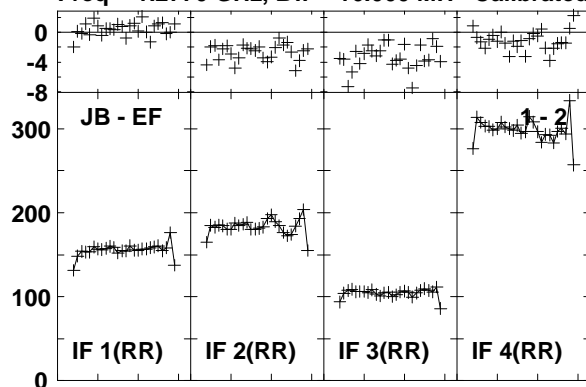

Lower frame: Milli Ampl Jy Top frame: Phas deg
Vector averaged cross-power spectrum Baseline: JB (01) - EF (02)
Timerange: 00/22:24:22 to 00/22:26:50

Plot file version 815 created 03-MAR-2016 01:14:18

J1545+5400 GN002C 1.UVDATA.1

Freq = 1.2770 GHz, Bw = 16.000 MH Calibrated with CL # 3 and BP # 1 (BP mode 1)

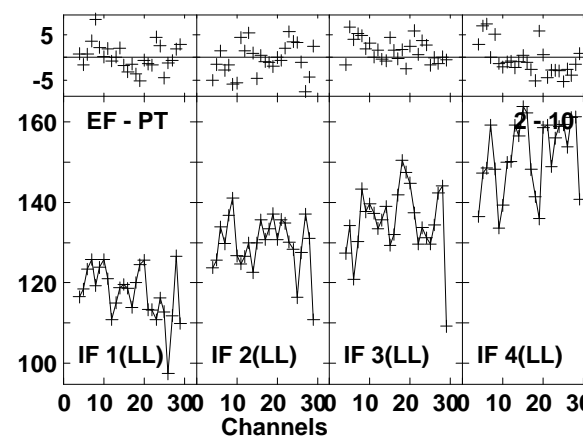
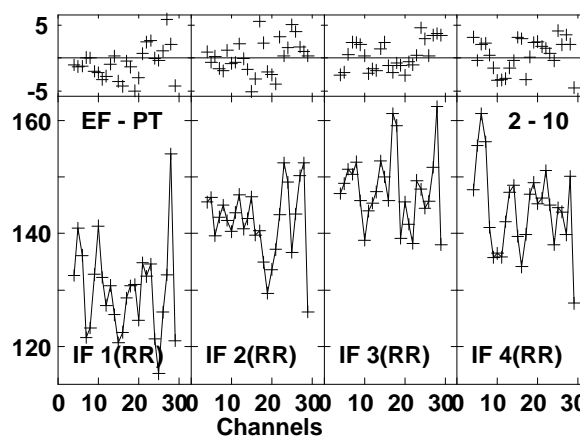
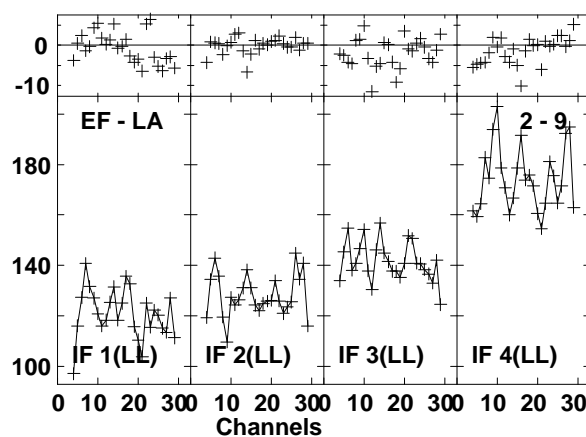
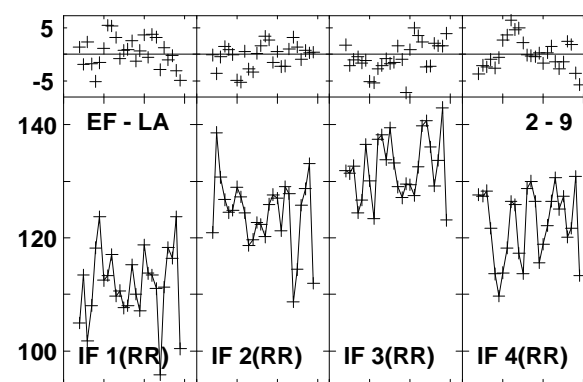
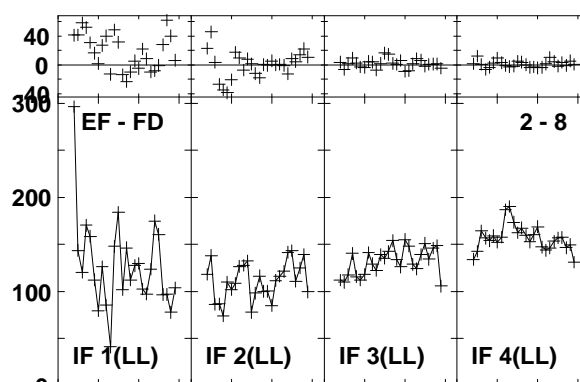
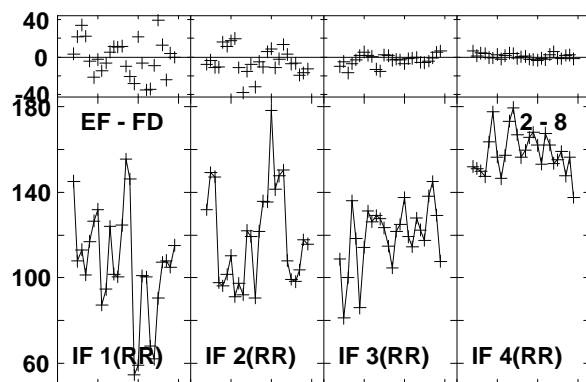
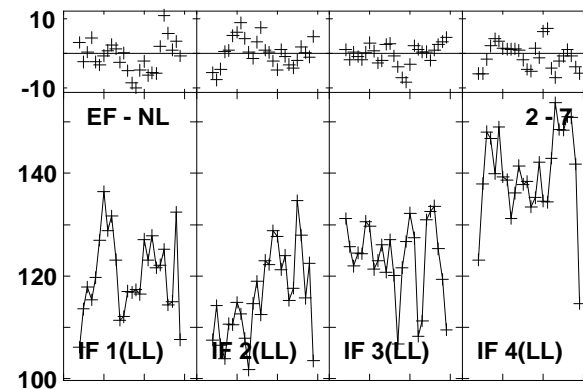
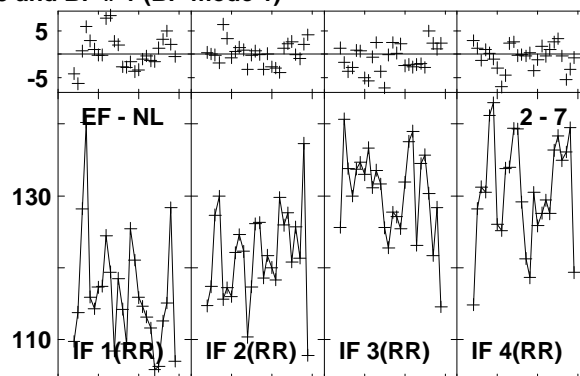
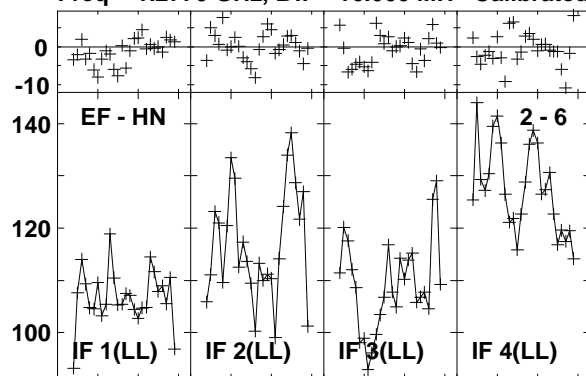

Lower frame: Milli Ampl Jy Top frame: Phas deg
Vector averaged cross-power spectrum Baseline: EF (02) - HN (06)
Timerange: 00/22:24:22 to 00/22:26:50

Plot file version 816 created 03-MAR-2016 01:14:18

J1545+5400 GN002C 1.UVDATA.1

Freq = 1.2770 GHz, Bw = 16.000 MH Calibrated with CL # 3 and BP # 1 (BP mode 1)

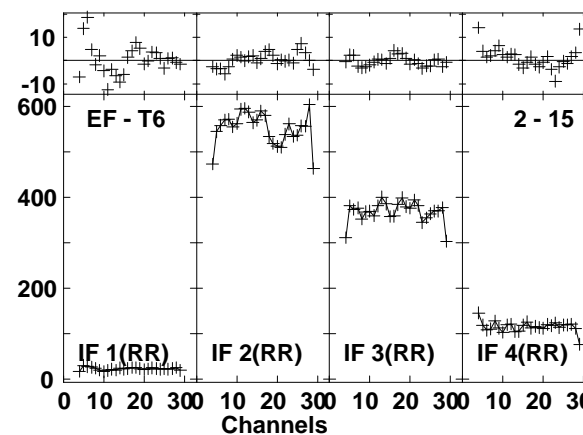
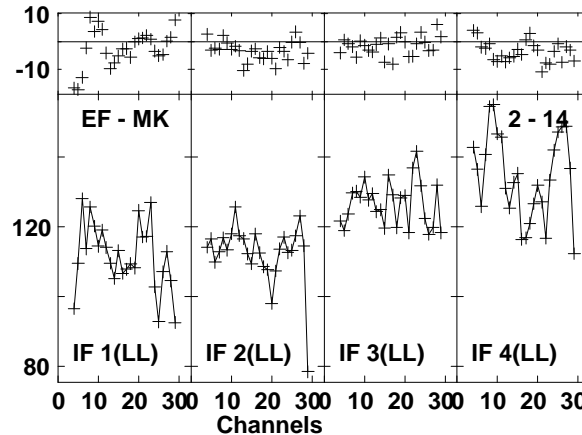
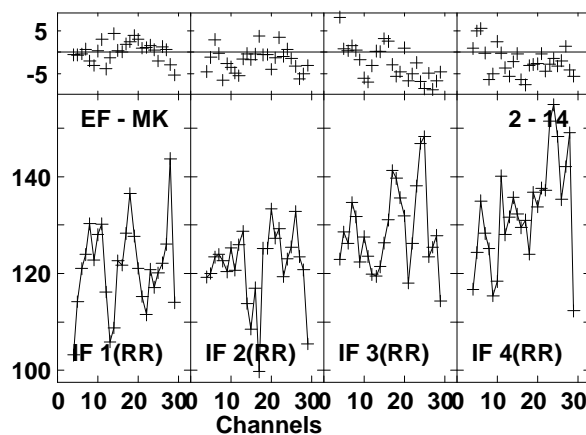
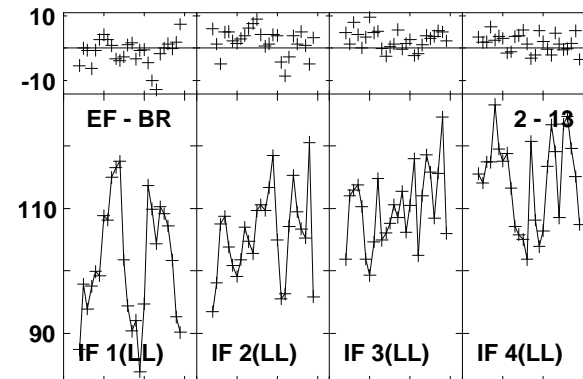
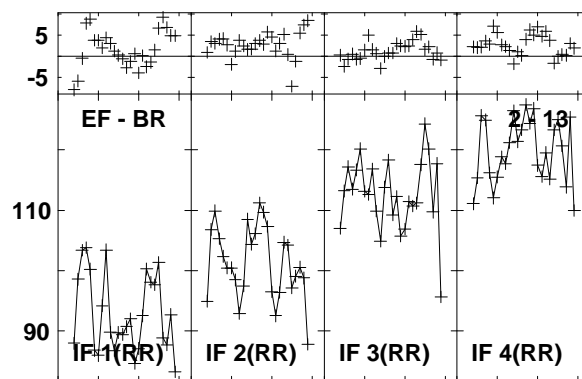
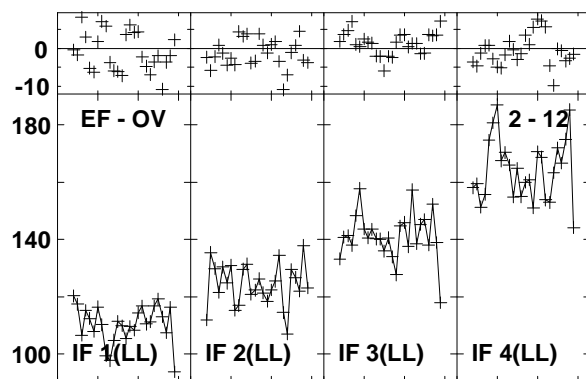
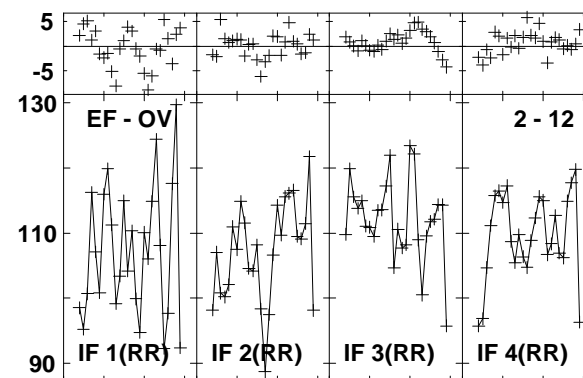
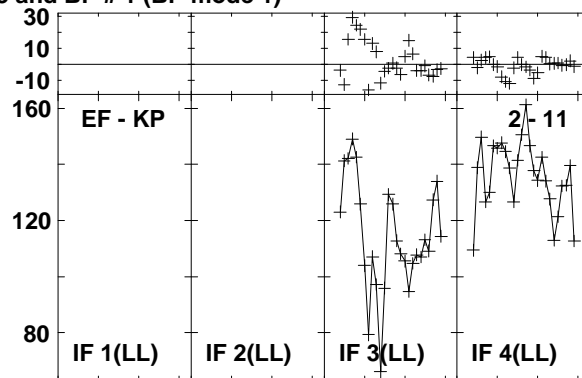
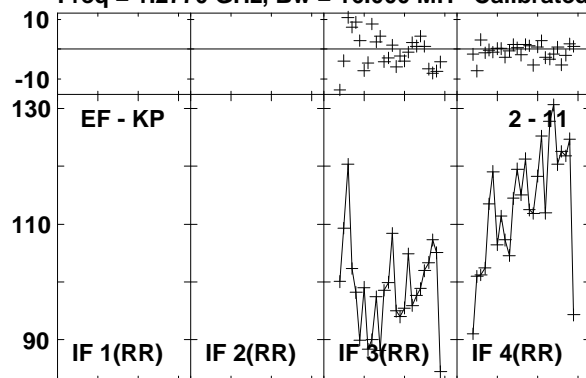

Lower frame: Milli Ampl Jy Top frame: Phas deg
Vector averaged cross-power spectrum Baseline: EF (02) - KP (11)
Timerange: 00/22:24:22 to 00/22:26:50

Plot file version 817 created 03-MAR-2016 01:14:18

J1545+5400 GN002C 1.UVDATA.1

Freq = 1.2770 GHz, Bw = 16.000 MH Calibrated with CL # 3 and BP # 1 (BP mode 1)

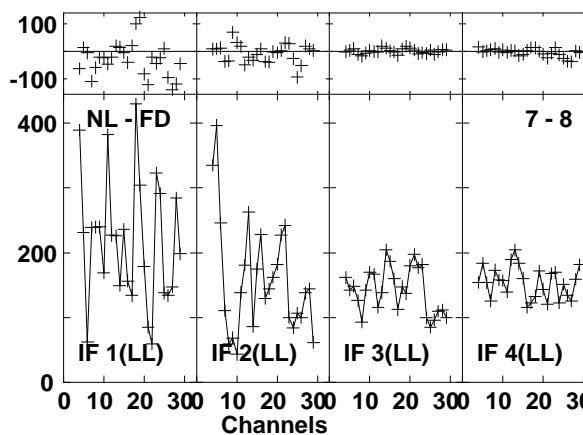
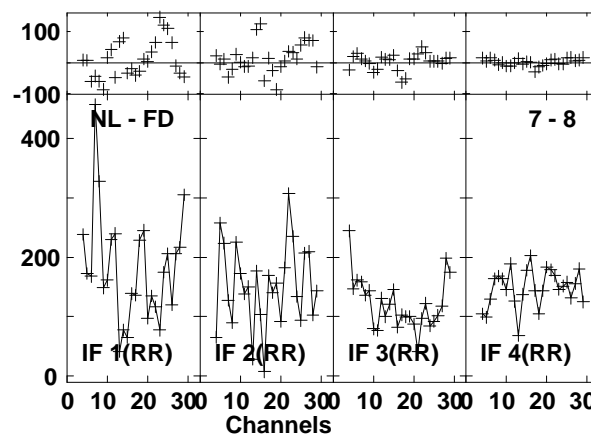
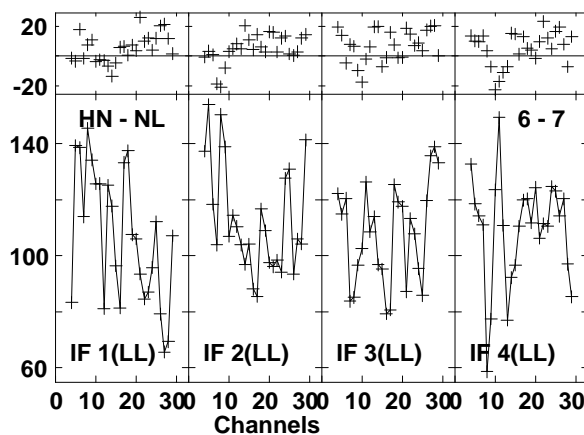
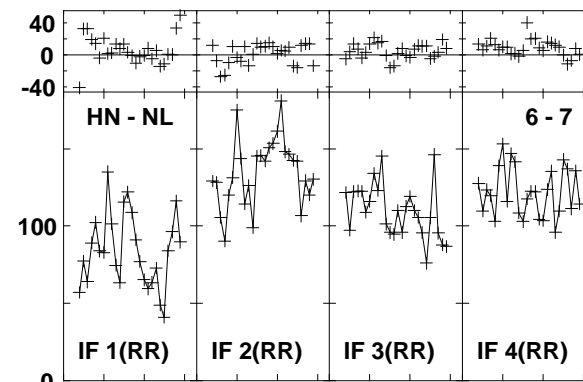
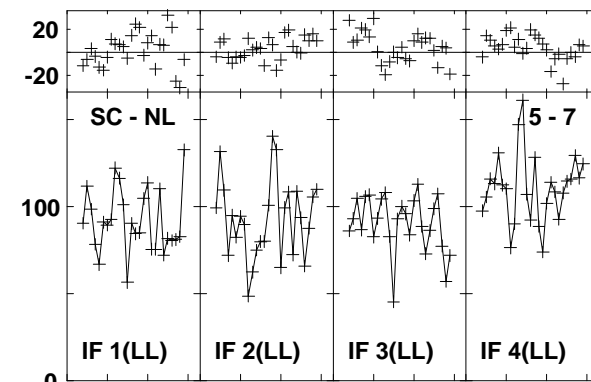
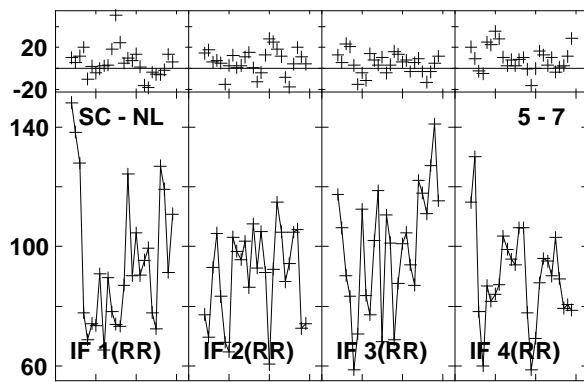
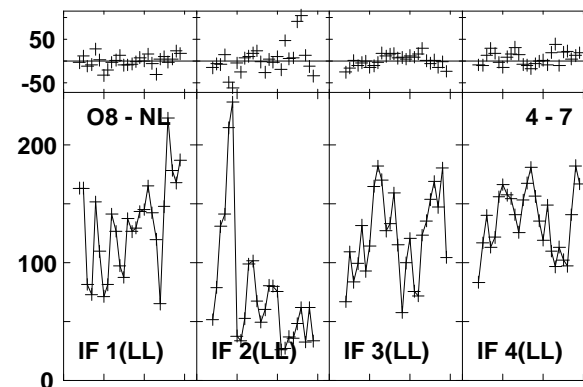
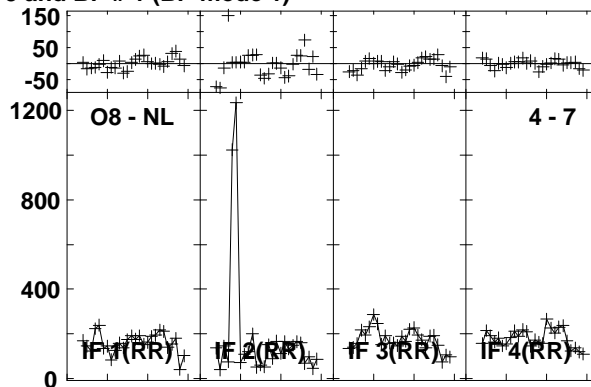
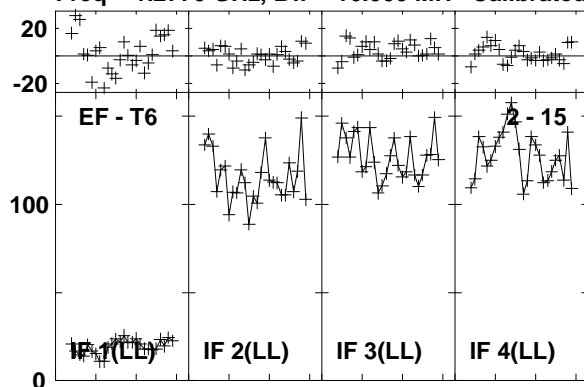

Lower frame: Milli Ampl Jy Top frame: Phas deg
Vector averaged cross-power spectrum Baseline: EF (02) - T6 (15)
Timerange: 00/22:24:22 to 00/22:26:50

Plot file version 818 created 03-MAR-2016 01:14:19

J1545+5400 GN002C 1.UVDATA.1

Freq = 1.2770 GHz, Bw = 16.000 MH Calibrated with CL # 3 and BP # 1 (BP mode 1)

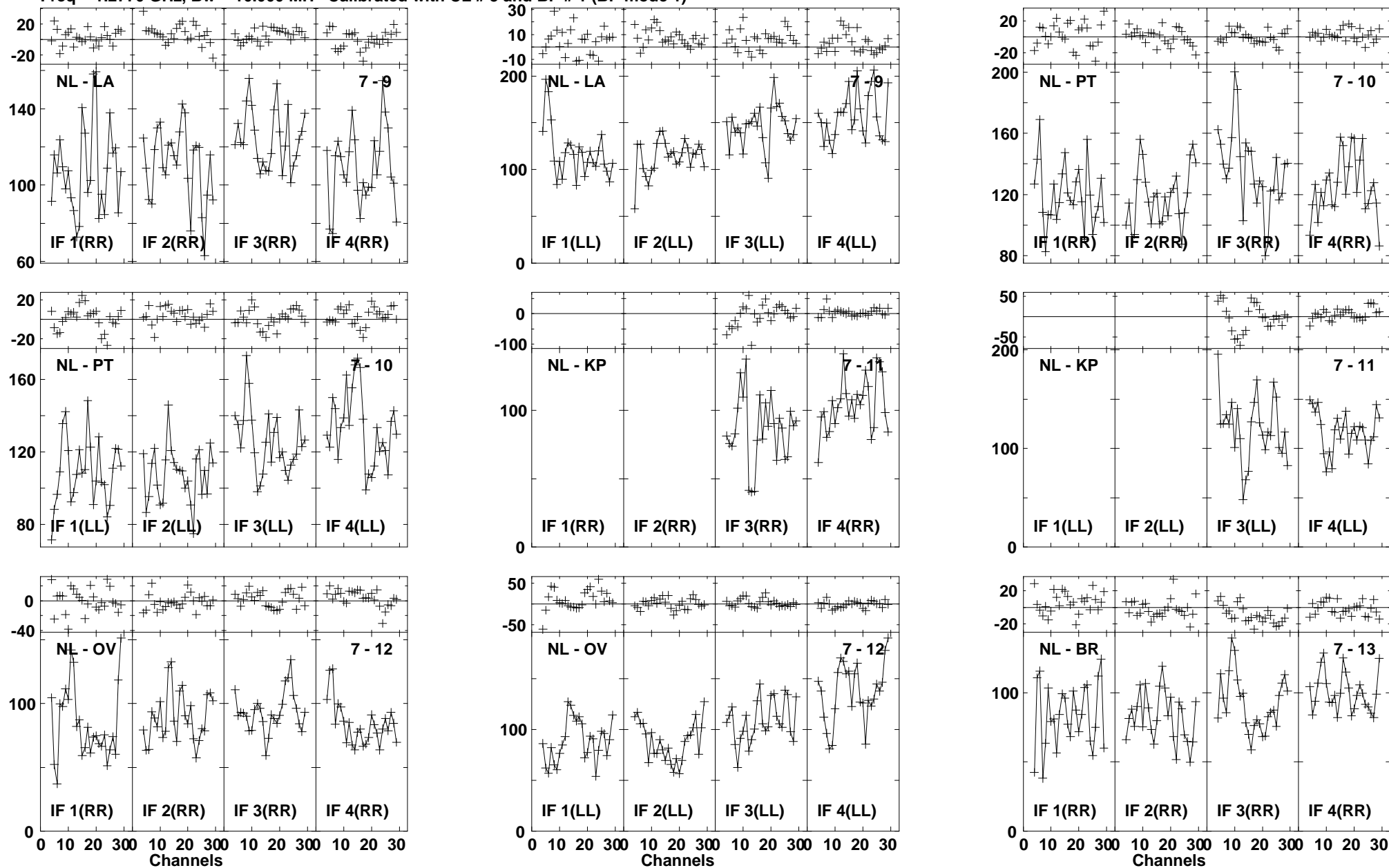

Lower frame: Milli Ampl Jy Top frame: Phas deg
Vector averaged cross-power spectrum Baseline: NL (07) - LA (09)
Timerange: 00/22:24:22 to 00/22:26:50

Plot file version 819 created 03-MAR-2016 01:14:19
 J1545+5400 GN002C 1.UVDATA.1
 Freq = 1.2770 GHz, Bw = 16.000 MH Calibrated with CL # 3 and BP # 1 (BP mode 1)

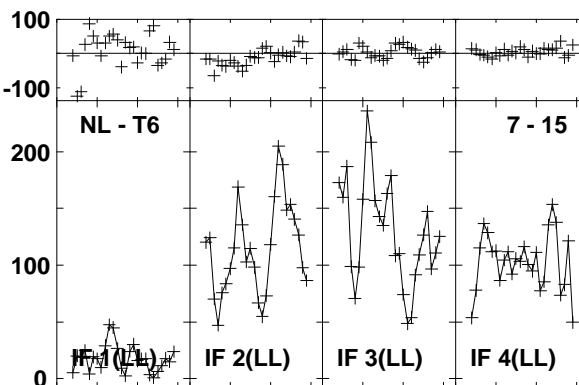
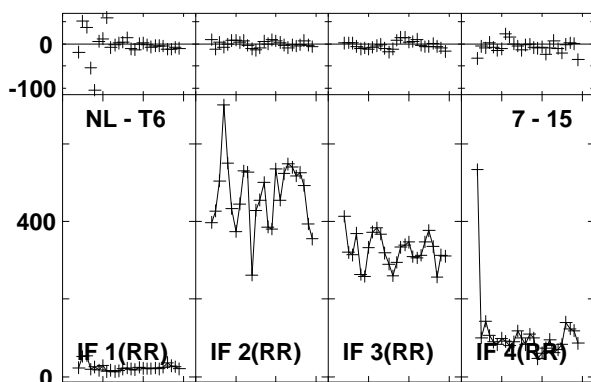
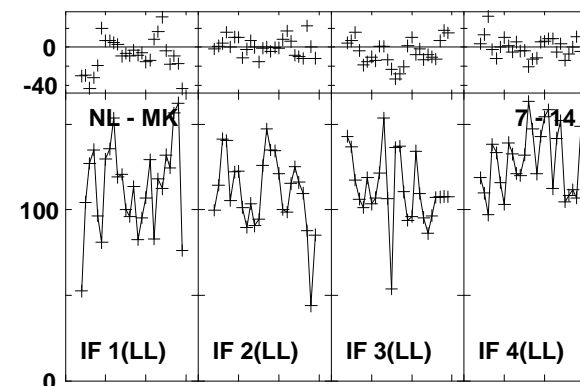
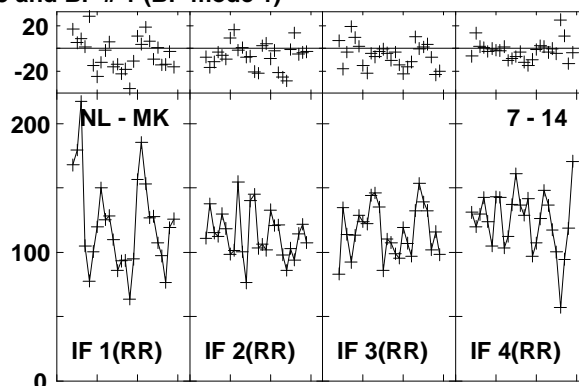
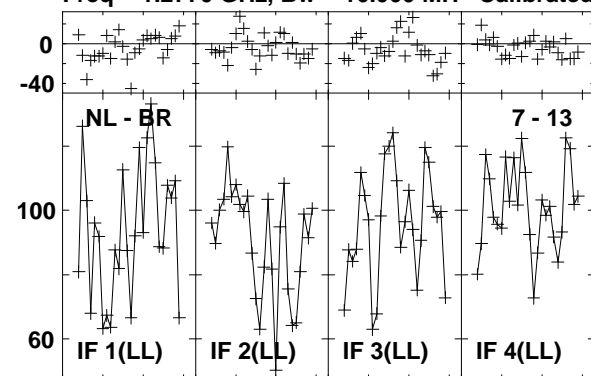

Lower frame: Milli Ampl Jy Top frame: Phas deg
 Vector averaged cross-power spectrum Baseline: NL (07) - BR (13)
 Timerange: 00/22:24:22 to 00/22:26:50

Plot file version 820 created 03-MAR-2016 01:14:19

4C52 GN002C 1.UVDATA.1

Freq = 1.2770 GHz, Bw = 16.000 MH Calibrated with CL # 3 and BP # 1 (BP mode 1)

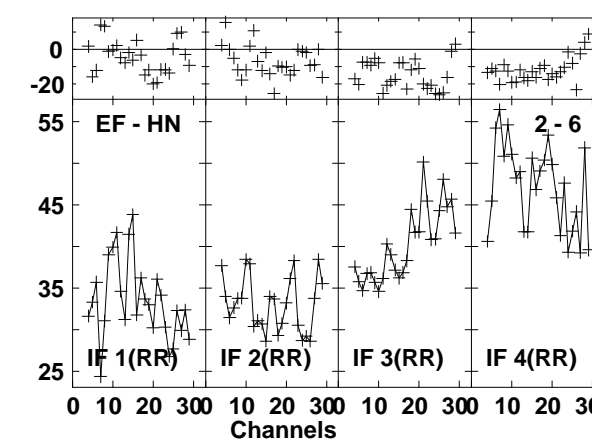
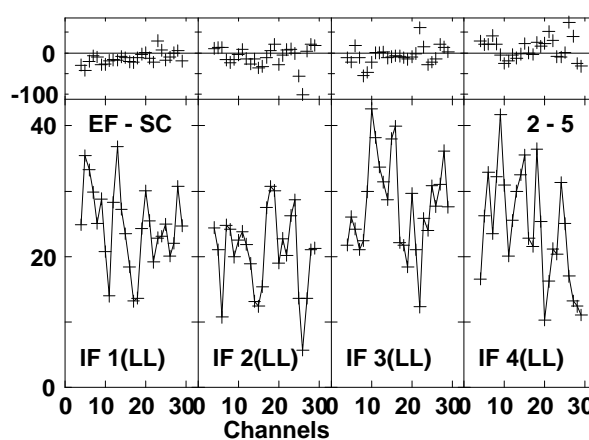
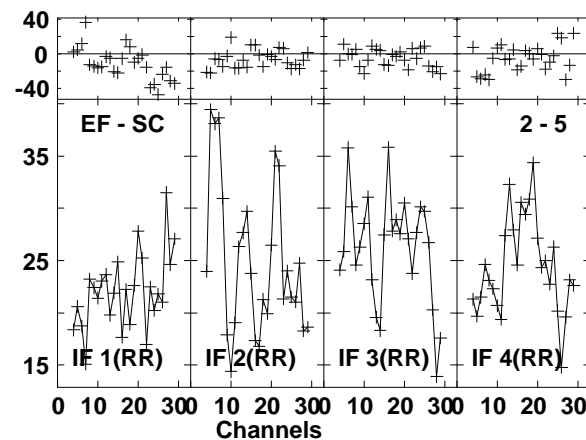
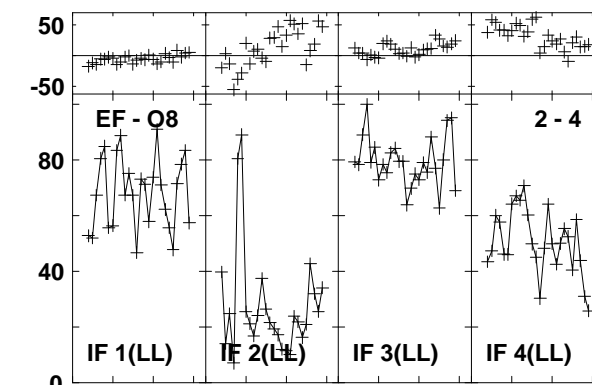
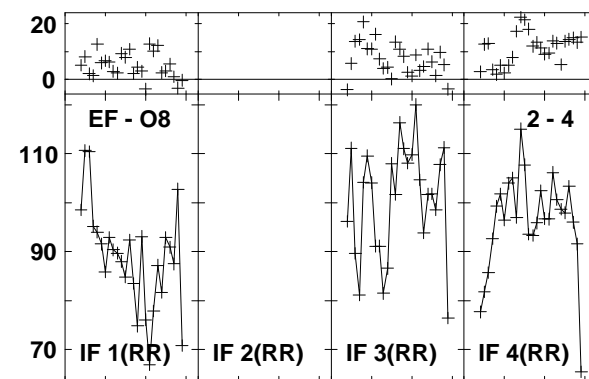
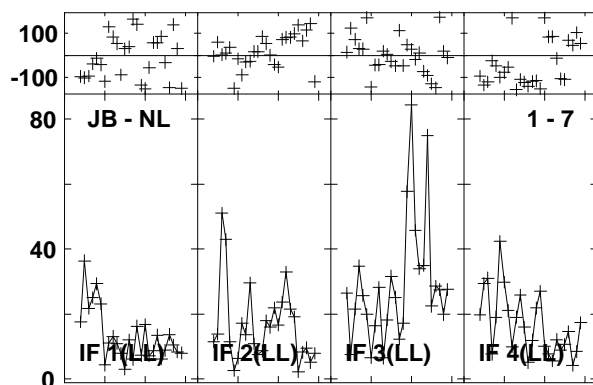
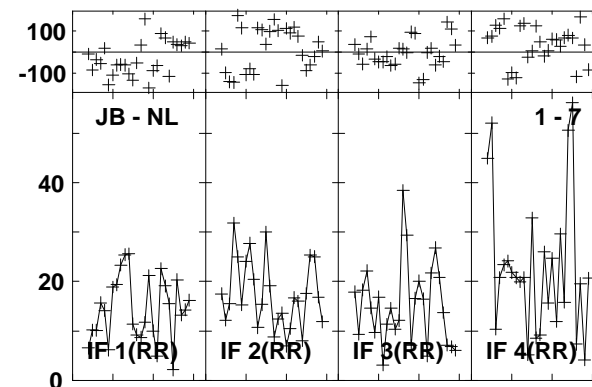
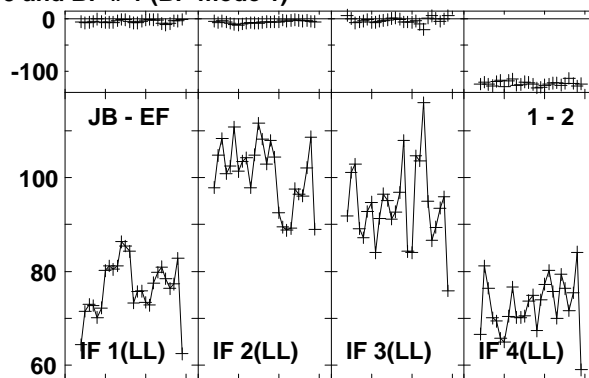
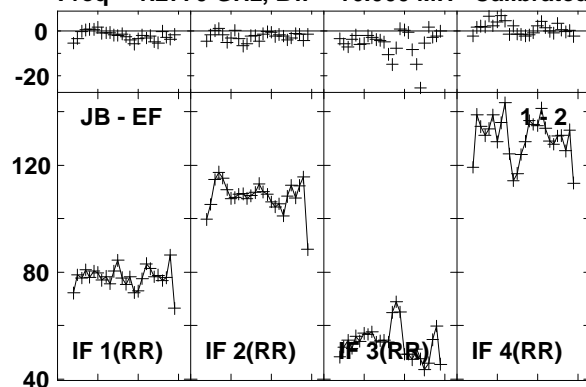

Lower frame: Milli Ampl Jy Top frame: Phas deg
Vector averaged cross-power spectrum Baseline: JB (01) - EF (02)
Timerange: 00/22:27:03 to 00/22:30:19

Plot file version 821 created 03-MAR-2016 01:14:19

4C52 GN002C 1.UVDATA.1

Freq = 1.2770 GHz, Bw = 16.000 MH Calibrated with CL # 3 and BP # 1 (BP mode 1)

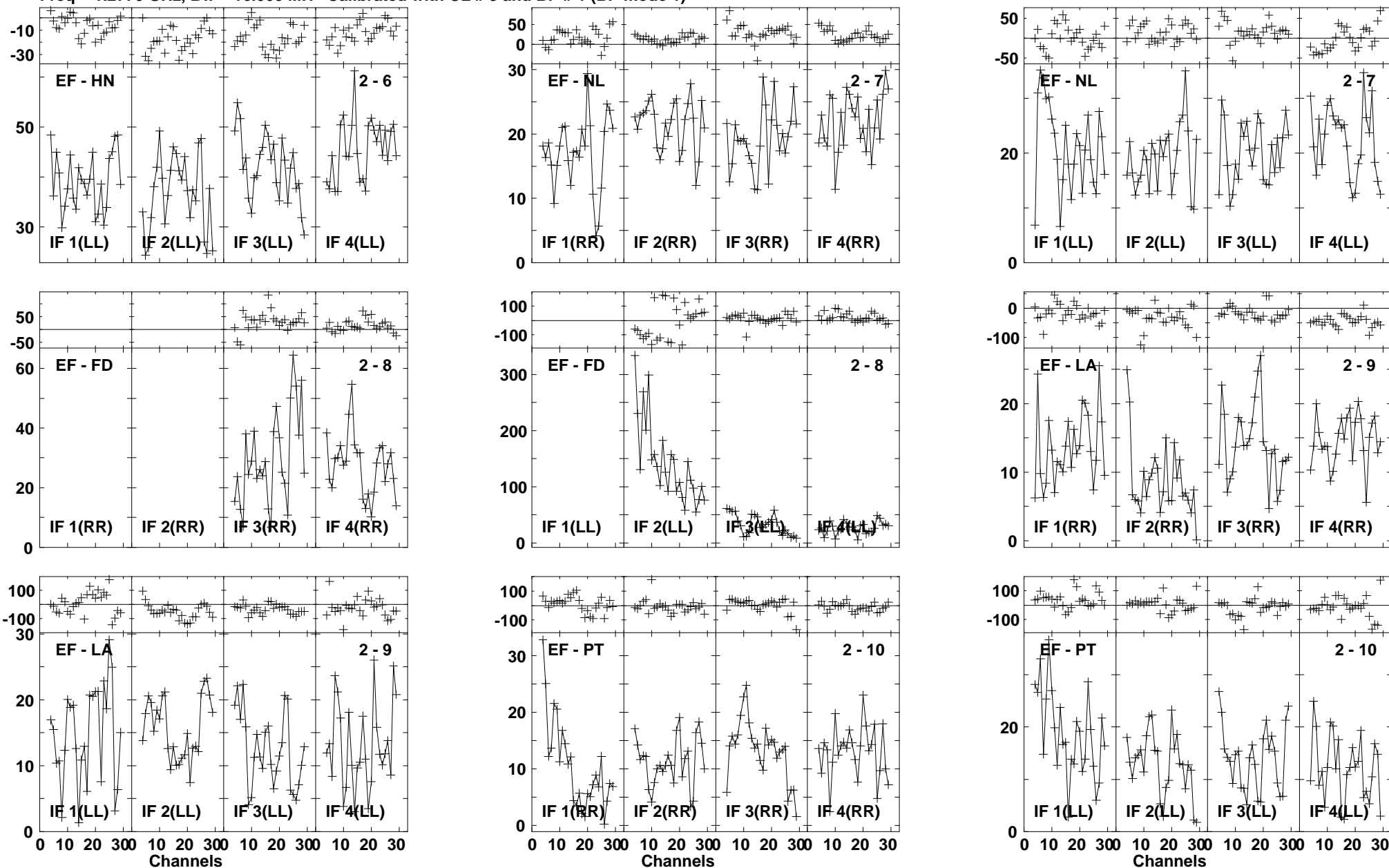

Lower frame: Milli Ampl Jy Top frame: Phas deg
Vector averaged cross-power spectrum Baseline: EF (02) - HN (06)
Timerange: 00/22:27:03 to 00/22:30:19

Plot file version 822 created 03-MAR-2016 01:14:19

4C52 GN002C 1.UVDATA.1

Freq = 1.2770 GHz, Bw = 16.000 MH Calibrated with CL # 3 and BP # 1 (BP mode 1)

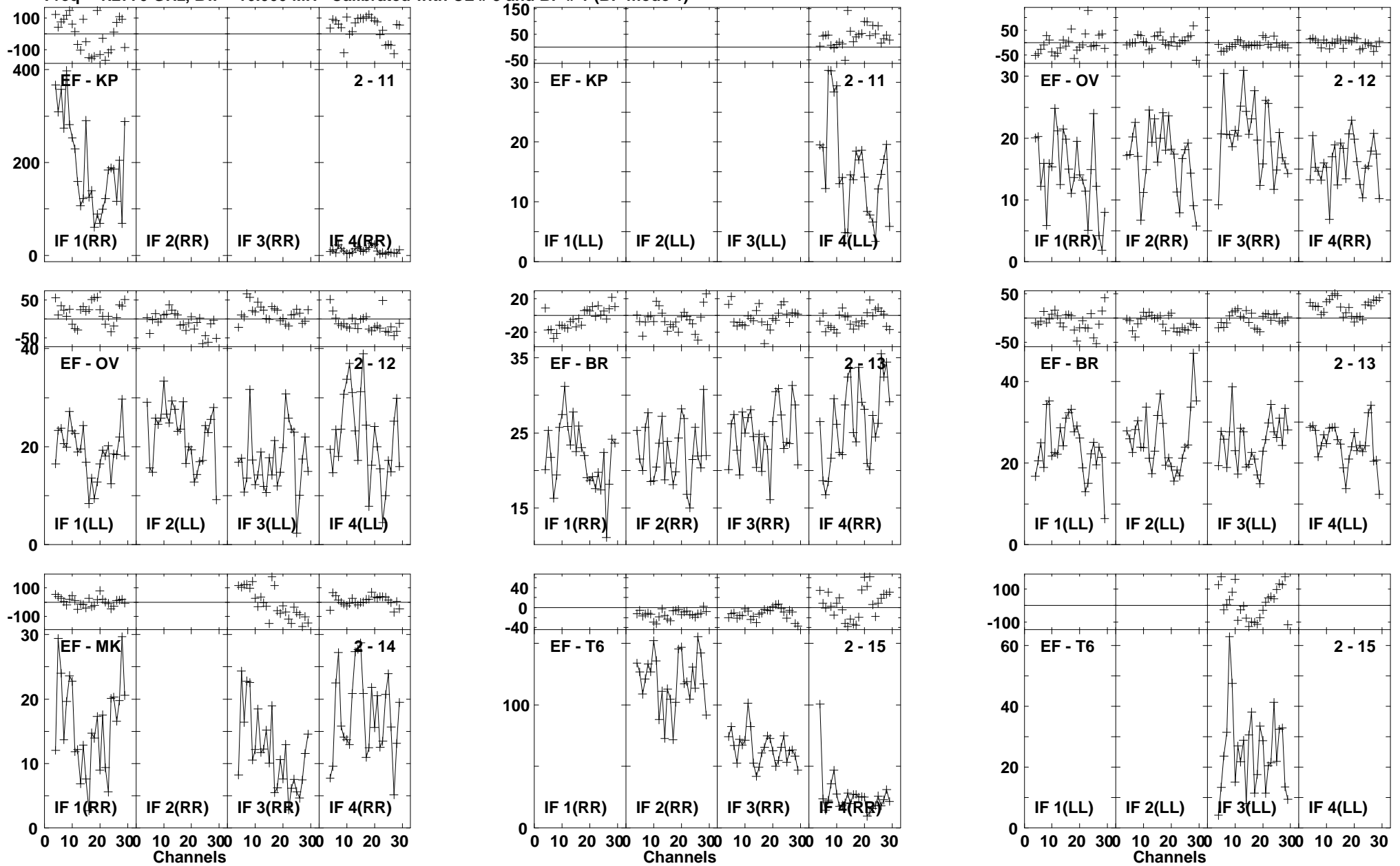

Lower frame: Milli Ampl Jy Top frame: Phas deg
Vector averaged cross-power spectrum Baseline: EF (02) - KP (11)
Timerange: 00/22:27:03 to 00/22:30:19

Plot file version 823 created 03-MAR-2016 01:14:19

4C52 GN002C 1.UVDATA.1

Freq = 1.2770 GHz, Bw = 16.000 MH Calibrated with CL # 3 and BP # 1 (BP mode 1)

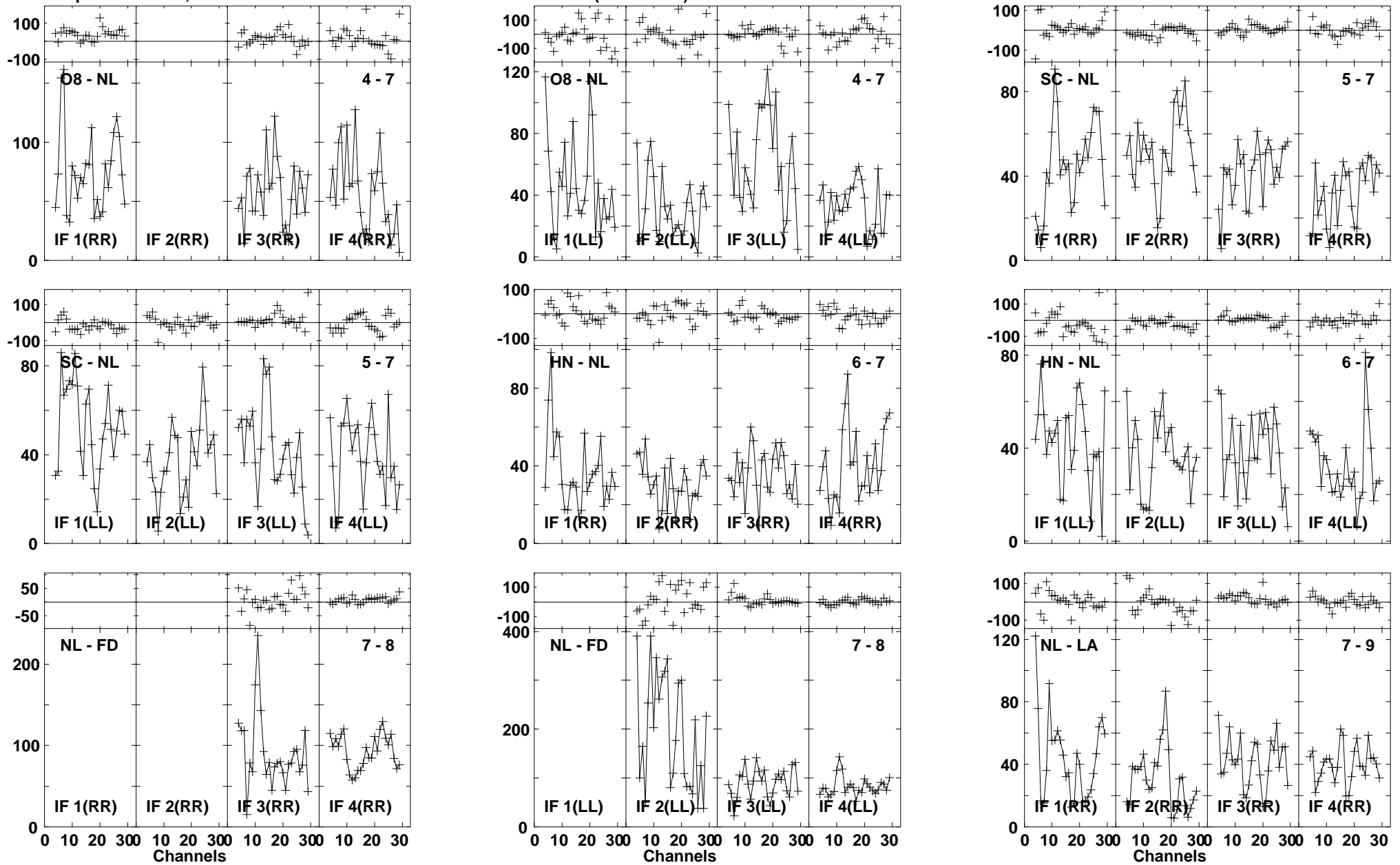

Lower frame: Milli Ampl Jy Top frame: Phas deg
Vector averaged cross-power spectrum Baseline: O8 (04) - NL (07)
Timerange: 00/22:27:03 to 00/22:30:19

Plot file version 824 created 03-MAR-2016 01:14:20

4C52 GN002C 1.UVDATA.1

Freq = 1.2770 GHz, Bw = 16.000 MH Calibrated with CL # 3 and BP # 1 (BP mode 1)

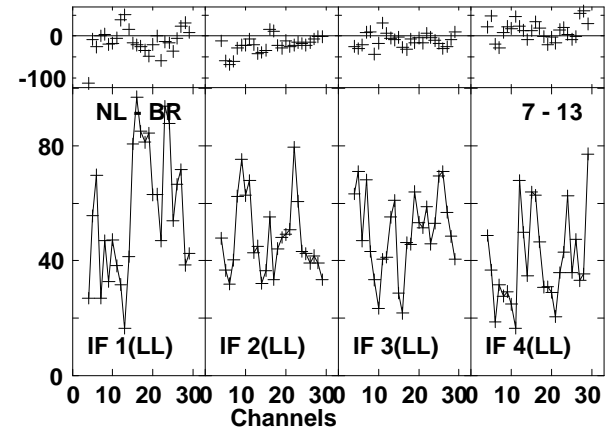
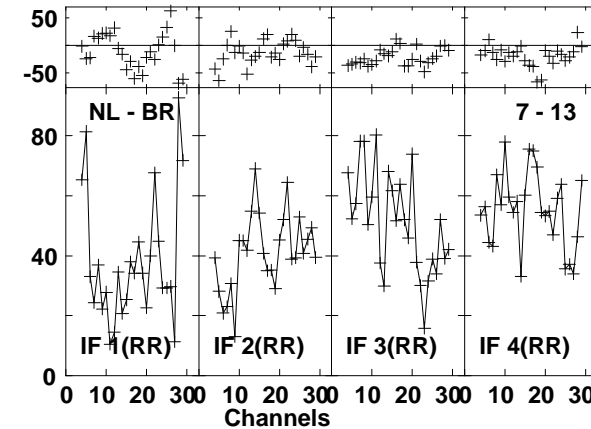
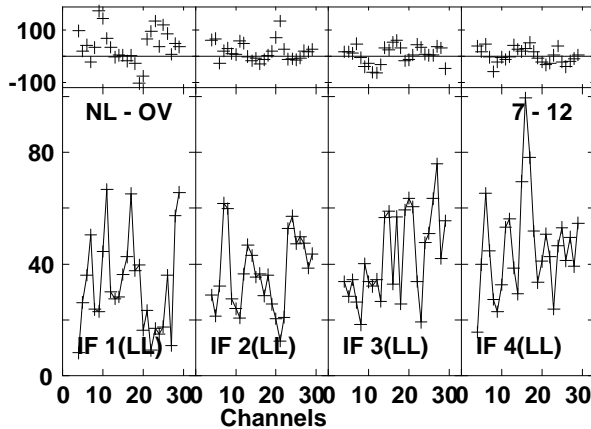
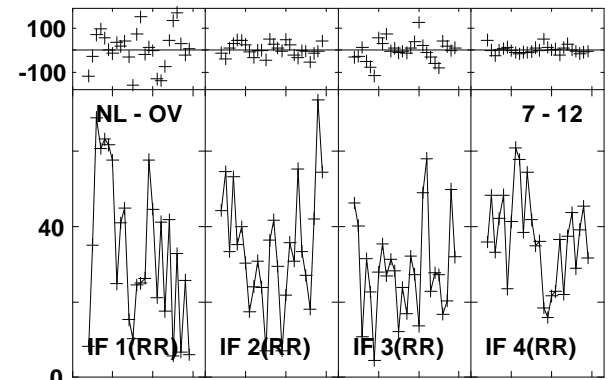
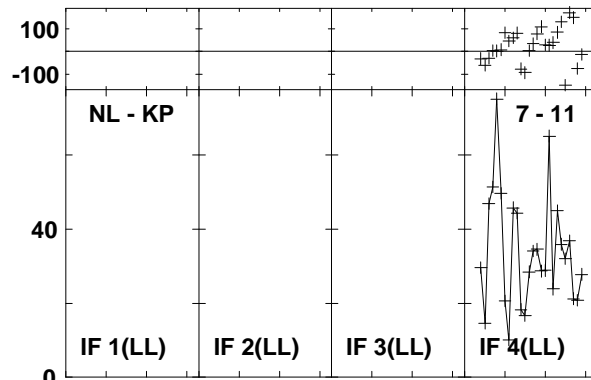
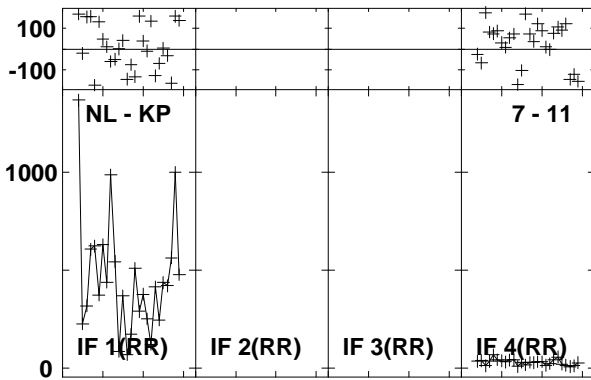
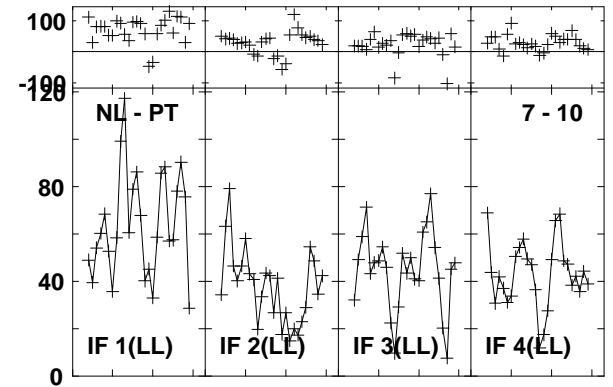
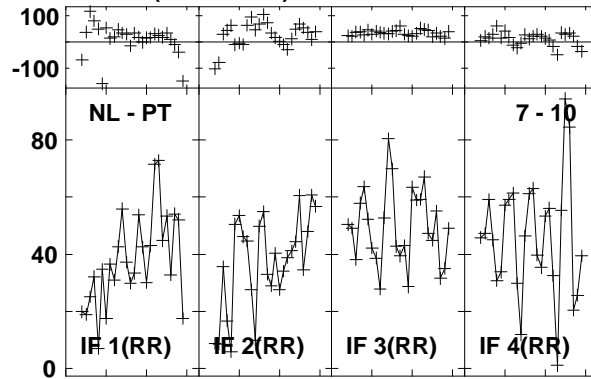
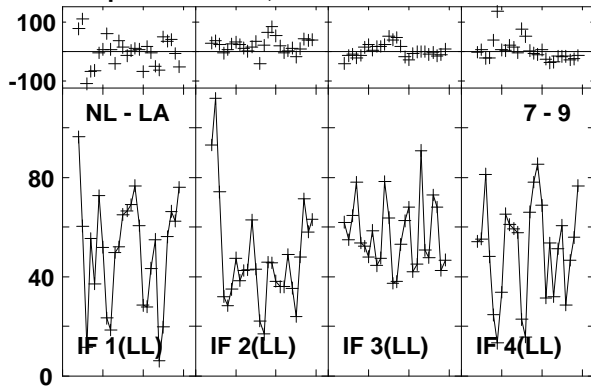

Lower frame: Milli Ampl Jy Top frame: Phas deg
Vector averaged cross-power spectrum Baseline: NL (07) - LA (09)
Timerange: 00/22:27:03 to 00/22:30:19

Plot file version 825 created 03-MAR-2016 01:14:20
 4C52 GN002C 1.UVDATA.1
 Freq = 1.2770 GHz, Bw = 16.000 MH Calibrated with CL # 3 and BP # 1 (BP mode 1)

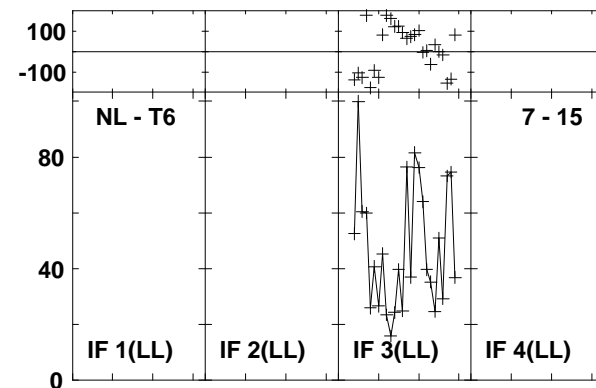
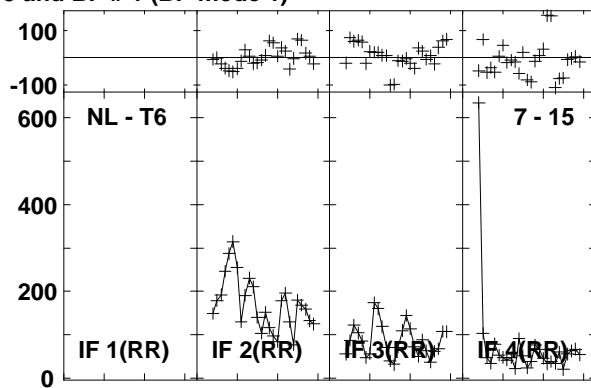
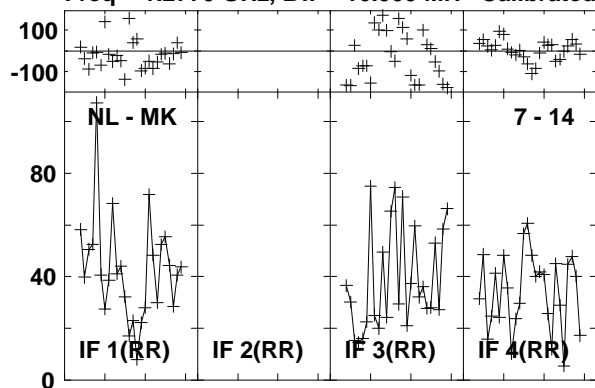

Lower frame: Milli Ampl Jy Top frame: Phas deg
 Vector averaged cross-power spectrum Baseline: NL (07) - MK (14)
 Timerange: 00/22:27:03 to 00/22:30:19

Plot file version 826 created 03-MAR-2016 01:14:20

J1545+5400 GN002C 1.UVDATA.1

Freq = 1.2770 GHz, Bw = 16.000 MH Calibrated with CL # 3 and BP # 1 (BP mode 1)

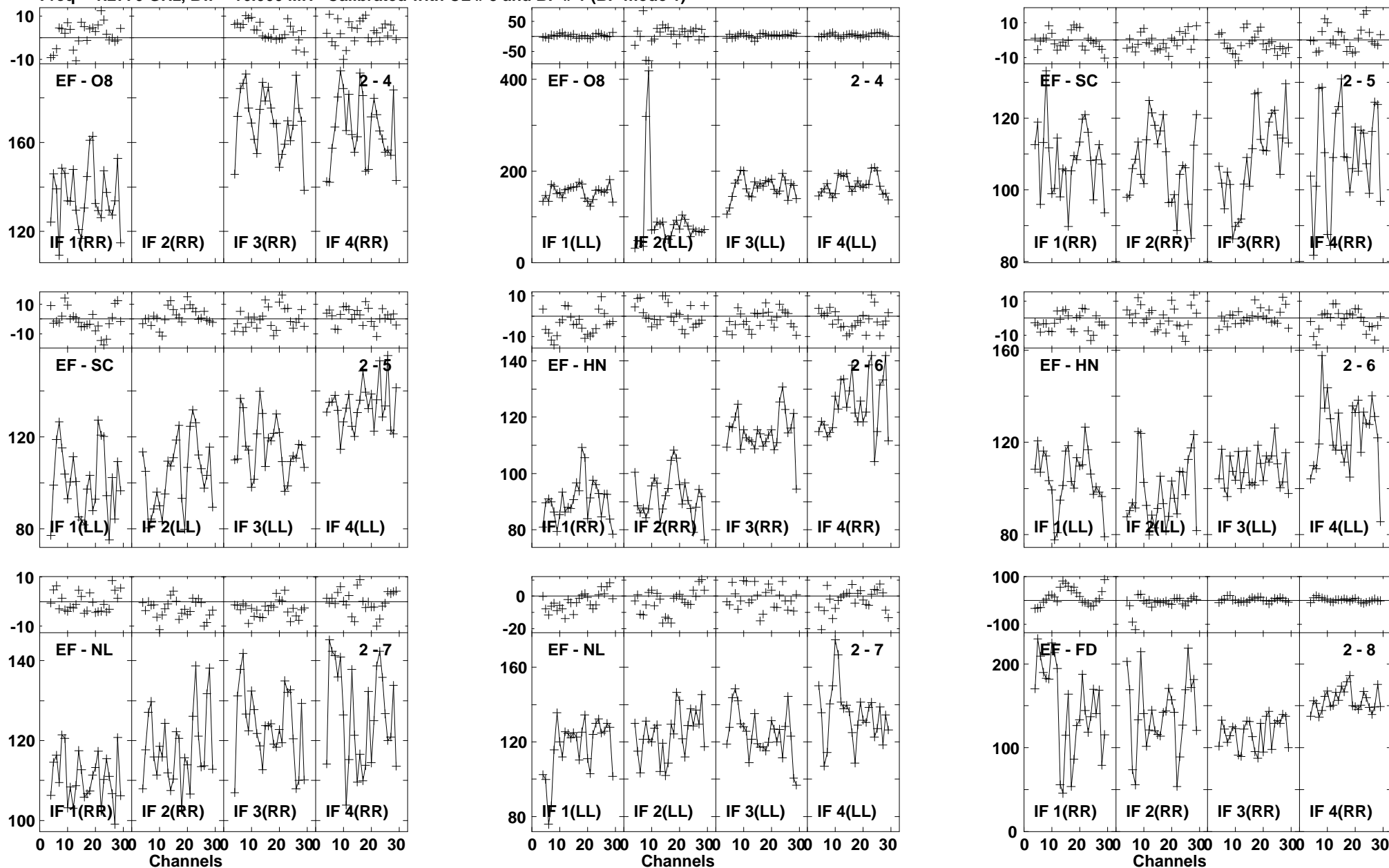

Lower frame: Milli Ampl Jy Top frame: Phas deg
Vector averaged cross-power spectrum Baseline: EF (02) - O8 (04)
Timerange: 00/22:31:12 to 00/22:32:10

Plot file version 827 created 03-MAR-2016 01:14:20

J1545+5400 GN002C 1.UVDATA.1

Freq = 1.2770 GHz, Bw = 16.000 MH Calibrated with CL # 3 and BP # 1 (BP mode 1)

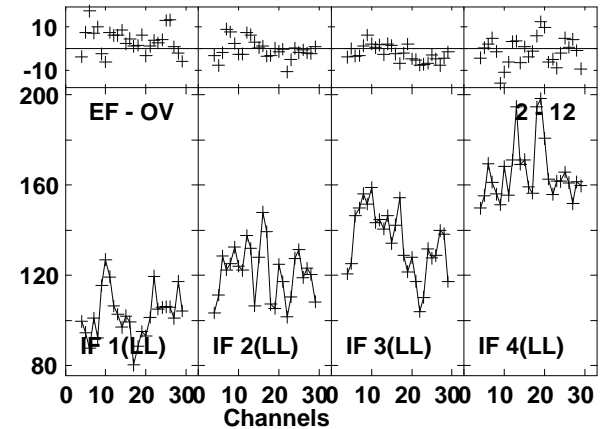
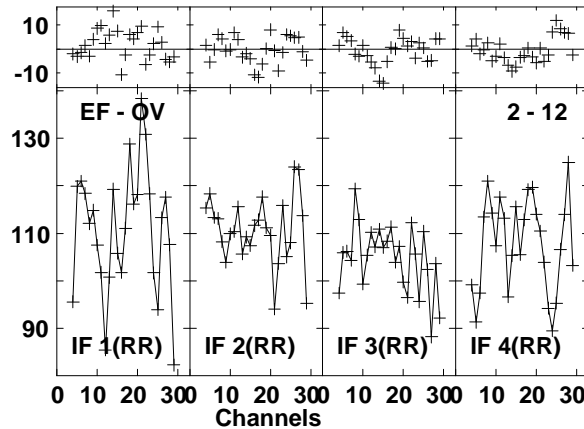
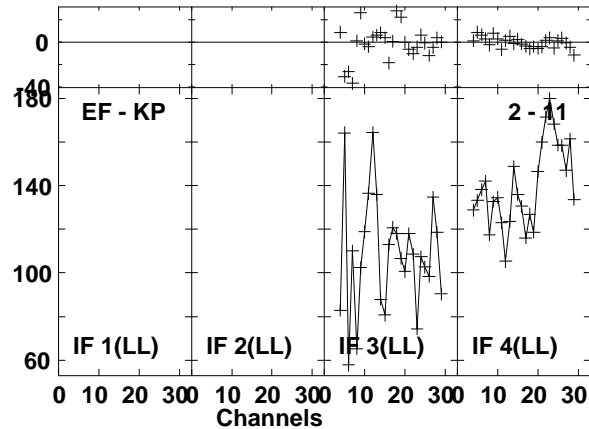
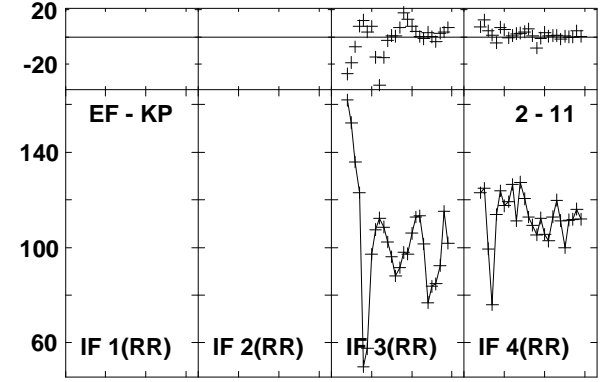
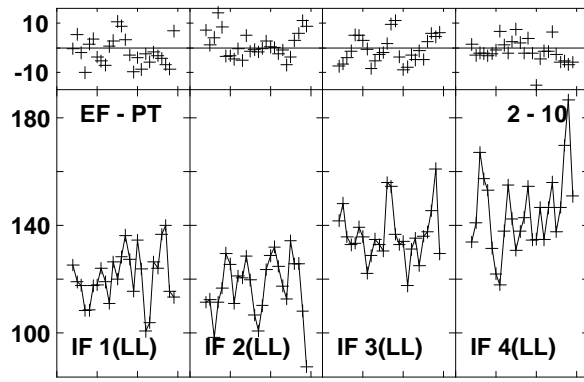
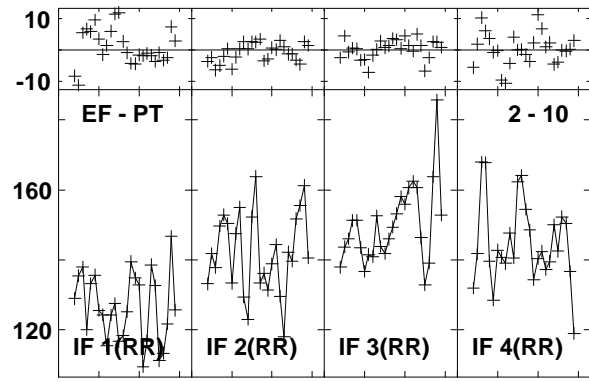
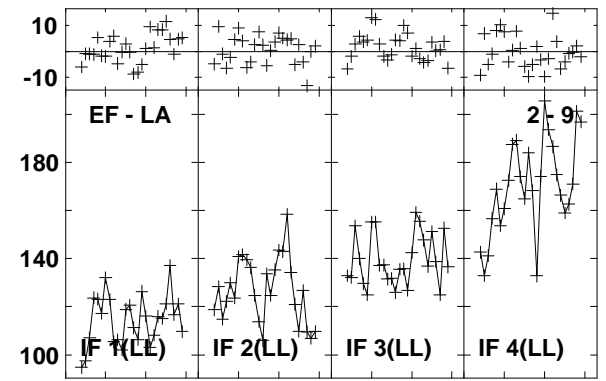
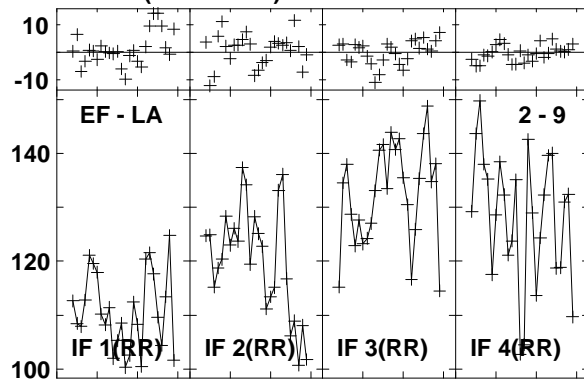
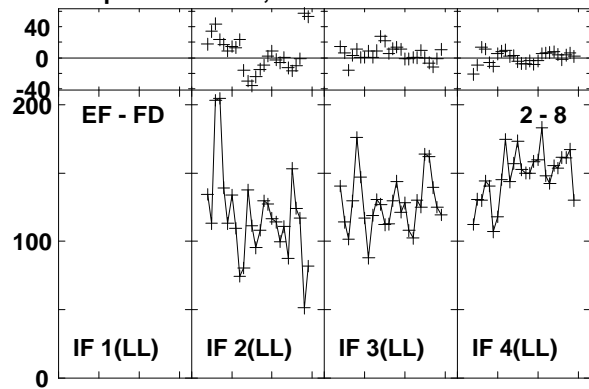

Lower frame: Milli Ampl Jy Top frame: Phas deg
Vector averaged cross-power spectrum Baseline: EF (02) - FD (08)
Timerange: 00/22:31:12 to 00/22:32:10

Plot file version 828 created 03-MAR-2016 01:14:20

J1545+5400 GN002C 1.UVDATA.1

Freq = 1.2770 GHz, Bw = 16.000 MH Calibrated with CL # 3 and BP # 1 (BP mode 1)

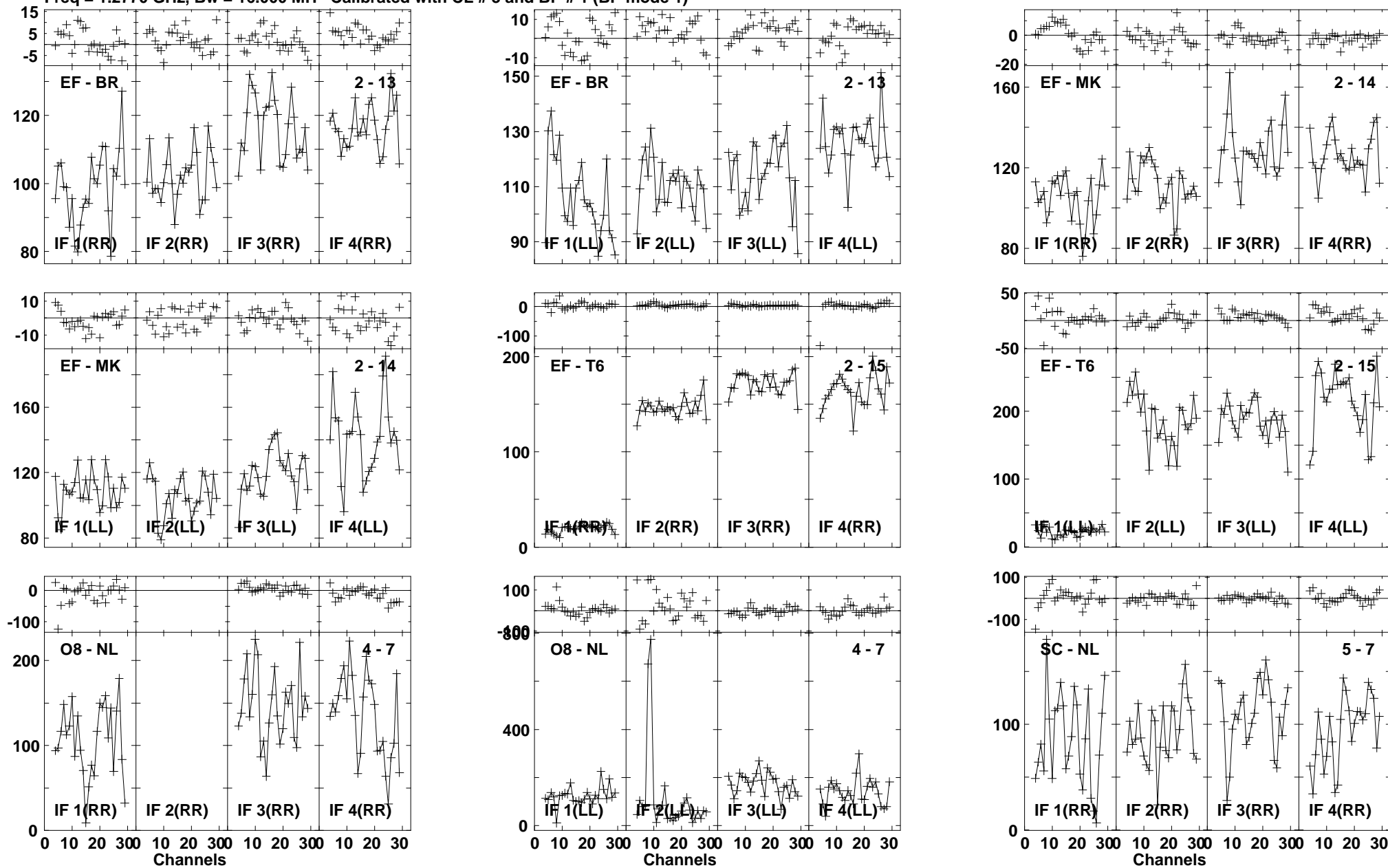

Lower frame: Milli Ampl Jy Top frame: Phas deg
Vector averaged cross-power spectrum Baseline: EF (02) - BR (13)
Timerange: 00/22:31:12 to 00/22:32:10

Plot file version 829 created 03-MAR-2016 01:14:20

J1545+5400 GN002C 1.UVDATA.1

Freq = 1.2770 GHz, Bw = 16.000 MH Calibrated with CL # 3 and BP # 1 (BP mode 1)

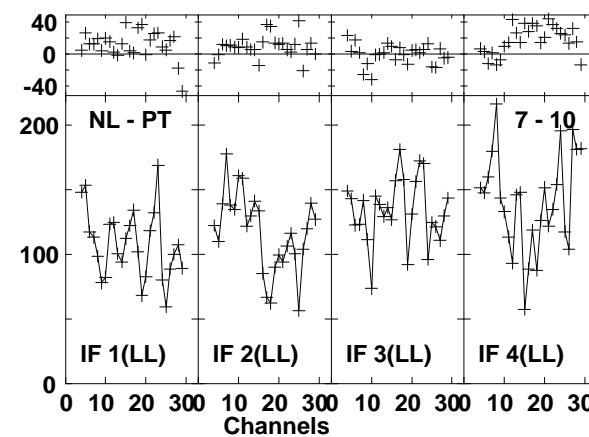
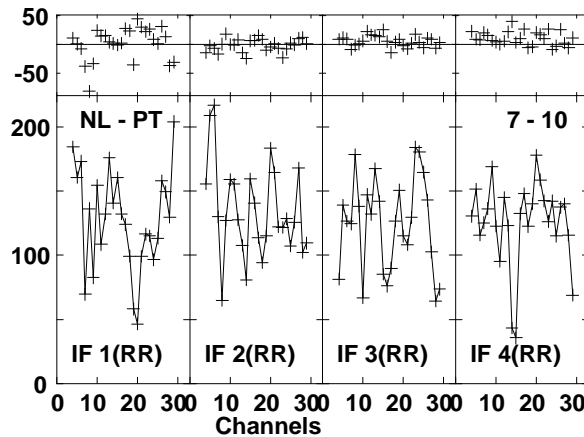
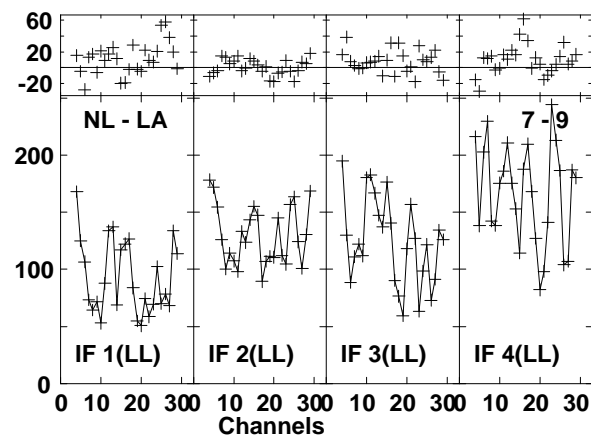
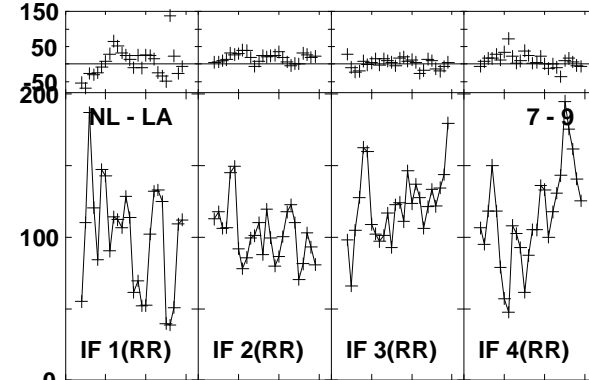
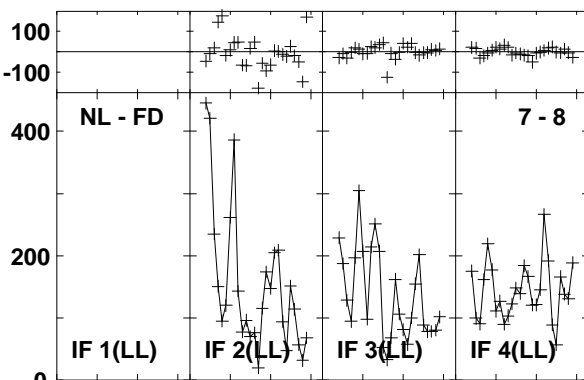
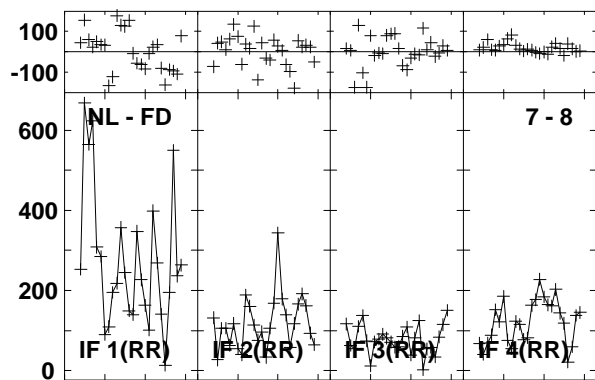
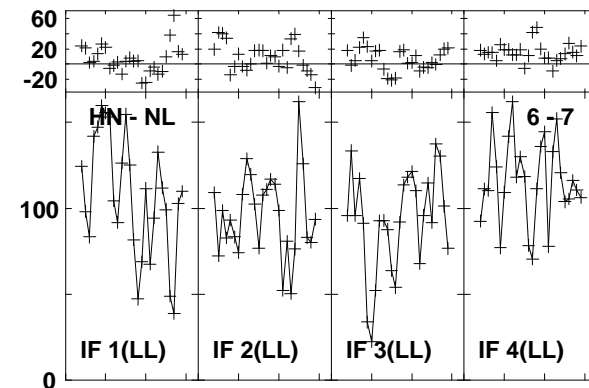
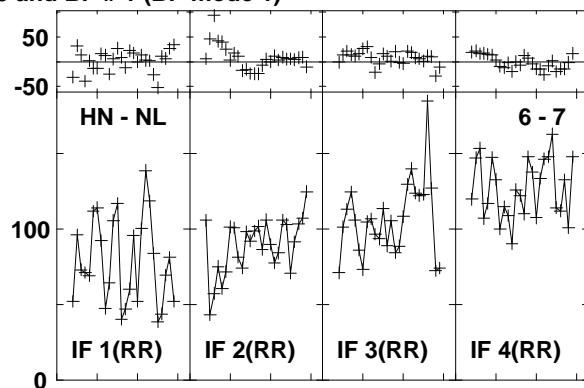
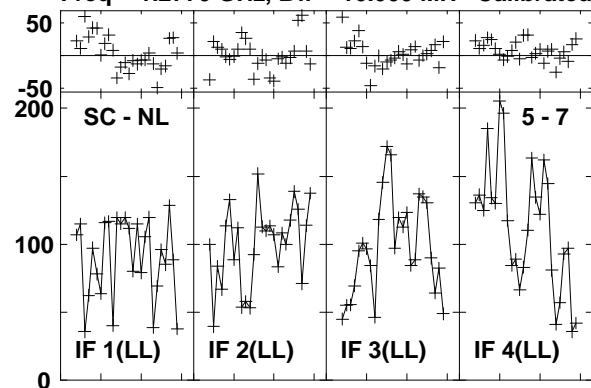

Lower frame: Milli Ampl Jy Top frame: Phas deg

Vector averaged cross-power spectrum Baseline: SC (05) - NL (07)

Timerange: 00/22:31:12 to 00/22:32:10

Plot file version 830 created 03-MAR-2016 01:14:21
 J1545+5400 GN002C 1.UVDATA.1
 Freq = 1.2770 GHz, Bw = 16.000 MH Calibrated with CL # 3 and BP # 1 (BP mode 1)

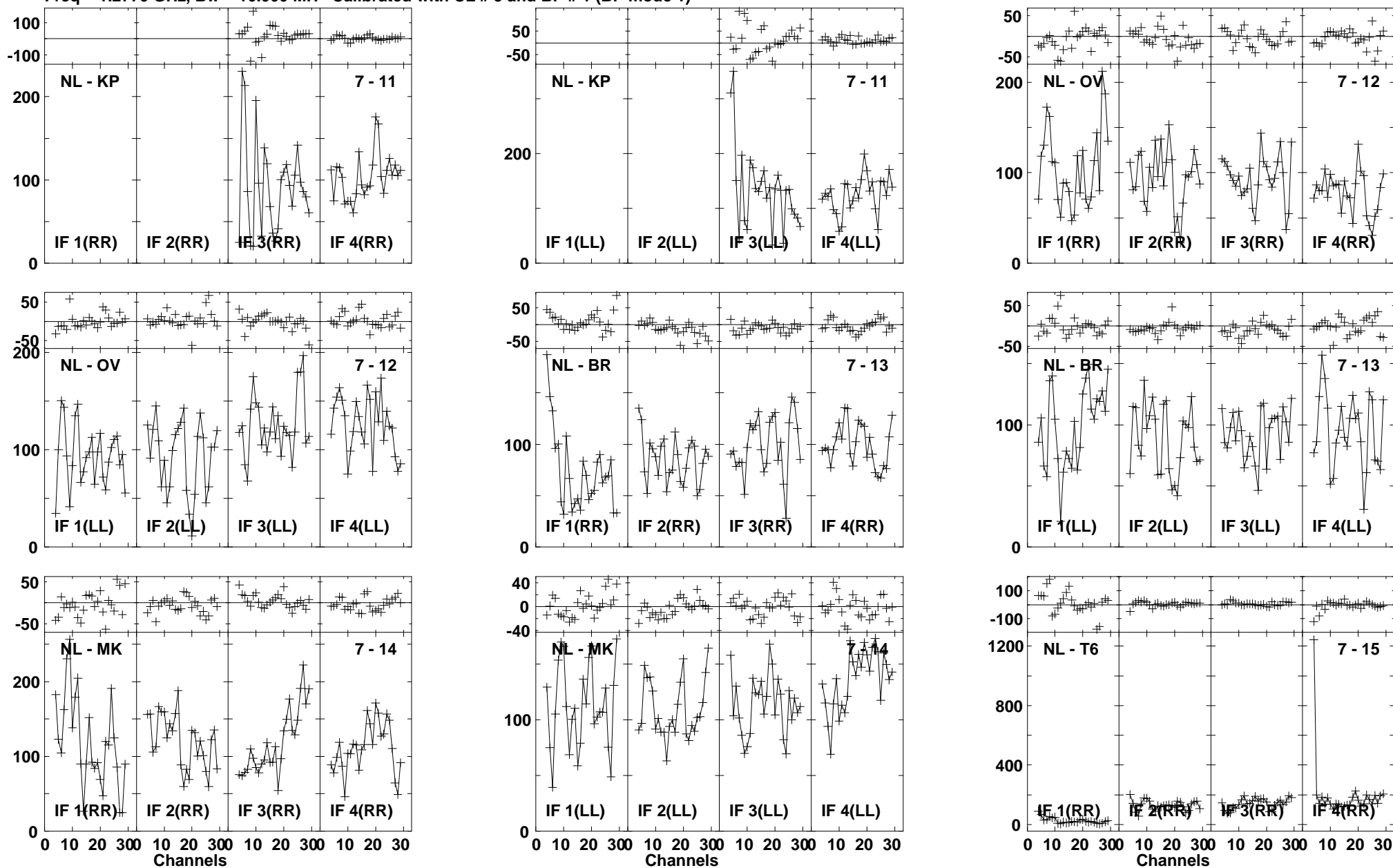

Lower frame: Milli Ampl Jy Top frame: Phas deg
 Vector averaged cross-power spectrum Baseline: NL (07) - KP (11)
 Timerange: 00:22:31:12 to 00:22:32:10

Plot file version 831 created 03-MAR-2016 01:14:21
J1545+5400 GN002C 1.UVDATA.1
Freq = 1.2770 GHz, Bw = 16.000 MH Calibrated with CL # 3 and BP # 1 (BP mode 1)

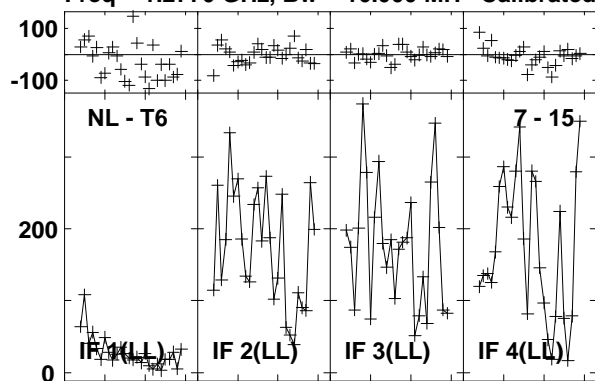

Lower frame: Milli Ampl Jy Top frame: Phas deg
Vector averaged cross-power spectrum Baseline: NL (07) - T6 (15)
Timerange: 00/22:31:12 to 00/22:32:10

Plot file version 832 created 03-MAR-2016 01:14:21

4C52 GN002C 1.UVDATA.1

Freq = 1.2770 GHz, Bw = 16.000 MH Calibrated with CL # 3 and BP # 1 (BP mode 1)

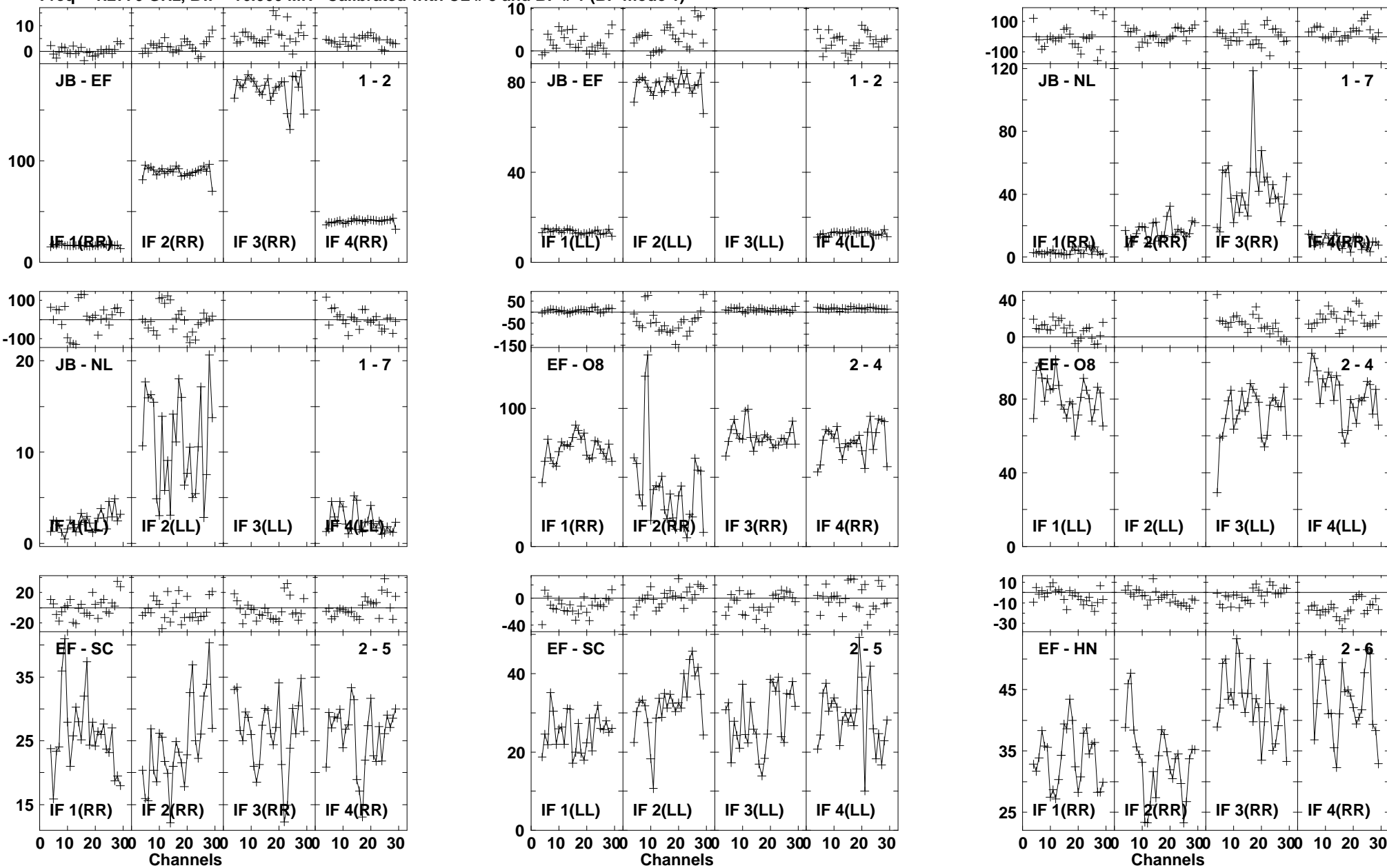

Lower frame: Milli Ampl Jy Top frame: Phas deg
Vector averaged cross-power spectrum Baseline: JB (01) - EF (02)
Timerange: 00/22:32:15 to 00/22:35:39

Plot file version 833 created 03-MAR-2016 01:14:21

4C52 GN002C 1.UVDATA.1

Freq = 1.2770 GHz, Bw = 16.000 MH Calibrated with CL # 3 and BP # 1 (BP mode 1)

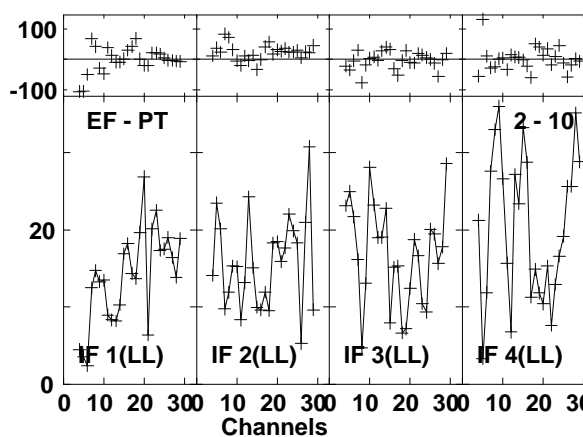
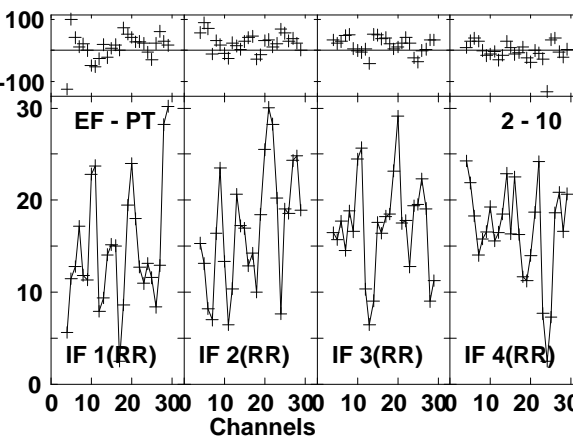
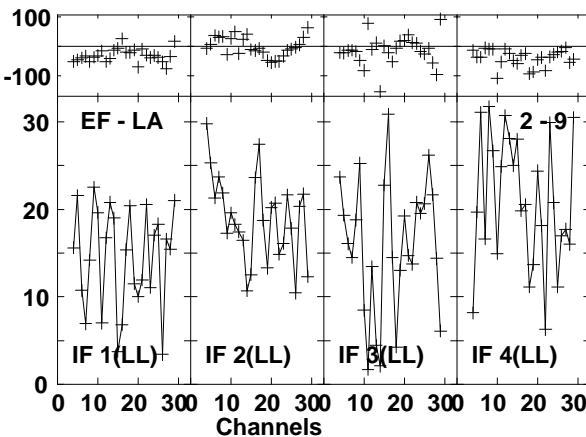
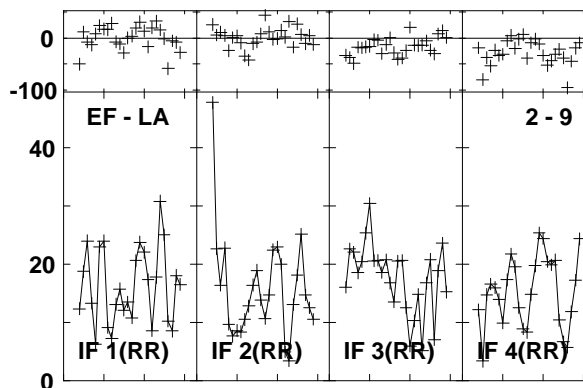
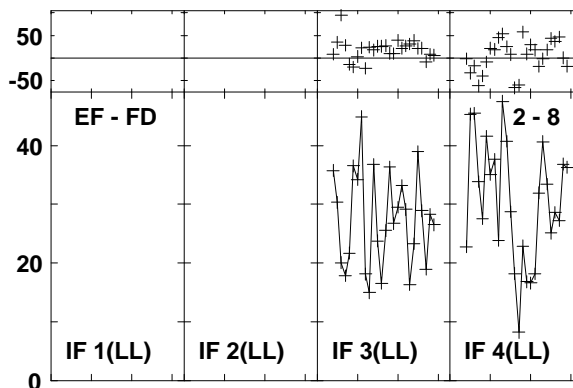
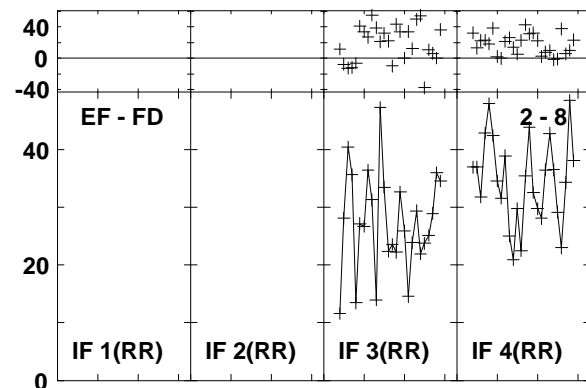
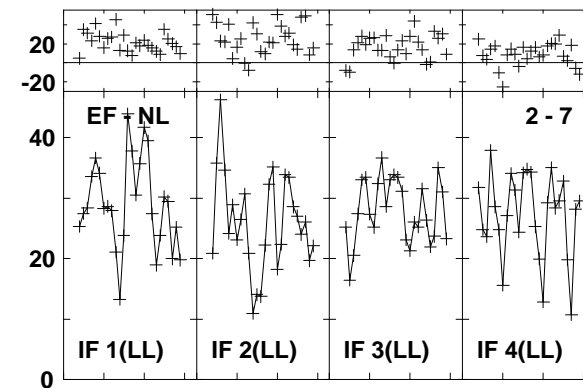
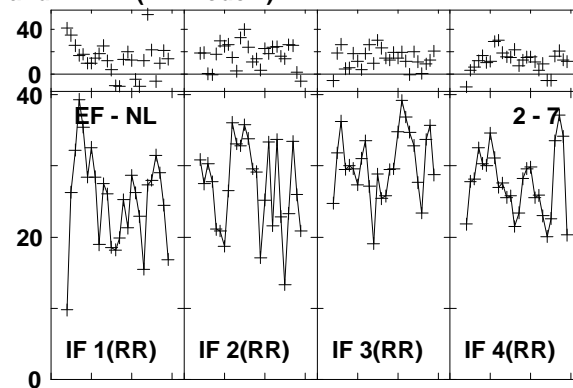
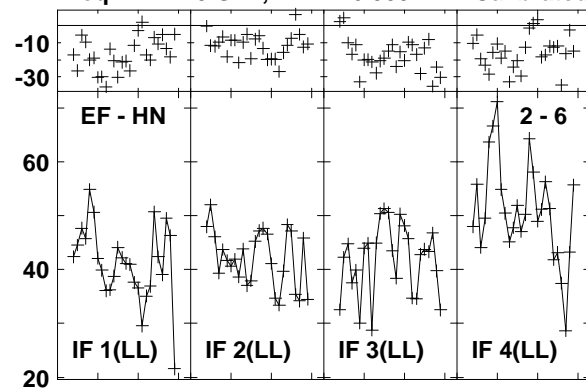

Lower frame: Milli Ampl Jy Top frame: Phas deg
Vector averaged cross-power spectrum Baseline: EF (02) - HN (06)
Timerange: 00/22:32:15 to 00/22:35:39

Plot file version 834 created 03-MAR-2016 01:14:21
 4C52 GN002C 1.UVDATA.1
 Freq = 1.2770 GHz, Bw = 16.000 MH Calibrated with CL # 3 and BP # 1 (BP mode 1)

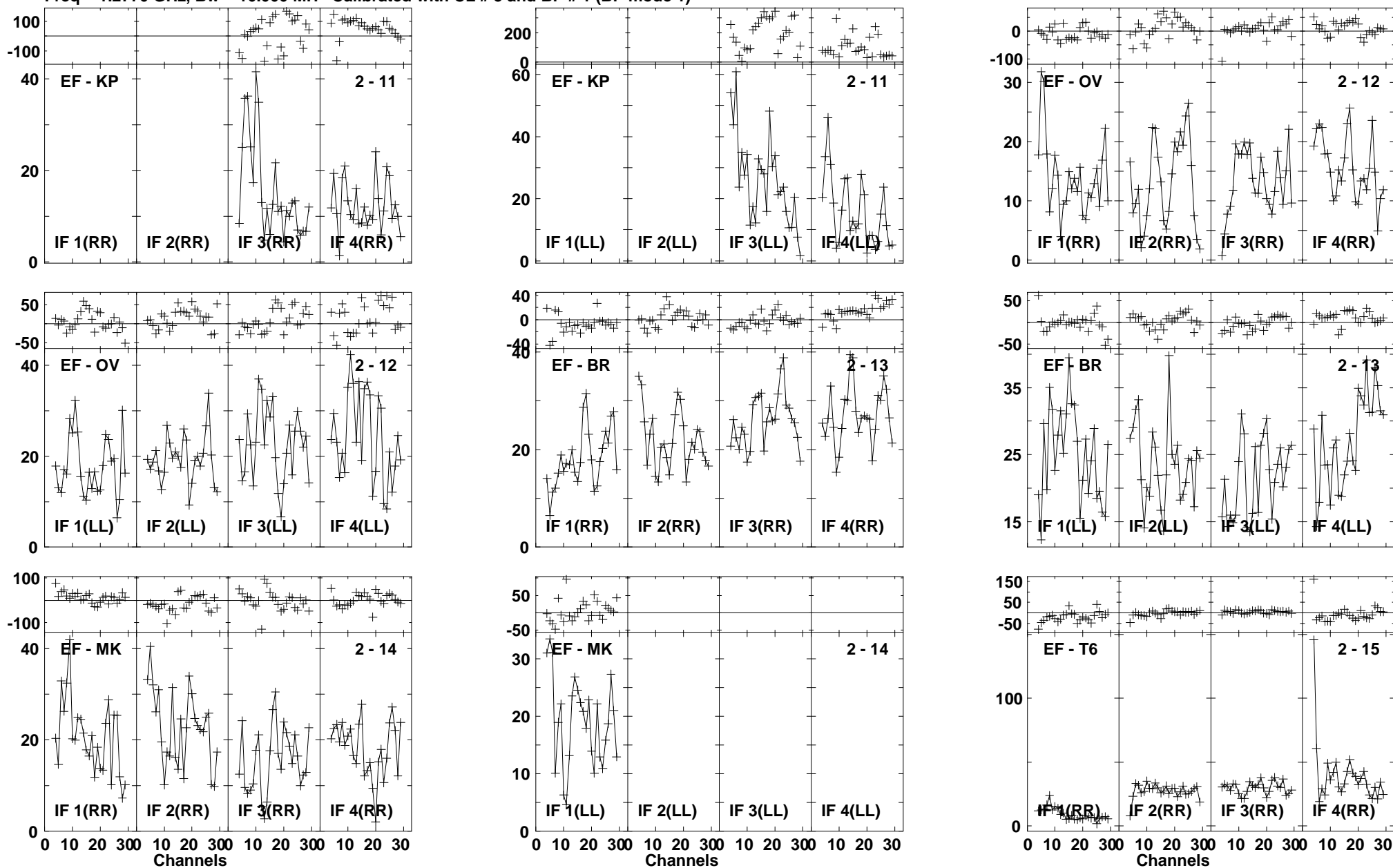

Lower frame: Milli Ampl Jy Top frame: Phas deg
 Vector averaged cross-power spectrum Baseline: EF (02) - KP (11)
 Timerange: 00/22:32:15 to 00/22:35:39

Plot file version 835 created 03-MAR-2016 01:14:21

4C52 GN002C 1.UVDATA.1

Freq = 1.2770 GHz, Bw = 16.000 MH Calibrated with CL # 3 and BP # 1 (BP mode 1)

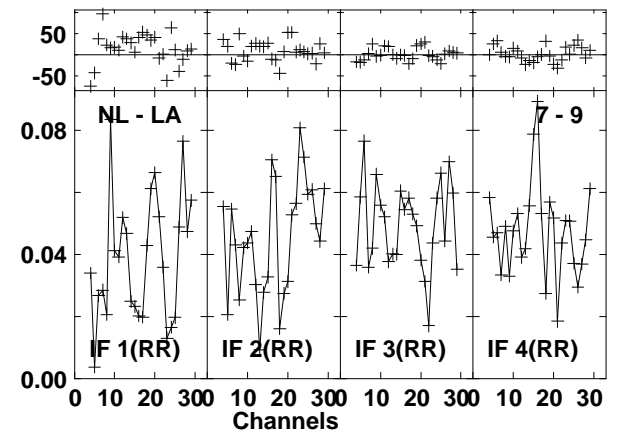
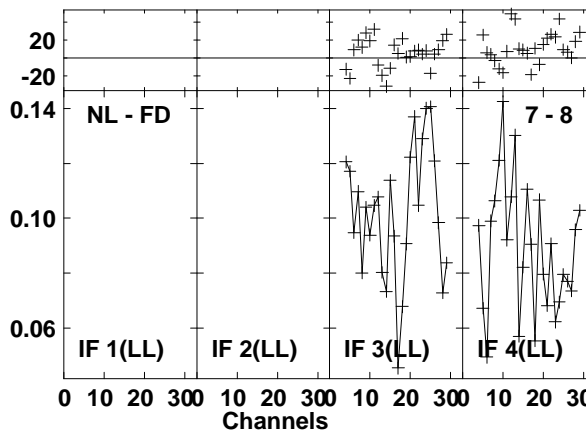
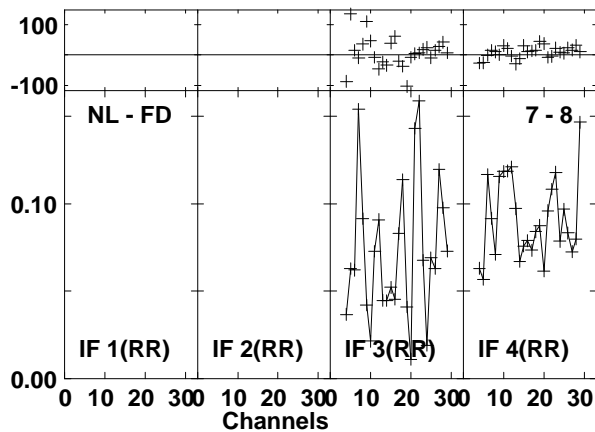
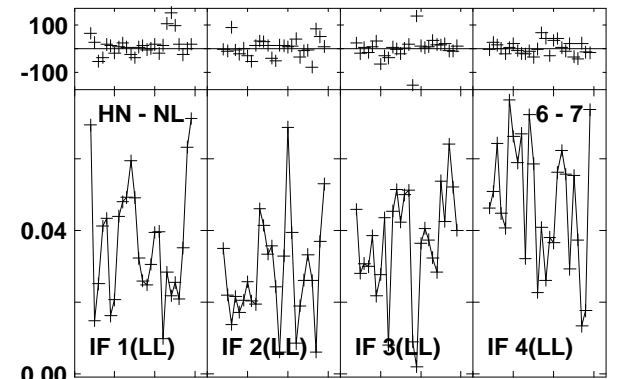
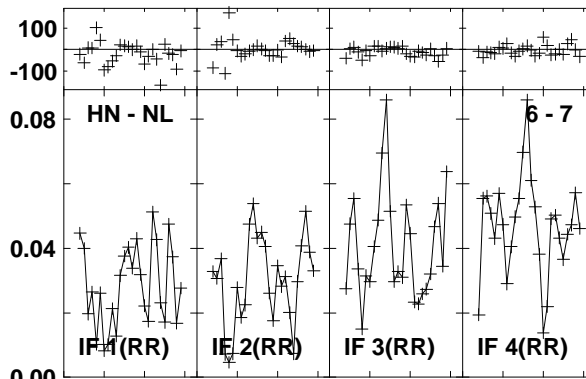
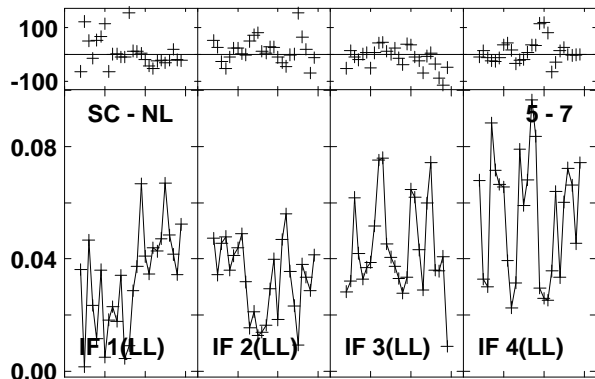
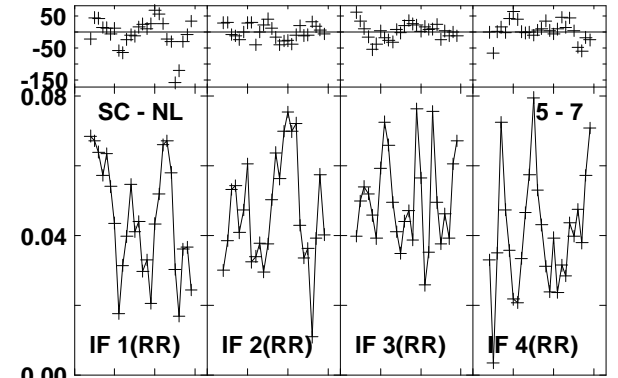
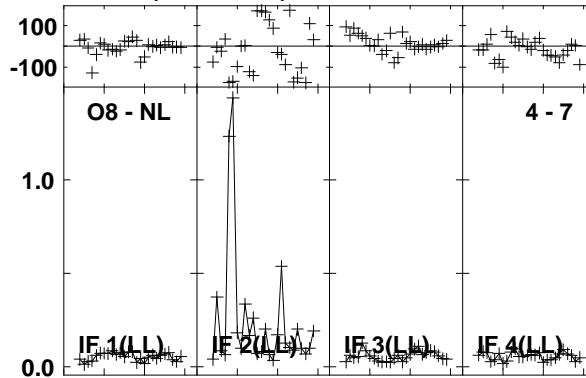
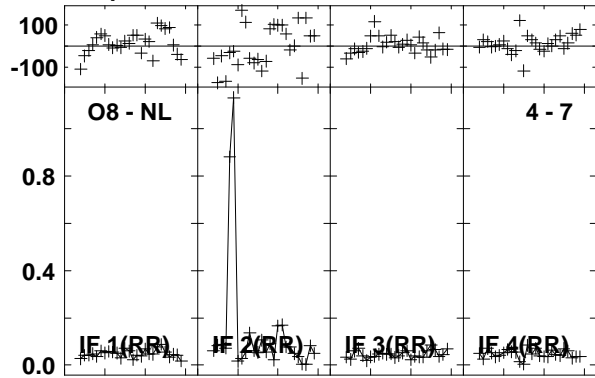

Lower frame: Ampl Jy Top frame: Phas deg
Vector averaged cross-power spectrum Baseline: O8 (04) - NL (07)
Timerange: 00/22:32:15 to 00/22:35:39

Plot file version 836 created 03-MAR-2016 01:14:22

4C52 GN002C 1.UVDATA.1

Freq = 1.2770 GHz, Bw = 16.000 MH Calibrated with CL # 3 and BP # 1 (BP mode 1)

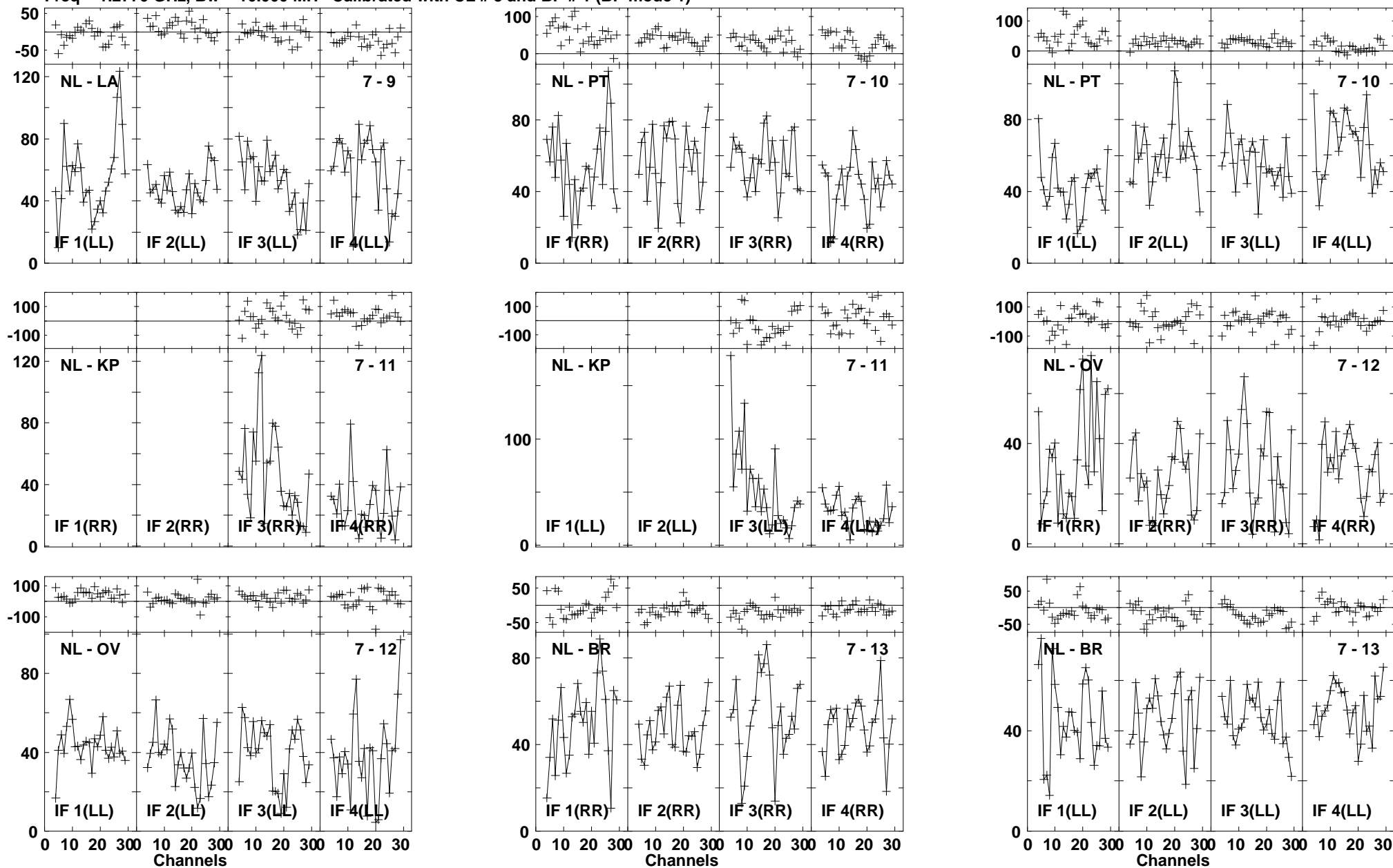

Lower frame: Milli Ampl Jy Top frame: Phas deg
Vector averaged cross-power spectrum Baseline: NL (07) - LA (09)
Timerange: 00/22:32:15 to 00/22:35:39

Plot file version 837 created 03-MAR-2016 01:14:22

4C52 GN002C 1.UVDATA.1

Freq = 1.2770 GHz, Bw = 16.000 MH Calibrated with CL # 3 and BP # 1 (BP mode 1)

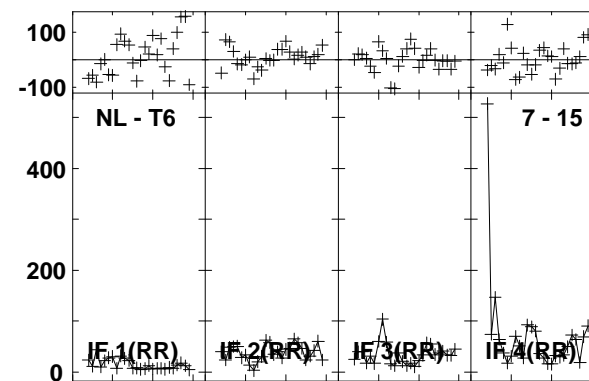
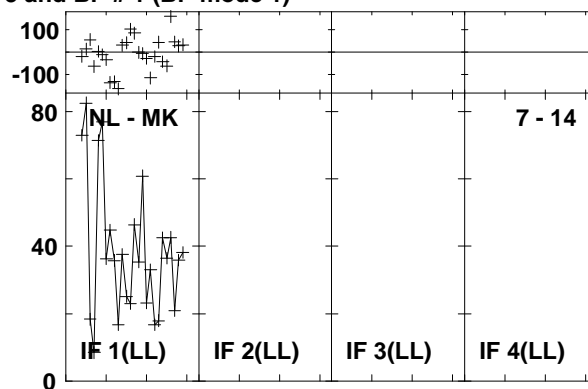
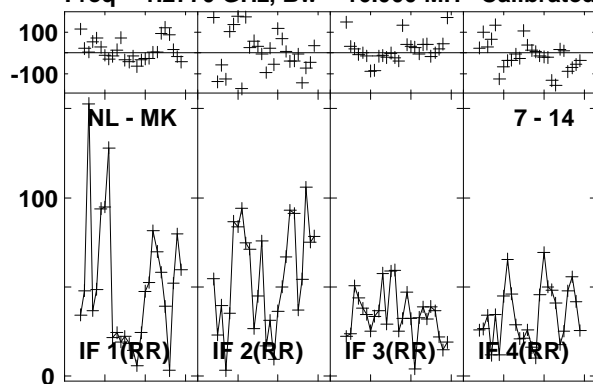

Lower frame: Milli Ampl Jy Top frame: Phas deg
Vector averaged cross-power spectrum Baseline: NL (07) - MK (14)
Timerange: 00/22:32:15 to 00/22:35:39

Plot file version 838 created 03-MAR-2016 01:14:22

J1545+5400 GN002C 1.UVDATA.1

Freq = 1.2770 GHz, Bw = 16.000 MH Calibrated with CL # 3 and BP # 1 (BP mode 1)

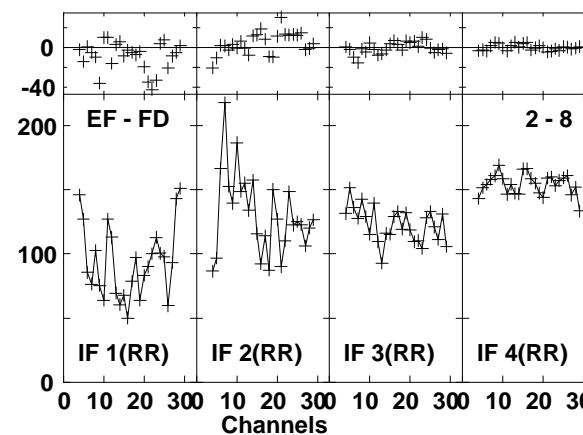
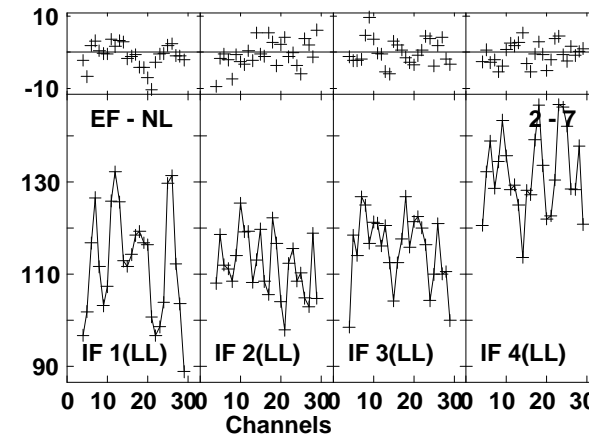
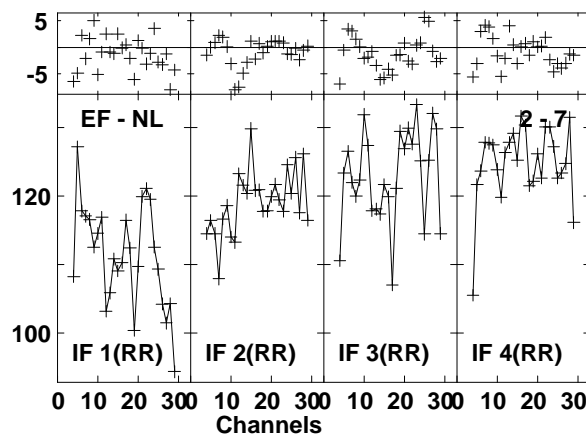
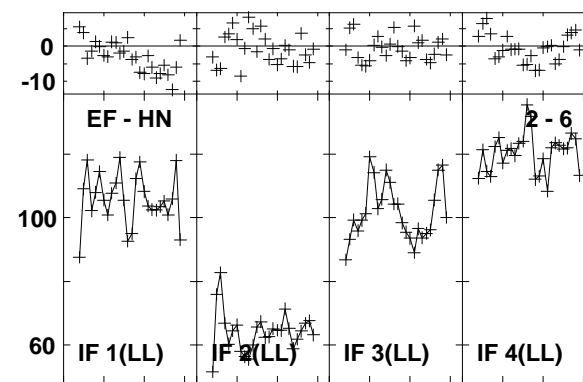
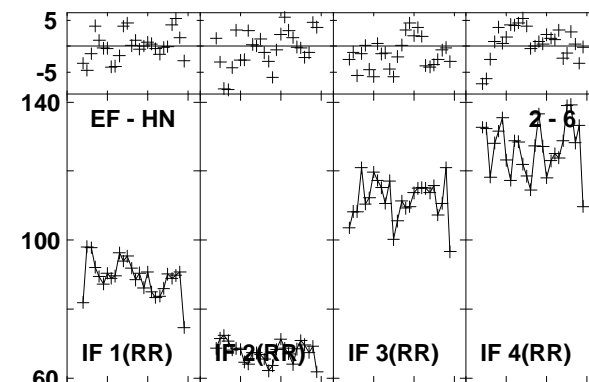
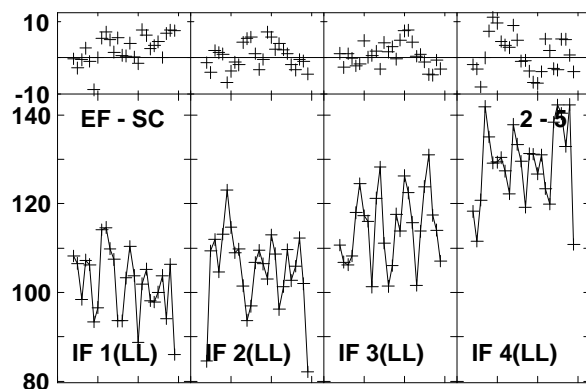
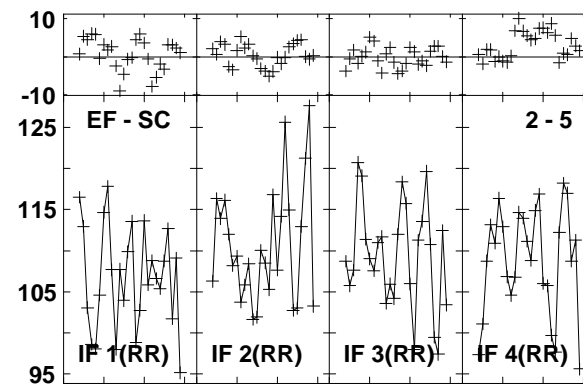
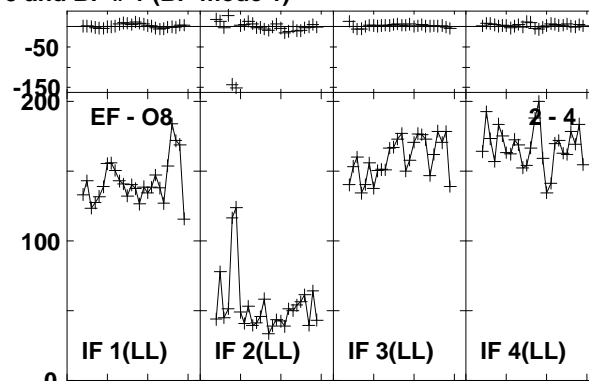
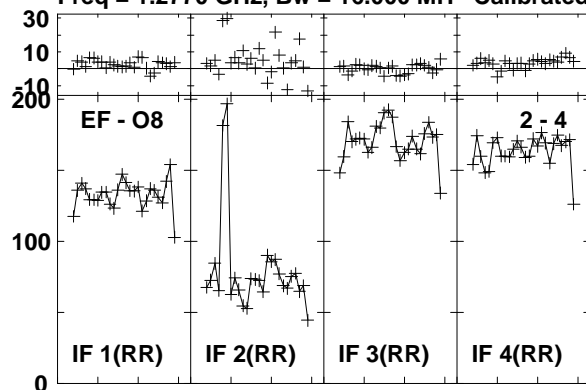

Lower frame: Milli Ampl Jy Top frame: Phas deg
Vector averaged cross-power spectrum Baseline: EF (02) - O8 (04)
Timerange: 00/22:36:32 to 00/22:39:00

Plot file version 839 created 03-MAR-2016 01:14:22

J1545+5400 GN002C 1.UVDATA.1

Freq = 1.2770 GHz, Bw = 16.000 MH Calibrated with CL # 3 and BP # 1 (BP mode 1)

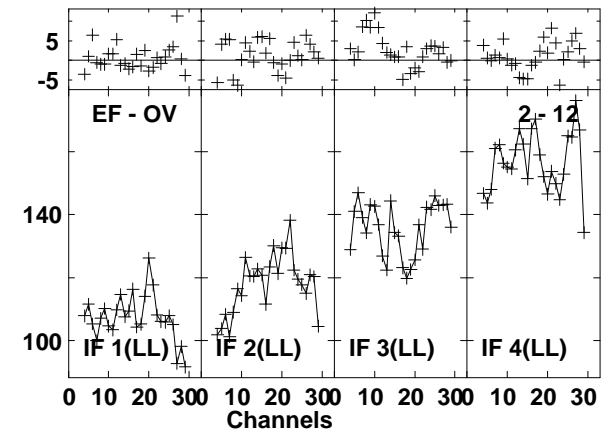
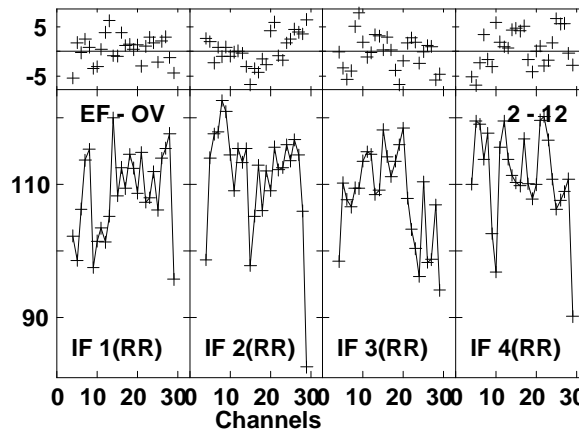
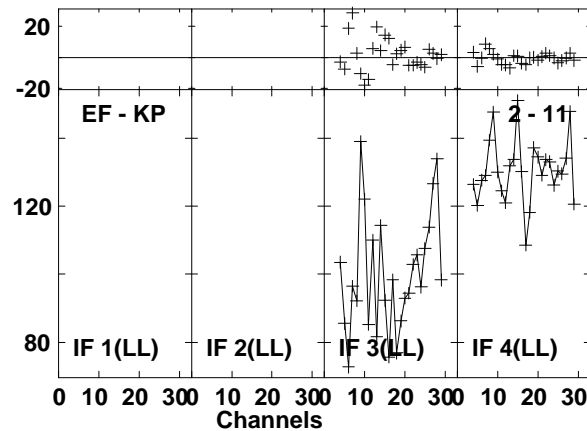
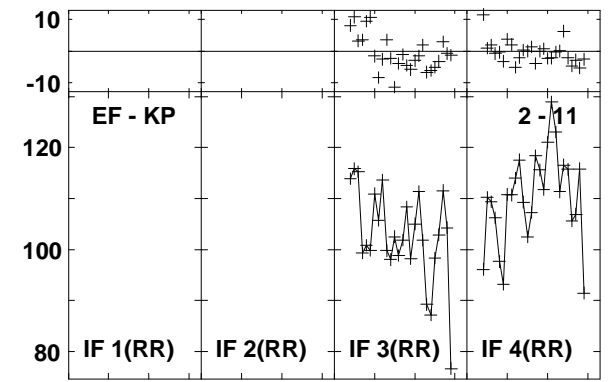
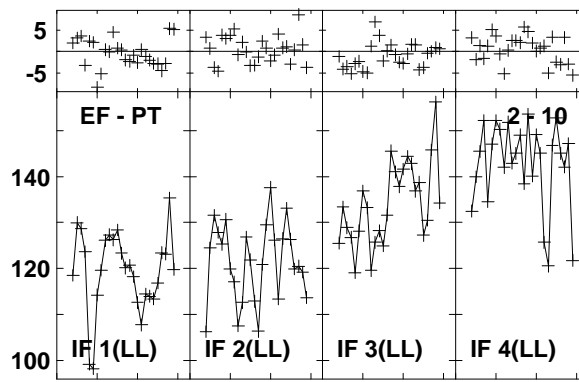
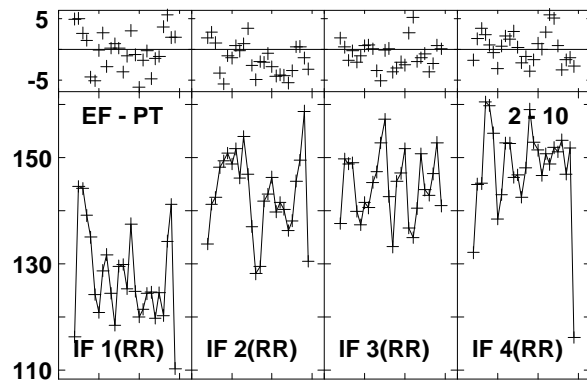
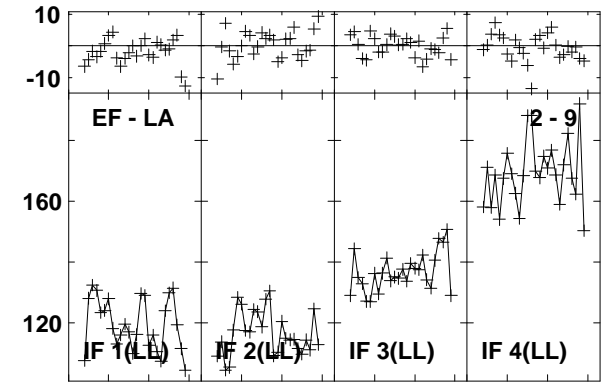
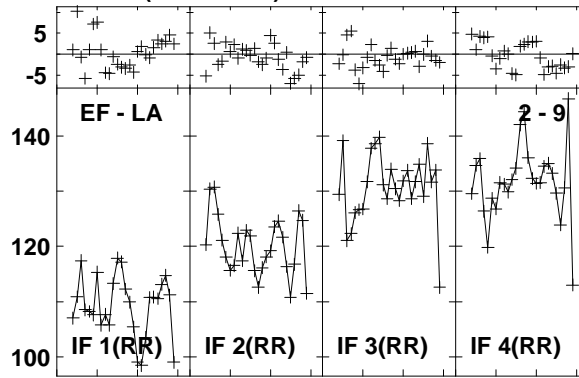
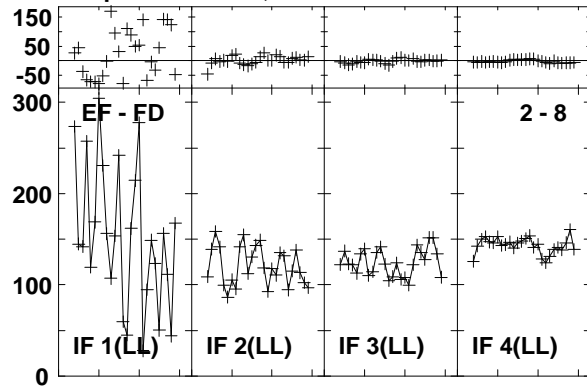

Lower frame: Milli Ampl Jy Top frame: Phas deg
Vector averaged cross-power spectrum Baseline: EF (02) - FD (08)
Timerange: 00/22:36:32 to 00/22:39:00

Plot file version 840 created 03-MAR-2016 01:14:22

J1545+5400 GN002C 1.UVDATA.1

Freq = 1.2770 GHz, Bw = 16.000 MH Calibrated with CL # 3 and BP # 1 (BP mode 1)

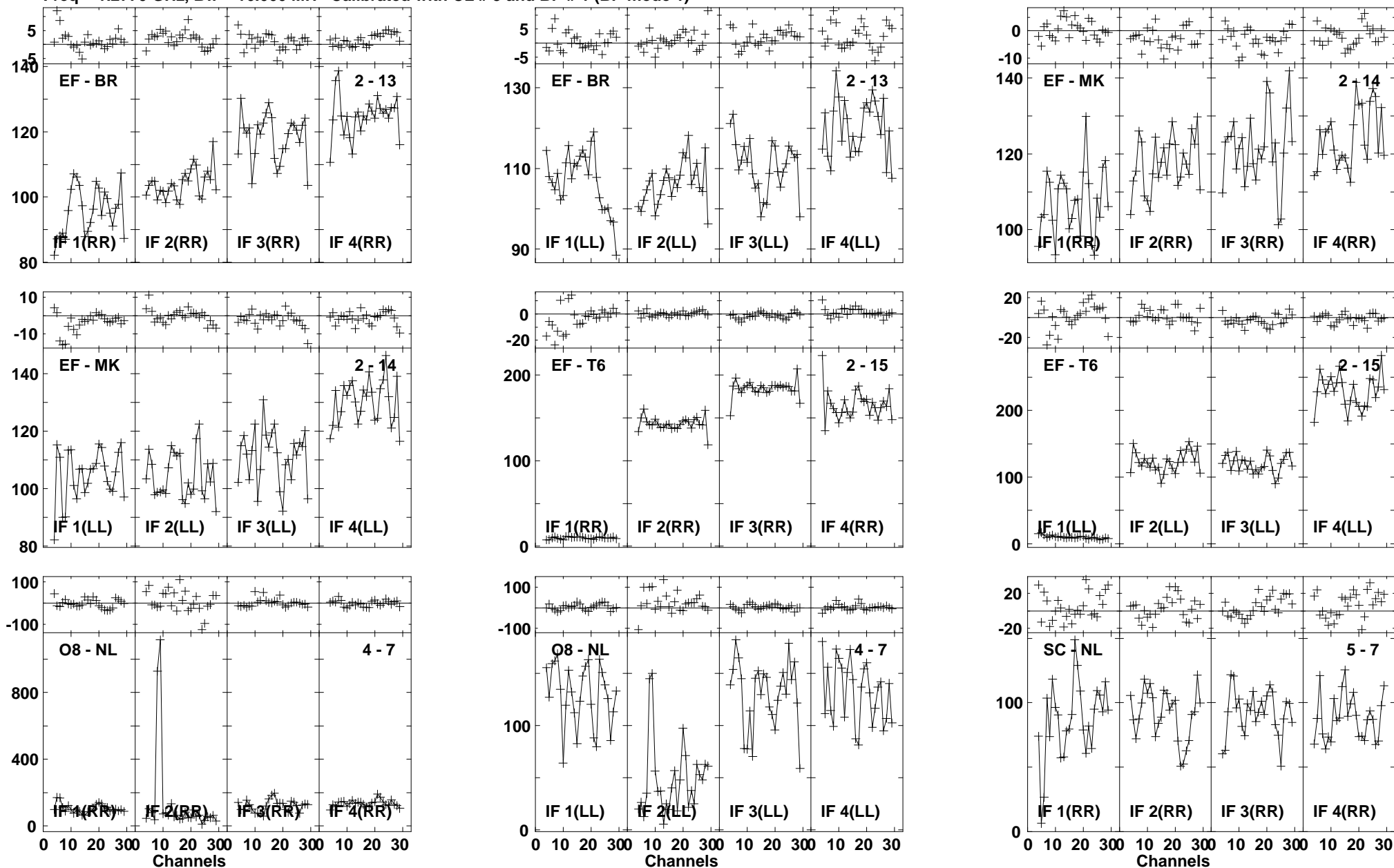

Lower frame: Milli Ampl Jy Top frame: Phas deg
Vector averaged cross-power spectrum Baseline: EF (02) - BR (13)
Timerange: 00/22:36:32 to 00/22:39:00

Plot file version 841 created 03-MAR-2016 01:14:22

J1545+5400 GN002C 1.UVDATA.1

Freq = 1.2770 GHz, Bw = 16.000 MH Calibrated with CL # 3 and BP # 1 (BP mode 1)

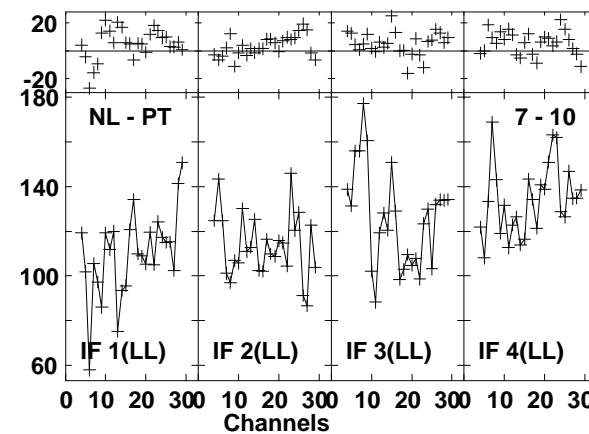
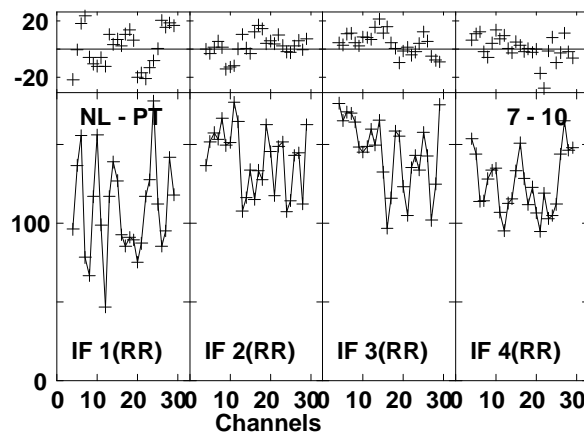
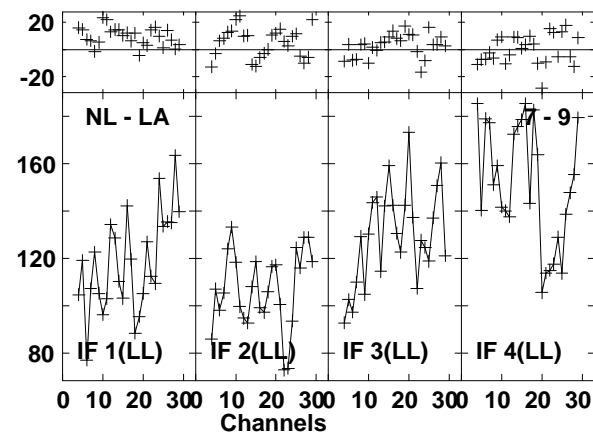
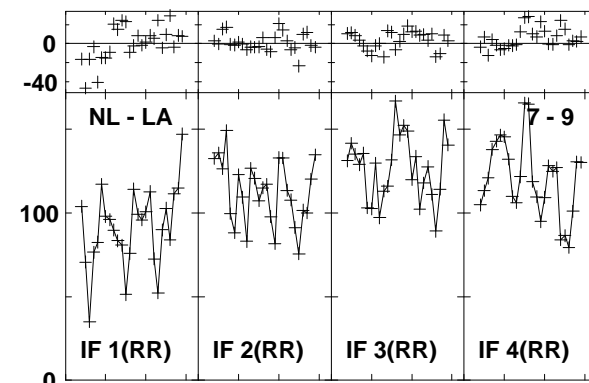
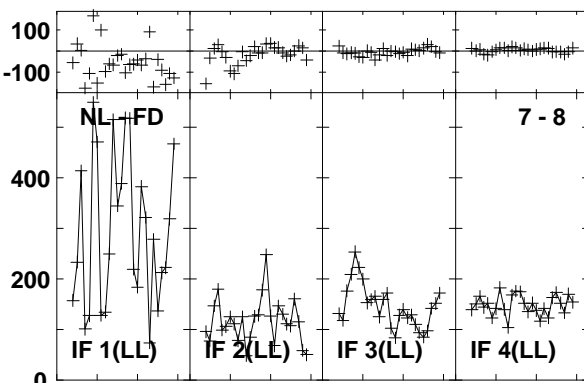
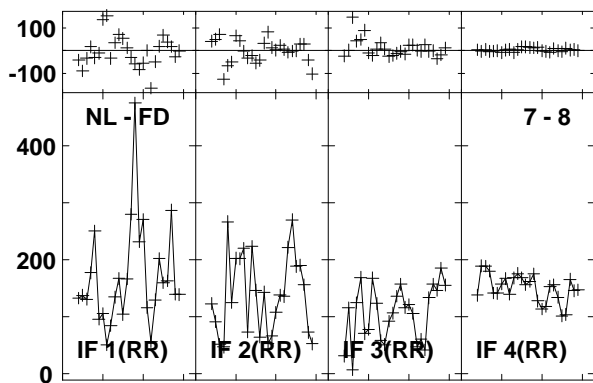
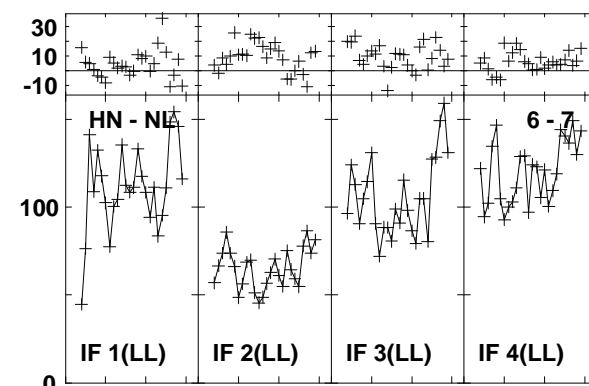
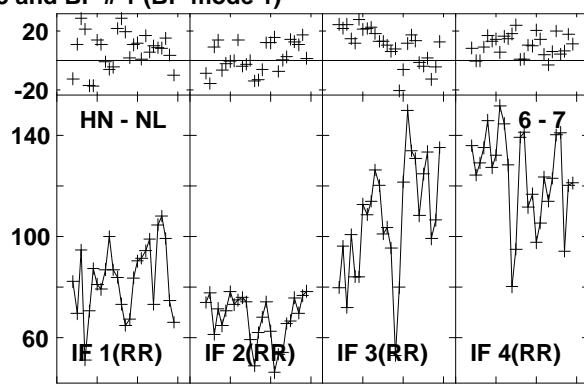
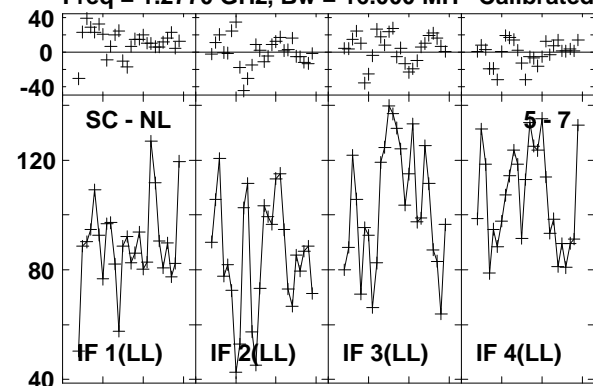

Lower frame: Milli Ampl Jy Top frame: Phas deg
Vector averaged cross-power spectrum Baseline: SC (05) - NL (07)
Timerange: 00:22:36:32 to 00:22:39:00

Plot file version 842 created 03-MAR-2016 01:14:23
 J1545+5400 GN002C 1.UVDATA.1
 Freq = 1.2770 GHz, Bw = 16.000 MH Calibrated with CL # 3 and BP # 1 (BP mode 1)

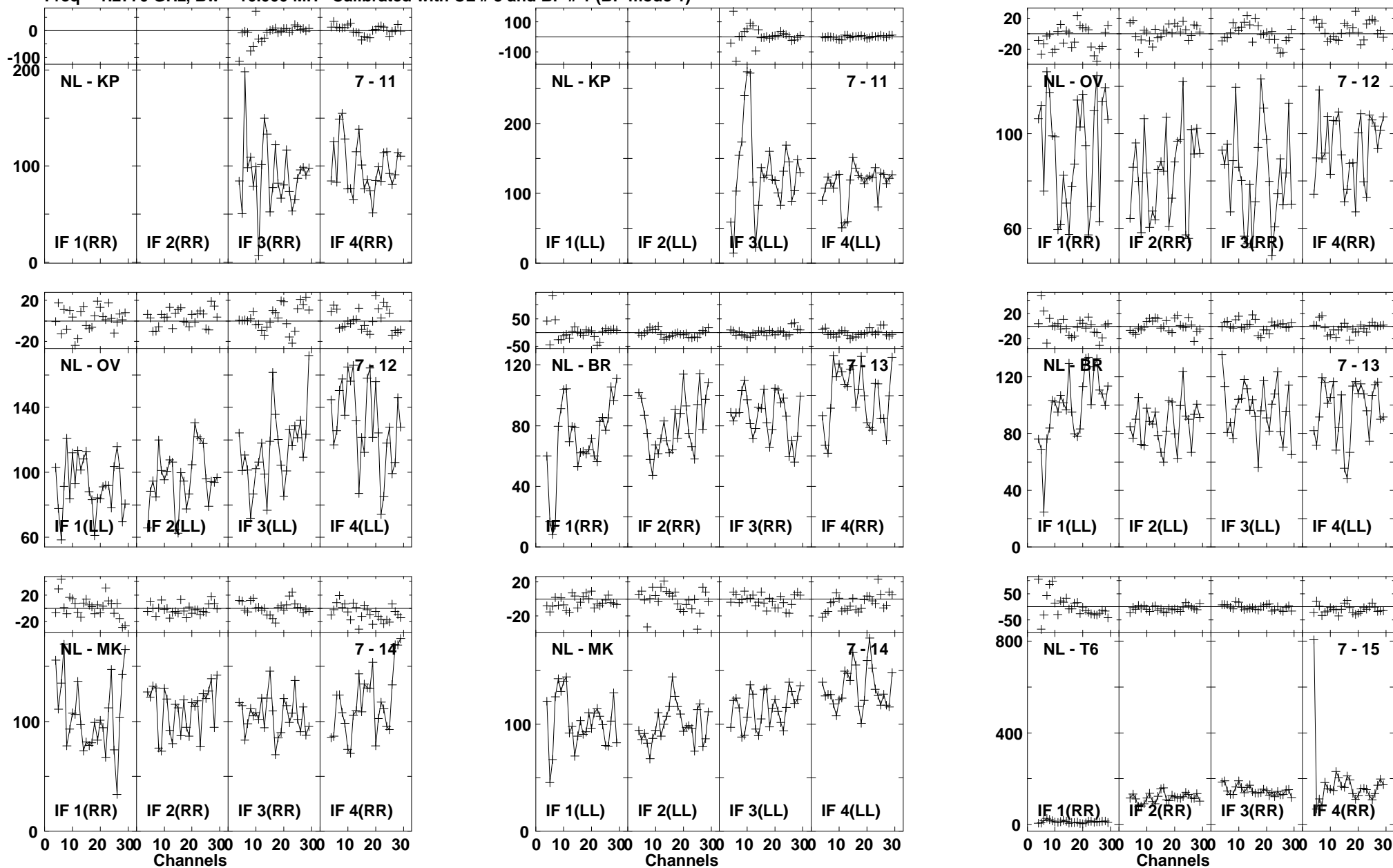

Lower frame: Milli Ampl Jy Top frame: Phas deg
 Vector averaged cross-power spectrum Baseline: NL (07) - KP (11)
 Timerange: 00/22:36:32 to 00/22:39:00

Plot file version 843 created 03-MAR-2016 01:14:23
J1545+5400 GN002C 1.UVDATA.1
Freq = 1.2770 GHz, Bw = 16.000 MH Calibrated with CL # 3 and BP # 1 (BP mode 1)

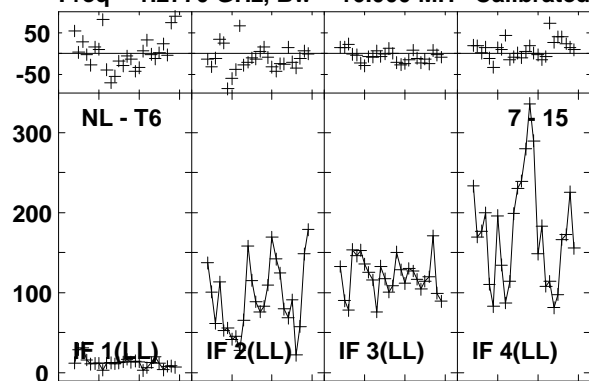

Lower frame: Milli Ampl Jy Top frame: Phas deg
Vector averaged cross-power spectrum Baseline: NL (07) - T6 (15)
Timerange: 00/22:36:32 to 00/22:39:00

Plot file version 844 created 03-MAR-2016 01:14:23

4C52 GN002C 1.UVDATA.1

Freq = 1.2770 GHz, Bw = 16.000 MH Calibrated with CL # 3 and BP # 1 (BP mode 1)

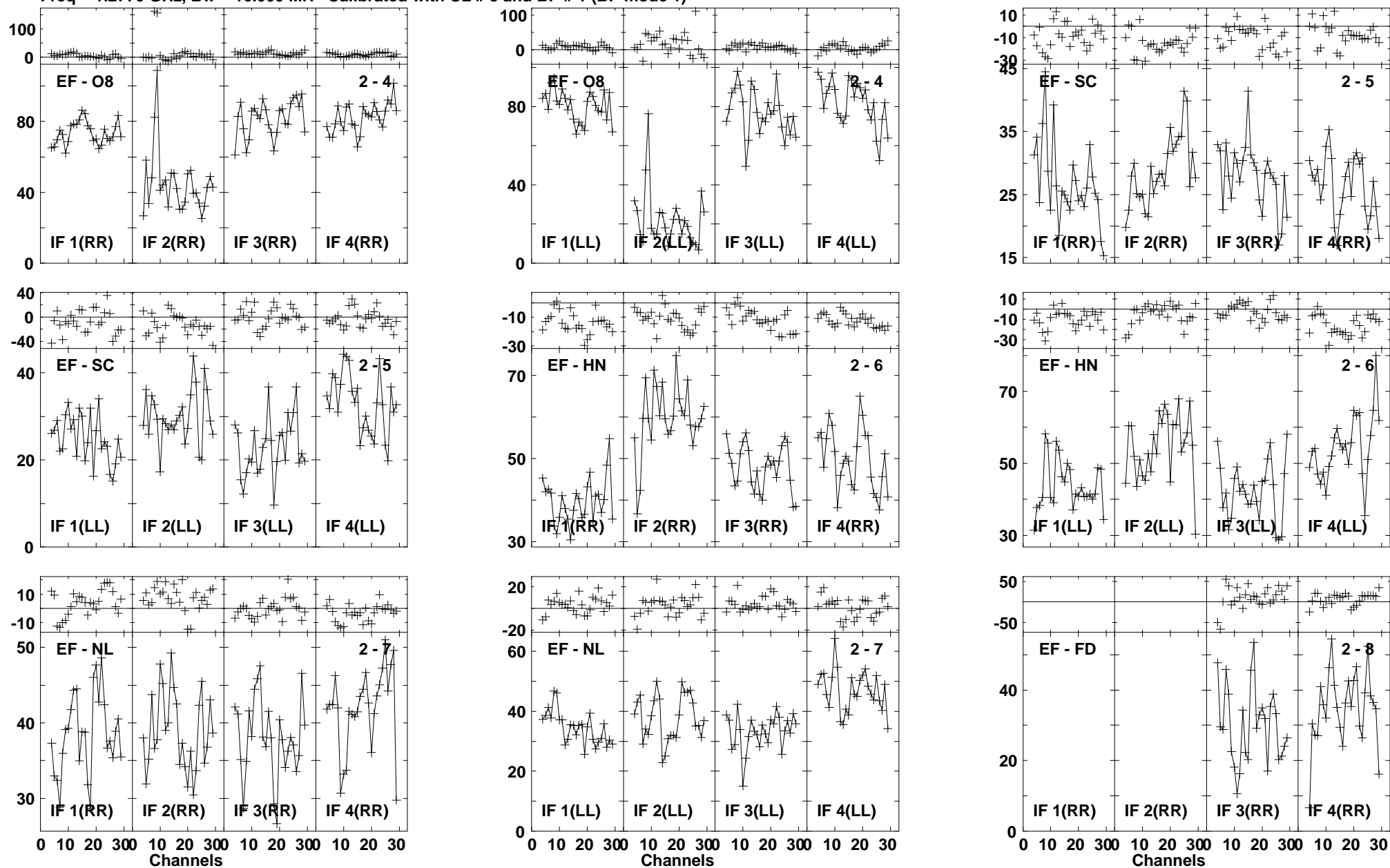

Lower frame: Milli Ampl Jy Top frame: Phas deg
Vector averaged cross-power spectrum Baseline: EF (02) - O8 (04)
Timerange: 00/22:39:13 to 00/22:42:29

Plot file version 845 created 03-MAR-2016 01:14:23

4C52 GN002C 1.UVDATA.1

Freq = 1.2770 GHz, Bw = 16.000 MH Calibrated with CL # 3 and BP # 1 (BP mode 1)

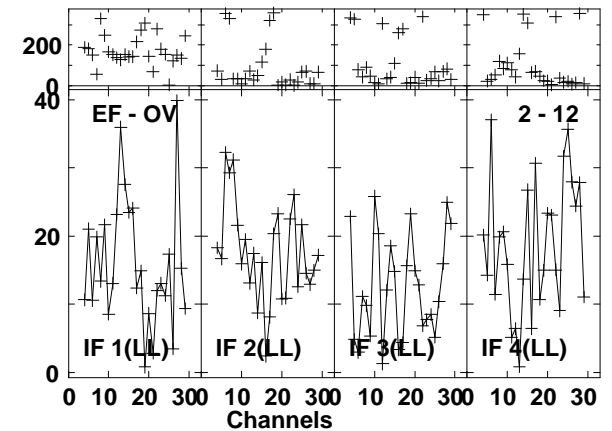
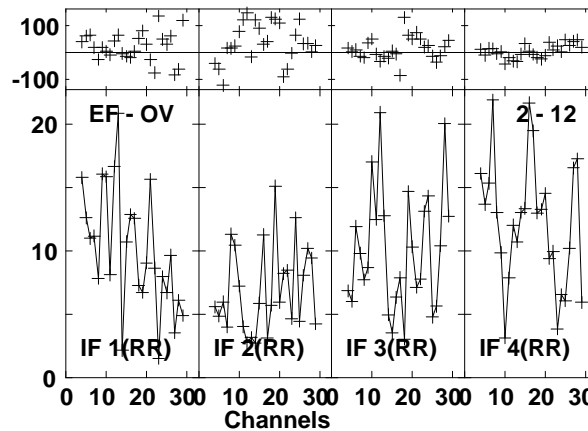
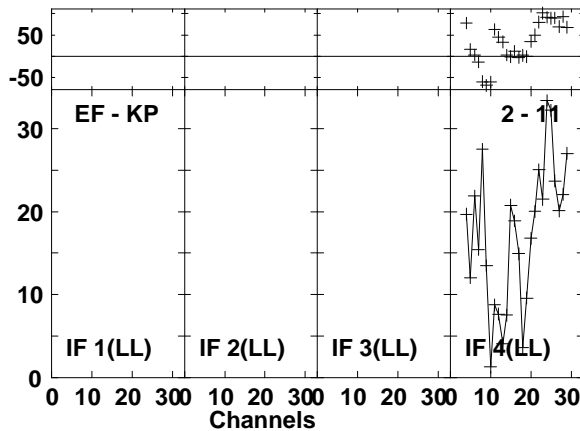
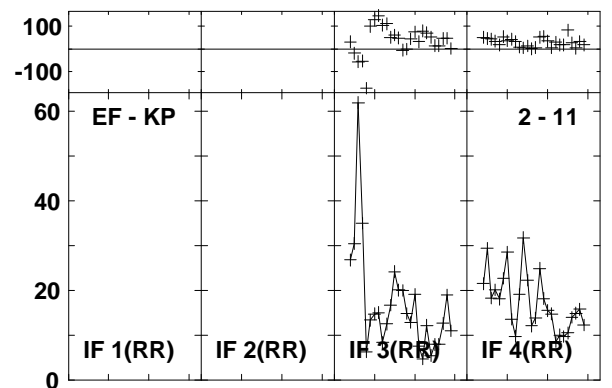
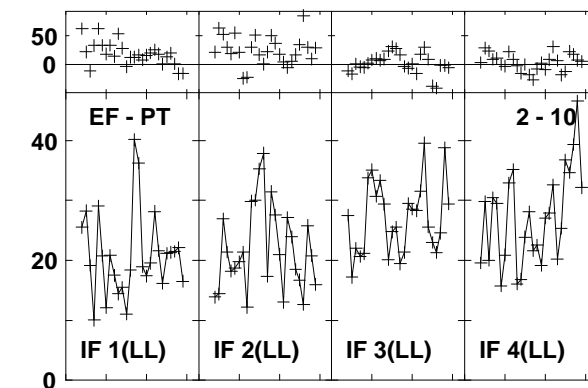
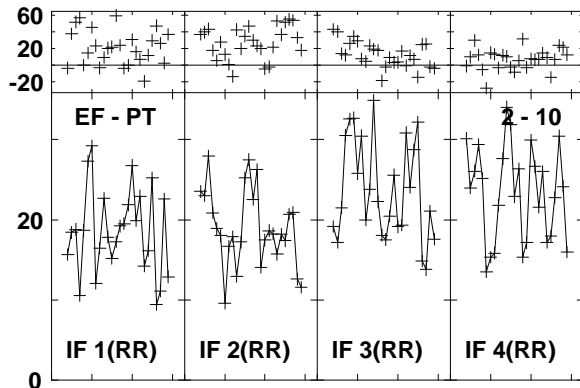
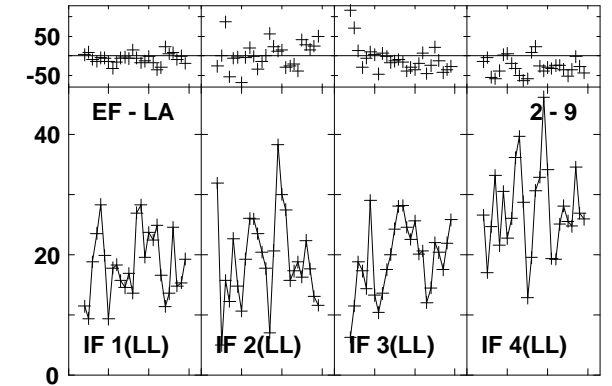
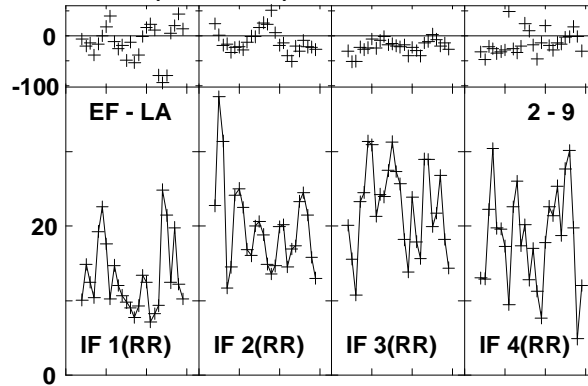
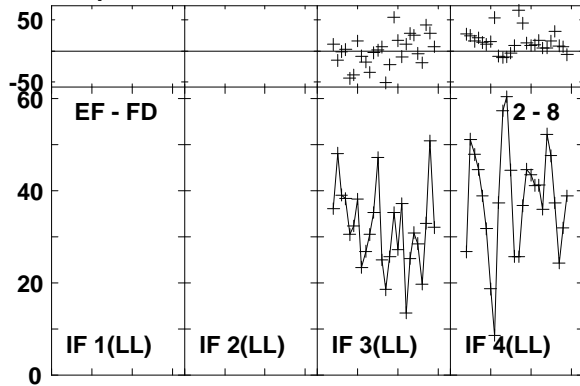

Lower frame: Milli Ampl Jy Top frame: Phas deg
Vector averaged cross-power spectrum Baseline: EF (02) - FD (08)
Timerange: 00/22:39:13 to 00/22:42:29

Plot file version 846 created 03-MAR-2016 01:14:23

4C52 GN002C 1.UVDATA.1

Freq = 1.2770 GHz, Bw = 16.000 MH Calibrated with CL # 3 and BP # 1 (BP mode 1)

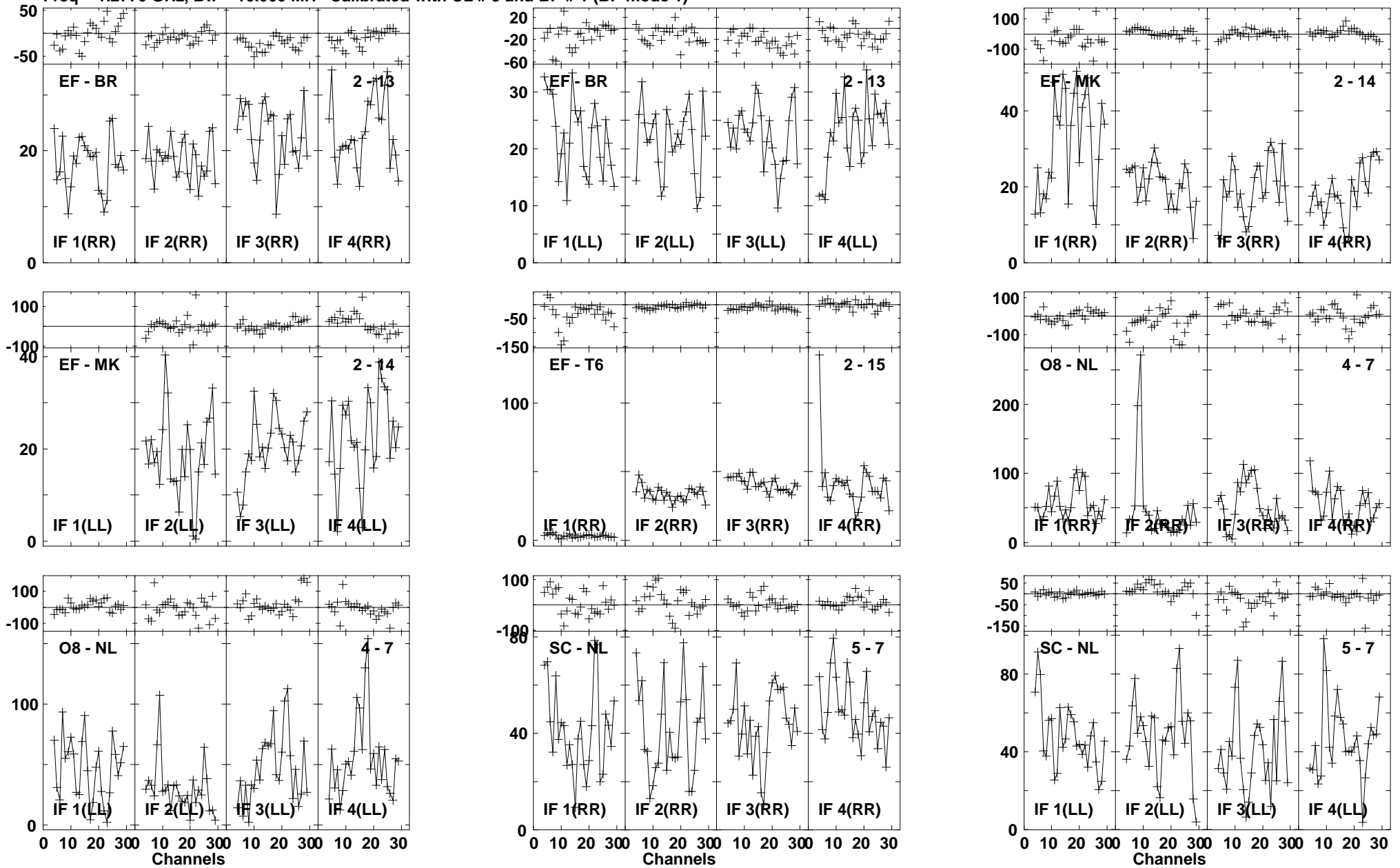

Lower frame: Milli Ampl Jy Top frame: Phas deg
Vector averaged cross-power spectrum Baseline: EF (02) - BR (13)
Timerange: 00/22:39:13 to 00/22:42:29

Plot file version 847 created 03-MAR-2016 01:14:23

4C52 GN002C 1.UVDATA.1

Freq = 1.2770 GHz, Bw = 16.000 MH Calibrated with CL # 3 and BP # 1 (BP mode 1)

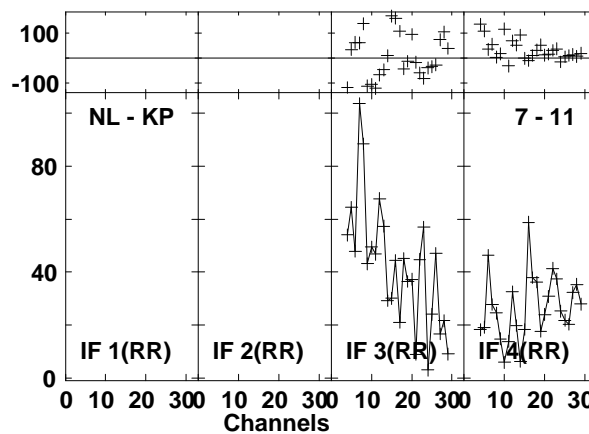
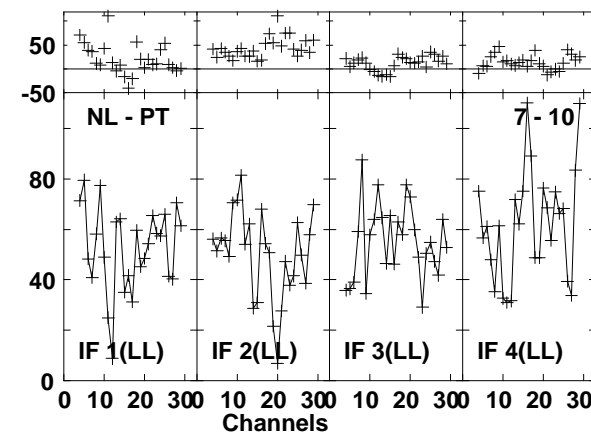
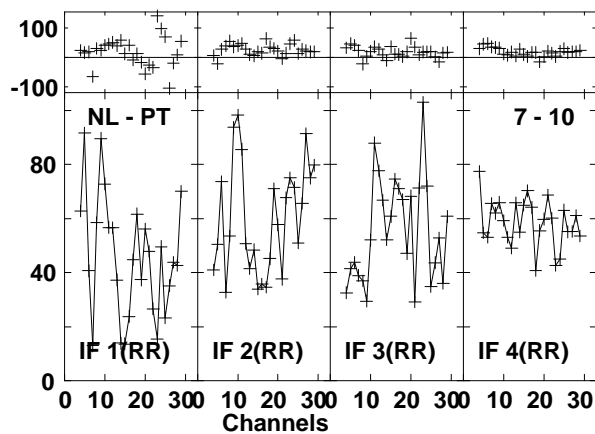
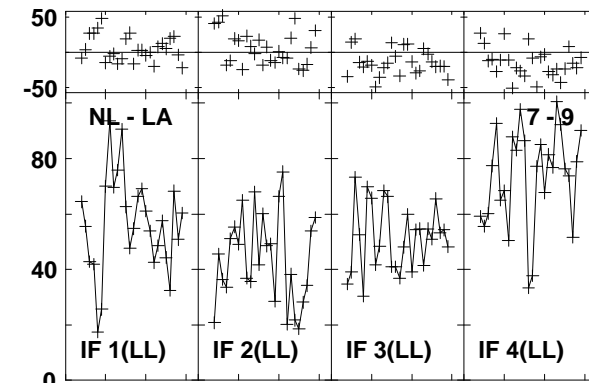
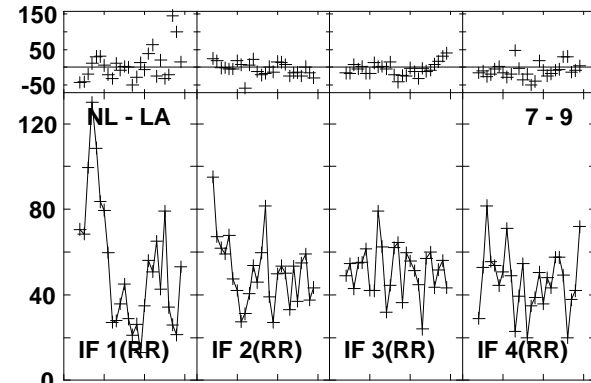
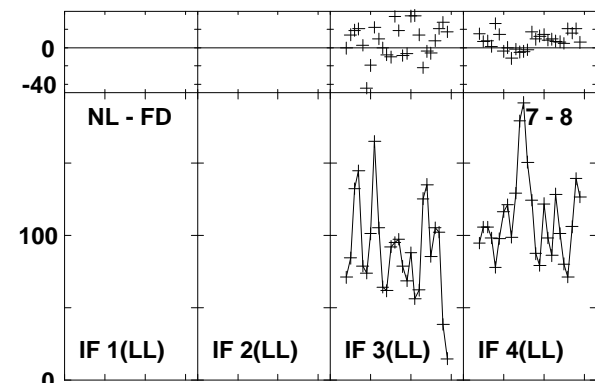
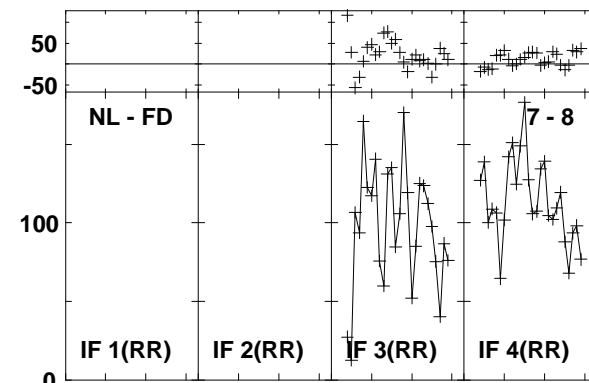
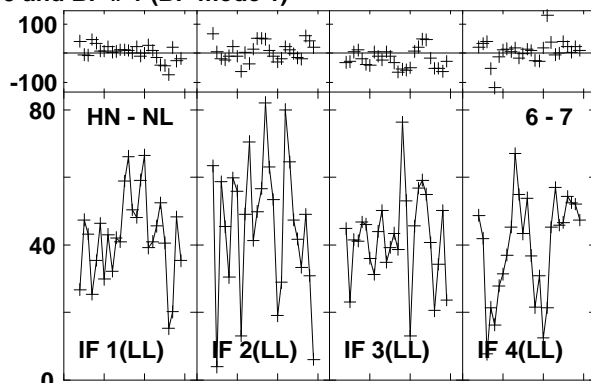
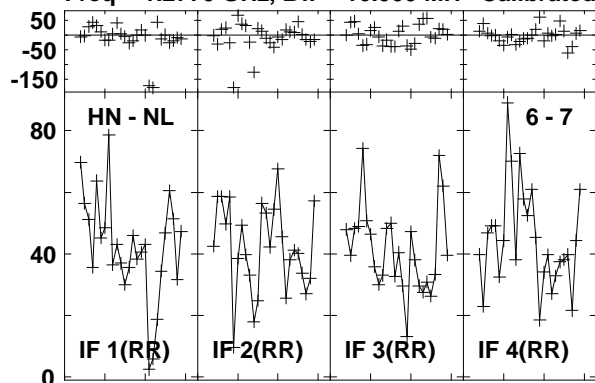

Lower frame: Milli Ampl Jy Top frame: Phas deg
Vector averaged cross-power spectrum Baseline: HN (06) - NL (07)
Timerange: 00/22:39:13 to 00/22:42:29

Plot file version 848 created 03-MAR-2016 01:14:24

4C52 GN002C 1.UVDATA.1

Freq = 1.2770 GHz, Bw = 16.000 MH Calibrated with CL # 3 and BP # 1 (BP mode 1)

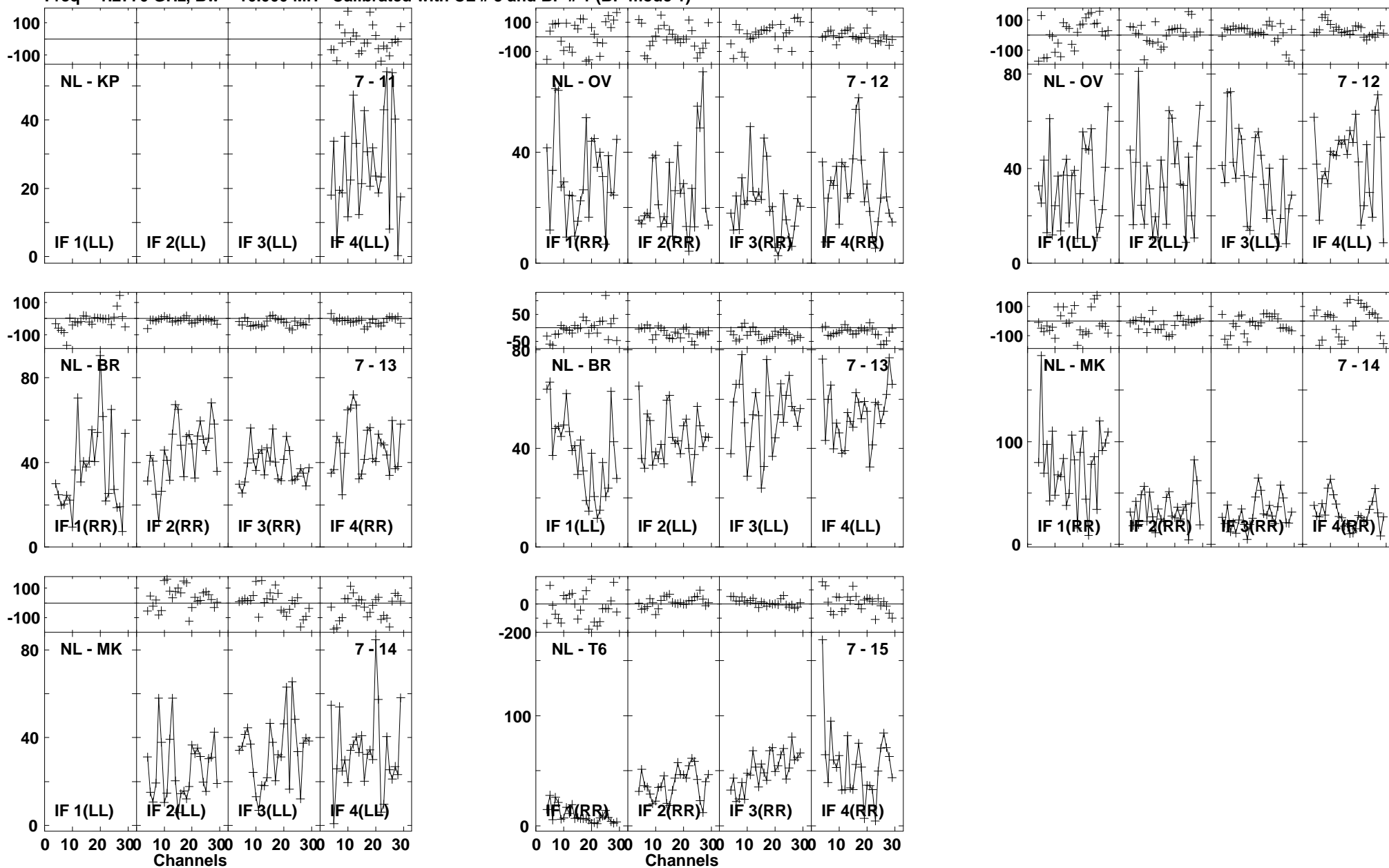

Lower frame: Milli Ampl Jy Top frame: Phas deg
Vector averaged cross-power spectrum Baseline: NL (07) - KP (11)
Timerange: 00/22:39:13 to 00/22:42:29

Plot file version 849 created 03-MAR-2016 01:14:24
 J1545+5400 GN002C 1.UVDATA.1
 Freq = 1.2770 GHz, Bw = 16.000 MH Calibrated with CL # 3 and BP # 1 (BP mode 1)

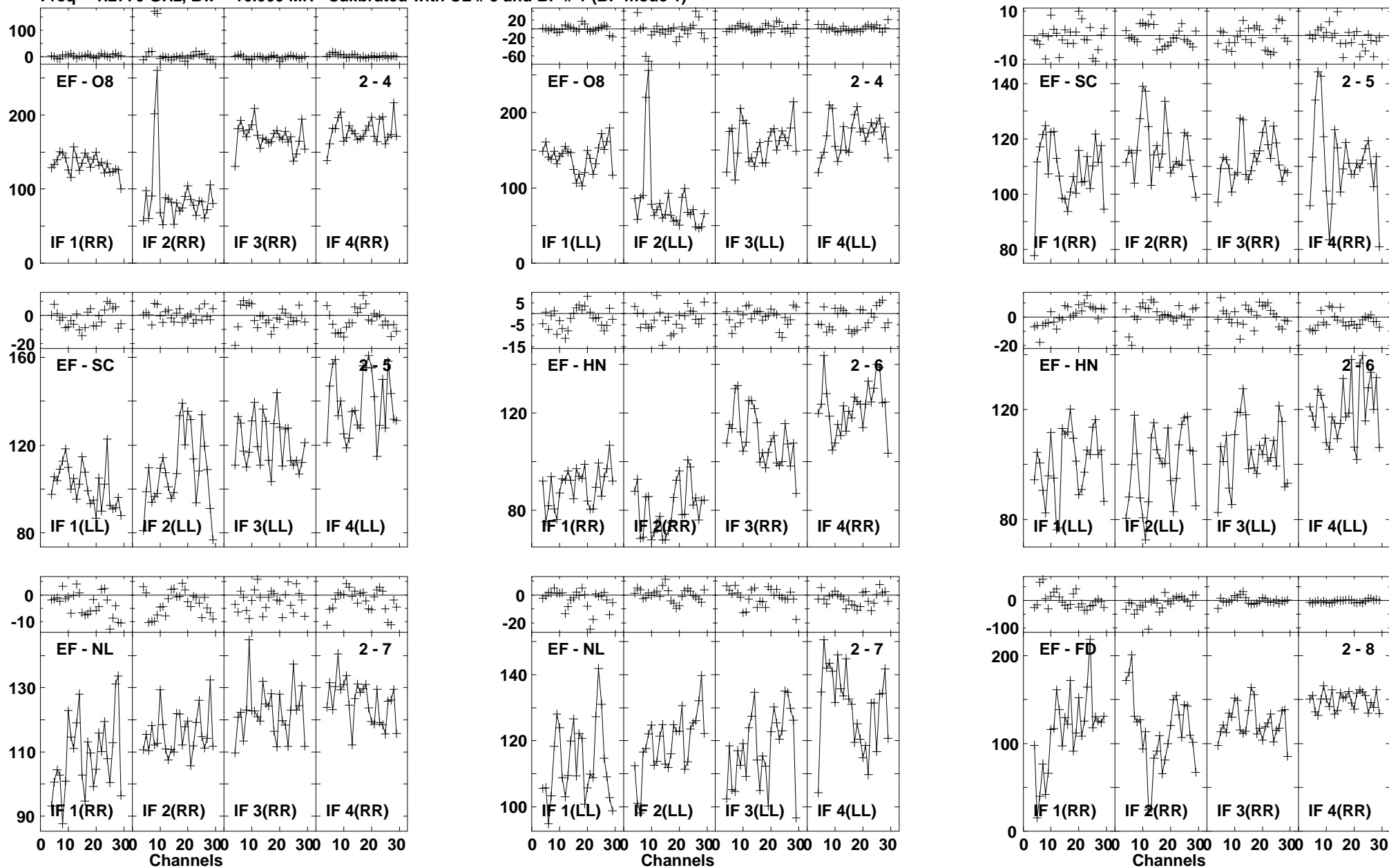

Lower frame: Milli Ampl Jy Top frame: Phas deg
 Vector averaged cross-power spectrum Baseline: EF (02) - O8 (04)
 Timerange: 00/22:43:22 to 00/22:44:20

Plot file version 850 created 03-MAR-2016 01:14:24

J1545+5400 GN002C 1.UVDATA.1

Freq = 1.2770 GHz, Bw = 16.000 MH Calibrated with CL # 3 and BP # 1 (BP mode 1)

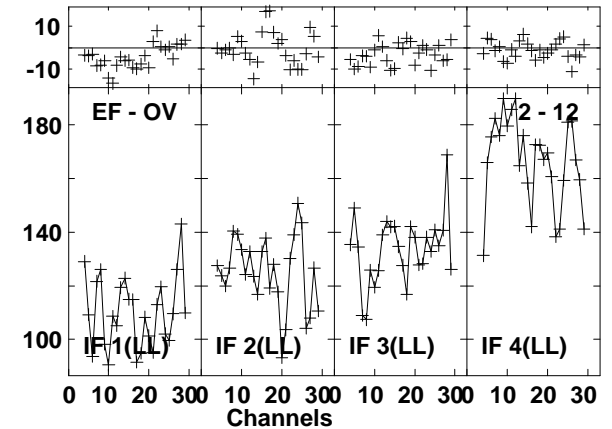
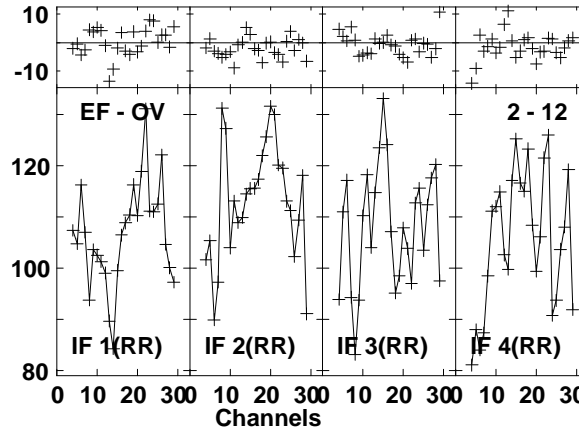
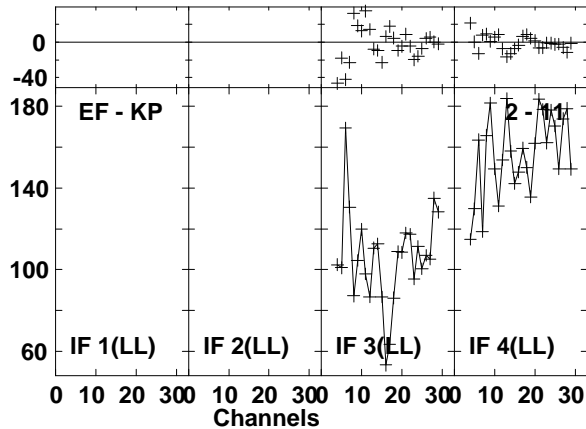
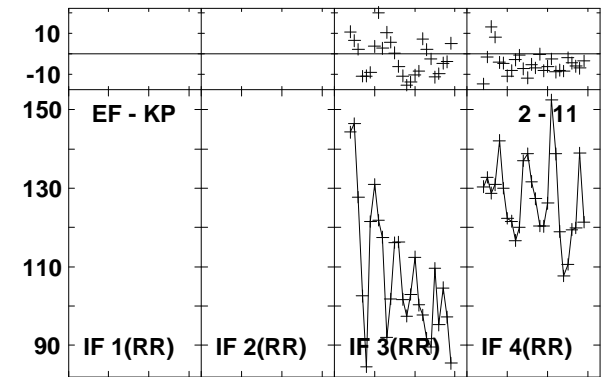
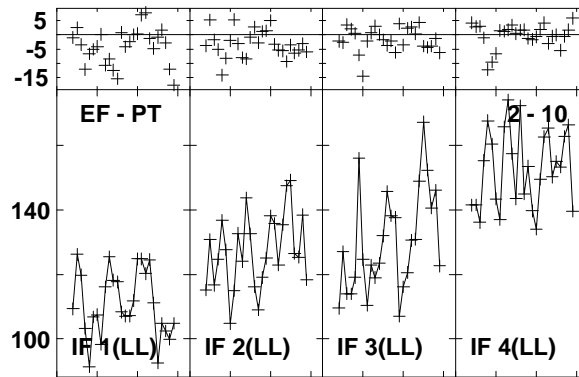
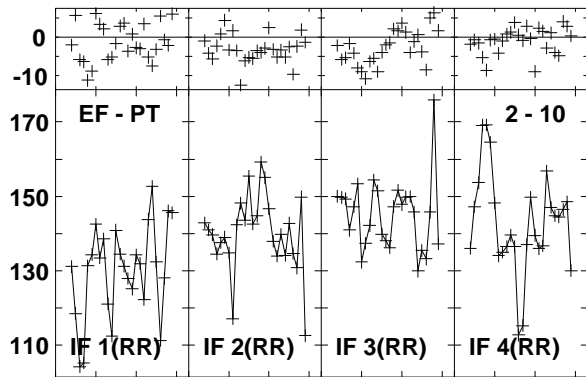
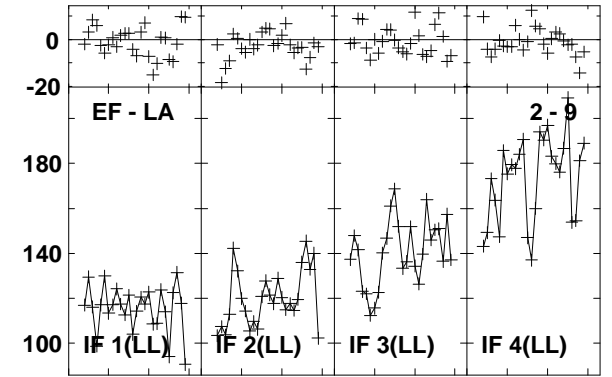
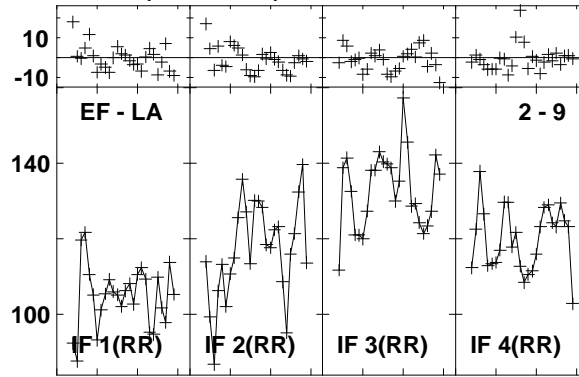
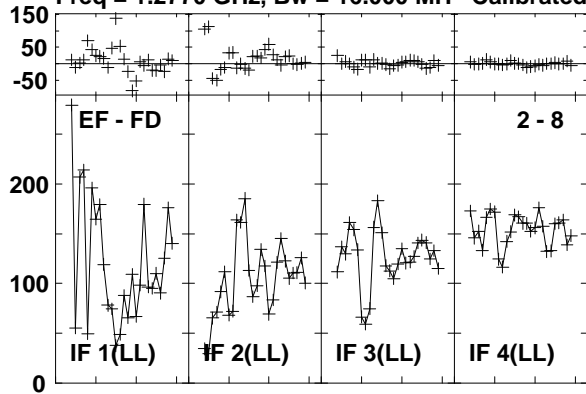

Lower frame: Milli Ampl Jy Top frame: Phas deg
Vector averaged cross-power spectrum Baseline: EF (02) - FD (08)
Timerange: 00/22:43:22 to 00/22:44:20

Plot file version 851 created 03-MAR-2016 01:14:24

J1545+5400 GN002C 1.UVDATA.1

Freq = 1.2770 GHz, Bw = 16.000 MH Calibrated with CL # 3 and BP # 1 (BP mode 1)

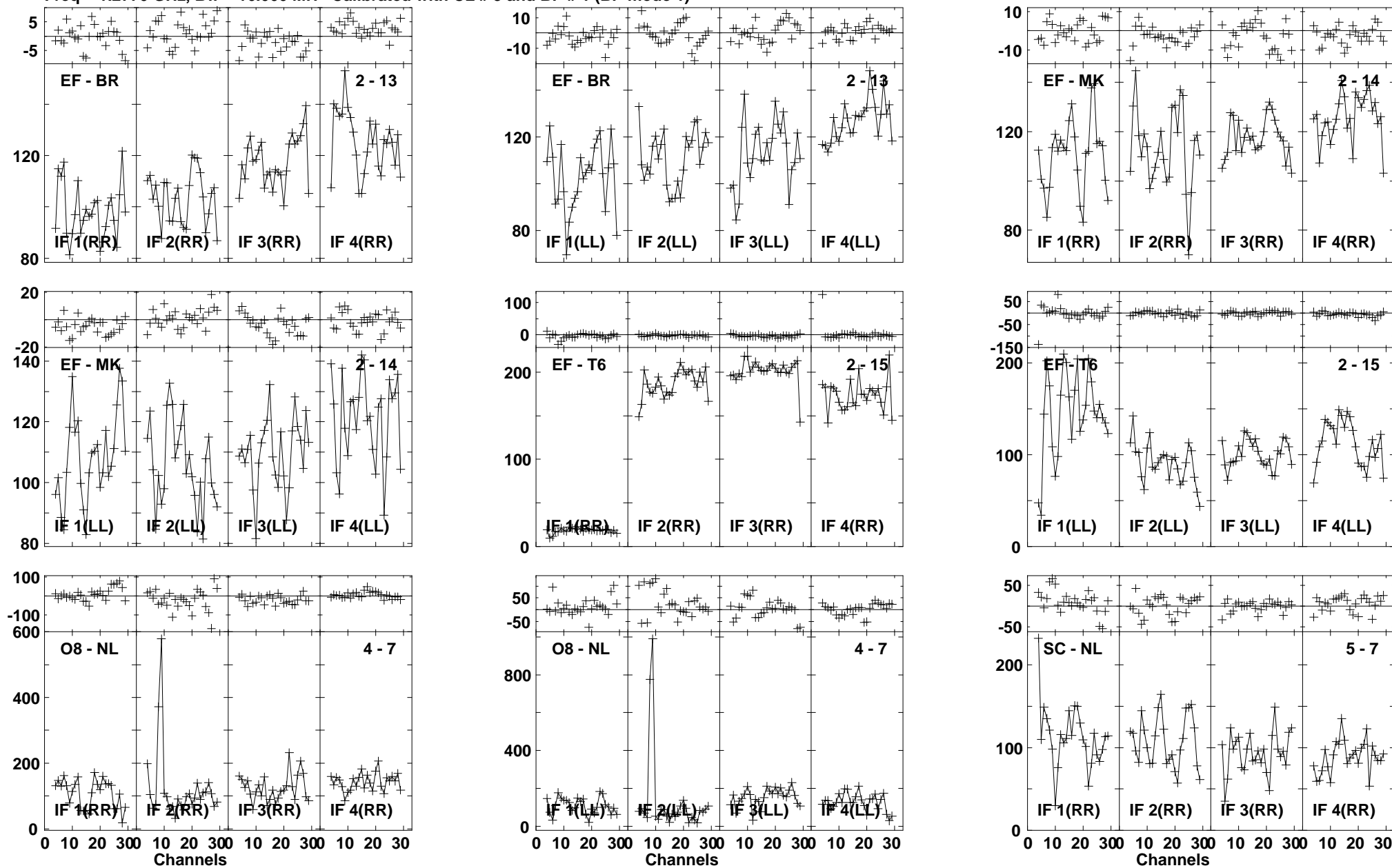

Lower frame: Milli Ampl Jy Top frame: Phas deg
Vector averaged cross-power spectrum Baseline: EF (02) - BR (13)
Timerange: 00/22:43:22 to 00/22:44:20

Plot file version 852 created 03-MAR-2016 01:14:24
 J1545+5400 GN002C 1.UVDATA.1
 Freq = 1.2770 GHz, Bw = 16.000 MH Calibrated with CL # 3 and BP # 1 (BP mode 1)

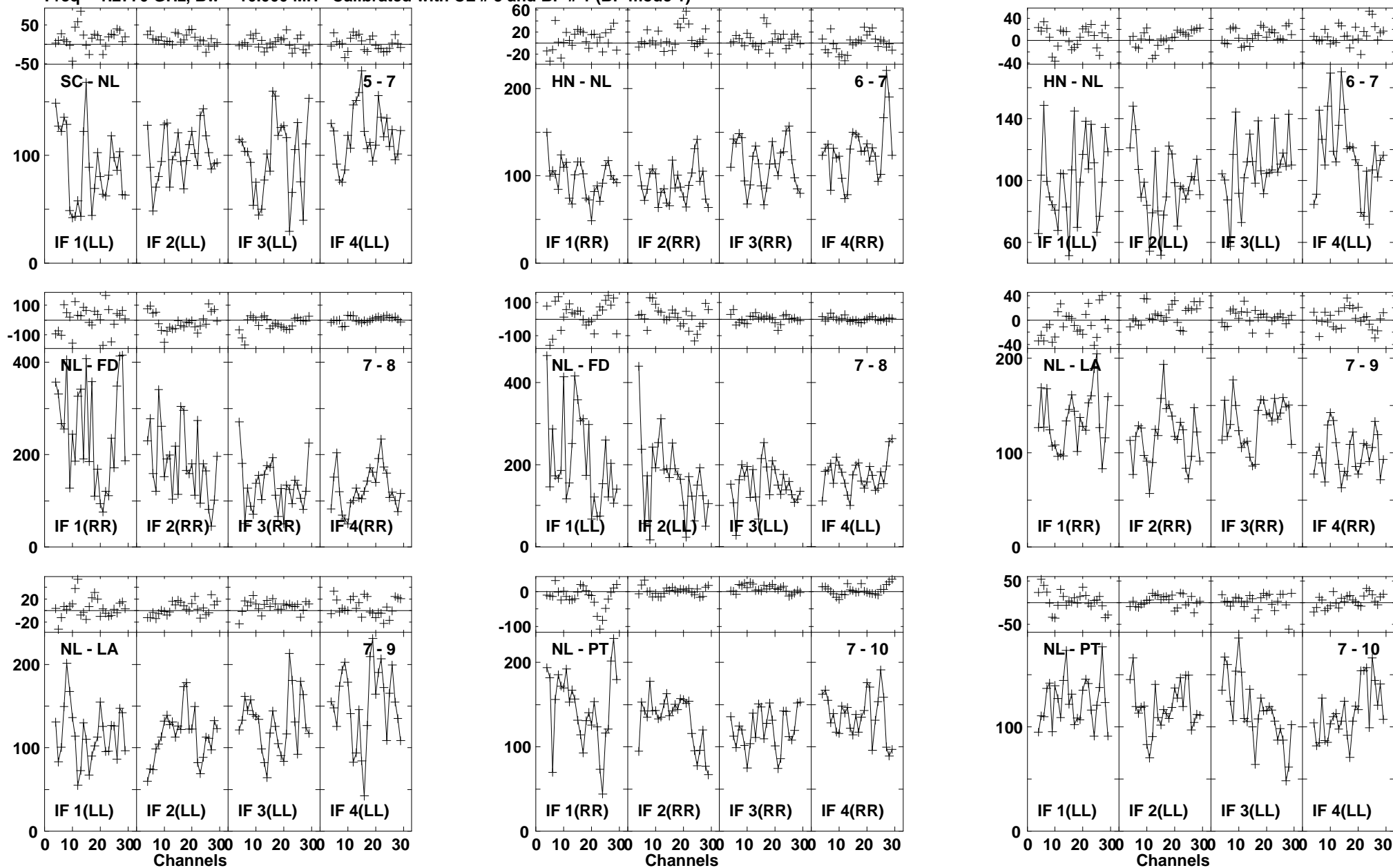

Lower frame: Milli Ampl Jy Top frame: Phas deg
 Vector averaged cross-power spectrum Baseline: SC (05) - NL (07)
 Timerange: 00:22:43:22 to 00:22:44:20

Plot file version 853 created 03-MAR-2016 01:14:25

J1545+5400 GN002C 1.UVDATA.1

Freq = 1.2770 GHz, Bw = 16.000 MH Calibrated with CL # 3 and BP # 1 (BP mode 1)

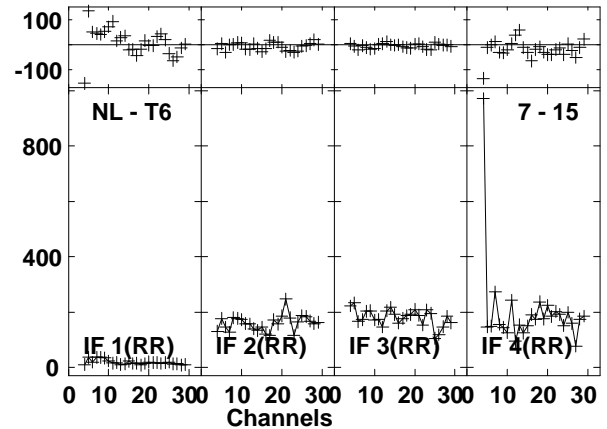
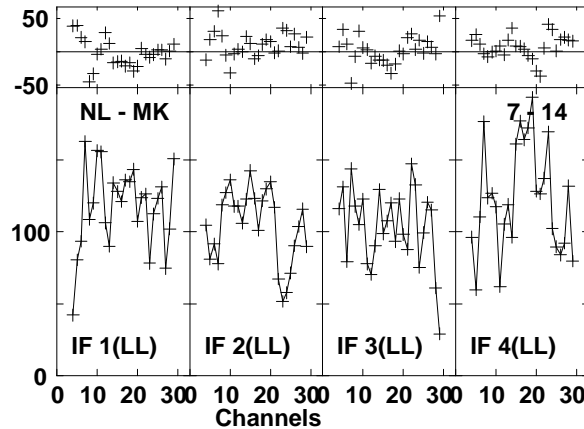
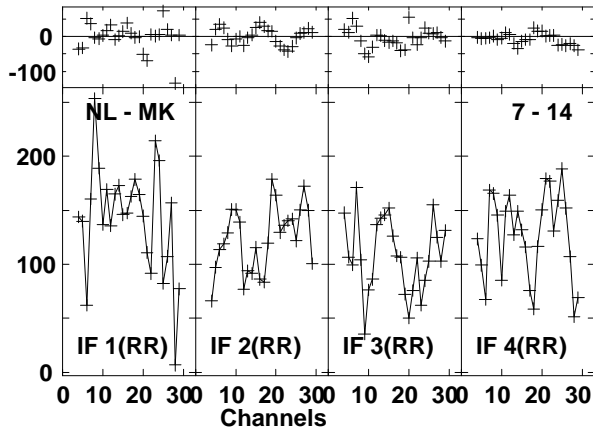
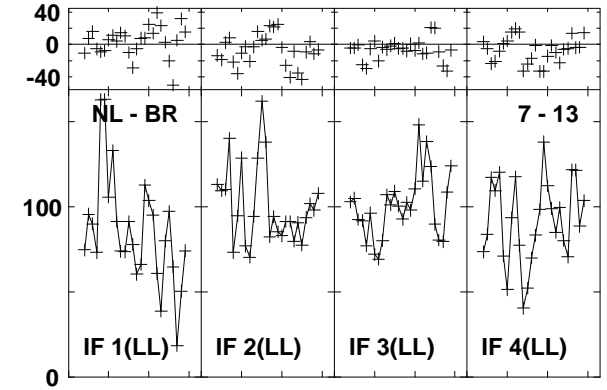
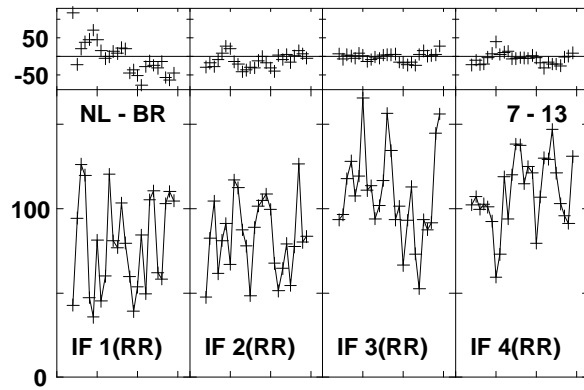
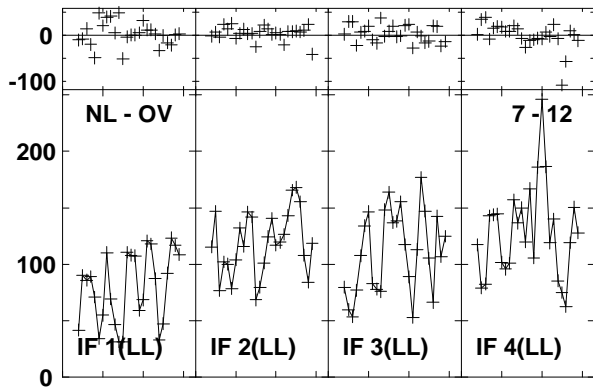
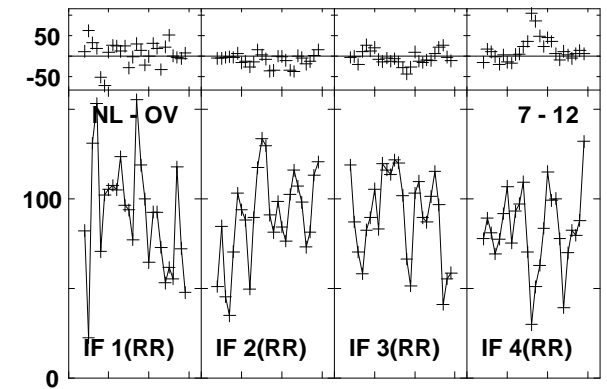
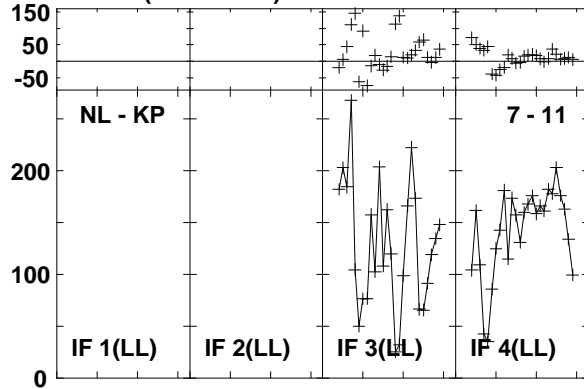
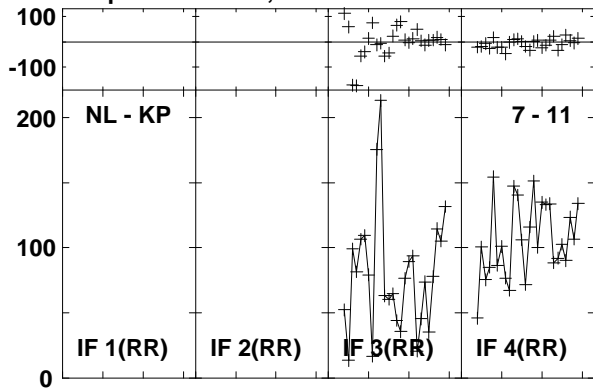

Lower frame: Milli Ampl Jy Top frame: Phas deg
Vector averaged cross-power spectrum Baseline: NL (07) - KP (11)
Timerange: 00/22:43:22 to 00/22:44:20

Plot file version 854 created 03-MAR-2016 01:14:25
J1545+5400 GN002C 1.UVDATA.1
Freq = 1.2770 GHz, Bw = 16.000 MH Calibrated with CL # 3 and BP # 1 (BP mode 1)

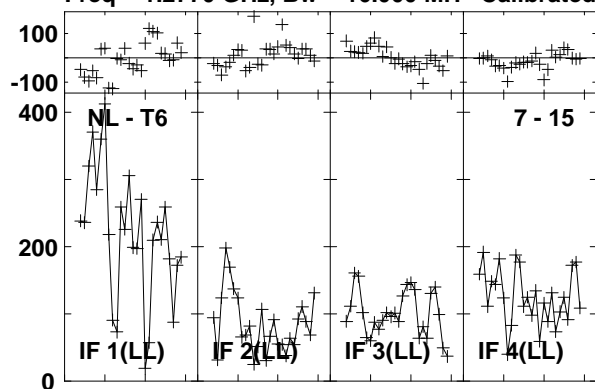

Lower frame: Milli Ampl Jy Top frame: Phas deg
Vector averaged cross-power spectrum Baseline: NL (07) - T6 (15)
Timerange: 00/22:43:22 to 00/22:44:20

Plot file version 855 created 03-MAR-2016 01:14:25

4C52 GN002C 1.UVDATA.1

Freq = 1.2770 GHz, Bw = 16.000 MH Calibrated with CL # 3 and BP # 1 (BP mode 1)

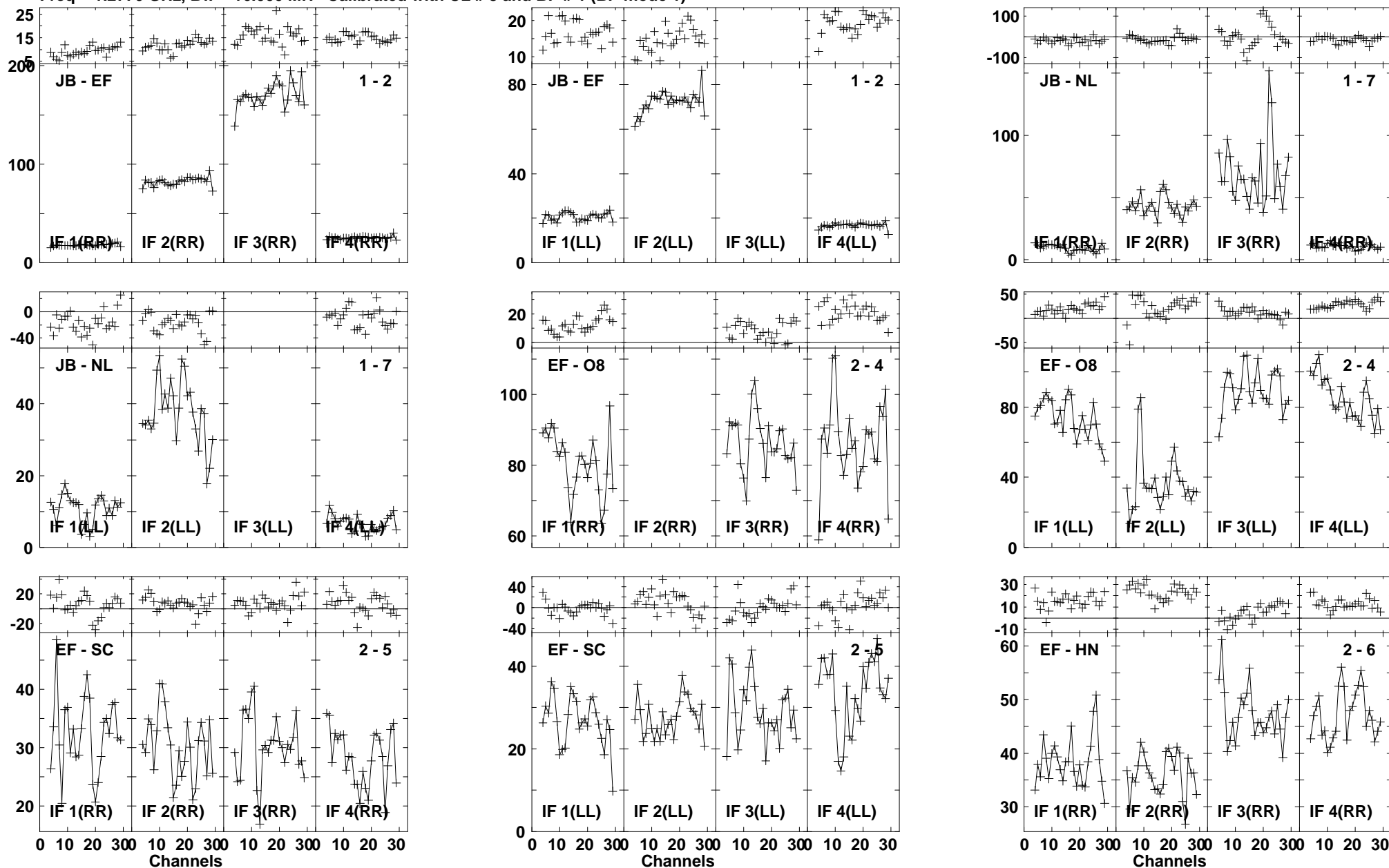

Lower frame: Milli Ampl Jy Top frame: Phas deg
Vector averaged cross-power spectrum Baseline: JB (01) - EF (02)
Timerange: 00/22:44:25 to 00/22:47:49

Plot file version 856 created 03-MAR-2016 01:14:25

4C52 GN002C 1.UVDATA.1

Freq = 1.2770 GHz, Bw = 16.000 MH Calibrated with CL # 3 and BP # 1 (BP mode 1)

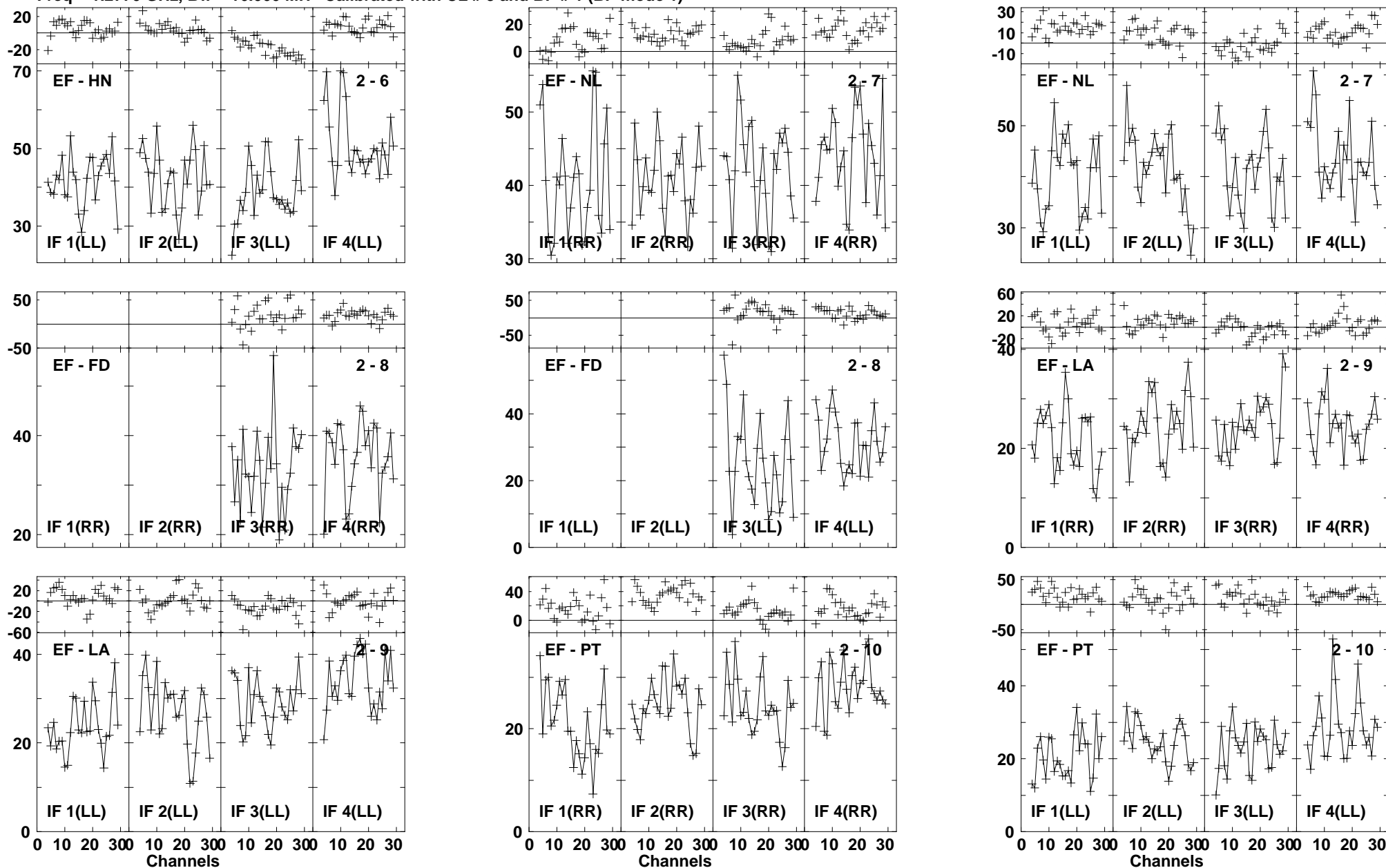

Lower frame: Milli Ampl Jy Top frame: Phas deg
Vector averaged cross-power spectrum Baseline: EF (02) - HN (06)
Timerange: 00/22:44:25 to 00/22:47:49

Plot file version 857 created 03-MAR-2016 01:14:25

4C52 GN002C 1.UVDATA.1

Freq = 1.2770 GHz, Bw = 16.000 MH Calibrated with CL # 3 and BP # 1 (BP mode 1)

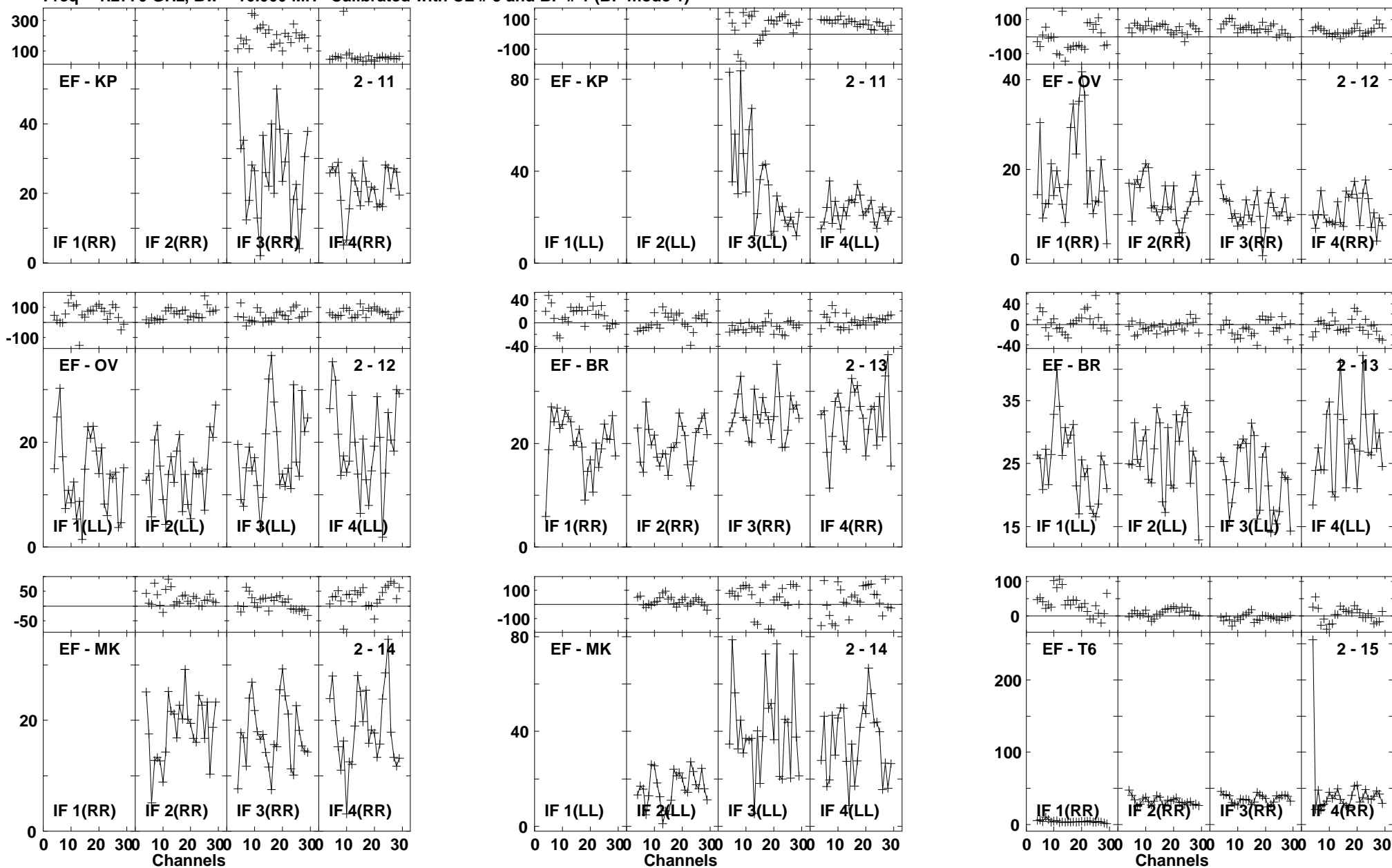

Lower frame: Milli Ampl Jy Top frame: Phas deg
Vector averaged cross-power spectrum Baseline: EF (02) - KP (11)
Timerange: 00/22:44:25 to 00/22:47:49

Plot file version 858 created 03-MAR-2016 01:14:25

4C52 GN002C 1.UVDATA.1

Freq = 1.2770 GHz, Bw = 16.000 MH Calibrated with CL # 3 and BP # 1 (BP mode 1)

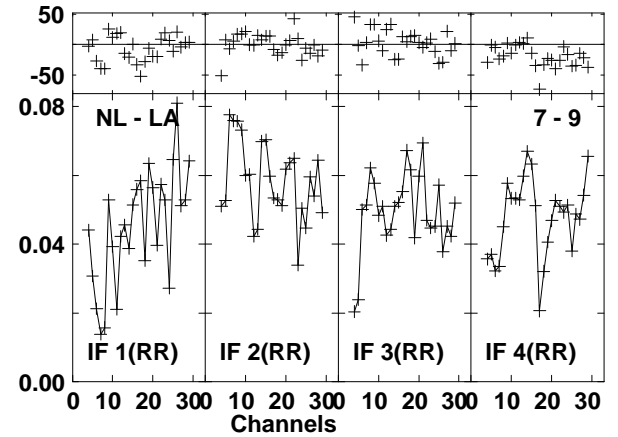
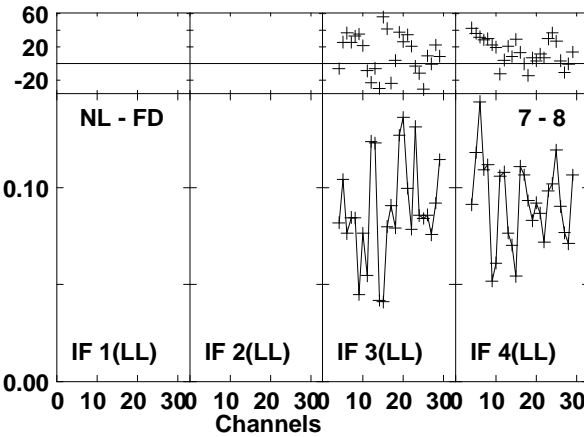
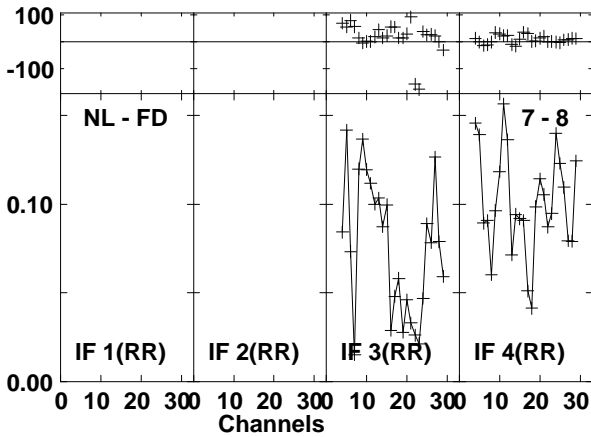
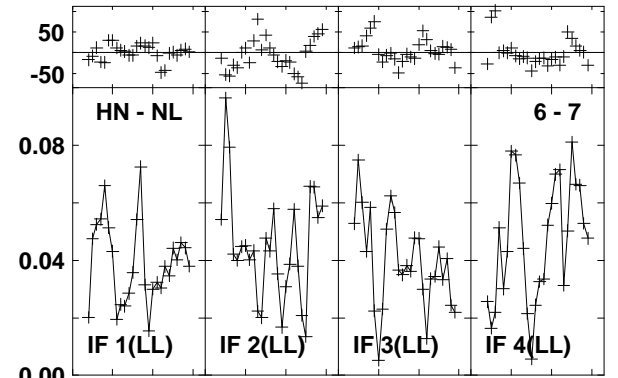
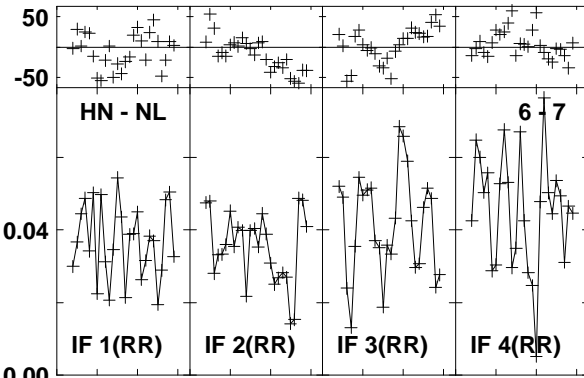
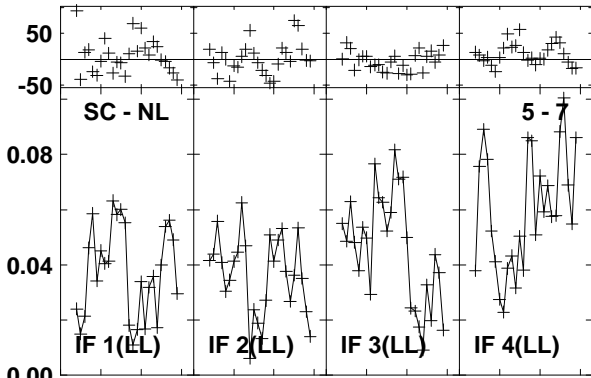
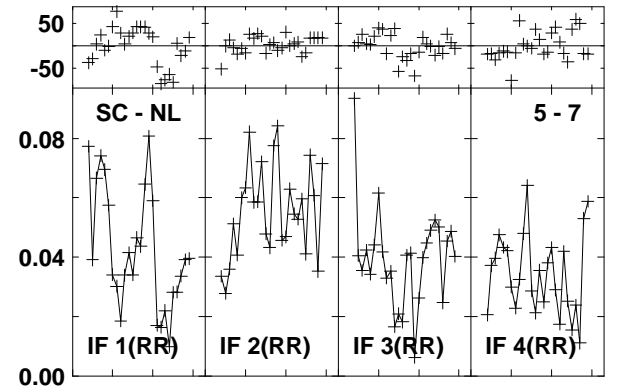
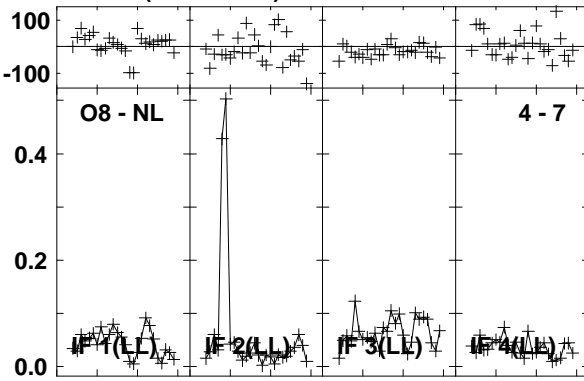
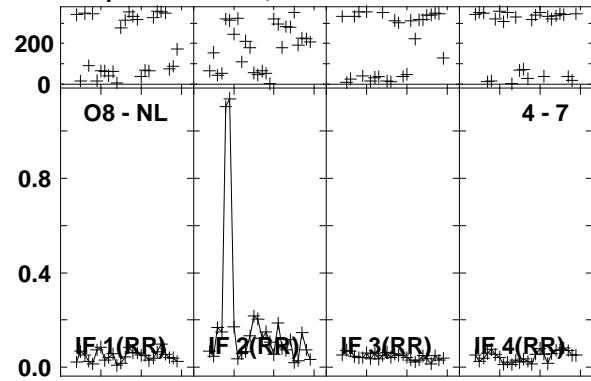

Lower frame: Ampl Jy Top frame: Phas deg
Vector averaged cross-power spectrum Baseline: O8 (04) - NL (07)
Timerange: 00/22:44:25 to 00/22:47:49

Plot file version 859 created 03-MAR-2016 01:14:25

4C52 GN002C 1.UVDATA.1

Freq = 1.2770 GHz, Bw = 16.000 MH Calibrated with CL # 3 and BP # 1 (BP mode 1)

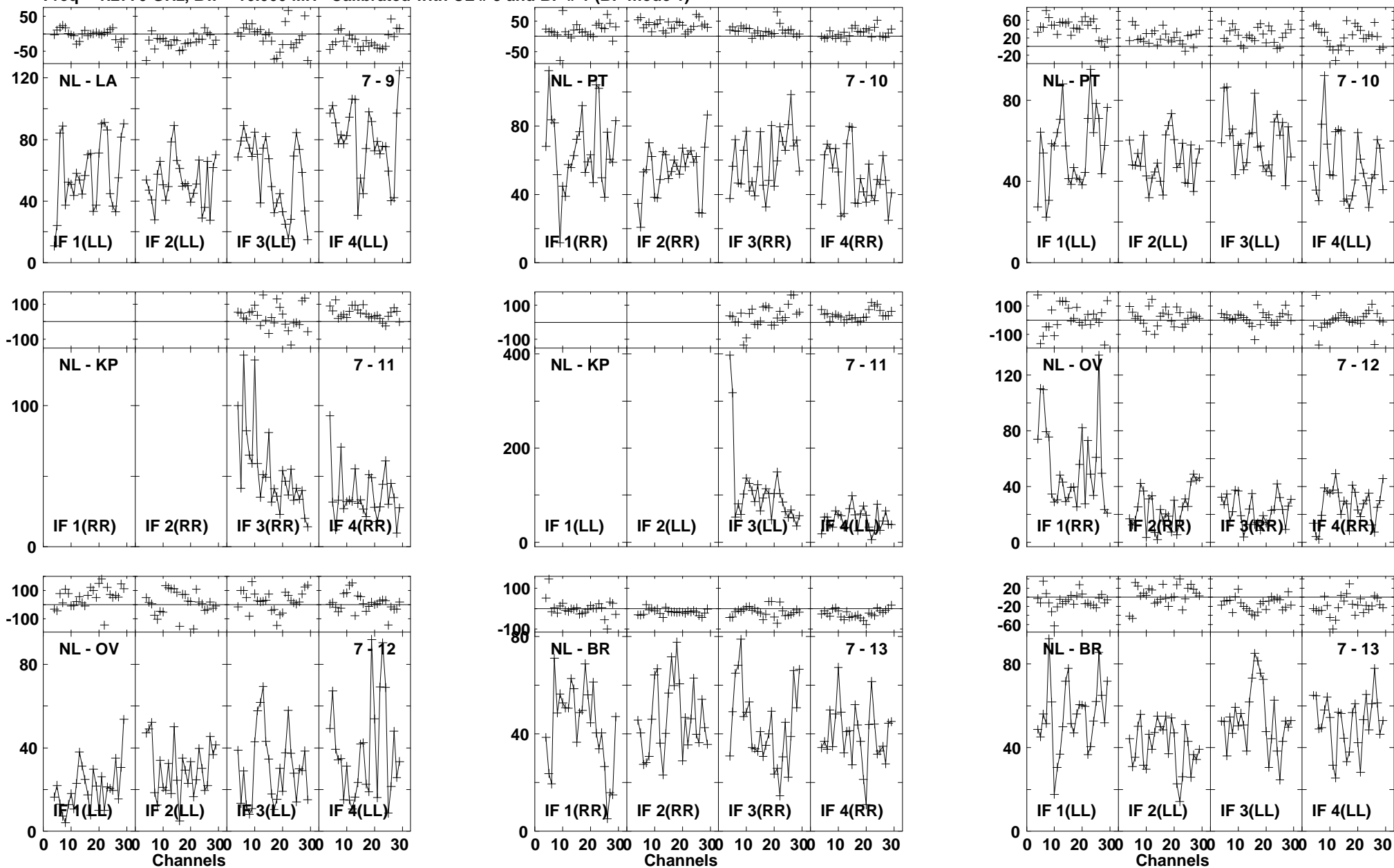

Lower frame: Milli Ampl Jy Top frame: Phas deg
Vector averaged cross-power spectrum Baseline: NL (07) - LA (09)
Timerange: 00:22:44:25 to 00:22:47:49

Plot file version 860 created 03-MAR-2016 01:14:26
 4C52 GN002C 1.UVDATA.1
 Freq = 1.2770 GHz, Bw = 16.000 MH Calibrated with CL # 3 and BP # 1 (BP mode 1)

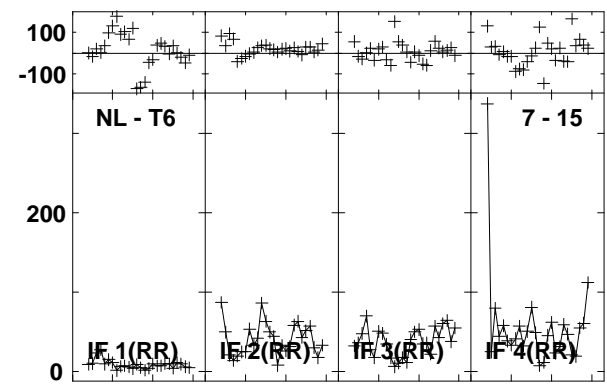
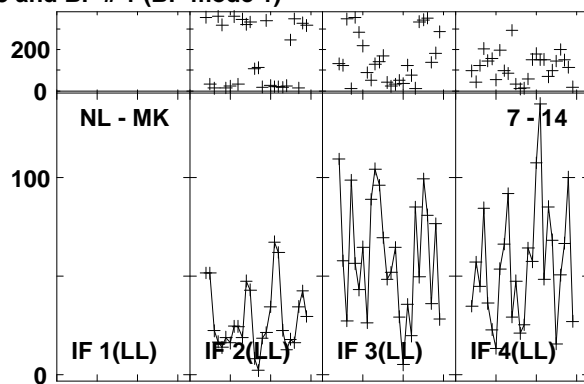
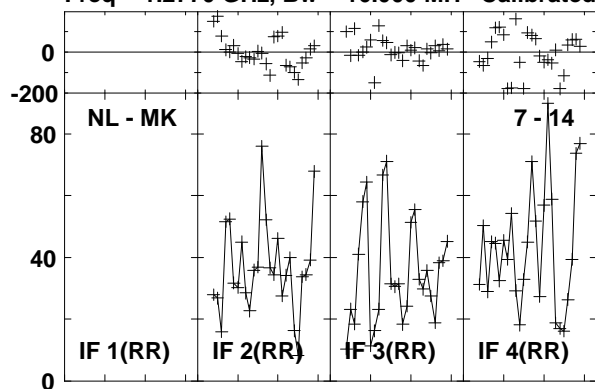

Lower frame: Milli Ampl Jy Top frame: Phas deg
 Vector averaged cross-power spectrum Baseline: NL (07) - MK (14)
 Timerange: 00/22:44:25 to 00/22:47:49

Plot file version 861 created 03-MAR-2016 01:14:26

J1545+5400 GN002C 1.UVDATA.1

Freq = 1.2770 GHz, Bw = 16.000 MH Calibrated with CL # 3 and BP # 1 (BP mode 1)

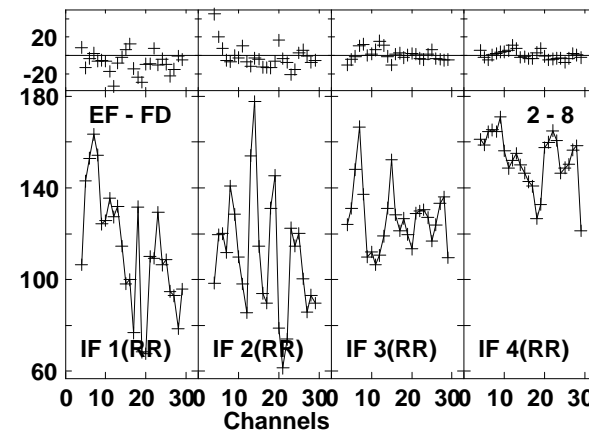
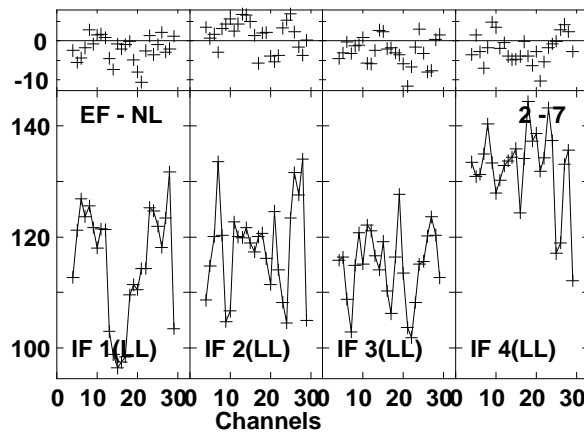
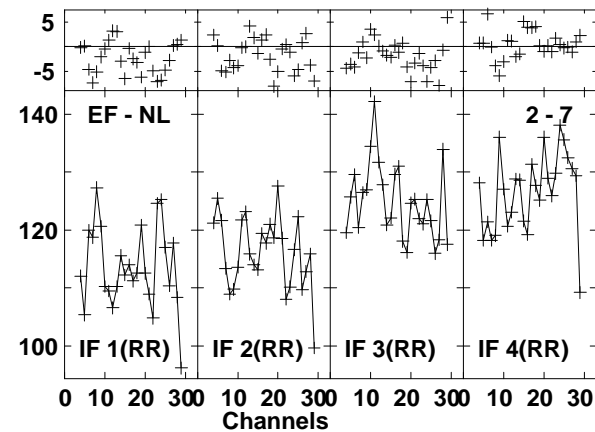
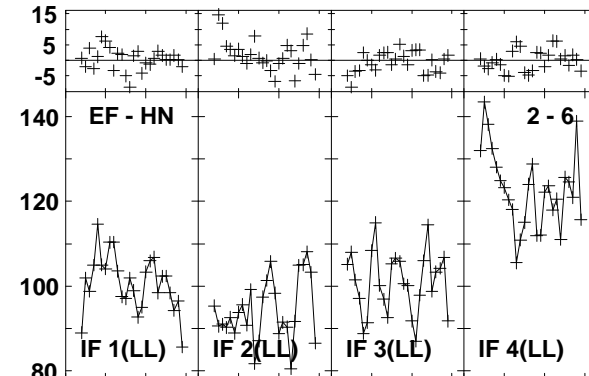
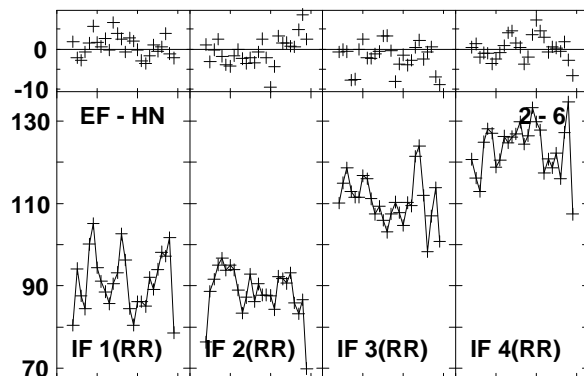
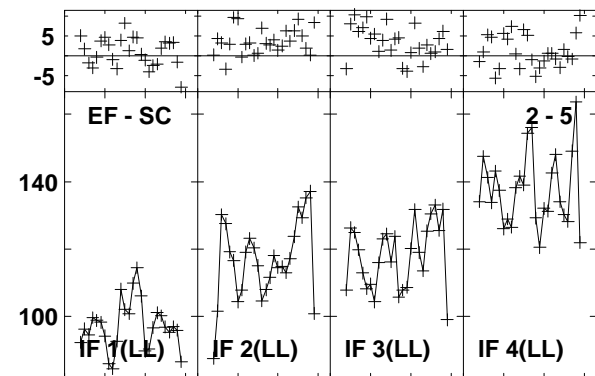
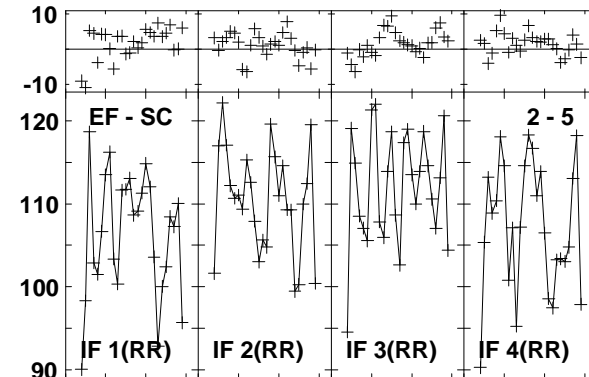
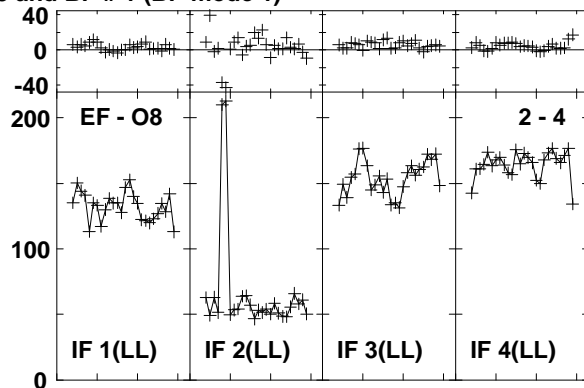
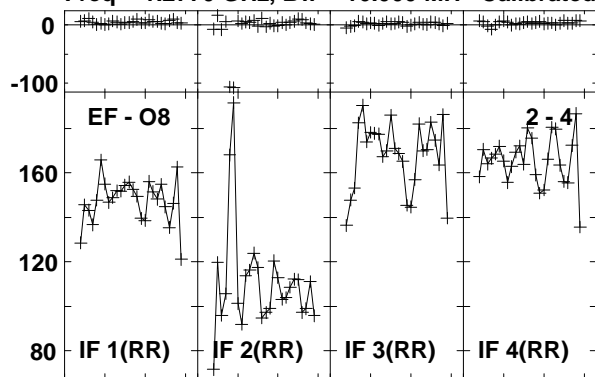

Lower frame: Milli Ampl Jy Top frame: Phas deg
Vector averaged cross-power spectrum Baseline: EF (02) - O8 (04)
Timerange: 00:22:48:42 to 00:22:51:10

Plot file version 862 created 03-MAR-2016 01:14:26
 J1545+5400 GN002C 1.UVDATA.1
 Freq = 1.2770 GHz, Bw = 16.000 MH Calibrated with CL # 3 and BP # 1 (BP mode 1)

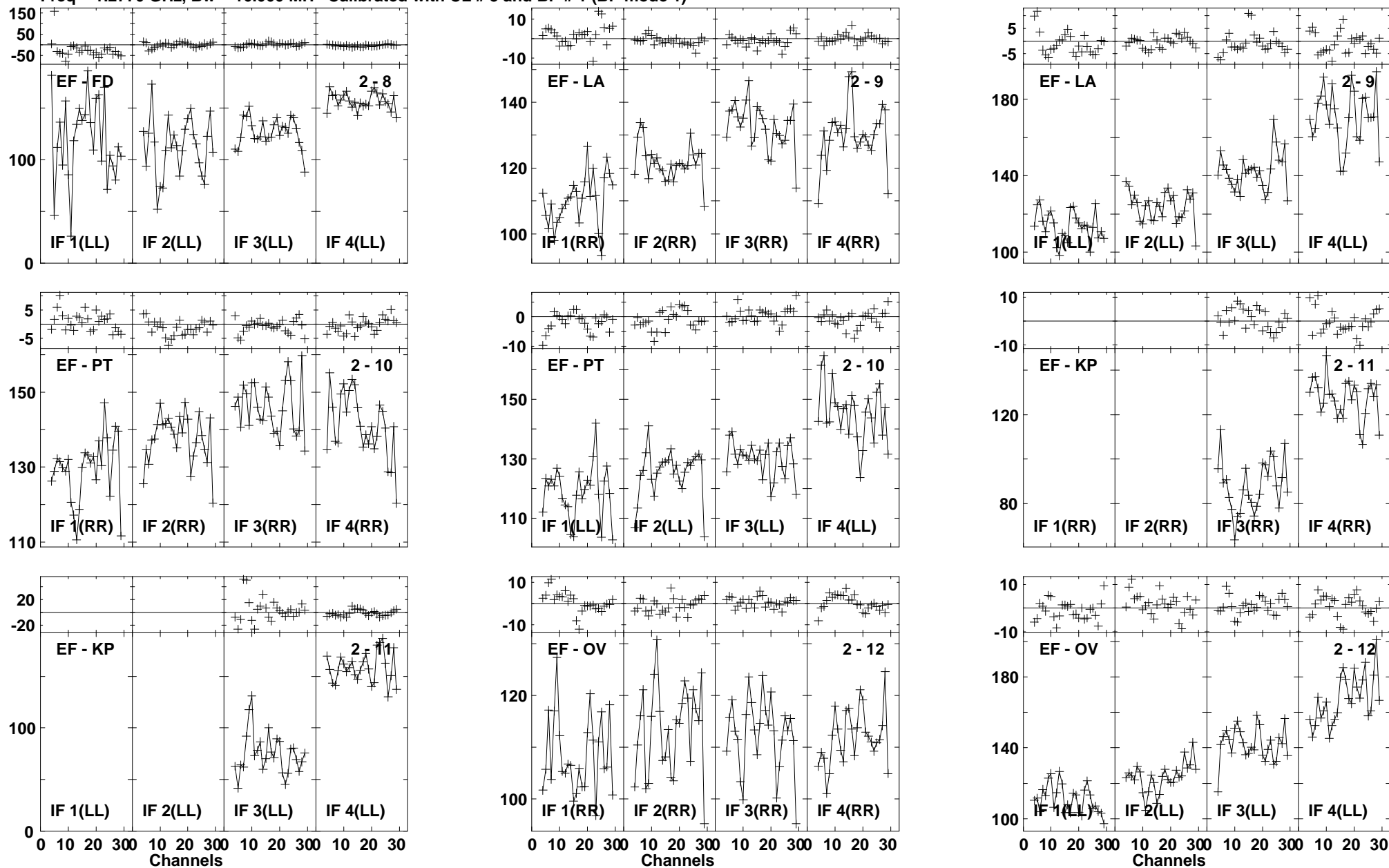

Lower frame: Milli Ampl Jy Top frame: Phas deg
 Vector averaged cross-power spectrum Baseline: EF (02) - FD (08)
 Timerange: 00/22:48:42 to 00/22:51:10

Plot file version 863 created 03-MAR-2016 01:14:26

J1545+5400 GN002C 1.UVDATA.1

Freq = 1.2770 GHz, Bw = 16.000 MH Calibrated with CL # 3 and BP # 1 (BP mode 1)

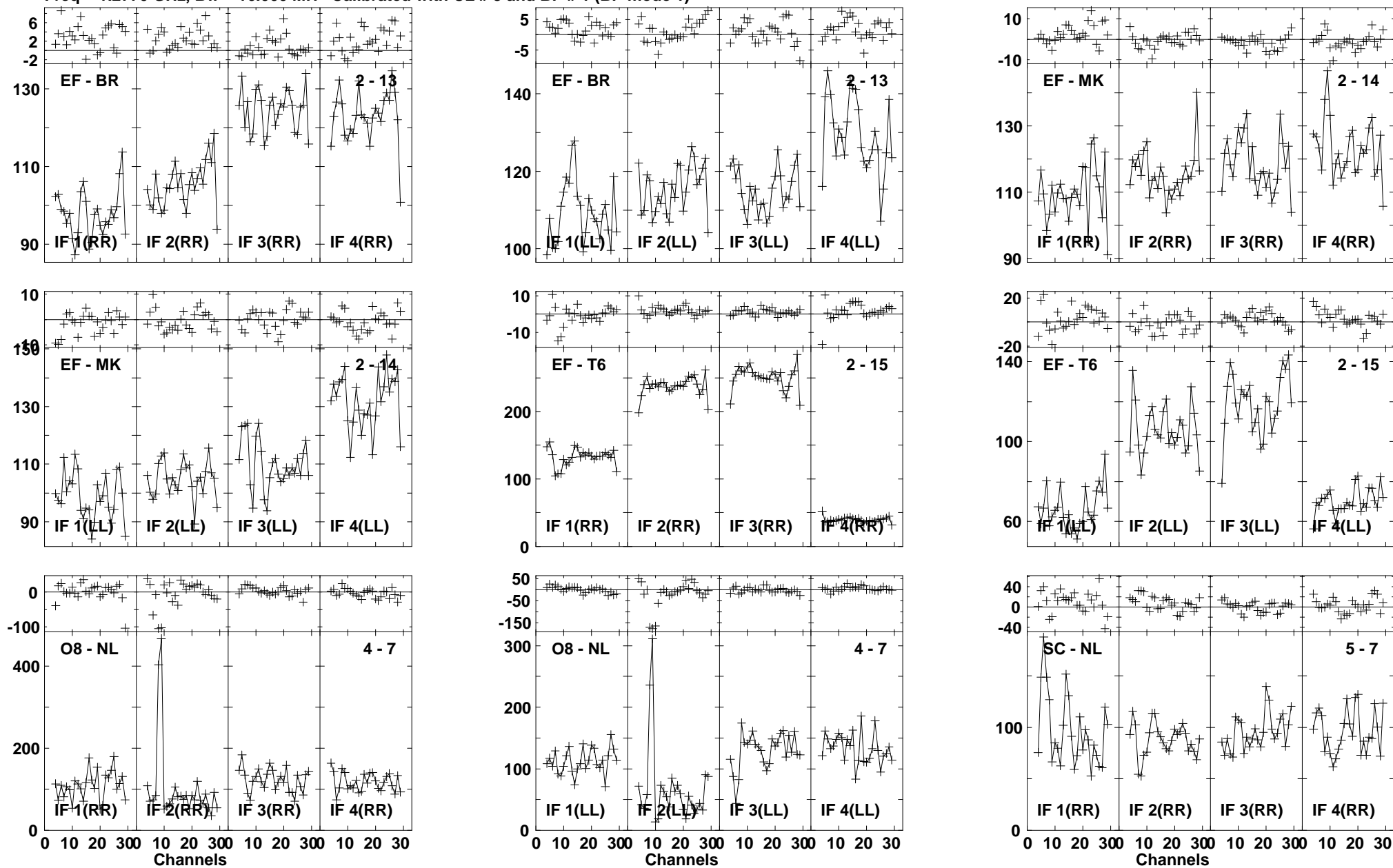

Lower frame: Milli Ampl Jy Top frame: Phas deg
Vector averaged cross-power spectrum Baseline: EF (02) - BR (13)
Timerange: 00/22:48:42 to 00/22:51:10

Plot file version 864 created 03-MAR-2016 01:14:26
 J1545+5400 GN002C 1.UVDATA.1
 Freq = 1.2770 GHz, Bw = 16.000 MH Calibrated with CL # 3 and BP # 1 (BP mode 1)

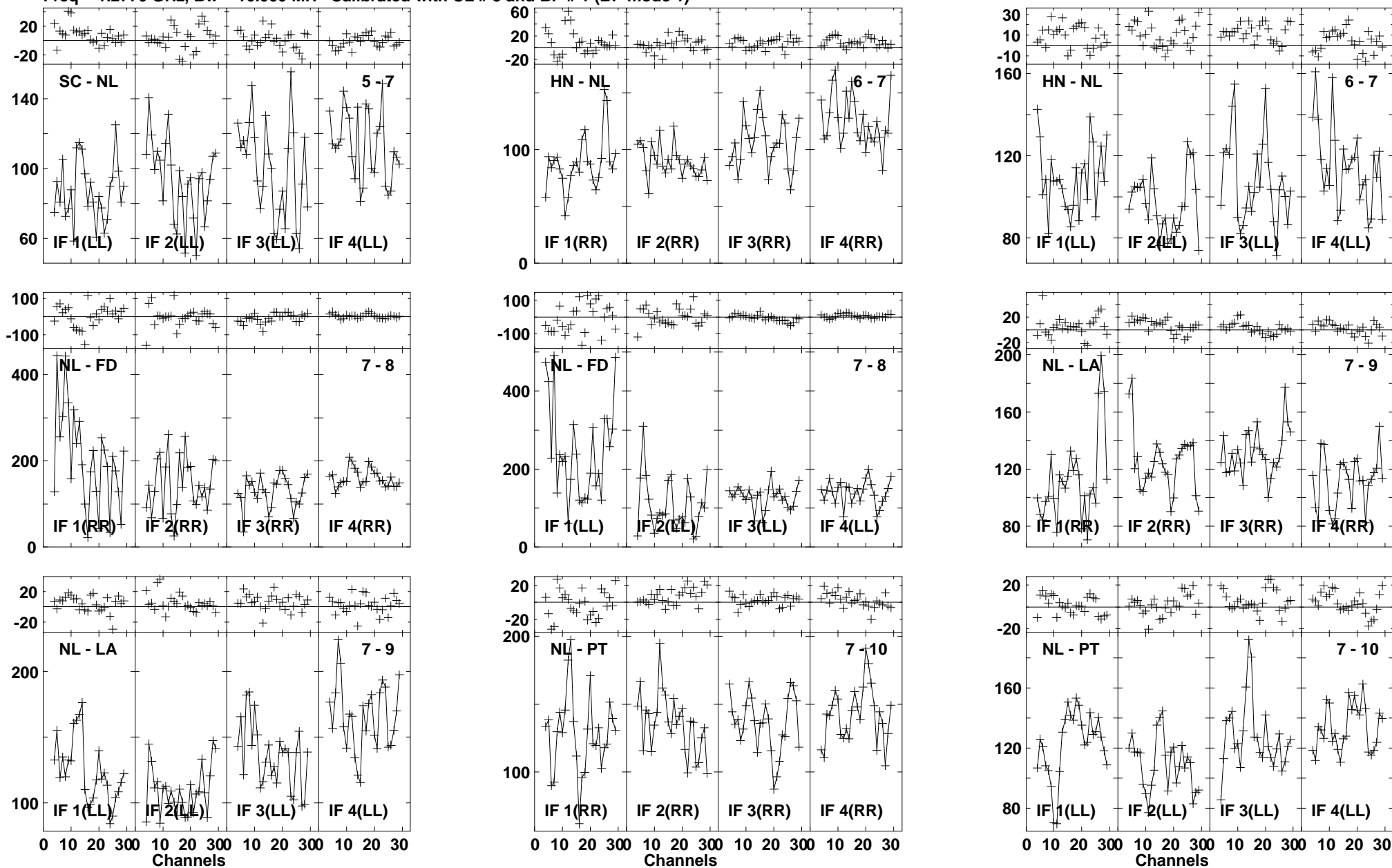

Lower frame: Milli Ampl Jy Top frame: Phas deg
 Vector averaged cross-power spectrum Baseline: SC (05) - NL (07)
 Timerange: 00:22:48:42 to 00:22:51:10

Plot file version 865 created 03-MAR-2016 01:14:27

J1545+5400 GN002C 1.UVDATA.1

Freq = 1.2770 GHz, Bw = 16.000 MH Calibrated with CL # 3 and BP # 1 (BP mode 1)

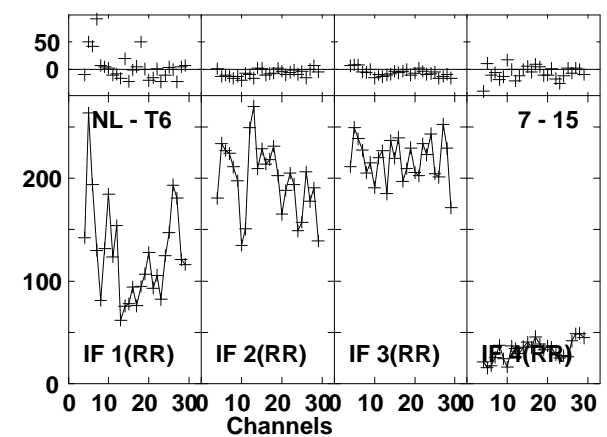
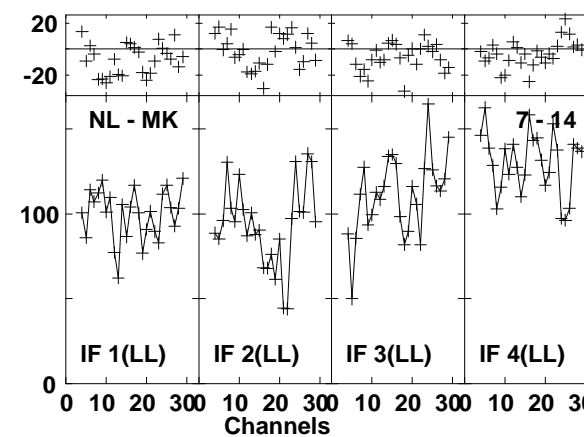
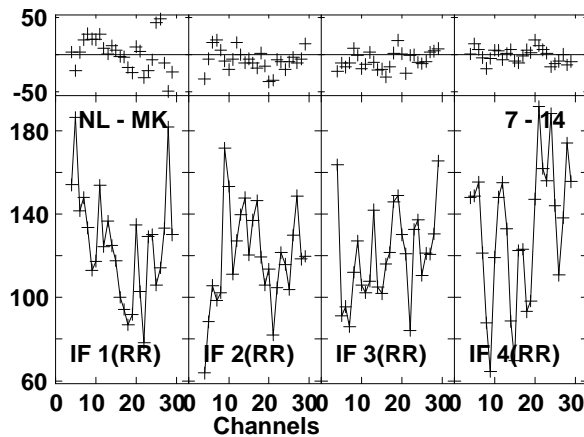
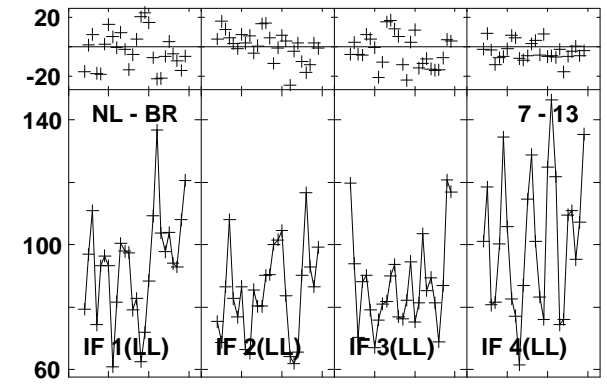
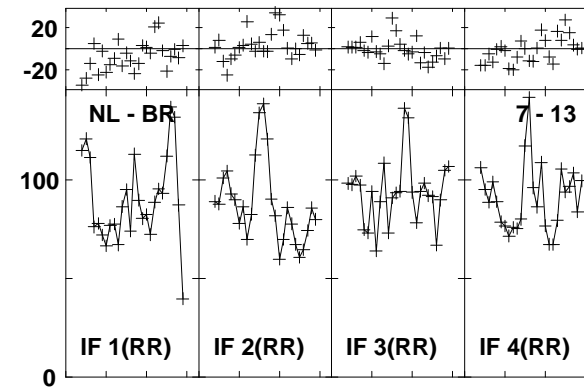
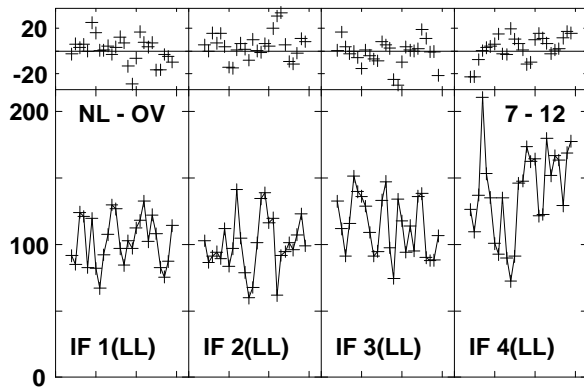
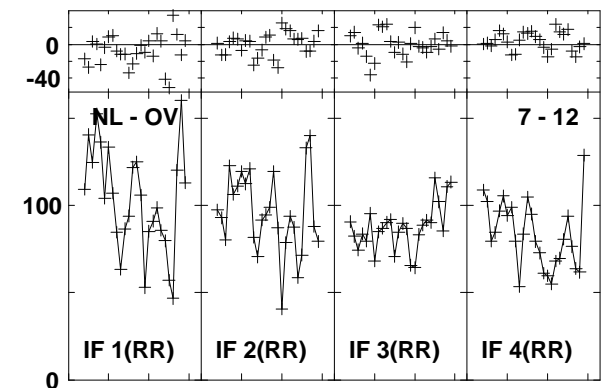
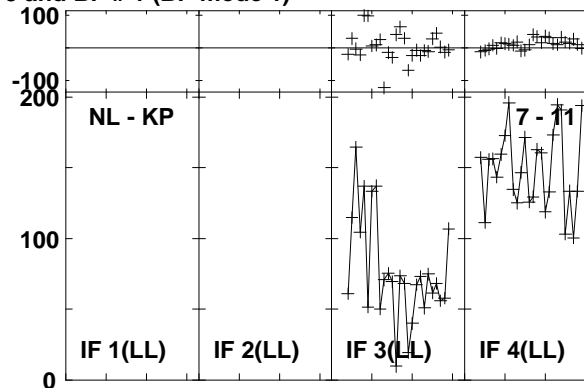
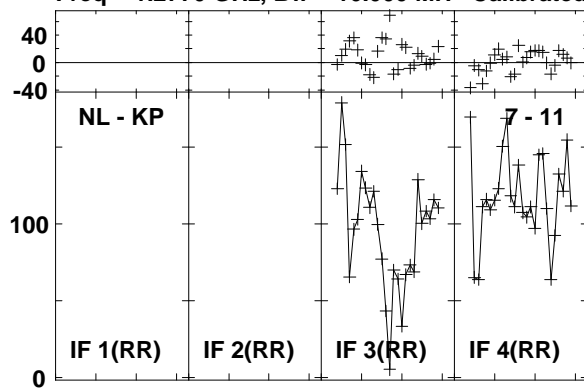

Lower frame: Milli Ampl Jy Top frame: Phas deg
Vector averaged cross-power spectrum Baseline: NL (07) - KP (11)
Timerange: 00:22:48:42 to 00:22:51:10

Plot file version 866 created 03-MAR-2016 01:14:27
J1545+5400 GN002C 1.UVDATA.1
Freq = 1.2770 GHz, Bw = 16.000 MH Calibrated with CL # 3 and BP # 1 (BP mode 1)

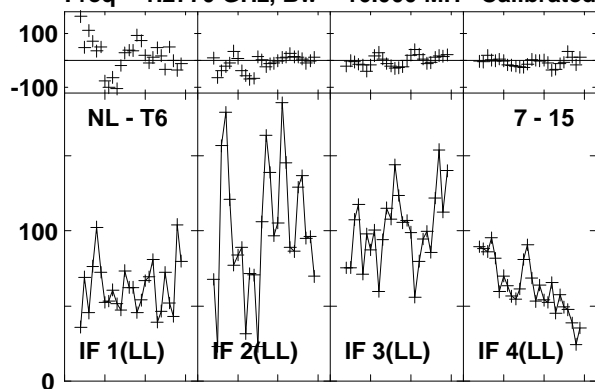

Lower frame: Milli Ampl Jy Top frame: Phas deg
Vector averaged cross-power spectrum Baseline: NL (07) - T6 (15)
Timerange: 00/22:48:42 to 00/22:51:10

Plot file version 867 created 03-MAR-2016 01:14:27

4C52 GN002C 1.UVDATA.1

Freq = 1.2770 GHz, Bw = 16.000 MH Calibrated with CL # 3 and BP # 1 (BP mode 1)

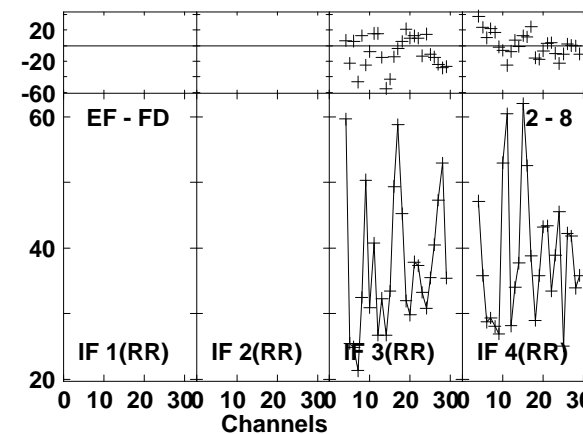
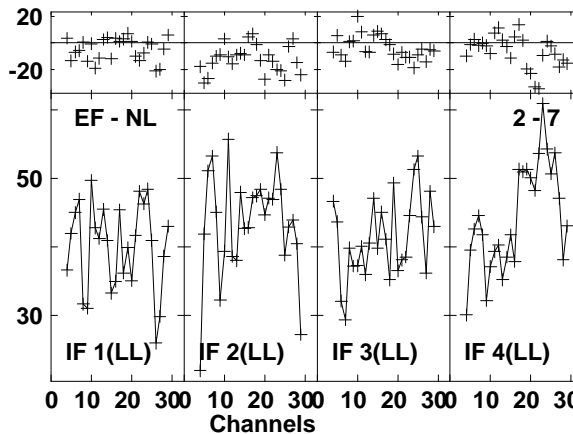
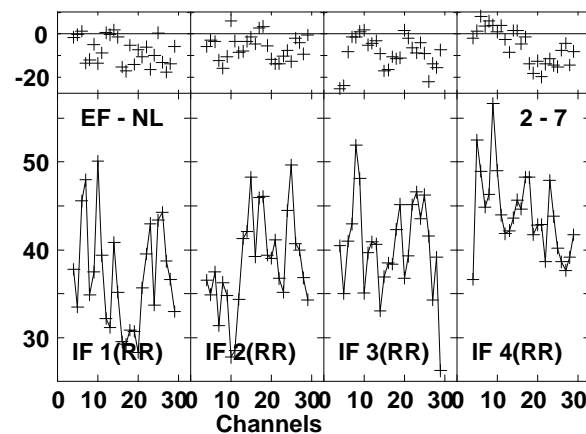
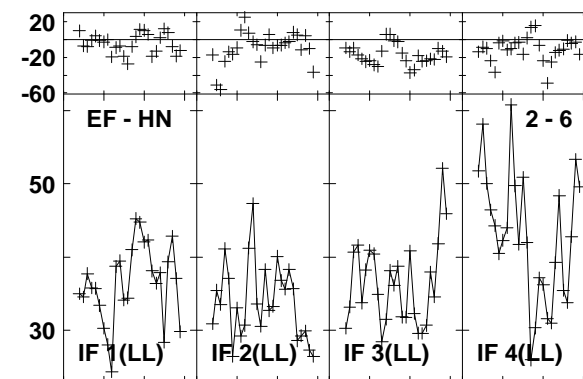
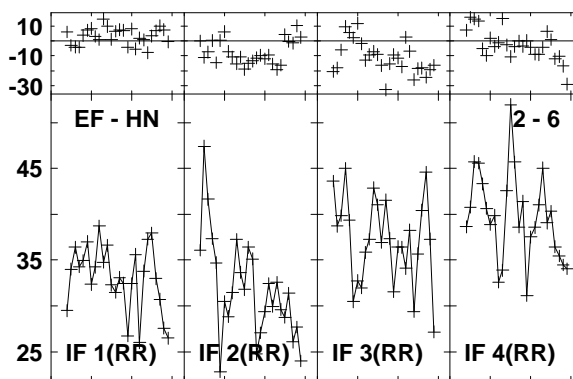
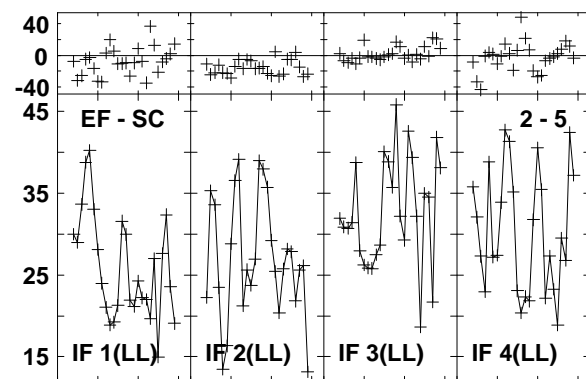
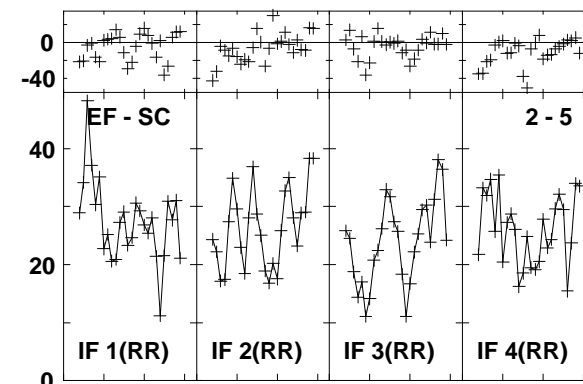
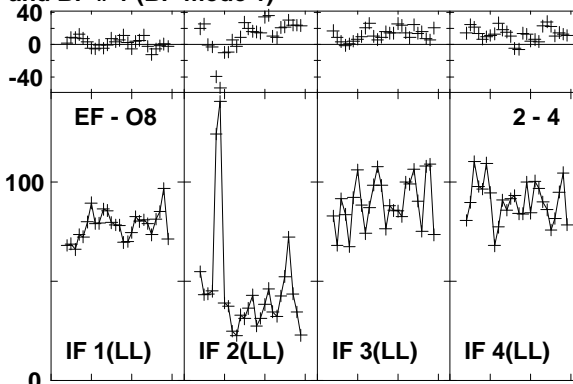
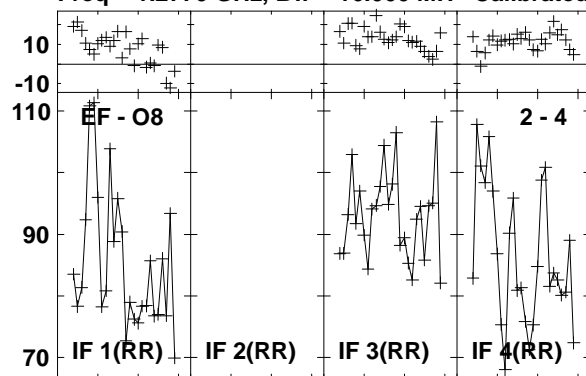

Lower frame: Milli Ampl Jy Top frame: Phas deg
Vector averaged cross-power spectrum Baseline: EF (02) - O8 (04)
Timerange: 00/22:51:23 to 00/22:54:39

Plot file version 868 created 03-MAR-2016 01:14:27

4C52 GN002C 1.UVDATA.1

Freq = 1.2770 GHz, Bw = 16.000 MH Calibrated with CL # 3 and BP # 1 (BP mode 1)

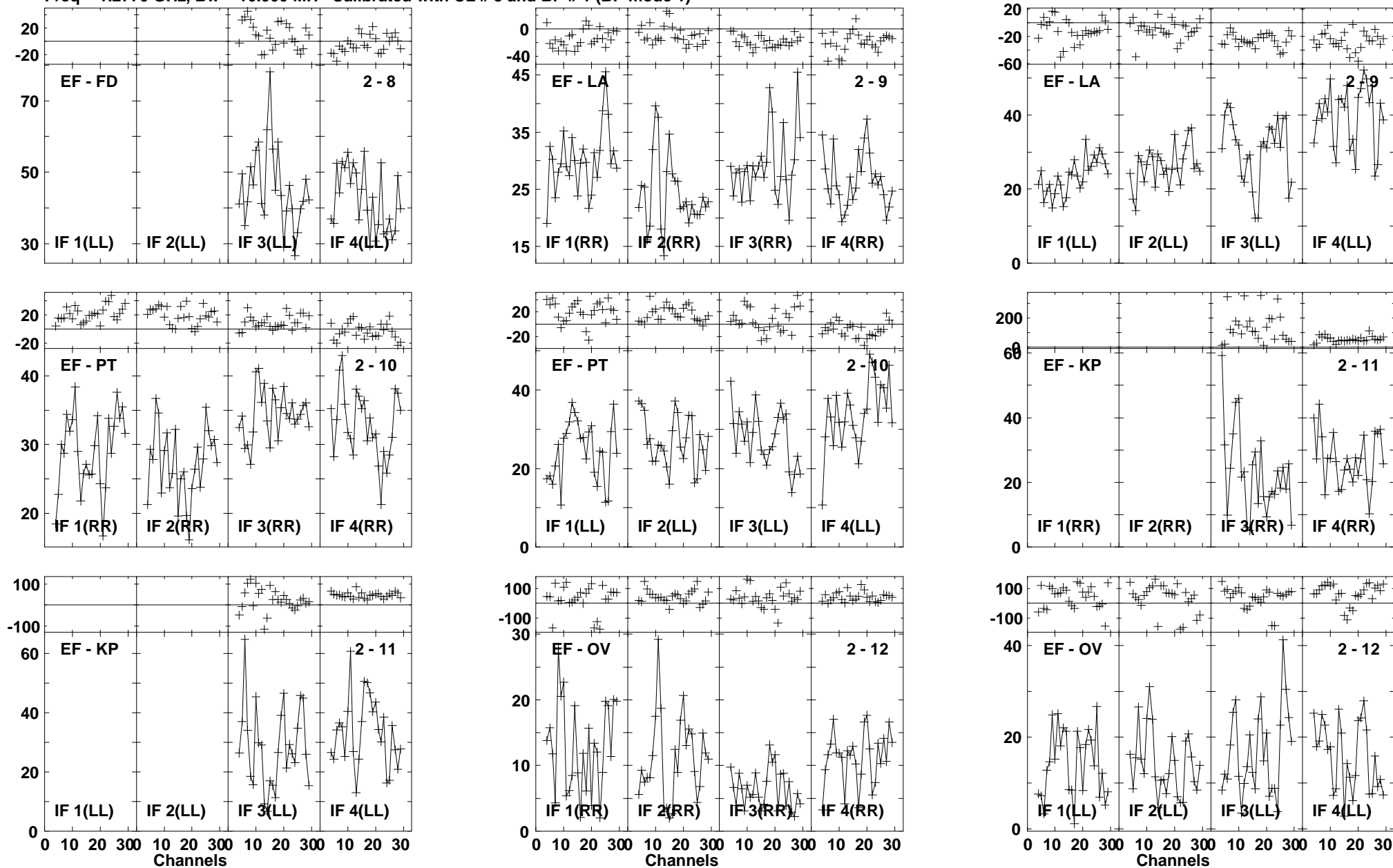

Lower frame: Milli Ampl Jy Top frame: Phas deg
Vector averaged cross-power spectrum Baseline: EF (02) - FD (08)
Timerange: 00/22:51:23 to 00/22:54:39

Plot file version 869 created 03-MAR-2016 01:14:27

4C52 GN002C 1.UVDATA.1

Freq = 1.2770 GHz, Bw = 16.000 MH Calibrated with CL # 3 and BP # 1 (BP mode 1)

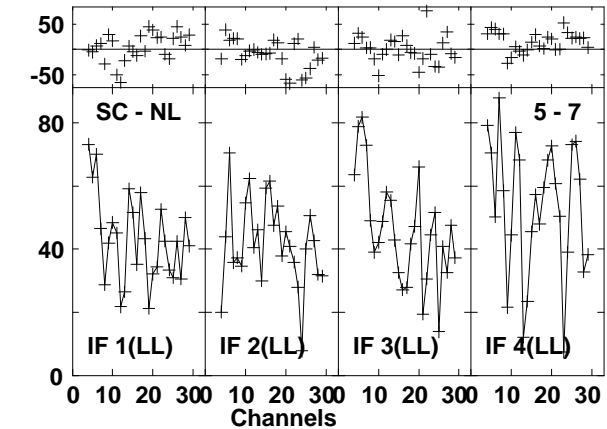
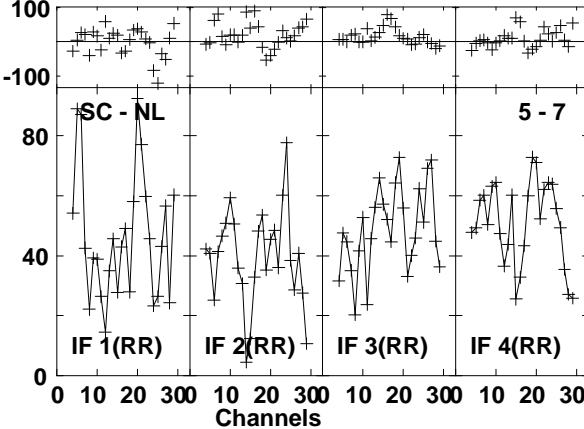
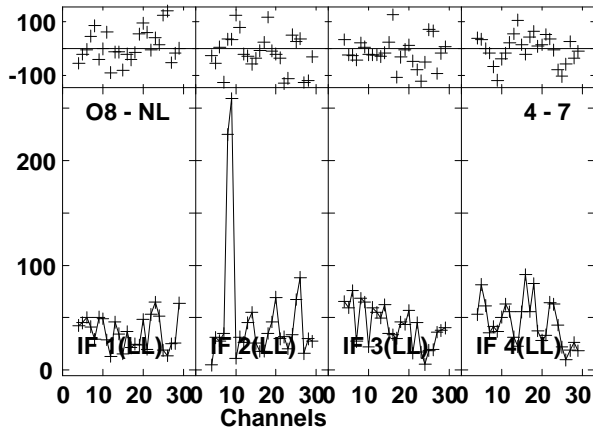
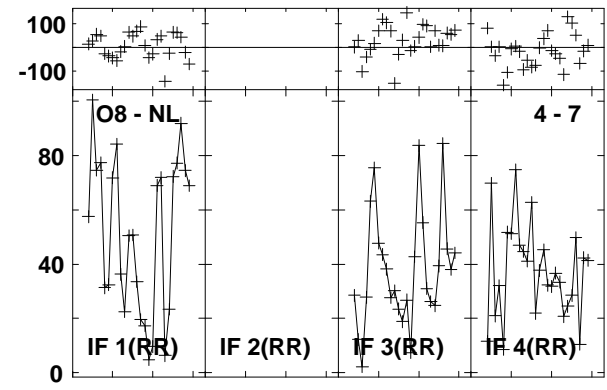
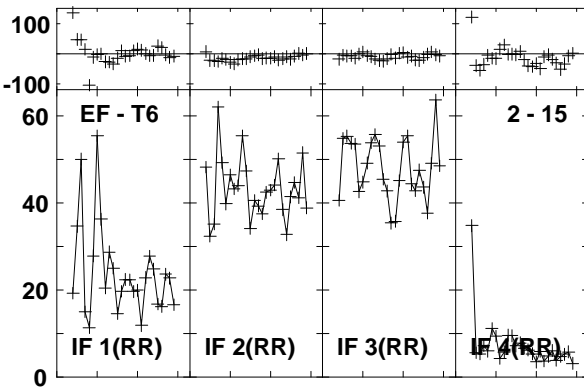
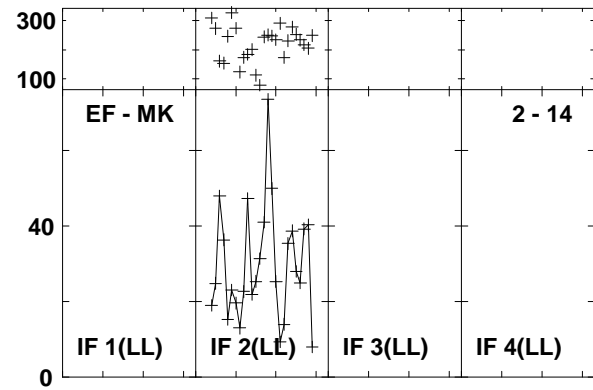
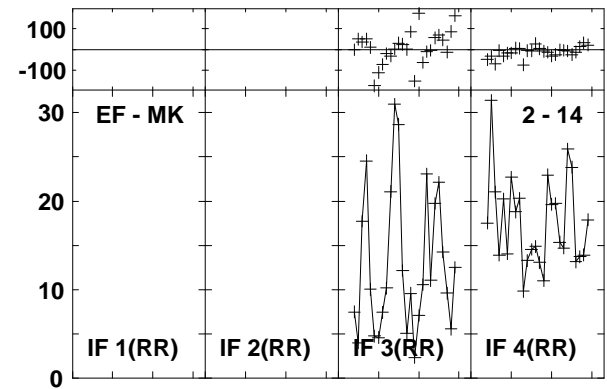
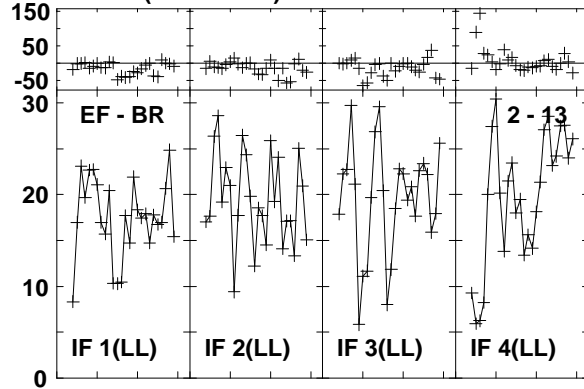
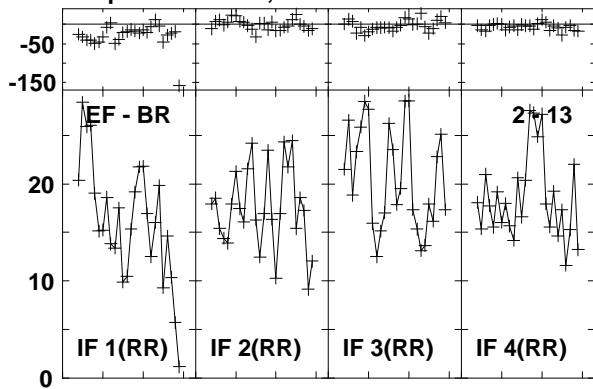

Lower frame: Milli Ampl Jy Top frame: Phas deg
Vector averaged cross-power spectrum Baseline: EF (02) - BR (13)
Timerange: 00/22:51:23 to 00/22:54:39

Plot file version 870 created 03-MAR-2016 01:14:28

4C52 GN002C 1.UVDATA.1

Freq = 1.2770 GHz, Bw = 16.000 MH Calibrated with CL # 3 and BP # 1 (BP mode 1)

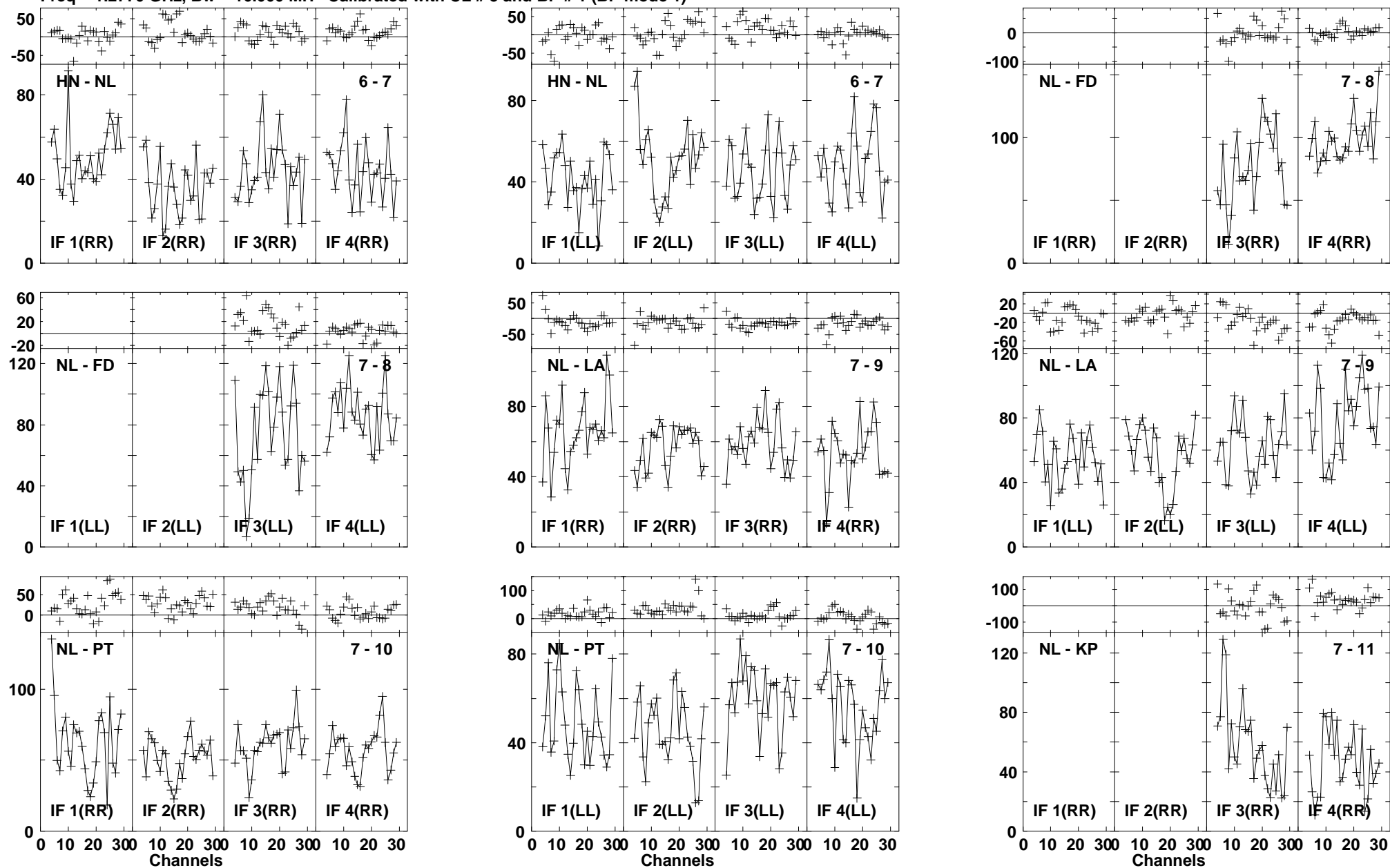

Lower frame: Milli Ampl Jy Top frame: Phas deg
Vector averaged cross-power spectrum Baseline: HN (06) - NL (07)
Timerange: 00/22:51:23 to 00/22:54:39

Plot file version 871 created 03-MAR-2016 01:14:28

4C52 GN002C 1.UVDATA.1

Freq = 1.2770 GHz, Bw = 16.000 MH Calibrated with CL # 3 and BP # 1 (BP mode 1)

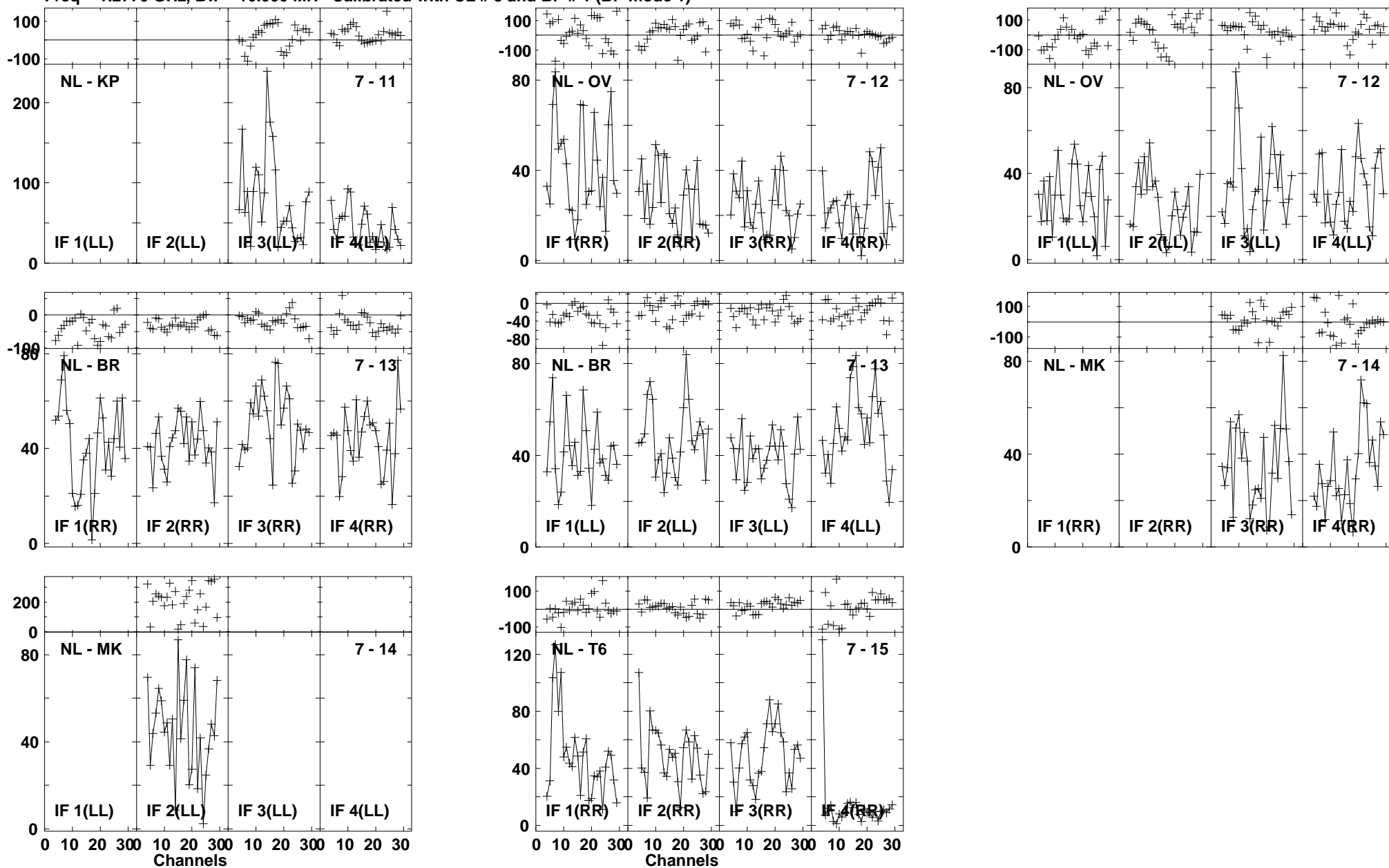

Lower frame: Milli Ampl Jy Top frame: Phas deg
Vector averaged cross-power spectrum Baseline: NL (07) - KP (11)
Timerange: 00/22:51:23 to 00/22:54:39

Plot file version 872 created 03-MAR-2016 01:14:28

J1545+5400 GN002C 1.UVDATA.1

Freq = 1.2770 GHz, Bw = 16.000 MH Calibrated with CL # 3 and BP # 1 (BP mode 1)

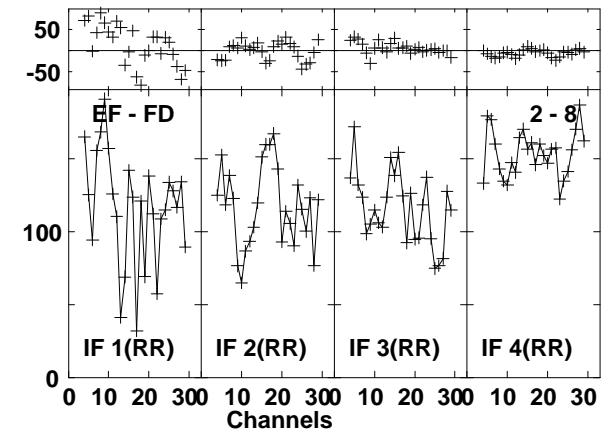
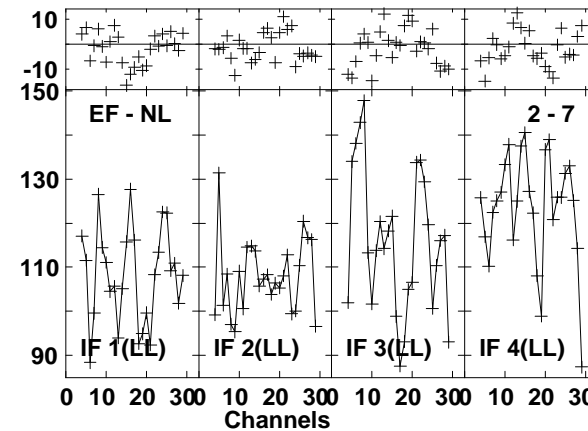
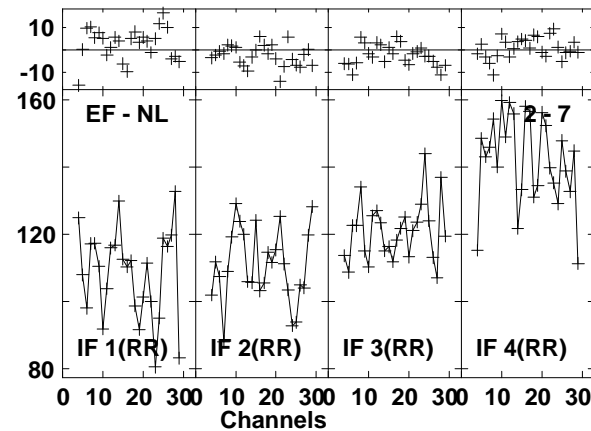
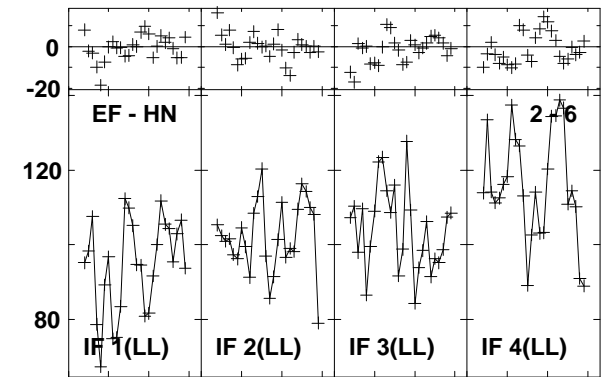
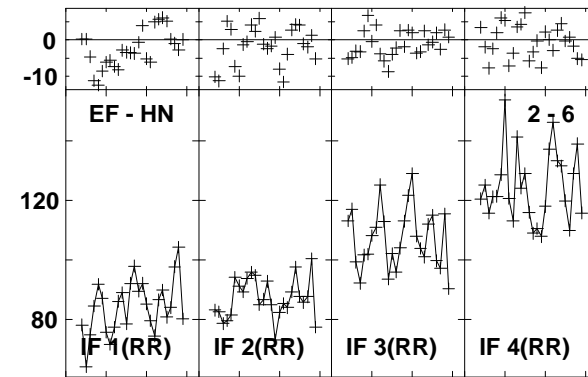
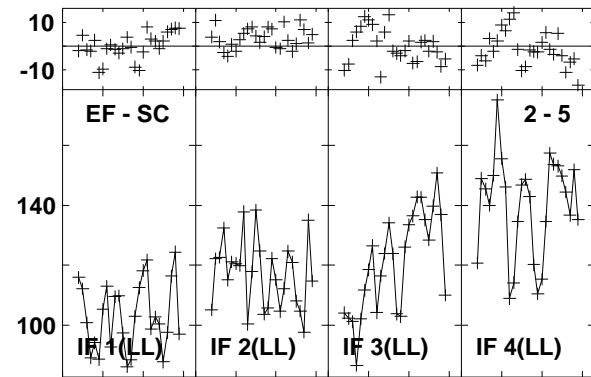
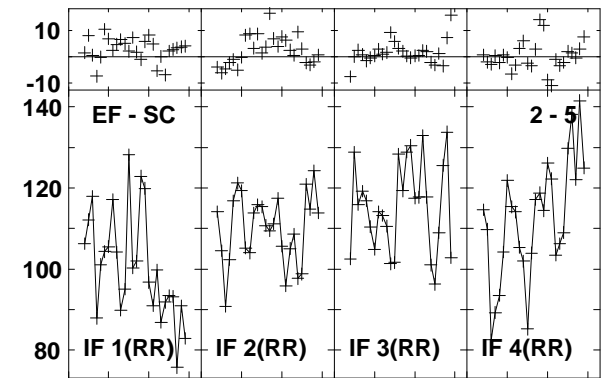
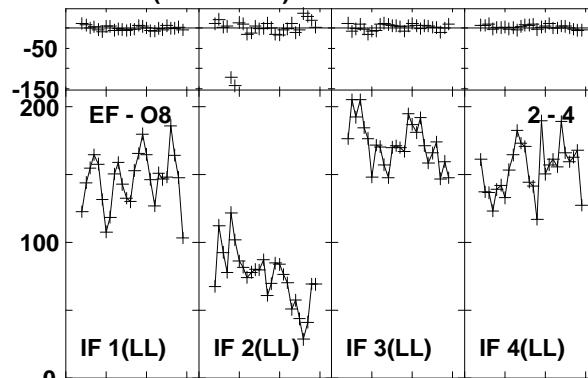
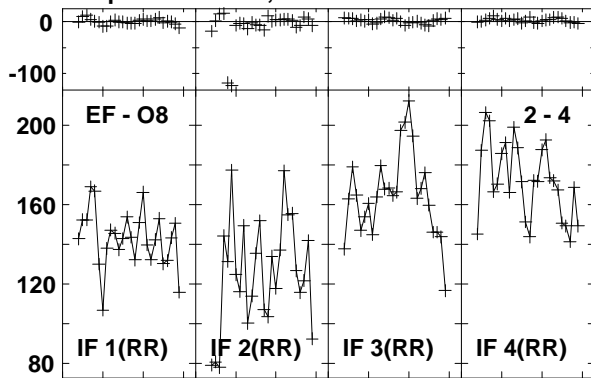

Lower frame: Milli Ampl Jy Top frame: Phas deg

Vector averaged cross-power spectrum Baseline: EF (02) - O8 (04)

Timerange: 00/22:55:32 to 00/22:56:30

Plot file version 873 created 03-MAR-2016 01:14:28

J1545+5400 GN002C 1.UVDATA.1

Freq = 1.2770 GHz, Bw = 16.000 MH Calibrated with CL # 3 and BP # 1 (BP mode 1)

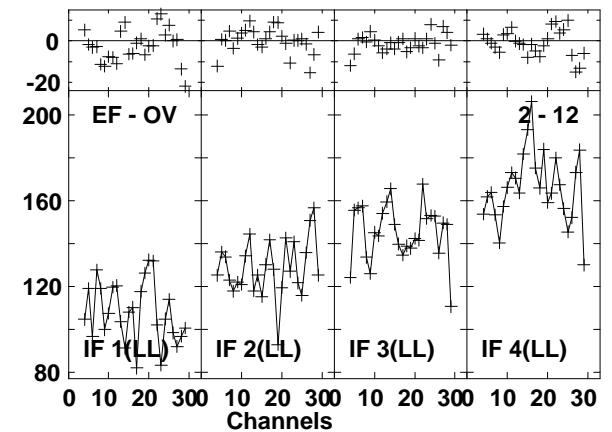
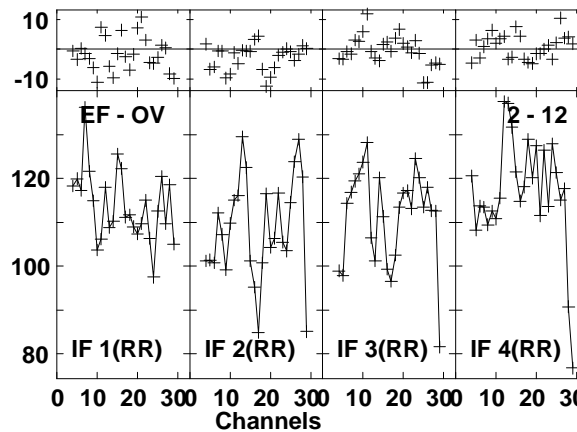
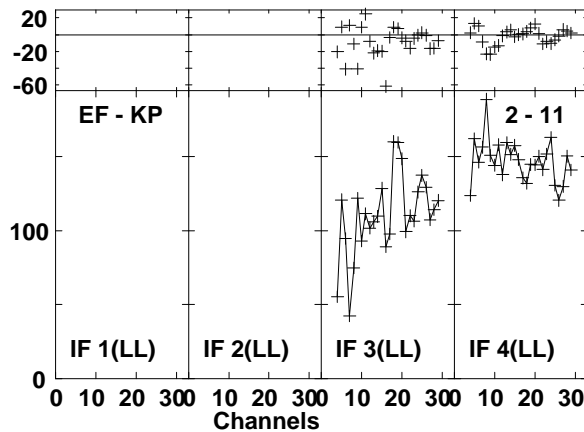
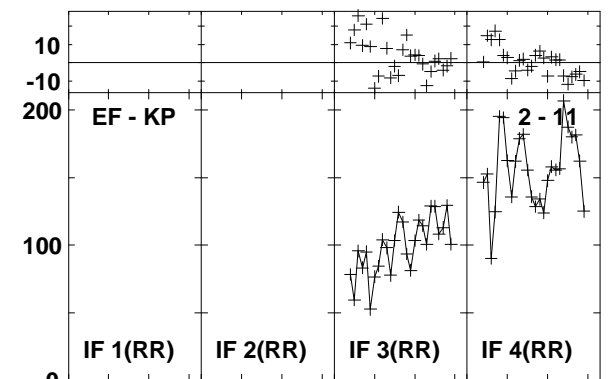
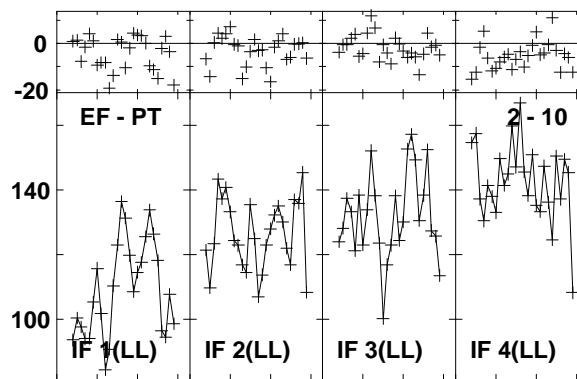
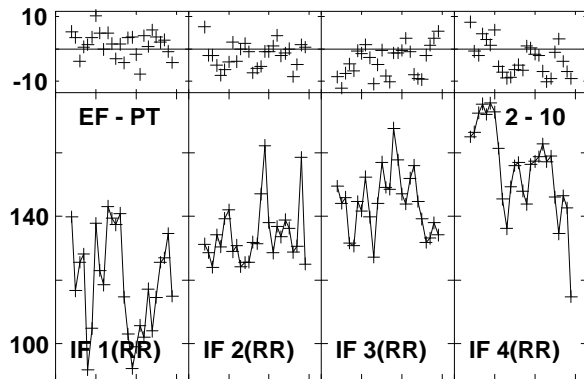
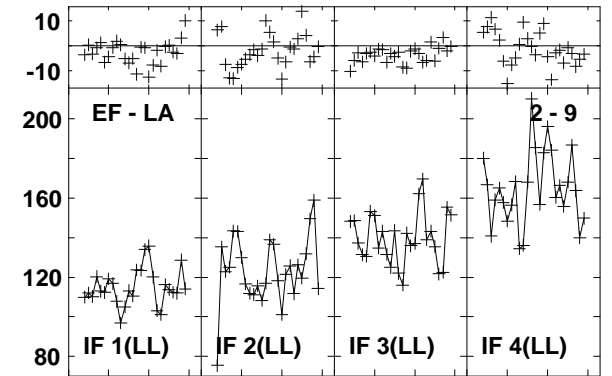
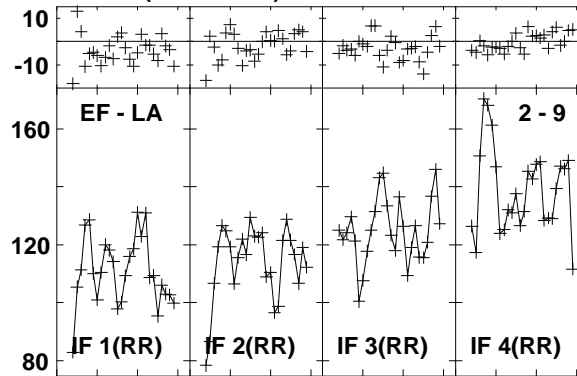
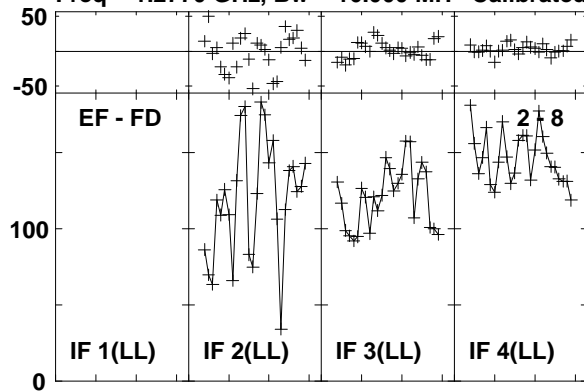

Lower frame: Milli Ampl Jy Top frame: Phas deg
Vector averaged cross-power spectrum Baseline: EF (02) - FD (08)
Timerange: 00/22:55:32 to 00/22:56:30

Plot file version 874 created 03-MAR-2016 01:14:28

J1545+5400 GN002C 1.UVDATA.1

Freq = 1.2770 GHz, Bw = 16.000 MH Calibrated with CL # 3 and BP # 1 (BP mode 1)

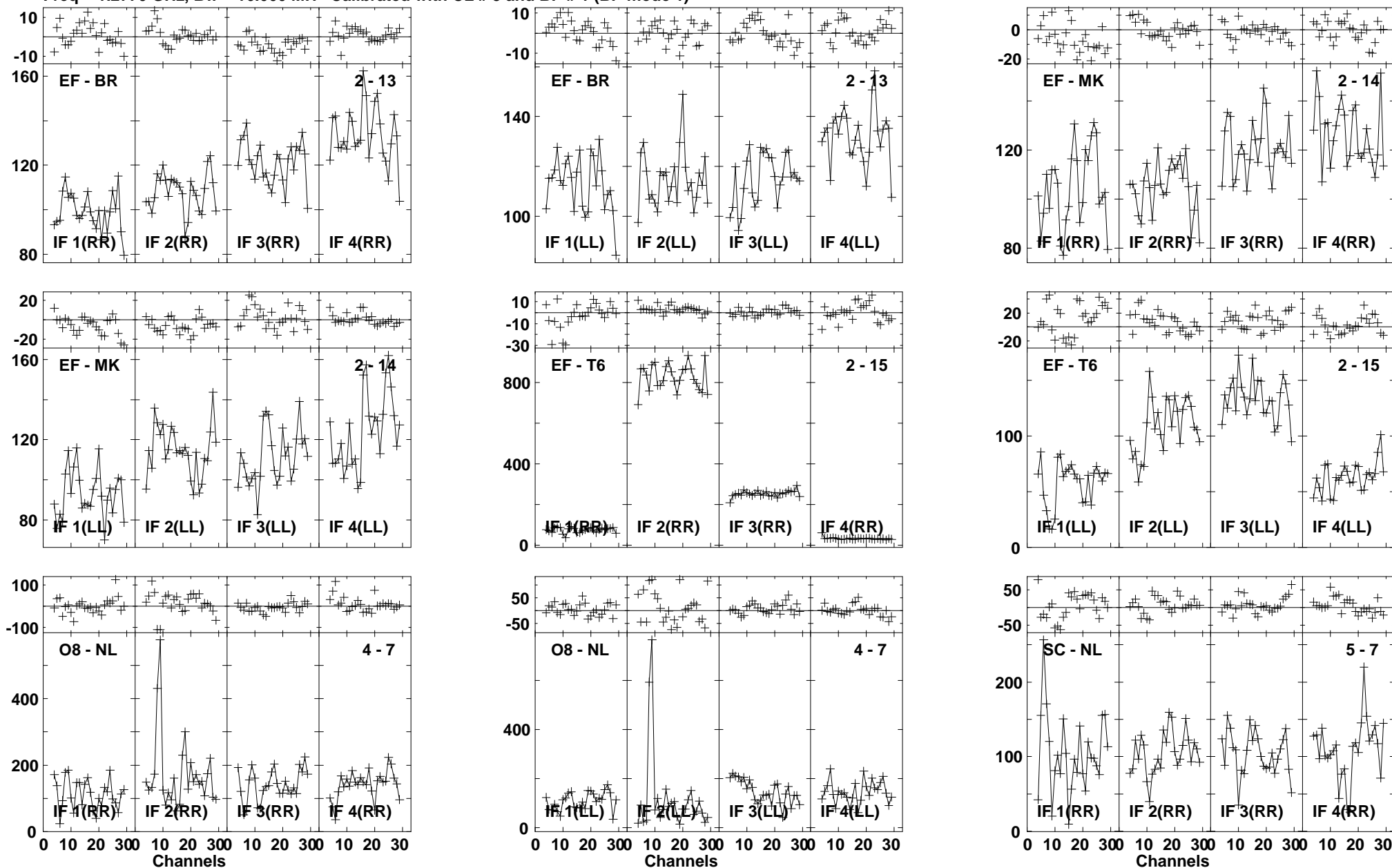

Lower frame: Milli Ampl Jy Top frame: Phas deg
Vector averaged cross-power spectrum Baseline: EF (02) - BR (13)
Timerange: 00/22:55:32 to 00/22:56:30

Plot file version 875 created 03-MAR-2016 01:14:29
 J1545+5400 GN002C 1.UVDATA.1
 Freq = 1.2770 GHz, Bw = 16.000 MH Calibrated with CL # 3 and BP # 1 (BP mode 1)

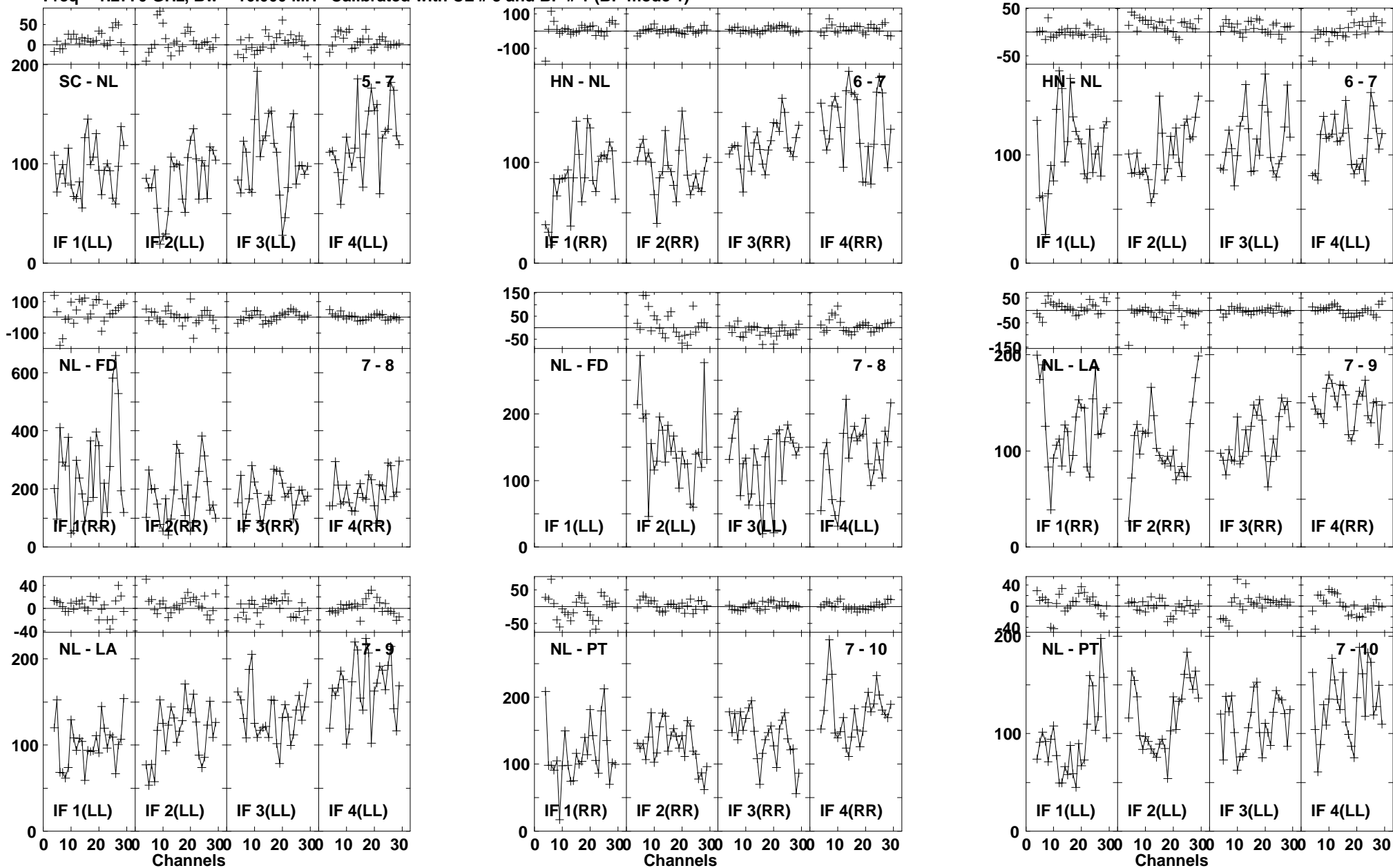

Lower frame: Milli Ampl Jy Top frame: Phas deg
 Vector averaged cross-power spectrum Baseline: SC (05) - NL (07)
 Timerange: 00:22:55:32 to 00:22:56:30

Plot file version 876 created 03-MAR-2016 01:14:29

J1545+5400 GN002C 1.UVDATA.1

Freq = 1.2770 GHz, Bw = 16.000 MH Calibrated with CL # 3 and BP # 1 (BP mode 1)

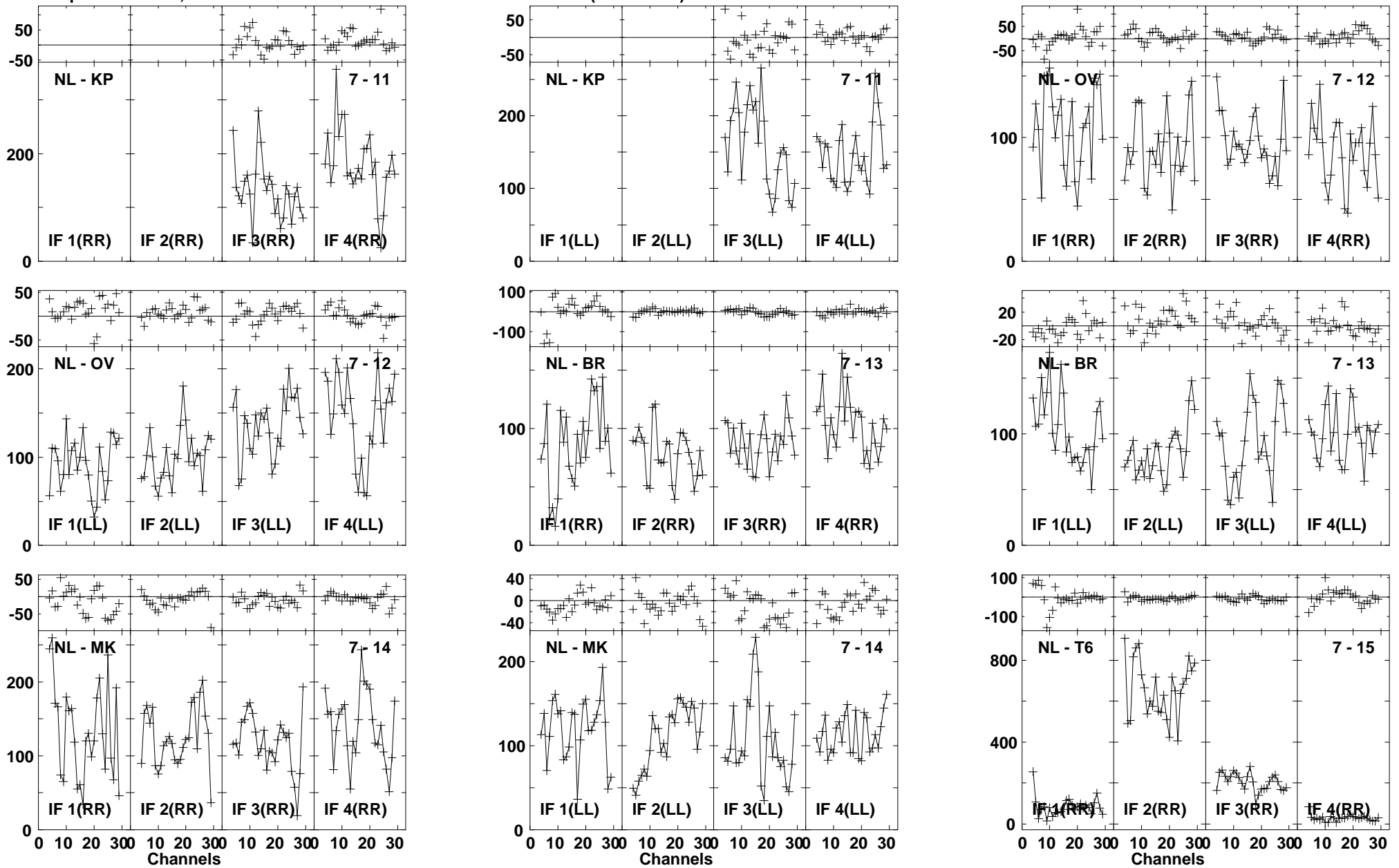

Lower frame: Milli Ampl Jy Top frame: Phas deg
Vector averaged cross-power spectrum Baseline: NL (07) - KP (11)
Timerange: 00/22:55:32 to 00/22:56:30

Plot file version 877 created 03-MAR-2016 01:14:29
J1545+5400 GN002C 1.UVDATA.1
Freq = 1.2770 GHz, Bw = 16.000 MH Calibrated with CL # 3 and BP # 1 (BP mode 1)

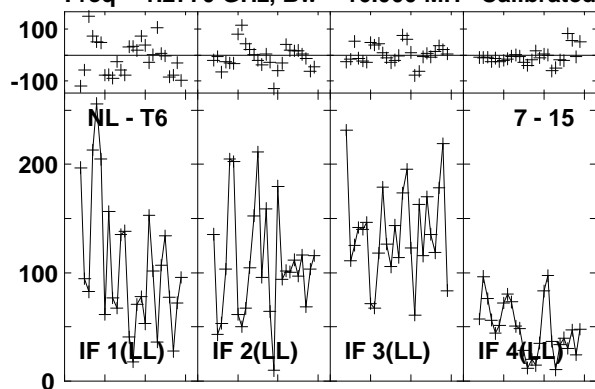

Lower frame: Milli Ampl Jy Top frame: Phas deg
Vector averaged cross-power spectrum Baseline: NL (07) - T6 (15)
Timerange: 00/22:55:32 to 00/22:56:30

Plot file version 878 created 03-MAR-2016 01:14:29

4C52 GN002C 1.UVDATA.1

Freq = 1.2770 GHz, Bw = 16.000 MH Calibrated with CL # 3 and BP # 1 (BP mode 1)

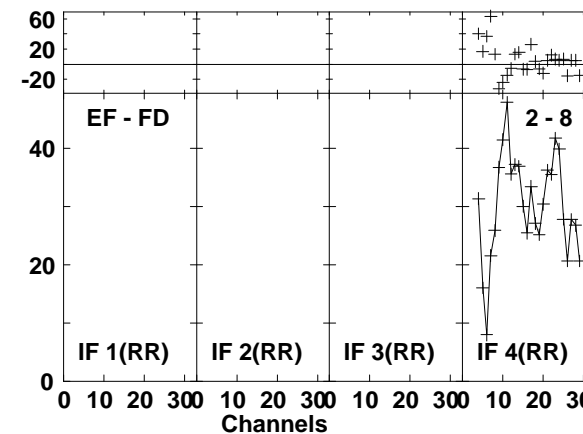
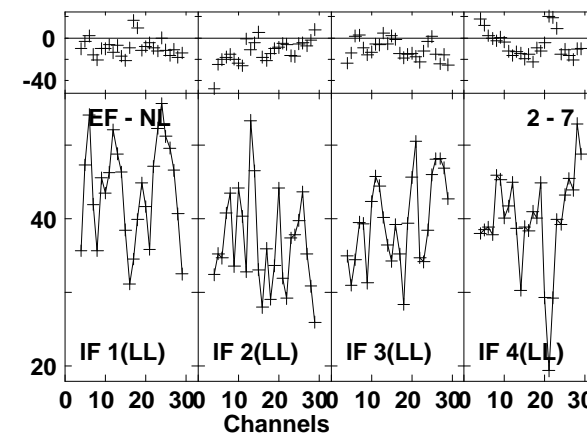
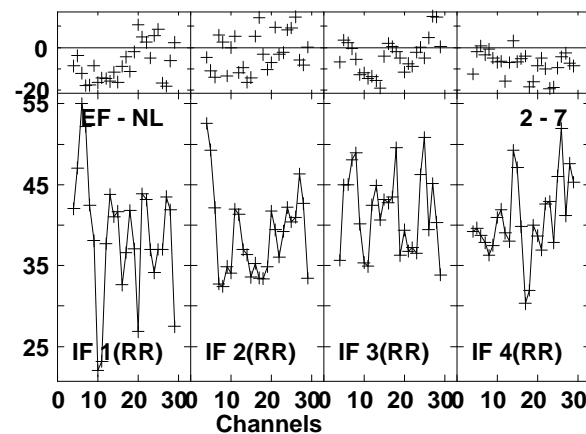
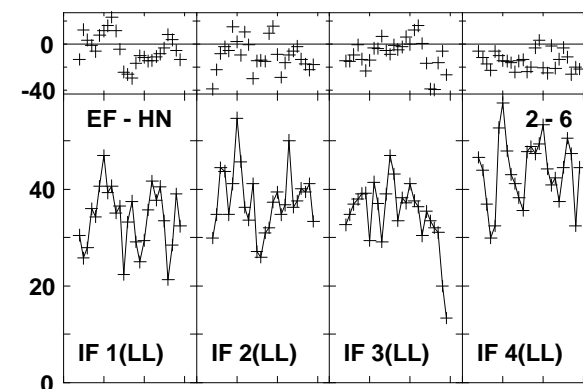
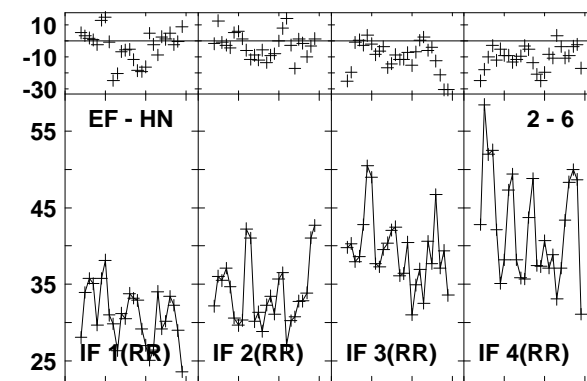
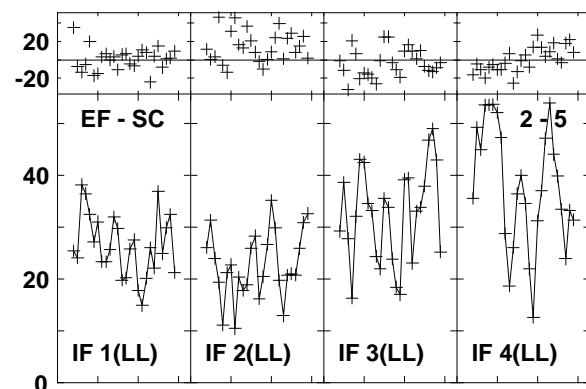
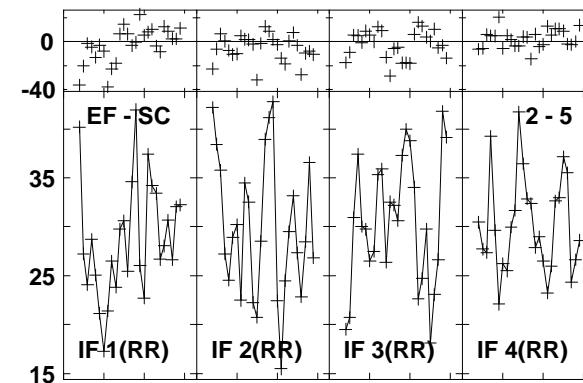
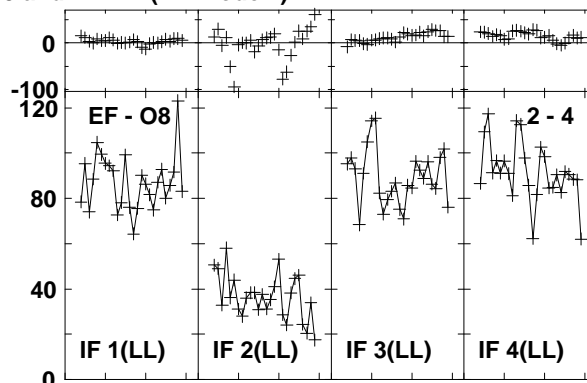
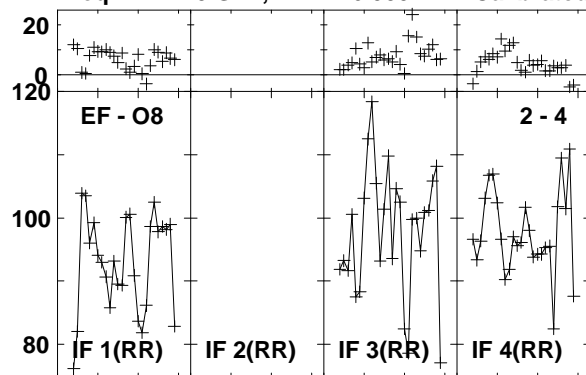

Lower frame: Milli Ampl Jy Top frame: Phas deg
Vector averaged cross-power spectrum Baseline: EF (02) - O8 (04)
Timerange: 00/22:56:35 to 00/22:59:59

Plot file version 879 created 03-MAR-2016 01:14:29

4C52 GN002C 1.UVDATA.1

Freq = 1.2770 GHz, Bw = 16.000 MH Calibrated with CL # 3 and BP # 1 (BP mode 1)

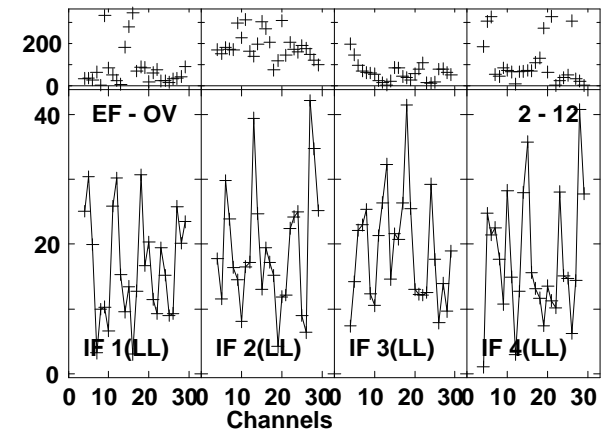
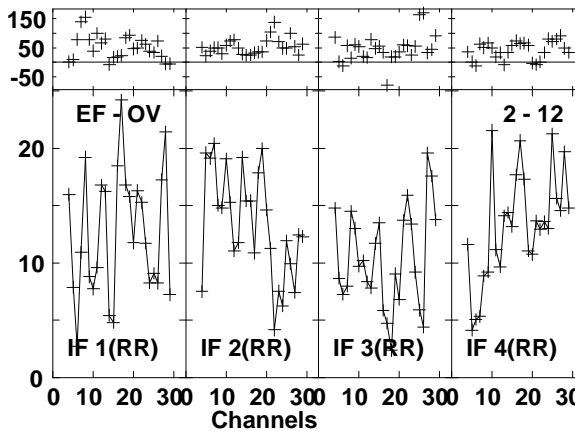
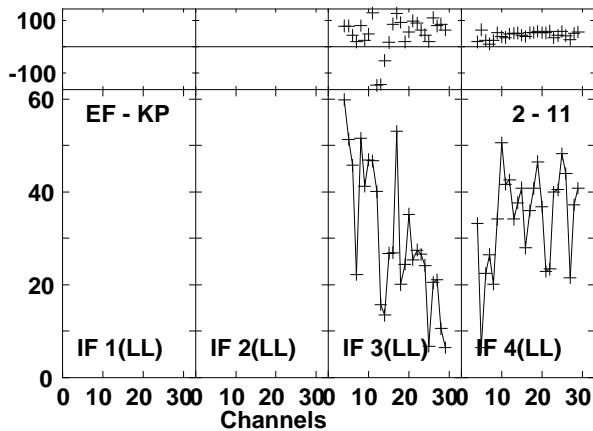
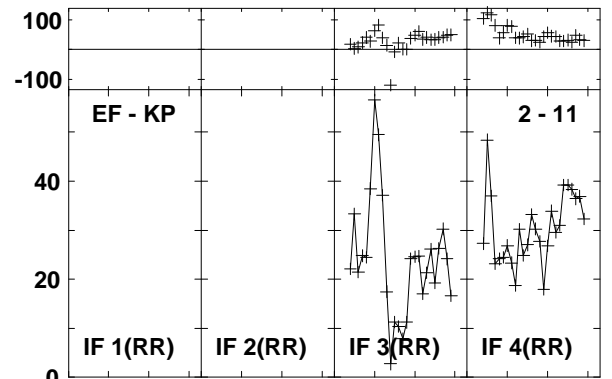
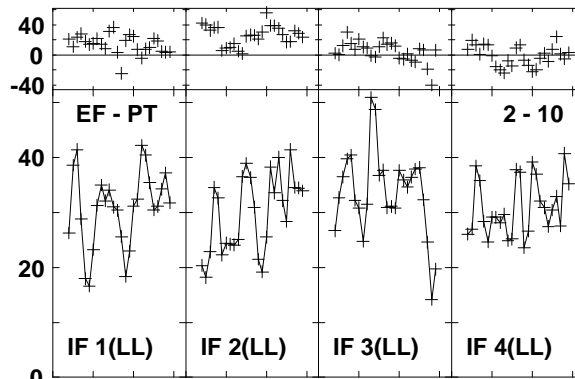
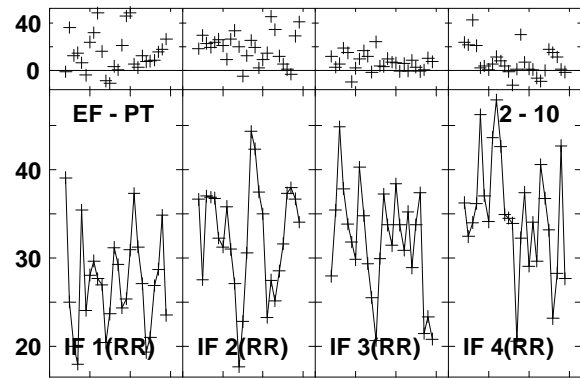
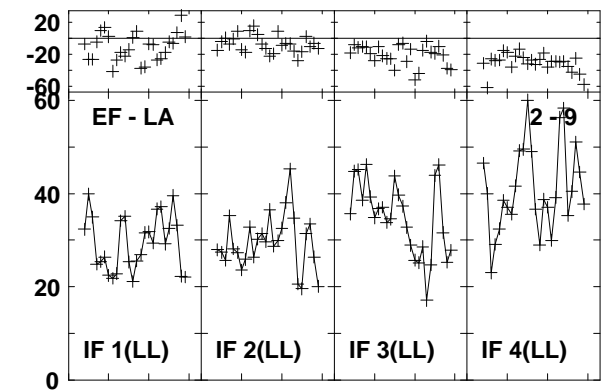
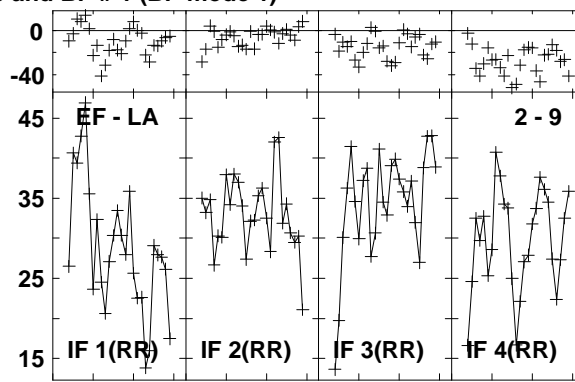
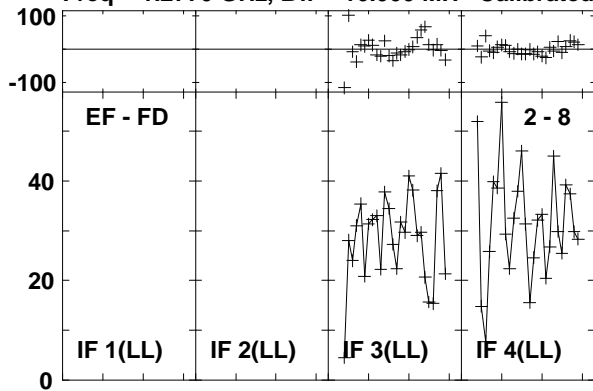

Lower frame: Milli Ampl Jy Top frame: Phas deg
Vector averaged cross-power spectrum Baseline: EF (02) - FD (08)
Timerange: 00/22:56:35 to 00/22:59:59

Plot file version 880 created 03-MAR-2016 01:14:29

4C52 GN002C 1.UVDATA.1

Freq = 1.2770 GHz, Bw = 16.000 MH Calibrated with CL # 3 and BP # 1 (BP mode 1)

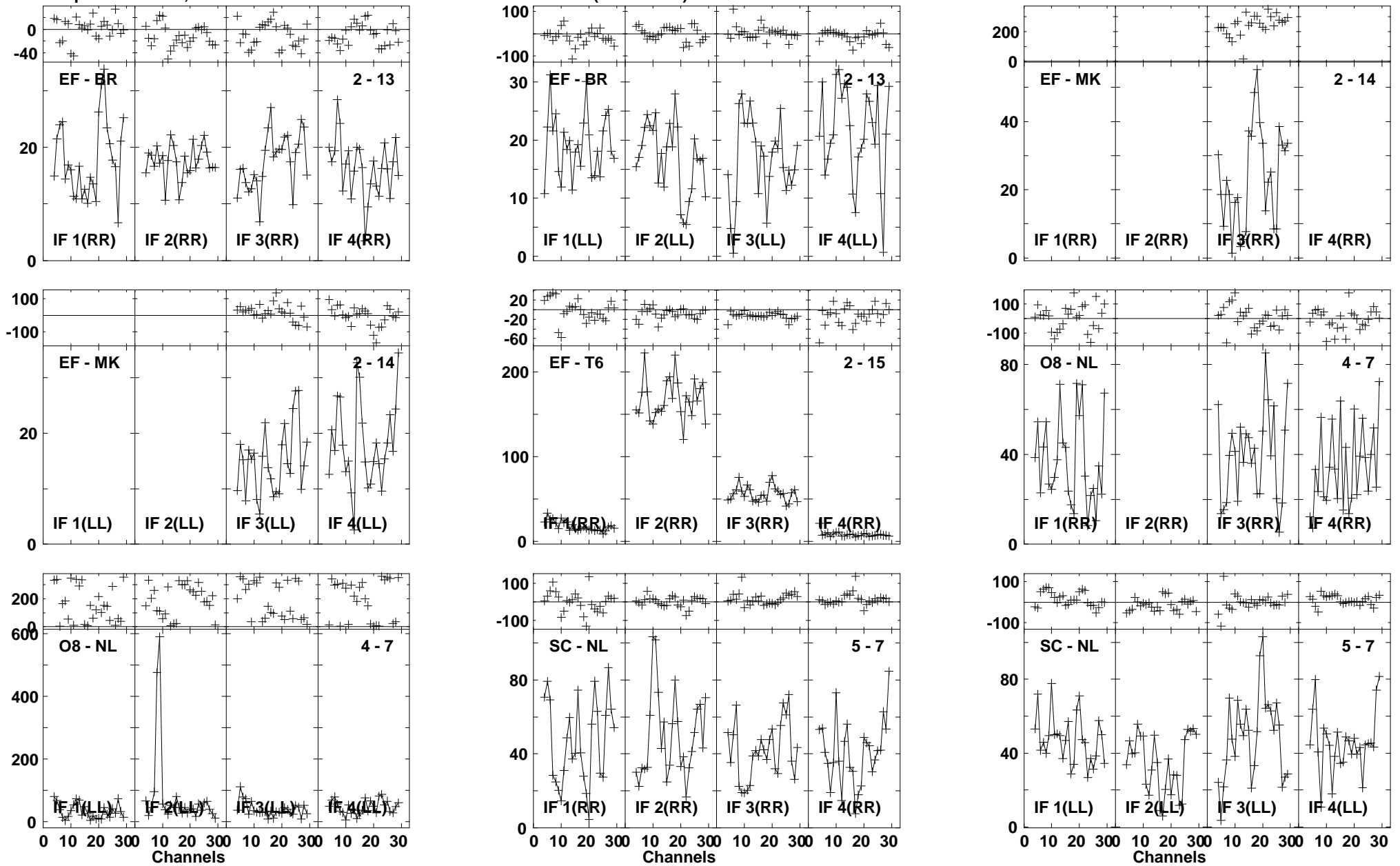

Plot file version 881 created 03-MAR-2016 01:14:30

4C52 GN002C 1.UVDATA.1

Freq = 1.2770 GHz, Bw = 16.000 MH Calibrated with CL # 3 and BP # 1 (BP mode 1)

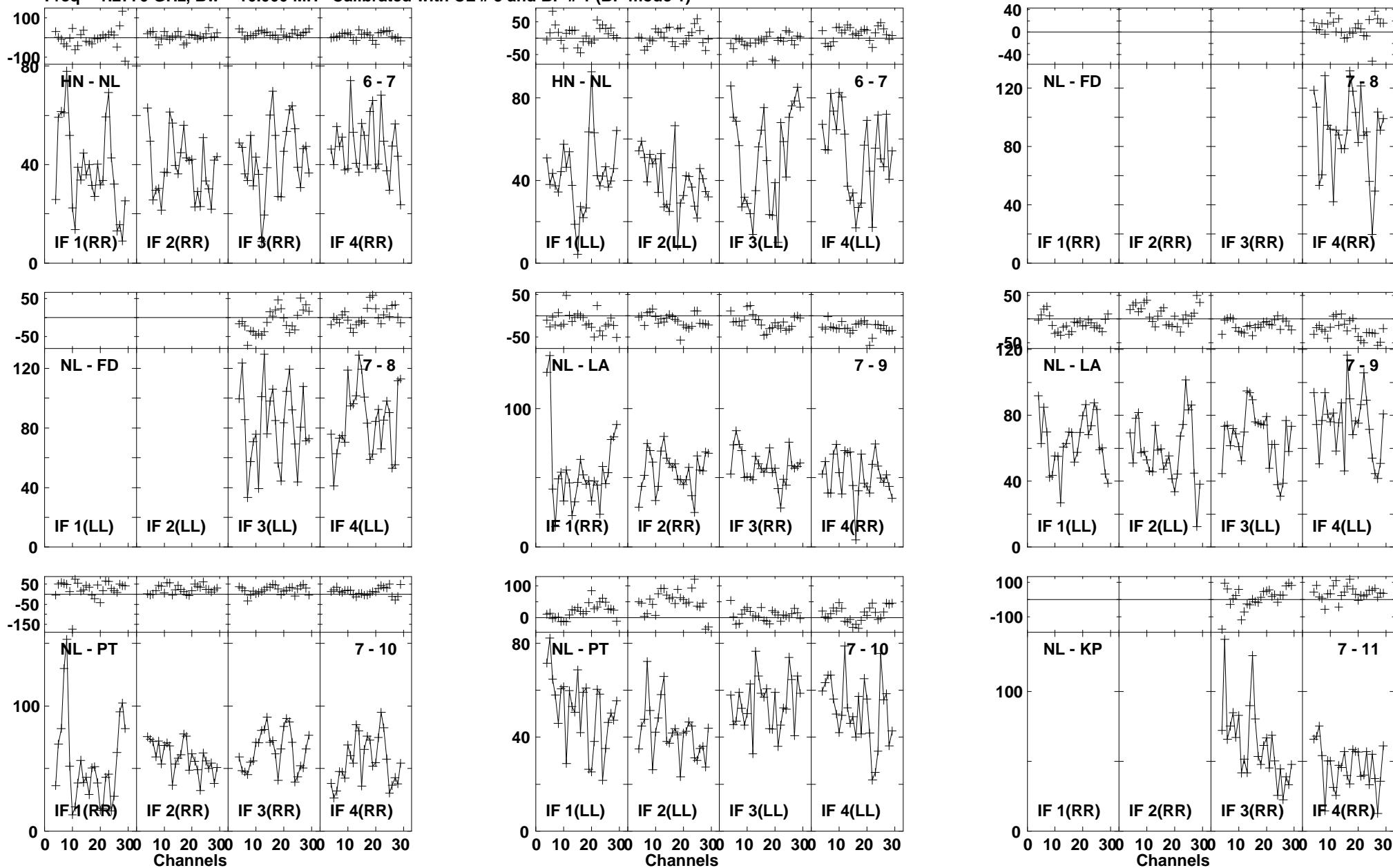

Lower frame: Milli Ampl Jy Top frame: Phas deg
Vector averaged cross-power spectrum Baseline: HN (06) - NL (07)
Timerange: 00/22:56:35 to 00/22:59:59

Plot file version 882 created 03-MAR-2016 01:14:30

4C52 GN002C 1.UVDATA.1

Freq = 1.2770 GHz, Bw = 16.000 MH Calibrated with CL # 3 and BP # 1 (BP mode 1)

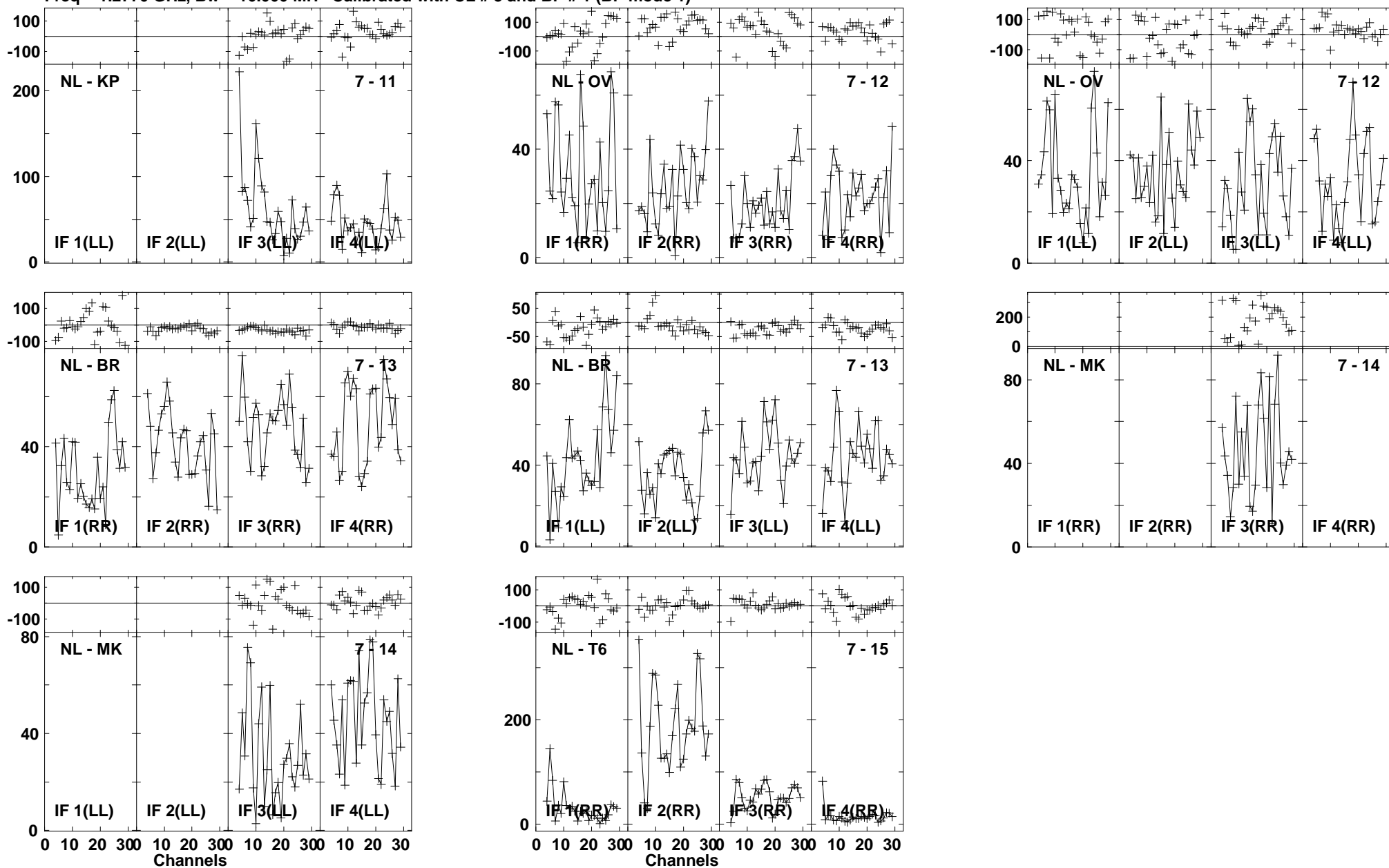

Lower frame: Milli Ampl Jy Top frame: Phas deg
Vector averaged cross-power spectrum Baseline: NL (07) - KP (11)
Timerange: 00/22:56:35 to 00/22:59:59

Plot file version 883 created 03-MAR-2016 01:14:30
 J1545+5400 GN002C 1.UVDATA.1
 Freq = 1.2770 GHz, Bw = 16.000 MH Calibrated with CL # 3 and BP # 1 (BP mode 1)

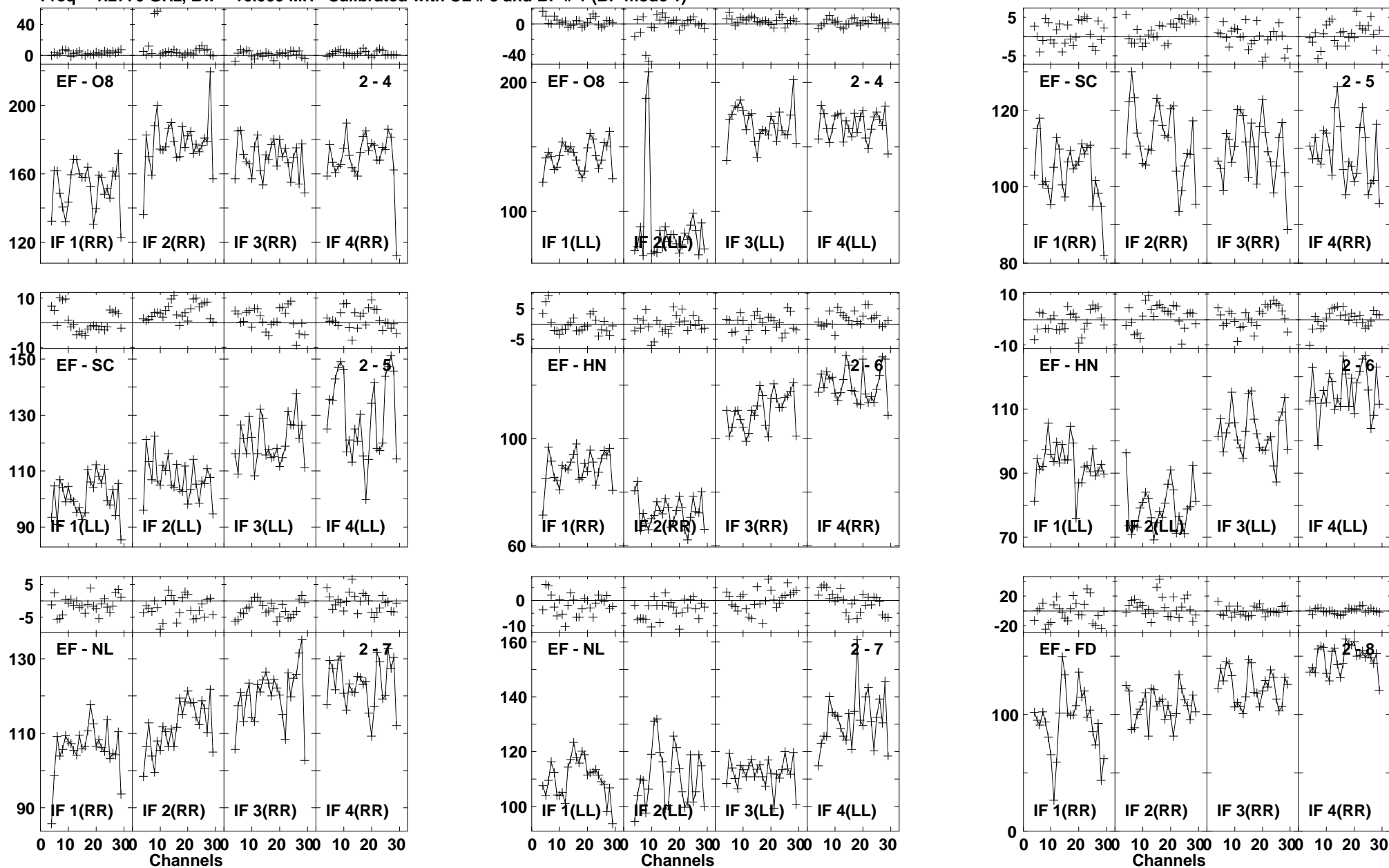

Lower frame: Milli Ampl Jy Top frame: Phas deg
 Vector averaged cross-power spectrum Baseline: EF (02) - O8 (04)
 Timerange: 00/23:00:52 to 00/23:03:20

Plot file version 884 created 03-MAR-2016 01:14:30

J1545+5400 GN002C 1.UVDATA.1

Freq = 1.2770 GHz, Bw = 16.000 MH Calibrated with CL # 3 and BP # 1 (BP mode 1)

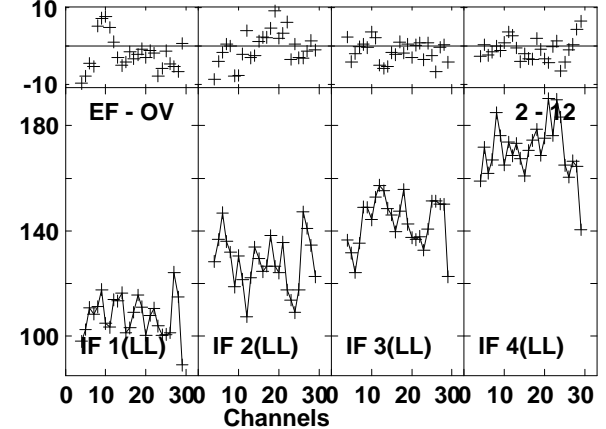
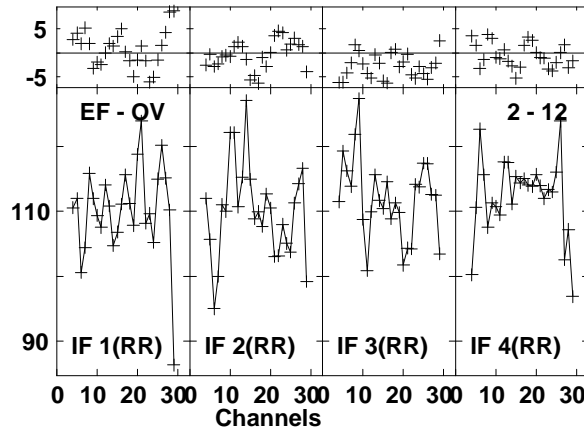
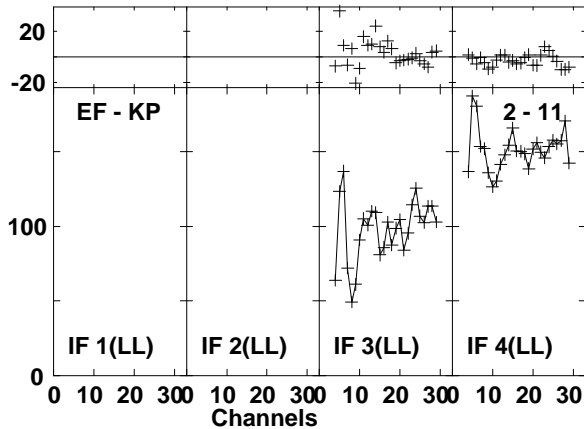
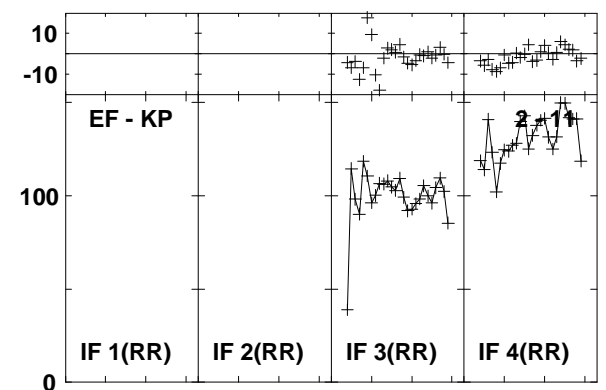
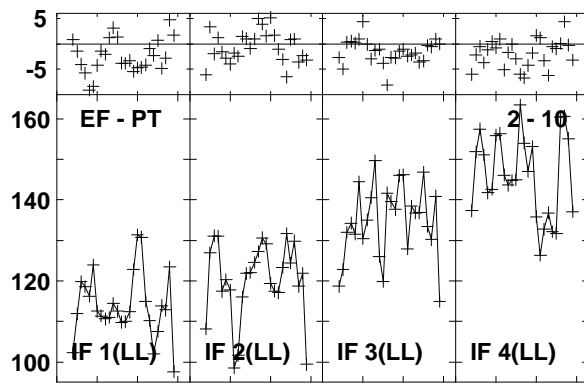
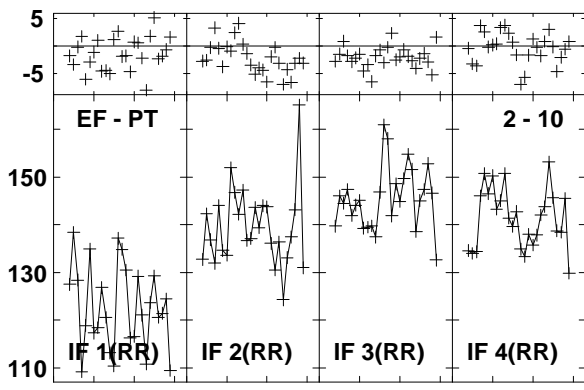
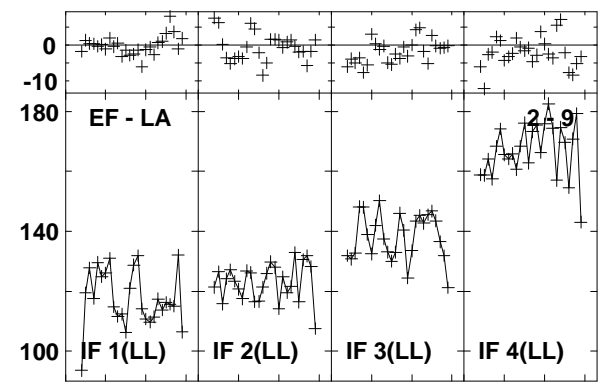
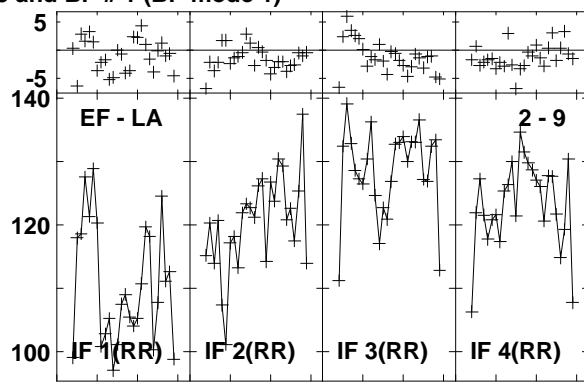
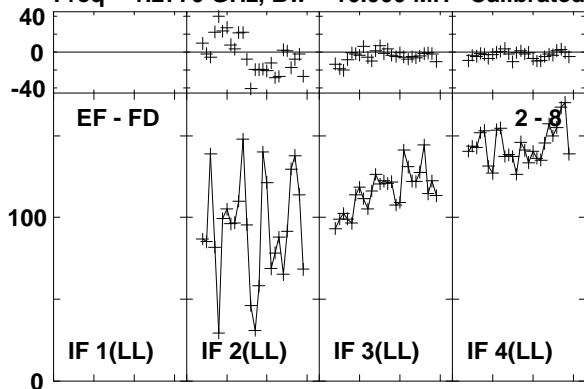

Lower frame: Milli Ampl Jy Top frame: Phas deg
Vector averaged cross-power spectrum Baseline: EF (02) - FD (08)
Timerange: 00/23:00:52 to 00/23:03:20

Plot file version 885 created 03-MAR-2016 01:14:31
 J1545+5400 GN002C 1.UVDATA.1
 Freq = 1.2770 GHz, Bw = 16.000 MH Calibrated with CL # 3 and BP # 1 (BP mode 1)

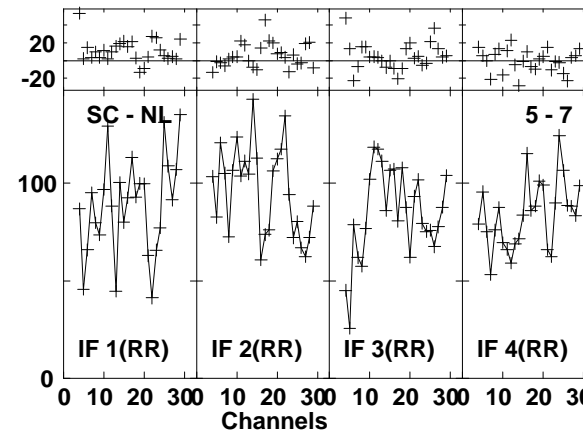
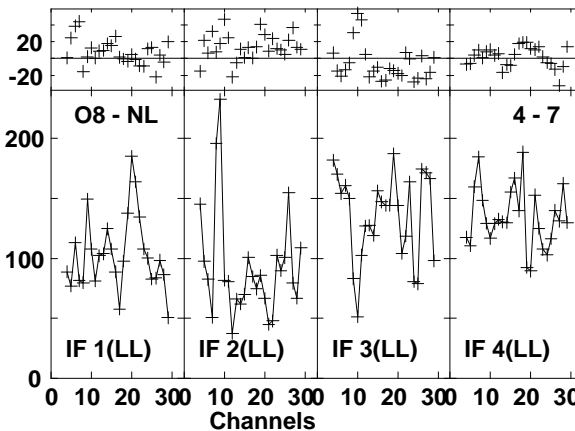
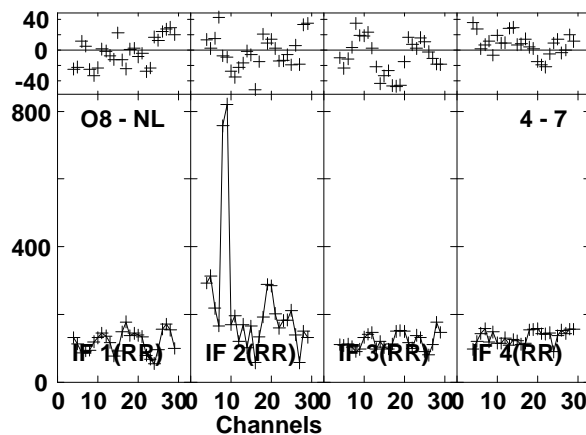
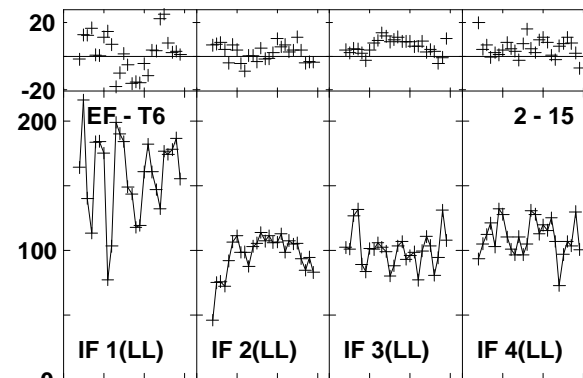
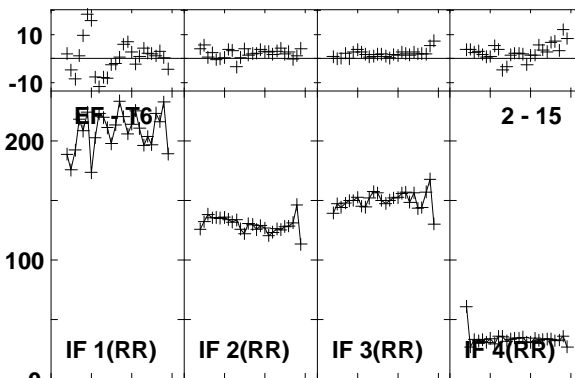
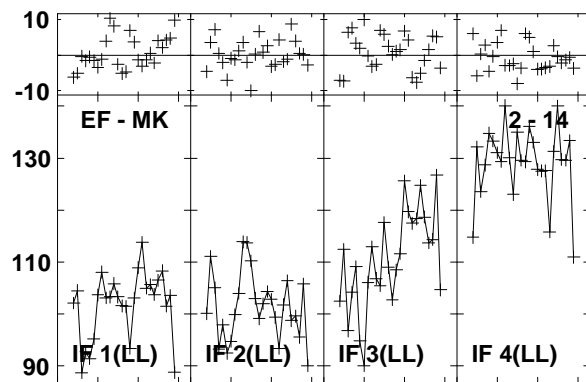
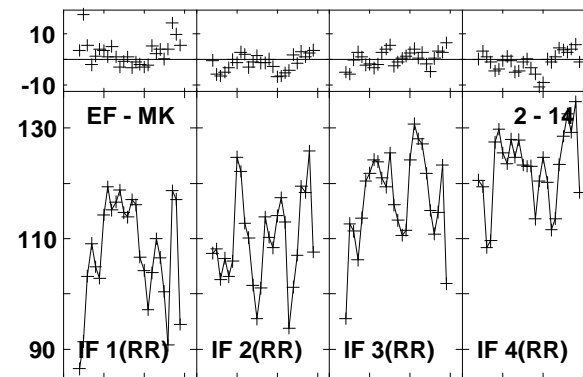
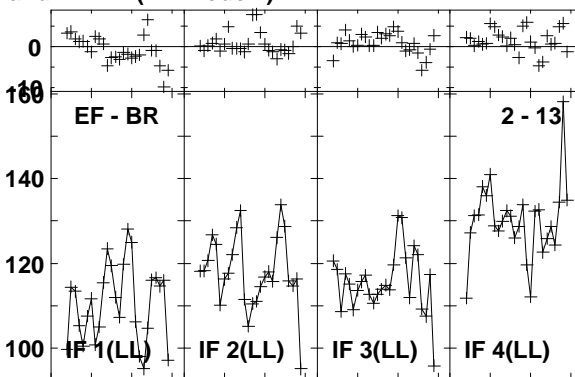
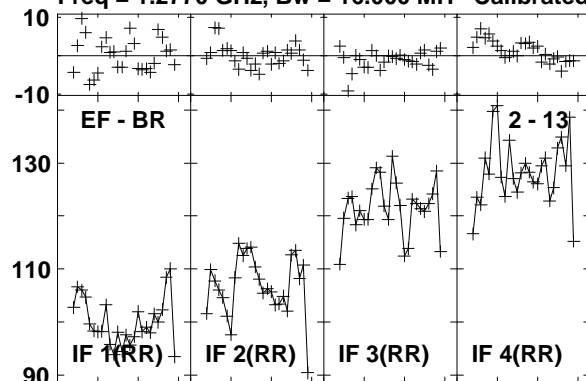

Lower frame: Milli Ampl Jy Top frame: Phas deg
 Vector averaged cross-power spectrum Baseline: EF (02) - BR (13)
 Timerange: 00/23:00:52 to 00/23:03:20

Plot file version 886 created 03-MAR-2016 01:14:31

J1545+5400 GN002C 1.UVDATA.1

Freq = 1.2770 GHz, Bw = 16.000 MH Calibrated with CL # 3 and BP # 1 (BP mode 1)

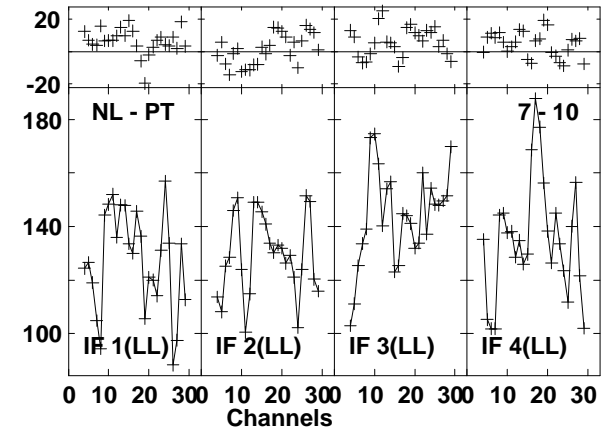
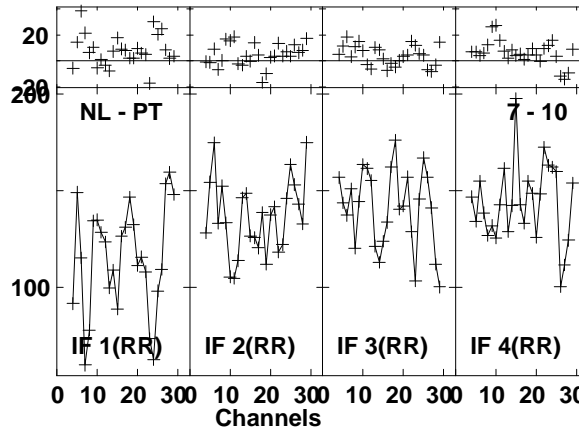
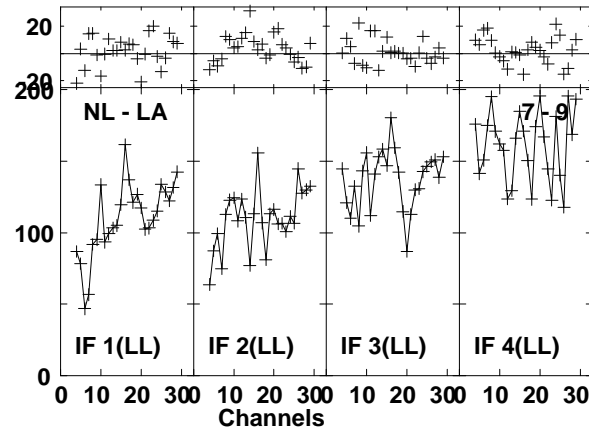
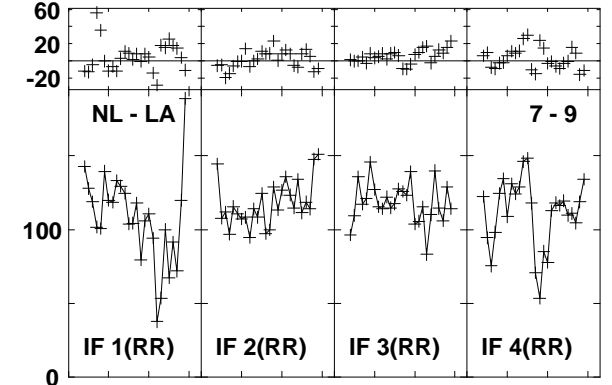
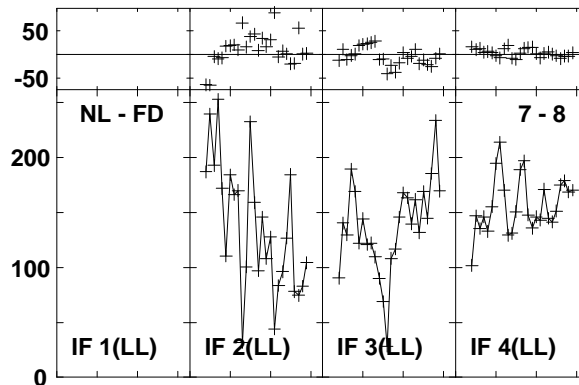
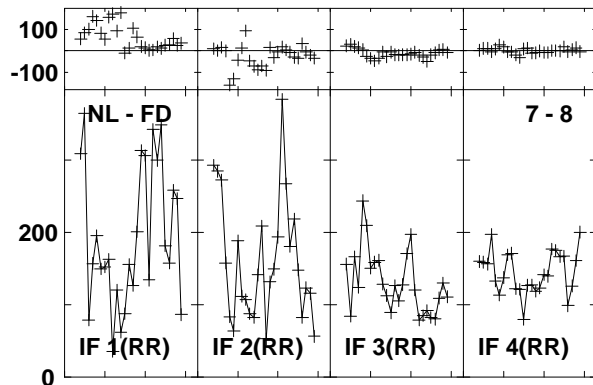
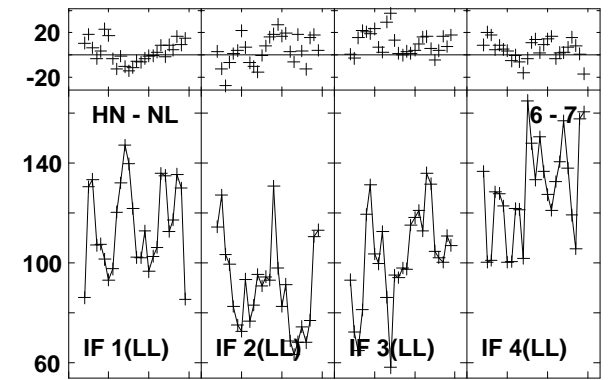
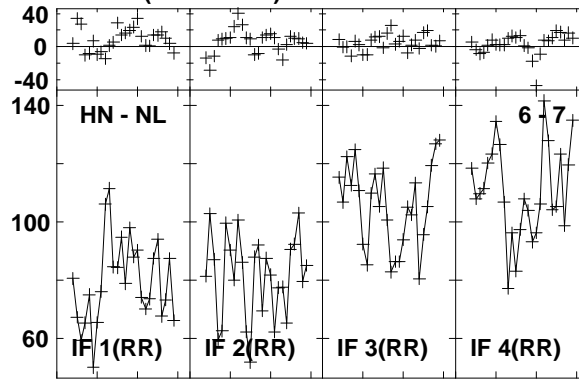
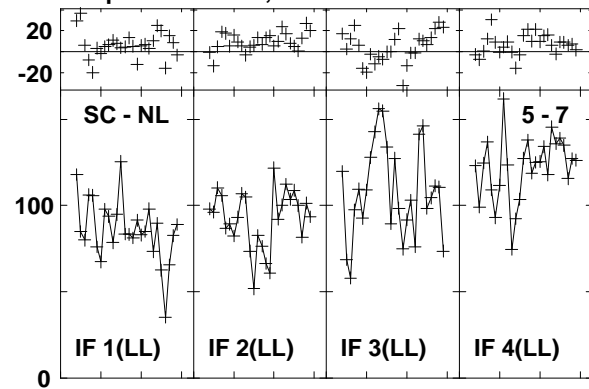

Lower frame: Milli Ampl Jy Top frame: Phas deg

Vector averaged cross-power spectrum Baseline: SC (05) - NL (07)

Timerange: 00/23:00:52 to 00/23:03:20

Plot file version 887 created 03-MAR-2016 01:14:31

J1545+5400 GN002C 1.UVDATA.1

Freq = 1.2770 GHz, Bw = 16.000 MH Calibrated with CL # 3 and BP # 1 (BP mode 1)

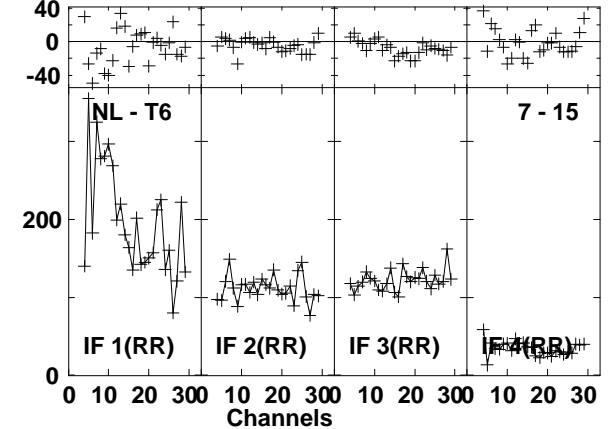
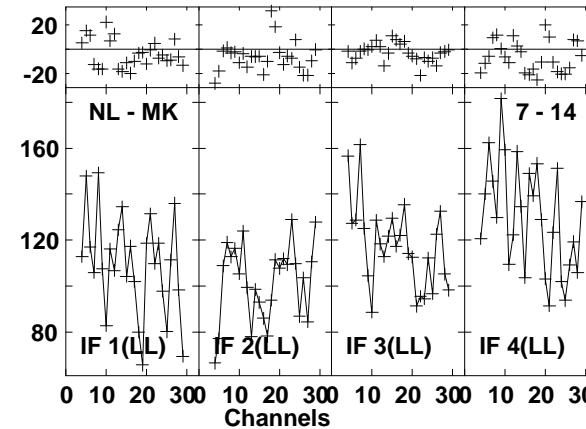
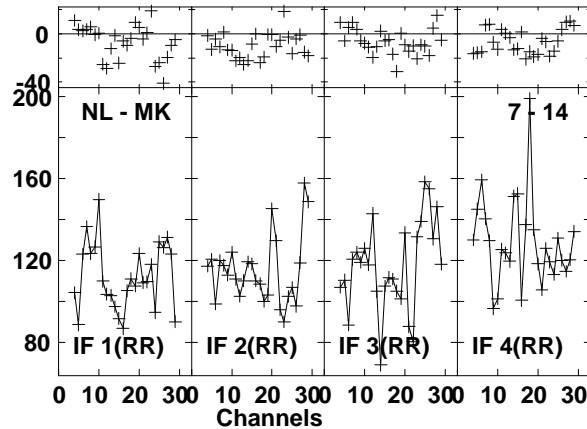
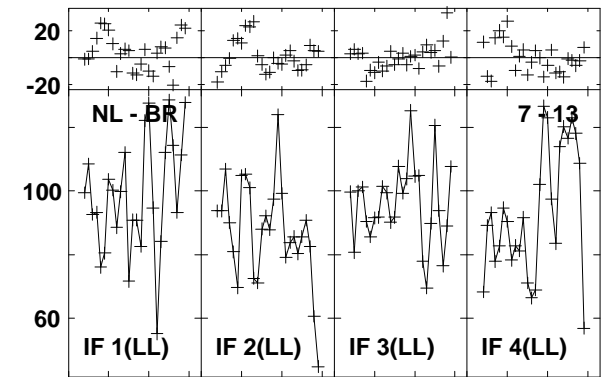
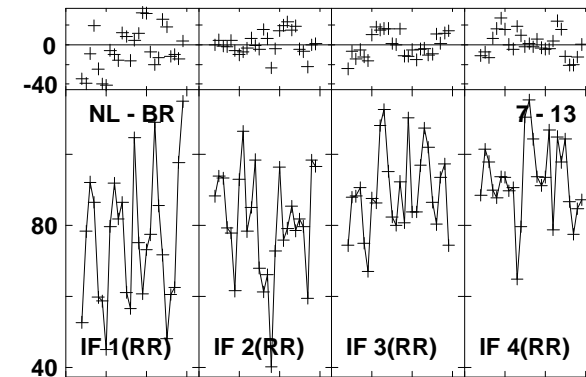
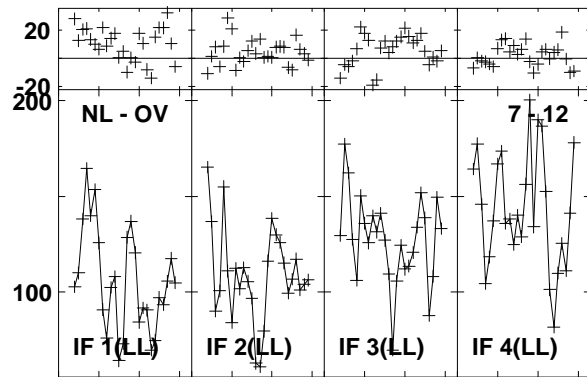
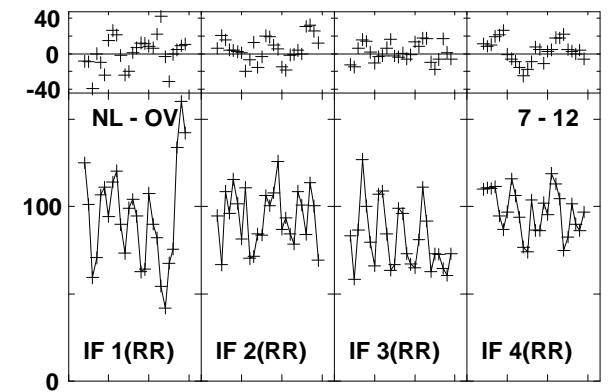
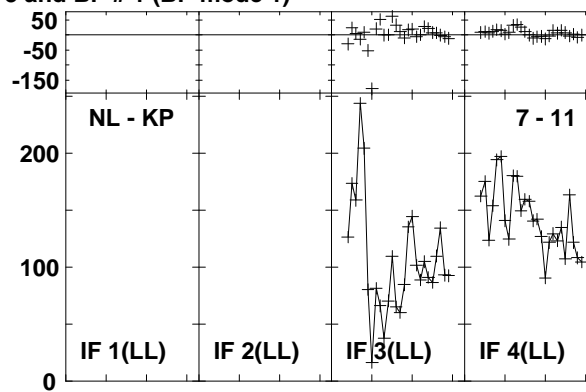
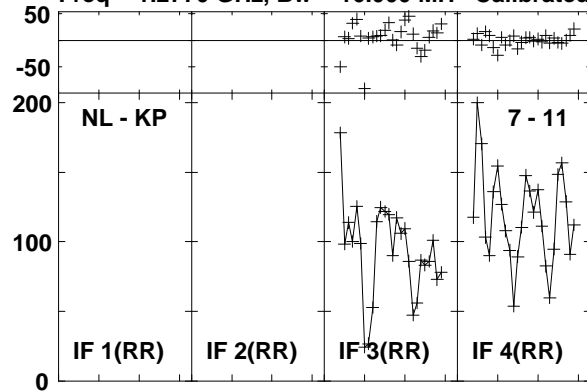

Lower frame: Milli Ampl Jy Top frame: Phas deg
Vector averaged cross-power spectrum Baseline: NL (07) - KP (11)
Timerange: 00/23:00:52 to 00/23:03:20

Plot file version 888 created 03-MAR-2016 01:14:31
J1545+5400 GN002C 1.UVDATA.1
Freq = 1.2770 GHz, Bw = 16.000 MH Calibrated with CL # 3 and BP # 1 (BP mode 1)

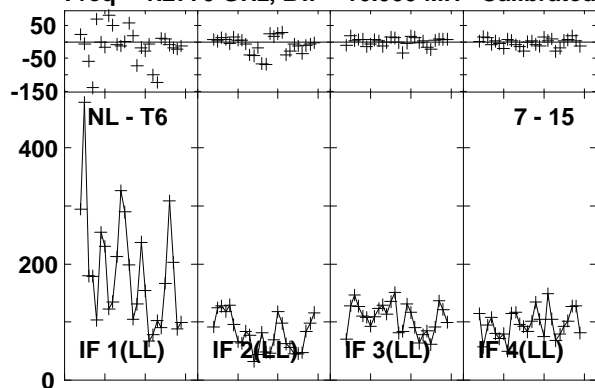

Lower frame: Milli Ampl Jy Top frame: Phas deg
Vector averaged cross-power spectrum Baseline: NL (07) - T6 (15)
Timerange: 00/23:00:52 to 00/23:03:20

Plot file version 889 created 03-MAR-2016 01:14:31

4C52 GN002C 1.UVDATA.1

Freq = 1.2770 GHz, Bw = 16.000 MH Calibrated with CL # 3 and BP # 1 (BP mode 1)

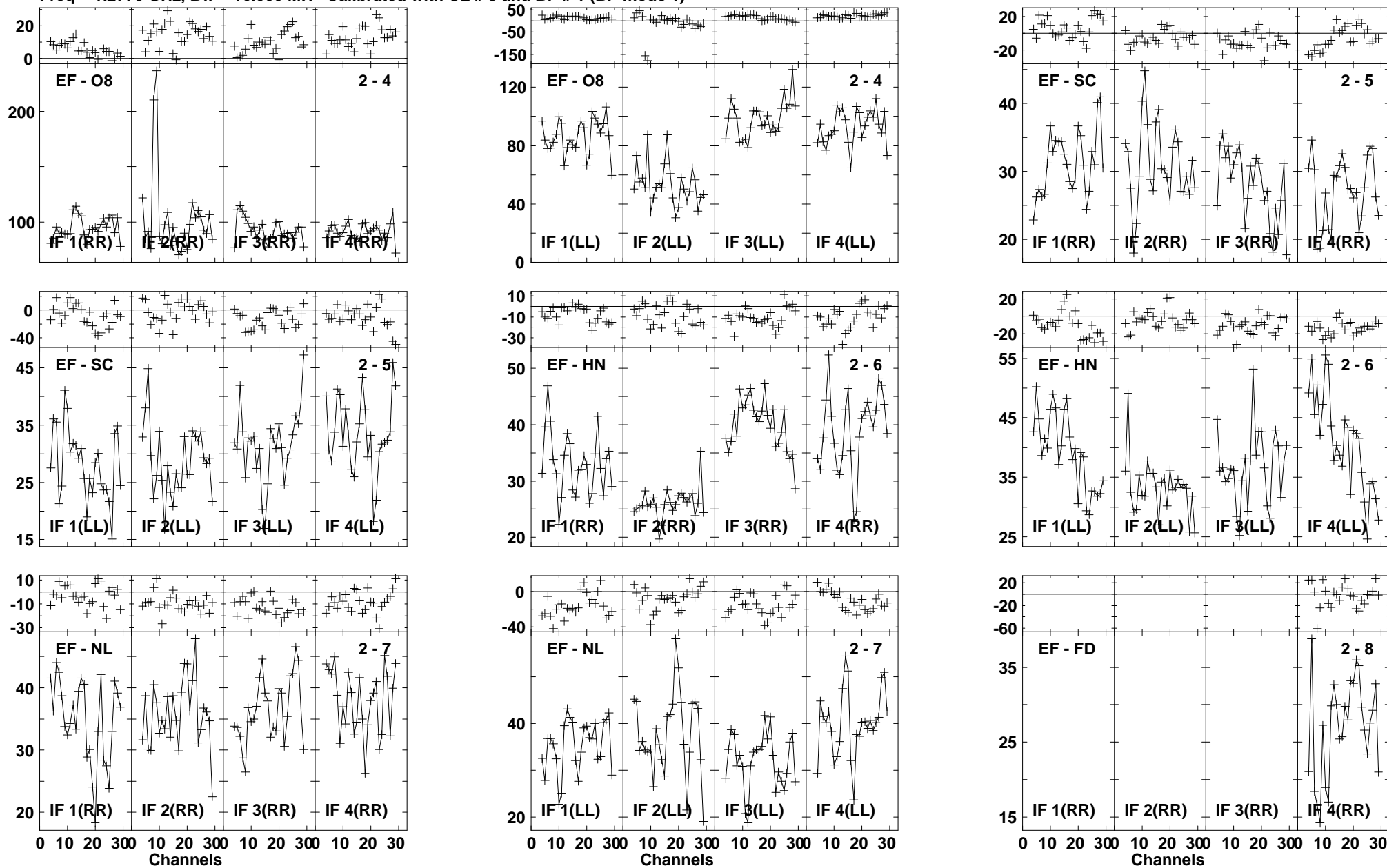

Lower frame: Milli Ampl Jy Top frame: Phas deg
Vector averaged cross-power spectrum Baseline: EF (02) - O8 (04)
Timerange: 00/23:03:33 to 00/23:06:49

Plot file version 890 created 03-MAR-2016 01:14:31

4C52 GN002C 1.UVDATA.1

Freq = 1.2770 GHz, Bw = 16.000 MH Calibrated with CL # 3 and BP # 1 (BP mode 1)

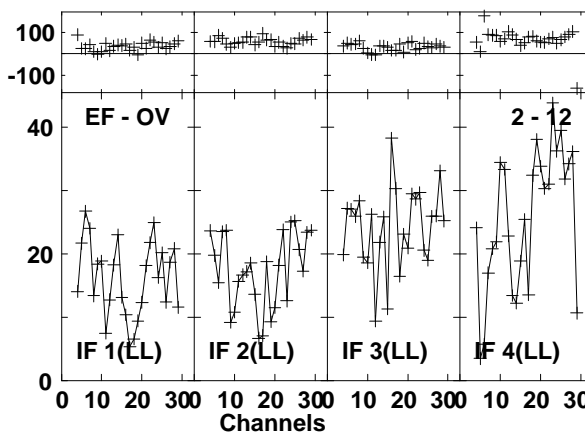
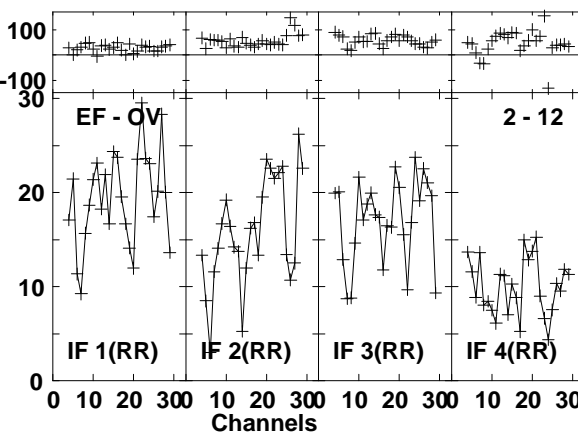
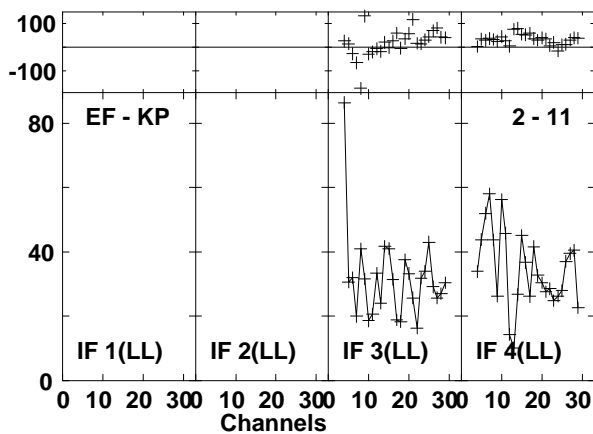
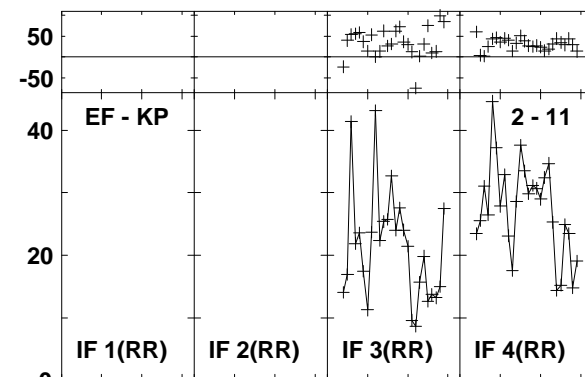
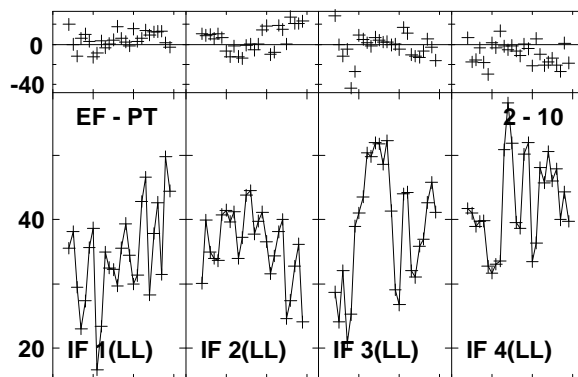
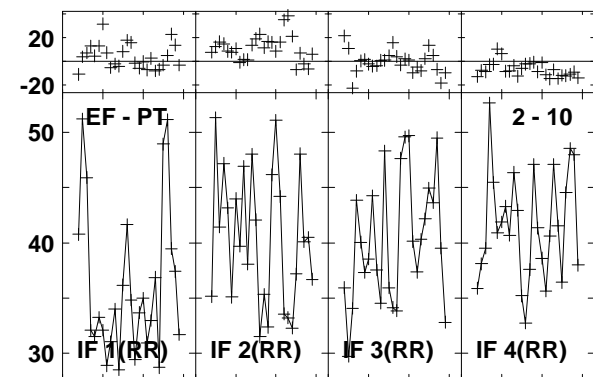
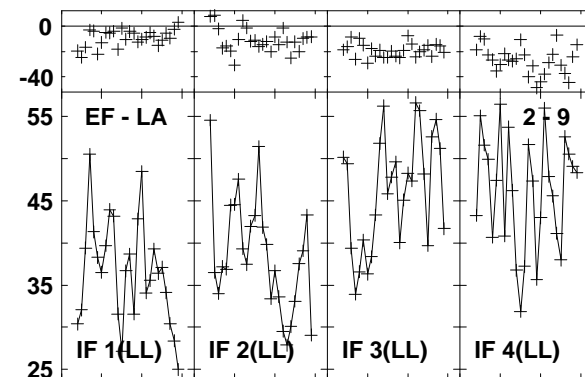
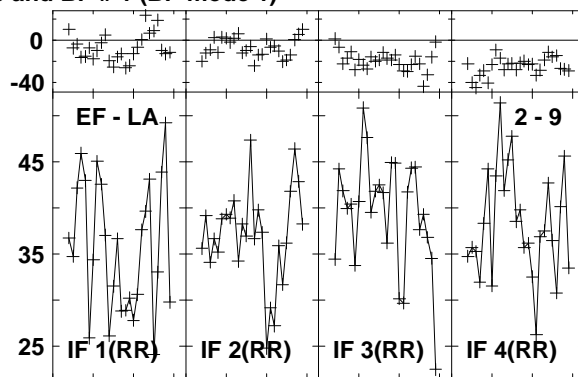
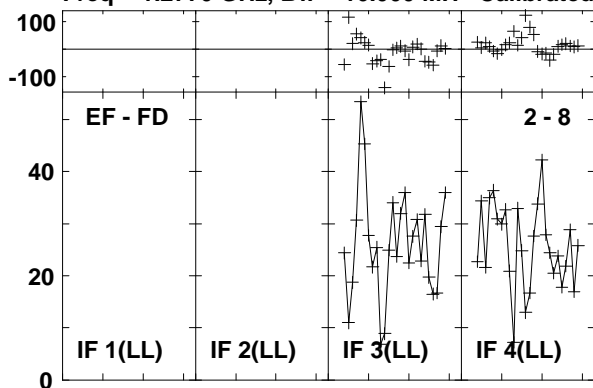

Lower frame: Milli Ampl Jy Top frame: Phas deg
Vector averaged cross-power spectrum Baseline: EF (02) - FD (08)
Timerange: 00/23:03:33 to 00/23:06:49

Plot file version 891 created 03-MAR-2016 01:14:32

4C52 GN002C 1.UVDATA.1

Freq = 1.2770 GHz, Bw = 16.000 MH Calibrated with CL # 3 and BP # 1 (BP mode 1)

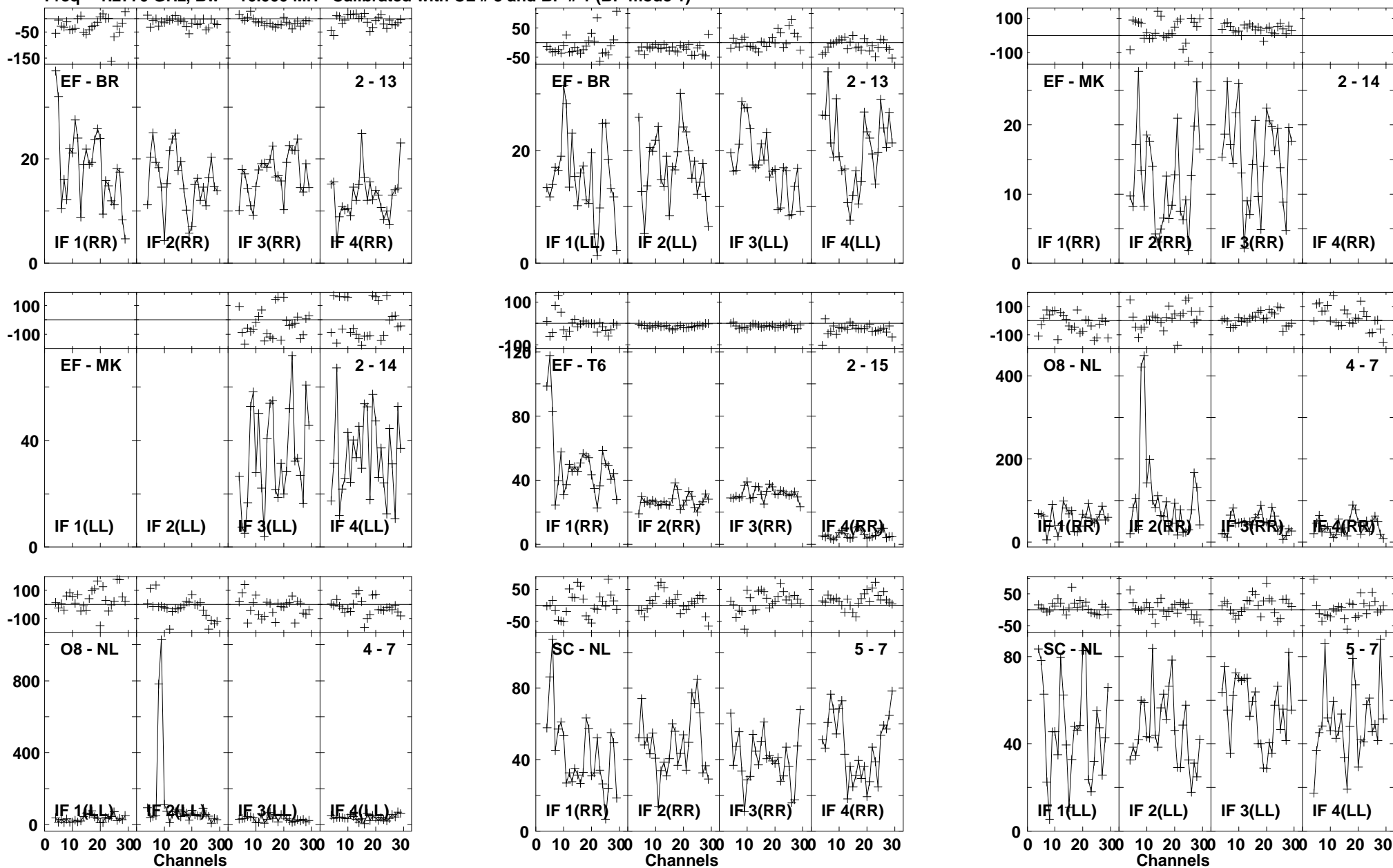

Lower frame: Milli Ampl Jy Top frame: Phas deg
Vector averaged cross-power spectrum Baseline: EF (02) - BR (13)
Timerange: 00/23:03:33 to 00/23:06:49

Plot file version 892 created 03-MAR-2016 01:14:32

4C52 GN002C 1.UVDATA.1

Freq = 1.2770 GHz, Bw = 16.000 MH Calibrated with CL # 3 and BP # 1 (BP mode 1)

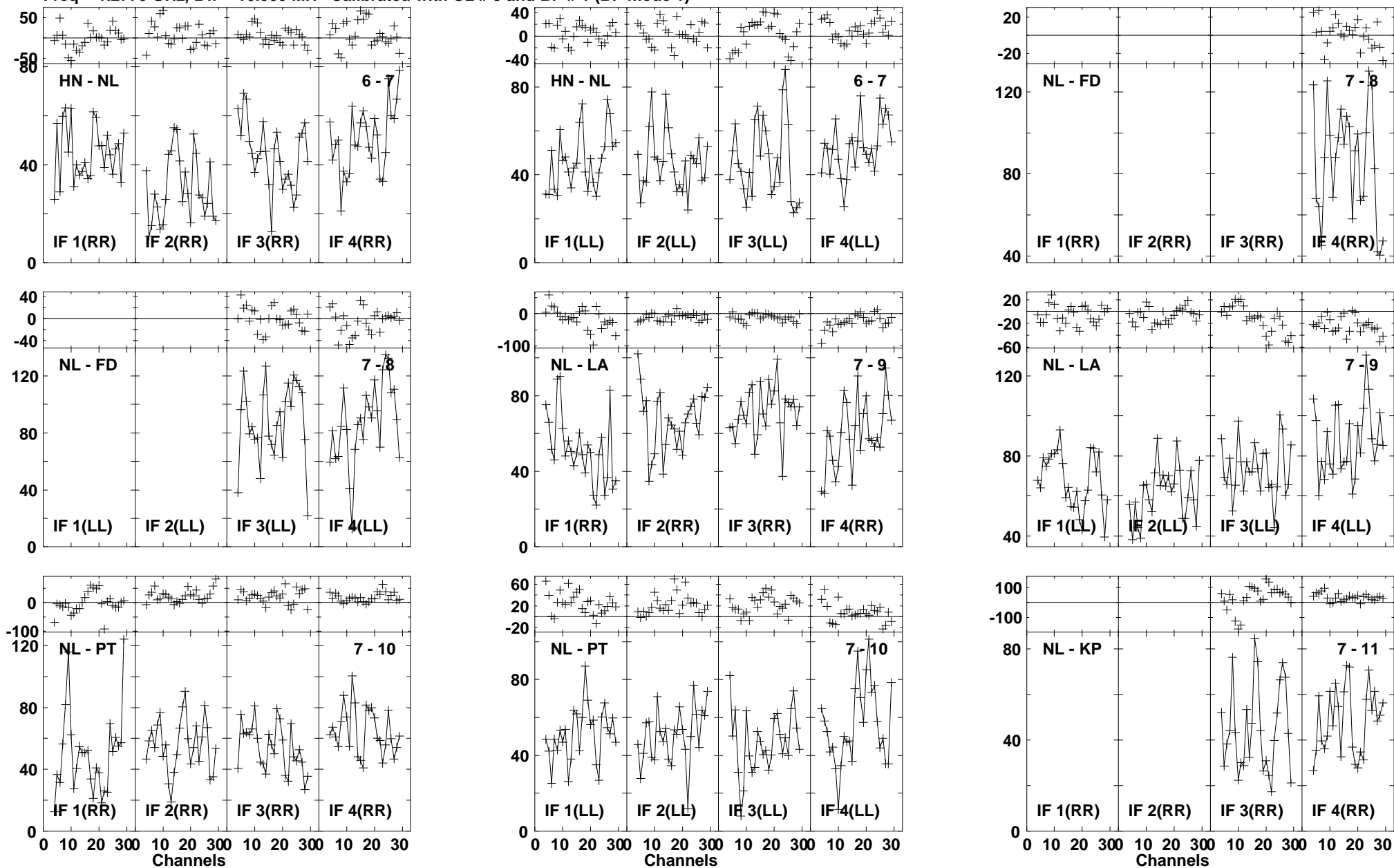

Lower frame: Milli Ampl Jy Top frame: Phas deg
Vector averaged cross-power spectrum Baseline: HN (06) - NL (07)
Timerange: 00/23:03:33 to 00/23:06:49

Plot file version 893 created 03-MAR-2016 01:14:32

4C52 GN002C 1.UVDATA.1

Freq = 1.2770 GHz, Bw = 16.000 MH Calibrated with CL # 3 and BP # 1 (BP mode 1)

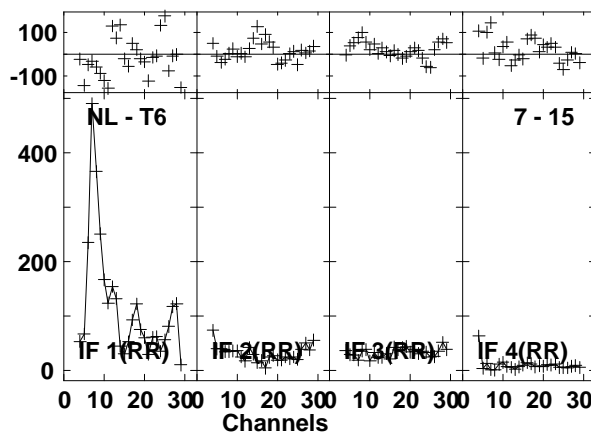
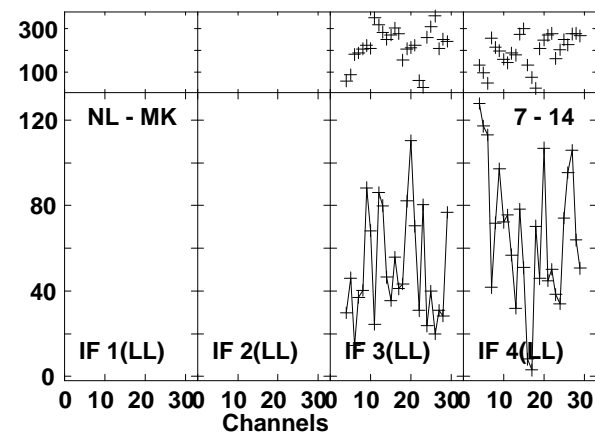
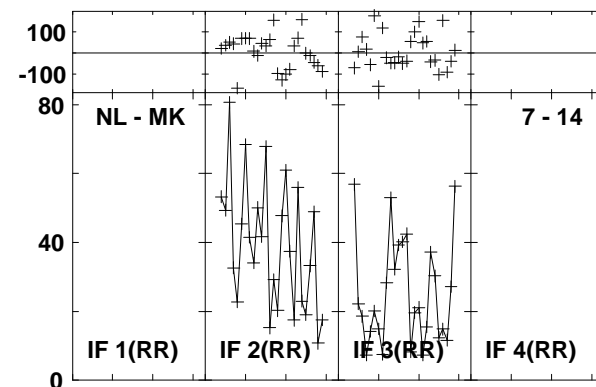
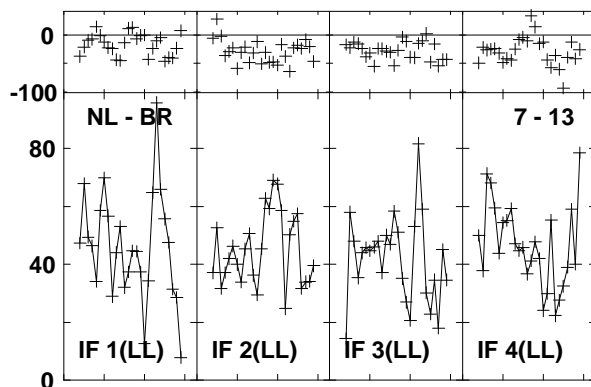
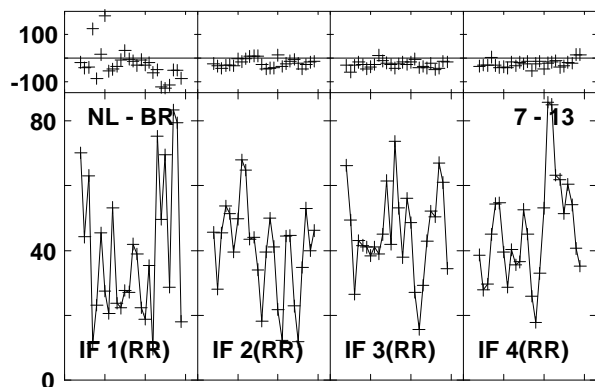
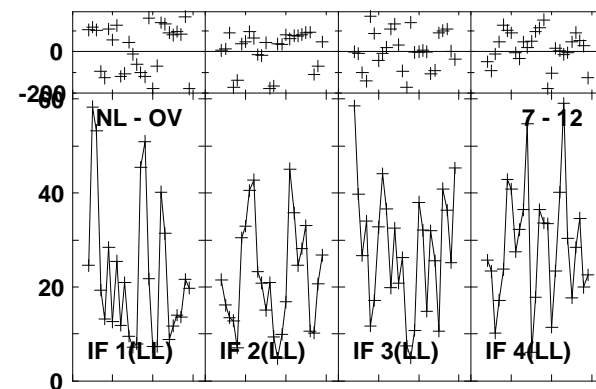
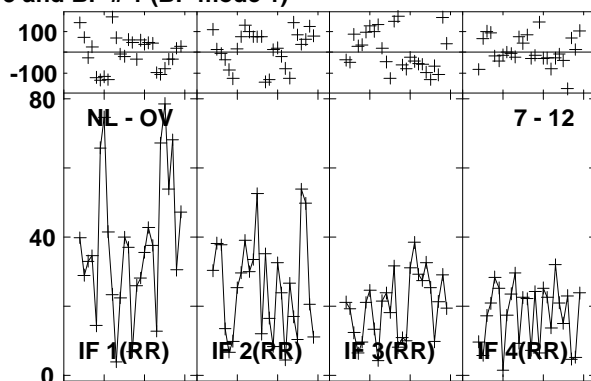
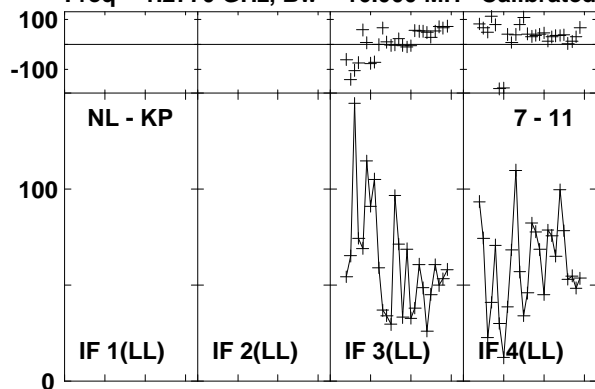

Lower frame: Milli Ampl Jy Top frame: Phas deg

Vector averaged cross-power spectrum Baseline: NL (07) - KP (11)

Timerange: 00/23:03:33 to 00/23:06:49

Plot file version 894 created 03-MAR-2016 01:14:32

J1545+5400 GN002C 1.UVDATA.1

Freq = 1.2770 GHz, Bw = 16.000 MH Calibrated with CL # 3 and BP # 1 (BP mode 1)

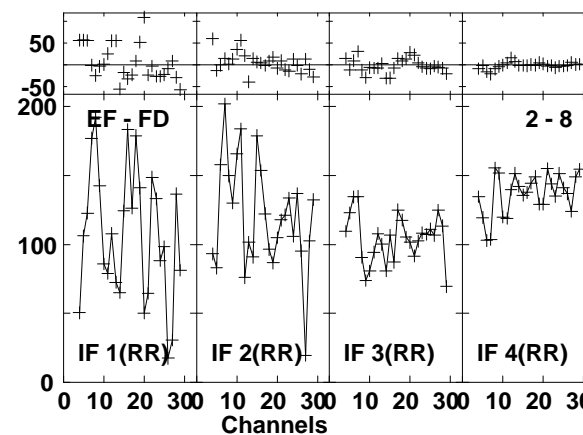
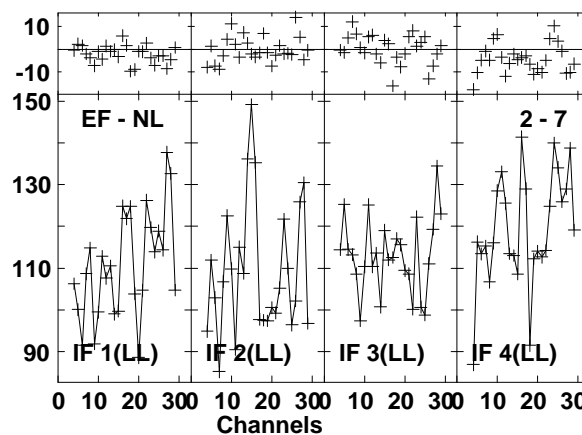
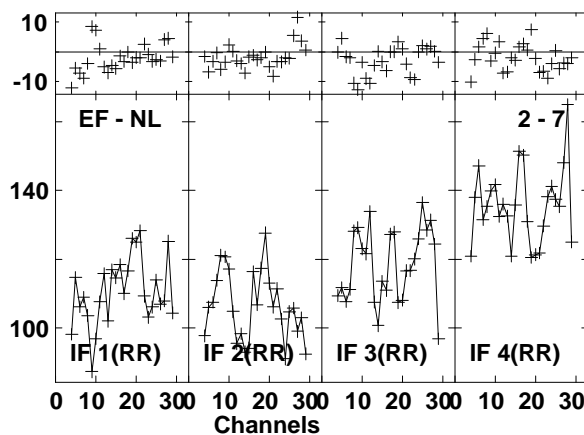
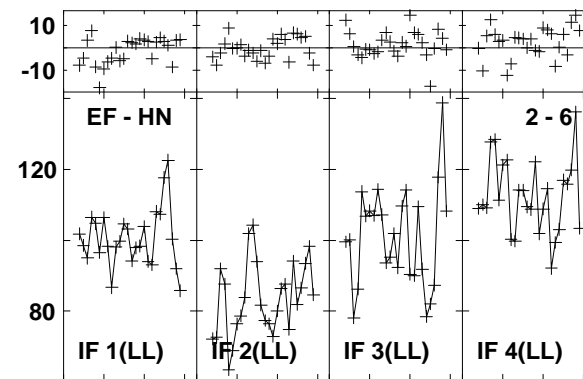
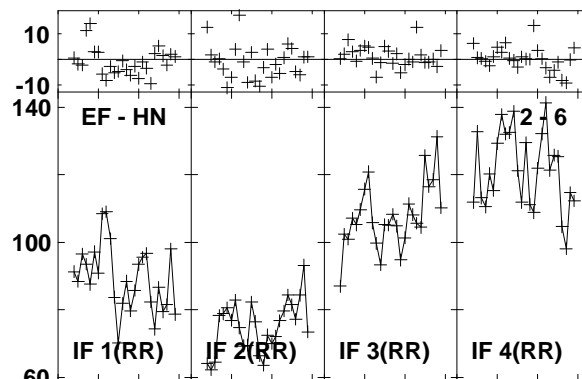
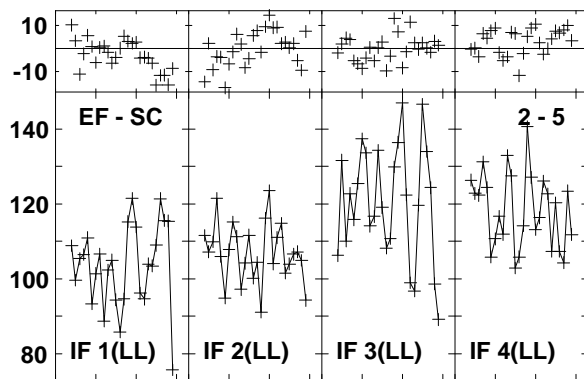
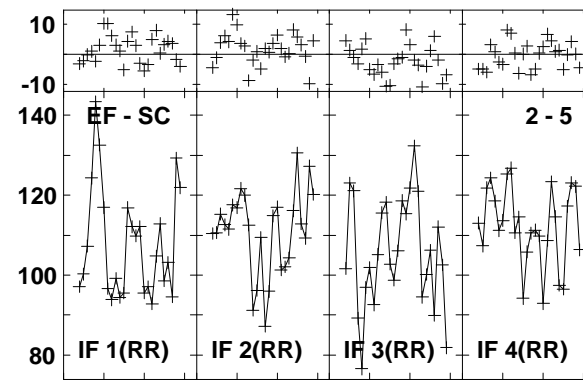
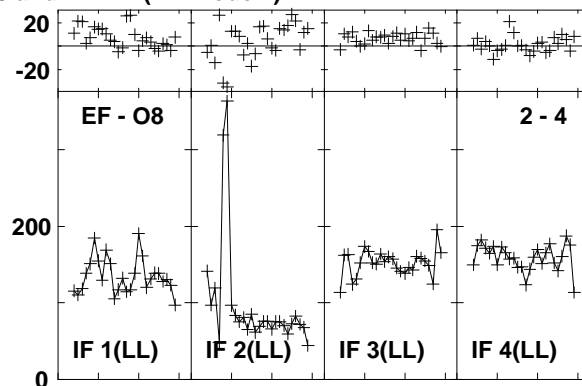
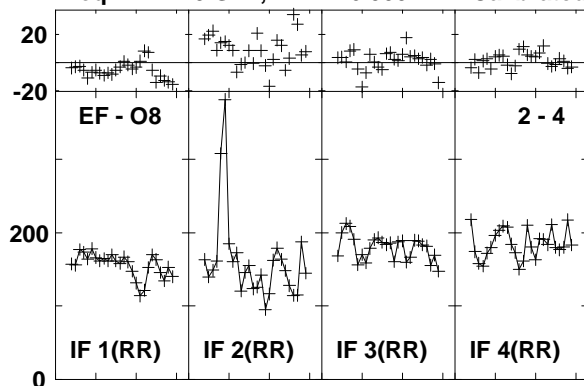

Lower frame: Milli Ampl Jy Top frame: Phas deg
Vector averaged cross-power spectrum Baseline: EF (02) - O8 (04)
Timerange: 00/23:07:42 to 00/23:08:40

Plot file version 895 created 03-MAR-2016 01:14:32
 J1545+5400 GN002C 1.UVDATA.1
 Freq = 1.2770 GHz, Bw = 16.000 MH Calibrated with CL # 3 and BP # 1 (BP mode 1)

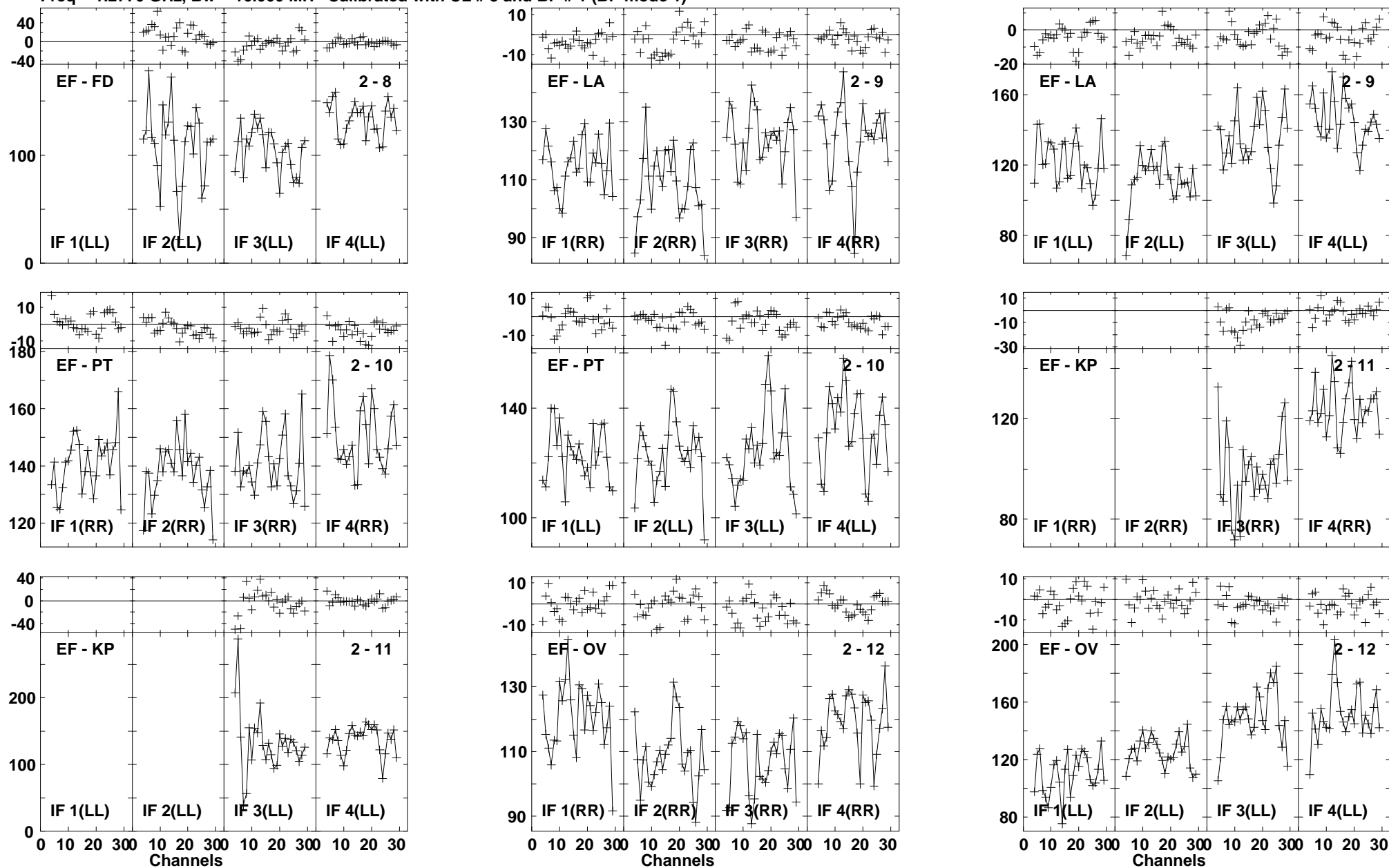

Lower frame: Milli Ampl Jy Top frame: Phas deg
 Vector averaged cross-power spectrum Baseline: EF (02) - FD (08)
 Timerange: 00/23:07:42 to 00/23:08:40

Plot file version 896 created 03-MAR-2016 01:14:33

J1545+5400 GN002C 1.UVDATA.1

Freq = 1.2770 GHz, Bw = 16.000 MH Calibrated with CL # 3 and BP # 1 (BP mode 1)

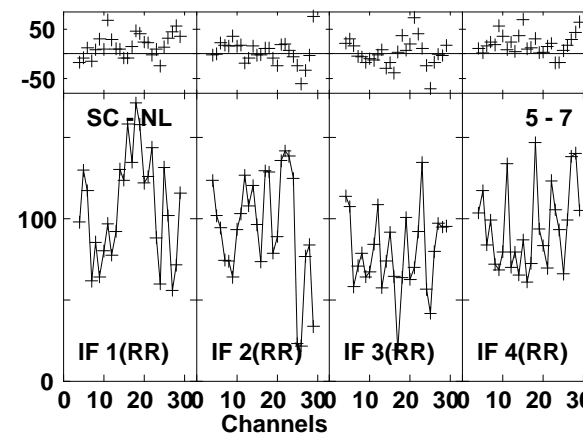
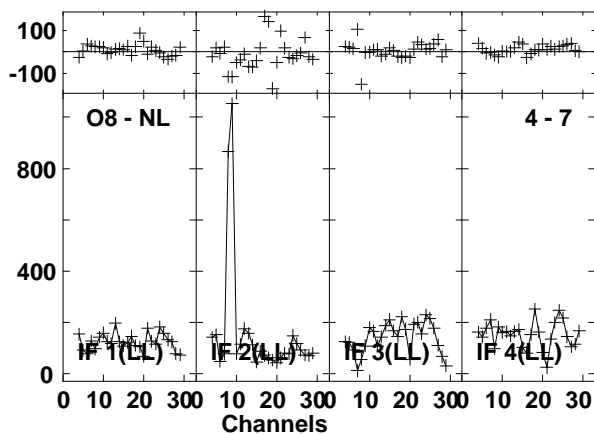
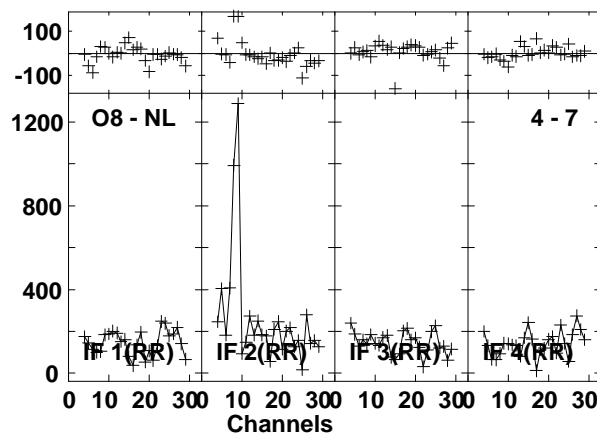
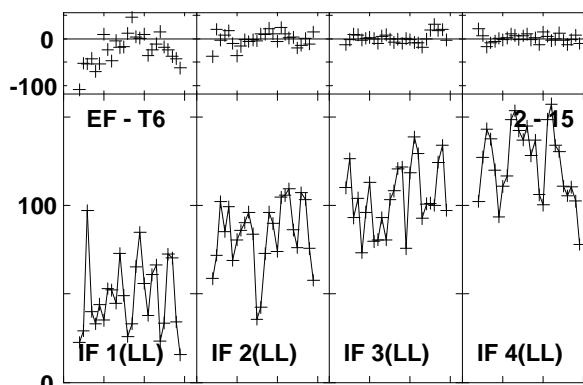
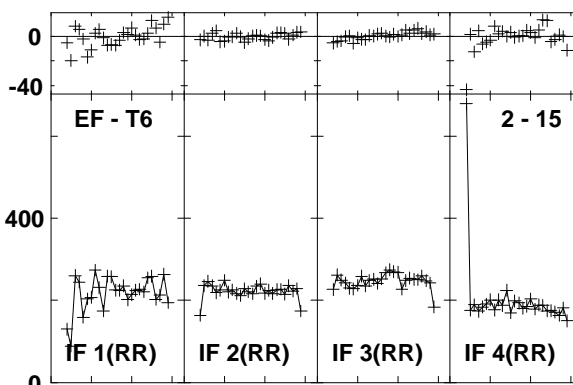
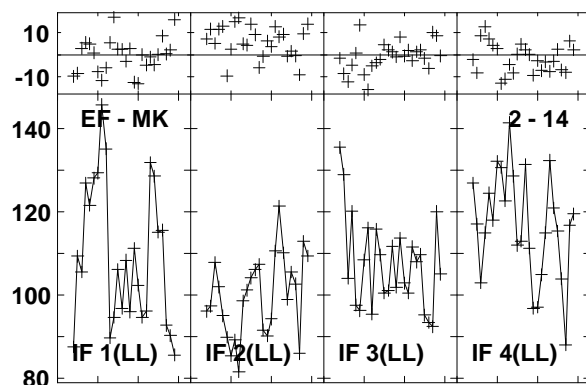
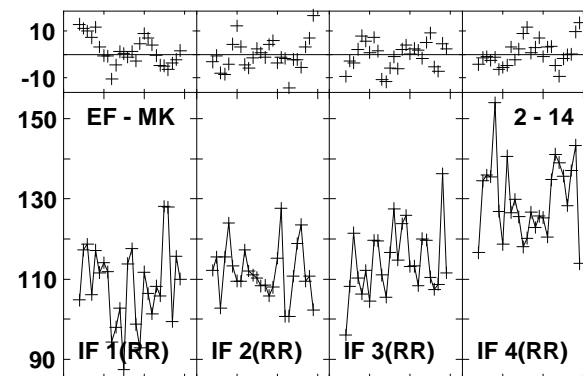
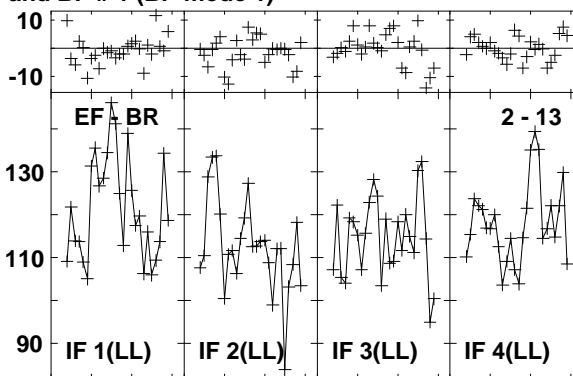
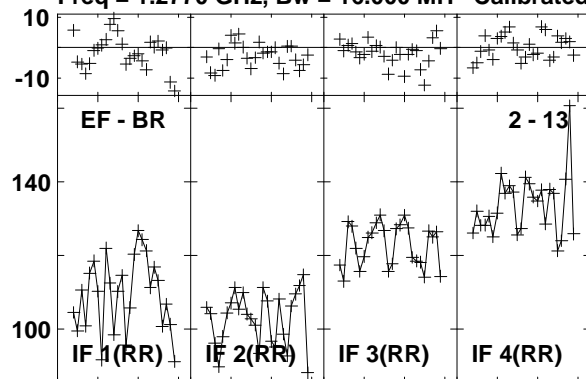

Lower frame: Milli Ampl Jy Top frame: Phas deg
Vector averaged cross-power spectrum Baseline: EF (02) - BR (13)
Timerange: 00/23:07:42 to 00/23:08:40

Plot file version 897 created 03-MAR-2016 01:14:33

J1545+5400 GN002C 1.UVDATA.1

Freq = 1.2770 GHz, Bw = 16.000 MH Calibrated with CL # 3 and BP # 1 (BP mode 1)

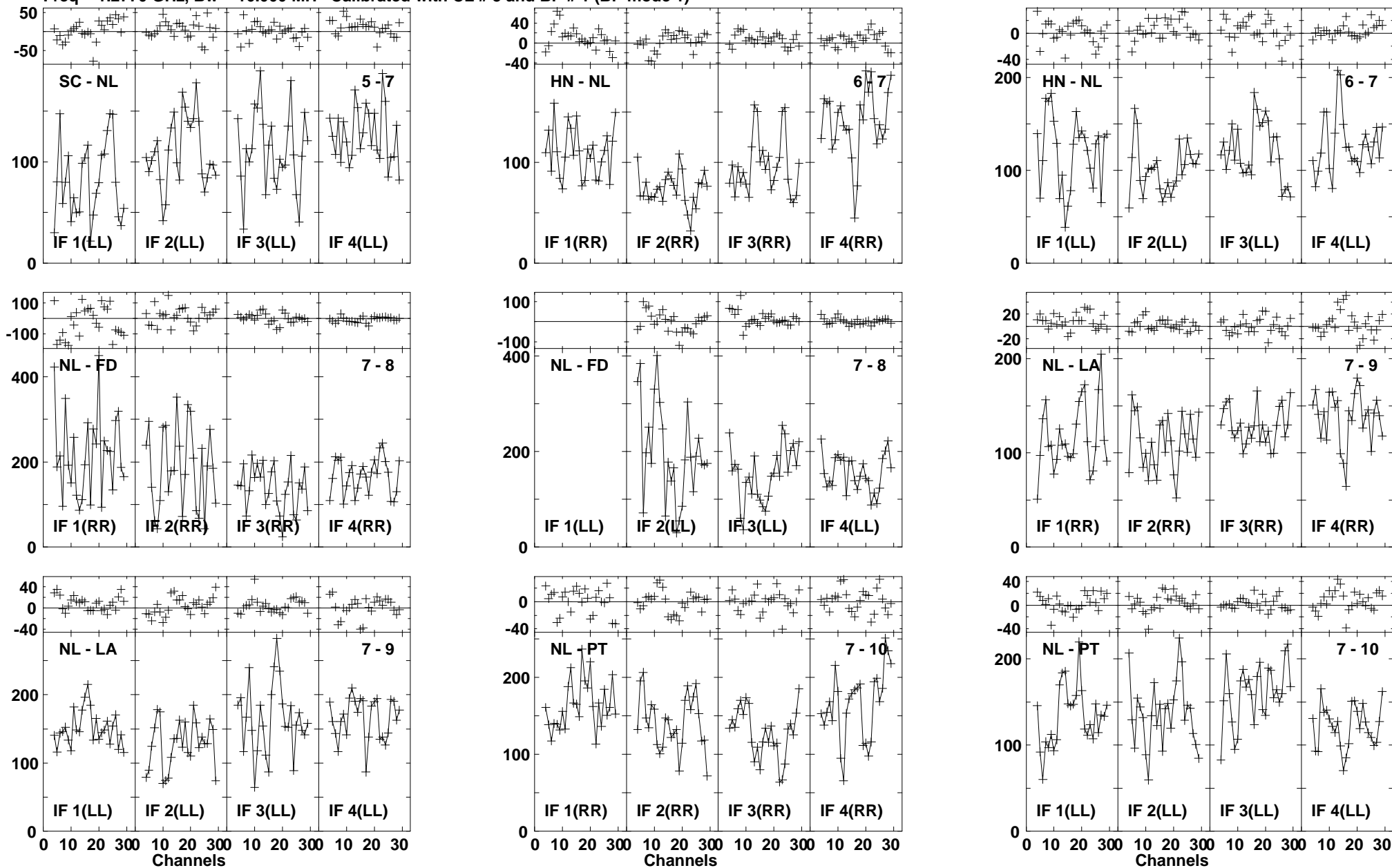

Lower frame: Milli Ampl Jy Top frame: Phas deg
Vector averaged cross-power spectrum Baseline: SC (05) - NL (07)
Timerange: 00/23:07:42 to 00/23:08:40

Plot file version 898 created 03-MAR-2016 01:14:33

J1545+5400 GN002C 1.UVDATA.1

Freq = 1.2770 GHz, Bw = 16.000 MH Calibrated with CL # 3 and BP # 1 (BP mode 1)

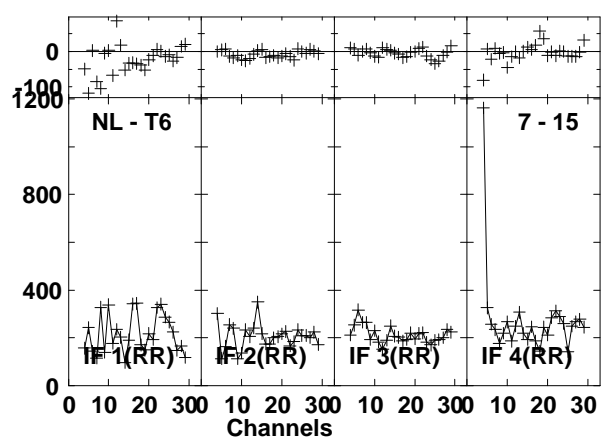
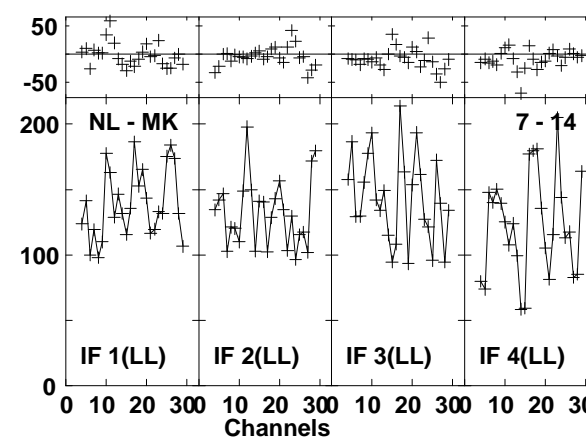
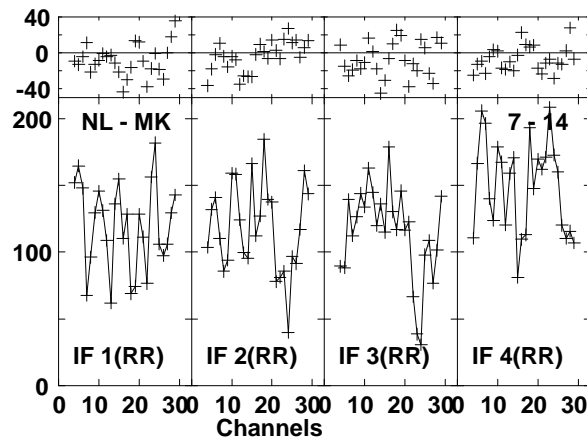
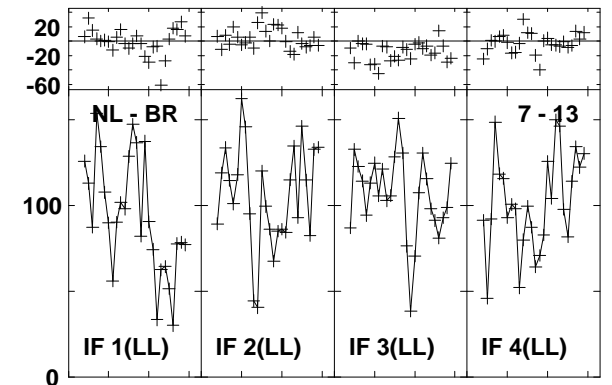
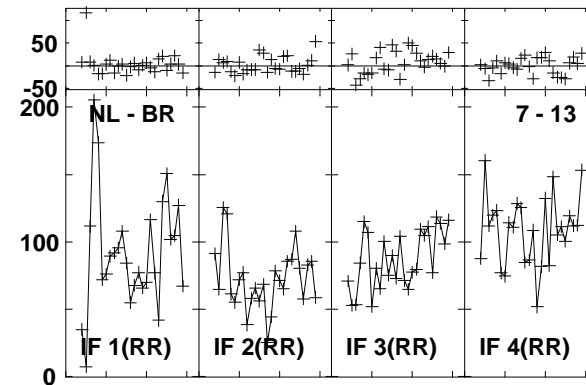
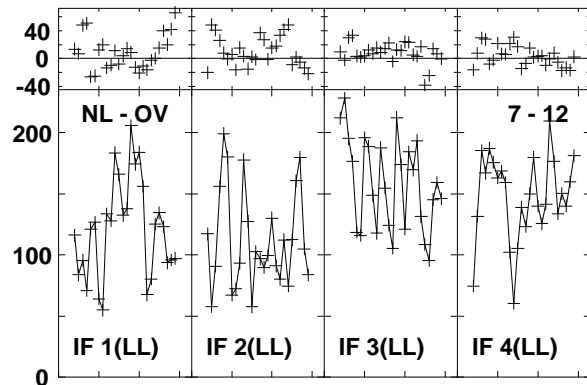
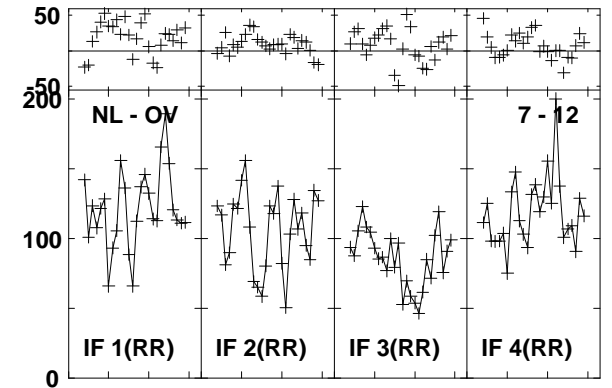
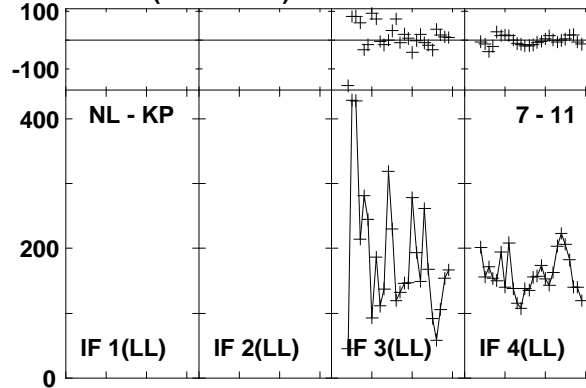
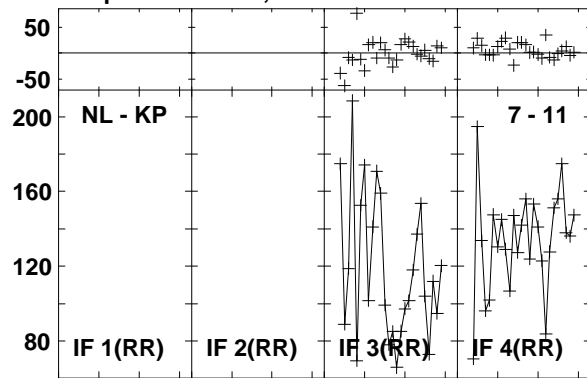

Lower frame: Milli Ampl Jy Top frame: Phas deg

Vector averaged cross-power spectrum Baseline: NL (07) - KP (11)

Timerange: 00/23:07:42 to 00/23:08:40

Plot file version 899 created 03-MAR-2016 01:14:33
J1545+5400 GN002C 1.UVDATA.1
Freq = 1.2770 GHz, Bw = 16.000 MH Calibrated with CL # 3 and BP # 1 (BP mode 1)

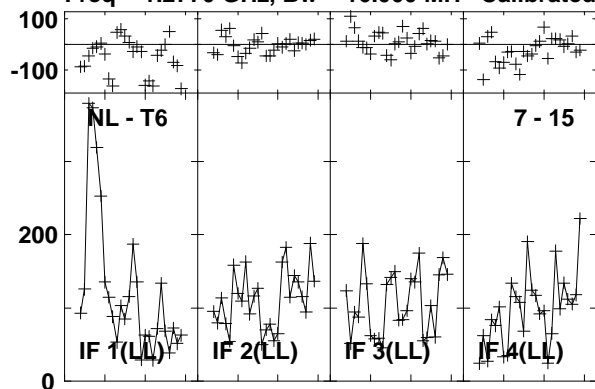

Lower frame: Milli Ampl Jy Top frame: Phas deg
Vector averaged cross-power spectrum Baseline: NL (07) - T6 (15)
Timerange: 00/23:07:42 to 00/23:08:40

Plot file version 900 created 03-MAR-2016 01:14:33

4C52 GN002C 1.UVDATA.1

Freq = 1.2770 GHz, Bw = 16.000 MH Calibrated with CL # 3 and BP # 1 (BP mode 1)

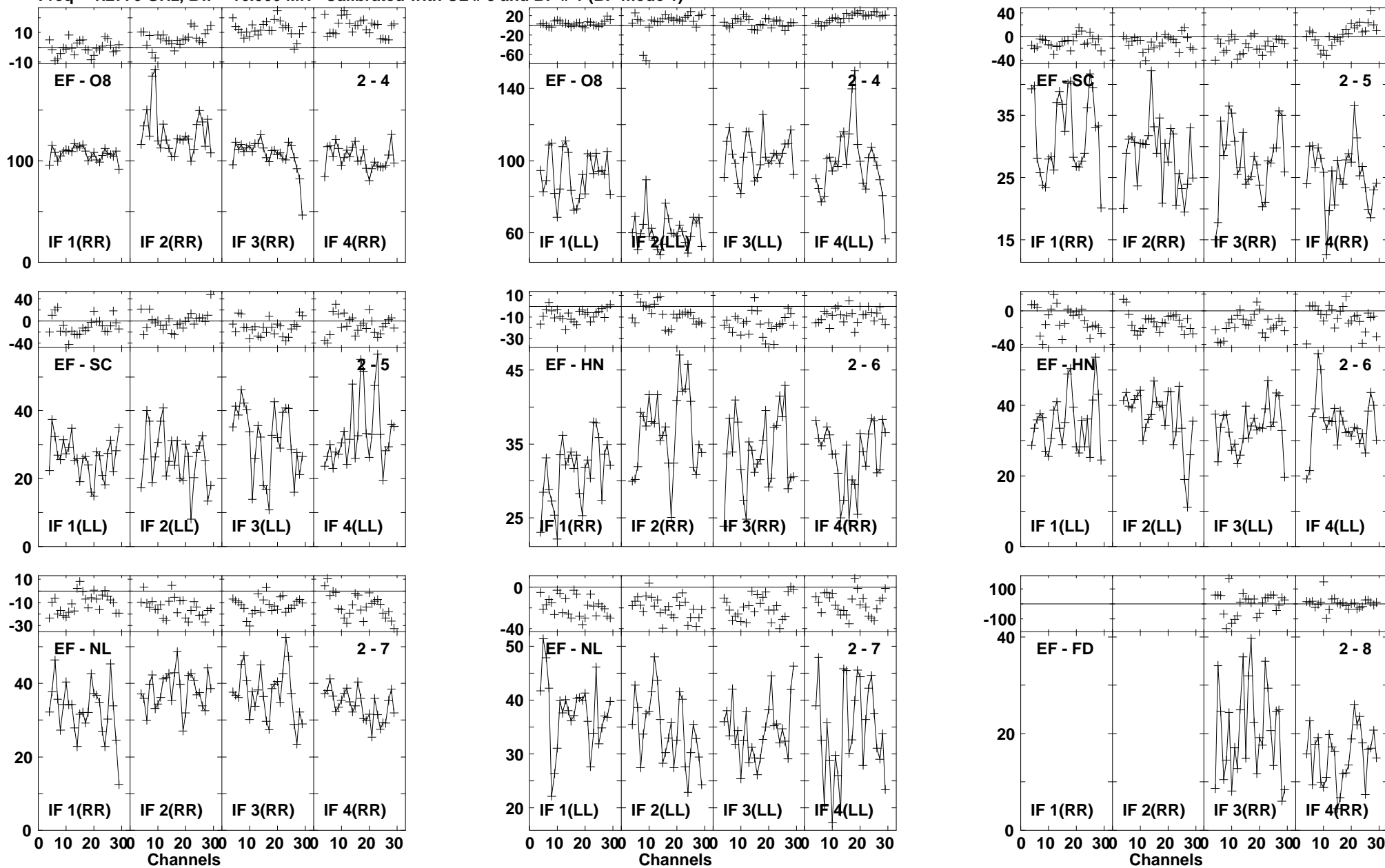

Plot file version 901 created 03-MAR-2016 01:14:33

4C52 GN002C 1.UVDATA.1

Freq = 1.2770 GHz, Bw = 16.000 MH Calibrated with CL # 3 and BP # 1 (BP mode 1)

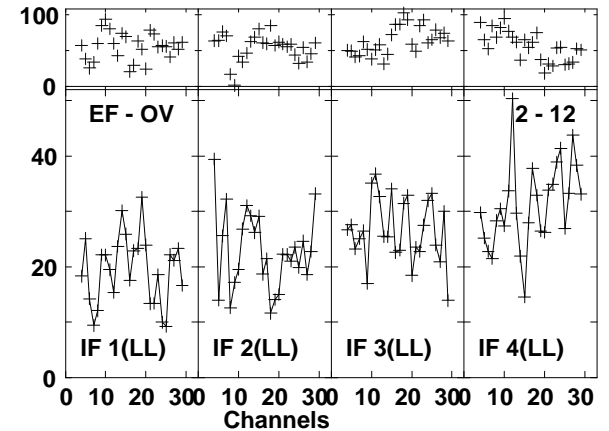
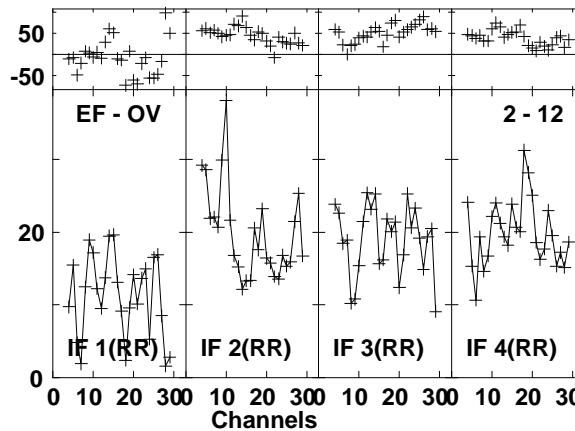
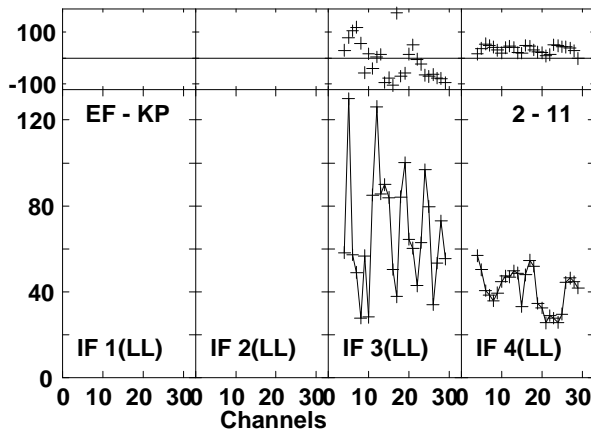
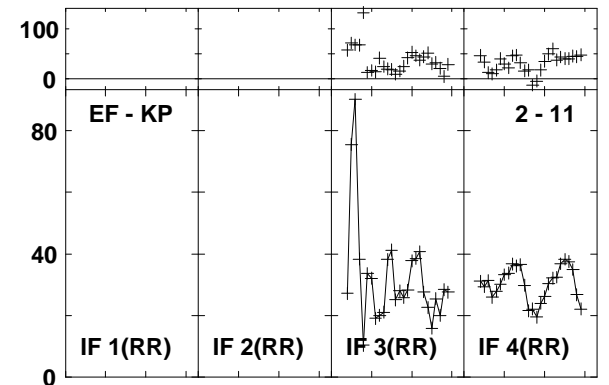
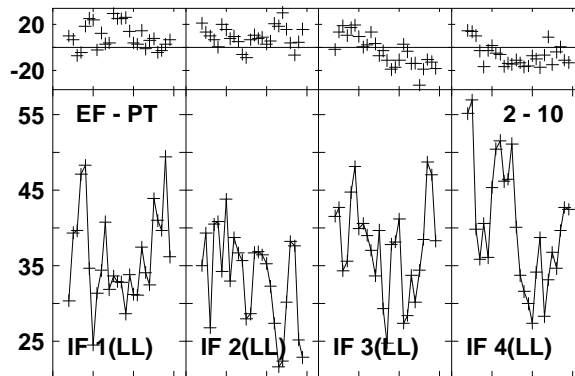
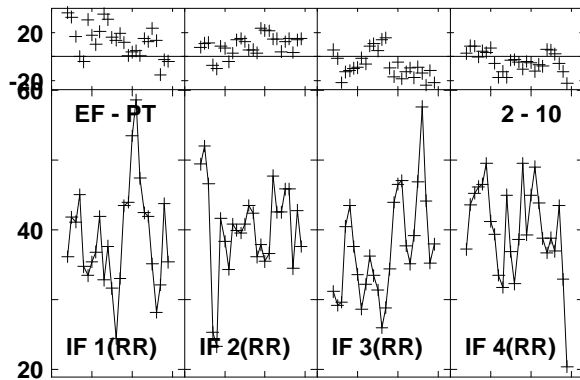
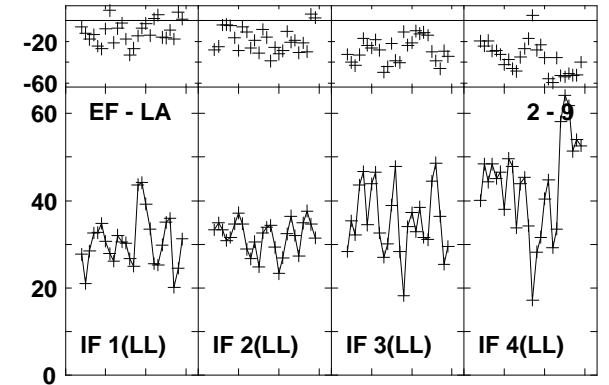
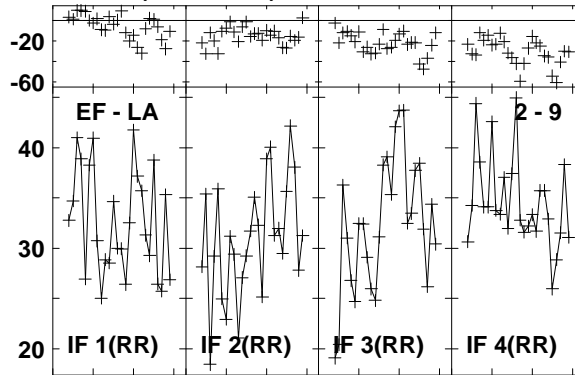
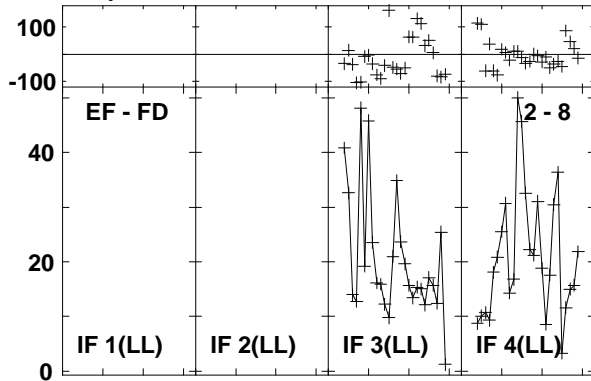

Lower frame: Milli Ampl Jy Top frame: Phas deg

Vector averaged cross-power spectrum Baseline: EF (02) - FD (08)

Timerange: 00/23:08:45 to 00/23:12:09

Plot file version 902 created 03-MAR-2016 01:14:34

4C52 GN002C 1.UVDATA.1

Freq = 1.2770 GHz, Bw = 16.000 MH Calibrated with CL # 3 and BP # 1 (BP mode 1)

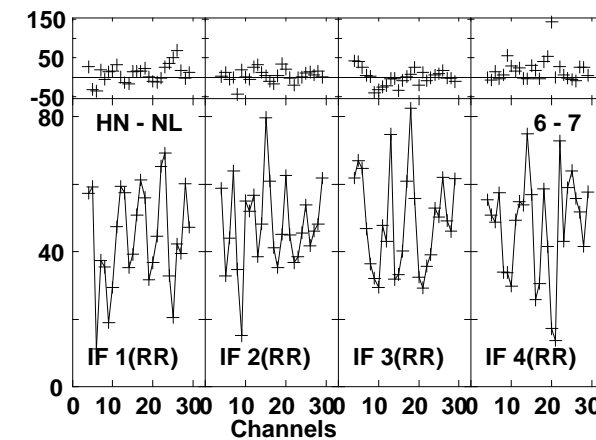
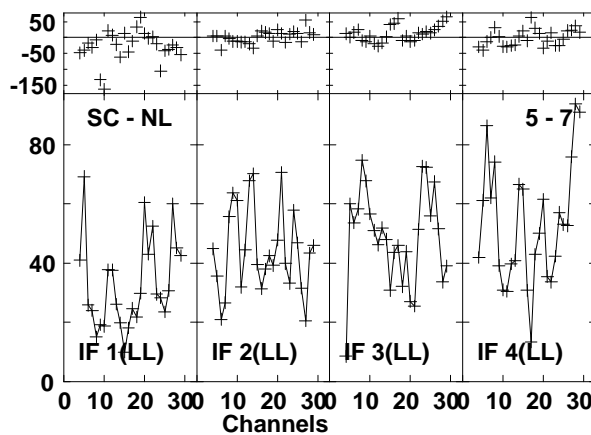
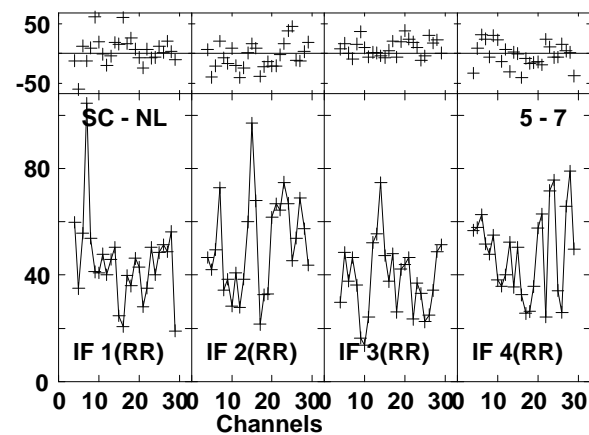
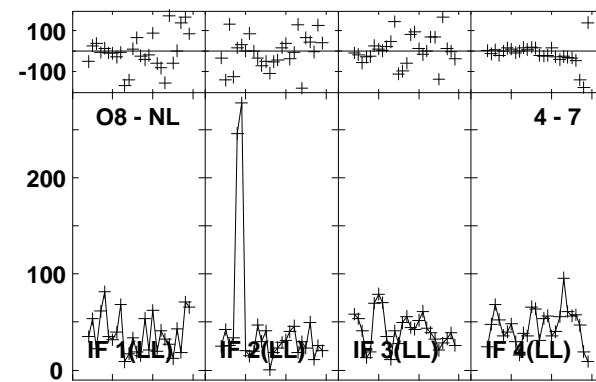
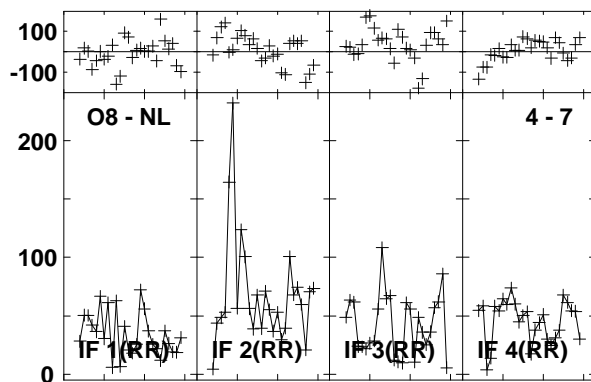
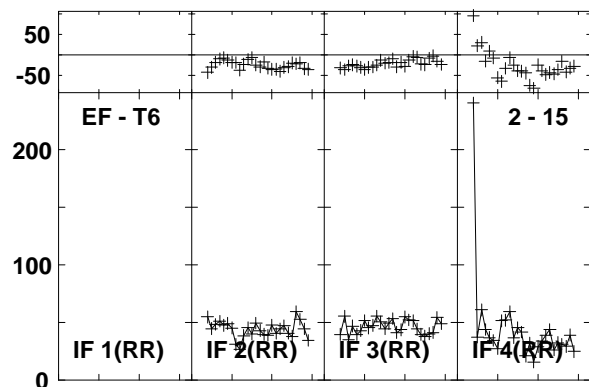
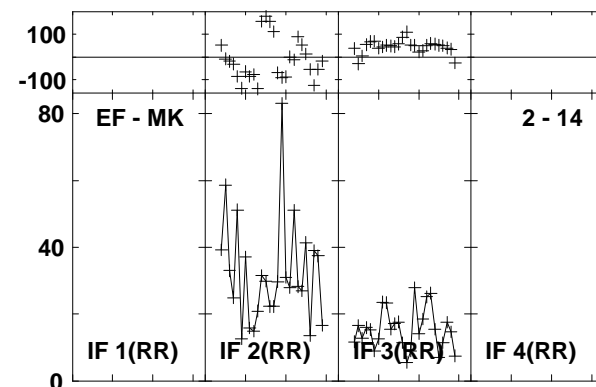
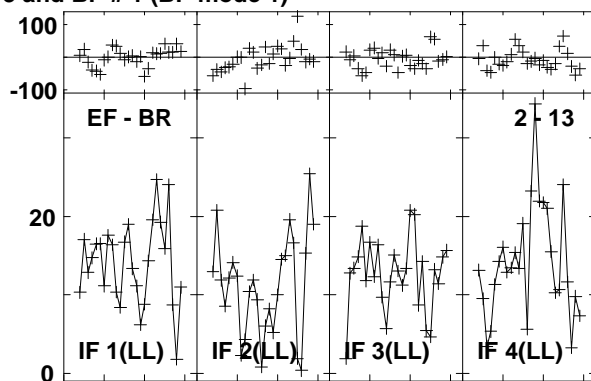
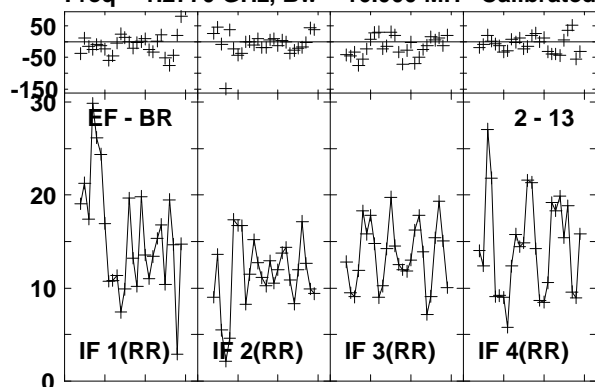

Lower frame: Milli Ampl Jy Top frame: Phas deg

Vector averaged cross-power spectrum Baseline: EF (02) - BR (13)

Timerange: 00/23:08:45 to 00/23:12:09

Plot file version 903 created 03-MAR-2016 01:14:34

4C52 GN002C 1.UVDATA.1

Freq = 1.2770 GHz, Bw = 16.000 MH Calibrated with CL # 3 and BP # 1 (BP mode 1)

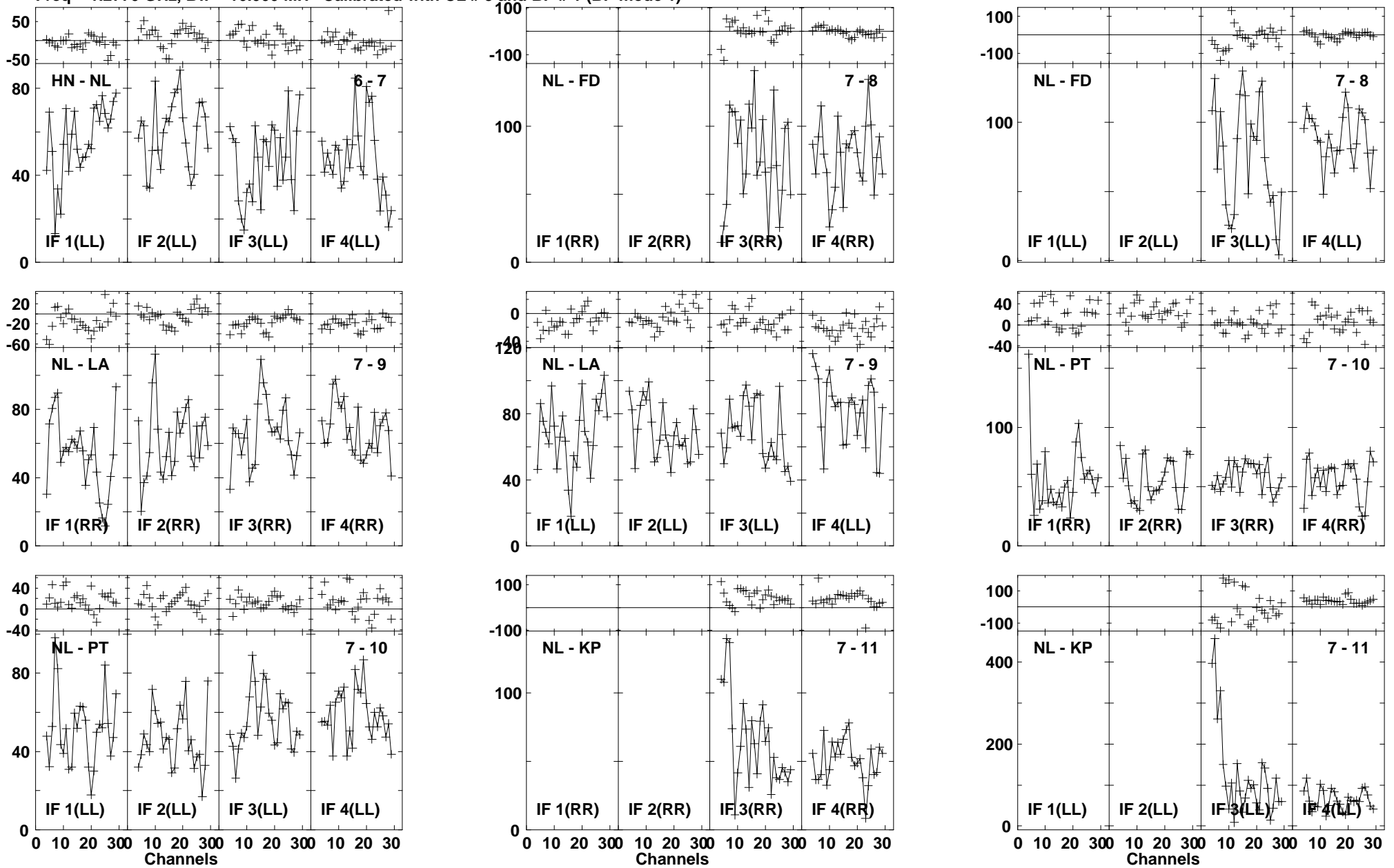

Lower frame: Milli Ampl Jy Top frame: Phas deg
Vector averaged cross-power spectrum Baseline: HN (06) - NL (07)
Timerange: 00/23:08:45 to 00/23:12:09

Plot file version 904 created 03-MAR-2016 01:14:34
 4C52 GN002C 1.UVDATA.1
 Freq = 1.2770 GHz, Bw = 16.000 MH Calibrated with CL # 3 and BP # 1 (BP mode 1)

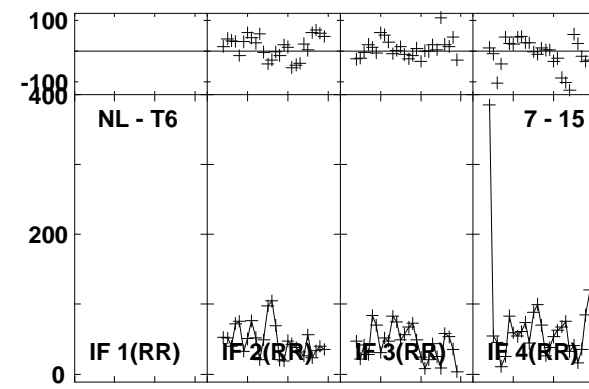
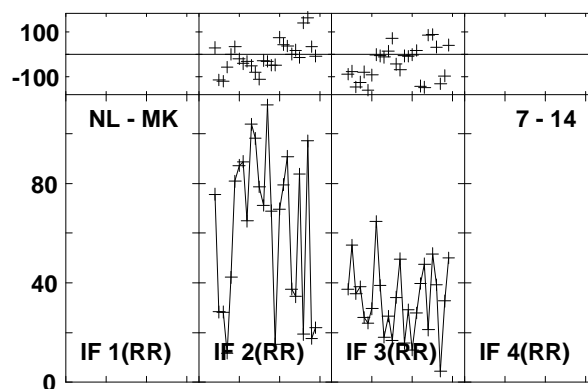
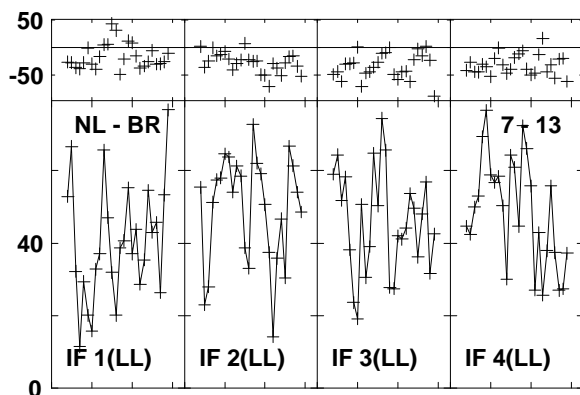
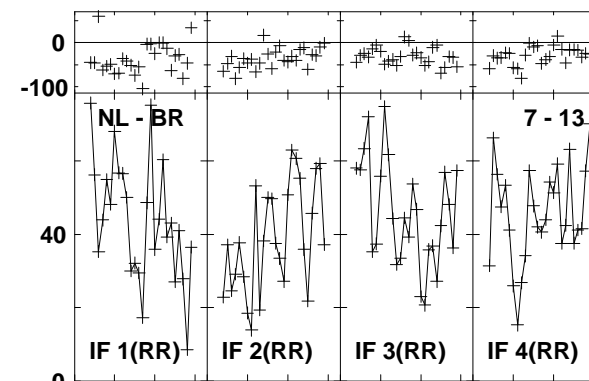
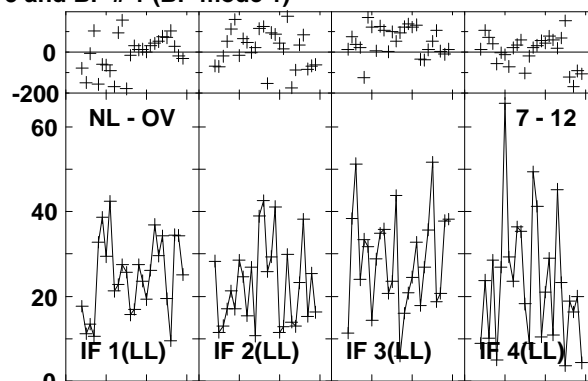
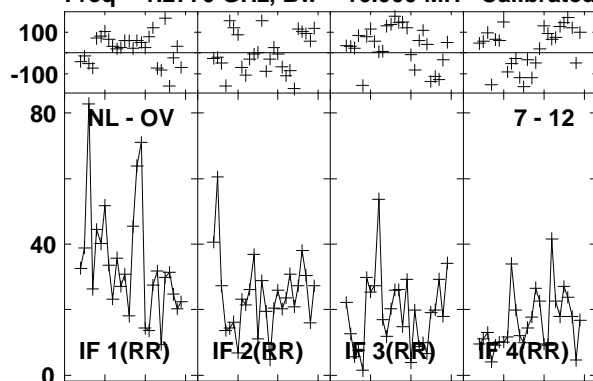

Lower frame: Milli Ampl Jy Top frame: Phas deg
 Vector averaged cross-power spectrum Baseline: NL (07) - OV (12)
 Timerange: 00/23:08:45 to 00/23:12:09

Plot file version 905 created 03-MAR-2016 01:14:34

J1545+5400 GN002C 1.UVDATA.1

Freq = 1.2770 GHz, Bw = 16.000 MH Calibrated with CL # 3 and BP # 1 (BP mode 1)

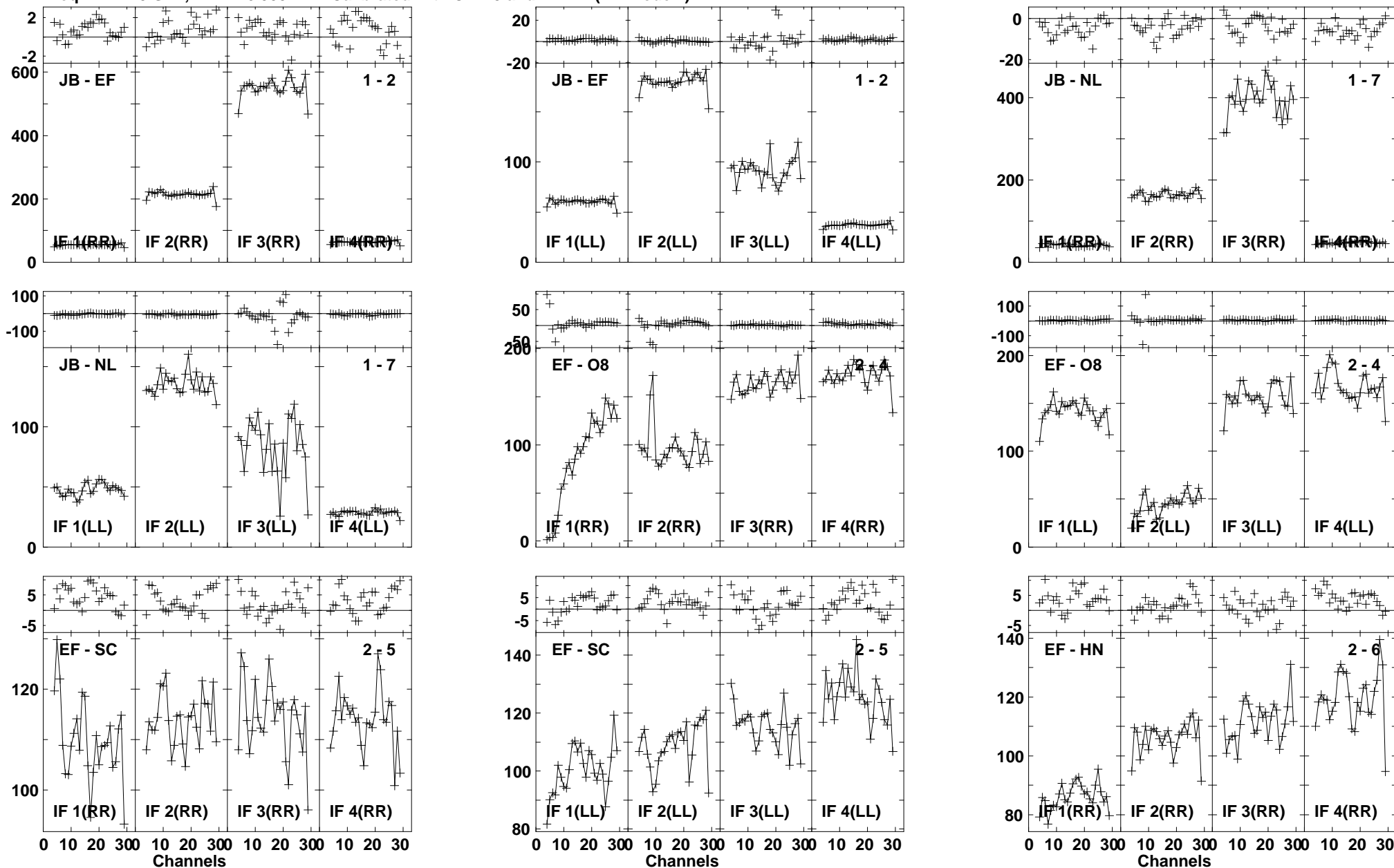

Lower frame: Milli Ampl Jy Top frame: Phas deg
Vector averaged cross-power spectrum Baseline: JB (01) - EF (02)
Timerange: 00/23:13:02 to 00/23:15:30

Plot file version 906 created 03-MAR-2016 01:14:35

J1545+5400 GN002C 1.UVDATA.1

Freq = 1.2770 GHz, Bw = 16.000 MH Calibrated with CL # 3 and BP # 1 (BP mode 1)

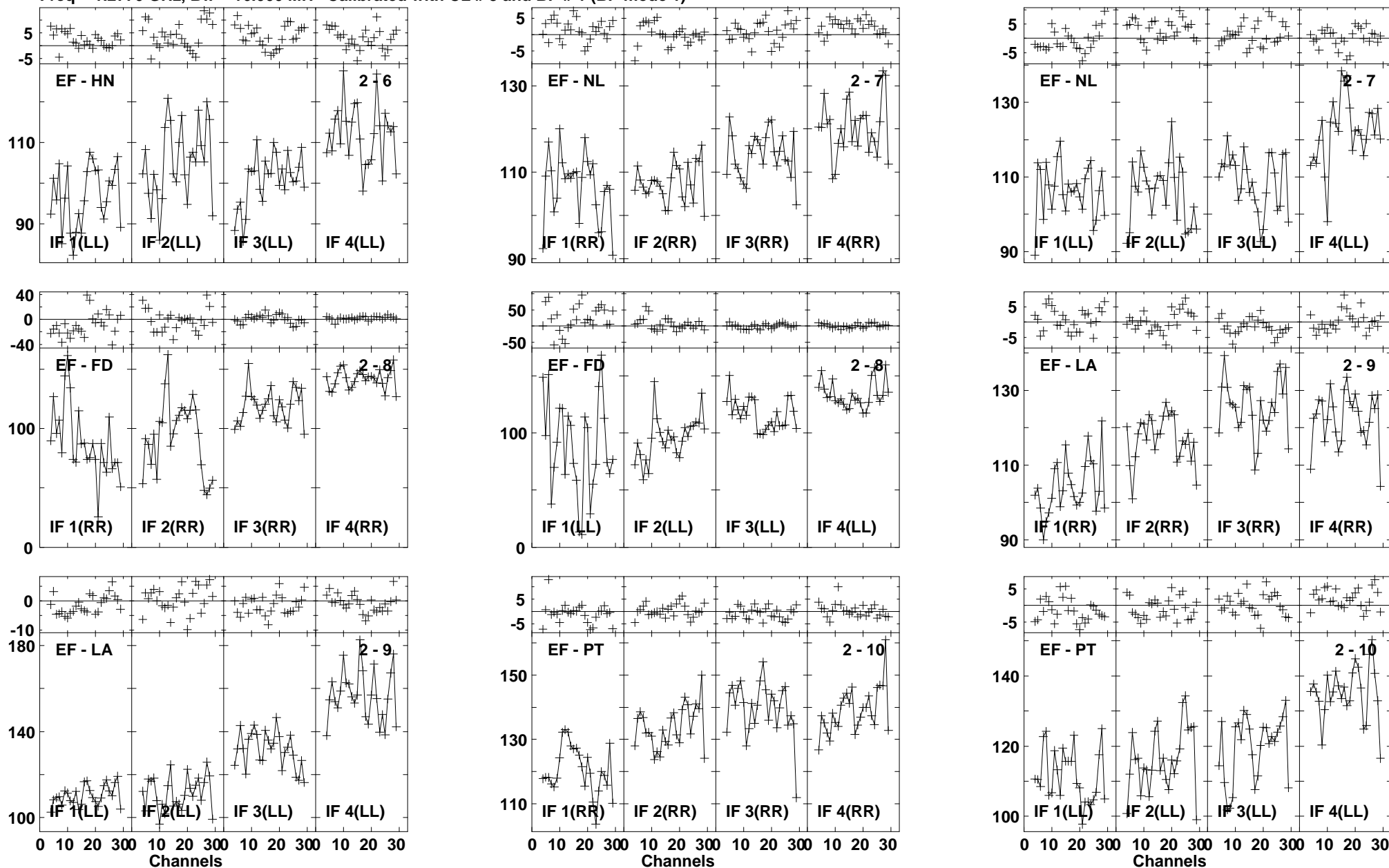

Lower frame: Milli Ampl Jy Top frame: Phas deg
Vector averaged cross-power spectrum Baseline: EF (02) - HN (06)
Timerange: 00/23:13:02 to 00/23:15:30

Plot file version 907 created 03-MAR-2016 01:14:35

J1545+5400 GN002C 1.UVDATA.1

Freq = 1.2770 GHz, Bw = 16.000 MH Calibrated with CL # 3 and BP # 1 (BP mode 1)

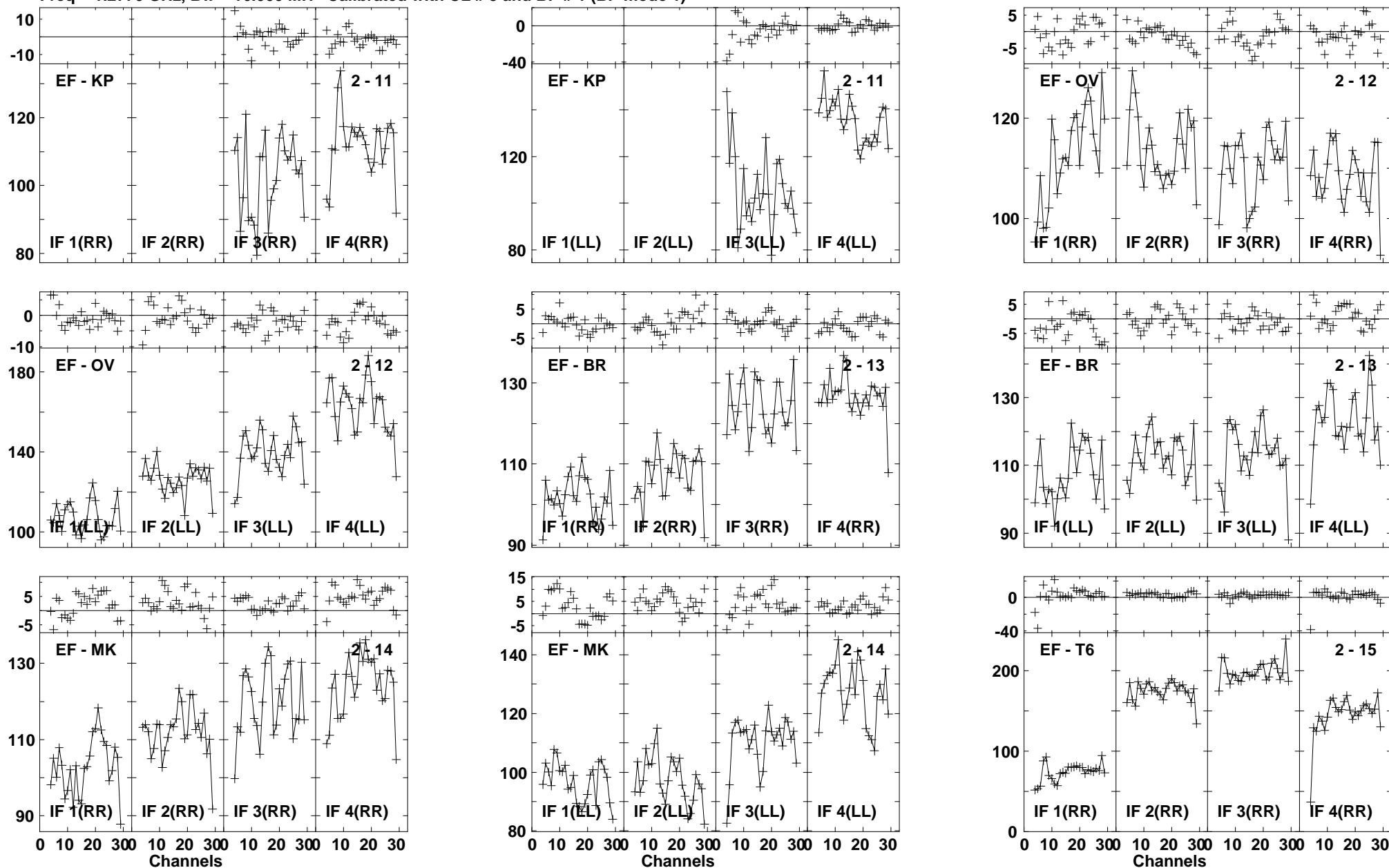

Lower frame: Milli Ampl Jy Top frame: Phas deg
Vector averaged cross-power spectrum Baseline: EF (02) - KP (11)
Timerange: 00/23:13:02 to 00/23:15:30

Plot file version 908 created 03-MAR-2016 01:14:35

J1545+5400 GN002C 1.UVDATA.1

Freq = 1.2770 GHz, Bw = 16.000 MH Calibrated with CL # 3 and BP # 1 (BP mode 1)

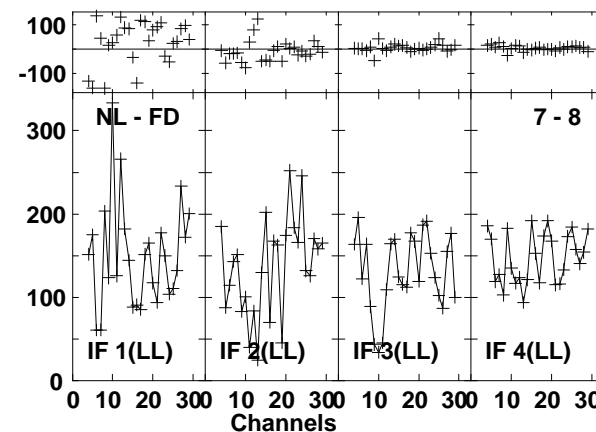
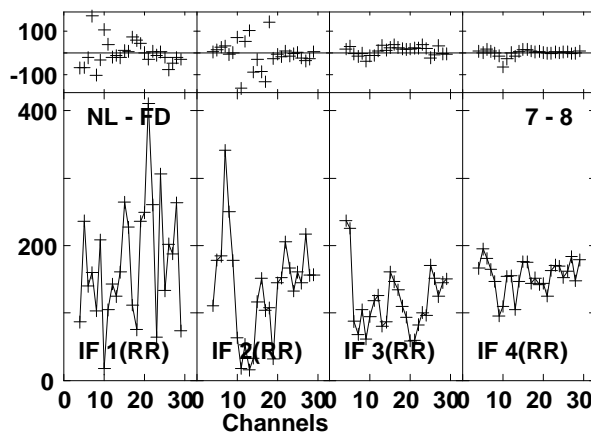
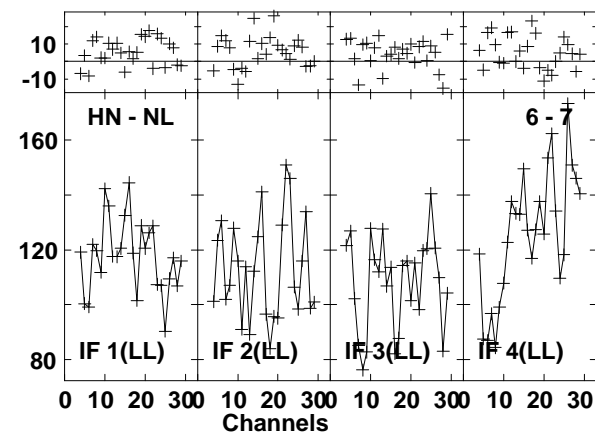
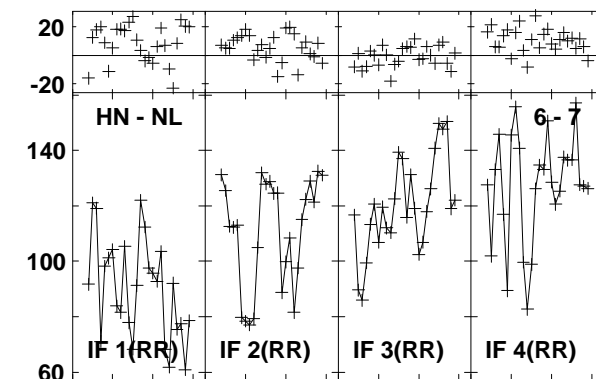
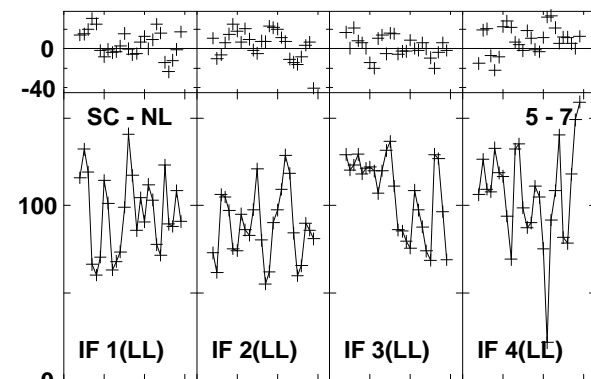
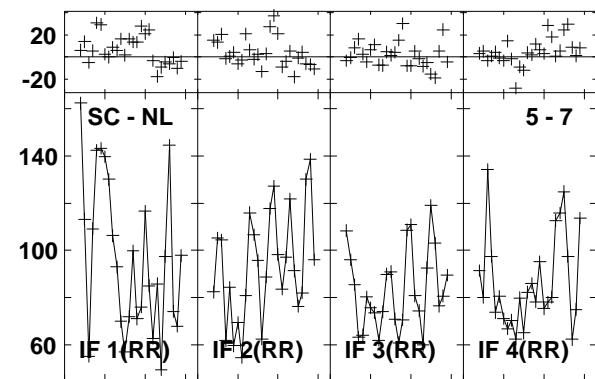
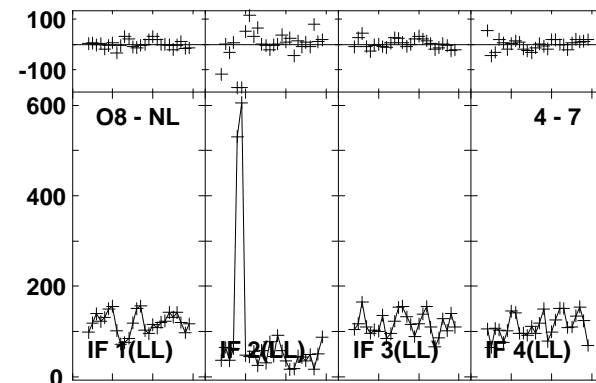
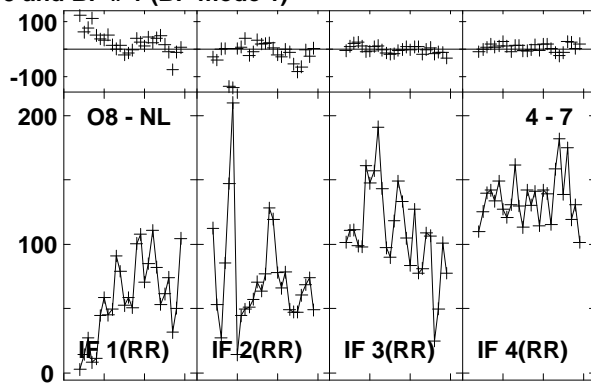
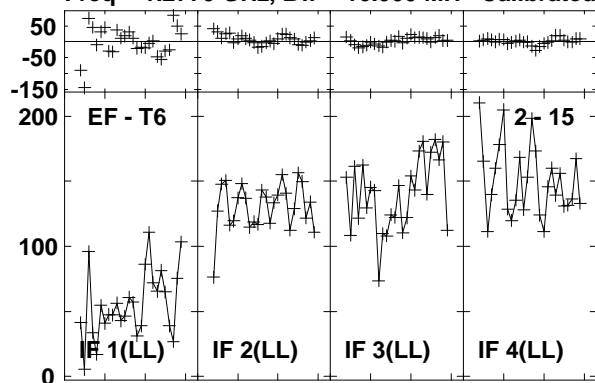

Lower frame: Milli Ampl Jy Top frame: Phas deg
Vector averaged cross-power spectrum Baseline: EF (02) - T6 (15)
Timerange: 00/23:13:02 to 00/23:15:30

Plot file version 909 created 03-MAR-2016 01:14:35

J1545+5400 GN002C 1.UVDATA.1

Freq = 1.2770 GHz, Bw = 16.000 MH Calibrated with CL # 3 and BP # 1 (BP mode 1)

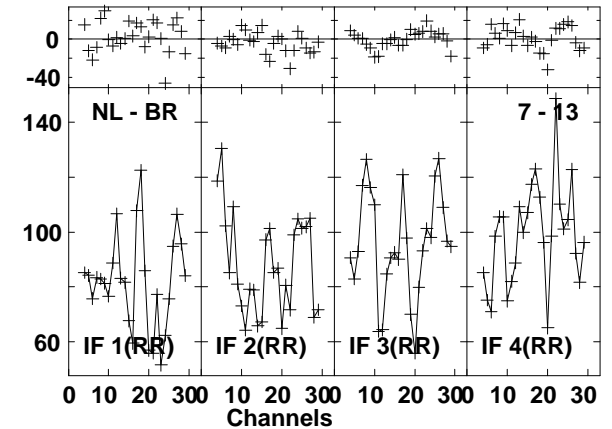
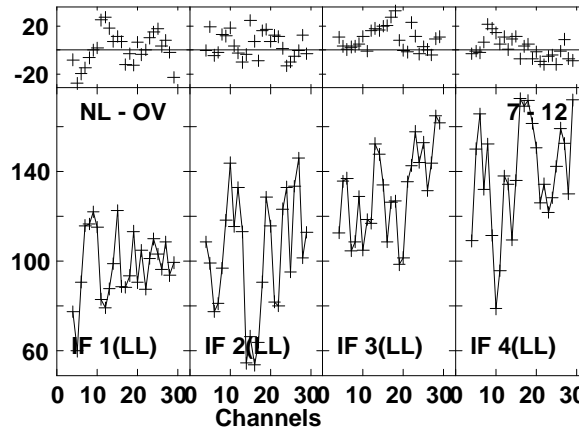
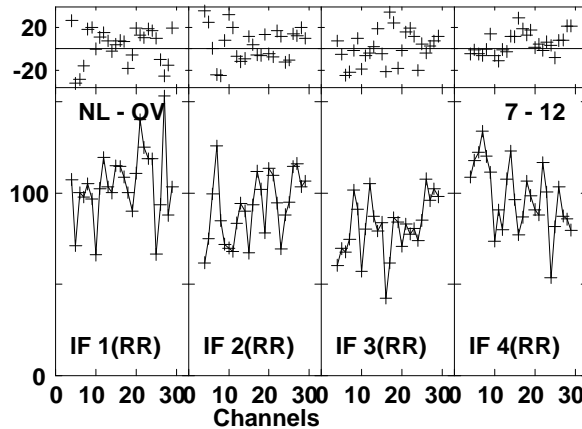
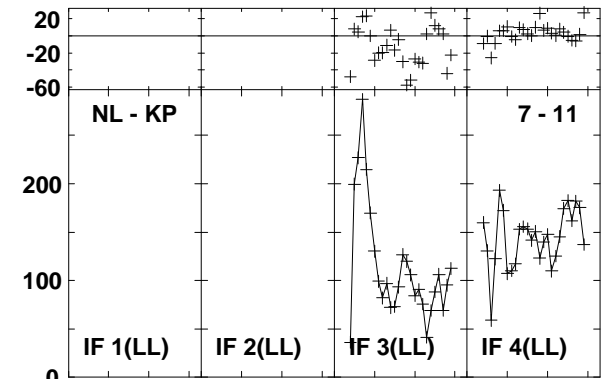
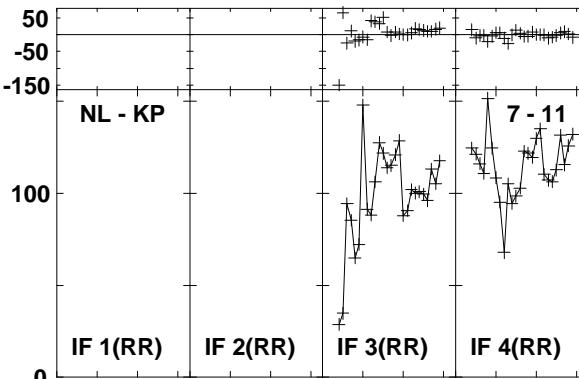
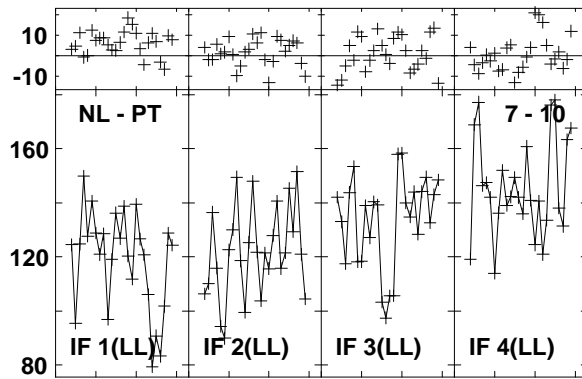
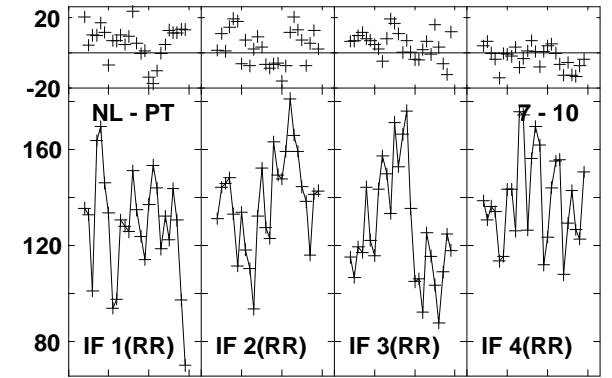
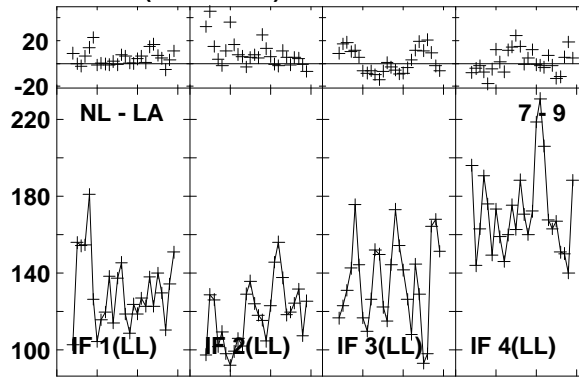
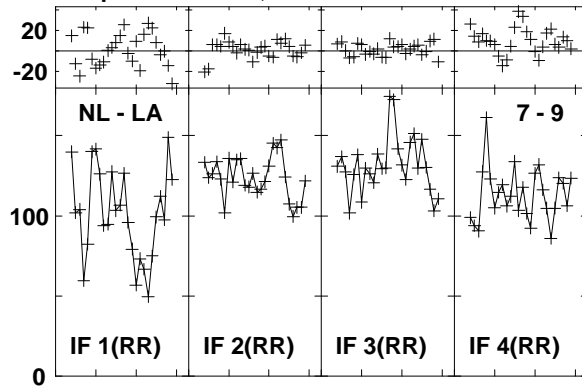

Lower frame: Milli Ampl Jy Top frame: Phas deg
Vector averaged cross-power spectrum Baseline: NL (07) - LA (09)
Timerange: 00/23:13:02 to 00/23:15:30

Plot file version 910 created 03-MAR-2016 01:14:35

J1545+5400 GN002C 1.UVDATA.1

Freq = 1.2770 GHz, Bw = 16.000 MH Calibrated with CL # 3 and BP # 1 (BP mode 1)

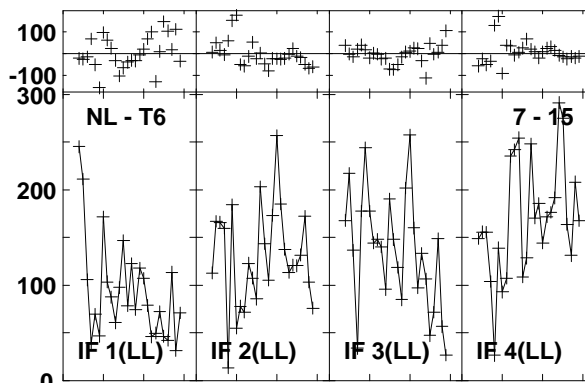
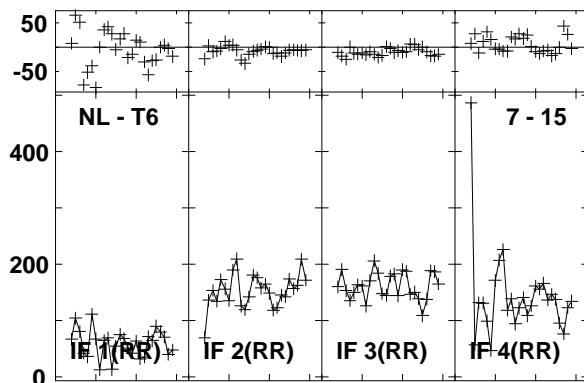
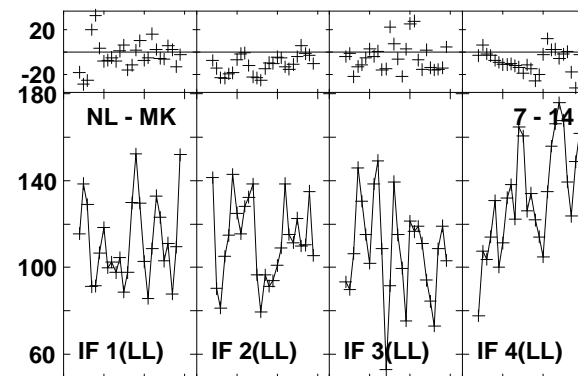
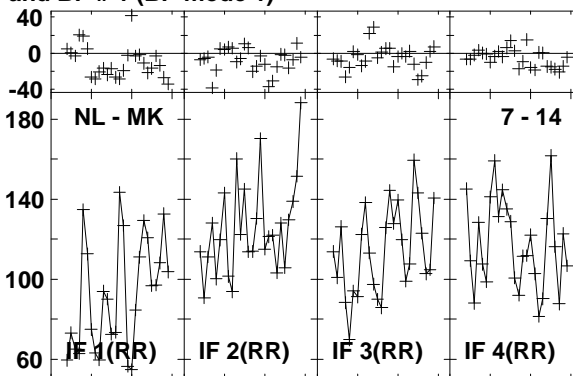
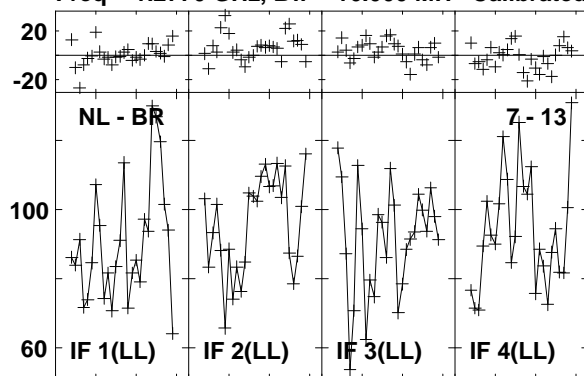

Lower frame: Milli Ampl Jy Top frame: Phas deg
Vector averaged cross-power spectrum Baseline: NL (07) - BR (13)
Timerange: 00/23:13:02 to 00/23:15:30

Plot file version 911 created 03-MAR-2016 01:14:35

4C52 GN002C 1.UVDATA.1

Freq = 1.2770 GHz, Bw = 16.000 MH Calibrated with CL # 3 and BP # 1 (BP mode 1)

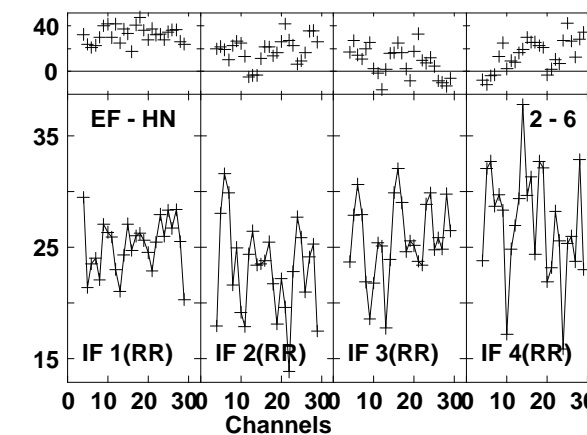
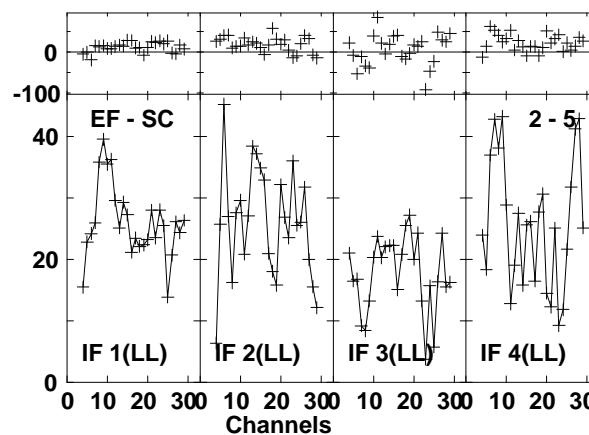
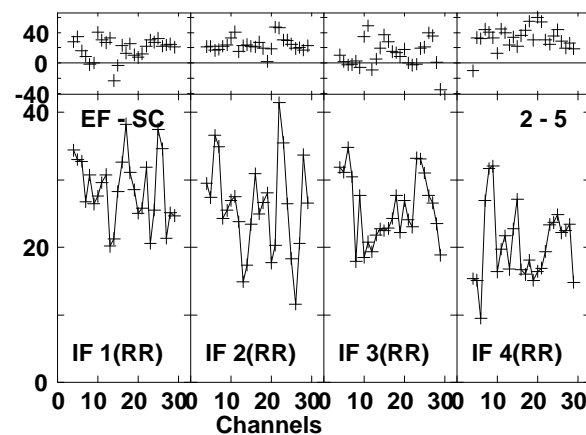
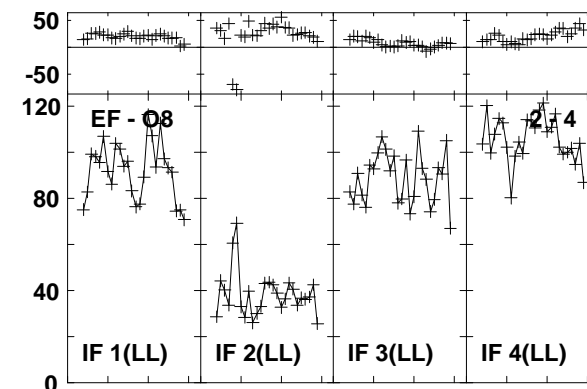
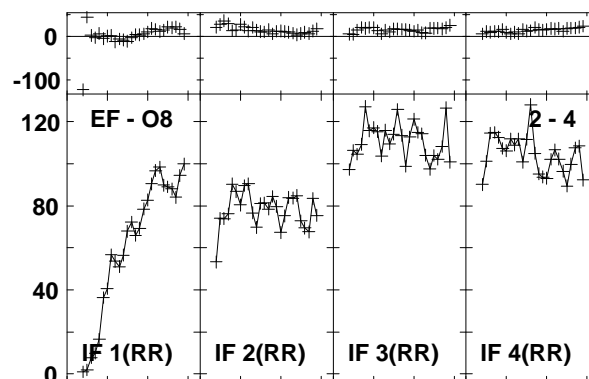
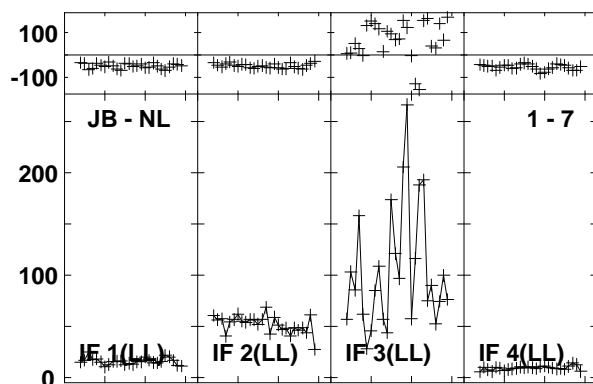
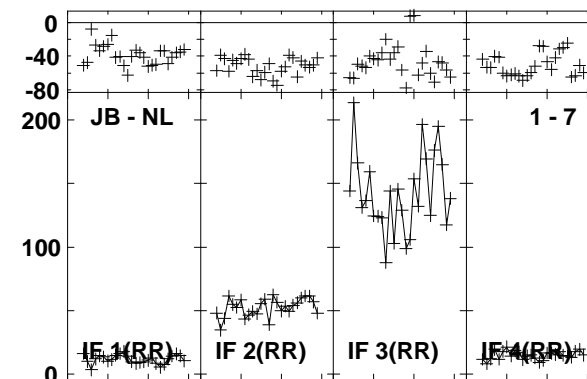
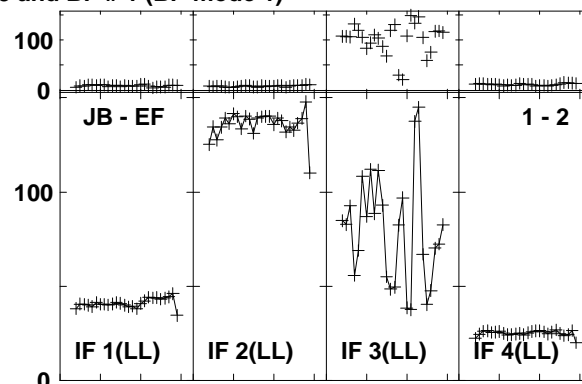
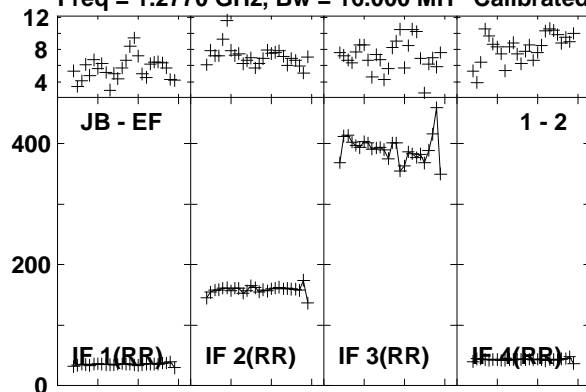

Lower frame: Milli Ampl Jy Top frame: Phas deg
Vector averaged cross-power spectrum Baseline: JB (01) - EF (02)
Timerange: 00/23:15:43 to 00/23:18:59

Plot file version 912 created 03-MAR-2016 01:14:36

4C52 GN002C 1.UVDATA.1

Freq = 1.2770 GHz, Bw = 16.000 MH Calibrated with CL # 3 and BP # 1 (BP mode 1)

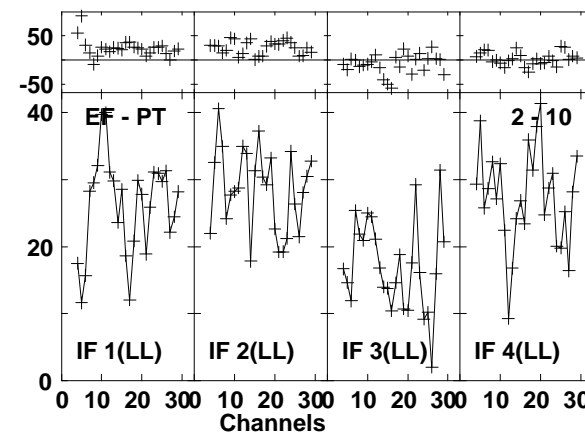
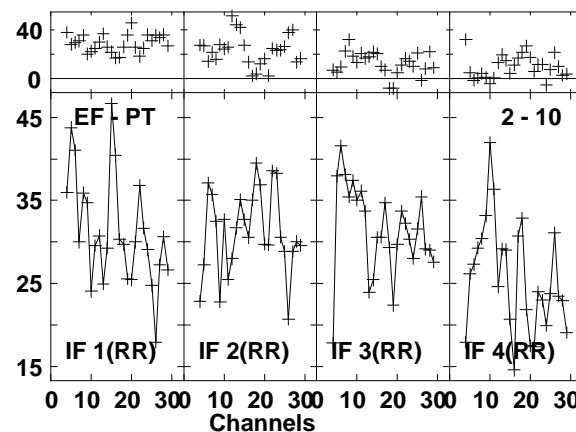
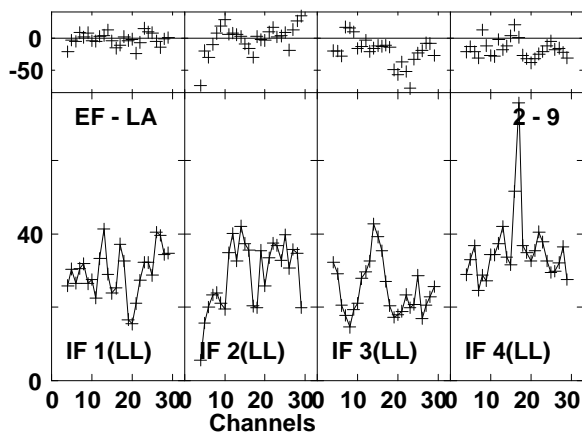
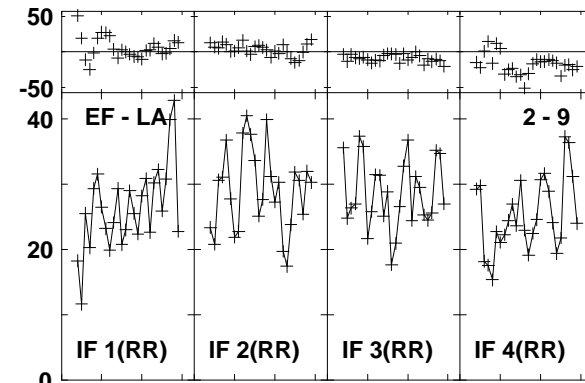
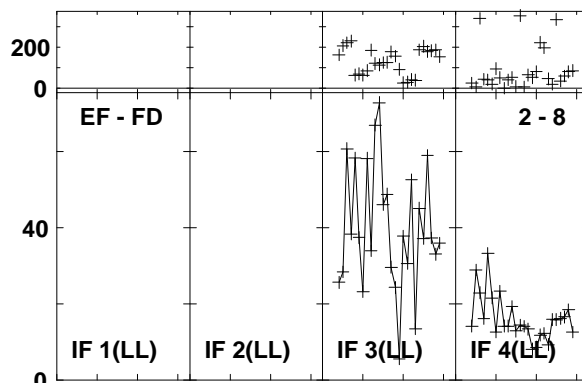
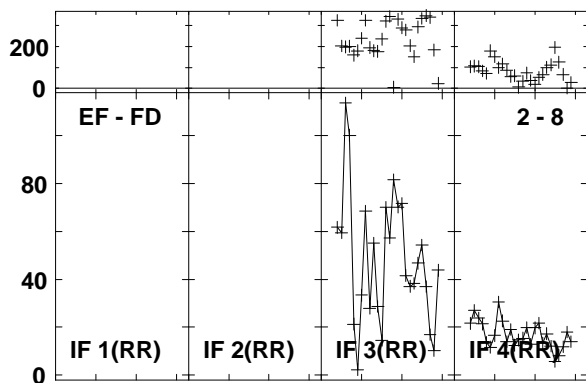
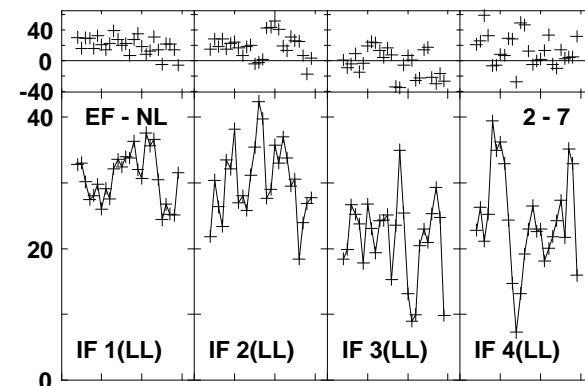
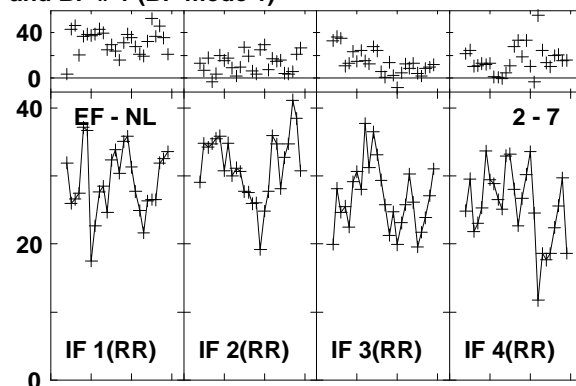
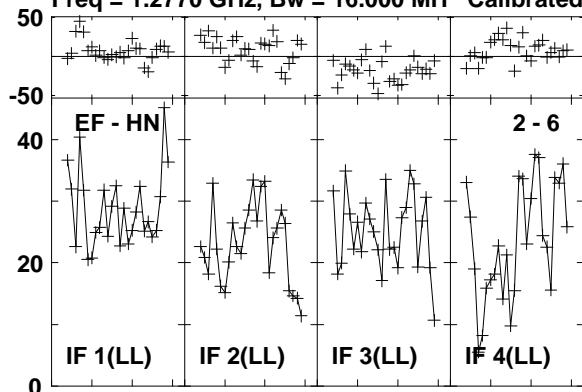

Lower frame: Milli Ampl Jy Top frame: Phas deg
Vector averaged cross-power spectrum Baseline: EF (02) - HN (06)
Timerange: 00/23:15:43 to 00/23:18:59

Plot file version 913 created 03-MAR-2016 01:14:36

4C52 GN002C 1.UVDATA.1

Freq = 1.2770 GHz, Bw = 16.000 MH Calibrated with CL # 3 and BP # 1 (BP mode 1)

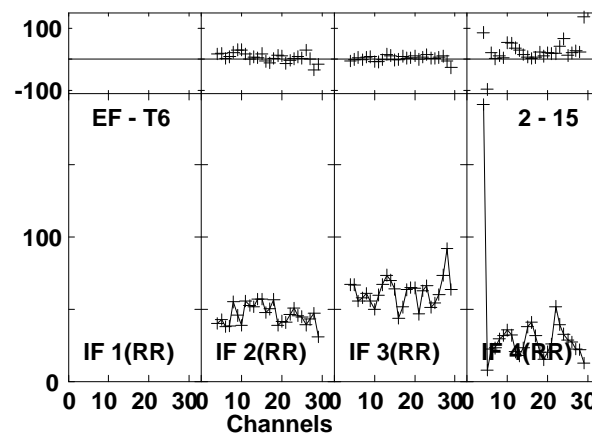
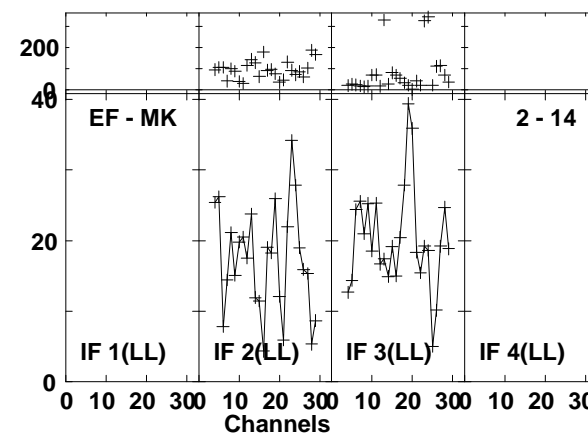
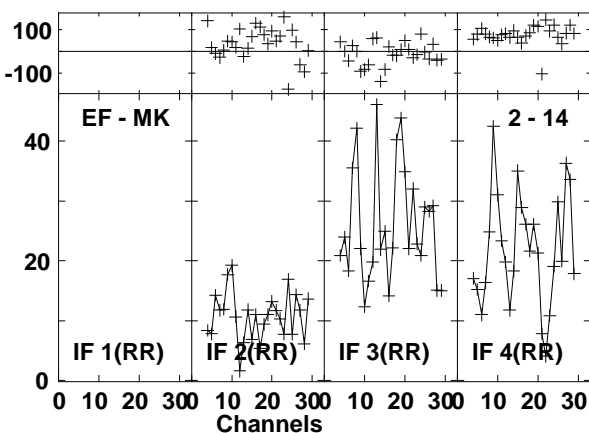
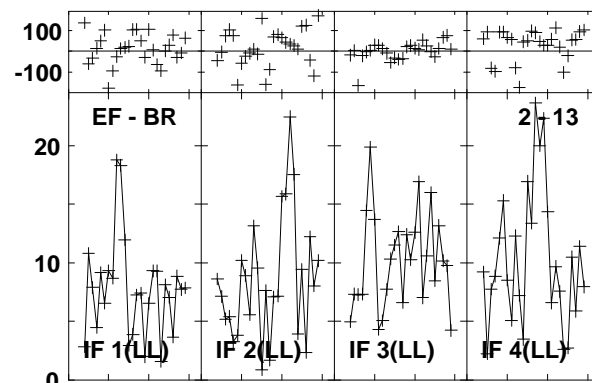
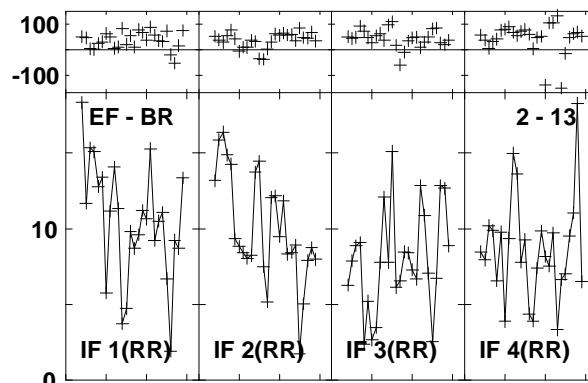
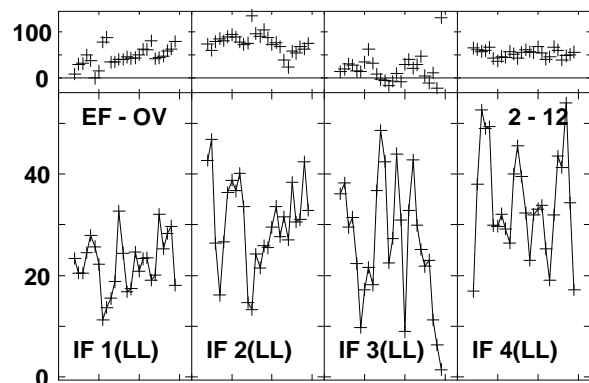
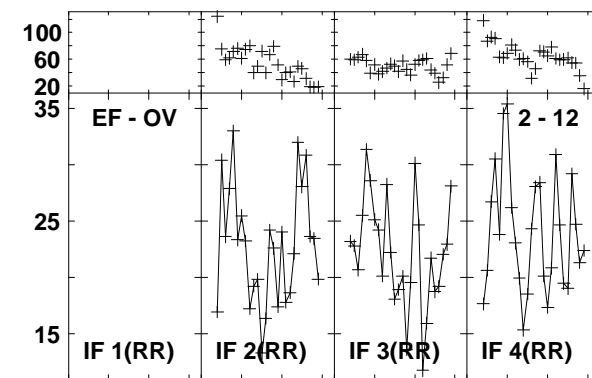
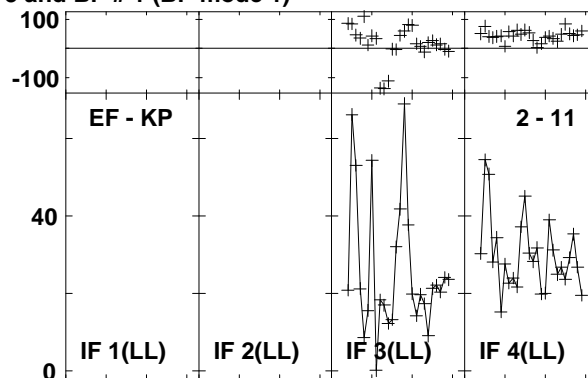
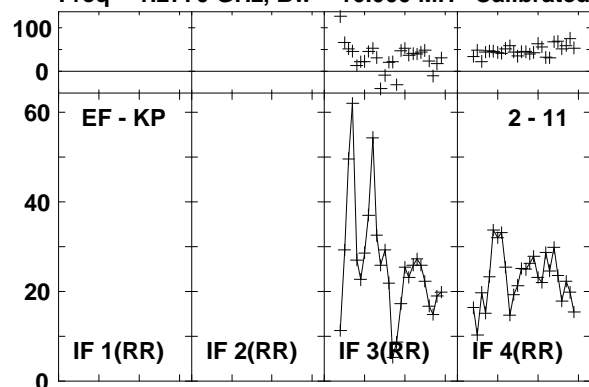

Lower frame: Milli Ampl Jy Top frame: Phas deg

Vector averaged cross-power spectrum Baseline: EF (02) - KP (11)

Timerange: 00/23:15:43 to 00/23:18:59

Plot file version 914 created 03-MAR-2016 01:14:36

4C52 GN002C 1.UVDATA.1

Freq = 1.2770 GHz, Bw = 16.000 MH Calibrated with CL # 3 and BP # 1 (BP mode 1)

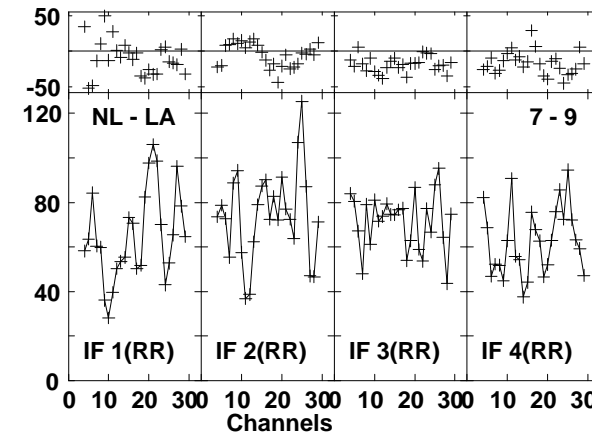
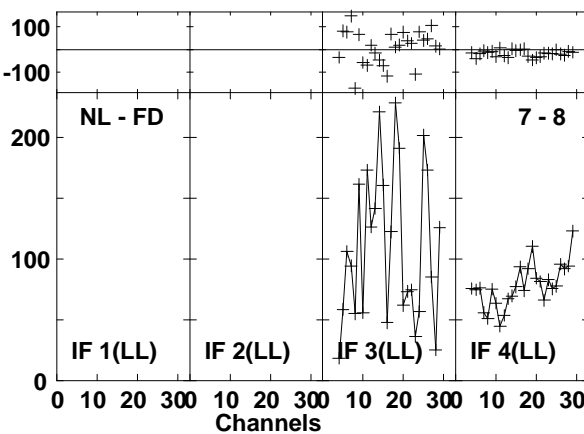
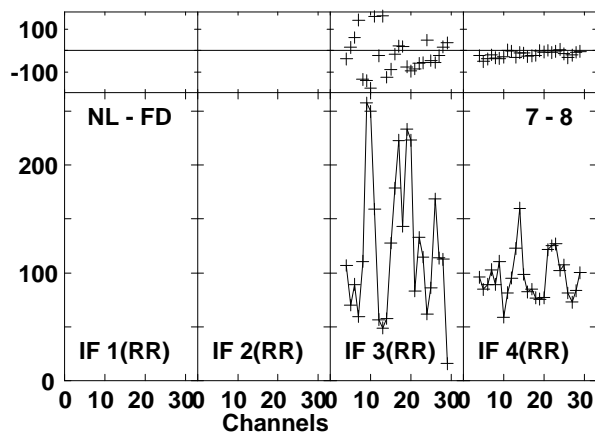
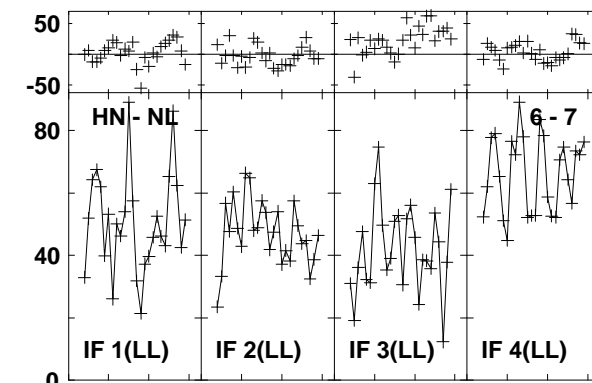
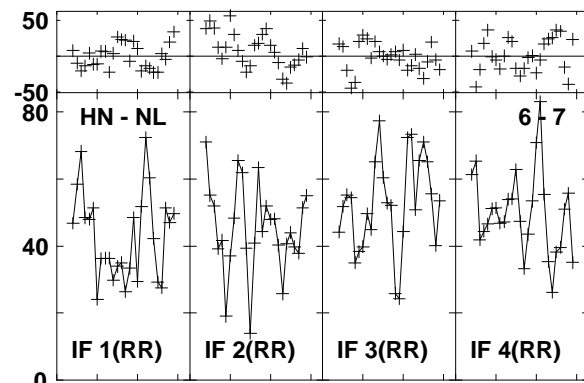
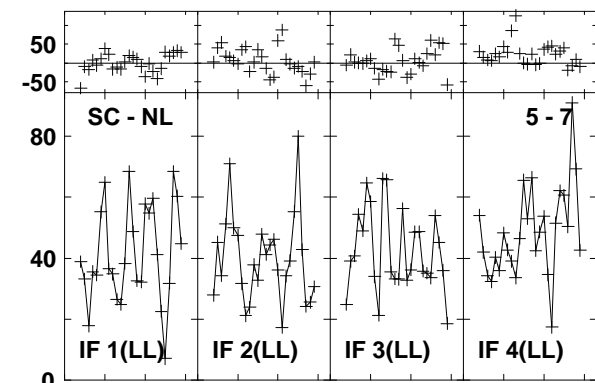
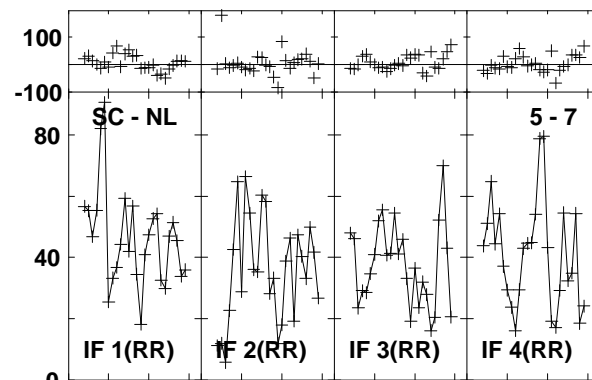
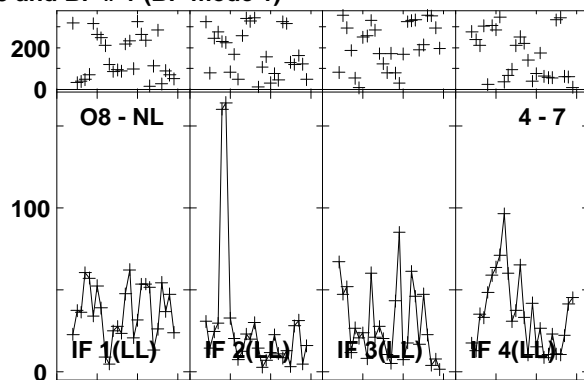
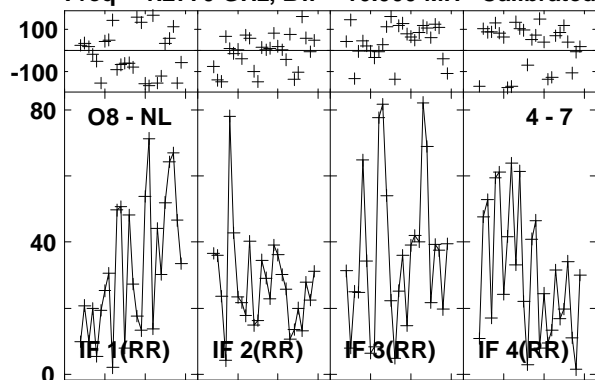

Lower frame: Milli Ampl Jy Top frame: Phas deg
Vector averaged cross-power spectrum Baseline: O8 (04) - NL (07)
Timerange: 00/23:15:43 to 00/23:18:59

Plot file version 915 created 03-MAR-2016 01:14:36

4C52 GN002C 1.UVDATA.1

Freq = 1.2770 GHz, Bw = 16.000 MH Calibrated with CL # 3 and BP # 1 (BP mode 1)

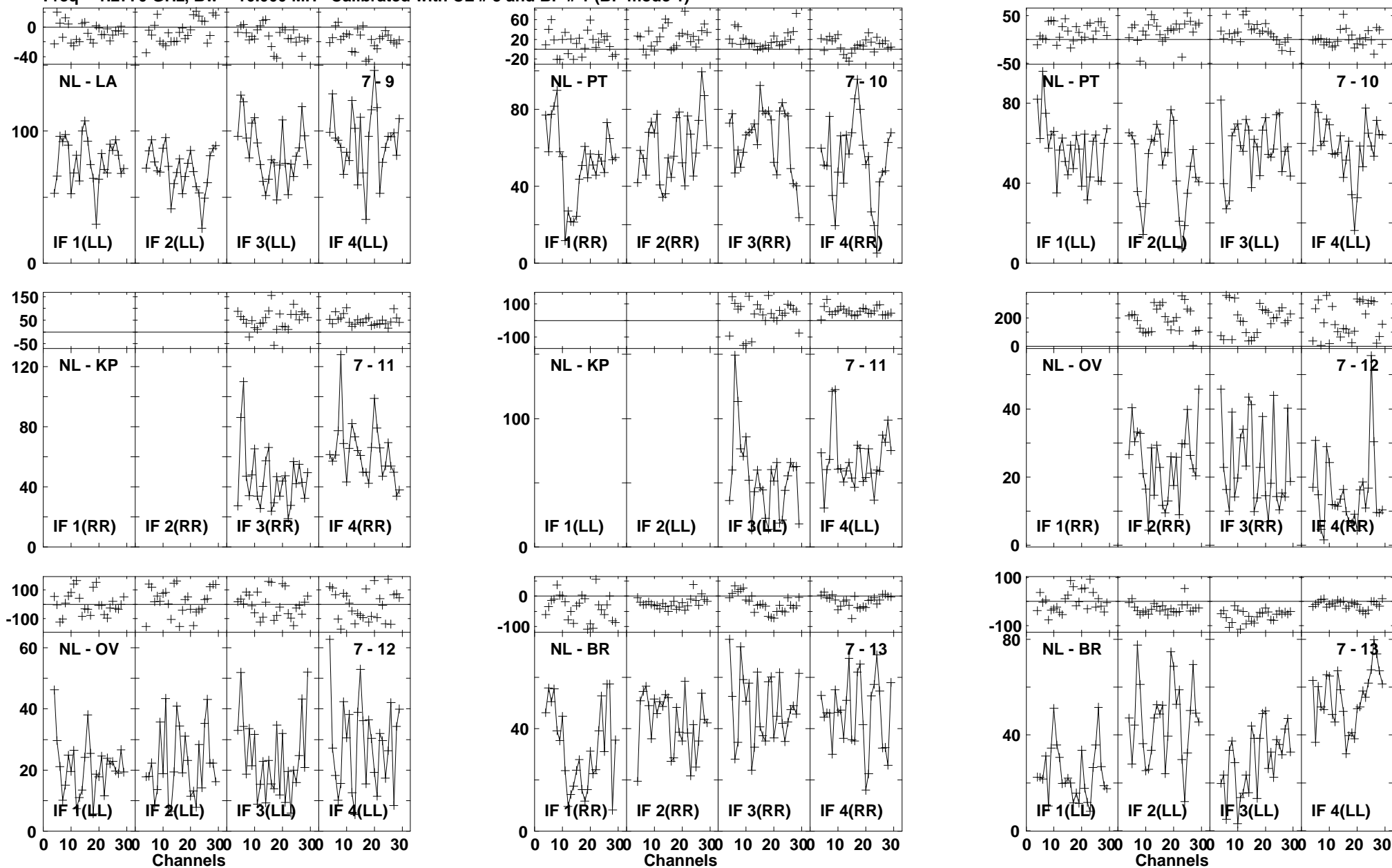

Lower frame: Milli Ampl Jy Top frame: Phas deg
Vector averaged cross-power spectrum Baseline: NL (07) - LA (09)
Timerange: 00/23:15:43 to 00/23:18:59

Plot file version 916 created 03-MAR-2016 01:14:36

4C52 GN002C 1.UVDATA.1

Freq = 1.2770 GHz, Bw = 16.000 MH Calibrated with CL # 3 and BP # 1 (BP mode 1)

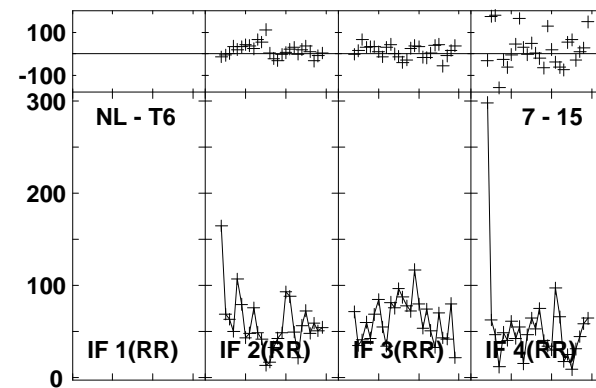
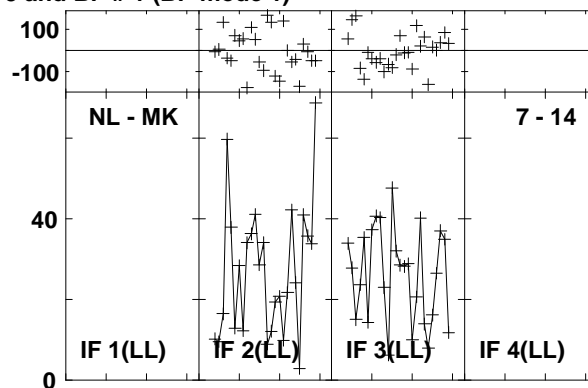
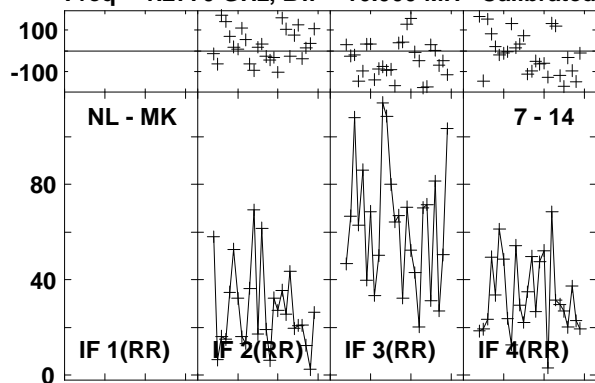

Lower frame: Milli Ampl Jy Top frame: Phas deg
Vector averaged cross-power spectrum Baseline: NL (07) - MK (14)
Timerange: 00/23:15:43 to 00/23:18:59

Plot file version 917 created 03-MAR-2016 01:14:37

J1545+5400 GN002C 1.UVDATA.1

Freq = 1.2770 GHz, Bw = 16.000 MH Calibrated with CL # 3 and BP # 1 (BP mode 1)

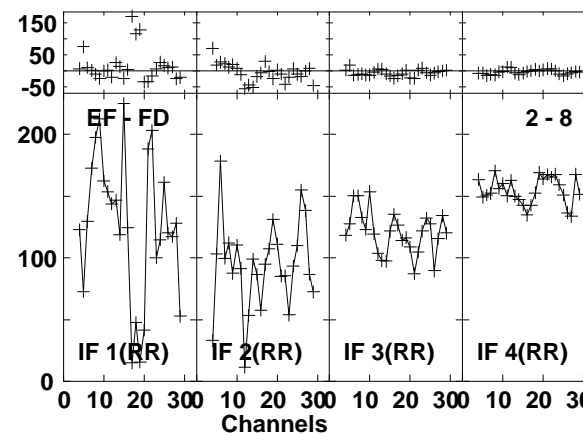
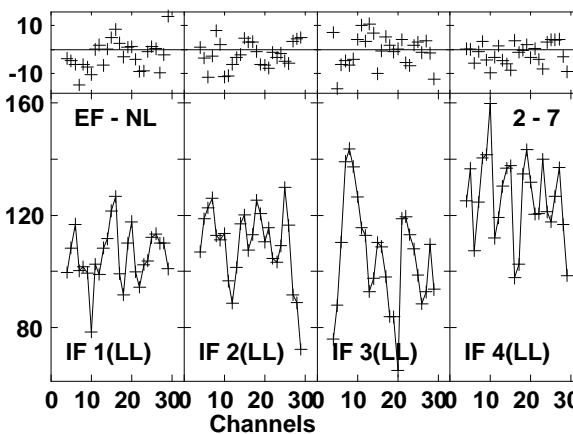
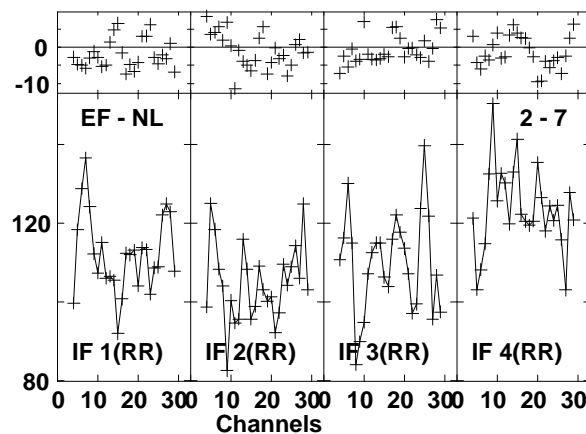
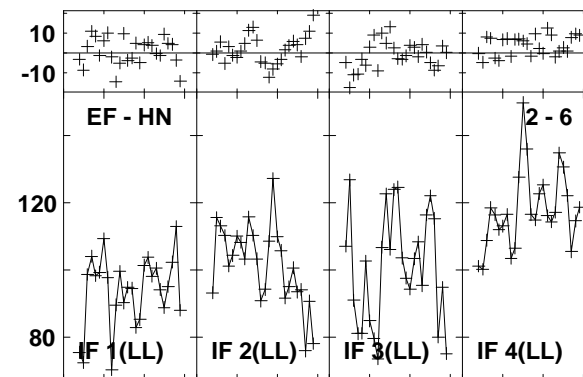
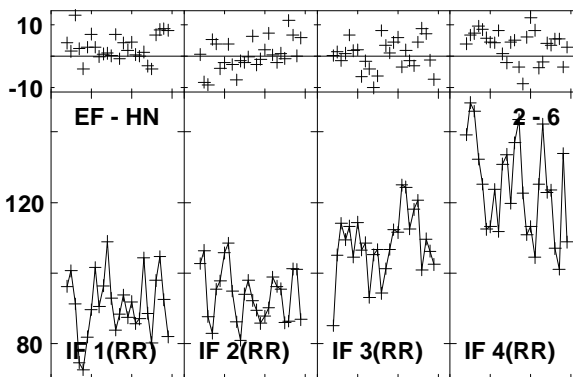
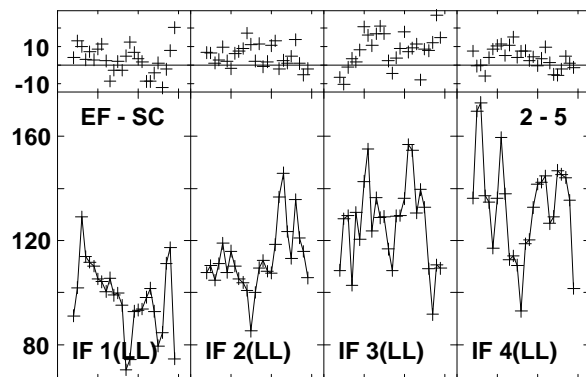
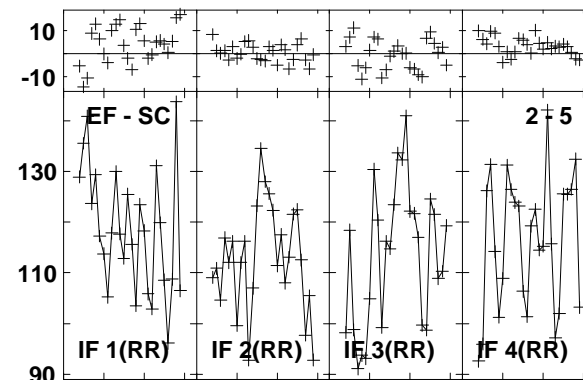
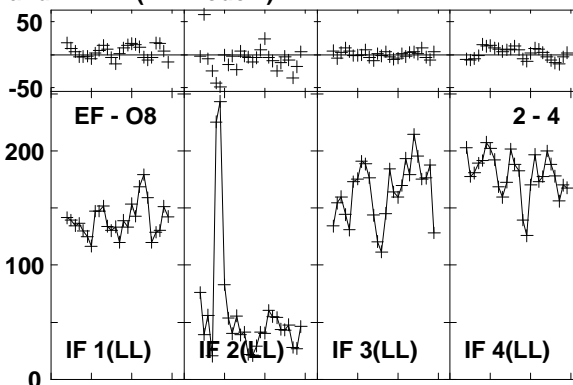
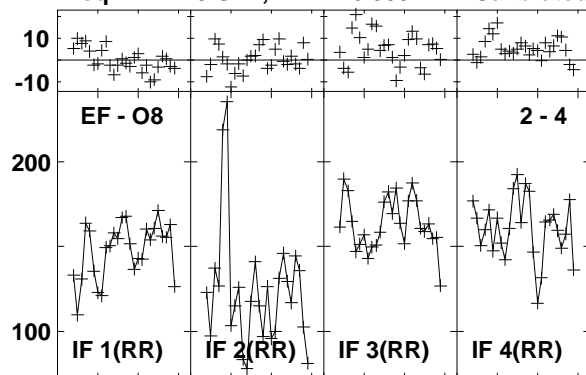

Lower frame: Milli Ampl Jy Top frame: Phas deg
Vector averaged cross-power spectrum Baseline: EF (02) - O8 (04)
Timerange: 00/23:19:52 to 00/23:20:50

Plot file version 918 created 03-MAR-2016 01:14:37
 J1545+5400 GN002C 1.UVDATA.1
 Freq = 1.2770 GHz, Bw = 16.000 MH Calibrated with CL # 3 and BP # 1 (BP mode 1)

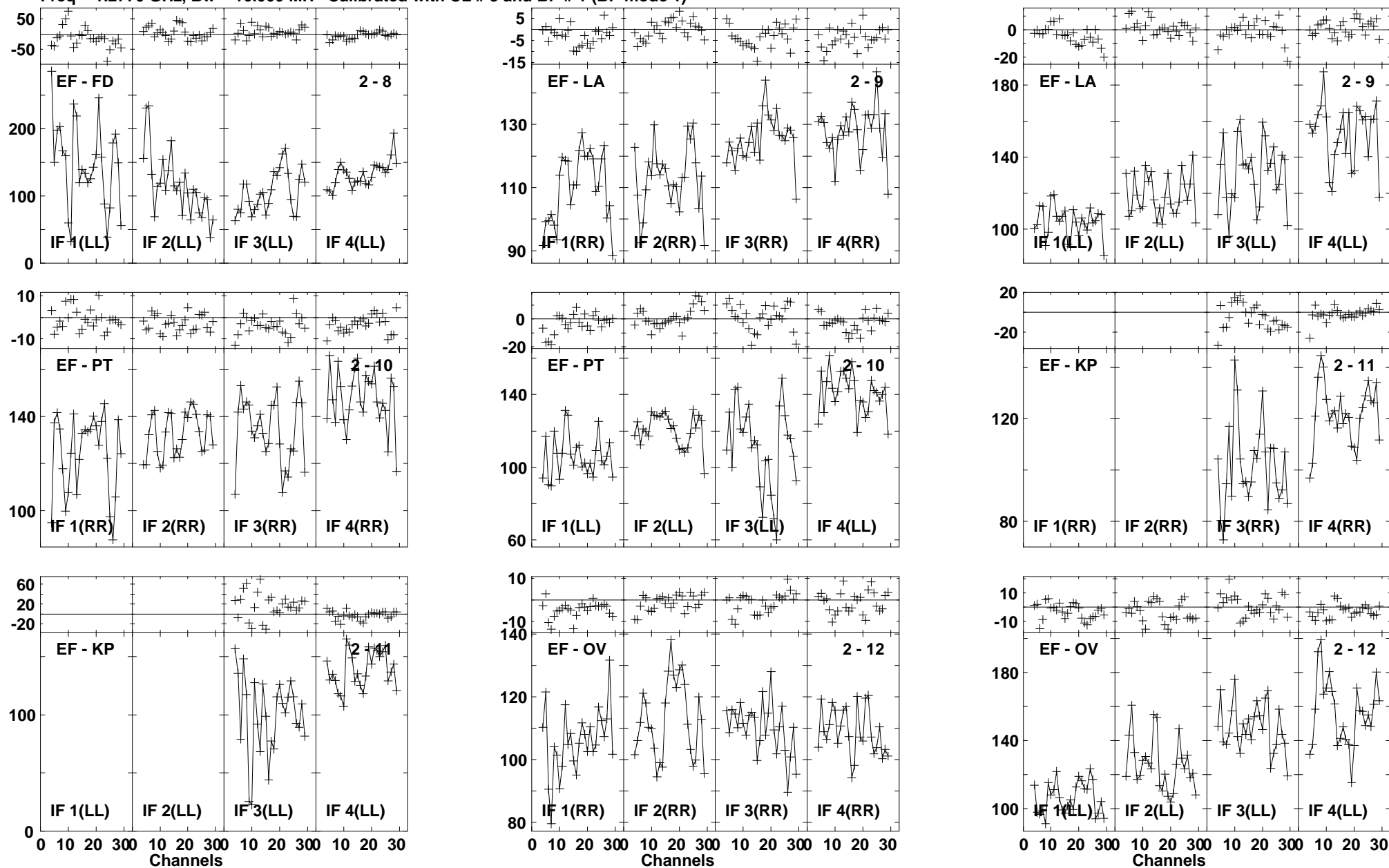

Lower frame: Milli Ampl Jy Top frame: Phas deg
 Vector averaged cross-power spectrum Baseline: EF (02) - FD (08)
 Timerange: 00/23:19:52 to 00/23:20:50

Plot file version 919 created 03-MAR-2016 01:14:37

J1545+5400 GN002C 1.UVDATA.1

Freq = 1.2770 GHz, Bw = 16.000 MH Calibrated with CL # 3 and BP # 1 (BP mode 1)

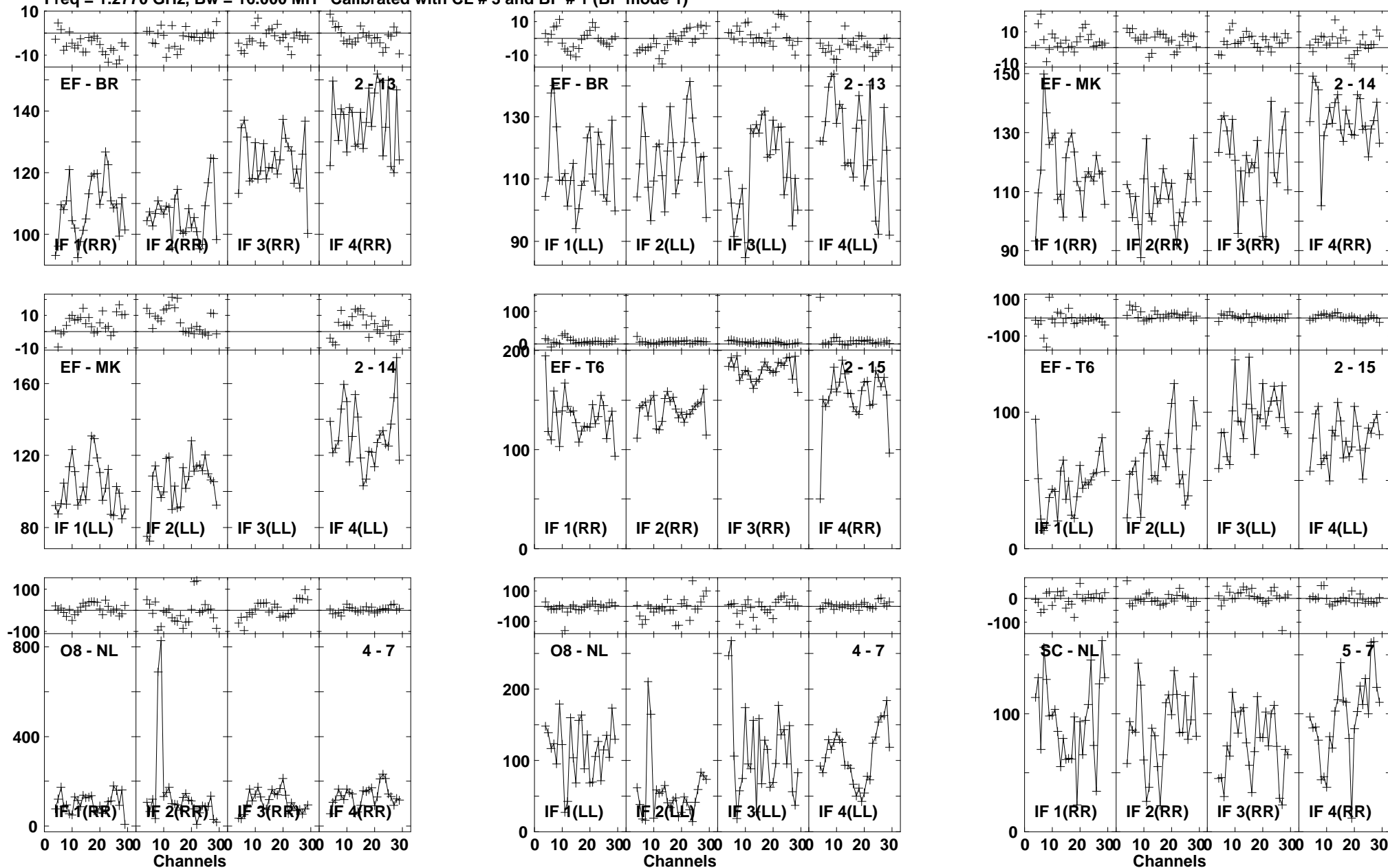

Lower frame: Milli Ampl Jy Top frame: Phas deg
Vector averaged cross-power spectrum Baseline: EF (02) - BR (13)
Timerange: 00/23:19:52 to 00/23:20:50

Plot file version 920 created 03-MAR-2016 01:14:37

J1545+5400 GN002C 1.UVDATA.1

Freq = 1.2770 GHz, Bw = 16.000 MH Calibrated with CL # 3 and BP # 1 (BP mode 1)

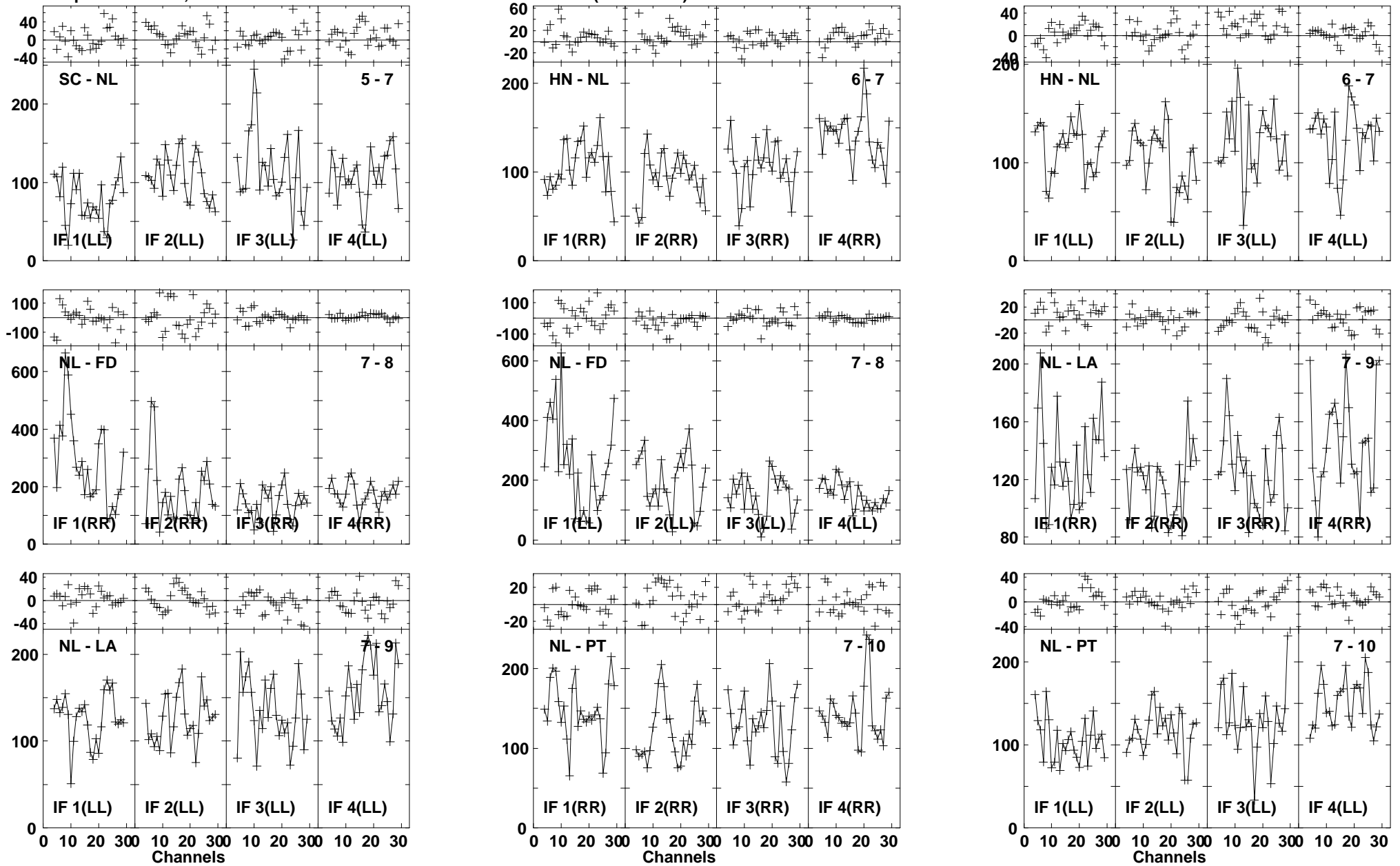

Lower frame: Milli Ampl Jy Top frame: Phas deg
Vector averaged cross-power spectrum Baseline: SC (05) - NL (07)
Timerange: 00/23:19:52 to 00/23:20:50

Plot file version 921 created 03-MAR-2016 01:14:37
 J1545+5400 GN002C 1.UVDATA.1
 Freq = 1.2770 GHz, Bw = 16.000 MH Calibrated with CL # 3 and BP # 1 (BP mode 1)

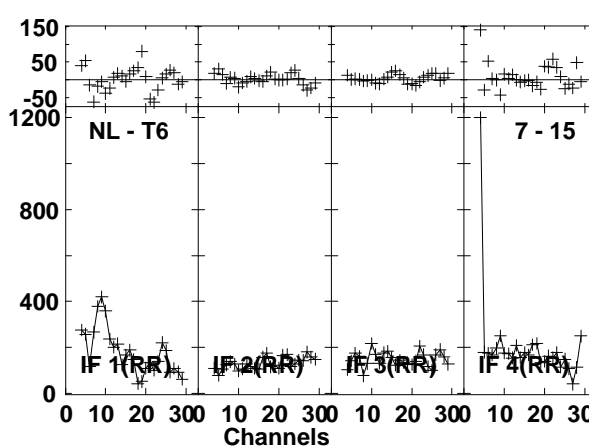
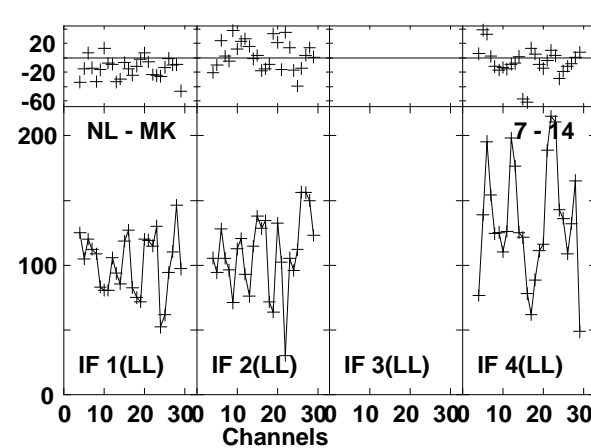
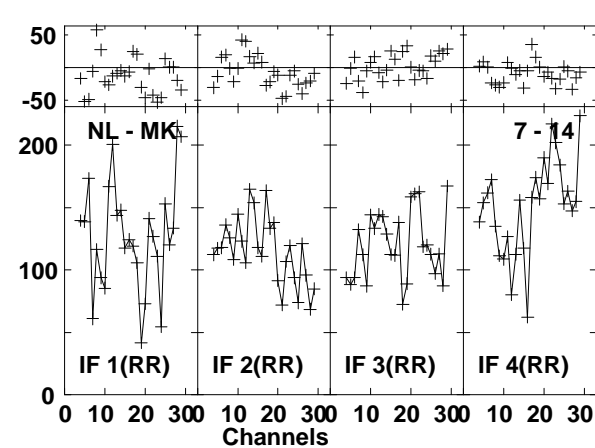
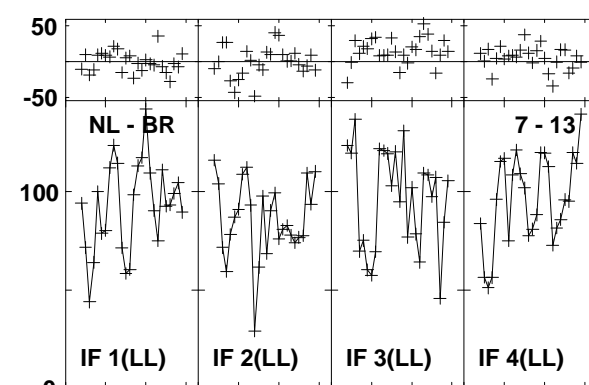
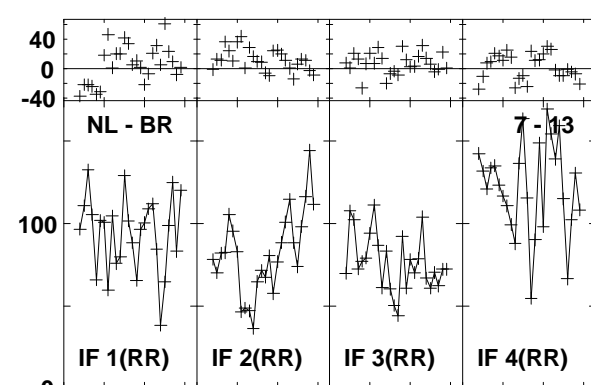
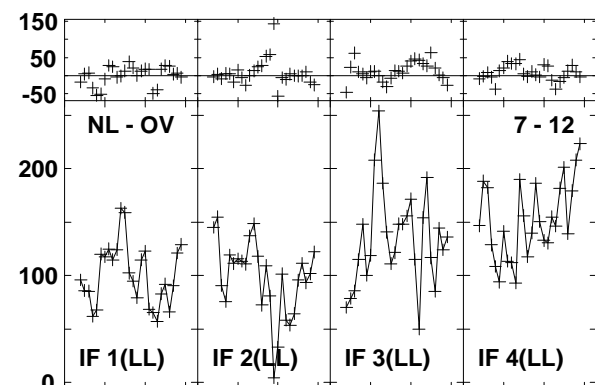
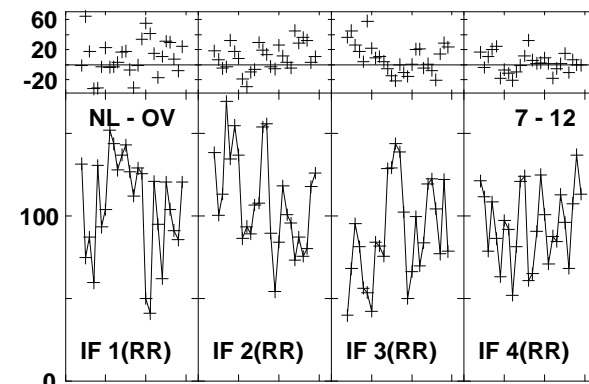
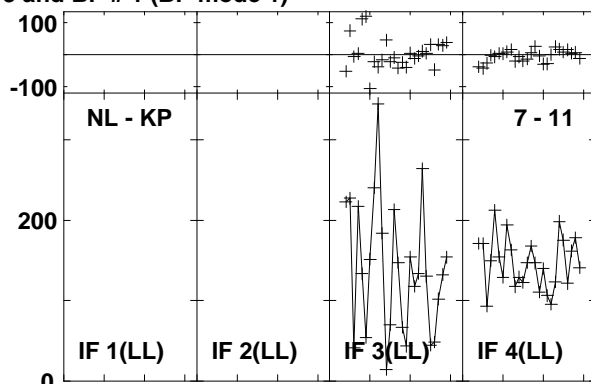
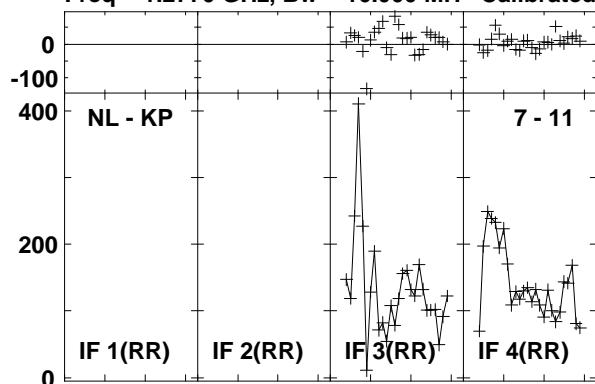

Lower frame: Milli Ampl Jy Top frame: Phas deg
 Vector averaged cross-power spectrum Baseline: NL (07) - KP (11)
 Timerange: 00/23:19:52 to 00/23:20:50

Plot file version 922 created 03-MAR-2016 01:14:37
J1545+5400 GN002C 1.UVDATA.1
Freq = 1.2770 GHz, Bw = 16.000 MH Calibrated with CL # 3 and BP # 1 (BP mode 1)

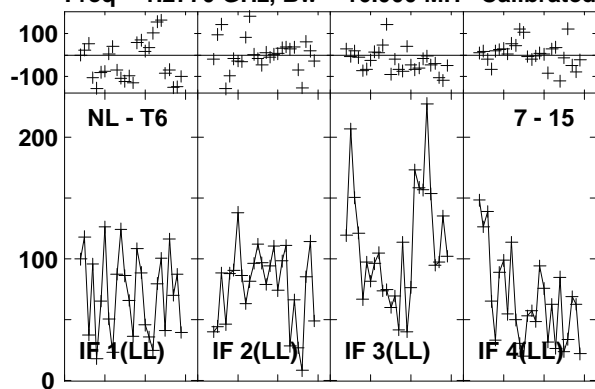

Lower frame: Milli Ampl Jy Top frame: Phas deg
Vector averaged cross-power spectrum Baseline: NL (07) - T6 (15)
Timerange: 00/23:19:52 to 00/23:20:50

Plot file version 923 created 03-MAR-2016 01:14:37

4C52 GN002C 1.UVDATA.1

Freq = 1.2770 GHz, Bw = 16.000 MH Calibrated with CL # 3 and BP # 1 (BP mode 1)

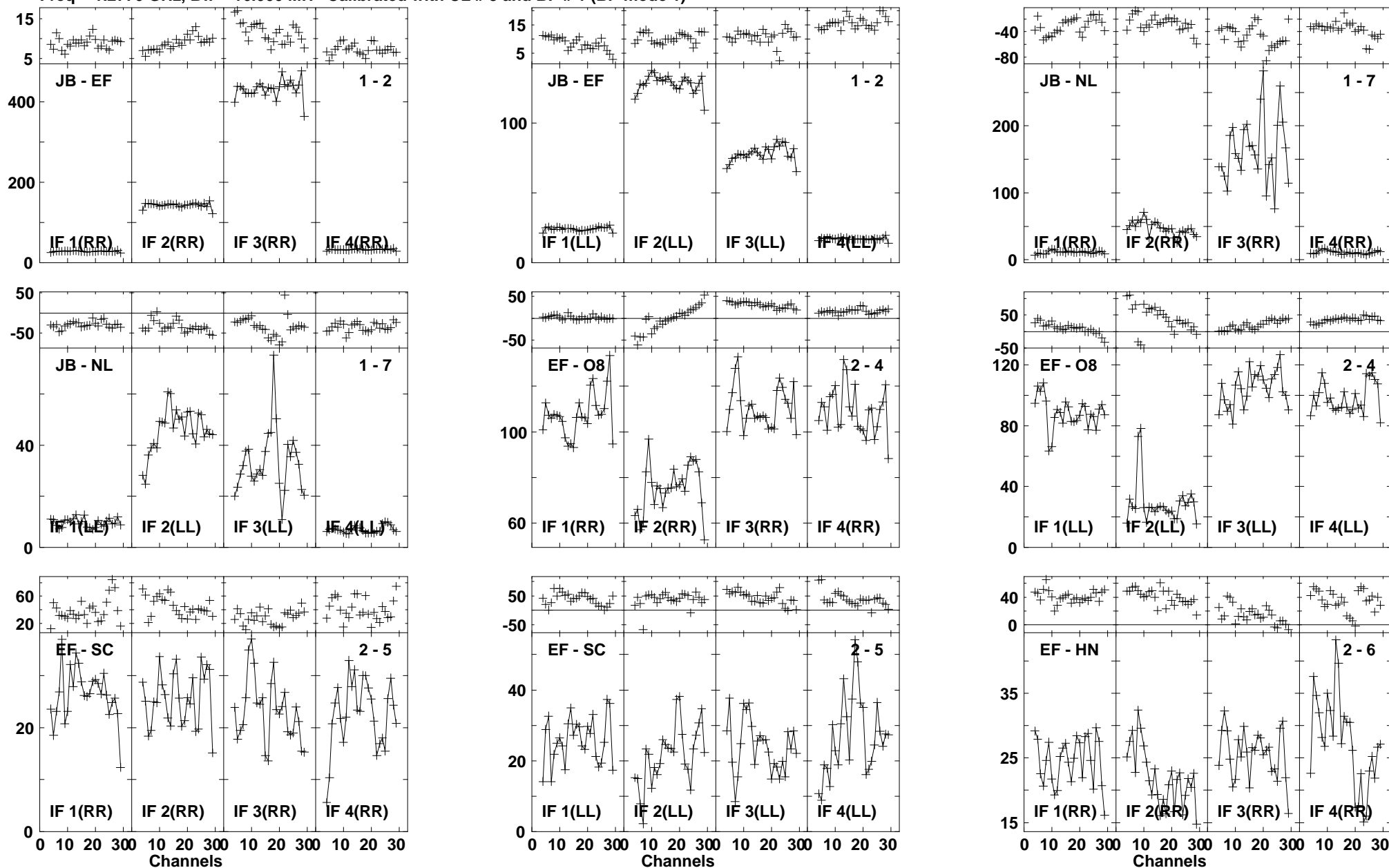

Lower frame: Milli Ampl Jy Top frame: Phas deg
Vector averaged cross-power spectrum Baseline: JB (01) - EF (02)
Timerange: 00/23:20:55 to 00/23:24:19

Plot file version 924 created 03-MAR-2016 01:14:38

4C52 GN002C 1.UVDATA.1

Freq = 1.2770 GHz, Bw = 16.000 MH Calibrated with CL # 3 and BP # 1 (BP mode 1)

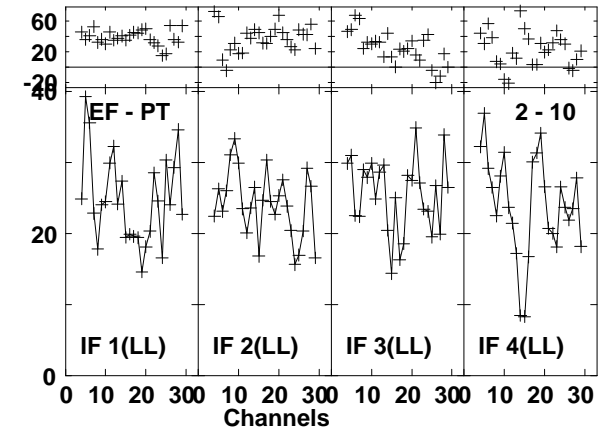
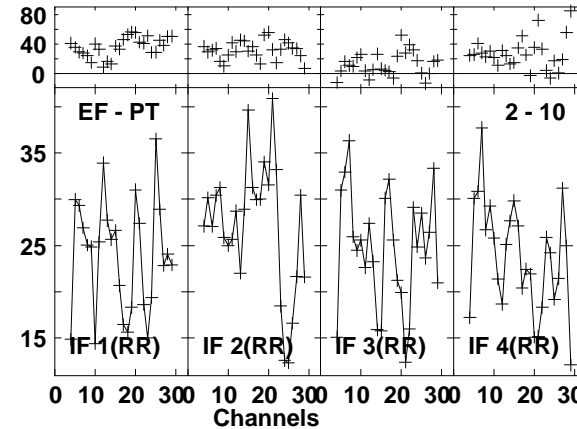
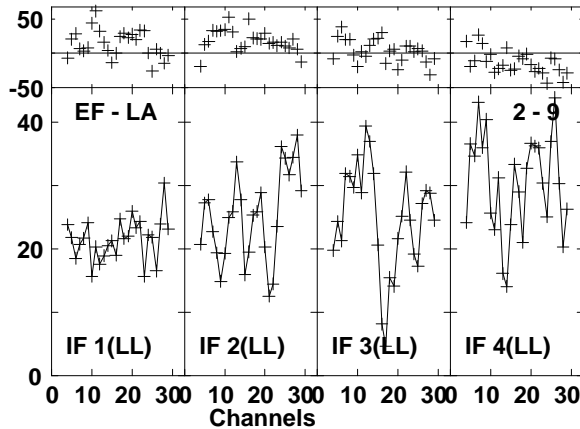
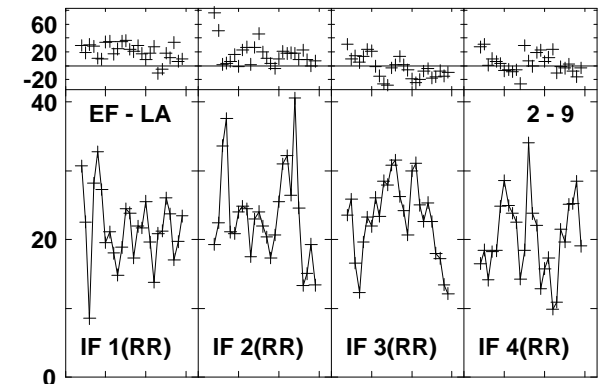
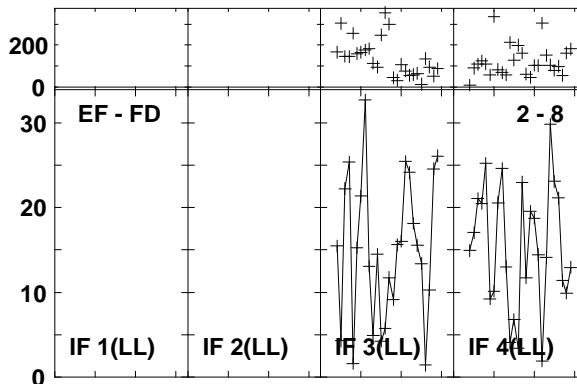
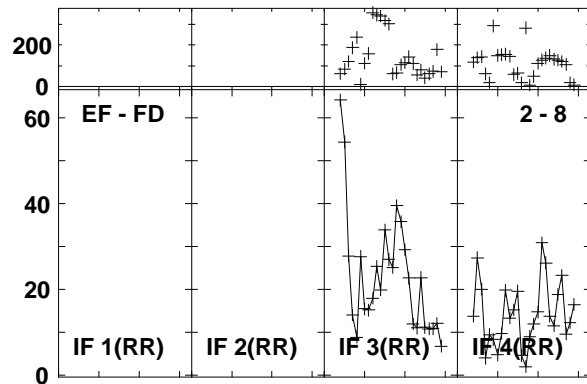
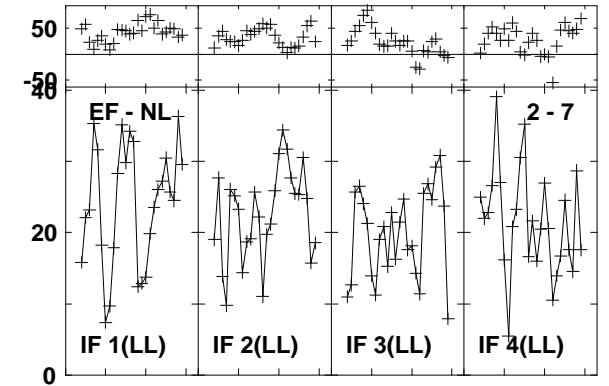
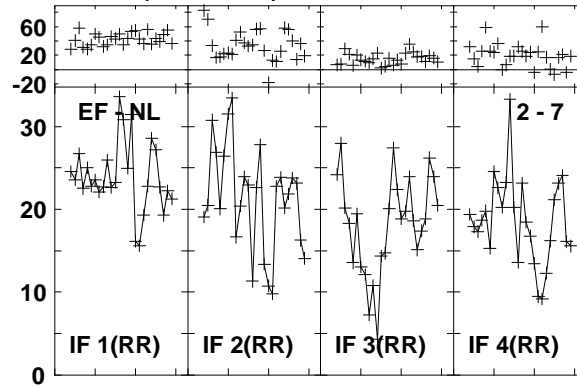
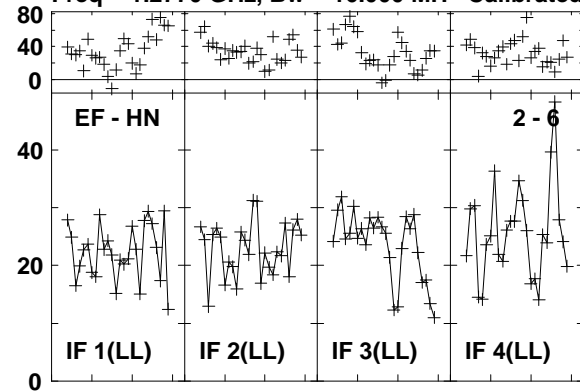

Lower frame: Milli Ampl Jy Top frame: Phas deg
Vector averaged cross-power spectrum Baseline: EF (02) - HN (06)
Timerange: 00/23:20:55 to 00/23:24:19

Plot file version 925 created 03-MAR-2016 01:14:38
 4C52 GN002C 1.UVDATA.1
 Freq = 1.2770 GHz, Bw = 16.000 MH Calibrated with CL # 3 and BP # 1 (BP mode 1)

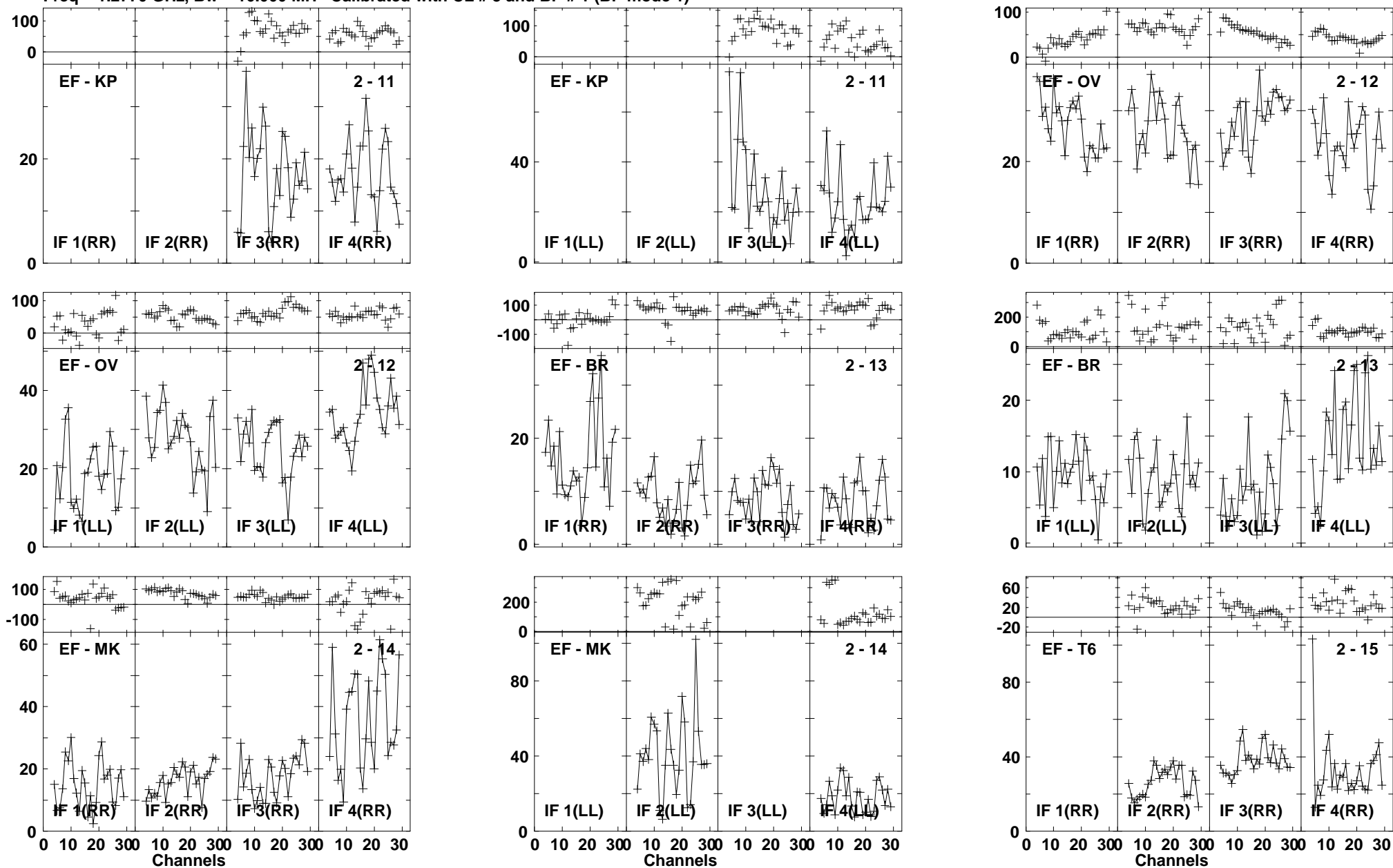

Lower frame: Milli Ampl Jy Top frame: Phas deg
 Vector averaged cross-power spectrum Baseline: EF (02) - KP (11)
 Timerange: 00/23:20:55 to 00/23:24:19

Plot file version 926 created 03-MAR-2016 01:14:38

4C52 GN002C 1.UVDATA.1

Freq = 1.2770 GHz, Bw = 16.000 MH Calibrated with CL # 3 and BP # 1 (BP mode 1)

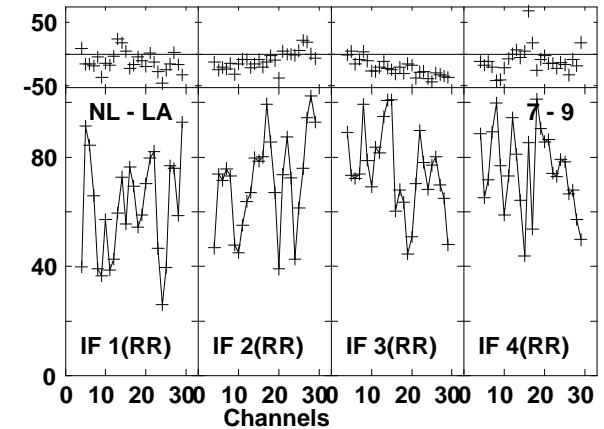
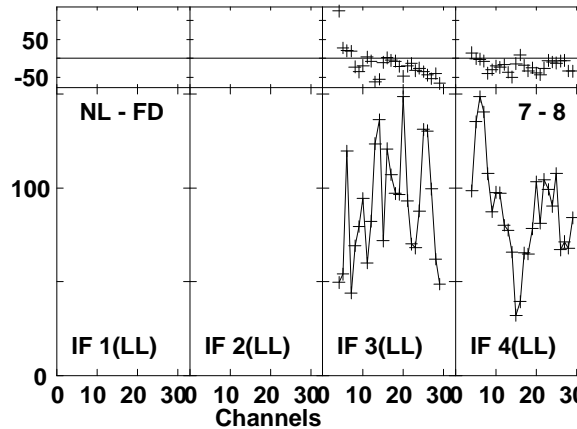
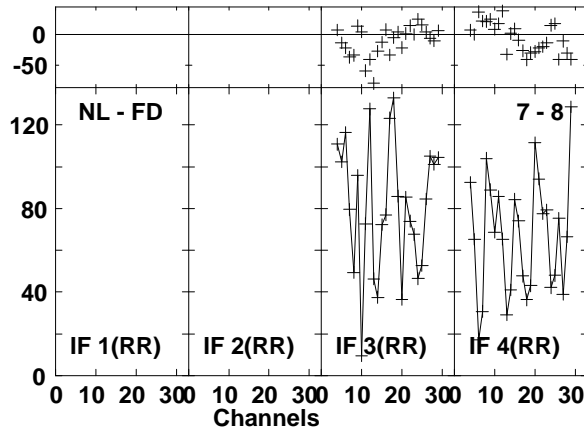
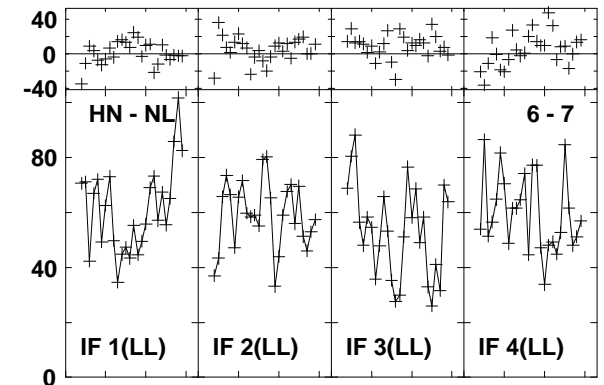
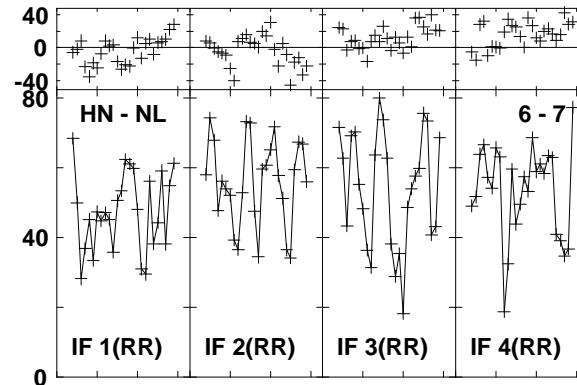
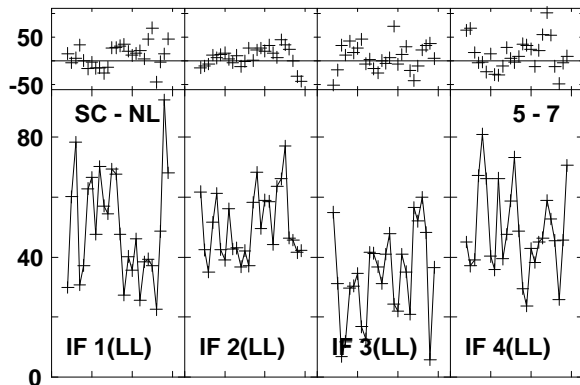
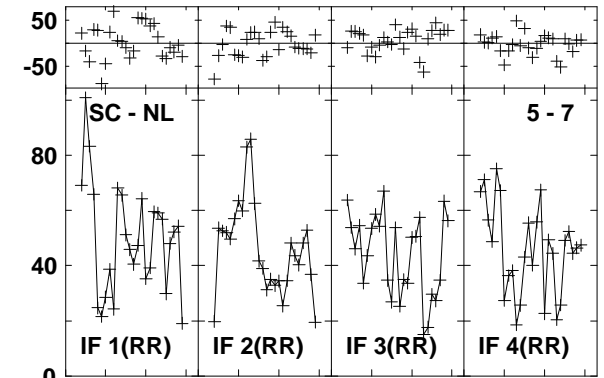
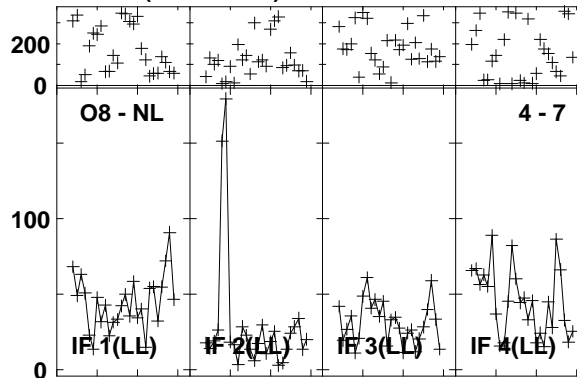
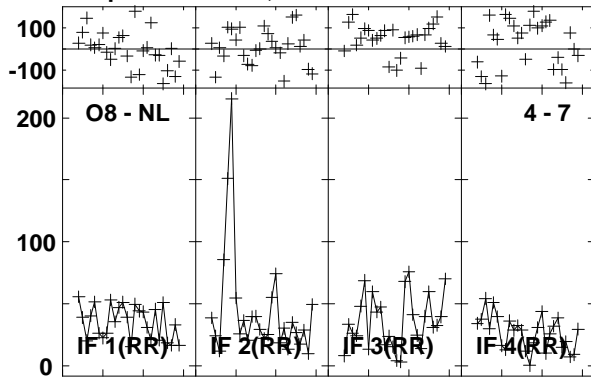

Lower frame: Milli Ampl Jy Top frame: Phas deg
Vector averaged cross-power spectrum Baseline: O8 (04) - NL (07)
Timerange: 00/23:20:55 to 00/23:24:19

Plot file version 927 created 03-MAR-2016 01:14:38

4C52 GN002C 1.UVDATA.1

Freq = 1.2770 GHz, Bw = 16.000 MH Calibrated with CL # 3 and BP # 1 (BP mode 1)

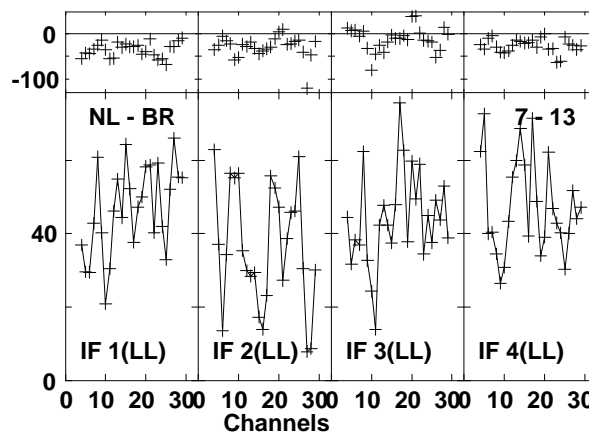
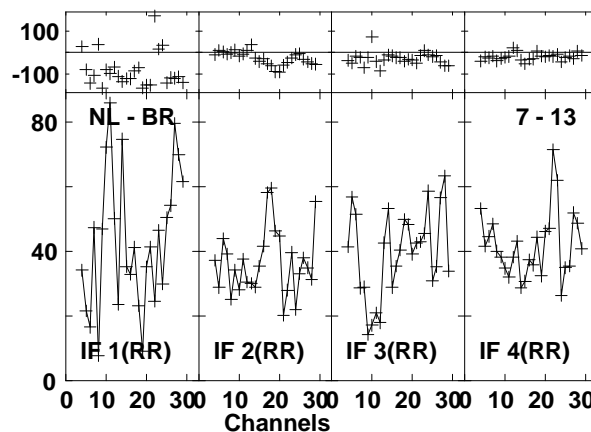
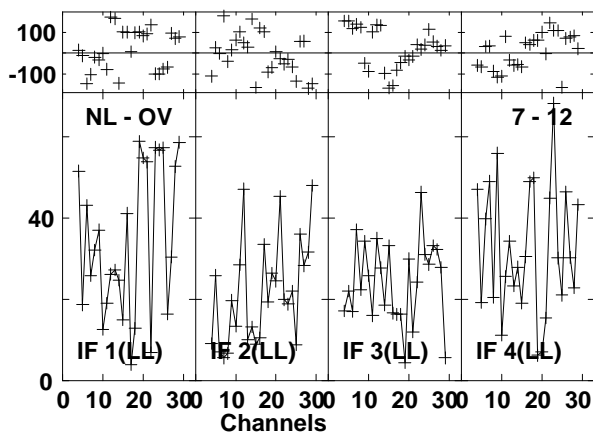
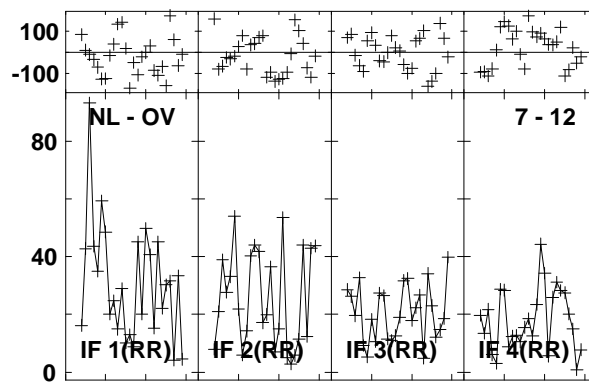
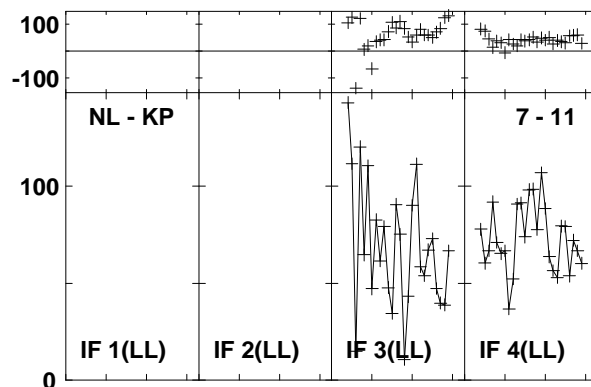
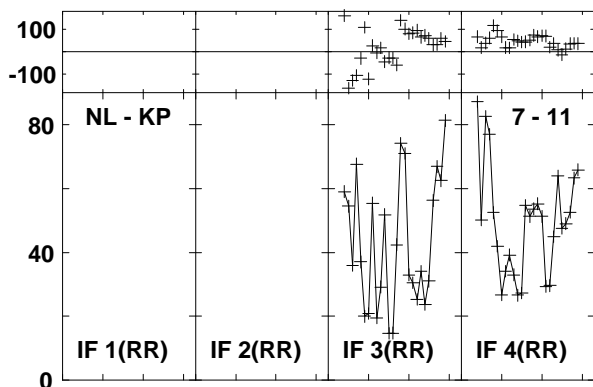
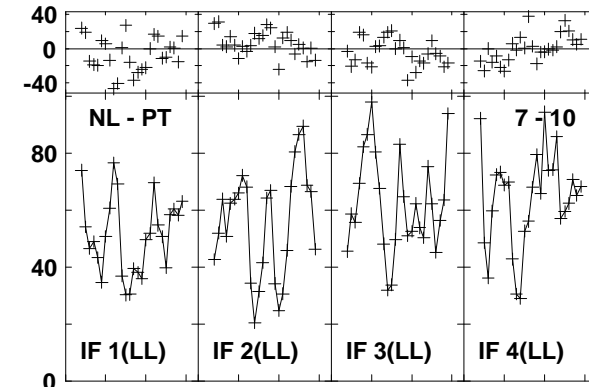
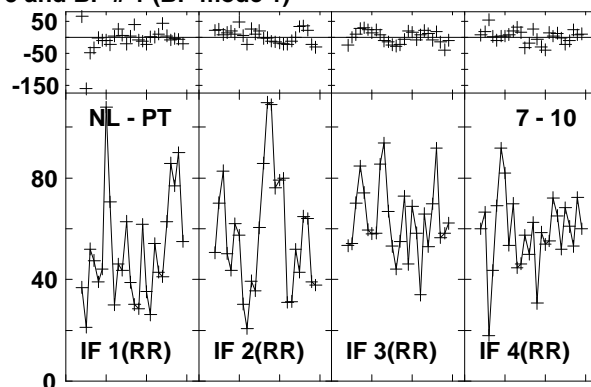
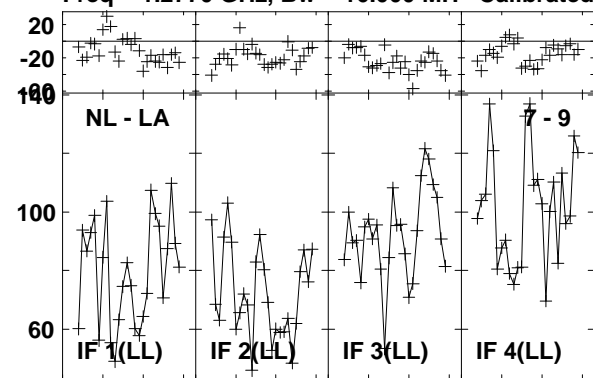

Lower frame: Milli Ampl Jy Top frame: Phas deg
Vector averaged cross-power spectrum Baseline: NL (07) - LA (09)
Timerange: 00/23:20:55 to 00/23:24:19

Plot file version 928 created 03-MAR-2016 01:14:38

4C52 GN002C 1.UVDATA.1

Freq = 1.2770 GHz, Bw = 16.000 MH Calibrated with CL # 3 and BP # 1 (BP mode 1)

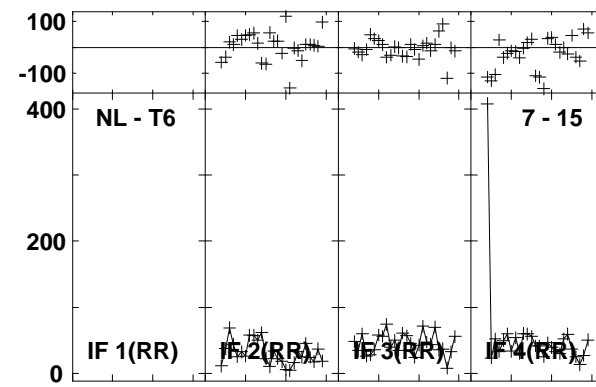
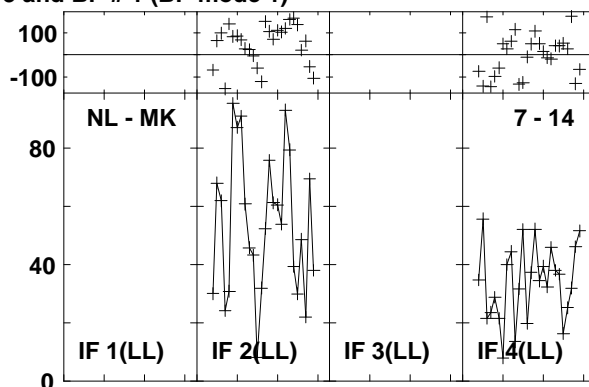
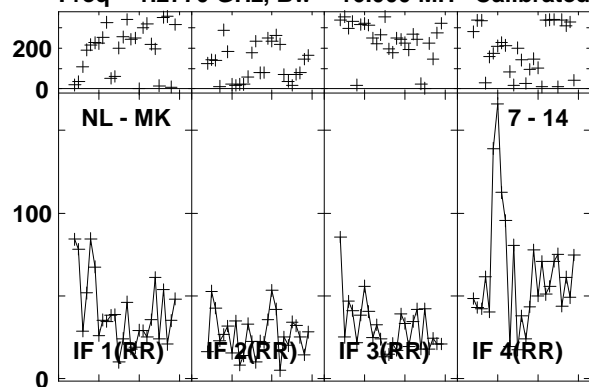

Lower frame: Milli Ampl Jy Top frame: Phas deg
Vector averaged cross-power spectrum Baseline: NL (07) - MK (14)
Timerange: 00/23:20:55 to 00/23:24:19

Plot file version 929 created 03-MAR-2016 01:14:39

J1545+5400 GN002C 1.UVDATA.1

Freq = 1.2770 GHz, Bw = 16.000 MH Calibrated with CL # 3 and BP # 1 (BP mode 1)

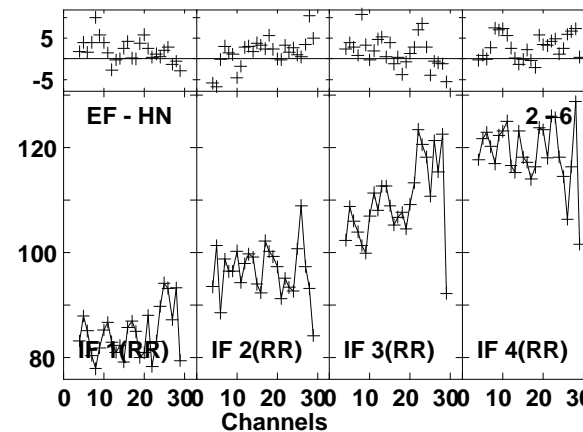
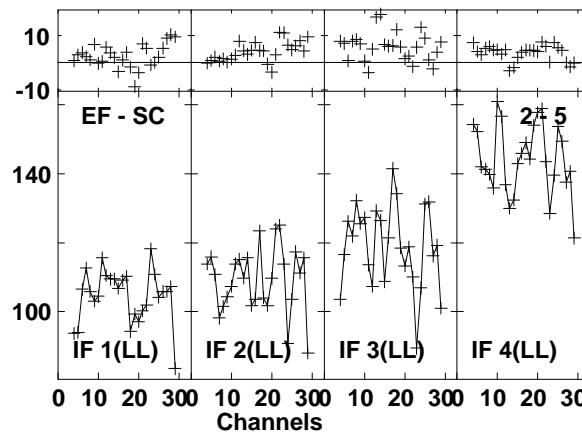
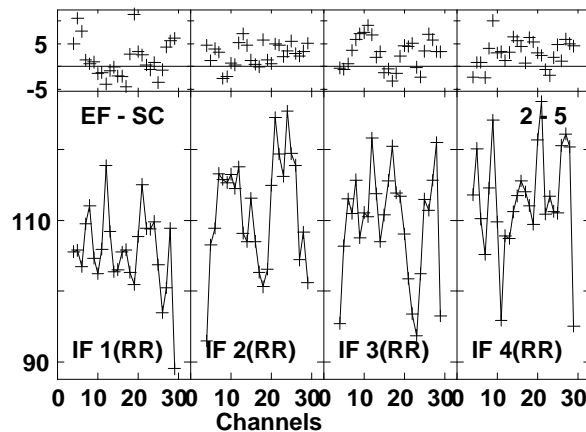
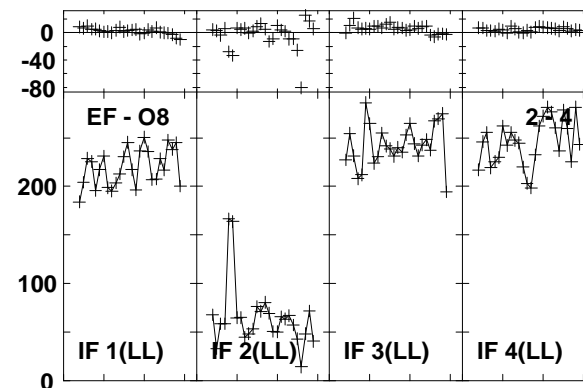
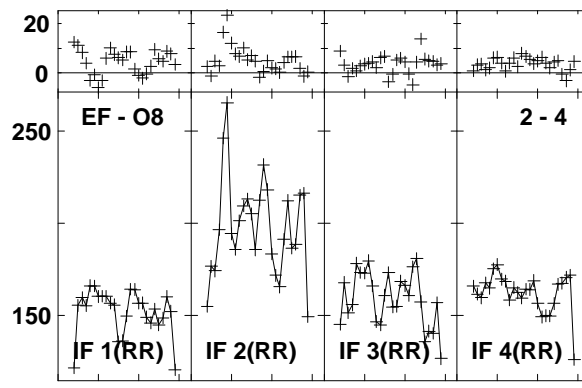
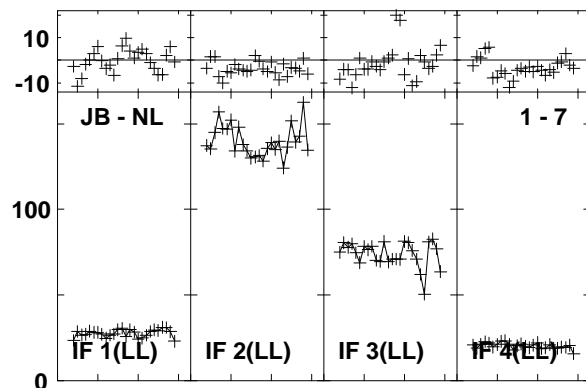
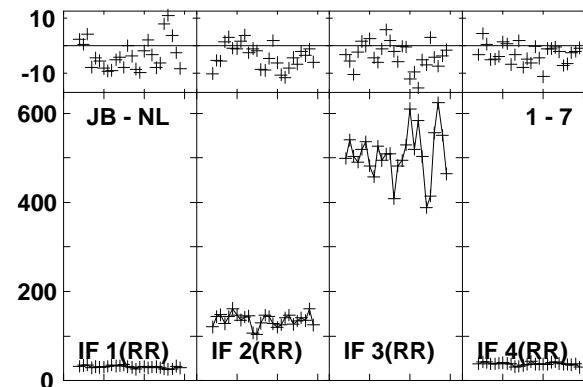
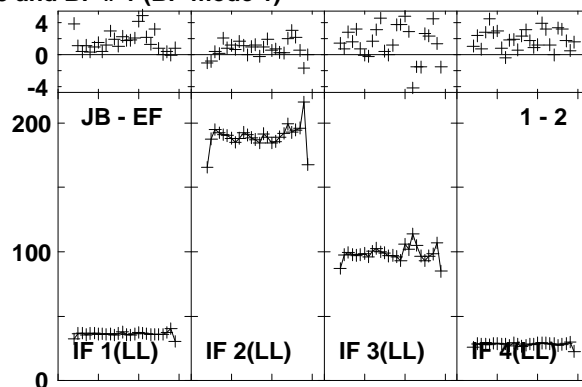
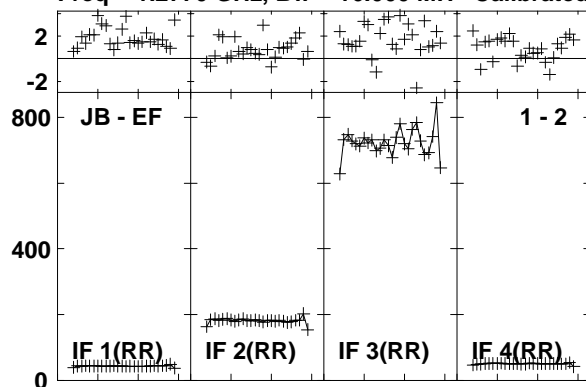

Lower frame: Milli Ampl Jy Top frame: Phas deg
Vector averaged cross-power spectrum Baseline: JB (01) - EF (02)
Timerange: 00/23:25:12 to 00/23:27:40

Plot file version 930 created 03-MAR-2016 01:14:39

J1545+5400 GN002C 1.UVDATA.1

Freq = 1.2770 GHz, Bw = 16.000 MH Calibrated with CL # 3 and BP # 1 (BP mode 1)

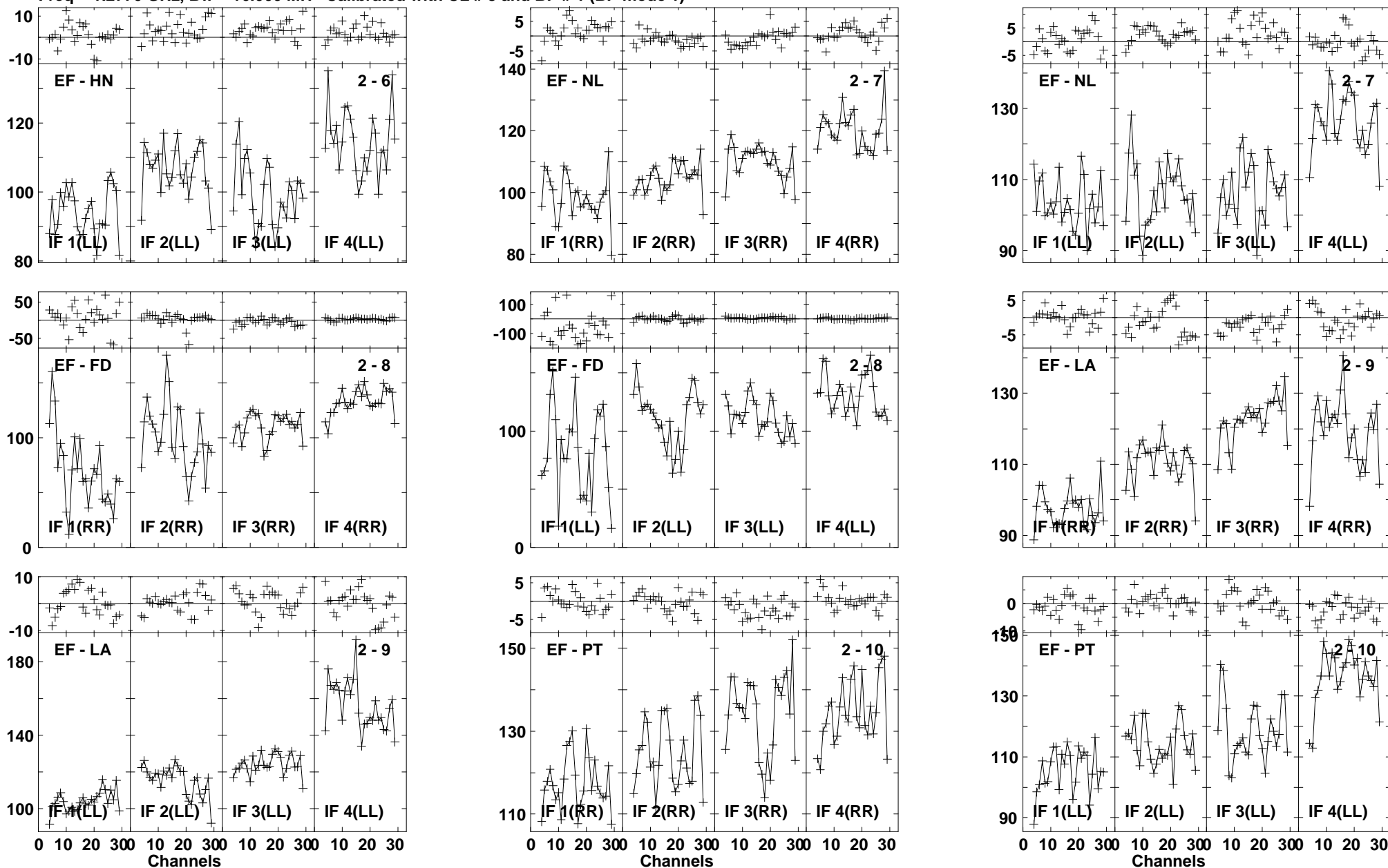

Lower frame: Milli Ampl Jy Top frame: Phas deg
Vector averaged cross-power spectrum Baseline: EF (02) - HN (06)
Timerange: 00/23:25:12 to 00/23:27:40

Plot file version 931 created 03-MAR-2016 01:14:39
 J1545+5400 GN002C 1.UVDATA.1
 Freq = 1.2770 GHz, Bw = 16.000 MH Calibrated with CL # 3 and BP # 1 (BP mode 1)

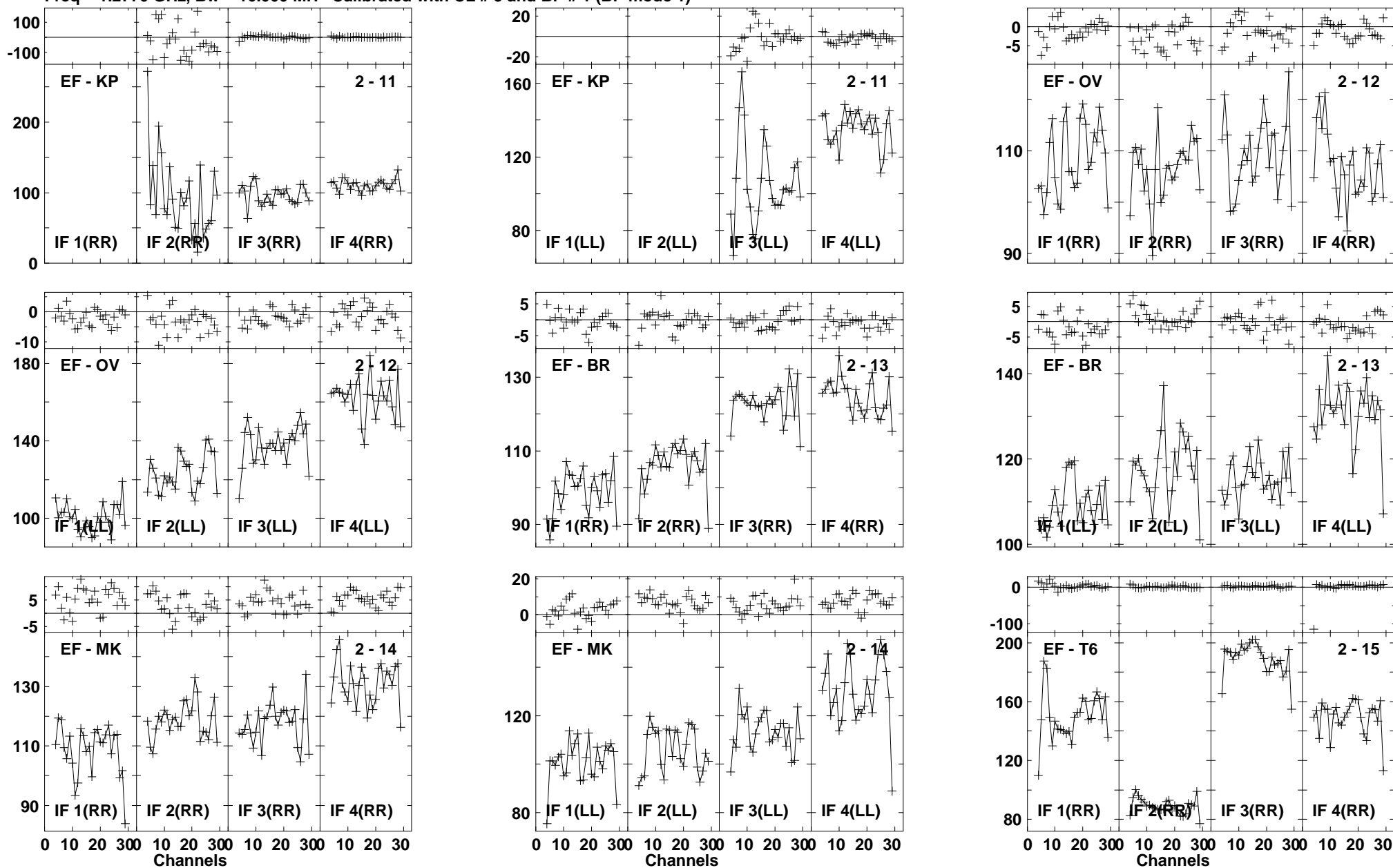

Lower frame: Milli Ampl Jy Top frame: Phas deg
 Vector averaged cross-power spectrum Baseline: EF (02) - KP (11)
 Timerange: 00/23:25:12 to 00/23:27:40

Plot file version 932 created 03-MAR-2016 01:14:39

J1545+5400 GN002C 1.UVDATA.1

Freq = 1.2770 GHz, Bw = 16.000 MH Calibrated with CL # 3 and BP # 1 (BP mode 1)

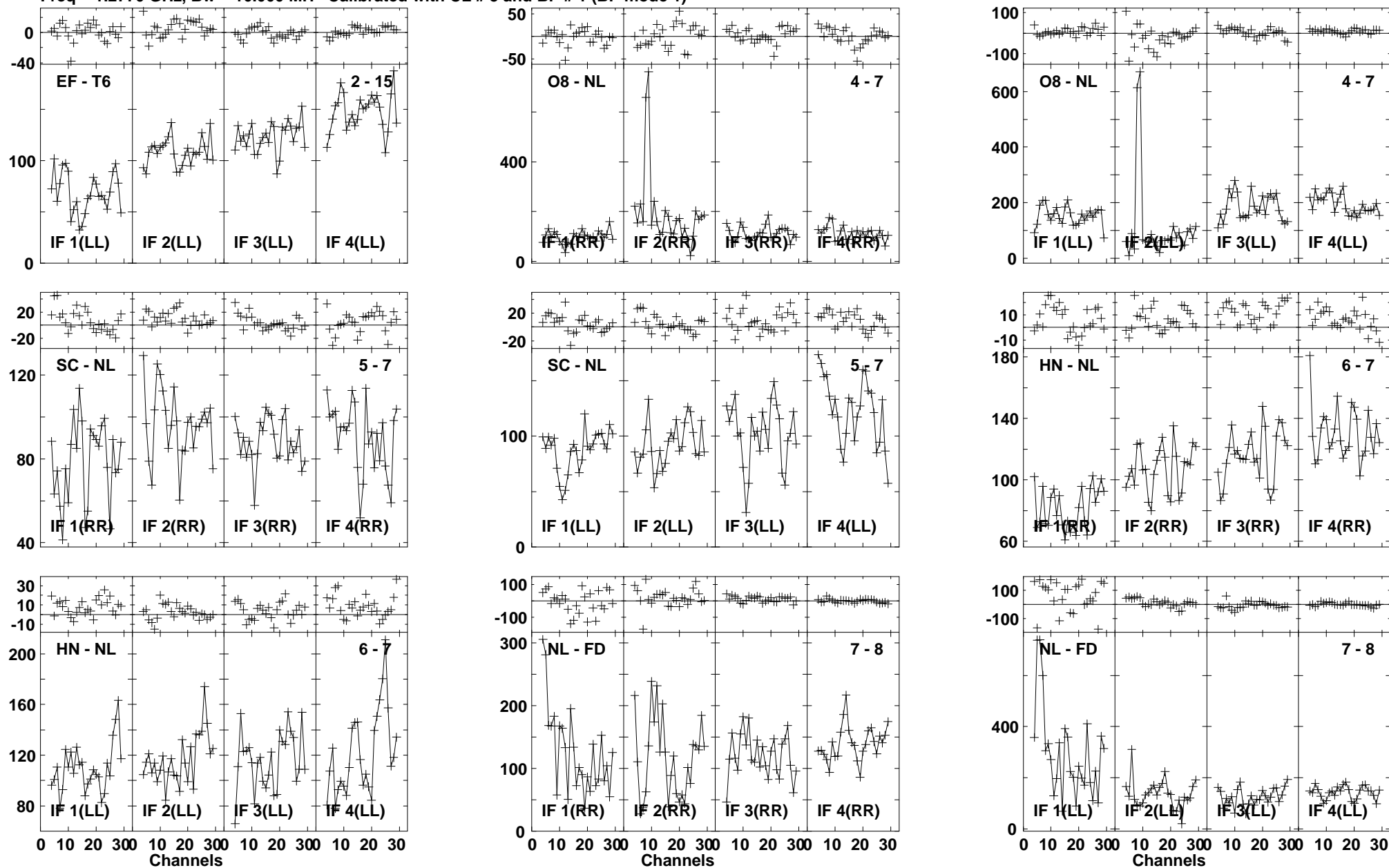

Lower frame: Milli Ampl Jy Top frame: Phas deg
Vector averaged cross-power spectrum Baseline: EF (02) - T6 (15)
Timerange: 00/23:25:12 to 00/23:27:40

Plot file version 933 created 03-MAR-2016 01:14:39

J1545+5400 GN002C 1.UVDATA.1

Freq = 1.2770 GHz, Bw = 16.000 MH Calibrated with CL # 3 and BP # 1 (BP mode 1)

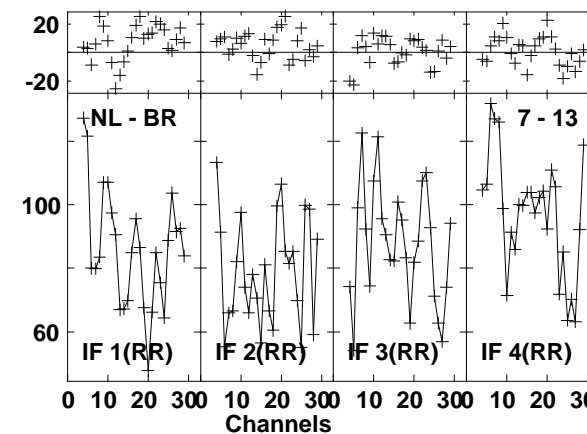
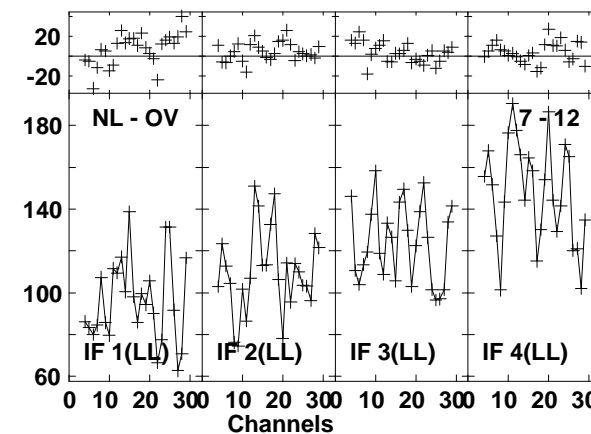
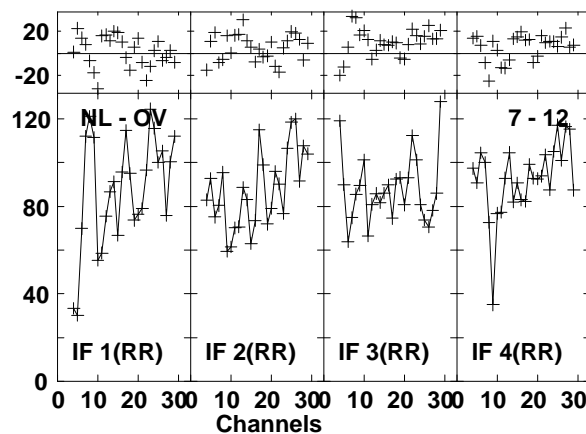
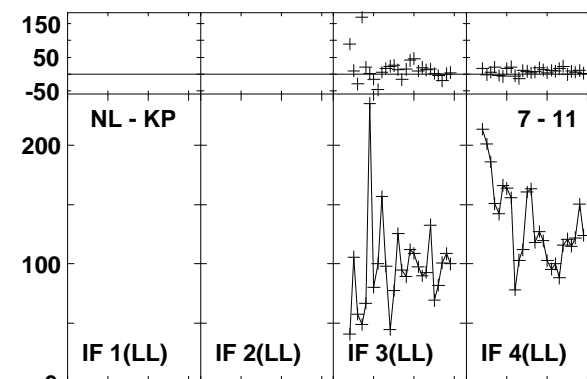
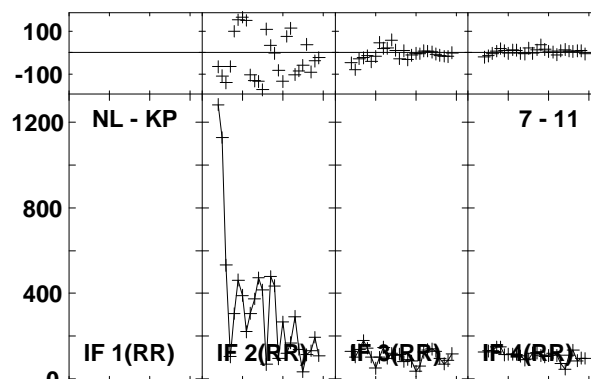
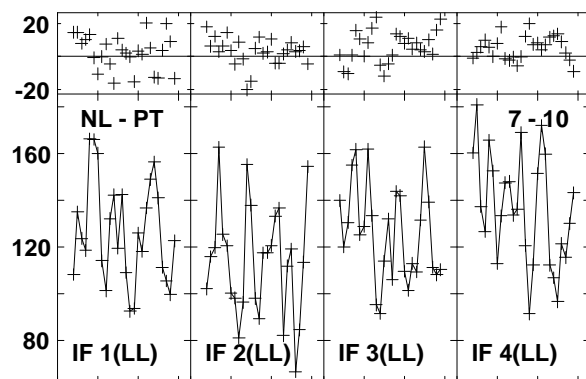
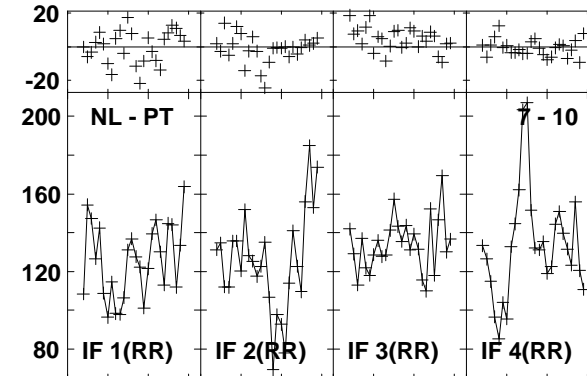
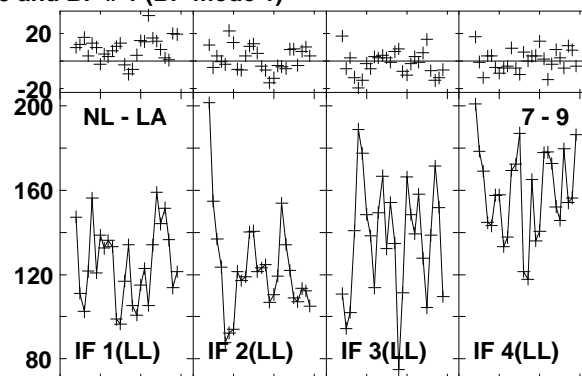
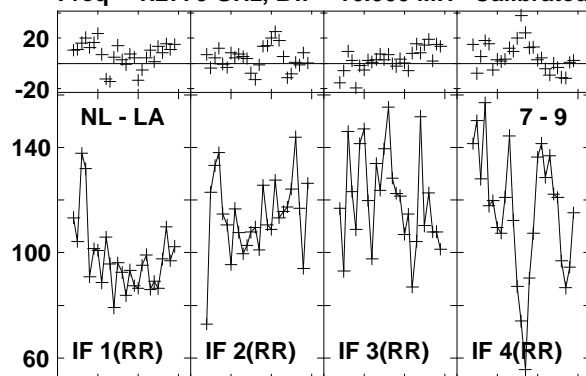

Lower frame: Milli Ampl Jy Top frame: Phas deg
Vector averaged cross-power spectrum Baseline: NL (07) - LA (09)
Timerange: 00/23:25:12 to 00/23:27:40

Plot file version 934 created 03-MAR-2016 01:14:39
 J1545+5400 GN002C 1.UVDATA.1
 Freq = 1.2770 GHz, Bw = 16.000 MH Calibrated with CL # 3 and BP # 1 (BP mode 1)

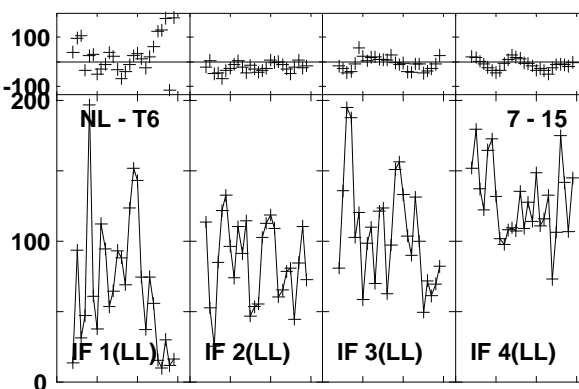
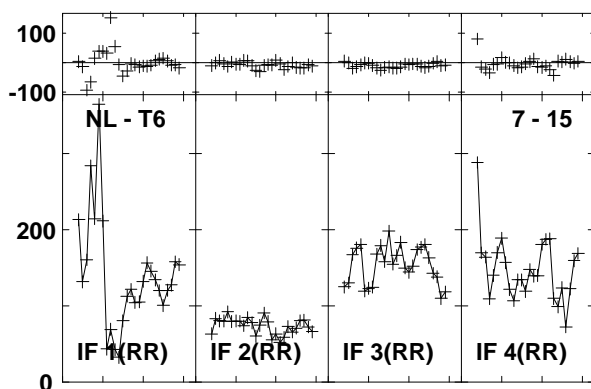
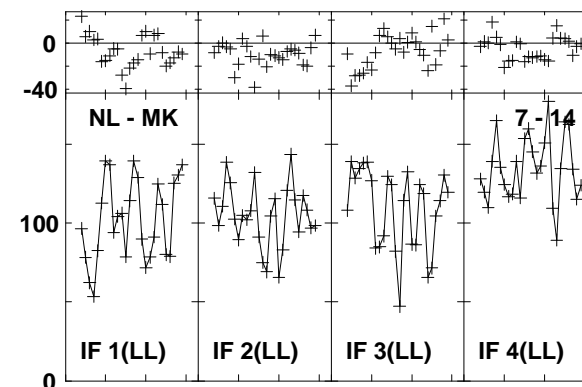
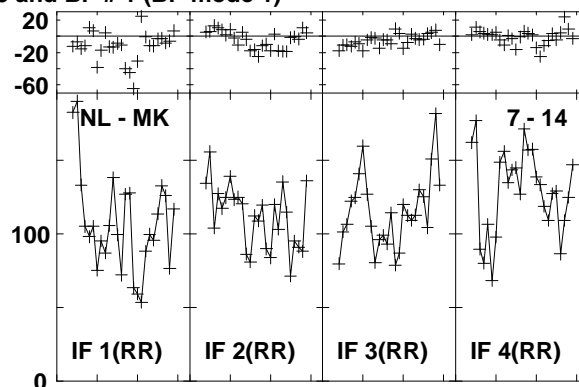
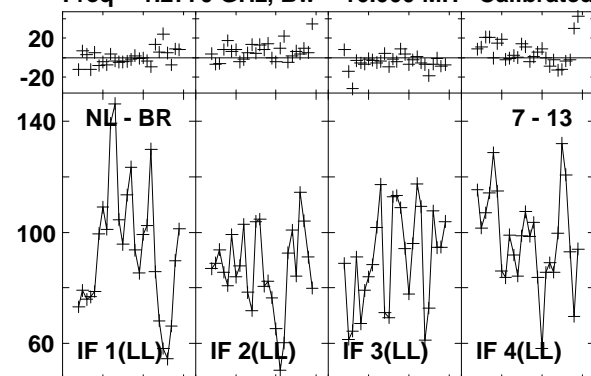

Lower frame: Milli Ampl Jy Top frame: Phas deg
 Vector averaged cross-power spectrum Baseline: NL (07) - BR (13)
 Timerange: 00/23:25:12 to 00/23:27:40

Plot file version 935 created 03-MAR-2016 01:14:40

4C52 GN002C 1.UVDATA.1

Freq = 1.2770 GHz, Bw = 16.000 MH Calibrated with CL # 3 and BP # 1 (BP mode 1)

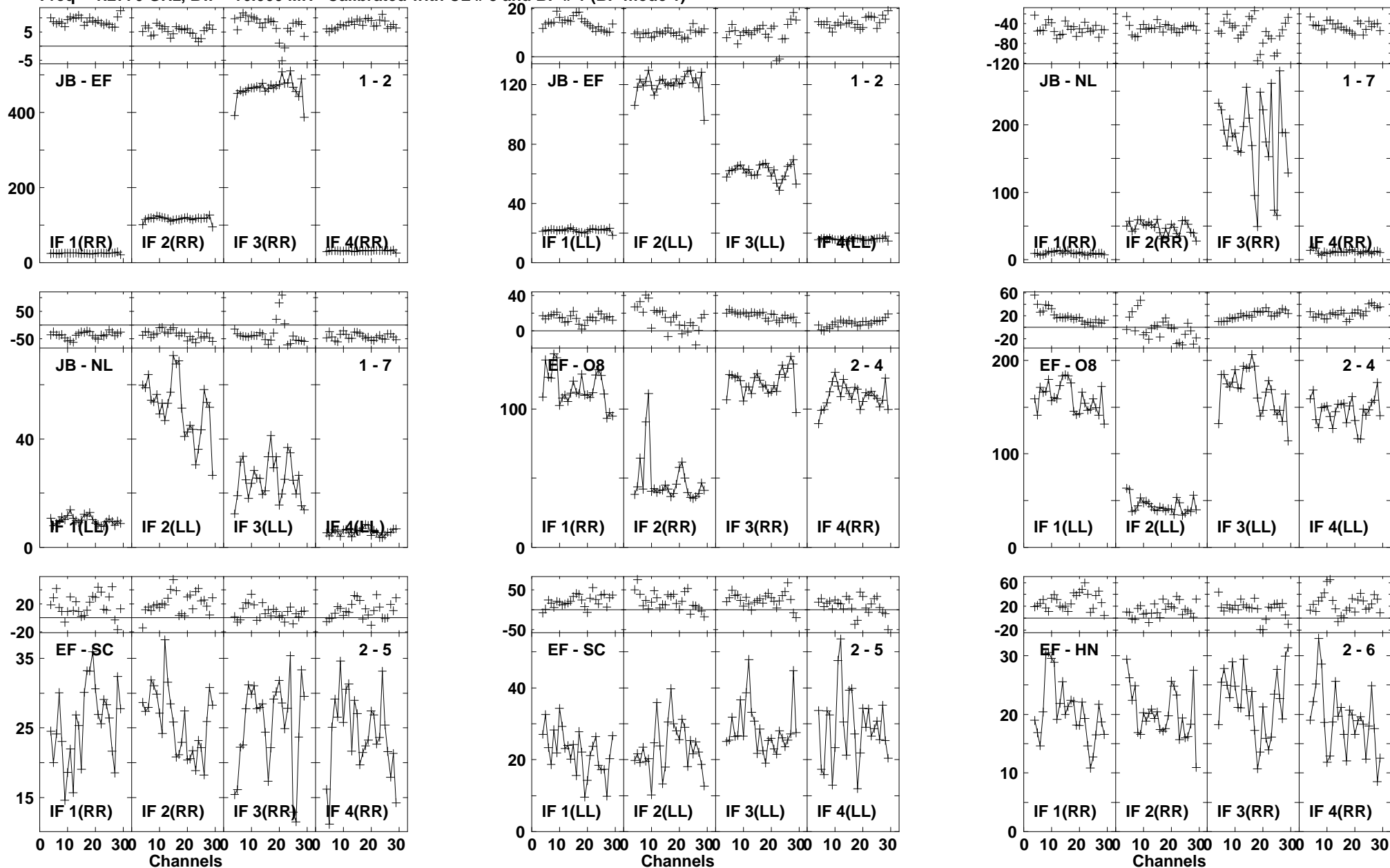

Lower frame: Milli Ampl Jy Top frame: Phas deg
Vector averaged cross-power spectrum Baseline: JB (01) - EF (02)
Timerange: 00/23:27:53 to 00/23:31:09

Plot file version 936 created 03-MAR-2016 01:14:40

4C52 GN002C 1.UVDATA.1

Freq = 1.2770 GHz, Bw = 16.000 MH Calibrated with CL # 3 and BP # 1 (BP mode 1)

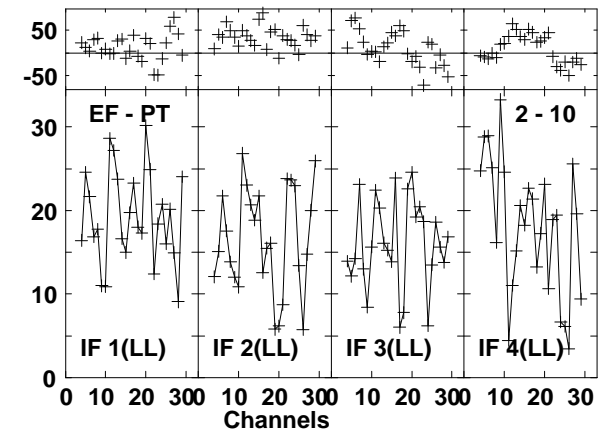
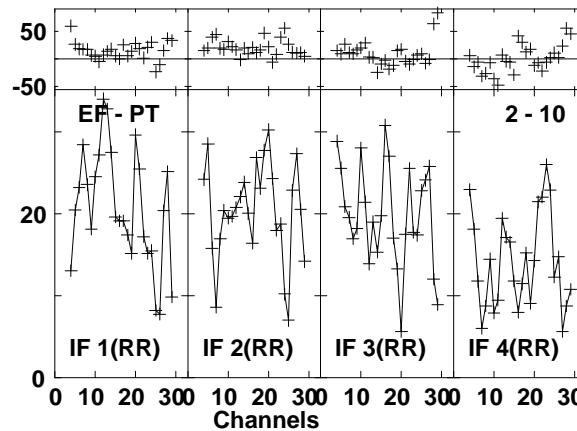
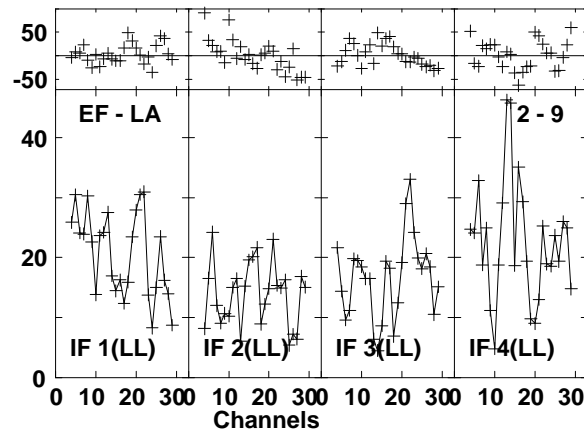
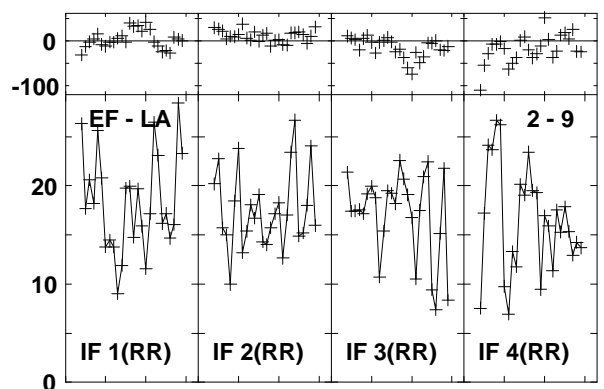
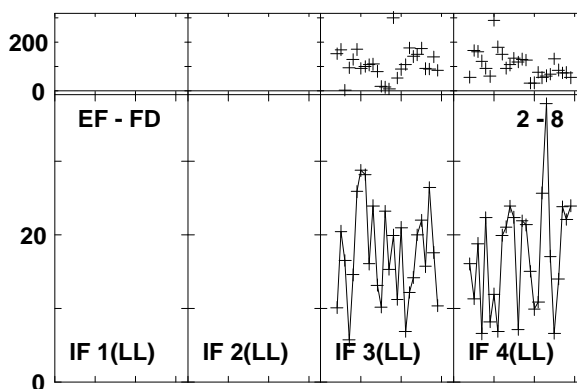
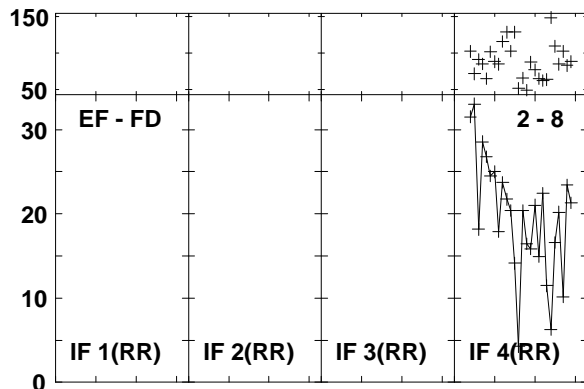
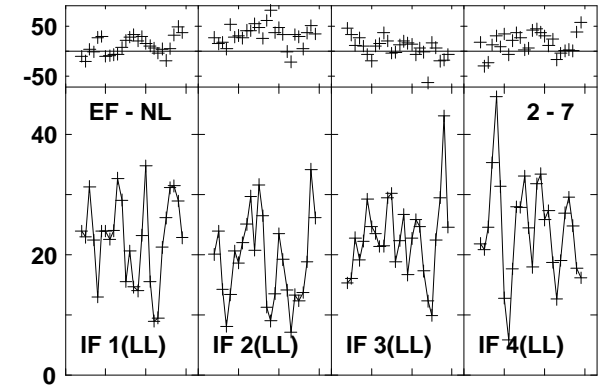
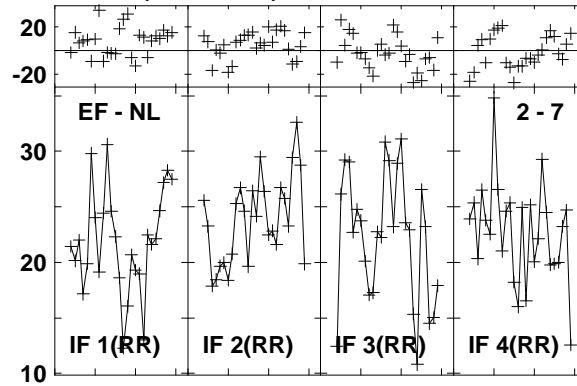
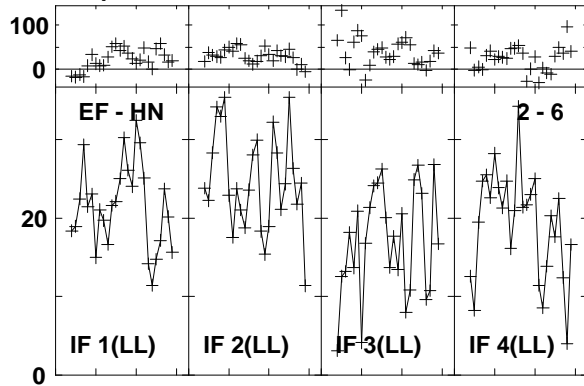

Lower frame: Milli Ampl Jy Top frame: Phas deg
Vector averaged cross-power spectrum Baseline: EF (02) - HN (06)
Timerange: 00/23:27:53 to 00/23:31:09

Plot file version 937 created 03-MAR-2016 01:14:40

4C52 GN002C 1.UVDATA.1

Freq = 1.2770 GHz, Bw = 16.000 MH Calibrated with CL # 3 and BP # 1 (BP mode 1)

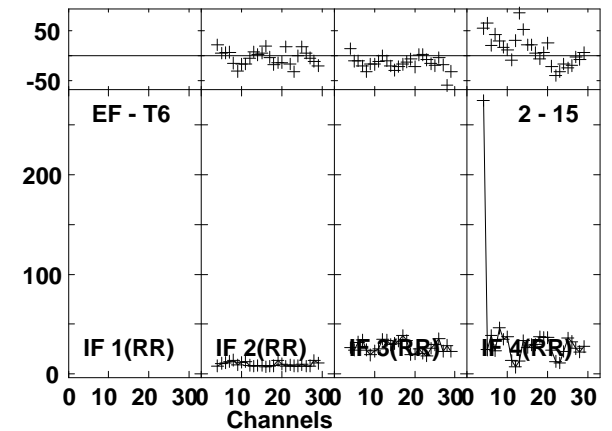
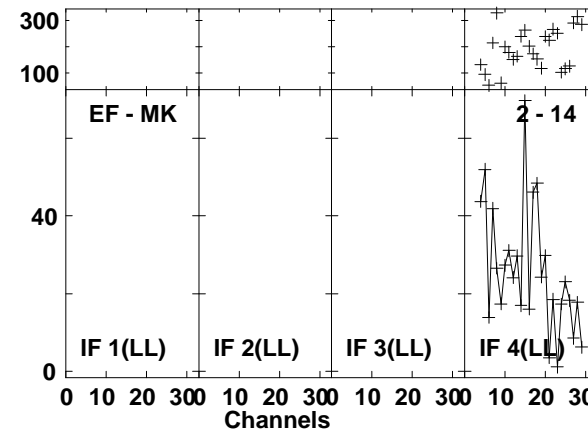
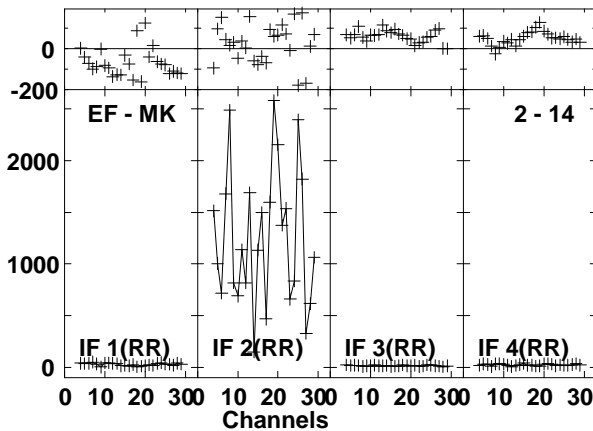
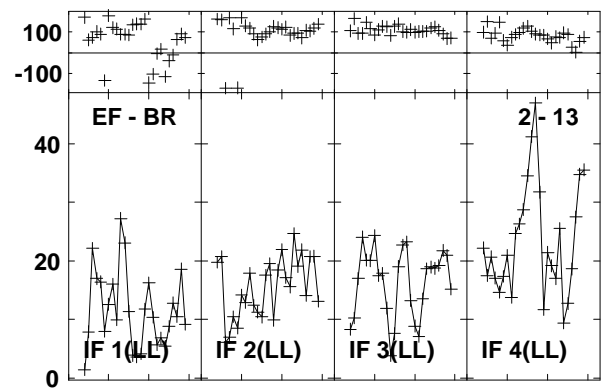
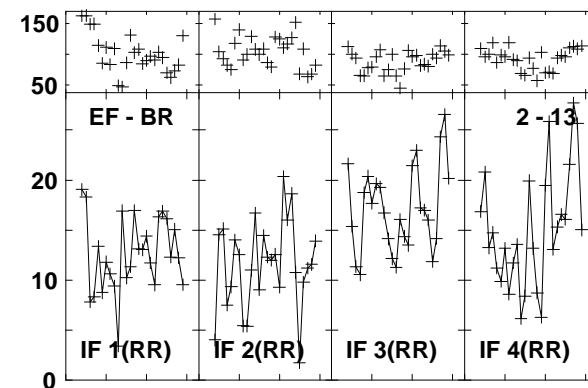
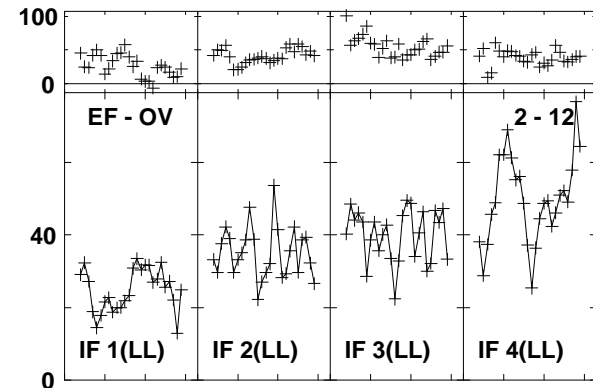
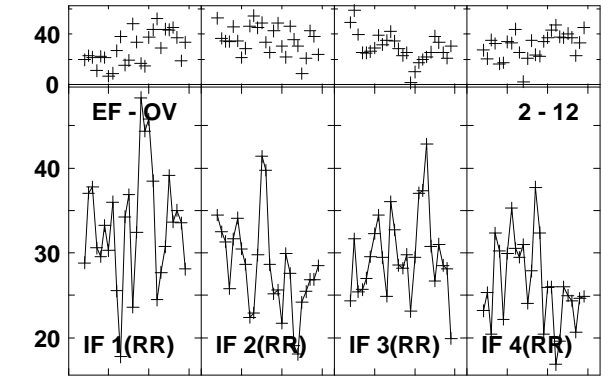
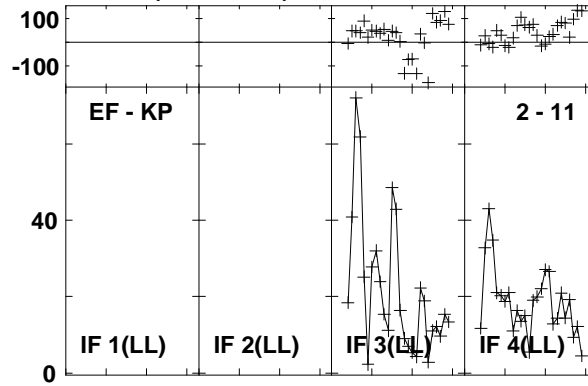
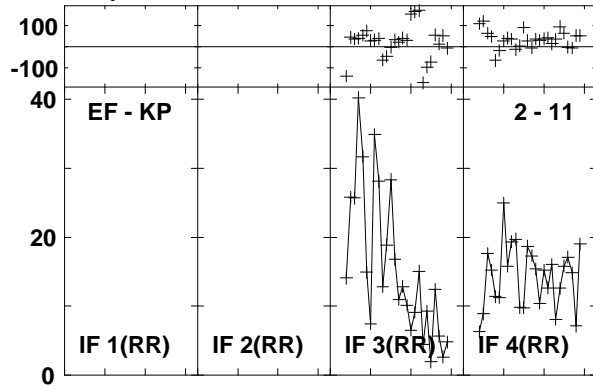

Lower frame: Milli Ampl Jy Top frame: Phas deg

Vector averaged cross-power spectrum Baseline: EF (02) - KP (11)

Timerange: 00/23:27:53 to 00/23:31:09

Plot file version 938 created 03-MAR-2016 01:14:40

4C52 GN002C 1.UVDATA.1

Freq = 1.2770 GHz, Bw = 16.000 MH Calibrated with CL # 3 and BP # 1 (BP mode 1)

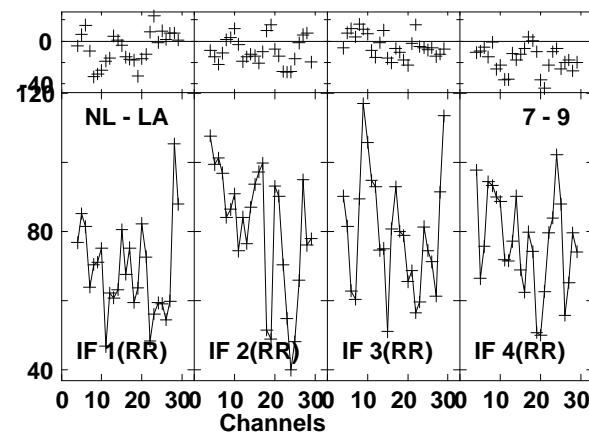
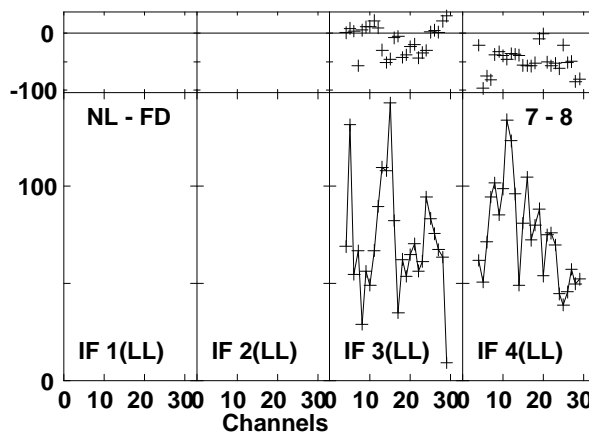
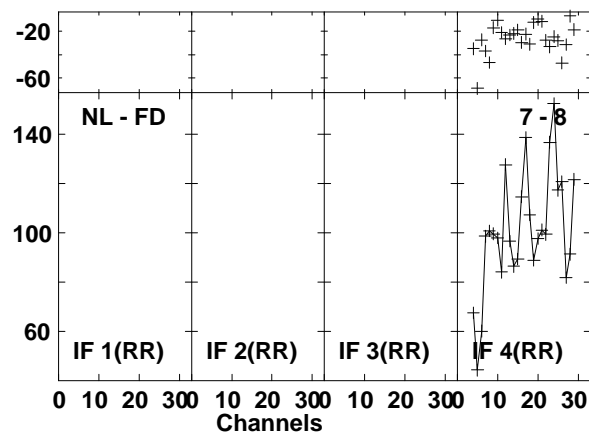
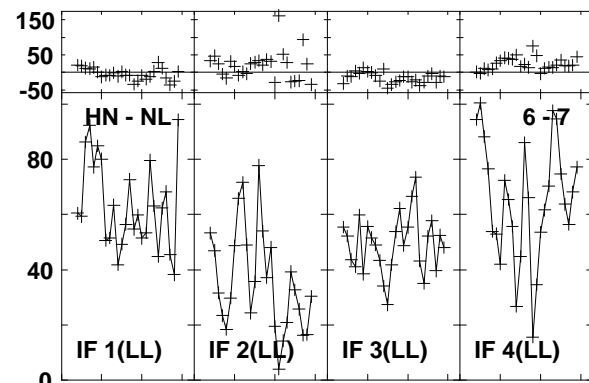
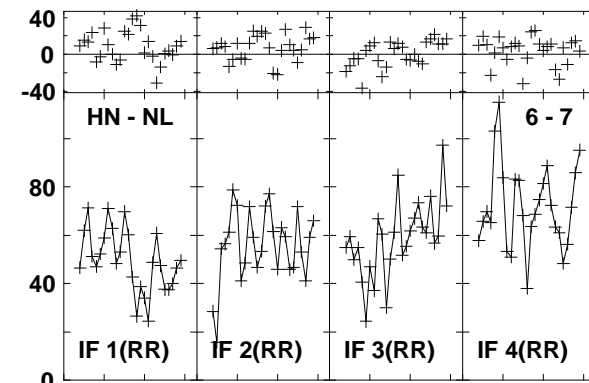
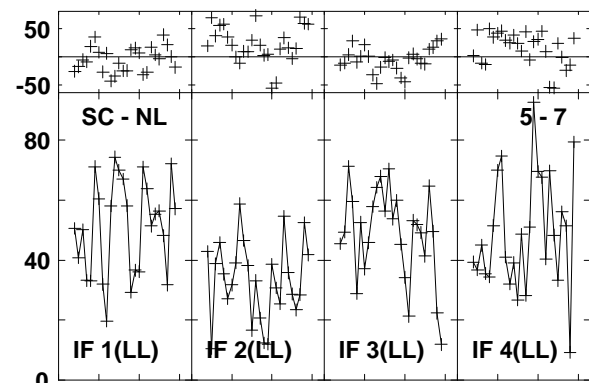
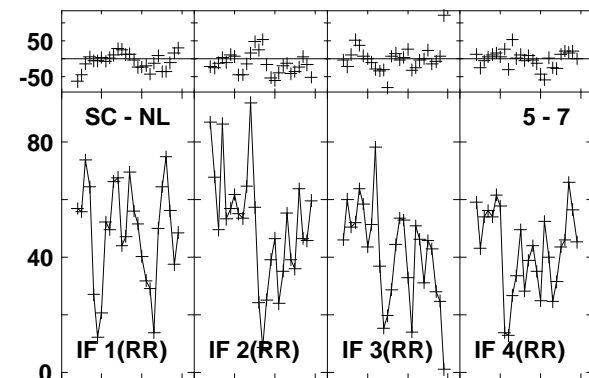
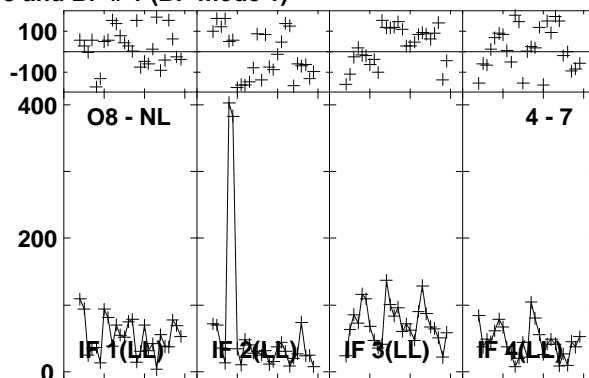
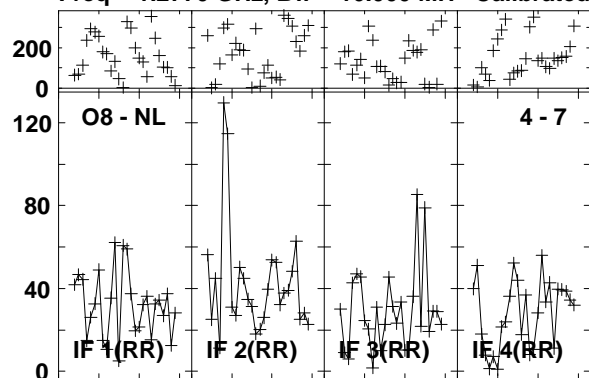

Lower frame: Milli Ampl Jy Top frame: Phas deg
Vector averaged cross-power spectrum Baseline: O8 (04) - NL (07)
Timerange: 00/23:27:53 to 00/23:31:09

Plot file version 939 created 03-MAR-2016 01:14:40

4C52 GN002C 1.UVDATA.1

Freq = 1.2770 GHz, Bw = 16.000 MH Calibrated with CL # 3 and BP # 1 (BP mode 1)

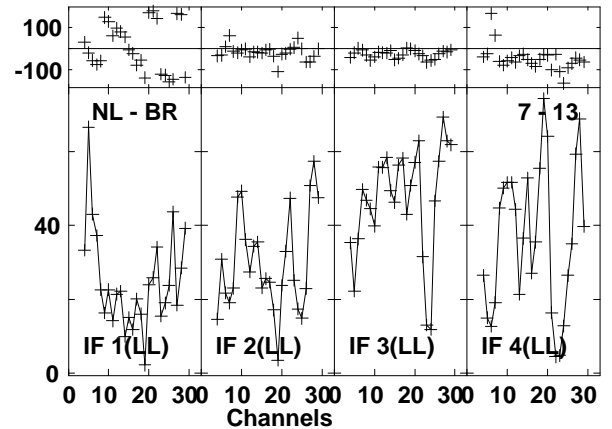
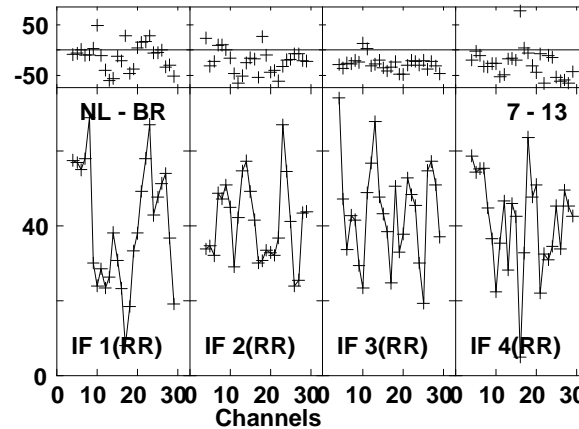
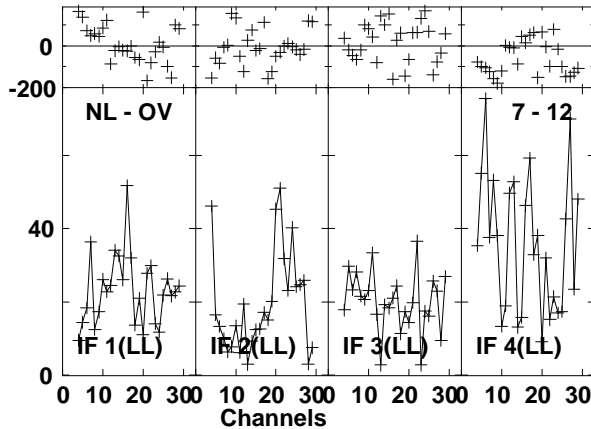
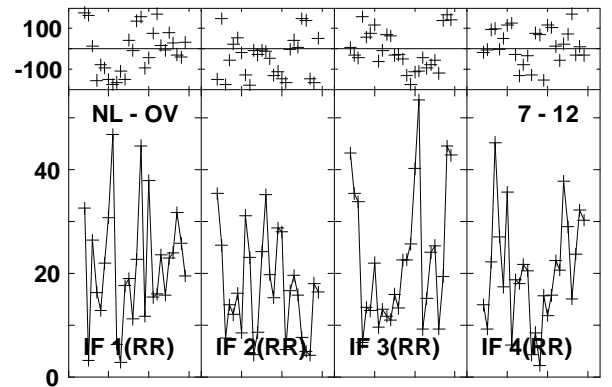
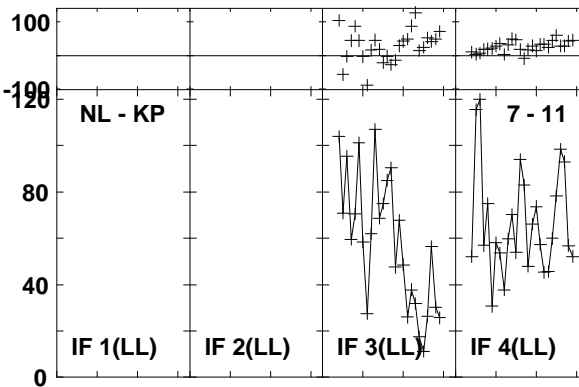
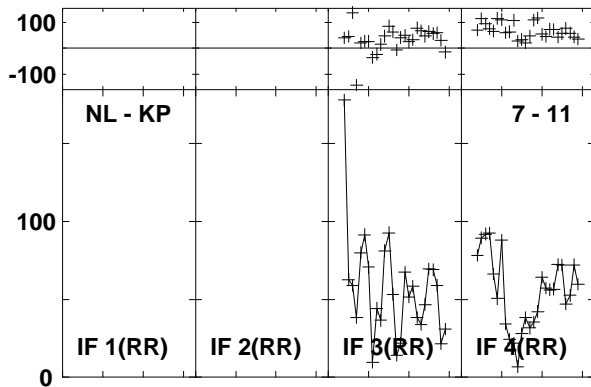
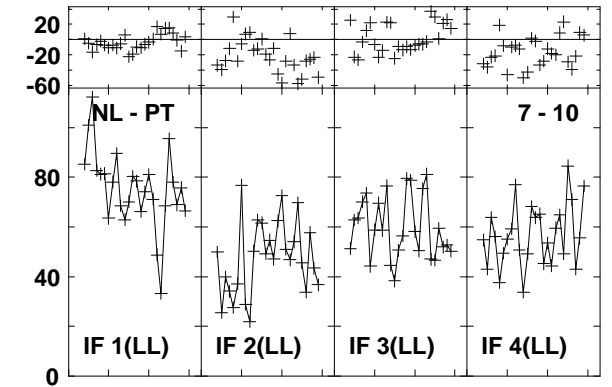
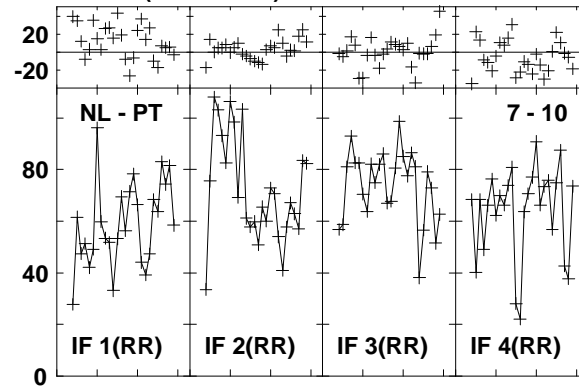
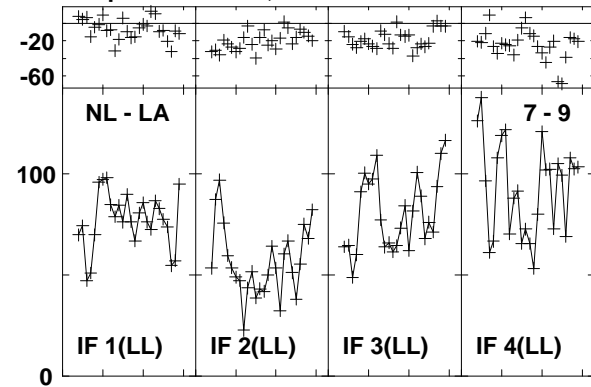

Lower frame: Milli Ampl Jy Top frame: Phas deg
Vector averaged cross-power spectrum Baseline: NL (07) - LA (09)
Timerange: 00/23:27:53 to 00/23:31:09

Plot file version 940 created 03-MAR-2016 01:14:40

4C52 GN002C 1.UVDATA.1

Freq = 1.2770 GHz, Bw = 16.000 MH Calibrated with CL # 3 and BP # 1 (BP mode 1)

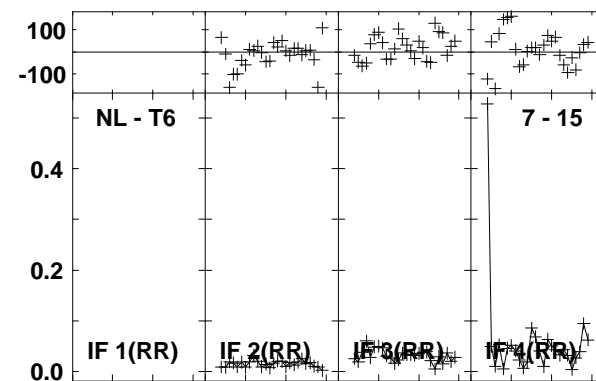
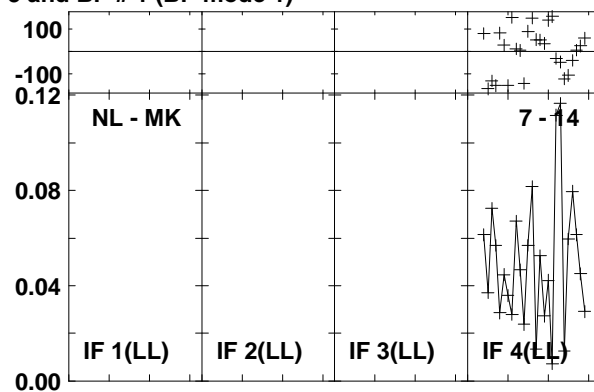
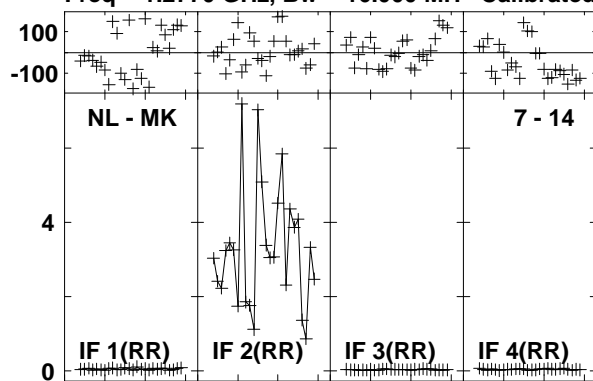

Lower frame: Ampl Jy Top frame: Phas deg
Vector averaged cross-power spectrum Baseline: NL (07) - MK (14)
Timerange: 00/23:27:53 to 00/23:31:09

Plot file version 941 created 03-MAR-2016 01:14:41

J1545+5400 GN002C 1.UVDATA.1

Freq = 1.2770 GHz, Bw = 16.000 MH Calibrated with CL # 3 and BP # 1 (BP mode 1)

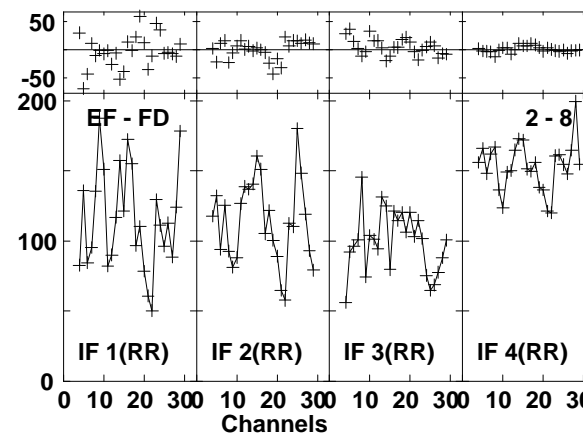
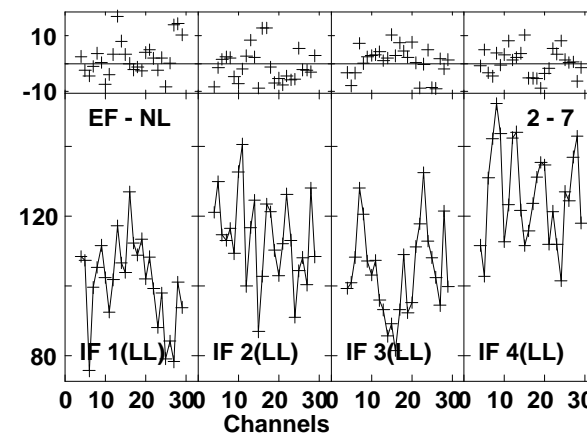
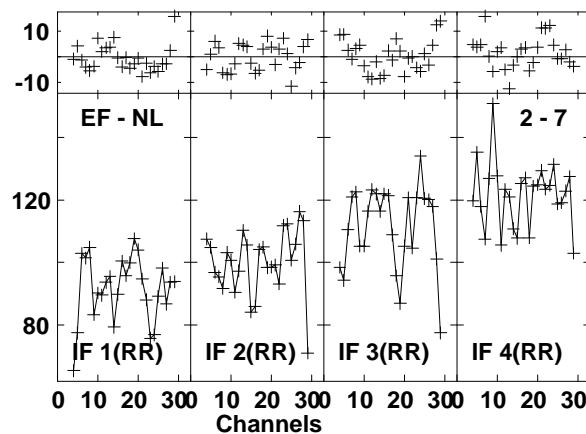
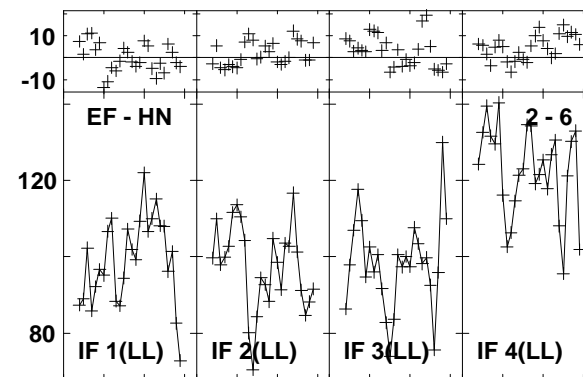
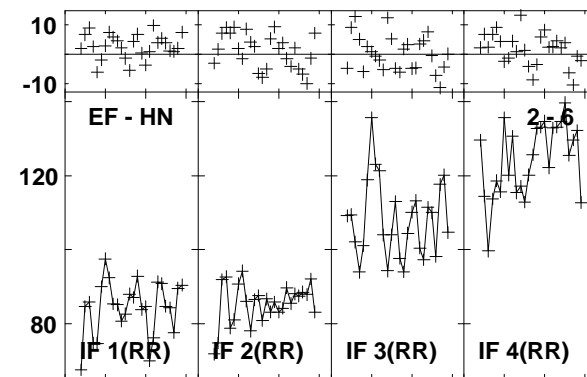
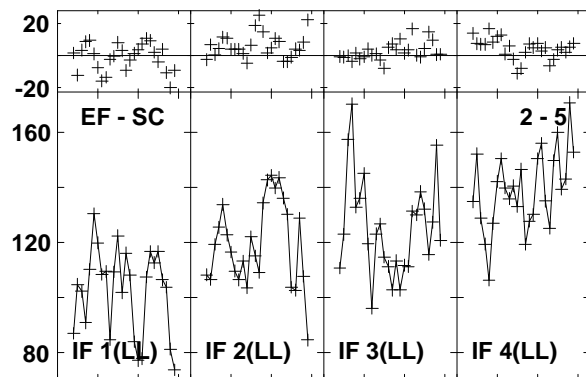
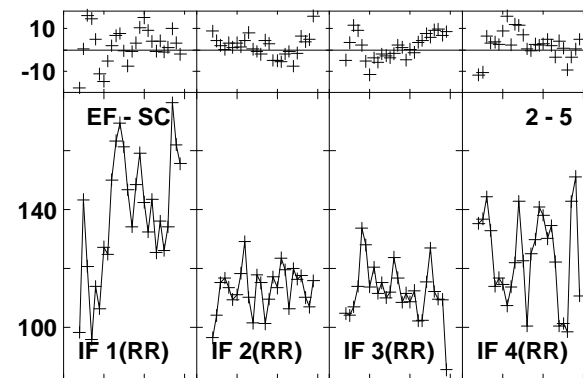
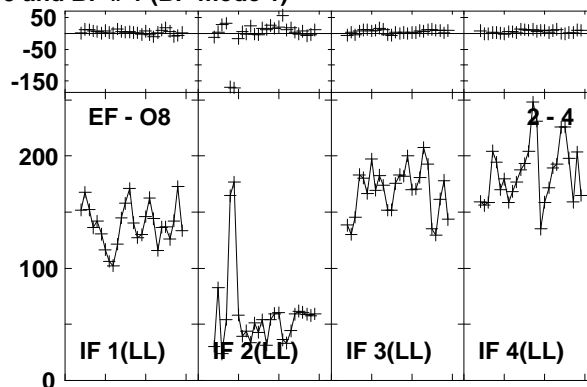
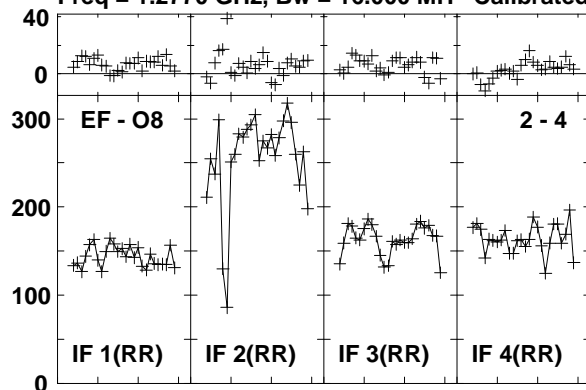

Lower frame: Milli Ampl Jy Top frame: Phas deg
Vector averaged cross-power spectrum Baseline: EF (02) - O8 (04)
Timerange: 00/23:32:02 to 00/23:33:00

Plot file version 942 created 03-MAR-2016 01:14:41
 J1545+5400 GN002C 1.UVDATA.1
 Freq = 1.2770 GHz, Bw = 16.000 MH Calibrated with CL # 3 and BP # 1 (BP mode 1)

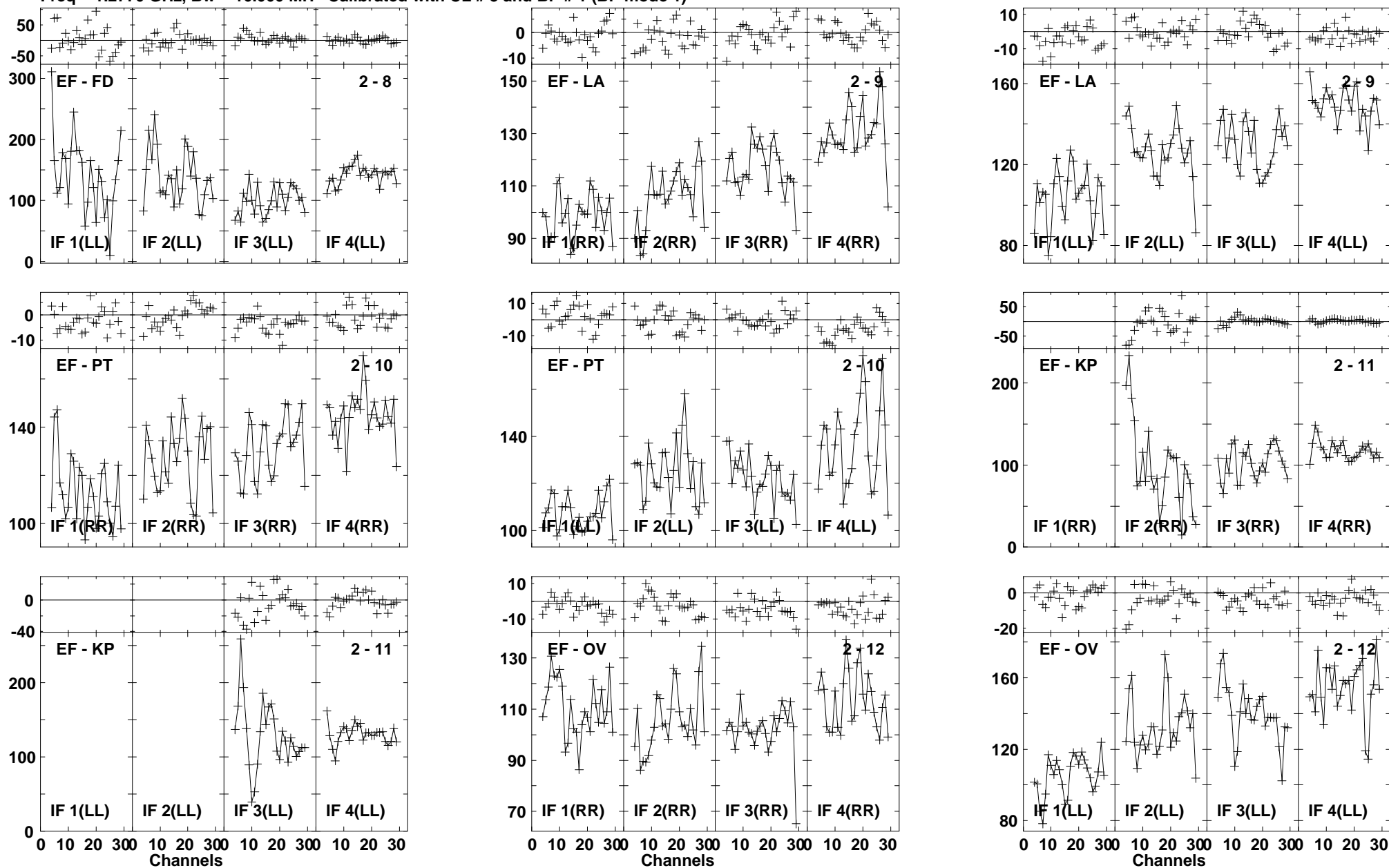

Lower frame: Milli Ampl Jy Top frame: Phas deg
 Vector averaged cross-power spectrum Baseline: EF (02) - FD (08)
 Timerange: 00/23:32:02 to 00/23:33:00

Plot file version 943 created 03-MAR-2016 01:14:41
 J1545+5400 GN002C 1.UVDATA.1
 Freq = 1.2770 GHz, Bw = 16.000 MH Calibrated with CL # 3 and BP # 1 (BP mode 1)

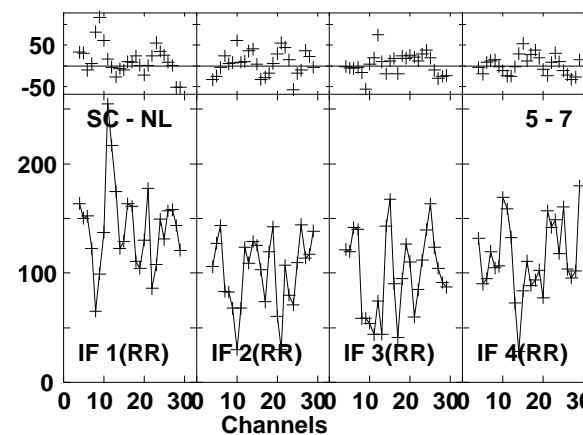
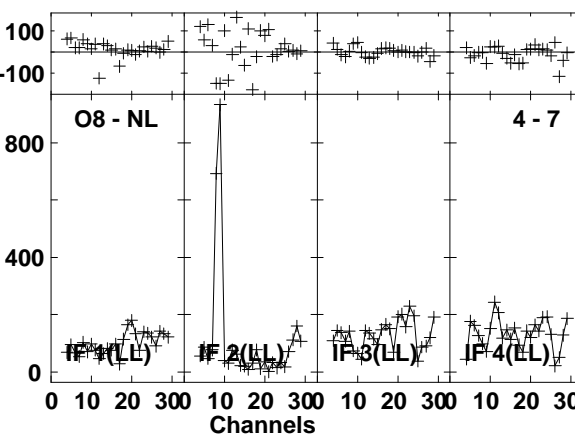
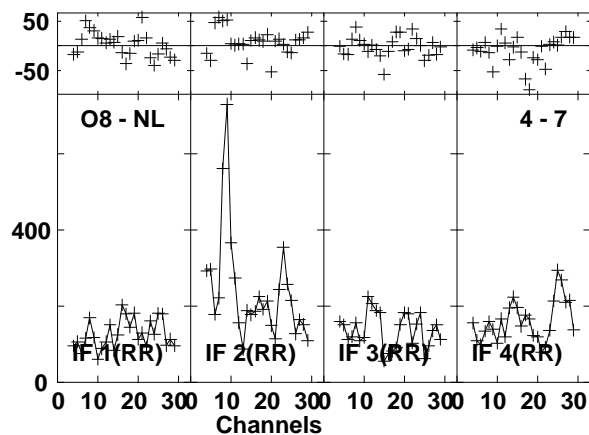
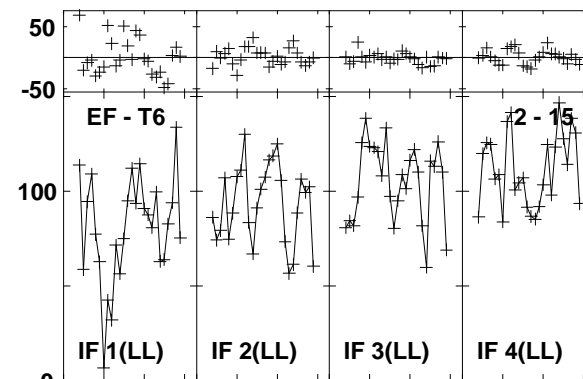
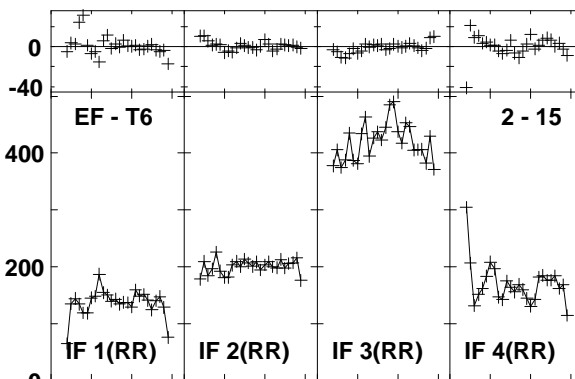
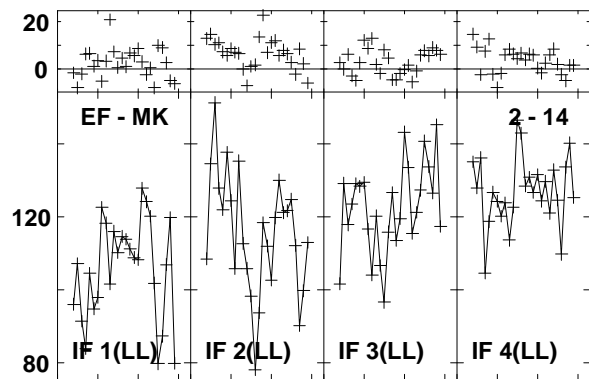
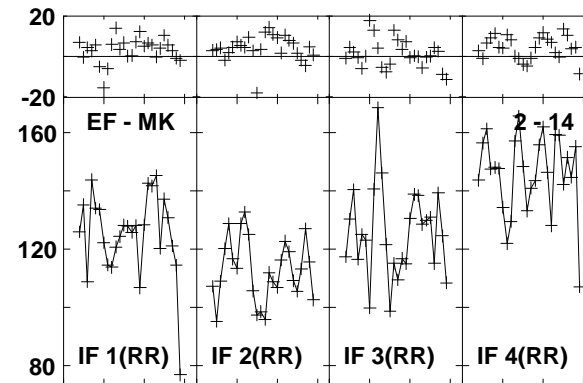
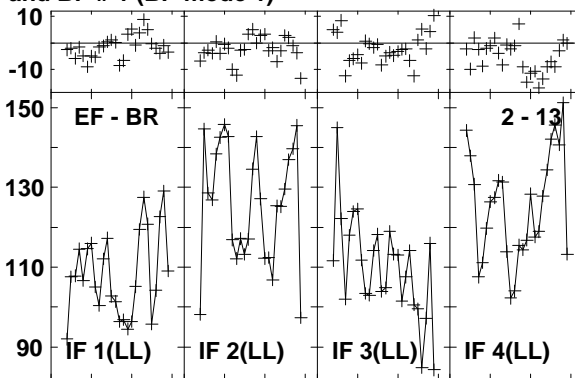
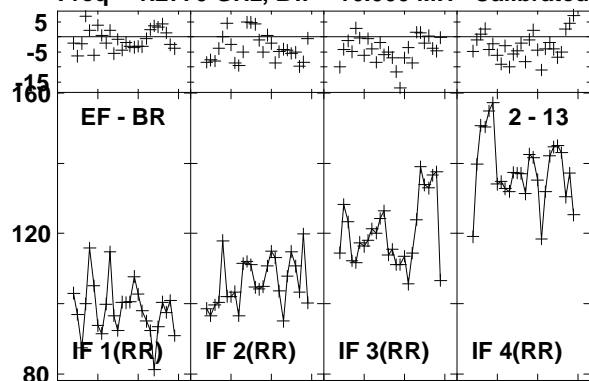

Lower frame: Milli Ampl Jy Top frame: Phas deg
 Vector averaged cross-power spectrum Baseline: EF (02) - BR (13)
 Timerange: 00/23:32:02 to 00/23:33:00

Plot file version 944 created 03-MAR-2016 01:14:41

J1545+5400 GN002C 1.UVDATA.1

Freq = 1.2770 GHz, Bw = 16.000 MH Calibrated with CL # 3 and BP # 1 (BP mode 1)

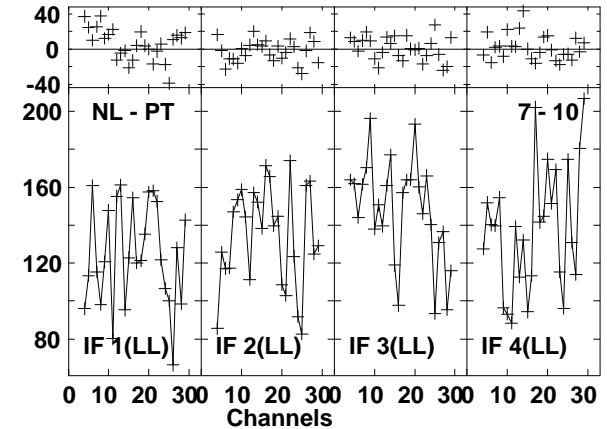
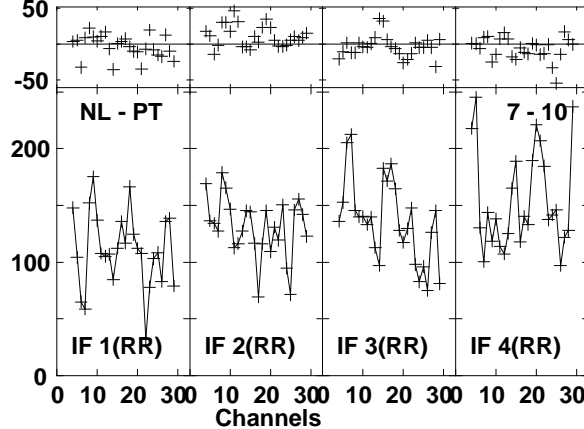
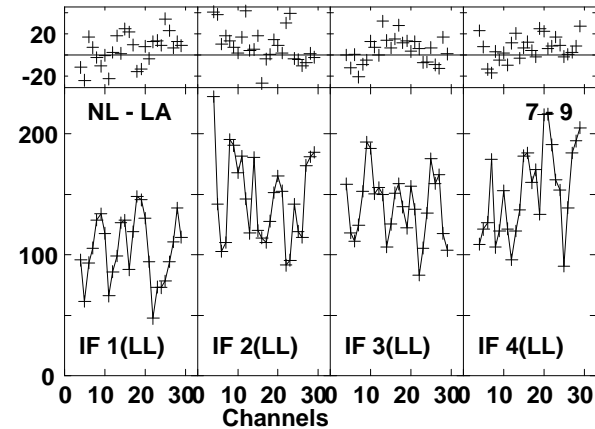
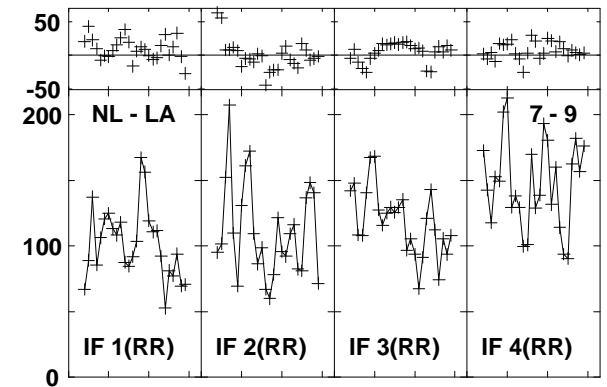
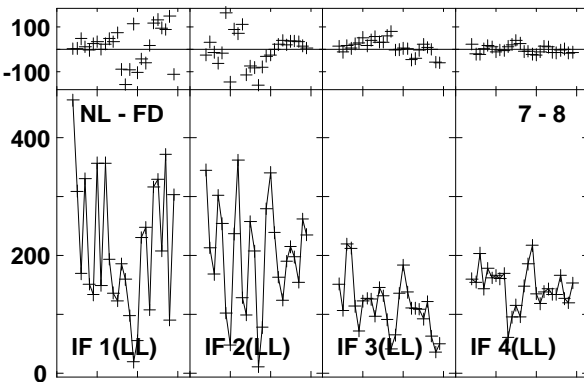
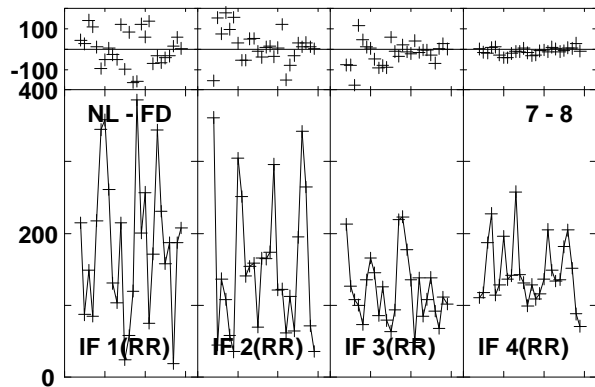
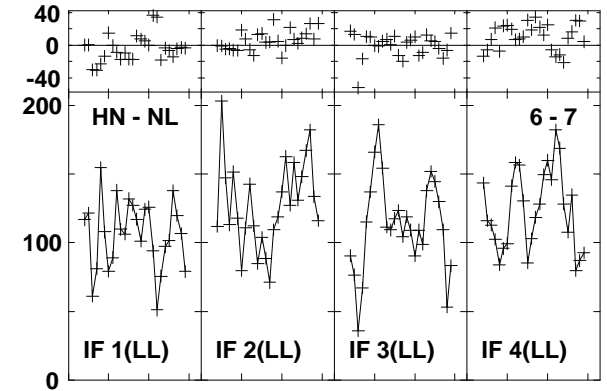
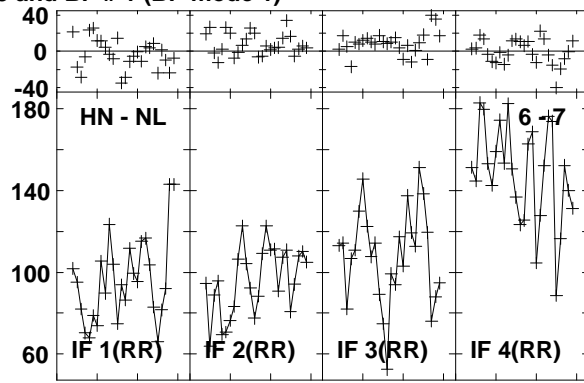
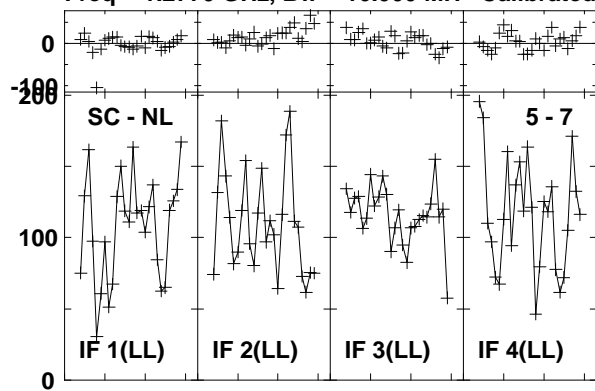

Lower frame: Milli Ampl Jy Top frame: Phas deg
Vector averaged cross-power spectrum Baseline: SC (05) - NL (07)
Timerange: 00/23:32:02 to 00/23:33:00

Plot file version 945 created 03-MAR-2016 01:14:41

J1545+5400 GN002C 1.UVDATA.1

Freq = 1.2770 GHz, Bw = 16.000 MH Calibrated with CL # 3 and BP # 1 (BP mode 1)

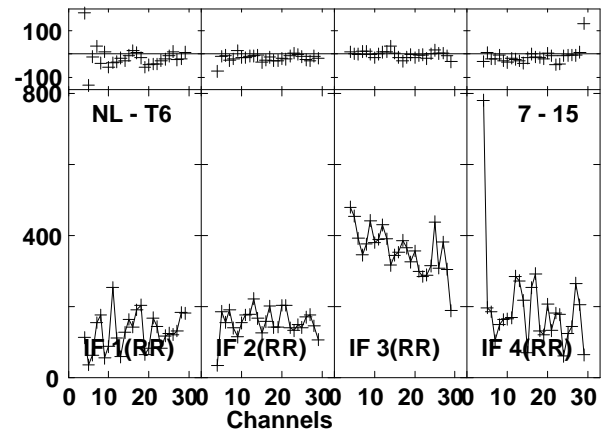
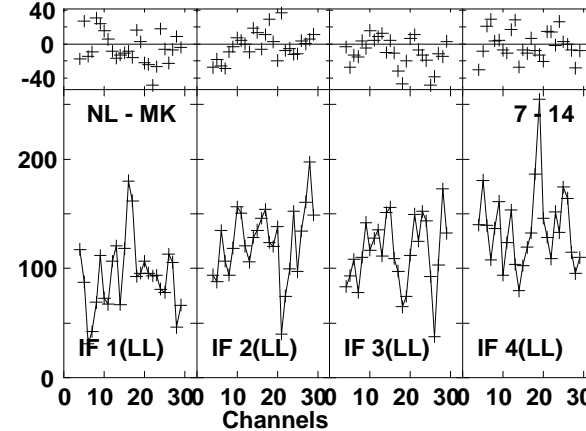
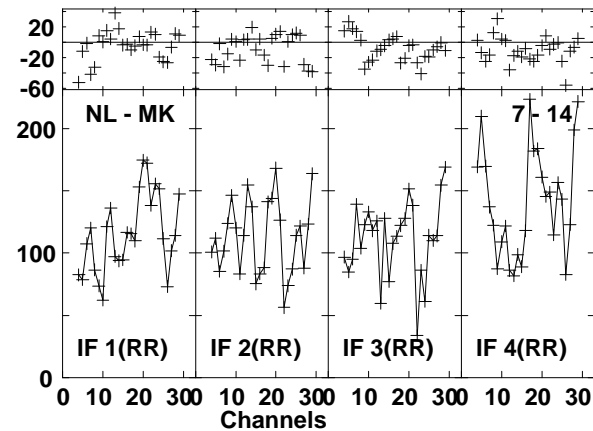
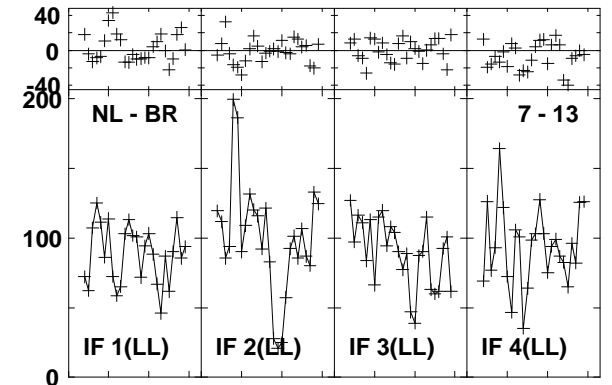
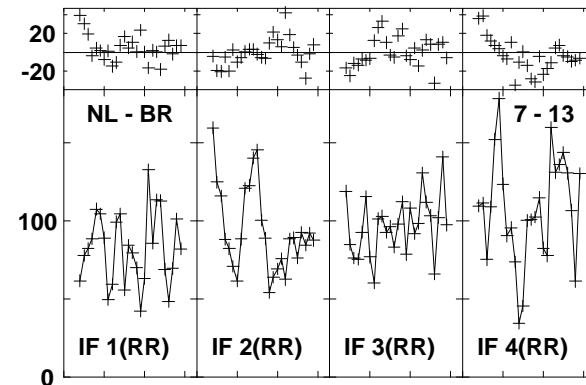
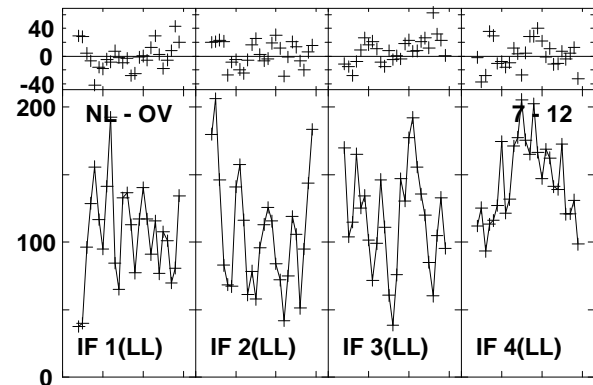
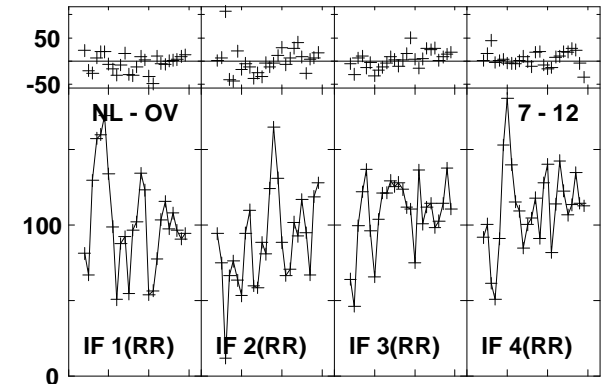
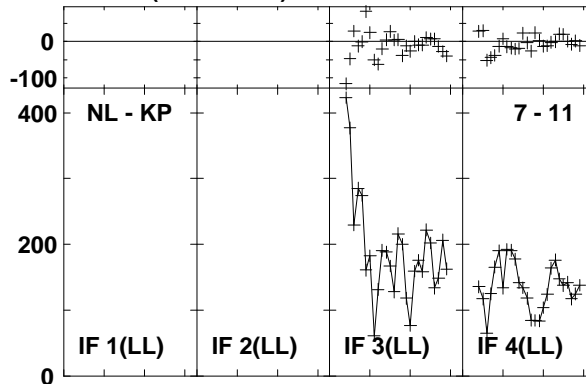
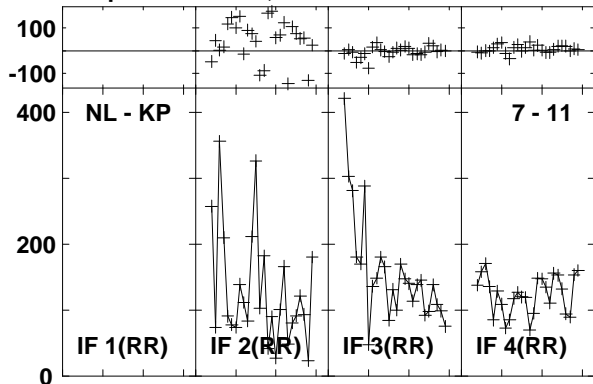

Lower frame: Milli Ampl Jy Top frame: Phas deg

Vector averaged cross-power spectrum Baseline: NL (07) - KP (11)

Timerange: 00/23:32:02 to 00/23:33:00

Plot file version 946 created 03-MAR-2016 01:14:41
J1545+5400 GN002C 1.UVDATA.1
Freq = 1.2770 GHz, Bw = 16.000 MH Calibrated with CL # 3 and BP # 1 (BP mode 1)

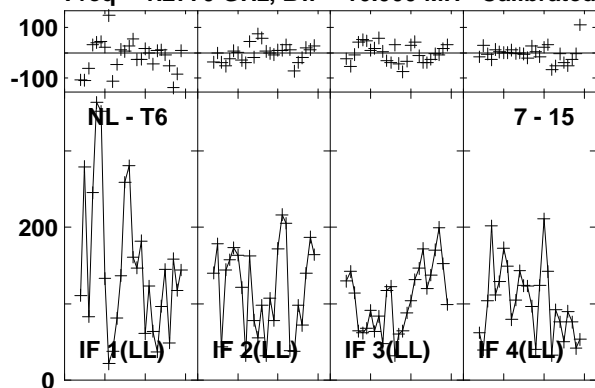

Lower frame: Milli Ampl Jy Top frame: Phas deg
Vector averaged cross-power spectrum Baseline: NL (07) - T6 (15)
Timerange: 00/23:32:02 to 00/23:33:00

Plot file version 947 created 03-MAR-2016 01:14:41

4C52 GN002C 1.UVDATA.1

Freq = 1.2770 GHz, Bw = 16.000 MH Calibrated with CL # 3 and BP # 1 (BP mode 1)

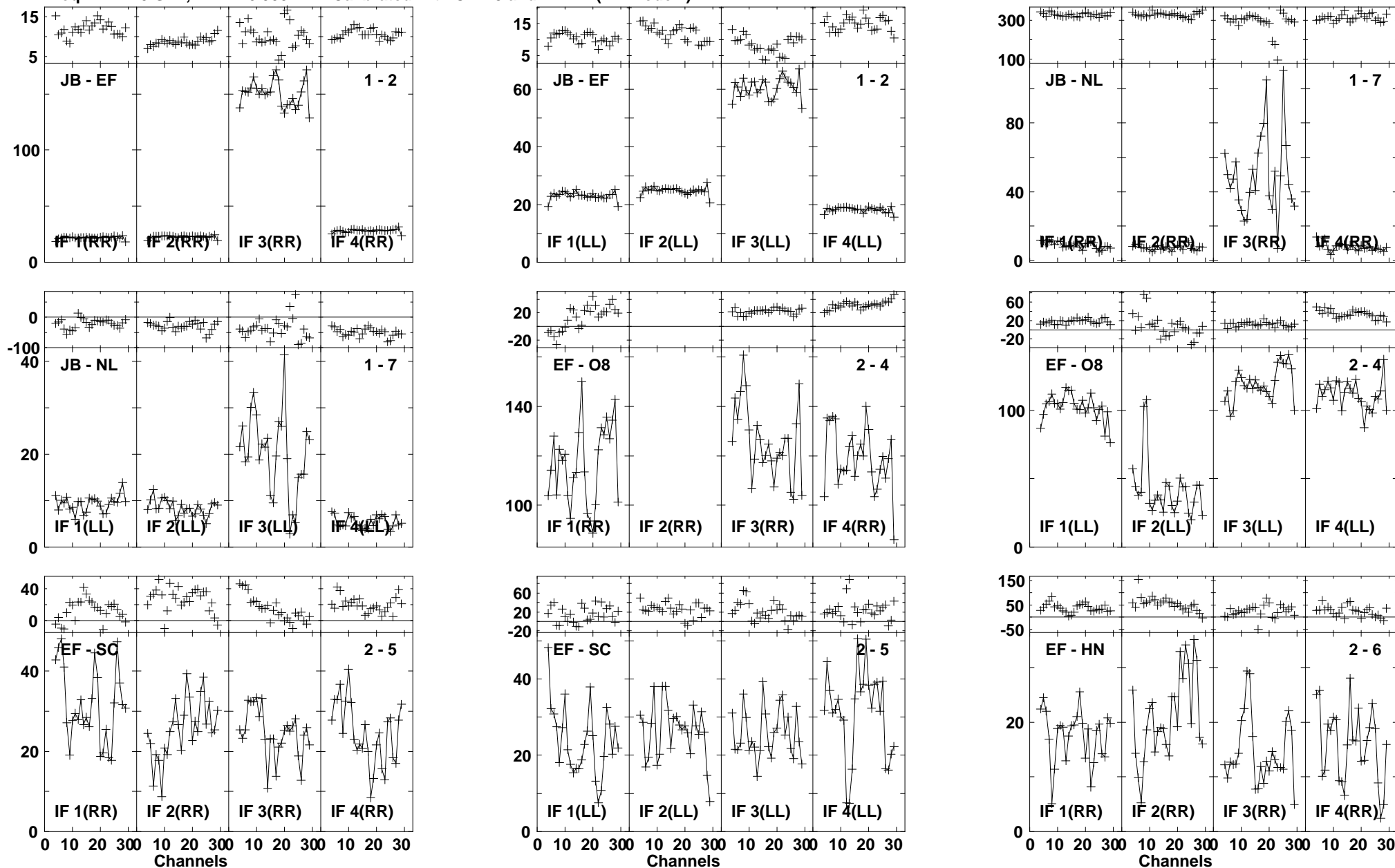

Lower frame: Milli Ampl Jy Top frame: Phas deg
Vector averaged cross-power spectrum Baseline: JB (01) - EF (02)
Timerange: 00/23:33:05 to 00/23:36:29

Plot file version 948 created 03-MAR-2016 01:14:42

4C52 GN002C 1.UVDATA.1

Freq = 1.2770 GHz, Bw = 16.000 MH Calibrated with CL # 3 and BP # 1 (BP mode 1)

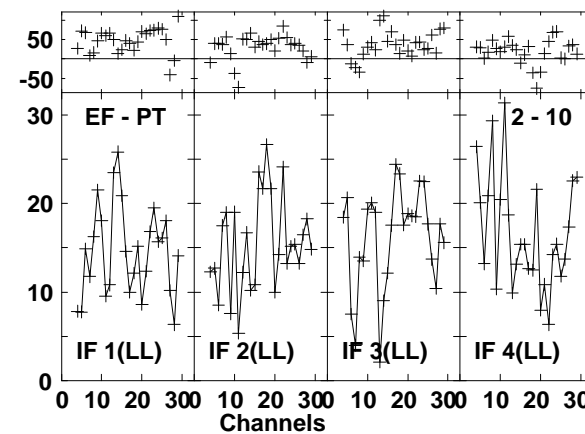
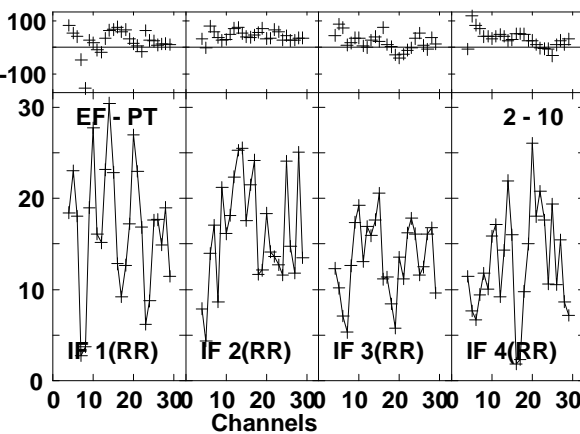
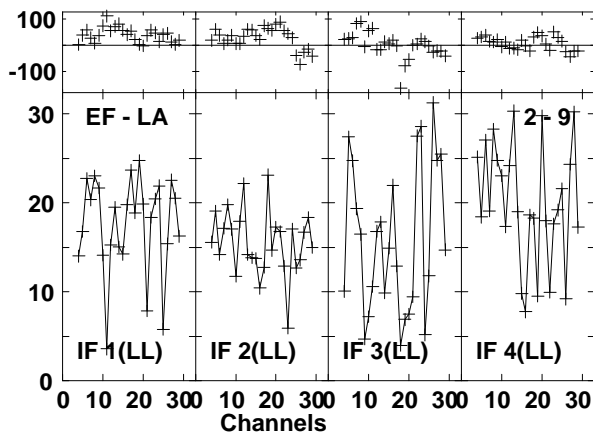
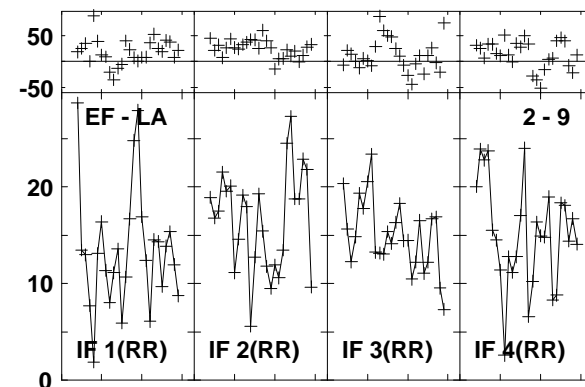
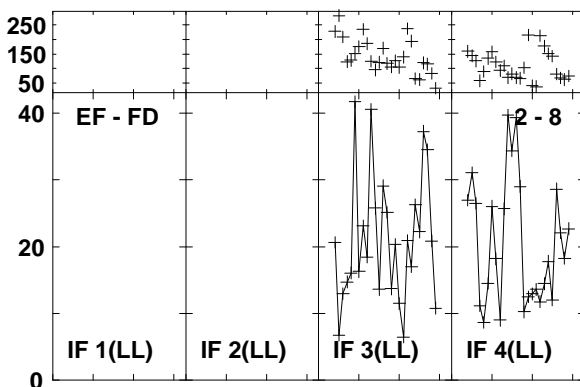
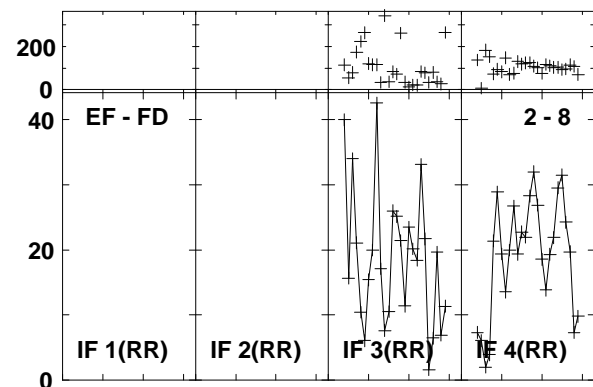
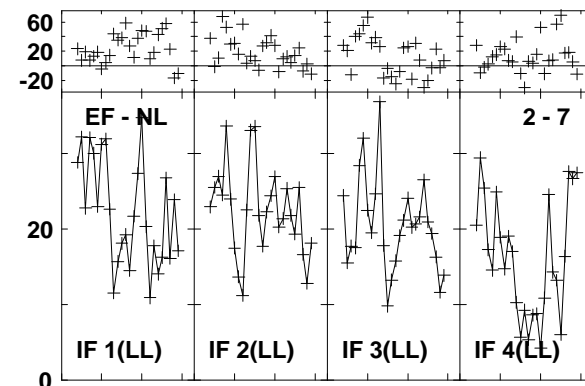
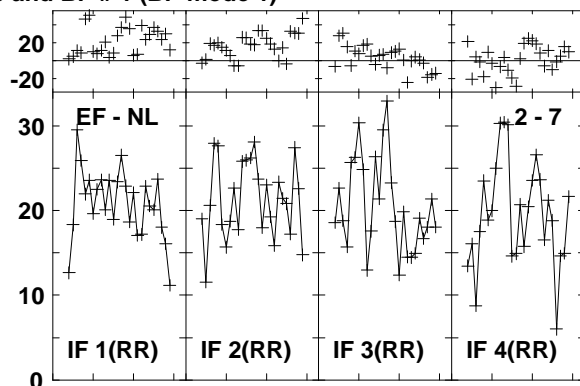
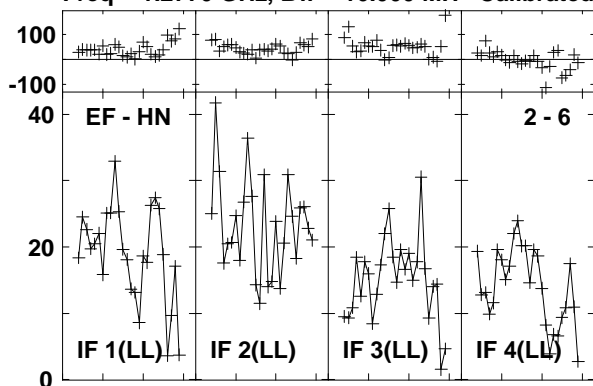

Lower frame: Milli Ampl Jy Top frame: Phas deg
Vector averaged cross-power spectrum Baseline: EF (02) - HN (06)
Timerange: 00/23:33:05 to 00/23:36:29

Plot file version 949 created 03-MAR-2016 01:14:42

4C52 GN002C 1.UVDATA.1

Freq = 1.2770 GHz, Bw = 16.000 MH Calibrated with CL # 3 and BP # 1 (BP mode 1)

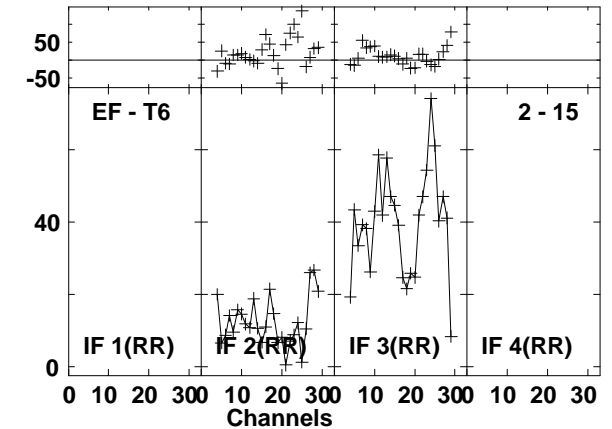
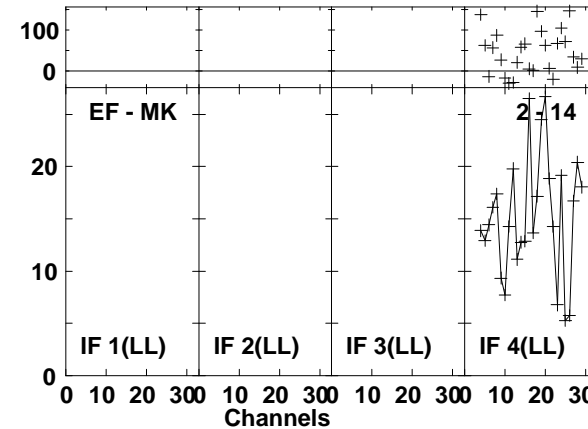
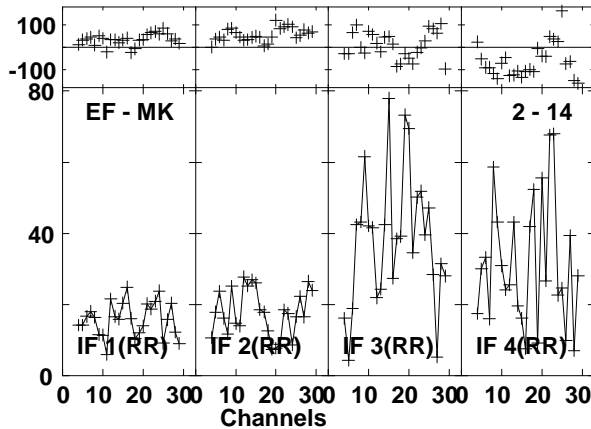
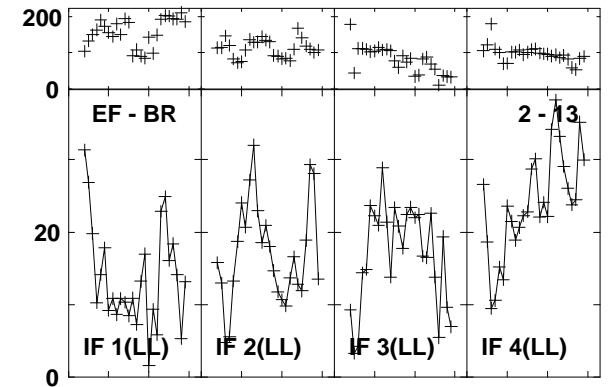
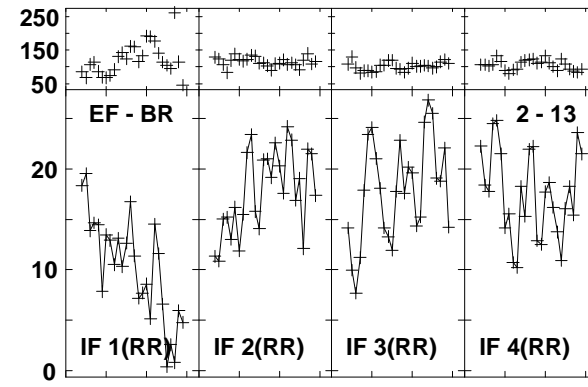
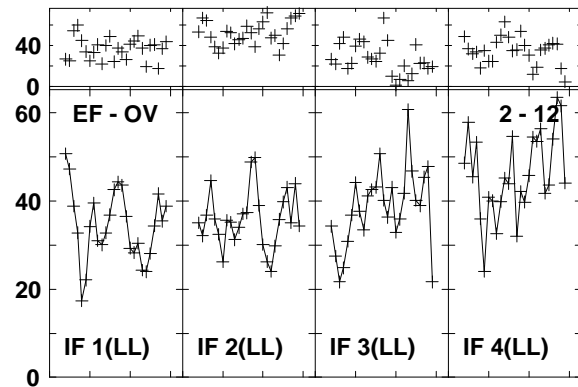
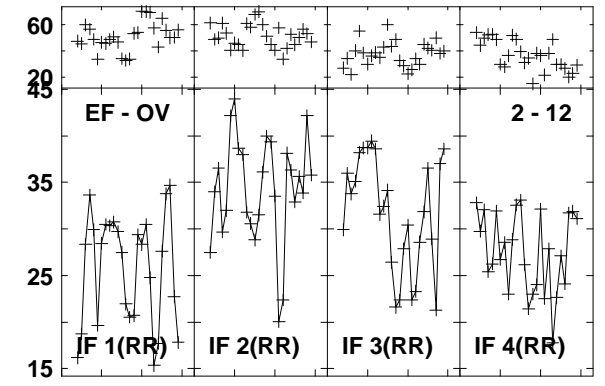
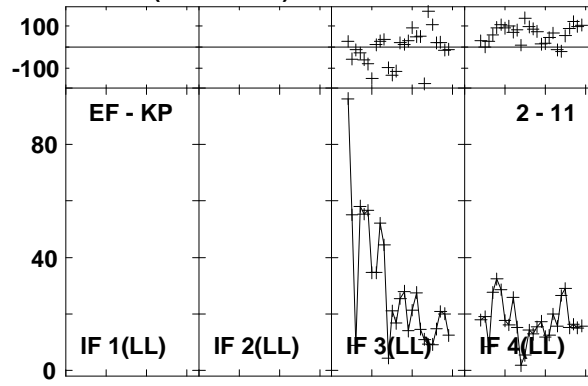
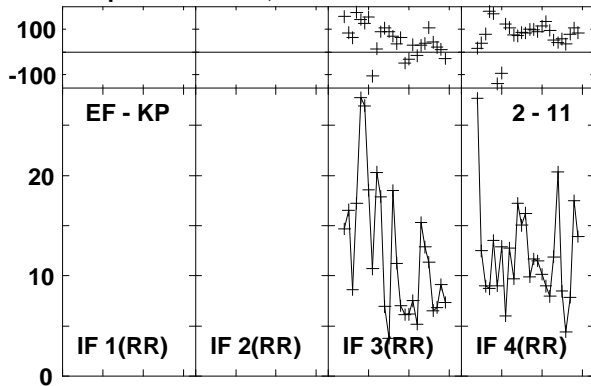

Lower frame: Milli Ampl Jy Top frame: Phas deg

Vector averaged cross-power spectrum Baseline: EF (02) - KP (11)

Timerange: 00/23:33:05 to 00/23:36:29

Plot file version 950 created 03-MAR-2016 01:14:42

4C52 GN002C 1.UVDATA.1

Freq = 1.2770 GHz, Bw = 16.000 MH Calibrated with CL # 3 and BP # 1 (BP mode 1)

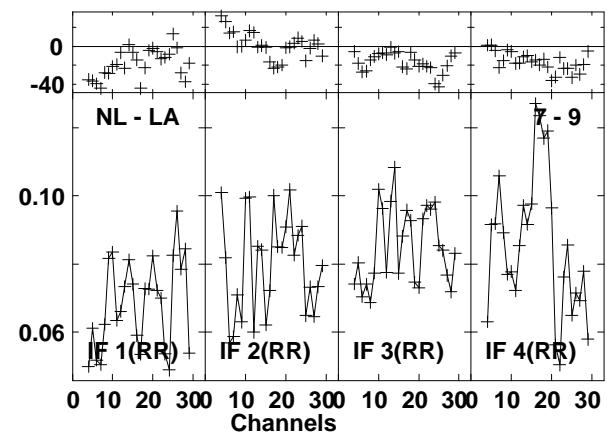
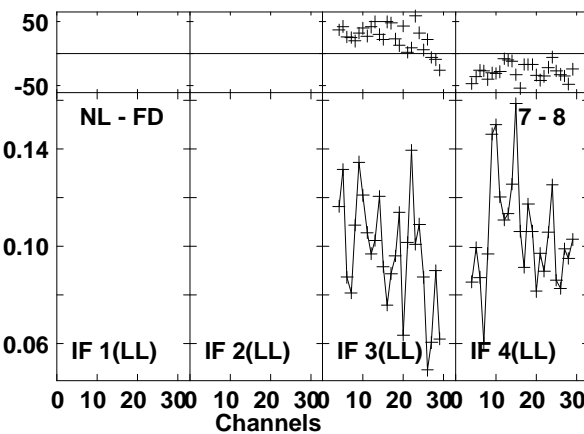
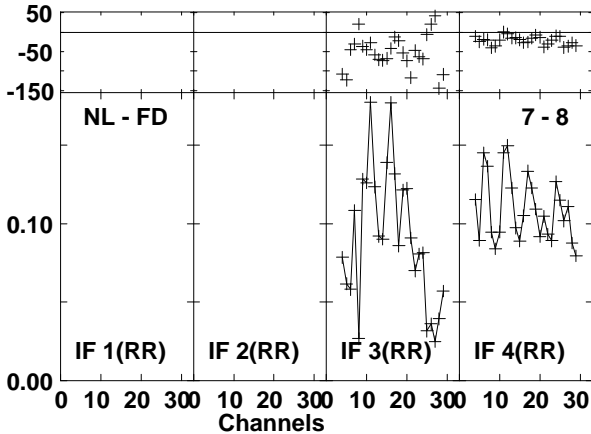
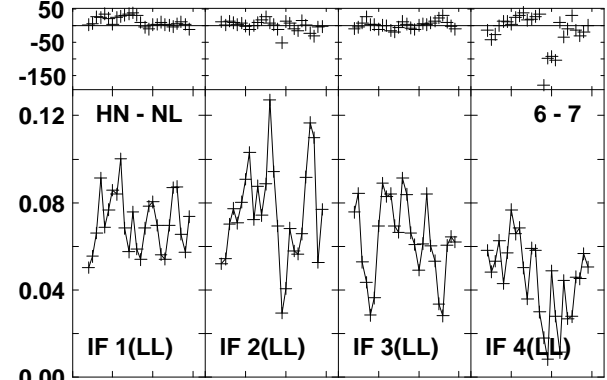
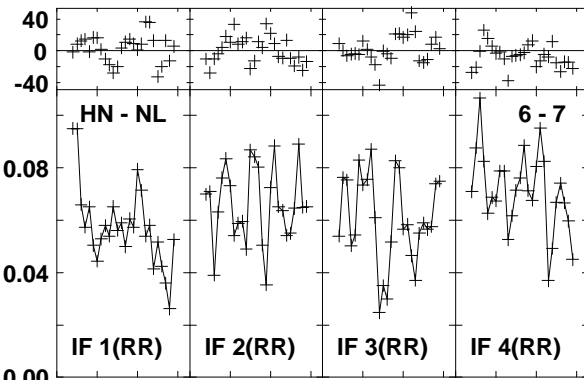
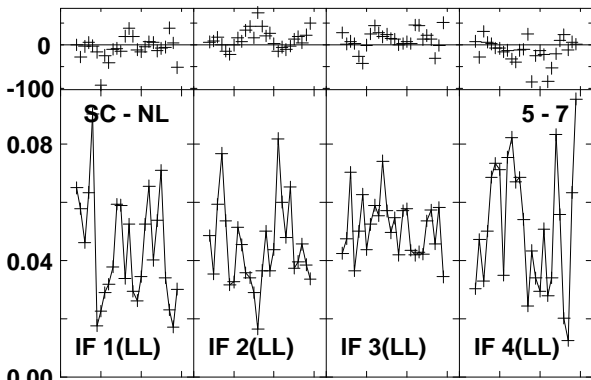
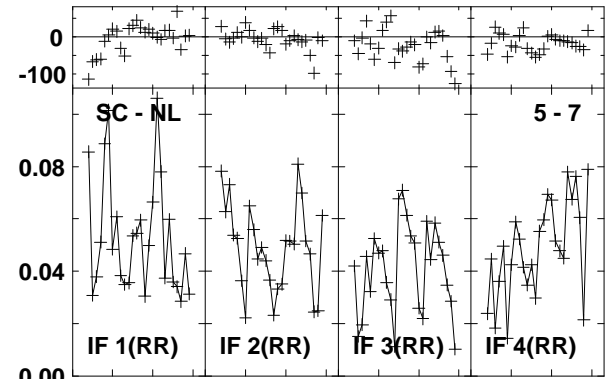
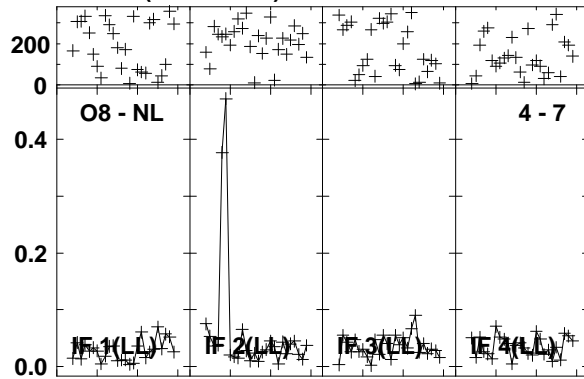
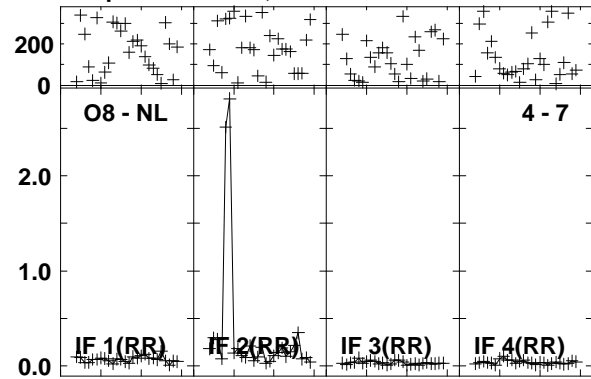

Lower frame: Ampl Jy Top frame: Phas deg
Vector averaged cross-power spectrum Baseline: O8 (04) - NL (07)
Timerange: 00/23:33:05 to 00/23:36:29

Plot file version 951 created 03-MAR-2016 01:14:42

4C52 GN002C 1.UVDATA.1

Freq = 1.2770 GHz, Bw = 16.000 MH Calibrated with CL # 3 and BP # 1 (BP mode 1)

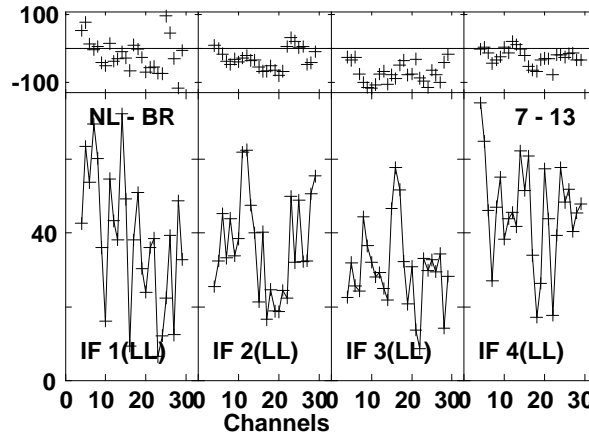
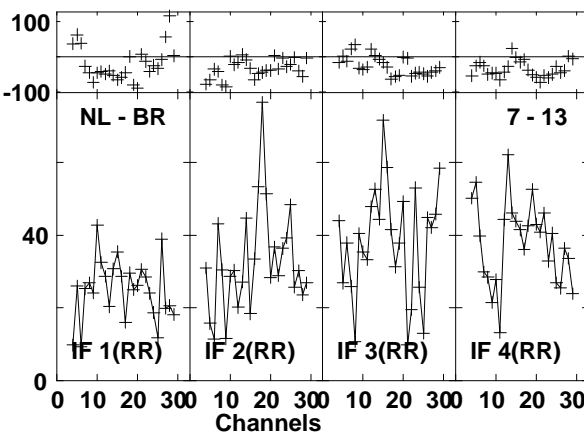
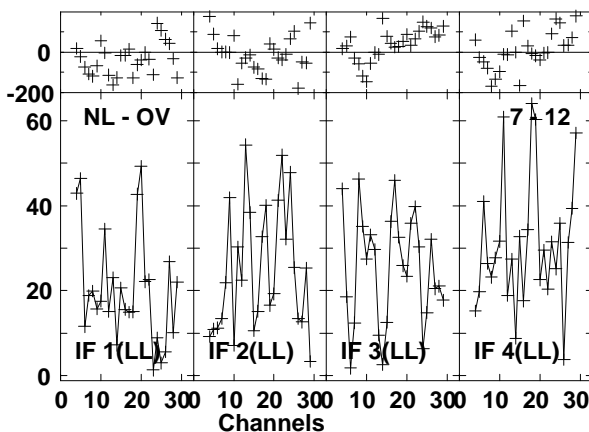
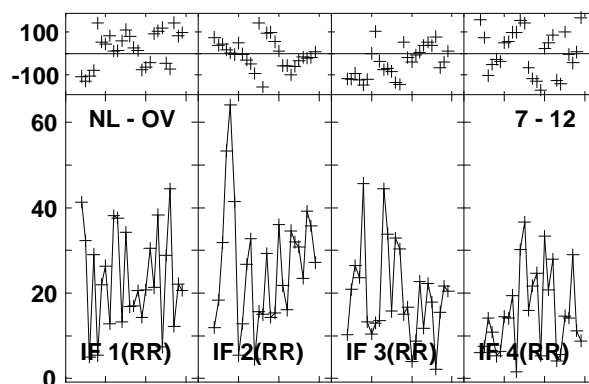
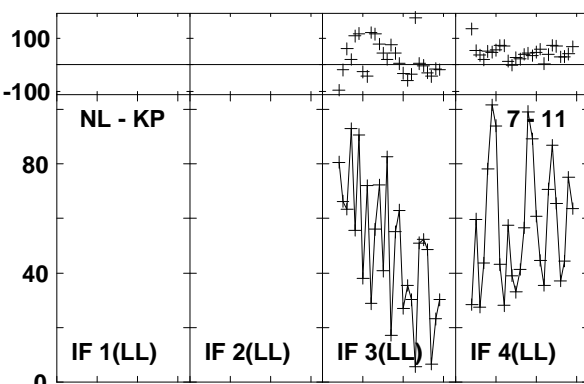
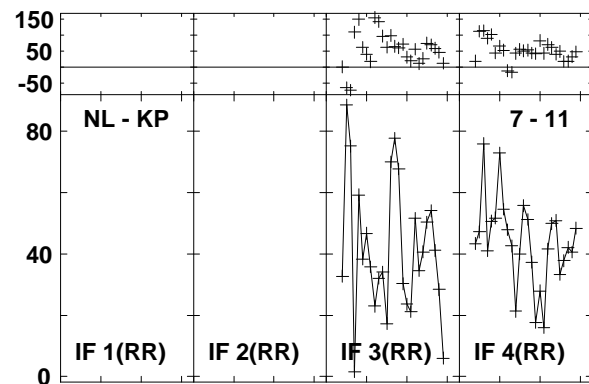
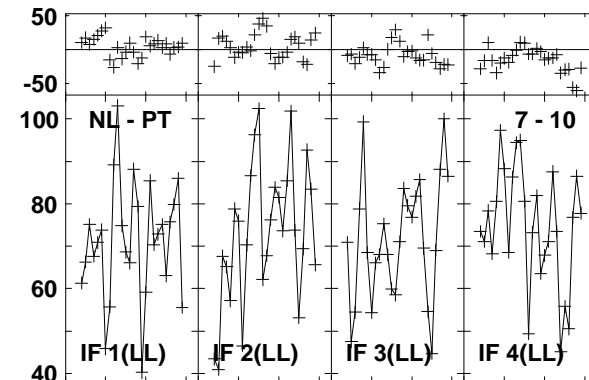
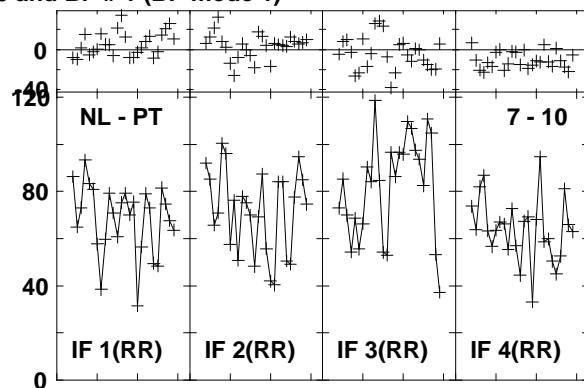
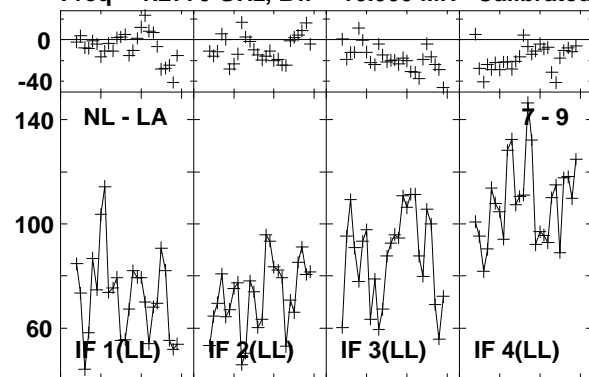

Lower frame: Milli Ampl Jy Top frame: Phas deg

Vector averaged cross-power spectrum Baseline: NL (07) - LA (09)

Timerange: 00/23:33:05 to 00/23:36:29

Plot file version 952 created 03-MAR-2016 01:14:42

4C52 GN002C 1.UVDATA.1

Freq = 1.2770 GHz, Bw = 16.000 MH Calibrated with CL # 3 and BP # 1 (BP mode 1)

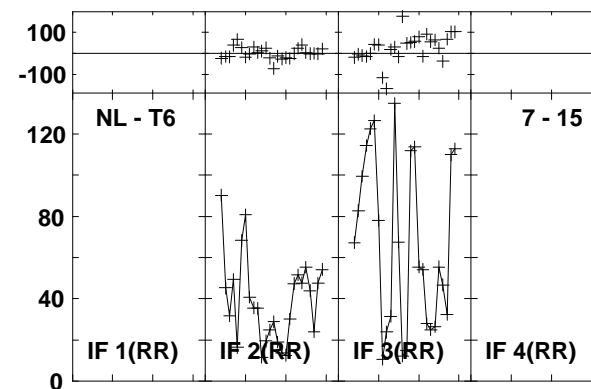
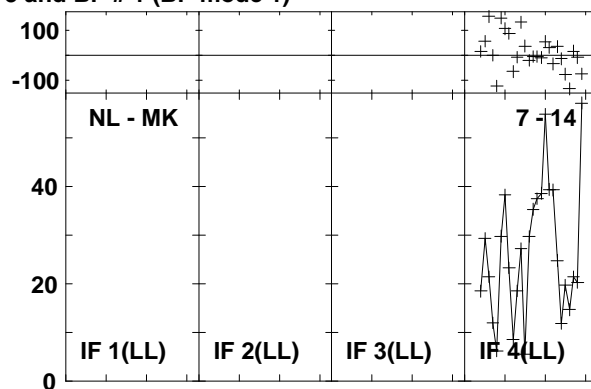
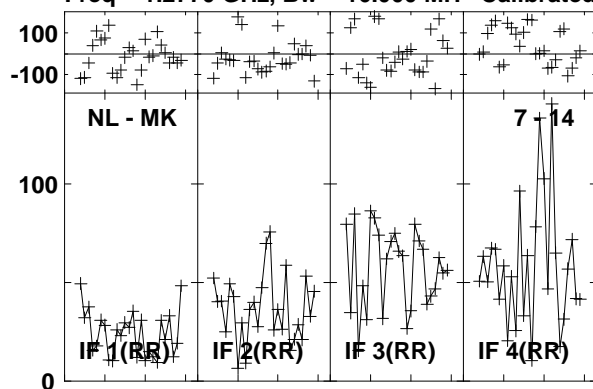

Lower frame: Milli Ampl Jy Top frame: Phas deg
Vector averaged cross-power spectrum Baseline: NL (07) - MK (14)
Timerange: 00/23:33:05 to 00/23:36:29

Plot file version 953 created 03-MAR-2016 01:14:42

J1545+5400 GN002C 1.UVDATA.1

Freq = 1.2770 GHz, Bw = 16.000 MH Calibrated with CL # 3 and BP # 1 (BP mode 1)

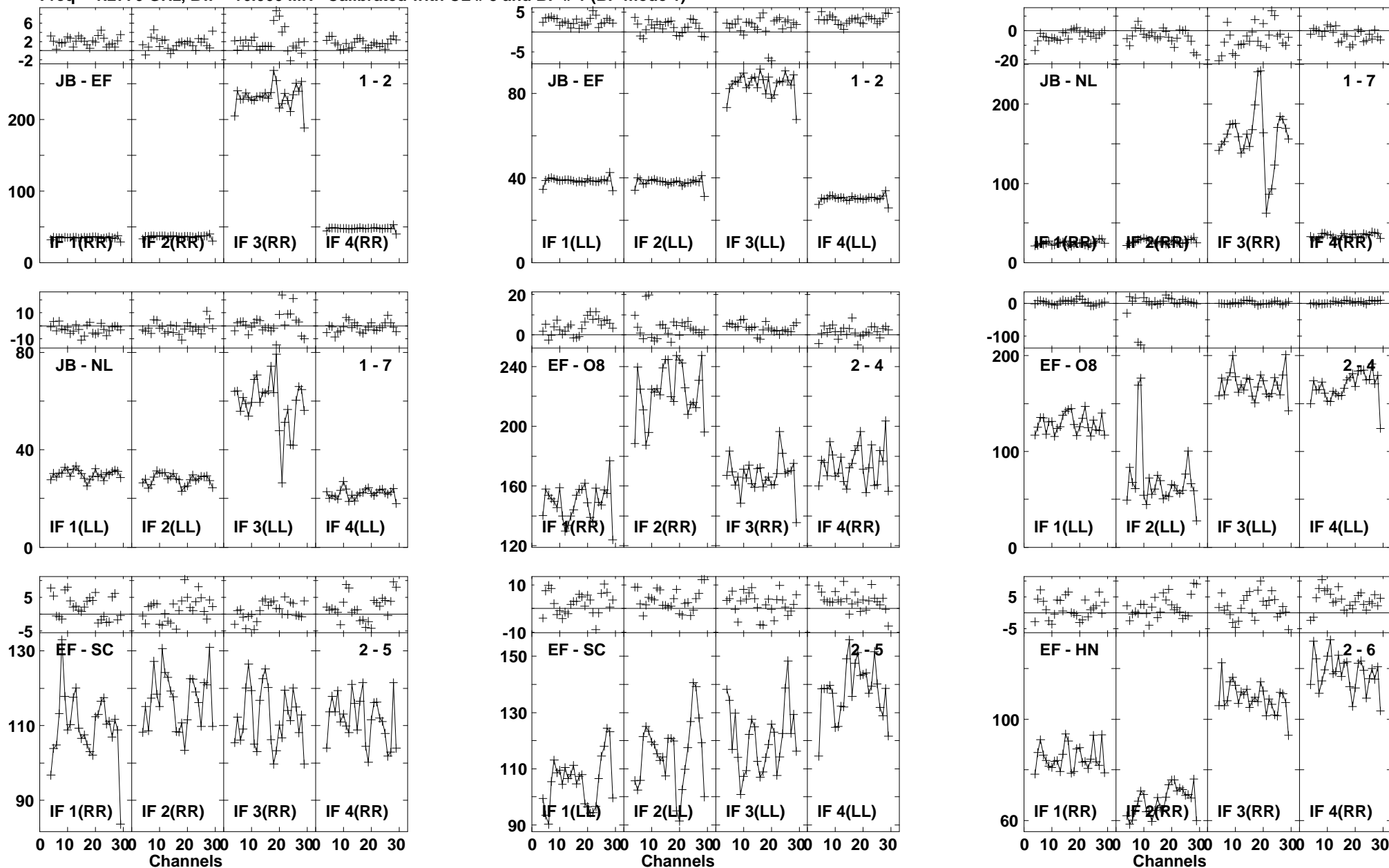

Lower frame: Milli Ampl Jy Top frame: Phas deg
Vector averaged cross-power spectrum Baseline: JB (01) - EF (02)
Timerange: 00/23:37:22 to 00/23:39:50

Plot file version 954 created 03-MAR-2016 01:14:43

J1545+5400 GN002C 1.UVDATA.1

Freq = 1.2770 GHz, Bw = 16.000 MH Calibrated with CL # 3 and BP # 1 (BP mode 1)

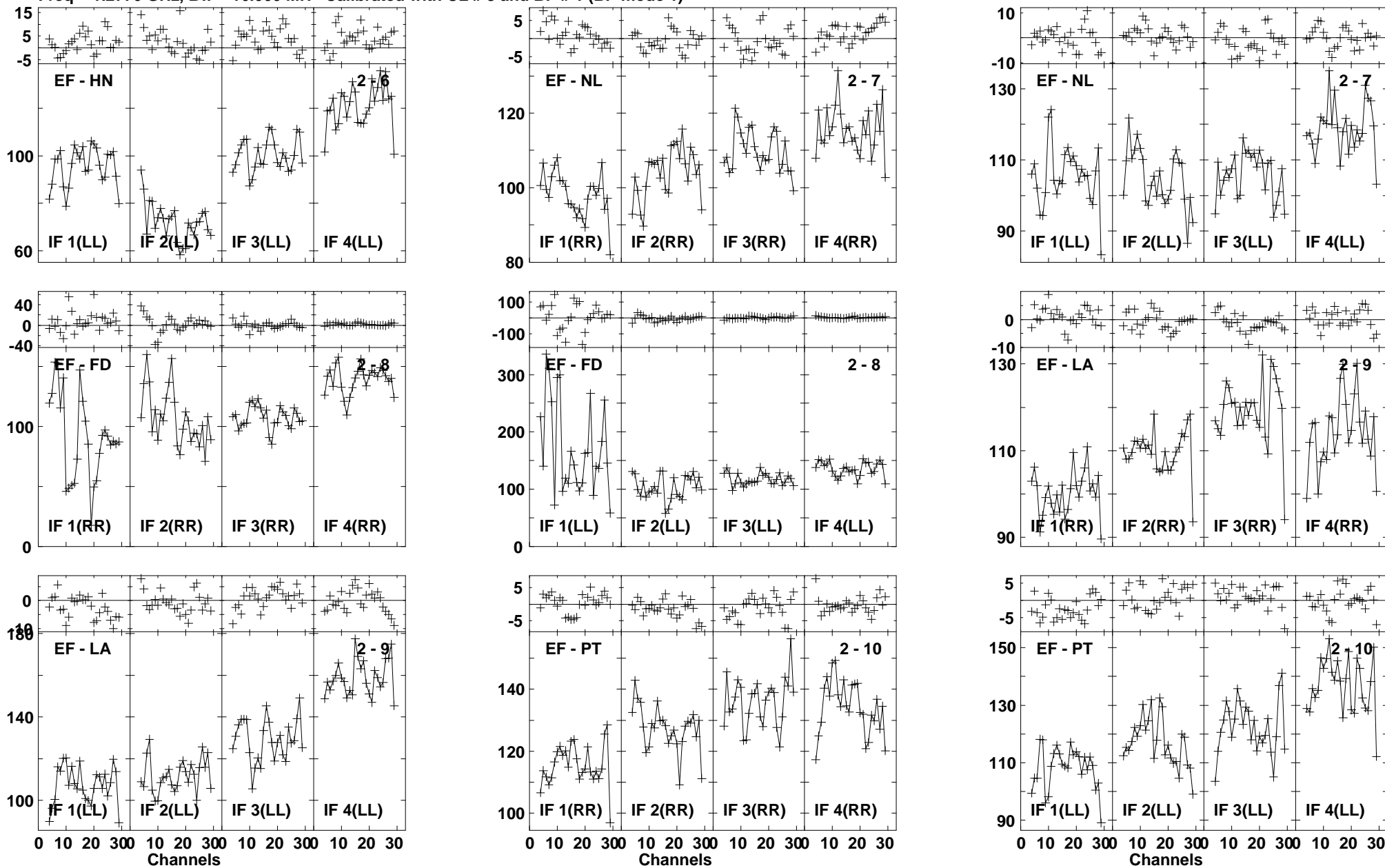

Lower frame: Milli Ampl Jy Top frame: Phas deg
Vector averaged cross-power spectrum Baseline: EF (02) - HN (06)
Timerange: 00/23:37:22 to 00/23:39:50

Plot file version 955 created 03-MAR-2016 01:14:43
 J1545+5400 GN002C 1.UVDATA.1
 Freq = 1.2770 GHz, Bw = 16.000 MH Calibrated with CL # 3 and BP # 1 (BP mode 1)

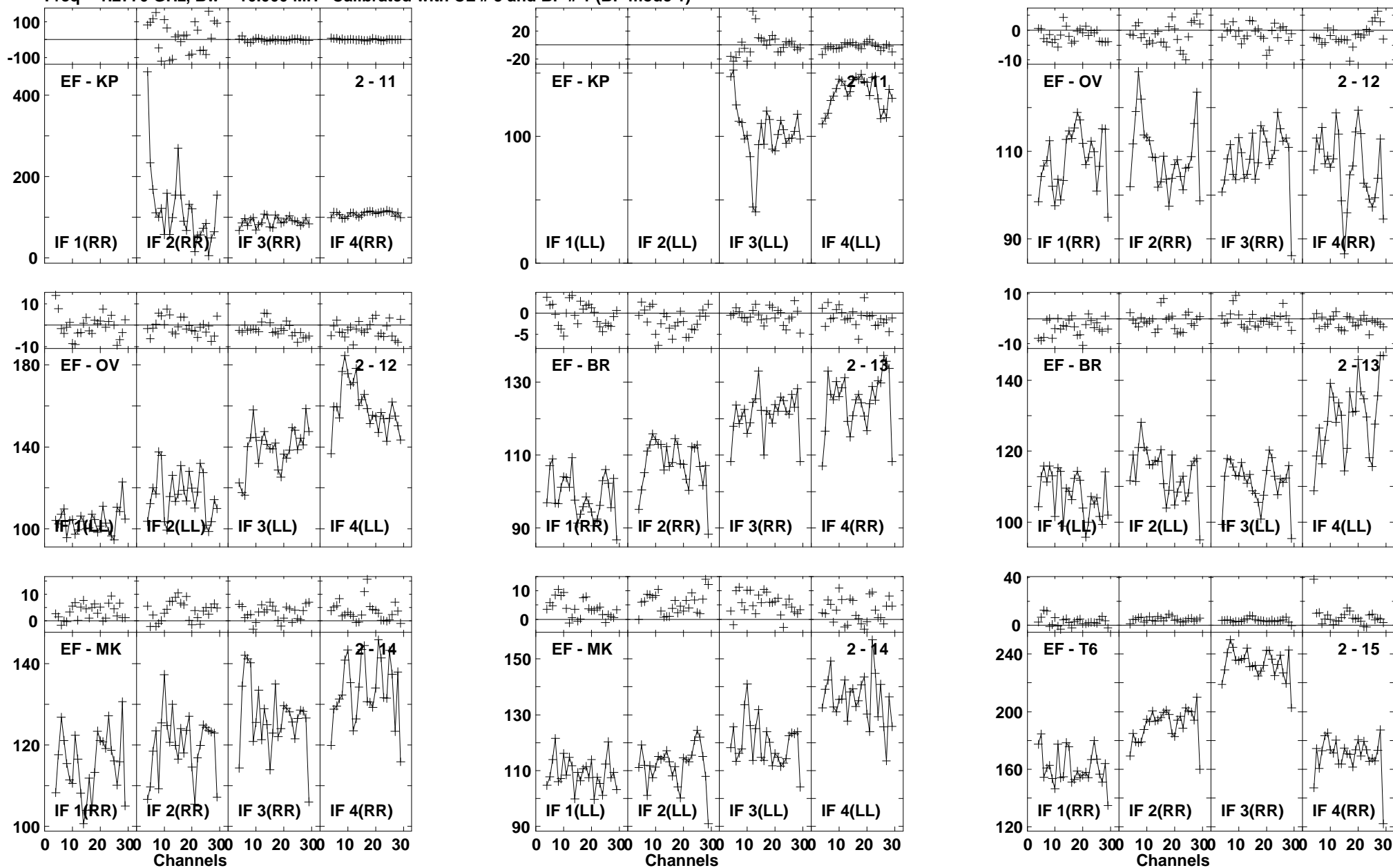

Lower frame: Milli Ampl Jy Top frame: Phas deg
 Vector averaged cross-power spectrum Baseline: EF (02) - KP (11)
 Timerange: 00/23:37:22 to 00/23:39:50

Plot file version 956 created 03-MAR-2016 01:14:43

J1545+5400 GN002C 1.UVDATA.1

Freq = 1.2770 GHz, Bw = 16.000 MH Calibrated with CL # 3 and BP # 1 (BP mode 1)

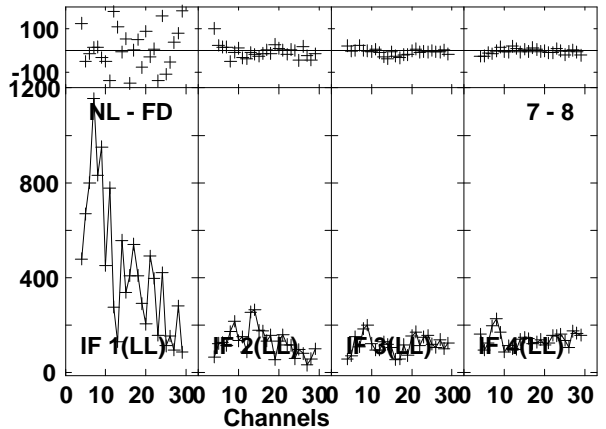
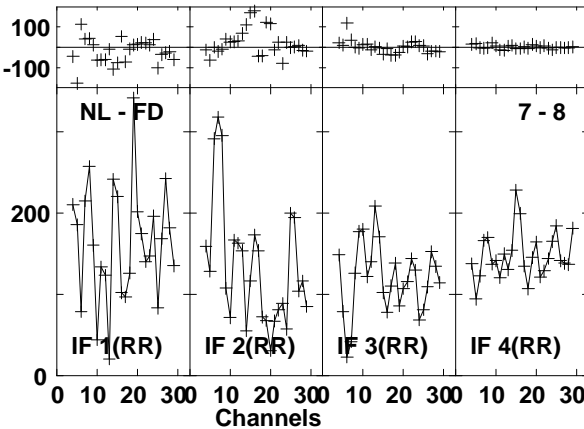
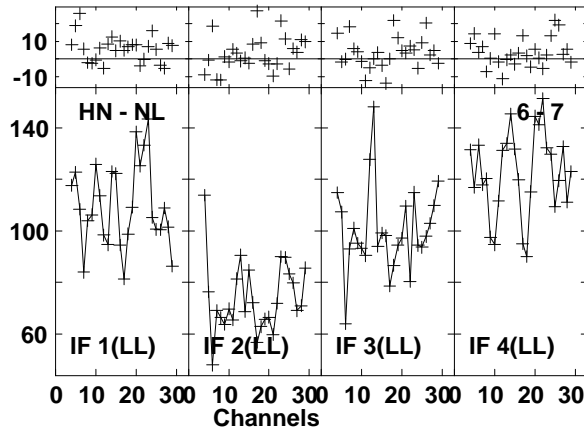
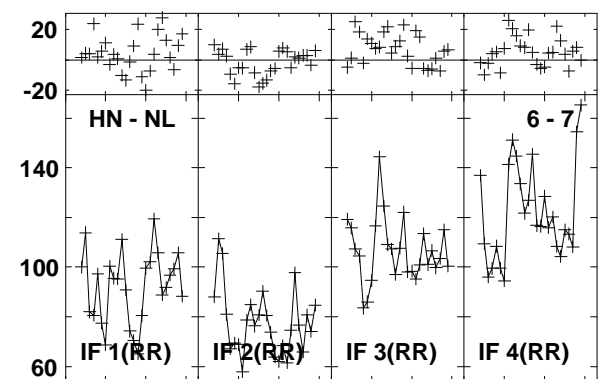
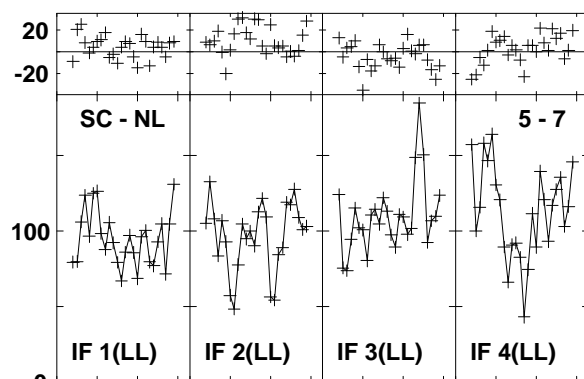
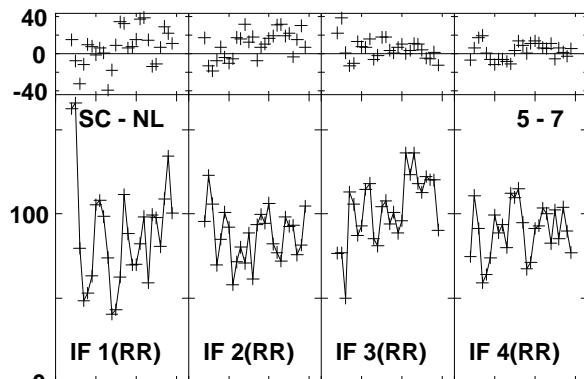
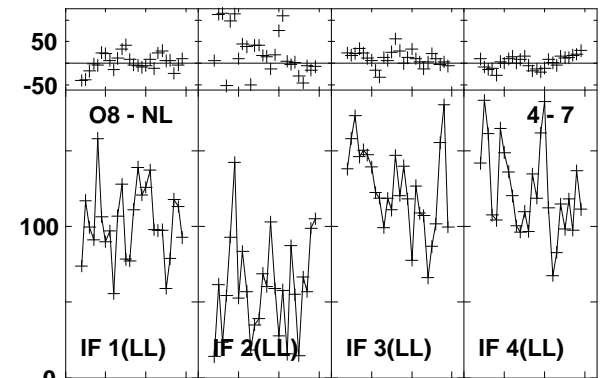
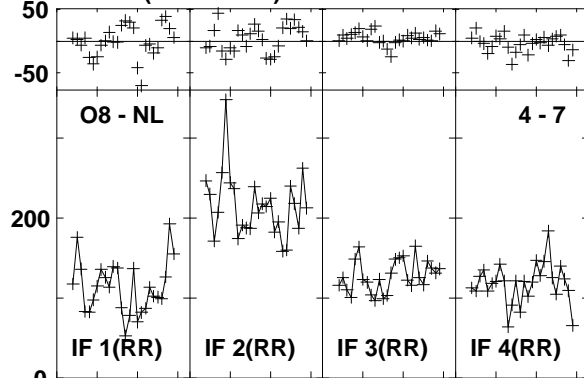
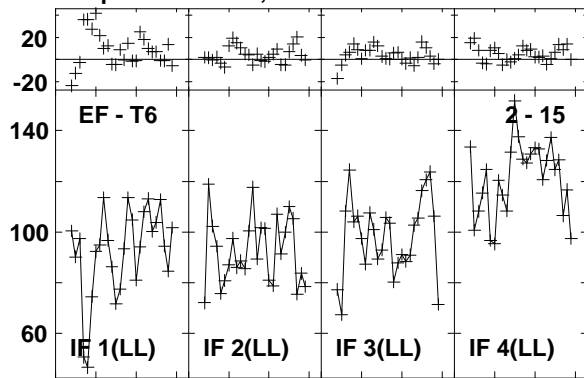

Lower frame: Milli Ampl Jy Top frame: Phas deg
Vector averaged cross-power spectrum Baseline: EF (02) - T6 (15)
Timerange: 00/23:37:22 to 00/23:39:50

Plot file version 957 created 03-MAR-2016 01:14:43

J1545+5400 GN002C 1.UVDATA.1

Freq = 1.2770 GHz, Bw = 16.000 MH Calibrated with CL # 3 and BP # 1 (BP mode 1)

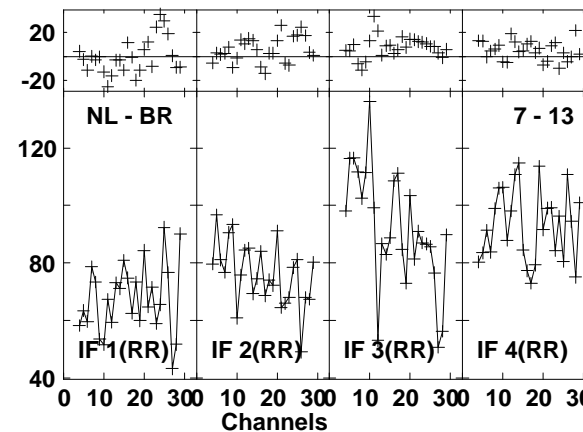
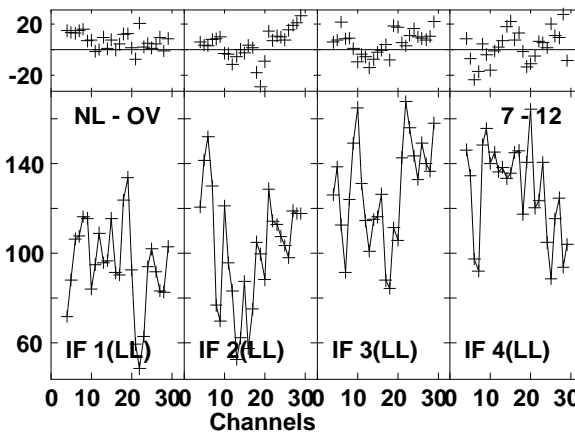
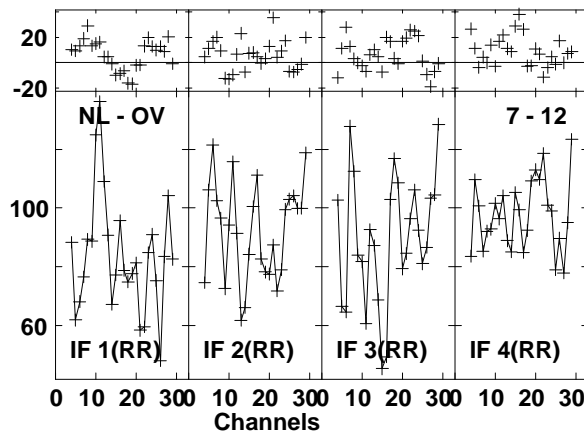
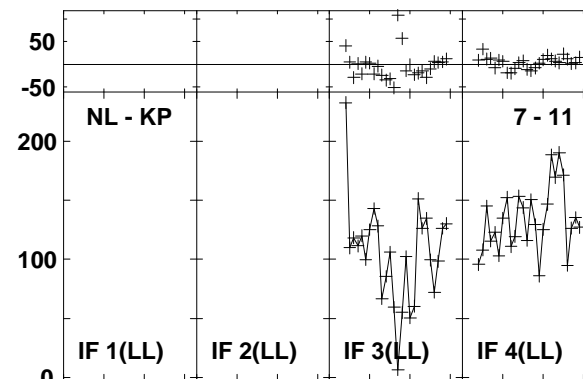
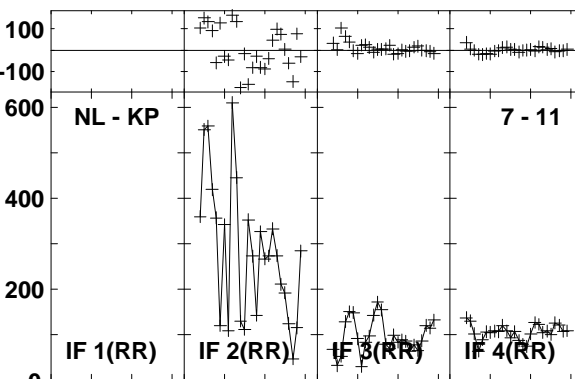
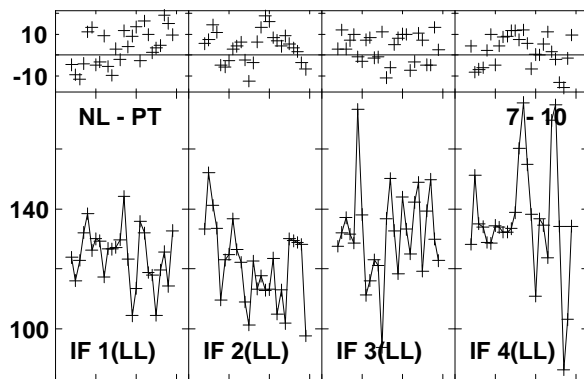
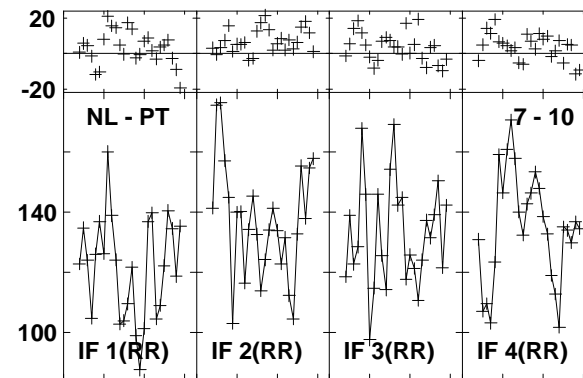
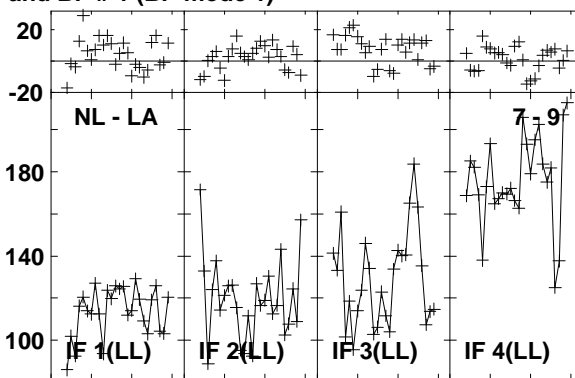
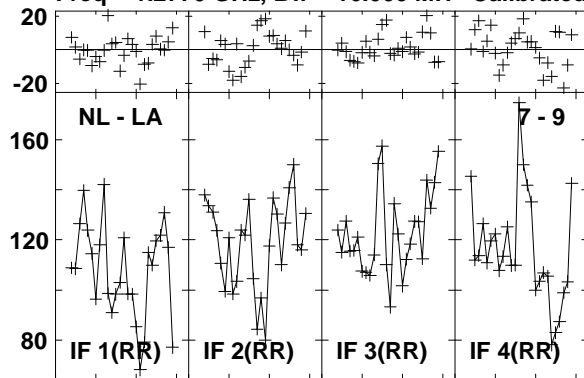

Lower frame: Milli Ampl Jy Top frame: Phas deg
Vector averaged cross-power spectrum Baseline: NL (07) - LA (09)
Timerange: 00/23:37:22 to 00/23:39:50

Plot file version 958 created 03-MAR-2016 01:14:43
 J1545+5400 GN002C 1.UVDATA.1
 Freq = 1.2770 GHz, Bw = 16.000 MH Calibrated with CL # 3 and BP # 1 (BP mode 1)

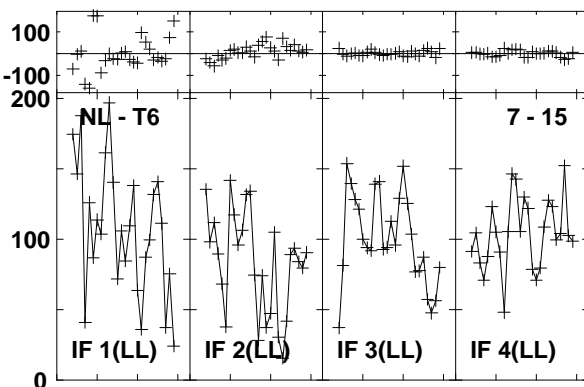
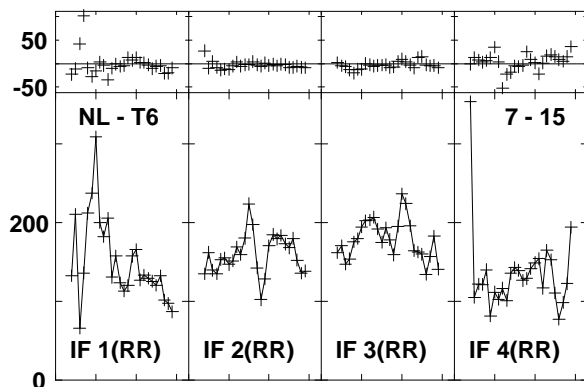
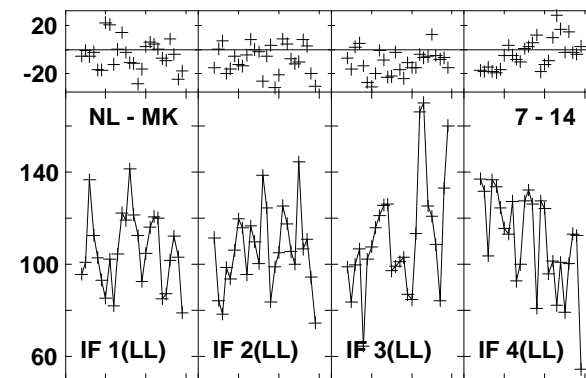
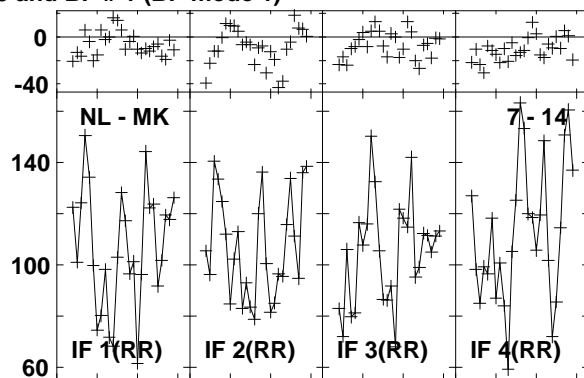
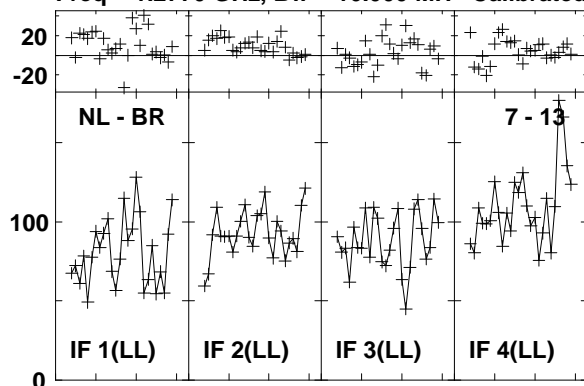

Lower frame: Milli Ampl Jy Top frame: Phas deg
 Vector averaged cross-power spectrum Baseline: NL (07) - BR (13)
 Timerange: 00/23:37:22 to 00/23:39:50

Plot file version 959 created 03-MAR-2016 01:14:44

J1638+5720 GN002C 1.UVDATA.1

Freq = 1.2770 GHz, Bw = 16.000 MH Calibrated with CL # 3 and BP # 1 (BP mode 1)

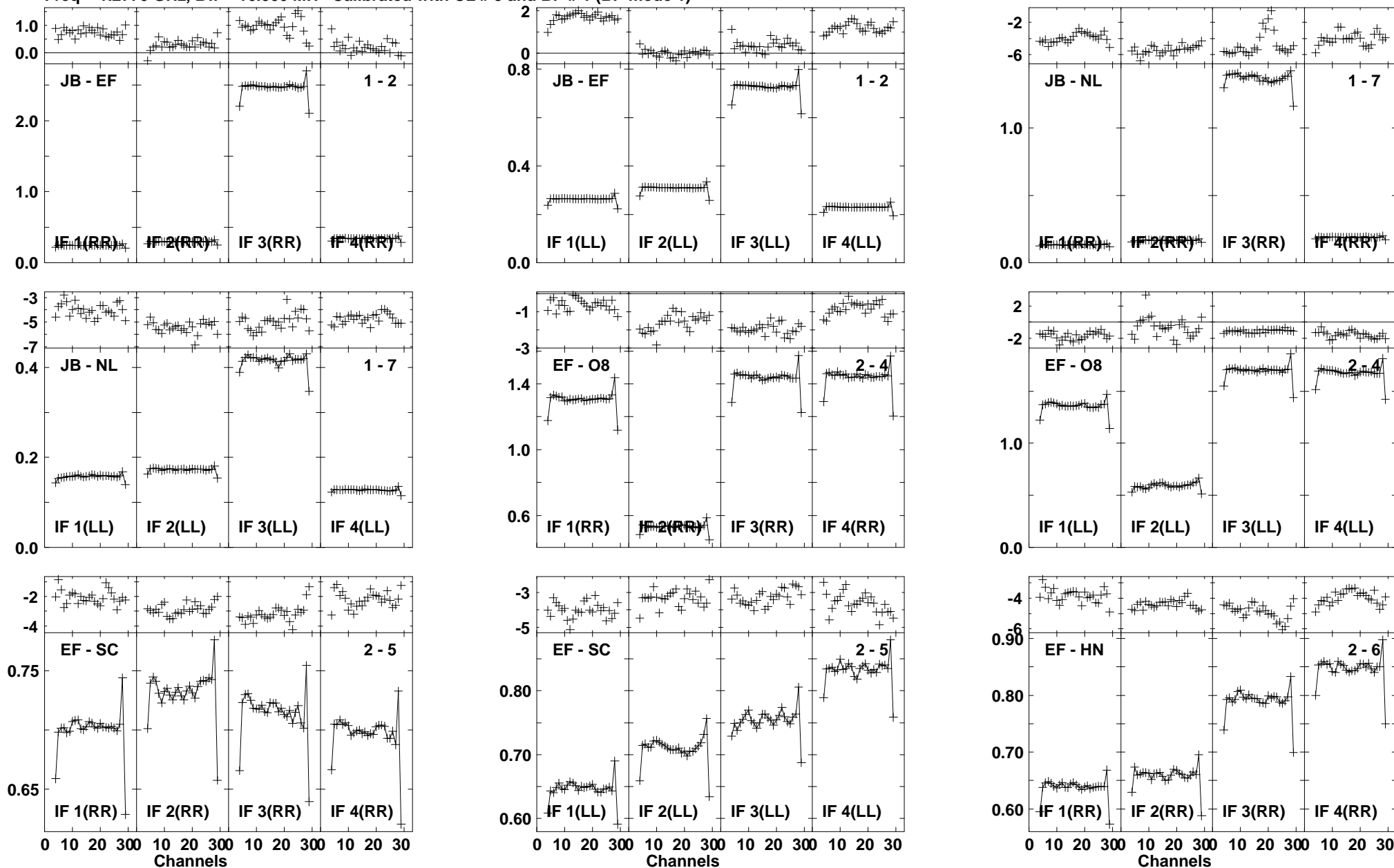

Lower frame: Ampl Jy Top frame: Phas deg
Vector averaged cross-power spectrum Baseline: JB (01) - EF (02)
Timerange: 00/23:41:02 to 00/23:44:50

Plot file version 960 created 03-MAR-2016 01:14:44

J1638+5720 GN002C 1.UVDATA.1

Freq = 1.2770 GHz, Bw = 16.000 MH Calibrated with CL # 3 and BP # 1 (BP mode 1)

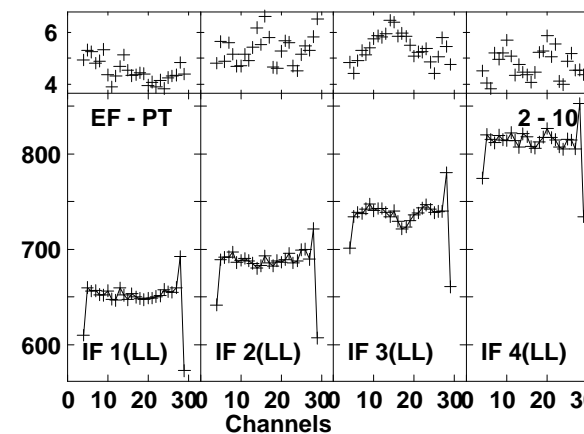
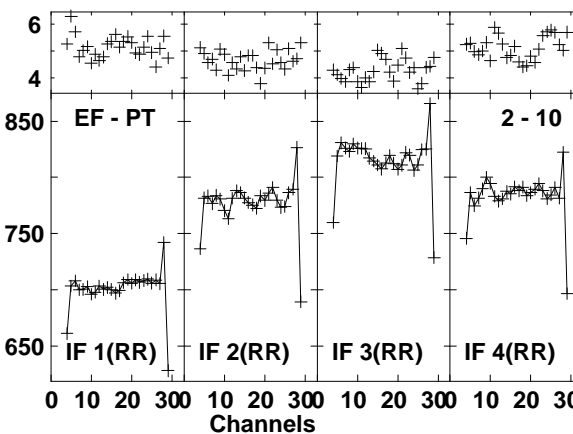
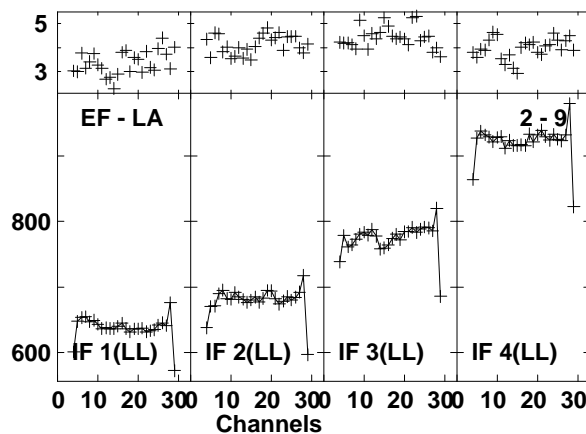
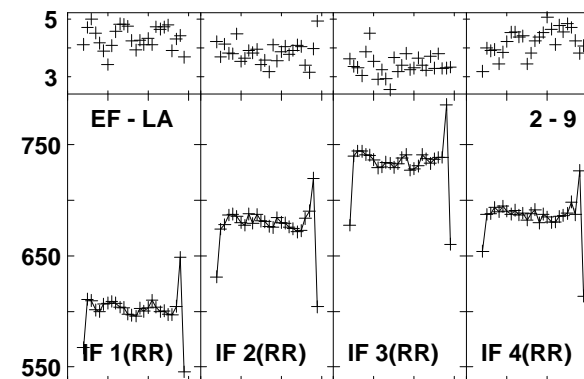
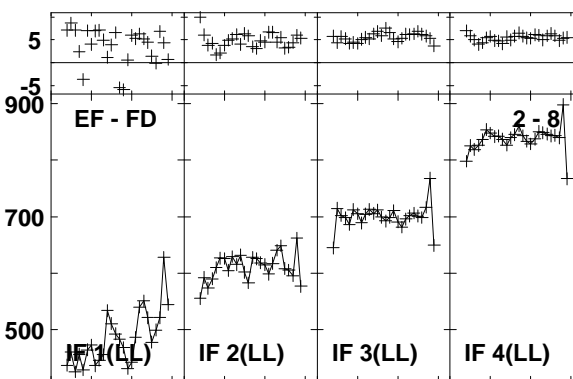
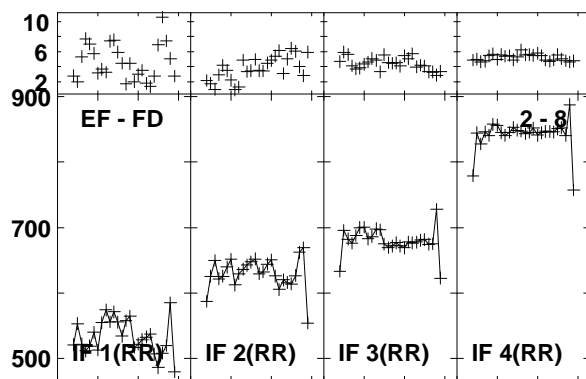
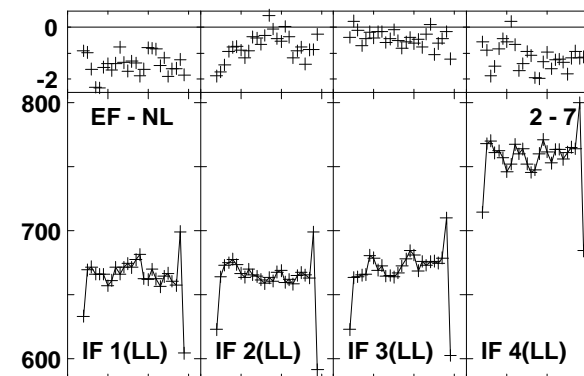
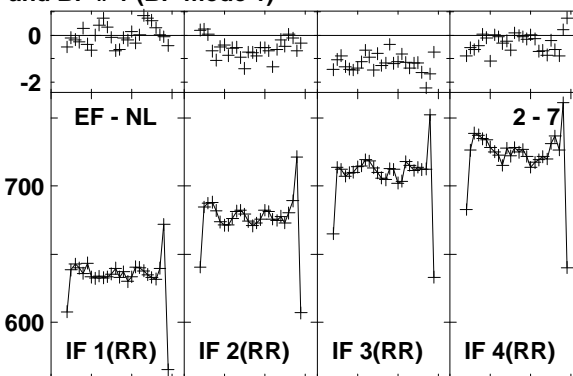
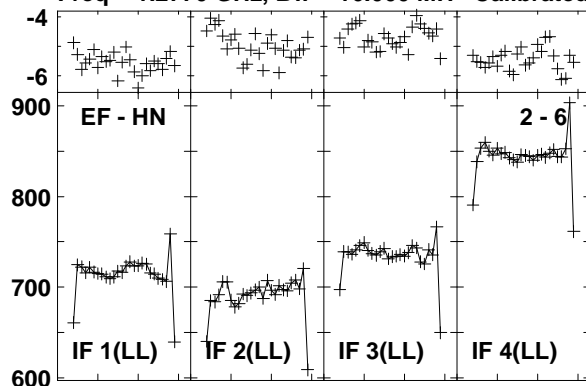

Lower frame: Milli Ampl Jy Top frame: Phas deg
Vector averaged cross-power spectrum Baseline: EF (02) - HN (06)
Timerange: 00/23:41:02 to 00/23:44:50

Plot file version 961 created 03-MAR-2016 01:14:44

J1638+5720 GN002C 1.UVDATA.1

Freq = 1.2770 GHz, Bw = 16.000 MH Calibrated with CL # 3 and BP # 1 (BP mode 1)

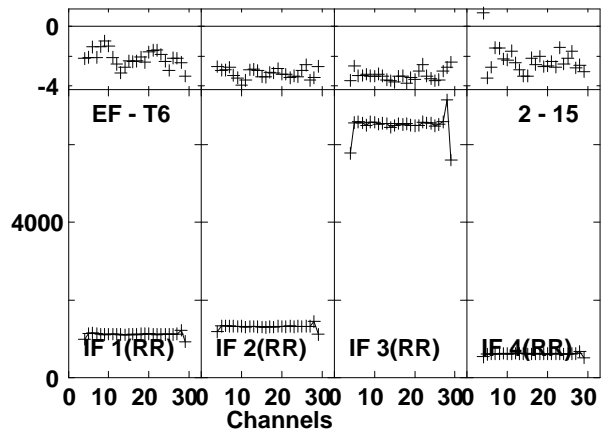
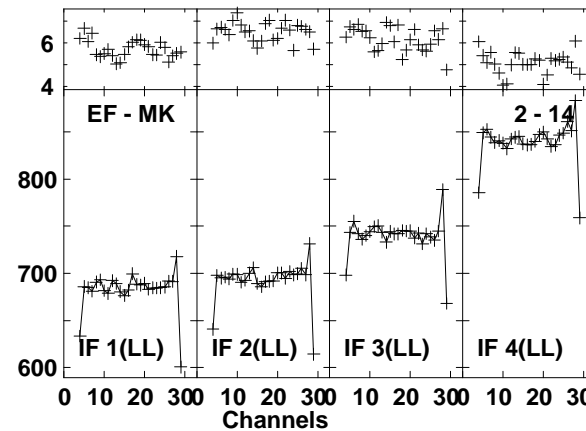
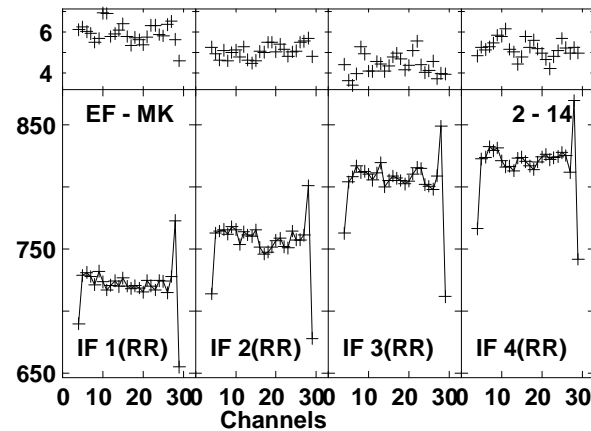
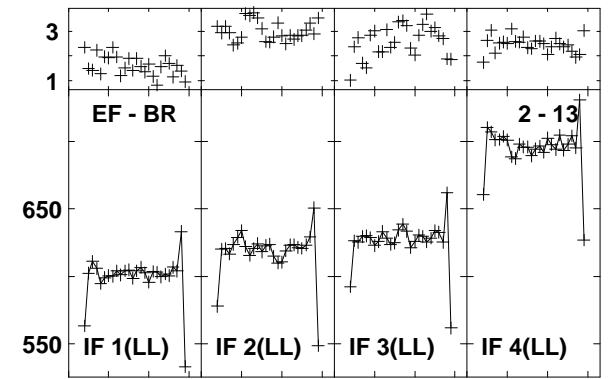
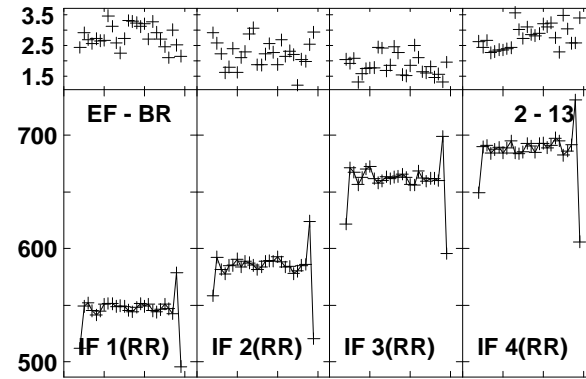
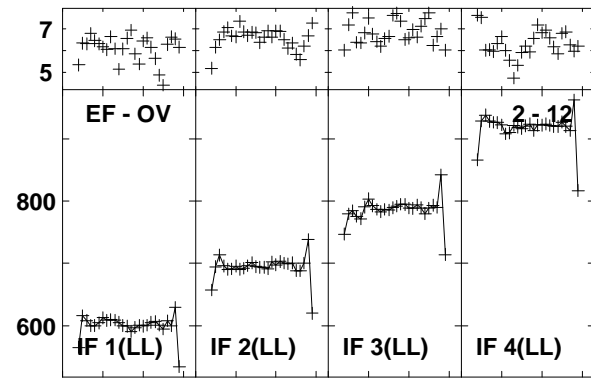
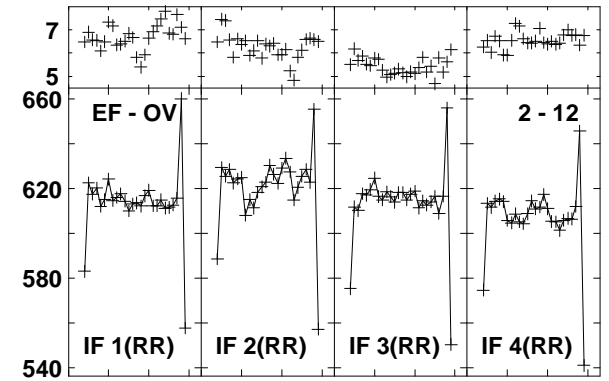
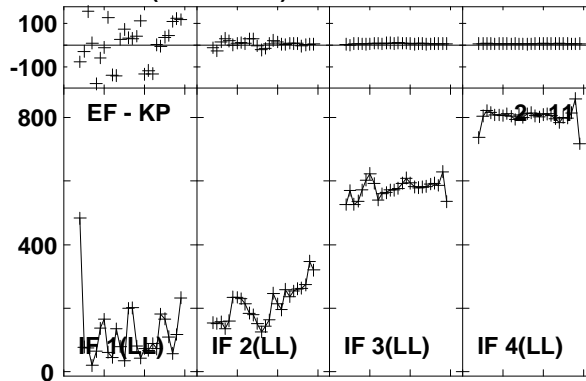
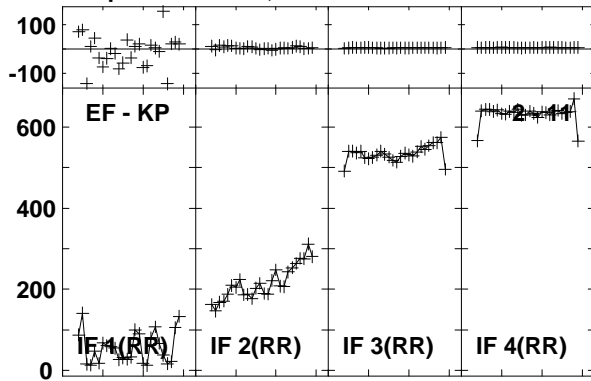

Lower frame: Milli Ampl Jy Top frame: Phas deg
Vector averaged cross-power spectrum Baseline: EF (02) - KP (11)
Timerange: 00/23:41:02 to 00/23:44:50

Plot file version 962 created 03-MAR-2016 01:14:44

J1638+5720 GN002C 1.UVDATA.1

Freq = 1.2770 GHz, Bw = 16.000 MH Calibrated with CL # 3 and BP # 1 (BP mode 1)

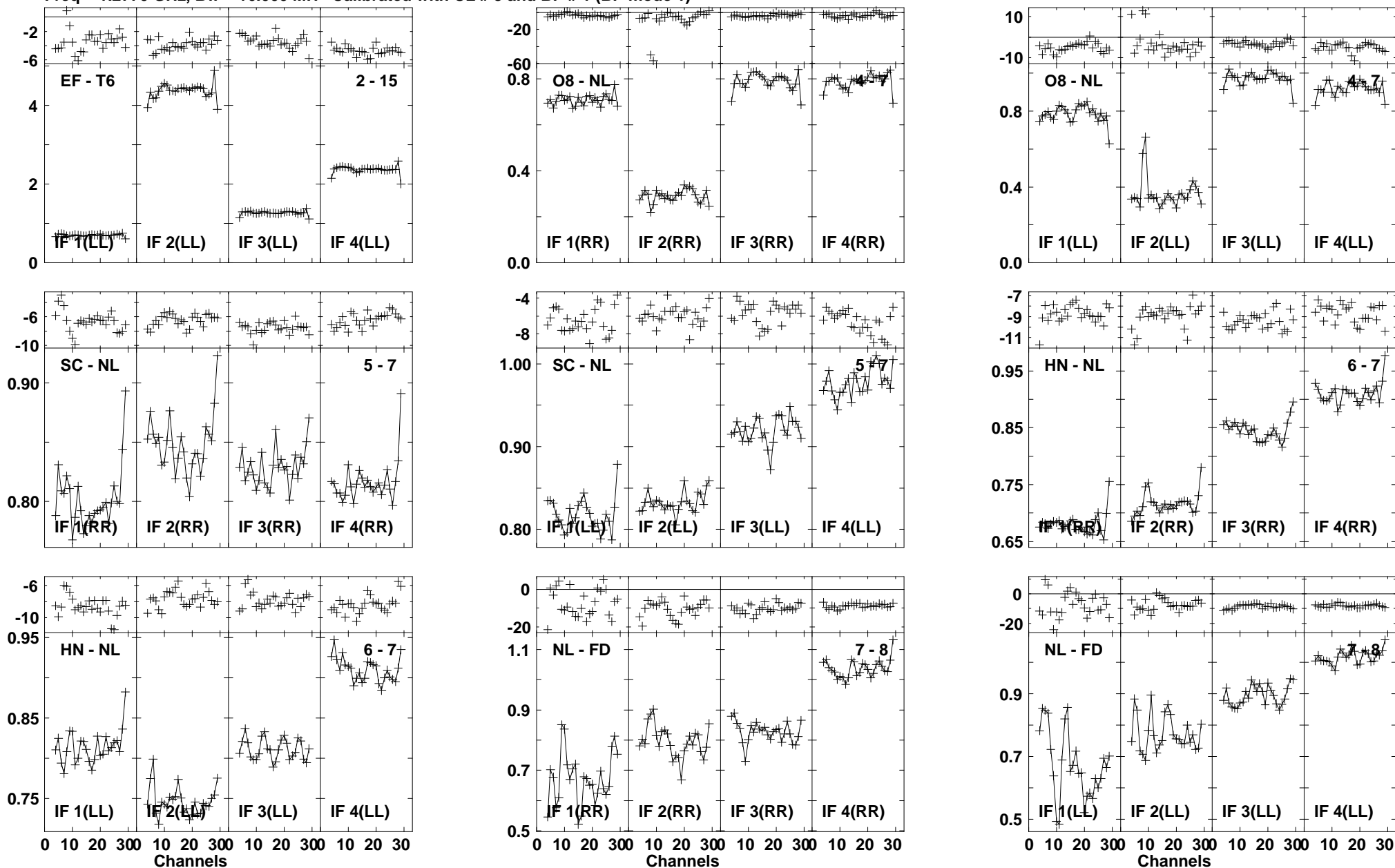

Lower frame: Ampl Jy Top frame: Phas deg
Vector averaged cross-power spectrum Baseline: EF (02) - T6 (15)
Timerange: 00/23:41:02 to 00/23:44:50

Plot file version 963 created 03-MAR-2016 01:14:44

J1638+5720 GN002C 1.UVDATA.1

Freq = 1.2770 GHz, Bw = 16.000 MH Calibrated with CL # 3 and BP # 1 (BP mode 1)

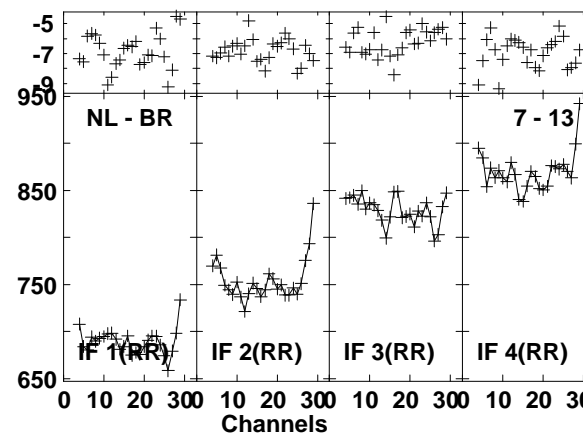
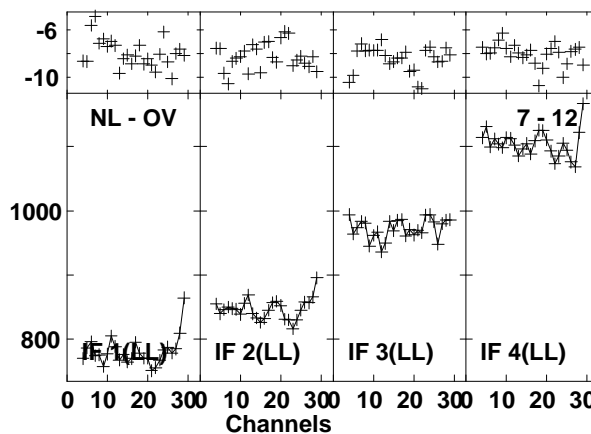
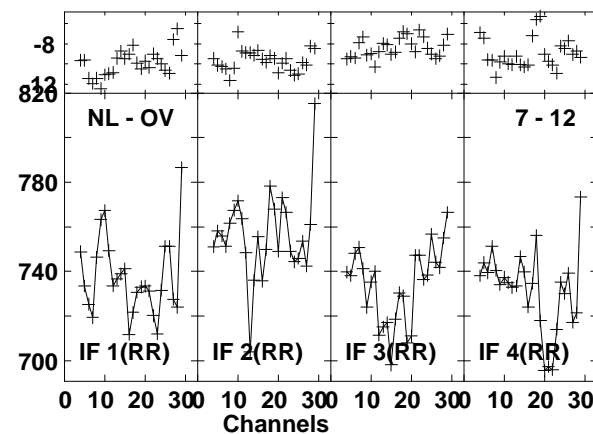
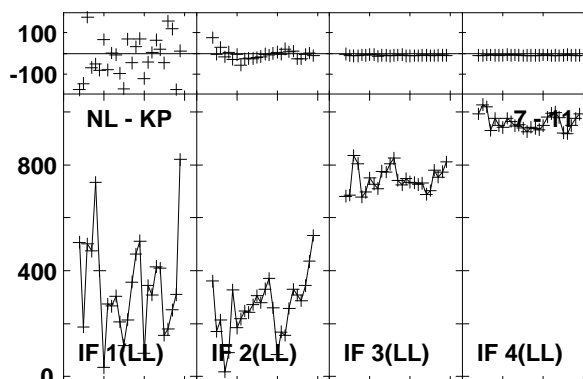
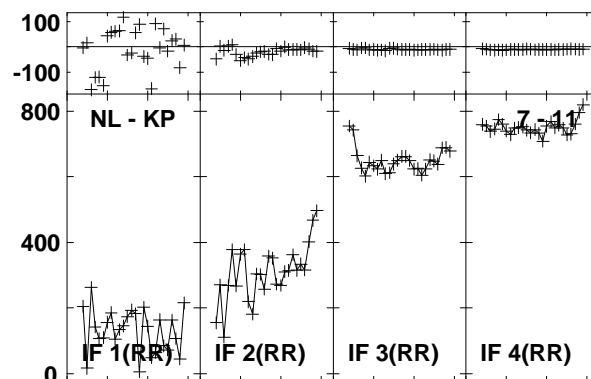
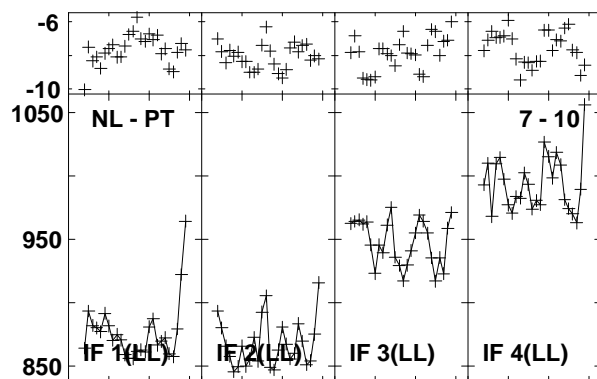
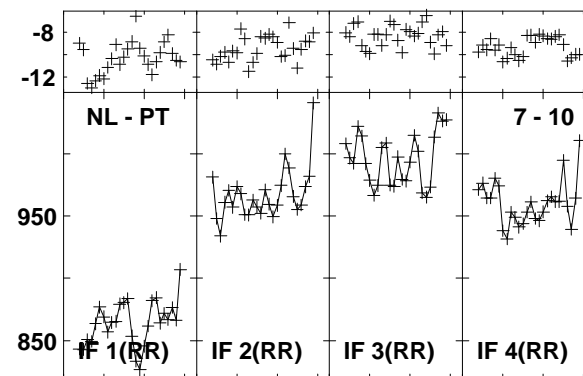
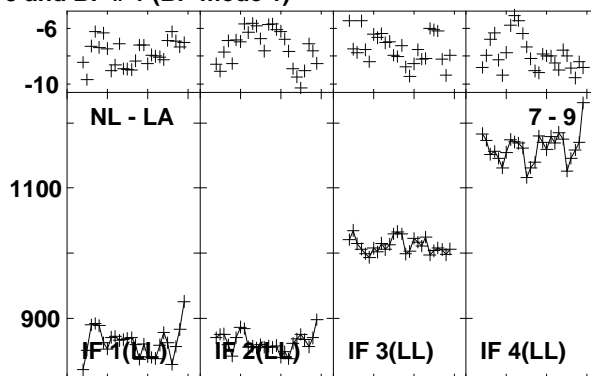
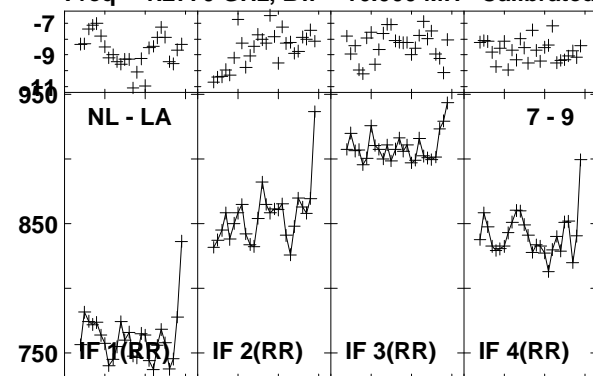

Lower frame: Milli Ampl Jy Top frame: Phas deg
Vector averaged cross-power spectrum Baseline: NL (07) - LA (09)
Timerange: 00/23:41:02 to 00/23:44:50

Plot file version 964 created 03-MAR-2016 01:14:44
 J1638+5720 GN002C 1.UVDATA.1
 Freq = 1.2770 GHz, Bw = 16.000 MH Calibrated with CL # 3 and BP # 1 (BP mode 1)

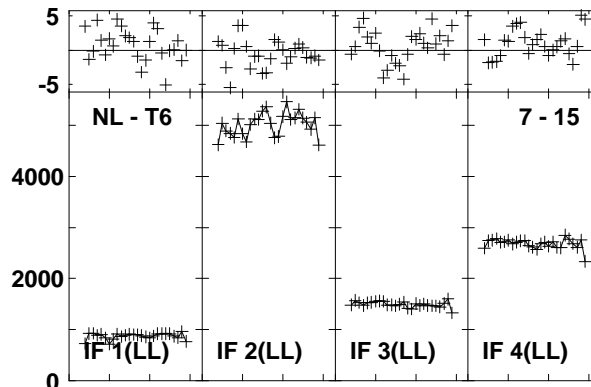
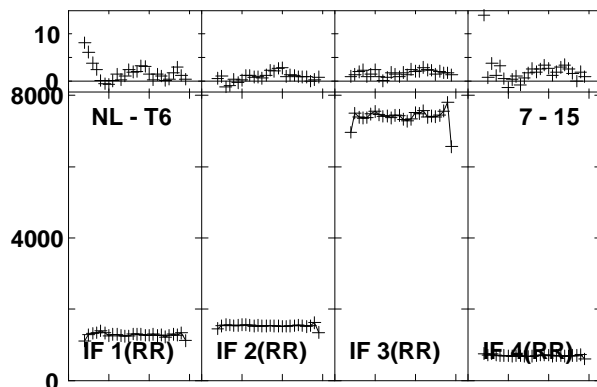
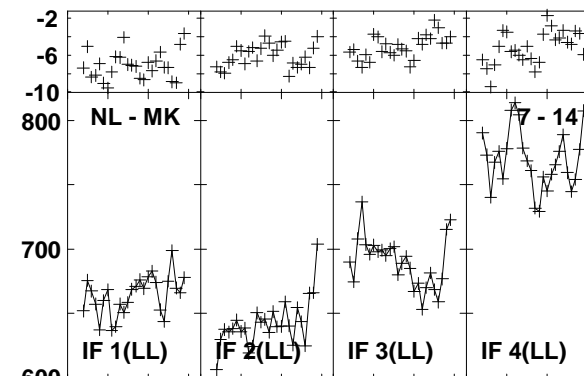
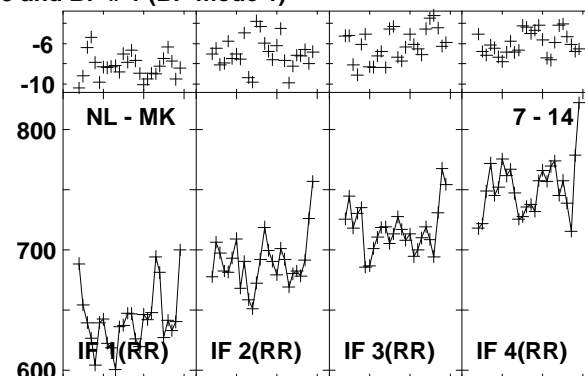
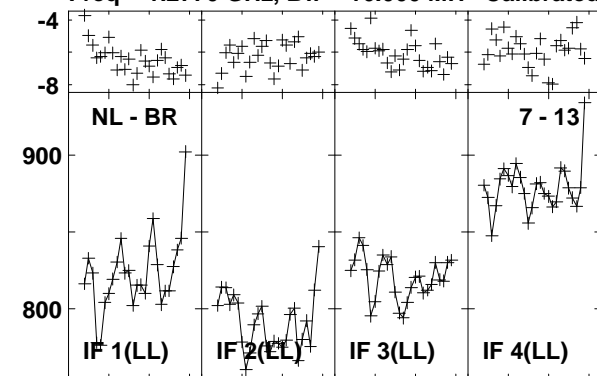

Lower frame: Milli Ampl Jy Top frame: Phas deg
 Vector averaged cross-power spectrum Baseline: NL (07) - BR (13)
 Timerange: 00/23:41:02 to 00/23:44:50

Plot file version 965 created 03-MAR-2016 01:14:45

J1545+5400 GN002C 1.UVDATA.1

Freq = 1.2770 GHz, Bw = 16.000 MH Calibrated with CL # 3 and BP # 1 (BP mode 1)

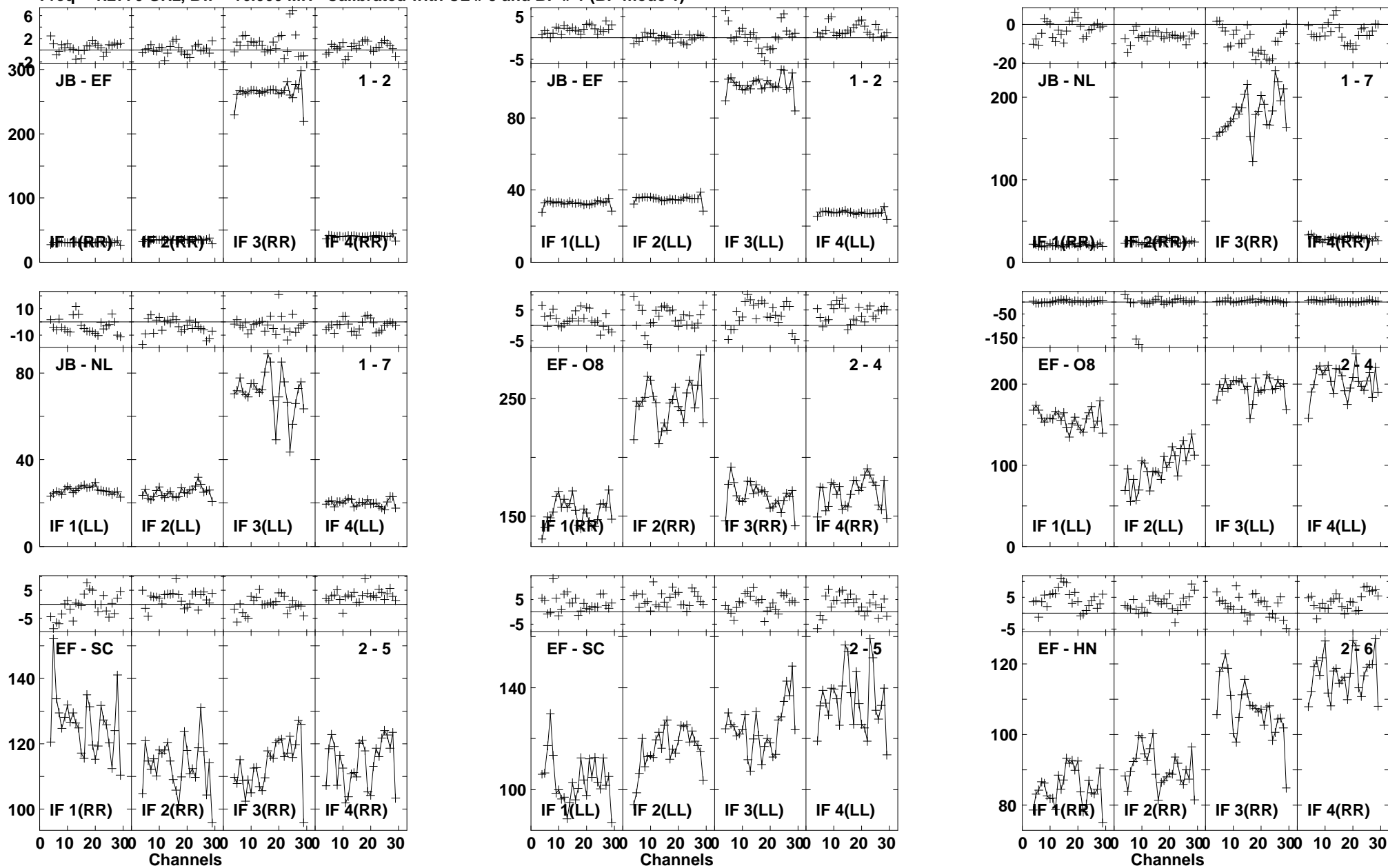

Lower frame: Milli Ampl Jy Top frame: Phas deg
Vector averaged cross-power spectrum Baseline: JB (01) - EF (02)
Timerange: 00/23:46:02 to 00/23:48:50

Plot file version 966 created 03-MAR-2016 01:14:45

J1545+5400 GN002C 1.UVDATA.1

Freq = 1.2770 GHz, Bw = 16.000 MH Calibrated with CL # 3 and BP # 1 (BP mode 1)

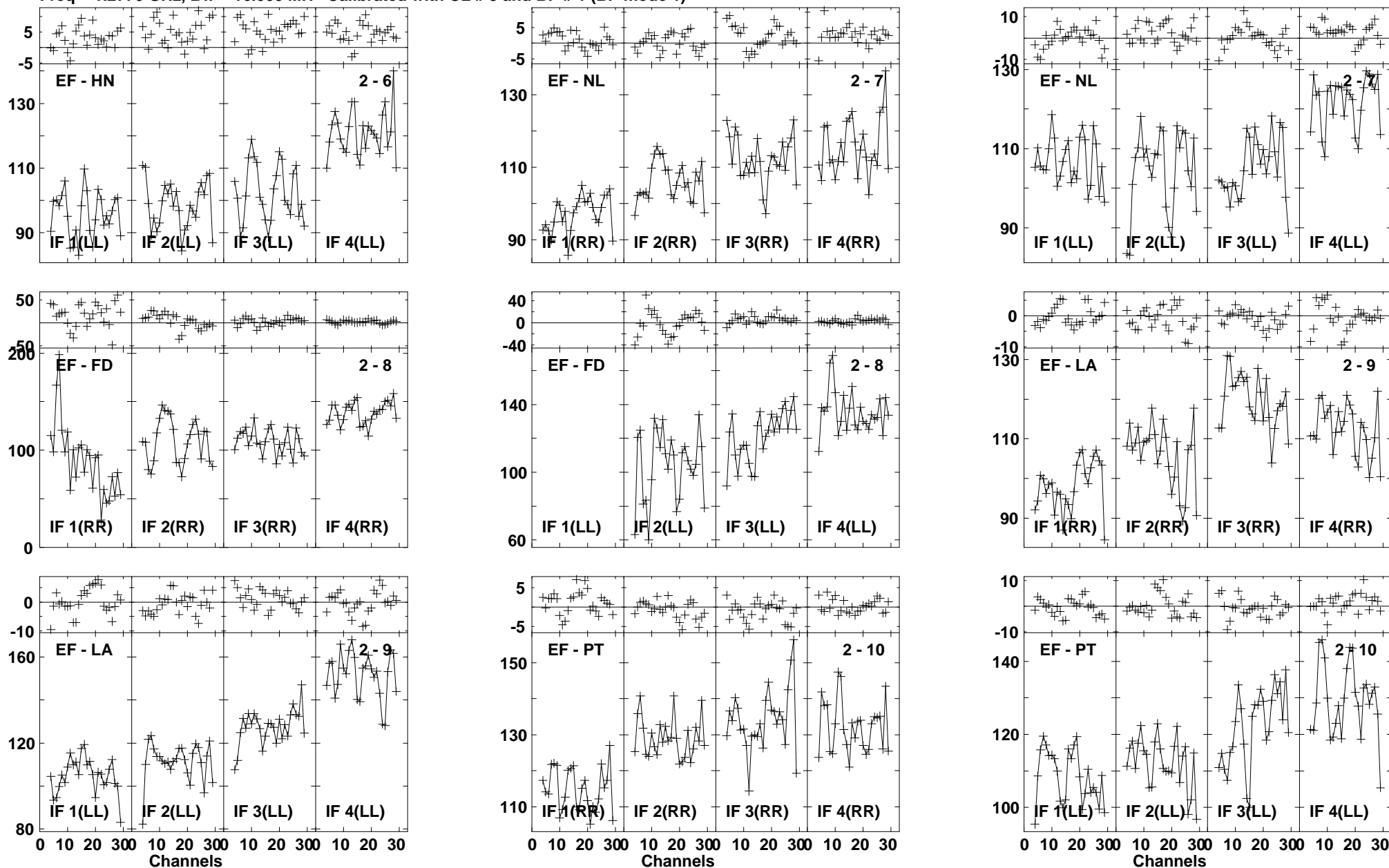

Lower frame: Milli Ampl Jy Top frame: Phas deg
Vector averaged cross-power spectrum Baseline: EF (02) - HN (06)
Timerange: 00/23:46:02 to 00/23:48:50

Plot file version 967 created 03-MAR-2016 01:14:45

J1545+5400 GN002C 1.UVDATA.1

Freq = 1.2770 GHz, Bw = 16.000 MH Calibrated with CL # 3 and BP # 1 (BP mode 1)

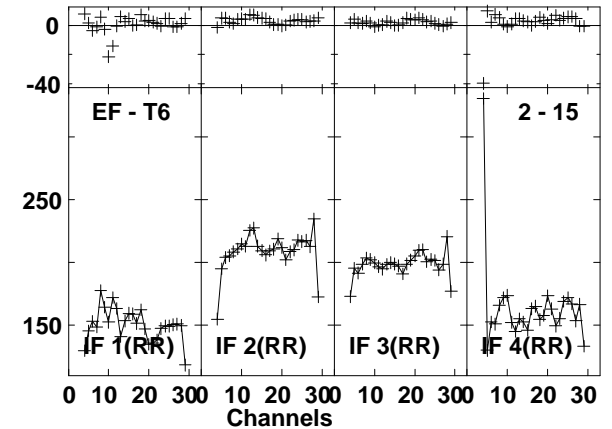
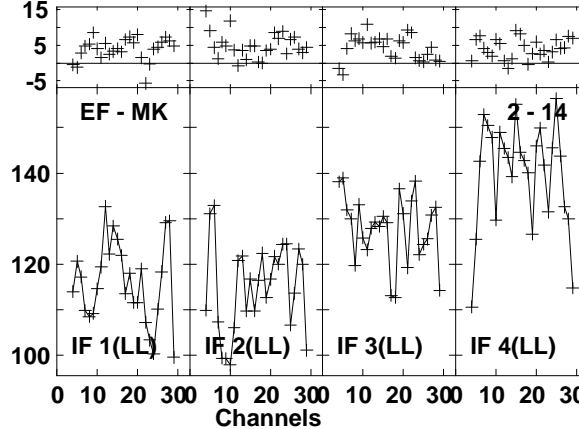
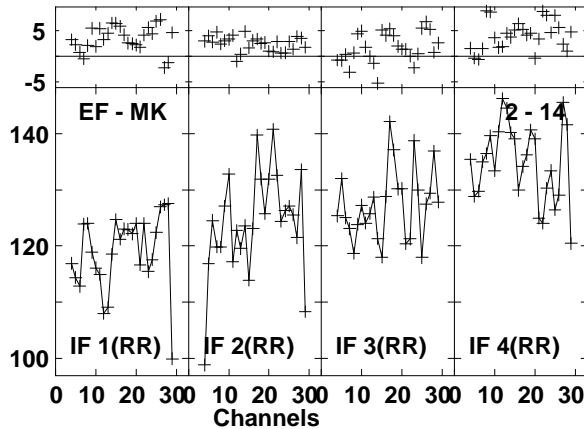
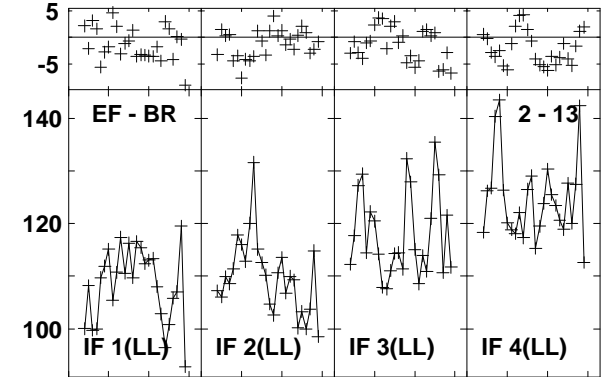
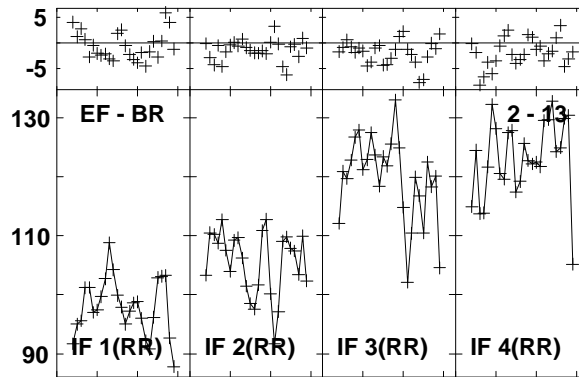
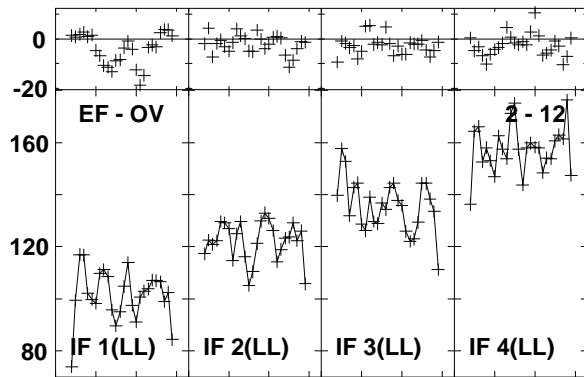
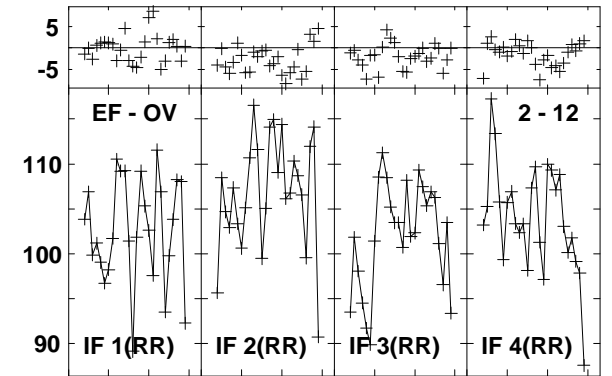
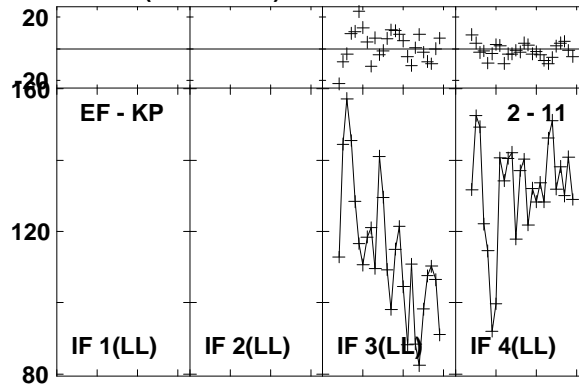
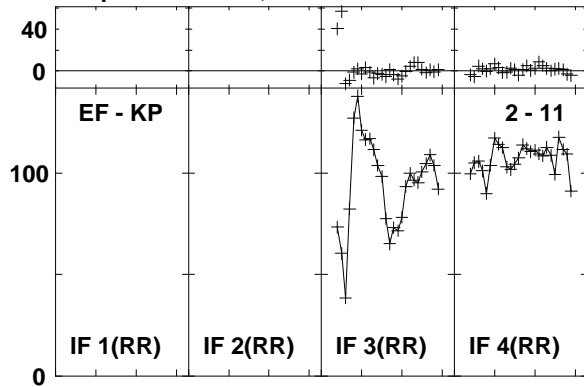

Lower frame: Milli Ampl Jy Top frame: Phas deg
Vector averaged cross-power spectrum Baseline: EF (02) - KP (11)
Timerange: 00/23:46:02 to 00/23:48:50

Plot file version 968 created 03-MAR-2016 01:14:45

J1545+5400 GN002C 1.UVDATA.1

Freq = 1.2770 GHz, Bw = 16.000 MH Calibrated with CL # 3 and BP # 1 (BP mode 1)

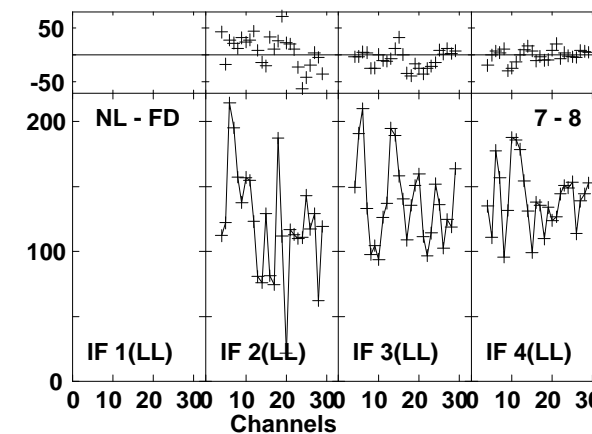
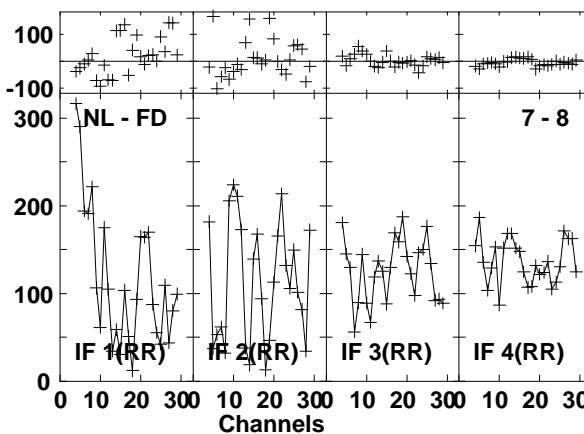
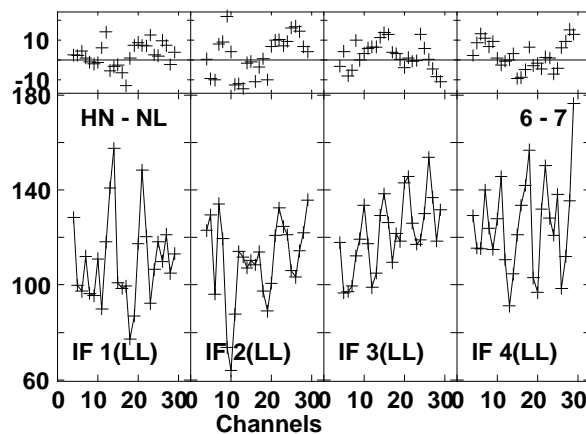
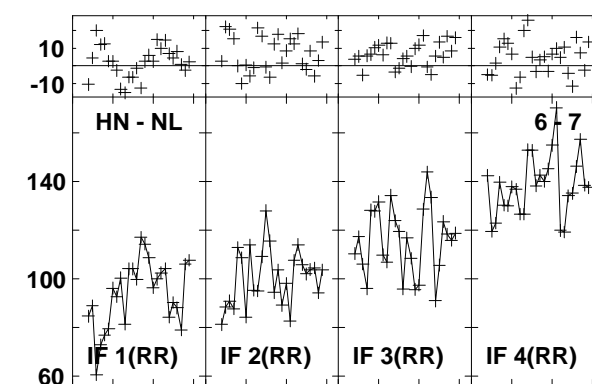
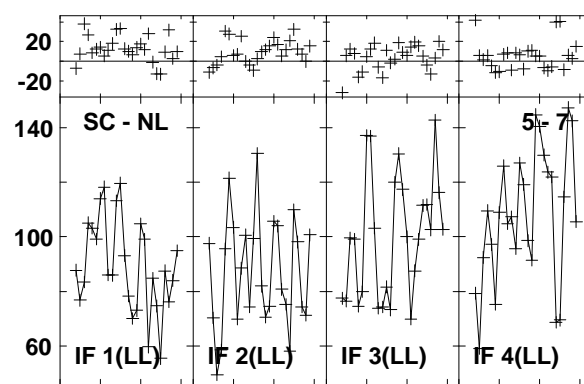
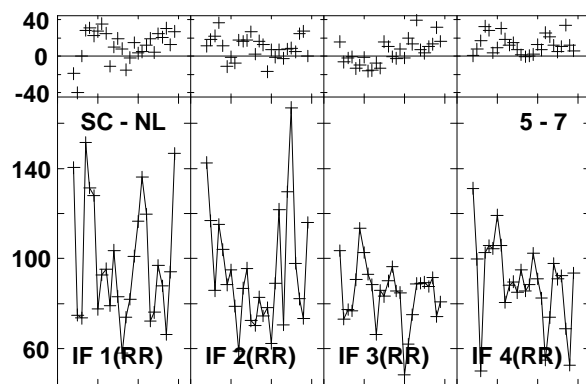
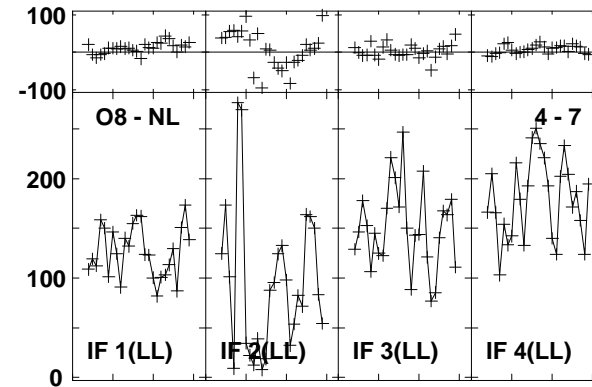
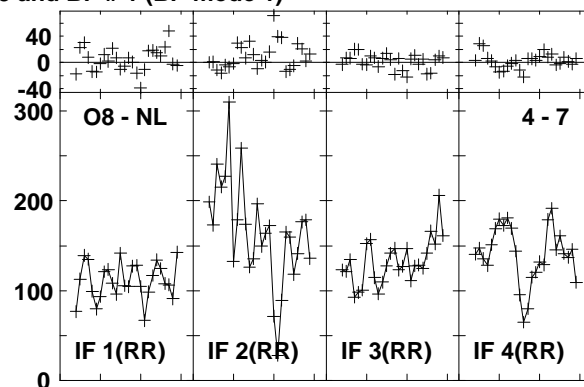
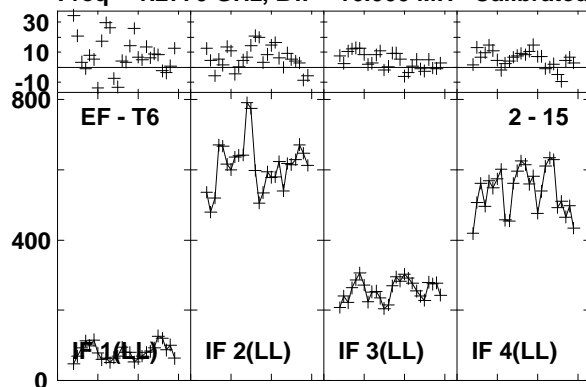

Lower frame: Milli Ampl Jy Top frame: Phas deg
Vector averaged cross-power spectrum Baseline: EF (02) - T6 (15)
Timerange: 00/23:46:02 to 00/23:48:50

Plot file version 969 created 03-MAR-2016 01:14:45

J1545+5400 GN002C 1.UVDATA.1

Freq = 1.2770 GHz, Bw = 16.000 MH Calibrated with CL # 3 and BP # 1 (BP mode 1)

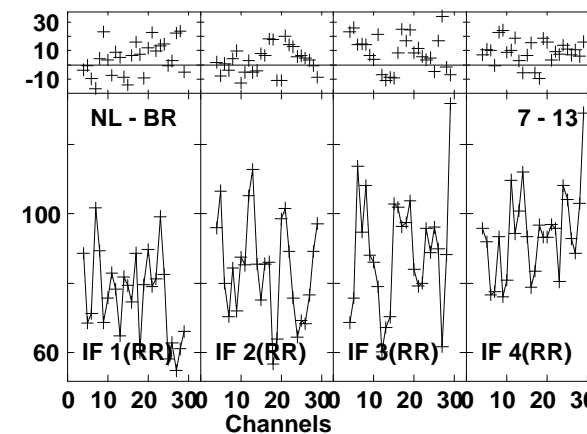
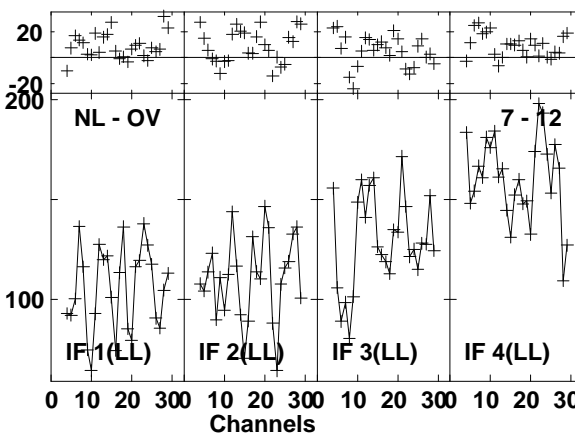
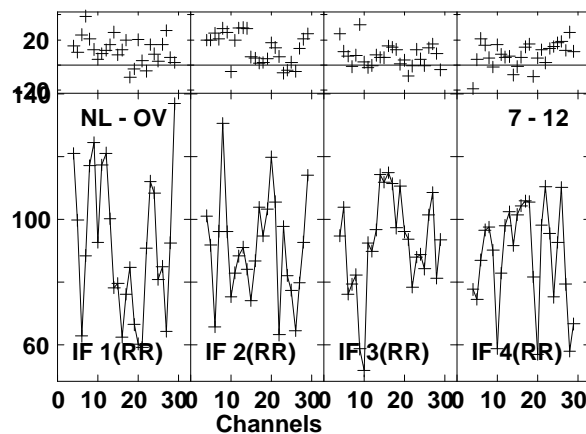
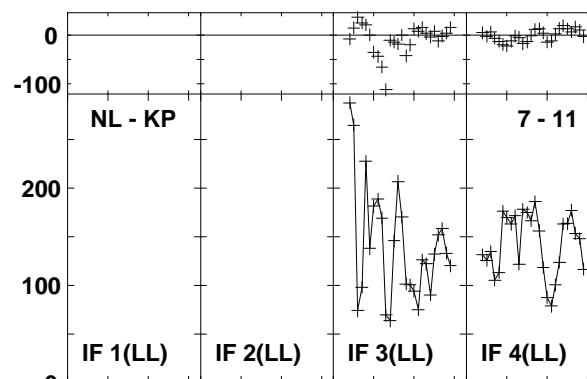
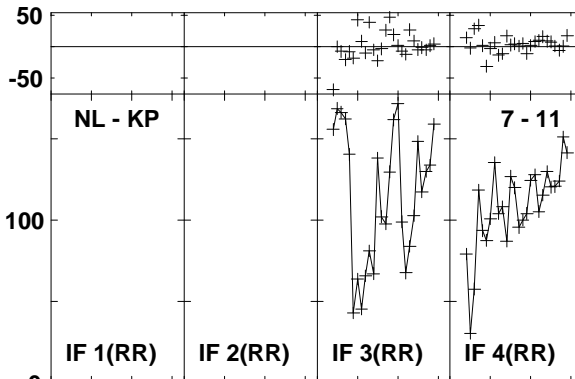
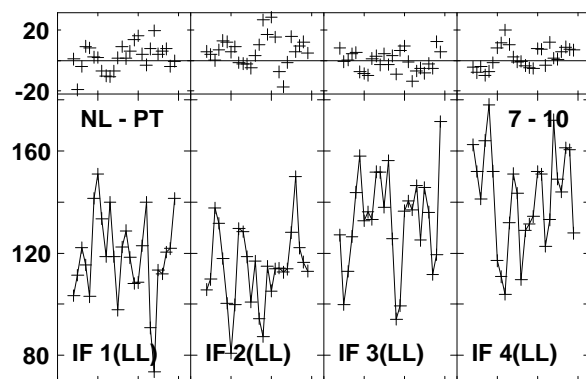
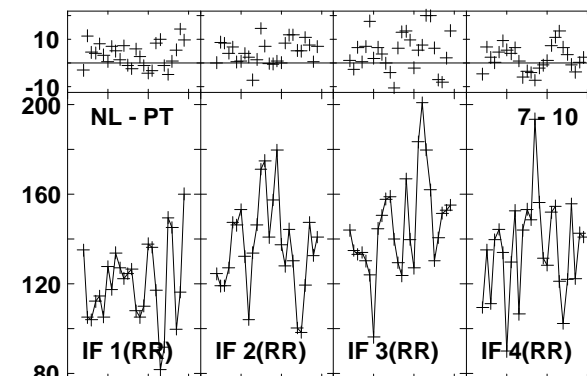
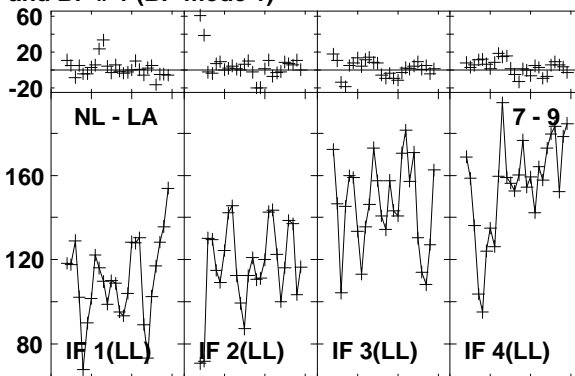
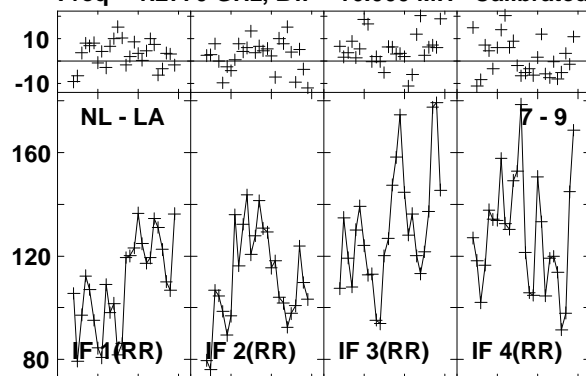

Lower frame: Milli Ampl Jy Top frame: Phas deg
Vector averaged cross-power spectrum Baseline: NL (07) - LA (09)
Timerange: 00/23:46:02 to 00/23:48:50

Plot file version 970 created 03-MAR-2016 01:14:46

J1545+5400 GN002C 1.UVDATA.1

Freq = 1.2770 GHz, Bw = 16.000 MH Calibrated with CL # 3 and BP # 1 (BP mode 1)

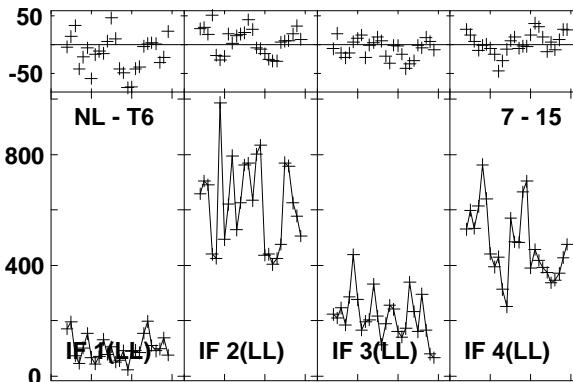
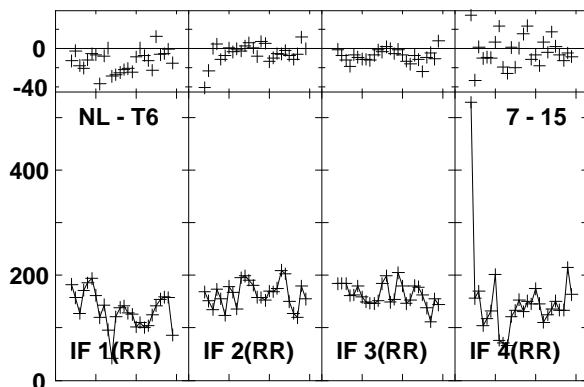
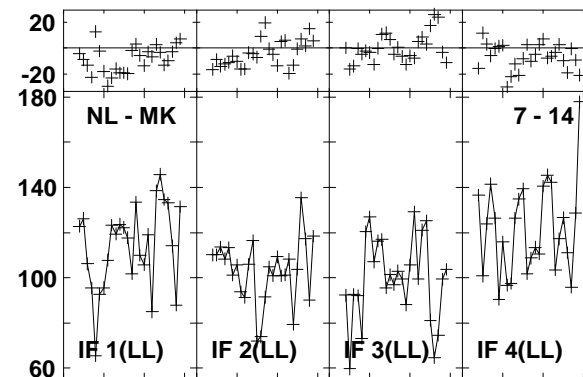
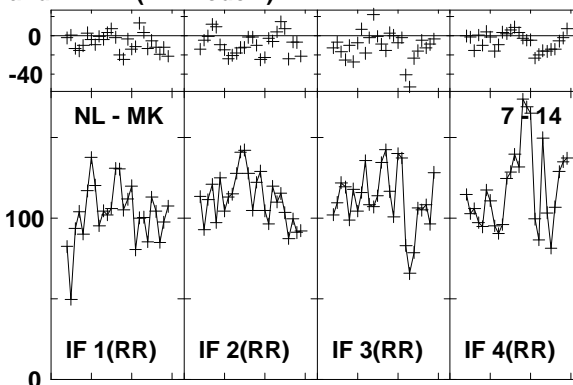
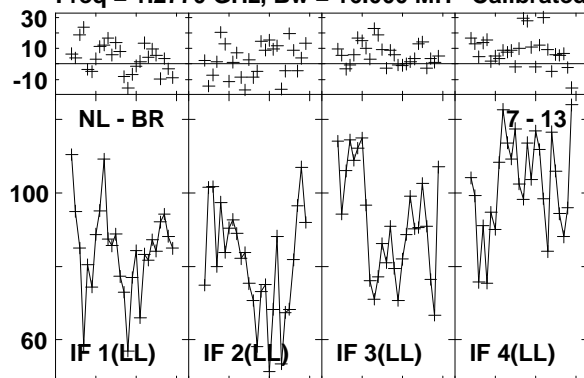

Lower frame: Milli Ampl Jy Top frame: Phas deg
Vector averaged cross-power spectrum Baseline: NL (07) - BR (13)
Timerange: 00/23:46:02 to 00/23:48:50

Plot file version 971 created 03-MAR-2016 01:14:46

4C52 GN002C 1.UVDATA.1

Freq = 1.2770 GHz, Bw = 16.000 MH Calibrated with CL # 3 and BP # 1 (BP mode 1)

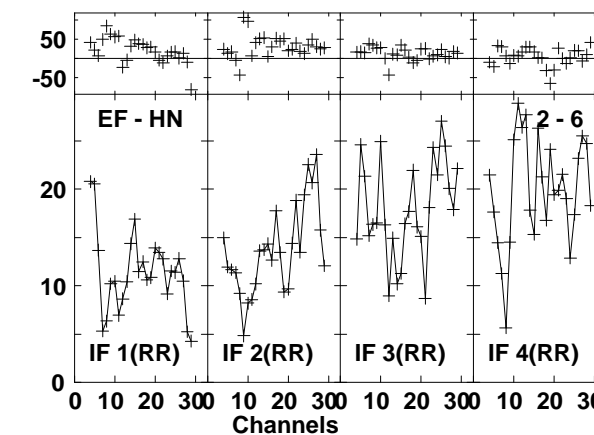
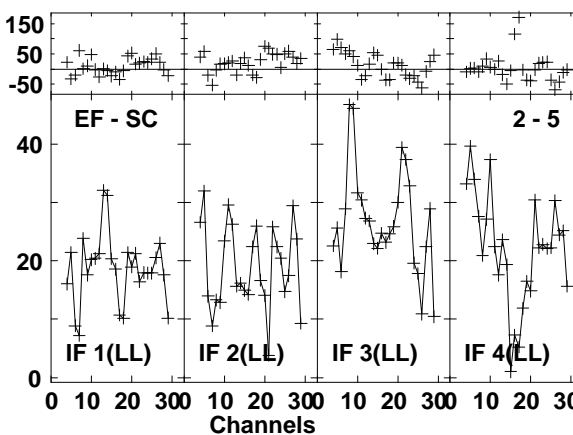
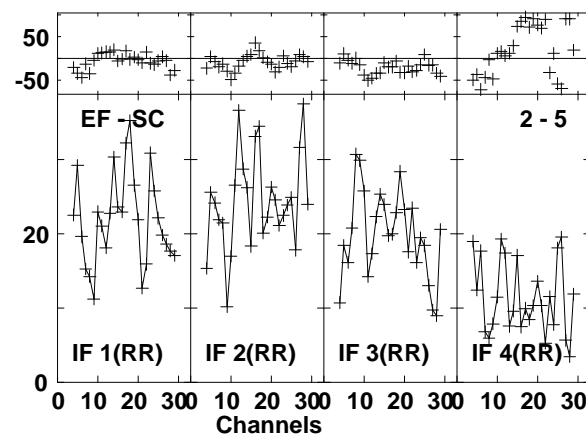
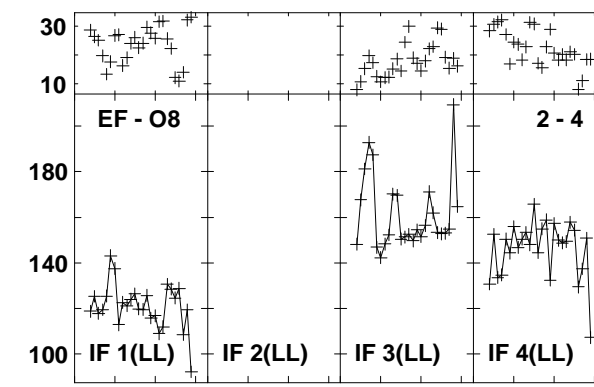
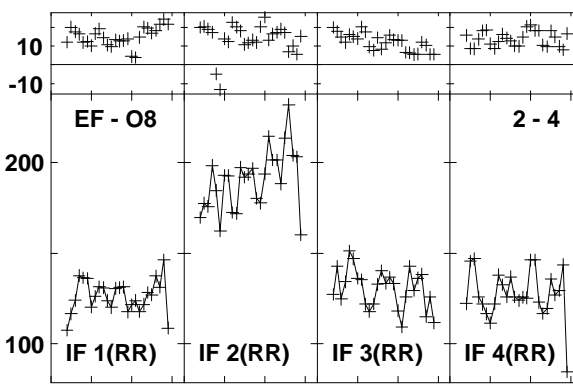
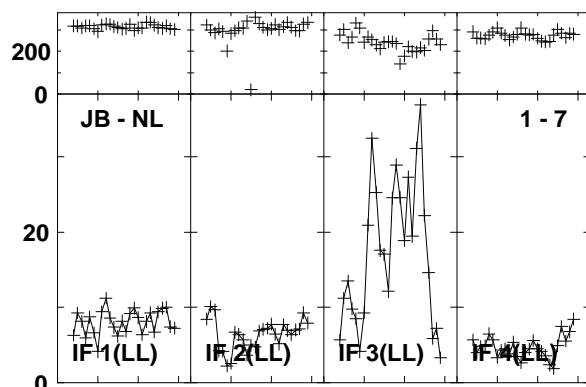
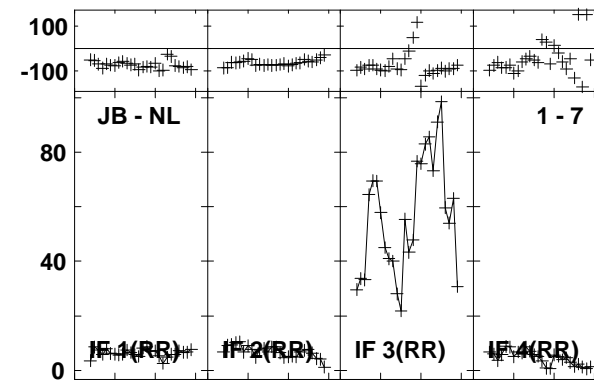
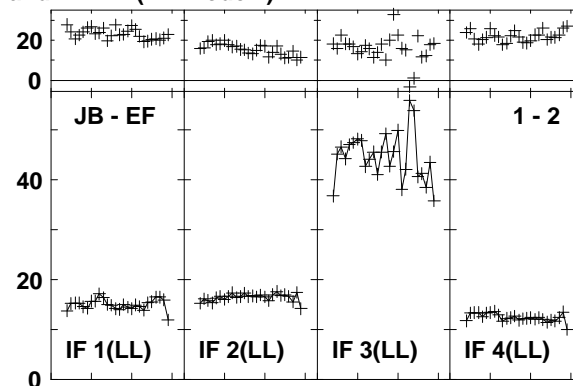
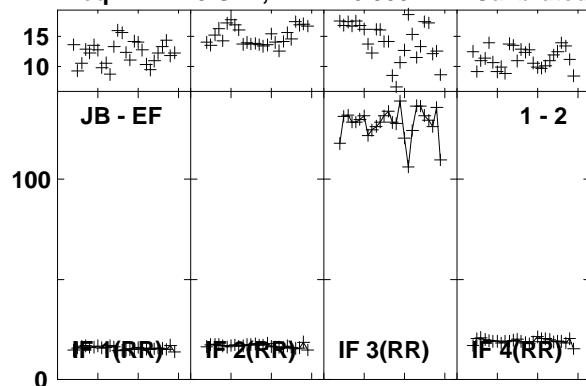

Lower frame: Milli Ampl Jy Top frame: Phas deg
Vector averaged cross-power spectrum Baseline: JB (01) - EF (02)
Timerange: 00/23:49:03 to 00/23:52:19

Plot file version 972 created 03-MAR-2016 01:14:46

4C52 GN002C 1.UVDATA.1

Freq = 1.2770 GHz, Bw = 16.000 MH Calibrated with CL # 3 and BP # 1 (BP mode 1)

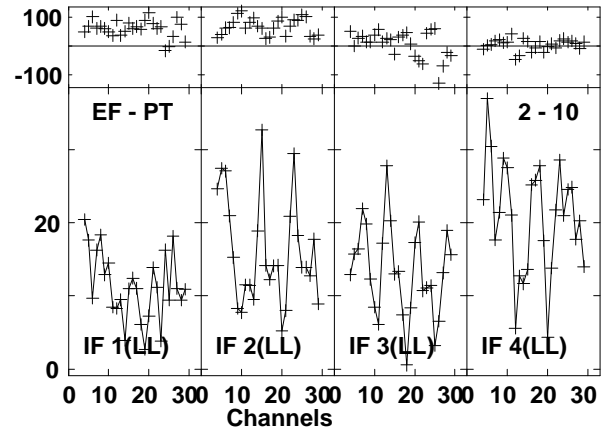
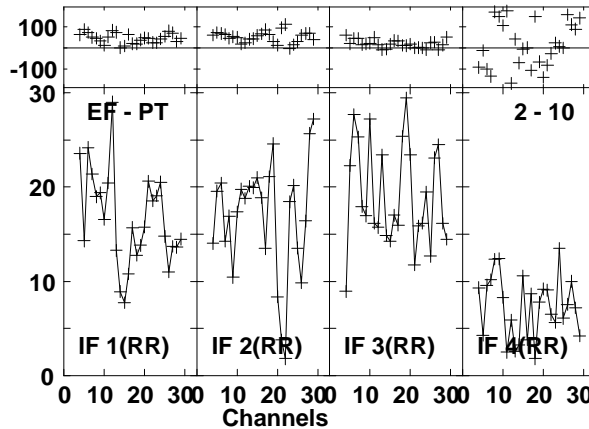
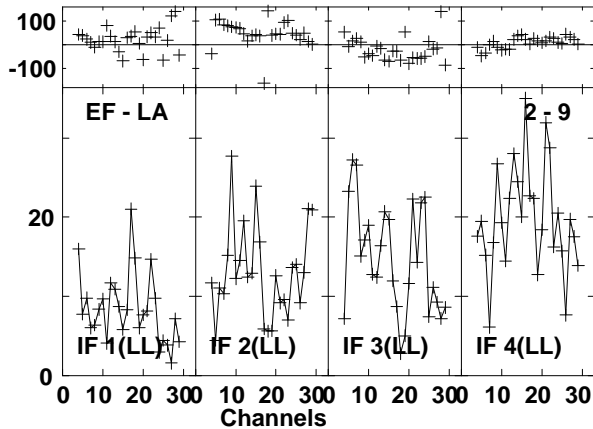
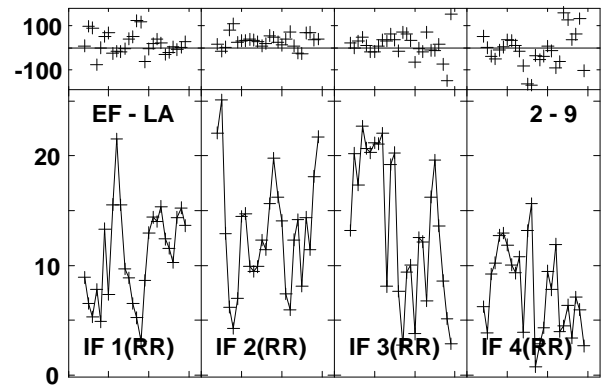
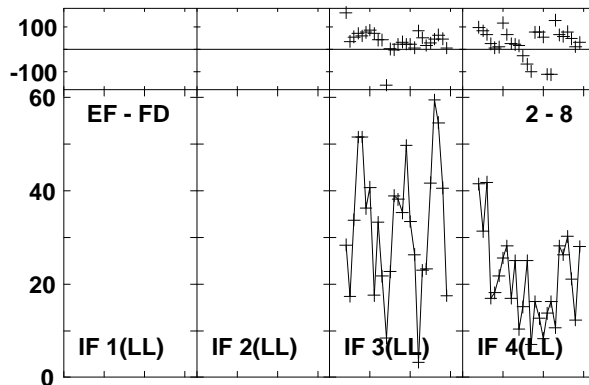
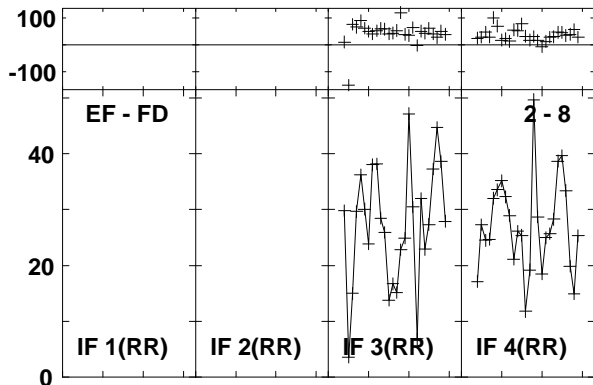
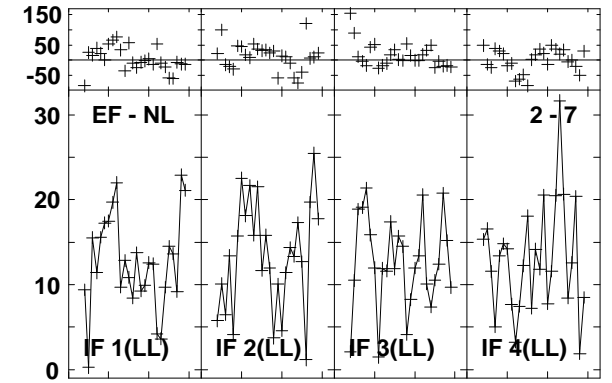
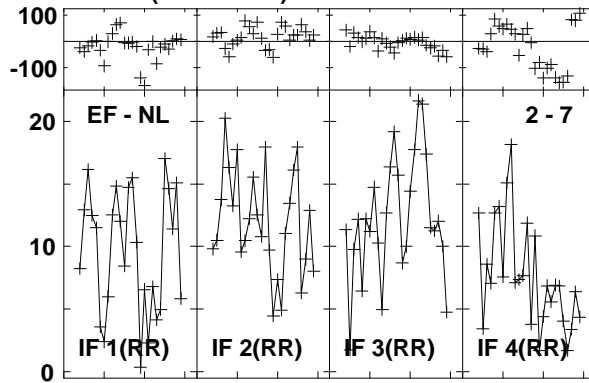
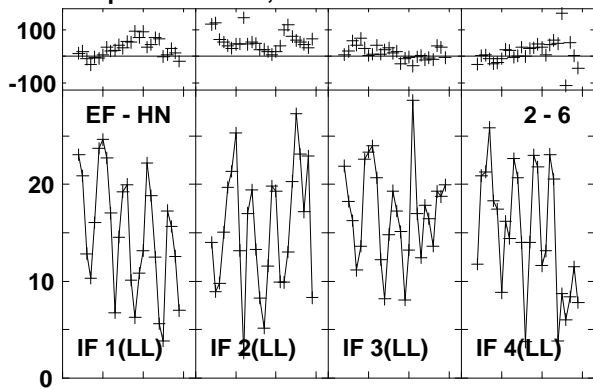

Lower frame: Milli Ampl Jy Top frame: Phas deg
Vector averaged cross-power spectrum Baseline: EF (02) - HN (06)
Timerange: 00/23:49:03 to 00/23:52:19

Plot file version 973 created 03-MAR-2016 01:14:46
 4C52 GN002C 1.UVDATA.1
 Freq = 1.2770 GHz, Bw = 16.000 MH Calibrated with CL # 3 and BP # 1 (BP mode 1)

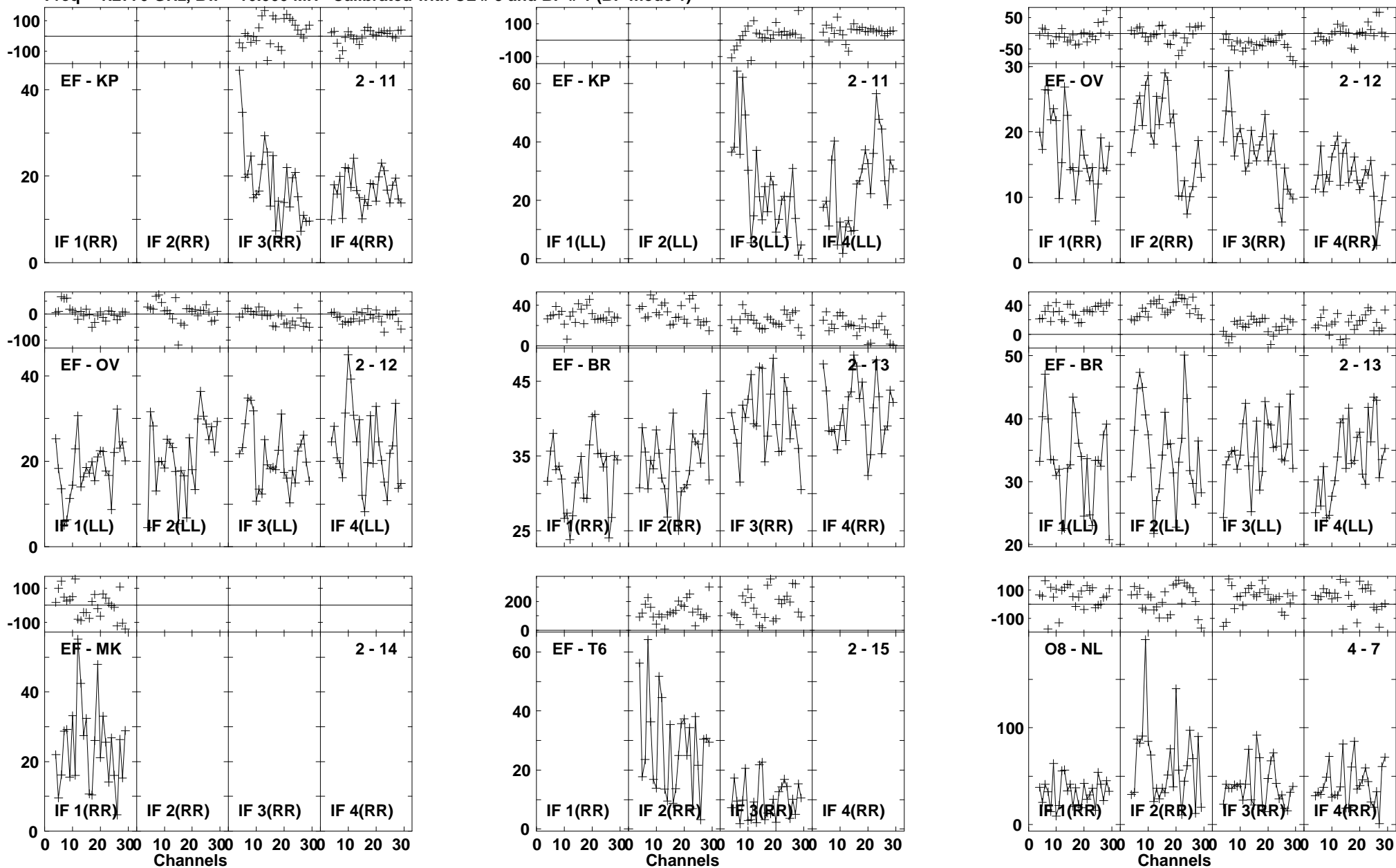

Lower frame: Milli Ampl Jy Top frame: Phas deg
 Vector averaged cross-power spectrum Baseline: EF (02) - KP (11)
 Timerange: 00/23:49:03 to 00/23:52:19

Plot file version 974 created 03-MAR-2016 01:14:46

4C52 GN002C 1.UVDATA.1

Freq = 1.2770 GHz, Bw = 16.000 MH Calibrated with CL # 3 and BP # 1 (BP mode 1)

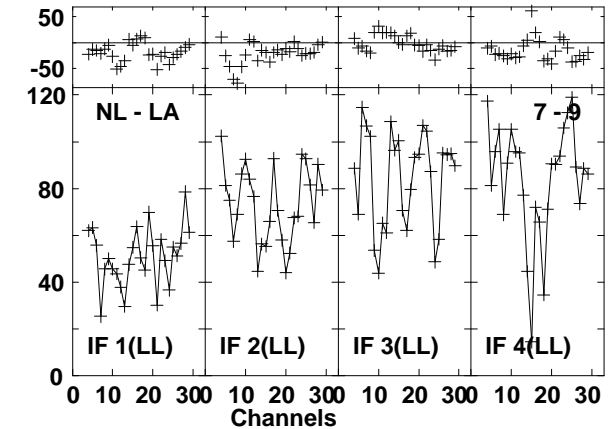
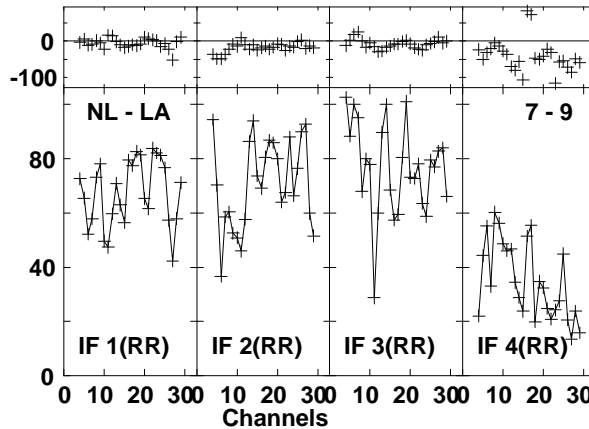
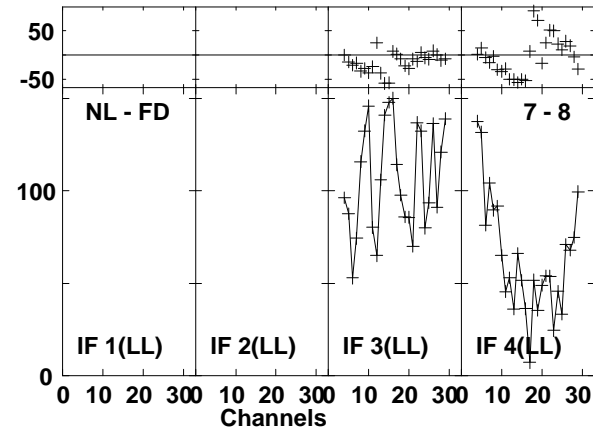
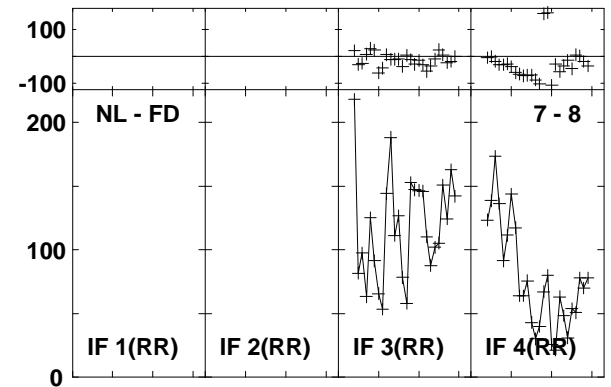
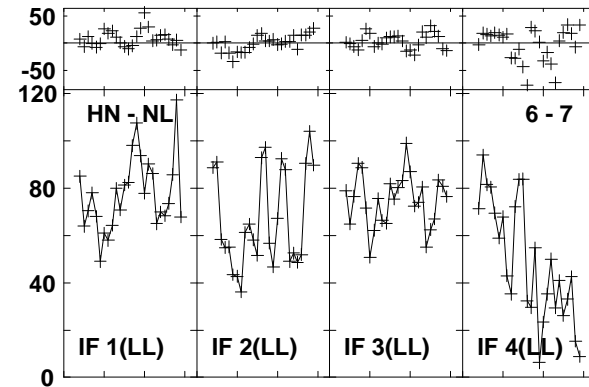
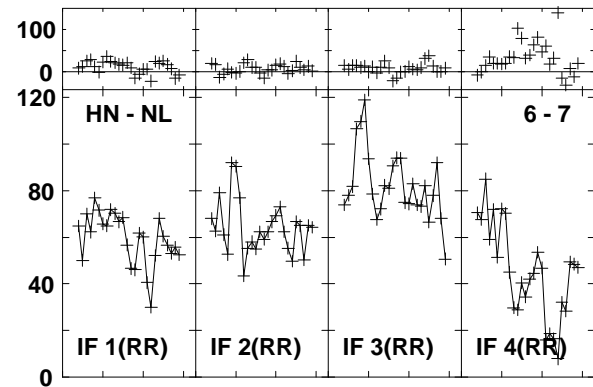
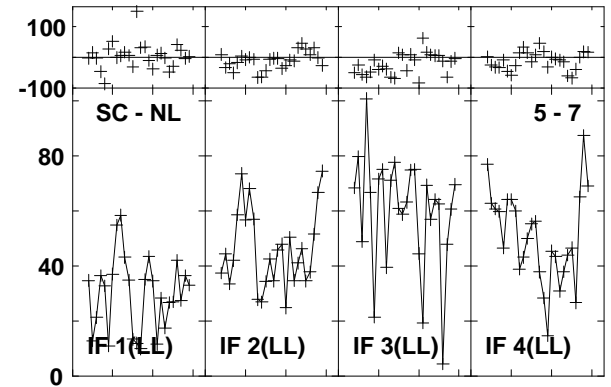
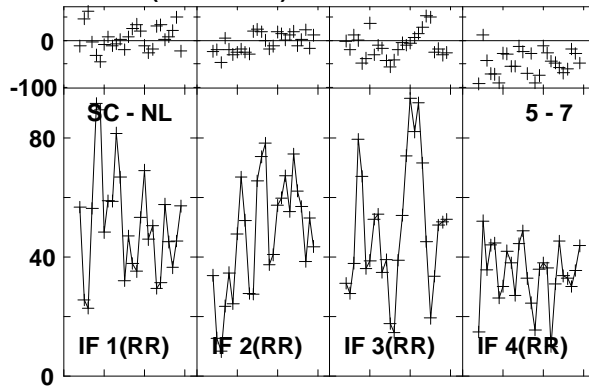
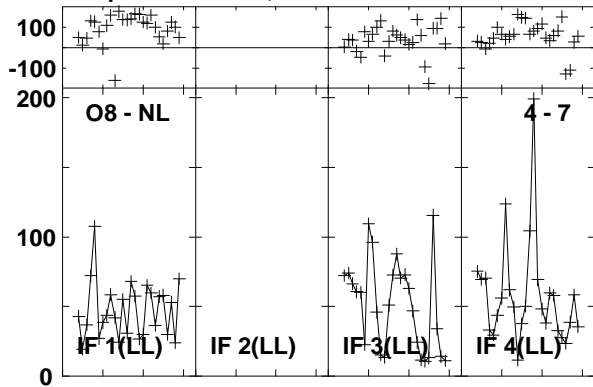

Lower frame: Milli Ampl Jy Top frame: Phas deg
Vector averaged cross-power spectrum Baseline: O8 (04) - NL (07)
Timerange: 00/23:49:03 to 00/23:52:19

Plot file version 975 created 03-MAR-2016 01:14:46

4C52 GN002C 1.UVDATA.1

Freq = 1.2770 GHz, Bw = 16.000 MH Calibrated with CL # 3 and BP # 1 (BP mode 1)

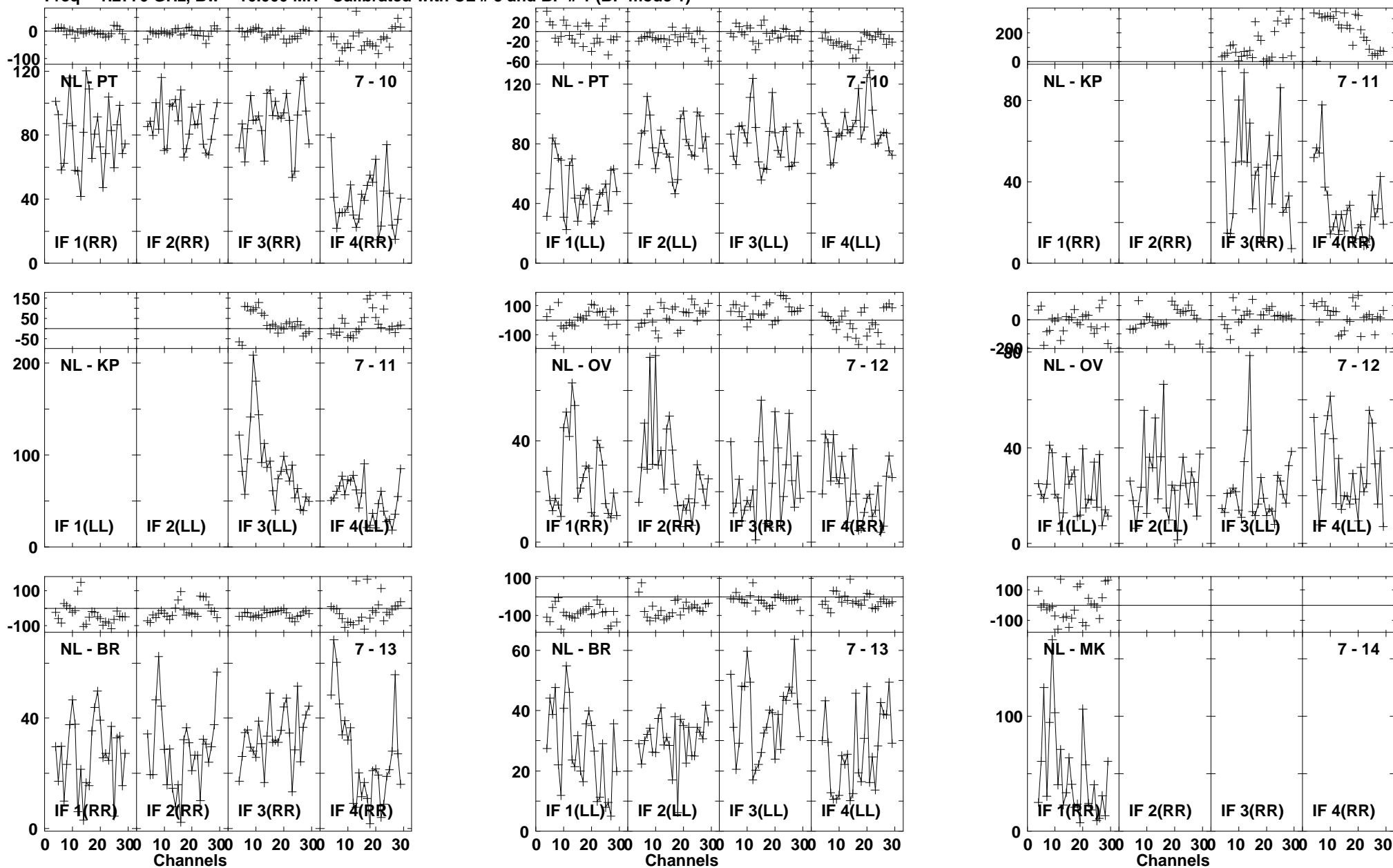

Lower frame: Milli Ampl Jy Top frame: Phas deg
Vector averaged cross-power spectrum Baseline: NL (07) - PT (10)
Timerange: 00/23:49:03 to 00/23:52:19

Plot file version 976 created 03-MAR-2016 01:14:47
4C52 GN002C 1.UVDATA.1
Freq = 1.2770 GHz, Bw = 16.000 MH Calibrated with CL # 3 and BP # 1 (BP mode 1)

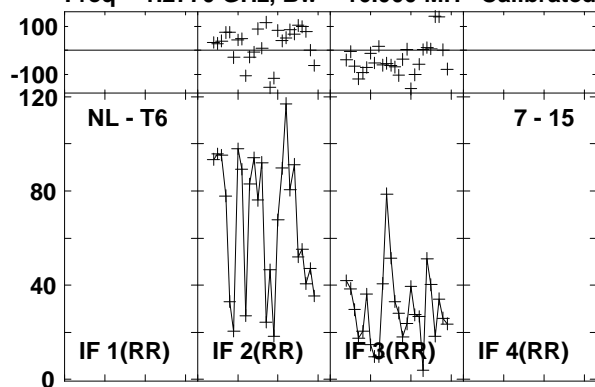

Lower frame: Milli Ampl Jy Top frame: Phas deg
Vector averaged cross-power spectrum Baseline: NL (07) - T6 (15)
Timerange: 00/23:49:03 to 00/23:52:19

Plot file version 977 created 03-MAR-2016 01:14:47

J1545+5400 GN002C 1.UVDATA.1

Freq = 1.2770 GHz, Bw = 16.000 MH Calibrated with CL # 3 and BP # 1 (BP mode 1)

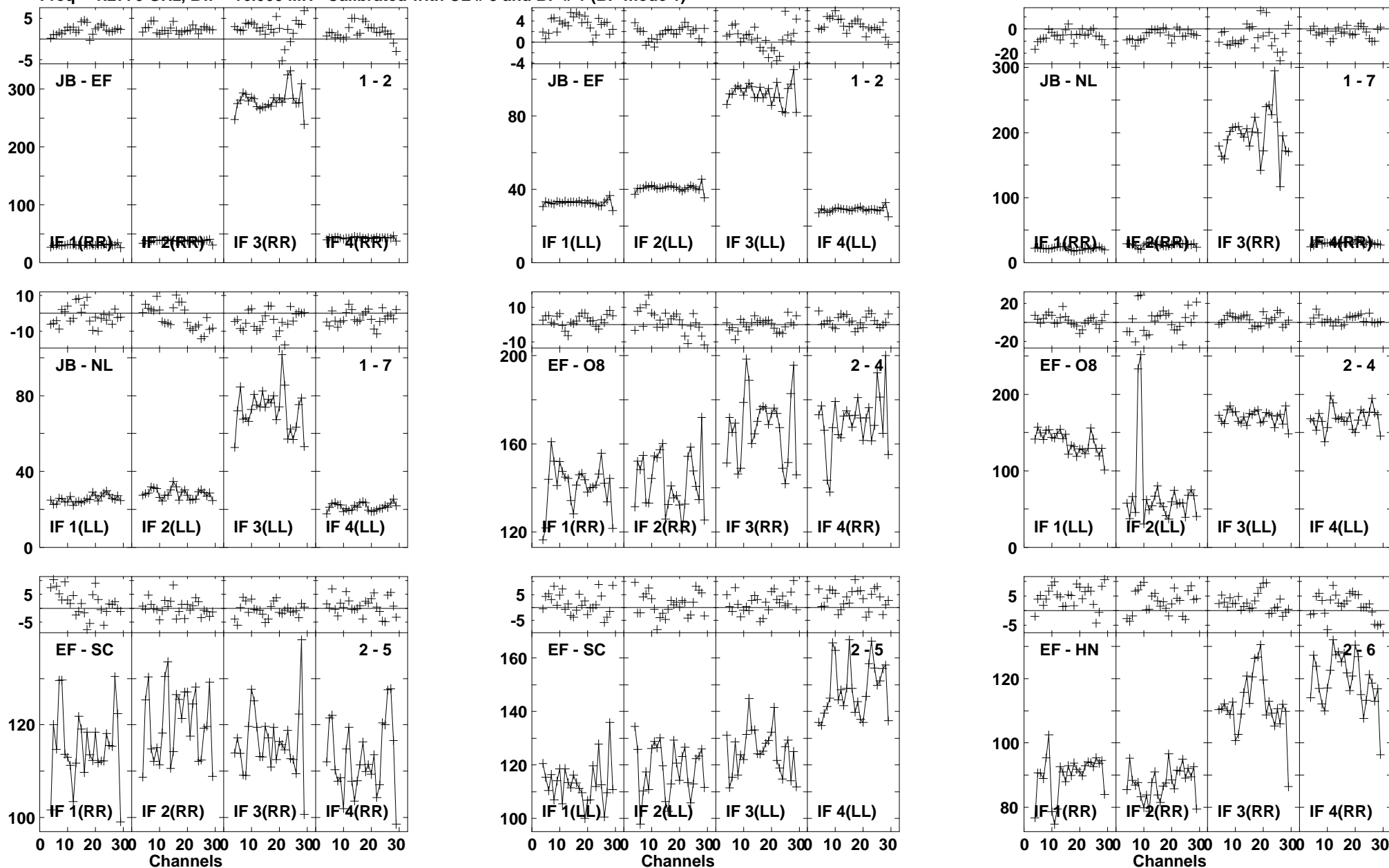

Lower frame: Milli Ampl Jy Top frame: Phas deg
Vector averaged cross-power spectrum Baseline: JB (01) - EF (02)
Timerange: 00/23:53:12 to 00/23:55:10

Plot file version 978 created 03-MAR-2016 01:14:47

J1545+5400 GN002C 1.UVDATA.1

Freq = 1.2770 GHz, Bw = 16.000 MH Calibrated with CL # 3 and BP # 1 (BP mode 1)

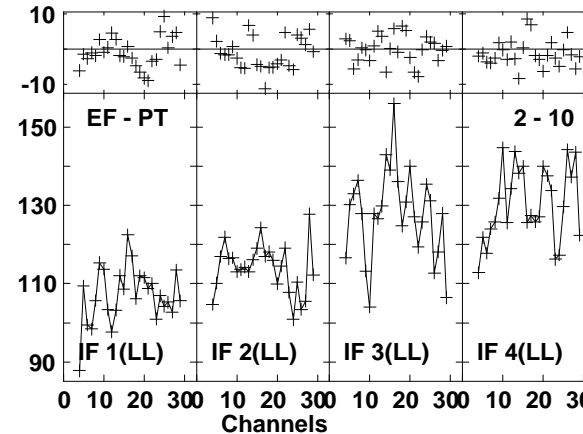
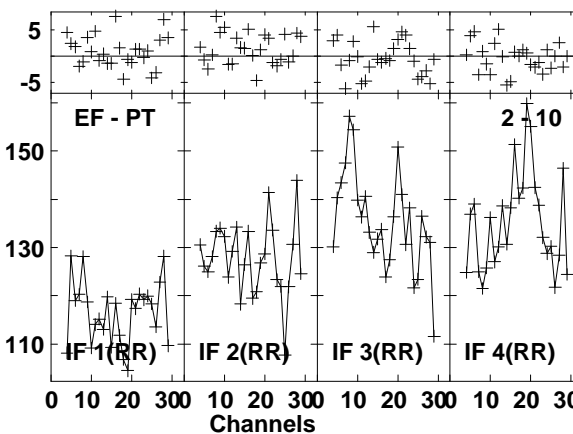
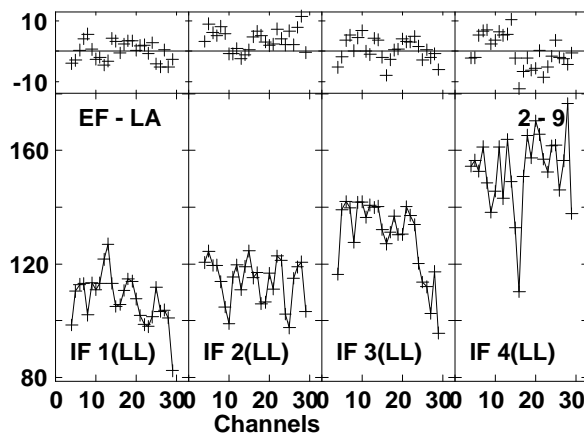
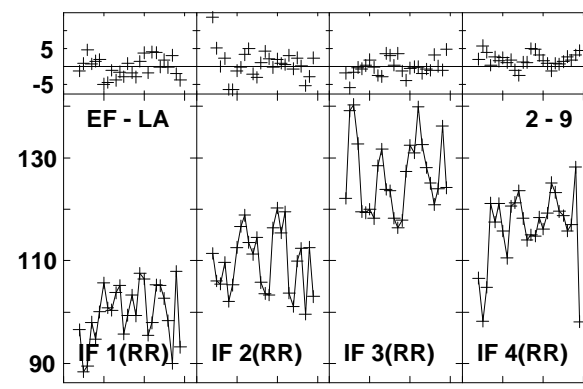
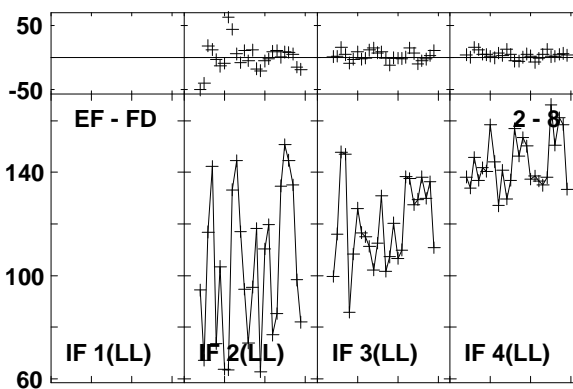
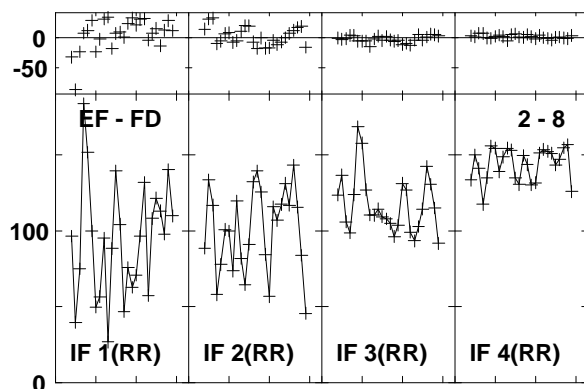
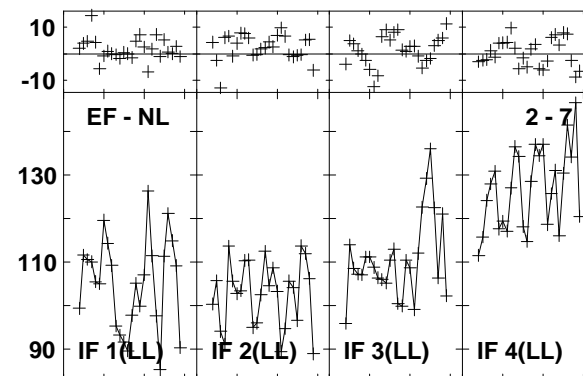
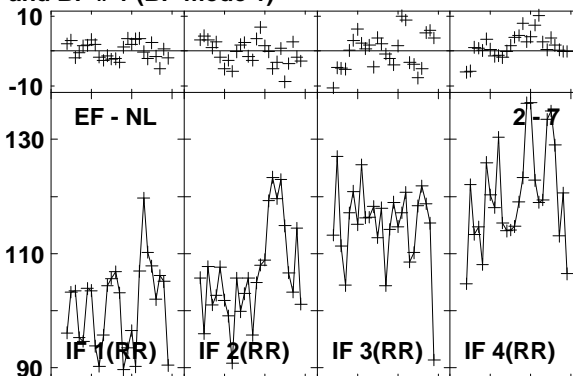
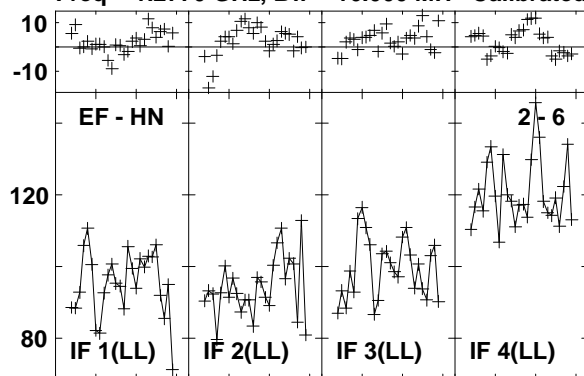

Lower frame: Milli Ampl Jy Top frame: Phas deg
Vector averaged cross-power spectrum Baseline: EF (02) - HN (06)
Timerange: 00/23:53:12 to 00/23:55:10

Plot file version 979 created 03-MAR-2016 01:14:47

J1545+5400 GN002C 1.UVDATA.1

Freq = 1.2770 GHz, Bw = 16.000 MH Calibrated with CL # 3 and BP # 1 (BP mode 1)

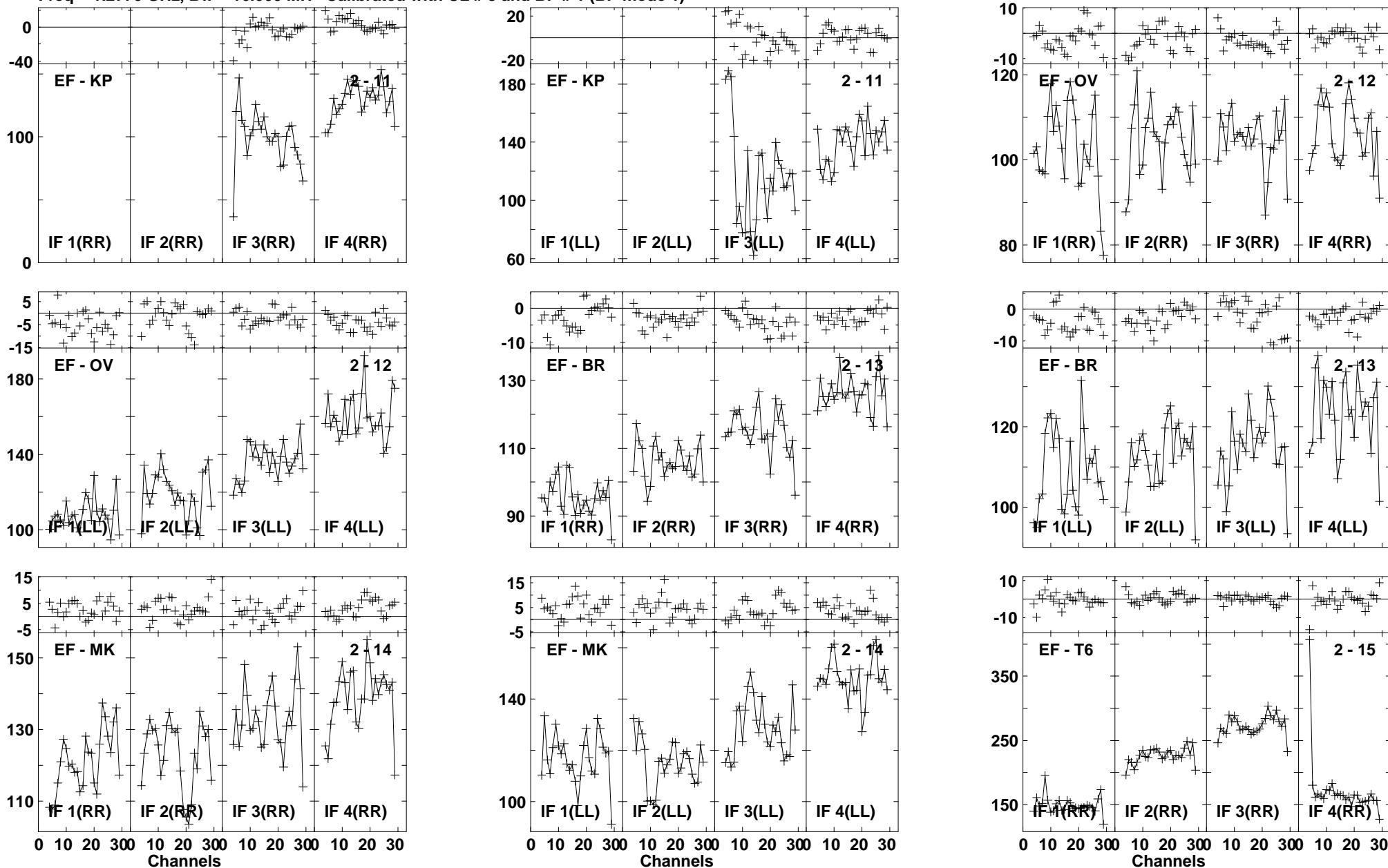

Lower frame: Milli Ampl Jy Top frame: Phas deg
Vector averaged cross-power spectrum Baseline: EF (02) - KP (11)
Timerange: 00/23:53:12 to 00/23:55:10

Plot file version 980 created 03-MAR-2016 01:14:47

J1545+5400 GN002C 1.UVDATA.1

Freq = 1.2770 GHz, Bw = 16.000 MH Calibrated with CL # 3 and BP # 1 (BP mode 1)

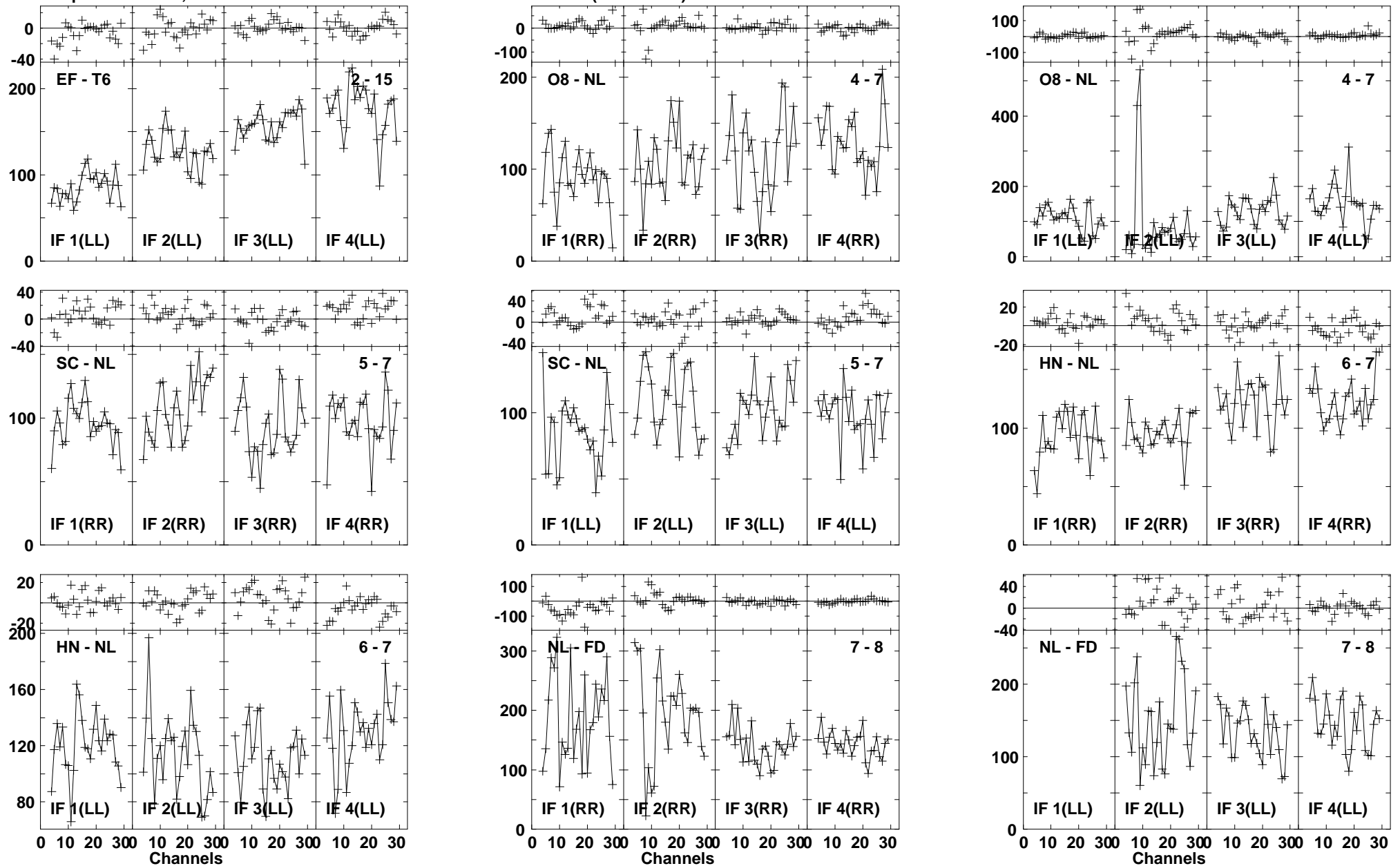

Lower frame: Milli Ampl Jy Top frame: Phas deg
Vector averaged cross-power spectrum Baseline: EF (02) - T6 (15)
Timerange: 00/23:53:12 to 00/23:55:10

Plot file version 981 created 03-MAR-2016 01:14:47

J1545+5400 GN002C 1.UVDATA.1

Freq = 1.2770 GHz, Bw = 16.000 MH Calibrated with CL # 3 and BP # 1 (BP mode 1)

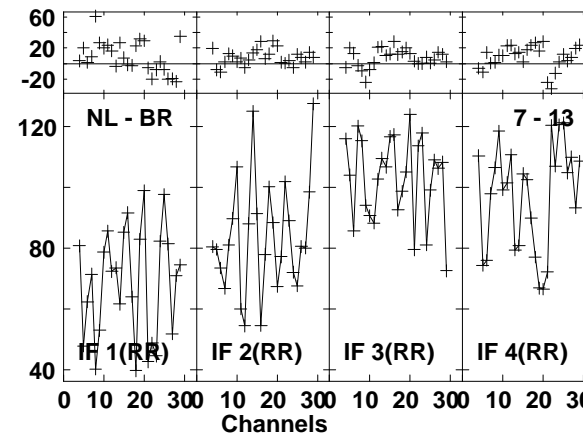
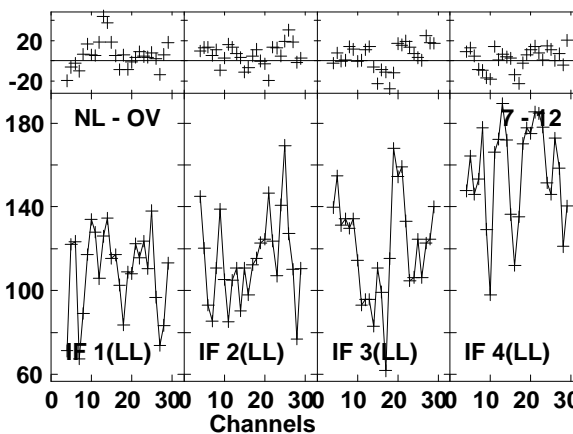
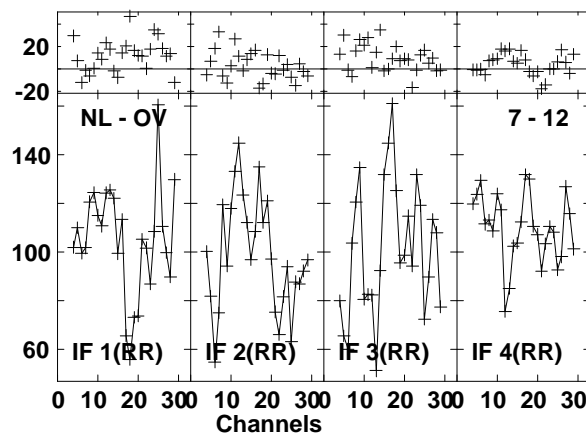
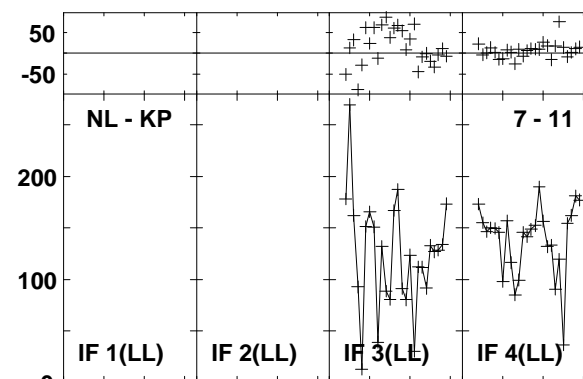
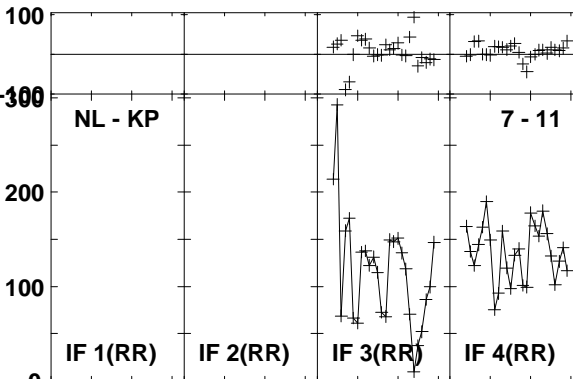
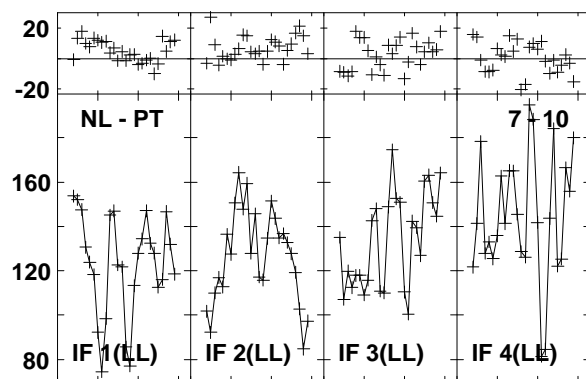
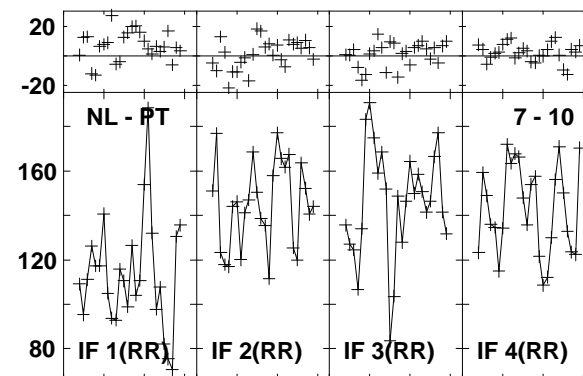
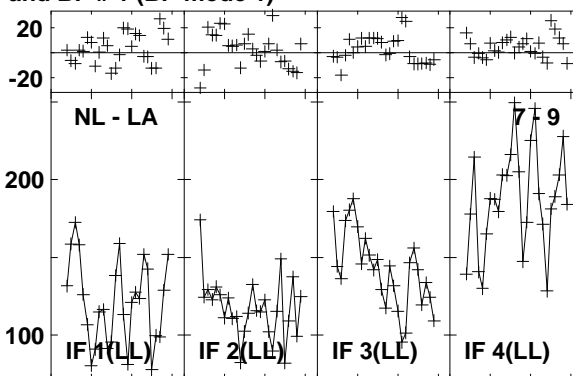
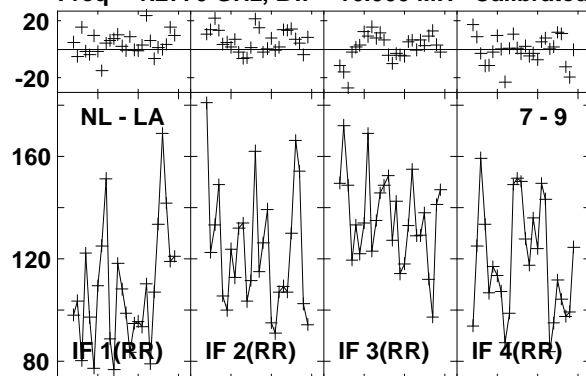

Lower frame: Milli Ampl Jy Top frame: Phas deg
Vector averaged cross-power spectrum Baseline: NL (07) - LA (09)
Timerange: 00/23:53:12 to 00/23:55:10

Plot file version 982 created 03-MAR-2016 01:14:48

J1545+5400 GN002C 1.UVDATA.1

Freq = 1.2770 GHz, Bw = 16.000 MH Calibrated with CL # 3 and BP # 1 (BP mode 1)

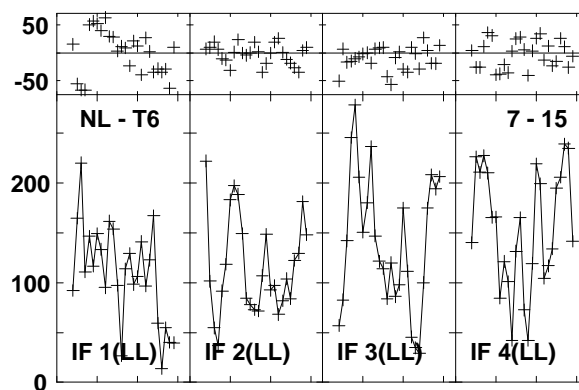
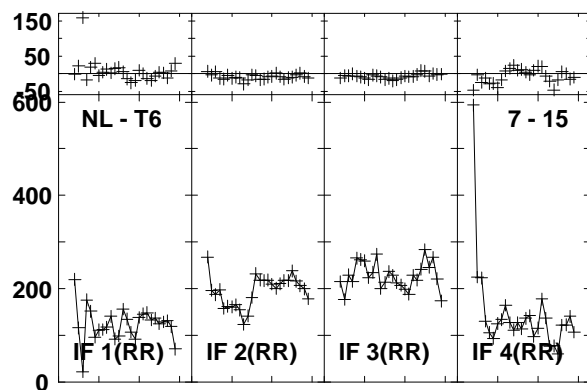
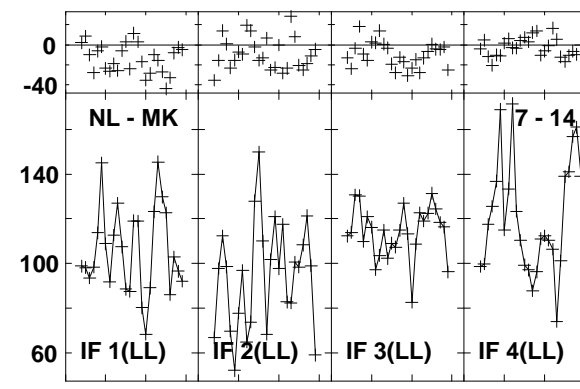
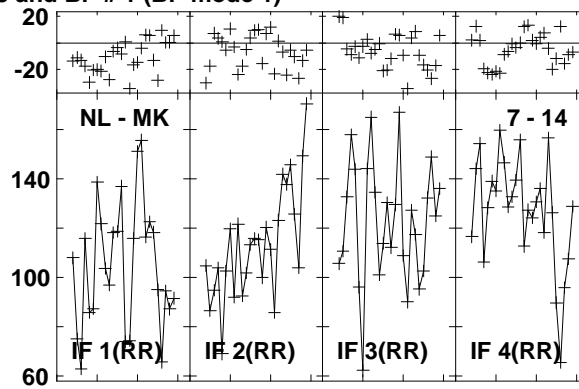
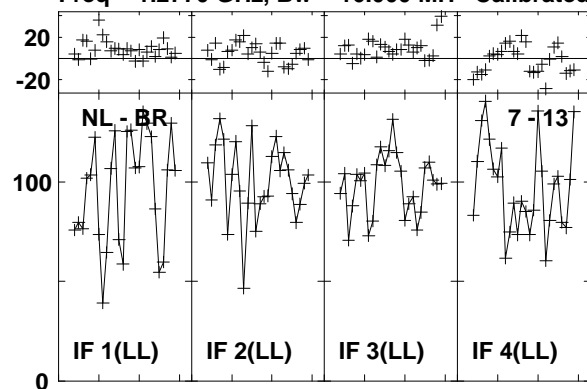

Lower frame: Milli Ampl Jy Top frame: Phas deg
Vector averaged cross-power spectrum Baseline: NL (07) - BR (13)
Timerange: 00/23:53:12 to 00/23:55:10

Plot file version 983 created 03-MAR-2016 01:14:48

4C52 GN002C 1.UVDATA.1

Freq = 1.2770 GHz, Bw = 16.000 MH Calibrated with CL # 3 and BP # 1 (BP mode 1)

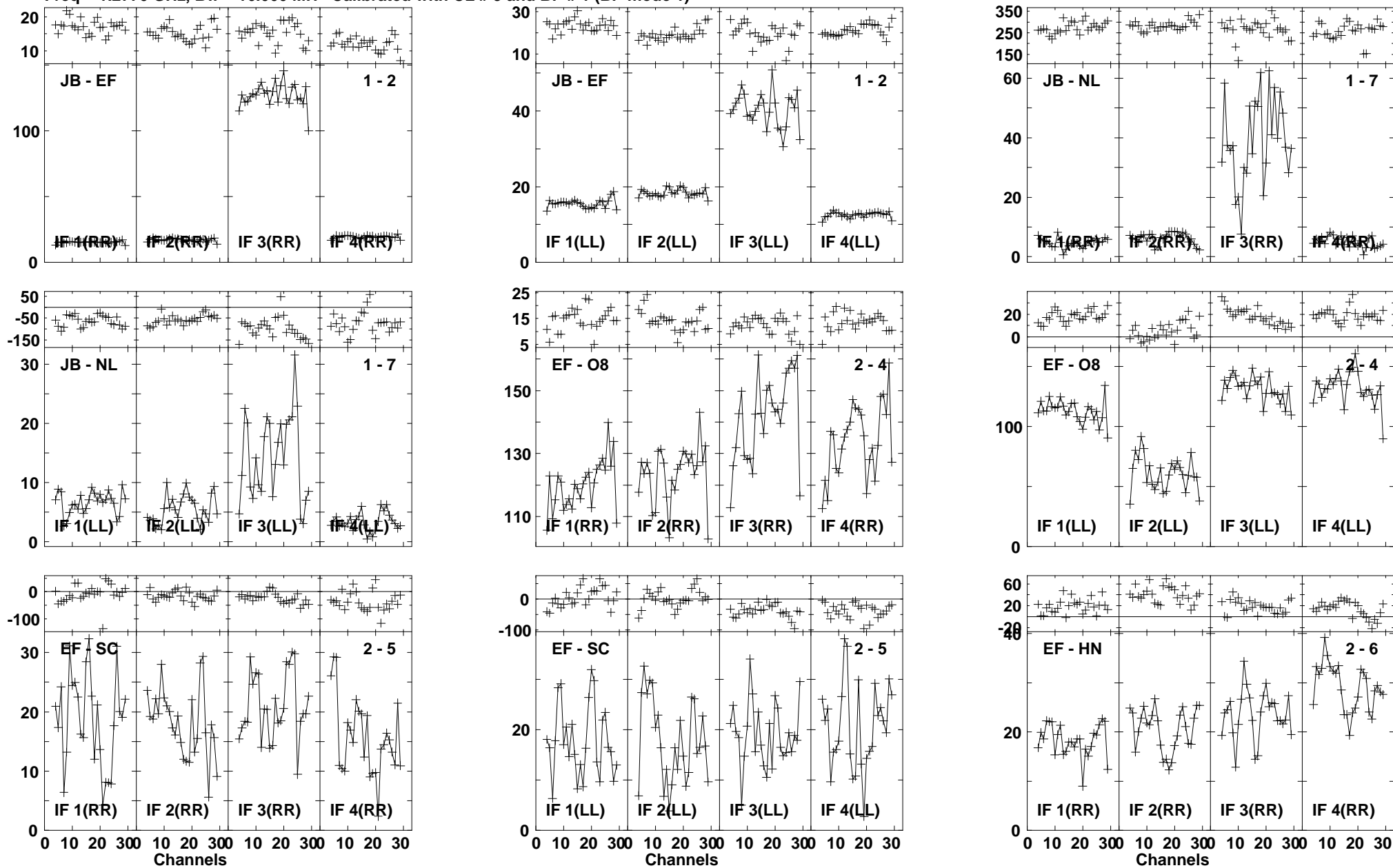

Lower frame: Milli Ampl Jy Top frame: Phas deg
Vector averaged cross-power spectrum Baseline: JB (01) - EF (02)
Timerange: 00/23:55:23 to 00/23:58:39

Plot file version 984 created 03-MAR-2016 01:14:48

4C52 GN002C 1.UVDATA.1

Freq = 1.2770 GHz, Bw = 16.000 MH Calibrated with CL # 3 and BP # 1 (BP mode 1)

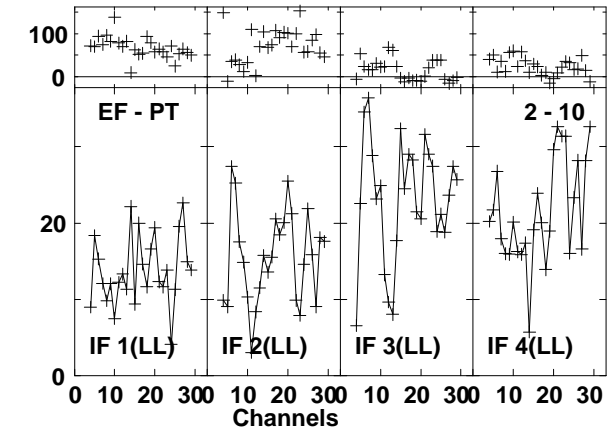
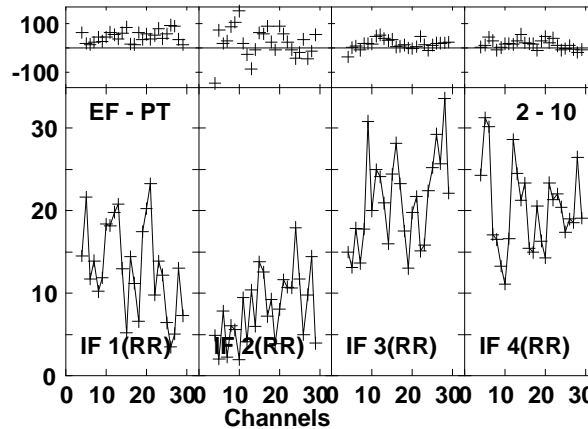
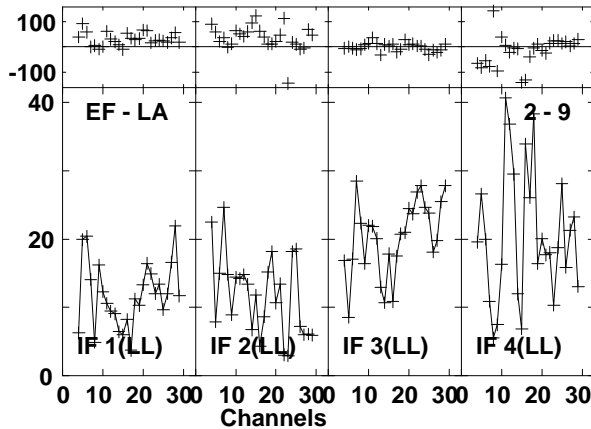
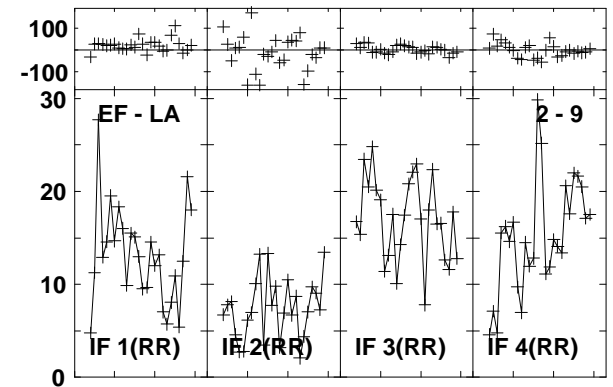
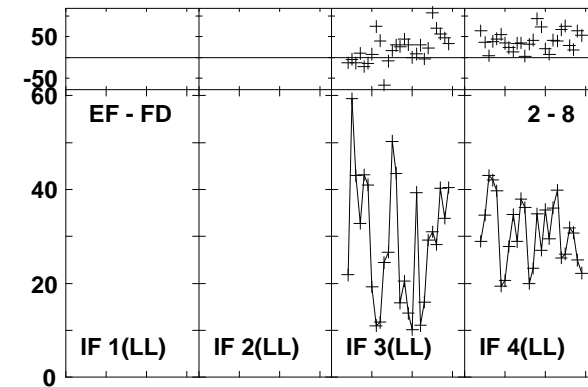
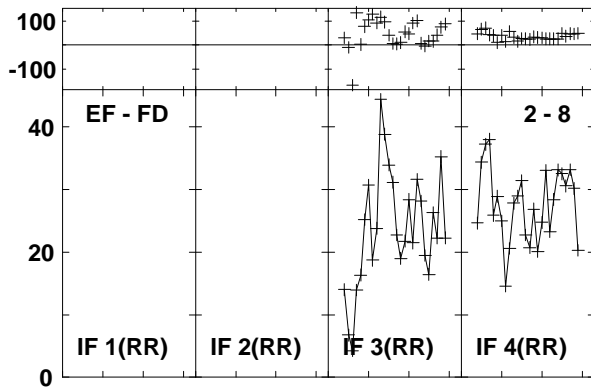
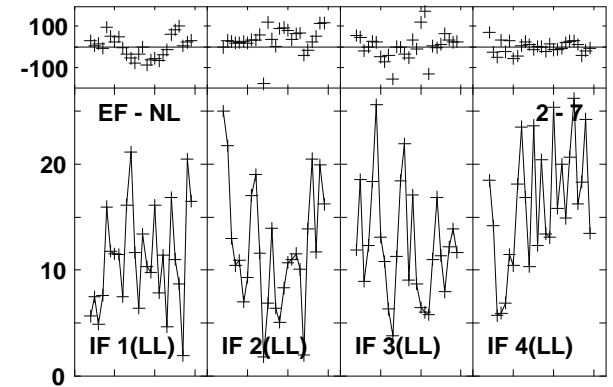
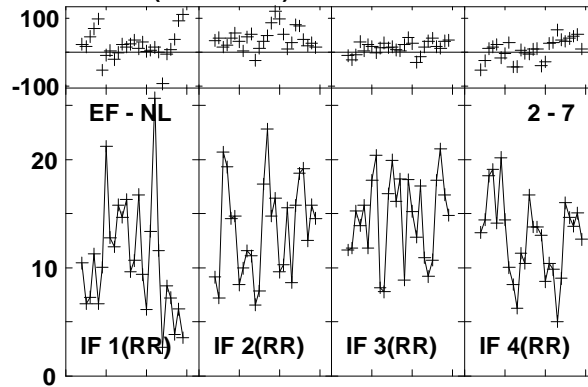
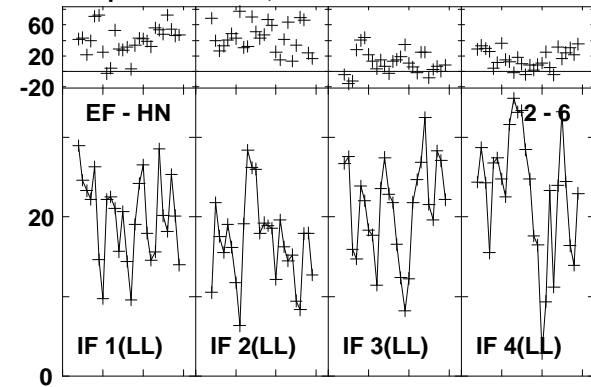

Lower frame: Milli Ampl Jy Top frame: Phas deg
Vector averaged cross-power spectrum Baseline: EF (02) - HN (06)
Timerange: 00/23:55:23 to 00/23:58:39

Plot file version 985 created 03-MAR-2016 01:14:48
 4C52 GN002C 1.UVDATA.1
 Freq = 1.2770 GHz, Bw = 16.000 MH Calibrated with CL # 3 and BP # 1 (BP mode 1)

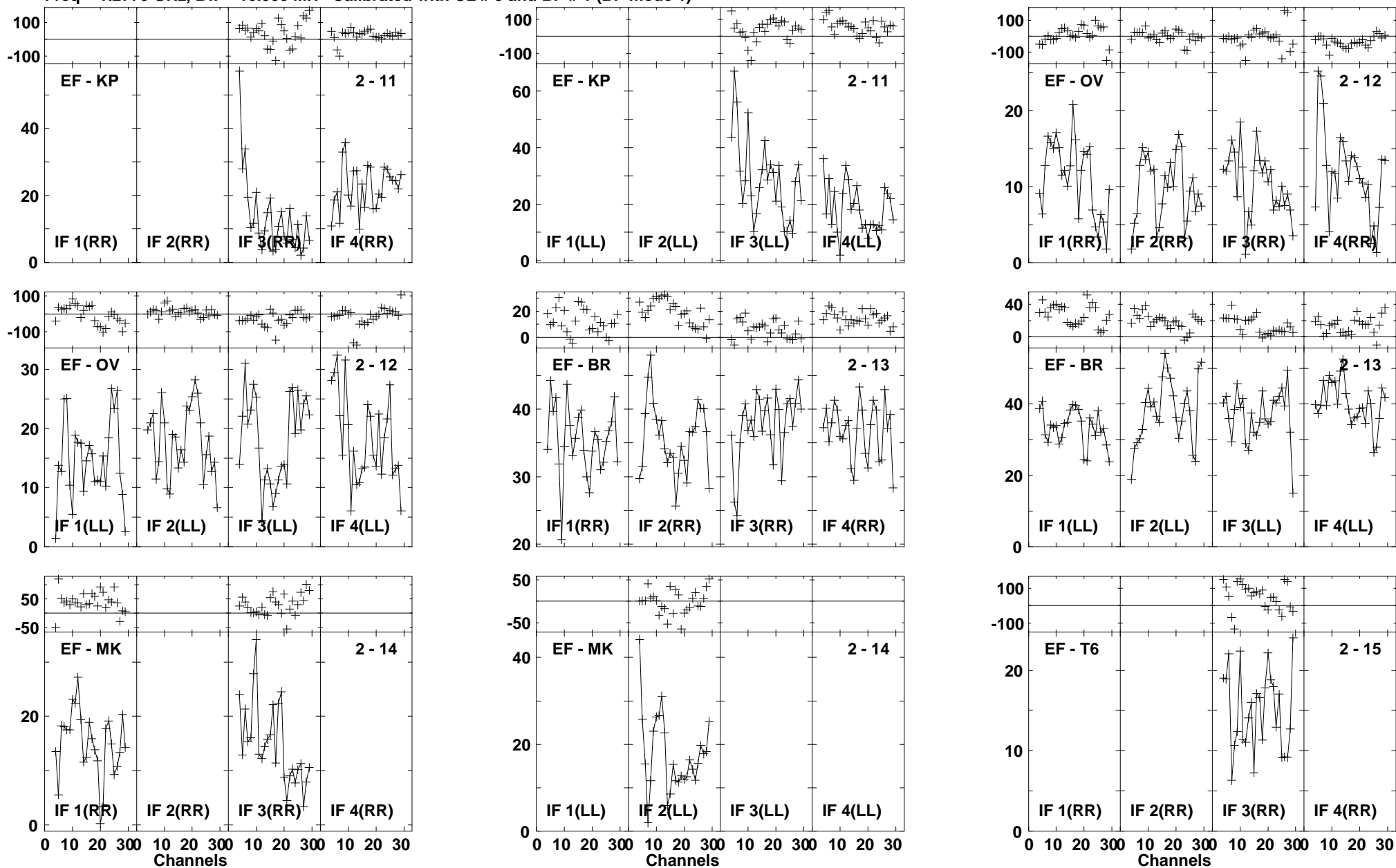

Lower frame: Milli Ampl Jy Top frame: Phas deg
 Vector averaged cross-power spectrum Baseline: EF (02) - KP (11)
 Timerange: 00/23:55:23 to 00/23:58:39

Plot file version 986 created 03-MAR-2016 01:14:48

4C52 GN002C 1.UVDATA.1

Freq = 1.2770 GHz, Bw = 16.000 MH Calibrated with CL # 3 and BP # 1 (BP mode 1)

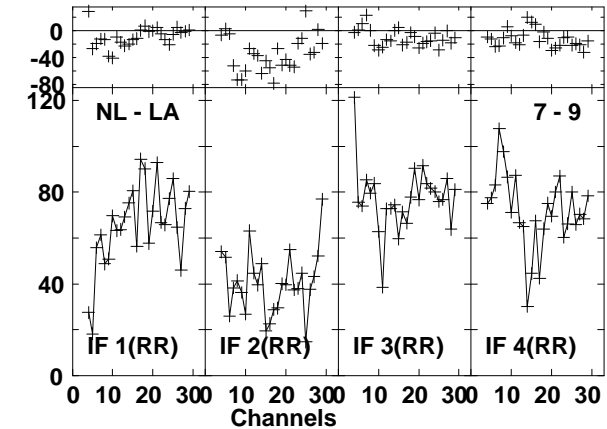
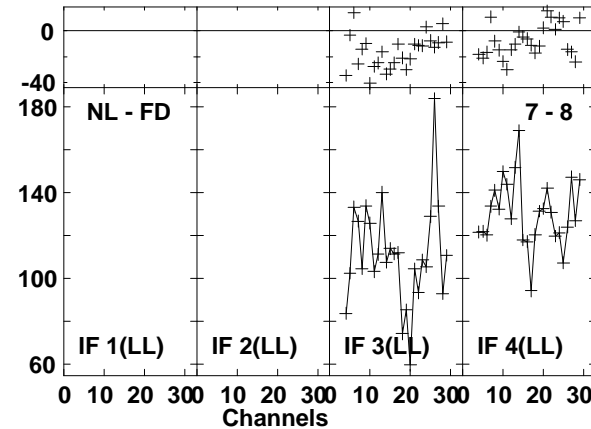
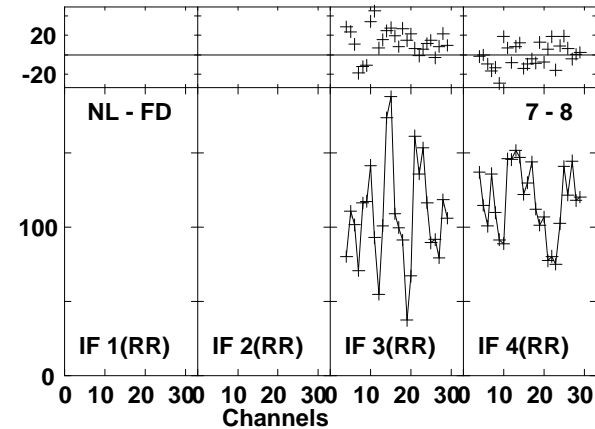
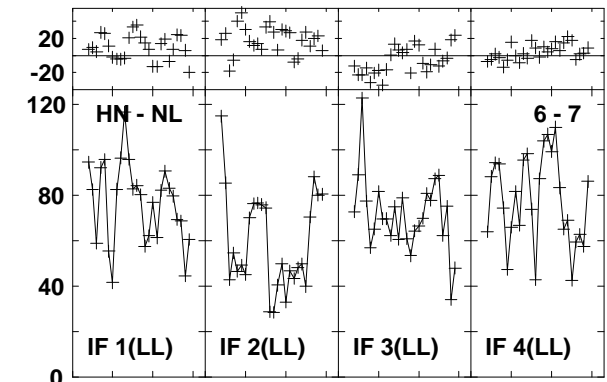
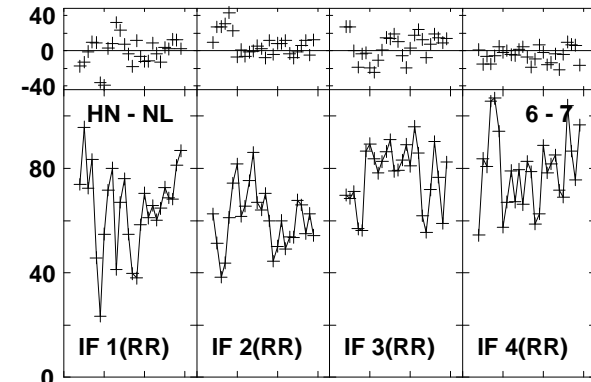
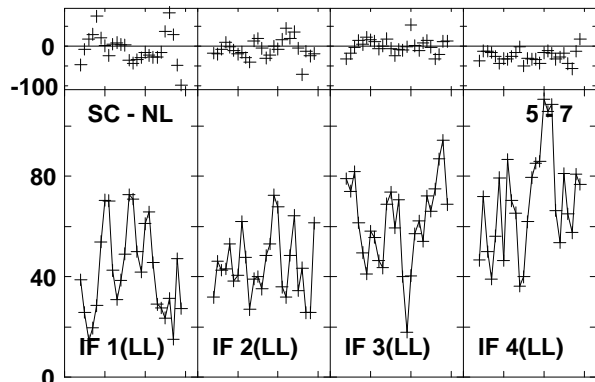
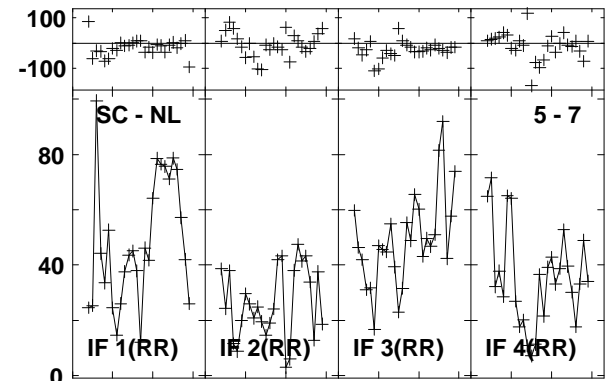
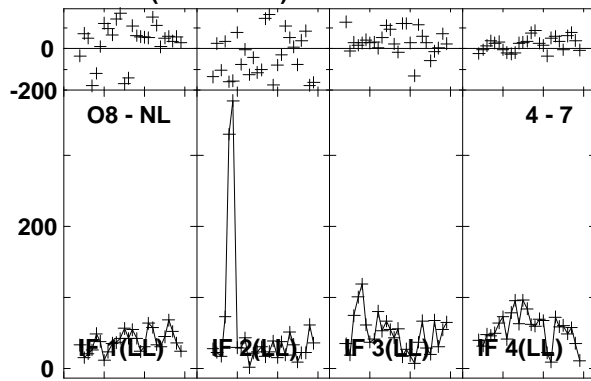
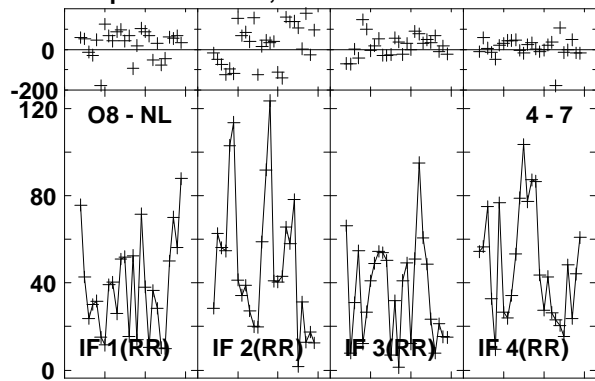

Lower frame: Milli Ampl Jy Top frame: Phas deg
Vector averaged cross-power spectrum Baseline: O8 (04) - NL (07)
Timerange: 00/23:55:23 to 00/23:58:39

Plot file version 987 created 03-MAR-2016 01:14:49

4C52 GN002C 1.UVDATA.1

Freq = 1.2770 GHz, Bw = 16.000 MH Calibrated with CL # 3 and BP # 1 (BP mode 1)

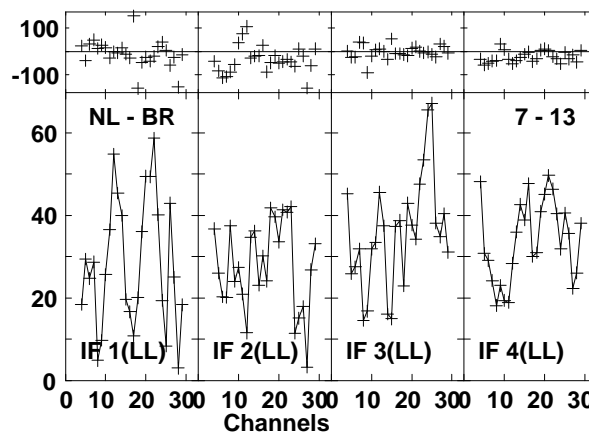
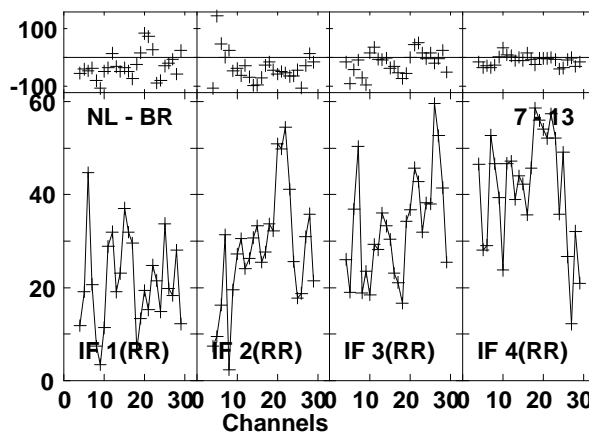
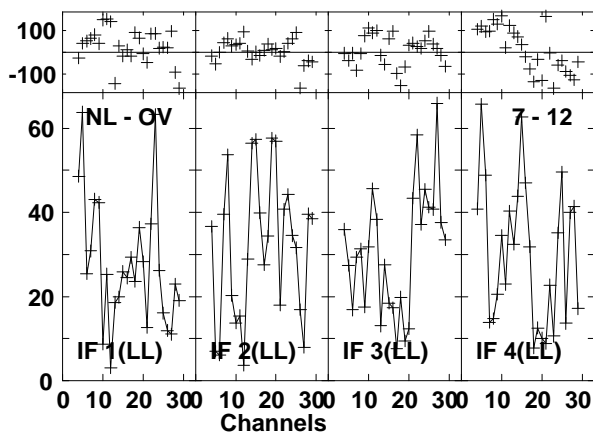
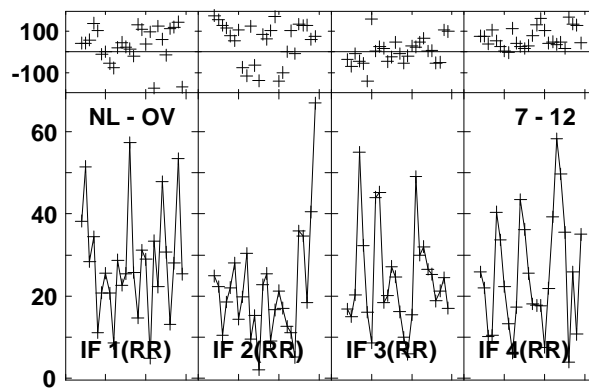
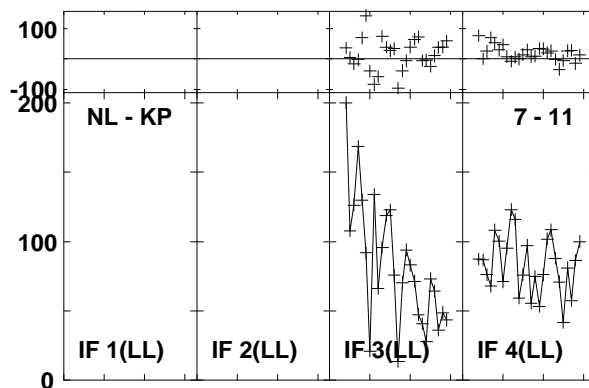
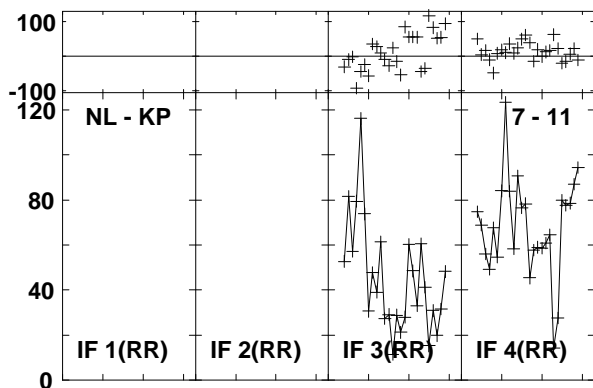
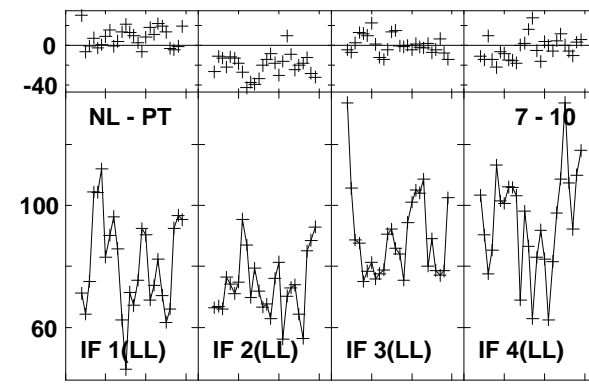
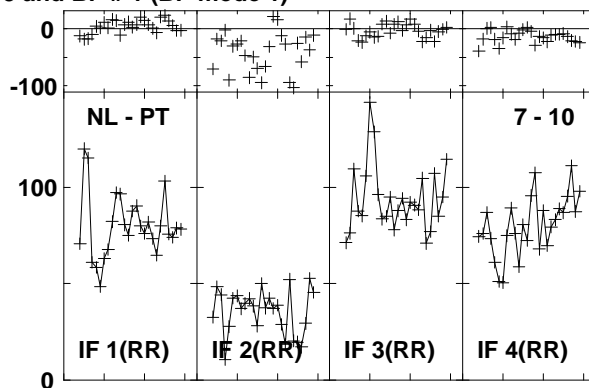
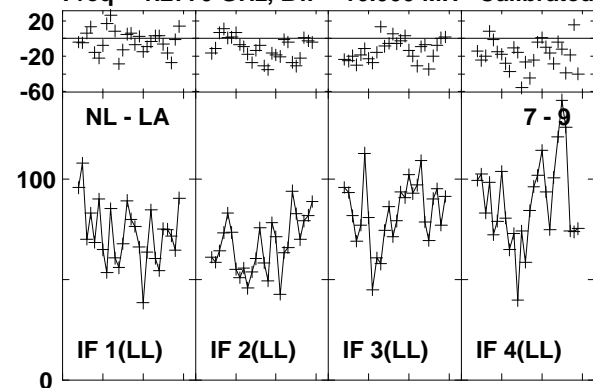

Lower frame: Milli Ampl Jy Top frame: Phas deg
Vector averaged cross-power spectrum Baseline: NL (07) - LA (09)
Timerange: 00/23:55:23 to 00/23:58:39

Plot file version 988 created 03-MAR-2016 01:14:49

4C52 GN002C 1.UVDATA.1

Freq = 1.2770 GHz, Bw = 16.000 MH Calibrated with CL # 3 and BP # 1 (BP mode 1)

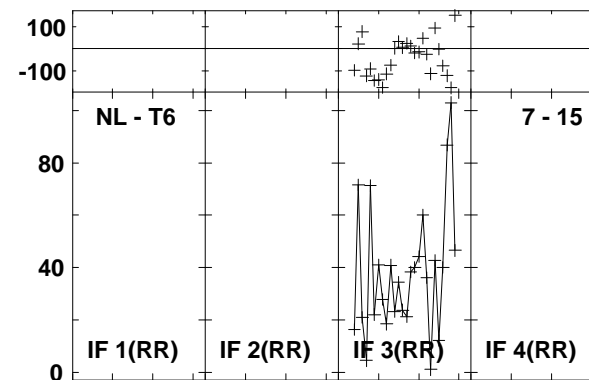
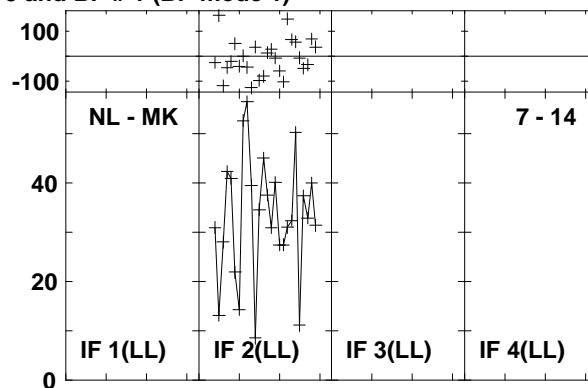
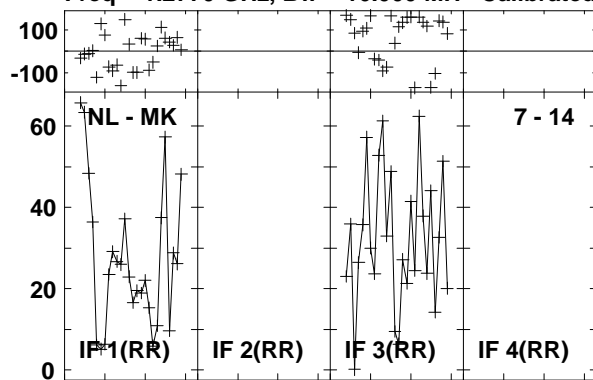

Lower frame: Milli Ampl Jy Top frame: Phas deg
Vector averaged cross-power spectrum Baseline: NL (07) - MK (14)
Timerange: 00/23:55:23 to 00/23:58:39

Plot file version 989 created 03-MAR-2016 01:14:49

J1545+5400 GN002C 1.UVDATA.1

Freq = 1.2770 GHz, Bw = 16.000 MH Calibrated with CL # 3 and BP # 1 (BP mode 1)

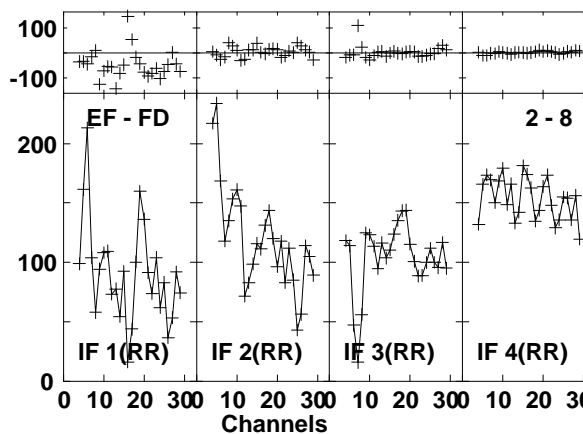
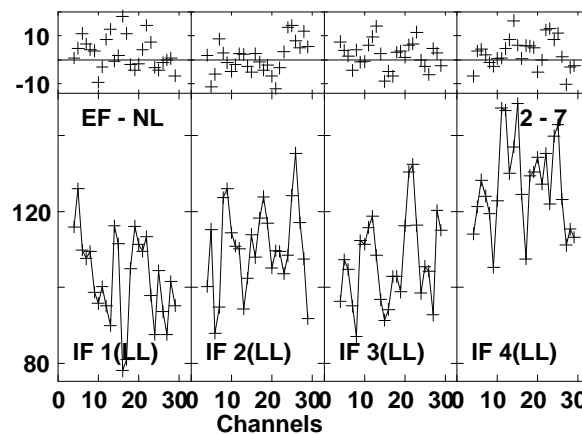
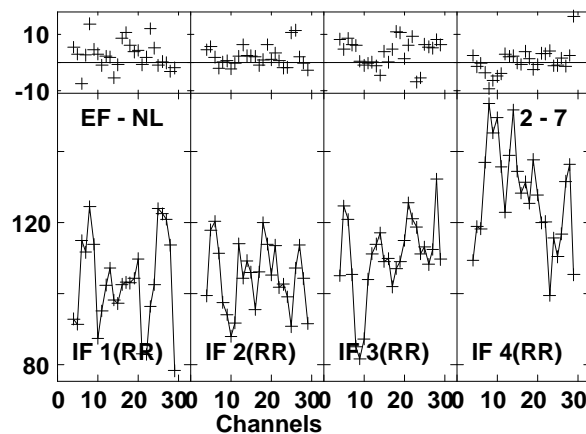
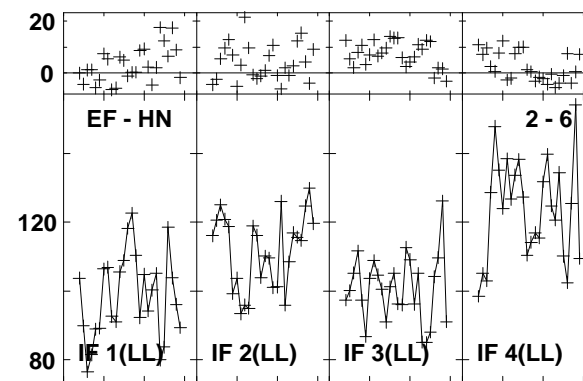
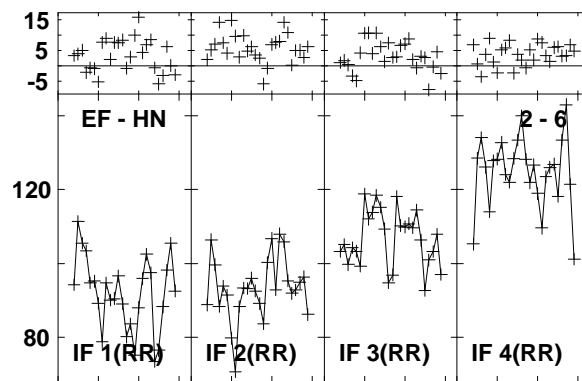
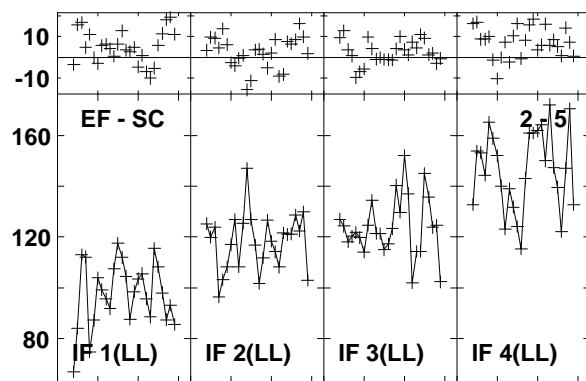
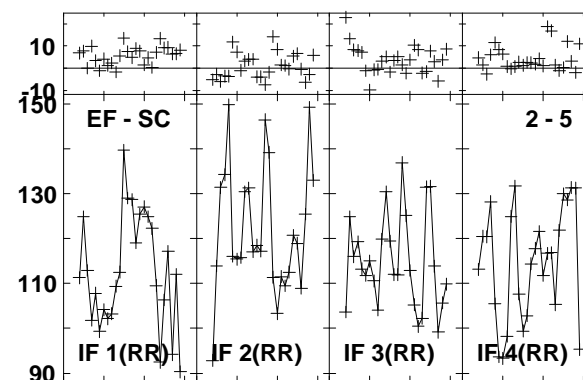
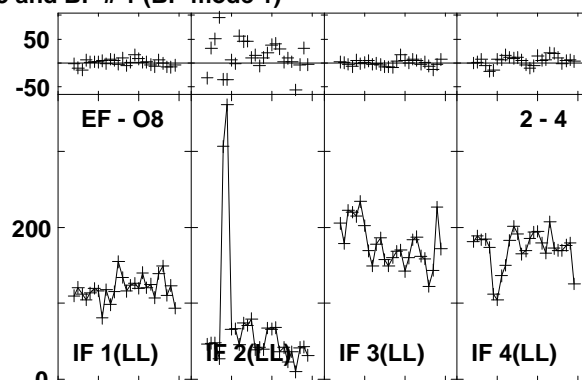
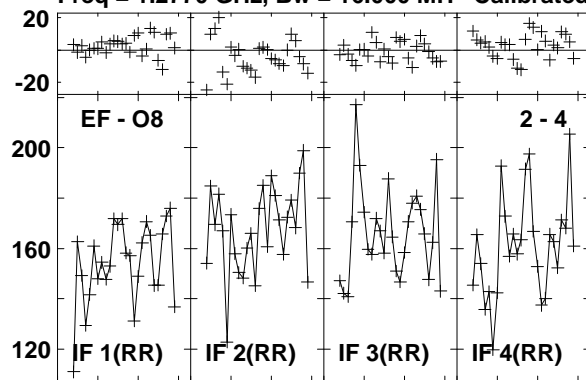

Lower frame: Milli Ampl Jy Top frame: Phas deg
Vector averaged cross-power spectrum Baseline: EF (02) - O8 (04)
Timerange: 00/23:59:32 to 01/00:00:30

Plot file version 990 created 03-MAR-2016 01:14:49

J1545+5400 GN002C 1.UVDATA.1

Freq = 1.2770 GHz, Bw = 16.000 MH Calibrated with CL # 3 and BP # 1 (BP mode 1)

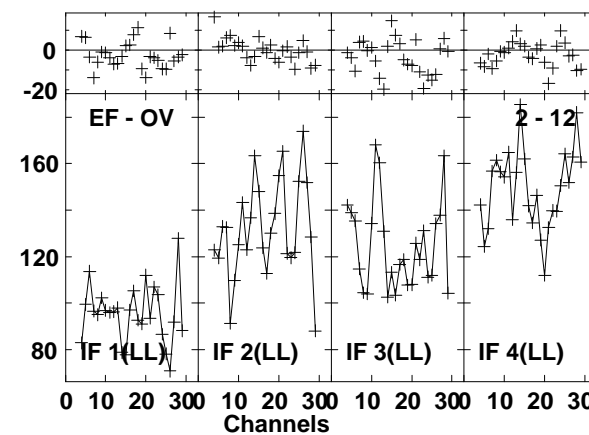
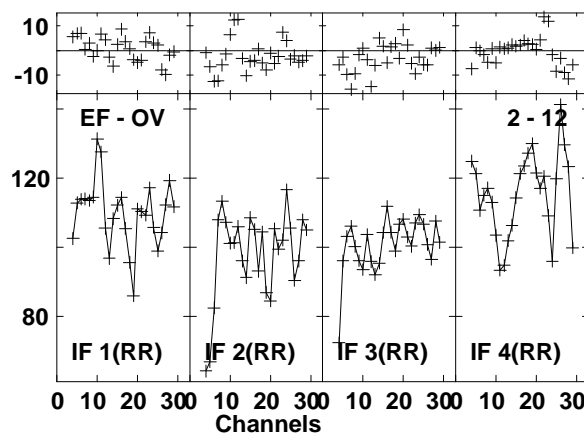
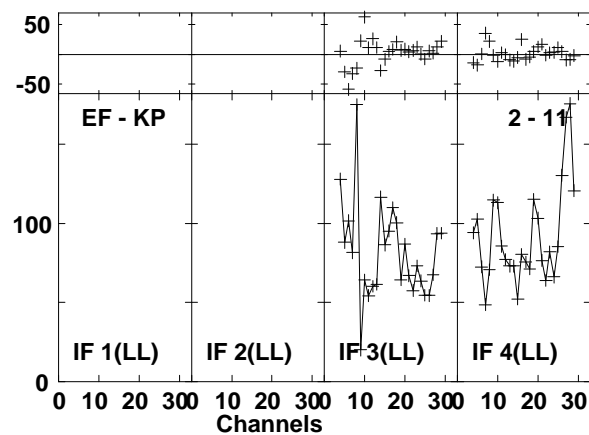
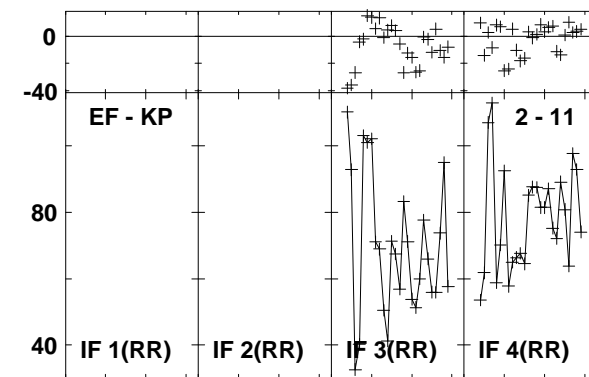
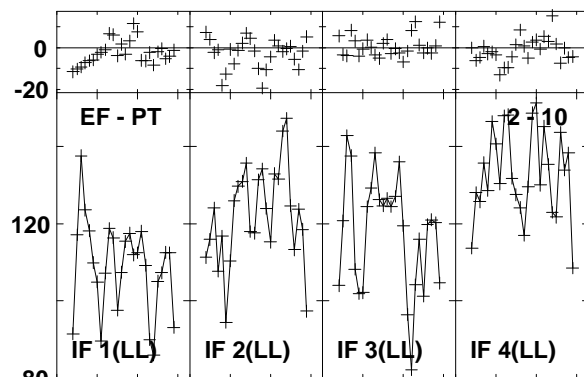
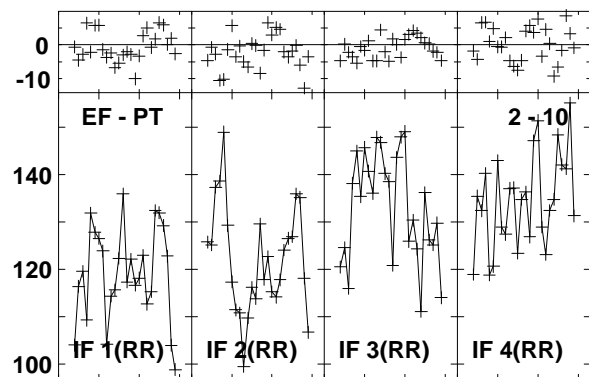
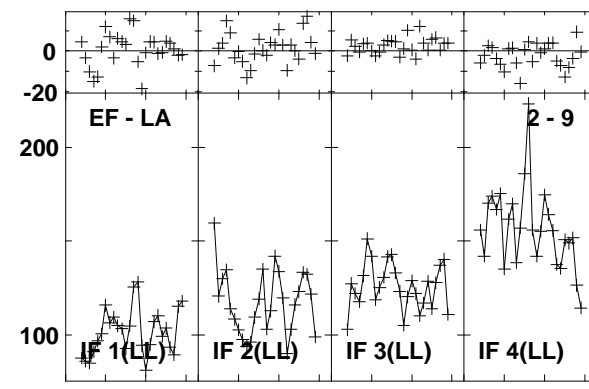
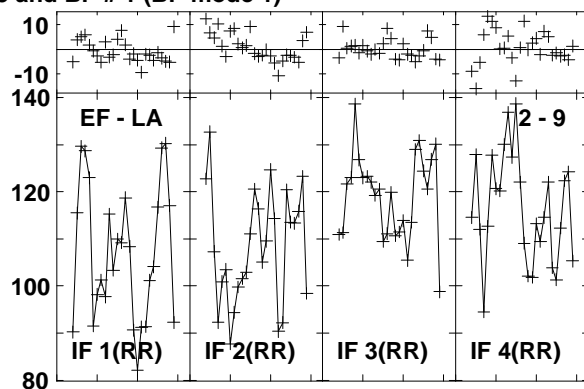
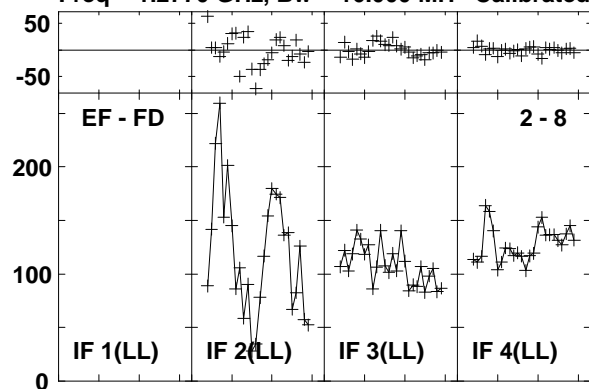

Lower frame: Milli Ampl Jy Top frame: Phas deg
Vector averaged cross-power spectrum Baseline: EF (02) - FD (08)
Timerange: 00/23:59:32 to 01/00:00:30

Plot file version 991 created 03-MAR-2016 01:14:49

J1545+5400 GN002C 1.UVDATA.1

Freq = 1.2770 GHz, Bw = 16.000 MH Calibrated with CL # 3 and BP # 1 (BP mode 1)

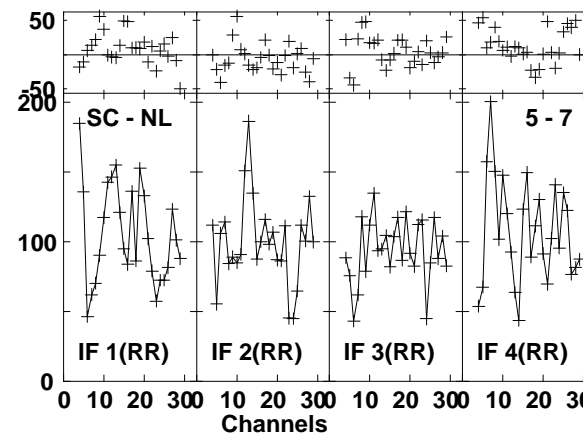
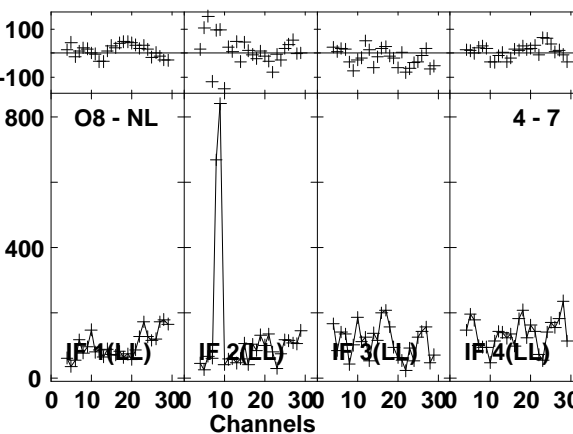
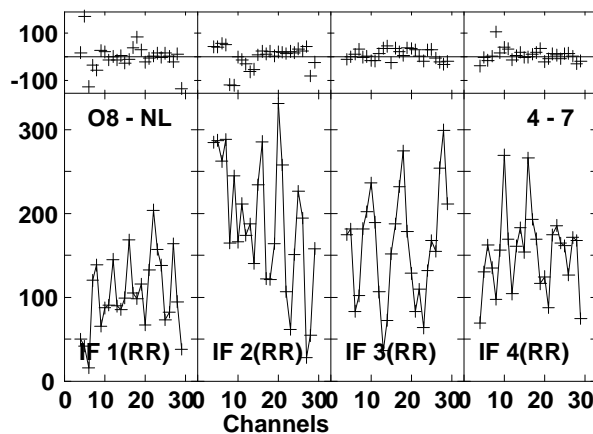
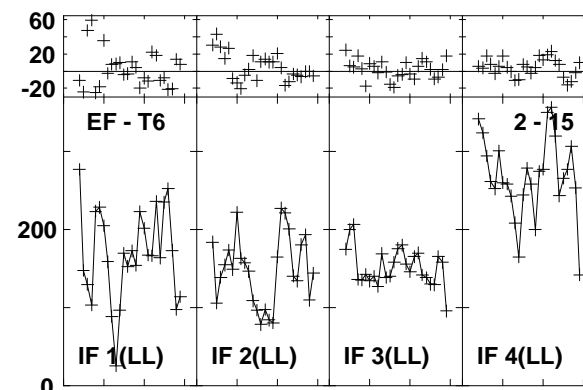
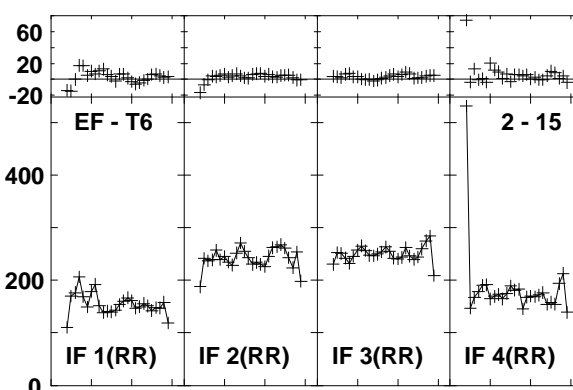
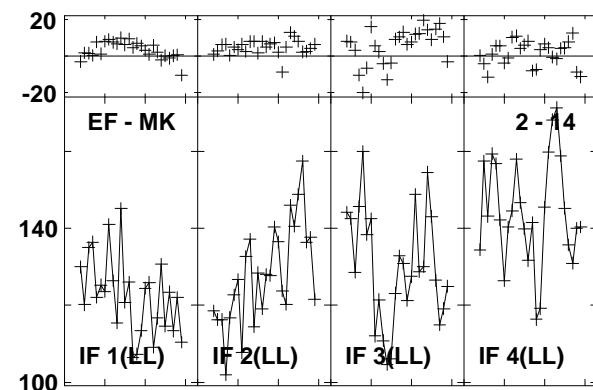
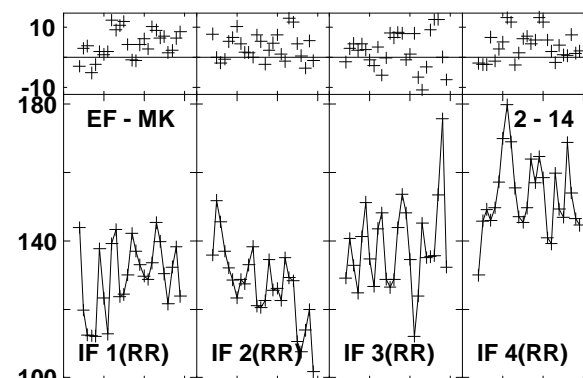
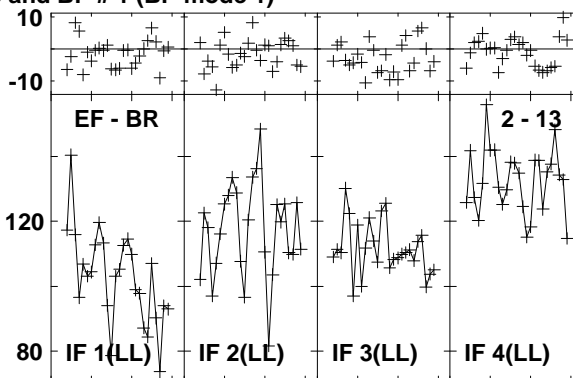
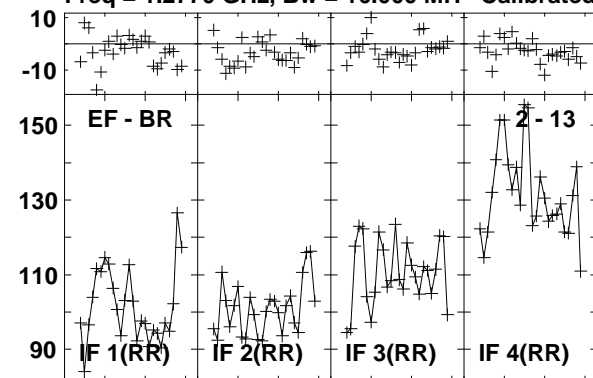

Lower frame: Milli Ampl Jy Top frame: Phas deg
Vector averaged cross-power spectrum Baseline: EF (02) - BR (13)
Timerange: 00/23:59:32 to 01/00:00:30

Plot file version 992 created 03-MAR-2016 01:14:49
 J1545+5400 GN002C 1.UVDATA.1
 Freq = 1.2770 GHz, Bw = 16.000 MH Calibrated with CL # 3 and BP # 1 (BP mode 1)

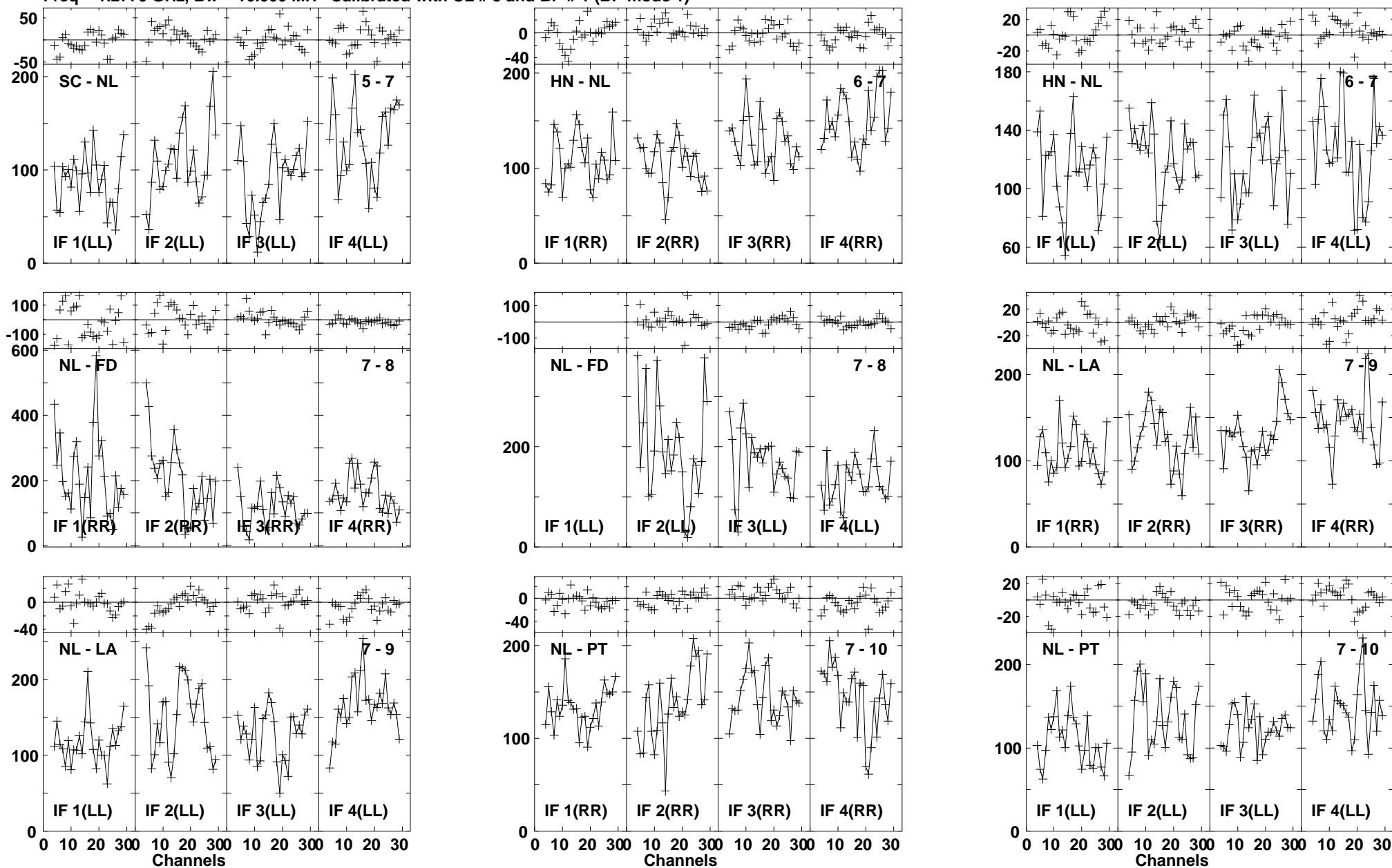

Lower frame: Milli Ampl Jy Top frame: Phas deg
 Vector averaged cross-power spectrum Baseline: SC (05) - NL (07)
 Timerange: 00/23:59:32 to 01/00:00:30

Plot file version 993 created 03-MAR-2016 01:14:50
 J1545+5400 GN002C 1.UVDATA.1
 Freq = 1.2770 GHz, Bw = 16.000 MH Calibrated with CL # 3 and BP # 1 (BP mode 1)

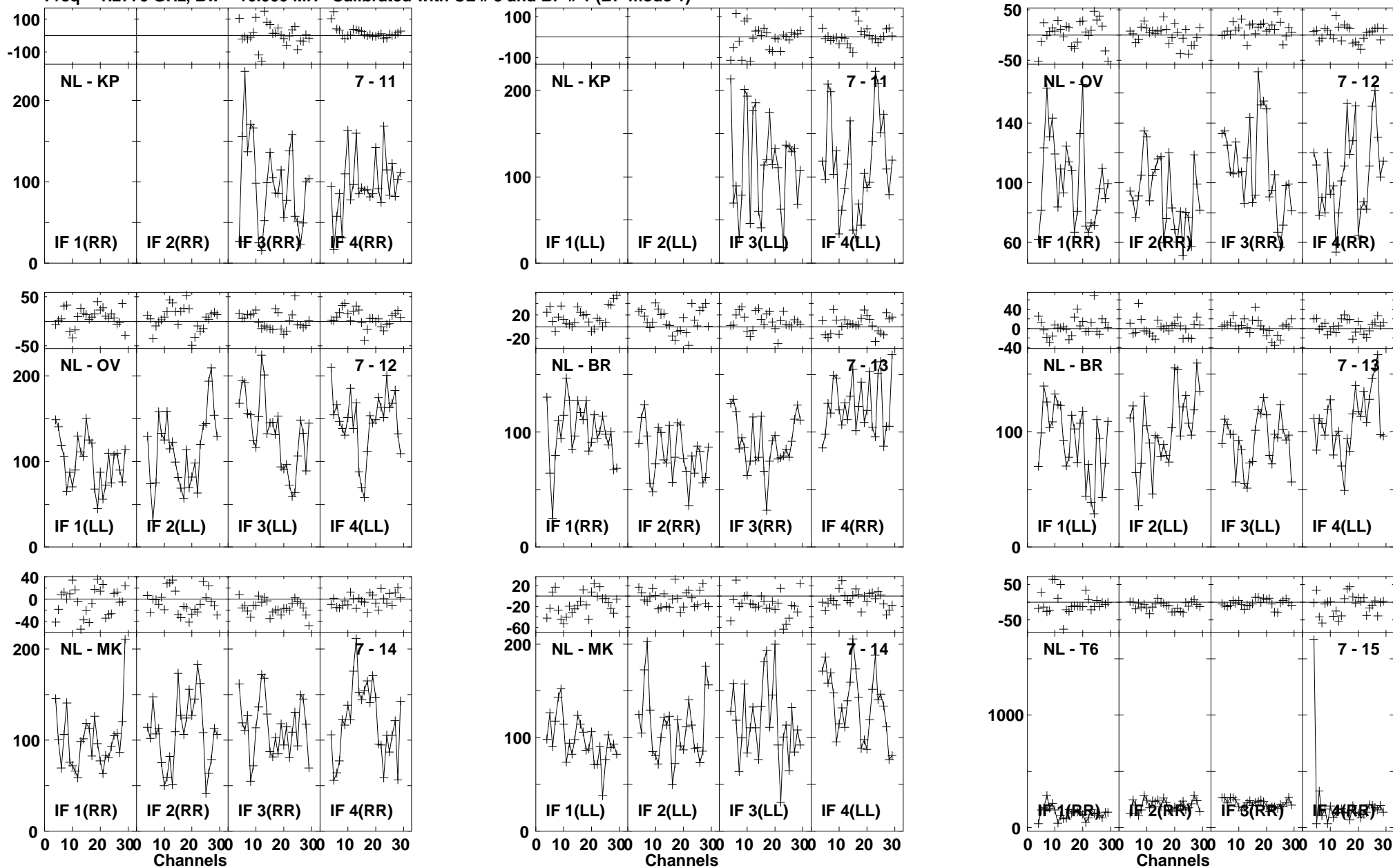

Lower frame: Milli Ampl Jy Top frame: Phas deg
 Vector averaged cross-power spectrum Baseline: NL (07) - KP (11)
 Timerange: 00/23:59:32 to 01/00:00:30

Plot file version 994 created 03-MAR-2016 01:14:50
J1545+5400 GN002C 1.UVDATA.1
Freq = 1.2770 GHz, Bw = 16.000 MH Calibrated with CL # 3 and BP # 1 (BP mode 1)

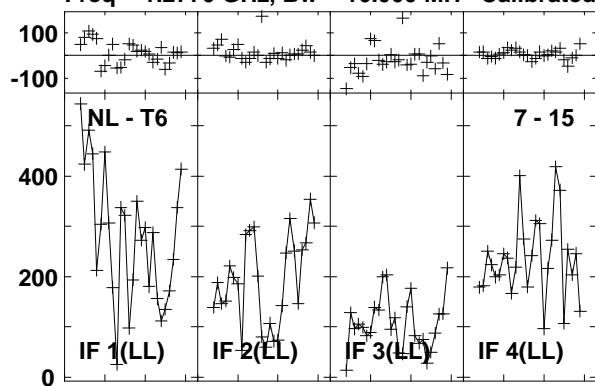

Lower frame: Milli Ampl Jy Top frame: Phas deg
Vector averaged cross-power spectrum Baseline: NL (07) - T6 (15)
Timerange: 00/23:59:32 to 01/00:00:30

Plot file version 995 created 03-MAR-2016 01:14:50

4C52 GN002C 1.UVDATA.1

Freq = 1.2770 GHz, Bw = 16.000 MH Calibrated with CL # 3 and BP # 1 (BP mode 1)

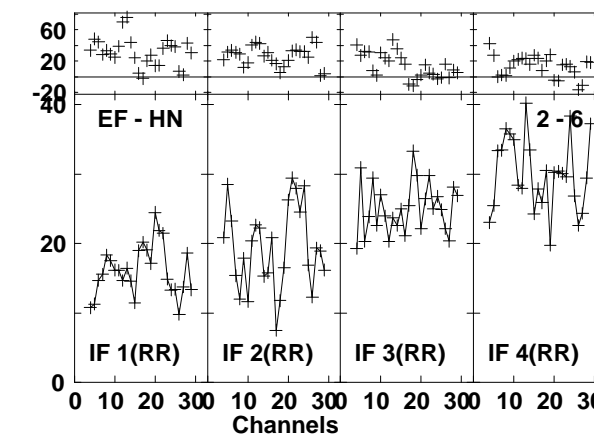
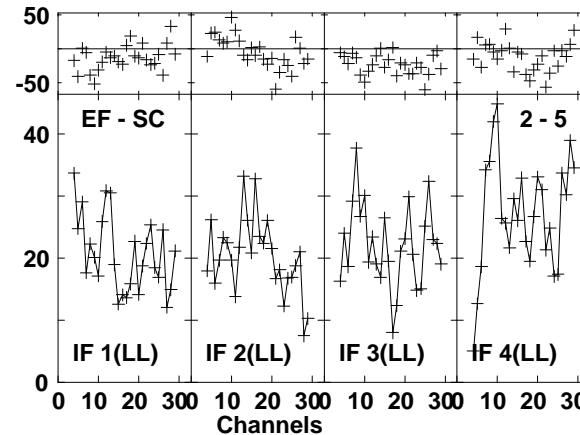
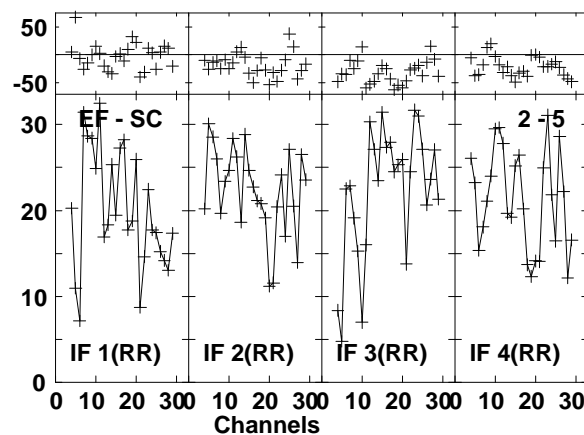
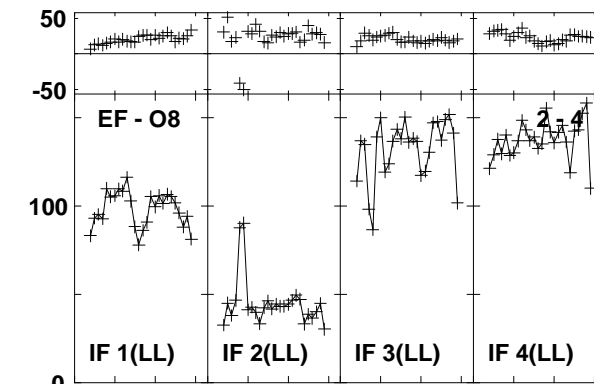
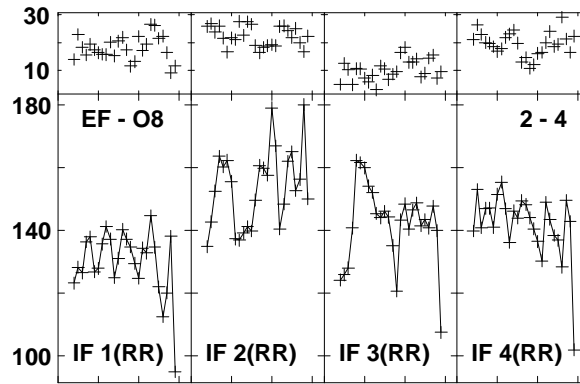
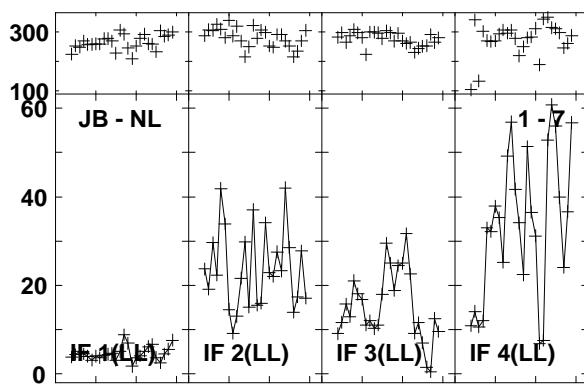
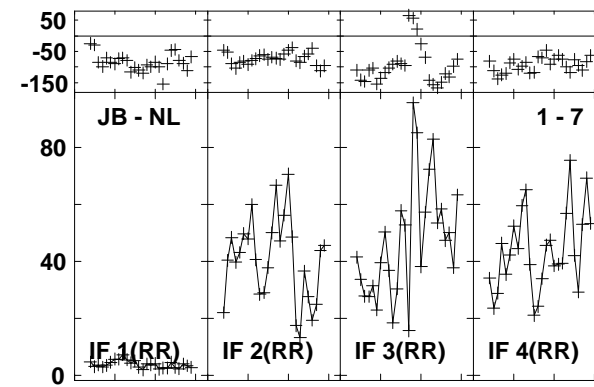
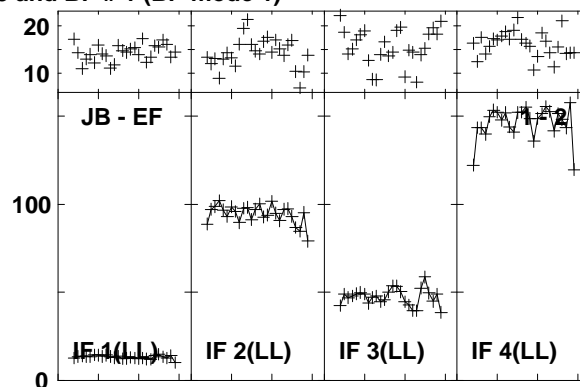
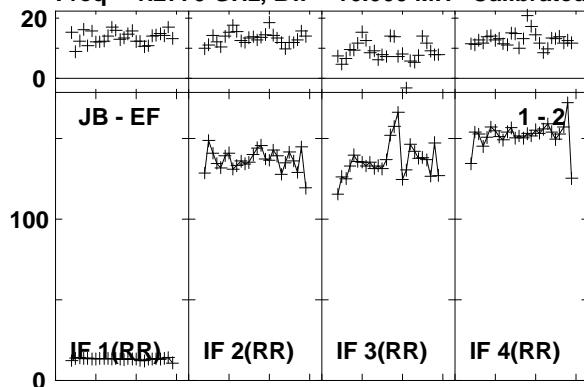

Lower frame: Milli Ampl Jy Top frame: Phas deg
Vector averaged cross-power spectrum Baseline: JB (01) - EF (02)
Timerange: 01/00:00:35 to 01/00:03:59

Plot file version 996 created 03-MAR-2016 01:14:50

4C52 GN002C 1.UVDATA.1

Freq = 1.2770 GHz, Bw = 16.000 MH Calibrated with CL # 3 and BP # 1 (BP mode 1)

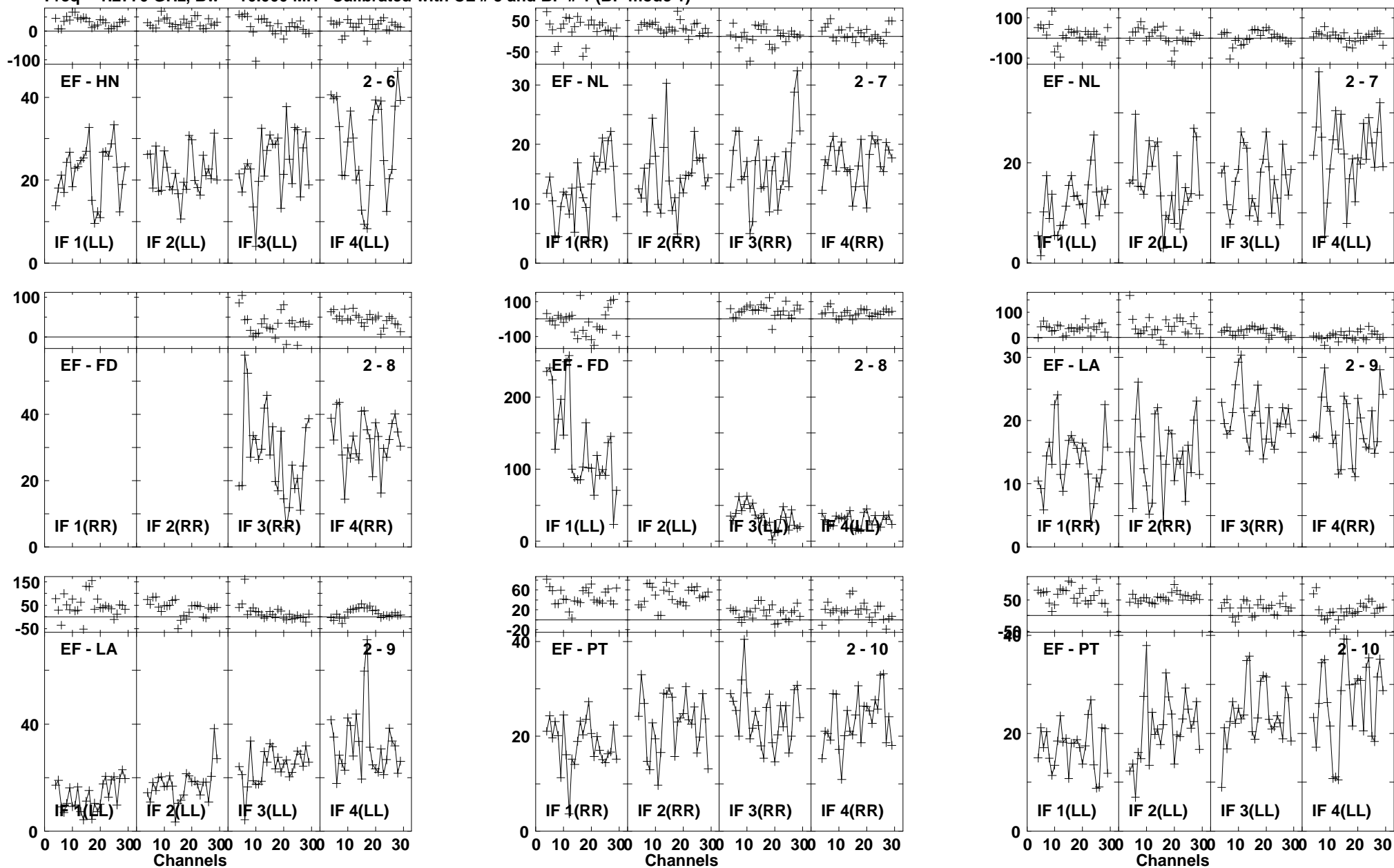

Plot file version 997 created 03-MAR-2016 01:14:50
 4C52 GN002C 1.UVDATA.1
 Freq = 1.2770 GHz, Bw = 16.000 MH Calibrated with CL # 3 and BP # 1 (BP mode 1)

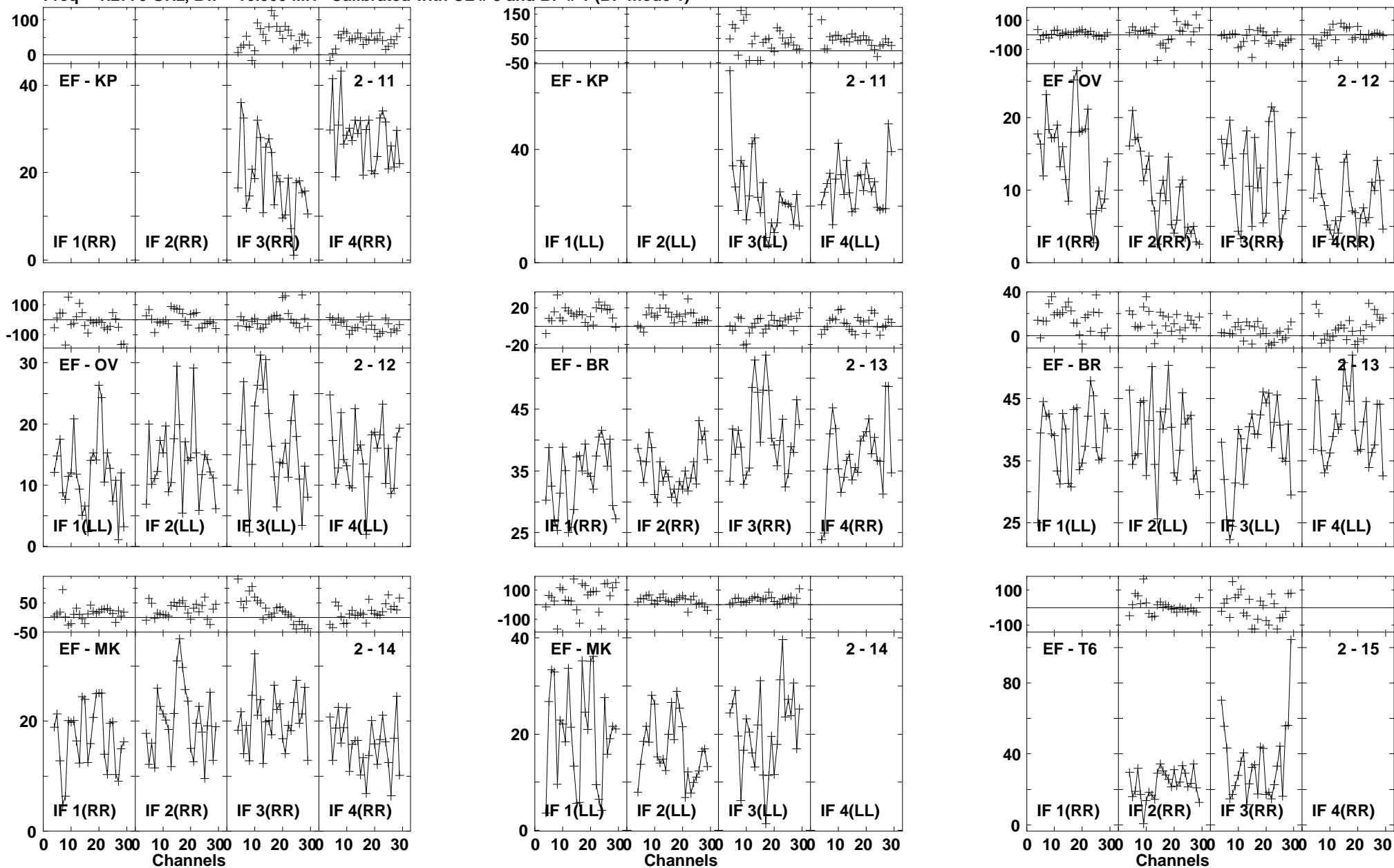

Lower frame: Milli Ampl Jy Top frame: Phas deg
 Vector averaged cross-power spectrum Baseline: EF (02) - KP (11)
 Timerange: 01/00:00:35 to 01/00:03:59

Plot file version 998 created 03-MAR-2016 01:14:50

4C52 GN002C 1.UVDATA.1

Freq = 1.2770 GHz, Bw = 16.000 MH Calibrated with CL # 3 and BP # 1 (BP mode 1)

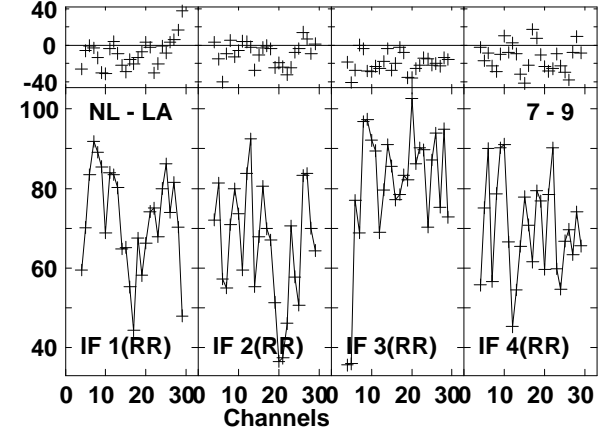
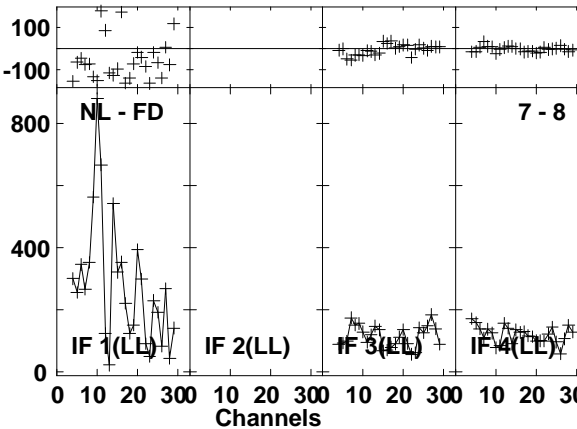
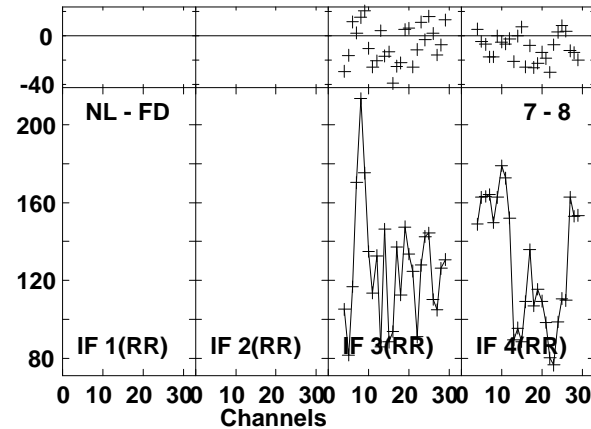
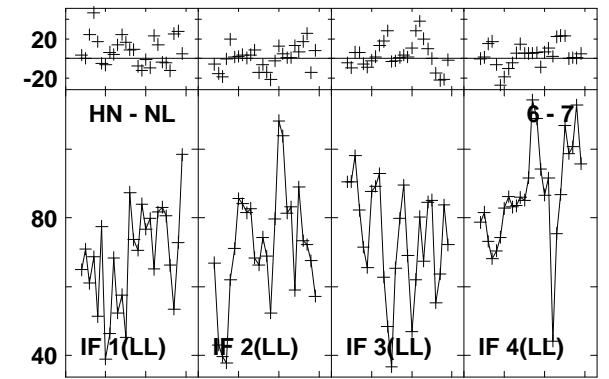
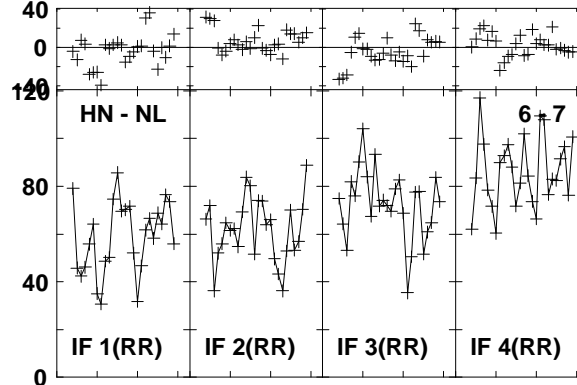
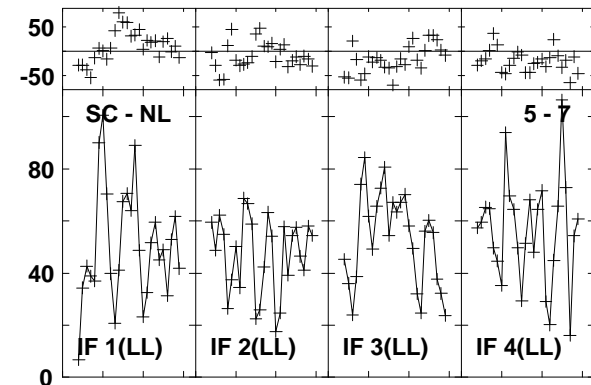
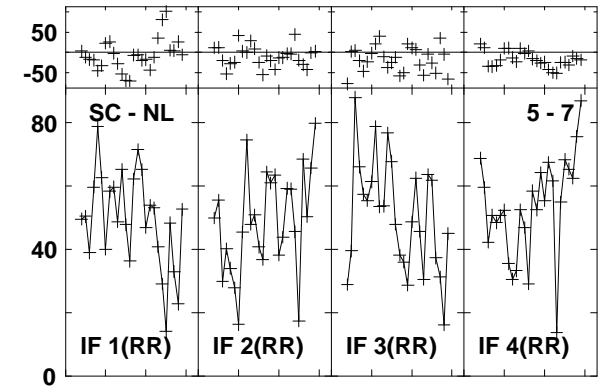
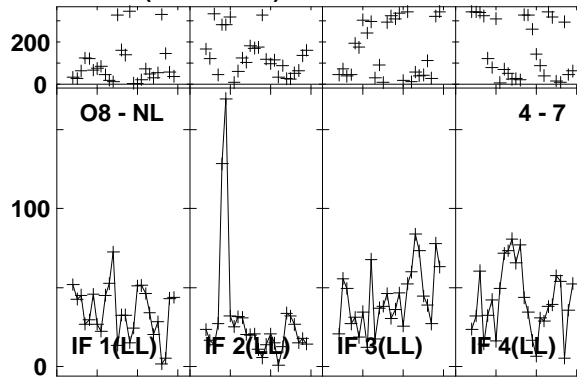
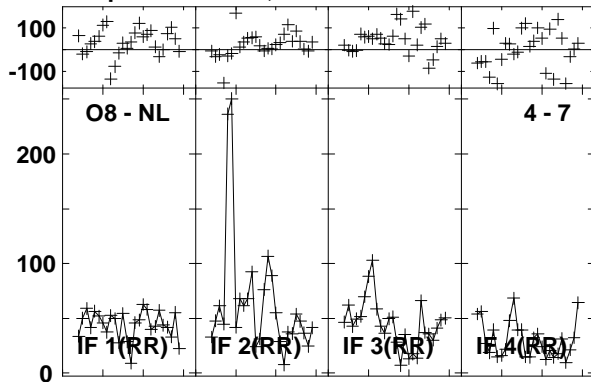

Lower frame: Milli Ampl Jy Top frame: Phas deg
Vector averaged cross-power spectrum Baseline: O8 (04) - NL (07)
Timerange: 01/00:00:35 to 01/00:03:59

Plot file version 999 created 03-MAR-2016 01:14:51

4C52 GN002C 1.UVDATA.1

Freq = 1.2770 GHz, Bw = 16.000 MH Calibrated with CL # 3 and BP # 1 (BP mode 1)

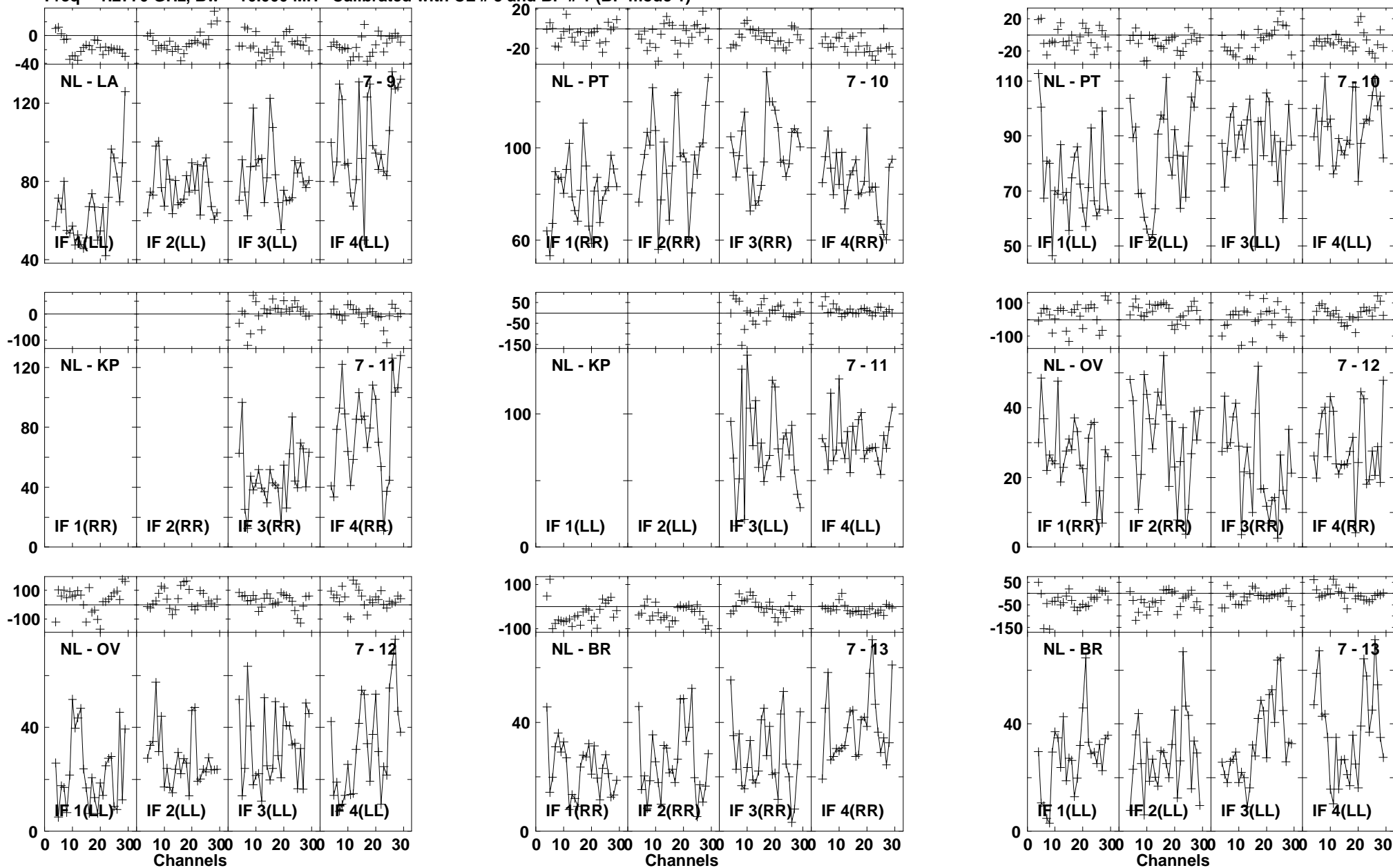

Lower frame: Milli Ampl Jy Top frame: Phas deg
Vector averaged cross-power spectrum Baseline: NL (07) - LA (09)
Timerange: 01/00:00:35 to 01/00:03:59

Plot file version1000 created 03-MAR-2016 01:14:51

4C52 GN002C 1.UVDATA.1

Freq = 1.2770 GHz, Bw = 16.000 MH Calibrated with CL # 3 and BP # 1 (BP mode 1)

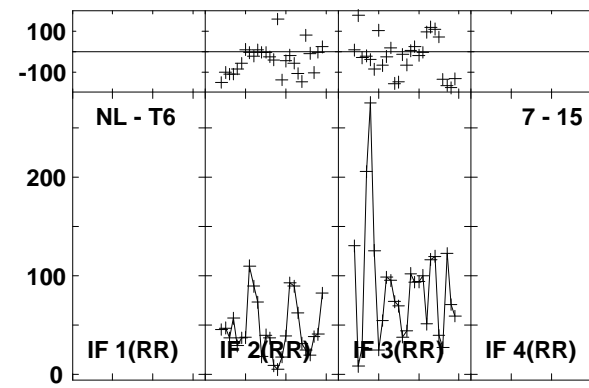
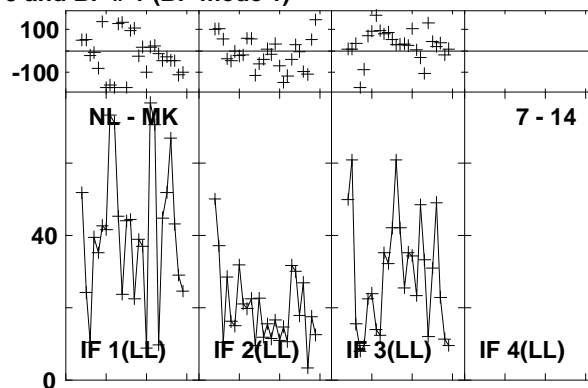
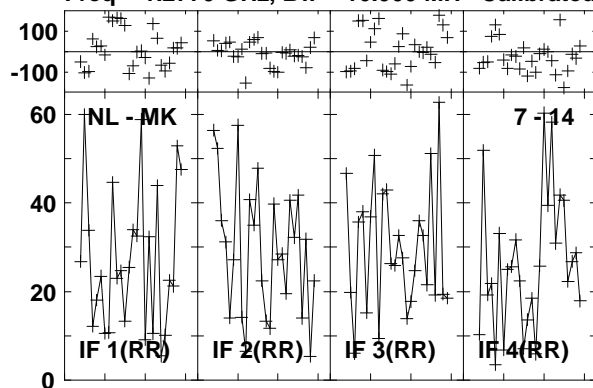

Lower frame: Milli Ampl Jy Top frame: Phas deg
Vector averaged cross-power spectrum Baseline: NL (07) - MK (14)
Timerange: 01/00:00:35 to 01/00:03:59

Plot file version1001 created 03-MAR-2016 01:14:51

J1545+5400 GN002C 1.UVDATA.1

Freq = 1.2770 GHz, Bw = 16.000 MH Calibrated with CL # 3 and BP # 1 (BP mode 1)

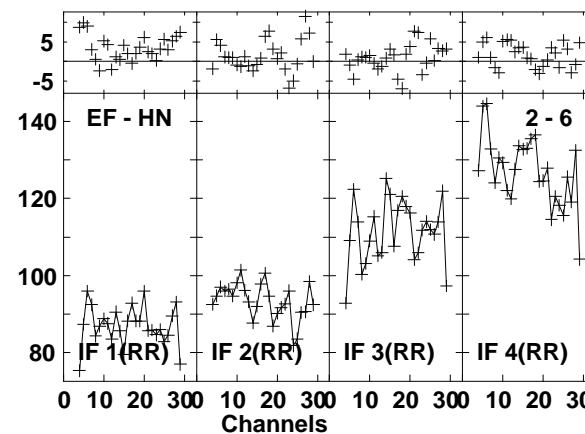
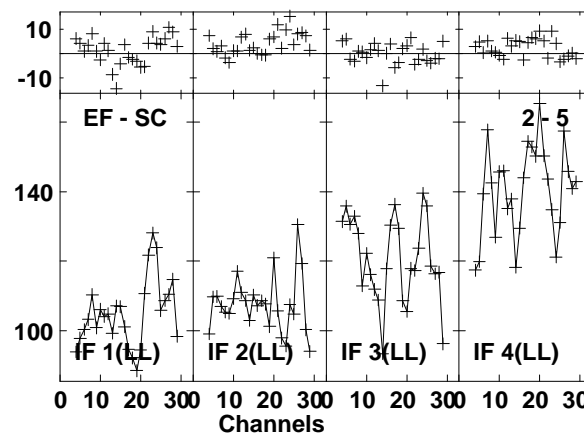
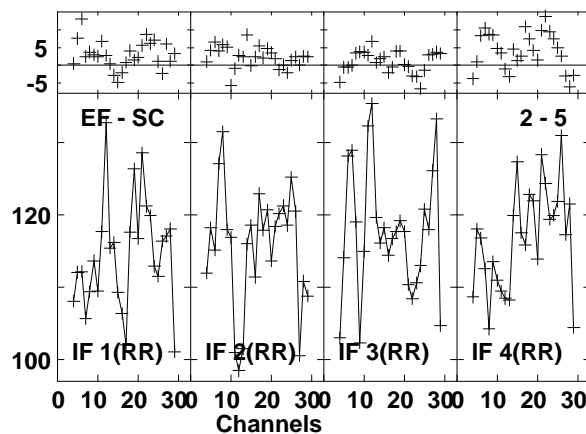
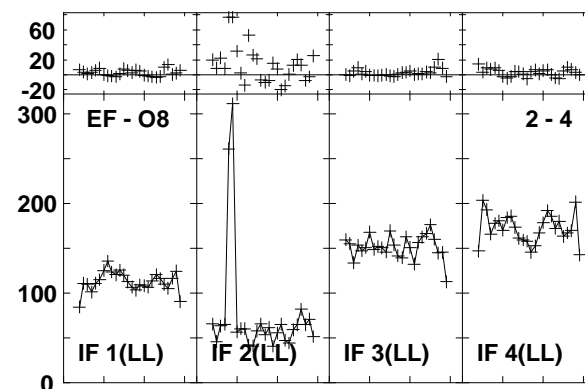
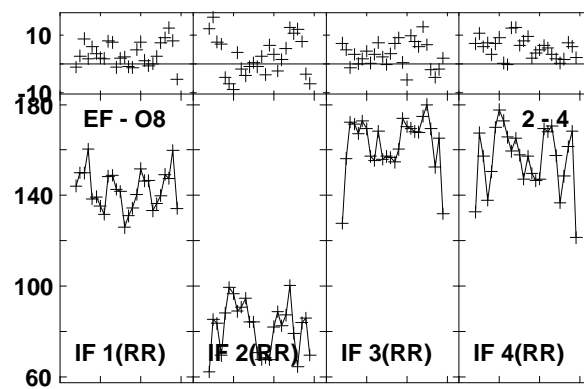
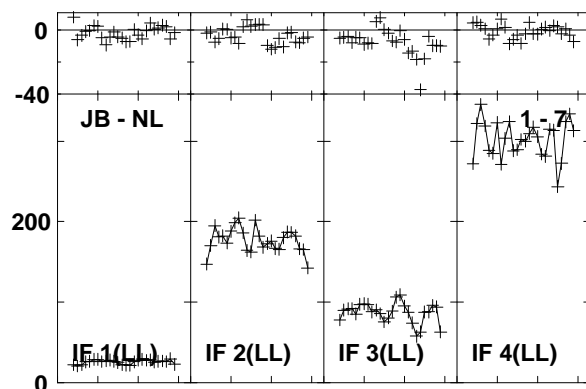
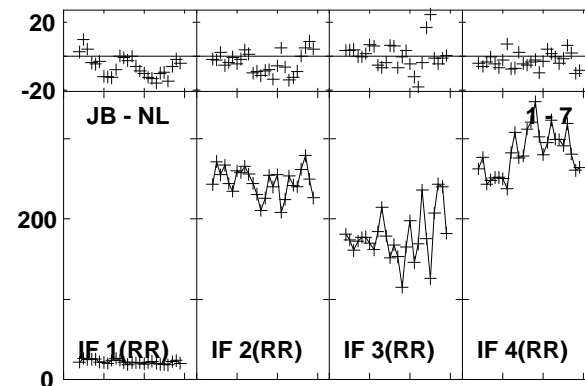
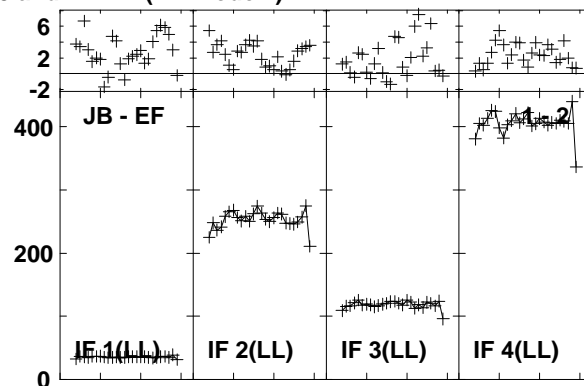
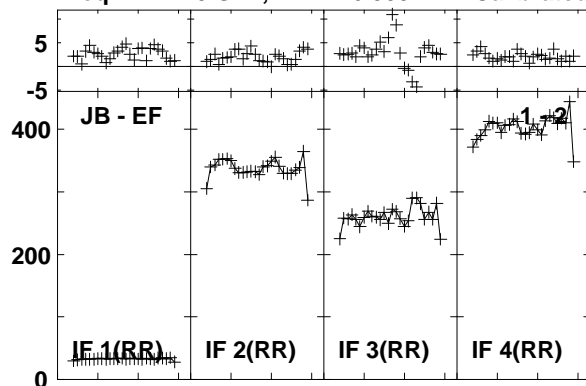

Lower frame: Milli Ampl Jy Top frame: Phas deg
Vector averaged cross-power spectrum Baseline: JB (01) - EF (02)
Timerange: 01/00:04:52 to 01/00:06:50

Plot file version1002 created 03-MAR-2016 01:14:51

J1545+5400 GN002C 1.UVDATA.1

Freq = 1.2770 GHz, Bw = 16.000 MH Calibrated with CL # 3 and BP # 1 (BP mode 1)

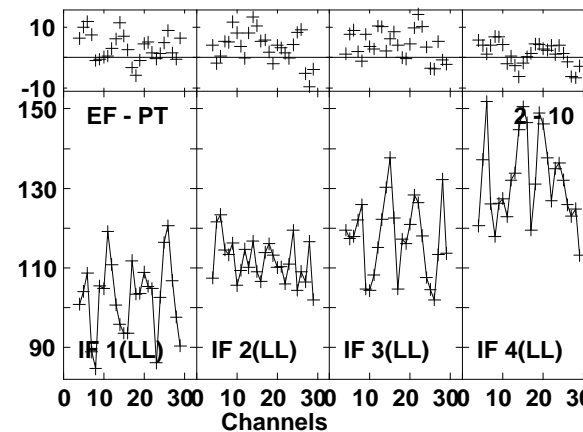
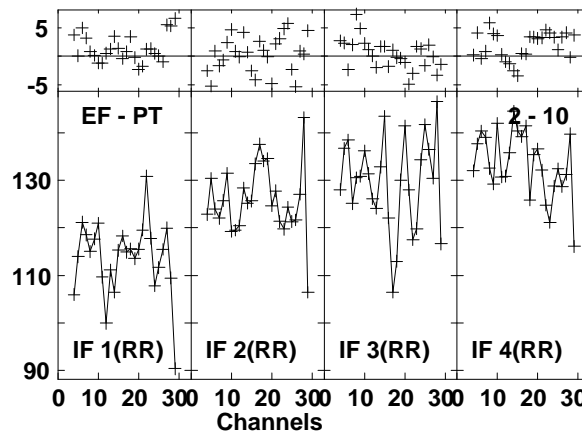
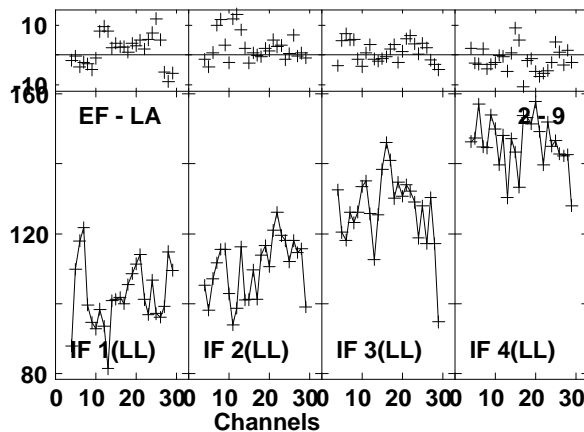
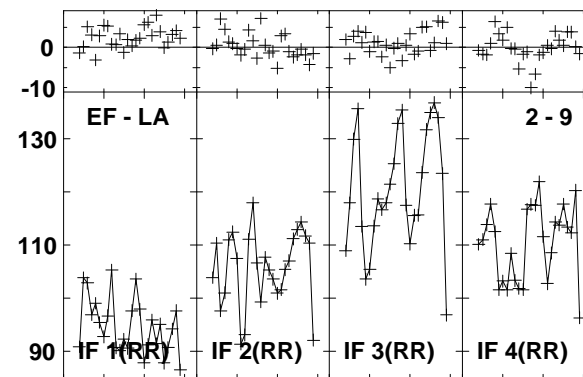
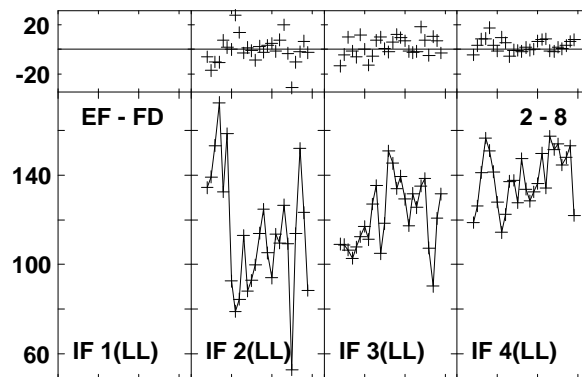
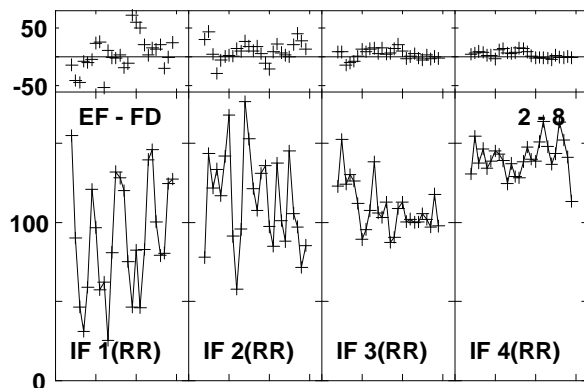
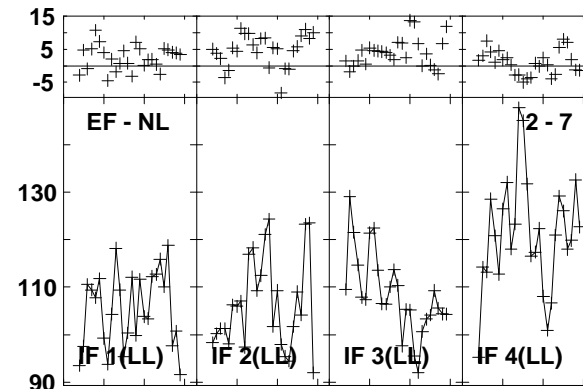
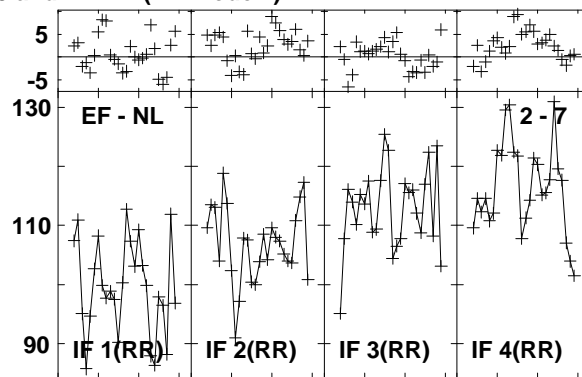
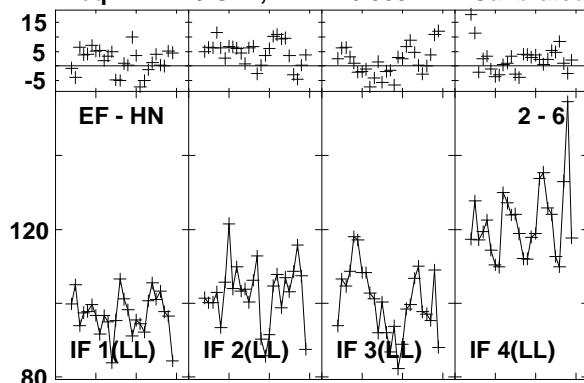

Lower frame: Milli Ampl Jy Top frame: Phas deg
Vector averaged cross-power spectrum Baseline: EF (02) - HN (06)
Timerange: 01/00:04:52 to 01/00:06:50

Plot file version1003 created 03-MAR-2016 01:14:51

J1545+5400 GN002C 1.UVDATA.1

Freq = 1.2770 GHz, Bw = 16.000 MH Calibrated with CL # 3 and BP # 1 (BP mode 1)

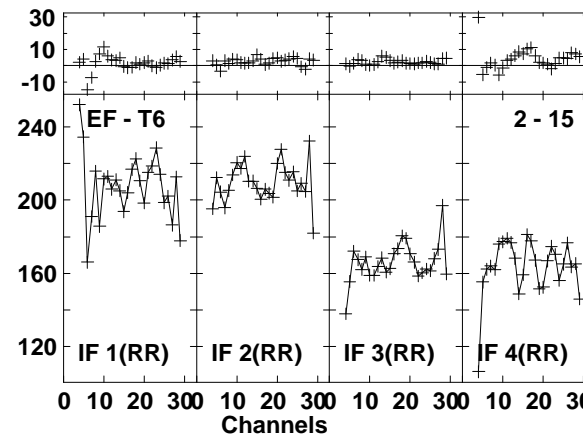
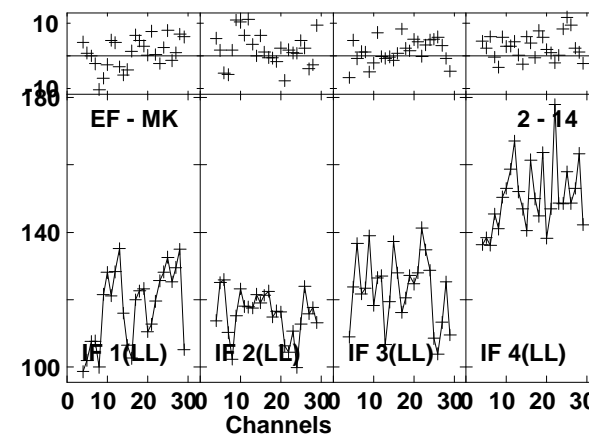
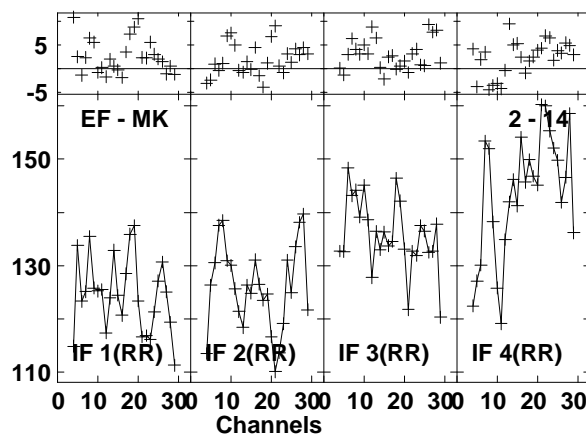
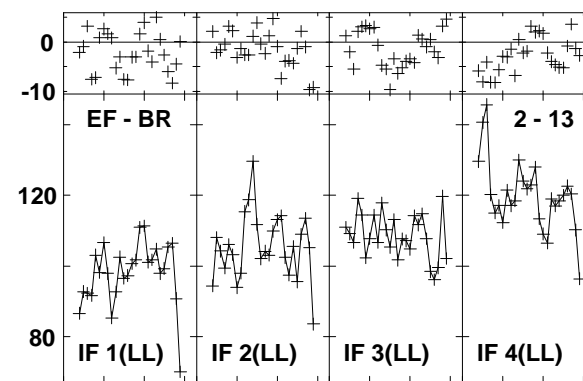
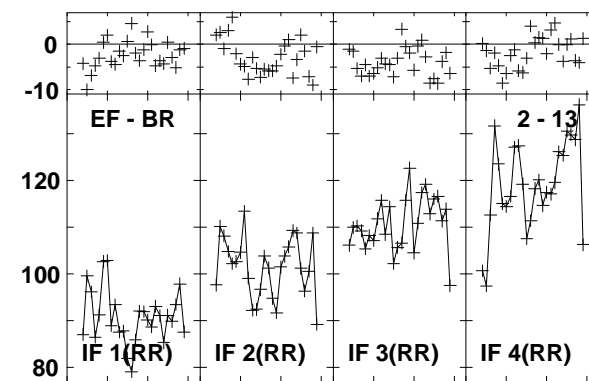
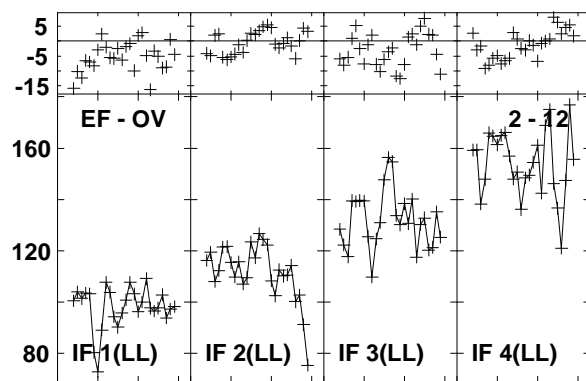
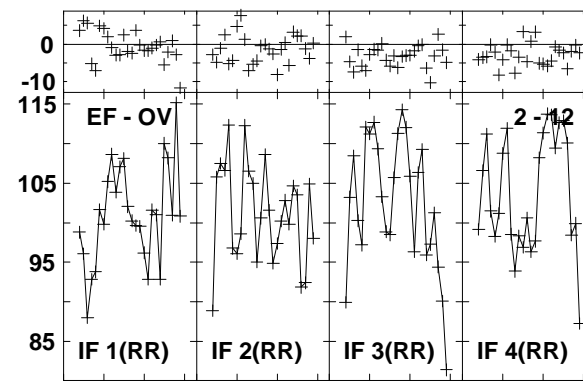
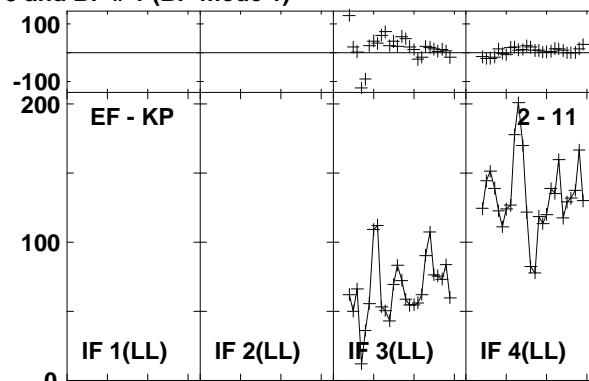
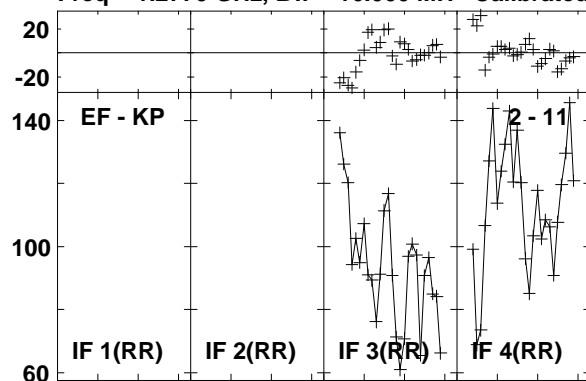

Lower frame: Milli Ampl Jy Top frame: Phas deg
Vector averaged cross-power spectrum Baseline: EF (02) - KP (11)
Timerange: 01/00:04:52 to 01/00:06:50

Plot file version1004 created 03-MAR-2016 01:14:51
 J1545+5400 GN002C 1.UVDATA.1
 Freq = 1.2770 GHz, Bw = 16.000 MH Calibrated with CL # 3 and BP # 1 (BP mode 1)

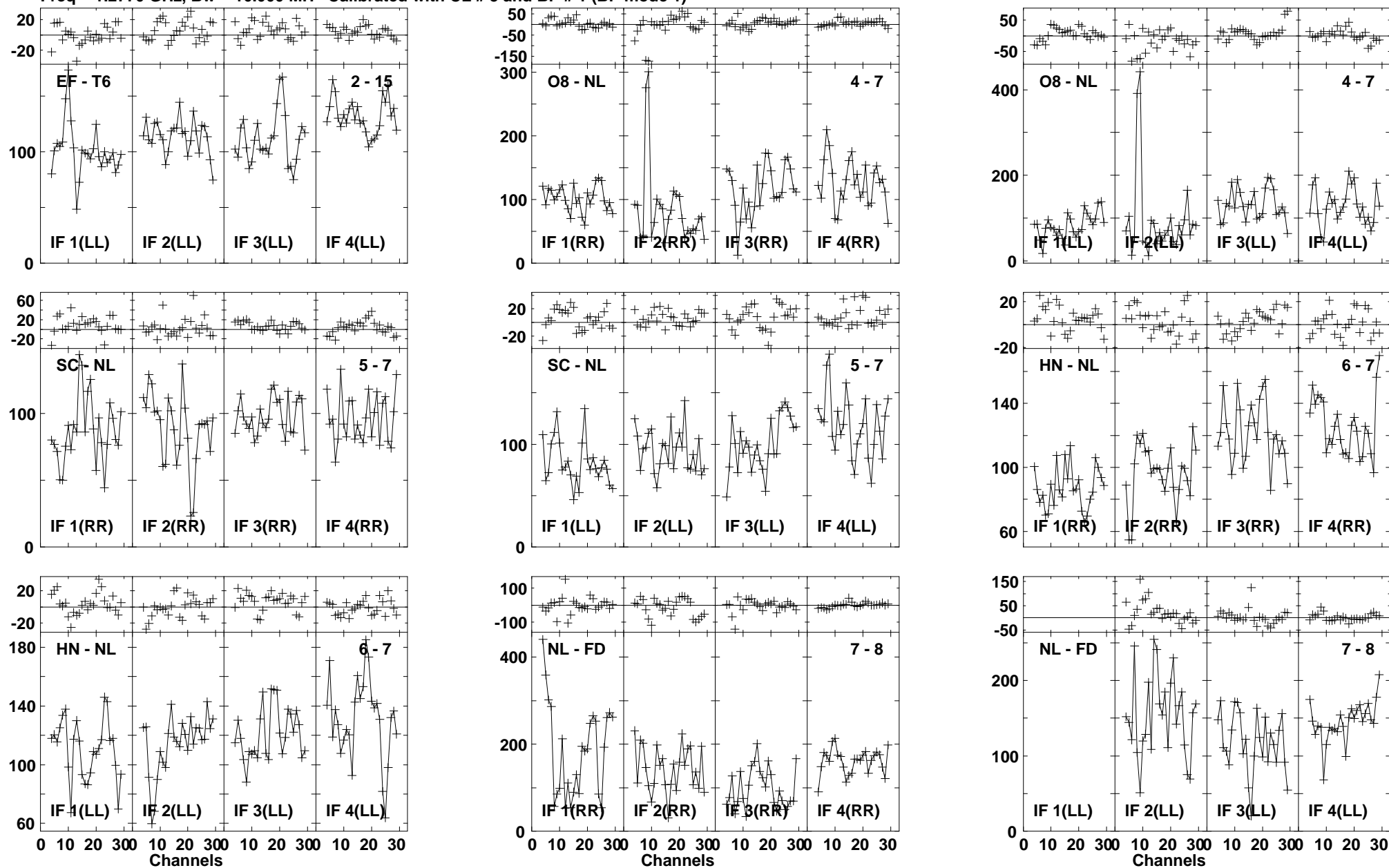

Lower frame: Milli Ampl Jy Top frame: Phas deg
 Vector averaged cross-power spectrum Baseline: EF (02) - T6 (15)
 Timerange: 01/00:04:52 to 01/00:06:50

Plot file version1005 created 03-MAR-2016 01:14:52

J1545+5400 GN002C 1.UVDATA.1

Freq = 1.2770 GHz, Bw = 16.000 MH Calibrated with CL # 3 and BP # 1 (BP mode 1)

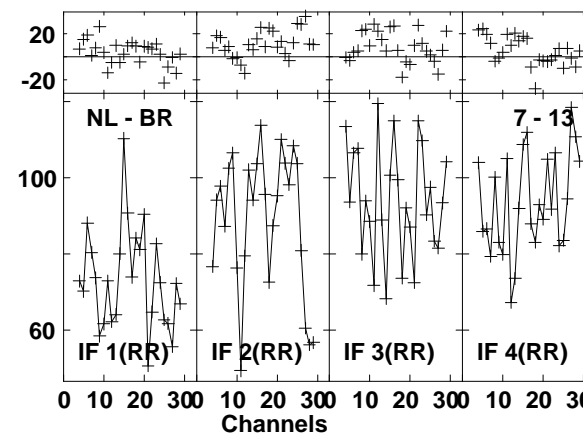
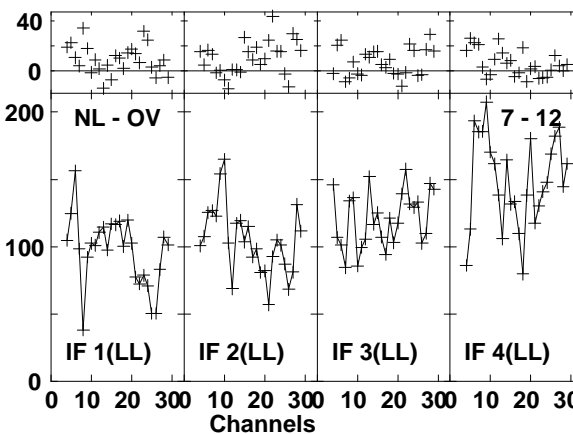
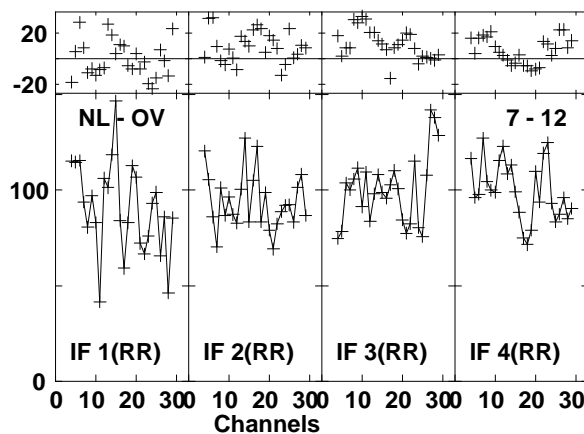
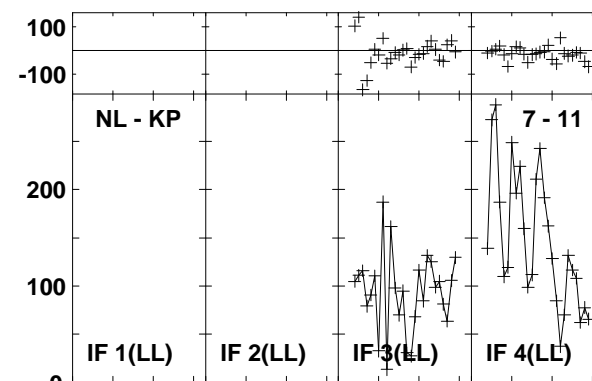
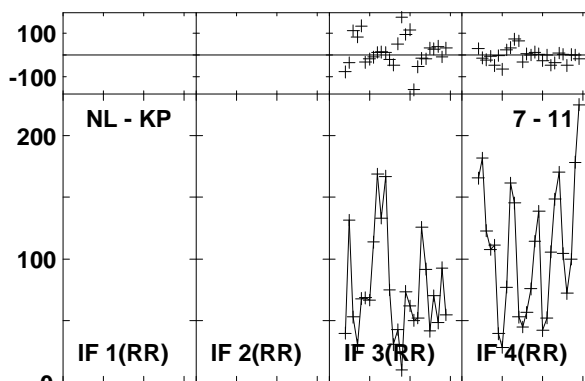
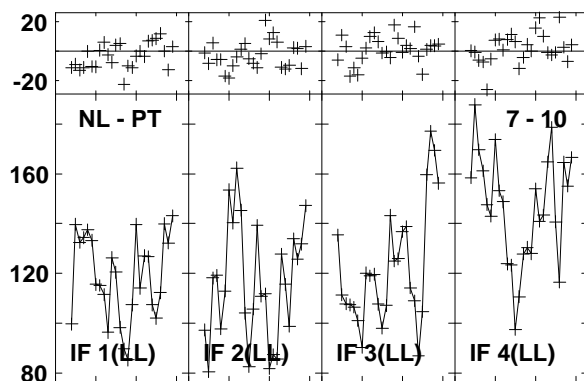
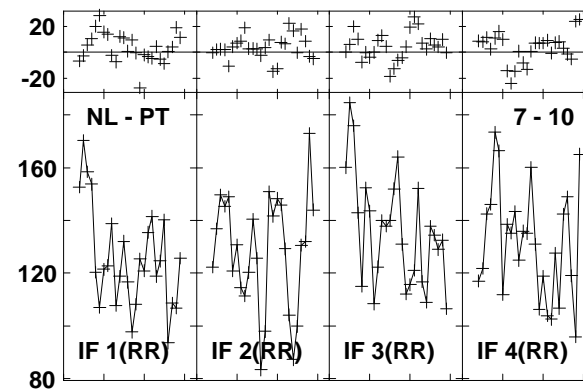
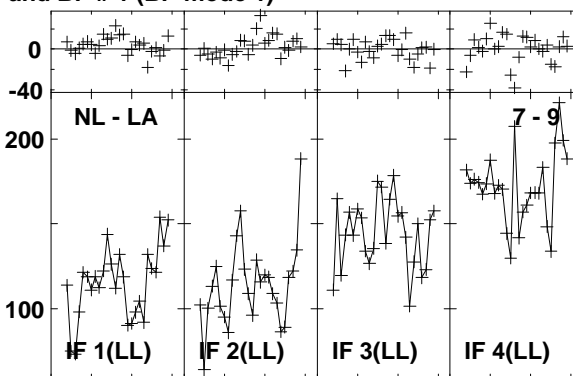
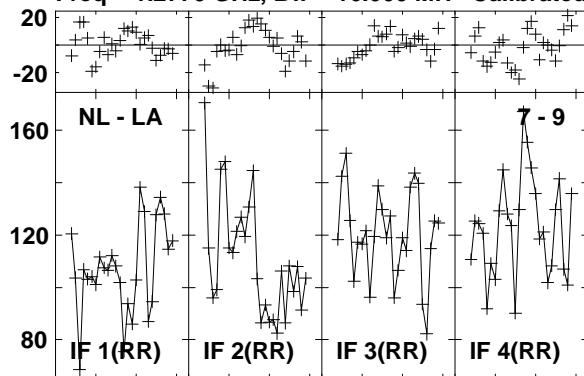

Lower frame: Milli Ampl Jy Top frame: Phas deg
Vector averaged cross-power spectrum Baseline: NL (07) - LA (09)
Timerange: 01/00:04:52 to 01/00:06:50

Plot file version1006 created 03-MAR-2016 01:14:52
 J1545+5400 GN002C 1.UVDATA.1
 Freq = 1.2770 GHz, Bw = 16.000 MH Calibrated with CL # 3 and BP # 1 (BP mode 1)

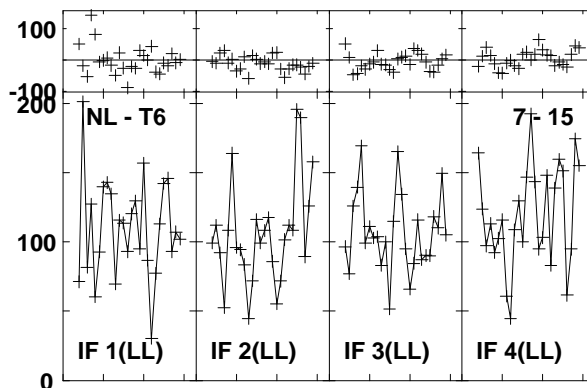
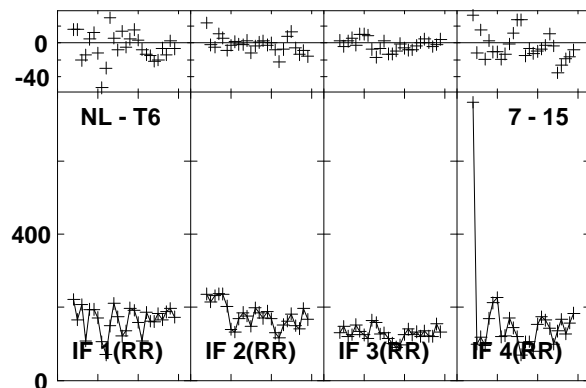
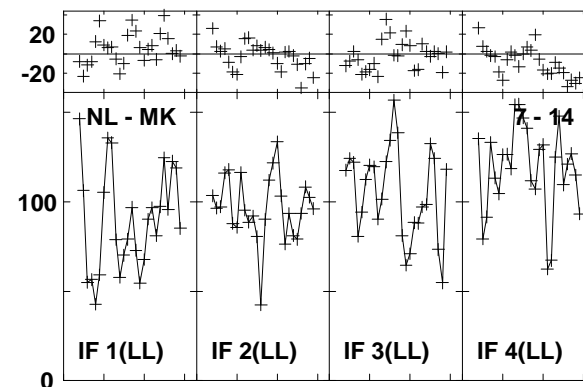
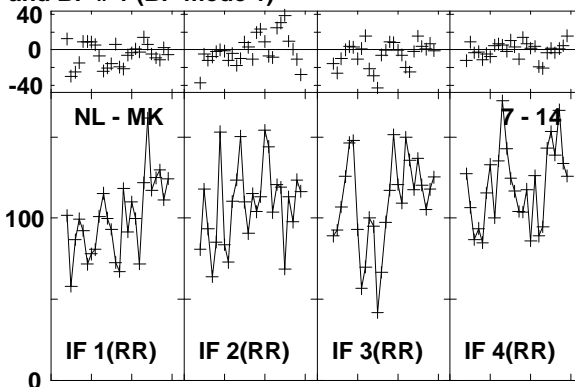
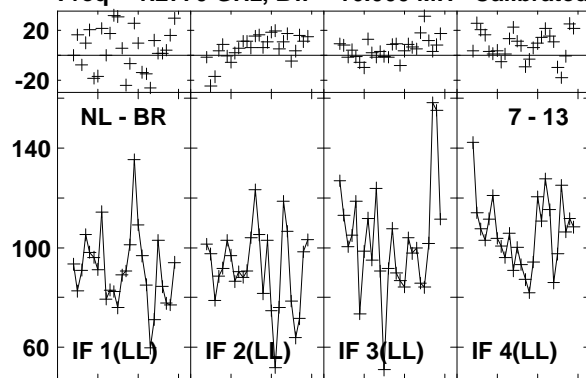

Lower frame: Milli Ampl Jy Top frame: Phas deg
 Vector averaged cross-power spectrum Baseline: NL (07) - BR (13)
 Timerange: 01/00:04:52 to 01/00:06:50

Plot file version1007 created 03-MAR-2016 01:14:52

4C52 GN002C 1.UVDATA.1

Freq = 1.2770 GHz, Bw = 16.000 MH Calibrated with CL # 3 and BP # 1 (BP mode 1)

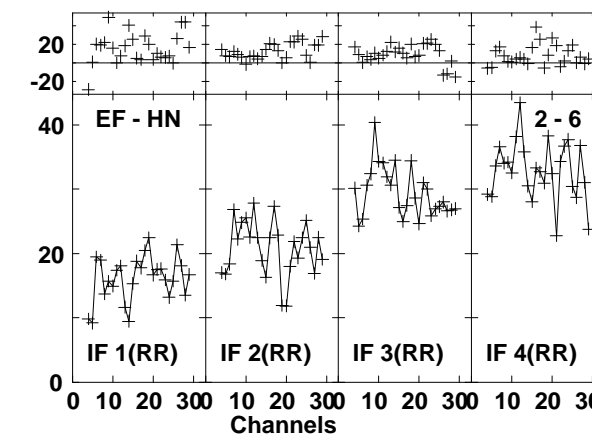
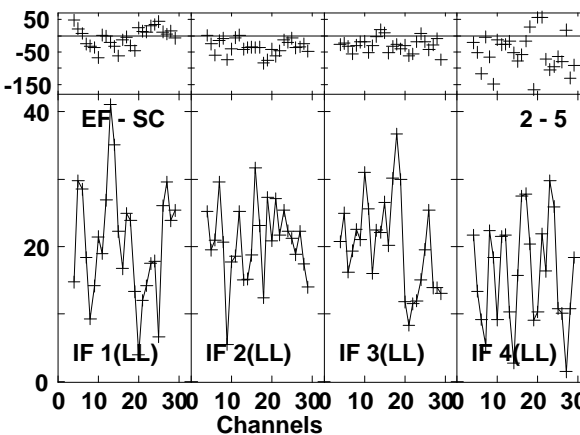
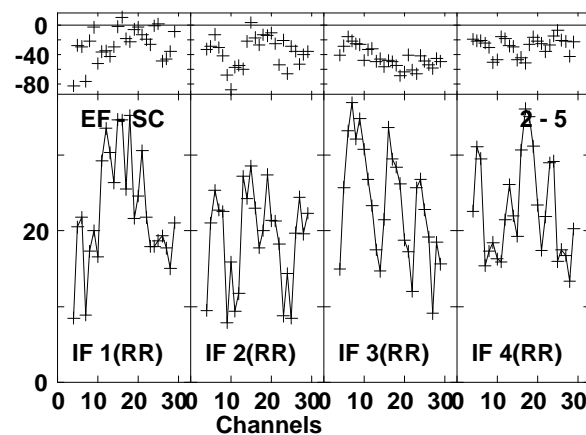
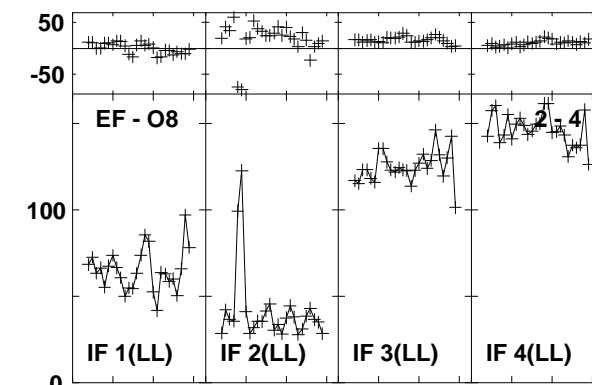
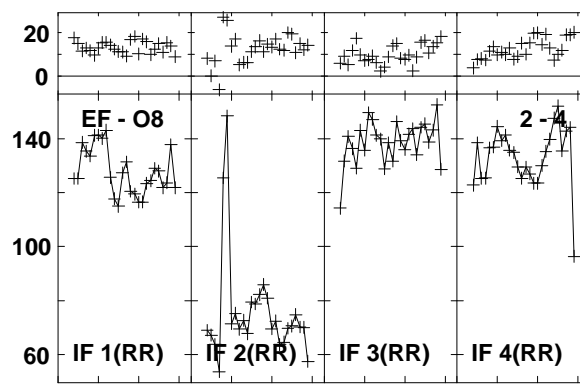
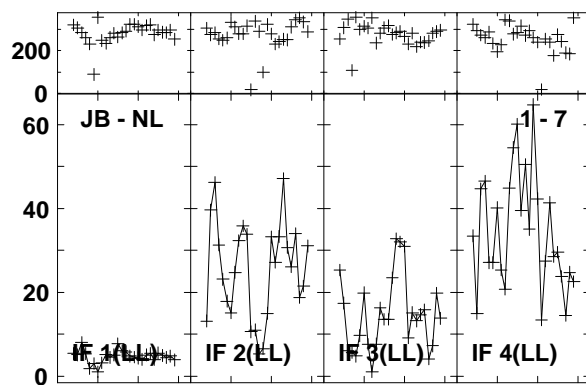
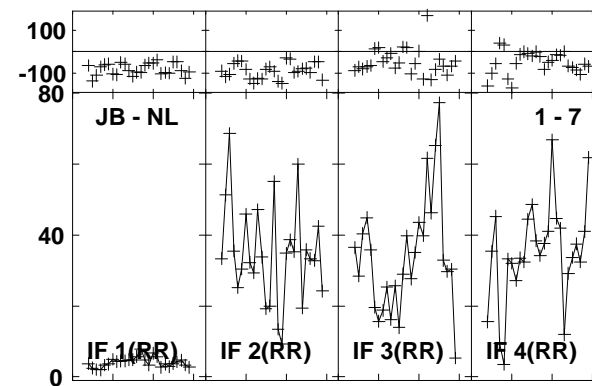
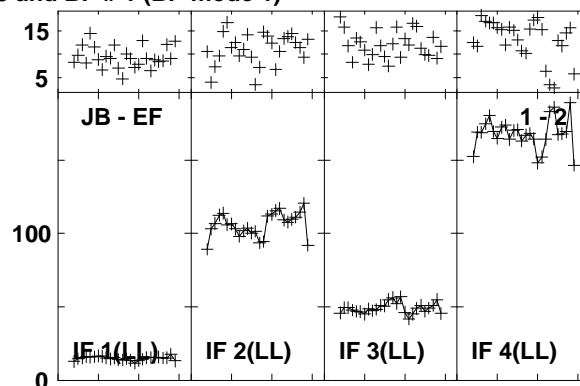
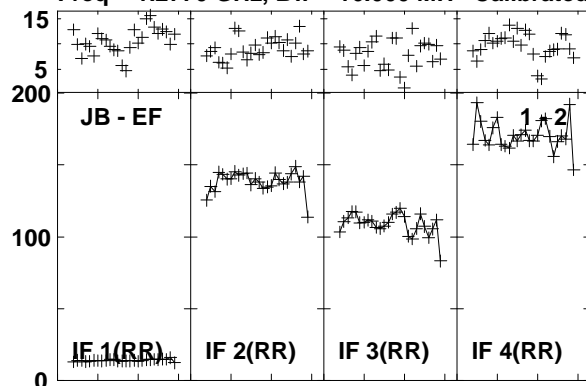

Lower frame: Milli Ampl Jy Top frame: Phas deg
Vector averaged cross-power spectrum Baseline: JB (01) - EF (02)
Timerange: 01/00:07:03 to 01/00:10:19

Plot file version1008 created 03-MAR-2016 01:14:52

4C52 GN002C 1.UVDATA.1

Freq = 1.2770 GHz, Bw = 16.000 MH Calibrated with CL # 3 and BP # 1 (BP mode 1)

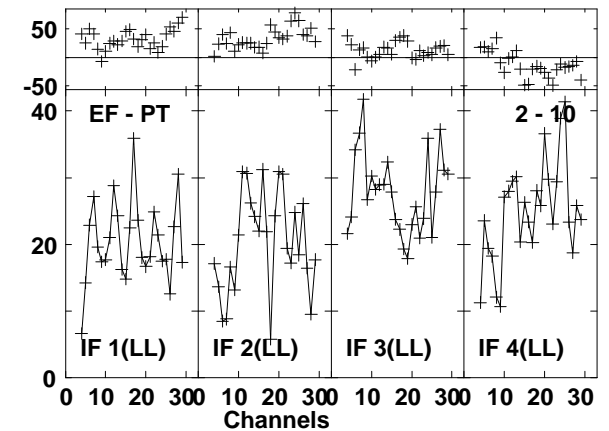
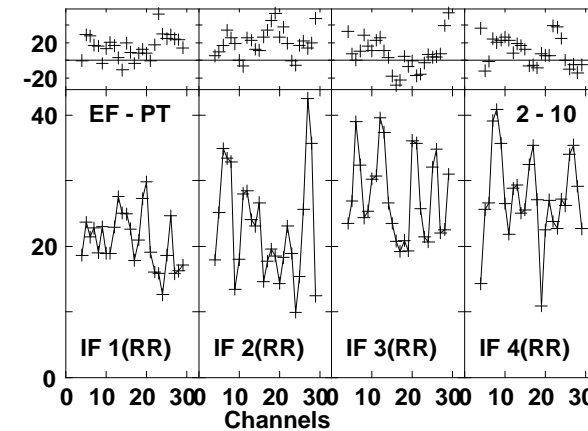
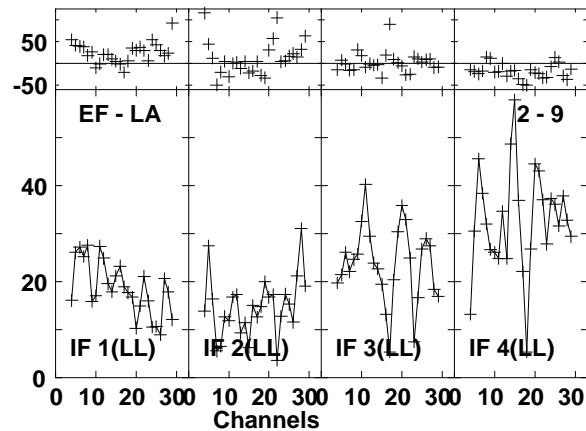
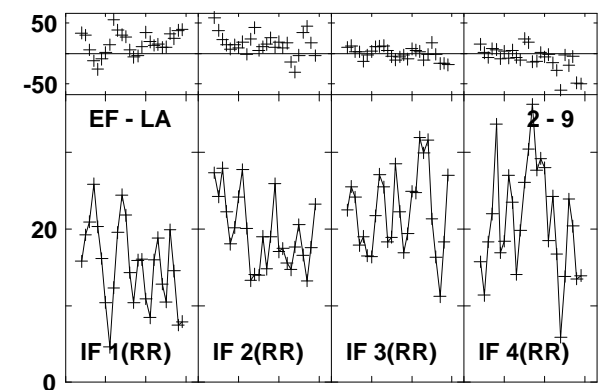
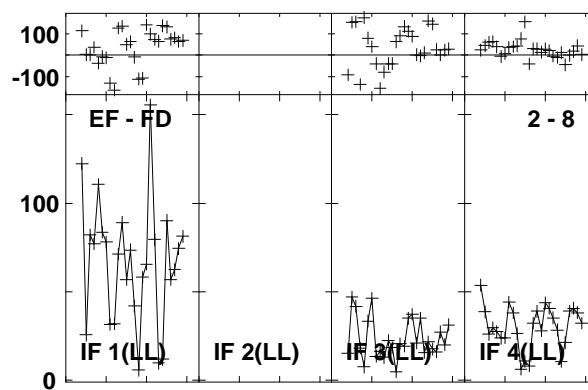
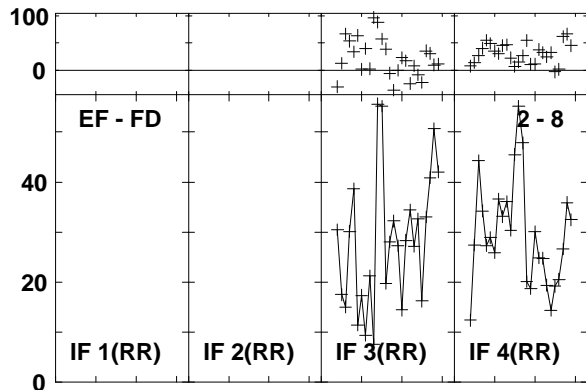
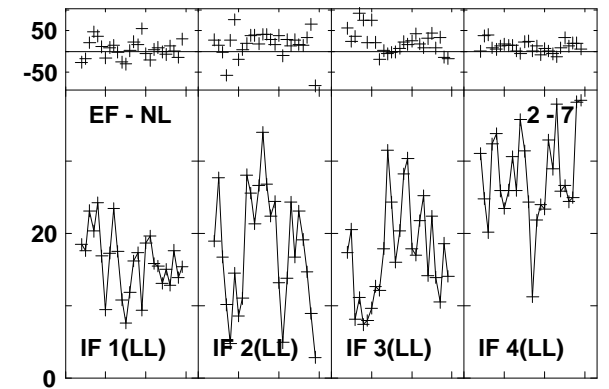
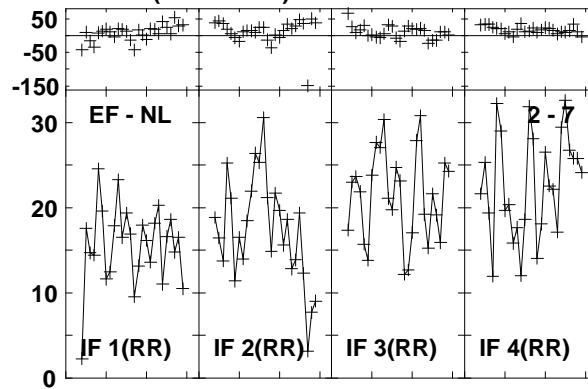
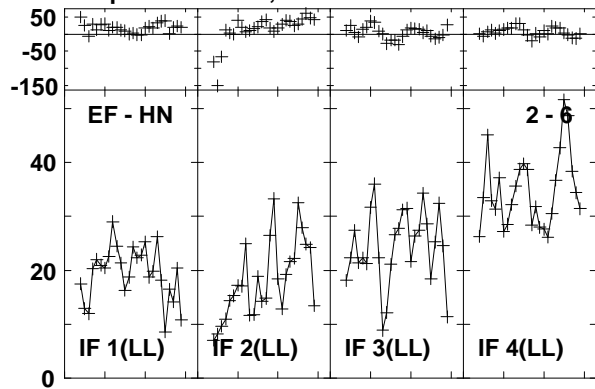

Lower frame: Milli Ampl Jy Top frame: Phas deg
Vector averaged cross-power spectrum Baseline: EF (02) - HN (06)
Timerange: 01/00:07:03 to 01/00:10:19

Plot file version1009 created 03-MAR-2016 01:14:52

4C52 GN002C 1.UVDATA.1

Freq = 1.2770 GHz, Bw = 16.000 MH Calibrated with CL # 3 and BP # 1 (BP mode 1)

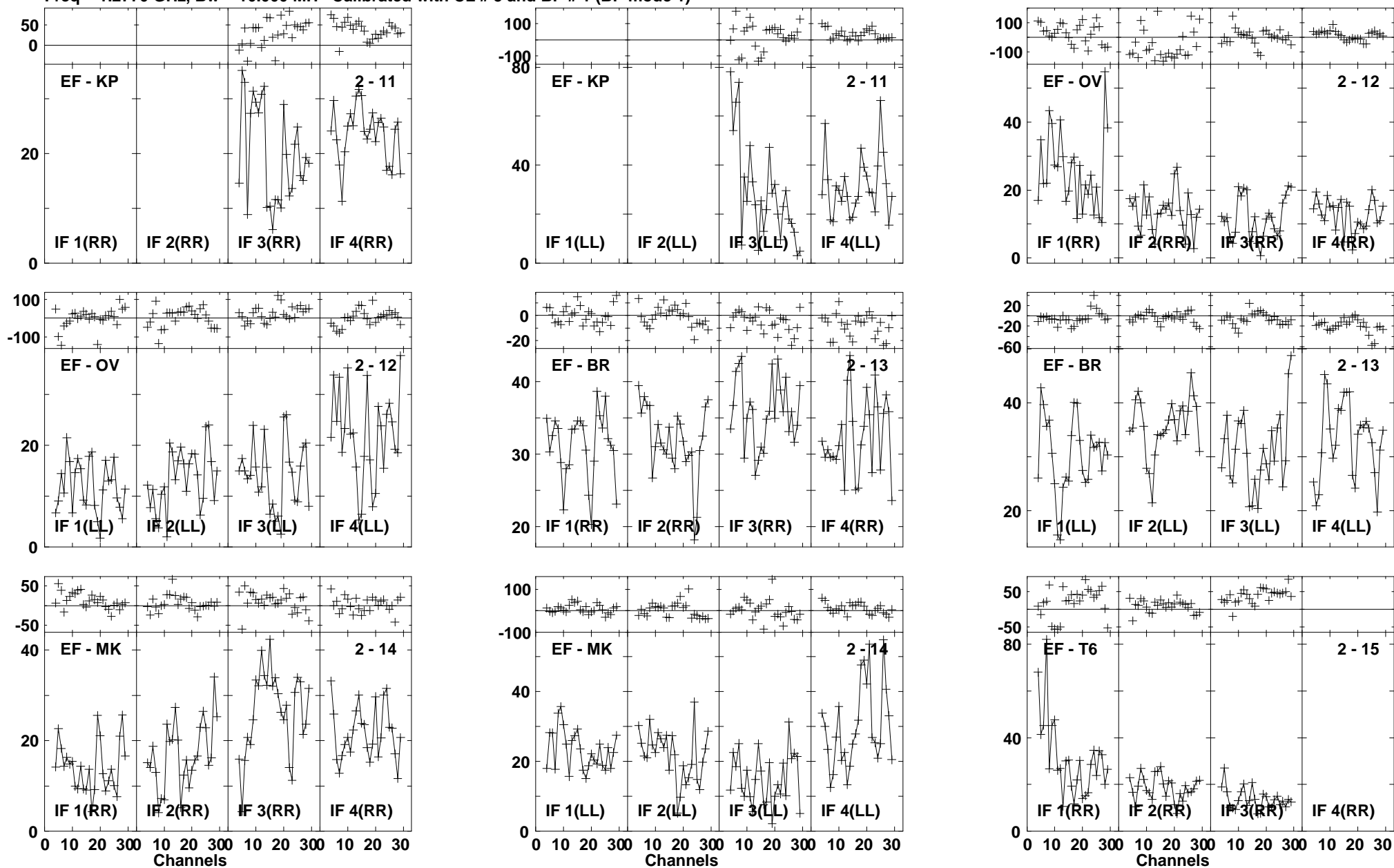

Lower frame: Milli Ampl Jy Top frame: Phas deg
Vector averaged cross-power spectrum Baseline: EF (02) - KP (11)
Timerange: 01/00:07:03 to 01/00:10:19

Plot file version1010 created 03-MAR-2016 01:14:52

4C52 GN002C 1.UVDATA.1

Freq = 1.2770 GHz, Bw = 16.000 MH Calibrated with CL # 3 and BP # 1 (BP mode 1)

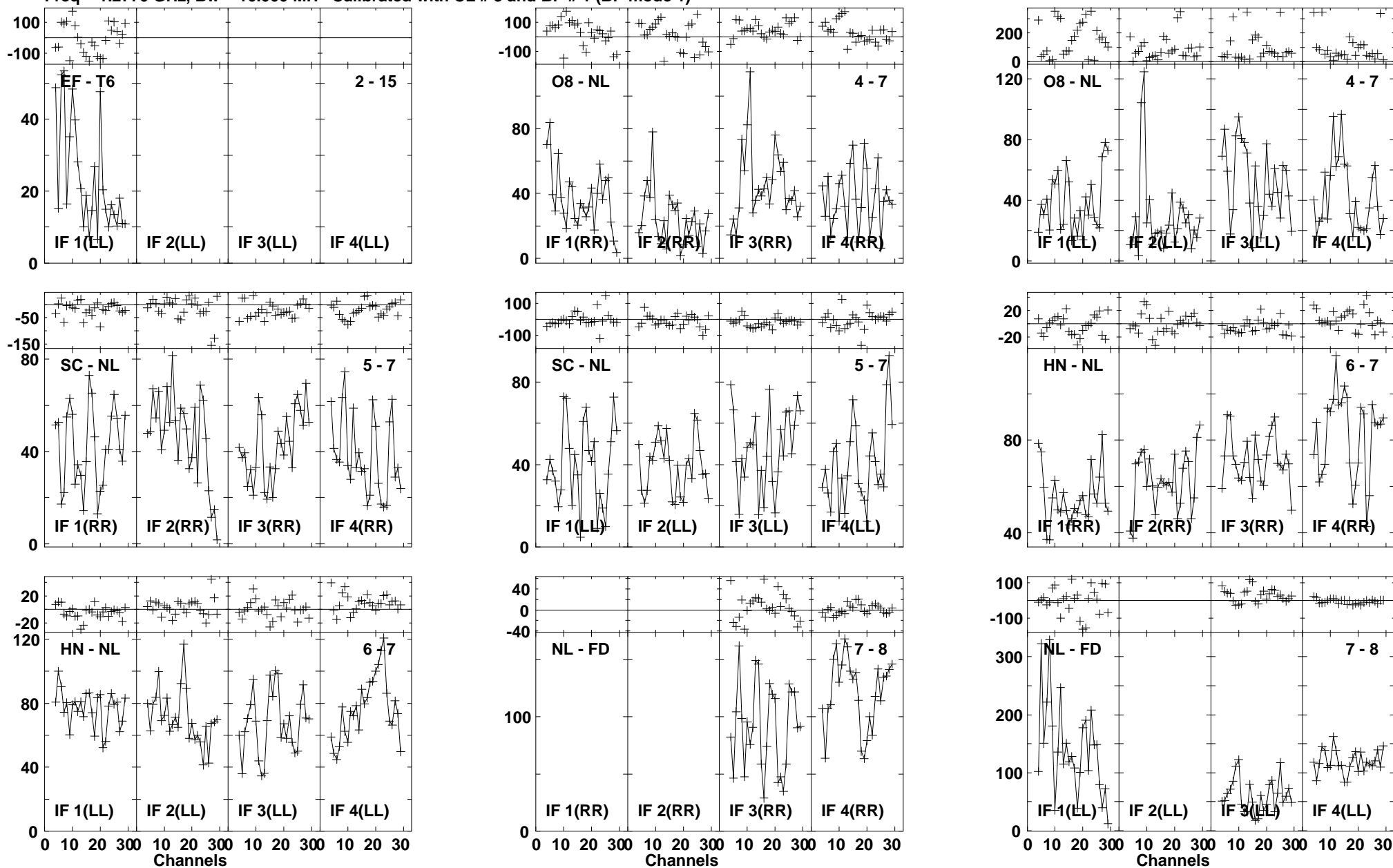

Lower frame: Milli Ampl Jy Top frame: Phas deg
Vector averaged cross-power spectrum Baseline: EF (02) - T6 (15)
Timerange: 01/00:07:03 to 01/00:10:19

Plot file version1011 created 03-MAR-2016 01:14:53

4C52 GN002C 1.UVDATA.1

Freq = 1.2770 GHz, Bw = 16.000 MH Calibrated with CL # 3 and BP # 1 (BP mode 1)

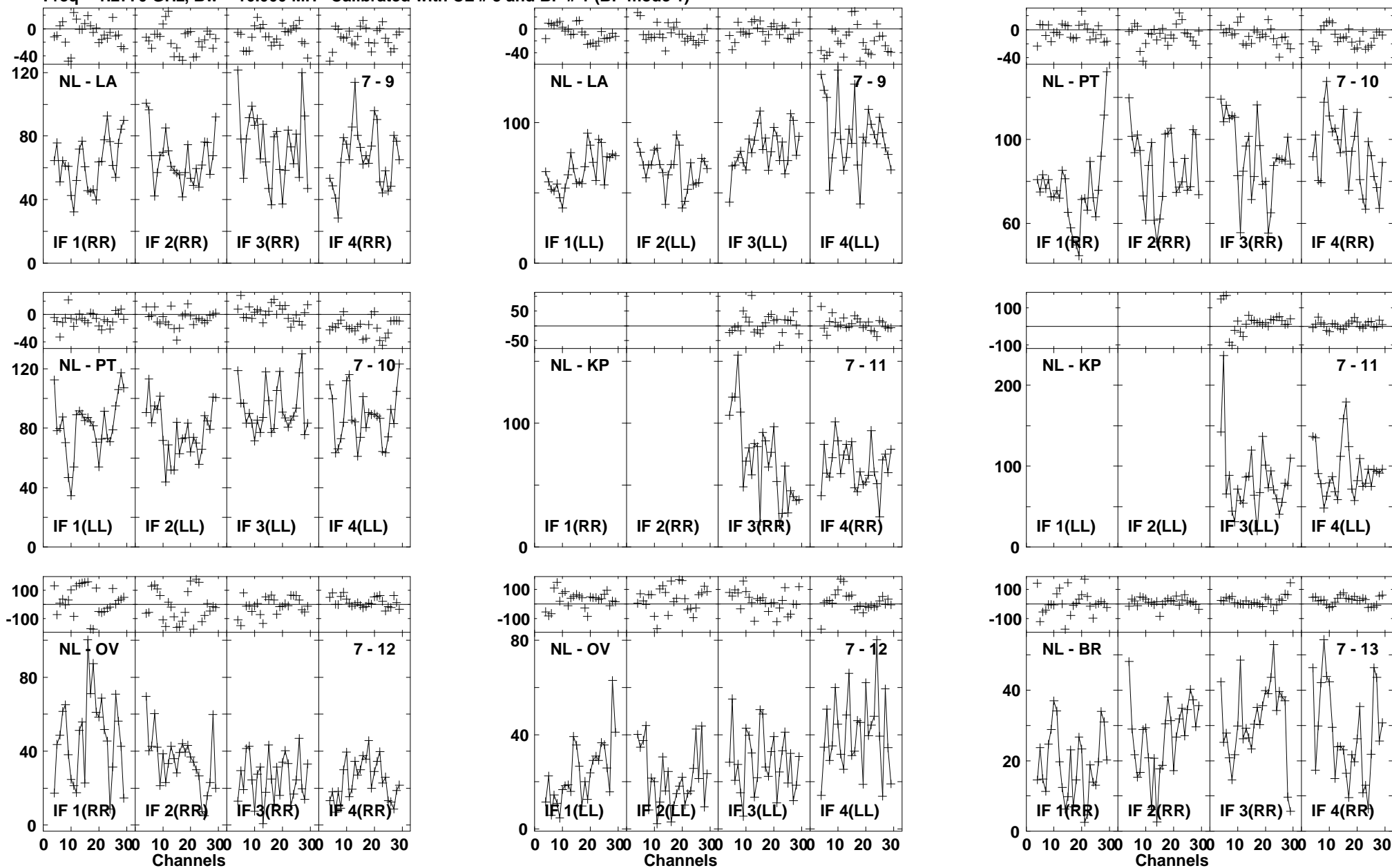

Lower frame: Milli Ampl Jy Top frame: Phas deg
Vector averaged cross-power spectrum Baseline: NL (07) - LA (09)
Timerange: 01/00:07:03 to 01/00:10:19

Plot file version1012 created 03-MAR-2016 01:14:53

4C52 GN002C 1.UVDATA.1

Freq = 1.2770 GHz, Bw = 16.000 MH Calibrated with CL # 3 and BP # 1 (BP mode 1)

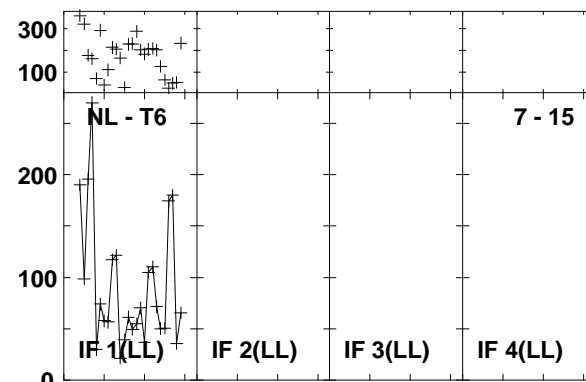
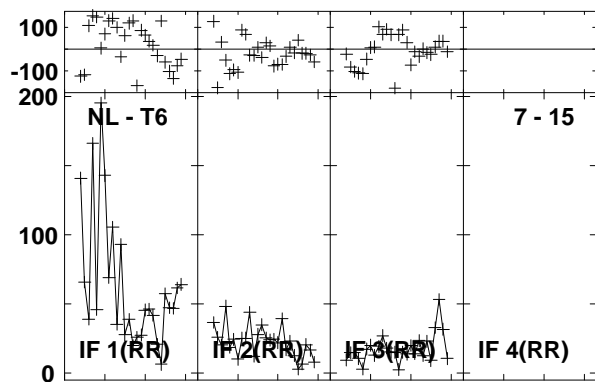
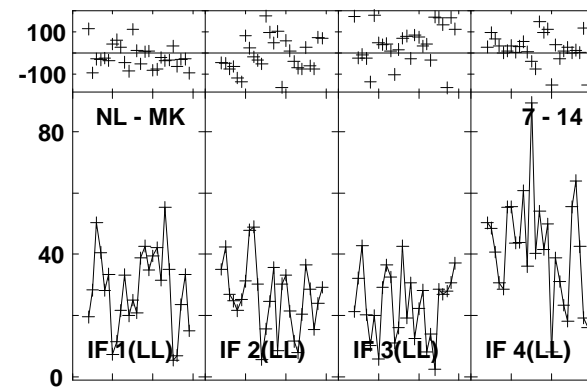
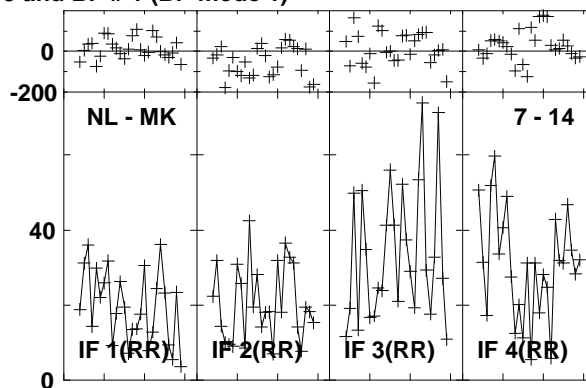
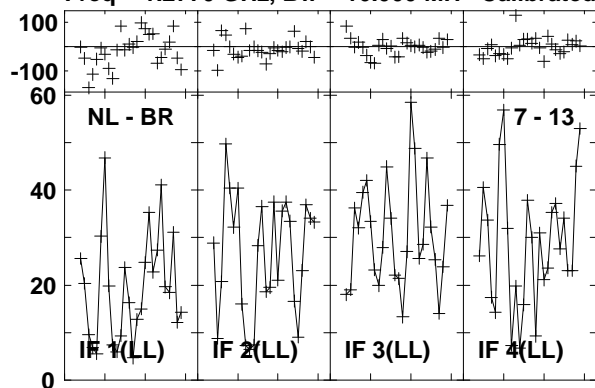

Lower frame: Milli Ampl Jy Top frame: Phas deg
Vector averaged cross-power spectrum Baseline: NL (07) - BR (13)
Timerange: 01/00:07:03 to 01/00:10:19

Plot file version1013 created 03-MAR-2016 01:14:53

J1545+5400 GN002C 1.UVDATA.1

Freq = 1.2770 GHz, Bw = 16.000 MH Calibrated with CL # 3 and BP # 1 (BP mode 1)

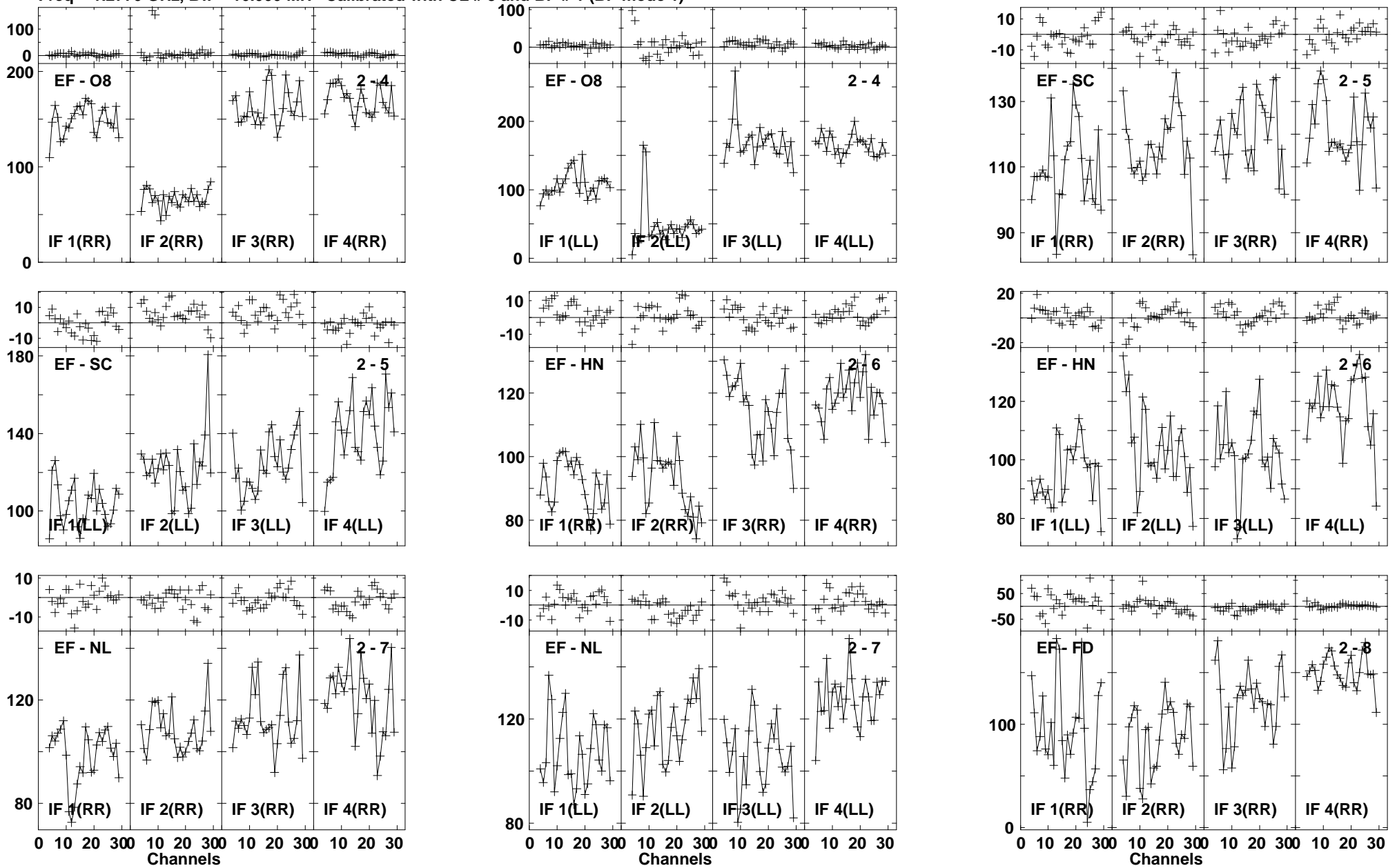

Lower frame: Milli Ampl Jy Top frame: Phas deg
Vector averaged cross-power spectrum Baseline: EF (02) - O8 (04)
Timerange: 01/00:11:12 to 01/00:12:10

Plot file version1014 created 03-MAR-2016 01:14:53

J1545+5400 GN002C 1.UVDATA.1

Freq = 1.2770 GHz, Bw = 16.000 MH Calibrated with CL # 3 and BP # 1 (BP mode 1)

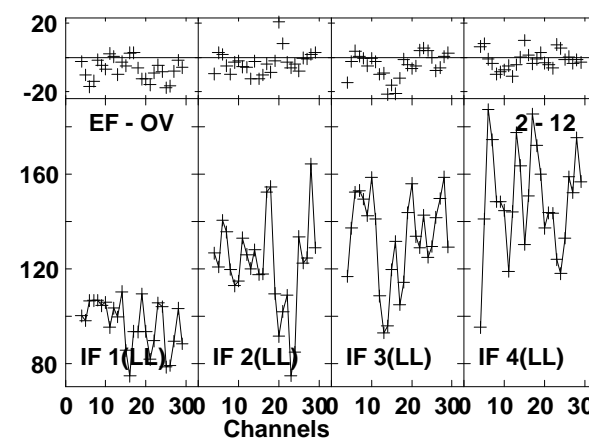
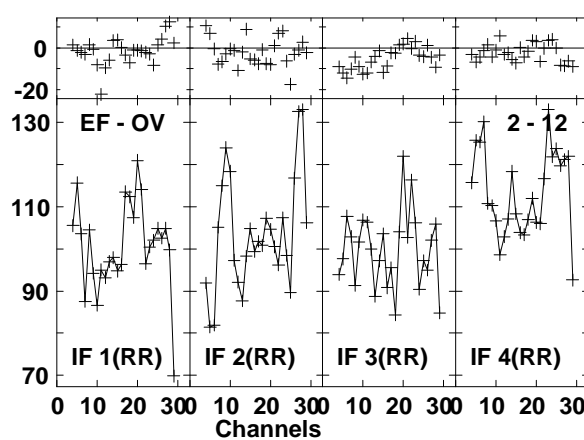
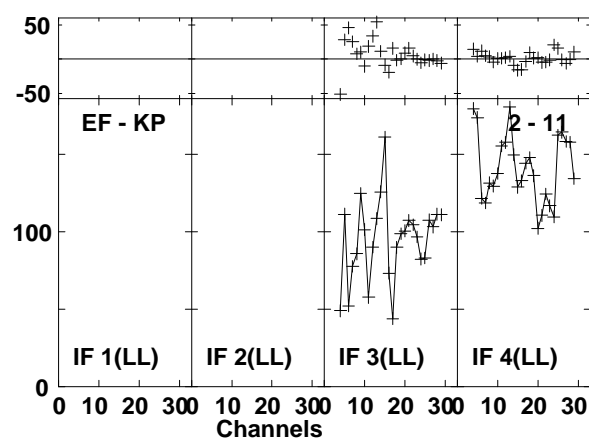
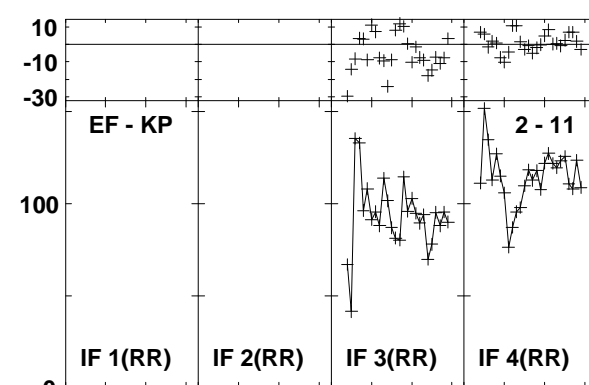
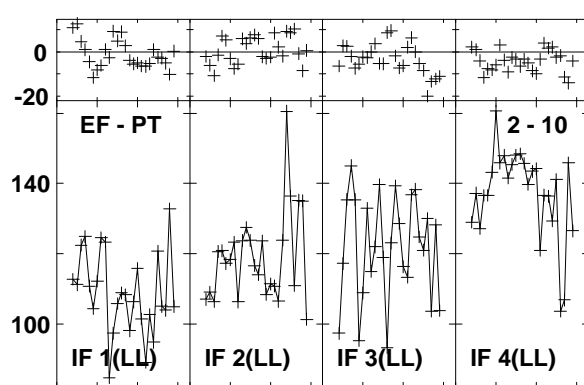
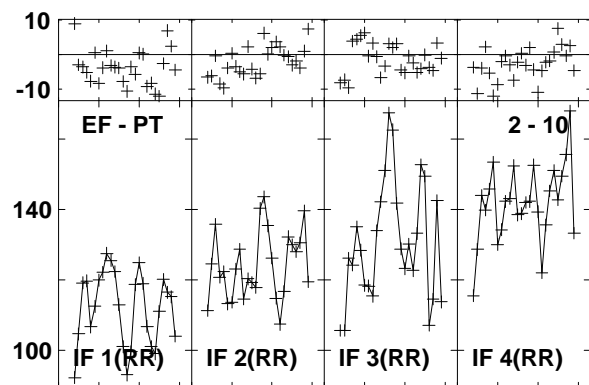
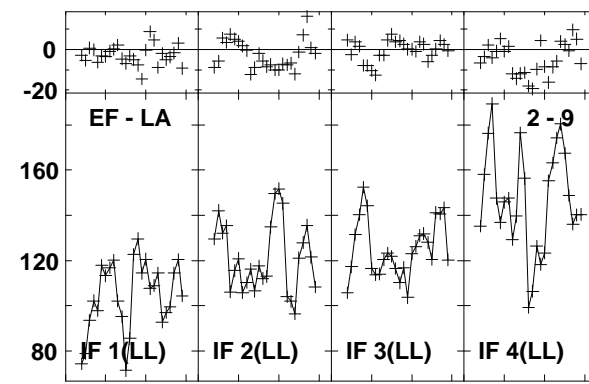
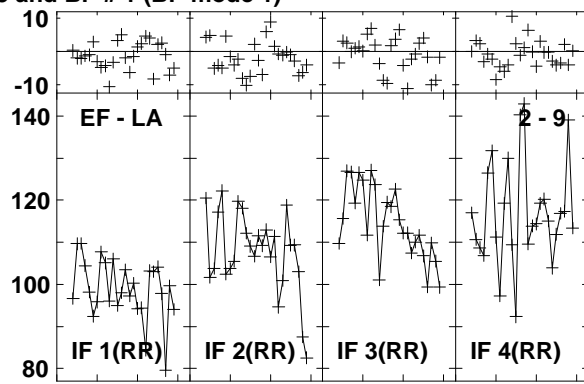
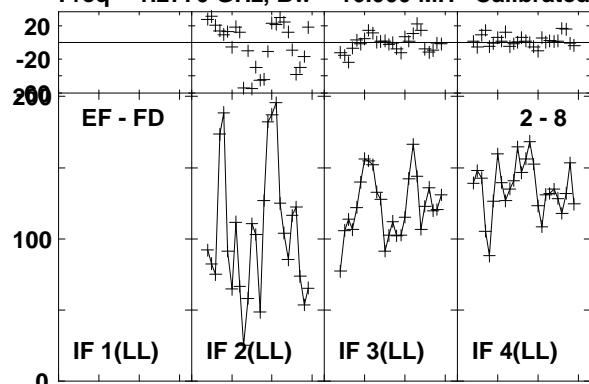

Lower frame: Milli Ampl Jy Top frame: Phas deg
Vector averaged cross-power spectrum Baseline: EF (02) - FD (08)
Timerange: 01/00:11:12 to 01/00:12:10

Plot file version1015 created 03-MAR-2016 01:14:53

J1545+5400 GN002C 1.UVDATA.1

Freq = 1.2770 GHz, Bw = 16.000 MH Calibrated with CL # 3 and BP # 1 (BP mode 1)

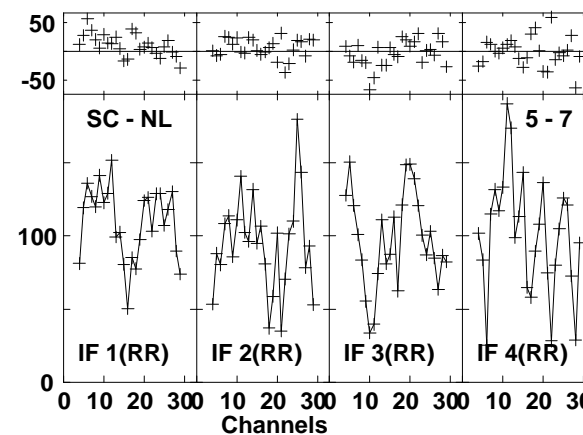
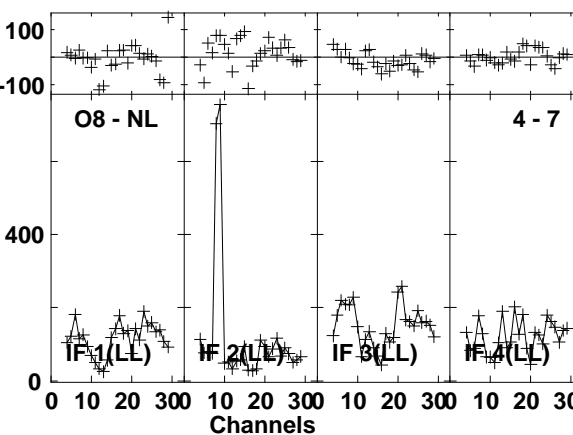
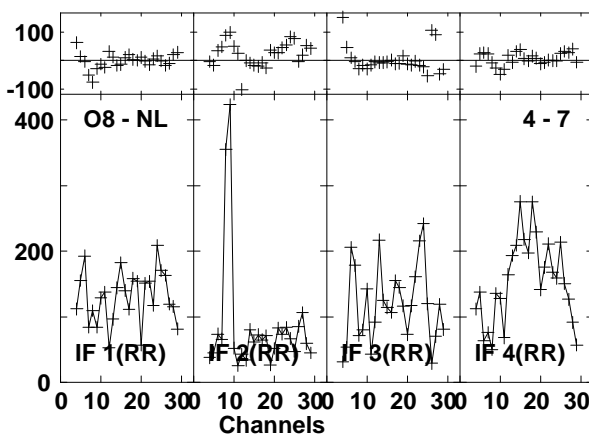
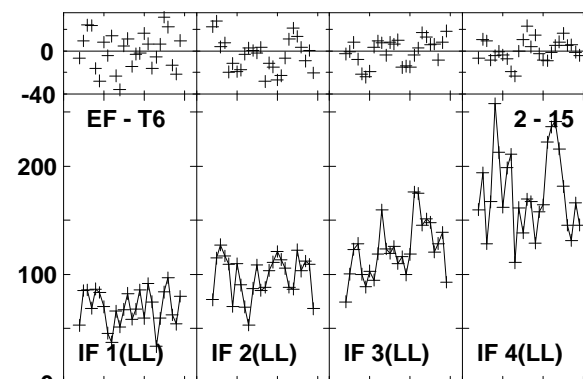
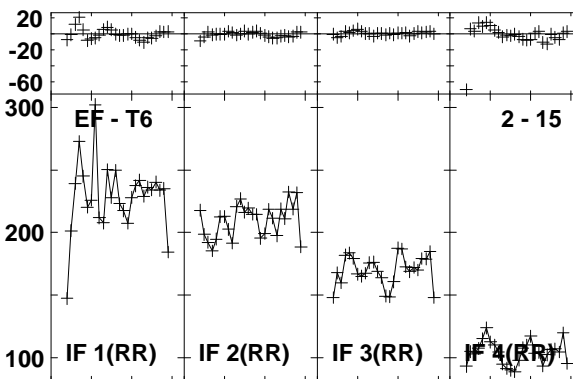
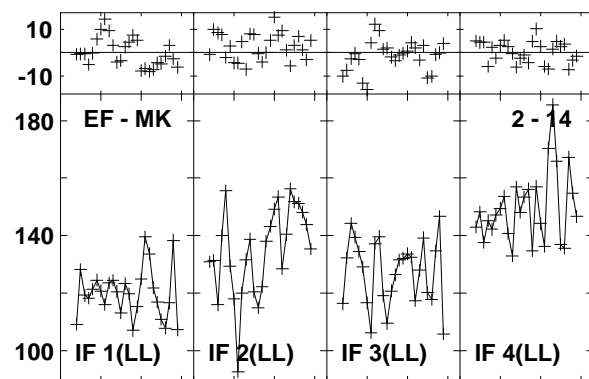
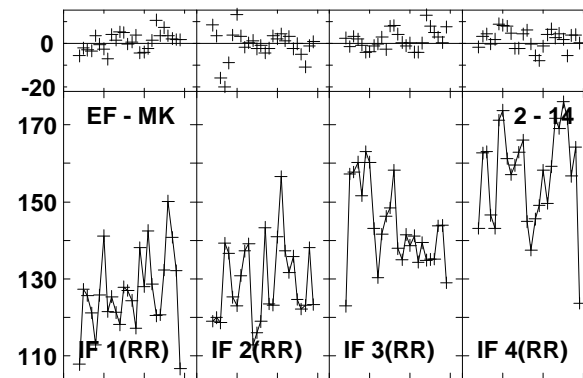
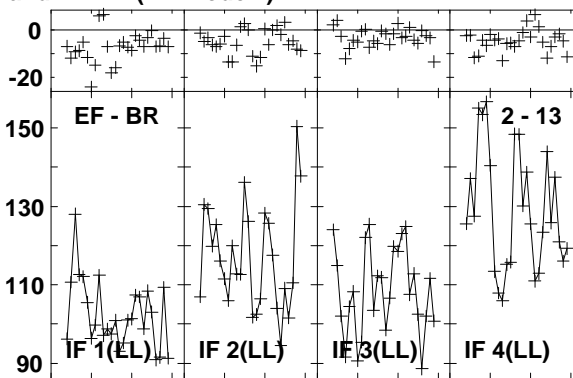
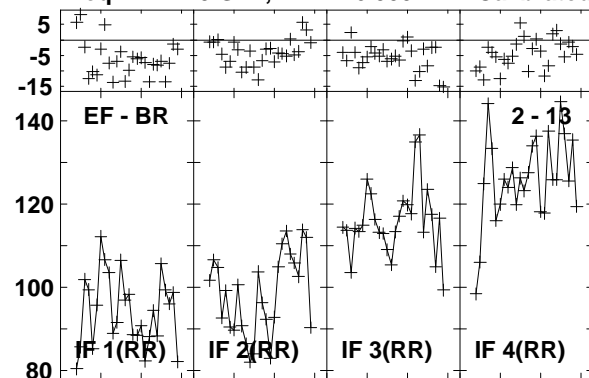

Lower frame: Milli Ampl Jy Top frame: Phas deg
Vector averaged cross-power spectrum Baseline: EF (02) - BR (13)
Timerange: 01/00:11:12 to 01/00:12:10

Plot file version1016 created 03-MAR-2016 01:14:53
 J1545+5400 GN002C 1.UVDATA.1
 Freq = 1.2770 GHz, Bw = 16.000 MH Calibrated with CL # 3 and BP # 1 (BP mode 1)

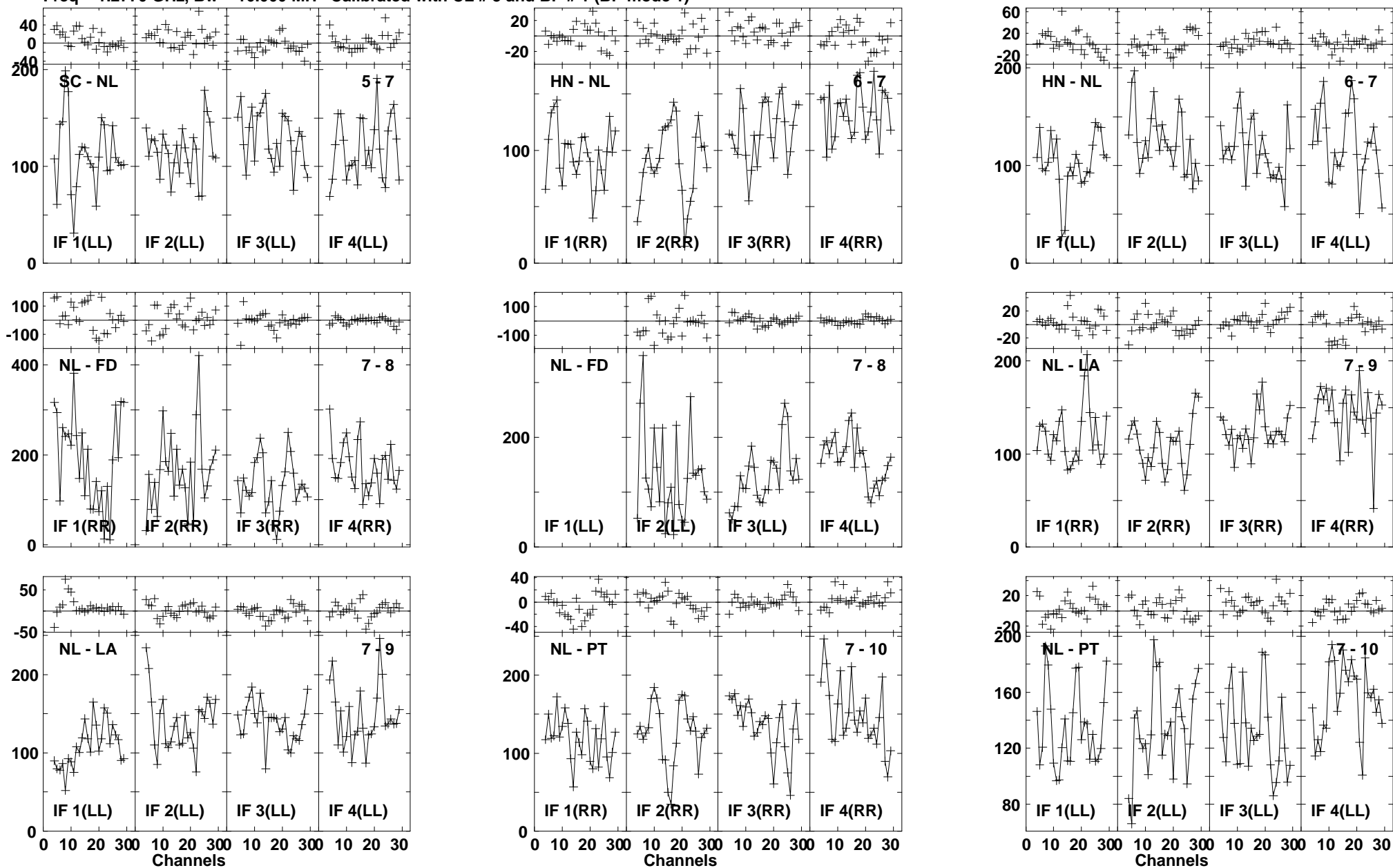

Lower frame: Milli Ampl Jy Top frame: Phas deg
 Vector averaged cross-power spectrum Baseline: SC (05) - NL (07)
 Timerange: 01/00:11:12 to 01/00:12:10

Plot file version1017 created 03-MAR-2016 01:14:54

J1545+5400 GN002C 1.UVDATA.1

Freq = 1.2770 GHz, Bw = 16.000 MH Calibrated with CL # 3 and BP # 1 (BP mode 1)

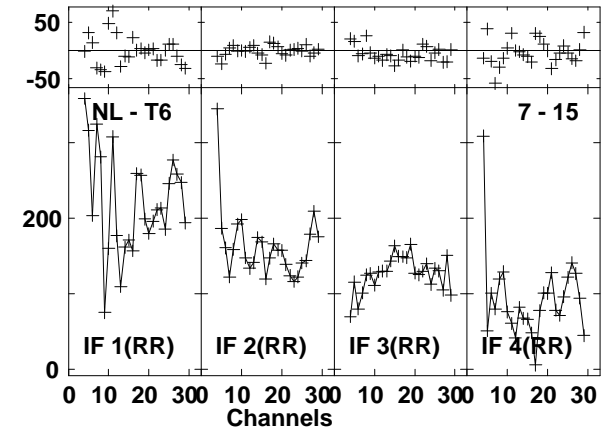
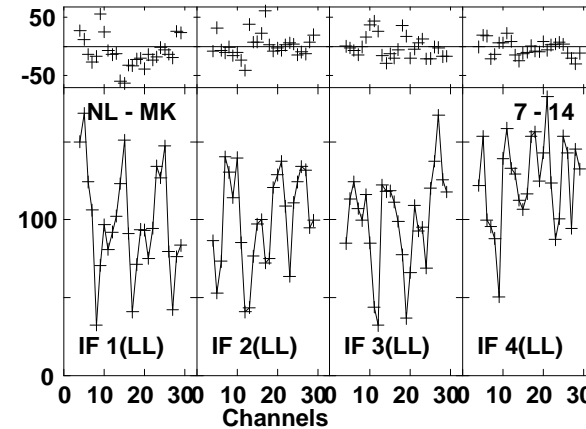
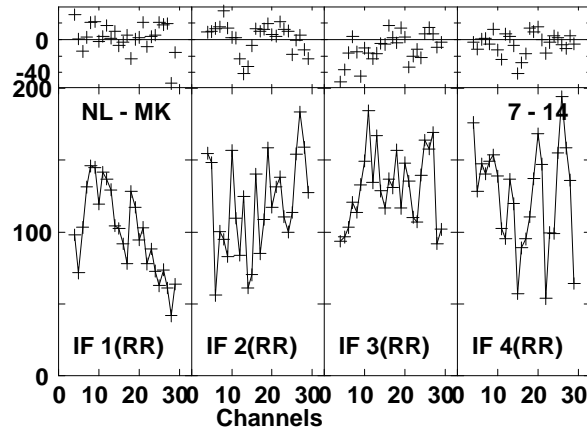
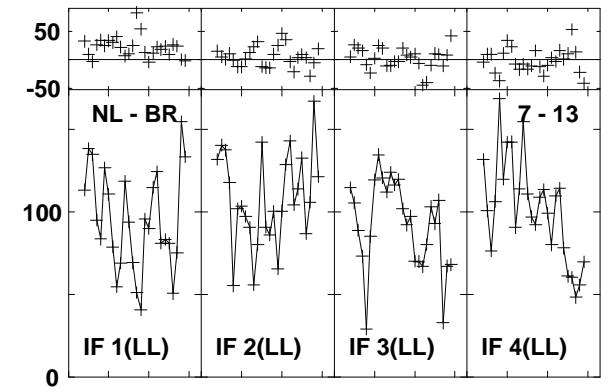
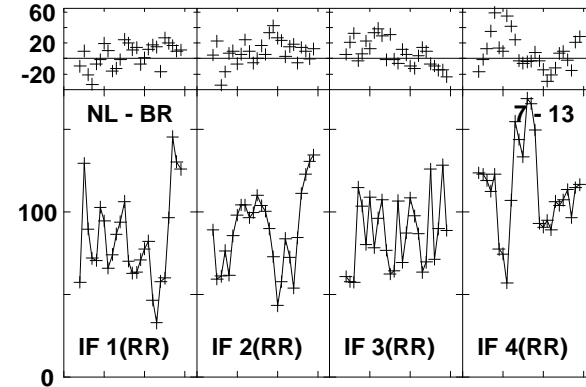
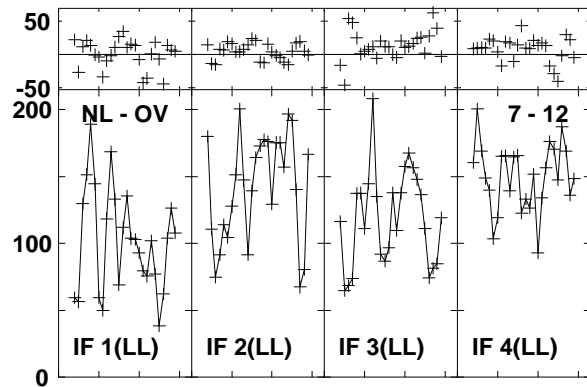
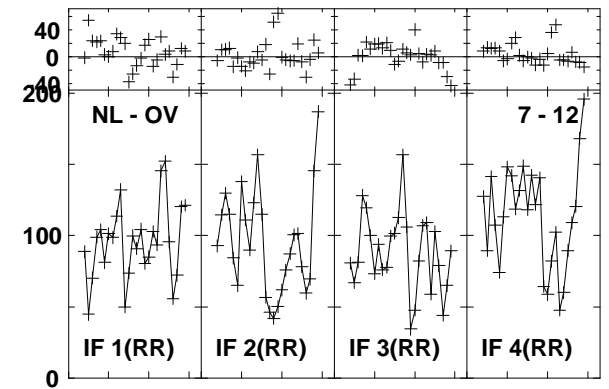
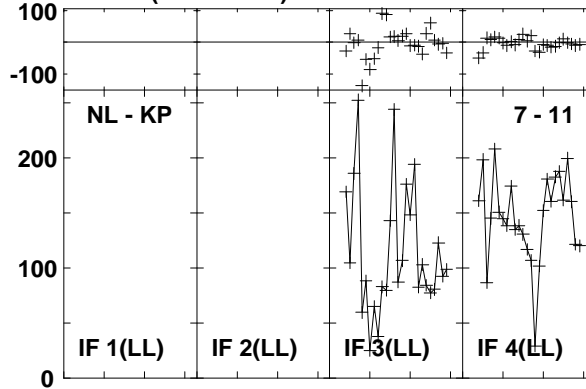
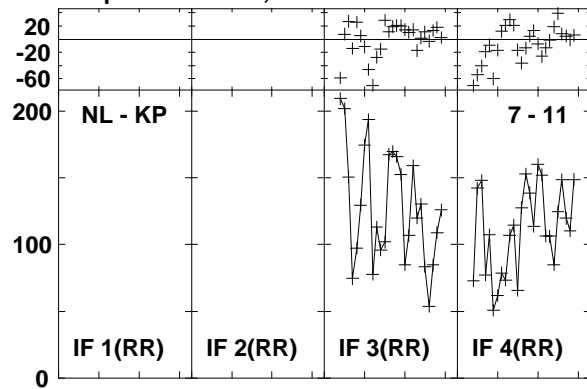

Lower frame: Milli Ampl Jy Top frame: Phas deg
Vector averaged cross-power spectrum Baseline: NL (07) - KP (11)
Timerange: 01/00:11:12 to 01/00:12:10

Plot file version1018 created 03-MAR-2016 01:14:54
J1545+5400 GN002C 1.UVDATA.1
Freq = 1.2770 GHz, Bw = 16.000 MH Calibrated with CL # 3 and BP # 1 (BP mode 1)

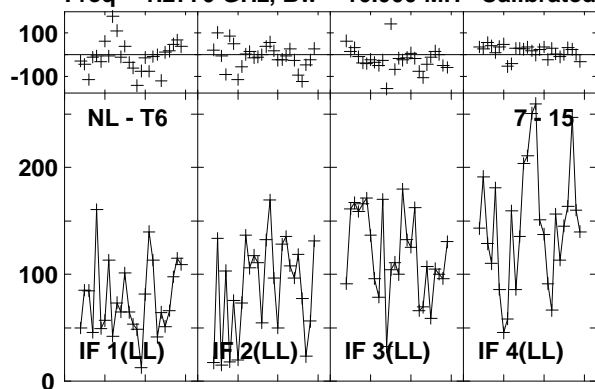

Lower frame: Milli Ampl Jy Top frame: Phas deg
Vector averaged cross-power spectrum Baseline: NL (07) - T6 (15)
Timerange: 01/00:11:12 to 01/00:12:10

Plot file version1019 created 03-MAR-2016 01:14:54

4C52 GN002C 1.UVDATA.1

Freq = 1.2770 GHz, Bw = 16.000 MH Calibrated with CL # 3 and BP # 1 (BP mode 1)

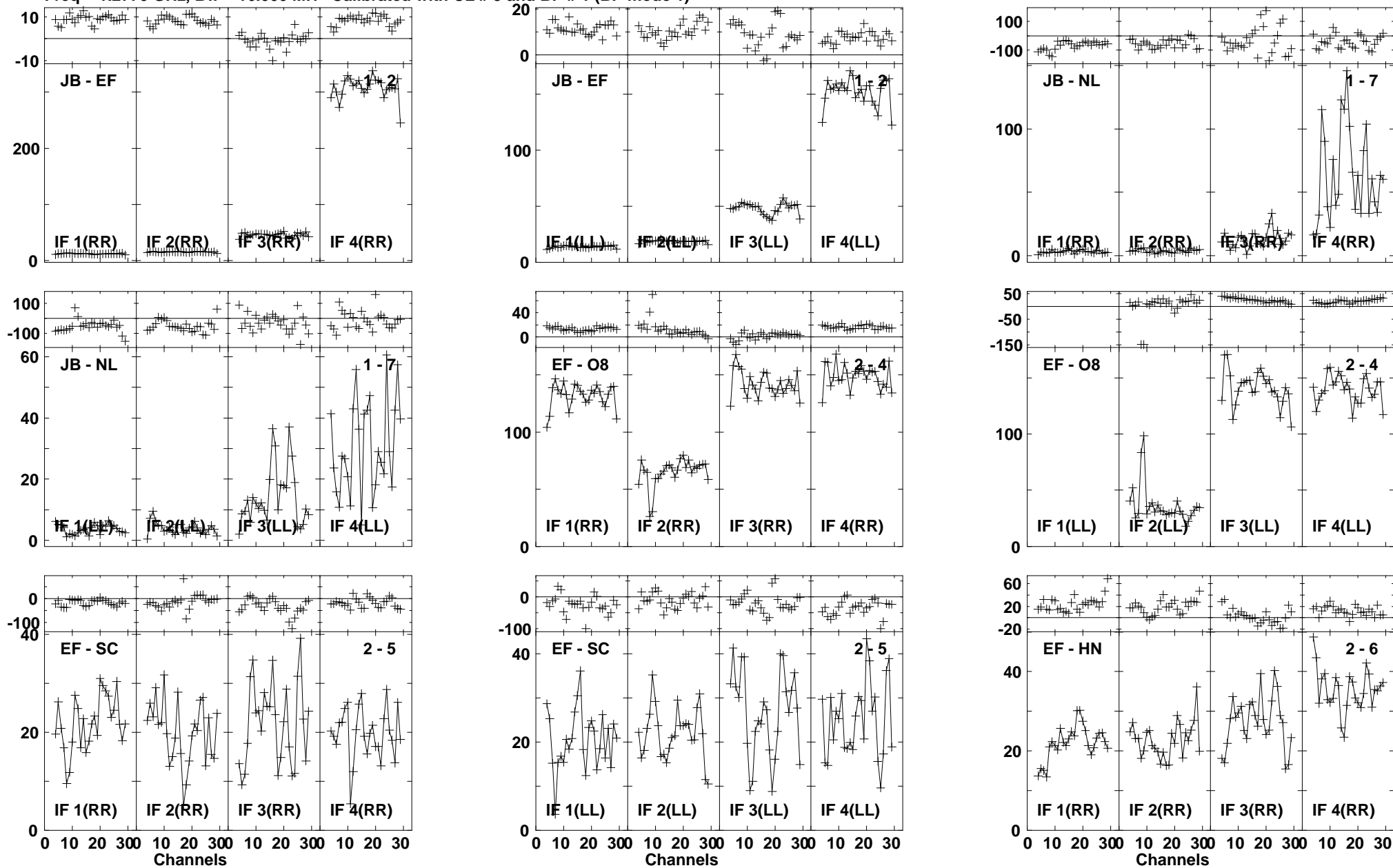

Lower frame: Milli Ampl Jy Top frame: Phas deg
Vector averaged cross-power spectrum Baseline: JB (01) - EF (02)
Timerange: 01/00:12:15 to 01/00:15:39

Plot file version1020 created 03-MAR-2016 01:14:54

4C52 GN002C 1.UVDATA.1

Freq = 1.2770 GHz, Bw = 16.000 MH Calibrated with CL # 3 and BP # 1 (BP mode 1)

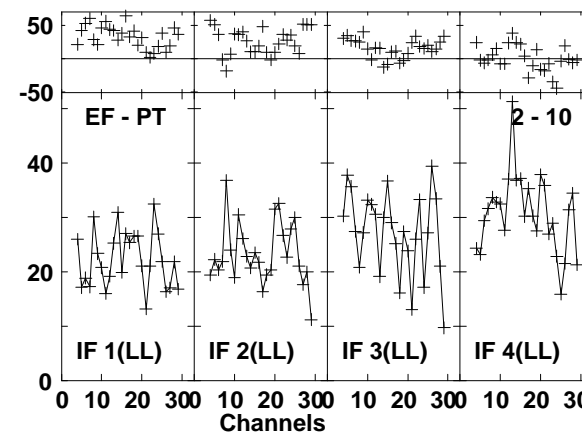
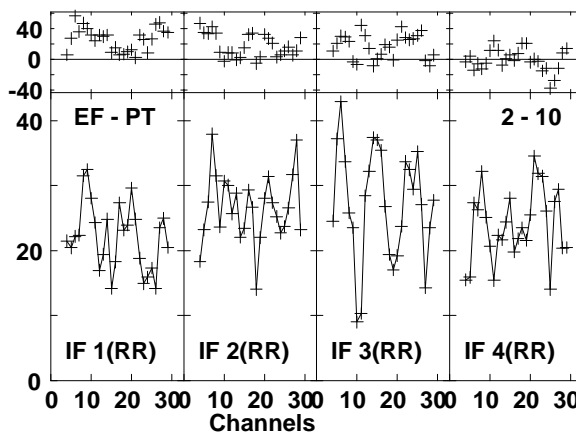
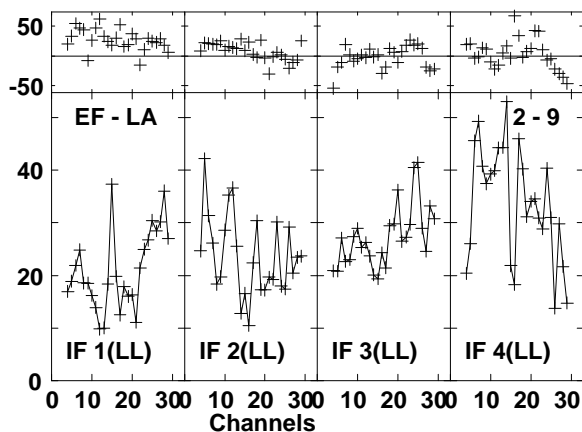
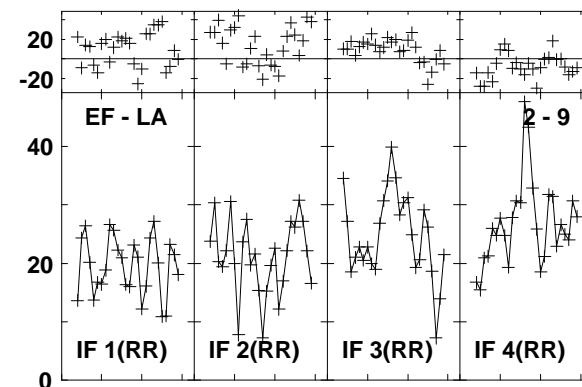
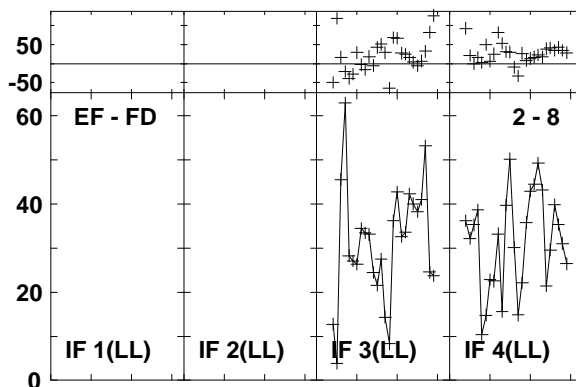
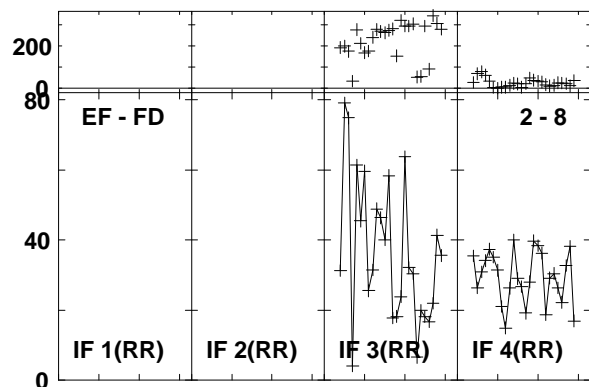
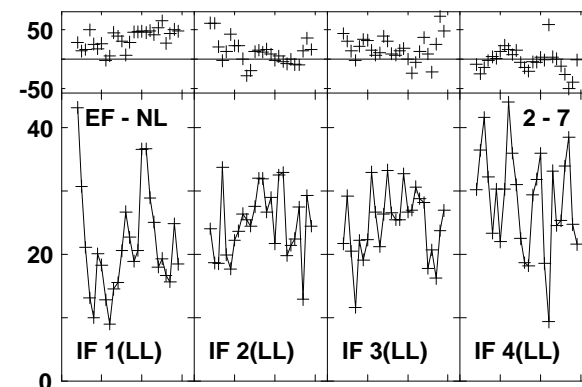
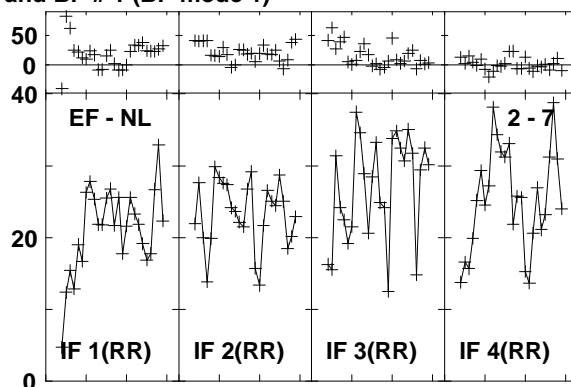
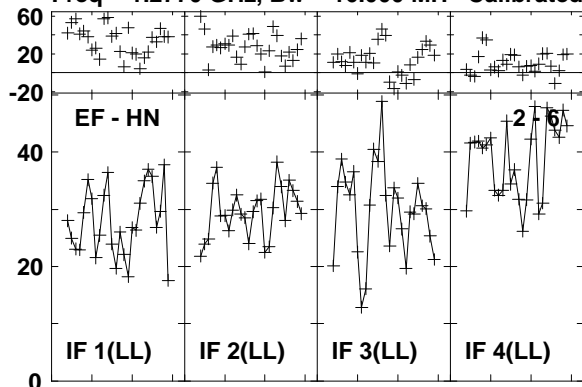

Lower frame: Milli Ampl Jy Top frame: Phas deg
Vector averaged cross-power spectrum Baseline: EF (02) - HN (06)
Timerange: 01/00:12:15 to 01/00:15:39

Plot file version1021 created 03-MAR-2016 01:14:54

4C52 GN002C 1.UVDATA.1

Freq = 1.2770 GHz, Bw = 16.000 MH Calibrated with CL # 3 and BP # 1 (BP mode 1)

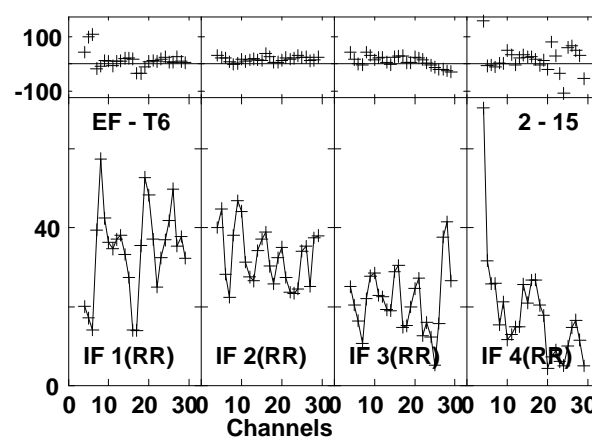
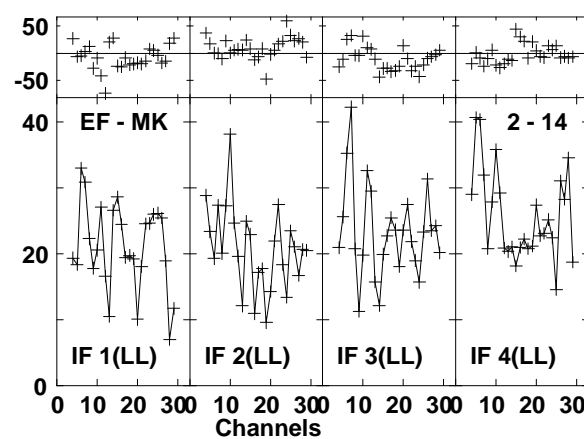
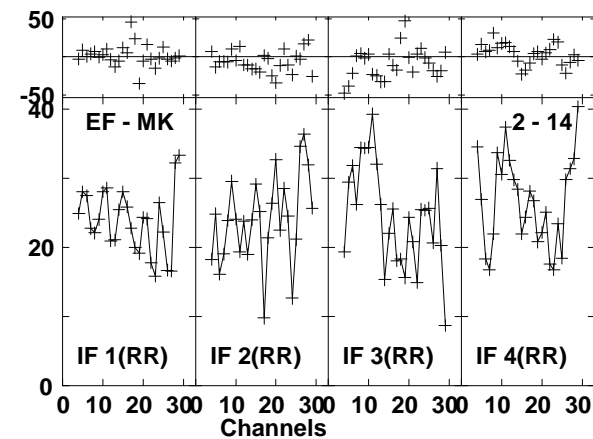
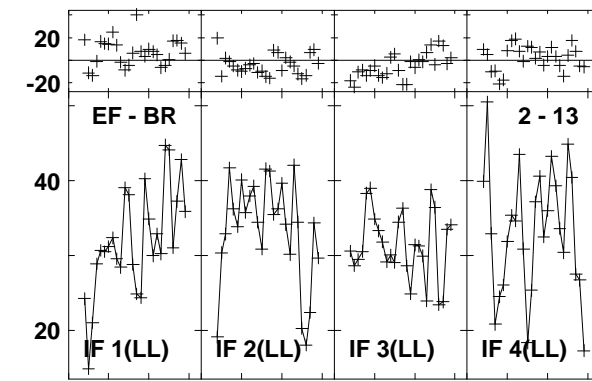
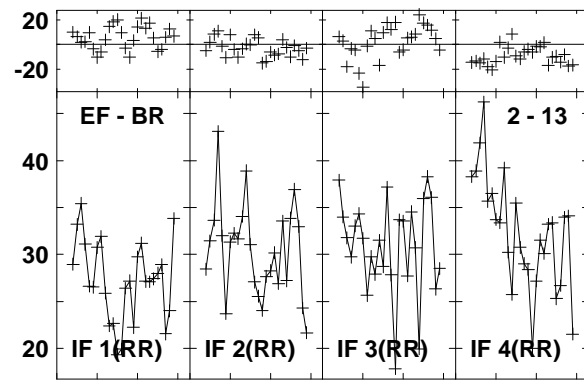
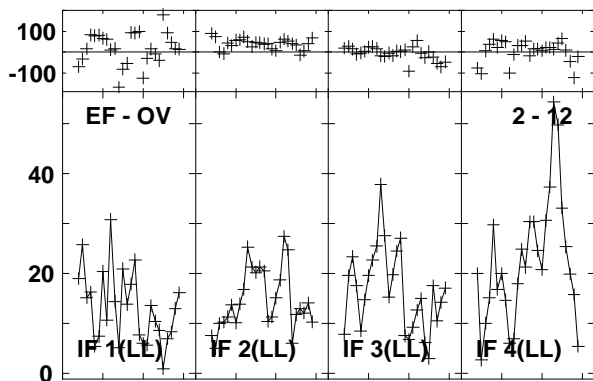
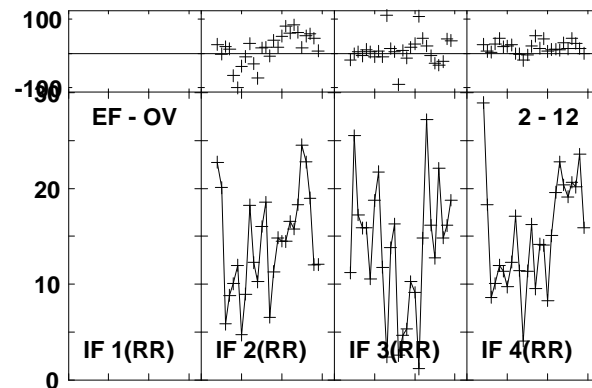
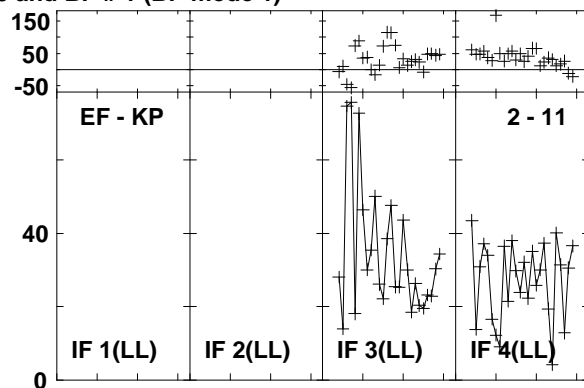
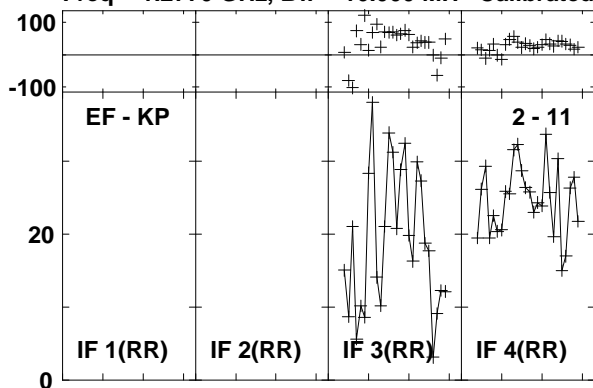

Lower frame: Milli Ampl Jy Top frame: Phas deg
Vector averaged cross-power spectrum Baseline: EF (02) - KP (11)
Timerange: 01/00:12:15 to 01/00:15:39

Plot file version1022 created 03-MAR-2016 01:14:54

4C52 GN002C 1.UVDATA.1

Freq = 1.2770 GHz, Bw = 16.000 MH Calibrated with CL # 3 and BP # 1 (BP mode 1)

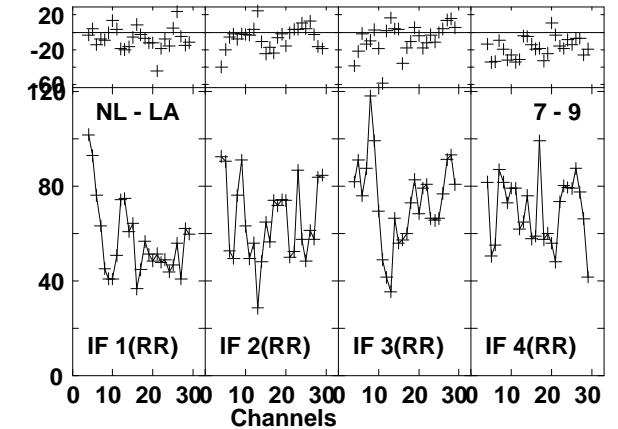
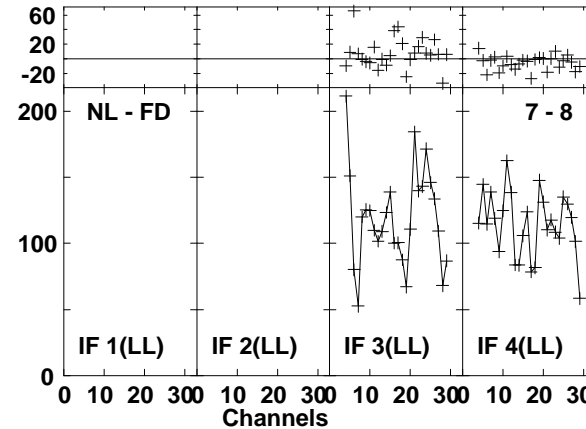
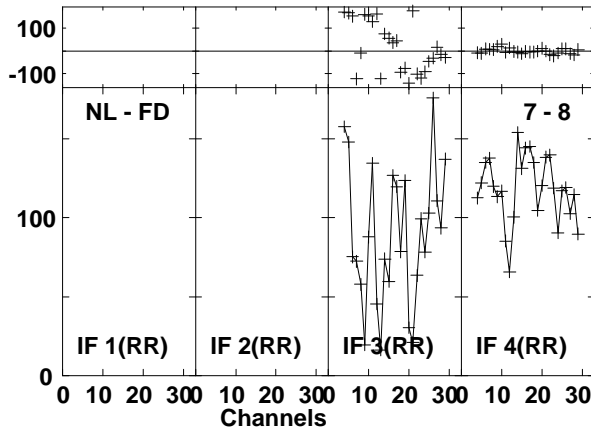
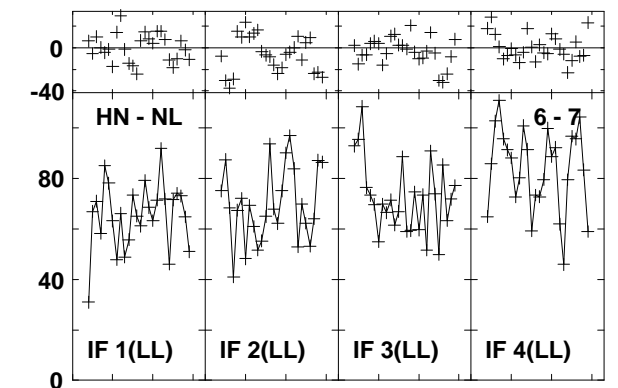
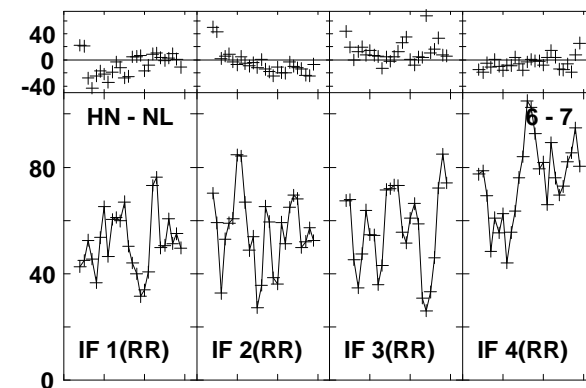
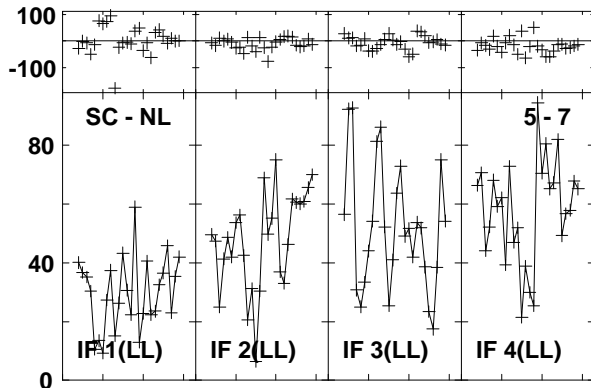
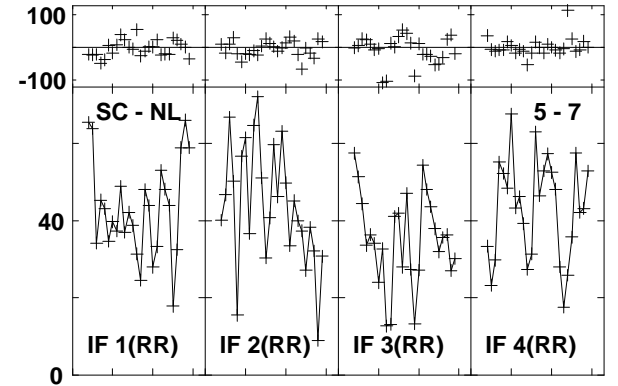
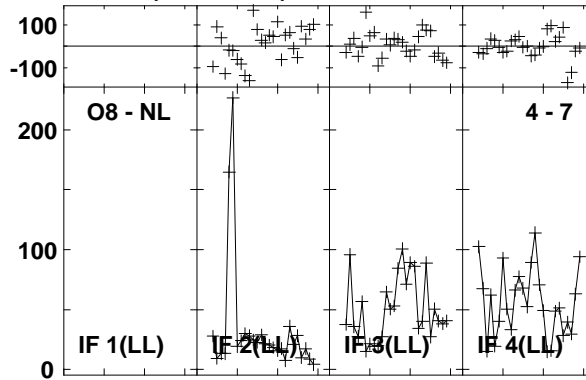
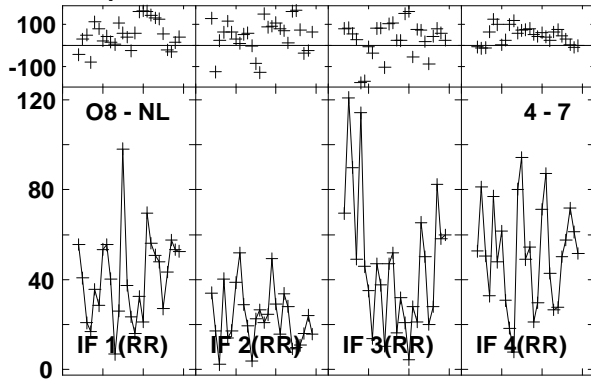

Lower frame: Milli Ampl Jy Top frame: Phas deg
Vector averaged cross-power spectrum Baseline: O8 (04) - NL (07)
Timerange: 01/00:12:15 to 01/00:15:39

Plot file version1023 created 03-MAR-2016 01:14:54

4C52 GN002C 1.UVDATA.1

Freq = 1.2770 GHz, Bw = 16.000 MH Calibrated with CL # 3 and BP # 1 (BP mode 1)

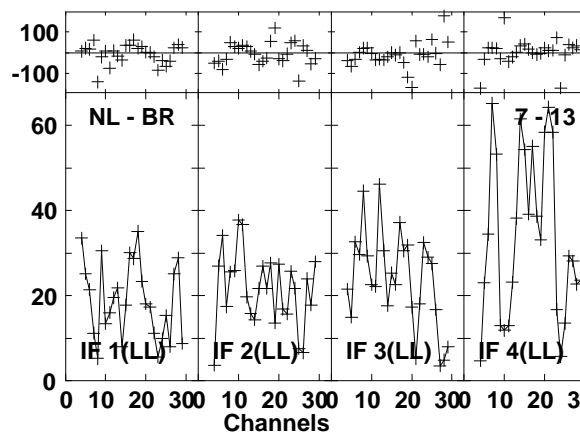
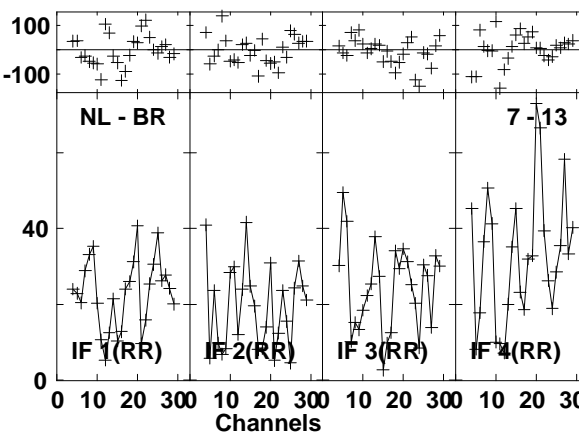
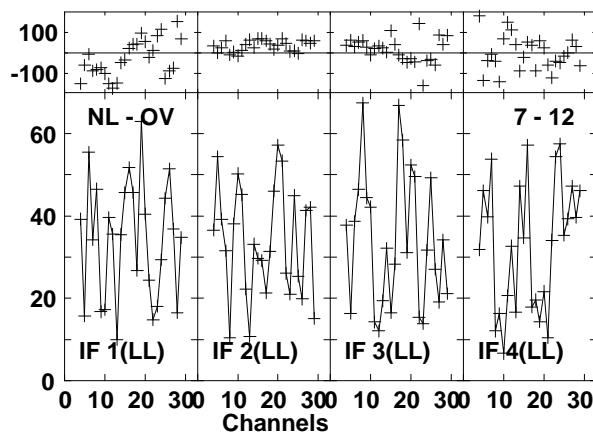
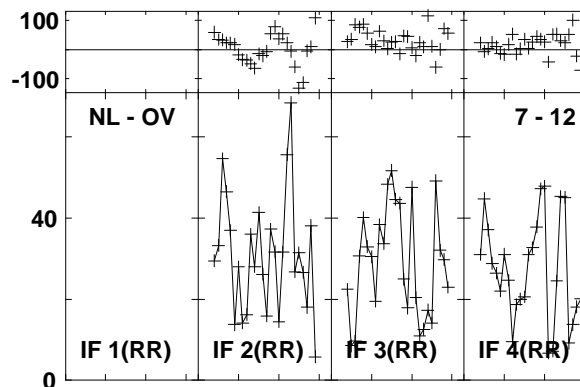
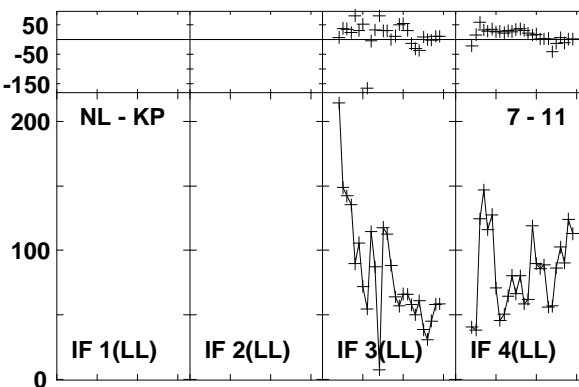
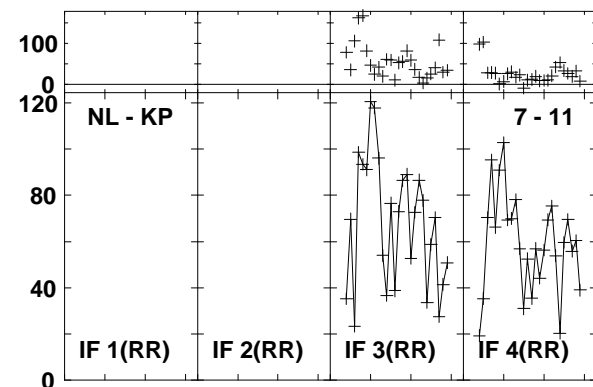
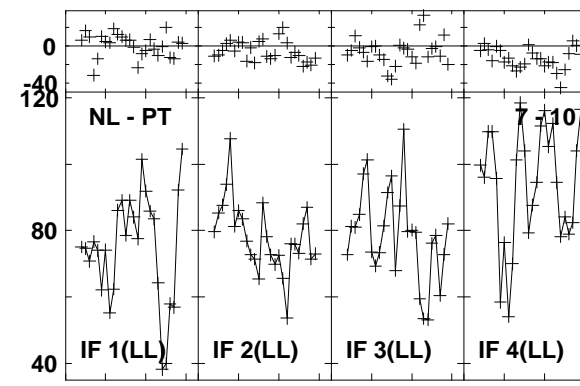
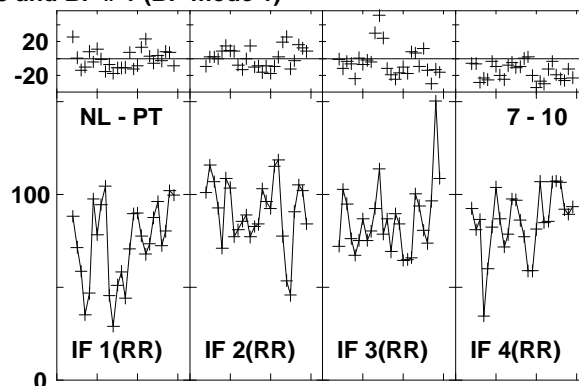
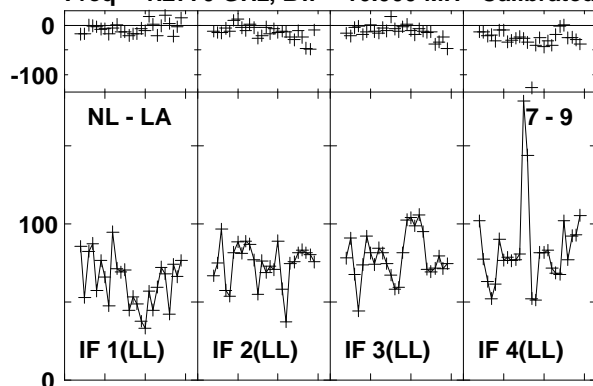

Lower frame: Milli Ampl Jy Top frame: Phas deg
Vector averaged cross-power spectrum Baseline: NL (07) - LA (09)
Timerange: 01/00:12:15 to 01/00:15:39

Plot file version1024 created 03-MAR-2016 01:14:55

4C52 GN002C 1.UVDATA.1

Freq = 1.2770 GHz, Bw = 16.000 MH Calibrated with CL # 3 and BP # 1 (BP mode 1)

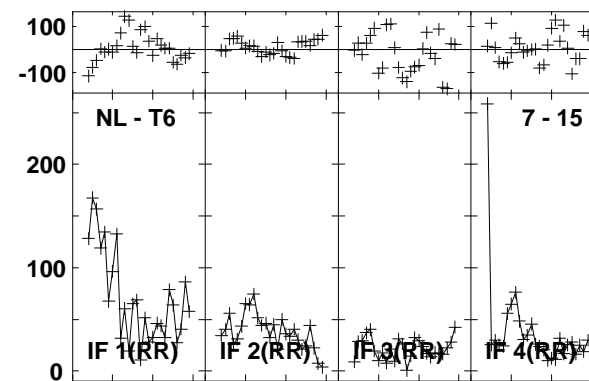
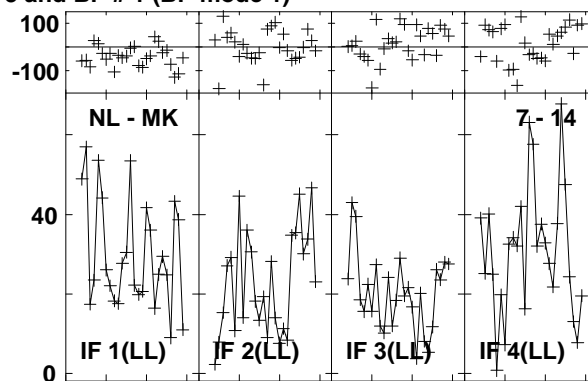
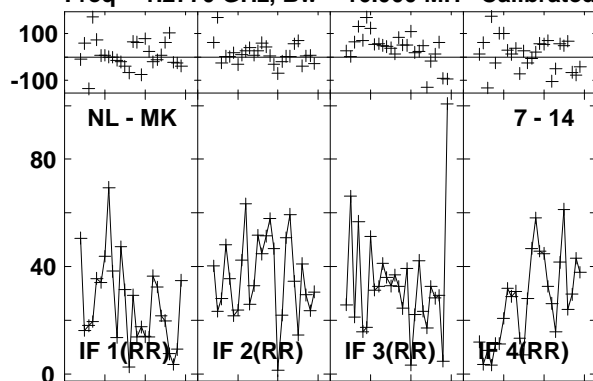

Lower frame: Milli Ampl Jy Top frame: Phas deg
Vector averaged cross-power spectrum Baseline: NL (07) - MK (14)
Timerange: 01/00:12:15 to 01/00:15:39

Plot file version1025 created 03-MAR-2016 01:14:55

J1545+5400 GN002C 1.UVDATA.1

Freq = 1.2770 GHz, Bw = 16.000 MH Calibrated with CL # 3 and BP # 1 (BP mode 1)

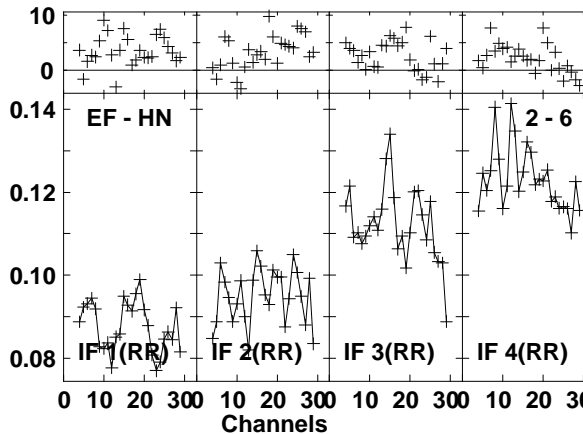
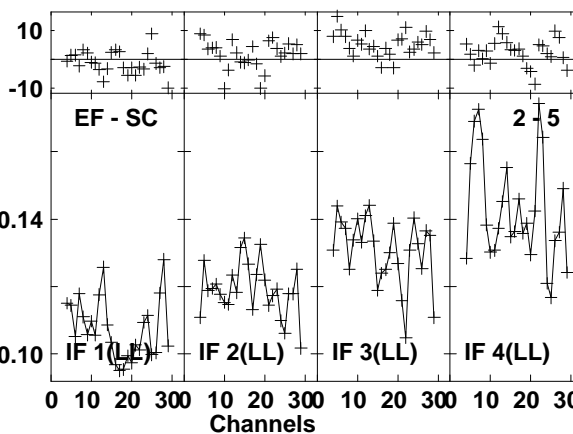
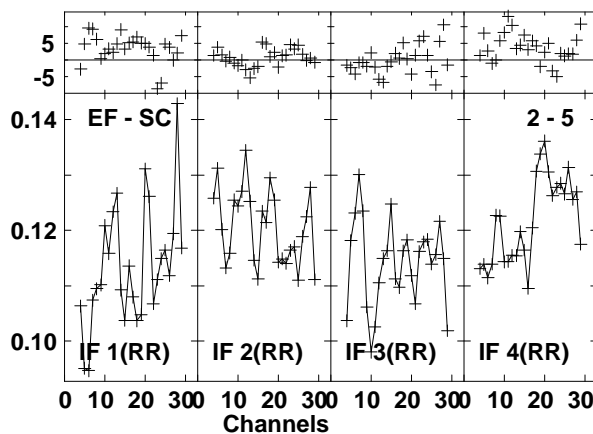
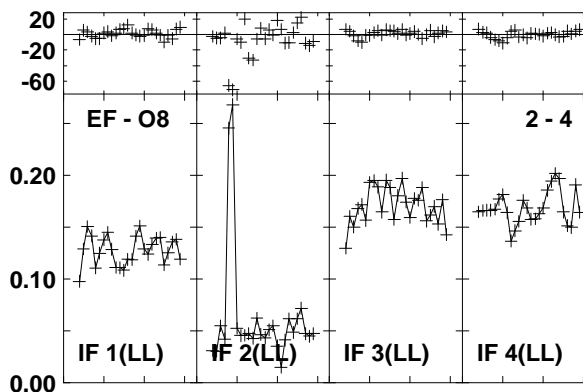
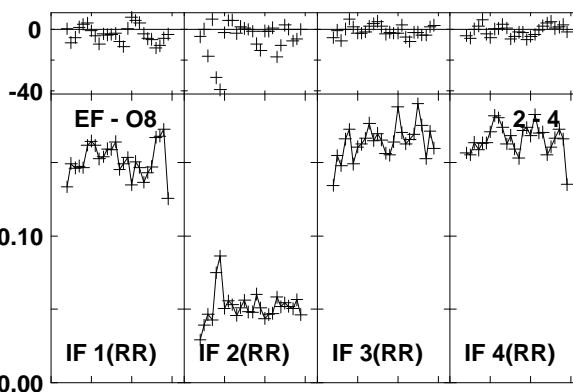
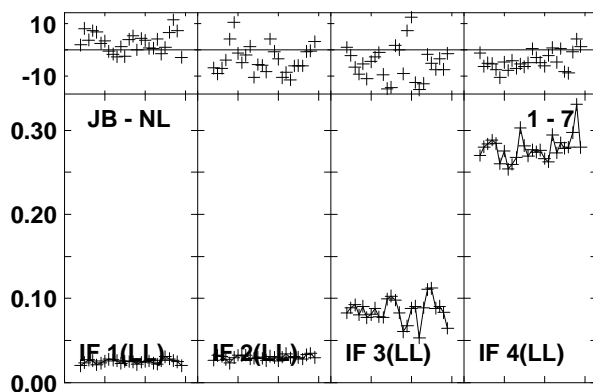
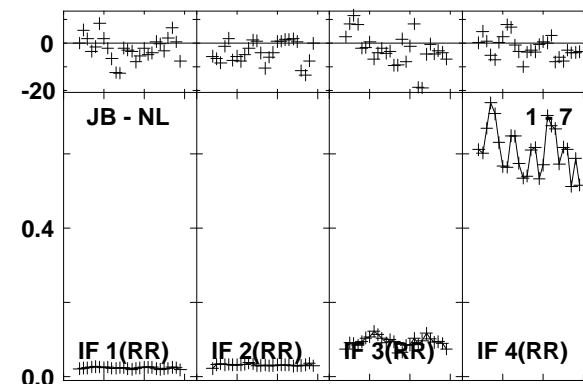
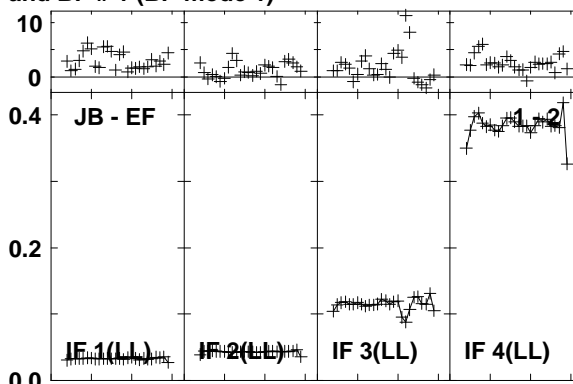
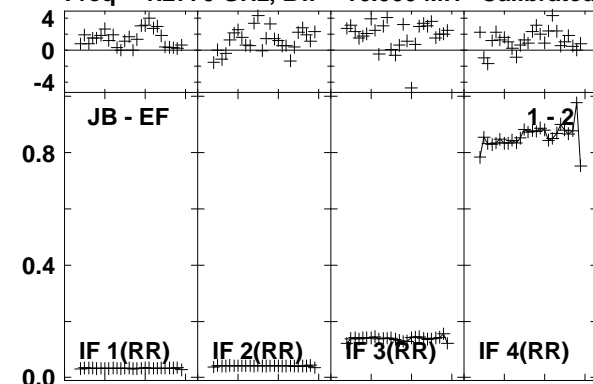

Lower frame: Ampl Jy Top frame: Phas deg
Vector averaged cross-power spectrum Baseline: JB (01) - EF (02)
Timerange: 01/00:16:32 to 01/00:18:30

Plot file version1026 created 03-MAR-2016 01:14:55

J1545+5400 GN002C 1.UVDATA.1

Freq = 1.2770 GHz, Bw = 16.000 MH Calibrated with CL # 3 and BP # 1 (BP mode 1)

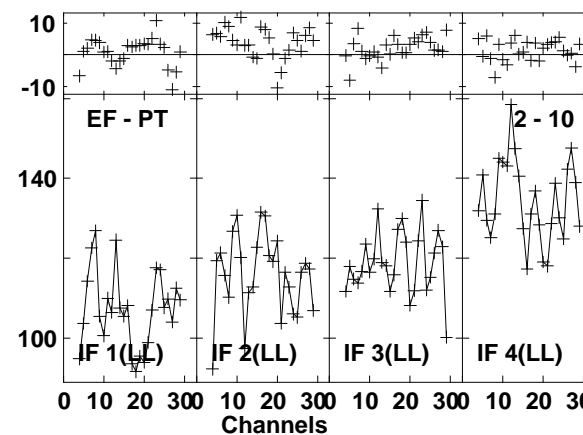
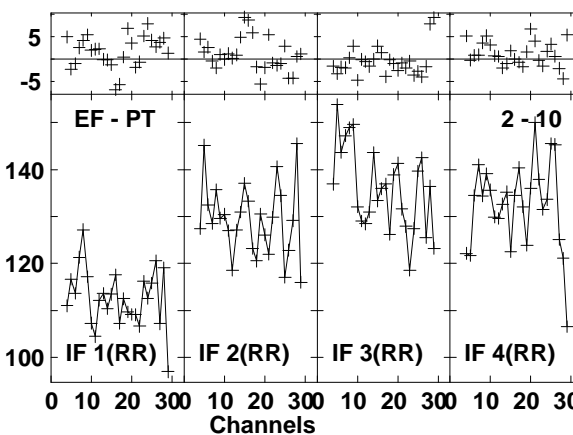
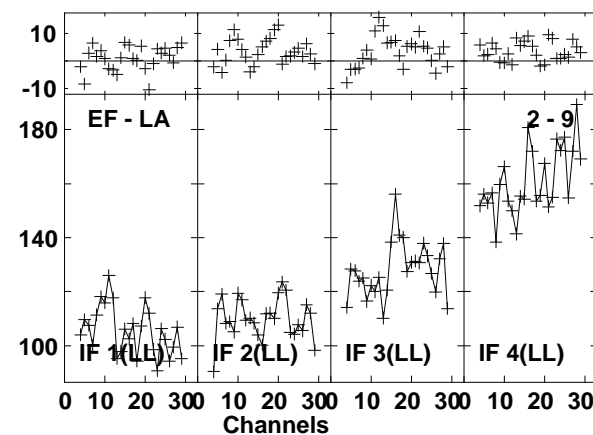
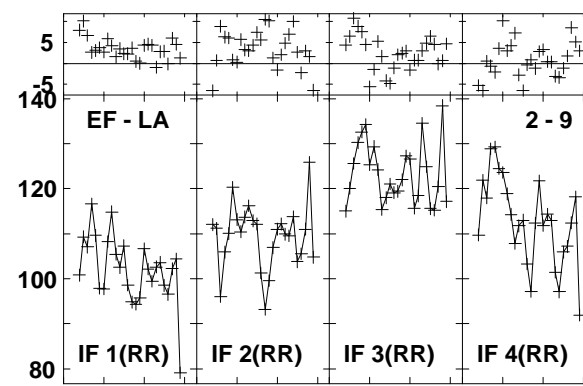
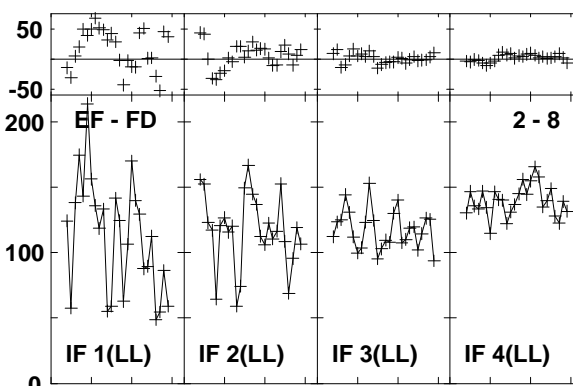
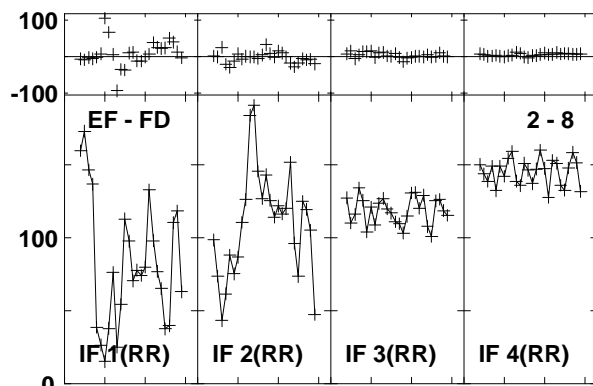
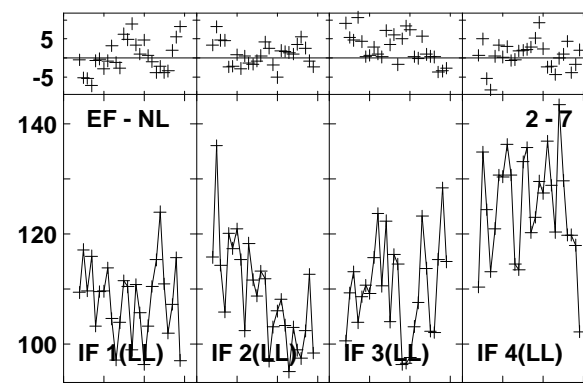
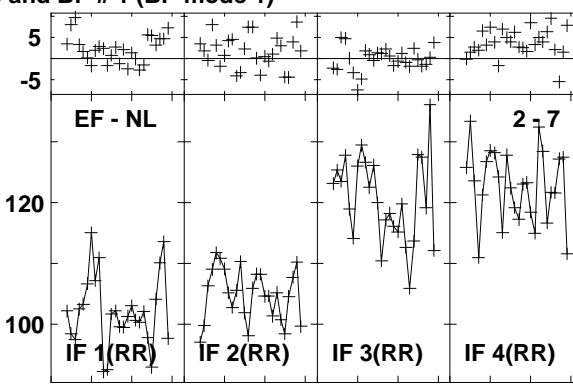
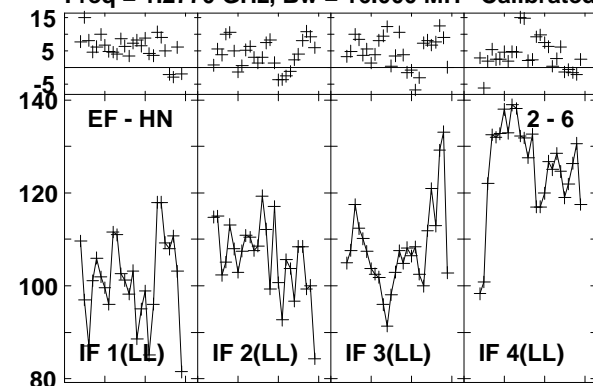

Lower frame: Milli Ampl Jy Top frame: Phas deg
Vector averaged cross-power spectrum Baseline: EF (02) - HN (06)
Timerange: 01/00:16:32 to 01/00:18:30

Plot file version1027 created 03-MAR-2016 01:14:55

J1545+5400 GN002C 1.UVDATA.1

Freq = 1.2770 GHz, Bw = 16.000 MH Calibrated with CL # 3 and BP # 1 (BP mode 1)

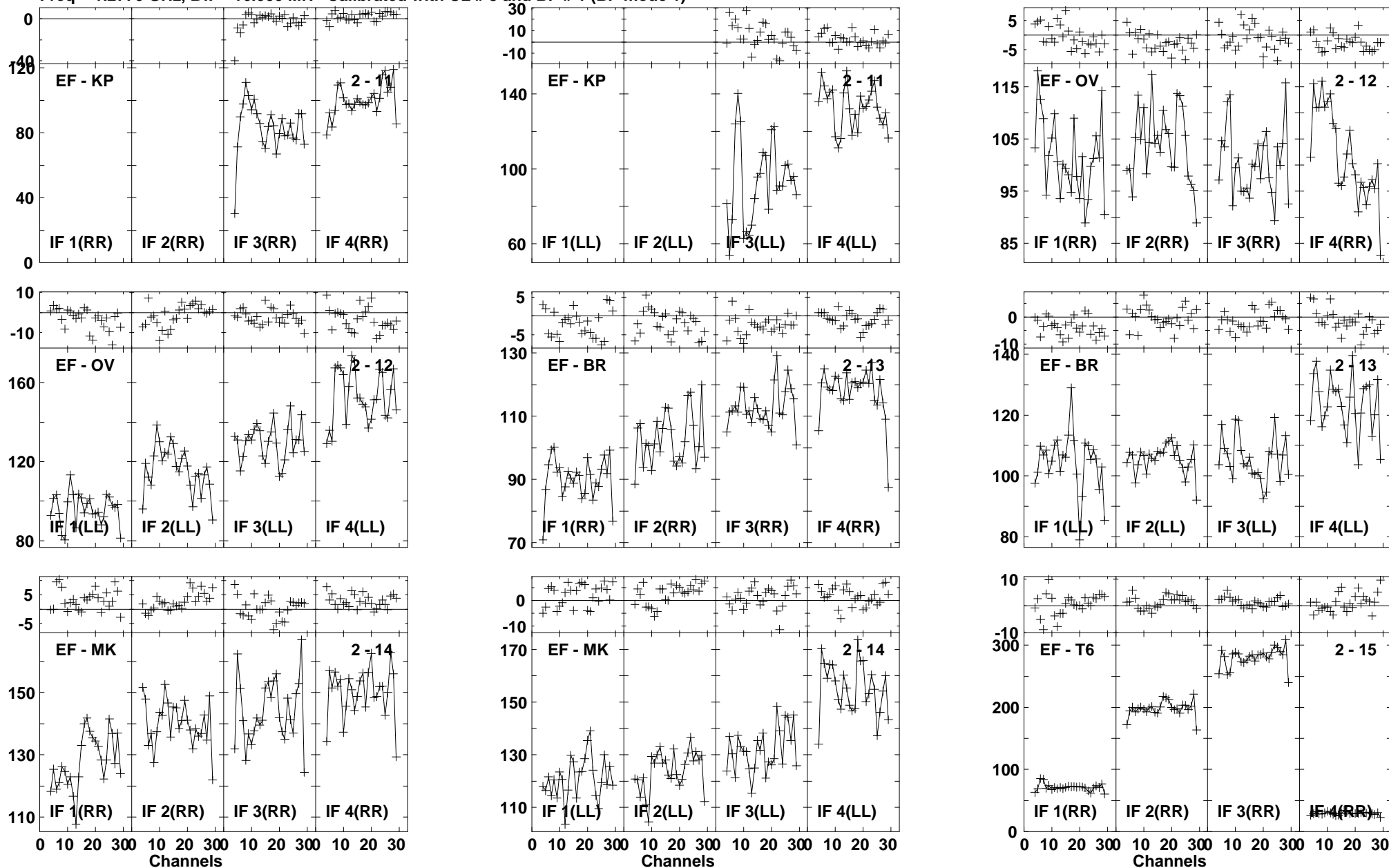

Lower frame: Milli Ampl Jy Top frame: Phas deg
Vector averaged cross-power spectrum Baseline: EF (02) - KP (11)
Timerange: 01/00:16:32 to 01/00:18:30

Plot file version1028 created 03-MAR-2016 01:14:55

J1545+5400 GN002C 1.UVDATA.1

Freq = 1.2770 GHz, Bw = 16.000 MH Calibrated with CL # 3 and BP # 1 (BP mode 1)

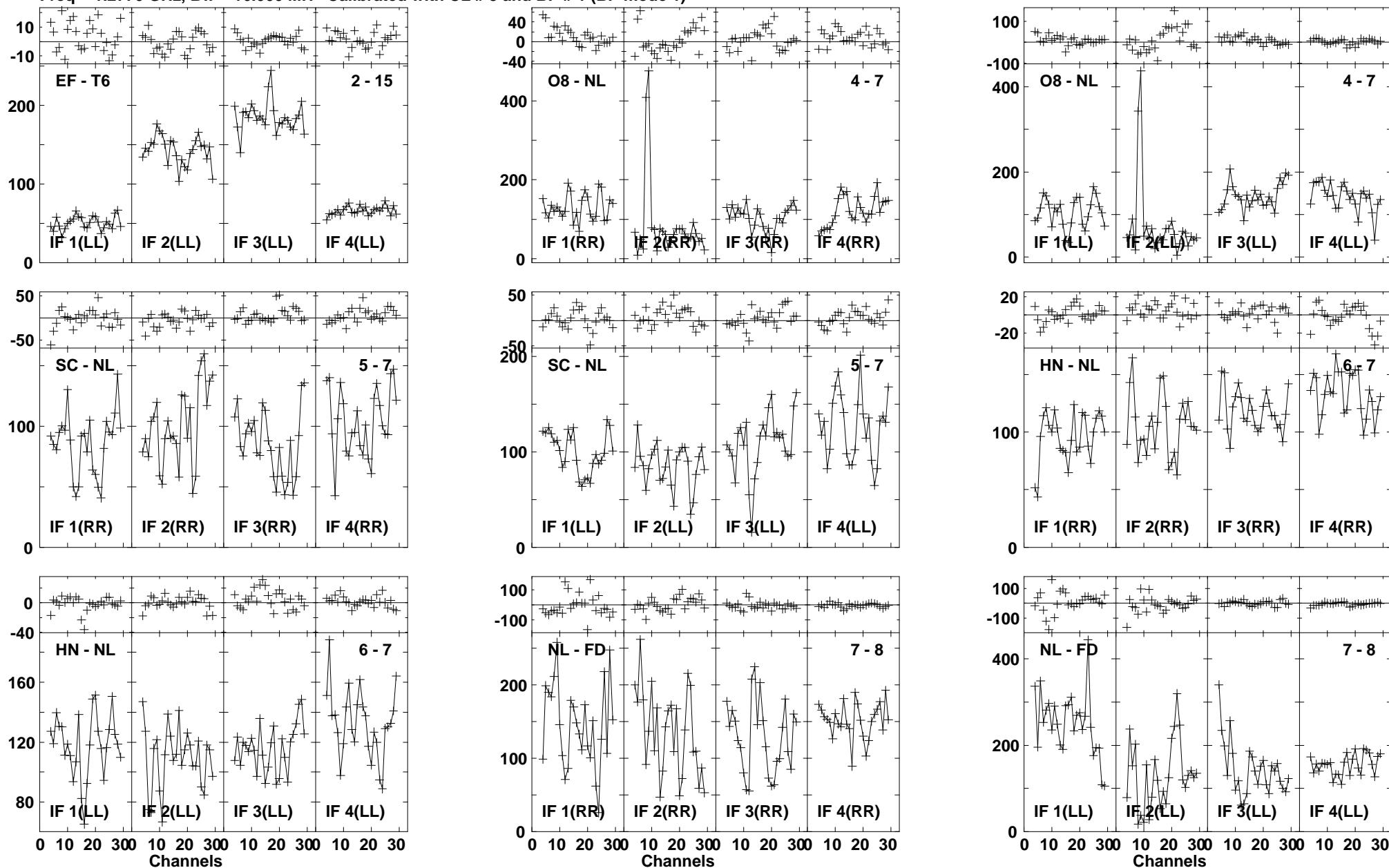

Lower frame: Milli Ampl Jy Top frame: Phas deg
Vector averaged cross-power spectrum Baseline: EF (02) - T6 (15)
Timerange: 01/00:16:32 to 01/00:18:30

Plot file version1029 created 03-MAR-2016 01:14:55

J1545+5400 GN002C 1.UVDATA.1

Freq = 1.2770 GHz, Bw = 16.000 MH Calibrated with CL # 3 and BP # 1 (BP mode 1)

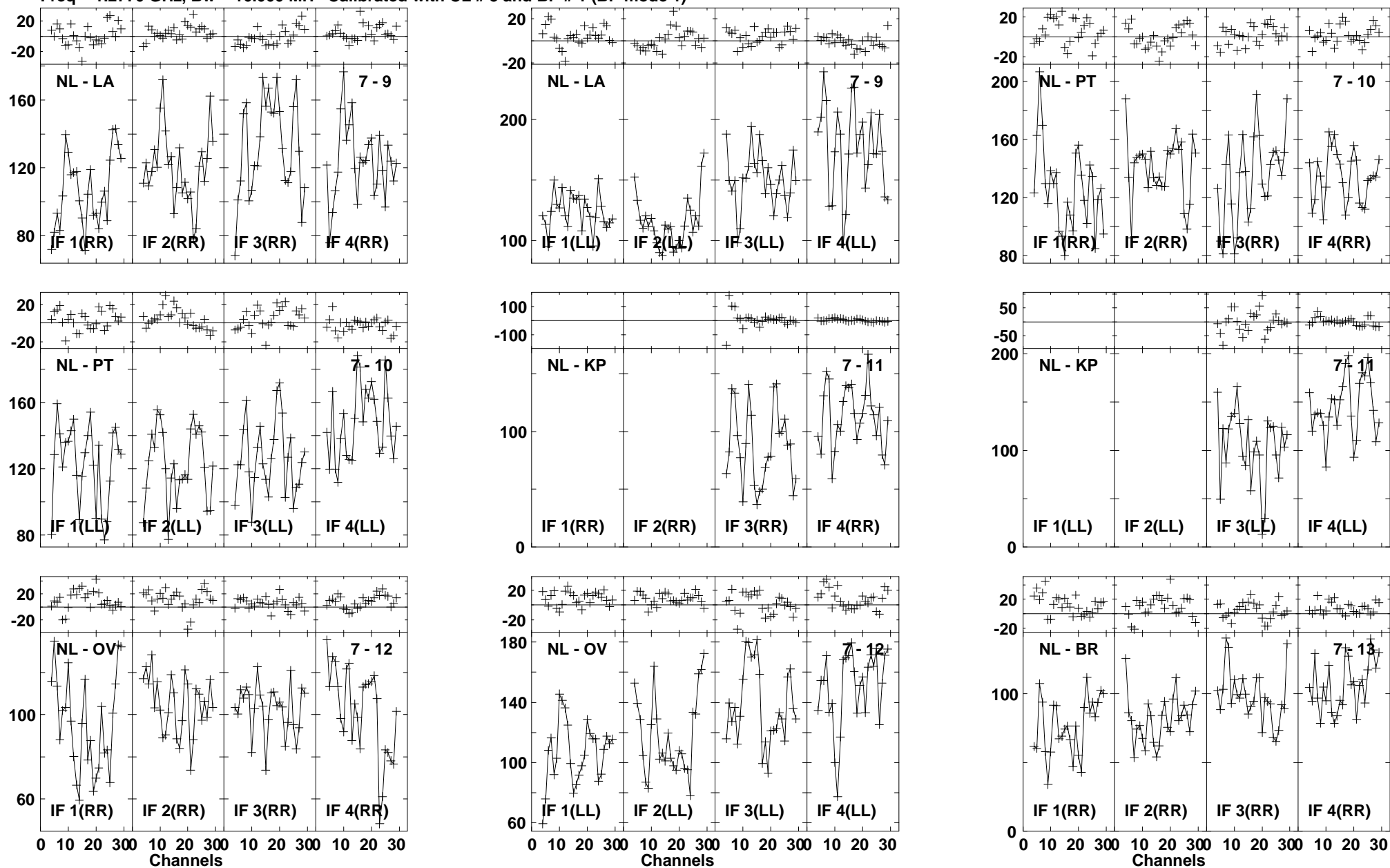

Lower frame: Milli Ampl Jy Top frame: Phas deg
Vector averaged cross-power spectrum Baseline: NL (07) - LA (09)
Timerange: 01/00:16:32 to 01/00:18:30

Plot file version1030 created 03-MAR-2016 01:14:56

J1545+5400 GN002C 1.UVDATA.1

Freq = 1.2770 GHz, Bw = 16.000 MH Calibrated with CL # 3 and BP # 1 (BP mode 1)

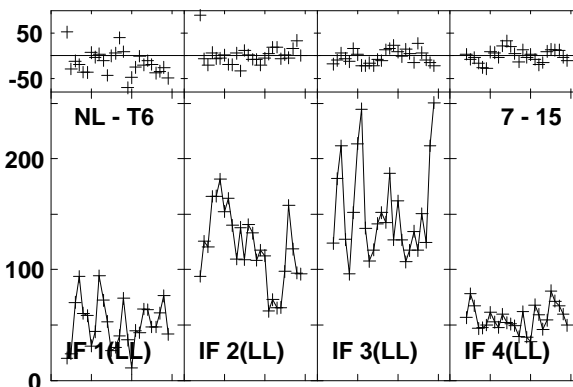
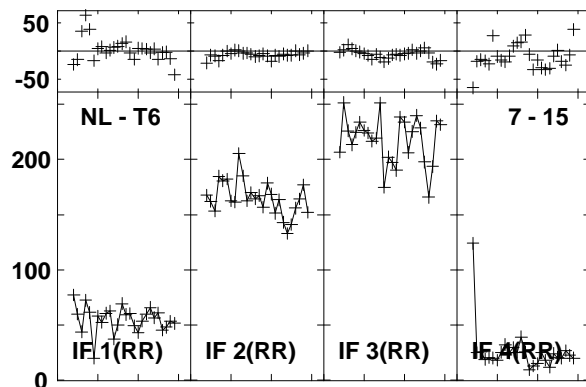
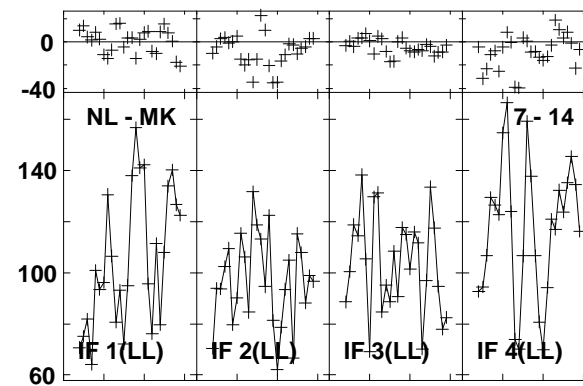
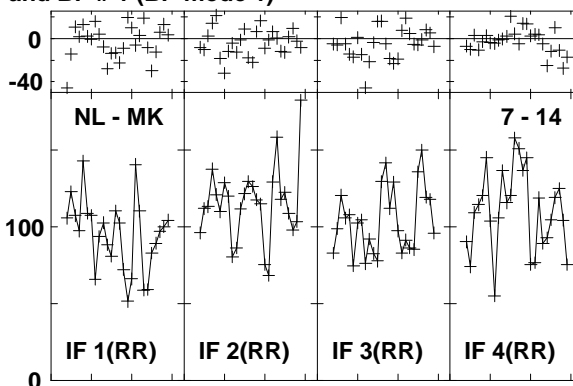
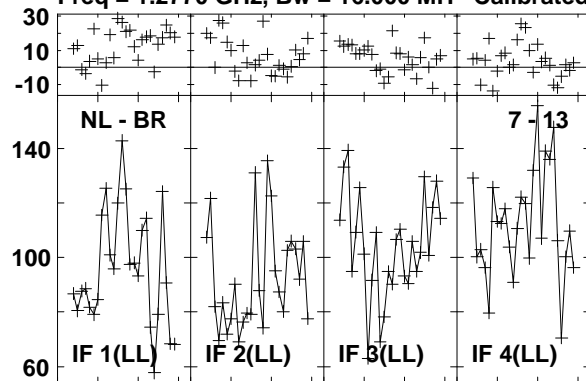

Lower frame: Milli Ampl Jy Top frame: Phas deg
Vector averaged cross-power spectrum Baseline: NL (07) - BR (13)
Timerange: 01/00:16:32 to 01/00:18:30

Plot file version1031 created 03-MAR-2016 01:14:56

4C52 GN002C 1.UVDATA.1

Freq = 1.2770 GHz, Bw = 16.000 MH Calibrated with CL # 3 and BP # 1 (BP mode 1)

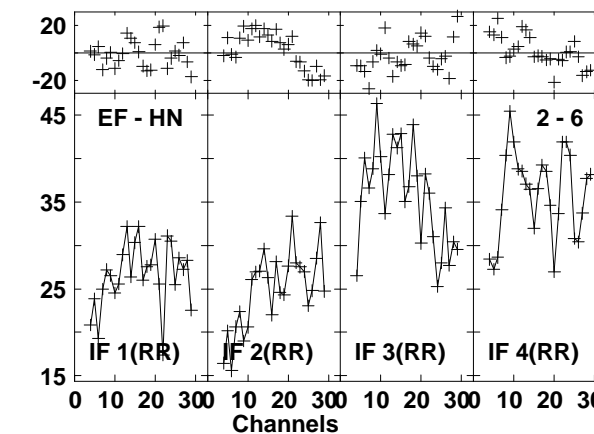
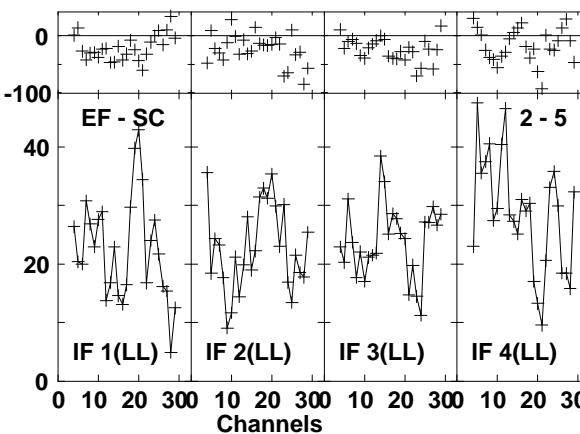
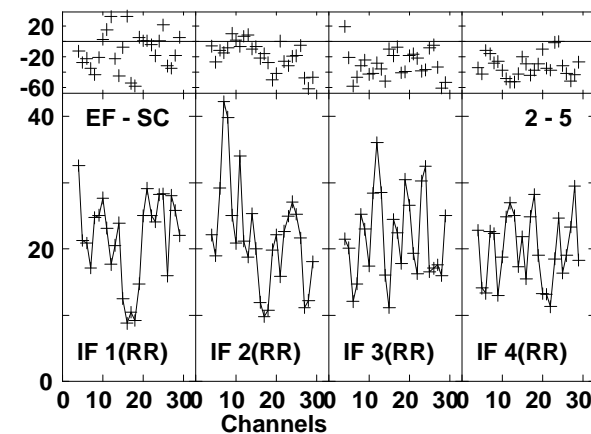
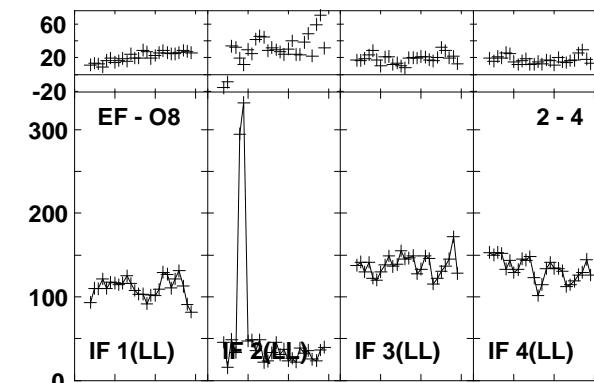
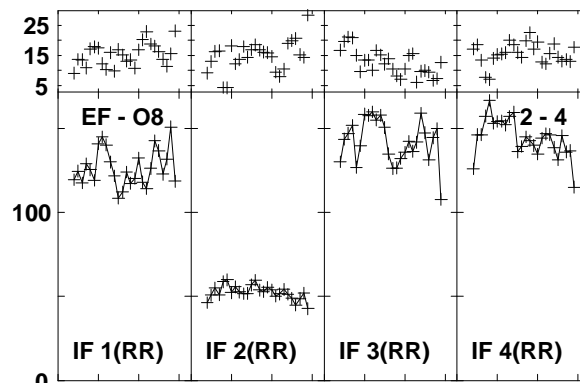
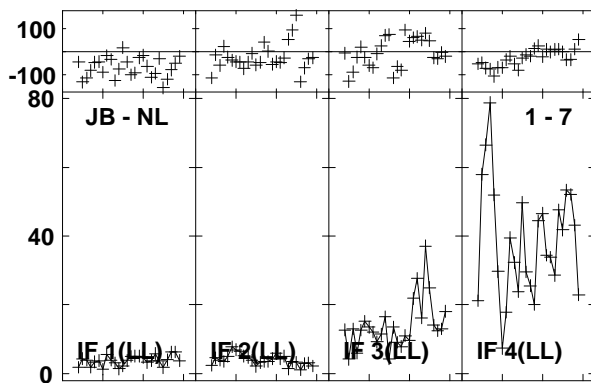
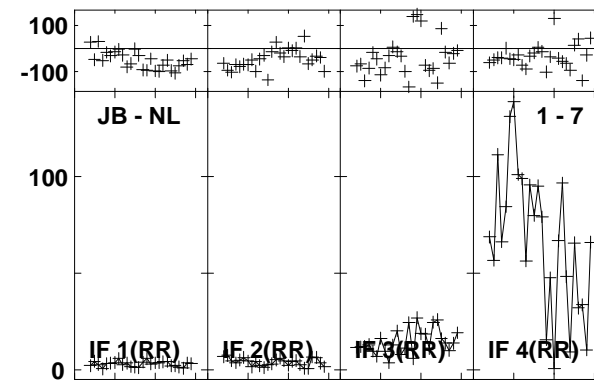
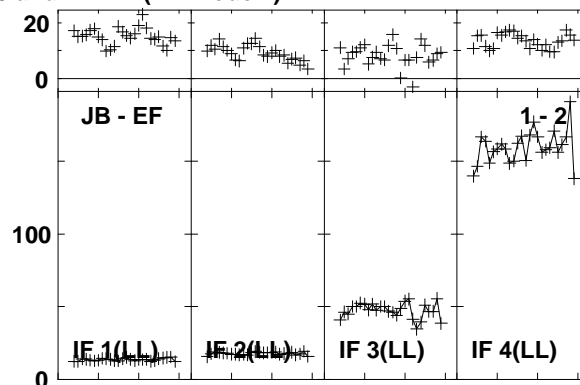
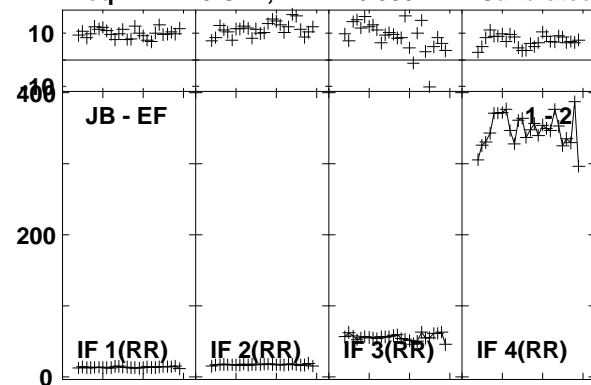

Lower frame: Milli Ampl Jy Top frame: Phas deg
Vector averaged cross-power spectrum Baseline: JB (01) - EF (02)
Timerange: 01/00:18:43 to 01/00:21:59

Plot file version1032 created 03-MAR-2016 01:14:56

4C52 GN002C 1.UVDATA.1

Freq = 1.2770 GHz, Bw = 16.000 MH Calibrated with CL # 3 and BP # 1 (BP mode 1)

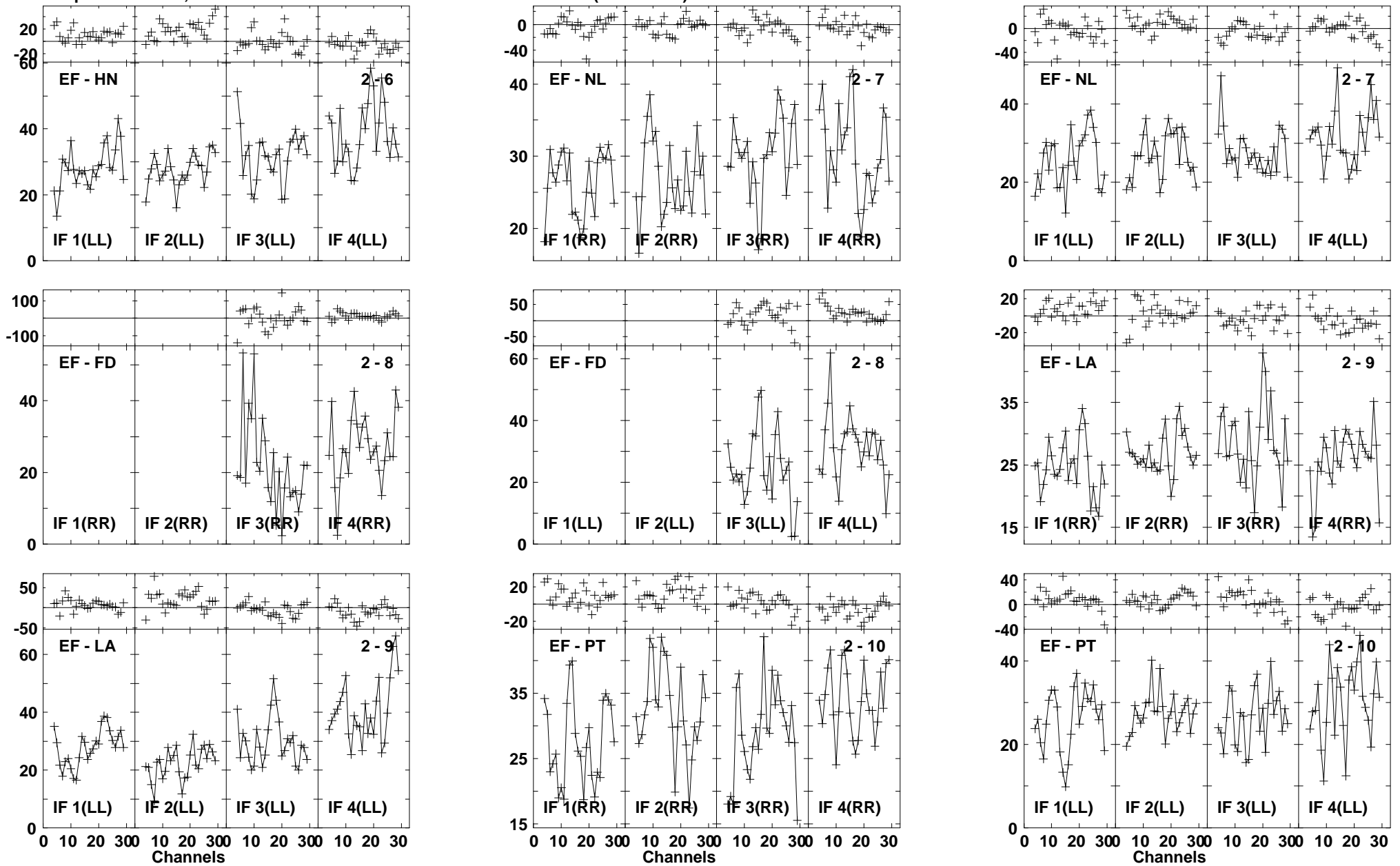

Lower frame: Milli Ampl Jy Top frame: Phas deg
Vector averaged cross-power spectrum Baseline: EF (02) - HN (06)
Timerange: 01/00:18:43 to 01/00:21:59

Plot file version1033 created 03-MAR-2016 01:14:56

4C52 GN002C 1.UVDATA.1

Freq = 1.2770 GHz, Bw = 16.000 MH Calibrated with CL # 3 and BP # 1 (BP mode 1)

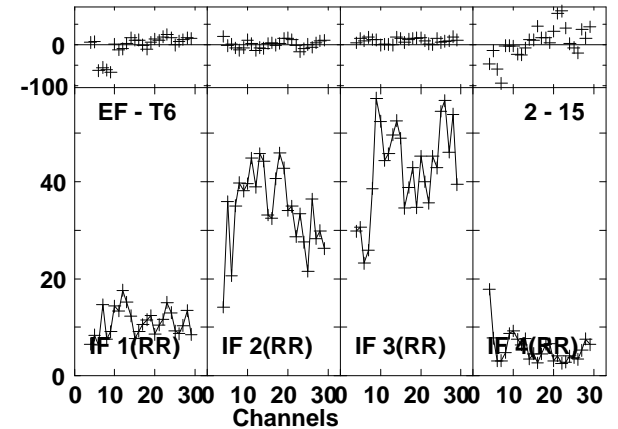
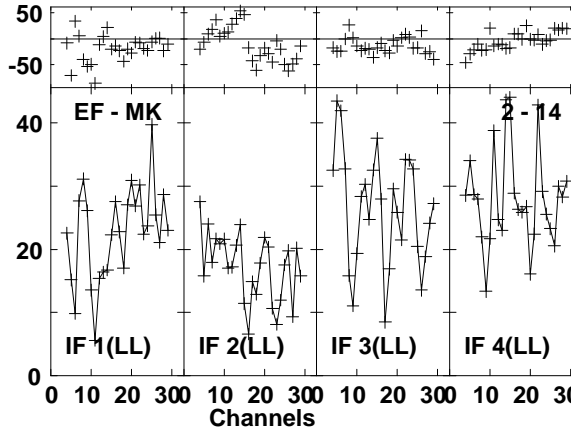
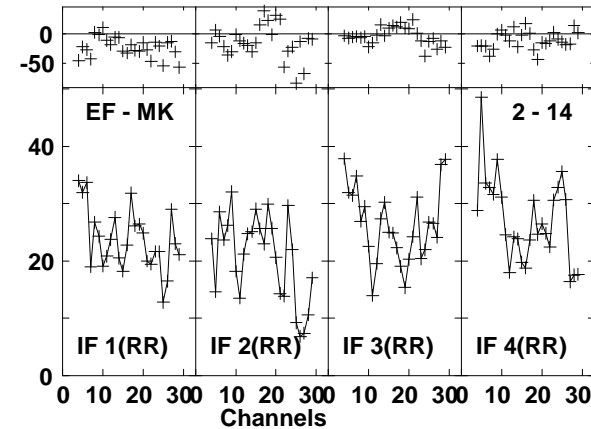
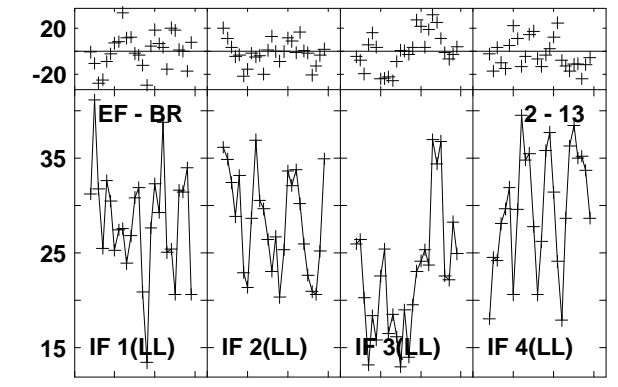
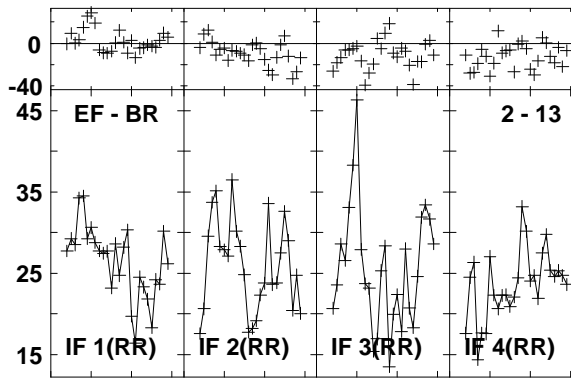
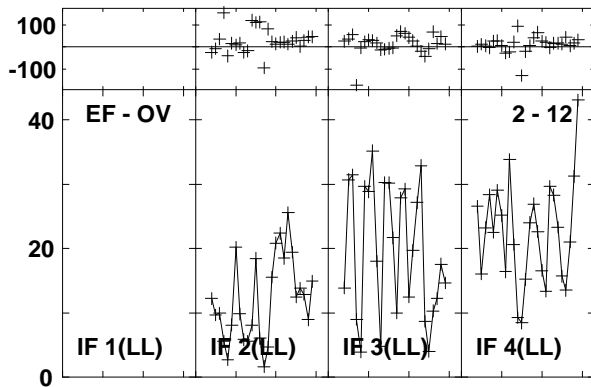
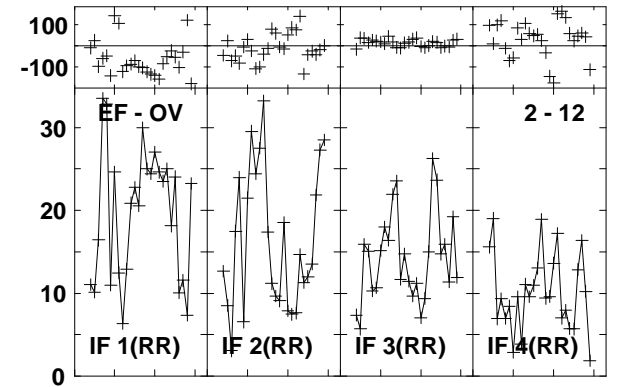
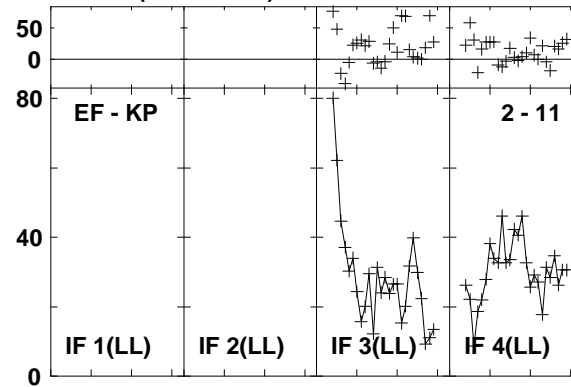
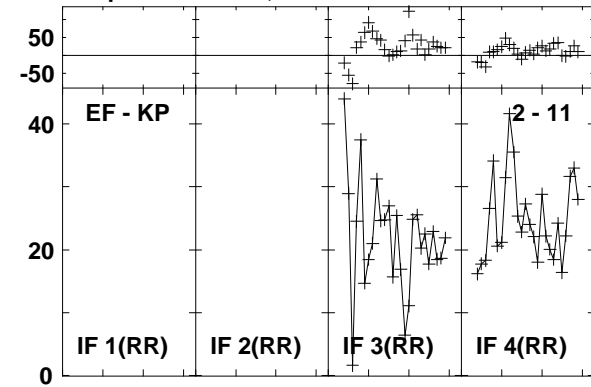

Lower frame: Milli Ampl Jy Top frame: Phas deg
Vector averaged cross-power spectrum Baseline: EF (02) - KP (11)
Timerange: 01/00:18:43 to 01/00:21:59

Plot file version1034 created 03-MAR-2016 01:14:56

4C52 GN002C 1.UVDATA.1

Freq = 1.2770 GHz, Bw = 16.000 MH Calibrated with CL # 3 and BP # 1 (BP mode 1)

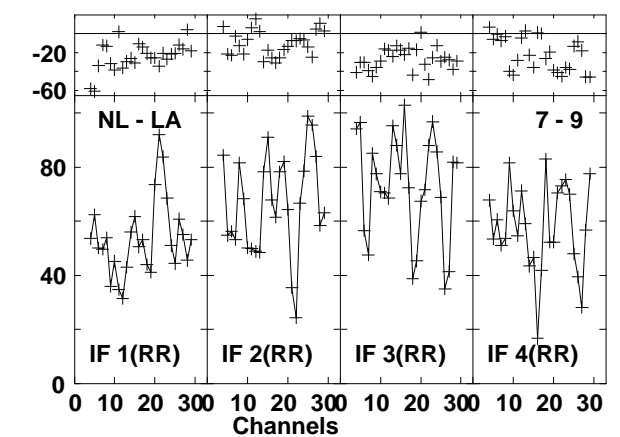
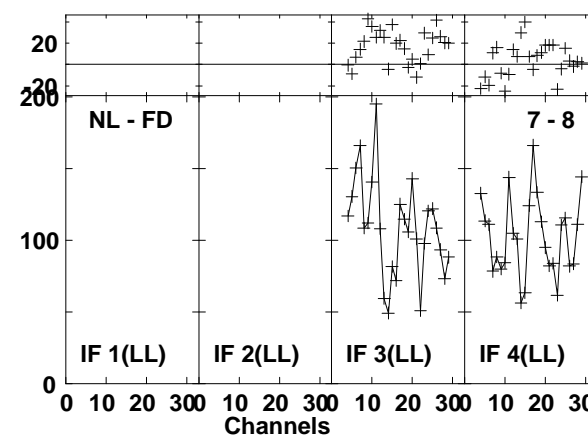
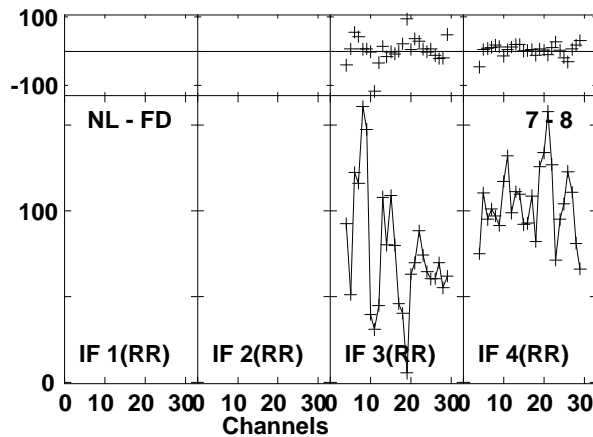
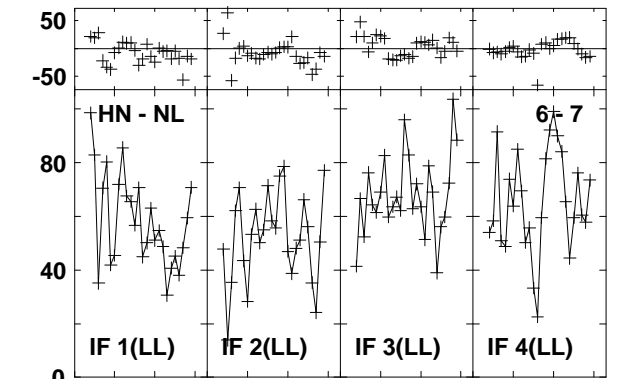
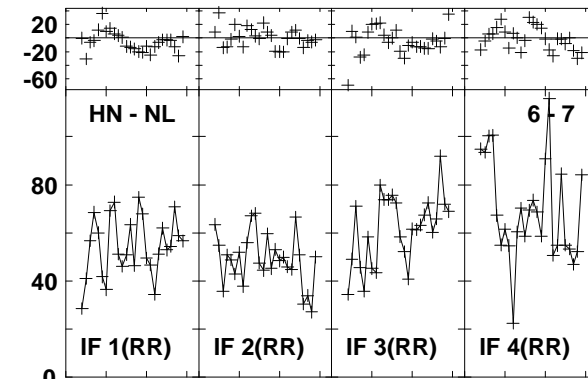
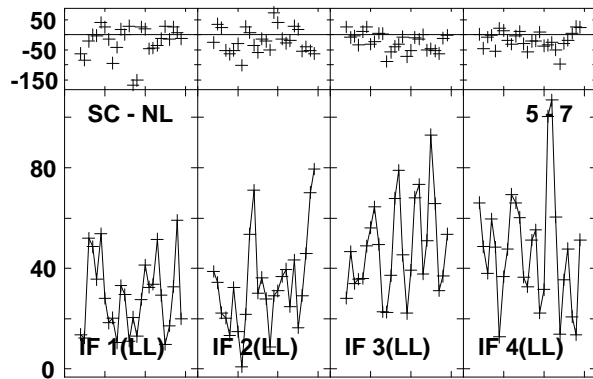
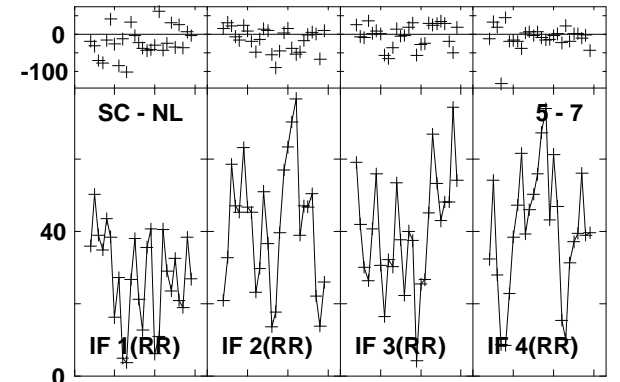
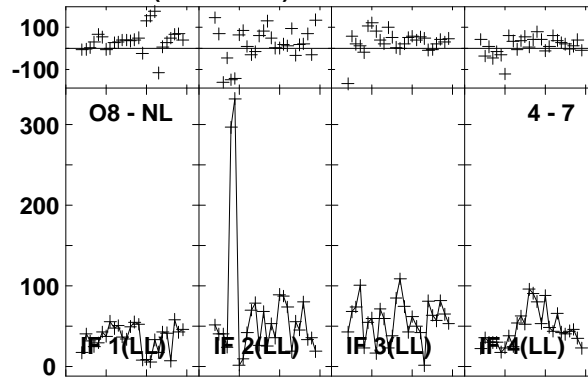
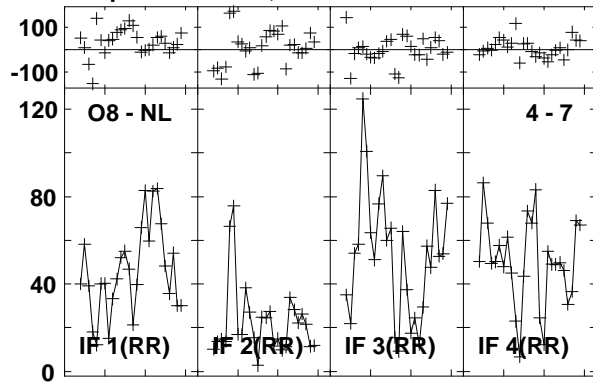

Lower frame: Milli Ampl Jy Top frame: Phas deg
Vector averaged cross-power spectrum Baseline: O8 (04) - NL (07)
Timerange: 01/00:18:43 to 01/00:21:59

Plot file version1035 created 03-MAR-2016 01:14:57

4C52 GN002C 1.UVDATA.1

Freq = 1.2770 GHz, Bw = 16.000 MH Calibrated with CL # 3 and BP # 1 (BP mode 1)

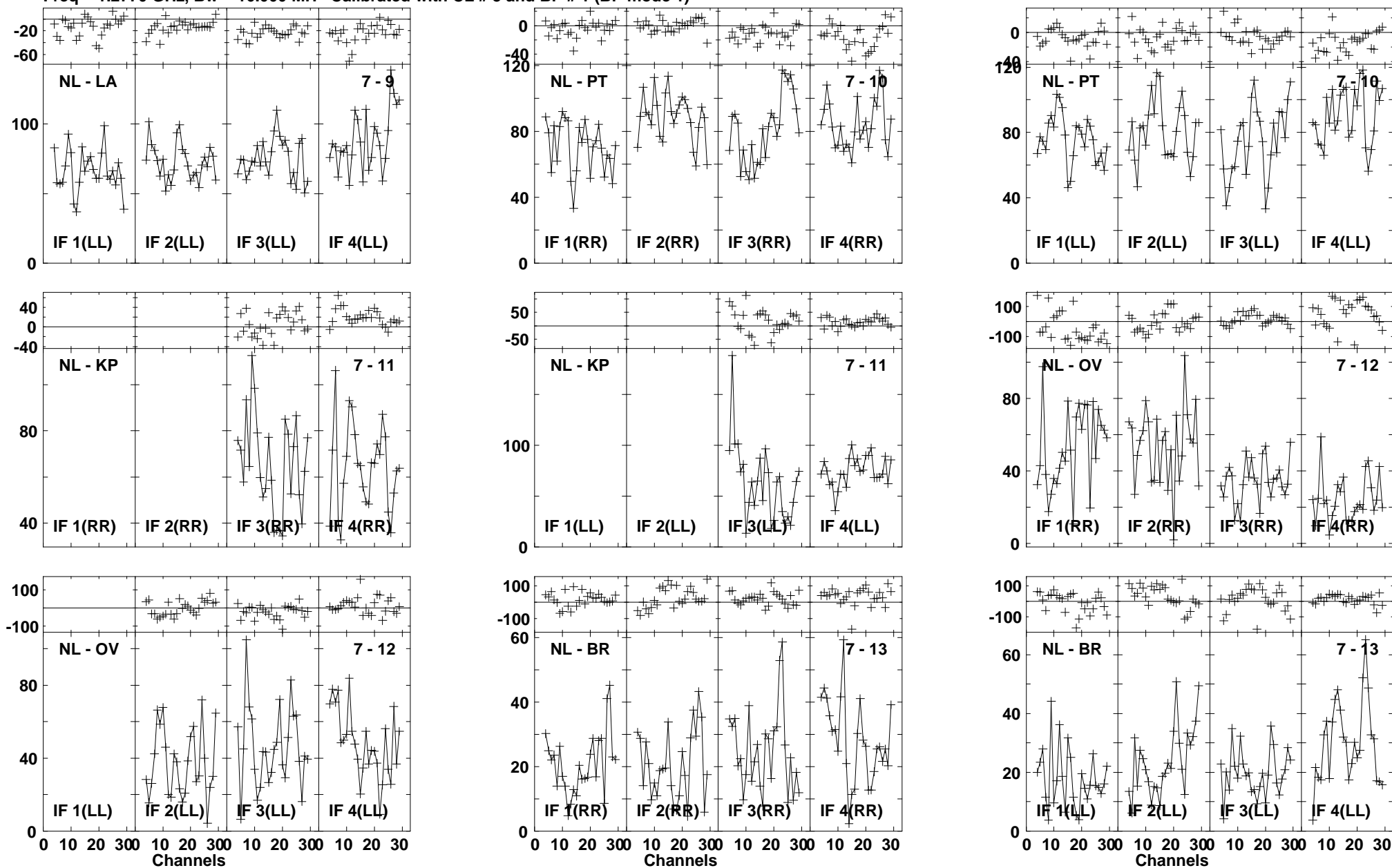

Lower frame: Milli Ampl Jy Top frame: Phas deg
Vector averaged cross-power spectrum Baseline: NL (07) - LA (09)
Timerange: 01/00:18:43 to 01/00:21:59

Plot file version1036 created 03-MAR-2016 01:14:57

4C52 GN002C 1.UVDATA.1

Freq = 1.2770 GHz, Bw = 16.000 MH Calibrated with CL # 3 and BP # 1 (BP mode 1)

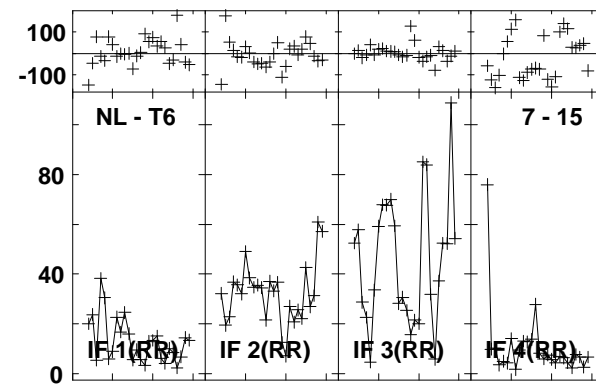
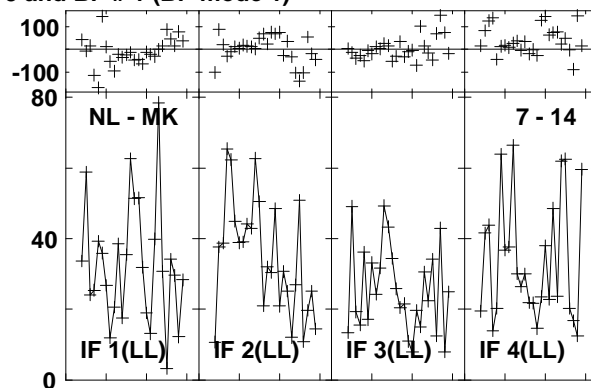
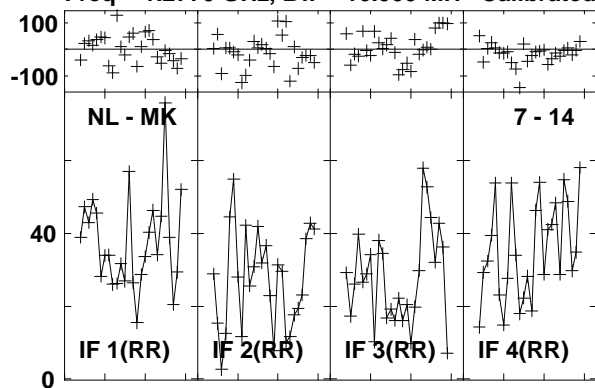

Lower frame: Milli Ampl Jy Top frame: Phas deg
Vector averaged cross-power spectrum Baseline: NL (07) - MK (14)
Timerange: 01/00:18:43 to 01/00:21:59

Plot file version1037 created 03-MAR-2016 01:14:57

J1545+5400 GN002C 1.UVDATA.1

Freq = 1.2770 GHz, Bw = 16.000 MH Calibrated with CL # 3 and BP # 1 (BP mode 1)

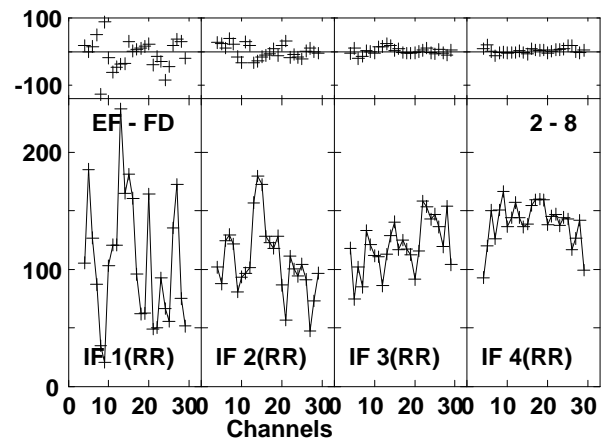
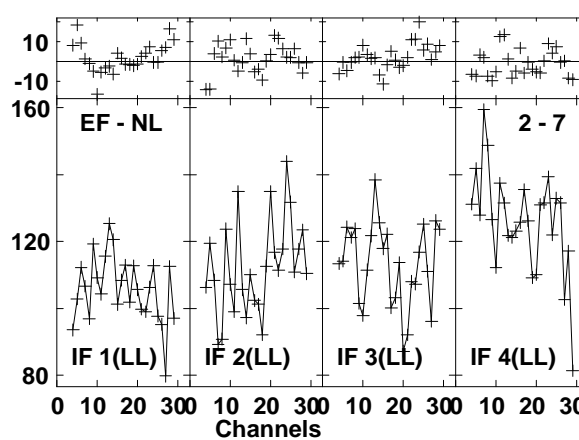
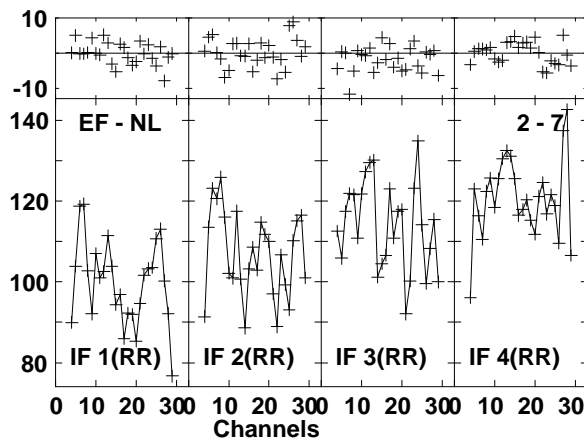
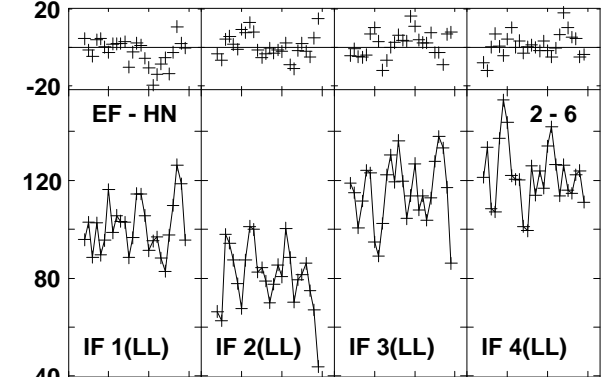
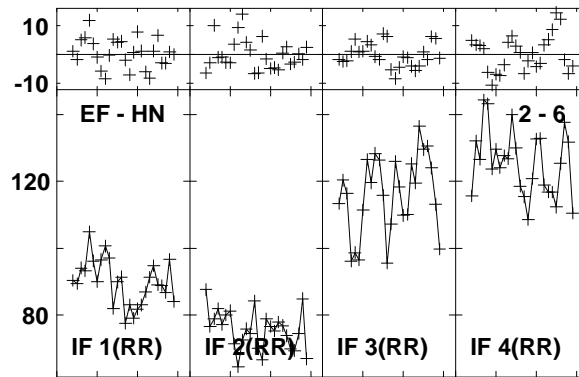
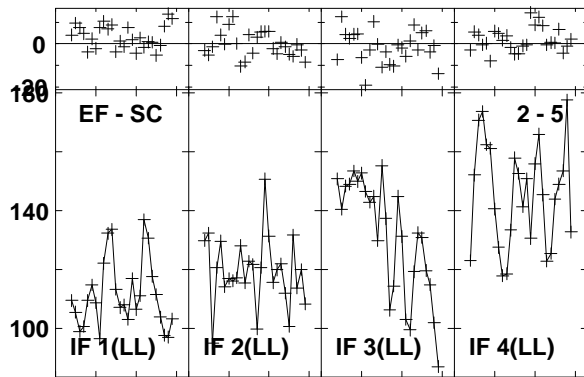
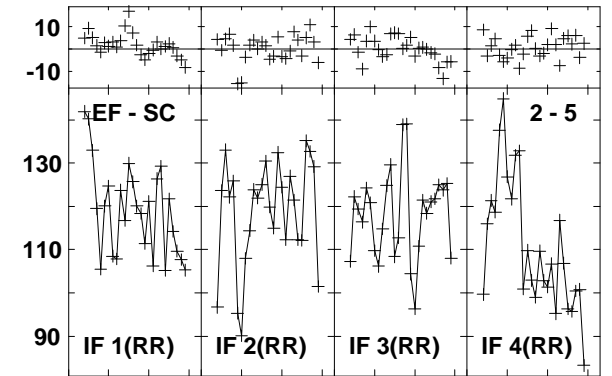
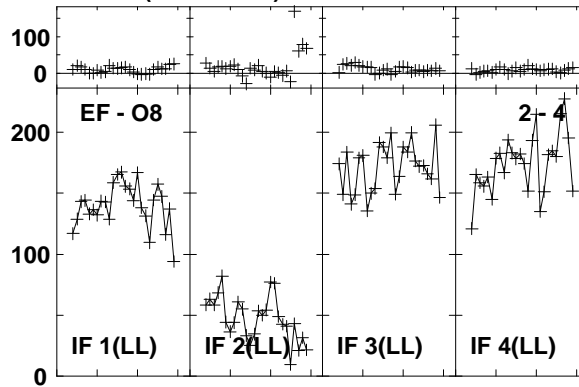
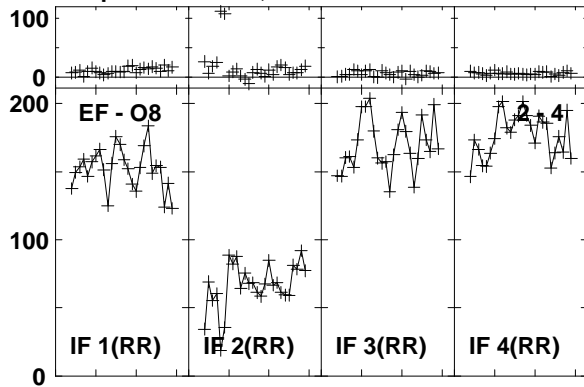

Lower frame: Milli Ampl Jy Top frame: Phas deg
Vector averaged cross-power spectrum Baseline: EF (02) - O8 (04)
Timerange: 01/00:22:52 to 01/00:23:50

Plot file version1038 created 03-MAR-2016 01:14:57

J1545+5400 GN002C 1.UVDATA.1

Freq = 1.2770 GHz, Bw = 16.000 MH Calibrated with CL # 3 and BP # 1 (BP mode 1)

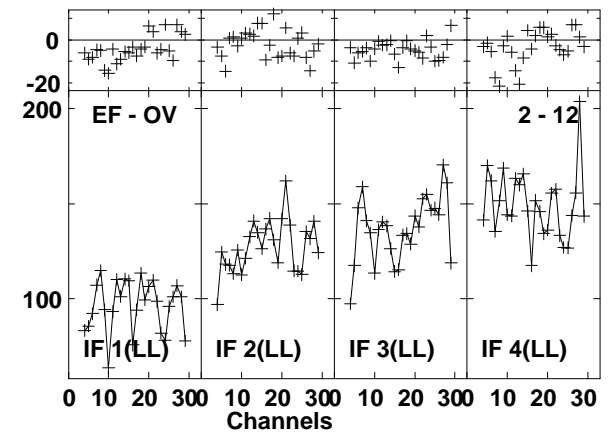
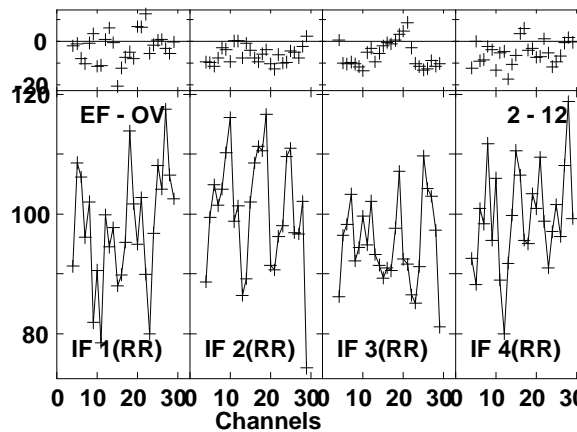
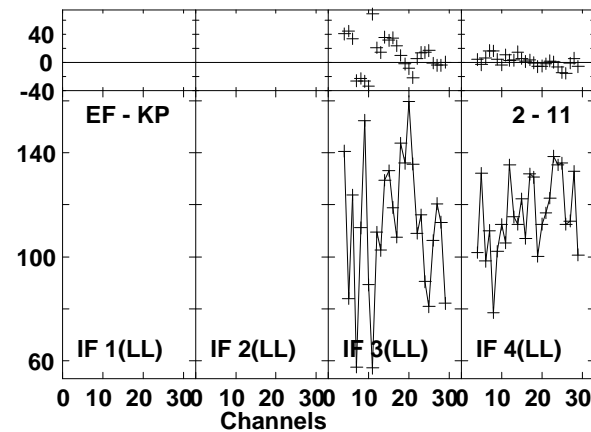
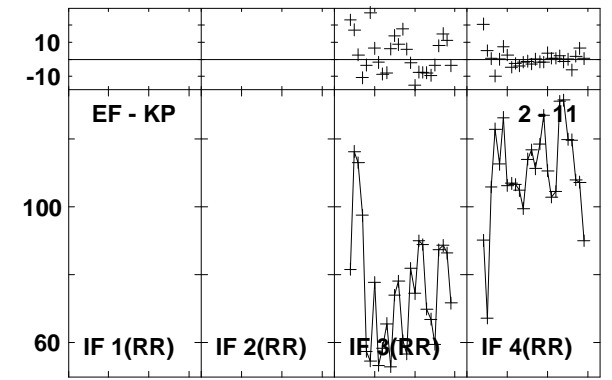
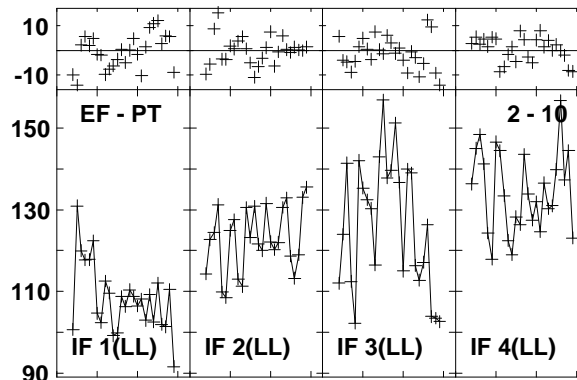
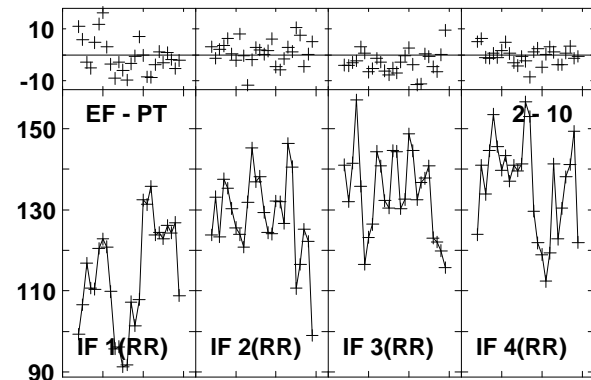
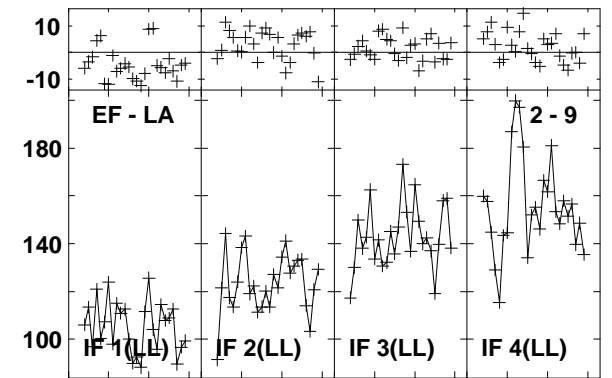
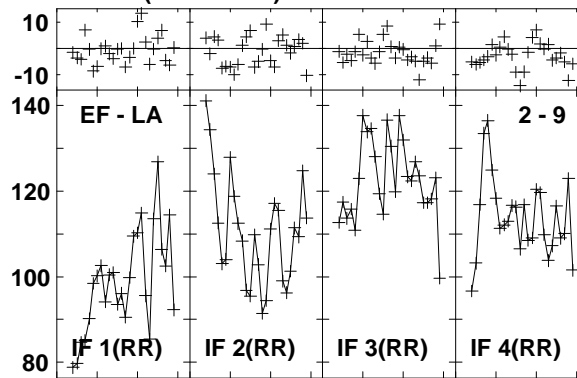
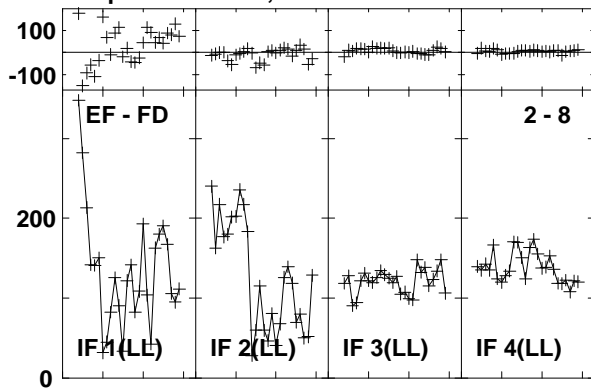

Lower frame: Milli Ampl Jy Top frame: Phas deg

Vector averaged cross-power spectrum Baseline: EF (02) - FD (08)

Timerange: 01/00:22:52 to 01/00:23:50

Plot file version1039 created 03-MAR-2016 01:14:57

J1545+5400 GN002C 1.UVDATA.1

Freq = 1.2770 GHz, Bw = 16.000 MH Calibrated with CL # 3 and BP # 1 (BP mode 1)

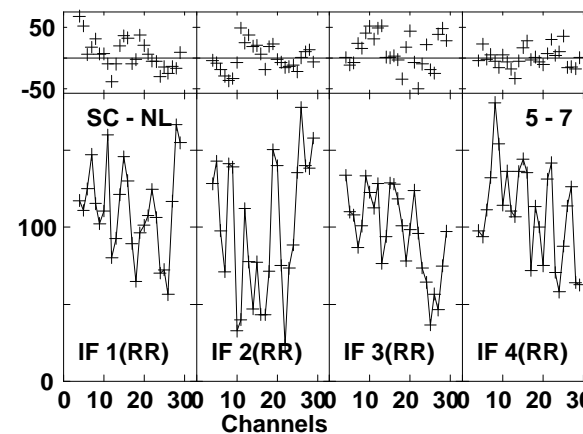
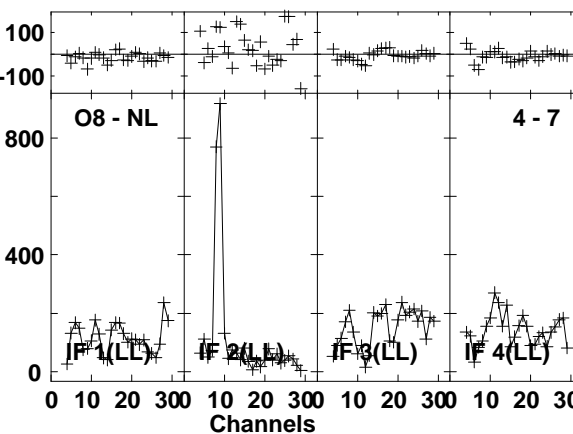
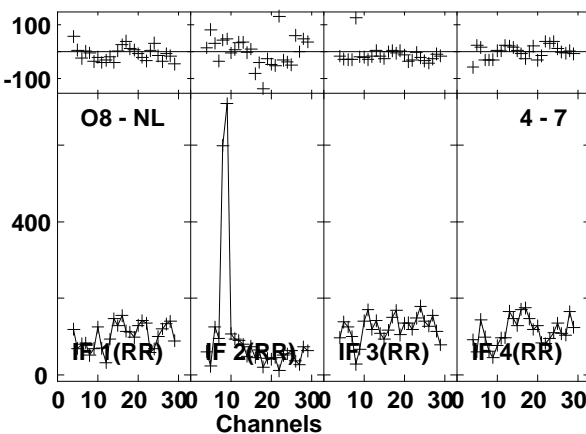
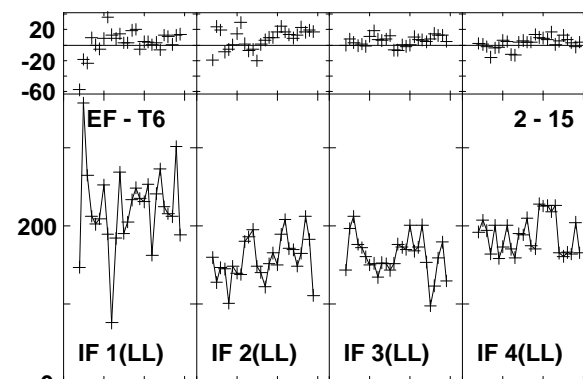
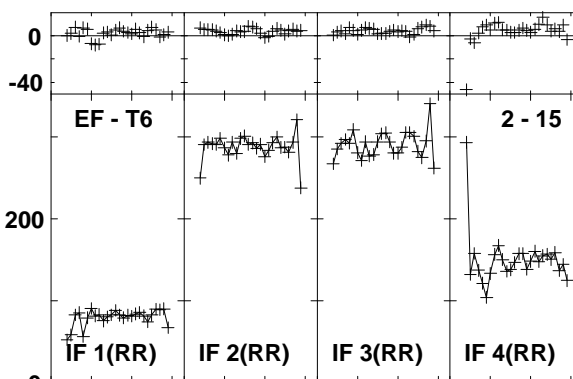
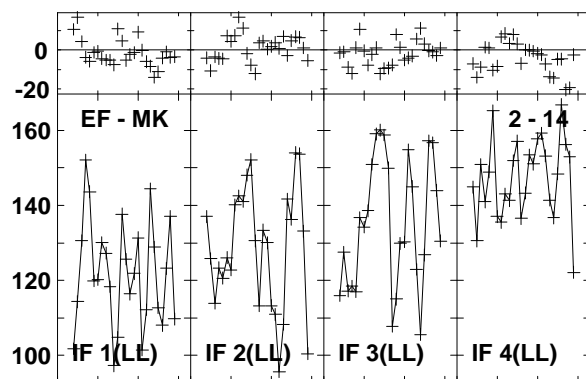
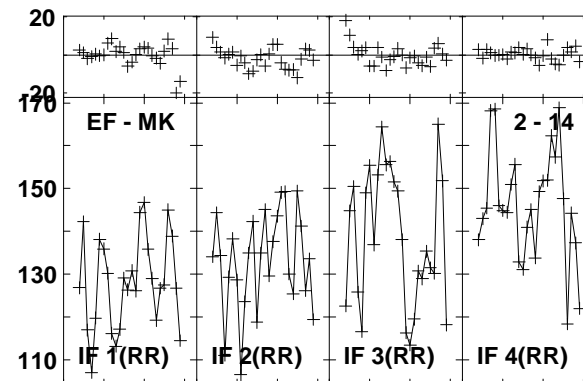
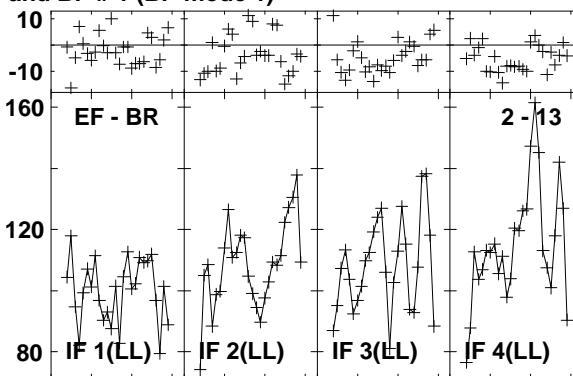
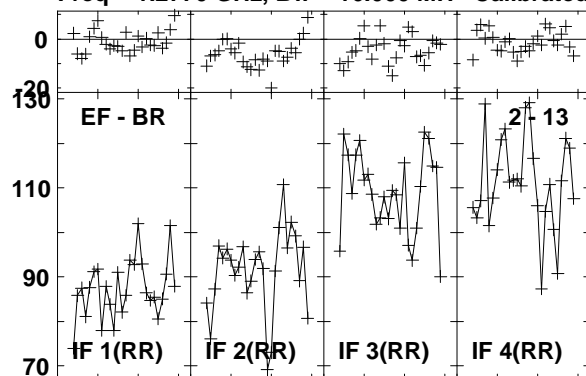

Lower frame: Milli Ampl Jy Top frame: Phas deg
Vector averaged cross-power spectrum Baseline: EF (02) - BR (13)
Timerange: 01/00:22:52 to 01/00:23:50

Plot file version1040 created 03-MAR-2016 01:14:57

J1545+5400 GN002C 1.UVDATA.1

Freq = 1.2770 GHz, Bw = 16.000 MH Calibrated with CL # 3 and BP # 1 (BP mode 1)

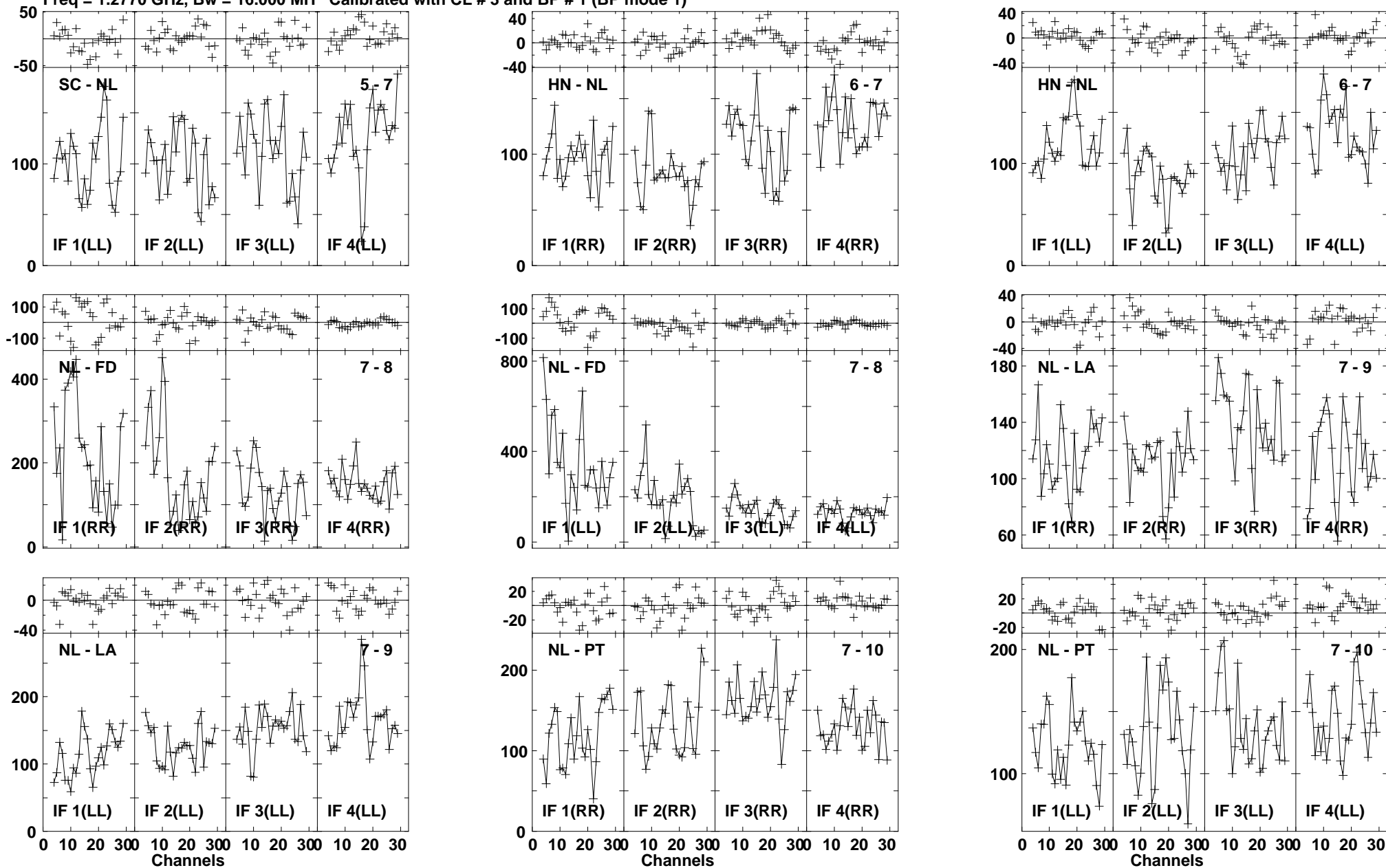

Lower frame: Milli Ampl Jy Top frame: Phas deg
Vector averaged cross-power spectrum Baseline: SC (05) - NL (07)
Timerange: 01/00:22:52 to 01/00:23:50

Plot file version1041 created 03-MAR-2016 01:14:58

J1545+5400 GN002C 1.UVDATA.1

Freq = 1.2770 GHz, Bw = 16.000 MH Calibrated with CL # 3 and BP # 1 (BP mode 1)

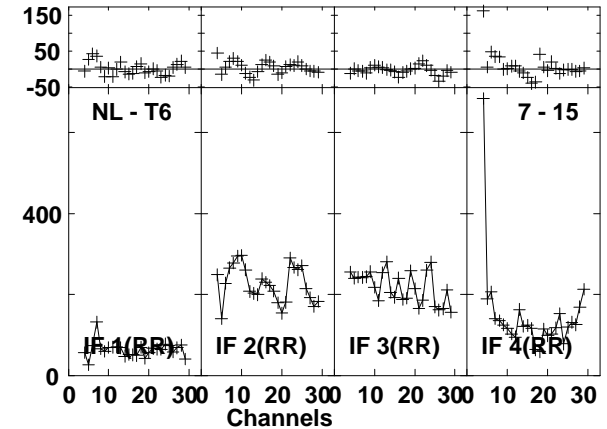
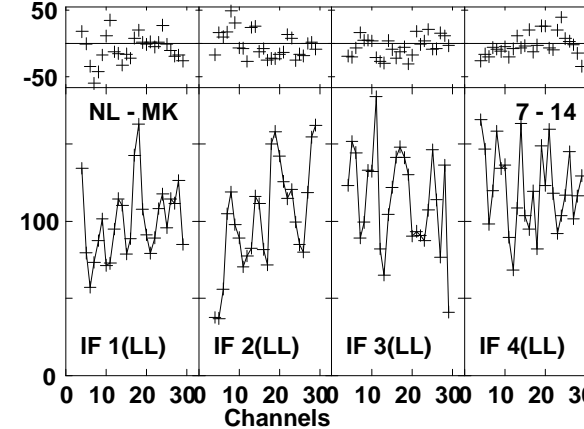
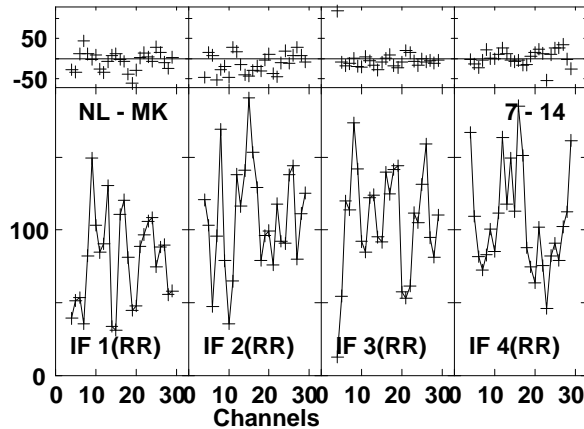
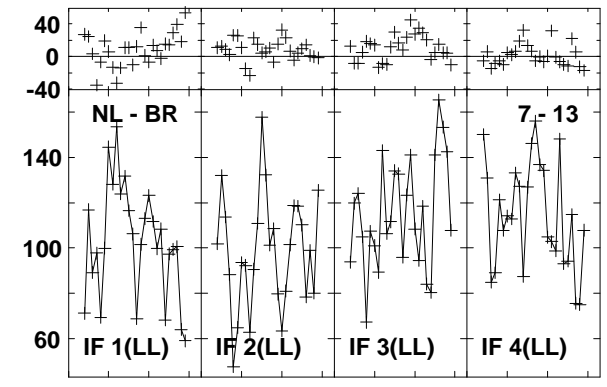
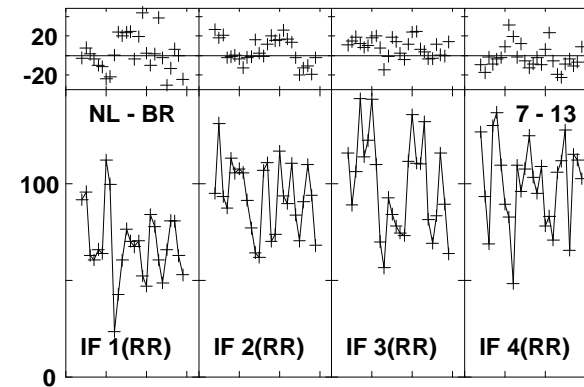
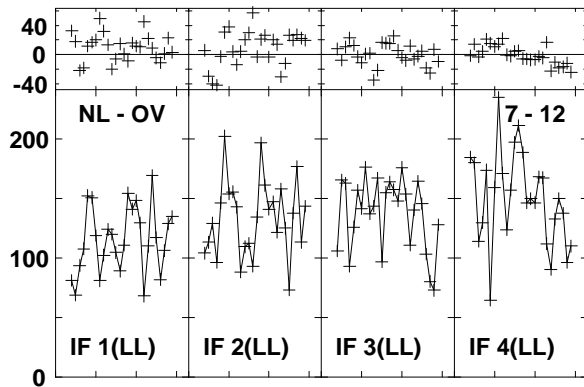
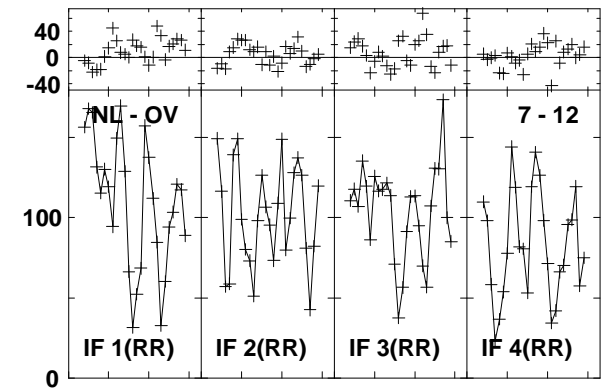
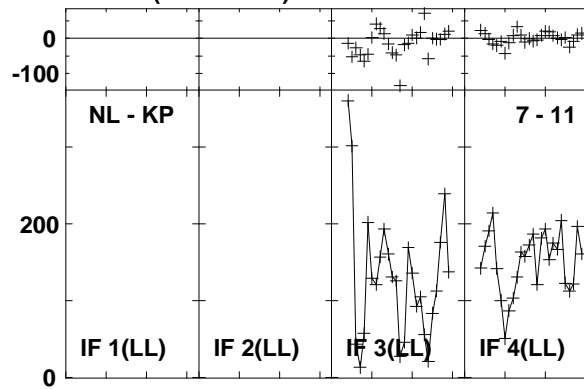
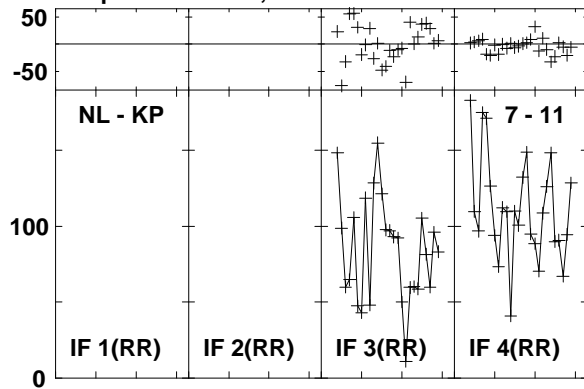

Lower frame: Milli Ampl Jy Top frame: Phas deg

Vector averaged cross-power spectrum Baseline: NL (07) - KP (11)

Timerange: 01/00:22:52 to 01/00:23:50

Plot file version1042 created 03-MAR-2016 01:14:58
J1545+5400 GN002C 1.UVDATA.1
Freq = 1.2770 GHz, Bw = 16.000 MH Calibrated with CL # 3 and BP # 1 (BP mode 1)

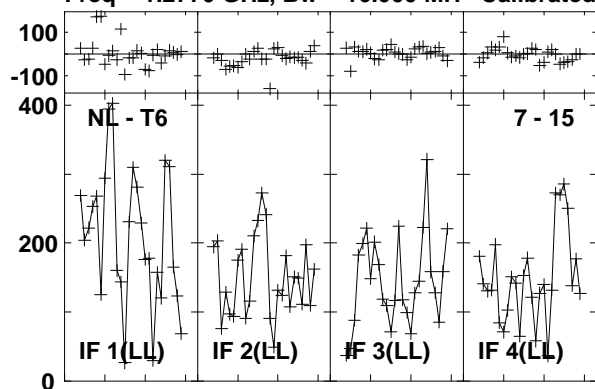

Lower frame: Milli Ampl Jy Top frame: Phas deg
Vector averaged cross-power spectrum Baseline: NL (07) - T6 (15)
Timerange: 01/00:22:52 to 01/00:23:50

Plot file version1043 created 03-MAR-2016 01:14:58

4C52 GN002C 1.UVDATA.1

Freq = 1.2770 GHz, Bw = 16.000 MH Calibrated with CL # 3 and BP # 1 (BP mode 1)

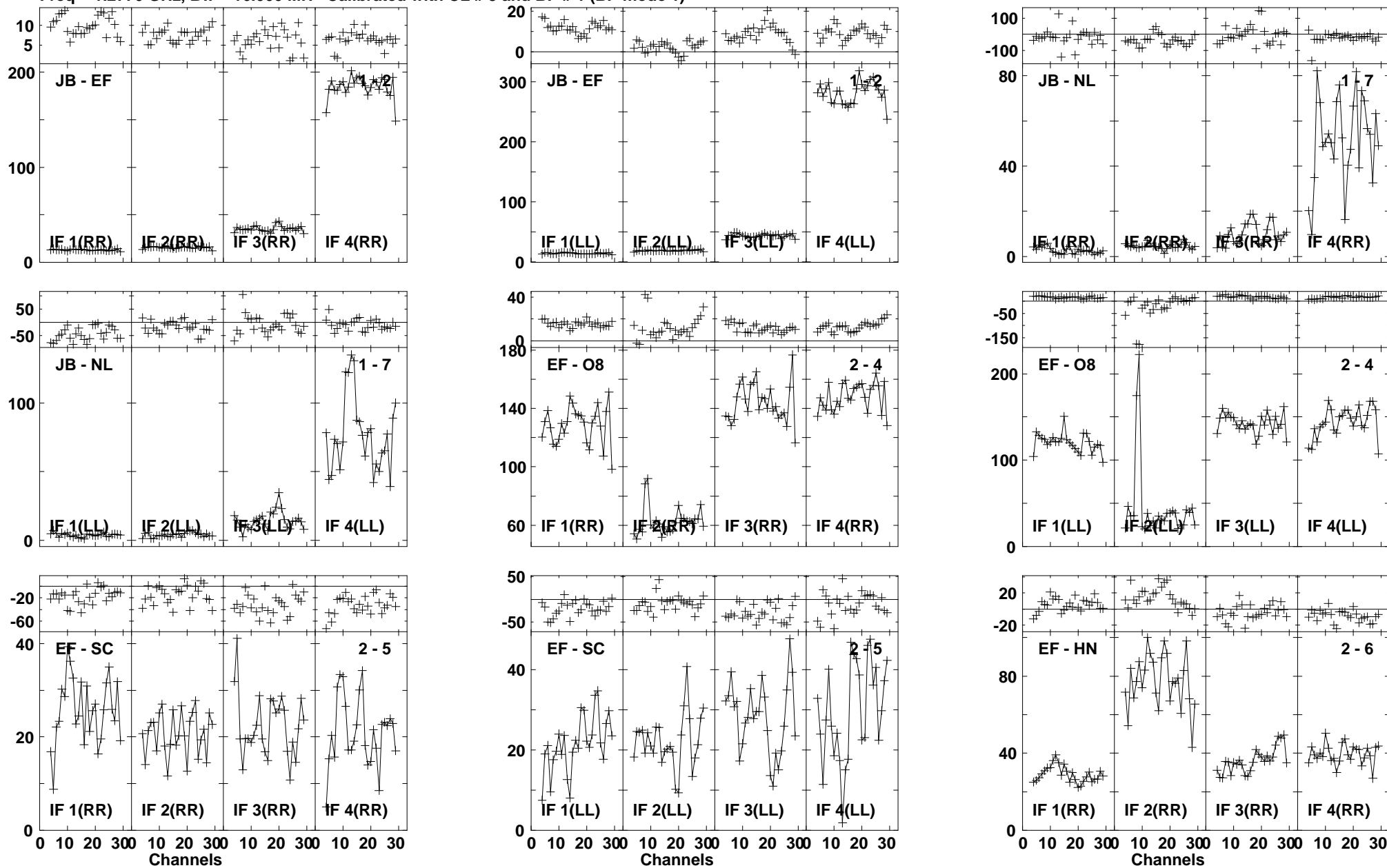

Lower frame: Milli Ampl Jy Top frame: Phas deg
Vector averaged cross-power spectrum Baseline: JB (01) - EF (02)
Timerange: 01/00:23:55 to 01/00:27:19

Plot file version1044 created 03-MAR-2016 01:14:58

4C52 GN002C 1.UVDATA.1

Freq = 1.2770 GHz, Bw = 16.000 MH Calibrated with CL # 3 and BP # 1 (BP mode 1)

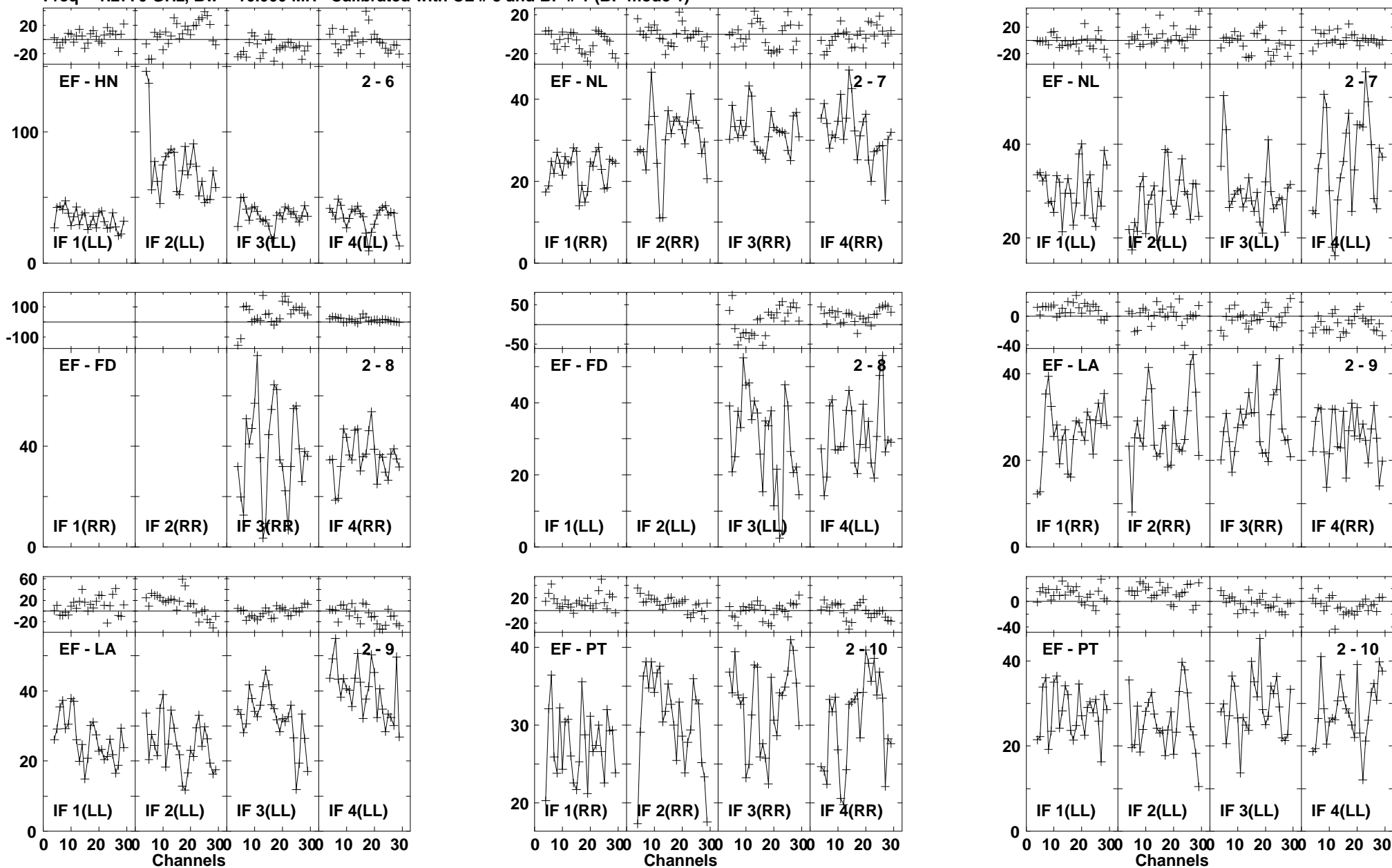

Lower frame: Milli Ampl Jy Top frame: Phas deg
Vector averaged cross-power spectrum Baseline: EF (02) - HN (06)
Timerange: 01/00:23:55 to 01/00:27:19

Plot file version1045 created 03-MAR-2016 01:14:58

4C52 GN002C 1.UVDATA.1

Freq = 1.2770 GHz, Bw = 16.000 MH Calibrated with CL # 3 and BP # 1 (BP mode 1)

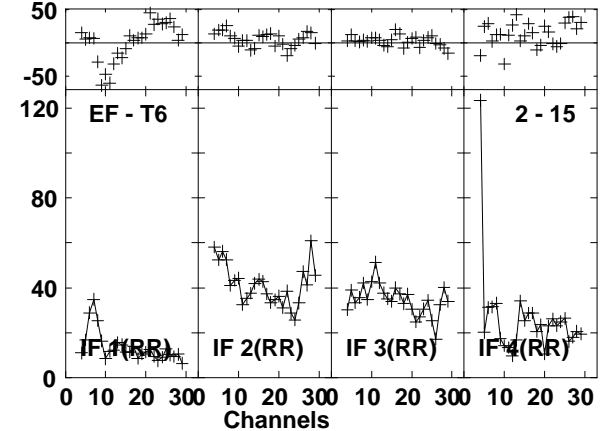
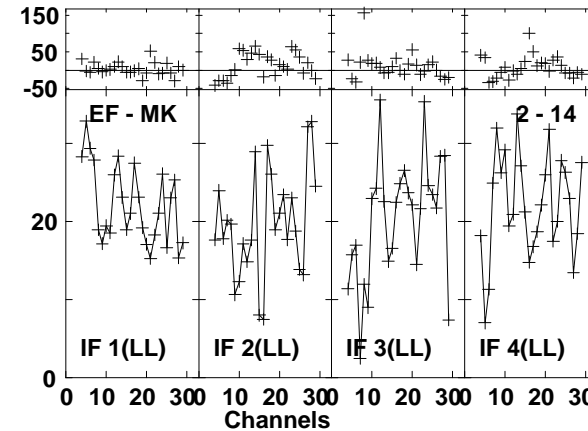
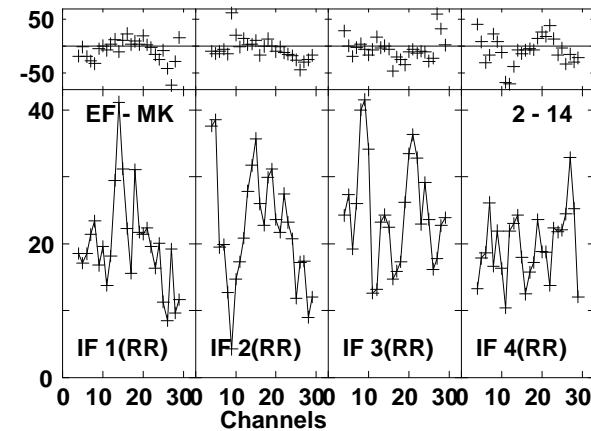
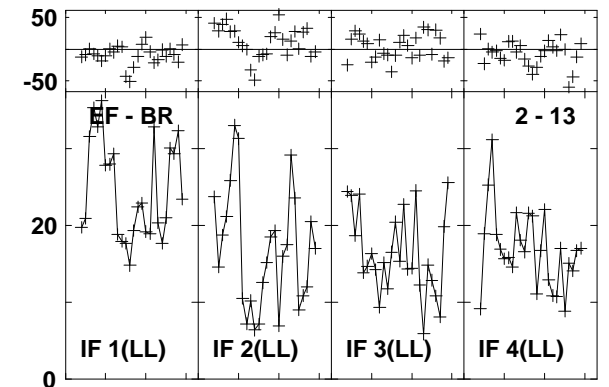
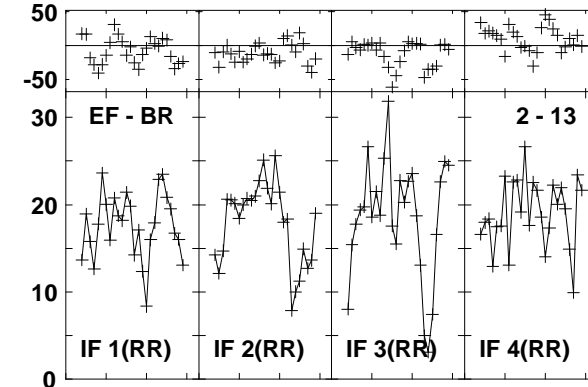
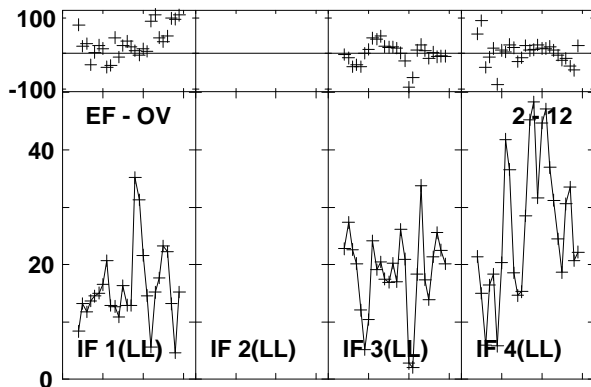
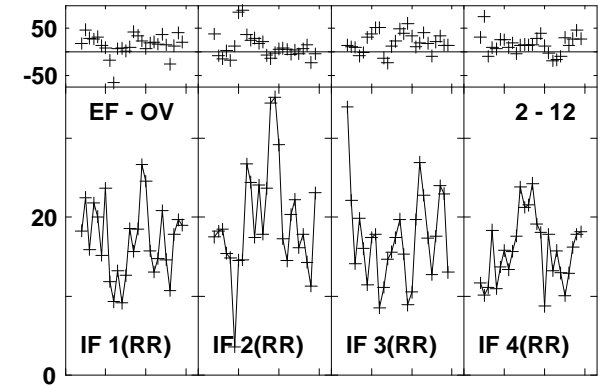
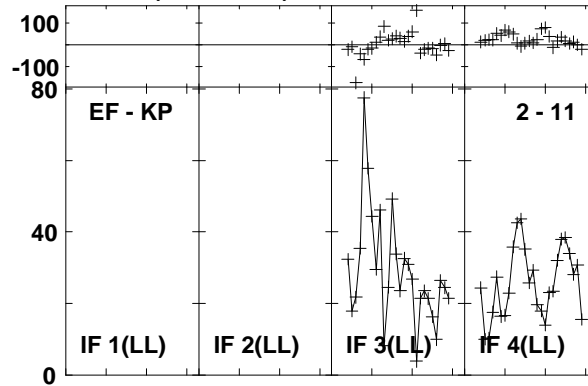
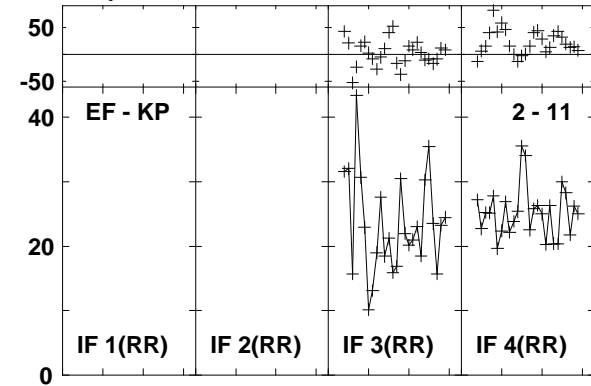

Lower frame: Milli Ampl Jy Top frame: Phas deg

Vector averaged cross-power spectrum Baseline: EF (02) - KP (11)

Timerange: 01/00:23:55 to 01/00:27:19

Plot file version1046 created 03-MAR-2016 01:14:59

4C52 GN002C 1.UVDATA.1

Freq = 1.2770 GHz, Bw = 16.000 MH Calibrated with CL # 3 and BP # 1 (BP mode 1)

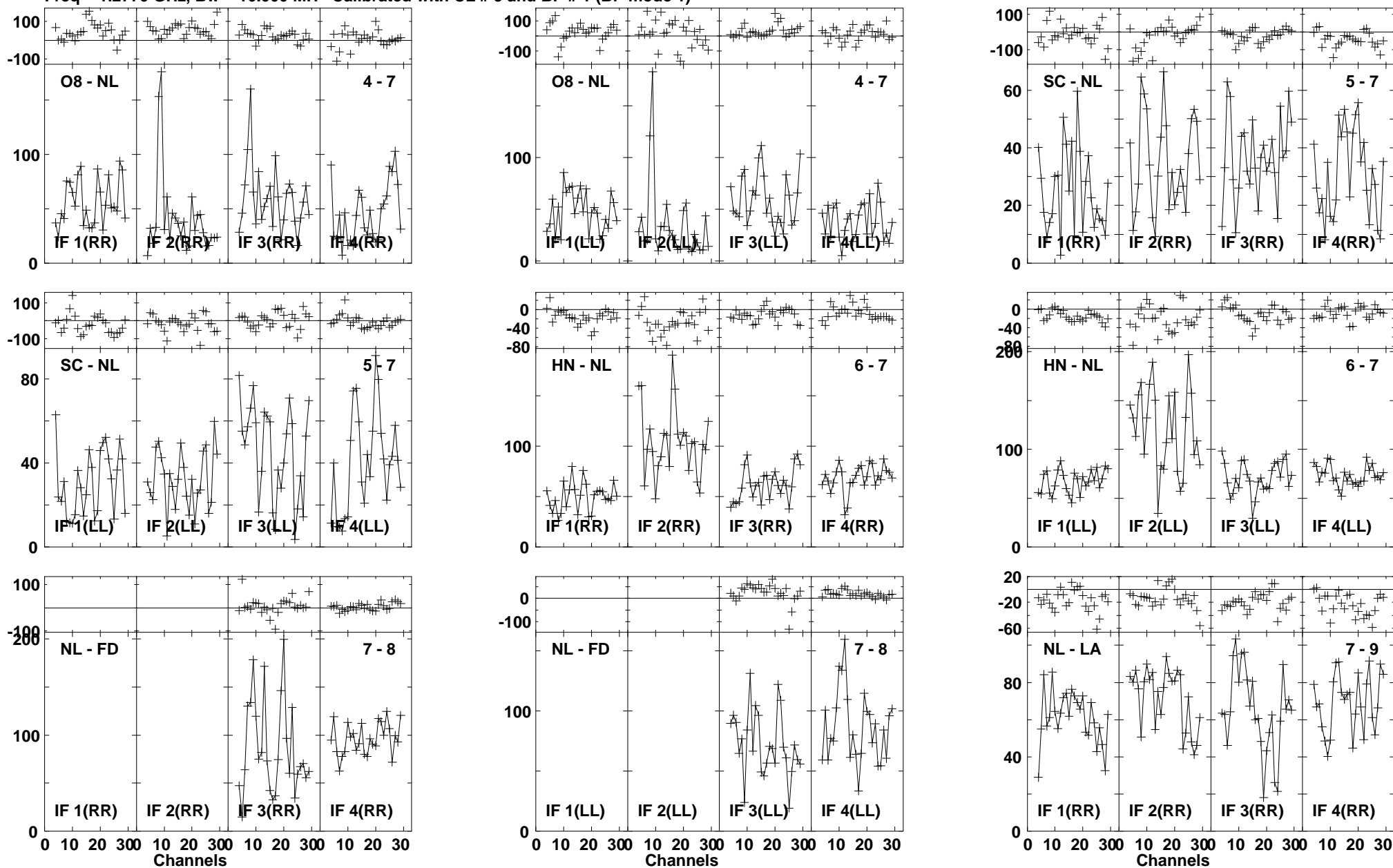

Lower frame: Milli Ampl Jy Top frame: Phas deg
Vector averaged cross-power spectrum Baseline: O8 (04) - NL (07)
Timerange: 01/00:23:55 to 01/00:27:19

Plot file version1047 created 03-MAR-2016 01:14:59

4C52 GN002C 1.UVDATA.1

Freq = 1.2770 GHz, Bw = 16.000 MH Calibrated with CL # 3 and BP # 1 (BP mode 1)

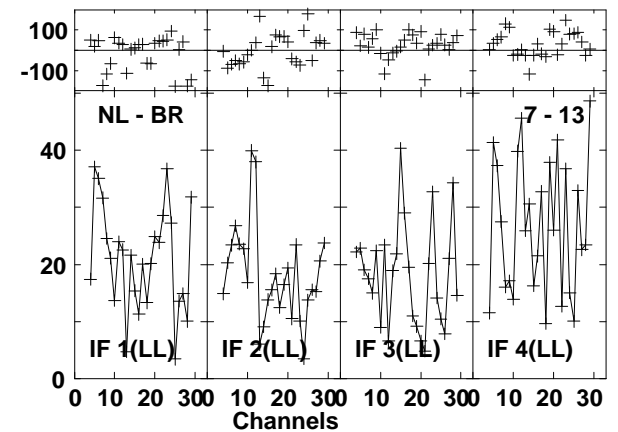
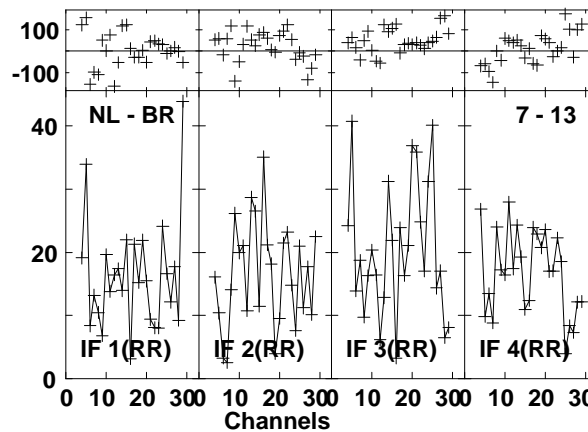
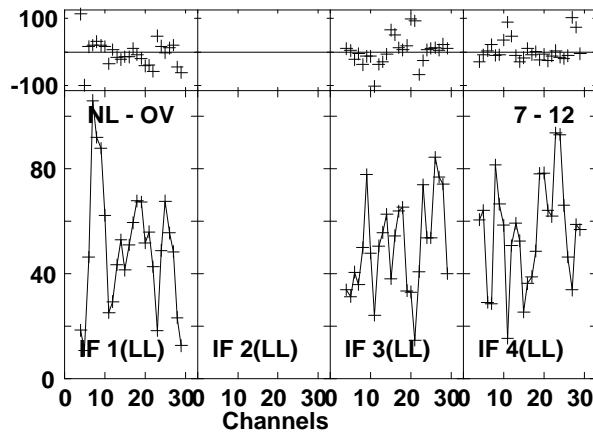
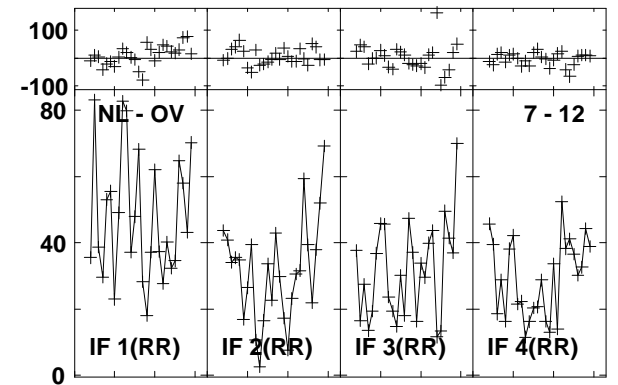
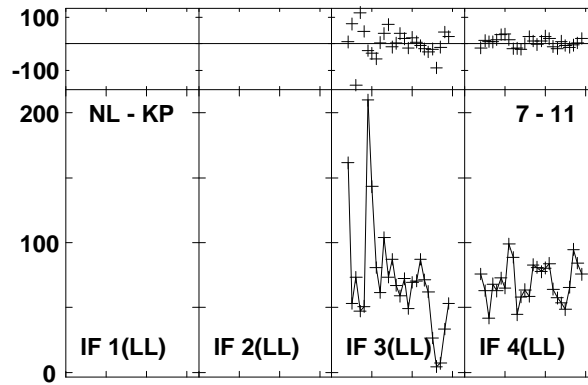
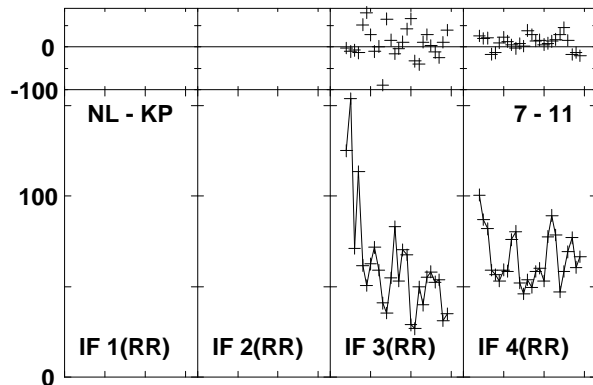
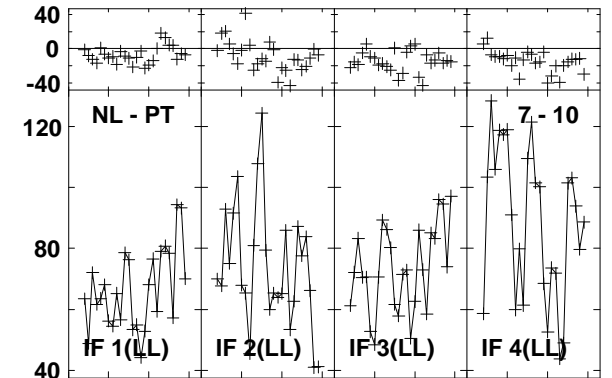
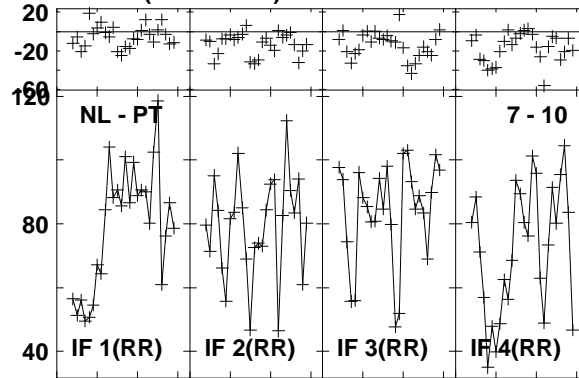
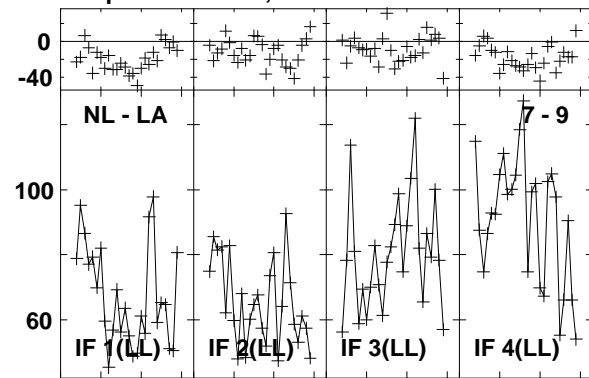

Lower frame: Milli Ampl Jy Top frame: Phas deg
Vector averaged cross-power spectrum Baseline: NL (07) - LA (09)
Timerange: 01/00:23:55 to 01/00:27:19

Plot file version1048 created 03-MAR-2016 01:14:59

4C52 GN002C 1.UVDATA.1

Freq = 1.2770 GHz, Bw = 16.000 MH Calibrated with CL # 3 and BP # 1 (BP mode 1)

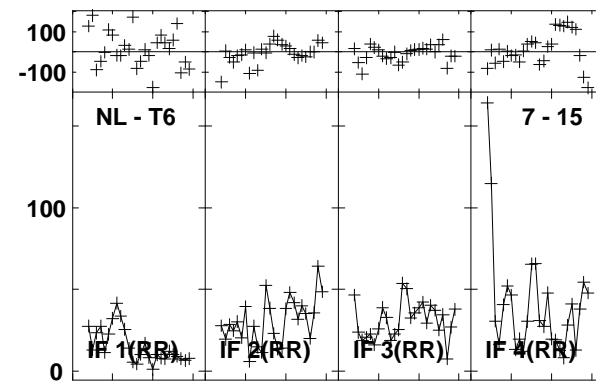
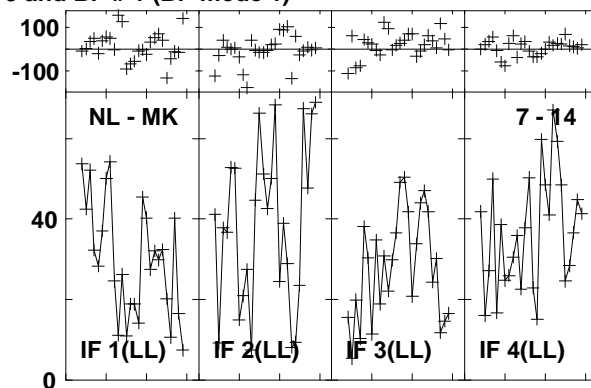
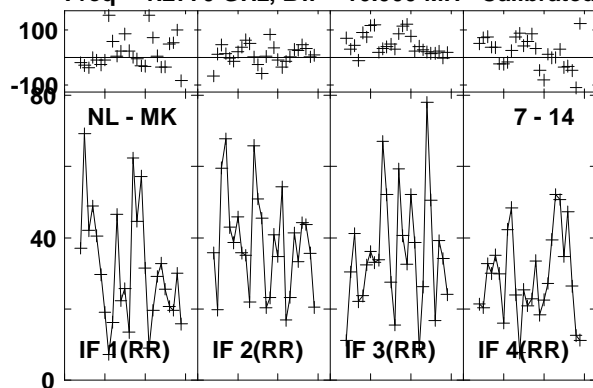

Lower frame: Milli Ampl Jy Top frame: Phas deg
Vector averaged cross-power spectrum Baseline: NL (07) - MK (14)
Timerange: 01/00:23:55 to 01/00:27:19

Plot file version1049 created 03-MAR-2016 01:14:59

J1545+5400 GN002C 1.UVDATA.1

Freq = 1.2770 GHz, Bw = 16.000 MH Calibrated with CL # 3 and BP # 1 (BP mode 1)

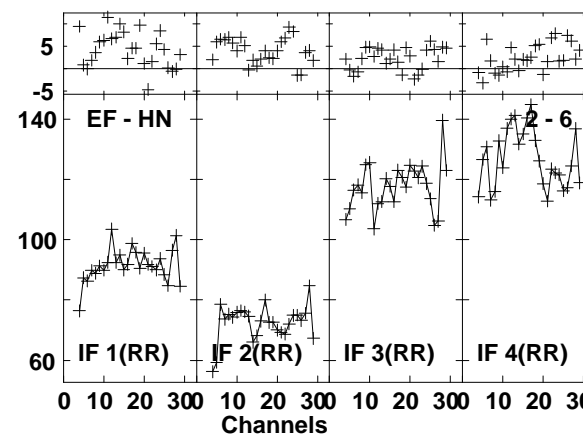
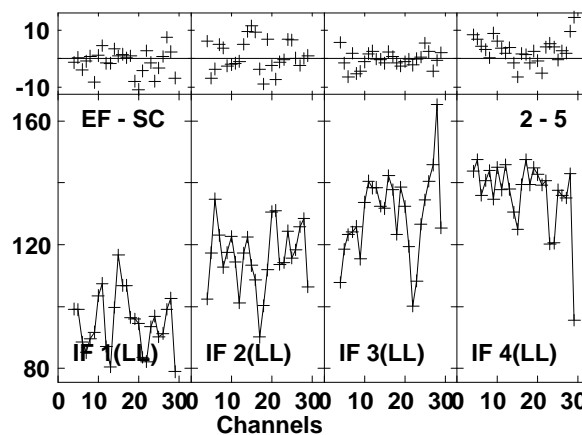
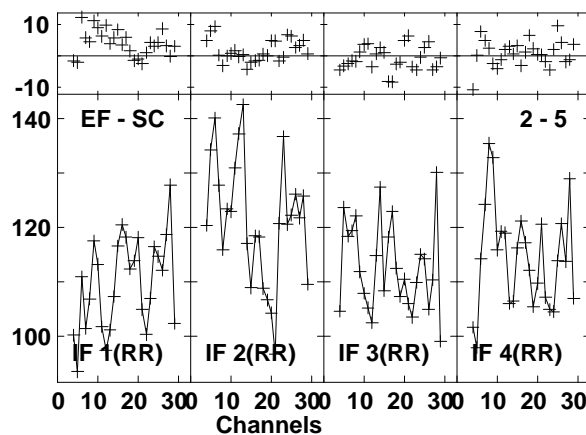
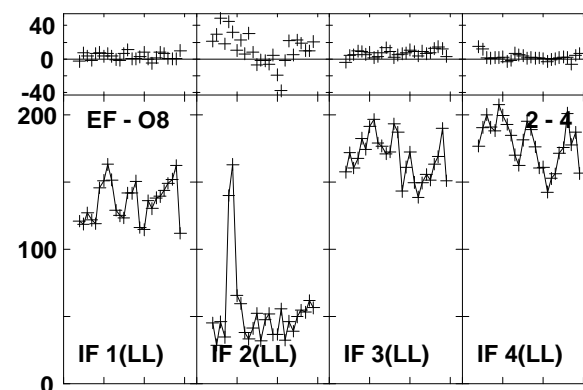
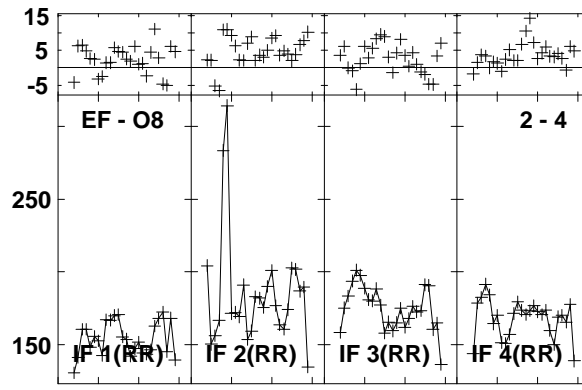
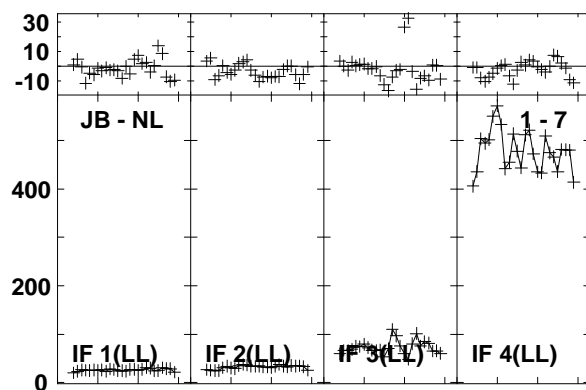
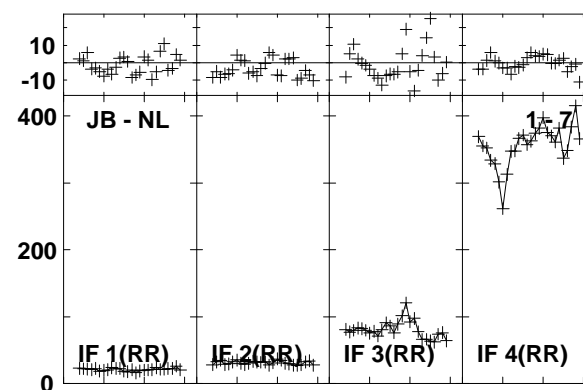
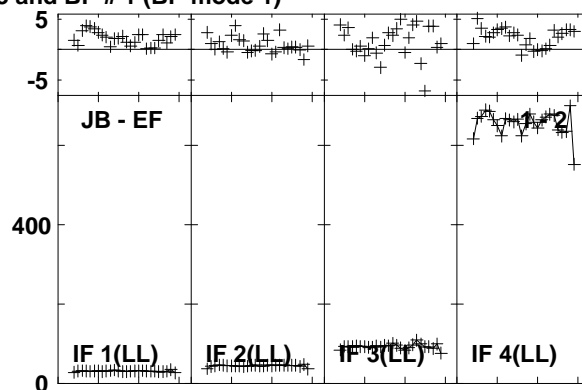
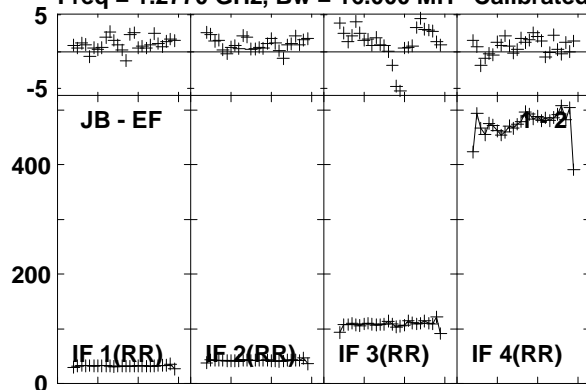

Lower frame: Milli Ampl Jy Top frame: Phas deg
Vector averaged cross-power spectrum Baseline: JB (01) - EF (02)
Timerange: 01/00:28:12 to 01/00:30:10

Plot file version1050 created 03-MAR-2016 01:14:59

J1545+5400 GN002C 1.UVDATA.1

Freq = 1.2770 GHz, Bw = 16.000 MH Calibrated with CL # 3 and BP # 1 (BP mode 1)

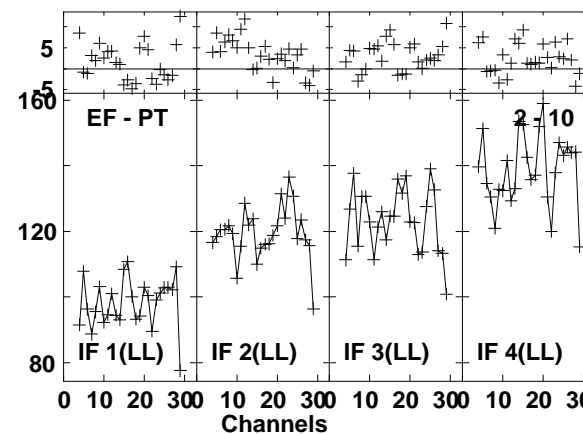
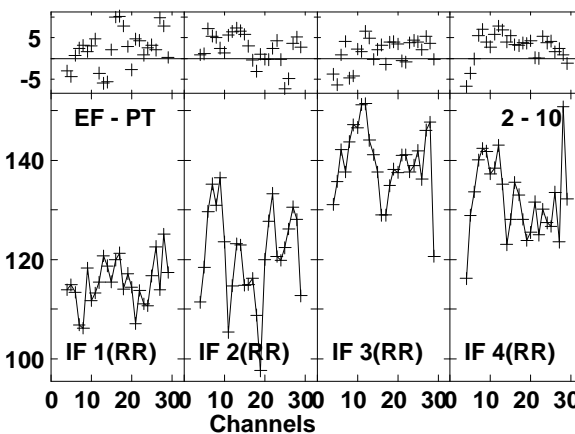
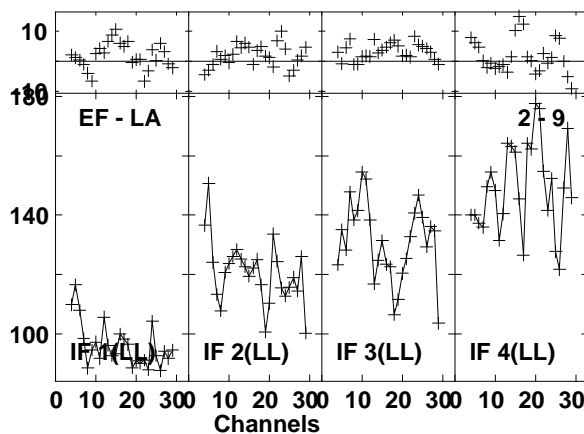
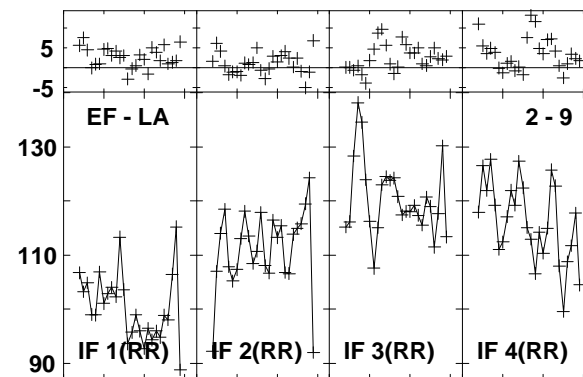
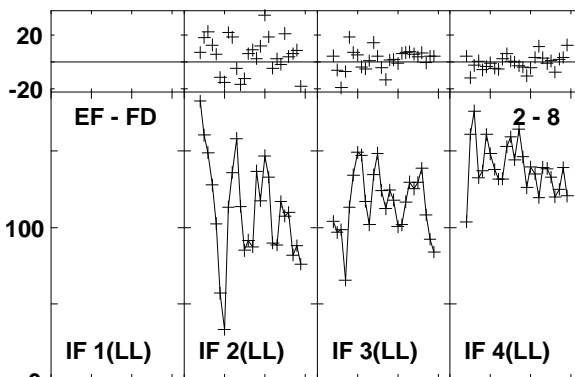
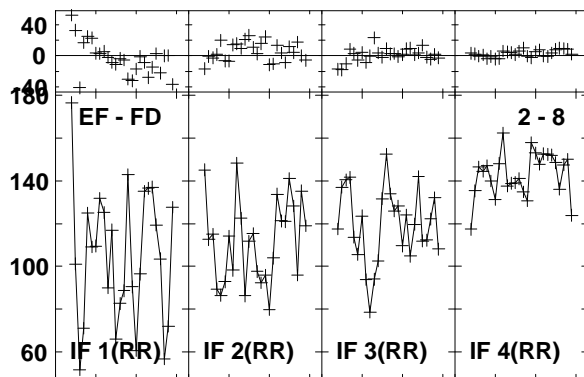
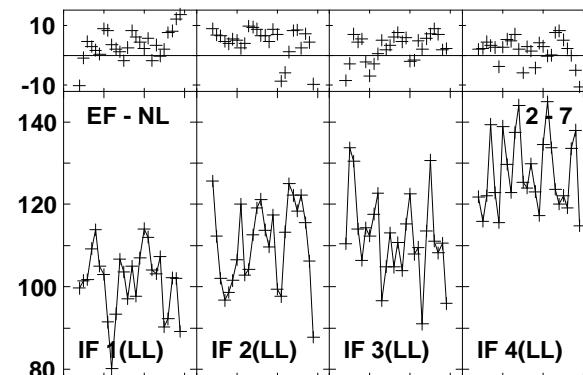
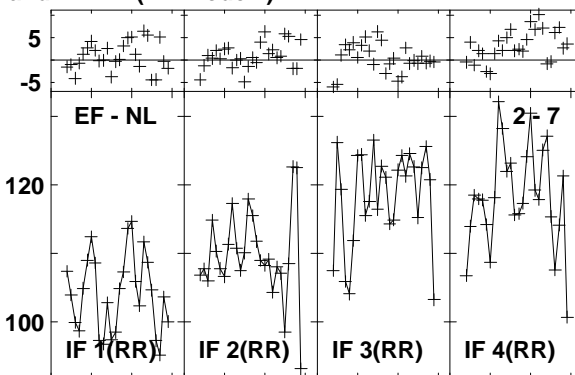
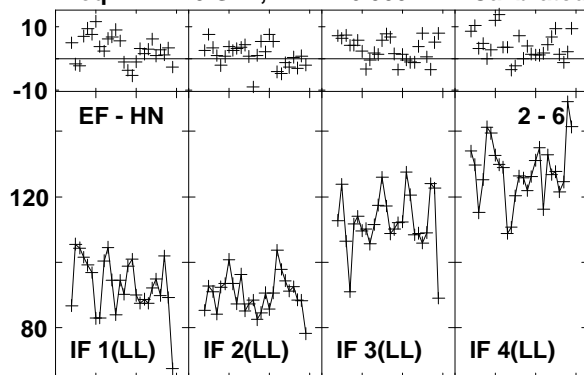

Lower frame: Milli Ampl Jy Top frame: Phas deg
Vector averaged cross-power spectrum Baseline: EF (02) - HN (06)
Timerange: 01/00:28:12 to 01/00:30:10

Plot file version1051 created 03-MAR-2016 01:14:59

J1545+5400 GN002C 1.UVDATA.1

Freq = 1.2770 GHz, Bw = 16.000 MH Calibrated with CL # 3 and BP # 1 (BP mode 1)

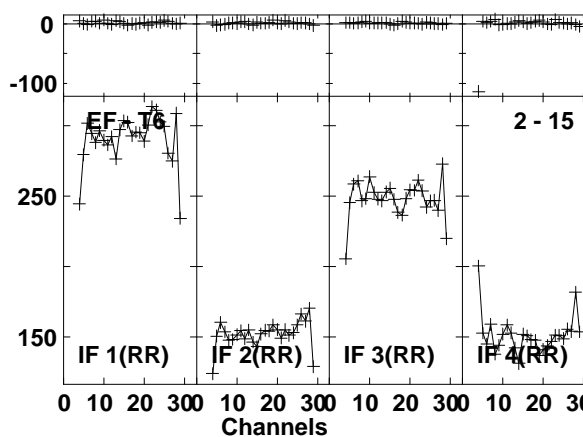
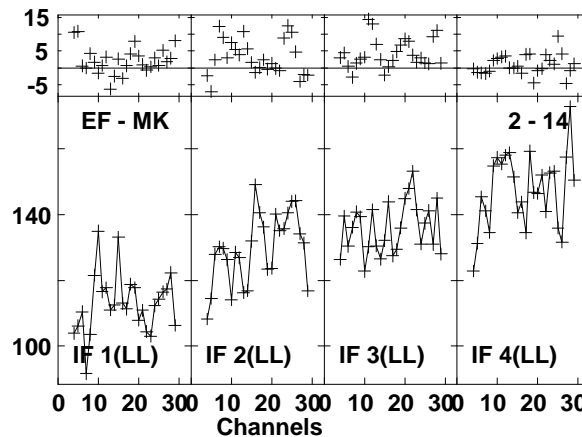
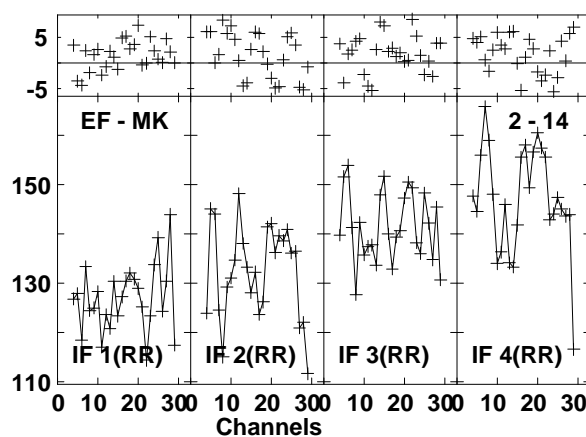
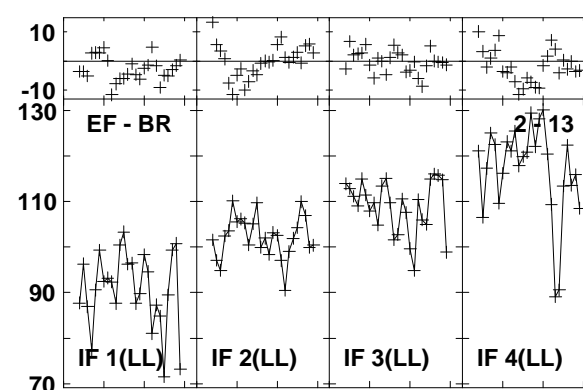
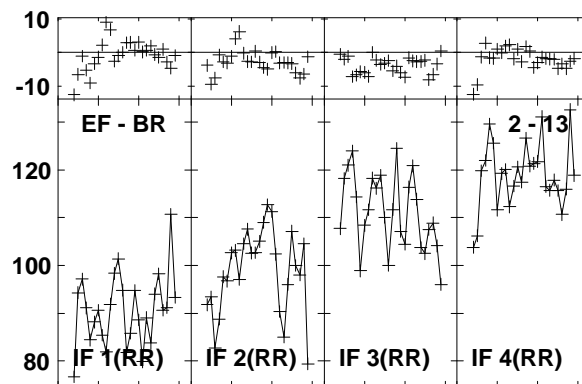
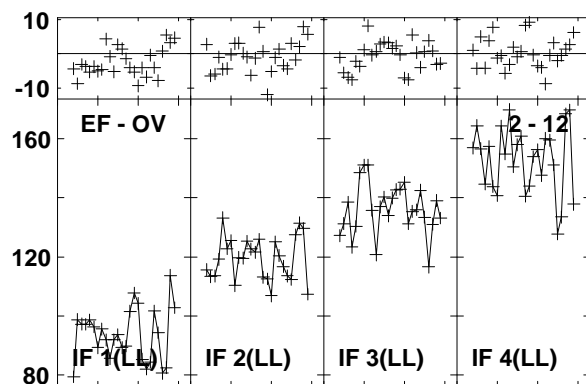
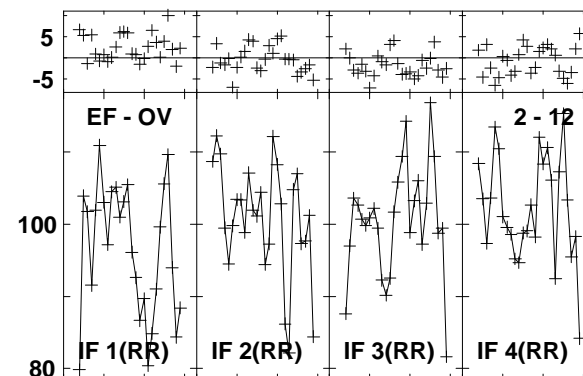
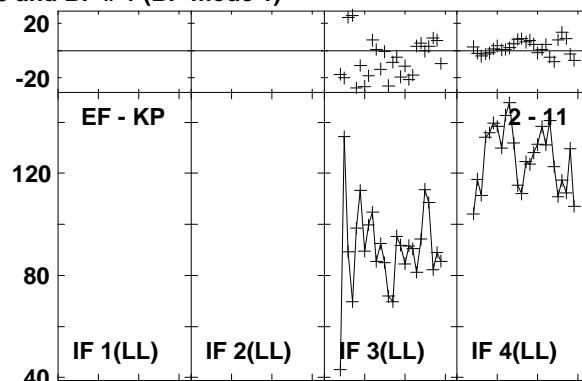
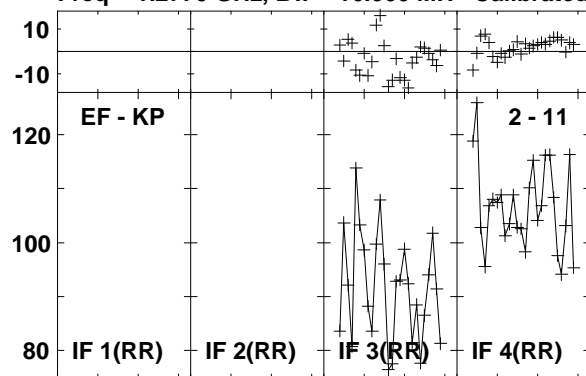

Lower frame: Milli Ampl Jy Top frame: Phas deg
Vector averaged cross-power spectrum Baseline: EF (02) - KP (11)
Timerange: 01/00:28:12 to 01/00:30:10

Plot file version1052 created 03-MAR-2016 01:15:00

J1545+5400 GN002C 1.UVDATA.1

Freq = 1.2770 GHz, Bw = 16.000 MH Calibrated with CL # 3 and BP # 1 (BP mode 1)

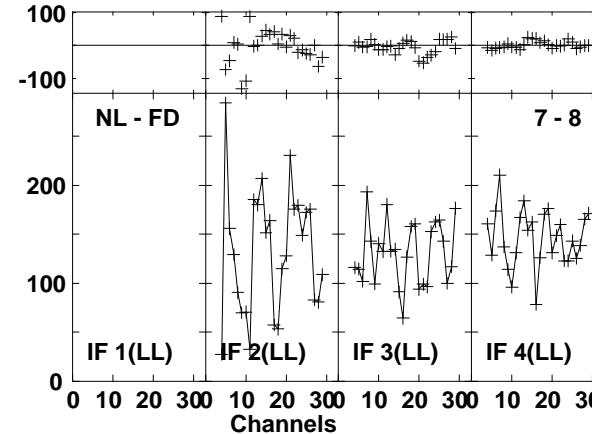
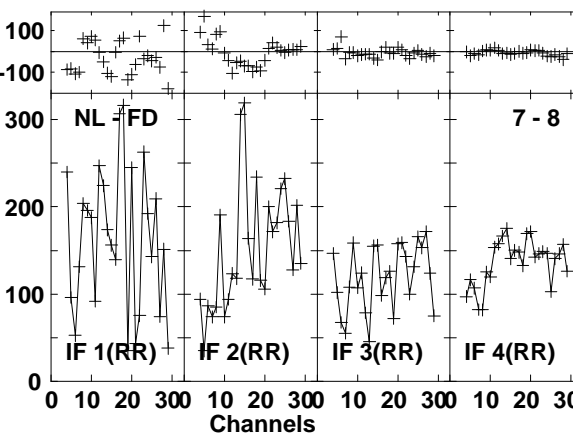
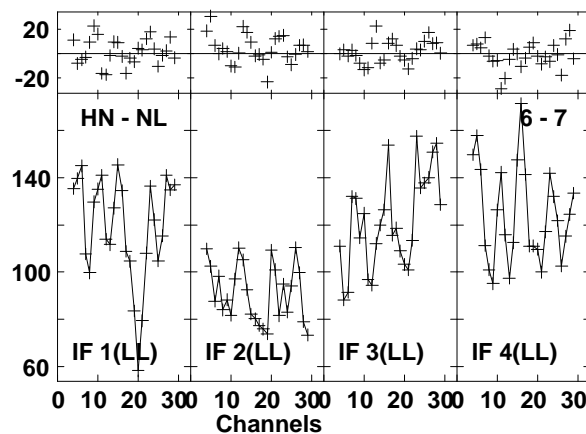
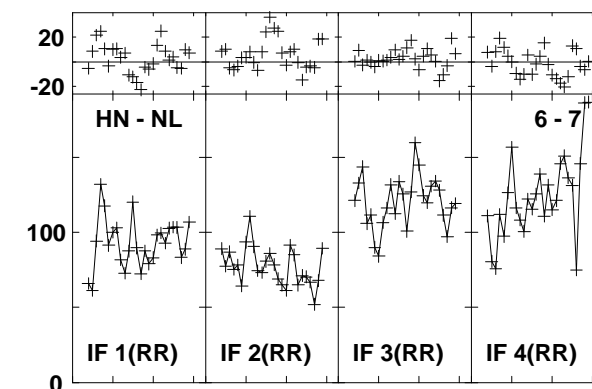
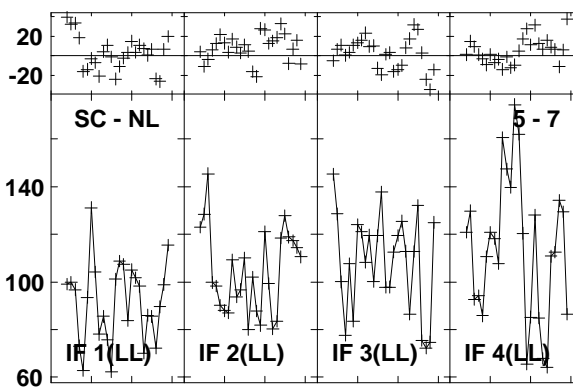
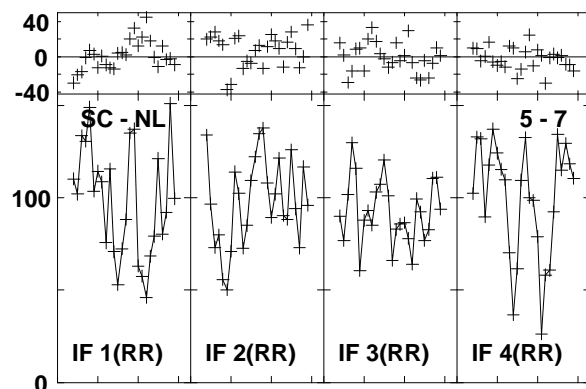
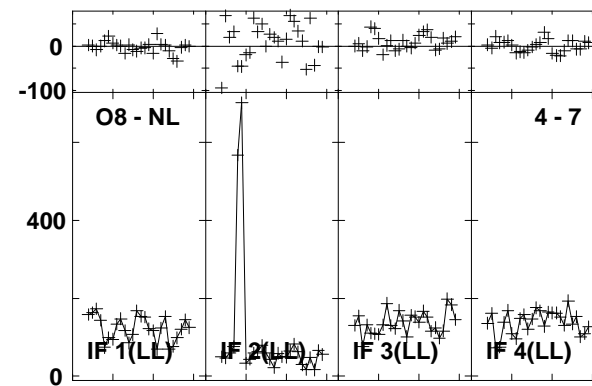
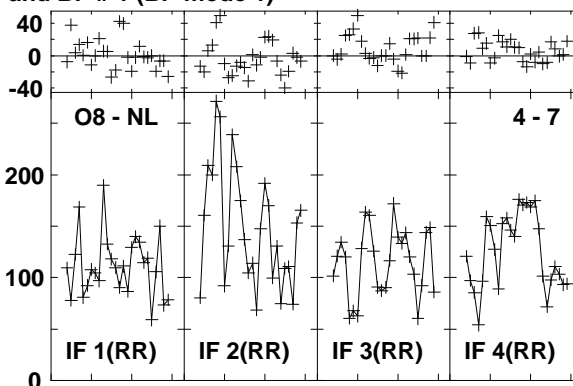
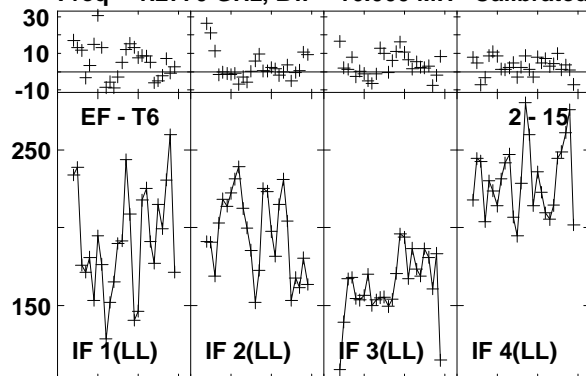

Lower frame: Milli Ampl Jy Top frame: Phas deg
Vector averaged cross-power spectrum Baseline: EF (02) - T6 (15)
Timerange: 01/00:28:12 to 01/00:30:10

Plot file version1053 created 03-MAR-2016 01:15:00

J1545+5400 GN002C 1.UVDATA.1

Freq = 1.2770 GHz, Bw = 16.000 MH Calibrated with CL # 3 and BP # 1 (BP mode 1)

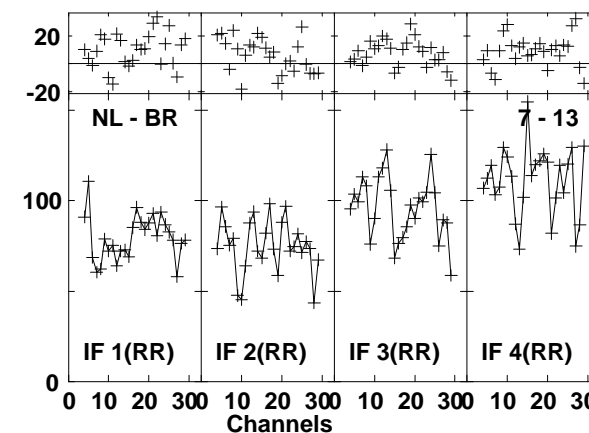
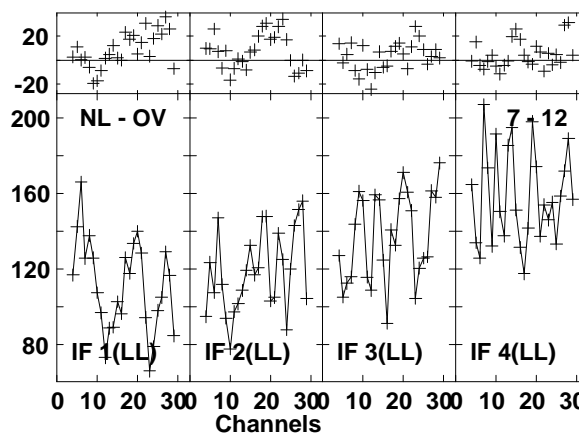
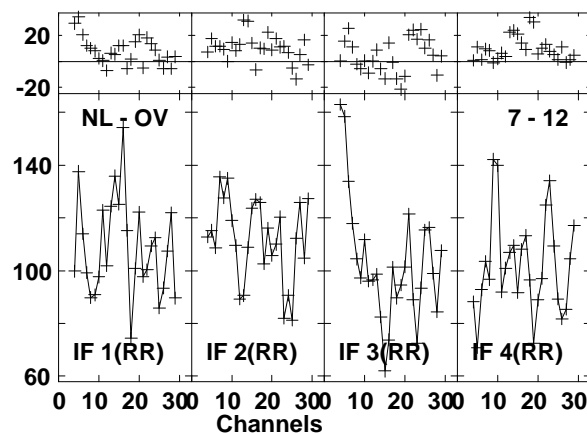
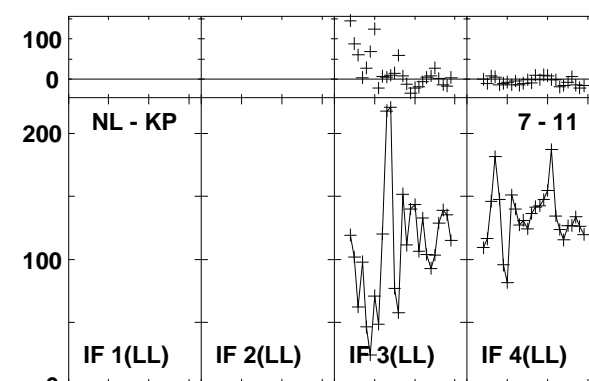
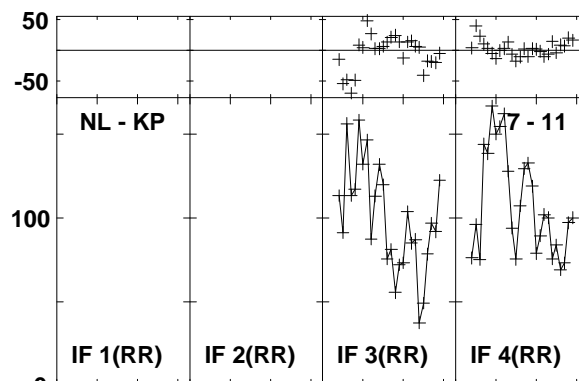
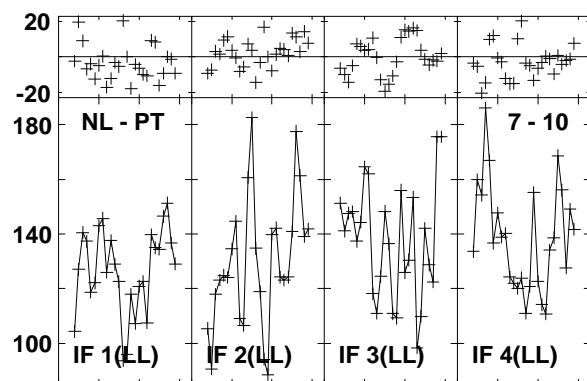
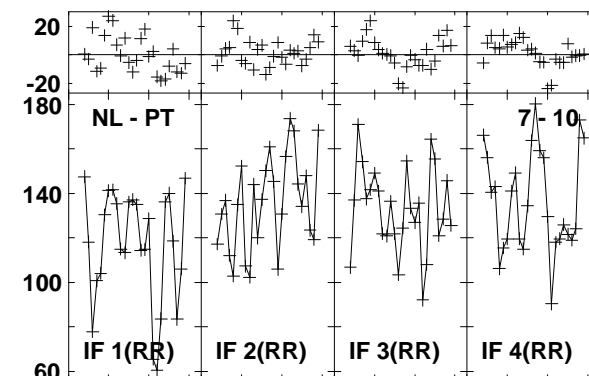
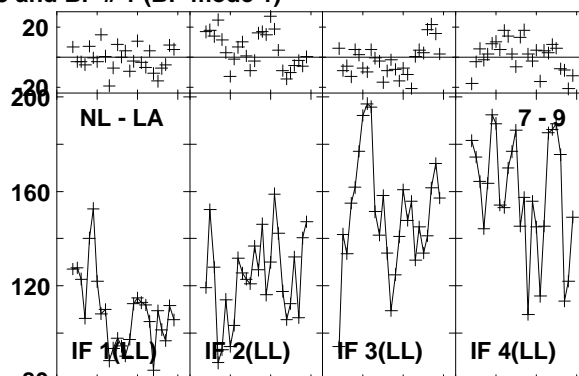
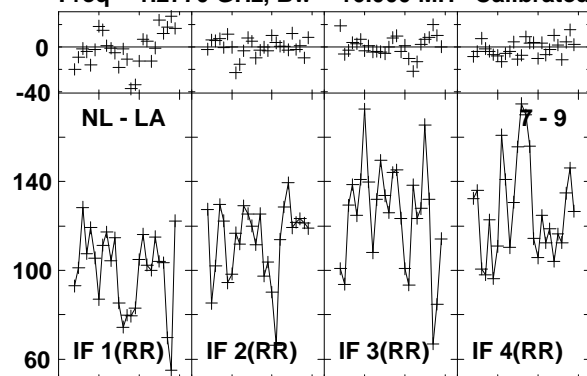

Lower frame: Milli Ampl Jy Top frame: Phas deg
Vector averaged cross-power spectrum Baseline: NL (07) - LA (09)
Timerange: 01/00:28:12 to 01/00:30:10

Plot file version1054 created 03-MAR-2016 01:15:00
 J1545+5400 GN002C 1.UVDATA.1
 Freq = 1.2770 GHz, Bw = 16.000 MH Calibrated with CL # 3 and BP # 1 (BP mode 1)

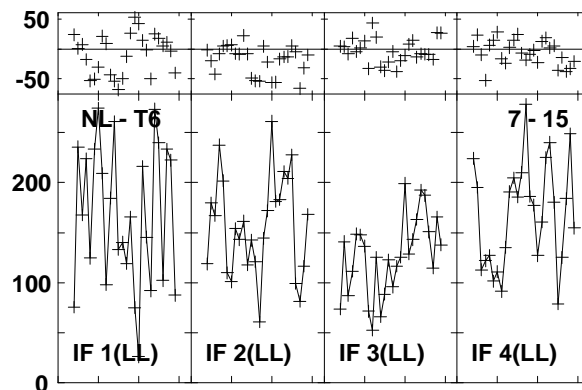
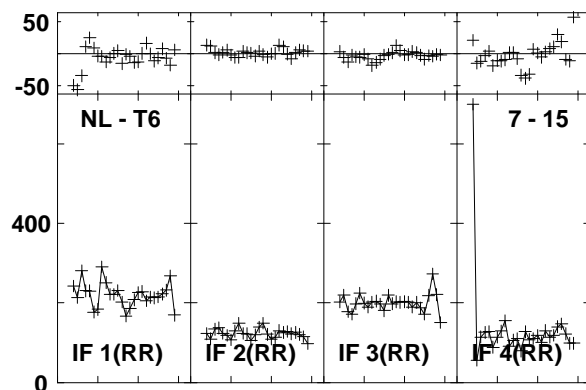
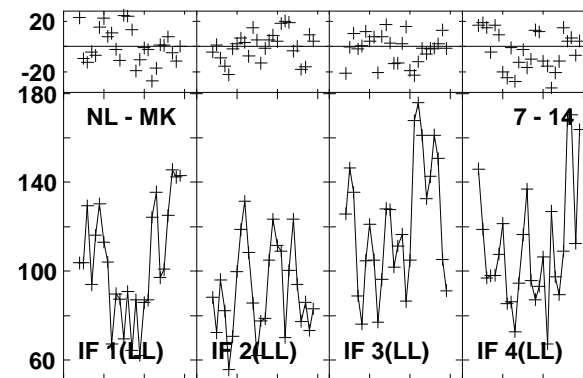
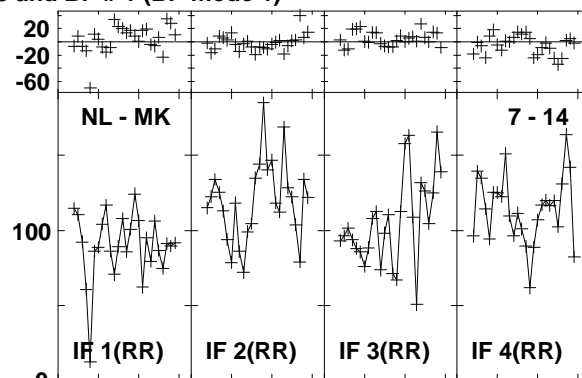
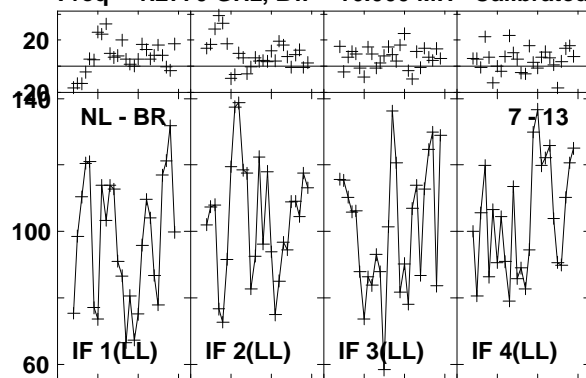

Lower frame: Milli Ampl Jy Top frame: Phas deg
 Vector averaged cross-power spectrum Baseline: NL (07) - BR (13)
 Timerange: 01/00:28:12 to 01/00:30:10

Plot file version1055 created 03-MAR-2016 01:15:00

4C52 GN002C 1.UVDATA.1

Freq = 1.2770 GHz, Bw = 16.000 MH Calibrated with CL # 3 and BP # 1 (BP mode 1)

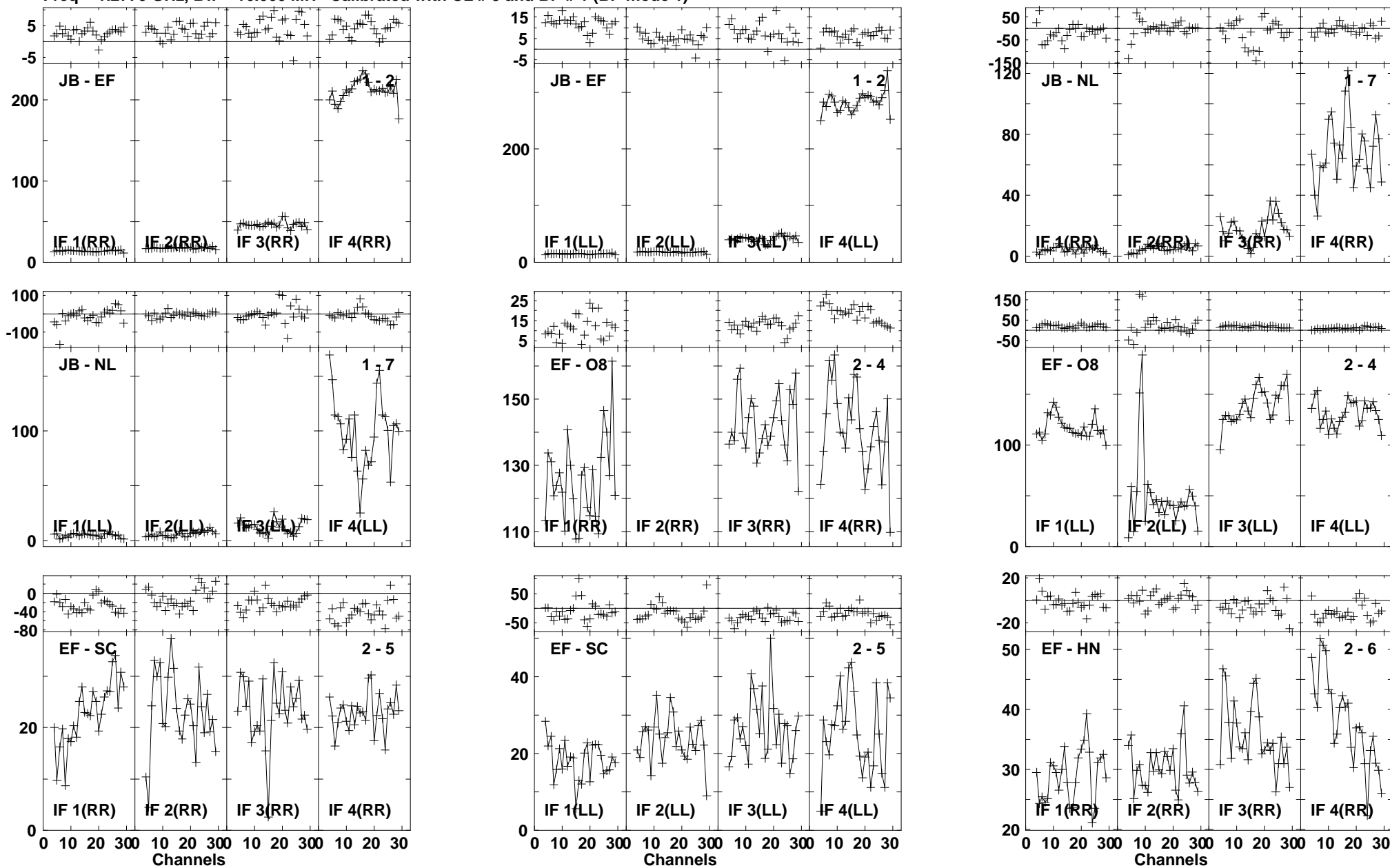

Lower frame: Milli Ampl Jy Top frame: Phas deg
Vector averaged cross-power spectrum Baseline: JB (01) - EF (02)
Timerange: 01/00:30:23 to 01/00:33:39

Plot file version1056 created 03-MAR-2016 01:15:00

4C52 GN002C 1.UVDATA.1

Freq = 1.2770 GHz, Bw = 16.000 MH Calibrated with CL # 3 and BP # 1 (BP mode 1)

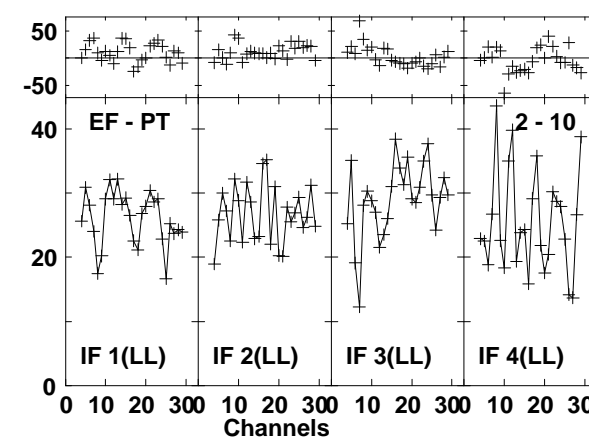
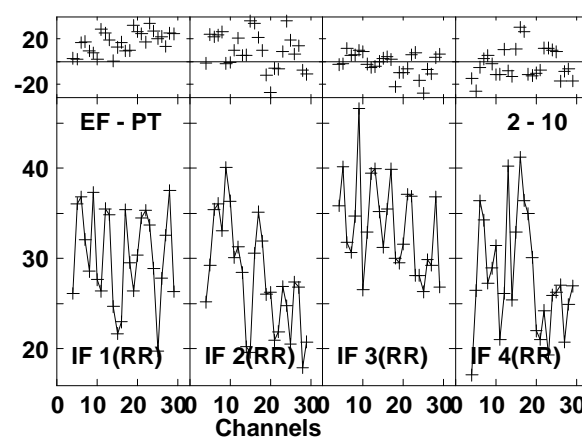
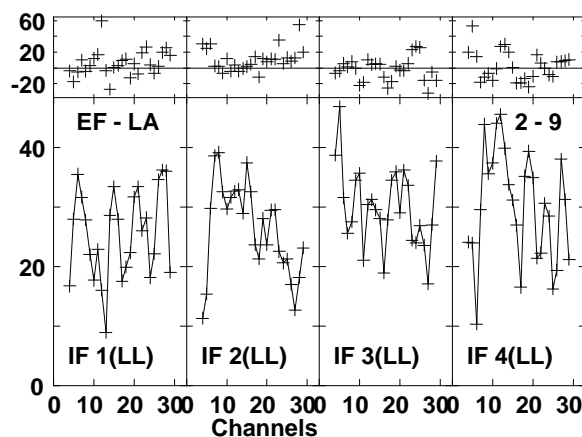
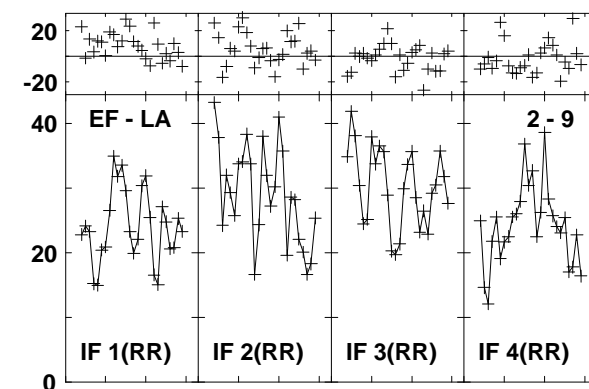
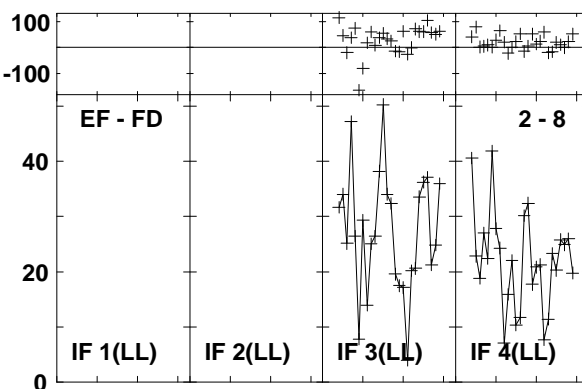
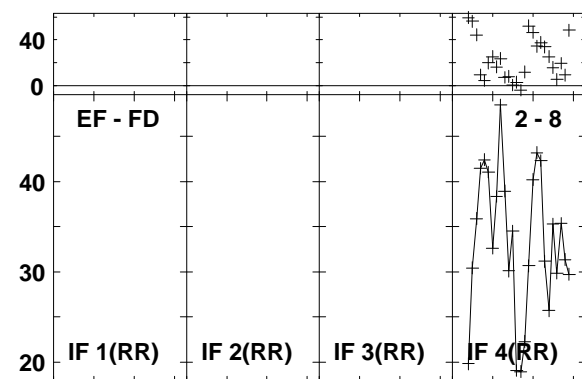
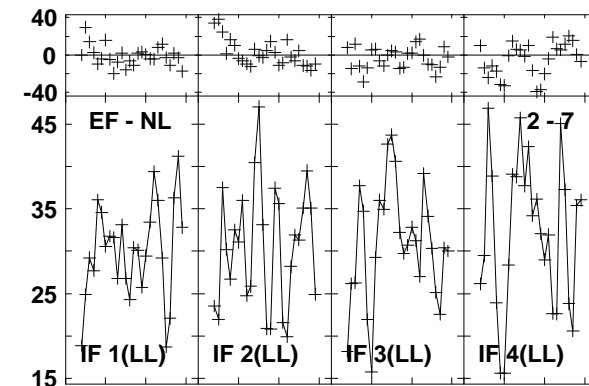
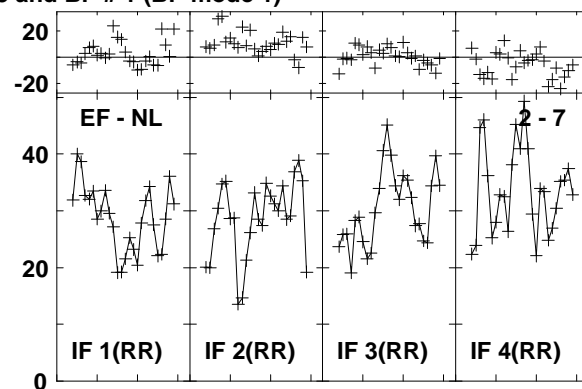
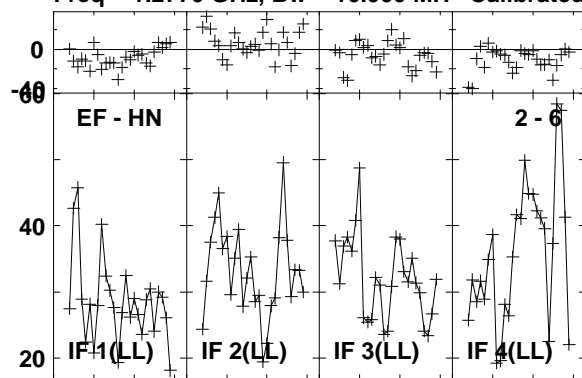

Lower frame: Milli Ampl Jy Top frame: Phas deg

Vector averaged cross-power spectrum Baseline: EF (02) - HN (06)

Timerange: 01/00:30:23 to 01/00:33:39

Plot file version1057 created 03-MAR-2016 01:15:00

4C52 GN002C 1.UVDATA.1

Freq = 1.2770 GHz, Bw = 16.000 MH Calibrated with CL # 3 and BP # 1 (BP mode 1)

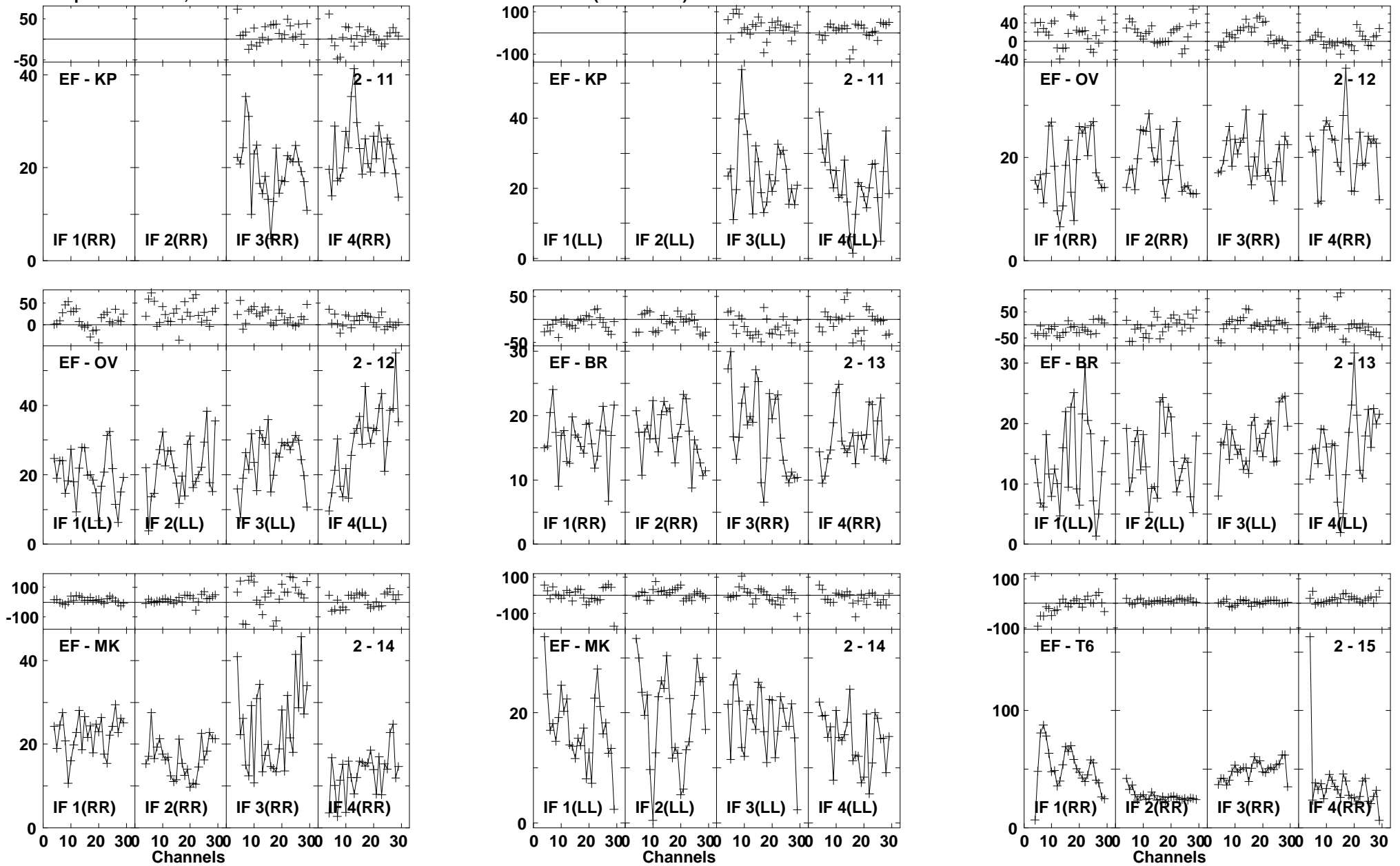

Lower frame: Milli Ampl Jy Top frame: Phas deg
Vector averaged cross-power spectrum Baseline: EF (02) - KP (11)
Timerange: 01/00:30:23 to 01/00:33:39

Plot file version1058 created 03-MAR-2016 01:15:01
 4C52 GN002C 1.UVDATA.1
 Freq = 1.2770 GHz, Bw = 16.000 MH Calibrated with CL # 3 and BP # 1 (BP mode 1)

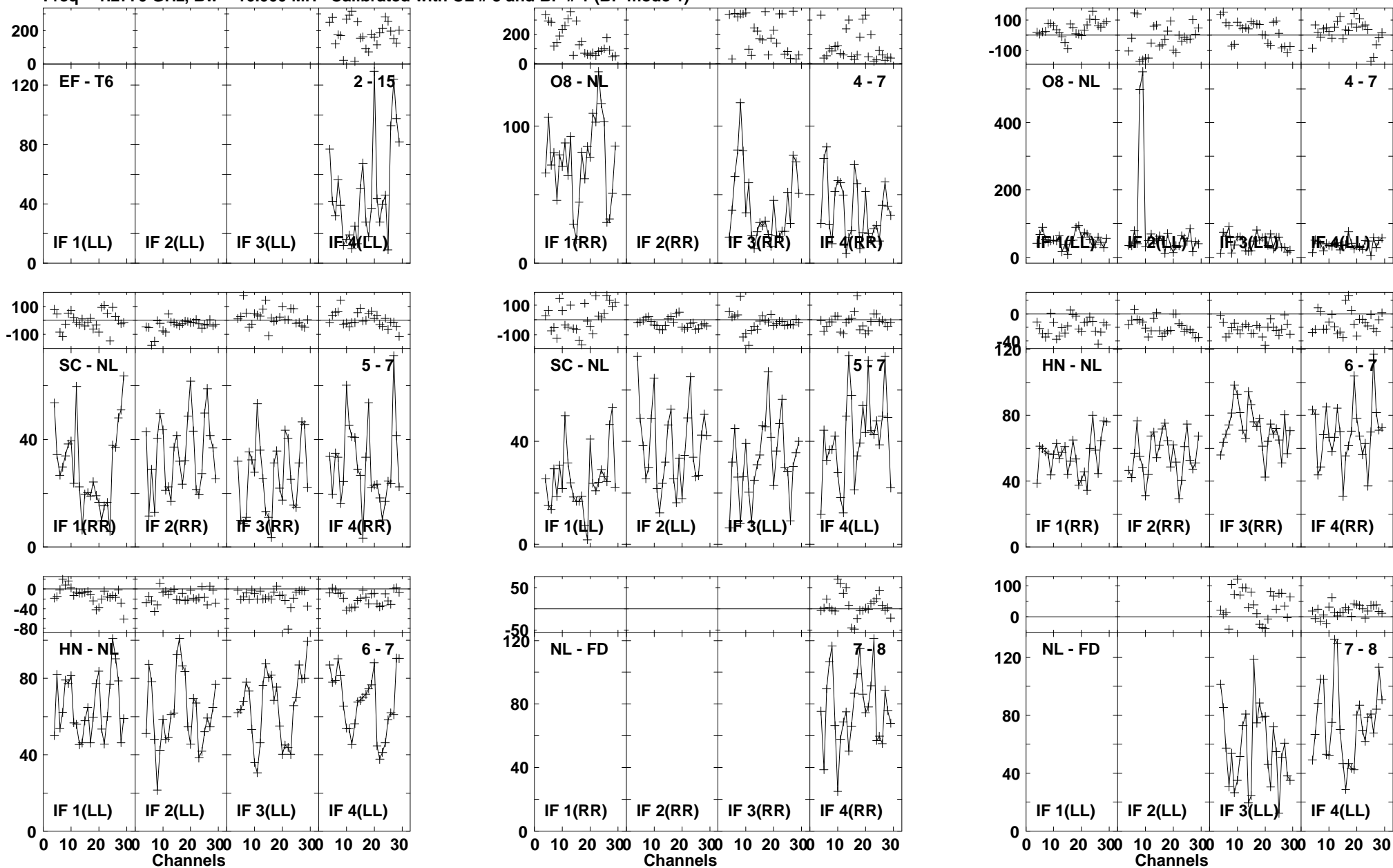

Lower frame: Milli Ampl Jy Top frame: Phas deg
 Vector averaged cross-power spectrum Baseline: EF (02) - T6 (15)
 Timerange: 01/00:30:23 to 01/00:33:39

Plot file version1059 created 03-MAR-2016 01:15:01
 4C52 GN002C 1.UVDATA.1

Freq = 1.2770 GHz, Bw = 16.000 MH Calibrated with CL # 3 and BP # 1 (BP mode 1)

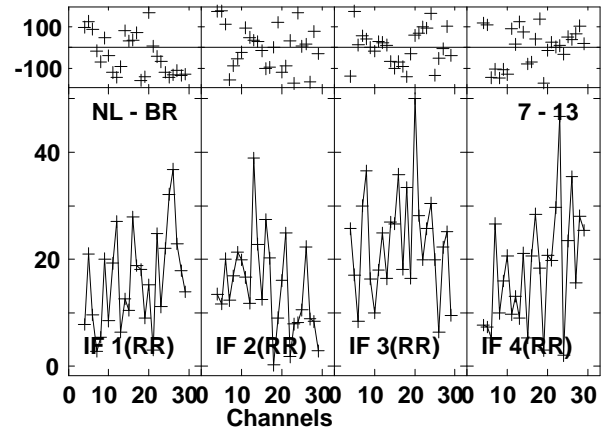
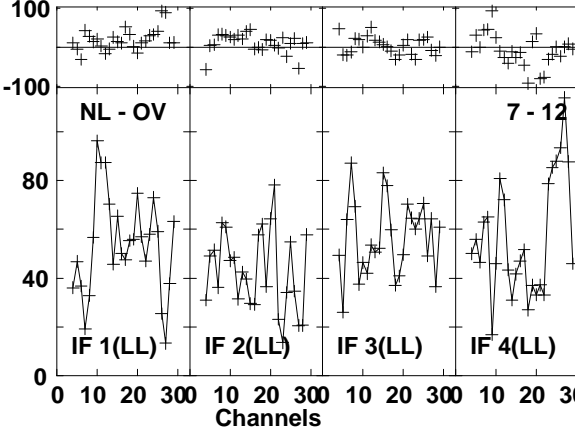
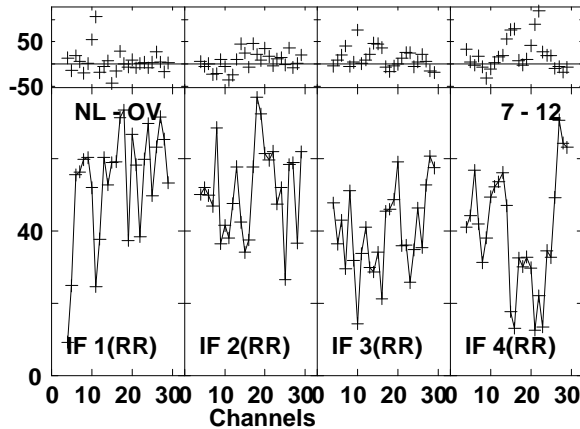
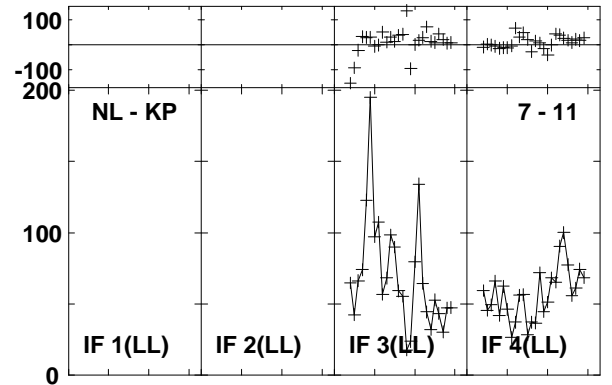
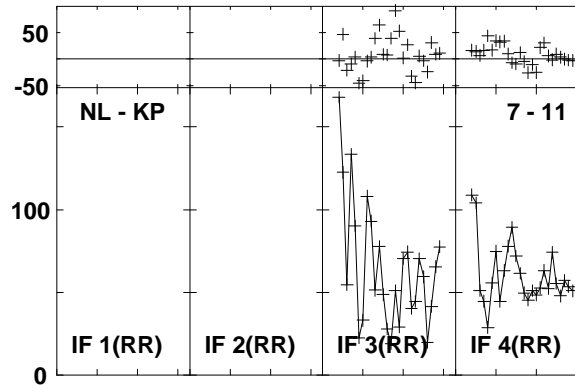
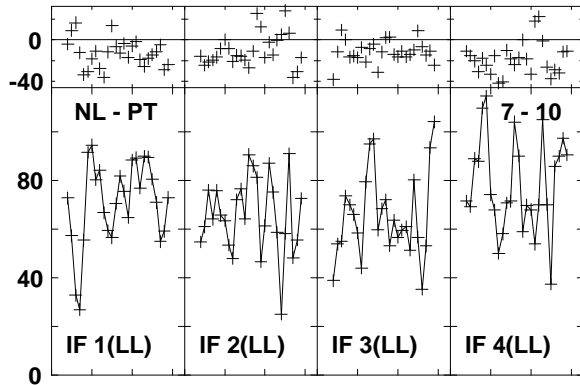
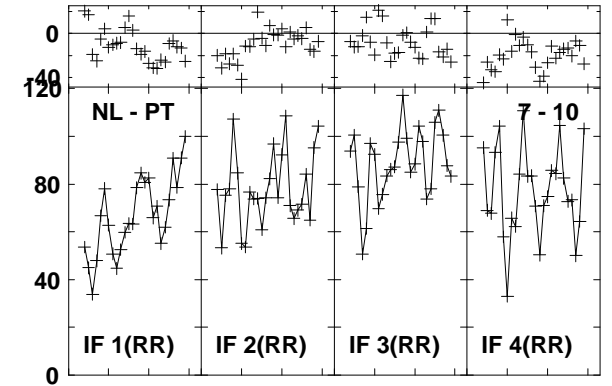
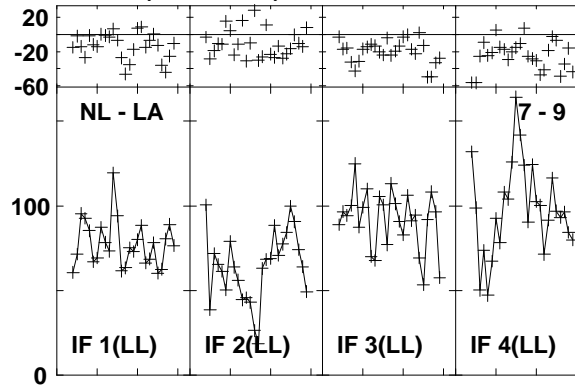
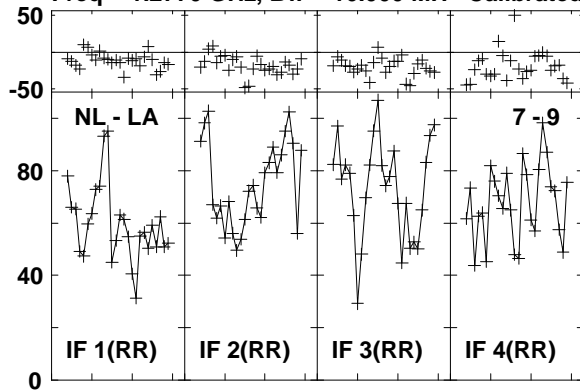

Lower frame: Milli Ampl Jy Top frame: Phas deg
 Vector averaged cross-power spectrum Baseline: NL (07) - LA (09)
 Timerange: 01/00:30:23 to 01/00:33:39

Plot file version1060 created 03-MAR-2016 01:15:01

4C52 GN002C 1.UVDATA.1

Freq = 1.2770 GHz, Bw = 16.000 MH Calibrated with CL # 3 and BP # 1 (BP mode 1)

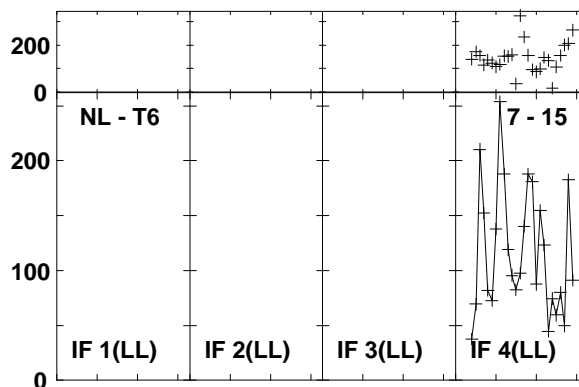
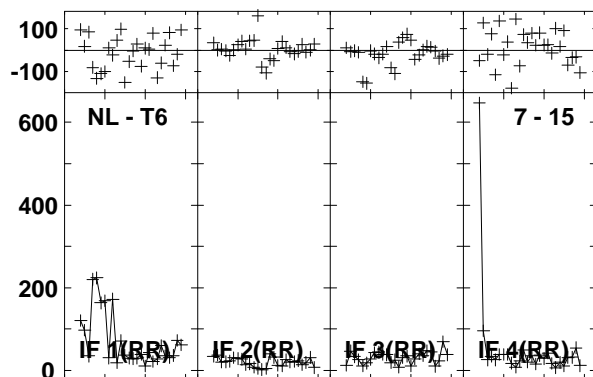
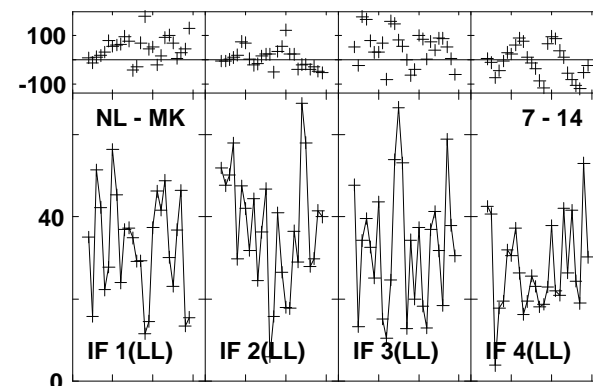
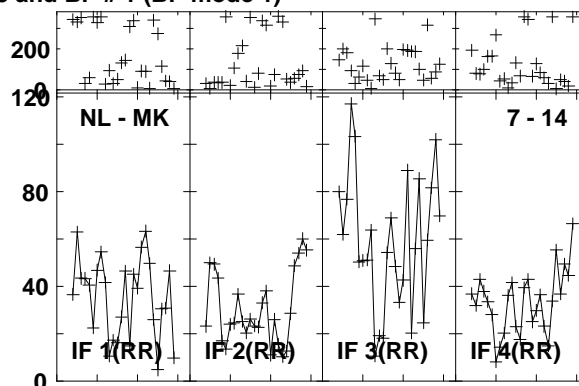
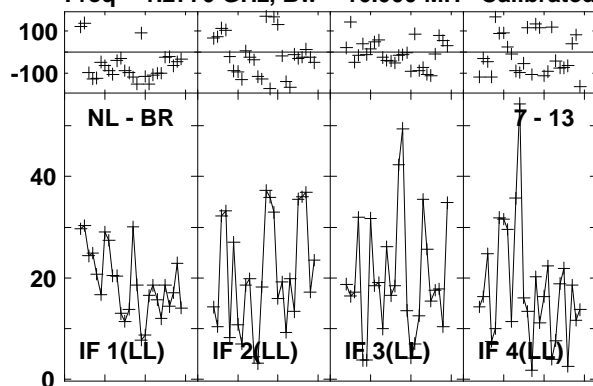

Lower frame: Milli Ampl Jy Top frame: Phas deg

Vector averaged cross-power spectrum Baseline: NL (07) - BR (13)

Timerange: 01/00:30:23 to 01/00:33:39

Plot file version1061 created 03-MAR-2016 01:15:01

J1545+5400 GN002C 1.UVDATA.1

Freq = 1.2770 GHz, Bw = 16.000 MH Calibrated with CL # 3 and BP # 1 (BP mode 1)

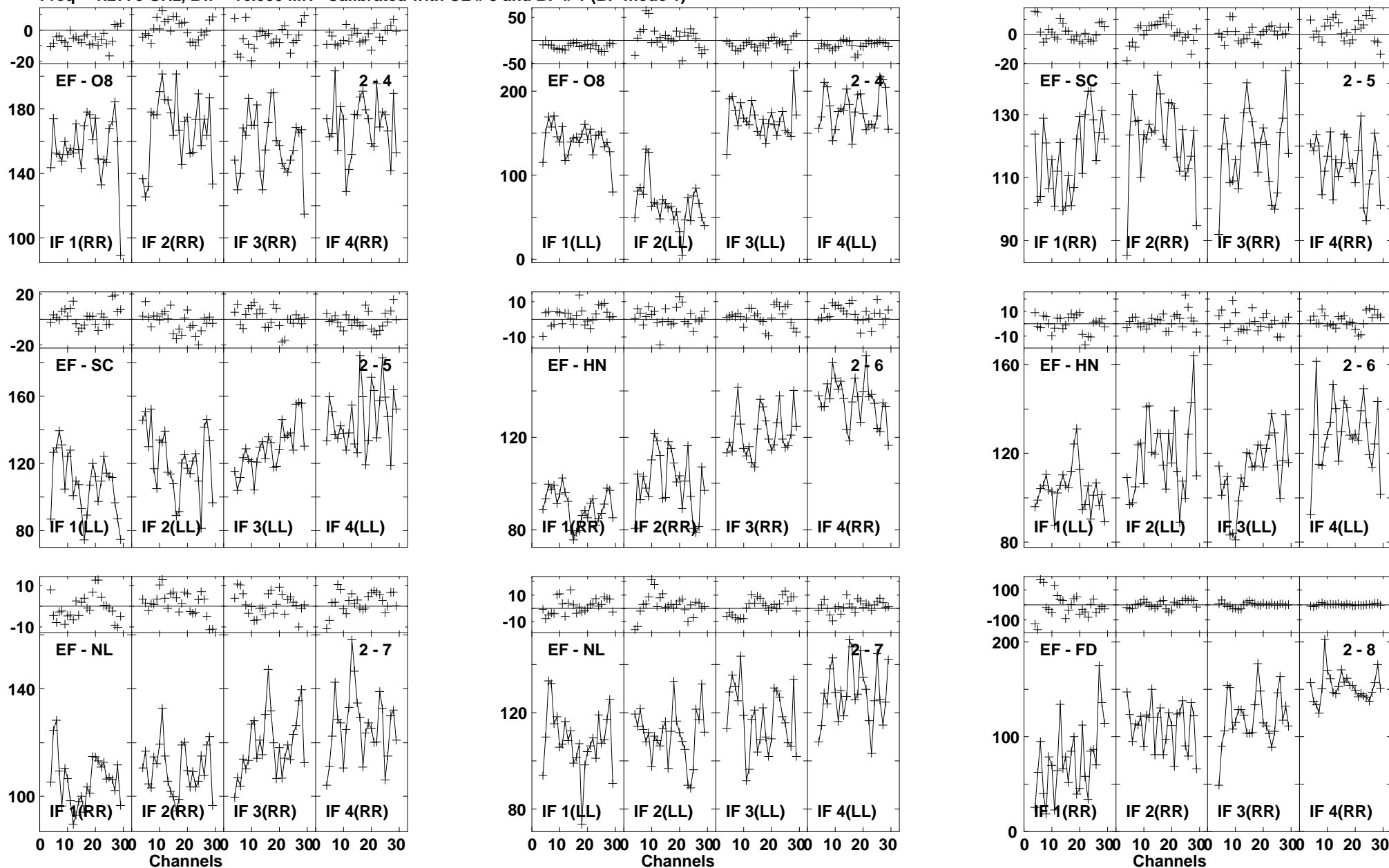

Lower frame: Milli Ampl Jy Top frame: Phas deg
Vector averaged cross-power spectrum Baseline: EF (02) - O8 (04)
Timerange: 01/00:34:32 to 01/00:35:30

Plot file version1062 created 03-MAR-2016 01:15:01

J1545+5400 GN002C 1.UVDATA.1

Freq = 1.2770 GHz, Bw = 16.000 MH Calibrated with CL # 3 and BP # 1 (BP mode 1)

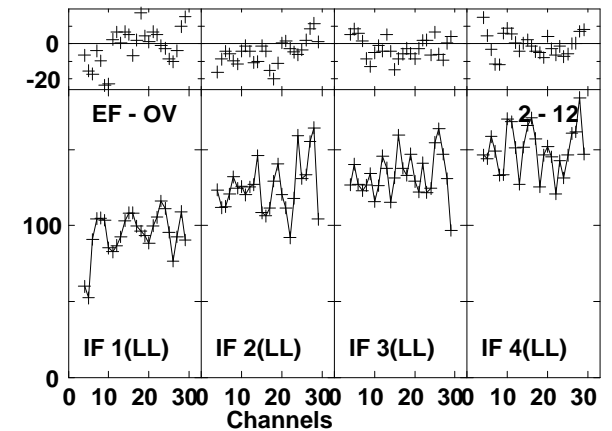
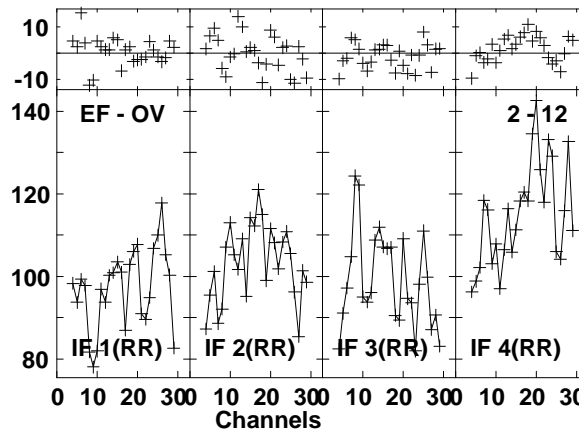
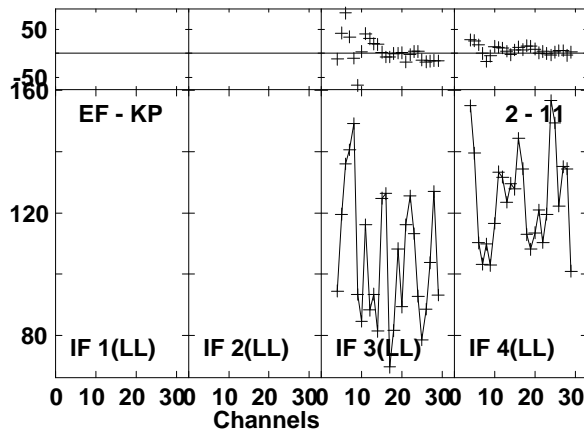
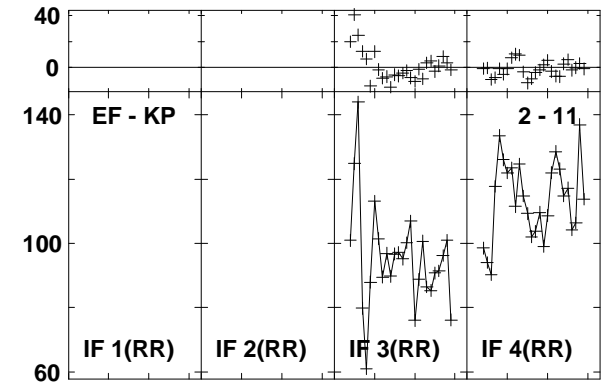
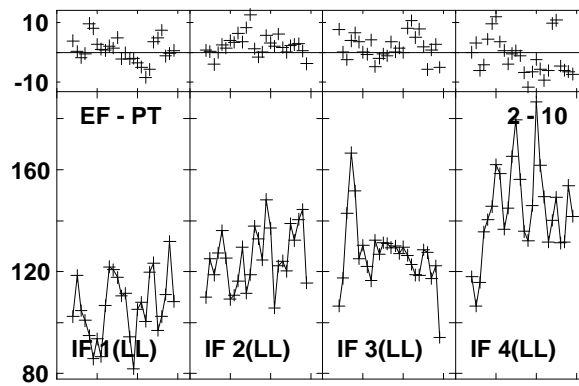
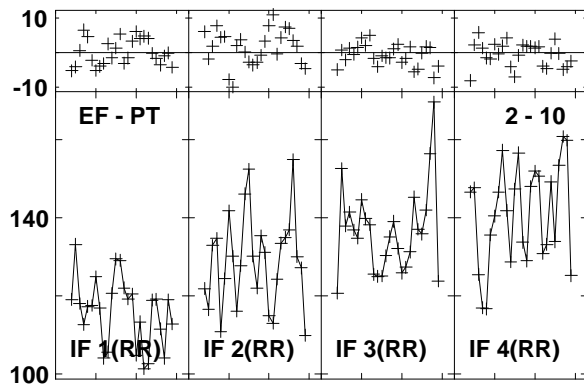
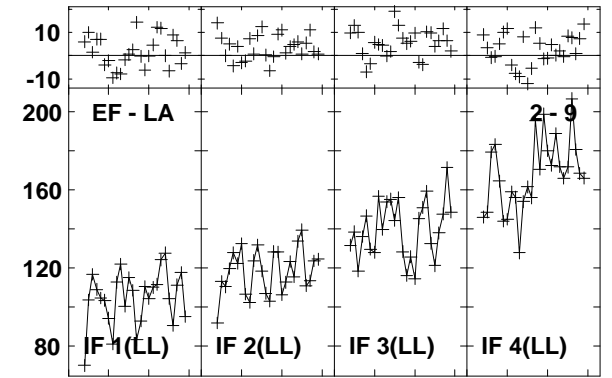
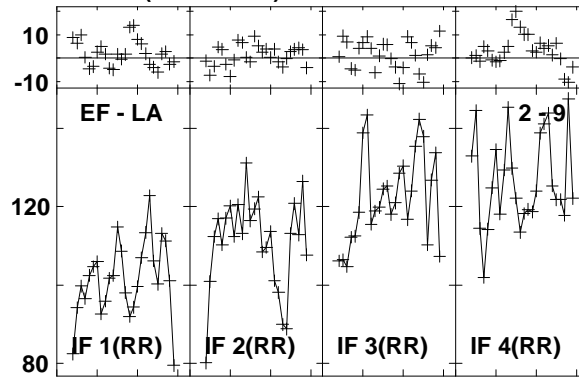
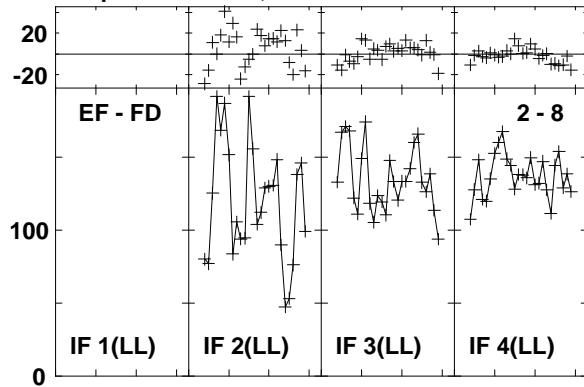

Lower frame: Milli Ampl Jy Top frame: Phas deg
Vector averaged cross-power spectrum Baseline: EF (02) - FD (08)
Timerange: 01/00:34:32 to 01/00:35:30

Plot file version1063 created 03-MAR-2016 01:15:02
 J1545+5400 GN002C 1.UVDATA.1
 Freq = 1.2770 GHz, Bw = 16.000 MH Calibrated with CL # 3 and BP # 1 (BP mode 1)

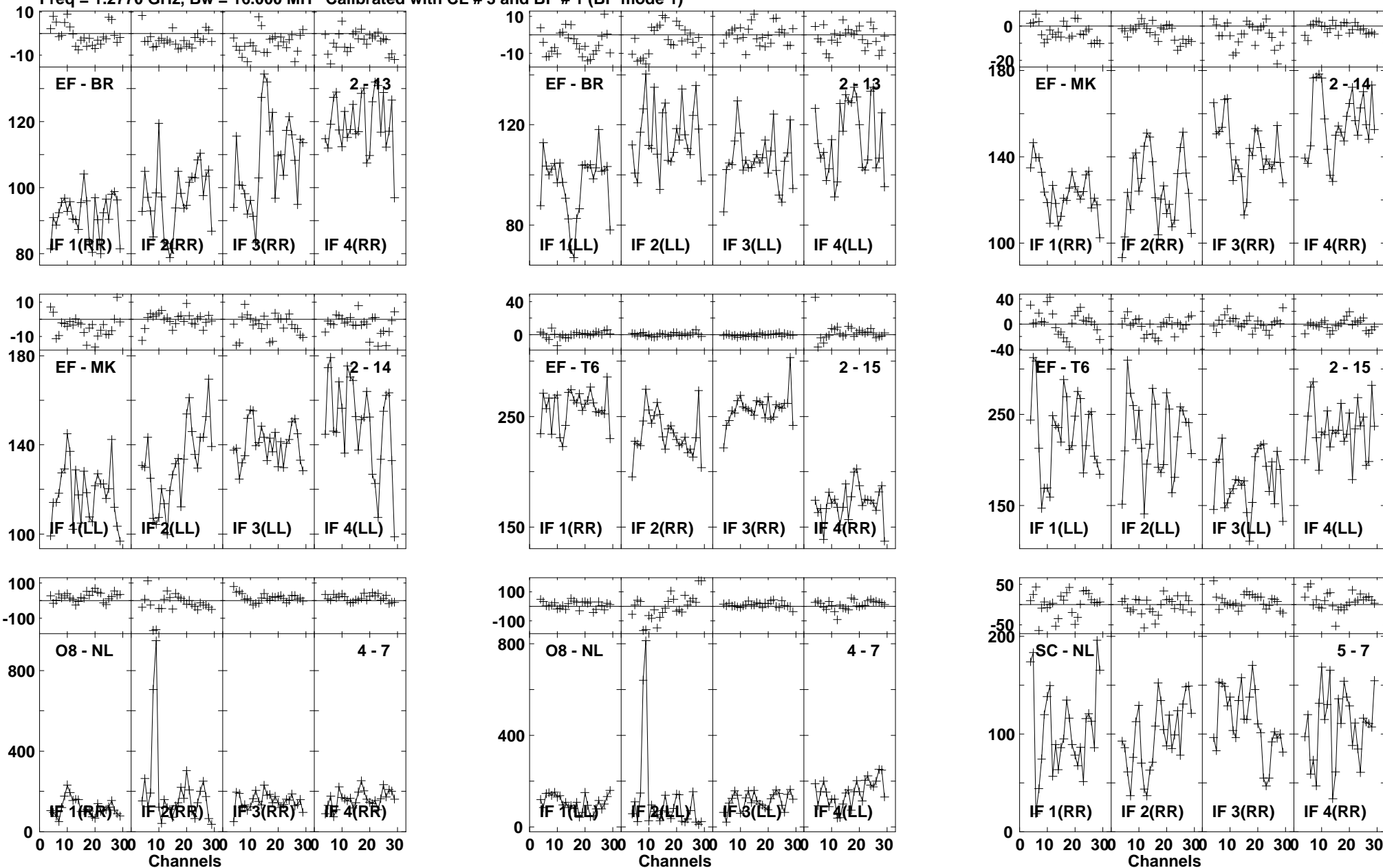

Lower frame: Milli Ampl Jy Top frame: Phas deg
 Vector averaged cross-power spectrum Baseline: EF (02) - BR (13)
 Timerange: 01/00:34:32 to 01/00:35:30

Plot file version1064 created 03-MAR-2016 01:15:02
 J1545+5400 GN002C 1.UVDATA.1
 Freq = 1.2770 GHz, Bw = 16.000 MH Calibrated with CL # 3 and BP # 1 (BP mode 1)

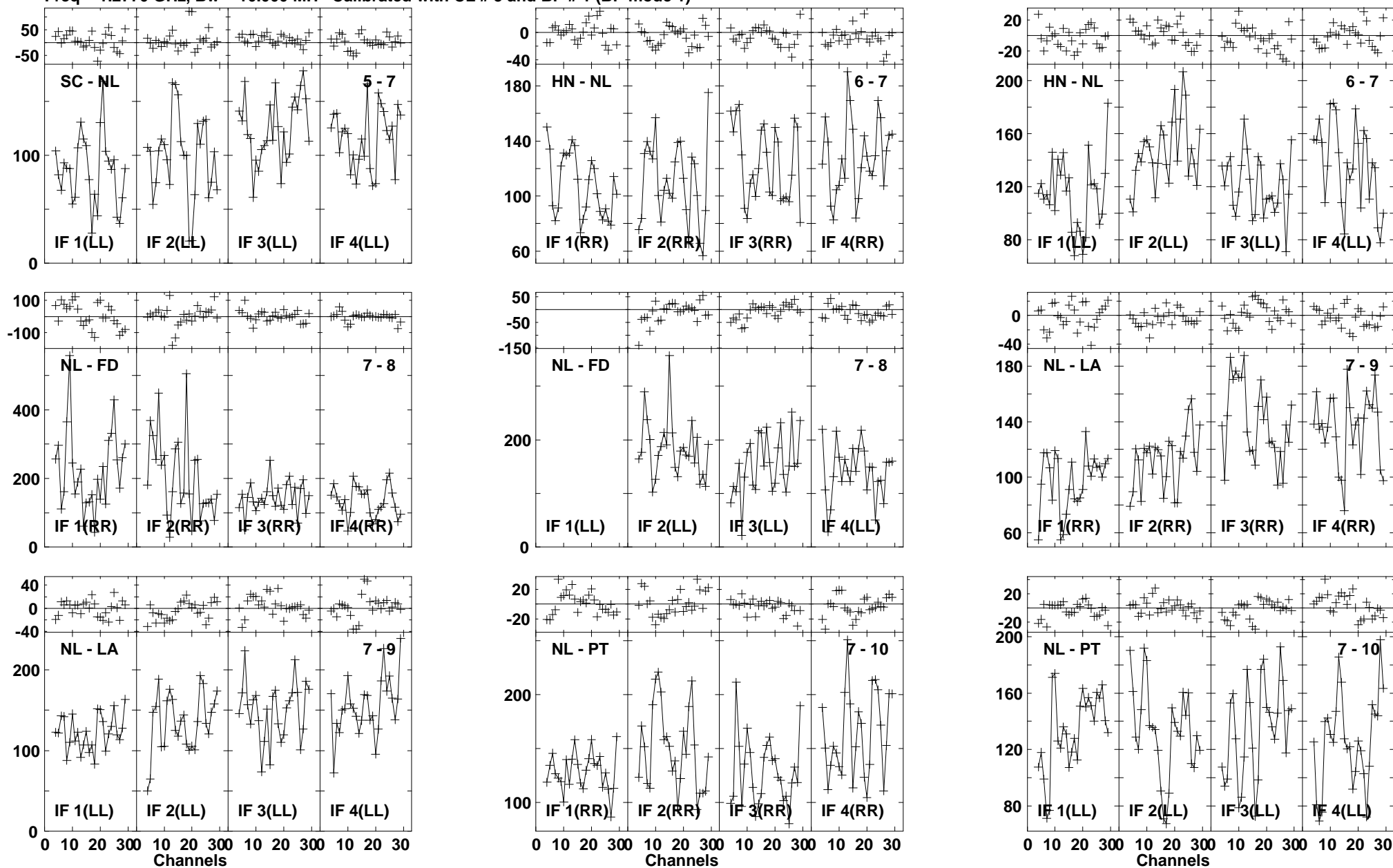

Lower frame: Milli Ampl Jy Top frame: Phas deg
 Vector averaged cross-power spectrum Baseline: SC (05) - NL (07)
 Timerange: 01/00:34:32 to 01/00:35:30

Plot file version1065 created 03-MAR-2016 01:15:02
 J1545+5400 GN002C 1.UVDATA.1
 Freq = 1.2770 GHz, Bw = 16.000 MH Calibrated with CL # 3 and BP # 1 (BP mode 1)

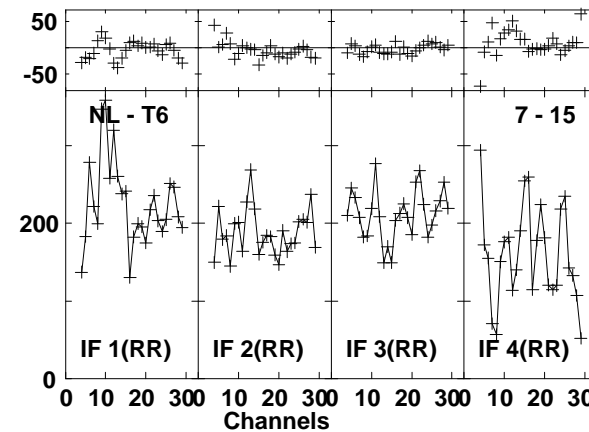
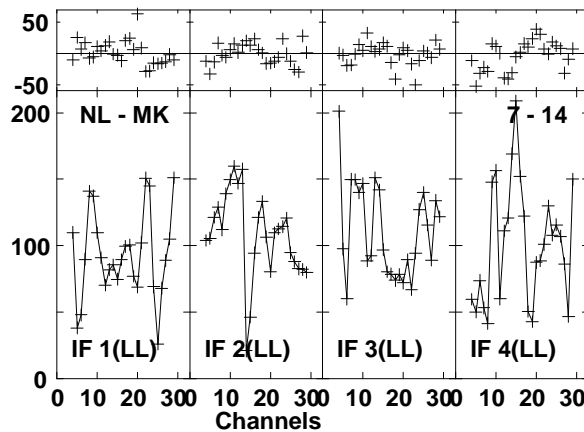
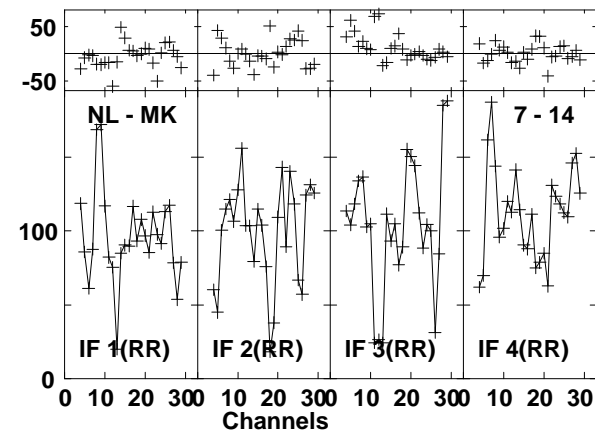
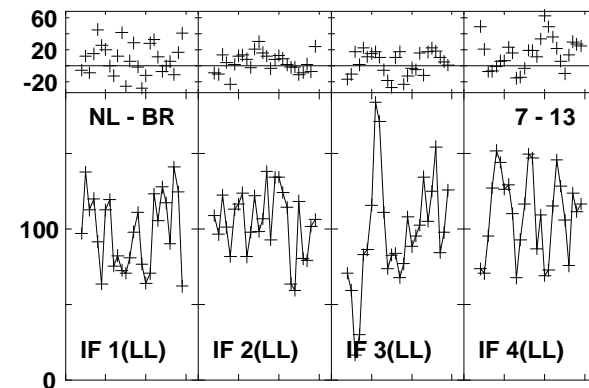
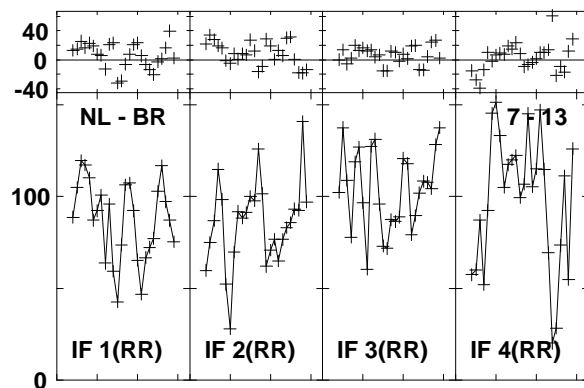
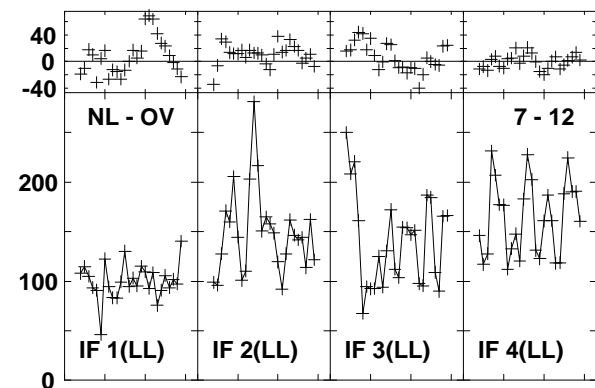
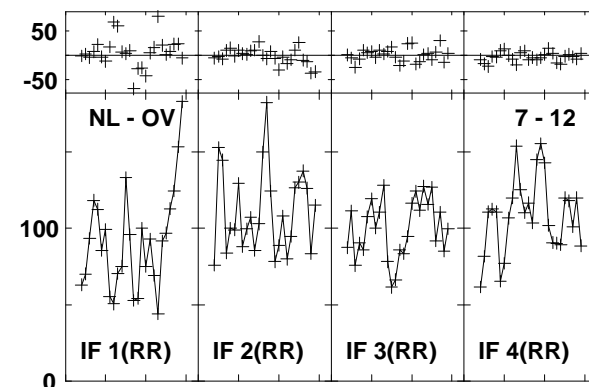
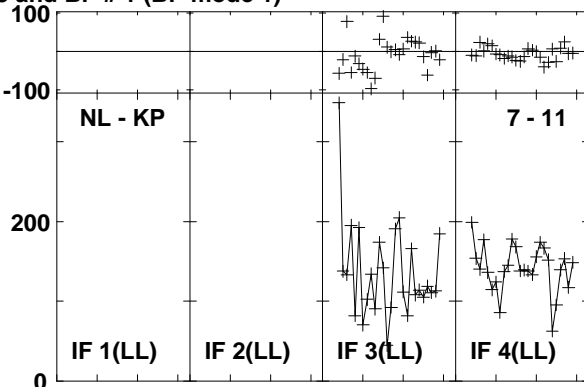
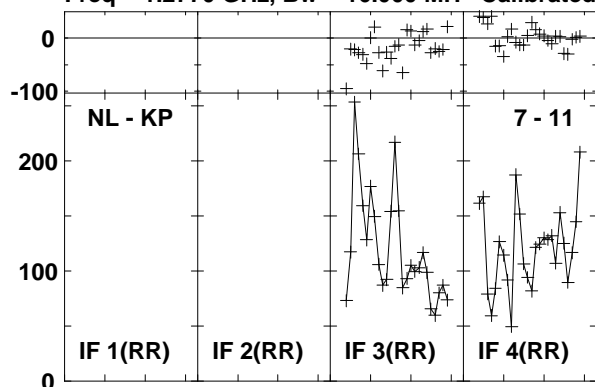

Lower frame: Milli Ampl Jy Top frame: Phas deg
 Vector averaged cross-power spectrum Baseline: NL (07) - KP (11)
 Timerange: 01/00:34:32 to 01/00:35:30

Plot file version1066 created 03-MAR-2016 01:15:02
J1545+5400 GN002C 1.UVDATA.1
Freq = 1.2770 GHz, Bw = 16.000 MH Calibrated with CL # 3 and BP # 1 (BP mode 1)

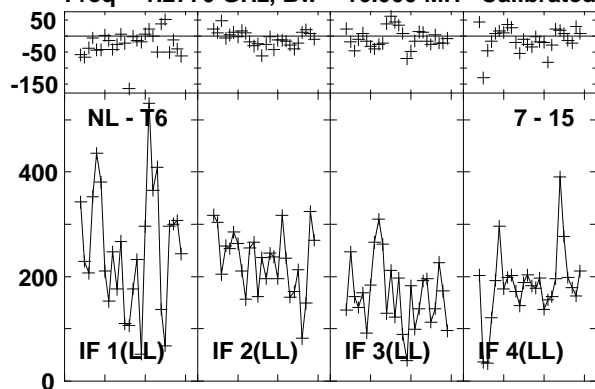

Lower frame: Milli Ampl Jy Top frame: Phas deg
Vector averaged cross-power spectrum Baseline: NL (07) - T6 (15)
Timerange: 01/00:34:32 to 01/00:35:30

Plot file version1067 created 03-MAR-2016 01:15:02

4C52 GN002C 1.UVDATA.1

Freq = 1.2770 GHz, Bw = 16.000 MH Calibrated with CL # 3 and BP # 1 (BP mode 1)

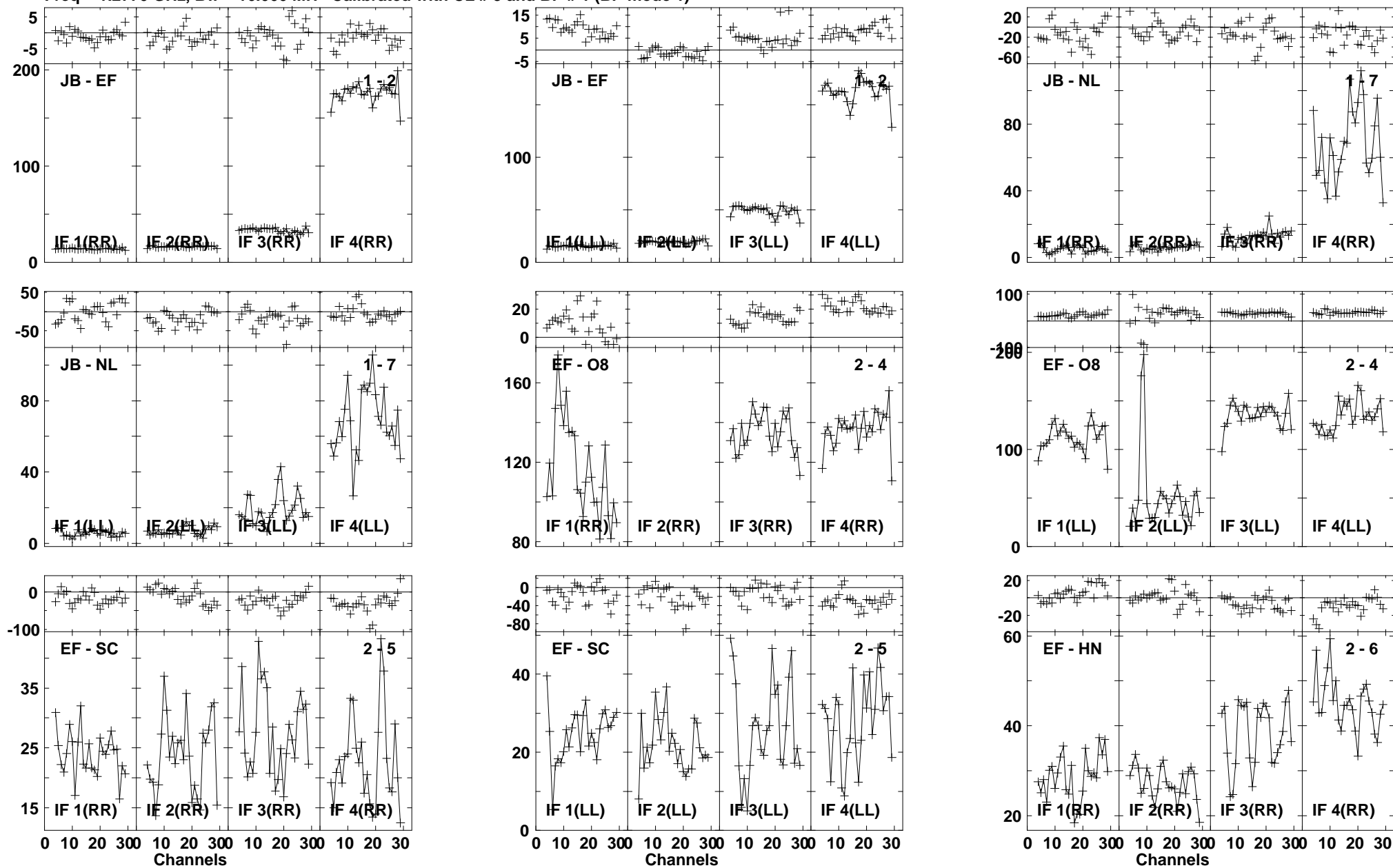

Lower frame: Milli Ampl Jy Top frame: Phas deg
Vector averaged cross-power spectrum Baseline: JB (01) - EF (02)
Timerange: 01/00:35:35 to 01/00:38:59

Plot file version1068 created 03-MAR-2016 01:15:03

4C52 GN002C 1.UVDATA.1

Freq = 1.2770 GHz, Bw = 16.000 MH Calibrated with CL # 3 and BP # 1 (BP mode 1)

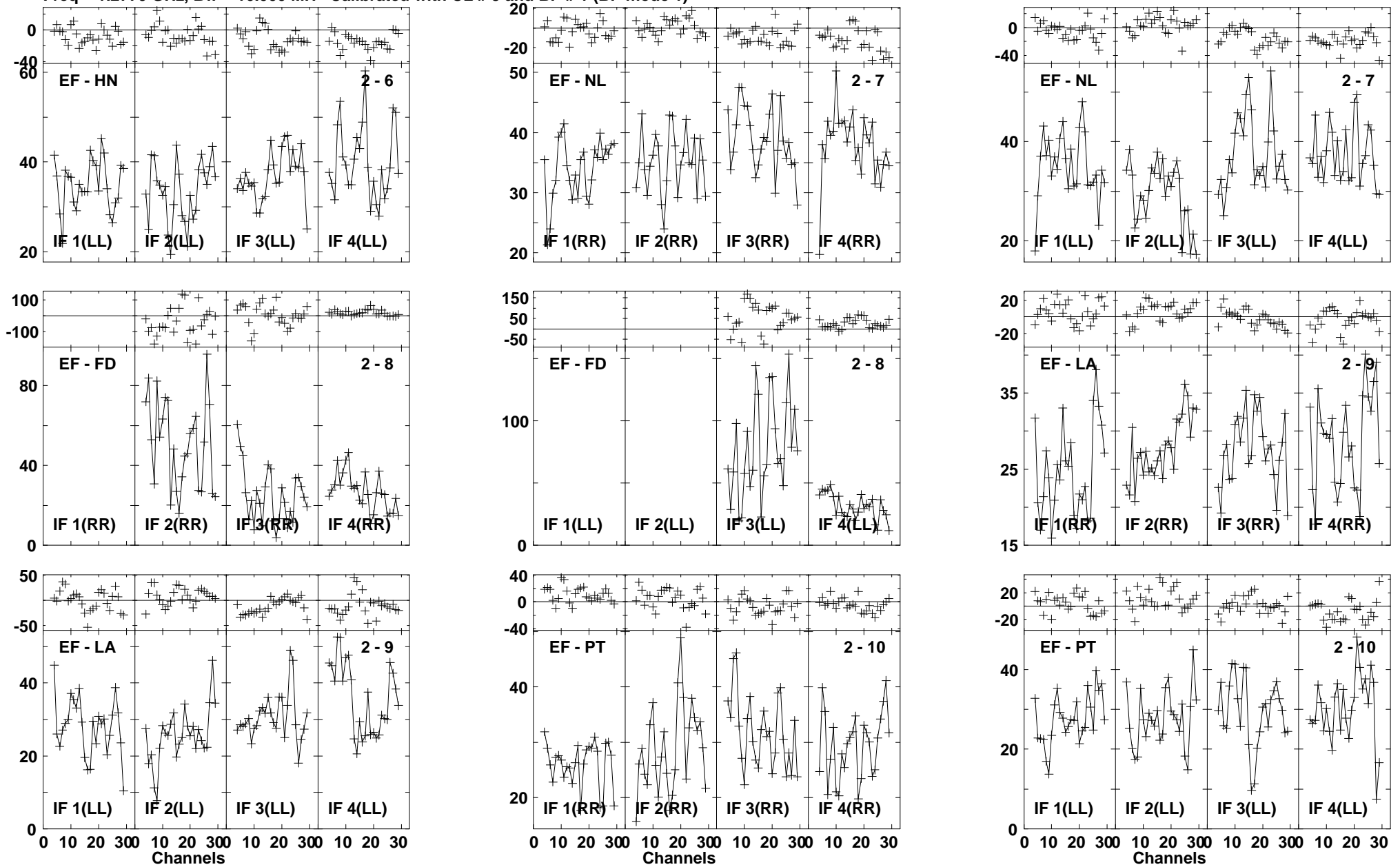

Lower frame: Milli Ampl Jy Top frame: Phas deg
Vector averaged cross-power spectrum Baseline: EF (02) - HN (06)
Timerange: 01/00:35:35 to 01/00:38:59

Plot file version1069 created 03-MAR-2016 01:15:03

4C52 GN002C 1.UVDATA.1

Freq = 1.2770 GHz, Bw = 16.000 MH Calibrated with CL # 3 and BP # 1 (BP mode 1)

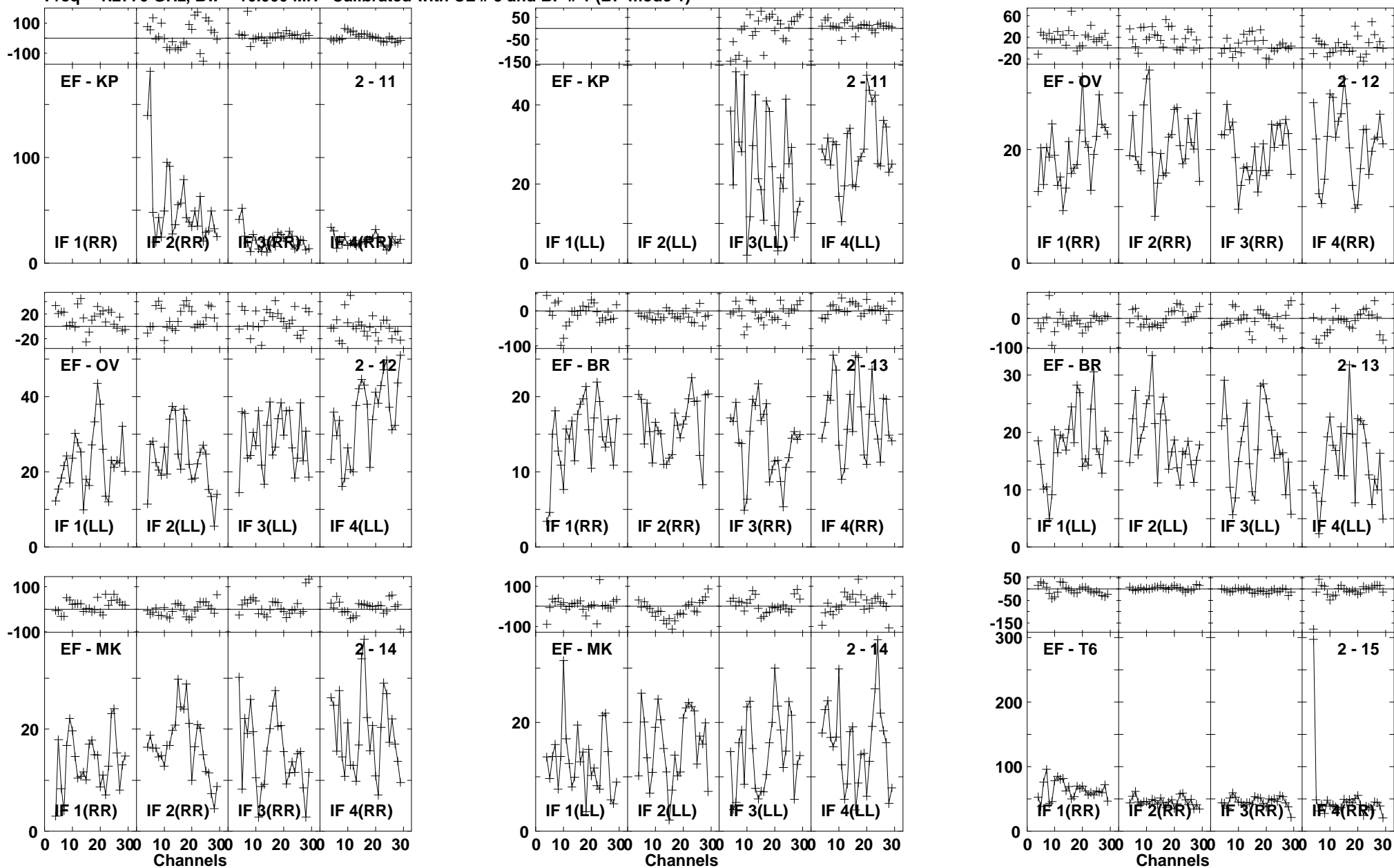

Lower frame: Milli Ampl Jy Top frame: Phas deg
Vector averaged cross-power spectrum Baseline: EF (02) - KP (11)
Timerange: 01/00:35:35 to 01/00:38:59

Plot file version1070 created 03-MAR-2016 01:15:03

4C52 GN002C 1.UVDATA.1

Freq = 1.2770 GHz, Bw = 16.000 MH Calibrated with CL # 3 and BP # 1 (BP mode 1)

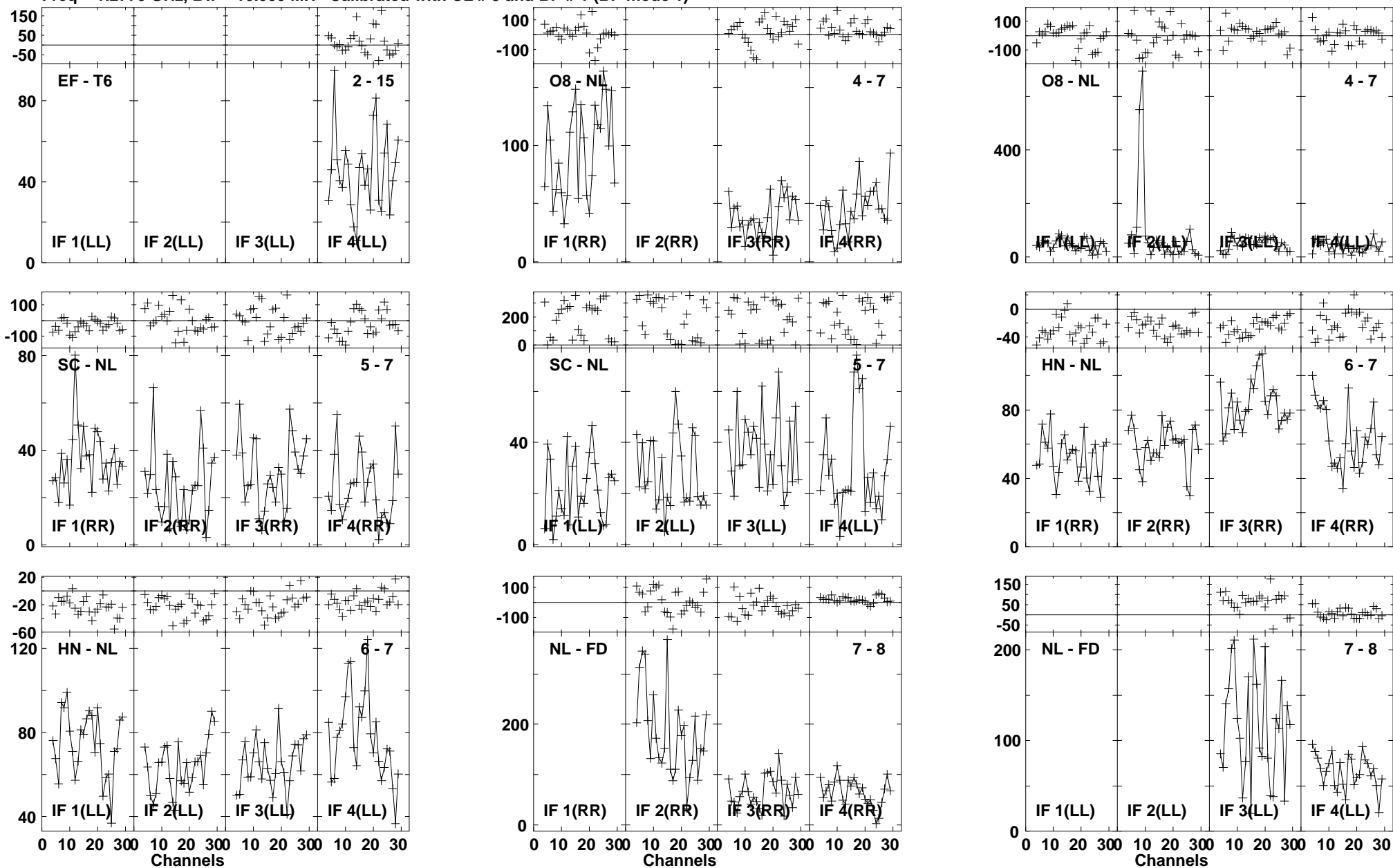

Lower frame: Milli Ampl Jy Top frame: Phas deg
Vector averaged cross-power spectrum Baseline: EF (02) - T6 (15)
Timerange: 01/00:35:35 to 01/00:38:59

Plot file version1071 created 03-MAR-2016 01:15:03

4C52 GN002C 1.UVDATA.1

Freq = 1.2770 GHz, Bw = 16.000 MH Calibrated with CL # 3 and BP # 1 (BP mode 1)

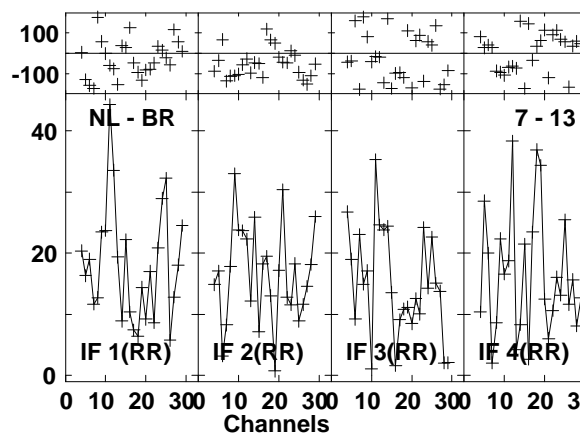
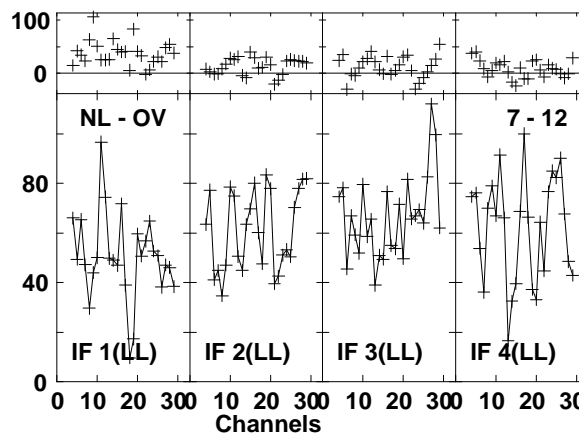
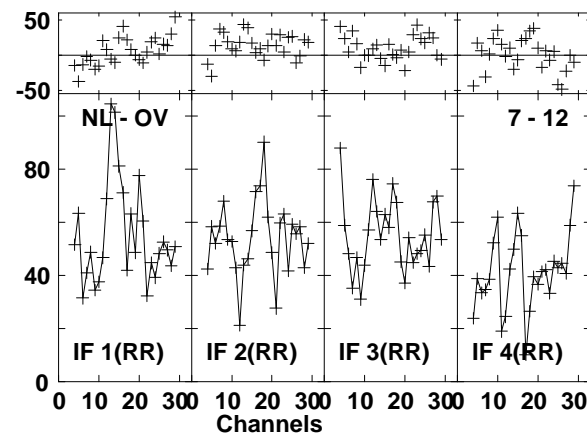
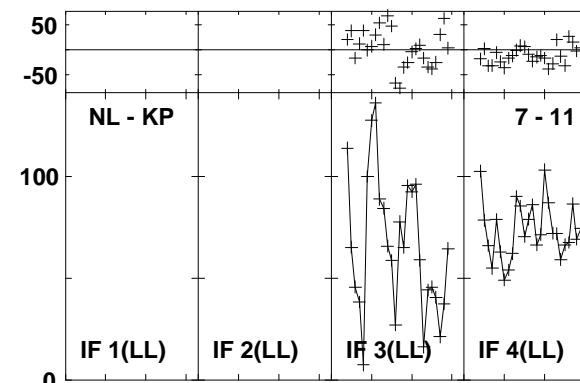
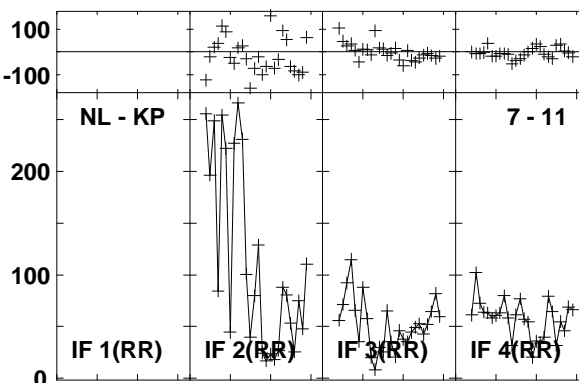
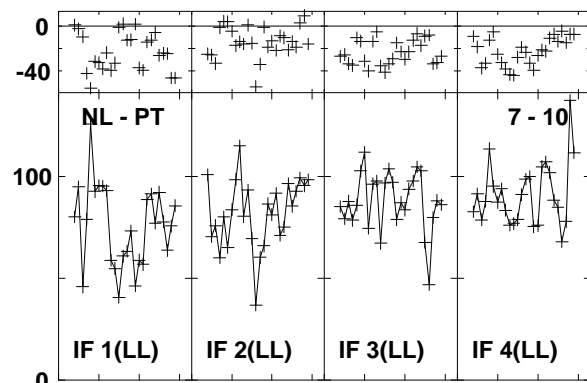
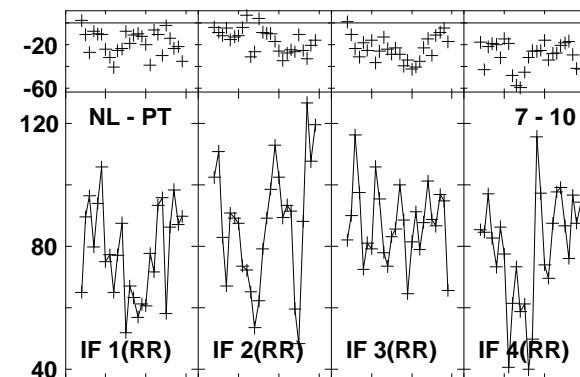
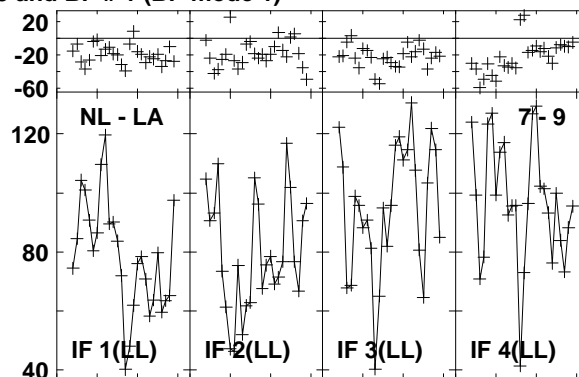
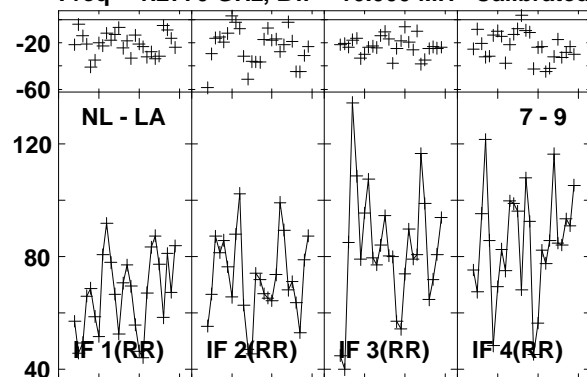

Lower frame: Milli Ampl Jy Top frame: Phas deg
Vector averaged cross-power spectrum Baseline: NL (07) - LA (09)
Timerange: 01/00:35:35 to 01/00:38:59

Plot file version1072 created 03-MAR-2016 01:15:03

4C52 GN002C 1.UVDATA.1

Freq = 1.2770 GHz, Bw = 16.000 MH Calibrated with CL # 3 and BP # 1 (BP mode 1)

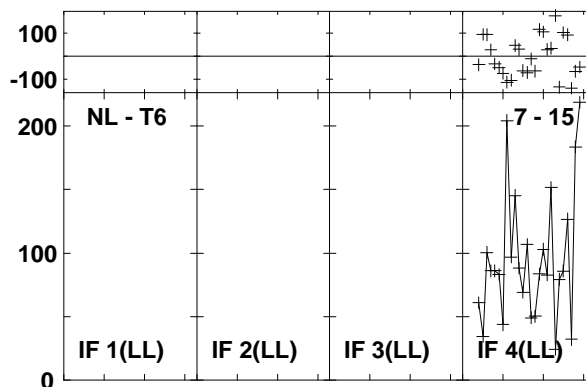
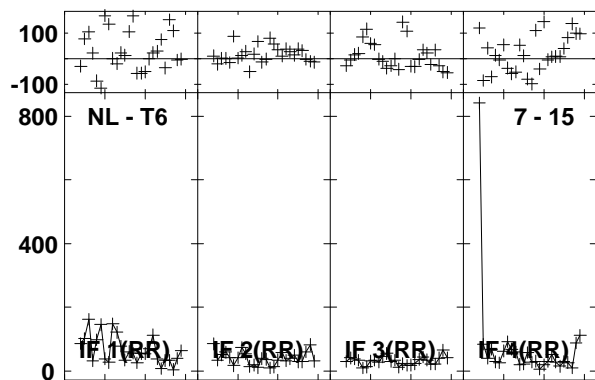
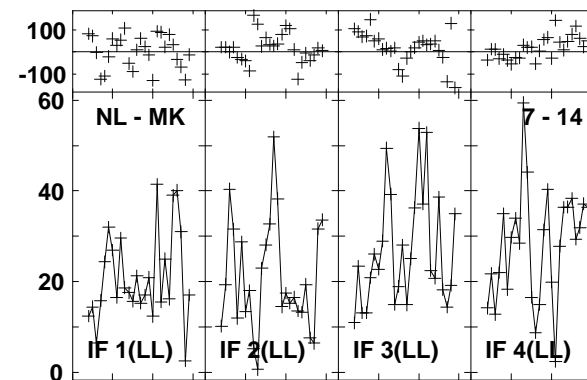
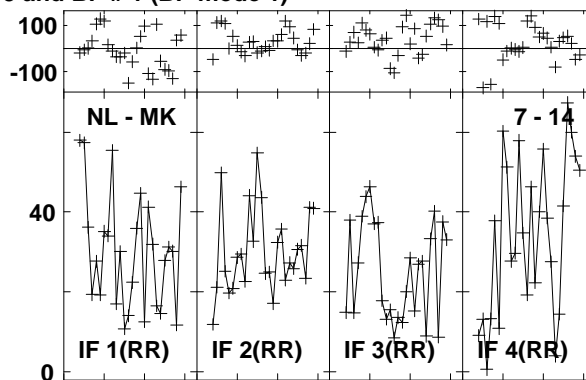
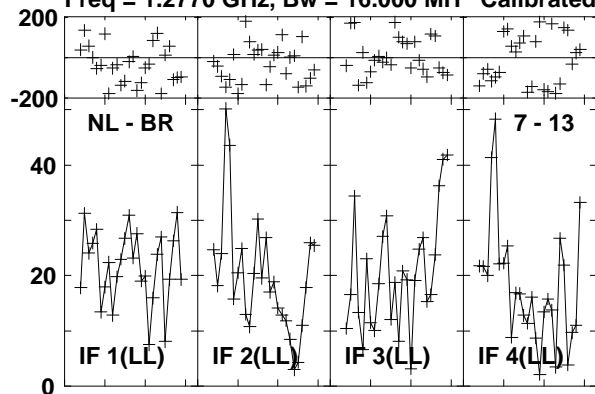

Lower frame: Milli Ampl Jy Top frame: Phas deg
Vector averaged cross-power spectrum Baseline: NL (07) - BR (13)
Timerange: 01/00:35:35 to 01/00:38:59

Plot file version1073 created 03-MAR-2016 01:15:03

J1545+5400 GN002C 1.UVDATA.1

Freq = 1.2770 GHz, Bw = 16.000 MH Calibrated with CL # 3 and BP # 1 (BP mode 1)

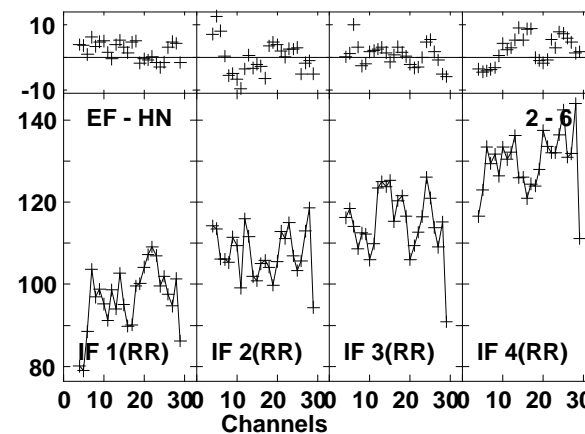
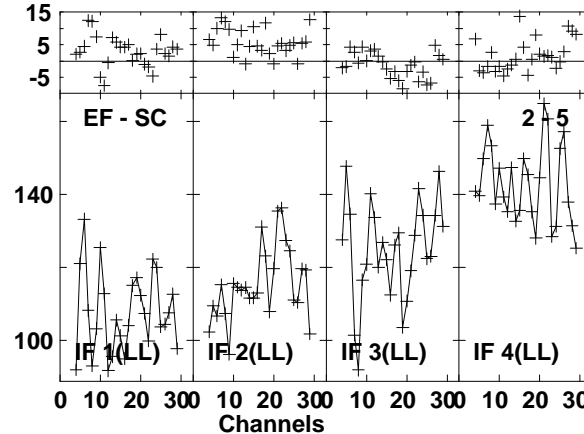
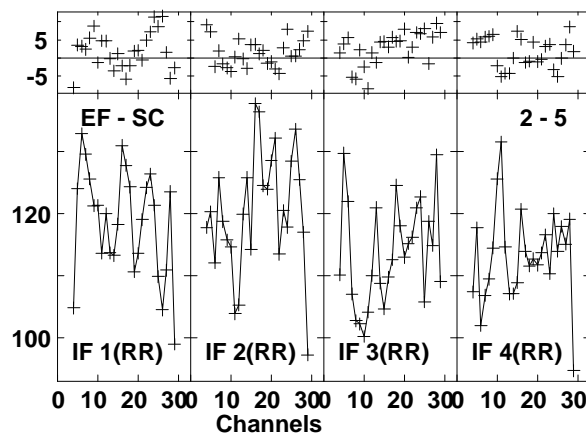
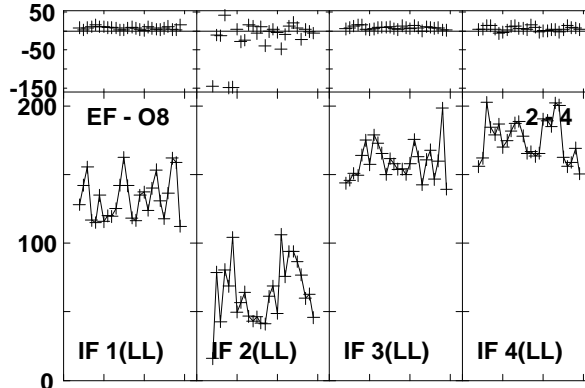
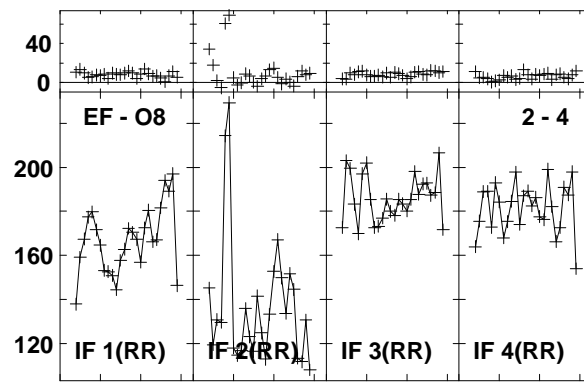
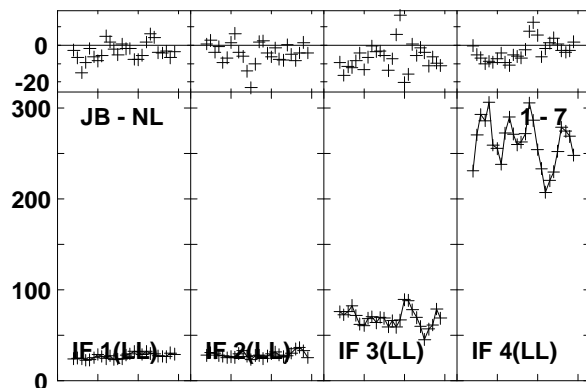
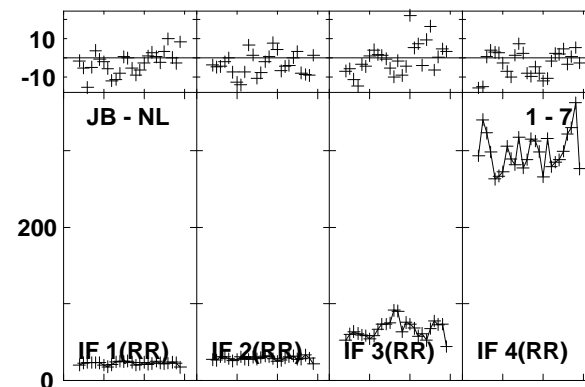
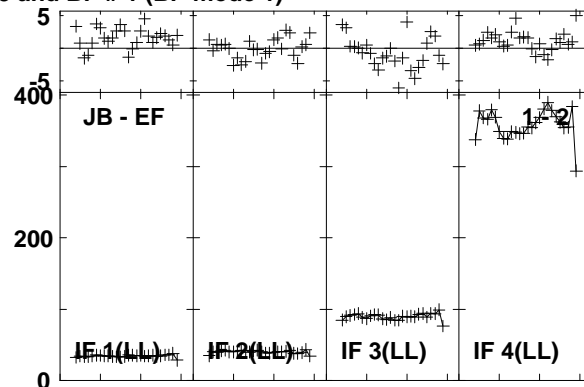
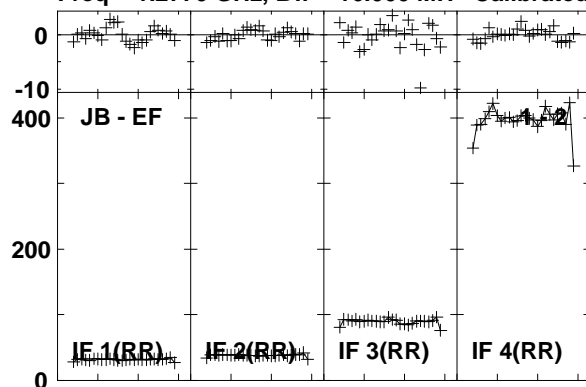

Lower frame: Milli Ampl Jy Top frame: Phas deg
Vector averaged cross-power spectrum Baseline: JB (01) - EF (02)
Timerange: 01/00:39:52 to 01/00:41:50

Plot file version1074 created 03-MAR-2016 01:15:04

J1545+5400 GN002C 1.UVDATA.1

Freq = 1.2770 GHz, Bw = 16.000 MH Calibrated with CL # 3 and BP # 1 (BP mode 1)

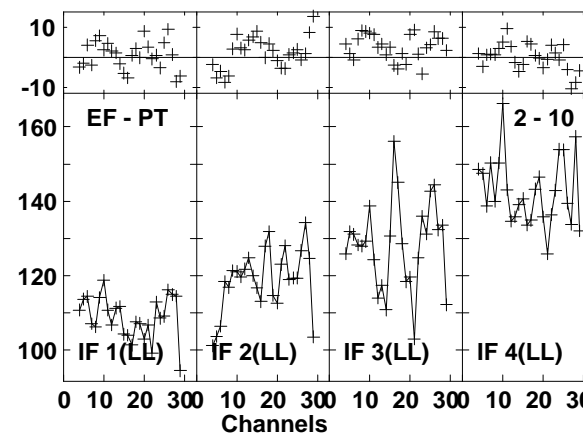
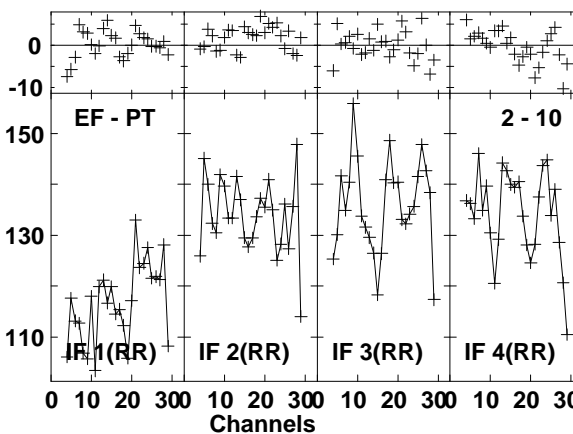
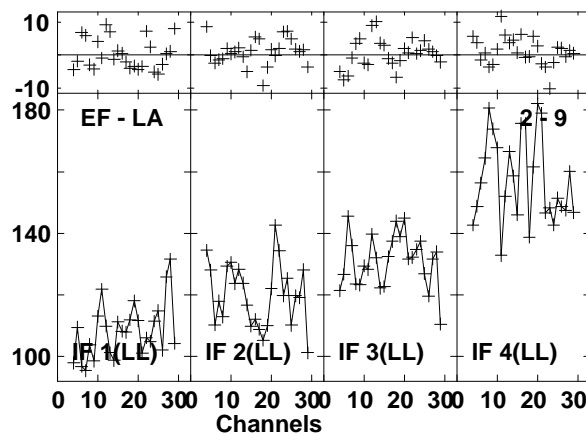
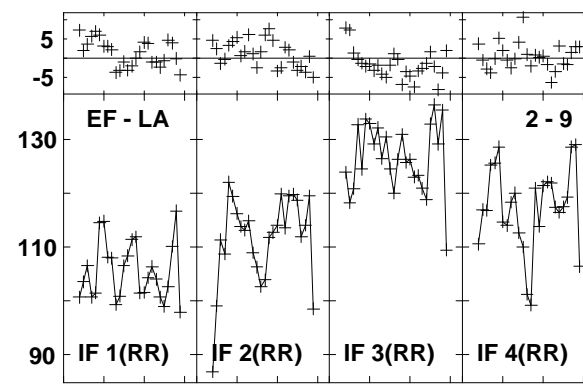
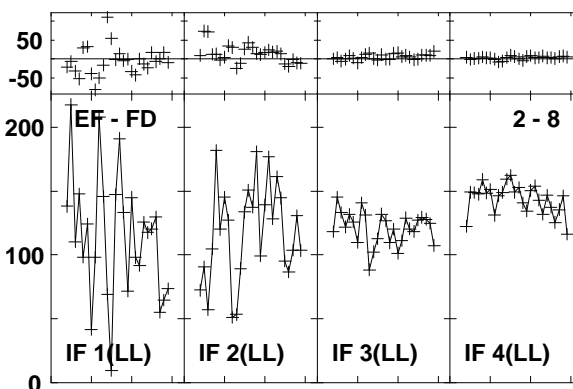
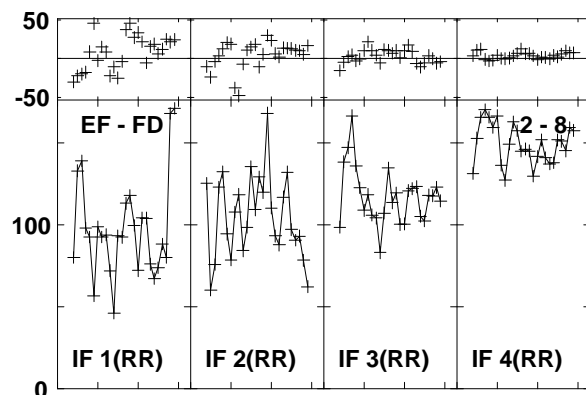
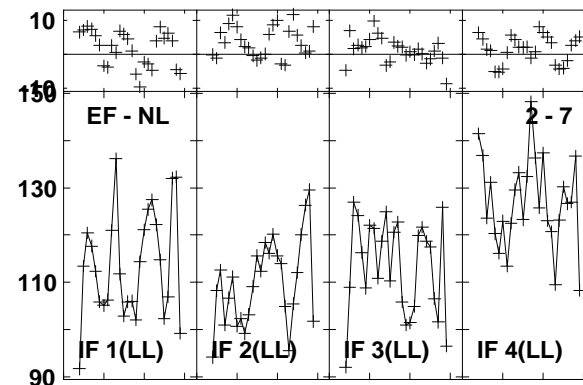
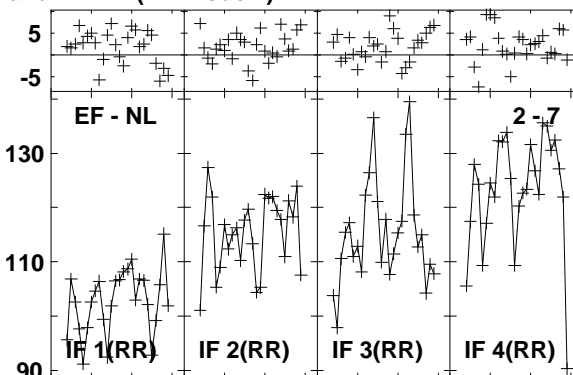
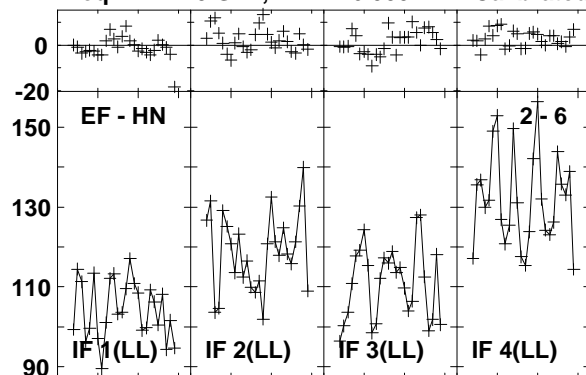

Lower frame: Milli Ampl Jy Top frame: Phas deg
Vector averaged cross-power spectrum Baseline: EF (02) - HN (06)
Timerange: 01/00:39:52 to 01/00:41:50

Plot file version1075 created 03-MAR-2016 01:15:04

J1545+5400 GN002C 1.UVDATA.1

Freq = 1.2770 GHz, Bw = 16.000 MH Calibrated with CL # 3 and BP # 1 (BP mode 1)

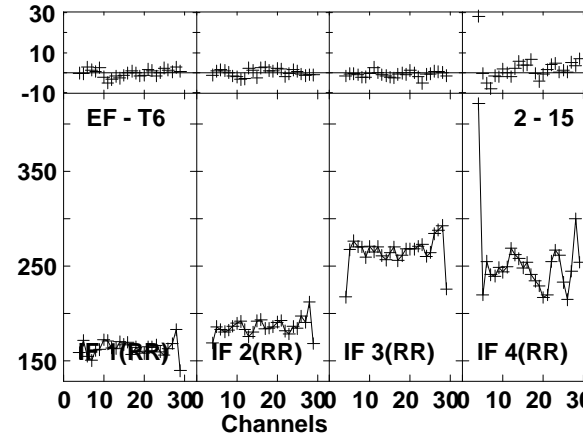
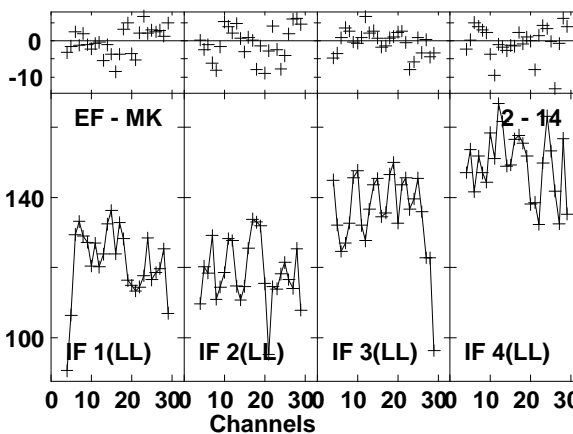
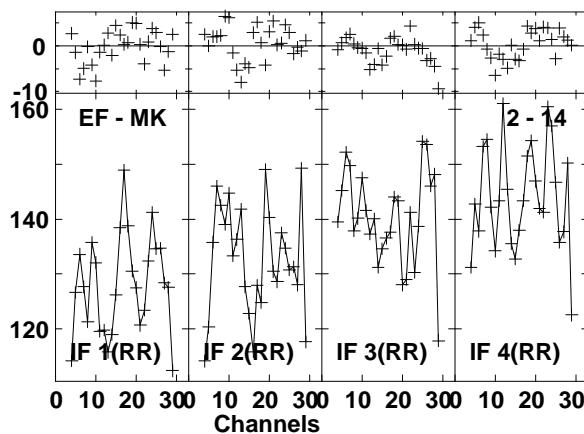
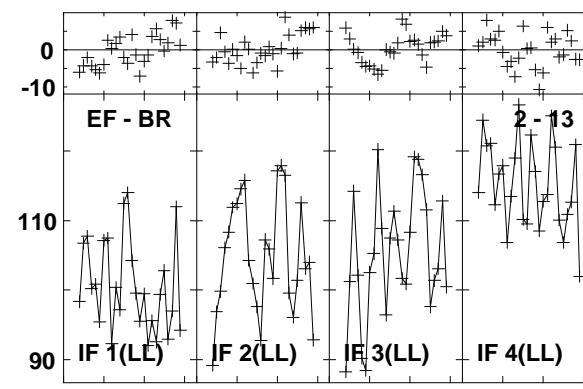
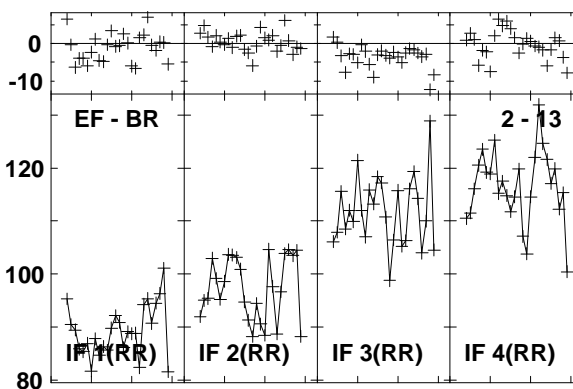
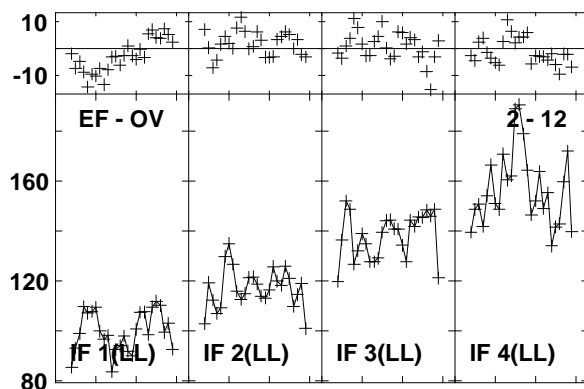
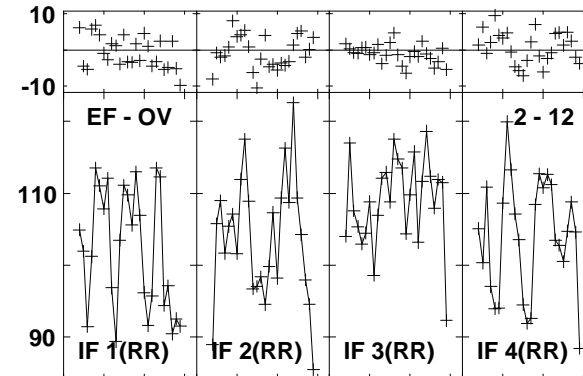
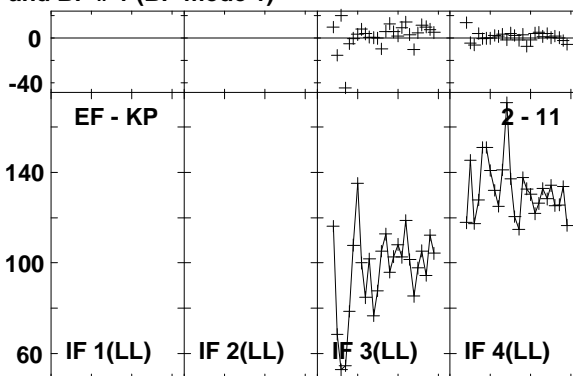
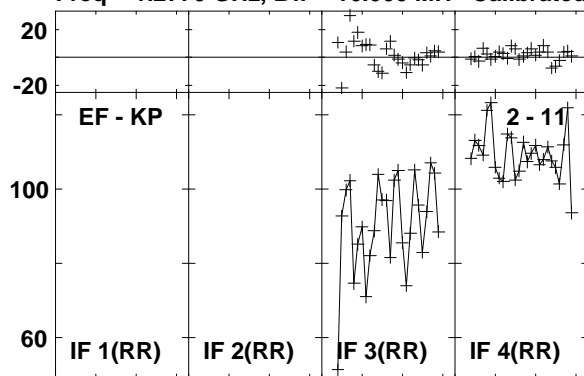

Lower frame: Milli Ampl Jy Top frame: Phas deg
Vector averaged cross-power spectrum Baseline: EF (02) - KP (11)
Timerange: 01/00:39:52 to 01/00:41:50

Plot file version1076 created 03-MAR-2016 01:15:04

J1545+5400 GN002C 1.UVDATA.1

Freq = 1.2770 GHz, Bw = 16.000 MH Calibrated with CL # 3 and BP # 1 (BP mode 1)

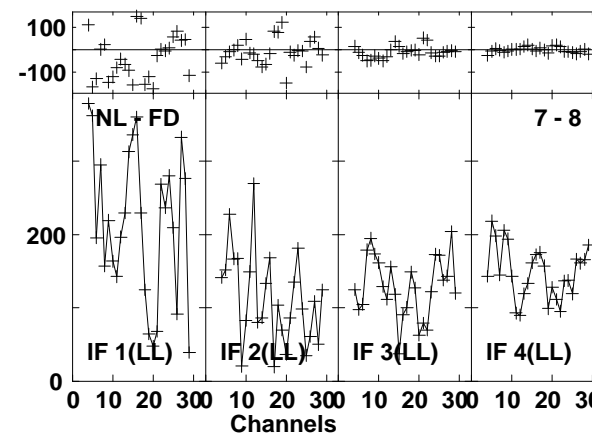
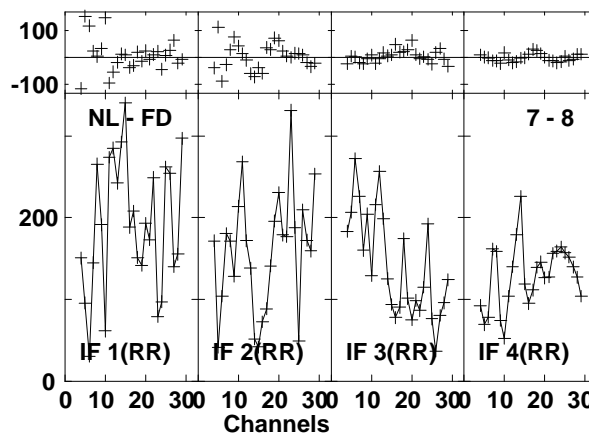
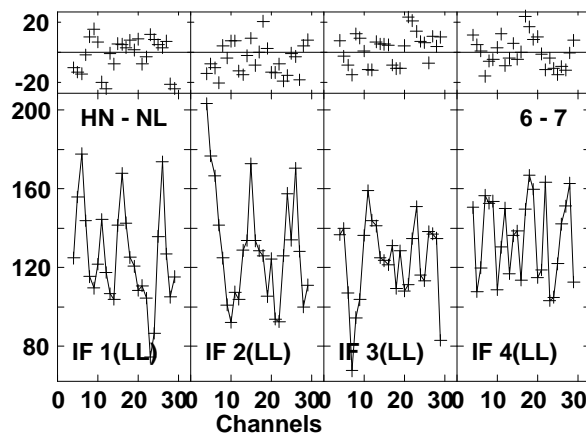
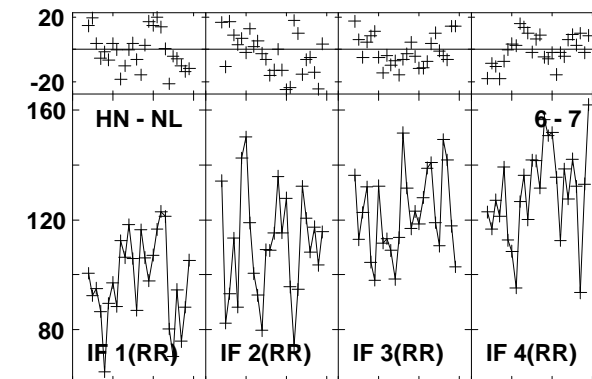
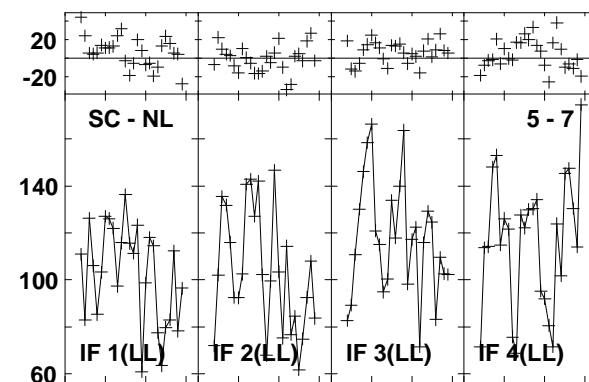
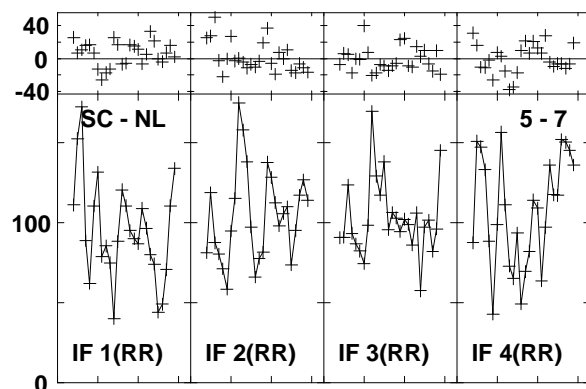
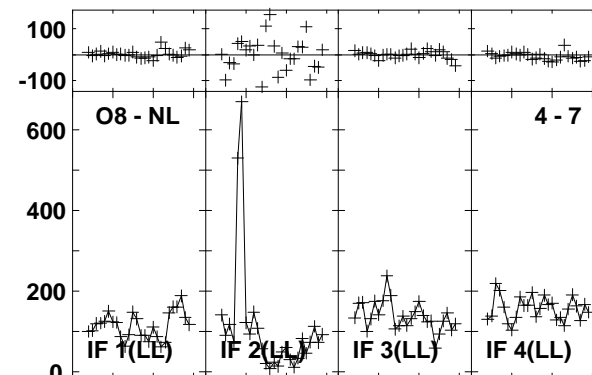
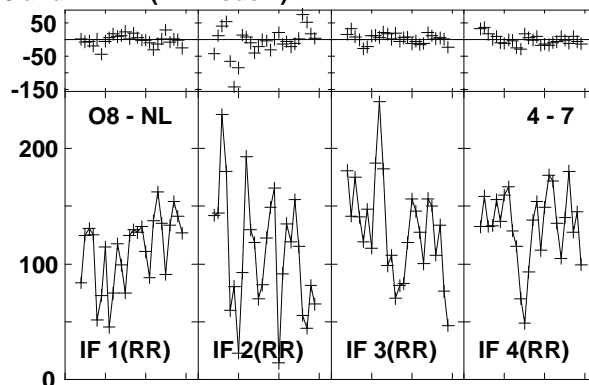
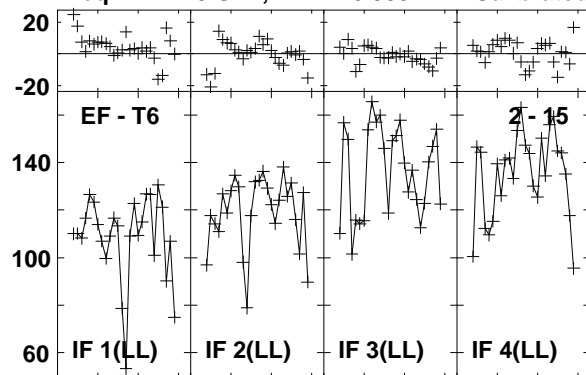

Lower frame: Milli Ampl Jy Top frame: Phas deg
Vector averaged cross-power spectrum Baseline: EF (02) - T6 (15)
Timerange: 01/00:39:52 to 01/00:41:50

Plot file version1077 created 03-MAR-2016 01:15:04

J1545+5400 GN002C 1.UVDATA.1

Freq = 1.2770 GHz, Bw = 16.000 MH Calibrated with CL # 3 and BP # 1 (BP mode 1)

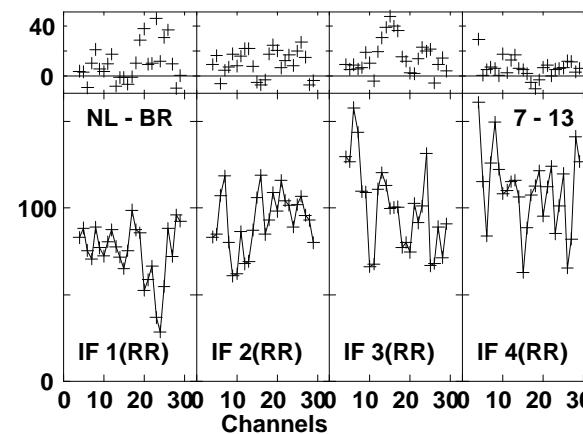
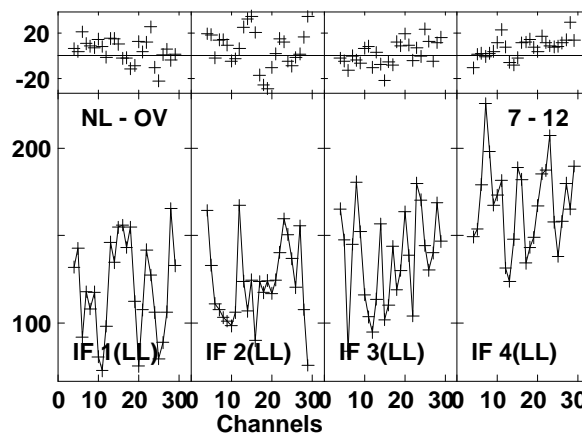
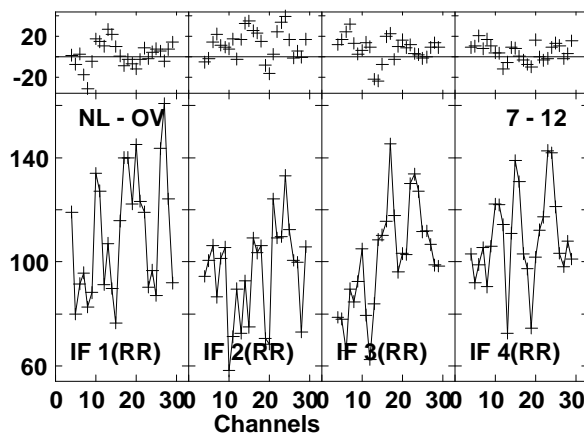
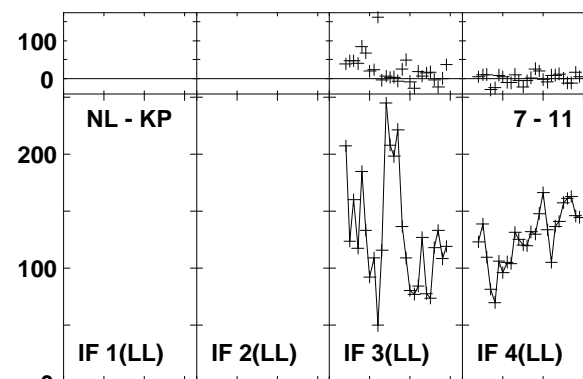
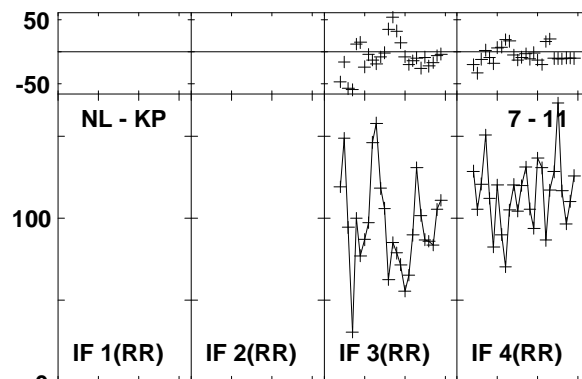
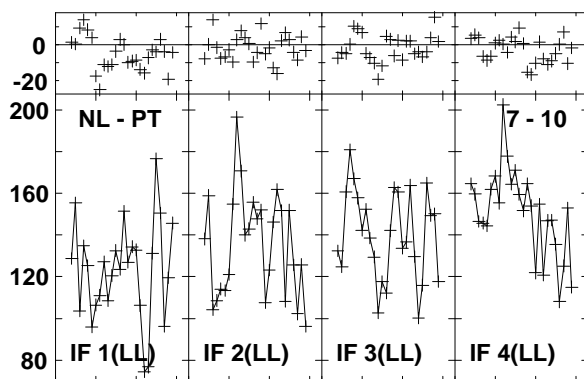
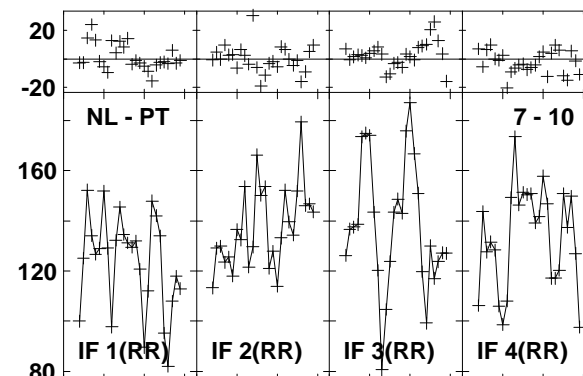
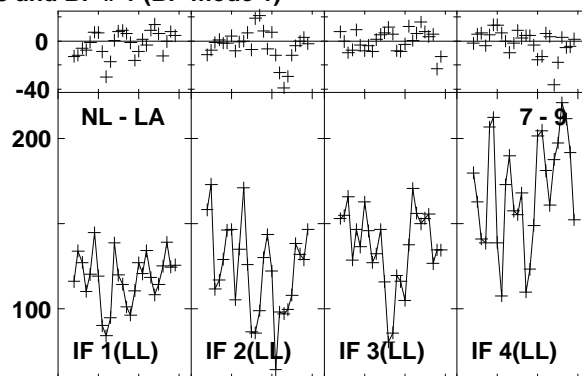
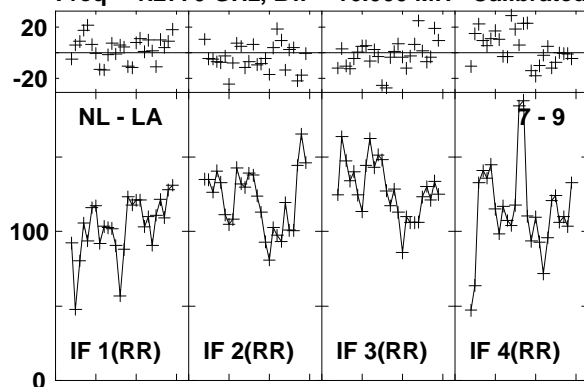

Lower frame: Milli Ampl Jy Top frame: Phas deg
Vector averaged cross-power spectrum Baseline: NL (07) - LA (09)
Timerange: 01/00:39:52 to 01/00:41:50

Plot file version1078 created 03-MAR-2016 01:15:04
 J1545+5400 GN002C 1.UVDATA.1
 Freq = 1.2770 GHz, Bw = 16.000 MH Calibrated with CL # 3 and BP # 1 (BP mode 1)

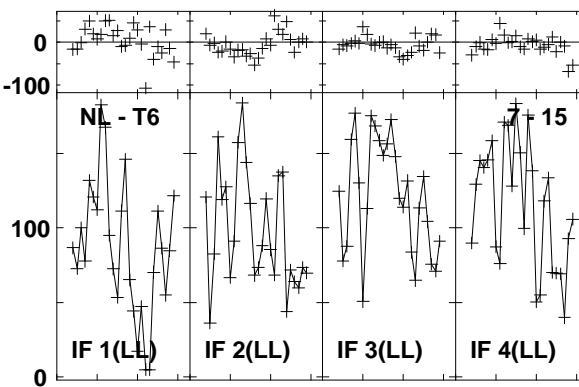
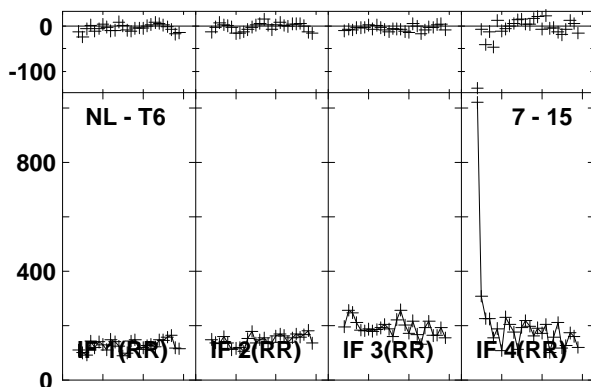
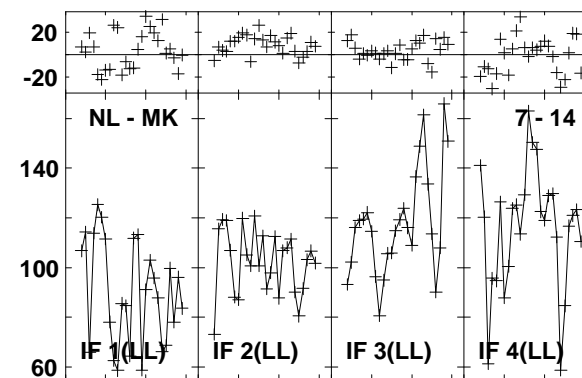
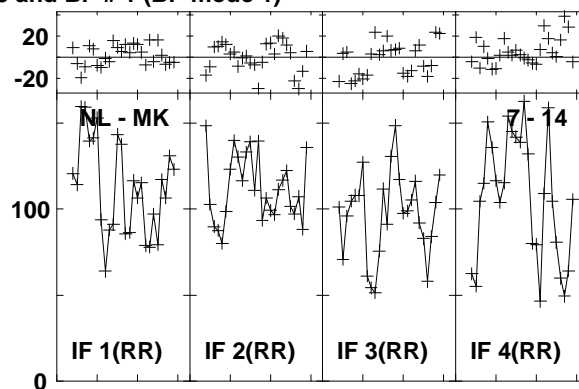
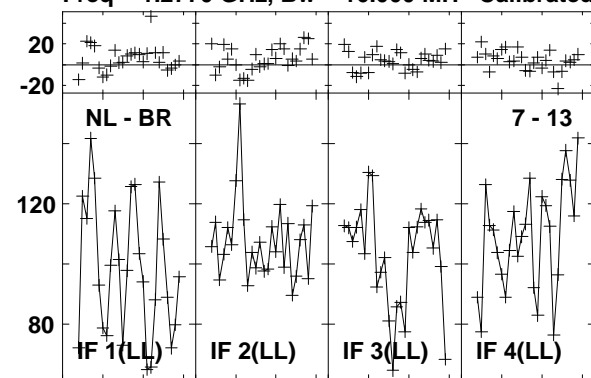

Lower frame: Milli Ampl Jy Top frame: Phas deg
 Vector averaged cross-power spectrum Baseline: NL (07) - BR (13)
 Timerange: 01/00:39:52 to 01/00:41:50

Plot file version1079 created 03-MAR-2016 01:15:04

4C52 GN002C 1.UVDATA.1

Freq = 1.2770 GHz, Bw = 16.000 MH Calibrated with CL # 3 and BP # 1 (BP mode 1)

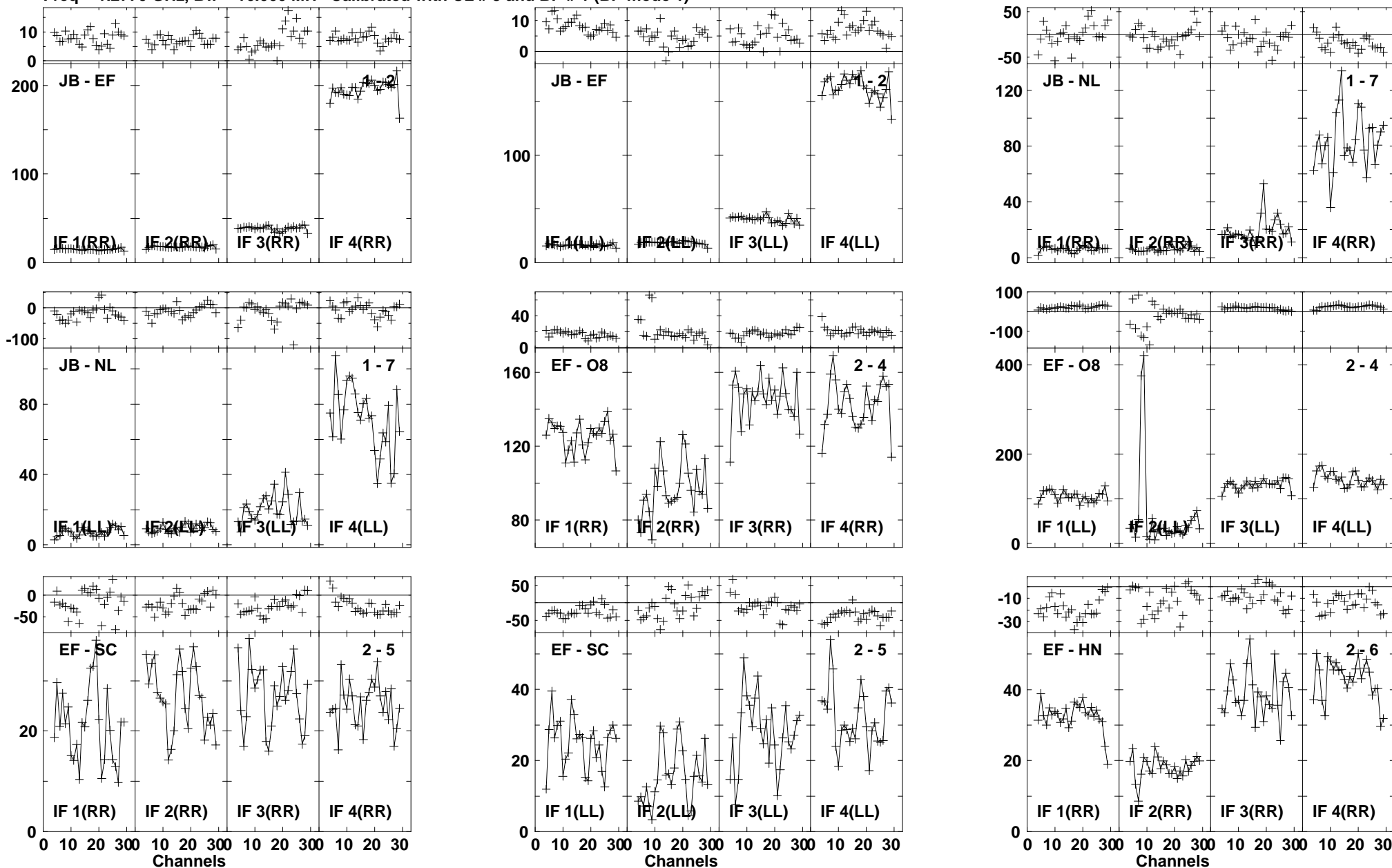

Lower frame: Milli Ampl Jy Top frame: Phas deg
Vector averaged cross-power spectrum Baseline: JB (01) - EF (02)
Timerange: 01/00:42:03 to 01/00:45:19

Plot file version1080 created 03-MAR-2016 01:15:05

4C52 GN002C 1.UVDATA.1

Freq = 1.2770 GHz, Bw = 16.000 MH Calibrated with CL # 3 and BP # 1 (BP mode 1)

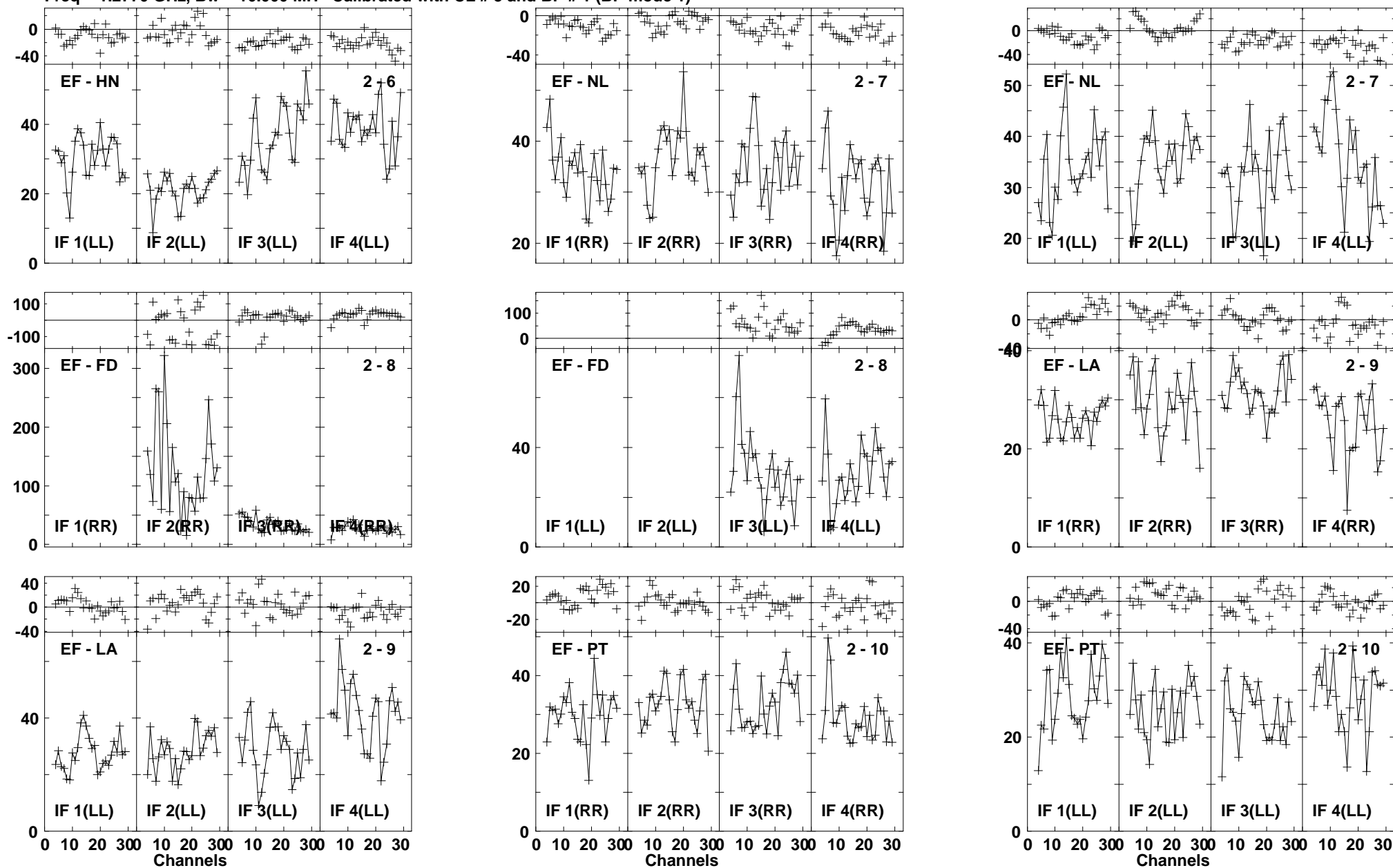

Plot file version1081 created 03-MAR-2016 01:15:05

4C52 GN002C 1.UVDATA.1

Freq = 1.2770 GHz, Bw = 16.000 MH Calibrated with CL # 3 and BP # 1 (BP mode 1)

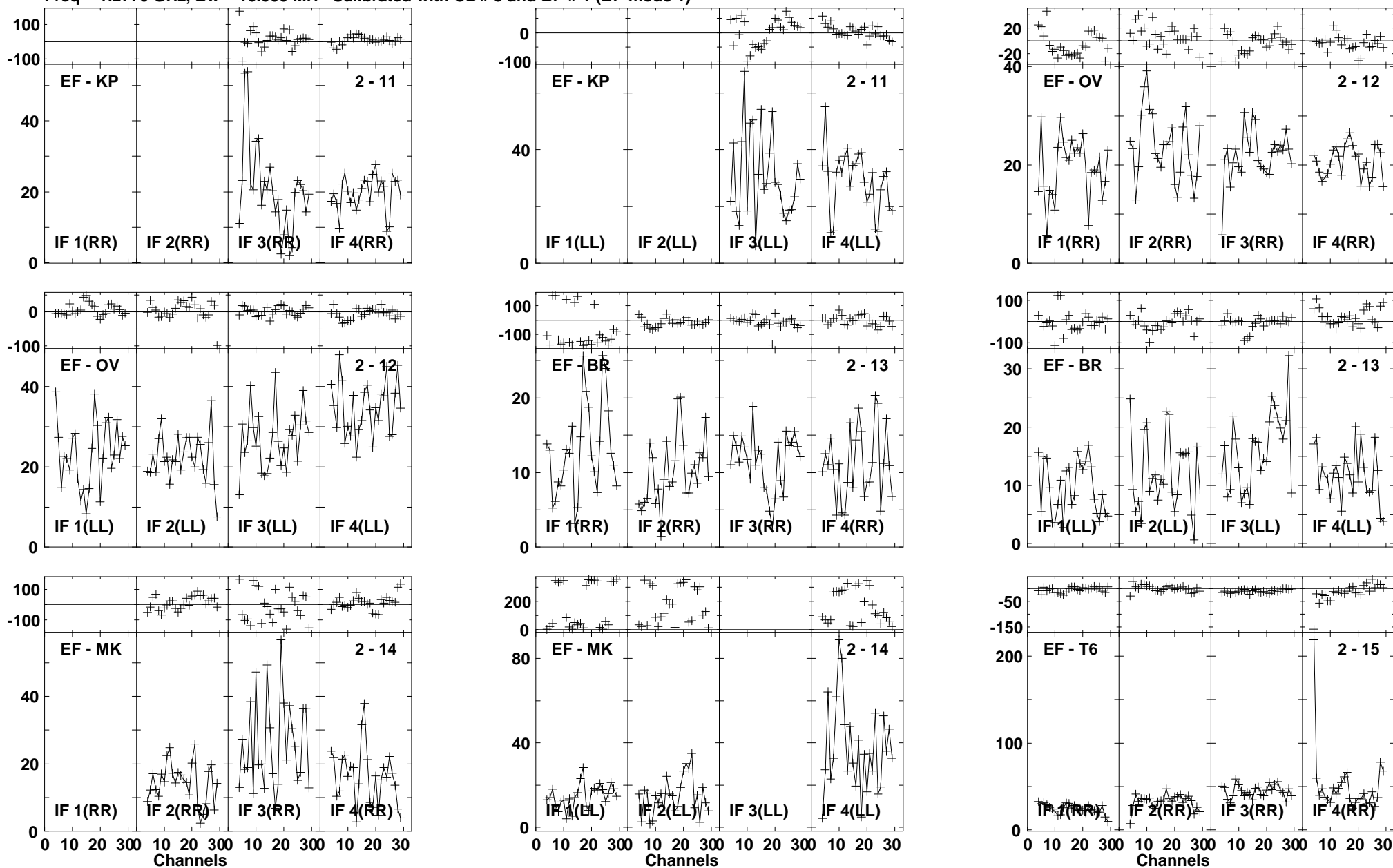

Lower frame: Milli Ampl Jy Top frame: Phas deg
Vector averaged cross-power spectrum Baseline: EF (02) - KP (11)
Timerange: 01/00:42:03 to 01/00:45:19

Plot file version1082 created 03-MAR-2016 01:15:05

4C52 GN002C 1.UVDATA.1

Freq = 1.2770 GHz, Bw = 16.000 MH Calibrated with CL # 3 and BP # 1 (BP mode 1)

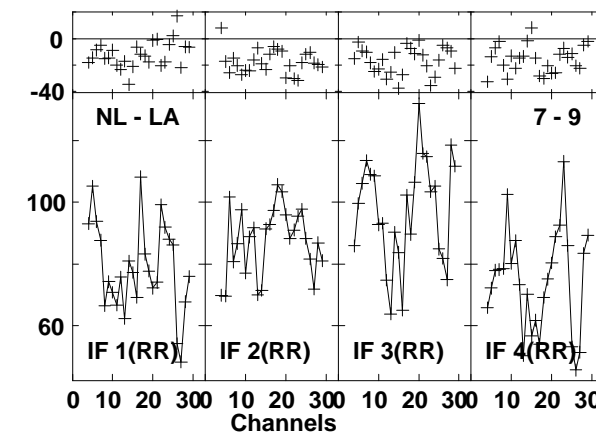
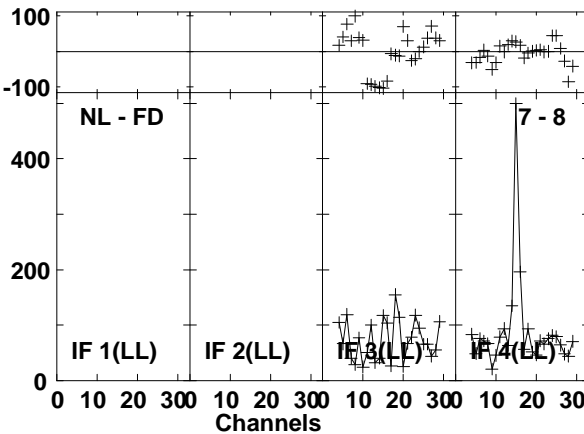
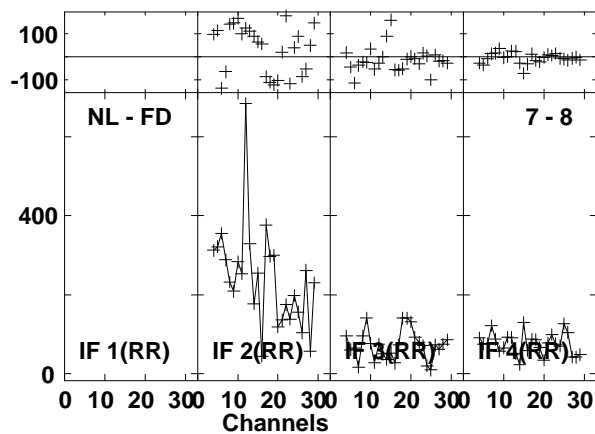
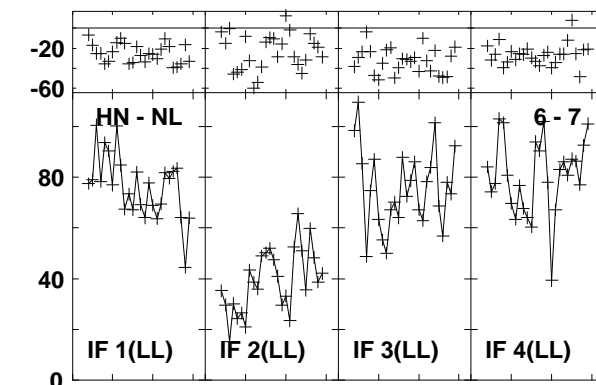
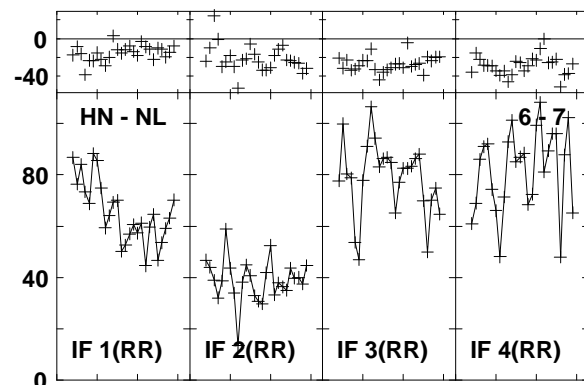
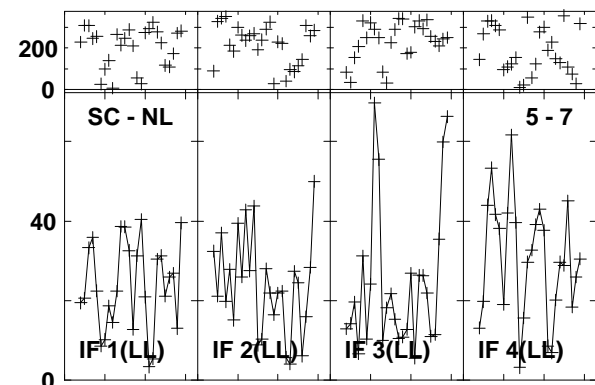
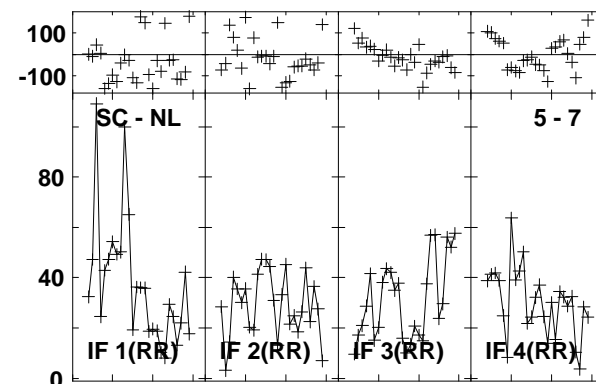
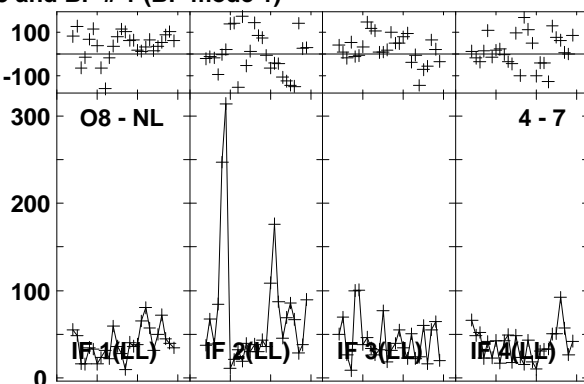
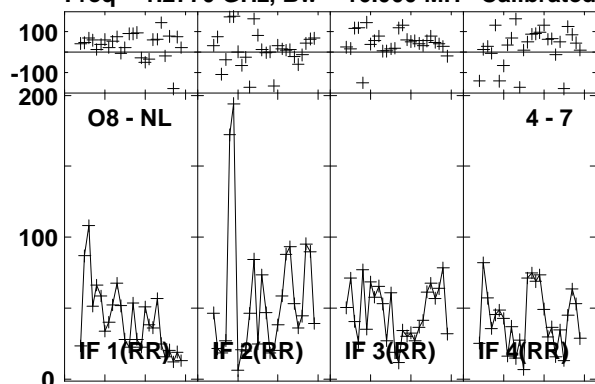

Lower frame: Milli Ampl Jy Top frame: Phas deg
Vector averaged cross-power spectrum Baseline: O8 (04) - NL (07)
Timerange: 01/00:42:03 to 01/00:45:19

Plot file version1083 created 03-MAR-2016 01:15:05

4C52 GN002C 1.UVDATA.1

Freq = 1.2770 GHz, Bw = 16.000 MH Calibrated with CL # 3 and BP # 1 (BP mode 1)

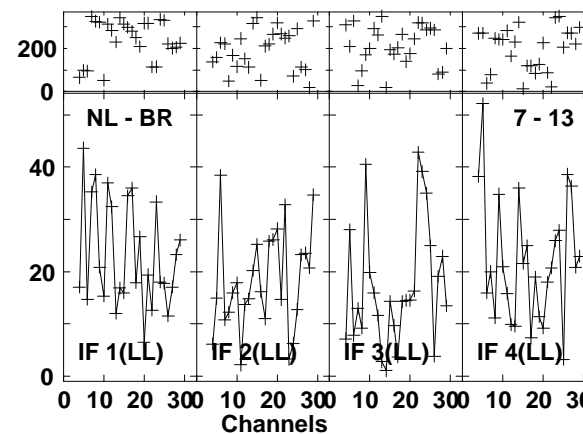
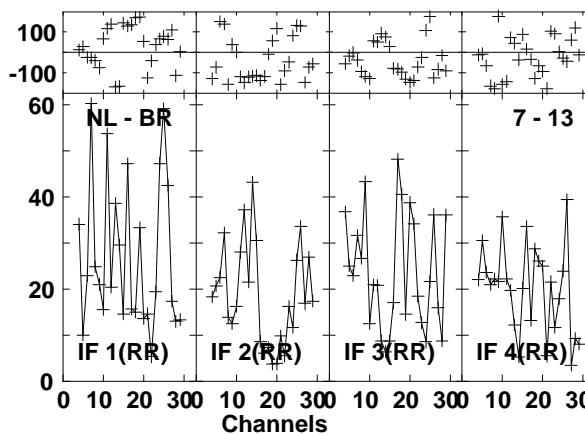
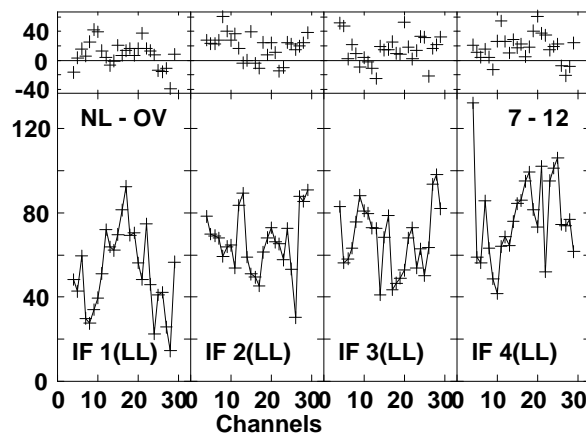
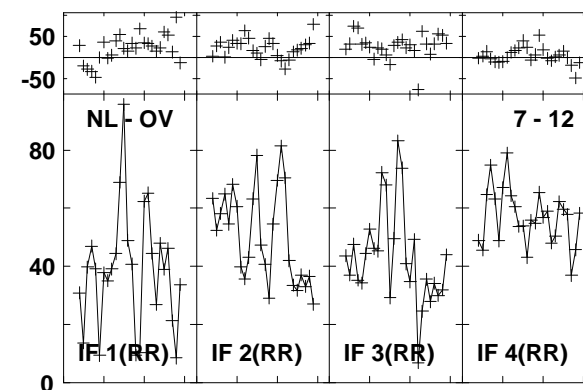
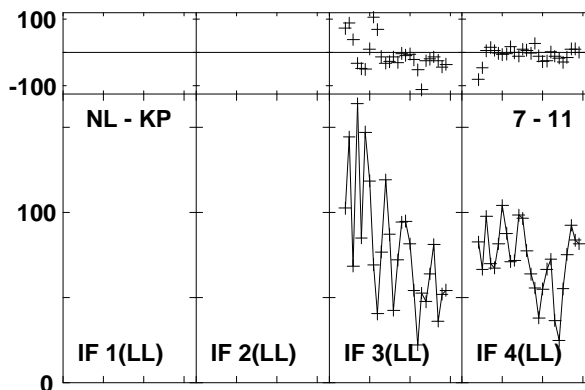
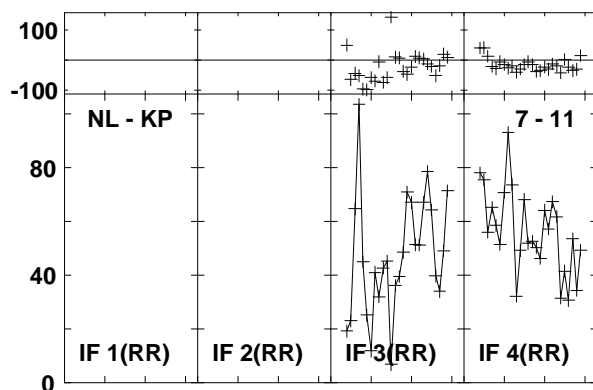
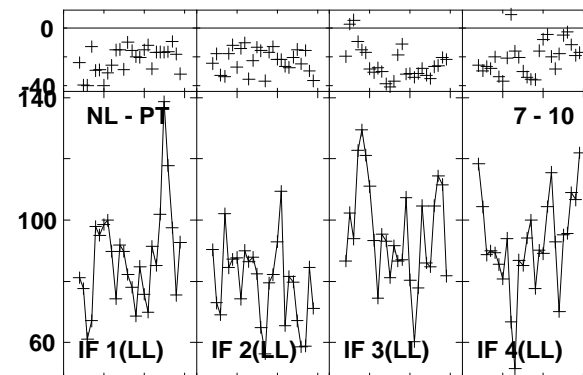
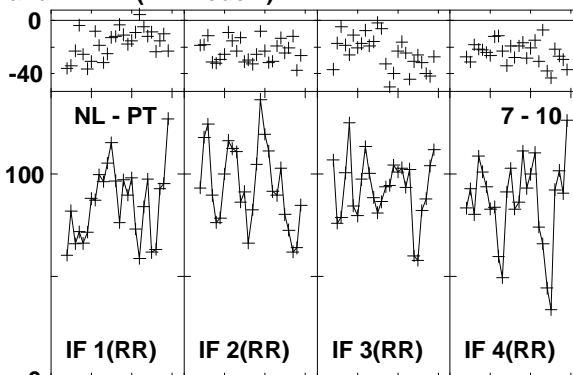
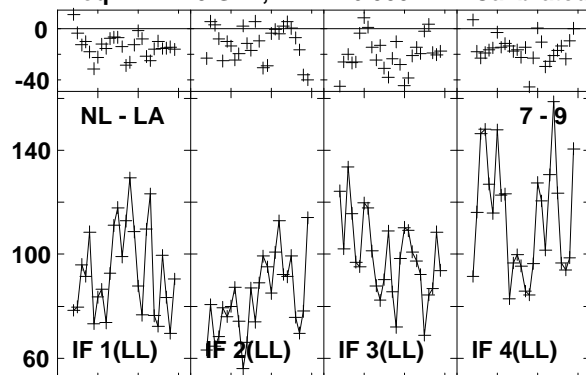

Lower frame: Milli Ampl Jy Top frame: Phas deg
Vector averaged cross-power spectrum Baseline: NL (07) - LA (09)
Timerange: 01/00:42:03 to 01/00:45:19

Plot file version1084 created 03-MAR-2016 01:15:05

4C52 GN002C 1.UVDATA.1

Freq = 1.2770 GHz, Bw = 16.000 MH Calibrated with CL # 3 and BP # 1 (BP mode 1)

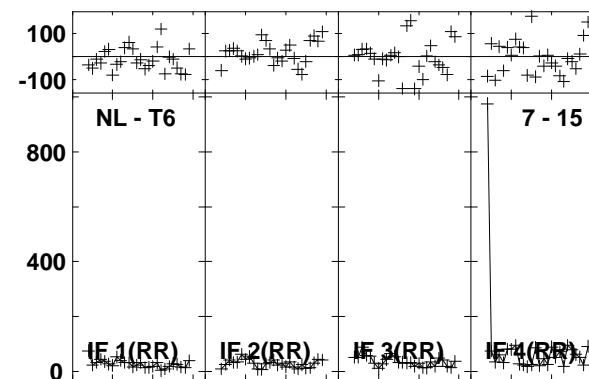
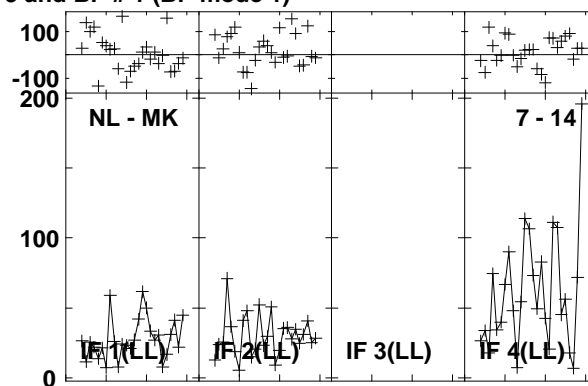
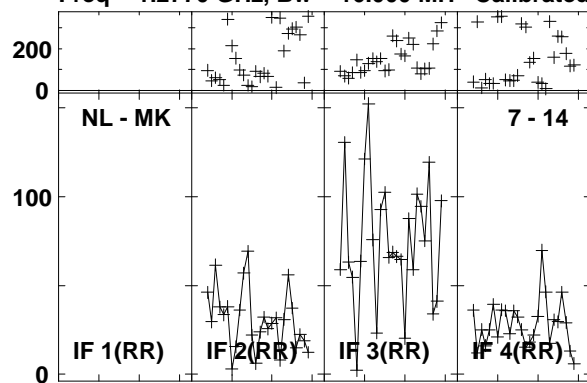

Lower frame: Milli Ampl Jy Top frame: Phas deg
Vector averaged cross-power spectrum Baseline: NL (07) - MK (14)
Timerange: 01/00:42:03 to 01/00:45:19

Plot file version1085 created 03-MAR-2016 01:15:06

J1545+5400 GN002C 1.UVDATA.1

Freq = 1.2770 GHz, Bw = 16.000 MH Calibrated with CL # 3 and BP # 1 (BP mode 1)

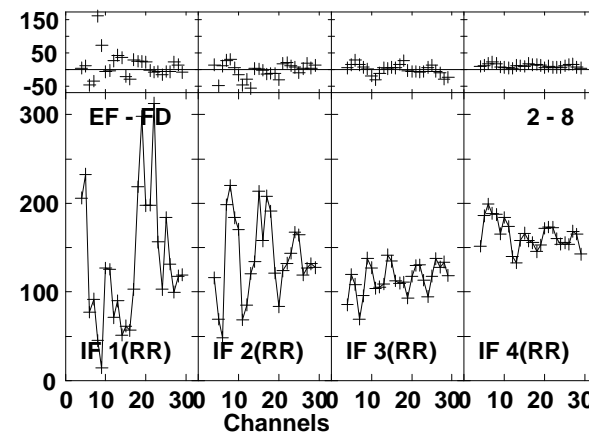
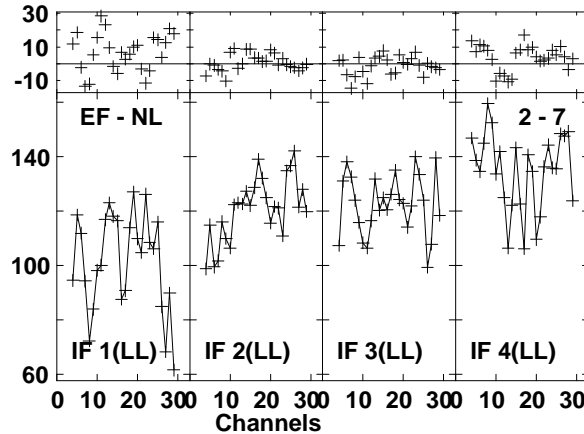
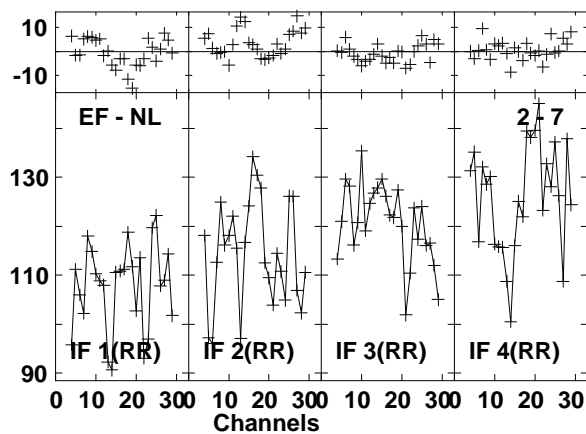
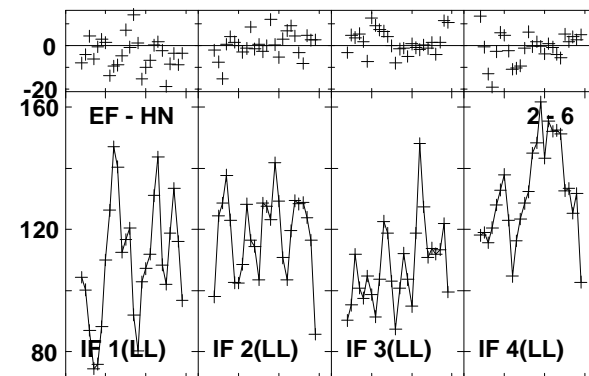
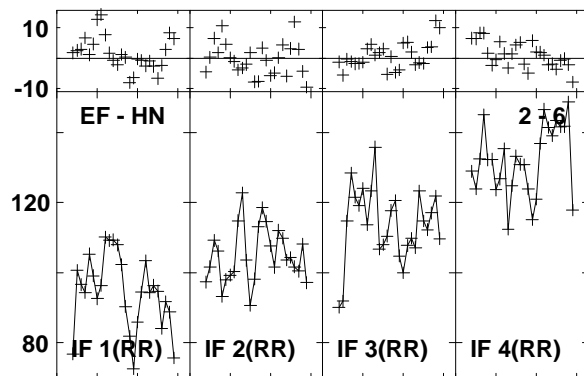
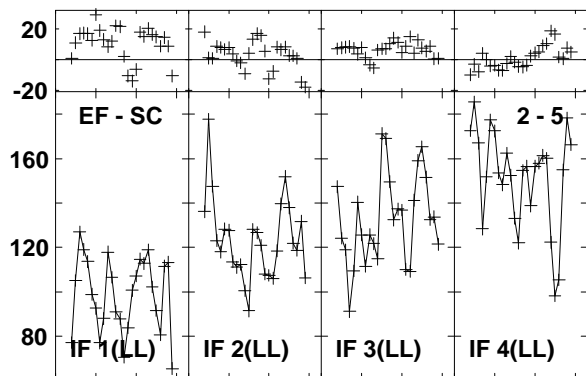
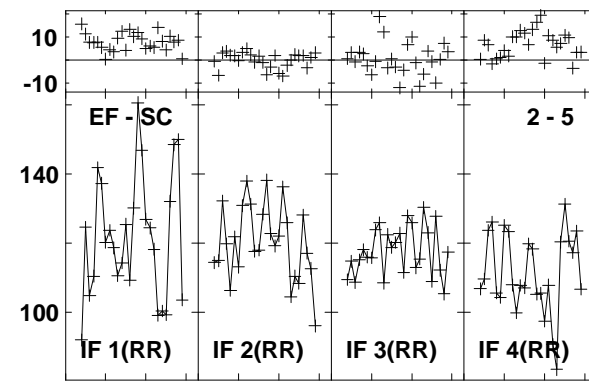
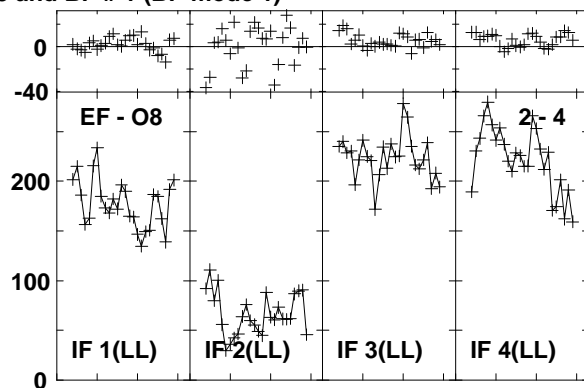
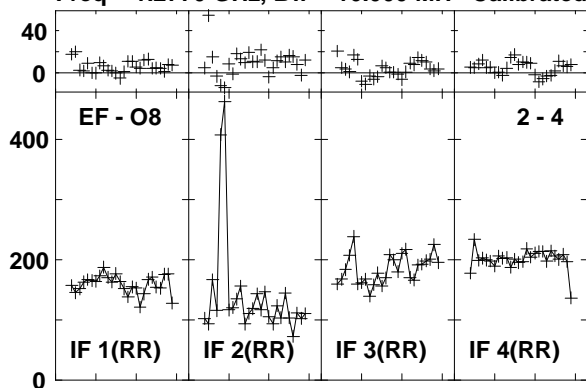

Lower frame: Milli Ampl Jy Top frame: Phas deg
Vector averaged cross-power spectrum Baseline: EF (02) - O8 (04)
Timerange: 01/00:46:12 to 01/00:47:10

Plot file version1086 created 03-MAR-2016 01:15:06
 J1545+5400 GN002C 1.UVDATA.1
 Freq = 1.2770 GHz, Bw = 16.000 MH Calibrated with CL # 3 and BP # 1 (BP mode 1)

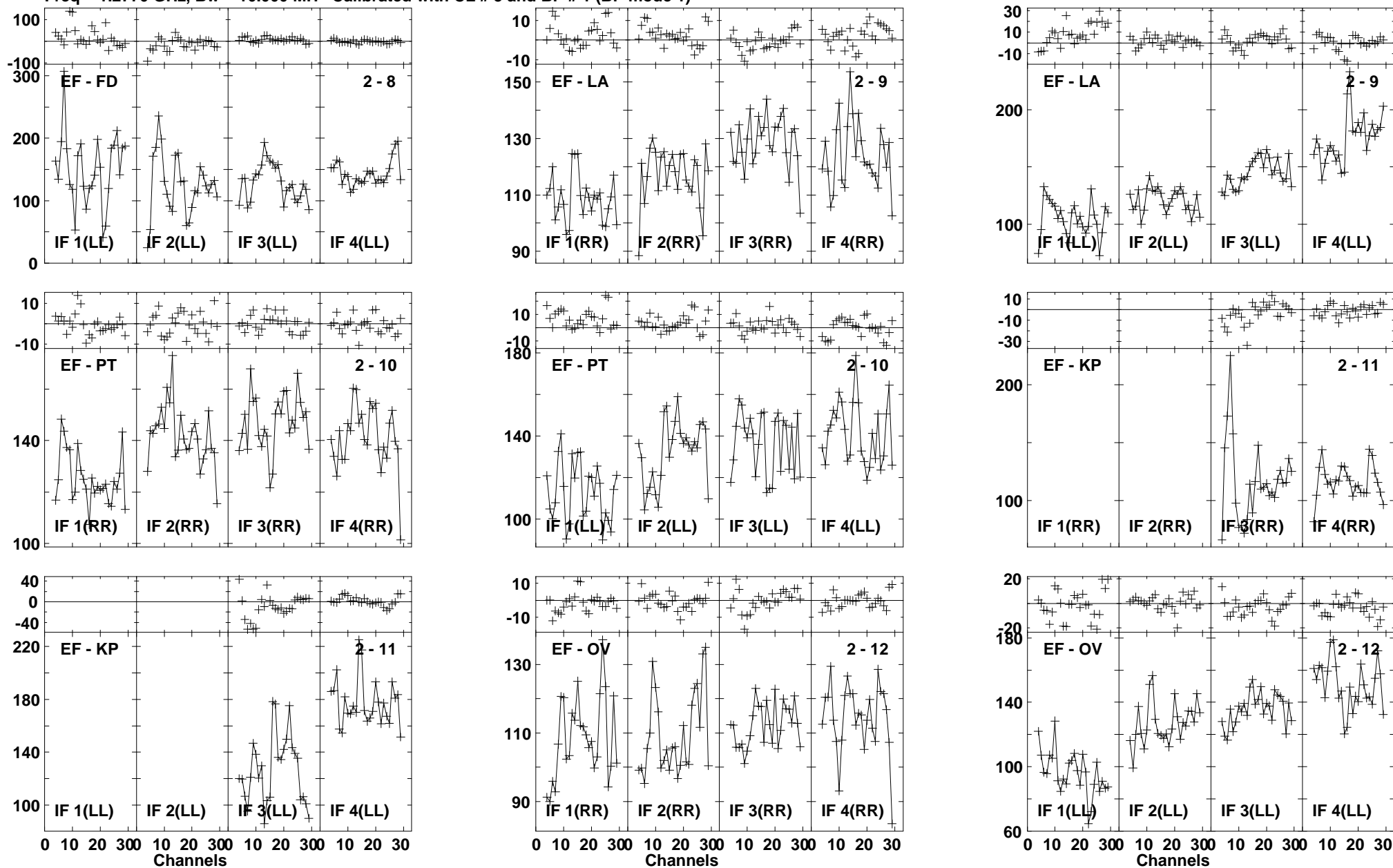

Lower frame: Milli Ampl Jy Top frame: Phas deg
 Vector averaged cross-power spectrum Baseline: EF (02) - FD (08)
 Timerange: 01/00:46:12 to 01/00:47:10

Plot file version1087 created 03-MAR-2016 01:15:06

J1545+5400 GN002C 1.UVDATA.1

Freq = 1.2770 GHz, Bw = 16.000 MH Calibrated with CL # 3 and BP # 1 (BP mode 1)

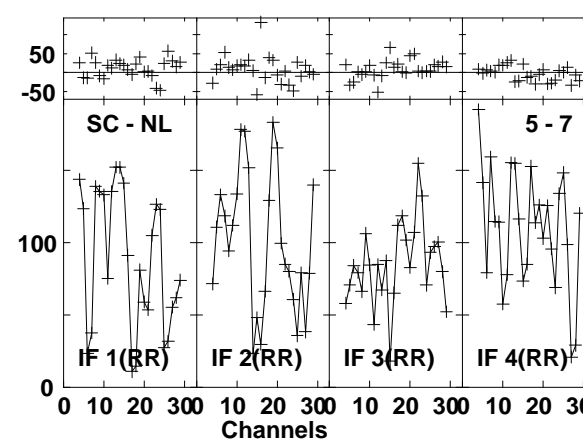
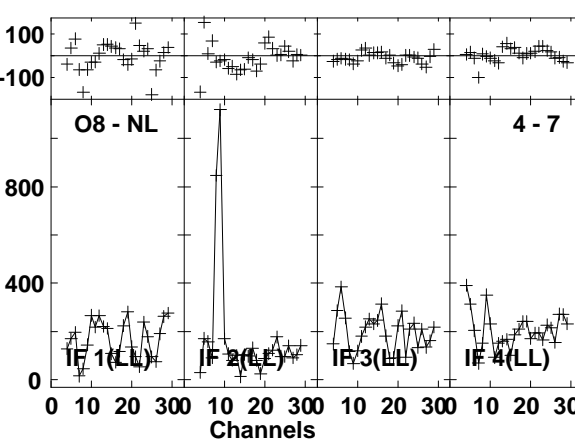
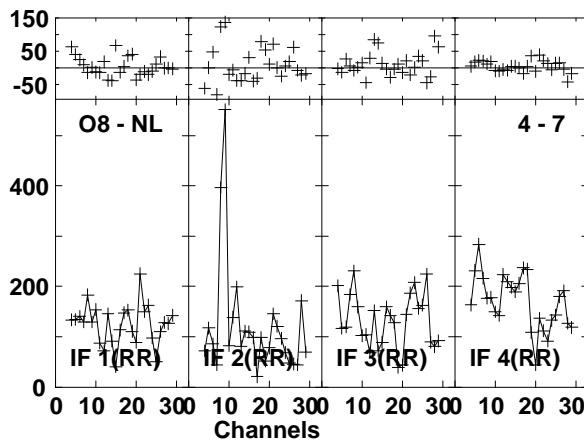
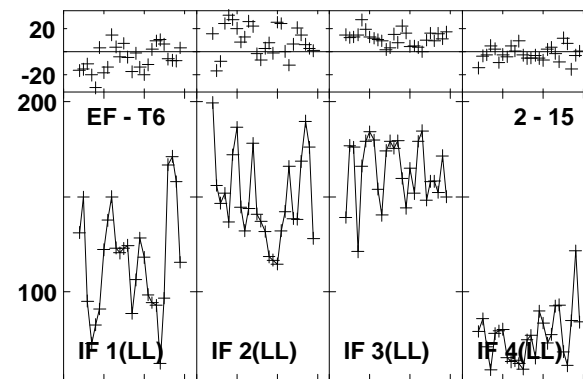
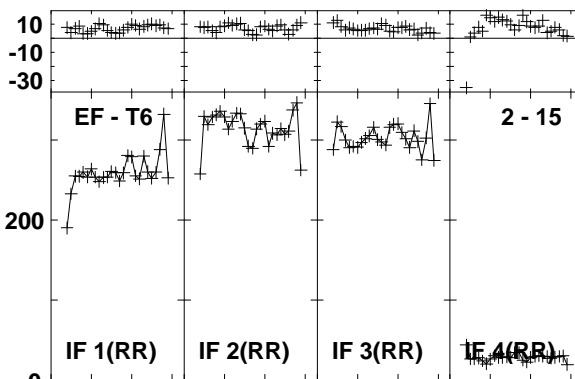
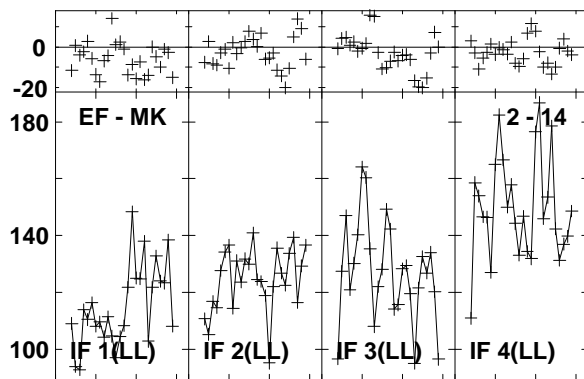
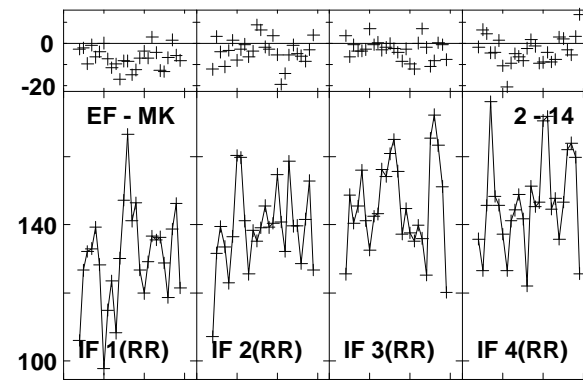
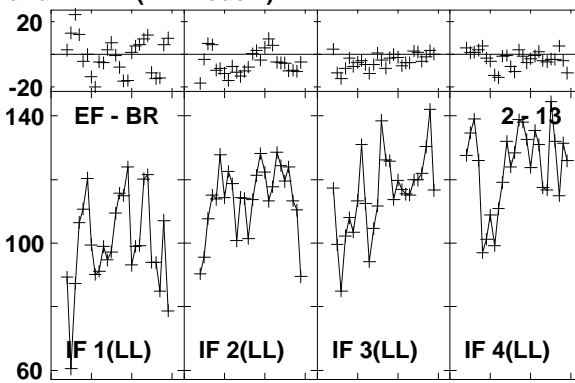
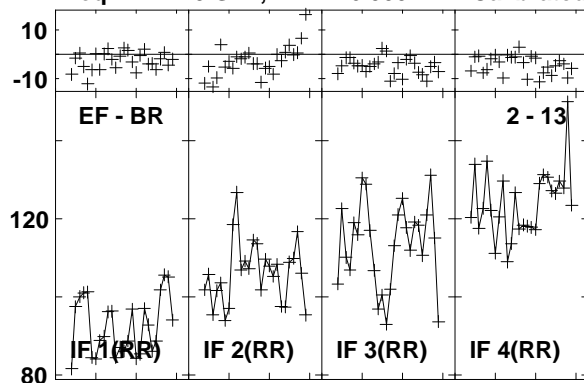

Lower frame: Milli Ampl Jy Top frame: Phas deg
Vector averaged cross-power spectrum Baseline: EF (02) - BR (13)
Timerange: 01/00:46:12 to 01/00:47:10

Plot file version1088 created 03-MAR-2016 01:15:06

J1545+5400 GN002C 1.UVDATA.1

Freq = 1.2770 GHz, Bw = 16.000 MH Calibrated with CL # 3 and BP # 1 (BP mode 1)

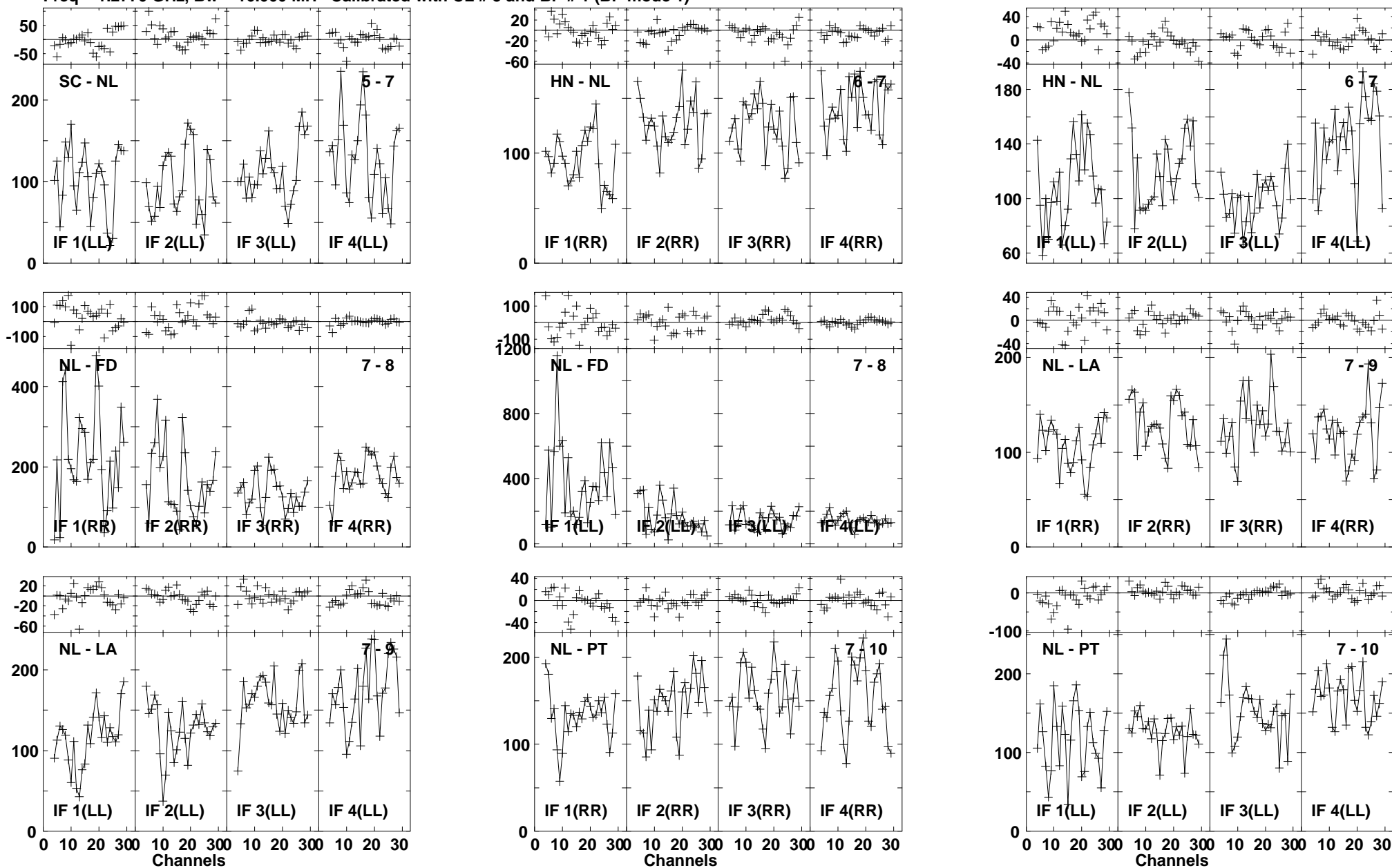

Plot file version1089 created 03-MAR-2016 01:15:07

J1545+5400 GN002C 1.UVDATA.1

Freq = 1.2770 GHz, Bw = 16.000 MH Calibrated with CL # 3 and BP # 1 (BP mode 1)

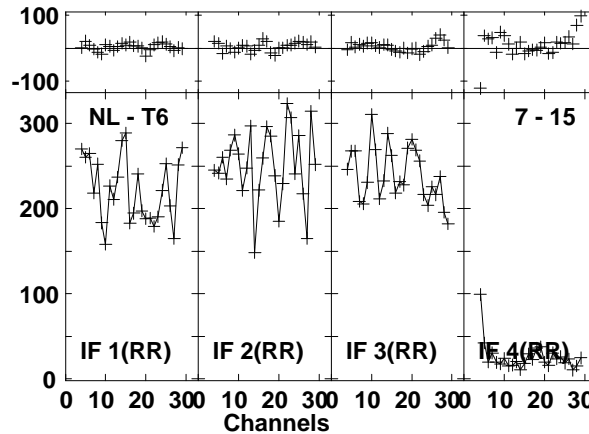
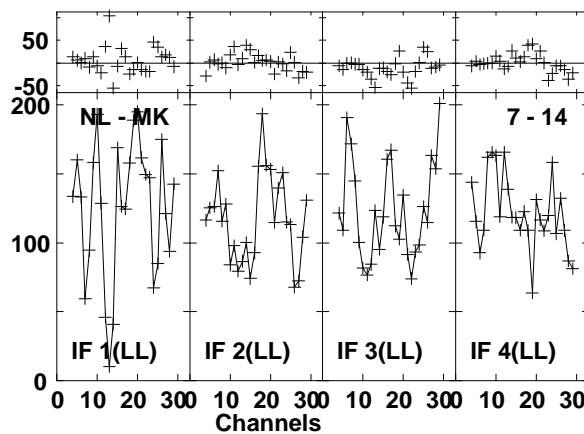
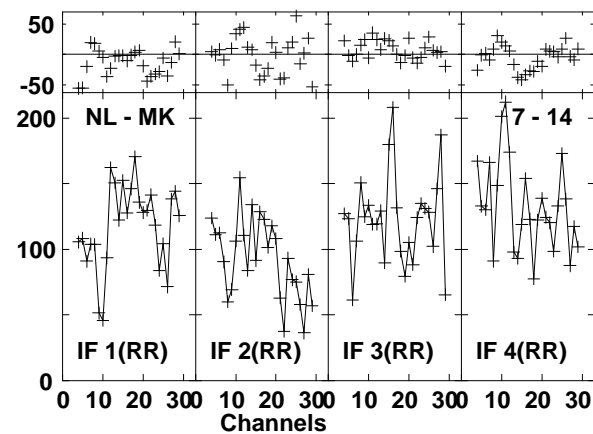
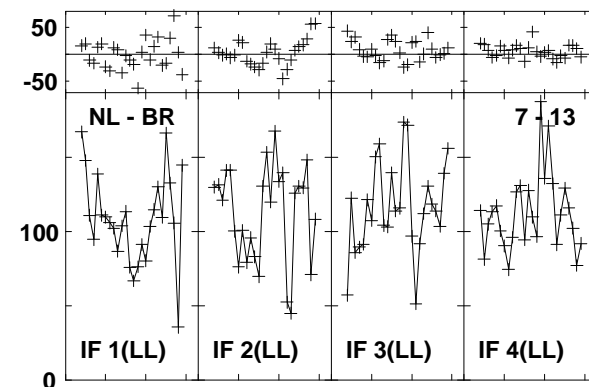
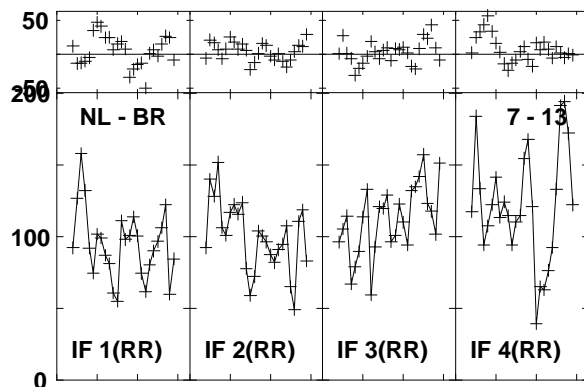
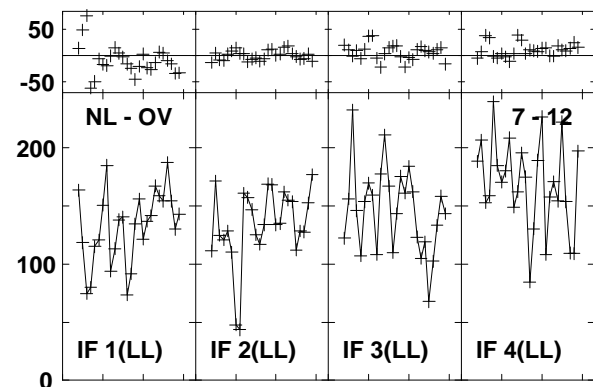
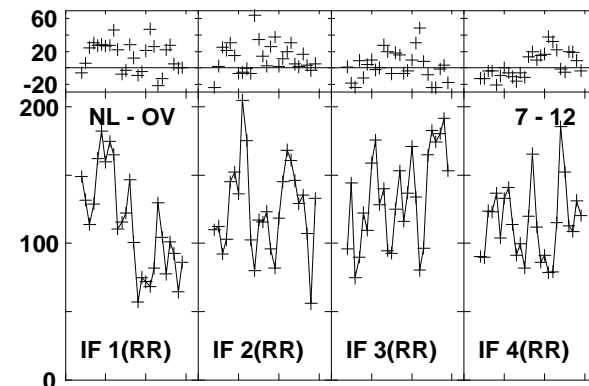
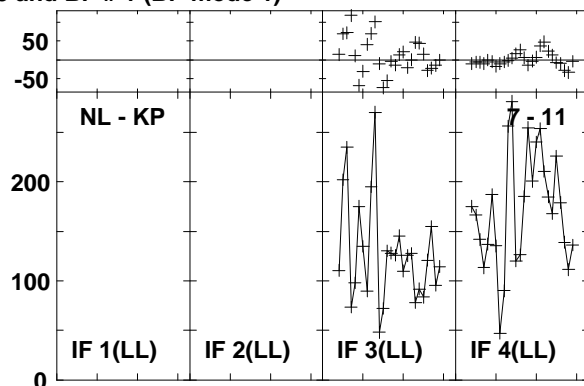
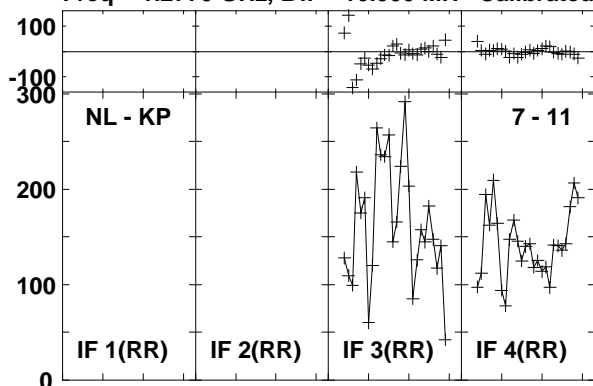

Lower frame: Milli Ampl Jy Top frame: Phas deg
Vector averaged cross-power spectrum Baseline: NL (07) - KP (11)
Timerange: 01/00:46:12 to 01/00:47:10

Plot file version1090 created 03-MAR-2016 01:15:07
J1545+5400 GN002C 1.UVDATA.1
Freq = 1.2770 GHz, Bw = 16.000 MH Calibrated with CL # 3 and BP # 1 (BP mode 1)

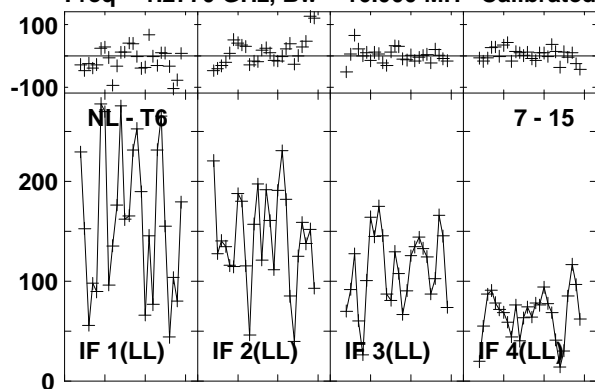

Lower frame: Milli Ampl Jy Top frame: Phas deg
Vector averaged cross-power spectrum Baseline: NL (07) - T6 (15)
Timerange: 01/00:46:12 to 01/00:47:10

Plot file version1091 created 03-MAR-2016 01:15:07

4C52 GN002C 1.UVDATA.1

Freq = 1.2770 GHz, Bw = 16.000 MH Calibrated with CL # 3 and BP # 1 (BP mode 1)

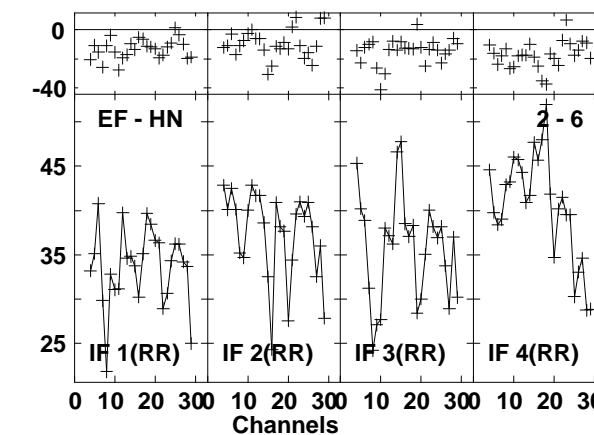
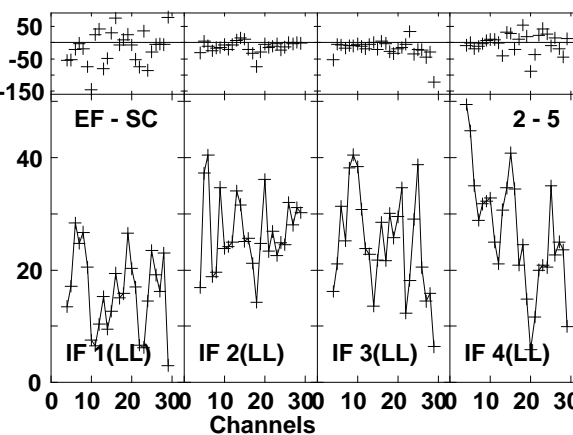
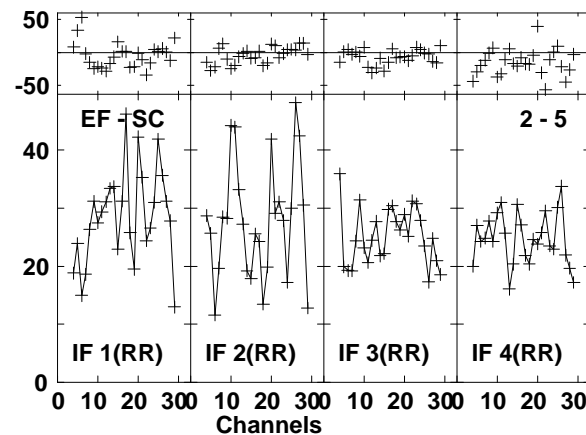
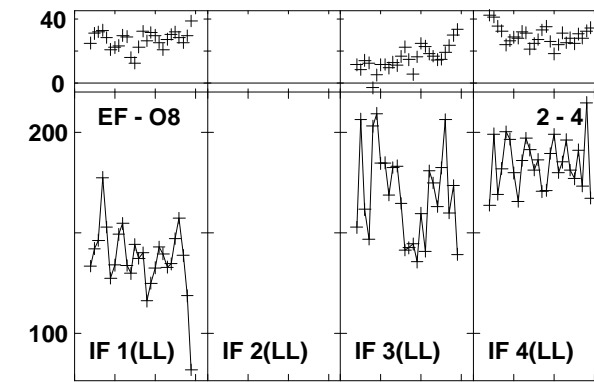
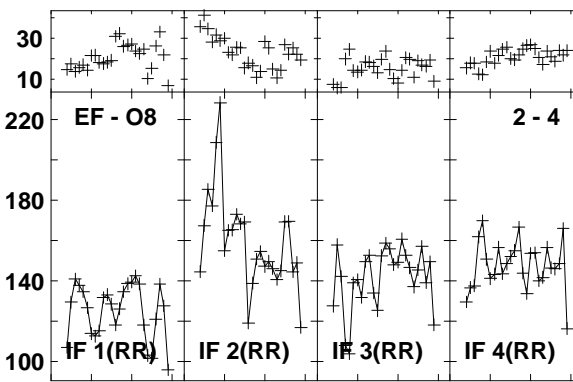
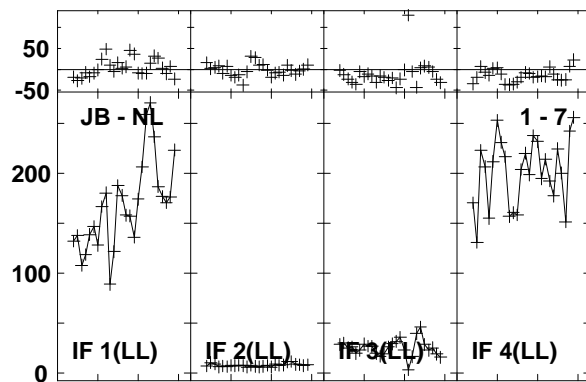
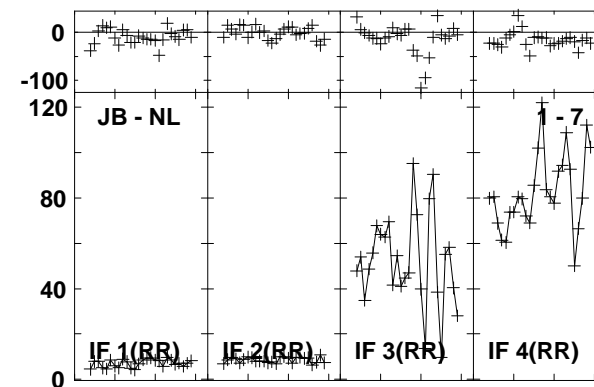
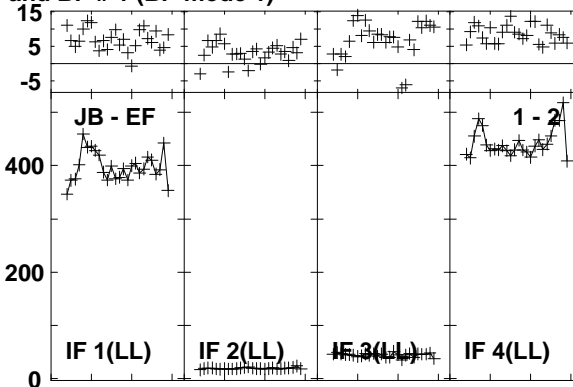
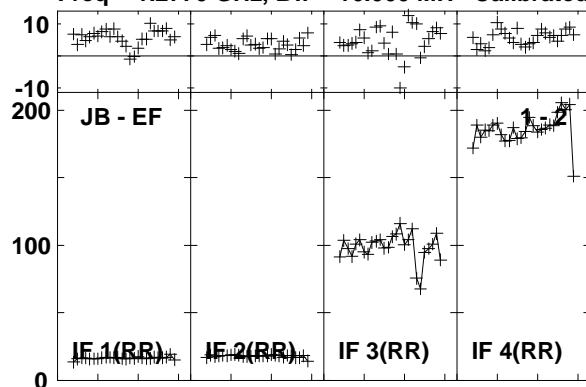

Lower frame: Milli Ampl Jy Top frame: Phas deg
Vector averaged cross-power spectrum Baseline: JB (01) - EF (02)
Timerange: 01/00:47:15 to 01/00:50:39

Plot file version1092 created 03-MAR-2016 01:15:07

4C52 GN002C 1.UVDATA.1

Freq = 1.2770 GHz, Bw = 16.000 MH Calibrated with CL # 3 and BP # 1 (BP mode 1)

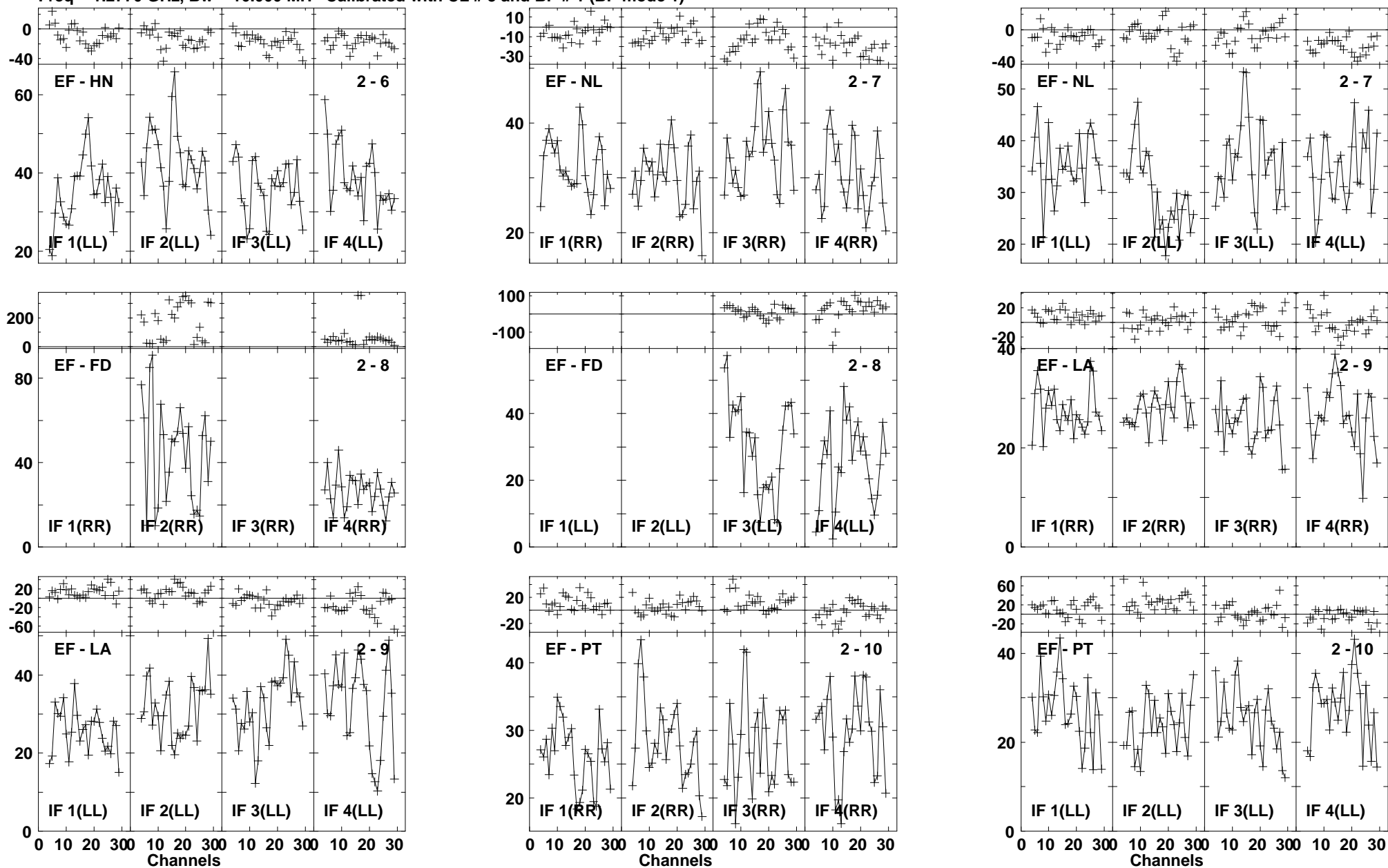

Lower frame: Milli Ampl Jy Top frame: Phas deg
Vector averaged cross-power spectrum Baseline: EF (02) - HN (06)
Timerange: 01/00:47:15 to 01/00:50:39

Plot file version1093 created 03-MAR-2016 01:15:08

4C52 GN002C 1.UVDATA.1

Freq = 1.2770 GHz, Bw = 16.000 MH Calibrated with CL # 3 and BP # 1 (BP mode 1)

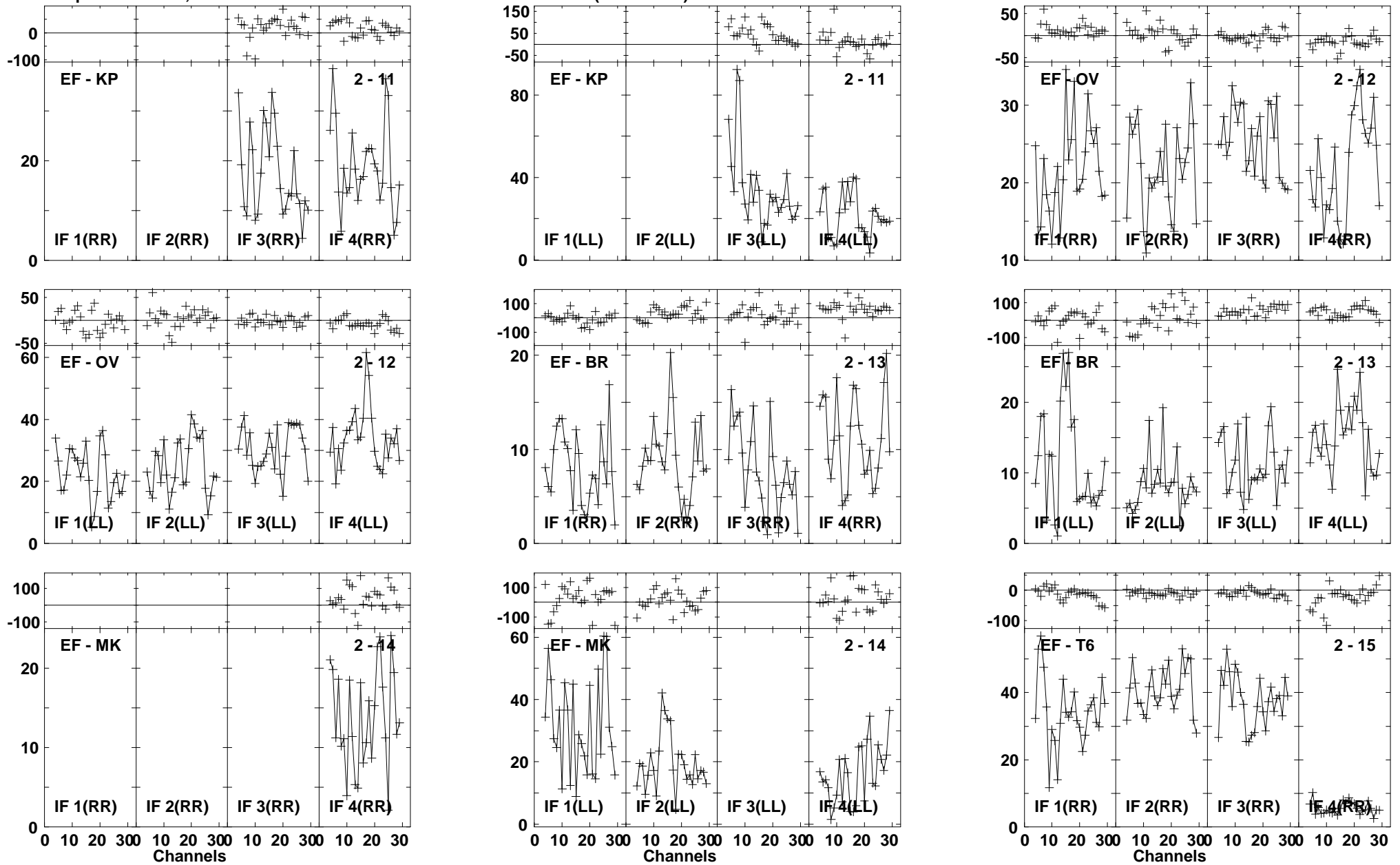

Lower frame: Milli Ampl Jy Top frame: Phas deg
Vector averaged cross-power spectrum Baseline: EF (02) - KP (11)
Timerange: 01/00:47:15 to 01/00:50:39

Plot file version1094 created 03-MAR-2016 01:15:08

4C52 GN002C 1.UVDATA.1

Freq = 1.2770 GHz, Bw = 16.000 MH Calibrated with CL # 3 and BP # 1 (BP mode 1)

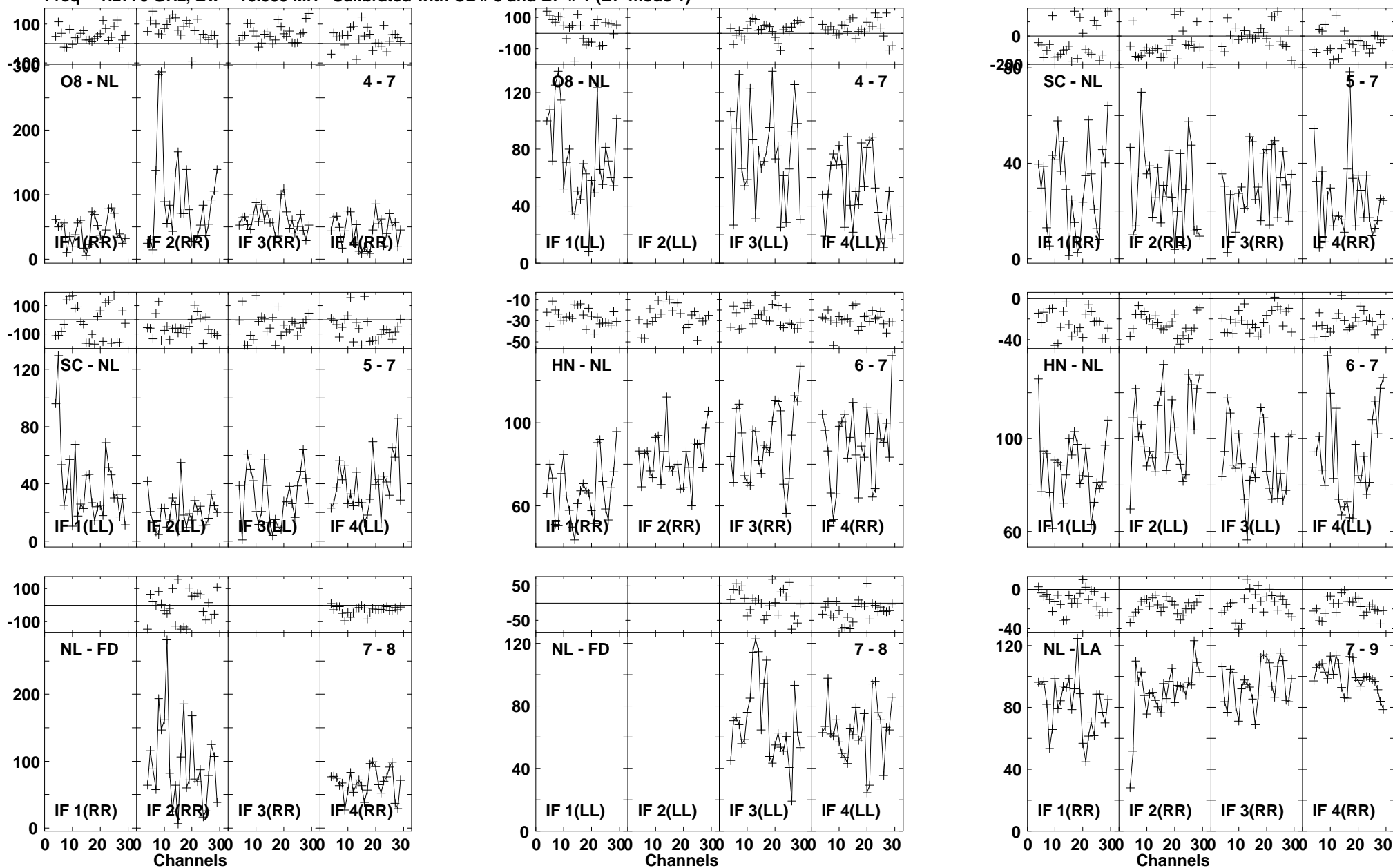

Lower frame: Milli Ampl Jy Top frame: Phas deg
Vector averaged cross-power spectrum Baseline: O8 (04) - NL (07)
Timerange: 01/00:47:15 to 01/00:50:39

Plot file version1095 created 03-MAR-2016 01:15:08

4C52 GN002C 1.UVDATA.1

Freq = 1.2770 GHz, Bw = 16.000 MH Calibrated with CL # 3 and BP # 1 (BP mode 1)

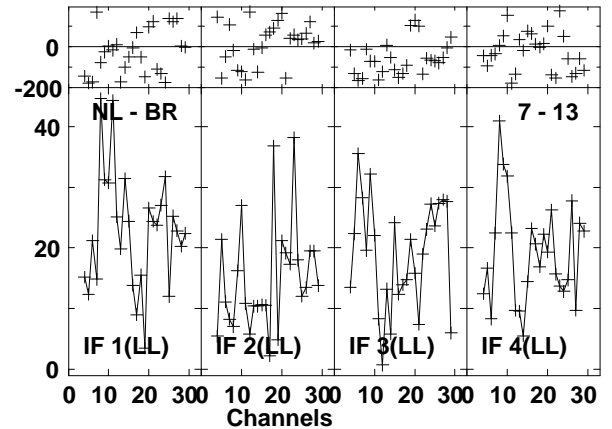
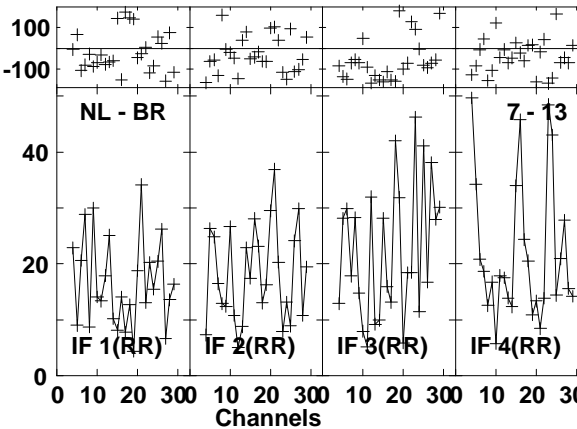
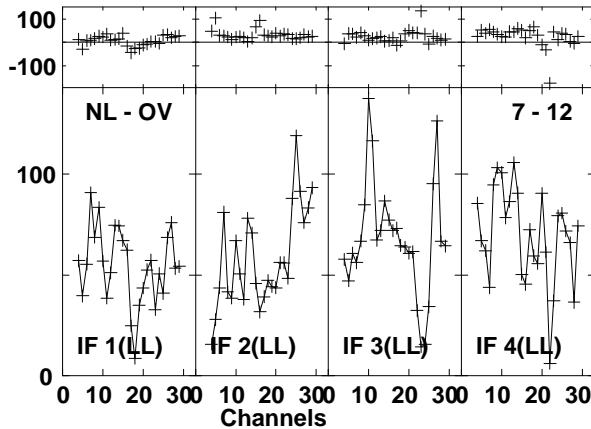
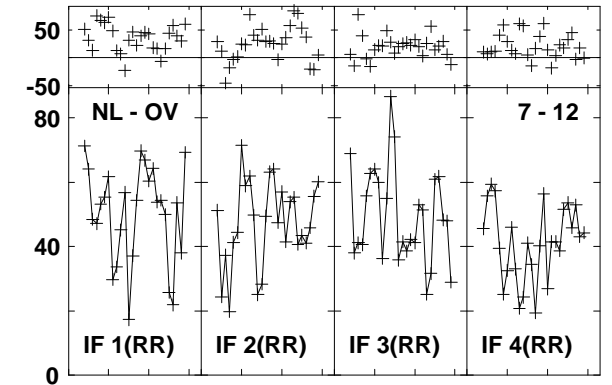
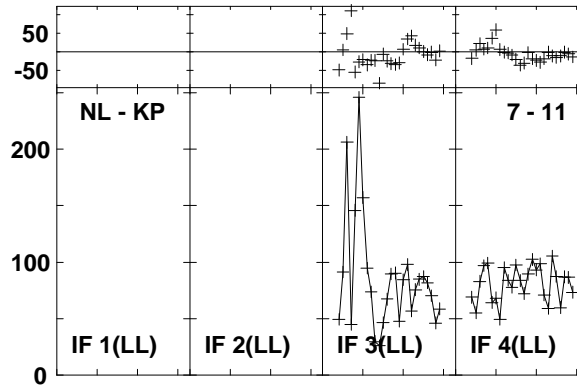
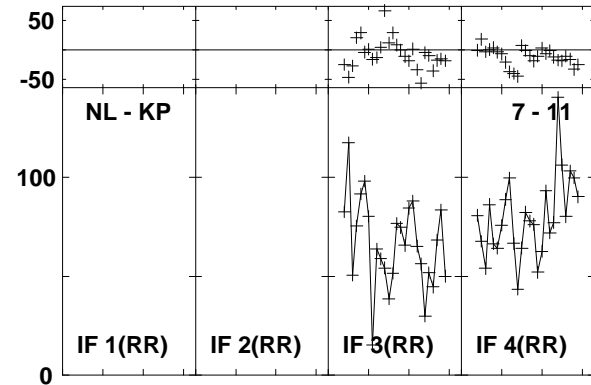
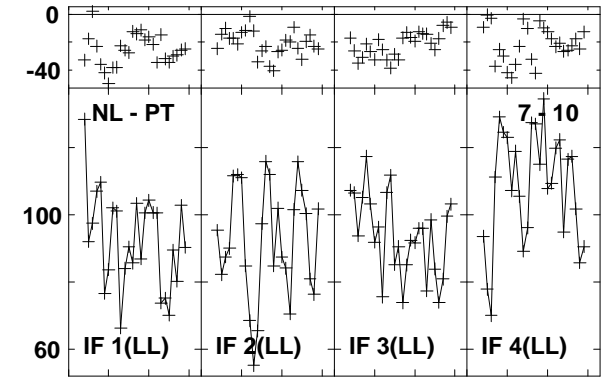
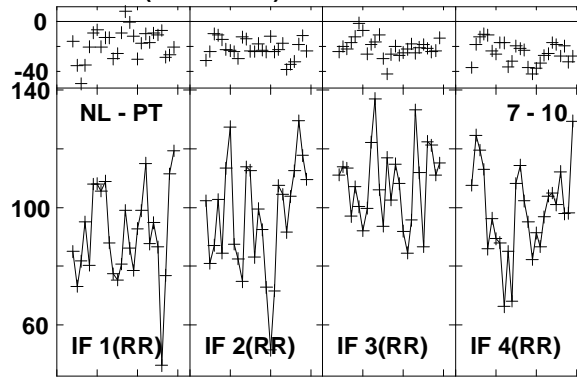
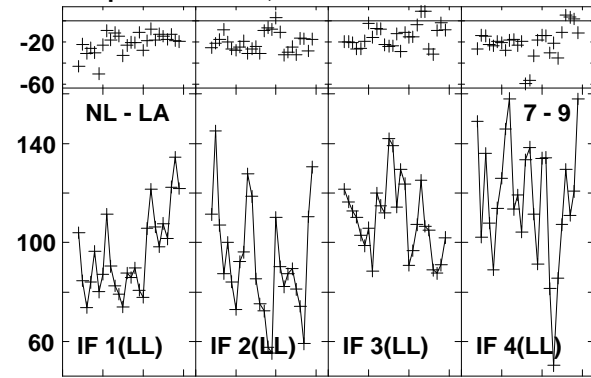

Lower frame: Milli Ampl Jy Top frame: Phas deg
Vector averaged cross-power spectrum Baseline: NL (07) - LA (09)
Timerange: 01/00:47:15 to 01/00:50:39

Plot file version1096 created 03-MAR-2016 01:15:08

4C52 GN002C 1.UVDATA.1

Freq = 1.2770 GHz, Bw = 16.000 MH Calibrated with CL # 3 and BP # 1 (BP mode 1)

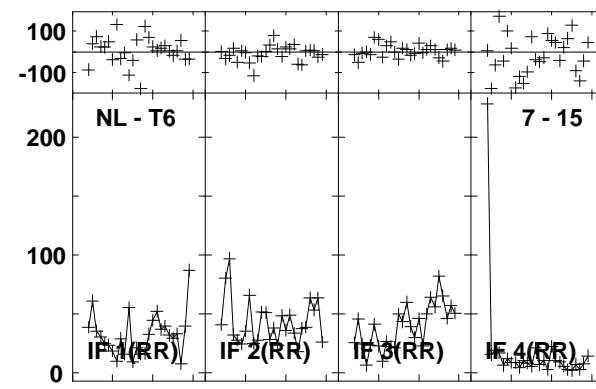
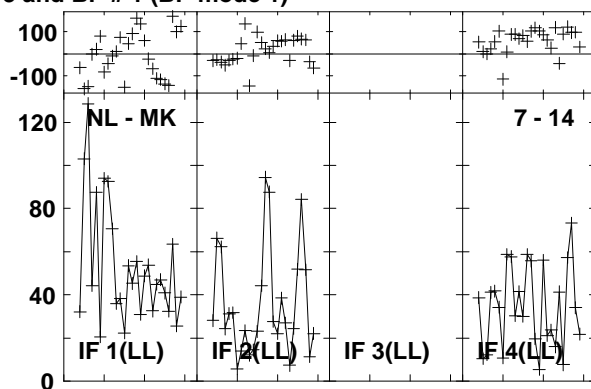
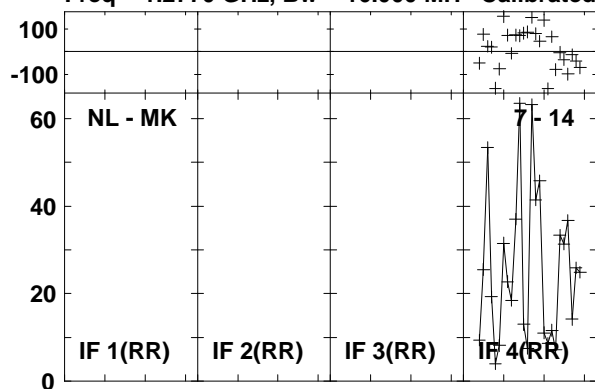

Lower frame: Milli Ampl Jy Top frame: Phas deg
Vector averaged cross-power spectrum Baseline: NL (07) - MK (14)
Timerange: 01/00:47:15 to 01/00:50:39

Plot file version1097 created 03-MAR-2016 01:15:08

J1545+5400 GN002C 1.UVDATA.1

Freq = 1.2770 GHz, Bw = 16.000 MH Calibrated with CL # 3 and BP # 1 (BP mode 1)

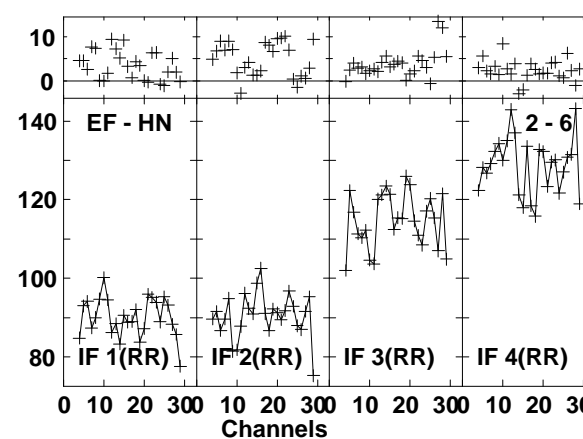
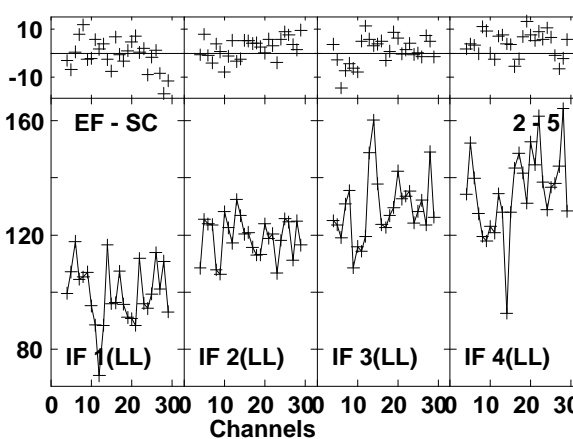
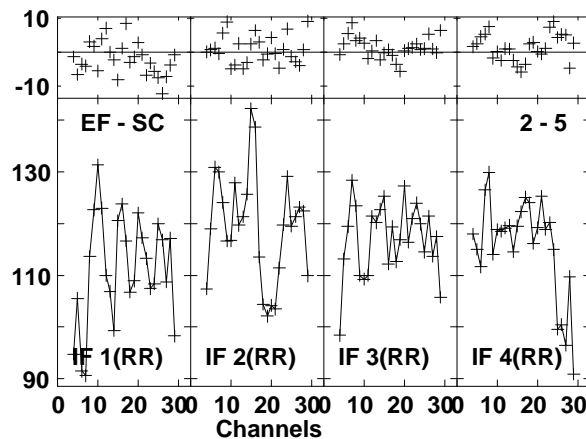
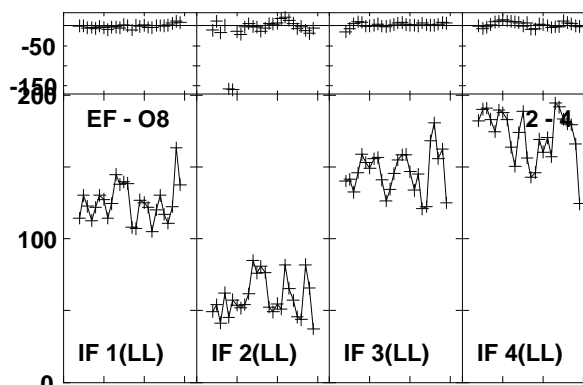
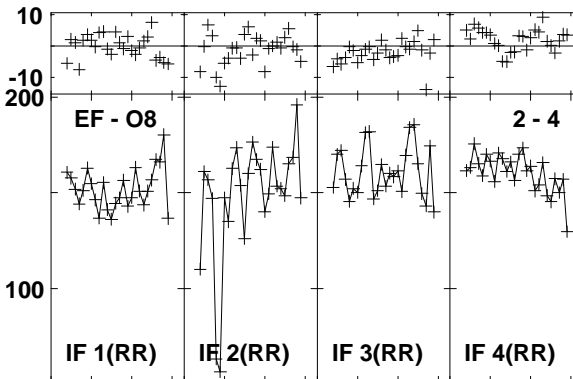
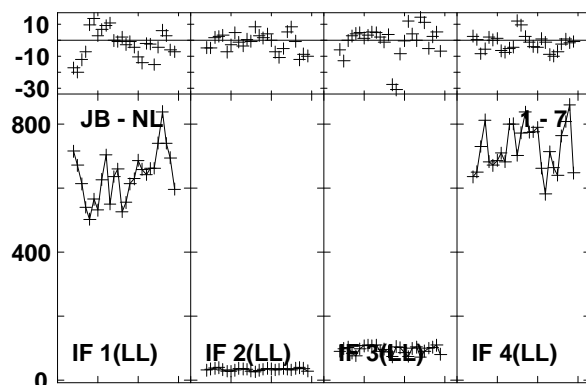
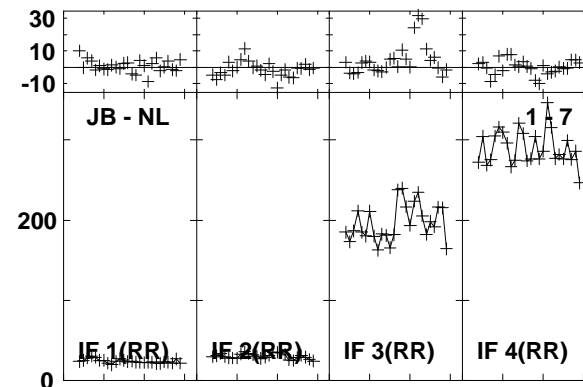
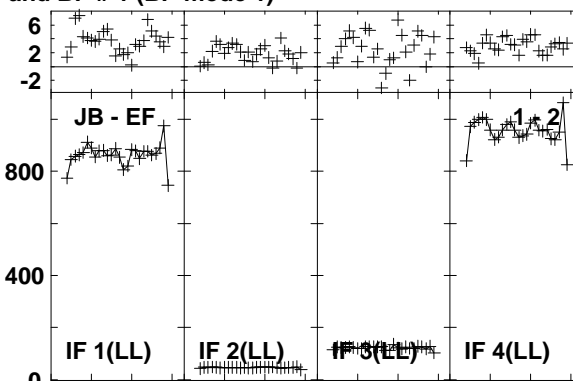
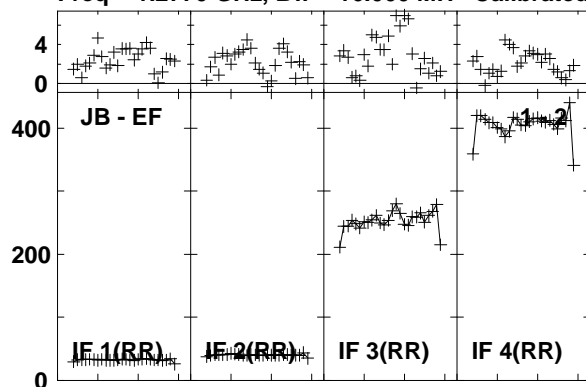

Lower frame: Milli Ampl Jy Top frame: Phas deg
Vector averaged cross-power spectrum Baseline: JB (01) - EF (02)
Timerange: 01/00:51:32 to 01/00:53:30

Plot file version1098 created 03-MAR-2016 01:15:09

J1545+5400 GN002C 1.UVDATA.1

Freq = 1.2770 GHz, Bw = 16.000 MH Calibrated with CL # 3 and BP # 1 (BP mode 1)

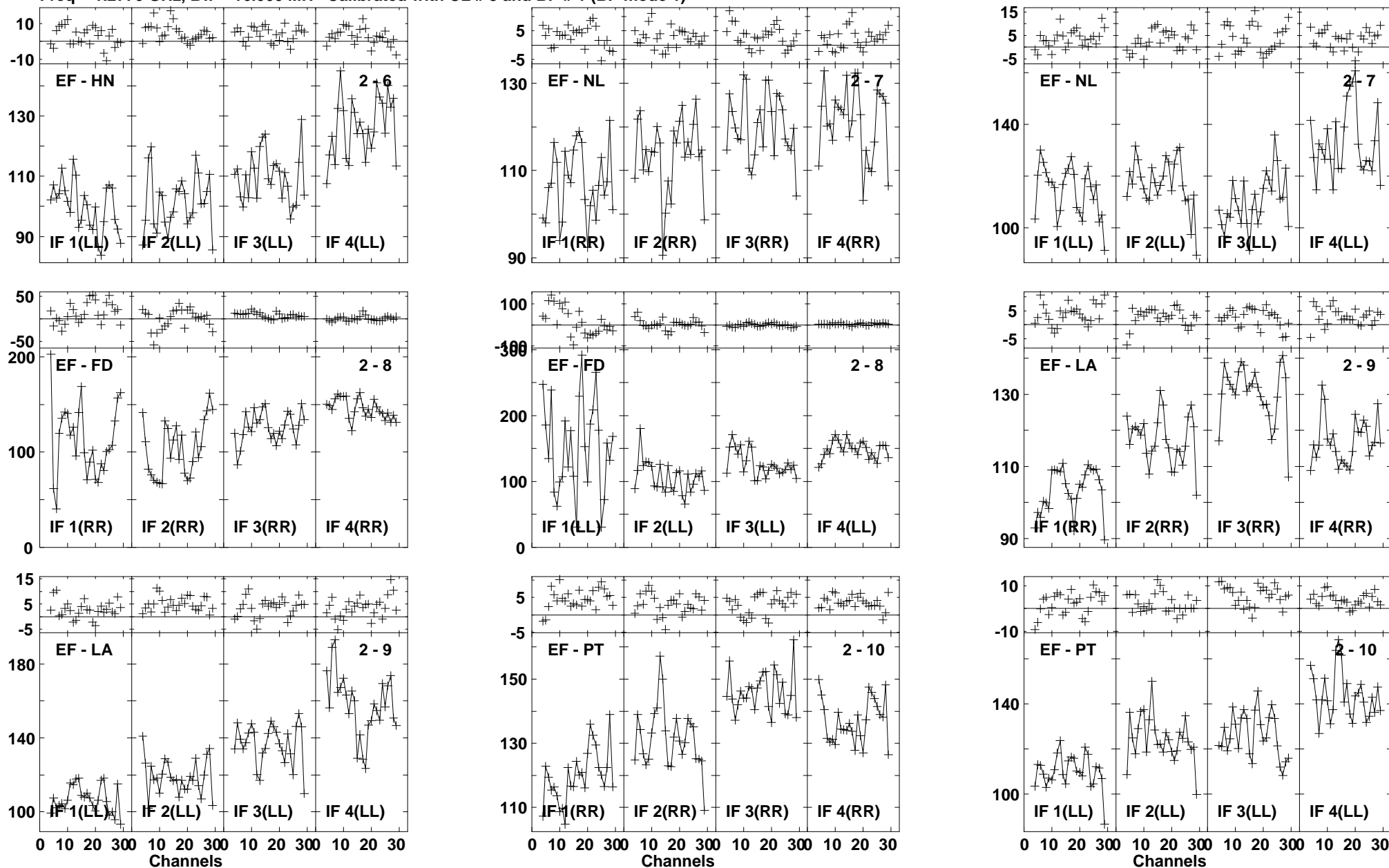

Lower frame: Milli Ampl Jy Top frame: Phas deg
Vector averaged cross-power spectrum Baseline: EF (02) - HN (06)
Timerange: 01/00:51:32 to 01/00:53:30

Plot file version1099 created 03-MAR-2016 01:15:09

J1545+5400 GN002C 1.UVDATA.1

Freq = 1.2770 GHz, Bw = 16.000 MH Calibrated with CL # 3 and BP # 1 (BP mode 1)

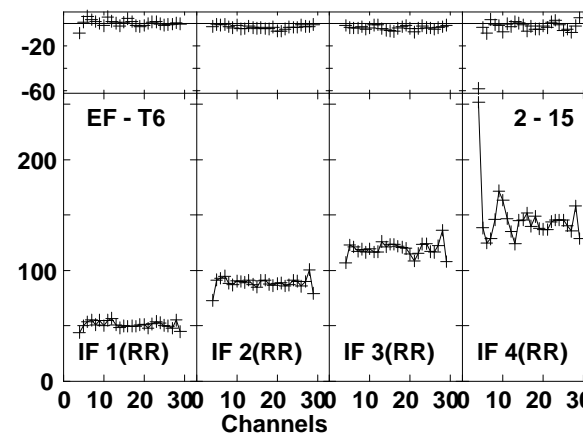
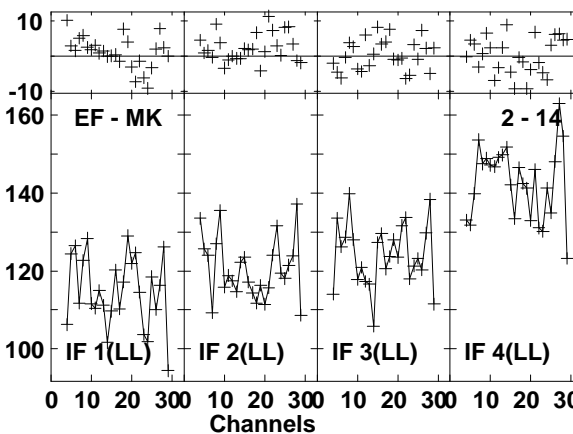
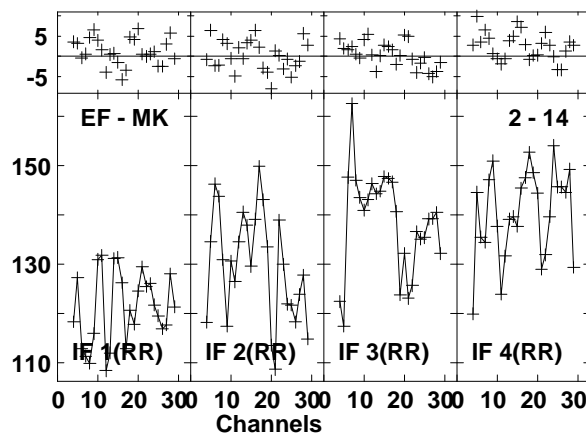
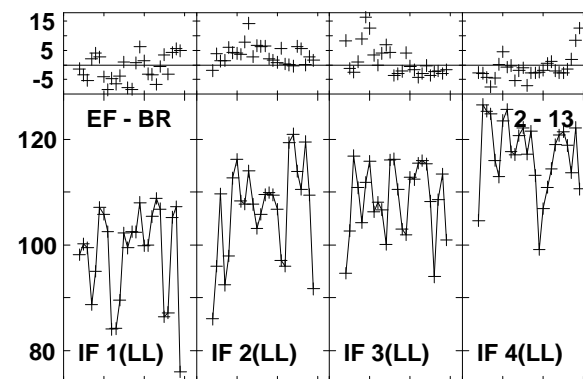
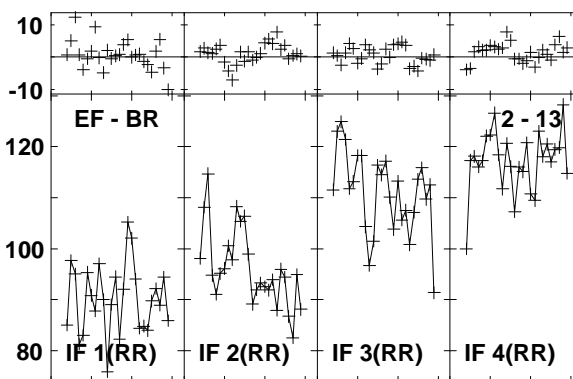
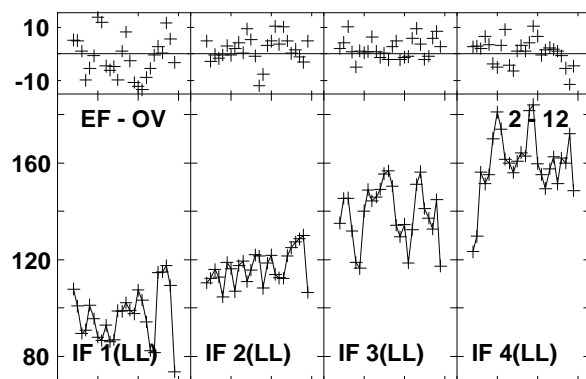
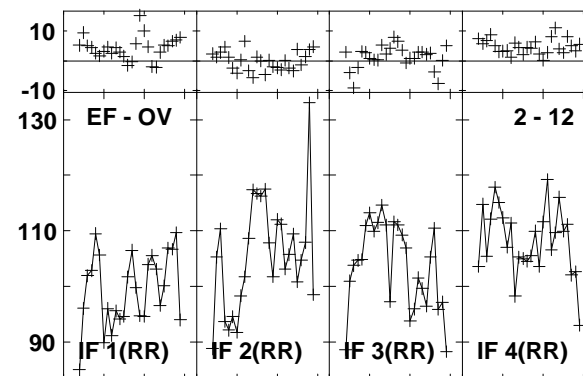
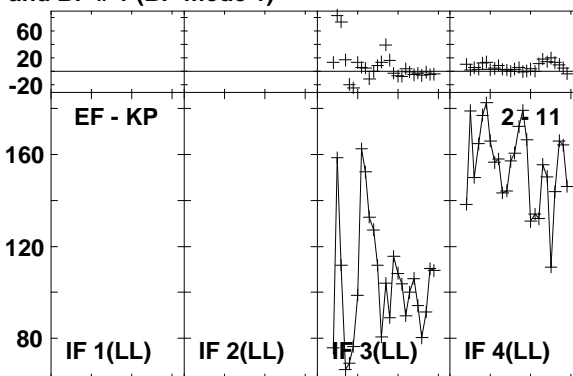
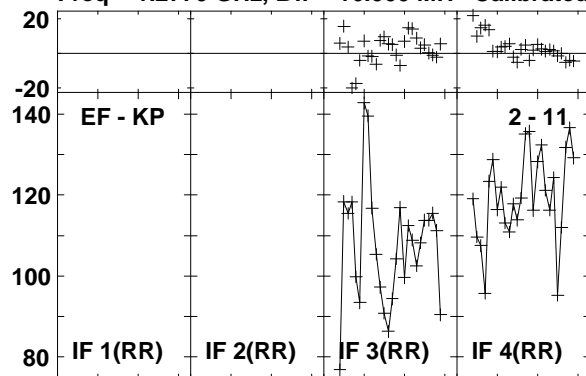

Lower frame: Milli Ampl Jy Top frame: Phas deg
Vector averaged cross-power spectrum Baseline: EF (02) - KP (11)
Timerange: 01/00:51:32 to 01/00:53:30

Plot file version1100 created 03-MAR-2016 01:15:09

J1545+5400 GN002C 1.UVDATA.1

Freq = 1.2770 GHz, Bw = 16.000 MH Calibrated with CL # 3 and BP # 1 (BP mode 1)

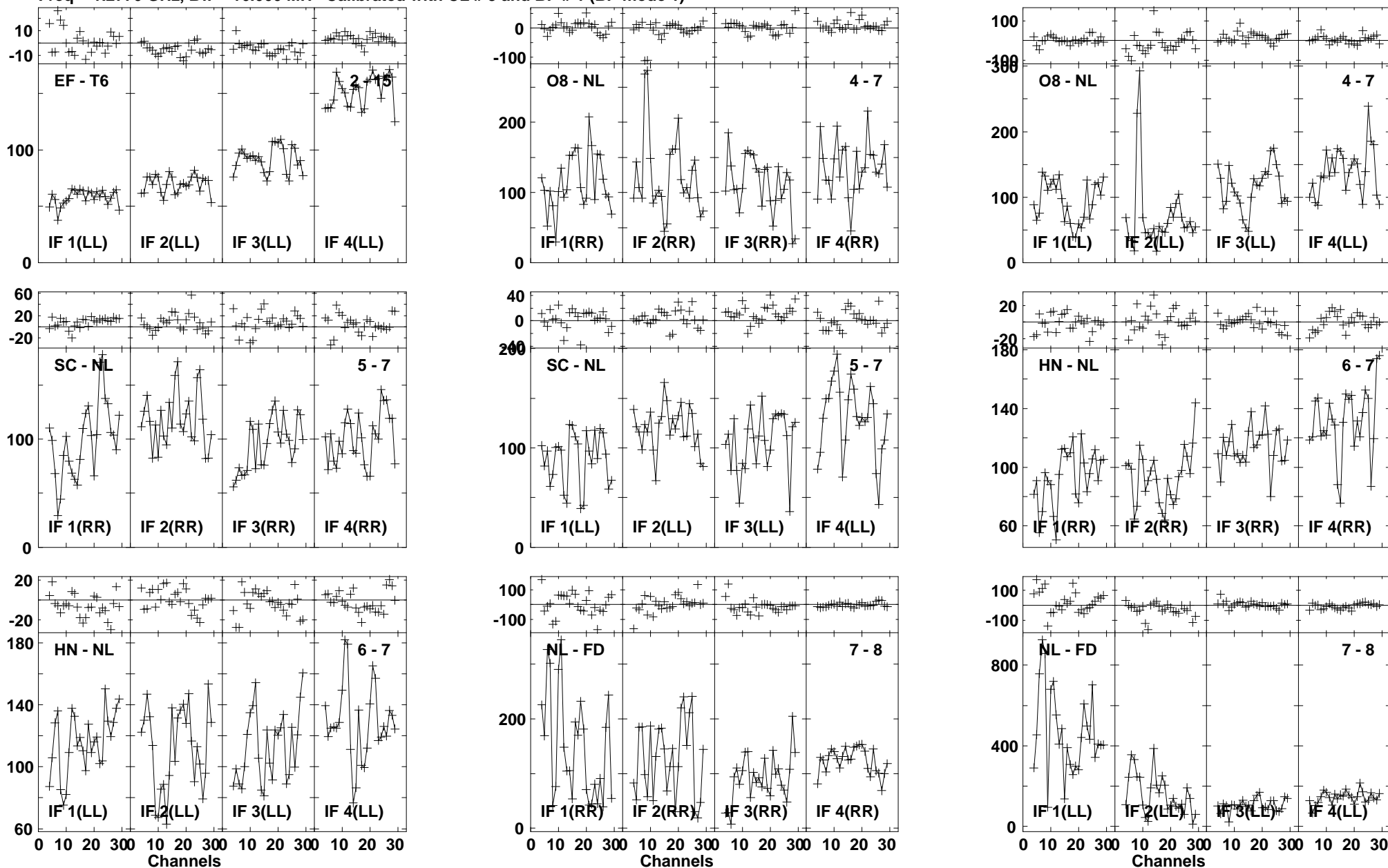

Lower frame: Milli Ampl Jy Top frame: Phas deg
Vector averaged cross-power spectrum Baseline: EF (02) - T6 (15)
Timerange: 01/00:51:32 to 01/00:53:30

Plot file version1101 created 03-MAR-2016 01:15:09

J1545+5400 GN002C 1.UVDATA.1

Freq = 1.2770 GHz, Bw = 16.000 MH Calibrated with CL # 3 and BP # 1 (BP mode 1)

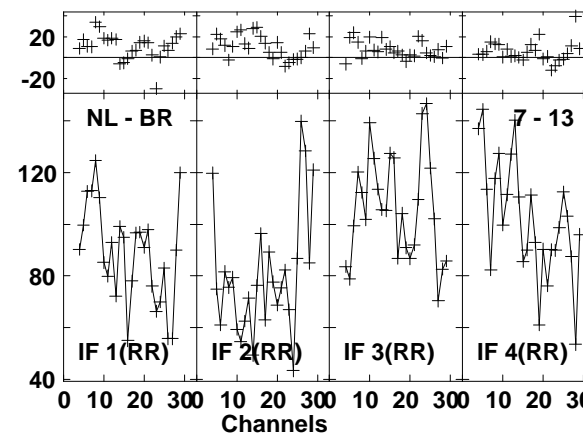
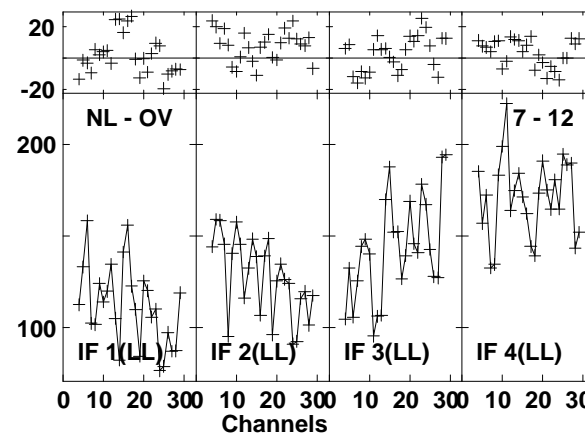
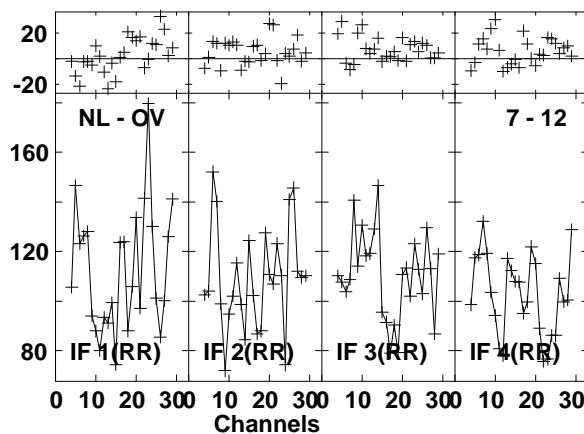
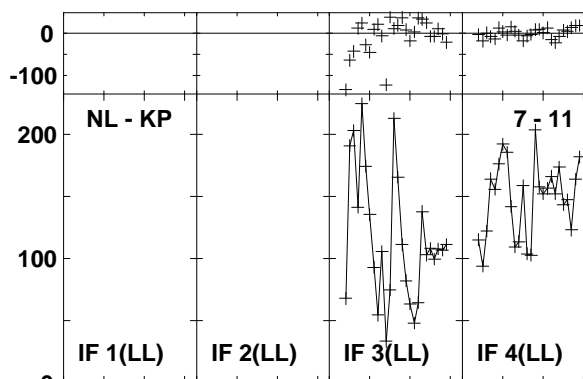
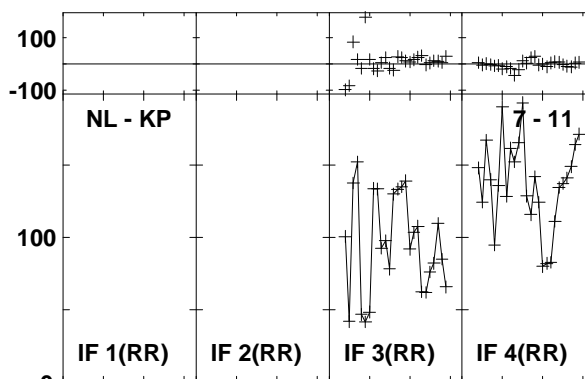
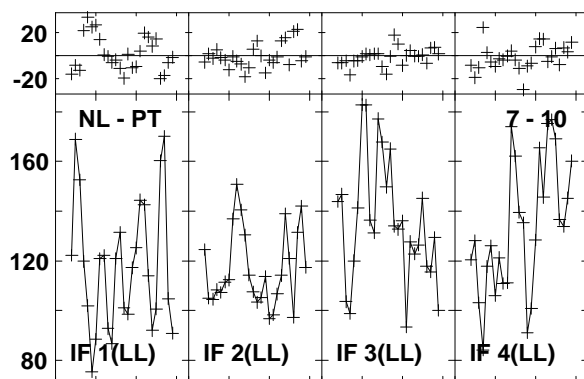
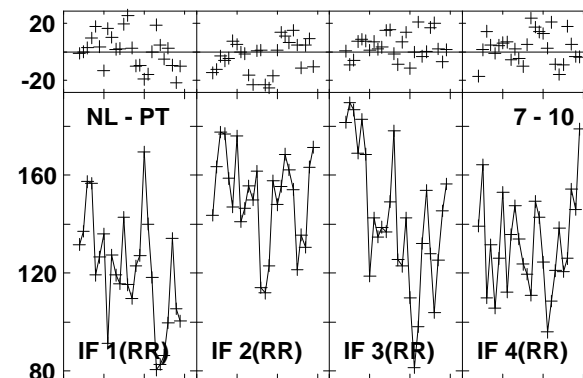
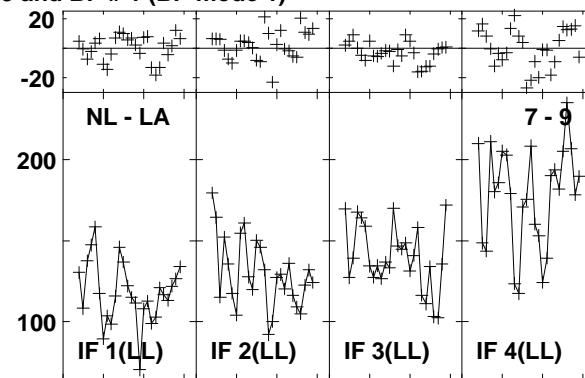
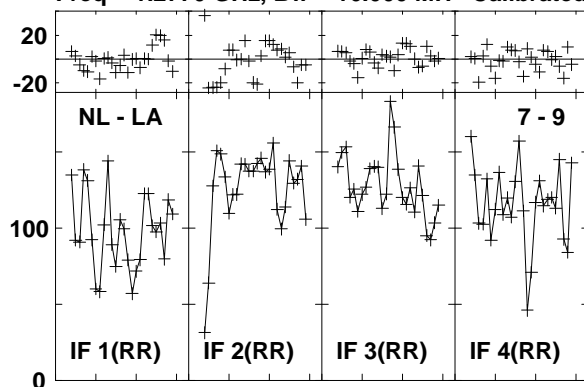

Lower frame: Milli Ampl Jy Top frame: Phas deg
Vector averaged cross-power spectrum Baseline: NL (07) - LA (09)
Timerange: 01/00:51:32 to 01/00:53:30

Plot file version1102 created 03-MAR-2016 01:15:09

J1545+5400 GN002C 1.UVDATA.1

Freq = 1.2770 GHz, Bw = 16.000 MH Calibrated with CL # 3 and BP # 1 (BP mode 1)

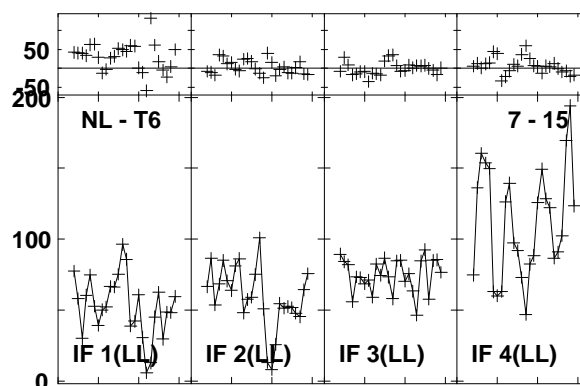
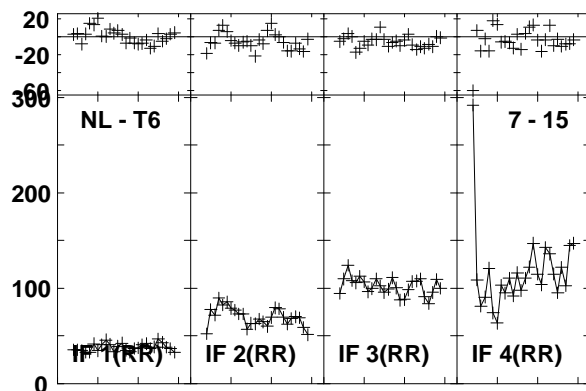
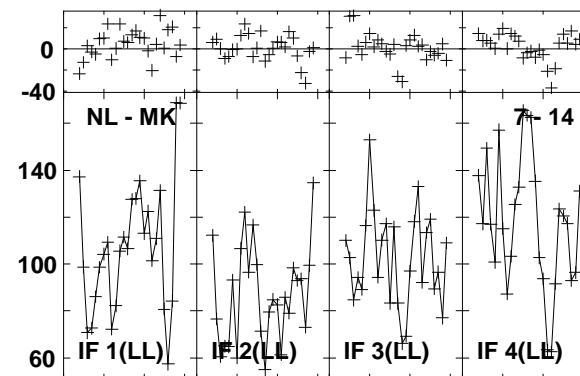
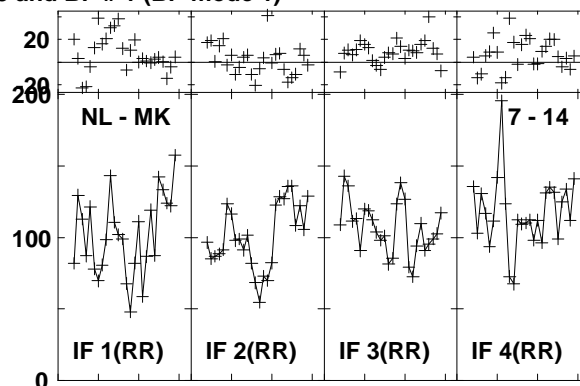
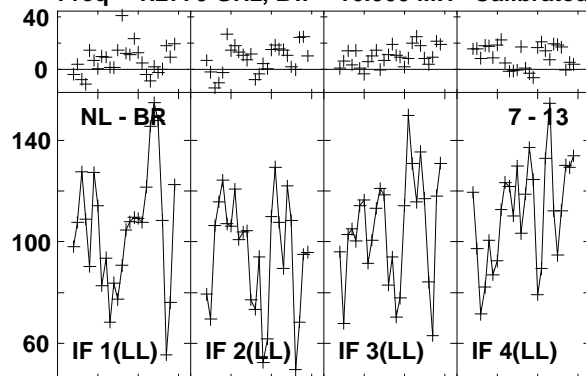

Lower frame: Milli Ampl Jy Top frame: Phas deg
Vector averaged cross-power spectrum Baseline: NL (07) - BR (13)
Timerange: 01/00:51:32 to 01/00:53:30

Plot file version1103 created 03-MAR-2016 01:15:09

4C52 GN002C 1.UVDATA.1

Freq = 1.2770 GHz, Bw = 16.000 MH Calibrated with CL # 3 and BP # 1 (BP mode 1)

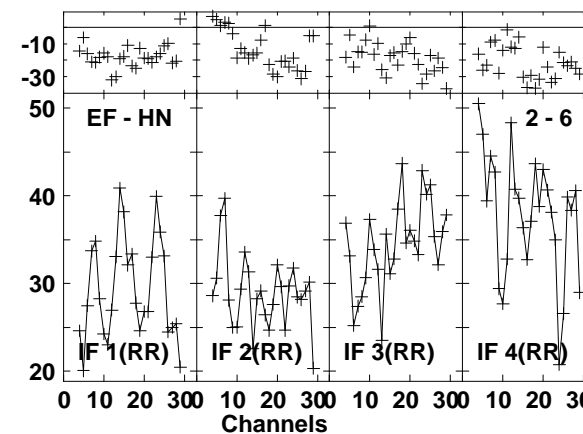
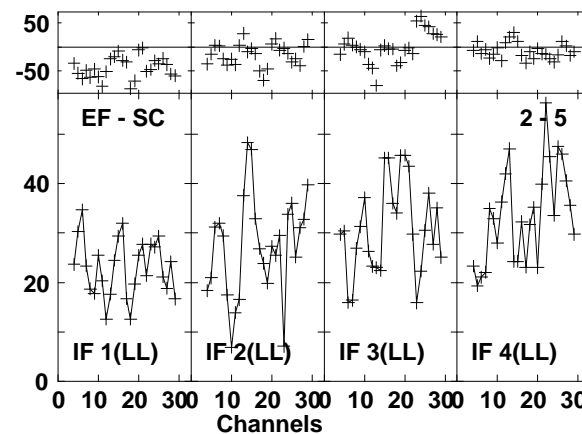
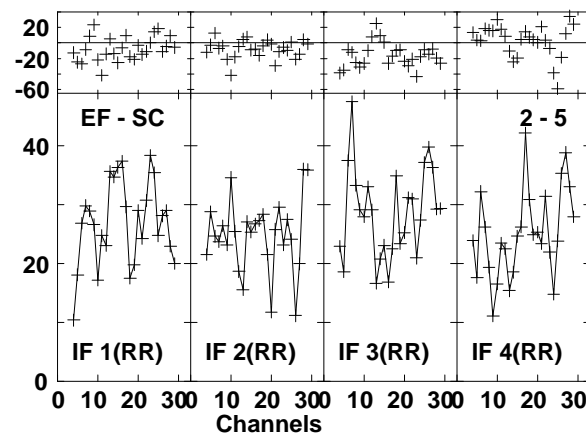
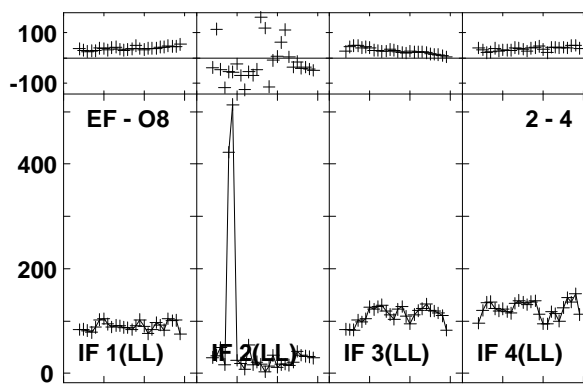
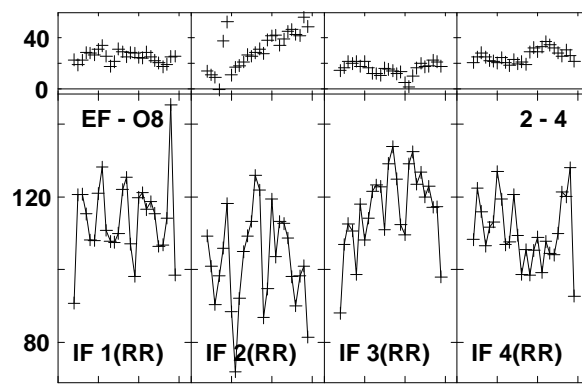
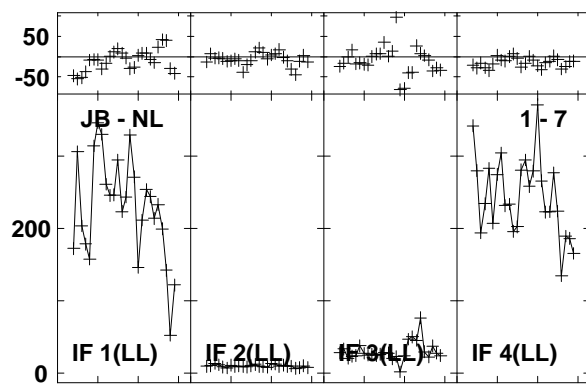
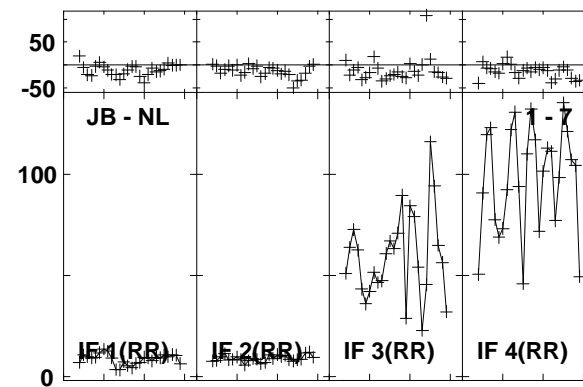
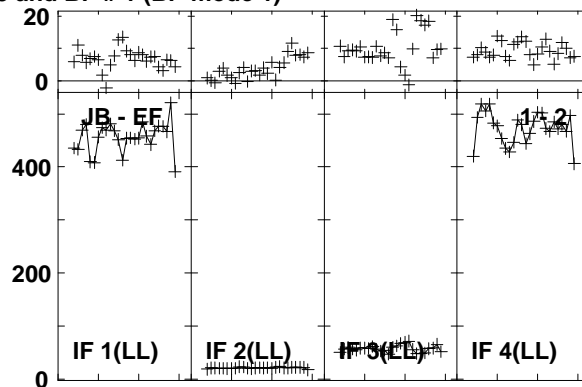
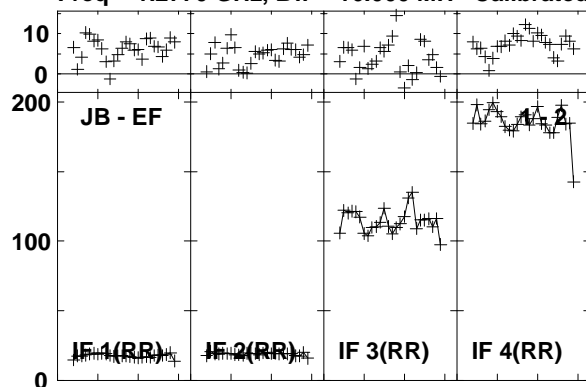

Lower frame: Milli Ampl Jy Top frame: Phas deg
Vector averaged cross-power spectrum Baseline: JB (01) - EF (02)
Timerange: 01/00:53:43 to 01/00:56:59

Plot file version1104 created 03-MAR-2016 01:15:10
 4C52 GN002C 1.UVDATA.1
 Freq = 1.2770 GHz, Bw = 16.000 MH Calibrated with CL # 3 and BP # 1 (BP mode 1)

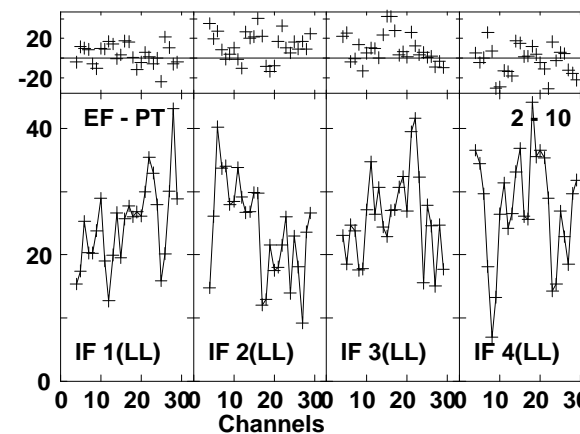
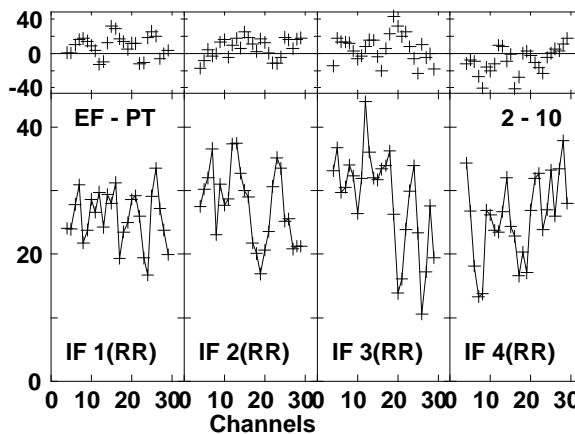
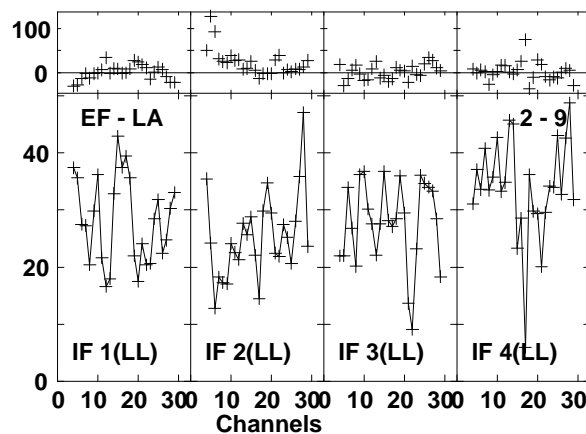
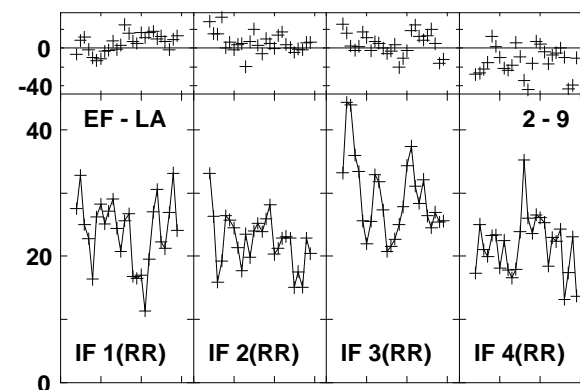
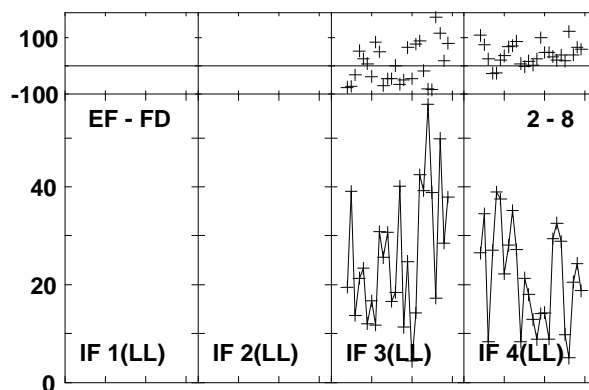
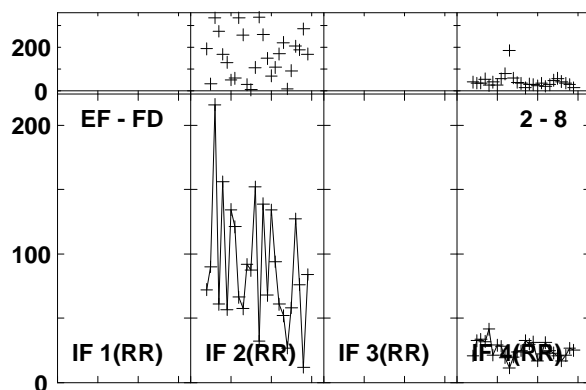
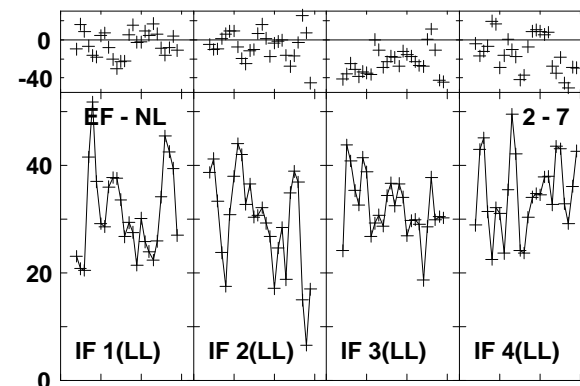
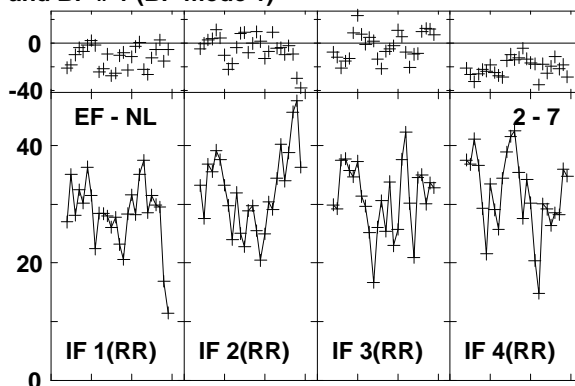
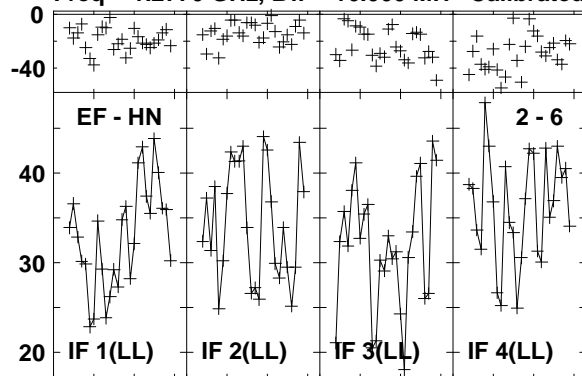

Lower frame: Milli Ampl Jy Top frame: Phas deg
 Vector averaged cross-power spectrum Baseline: EF (02) - HN (06)
 Timerange: 01/00:53:43 to 01/00:56:59

Plot file version1105 created 03-MAR-2016 01:15:10
 4C52 GN002C 1.UVDATA.1
 Freq = 1.2770 GHz, Bw = 16.000 MH Calibrated with CL # 3 and BP # 1 (BP mode 1)

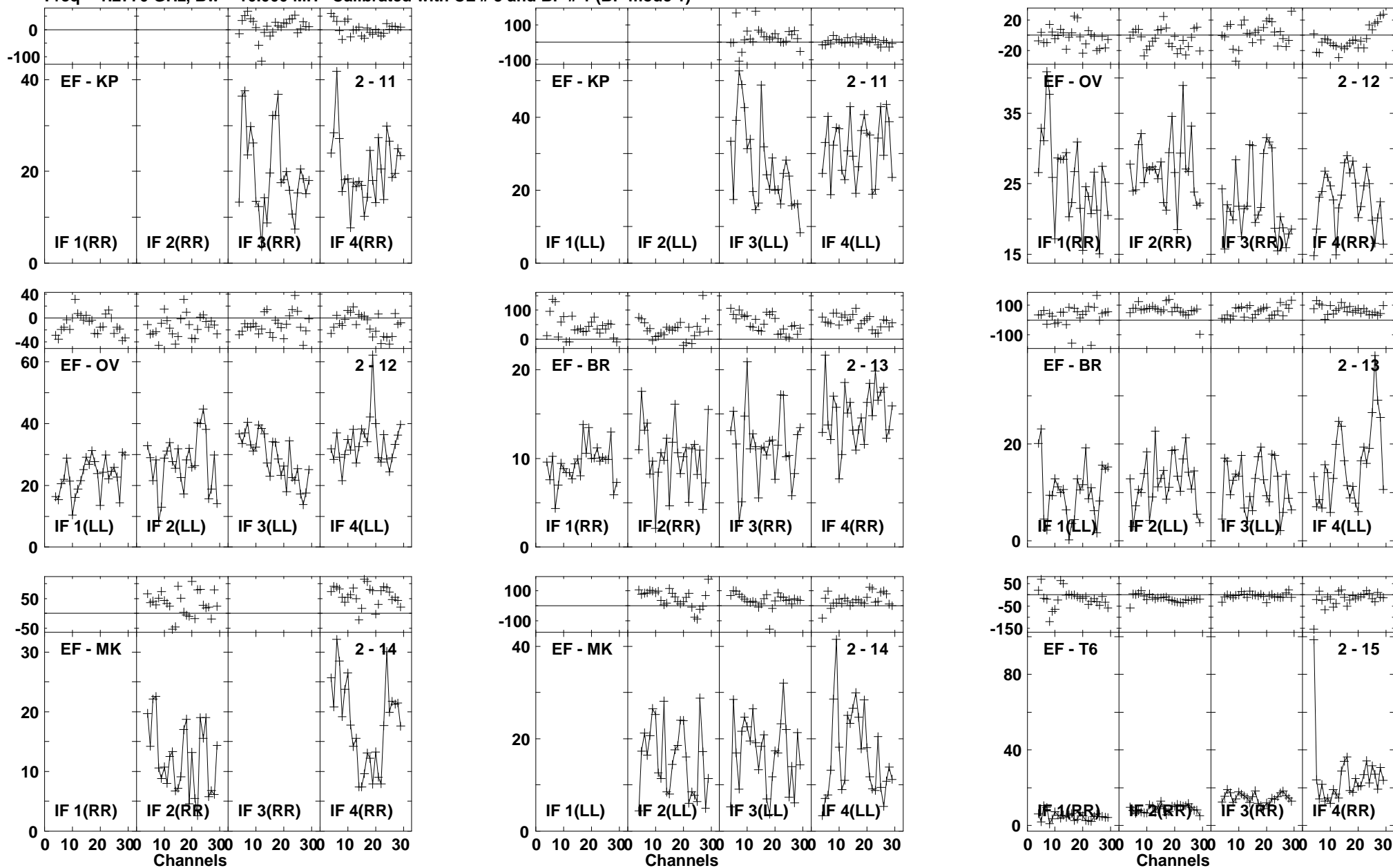

Lower frame: Milli Ampl Jy Top frame: Phas deg
 Vector averaged cross-power spectrum Baseline: EF (02) - KP (11)
 Timerange: 01/00:53:43 to 01/00:56:59

Plot file version1106 created 03-MAR-2016 01:15:10

4C52 GN002C 1.UVDATA.1

Freq = 1.2770 GHz, Bw = 16.000 MH Calibrated with CL # 3 and BP # 1 (BP mode 1)

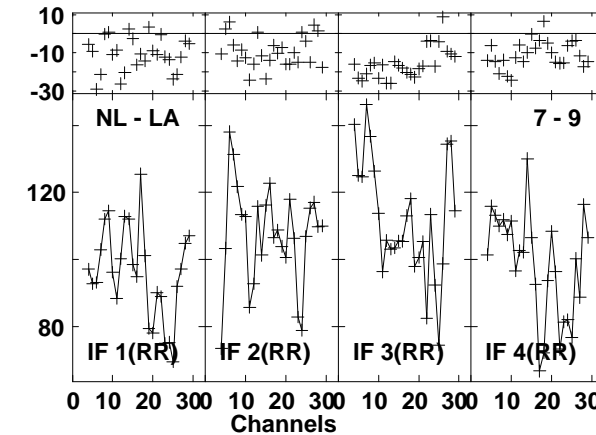
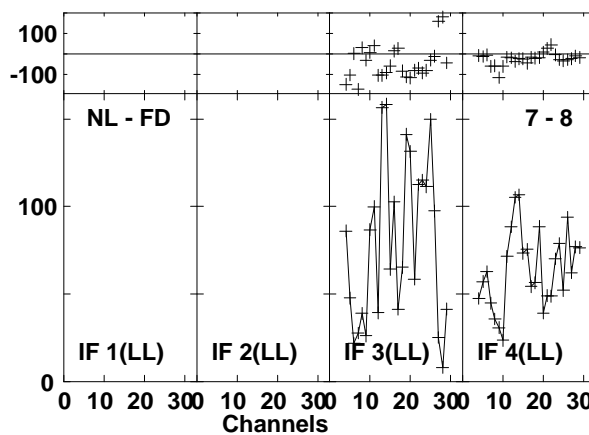
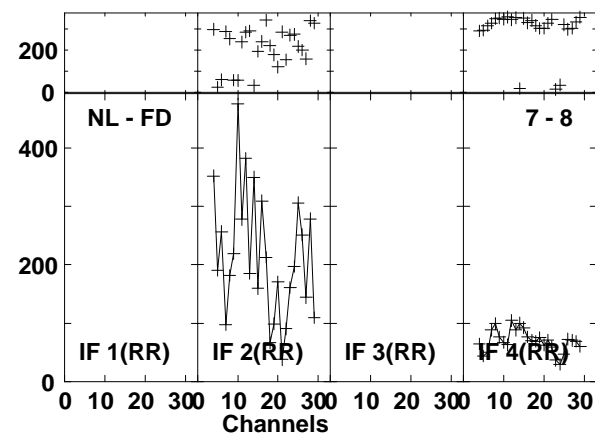
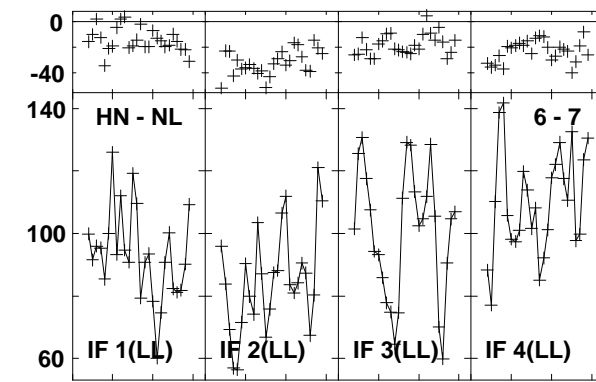
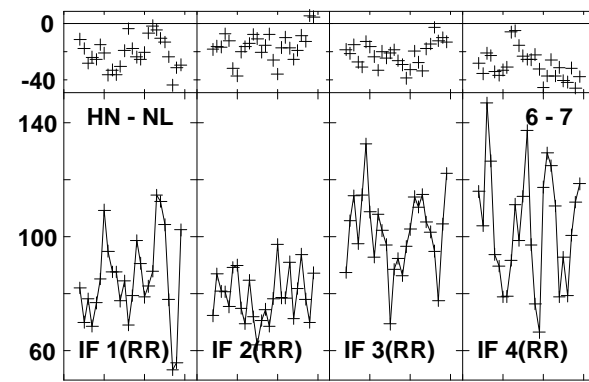
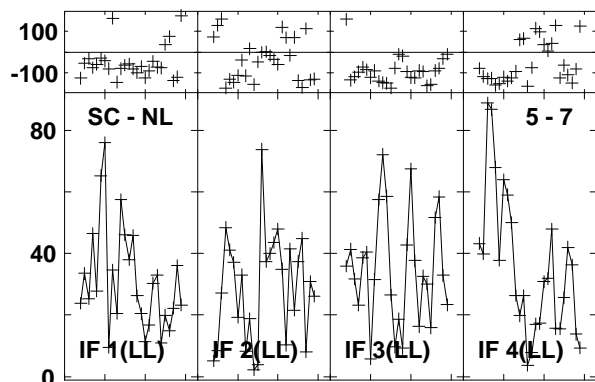
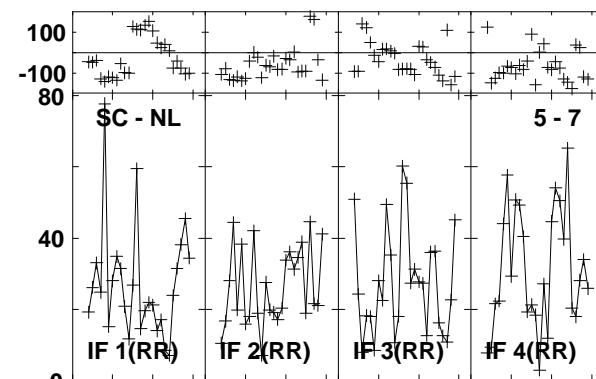
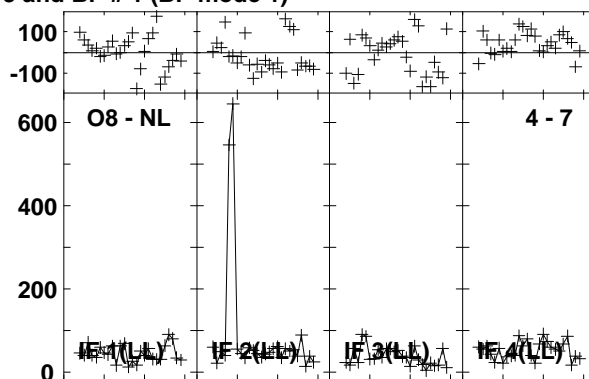
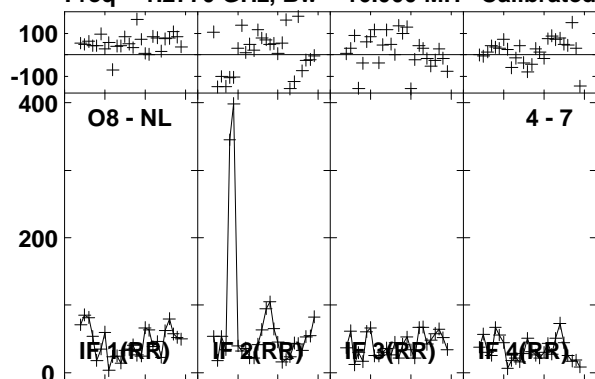

Lower frame: Milli Ampl Jy Top frame: Phas deg

Vector averaged cross-power spectrum Baseline: O8 (04) - NL (07)

Timerange: 01/00:53:43 to 01/00:56:59

Plot file version1107 created 03-MAR-2016 01:15:10

4C52 GN002C 1.UVDATA.1

Freq = 1.2770 GHz, Bw = 16.000 MH Calibrated with CL # 3 and BP # 1 (BP mode 1)

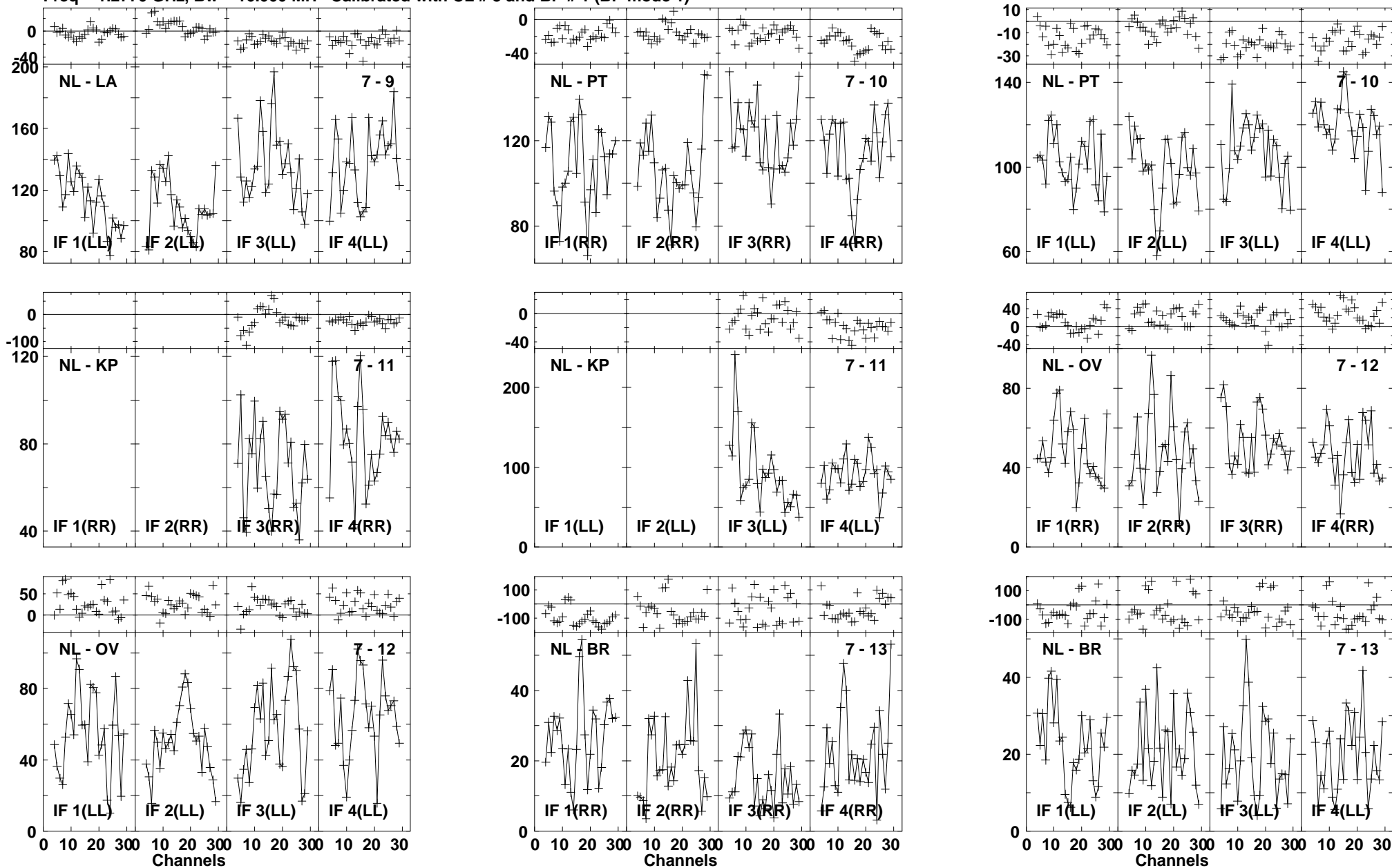

Lower frame: Milli Ampl Jy Top frame: Phas deg
Vector averaged cross-power spectrum Baseline: NL (07) - LA (09)
Timerange: 01/00:53:43 to 01/00:56:59

Plot file version1108 created 03-MAR-2016 01:15:10

4C52 GN002C 1.UVDATA.1

Freq = 1.2770 GHz, Bw = 16.000 MH Calibrated with CL # 3 and BP # 1 (BP mode 1)

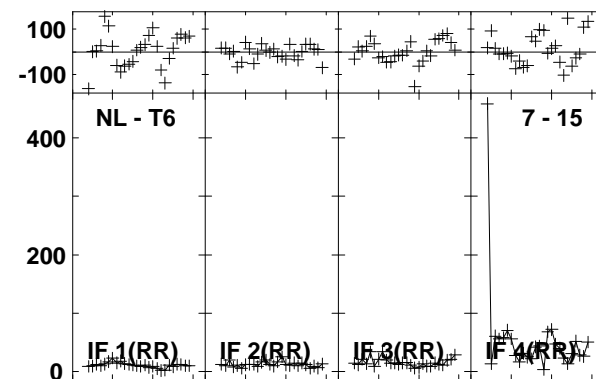
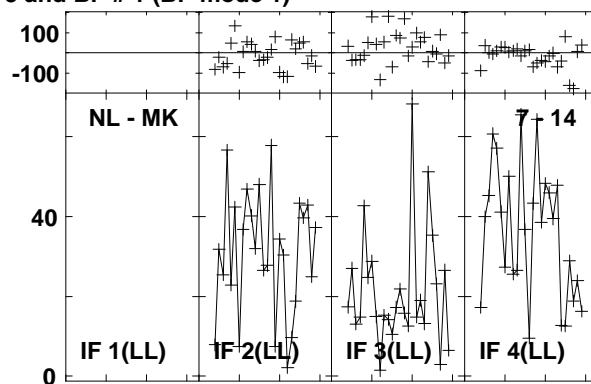
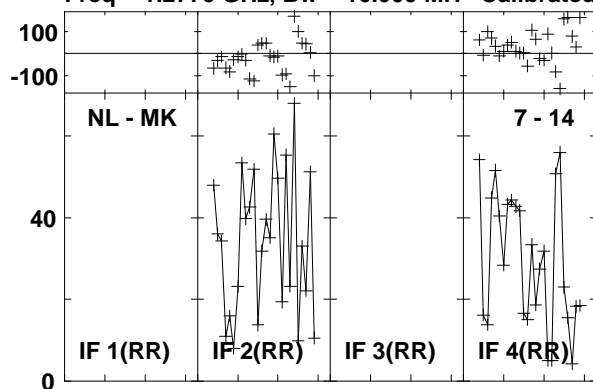

Lower frame: Milli Ampl Jy Top frame: Phas deg
Vector averaged cross-power spectrum Baseline: NL (07) - MK (14)
Timerange: 01/00:53:43 to 01/00:56:59

Plot file version1109 created 03-MAR-2016 01:15:11

J1545+5400 GN002C 1.UVDATA.1

Freq = 1.2770 GHz, Bw = 16.000 MH Calibrated with CL # 3 and BP # 1 (BP mode 1)

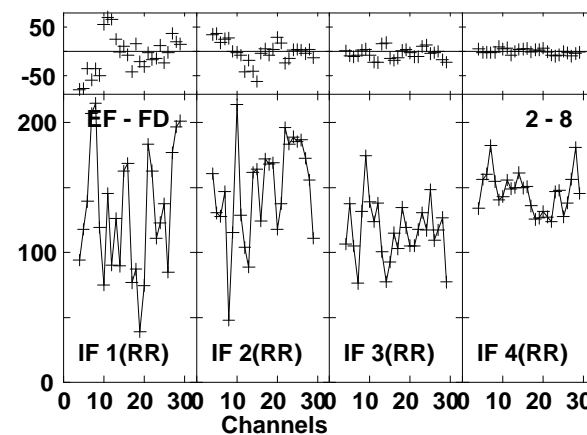
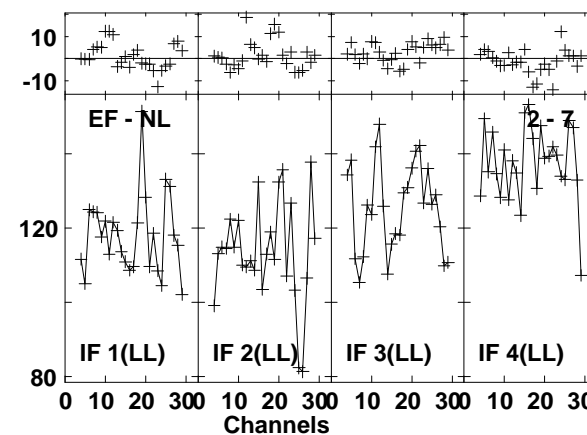
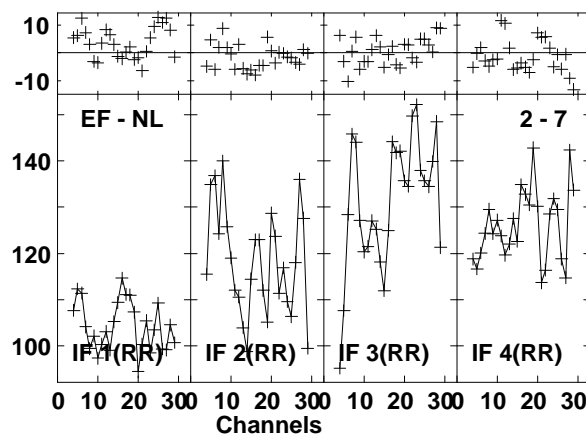
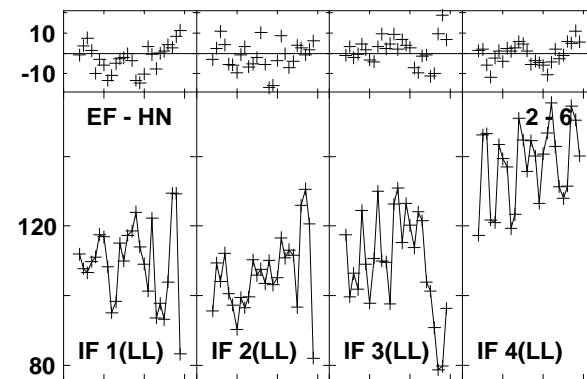
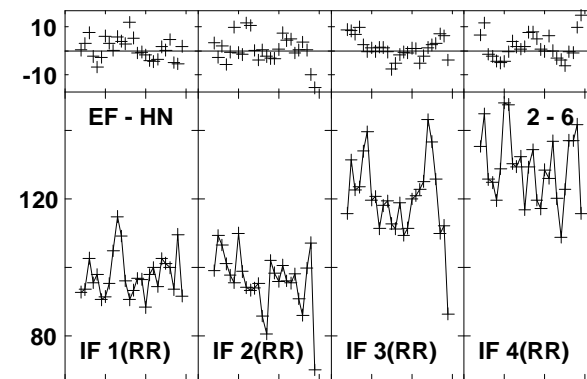
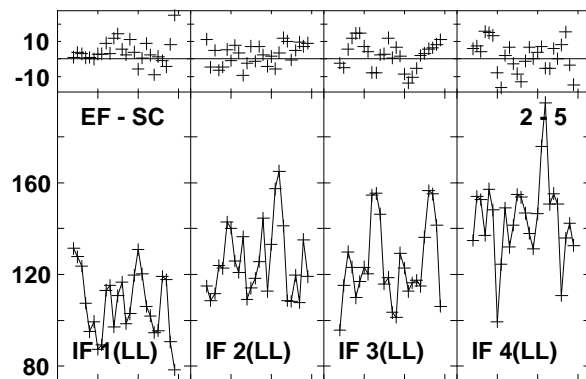
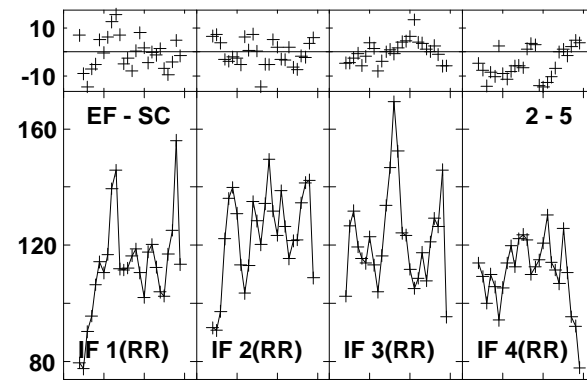
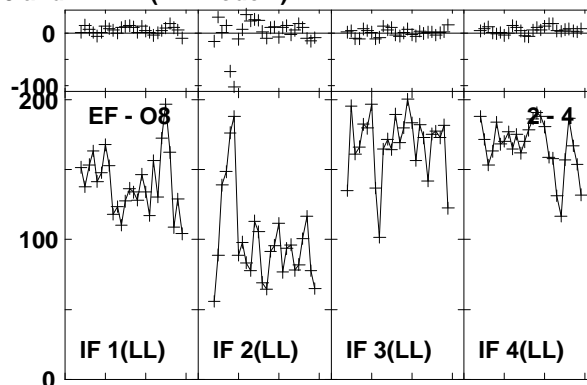
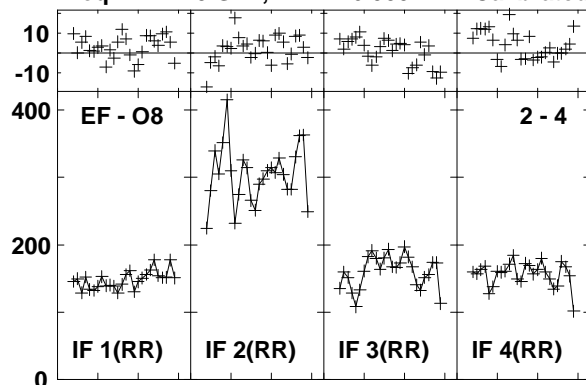

Lower frame: Milli Ampl Jy Top frame: Phas deg
Vector averaged cross-power spectrum Baseline: EF (02) - O8 (04)
Timerange: 01/00:57:52 to 01/00:58:50

Plot file version1110 created 03-MAR-2016 01:15:11

J1545+5400 GN002C 1.UVDATA.1

Freq = 1.2770 GHz, Bw = 16.000 MH Calibrated with CL # 3 and BP # 1 (BP mode 1)

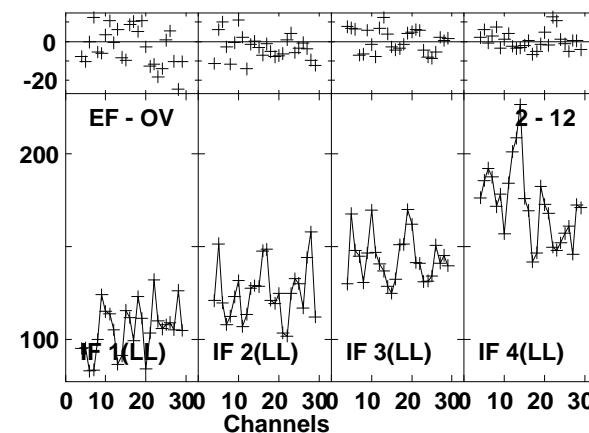
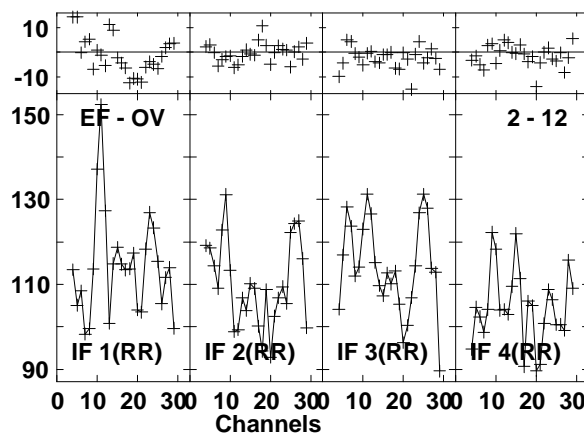
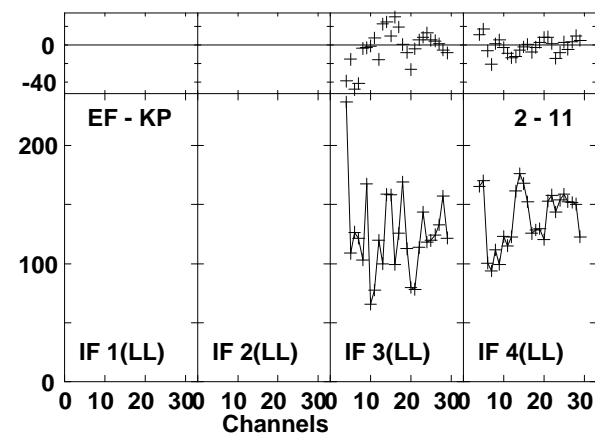
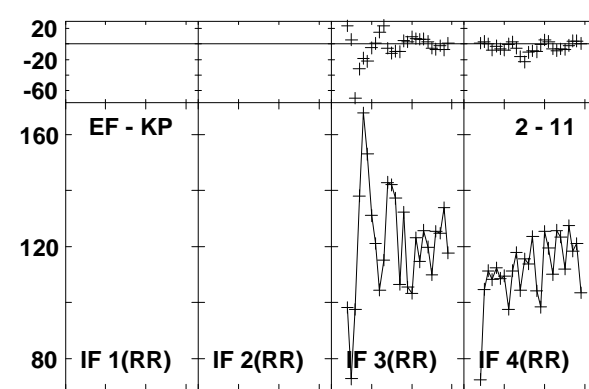
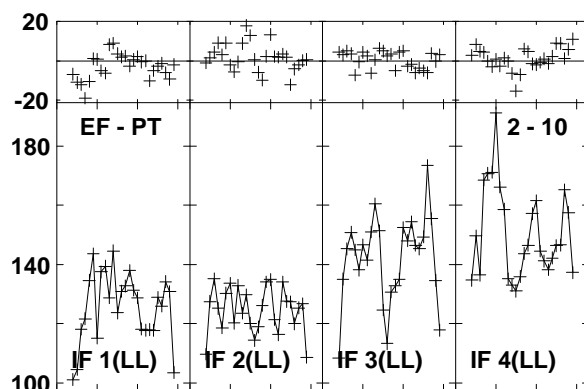
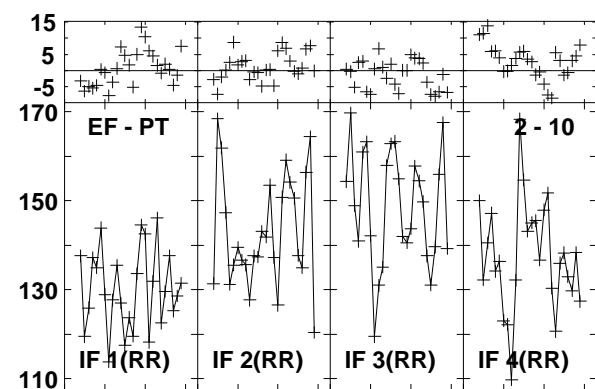
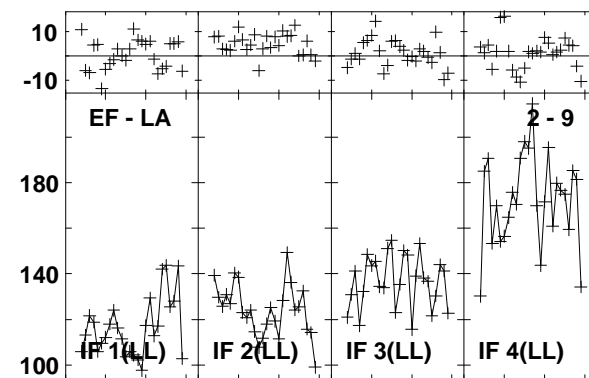
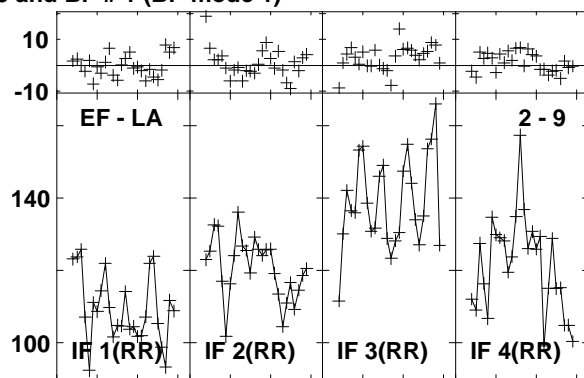
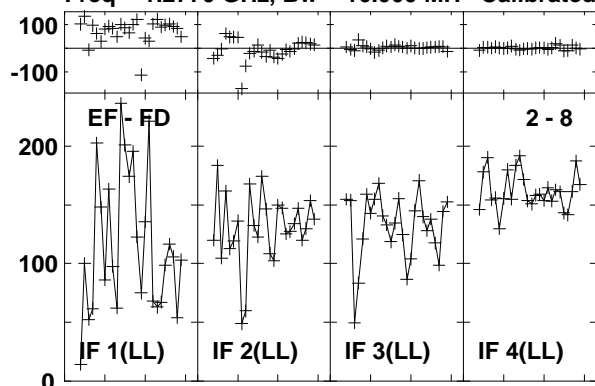

Lower frame: Milli Ampl Jy Top frame: Phas deg
Vector averaged cross-power spectrum Baseline: EF (02) - FD (08)
Timerange: 01/00:57:52 to 01/00:58:50

Plot file version1111 created 03-MAR-2016 01:15:11

J1545+5400 GN002C 1.UVDATA.1

Freq = 1.2770 GHz, Bw = 16.000 MH Calibrated with CL # 3 and BP # 1 (BP mode 1)

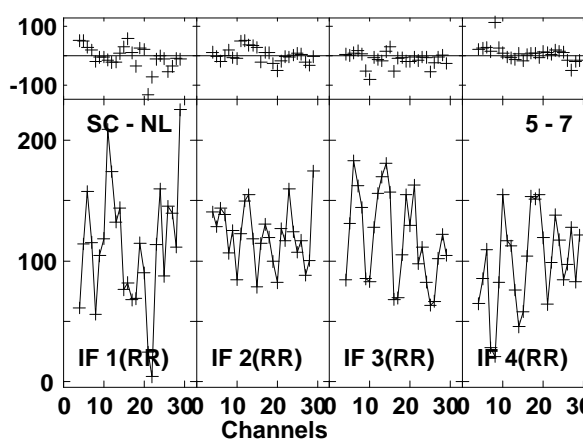
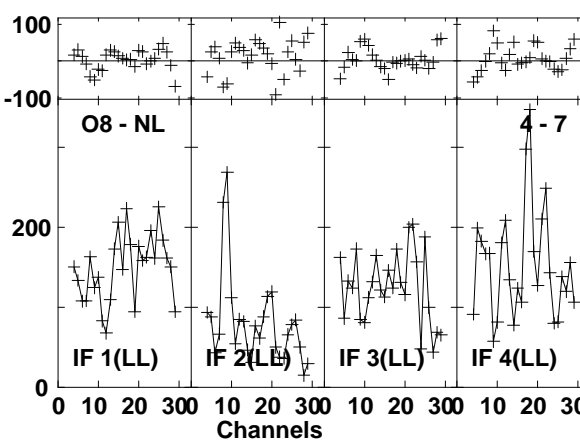
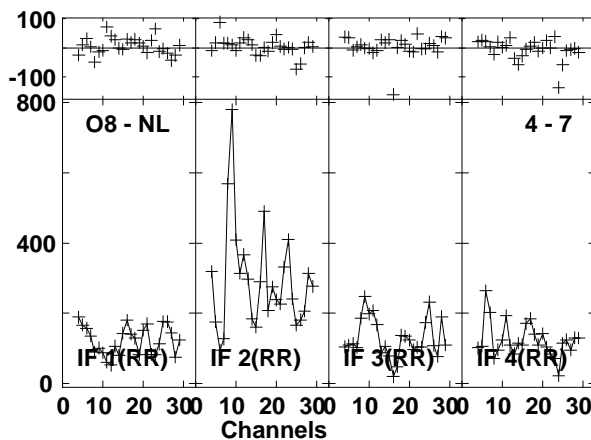
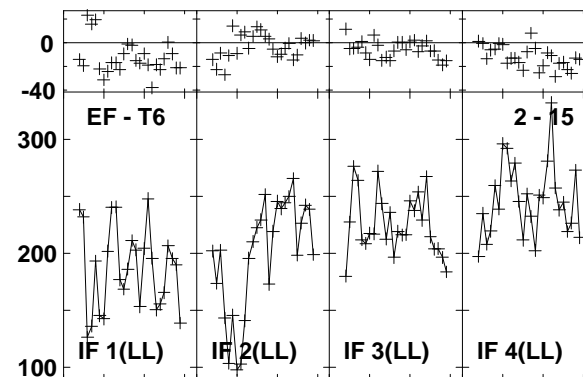
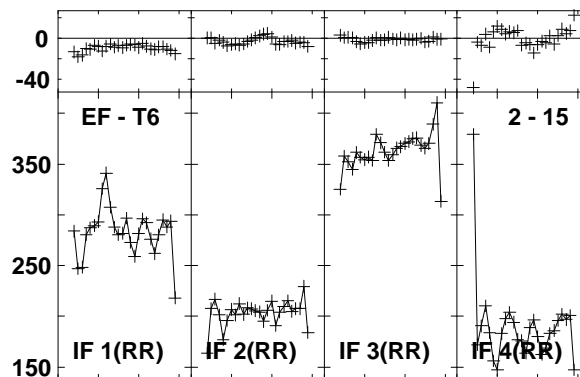
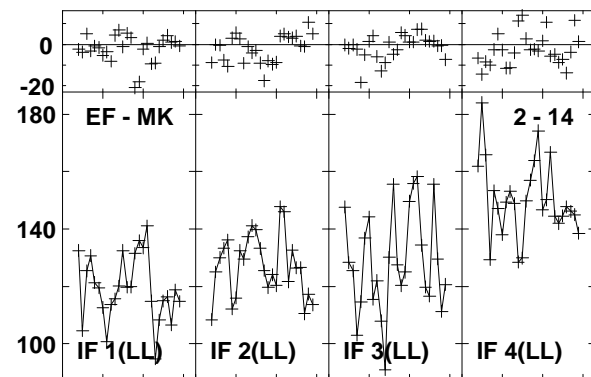
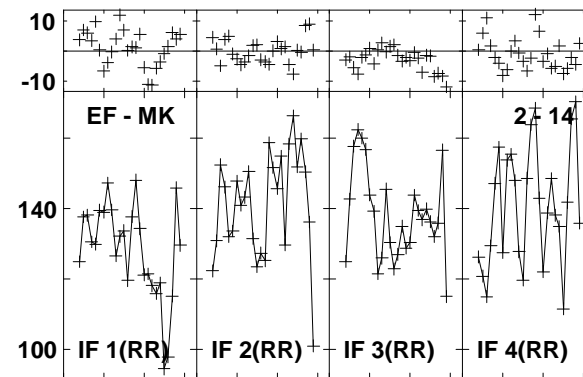
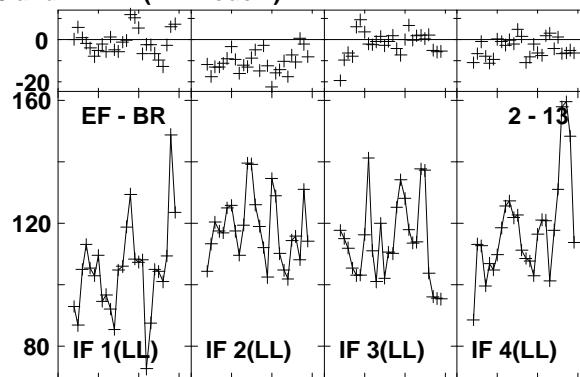
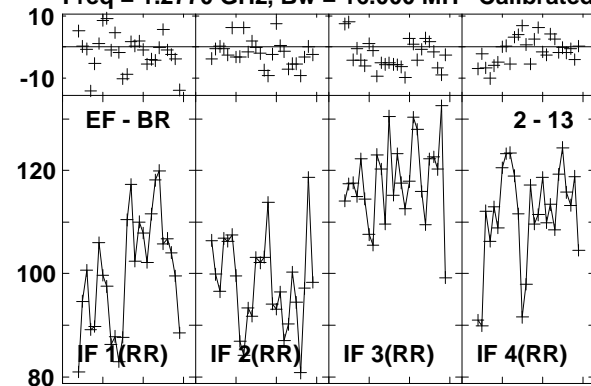

Lower frame: Milli Ampl Jy Top frame: Phas deg
Vector averaged cross-power spectrum Baseline: EF (02) - BR (13)
Timerange: 01/00:57:52 to 01/00:58:50

Plot file version1112 created 03-MAR-2016 01:15:11

J1545+5400 GN002C 1.UVDATA.1

Freq = 1.2770 GHz, Bw = 16.000 MH Calibrated with CL # 3 and BP # 1 (BP mode 1)

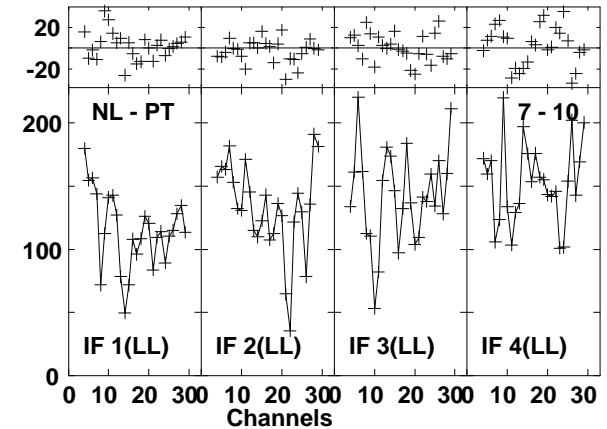
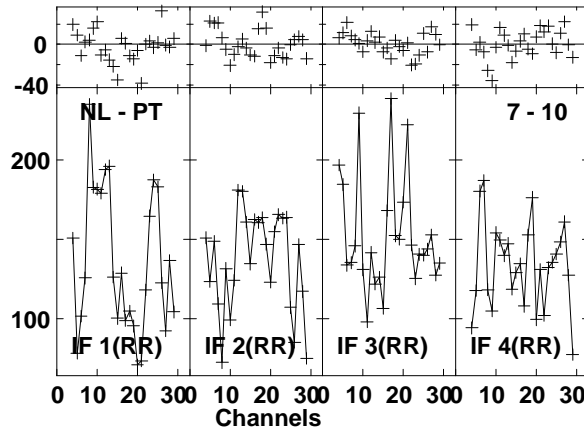
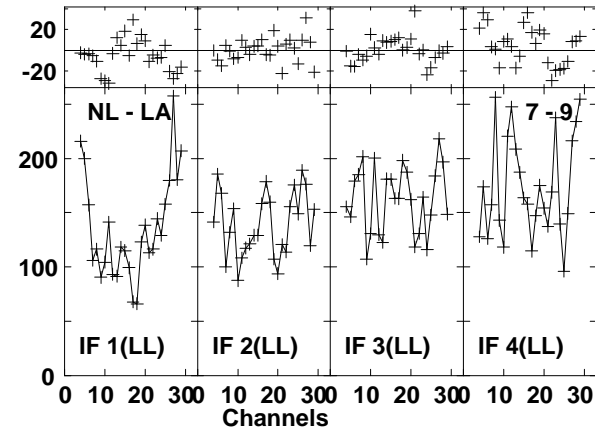
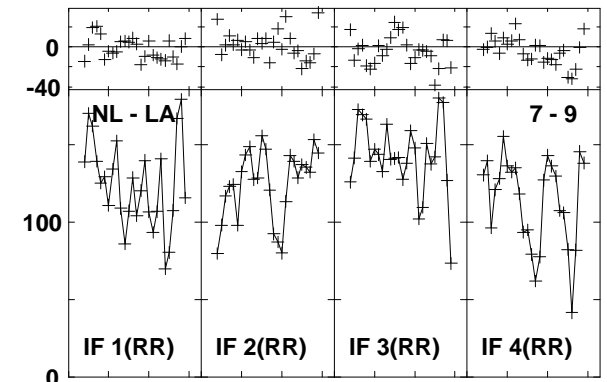
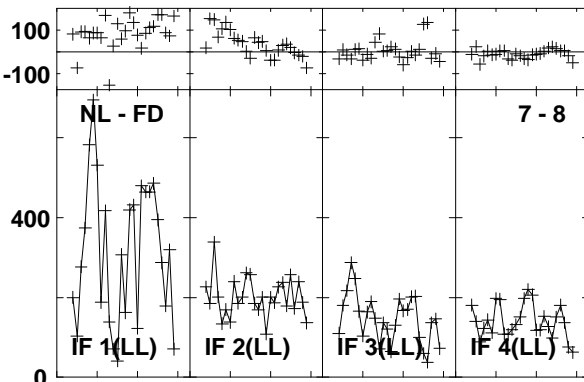
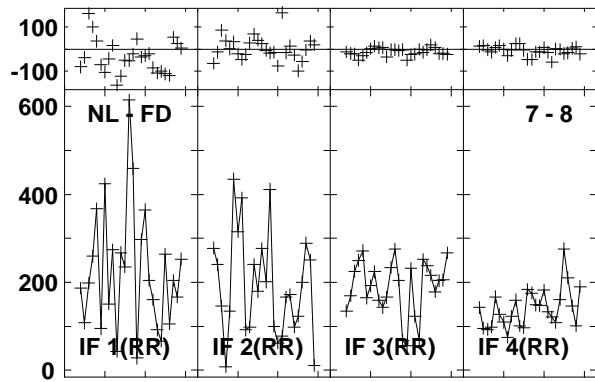
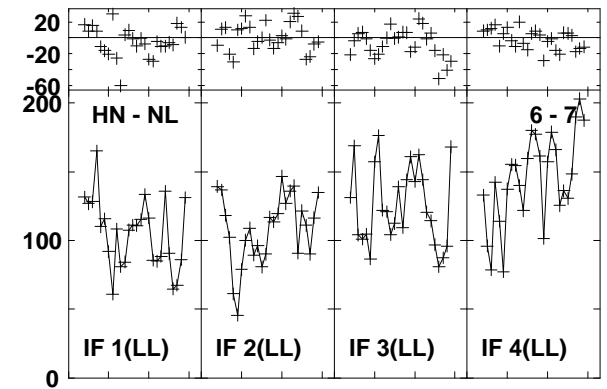
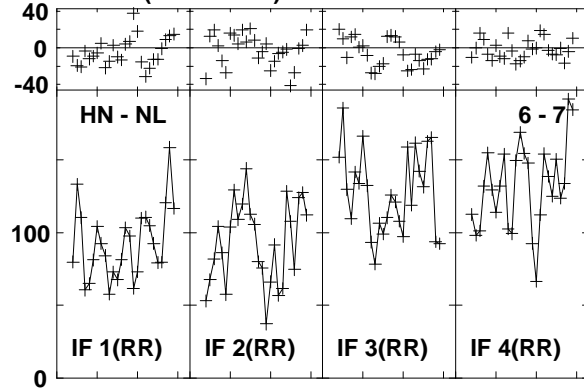
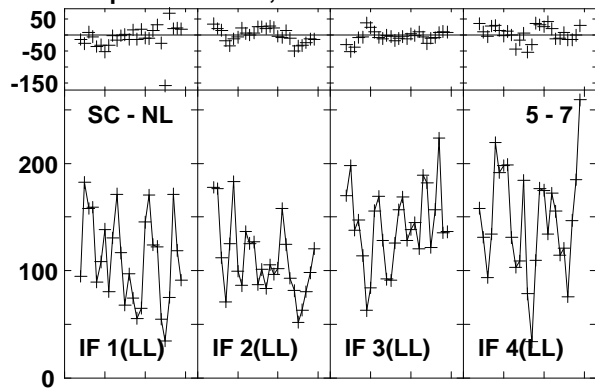

Lower frame: Milli Ampl Jy Top frame: Phas deg
Vector averaged cross-power spectrum Baseline: SC (05) - NL (07)
Timerange: 01/00:57:52 to 01/00:58:50

Plot file version1113 created 03-MAR-2016 01:15:11

J1545+5400 GN002C 1.UVDATA.1

Freq = 1.2770 GHz, Bw = 16.000 MH Calibrated with CL # 3 and BP # 1 (BP mode 1)

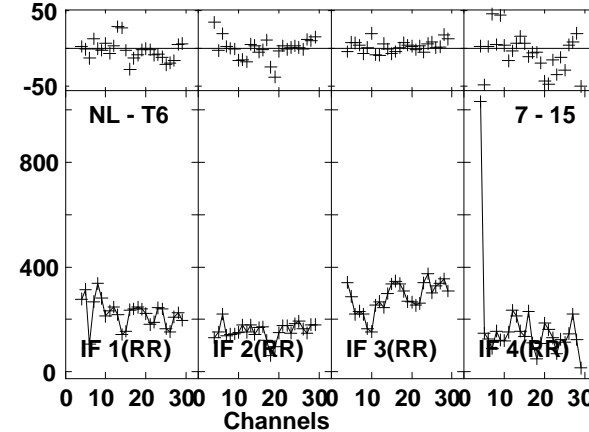
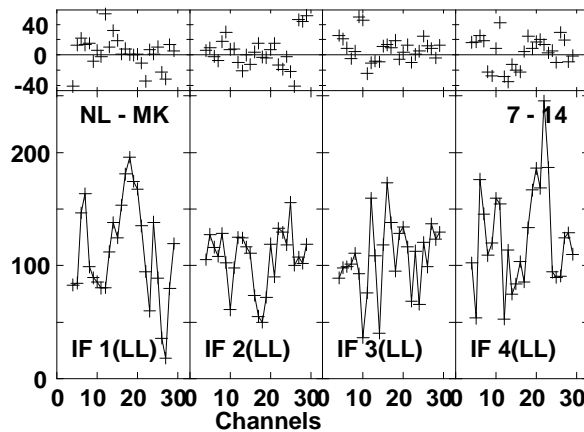
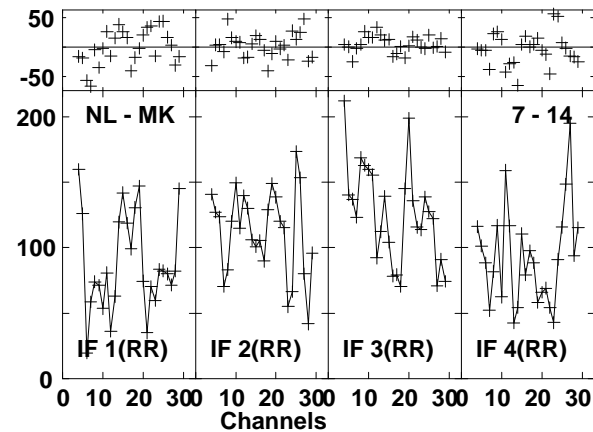
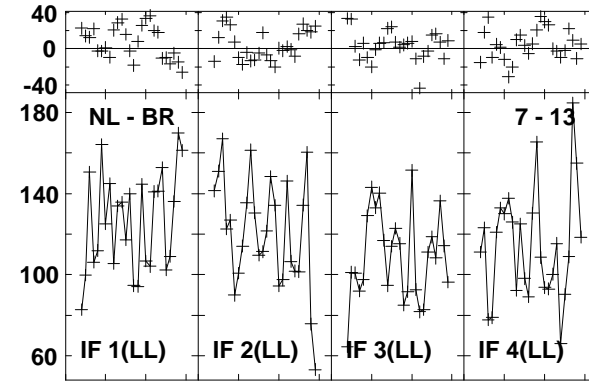
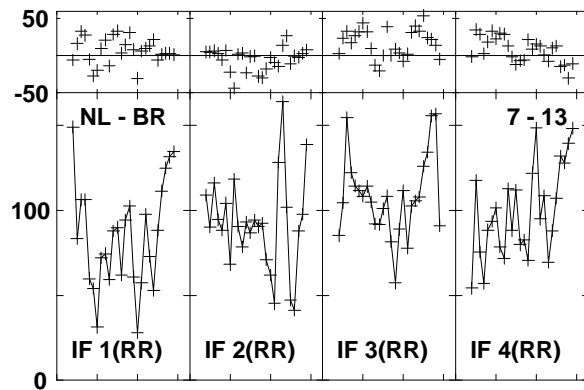
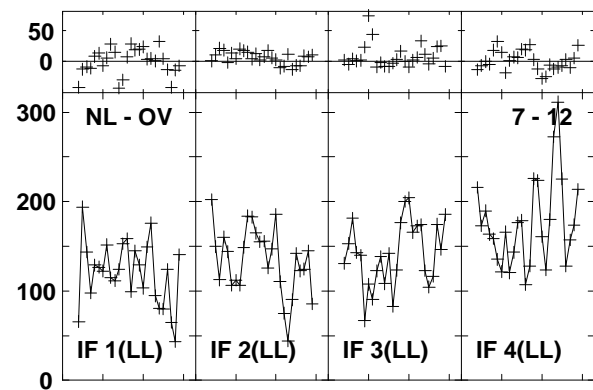
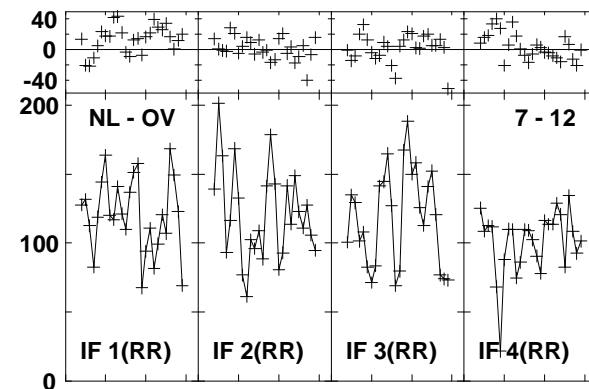
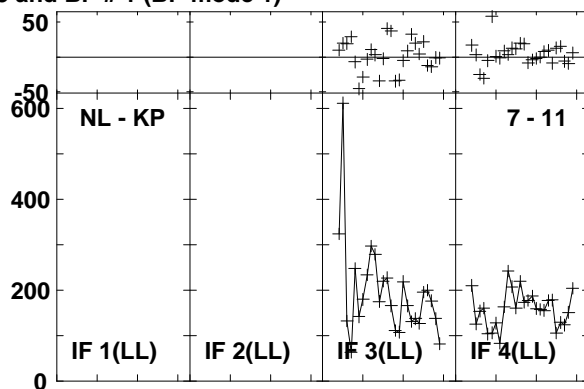
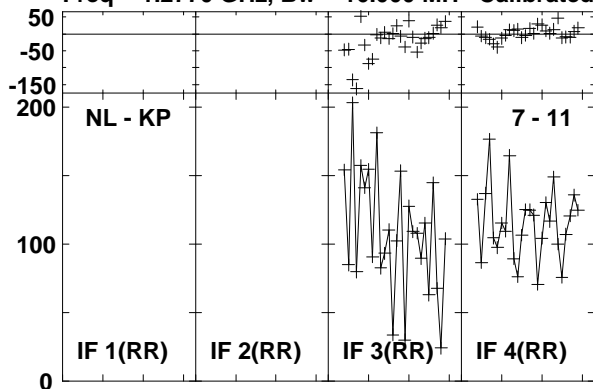

Lower frame: Milli Ampl Jy Top frame: Phas deg
Vector averaged cross-power spectrum Baseline: NL (07) - KP (11)
Timerange: 01/00:57:52 to 01/00:58:50

Plot file version1114 created 03-MAR-2016 01:15:11
J1545+5400 GN002C 1.UVDATA.1
Freq = 1.2770 GHz, Bw = 16.000 MH Calibrated with CL # 3 and BP # 1 (BP mode 1)

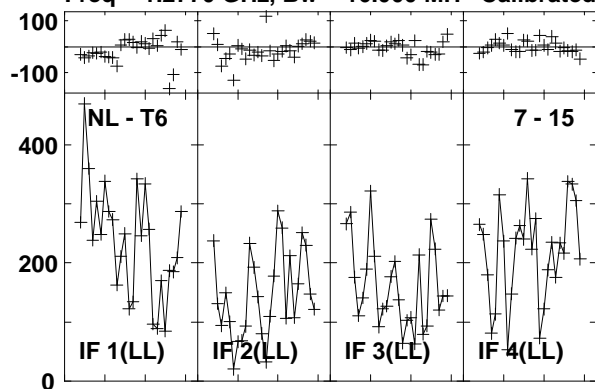

Lower frame: Milli Ampl Jy Top frame: Phas deg
Vector averaged cross-power spectrum Baseline: NL (07) - T6 (15)
Timerange: 01/00:57:52 to 01/00:58:50

Plot file version1115 created 03-MAR-2016 01:15:11

4C52 GN002C 1.UVDATA.1

Freq = 1.2770 GHz, Bw = 16.000 MH Calibrated with CL # 3 and BP # 1 (BP mode 1)

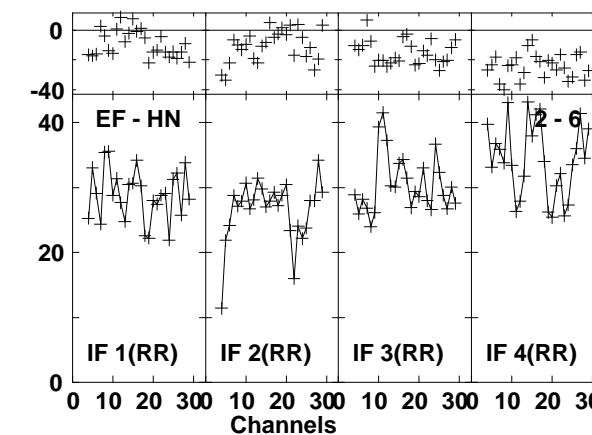
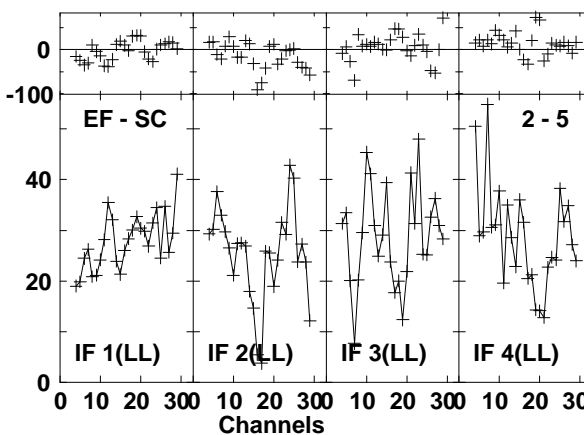
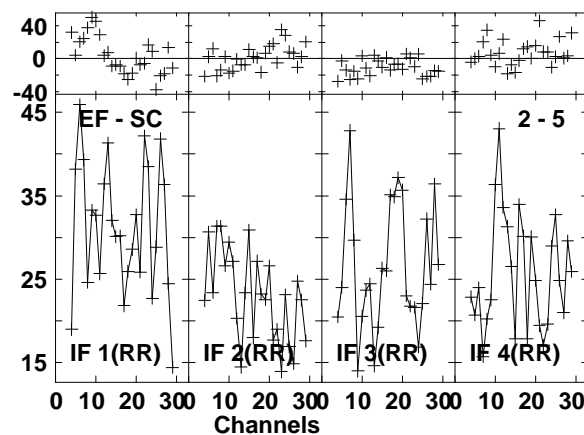
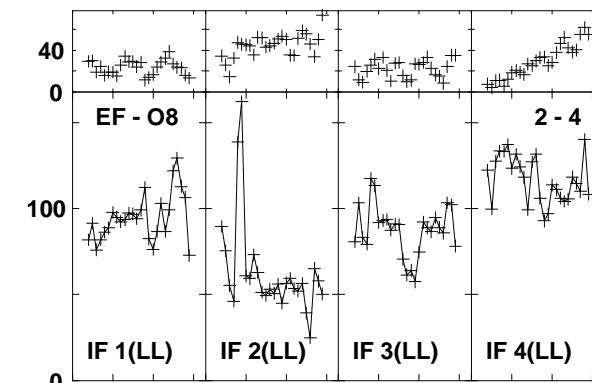
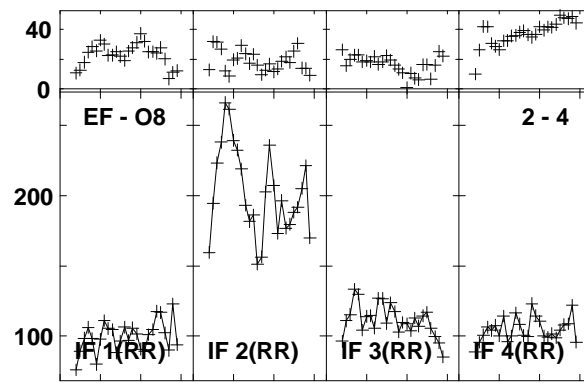
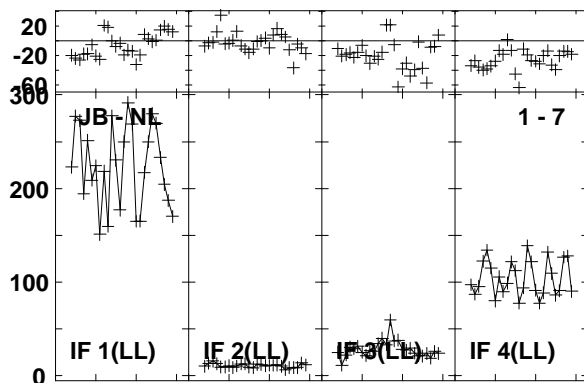
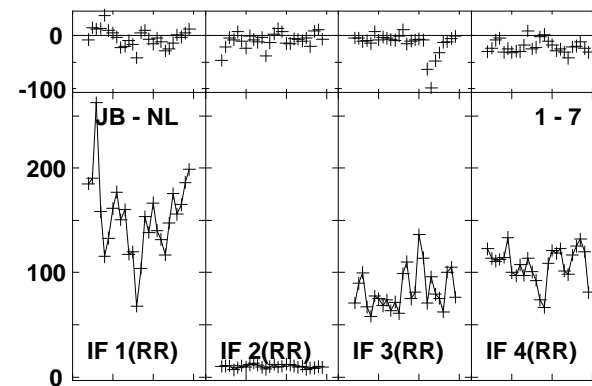
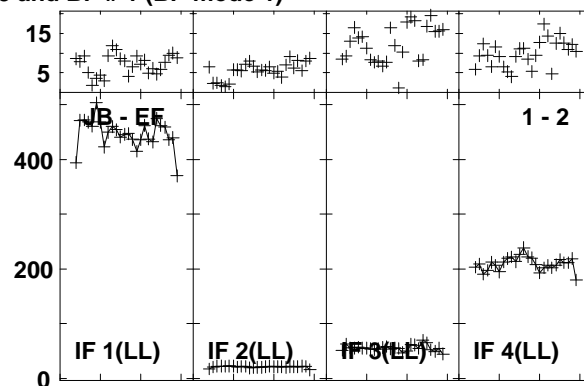
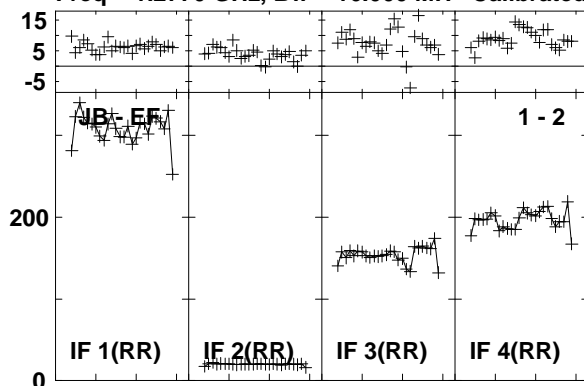

Lower frame: Milli Ampl Jy Top frame: Phas deg
Vector averaged cross-power spectrum Baseline: JB (01) - EF (02)
Timerange: 01/00:58:55 to 01/01:02:19

Plot file version1116 created 03-MAR-2016 01:15:12

4C52 GN002C 1.UVDATA.1

Freq = 1.2770 GHz, Bw = 16.000 MH Calibrated with CL # 3 and BP # 1 (BP mode 1)

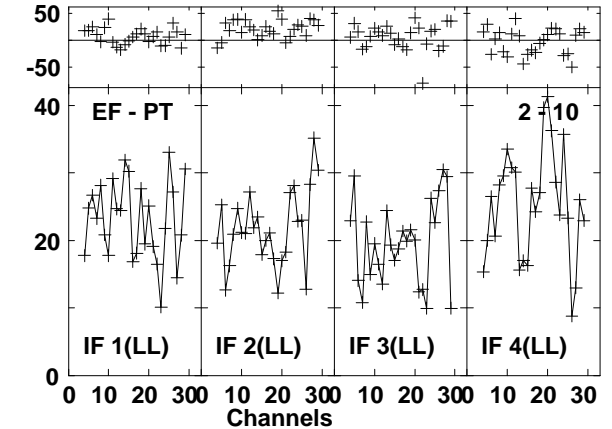
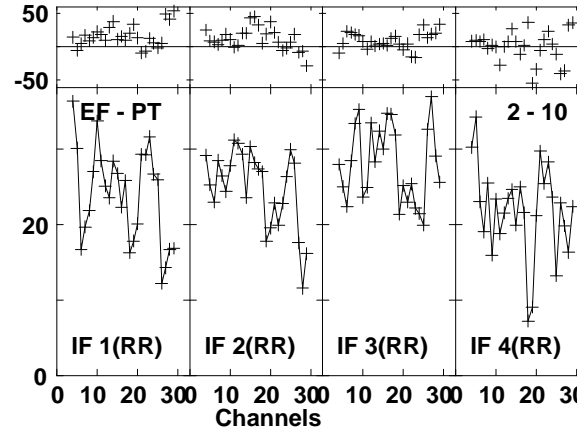
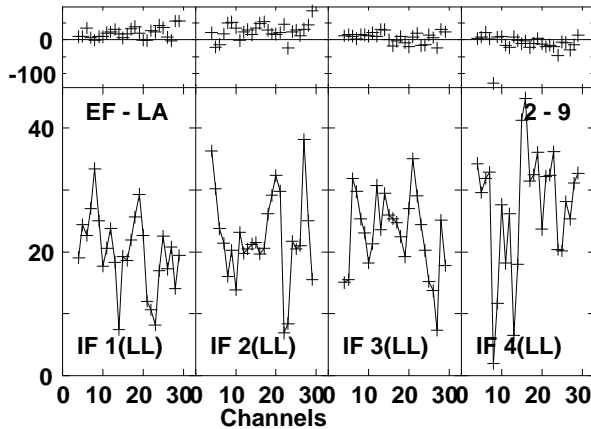
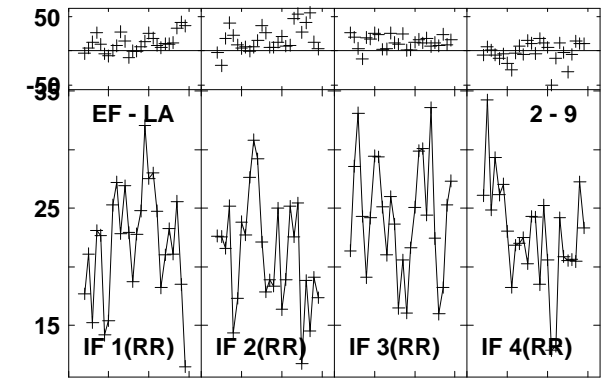
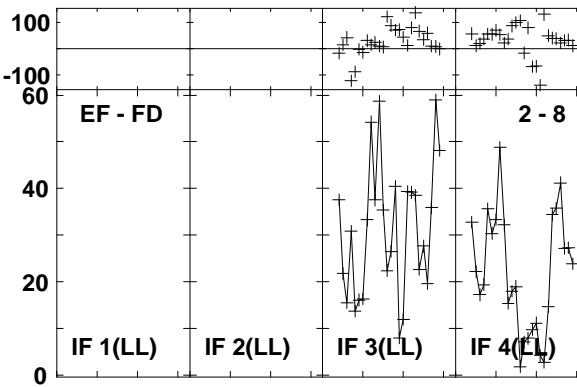
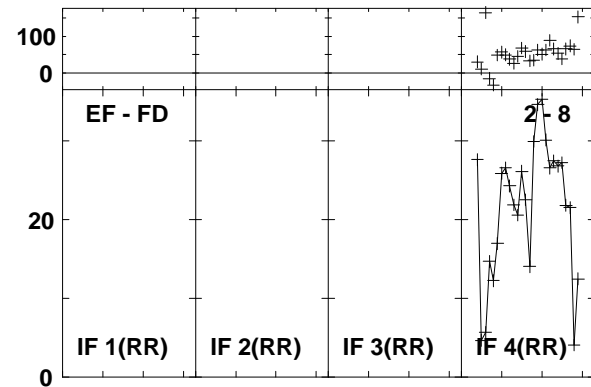
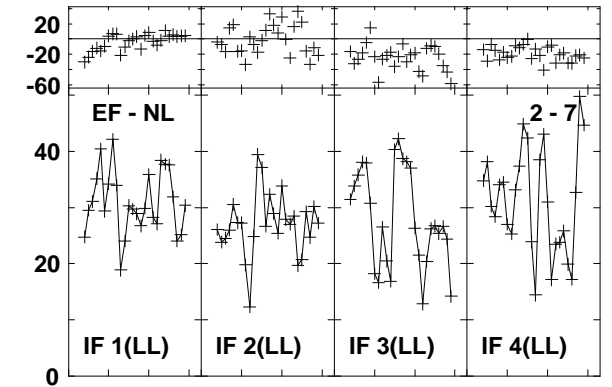
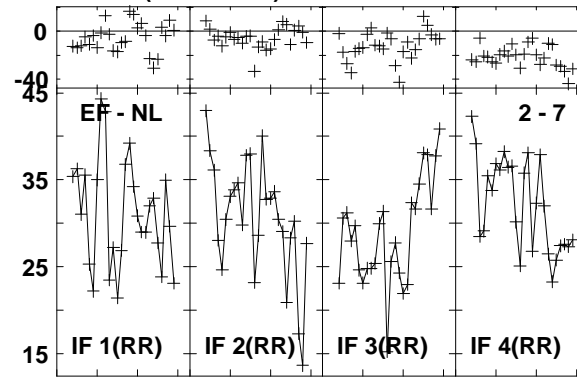
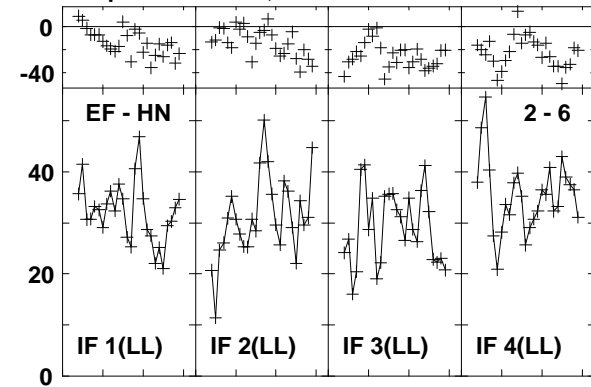

Lower frame: Milli Ampl Jy Top frame: Phas deg
Vector averaged cross-power spectrum Baseline: EF (02) - HN (06)
Timerange: 01/00:58:55 to 01/01:02:19

Plot file version1117 created 03-MAR-2016 01:15:12

4C52 GN002C 1.UVDATA.1

Freq = 1.2770 GHz, Bw = 16.000 MH Calibrated with CL # 3 and BP # 1 (BP mode 1)

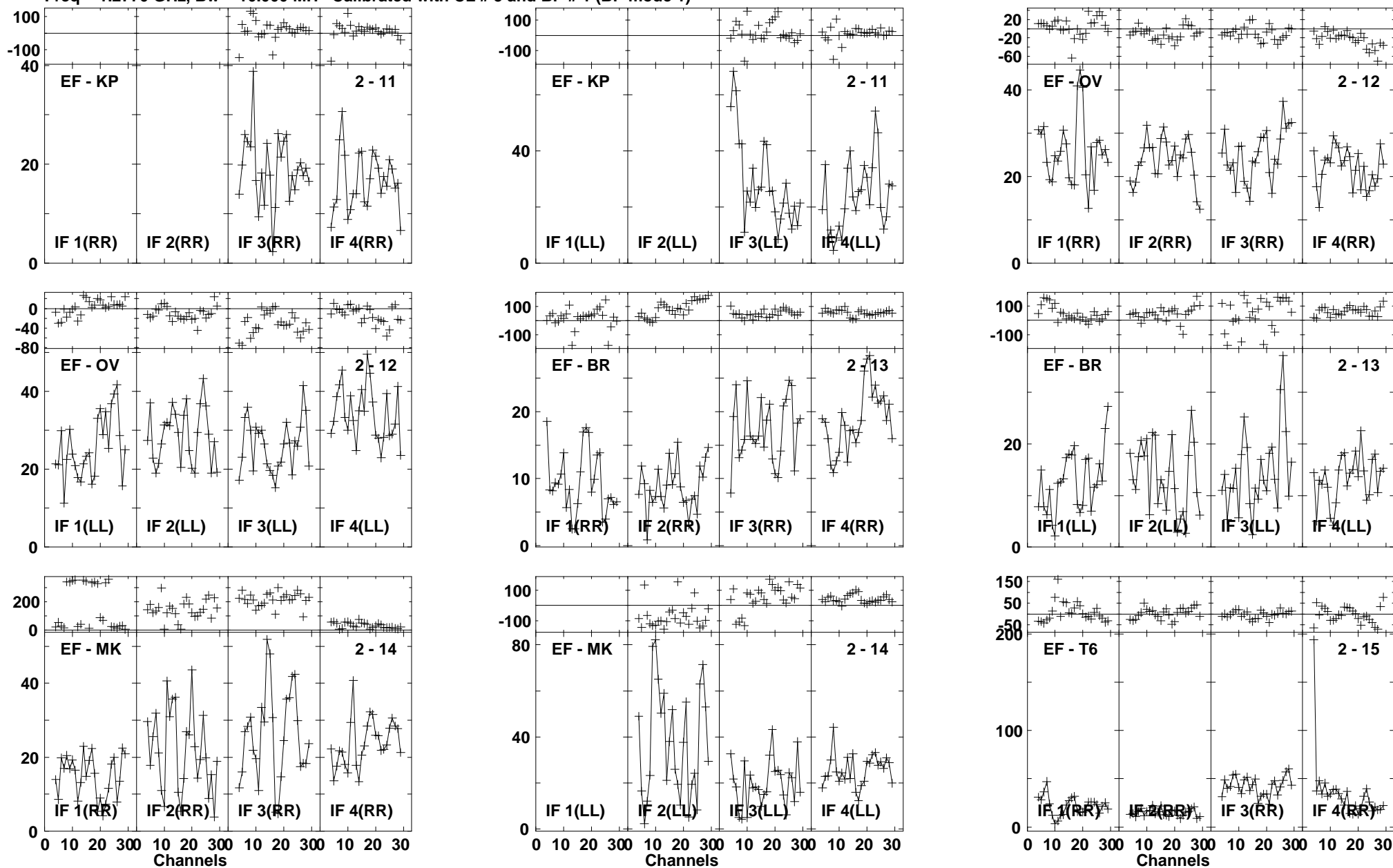

Lower frame: Milli Ampl Jy Top frame: Phas deg
Vector averaged cross-power spectrum Baseline: EF (02) - KP (11)
Timerange: 01/00:58:55 to 01/01:02:19

Plot file version1118 created 03-MAR-2016 01:15:12

4C52 GN002C 1.UVDATA.1

Freq = 1.2770 GHz, Bw = 16.000 MH Calibrated with CL # 3 and BP # 1 (BP mode 1)

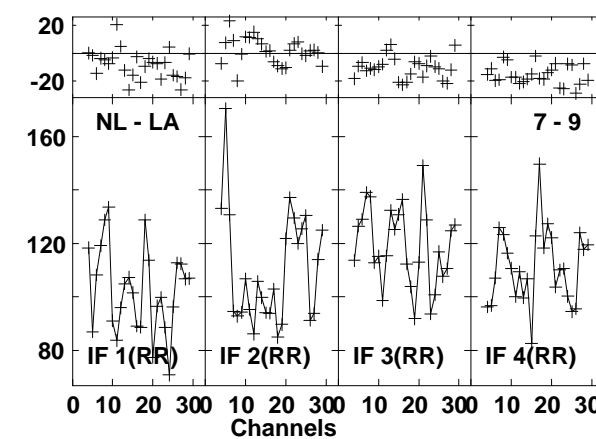
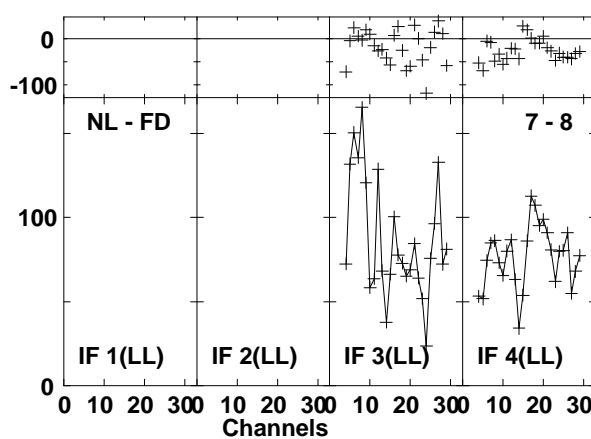
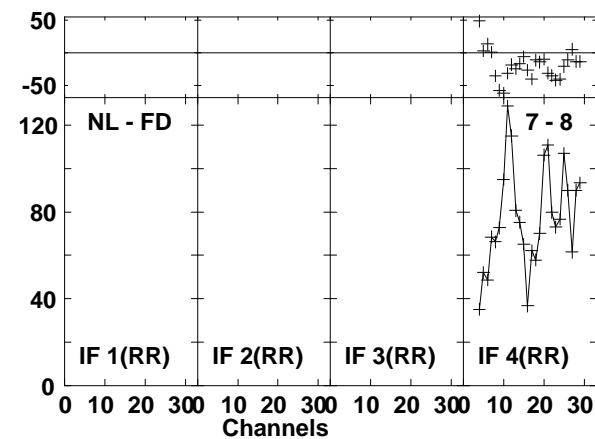
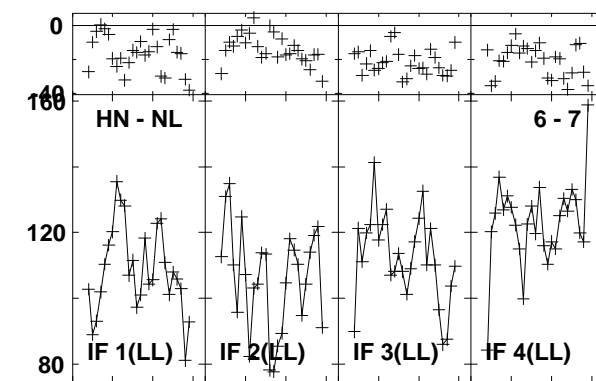
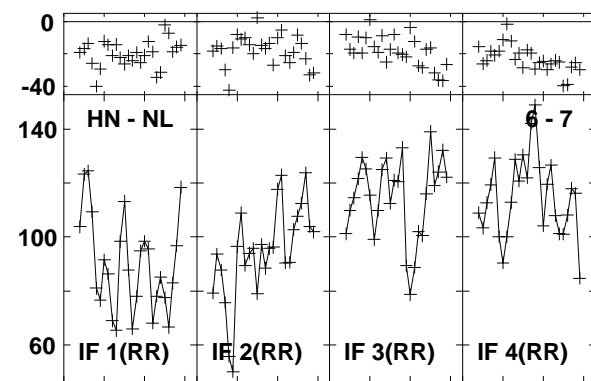
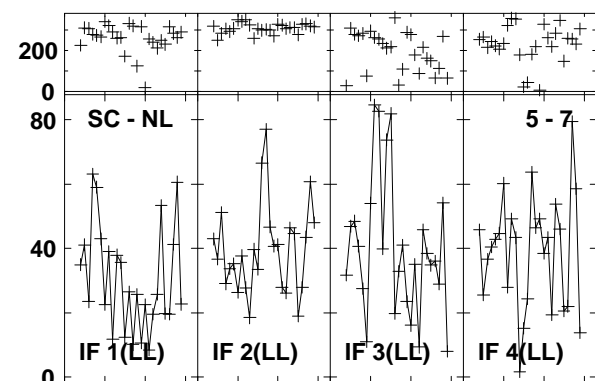
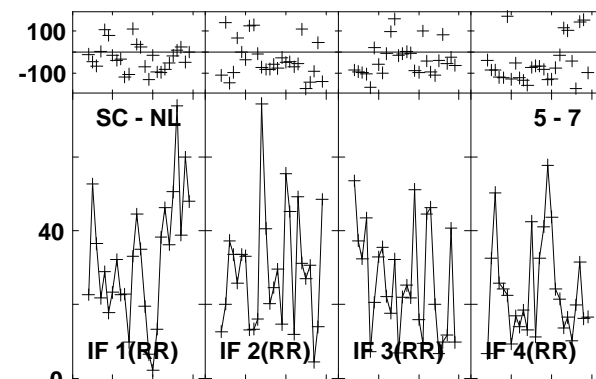
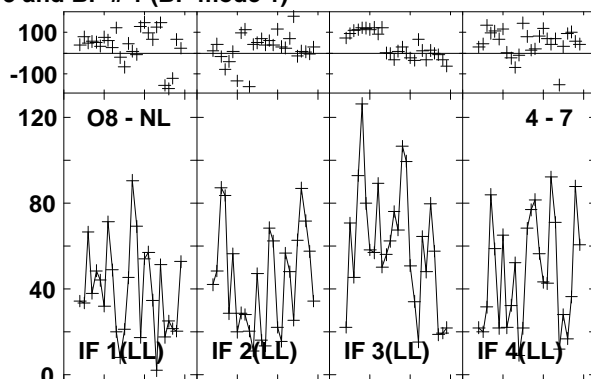
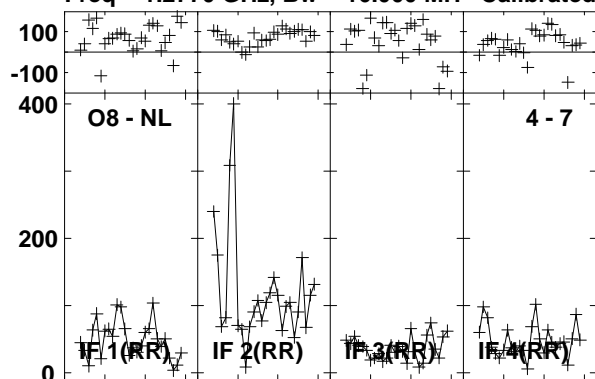

Lower frame: Milli Ampl Jy Top frame: Phas deg
Vector averaged cross-power spectrum Baseline: O8 (04) - NL (07)
Timerange: 01/00:58:55 to 01/01:02:19

Plot file version1119 created 03-MAR-2016 01:15:12

4C52 GN002C 1.UVDATA.1

Freq = 1.2770 GHz, Bw = 16.000 MH Calibrated with CL # 3 and BP # 1 (BP mode 1)

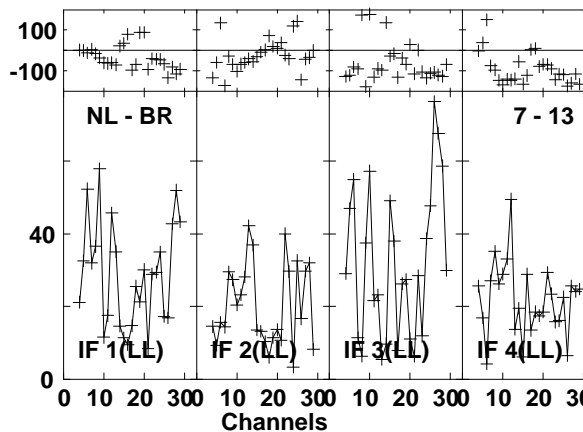
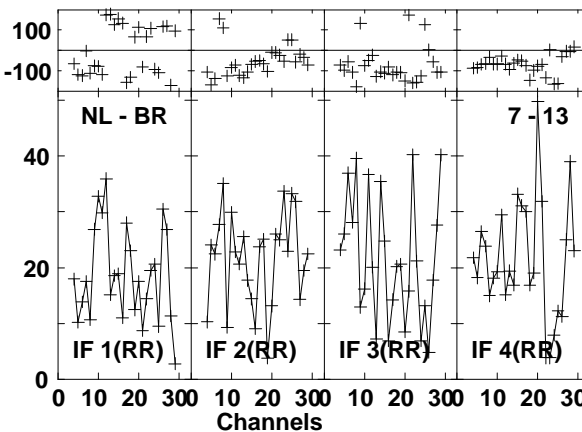
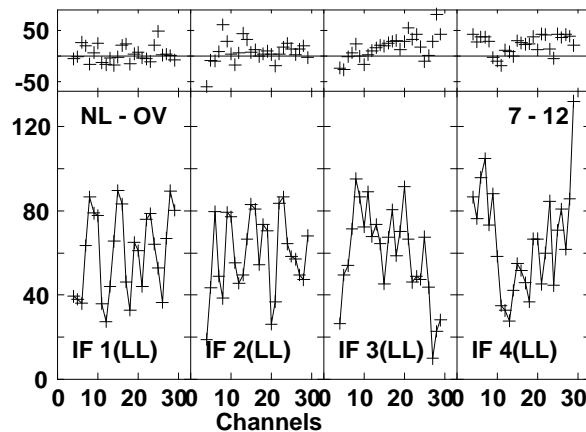
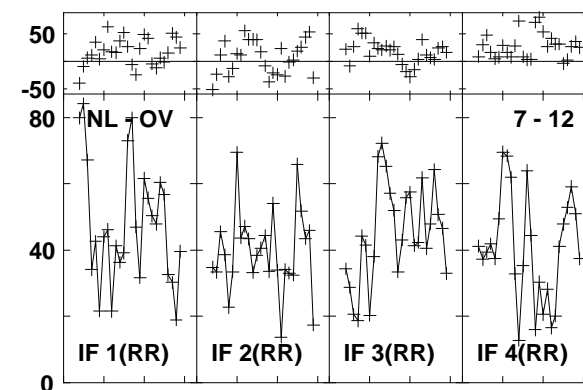
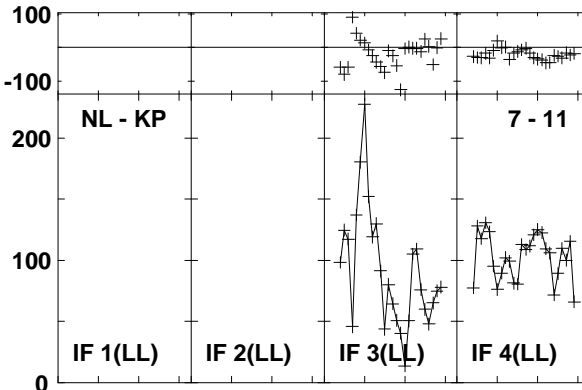
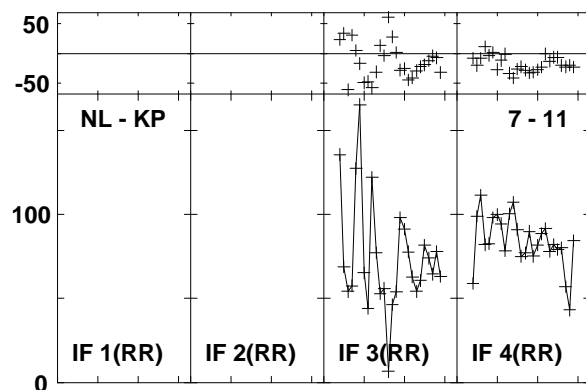
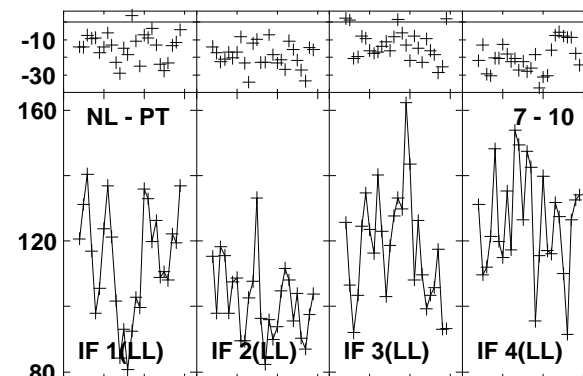
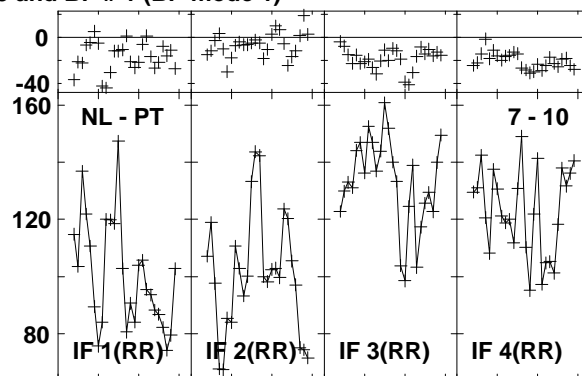
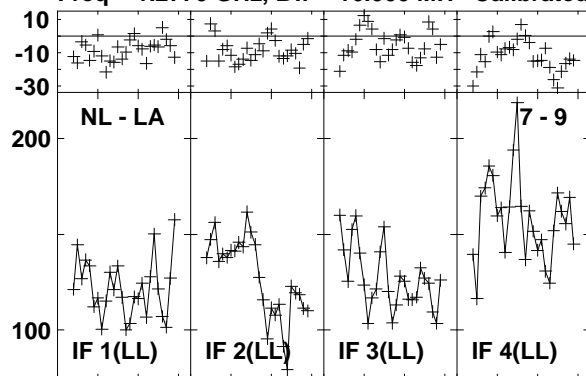

Lower frame: Milli Ampl Jy Top frame: Phas deg
Vector averaged cross-power spectrum Baseline: NL (07) - LA (09)
Timerange: 01/00:58:55 to 01/01:02:19

Plot file version1120 created 03-MAR-2016 01:15:12

4C52 GN002C 1.UVDATA.1

Freq = 1.2770 GHz, Bw = 16.000 MH Calibrated with CL # 3 and BP # 1 (BP mode 1)

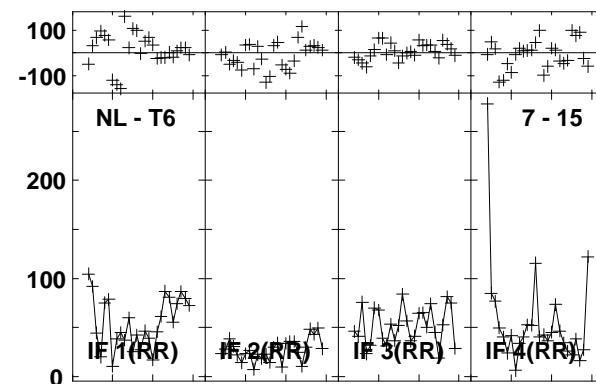
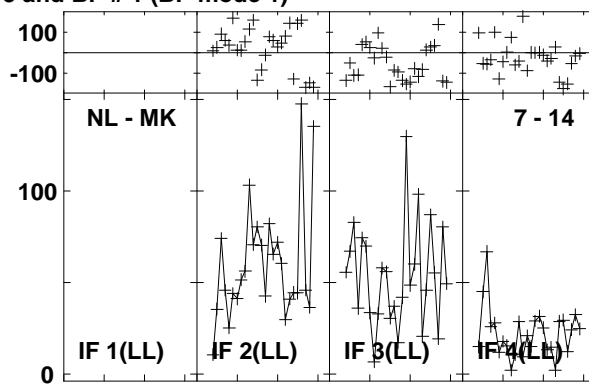
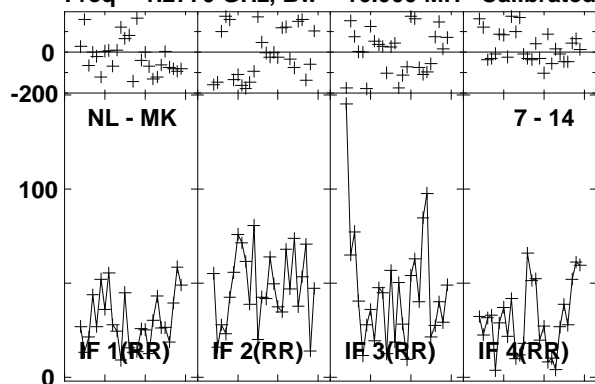

Lower frame: Milli Ampl Jy Top frame: Phas deg
Vector averaged cross-power spectrum Baseline: NL (07) - MK (14)
Timerange: 01/00:58:55 to 01/01:02:19

Plot file version1121 created 03-MAR-2016 01:15:12

J1545+5400 GN002C 1.UVDATA.1

Freq = 1.2770 GHz, Bw = 16.000 MH Calibrated with CL # 3 and BP # 1 (BP mode 1)

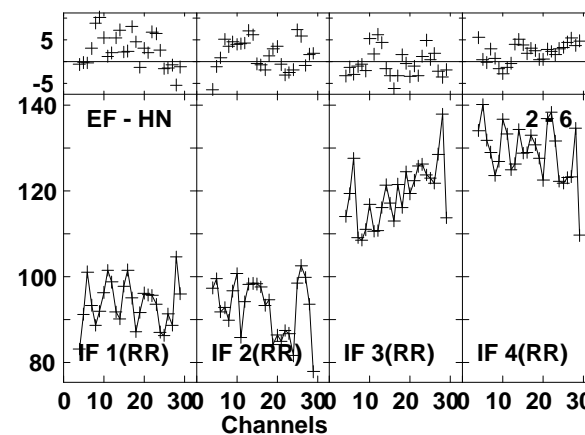
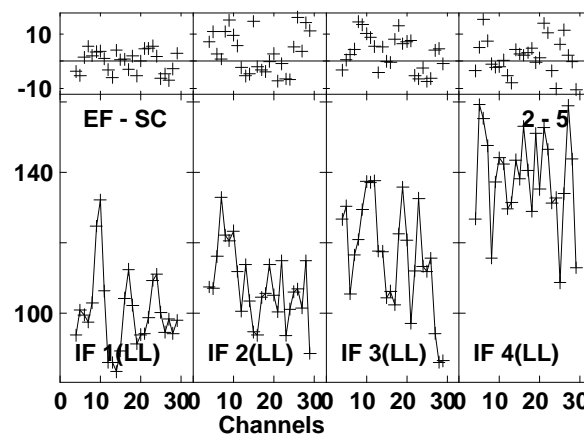
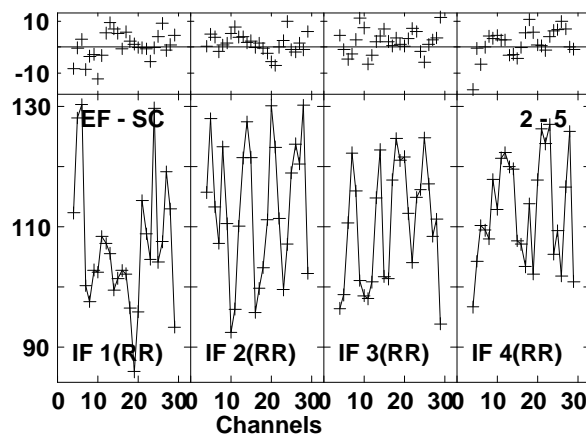
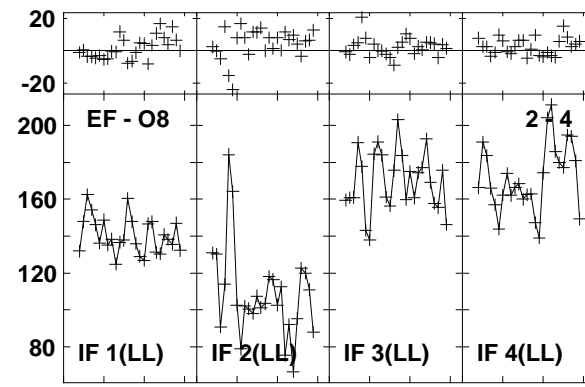
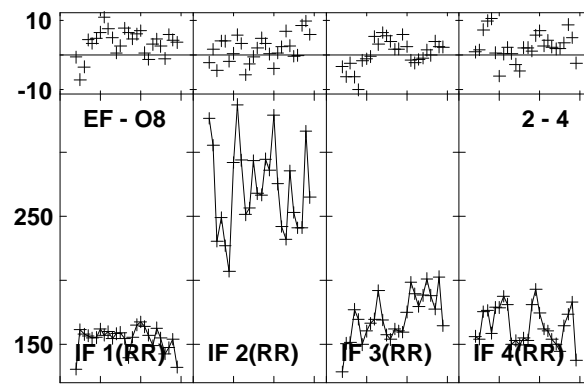
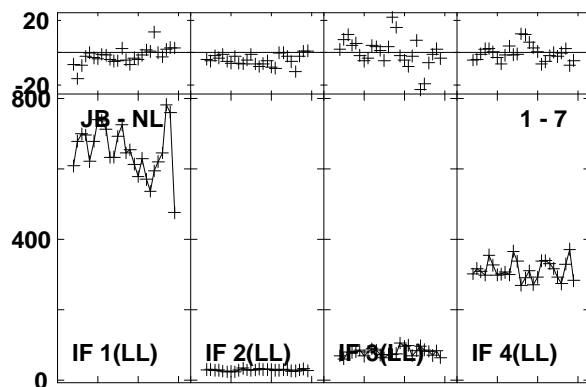
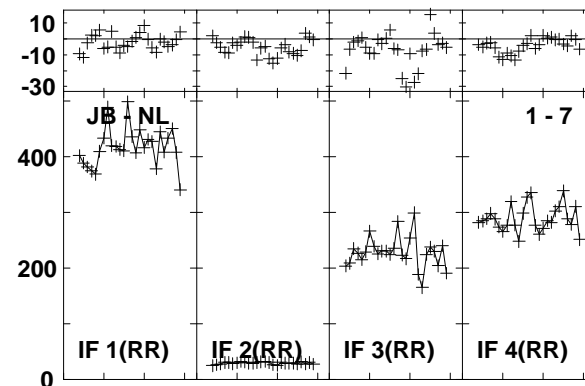
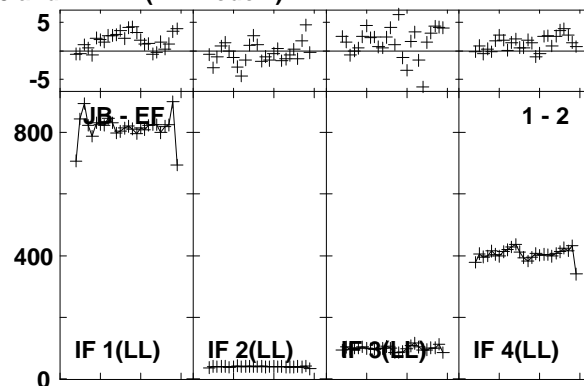
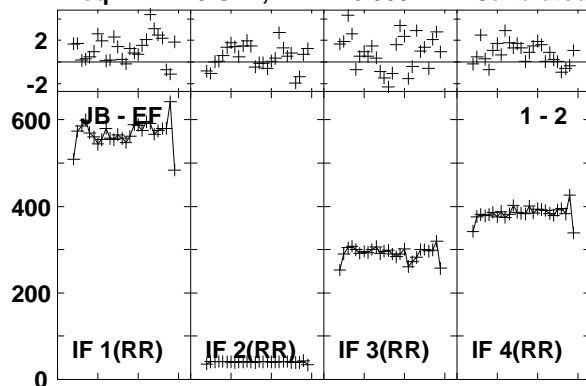

Lower frame: Milli Ampl Jy Top frame: Phas deg
Vector averaged cross-power spectrum Baseline: JB (01) - EF (02)
Timerange: 01/01:03:12 to 01/01:05:10

Plot file version1122 created 03-MAR-2016 01:15:13

J1545+5400 GN002C 1.UVDATA.1

Freq = 1.2770 GHz, Bw = 16.000 MH Calibrated with CL # 3 and BP # 1 (BP mode 1)

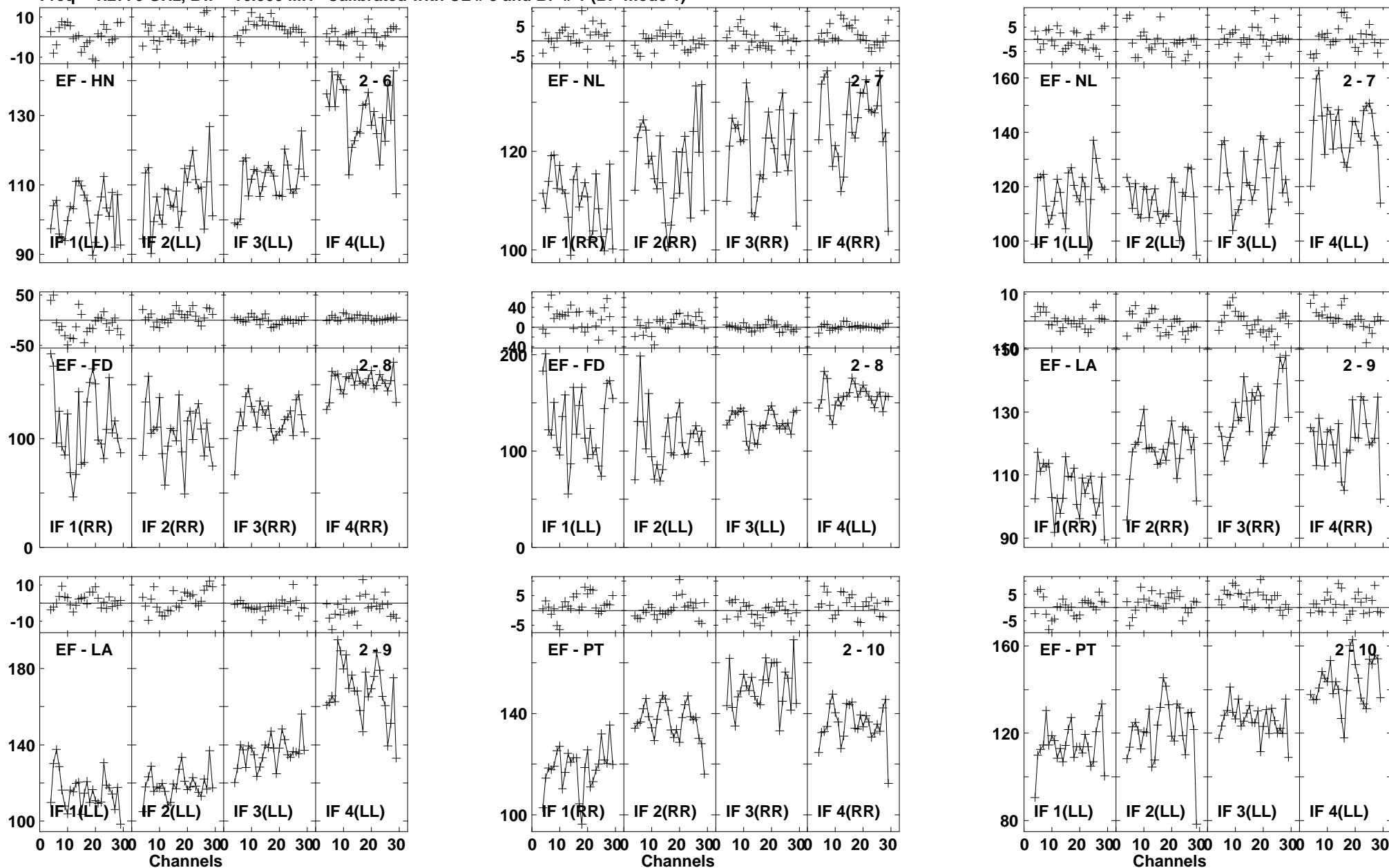

Lower frame: Milli Ampl Jy Top frame: Phas deg
Vector averaged cross-power spectrum Baseline: EF (02) - HN (06)
Timerange: 01/01:03:12 to 01/01:05:10

Plot file version1123 created 03-MAR-2016 01:15:13

J1545+5400 GN002C 1.UVDATA.1

Freq = 1.2770 GHz, Bw = 16.000 MH Calibrated with CL # 3 and BP # 1 (BP mode 1)

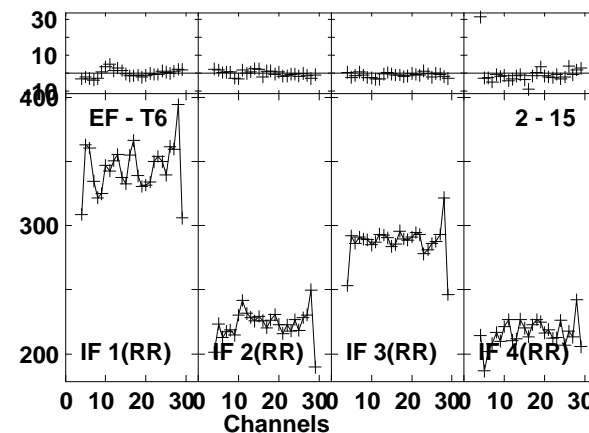
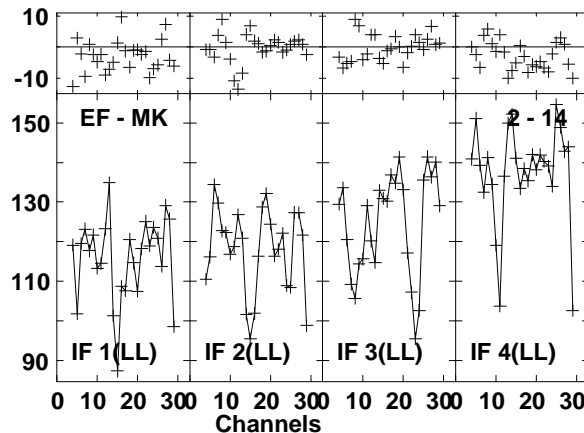
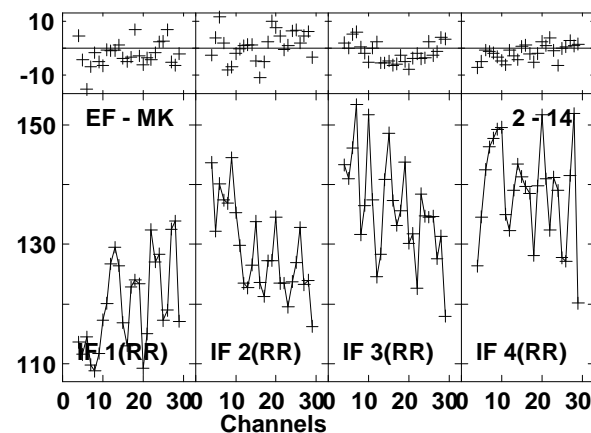
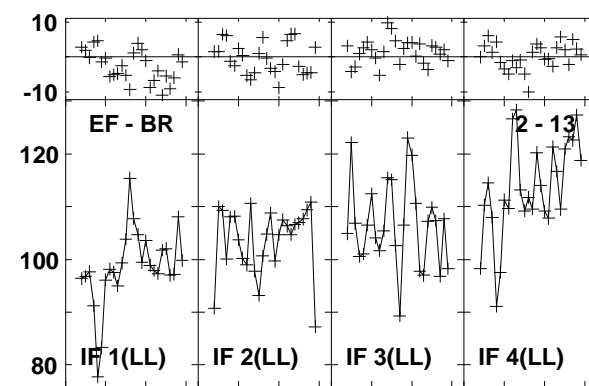
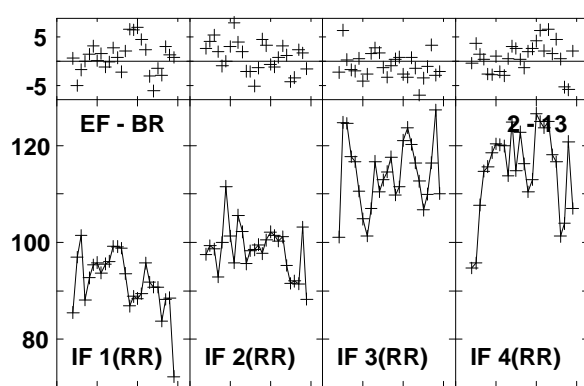
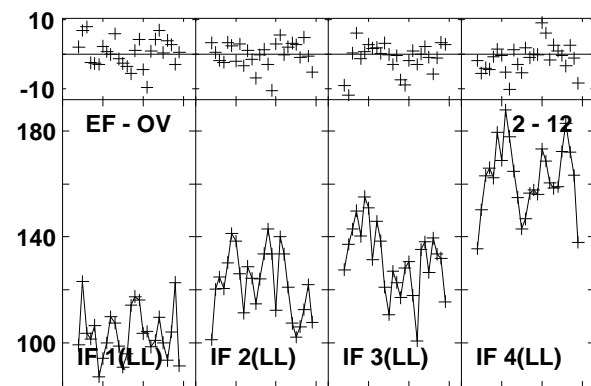
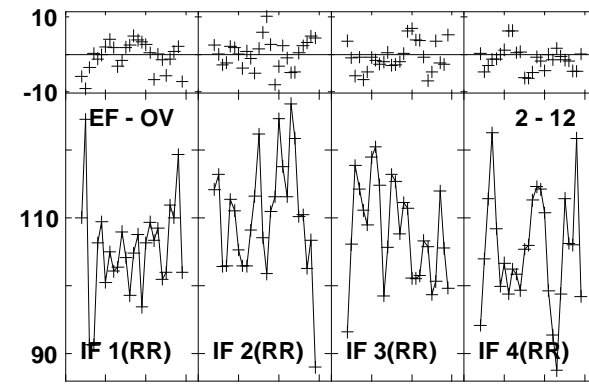
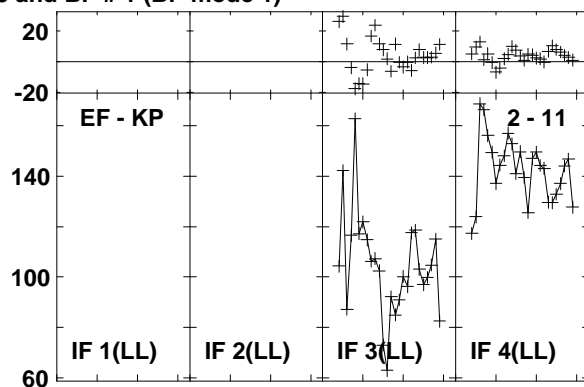
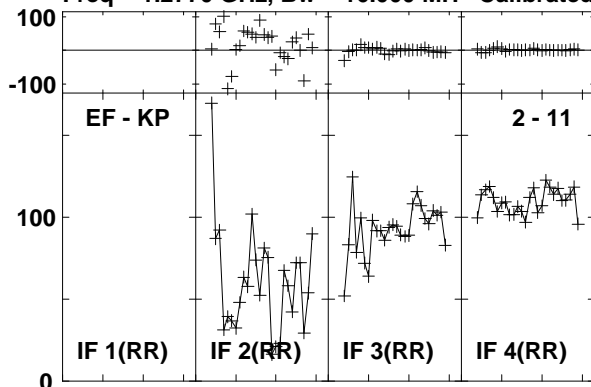

Lower frame: Milli Ampl Jy Top frame: Phas deg
Vector averaged cross-power spectrum Baseline: EF (02) - KP (11)
Timerange: 01/01:03:12 to 01/01:05:10

Plot file version1124 created 03-MAR-2016 01:15:13

J1545+5400 GN002C 1.UVDATA.1

Freq = 1.2770 GHz, Bw = 16.000 MH Calibrated with CL # 3 and BP # 1 (BP mode 1)

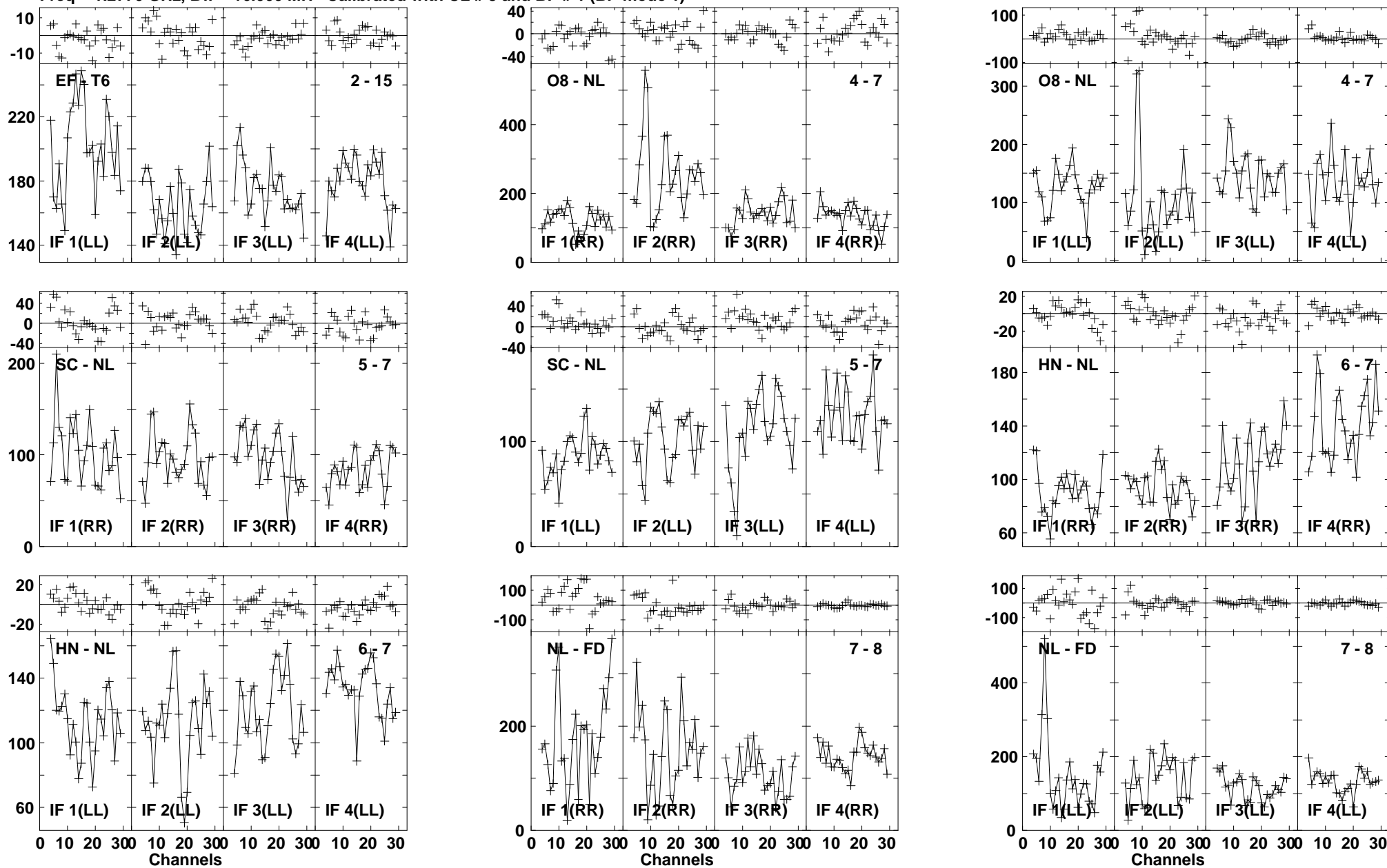

Lower frame: Milli Ampl Jy Top frame: Phas deg
Vector averaged cross-power spectrum Baseline: EF (02) - T6 (15)
Timerange: 01/01:03:12 to 01/01:05:10

Plot file version1125 created 03-MAR-2016 01:15:13

J1545+5400 GN002C 1.UVDATA.1

Freq = 1.2770 GHz, Bw = 16.000 MH Calibrated with CL # 3 and BP # 1 (BP mode 1)

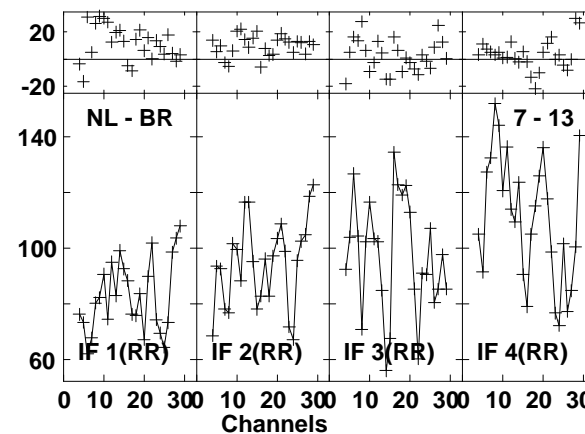
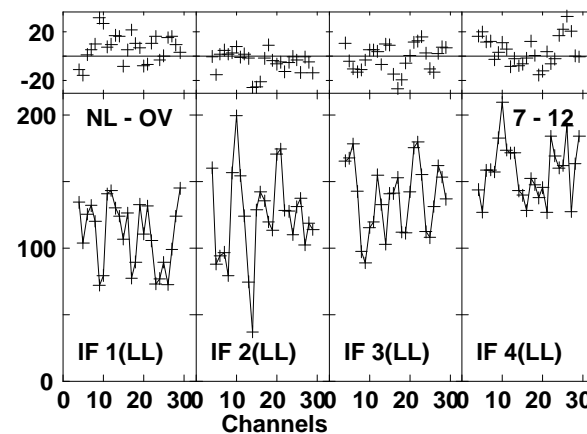
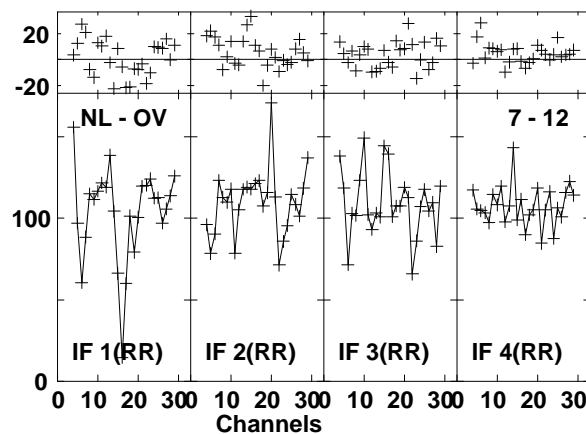
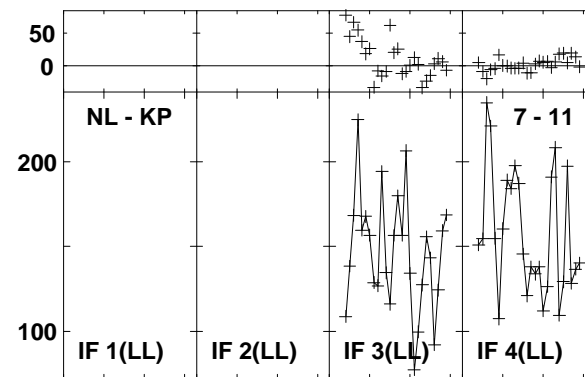
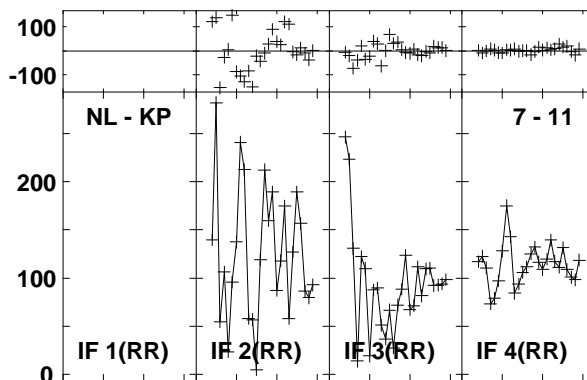
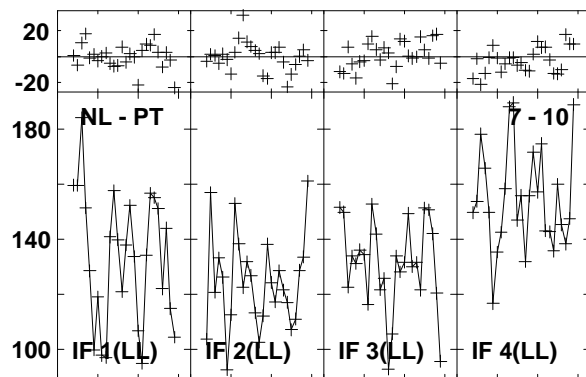
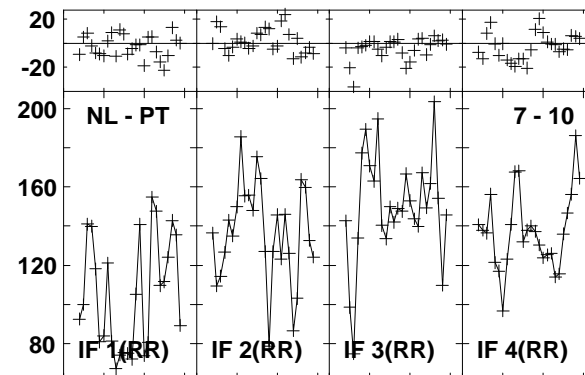
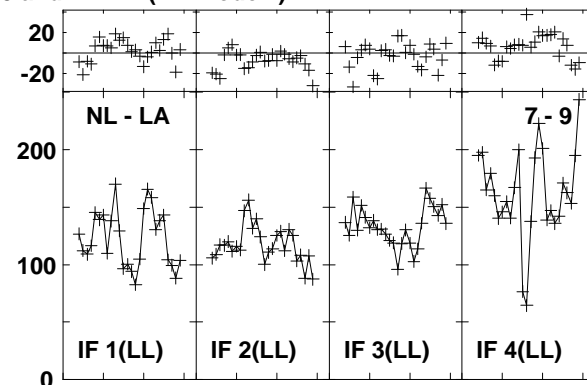
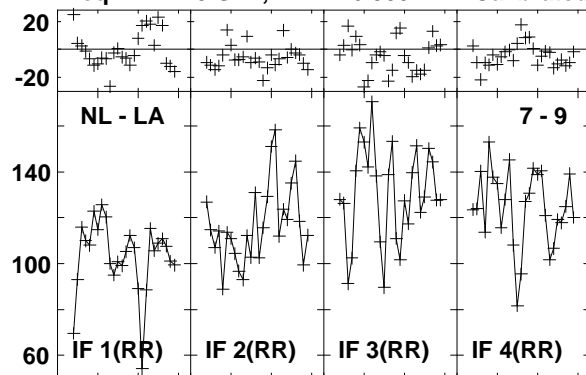

Lower frame: Milli Ampl Jy Top frame: Phas deg
Vector averaged cross-power spectrum Baseline: NL (07) - LA (09)
Timerange: 01/01:03:12 to 01/01:05:10

Plot file version1126 created 03-MAR-2016 01:15:13

J1545+5400 GN002C 1.UVDATA.1

Freq = 1.2770 GHz, Bw = 16.000 MH Calibrated with CL # 3 and BP # 1 (BP mode 1)

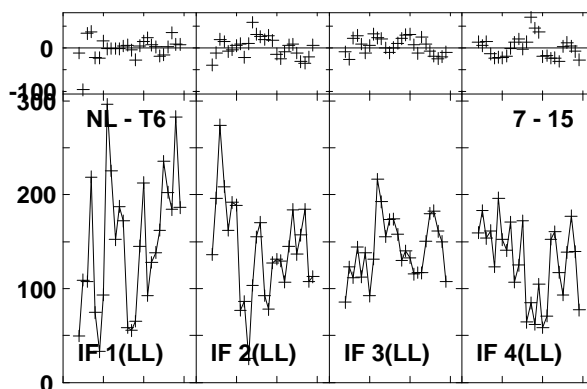
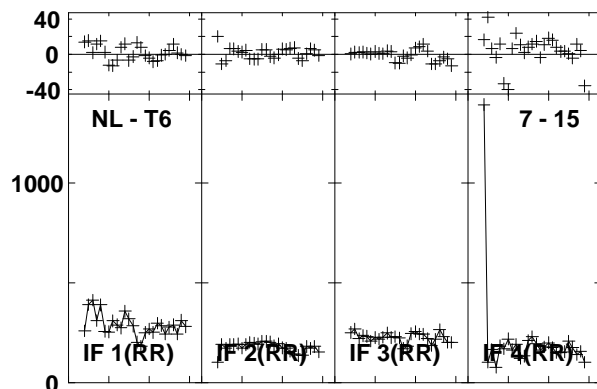
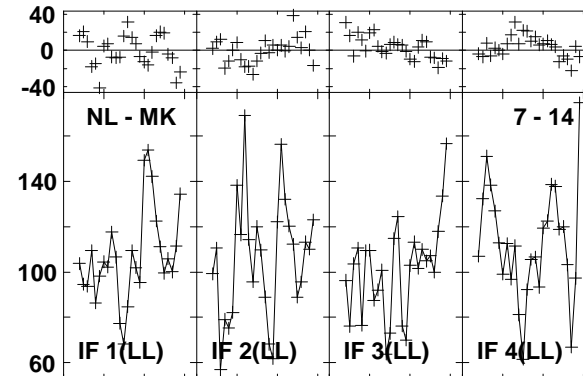
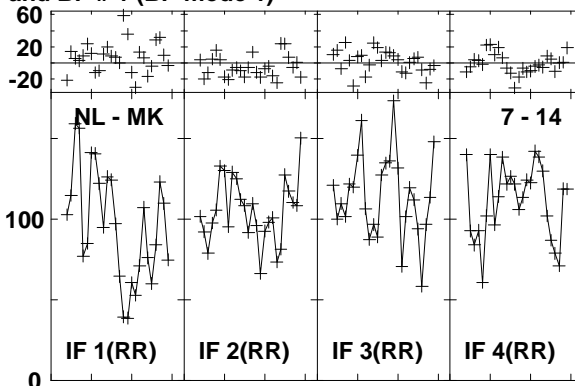
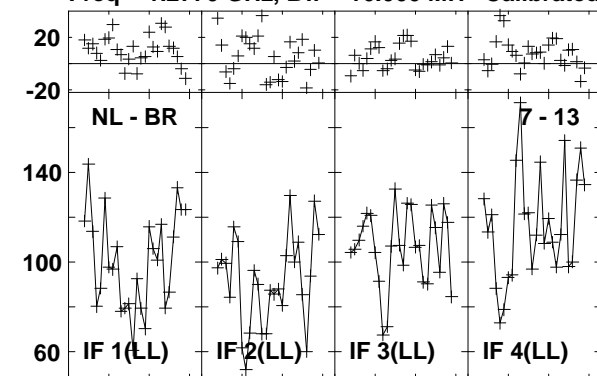

Lower frame: Milli Ampl Jy Top frame: Phas deg
Vector averaged cross-power spectrum Baseline: NL (07) - BR (13)
Timerange: 01/01:03:12 to 01/01:05:10

Plot file version1127 created 03-MAR-2016 01:15:13

J1638+5720 GN002C 1.UVDATA.1

Freq = 1.2770 GHz, Bw = 16.000 MH Calibrated with CL # 3 and BP # 1 (BP mode 1)

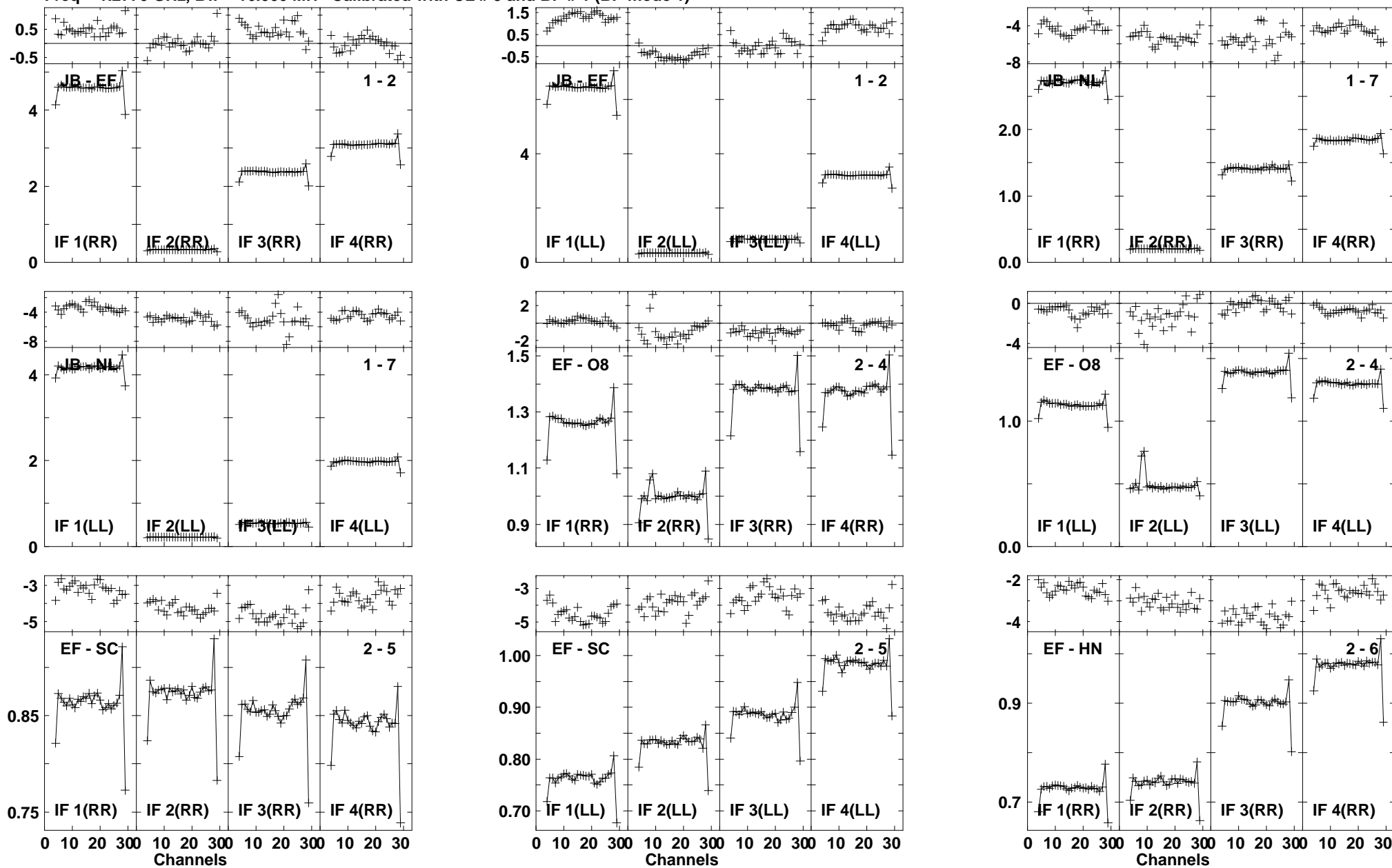

Lower frame: Ampl Jy Top frame: Phas deg
Vector averaged cross-power spectrum Baseline: JB (01) - EF (02)
Timerange: 01/01:06:15 to 01/01:10:03

Plot file version1128 created 03-MAR-2016 01:15:14

J1638+5720 GN002C 1.UVDATA.1

Freq = 1.2770 GHz, Bw = 16.000 MH Calibrated with CL # 3 and BP # 1 (BP mode 1)

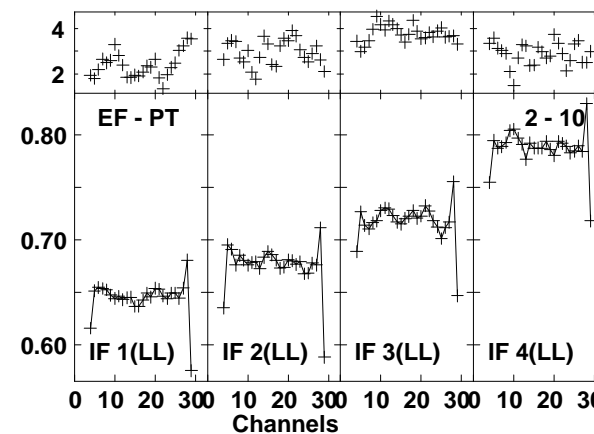
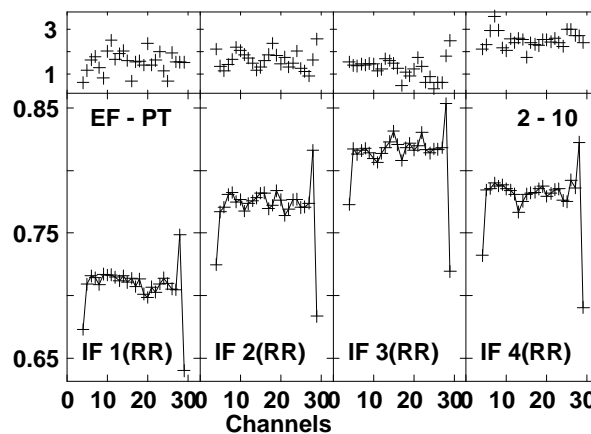
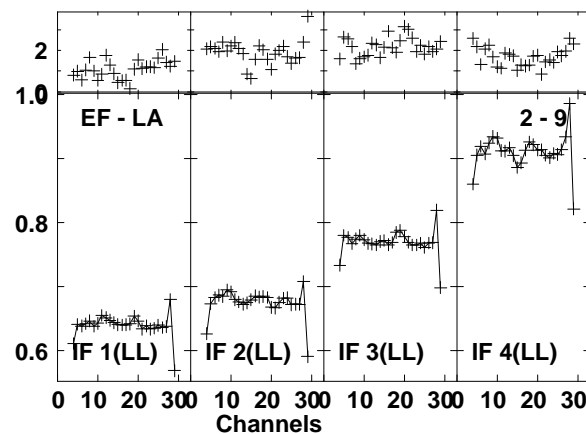
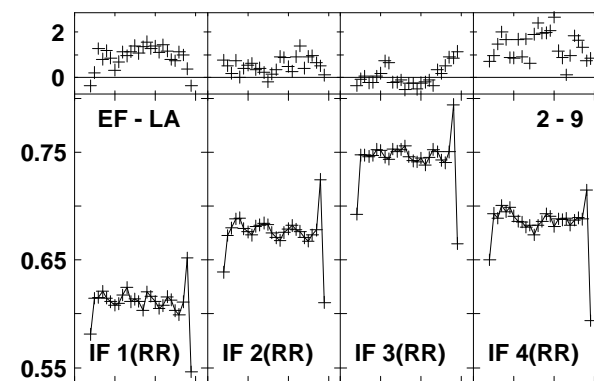
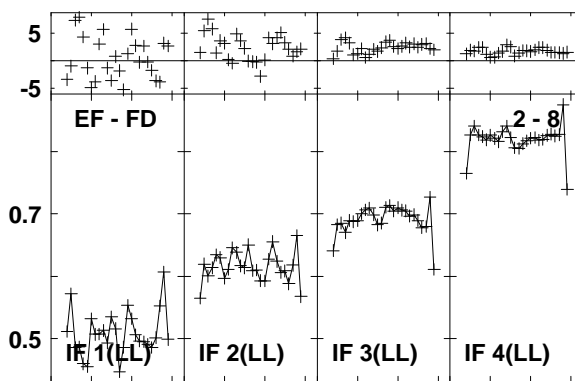
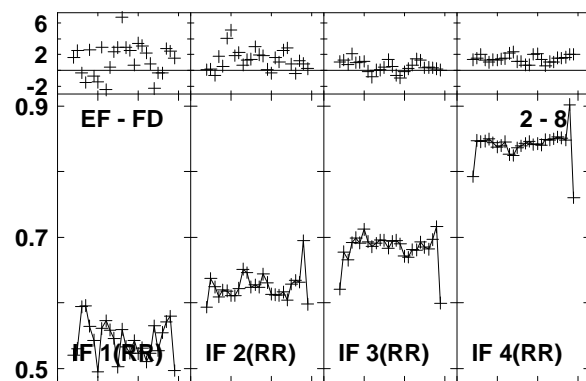
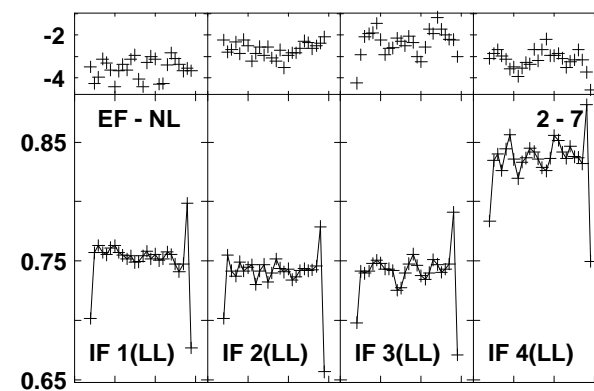
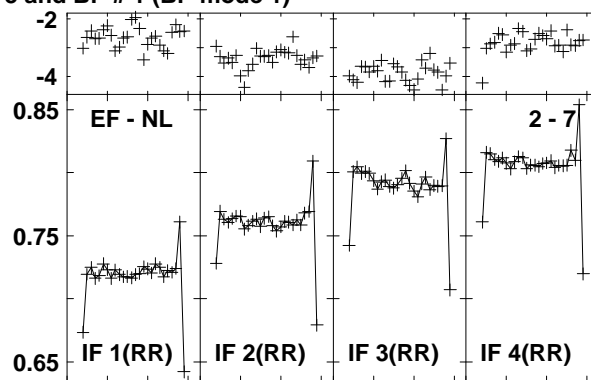
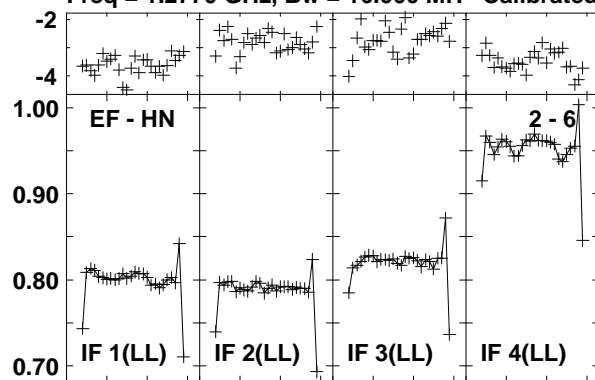

Lower frame: Ampl Jy Top frame: Phas deg
Vector averaged cross-power spectrum Baseline: EF (02) - HN (06)
Timerange: 01/01:06:15 to 01/01:10:03

Plot file version1129 created 03-MAR-2016 01:15:14

J1638+5720 GN002C 1.UVDATA.1

Freq = 1.2770 GHz, Bw = 16.000 MH Calibrated with CL # 3 and BP # 1 (BP mode 1)

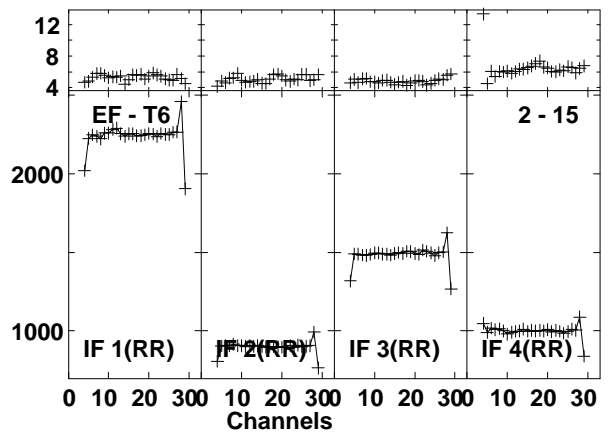
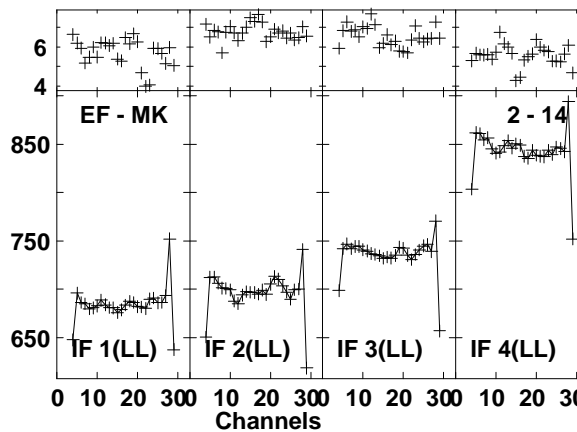
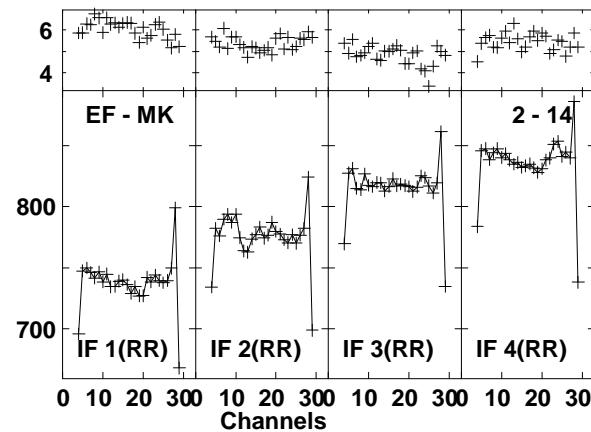
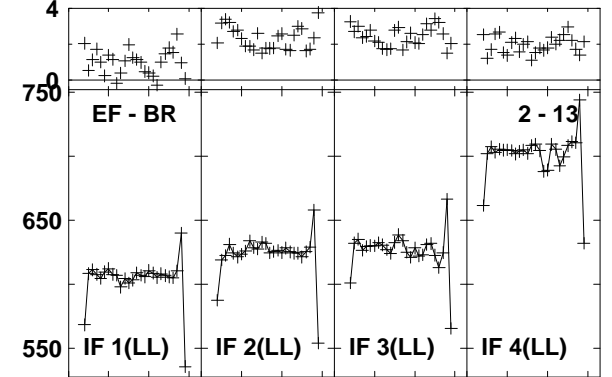
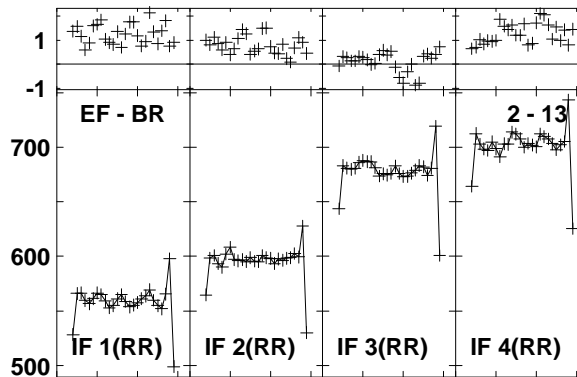
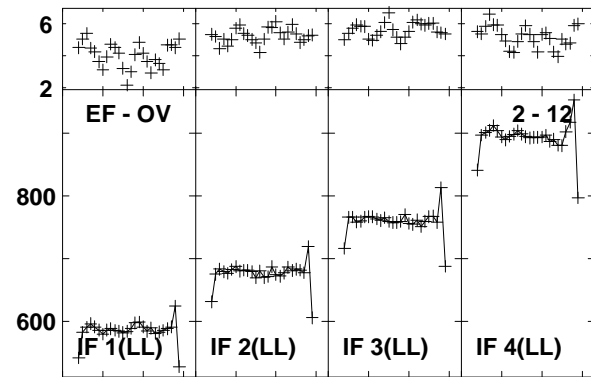
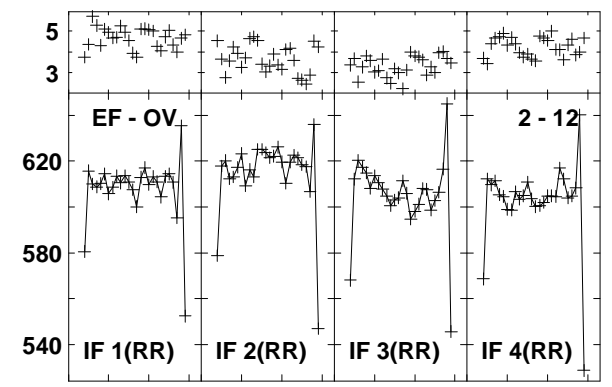
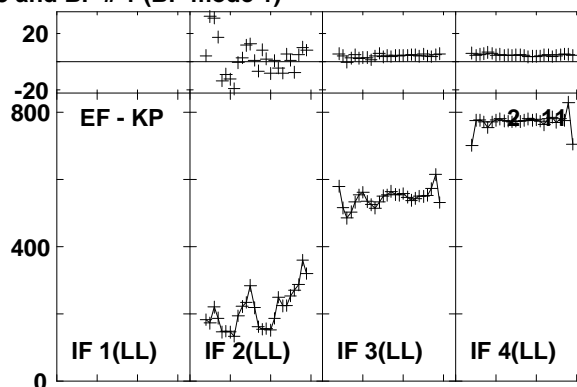
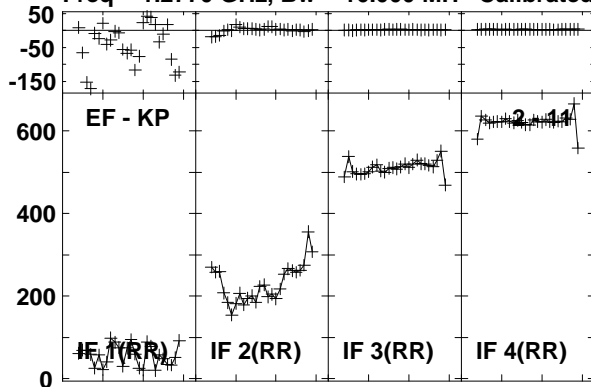

Lower frame: Milli Ampl Jy Top frame: Phas deg
Vector averaged cross-power spectrum Baseline: EF (02) - KP (11)
Timerange: 01/01:06:15 to 01/01:10:03

Plot file version1130 created 03-MAR-2016 01:15:14

J1638+5720 GN002C 1.UVDATA.1

Freq = 1.2770 GHz, Bw = 16.000 MH Calibrated with CL # 3 and BP # 1 (BP mode 1)

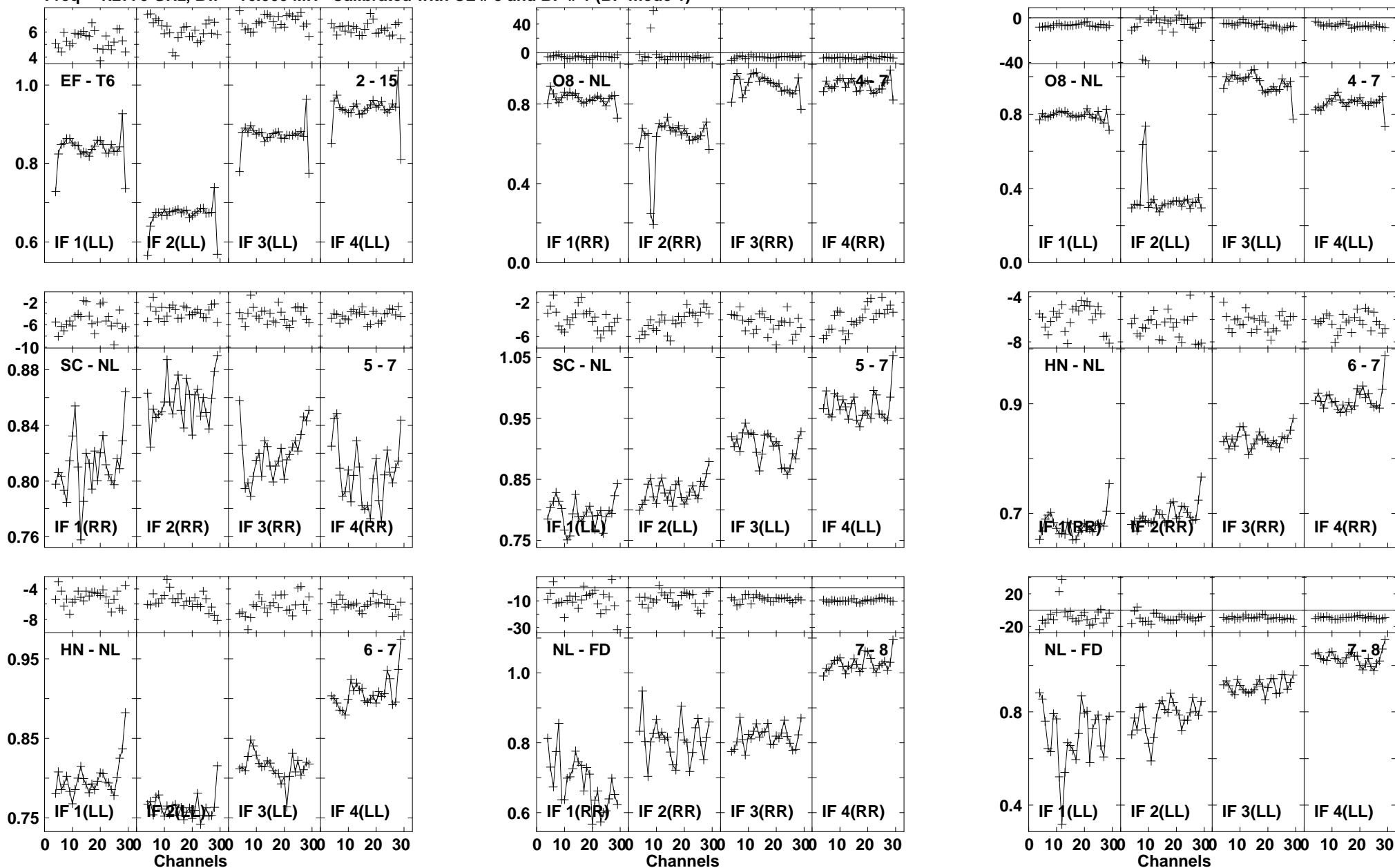

Lower frame: Ampl Jy Top frame: Phas deg
Vector averaged cross-power spectrum Baseline: EF (02) - T6 (15)
Timerange: 01/01:06:15 to 01/01:10:03

Plot file version1131 created 03-MAR-2016 01:15:14

J1638+5720 GN002C 1.UVDATA.1

Freq = 1.2770 GHz, Bw = 16.000 MH Calibrated with CL # 3 and BP # 1 (BP mode 1)

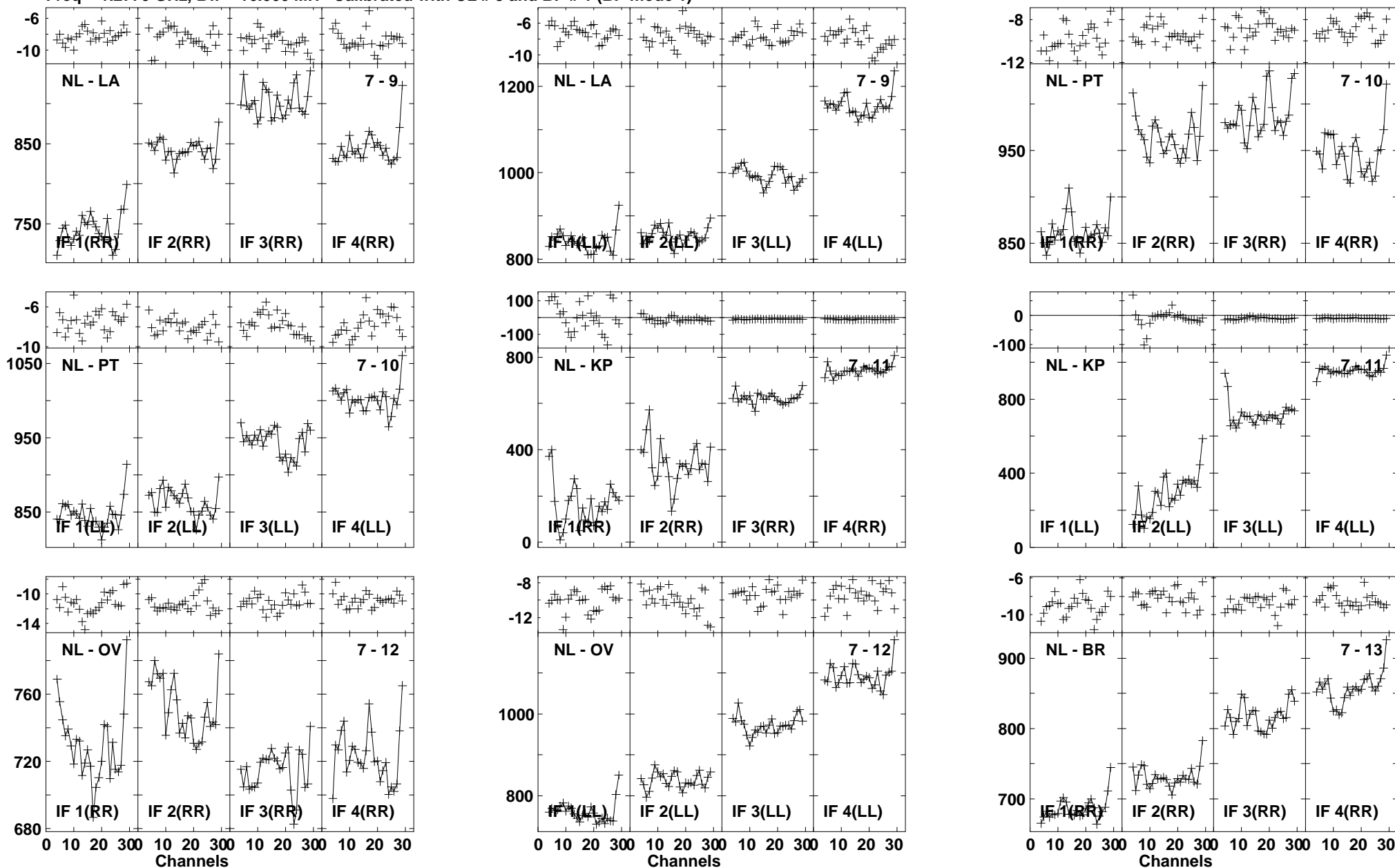

Lower frame: Milli Ampl Jy Top frame: Phas deg
Vector averaged cross-power spectrum Baseline: NL (07) - LA (09)
Timerange: 01/01:06:15 to 01/01:10:03

Plot file version1132 created 03-MAR-2016 01:15:14

J1638+5720 GN002C 1.UVDATA.1

Freq = 1.2770 GHz, Bw = 16.000 MH Calibrated with CL # 3 and BP # 1 (BP mode 1)

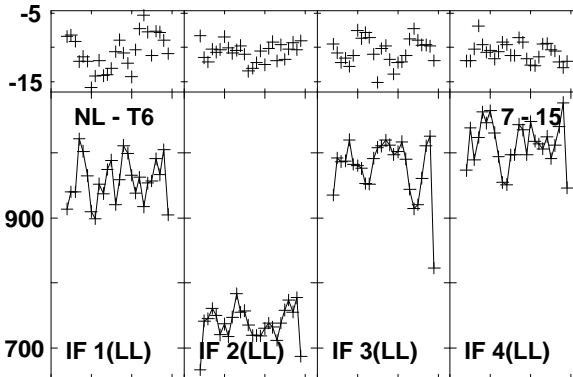
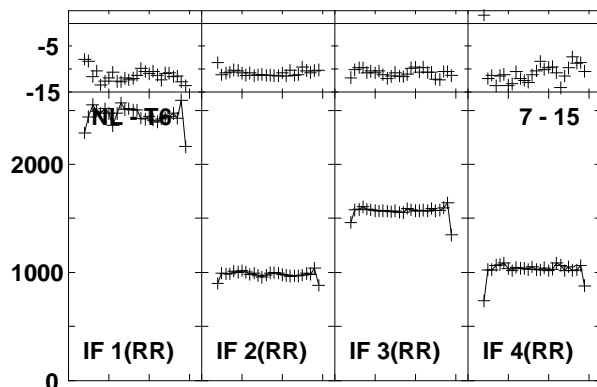
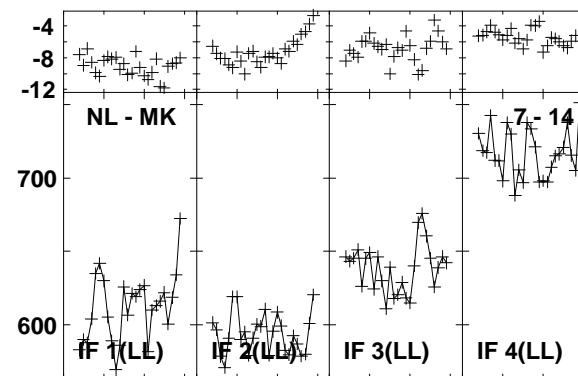
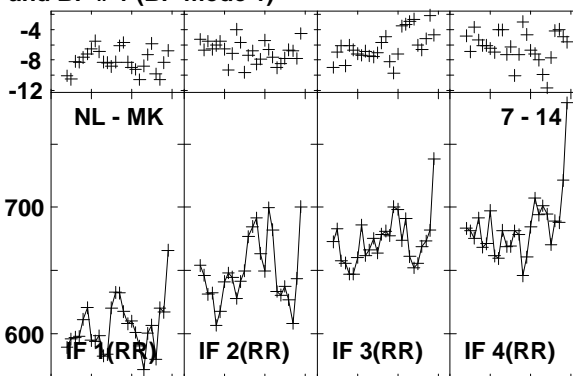
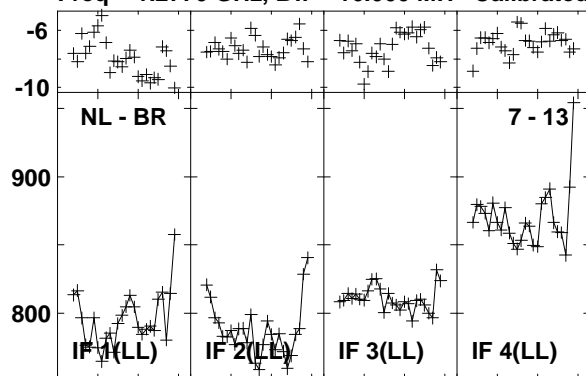

Lower frame: Milli Ampl Jy Top frame: Phas deg
Vector averaged cross-power spectrum Baseline: NL (07) - BR (13)
Timerange: 01/01:06:15 to 01/01:10:03

Plot file version1133 created 03-MAR-2016 01:15:15

J1545+5400 GN002C 1.UVDATA.1

Freq = 1.2770 GHz, Bw = 16.000 MH Calibrated with CL # 3 and BP # 1 (BP mode 1)

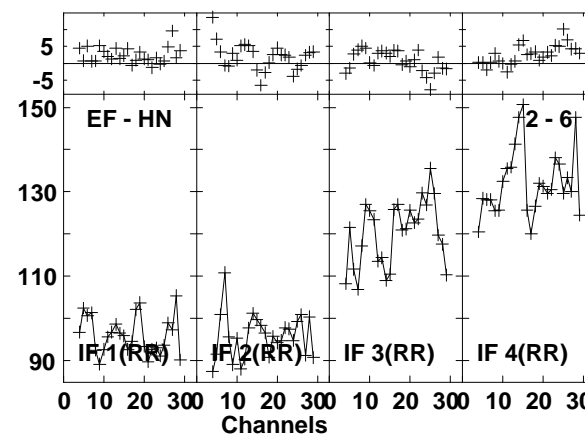
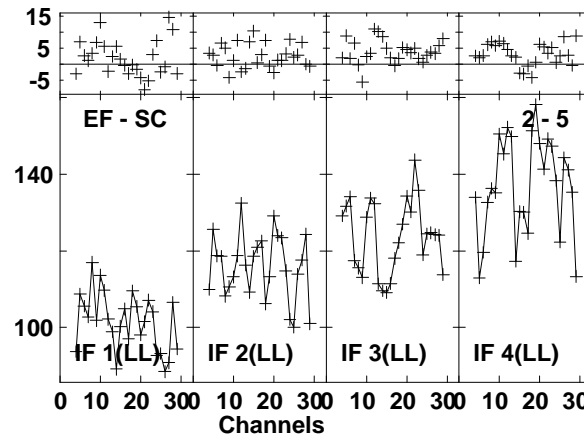
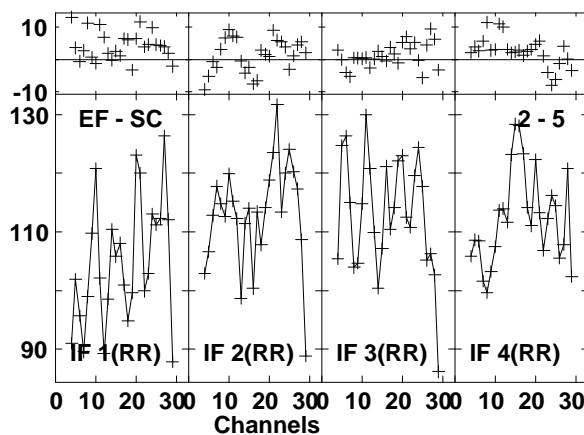
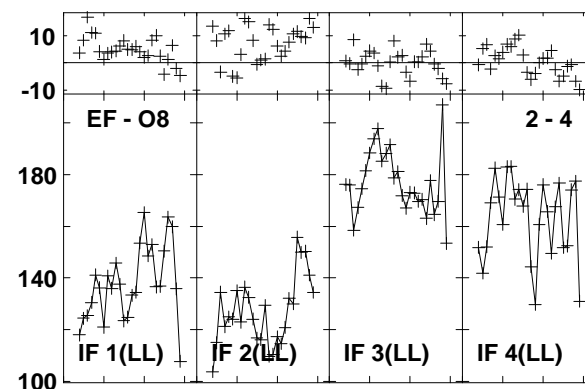
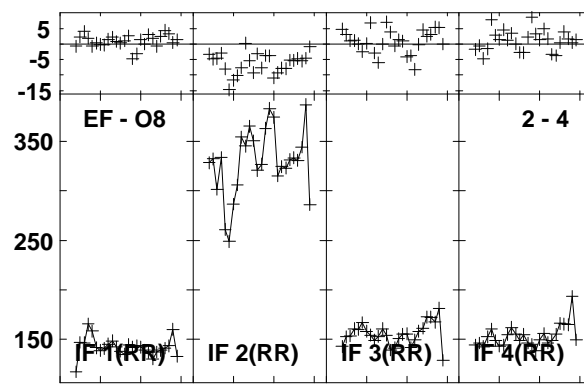
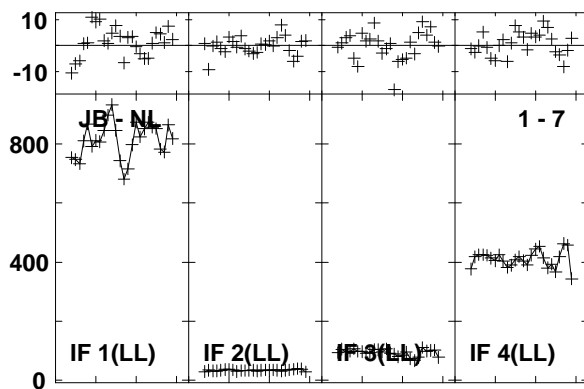
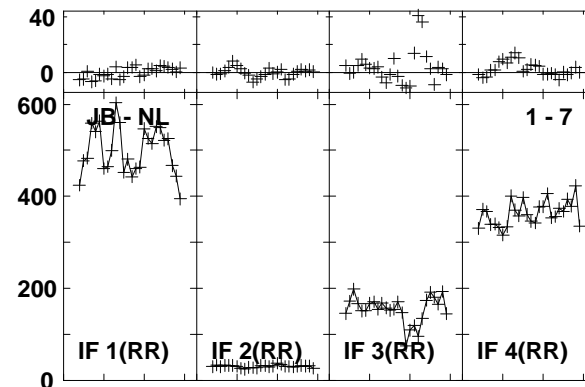
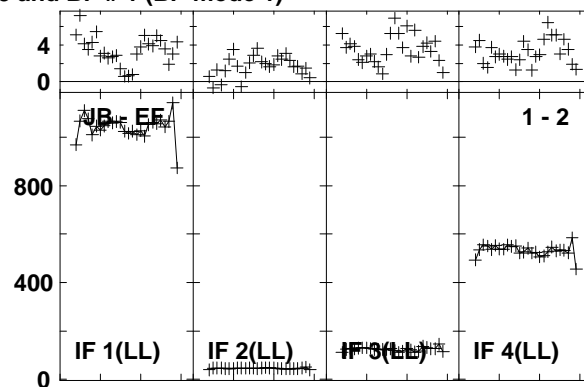
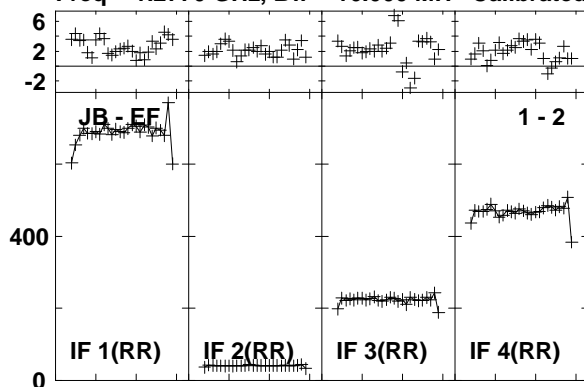

Lower frame: Milli Ampl Jy Top frame: Phas deg
Vector averaged cross-power spectrum Baseline: JB (01) - EF (02)
Timerange: 01/01:11:10 to 01/01:13:58

Plot file version1134 created 03-MAR-2016 01:15:15

J1545+5400 GN002C 1.UVDATA.1

Freq = 1.2770 GHz, Bw = 16.000 MH Calibrated with CL # 3 and BP # 1 (BP mode 1)

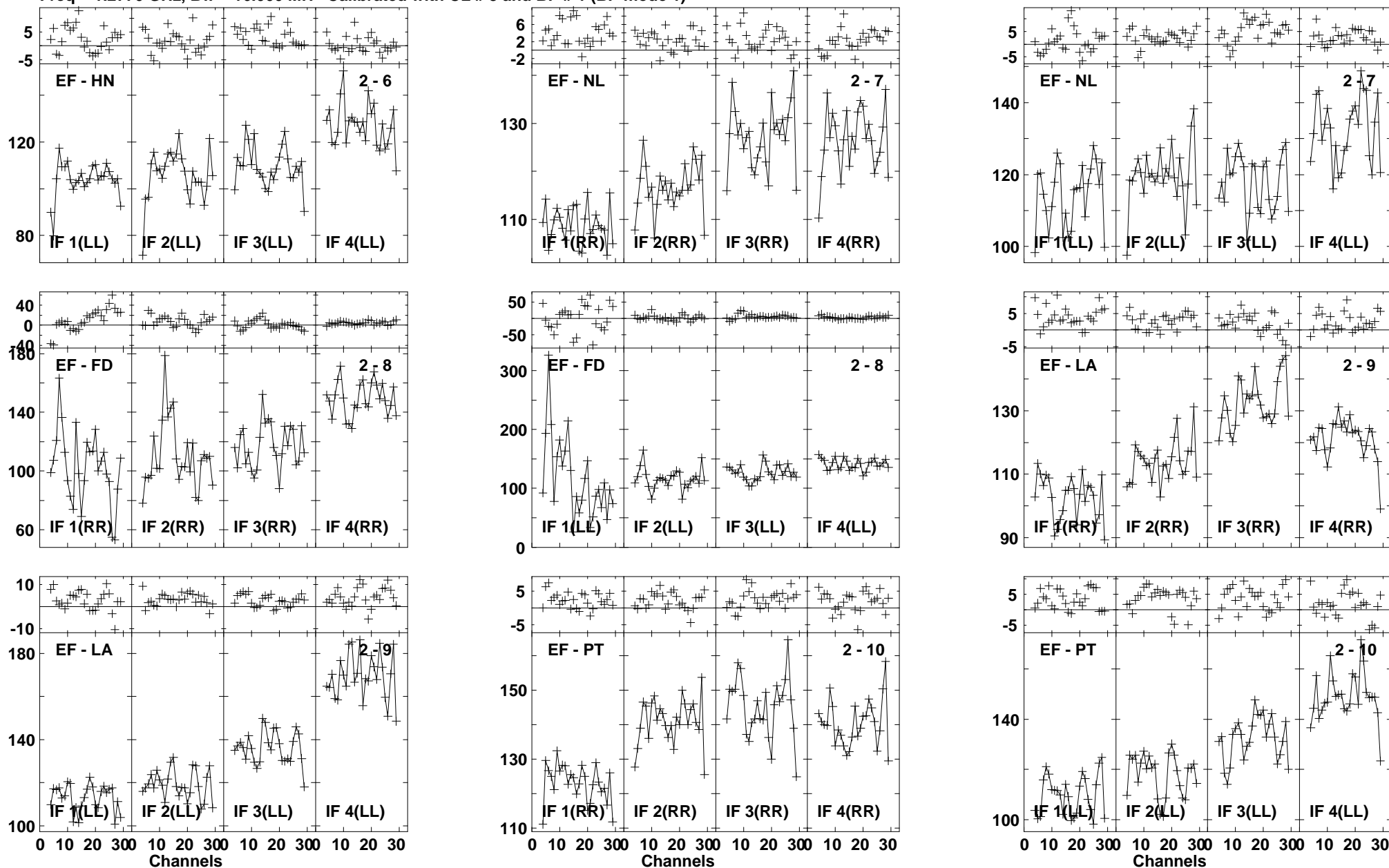

Lower frame: Milli Ampl Jy Top frame: Phas deg
 Vector averaged cross-power spectrum Baseline: EF (02) - HN (06)
 Timerange: 01/01:11:10 to 01/01:13:58

Plot file version1135 created 03-MAR-2016 01:15:15
 J1545+5400 GN002C 1.UVDATA.1
 Freq = 1.2770 GHz, Bw = 16.000 MH Calibrated with CL # 3 and BP # 1 (BP mode 1)

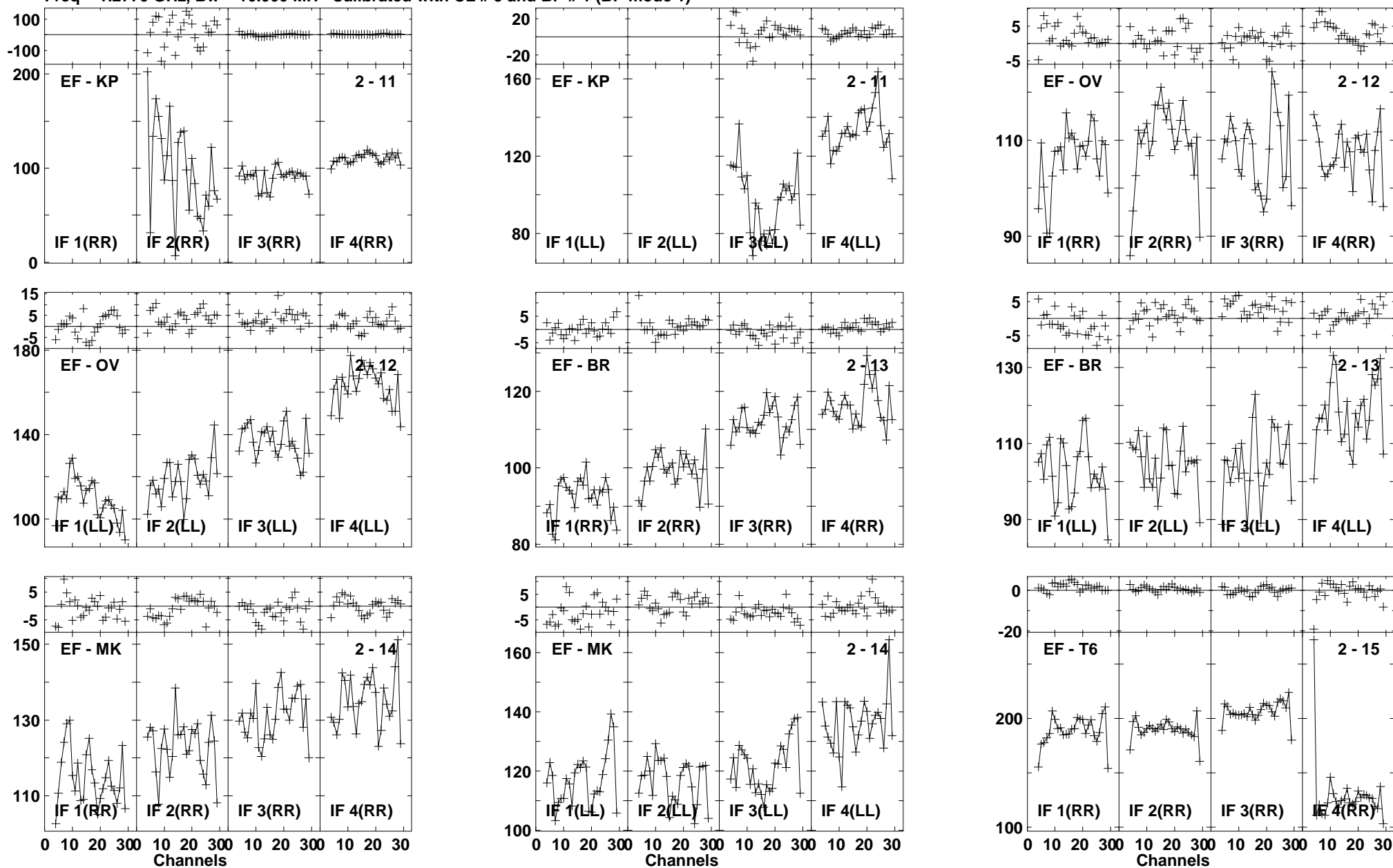

Lower frame: Milli Ampl Jy Top frame: Phas deg
 Vector averaged cross-power spectrum Baseline: EF (02) - KP (11)
 Timerange: 01/01:11:10 to 01/01:13:58

Plot file version1136 created 03-MAR-2016 01:15:15

J1545+5400 GN002C 1.UVDATA.1

Freq = 1.2770 GHz, Bw = 16.000 MH Calibrated with CL # 3 and BP # 1 (BP mode 1)

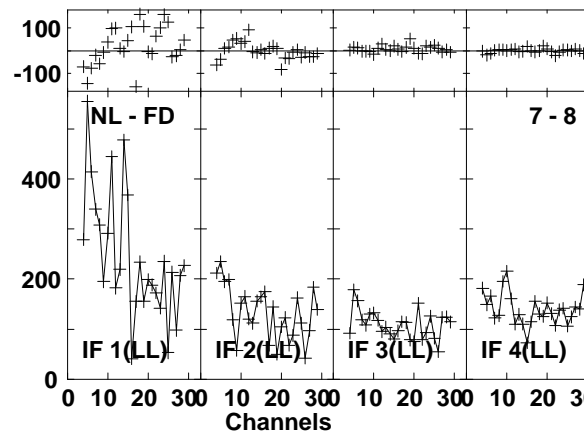
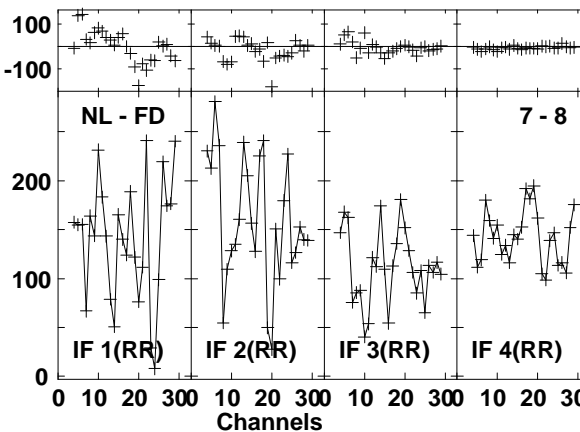
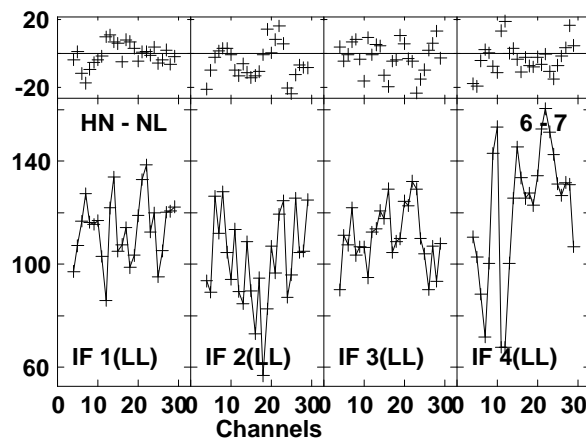
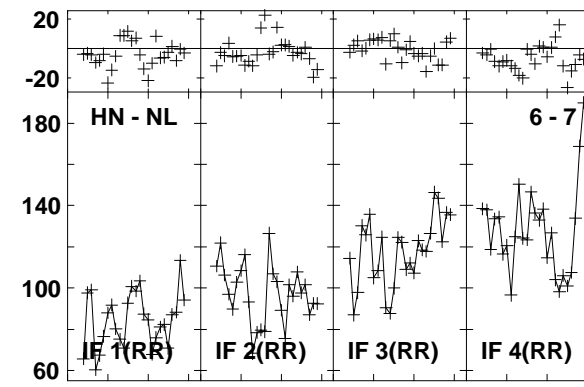
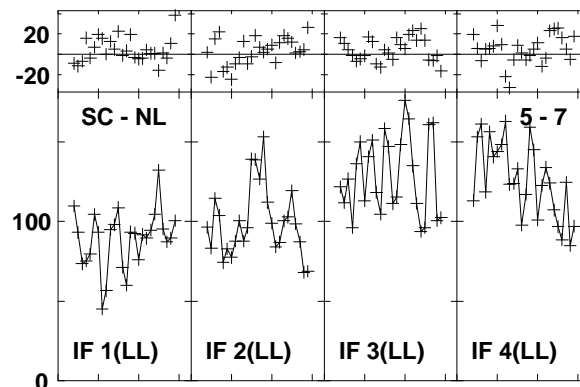
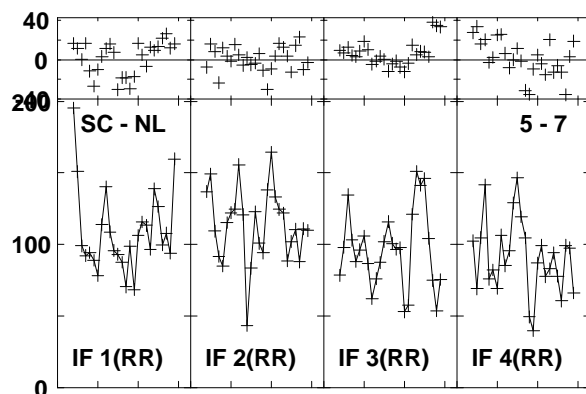
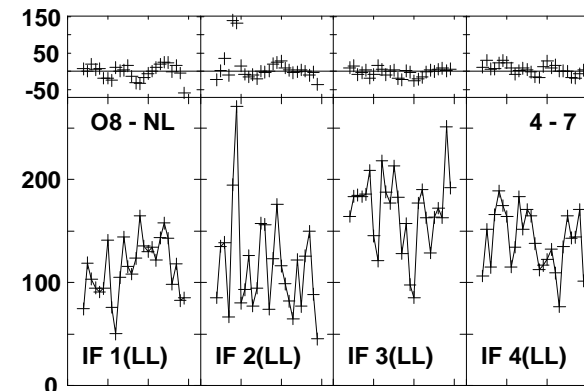
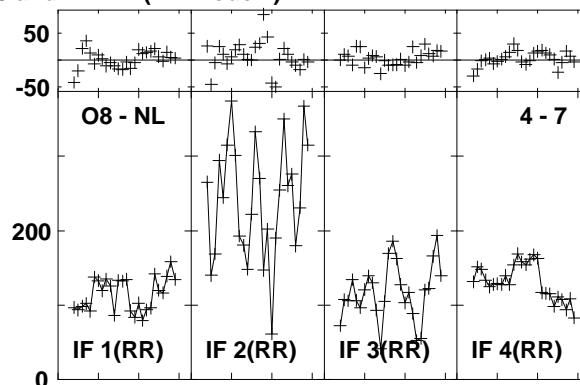
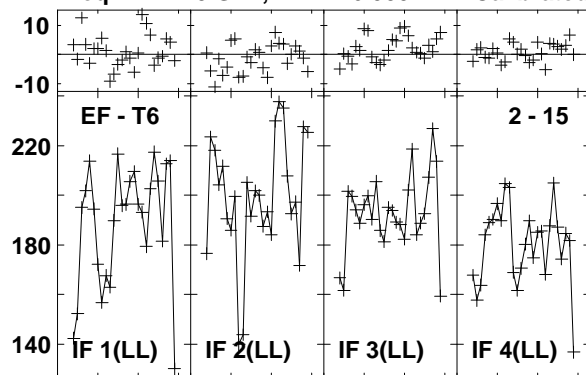

Lower frame: Milli Ampl Jy Top frame: Phas deg
Vector averaged cross-power spectrum Baseline: EF (02) - T6 (15)
Timerange: 01/01:11:10 to 01/01:13:58

Plot file version1137 created 03-MAR-2016 01:15:15
 J1545+5400 GN002C 1.UVDATA.1
 Freq = 1.2770 GHz, Bw = 16.000 MH Calibrated with CL # 3 and BP # 1 (BP mode 1)

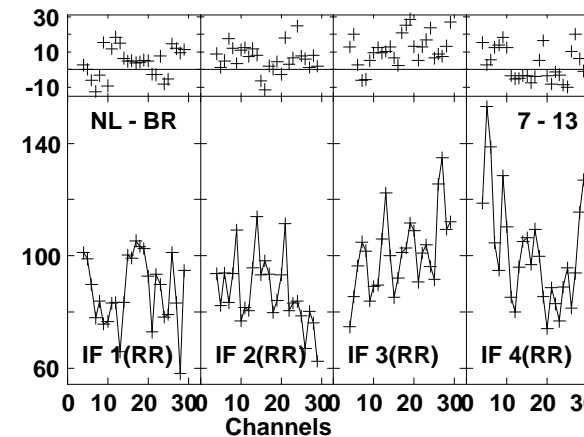
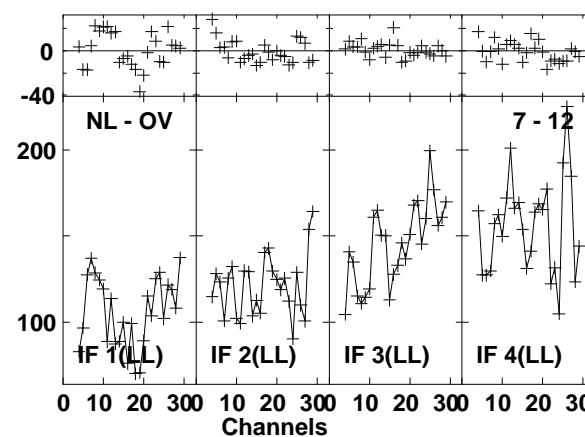
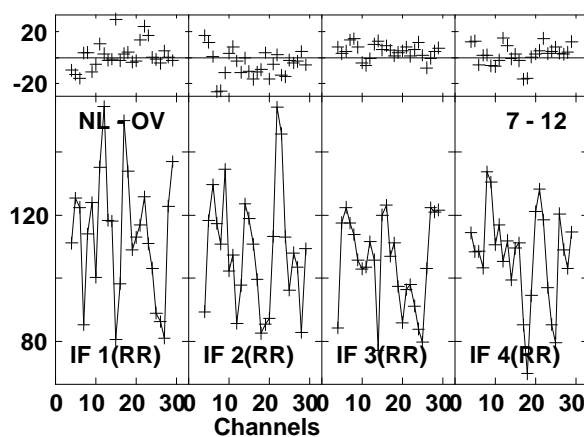
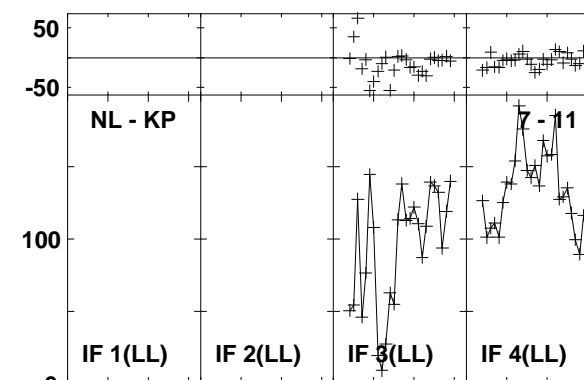
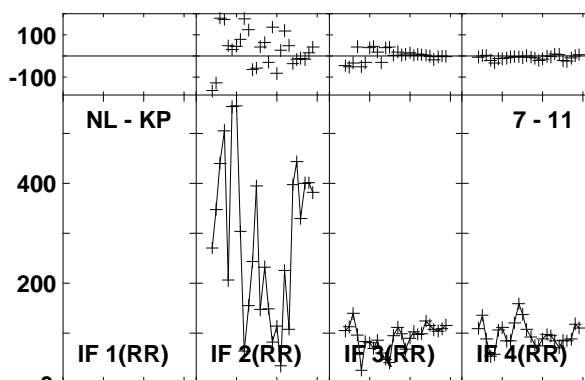
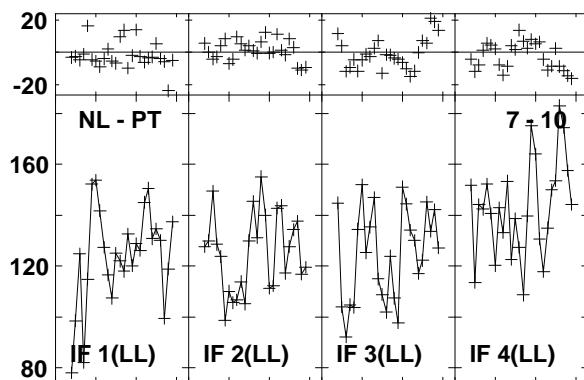
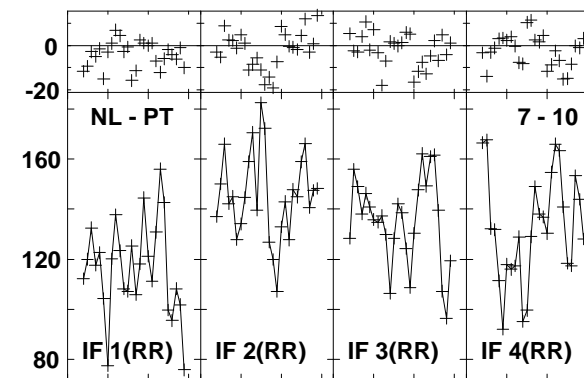
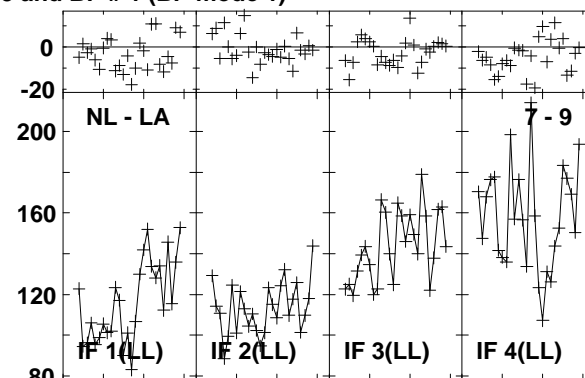
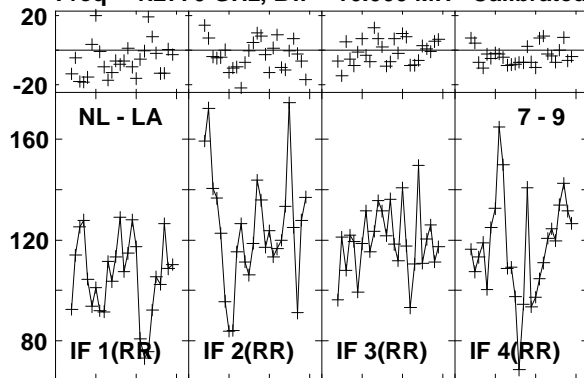

Lower frame: Milli Ampl Jy Top frame: Phas deg
 Vector averaged cross-power spectrum Baseline: NL (07) - LA (09)
 Timerange: 01/01:11:10 to 01/01:13:58

Plot file version1138 created 03-MAR-2016 01:15:16

J1545+5400 GN002C 1.UVDATA.1

Freq = 1.2770 GHz, Bw = 16.000 MH Calibrated with CL # 3 and BP # 1 (BP mode 1)

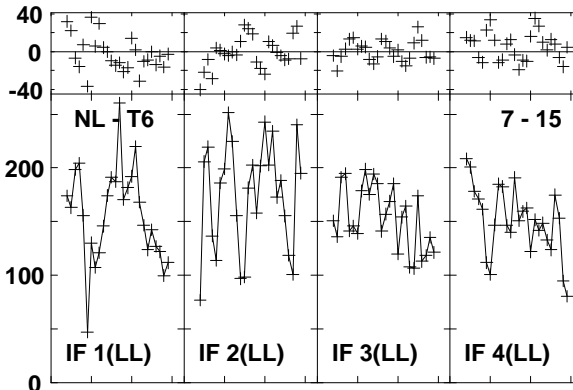
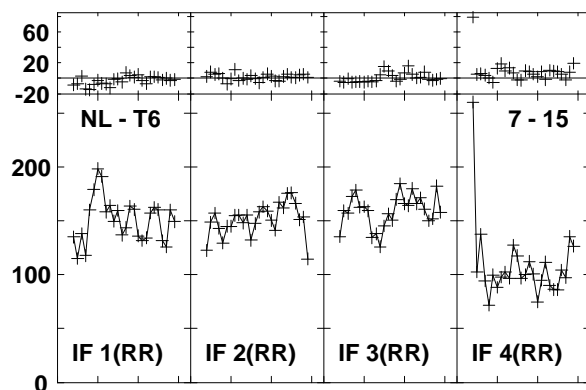
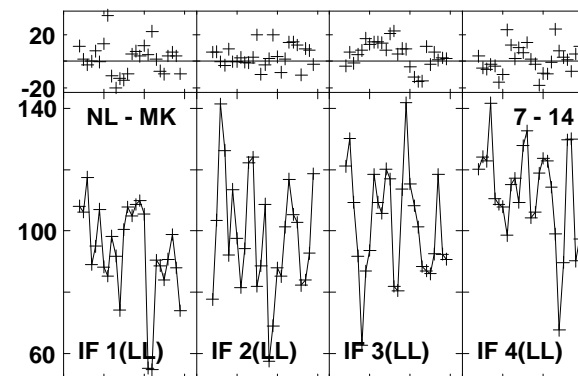
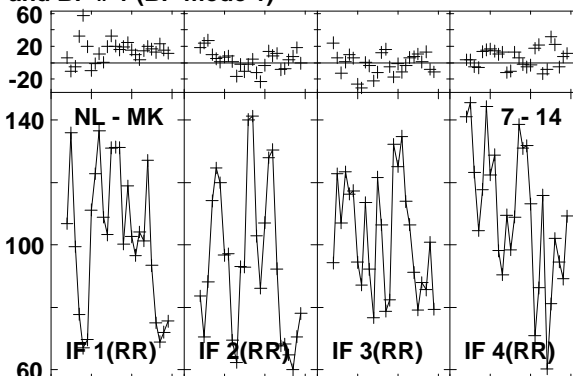
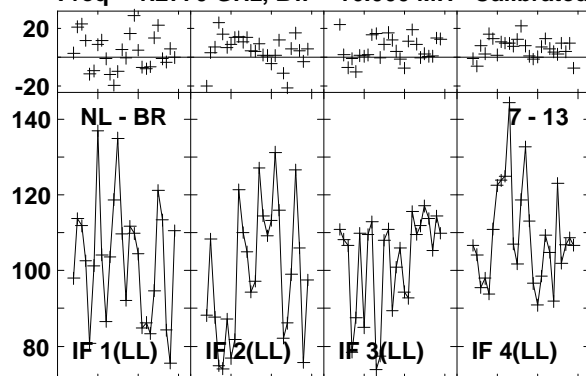

Lower frame: Milli Ampl Jy Top frame: Phas deg
Vector averaged cross-power spectrum Baseline: NL (07) - BR (13)
Timerange: 01/01:11:10 to 01/01:13:58

Plot file version1139 created 03-MAR-2016 01:15:16

4C52 GN002C 1.UVDATA.1

Freq = 1.2770 GHz, Bw = 16.000 MH Calibrated with CL # 3 and BP # 1 (BP mode 1)

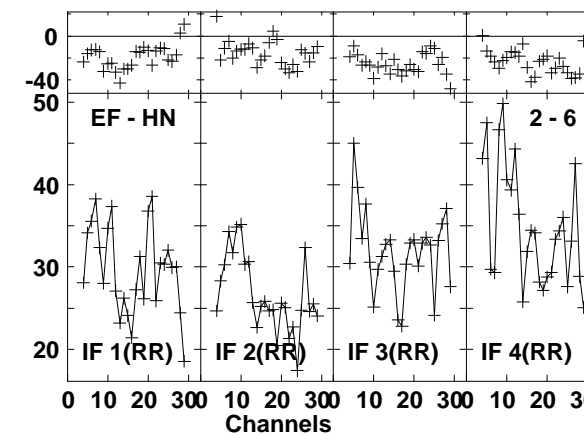
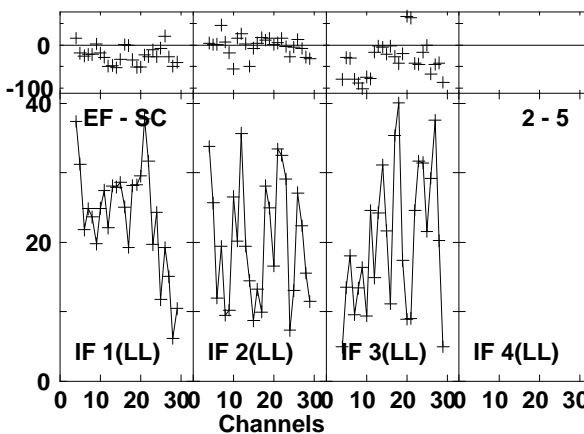
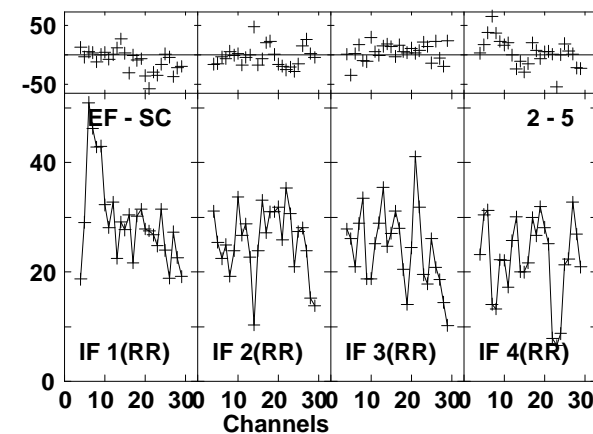
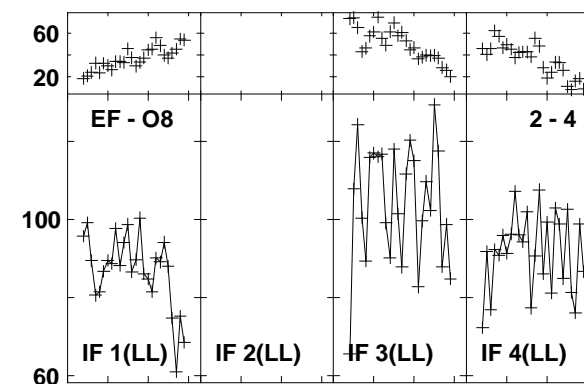
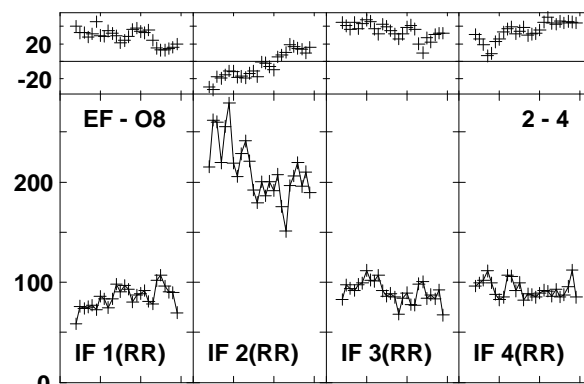
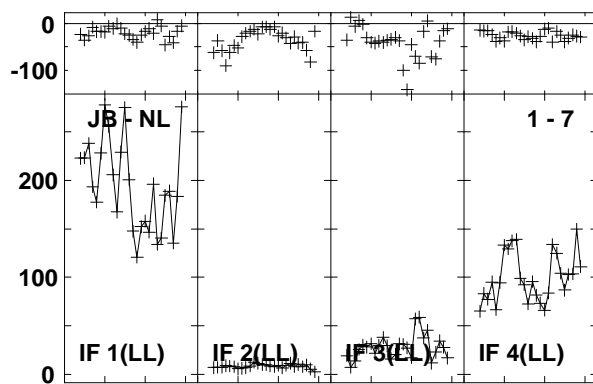
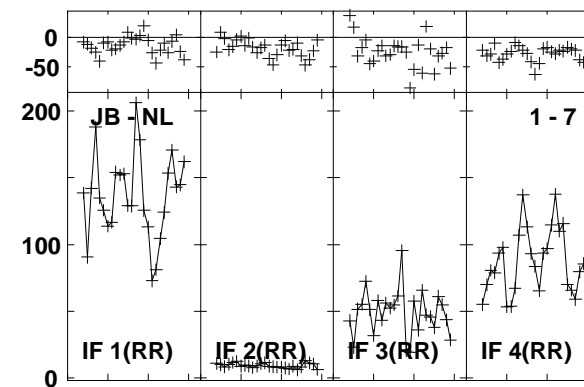
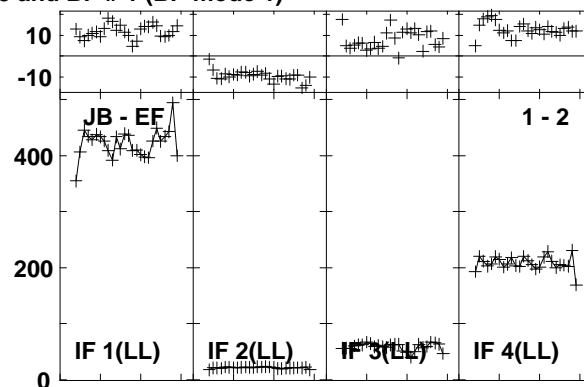
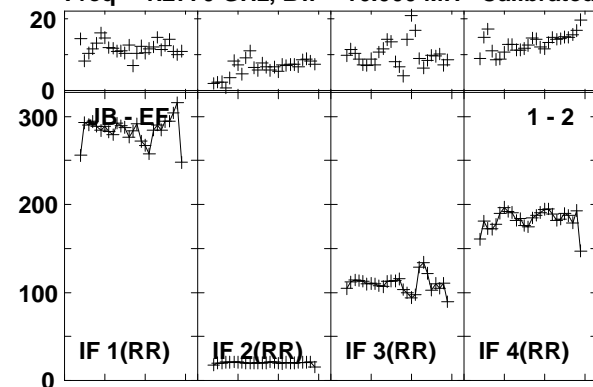

Lower frame: Milli Ampl Jy Top frame: Phas deg
Vector averaged cross-power spectrum Baseline: JB (01) - EF (02)
Timerange: 01/01:14:11 to 01/01:17:27

Plot file version1140 created 03-MAR-2016 01:15:16

4C52 GN002C 1.UVDATA.1

Freq = 1.2770 GHz, Bw = 16.000 MH Calibrated with CL # 3 and BP # 1 (BP mode 1)

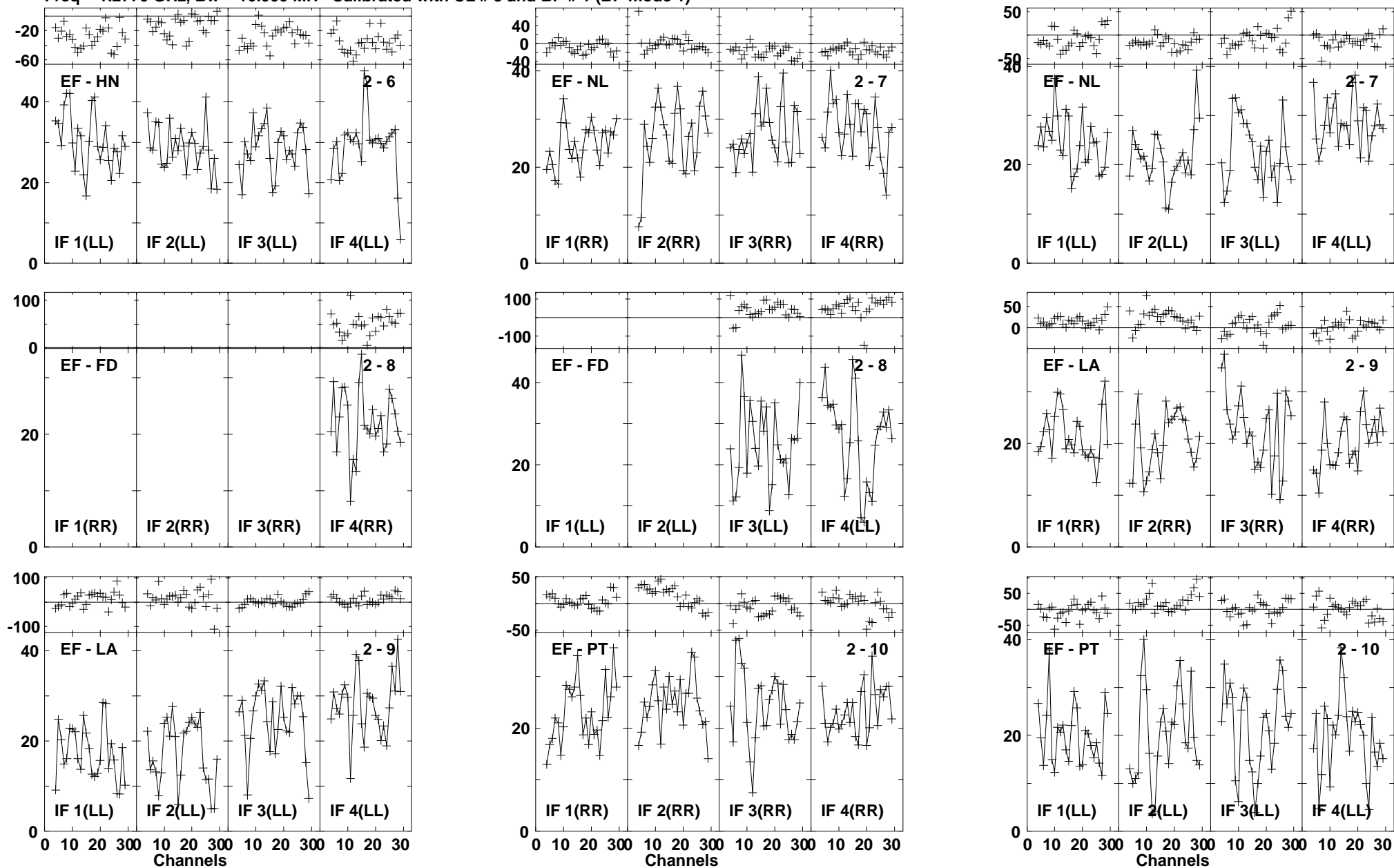

Lower frame: Milli Ampl Jy Top frame: Phas deg
Vector averaged cross-power spectrum Baseline: EF (02) - HN (06)
Timerange: 01/01:14:11 to 01/01:17:27

Plot file version1141 created 03-MAR-2016 01:15:16

4C52 GN002C 1.UVDATA.1

Freq = 1.2770 GHz, Bw = 16.000 MH Calibrated with CL # 3 and BP # 1 (BP mode 1)

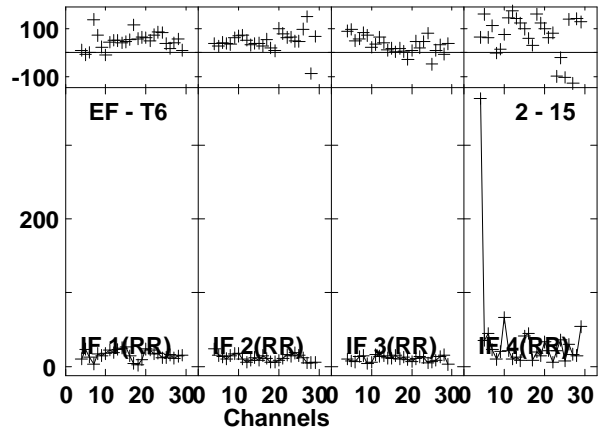
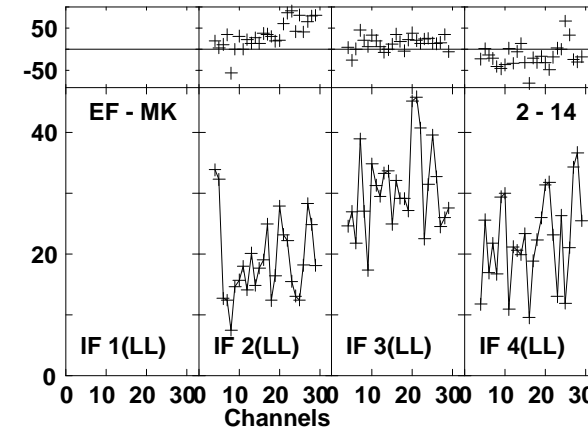
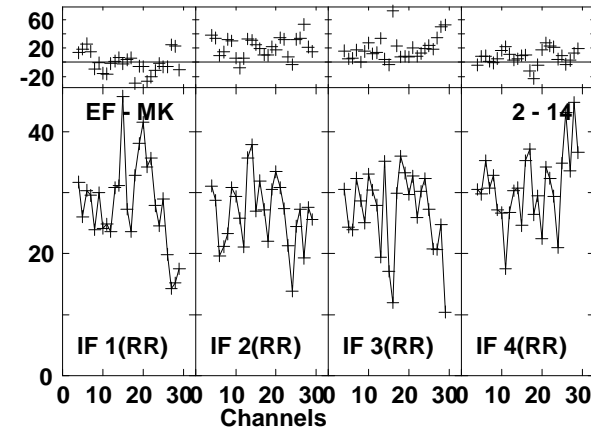
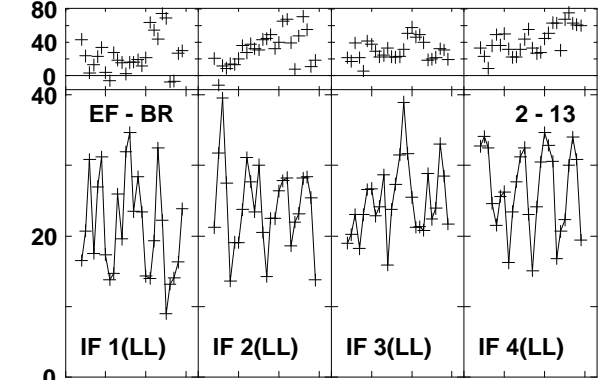
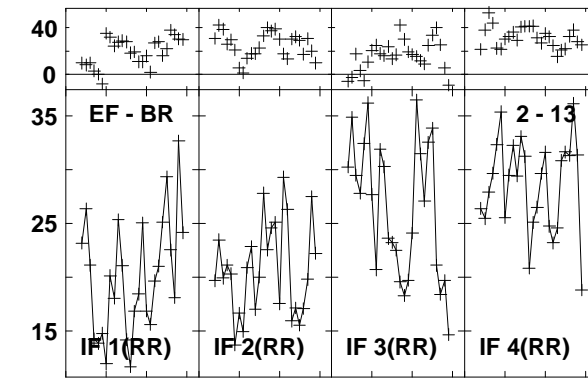
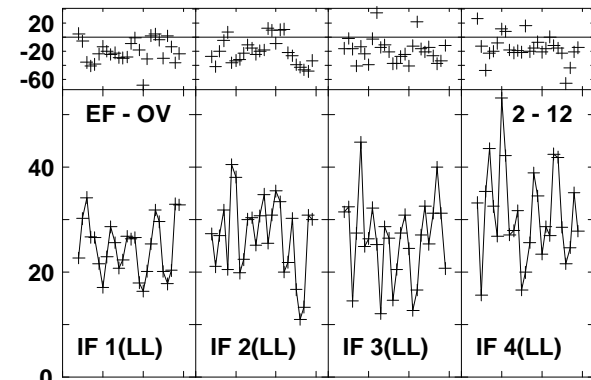
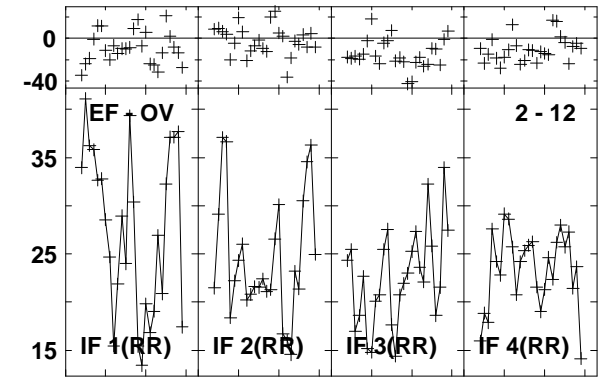
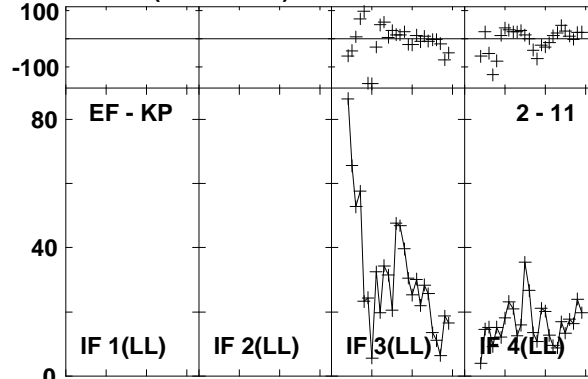
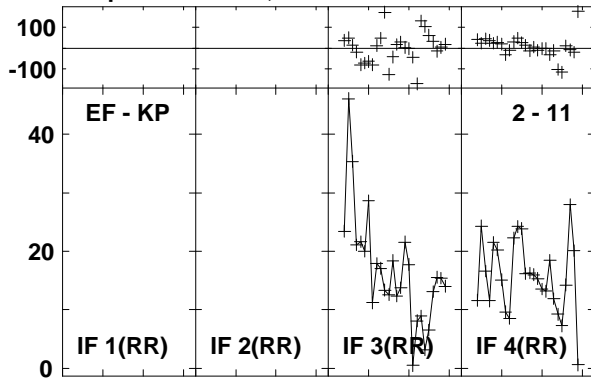

Lower frame: Milli Ampl Jy Top frame: Phas deg
Vector averaged cross-power spectrum Baseline: EF (02) - KP (11)
Timerange: 01/01:14:11 to 01/01:17:27

Plot file version1142 created 03-MAR-2016 01:15:16

4C52 GN002C 1.UVDATA.1

Freq = 1.2770 GHz, Bw = 16.000 MH Calibrated with CL # 3 and BP # 1 (BP mode 1)

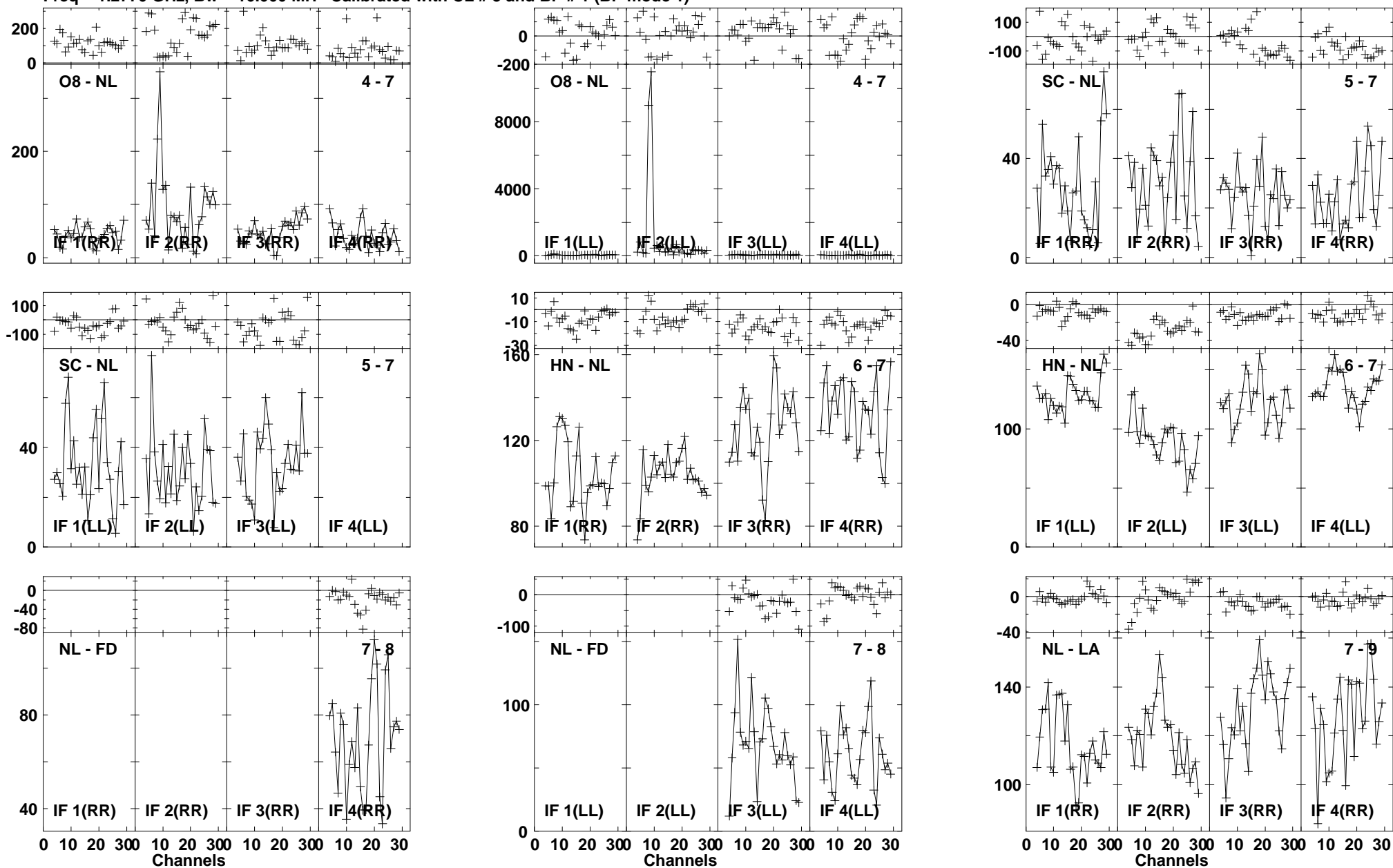

Lower frame: Milli Ampl Jy Top frame: Phas deg
Vector averaged cross-power spectrum Baseline: O8 (04) - NL (07)
Timerange: 01/01:14:11 to 01/01:17:27

Plot file version1143 created 03-MAR-2016 01:15:17

4C52 GN002C 1.UVDATA.1

Freq = 1.2770 GHz, Bw = 16.000 MH Calibrated with CL # 3 and BP # 1 (BP mode 1)

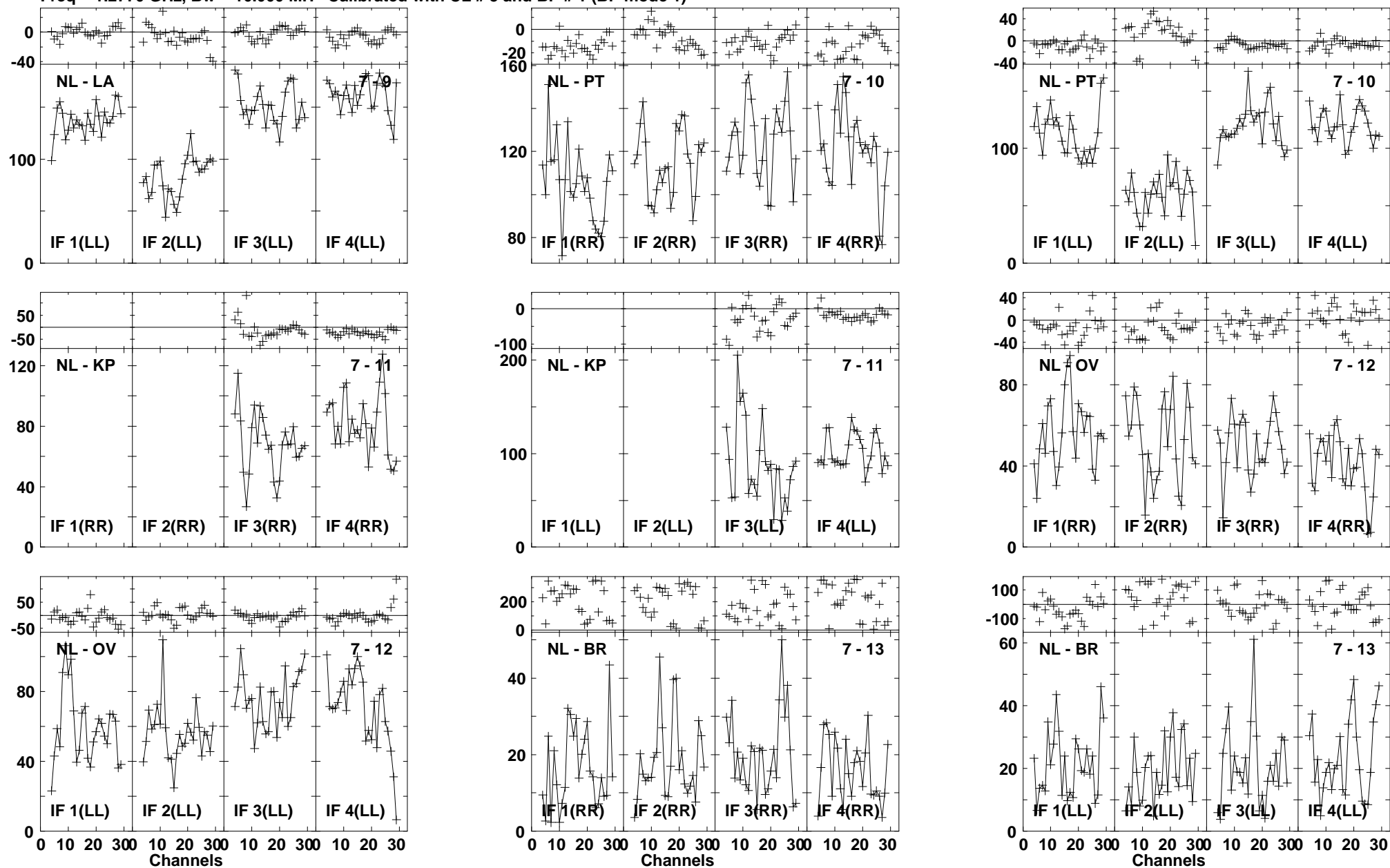

Lower frame: Milli Ampl Jy Top frame: Phas deg
Vector averaged cross-power spectrum Baseline: NL (07) - LA (09)
Timerange: 01/01:14:11 to 01/01:17:27

Plot file version1144 created 03-MAR-2016 01:15:17

4C52 GN002C 1.UVDATA.1

Freq = 1.2770 GHz, Bw = 16.000 MH Calibrated with CL # 3 and BP # 1 (BP mode 1)

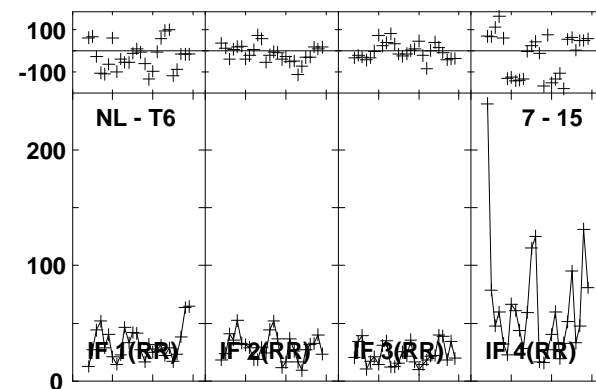
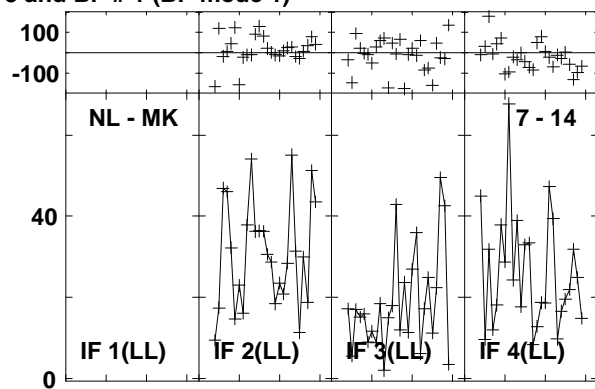
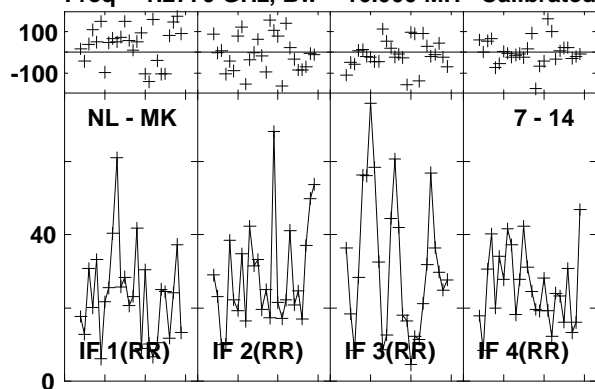

Lower frame: Milli Ampl Jy Top frame: Phas deg
Vector averaged cross-power spectrum Baseline: NL (07) - MK (14)
Timerange: 01/01:14:11 to 01/01:17:27

Plot file version1145 created 03-MAR-2016 01:15:17

J1545+5400 GN002C 1.UVDATA.1

Freq = 1.2770 GHz, Bw = 16.000 MH Calibrated with CL # 3 and BP # 1 (BP mode 1)

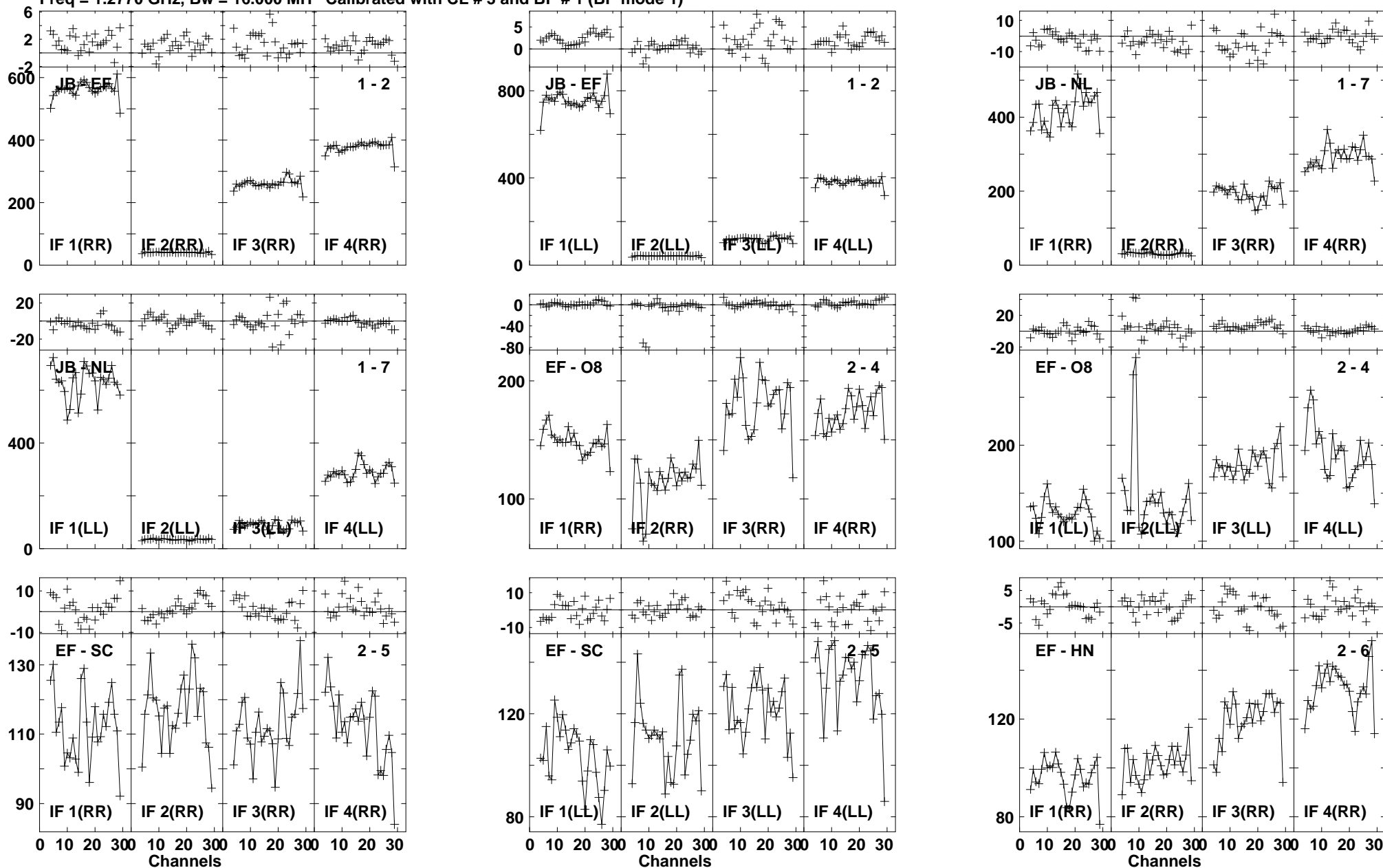

Lower frame: Milli Ampl Jy Top frame: Phas deg
Vector averaged cross-power spectrum Baseline: JB (01) - EF (02)
Timerange: 01/01:18:20 to 01/01:20:18

Plot file version1146 created 03-MAR-2016 01:15:17

J1545+5400 GN002C 1.UVDATA.1

Freq = 1.2770 GHz, Bw = 16.000 MH Calibrated with CL # 3 and BP # 1 (BP mode 1)

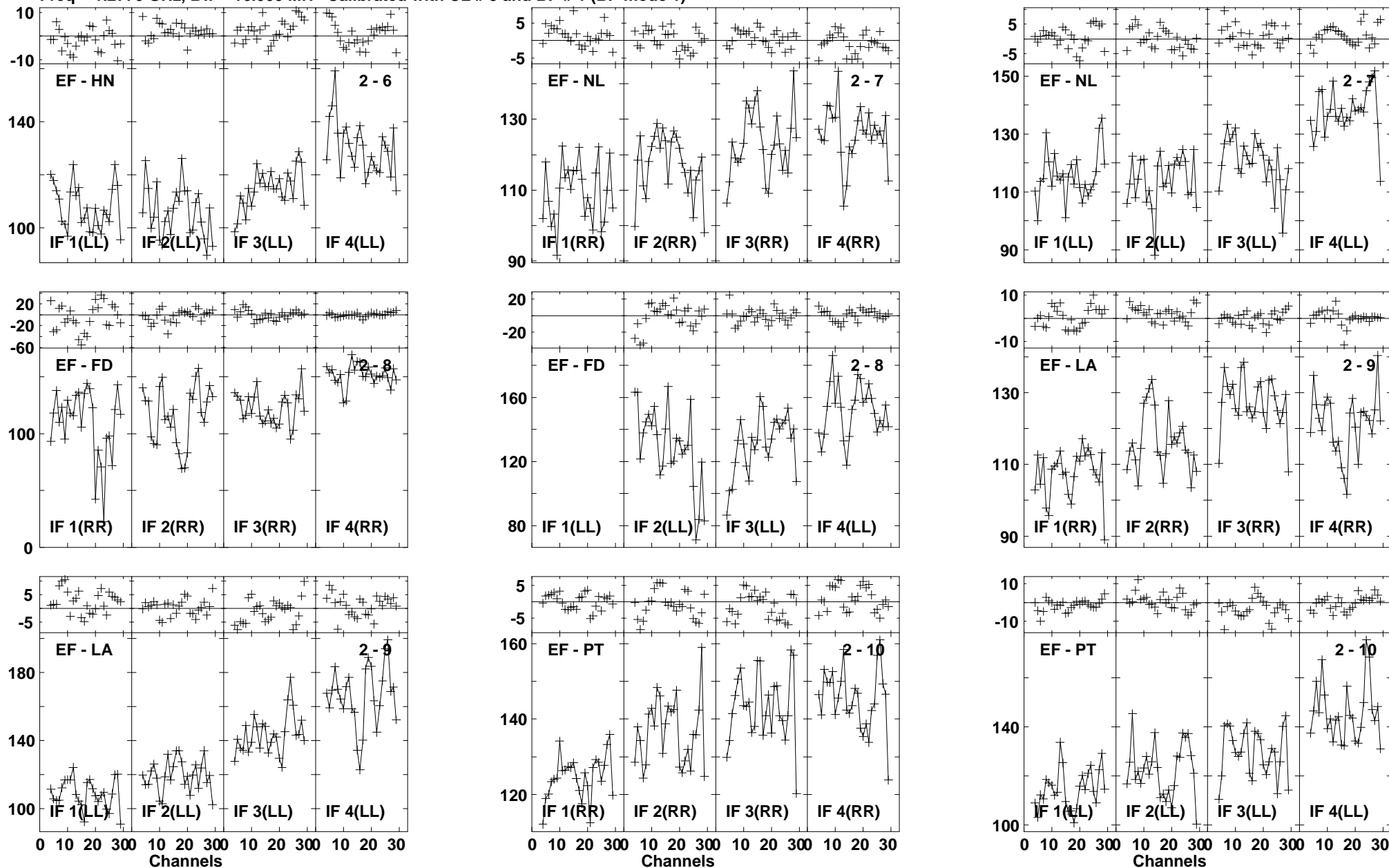

Lower frame: Milli Ampl Jy Top frame: Phas deg
Vector averaged cross-power spectrum Baseline: EF (02) - HN (06)
Timerange: 01/01:18:20 to 01/01:20:18

Plot file version1147 created 03-MAR-2016 01:15:17
 J1545+5400 GN002C 1.UVDATA.1
 Freq = 1.2770 GHz, Bw = 16.000 MH Calibrated with CL # 3 and BP # 1 (BP mode 1)

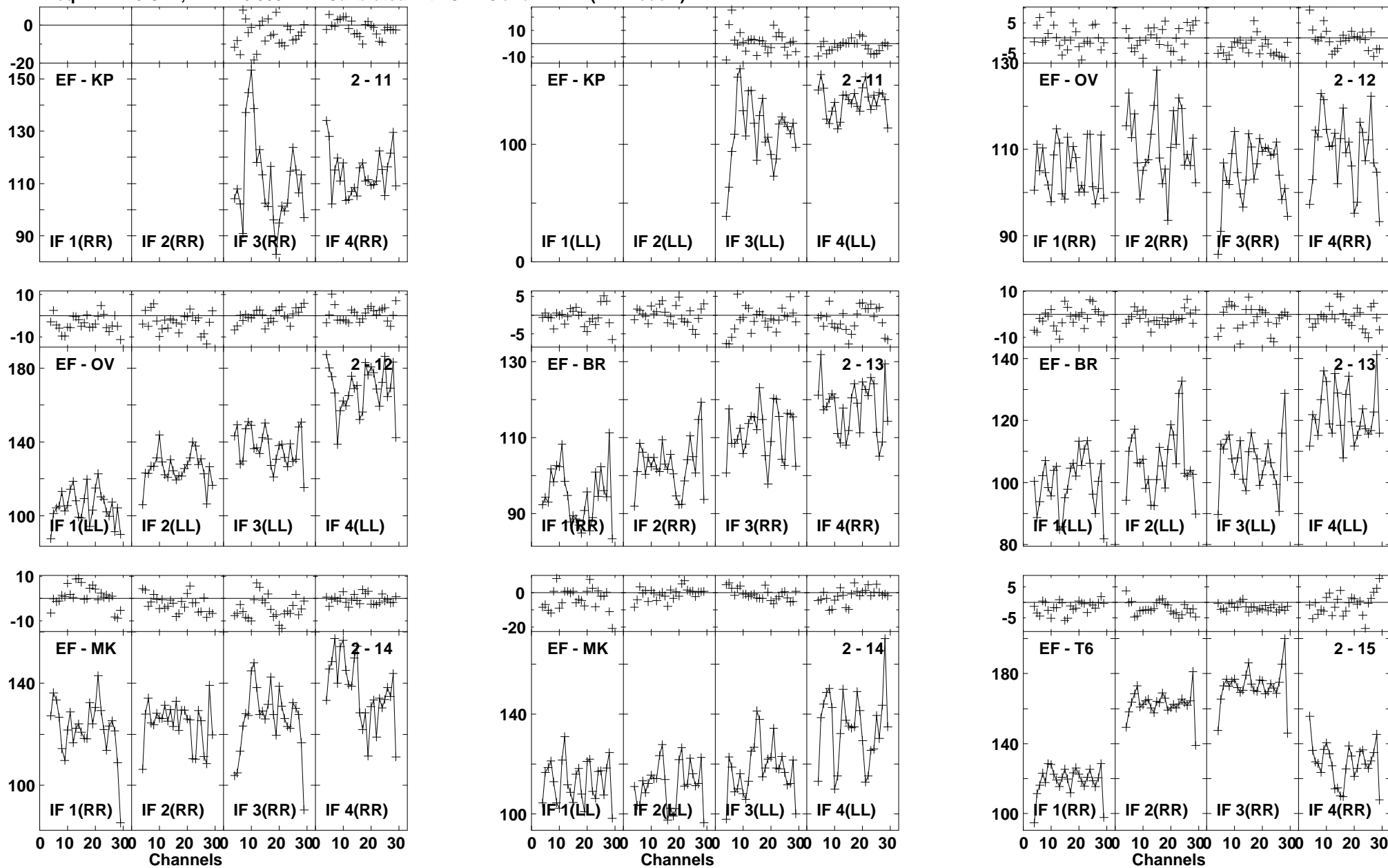

Lower frame: Milli Ampl Jy Top frame: Phas deg
 Vector averaged cross-power spectrum Baseline: EF (02) - KP (11)
 Timerange: 01/01:18:20 to 01/01:20:18

Plot file version1148 created 03-MAR-2016 01:15:17

J1545+5400 GN002C 1.UVDATA.1

Freq = 1.2770 GHz, Bw = 16.000 MH Calibrated with CL # 3 and BP # 1 (BP mode 1)

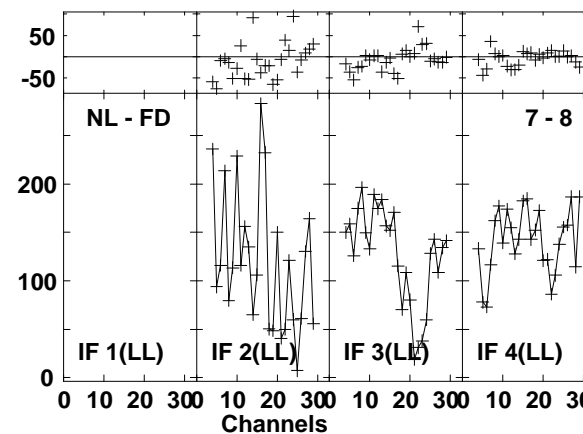
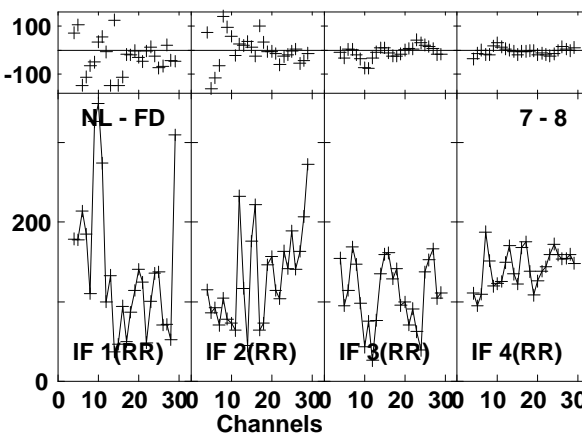
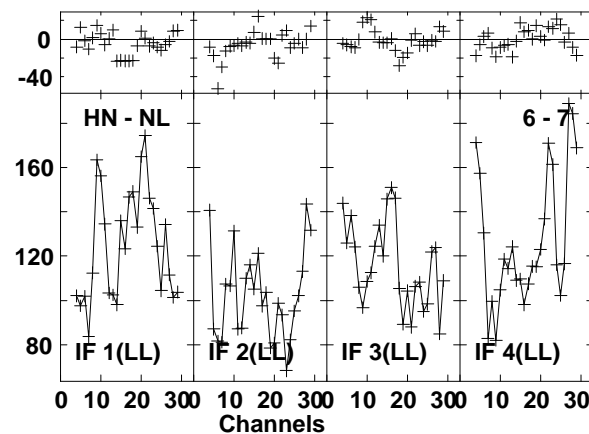
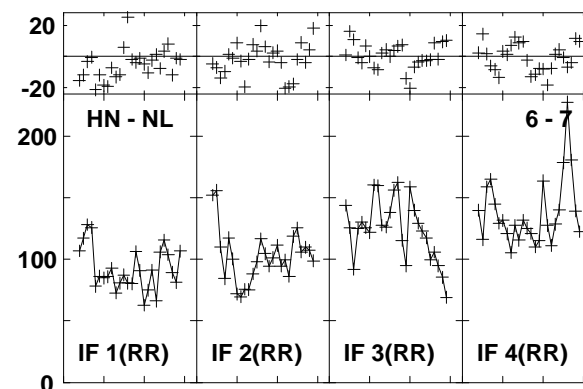
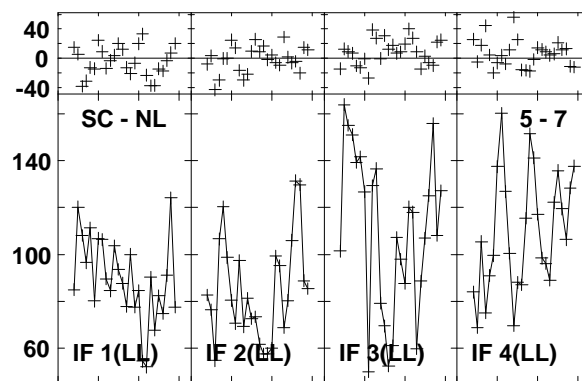
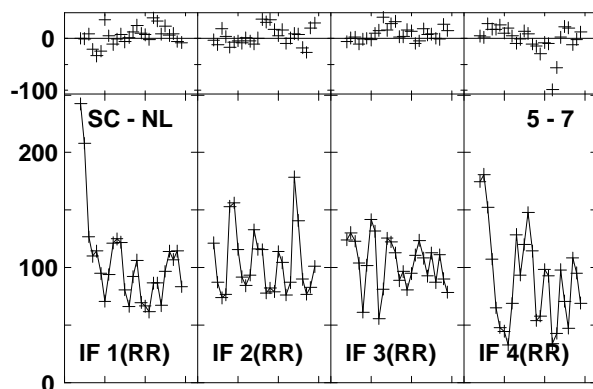
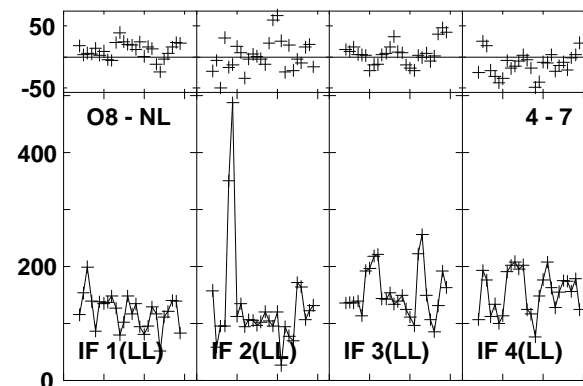
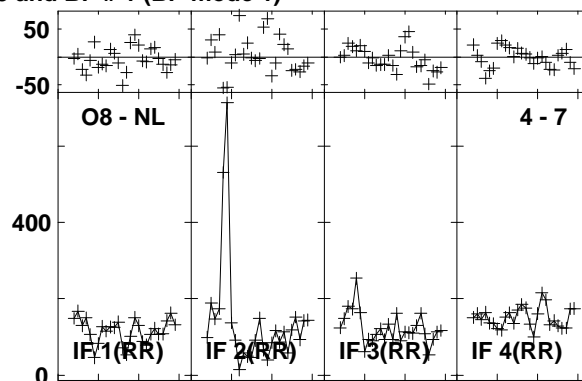
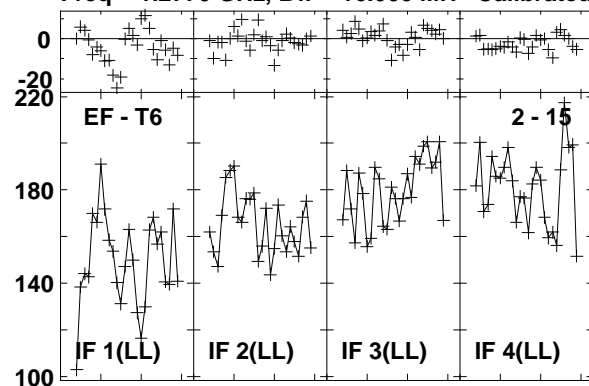

Lower frame: Milli Ampl Jy Top frame: Phas deg
Vector averaged cross-power spectrum Baseline: EF (02) - T6 (15)
Timerange: 01/01:18:20 to 01/01:20:18

Plot file version 1149 created 03-MAR-2016 01:15:17
 J1545+5400 GN002C 1.UVDATA.1
 Freq = 1.2770 GHz, Bw = 16.000 MH Calibrated with CL # 3 and BP # 1 (BP mode 1)

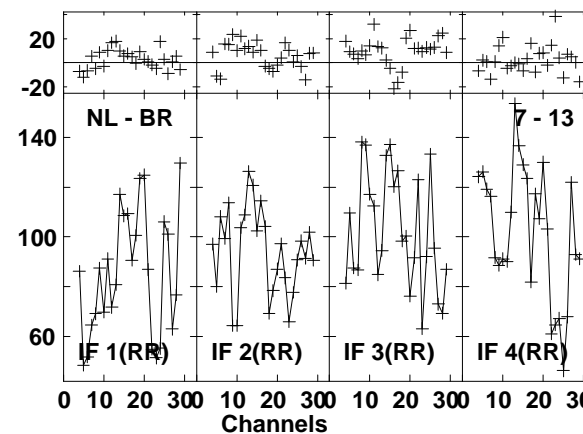
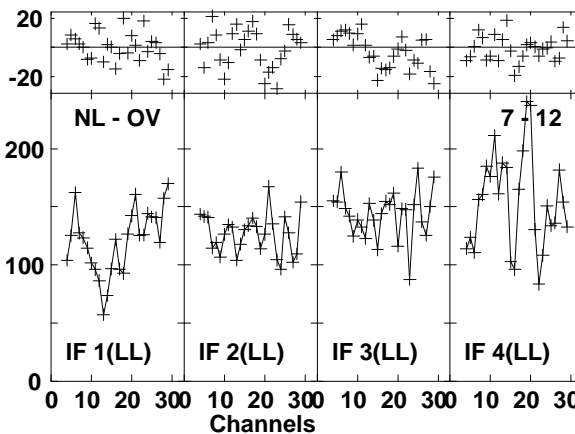
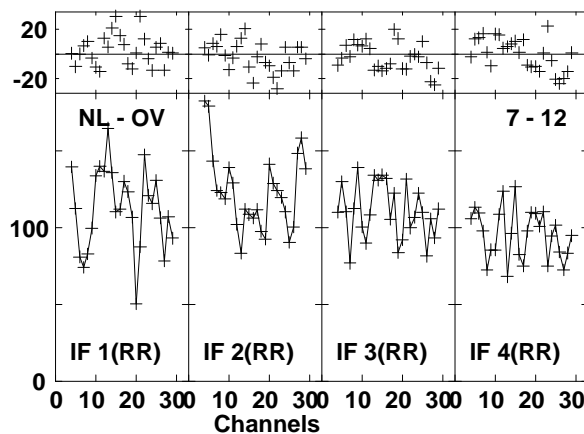
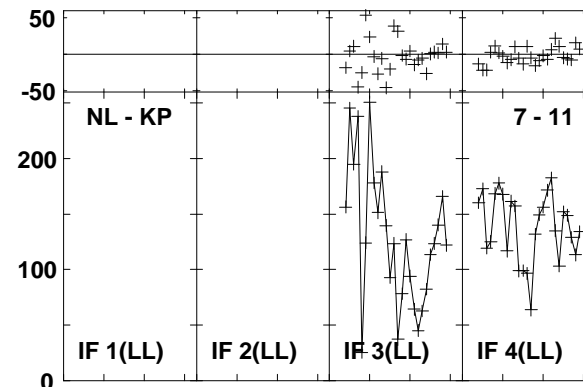
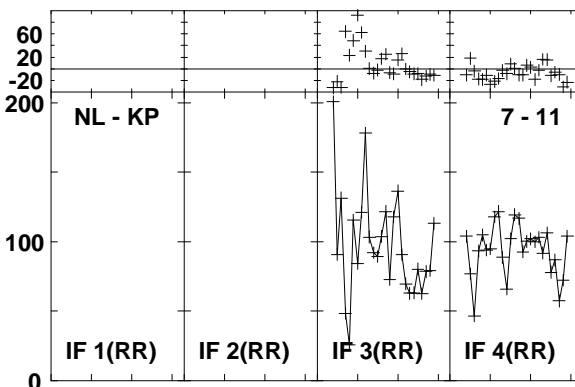
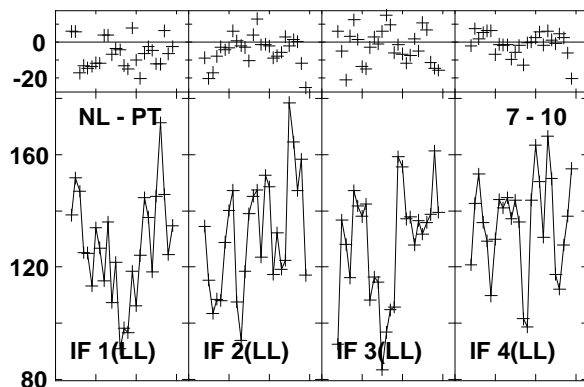
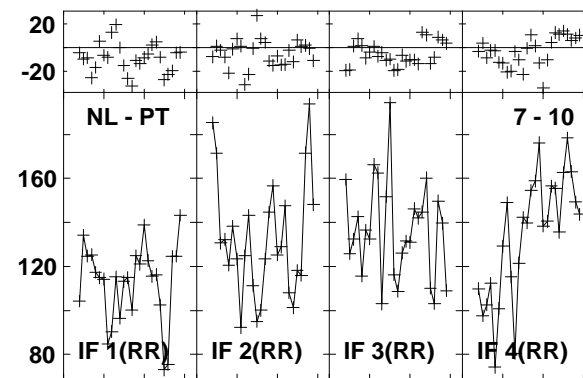
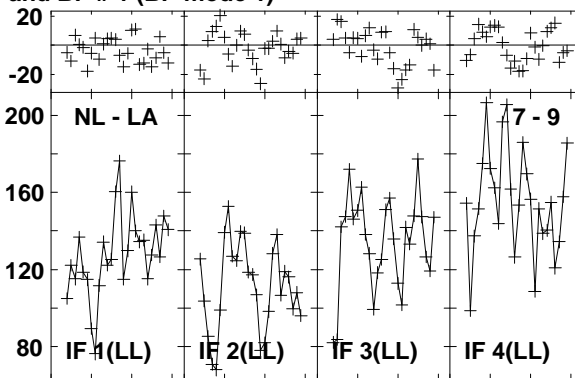
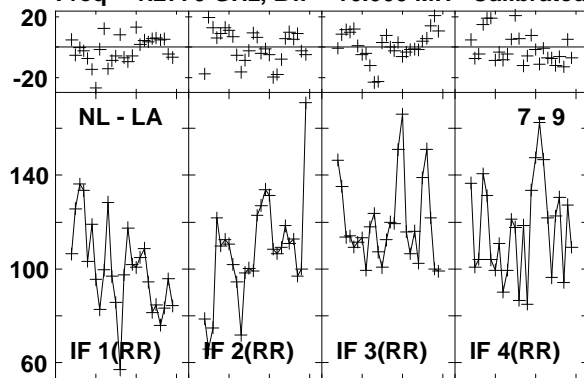

Lower frame: Milli Ampl Jy Top frame: Phas deg
 Vector averaged cross-power spectrum Baseline: NL (07) - LA (09)
 Timerange: 01/01:18:20 to 01/01:20:18

Plot file version1150 created 03-MAR-2016 01:15:18
 J1545+5400 GN002C 1.UVDATA.1
 Freq = 1.2770 GHz, Bw = 16.000 MH Calibrated with CL # 3 and BP # 1 (BP mode 1)

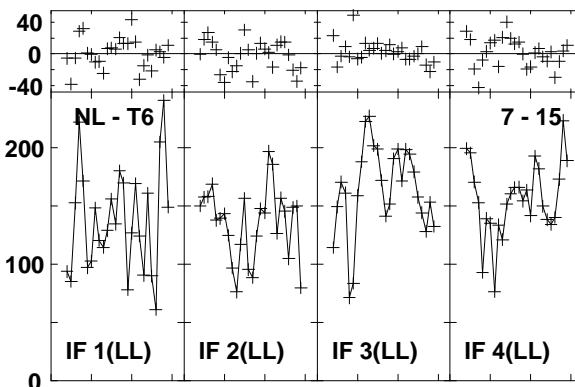
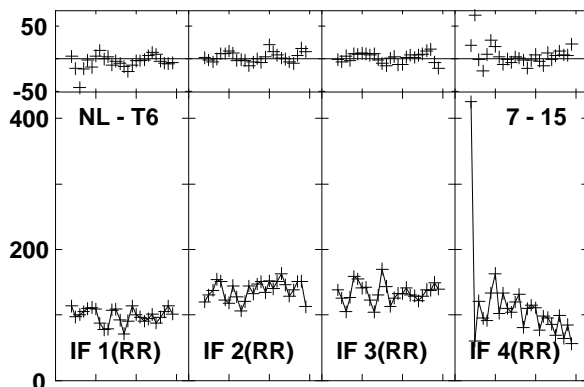
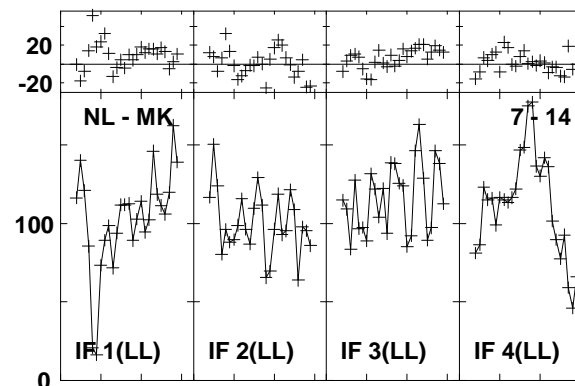
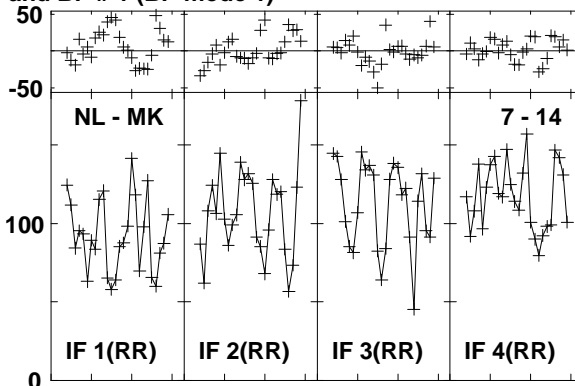
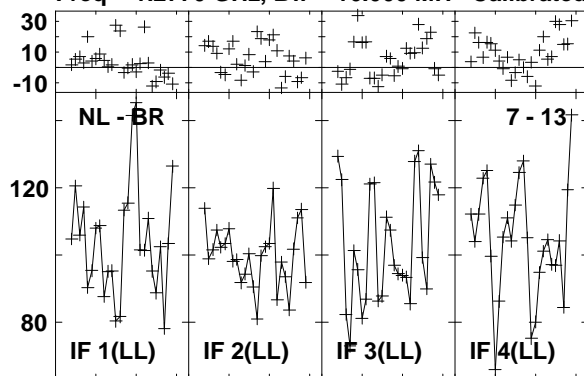

Lower frame: Milli Ampl Jy Top frame: Phas deg
 Vector averaged cross-power spectrum Baseline: NL (07) - BR (13)
 Timerange: 01/01:18:20 to 01/01:20:18

Plot file version1151 created 03-MAR-2016 01:15:18

4C52 GN002C 1.UVDATA.1

Freq = 1.2770 GHz, Bw = 16.000 MH Calibrated with CL # 3 and BP # 1 (BP mode 1)

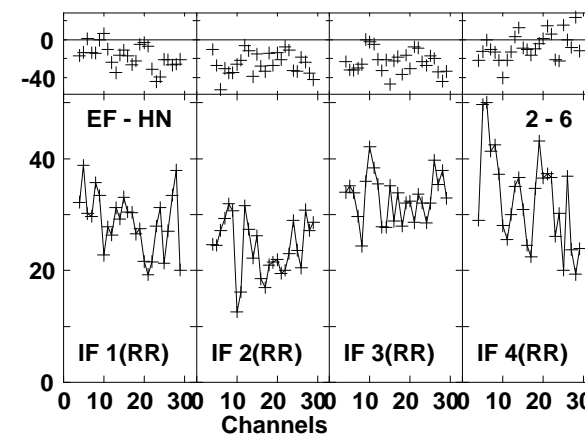
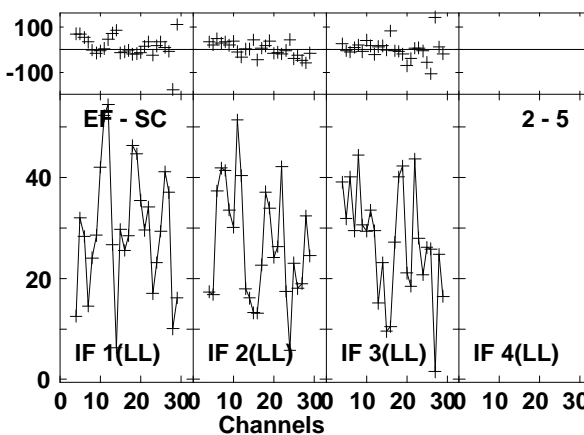
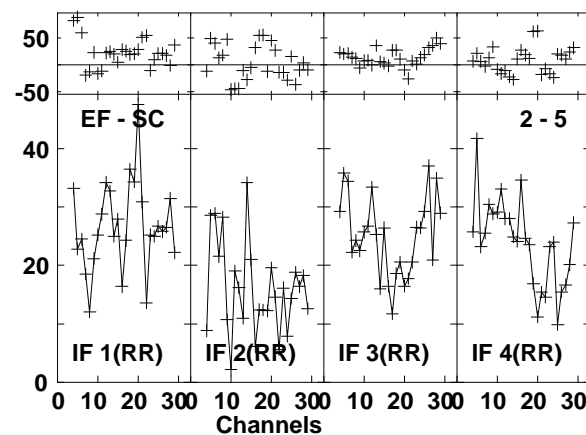
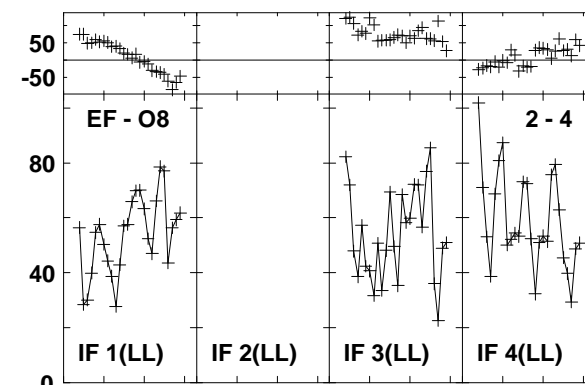
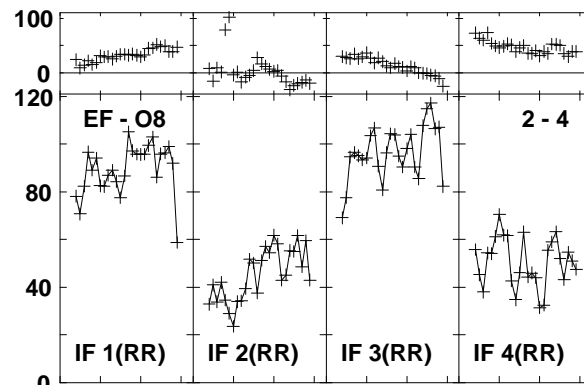
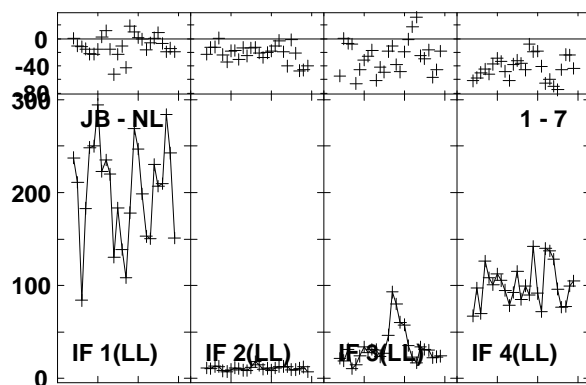
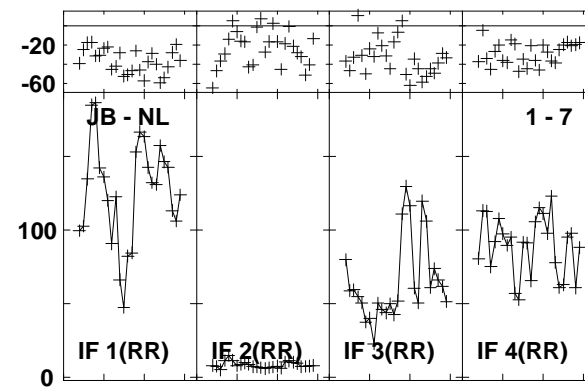
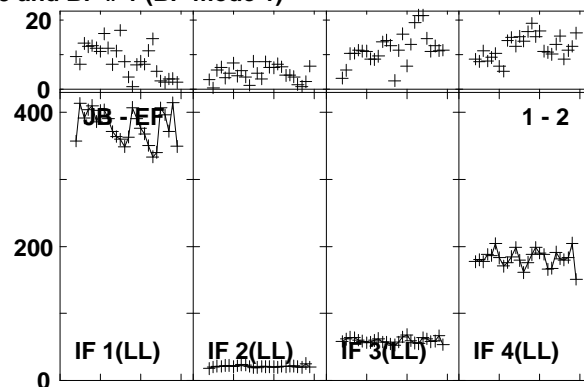
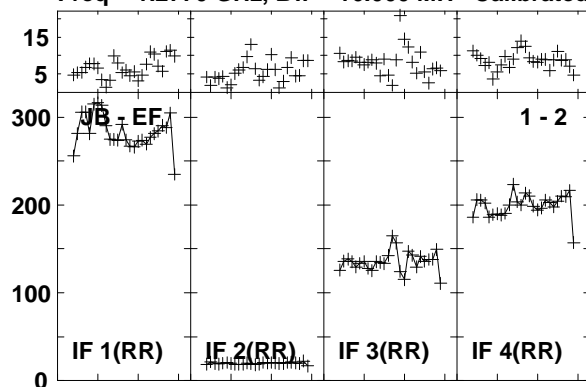

Lower frame: Milli Ampl Jy Top frame: Phas deg
Vector averaged cross-power spectrum Baseline: JB (01) - EF (02)
Timerange: 01/01:20:31 to 01/01:23:17

Plot file version1152 created 03-MAR-2016 01:15:18

4C52 GN002C 1.UVDATA.1

Freq = 1.2770 GHz, Bw = 16.000 MH Calibrated with CL # 3 and BP # 1 (BP mode 1)

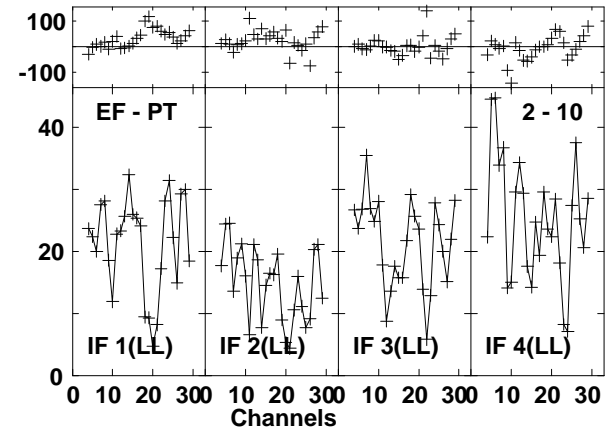
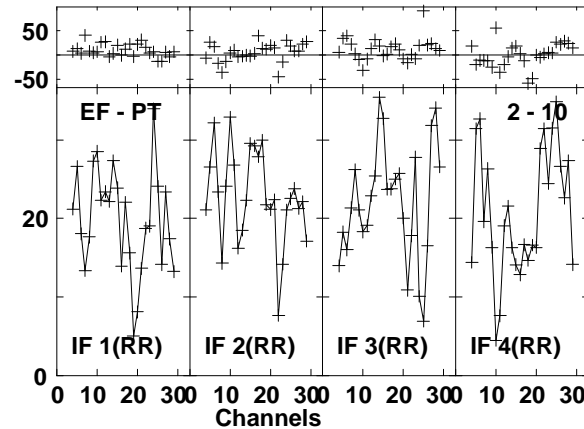
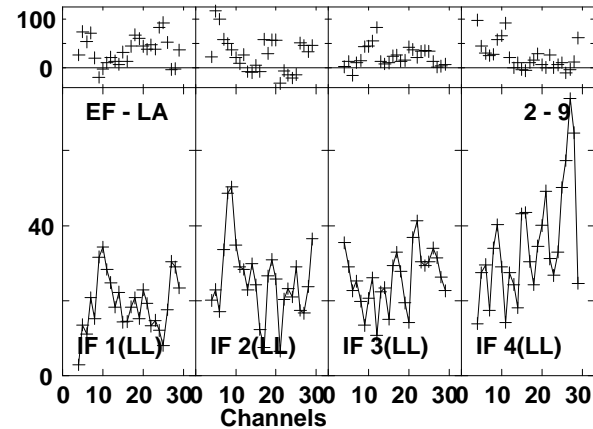
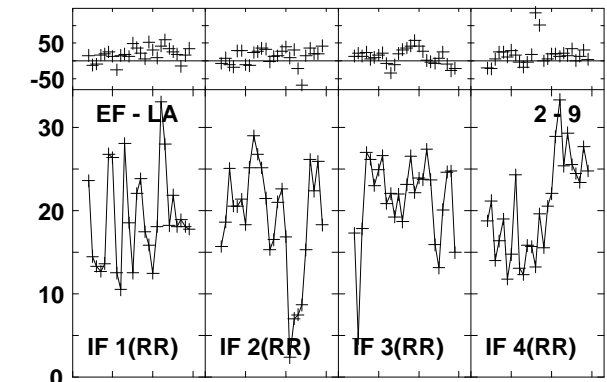
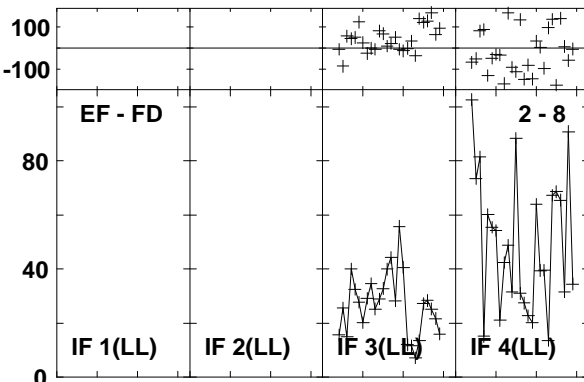
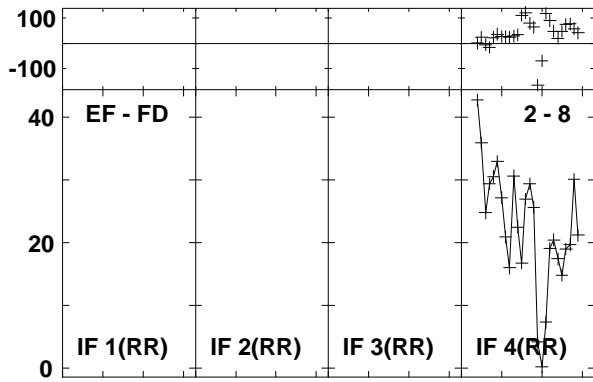
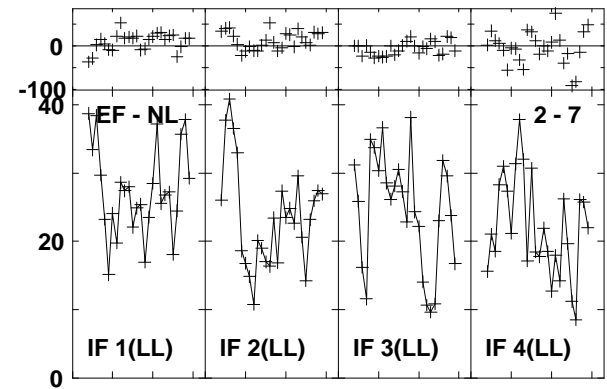
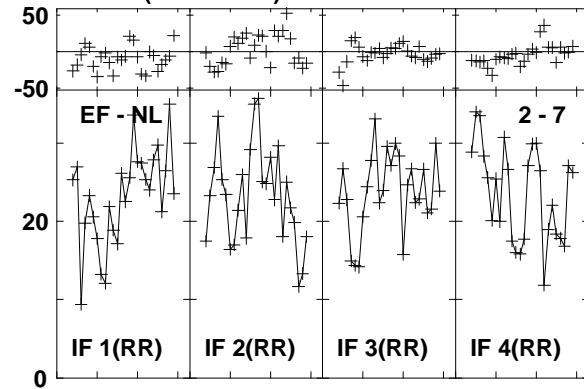
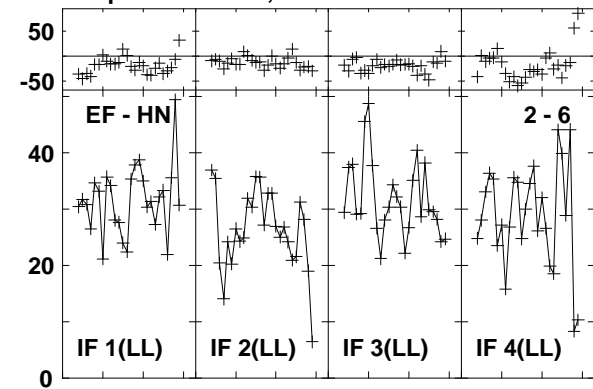

Lower frame: Milli Ampl Jy Top frame: Phas deg

Vector averaged cross-power spectrum Baseline: EF (02) - HN (06)

Timerange: 01/01:20:31 to 01/01:23:17

Plot file version1153 created 03-MAR-2016 01:15:18

4C52 GN002C 1.UVDATA.1

Freq = 1.2770 GHz, Bw = 16.000 MH Calibrated with CL # 3 and BP # 1 (BP mode 1)

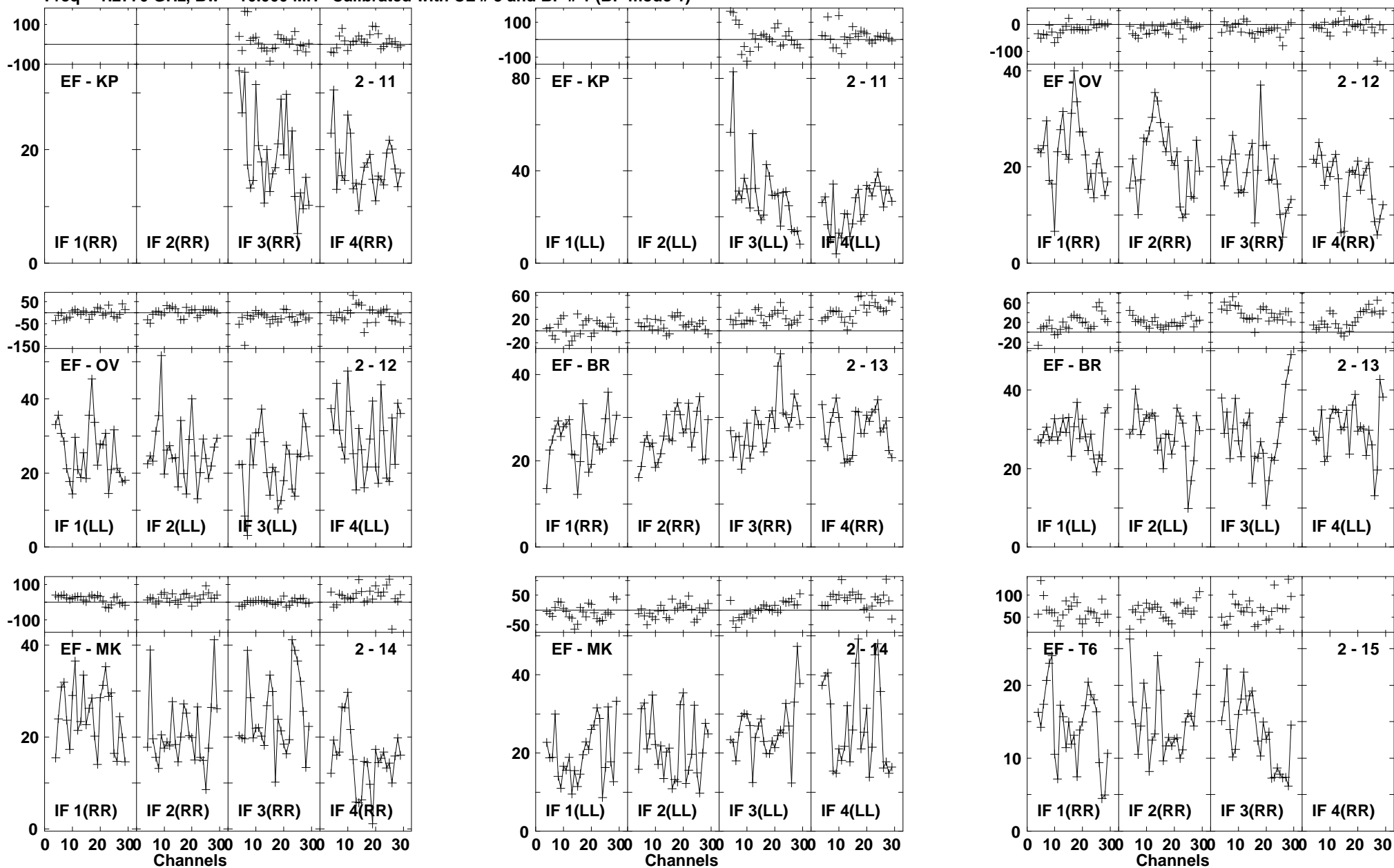

Lower frame: Milli Ampl Jy Top frame: Phas deg
Vector averaged cross-power spectrum Baseline: EF (02) - KP (11)
Timerange: 01/01:20:31 to 01/01:23:17

Plot file version1154 created 03-MAR-2016 01:15:18
 4C52 GN002C 1.UVDATA.1
 Freq = 1.2770 GHz, Bw = 16.000 MH Calibrated with CL # 3 and BP # 1 (BP mode 1)

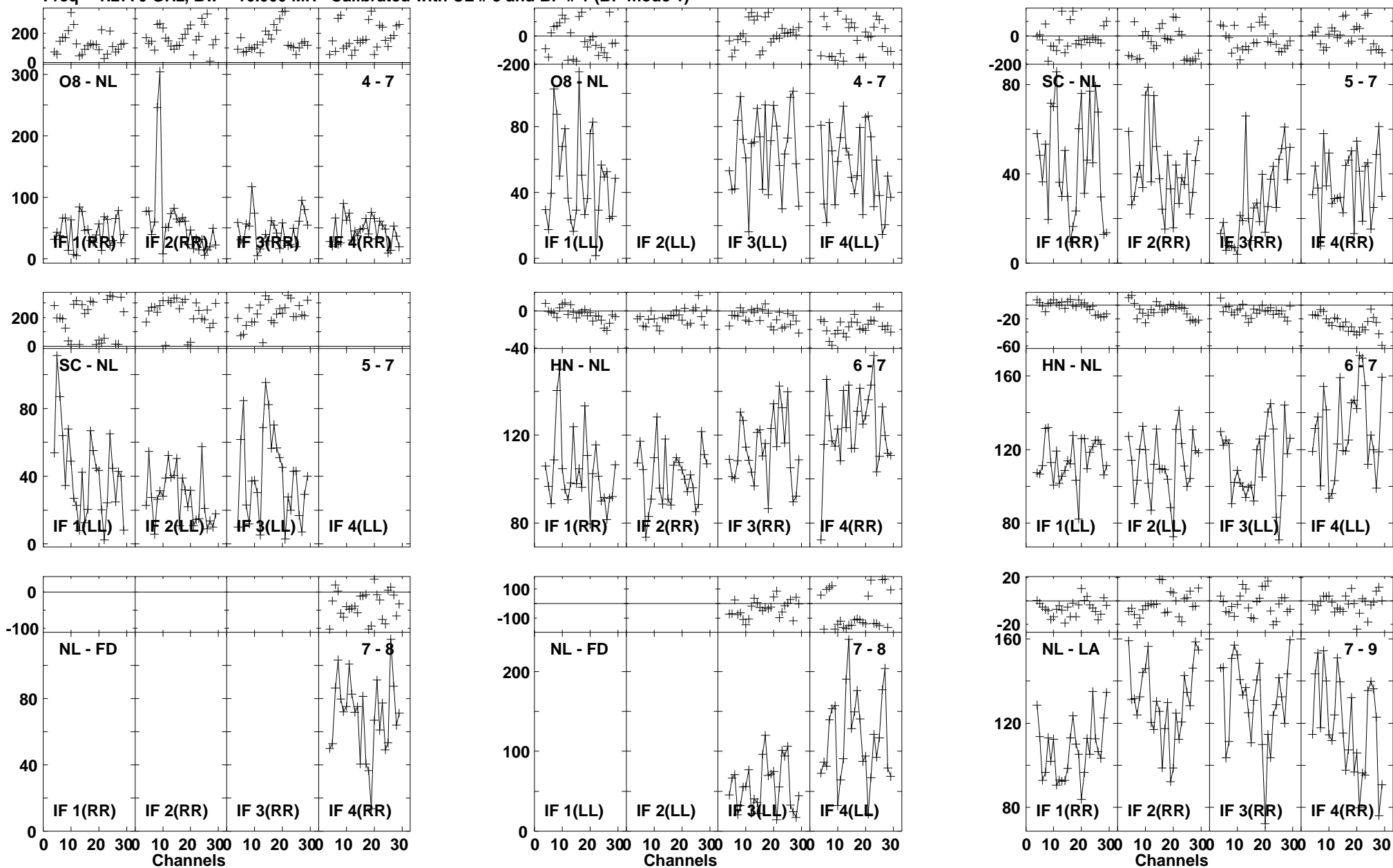

Lower frame: Milli Ampl Jy Top frame: Phas deg
 Vector averaged cross-power spectrum Baseline: O8 (04) - NL (07)
 Timerange: 01/01:20:31 to 01/01:23:17

Plot file version1155 created 03-MAR-2016 01:15:18

4C52 GN002C 1.UVDATA.1

Freq = 1.2770 GHz, Bw = 16.000 MH Calibrated with CL # 3 and BP # 1 (BP mode 1)

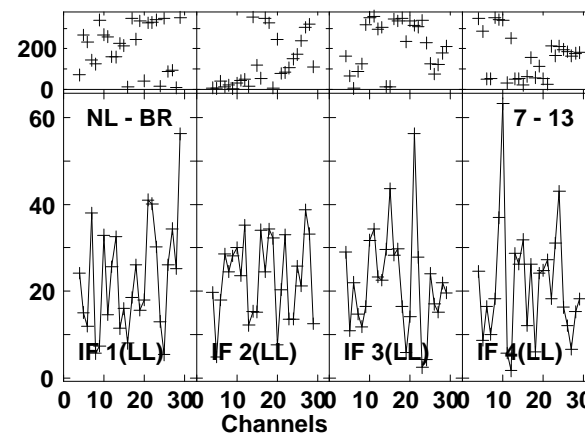
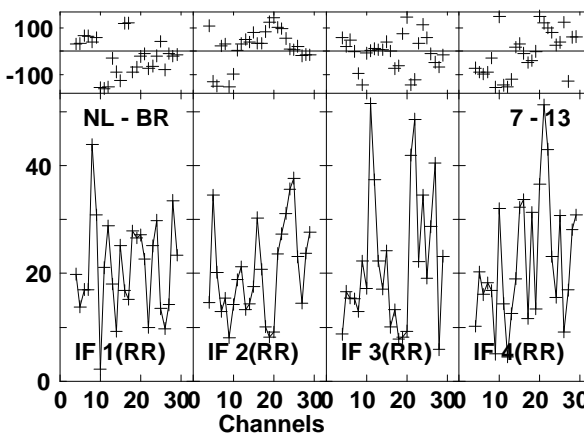
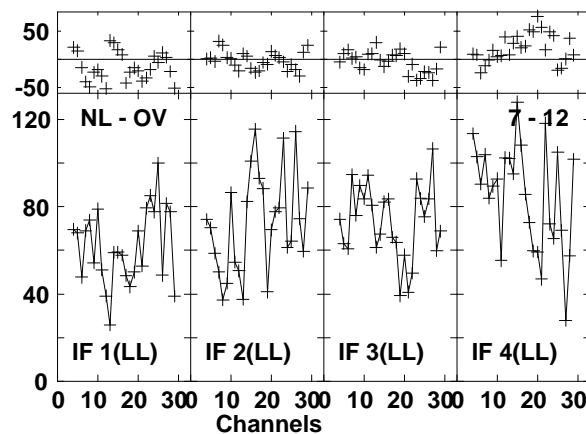
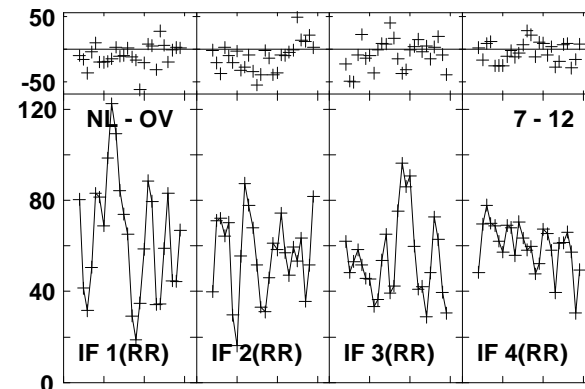
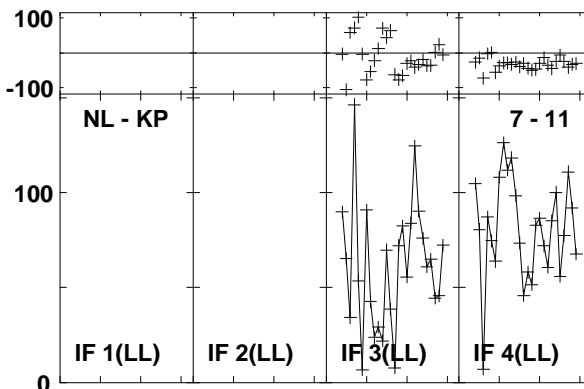
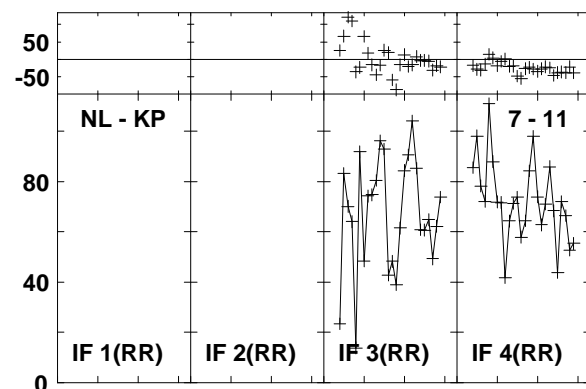
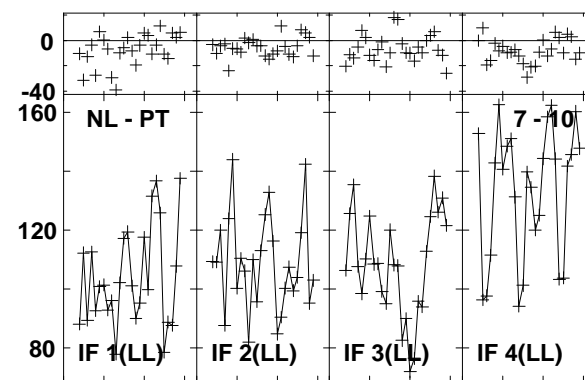
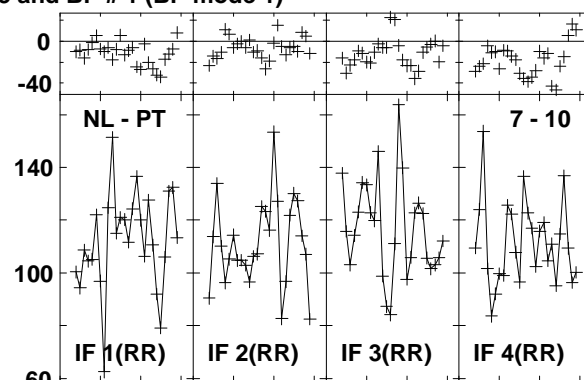
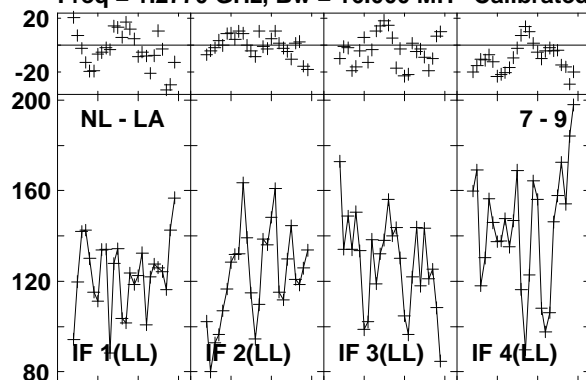

Lower frame: Milli Ampl Jy Top frame: Phas deg
Vector averaged cross-power spectrum Baseline: NL (07) - LA (09)
Timerange: 01/01:20:31 to 01/01:23:17

Plot file version1156 created 03-MAR-2016 01:15:19

4C52 GN002C 1.UVDATA.1

Freq = 1.2770 GHz, Bw = 16.000 MH Calibrated with CL # 3 and BP # 1 (BP mode 1)

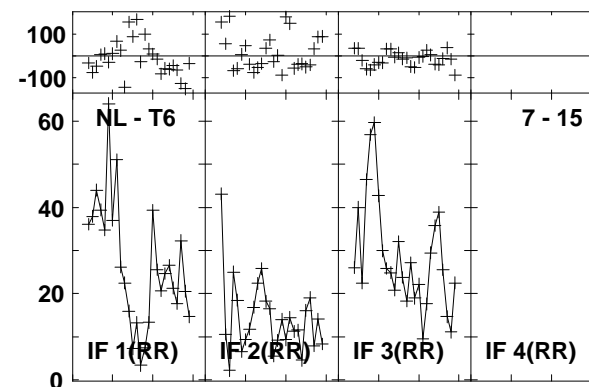
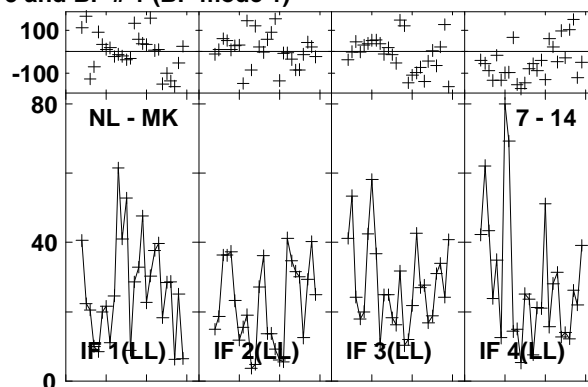
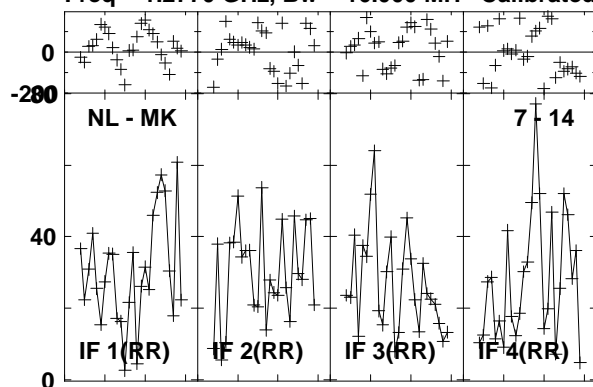

Lower frame: Milli Ampl Jy Top frame: Phas deg
Vector averaged cross-power spectrum Baseline: NL (07) - MK (14)
Timerange: 01/01:20:31 to 01/01:23:17

Plot file version1157 created 03-MAR-2016 01:15:19

J1545+5400 GN002C 1.UVDATA.1

Freq = 1.2770 GHz, Bw = 16.000 MH Calibrated with CL # 3 and BP # 1 (BP mode 1)

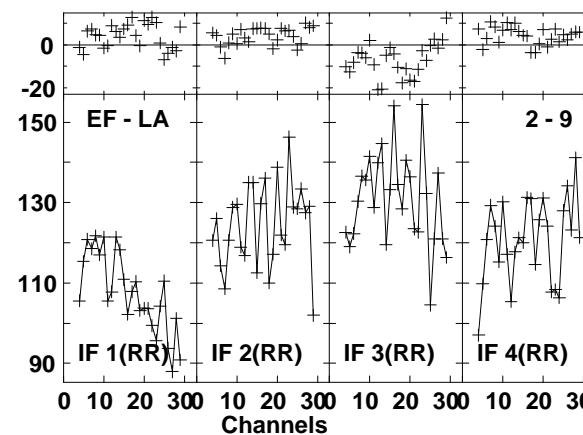
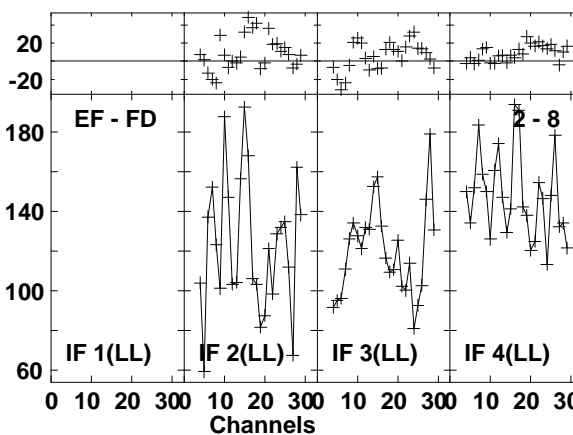
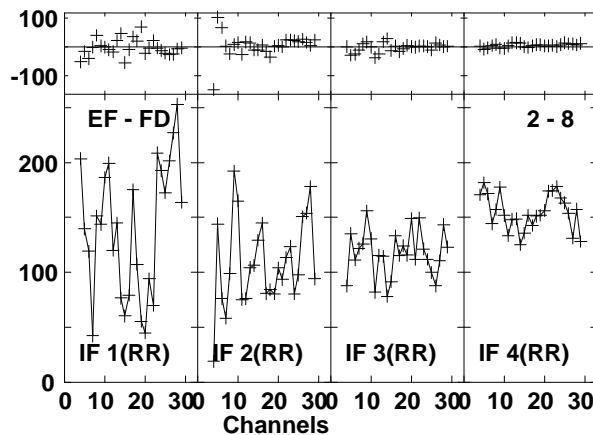
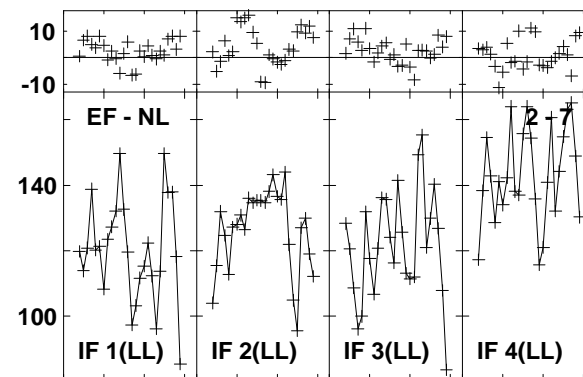
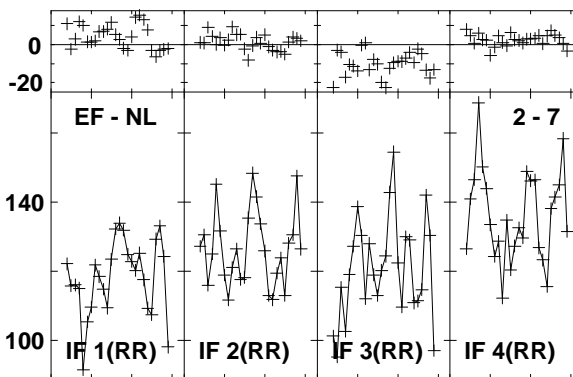
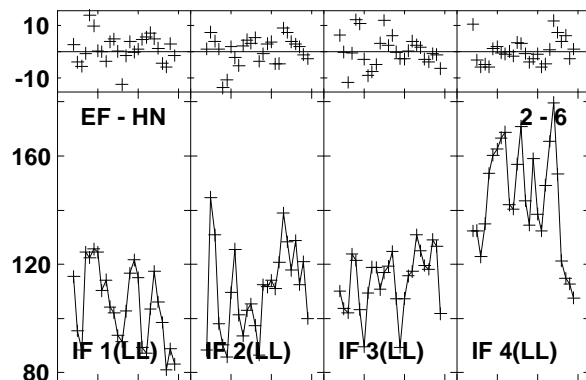
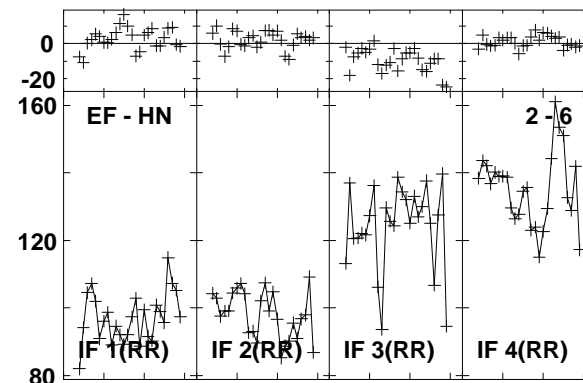
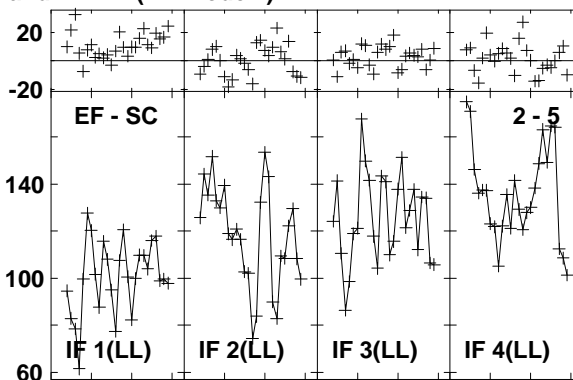
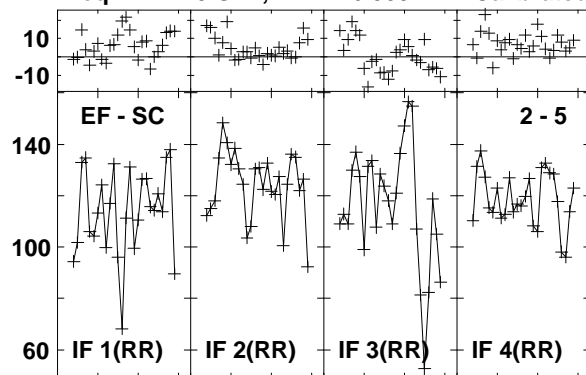

Lower frame: Milli Ampl Jy Top frame: Phas deg
Vector averaged cross-power spectrum Baseline: EF (02) - SC (05)
Timerange: 01/01:24:10 to 01/01:25:08

Plot file version1158 created 03-MAR-2016 01:15:19

J1545+5400 GN002C 1.UVDATA.1

Freq = 1.2770 GHz, Bw = 16.000 MH Calibrated with CL # 3 and BP # 1 (BP mode 1)

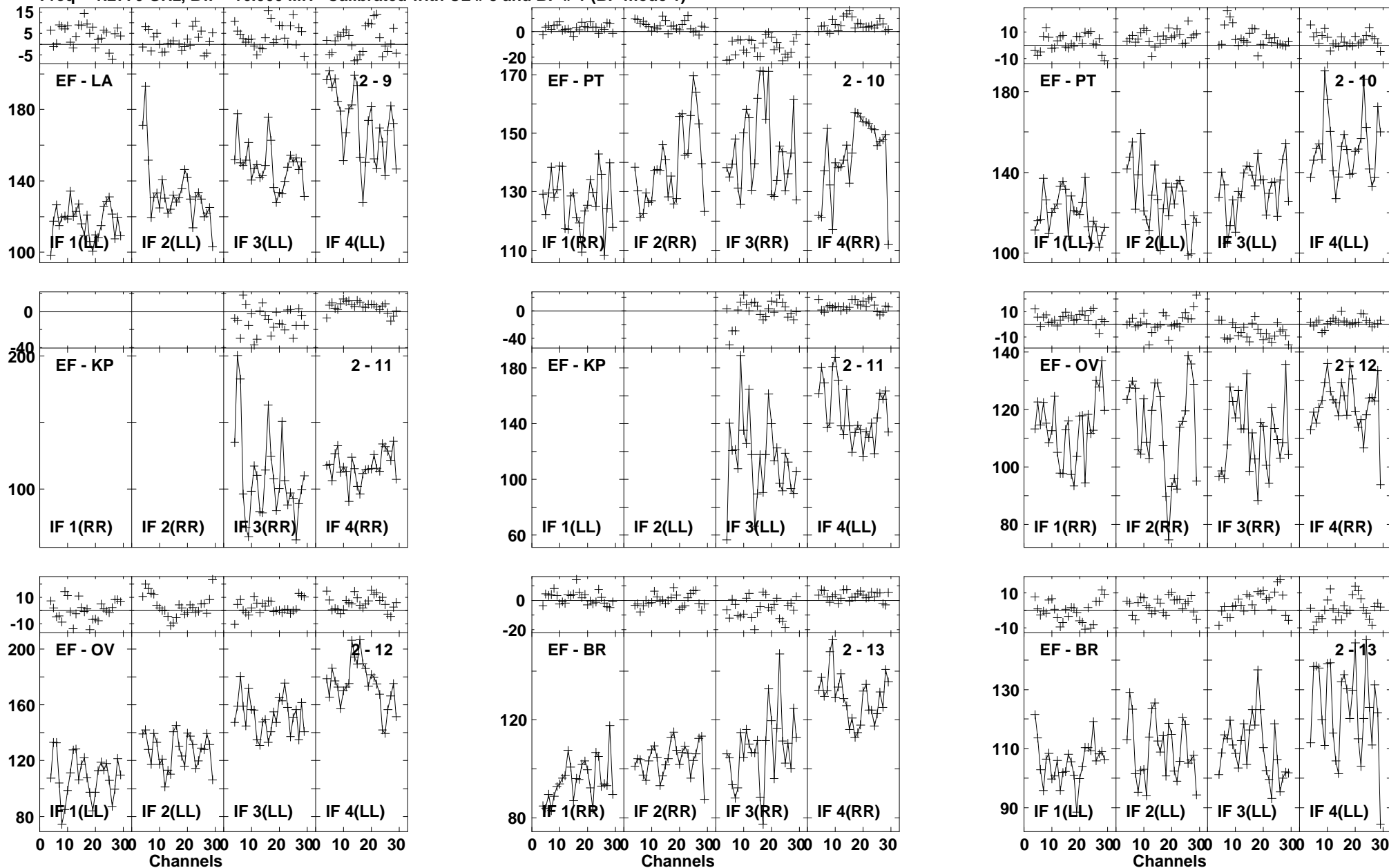

Lower frame: Milli Ampl Jy Top frame: Phas deg
Vector averaged cross-power spectrum Baseline: EF (02) - LA (09)
Timerange: 01/01:24:10 to 01/01:25:08

Plot file version1159 created 03-MAR-2016 01:15:19

J1545+5400 GN002C 1.UVDATA.1

Freq = 1.2770 GHz, Bw = 16.000 MH Calibrated with CL # 3 and BP # 1 (BP mode 1)

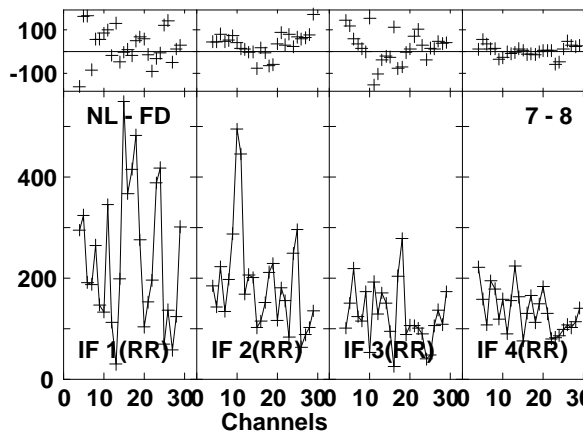
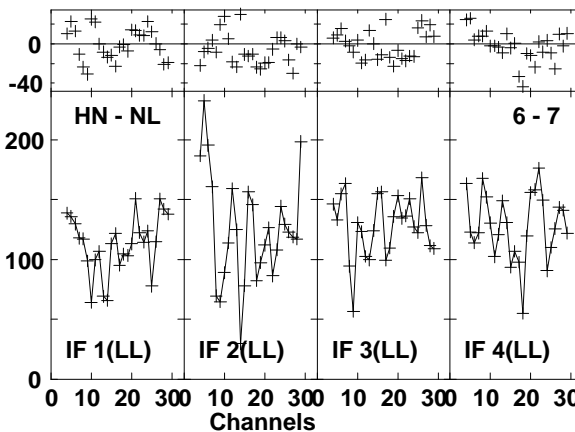
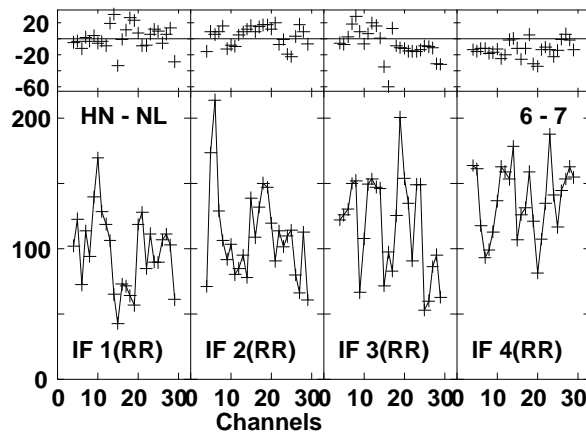
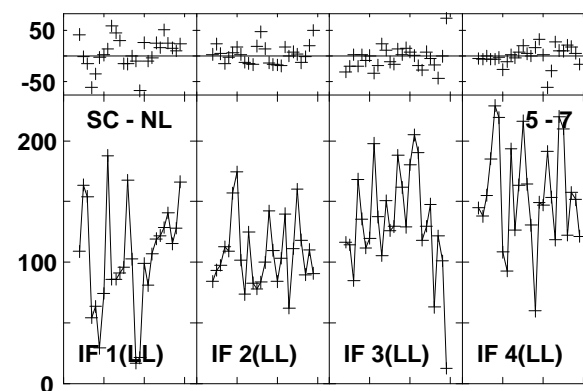
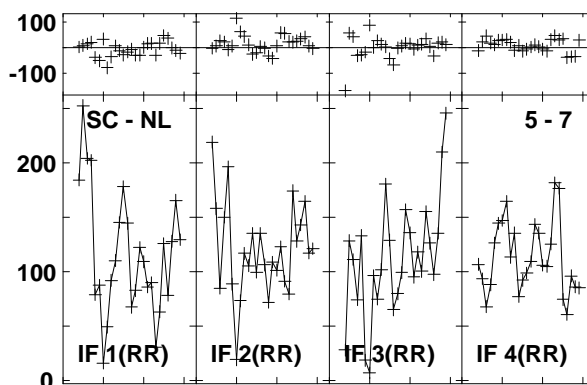
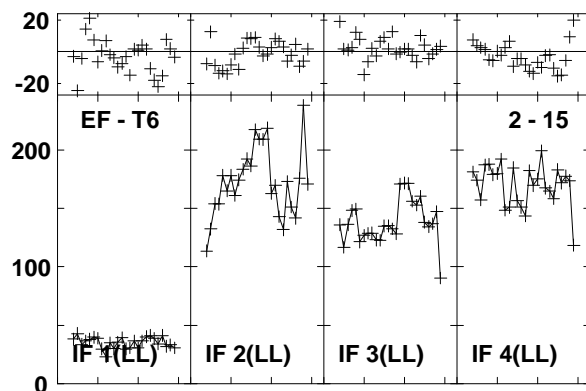
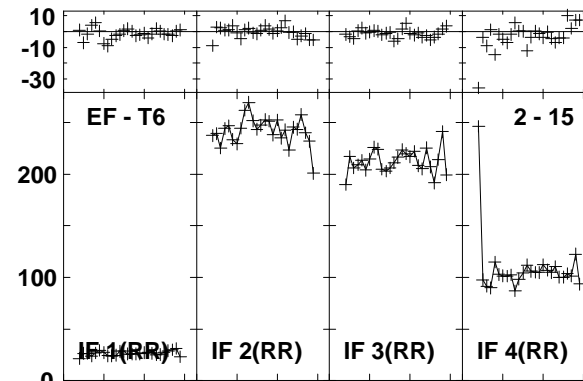
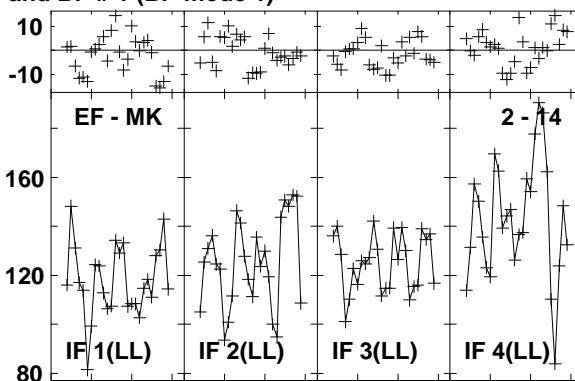
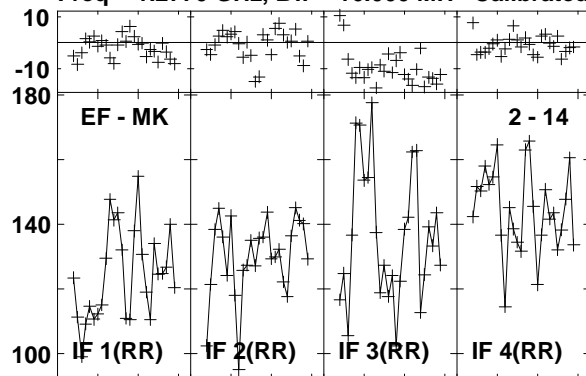

Lower frame: Milli Ampl Jy Top frame: Phas deg
Vector averaged cross-power spectrum Baseline: EF (02) - MK (14)
Timerange: 01/01:24:10 to 01/01:25:08

Plot file version1160 created 03-MAR-2016 01:15:19

J1545+5400 GN002C 1.UVDATA.1

Freq = 1.2770 GHz, Bw = 16.000 MH Calibrated with CL # 3 and BP # 1 (BP mode 1)

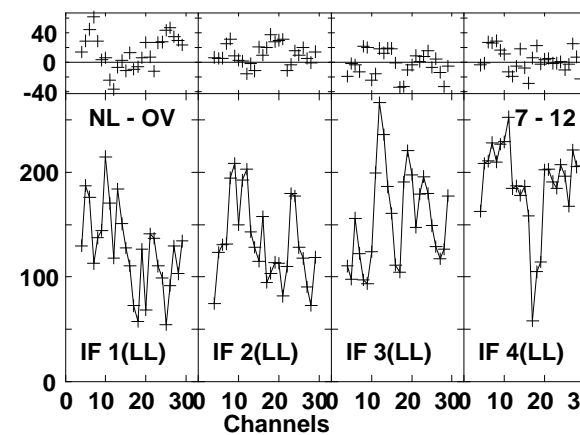
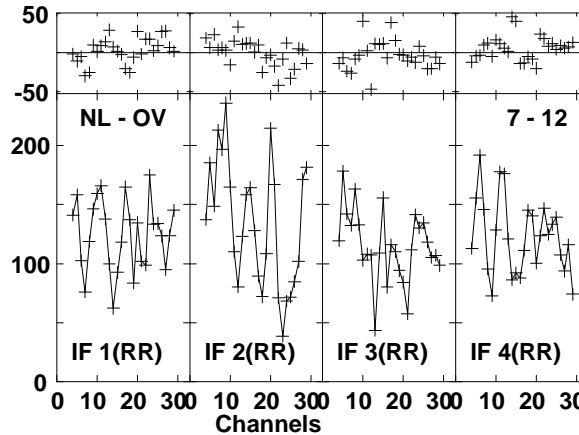
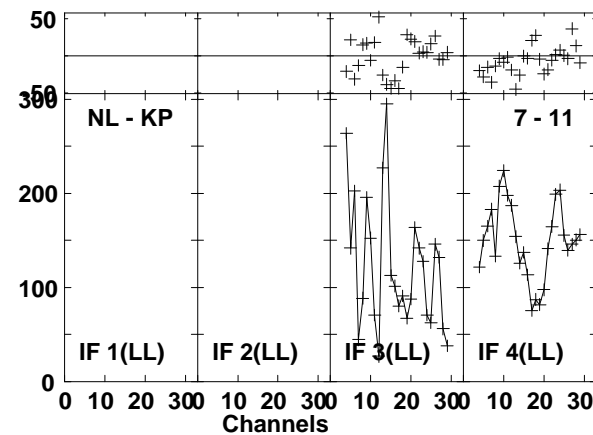
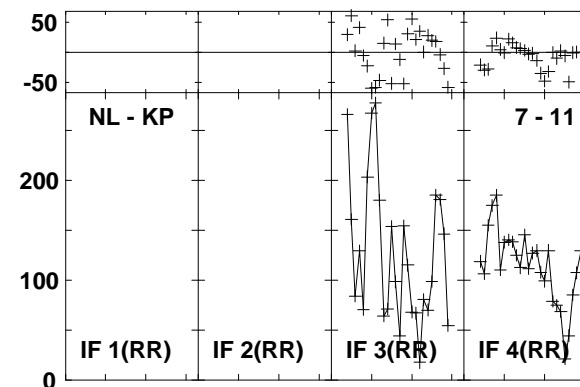
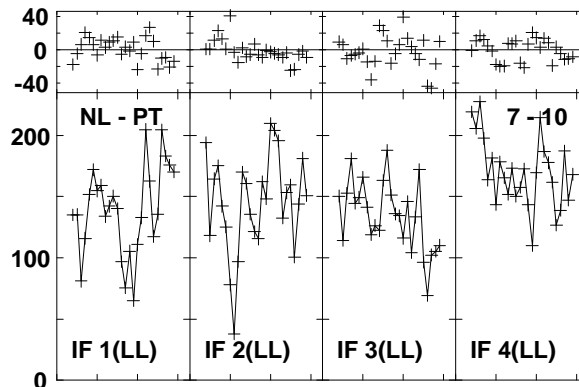
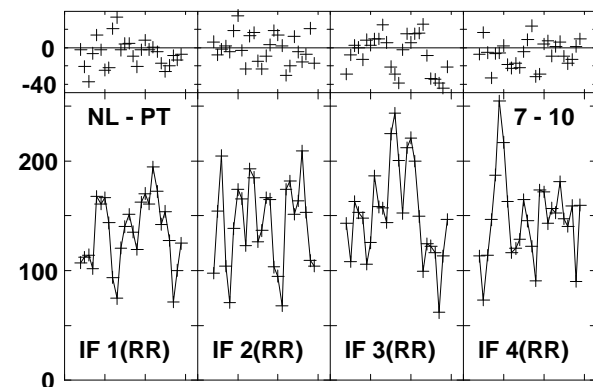
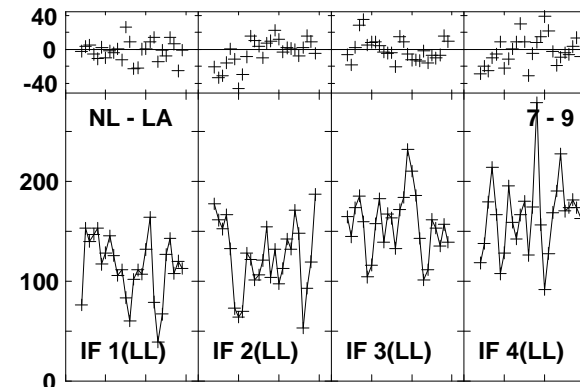
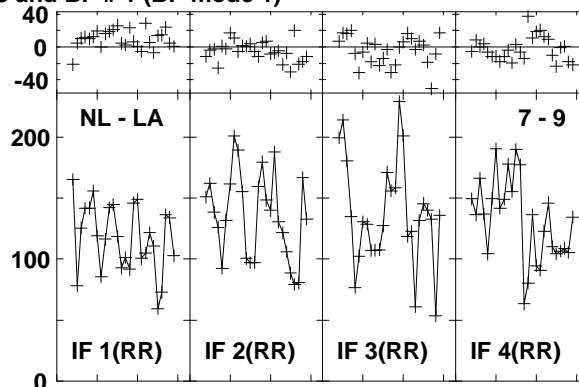
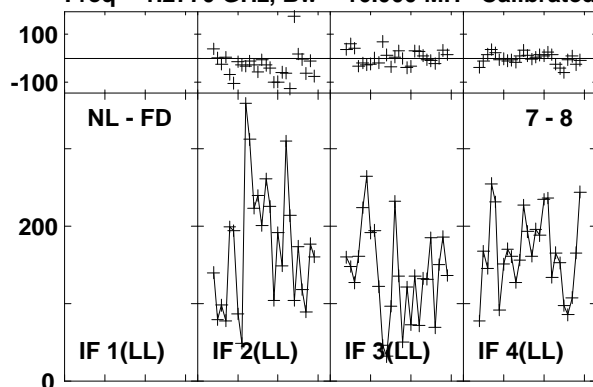

Lower frame: Milli Ampl Jy Top frame: Phas deg
Vector averaged cross-power spectrum Baseline: NL (07) - FD (08)
Timerange: 01/01:24:10 to 01/01:25:08

Plot file version1161 created 03-MAR-2016 01:15:19
 J1545+5400 GN002C 1.UVDATA.1
 Freq = 1.2770 GHz, Bw = 16.000 MH Calibrated with CL # 3 and BP # 1 (BP mode 1)

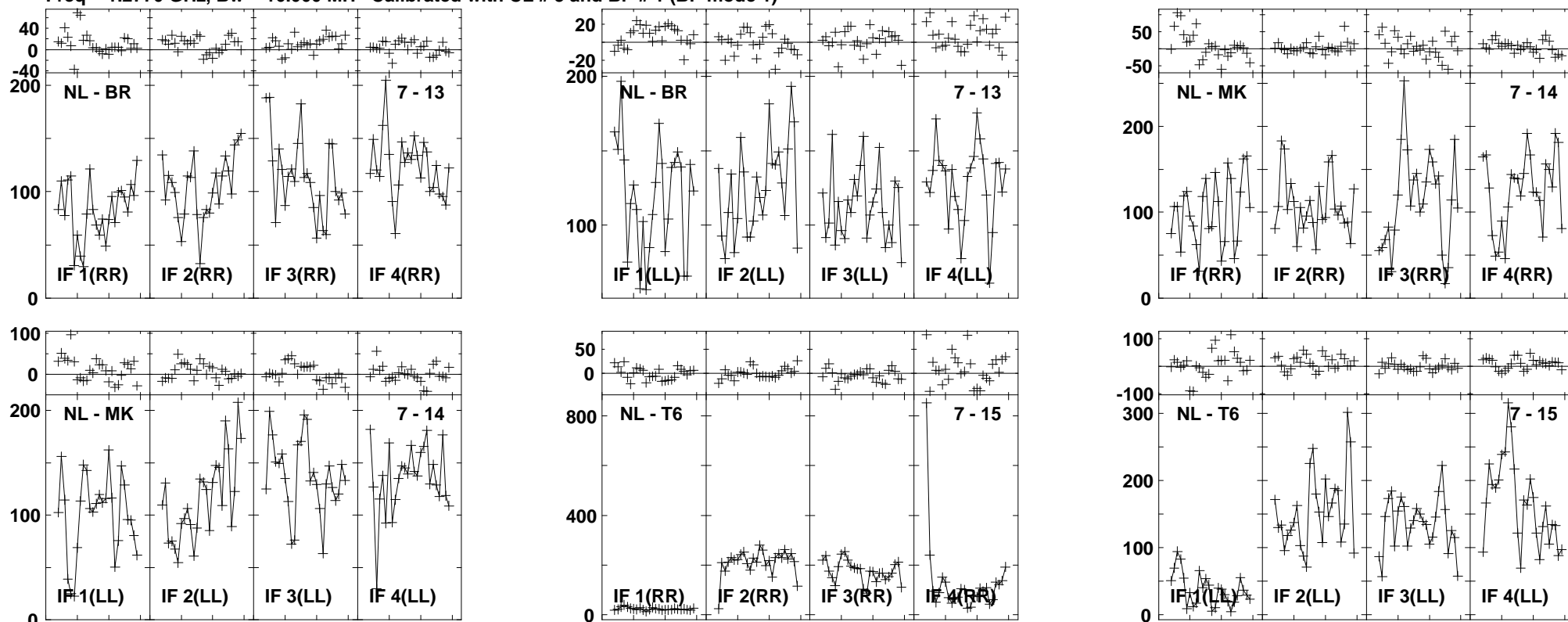

Lower frame: Milli Ampl Jy Top frame: Phas deg
 Vector averaged cross-power spectrum Baseline: NL (07) - BR (13)
 Timerange: 01/01:24:10 to 01/01:25:08

Plot file version1162 created 03-MAR-2016 01:15:20

4C52 GN002C 1.UVDATA.1

Freq = 1.2770 GHz, Bw = 16.000 MH Calibrated with CL # 3 and BP # 1 (BP mode 1)

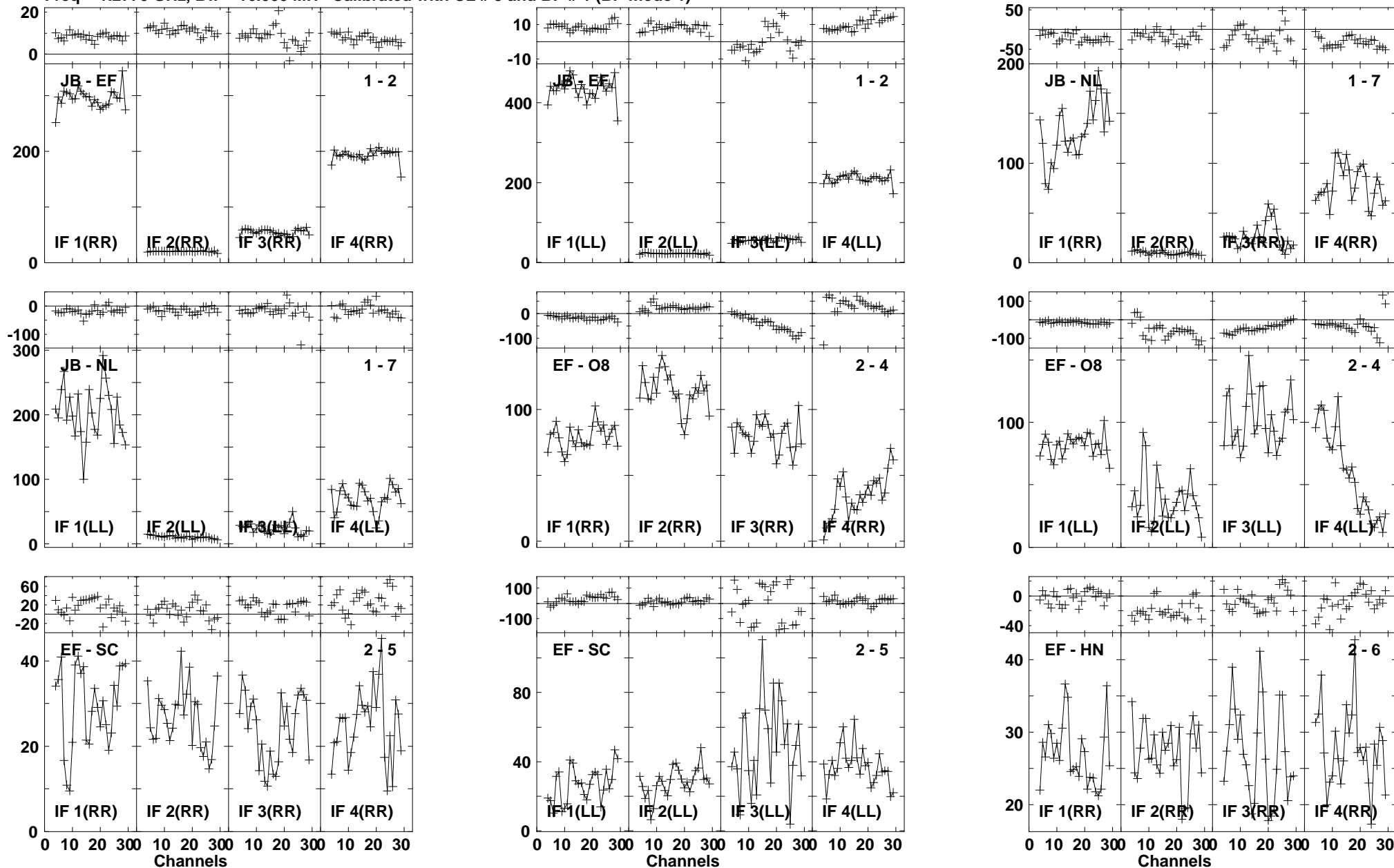

Lower frame: Milli Ampl Jy Top frame: Phas deg
Vector averaged cross-power spectrum Baseline: JB (01) - EF (02)
Timerange: 01/01:25:13 to 01/01:28:37

Plot file version1163 created 03-MAR-2016 01:15:20
 4C52 GN002C 1.UVDATA.1
 Freq = 1.2770 GHz, Bw = 16.000 MH Calibrated with CL # 3 and BP # 1 (BP mode 1)

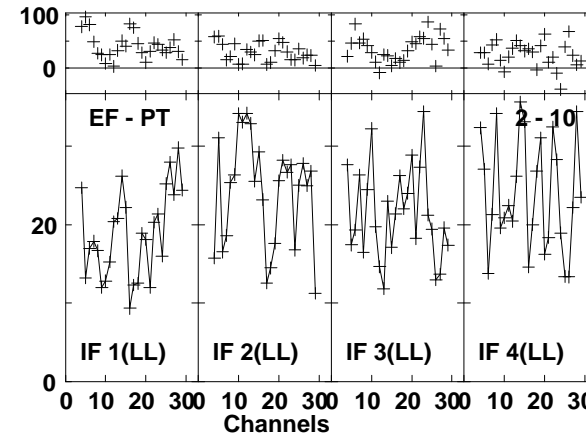
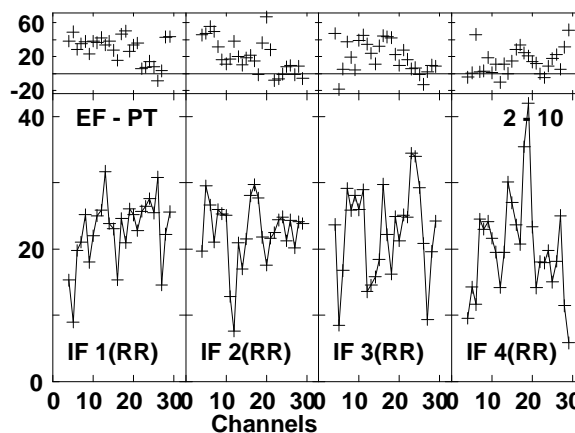
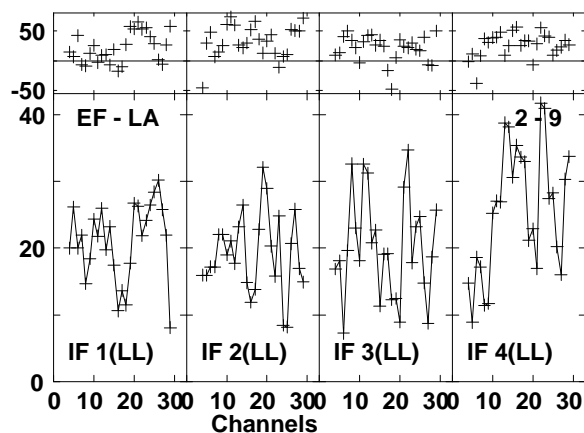
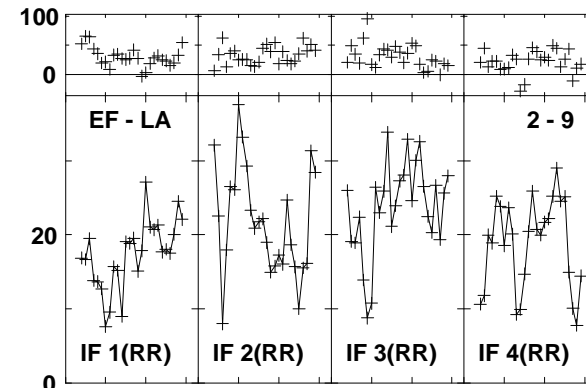
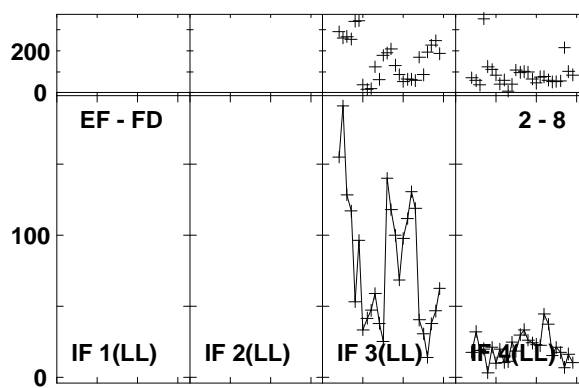
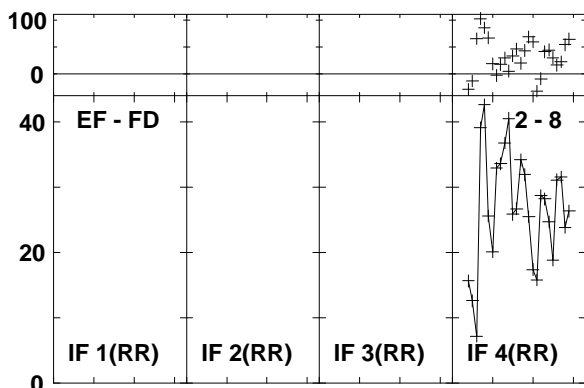
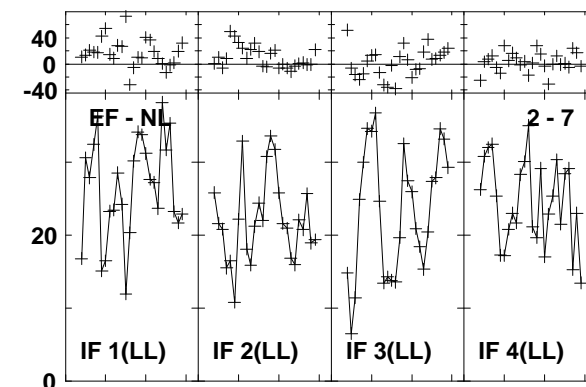
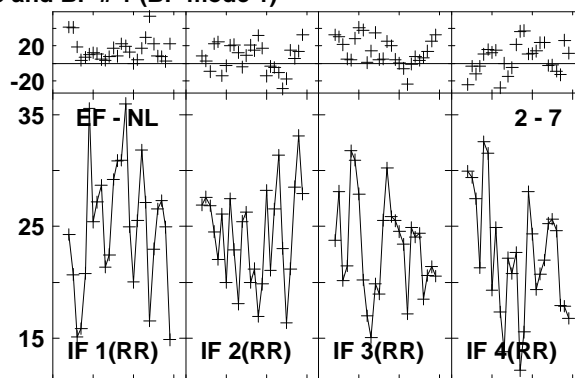
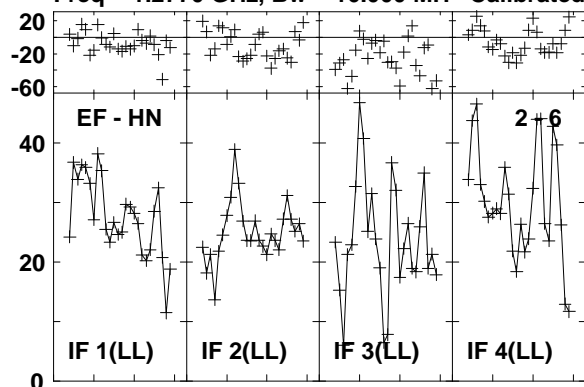

Lower frame: Milli Ampl Jy Top frame: Phas deg
 Vector averaged cross-power spectrum Baseline: EF (02) - HN (06)
 Timerange: 01/01:25:13 to 01/01:28:37

Plot file version1164 created 03-MAR-2016 01:15:20
 4C52 GN002C 1.UVDATA.1

Freq = 1.2770 GHz, Bw = 16.000 MH Calibrated with CL # 3 and BP # 1 (BP mode 1)

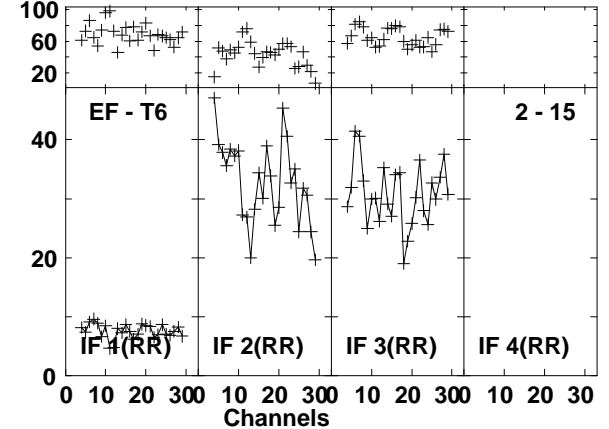
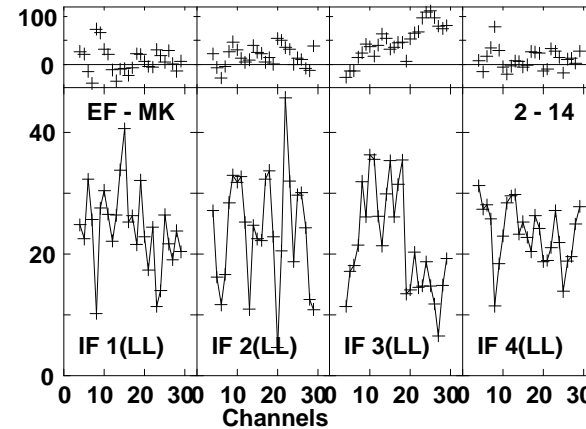
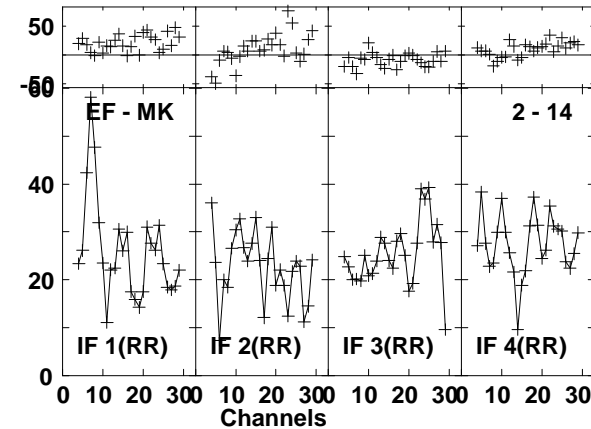
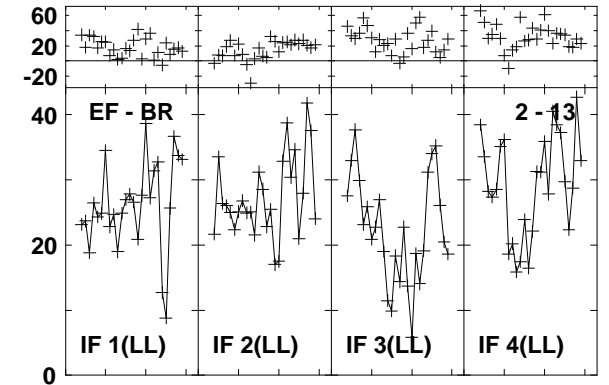
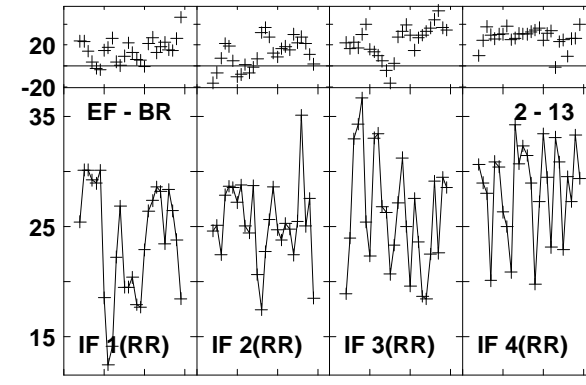
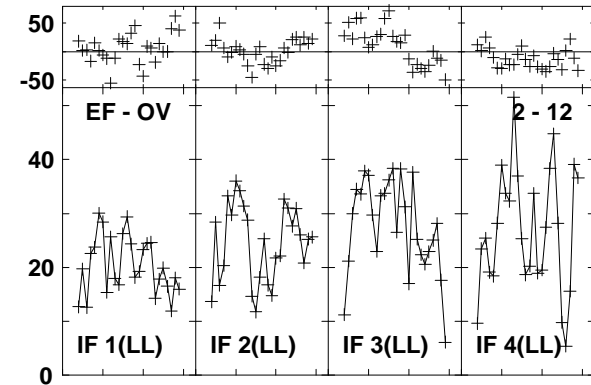
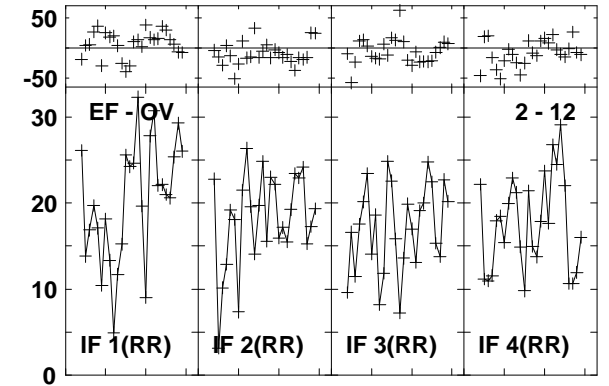
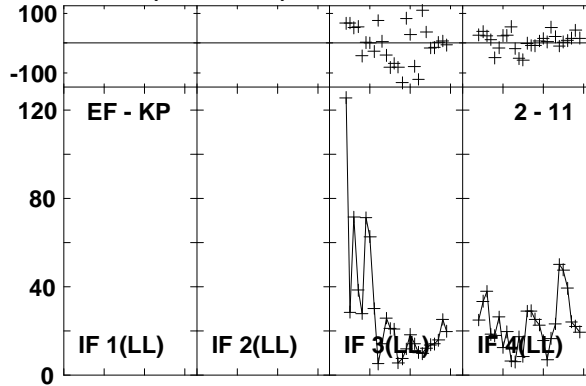
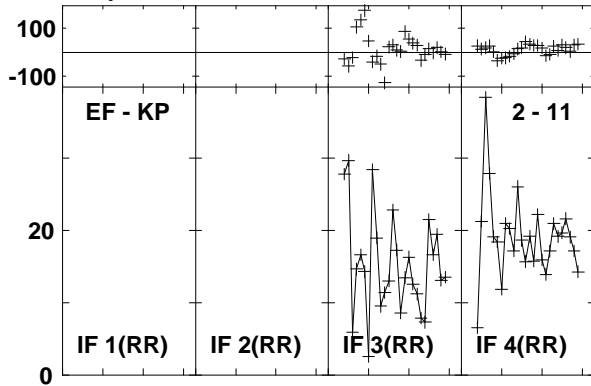

Lower frame: Milli Ampl Jy Top frame: Phas deg
 Vector averaged cross-power spectrum Baseline: EF (02) - KP (11)
 Timerange: 01/01:25:13 to 01/01:28:37

Plot file version1165 created 03-MAR-2016 01:15:20
 4C52 GN002C 1.UVDATA.1
 Freq = 1.2770 GHz, Bw = 16.000 MH Calibrated with CL # 3 and BP # 1 (BP mode 1)

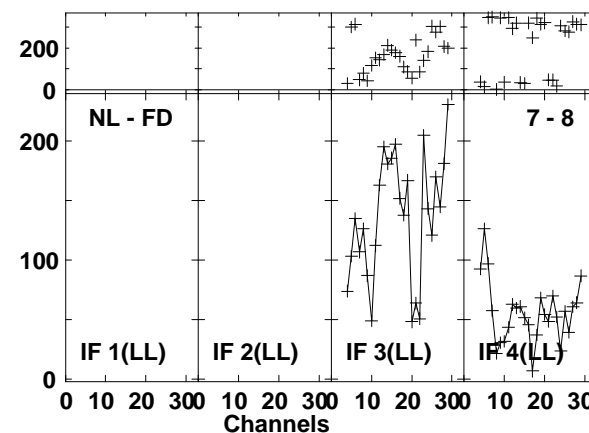
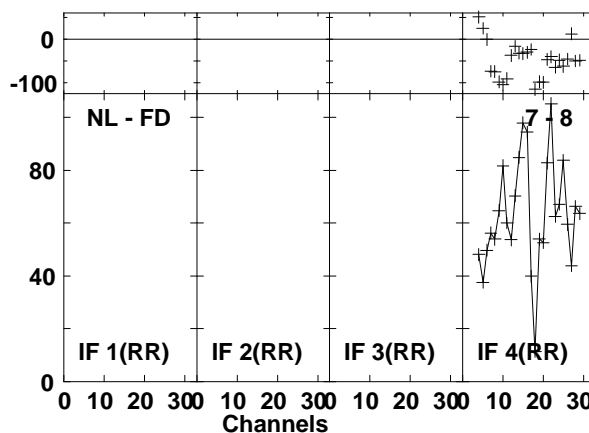
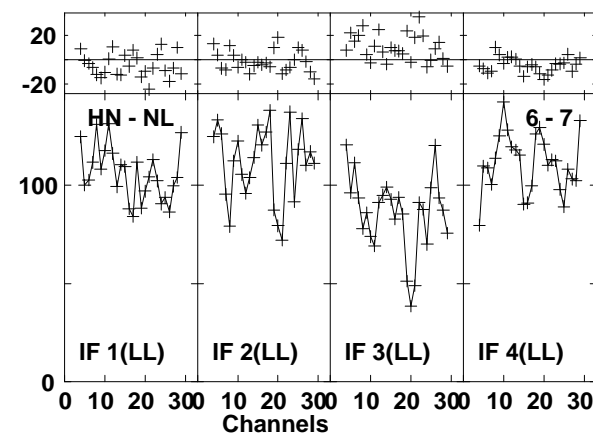
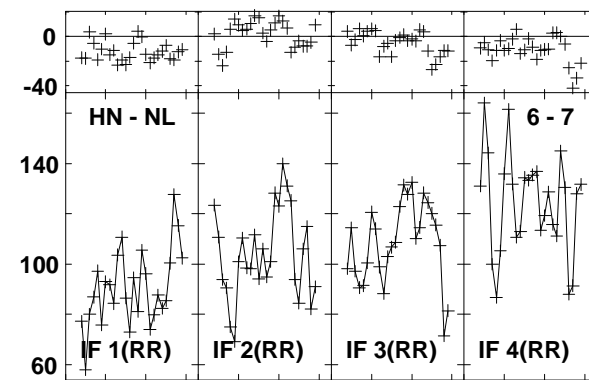
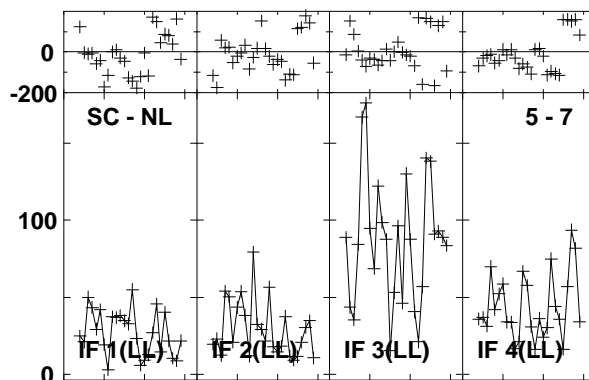
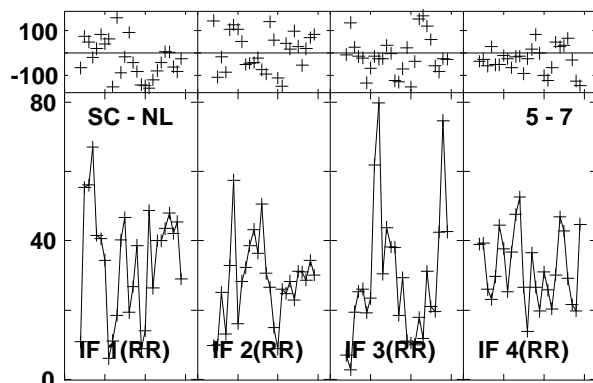
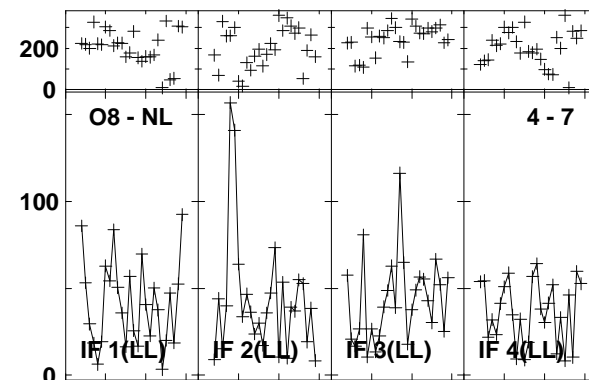
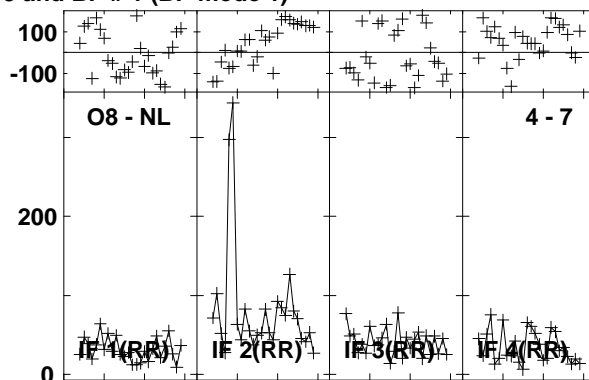
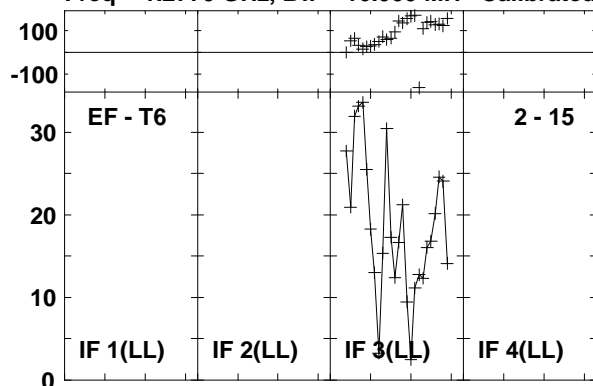

Lower frame: Milli Ampl Jy Top frame: Phas deg
 Vector averaged cross-power spectrum Baseline: EF (02) - T6 (15)
 Timerange: 01/01:25:13 to 01/01:28:37

Plot file version1166 created 03-MAR-2016 01:15:20

4C52 GN002C 1.UVDATA.1

Freq = 1.2770 GHz, Bw = 16.000 MH Calibrated with CL # 3 and BP # 1 (BP mode 1)

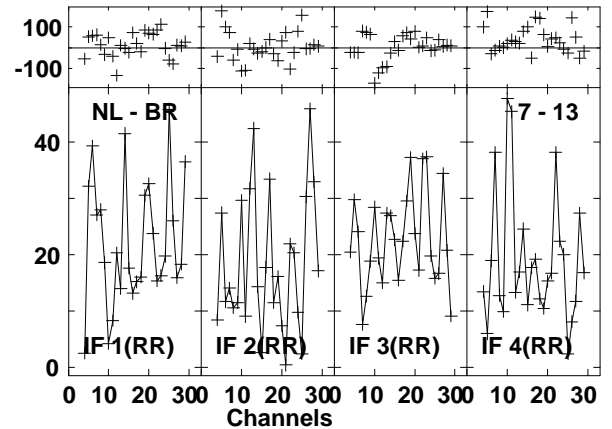
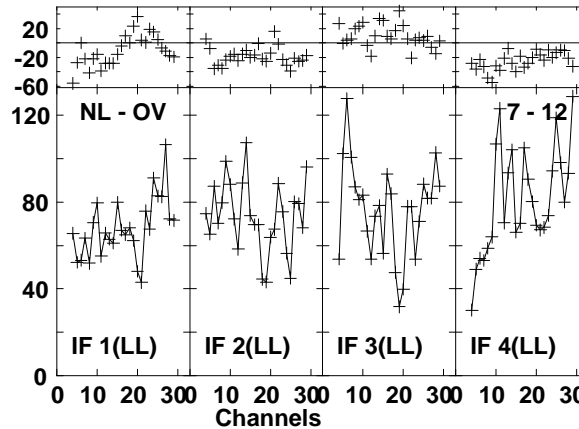
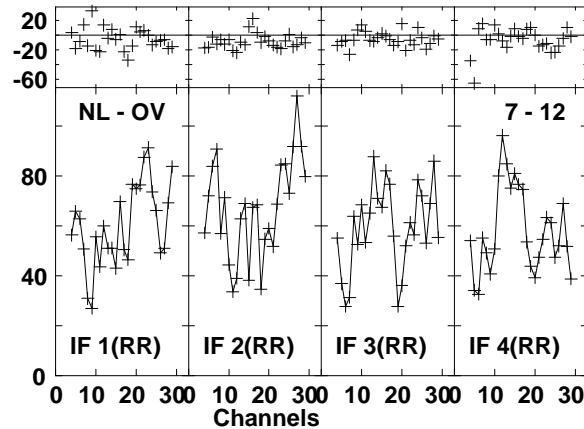
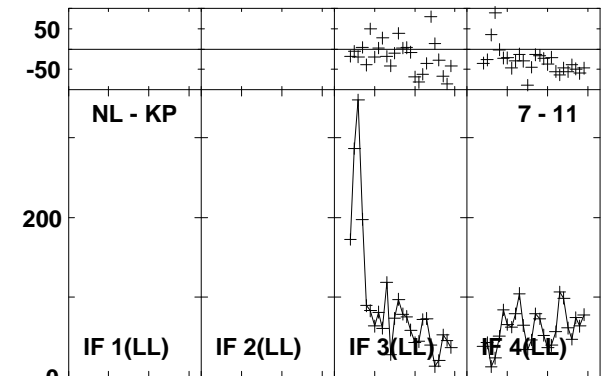
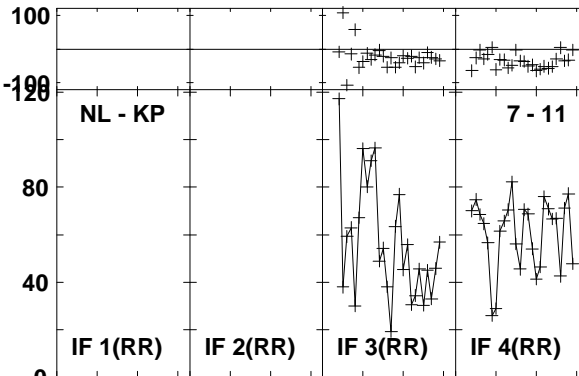
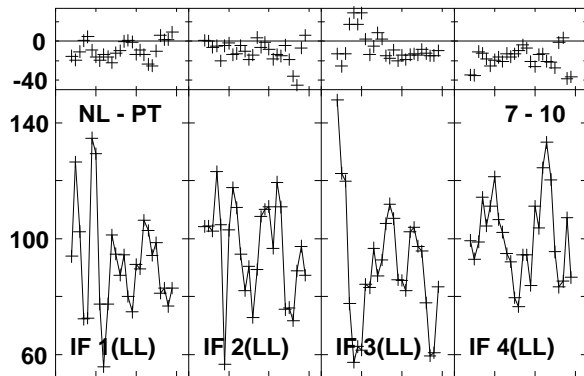
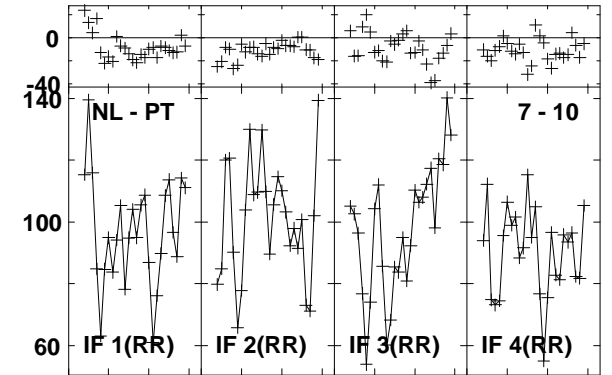
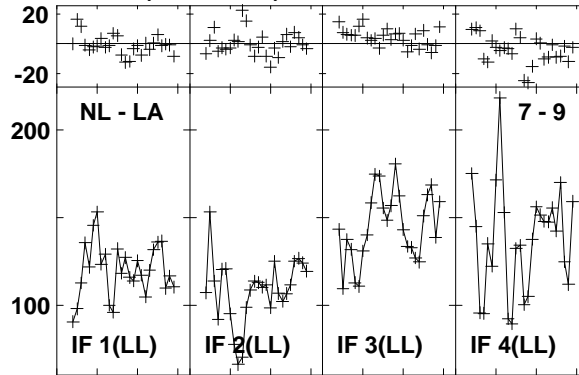
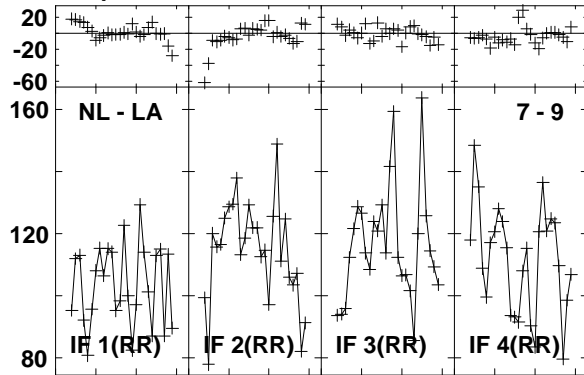

Lower frame: Milli Ampl Jy Top frame: Phas deg
Vector averaged cross-power spectrum Baseline: NL (07) - LA (09)
Timerange: 01/01:25:13 to 01/01:28:37

Plot file version1167 created 03-MAR-2016 01:15:20

4C52 GN002C 1.UVDATA.1

Freq = 1.2770 GHz, Bw = 16.000 MH Calibrated with CL # 3 and BP # 1 (BP mode 1)

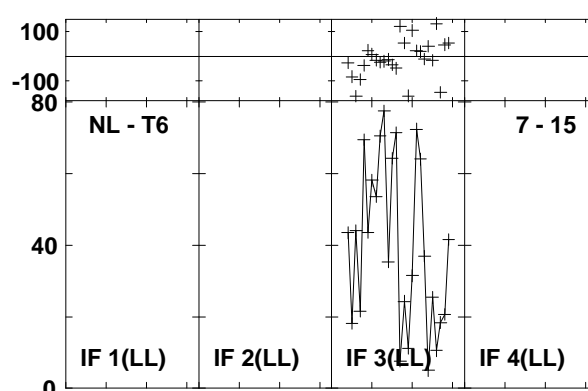
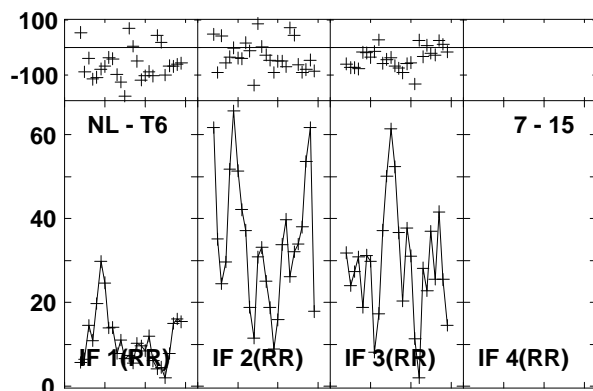
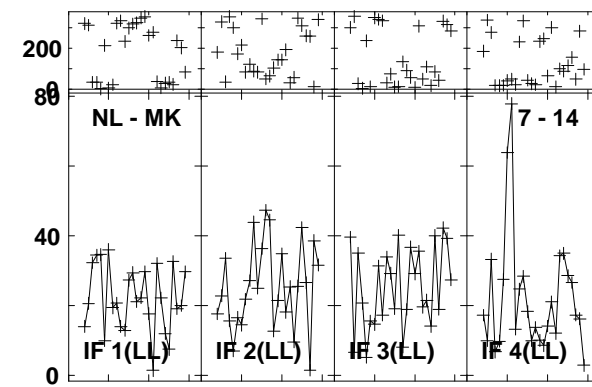
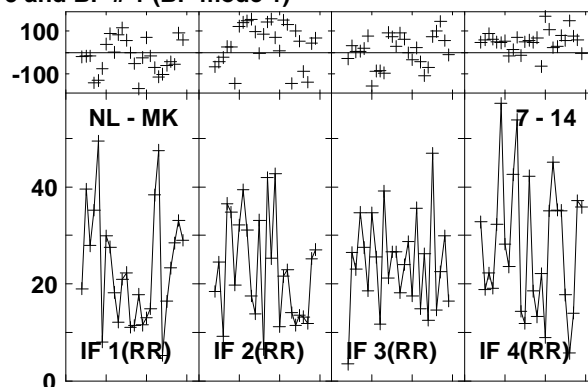
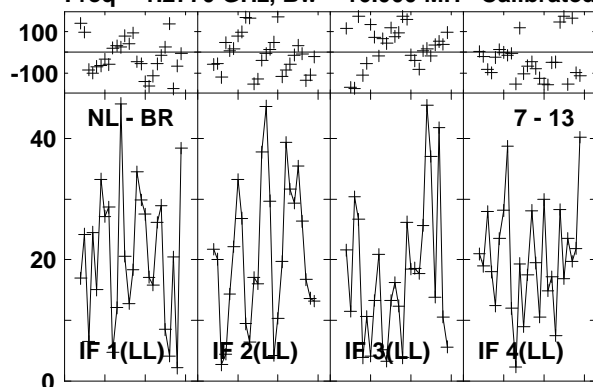

Lower frame: Milli Ampl Jy Top frame: Phas deg
Vector averaged cross-power spectrum Baseline: NL (07) - BR (13)
Timerange: 01/01:25:13 to 01/01:28:37

Plot file version1168 created 03-MAR-2016 01:15:21

J1545+5400 GN002C 1.UVDATA.1

Freq = 1.2770 GHz, Bw = 16.000 MH Calibrated with CL # 3 and BP # 1 (BP mode 1)

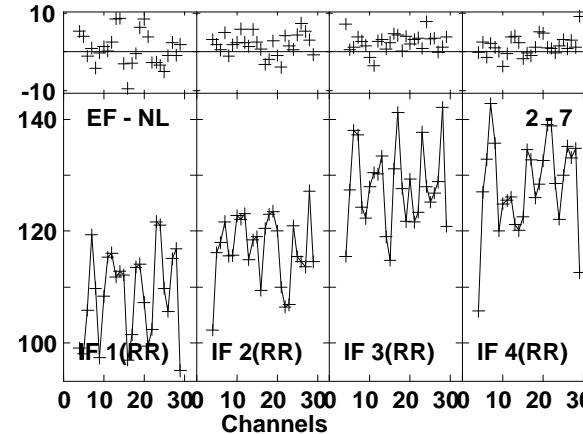
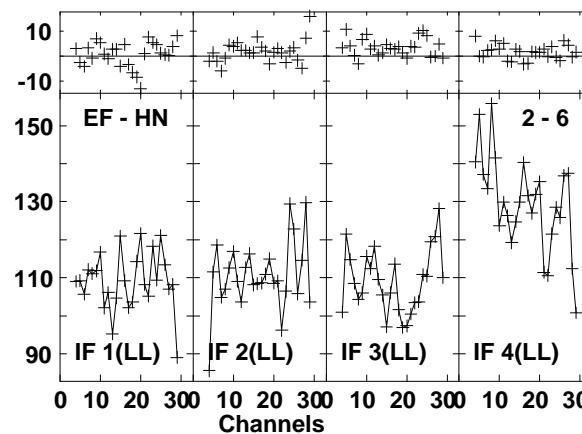
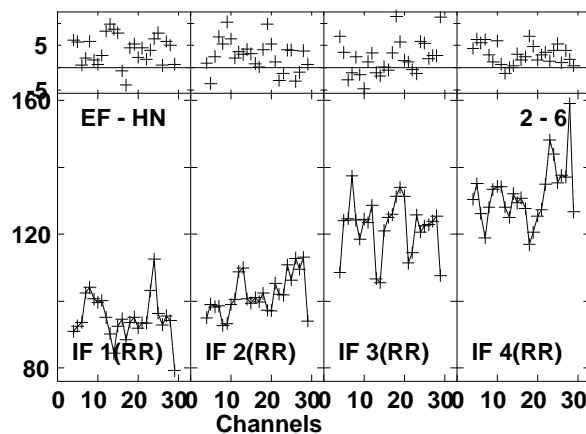
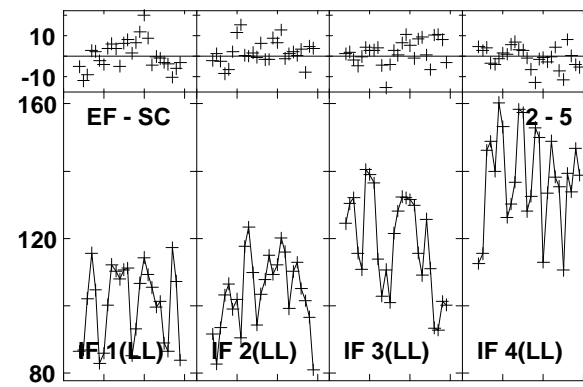
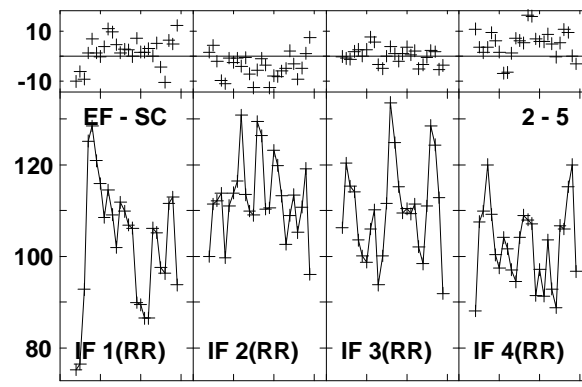
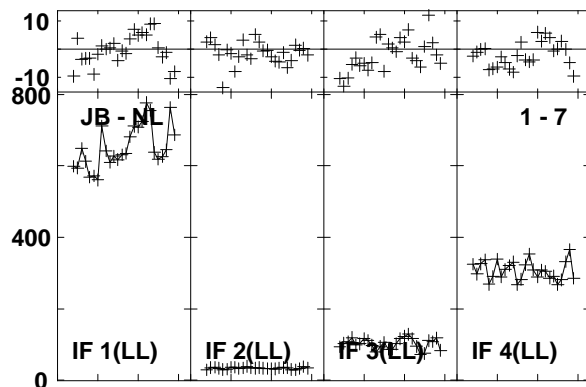
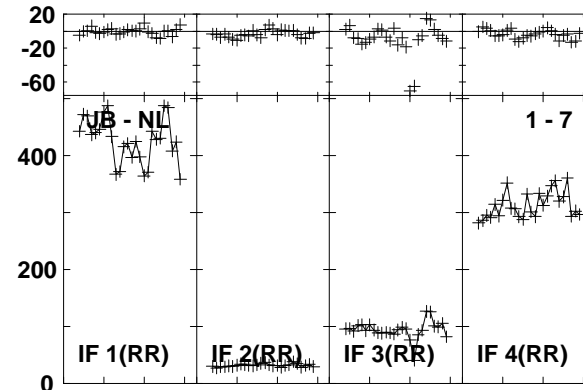
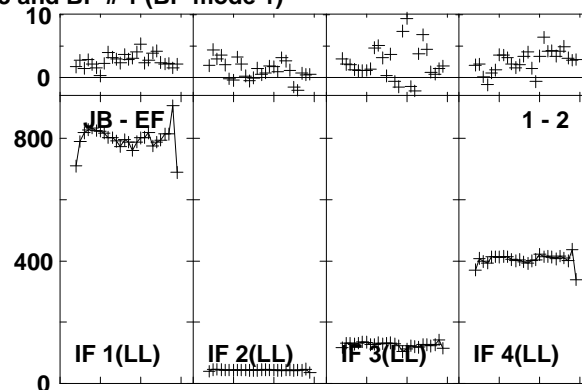
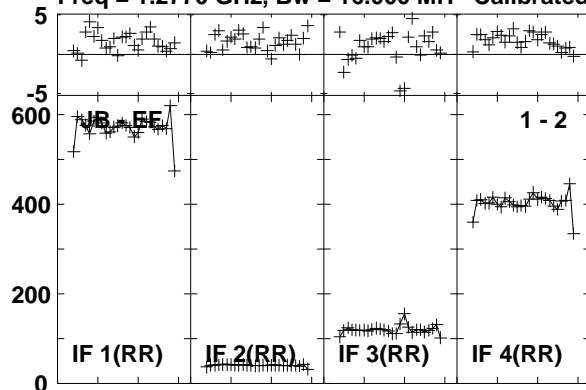

Lower frame: Milli Ampl Jy Top frame: Phas deg
Vector averaged cross-power spectrum Baseline: JB (01) - EF (02)
Timerange: 01/01:29:30 to 01/01:31:28

Plot file version 1169 created 03-MAR-2016 01:15:21

J1545+5400 GN002C 1.UVDATA.1

Freq = 1.2770 GHz, Bw = 16.000 MH Calibrated with CL # 3 and BP # 1 (BP mode 1)

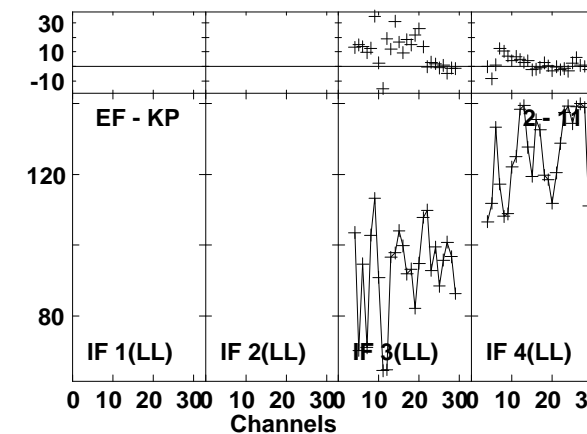
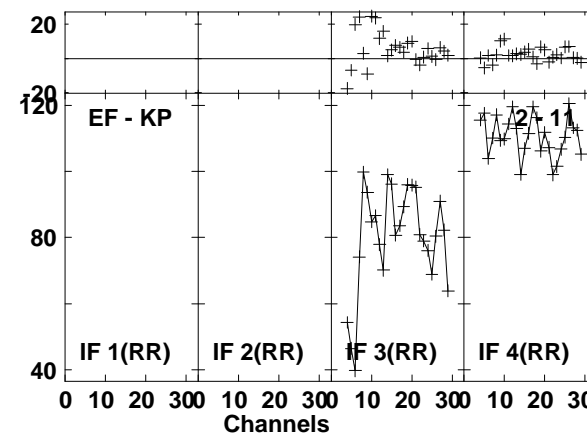
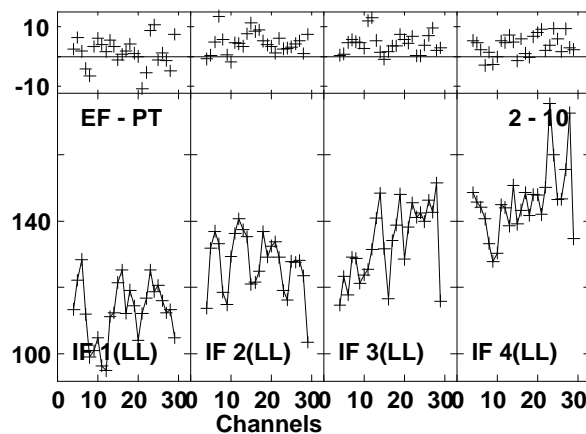
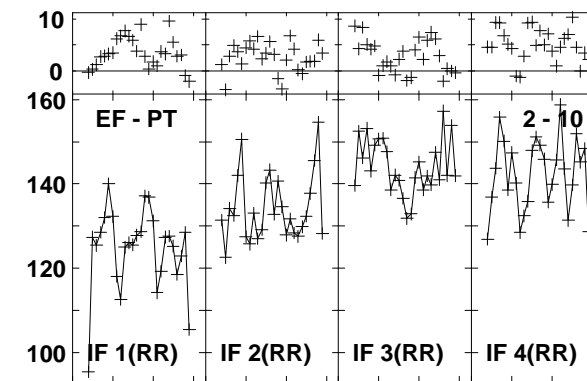
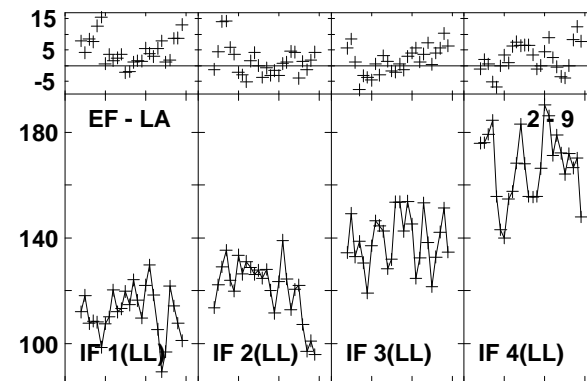
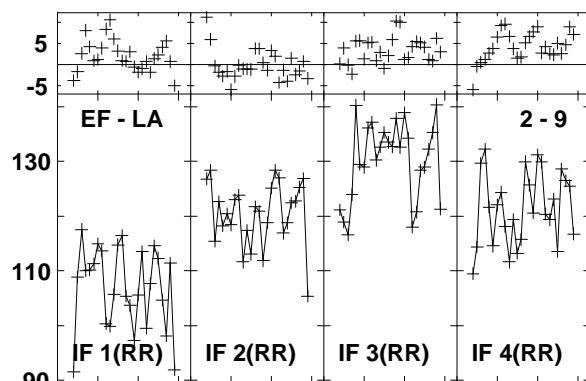
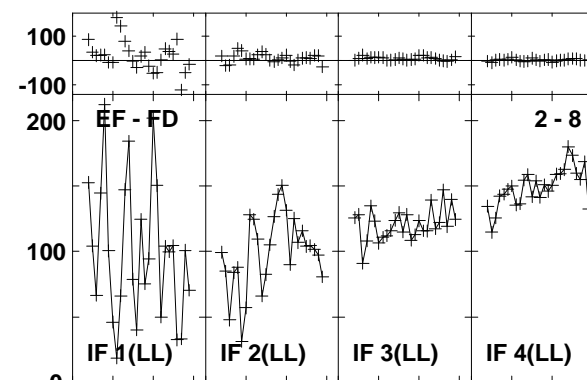
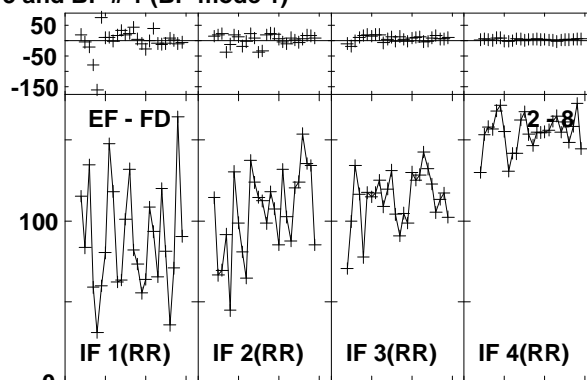
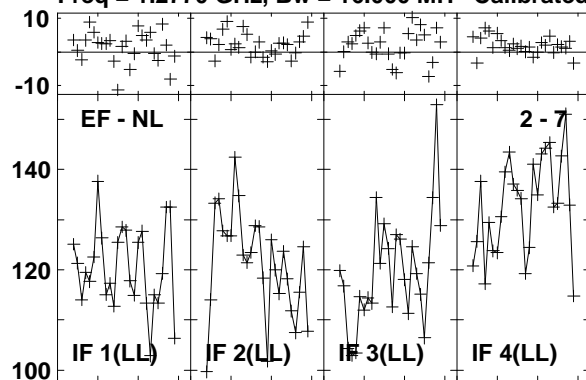

Lower frame: Milli Ampl Jy Top frame: Phas deg
Vector averaged cross-power spectrum Baseline: EF (02) - NL (07)
Timerange: 01/01:29:30 to 01/01:31:28

Plot file version1170 created 03-MAR-2016 01:15:21

J1545+5400 GN002C 1.UVDATA.1

Freq = 1.2770 GHz, Bw = 16.000 MH Calibrated with CL # 3 and BP # 1 (BP mode 1)

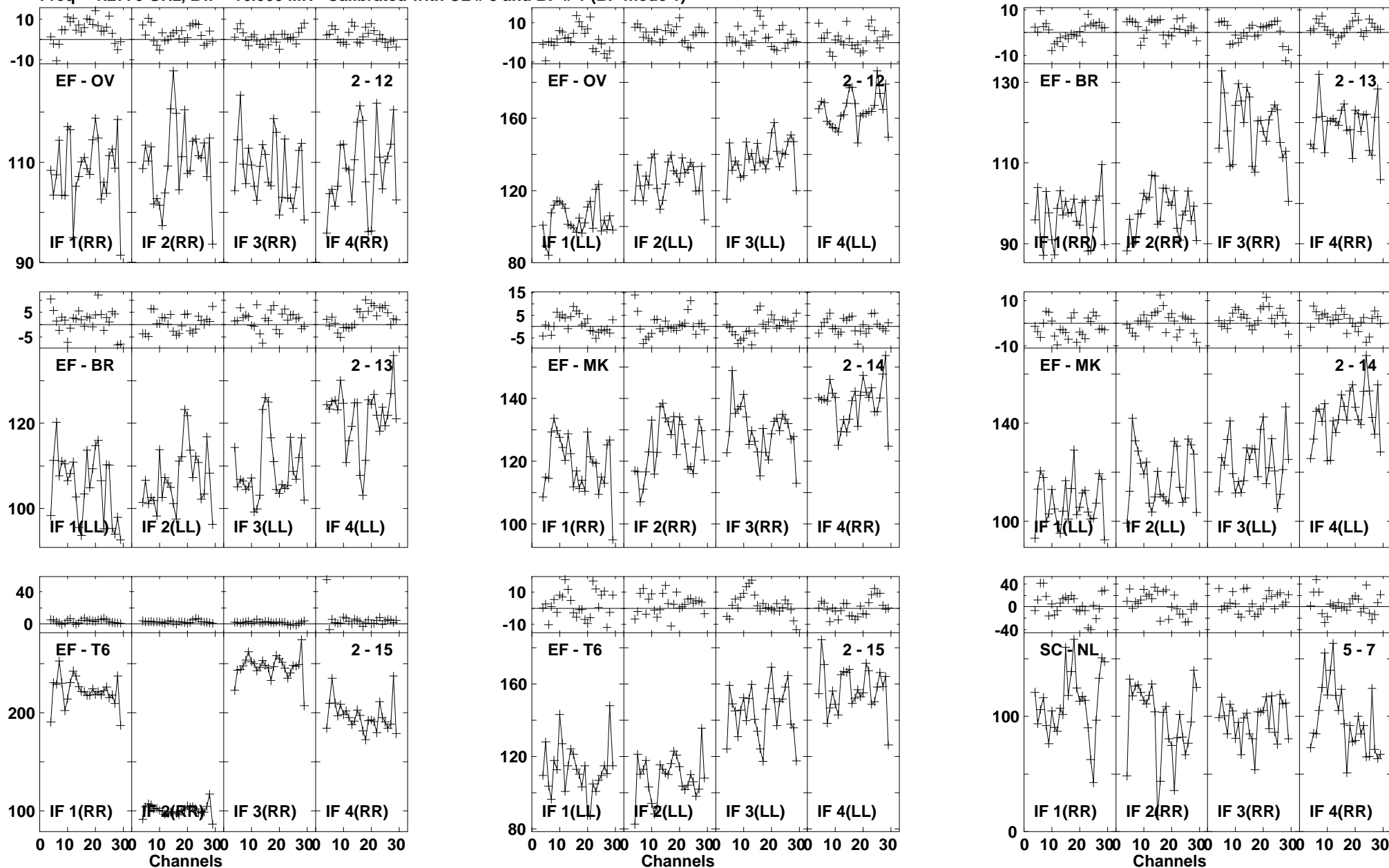

Plot file version1171 created 03-MAR-2016 01:15:21

J1545+5400 GN002C 1.UVDATA.1

Freq = 1.2770 GHz, Bw = 16.000 MH Calibrated with CL # 3 and BP # 1 (BP mode 1)

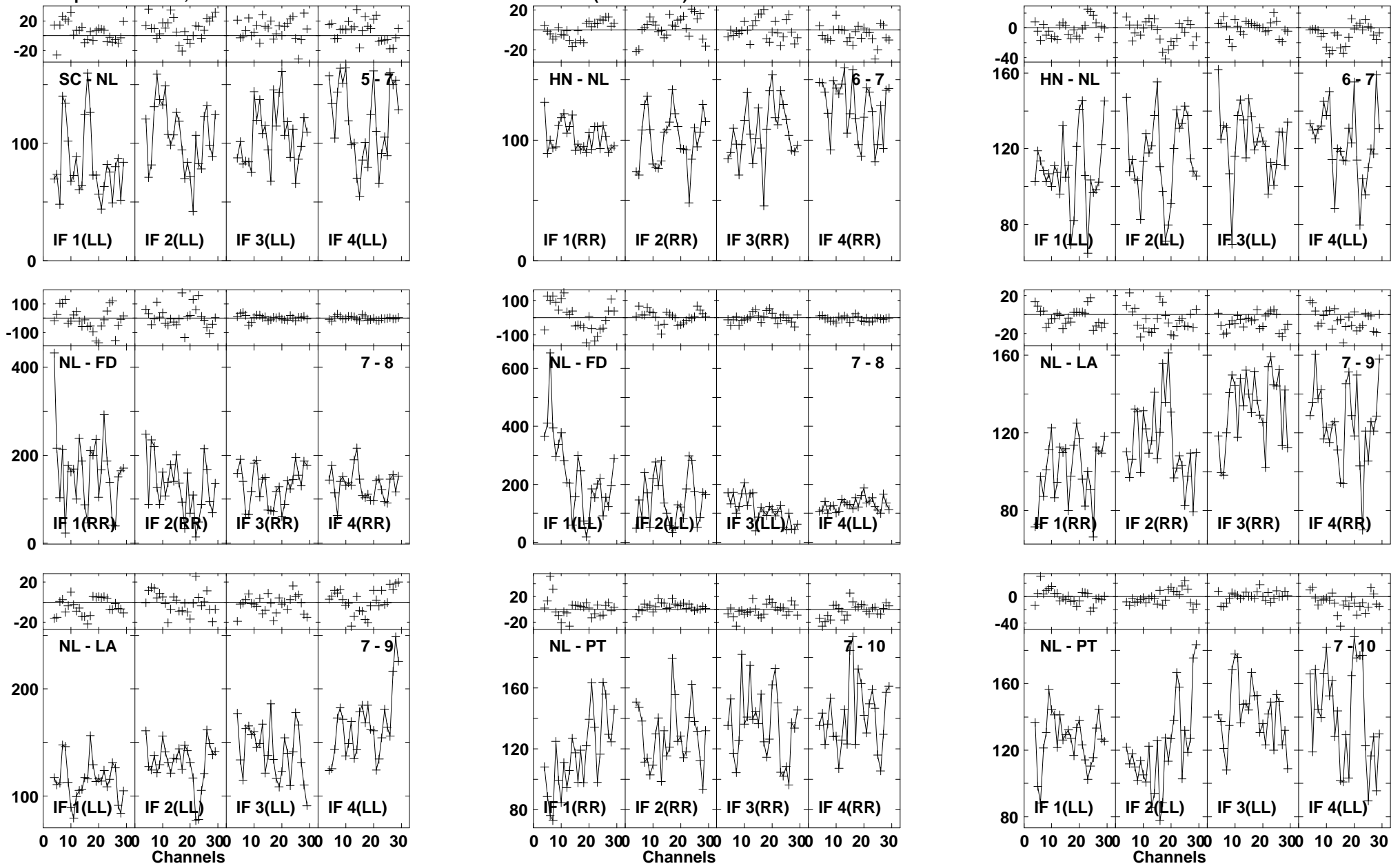

Lower frame: Milli Ampl Jy Top frame: Phas deg
Vector averaged cross-power spectrum Baseline: SC (05) - NL (07)
Timerange: 01/01:29:30 to 01/01:31:28

Plot file version1172 created 03-MAR-2016 01:15:21
 J1545+5400 GN002C 1.UVDATA.1
 Freq = 1.2770 GHz, Bw = 16.000 MH Calibrated with CL # 3 and BP # 1 (BP mode 1)

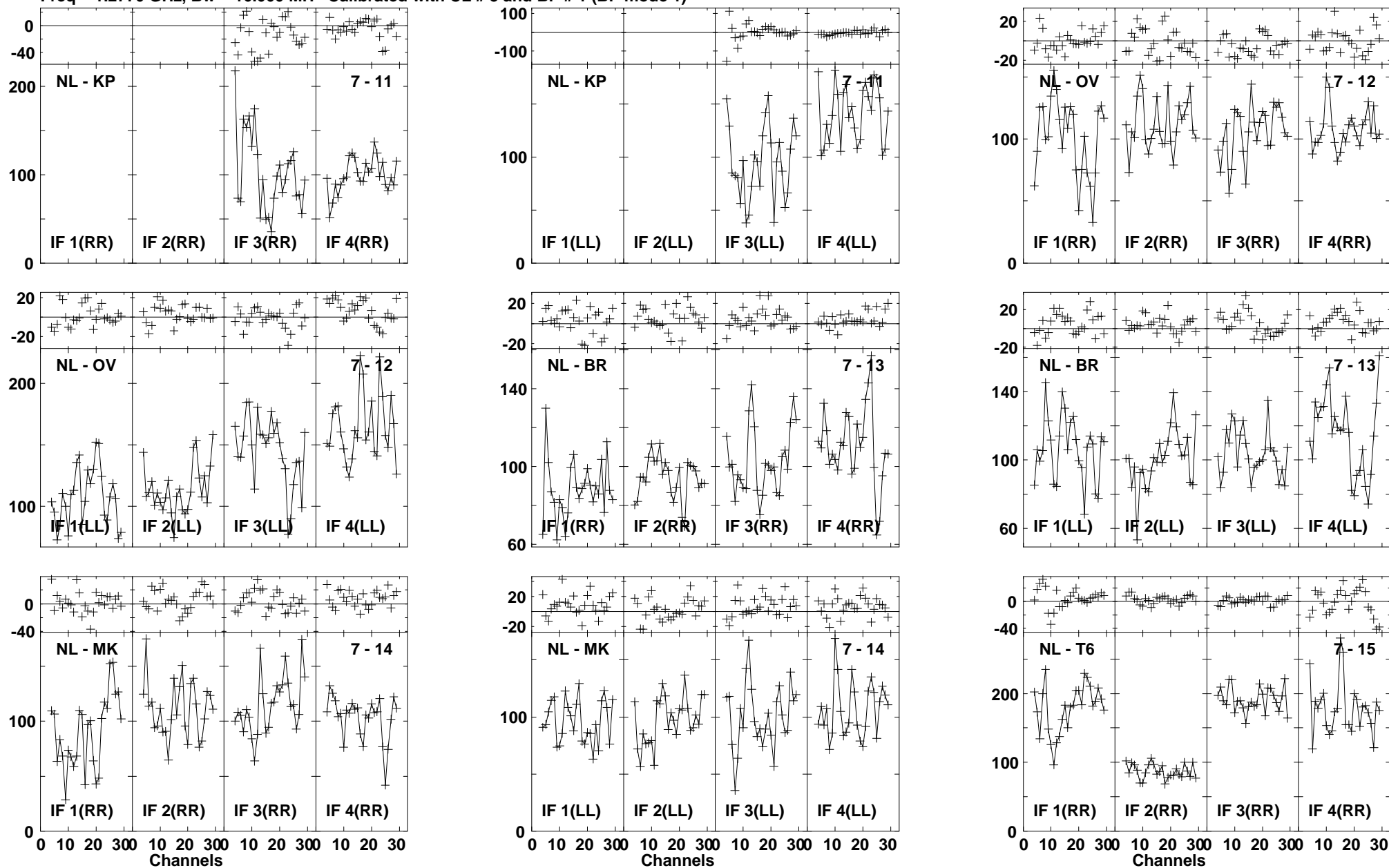

Lower frame: Milli Ampl Jy Top frame: Phas deg
 Vector averaged cross-power spectrum Baseline: NL (07) - KP (11)
 Timerange: 01/01:29:30 to 01/01:31:28

Plot file version1173 created 03-MAR-2016 01:15:22
J1545+5400 GN002C 1.UVDATA.1
Freq = 1.2770 GHz, Bw = 16.000 MH Calibrated with CL # 3 and BP # 1 (BP mode 1)

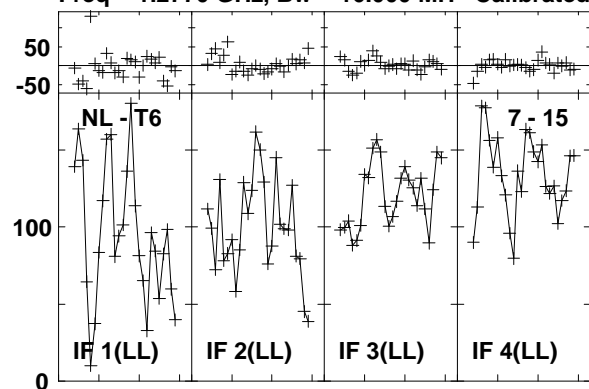

Lower frame: Milli Ampl Jy Top frame: Phas deg
Vector averaged cross-power spectrum Baseline: NL (07) - T6 (15)
Timerange: 01/01:29:30 to 01/01:31:28

Plot file version1174 created 03-MAR-2016 01:15:22

4C52 GN002C 1.UVDATA.1

Freq = 1.2770 GHz, Bw = 16.000 MH Calibrated with CL # 3 and BP # 1 (BP mode 1)

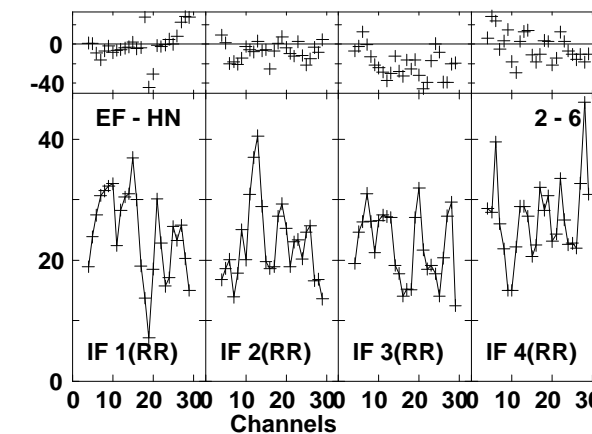
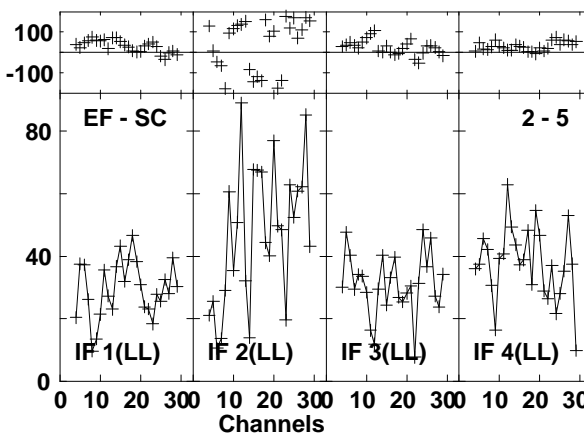
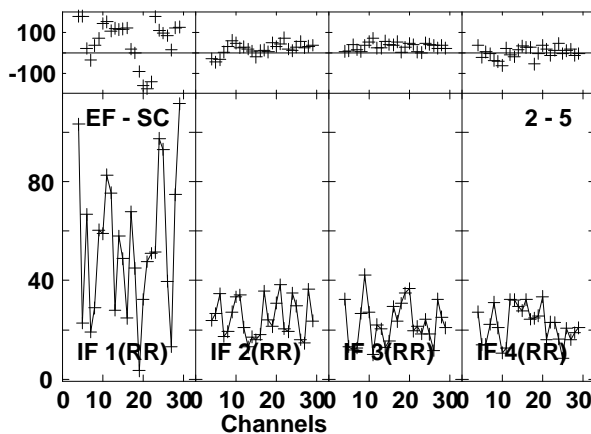
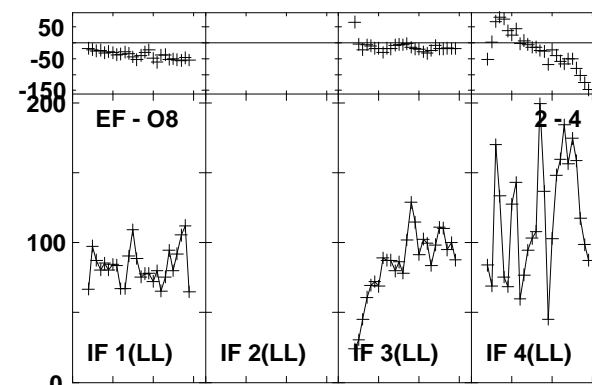
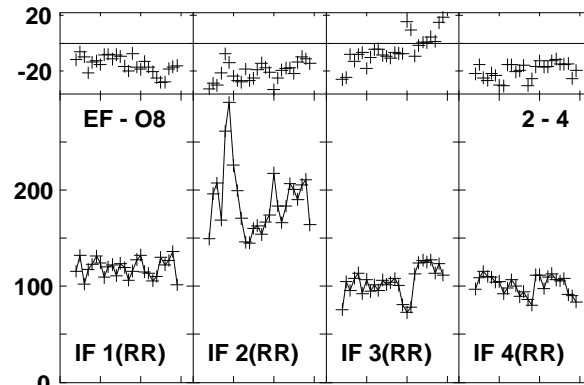
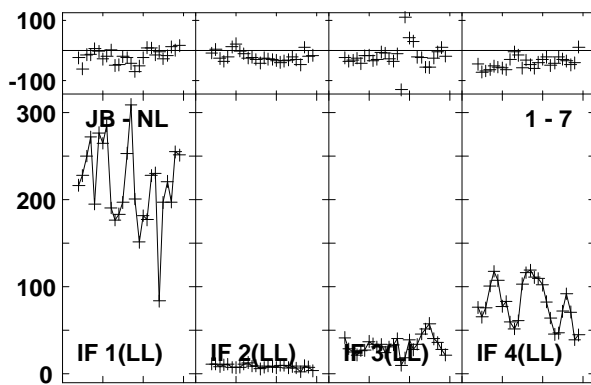
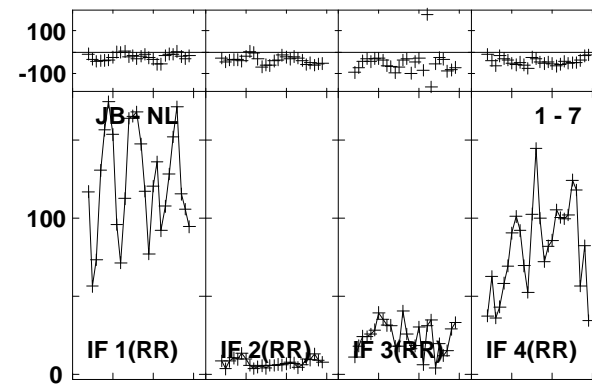
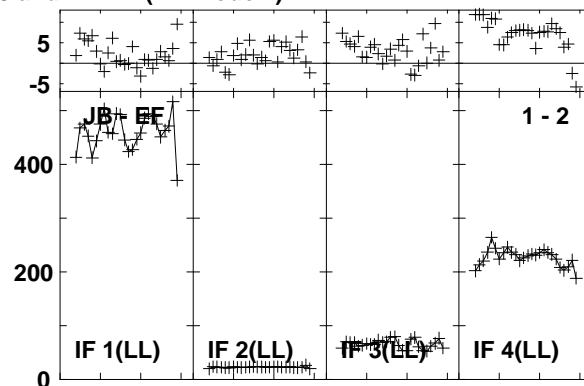
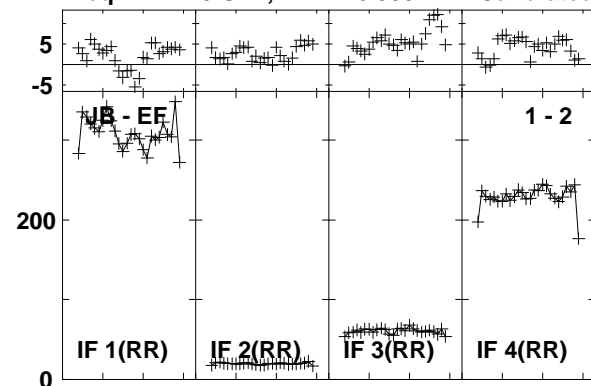

Lower frame: Milli Ampl Jy Top frame: Phas deg
Vector averaged cross-power spectrum Baseline: JB (01) - EF (02)
Timerange: 01/01:31:32 to 01/01:34:28

Plot file version1175 created 03-MAR-2016 01:15:22

4C52 GN002C 1.UVDATA.1

Freq = 1.2770 GHz, Bw = 16.000 MH Calibrated with CL # 3 and BP # 1 (BP mode 1)

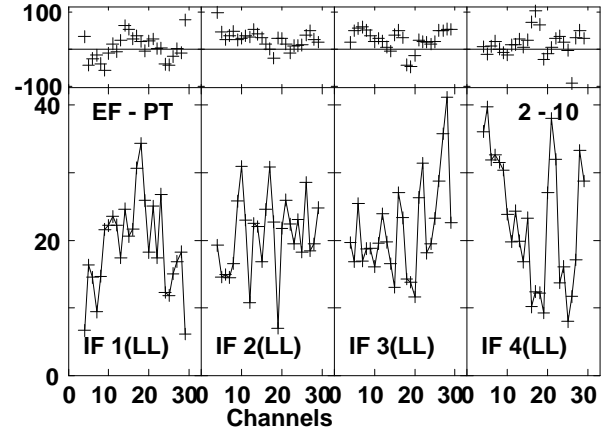
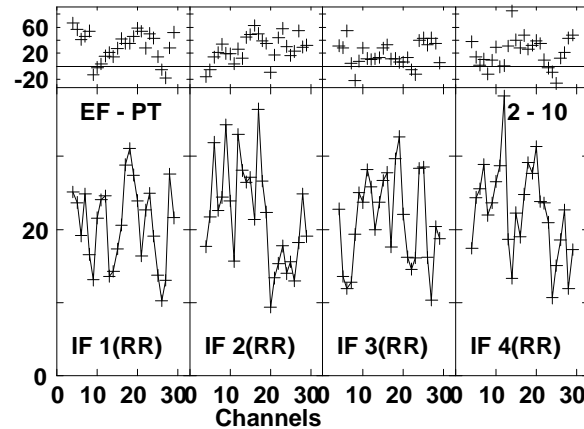
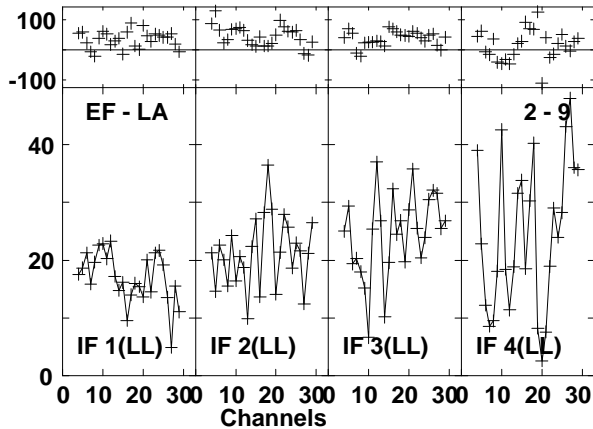
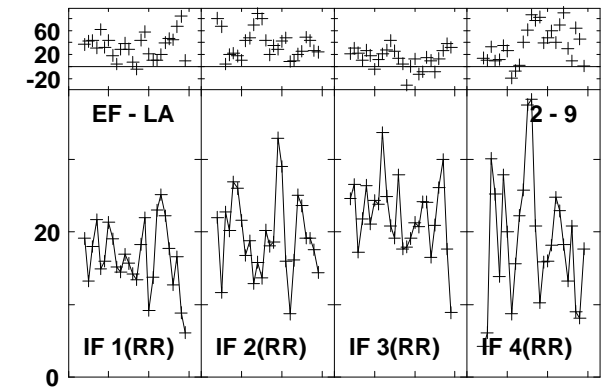
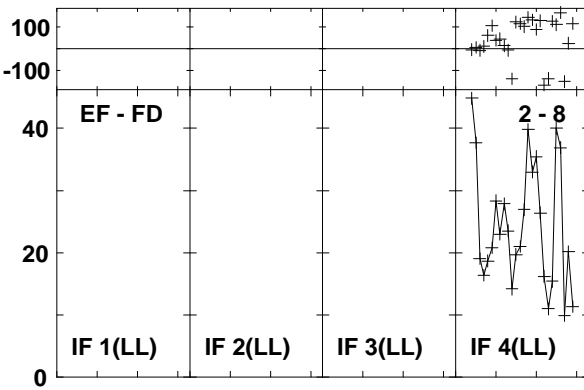
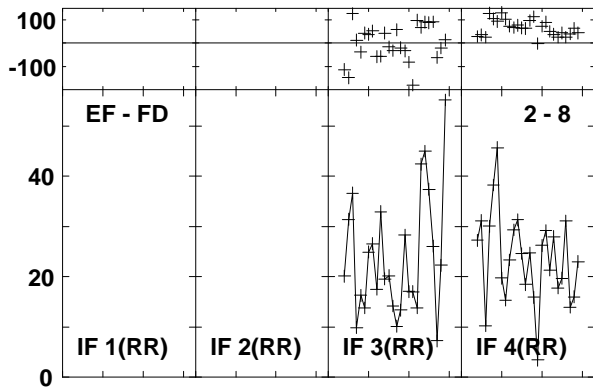
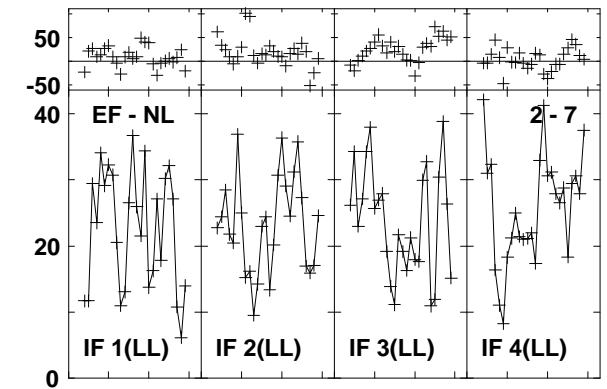
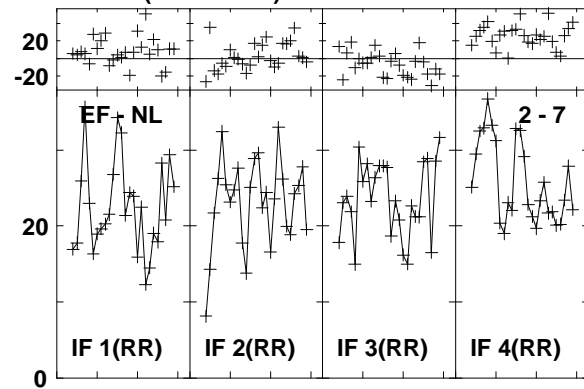
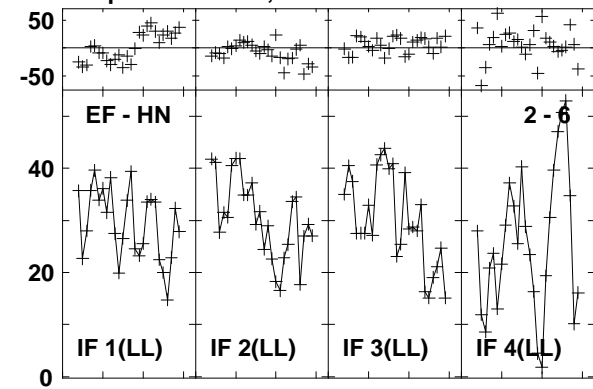

Lower frame: Milli Ampl Jy Top frame: Phas deg
Vector averaged cross-power spectrum Baseline: EF (02) - HN (06)
Timerange: 01/01:31:32 to 01/01:34:28

Plot file version1176 created 03-MAR-2016 01:15:22

4C52 GN002C 1.UVDATA.1

Freq = 1.2770 GHz, Bw = 16.000 MH Calibrated with CL # 3 and BP # 1 (BP mode 1)

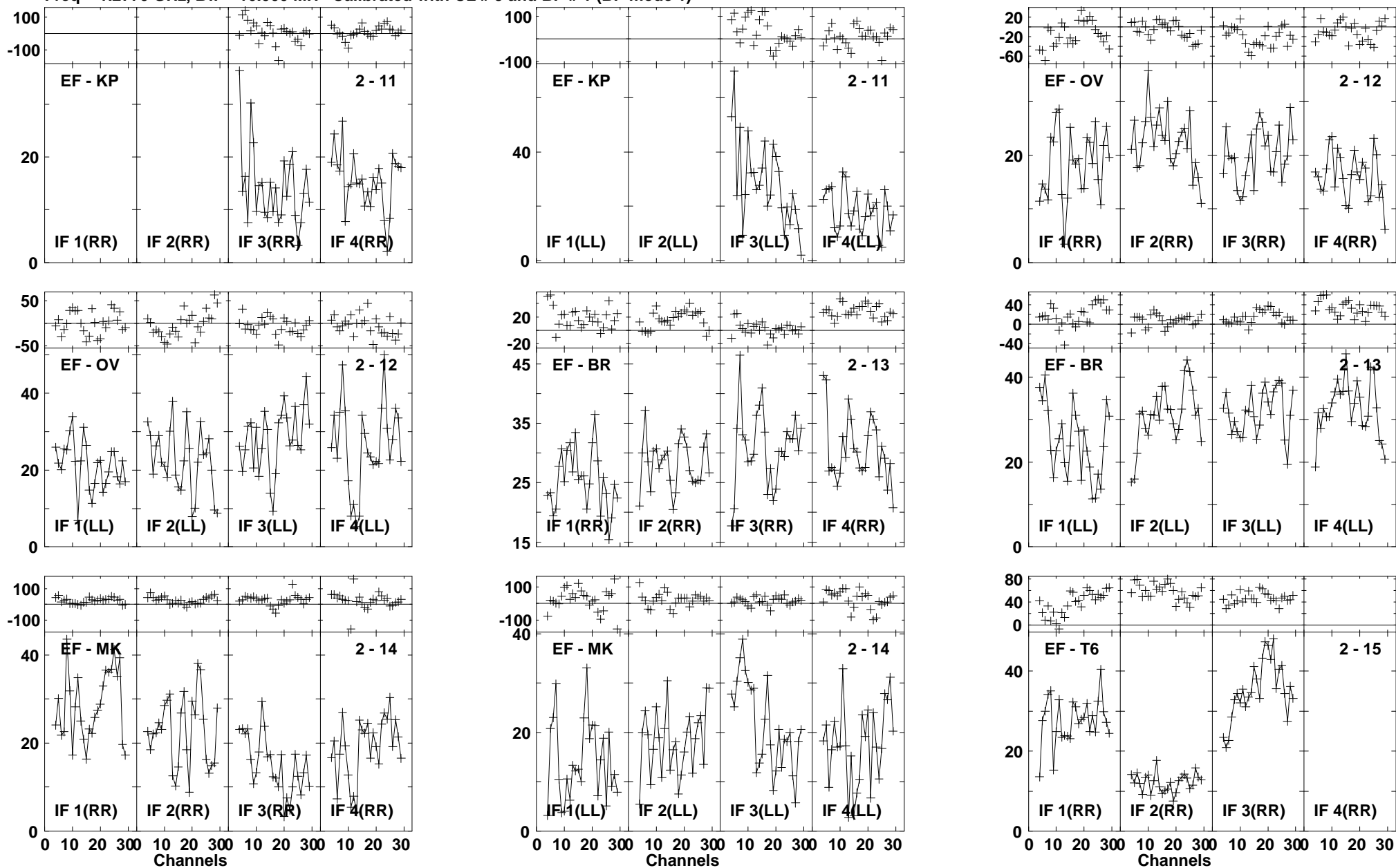

Lower frame: Milli Ampl Jy Top frame: Phas deg
Vector averaged cross-power spectrum Baseline: EF (02) - KP (11)
Timerange: 01/01:31:32 to 01/01:34:28

Plot file version1177 created 03-MAR-2016 01:15:22

4C52 GN002C 1.UVDATA.1

Freq = 1.2770 GHz, Bw = 16.000 MH Calibrated with CL # 3 and BP # 1 (BP mode 1)

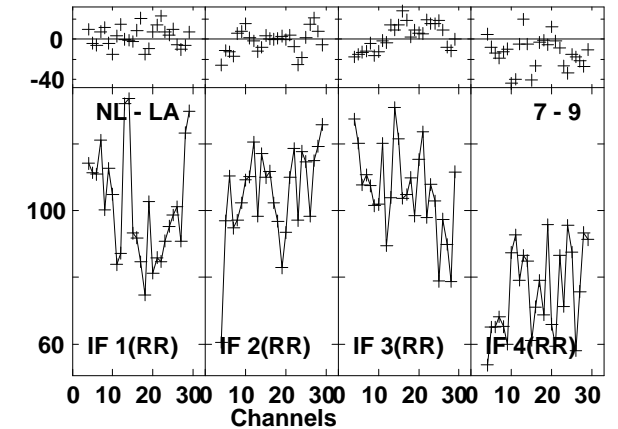
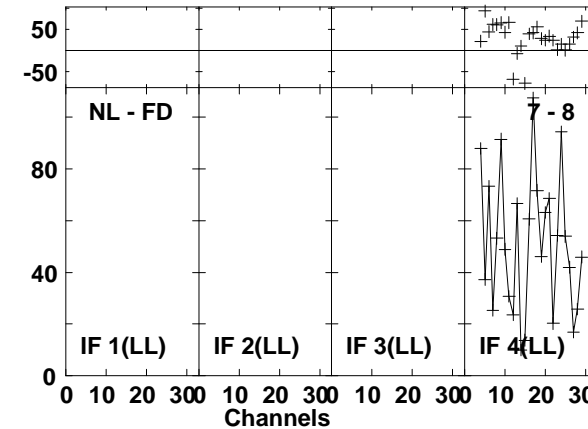
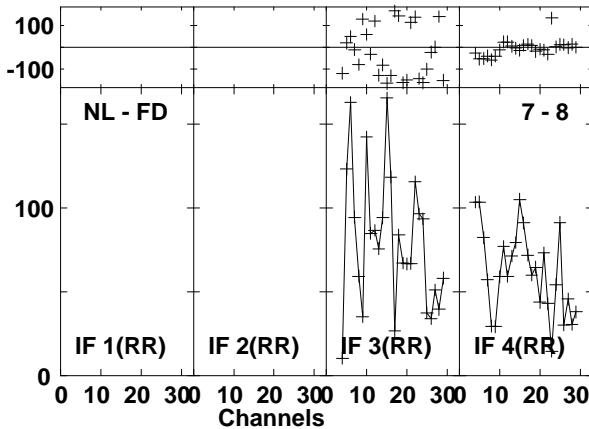
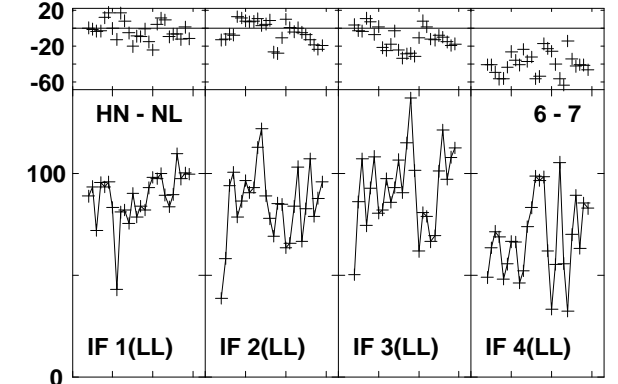
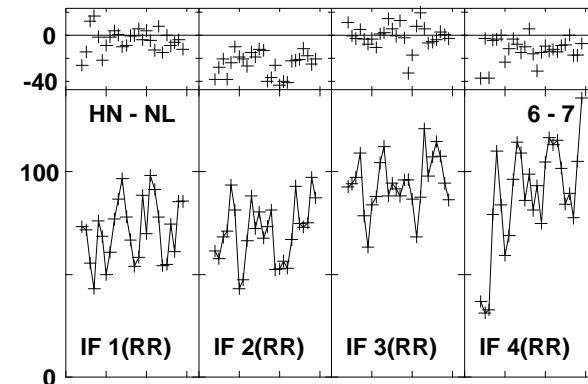
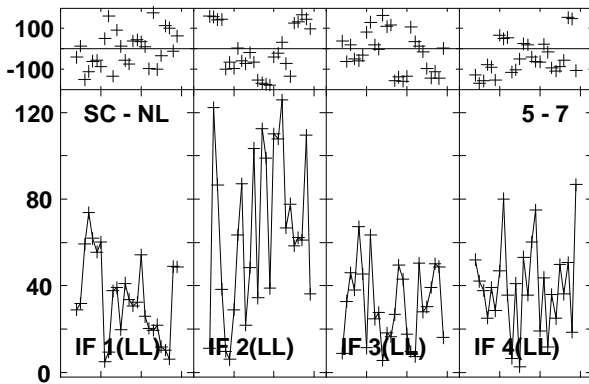
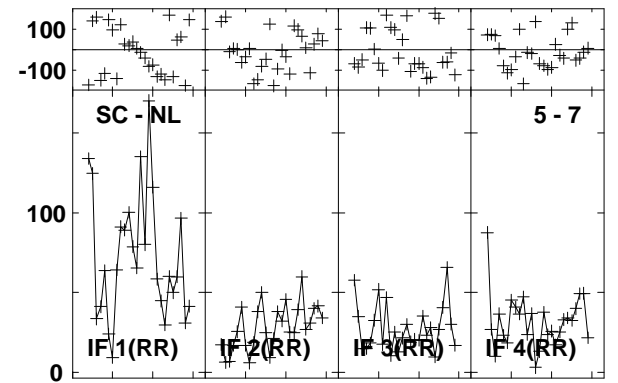
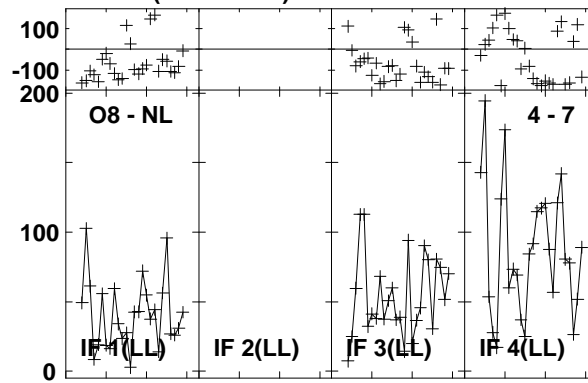
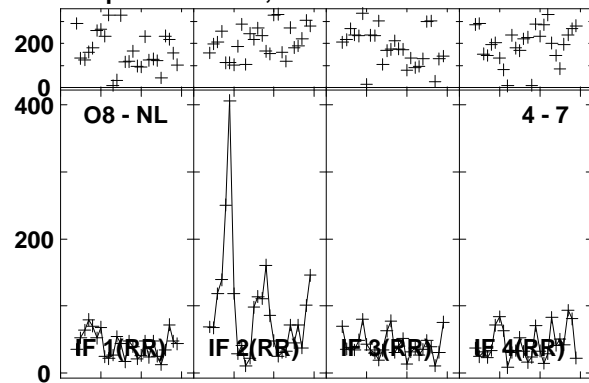

Lower frame: Milli Ampl Jy Top frame: Phas deg
Vector averaged cross-power spectrum Baseline: O8 (04) - NL (07)
Timerange: 01/01:31:32 to 01/01:34:28

Plot file version1178 created 03-MAR-2016 01:15:22

4C52 GN002C 1.UVDATA.1

Freq = 1.2770 GHz, Bw = 16.000 MH Calibrated with CL # 3 and BP # 1 (BP mode 1)

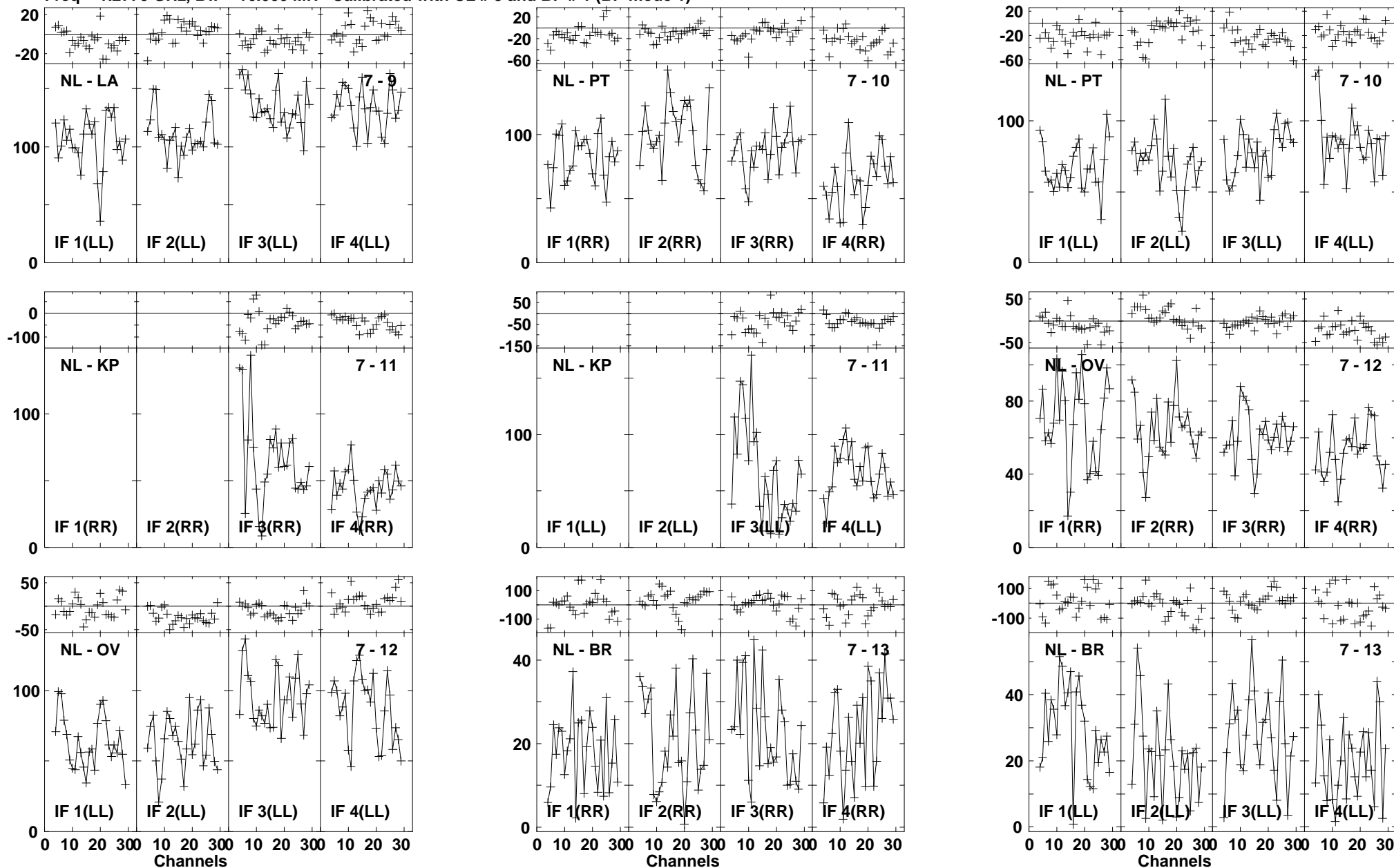

Lower frame: Milli Ampl Jy Top frame: Phas deg
Vector averaged cross-power spectrum Baseline: NL (07) - LA (09)
Timerange: 01/01:31:32 to 01/01:34:28

Plot file version1179 created 03-MAR-2016 01:15:23

4C52 GN002C 1.UVDATA.1

Freq = 1.2770 GHz, Bw = 16.000 MH Calibrated with CL # 3 and BP # 1 (BP mode 1)

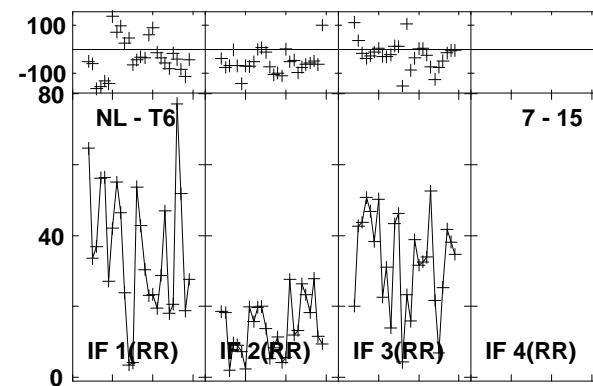
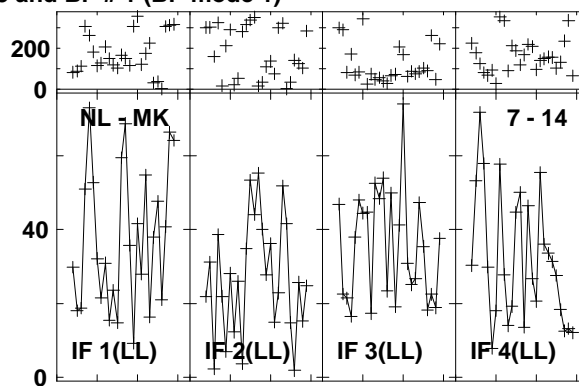
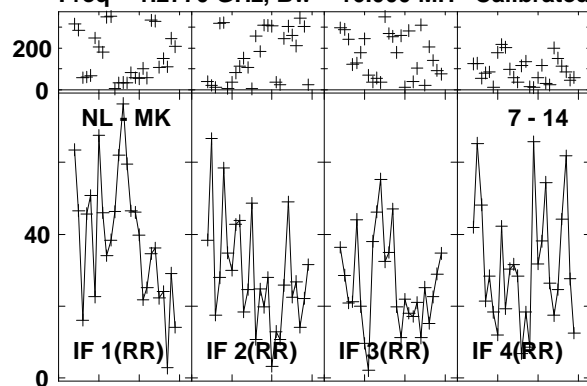

Lower frame: Milli Ampl Jy Top frame: Phas deg
Vector averaged cross-power spectrum Baseline: NL (07) - MK (14)
Timerange: 01/01:31:32 to 01/01:34:28

Plot file version1180 created 03-MAR-2016 01:15:23

J1545+5400 GN002C 1.UVDATA.1

Freq = 1.2770 GHz, Bw = 16.000 MH Calibrated with CL # 3 and BP # 1 (BP mode 1)

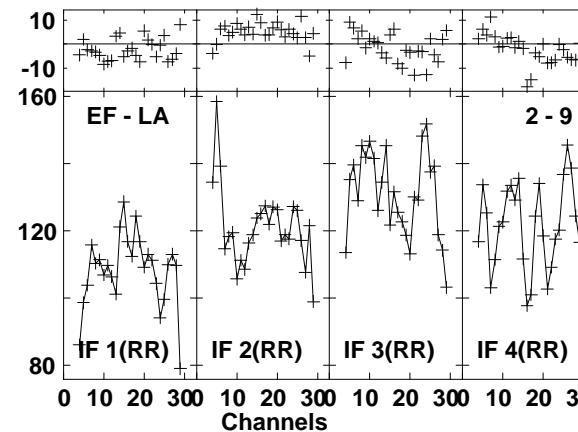
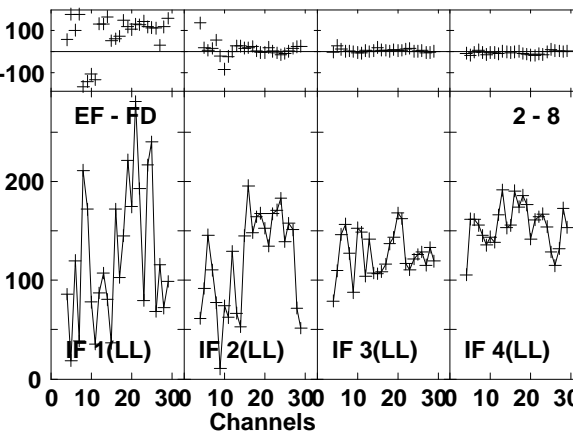
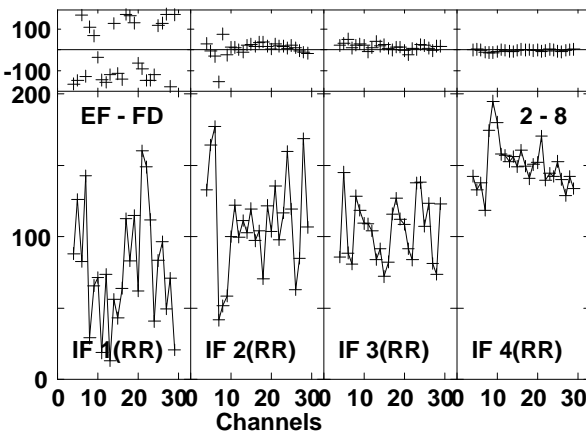
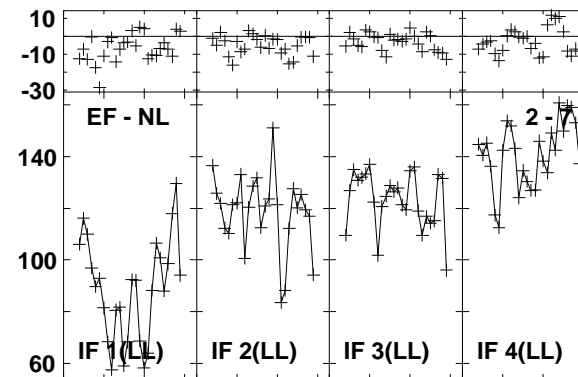
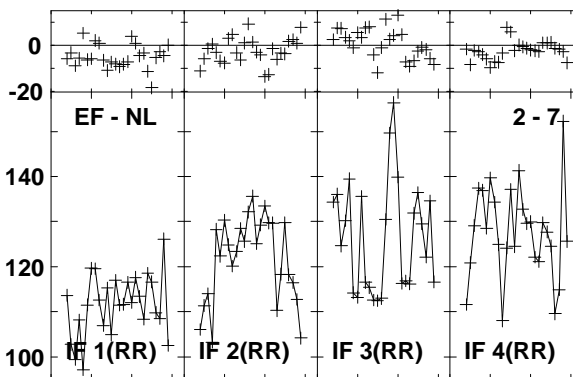
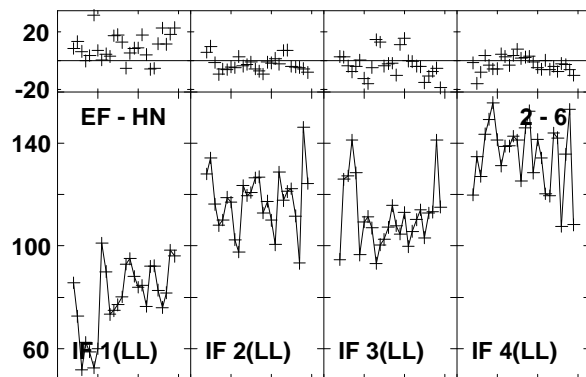
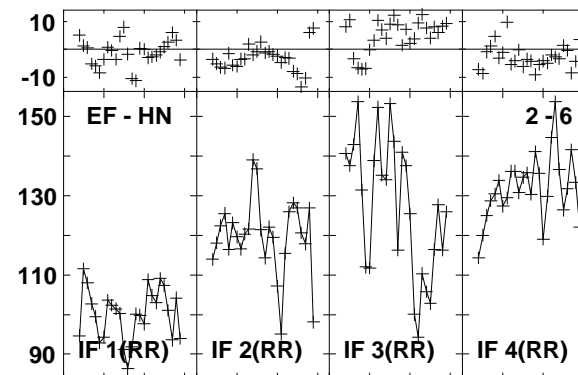
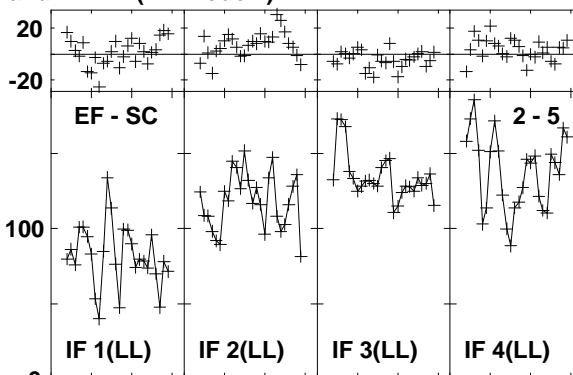
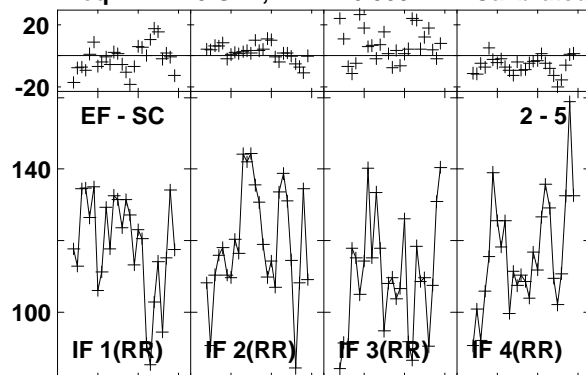

Lower frame: Milli Ampl Jy Top frame: Phas deg
Vector averaged cross-power spectrum Baseline: EF (02) - SC (05)
Timerange: 01/01:35:20 to 01/01:36:18

Plot file version1181 created 03-MAR-2016 01:15:23

J1545+5400 GN002C 1.UVDATA.1

Freq = 1.2770 GHz, Bw = 16.000 MH Calibrated with CL # 3 and BP # 1 (BP mode 1)

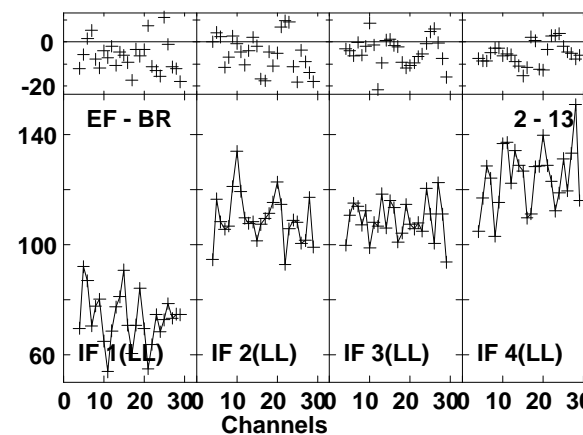
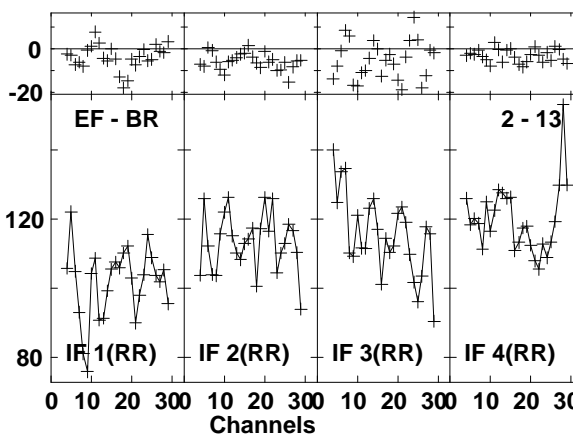
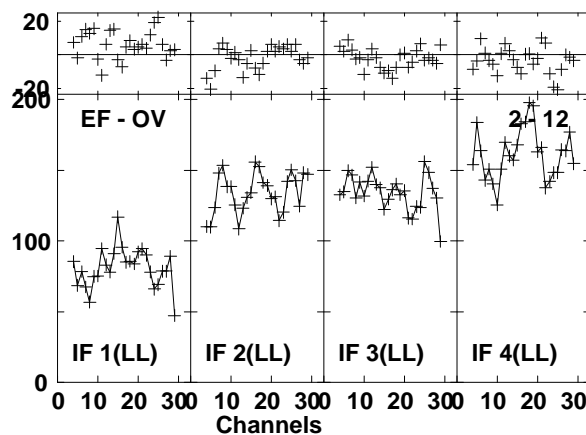
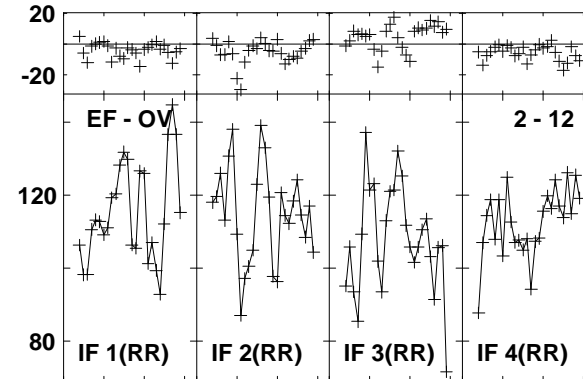
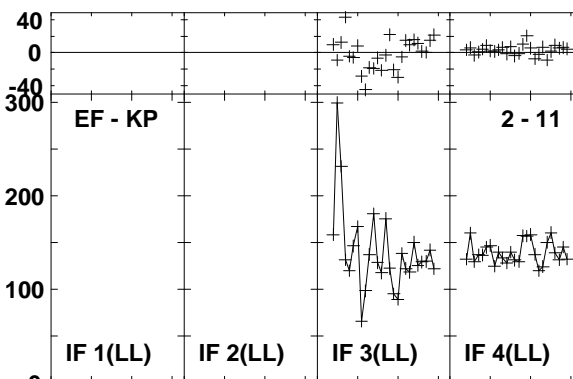
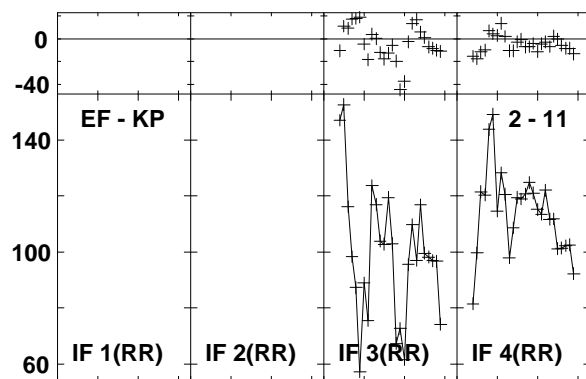
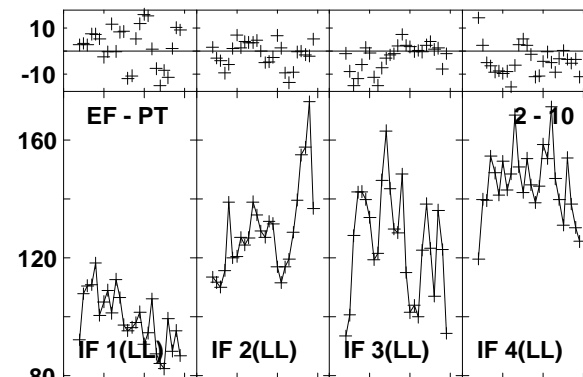
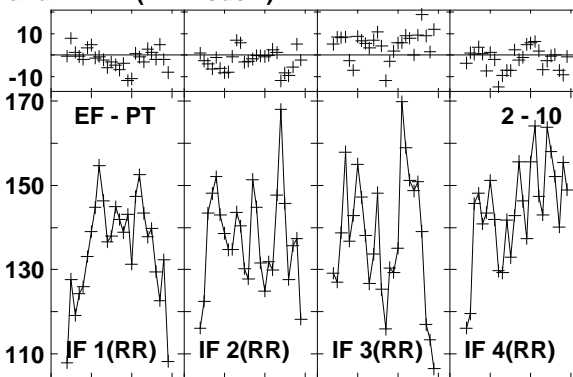
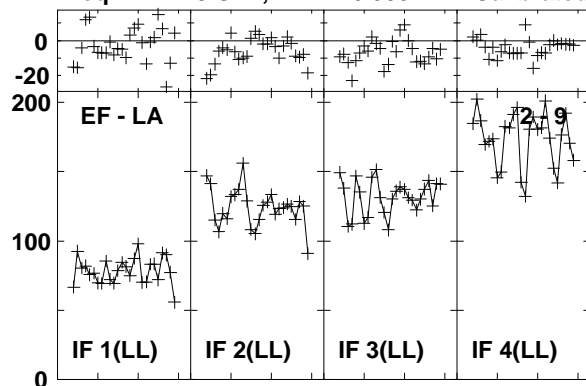

Lower frame: Milli Ampl Jy Top frame: Phas deg
Vector averaged cross-power spectrum Baseline: EF (02) - LA (09)
Timerange: 01/01:35:20 to 01/01:36:18

Plot file version1182 created 03-MAR-2016 01:15:23

J1545+5400 GN002C 1.UVDATA.1

Freq = 1.2770 GHz, Bw = 16.000 MH Calibrated with CL # 3 and BP # 1 (BP mode 1)

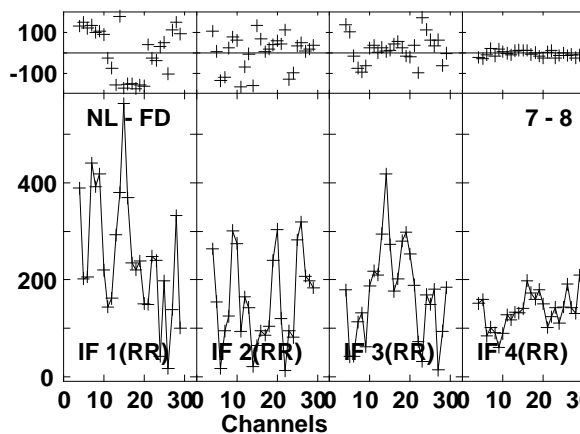
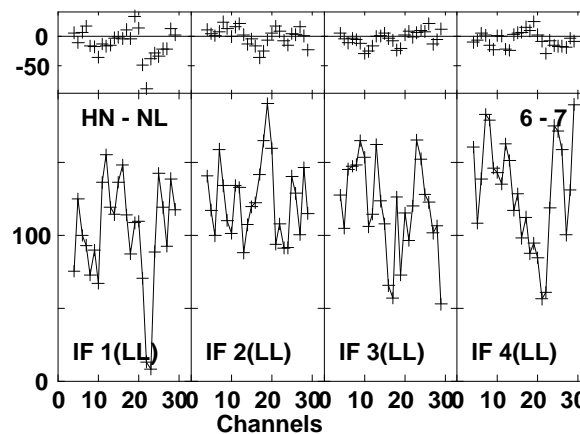
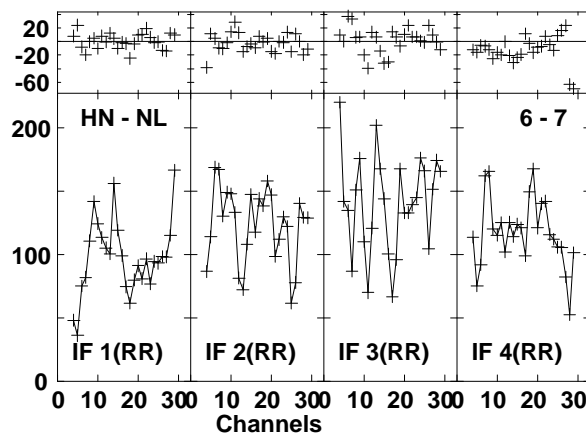
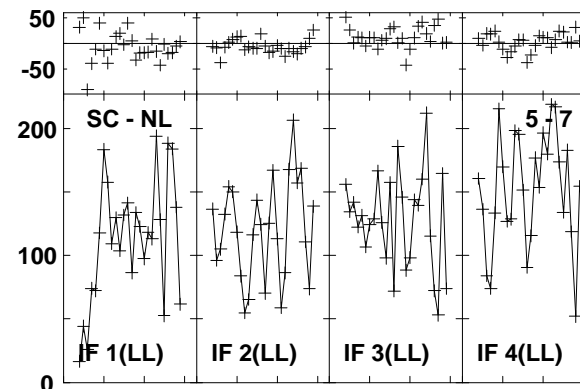
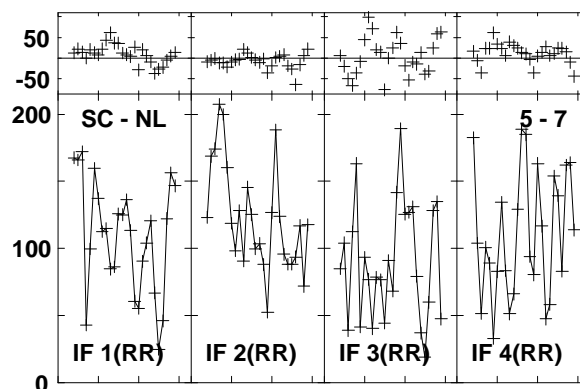
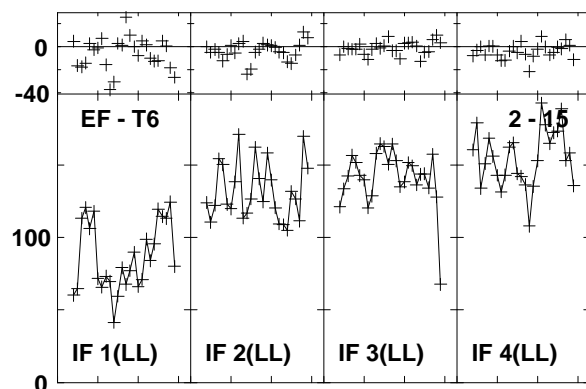
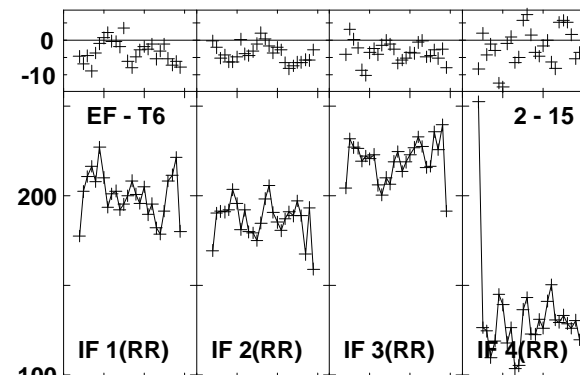
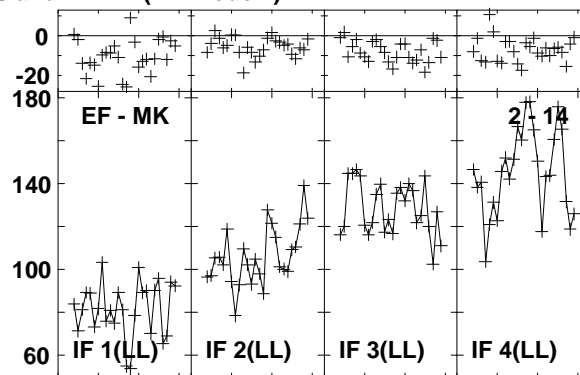
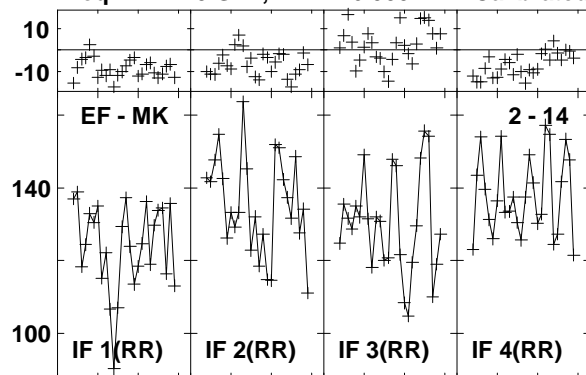

Lower frame: Milli Ampl Jy Top frame: Phas deg
Vector averaged cross-power spectrum Baseline: EF (02) - MK (14)
Timerange: 01/01:35:20 to 01/01:36:18

Plot file version1183 created 03-MAR-2016 01:15:23

J1545+5400 GN002C 1.UVDATA.1

Freq = 1.2770 GHz, Bw = 16.000 MH Calibrated with CL # 3 and BP # 1 (BP mode 1)

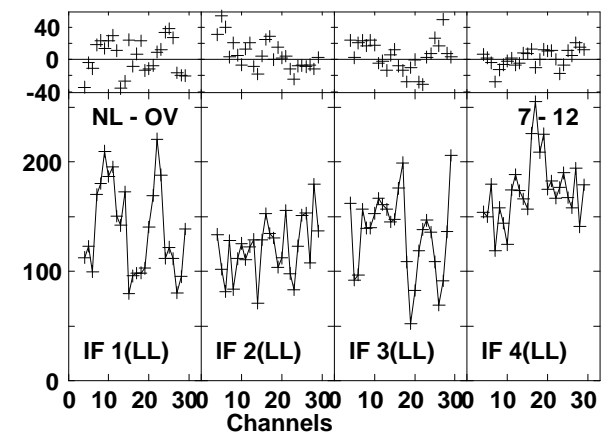
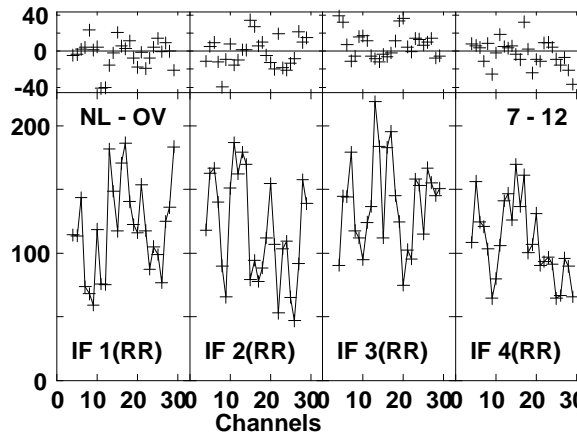
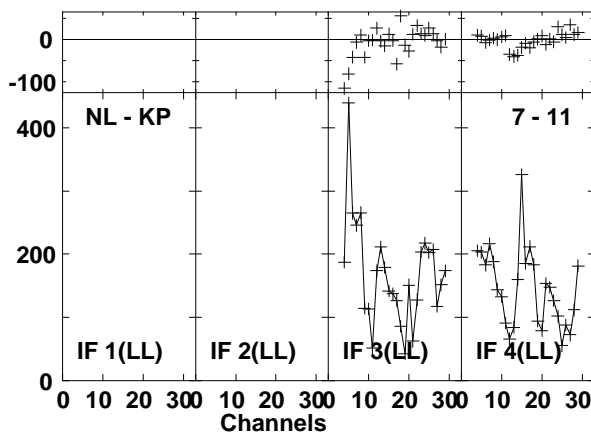
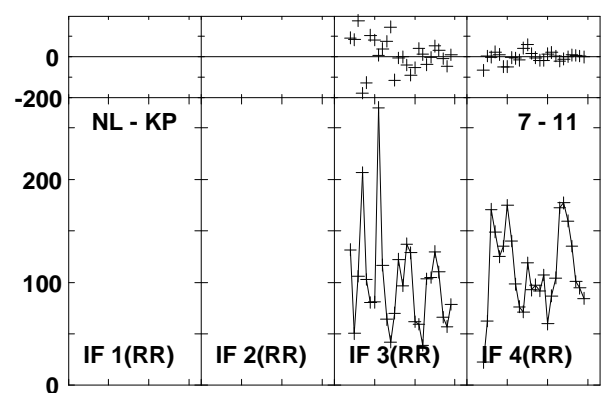
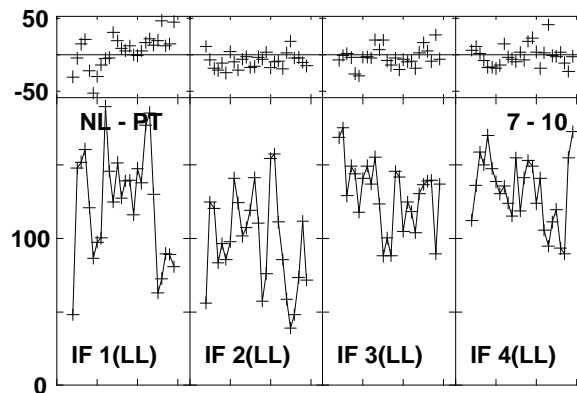
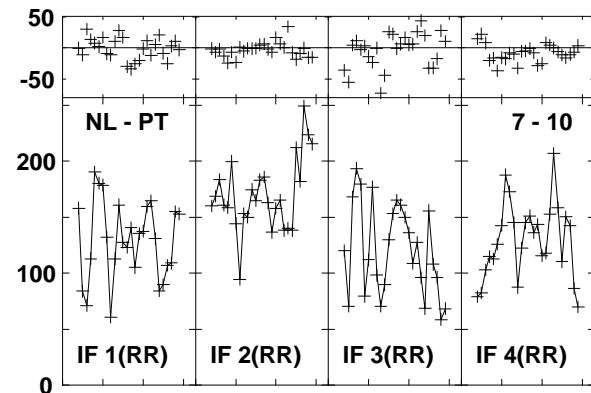
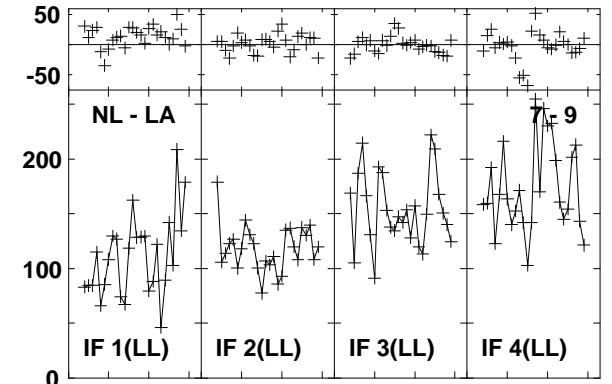
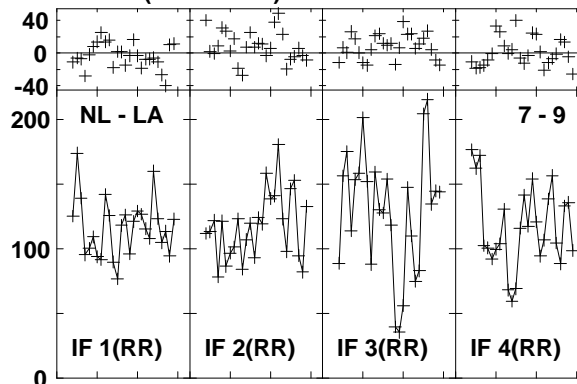
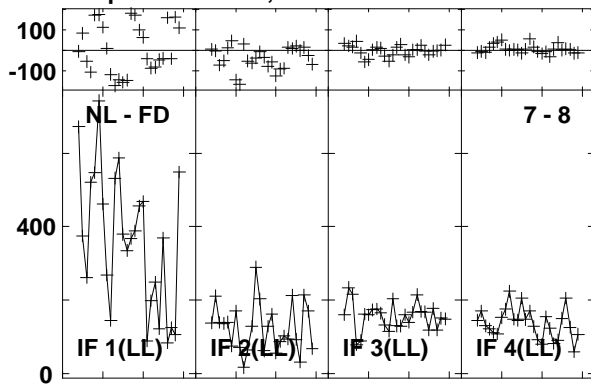

Lower frame: Milli Ampl Jy Top frame: Phas deg
Vector averaged cross-power spectrum Baseline: NL (07) - FD (08)
Timerange: 01/01:35:20 to 01/01:36:18

Plot file version1184 created 03-MAR-2016 01:15:23

J1545+5400 GN002C 1.UVDATA.1

Freq = 1.2770 GHz, Bw = 16.000 MH Calibrated with CL # 3 and BP # 1 (BP mode 1)

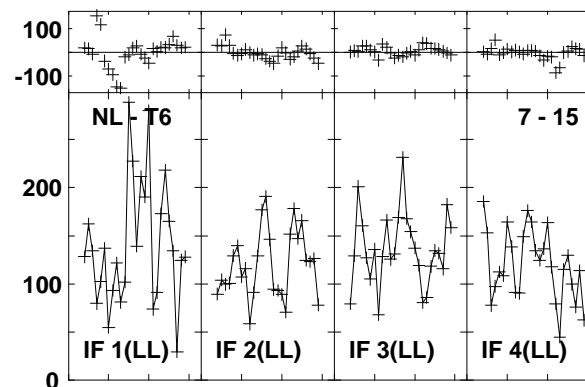
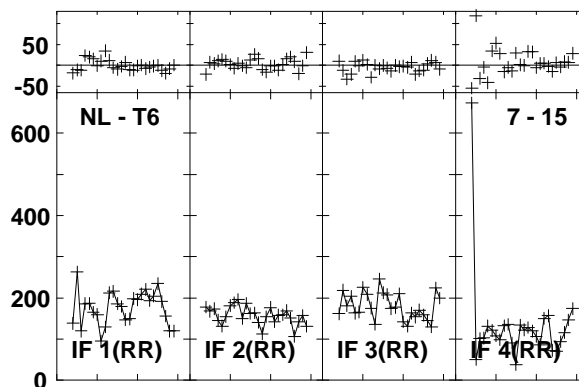
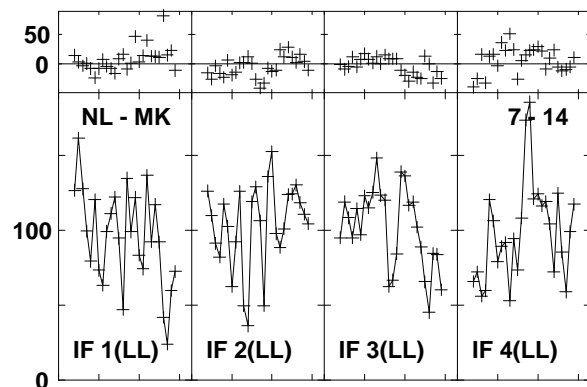
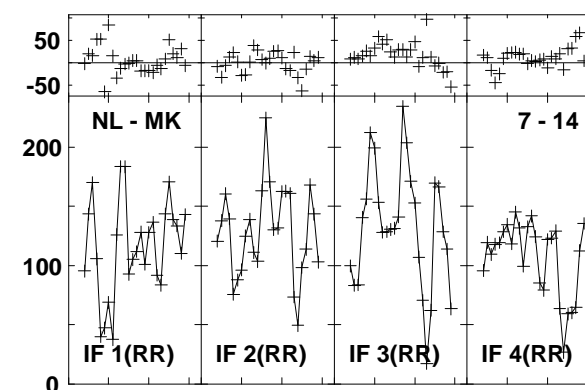
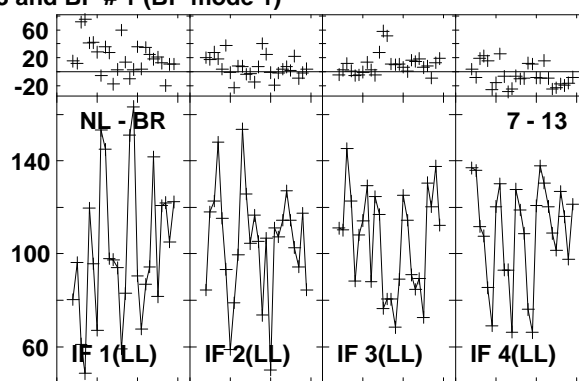
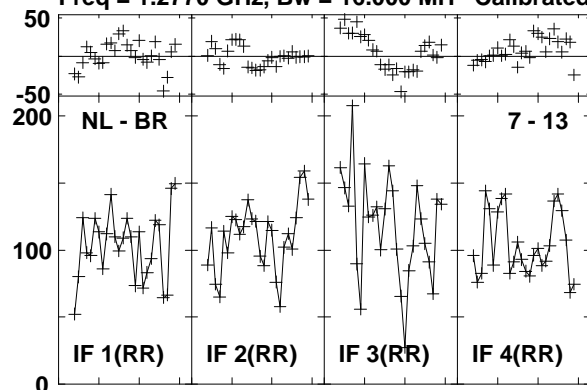

Lower frame: Milli Ampl Jy Top frame: Phas deg
Vector averaged cross-power spectrum Baseline: NL (07) - BR (13)
Timerange: 01/01:35:20 to 01/01:36:18

Plot file version1185 created 03-MAR-2016 01:15:24

4C52 GN002C 1.UVDATA.1

Freq = 1.2770 GHz, Bw = 16.000 MH Calibrated with CL # 3 and BP # 1 (BP mode 1)

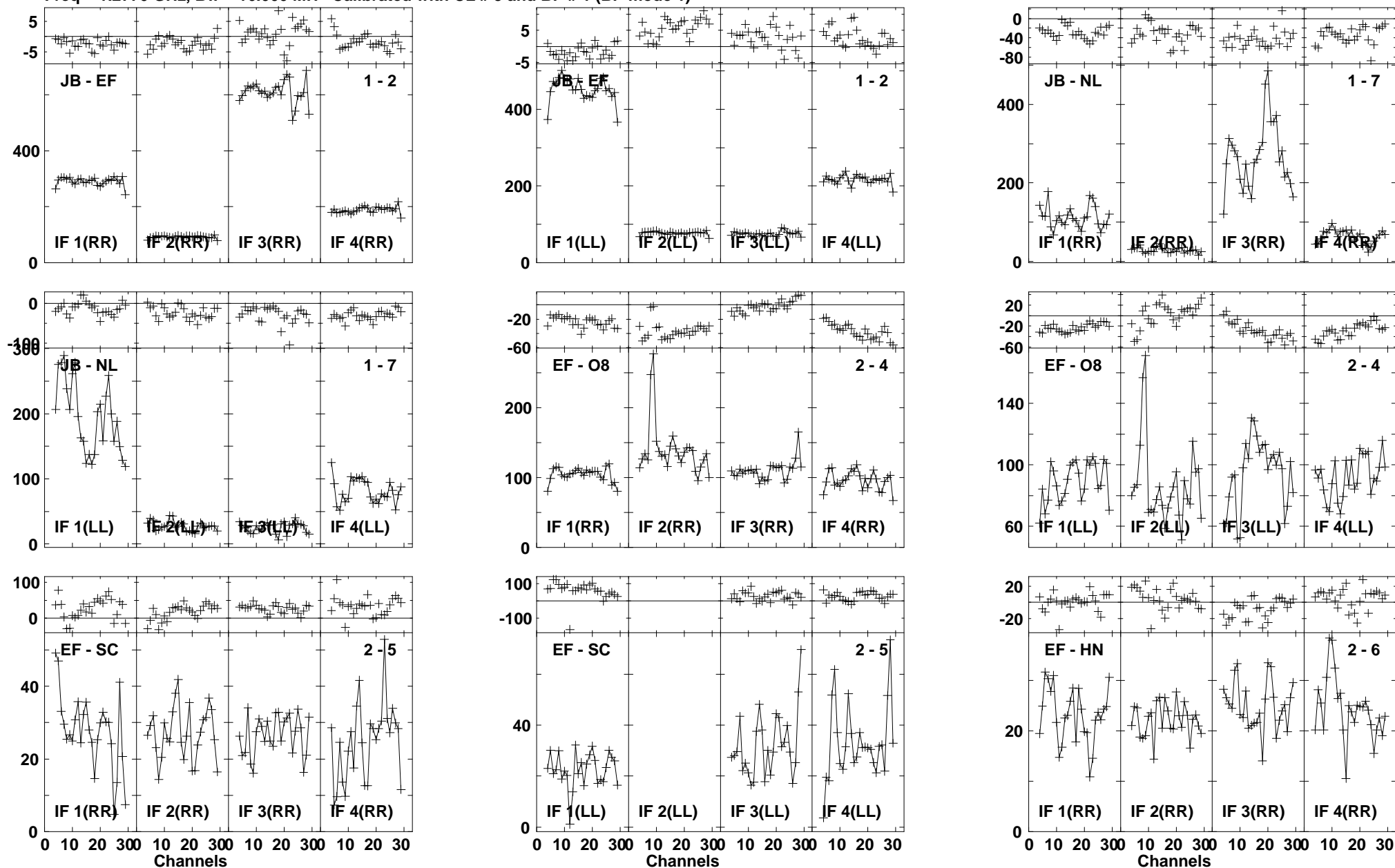

Lower frame: Milli Ampl Jy Top frame: Phas deg
Vector averaged cross-power spectrum Baseline: JB (01) - EF (02)
Timerange: 01/01:36:22 to 01/01:39:48

Plot file version1186 created 03-MAR-2016 01:15:24

4C52 GN002C 1.UVDATA.1

Freq = 1.2770 GHz, Bw = 16.000 MH Calibrated with CL # 3 and BP # 1 (BP mode 1)

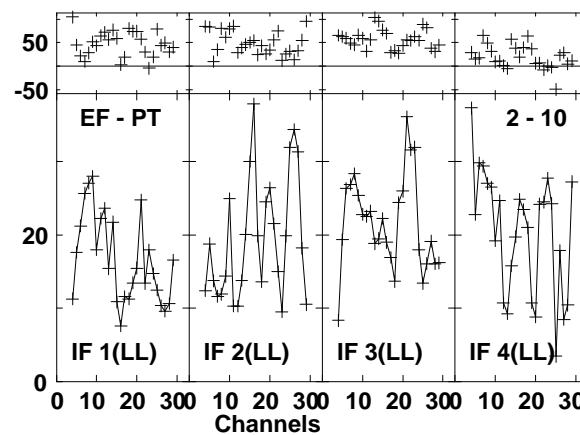
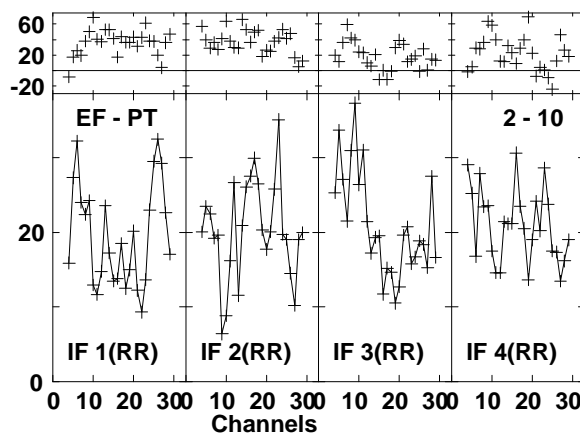
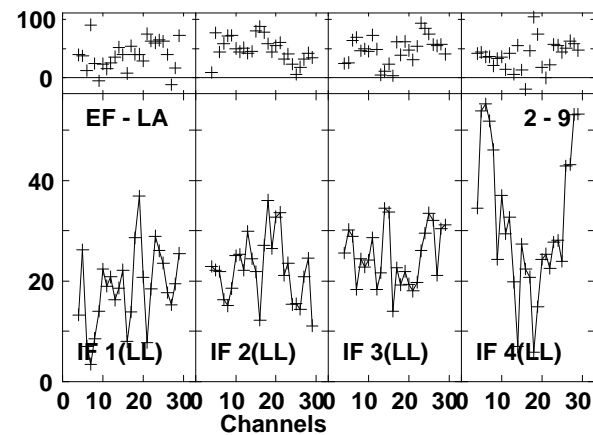
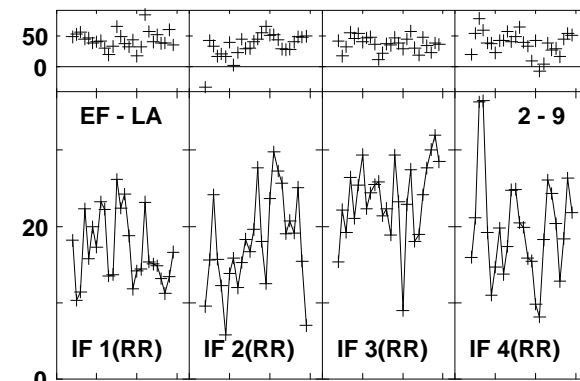
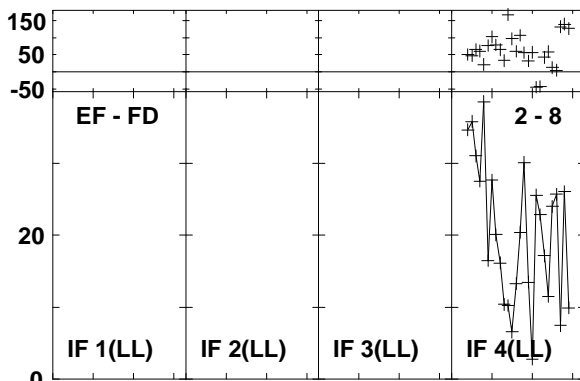
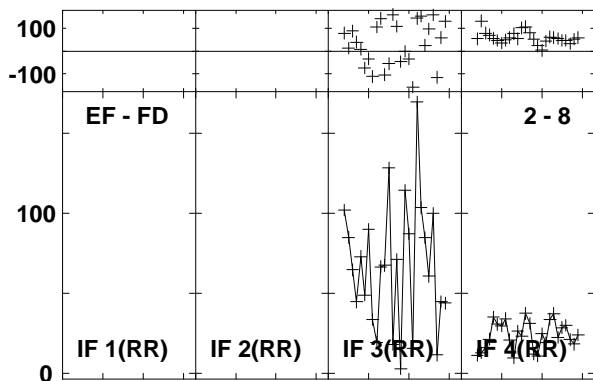
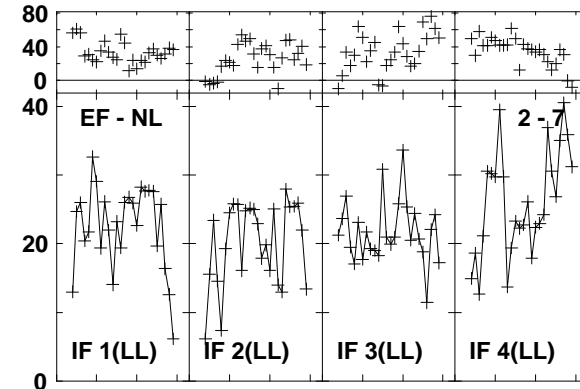
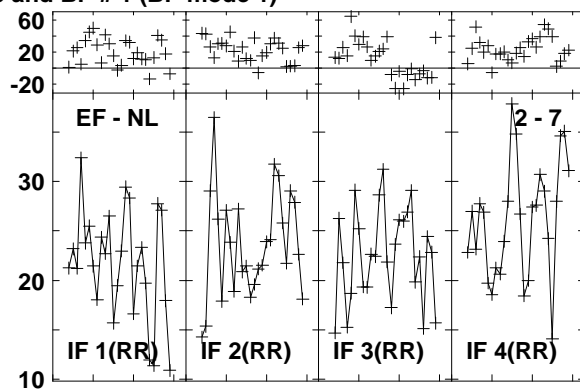
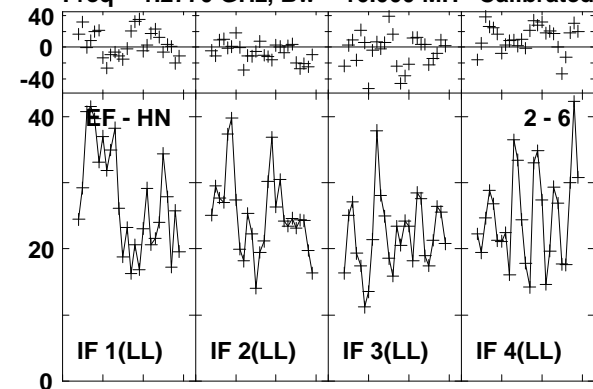

Lower frame: Milli Ampl Jy Top frame: Phas deg
Vector averaged cross-power spectrum Baseline: EF (02) - HN (06)
Timerange: 01/01:36:22 to 01/01:39:48

Plot file version1187 created 03-MAR-2016 01:15:24

4C52 GN002C 1.UVDATA.1

Freq = 1.2770 GHz, Bw = 16.000 MH Calibrated with CL # 3 and BP # 1 (BP mode 1)

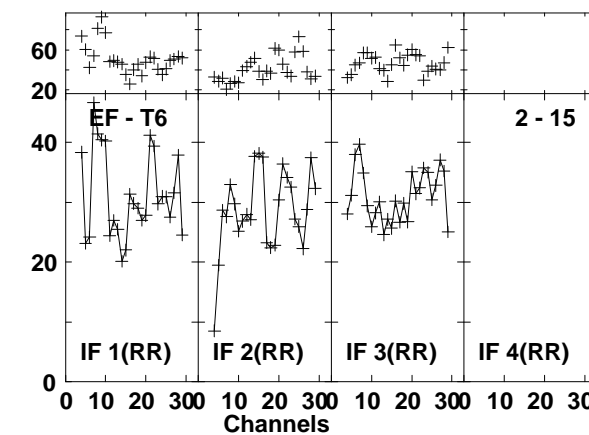
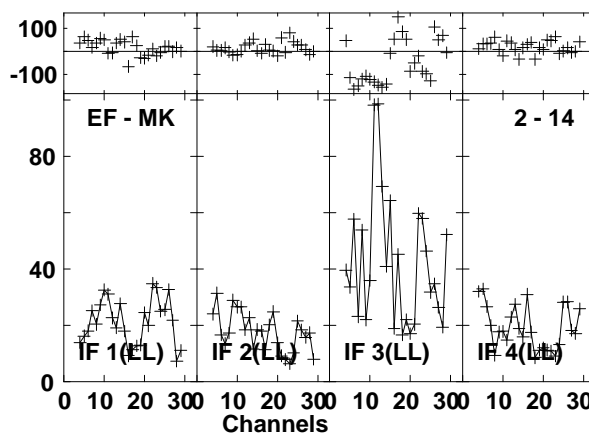
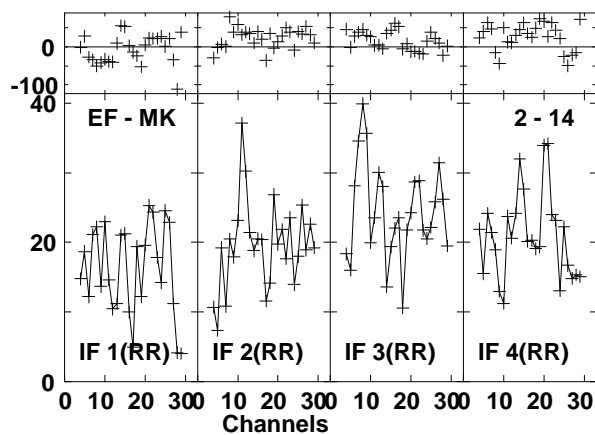
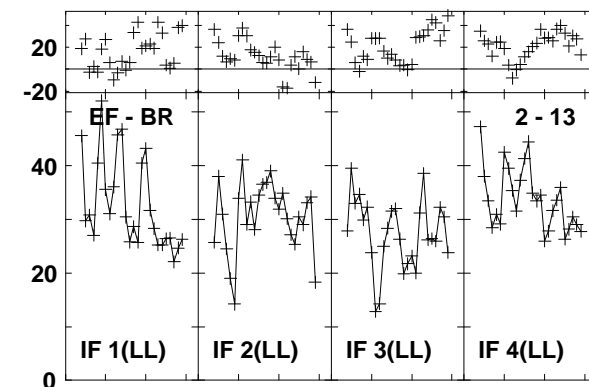
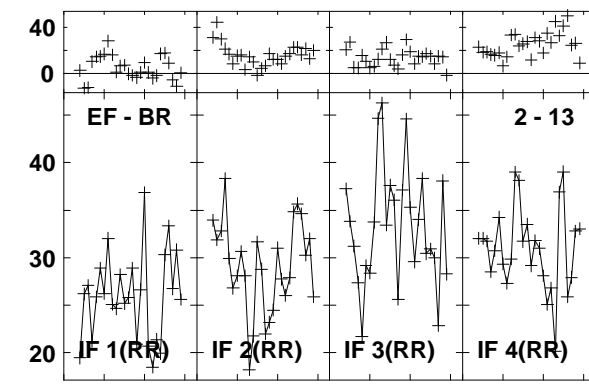
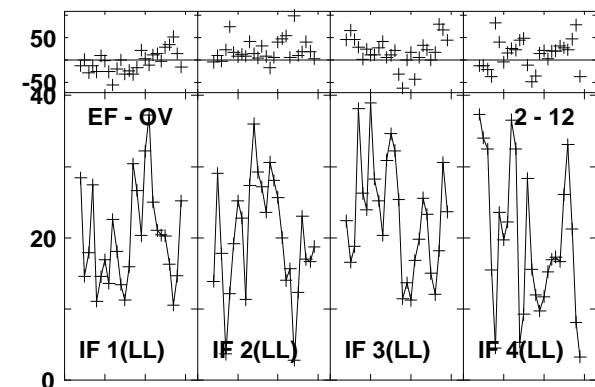
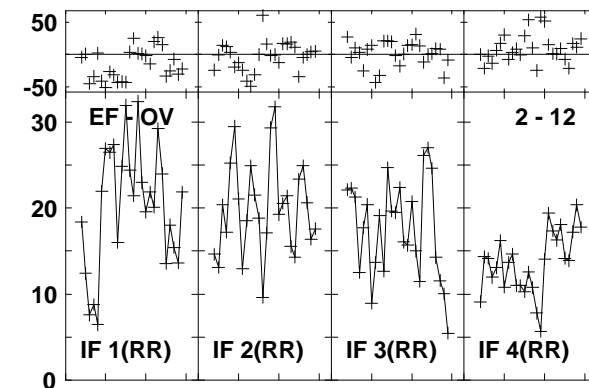
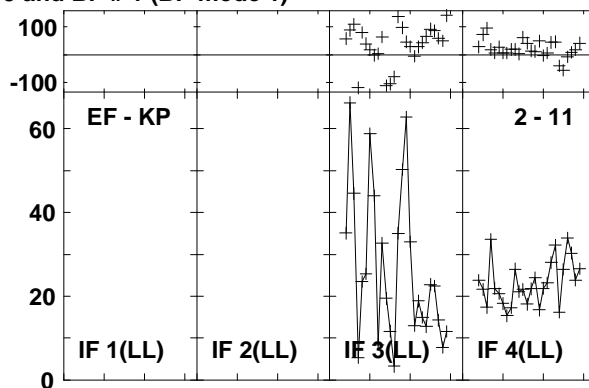
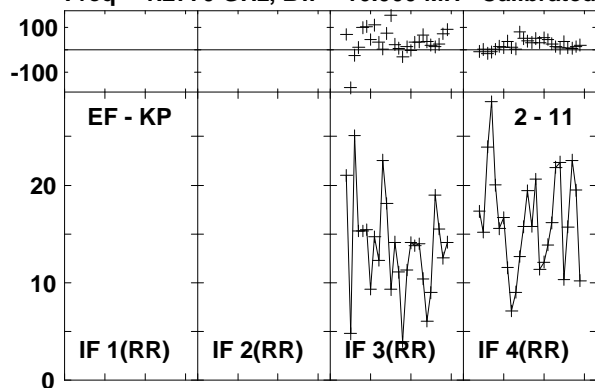

Lower frame: Milli Ampl Jy Top frame: Phas deg

Vector averaged cross-power spectrum Baseline: EF (02) - KP (11)

Timerange: 01/01:36:22 to 01/01:39:48

Plot file version1188 created 03-MAR-2016 01:15:24

4C52 GN002C 1.UVDATA.1

Freq = 1.2770 GHz, Bw = 16.000 MH Calibrated with CL # 3 and BP # 1 (BP mode 1)

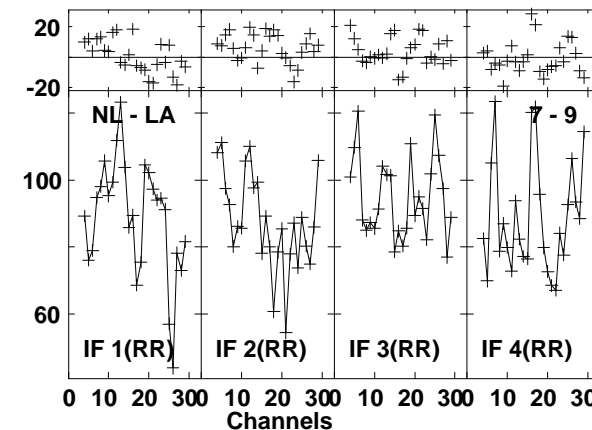
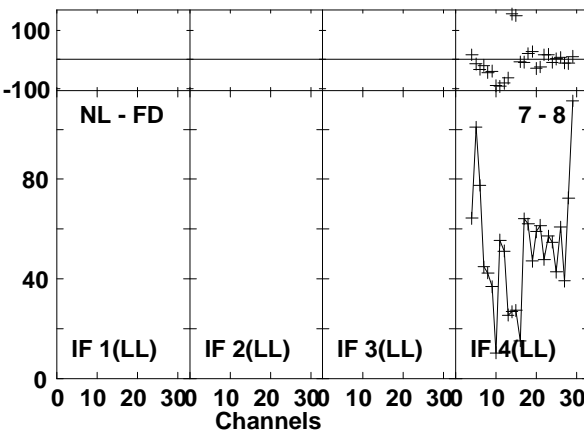
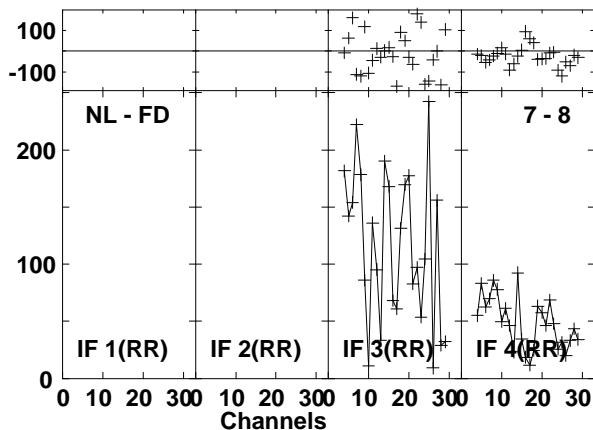
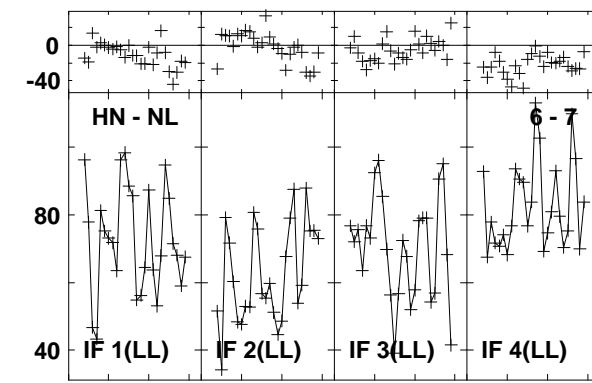
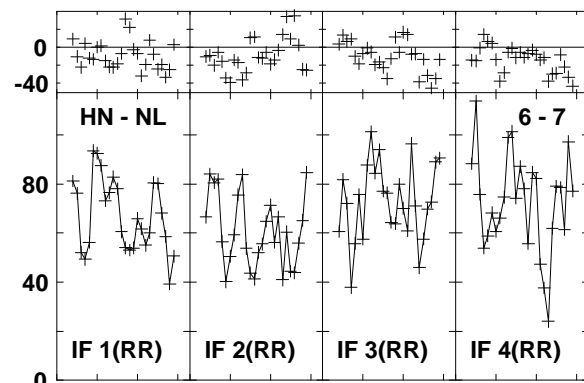
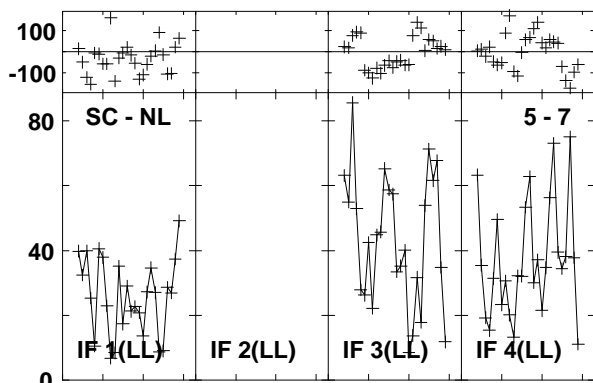
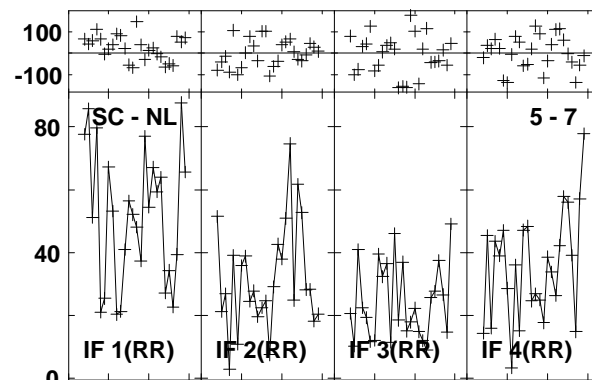
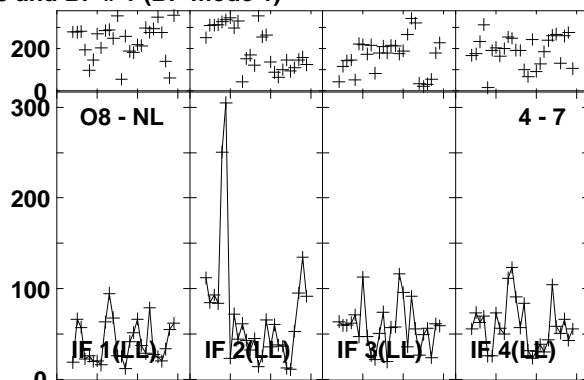
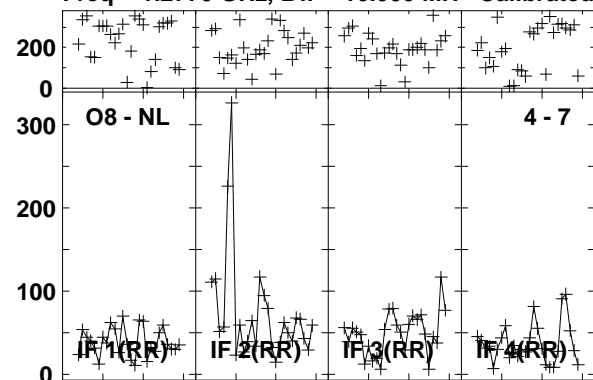

Lower frame: Milli Ampl Jy Top frame: Phas deg
Vector averaged cross-power spectrum Baseline: O8 (04) - NL (07)
Timerange: 01/01:36:22 to 01/01:39:48

Plot file version1189 created 03-MAR-2016 01:15:24

4C52 GN002C 1.UVDATA.1

Freq = 1.2770 GHz, Bw = 16.000 MH Calibrated with CL # 3 and BP # 1 (BP mode 1)

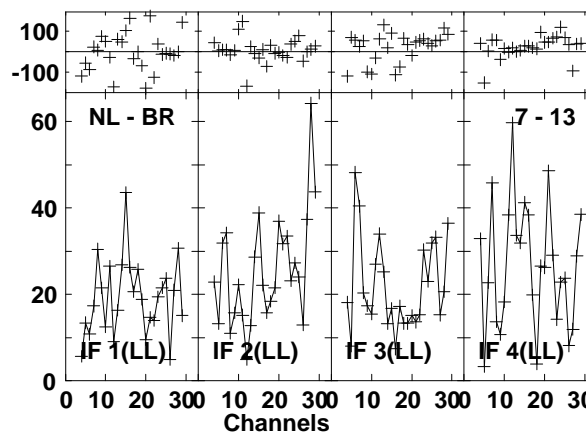
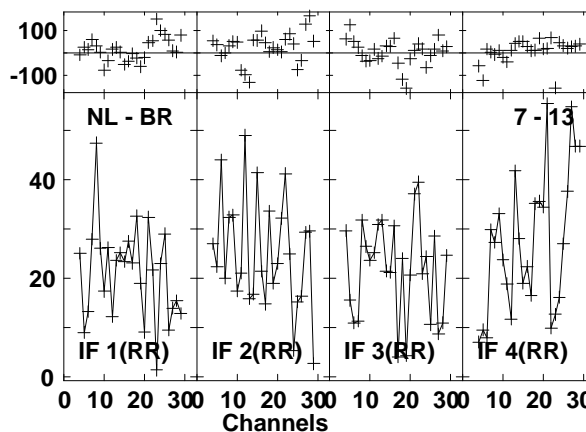
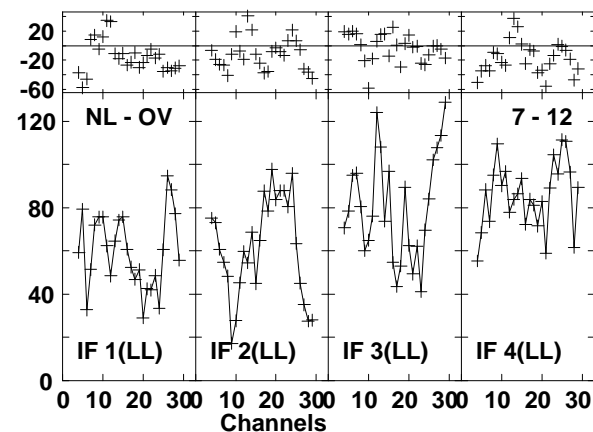
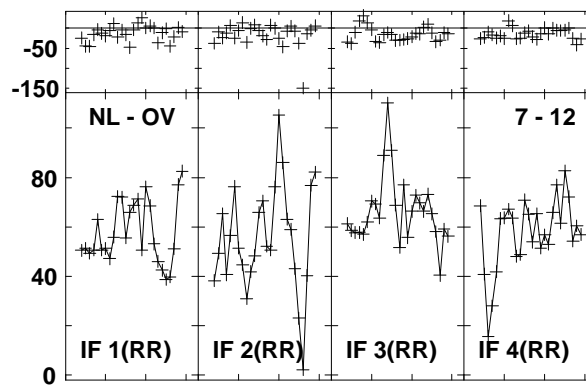
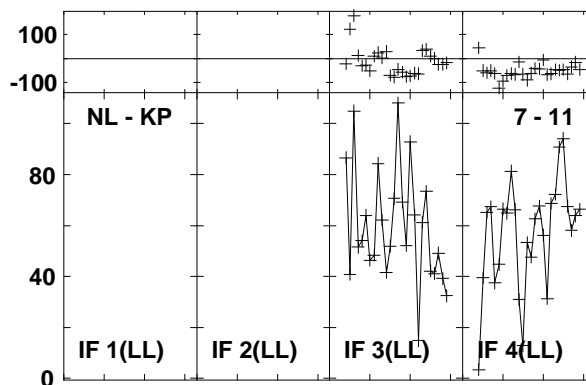
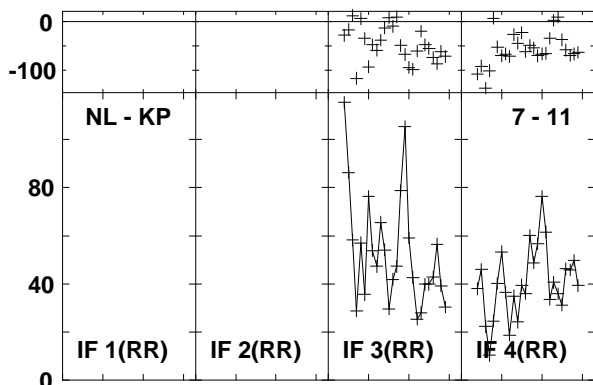
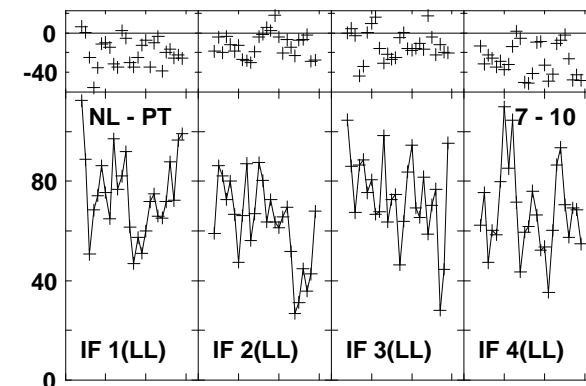
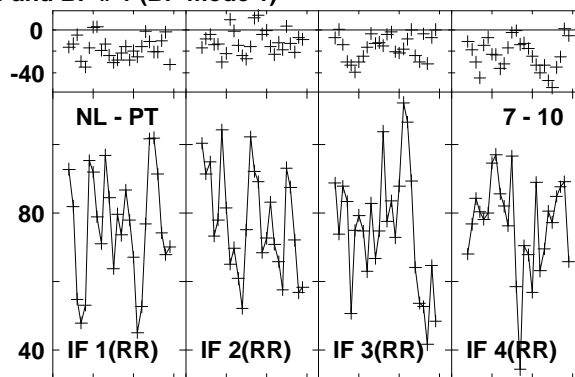
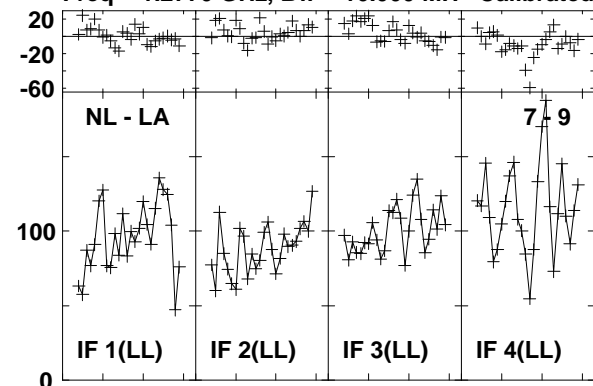

Lower frame: Milli Ampl Jy Top frame: Phas deg
Vector averaged cross-power spectrum Baseline: NL (07) - LA (09)
Timerange: 01/01:36:22 to 01/01:39:48

Plot file version1190 created 03-MAR-2016 01:15:25

4C52 GN002C 1.UVDATA.1

Freq = 1.2770 GHz, Bw = 16.000 MH Calibrated with CL # 3 and BP # 1 (BP mode 1)

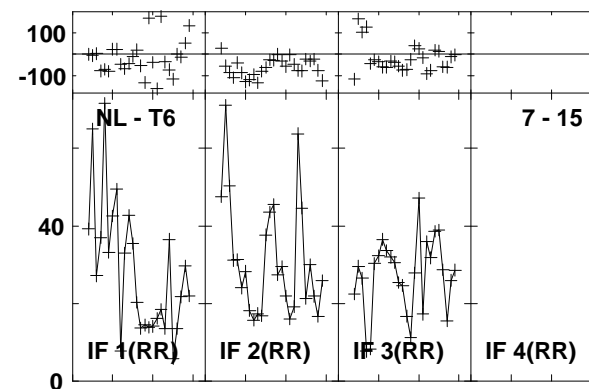
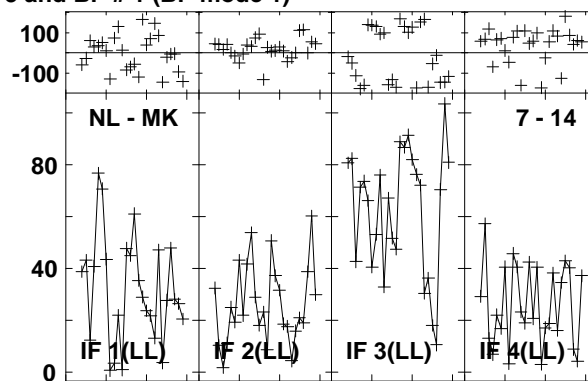
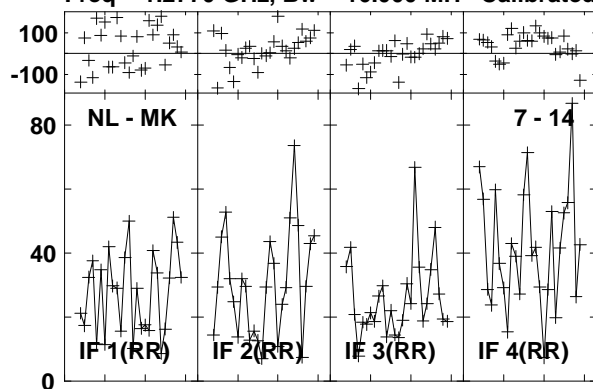

Lower frame: Milli Ampl Jy Top frame: Phas deg
Vector averaged cross-power spectrum Baseline: NL (07) - MK (14)
Timerange: 01/01:36:22 to 01/01:39:48

Plot file version1191 created 03-MAR-2016 01:15:25

J1545+5400 GN002C 1.UVDATA.1

Freq = 1.2770 GHz, Bw = 16.000 MH Calibrated with CL # 3 and BP # 1 (BP mode 1)

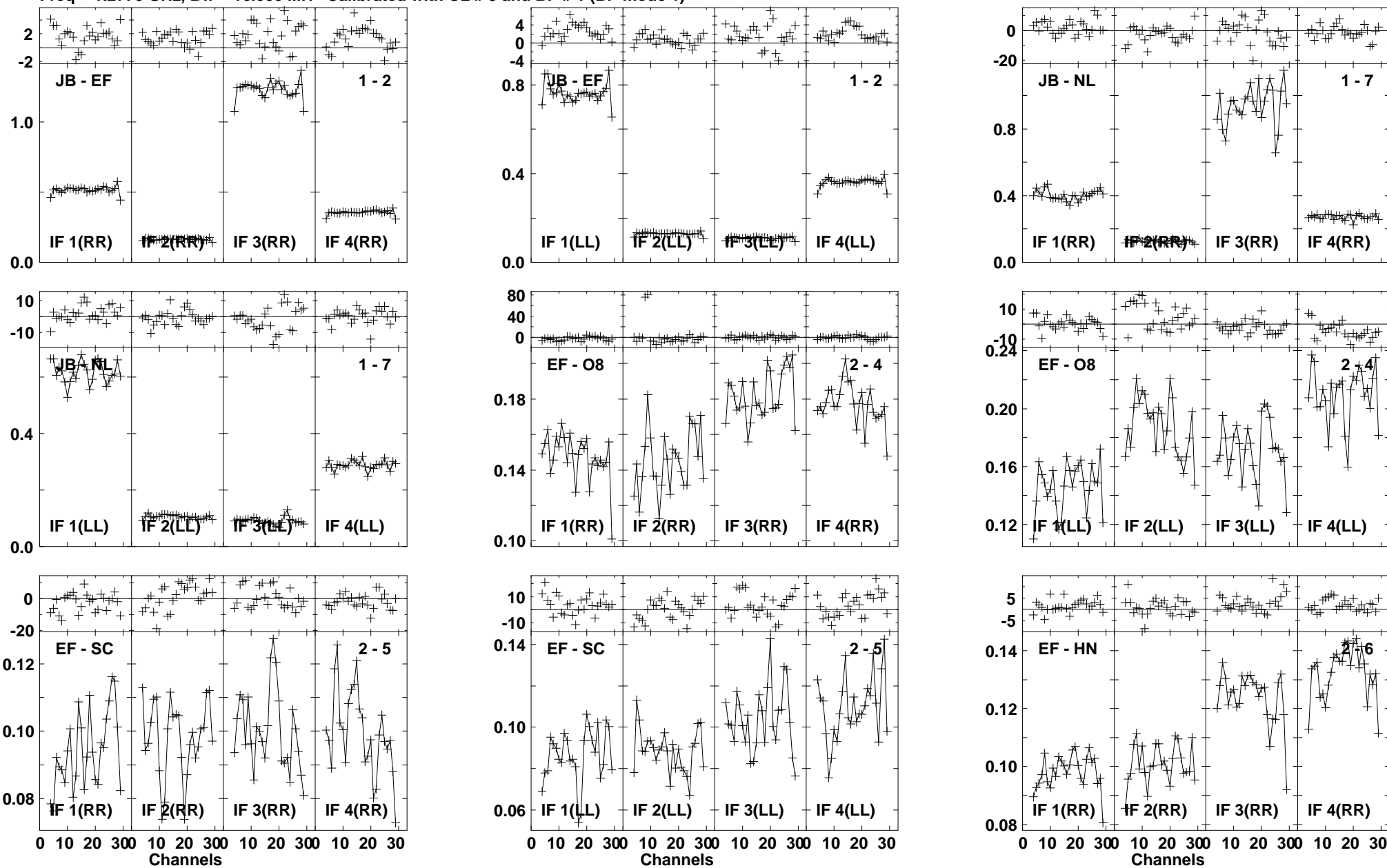

Lower frame: Ampl Jy Top frame: Phas deg
Vector averaged cross-power spectrum Baseline: JB (01) - EF (02)
Timerange: 01/01:40:40 to 01/01:42:38

Plot file version1192 created 03-MAR-2016 01:15:25

J1545+5400 GN002C 1.UVDATA.1

Freq = 1.2770 GHz, Bw = 16.000 MH Calibrated with CL # 3 and BP # 1 (BP mode 1)

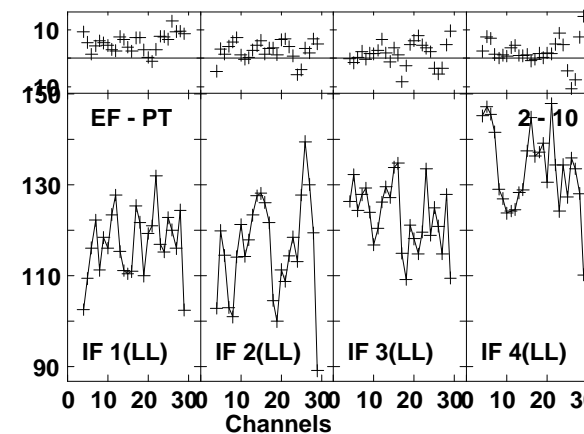
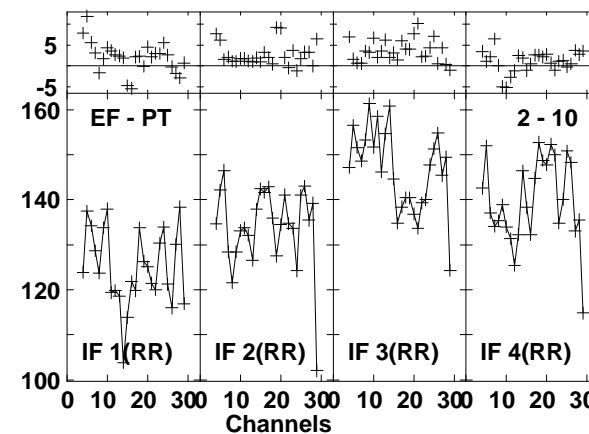
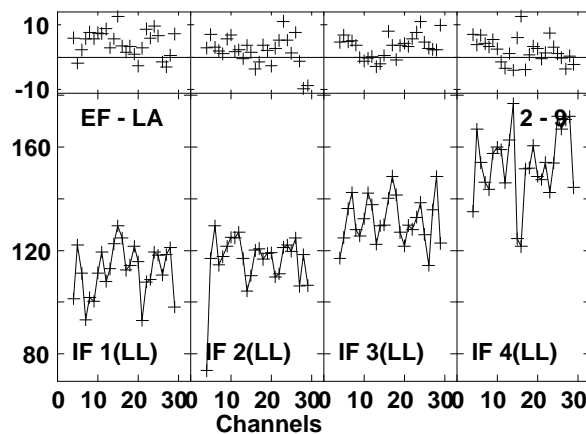
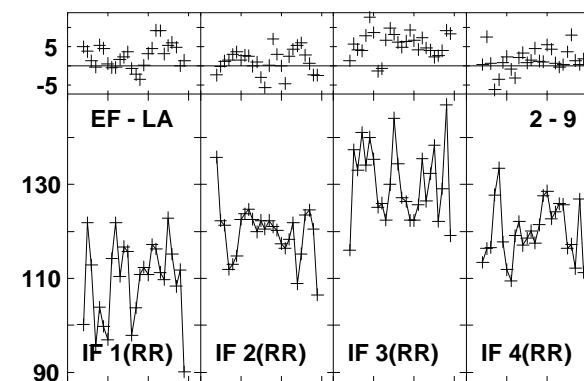
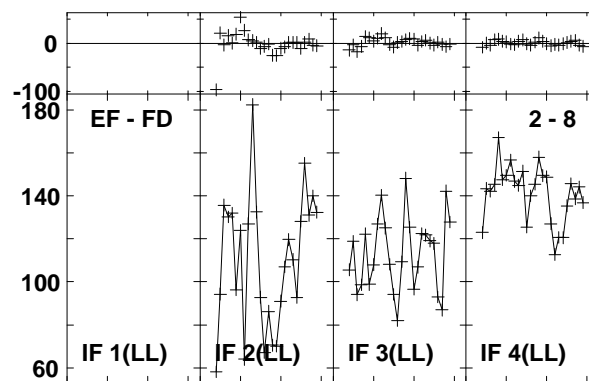
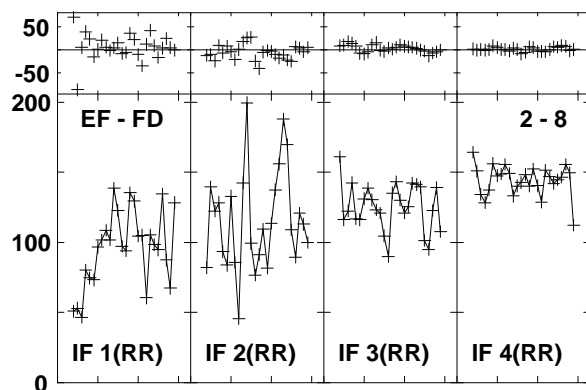
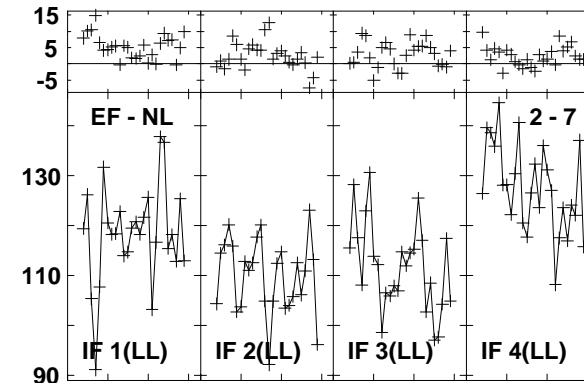
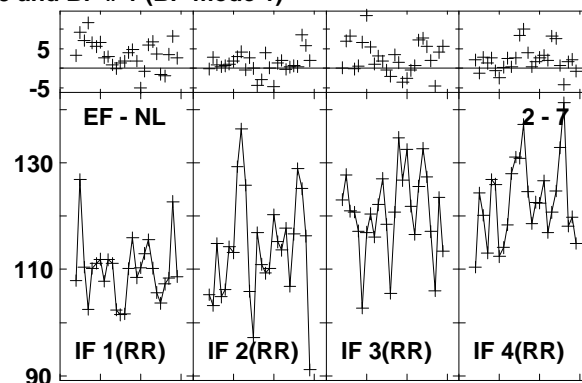
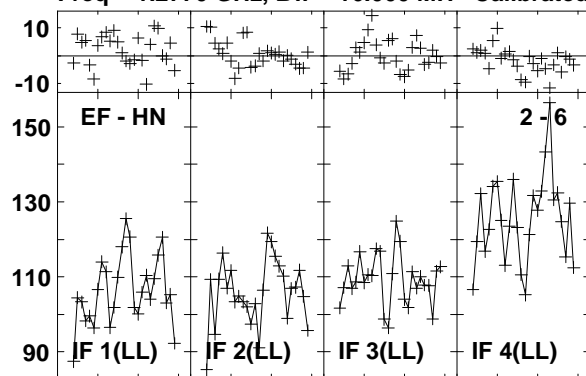

Lower frame: Milli Ampl Jy Top frame: Phas deg
Vector averaged cross-power spectrum Baseline: EF (02) - HN (06)
Timerange: 01/01:40:40 to 01/01:42:38

Plot file version1193 created 03-MAR-2016 01:15:25
 J1545+5400 GN002C 1.UVDATA.1
 Freq = 1.2770 GHz, Bw = 16.000 MH Calibrated with CL # 3 and BP # 1 (BP mode 1)

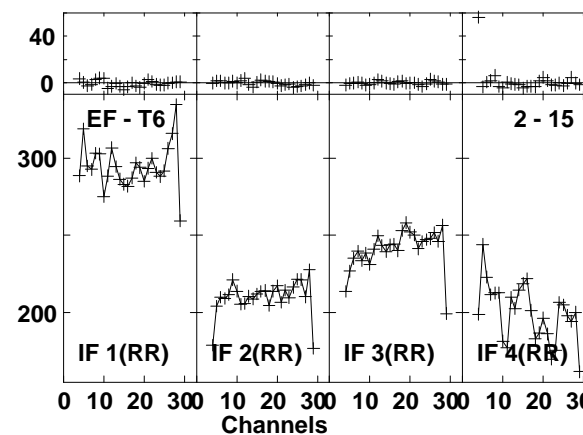
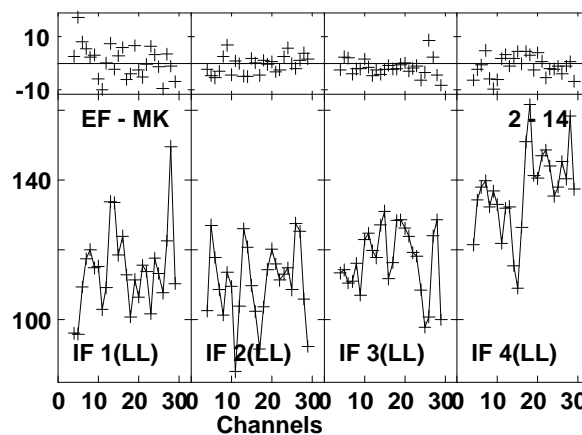
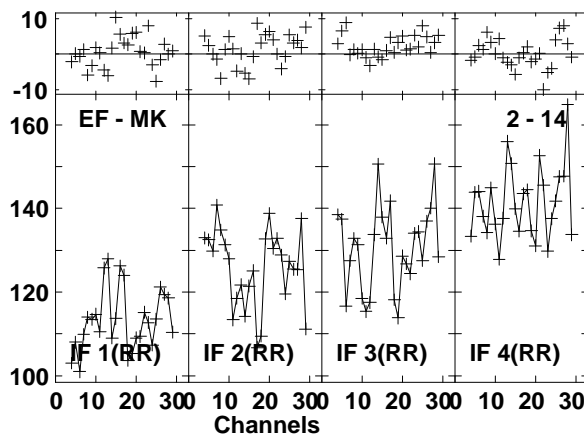
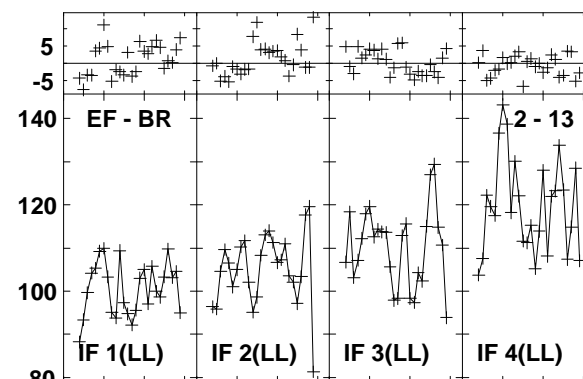
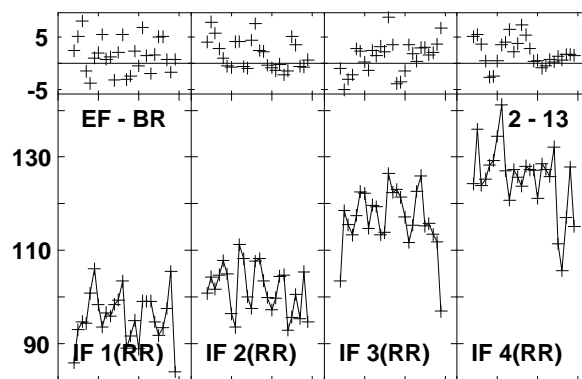
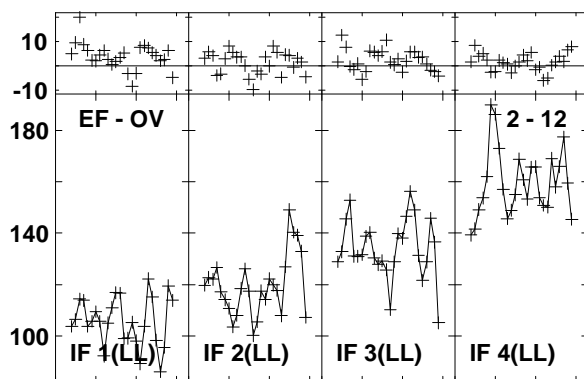
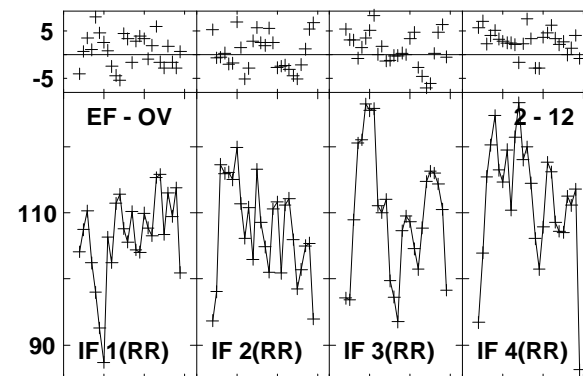
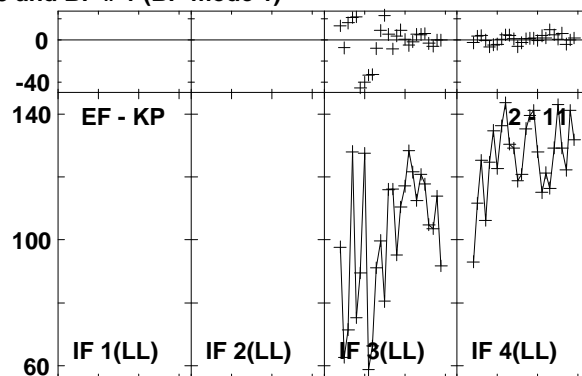
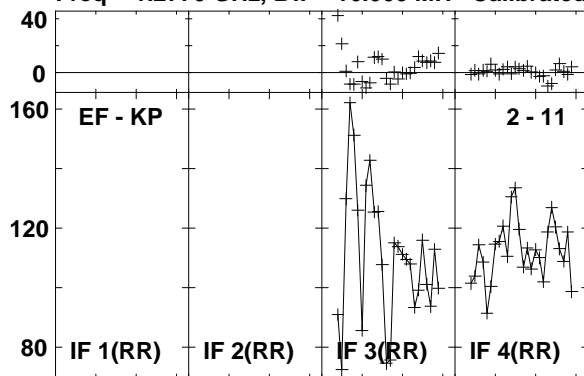

Lower frame: Milli Ampl Jy Top frame: Phas deg
 Vector averaged cross-power spectrum Baseline: EF (02) - KP (11)
 Timerange: 01/01:40:40 to 01/01:42:38

Plot file version1194 created 03-MAR-2016 01:15:25
 J1545+5400 GN002C 1.UVDATA.1
 Freq = 1.2770 GHz, Bw = 16.000 MH Calibrated with CL # 3 and BP # 1 (BP mode 1)

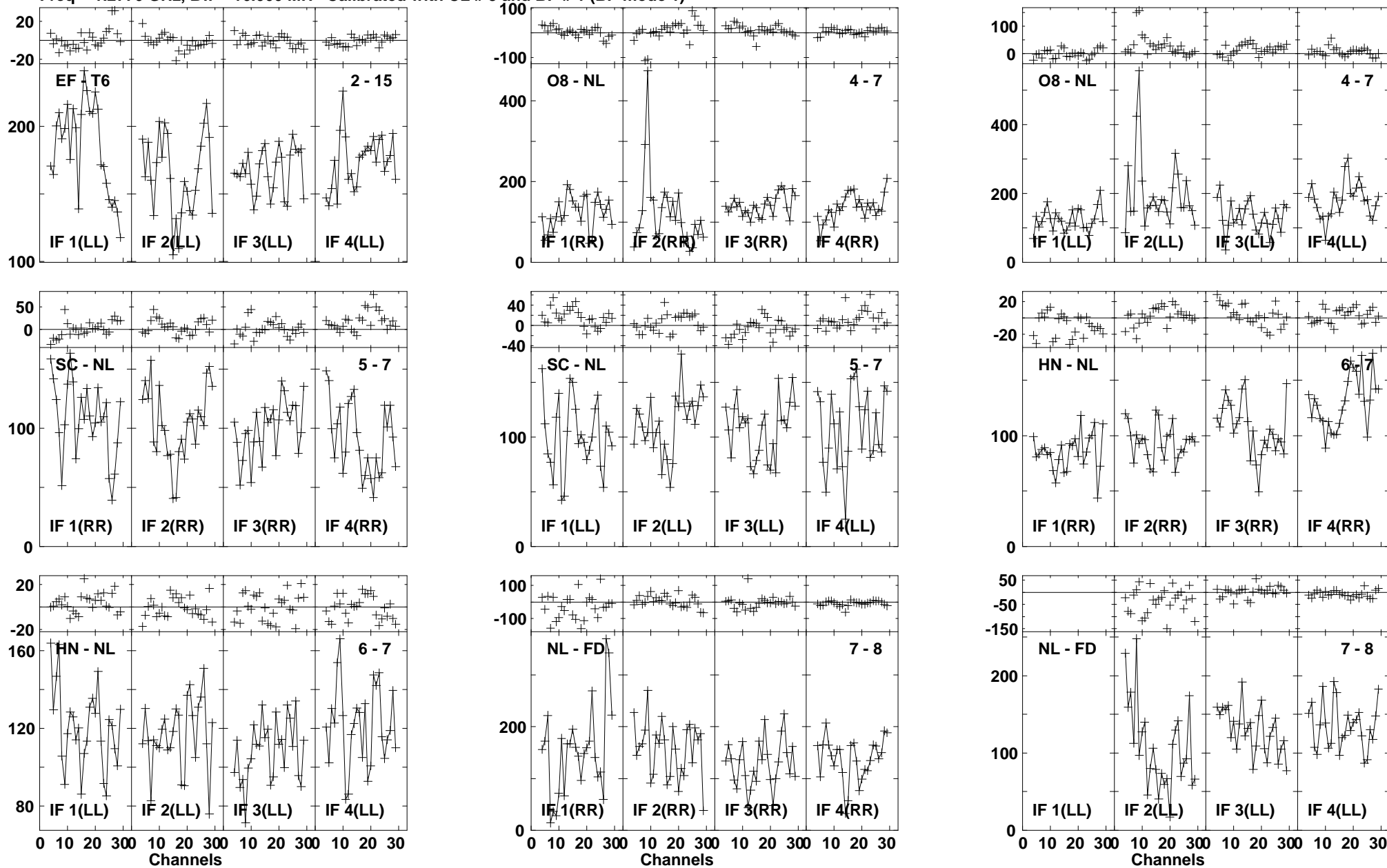

Lower frame: Milli Ampl Jy Top frame: Phas deg
 Vector averaged cross-power spectrum Baseline: EF (02) - T6 (15)
 Timerange: 01/01:40:40 to 01/01:42:38

Plot file version1195 created 03-MAR-2016 01:15:25
 J1545+5400 GN002C 1.UVDATA.1
 Freq = 1.2770 GHz, Bw = 16.000 MH Calibrated with CL # 3 and BP # 1 (BP mode 1)

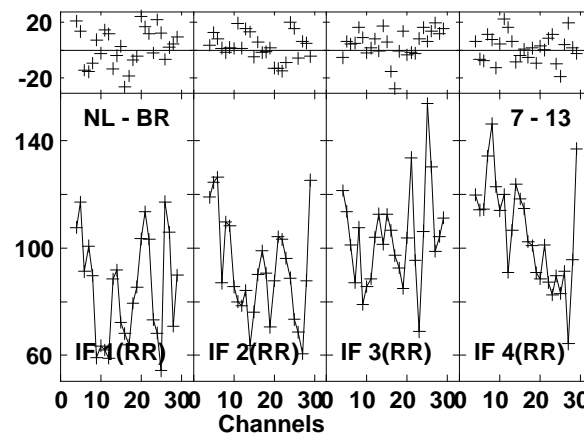
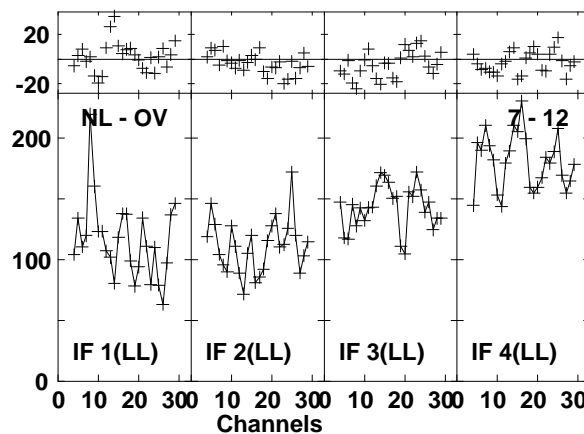
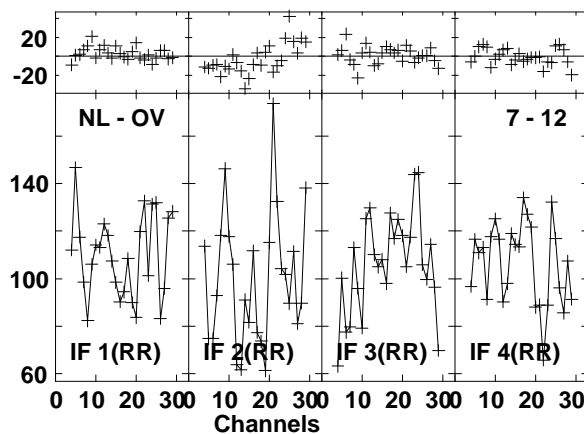
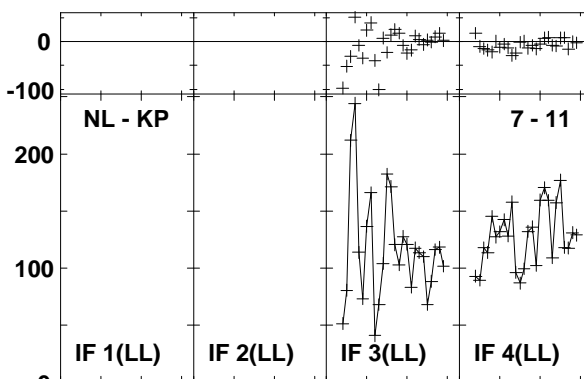
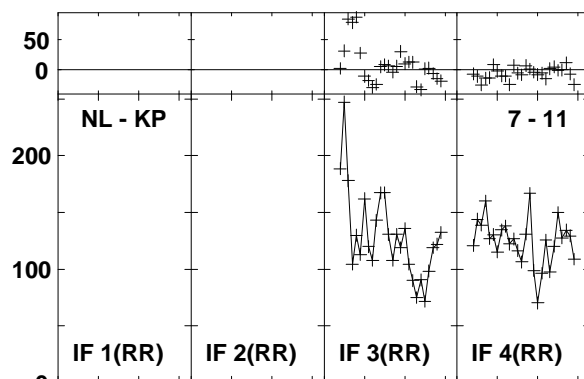
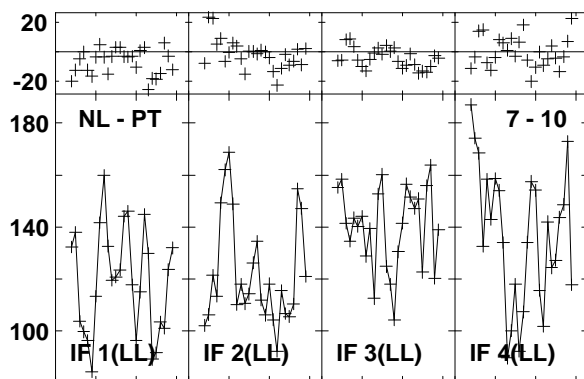
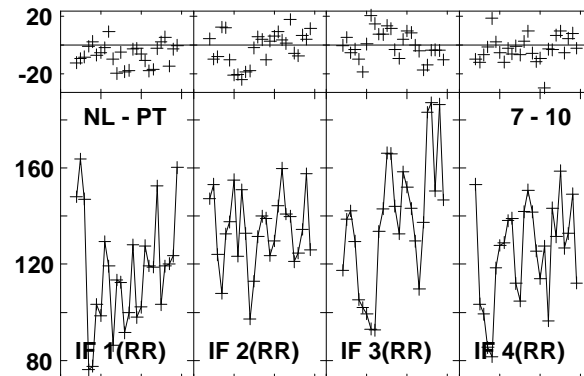
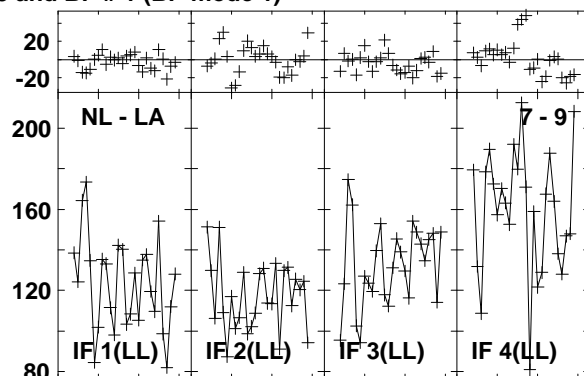
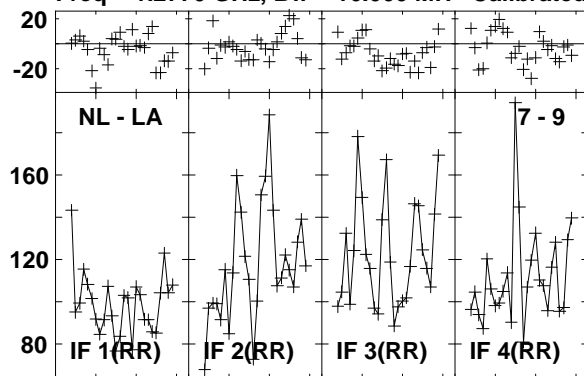

Lower frame: Milli Ampl Jy Top frame: Phas deg
 Vector averaged cross-power spectrum Baseline: NL (07) - LA (09)
 Timerange: 01/01:40:40 to 01/01:42:38

Plot file version1196 created 03-MAR-2016 01:15:26

J1545+5400 GN002C 1.UVDATA.1

Freq = 1.2770 GHz, Bw = 16.000 MH Calibrated with CL # 3 and BP # 1 (BP mode 1)

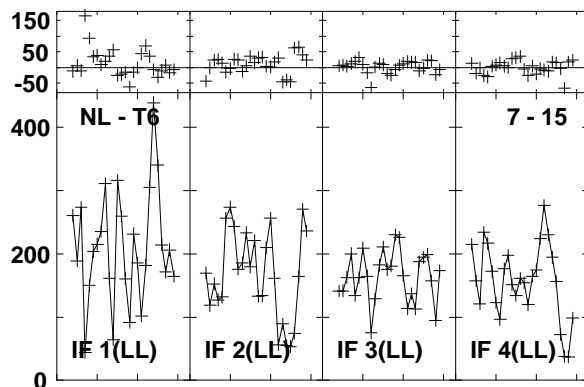
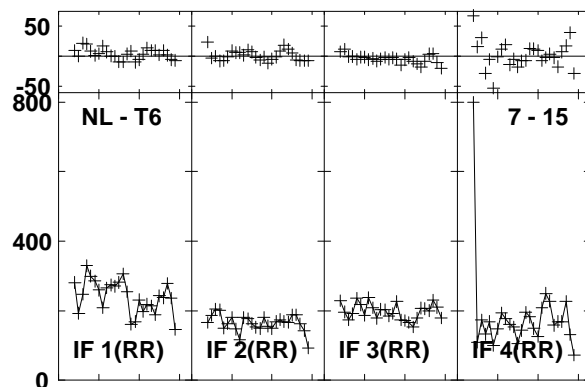
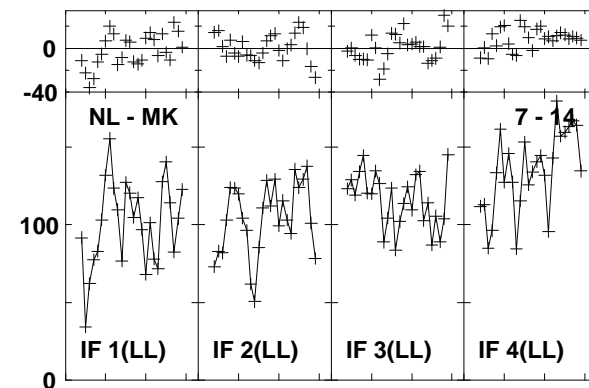
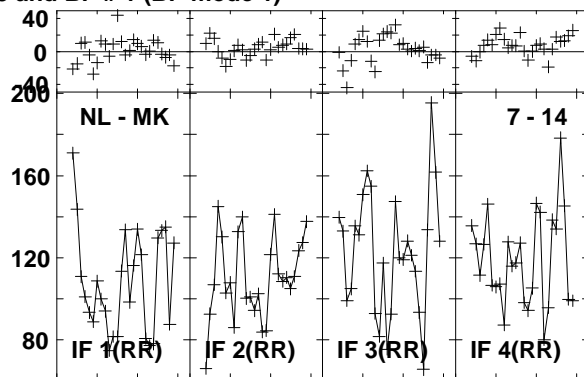
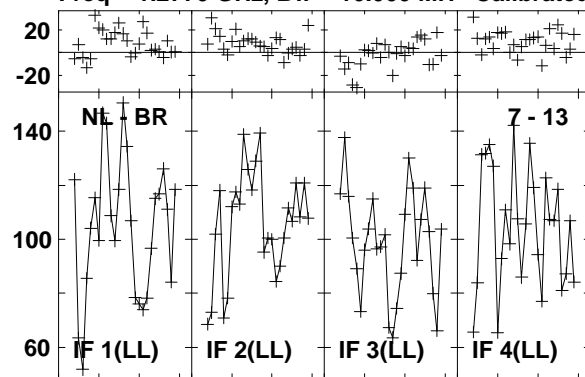

Lower frame: Milli Ampl Jy Top frame: Phas deg
Vector averaged cross-power spectrum Baseline: NL (07) - BR (13)
Timerange: 01/01:40:40 to 01/01:42:38

Plot file version1197 created 03-MAR-2016 01:15:26

4C52 GN002C 1.UVDATA.1

Freq = 1.2770 GHz, Bw = 16.000 MH Calibrated with CL # 3 and BP # 1 (BP mode 1)

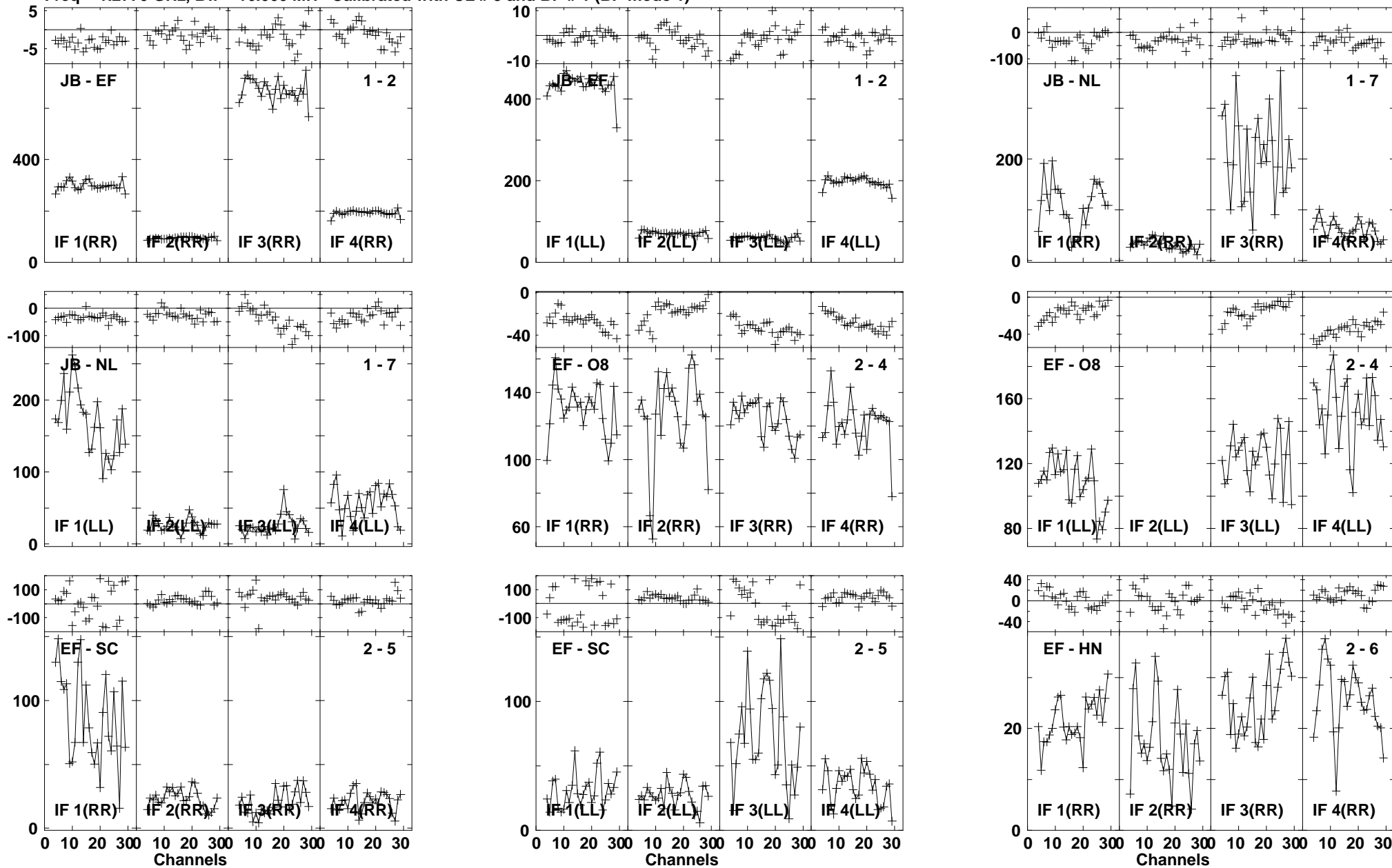

Lower frame: Milli Ampl Jy Top frame: Phas deg
Vector averaged cross-power spectrum Baseline: JB (01) - EF (02)
Timerange: 01/01:42:51 to 01/01:45:37

Plot file version1198 created 03-MAR-2016 01:15:26

4C52 GN002C 1.UVDATA.1

Freq = 1.2770 GHz, Bw = 16.000 MH Calibrated with CL # 3 and BP # 1 (BP mode 1)

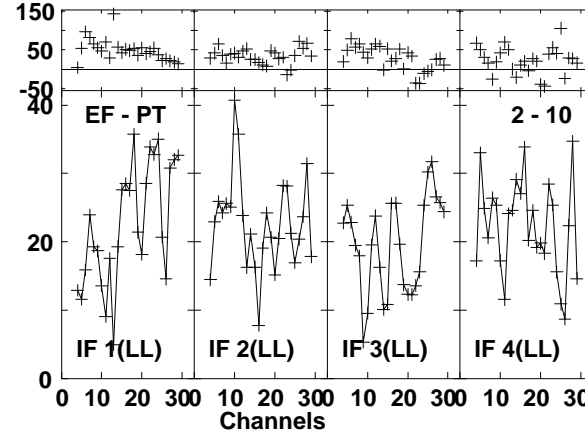
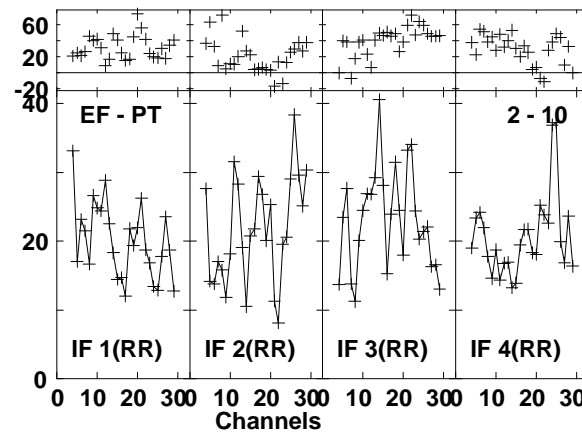
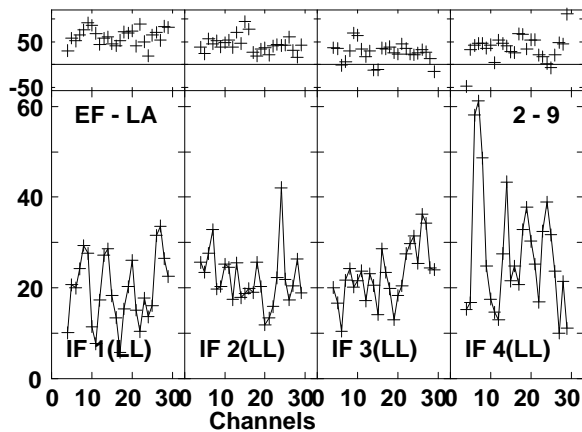
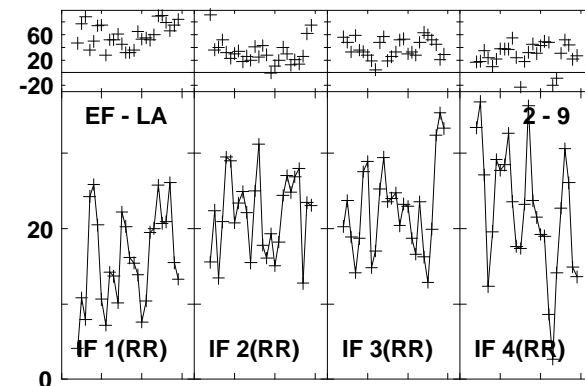
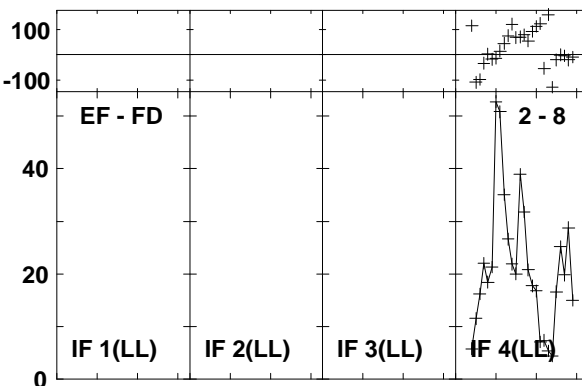
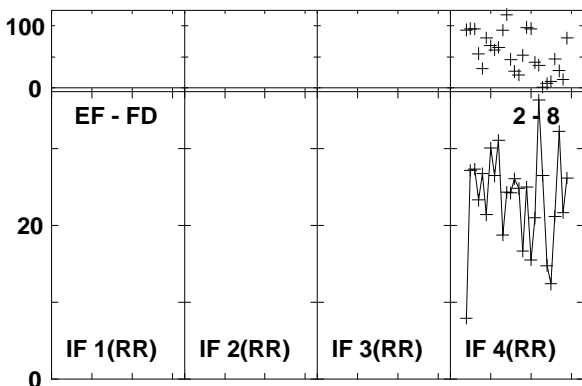
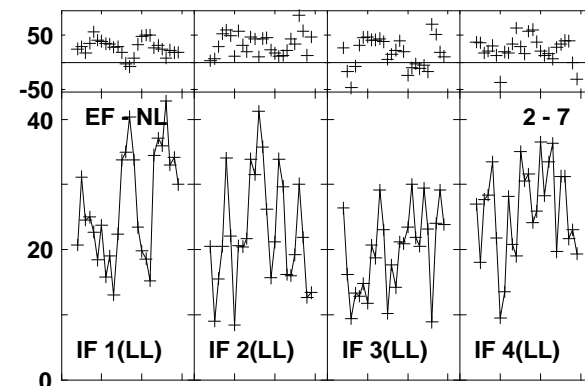
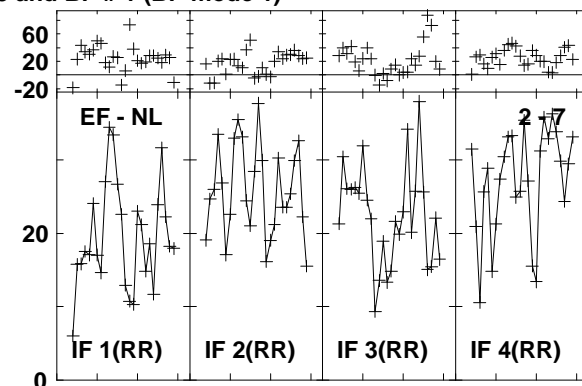
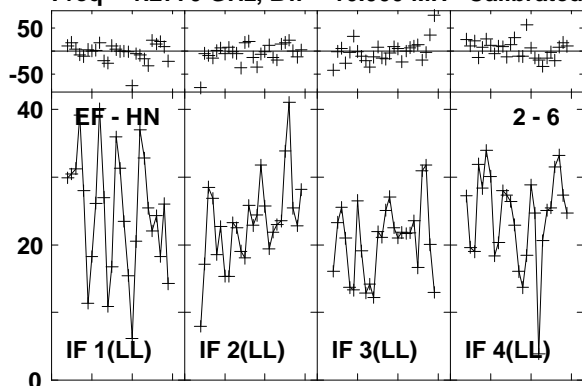

Lower frame: Milli Ampl Jy Top frame: Phas deg
Vector averaged cross-power spectrum Baseline: EF (02) - HN (06)
Timerange: 01/01:42:51 to 01/01:45:37

Plot file version1199 created 03-MAR-2016 01:15:26

4C52 GN002C 1.UVDATA.1

Freq = 1.2770 GHz, Bw = 16.000 MH Calibrated with CL # 3 and BP # 1 (BP mode 1)

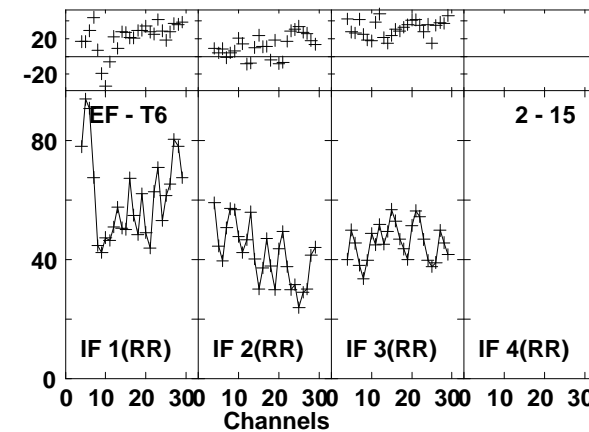
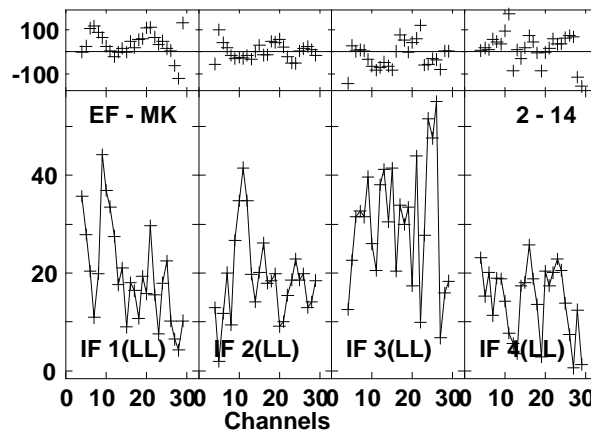
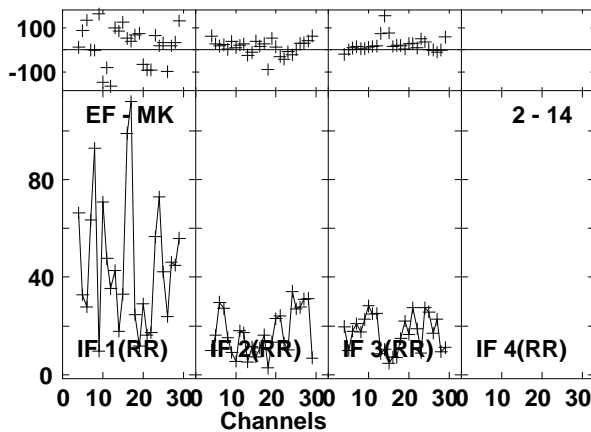
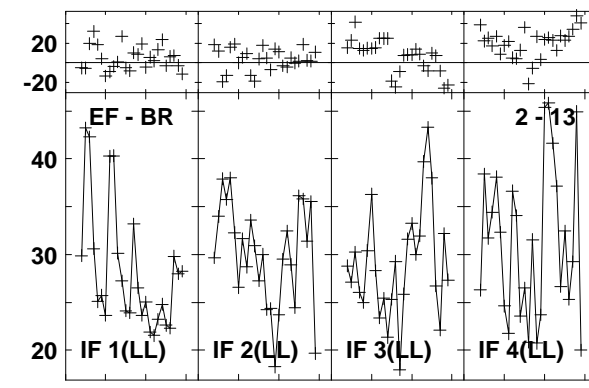
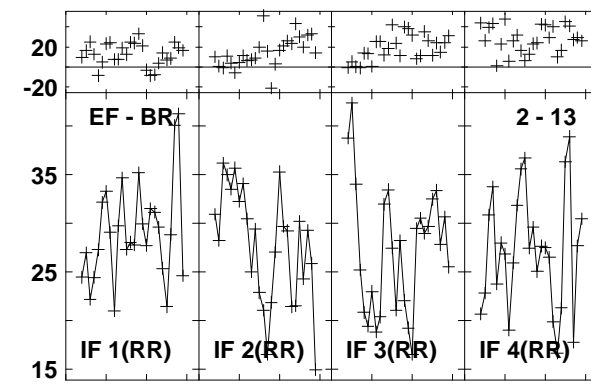
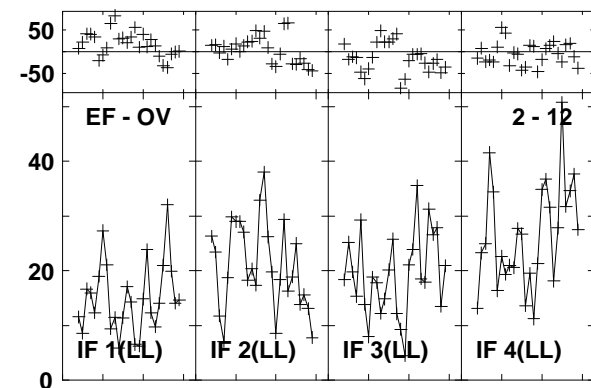
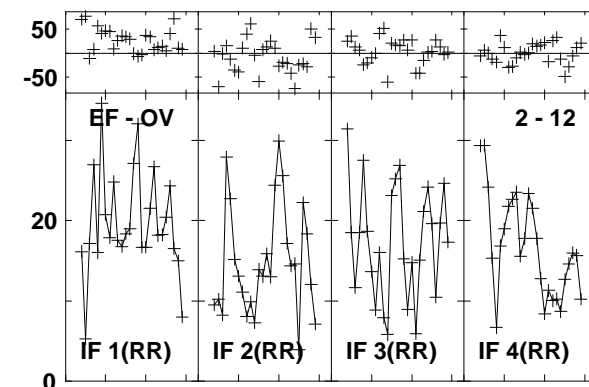
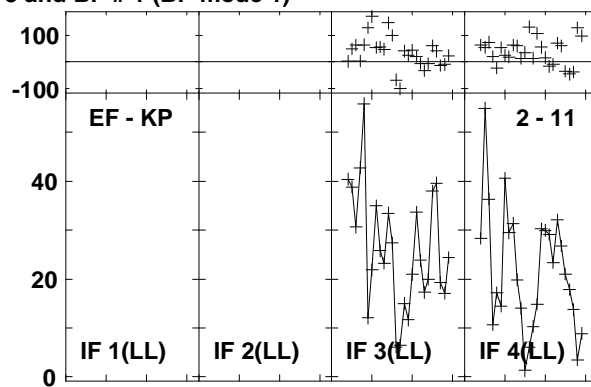
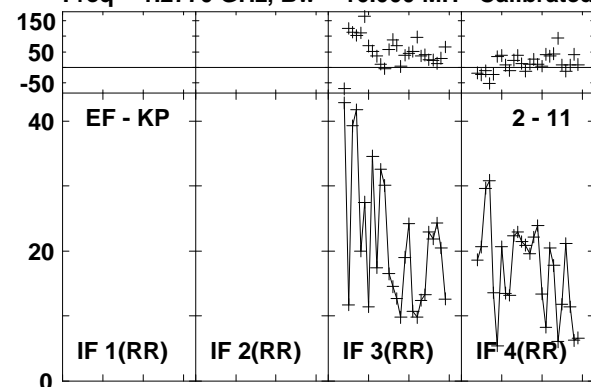

Lower frame: Milli Ampl Jy Top frame: Phas deg
Vector averaged cross-power spectrum Baseline: EF (02) - KP (11)
Timerange: 01/01:42:51 to 01/01:45:37

Plot file version1200 created 03-MAR-2016 01:15:26

4C52 GN002C 1.UVDATA.1

Freq = 1.2770 GHz, Bw = 16.000 MH Calibrated with CL # 3 and BP # 1 (BP mode 1)

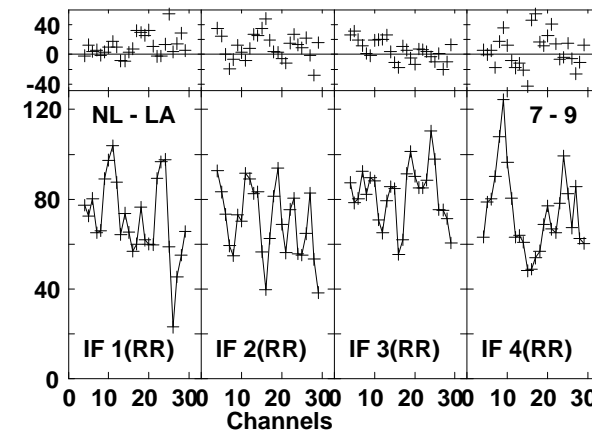
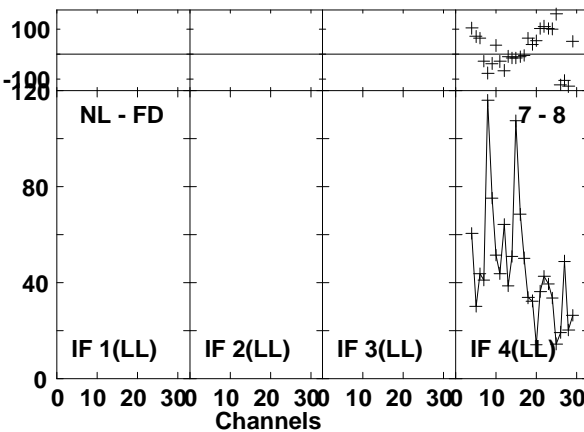
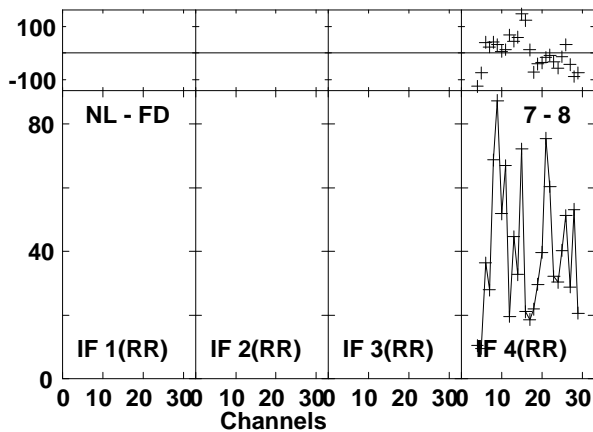
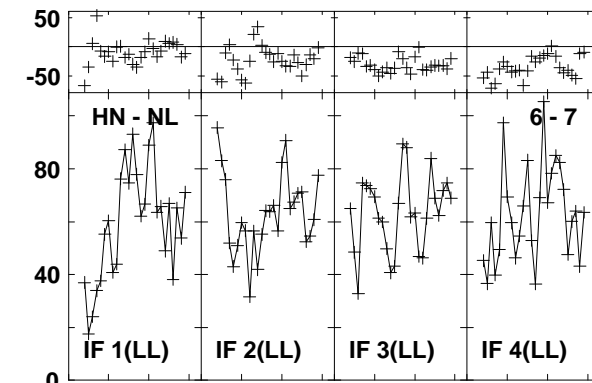
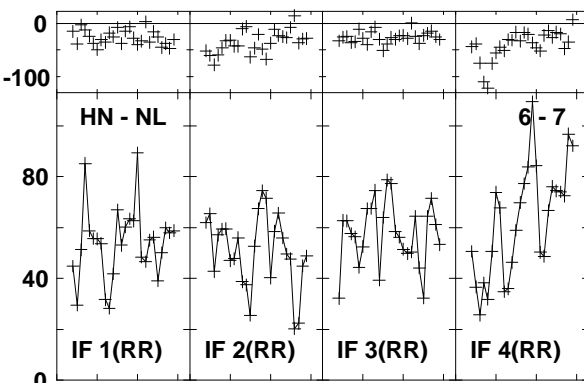
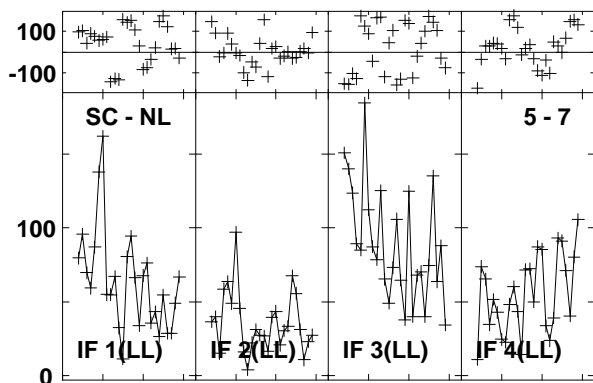
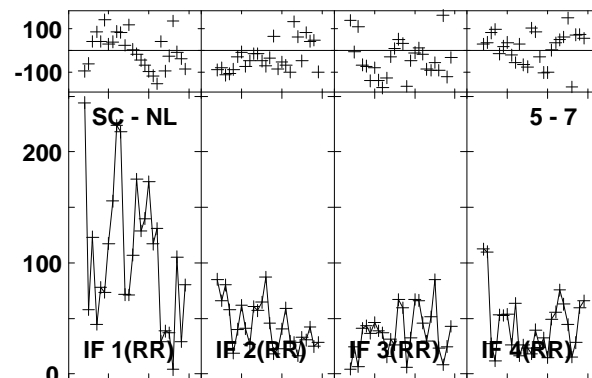
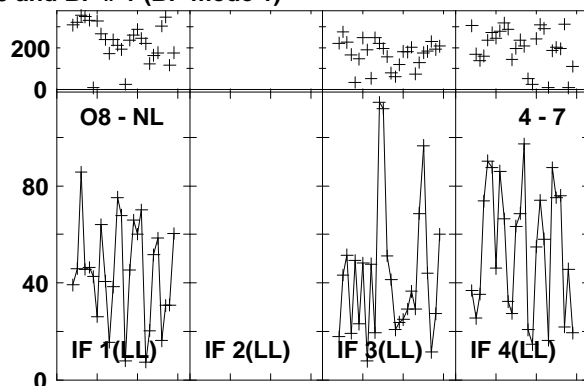
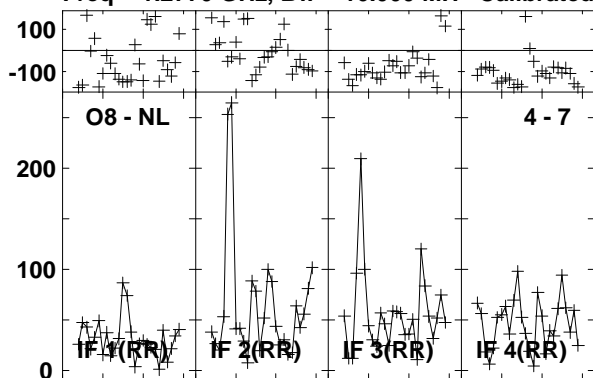

Lower frame: Milli Ampl Jy Top frame: Phas deg
Vector averaged cross-power spectrum Baseline: O8 (04) - NL (07)
Timerange: 01/01:42:51 to 01/01:45:37

Plot file version1201 created 03-MAR-2016 01:15:27

4C52 GN002C 1.UVDATA.1

Freq = 1.2770 GHz, Bw = 16.000 MH Calibrated with CL # 3 and BP # 1 (BP mode 1)

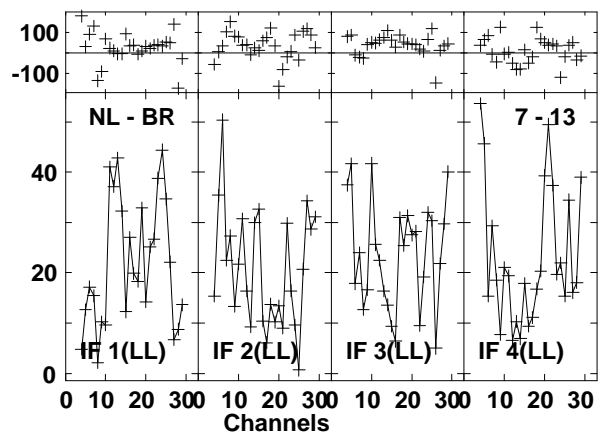
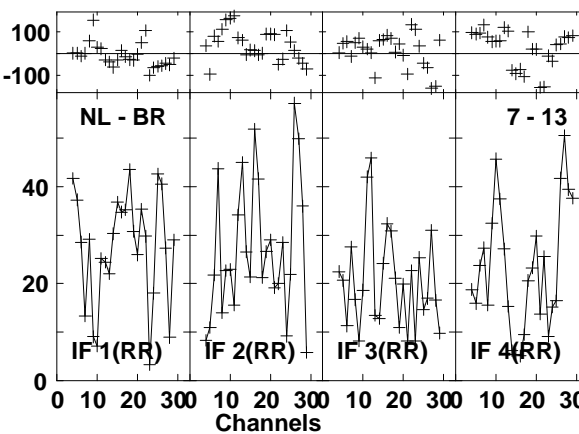
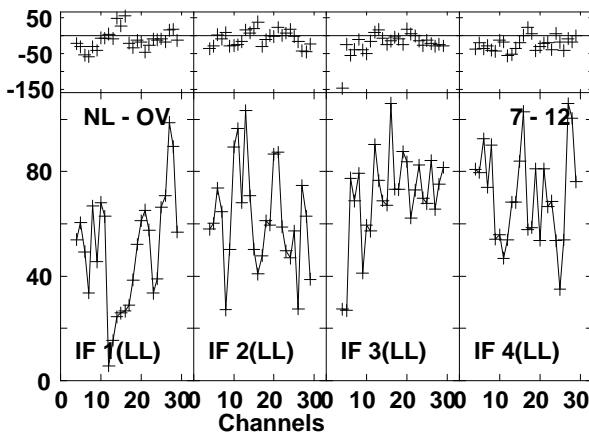
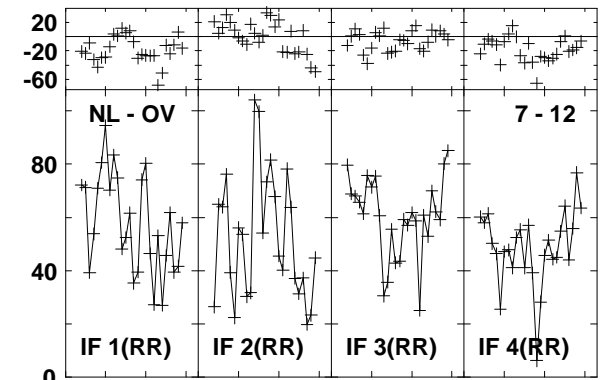
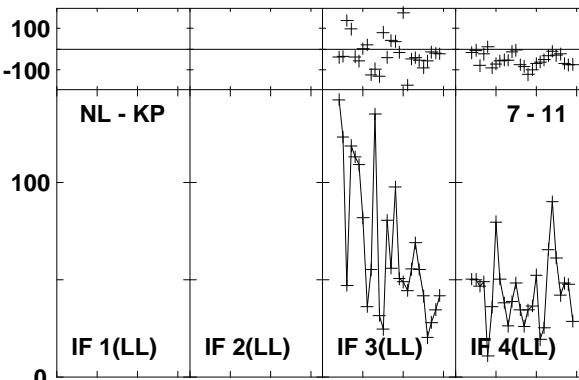
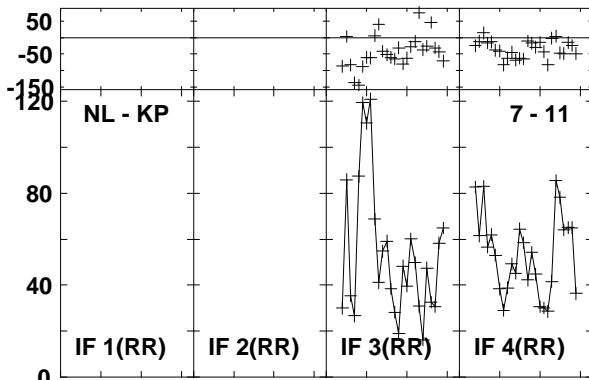
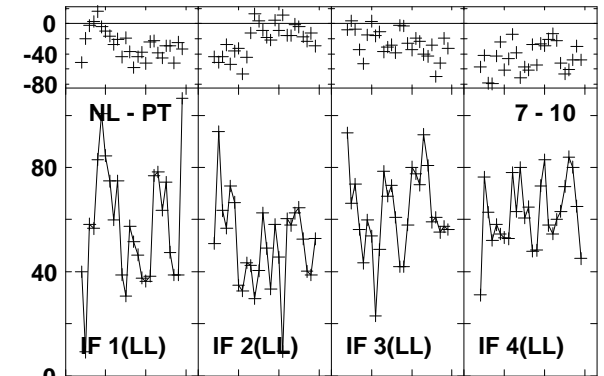
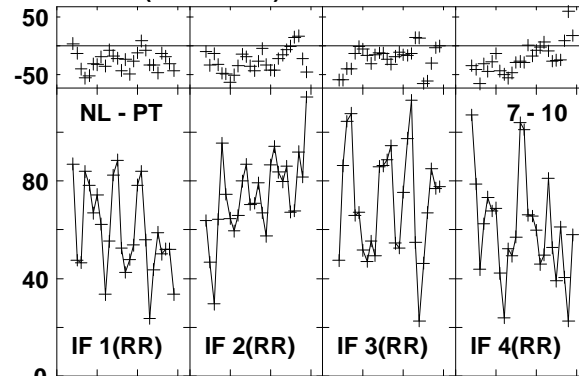
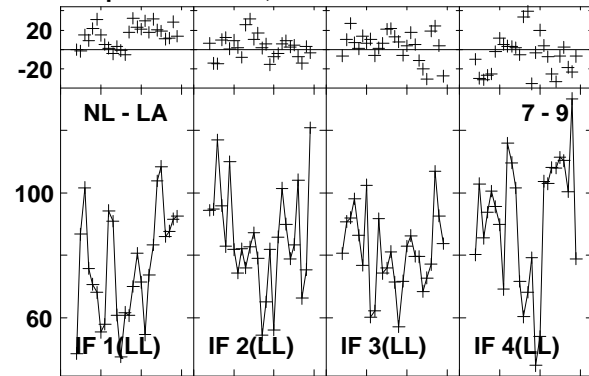

Lower frame: Milli Ampl Jy Top frame: Phas deg
Vector averaged cross-power spectrum Baseline: NL (07) - LA (09)
Timerange: 01/01:42:51 to 01/01:45:37

Plot file version1202 created 03-MAR-2016 01:15:27

4C52 GN002C 1.UVDATA.1

Freq = 1.2770 GHz, Bw = 16.000 MH Calibrated with CL # 3 and BP # 1 (BP mode 1)

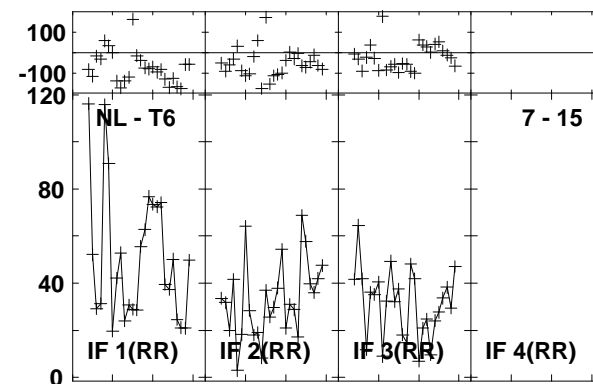
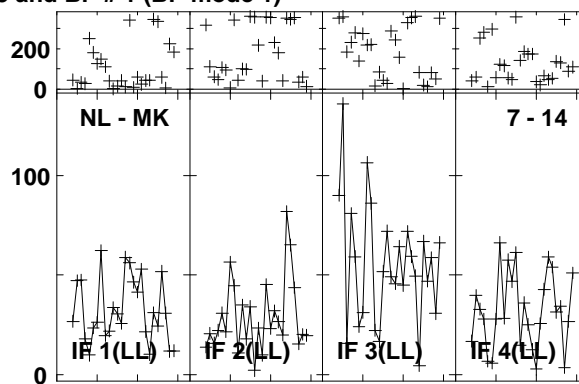
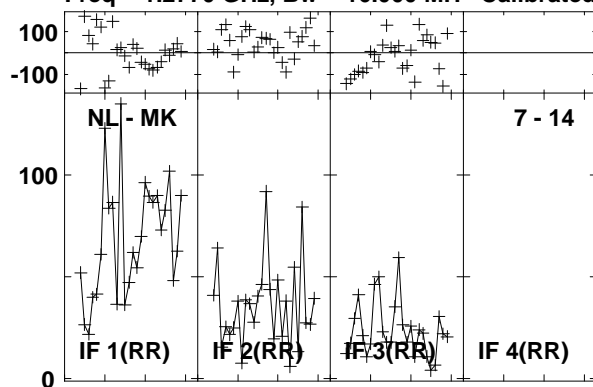

Lower frame: Milli Ampl Jy Top frame: Phas deg
Vector averaged cross-power spectrum Baseline: NL (07) - MK (14)
Timerange: 01/01:42:51 to 01/01:45:37

Plot file version1203 created 03-MAR-2016 01:15:27

J1545+5400 GN002C 1.UVDATA.1

Freq = 1.2770 GHz, Bw = 16.000 MH Calibrated with CL # 3 and BP # 1 (BP mode 1)

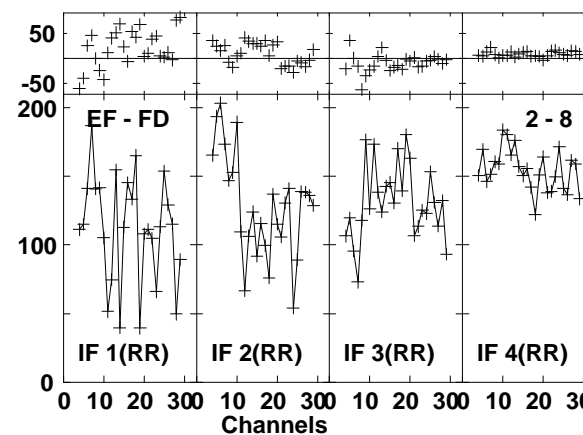
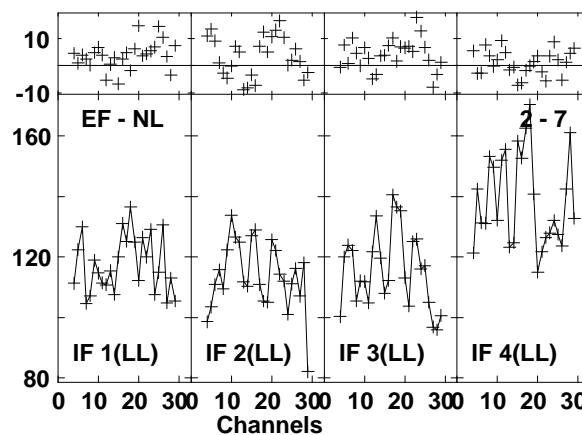
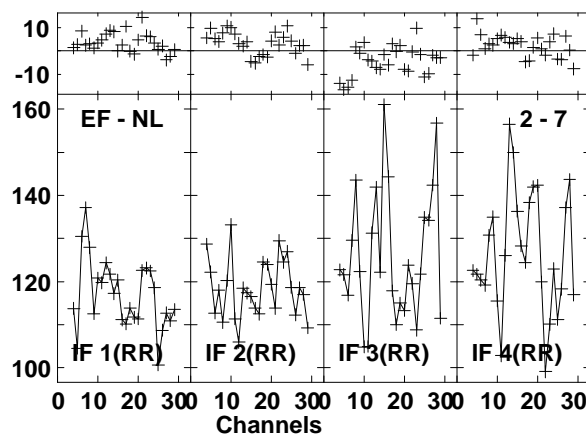
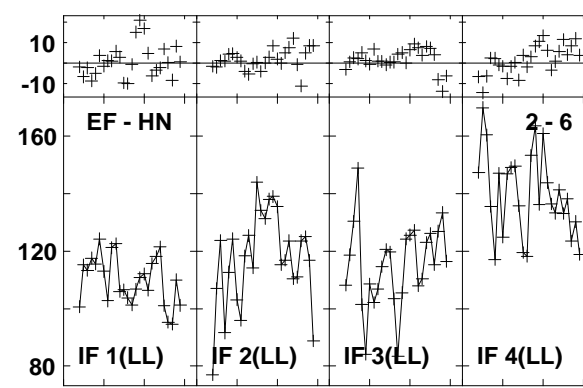
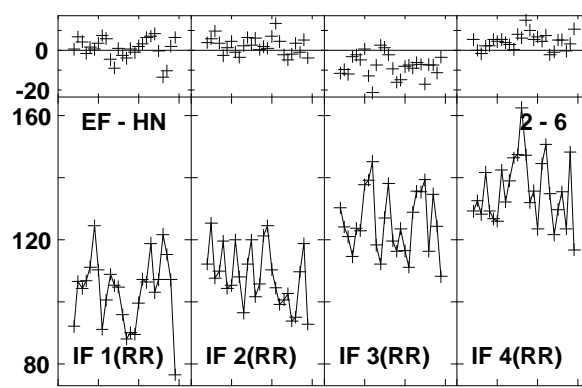
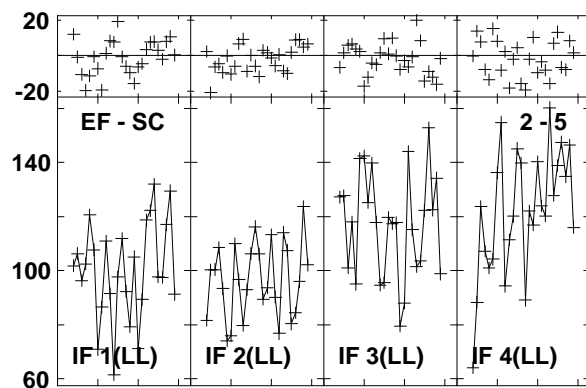
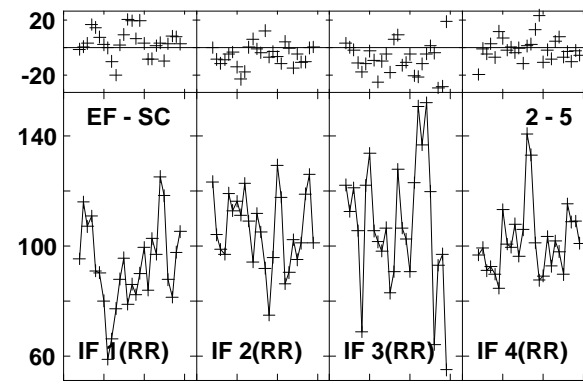
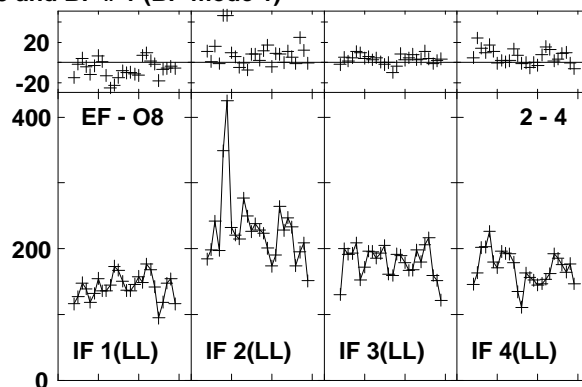
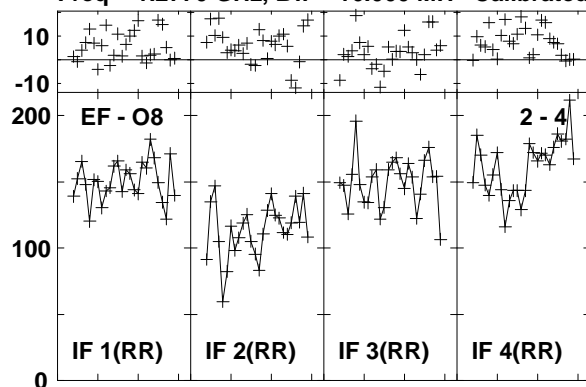

Lower frame: Milli Ampl Jy Top frame: Phas deg
Vector averaged cross-power spectrum Baseline: EF (02) - O8 (04)
Timerange: 01/01:46:30 to 01/01:47:28

Plot file version1204 created 03-MAR-2016 01:15:27

J1545+5400 GN002C 1.UVDATA.1

Freq = 1.2770 GHz, Bw = 16.000 MH Calibrated with CL # 3 and BP # 1 (BP mode 1)

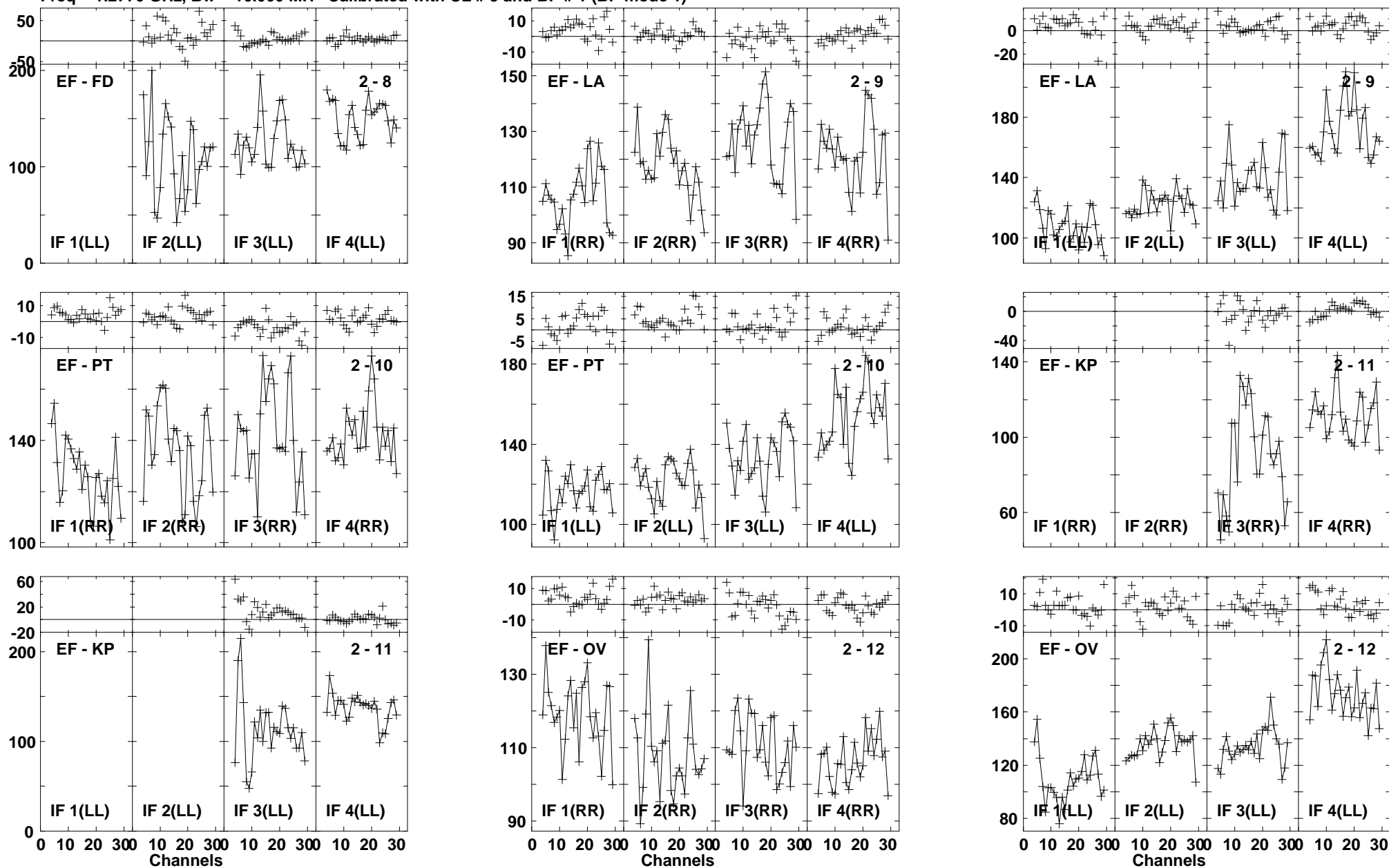

Lower frame: Milli Ampl Jy Top frame: Phas deg
Vector averaged cross-power spectrum Baseline: EF (02) - FD (08)
Timerange: 01/01:46:30 to 01/01:47:28

Plot file version1205 created 03-MAR-2016 01:15:27

J1545+5400 GN002C 1.UVDATA.1

Freq = 1.2770 GHz, Bw = 16.000 MH Calibrated with CL # 3 and BP # 1 (BP mode 1)

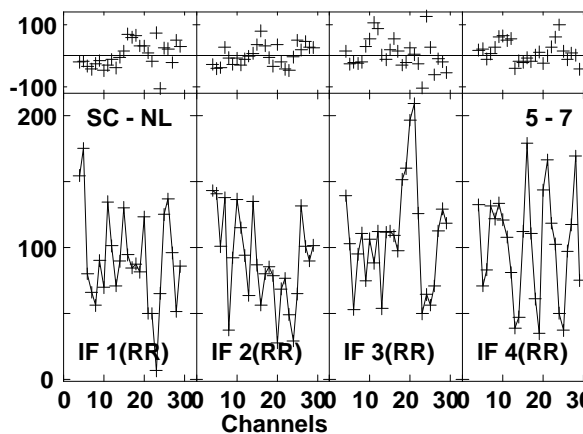
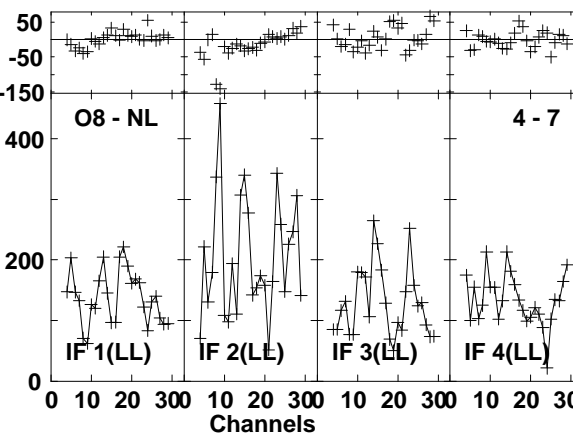
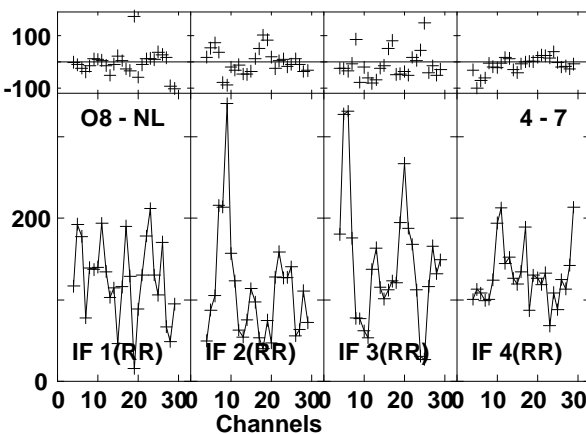
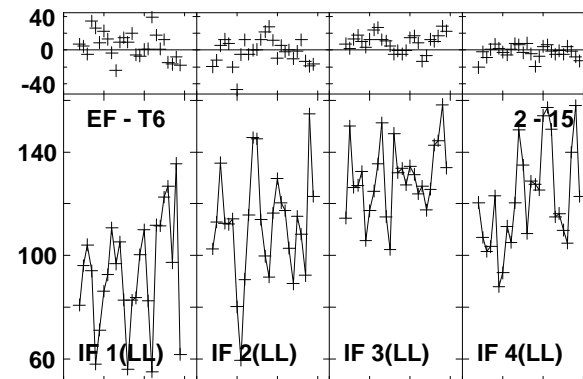
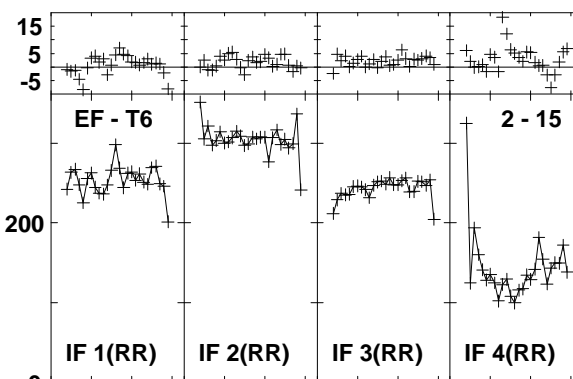
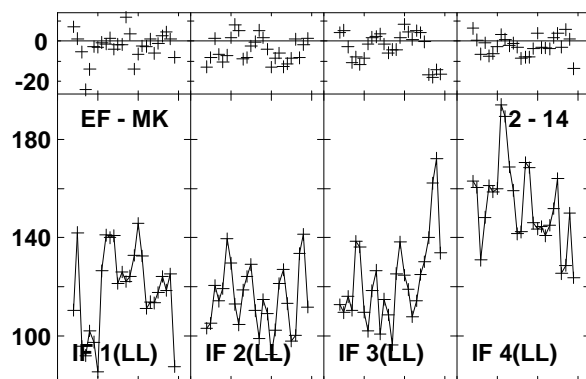
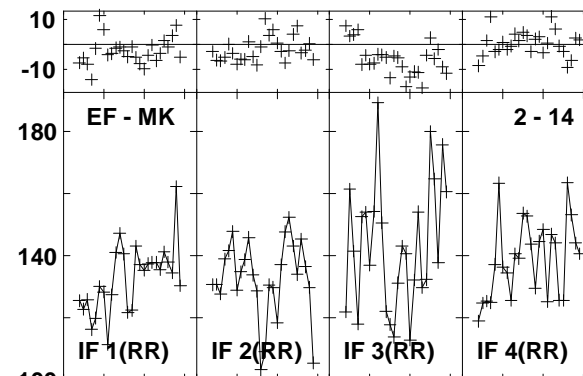
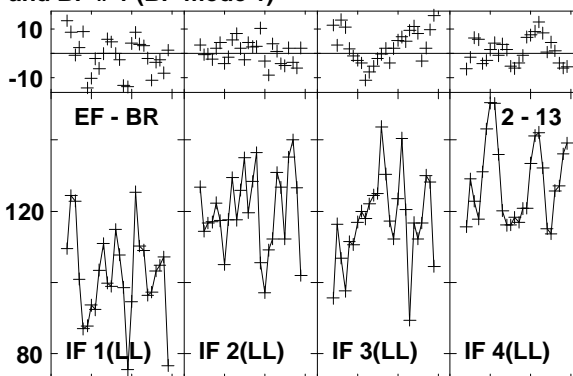
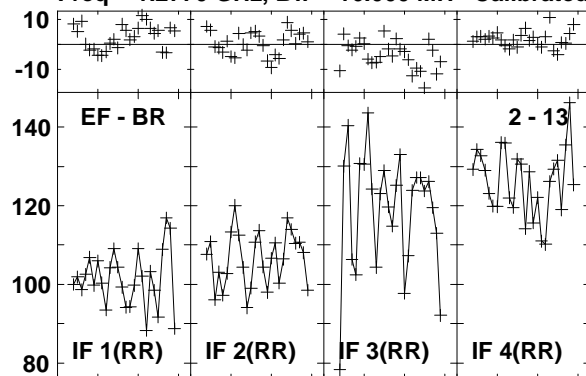

Lower frame: Milli Ampl Jy Top frame: Phas deg
Vector averaged cross-power spectrum Baseline: EF (02) - BR (13)
Timerange: 01/01:46:30 to 01/01:47:28

Plot file version1206 created 03-MAR-2016 01:15:27

J1545+5400 GN002C 1.UVDATA.1

Freq = 1.2770 GHz, Bw = 16.000 MH Calibrated with CL # 3 and BP # 1 (BP mode 1)

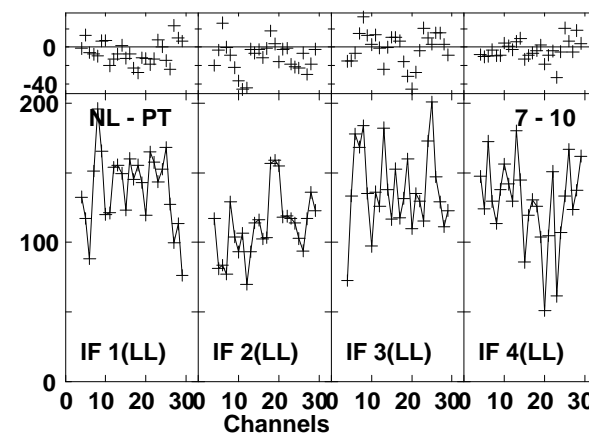
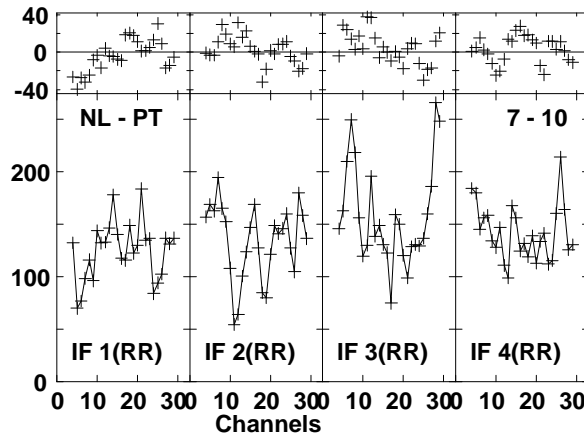
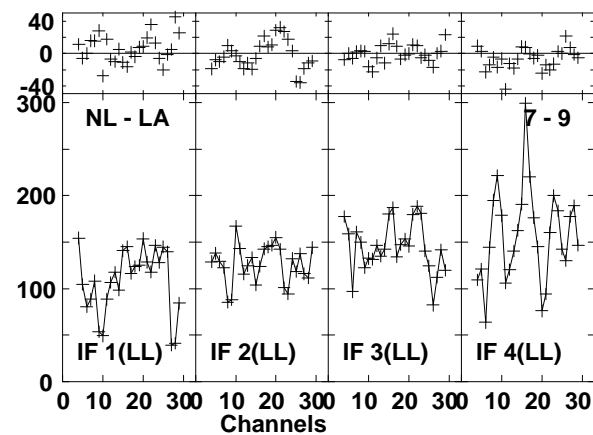
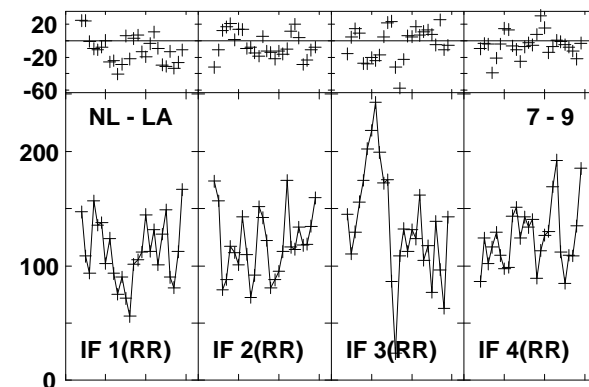
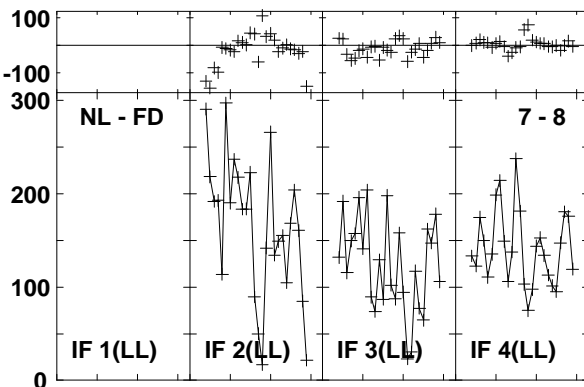
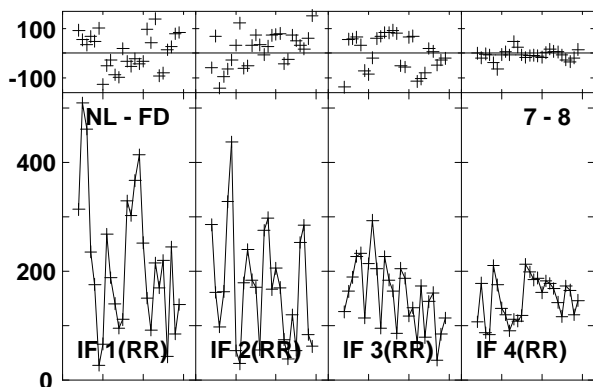
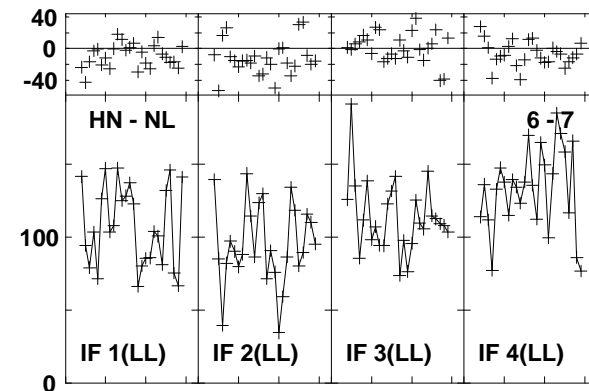
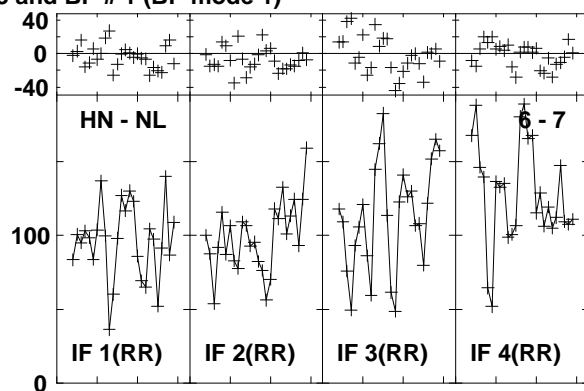
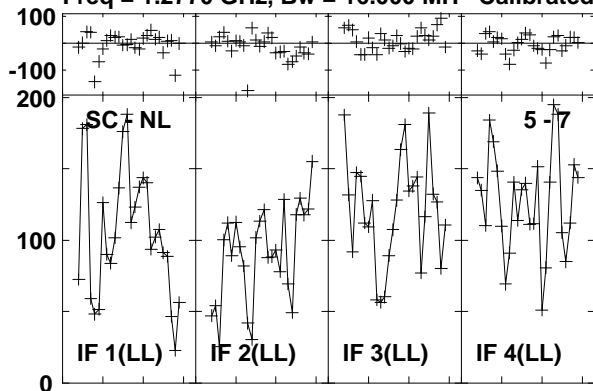

Lower frame: Milli Ampl Jy Top frame: Phas deg

Vector averaged cross-power spectrum Baseline: SC (05) - NL (07)

Timerange: 01/01:46:30 to 01/01:47:28

Plot file version1207 created 03-MAR-2016 01:15:28
 J1545+5400 GN002C 1.UVDATA.1
 Freq = 1.2770 GHz, Bw = 16.000 MH Calibrated with CL # 3 and BP # 1 (BP mode 1)

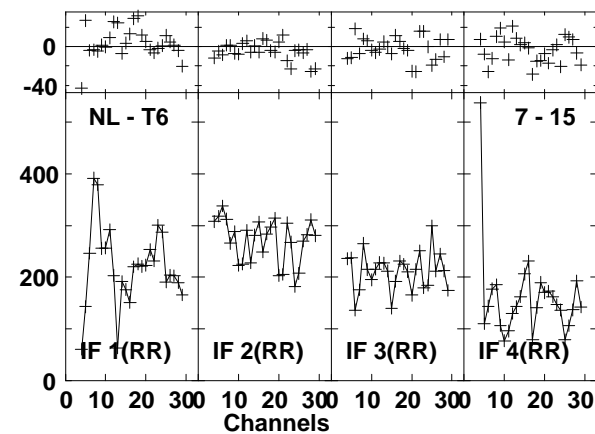
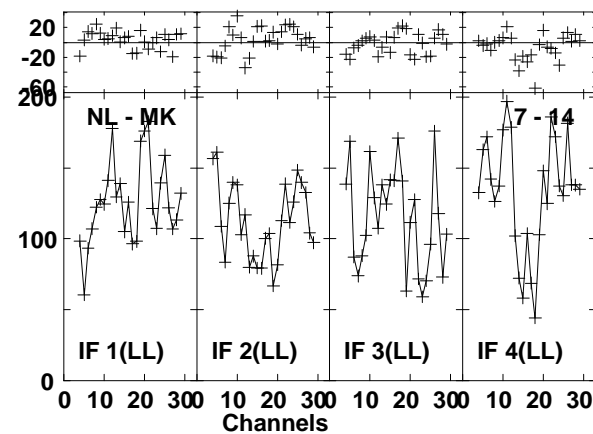
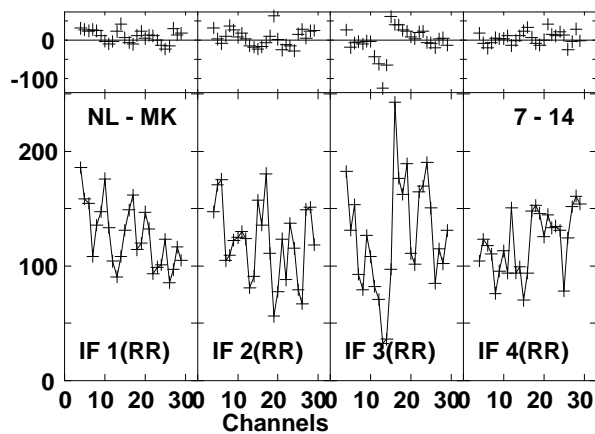
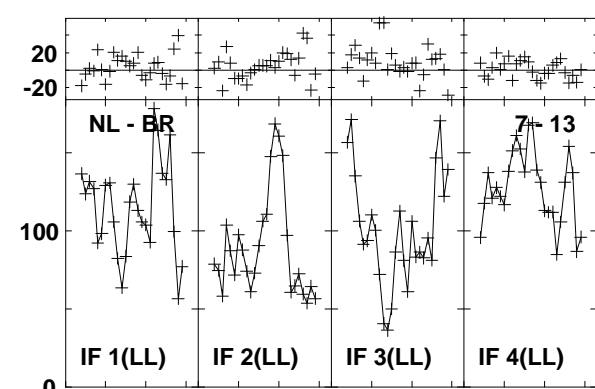
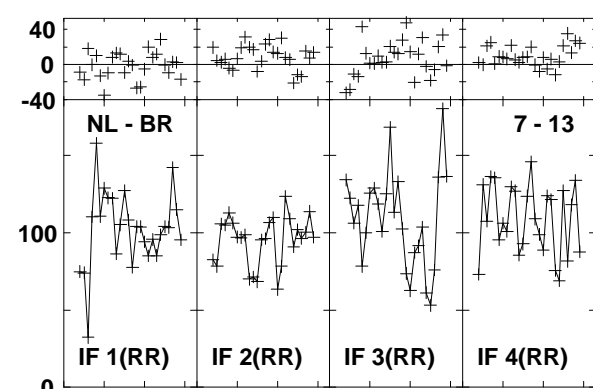
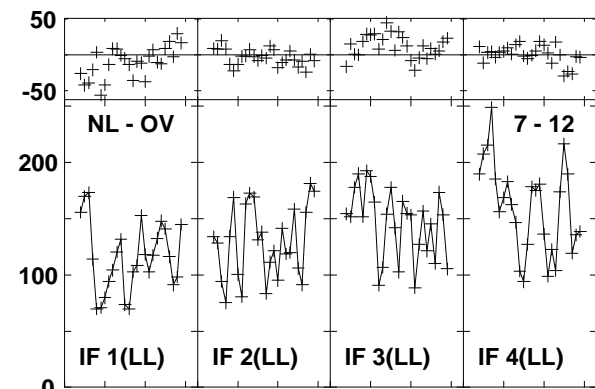
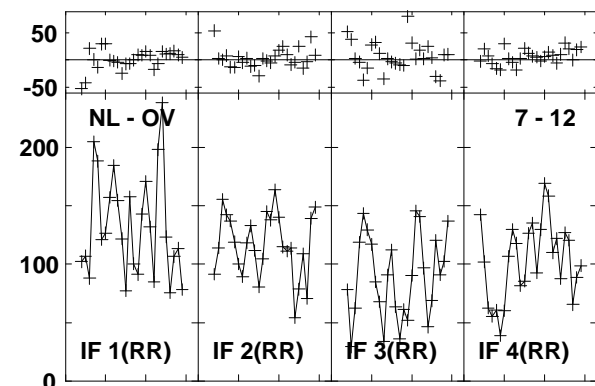
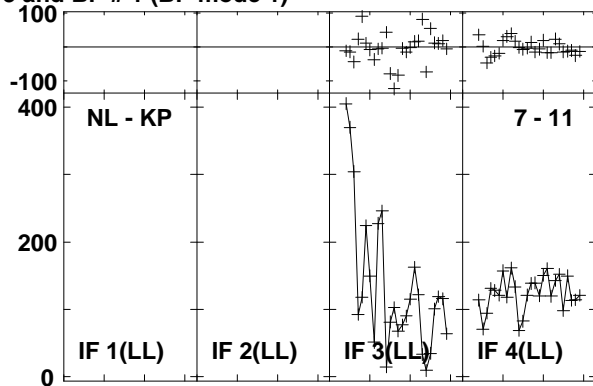
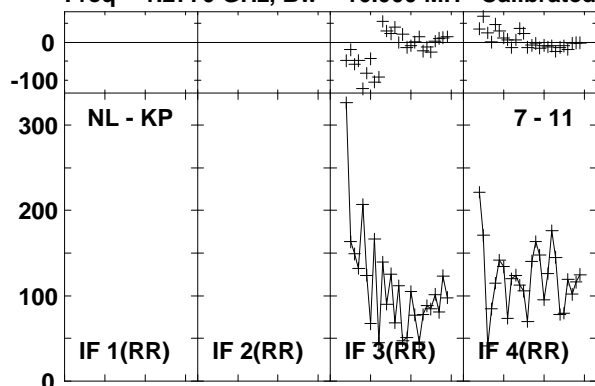

Lower frame: Milli Ampl Jy Top frame: Phas deg
 Vector averaged cross-power spectrum Baseline: NL (07) - KP (11)
 Timerange: 01/01:46:30 to 01/01:47:28

Plot file version1208 created 03-MAR-2016 01:15:28
J1545+5400 GN002C 1.UVDATA.1
Freq = 1.2770 GHz, Bw = 16.000 MH Calibrated with CL # 3 and BP # 1 (BP mode 1)

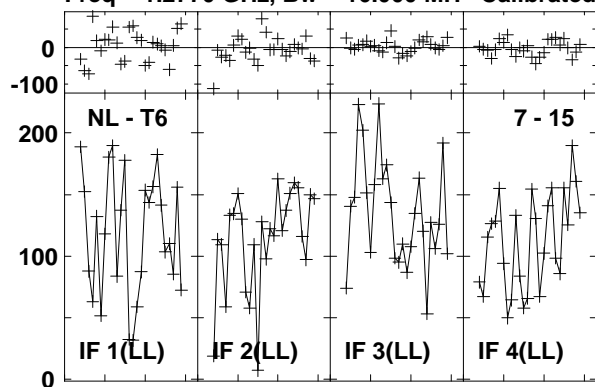

Lower frame: Milli Ampl Jy Top frame: Phas deg
Vector averaged cross-power spectrum Baseline: NL (07) - T6 (15)
Timerange: 01/01:46:30 to 01/01:47:28

Plot file version1209 created 03-MAR-2016 01:15:28

4C52 GN002C 1.UVDATA.1

Freq = 1.2770 GHz, Bw = 16.000 MH Calibrated with CL # 3 and BP # 1 (BP mode 1)

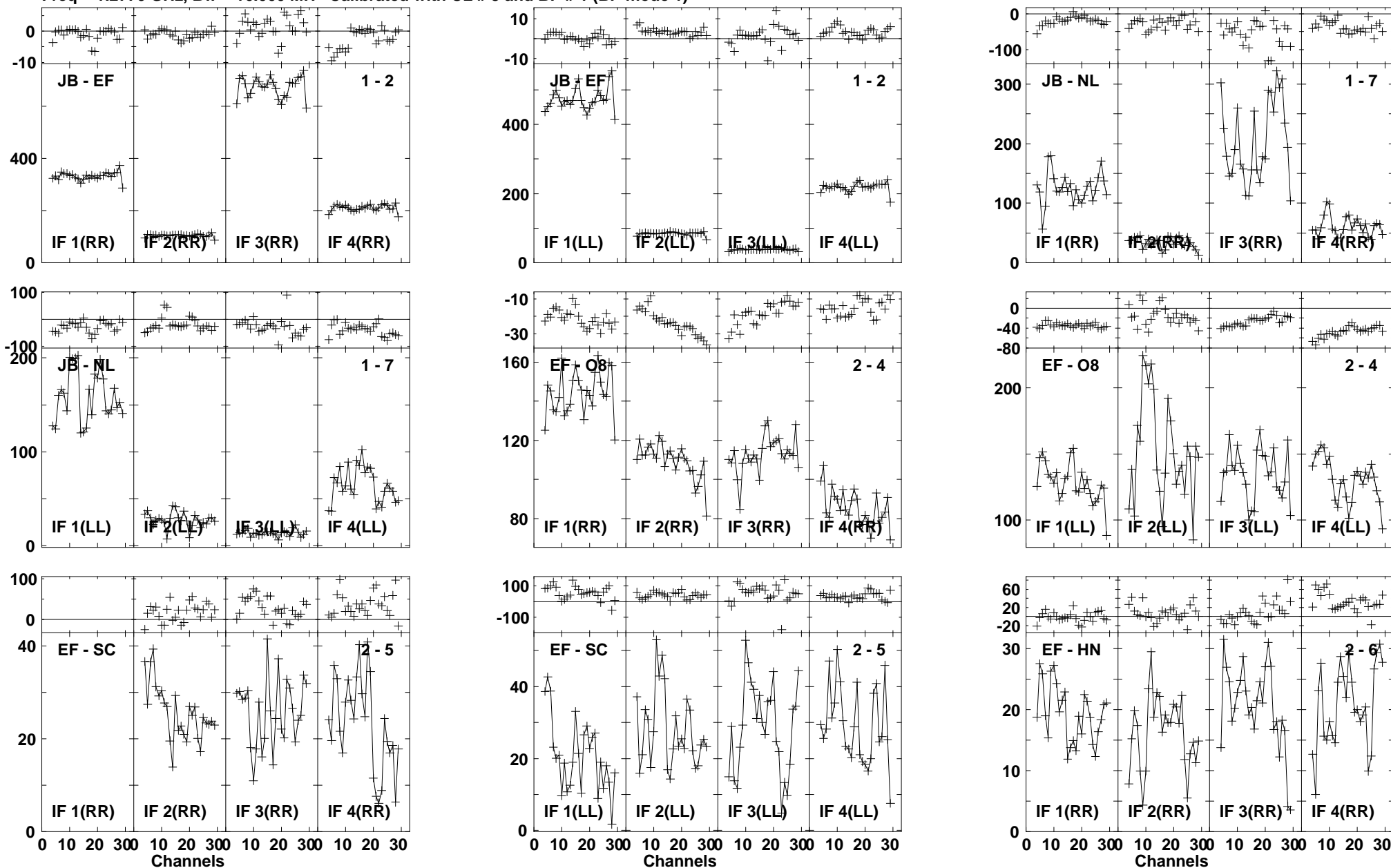

Lower frame: Milli Ampl Jy Top frame: Phas deg
Vector averaged cross-power spectrum Baseline: JB (01) - EF (02)
Timerange: 01/01:47:33 to 01/01:50:57

Plot file version1210 created 03-MAR-2016 01:15:28
 4C52 GN002C 1.UVDATA.1

Freq = 1.2770 GHz, Bw = 16.000 MH Calibrated with CL # 3 and BP # 1 (BP mode 1)

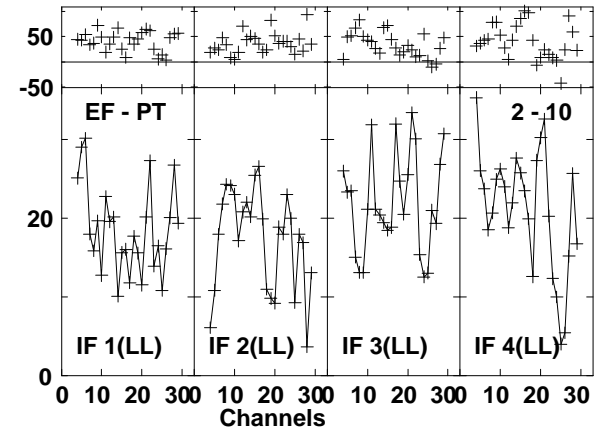
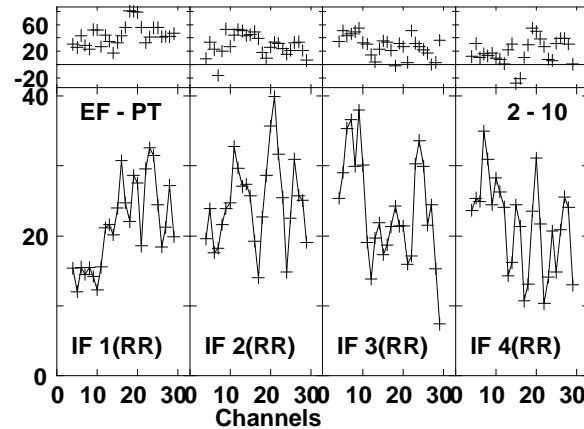
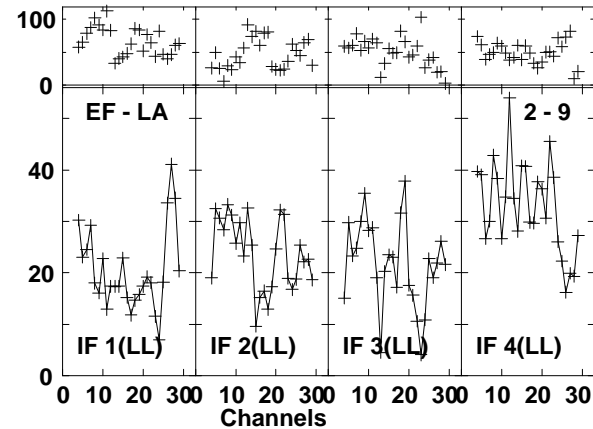
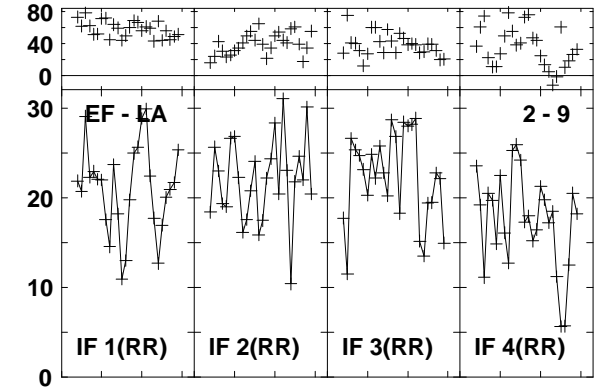
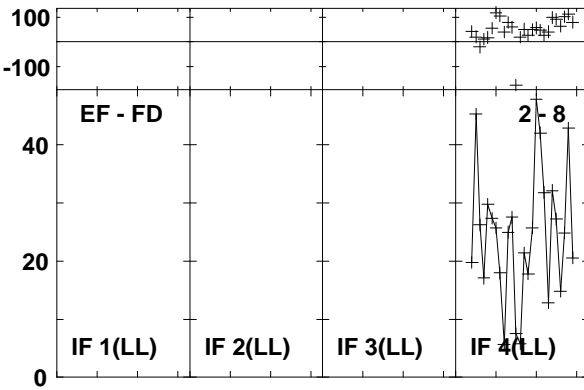
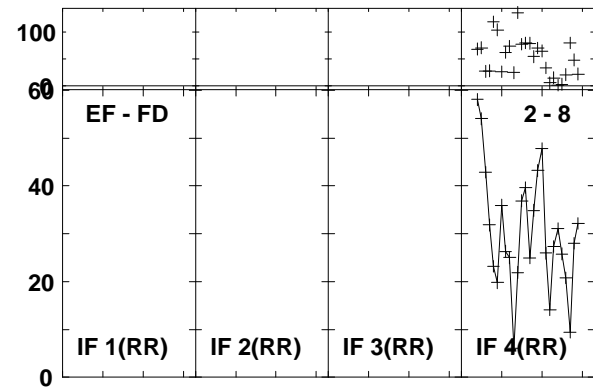
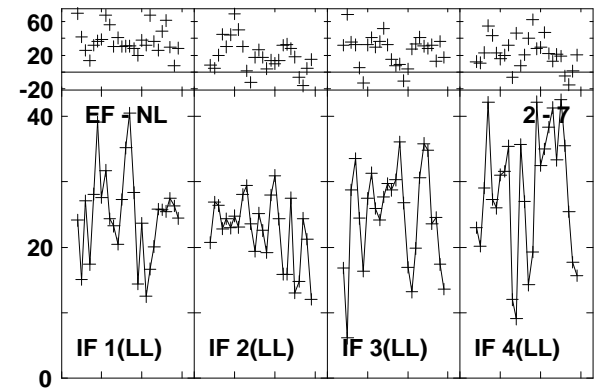
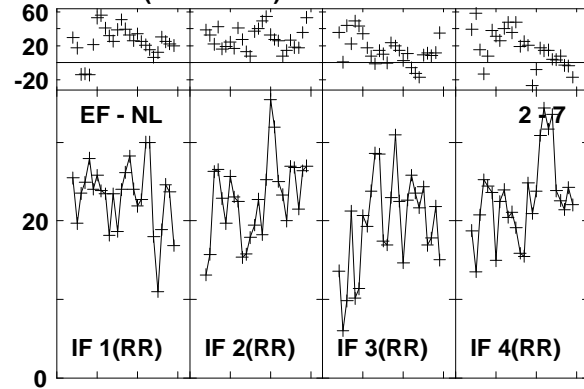
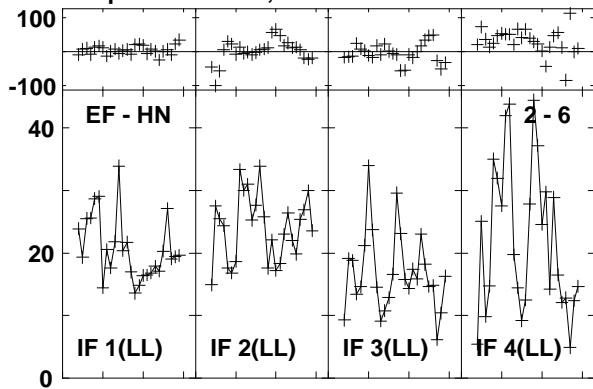

Lower frame: Milli Ampl Jy Top frame: Phas deg
 Vector averaged cross-power spectrum Baseline: EF (02) - HN (06)
 Timerange: 01/01:47:33 to 01/01:50:57

Plot file version1211 created 03-MAR-2016 01:15:28
 4C52 GN002C 1.UVDATA.1
 Freq = 1.2770 GHz, Bw = 16.000 MH Calibrated with CL # 3 and BP # 1 (BP mode 1)

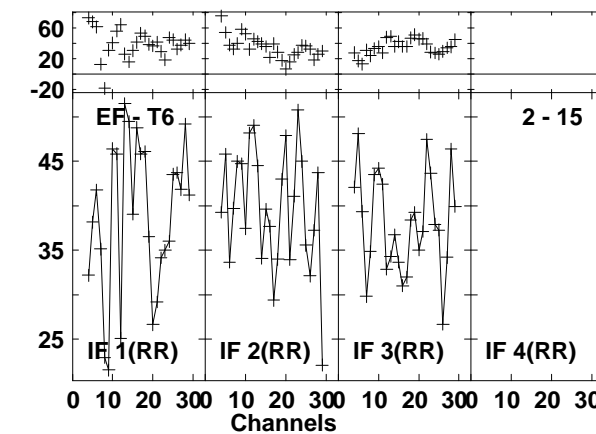
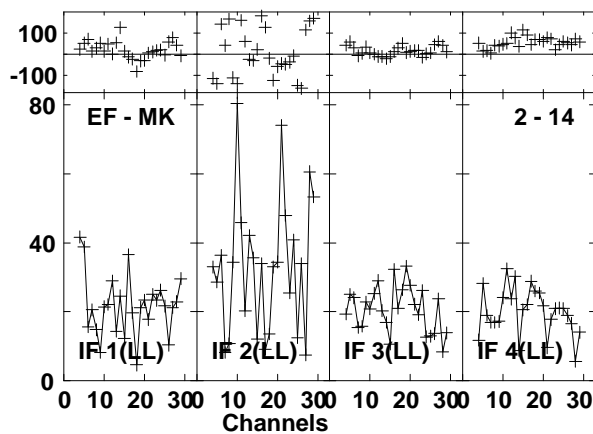
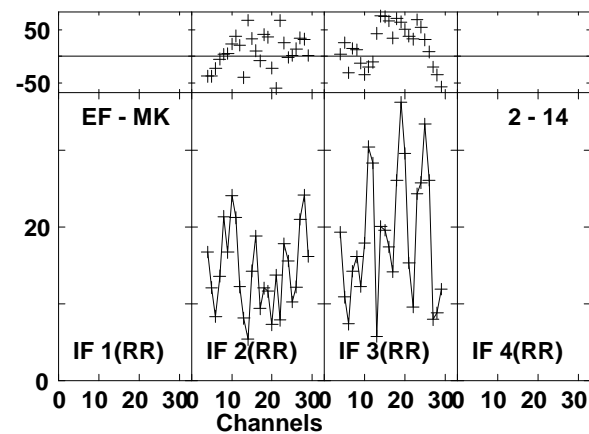
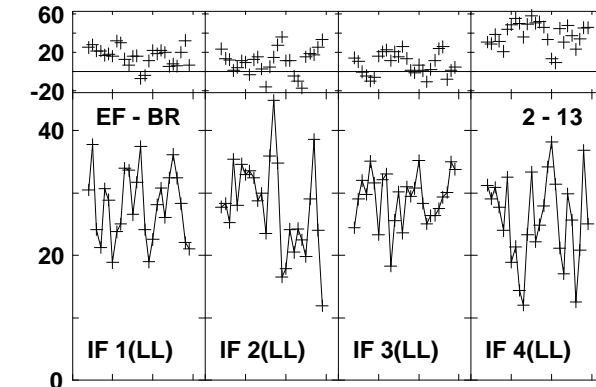
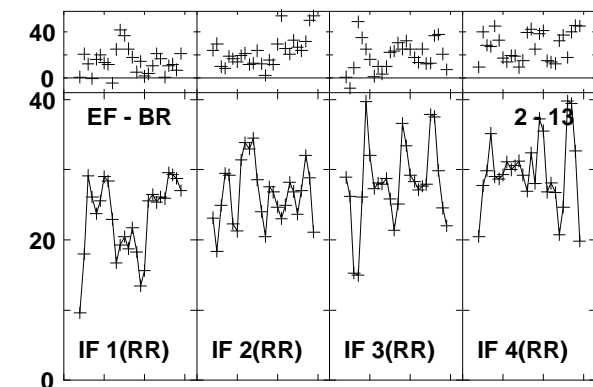
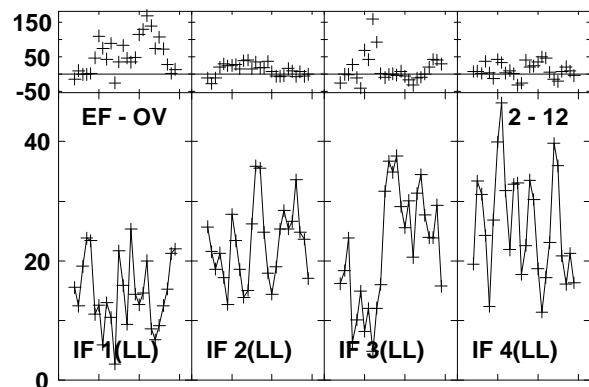
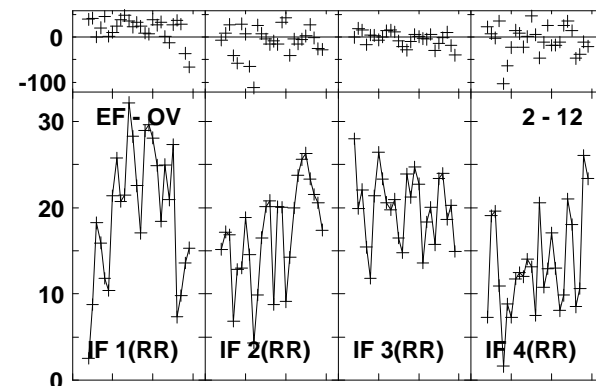
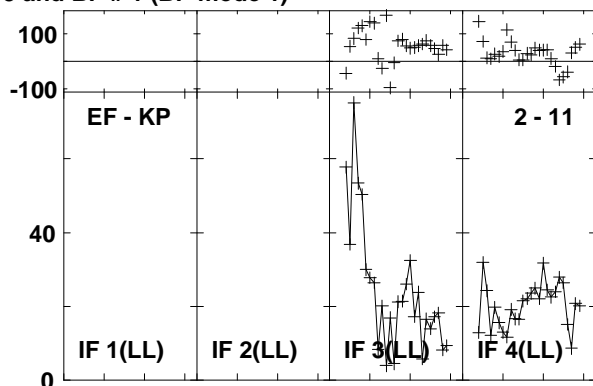
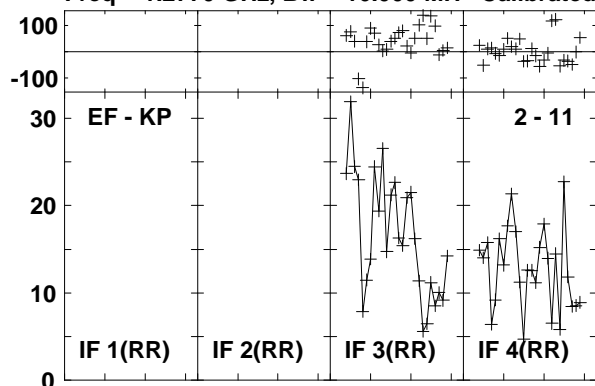

Lower frame: Milli Ampl Jy Top frame: Phas deg
 Vector averaged cross-power spectrum Baseline: EF (02) - KP (11)
 Timerange: 01/01:47:33 to 01/01:50:57

Plot file version1212 created 03-MAR-2016 01:15:28

4C52 GN002C 1.UVDATA.1

Freq = 1.2770 GHz, Bw = 16.000 MH Calibrated with CL # 3 and BP # 1 (BP mode 1)

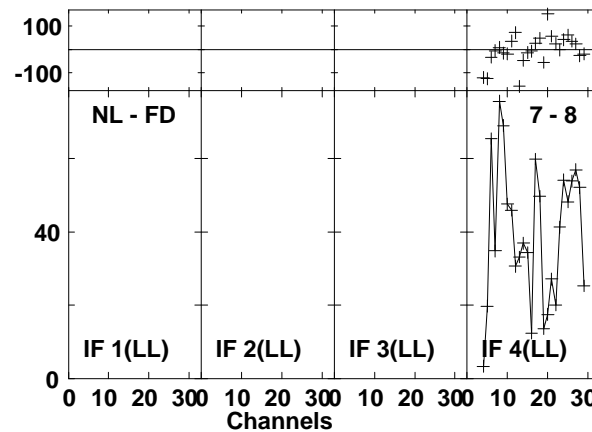
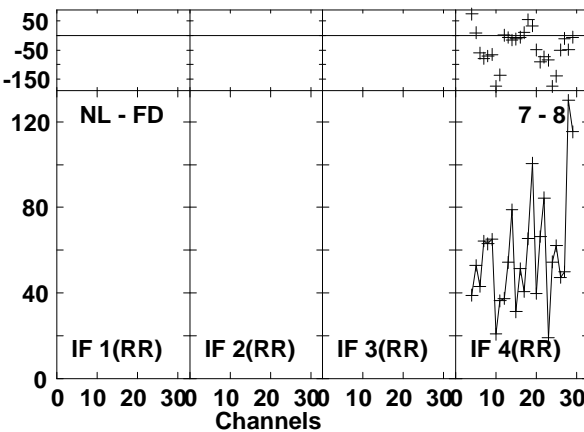
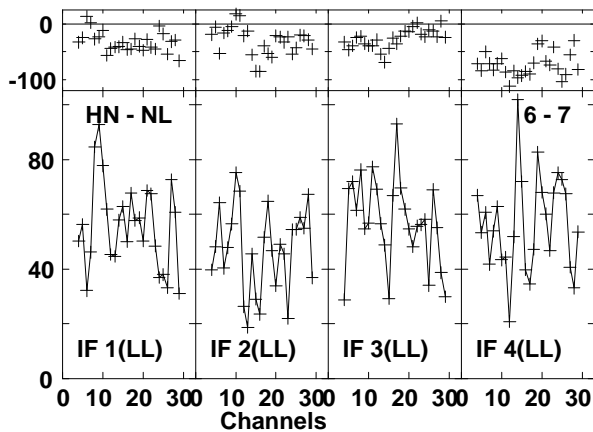
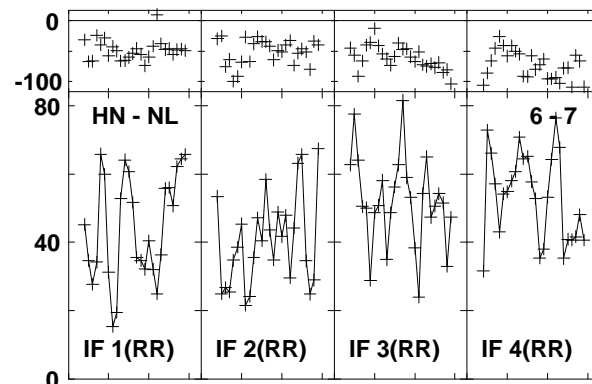
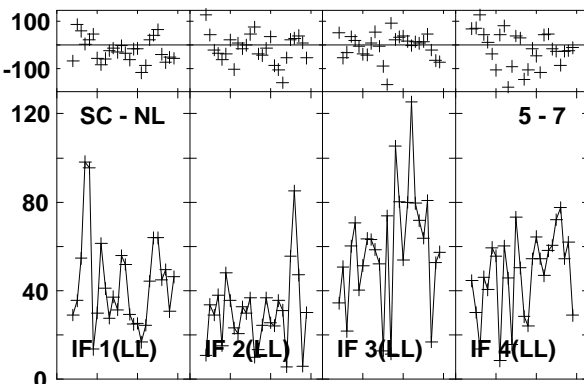
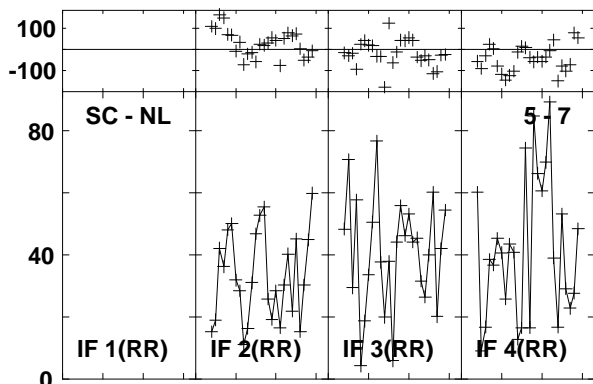
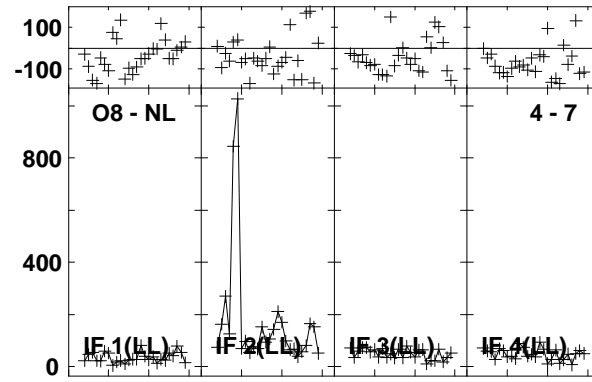
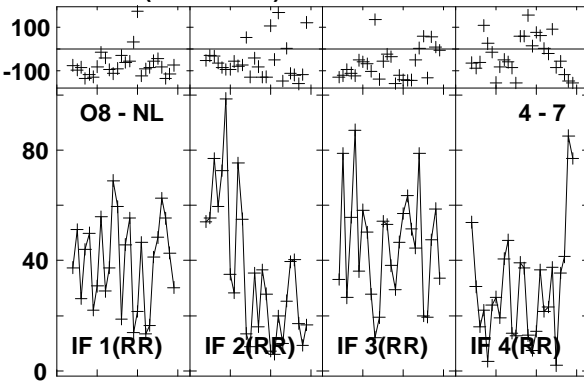
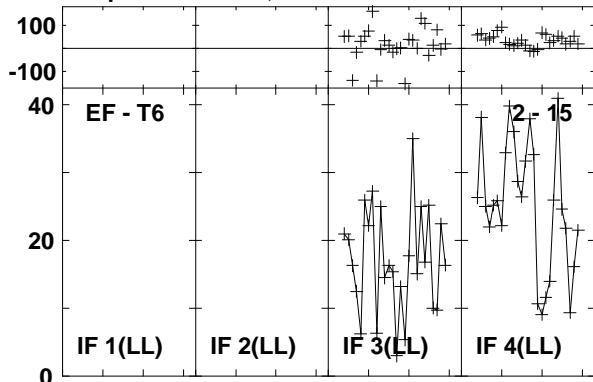

Lower frame: Milli Ampl Jy Top frame: Phas deg
Vector averaged cross-power spectrum Baseline: EF (02) - T6 (15)
Timerange: 01/01:47:33 to 01/01:50:57

Plot file version1213 created 03-MAR-2016 01:15:28

4C52 GN002C 1.UVDATA.1

Freq = 1.2770 GHz, Bw = 16.000 MH Calibrated with CL # 3 and BP # 1 (BP mode 1)

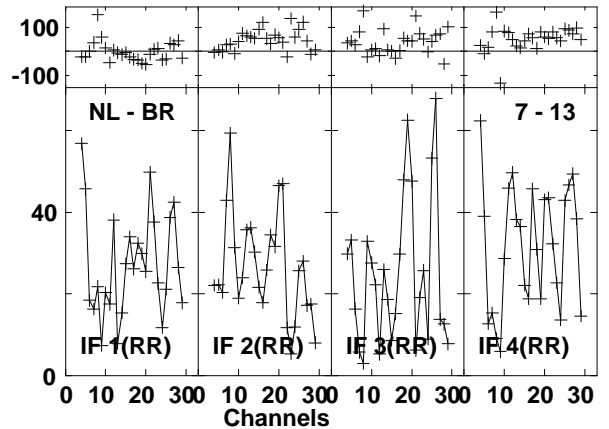
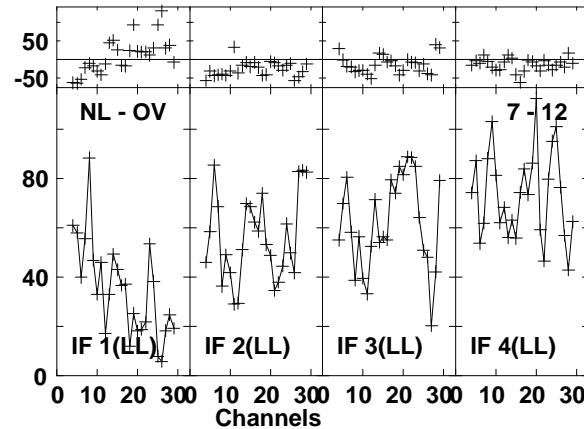
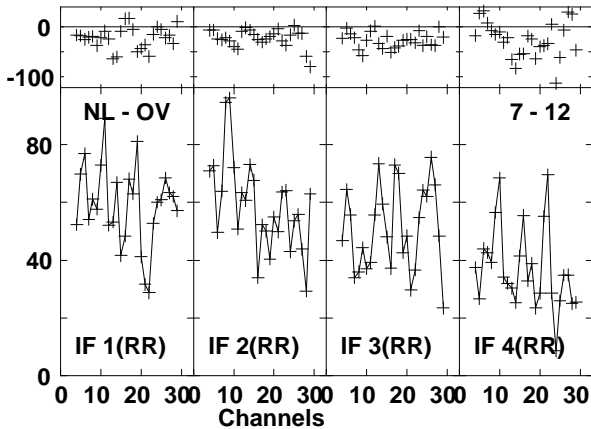
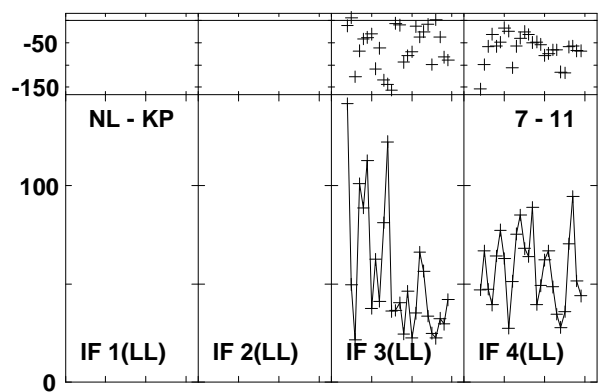
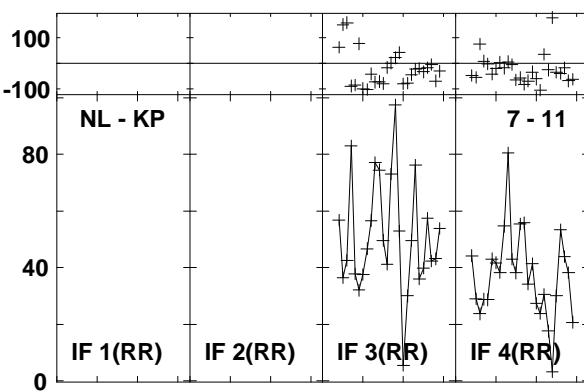
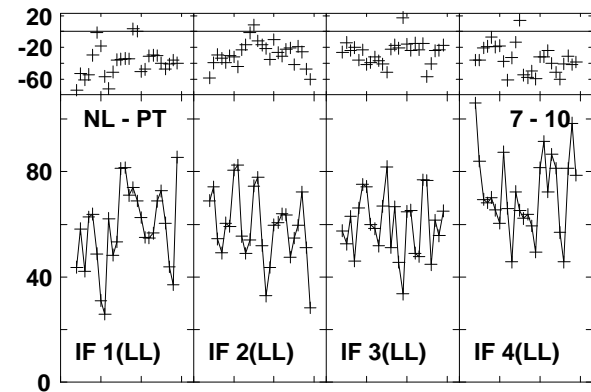
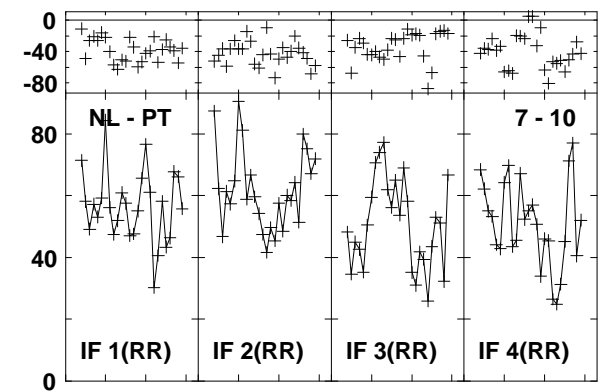
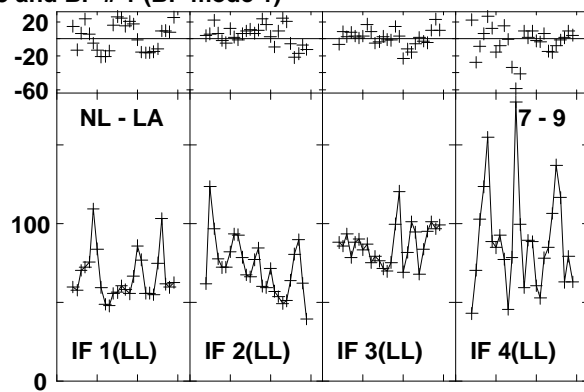
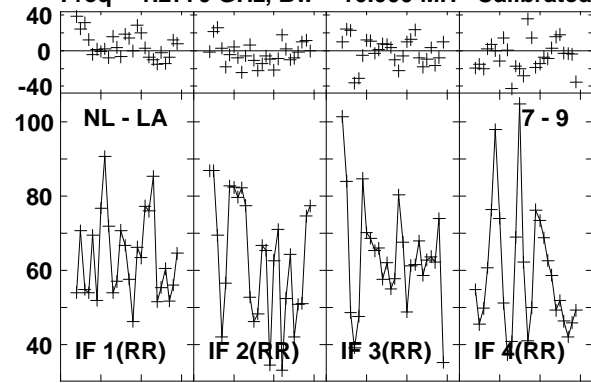

Lower frame: Milli Ampl Jy Top frame: Phas deg
Vector averaged cross-power spectrum Baseline: NL (07) - LA (09)
Timerange: 01/01:47:33 to 01/01:50:57

Plot file version1214 created 03-MAR-2016 01:15:29

4C52 GN002C 1.UVDATA.1

Freq = 1.2770 GHz, Bw = 16.000 MH Calibrated with CL # 3 and BP # 1 (BP mode 1)

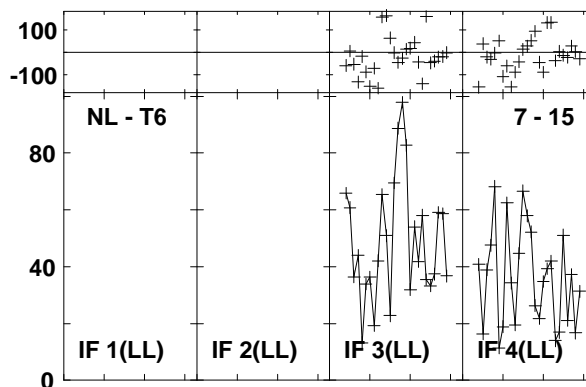
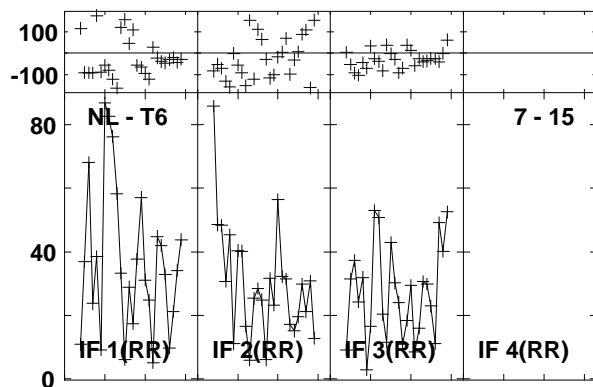
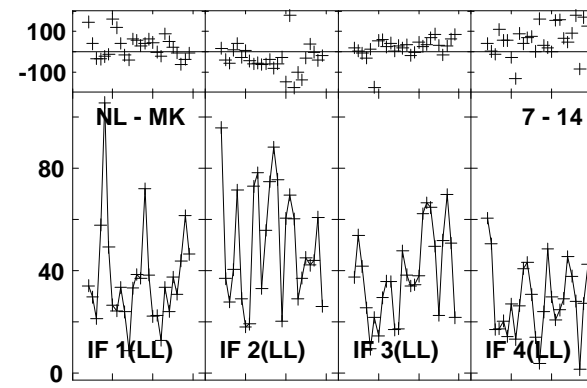
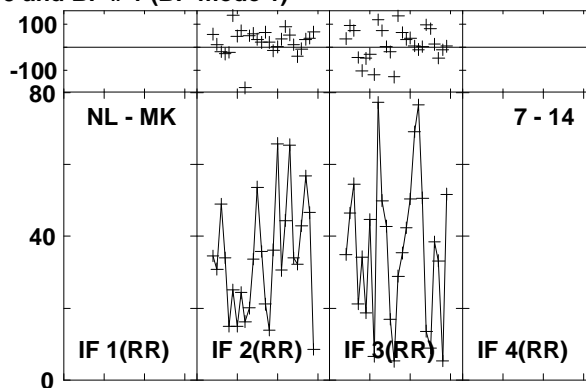
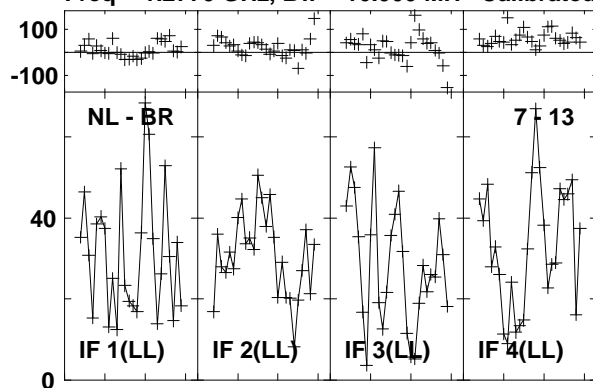

Lower frame: Milli Ampl Jy Top frame: Phas deg

Vector averaged cross-power spectrum Baseline: NL (07) - BR (13)

Timerange: 01/01:47:33 to 01/01:50:57

Plot file version1215 created 03-MAR-2016 01:15:29

J1545+5400 GN002C 1.UVDATA.1

Freq = 1.2770 GHz, Bw = 16.000 MH Calibrated with CL # 3 and BP # 1 (BP mode 1)

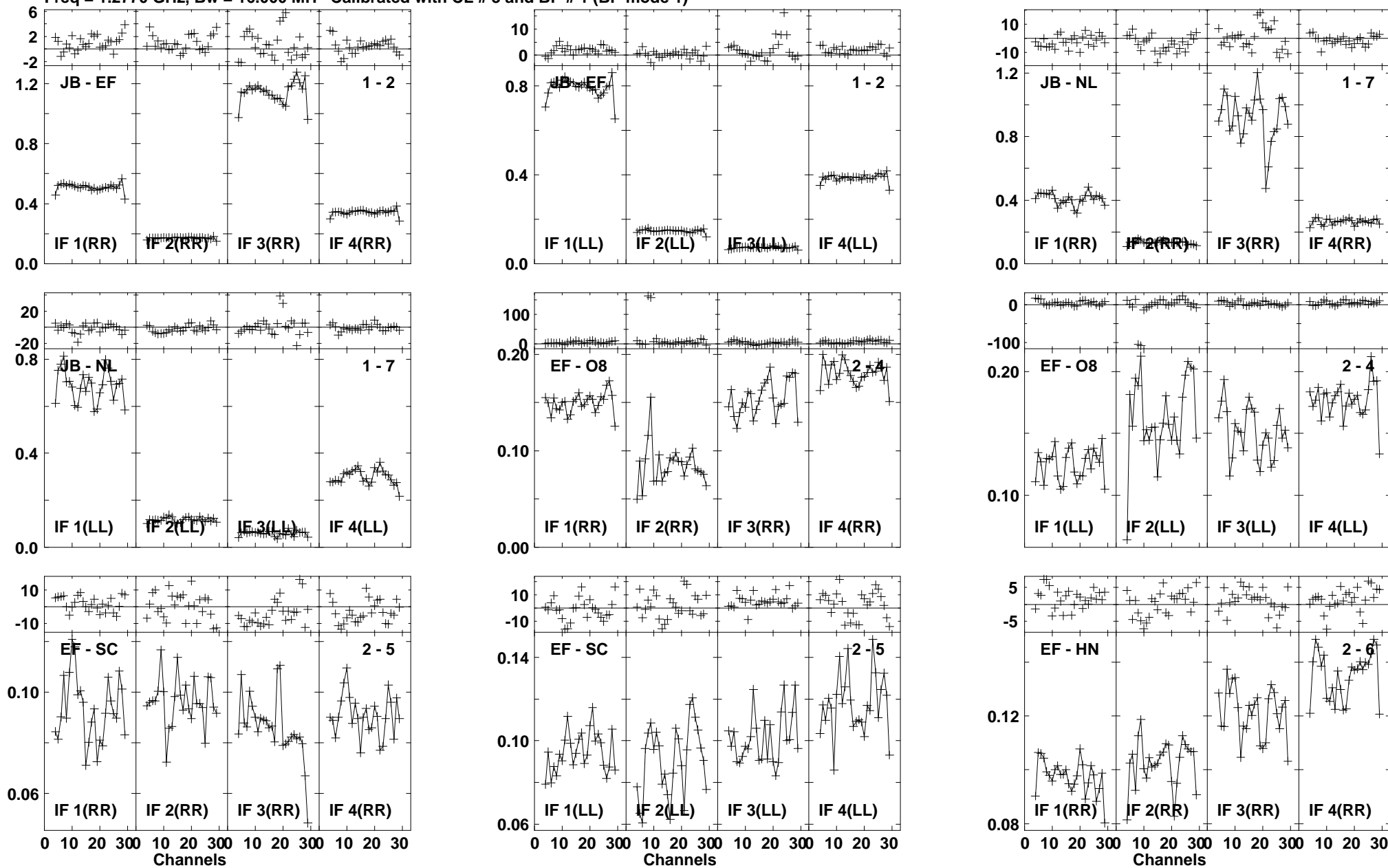

Lower frame: Ampl Jy Top frame: Phas deg
Vector averaged cross-power spectrum Baseline: JB (01) - EF (02)
Timerange: 01/01:51:50 to 01/01:53:48

Plot file version1216 created 03-MAR-2016 01:15:29

J1545+5400 GN002C 1.UVDATA.1

Freq = 1.2770 GHz, Bw = 16.000 MH Calibrated with CL # 3 and BP # 1 (BP mode 1)

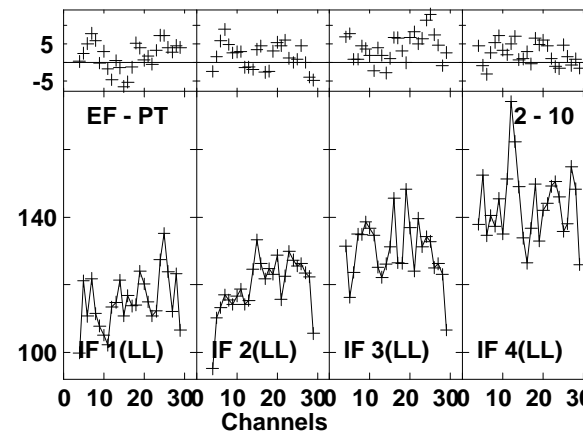
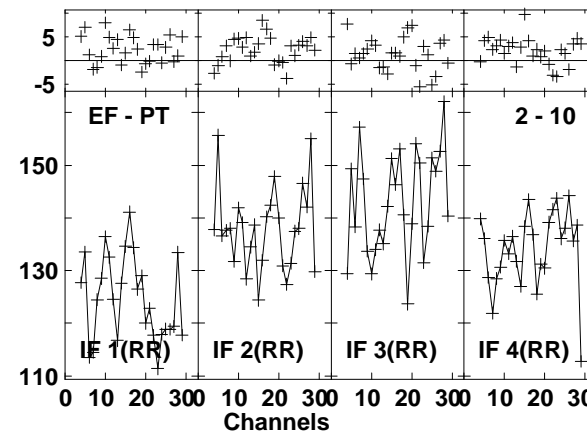
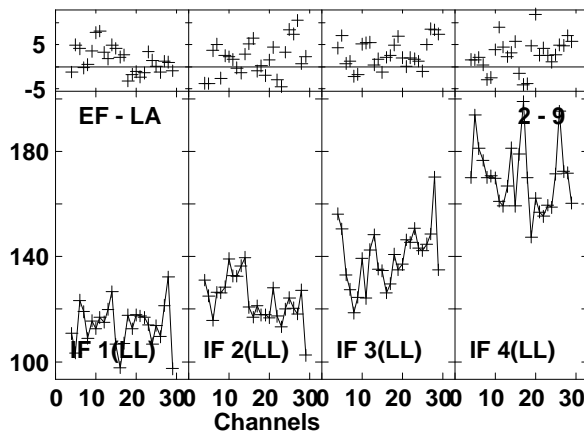
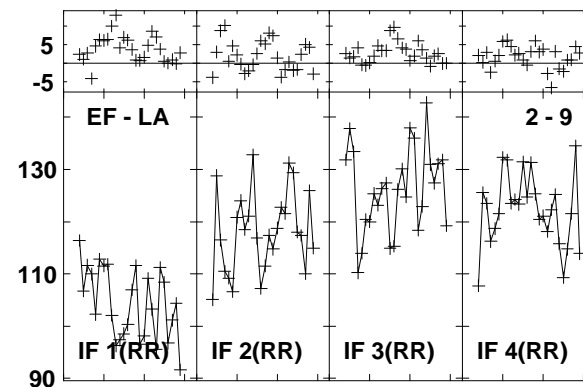
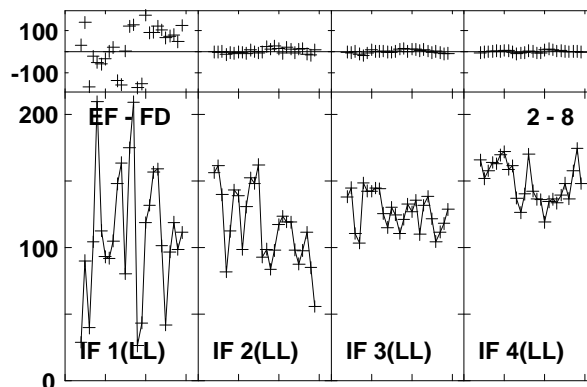
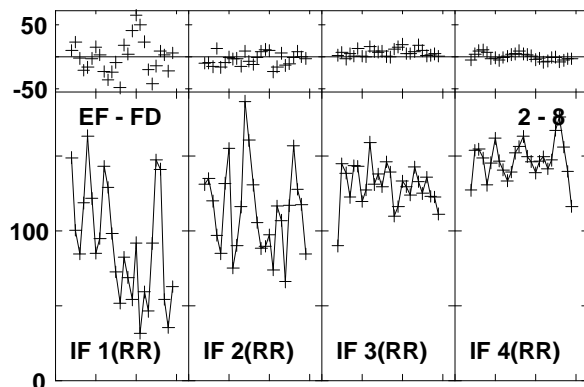
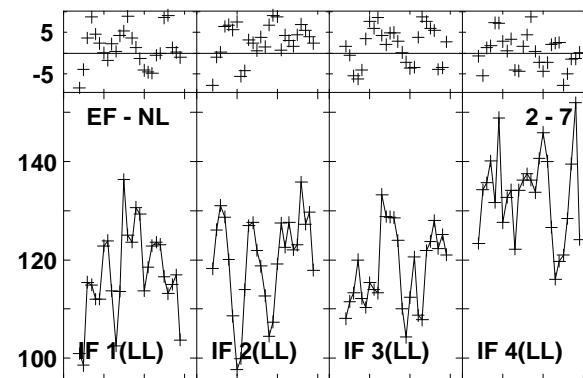
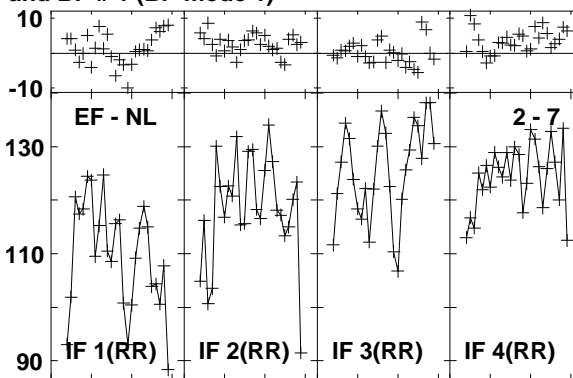
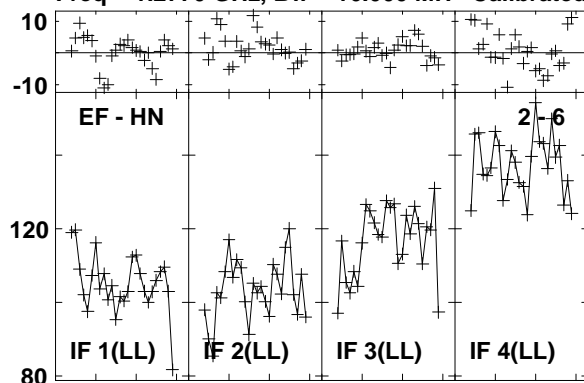

Lower frame: Milli Ampl Jy Top frame: Phas deg
Vector averaged cross-power spectrum Baseline: EF (02) - HN (06)
Timerange: 01/01:51:50 to 01/01:53:48

Plot file version1217 created 03-MAR-2016 01:15:29

J1545+5400 GN002C 1.UVDATA.1

Freq = 1.2770 GHz, Bw = 16.000 MH Calibrated with CL # 3 and BP # 1 (BP mode 1)

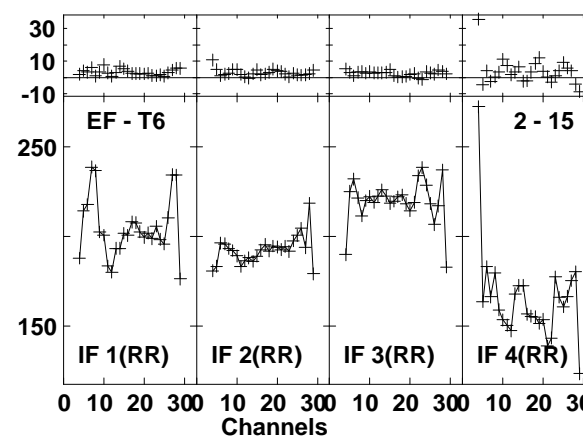
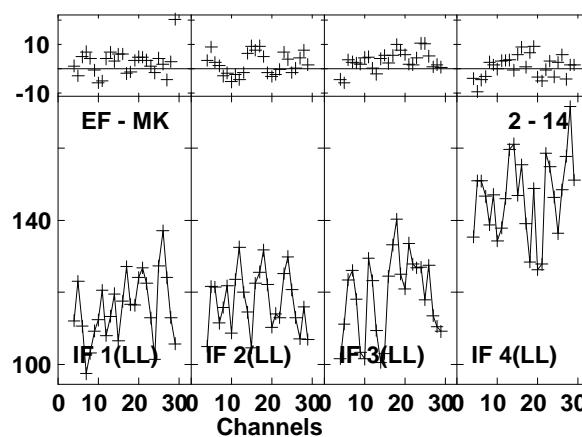
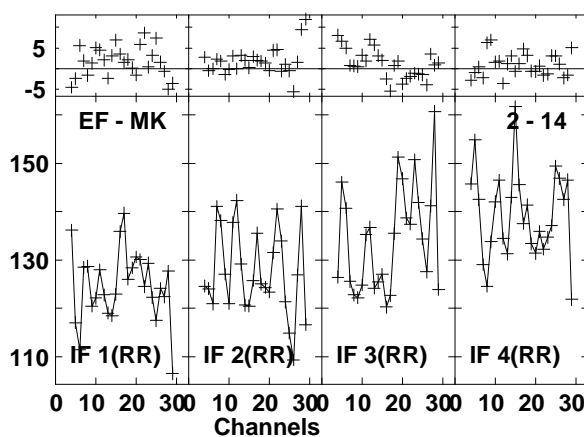
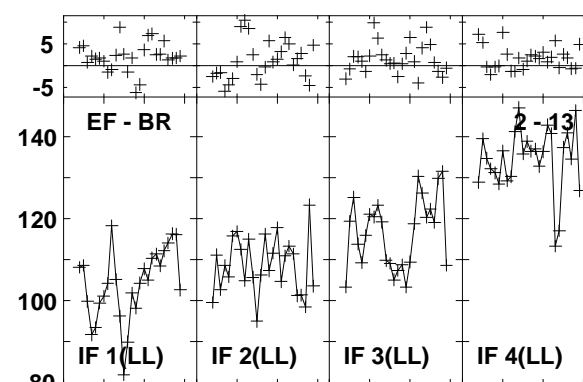
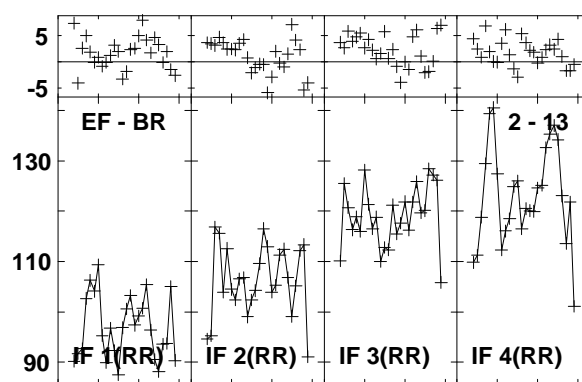
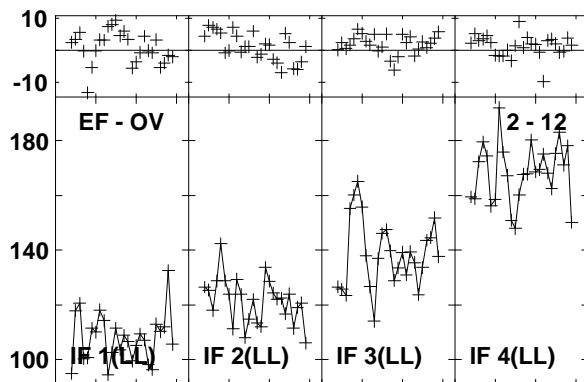
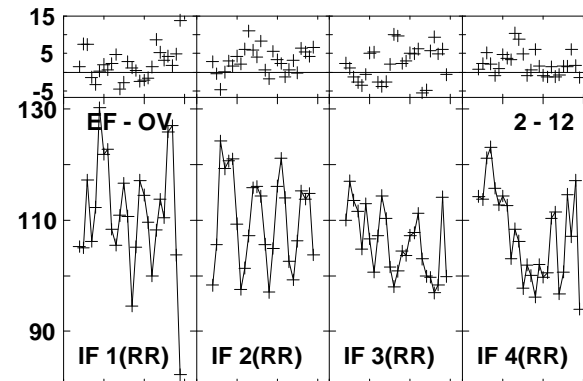
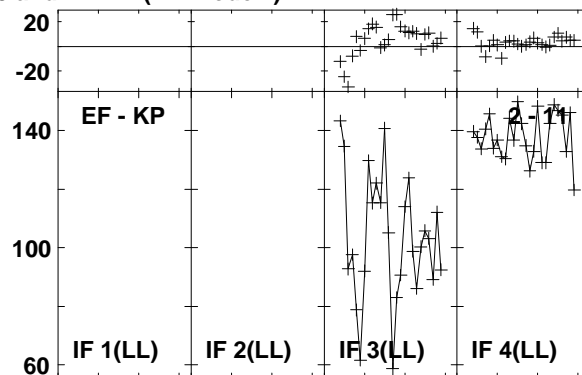
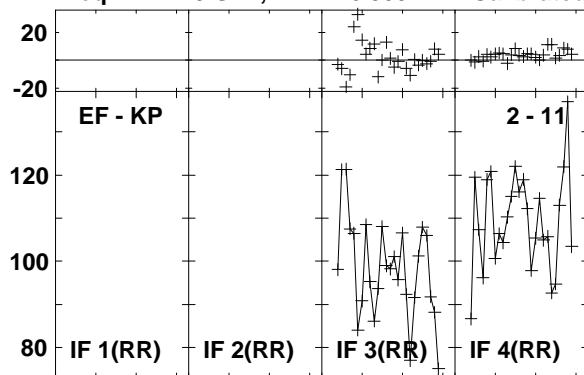

Lower frame: Milli Ampl Jy Top frame: Phas deg
Vector averaged cross-power spectrum Baseline: EF (02) - KP (11)
Timerange: 01/01:51:50 to 01/01:53:48

Plot file version1218 created 03-MAR-2016 01:15:29

J1545+5400 GN002C 1.UVDATA.1

Freq = 1.2770 GHz, Bw = 16.000 MH Calibrated with CL # 3 and BP # 1 (BP mode 1)

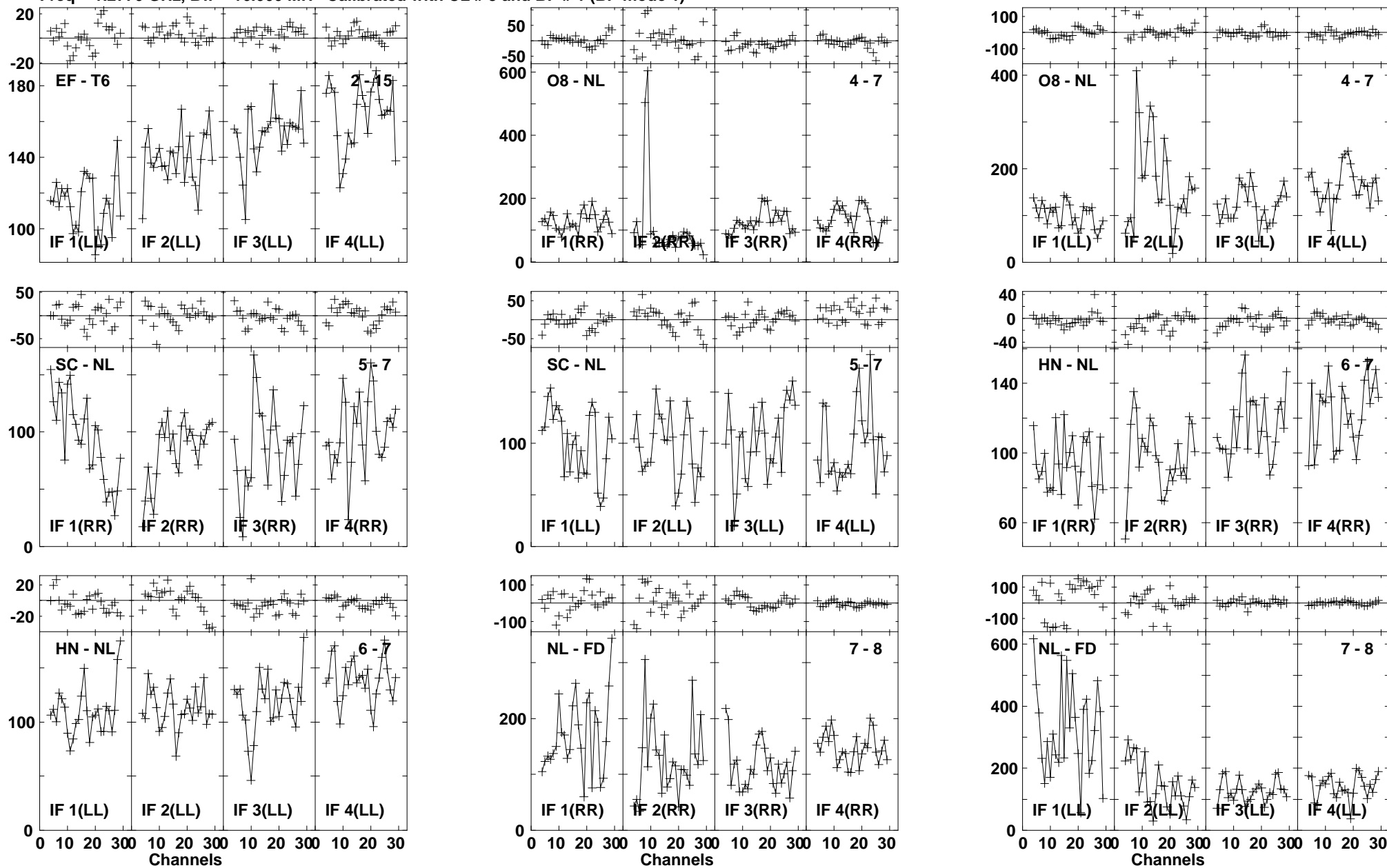

Lower frame: Milli Ampl Jy Top frame: Phas deg
Vector averaged cross-power spectrum Baseline: EF (02) - T6 (15)
Timerange: 01/01:51:50 to 01/01:53:48

Plot file version1219 created 03-MAR-2016 01:15:29

J1545+5400 GN002C 1.UVDATA.1

Freq = 1.2770 GHz, Bw = 16.000 MH Calibrated with CL # 3 and BP # 1 (BP mode 1)

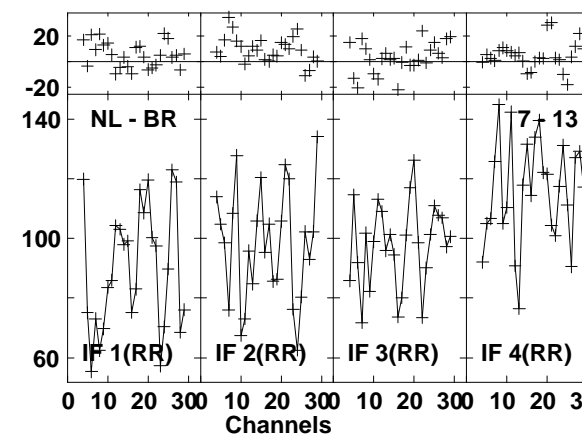
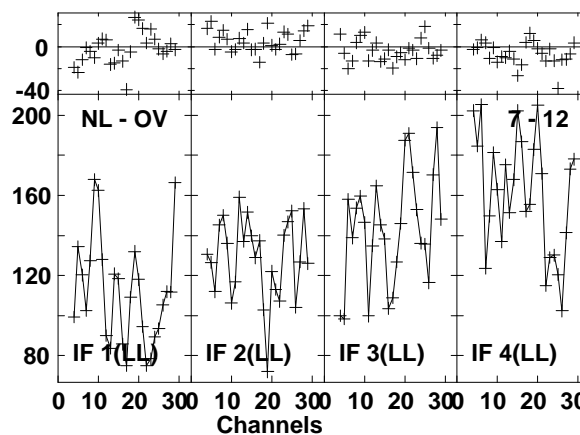
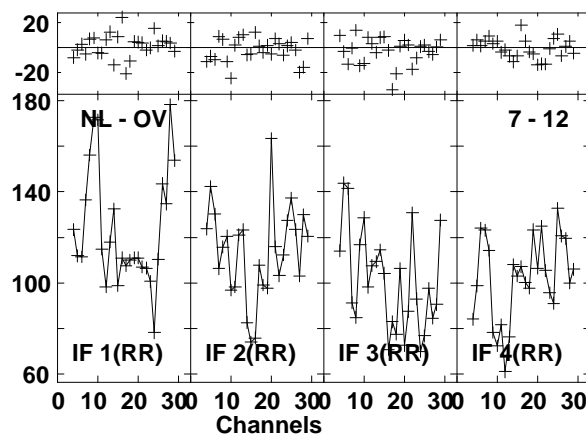
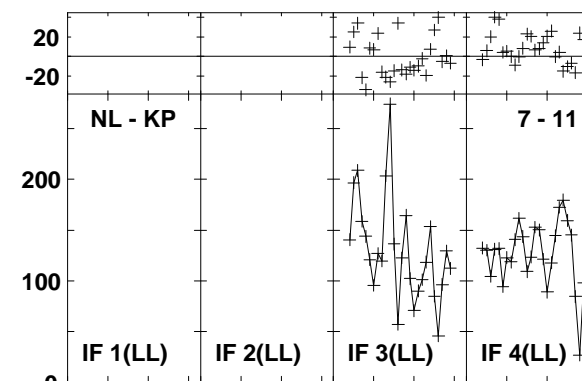
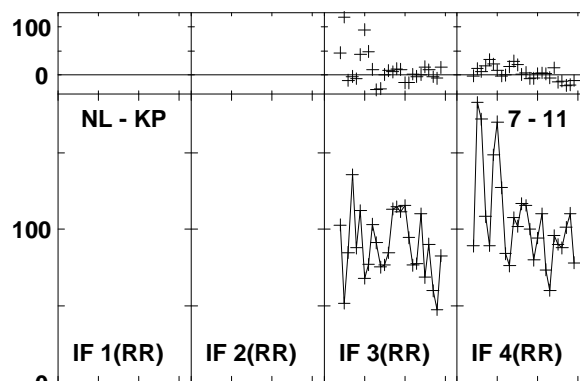
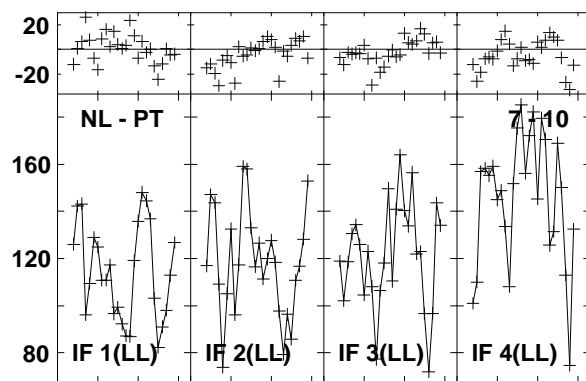
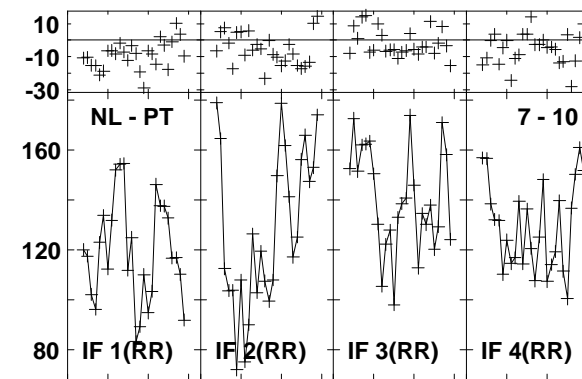
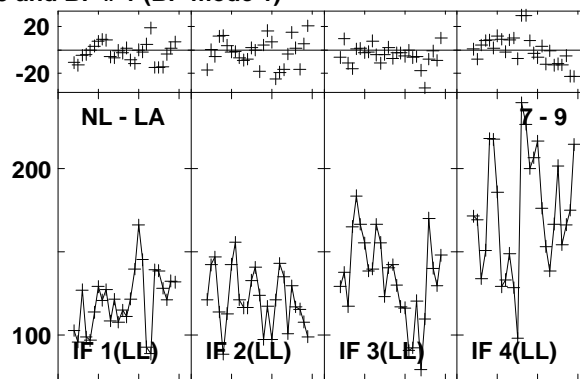
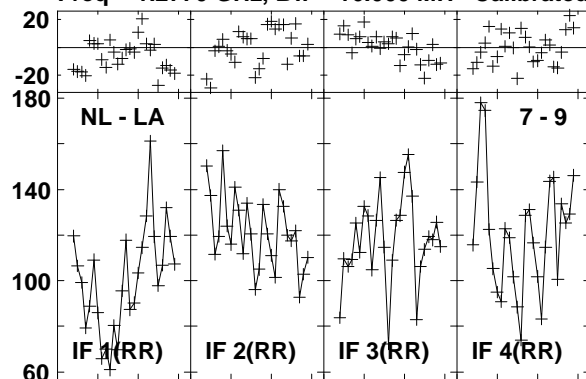

Lower frame: Milli Ampl Jy Top frame: Phas deg
Vector averaged cross-power spectrum Baseline: NL (07) - LA (09)
Timerange: 01/01:51:50 to 01/01:53:48

Plot file version1220 created 03-MAR-2016 01:15:30

J1545+5400 GN002C 1.UVDATA.1

Freq = 1.2770 GHz, Bw = 16.000 MH Calibrated with CL # 3 and BP # 1 (BP mode 1)

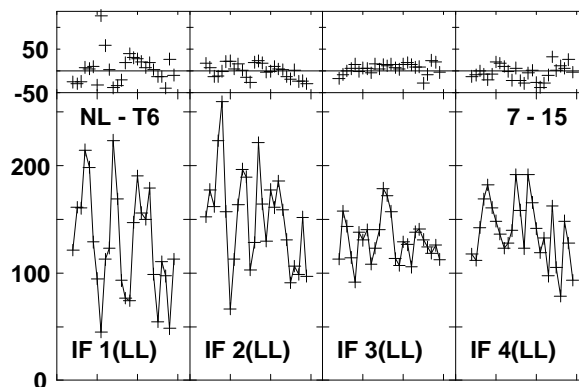
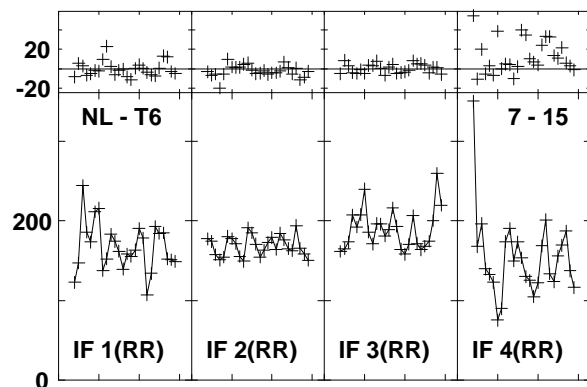
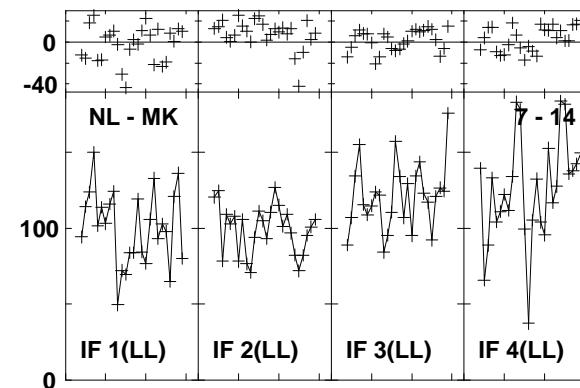
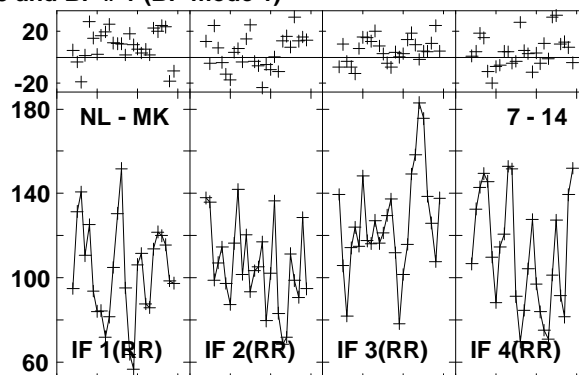
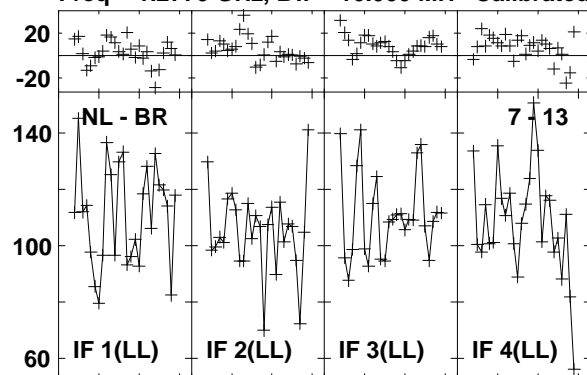

Lower frame: Milli Ampl Jy Top frame: Phas deg

Vector averaged cross-power spectrum Baseline: NL (07) - BR (13)

Timerange: 01/01:51:50 to 01/01:53:48

Plot file version1221 created 03-MAR-2016 01:15:30

4C52 GN002C 1.UVDATA.1

Freq = 1.2770 GHz, Bw = 16.000 MH Calibrated with CL # 3 and BP # 1 (BP mode 1)

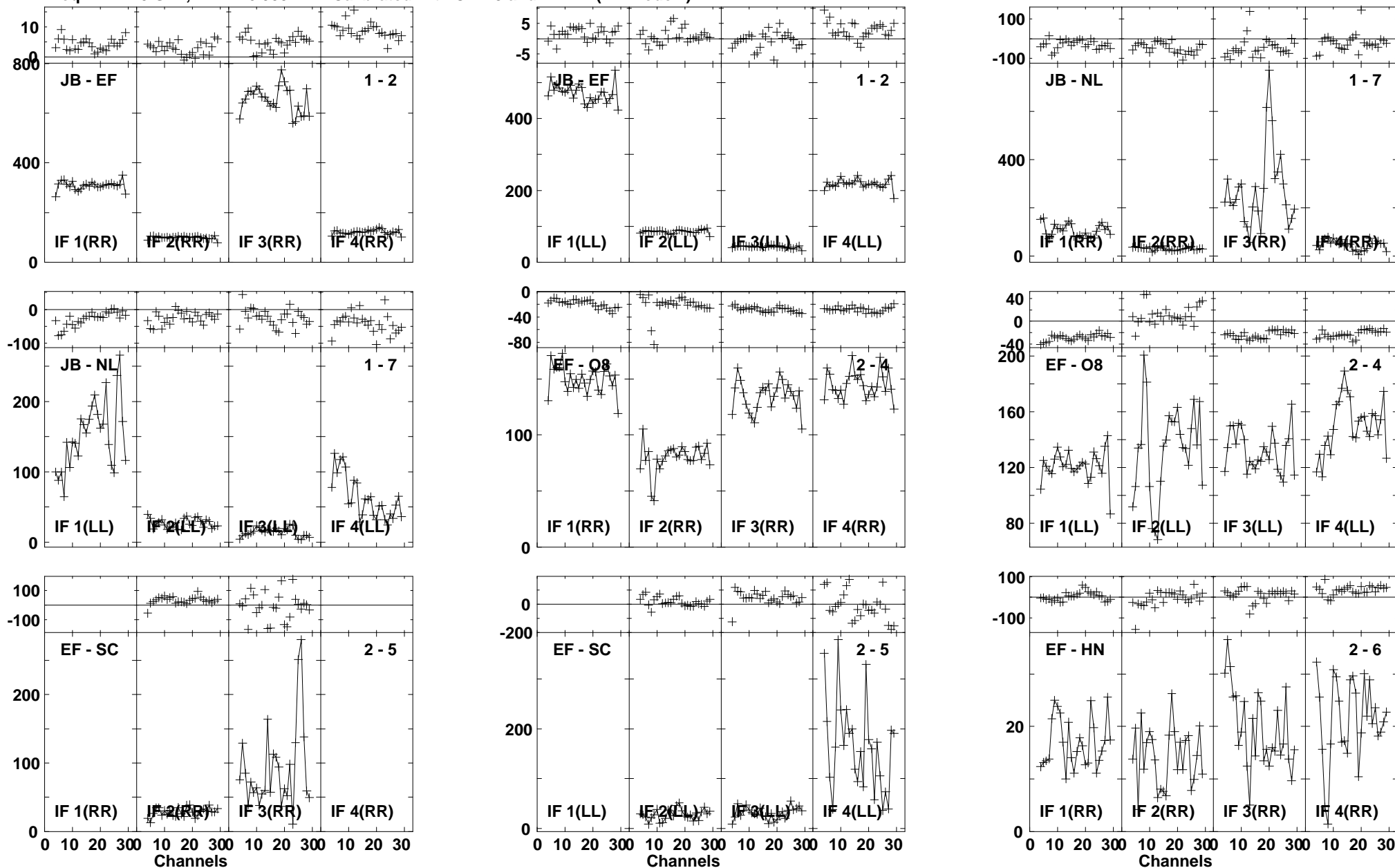

Plot file version1222 created 03-MAR-2016 01:15:30

4C52 GN002C 1.UVDATA.1

Freq = 1.2770 GHz, Bw = 16.000 MH Calibrated with CL # 3 and BP # 1 (BP mode 1)

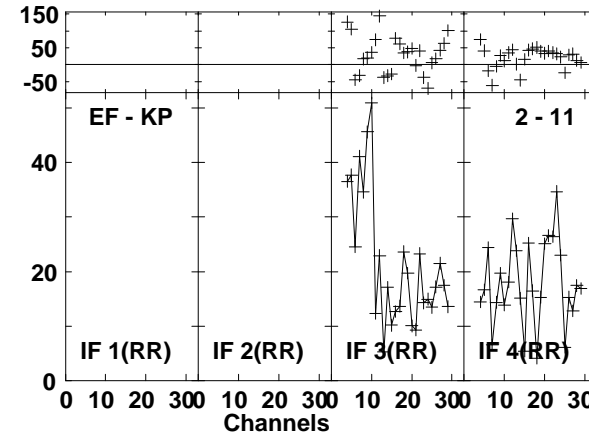
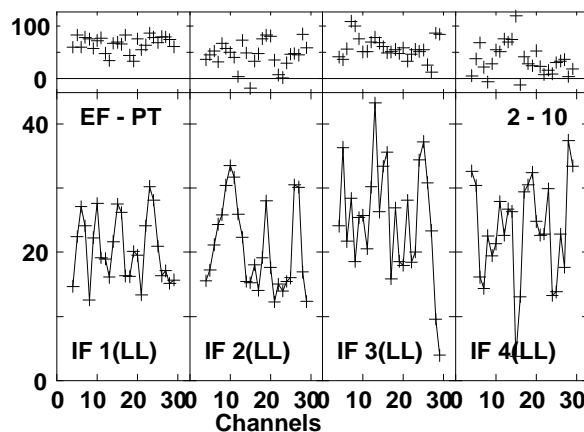
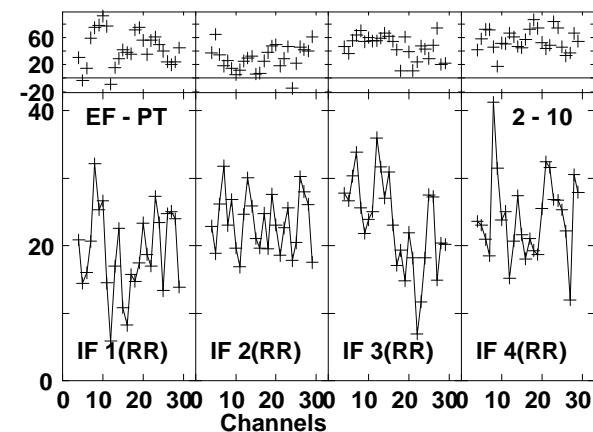
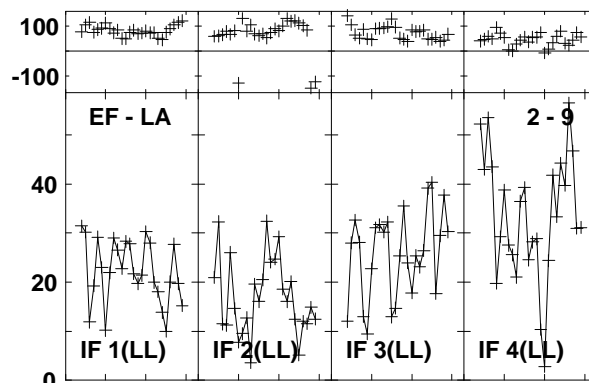
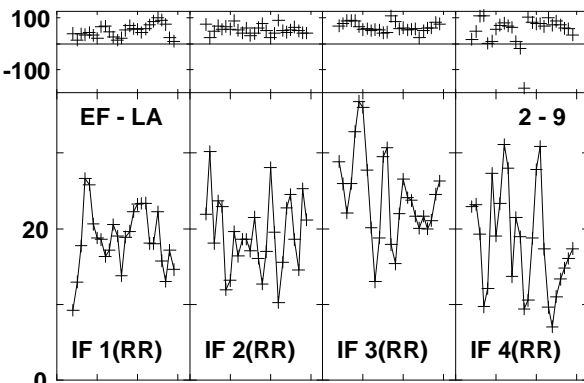
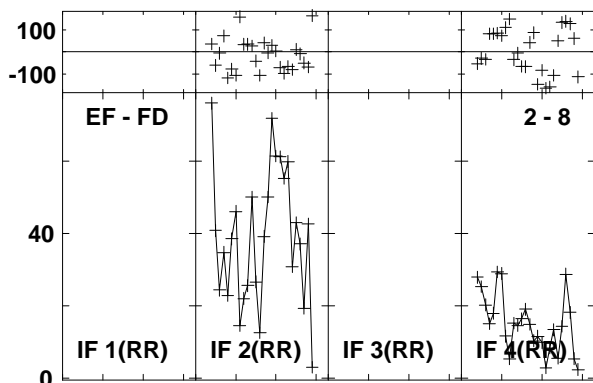
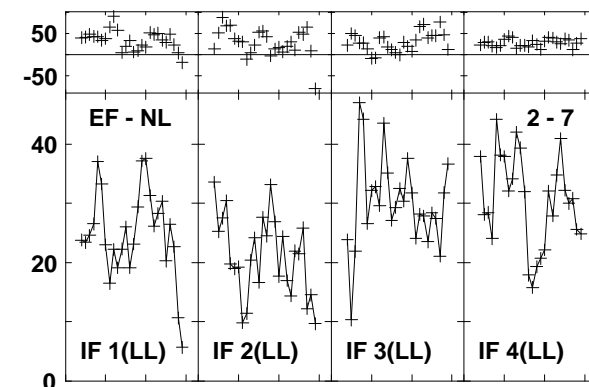
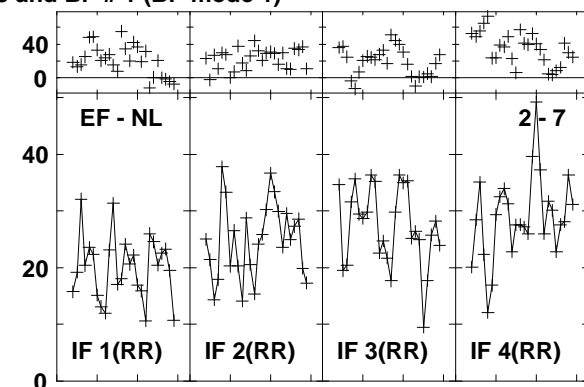
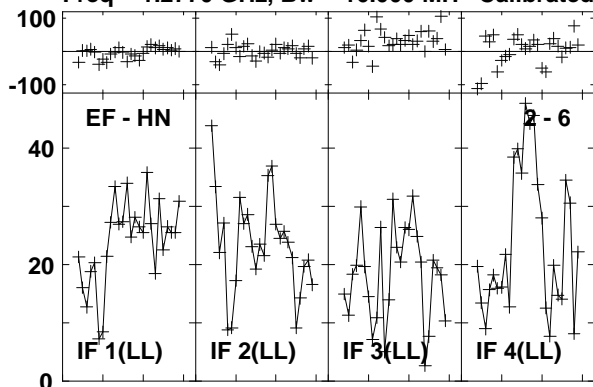

Lower frame: Milli Ampl Jy Top frame: Phas deg
Vector averaged cross-power spectrum Baseline: EF (02) - HN (06)
Timerange: 01/01:54:01 to 01/01:56:47

Plot file version1223 created 03-MAR-2016 01:15:30

4C52 GN002C 1.UVDATA.1

Freq = 1.2770 GHz, Bw = 16.000 MH Calibrated with CL # 3 and BP # 1 (BP mode 1)

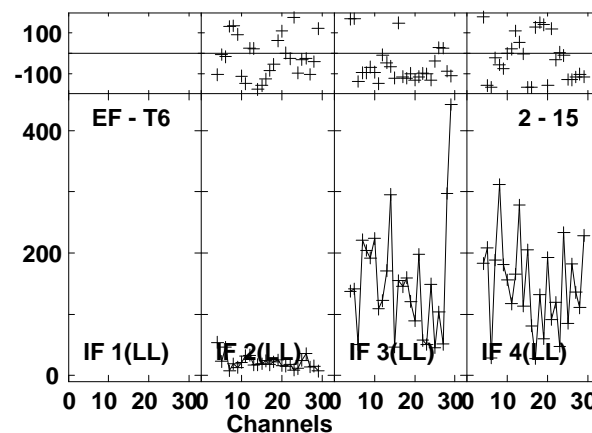
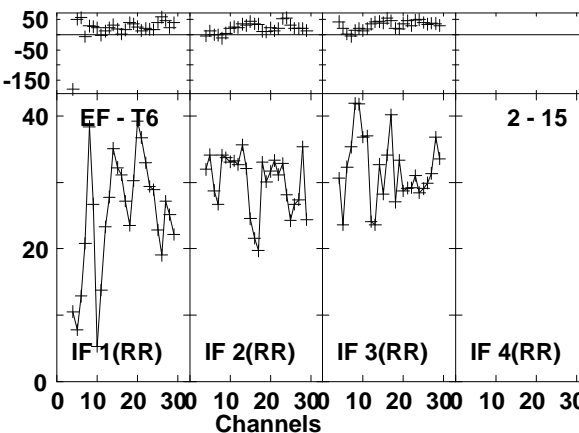
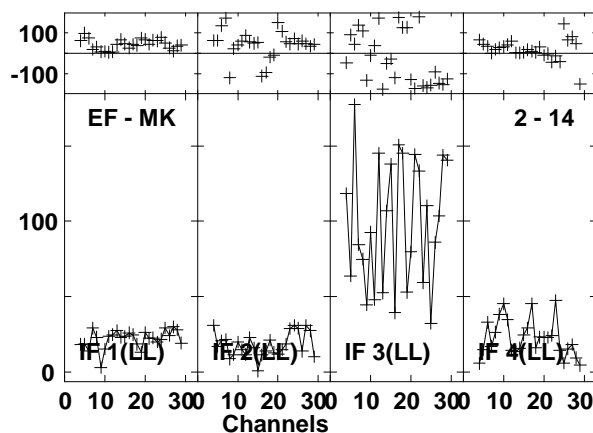
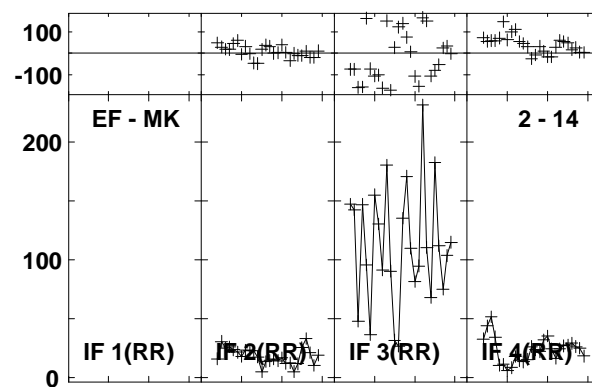
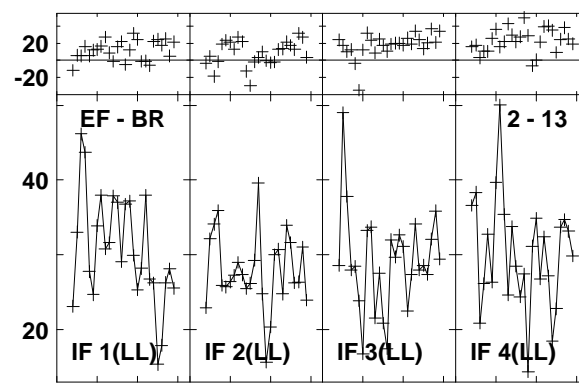
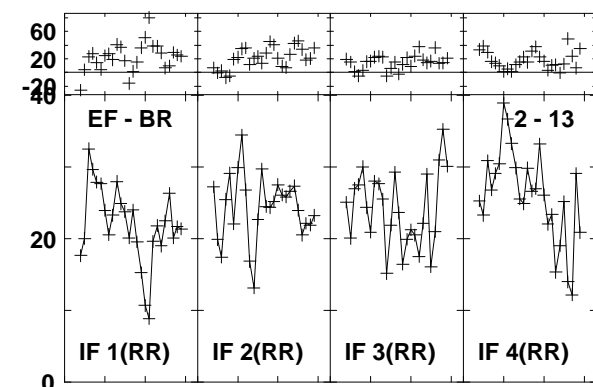
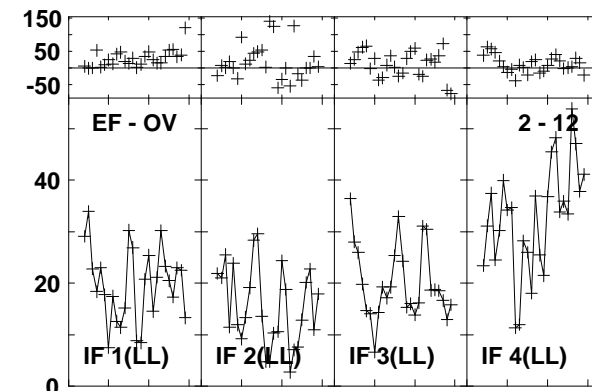
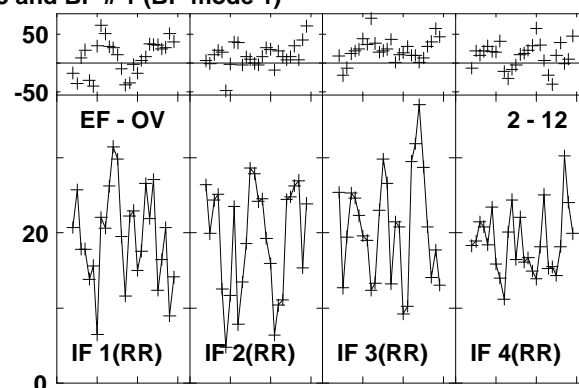
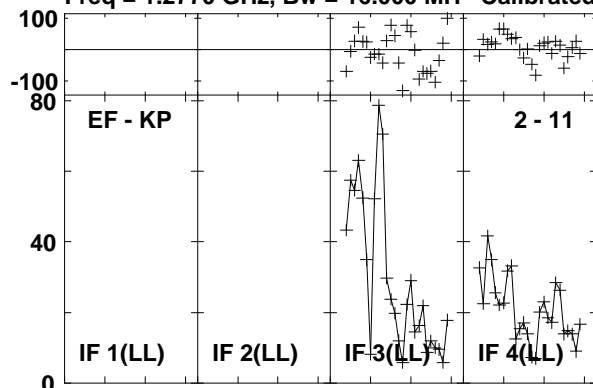

Lower frame: Milli Ampl Jy Top frame: Phas deg

Vector averaged cross-power spectrum Baseline: EF (02) - KP (11)

Timerange: 01/01:54:01 to 01/01:56:47

Plot file version1224 created 03-MAR-2016 01:15:30

4C52 GN002C 1.UVDATA.1

Freq = 1.2770 GHz, Bw = 16.000 MH Calibrated with CL # 3 and BP # 1 (BP mode 1)

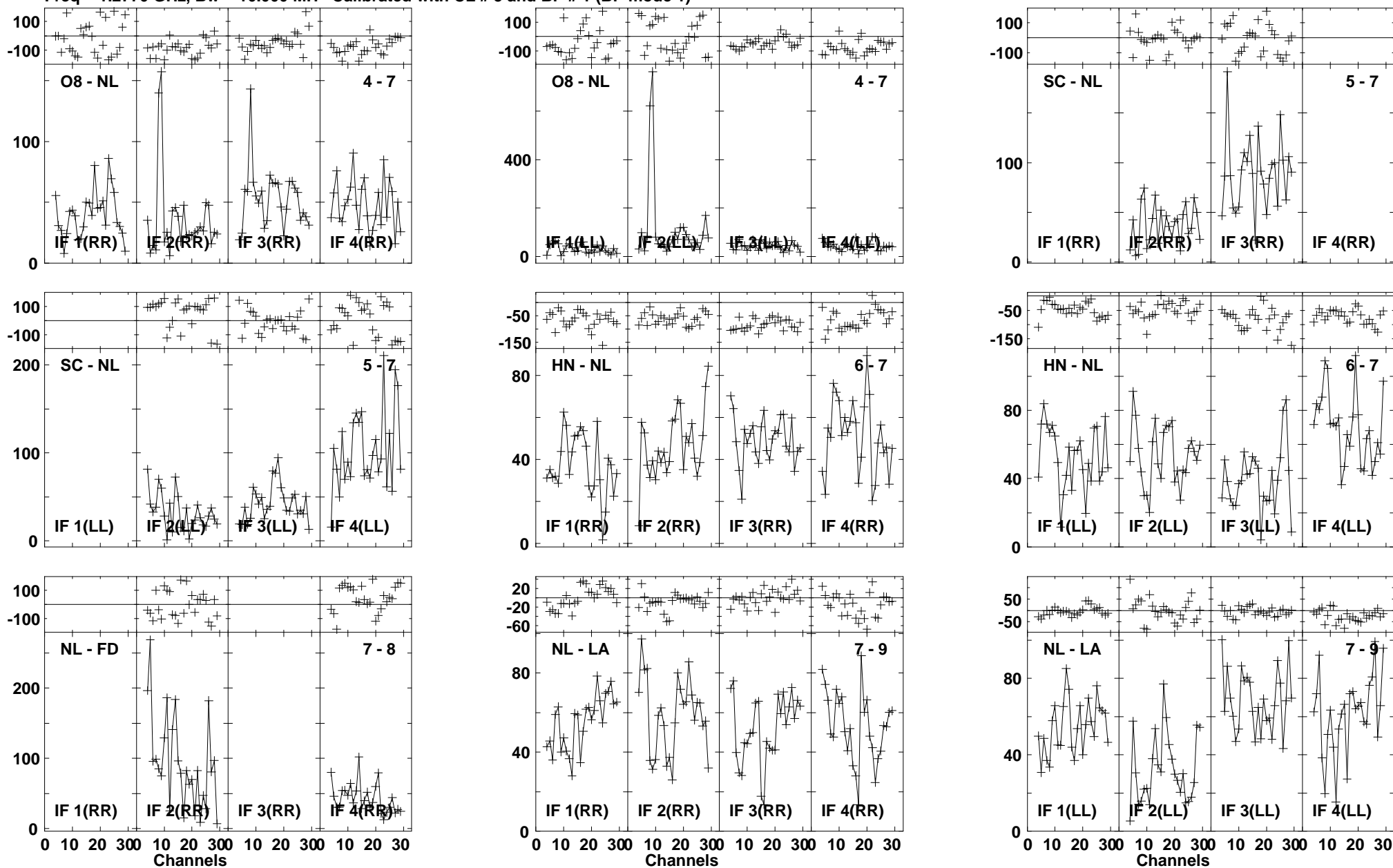

Lower frame: Milli Ampl Jy Top frame: Phas deg

Vector averaged cross-power spectrum Baseline: O8 (04) - NL (07)

Timerange: 01/01:54:01 to 01/01:56:47

Plot file version1225 created 03-MAR-2016 01:15:31

4C52 GN002C 1.UVDATA.1

Freq = 1.2770 GHz, Bw = 16.000 MH Calibrated with CL # 3 and BP # 1 (BP mode 1)

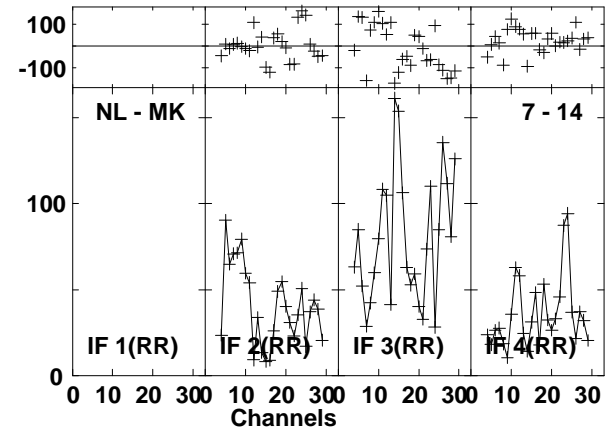
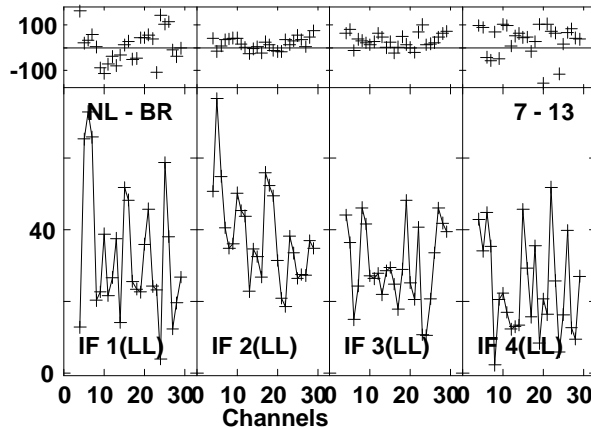
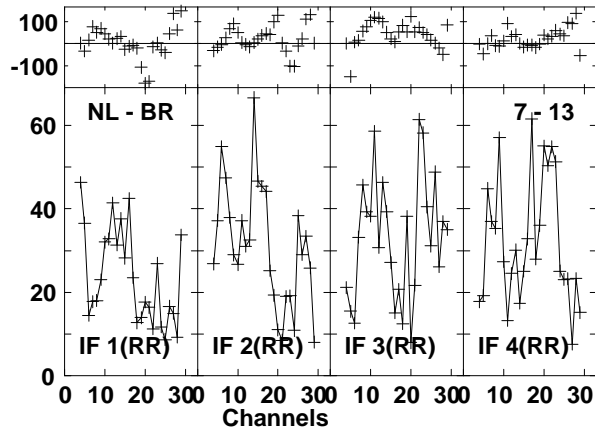
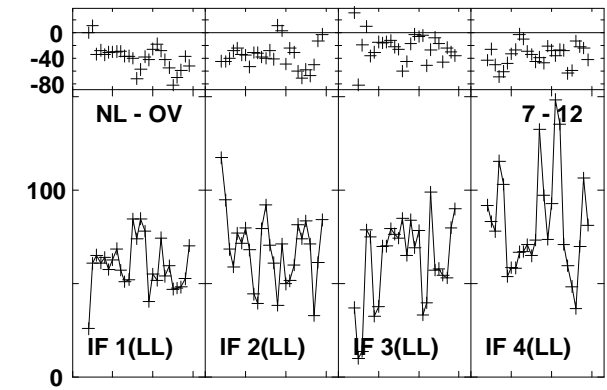
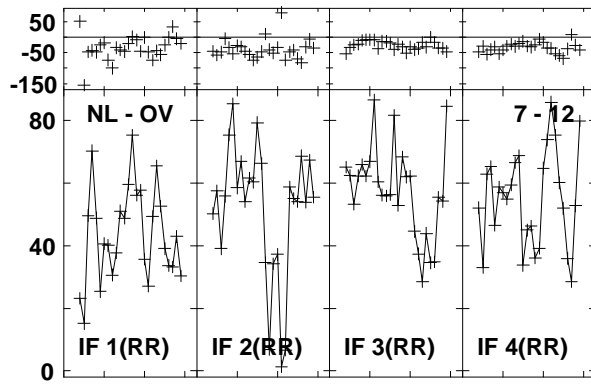
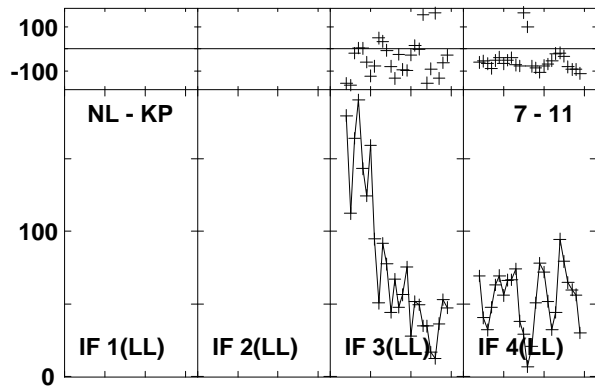
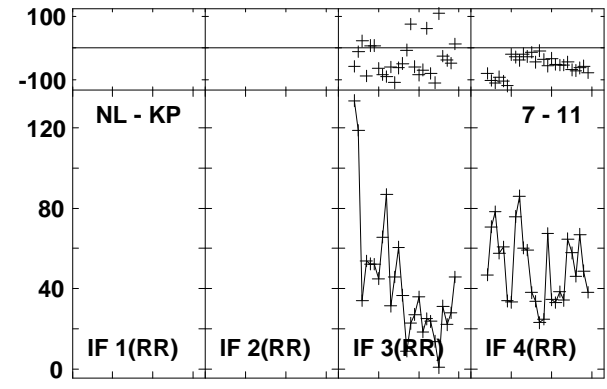
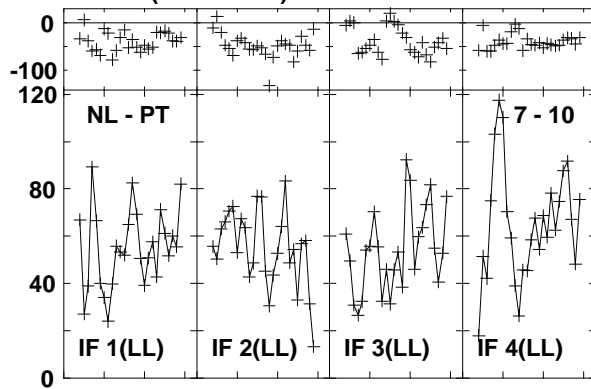
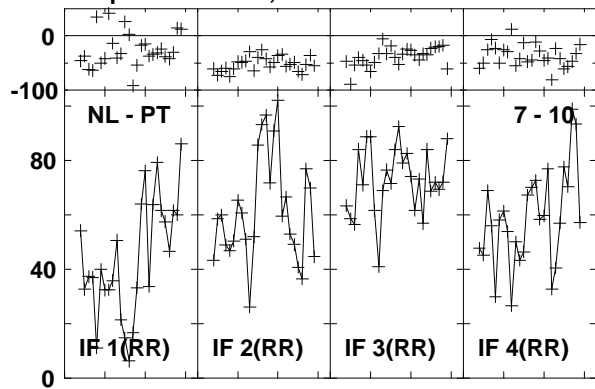

Lower frame: Milli Ampl Jy Top frame: Phas deg
Vector averaged cross-power spectrum Baseline: NL (07) - PT (10)
Timerange: 01/01:54:01 to 01/01:56:47

Plot file version1226 created 03-MAR-2016 01:15:31

4C52 GN002C 1.UVDATA.1

Freq = 1.2770 GHz, Bw = 16.000 MH Calibrated with CL # 3 and BP # 1 (BP mode 1)

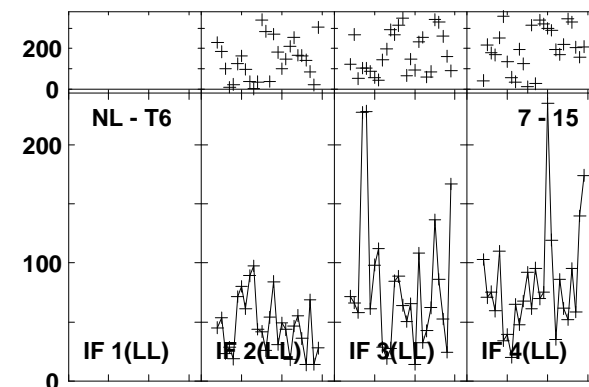
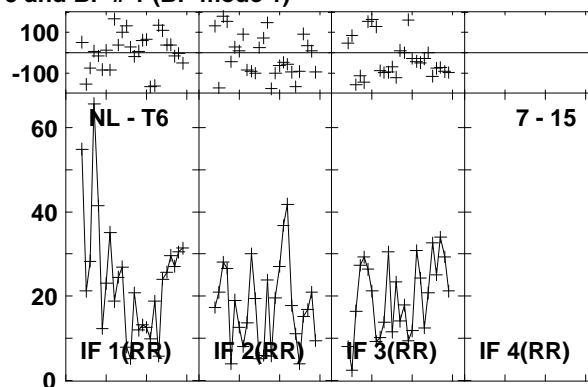
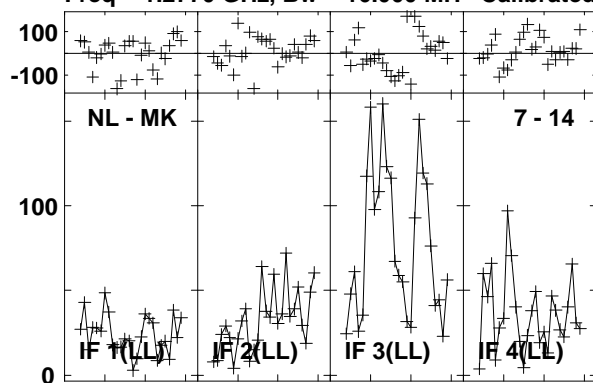

Lower frame: Milli Ampl Jy Top frame: Phas deg
Vector averaged cross-power spectrum Baseline: NL (07) - MK (14)
Timerange: 01/01:54:01 to 01/01:56:47

Plot file version1227 created 03-MAR-2016 01:15:31

J1545+5400 GN002C 1.UVDATA.1

Freq = 1.2770 GHz, Bw = 16.000 MH Calibrated with CL # 3 and BP # 1 (BP mode 1)

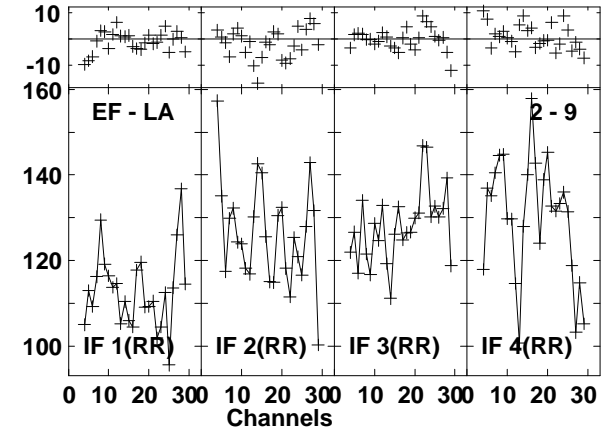
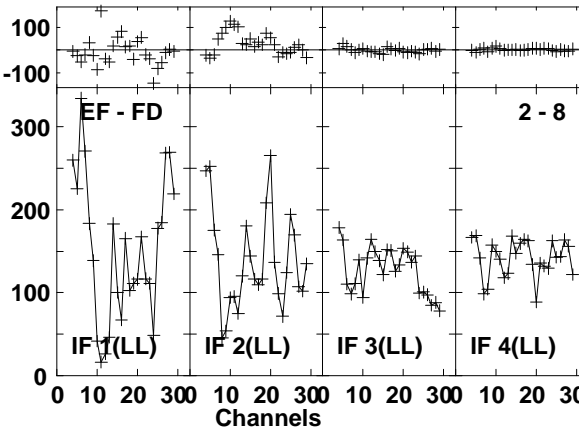
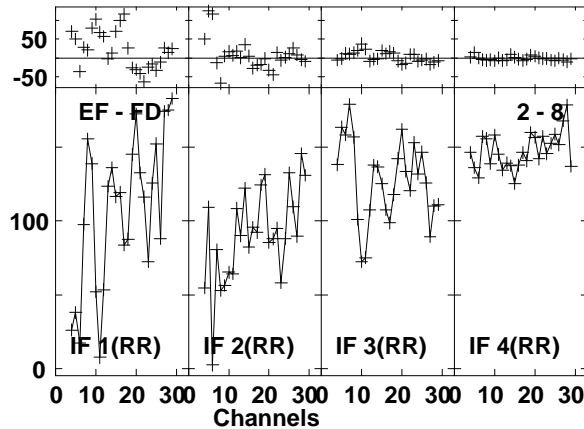
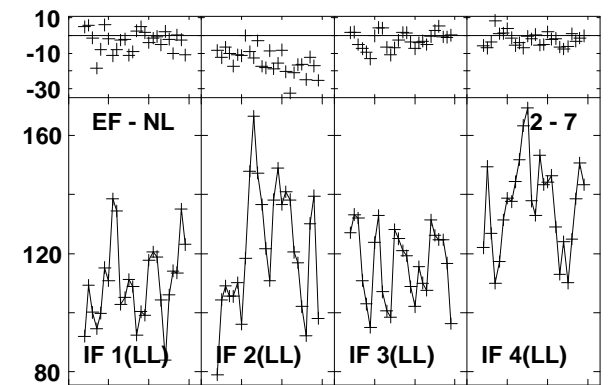
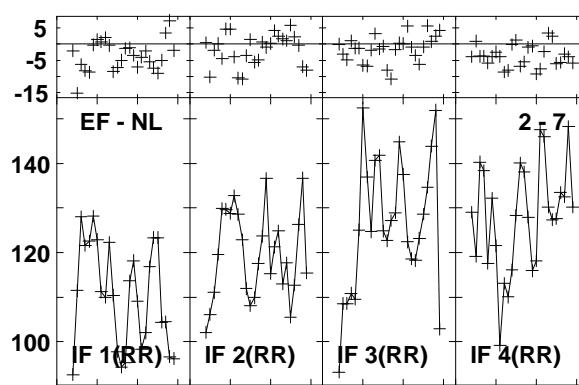
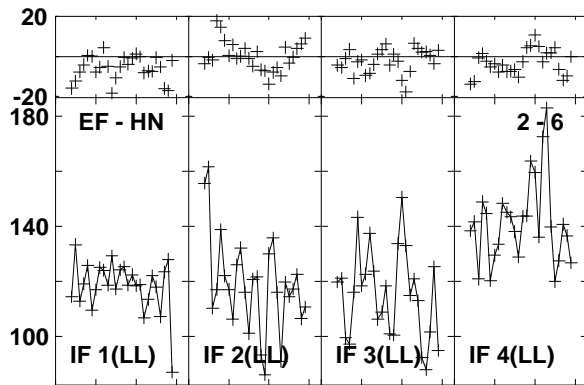
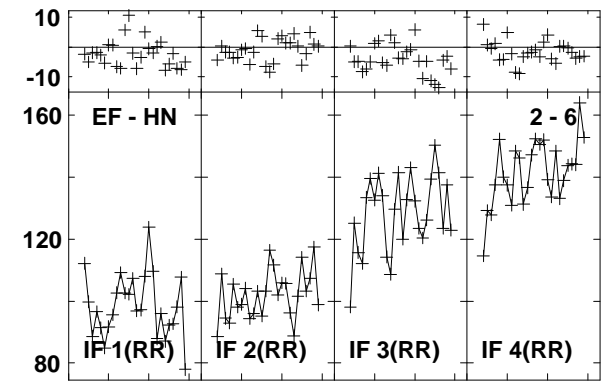
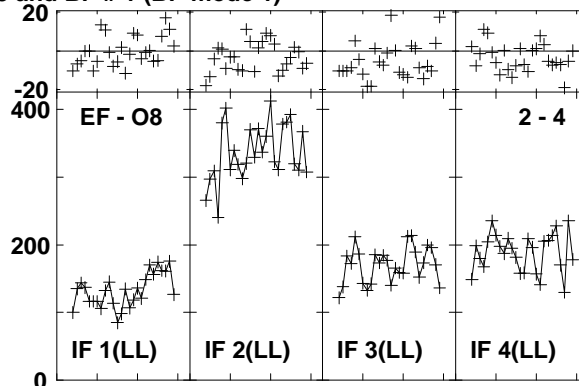
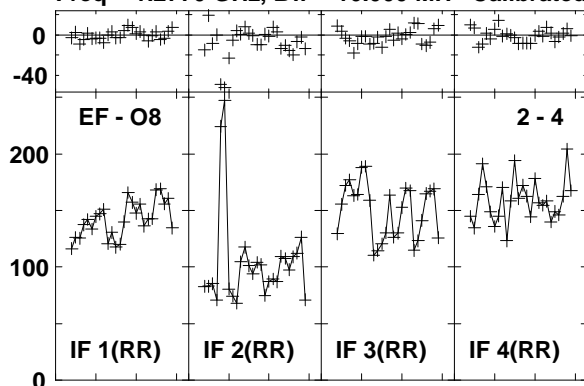

Lower frame: Milli Ampl Jy Top frame: Phas deg

Vector averaged cross-power spectrum Baseline: EF (02) - O8 (04)

Timerange: 01/01:57:40 to 01/01:58:38

Plot file version1228 created 03-MAR-2016 01:15:31

J1545+5400 GN002C 1.UVDATA.1

Freq = 1.2770 GHz, Bw = 16.000 MH Calibrated with CL # 3 and BP # 1 (BP mode 1)

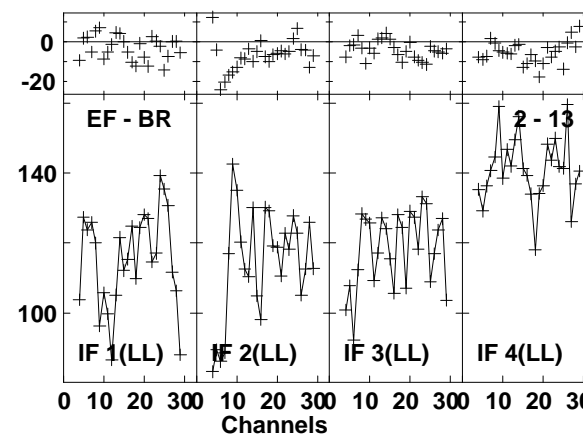
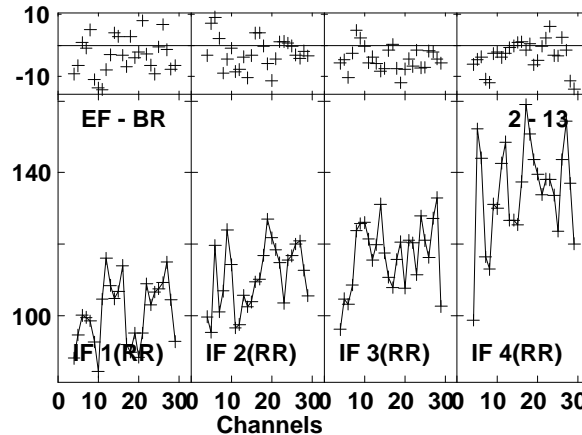
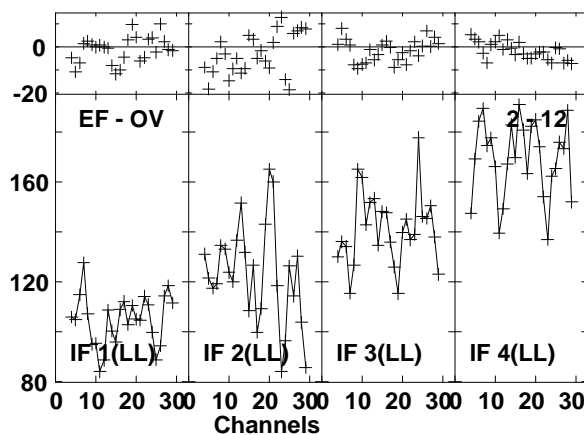
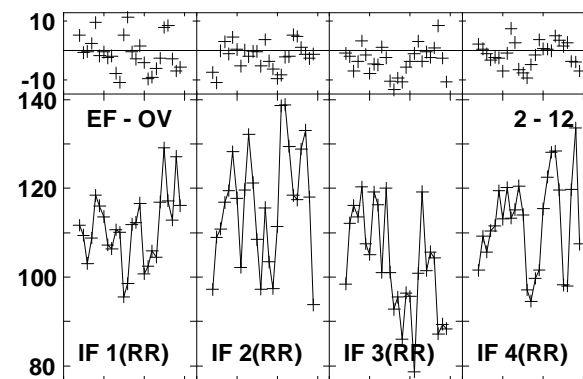
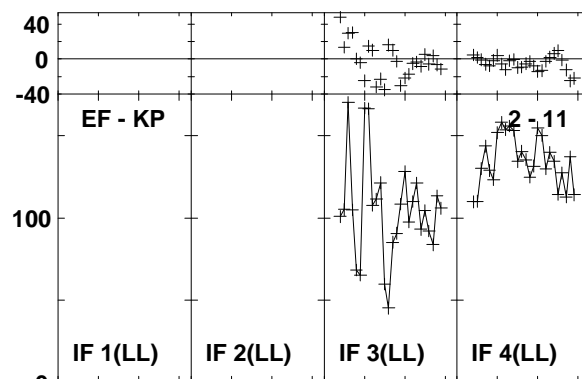
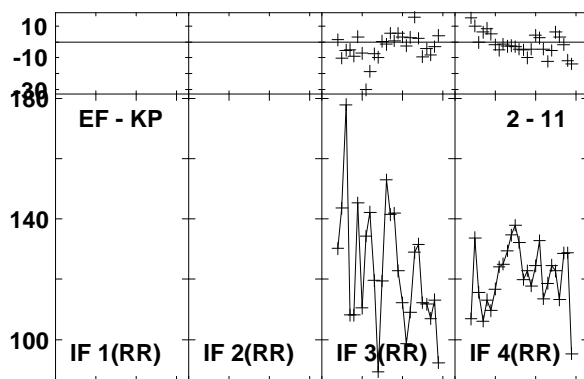
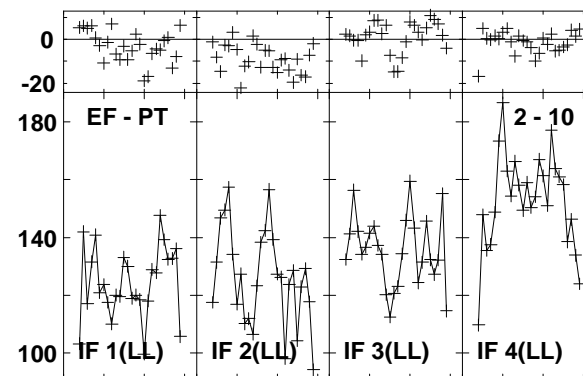
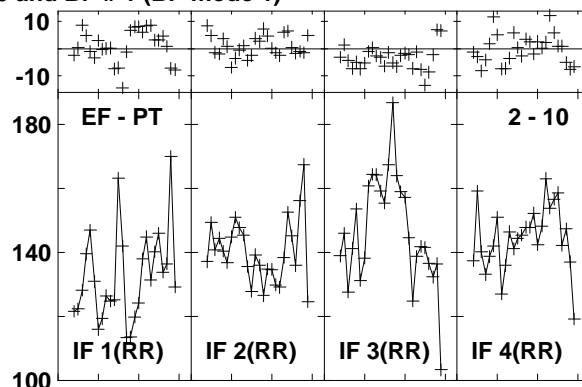
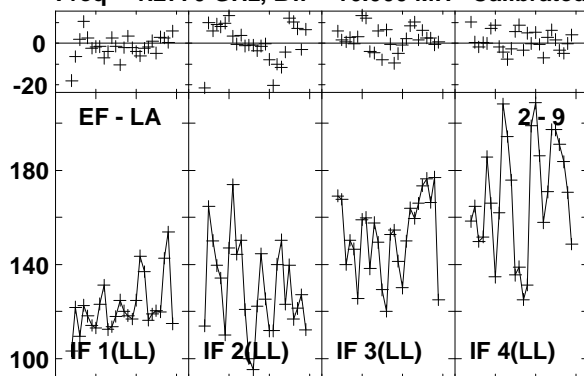

Lower frame: Milli Ampl Jy Top frame: Phas deg
Vector averaged cross-power spectrum Baseline: EF (02) - LA (09)
Timerange: 01/01:57:40 to 01/01:58:38

Plot file version1229 created 03-MAR-2016 01:15:31

J1545+5400 GN002C 1.UVDATA.1

Freq = 1.2770 GHz, Bw = 16.000 MH Calibrated with CL # 3 and BP # 1 (BP mode 1)

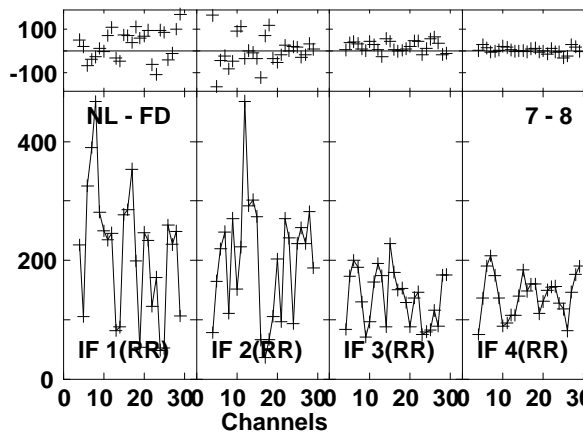
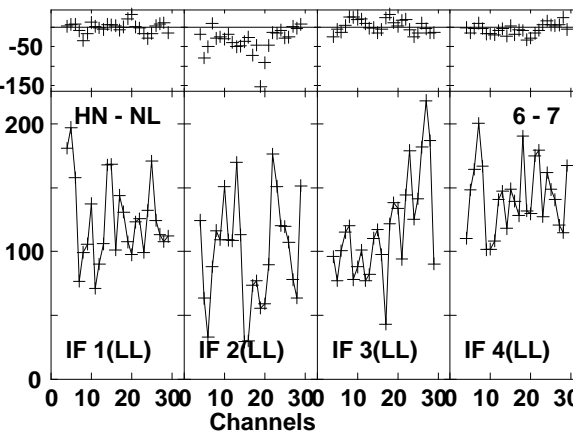
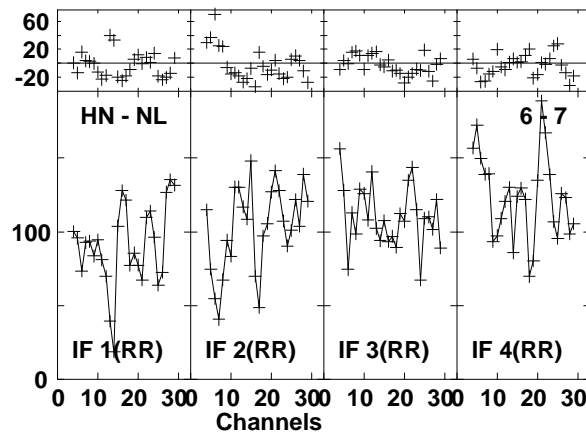
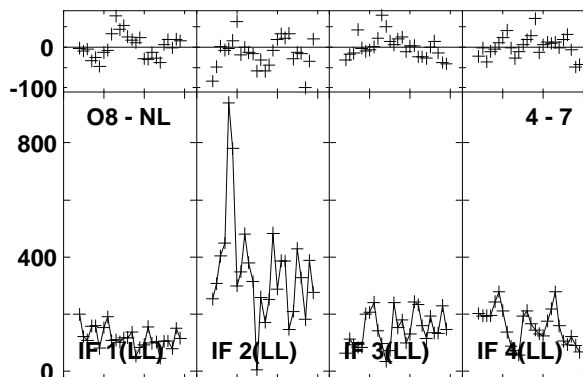
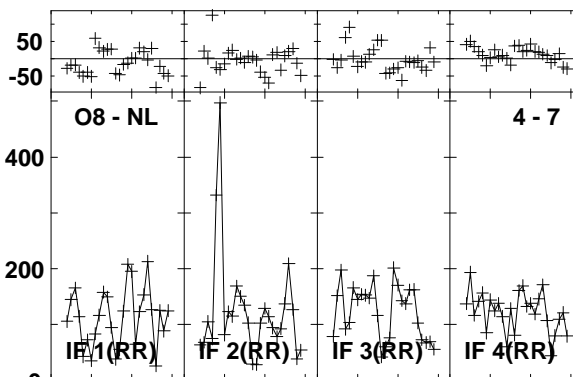
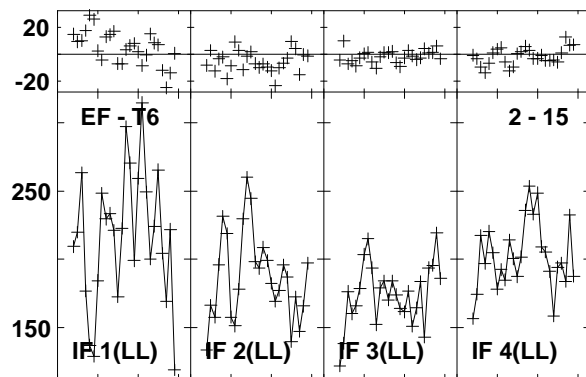
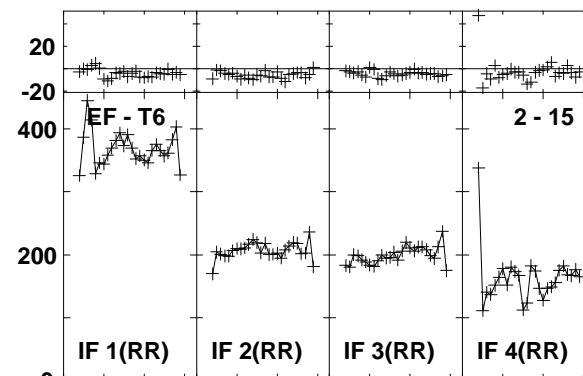
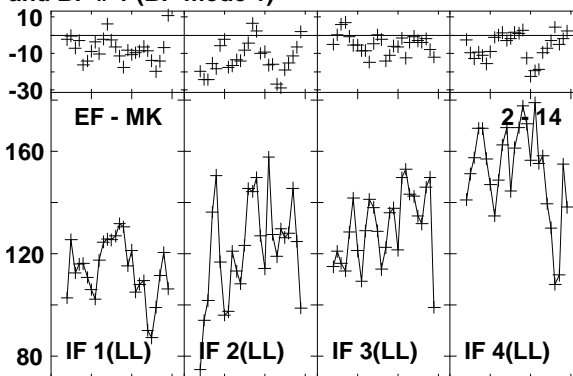
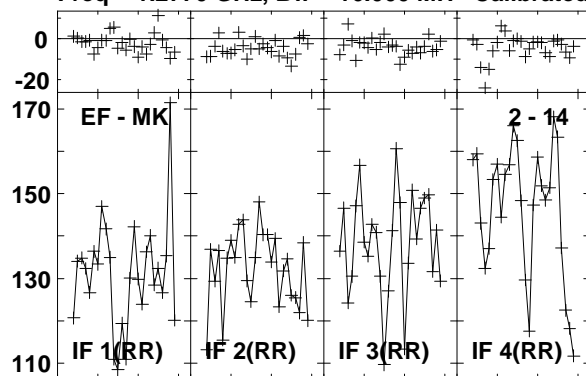

Lower frame: Milli Ampl Jy Top frame: Phas deg
Vector averaged cross-power spectrum Baseline: EF (02) - MK (14)
Timerange: 01/01:57:40 to 01/01:58:38

Plot file version1230 created 03-MAR-2016 01:15:31

J1545+5400 GN002C 1.UVDATA.1

Freq = 1.2770 GHz, Bw = 16.000 MH Calibrated with CL # 3 and BP # 1 (BP mode 1)

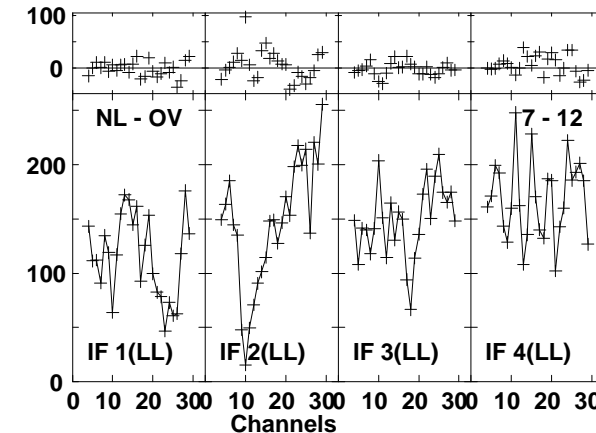
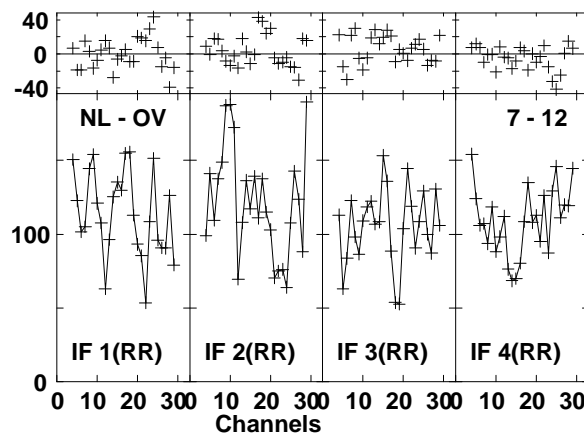
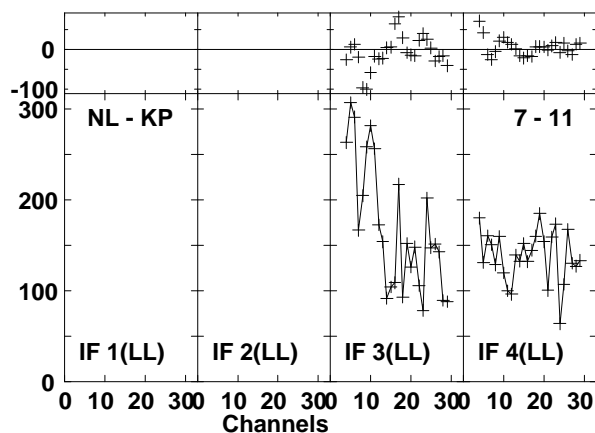
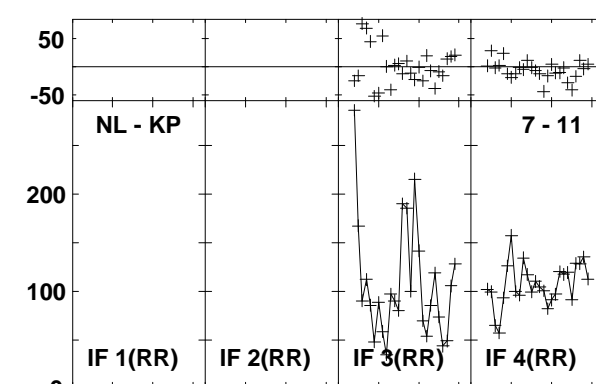
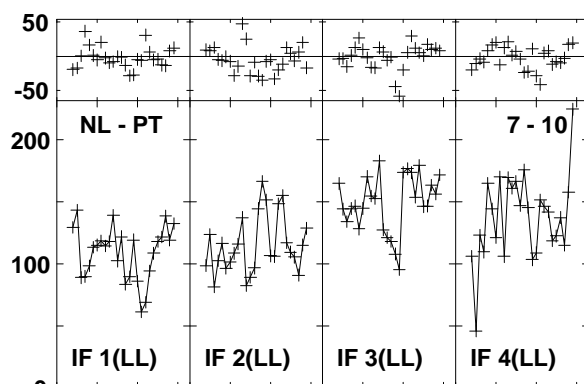
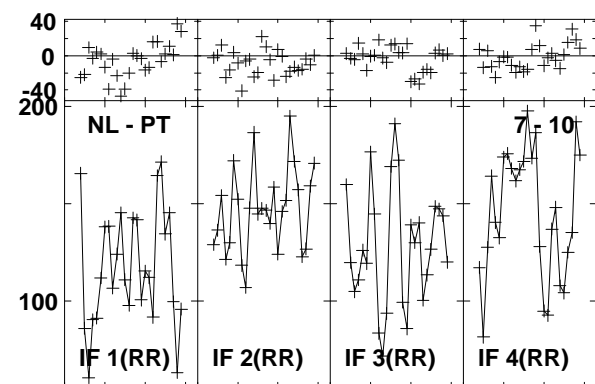
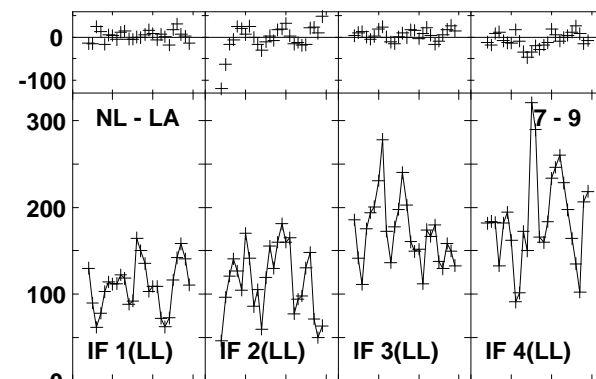
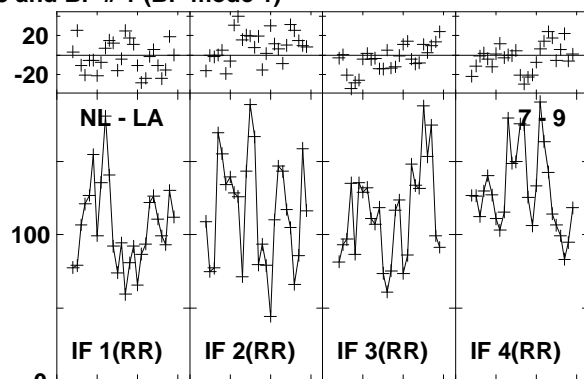
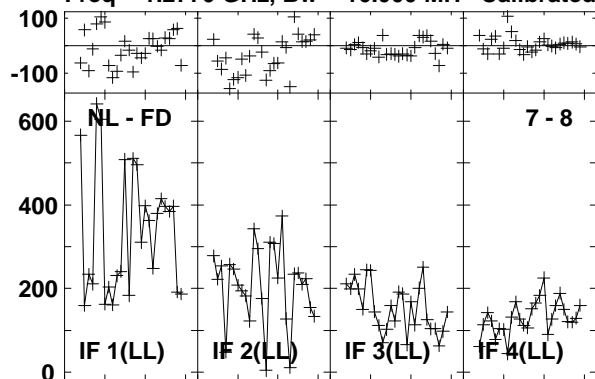

Lower frame: Milli Ampl Jy Top frame: Phas deg
Vector averaged cross-power spectrum Baseline: NL (07) - FD (08)
Timerange: 01/01:57:40 to 01/01:58:38

Plot file version1231 created 03-MAR-2016 01:15:32
 J1545+5400 GN002C 1.UVDATA.1
 Freq = 1.2770 GHz, Bw = 16.000 MH Calibrated with CL # 3 and BP # 1 (BP mode 1)

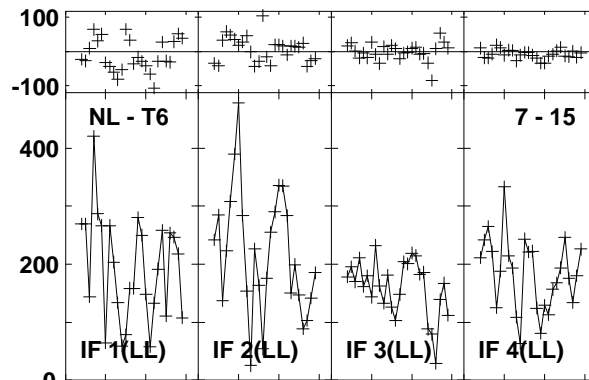
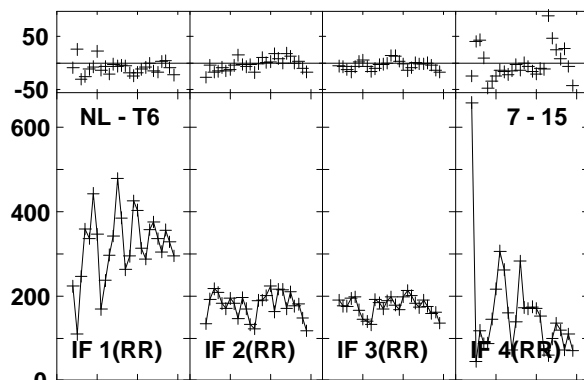
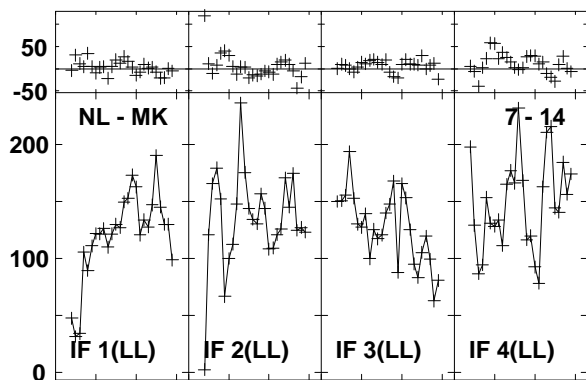
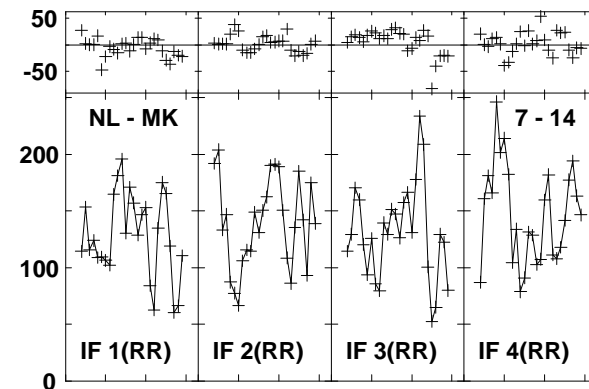
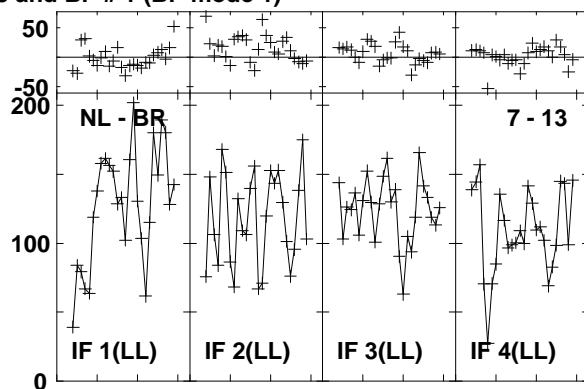
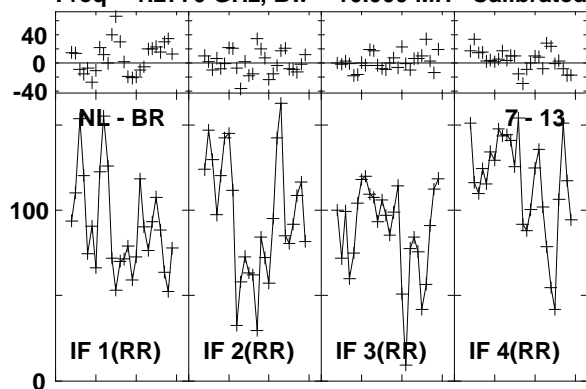

Lower frame: Milli Ampl Jy Top frame: Phas deg
 Vector averaged cross-power spectrum Baseline: NL (07) - BR (13)
 Timerange: 01/01:57:40 to 01/01:58:38

Plot file version1232 created 03-MAR-2016 01:15:32

4C52 GN002C 1.UVDATA.1

Freq = 1.2770 GHz, Bw = 16.000 MH Calibrated with CL # 3 and BP # 1 (BP mode 1)

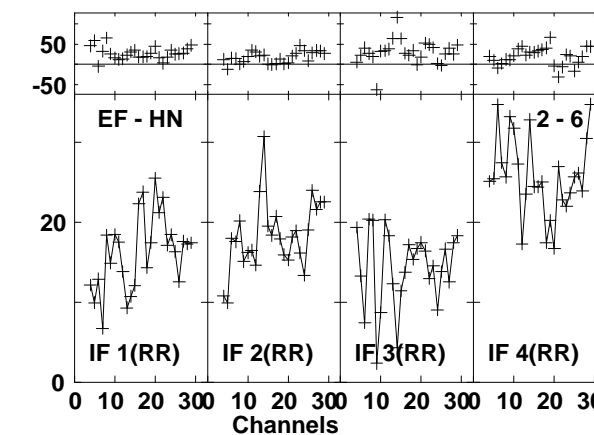
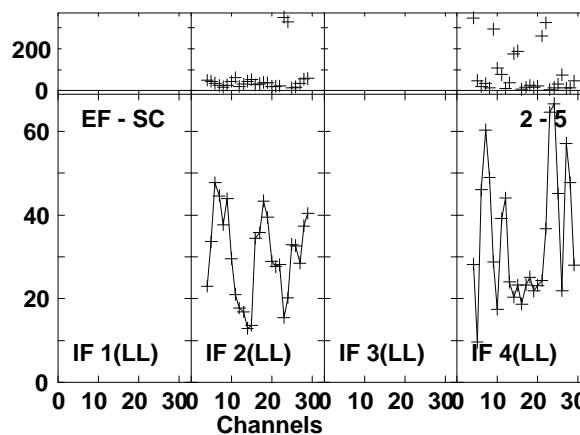
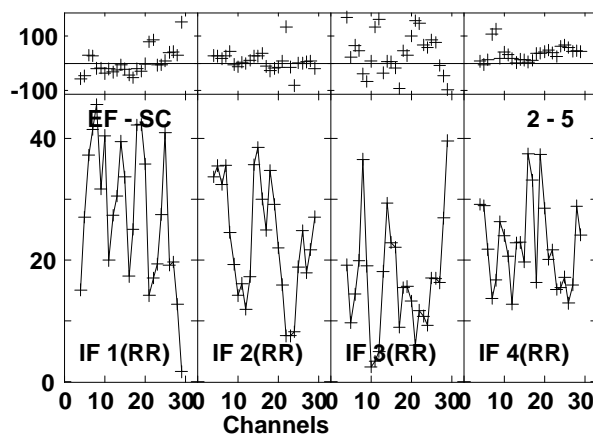
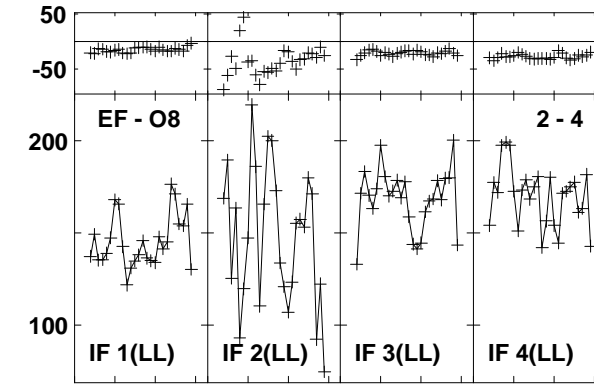
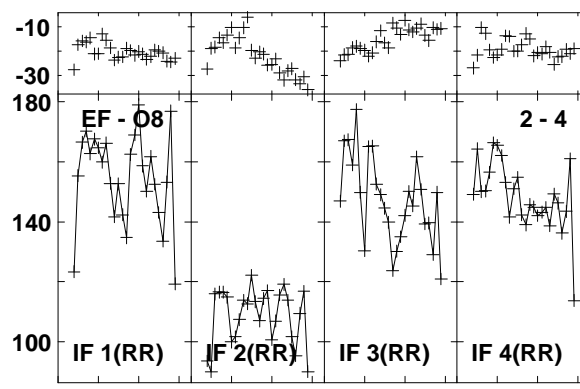
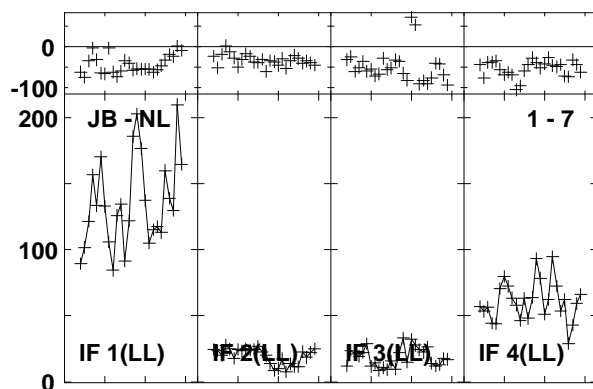
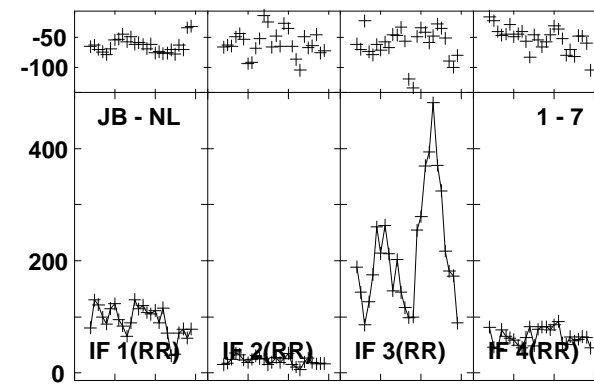
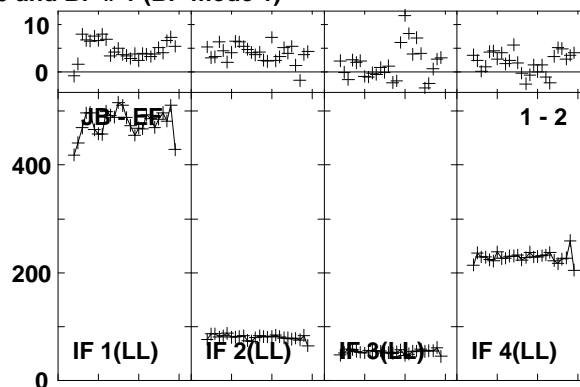
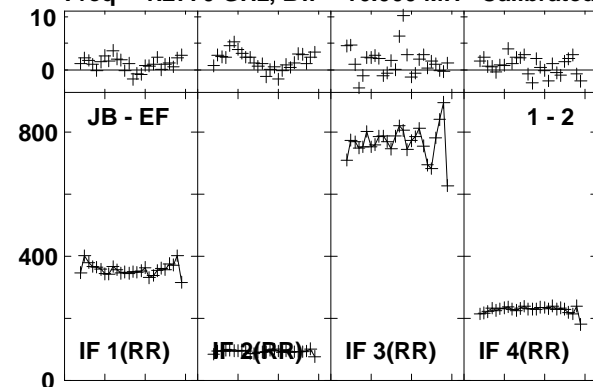

Lower frame: Milli Ampl Jy Top frame: Phas deg
Vector averaged cross-power spectrum Baseline: JB (01) - EF (02)
Timerange: 01/01:58:40 to 01/02:02:08

Plot file version1233 created 03-MAR-2016 01:15:32
 4C52 GN002C 1.UVDATA.1

Freq = 1.2770 GHz, Bw = 16.000 MH Calibrated with CL # 3 and BP # 1 (BP mode 1)

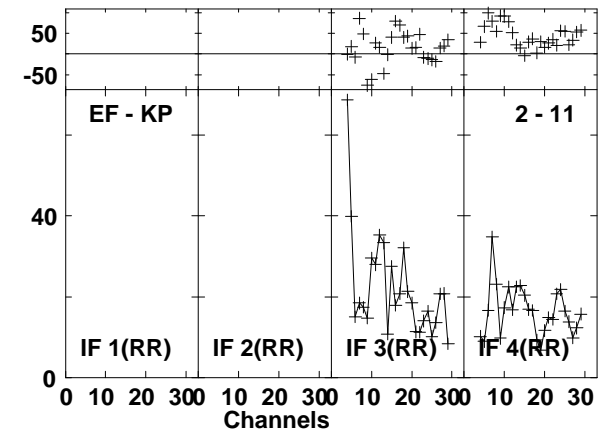
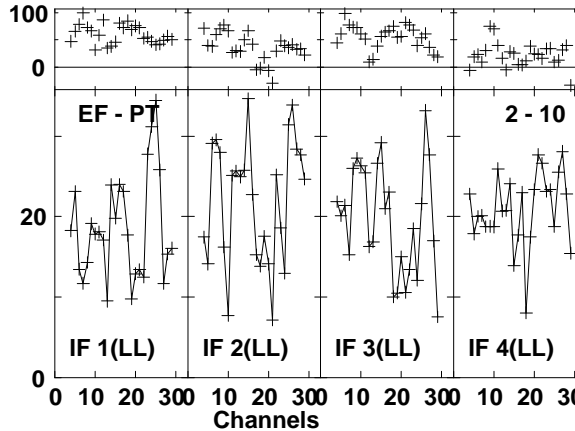
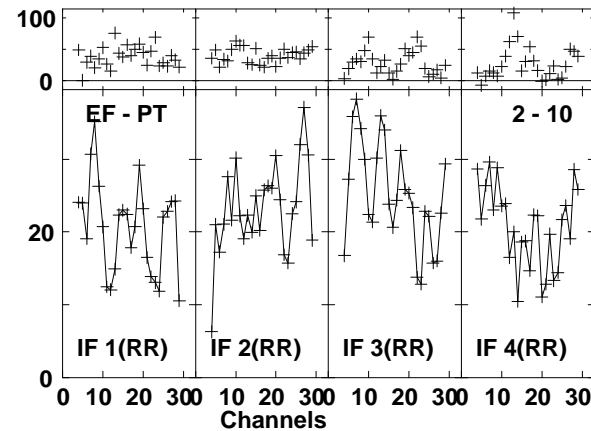
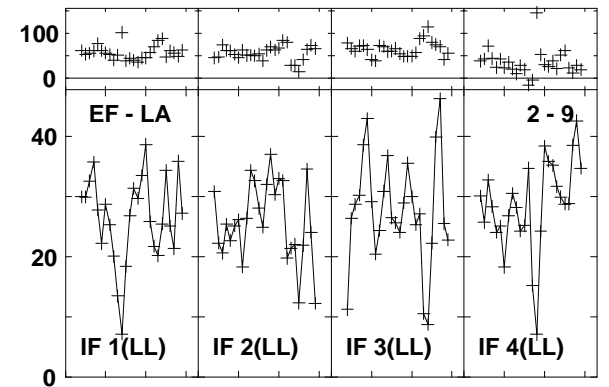
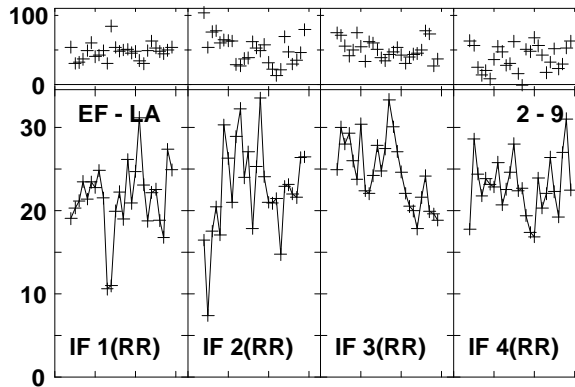
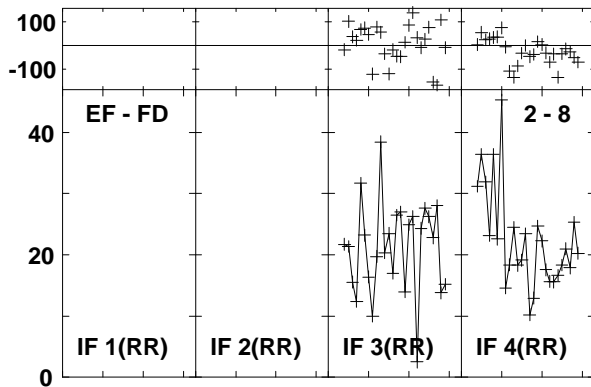
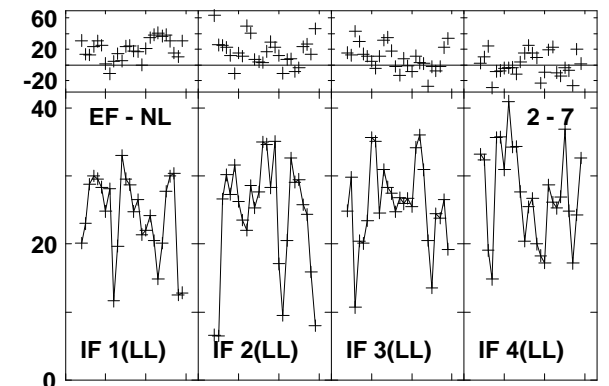
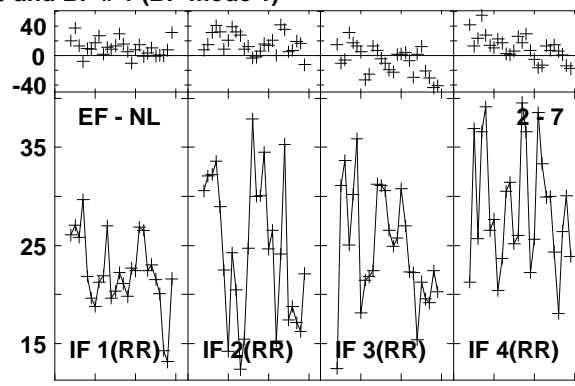
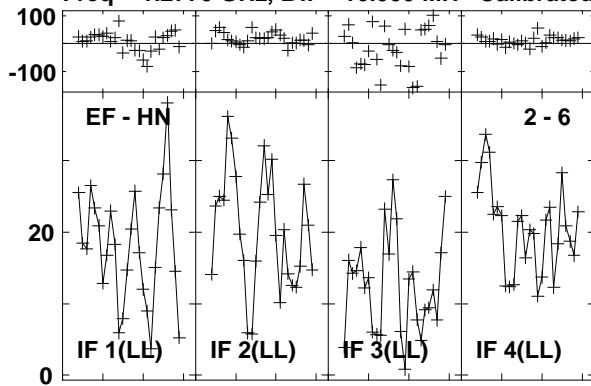

Lower frame: Milli Ampl Jy Top frame: Phas deg
 Vector averaged cross-power spectrum Baseline: EF (02) - HN (06)
 Timerange: 01/01:58:40 to 01/02:02:08

Plot file version1234 created 03-MAR-2016 01:15:32
 4C52 GN002C 1.UVDATA.1

Freq = 1.2770 GHz, Bw = 16.000 MH Calibrated with CL # 3 and BP # 1 (BP mode 1)

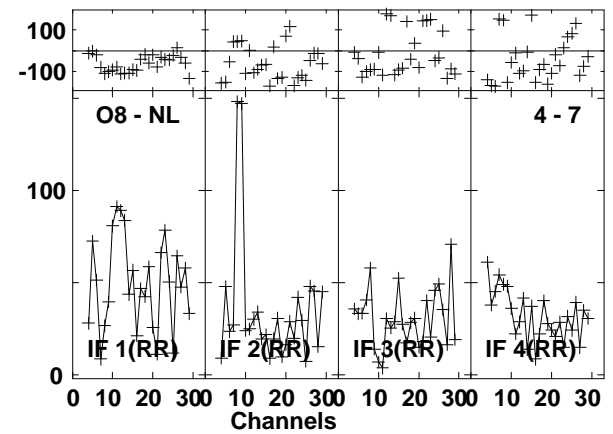
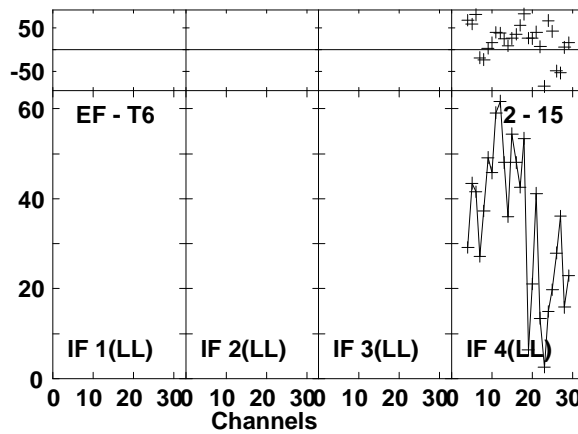
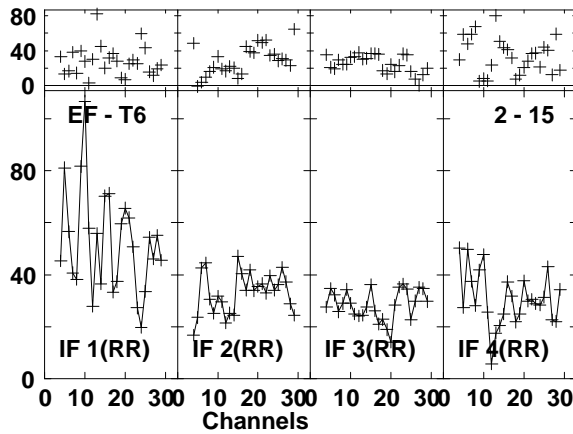
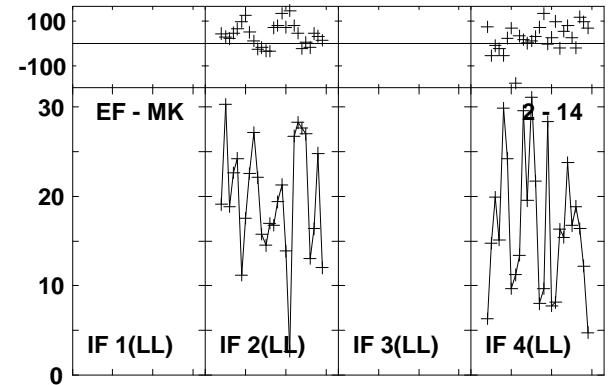
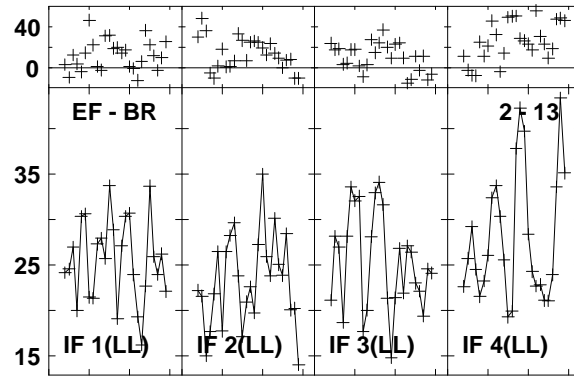
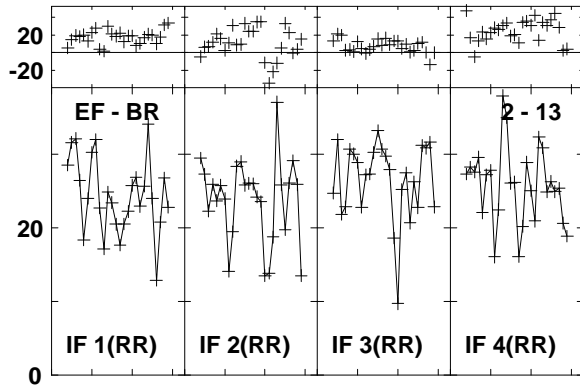
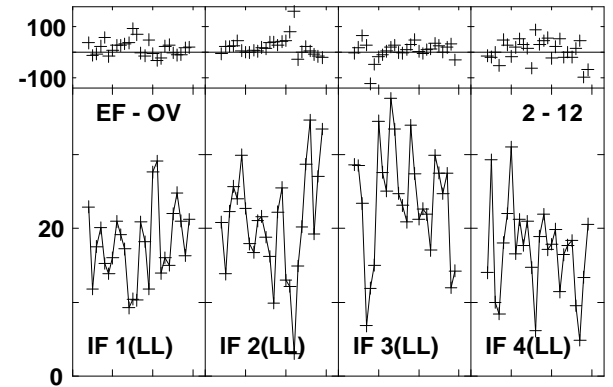
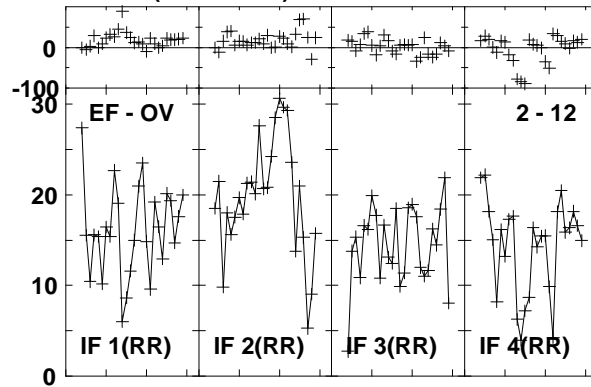
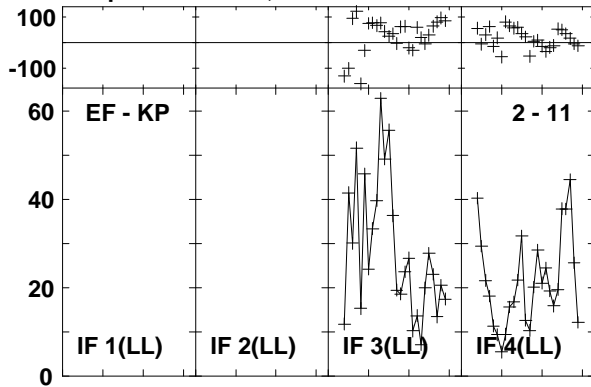

Lower frame: Milli Ampl Jy Top frame: Phas deg
 Vector averaged cross-power spectrum Baseline: EF (02) - KP (11)
 Timerange: 01/01:58:40 to 01/02:02:08

Plot file version1235 created 03-MAR-2016 01:15:32

4C52 GN002C 1.UVDATA.1

Freq = 1.2770 GHz, Bw = 16.000 MH Calibrated with CL # 3 and BP # 1 (BP mode 1)

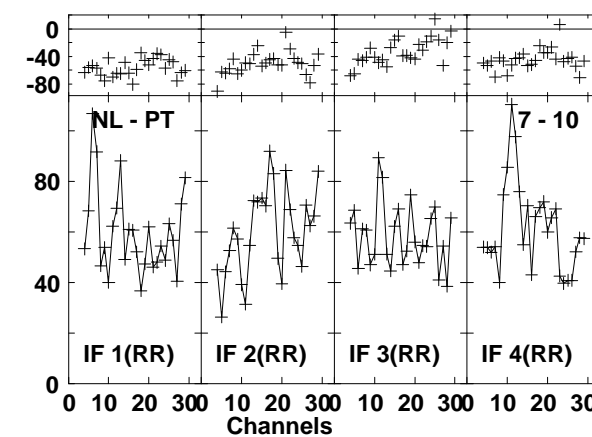
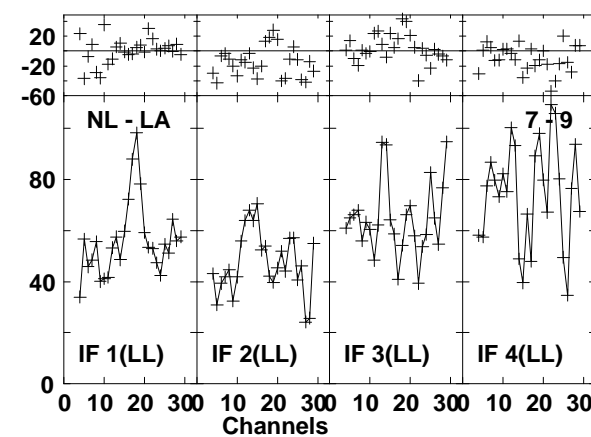
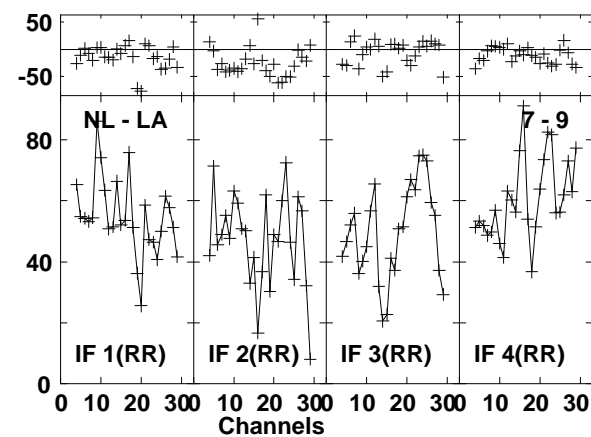
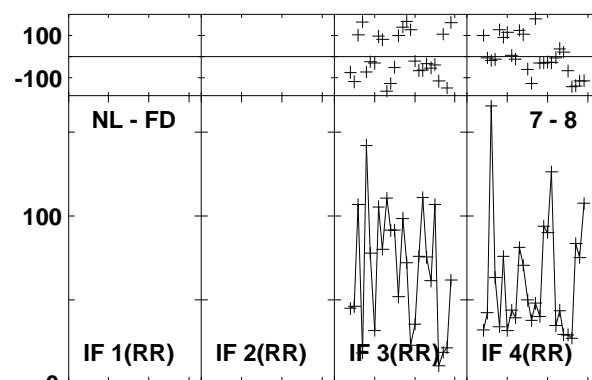
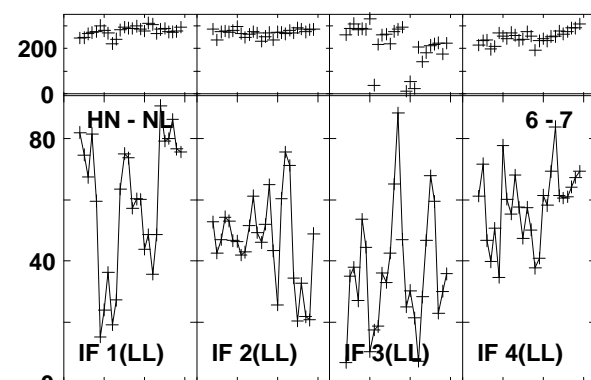
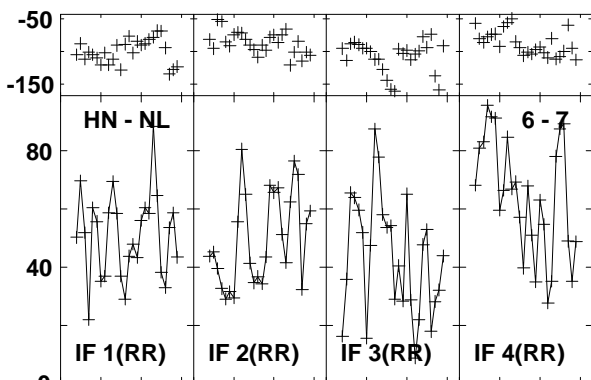
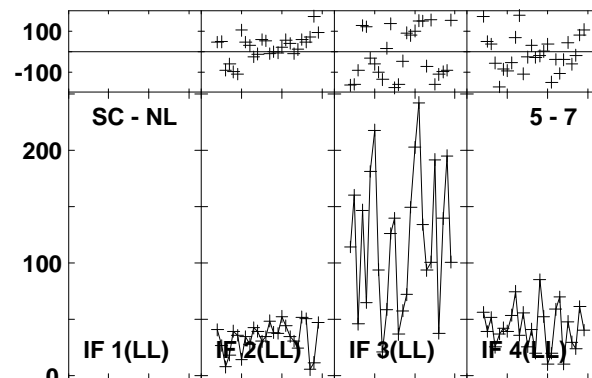
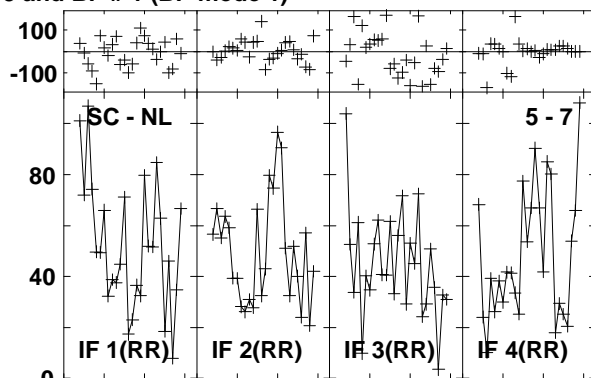
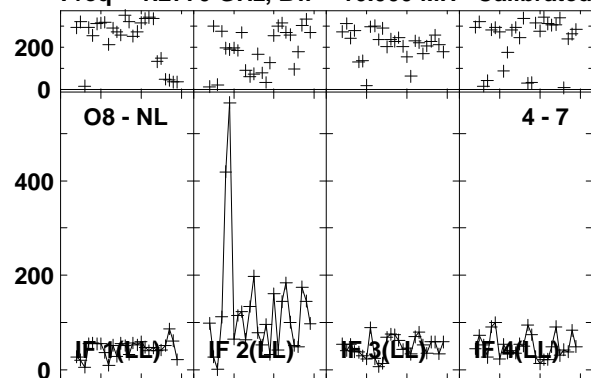

Lower frame: Milli Ampl Jy Top frame: Phas deg
Vector averaged cross-power spectrum Baseline: O8 (04) - NL (07)
Timerange: 01/01:58:40 to 01/02:02:08

Plot file version1236 created 03-MAR-2016 01:15:33

4C52 GN002C 1.UVDATA.1

Freq = 1.2770 GHz, Bw = 16.000 MH Calibrated with CL # 3 and BP # 1 (BP mode 1)

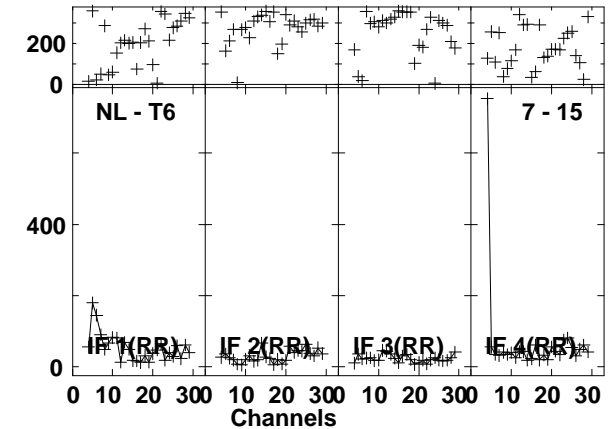
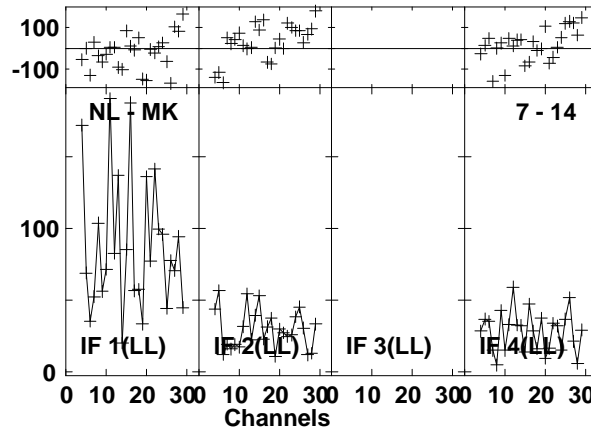
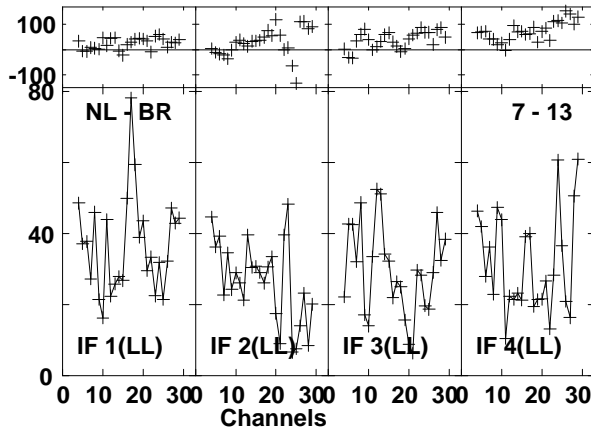
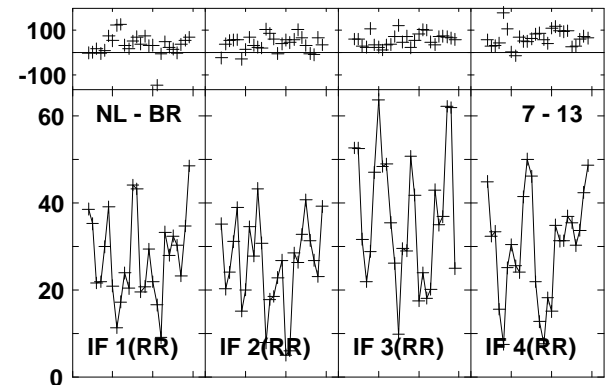
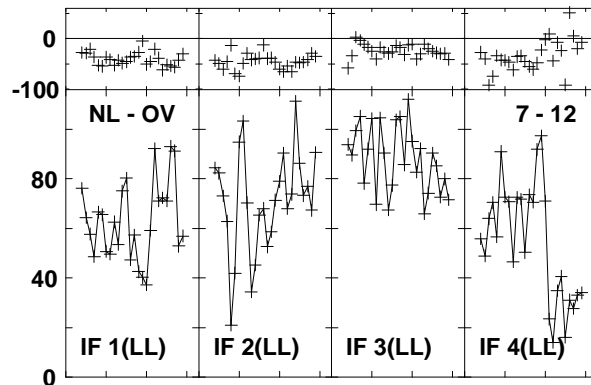
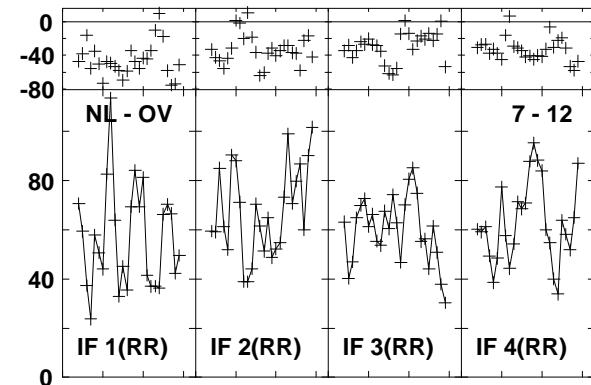
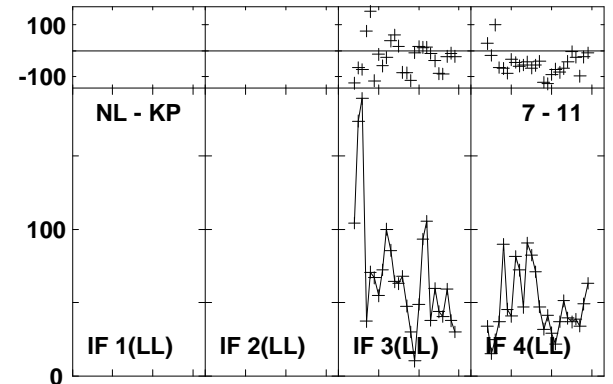
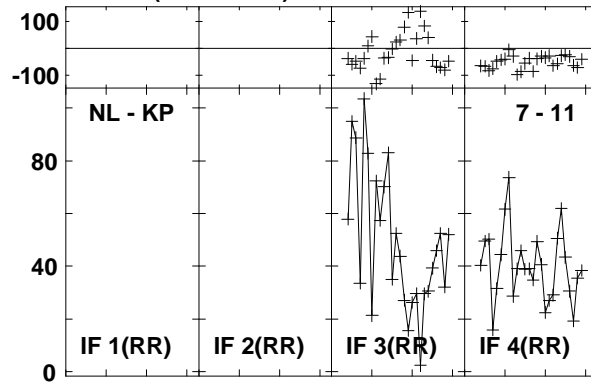
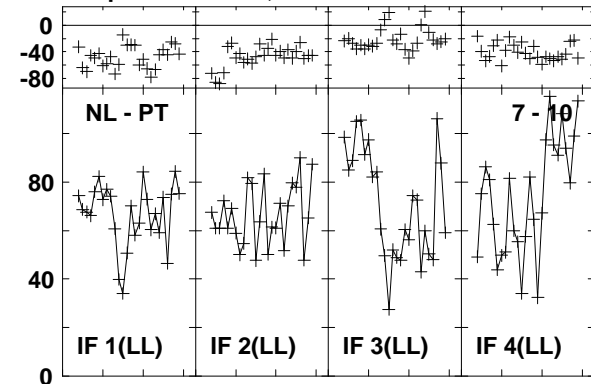

Lower frame: Milli Ampl Jy Top frame: Phas deg
Vector averaged cross-power spectrum Baseline: NL (07) - PT (10)
Timerange: 01/01:58:40 to 01/02:02:08

Plot file version1237 created 03-MAR-2016 01:15:33

4C52 GN002C 1.UVDATA.1

Freq = 1.2770 GHz, Bw = 16.000 MH Calibrated with CL # 3 and BP # 1 (BP mode 1)

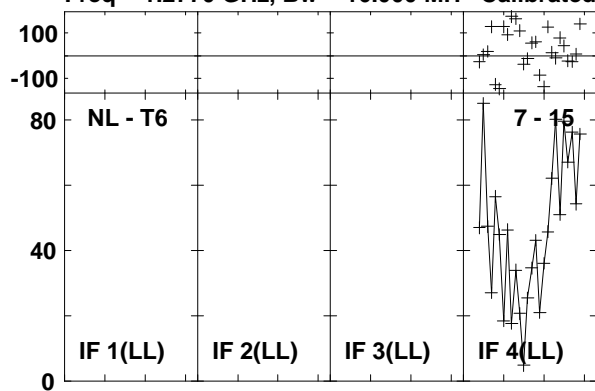

Lower frame: Milli Ampl Jy Top frame: Phas deg
Vector averaged cross-power spectrum Baseline: NL (07) - T6 (15)
Timerange: 01/01:58:40 to 01/02:02:08

Plot file version1238 created 03-MAR-2016 01:15:33

J1545+5400 GN002C 1.UVDATA.1

Freq = 1.2770 GHz, Bw = 16.000 MH Calibrated with CL # 3 and BP # 1 (BP mode 1)

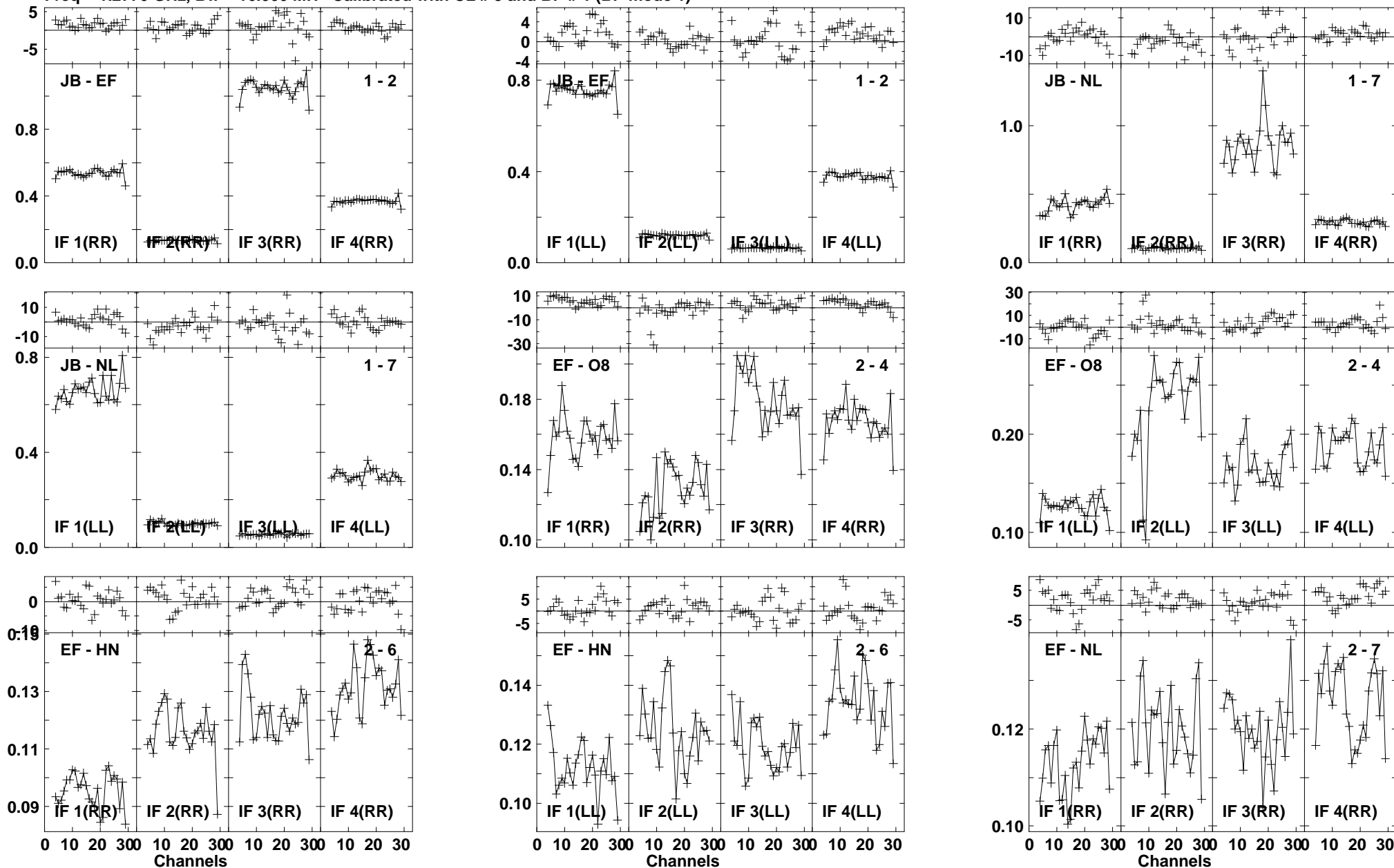

Lower frame: Ampl Jy Top frame: Phas deg
Vector averaged cross-power spectrum Baseline: JB (01) - EF (02)
Timerange: 01/02:03:00 to 01/02:04:58

Plot file version1239 created 03-MAR-2016 01:15:33

J1545+5400 GN002C 1.UVDATA.1

Freq = 1.2770 GHz, Bw = 16.000 MH Calibrated with CL # 3 and BP # 1 (BP mode 1)

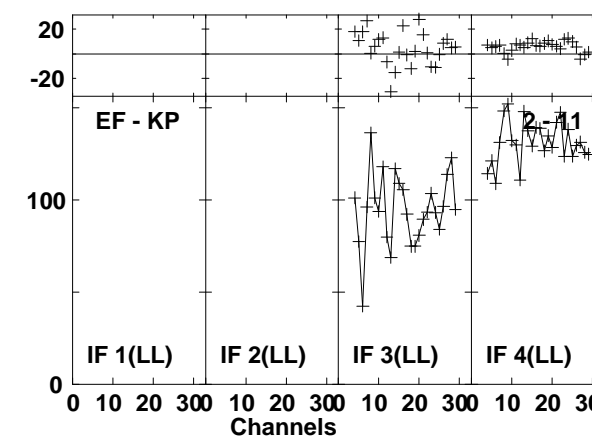
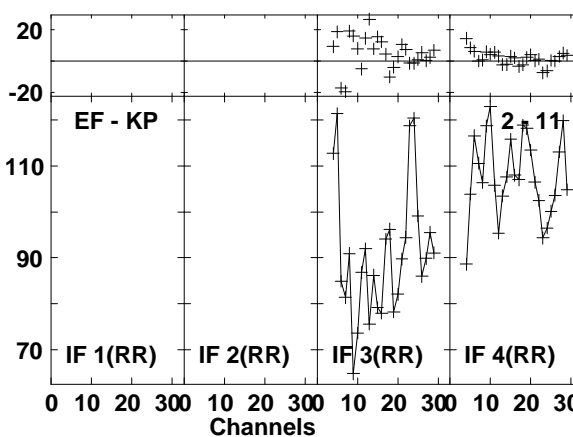
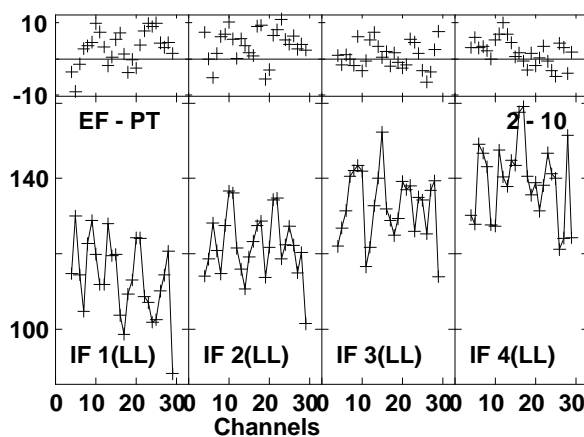
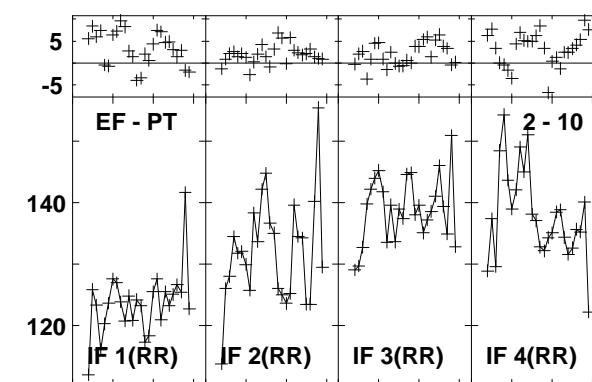
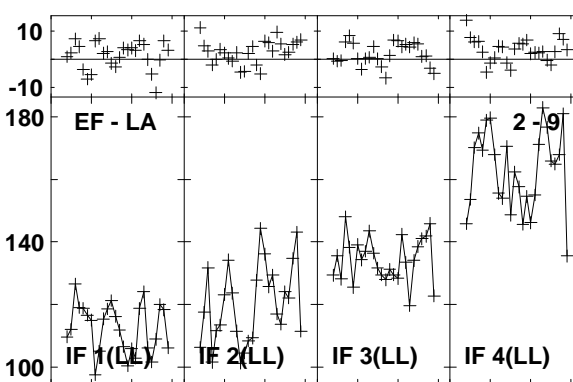
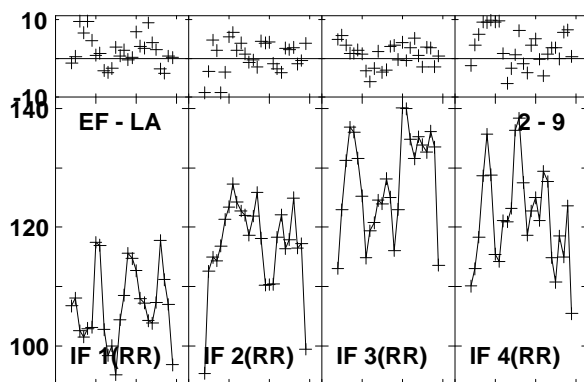
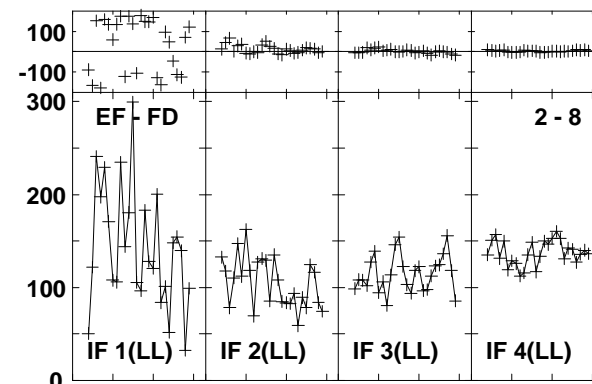
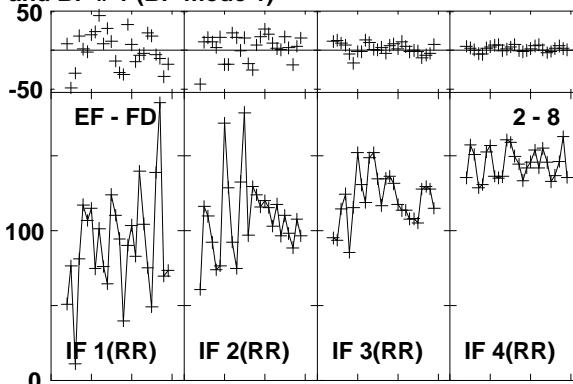
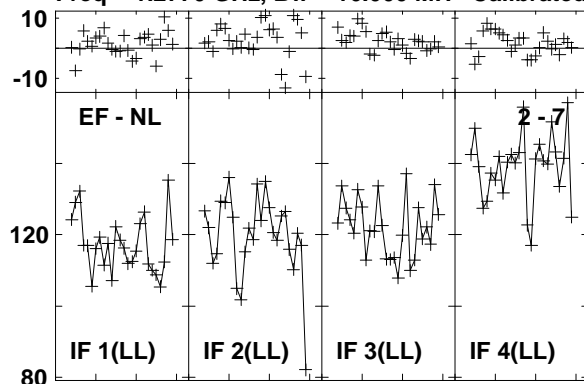

Lower frame: Milli Ampl Jy Top frame: Phas deg
Vector averaged cross-power spectrum Baseline: EF (02) - NL (07)
Timerange: 01/02:03:00 to 01/02:04:58

Plot file version1240 created 03-MAR-2016 01:15:33

J1545+5400 GN002C 1.UVDATA.1

Freq = 1.2770 GHz, Bw = 16.000 MH Calibrated with CL # 3 and BP # 1 (BP mode 1)

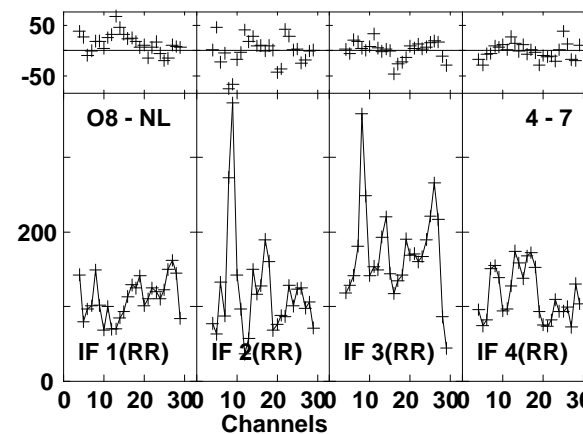
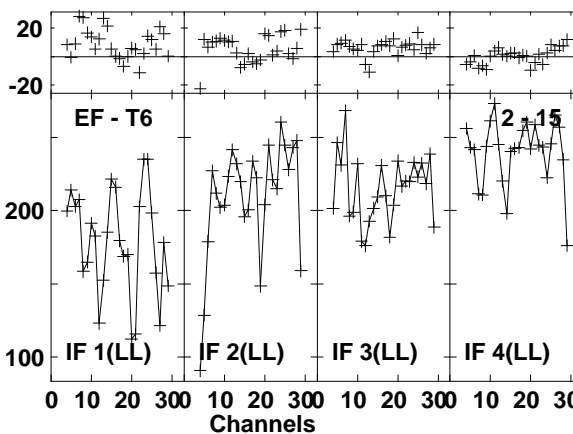
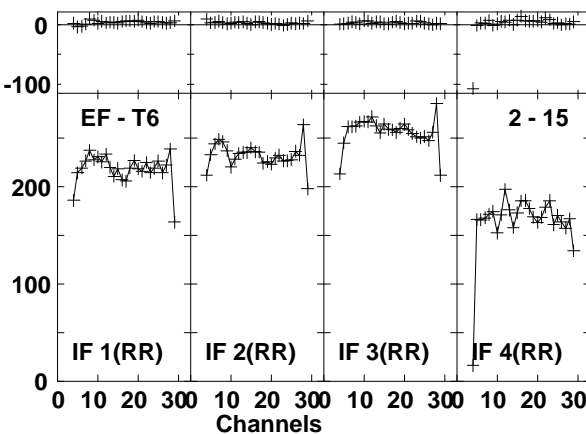
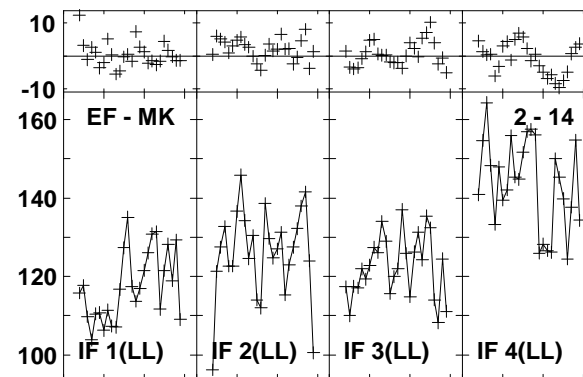
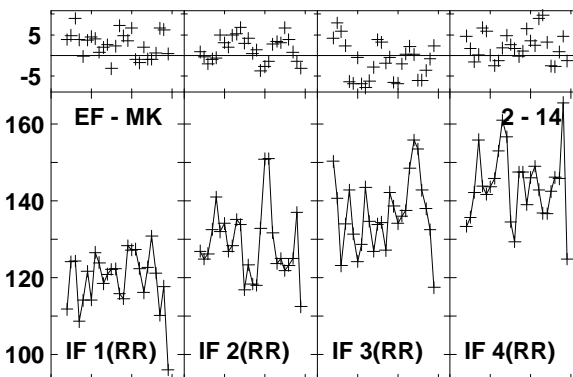
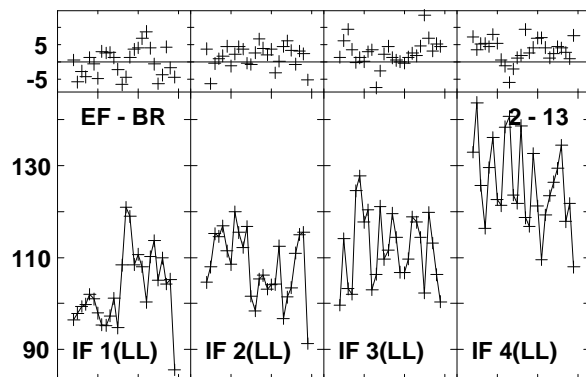
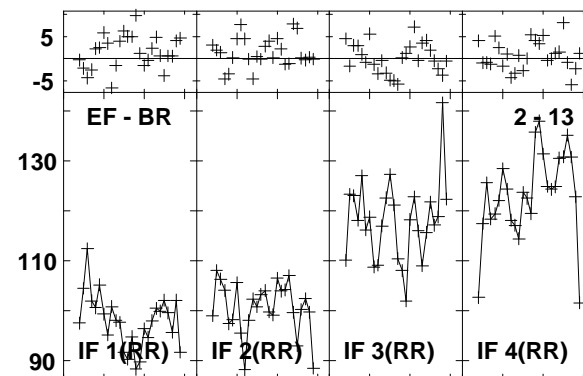
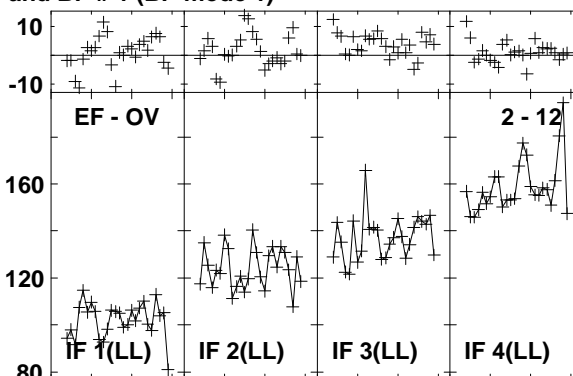
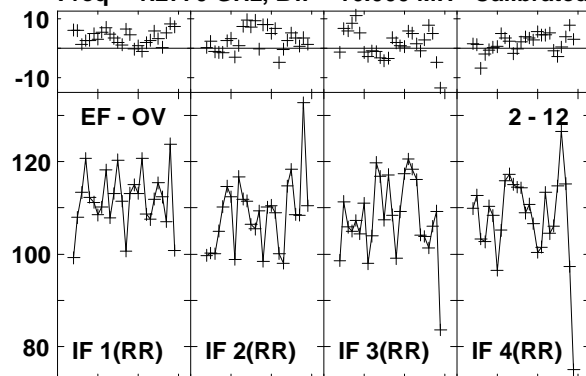

Lower frame: Milli Ampl Jy Top frame: Phas deg
Vector averaged cross-power spectrum Baseline: EF (02) - OV (12)
Timerange: 01/02:03:00 to 01/02:04:58

Plot file version1241 created 03-MAR-2016 01:15:34

J1545+5400 GN002C 1.UVDATA.1

Freq = 1.2770 GHz, Bw = 16.000 MH Calibrated with CL # 3 and BP # 1 (BP mode 1)

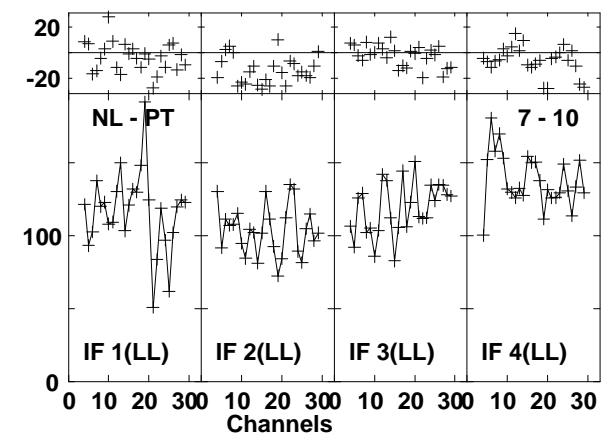
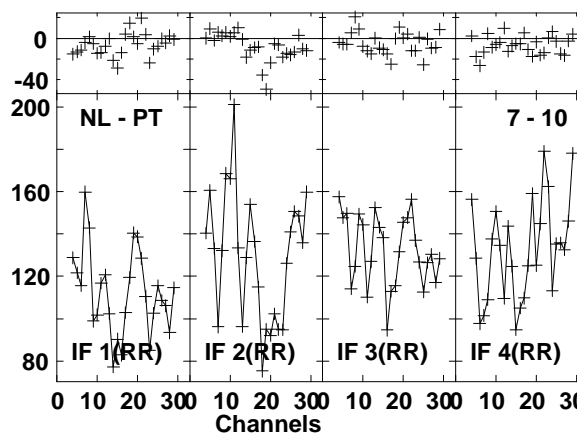
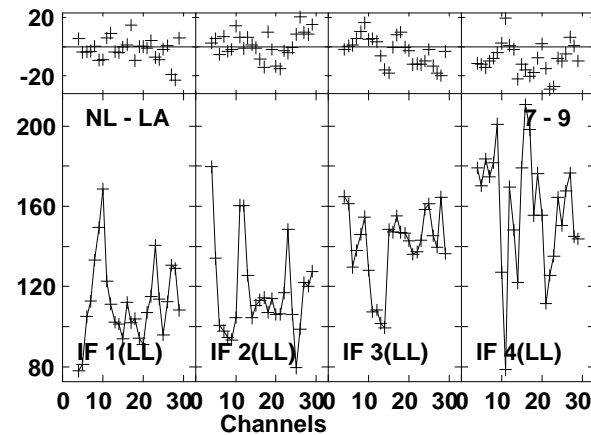
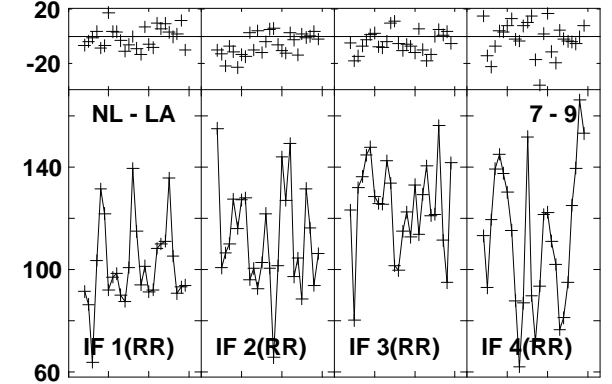
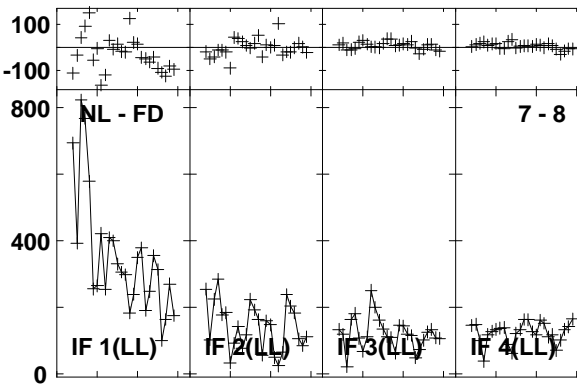
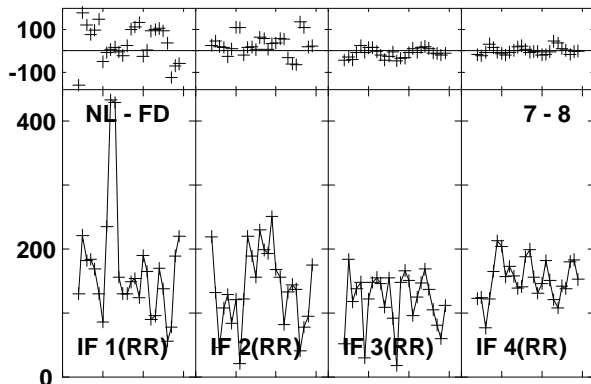
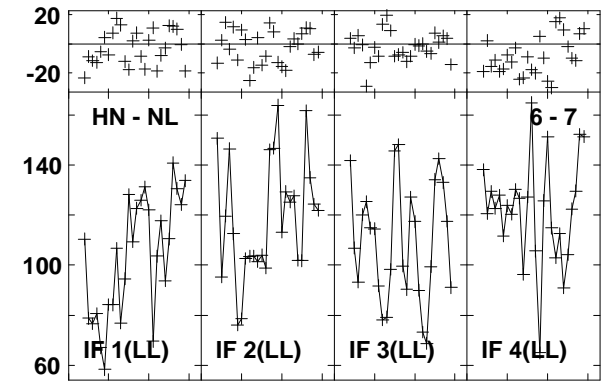
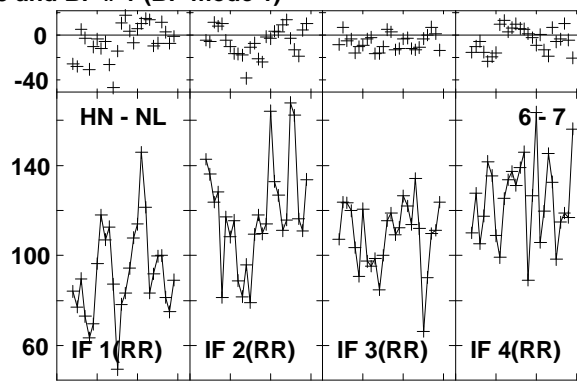
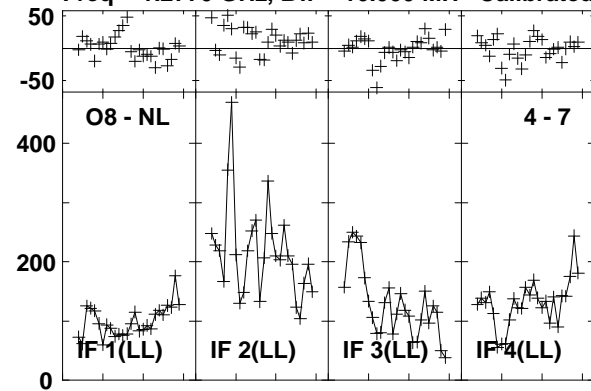

Lower frame: Milli Ampl Jy Top frame: Phas deg
Vector averaged cross-power spectrum Baseline: O8 (04) - NL (07)
Timerange: 01/02:03:00 to 01/02:04:58

Plot file version1242 created 03-MAR-2016 01:15:34

J1545+5400 GN002C 1.UVDATA.1

Freq = 1.2770 GHz, Bw = 16.000 MH Calibrated with CL # 3 and BP # 1 (BP mode 1)

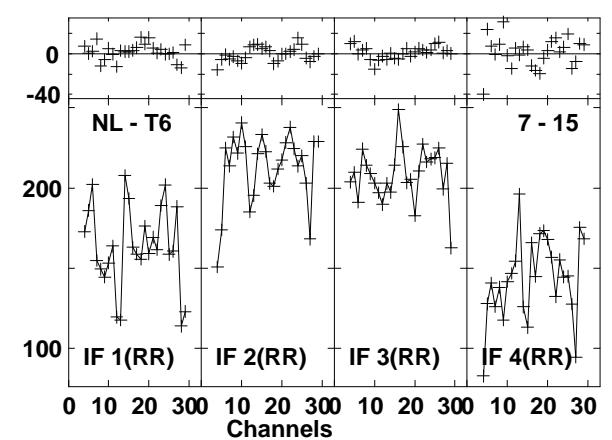
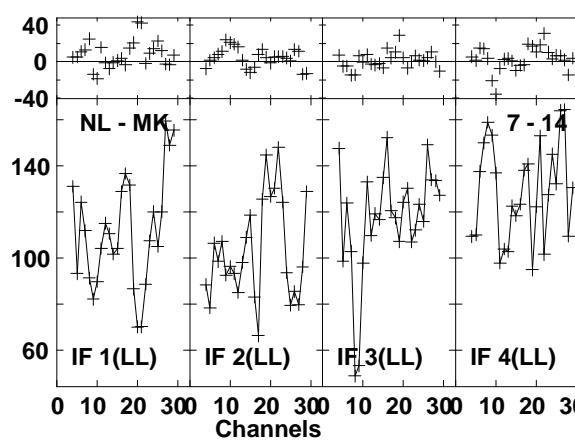
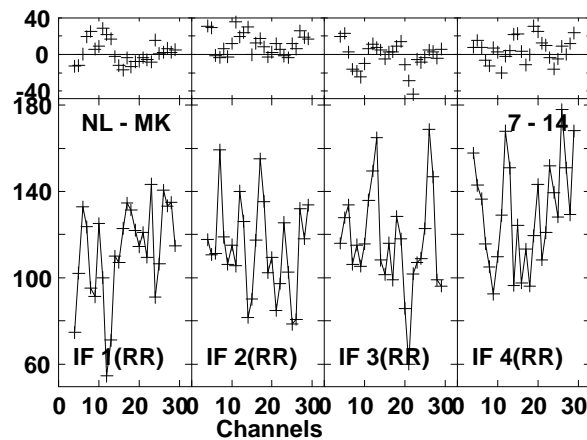
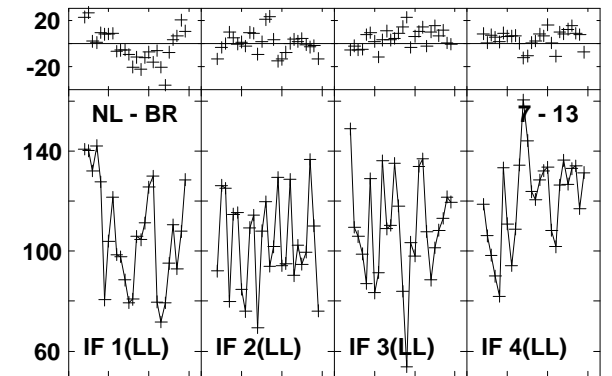
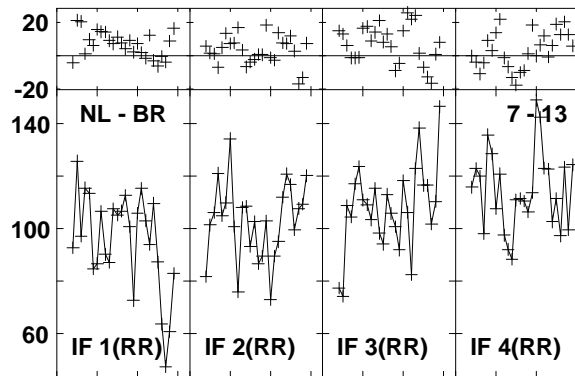
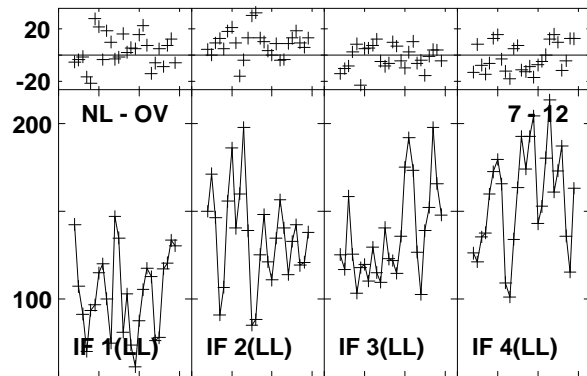
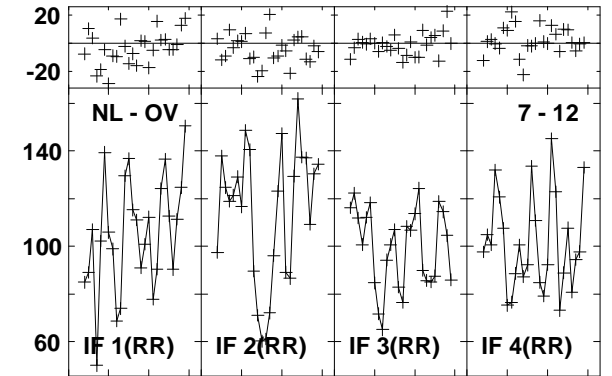
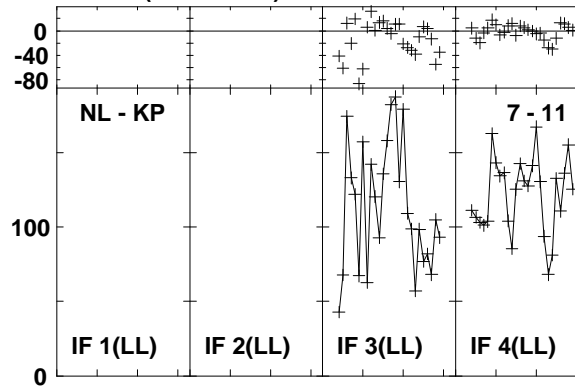
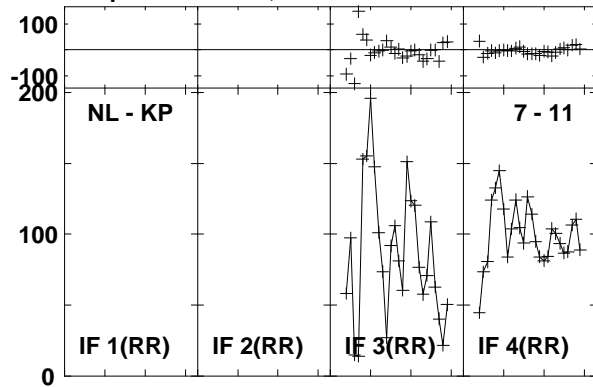

Lower frame: Milli Ampl Jy Top frame: Phas deg
Vector averaged cross-power spectrum Baseline: NL (07) - KP (11)
Timerange: 01/02:03:00 to 01/02:04:58

Plot file version1243 created 03-MAR-2016 01:15:34
J1545+5400 GN002C 1.UVDATA.1
Freq = 1.2770 GHz, Bw = 16.000 MH Calibrated with CL # 3 and BP # 1 (BP mode 1)

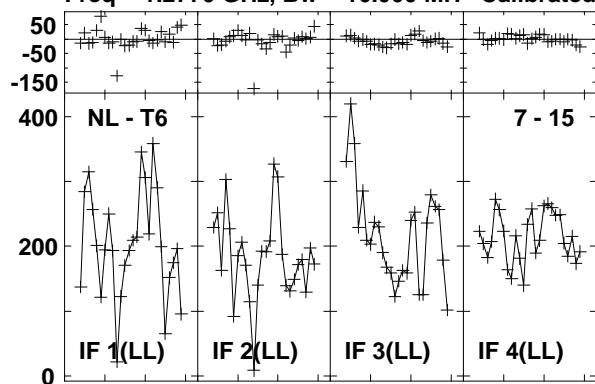

Lower frame: Milli Ampl Jy Top frame: Phas deg
Vector averaged cross-power spectrum Baseline: NL (07) - T6 (15)
Timerange: 01/02:03:00 to 01/02:04:58

Plot file version1244 created 03-MAR-2016 01:15:34

4C52 GN002C 1.UVDATA.1

Freq = 1.2770 GHz, Bw = 16.000 MH Calibrated with CL # 3 and BP # 1 (BP mode 1)

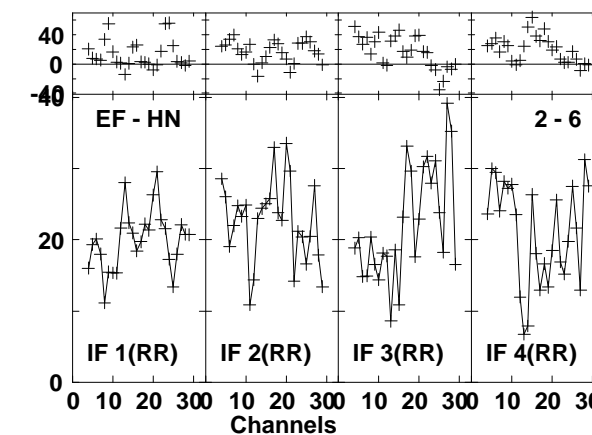
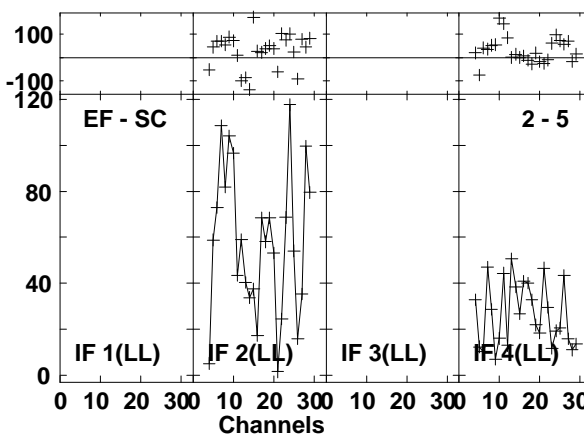
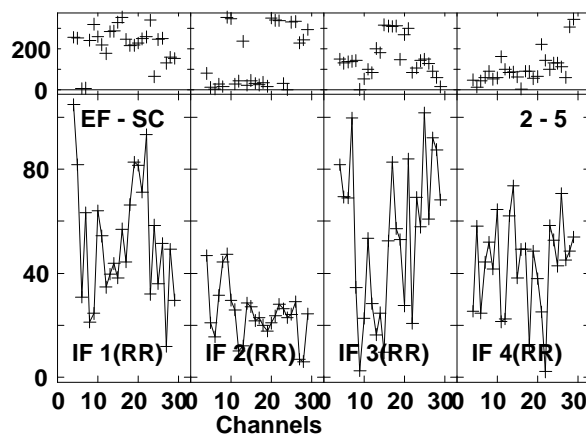
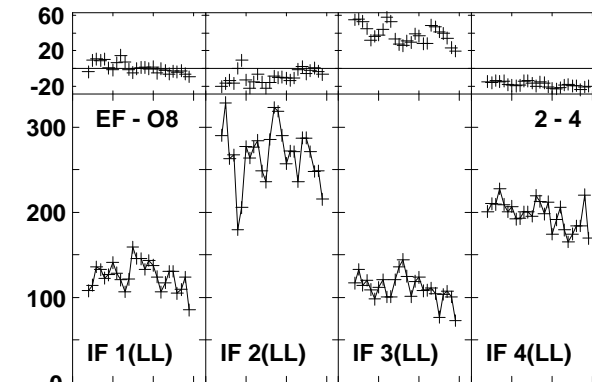
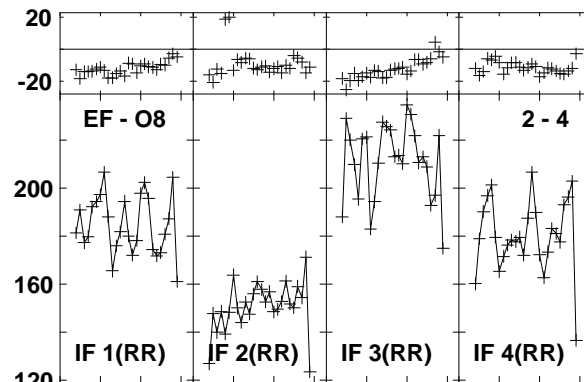
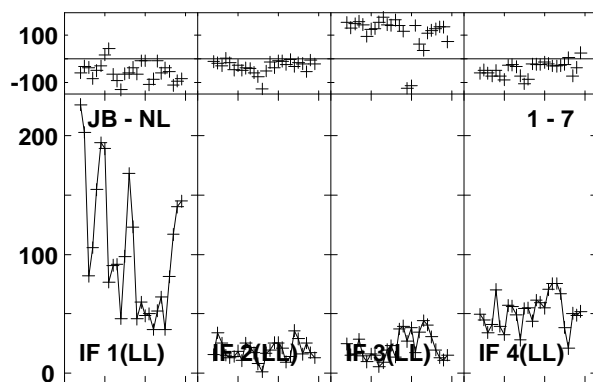
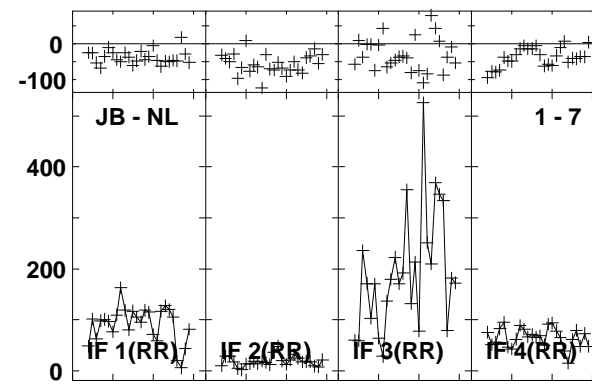
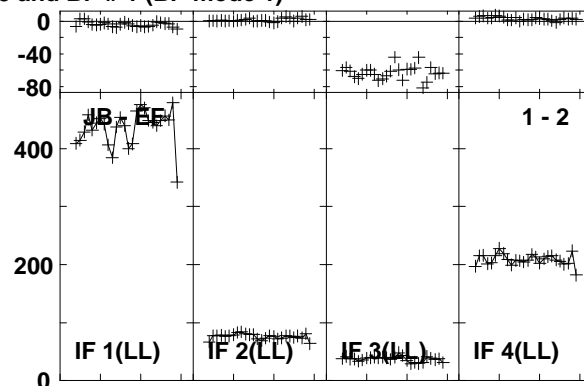
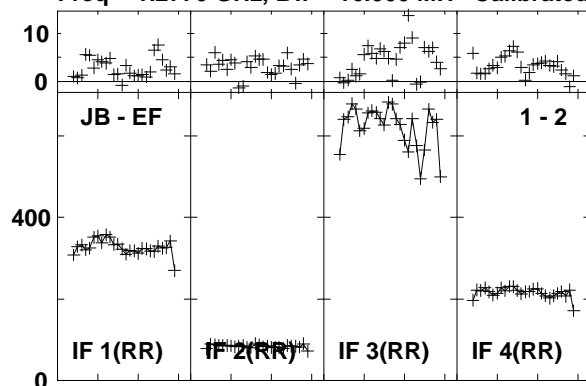

Lower frame: Milli Ampl Jy Top frame: Phas deg
Vector averaged cross-power spectrum Baseline: JB (01) - EF (02)
Timerange: 01/02:05:00 to 01/02:07:58

Plot file version1245 created 03-MAR-2016 01:15:34

4C52 GN002C 1.UVDATA.1

Freq = 1.2770 GHz, Bw = 16.000 MH Calibrated with CL # 3 and BP # 1 (BP mode 1)

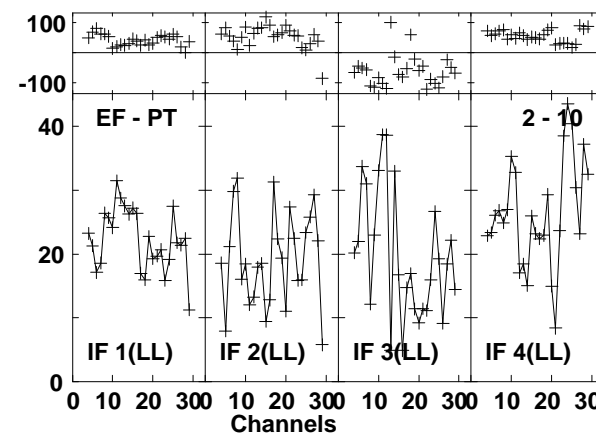
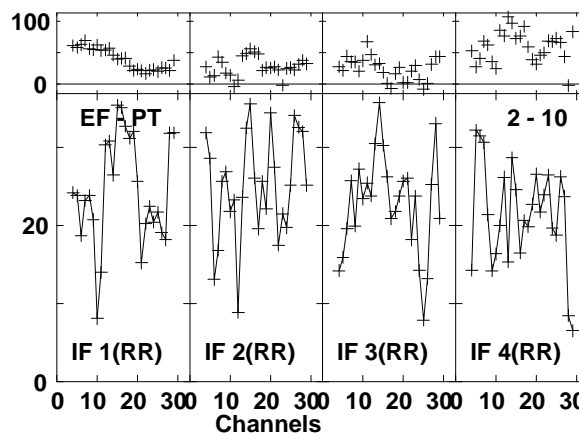
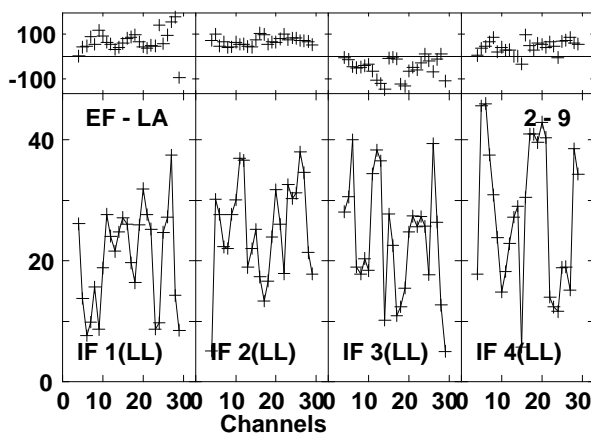
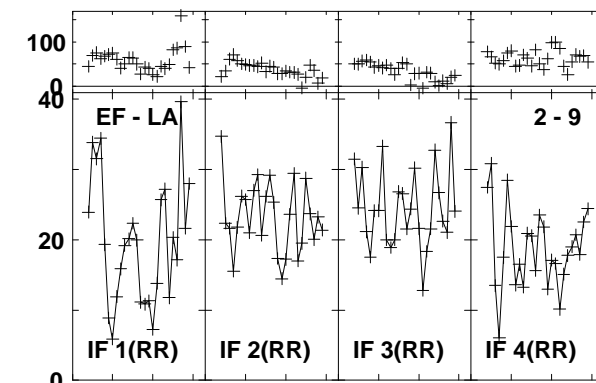
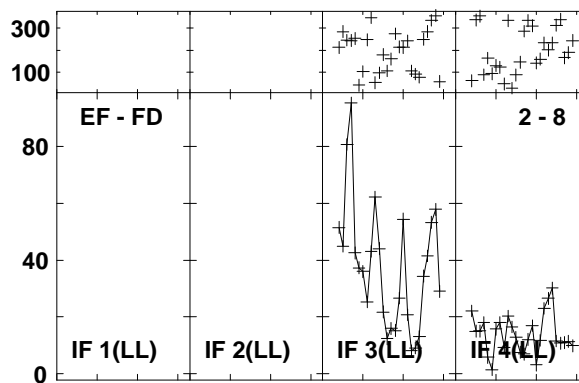
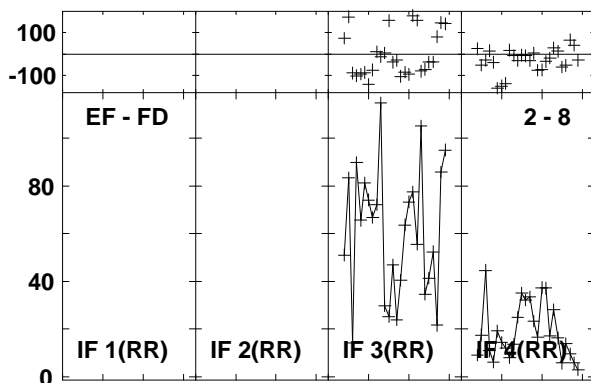
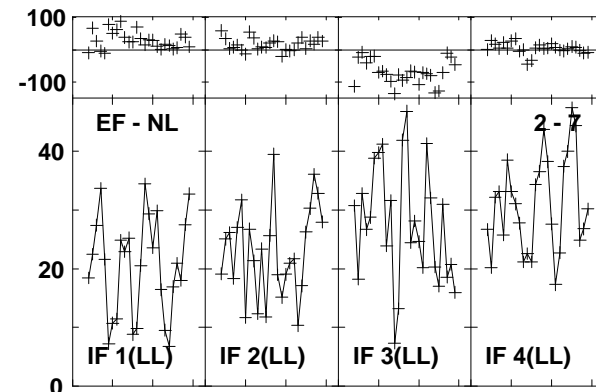
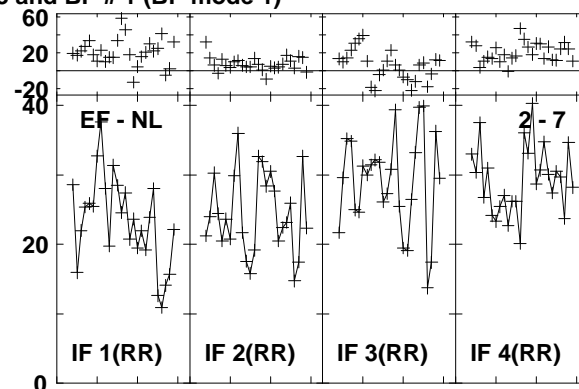
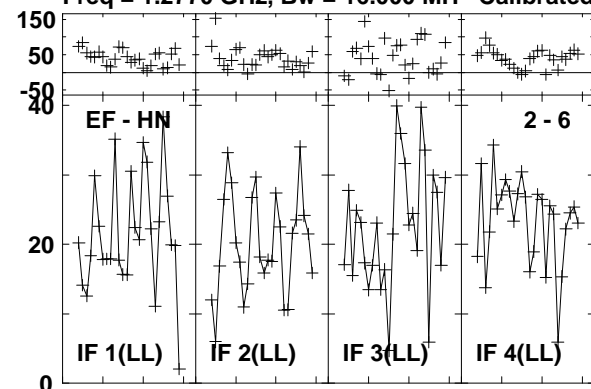

Lower frame: Milli Ampl Jy Top frame: Phas deg
Vector averaged cross-power spectrum Baseline: EF (02) - HN (06)
Timerange: 01/02:05:00 to 01/02:07:58

Plot file version1246 created 03-MAR-2016 01:15:34

4C52 GN002C 1.UVDATA.1

Freq = 1.2770 GHz, Bw = 16.000 MH Calibrated with CL # 3 and BP # 1 (BP mode 1)

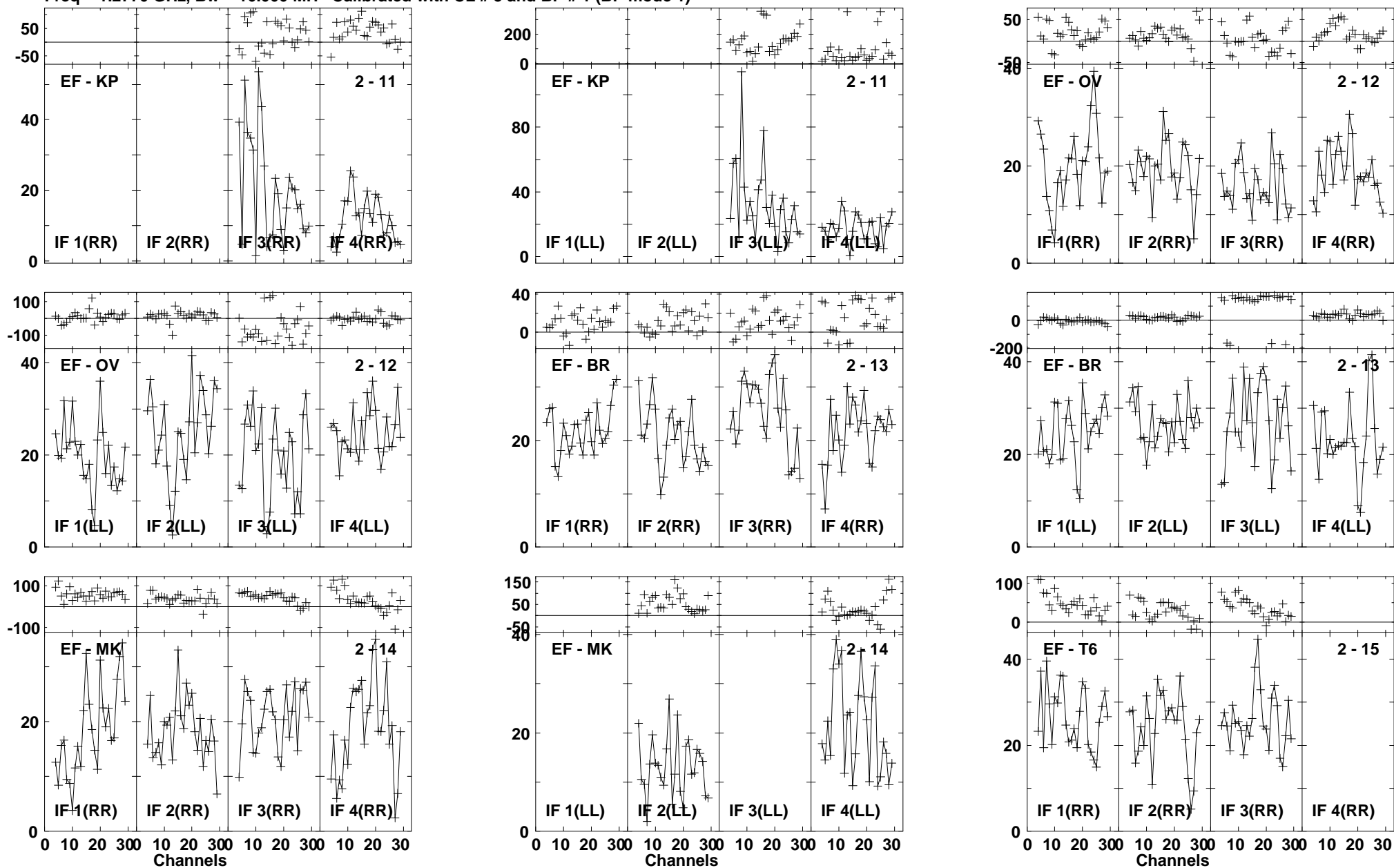

Lower frame: Milli Ampl Jy Top frame: Phas deg
Vector averaged cross-power spectrum Baseline: EF (02) - KP (11)
Timerange: 01/02:05:00 to 01/02:07:58

Plot file version1247 created 03-MAR-2016 01:15:35

4C52 GN002C 1.UVDATA.1

Freq = 1.2770 GHz, Bw = 16.000 MH Calibrated with CL # 3 and BP # 1 (BP mode 1)

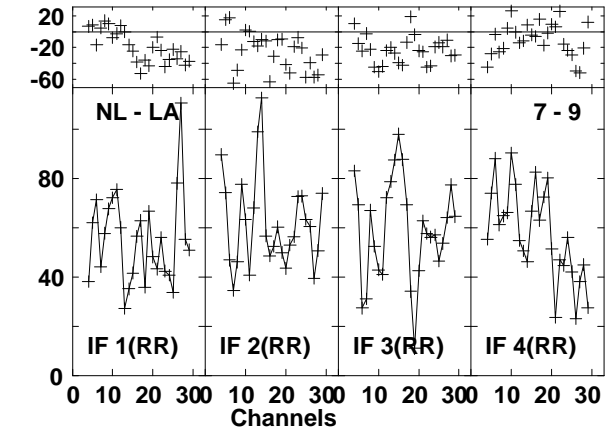
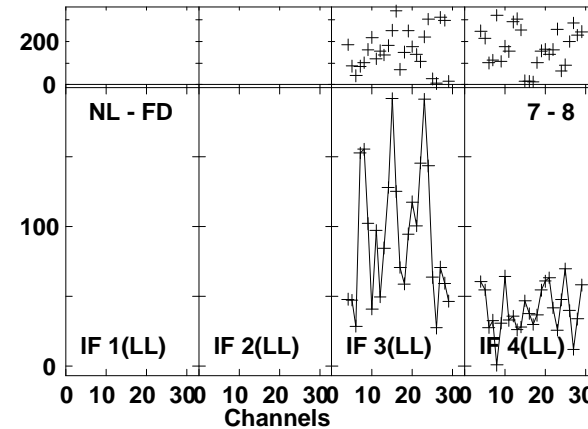
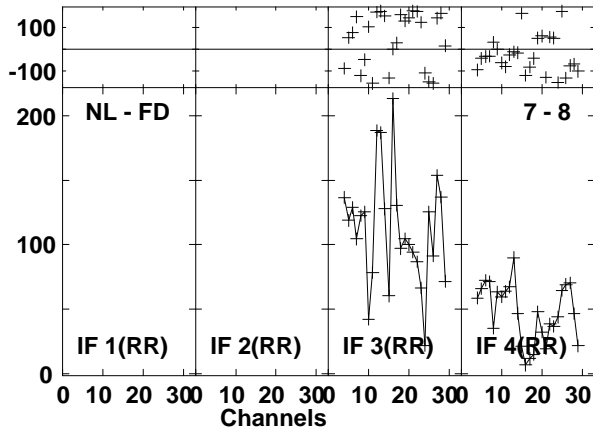
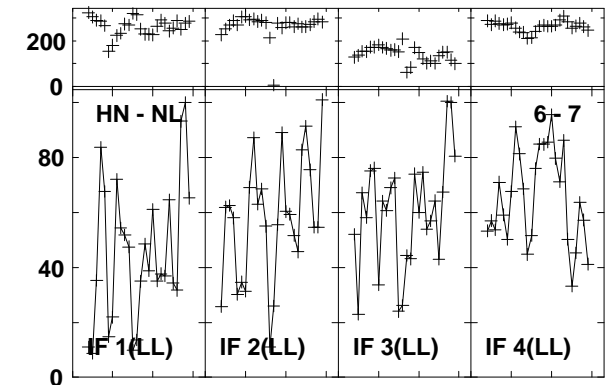
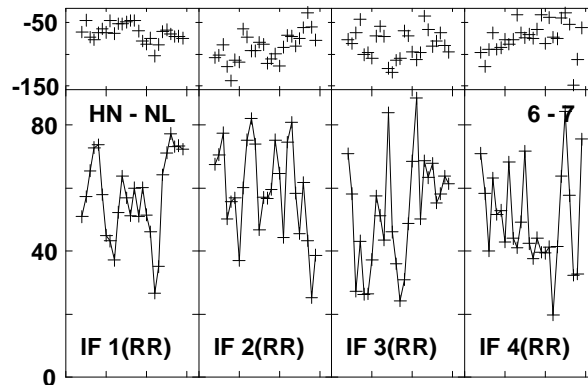
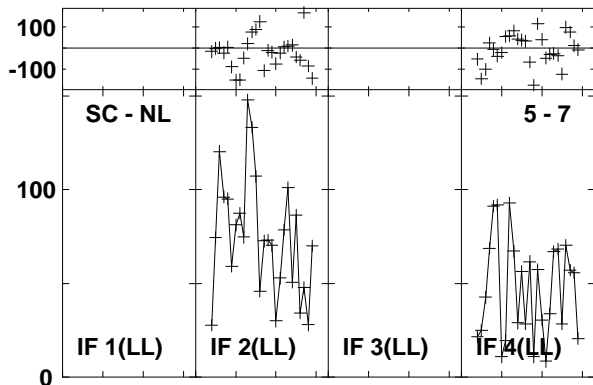
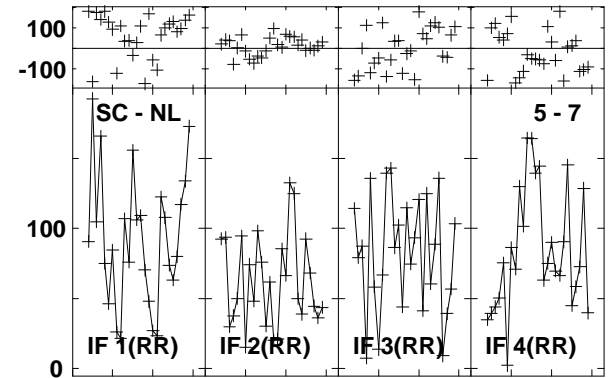
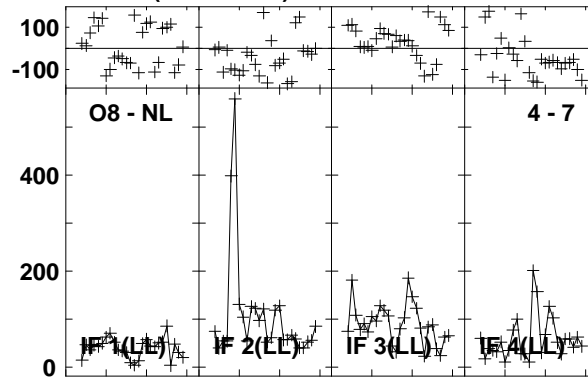
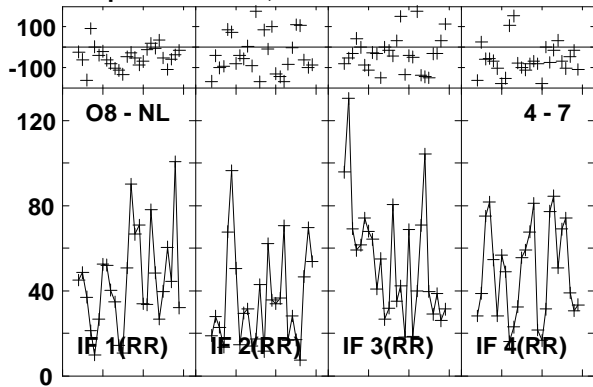

Lower frame: Milli Ampl Jy Top frame: Phas deg
Vector averaged cross-power spectrum Baseline: O8 (04) - NL (07)
Timerange: 01/02:05:00 to 01/02:07:58

Plot file version1248 created 03-MAR-2016 01:15:35

4C52 GN002C 1.UVDATA.1

Freq = 1.2770 GHz, Bw = 16.000 MH Calibrated with CL # 3 and BP # 1 (BP mode 1)

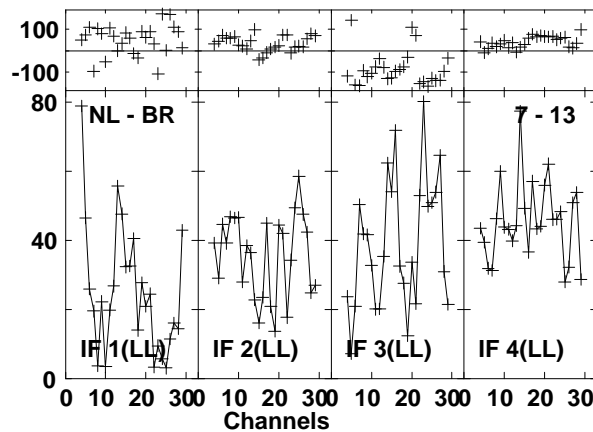
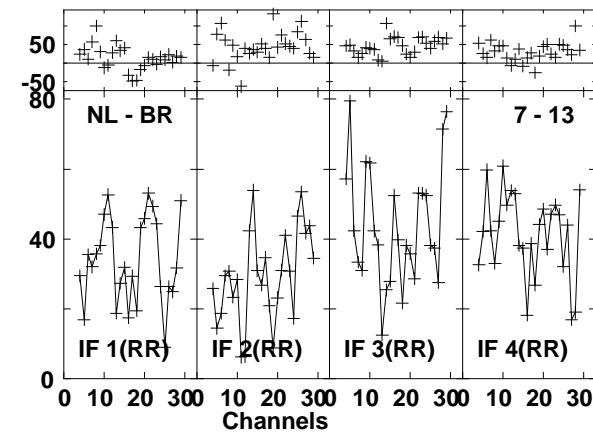
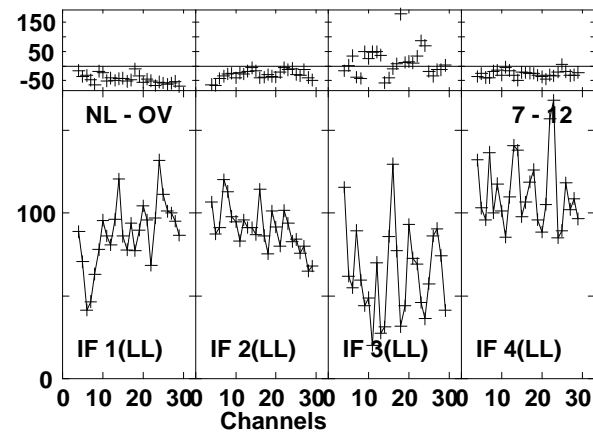
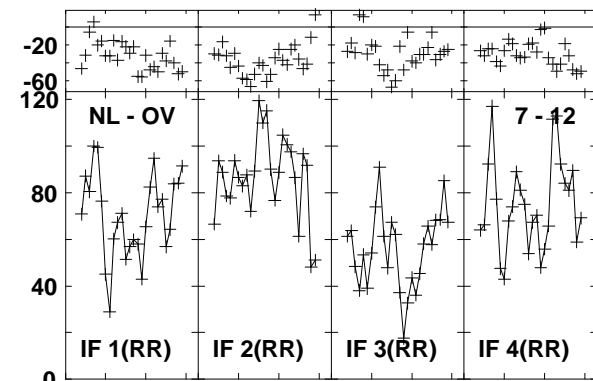
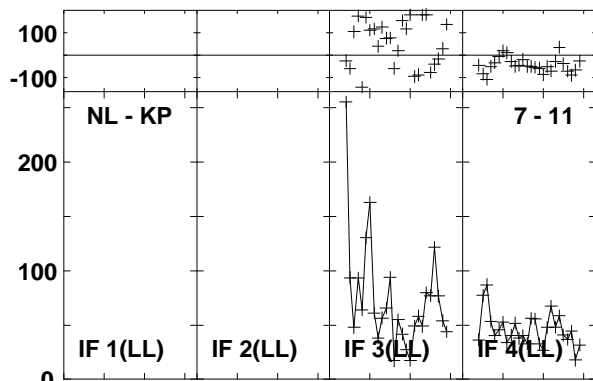
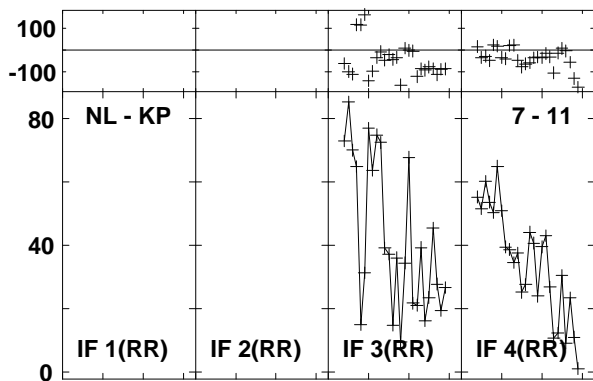
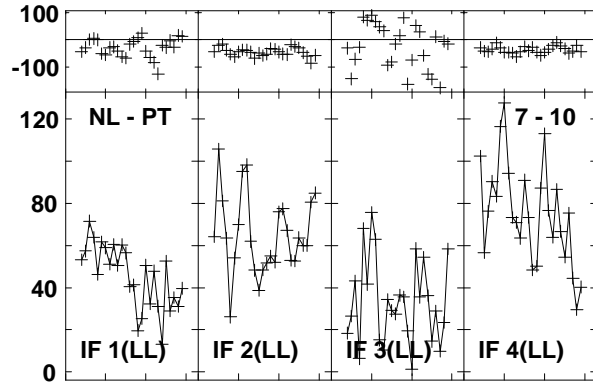
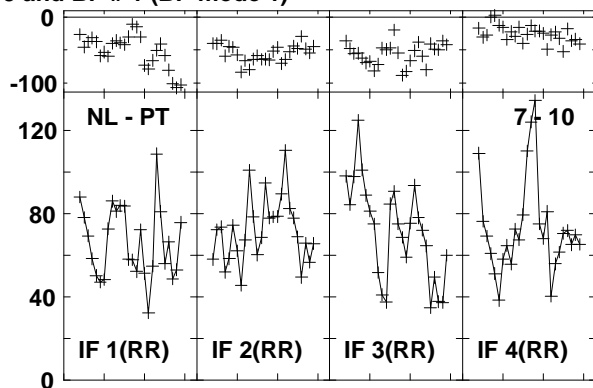
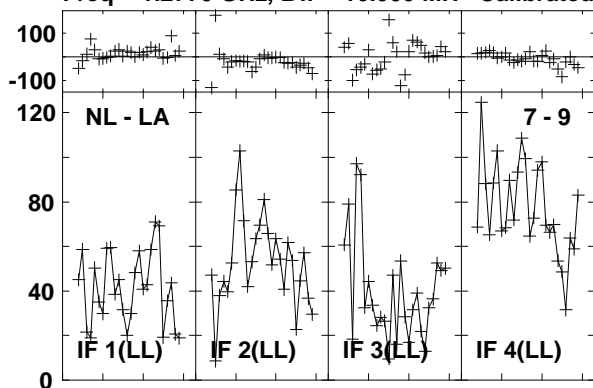

Lower frame: Milli Ampl Jy Top frame: Phas deg
Vector averaged cross-power spectrum Baseline: NL (07) - LA (09)
Timerange: 01/02:05:00 to 01/02:07:58

Plot file version1249 created 03-MAR-2016 01:15:35

4C52 GN002C 1.UVDATA.1

Freq = 1.2770 GHz, Bw = 16.000 MH Calibrated with CL # 3 and BP # 1 (BP mode 1)

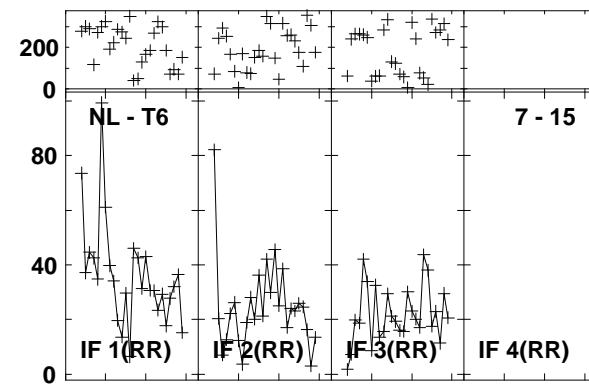
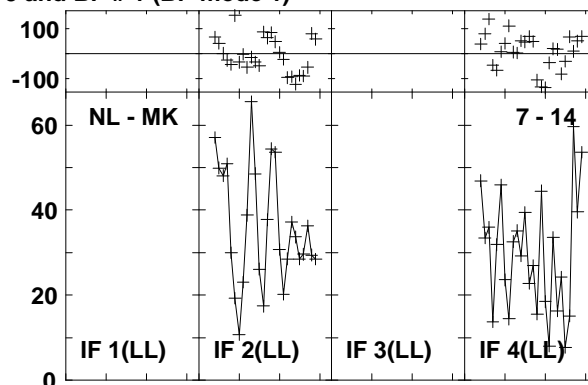
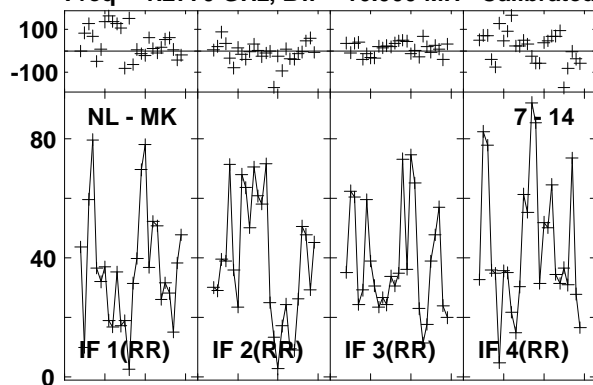

Lower frame: Milli Ampl Jy Top frame: Phas deg
Vector averaged cross-power spectrum Baseline: NL (07) - MK (14)
Timerange: 01/02:05:00 to 01/02:07:58

Plot file version1250 created 03-MAR-2016 01:15:35

J1545+5400 GN002C 1.UVDATA.1

Freq = 1.2770 GHz, Bw = 16.000 MH Calibrated with CL # 3 and BP # 1 (BP mode 1)

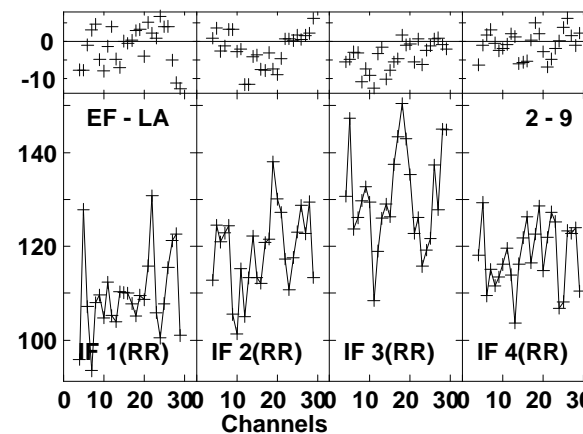
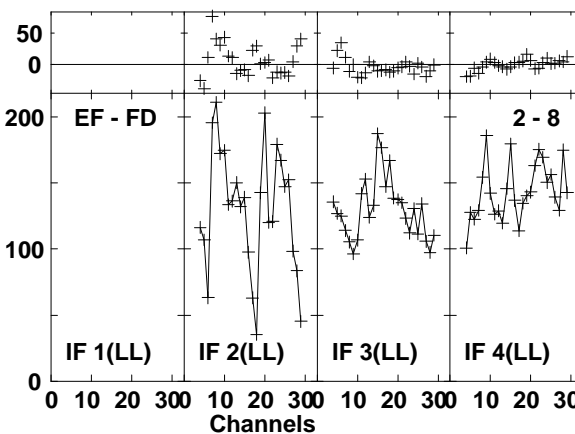
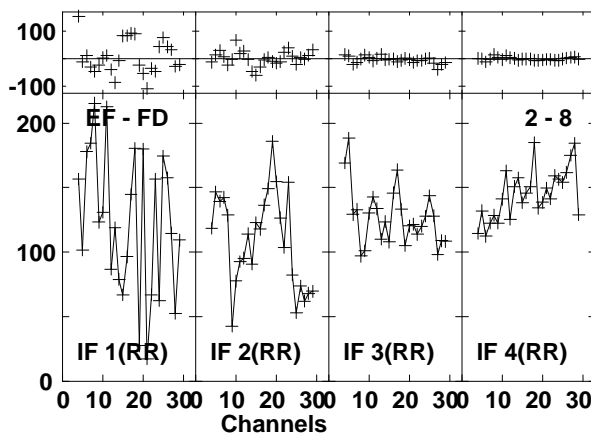
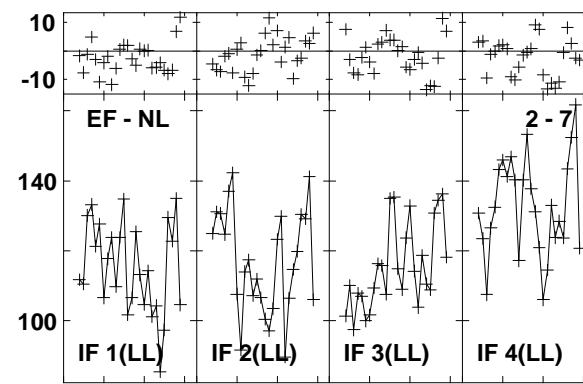
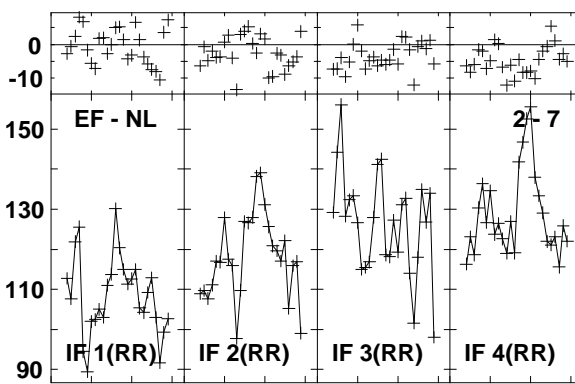
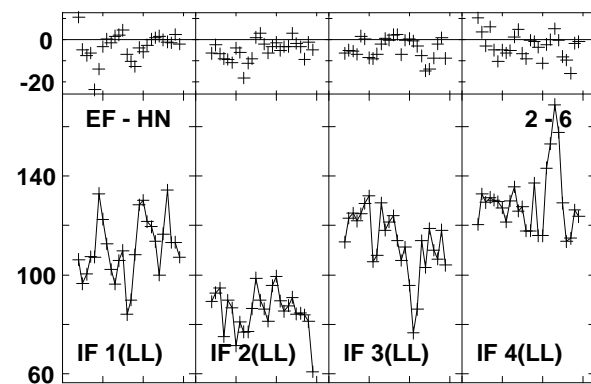
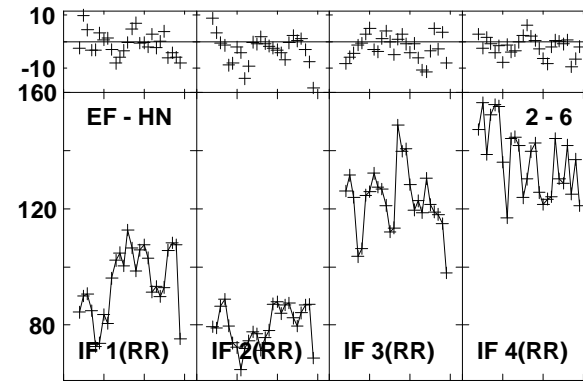
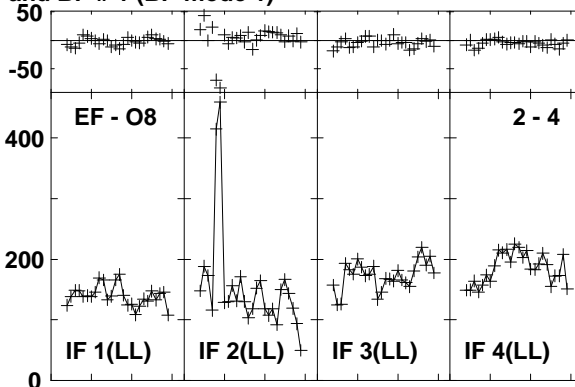
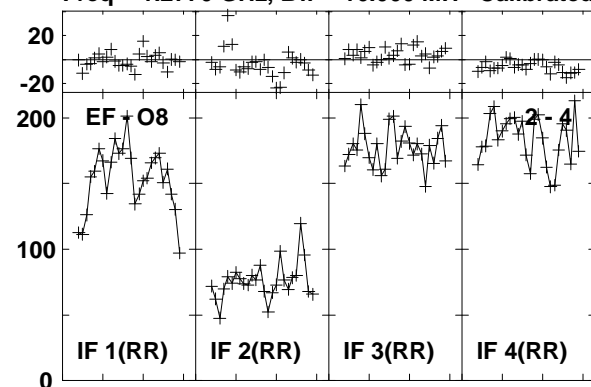

Lower frame: Milli Ampl Jy Top frame: Phas deg
Vector averaged cross-power spectrum Baseline: EF (02) - O8 (04)
Timerange: 01/02:08:50 to 01/02:09:48

Plot file version1251 created 03-MAR-2016 01:15:35

J1545+5400 GN002C 1.UVDATA.1

Freq = 1.2770 GHz, Bw = 16.000 MH Calibrated with CL # 3 and BP # 1 (BP mode 1)

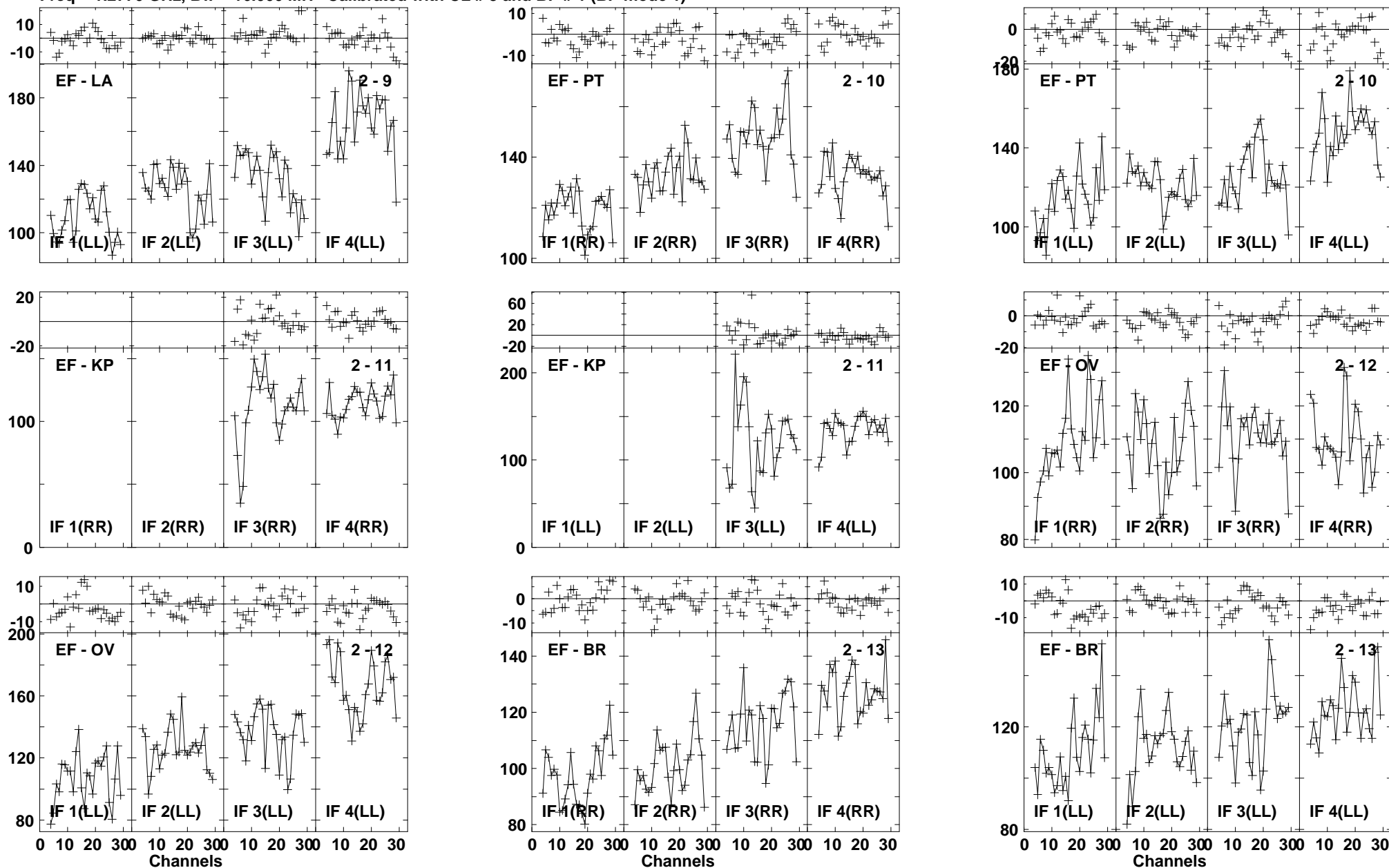

Lower frame: Milli Ampl Jy Top frame: Phas deg
Vector averaged cross-power spectrum Baseline: EF (02) - LA (09)
Timerange: 01/02:08:50 to 01/02:09:48

Plot file version1252 created 03-MAR-2016 01:15:35

J1545+5400 GN002C 1.UVDATA.1

Freq = 1.2770 GHz, Bw = 16.000 MH Calibrated with CL # 3 and BP # 1 (BP mode 1)

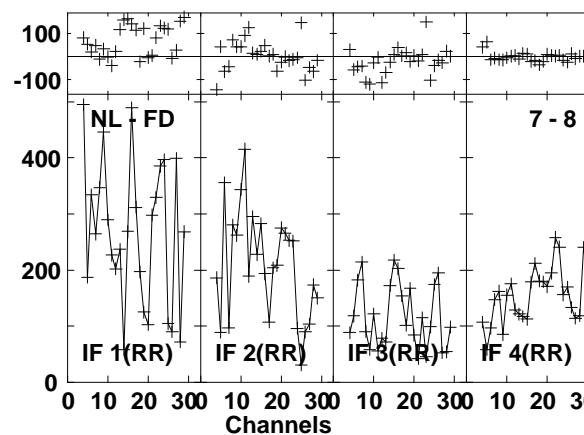
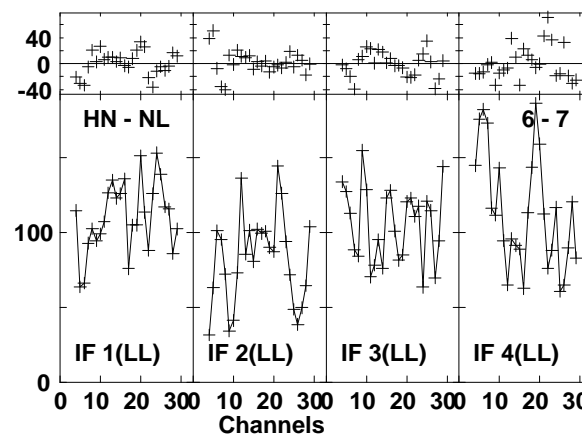
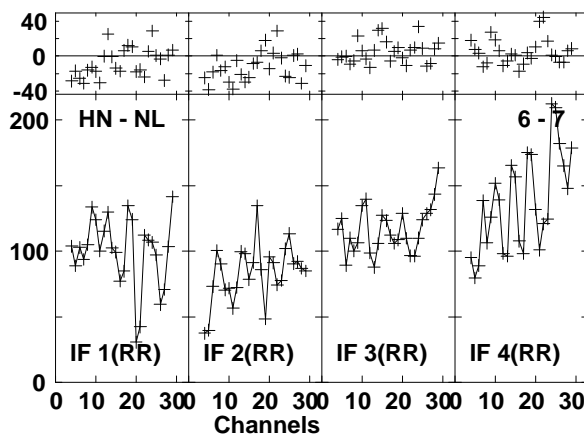
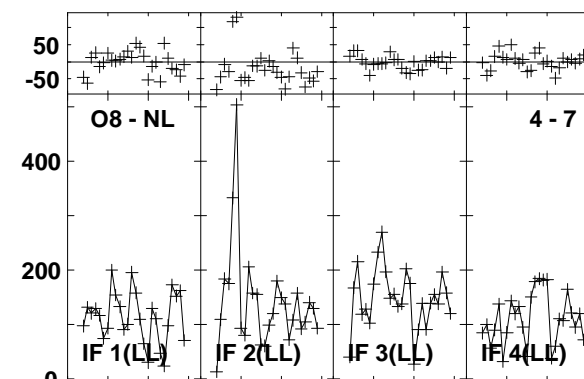
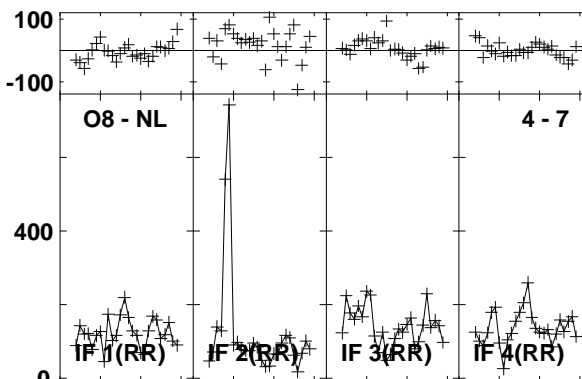
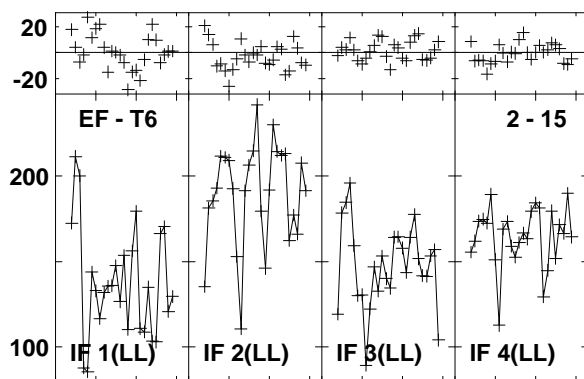
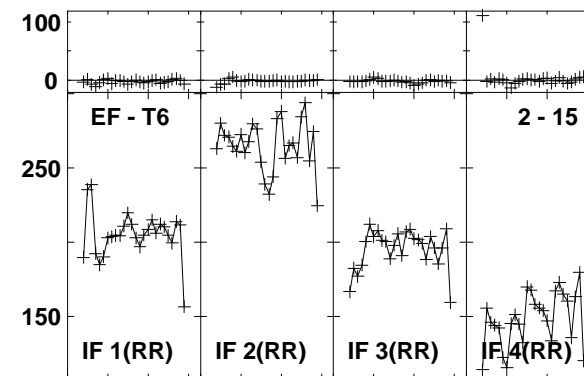
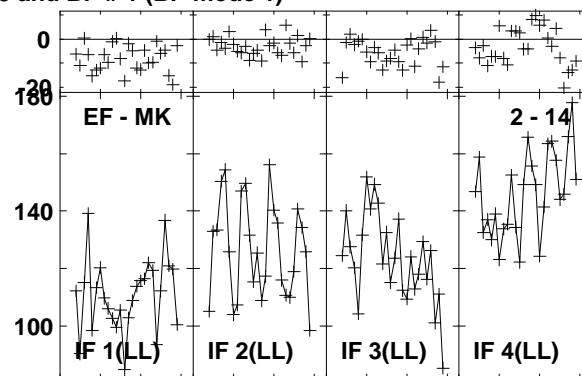
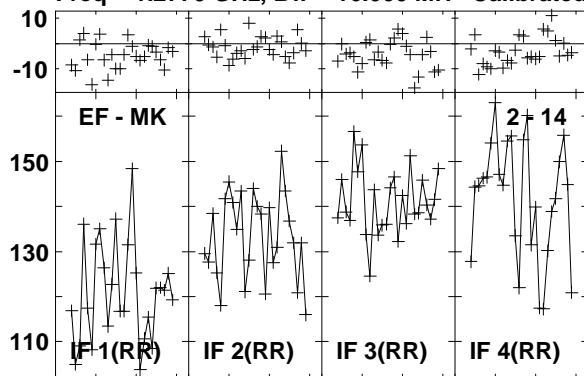

Lower frame: Milli Ampl Jy Top frame: Phas deg
Vector averaged cross-power spectrum Baseline: EF (02) - MK (14)
Timerange: 01/02:08:50 to 01/02:09:48

Plot file version1253 created 03-MAR-2016 01:15:36
 J1545+5400 GN002C 1.UVDATA.1
 Freq = 1.2770 GHz, Bw = 16.000 MH Calibrated with CL # 3 and BP # 1 (BP mode 1)

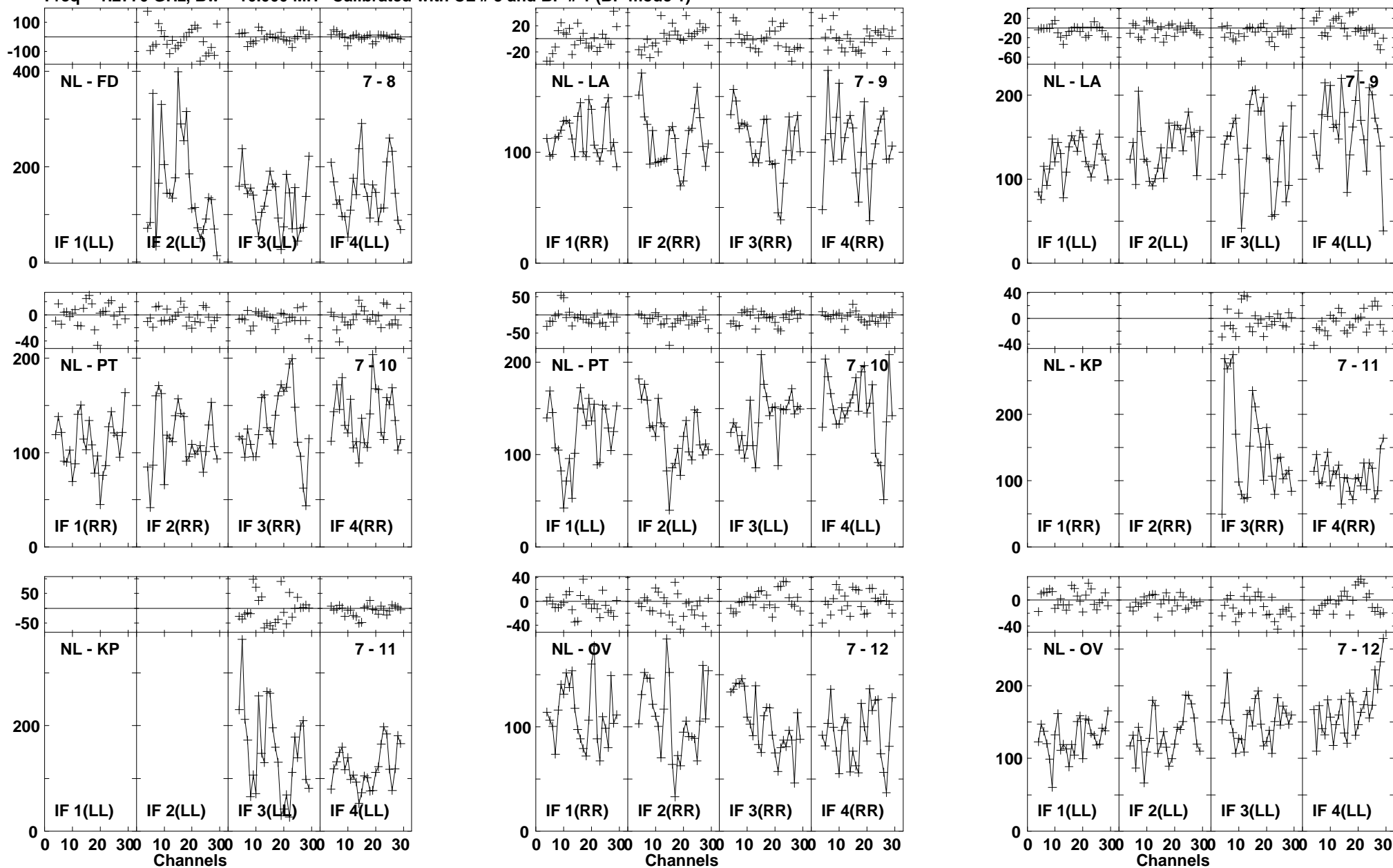

Lower frame: Milli Ampl Jy Top frame: Phas deg
 Vector averaged cross-power spectrum Baseline: NL (07) - FD (08)
 Timerange: 01/02:08:50 to 01/02:09:48

Plot file version1254 created 03-MAR-2016 01:15:36

J1545+5400 GN002C 1.UVDATA.1

Freq = 1.2770 GHz, Bw = 16.000 MH Calibrated with CL # 3 and BP # 1 (BP mode 1)

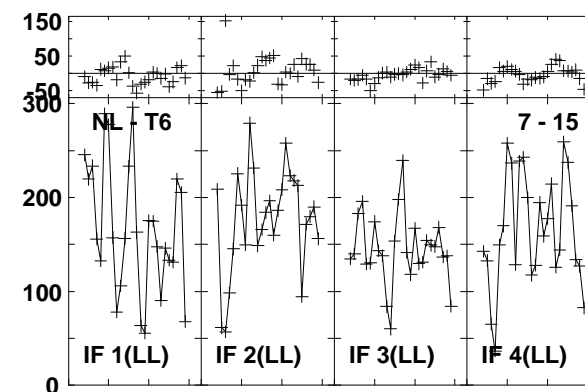
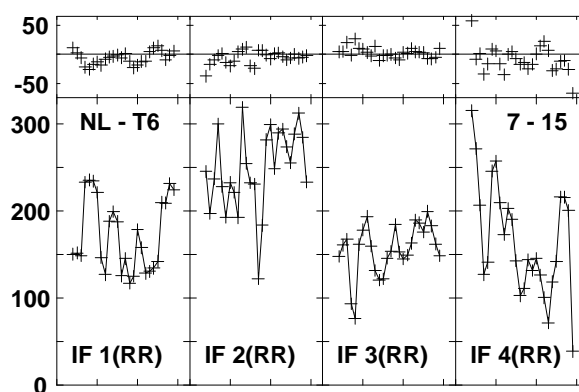
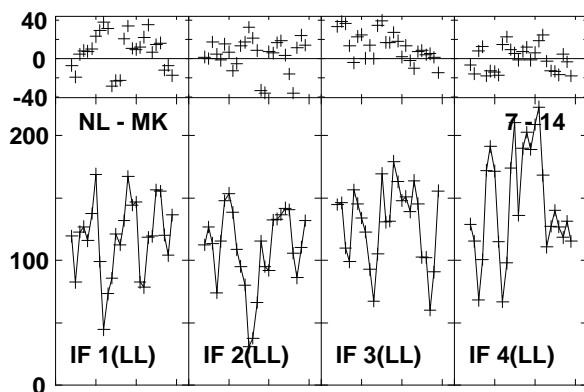
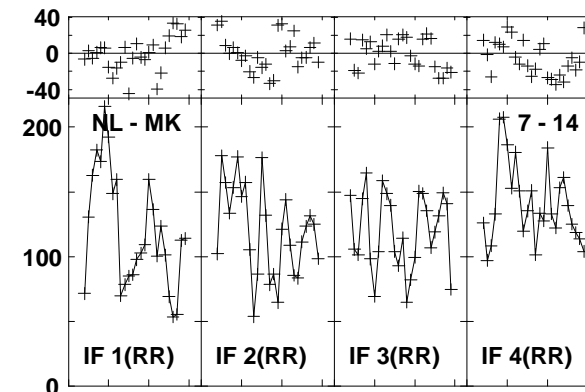
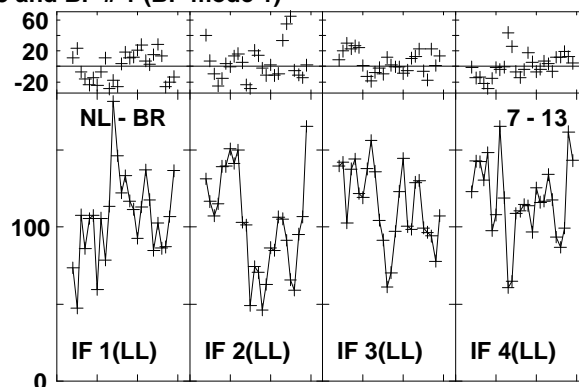
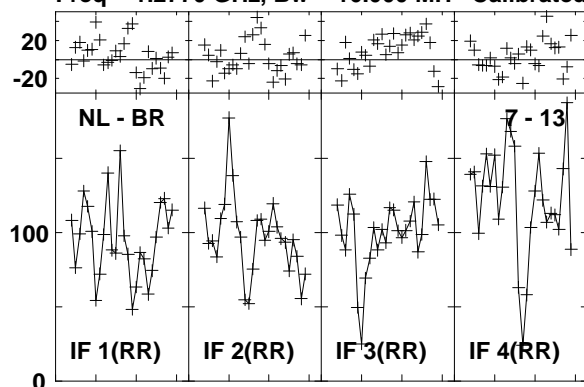

Lower frame: Milli Ampl Jy Top frame: Phas deg
Vector averaged cross-power spectrum Baseline: NL (07) - BR (13)
Timerange: 01/02:08:50 to 01/02:09:48

Plot file version1255 created 03-MAR-2016 01:15:36

4C52 GN002C 1.UVDATA.1

Freq = 1.2770 GHz, Bw = 16.000 MH Calibrated with CL # 3 and BP # 1 (BP mode 1)

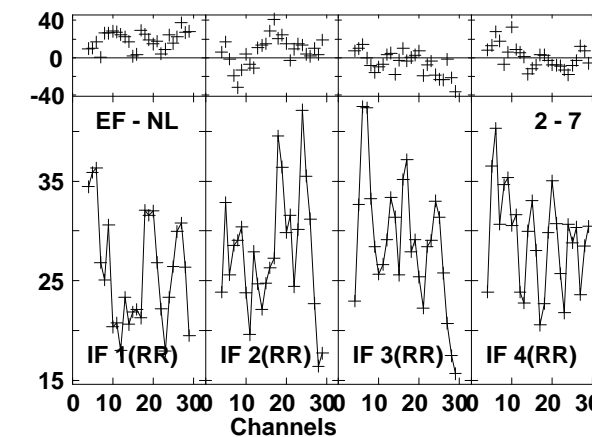
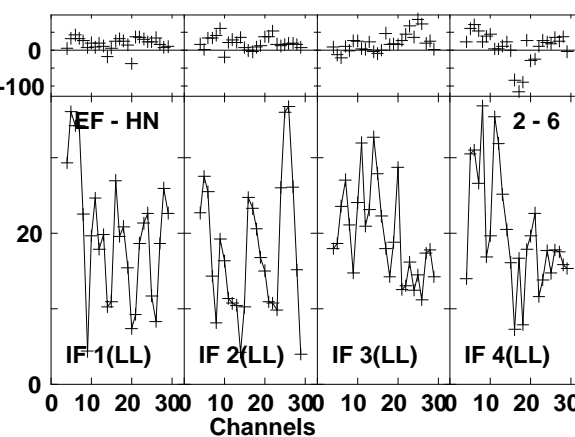
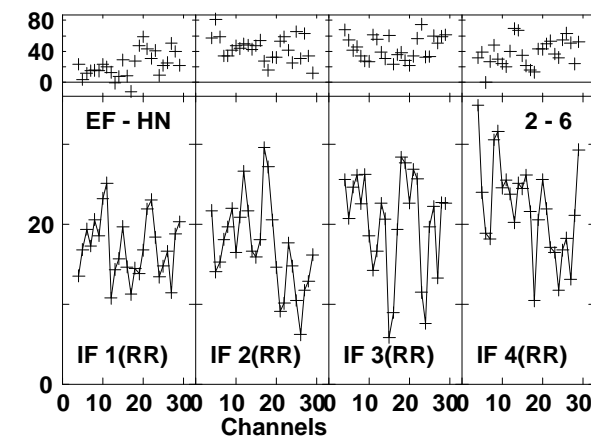
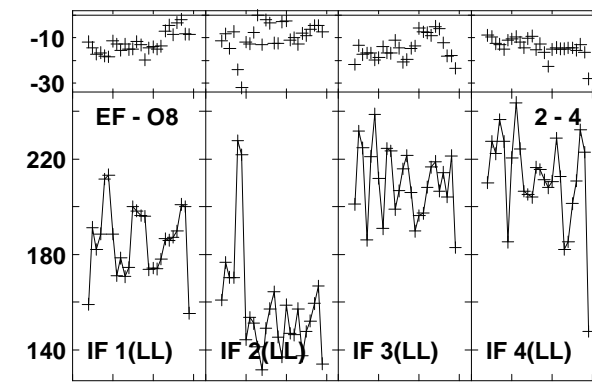
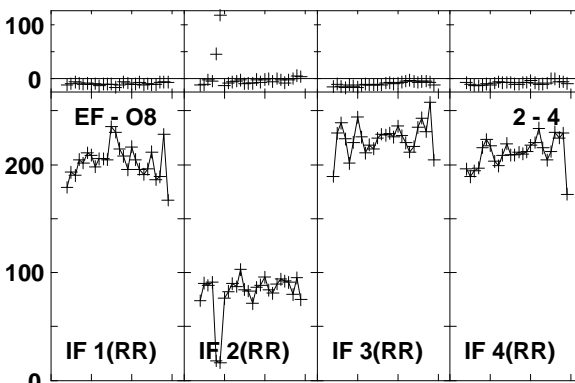
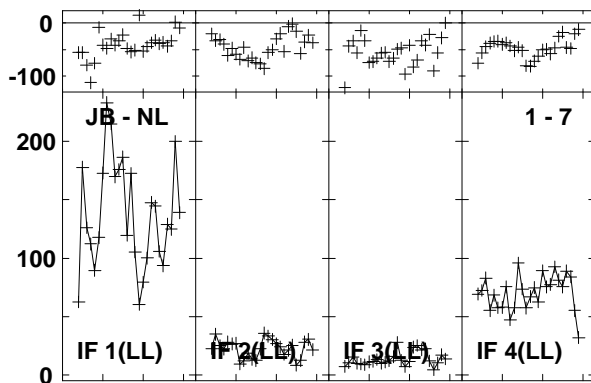
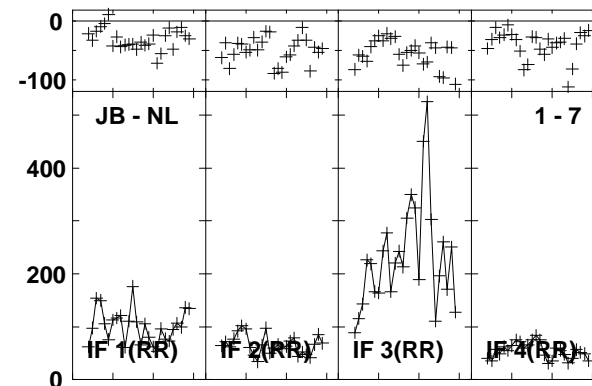
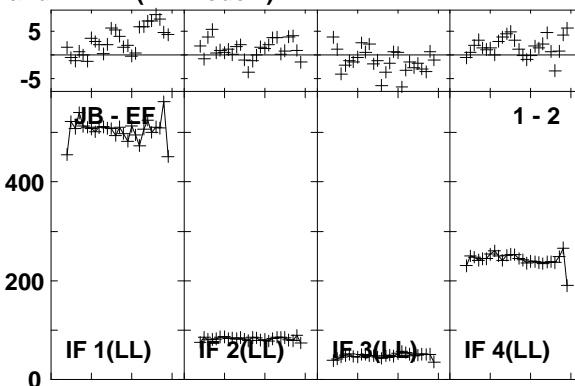
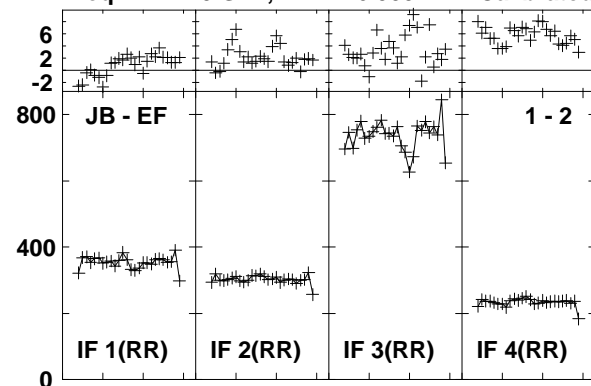

Lower frame: Milli Ampl Jy Top frame: Phas deg
Vector averaged cross-power spectrum Baseline: JB (01) - EF (02)
Timerange: 01/02:09:53 to 01/02:13:17

Plot file version1256 created 03-MAR-2016 01:15:36

4C52 GN002C 1.UVDATA.1

Freq = 1.2770 GHz, Bw = 16.000 MH Calibrated with CL # 3 and BP # 1 (BP mode 1)

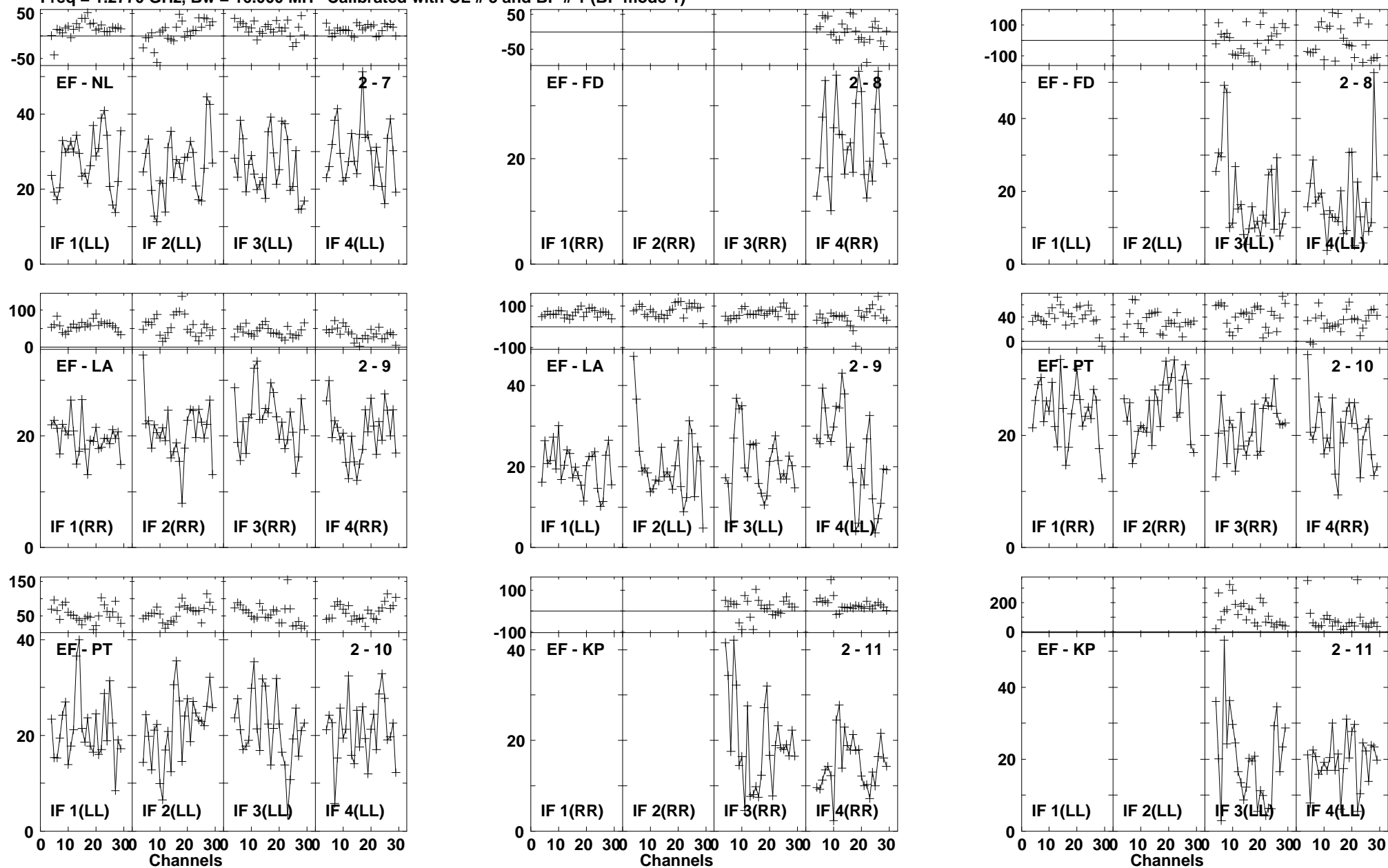

Lower frame: Milli Ampl Jy Top frame: Phas deg
Vector averaged cross-power spectrum Baseline: EF (02) - NL (07)
Timerange: 01/02:09:53 to 01/02:13:17

Plot file version1257 created 03-MAR-2016 01:15:36

4C52 GN002C 1.UVDATA.1

Freq = 1.2770 GHz, Bw = 16.000 MH Calibrated with CL # 3 and BP # 1 (BP mode 1)

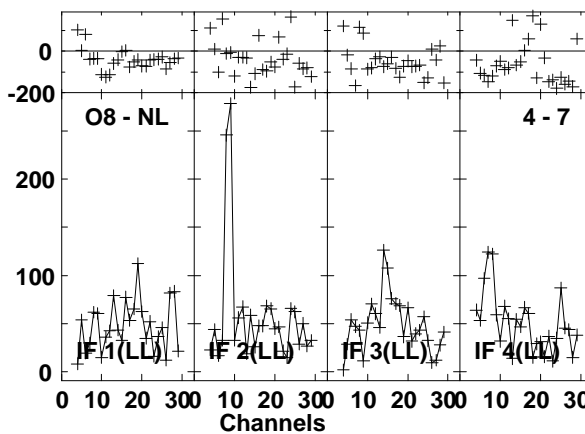
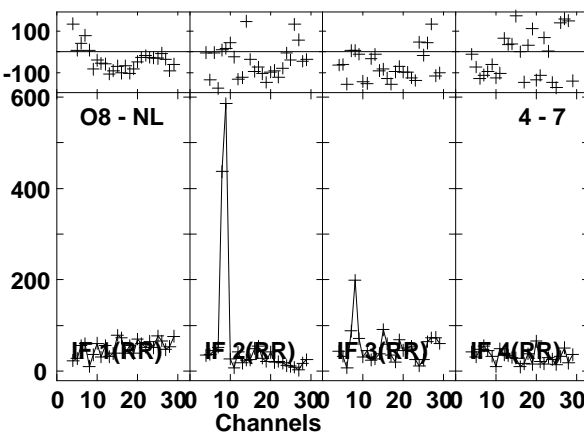
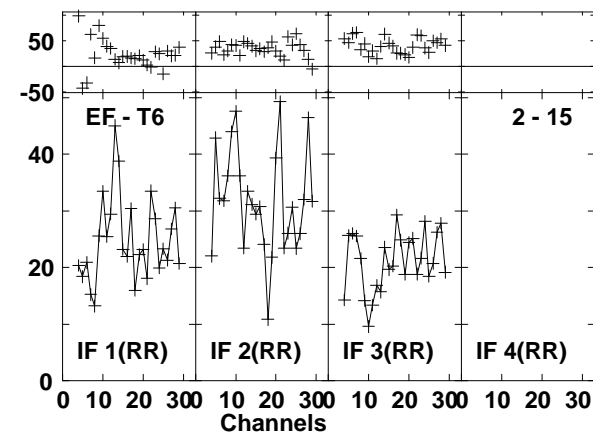
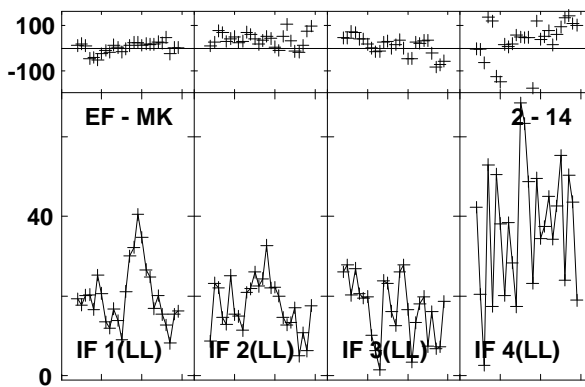
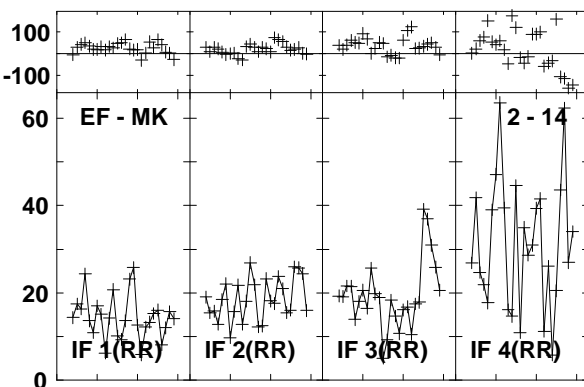
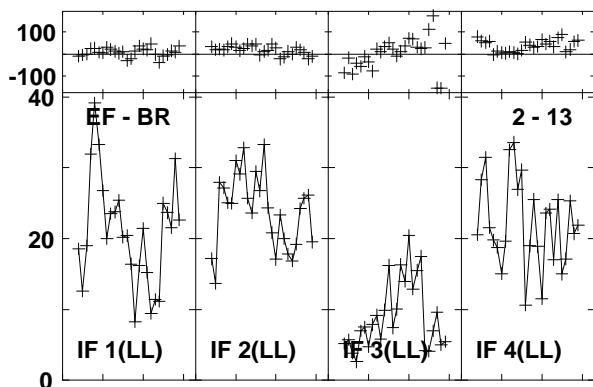
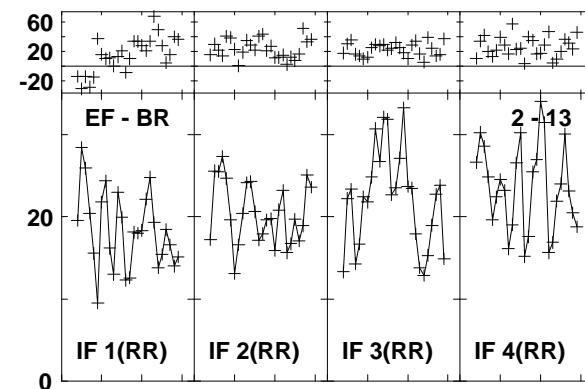
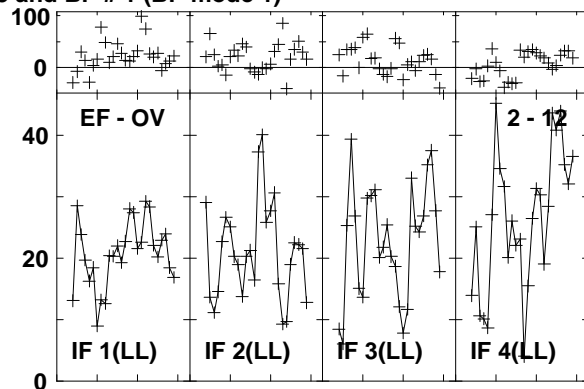
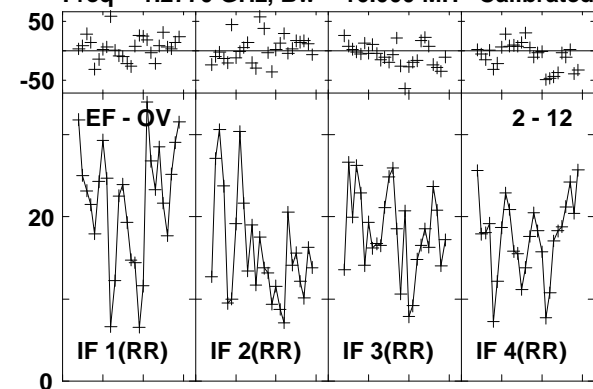

Lower frame: Milli Ampl Jy Top frame: Phas deg
Vector averaged cross-power spectrum Baseline: EF (02) - OV (12)
Timerange: 01/02:09:53 to 01/02:13:17

Plot file version1258 created 03-MAR-2016 01:15:37

4C52 GN002C 1.UVDATA.1

Freq = 1.2770 GHz, Bw = 16.000 MH Calibrated with CL # 3 and BP # 1 (BP mode 1)

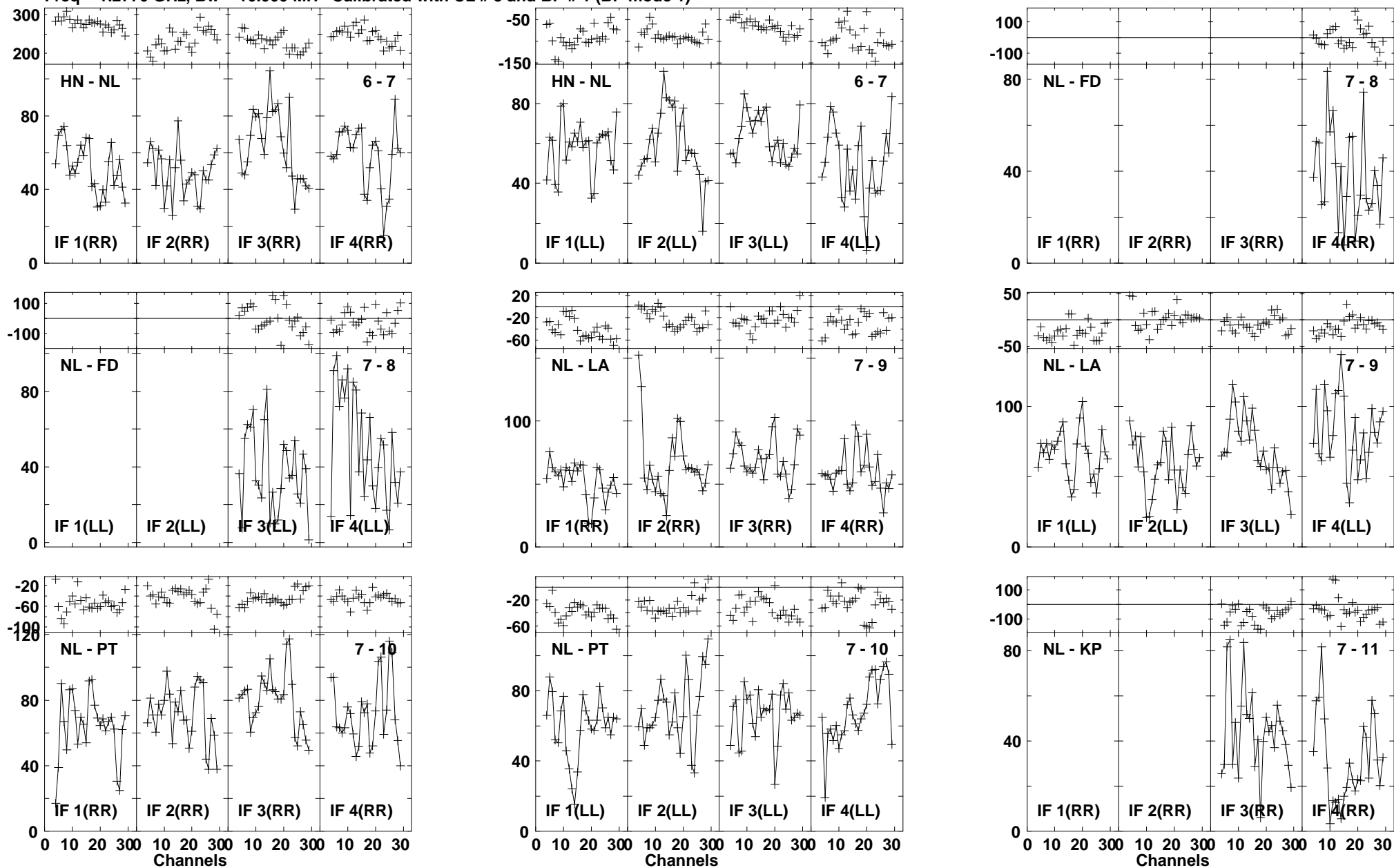

Lower frame: Milli Ampl Jy Top frame: Phas deg
Vector averaged cross-power spectrum Baseline: HN (06) - NL (07)
Timerange: 01/02:09:53 to 01/02:13:17

Plot file version1259 created 03-MAR-2016 01:15:37

4C52 GN002C 1.UVDATA.1

Freq = 1.2770 GHz, Bw = 16.000 MH Calibrated with CL # 3 and BP # 1 (BP mode 1)

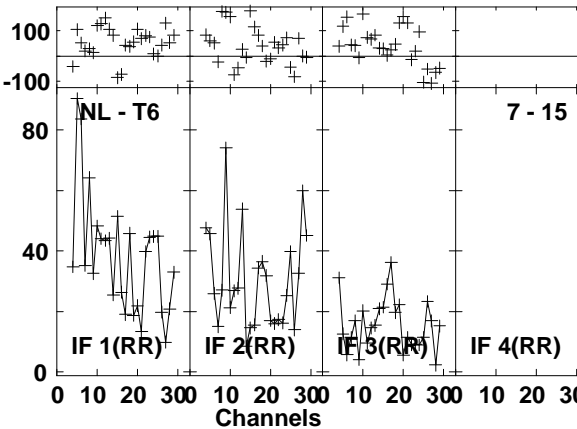
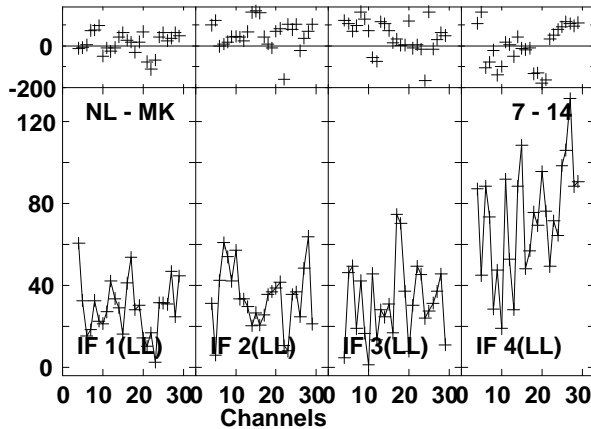
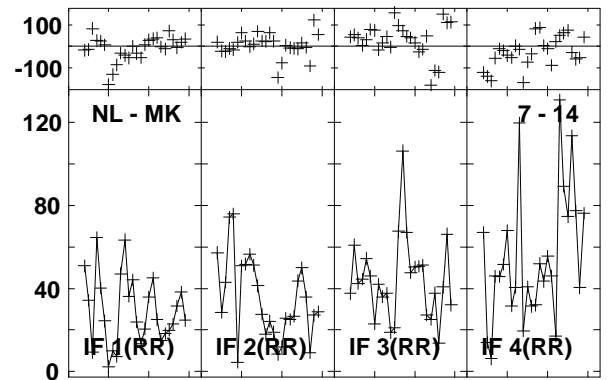
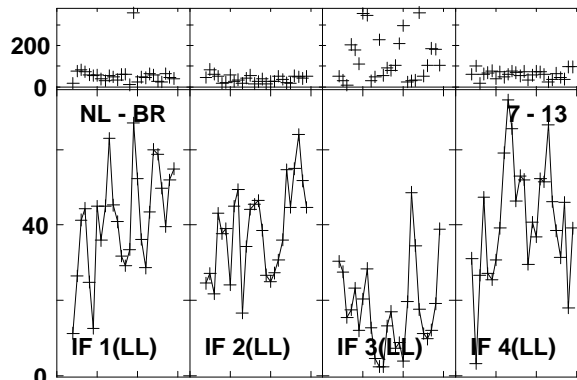
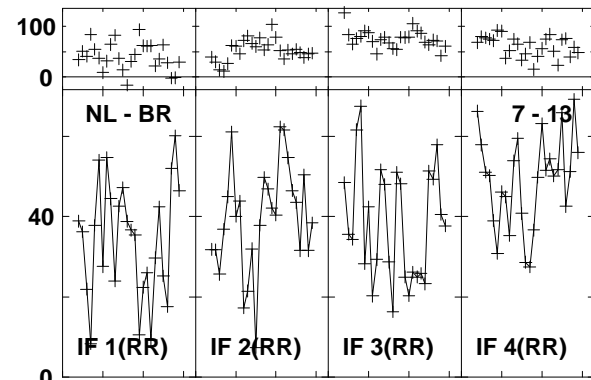
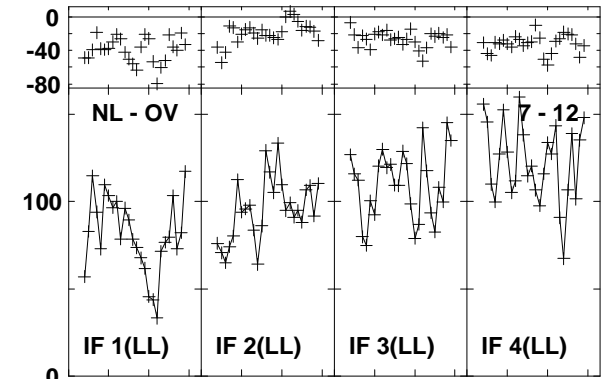
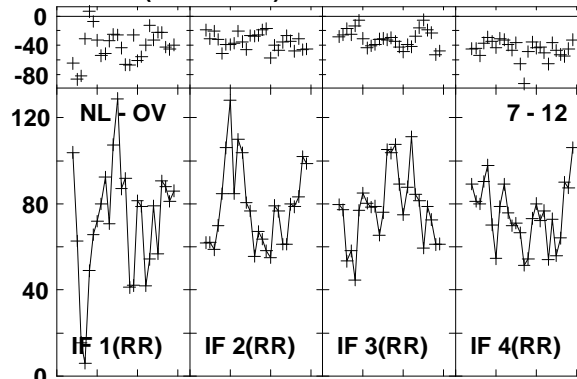
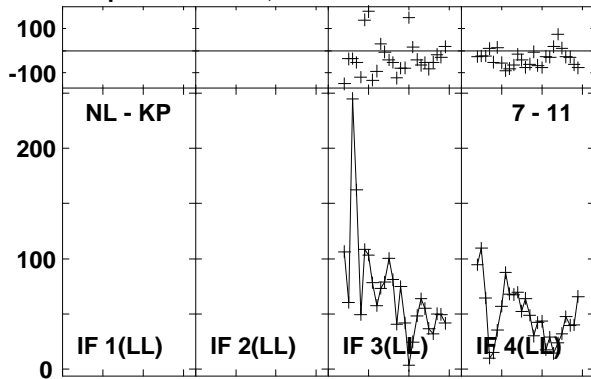

Lower frame: Milli Ampl Jy Top frame: Phas deg

Vector averaged cross-power spectrum Baseline: NL (07) - KP (11)

Timerange: 01/02:09:53 to 01/02:13:17

Plot file version1260 created 03-MAR-2016 01:15:37

J1545+5400 GN002C 1.UVDATA.1

Freq = 1.2770 GHz, Bw = 16.000 MH Calibrated with CL # 3 and BP # 1 (BP mode 1)

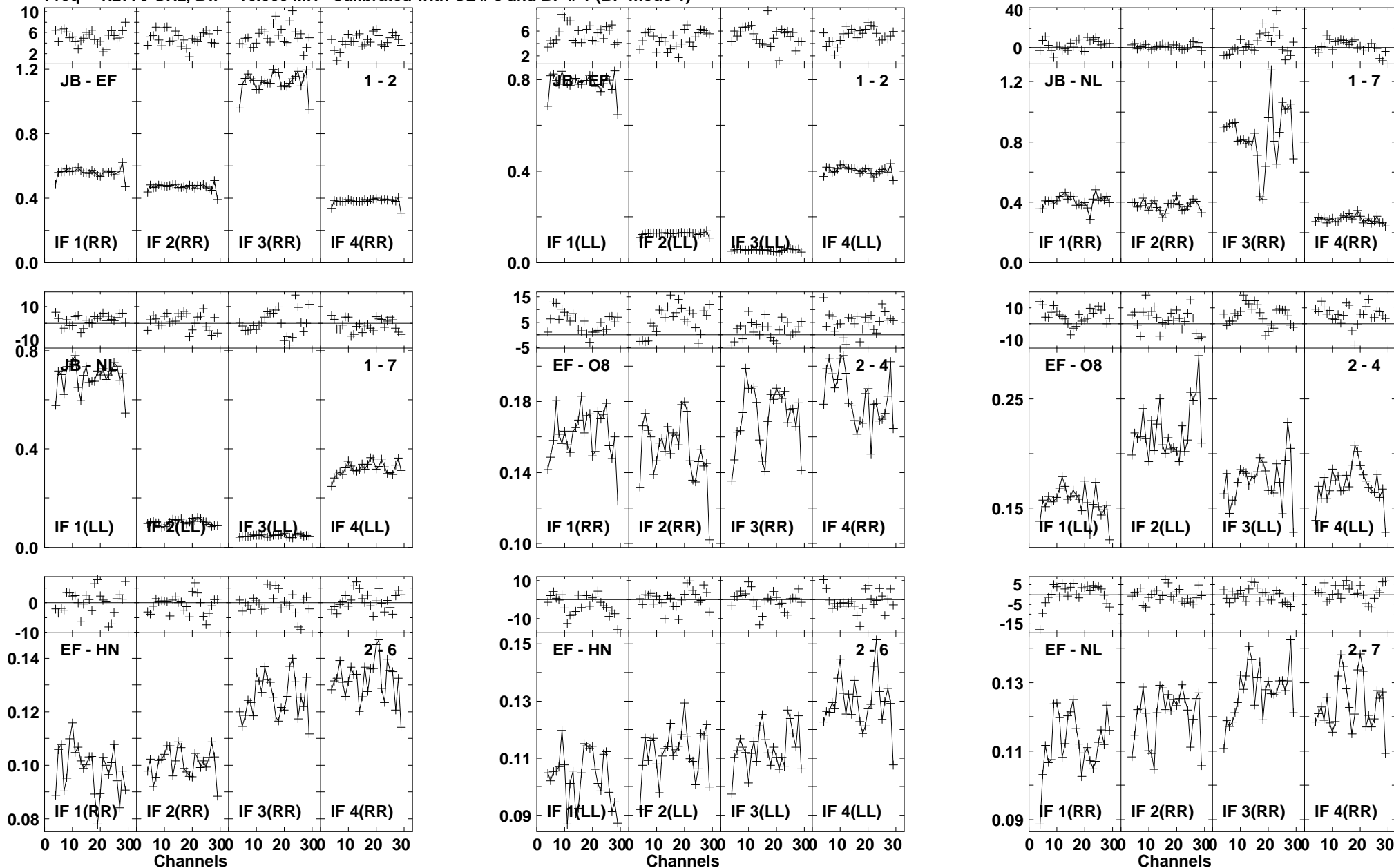

Lower frame: Ampl Jy Top frame: Phas deg
Vector averaged cross-power spectrum Baseline: JB (01) - EF (02)
Timerange: 01/02:14:10 to 01/02:16:08

Plot file version1261 created 03-MAR-2016 01:15:37

J1545+5400 GN002C 1.UVDATA.1

Freq = 1.2770 GHz, Bw = 16.000 MH Calibrated with CL # 3 and BP # 1 (BP mode 1)

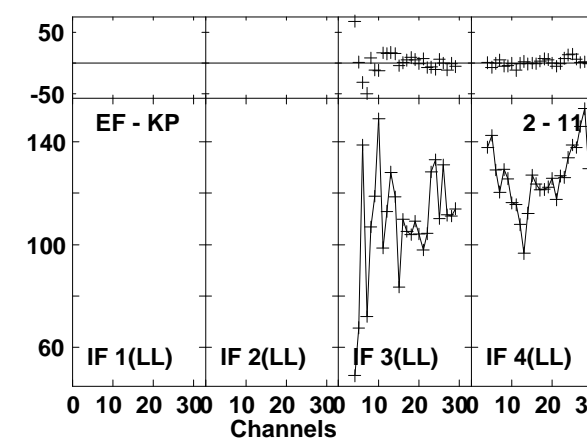
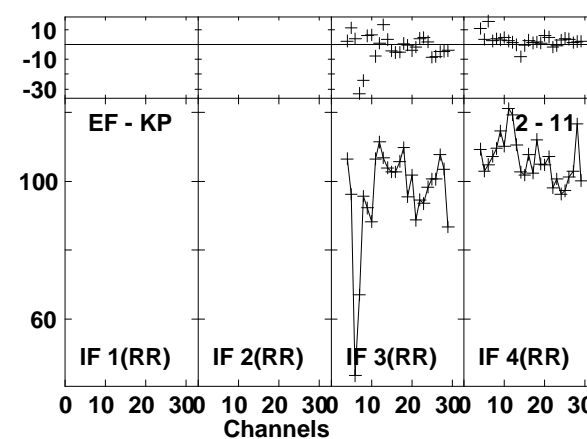
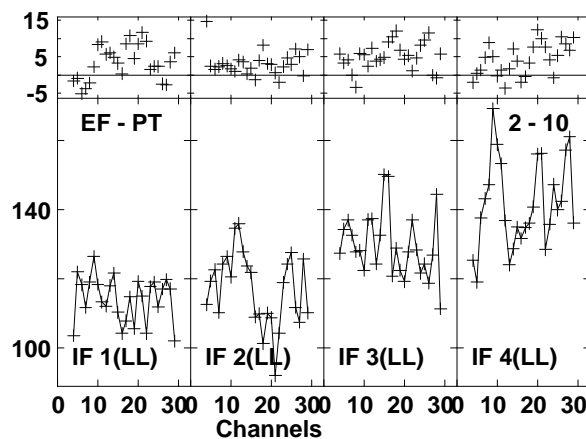
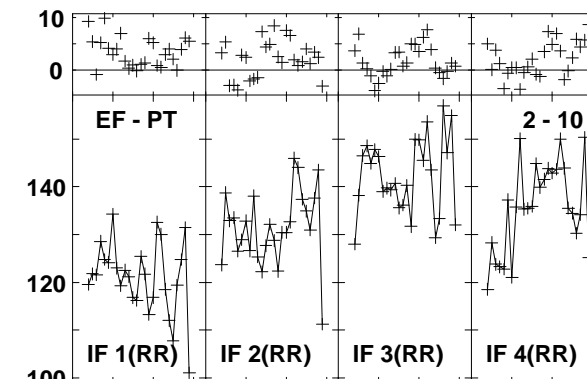
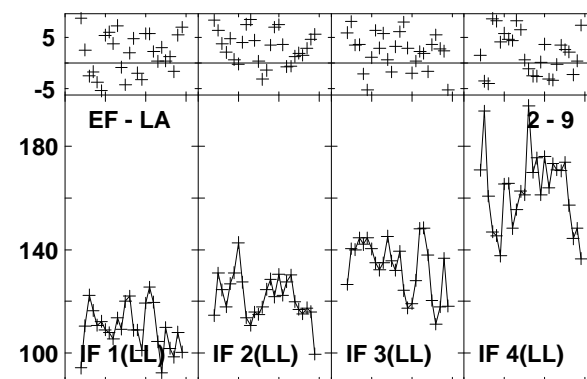
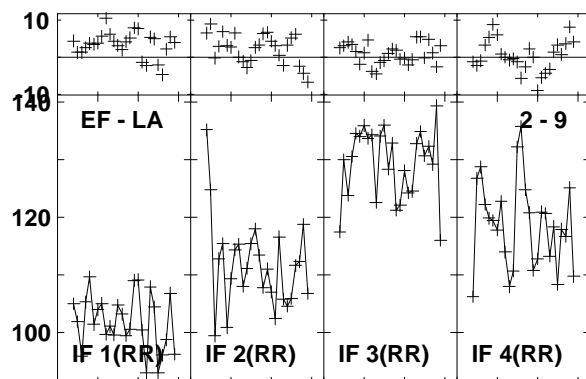
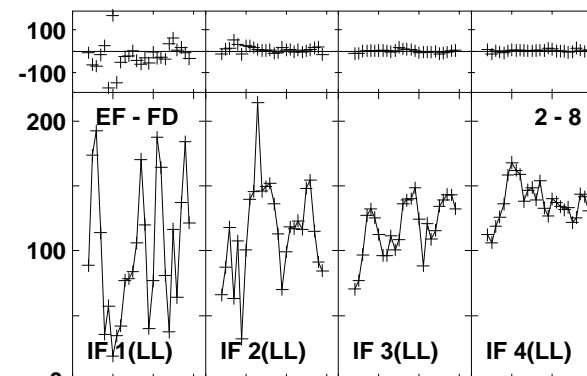
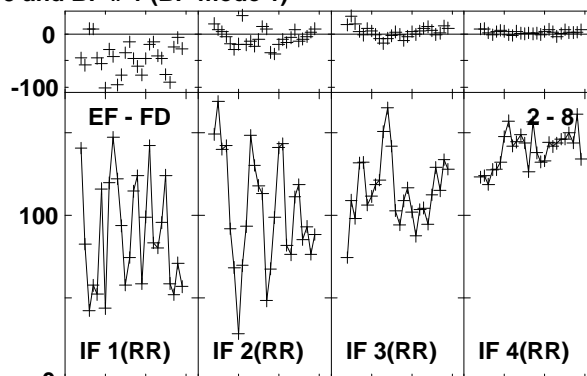
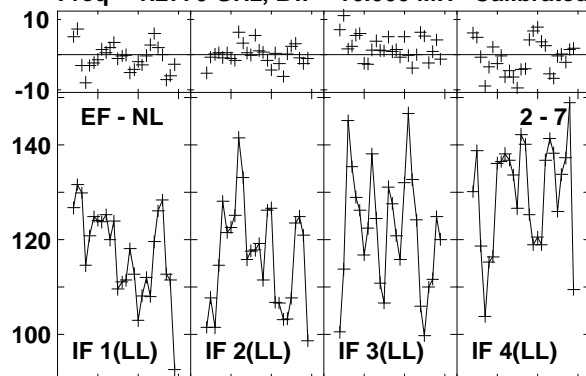

Lower frame: Milli Ampl Jy Top frame: Phas deg
Vector averaged cross-power spectrum Baseline: EF (02) - NL (07)
Timerange: 01/02:14:10 to 01/02:16:08

Plot file version1262 created 03-MAR-2016 01:15:37

J1545+5400 GN002C 1.UVDATA.1

Freq = 1.2770 GHz, Bw = 16.000 MH Calibrated with CL # 3 and BP # 1 (BP mode 1)

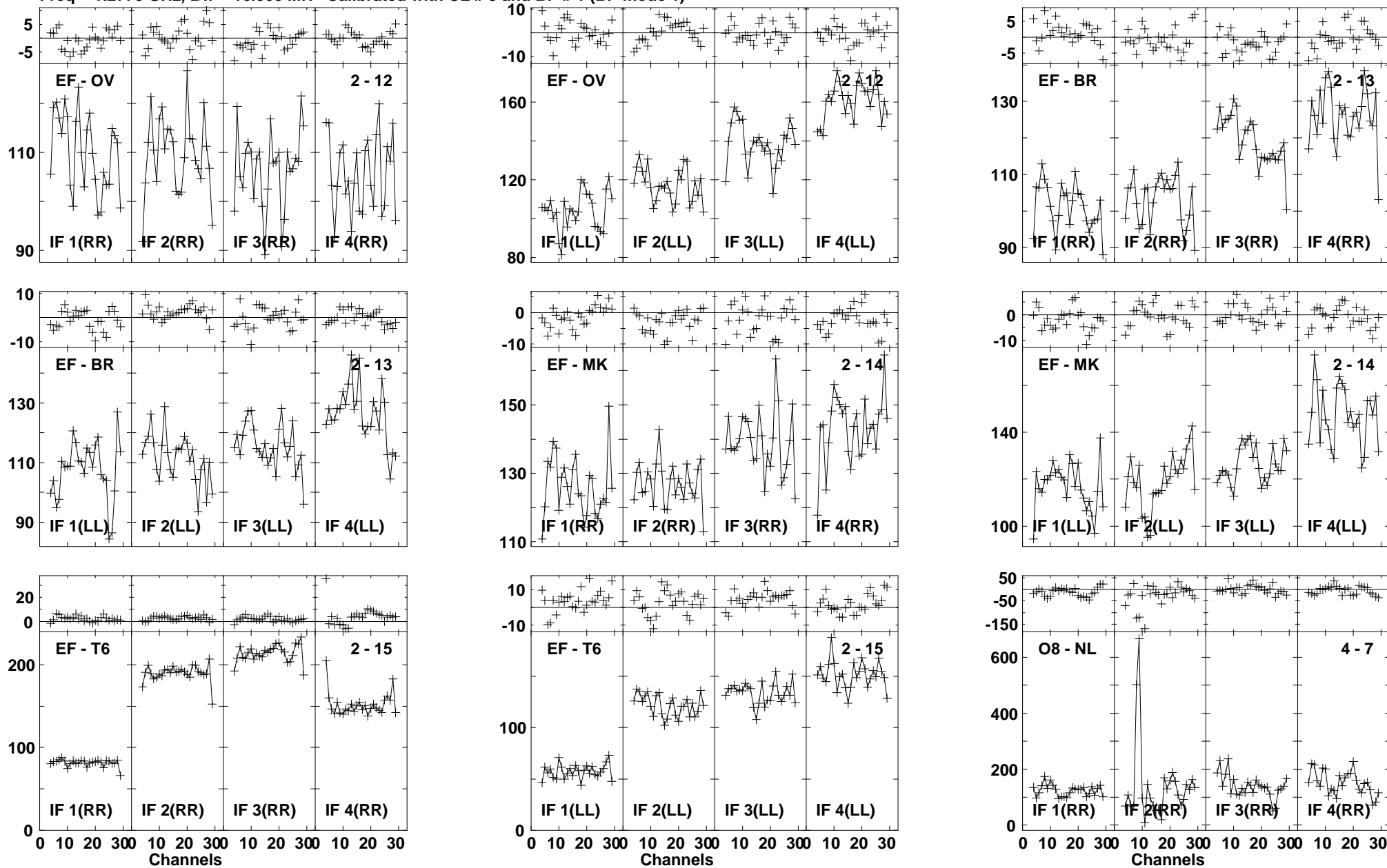

Lower frame: Milli Ampl Jy Top frame: Phas deg
Vector averaged cross-power spectrum Baseline: EF (02) - OV (12)
Timerange: 01/02:14:10 to 01/02:16:08

Plot file version1263 created 03-MAR-2016 01:15:38

J1545+5400 GN002C 1.UVDATA.1

Freq = 1.2770 GHz, Bw = 16.000 MH Calibrated with CL # 3 and BP # 1 (BP mode 1)

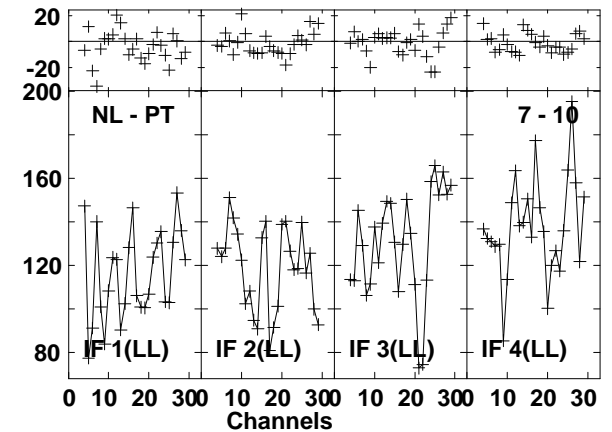
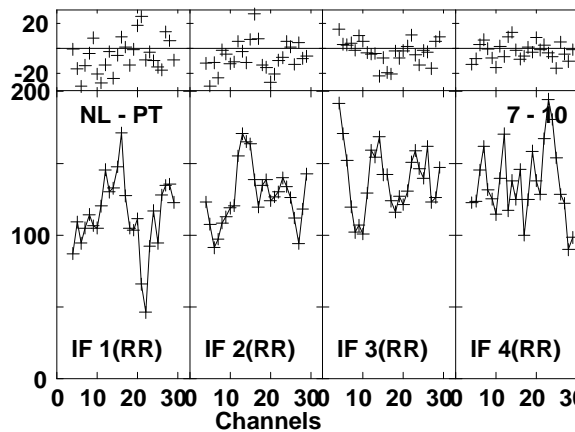
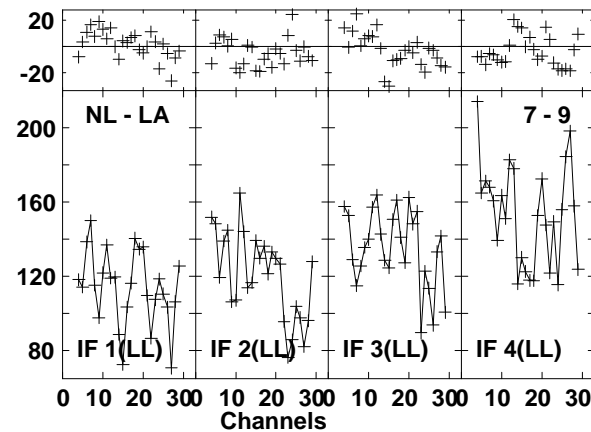
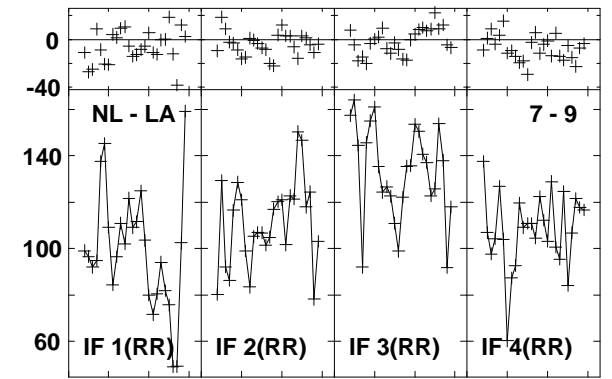
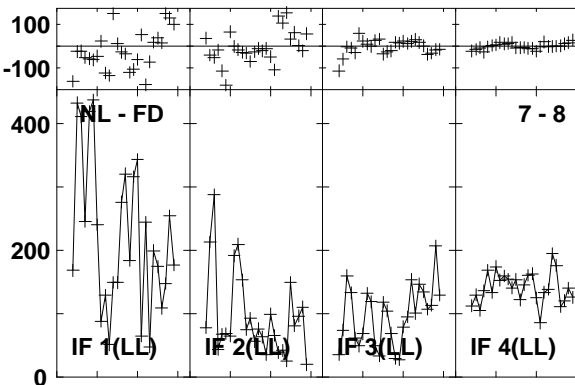
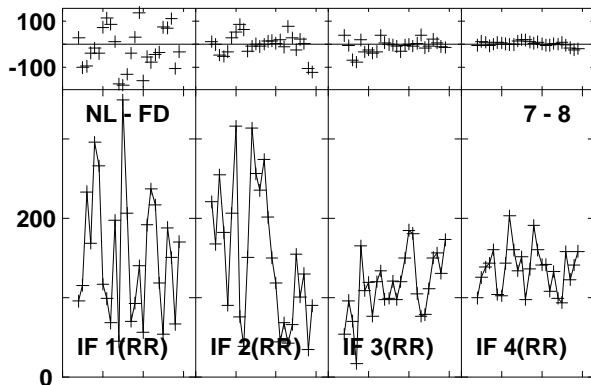
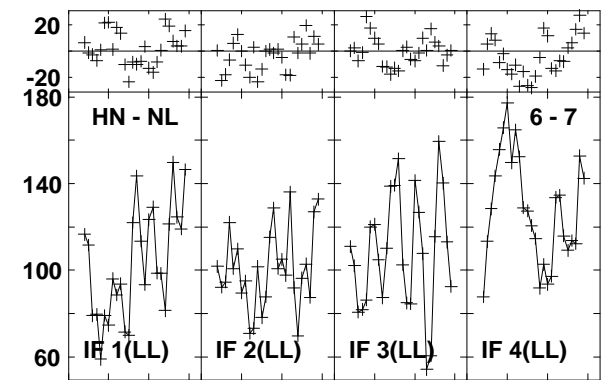
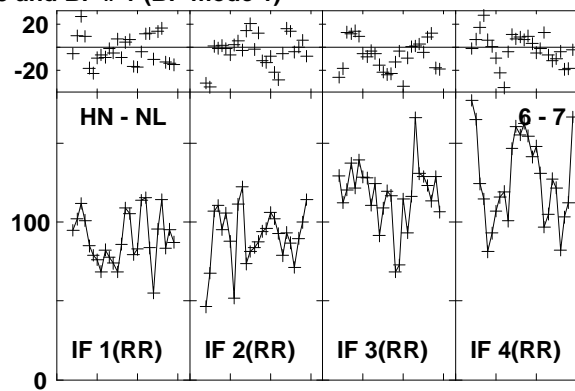
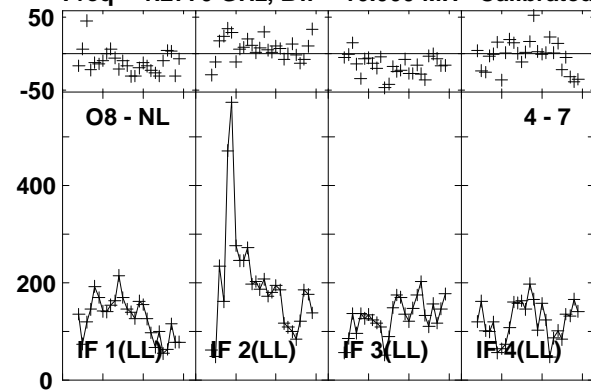

Lower frame: Milli Ampl Jy Top frame: Phas deg
Vector averaged cross-power spectrum Baseline: O8 (04) - NL (07)
Timerange: 01/02:14:10 to 01/02:16:08

Plot file version1264 created 03-MAR-2016 01:15:38

J1545+5400 GN002C 1.UVDATA.1

Freq = 1.2770 GHz, Bw = 16.000 MH Calibrated with CL # 3 and BP # 1 (BP mode 1)

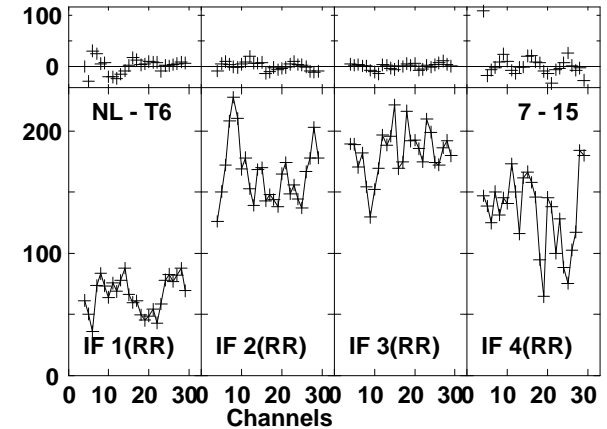
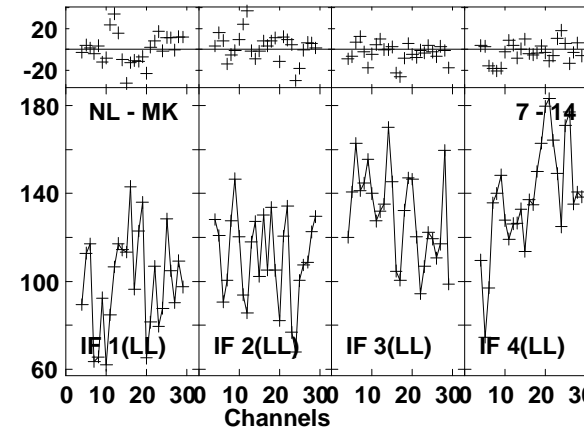
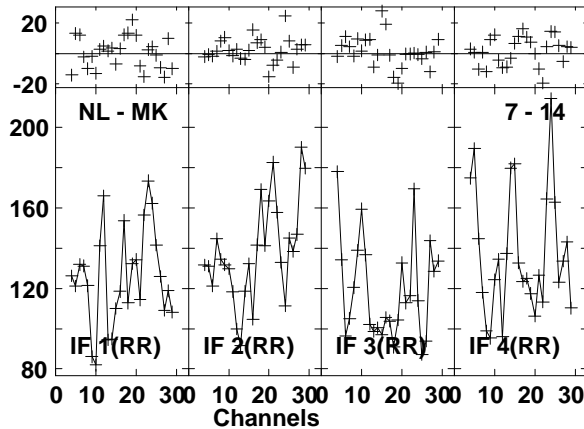
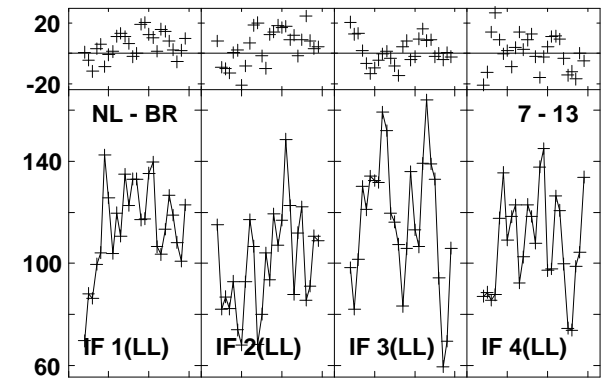
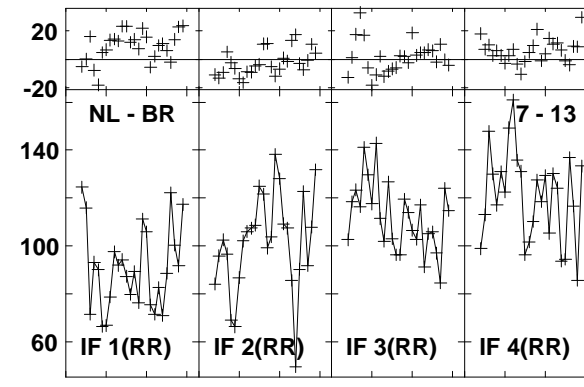
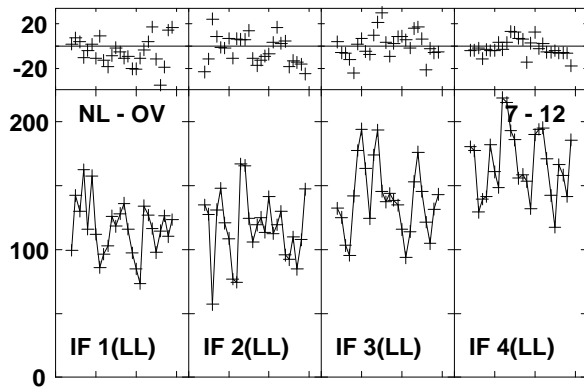
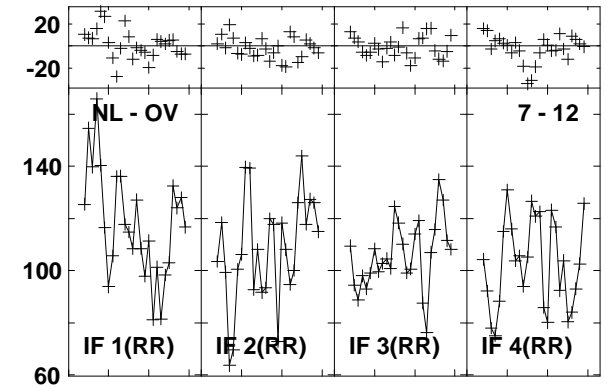
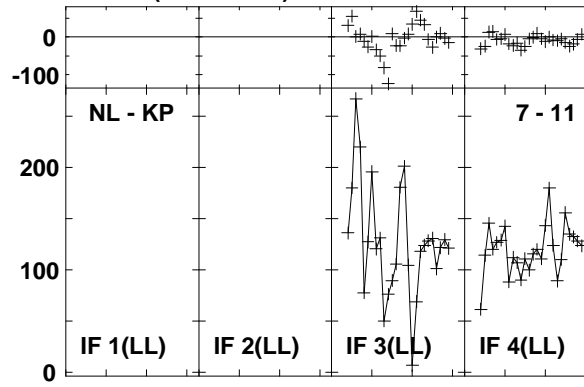
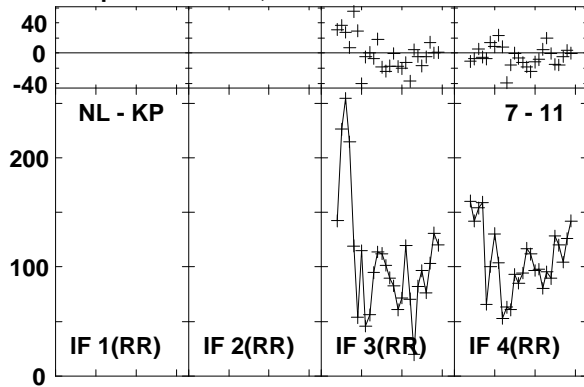

Lower frame: Milli Ampl Jy Top frame: Phas deg
Vector averaged cross-power spectrum Baseline: NL (07) - KP (11)
Timerange: 01/02:14:10 to 01/02:16:08

Plot file version1265 created 03-MAR-2016 01:15:38
J1545+5400 GN002C 1.UVDATA.1
Freq = 1.2770 GHz, Bw = 16.000 MH Calibrated with CL # 3 and BP # 1 (BP mode 1)

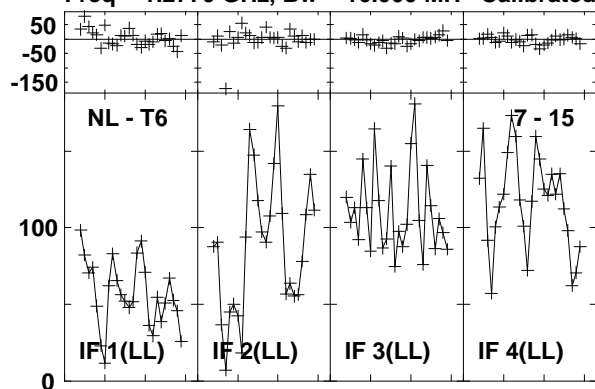

Lower frame: Milli Ampl Jy Top frame: Phas deg
Vector averaged cross-power spectrum Baseline: NL (07) - T6 (15)
Timerange: 01/02:14:10 to 01/02:16:08

Plot file version1266 created 03-MAR-2016 01:15:38

4C52 GN002C 1.UVDATA.1

Freq = 1.2770 GHz, Bw = 16.000 MH Calibrated with CL # 3 and BP # 1 (BP mode 1)

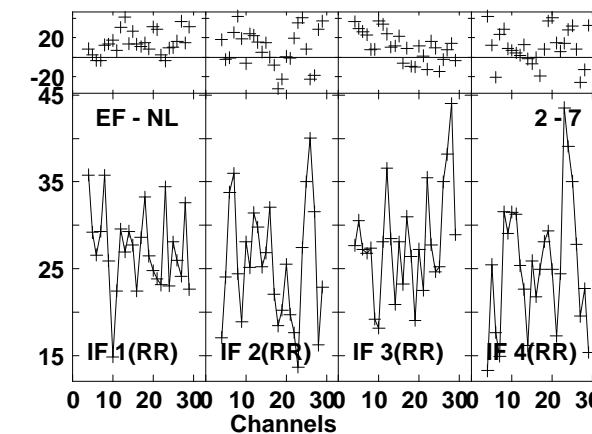
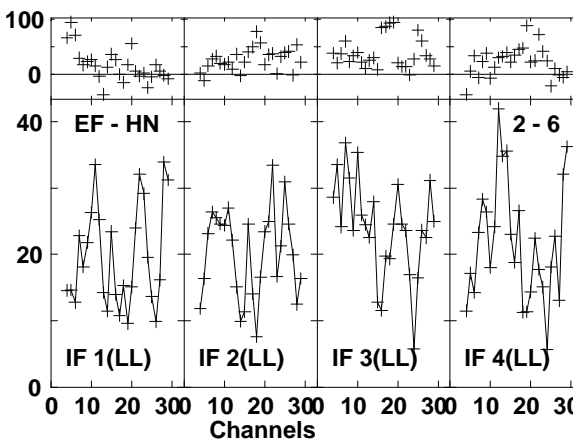
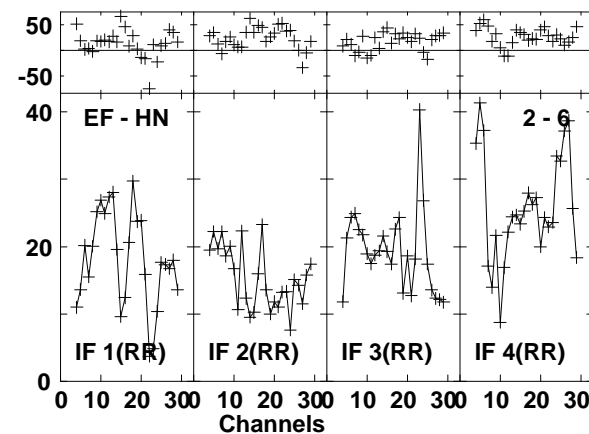
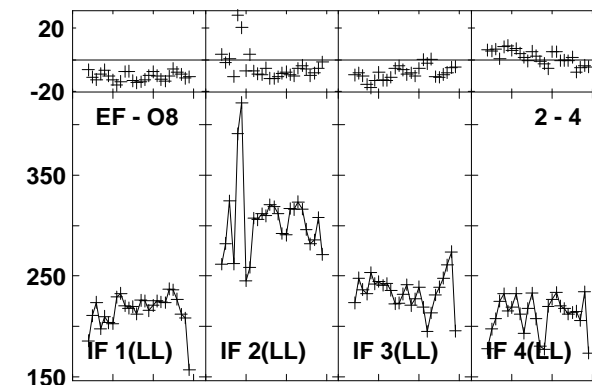
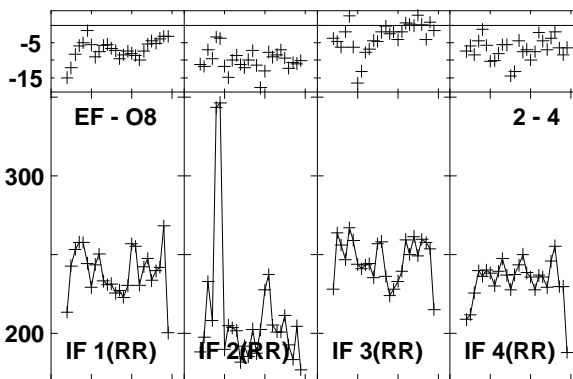
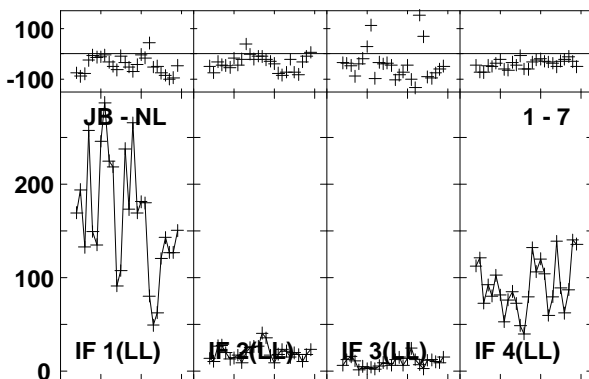
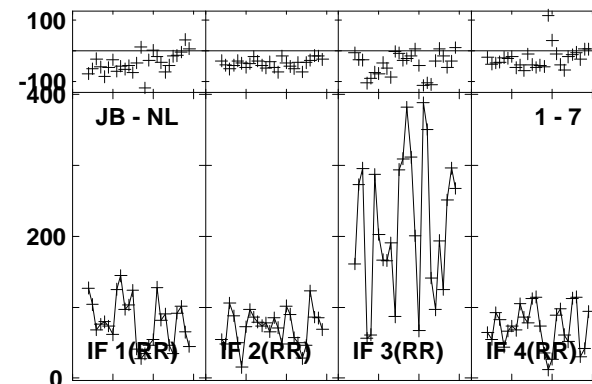
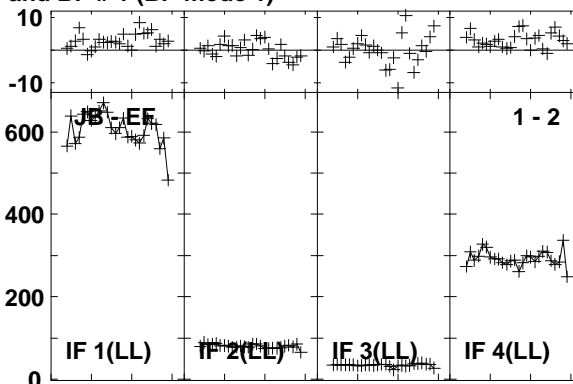
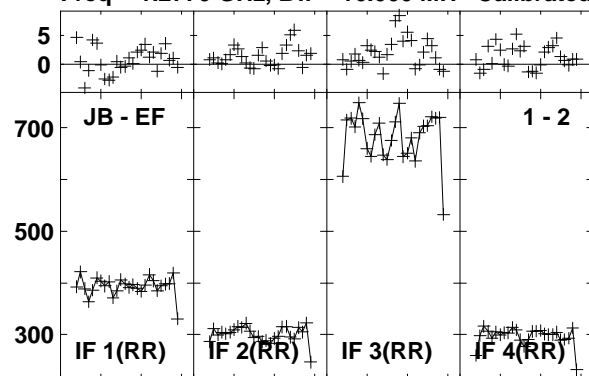

Lower frame: Milli Ampl Jy Top frame: Phas deg
Vector averaged cross-power spectrum Baseline: JB (01) - EF (02)
Timerange: 01/02:16:20 to 01/02:19:08

Plot file version1267 created 03-MAR-2016 01:15:38

4C52 GN002C 1.UVDATA.1

Freq = 1.2770 GHz, Bw = 16.000 MH Calibrated with CL # 3 and BP # 1 (BP mode 1)

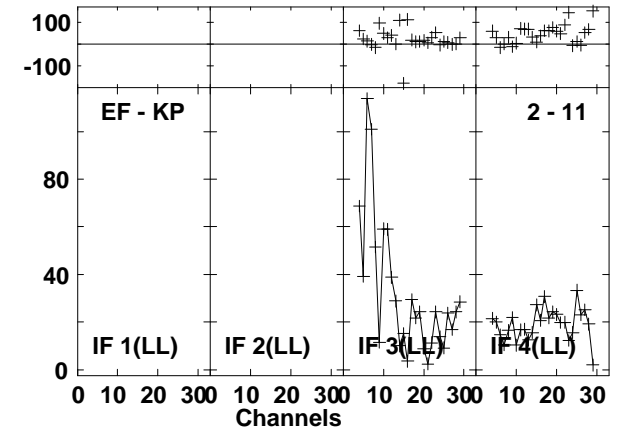
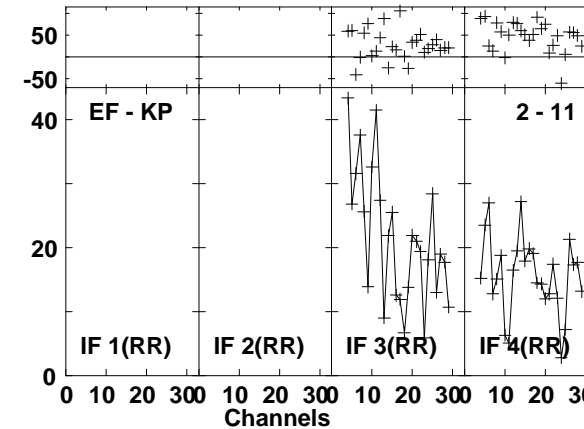
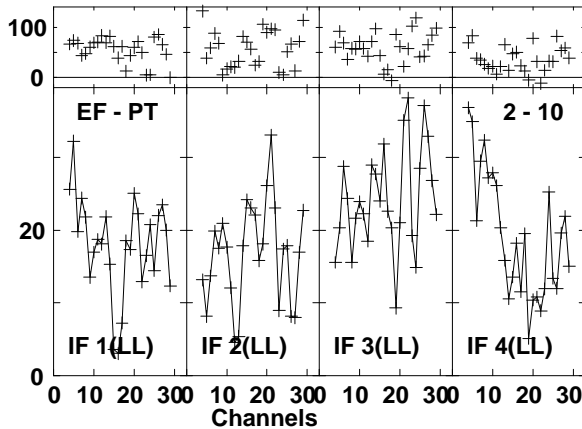
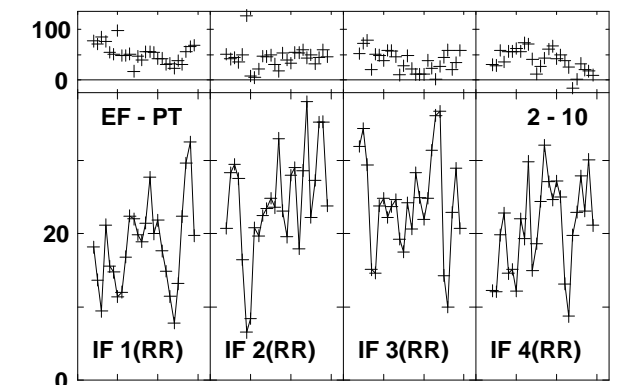
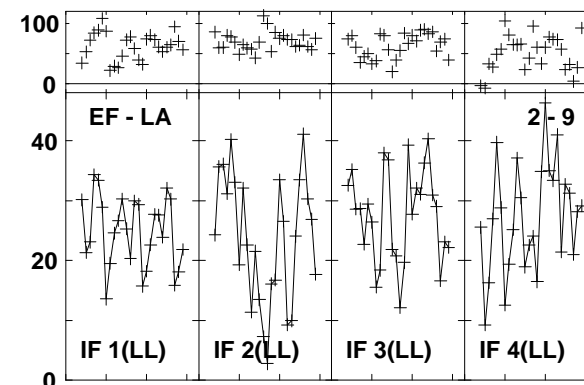
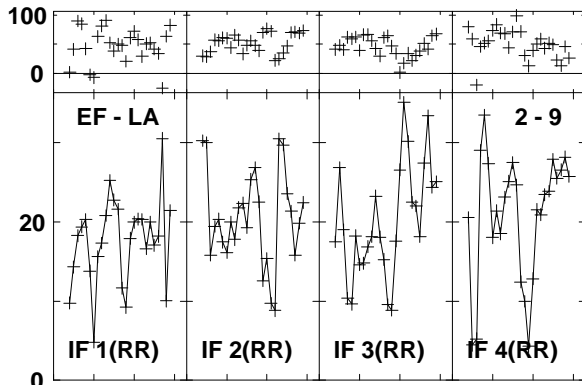
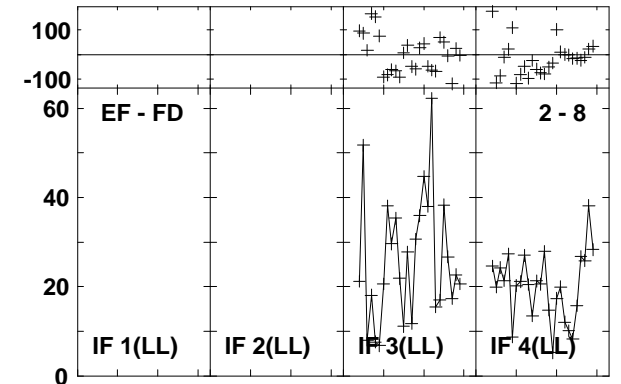
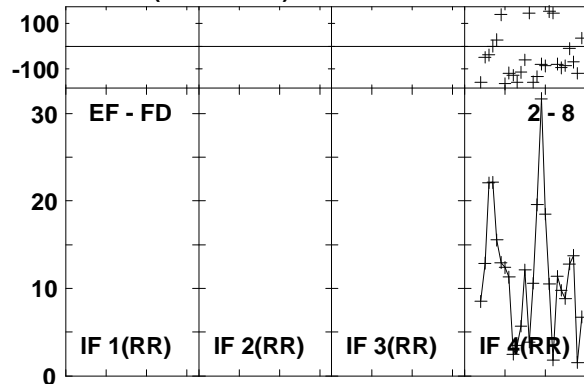
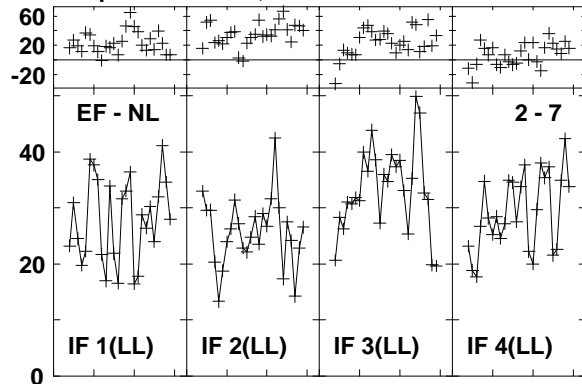

Lower frame: Milli Ampl Jy Top frame: Phas deg
Vector averaged cross-power spectrum Baseline: EF (02) - NL (07)
Timerange: 01/02:16:20 to 01/02:19:08

Plot file version1268 created 03-MAR-2016 01:15:38

4C52 GN002C 1.UVDATA.1

Freq = 1.2770 GHz, Bw = 16.000 MH Calibrated with CL # 3 and BP # 1 (BP mode 1)

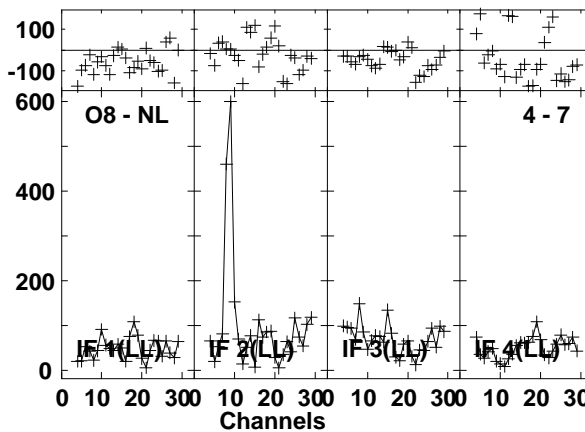
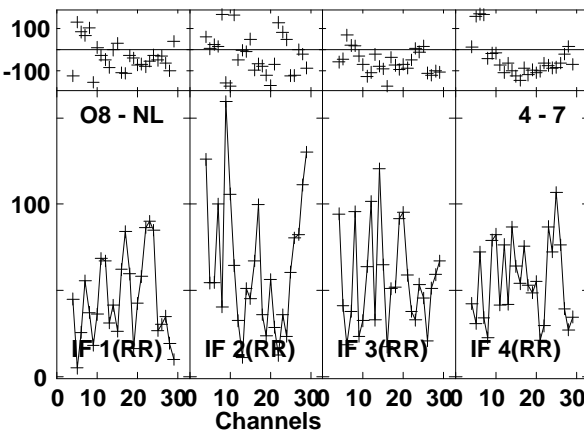
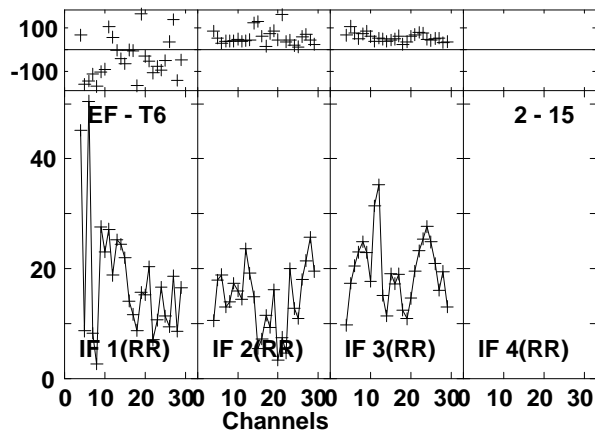
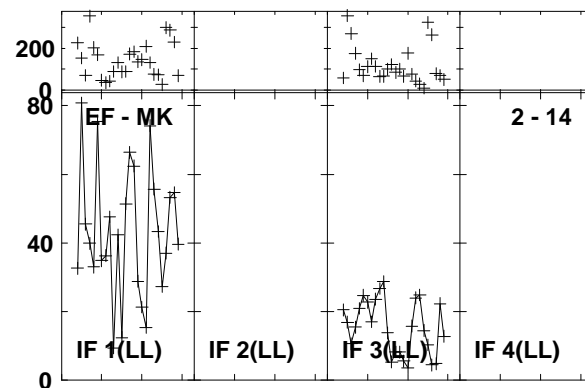
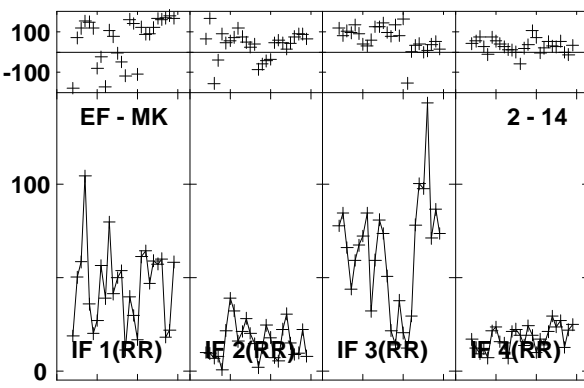
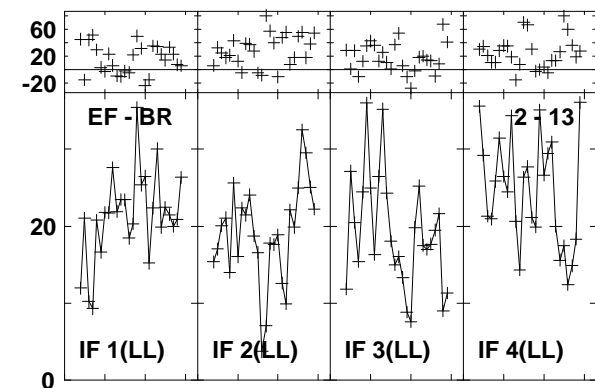
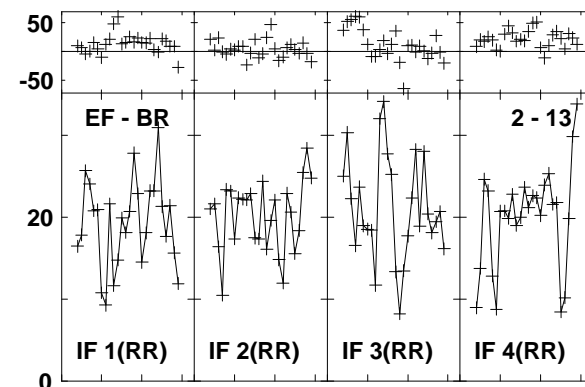
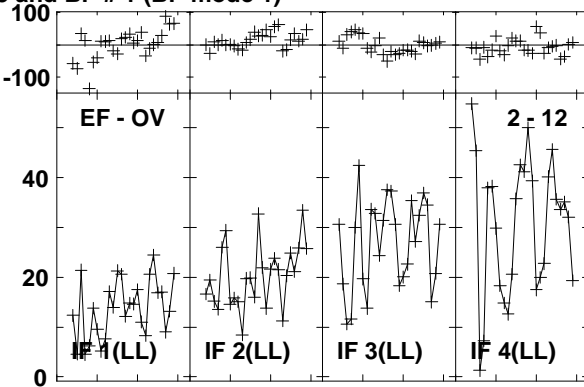
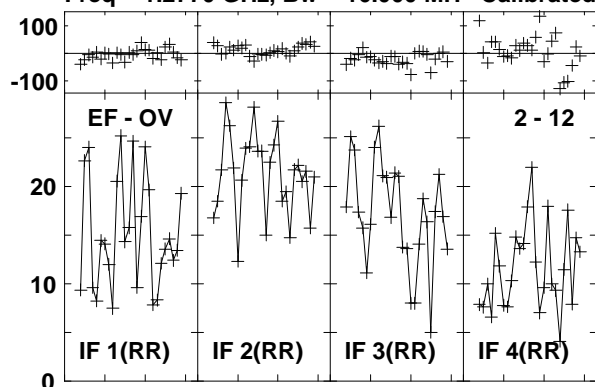

Lower frame: Milli Ampl Jy Top frame: Phas deg
Vector averaged cross-power spectrum Baseline: EF (02) - OV (12)
Timerange: 01/02:16:20 to 01/02:19:08

Plot file version1269 created 03-MAR-2016 01:15:39
 4C52 GN002C 1.UVDATA.1

Freq = 1.2770 GHz, Bw = 16.000 MH Calibrated with CL # 3 and BP # 1 (BP mode 1)

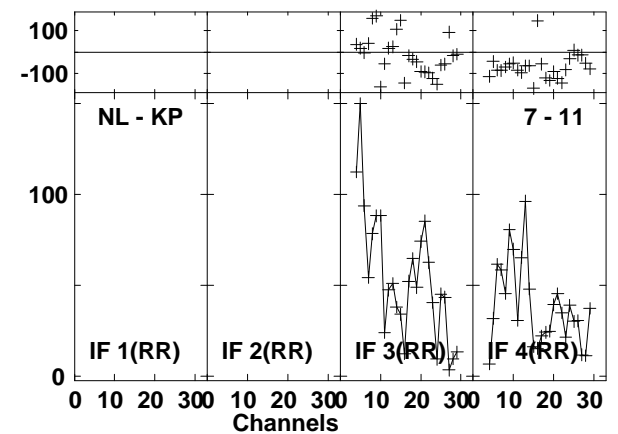
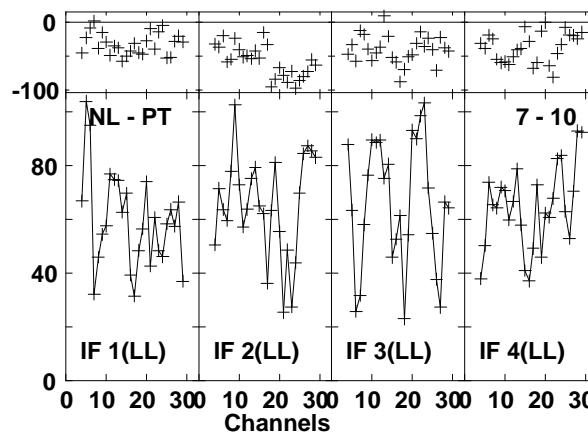
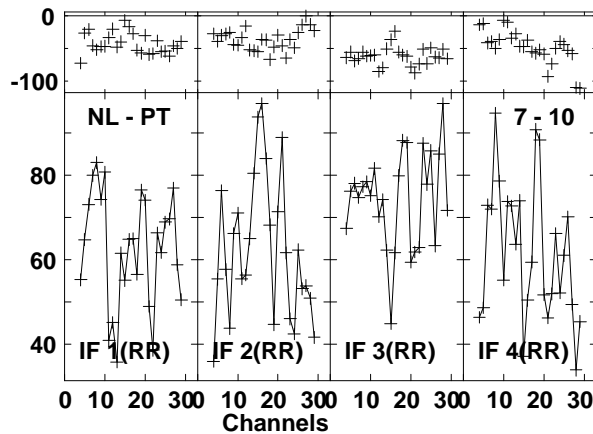
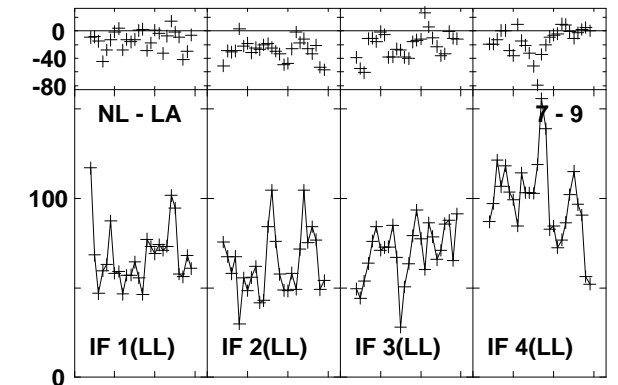
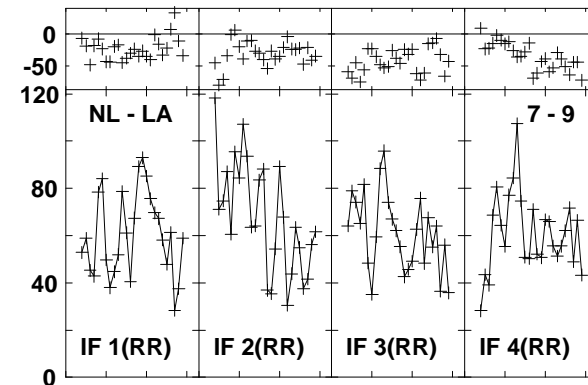
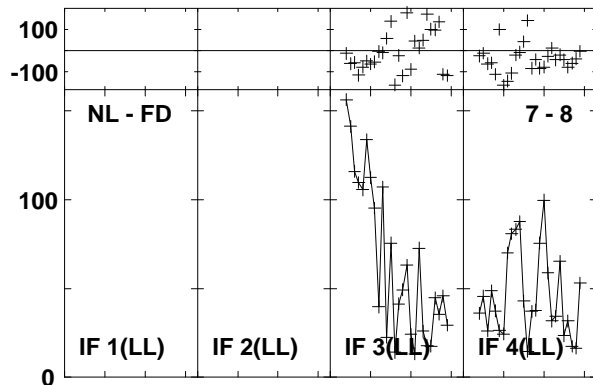
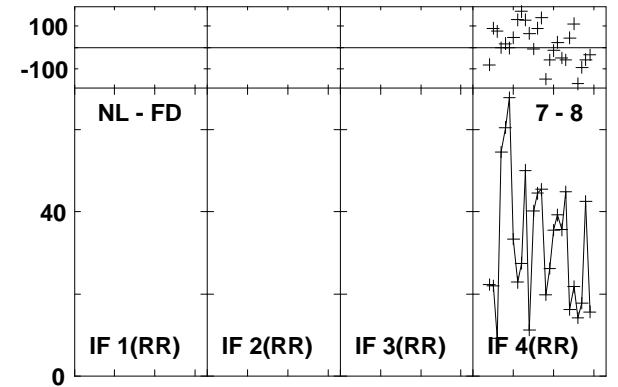
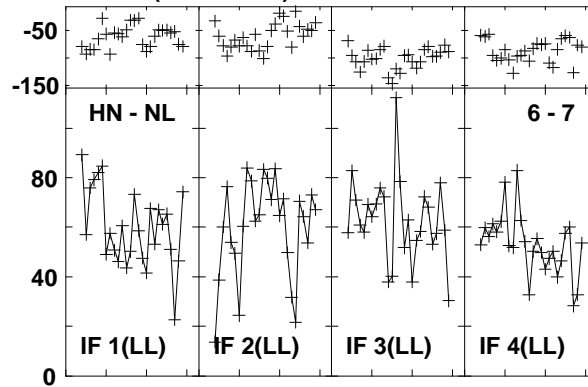
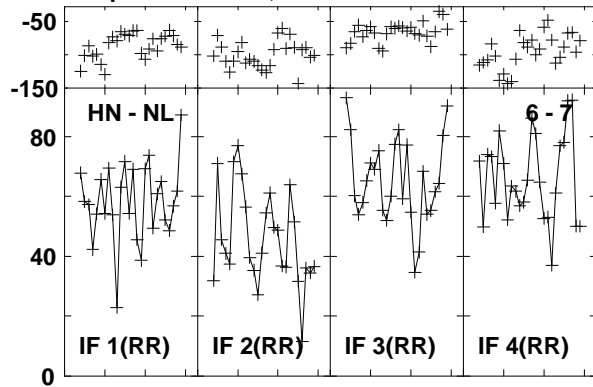

Lower frame: Milli Ampl Jy Top frame: Phas deg
 Vector averaged cross-power spectrum Baseline: HN (06) - NL (07)
 Timerange: 01/02:16:20 to 01/02:19:08

Plot file version1270 created 03-MAR-2016 01:15:39

4C52 GN002C 1.UVDATA.1

Freq = 1.2770 GHz, Bw = 16.000 MH Calibrated with CL # 3 and BP # 1 (BP mode 1)

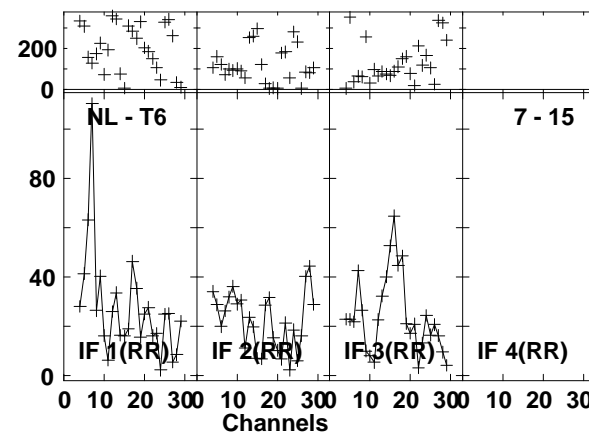
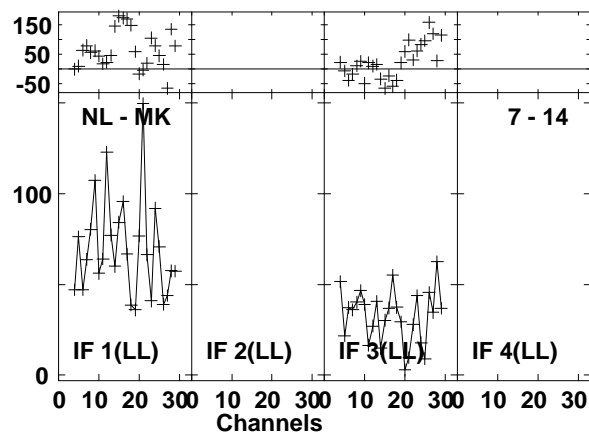
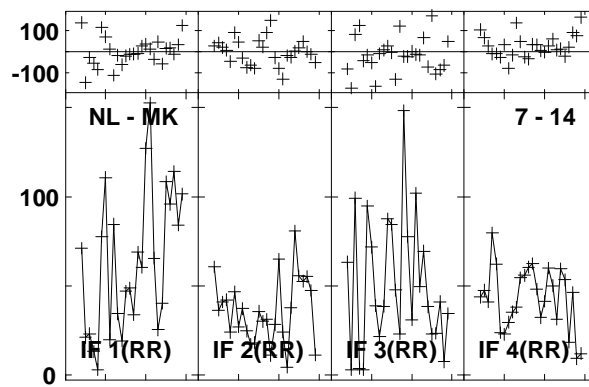
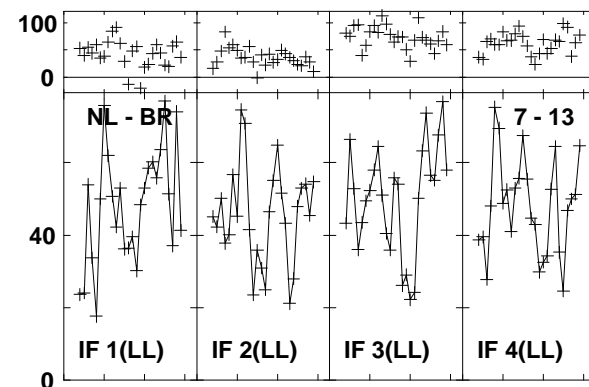
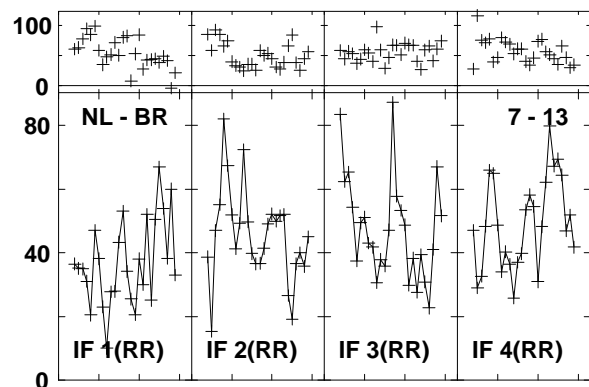
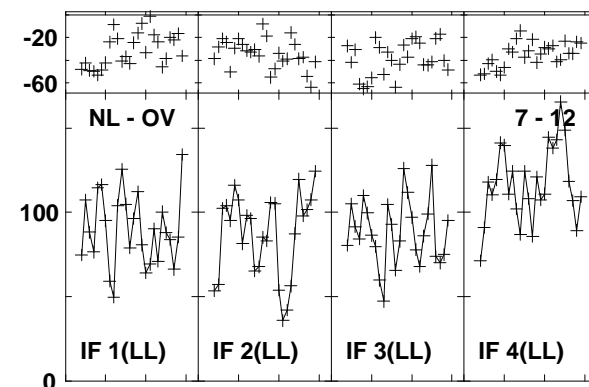
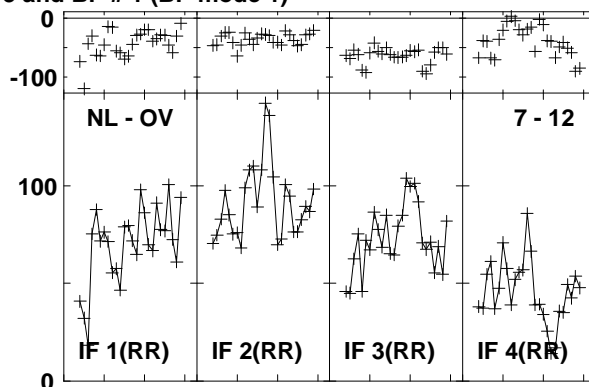
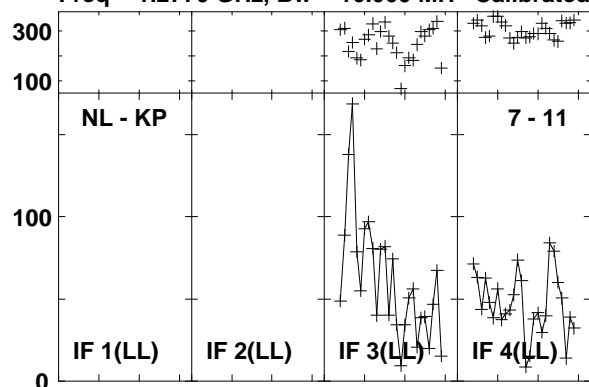

Lower frame: Milli Ampl Jy Top frame: Phas deg
Vector averaged cross-power spectrum Baseline: NL (07) - KP (11)
Timerange: 01/02:16:20 to 01/02:19:08

Plot file version1271 created 03-MAR-2016 01:15:39

J1545+5400 GN002C 1.UVDATA.1

Freq = 1.2770 GHz, Bw = 16.000 MH Calibrated with CL # 3 and BP # 1 (BP mode 1)

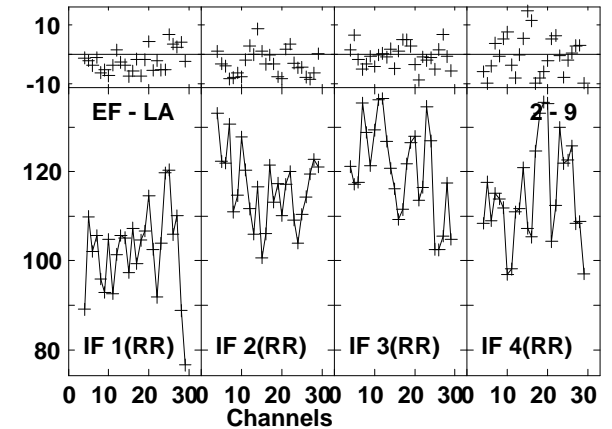
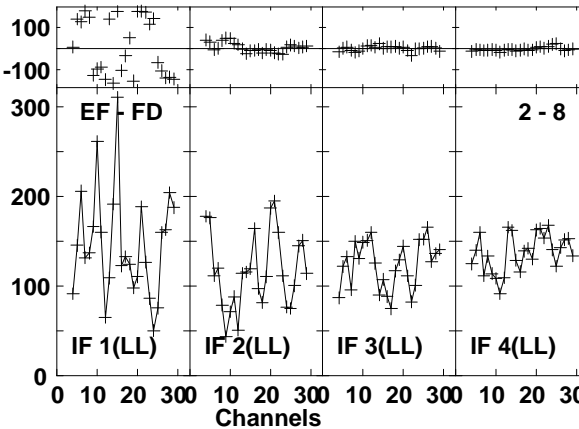
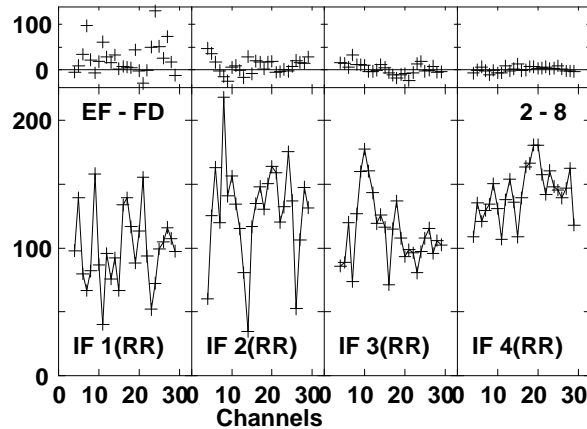
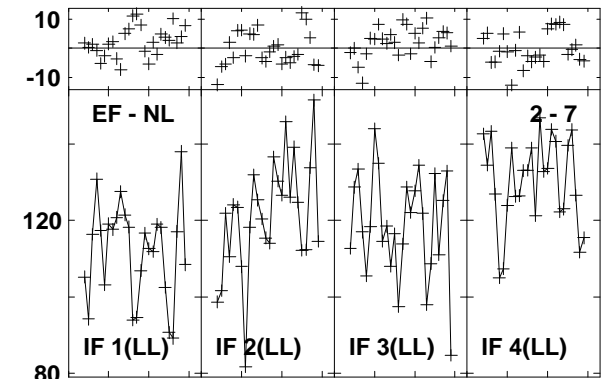
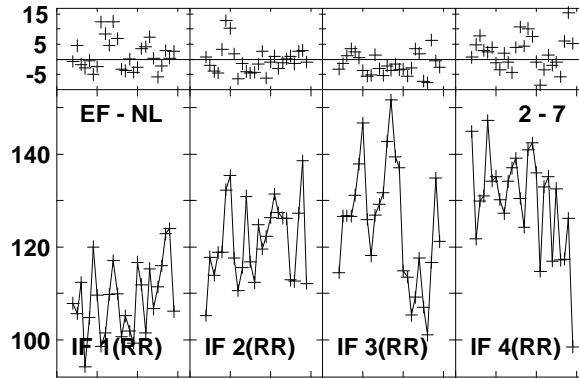
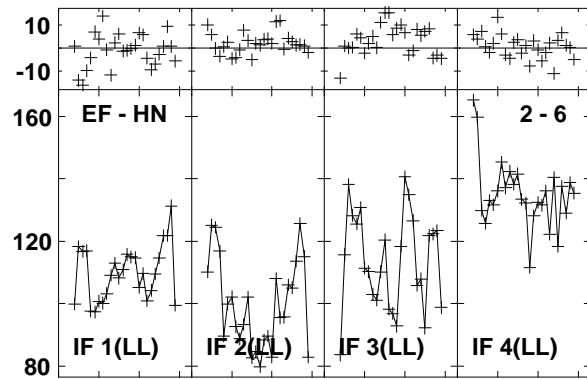
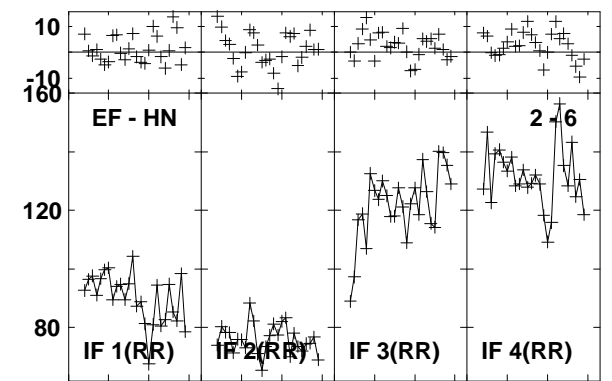
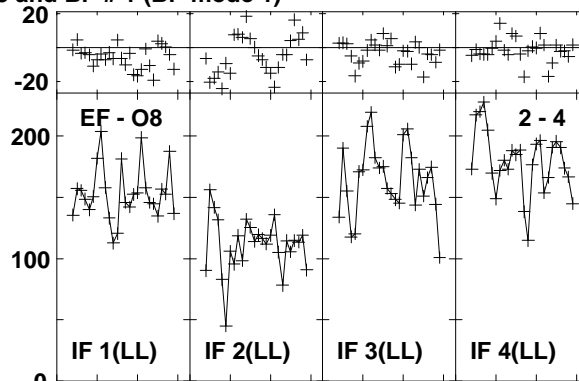
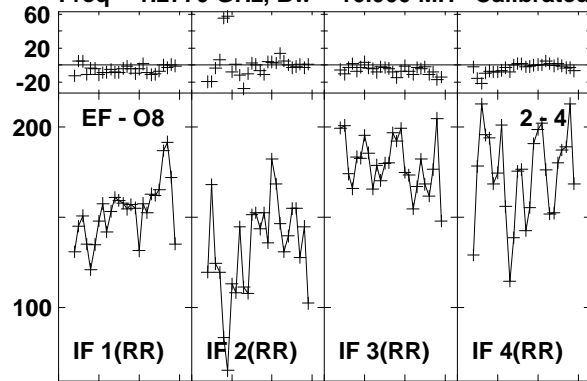

Lower frame: Milli Ampl Jy Top frame: Phas deg

Vector averaged cross-power spectrum Baseline: EF (02) - O8 (04)

Timerange: 01/02:20:00 to 01/02:20:58

Plot file version1272 created 03-MAR-2016 01:15:39

J1545+5400 GN002C 1.UVDATA.1

Freq = 1.2770 GHz, Bw = 16.000 MH Calibrated with CL # 3 and BP # 1 (BP mode 1)

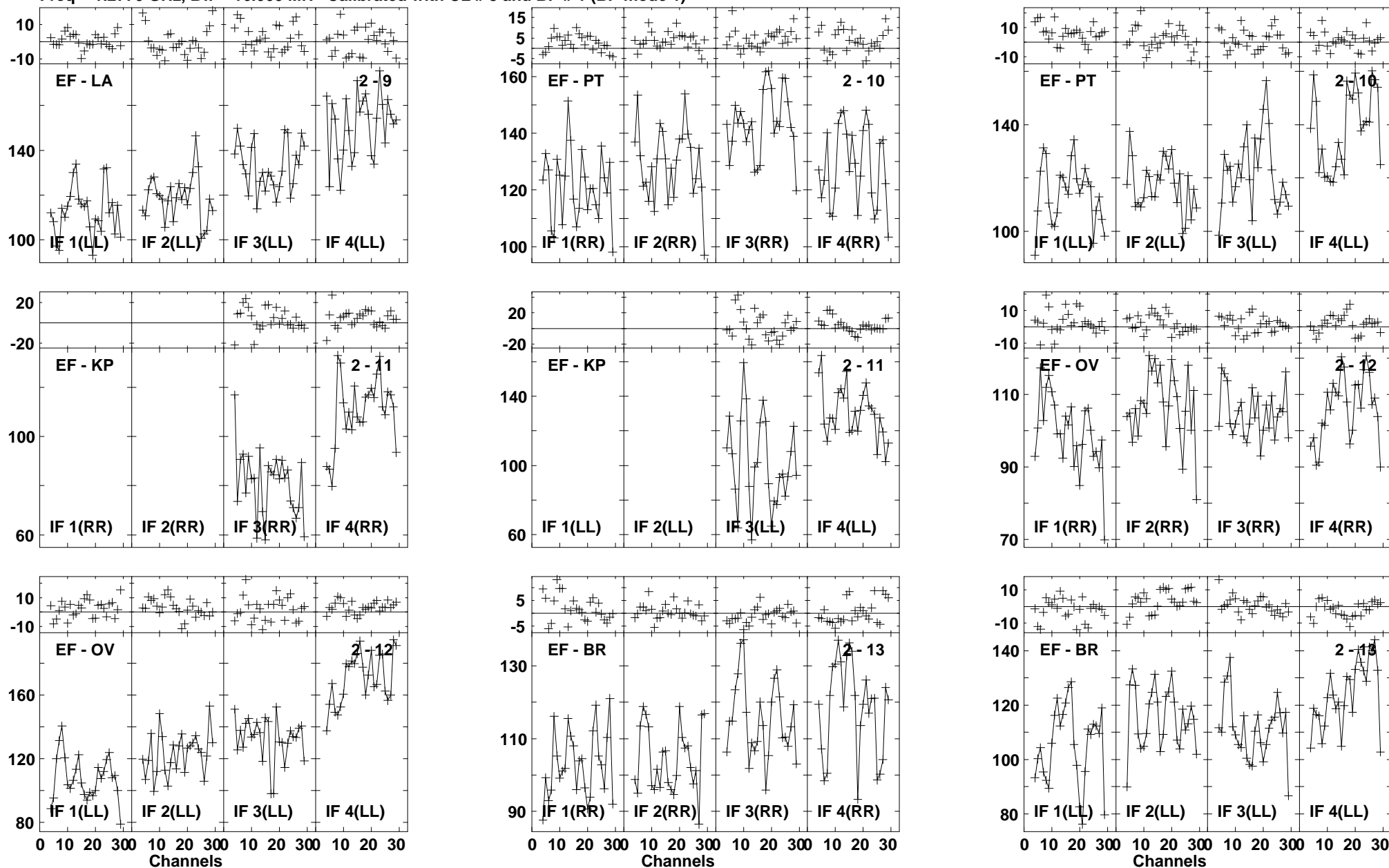

Lower frame: Milli Ampl Jy Top frame: Phas deg
Vector averaged cross-power spectrum Baseline: EF (02) - LA (09)
Timerange: 01/02:20:00 to 01/02:20:58

Plot file version1273 created 03-MAR-2016 01:15:40

J1545+5400 GN002C 1.UVDATA.1

Freq = 1.2770 GHz, Bw = 16.000 MH Calibrated with CL # 3 and BP # 1 (BP mode 1)

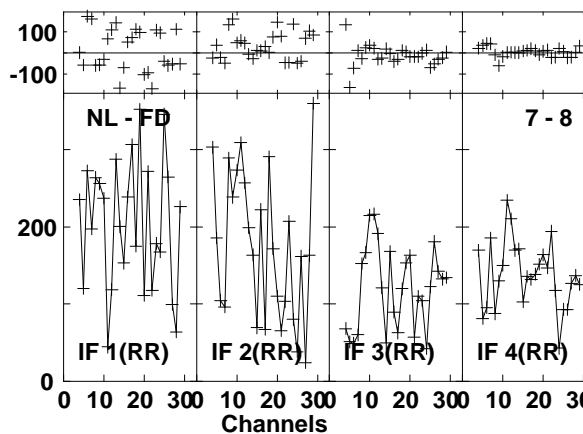
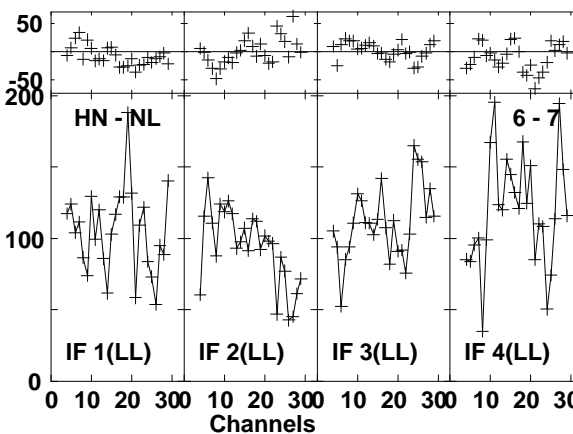
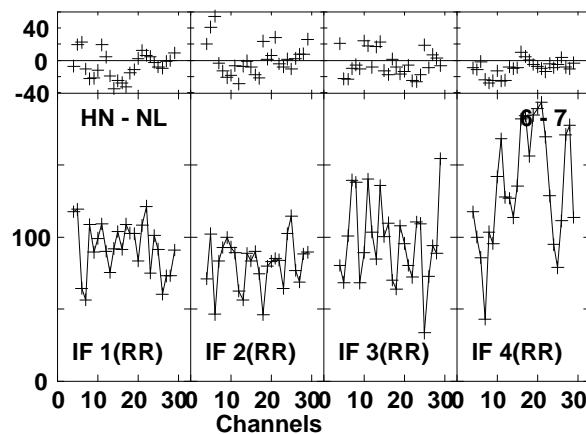
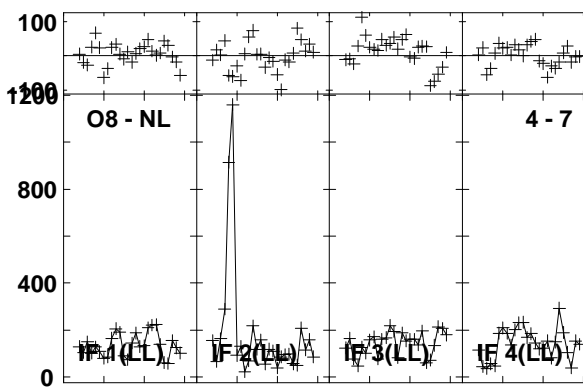
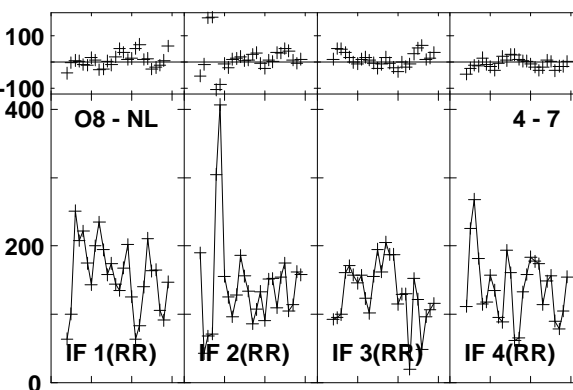
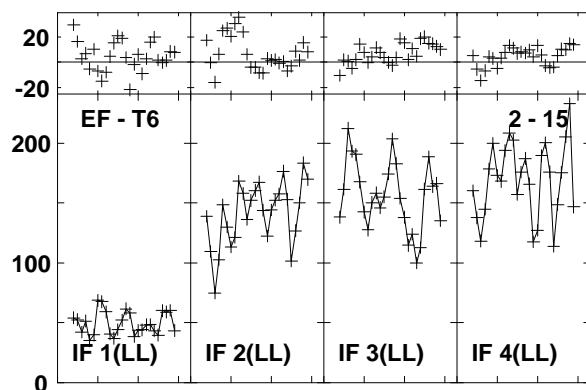
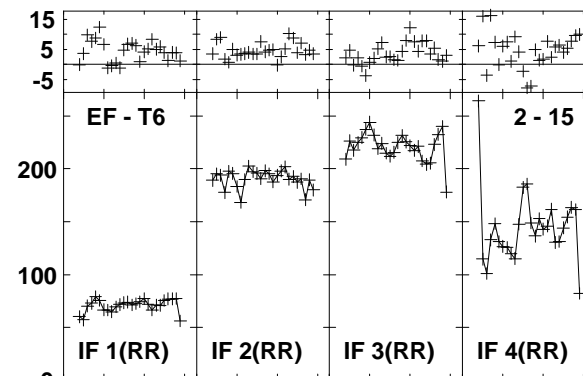
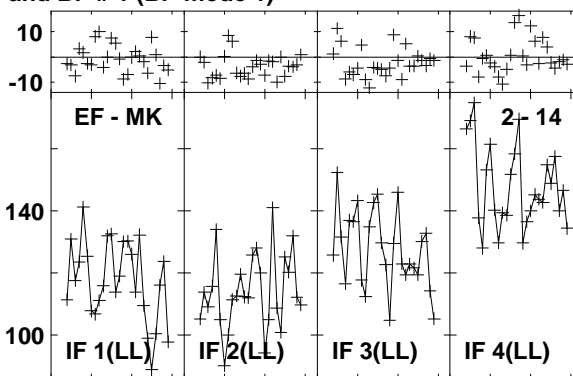
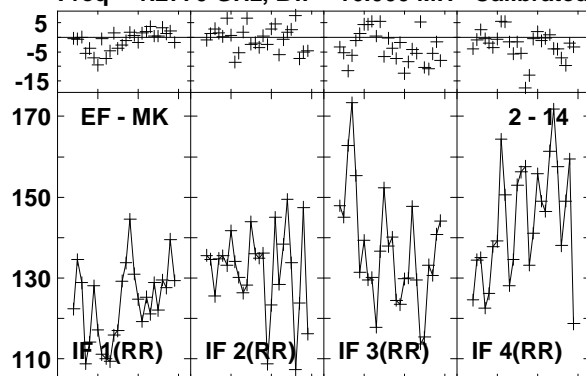

Lower frame: Milli Ampl Jy Top frame: Phas deg
Vector averaged cross-power spectrum Baseline: EF (02) - MK (14)
Timerange: 01/02:20:00 to 01/02:20:58

Plot file version1274 created 03-MAR-2016 01:15:40
 J1545+5400 GN002C 1.UVDATA.1
 Freq = 1.2770 GHz, Bw = 16.000 MH Calibrated with CL # 3 and BP # 1 (BP mode 1)

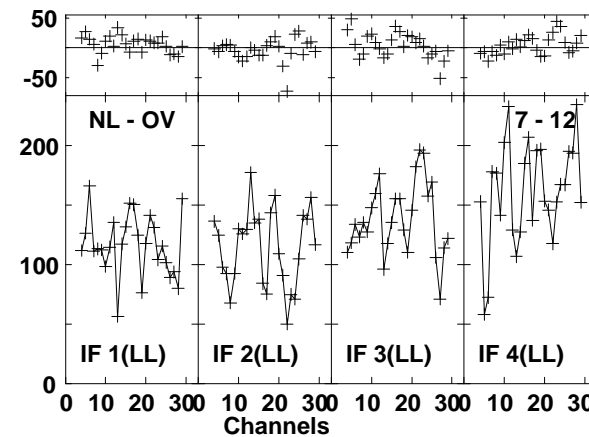
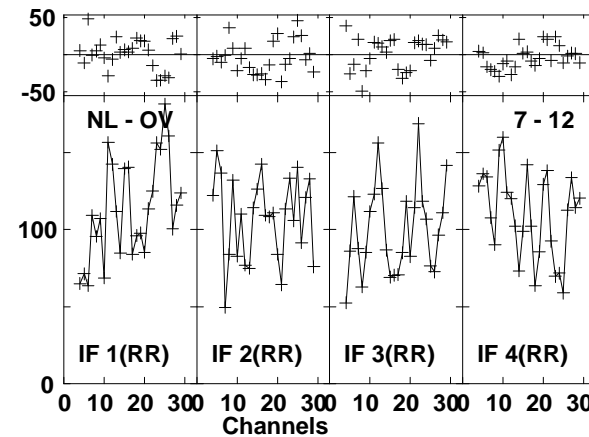
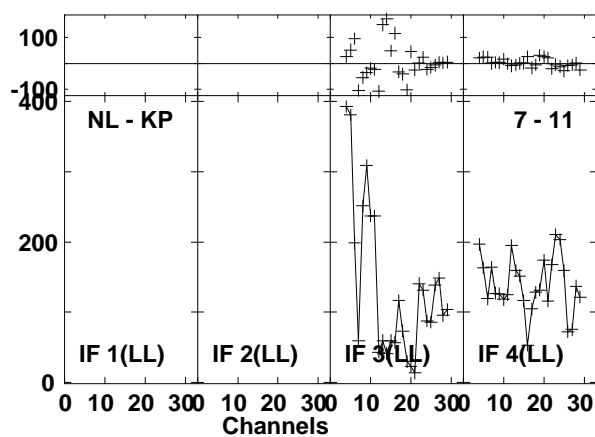
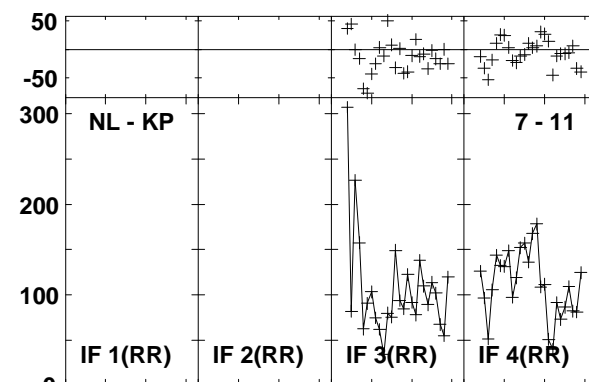
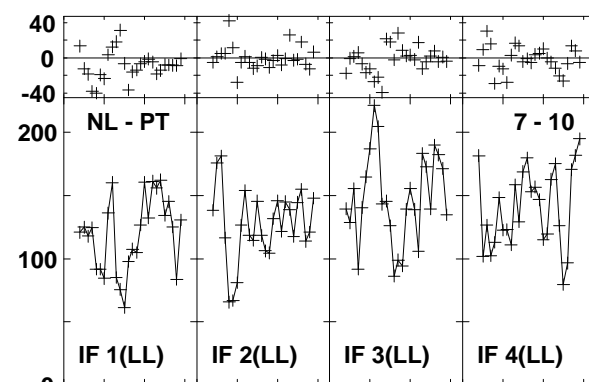
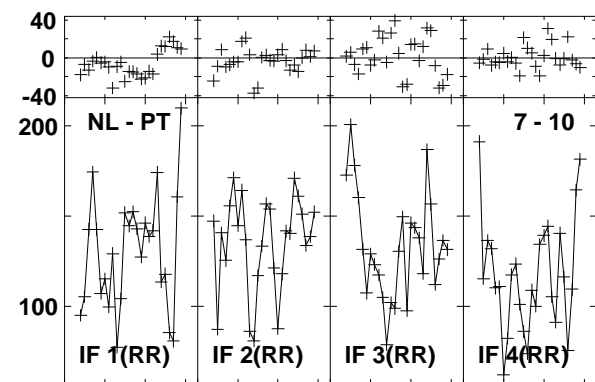
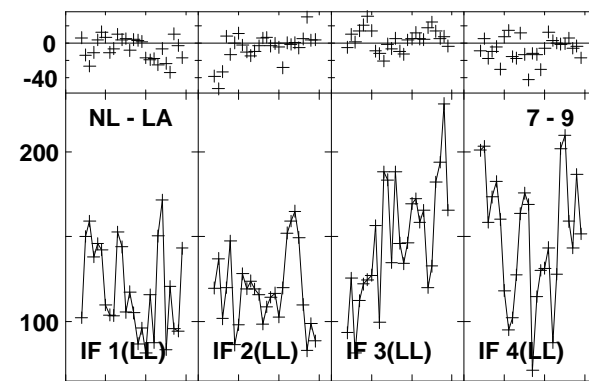
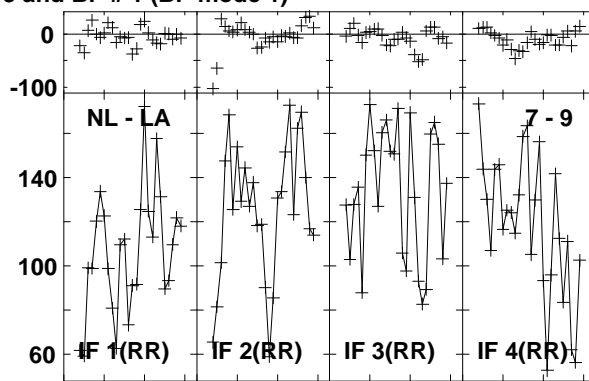
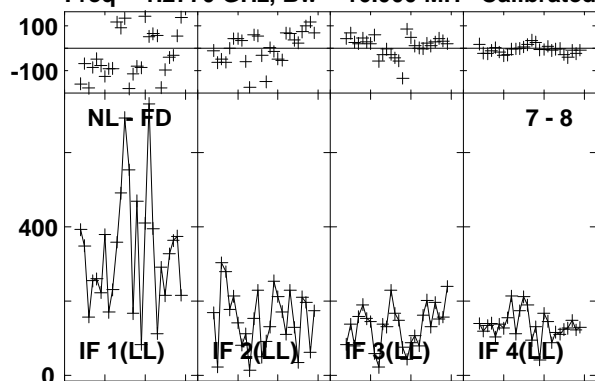

Lower frame: Milli Ampl Jy Top frame: Phas deg
 Vector averaged cross-power spectrum Baseline: NL (07) - FD (08)
 Timerange: 01/02:20:00 to 01/02:20:58

Plot file version1275 created 03-MAR-2016 01:15:40
 J1545+5400 GN002C 1.UVDATA.1
 Freq = 1.2770 GHz, Bw = 16.000 MH Calibrated with CL # 3 and BP # 1 (BP mode 1)

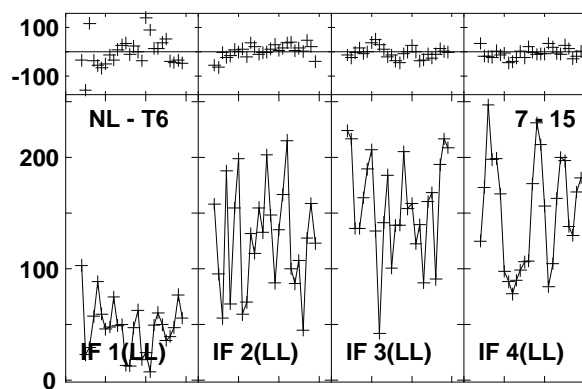
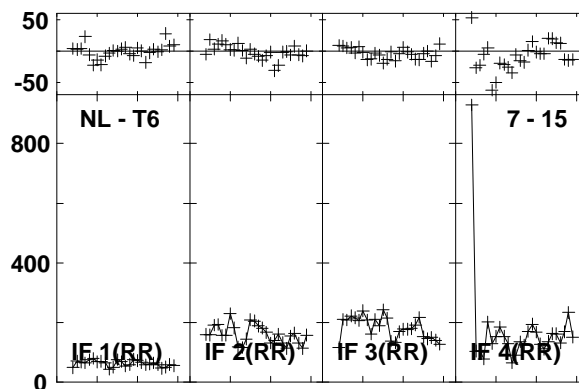
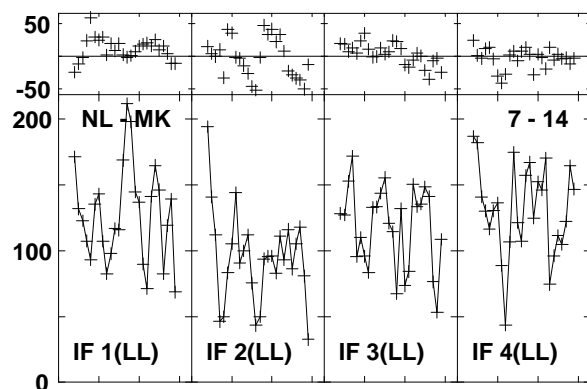
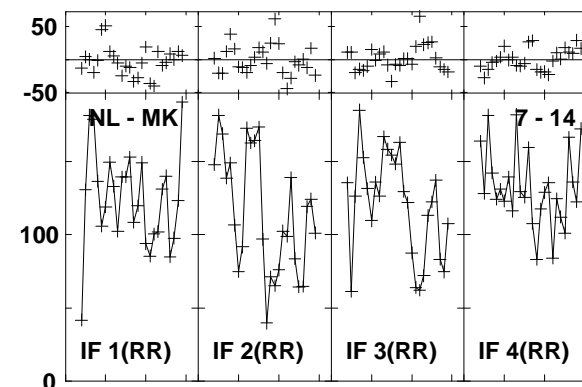
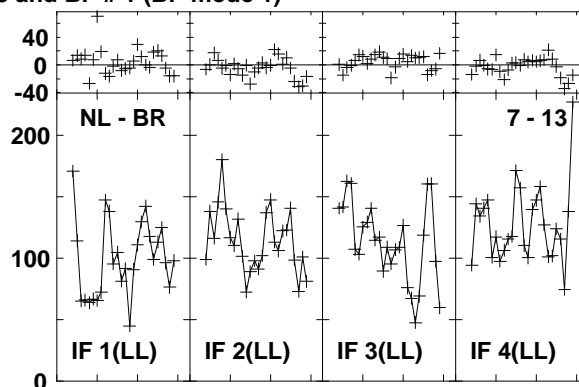
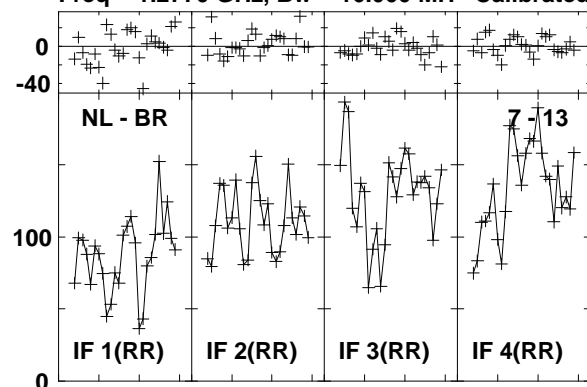

Lower frame: Milli Ampl Jy Top frame: Phas deg
 Vector averaged cross-power spectrum Baseline: NL (07) - BR (13)
 Timerange: 01/02:20:00 to 01/02:20:58

Plot file version1276 created 03-MAR-2016 01:15:40

4C52 GN002C 1.UVDATA.1

Freq = 1.2770 GHz, Bw = 16.000 MH Calibrated with CL # 3 and BP # 1 (BP mode 1)

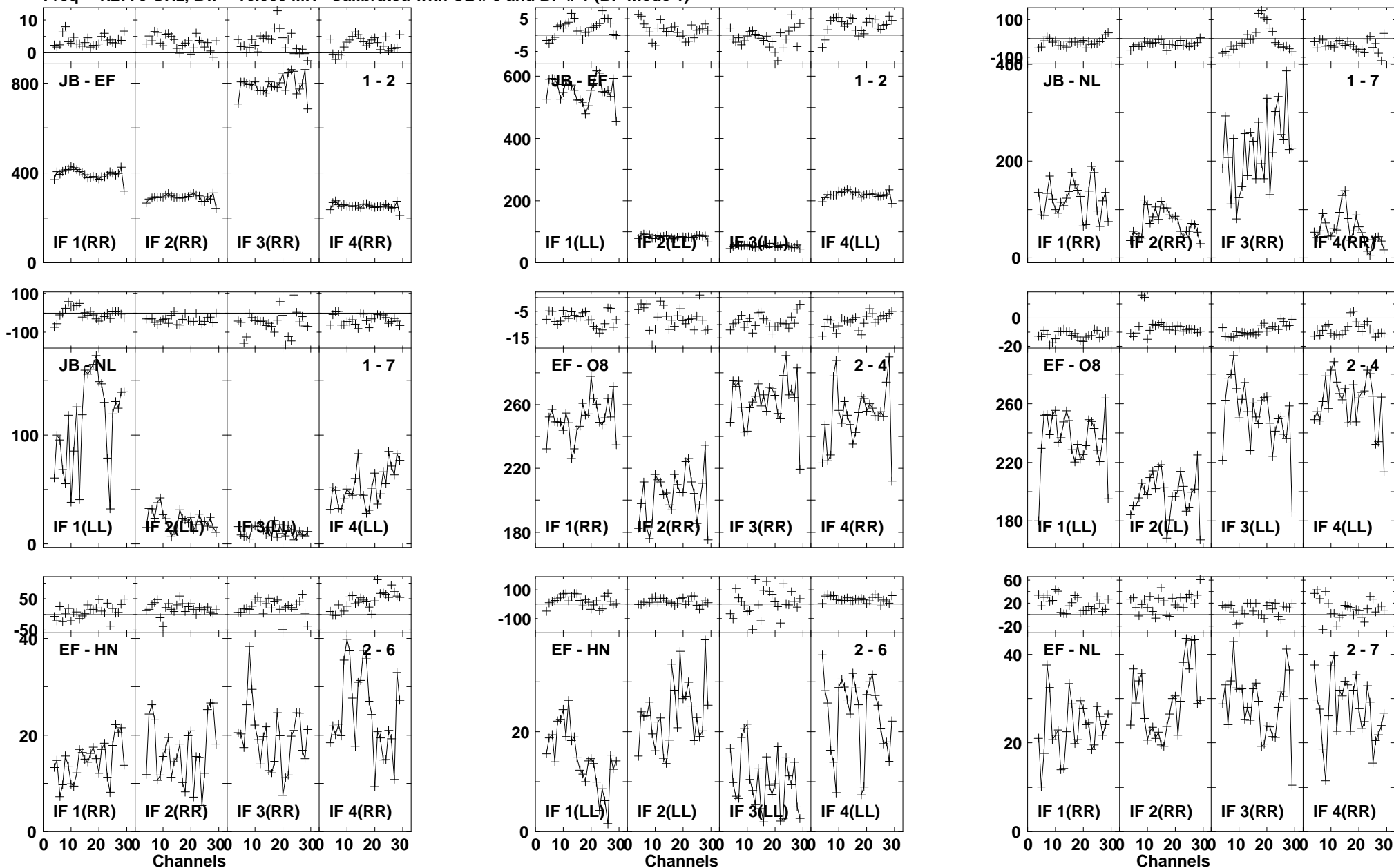

Lower frame: Milli Ampl Jy Top frame: Phas deg
Vector averaged cross-power spectrum Baseline: JB (01) - EF (02)
Timerange: 01/02:21:03 to 01/02:23:57

Plot file version1277 created 03-MAR-2016 01:15:40

4C52 GN002C 1.UVDATA.1

Freq = 1.2770 GHz, Bw = 16.000 MH Calibrated with CL # 3 and BP # 1 (BP mode 1)

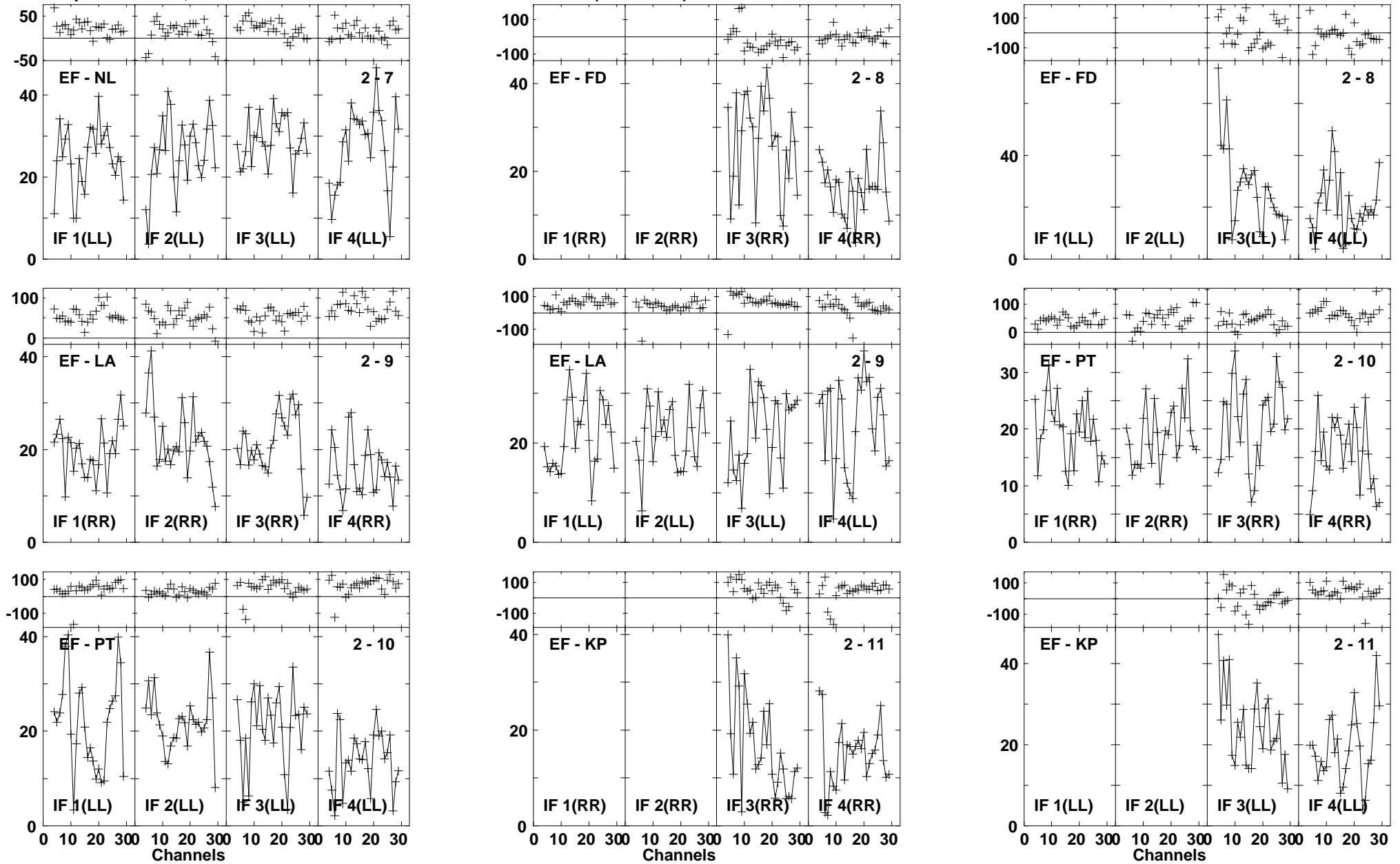

Lower frame: Milli Ampl Jy Top frame: Phas deg
Vector averaged cross-power spectrum Baseline: EF (02) - NL (07)
Timerange: 01/02:21:03 to 01/02:23:57

Plot file version1278 created 03-MAR-2016 01:15:40

4C52 GN002C 1.UVDATA.1

Freq = 1.2770 GHz, Bw = 16.000 MH Calibrated with CL # 3 and BP # 1 (BP mode 1)

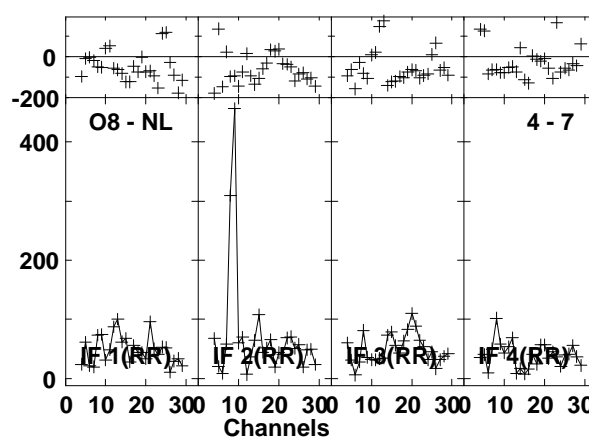
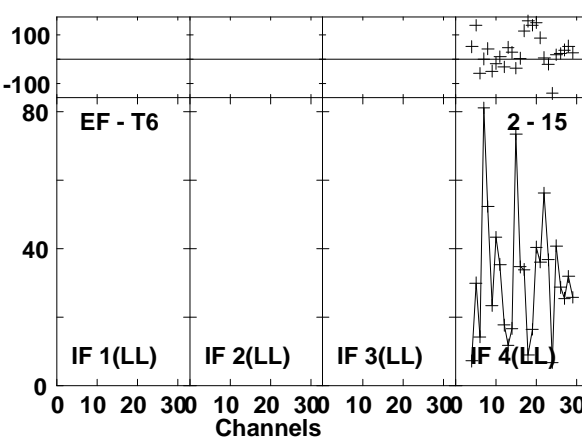
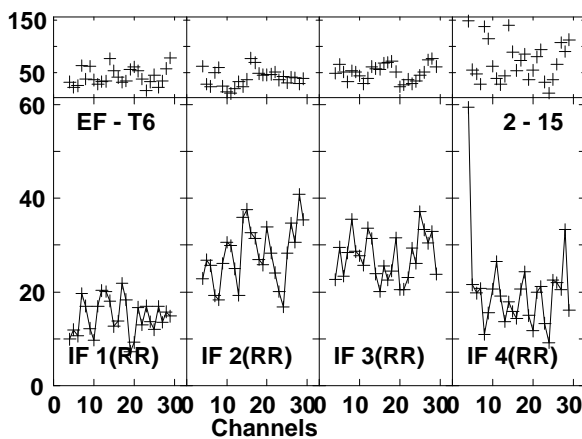
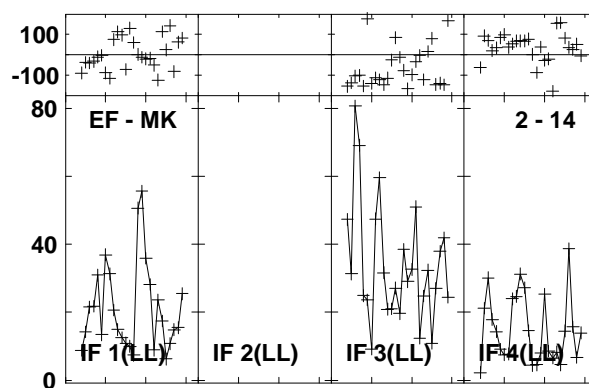
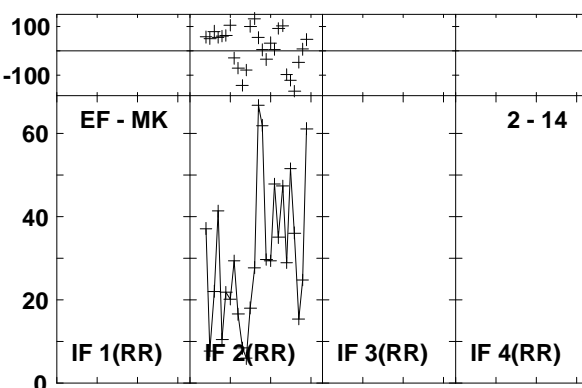
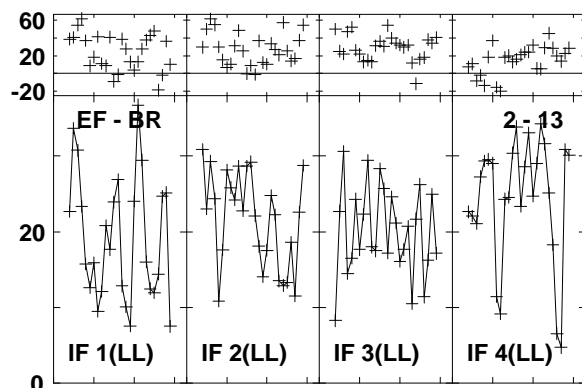
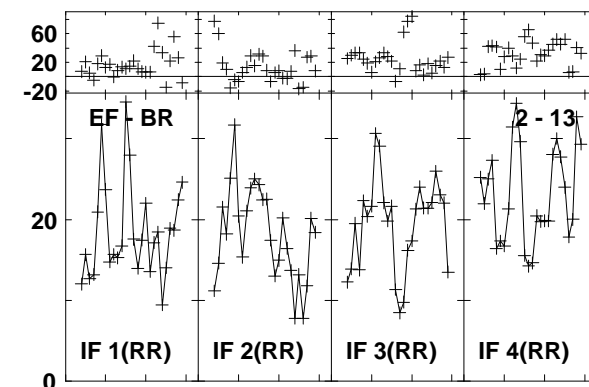
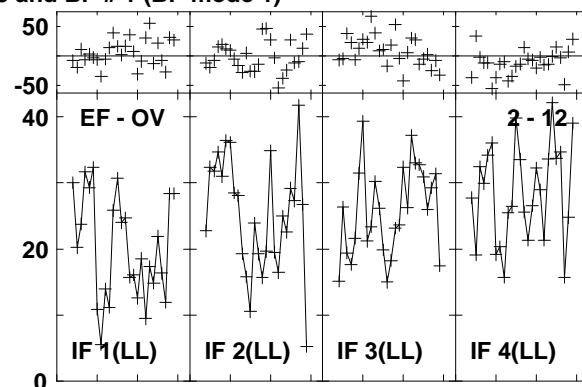
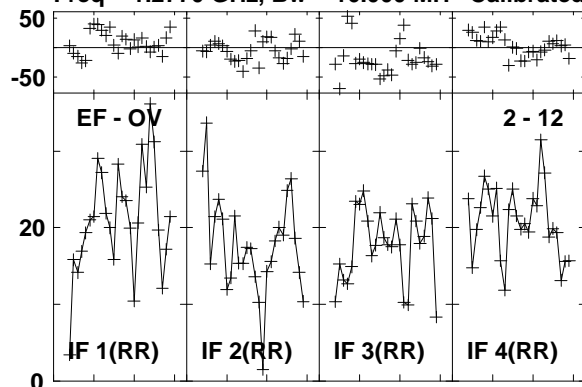

Lower frame: Milli Ampl Jy Top frame: Phas deg
Vector averaged cross-power spectrum Baseline: EF (02) - OV (12)
Timerange: 01/02:21:03 to 01/02:23:57

Plot file version1279 created 03-MAR-2016 01:15:41
 4C52 GN002C 1.UVDATA.1

Freq = 1.2770 GHz, Bw = 16.000 MH Calibrated with CL # 3 and BP # 1 (BP mode 1)

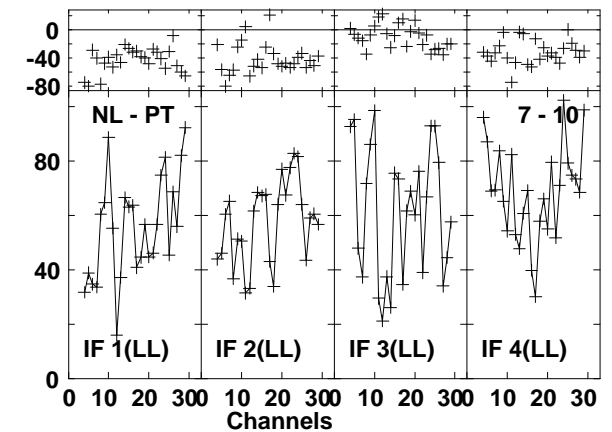
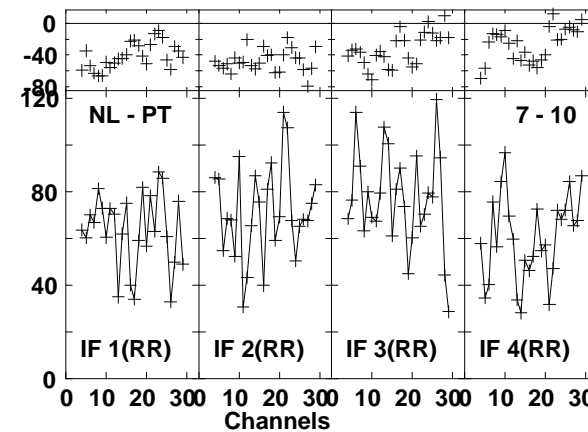
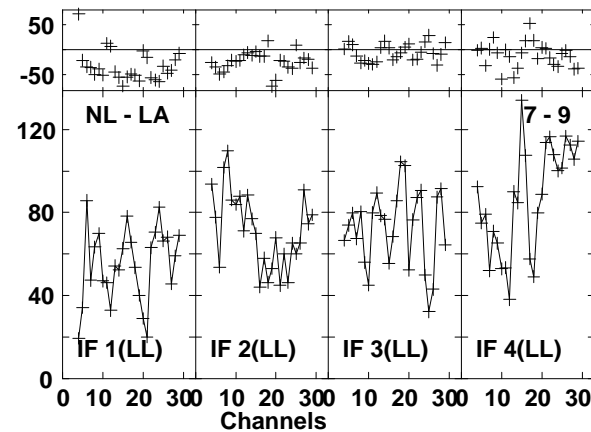
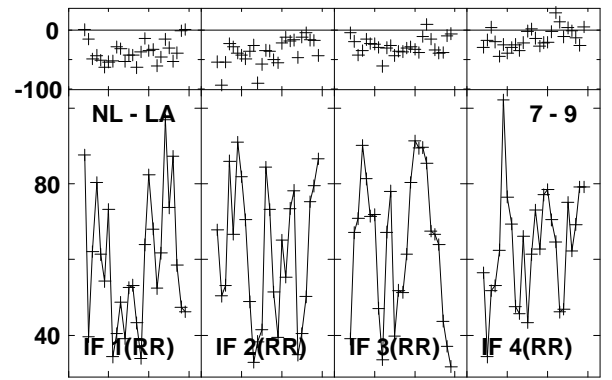
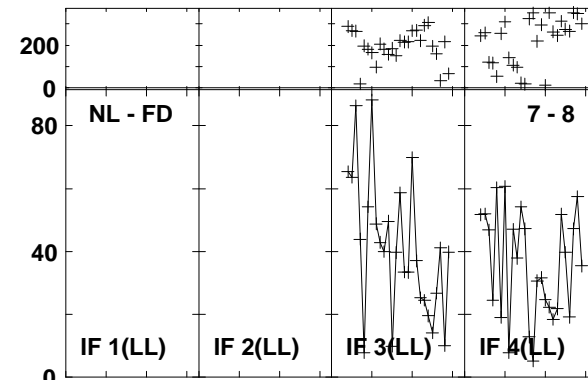
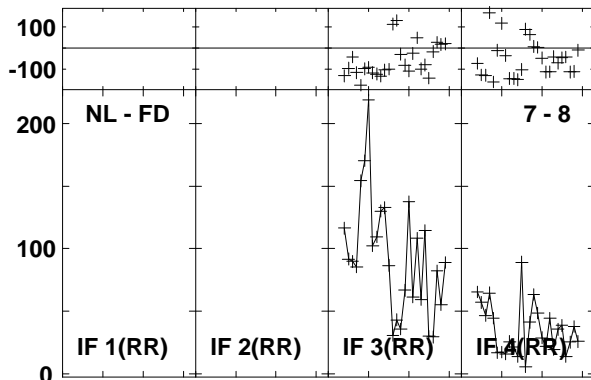
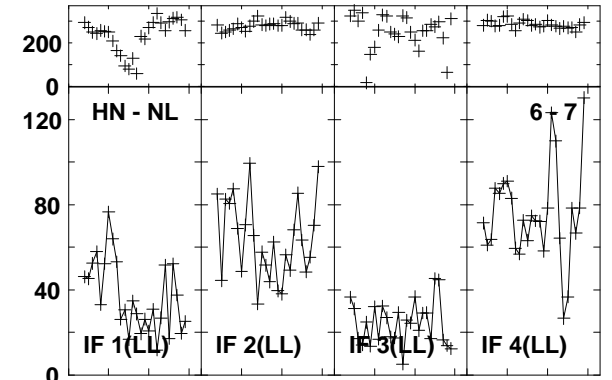
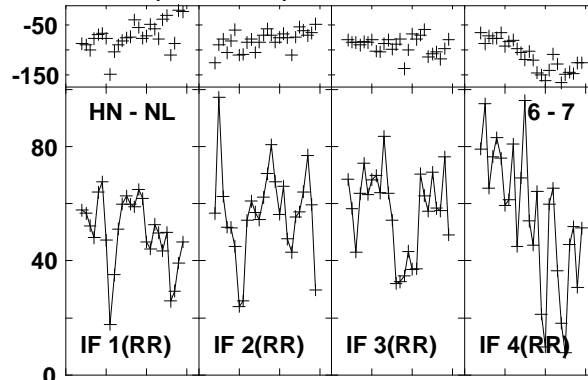
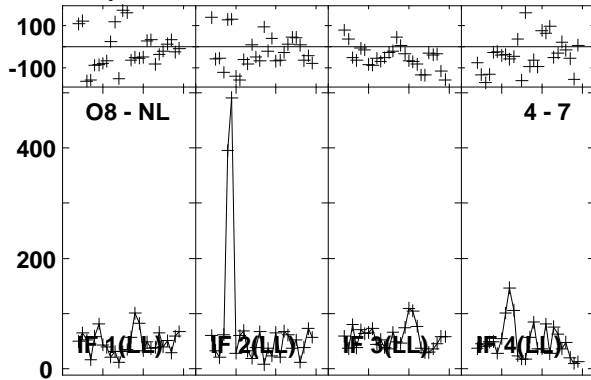

Lower frame: Milli Ampl Jy Top frame: Phas deg
 Vector averaged cross-power spectrum Baseline: O8 (04) - NL (07)
 Timerange: 01/02:21:03 to 01/02:23:57

Plot file version1280 created 03-MAR-2016 01:15:41
 4C52 GN002C 1.UVDATA.1
 Freq = 1.2770 GHz, Bw = 16.000 MH Calibrated with CL # 3 and BP # 1 (BP mode 1)

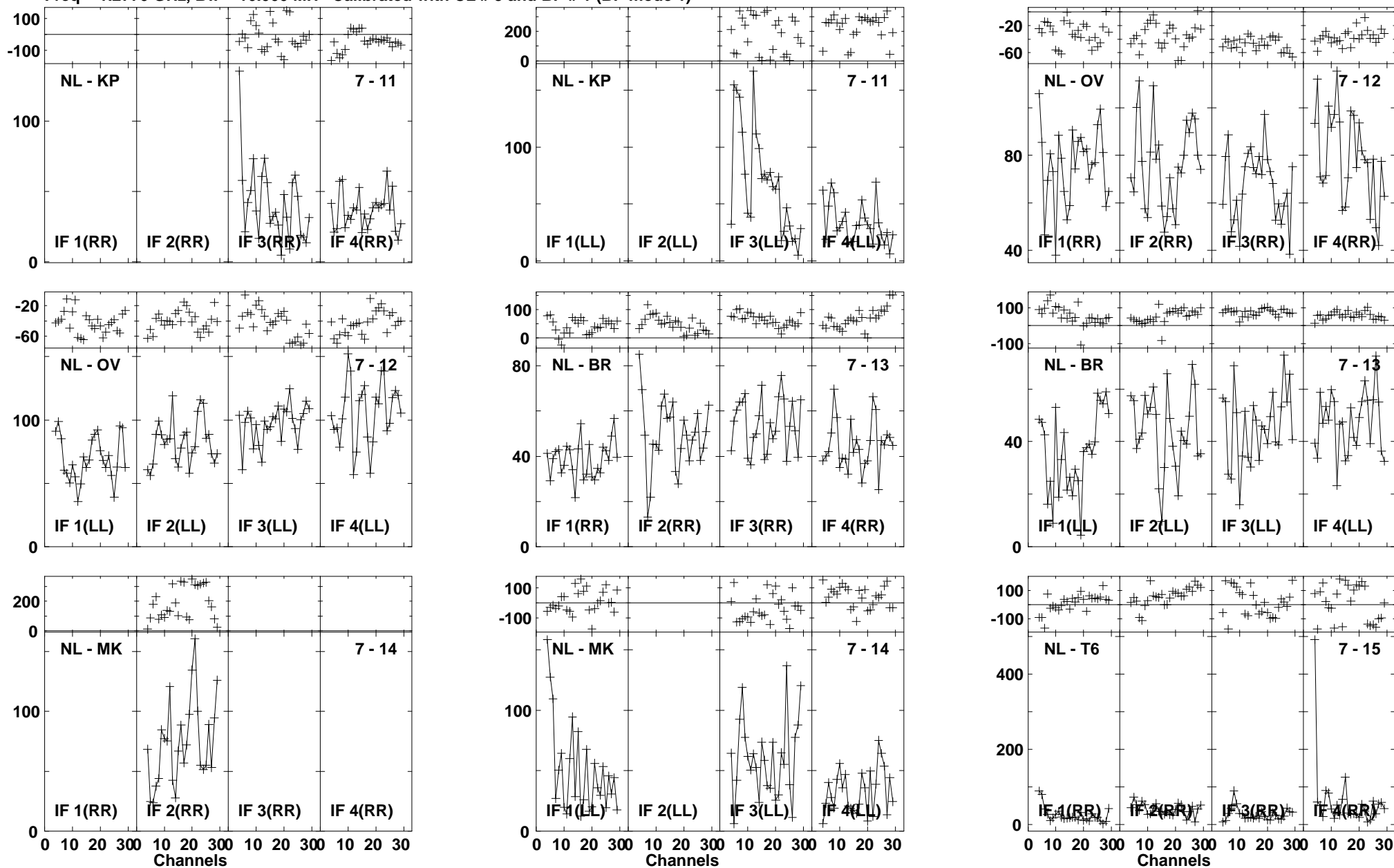

Lower frame: Milli Ampl Jy Top frame: Phas deg
 Vector averaged cross-power spectrum Baseline: NL (07) - KP (11)
 Timerange: 01/02:21:03 to 01/02:23:57

Plot file version1281 created 03-MAR-2016 01:15:41
4C52 GN002C 1.UVDATA.1
Freq = 1.2770 GHz, Bw = 16.000 MH Calibrated with CL # 3 and BP # 1 (BP mode 1)

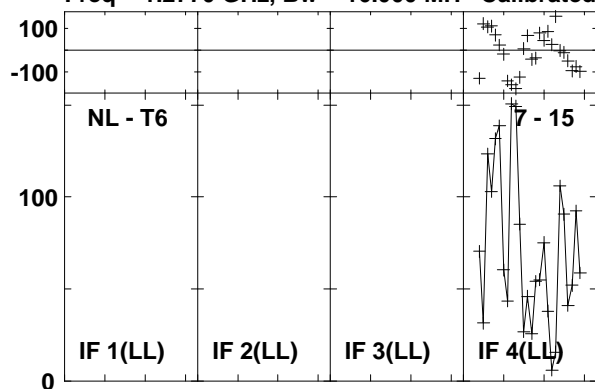

Lower frame: Milli Ampl Jy Top frame: Phas deg
Vector averaged cross-power spectrum Baseline: NL (07) - T6 (15)
Timerange: 01/02:21:03 to 01/02:23:57

Plot file version1282 created 03-MAR-2016 01:15:41

J1545+5400 GN002C 1.UVDATA.1

Freq = 1.2770 GHz, Bw = 16.000 MH Calibrated with CL # 3 and BP # 1 (BP mode 1)

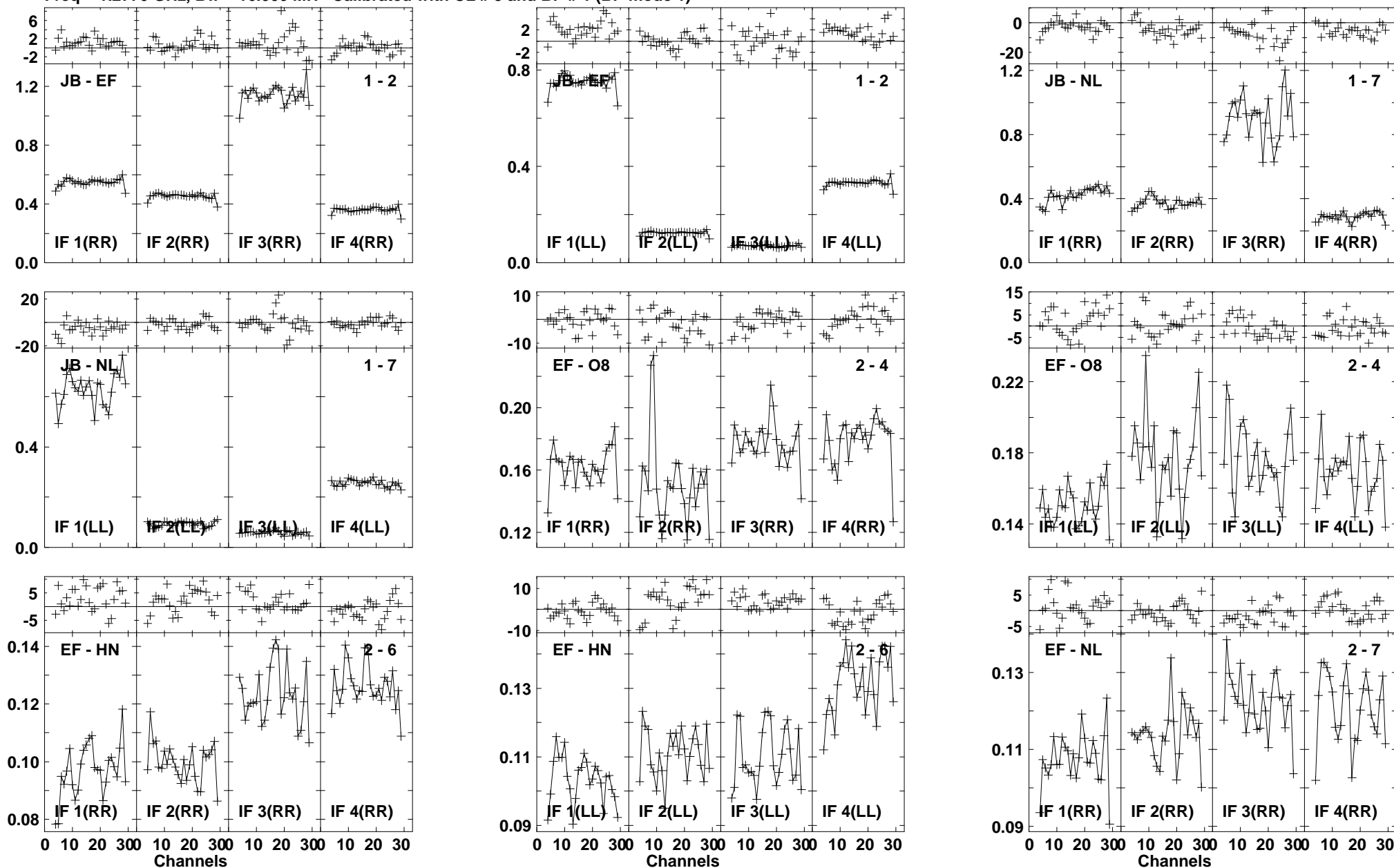

Plot file version1283 created 03-MAR-2016 01:15:41

J1545+5400 GN002C 1.UVDATA.1

Freq = 1.2770 GHz, Bw = 16.000 MH Calibrated with CL # 3 and BP # 1 (BP mode 1)

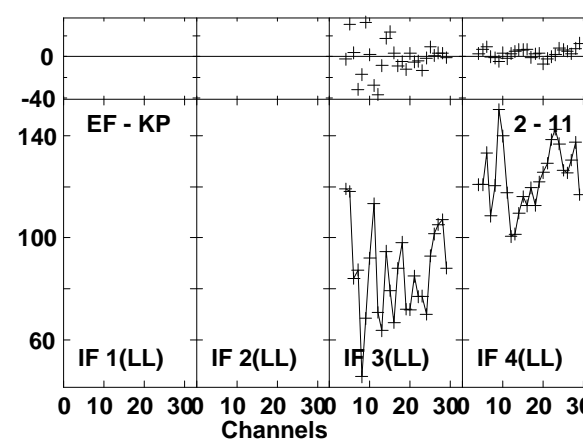
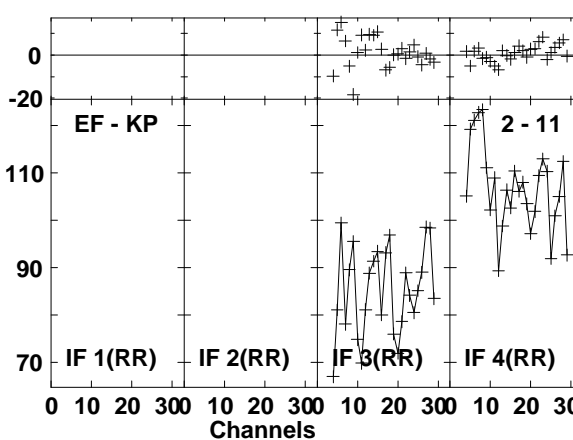
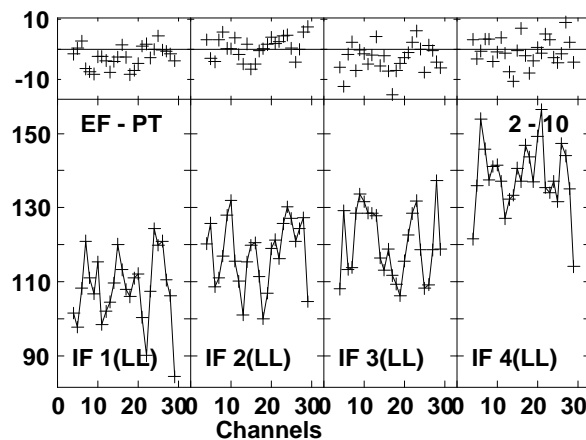
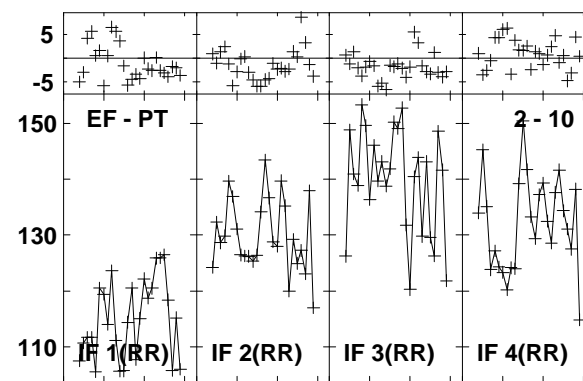
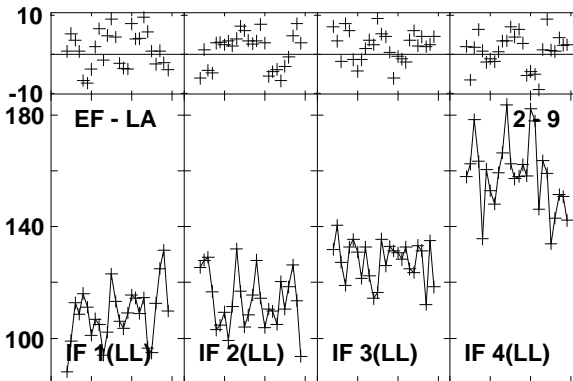
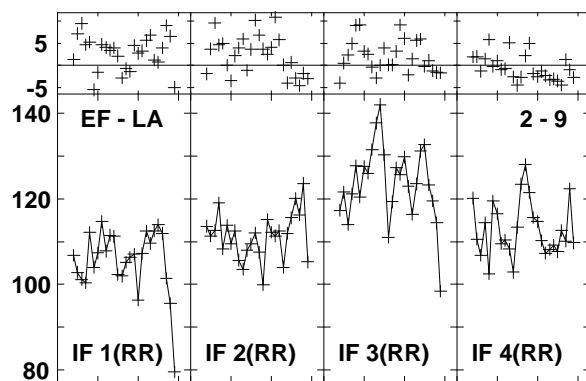
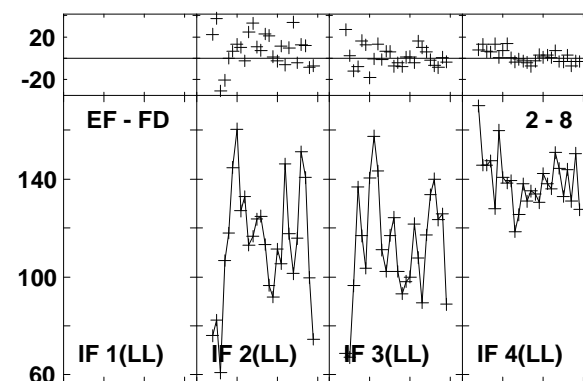
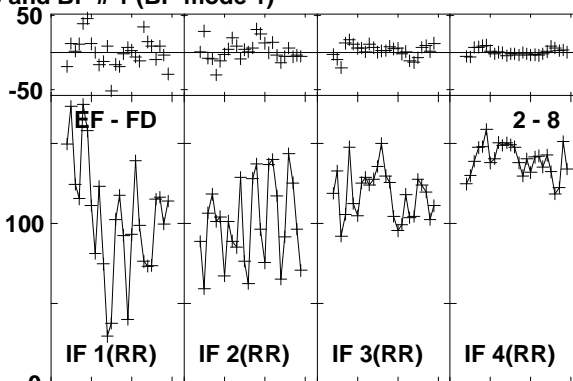
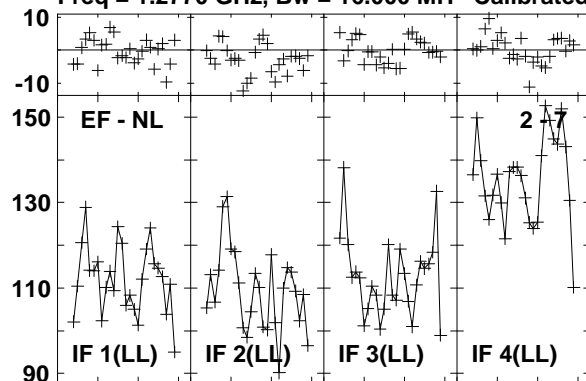

Lower frame: Milli Ampl Jy Top frame: Phas deg
Vector averaged cross-power spectrum Baseline: EF (02) - NL (07)
Timerange: 01/02:24:50 to 01/02:26:48

Plot file version1284 created 03-MAR-2016 01:15:41

J1545+5400 GN002C 1.UVDATA.1

Freq = 1.2770 GHz, Bw = 16.000 MH Calibrated with CL # 3 and BP # 1 (BP mode 1)

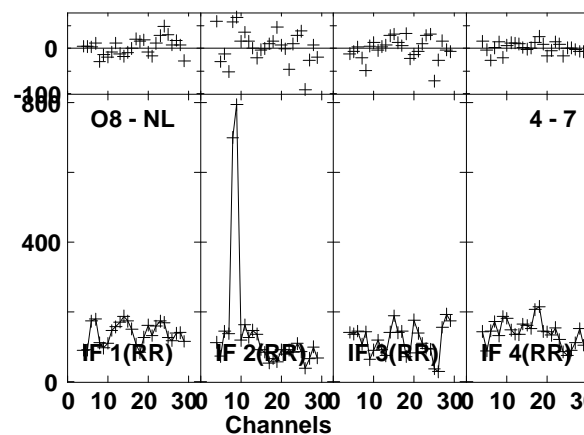
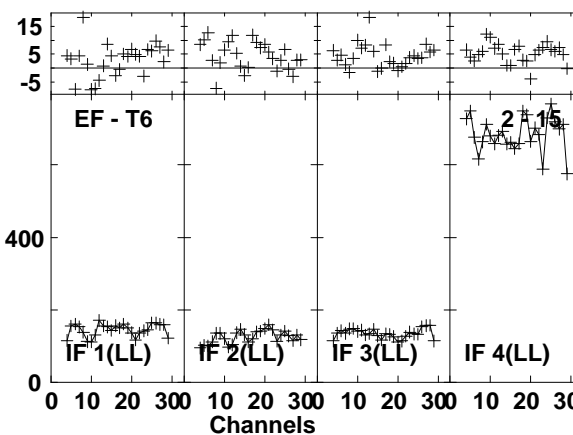
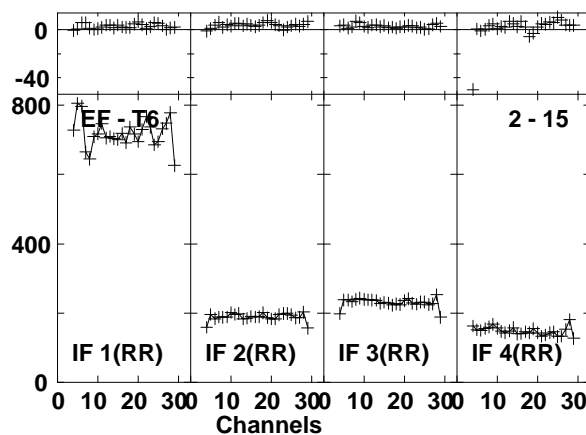
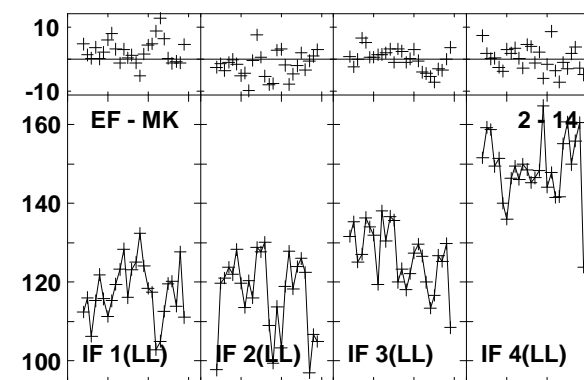
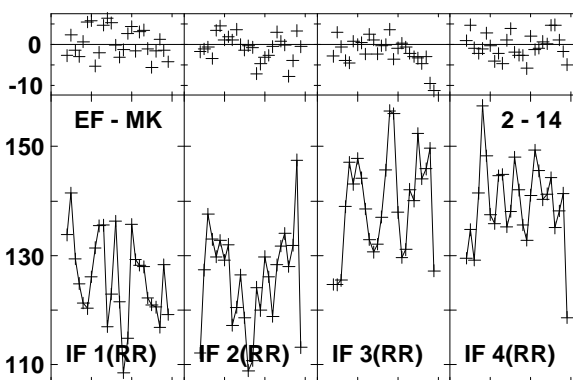
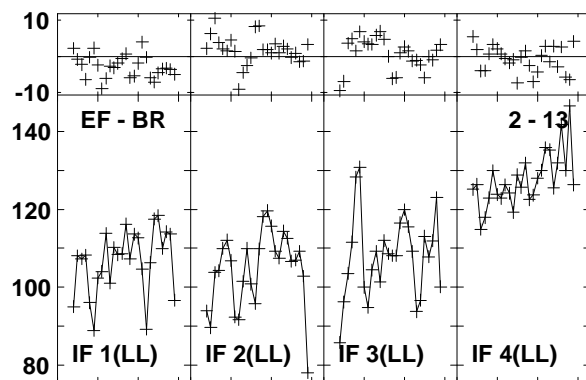
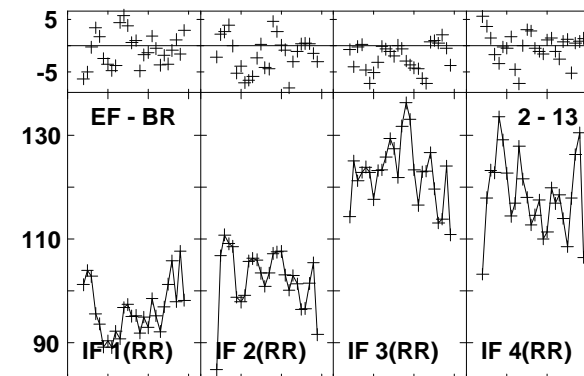
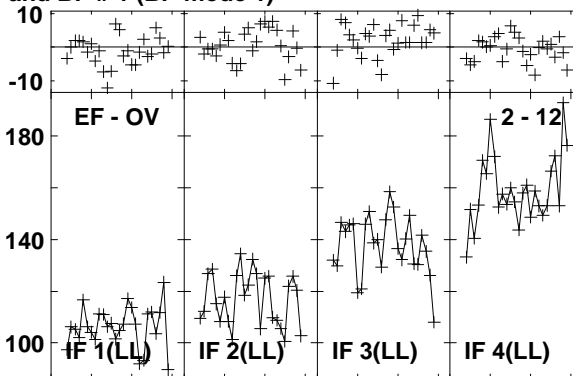
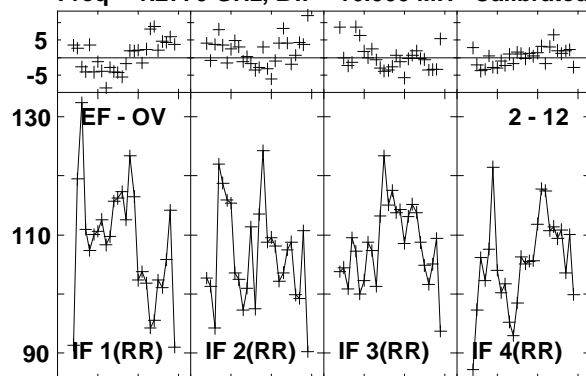

Lower frame: Milli Ampl Jy Top frame: Phas deg
Vector averaged cross-power spectrum Baseline: EF (02) - OV (12)
Timerange: 01/02:24:50 to 01/02:26:48

Plot file version1285 created 03-MAR-2016 01:15:42

J1545+5400 GN002C 1.UVDATA.1

Freq = 1.2770 GHz, Bw = 16.000 MH Calibrated with CL # 3 and BP # 1 (BP mode 1)

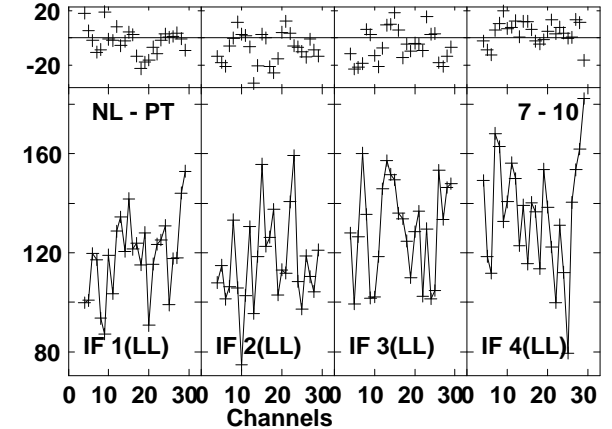
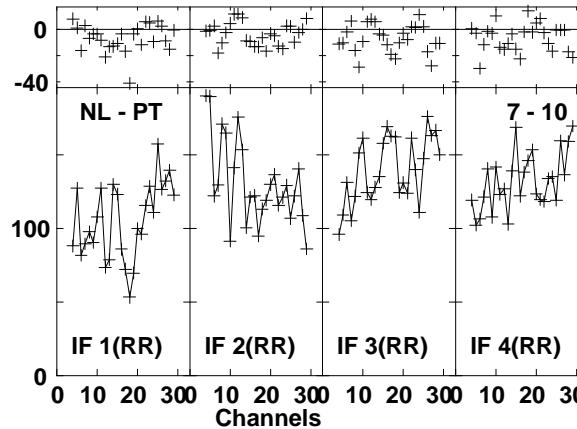
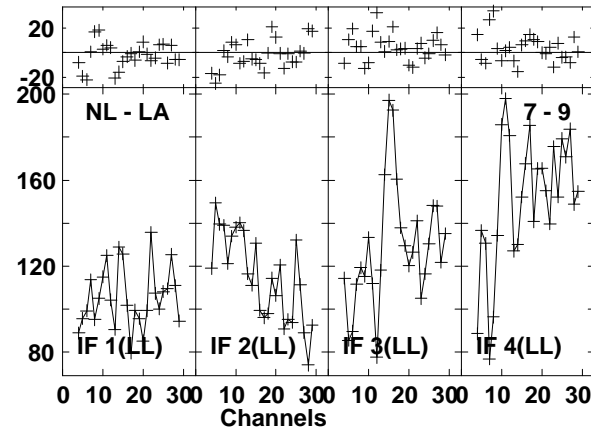
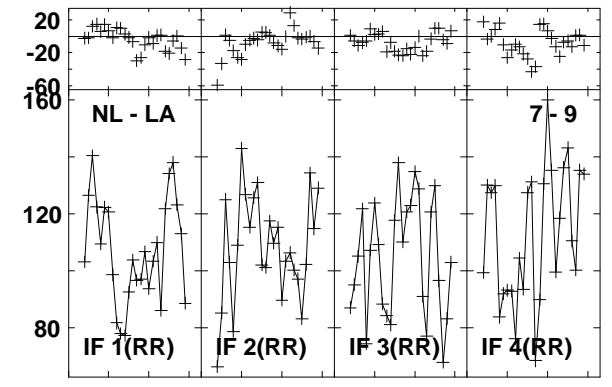
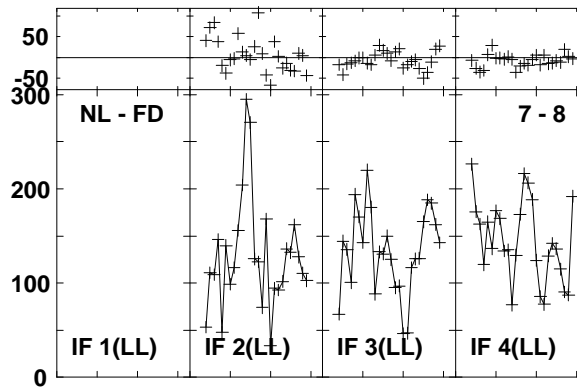
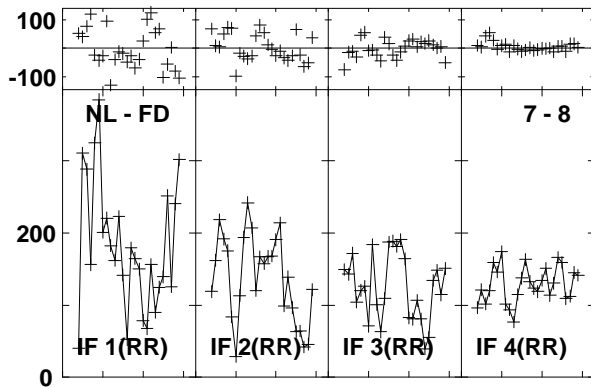
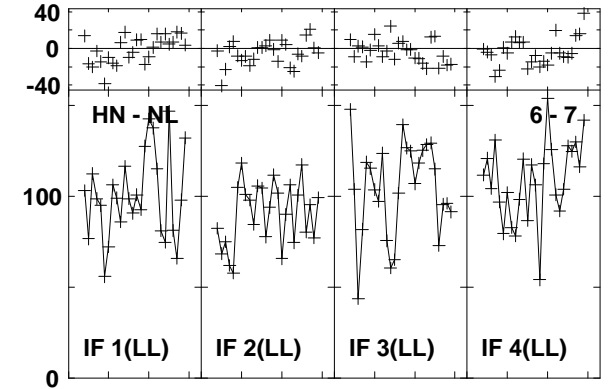
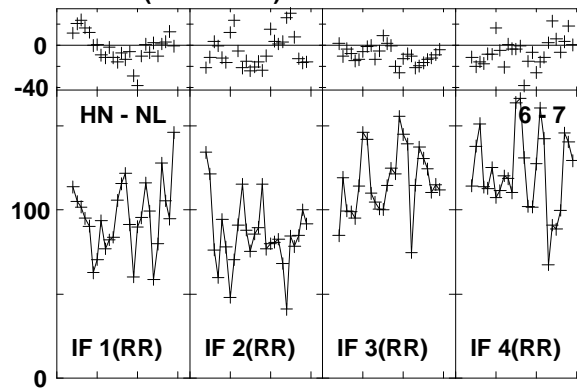
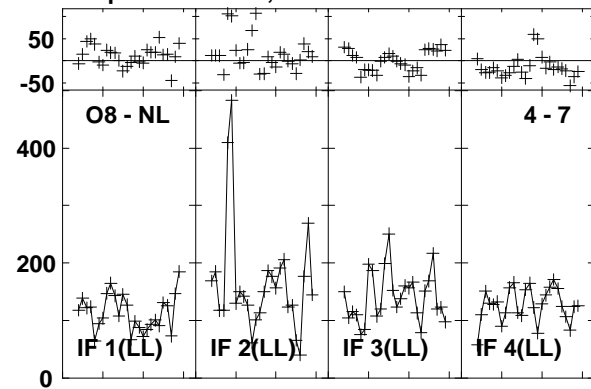

Lower frame: Milli Ampl Jy Top frame: Phas deg

Vector averaged cross-power spectrum Baseline: O8 (04) - NL (07)

Timerange: 01/02:24:50 to 01/02:26:48

Plot file version1286 created 03-MAR-2016 01:15:42

J1545+5400 GN002C 1.UVDATA.1

Freq = 1.2770 GHz, Bw = 16.000 MH Calibrated with CL # 3 and BP # 1 (BP mode 1)

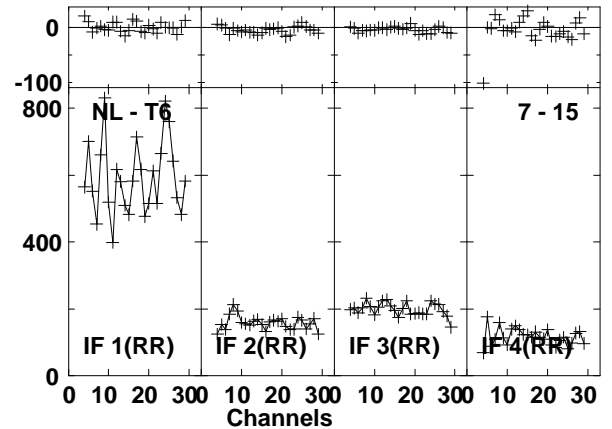
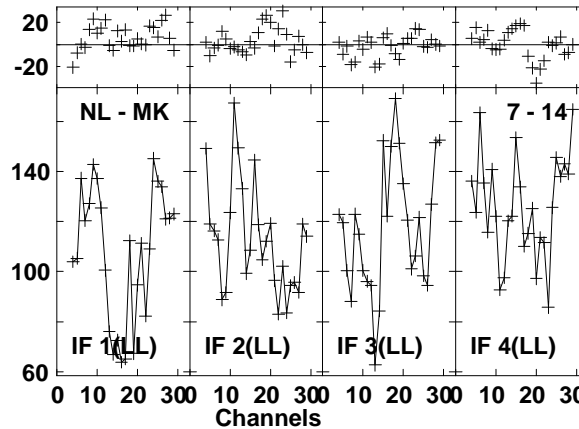
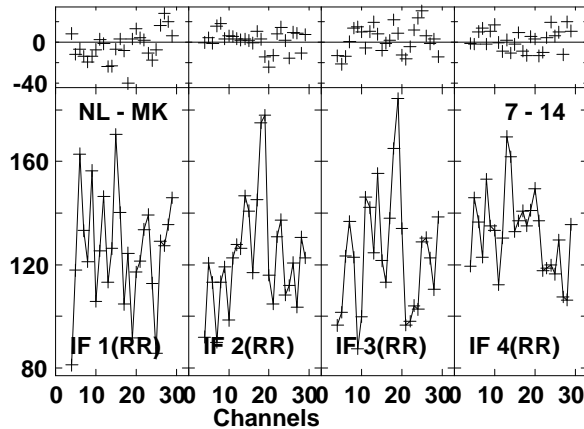
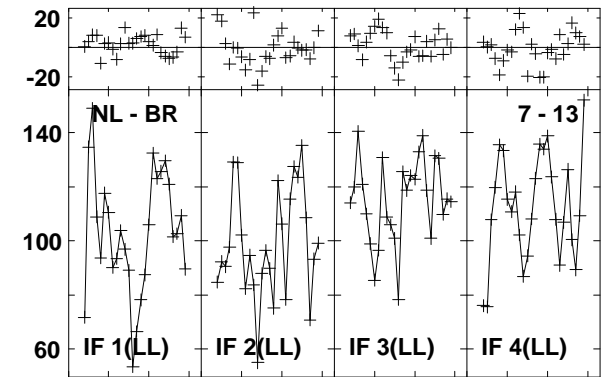
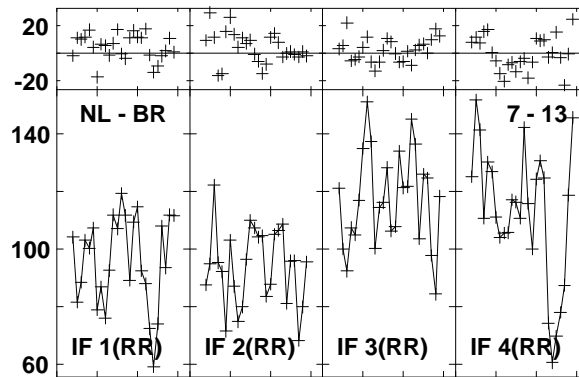
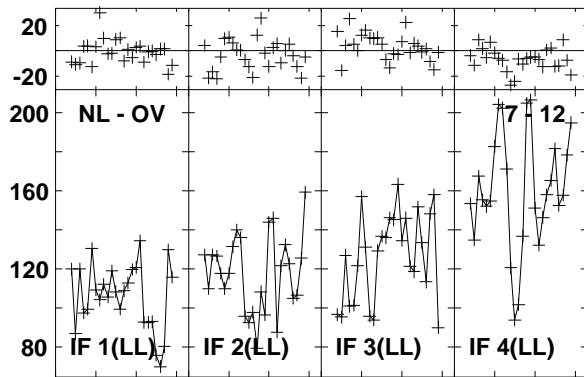
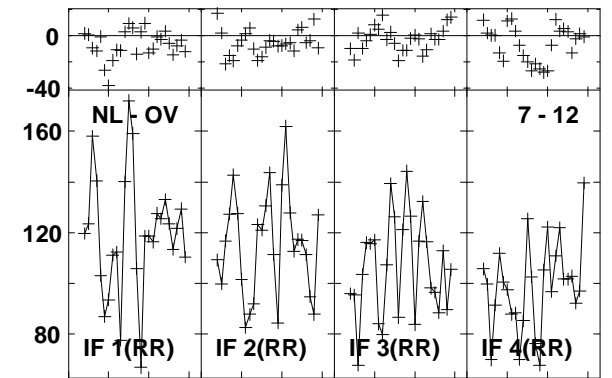
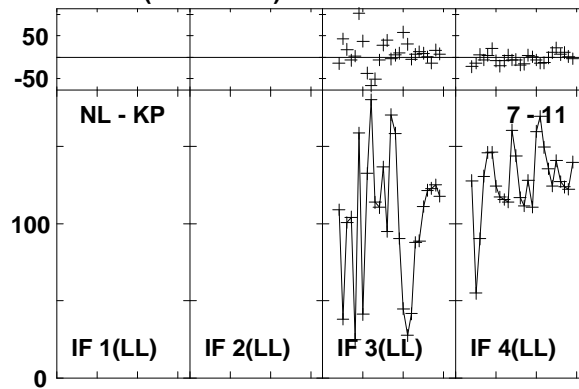
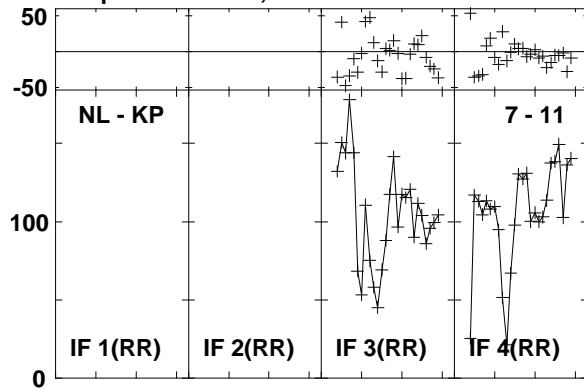

Lower frame: Milli Ampl Jy Top frame: Phas deg
Vector averaged cross-power spectrum Baseline: NL (07) - KP (11)
Timerange: 01/02:24:50 to 01/02:26:48

Plot file version1287 created 03-MAR-2016 01:15:42
J1545+5400 GN002C 1.UVDATA.1
Freq = 1.2770 GHz, Bw = 16.000 MH Calibrated with CL # 3 and BP # 1 (BP mode 1)

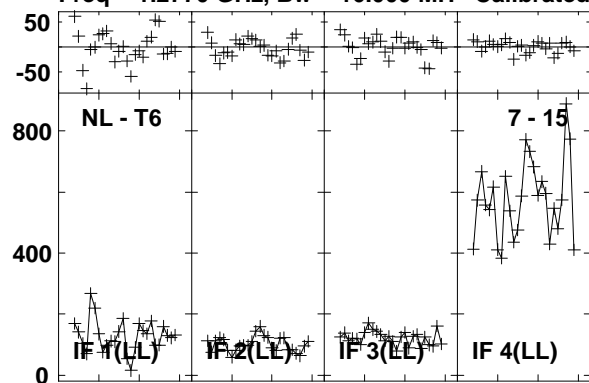

Lower frame: Milli Ampl Jy Top frame: Phas deg
Vector averaged cross-power spectrum Baseline: NL (07) - T6 (15)
Timerange: 01/02:24:50 to 01/02:26:48

Plot file version1288 created 03-MAR-2016 01:15:42

J1638+5720 GN002C 1.UVDATA.1

Freq = 1.2770 GHz, Bw = 16.000 MH Calibrated with CL # 3 and BP # 1 (BP mode 1)

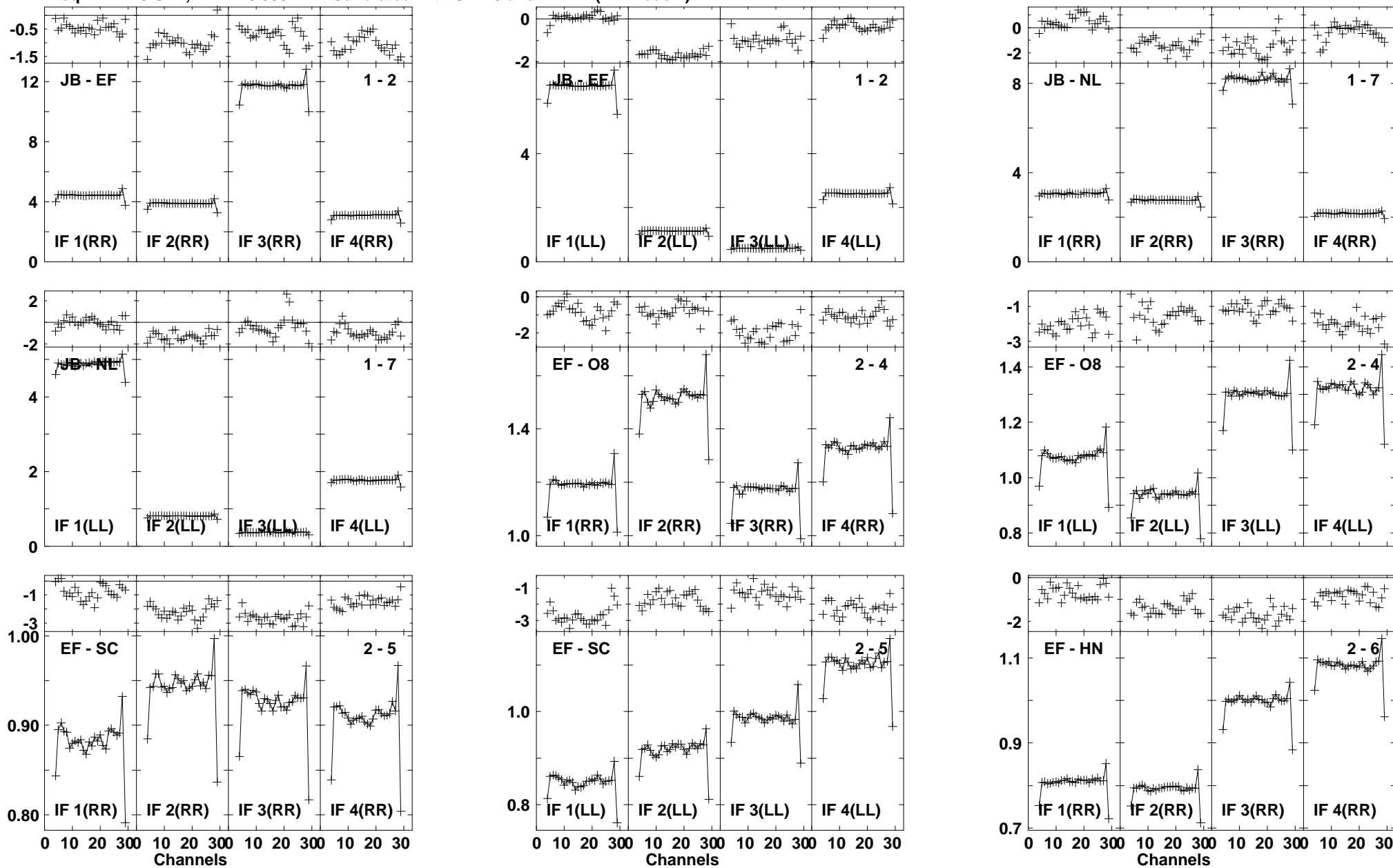

Lower frame: Ampl Jy Top frame: Phas deg
Vector averaged cross-power spectrum Baseline: JB (01) - EF (02)
Timerange: 01/02:27:53 to 01/02:31:41

Plot file version1289 created 03-MAR-2016 01:15:42

J1638+5720 GN002C 1.UVDATA.1

Freq = 1.2770 GHz, Bw = 16.000 MH Calibrated with CL # 3 and BP # 1 (BP mode 1)

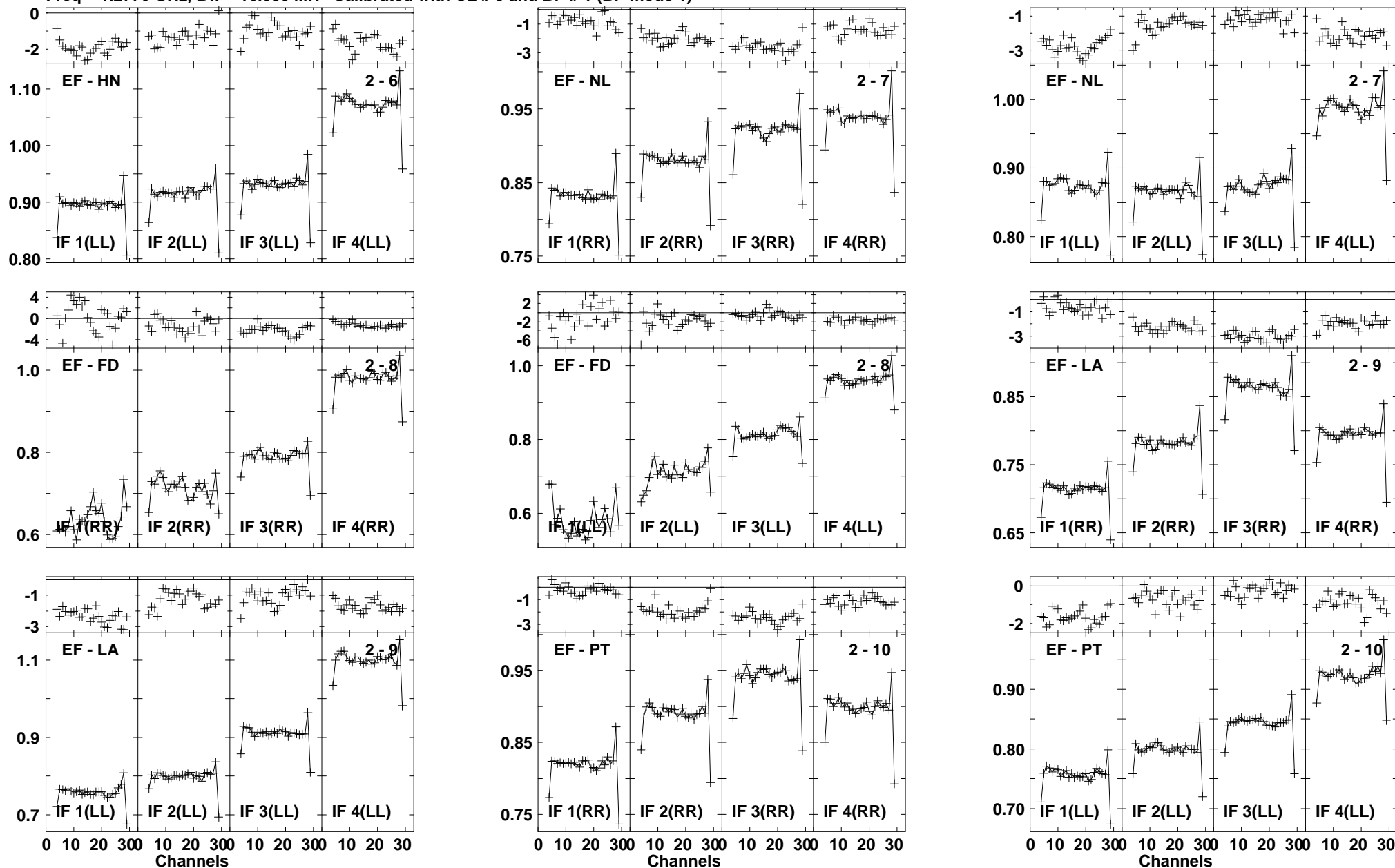

Lower frame: Ampl Jy Top frame: Phas deg
Vector averaged cross-power spectrum Baseline: EF (02) - HN (06)
Timerange: 01/02:27:53 to 01/02:31:41

Plot file version1290 created 03-MAR-2016 01:15:42
 J1638+5720 GN002C 1.UVDATA.1
 Freq = 1.2770 GHz, Bw = 16.000 MH Calibrated with CL # 3 and BP # 1 (BP mode 1)

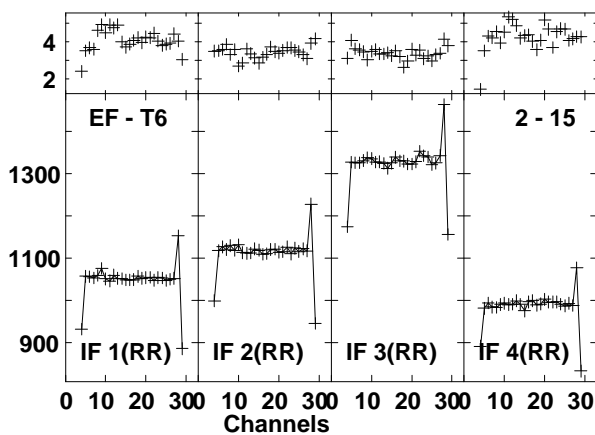
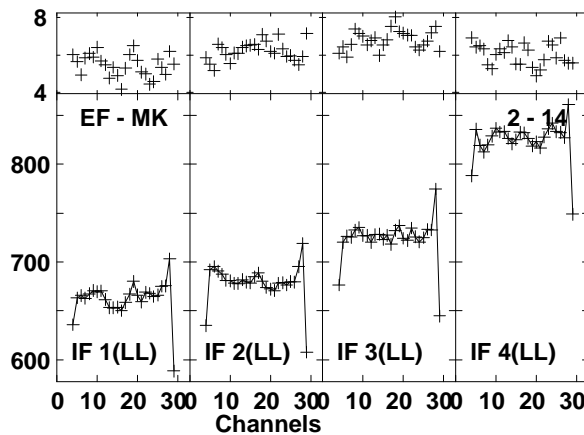
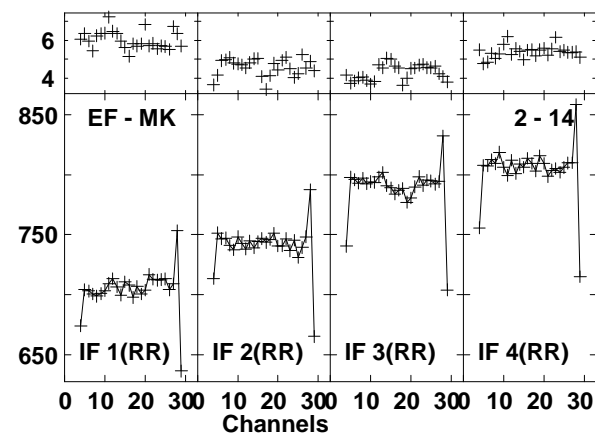
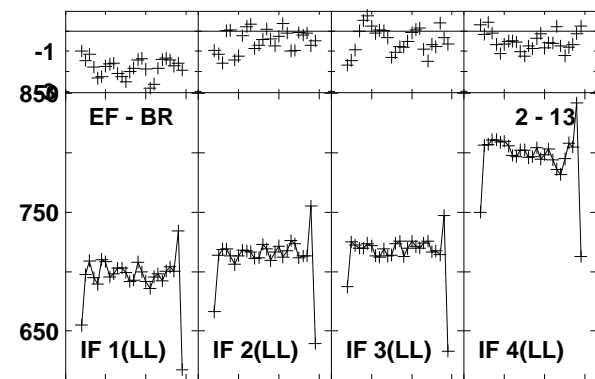
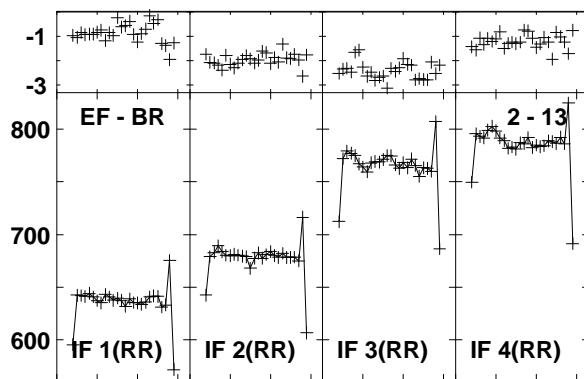
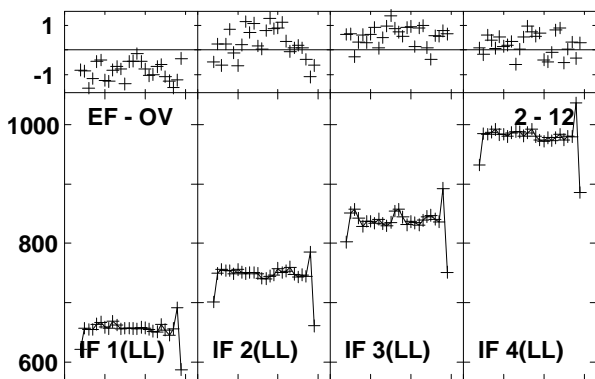
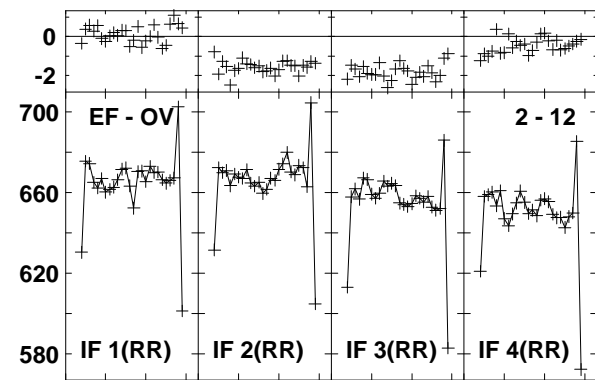
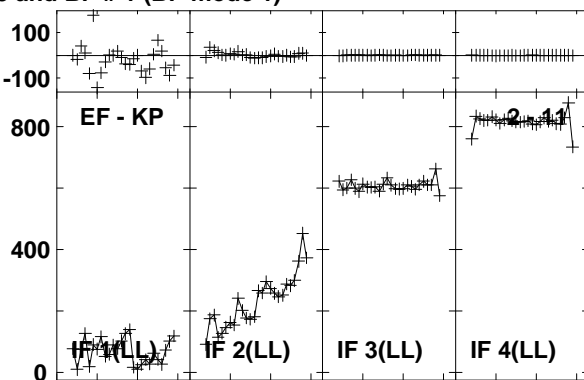
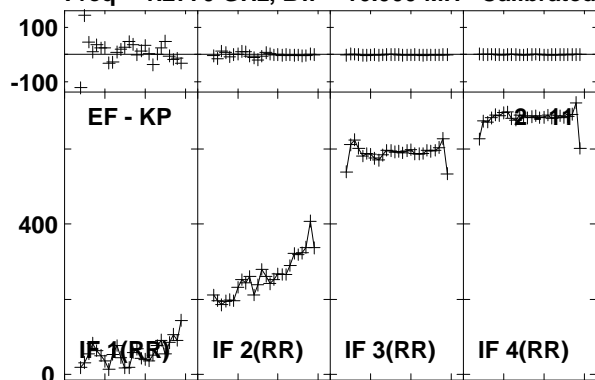

Lower frame: Milli Ampl Jy Top frame: Phas deg
 Vector averaged cross-power spectrum Baseline: EF (02) - KP (11)
 Timerange: 01/02:27:53 to 01/02:31:41

Plot file version1291 created 03-MAR-2016 01:15:43

J1638+5720 GN002C 1.UVDATA.1

Freq = 1.2770 GHz, Bw = 16.000 MH Calibrated with CL # 3 and BP # 1 (BP mode 1)

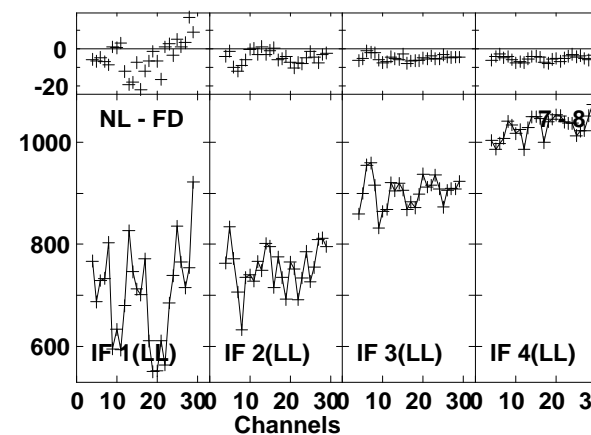
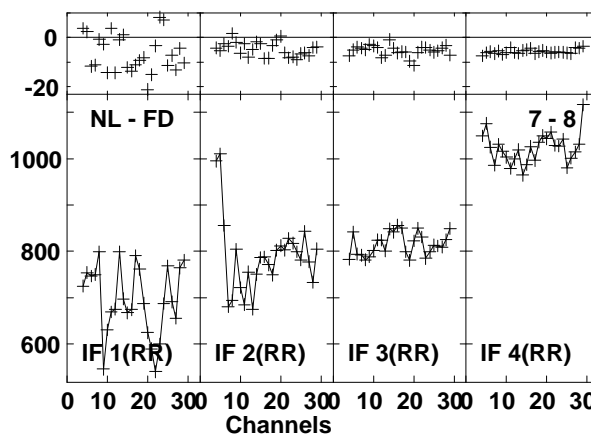
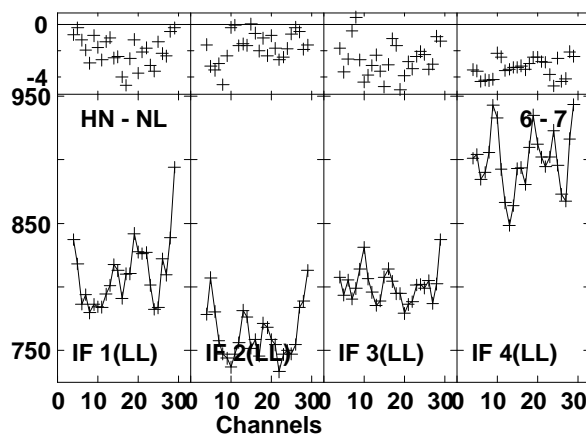
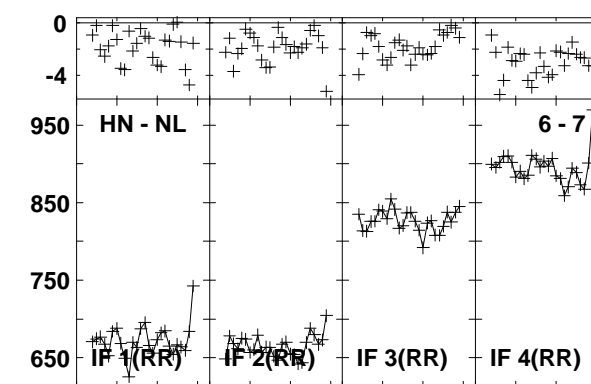
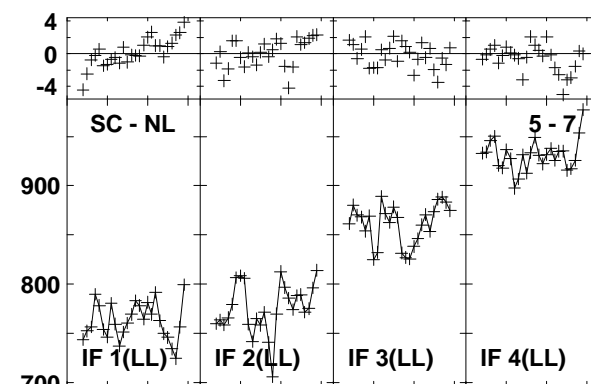
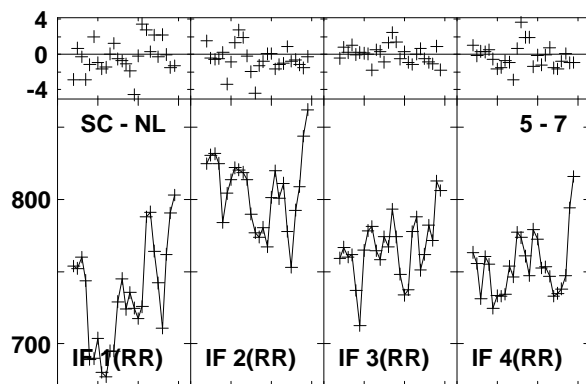
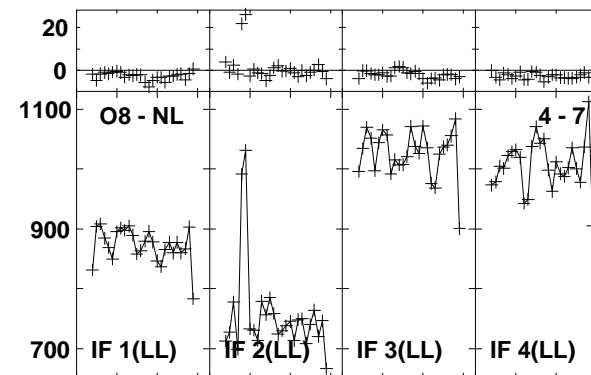
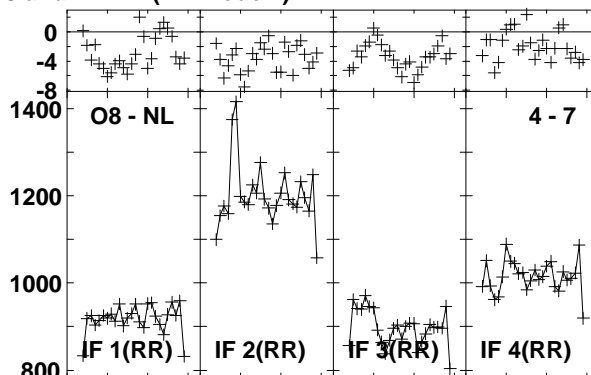
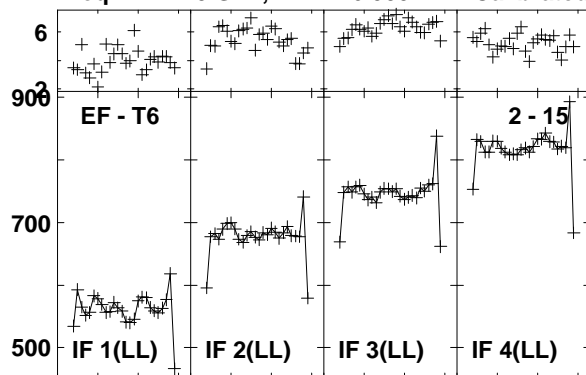

Lower frame: Milli Ampl Jy Top frame: Phas deg
Vector averaged cross-power spectrum Baseline: EF (02) - T6 (15)
Timerange: 01/02:27:53 to 01/02:31:41

Plot file version1292 created 03-MAR-2016 01:15:43

J1638+5720 GN002C 1.UVDATA.1

Freq = 1.2770 GHz, Bw = 16.000 MH Calibrated with CL # 3 and BP # 1 (BP mode 1)

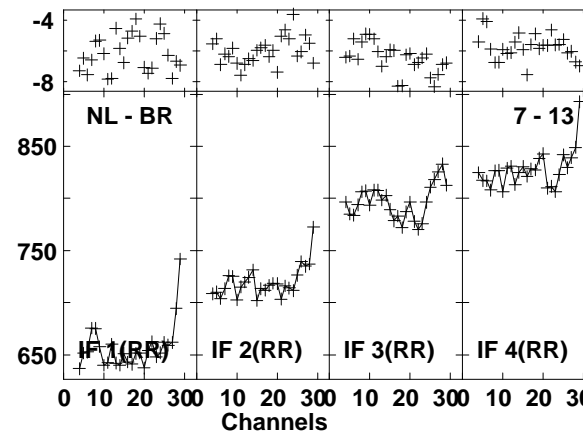
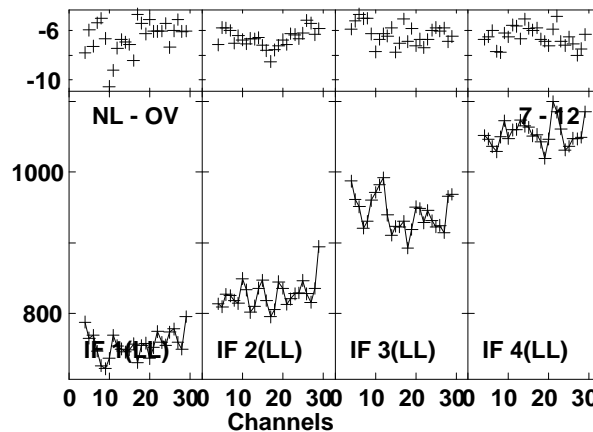
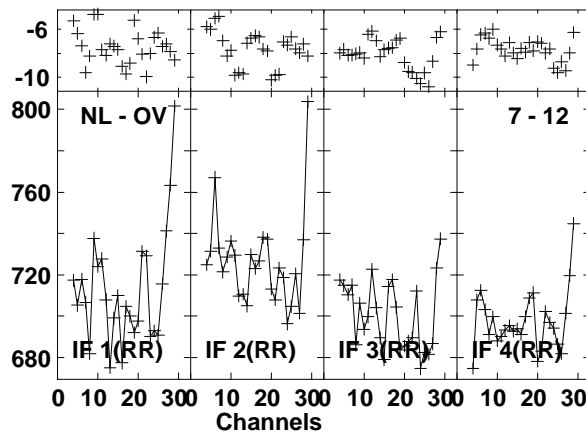
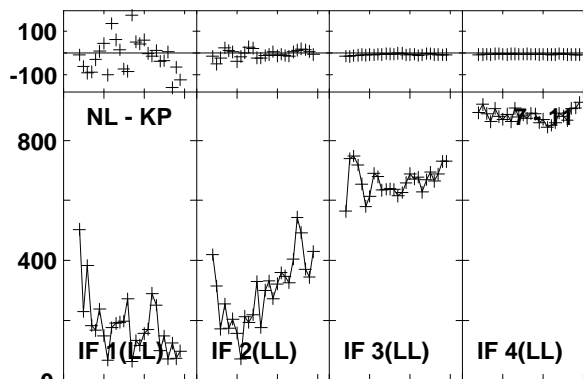
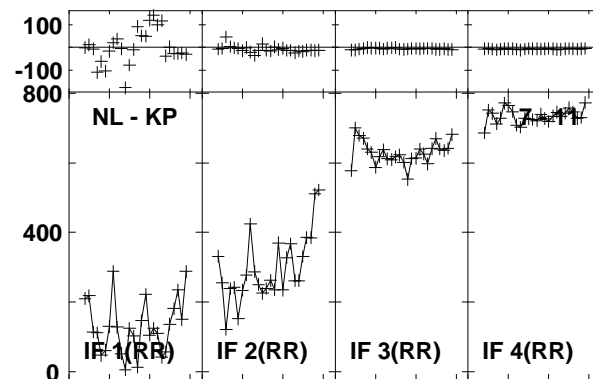
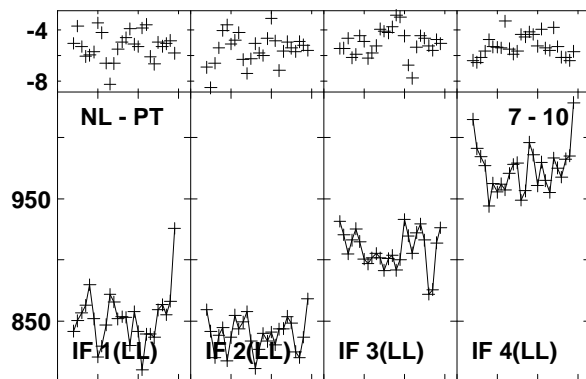
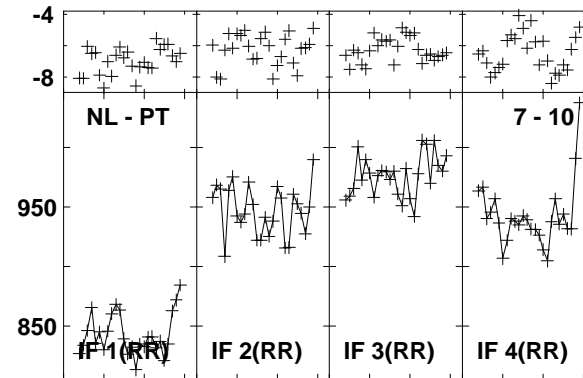
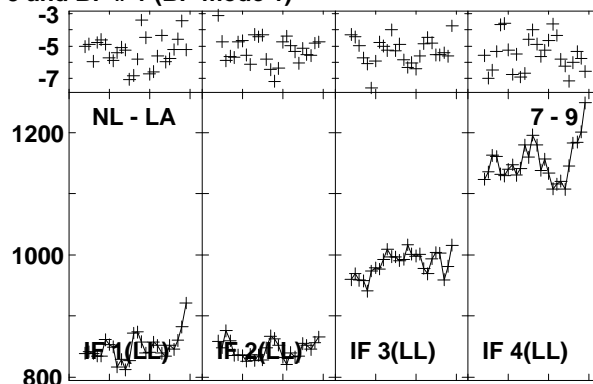
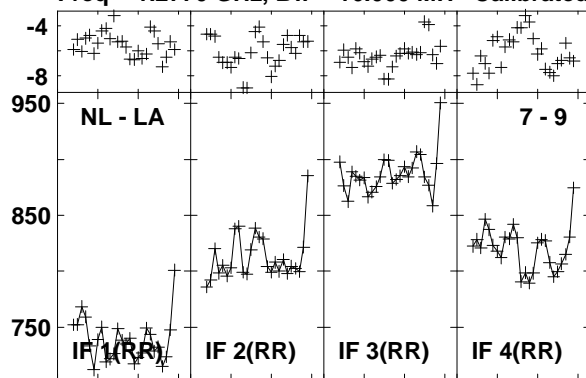

Lower frame: Milli Ampl Jy Top frame: Phas deg
Vector averaged cross-power spectrum Baseline: NL (07) - LA (09)
Timerange: 01/02:27:53 to 01/02:31:41

Plot file version1293 created 03-MAR-2016 01:15:43
 J1638+5720 GN002C 1.UVDATA.1
 Freq = 1.2770 GHz, Bw = 16.000 MH Calibrated with CL # 3 and BP # 1 (BP mode 1)

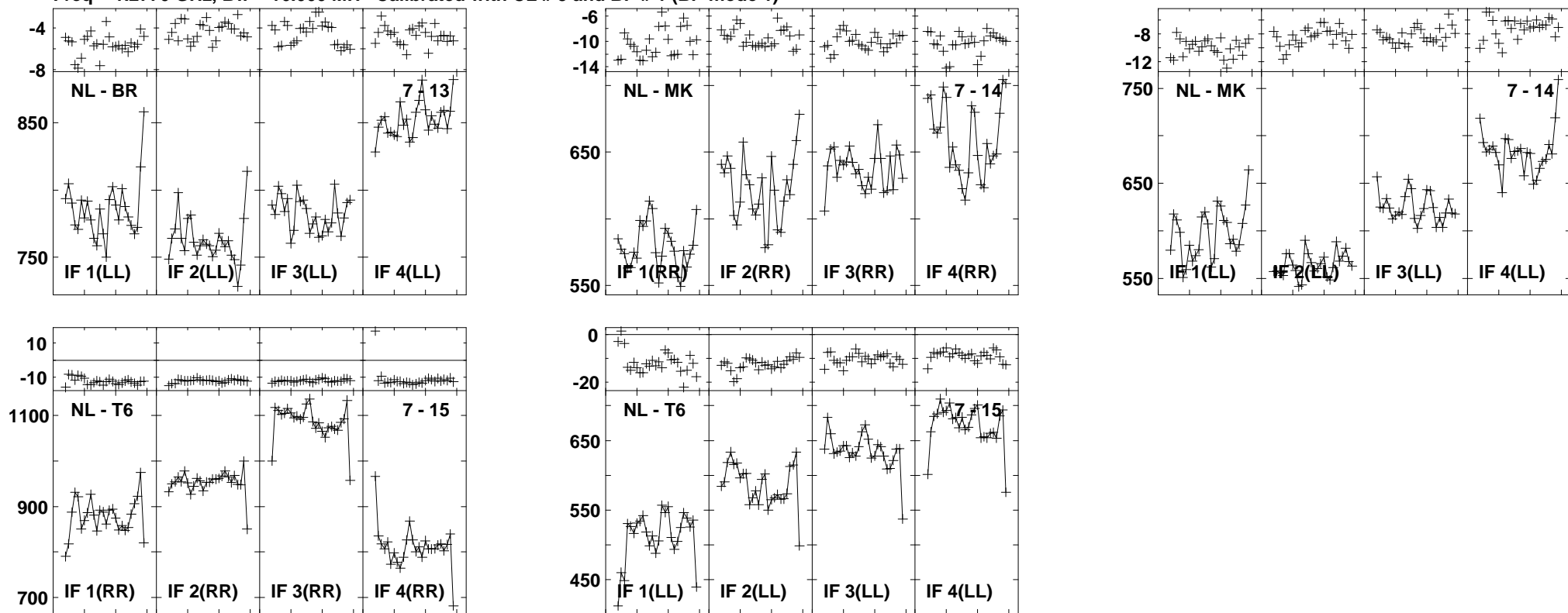

Lower frame: Milli Ampl Jy Top frame: Phas deg
 Vector averaged cross-power spectrum Baseline: NL (07) - BR (13)
 Timerange: 01/02:27:53 to 01/02:31:41

Plot file version1294 created 03-MAR-2016 01:15:43

J1545+5400 GN002C 1.UVDATA.1

Freq = 1.2770 GHz, Bw = 16.000 MH Calibrated with CL # 3 and BP # 1 (BP mode 1)

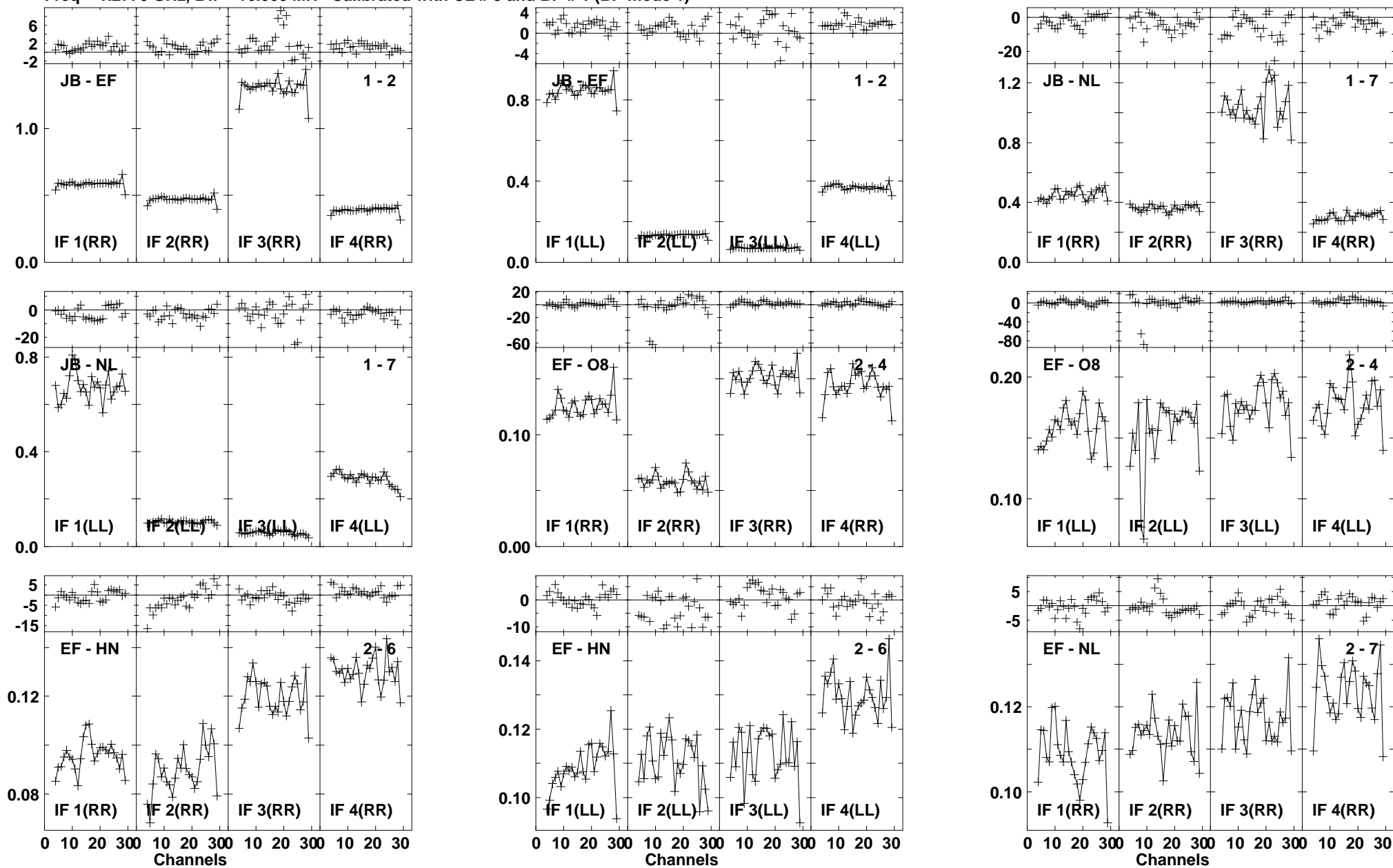

Lower frame: Ampl Jy Top frame: Phas deg
Vector averaged cross-power spectrum Baseline: JB (01) - EF (02)
Timerange: 01/02:32:47 to 01/02:35:35

Plot file version1295 created 03-MAR-2016 01:15:43

J1545+5400 GN002C 1.UVDATA.1

Freq = 1.2770 GHz, Bw = 16.000 MH Calibrated with CL # 3 and BP # 1 (BP mode 1)

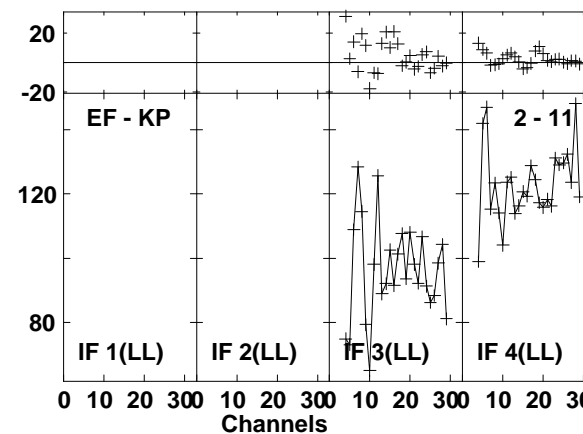
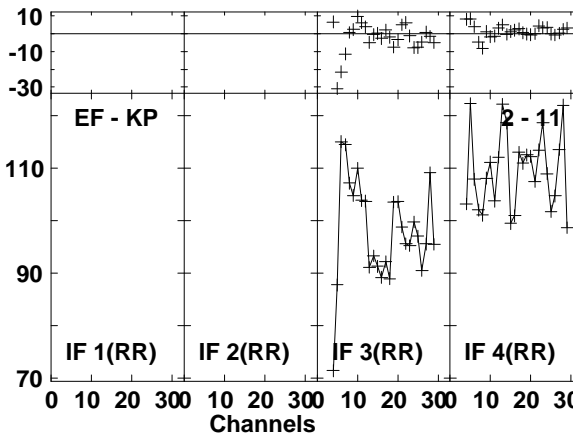
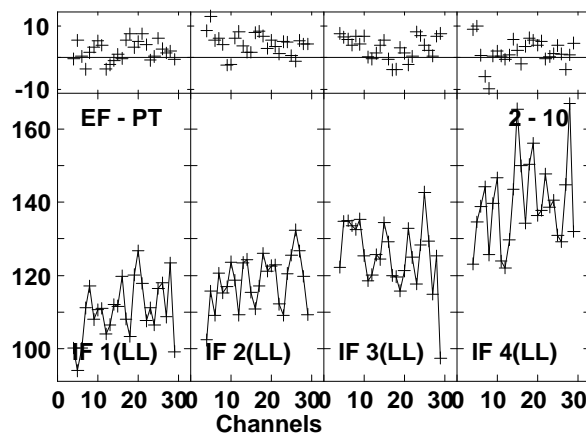
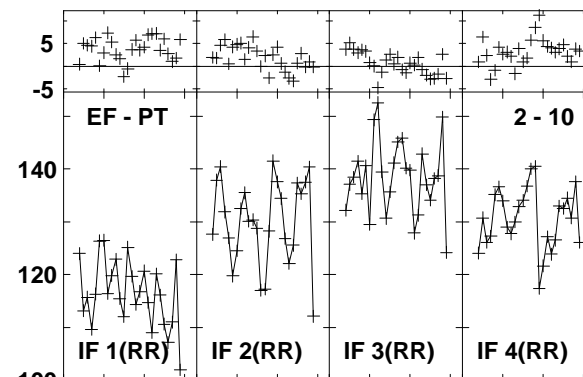
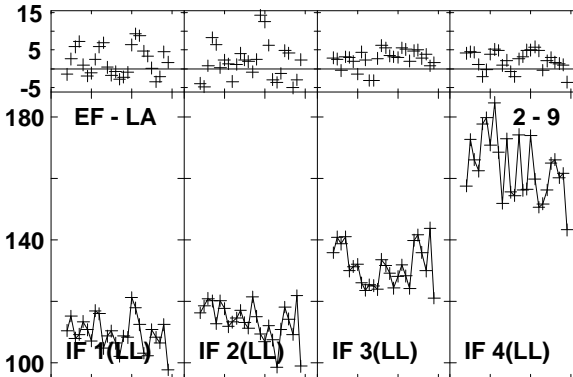
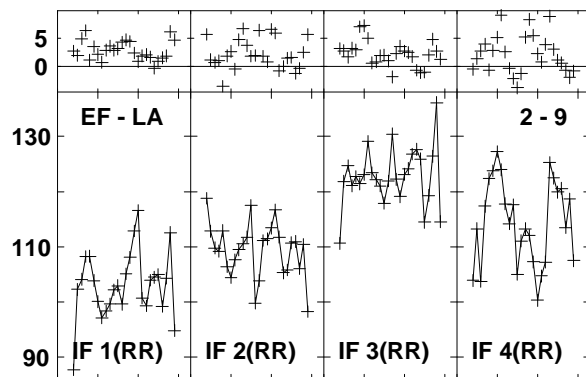
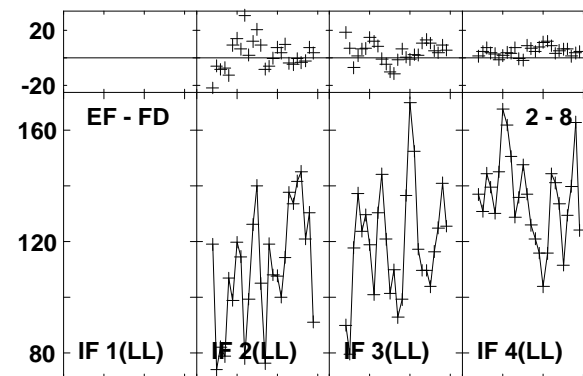
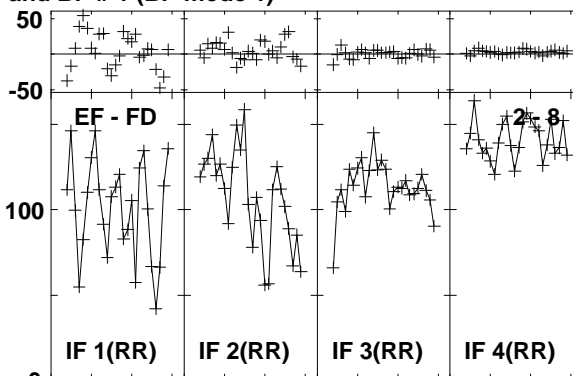
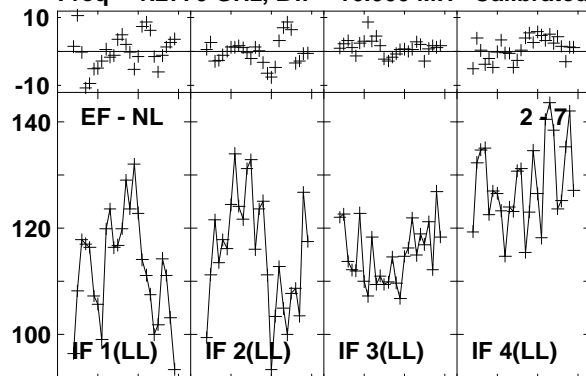

Lower frame: Milli Ampl Jy Top frame: Phas deg
Vector averaged cross-power spectrum Baseline: EF (02) - NL (07)
Timerange: 01/02:32:47 to 01/02:35:35

Plot file version1296 created 03-MAR-2016 01:15:44

J1545+5400 GN002C 1.UVDATA.1

Freq = 1.2770 GHz, Bw = 16.000 MH Calibrated with CL # 3 and BP # 1 (BP mode 1)

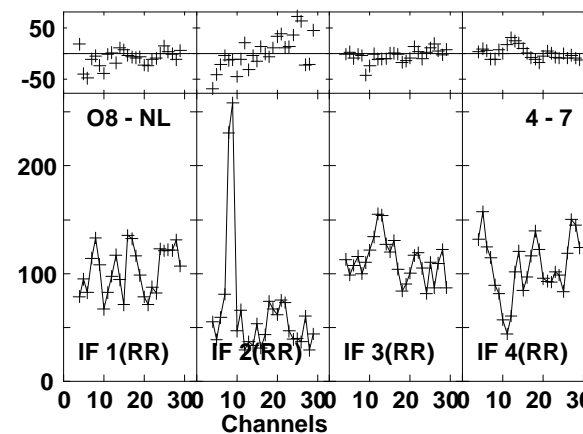
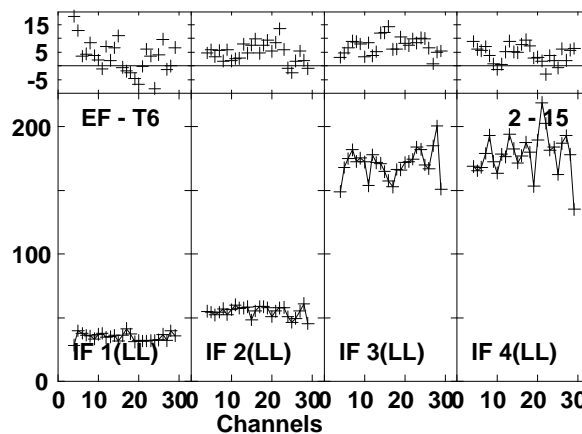
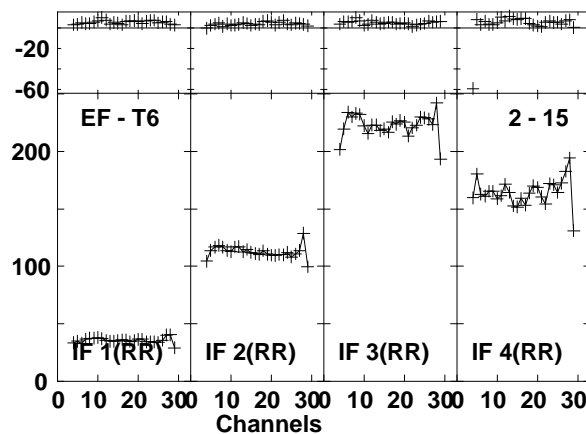
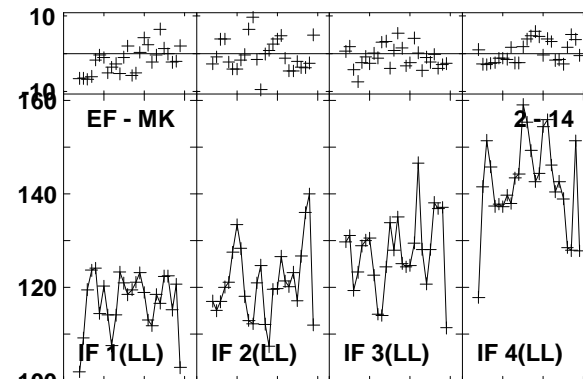
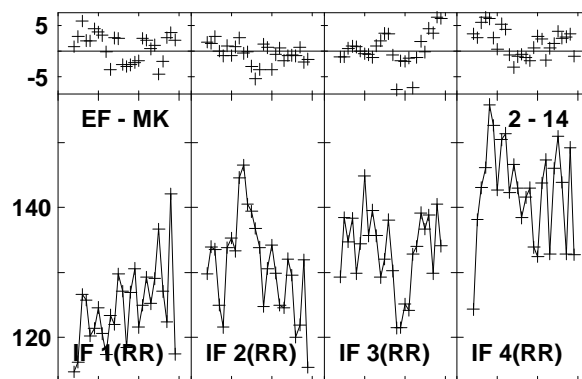
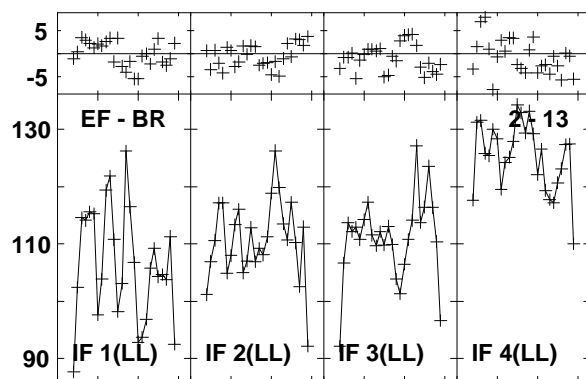
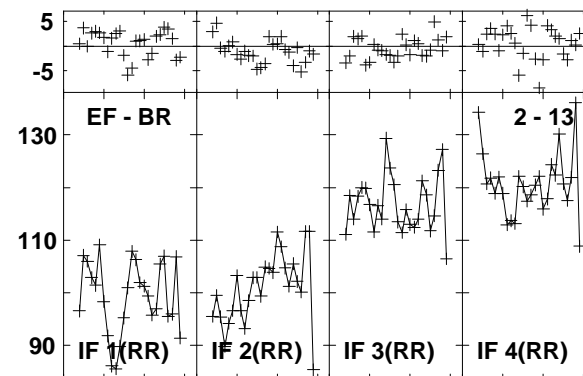
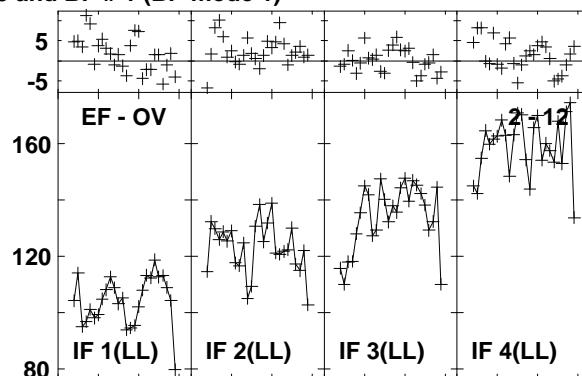
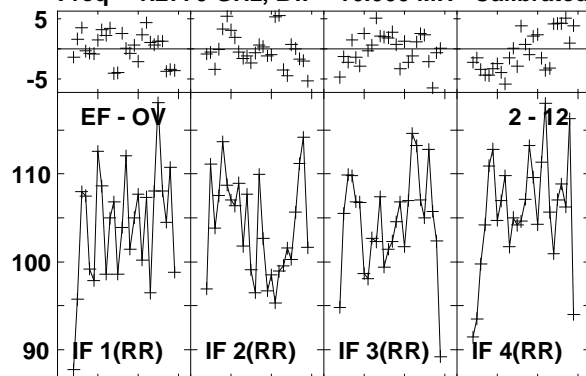

Lower frame: Milli Ampl Jy Top frame: Phas deg
Vector averaged cross-power spectrum Baseline: EF (02) - OV (12)
Timerange: 01/02:32:47 to 01/02:35:35

Plot file version1297 created 03-MAR-2016 01:15:44

J1545+5400 GN002C 1.UVDATA.1

Freq = 1.2770 GHz, Bw = 16.000 MH Calibrated with CL # 3 and BP # 1 (BP mode 1)

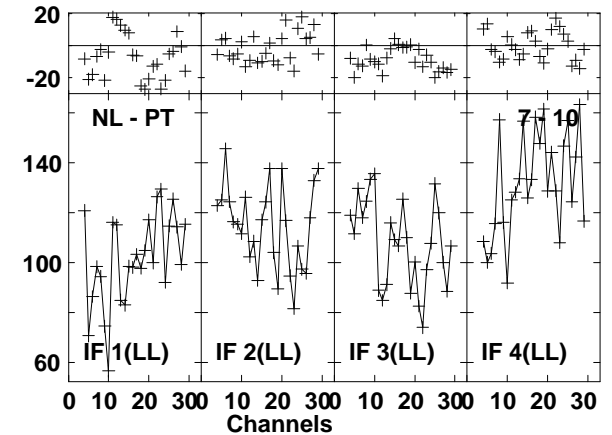
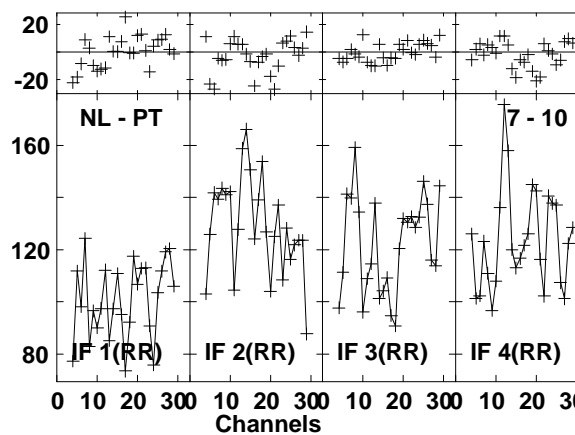
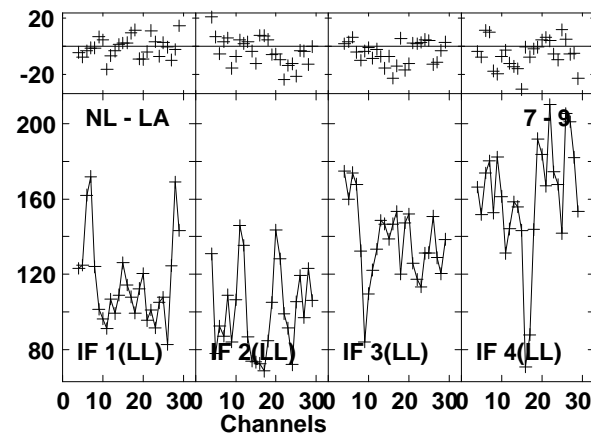
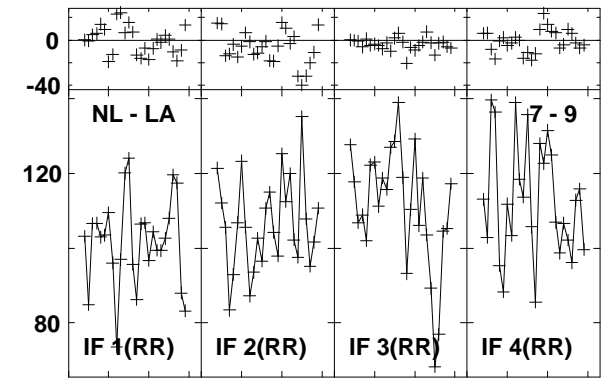
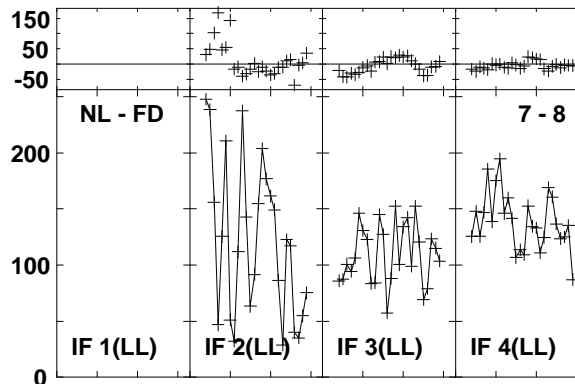
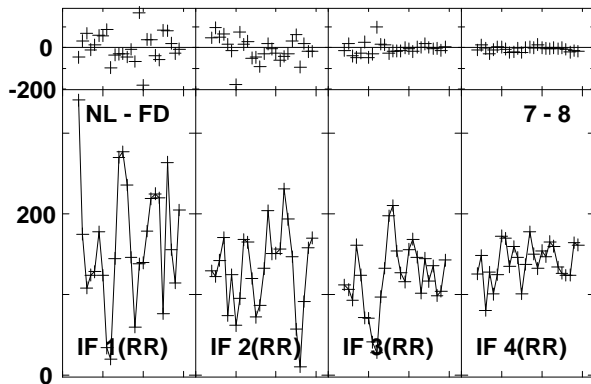
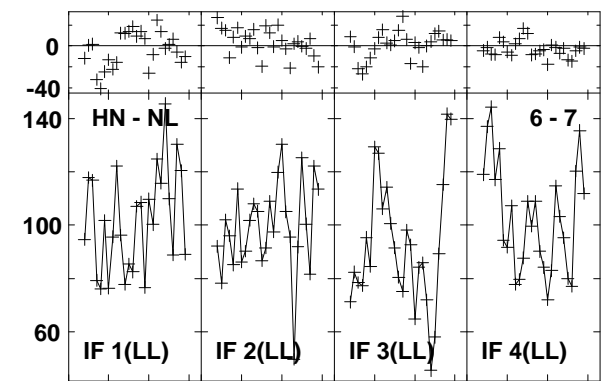
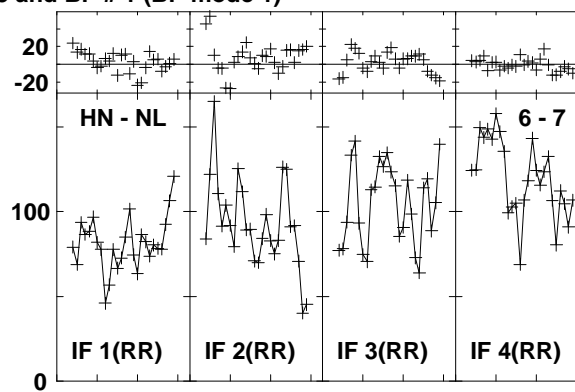
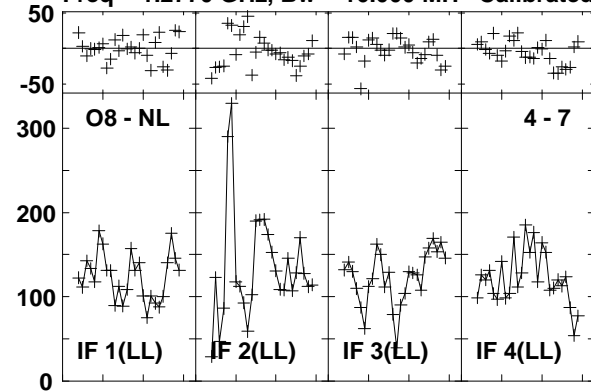

Lower frame: Milli Ampl Jy Top frame: Phas deg
Vector averaged cross-power spectrum Baseline: O8 (04) - NL (07)
Timerange: 01/02:32:47 to 01/02:35:35

Plot file version1298 created 03-MAR-2016 01:15:44
 J1545+5400 GN002C 1.UVDATA.1
 Freq = 1.2770 GHz, Bw = 16.000 MH Calibrated with CL # 3 and BP # 1 (BP mode 1)

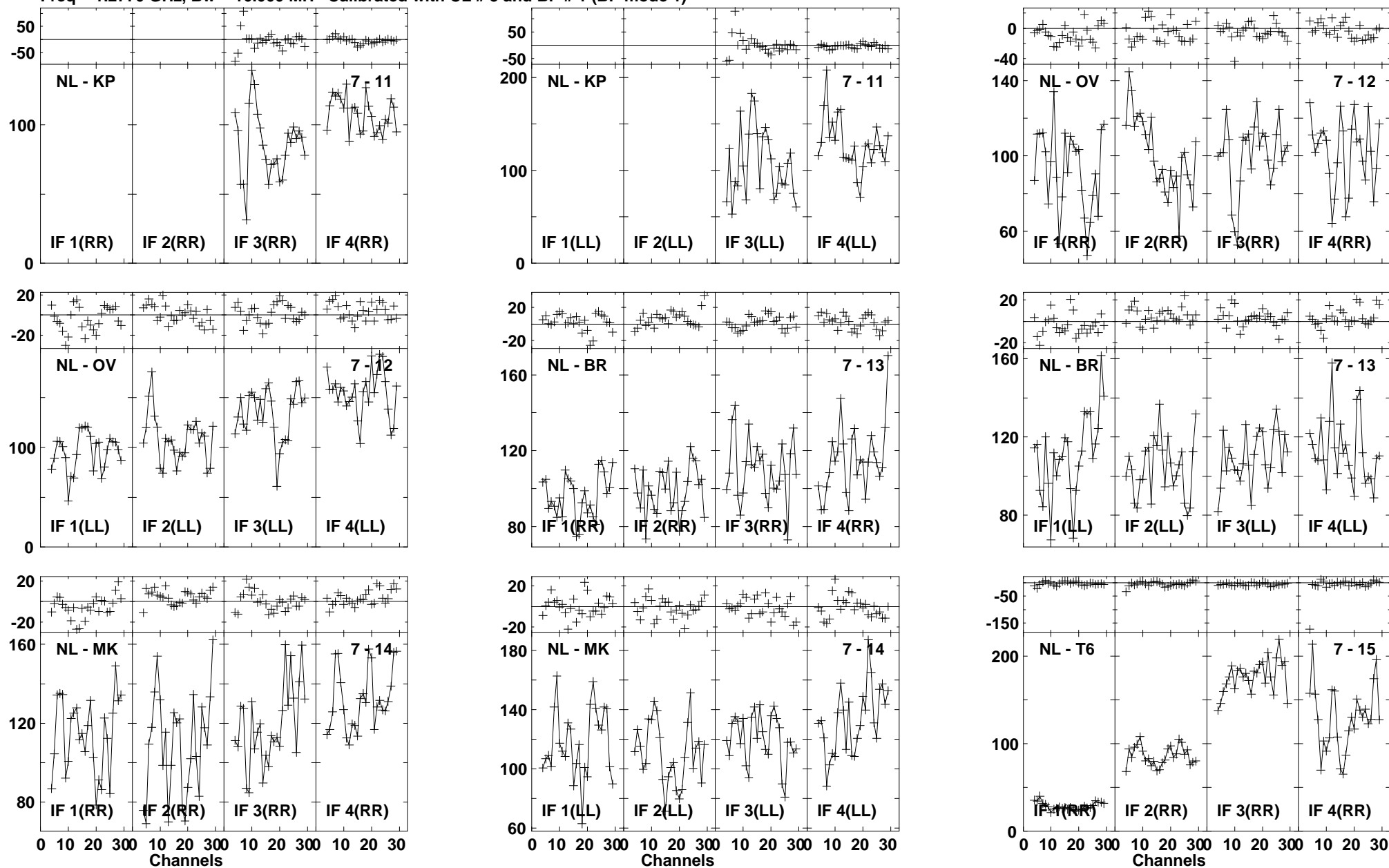

Lower frame: Milli Ampl Jy Top frame: Phas deg
 Vector averaged cross-power spectrum Baseline: NL (07) - KP (11)
 Timerange: 01/02:32:47 to 01/02:35:35

Plot file version1299 created 03-MAR-2016 01:15:44
J1545+5400 GN002C 1.UVDATA.1
Freq = 1.2770 GHz, Bw = 16.000 MH Calibrated with CL # 3 and BP # 1 (BP mode 1)

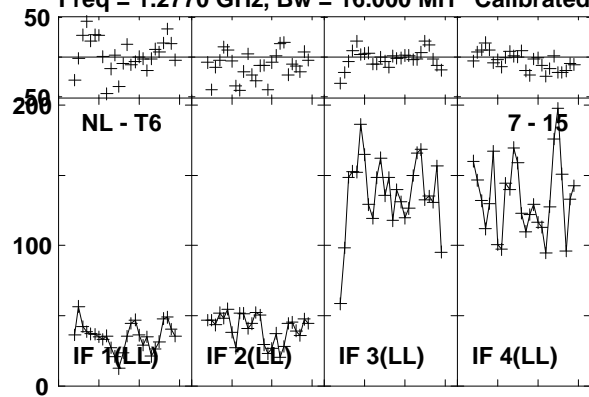

Lower frame: Milli Ampl Jy Top frame: Phas deg
Vector averaged cross-power spectrum Baseline: NL (07) - T6 (15)
Timerange: 01/02:32:47 to 01/02:35:35

Plot file version1300 created 03-MAR-2016 01:15:44

4C52 GN002C 1.UVDATA.1

Freq = 1.2770 GHz, Bw = 16.000 MH Calibrated with CL # 3 and BP # 1 (BP mode 1)

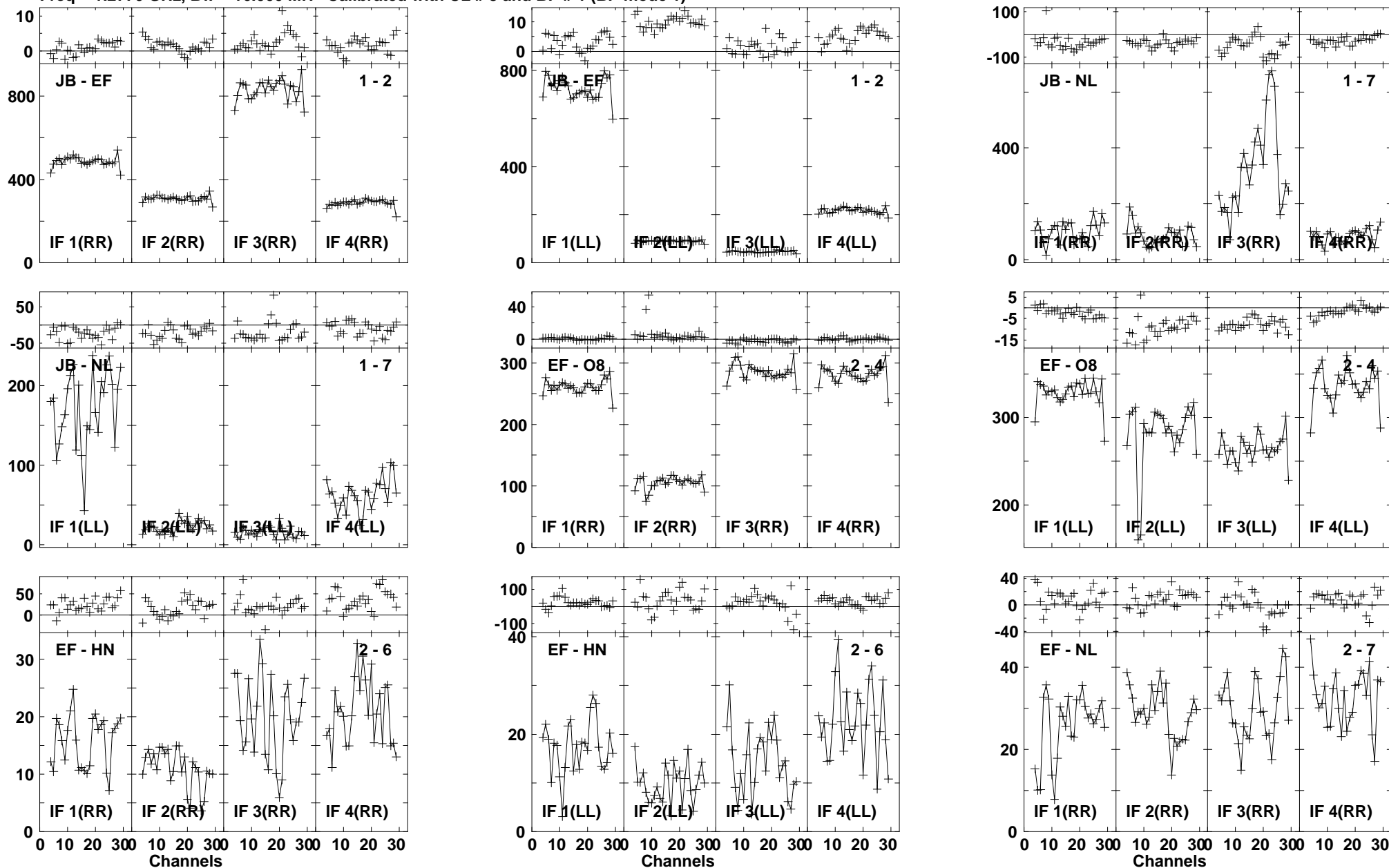

Lower frame: Milli Ampl Jy Top frame: Phas deg
Vector averaged cross-power spectrum Baseline: JB (01) - EF (02)
Timerange: 01/02:35:47 to 01/02:38:55

Plot file version1301 created 03-MAR-2016 01:15:44

4C52 GN002C 1.UVDATA.1

Freq = 1.2770 GHz, Bw = 16.000 MH Calibrated with CL # 3 and BP # 1 (BP mode 1)

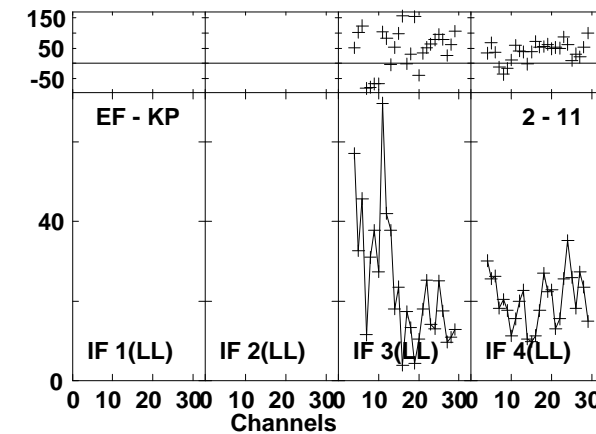
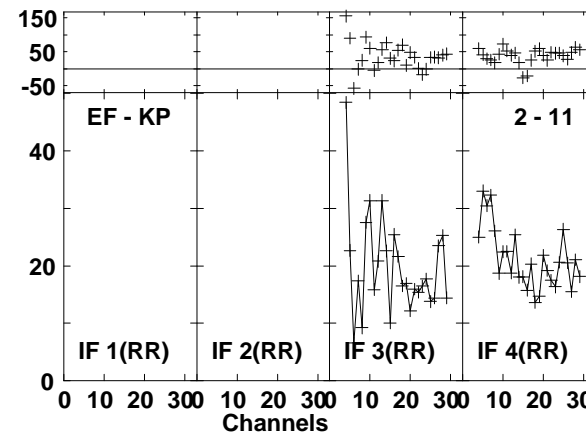
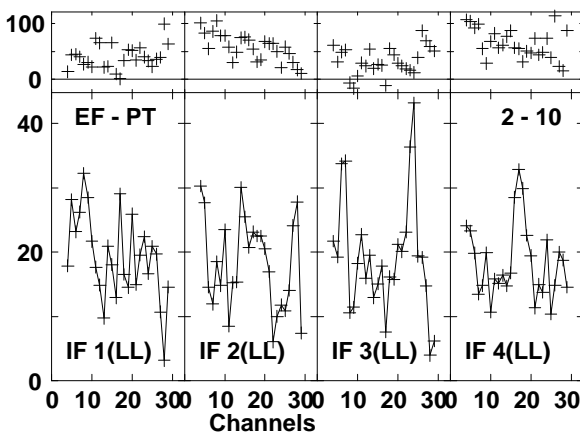
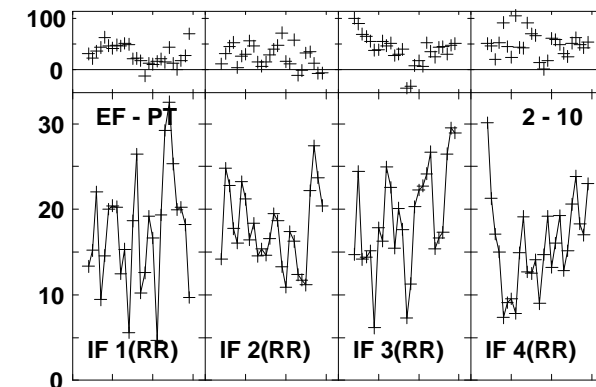
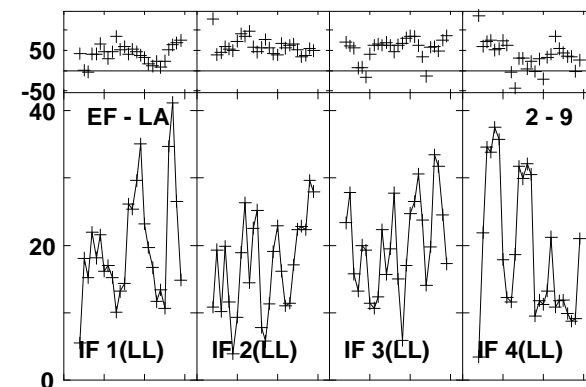
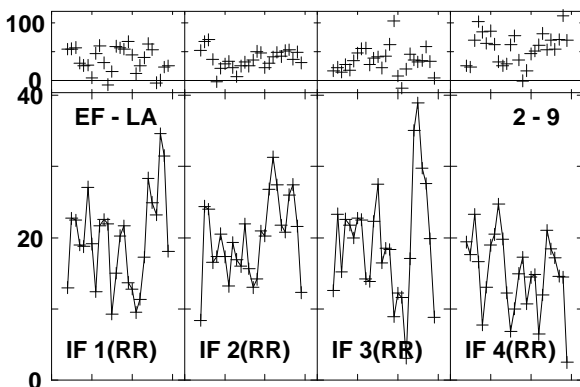
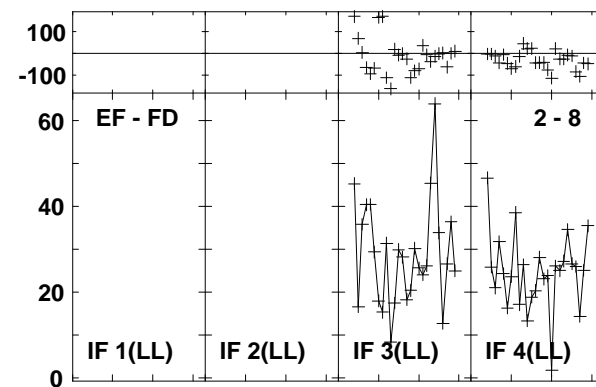
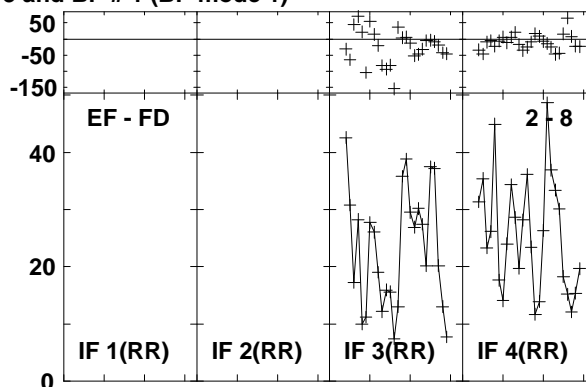
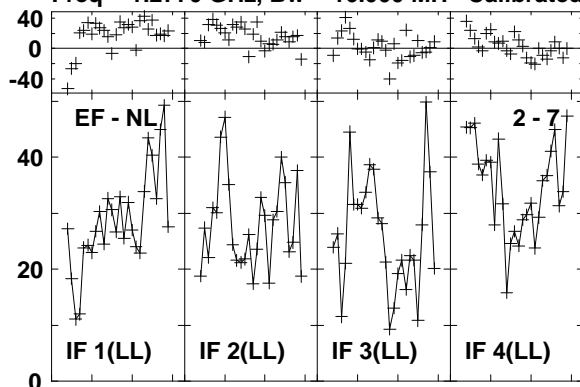

Lower frame: Milli Ampl Jy Top frame: Phas deg
Vector averaged cross-power spectrum Baseline: EF (02) - NL (07)
Timerange: 01/02:35:47 to 01/02:38:55

Plot file version1302 created 03-MAR-2016 01:15:45

4C52 GN002C 1.UVDATA.1

Freq = 1.2770 GHz, Bw = 16.000 MH Calibrated with CL # 3 and BP # 1 (BP mode 1)

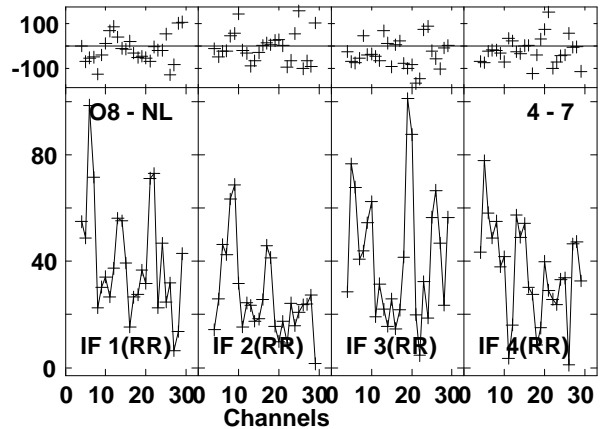
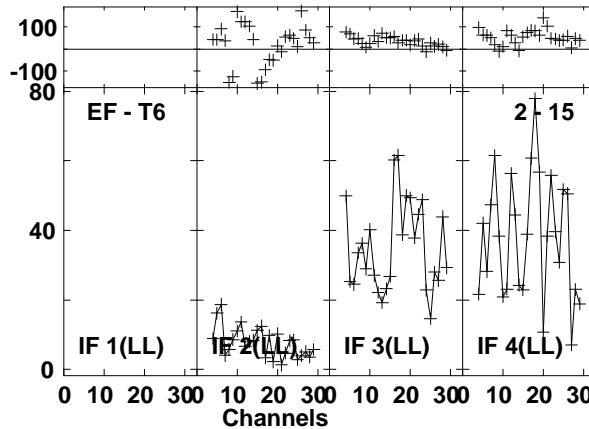
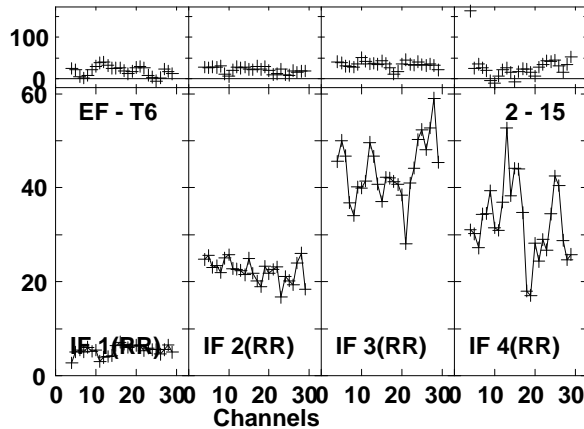
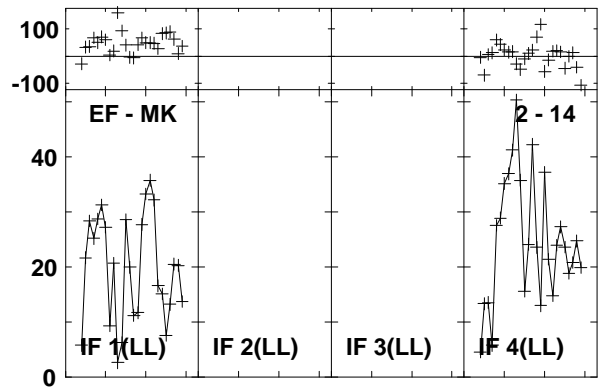
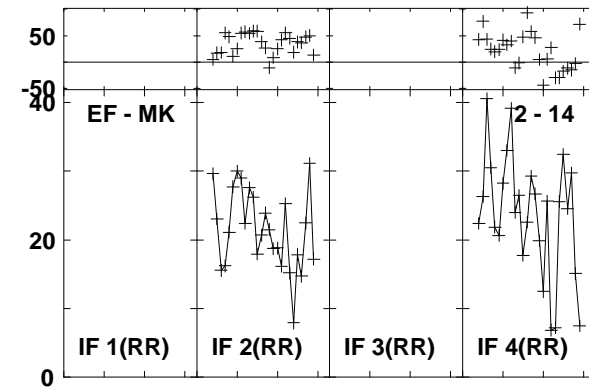
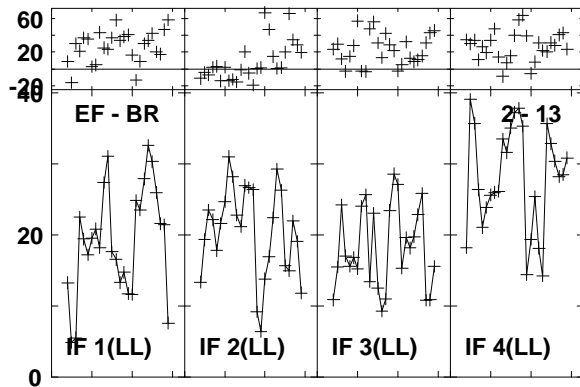
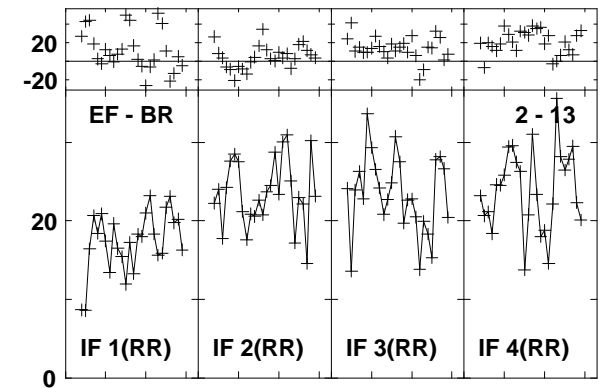
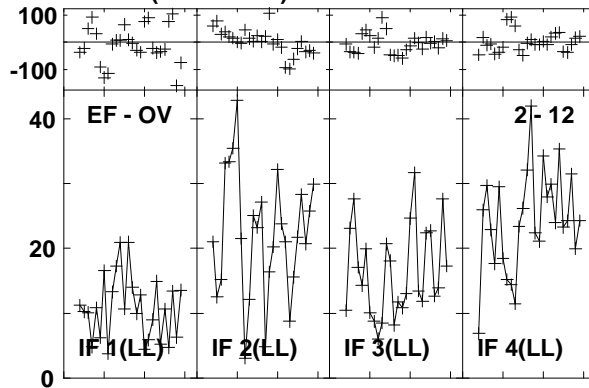
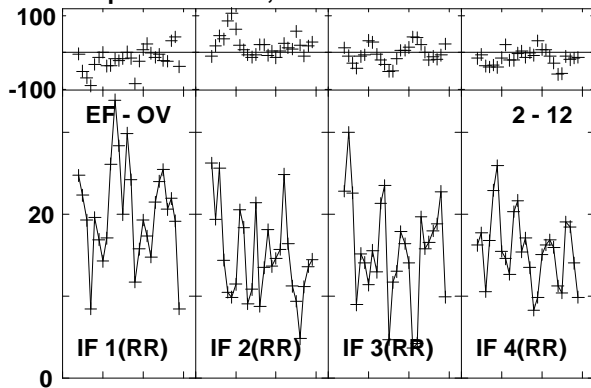

Lower frame: Milli Ampl Jy Top frame: Phas deg
Vector averaged cross-power spectrum Baseline: EF (02) - OV (12)
Timerange: 01/02:35:47 to 01/02:38:55

Plot file version1303 created 03-MAR-2016 01:15:45
 4C52 GN002C 1.UVDATA.1
 Freq = 1.2770 GHz, Bw = 16.000 MH Calibrated with CL # 3 and BP # 1 (BP mode 1)

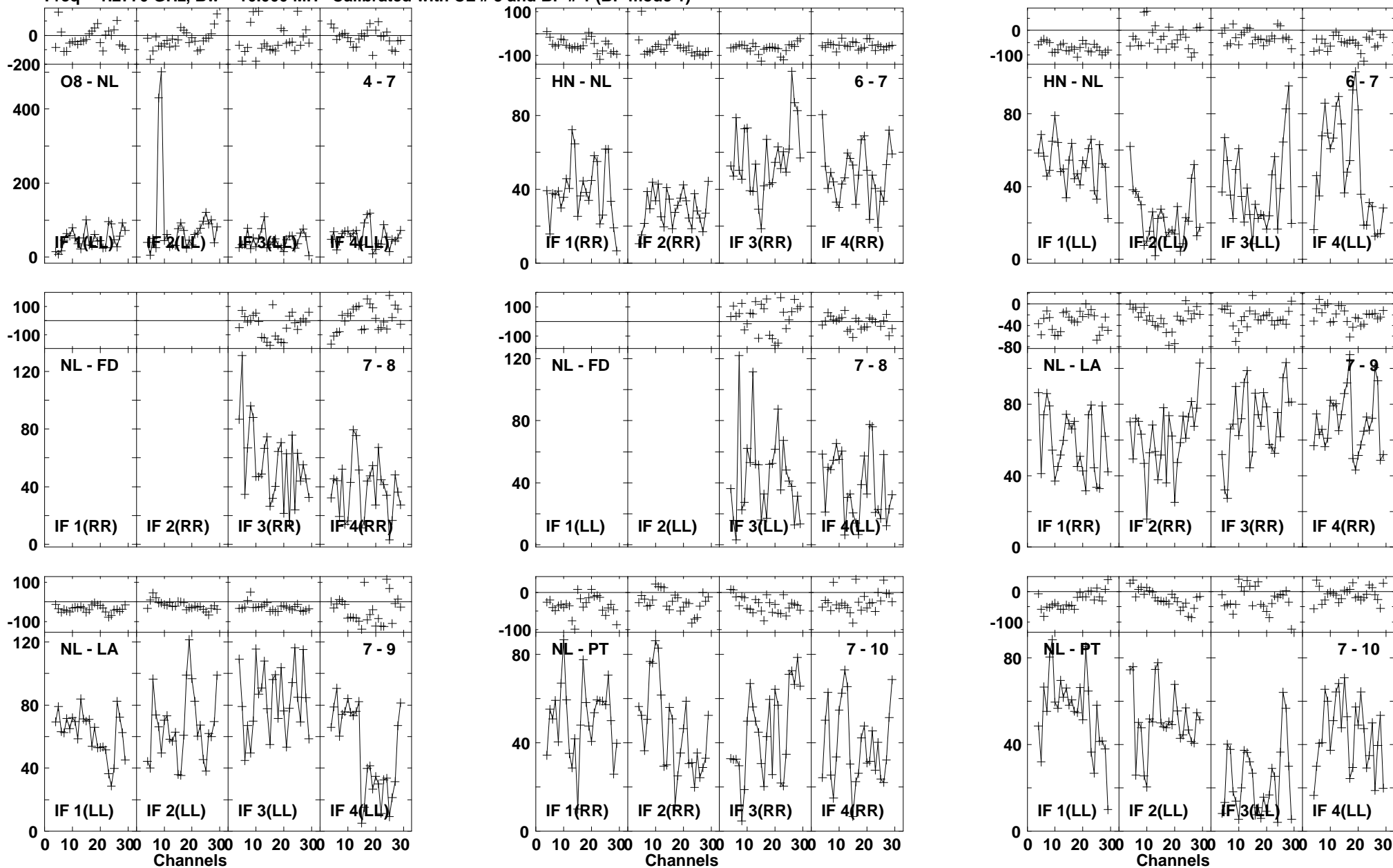

Lower frame: Milli Ampl Jy Top frame: Phas deg
 Vector averaged cross-power spectrum Baseline: O8 (04) - NL (07)
 Timerange: 01/02:35:47 to 01/02:38:55

Plot file version1304 created 03-MAR-2016 01:15:45

4C52 GN002C 1.UVDATA.1

Freq = 1.2770 GHz, Bw = 16.000 MH Calibrated with CL # 3 and BP # 1 (BP mode 1)

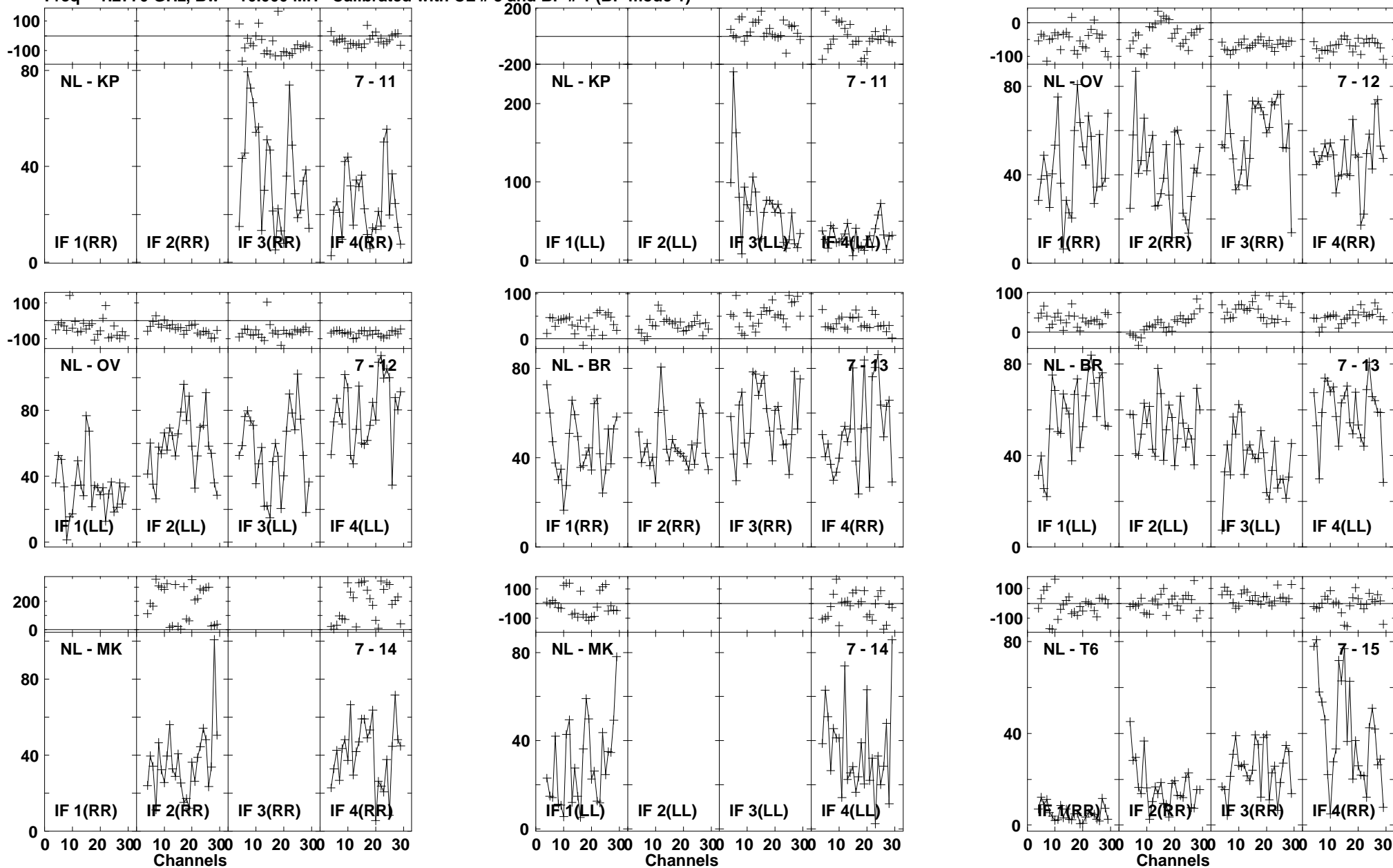

Lower frame: Milli Ampl Jy Top frame: Phas deg
Vector averaged cross-power spectrum Baseline: NL (07) - KP (11)
Timerange: 01/02:35:47 to 01/02:38:55

Plot file version1305 created 03-MAR-2016 01:15:45
4C52 GN002C 1.UVDATA.1
Freq = 1.2770 GHz, Bw = 16.000 MH Calibrated with CL # 3 and BP # 1 (BP mode 1)

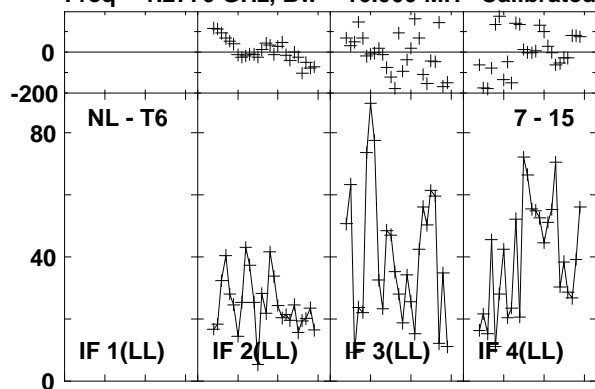

Lower frame: Milli Ampl Jy Top frame: Phas deg
Vector averaged cross-power spectrum Baseline: NL (07) - T6 (15)
Timerange: 01/02:35:47 to 01/02:38:55

Plot file version1306 created 03-MAR-2016 01:15:45

J1545+5400 GN002C 1.UVDATA.1

Freq = 1.2770 GHz, Bw = 16.000 MH Calibrated with CL # 3 and BP # 1 (BP mode 1)

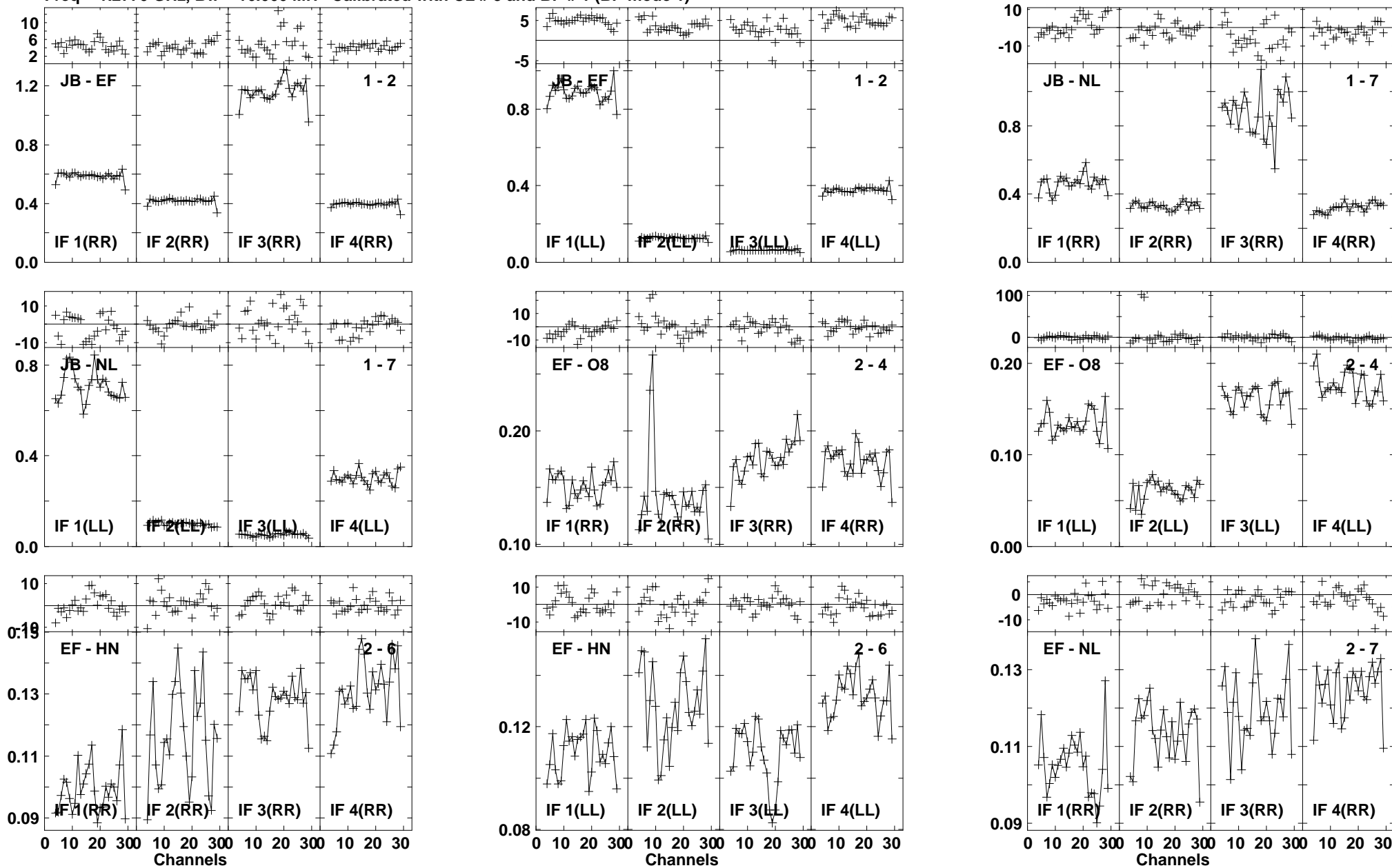

Lower frame: Ampl Jy Top frame: Phas deg
Vector averaged cross-power spectrum Baseline: JB (01) - EF (02)
Timerange: 01/02:39:47 to 01/02:41:45

Plot file version1307 created 03-MAR-2016 01:15:45
 J1545+5400 GN002C 1.UVDATA.1
 Freq = 1.2770 GHz, Bw = 16.000 MH Calibrated with CL # 3 and BP # 1 (BP mode 1)

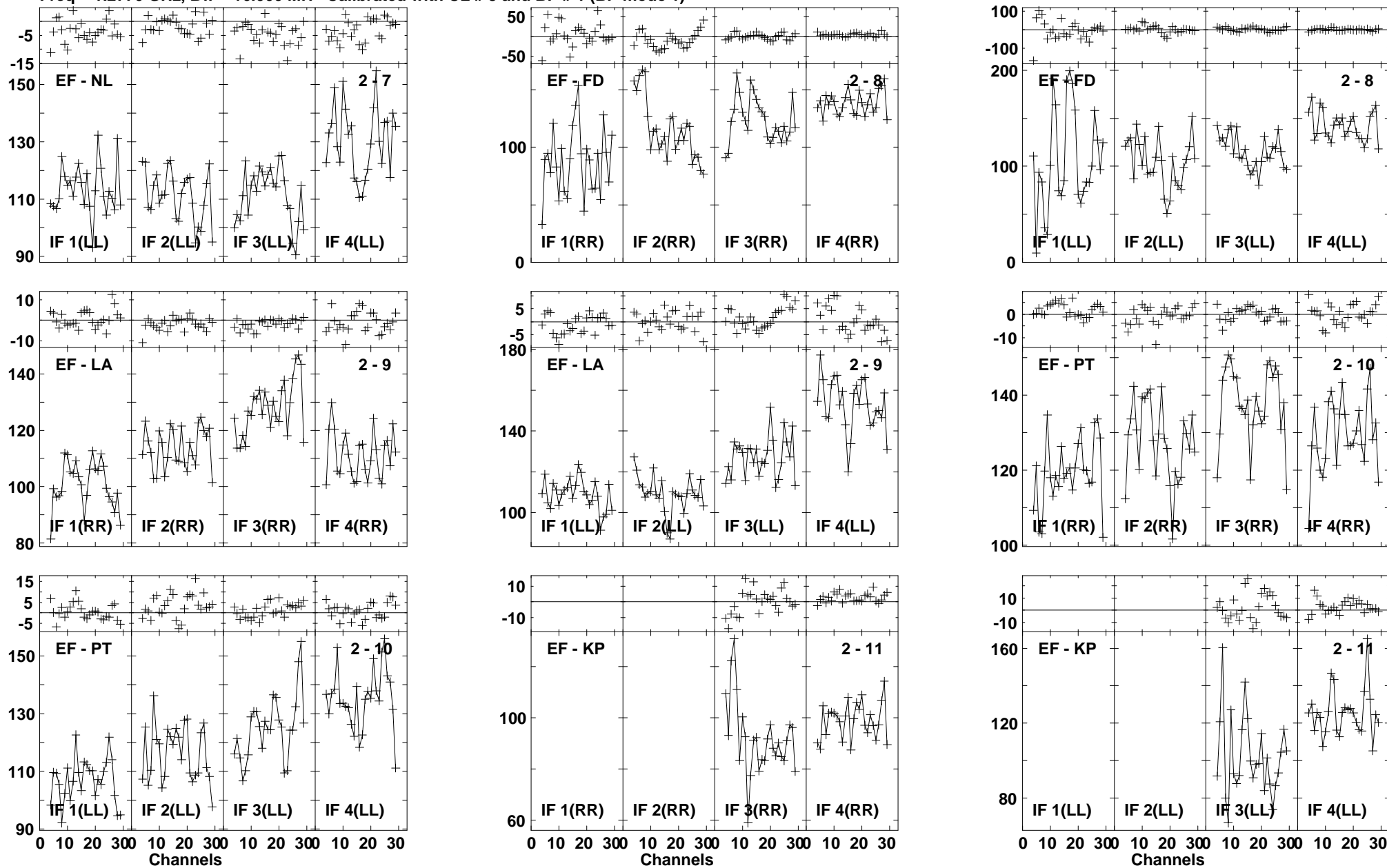

Lower frame: Milli Ampl Jy Top frame: Phas deg
 Vector averaged cross-power spectrum Baseline: EF (02) - NL (07)
 Timerange: 01/02:39:47 to 01/02:41:45

Plot file version1308 created 03-MAR-2016 01:15:45

J1545+5400 GN002C 1.UVDATA.1

Freq = 1.2770 GHz, Bw = 16.000 MH Calibrated with CL # 3 and BP # 1 (BP mode 1)

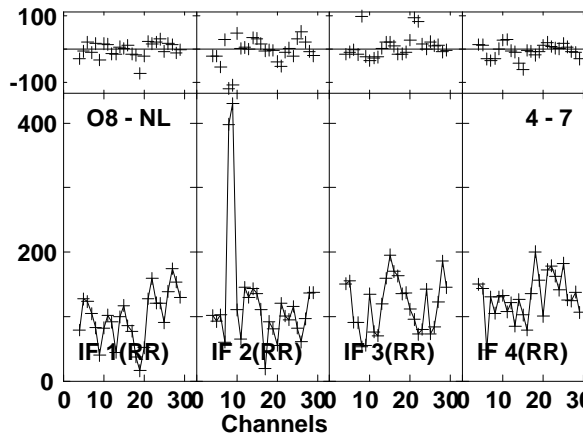
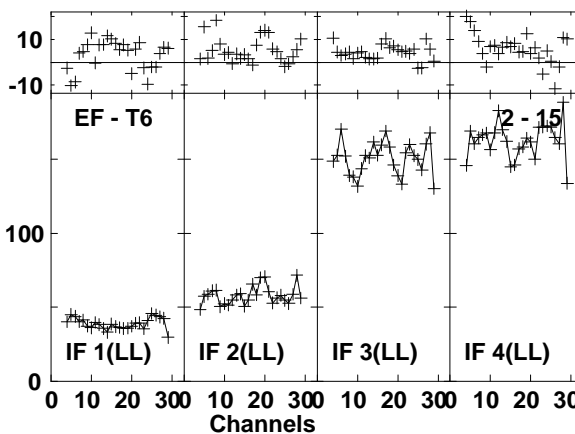
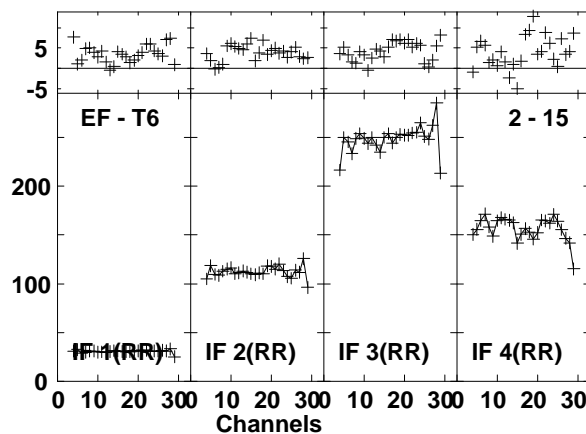
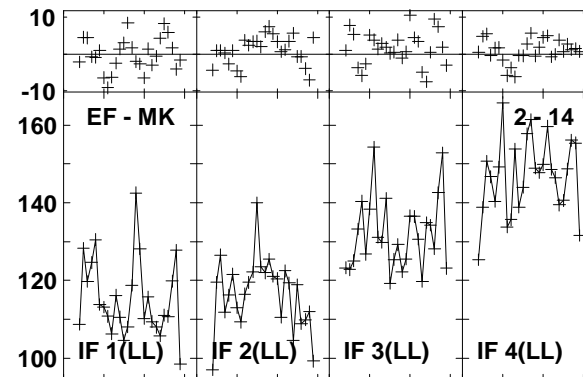
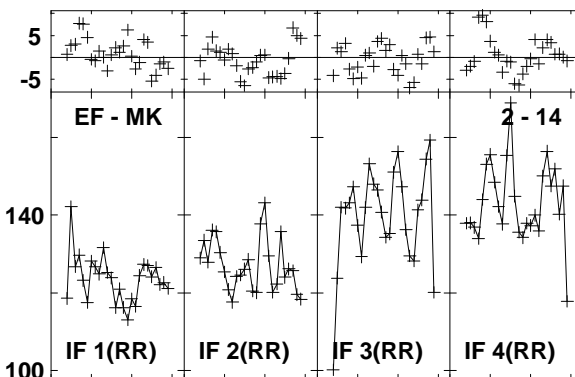
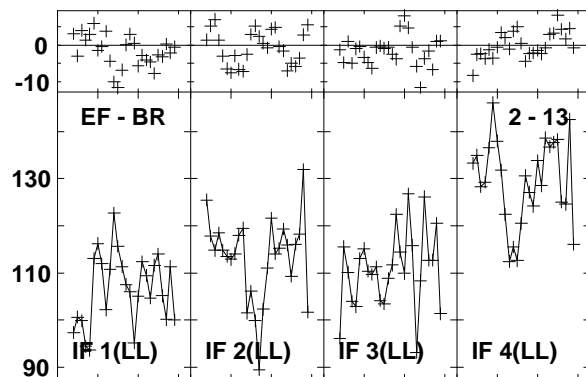
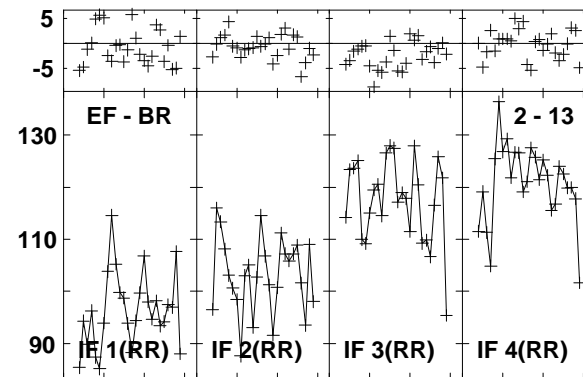
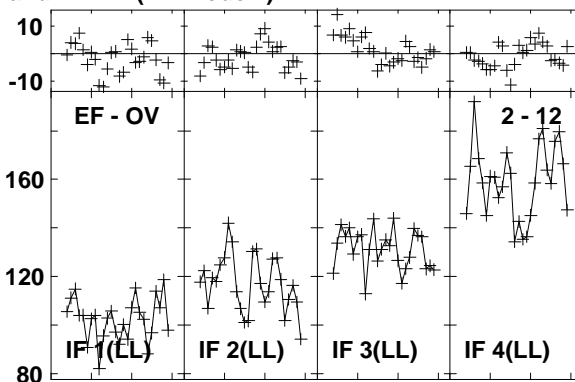
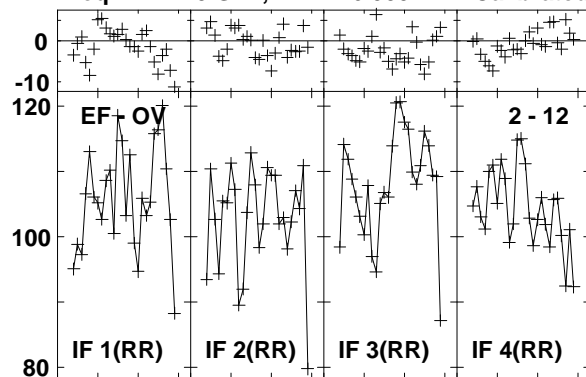

Lower frame: Milli Ampl Jy Top frame: Phas deg
Vector averaged cross-power spectrum Baseline: EF (02) - OV (12)
Timerange: 01/02:39:47 to 01/02:41:45

Plot file version1309 created 03-MAR-2016 01:15:46
 J1545+5400 GN002C 1.UVDATA.1
 Freq = 1.2770 GHz, Bw = 16.000 MH Calibrated with CL # 3 and BP # 1 (BP mode 1)

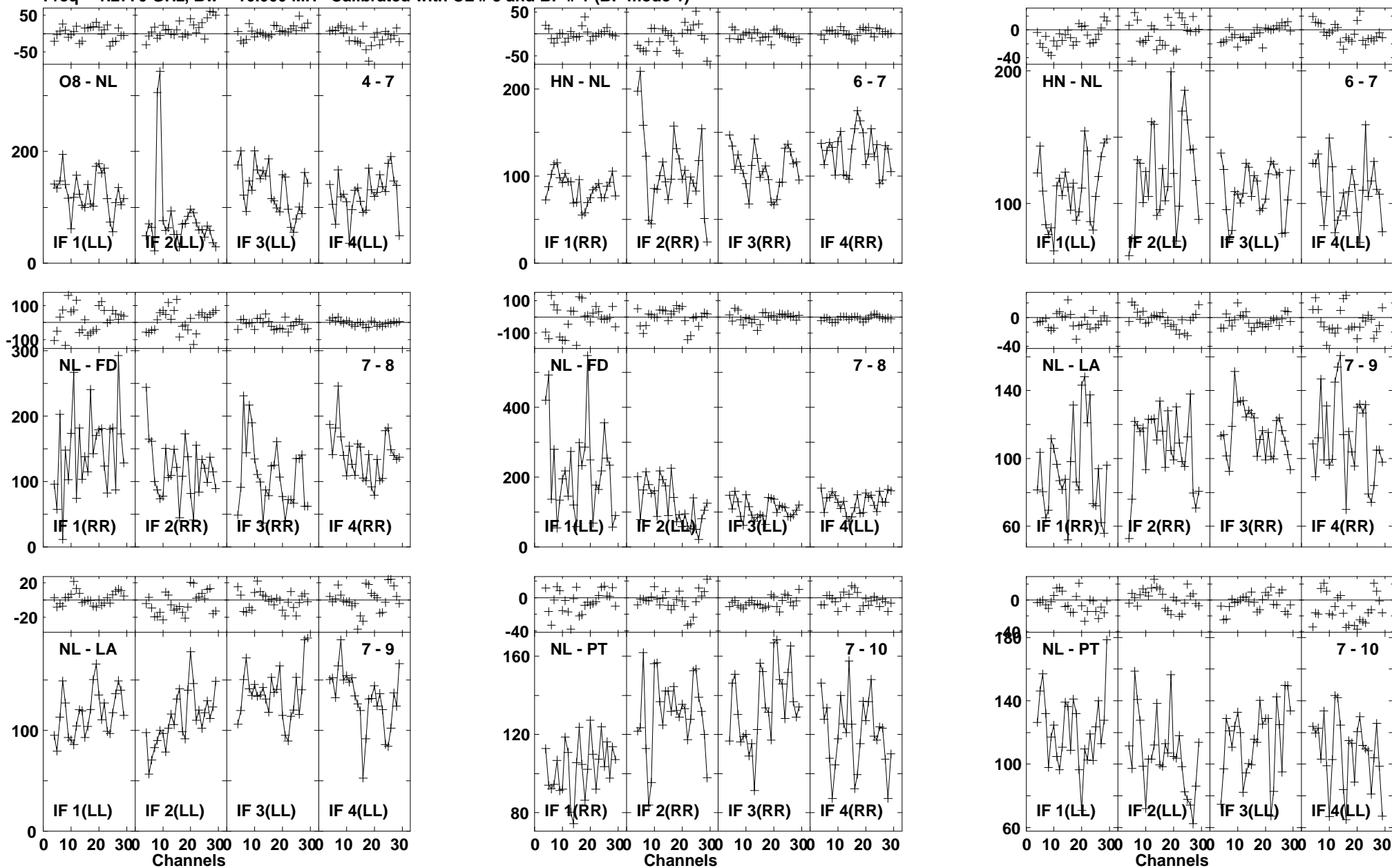

Lower frame: Milli Ampl Jy Top frame: Phas deg
 Vector averaged cross-power spectrum Baseline: O8 (04) - NL (07)
 Timerange: 01/02:39:47 to 01/02:41:45

Plot file version1310 created 03-MAR-2016 01:15:46

J1545+5400 GN002C 1.UVDATA.1

Freq = 1.2770 GHz, Bw = 16.000 MH Calibrated with CL # 3 and BP # 1 (BP mode 1)

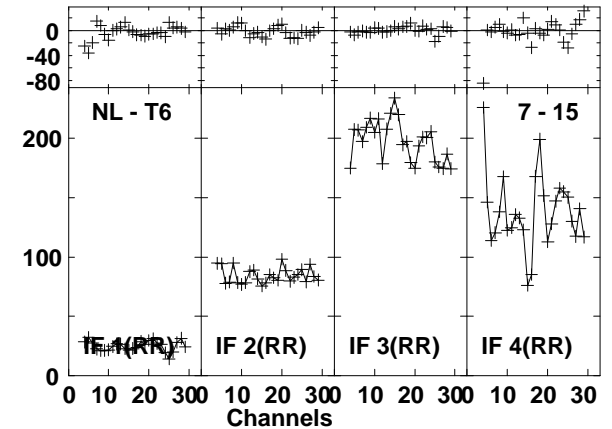
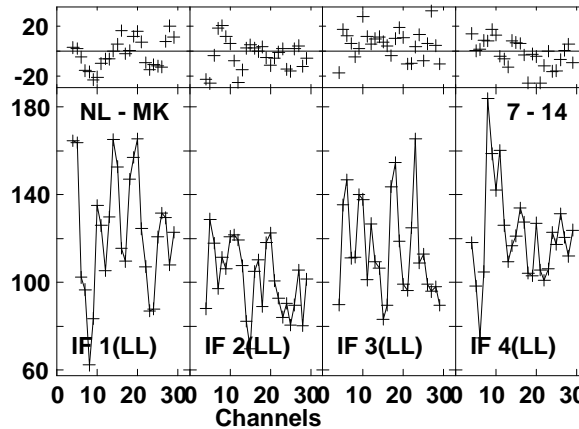
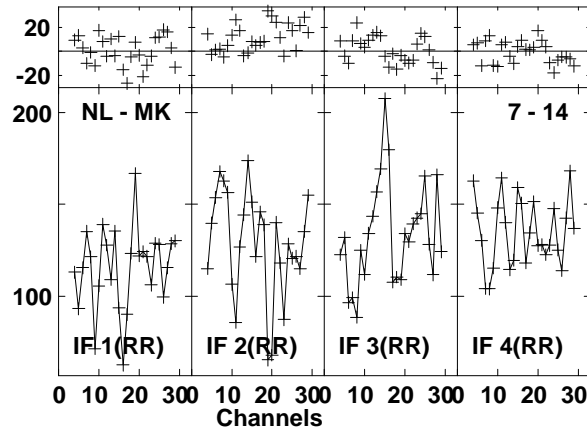
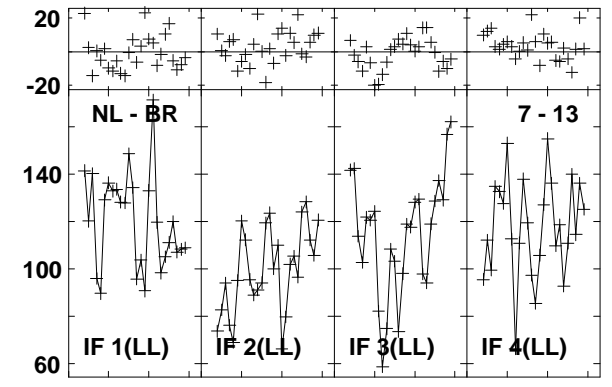
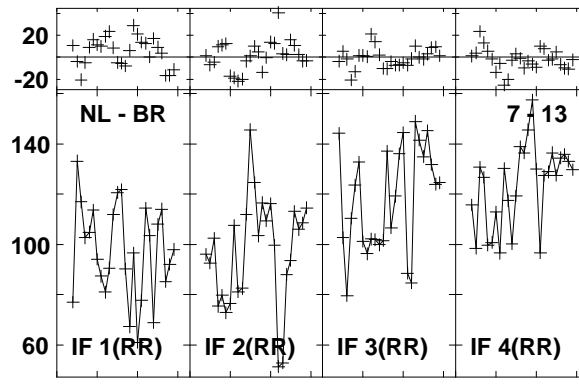
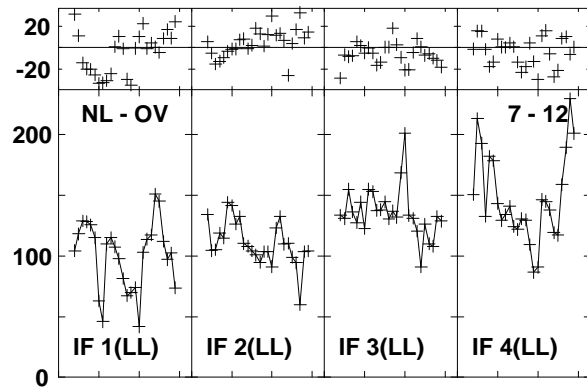
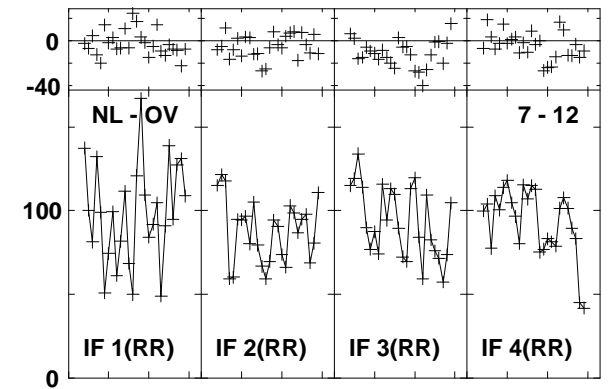
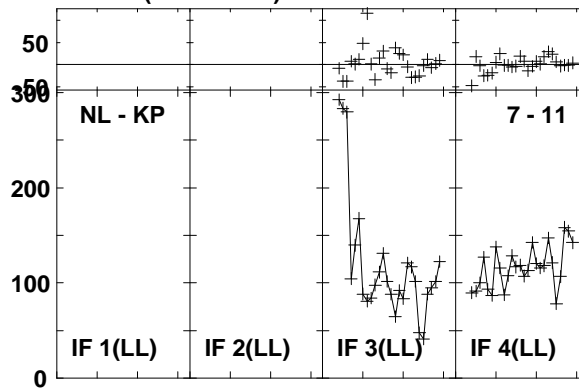
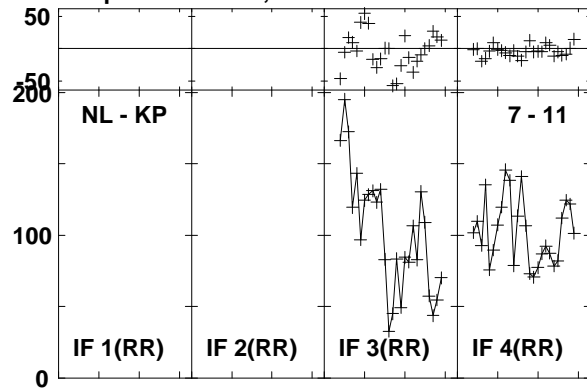

Lower frame: Milli Ampl Jy Top frame: Phas deg
Vector averaged cross-power spectrum Baseline: NL (07) - KP (11)
Timerange: 01/02:39:47 to 01/02:41:45

Plot file version1311 created 03-MAR-2016 01:15:46
J1545+5400 GN002C 1.UVDATA.1
Freq = 1.2770 GHz, Bw = 16.000 MH Calibrated with CL # 3 and BP # 1 (BP mode 1)

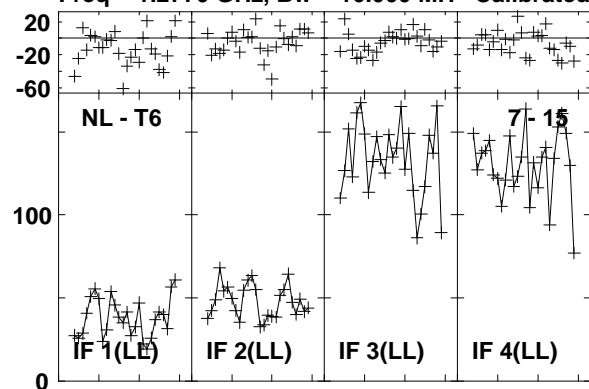

Lower frame: Milli Ampl Jy Top frame: Phas deg
Vector averaged cross-power spectrum Baseline: NL (07) - T6 (15)
Timerange: 01/02:39:47 to 01/02:41:45

Plot file version1312 created 03-MAR-2016 01:15:46

4C52 GN002C 1.UVDATA.1

Freq = 1.2770 GHz, Bw = 16.000 MH Calibrated with CL # 3 and BP # 1 (BP mode 1)

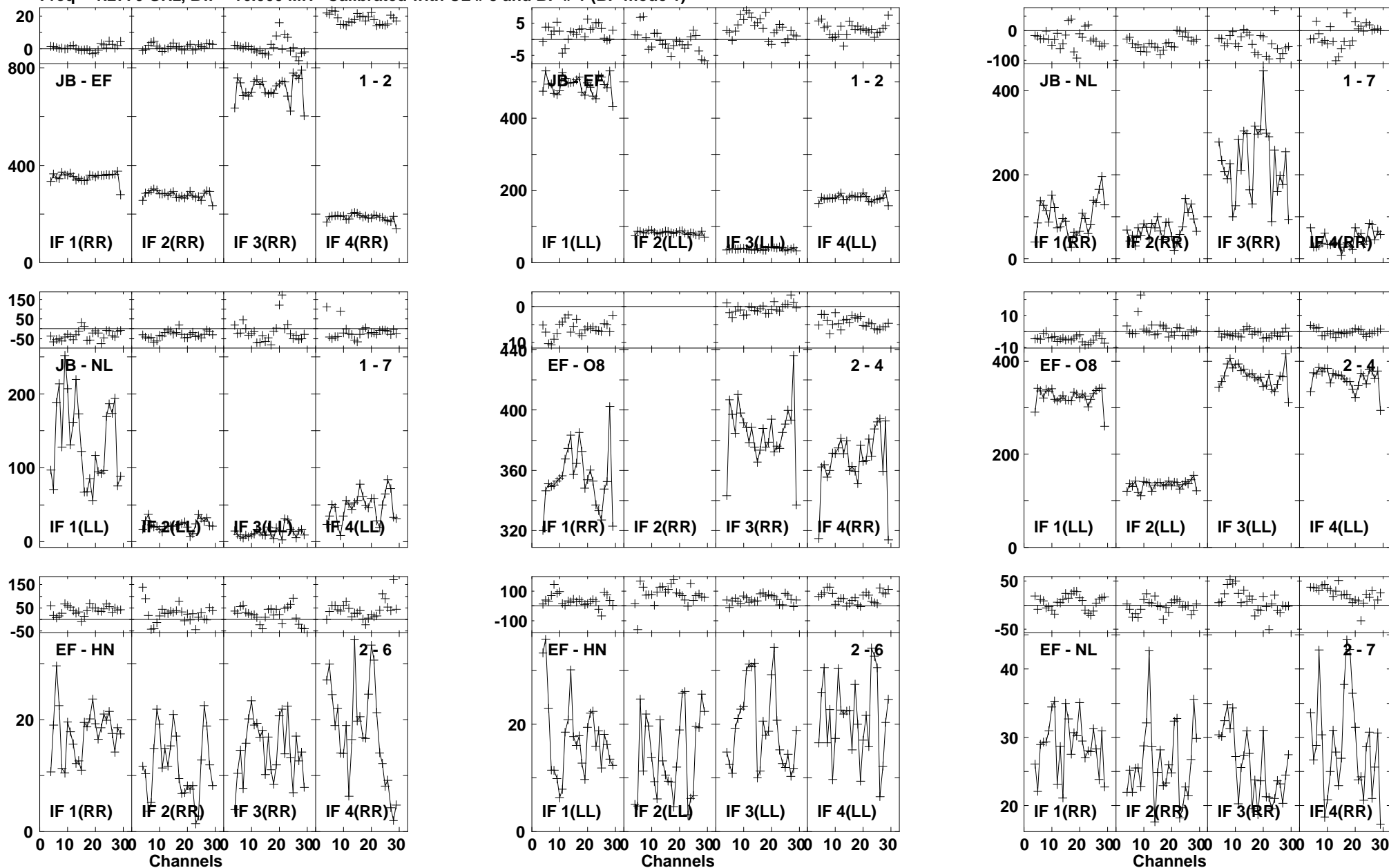

Lower frame: Milli Ampl Jy Top frame: Phas deg
Vector averaged cross-power spectrum Baseline: JB (01) - EF (02)
Timerange: 01/02:41:57 to 01/02:44:45

Plot file version1313 created 03-MAR-2016 01:15:46

4C52 GN002C 1.UVDATA.1

Freq = 1.2770 GHz, Bw = 16.000 MH Calibrated with CL # 3 and BP # 1 (BP mode 1)

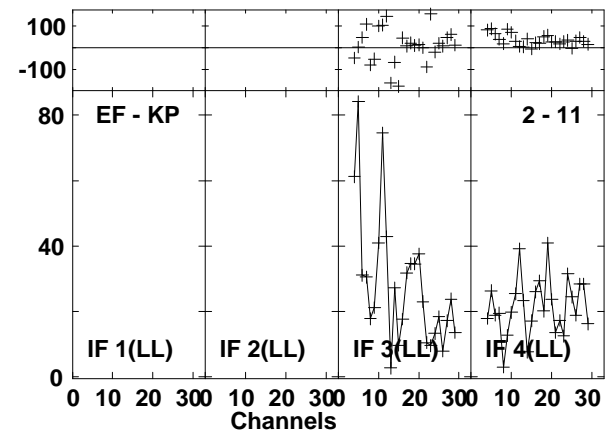
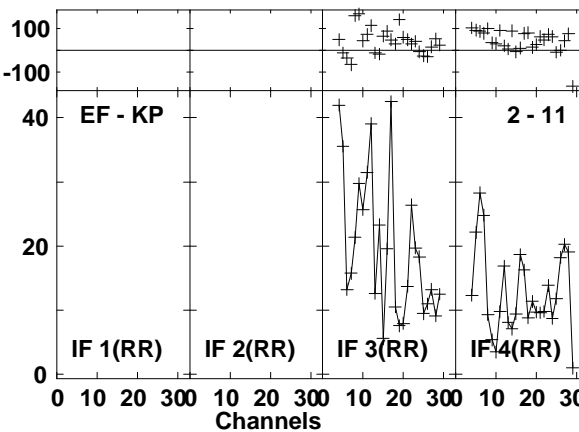
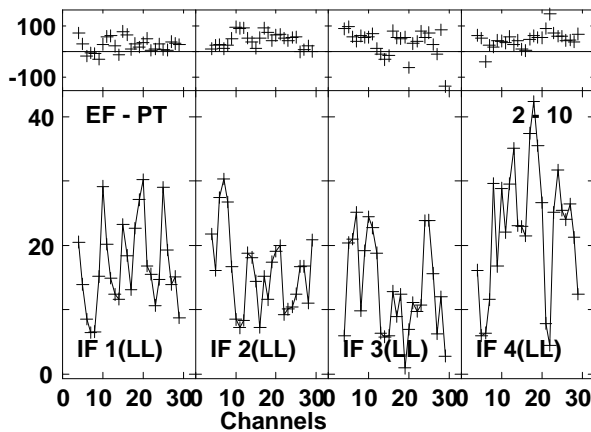
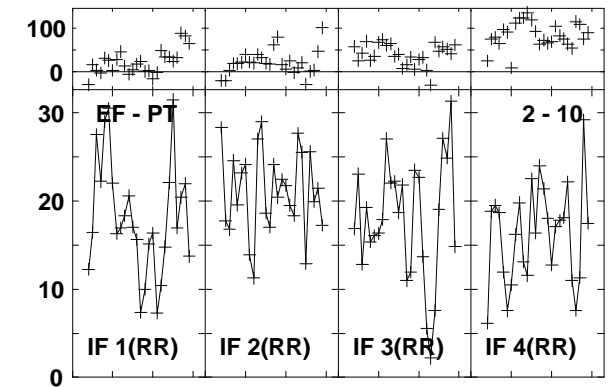
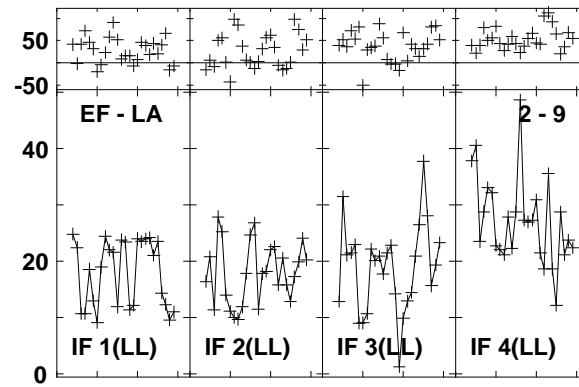
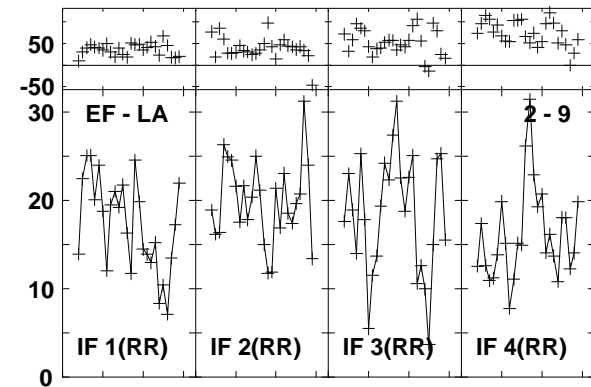
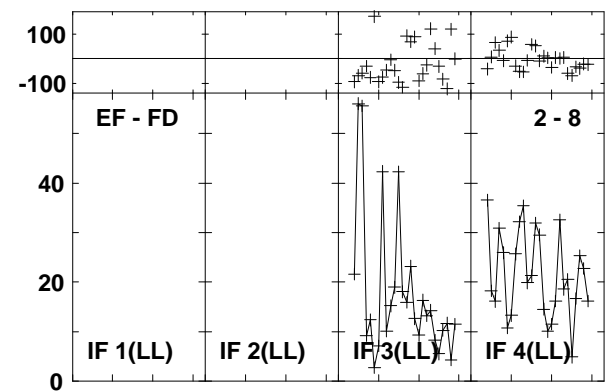
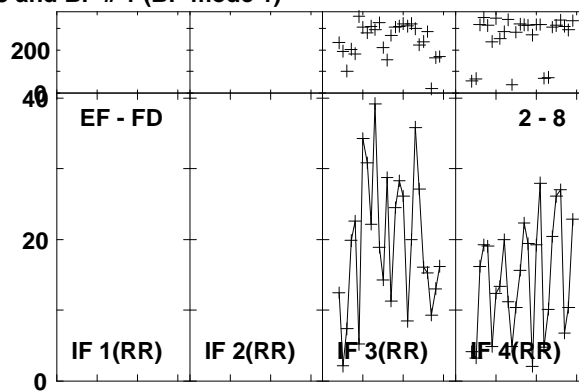
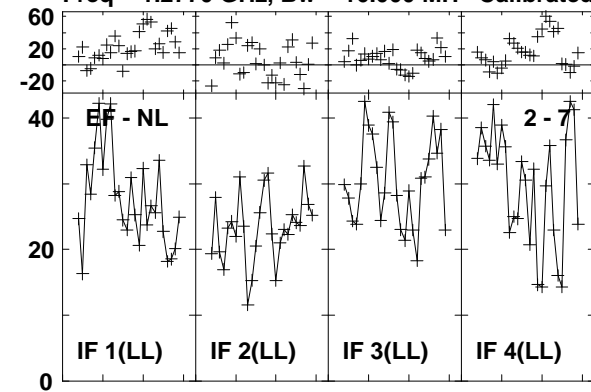

Lower frame: Milli Ampl Jy Top frame: Phas deg
Vector averaged cross-power spectrum Baseline: EF (02) - NL (07)
Timerange: 01/02:41:57 to 01/02:44:45

Plot file version1314 created 03-MAR-2016 01:15:46
 4C52 GN002C 1.UVDATA.1

Freq = 1.2770 GHz, Bw = 16.000 MH Calibrated with CL # 3 and BP # 1 (BP mode 1)

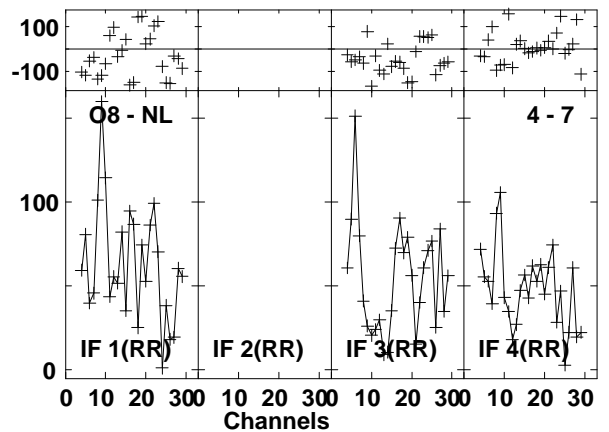
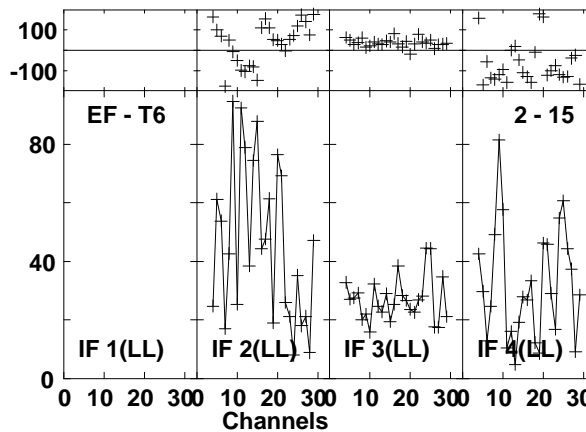
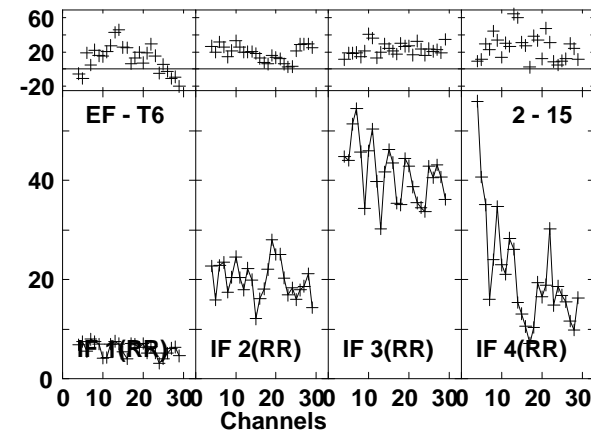
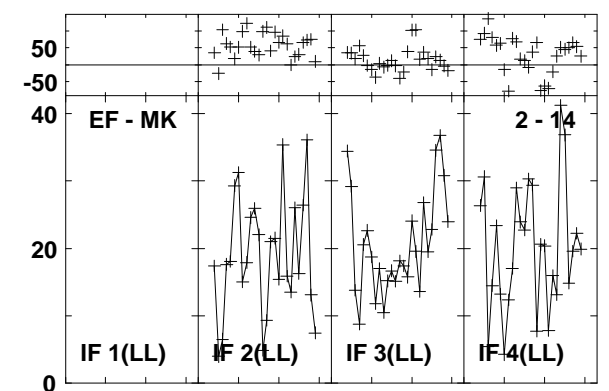
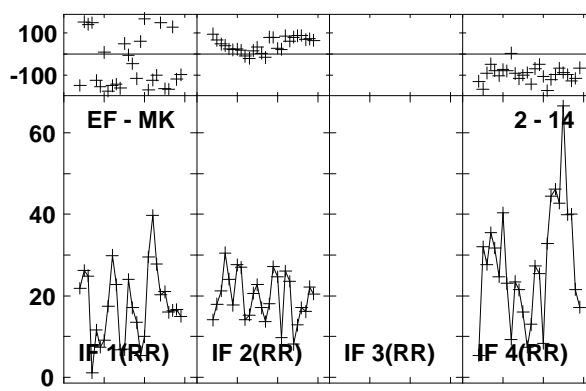
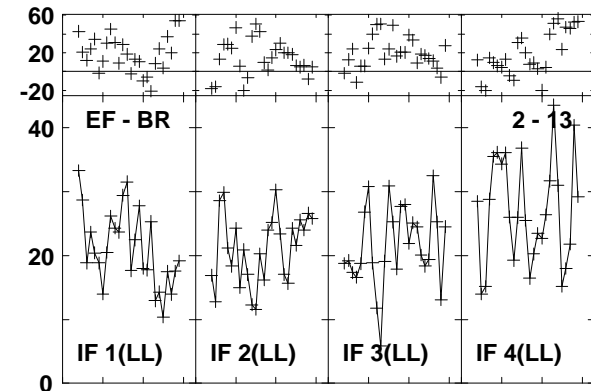
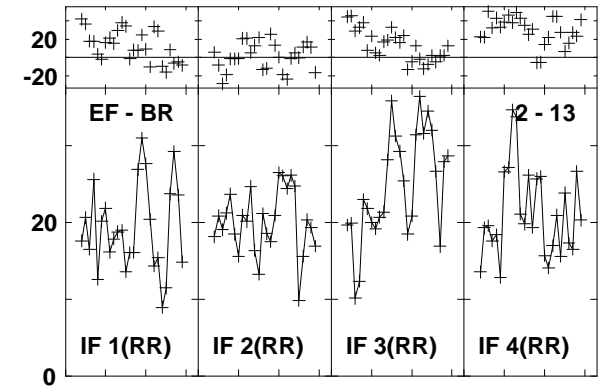
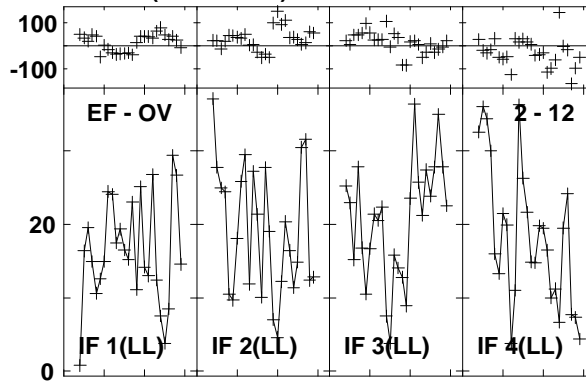
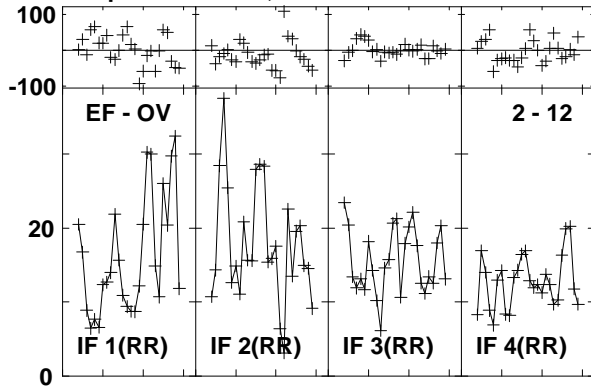

Lower frame: Milli Ampl Jy Top frame: Phas deg
 Vector averaged cross-power spectrum Baseline: EF (02) - OV (12)
 Timerange: 01/02:41:57 to 01/02:44:45

Plot file version1315 created 03-MAR-2016 01:15:47

4C52 GN002C 1.UVDATA.1

Freq = 1.2770 GHz, Bw = 16.000 MH Calibrated with CL # 3 and BP # 1 (BP mode 1)

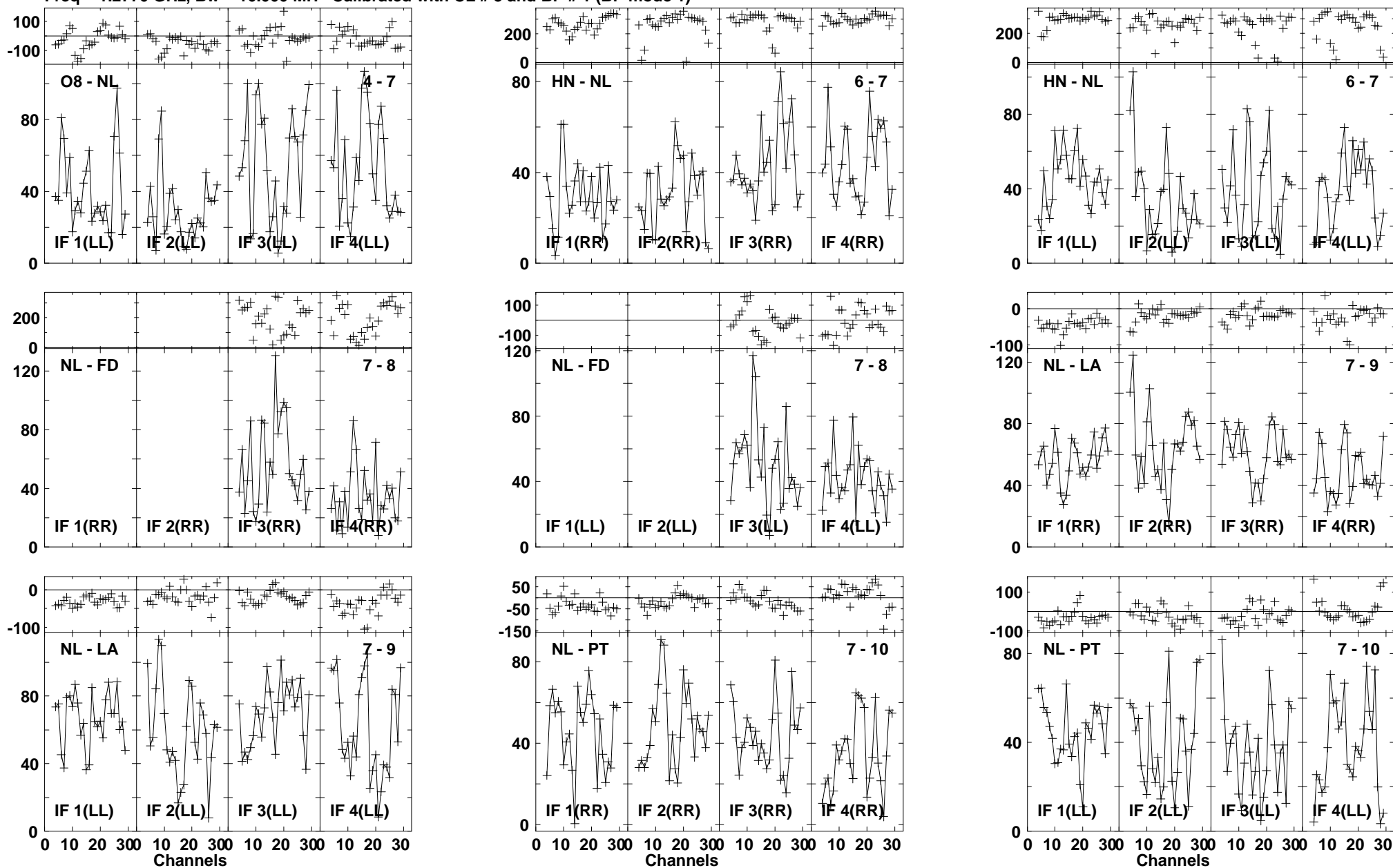

Lower frame: Milli Ampl Jy Top frame: Phas deg
Vector averaged cross-power spectrum Baseline: O8 (04) - NL (07)
Timerange: 01/02:41:57 to 01/02:44:45

Plot file version1316 created 03-MAR-2016 01:15:47

4C52 GN002C 1.UVDATA.1

Freq = 1.2770 GHz, Bw = 16.000 MH Calibrated with CL # 3 and BP # 1 (BP mode 1)

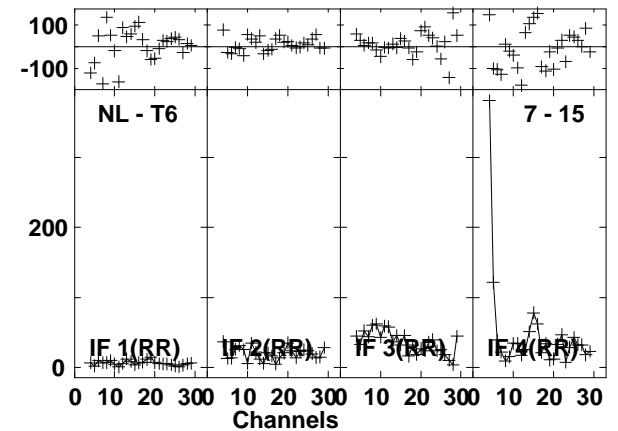
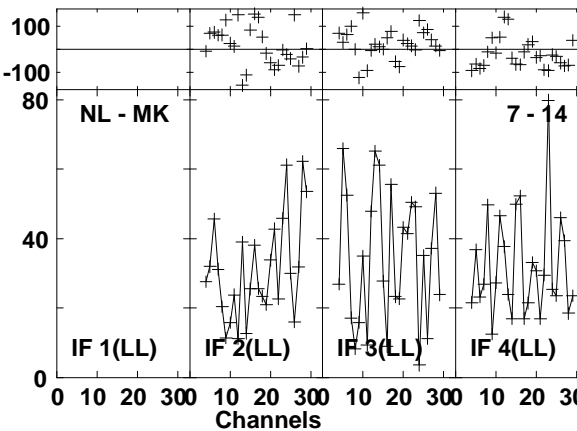
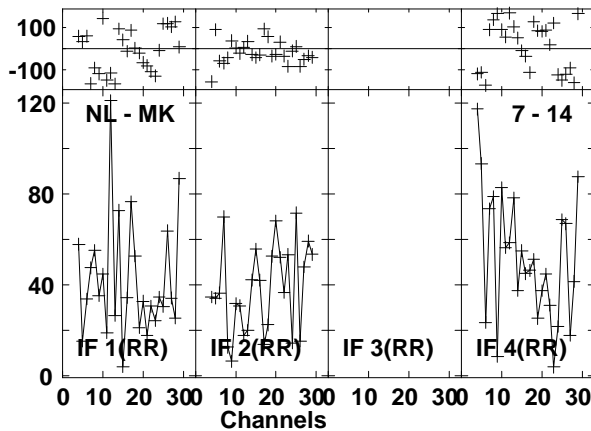
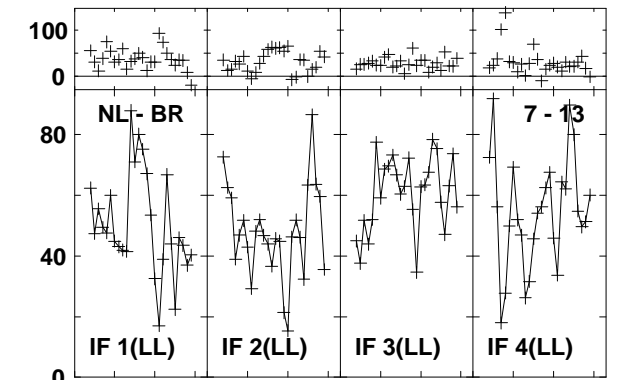
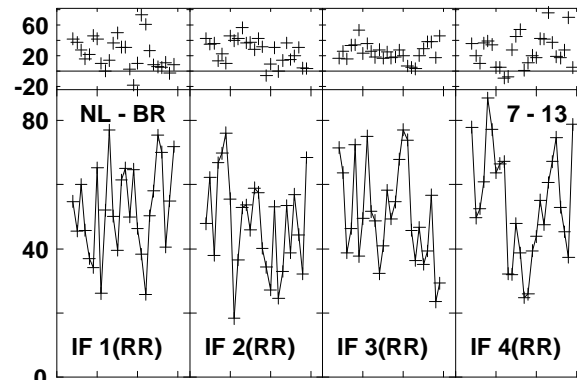
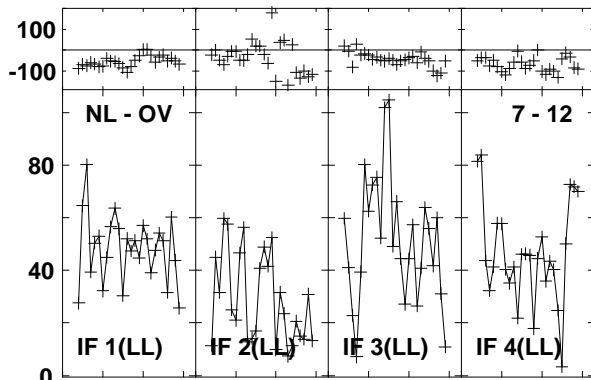
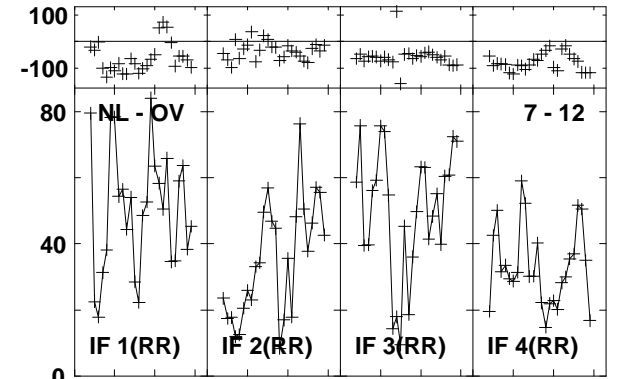
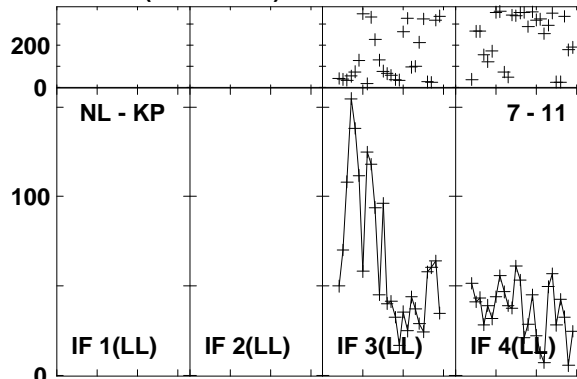
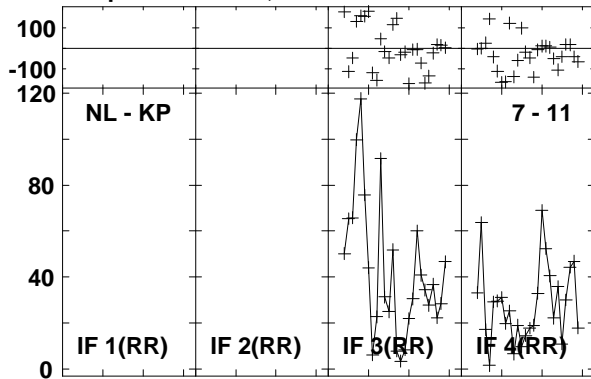

Lower frame: Milli Ampl Jy Top frame: Phas deg

Vector averaged cross-power spectrum Baseline: NL (07) - KP (11)

Timerange: 01/02:41:57 to 01/02:44:45

Plot file version1317 created 03-MAR-2016 01:15:47

4C52 GN002C 1.UVDATA.1

Freq = 1.2770 GHz, Bw = 16.000 MH Calibrated with CL # 3 and BP # 1 (BP mode 1)

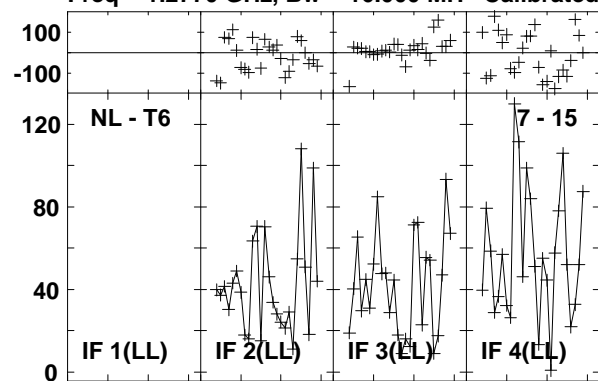

Lower frame: Milli Ampl Jy Top frame: Phas deg
Vector averaged cross-power spectrum Baseline: NL (07) - T6 (15)
Timerange: 01/02:41:57 to 01/02:44:45

Plot file version1318 created 03-MAR-2016 01:15:47

J1545+5400 GN002C 1.UVDATA.1

Freq = 1.2770 GHz, Bw = 16.000 MH Calibrated with CL # 3 and BP # 1 (BP mode 1)

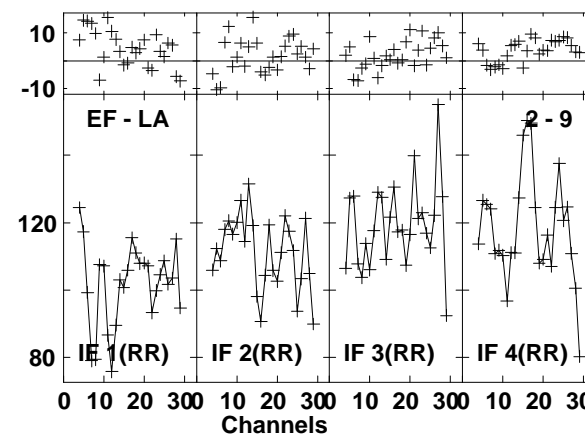
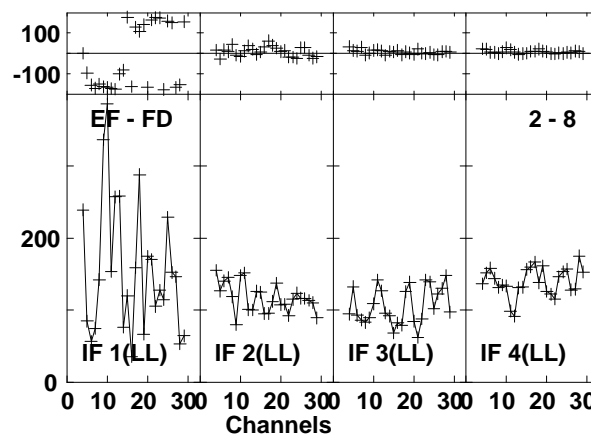
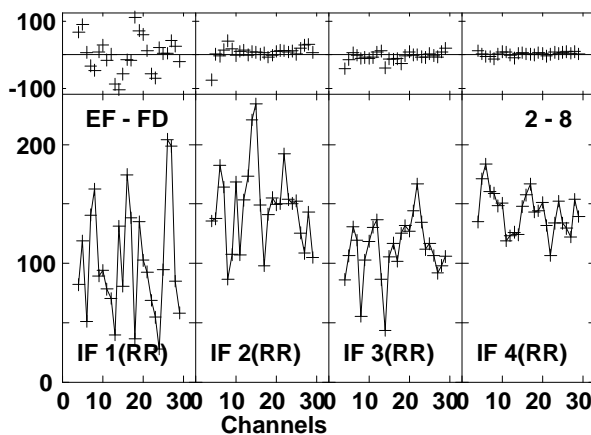
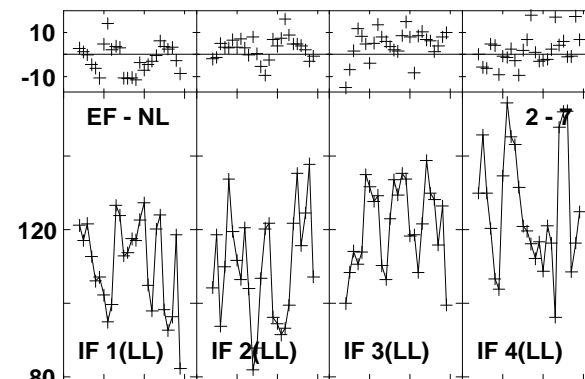
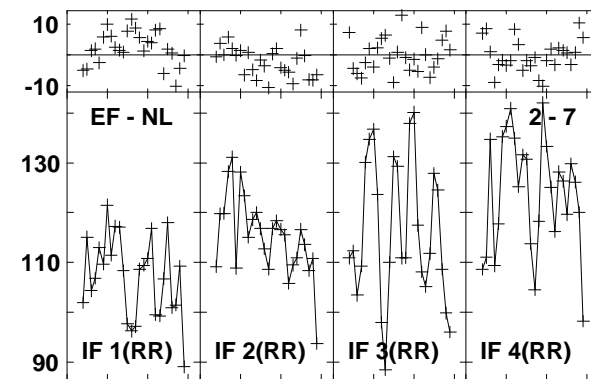
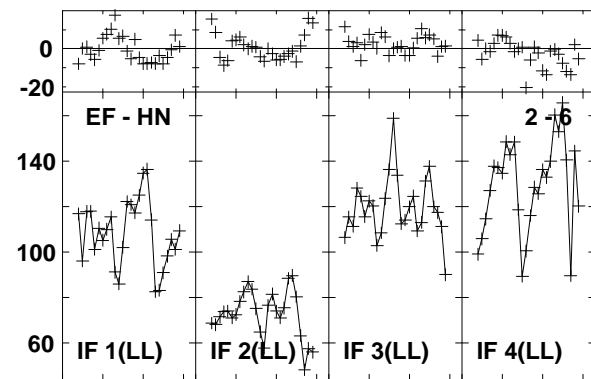
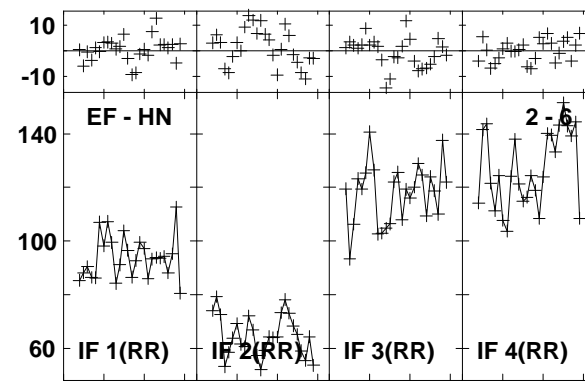
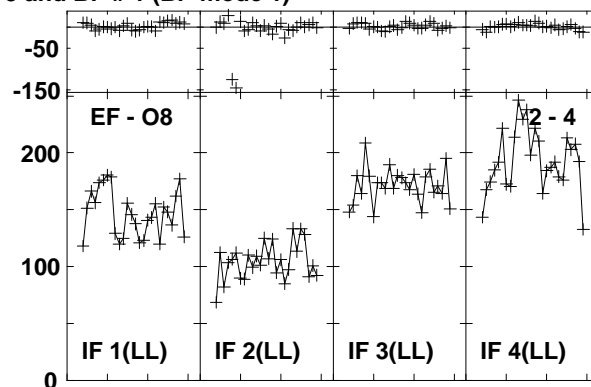
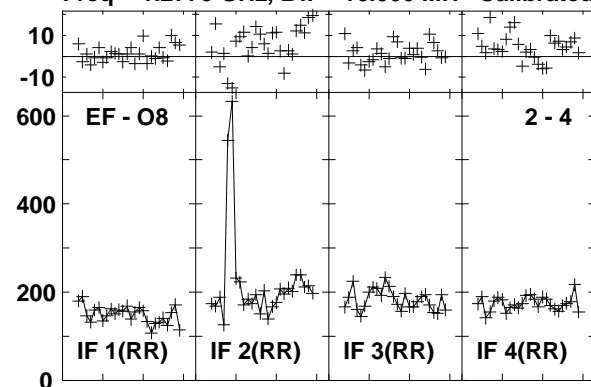

Lower frame: Milli Ampl Jy Top frame: Phas deg
Vector averaged cross-power spectrum Baseline: EF (02) - O8 (04)
Timerange: 01/02:45:37 to 01/02:46:35

Plot file version1319 created 03-MAR-2016 01:15:47

J1545+5400 GN002C 1.UVDATA.1

Freq = 1.2770 GHz, Bw = 16.000 MH Calibrated with CL # 3 and BP # 1 (BP mode 1)

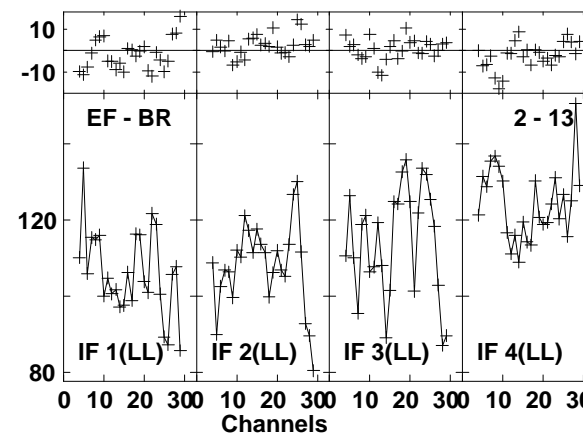
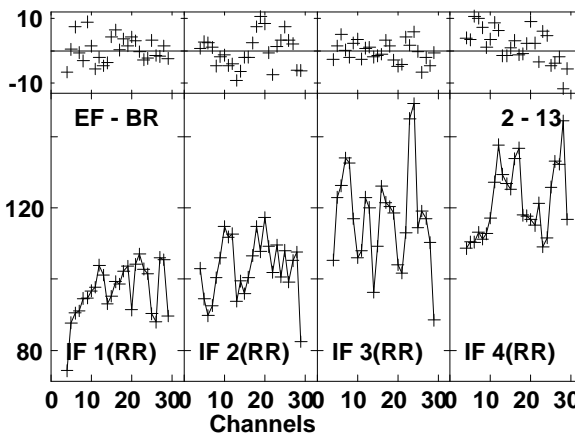
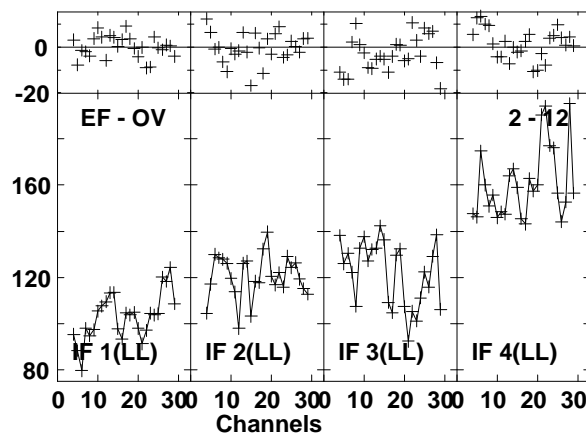
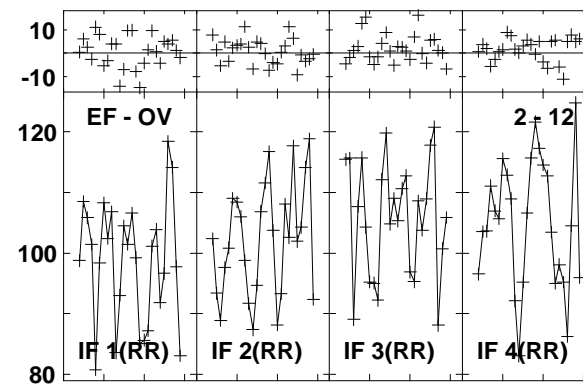
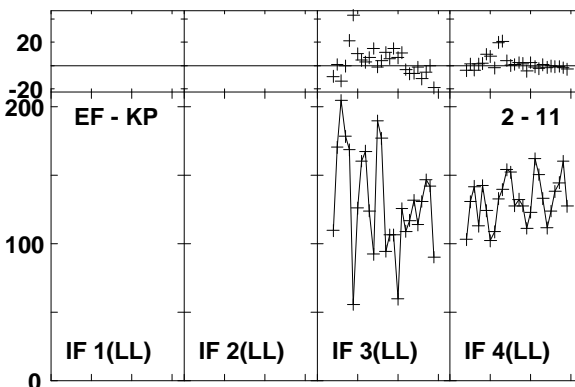
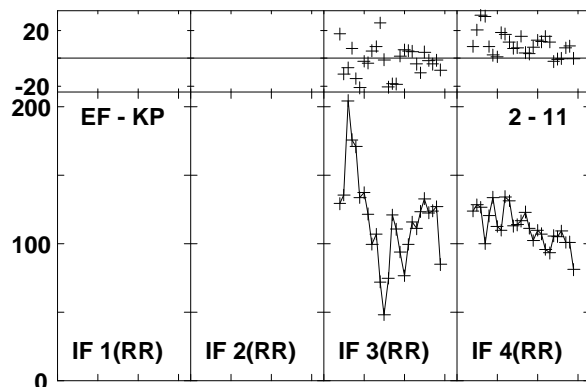
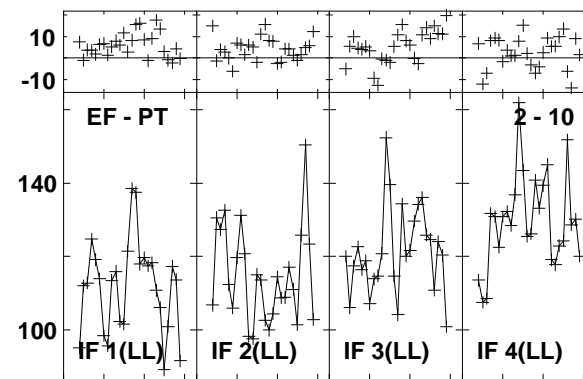
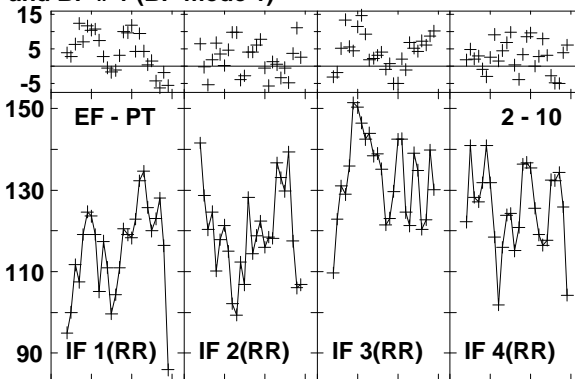
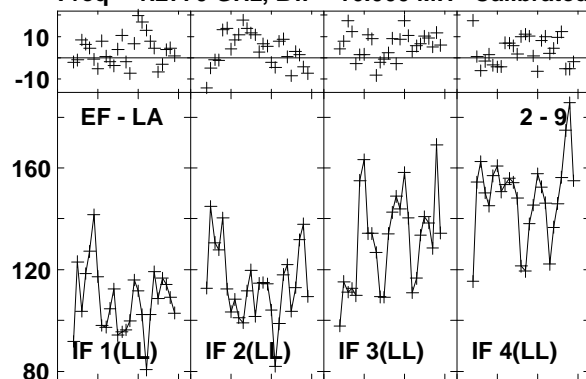

Lower frame: Milli Ampl Jy Top frame: Phas deg
Vector averaged cross-power spectrum Baseline: EF (02) - LA (09)
Timerange: 01/02:45:37 to 01/02:46:35

Plot file version1320 created 03-MAR-2016 01:15:47

J1545+5400 GN002C 1.UVDATA.1

Freq = 1.2770 GHz, Bw = 16.000 MH Calibrated with CL # 3 and BP # 1 (BP mode 1)

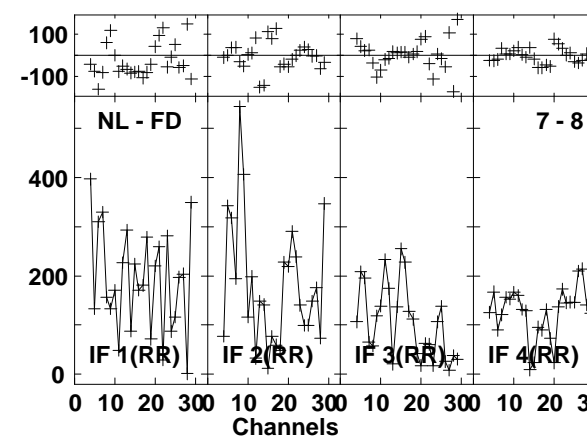
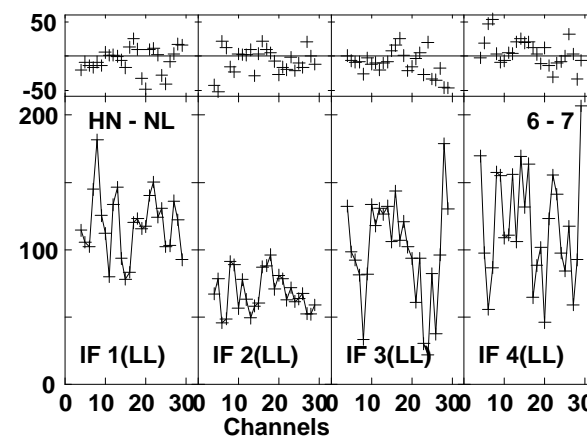
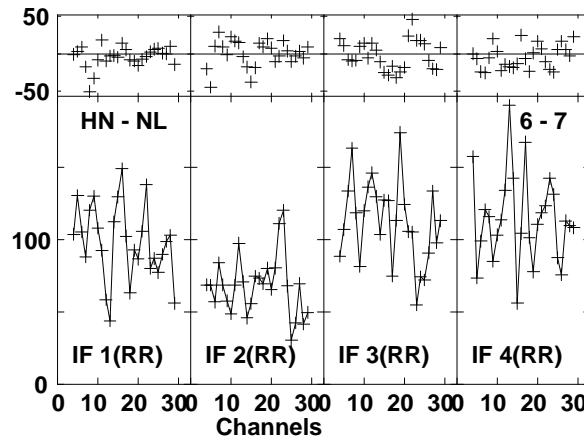
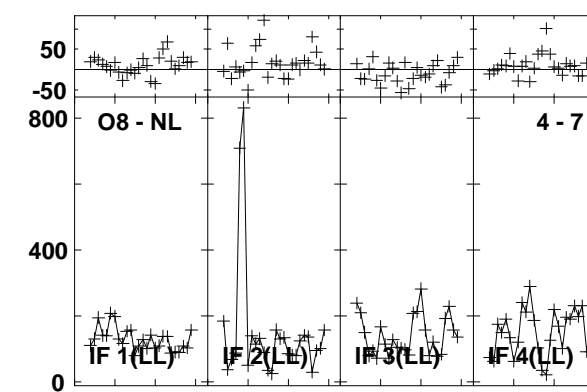
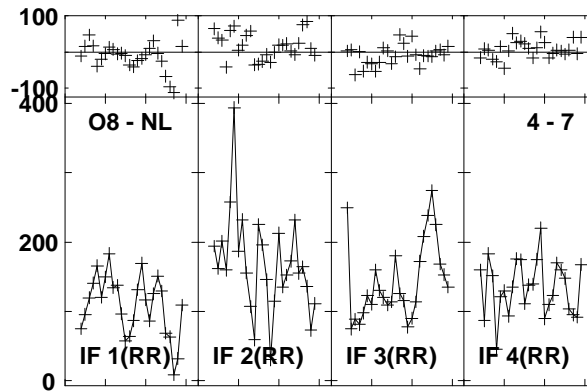
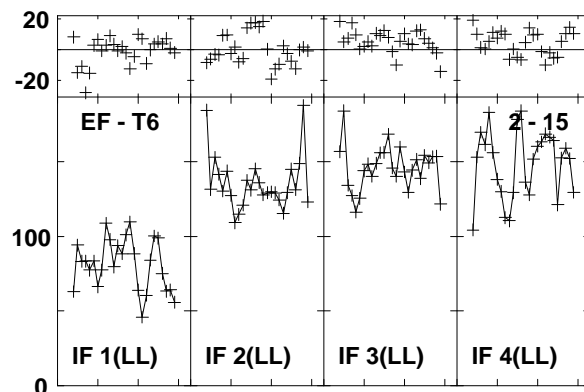
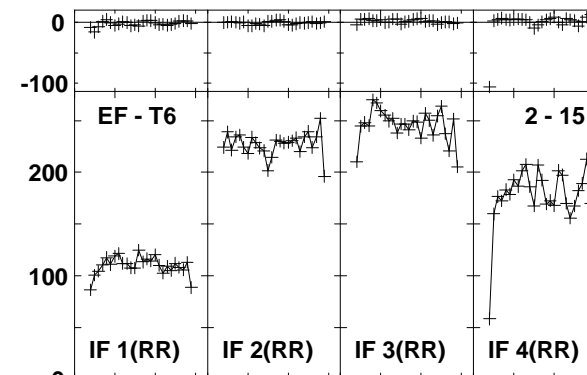
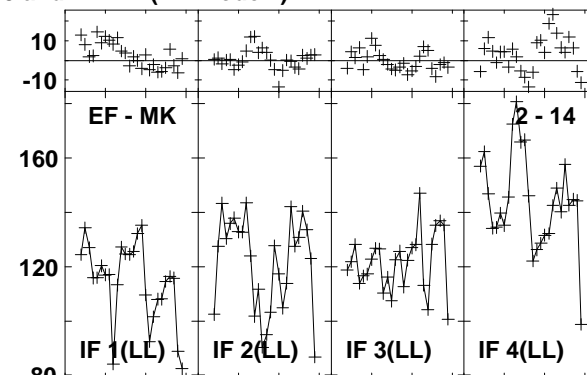
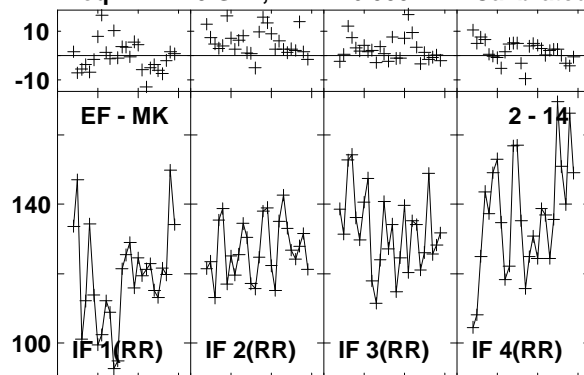

Lower frame: Milli Ampl Jy Top frame: Phas deg
Vector averaged cross-power spectrum Baseline: EF (02) - MK (14)
Timerange: 01/02:45:37 to 01/02:46:35

Plot file version1321 created 03-MAR-2016 01:15:48
 J1545+5400 GN002C 1.UVDATA.1
 Freq = 1.2770 GHz, Bw = 16.000 MH Calibrated with CL # 3 and BP # 1 (BP mode 1)

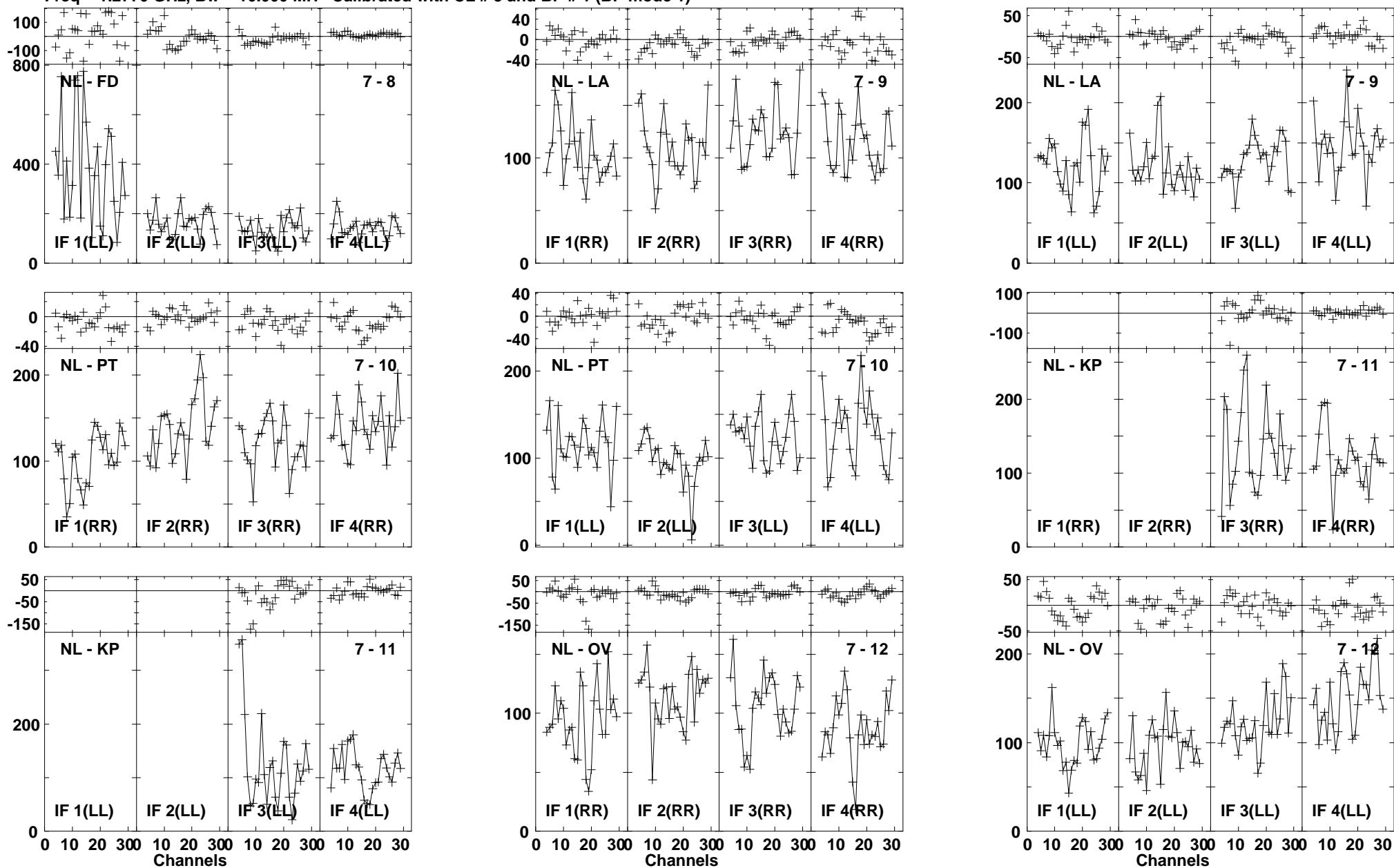

Lower frame: Milli Ampl Jy Top frame: Phas deg
 Vector averaged cross-power spectrum Baseline: NL (07) - FD (08)
 Timerange: 01/02:45:37 to 01/02:46:35

Plot file version1322 created 03-MAR-2016 01:15:48
 J1545+5400 GN002C 1.UVDATA.1
 Freq = 1.2770 GHz, Bw = 16.000 MH Calibrated with CL # 3 and BP # 1 (BP mode 1)

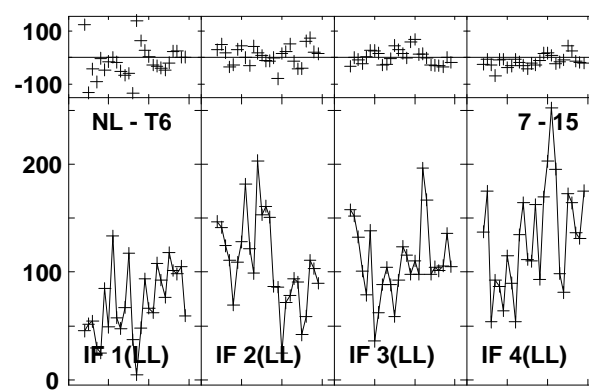
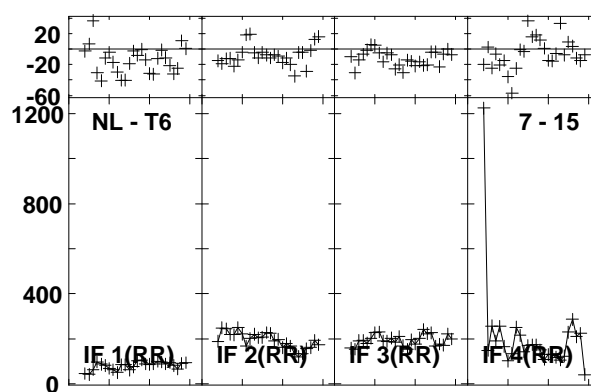
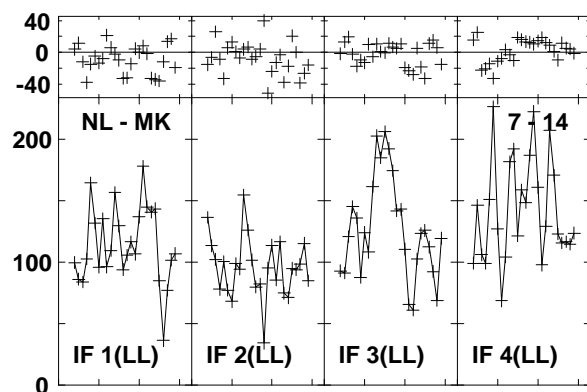
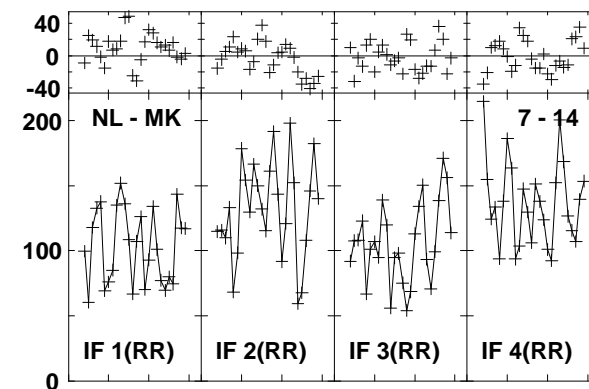
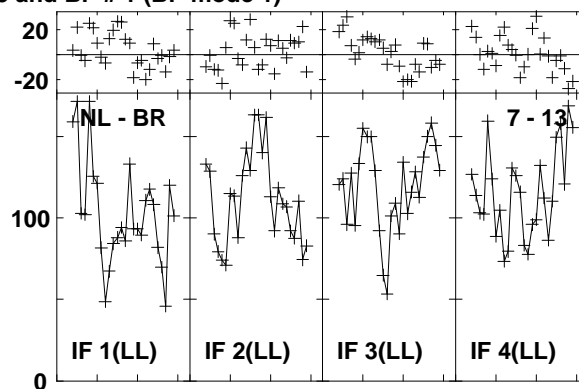
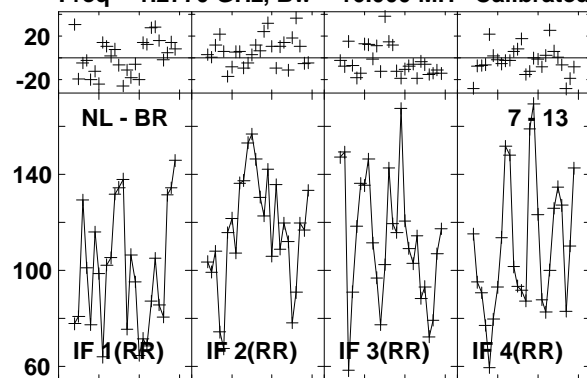

Lower frame: Milli Ampl Jy Top frame: Phas deg
 Vector averaged cross-power spectrum Baseline: NL (07) - BR (13)
 Timerange: 01/02:45:37 to 01/02:46:35

Plot file version1323 created 03-MAR-2016 01:15:48

4C52 GN002C 1.UVDATA.1

Freq = 1.2770 GHz, Bw = 16.000 MH Calibrated with CL # 3 and BP # 1 (BP mode 1)

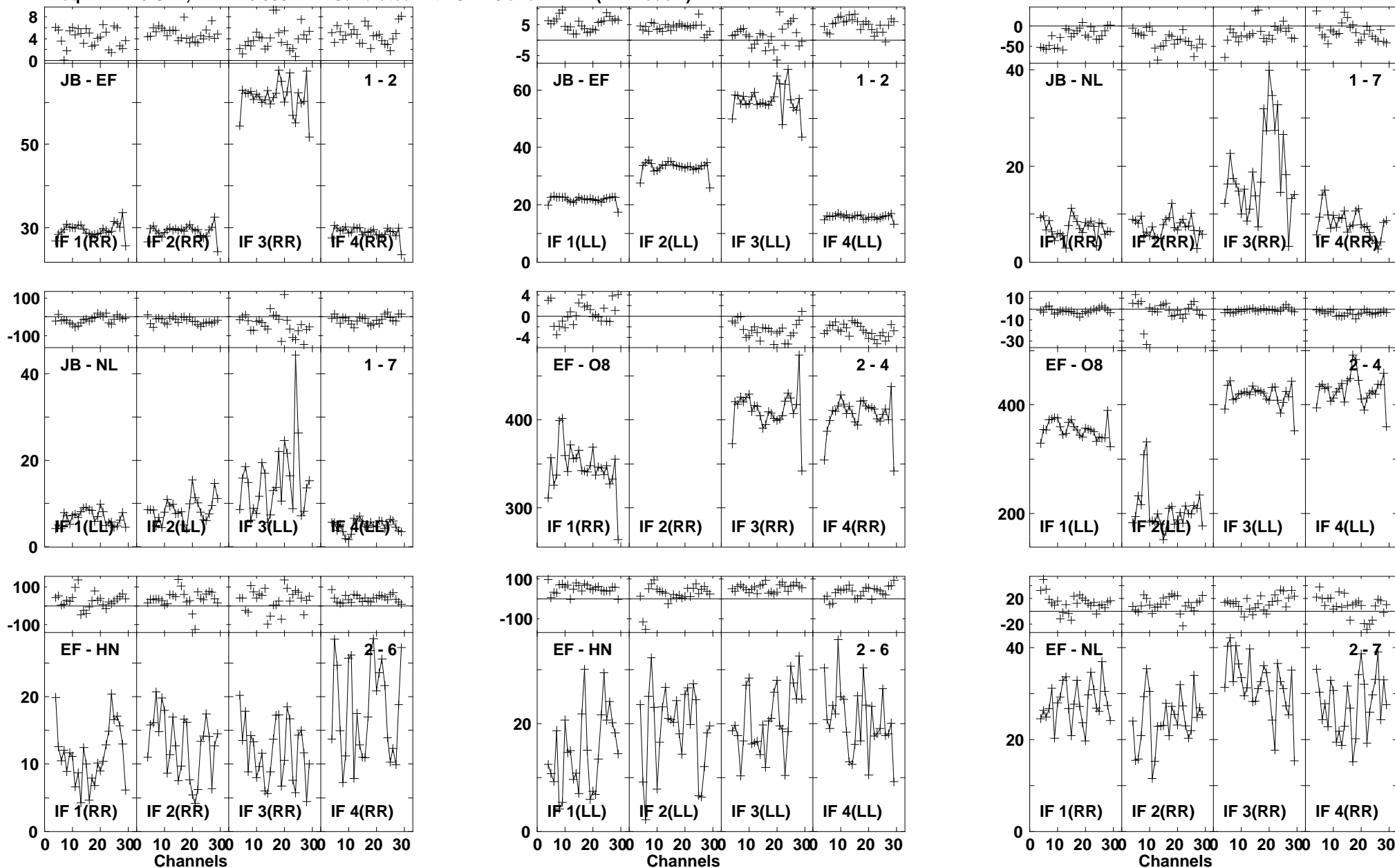

Lower frame: Milli Ampl Jy Top frame: Phas deg
Vector averaged cross-power spectrum Baseline: JB (01) - EF (02)
Timerange: 01/02:46:40 to 01/02:49:54

Plot file version1324 created 03-MAR-2016 01:15:48

4C52 GN002C 1.UVDATA.1

Freq = 1.2770 GHz, Bw = 16.000 MH Calibrated with CL # 3 and BP # 1 (BP mode 1)

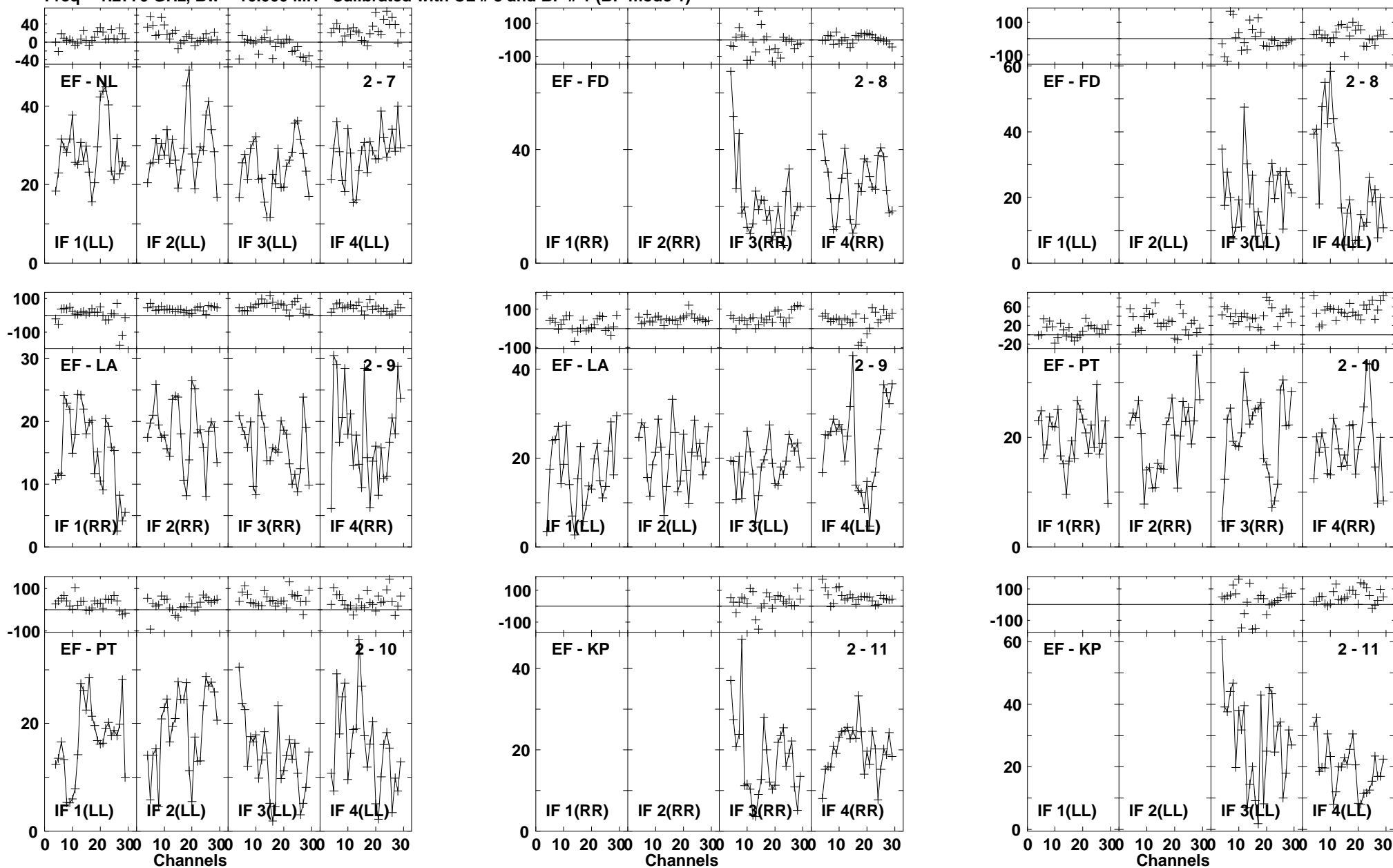

Lower frame: Milli Ampl Jy Top frame: Phas deg
Vector averaged cross-power spectrum Baseline: EF (02) - NL (07)
Timerange: 01/02:46:40 to 01/02:49:54

Plot file version1325 created 03-MAR-2016 01:15:48

4C52 GN002C 1.UVDATA.1

Freq = 1.2770 GHz, Bw = 16.000 MH Calibrated with CL # 3 and BP # 1 (BP mode 1)

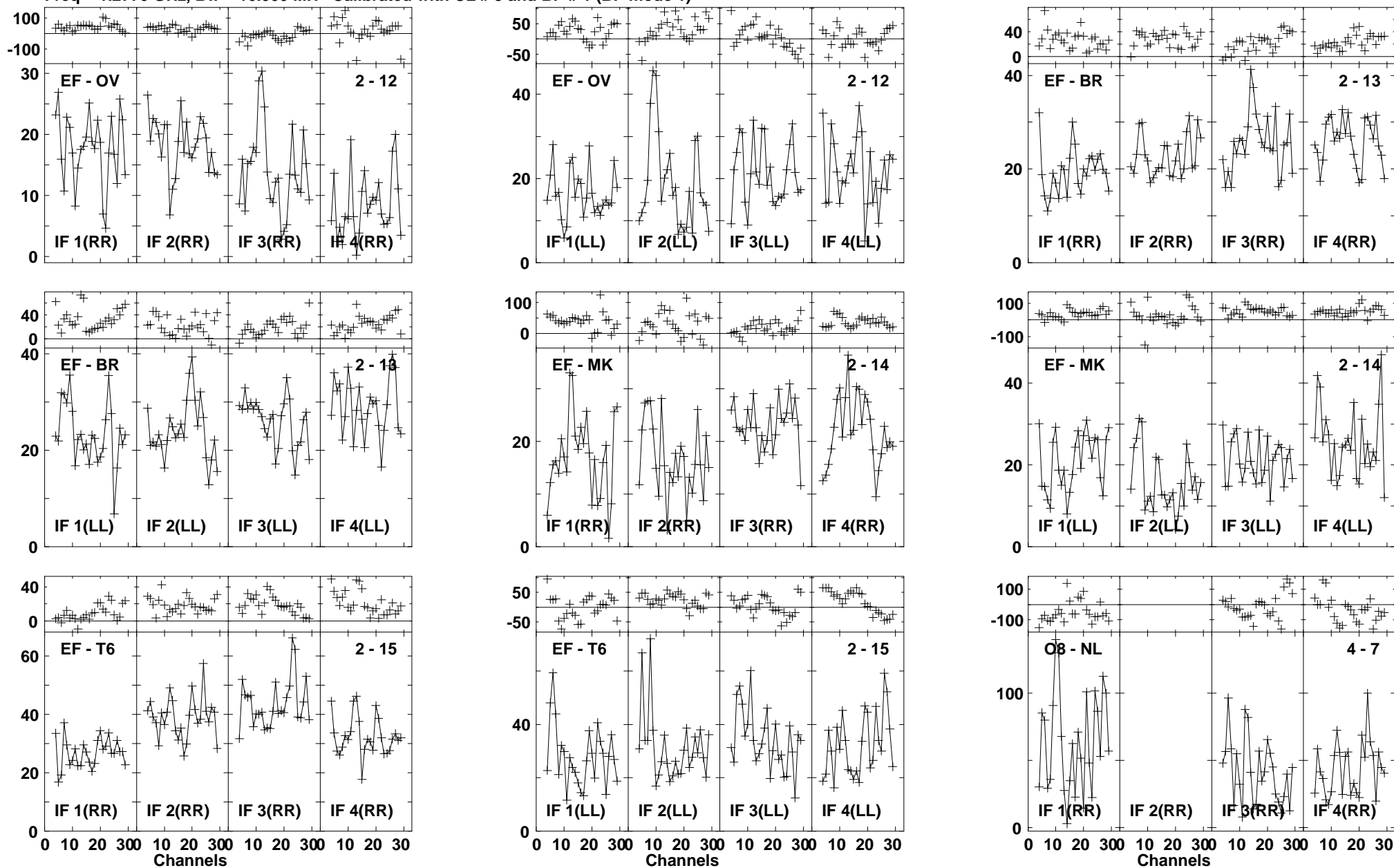

Lower frame: Milli Ampl Jy Top frame: Phas deg
Vector averaged cross-power spectrum Baseline: EF (02) - OV (12)
Timerange: 01/02:46:40 to 01/02:49:54

Plot file version1326 created 03-MAR-2016 01:15:49

4C52 GN002C 1.UVDATA.1

Freq = 1.2770 GHz, Bw = 16.000 MH Calibrated with CL # 3 and BP # 1 (BP mode 1)

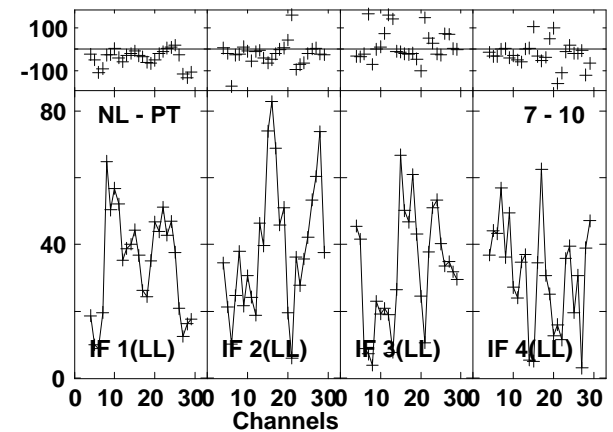
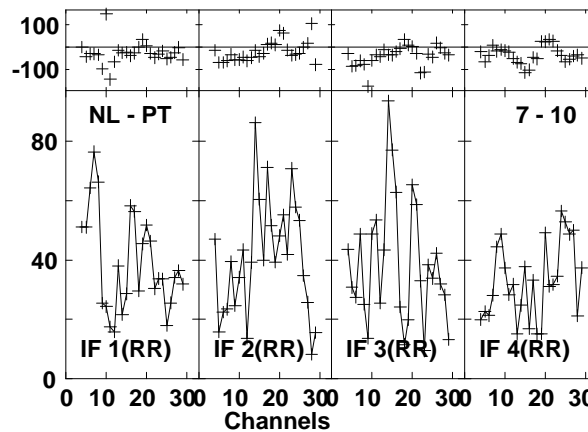
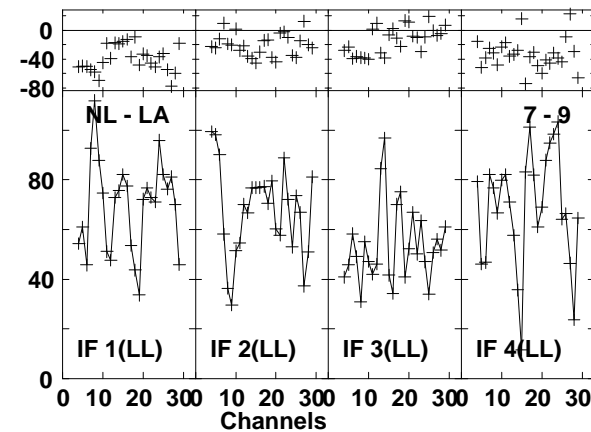
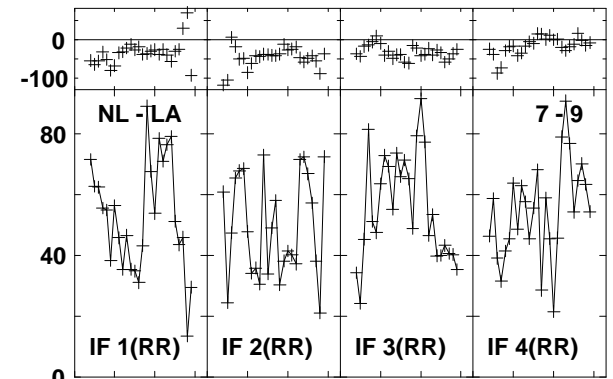
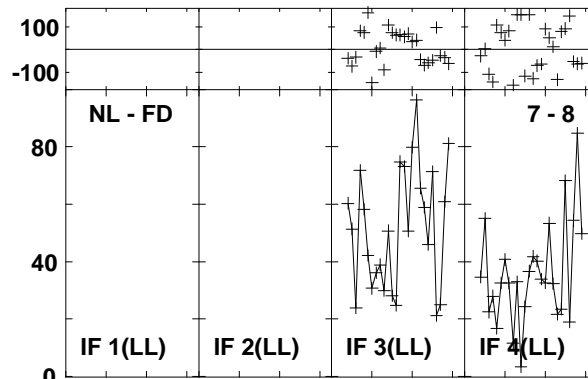
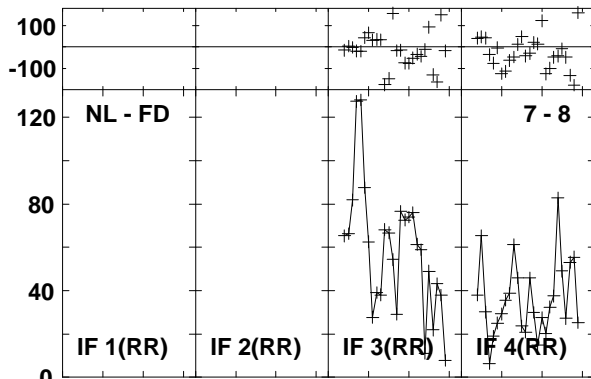
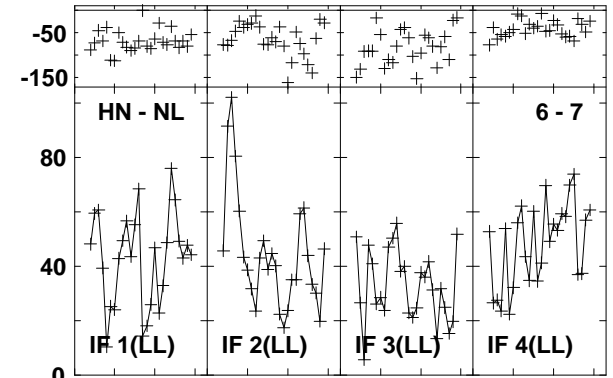
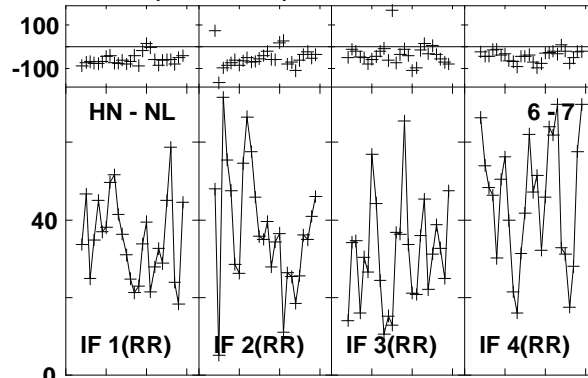
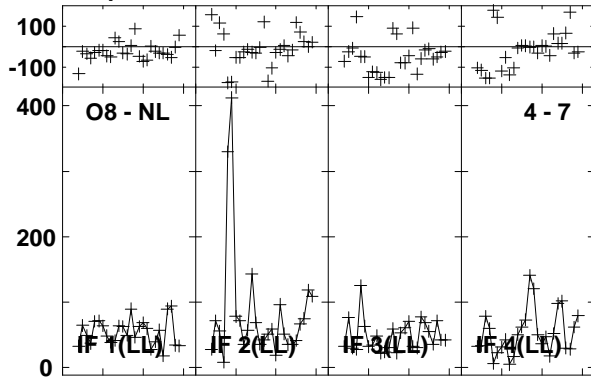

Lower frame: Milli Ampl Jy Top frame: Phas deg
Vector averaged cross-power spectrum Baseline: O8 (04) - NL (07)
Timerange: 01/02:46:40 to 01/02:49:54

Plot file version1327 created 03-MAR-2016 01:15:49

4C52 GN002C 1.UVDATA.1

Freq = 1.2770 GHz, Bw = 16.000 MH Calibrated with CL # 3 and BP # 1 (BP mode 1)

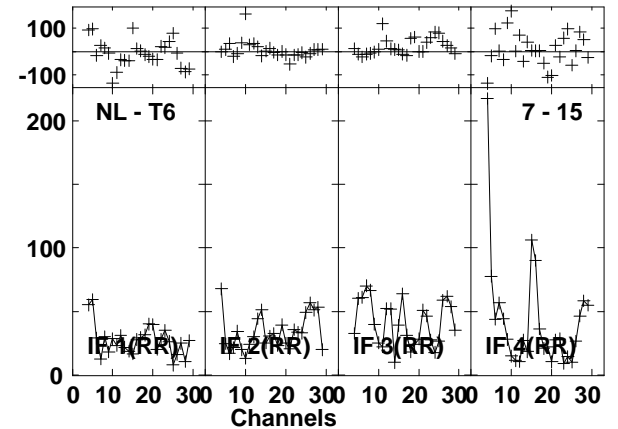
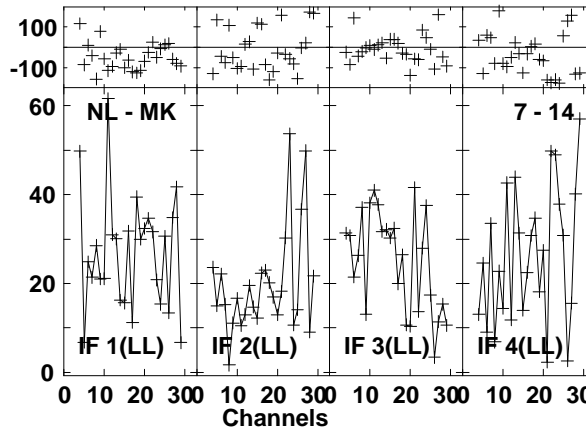
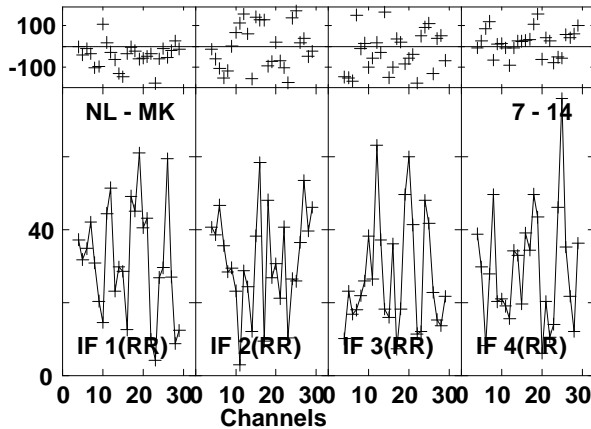
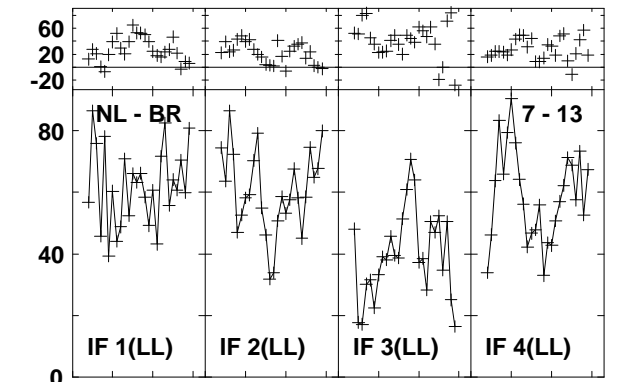
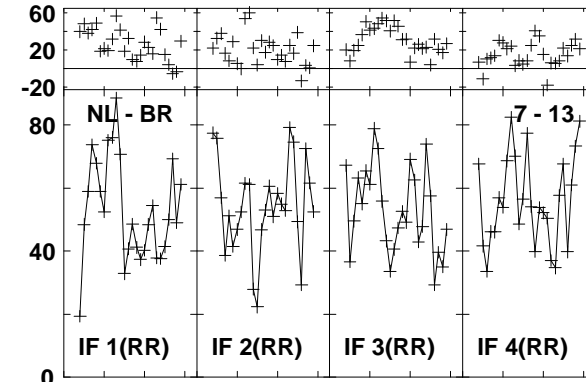
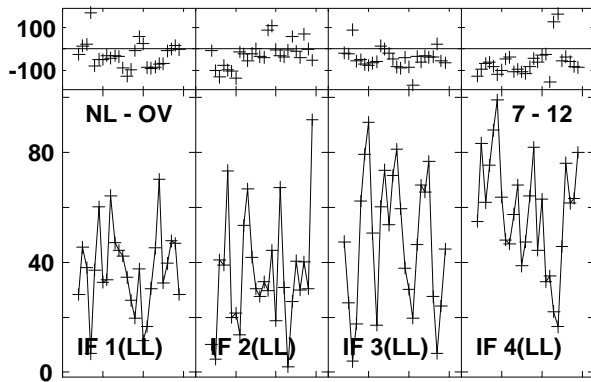
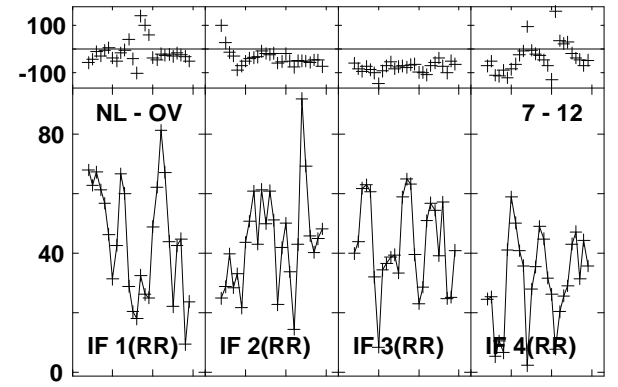
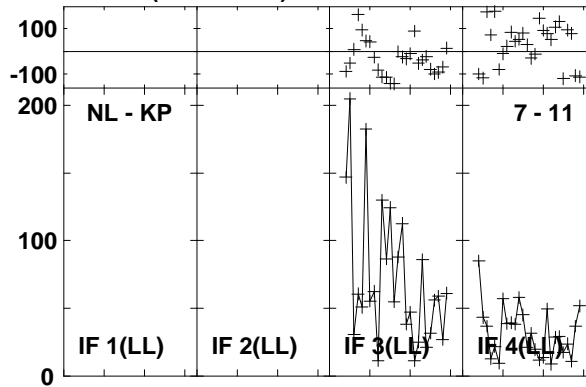
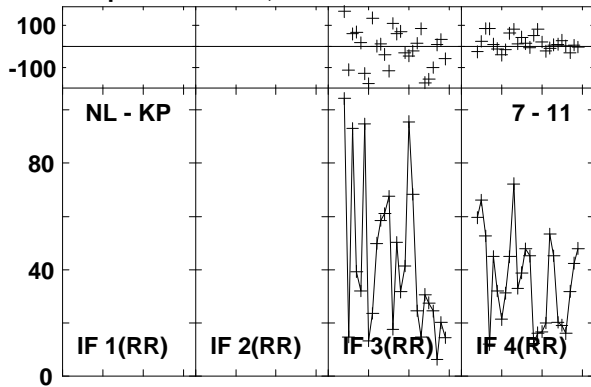

Lower frame: Milli Ampl Jy Top frame: Phas deg

Vector averaged cross-power spectrum Baseline: NL (07) - KP (11)

Timerange: 01/02:46:40 to 01/02:49:54

Plot file version1328 created 03-MAR-2016 01:15:49
4C52 GN002C 1.UVDATA.1
Freq = 1.2770 GHz, Bw = 16.000 MH Calibrated with CL # 3 and BP # 1 (BP mode 1)

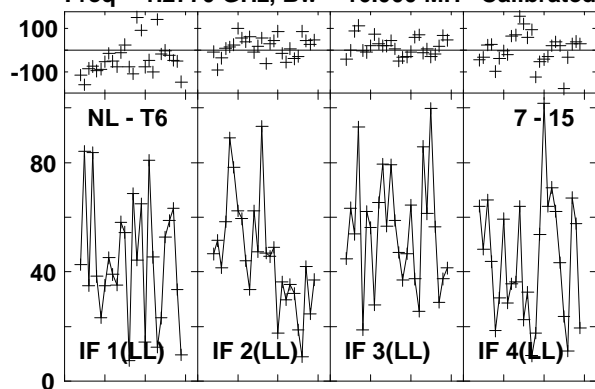

Lower frame: Milli Ampl Jy Top frame: Phas deg
Vector averaged cross-power spectrum Baseline: NL (07) - T6 (15)
Timerange: 01/02:46:40 to 01/02:49:54

Plot file version1329 created 03-MAR-2016 01:15:49

J1545+5400 GN002C 1.UVDATA.1

Freq = 1.2770 GHz, Bw = 16.000 MH Calibrated with CL # 3 and BP # 1 (BP mode 1)

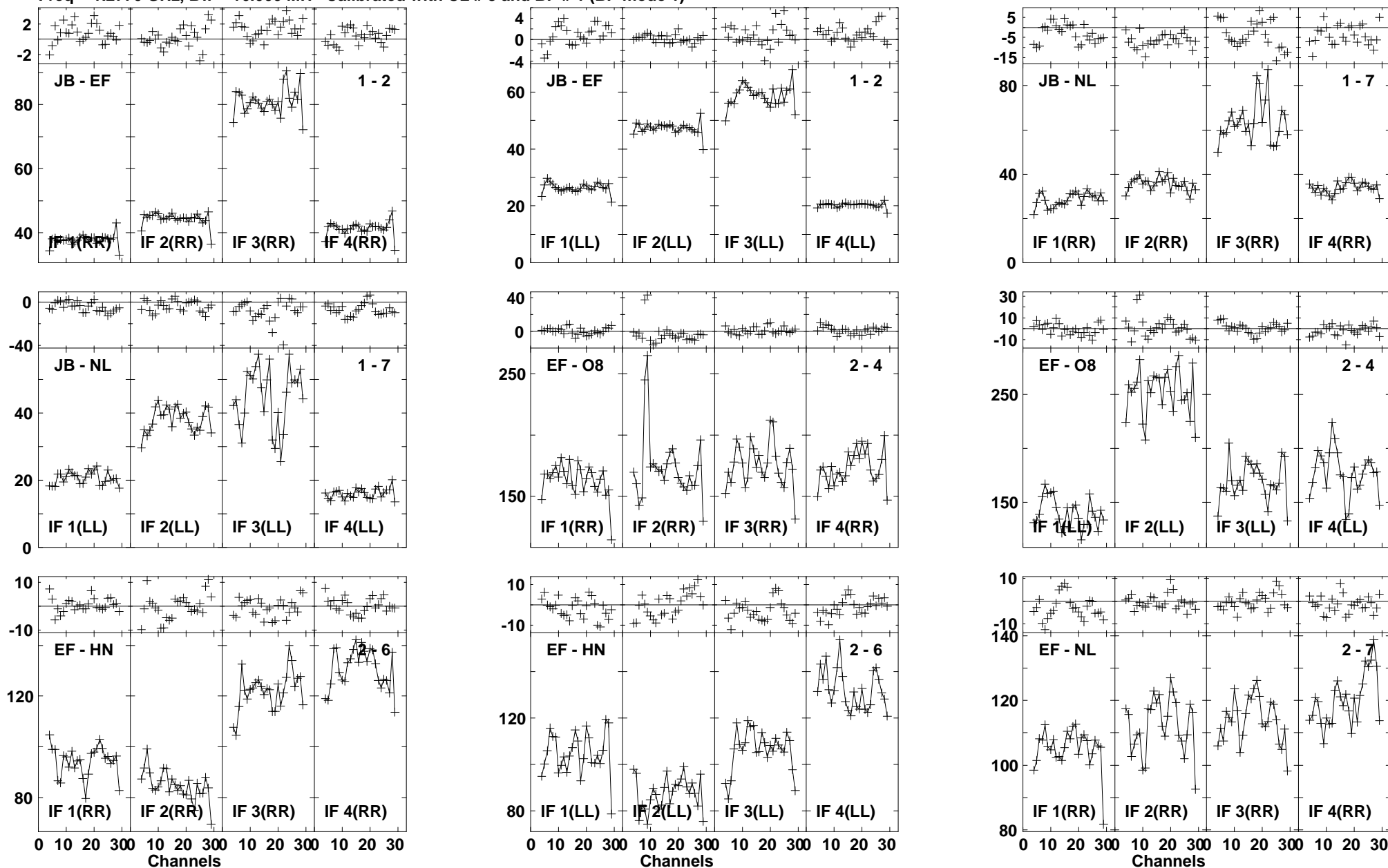

Lower frame: Milli Ampl Jy Top frame: Phas deg
Vector averaged cross-power spectrum Baseline: JB (01) - EF (02)
Timerange: 01/02:50:47 to 01/02:52:45

Plot file version1330 created 03-MAR-2016 01:15:49

J1545+5400 GN002C 1.UVDATA.1

Freq = 1.2770 GHz, Bw = 16.000 MH Calibrated with CL # 3 and BP # 1 (BP mode 1)

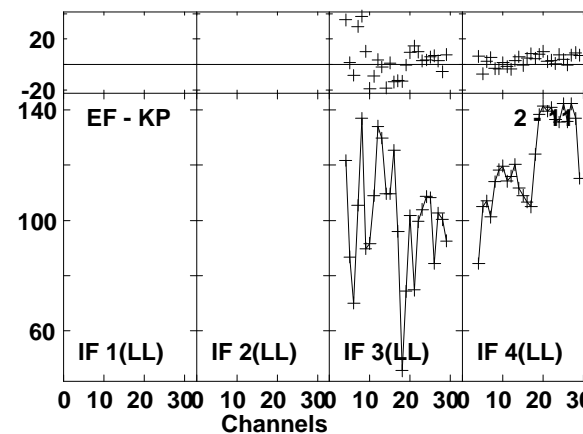
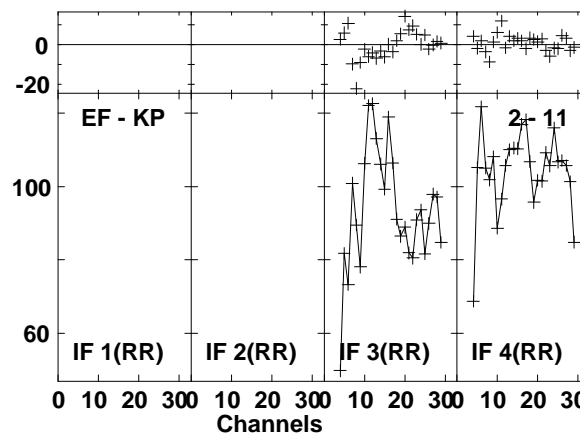
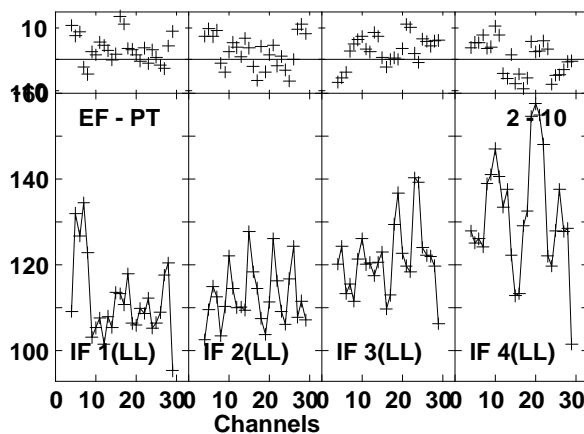
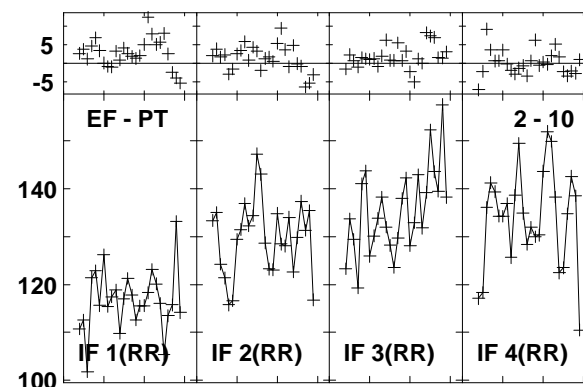
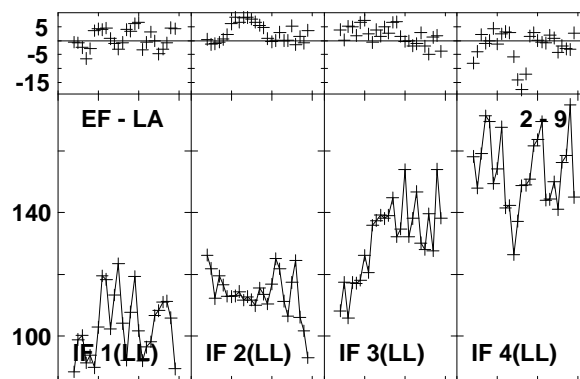
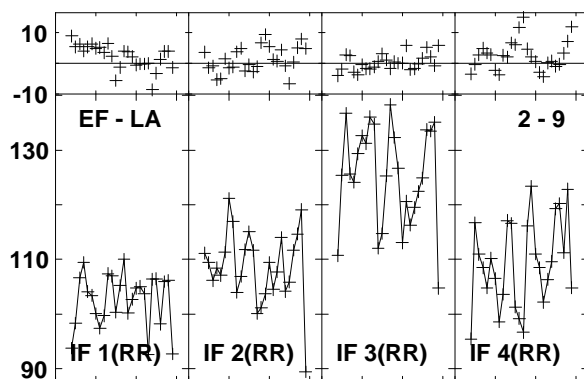
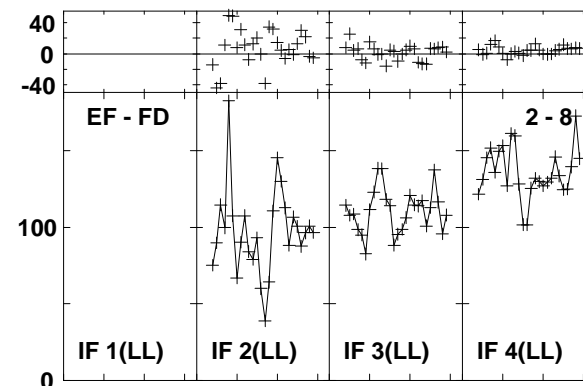
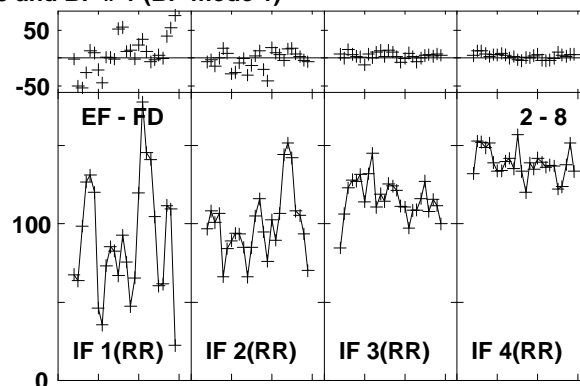
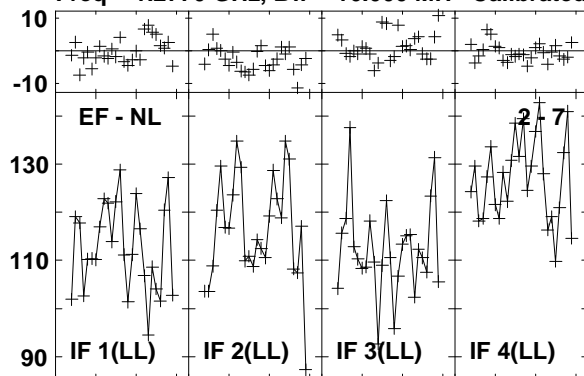

Lower frame: Milli Ampl Jy Top frame: Phas deg
Vector averaged cross-power spectrum Baseline: EF (02) - NL (07)
Timerange: 01/02:50:47 to 01/02:52:45

Plot file version1331 created 03-MAR-2016 01:15:49

J1545+5400 GN002C 1.UVDATA.1

Freq = 1.2770 GHz, Bw = 16.000 MH Calibrated with CL # 3 and BP # 1 (BP mode 1)

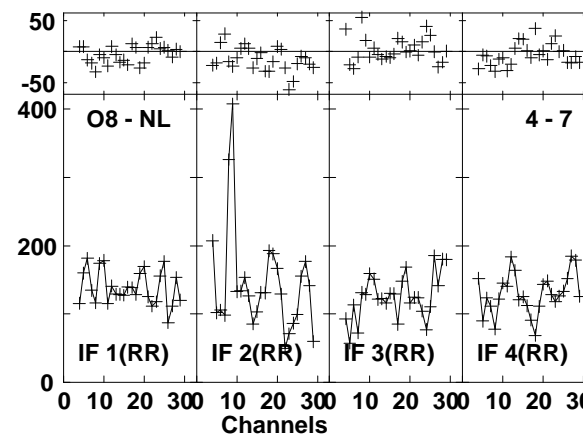
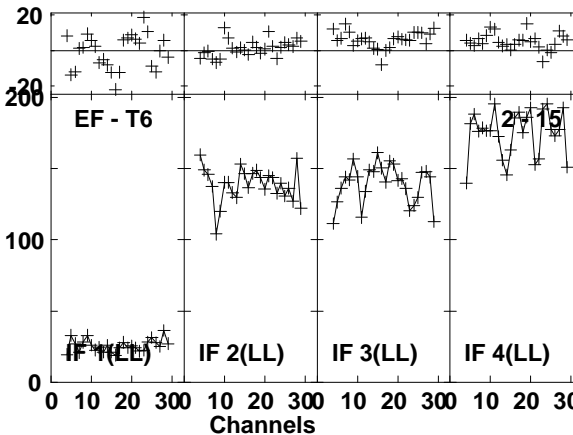
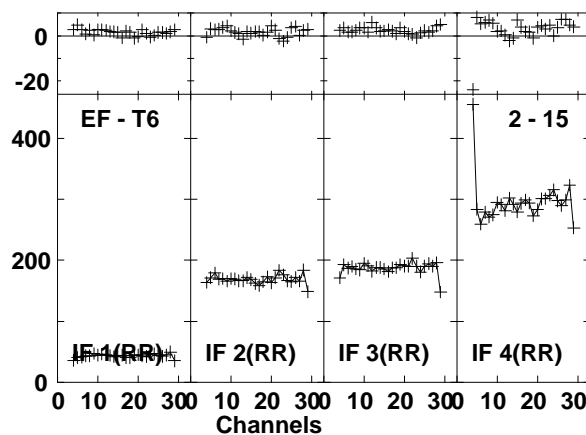
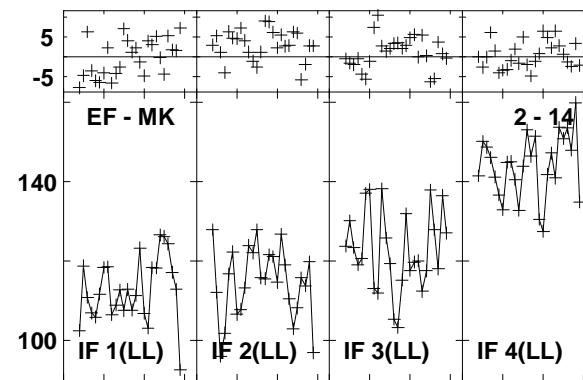
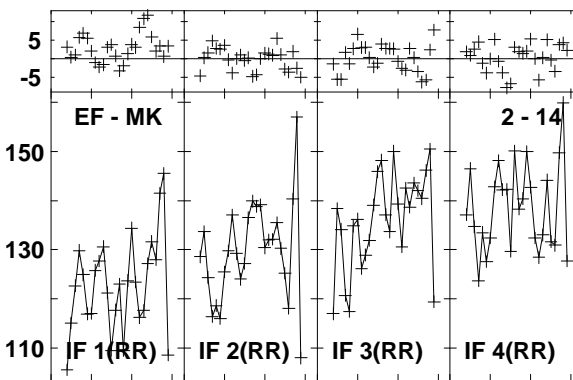
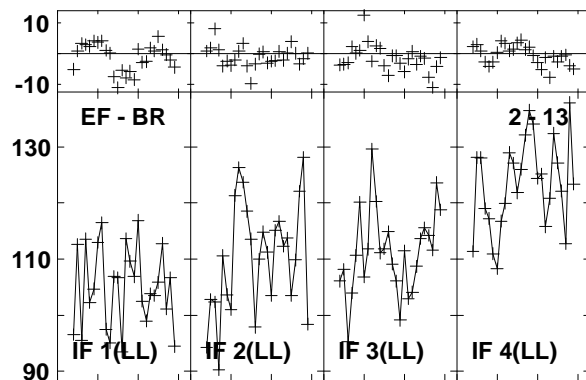
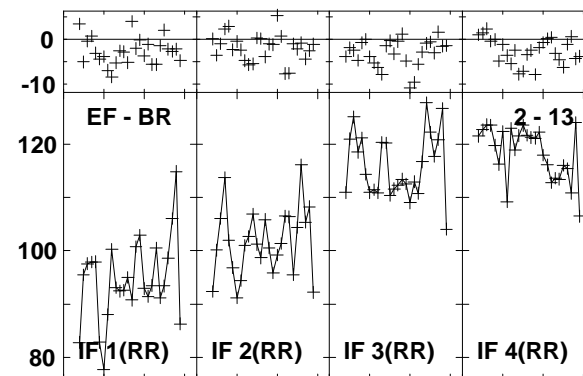
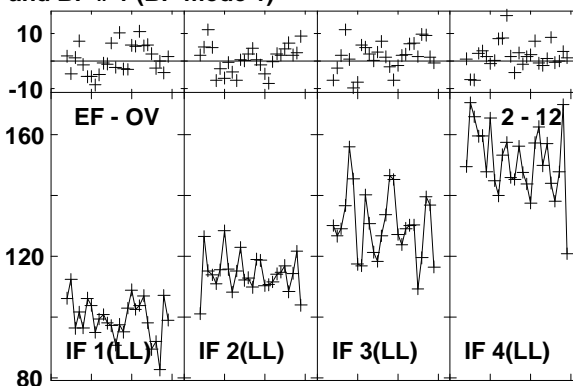
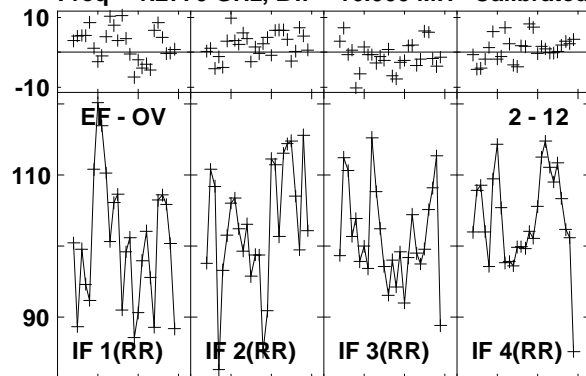

Lower frame: Milli Ampl Jy Top frame: Phas deg
Vector averaged cross-power spectrum Baseline: EF (02) - OV (12)
Timerange: 01/02:50:47 to 01/02:52:45

Plot file version1332 created 03-MAR-2016 01:15:50

J1545+5400 GN002C 1.UVDATA.1

Freq = 1.2770 GHz, Bw = 16.000 MH Calibrated with CL # 3 and BP # 1 (BP mode 1)

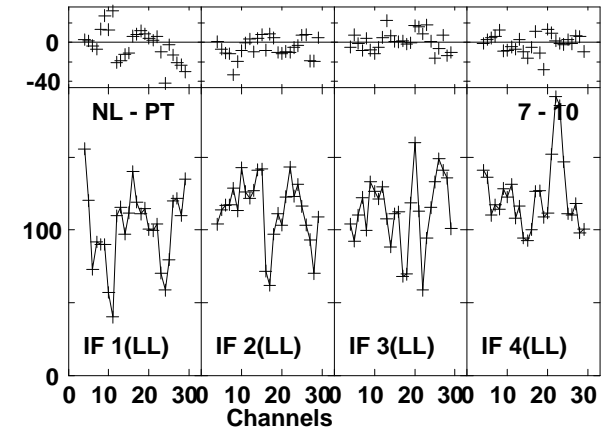
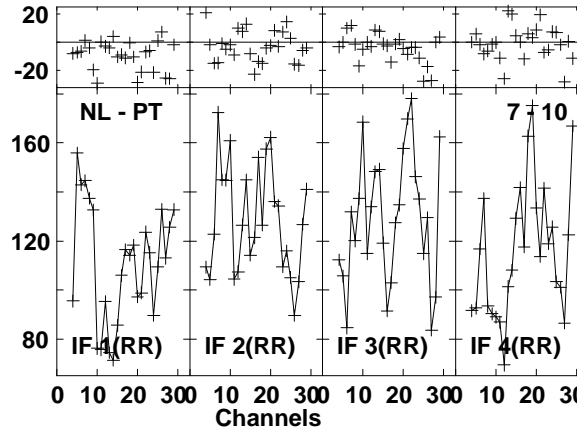
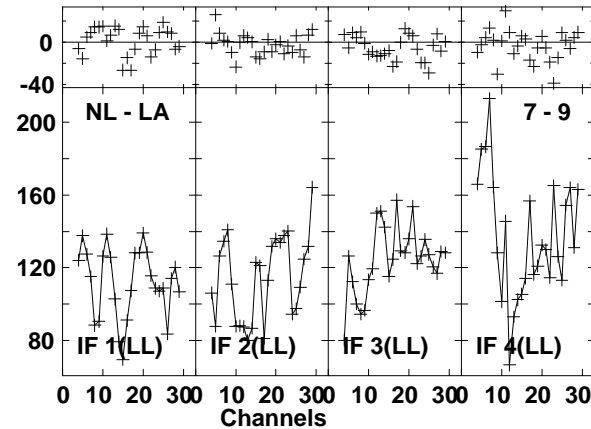
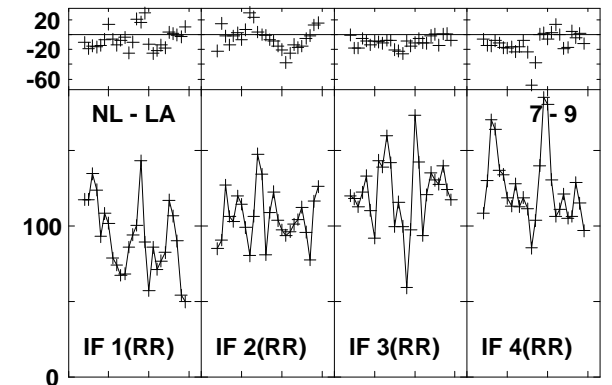
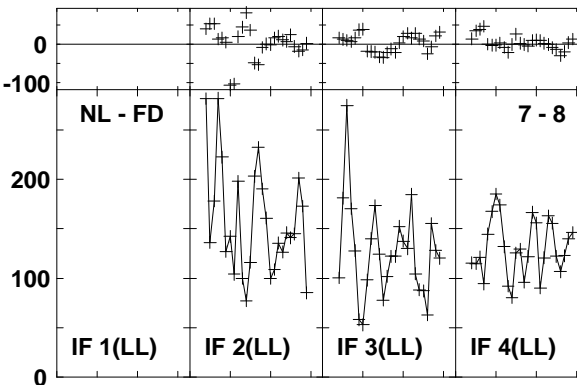
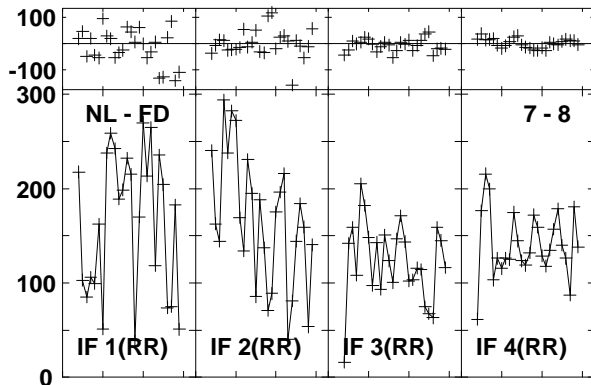
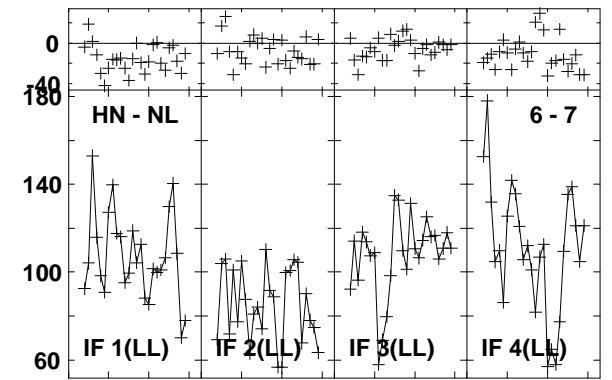
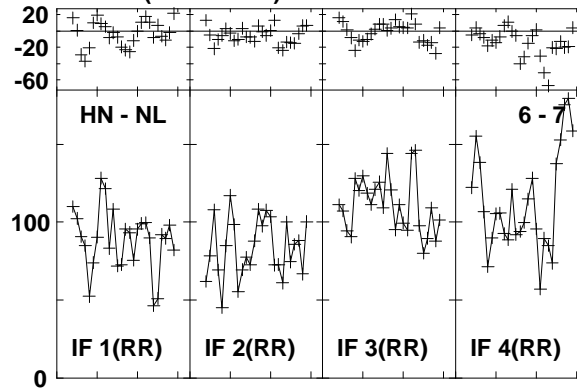
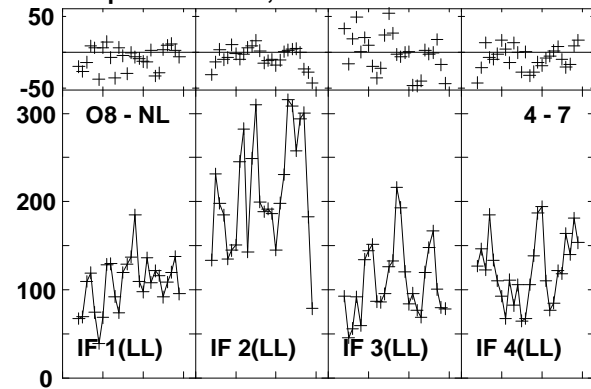

Lower frame: Milli Ampl Jy Top frame: Phas deg
Vector averaged cross-power spectrum Baseline: O8 (04) - NL (07)
Timerange: 01/02:50:47 to 01/02:52:45

Plot file version1333 created 03-MAR-2016 01:15:50
 J1545+5400 GN002C 1.UVDATA.1
 Freq = 1.2770 GHz, Bw = 16.000 MH Calibrated with CL # 3 and BP # 1 (BP mode 1)

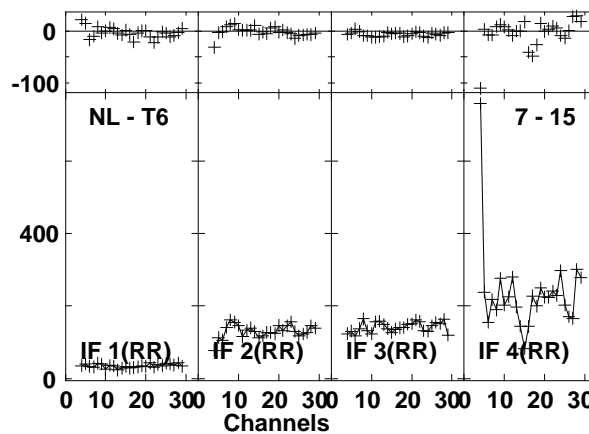
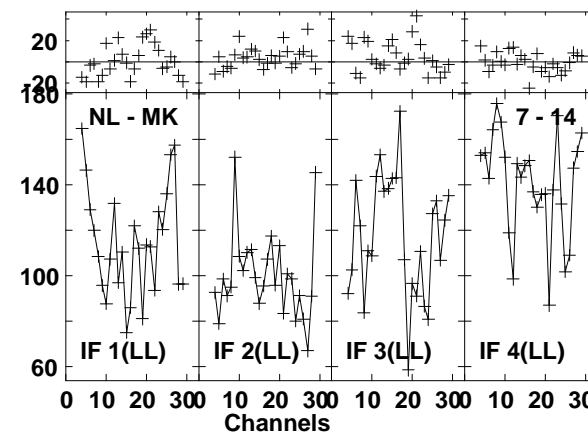
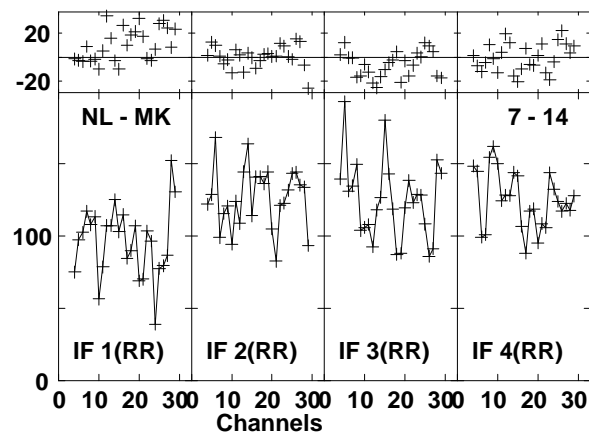
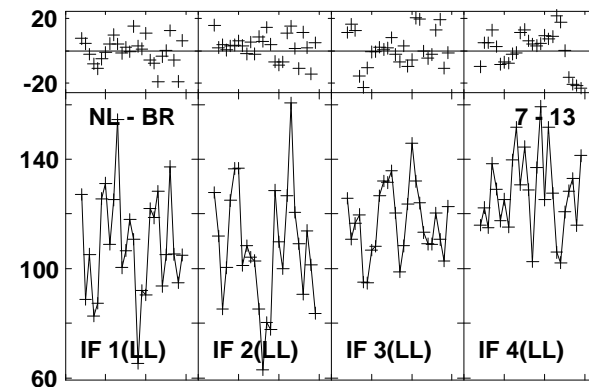
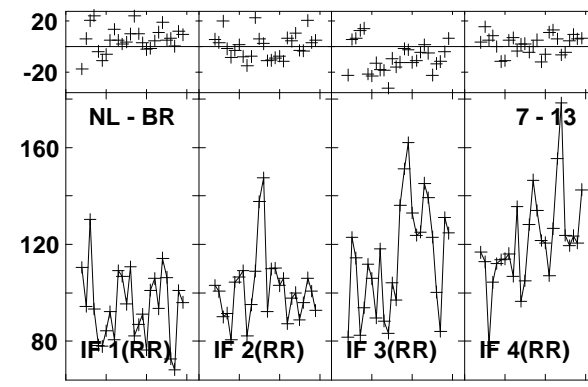
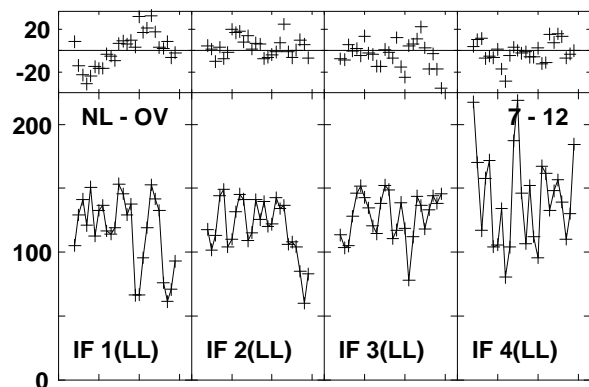
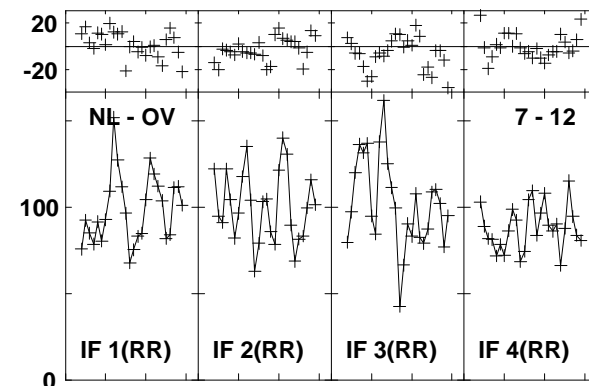
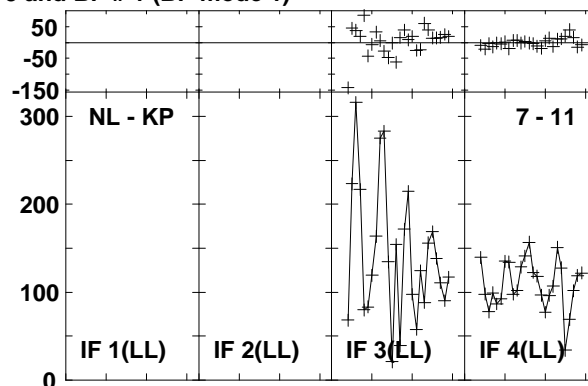
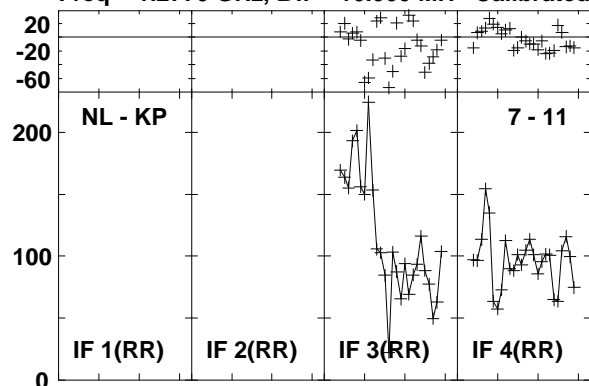

Lower frame: Milli Ampl Jy Top frame: Phas deg
 Vector averaged cross-power spectrum Baseline: NL (07) - KP (11)
 Timerange: 01/02:50:47 to 01/02:52:45

Plot file version1334 created 03-MAR-2016 01:15:50
J1545+5400 GN002C 1.UVDATA.1
Freq = 1.2770 GHz, Bw = 16.000 MH Calibrated with CL # 3 and BP # 1 (BP mode 1)

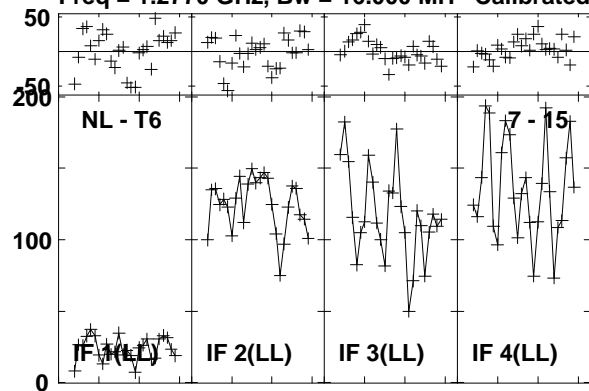

Lower frame: Milli Ampl Jy Top frame: Phas deg
Vector averaged cross-power spectrum Baseline: NL (07) - T6 (15)
Timerange: 01/02:50:47 to 01/02:52:45

Plot file version1335 created 03-MAR-2016 01:15:50

4C52 GN002C 1.UVDATA.1

Freq = 1.2770 GHz, Bw = 16.000 MH Calibrated with CL # 3 and BP # 1 (BP mode 1)

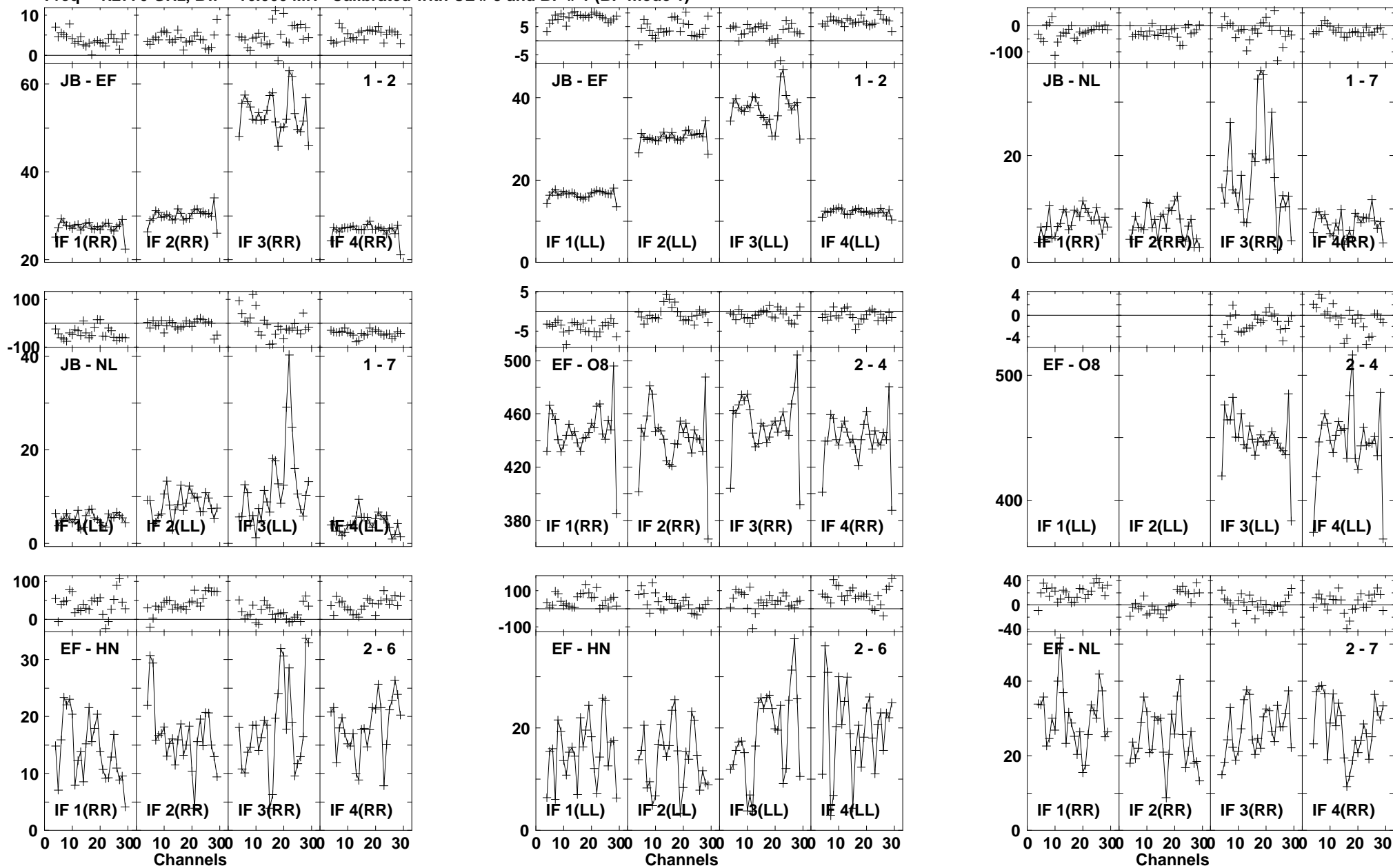

Lower frame: Milli Ampl Jy Top frame: Phas deg
Vector averaged cross-power spectrum Baseline: JB (01) - EF (02)
Timerange: 01/02:52:57 to 01/02:55:45

Plot file version1336 created 03-MAR-2016 01:15:50

4C52 GN002C 1.UVDATA.1

Freq = 1.2770 GHz, Bw = 16.000 MH Calibrated with CL # 3 and BP # 1 (BP mode 1)

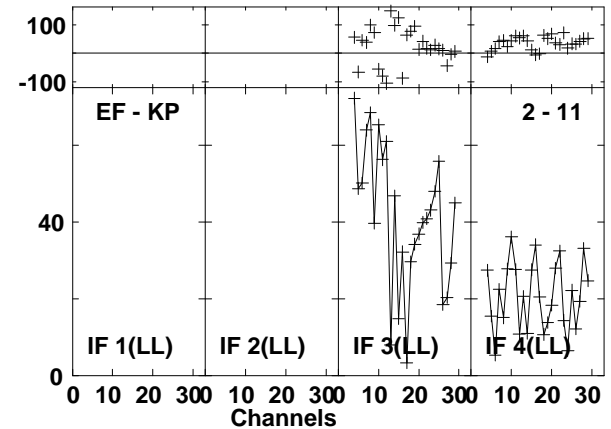
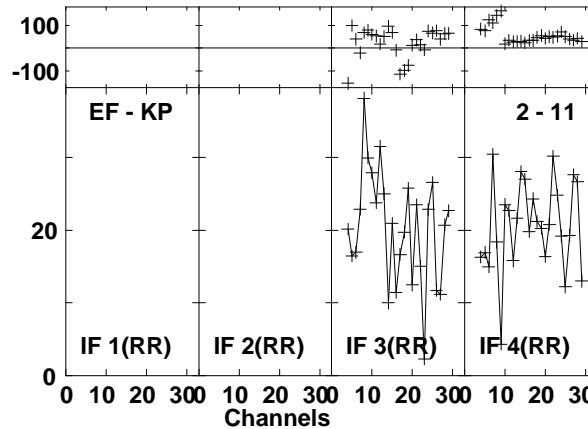
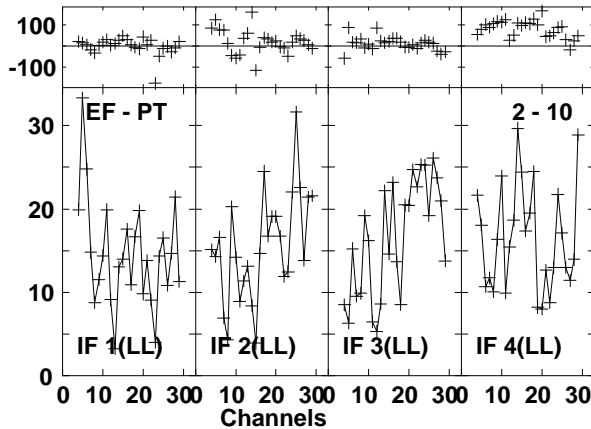
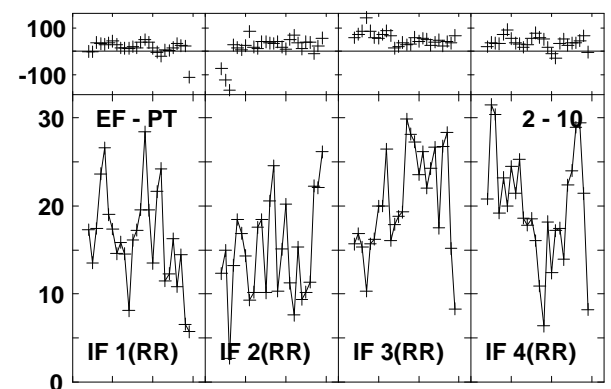
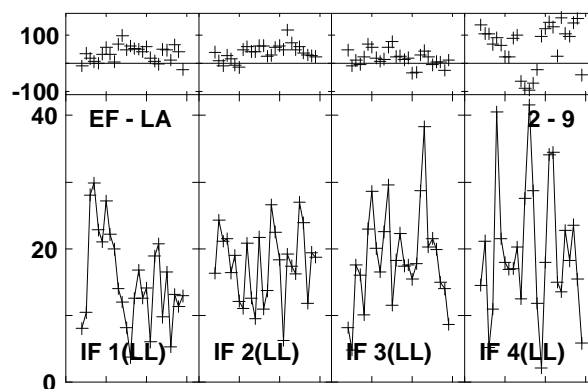
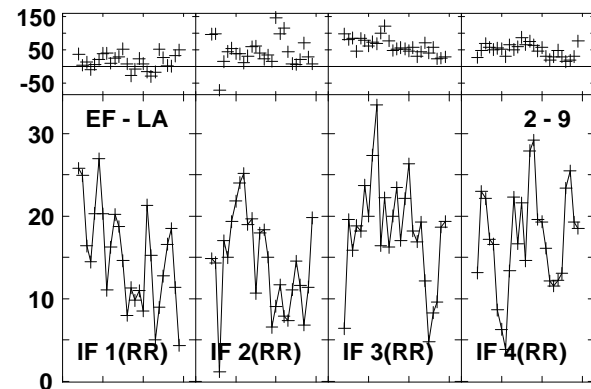
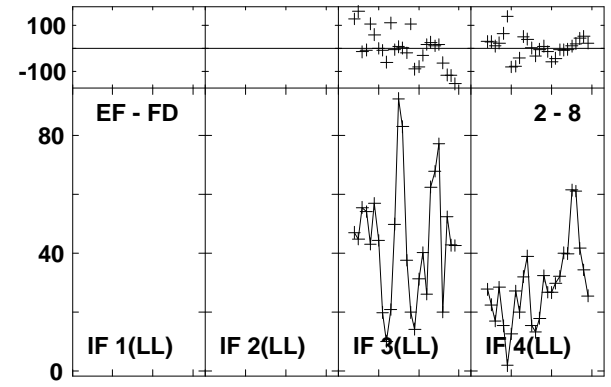
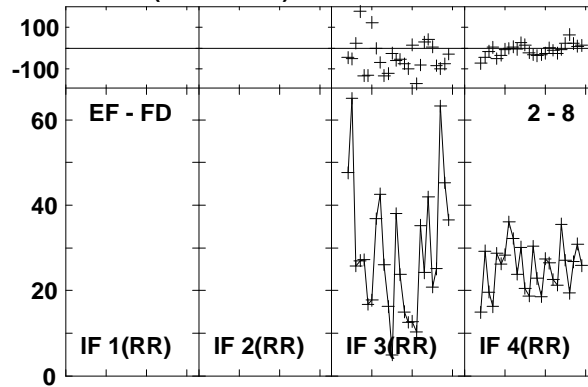
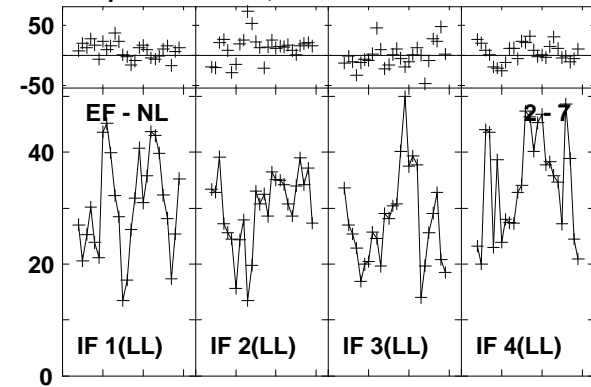

Lower frame: Milli Ampl Jy Top frame: Phas deg
Vector averaged cross-power spectrum Baseline: EF (02) - NL (07)
Timerange: 01/02:52:57 to 01/02:55:45

Plot file version1337 created 03-MAR-2016 01:15:50

4C52 GN002C 1.UVDATA.1

Freq = 1.2770 GHz, Bw = 16.000 MH Calibrated with CL # 3 and BP # 1 (BP mode 1)

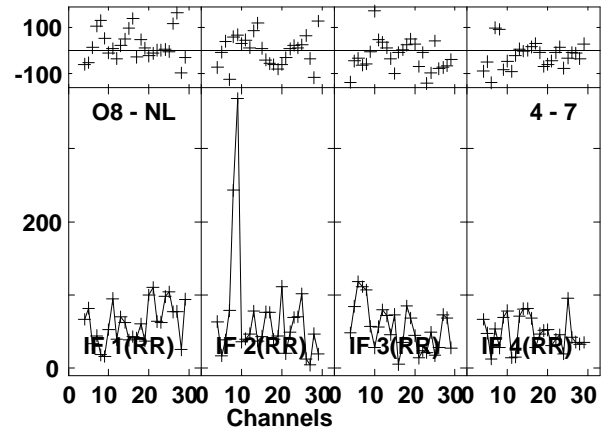
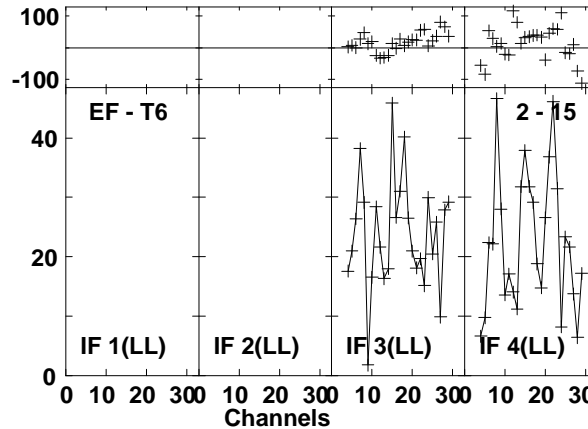
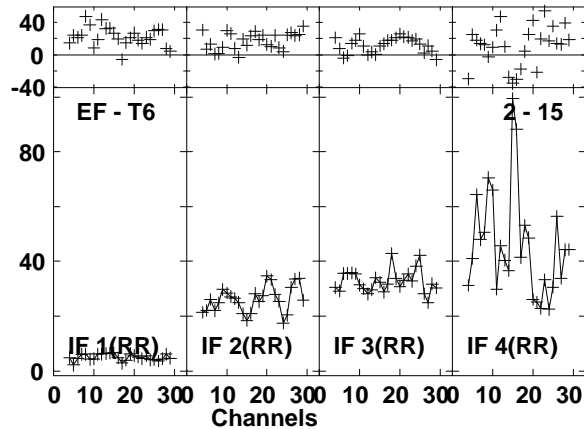
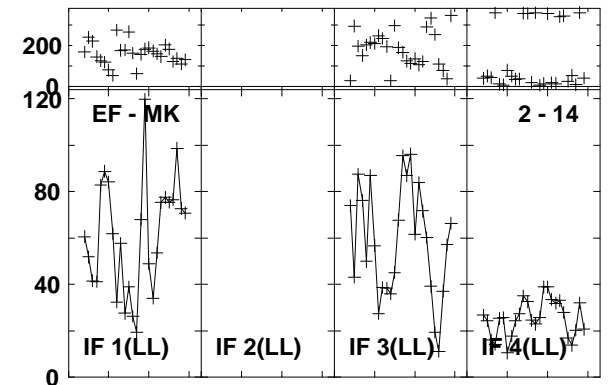
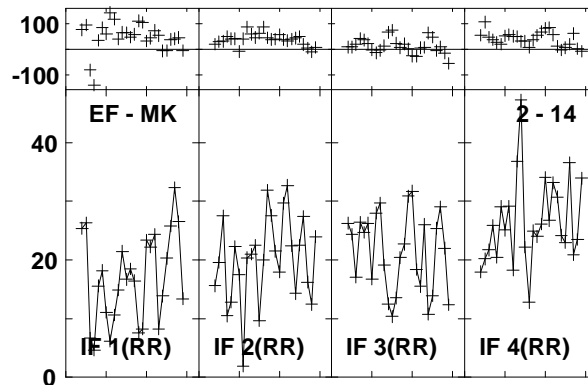
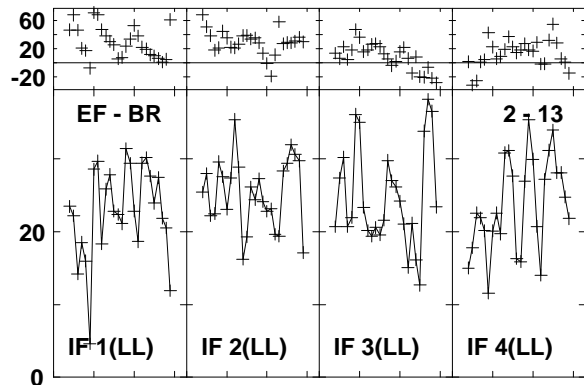
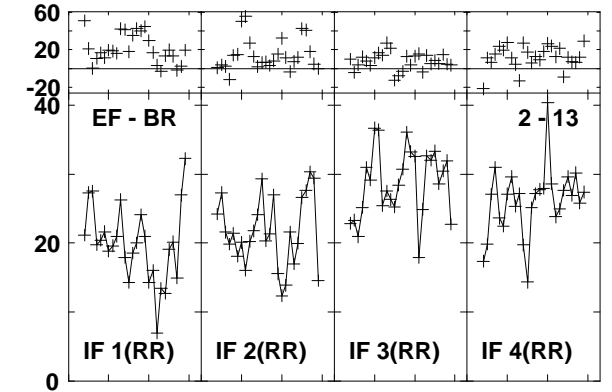
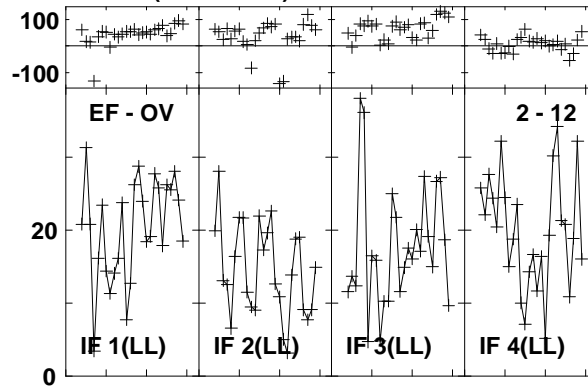
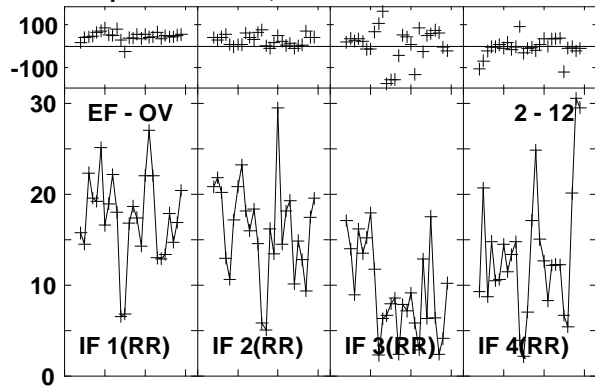

Lower frame: Milli Ampl Jy Top frame: Phas deg
Vector averaged cross-power spectrum Baseline: EF (02) - OV (12)
Timerange: 01/02:52:57 to 01/02:55:45

Plot file version1338 created 03-MAR-2016 01:15:51
 4C52 GN002C 1.UVDATA.1
 Freq = 1.2770 GHz, Bw = 16.000 MH Calibrated with CL # 3 and BP # 1 (BP mode 1)

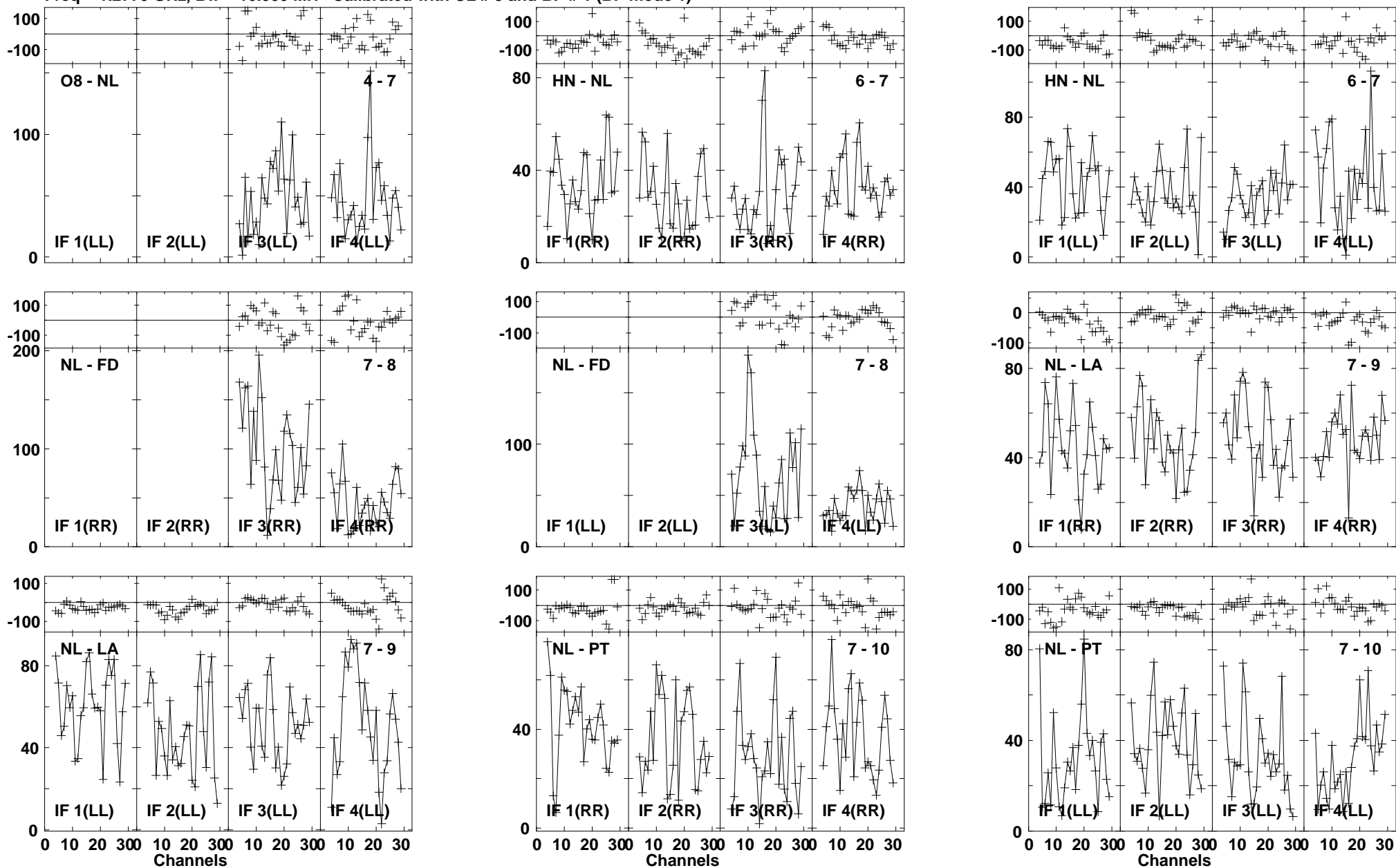

Lower frame: Milli Ampl Jy Top frame: Phas deg
 Vector averaged cross-power spectrum Baseline: O8 (04) - NL (07)
 Timerange: 01/02:52:57 to 01/02:55:45

Plot file version1339 created 03-MAR-2016 01:15:51

4C52 GN002C 1.UVDATA.1

Freq = 1.2770 GHz, Bw = 16.000 MH Calibrated with CL # 3 and BP # 1 (BP mode 1)

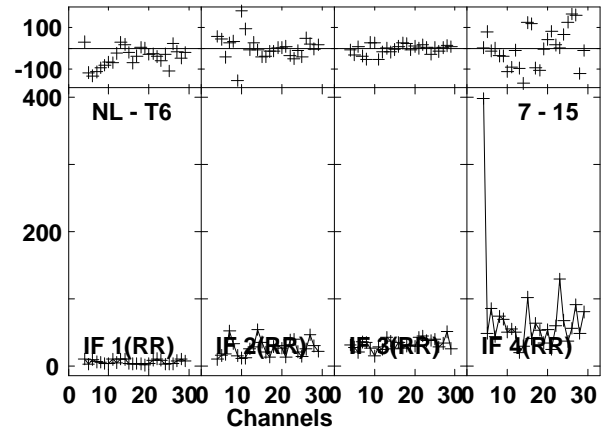
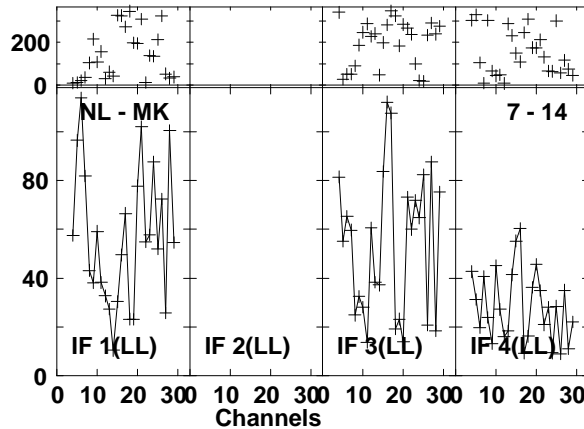
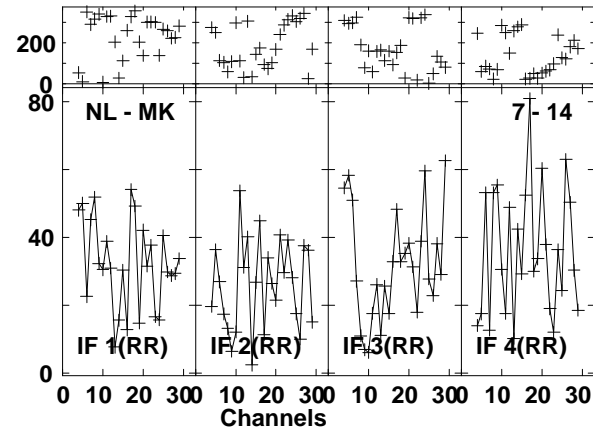
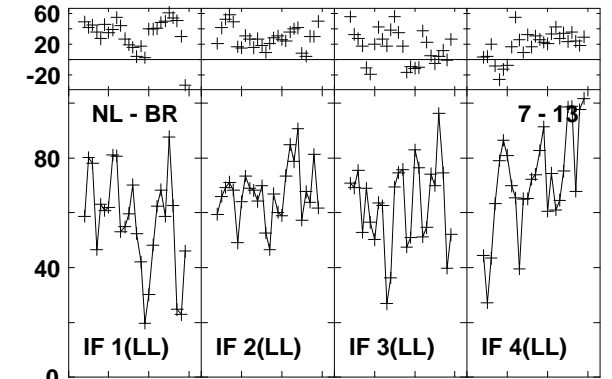
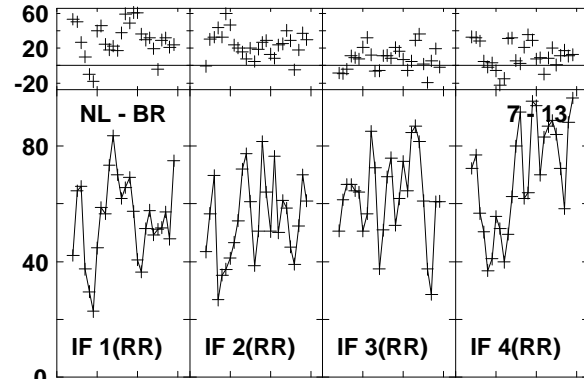
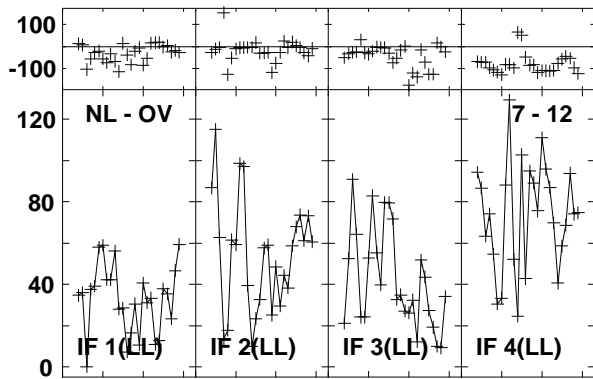
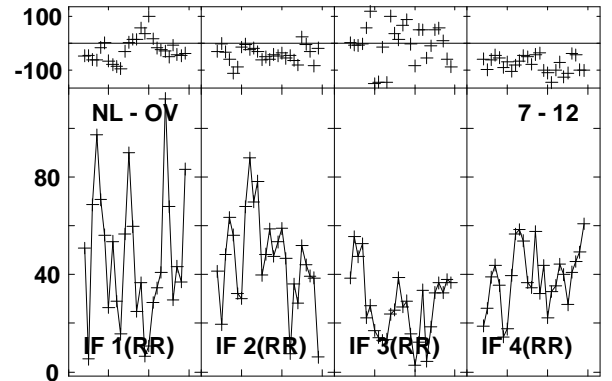
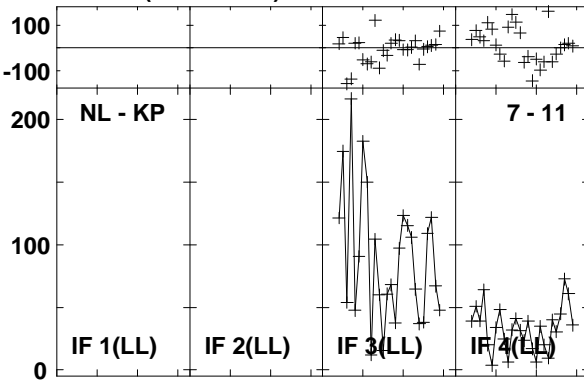
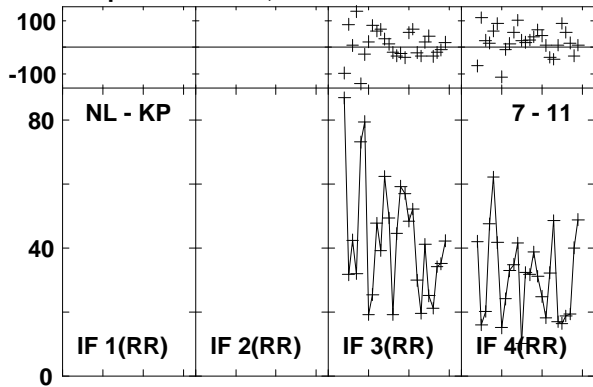

Lower frame: Milli Ampl Jy Top frame: Phas deg

Vector averaged cross-power spectrum Baseline: NL (07) - KP (11)

Timerange: 01/02:52:57 to 01/02:55:45

Plot file version1340 created 03-MAR-2016 01:15:51
4C52 GN002C 1.UVDATA.1
Freq = 1.2770 GHz, Bw = 16.000 MH Calibrated with CL # 3 and BP # 1 (BP mode 1)

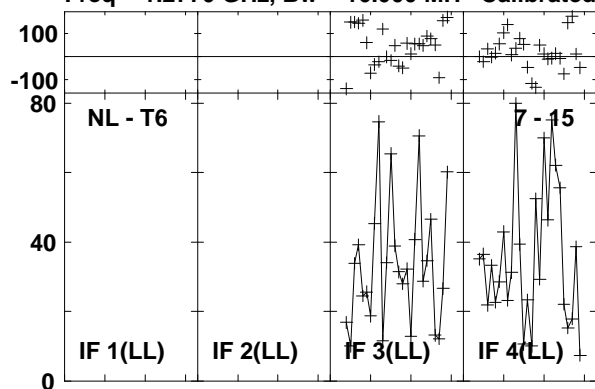

Lower frame: Milli Ampl Jy Top frame: Phas deg
Vector averaged cross-power spectrum Baseline: NL (07) - T6 (15)
Timerange: 01/02:52:57 to 01/02:55:45

Plot file version1341 created 03-MAR-2016 01:15:51
 J1545+5400 GN002C 1.UVDATA.1
 Freq = 1.2770 GHz, Bw = 16.000 MH Calibrated with CL # 3 and BP # 1 (BP mode 1)

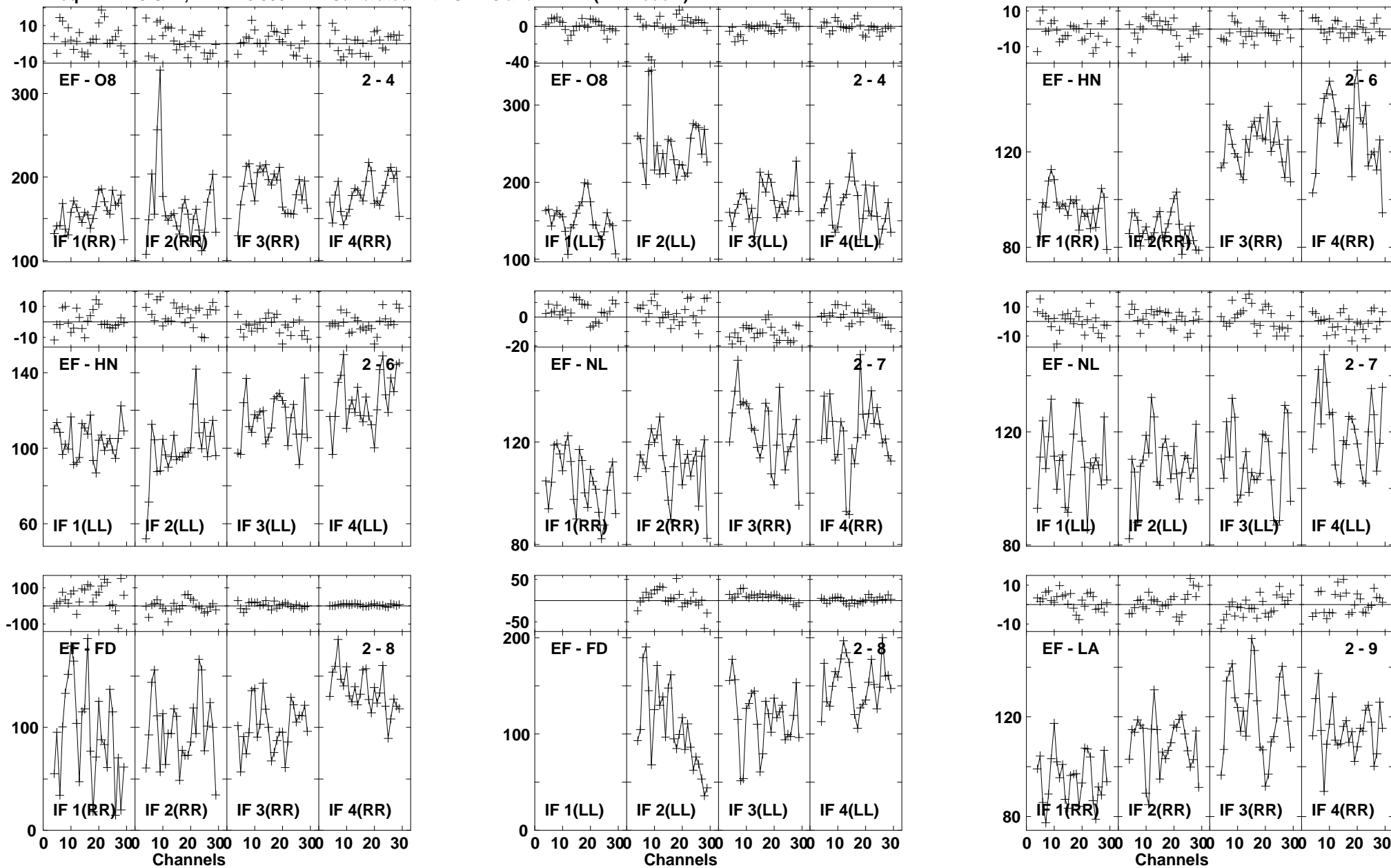

Lower frame: Milli Ampl Jy Top frame: Phas deg
 Vector averaged cross-power spectrum Baseline: EF (02) - O8 (04)
 Timerange: 01/02:56:37 to 01/02:57:35

Plot file version1342 created 03-MAR-2016 01:15:51

J1545+5400 GN002C 1.UVDATA.1

Freq = 1.2770 GHz, Bw = 16.000 MH Calibrated with CL # 3 and BP # 1 (BP mode 1)

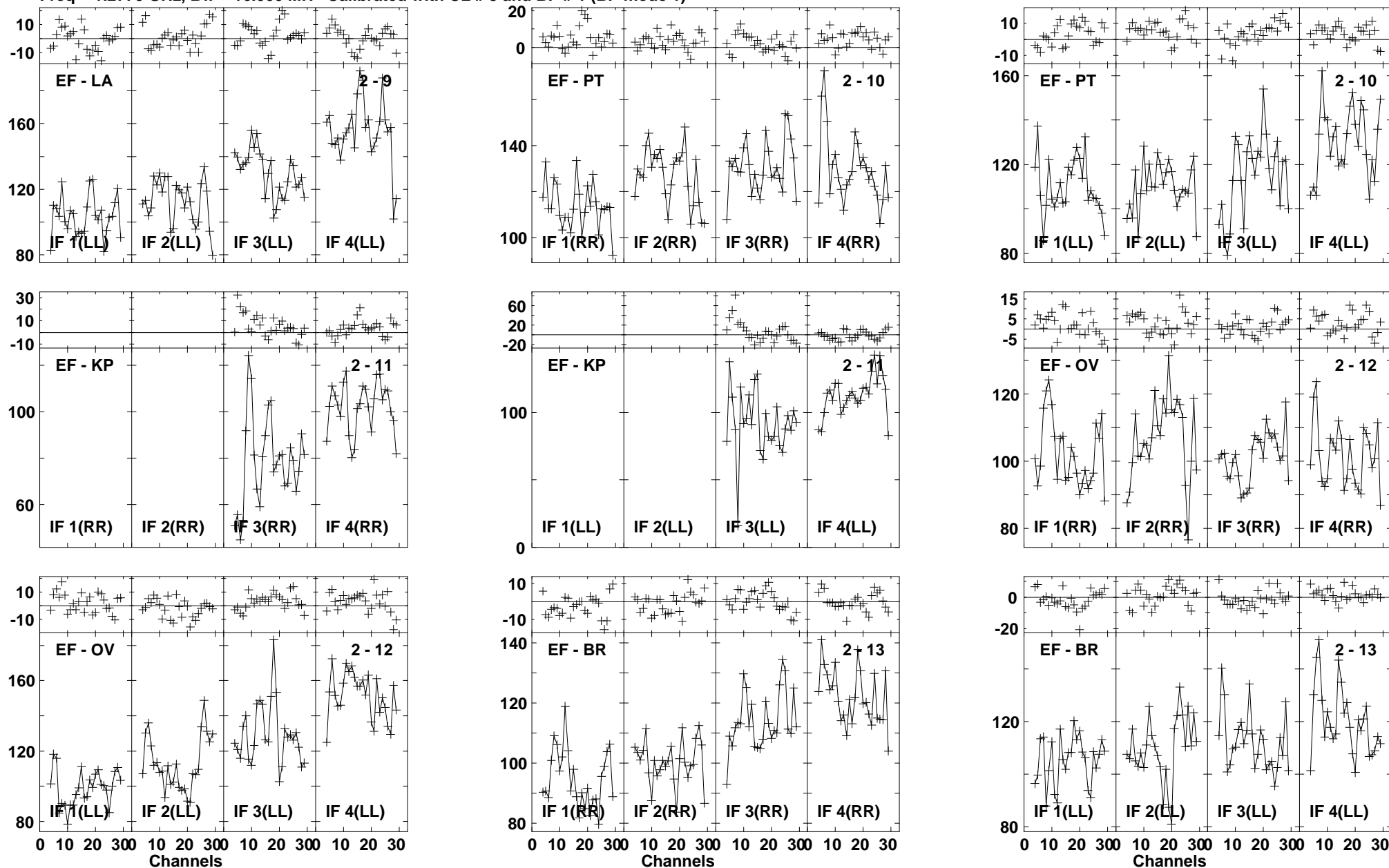

Plot file version1343 created 03-MAR-2016 01:15:52

J1545+5400 GN002C 1.UVDATA.1

Freq = 1.2770 GHz, Bw = 16.000 MH Calibrated with CL # 3 and BP # 1 (BP mode 1)

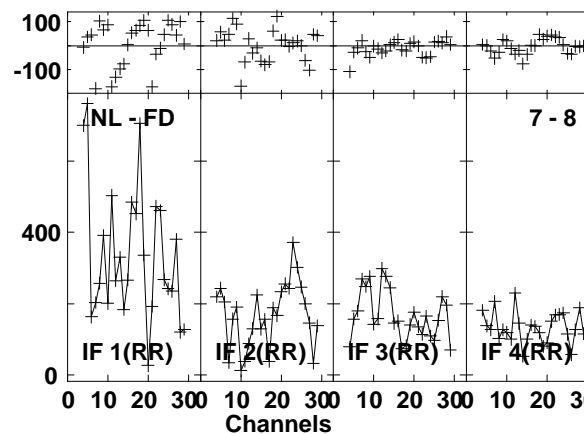
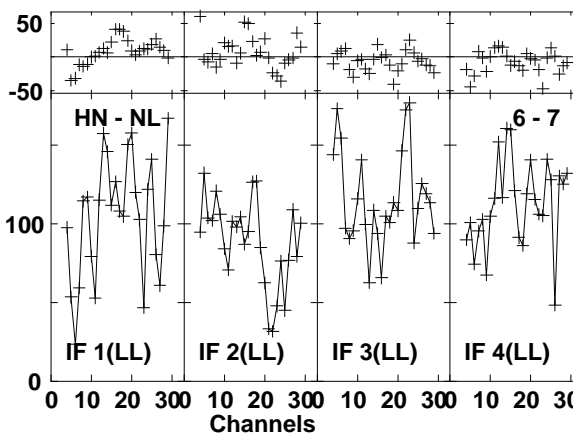
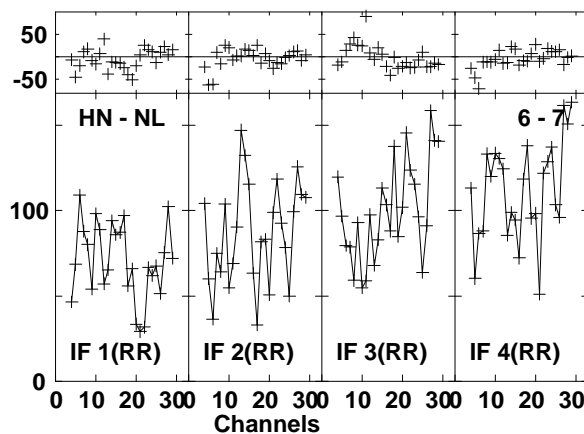
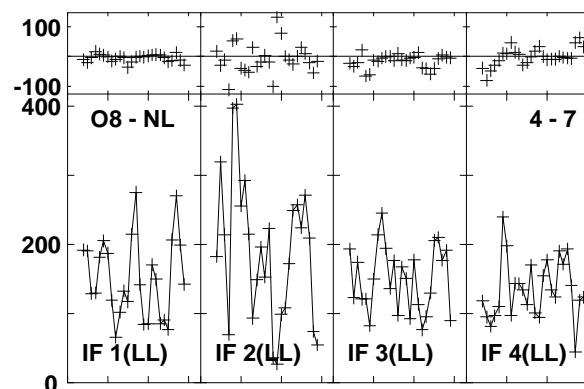
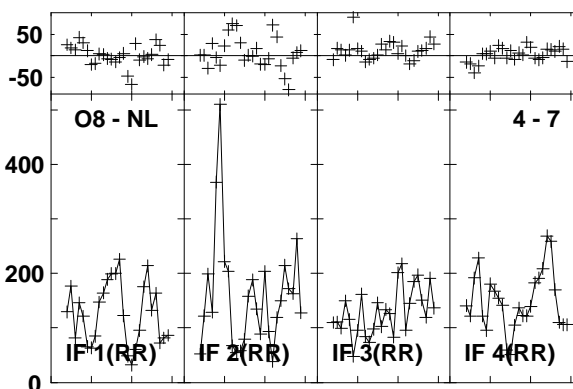
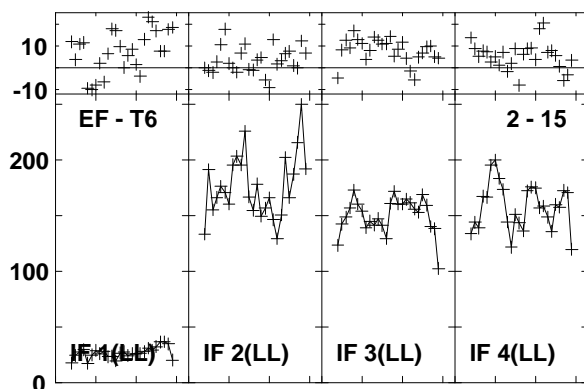
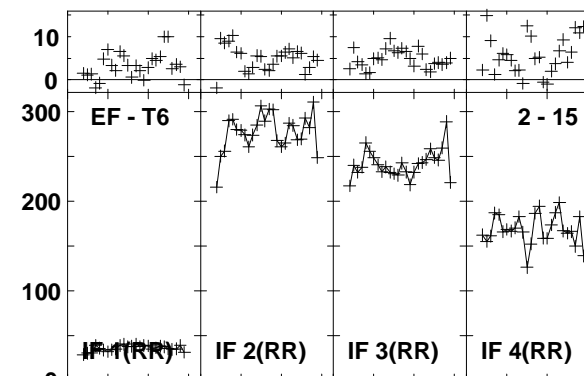
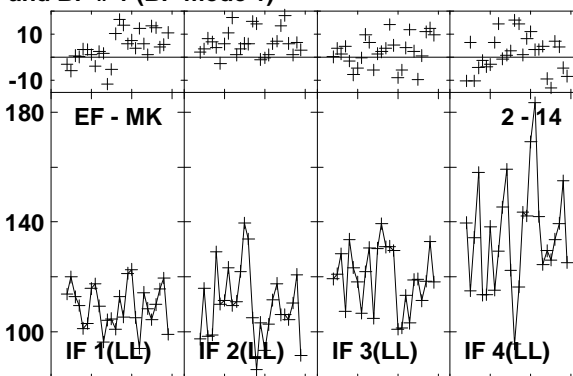
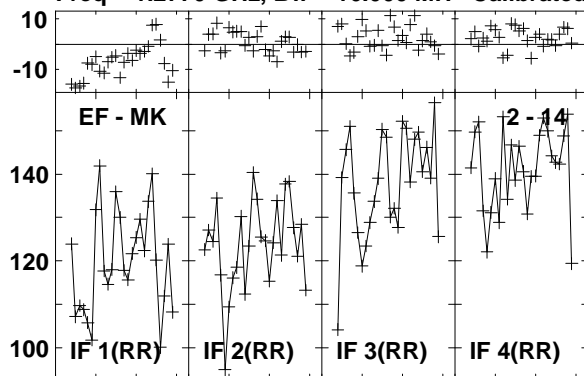

Lower frame: Milli Ampl Jy Top frame: Phas deg
Vector averaged cross-power spectrum Baseline: EF (02) - MK (14)
Timerange: 01/02:56:37 to 01/02:57:35

Plot file version1344 created 03-MAR-2016 01:15:52
 J1545+5400 GN002C 1.UVDATA.1
 Freq = 1.2770 GHz, Bw = 16.000 MH Calibrated with CL # 3 and BP # 1 (BP mode 1)

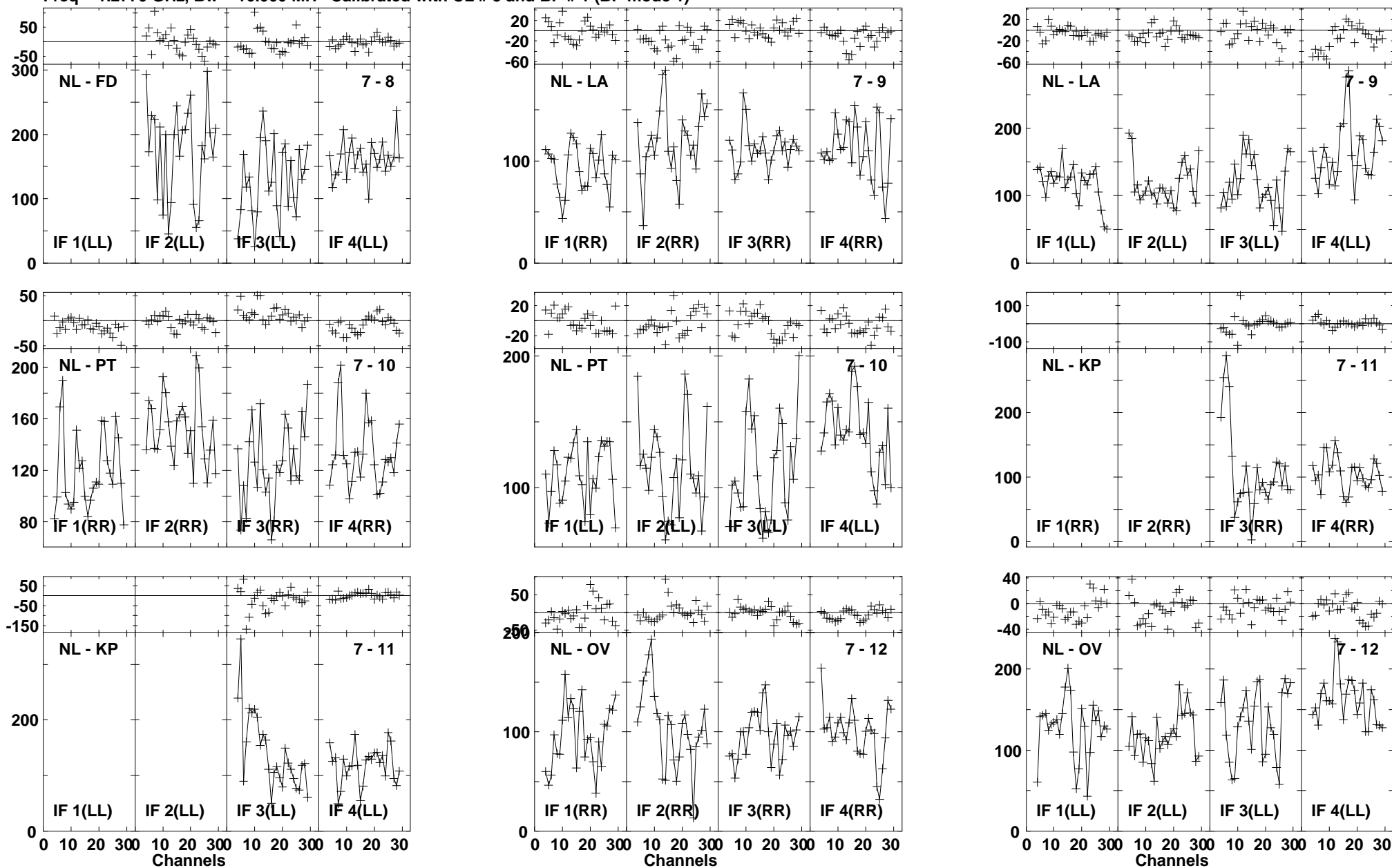

Lower frame: Milli Ampl Jy Top frame: Phas deg
 Vector averaged cross-power spectrum Baseline: NL (07) - FD (08)
 Timerange: 01/02:56:37 to 01/02:57:35

Plot file version1345 created 03-MAR-2016 01:15:52

J1545+5400 GN002C 1.UVDATA.1

Freq = 1.2770 GHz, Bw = 16.000 MH Calibrated with CL # 3 and BP # 1 (BP mode 1)

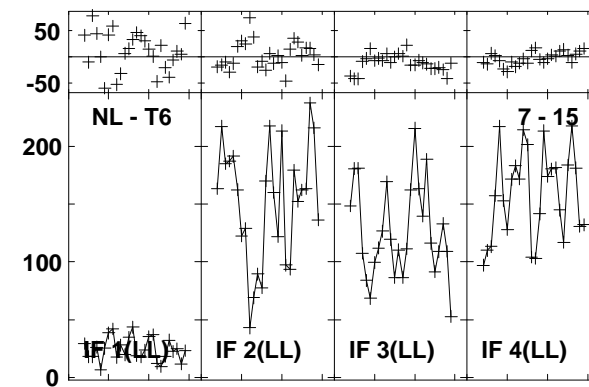
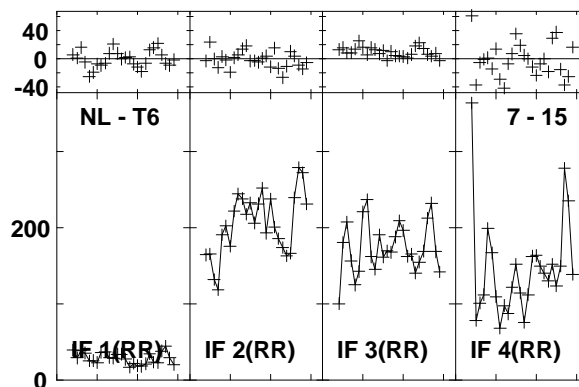
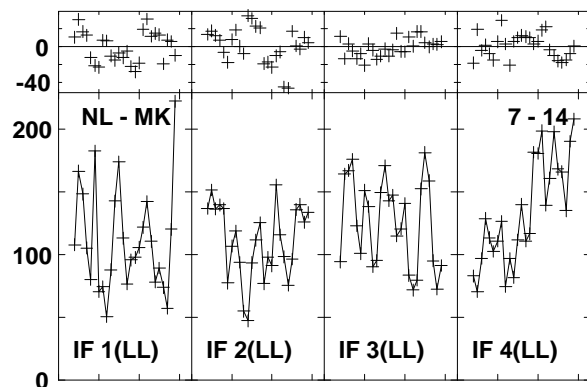
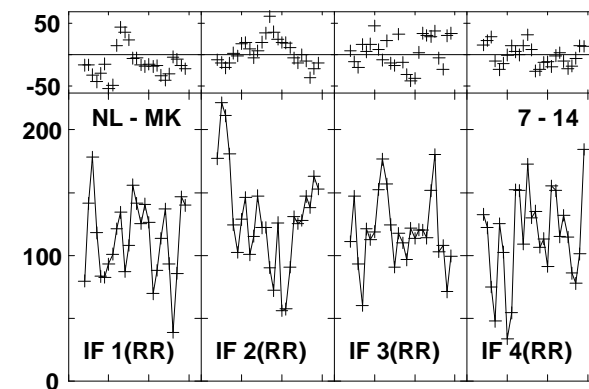
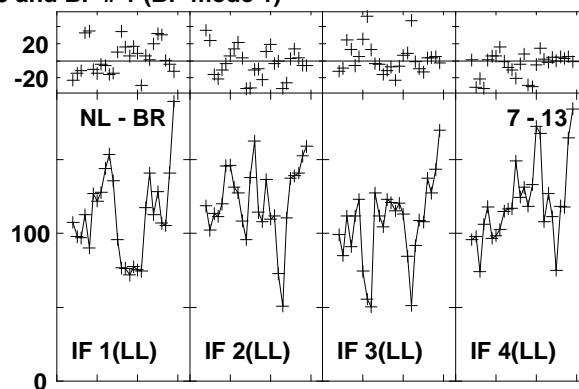
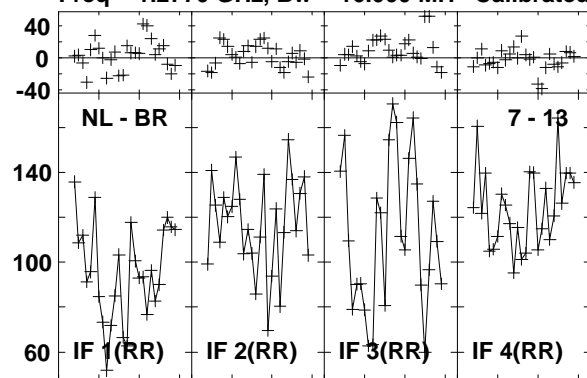

Lower frame: Milli Ampl Jy Top frame: Phas deg
Vector averaged cross-power spectrum Baseline: NL (07) - BR (13)
Timerange: 01/02:56:37 to 01/02:57:35

Plot file version1346 created 03-MAR-2016 01:15:52

4C52 GN002C 1.UVDATA.1

Freq = 1.2770 GHz, Bw = 16.000 MH Calibrated with CL # 3 and BP # 1 (BP mode 1)

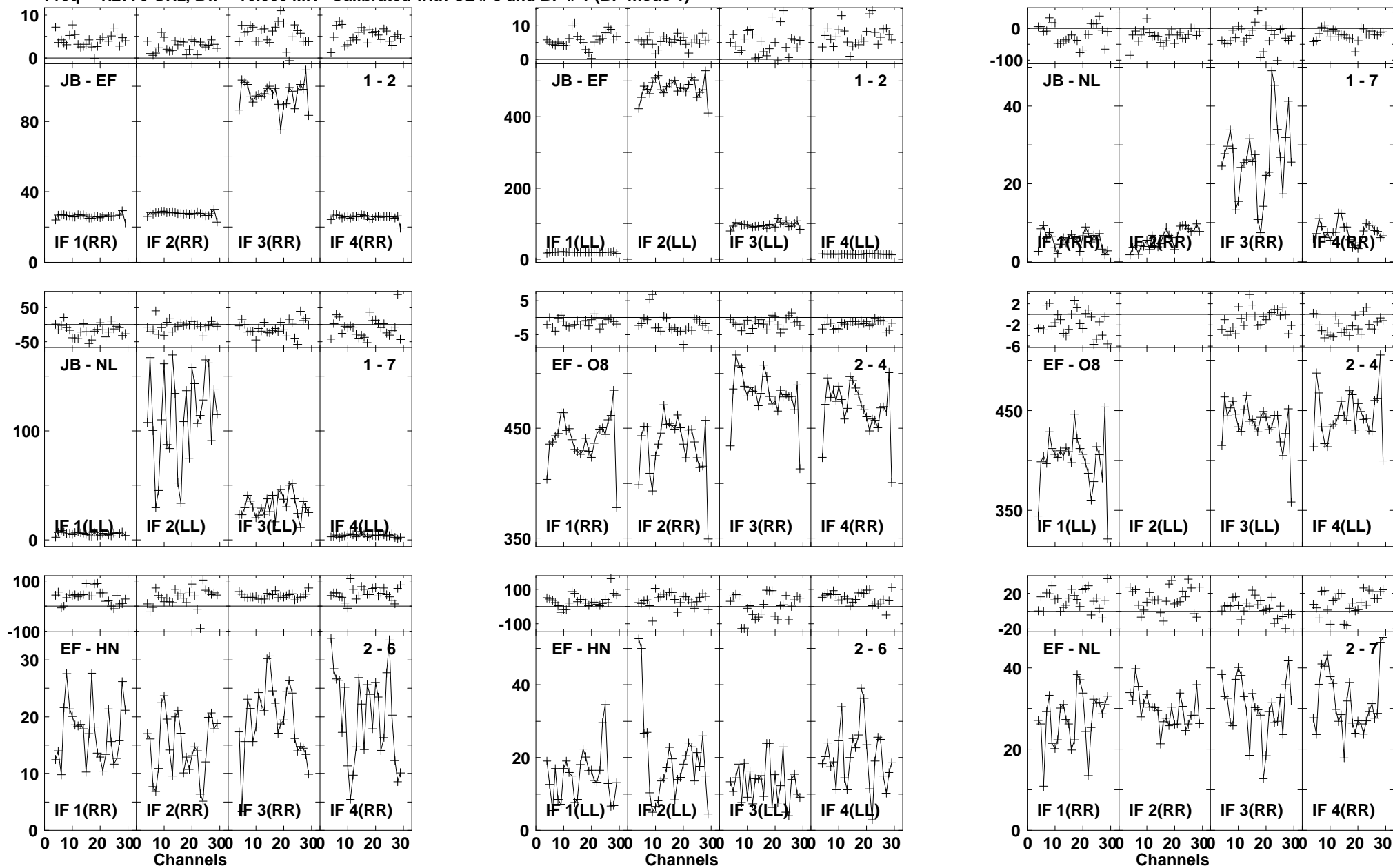

Lower frame: Milli Ampl Jy Top frame: Phas deg
Vector averaged cross-power spectrum Baseline: JB (01) - EF (02)
Timerange: 01/02:57:40 to 01/03:00:54

Plot file version1347 created 03-MAR-2016 01:15:52

4C52 GN002C 1.UVDATA.1

Freq = 1.2770 GHz, Bw = 16.000 MH Calibrated with CL # 3 and BP # 1 (BP mode 1)

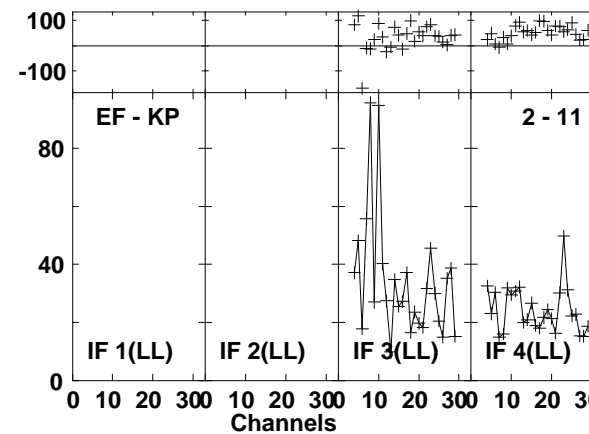
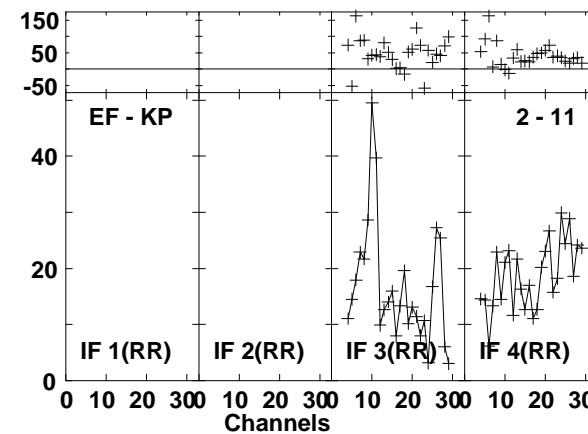
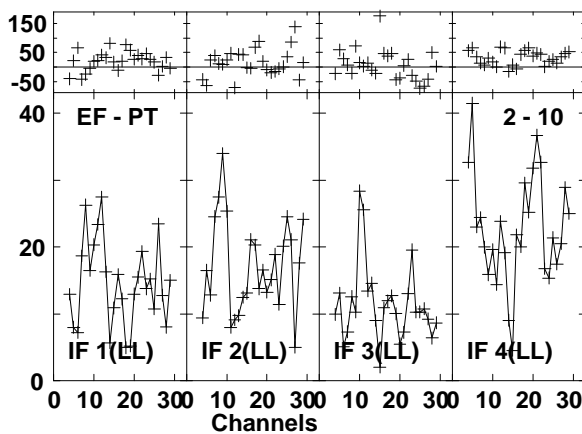
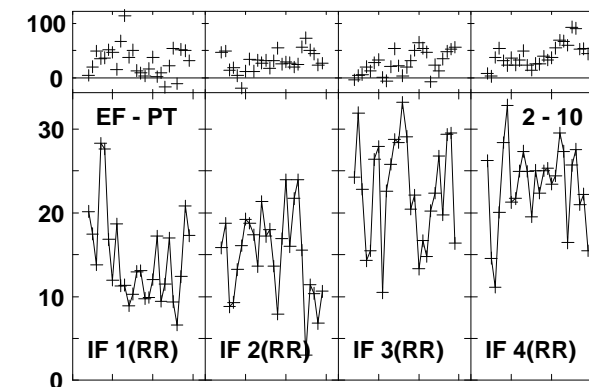
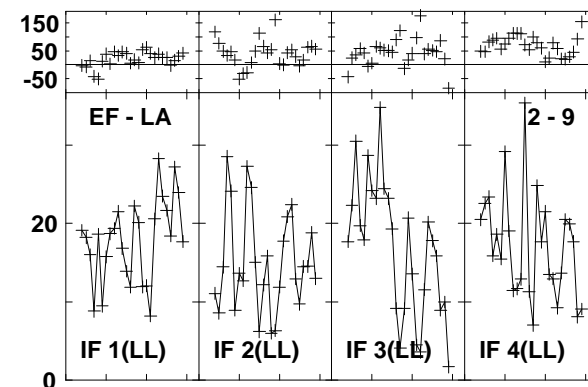
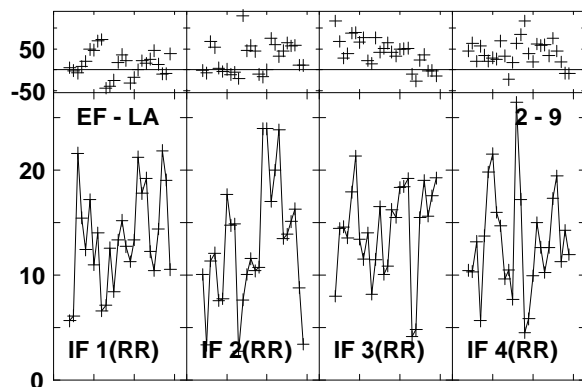
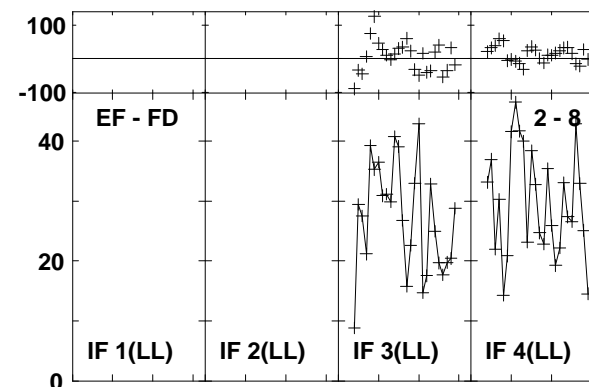
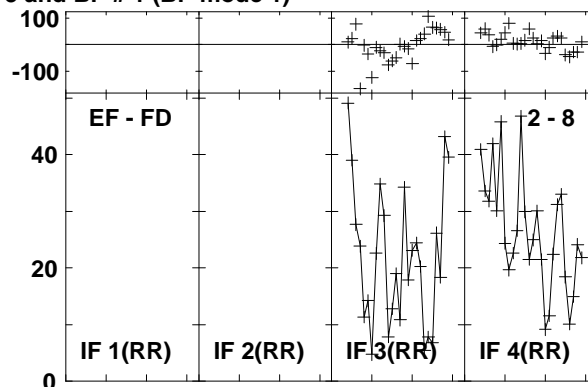
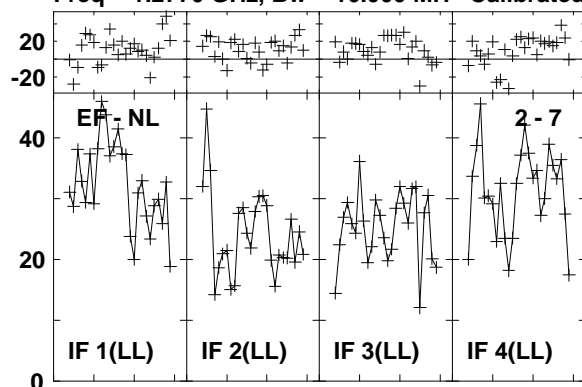

Lower frame: Milli Ampl Jy Top frame: Phas deg
Vector averaged cross-power spectrum Baseline: EF (02) - NL (07)
Timerange: 01/02:57:40 to 01/03:00:54

Plot file version1348 created 03-MAR-2016 01:15:53

4C52 GN002C 1.UVDATA.1

Freq = 1.2770 GHz, Bw = 16.000 MH Calibrated with CL # 3 and BP # 1 (BP mode 1)

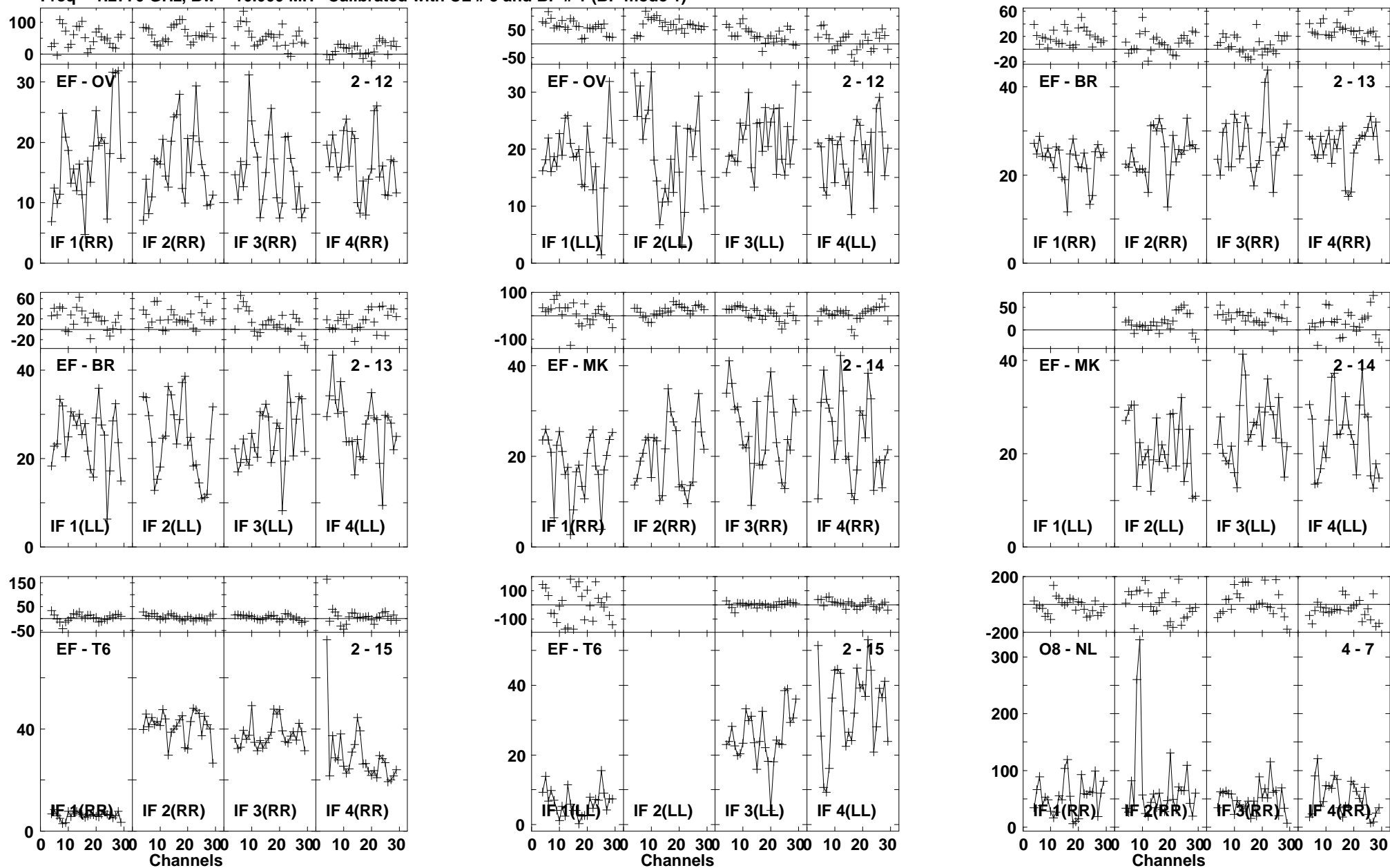

Lower frame: Milli Ampl Jy Top frame: Phas deg
Vector averaged cross-power spectrum Baseline: EF (02) - OV (12)
Timerange: 01/02:57:40 to 01/03:00:54

Plot file version1349 created 03-MAR-2016 01:15:53

4C52 GN002C 1.UVDATA.1

Freq = 1.2770 GHz, Bw = 16.000 MH Calibrated with CL # 3 and BP # 1 (BP mode 1)

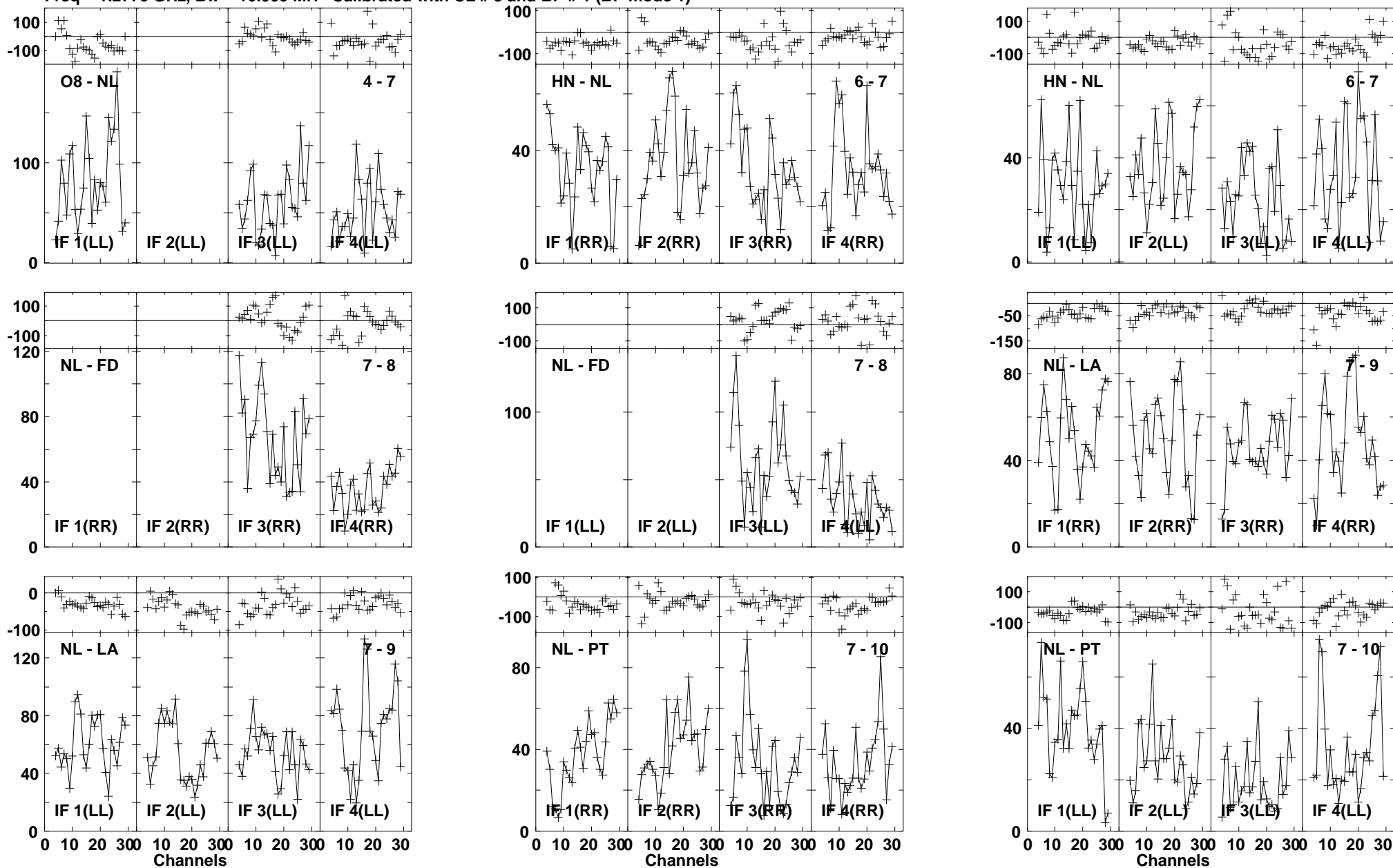

Lower frame: Milli Ampl Jy Top frame: Phas deg
Vector averaged cross-power spectrum Baseline: O8 (04) - NL (07)
Timerange: 01/02:57:40 to 01/03:00:54

Plot file version1350 created 03-MAR-2016 01:15:53

4C52 GN002C 1.UVDATA.1

Freq = 1.2770 GHz, Bw = 16.000 MH Calibrated with CL # 3 and BP # 1 (BP mode 1)

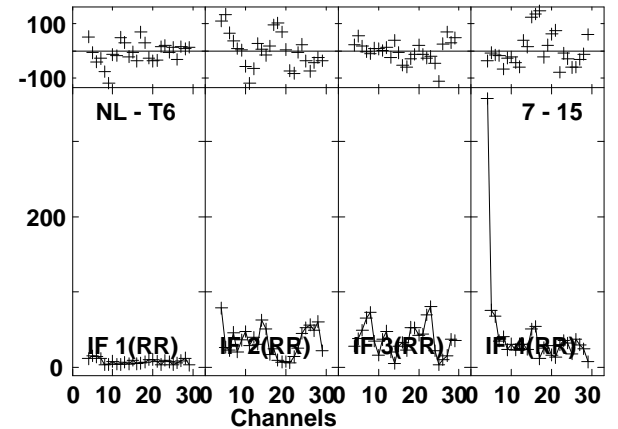
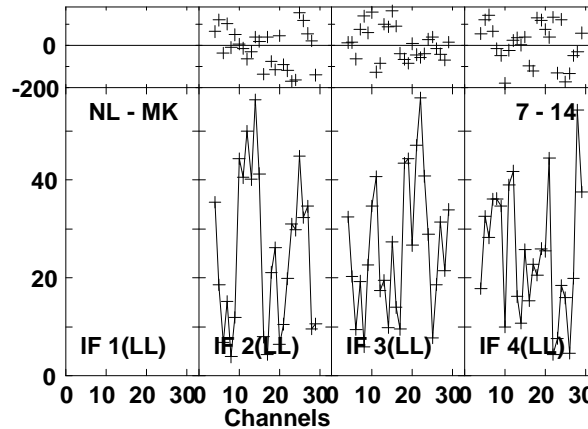
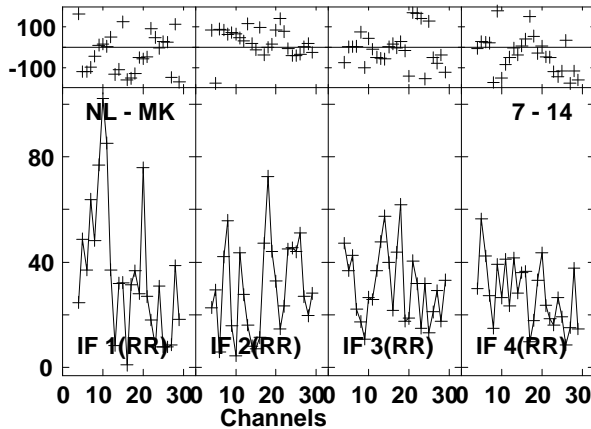
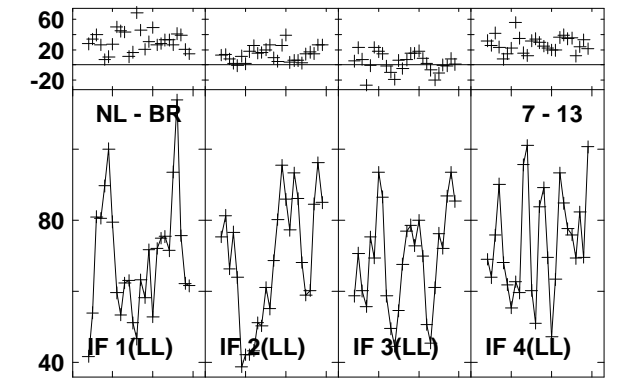
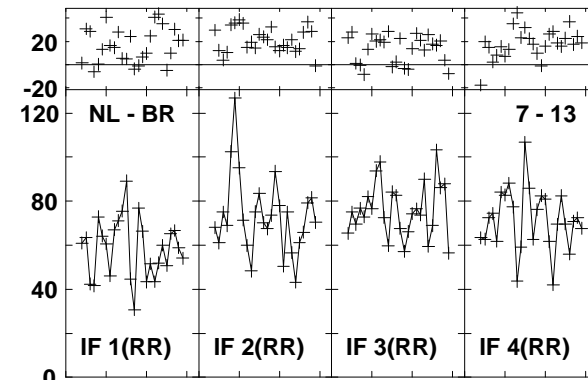
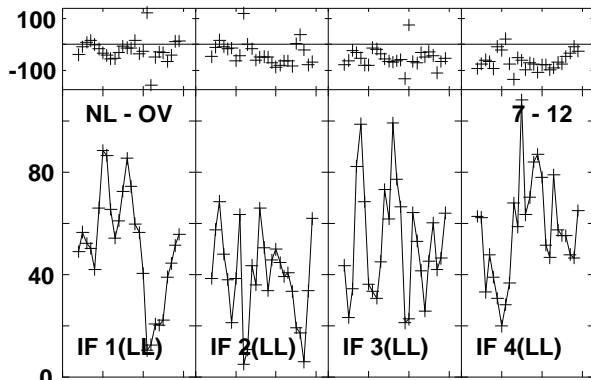
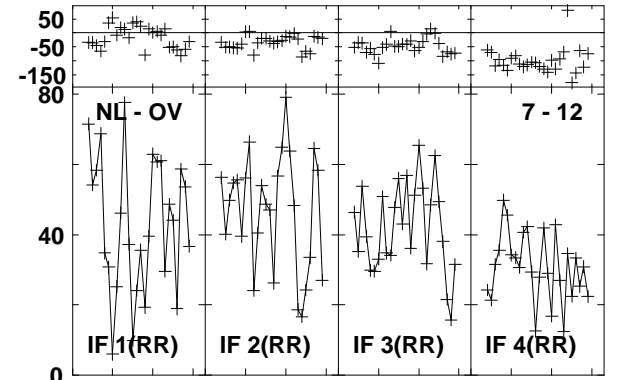
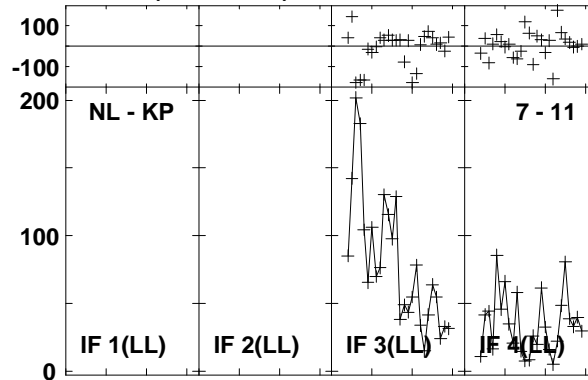
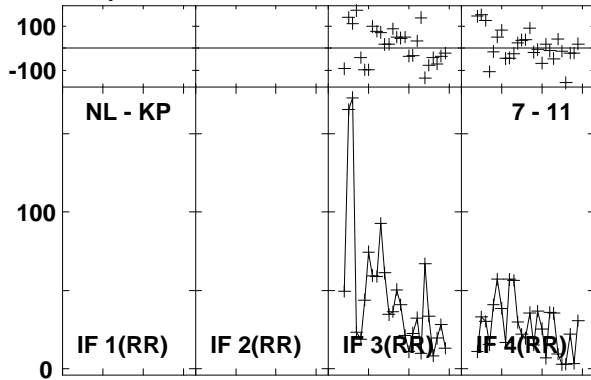

Lower frame: Milli Ampl Jy Top frame: Phas deg
Vector averaged cross-power spectrum Baseline: NL (07) - KP (11)
Timerange: 01/02:57:40 to 01/03:00:54

Plot file version1351 created 03-MAR-2016 01:15:53
4C52 GN002C 1.UVDATA.1
Freq = 1.2770 GHz, Bw = 16.000 MH Calibrated with CL # 3 and BP # 1 (BP mode 1)

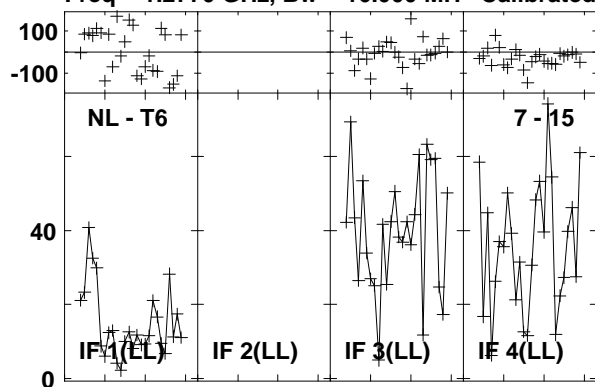

Lower frame: Milli Ampl Jy Top frame: Phas deg
Vector averaged cross-power spectrum Baseline: NL (07) - T6 (15)
Timerange: 01/02:57:40 to 01/03:00:54

Plot file version1352 created 03-MAR-2016 01:15:53

J1545+5400 GN002C 1.UVDATA.1

Freq = 1.2770 GHz, Bw = 16.000 MH Calibrated with CL # 3 and BP # 1 (BP mode 1)

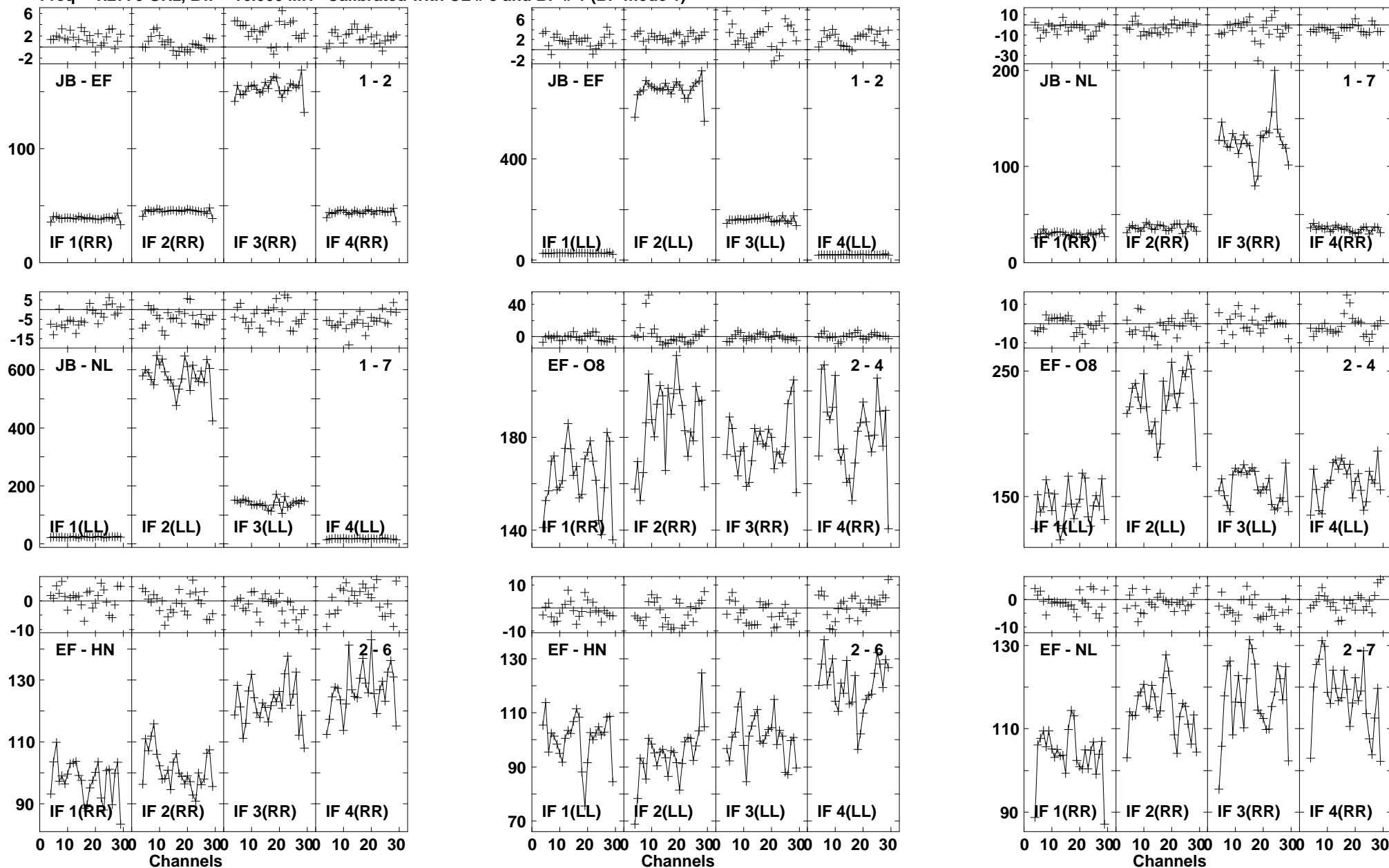

Lower frame: Milli Ampl Jy Top frame: Phas deg
Vector averaged cross-power spectrum Baseline: JB (01) - EF (02)
Timerange: 01/03:01:47 to 01/03:03:45

Plot file version1353 created 03-MAR-2016 01:15:53

J1545+5400 GN002C 1.UVDATA.1

Freq = 1.2770 GHz, Bw = 16.000 MH Calibrated with CL # 3 and BP # 1 (BP mode 1)

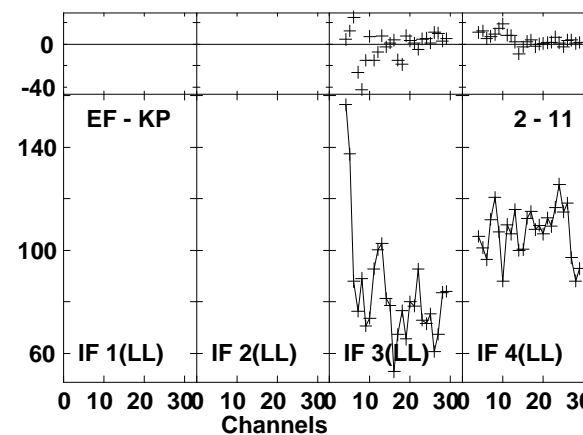
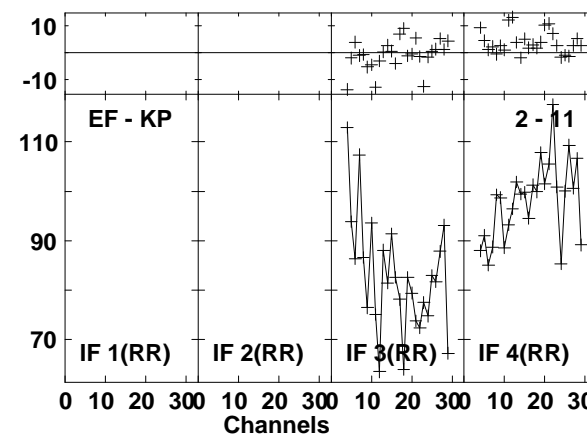
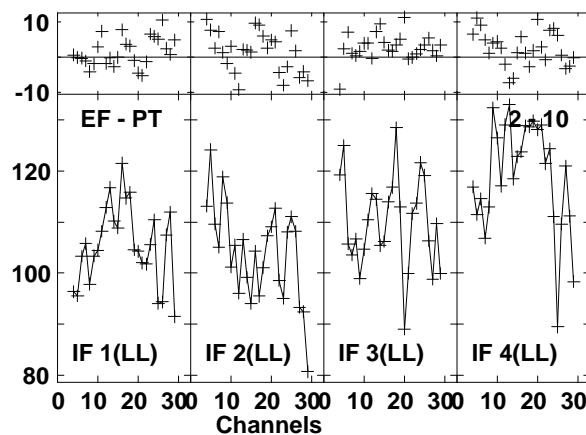
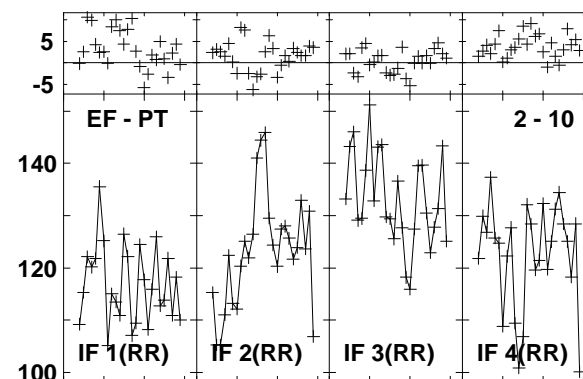
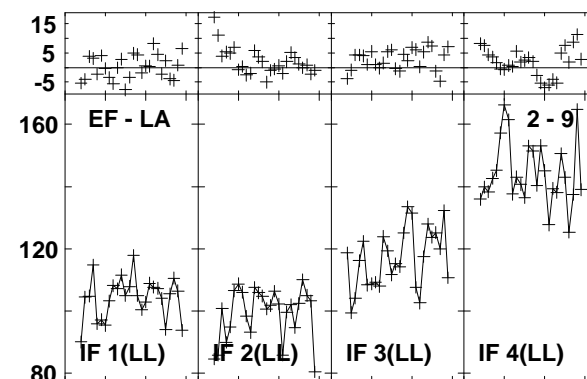
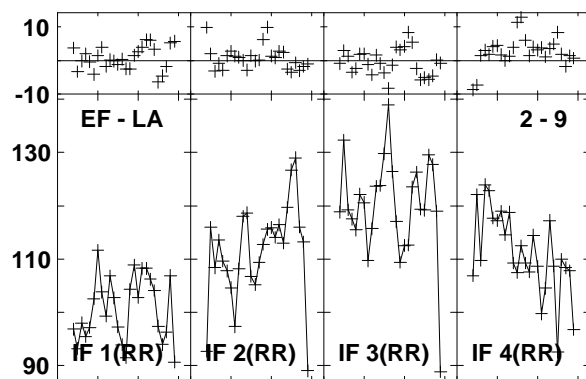
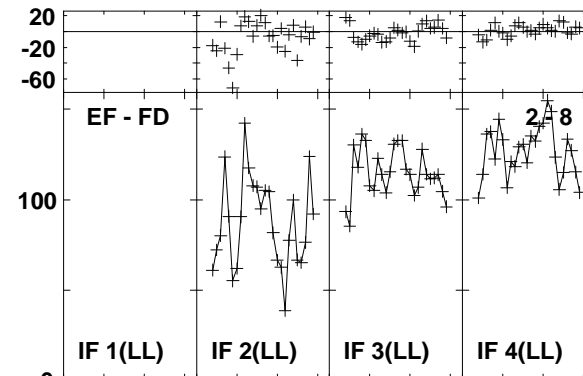
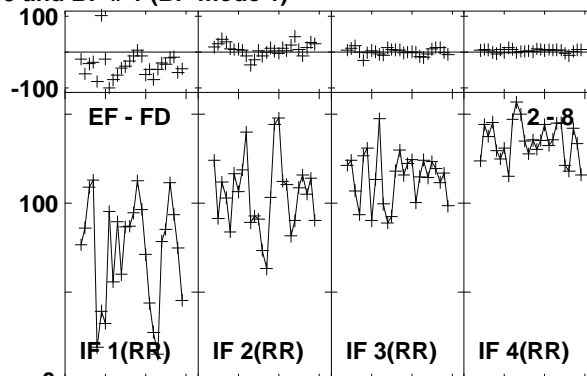
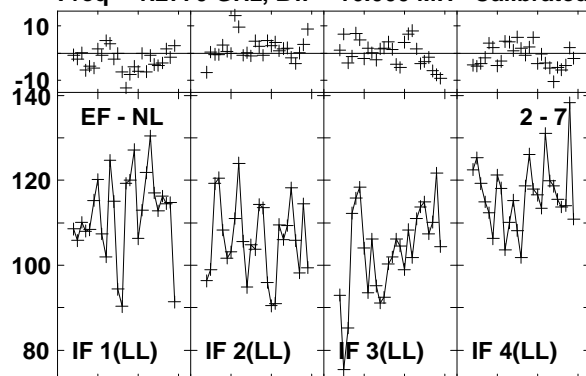

Lower frame: Milli Ampl Jy Top frame: Phas deg
Vector averaged cross-power spectrum Baseline: EF (02) - NL (07)
Timerange: 01/03:01:47 to 01/03:03:45

Plot file version1354 created 03-MAR-2016 01:15:54

J1545+5400 GN002C 1.UVDATA.1

Freq = 1.2770 GHz, Bw = 16.000 MH Calibrated with CL # 3 and BP # 1 (BP mode 1)

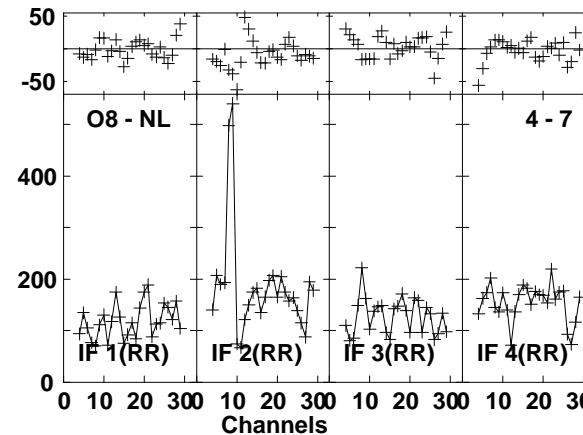
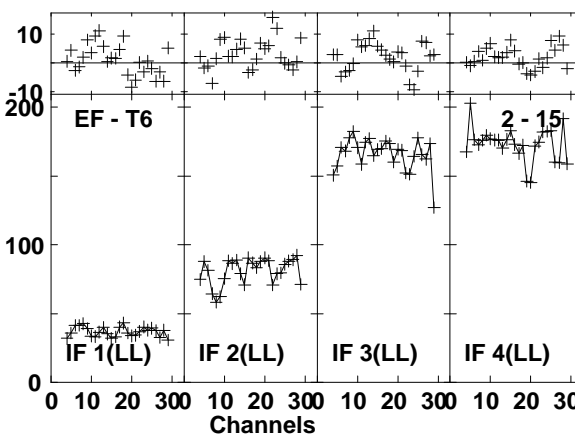
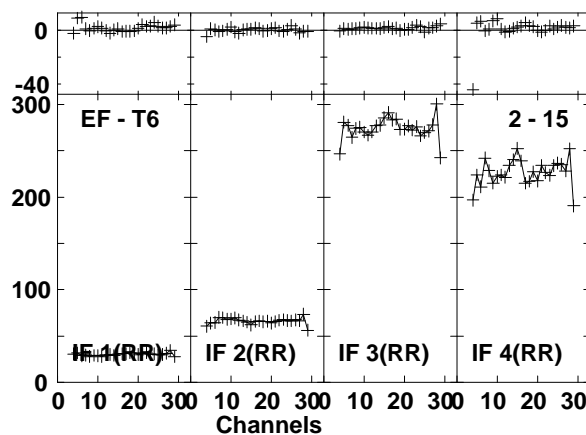
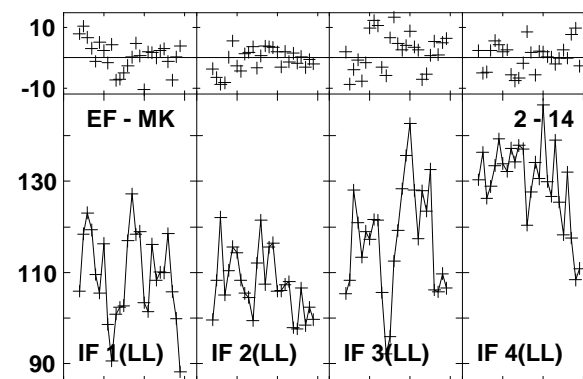
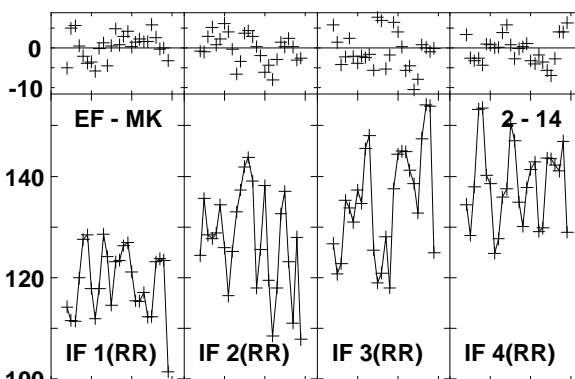
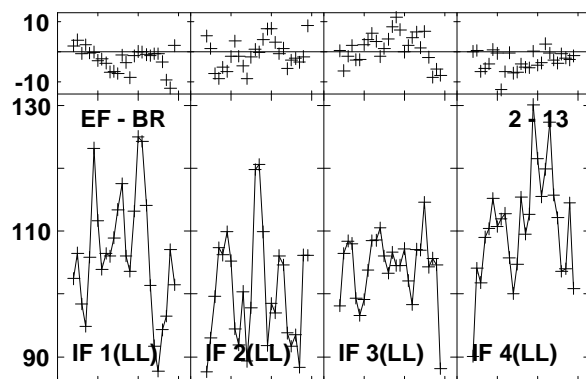
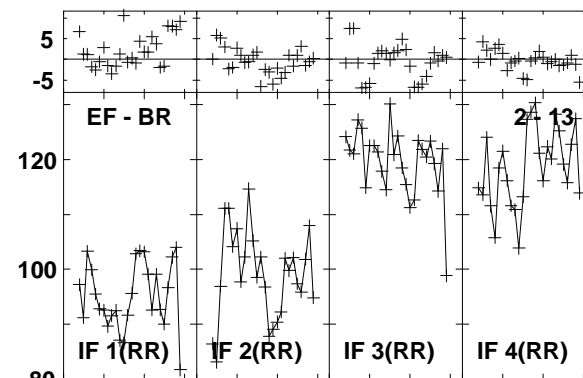
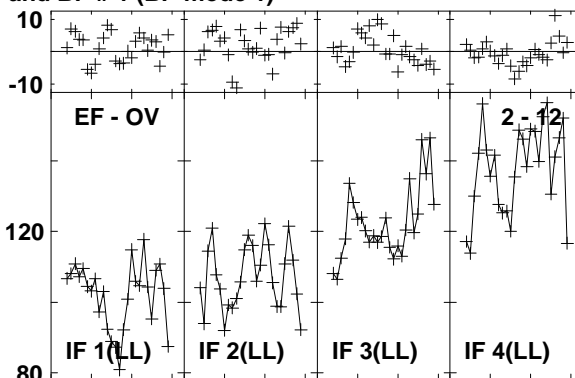
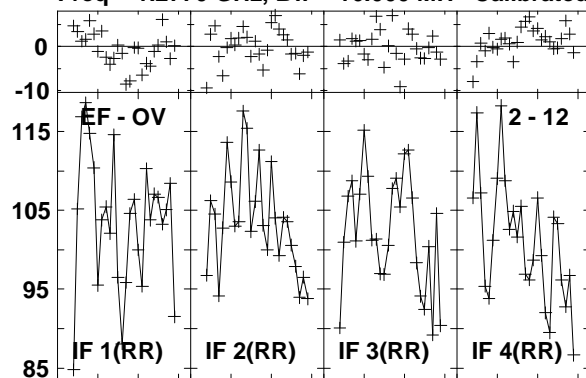

Lower frame: Milli Ampl Jy Top frame: Phas deg
Vector averaged cross-power spectrum Baseline: EF (02) - OV (12)
Timerange: 01/03:01:47 to 01/03:03:45

Plot file version1355 created 03-MAR-2016 01:15:54

J1545+5400 GN002C 1.UVDATA.1

Freq = 1.2770 GHz, Bw = 16.000 MH Calibrated with CL # 3 and BP # 1 (BP mode 1)

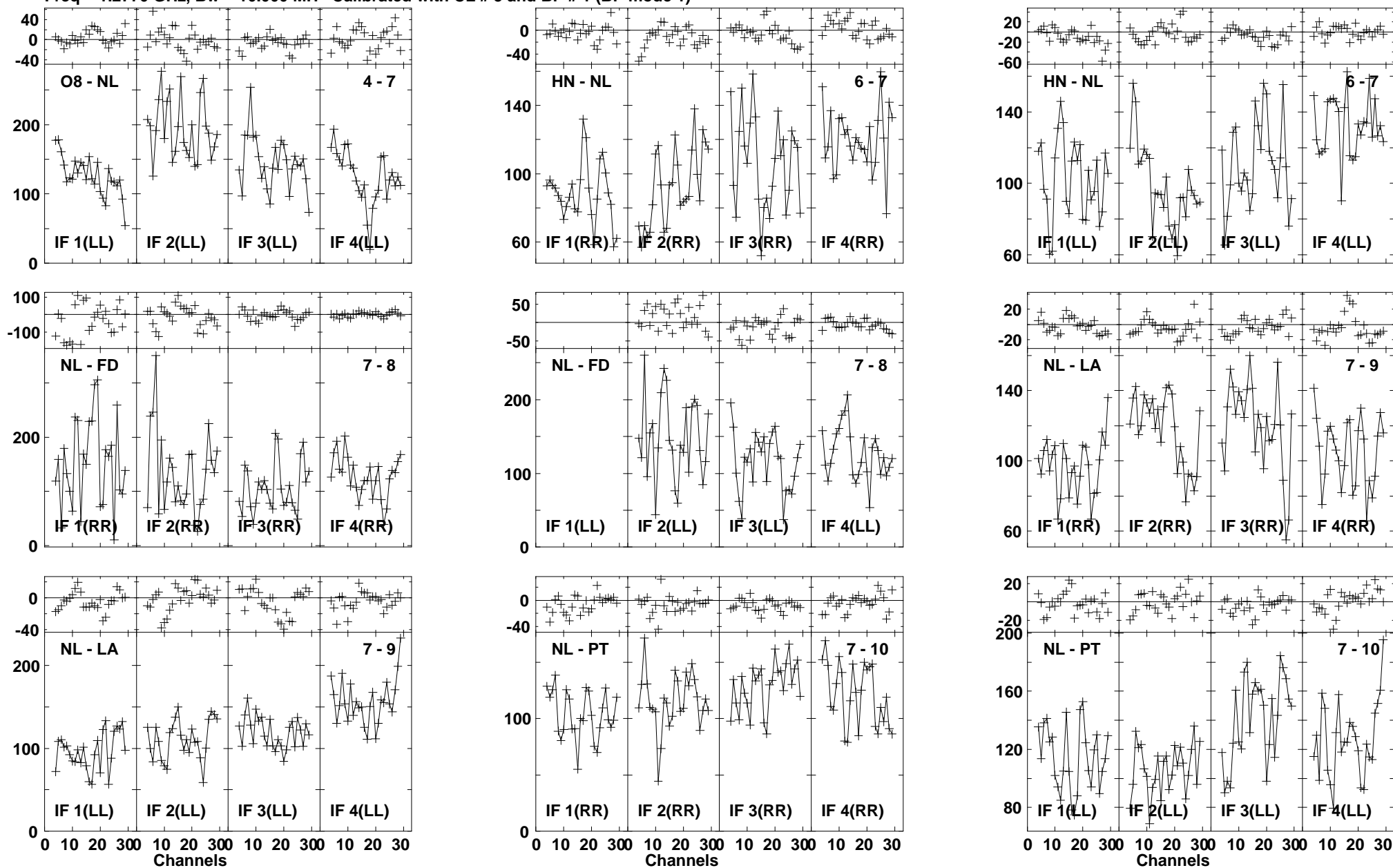

Lower frame: Milli Ampl Jy Top frame: Phas deg
Vector averaged cross-power spectrum Baseline: O8 (04) - NL (07)
Timerange: 01/03:01:47 to 01/03:03:45

Plot file version1356 created 03-MAR-2016 01:15:54

J1545+5400 GN002C 1.UVDATA.1

Freq = 1.2770 GHz, Bw = 16.000 MH Calibrated with CL # 3 and BP # 1 (BP mode 1)

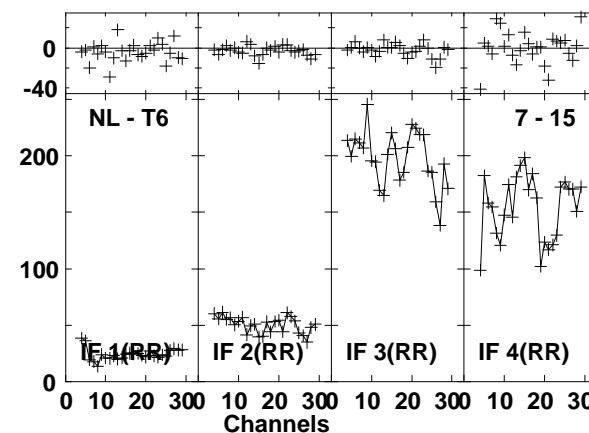
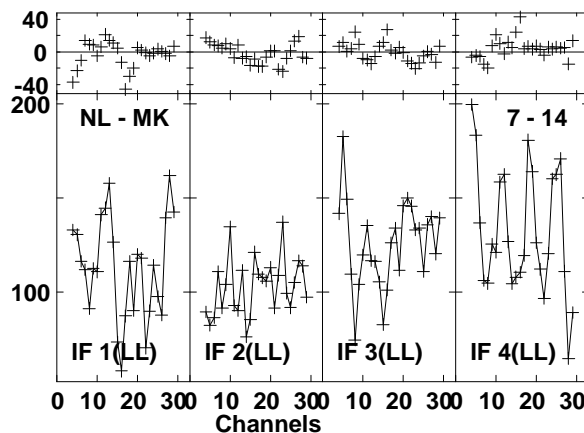
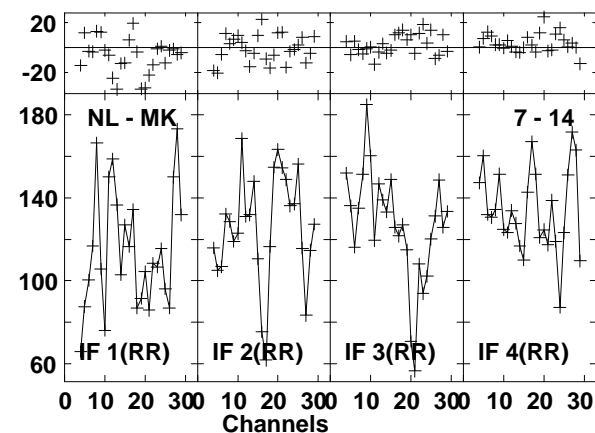
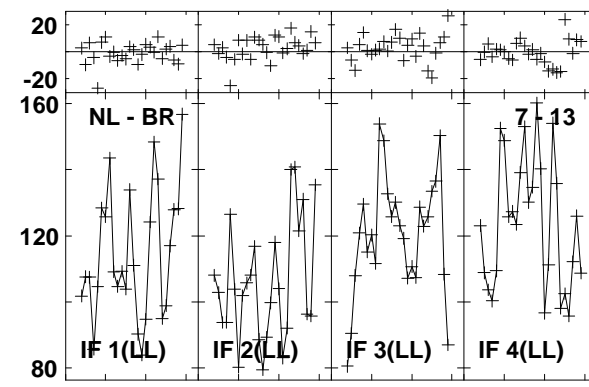
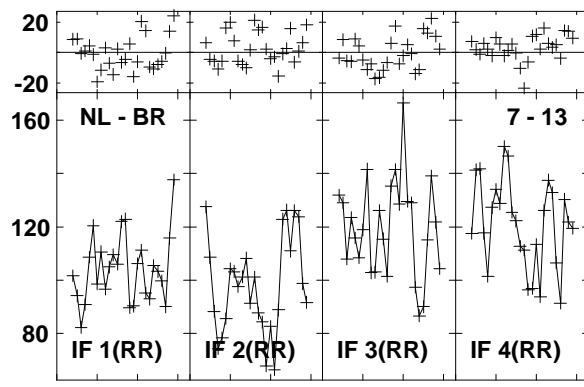
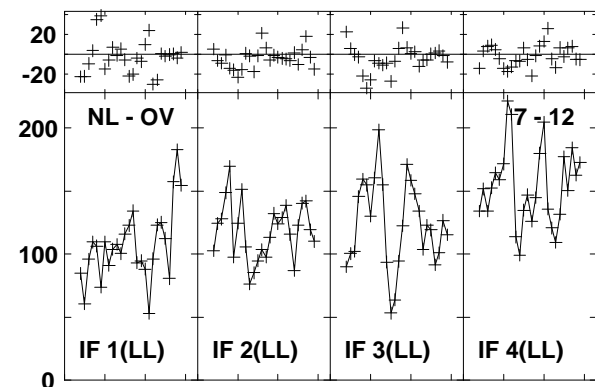
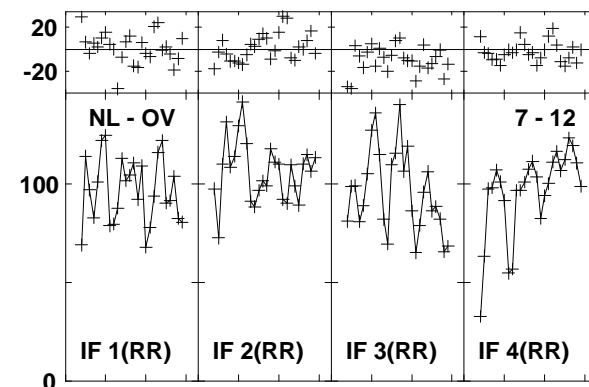
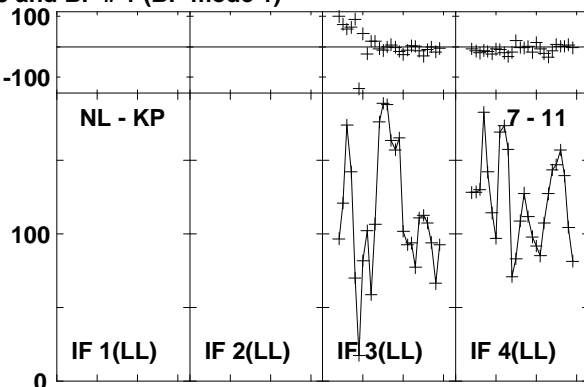
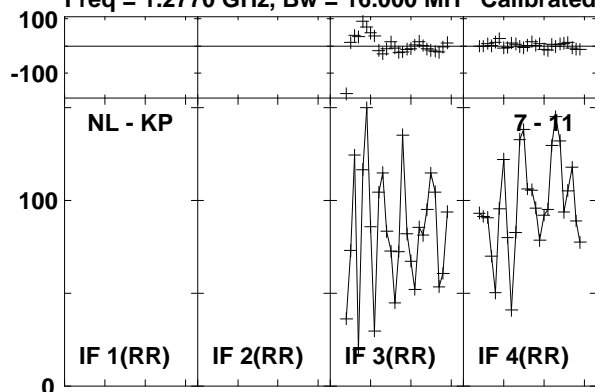

Lower frame: Milli Ampl Jy Top frame: Phas deg
Vector averaged cross-power spectrum Baseline: NL (07) - KP (11)
Timerange: 01/03:01:47 to 01/03:03:45

Plot file version1357 created 03-MAR-2016 01:15:54
J1545+5400 GN002C 1.UVDATA.1
Freq = 1.2770 GHz, Bw = 16.000 MH Calibrated with CL # 3 and BP # 1 (BP mode 1)

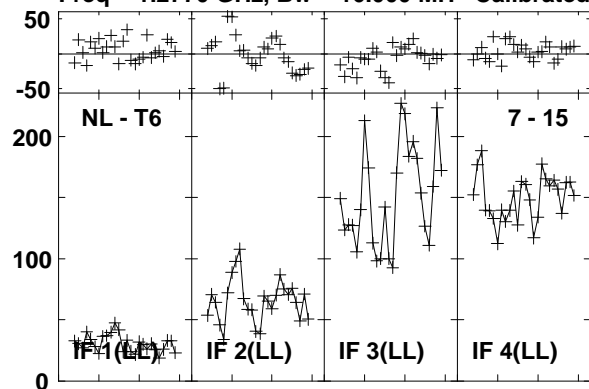

Lower frame: Milli Ampl Jy Top frame: Phas deg
Vector averaged cross-power spectrum Baseline: NL (07) - T6 (15)
Timerange: 01/03:01:47 to 01/03:03:45

Plot file version1358 created 03-MAR-2016 01:15:54

4C52 GN002C 1.UVDATA.1

Freq = 1.2770 GHz, Bw = 16.000 MH Calibrated with CL # 3 and BP # 1 (BP mode 1)

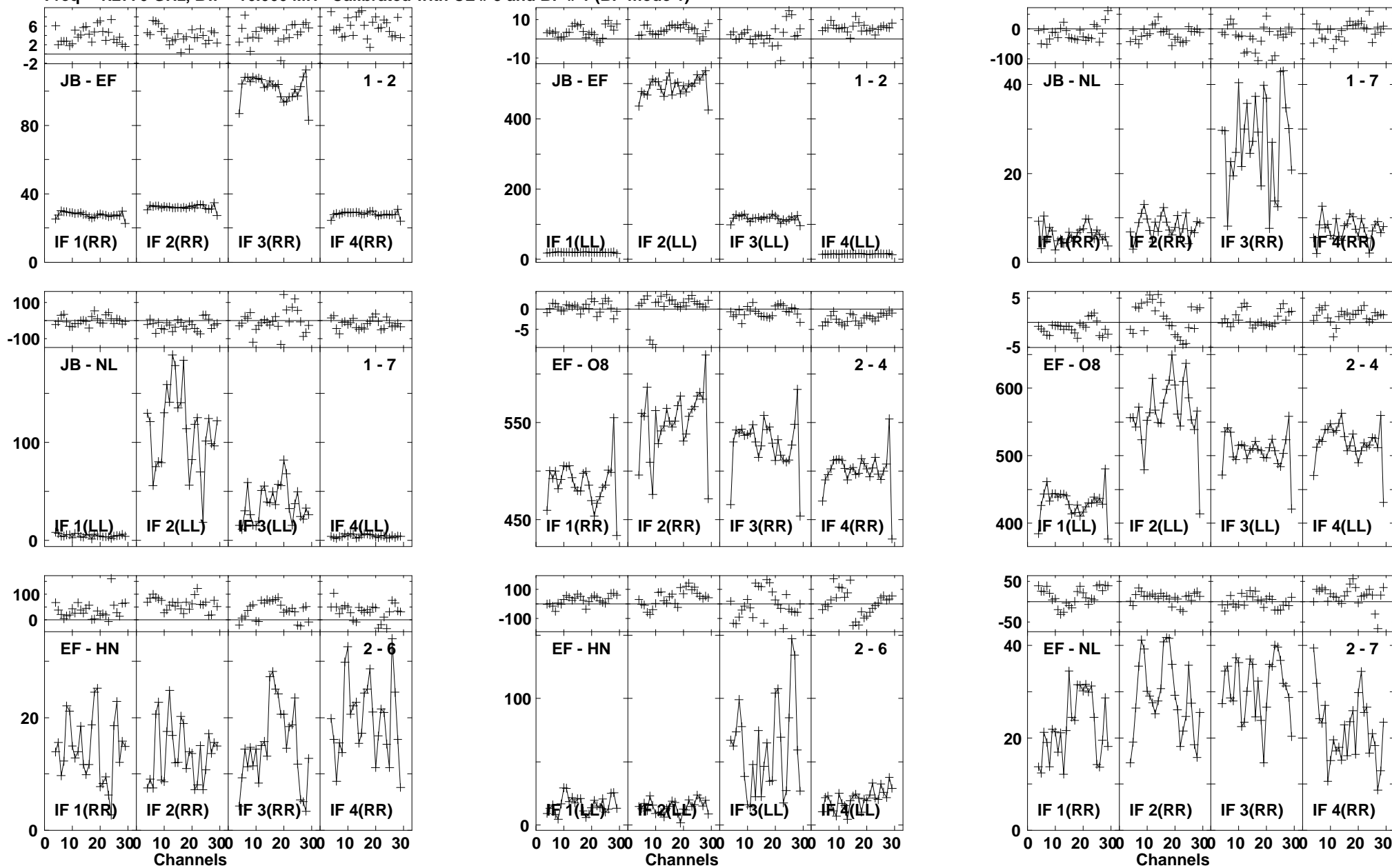

Lower frame: Milli Ampl Jy Top frame: Phas deg
Vector averaged cross-power spectrum Baseline: JB (01) - EF (02)
Timerange: 01/03:03:57 to 01/03:06:45

Plot file version1359 created 03-MAR-2016 01:15:54

4C52 GN002C 1.UVDATA.1

Freq = 1.2770 GHz, Bw = 16.000 MH Calibrated with CL # 3 and BP # 1 (BP mode 1)

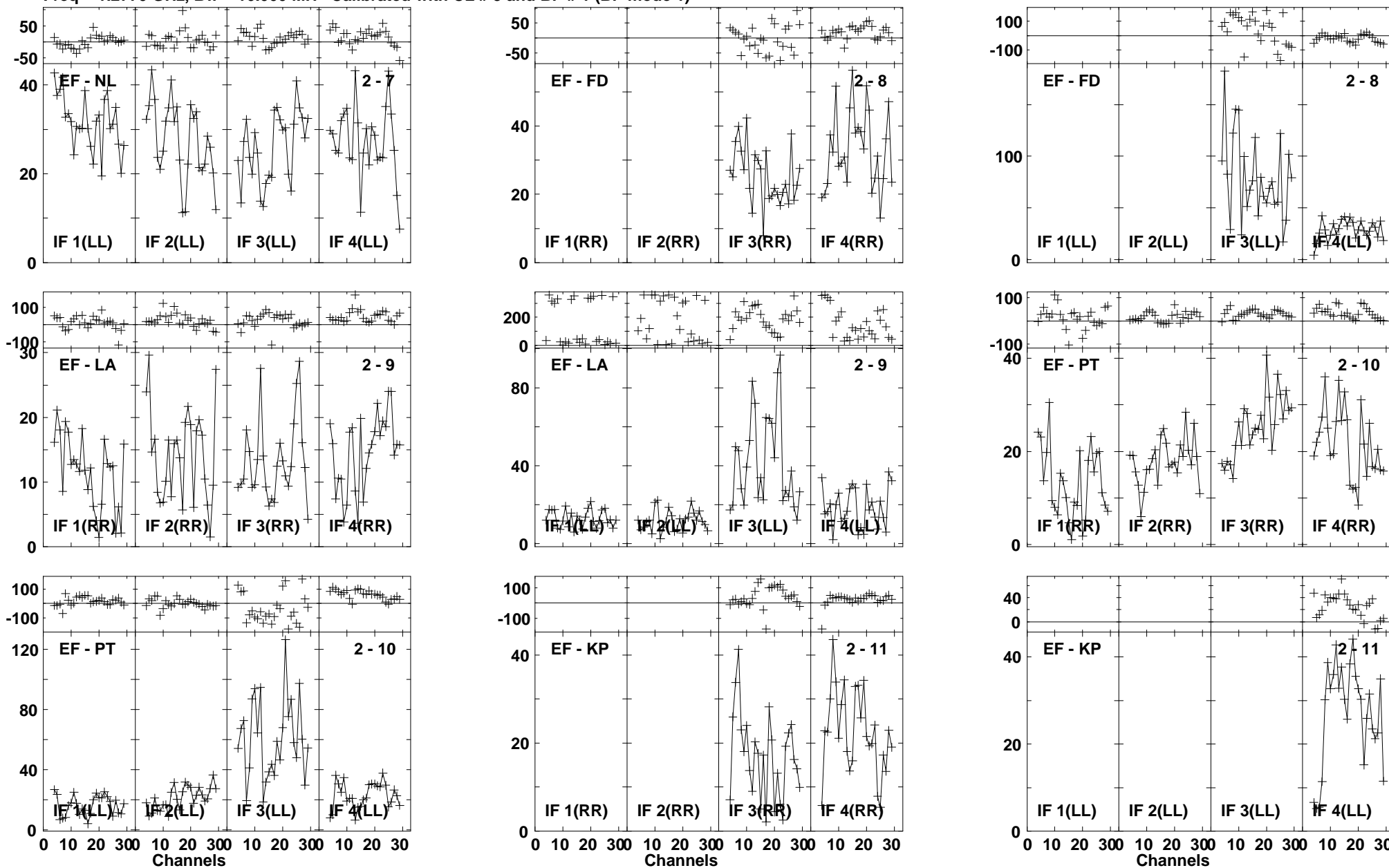

Lower frame: Milli Ampl Jy Top frame: Phas deg
Vector averaged cross-power spectrum Baseline: EF (02) - NL (07)
Timerange: 01/03:03:57 to 01/03:06:45

Plot file version1360 created 03-MAR-2016 01:15:55

4C52 GN002C 1.UVDATA.1

Freq = 1.2770 GHz, Bw = 16.000 MH Calibrated with CL # 3 and BP # 1 (BP mode 1)

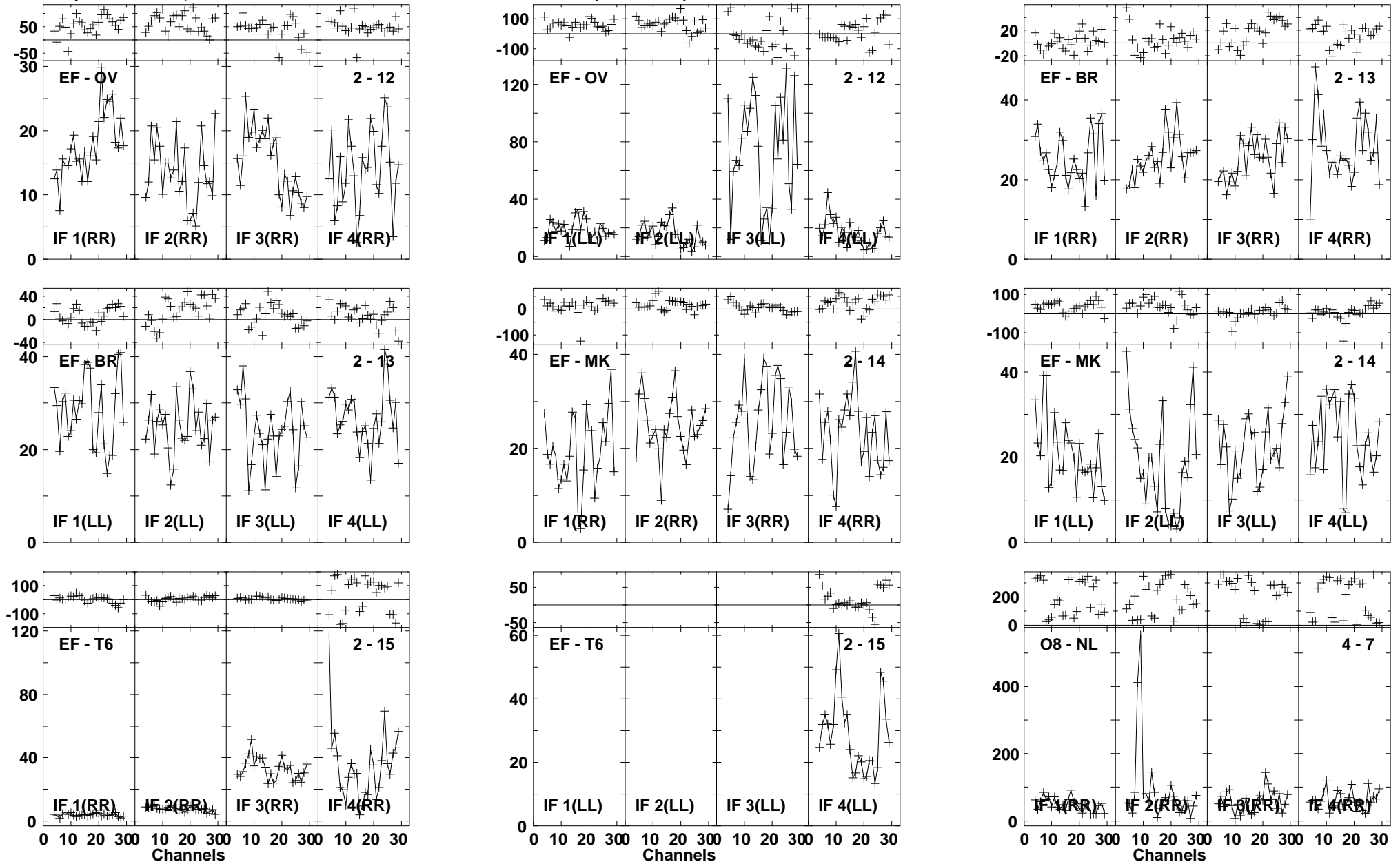

Plot file version1361 created 03-MAR-2016 01:15:55

4C52 GN002C 1.UVDATA.1

Freq = 1.2770 GHz, Bw = 16.000 MH Calibrated with CL # 3 and BP # 1 (BP mode 1)

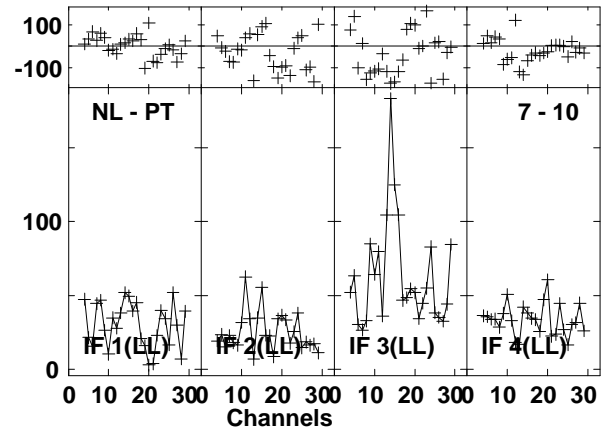
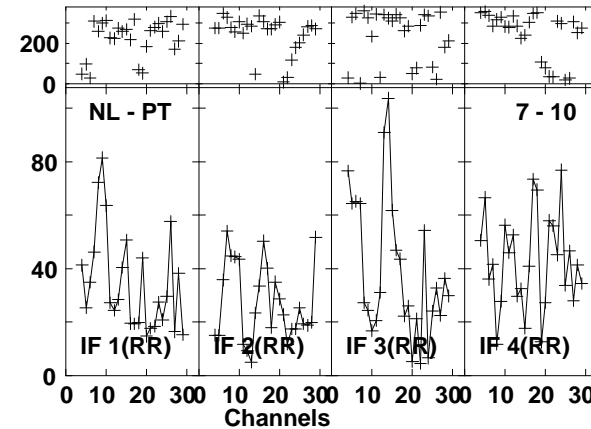
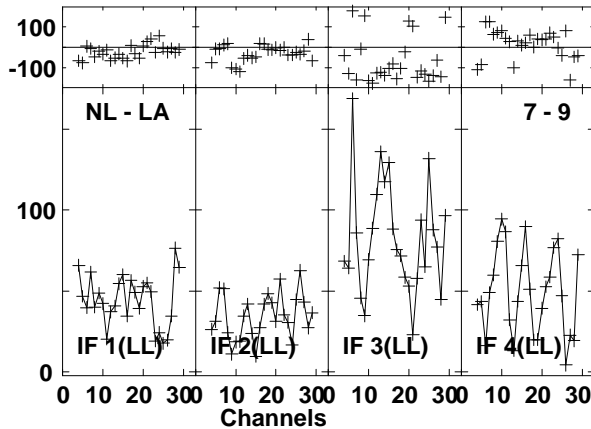
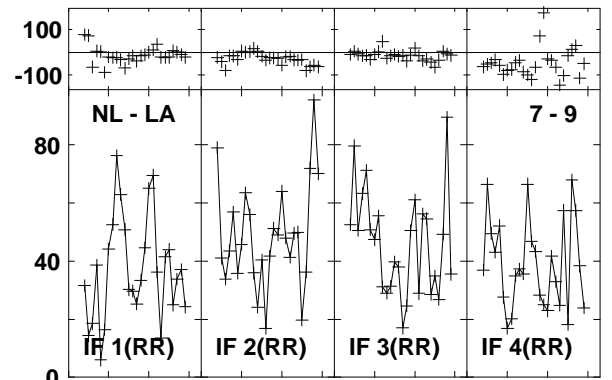
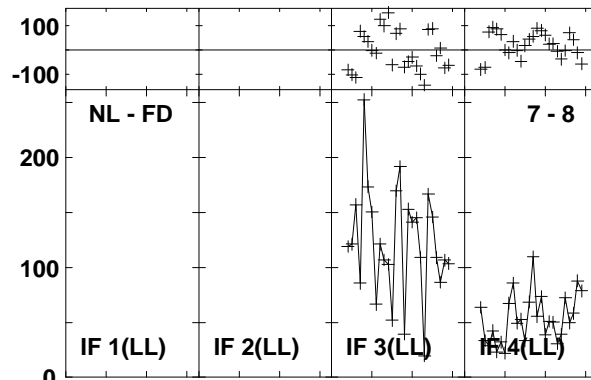
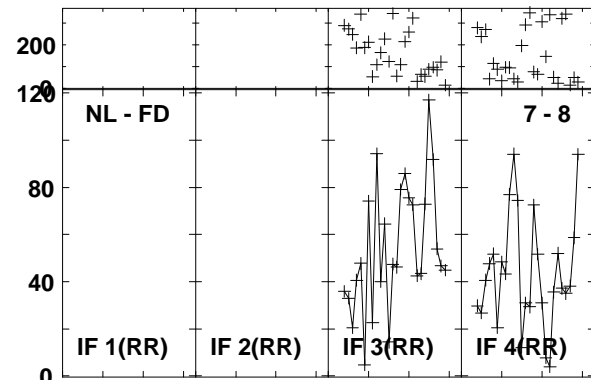
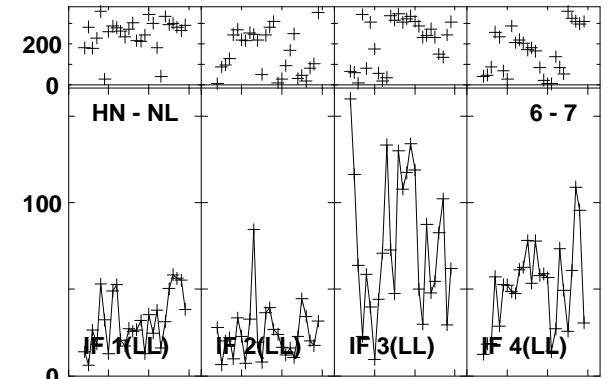
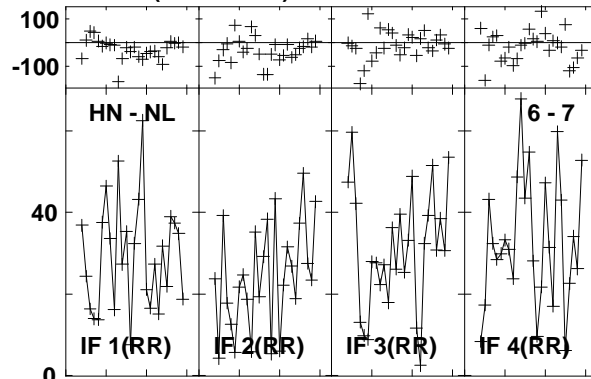
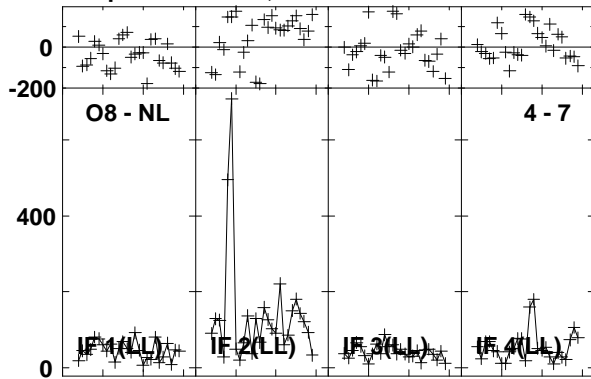

Lower frame: Milli Ampl Jy Top frame: Phas deg
Vector averaged cross-power spectrum Baseline: O8 (04) - NL (07)
Timerange: 01/03:03:57 to 01/03:06:45

Plot file version1362 created 03-MAR-2016 01:15:55

4C52 GN002C 1.UVDATA.1

Freq = 1.2770 GHz, Bw = 16.000 MH Calibrated with CL # 3 and BP # 1 (BP mode 1)

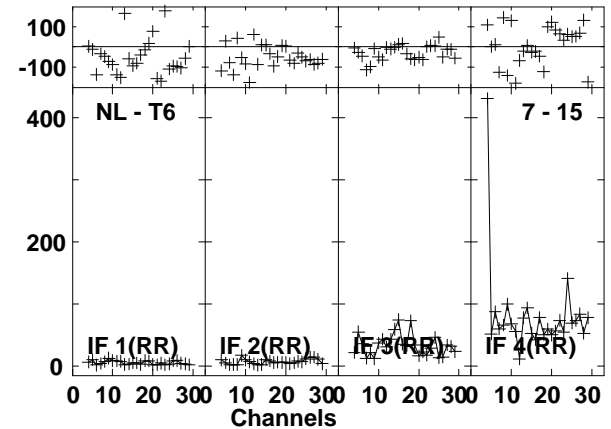
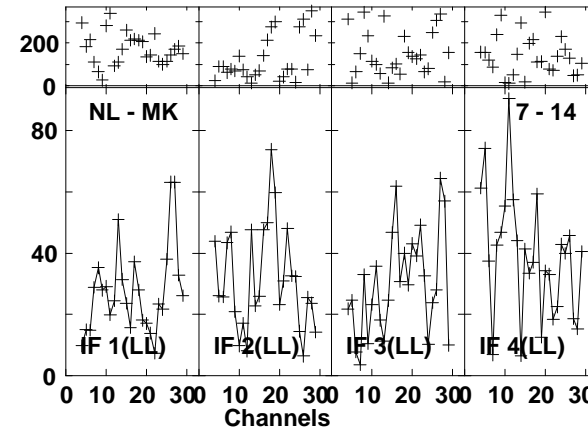
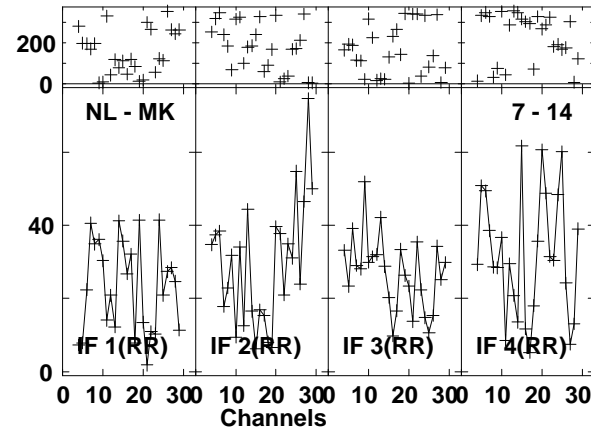
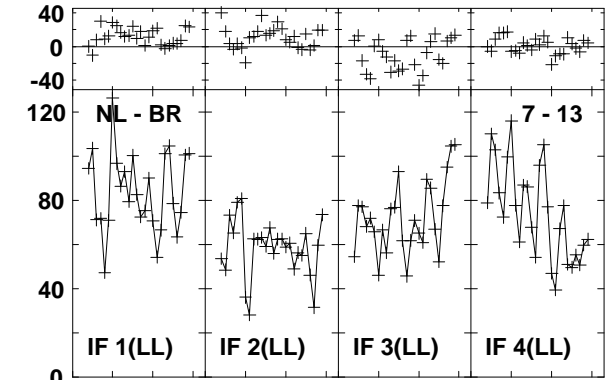
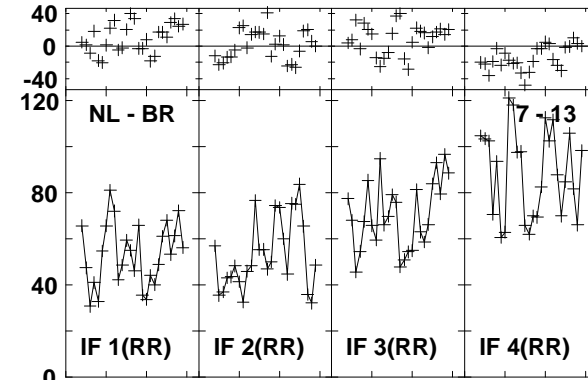
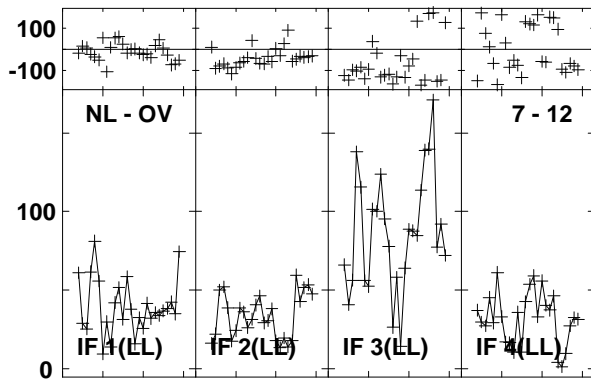
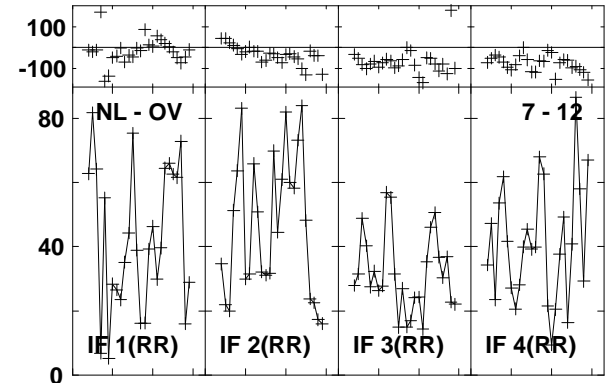
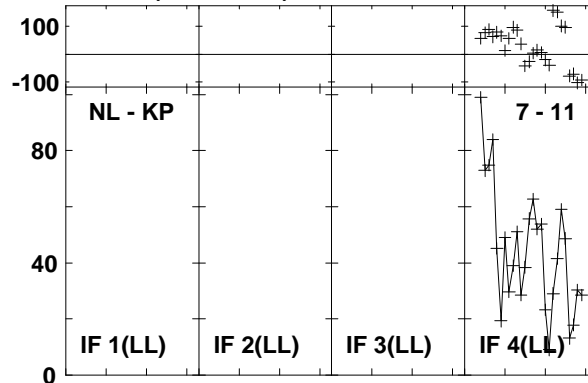
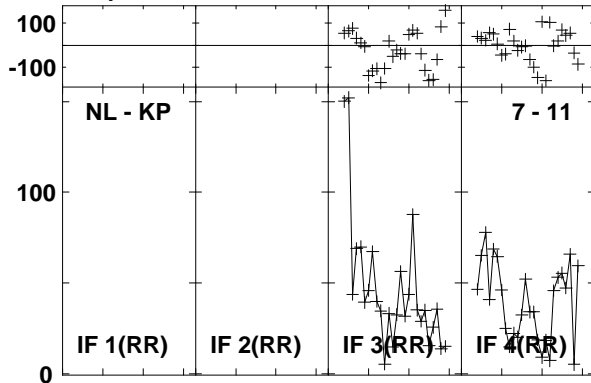

Lower frame: Milli Ampl Jy Top frame: Phas deg

Vector averaged cross-power spectrum Baseline: NL (07) - KP (11)

Timerange: 01/03:03:57 to 01/03:06:45

Plot file version1363 created 03-MAR-2016 01:15:55
4C52 GN002C 1.UVDATA.1
Freq = 1.2770 GHz, Bw = 16.000 MH Calibrated with CL # 3 and BP # 1 (BP mode 1)

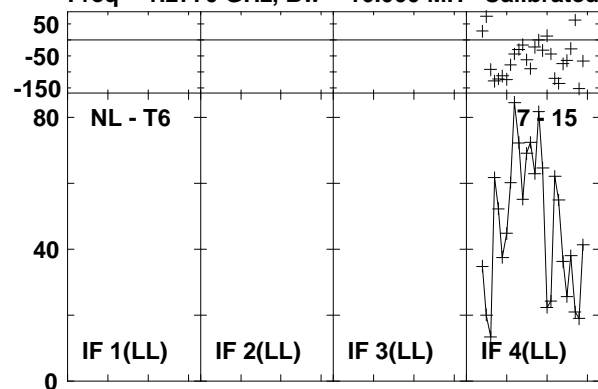

Lower frame: Milli Ampl Jy Top frame: Phas deg
Vector averaged cross-power spectrum Baseline: NL (07) - T6 (15)
Timerange: 01/03:03:57 to 01/03:06:45

Plot file version1364 created 03-MAR-2016 01:15:55

J1545+5400 GN002C 1.UVDATA.1

Freq = 1.2770 GHz, Bw = 16.000 MH Calibrated with CL # 3 and BP # 1 (BP mode 1)

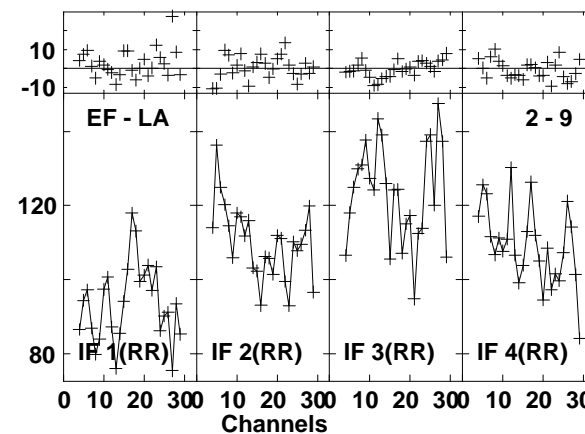
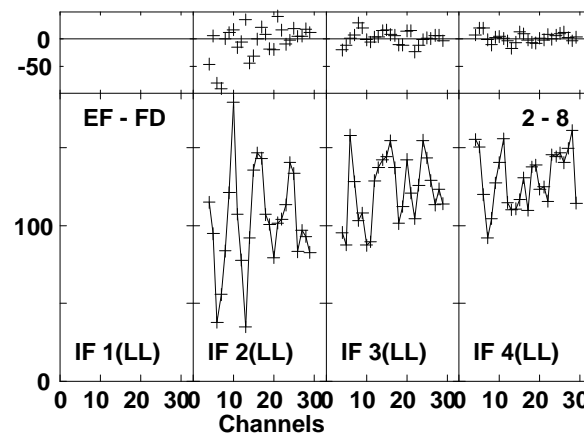
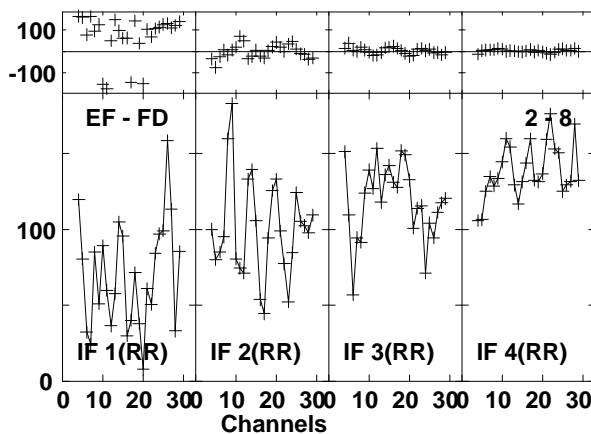
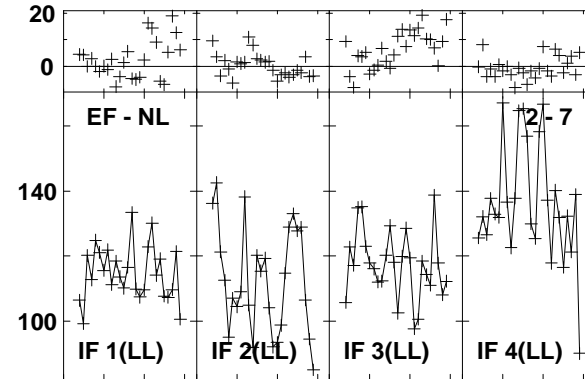
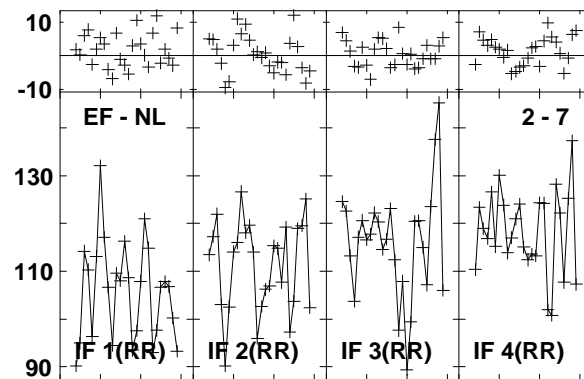
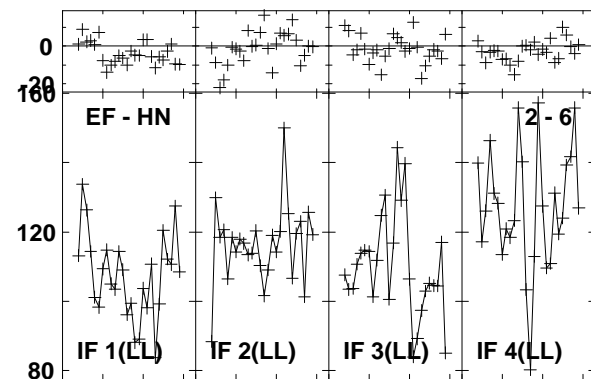
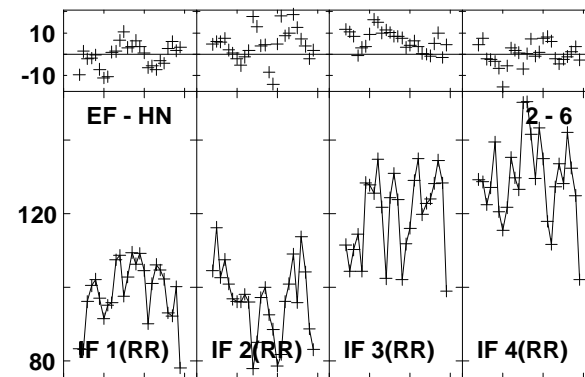
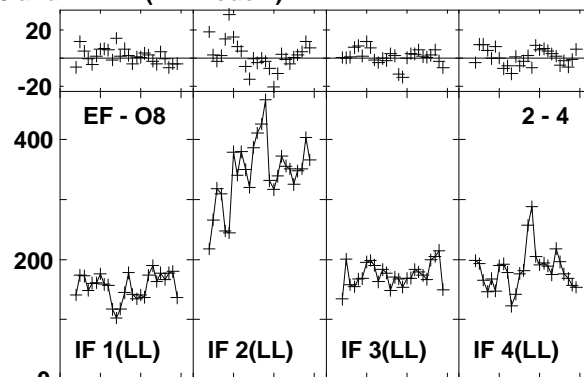
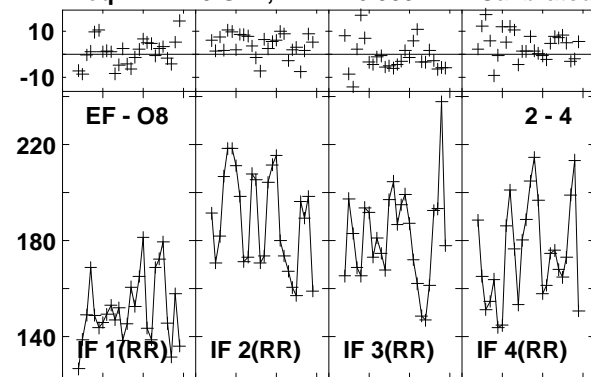

Lower frame: Milli Ampl Jy Top frame: Phas deg
Vector averaged cross-power spectrum Baseline: EF (02) - O8 (04)
Timerange: 01/03:07:37 to 01/03:08:35

Plot file version1365 created 03-MAR-2016 01:15:56

J1545+5400 GN002C 1.UVDATA.1

Freq = 1.2770 GHz, Bw = 16.000 MH Calibrated with CL # 3 and BP # 1 (BP mode 1)

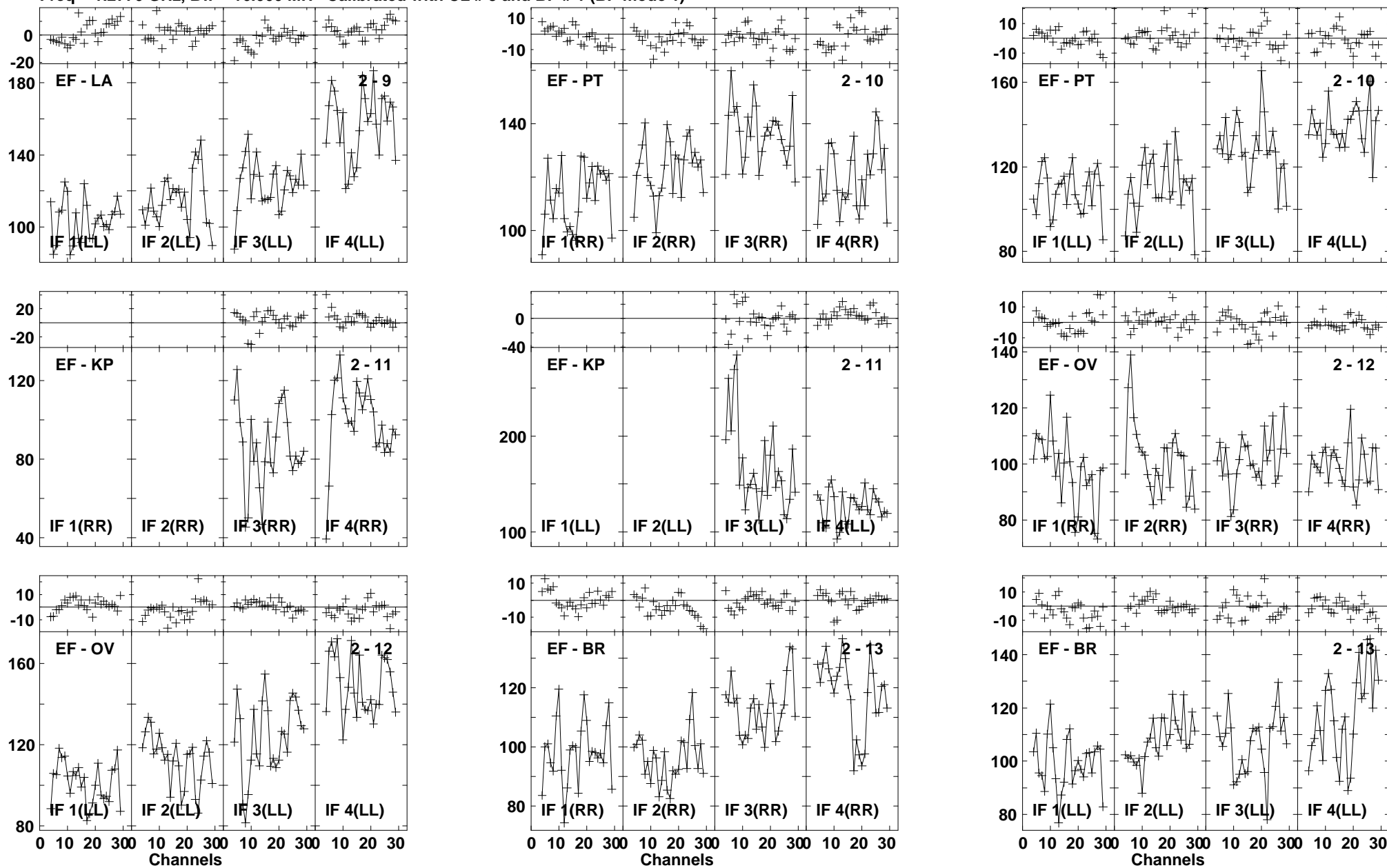

Lower frame: Milli Ampl Jy Top frame: Phas deg
Vector averaged cross-power spectrum Baseline: EF (02) - LA (09)
Timerange: 01/03:07:37 to 01/03:08:35

Plot file version1366 created 03-MAR-2016 01:15:56

J1545+5400 GN002C 1.UVDATA.1

Freq = 1.2770 GHz, Bw = 16.000 MH Calibrated with CL # 3 and BP # 1 (BP mode 1)

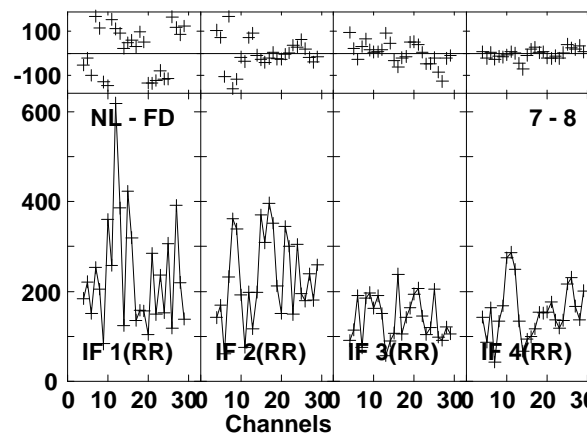
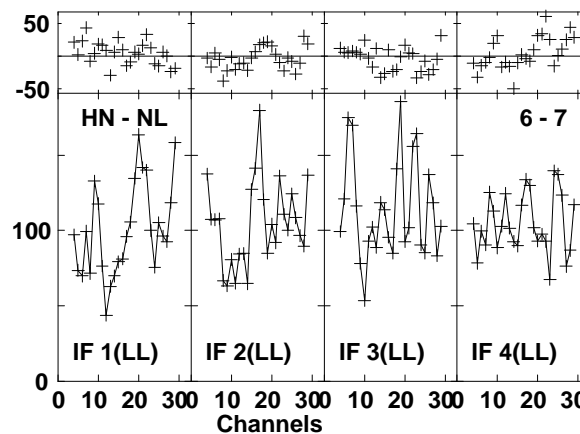
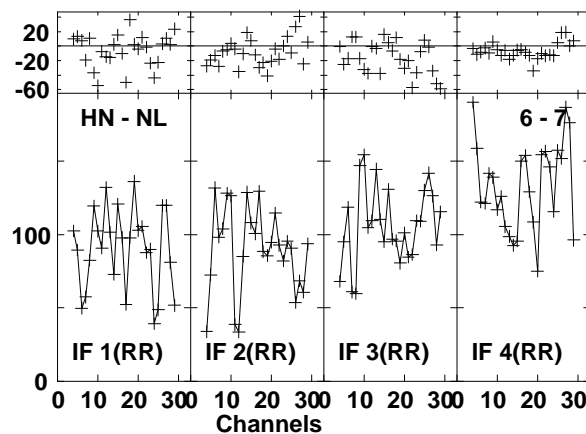
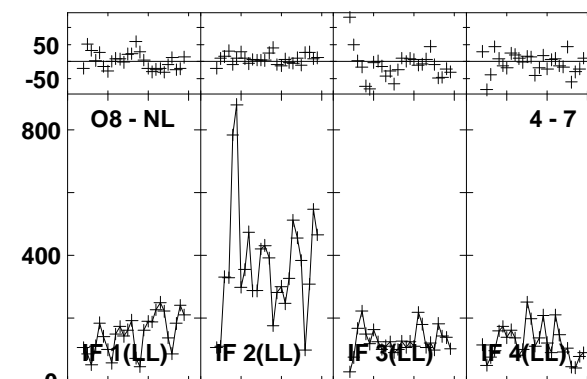
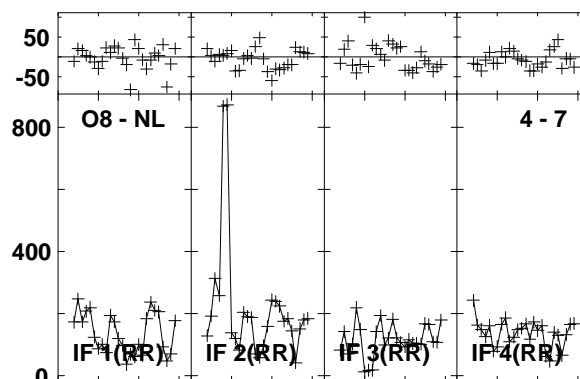
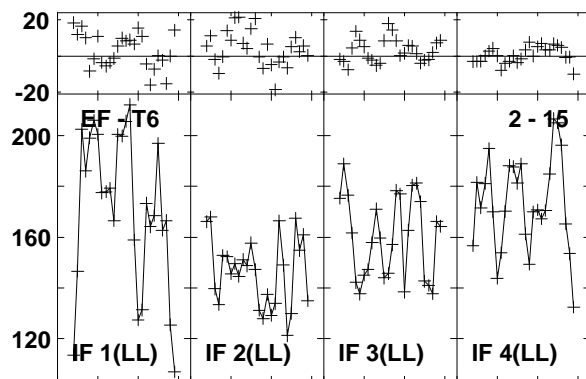
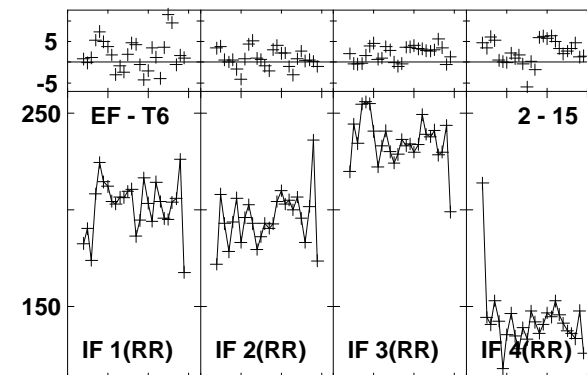
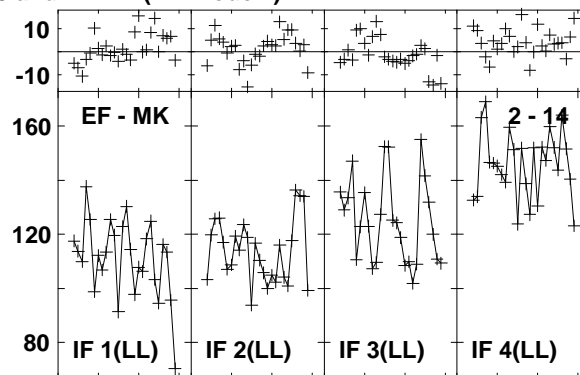
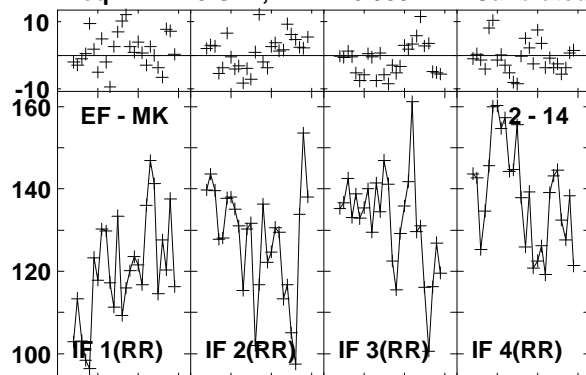

Lower frame: Milli Ampl Jy Top frame: Phas deg
Vector averaged cross-power spectrum Baseline: EF (02) - MK (14)
Timerange: 01/03:07:37 to 01/03:08:35

Plot file version1367 created 03-MAR-2016 01:15:56
 J1545+5400 GN002C 1.UVDATA.1
 Freq = 1.2770 GHz, Bw = 16.000 MH Calibrated with CL # 3 and BP # 1 (BP mode 1)

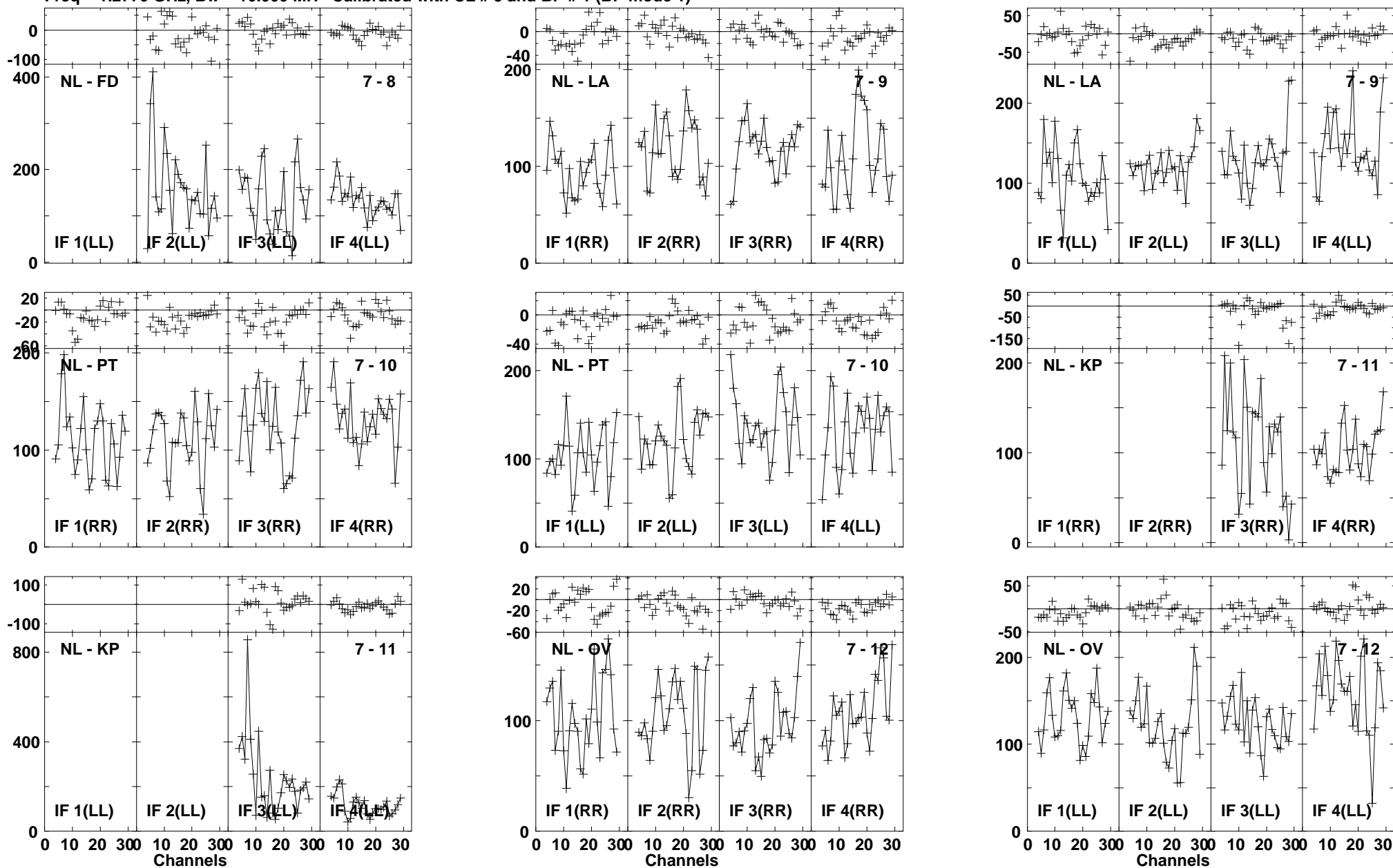

Lower frame: Milli Ampl Jy Top frame: Phas deg
 Vector averaged cross-power spectrum Baseline: NL (07) - FD (08)
 Timerange: 01/03:07:37 to 01/03:08:35

Plot file version1368 created 03-MAR-2016 01:15:56

J1545+5400 GN002C 1.UVDATA.1

Freq = 1.2770 GHz, Bw = 16.000 MH Calibrated with CL # 3 and BP # 1 (BP mode 1)

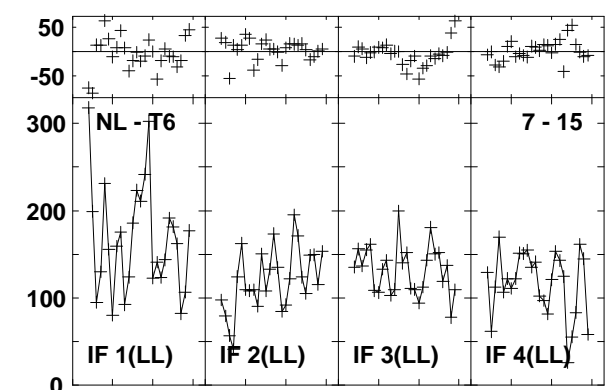
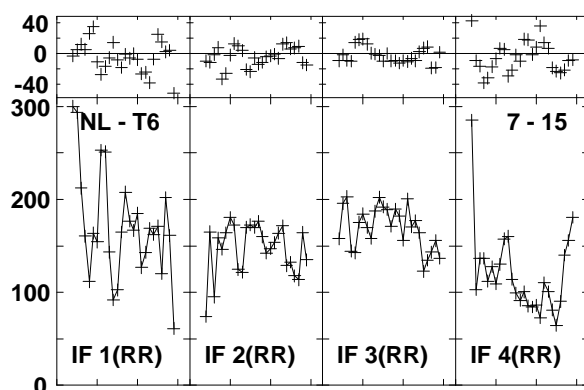
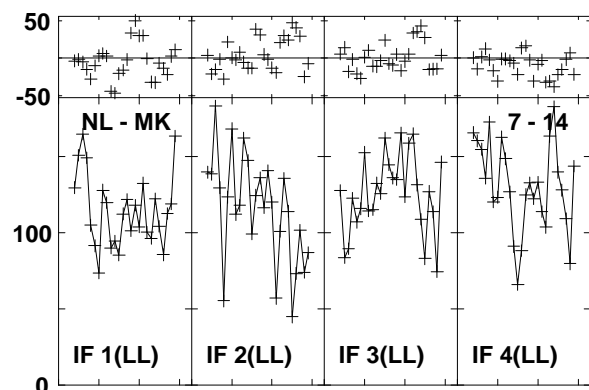
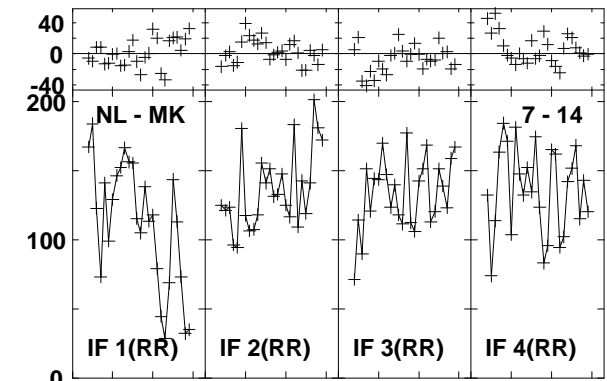
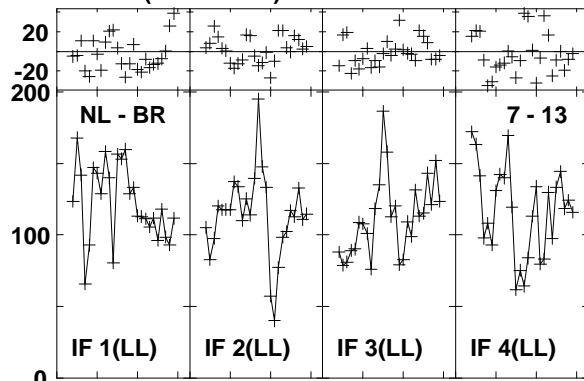
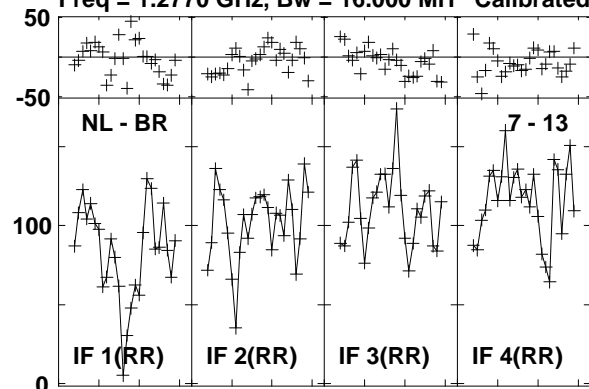

Lower frame: Milli Ampl Jy Top frame: Phas deg
Vector averaged cross-power spectrum Baseline: NL (07) - BR (13)
Timerange: 01/03:07:37 to 01/03:08:35

Plot file version1369 created 03-MAR-2016 01:15:56

4C52 GN002C 1.UVDATA.1

Freq = 1.2770 GHz, Bw = 16.000 MH Calibrated with CL # 3 and BP # 1 (BP mode 1)

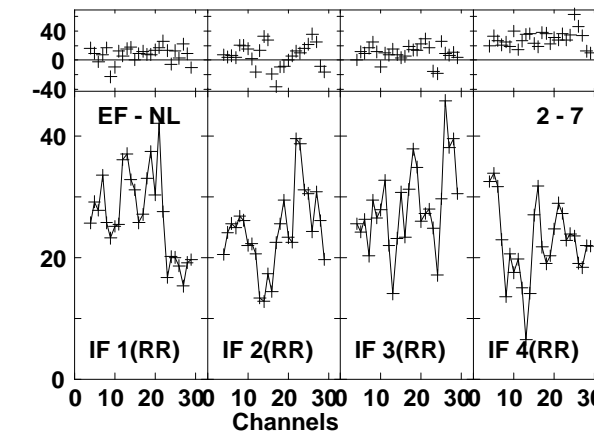
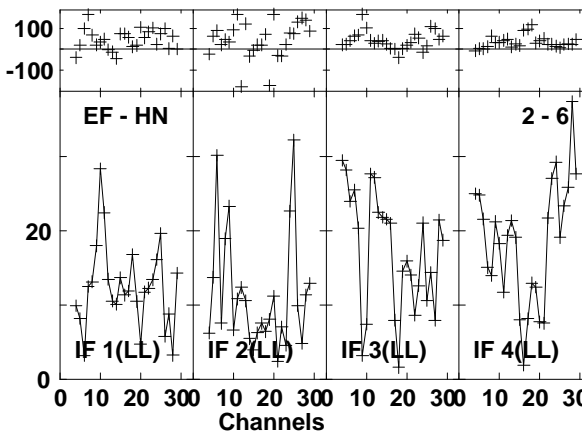
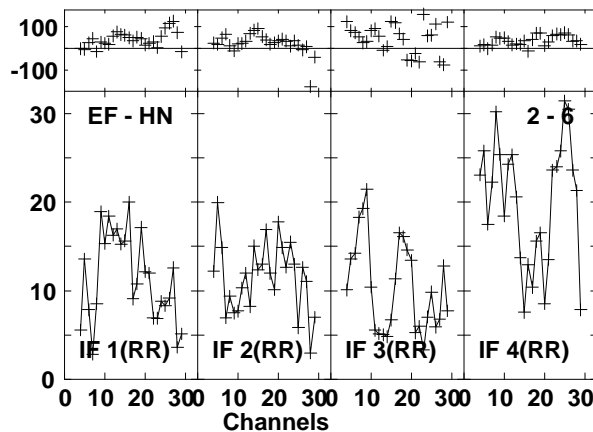
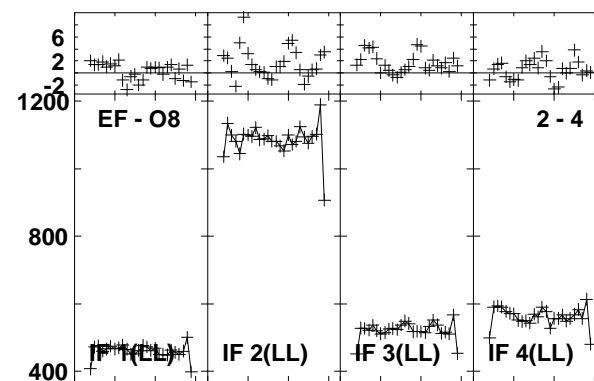
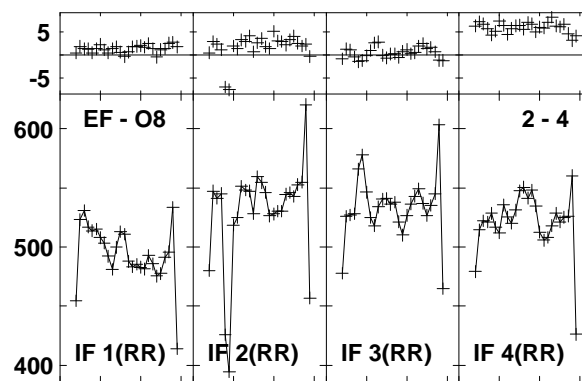
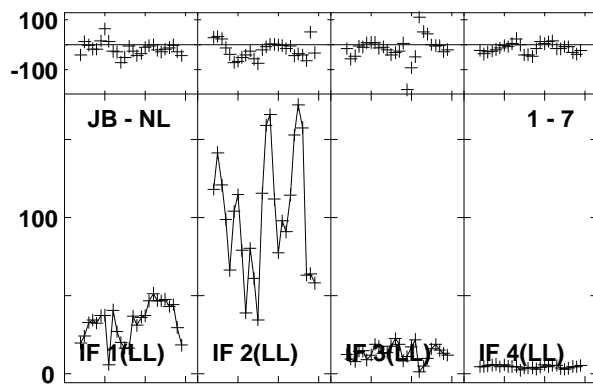
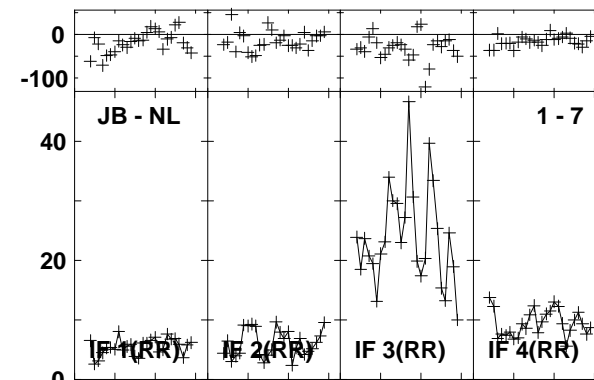
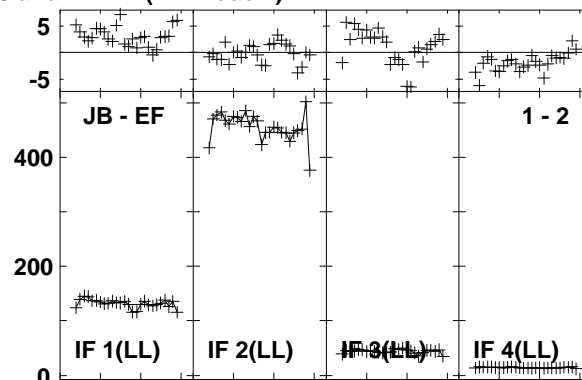
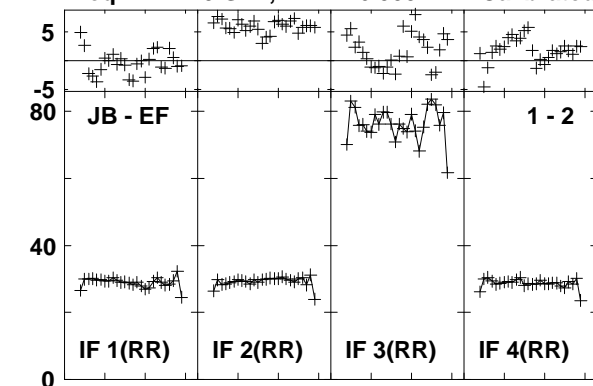

Lower frame: Milli Ampl Jy Top frame: Phas deg
Vector averaged cross-power spectrum Baseline: JB (01) - EF (02)
Timerange: 01/03:08:40 to 01/03:11:54

Plot file version1370 created 03-MAR-2016 01:15:56

4C52 GN002C 1.UVDATA.1

Freq = 1.2770 GHz, Bw = 16.000 MH Calibrated with CL # 3 and BP # 1 (BP mode 1)

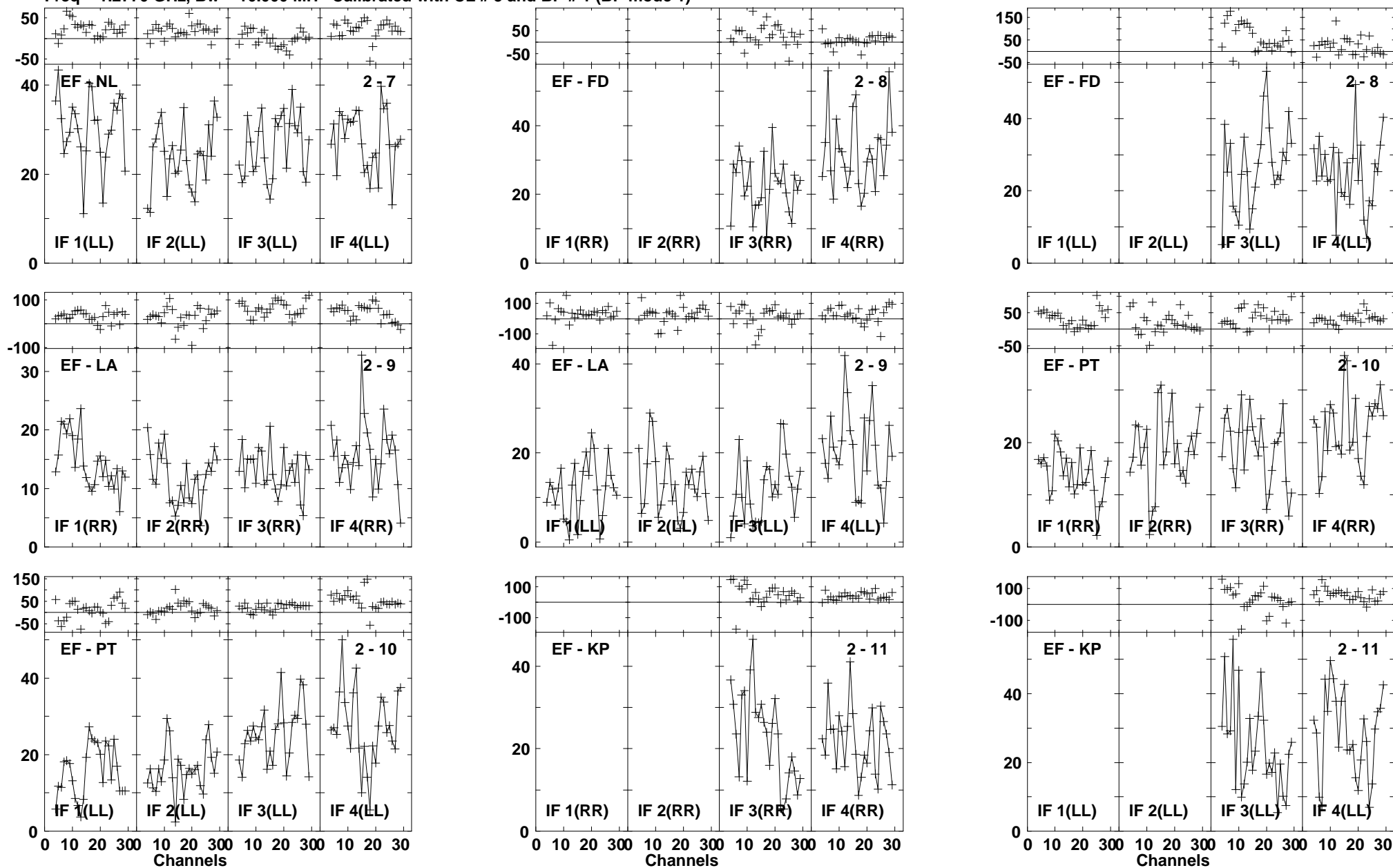

Lower frame: Milli Ampl Jy Top frame: Phas deg
Vector averaged cross-power spectrum Baseline: EF (02) - NL (07)
Timerange: 01/03:08:40 to 01/03:11:54

Plot file version1371 created 03-MAR-2016 01:15:57

4C52 GN002C 1.UVDATA.1

Freq = 1.2770 GHz, Bw = 16.000 MH Calibrated with CL # 3 and BP # 1 (BP mode 1)

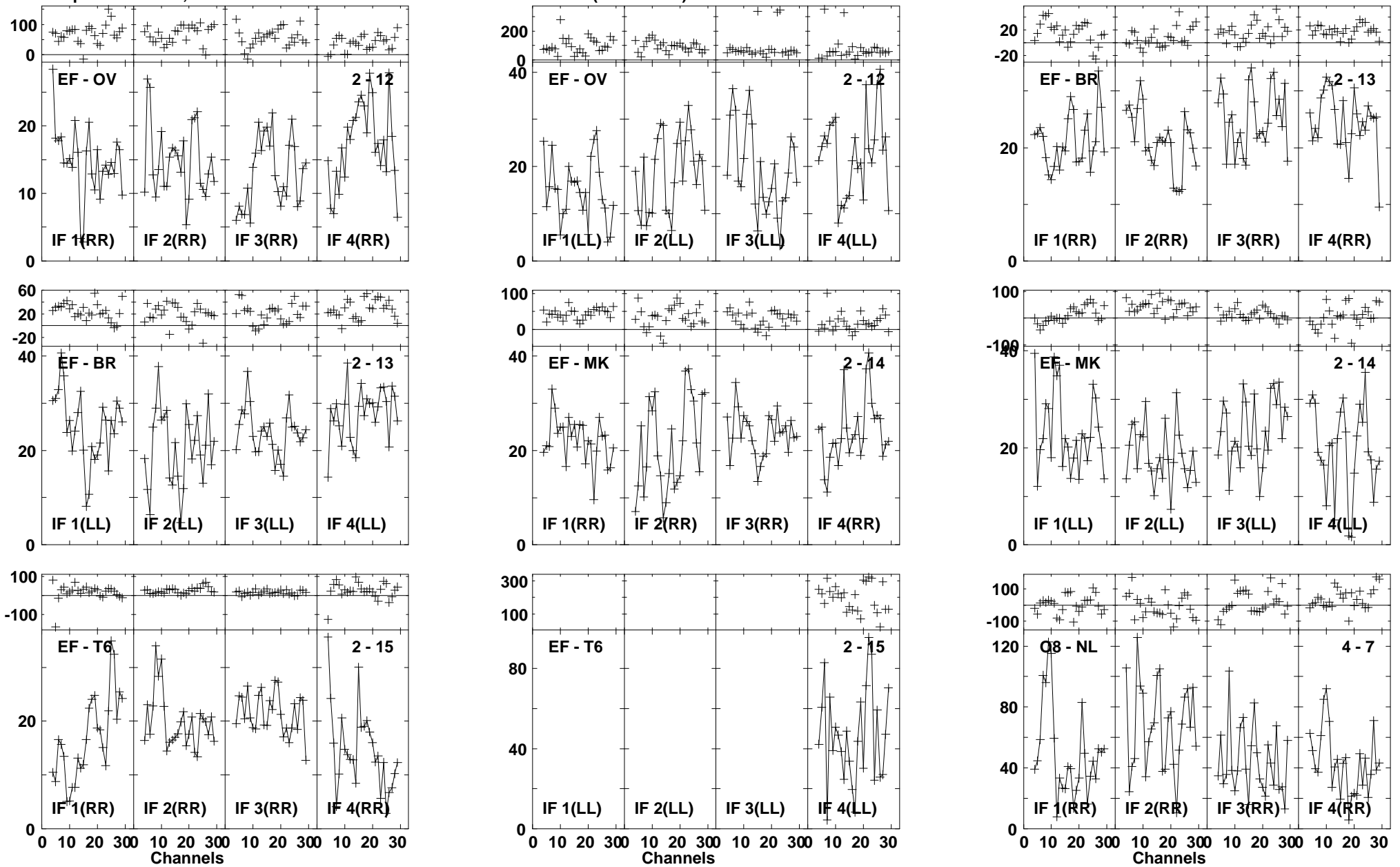

Lower frame: Milli Ampl Jy Top frame: Phas deg
Vector averaged cross-power spectrum Baseline: EF (02) - OV (12)
Timerange: 01/03:08:40 to 01/03:11:54

Plot file version1372 created 03-MAR-2016 01:15:57

4C52 GN002C 1.UVDATA.1

Freq = 1.2770 GHz, Bw = 16.000 MH Calibrated with CL # 3 and BP # 1 (BP mode 1)

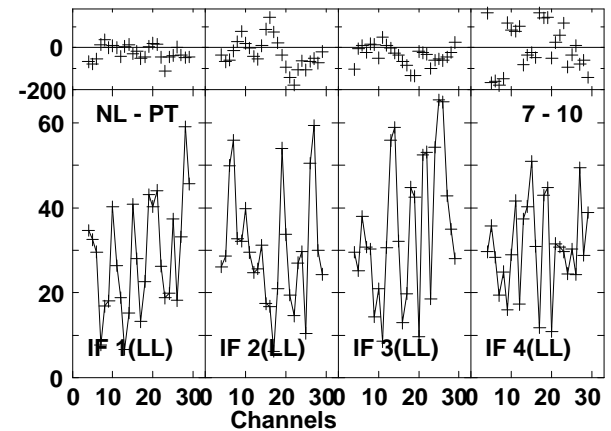
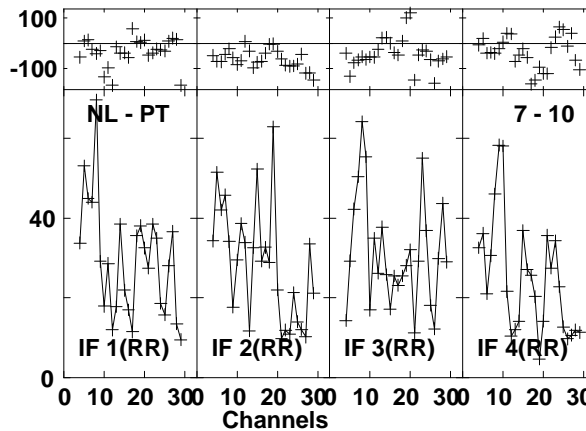
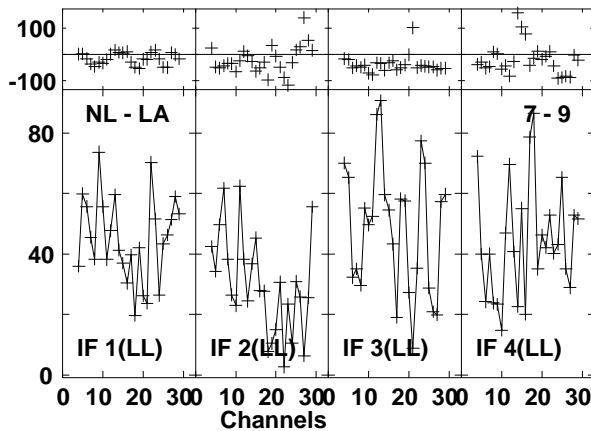
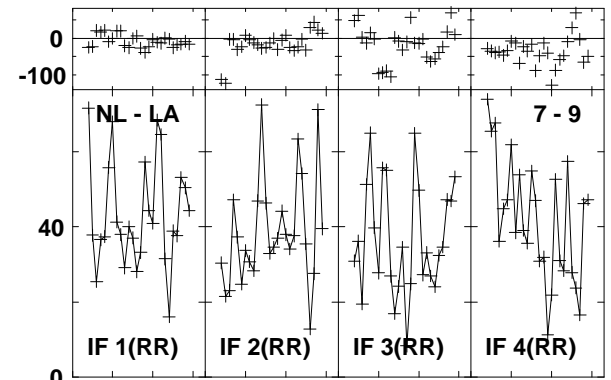
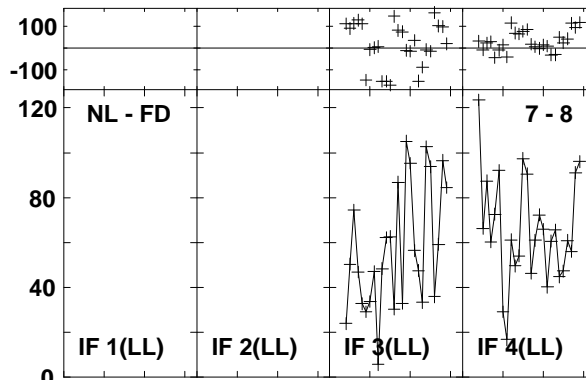
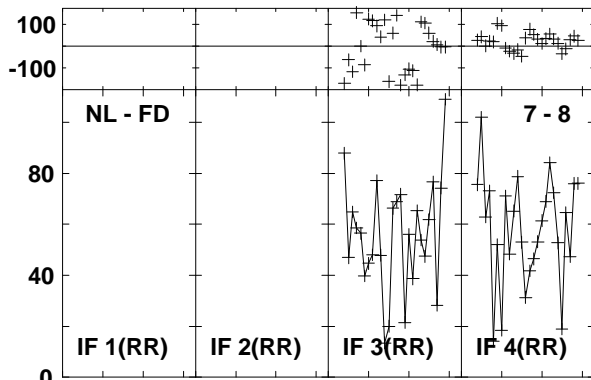
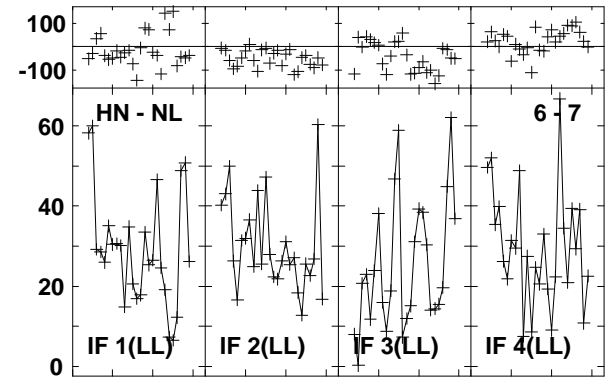
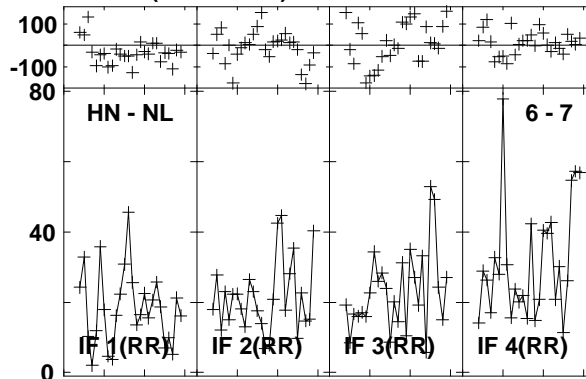
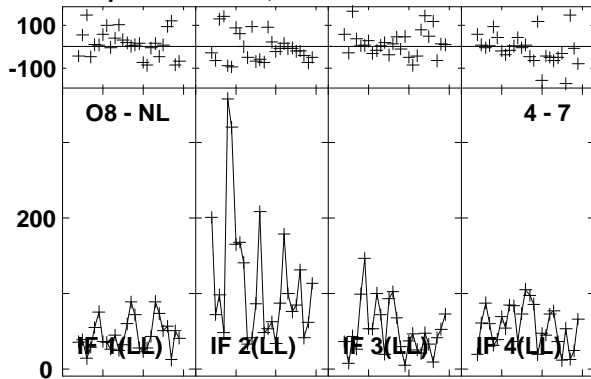

Lower frame: Milli Ampl Jy Top frame: Phas deg
Vector averaged cross-power spectrum Baseline: O8 (04) - NL (07)
Timerange: 01/03:08:40 to 01/03:11:54

Plot file version1373 created 03-MAR-2016 01:15:57

4C52 GN002C 1.UVDATA.1

Freq = 1.2770 GHz, Bw = 16.000 MH Calibrated with CL # 3 and BP # 1 (BP mode 1)

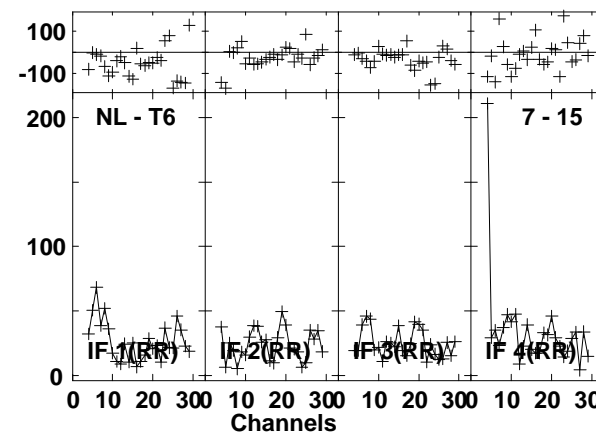
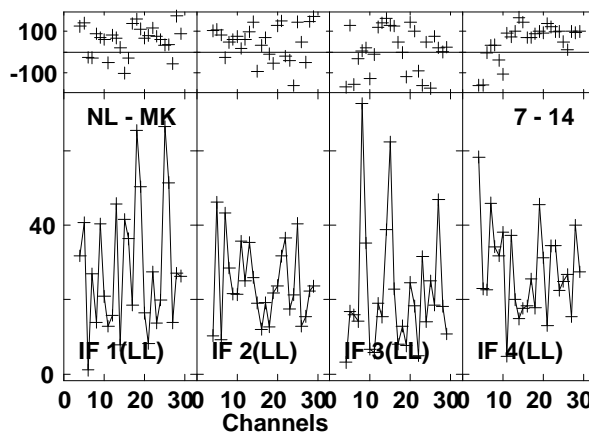
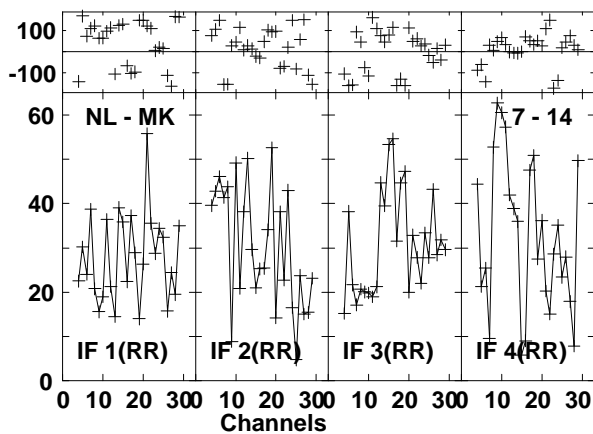
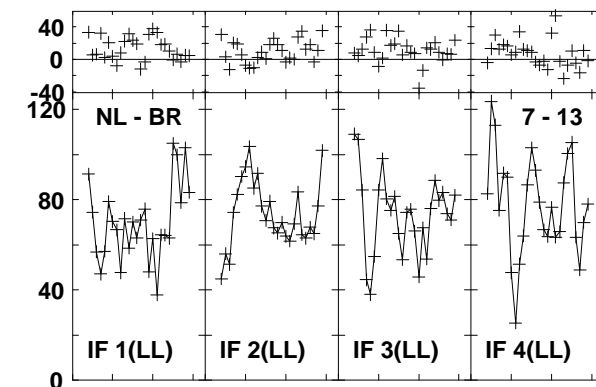
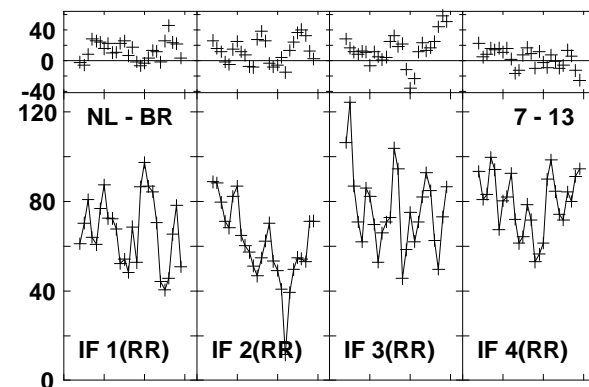
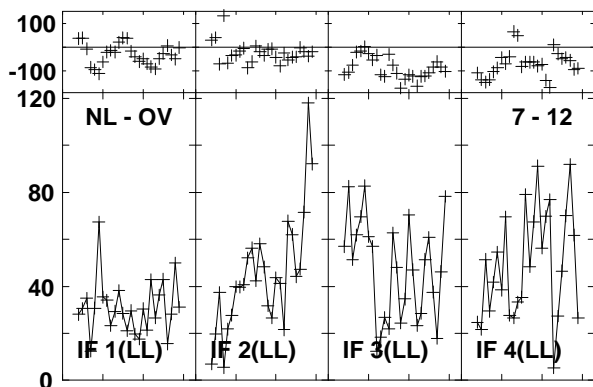
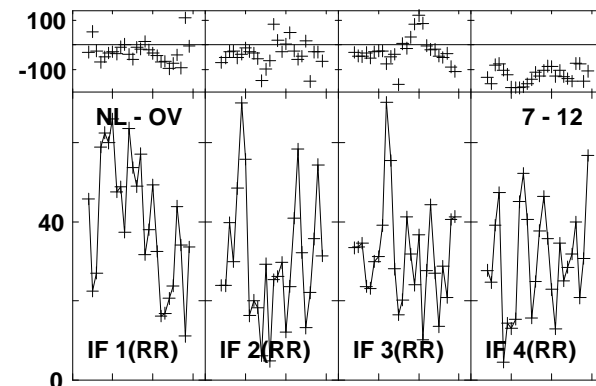
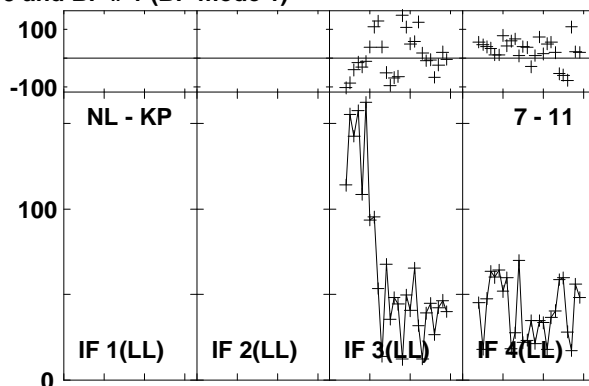
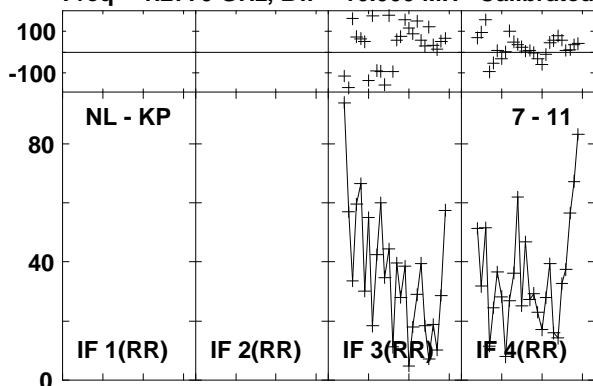

Lower frame: Milli Ampl Jy Top frame: Phas deg
Vector averaged cross-power spectrum Baseline: NL (07) - KP (11)
Timerange: 01/03:08:40 to 01/03:11:54

Plot file version1374 created 03-MAR-2016 01:15:57
4C52 GN002C 1.UVDATA.1
Freq = 1.2770 GHz, Bw = 16.000 MH Calibrated with CL # 3 and BP # 1 (BP mode 1)

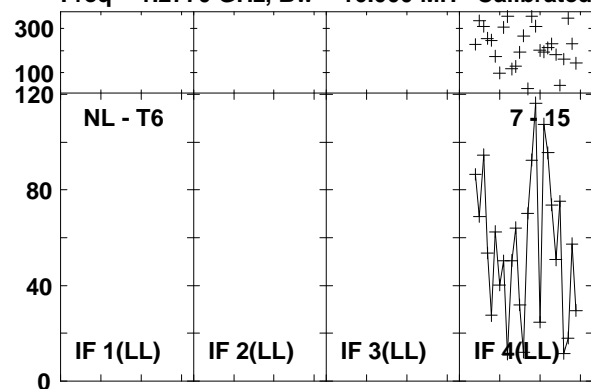

Lower frame: Milli Ampl Jy Top frame: Phas deg
Vector averaged cross-power spectrum Baseline: NL (07) - T6 (15)
Timerange: 01/03:08:40 to 01/03:11:54

Plot file version1375 created 03-MAR-2016 01:15:57

J1545+5400 GN002C 1.UVDATA.1

Freq = 1.2770 GHz, Bw = 16.000 MH Calibrated with CL # 3 and BP # 1 (BP mode 1)

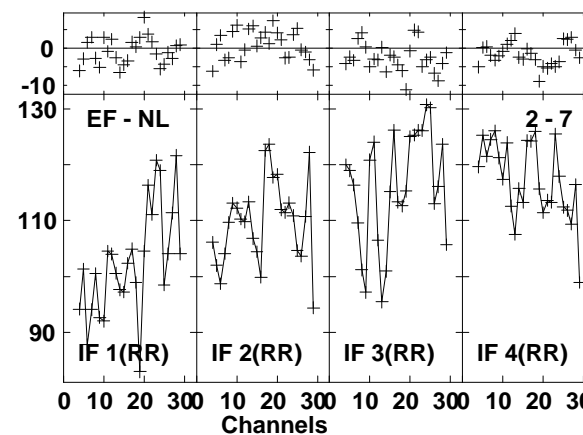
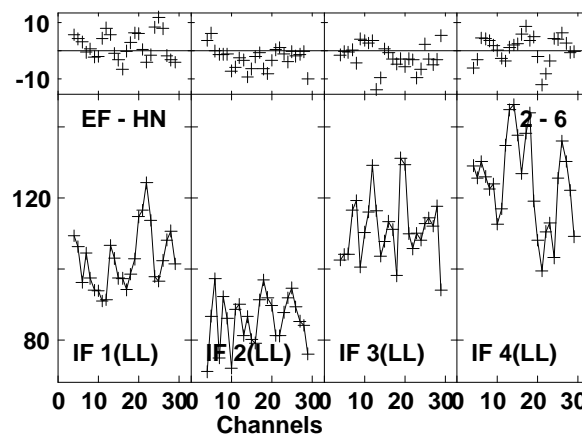
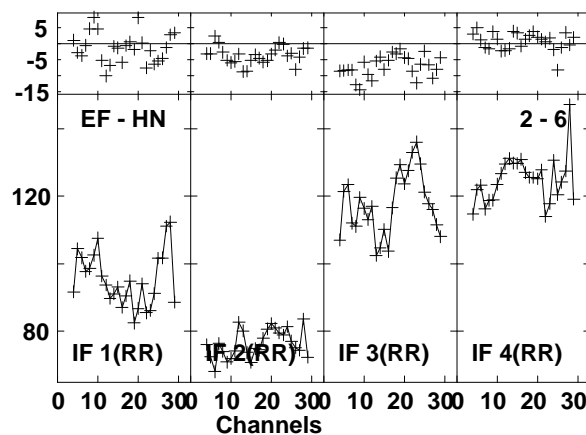
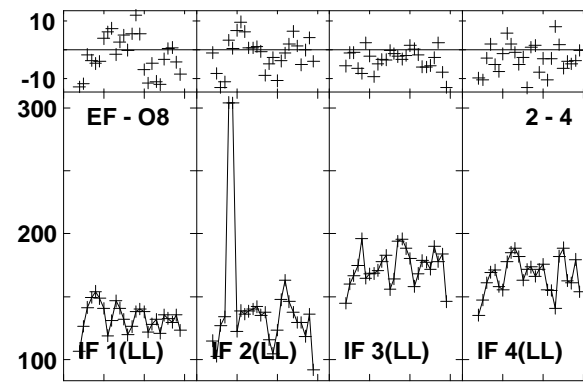
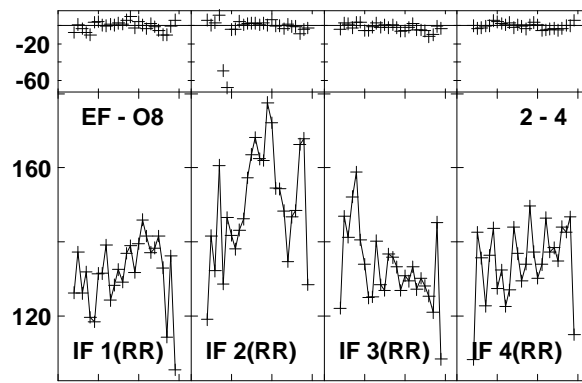
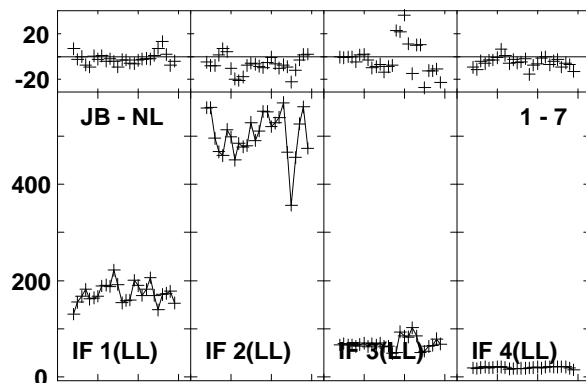
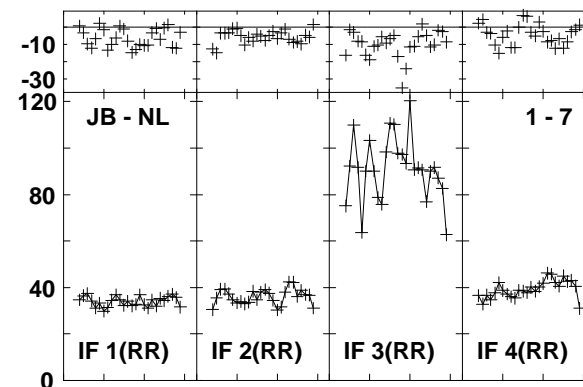
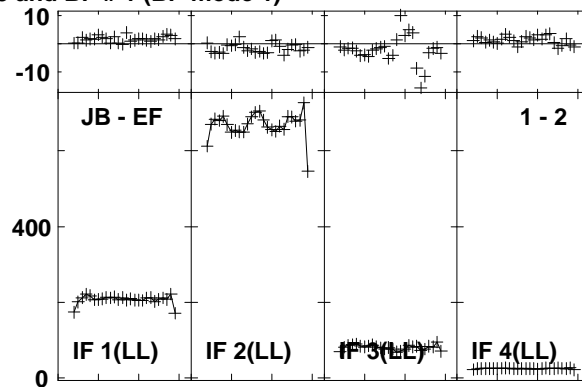
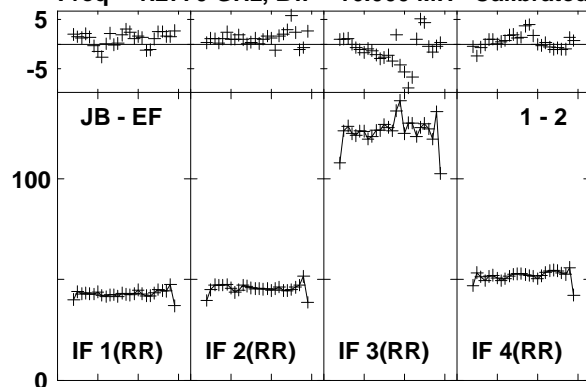

Lower frame: Milli Ampl Jy Top frame: Phas deg
Vector averaged cross-power spectrum Baseline: JB (01) - EF (02)
Timerange: 01/03:12:47 to 01/03:14:45

Plot file version1376 created 03-MAR-2016 01:15:57

J1545+5400 GN002C 1.UVDATA.1

Freq = 1.2770 GHz, Bw = 16.000 MH Calibrated with CL # 3 and BP # 1 (BP mode 1)

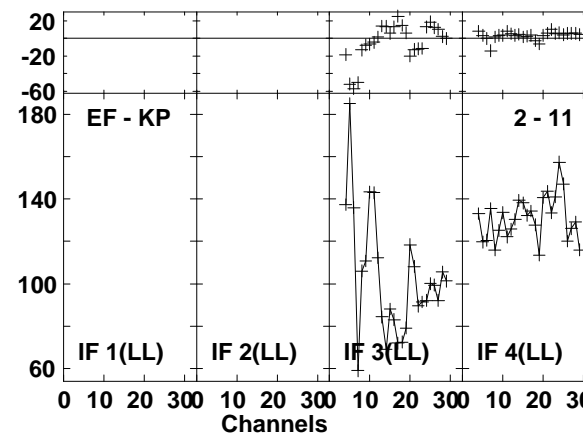
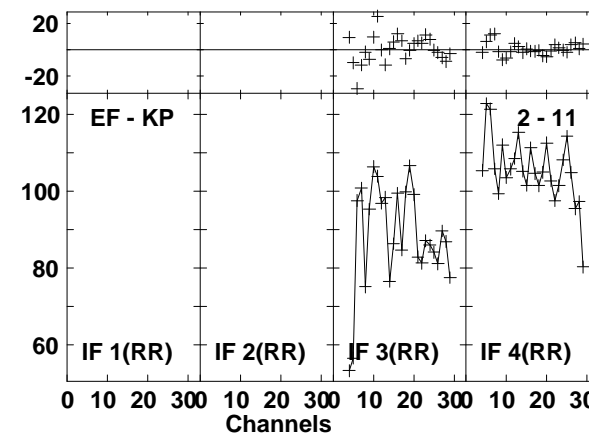
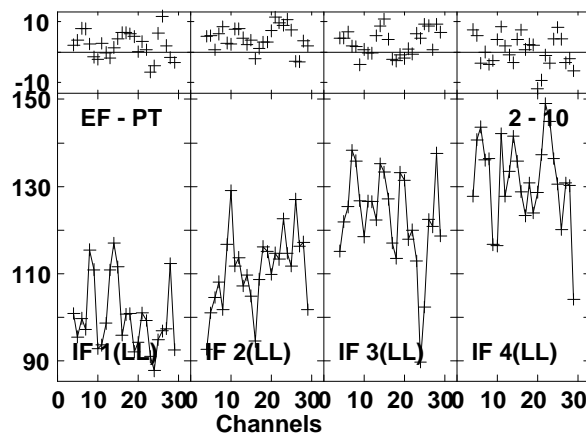
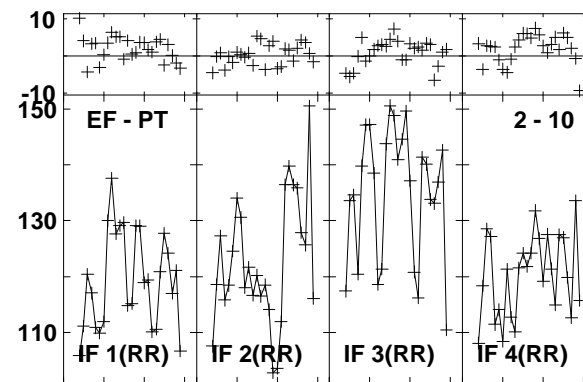
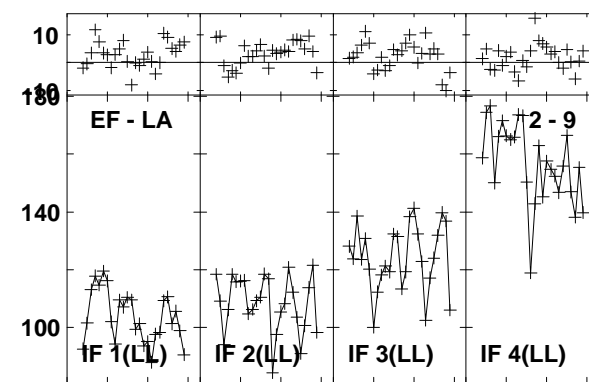
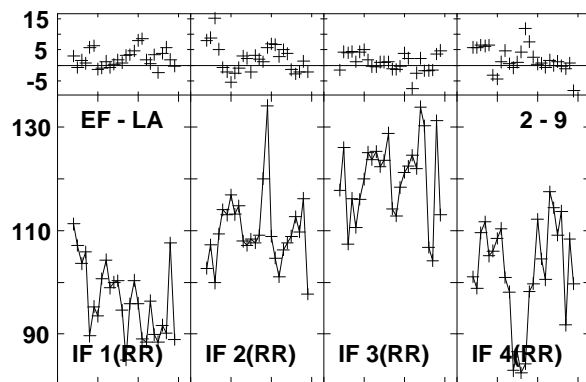
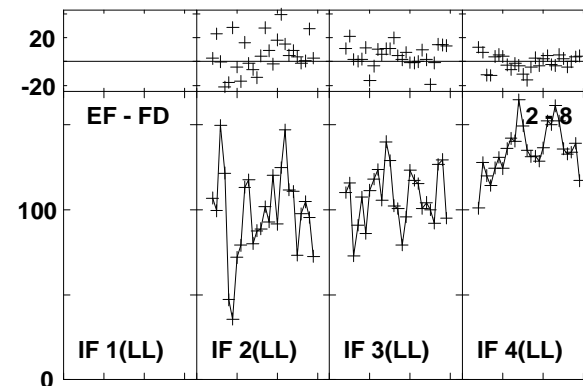
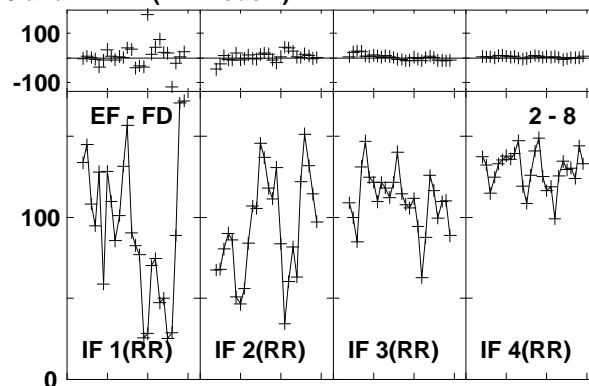
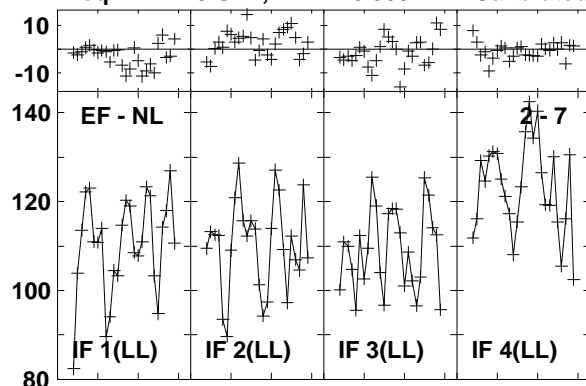

Lower frame: Milli Ampl Jy Top frame: Phas deg
Vector averaged cross-power spectrum Baseline: EF (02) - NL (07)
Timerange: 01/03:12:47 to 01/03:14:45

Plot file version1377 created 03-MAR-2016 01:15:58

J1545+5400 GN002C 1.UVDATA.1

Freq = 1.2770 GHz, Bw = 16.000 MH Calibrated with CL # 3 and BP # 1 (BP mode 1)

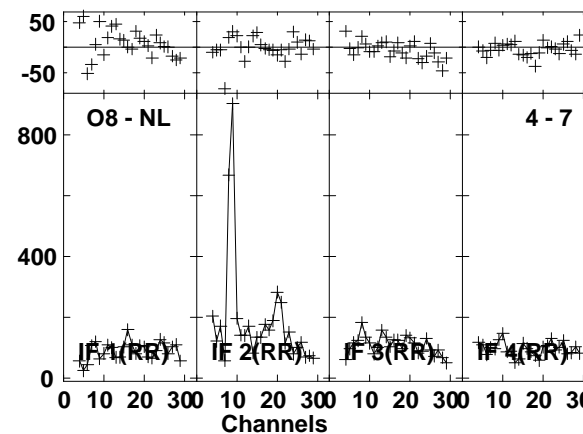
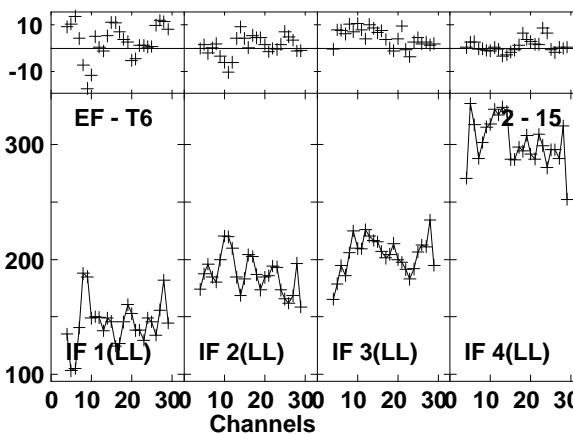
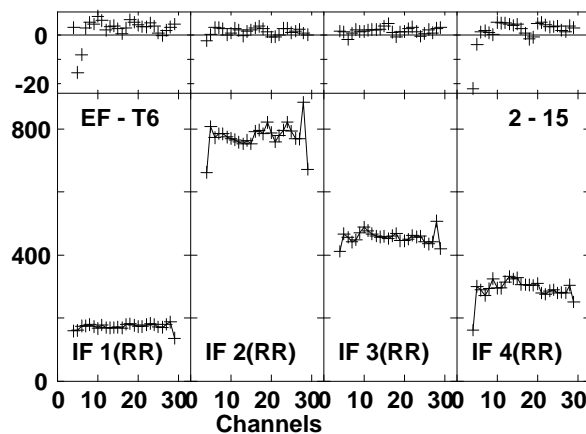
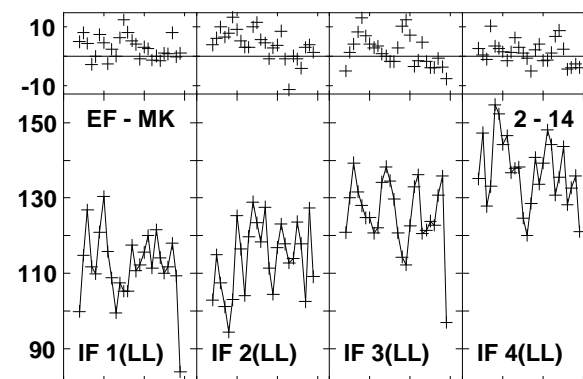
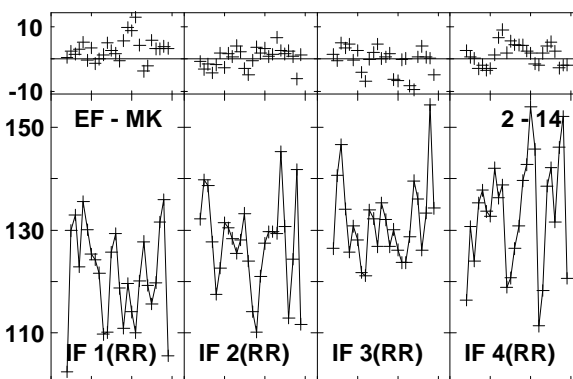
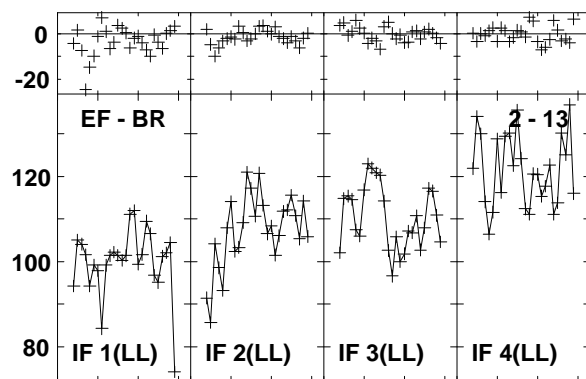
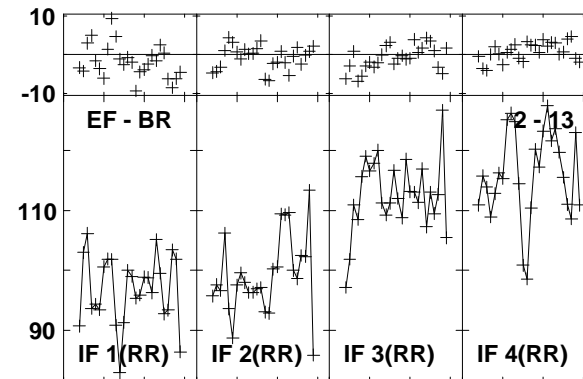
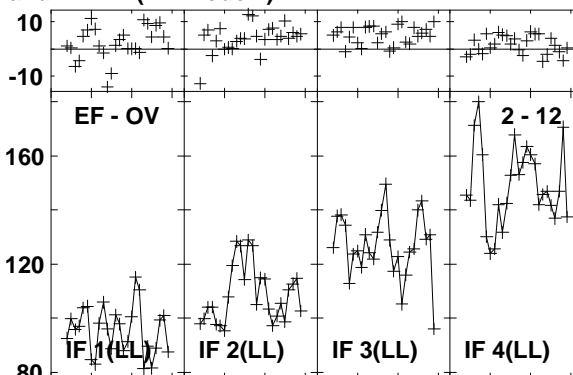
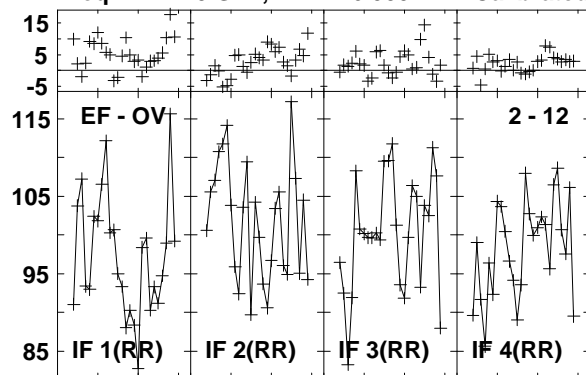

Lower frame: Milli Ampl Jy Top frame: Phas deg
Vector averaged cross-power spectrum Baseline: EF (02) - OV (12)
Timerange: 01/03:12:47 to 01/03:14:45

Plot file version1378 created 03-MAR-2016 01:15:58

J1545+5400 GN002C 1.UVDATA.1

Freq = 1.2770 GHz, Bw = 16.000 MH Calibrated with CL # 3 and BP # 1 (BP mode 1)

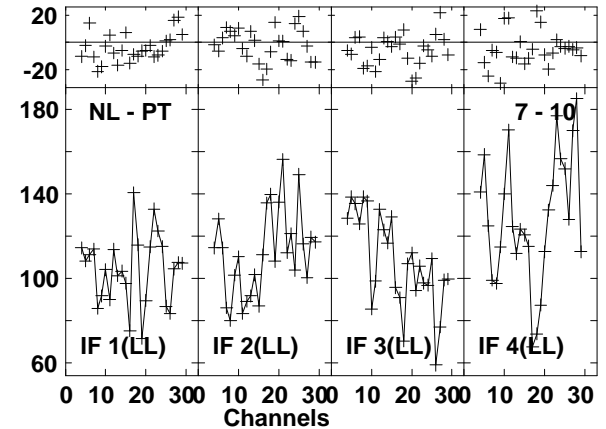
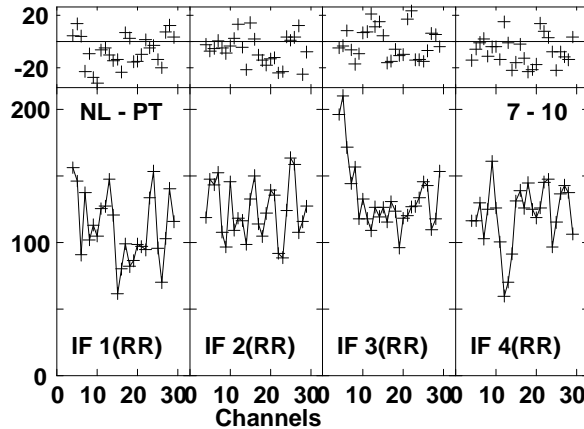
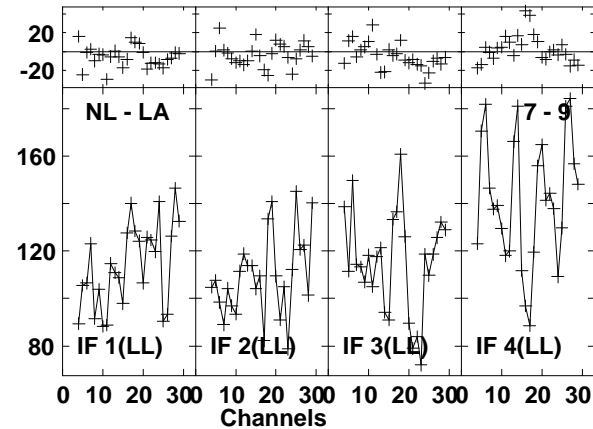
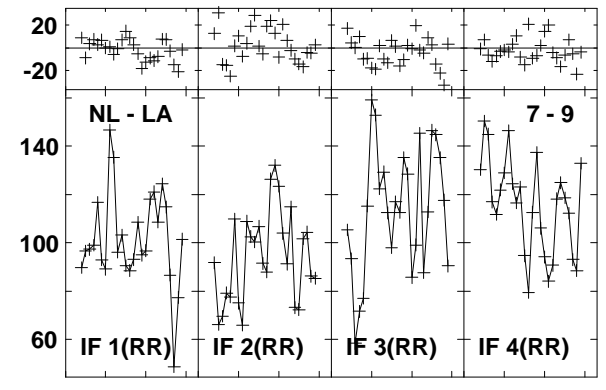
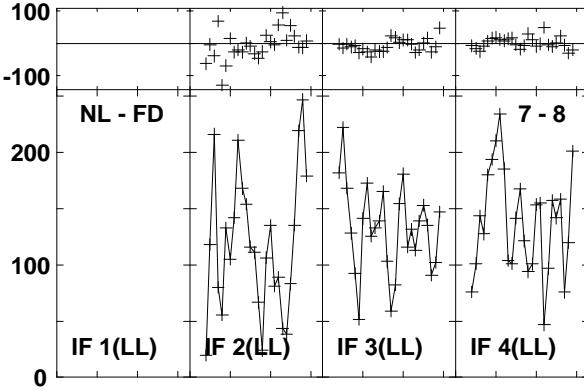
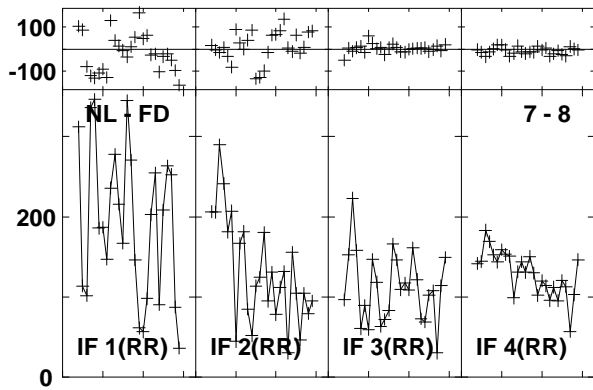
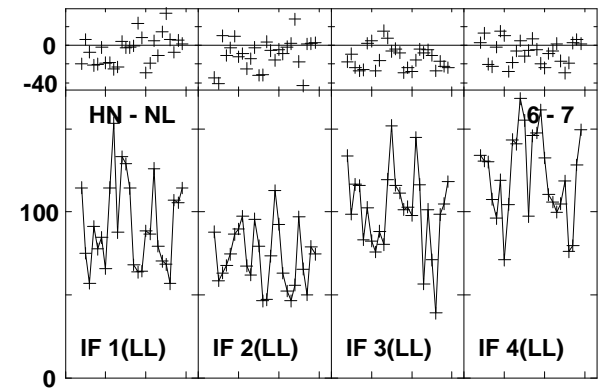
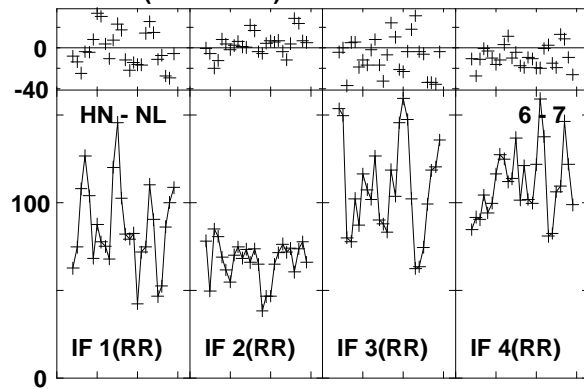
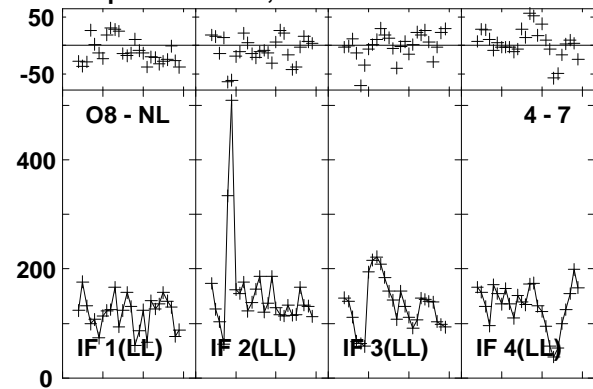

Lower frame: Milli Ampl Jy Top frame: Phas deg
Vector averaged cross-power spectrum Baseline: O8 (04) - NL (07)
Timerange: 01/03:12:47 to 01/03:14:45

Plot file version1379 created 03-MAR-2016 01:15:58
 J1545+5400 GN002C 1.UVDATA.1
 Freq = 1.2770 GHz, Bw = 16.000 MH Calibrated with CL # 3 and BP # 1 (BP mode 1)

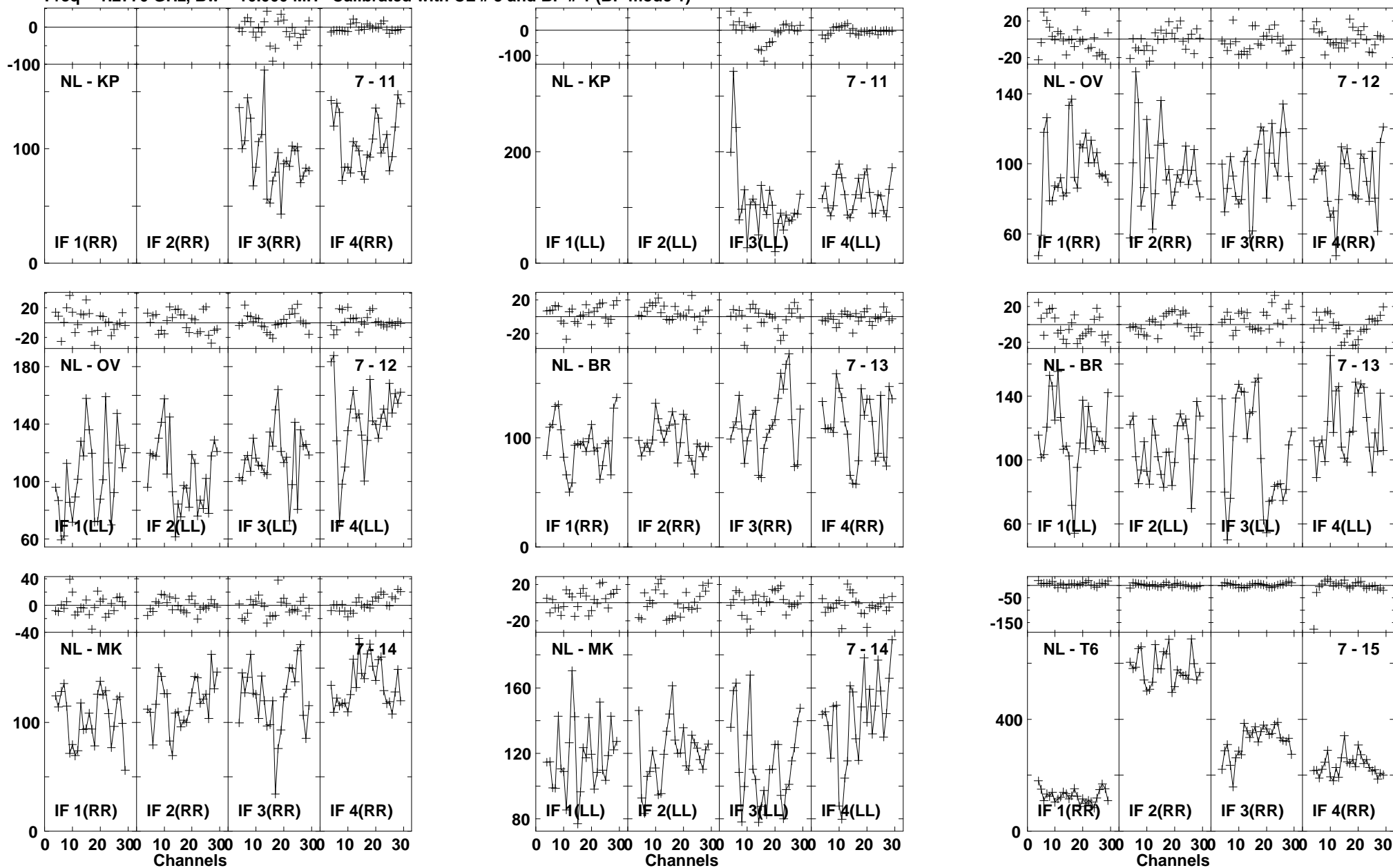

Lower frame: Milli Ampl Jy Top frame: Phas deg
 Vector averaged cross-power spectrum Baseline: NL (07) - KP (11)
 Timerange: 01/03:12:47 to 01/03:14:45

Plot file version1380 created 03-MAR-2016 01:15:58
J1545+5400 GN002C 1.UVDATA.1
Freq = 1.2770 GHz, Bw = 16.000 MH Calibrated with CL # 3 and BP # 1 (BP mode 1)

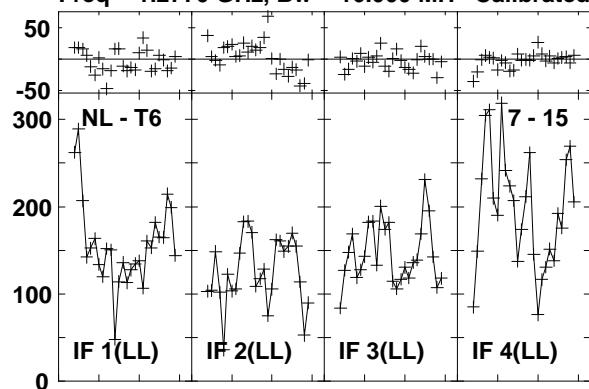

Lower frame: Milli Ampl Jy Top frame: Phas deg
Vector averaged cross-power spectrum Baseline: NL (07) - T6 (15)
Timerange: 01/03:12:47 to 01/03:14:45

Plot file version1381 created 03-MAR-2016 01:15:58

4C52 GN002C 1.UVDATA.1

Freq = 1.2770 GHz, Bw = 16.000 MH Calibrated with CL # 3 and BP # 1 (BP mode 1)

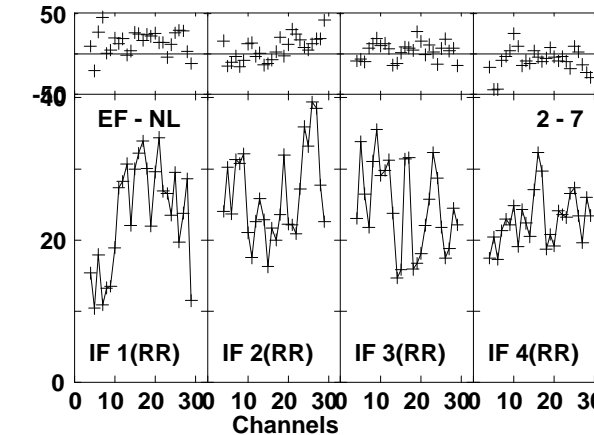
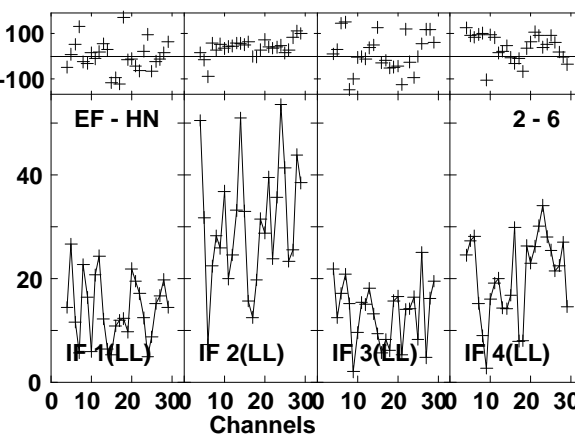
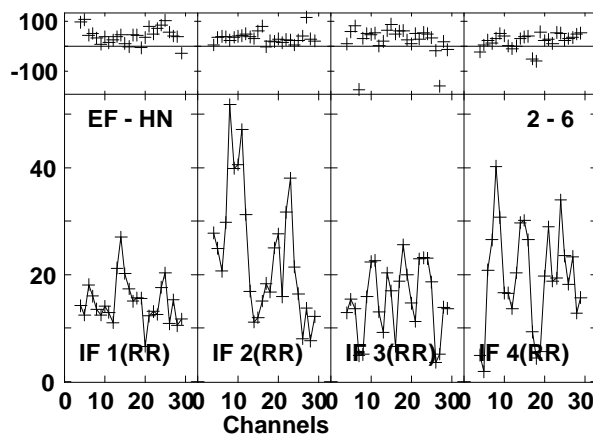
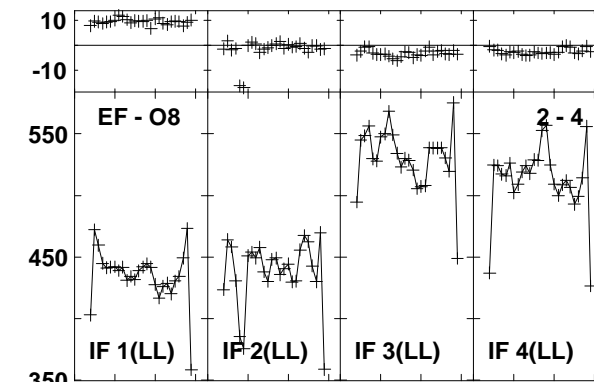
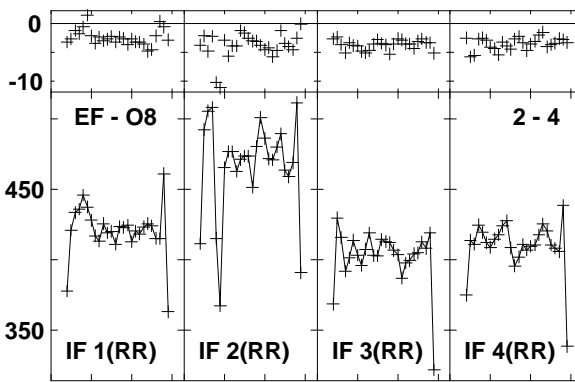
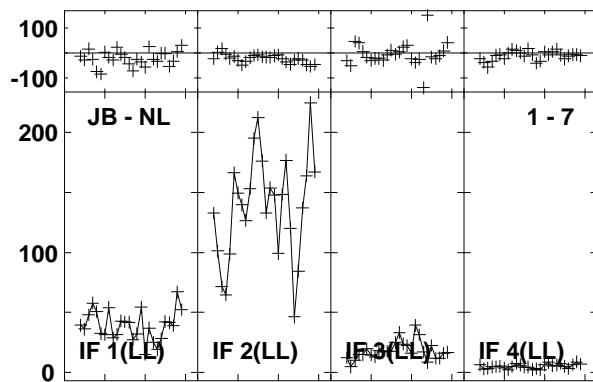
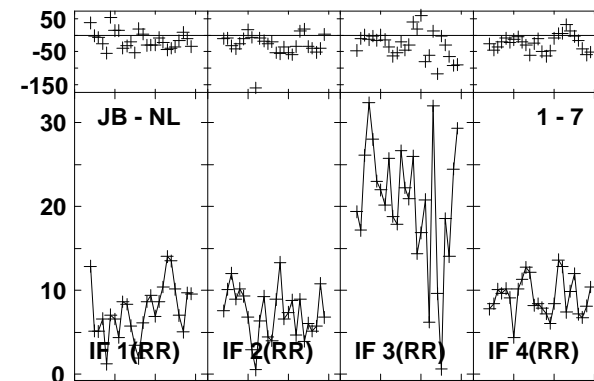
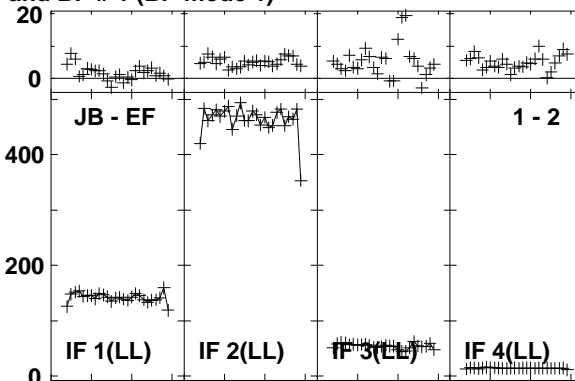
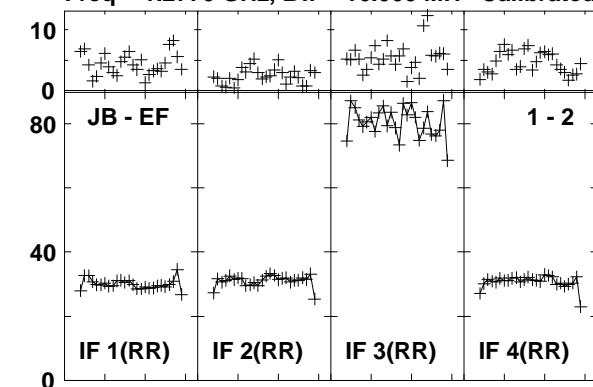

Lower frame: Milli Ampl Jy Top frame: Phas deg
Vector averaged cross-power spectrum Baseline: JB (01) - EF (02)
Timerange: 01/03:14:57 to 01/03:17:45

Plot file version1382 created 03-MAR-2016 01:15:58

4C52 GN002C 1.UVDATA.1

Freq = 1.2770 GHz, Bw = 16.000 MH Calibrated with CL # 3 and BP # 1 (BP mode 1)

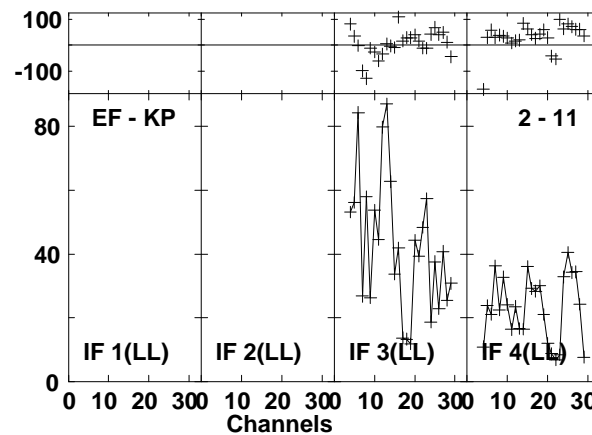
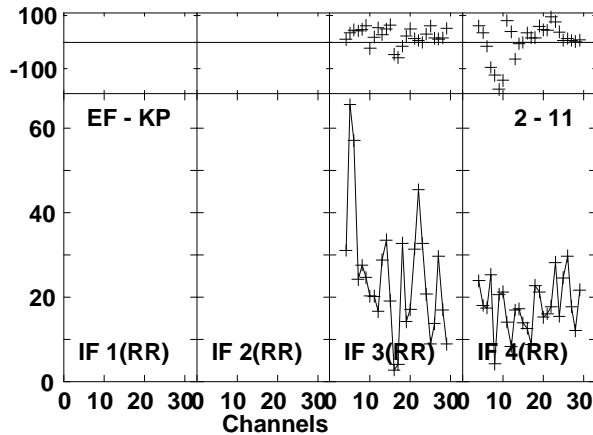
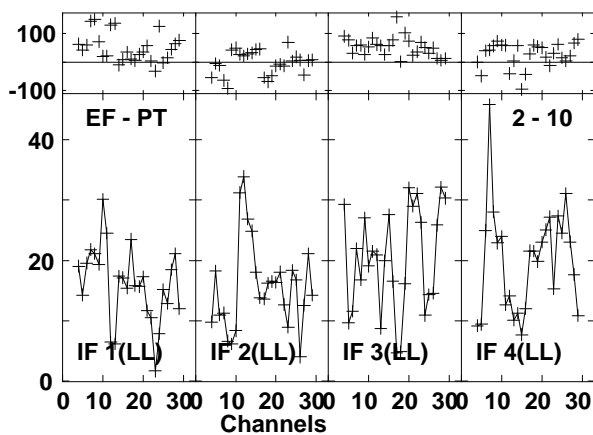
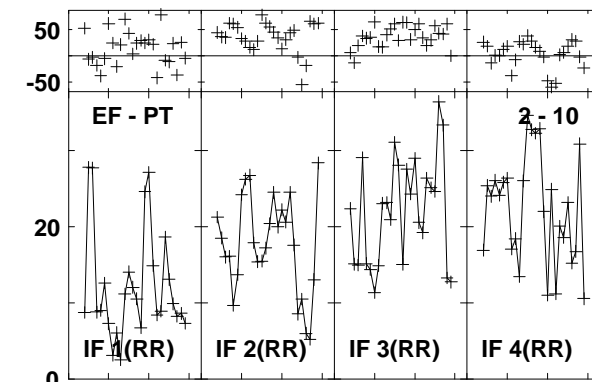
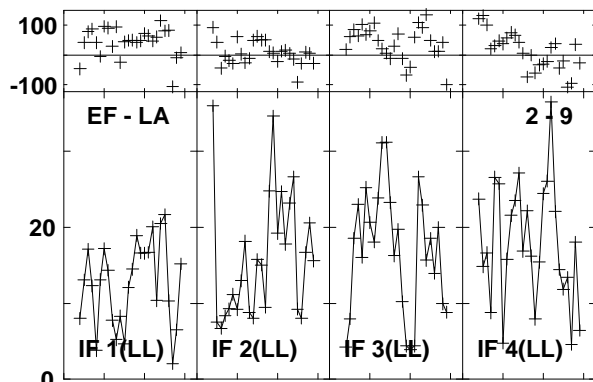
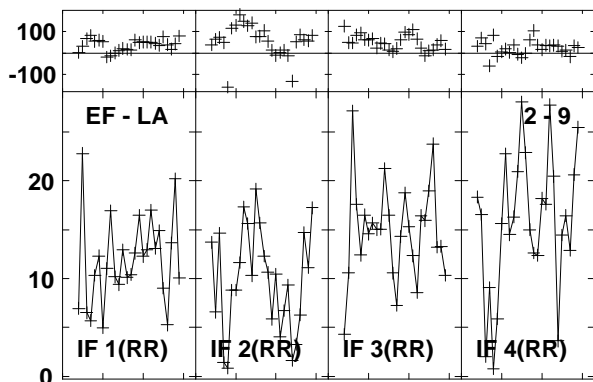
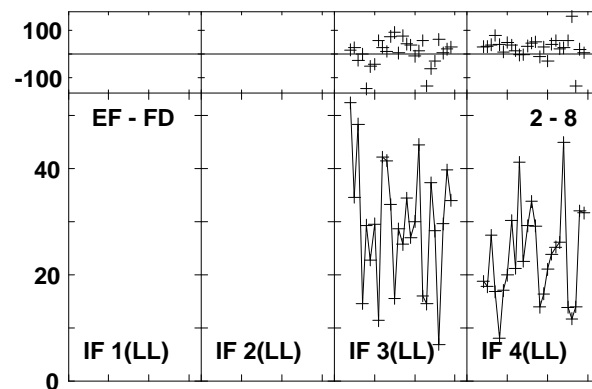
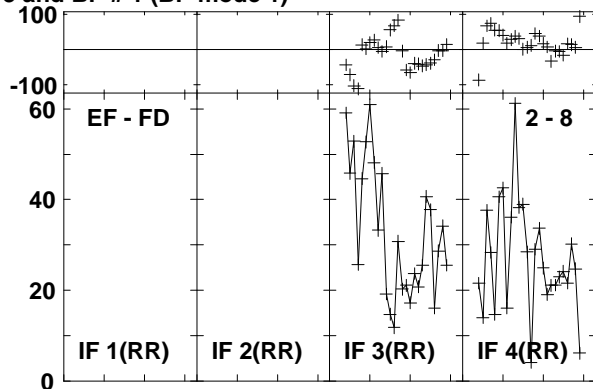
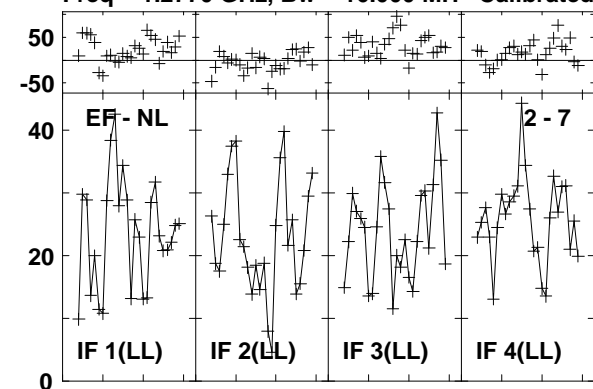

Lower frame: Milli Ampl Jy Top frame: Phas deg
Vector averaged cross-power spectrum Baseline: EF (02) - NL (07)
Timerange: 01/03:14:57 to 01/03:17:45

Plot file version1383 created 03-MAR-2016 01:15:58

4C52 GN002C 1.UVDATA.1

Freq = 1.2770 GHz, Bw = 16.000 MH Calibrated with CL # 3 and BP # 1 (BP mode 1)

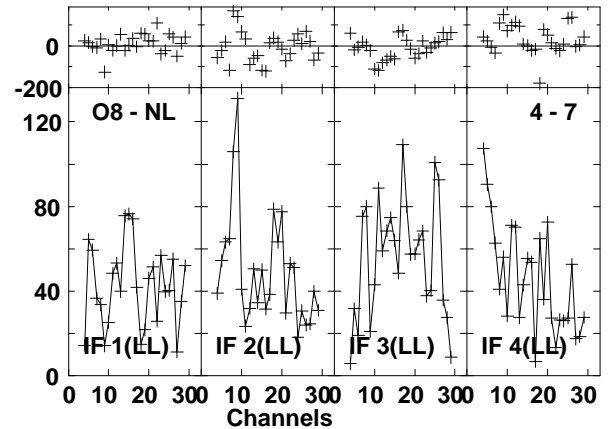
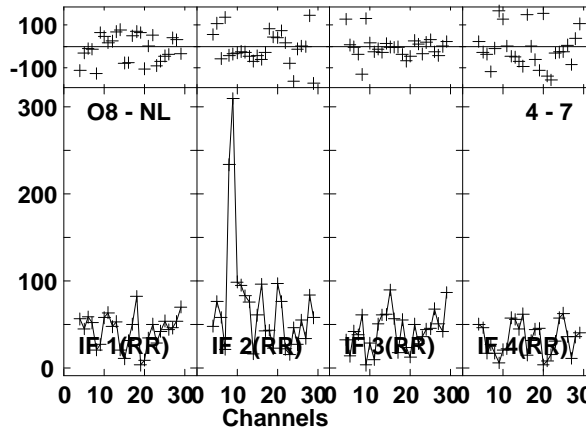
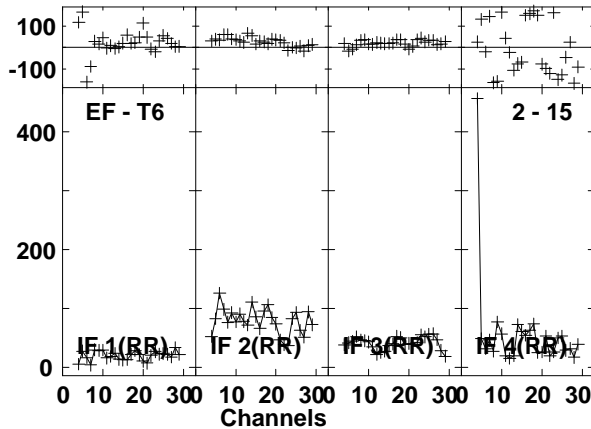
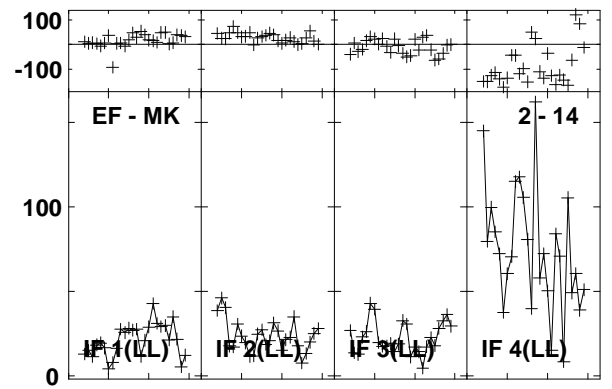
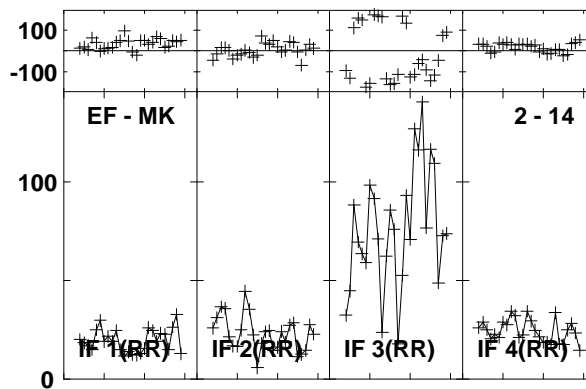
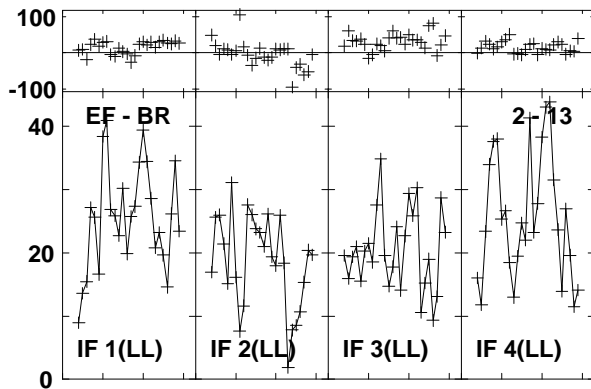
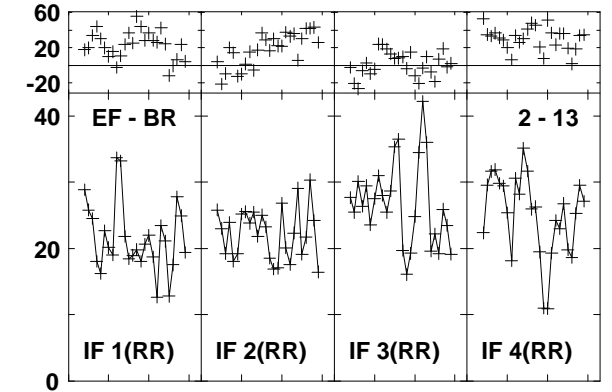
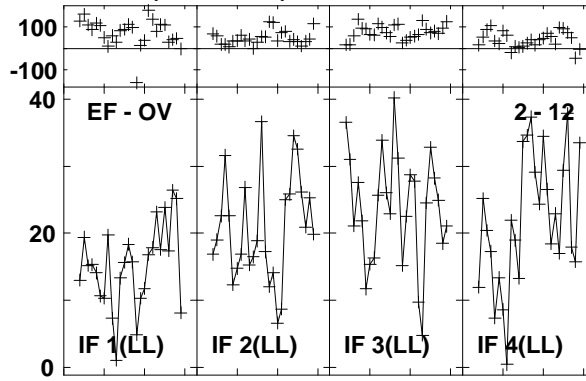
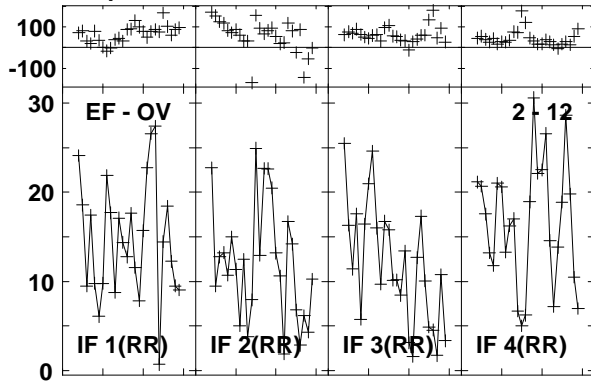

Lower frame: Milli Ampl Jy Top frame: Phas deg

Vector averaged cross-power spectrum Baseline: EF (02) - OV (12)

Timerange: 01/03:14:57 to 01/03:17:45

Plot file version1384 created 03-MAR-2016 01:15:59

4C52 GN002C 1.UVDATA.1

Freq = 1.2770 GHz, Bw = 16.000 MH Calibrated with CL # 3 and BP # 1 (BP mode 1)

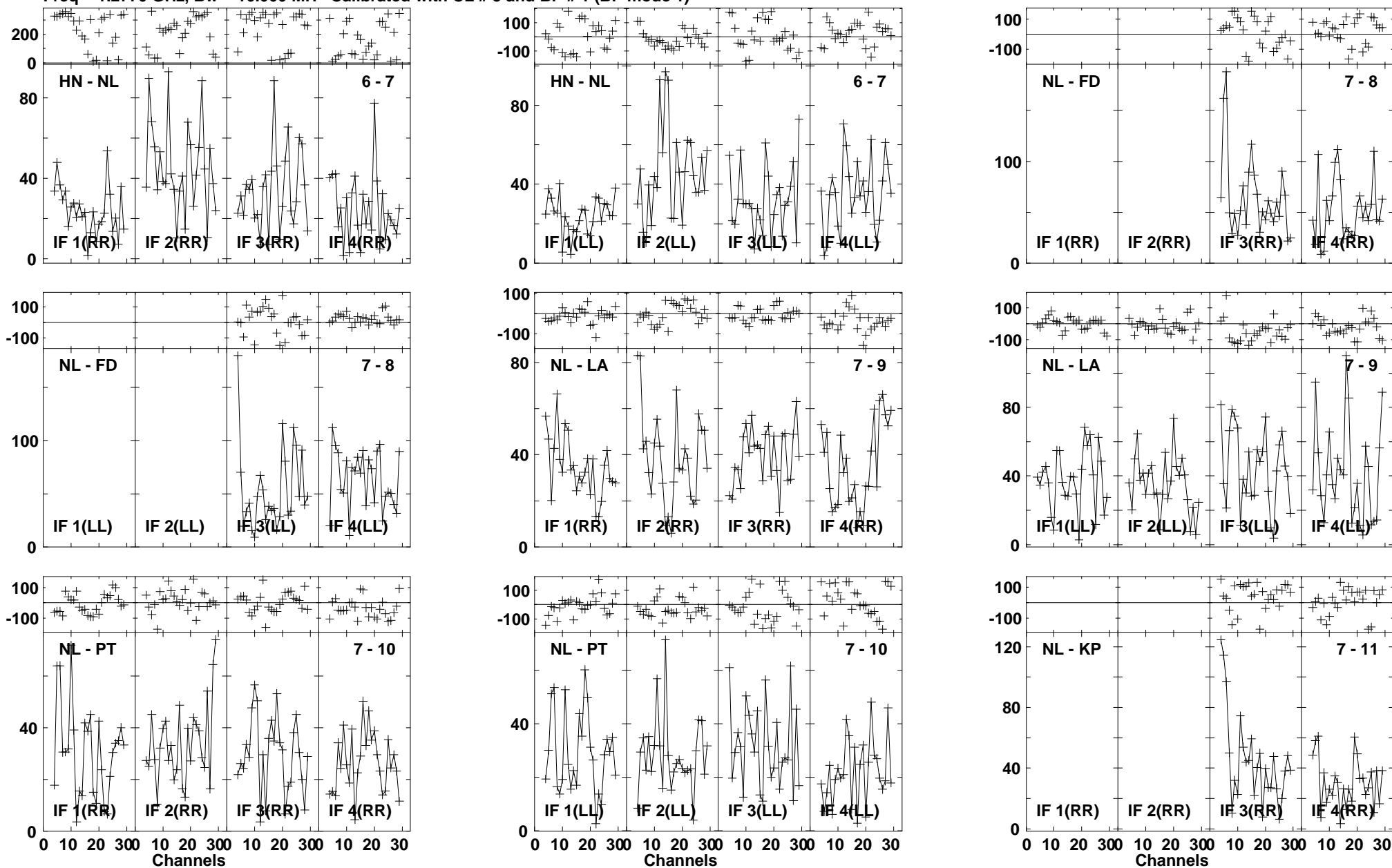

Lower frame: Milli Ampl Jy Top frame: Phas deg
Vector averaged cross-power spectrum Baseline: HN (06) - NL (07)
Timerange: 01/03:14:57 to 01/03:17:45

Plot file version1385 created 03-MAR-2016 01:15:59
 4C52 GN002C 1.UVDATA.1
 Freq = 1.2770 GHz, Bw = 16.000 MH Calibrated with CL # 3 and BP # 1 (BP mode 1)

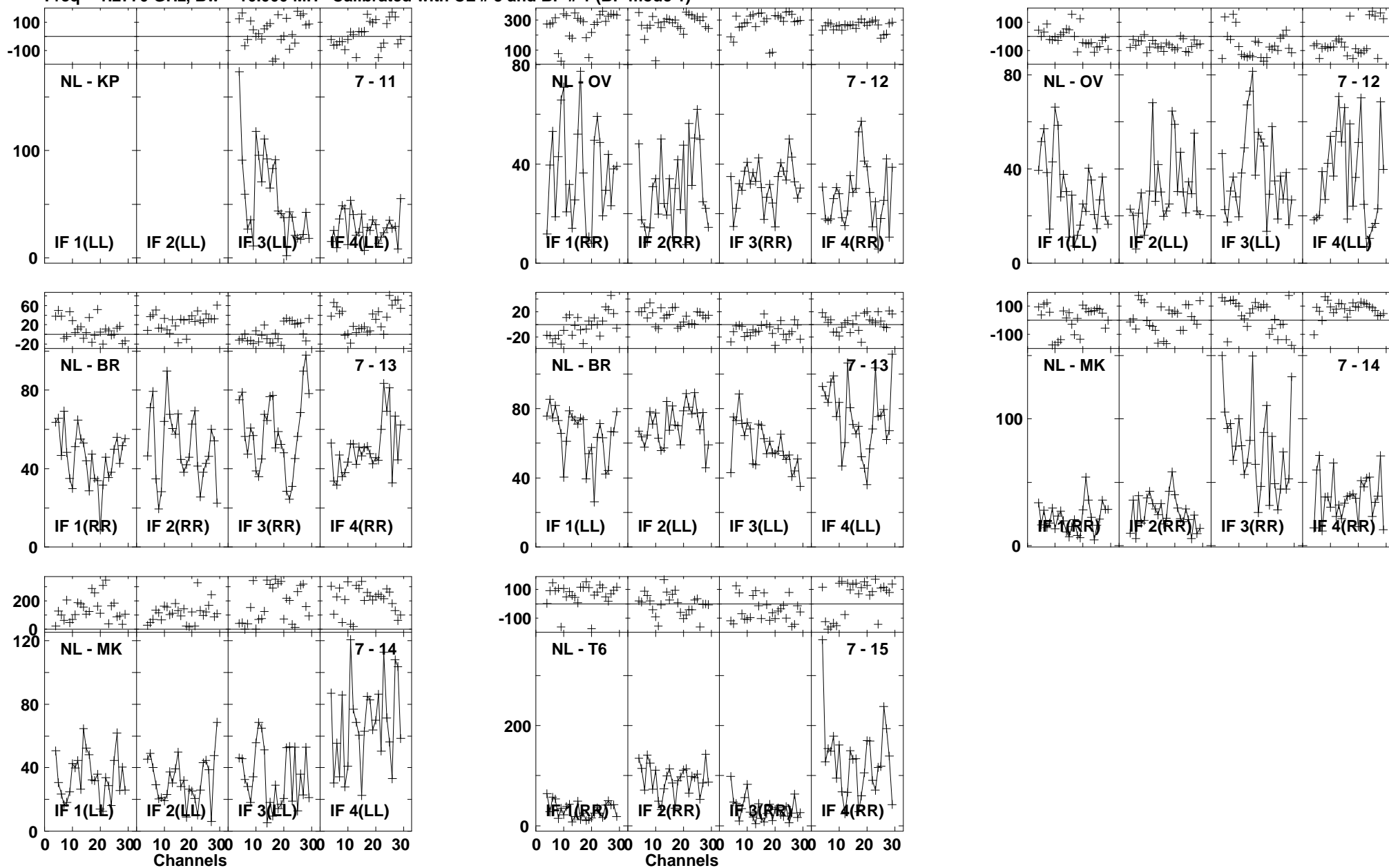

Lower frame: Milli Ampl Jy Top frame: Phas deg
 Vector averaged cross-power spectrum Baseline: NL (07) - KP (11)
 Timerange: 01/03:14:57 to 01/03:17:45

Plot file version1386 created 03-MAR-2016 01:15:59

J1545+5400 GN002C 1.UVDATA.1

Freq = 1.2770 GHz, Bw = 16.000 MH Calibrated with CL # 3 and BP # 1 (BP mode 1)

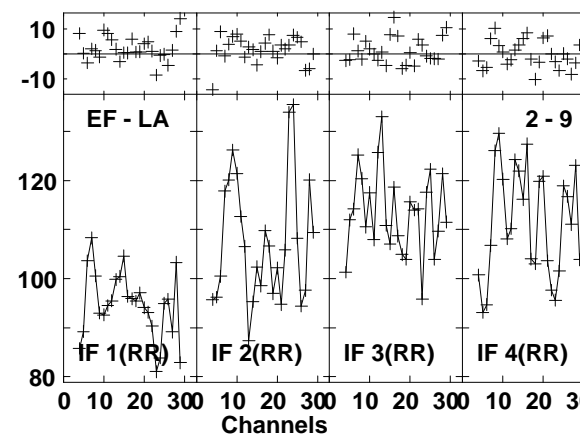
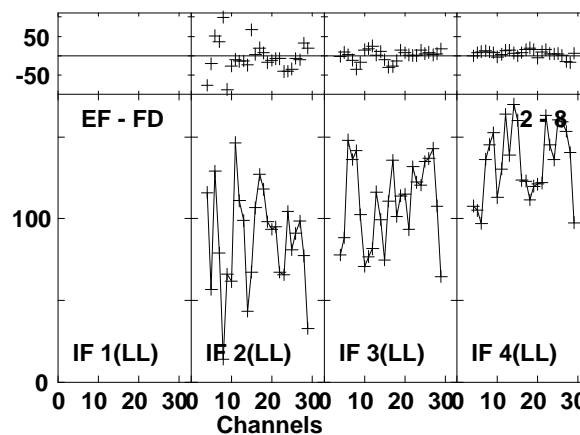
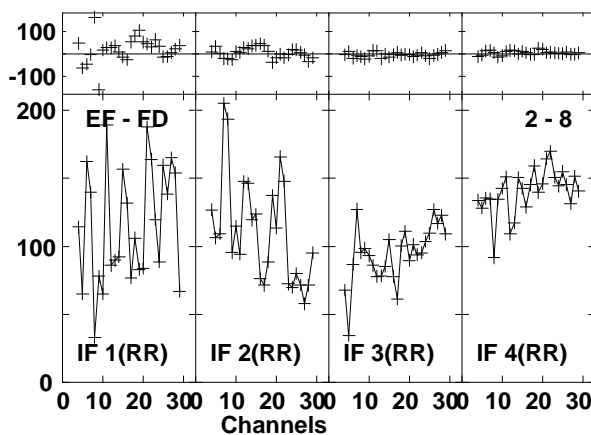
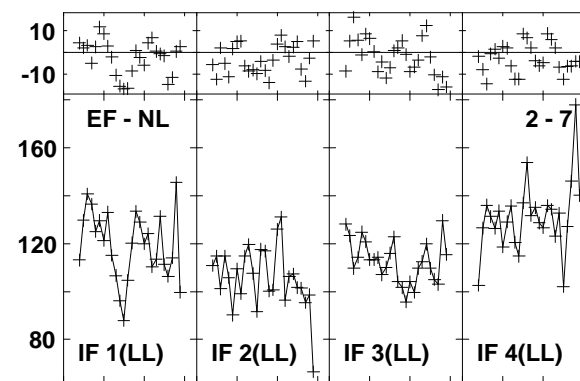
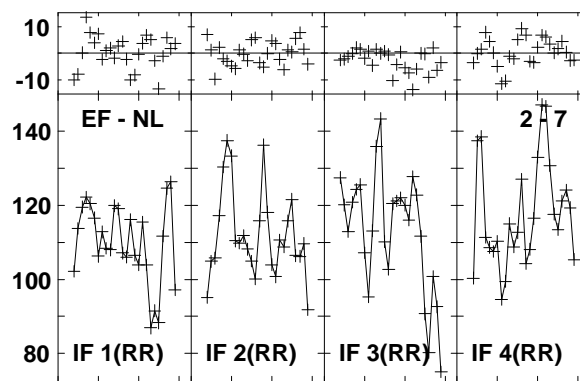
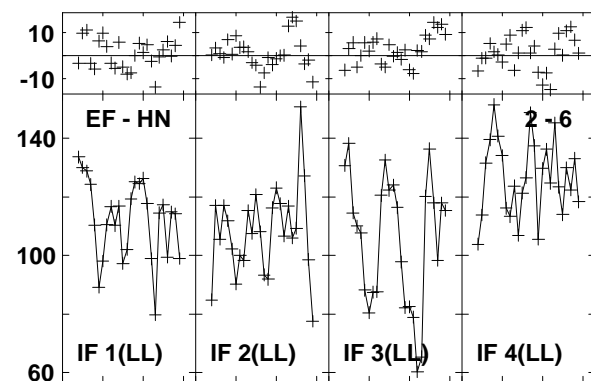
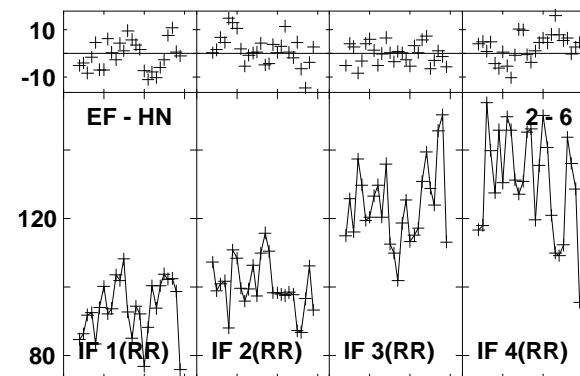
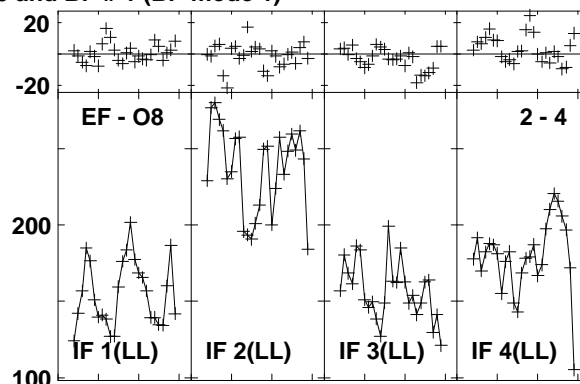
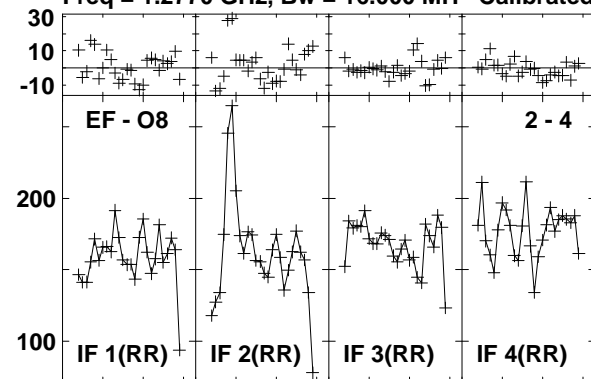

Lower frame: Milli Ampl Jy Top frame: Phas deg
Vector averaged cross-power spectrum Baseline: EF (02) - O8 (04)
Timerange: 01/03:18:37 to 01/03:19:35

Plot file version1387 created 03-MAR-2016 01:15:59

J1545+5400 GN002C 1.UVDATA.1

Freq = 1.2770 GHz, Bw = 16.000 MH Calibrated with CL # 3 and BP # 1 (BP mode 1)

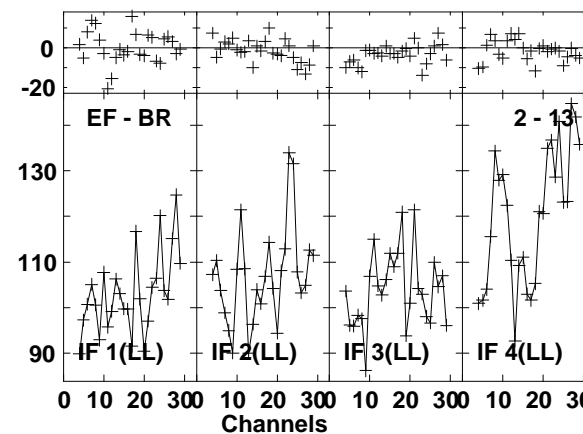
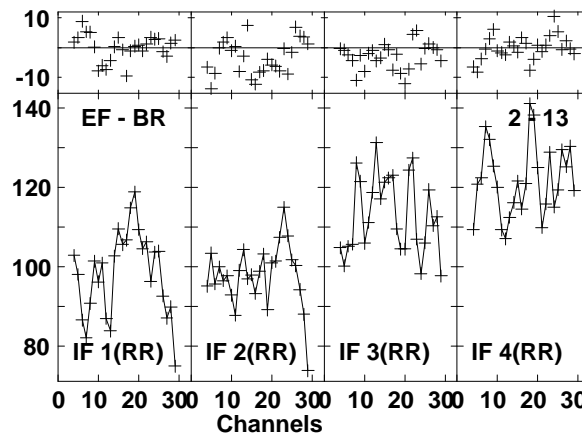
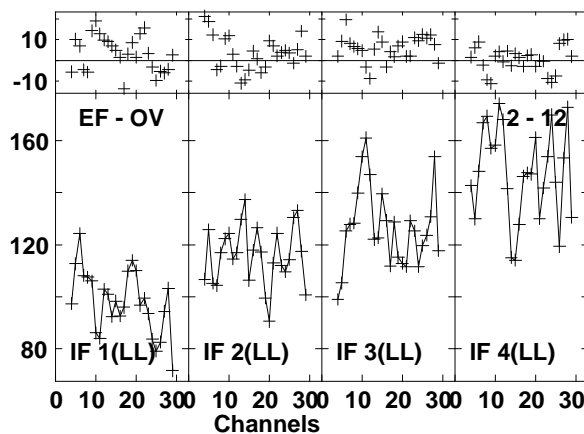
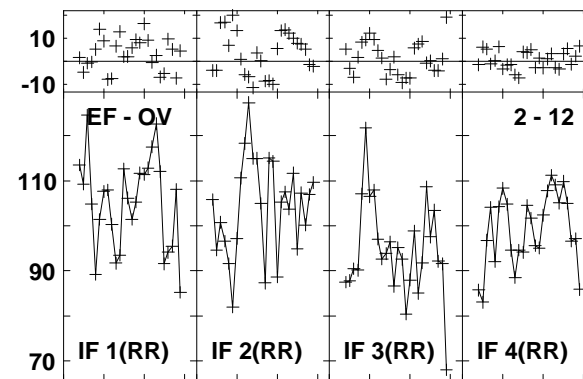
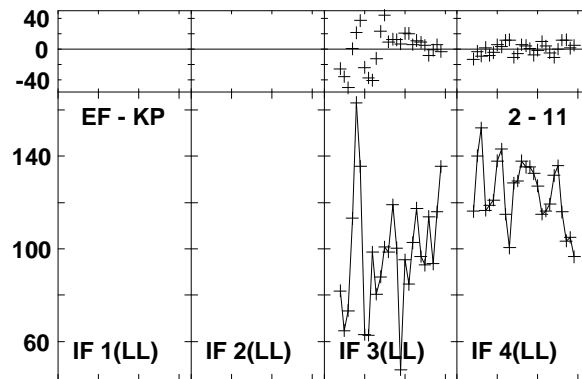
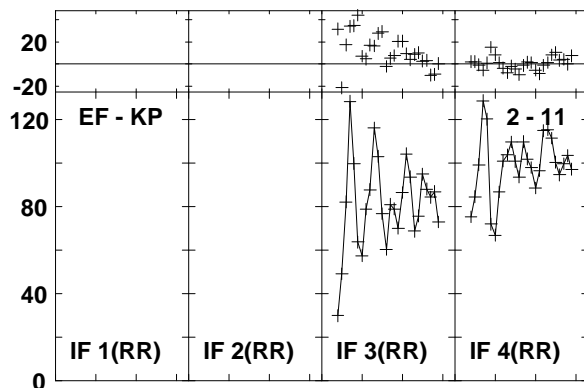
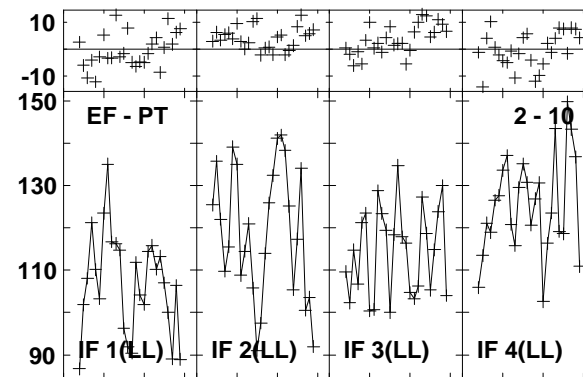
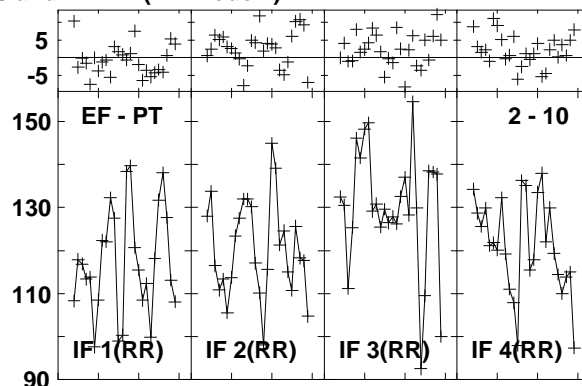
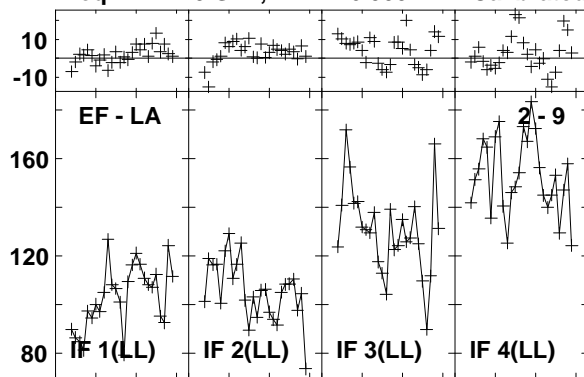

Lower frame: Milli Ampl Jy Top frame: Phas deg
Vector averaged cross-power spectrum Baseline: EF (02) - LA (09)
Timerange: 01/03:18:37 to 01/03:19:35

Plot file version1388 created 03-MAR-2016 01:15:59

J1545+5400 GN002C 1.UVDATA.1

Freq = 1.2770 GHz, Bw = 16.000 MH Calibrated with CL # 3 and BP # 1 (BP mode 1)

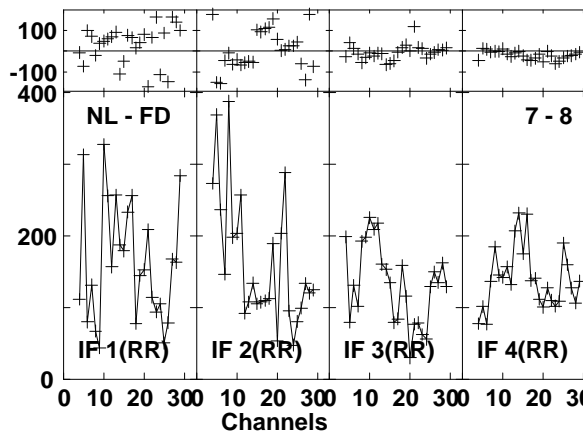
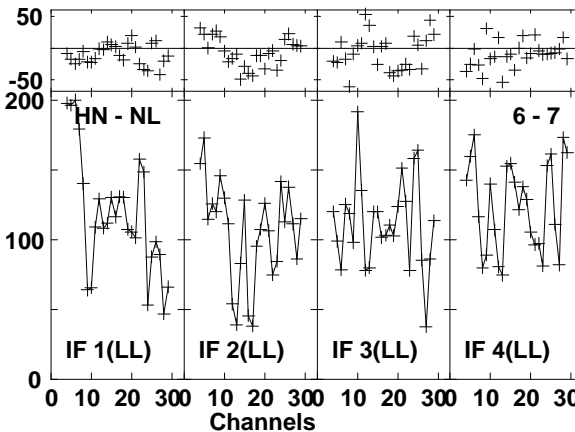
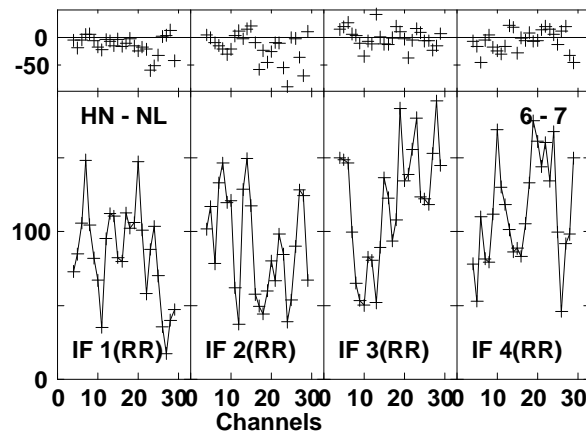
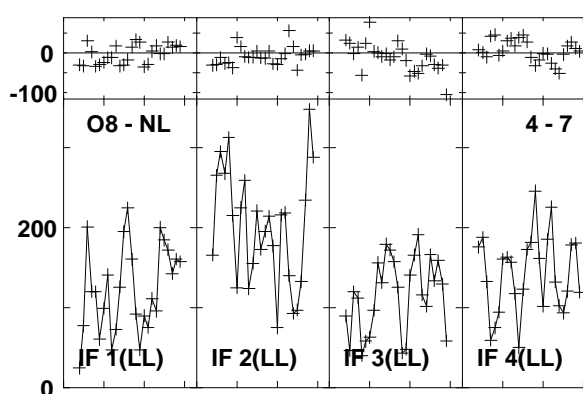
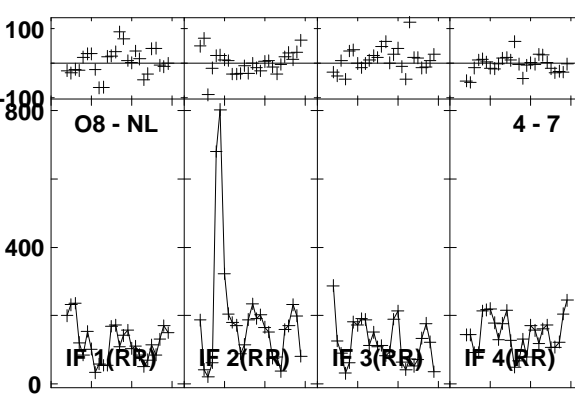
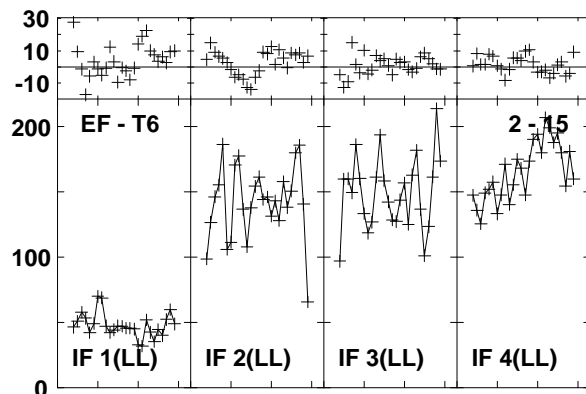
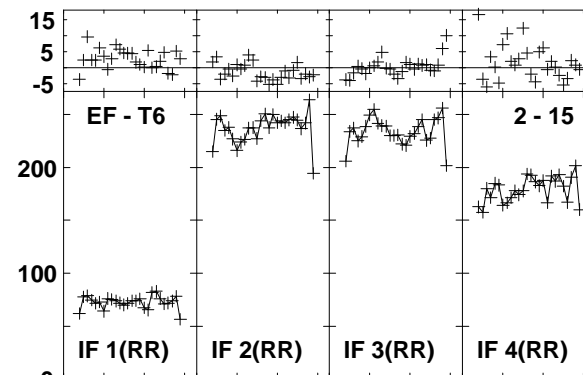
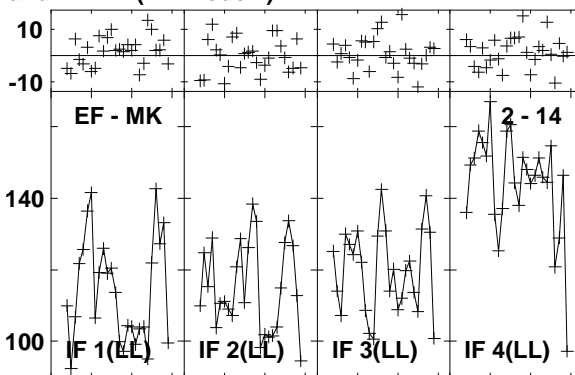
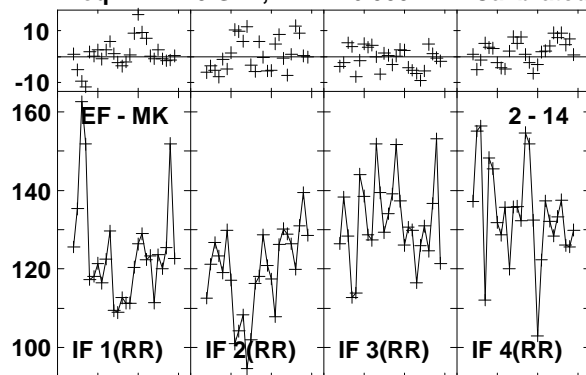

Lower frame: Milli Ampl Jy Top frame: Phas deg
Vector averaged cross-power spectrum Baseline: EF (02) - MK (14)
Timerange: 01/03:18:37 to 01/03:19:35

Plot file version1389 created 03-MAR-2016 01:16:00
 J1545+5400 GN002C 1.UVDATA.1
 Freq = 1.2770 GHz, Bw = 16.000 MH Calibrated with CL # 3 and BP # 1 (BP mode 1)

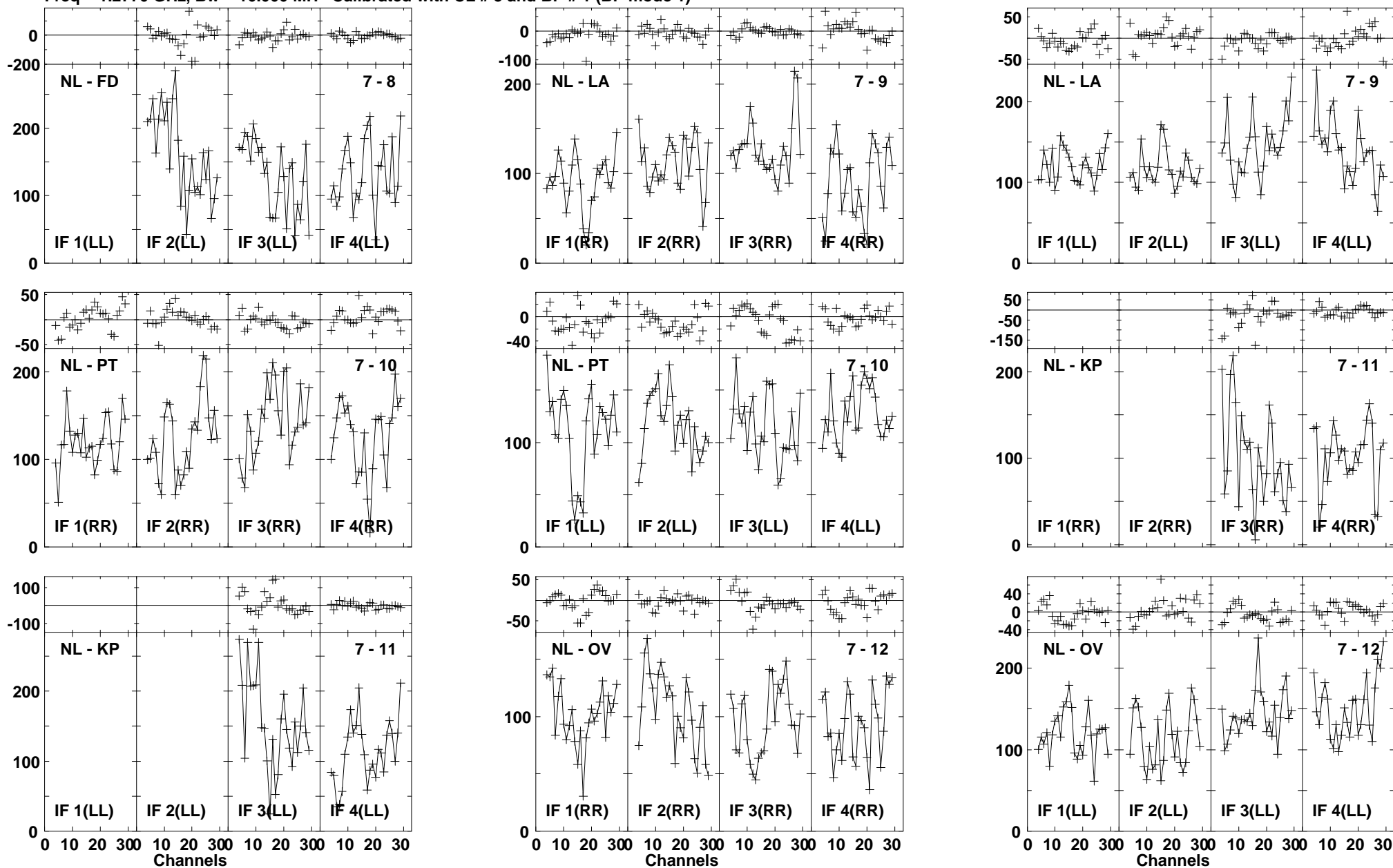

Lower frame: Milli Ampl Jy Top frame: Phas deg
 Vector averaged cross-power spectrum Baseline: NL (07) - FD (08)
 Timerange: 01/03:18:37 to 01/03:19:35

Plot file version1390 created 03-MAR-2016 01:16:00

J1545+5400 GN002C 1.UVDATA.1

Freq = 1.2770 GHz, Bw = 16.000 MH Calibrated with CL # 3 and BP # 1 (BP mode 1)

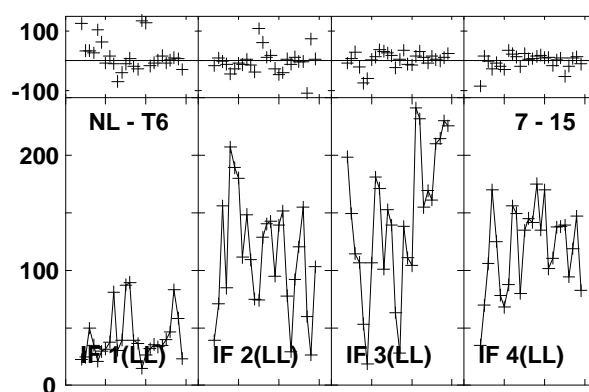
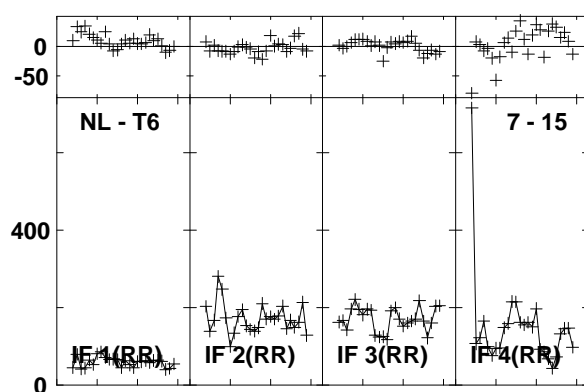
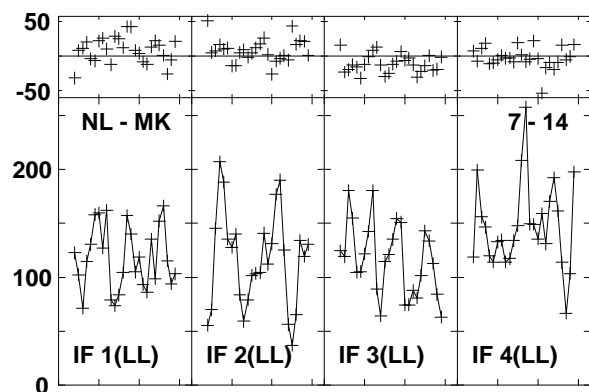
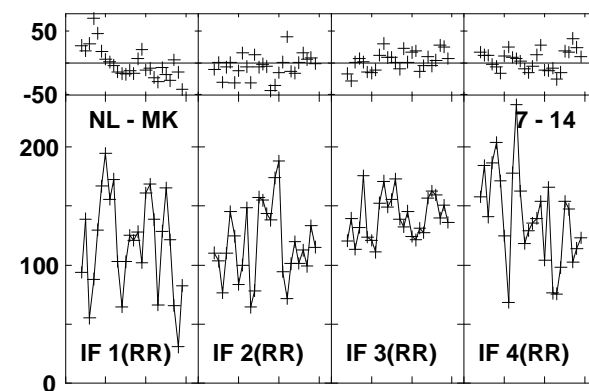
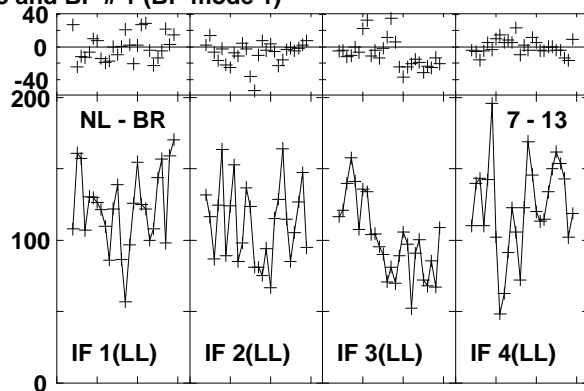
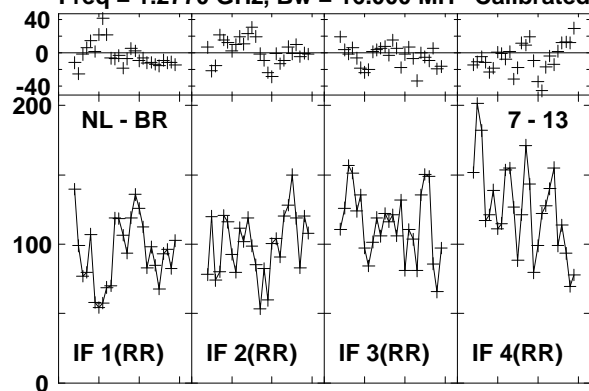

Lower frame: Milli Ampl Jy Top frame: Phas deg
Vector averaged cross-power spectrum Baseline: NL (07) - BR (13)
Timerange: 01/03:18:37 to 01/03:19:35

Plot file version1391 created 03-MAR-2016 01:16:00

4C52 GN002C 1.UVDATA.1

Freq = 1.2770 GHz, Bw = 16.000 MH Calibrated with CL # 3 and BP # 1 (BP mode 1)

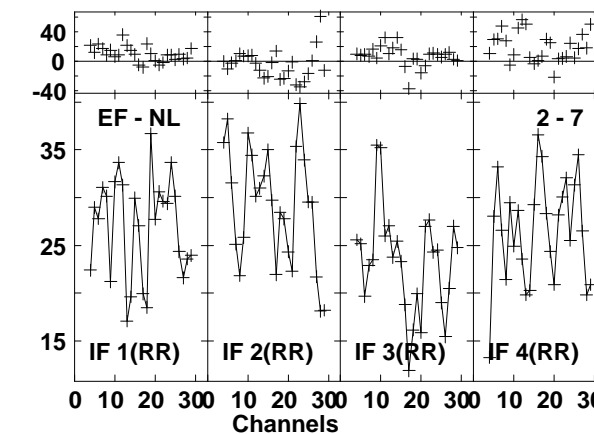
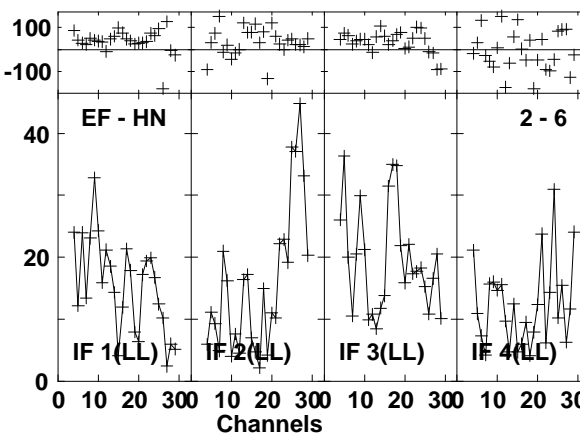
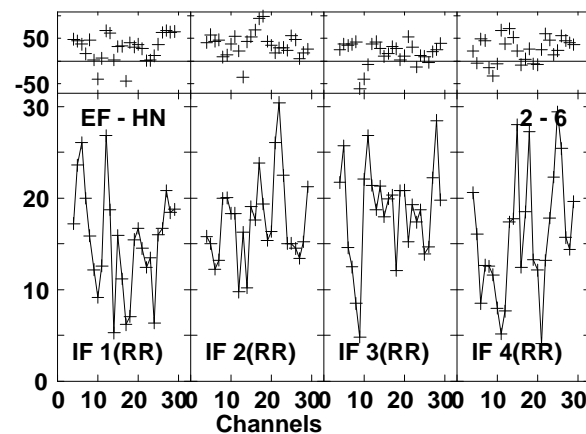
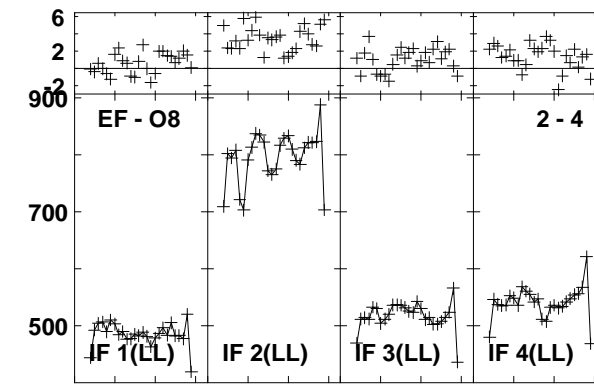
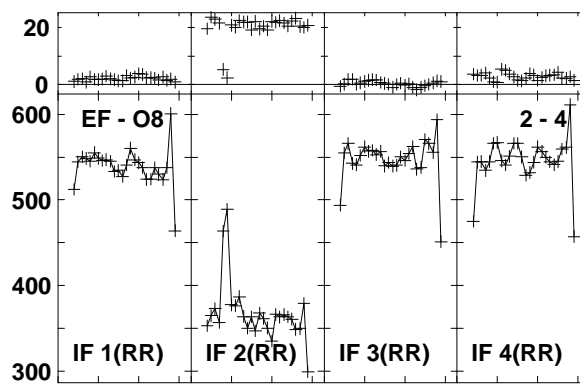
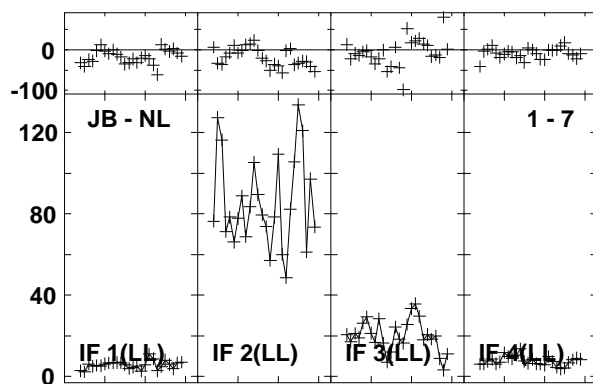
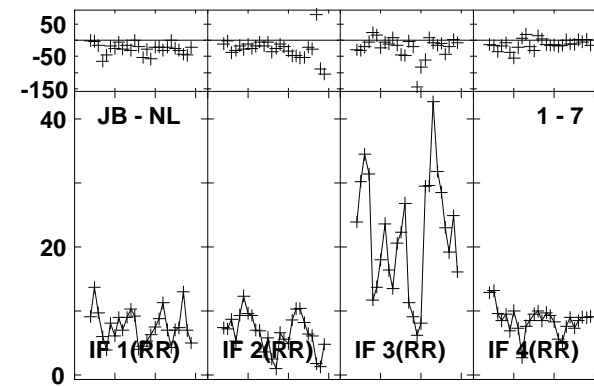
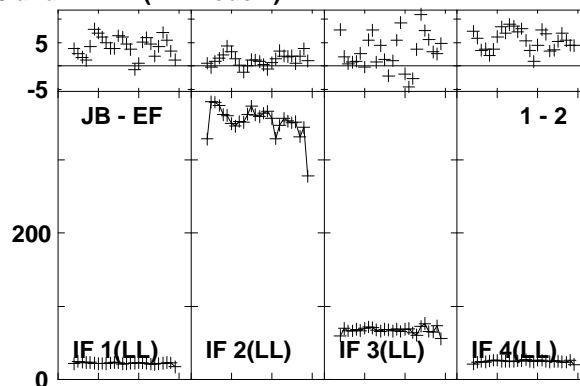
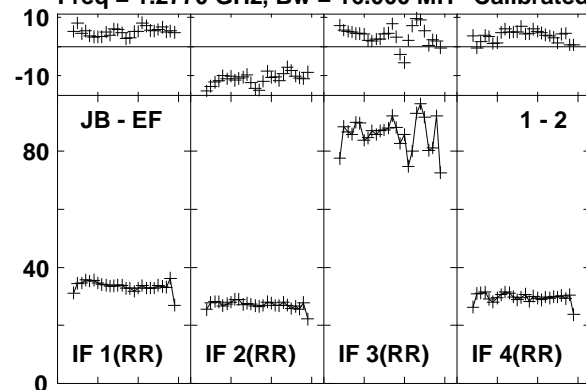

Lower frame: Milli Ampl Jy Top frame: Phas deg
Vector averaged cross-power spectrum Baseline: JB (01) - EF (02)
Timerange: 01/03:19:40 to 01/03:22:54

Plot file version1392 created 03-MAR-2016 01:16:00

4C52 GN002C 1.UVDATA.1

Freq = 1.2770 GHz, Bw = 16.000 MH Calibrated with CL # 3 and BP # 1 (BP mode 1)

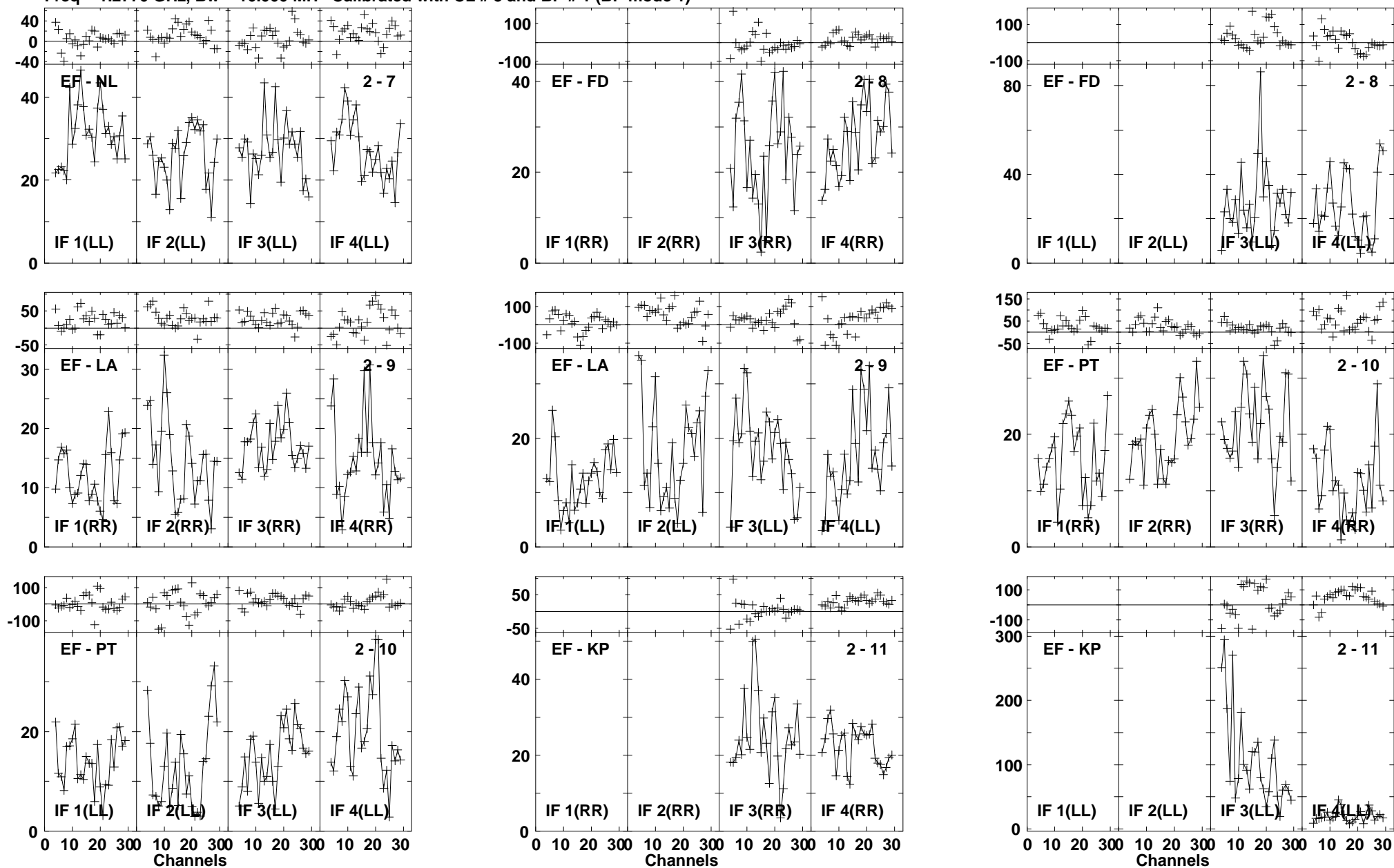

Lower frame: Milli Ampl Jy Top frame: Phas deg
Vector averaged cross-power spectrum Baseline: EF (02) - NL (07)
Timerange: 01/03:19:40 to 01/03:22:54

Plot file version1393 created 03-MAR-2016 01:16:00

4C52 GN002C 1.UVDATA.1

Freq = 1.2770 GHz, Bw = 16.000 MH Calibrated with CL # 3 and BP # 1 (BP mode 1)

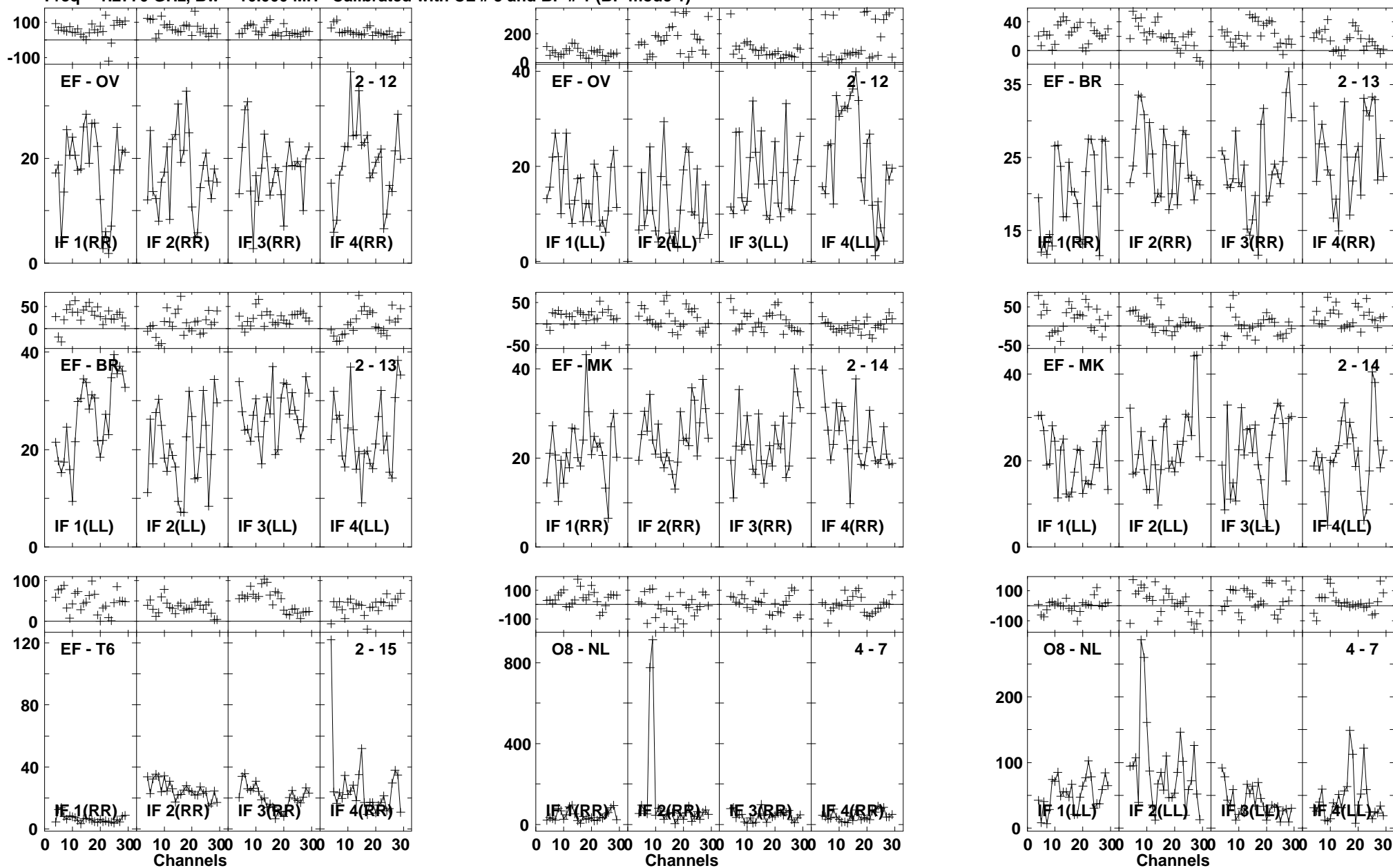

Lower frame: Milli Ampl Jy Top frame: Phas deg
Vector averaged cross-power spectrum Baseline: EF (02) - OV (12)
Timerange: 01/03:19:40 to 01/03:22:54

Plot file version1394 created 03-MAR-2016 01:16:01

4C52 GN002C 1.UVDATA.1

Freq = 1.2770 GHz, Bw = 16.000 MH Calibrated with CL # 3 and BP # 1 (BP mode 1)

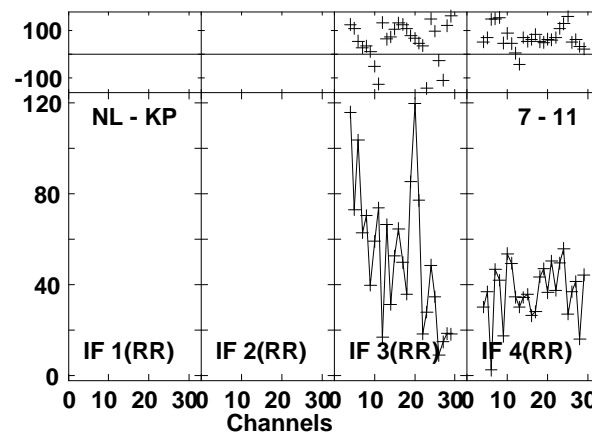
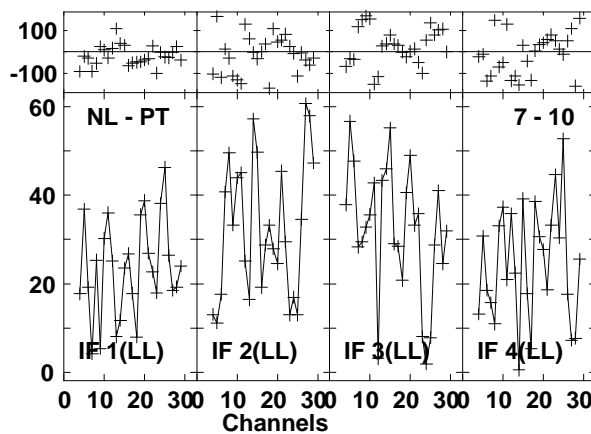
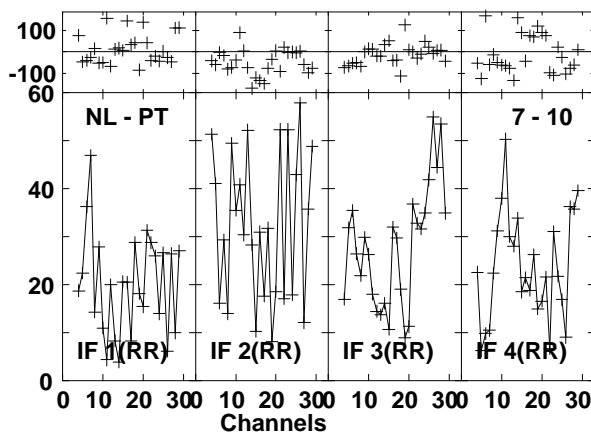
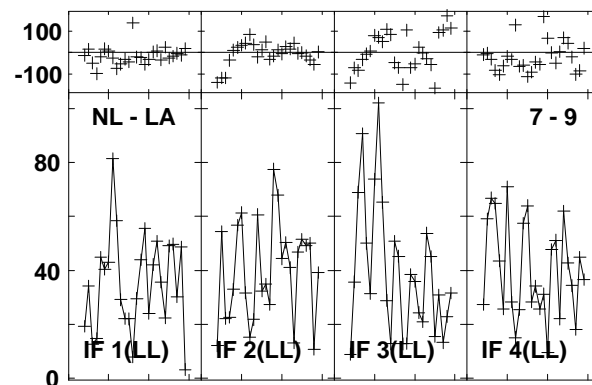
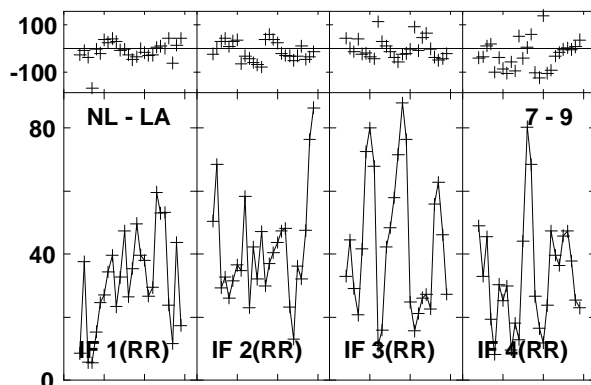
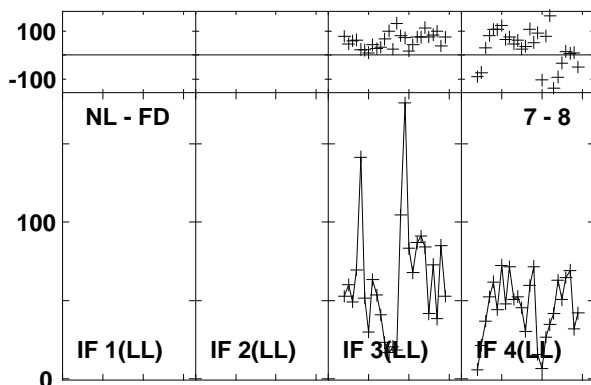
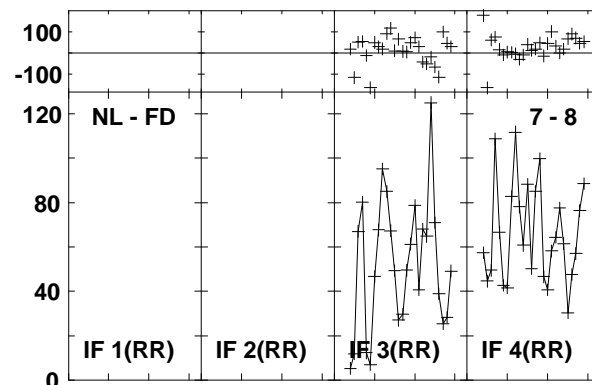
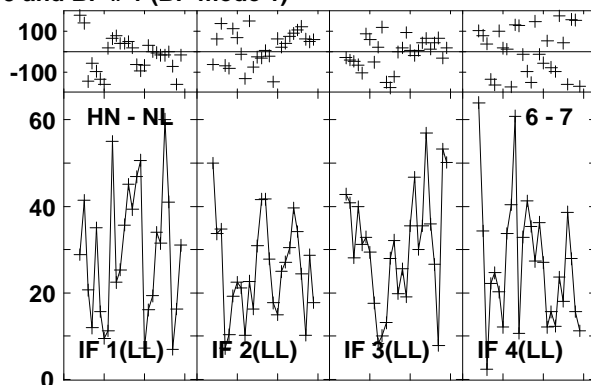
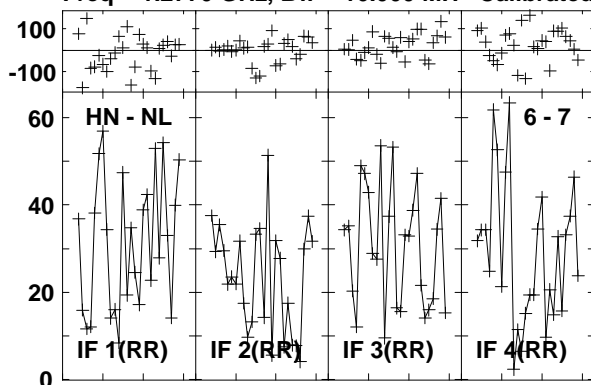

Lower frame: Milli Ampl Jy Top frame: Phas deg
Vector averaged cross-power spectrum Baseline: HN (06) - NL (07)
Timerange: 01/03:19:40 to 01/03:22:54

Plot file version1395 created 03-MAR-2016 01:16:01

4C52 GN002C 1.UVDATA.1

Freq = 1.2770 GHz, Bw = 16.000 MH Calibrated with CL # 3 and BP # 1 (BP mode 1)

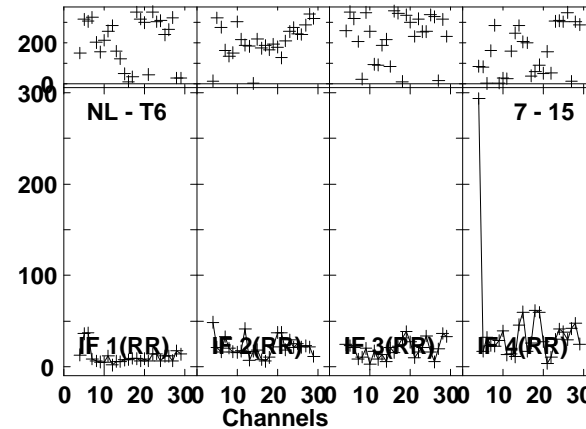
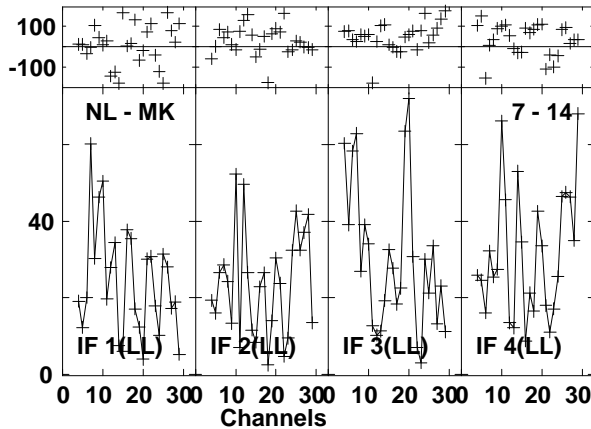
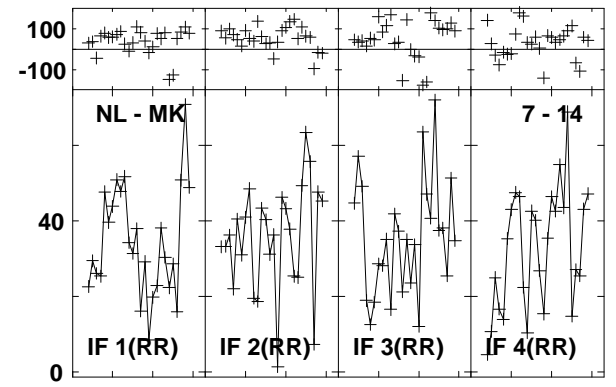
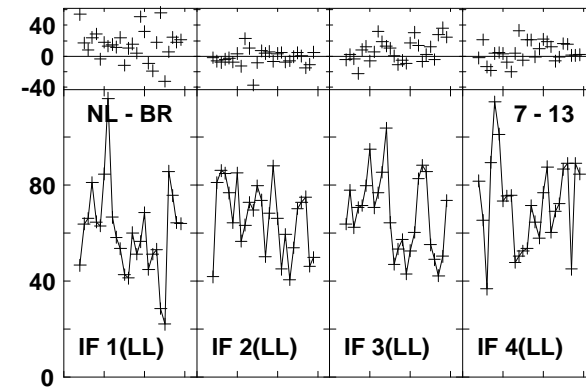
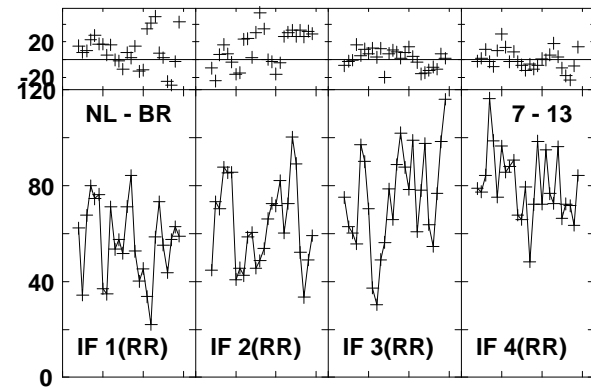
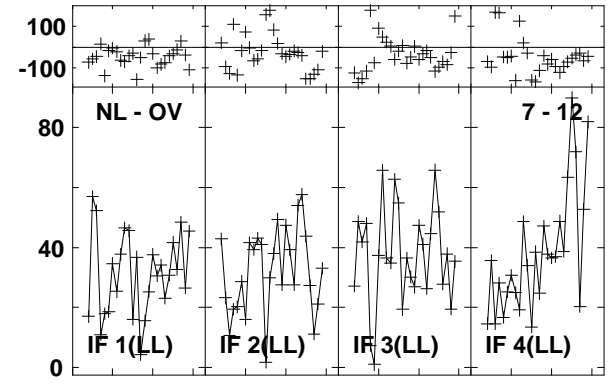
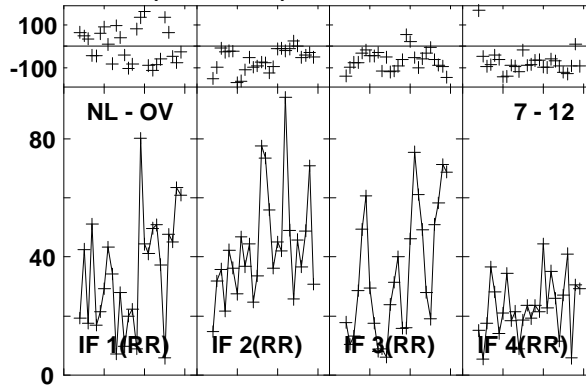
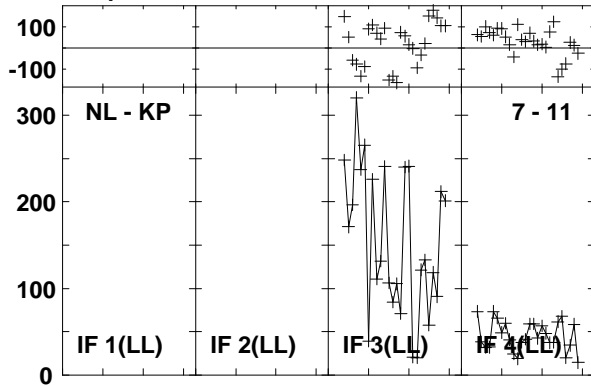

Lower frame: Milli Ampl Jy Top frame: Phas deg

Vector averaged cross-power spectrum Baseline: NL (07) - KP (11)

Timerange: 01/03:19:40 to 01/03:22:54

Plot file version1396 created 03-MAR-2016 01:16:01

J1545+5400 GN002C 1.UVDATA.1

Freq = 1.2770 GHz, Bw = 16.000 MH Calibrated with CL # 3 and BP # 1 (BP mode 1)

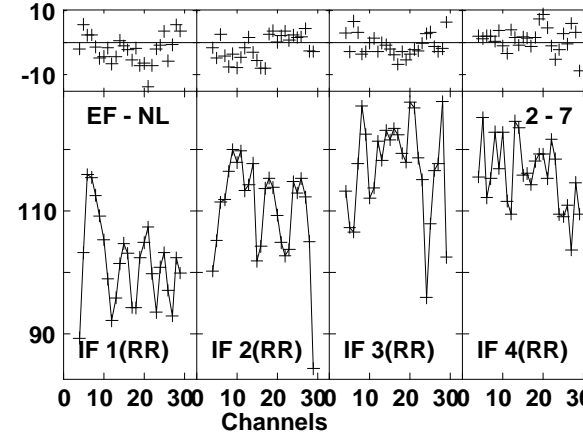
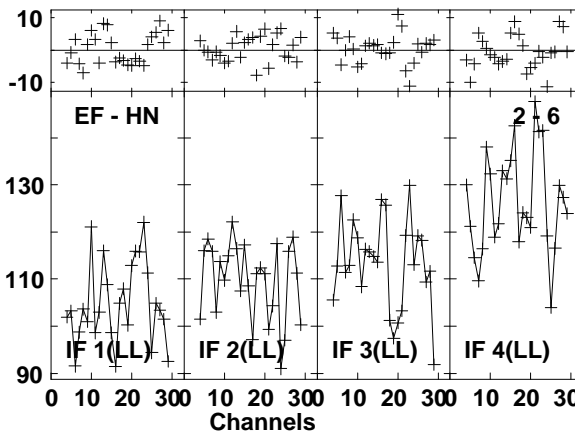
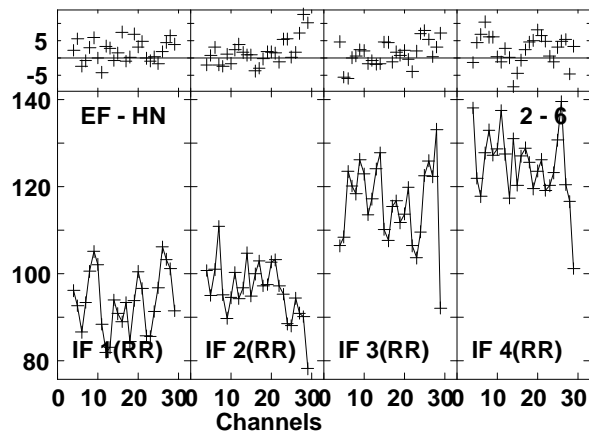
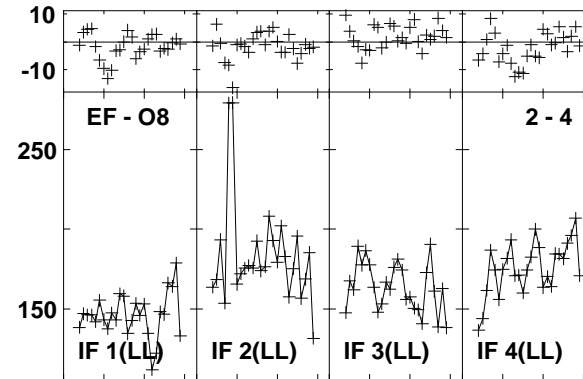
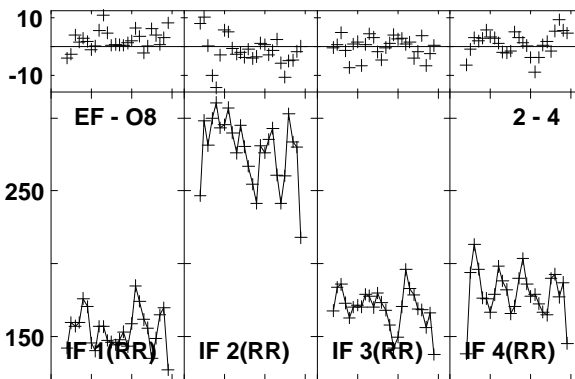
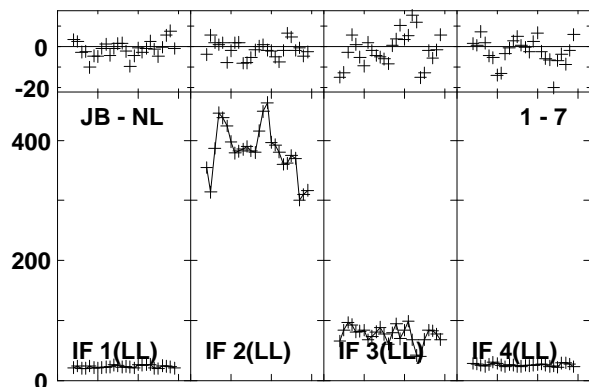
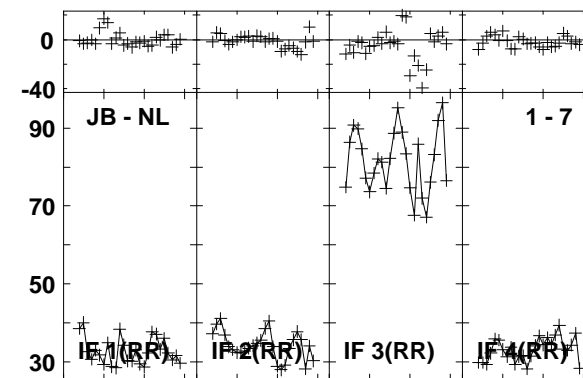
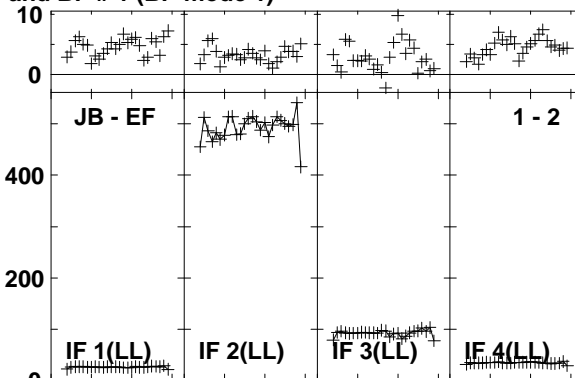
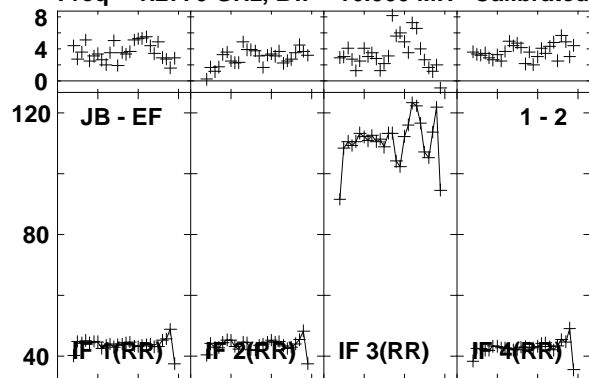

Lower frame: Milli Ampl Jy Top frame: Phas deg
Vector averaged cross-power spectrum Baseline: JB (01) - EF (02)
Timerange: 01/03:23:47 to 01/03:25:45

Plot file version1397 created 03-MAR-2016 01:16:01

J1545+5400 GN002C 1.UVDATA.1

Freq = 1.2770 GHz, Bw = 16.000 MH Calibrated with CL # 3 and BP # 1 (BP mode 1)

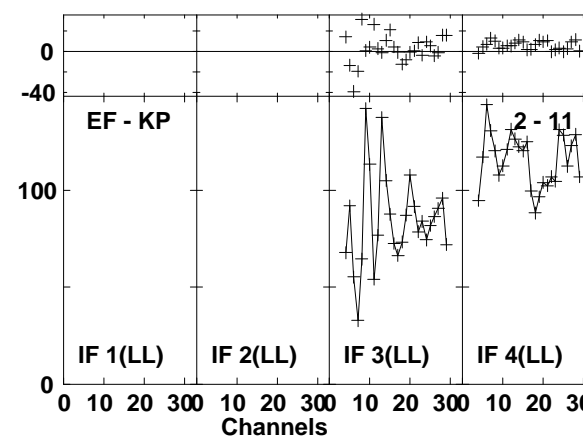
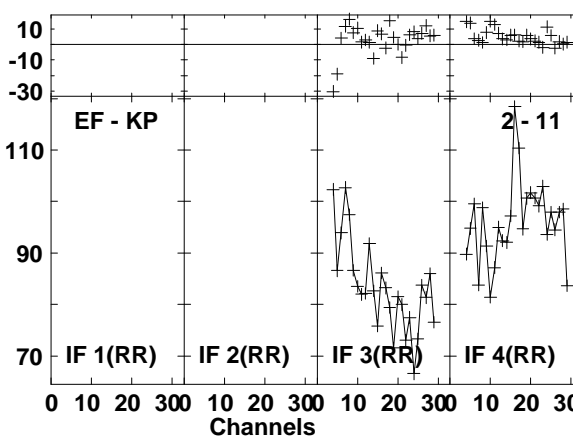
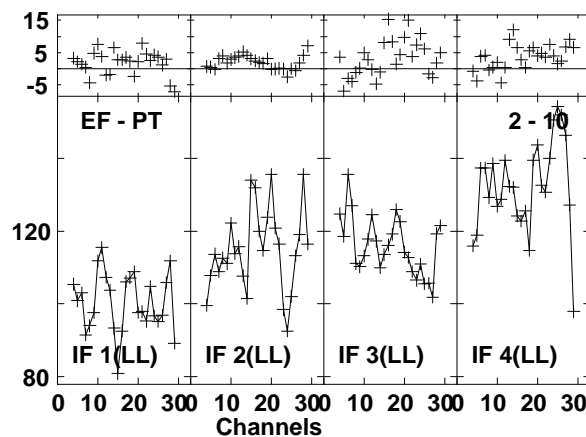
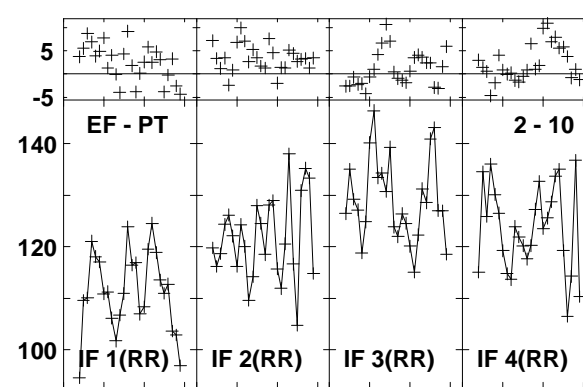
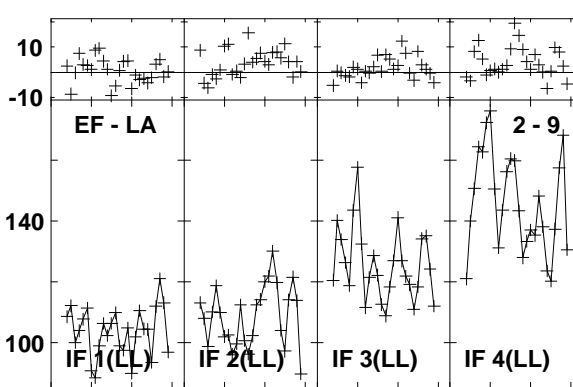
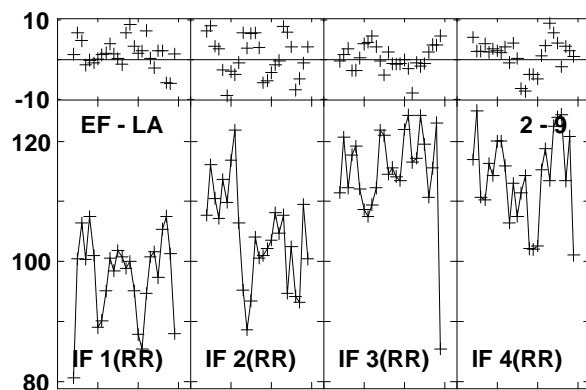
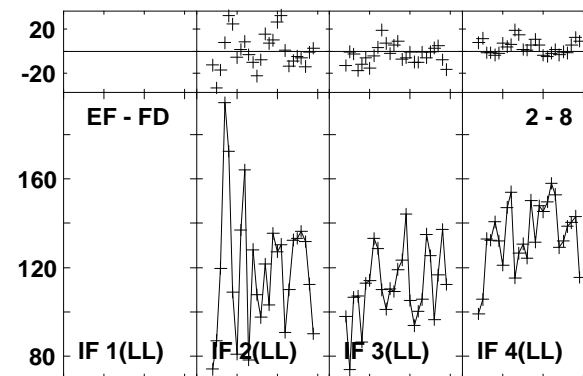
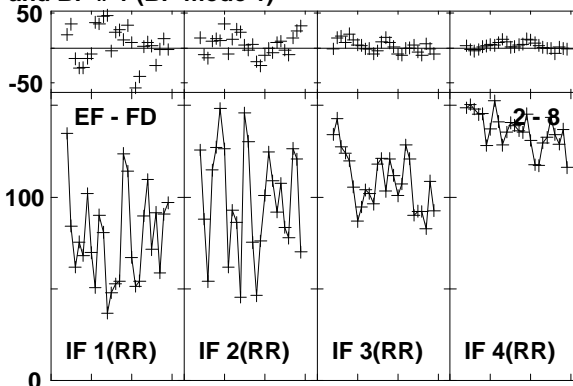
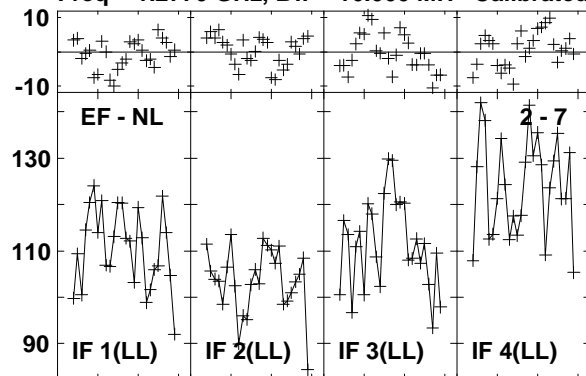

Lower frame: Milli Ampl Jy Top frame: Phas deg
Vector averaged cross-power spectrum Baseline: EF (02) - NL (07)
Timerange: 01/03:23:47 to 01/03:25:45

Plot file version1398 created 03-MAR-2016 01:16:01

J1545+5400 GN002C 1.UVDATA.1

Freq = 1.2770 GHz, Bw = 16.000 MH Calibrated with CL # 3 and BP # 1 (BP mode 1)

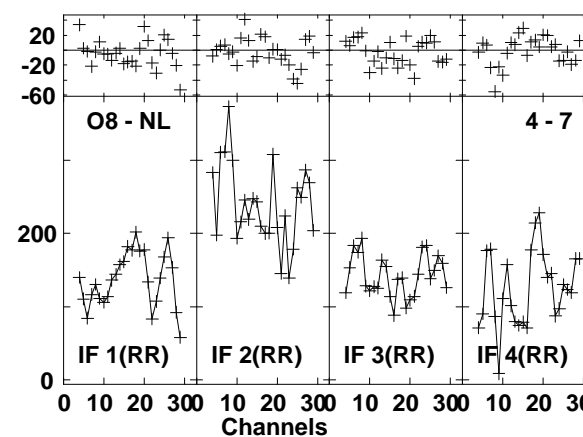
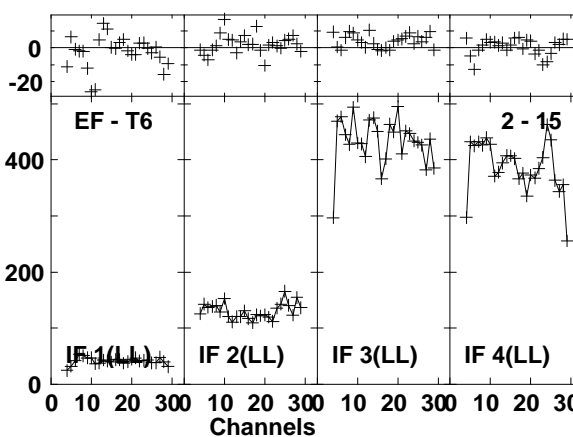
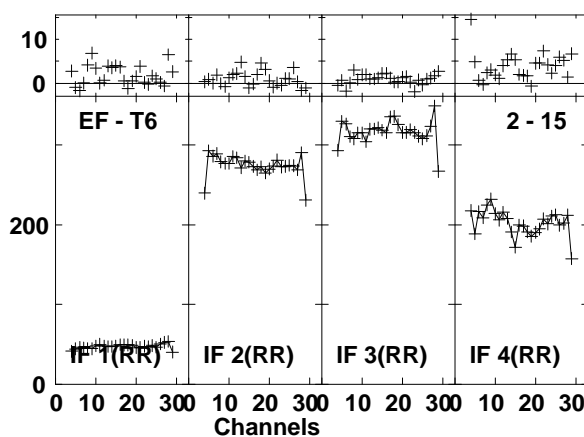
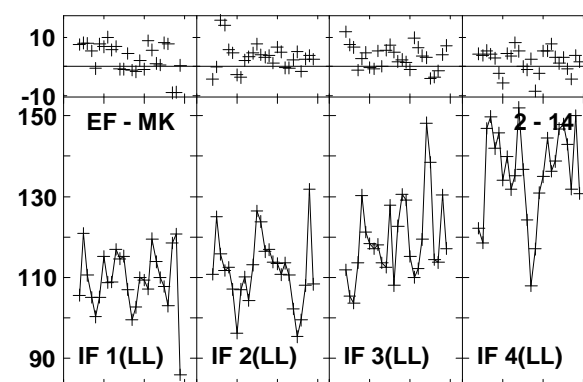
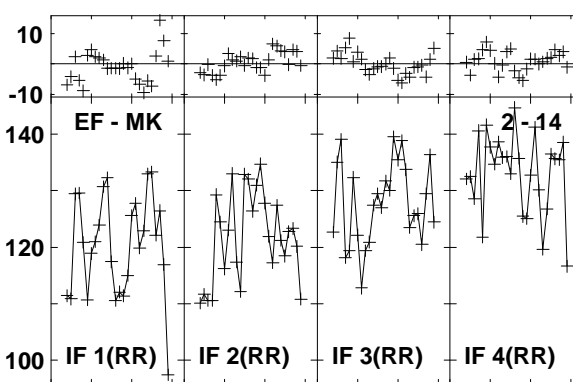
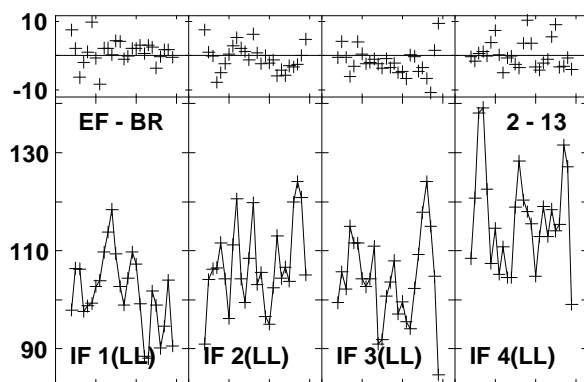
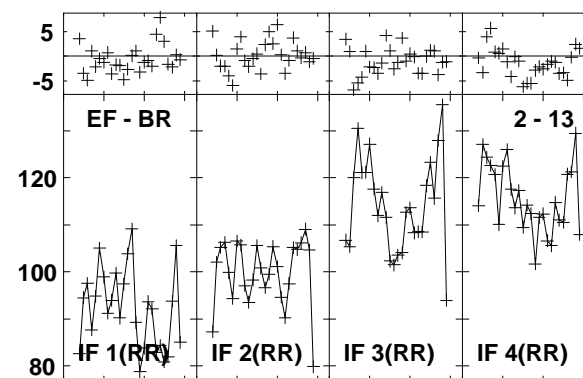
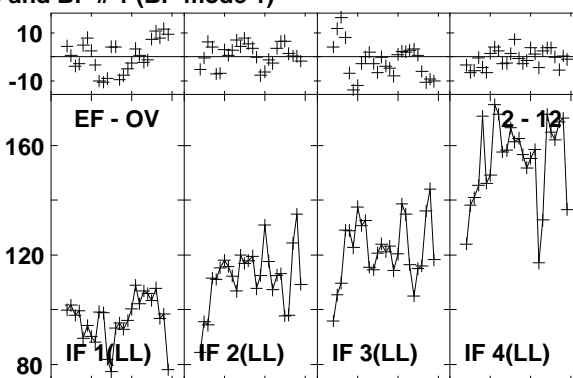
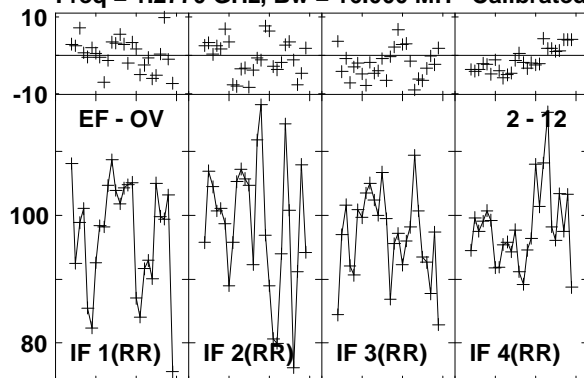

Lower frame: Milli Ampl Jy Top frame: Phas deg
Vector averaged cross-power spectrum Baseline: EF (02) - OV (12)
Timerange: 01/03:23:47 to 01/03:25:45

Plot file version1399 created 03-MAR-2016 01:16:02

J1545+5400 GN002C 1.UVDATA.1

Freq = 1.2770 GHz, Bw = 16.000 MH Calibrated with CL # 3 and BP # 1 (BP mode 1)

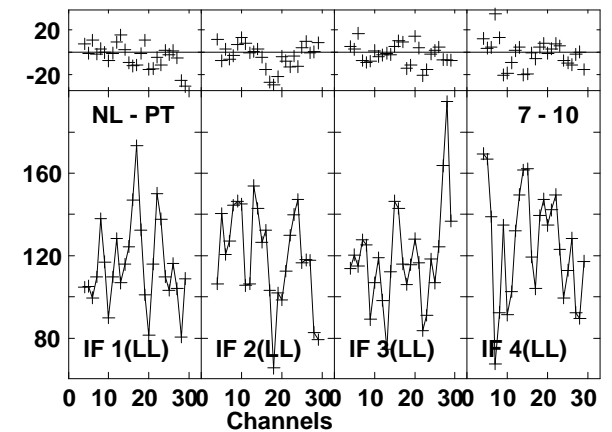
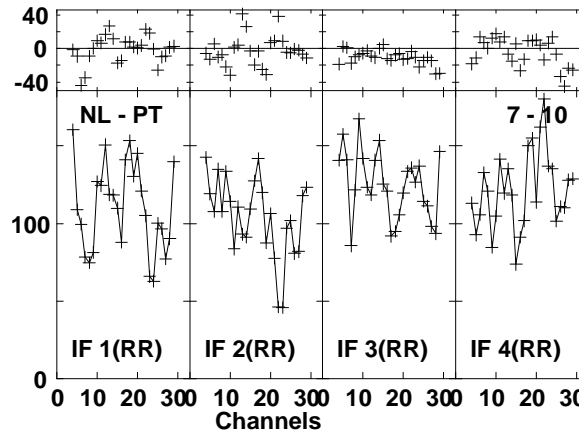
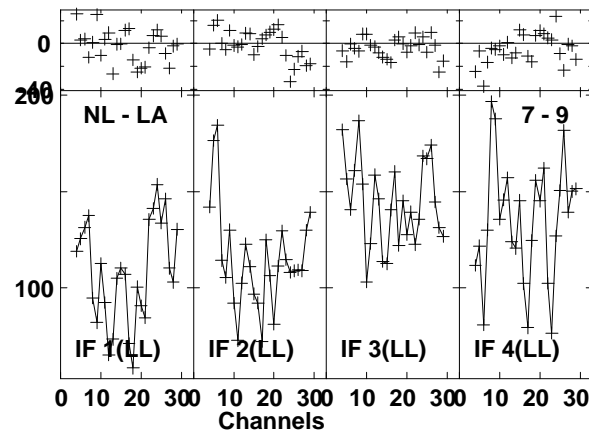
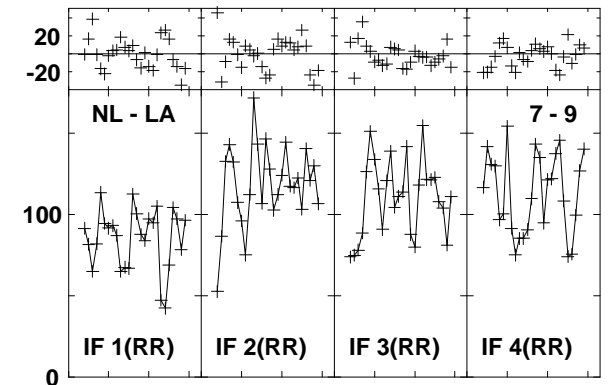
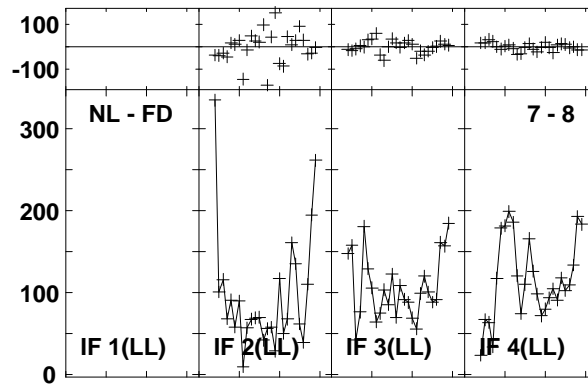
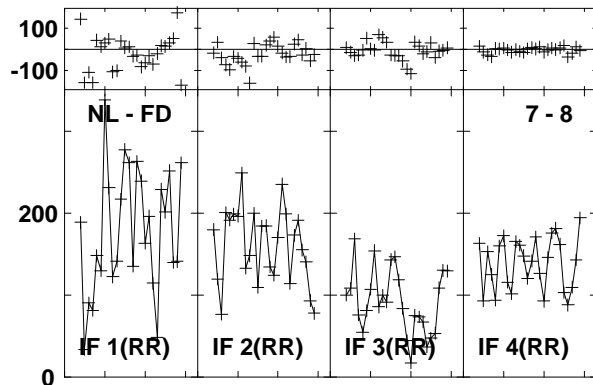
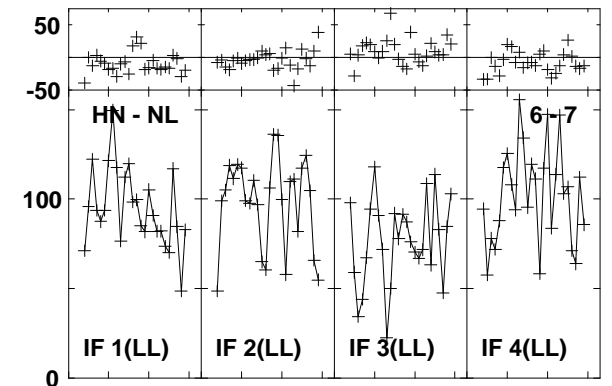
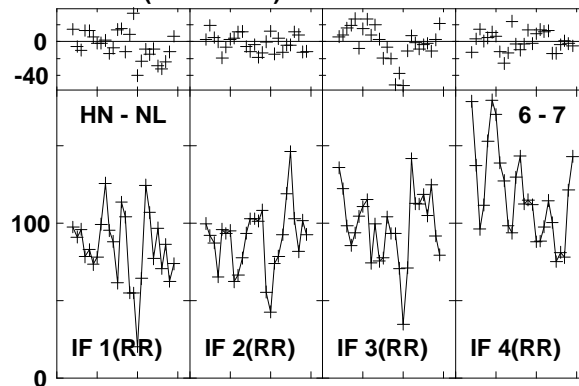
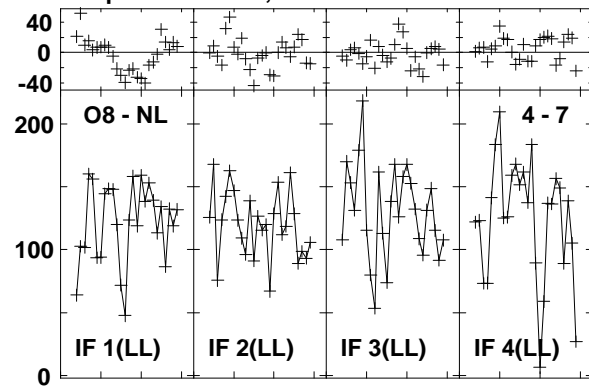

Lower frame: Milli Ampl Jy Top frame: Phas deg
Vector averaged cross-power spectrum Baseline: O8 (04) - NL (07)
Timerange: 01/03:23:47 to 01/03:25:45

Plot file version1400 created 03-MAR-2016 01:16:02

J1545+5400 GN002C 1.UVDATA.1

Freq = 1.2770 GHz, Bw = 16.000 MH Calibrated with CL # 3 and BP # 1 (BP mode 1)

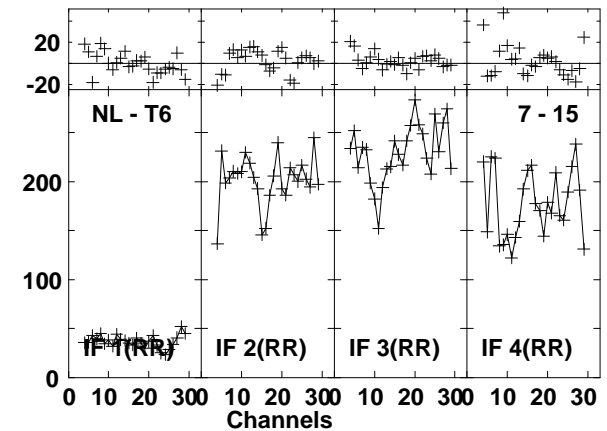
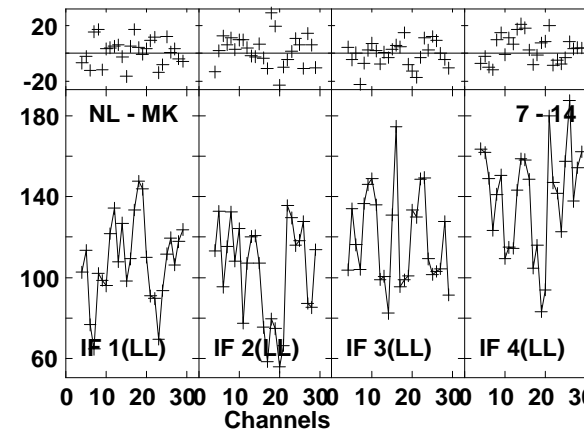
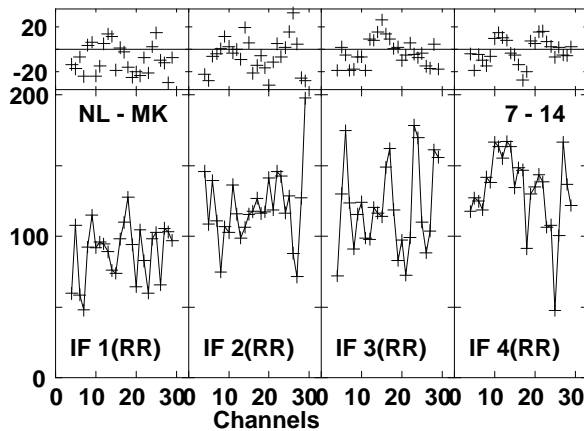
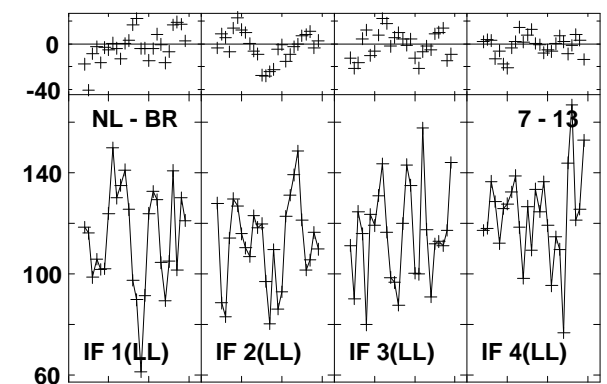
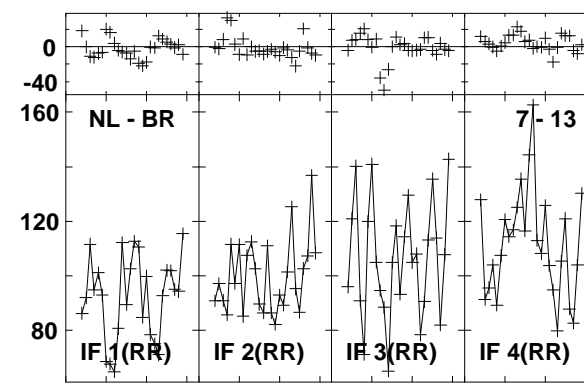
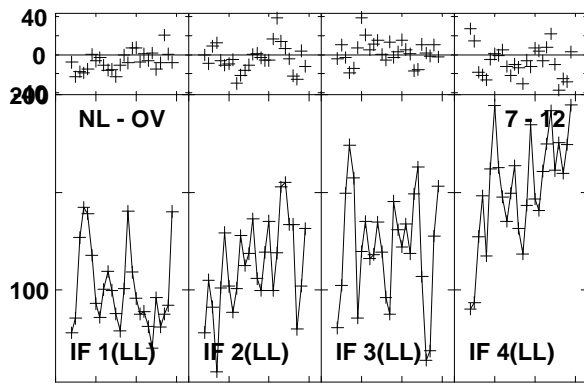
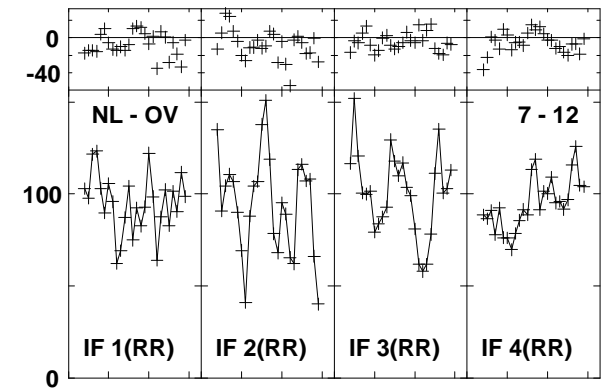
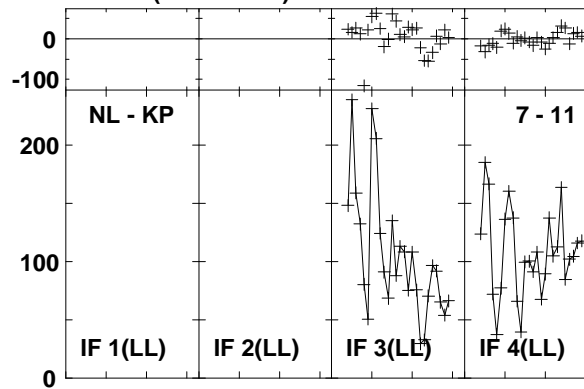
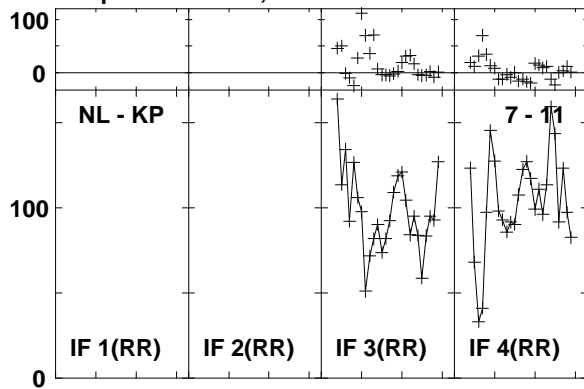

Lower frame: Milli Ampl Jy Top frame: Phas deg
Vector averaged cross-power spectrum Baseline: NL (07) - KP (11)
Timerange: 01/03:23:47 to 01/03:25:45

Plot file version1401 created 03-MAR-2016 01:16:02
J1545+5400 GN002C 1.UVDATA.1
Freq = 1.2770 GHz, Bw = 16.000 MH Calibrated with CL # 3 and BP # 1 (BP mode 1)

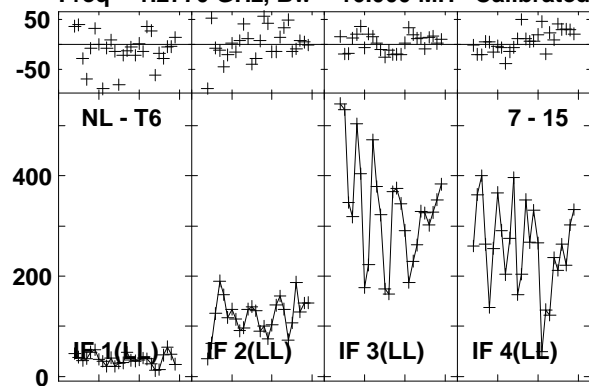

Lower frame: Milli Ampl Jy Top frame: Phas deg
Vector averaged cross-power spectrum Baseline: NL (07) - T6 (15)
Timerange: 01/03:23:47 to 01/03:25:45

Plot file version1402 created 03-MAR-2016 01:16:02

4C52 GN002C 1.UVDATA.1

Freq = 1.2770 GHz, Bw = 16.000 MH Calibrated with CL # 3 and BP # 1 (BP mode 1)

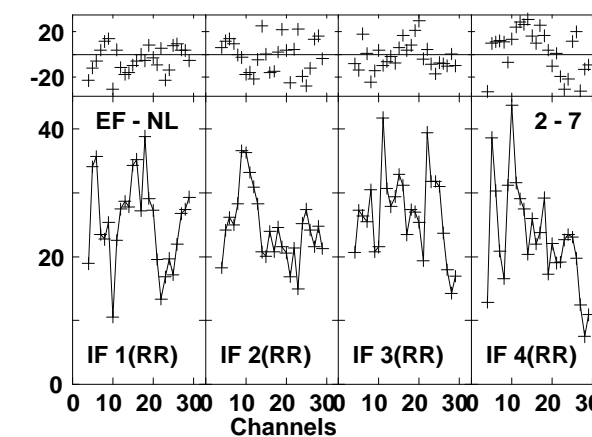
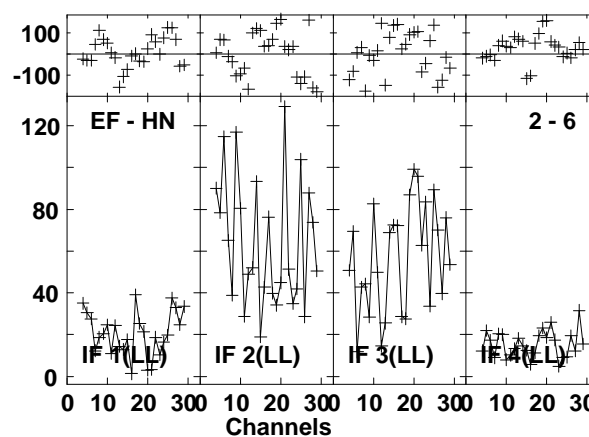
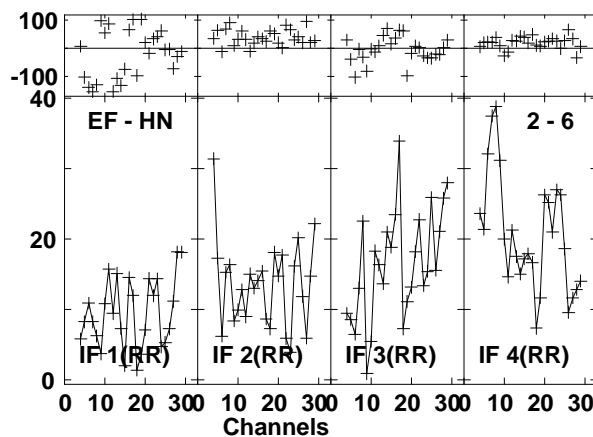
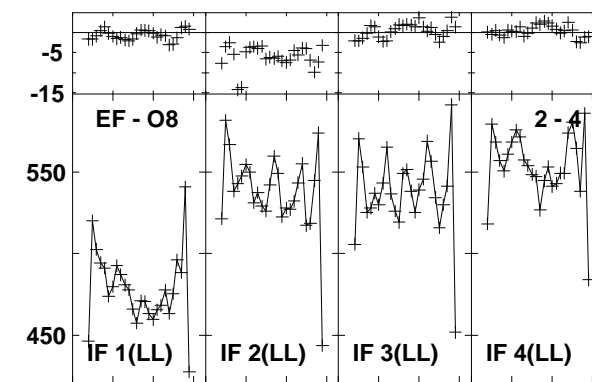
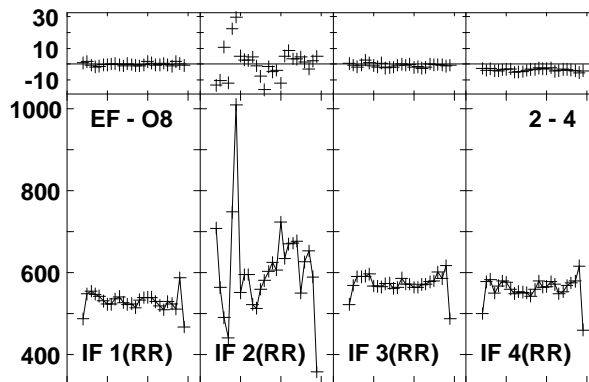
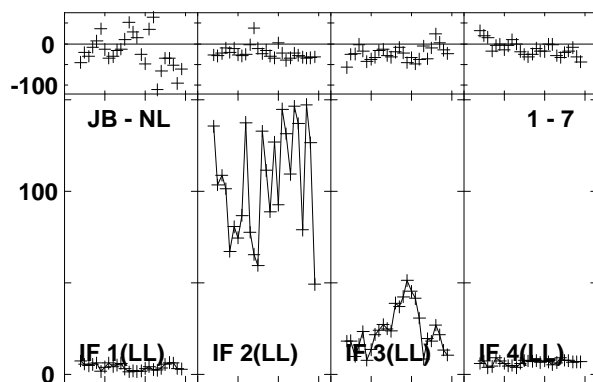
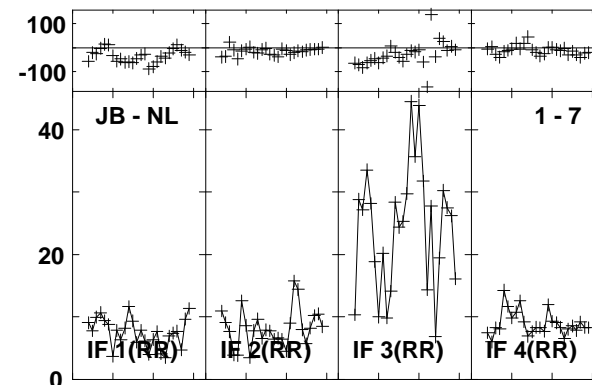
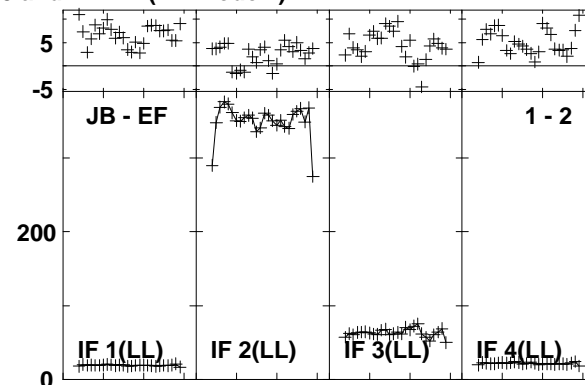
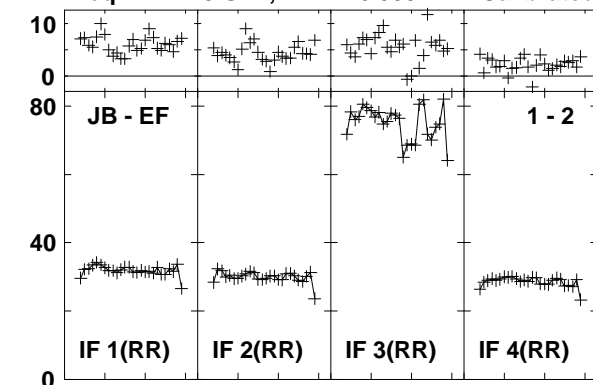

Lower frame: Milli Ampl Jy Top frame: Phas deg
Vector averaged cross-power spectrum Baseline: JB (01) - EF (02)
Timerange: 01/03:25:57 to 01/03:28:45

Plot file version1403 created 03-MAR-2016 01:16:02

4C52 GN002C 1.UVDATA.1

Freq = 1.2770 GHz, Bw = 16.000 MH Calibrated with CL # 3 and BP # 1 (BP mode 1)

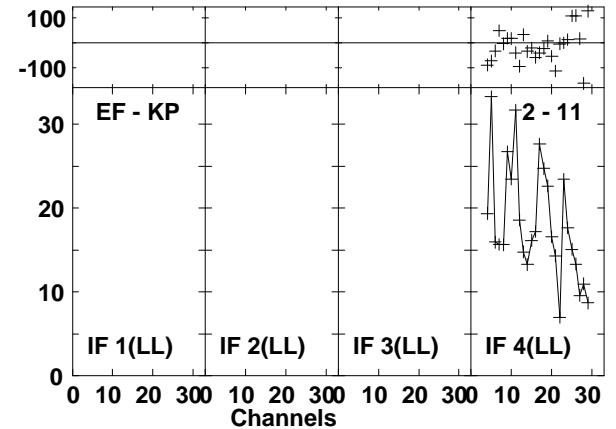
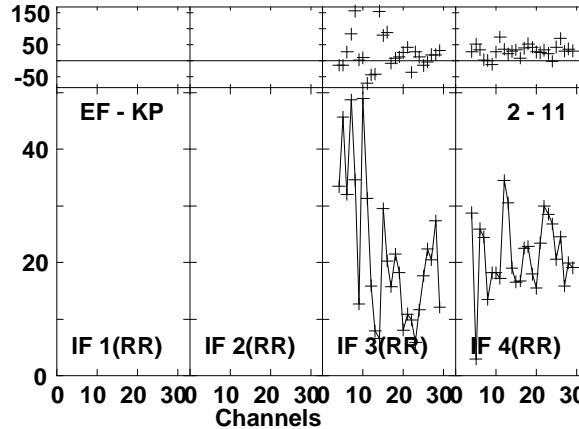
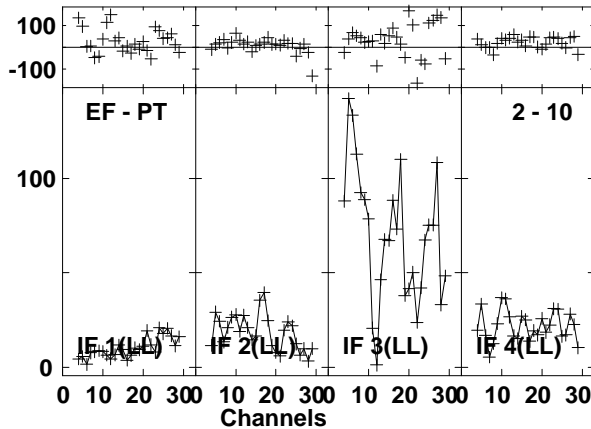
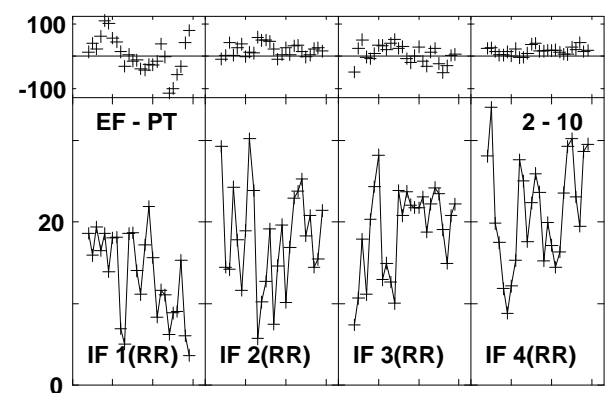
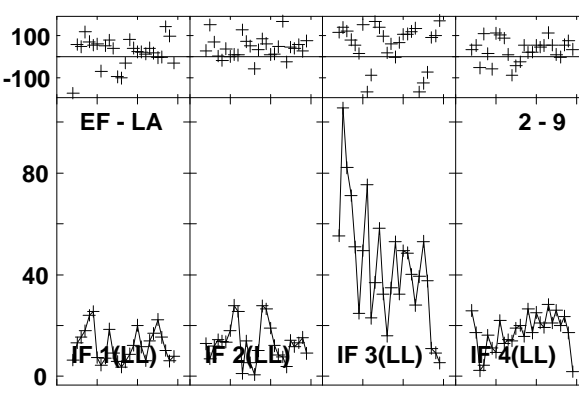
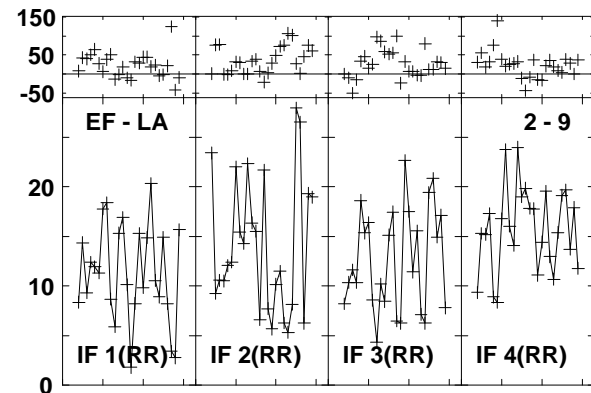
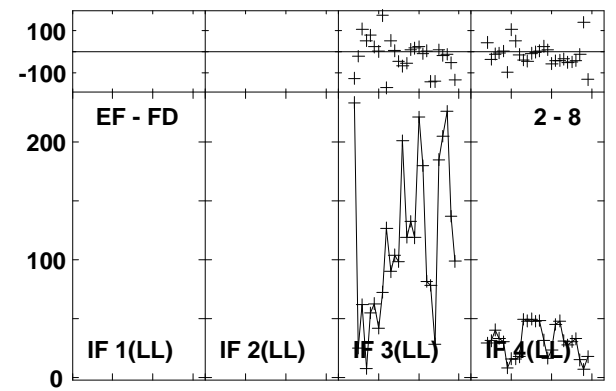
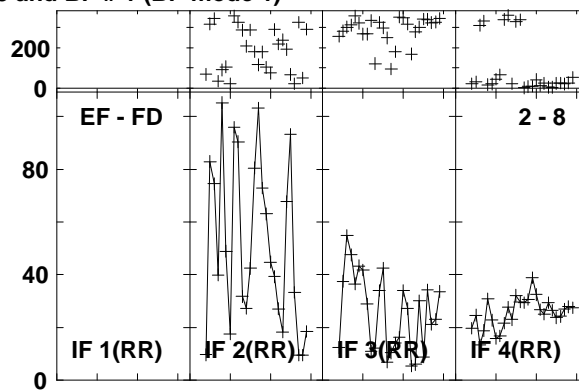
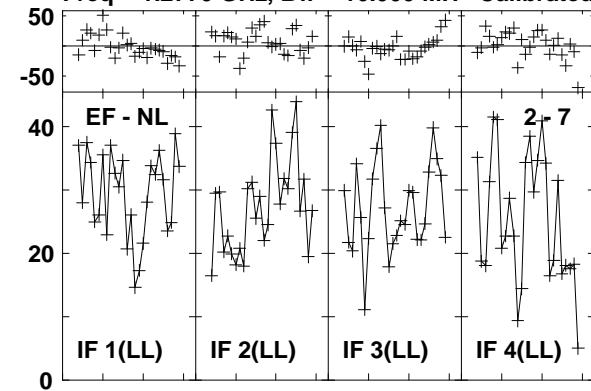

Lower frame: Milli Ampl Jy Top frame: Phas deg
Vector averaged cross-power spectrum Baseline: EF (02) - NL (07)
Timerange: 01/03:25:57 to 01/03:28:45

Plot file version1404 created 03-MAR-2016 01:16:02

4C52 GN002C 1.UVDATA.1

Freq = 1.2770 GHz, Bw = 16.000 MH Calibrated with CL # 3 and BP # 1 (BP mode 1)

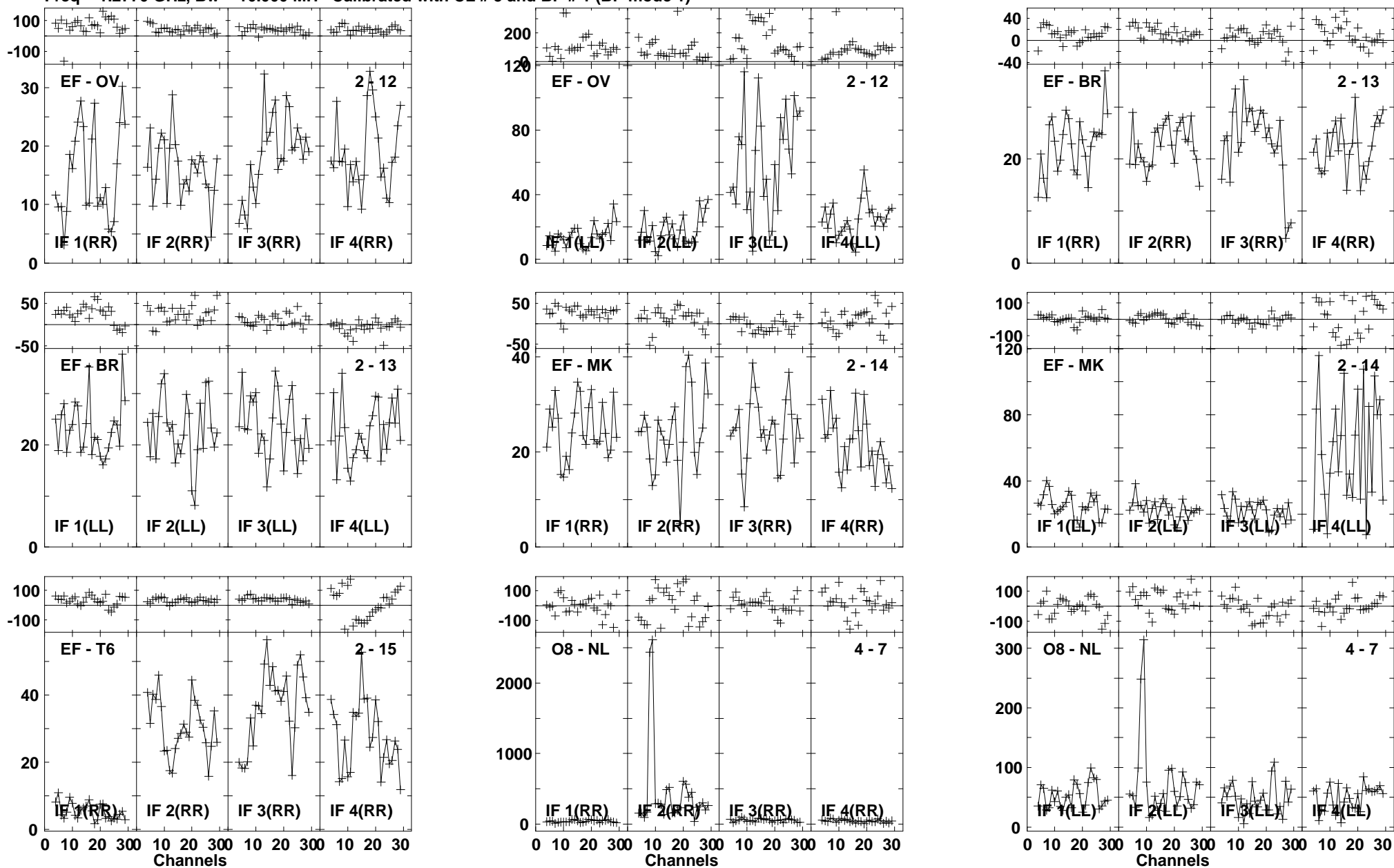

Lower frame: Milli Ampl Jy Top frame: Phas deg
Vector averaged cross-power spectrum Baseline: EF (02) - OV (12)
Timerange: 01/03:25:57 to 01/03:28:45

Plot file version1405 created 03-MAR-2016 01:16:03

4C52 GN002C 1.UVDATA.1

Freq = 1.2770 GHz, Bw = 16.000 MH Calibrated with CL # 3 and BP # 1 (BP mode 1)

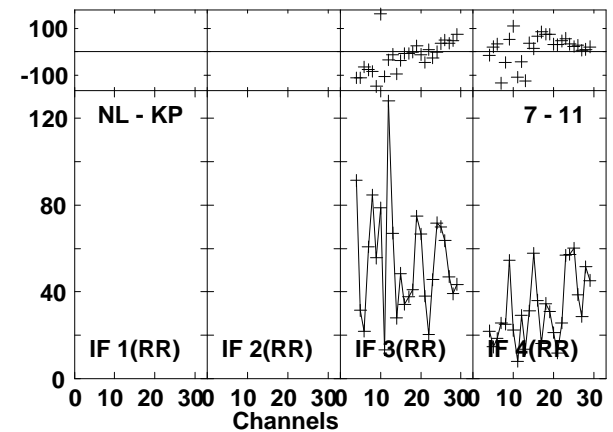
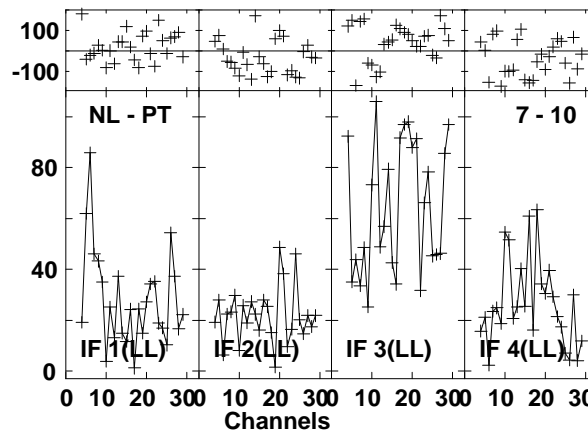
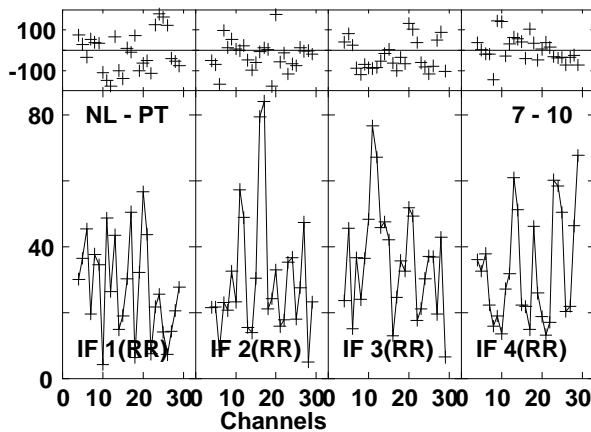
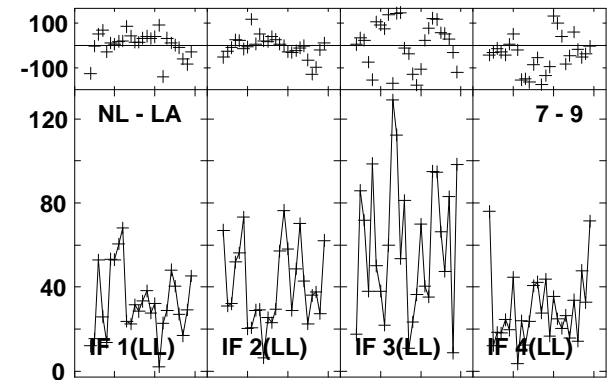
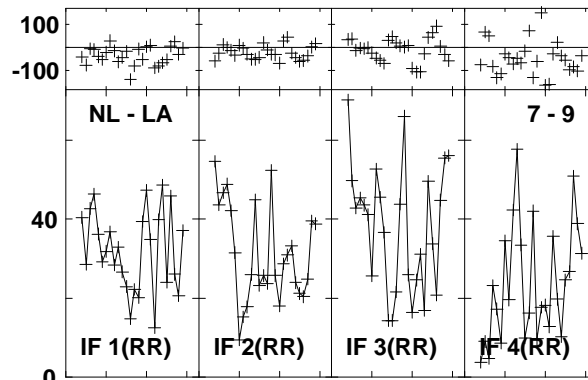
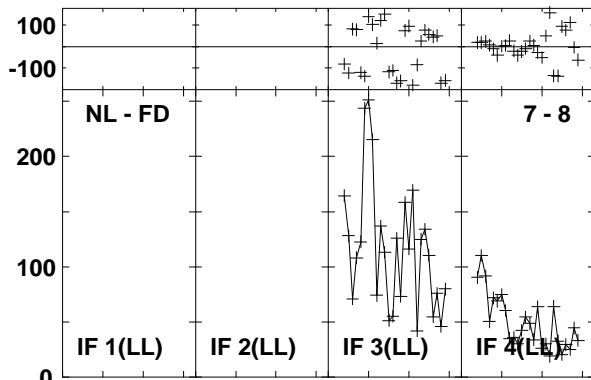
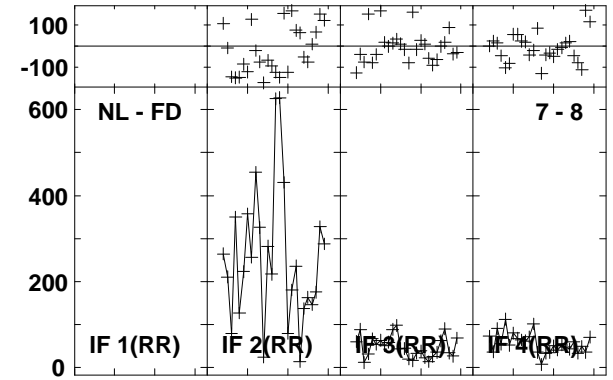
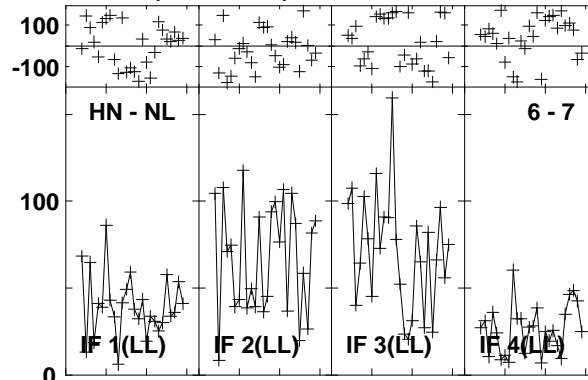
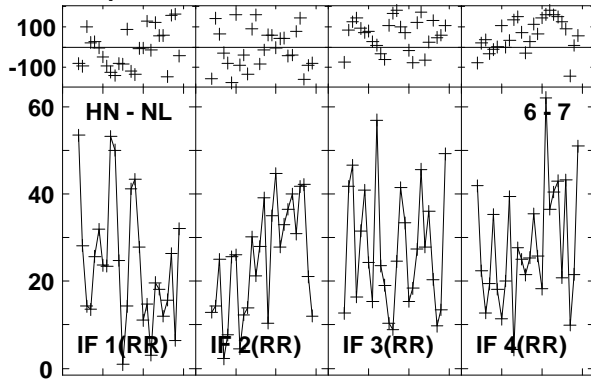

Lower frame: Milli Ampl Jy Top frame: Phas deg
Vector averaged cross-power spectrum Baseline: HN (06) - NL (07)
Timerange: 01/03:25:57 to 01/03:28:45

Plot file version1406 created 03-MAR-2016 01:16:03

4C52 GN002C 1.UVDATA.1

Freq = 1.2770 GHz, Bw = 16.000 MH Calibrated with CL # 3 and BP # 1 (BP mode 1)

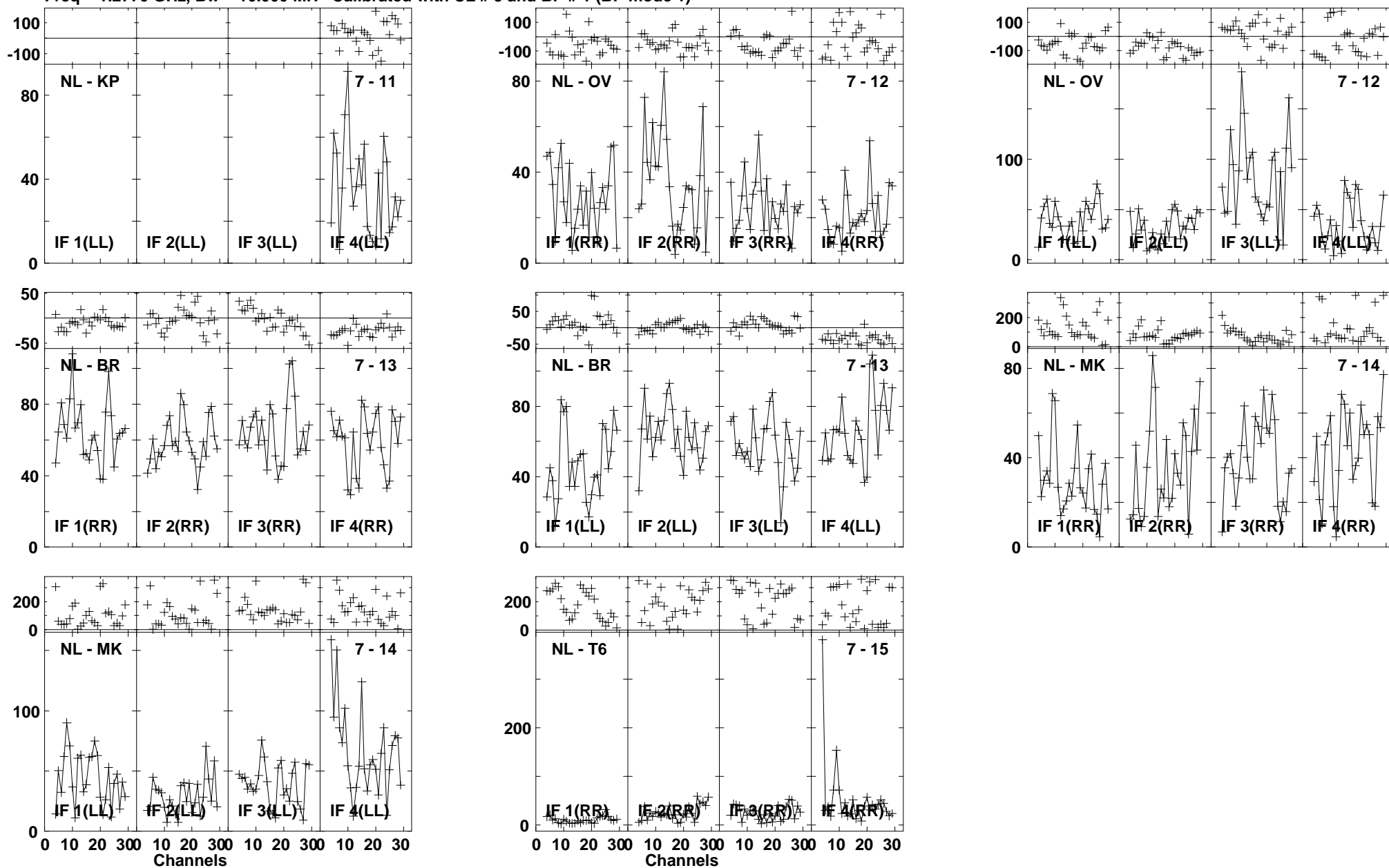

Lower frame: Milli Ampl Jy Top frame: Phas deg
Vector averaged cross-power spectrum Baseline: NL (07) - KP (11)
Timerange: 01/03:25:57 to 01/03:28:45

Plot file version1407 created 03-MAR-2016 01:16:03

J1545+5400 GN002C 1.UVDATA.1

Freq = 1.2770 GHz, Bw = 16.000 MH Calibrated with CL # 3 and BP # 1 (BP mode 1)

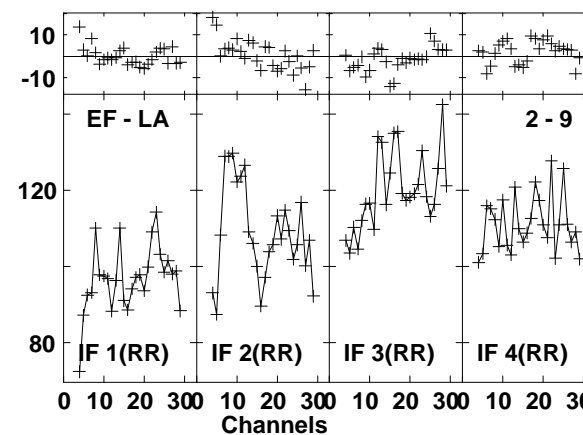
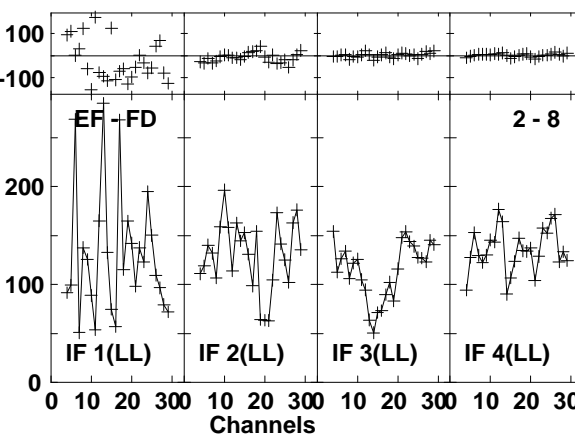
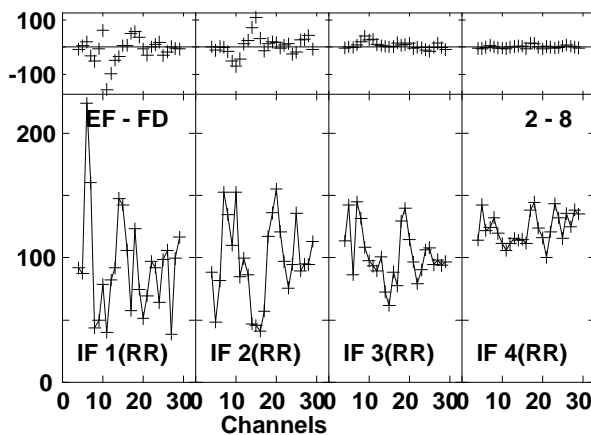
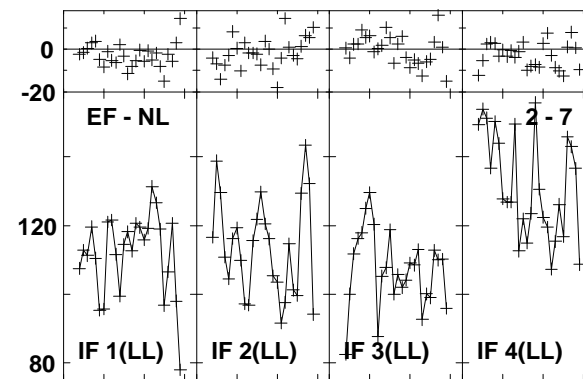
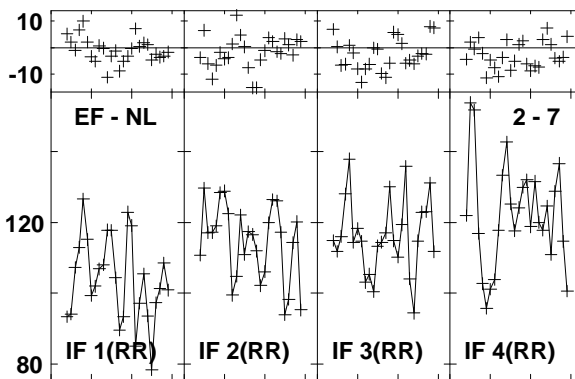
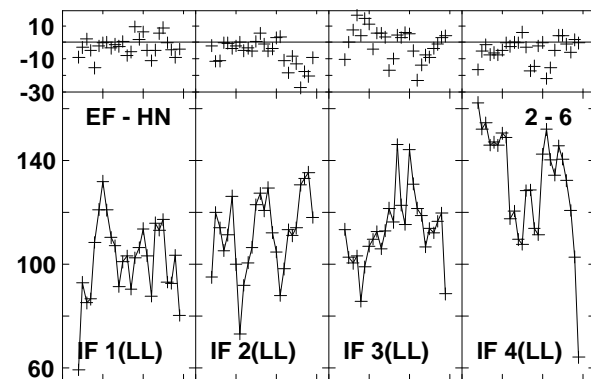
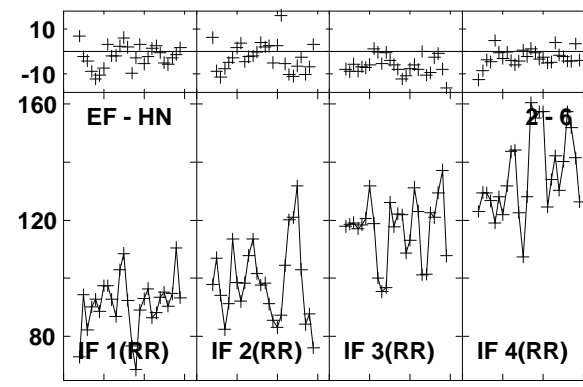
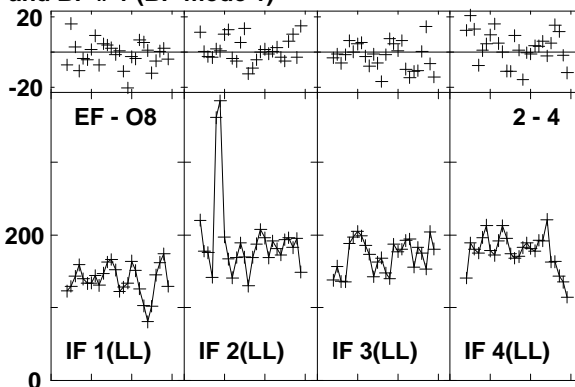
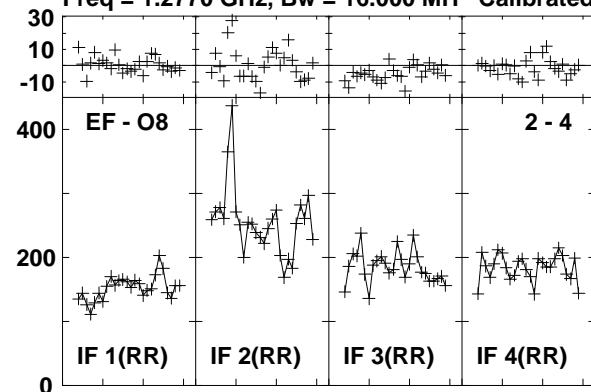

Lower frame: Milli Ampl Jy Top frame: Phas deg
Vector averaged cross-power spectrum Baseline: EF (02) - O8 (04)
Timerange: 01/03:29:37 to 01/03:30:35

Plot file version1408 created 03-MAR-2016 01:16:03

J1545+5400 GN002C 1.UVDATA.1

Freq = 1.2770 GHz, Bw = 16.000 MH Calibrated with CL # 3 and BP # 1 (BP mode 1)

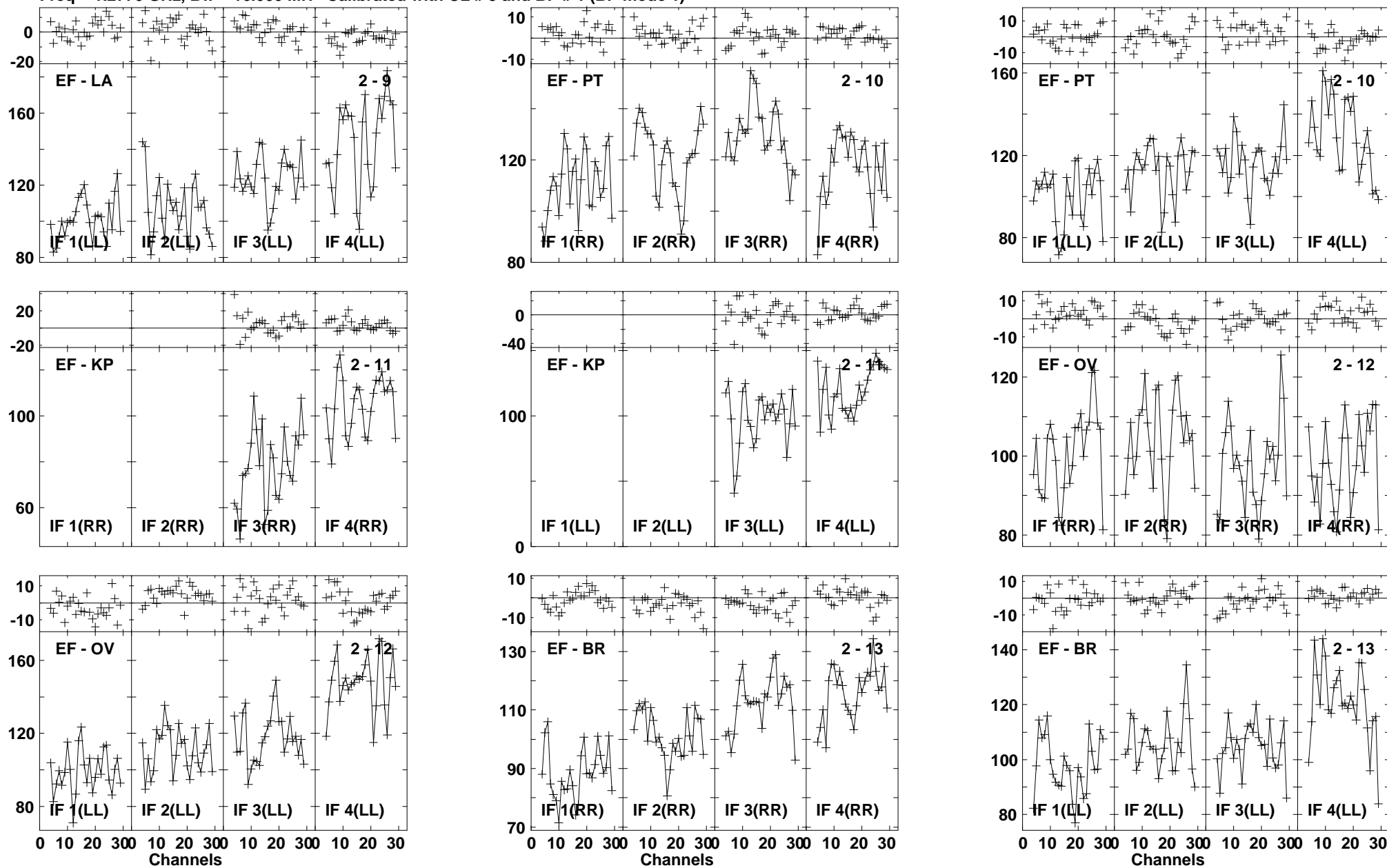

Plot file version1409 created 03-MAR-2016 01:16:03

J1545+5400 GN002C 1.UVDATA.1

Freq = 1.2770 GHz, Bw = 16.000 MH Calibrated with CL # 3 and BP # 1 (BP mode 1)

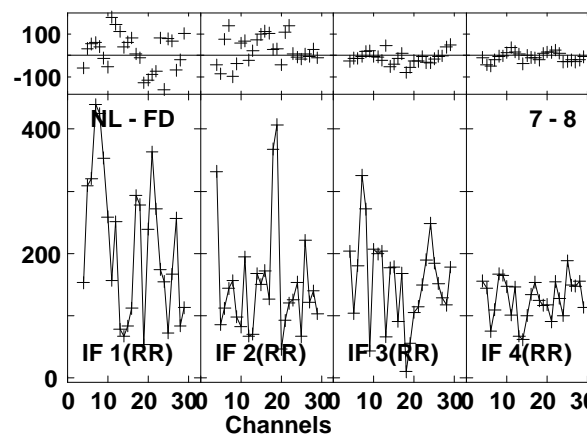
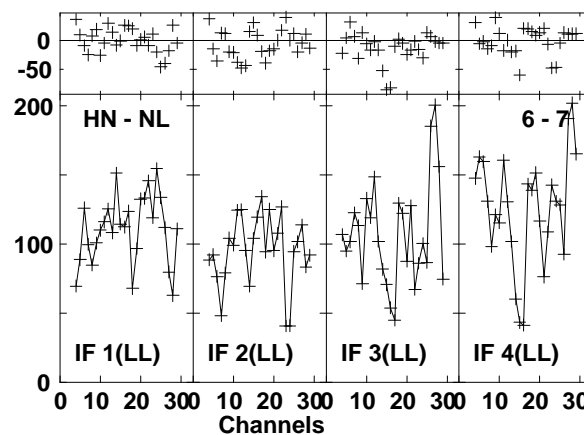
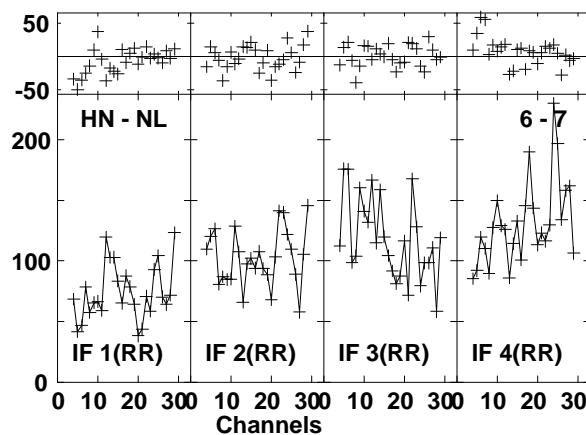
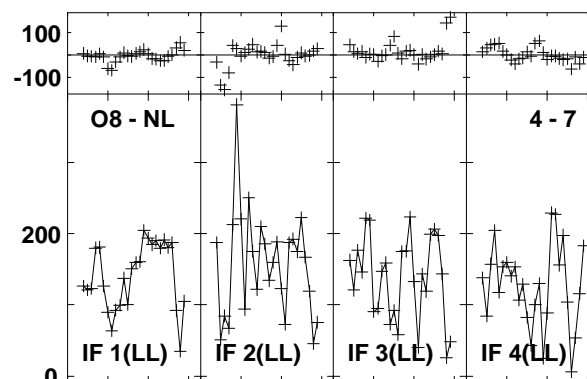
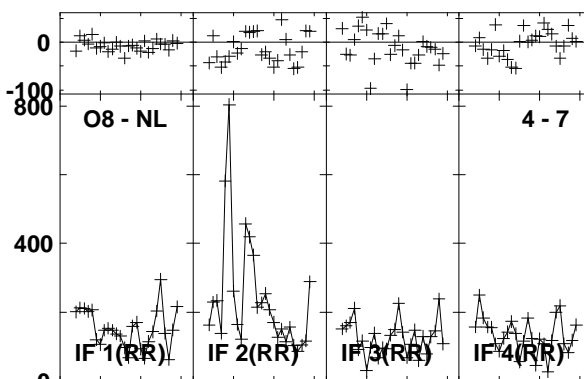
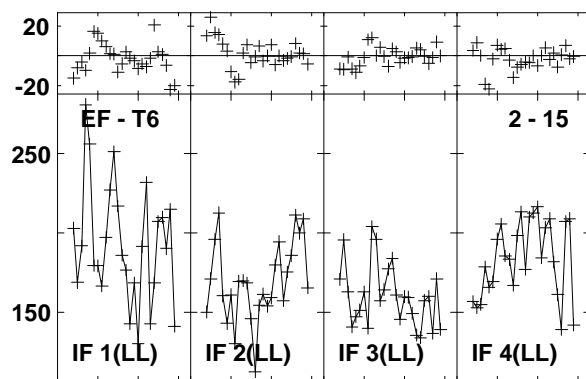
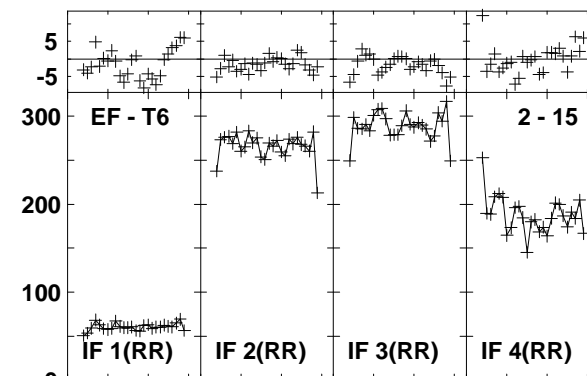
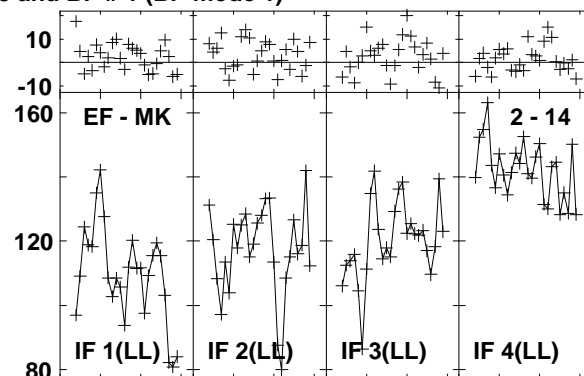
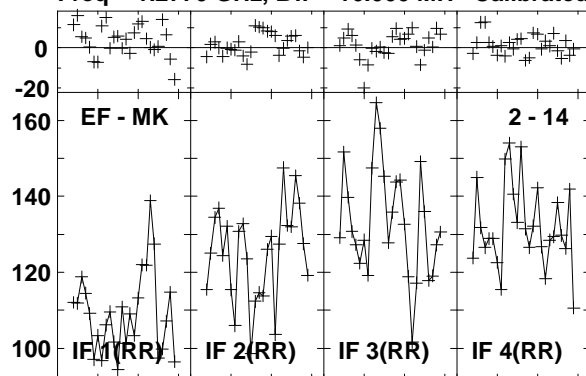

Lower frame: Milli Ampl Jy Top frame: Phas deg
Vector averaged cross-power spectrum Baseline: EF (02) - MK (14)
Timerange: 01/03:29:37 to 01/03:30:35

Plot file version1410 created 03-MAR-2016 01:16:04
 J1545+5400 GN002C 1.UVDATA.1
 Freq = 1.2770 GHz, Bw = 16.000 MH Calibrated with CL # 3 and BP # 1 (BP mode 1)

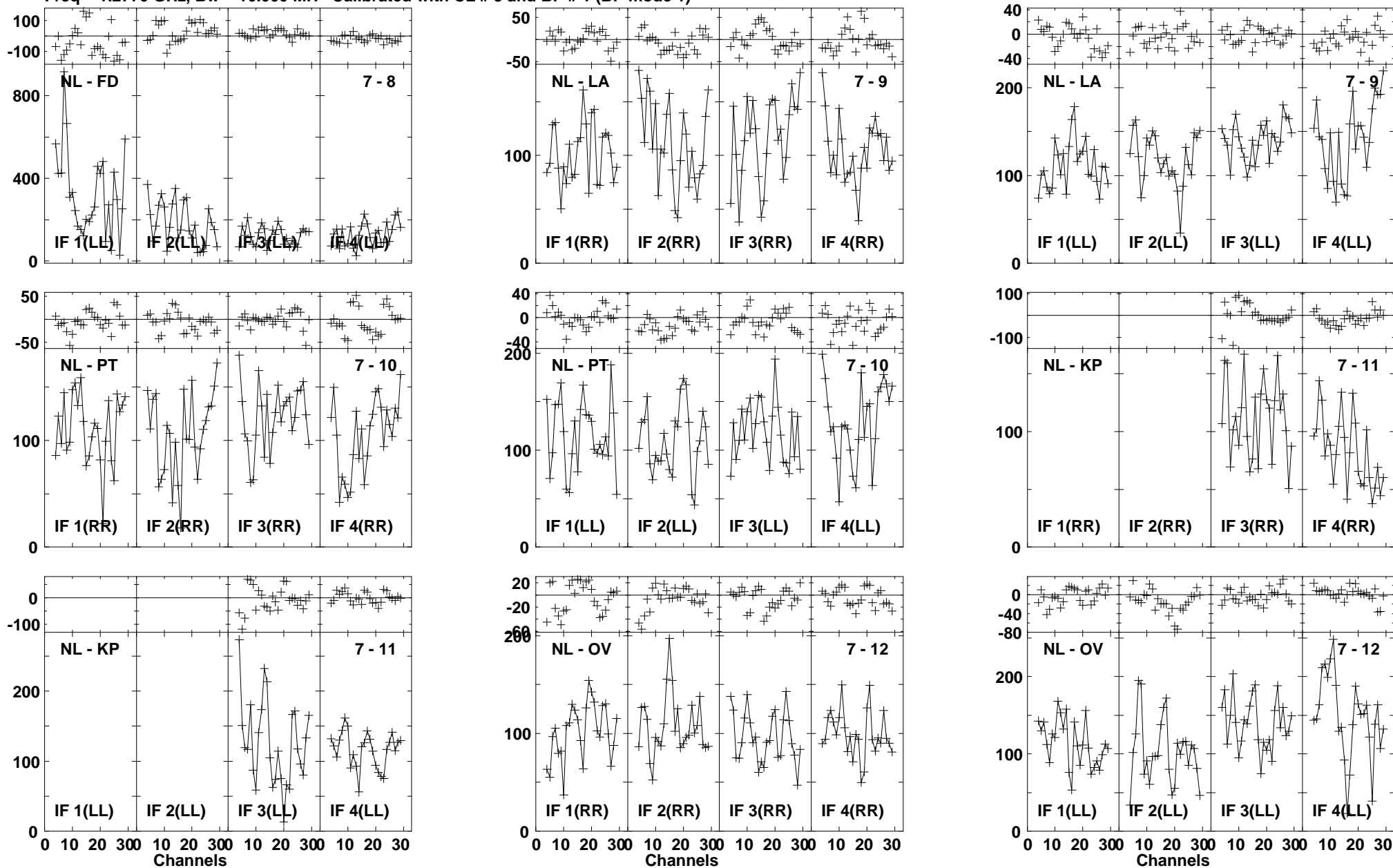

Lower frame: Milli Ampl Jy Top frame: Phas deg
 Vector averaged cross-power spectrum Baseline: NL (07) - FD (08)
 Timerange: 01/03:29:37 to 01/03:30:35

Plot file version1411 created 03-MAR-2016 01:16:04
 J1545+5400 GN002C 1.UVDATA.1
 Freq = 1.2770 GHz, Bw = 16.000 MH Calibrated with CL # 3 and BP # 1 (BP mode 1)

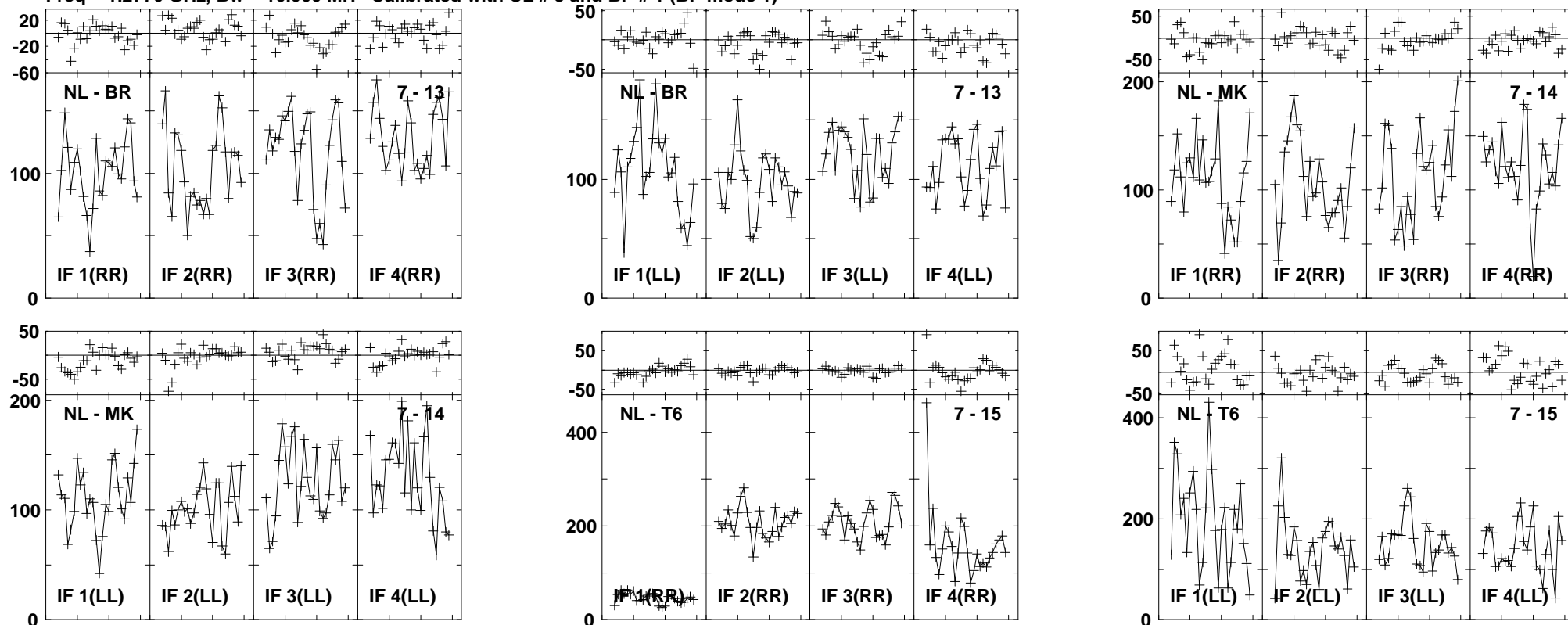

Lower frame: Milli Ampl Jy Top frame: Phas deg
 Vector averaged cross-power spectrum Baseline: NL (07) - BR (13)
 Timerange: 01/03:29:37 to 01/03:30:35

Plot file version1412 created 03-MAR-2016 01:16:04

4C52 GN002C 1.UVDATA.1

Freq = 1.2770 GHz, Bw = 16.000 MH Calibrated with CL # 3 and BP # 1 (BP mode 1)

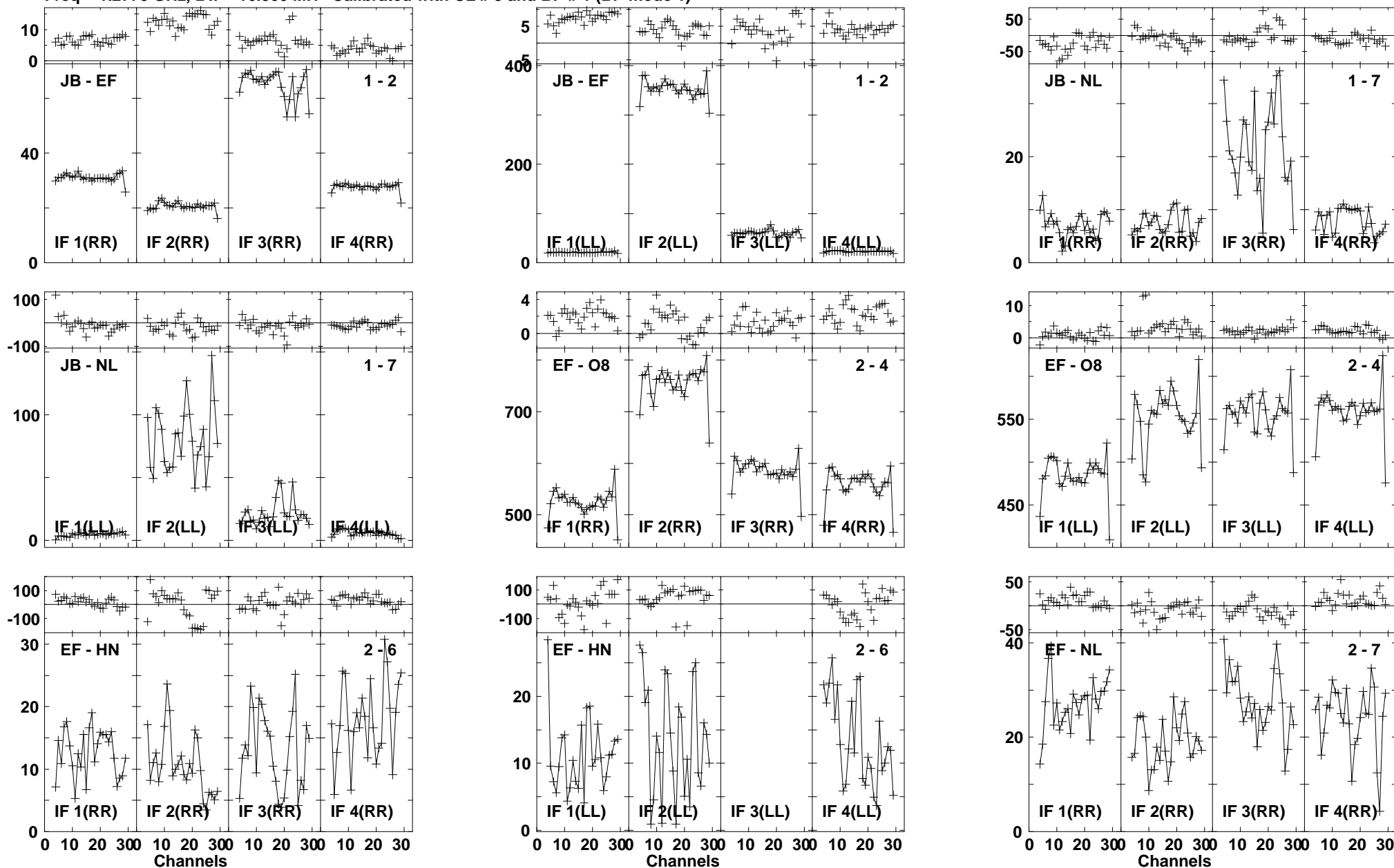

Lower frame: Milli Ampl Jy Top frame: Phas deg
Vector averaged cross-power spectrum Baseline: JB (01) - EF (02)
Timerange: 01/03:30:40 to 01/03:33:54

Plot file version1413 created 03-MAR-2016 01:16:04

4C52 GN002C 1.UVDATA.1

Freq = 1.2770 GHz, Bw = 16.000 MH Calibrated with CL # 3 and BP # 1 (BP mode 1)

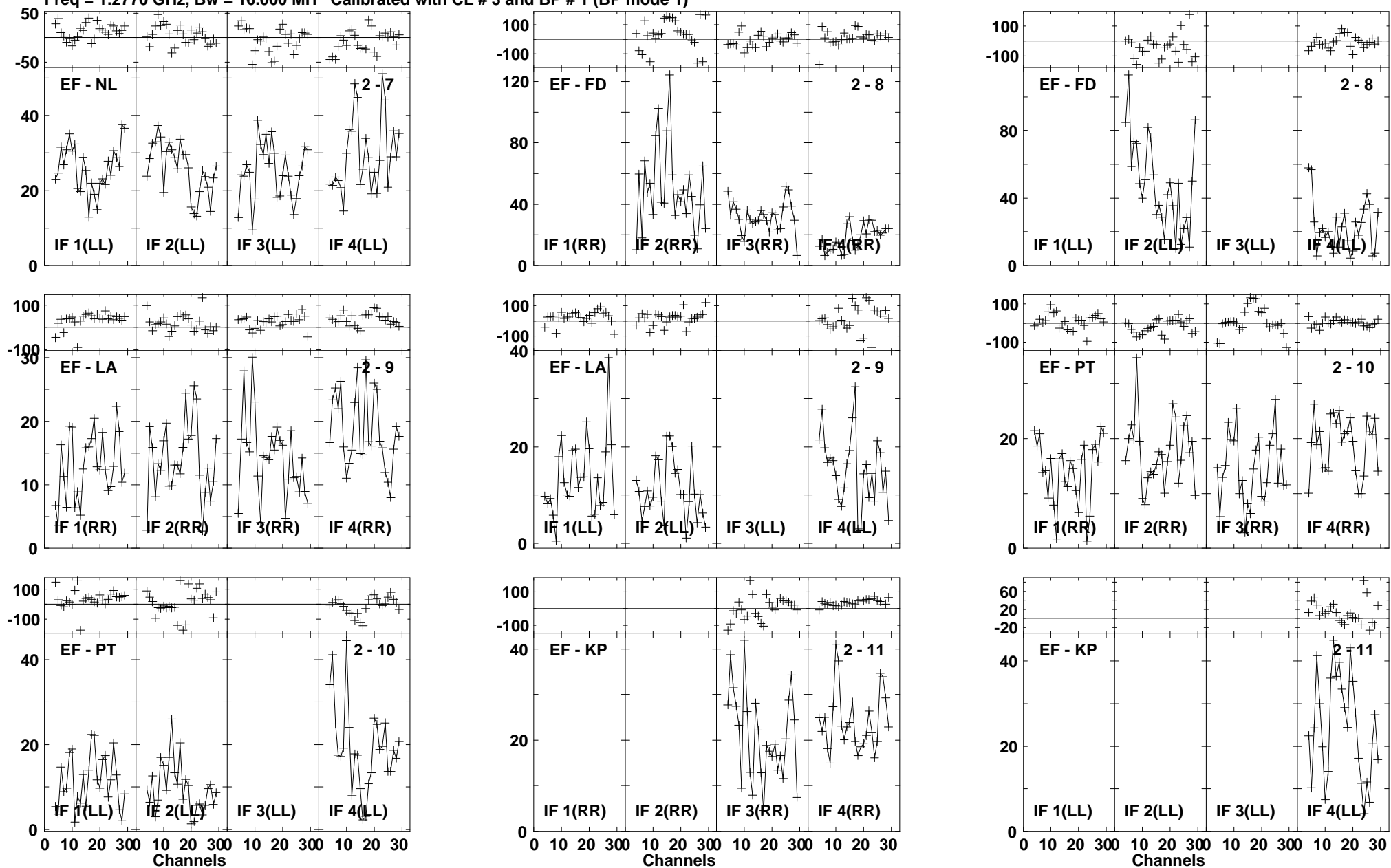

Lower frame: Milli Ampl Jy Top frame: Phas deg
Vector averaged cross-power spectrum Baseline: EF (02) - NL (07)
Timerange: 01/03:30:40 to 01/03:33:54

Plot file version1414 created 03-MAR-2016 01:16:04

4C52 GN002C 1.UVDATA.1

Freq = 1.2770 GHz, Bw = 16.000 MH Calibrated with CL # 3 and BP # 1 (BP mode 1)

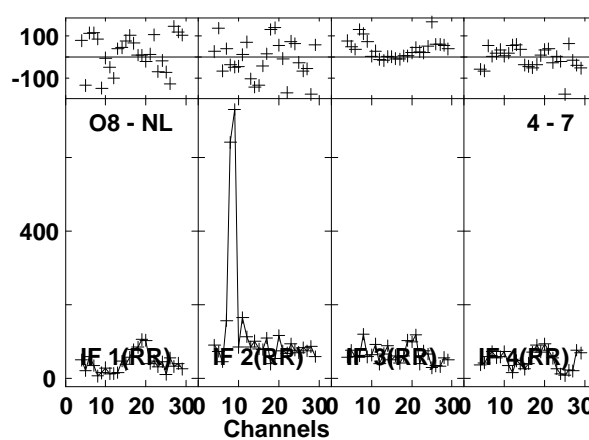
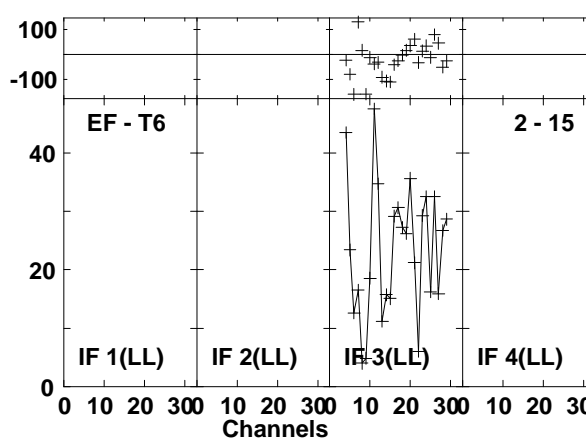
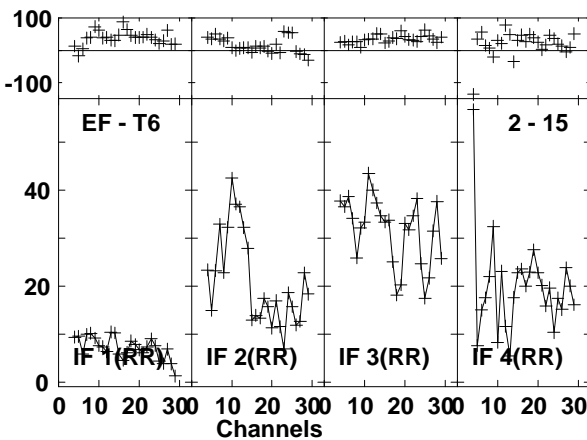
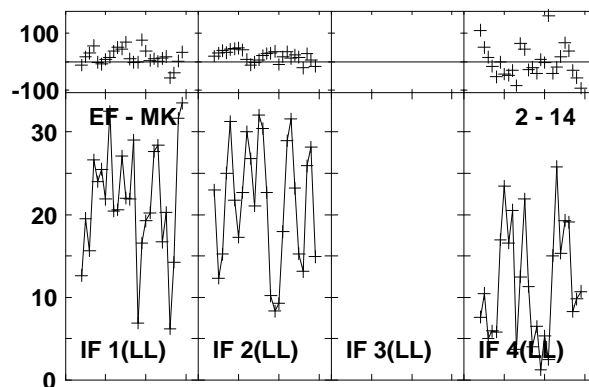
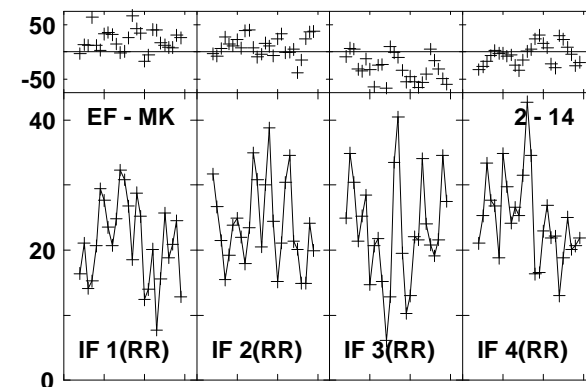
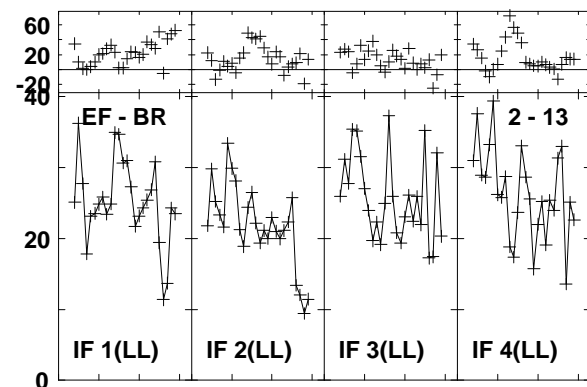
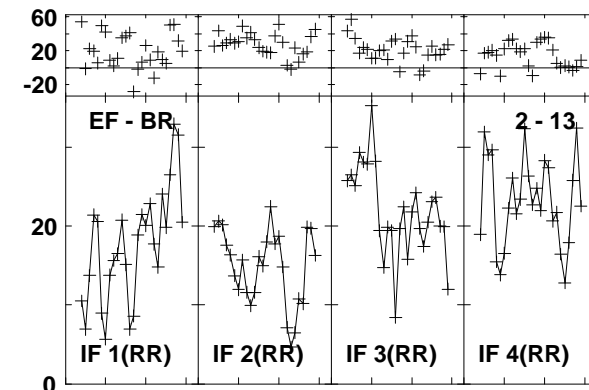
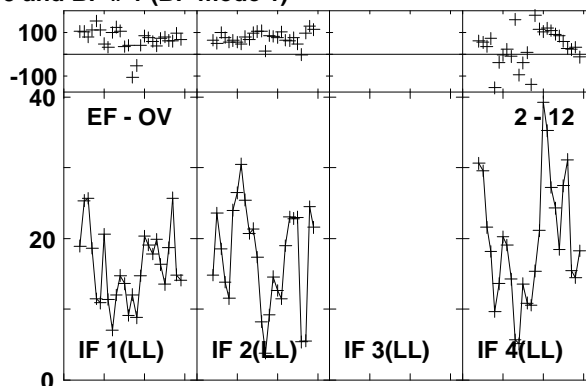
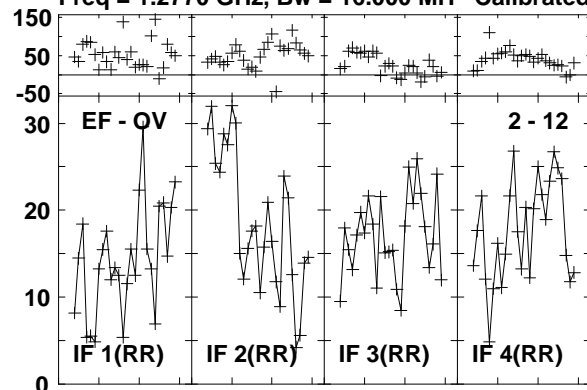

Lower frame: Milli Ampl Jy Top frame: Phas deg
Vector averaged cross-power spectrum Baseline: EF (02) - OV (12)
Timerange: 01/03:30:40 to 01/03:33:54

Plot file version1415 created 03-MAR-2016 01:16:04

4C52 GN002C 1.UVDATA.1

Freq = 1.2770 GHz, Bw = 16.000 MH Calibrated with CL # 3 and BP # 1 (BP mode 1)

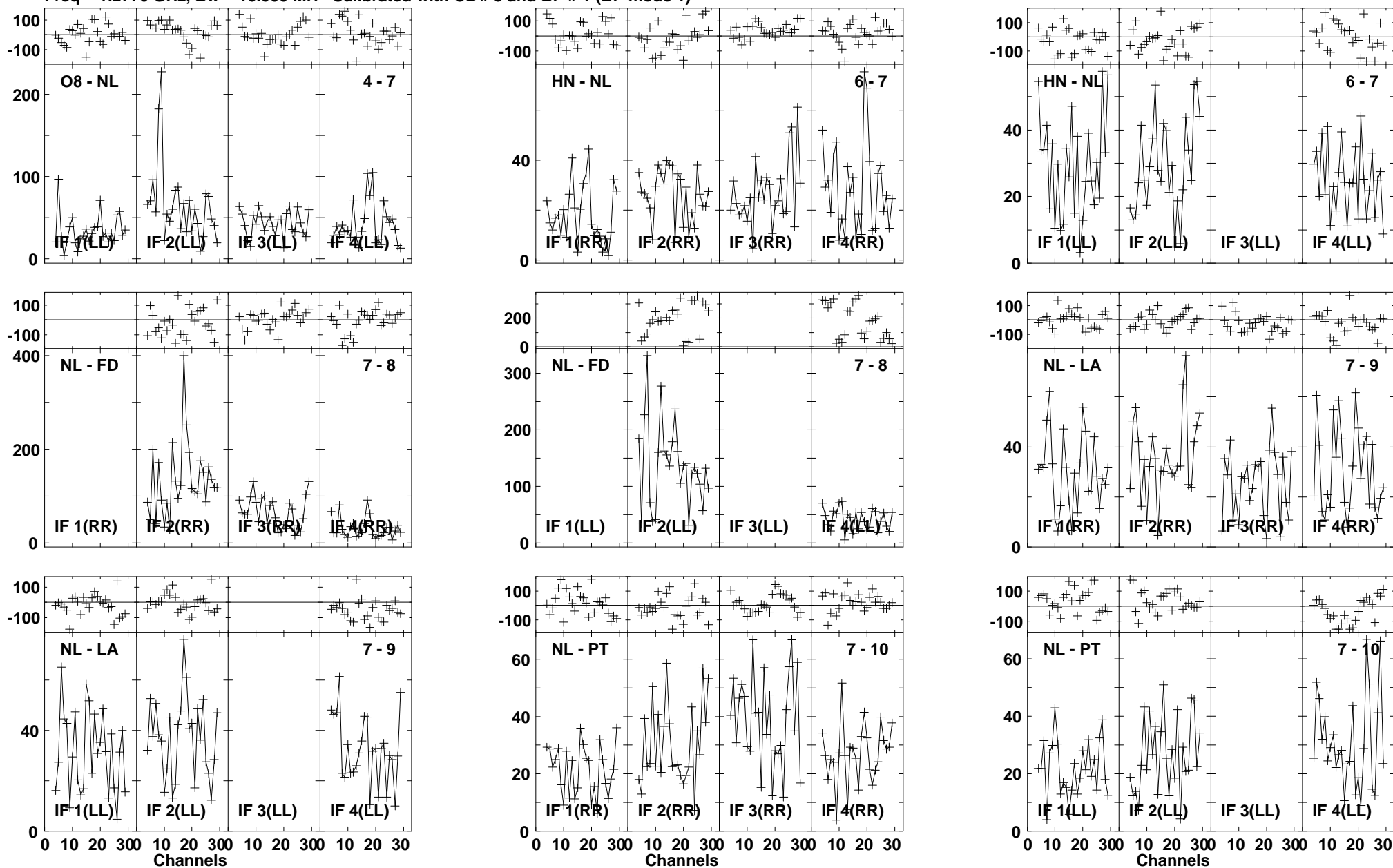

Lower frame: Milli Ampl Jy Top frame: Phas deg
Vector averaged cross-power spectrum Baseline: O8 (04) - NL (07)
Timerange: 01/03:30:40 to 01/03:33:54

Plot file version1416 created 03-MAR-2016 01:16:05

4C52 GN002C 1.UVDATA.1

Freq = 1.2770 GHz, Bw = 16.000 MH Calibrated with CL # 3 and BP # 1 (BP mode 1)

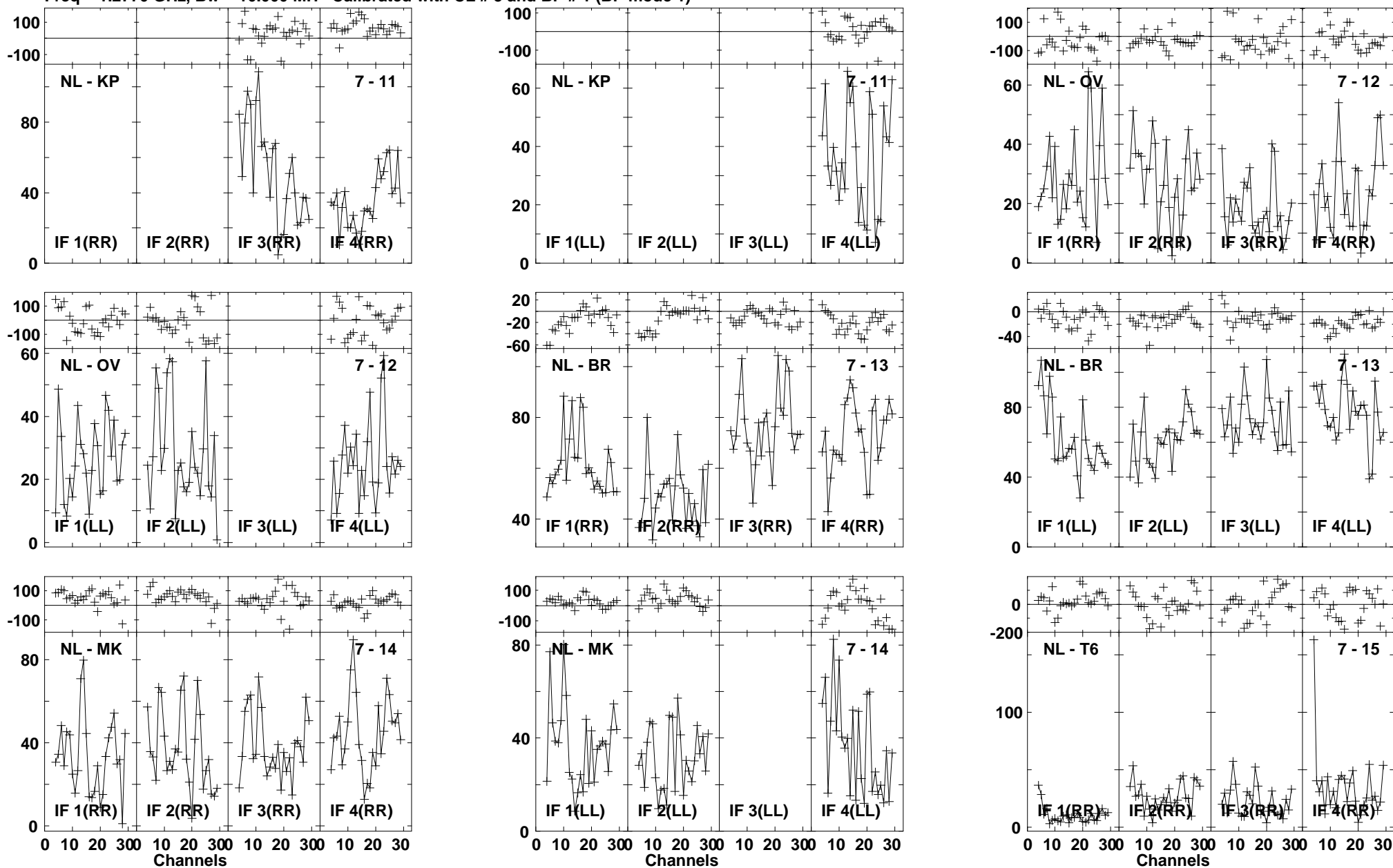

Lower frame: Milli Ampl Jy Top frame: Phas deg
Vector averaged cross-power spectrum Baseline: NL (07) - KP (11)
Timerange: 01/03:30:40 to 01/03:33:54

Plot file version1417 created 03-MAR-2016 01:16:05
4C52 GN002C 1.UVDATA.1
Freq = 1.2770 GHz, Bw = 16.000 MH Calibrated with CL # 3 and BP # 1 (BP mode 1)

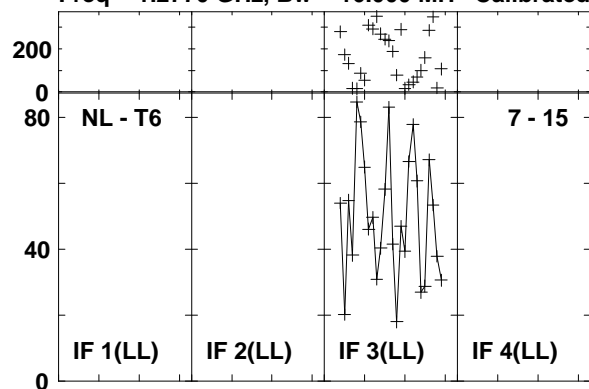

Lower frame: Milli Ampl Jy Top frame: Phas deg
Vector averaged cross-power spectrum Baseline: NL (07) - T6 (15)
Timerange: 01/03:30:40 to 01/03:33:54

Plot file version1418 created 03-MAR-2016 01:16:05

J1545+5400 GN002C 1.UVDATA.1

Freq = 1.2770 GHz, Bw = 16.000 MH Calibrated with CL # 3 and BP # 1 (BP mode 1)

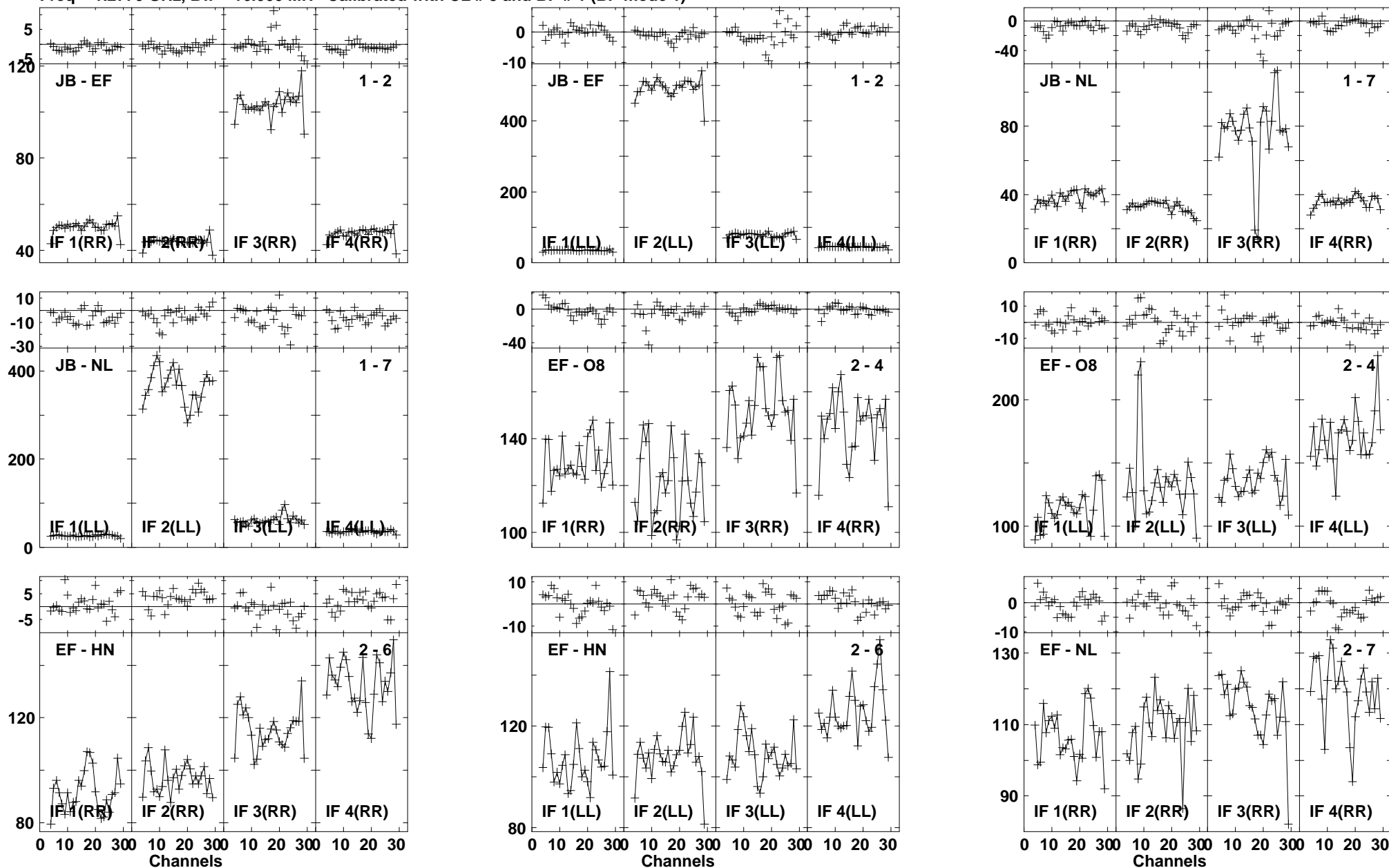

Lower frame: Milli Ampl Jy Top frame: Phas deg
Vector averaged cross-power spectrum Baseline: JB (01) - EF (02)
Timerange: 01/03/34:47 to 01/03/36:45

Plot file version1419 created 03-MAR-2016 01:16:05

J1545+5400 GN002C 1.UVDATA.1

Freq = 1.2770 GHz, Bw = 16.000 MH Calibrated with CL # 3 and BP # 1 (BP mode 1)

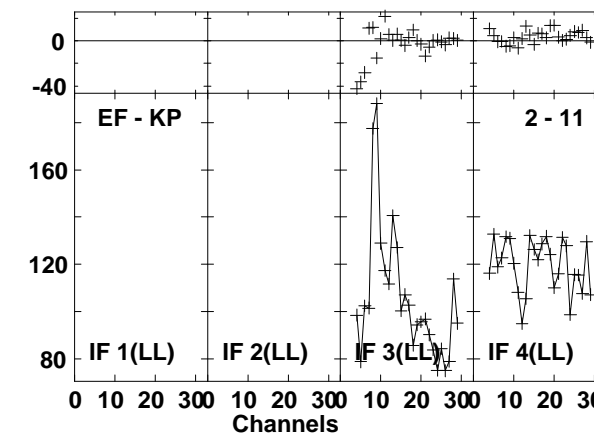
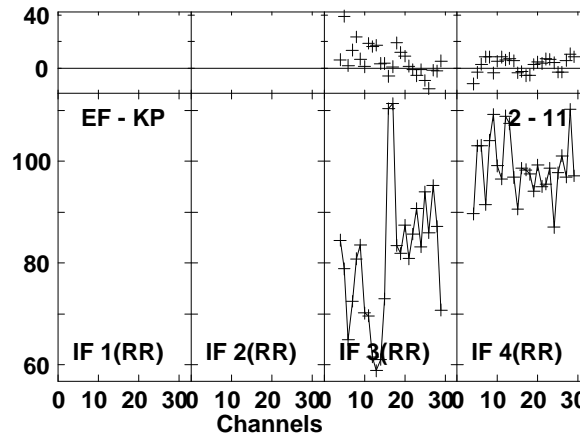
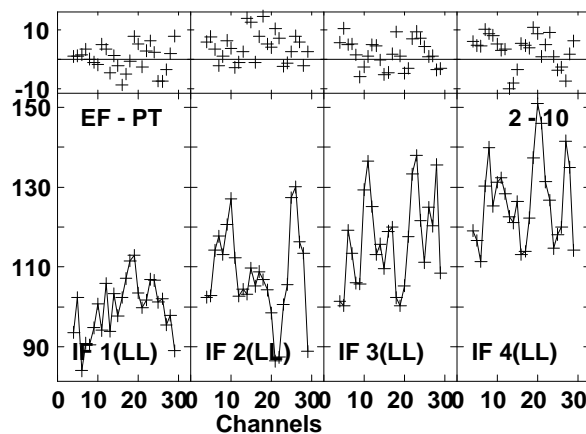
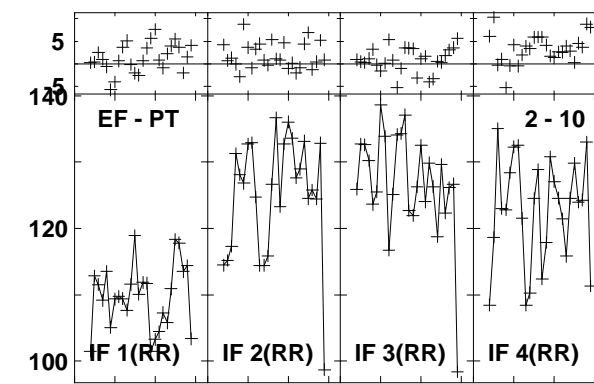
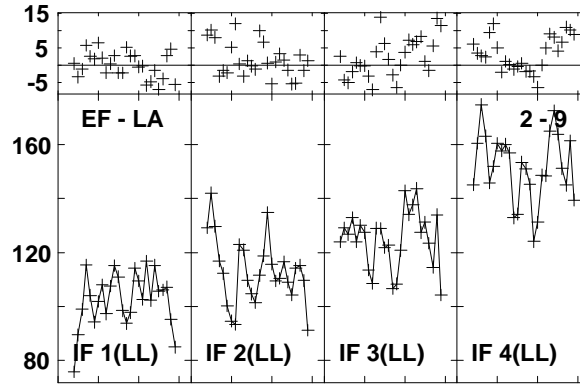
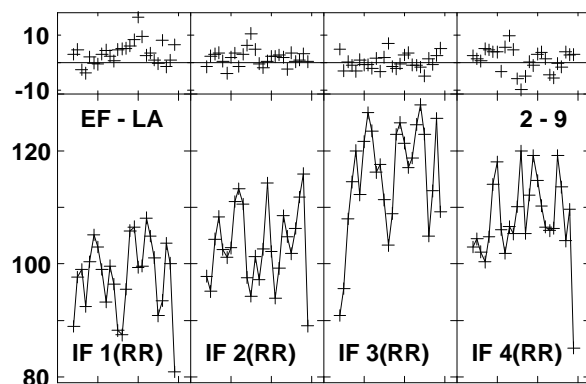
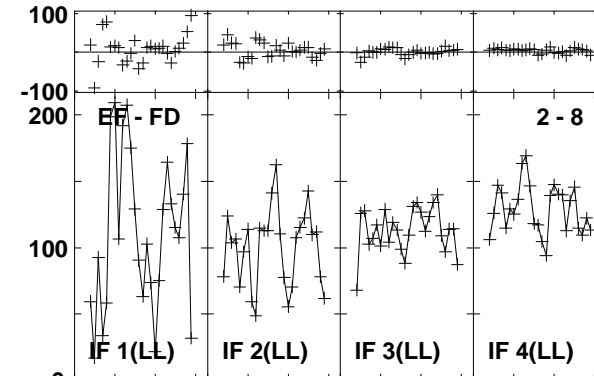
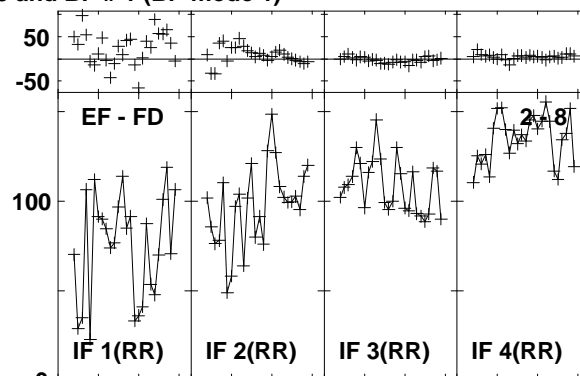
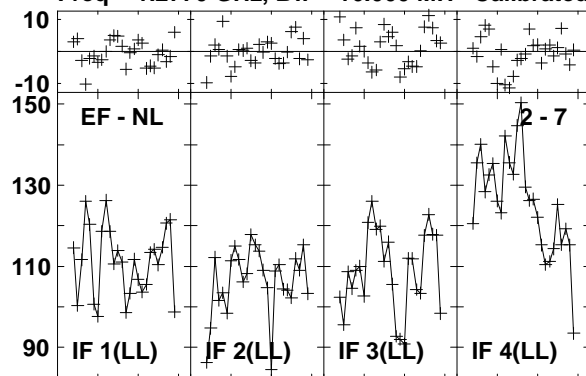

Lower frame: Milli Ampl Jy Top frame: Phas deg
Vector averaged cross-power spectrum Baseline: EF (02) - NL (07)
Timerange: 01/03:34:47 to 01/03:36:45

Plot file version1420 created 03-MAR-2016 01:16:05

J1545+5400 GN002C 1.UVDATA.1

Freq = 1.2770 GHz, Bw = 16.000 MH Calibrated with CL # 3 and BP # 1 (BP mode 1)

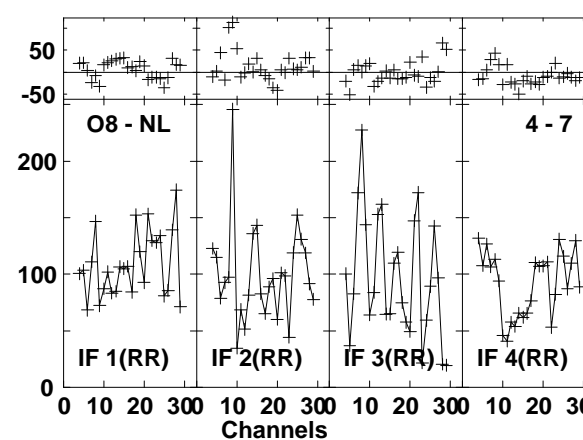
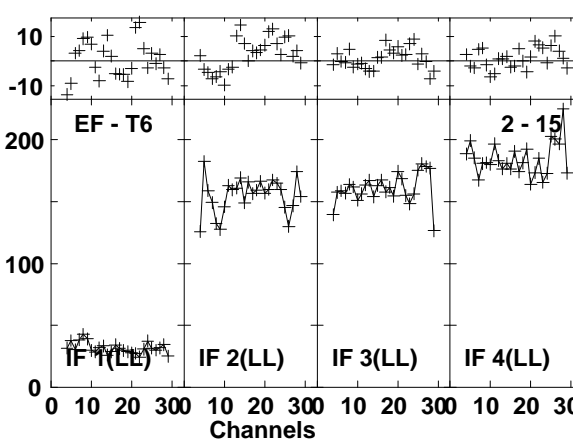
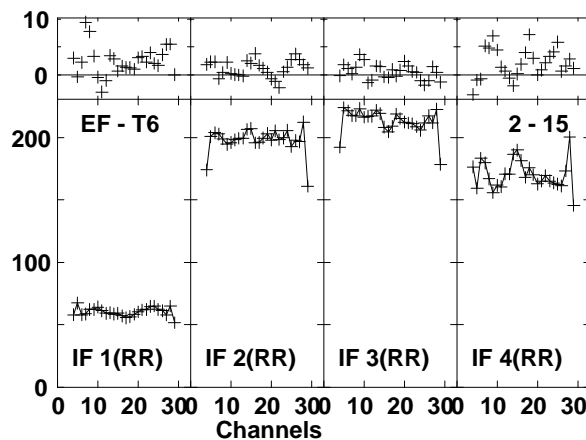
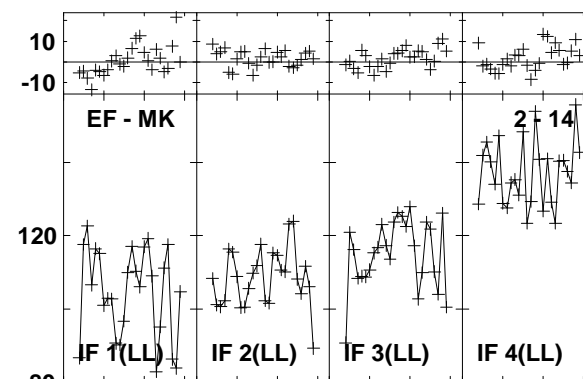
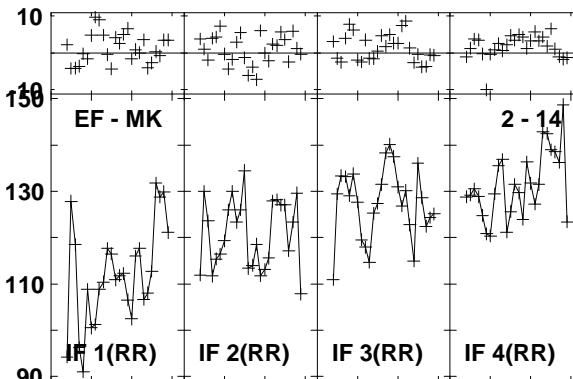
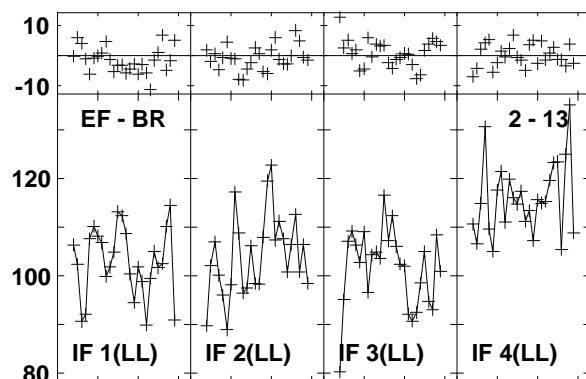
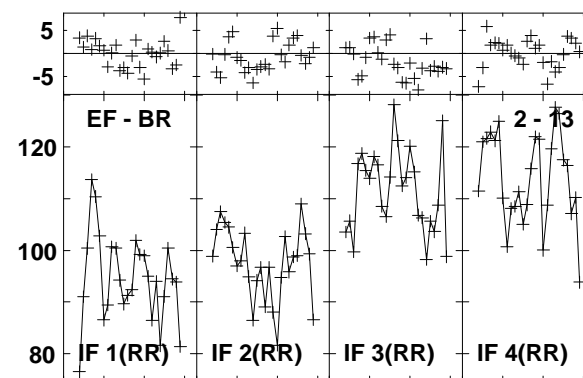
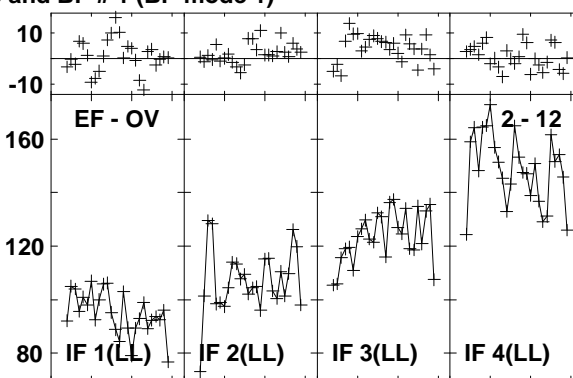
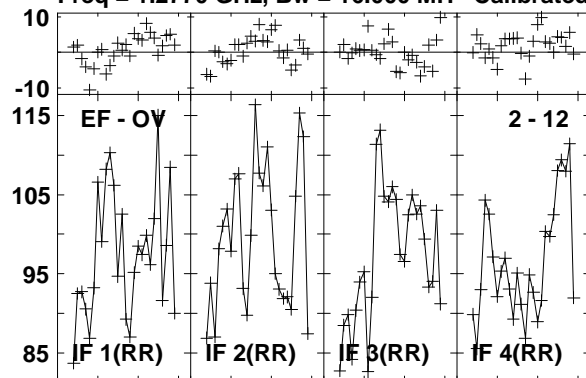

Lower frame: Milli Ampl Jy Top frame: Phas deg
Vector averaged cross-power spectrum Baseline: EF (02) - OV (12)
Timerange: 01/03:34:47 to 01/03:36:45

Plot file version1421 created 03-MAR-2016 01:16:05
 J1545+5400 GN002C 1.UVDATA.1
 Freq = 1.2770 GHz, Bw = 16.000 MH Calibrated with CL # 3 and BP # 1 (BP mode 1)

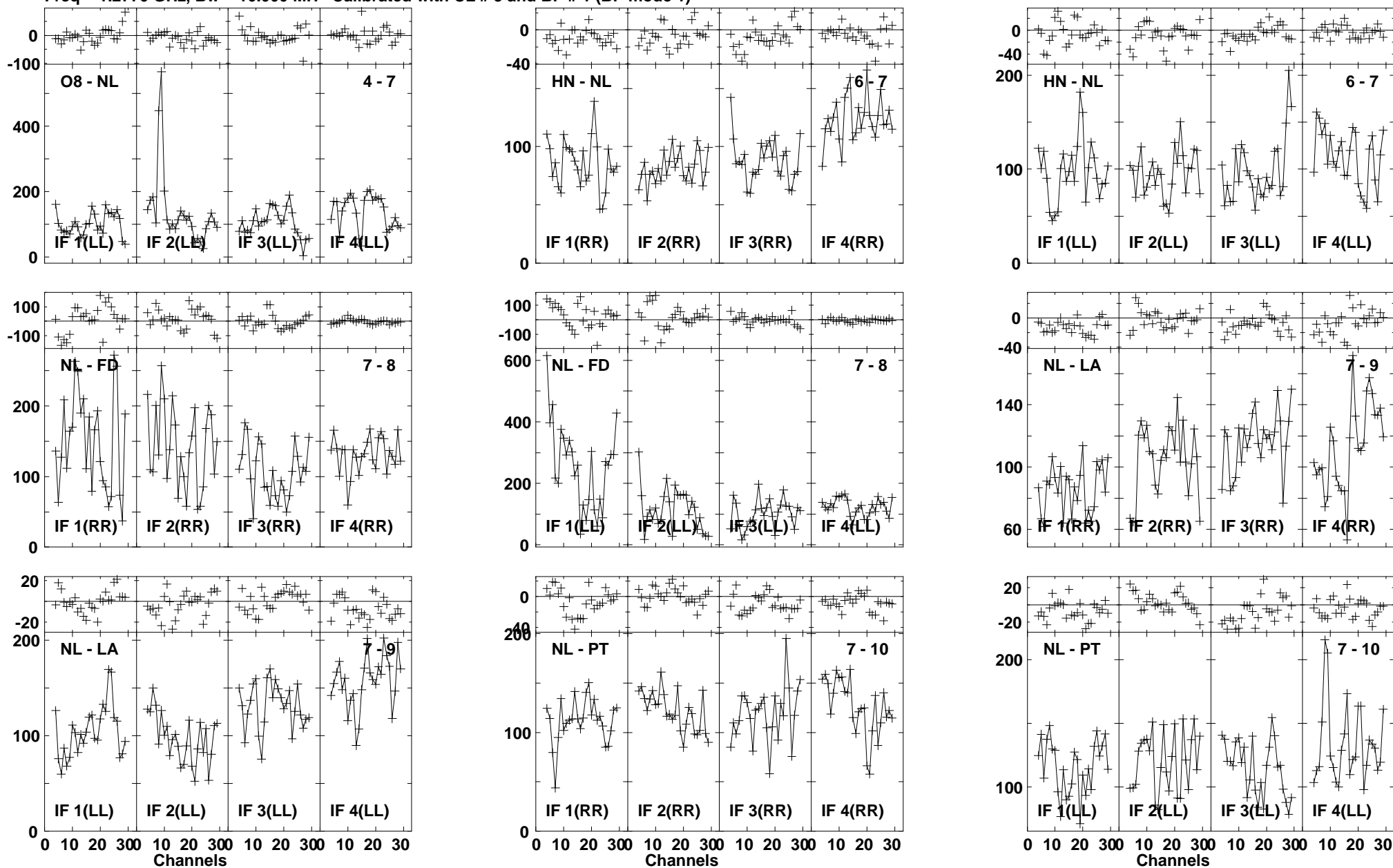

Lower frame: Milli Ampl Jy Top frame: Phas deg
 Vector averaged cross-power spectrum Baseline: O8 (04) - NL (07)
 Timerange: 01/03:34:47 to 01/03:36:45

Plot file version1422 created 03-MAR-2016 01:16:06

J1545+5400 GN002C 1.UVDATA.1

Freq = 1.2770 GHz, Bw = 16.000 MH Calibrated with CL # 3 and BP # 1 (BP mode 1)

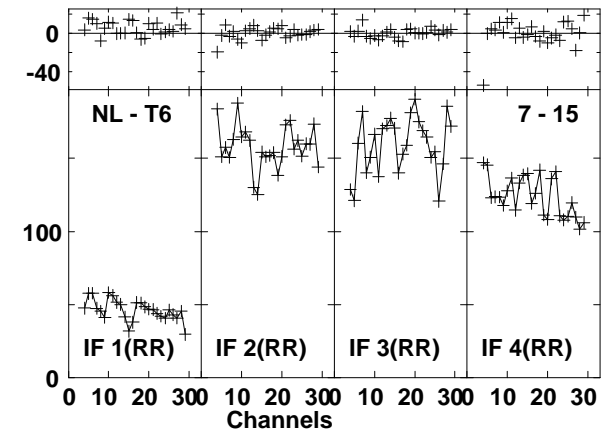
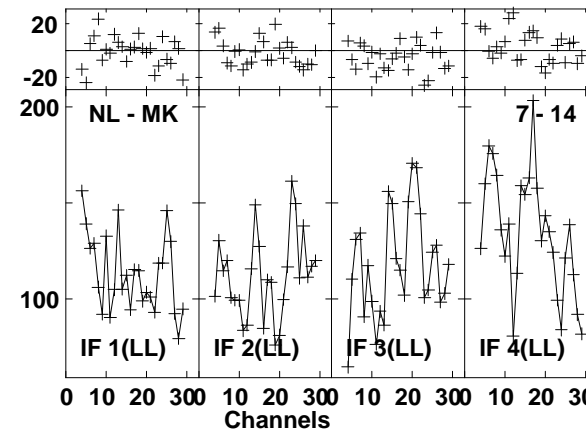
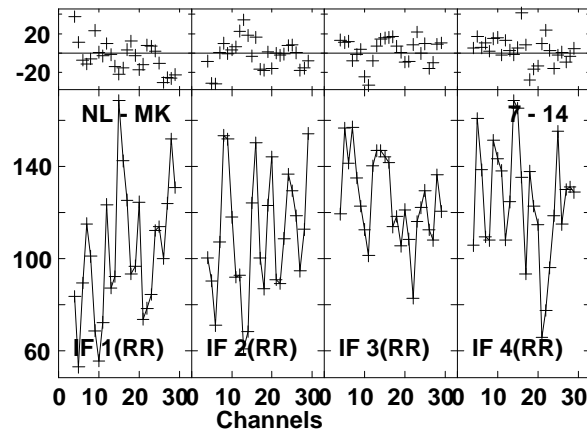
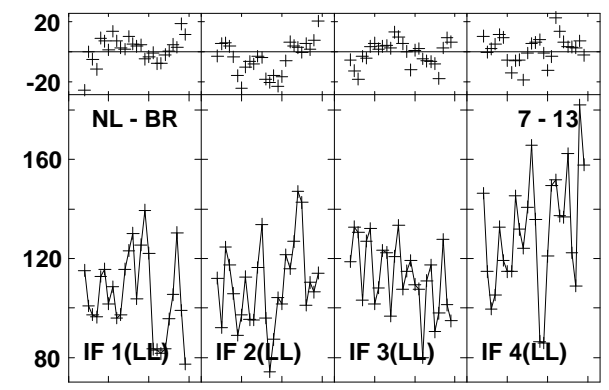
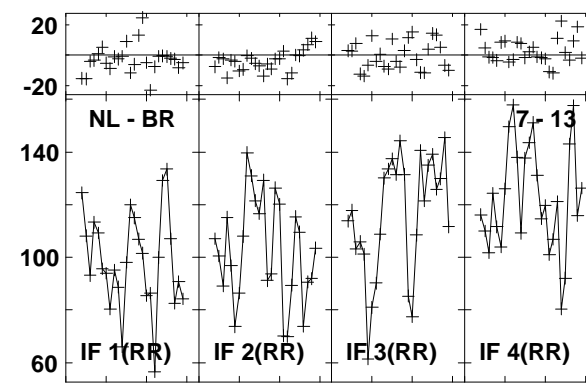
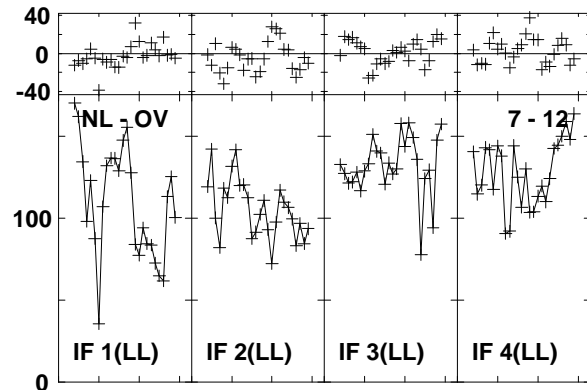
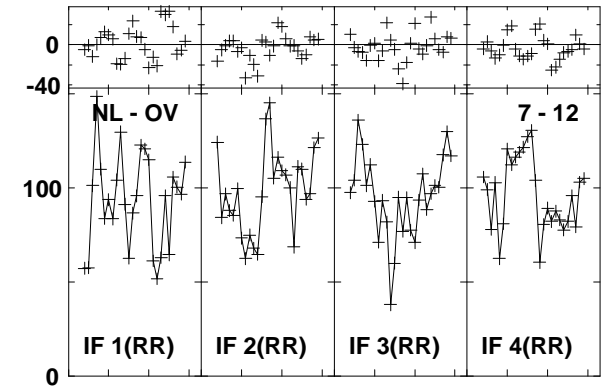
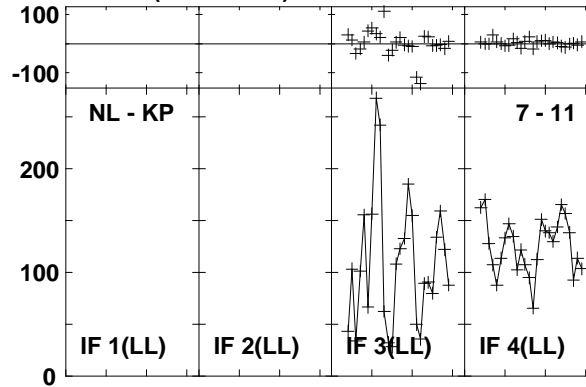
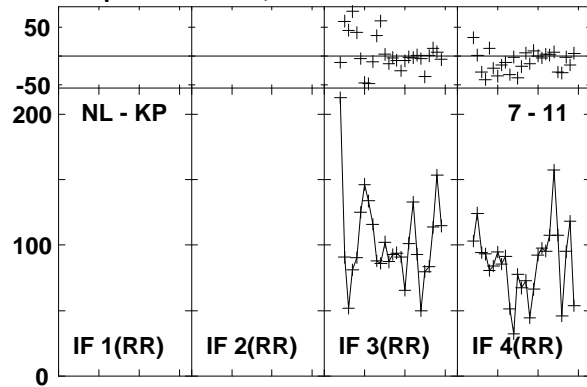

Lower frame: Milli Ampl Jy Top frame: Phas deg

Vector averaged cross-power spectrum Baseline: NL (07) - KP (11)

Timerange: 01/03:34:47 to 01/03:36:45

Plot file version1423 created 03-MAR-2016 01:16:06
J1545+5400 GN002C 1.UVDATA.1
Freq = 1.2770 GHz, Bw = 16.000 MH Calibrated with CL # 3 and BP # 1 (BP mode 1)

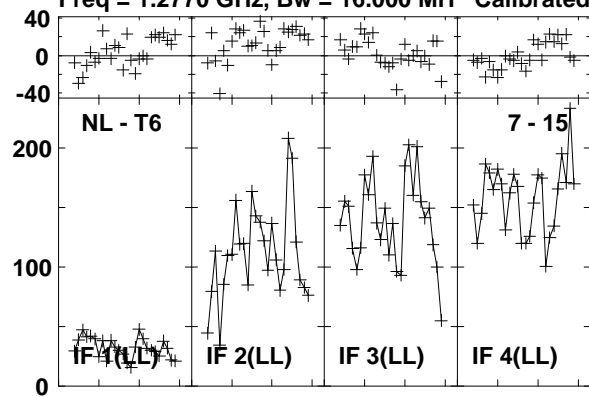

Lower frame: Milli Ampl Jy Top frame: Phas deg
Vector averaged cross-power spectrum Baseline: NL (07) - T6 (15)
Timerange: 01/03:34:47 to 01/03:36:45

Plot file version1424 created 03-MAR-2016 01:16:06
 4C52 GN002C 1.UVDATA.1
 Freq = 1.2770 GHz, Bw = 16.000 MH Calibrated with CL # 3 and BP # 1 (BP mode 1)

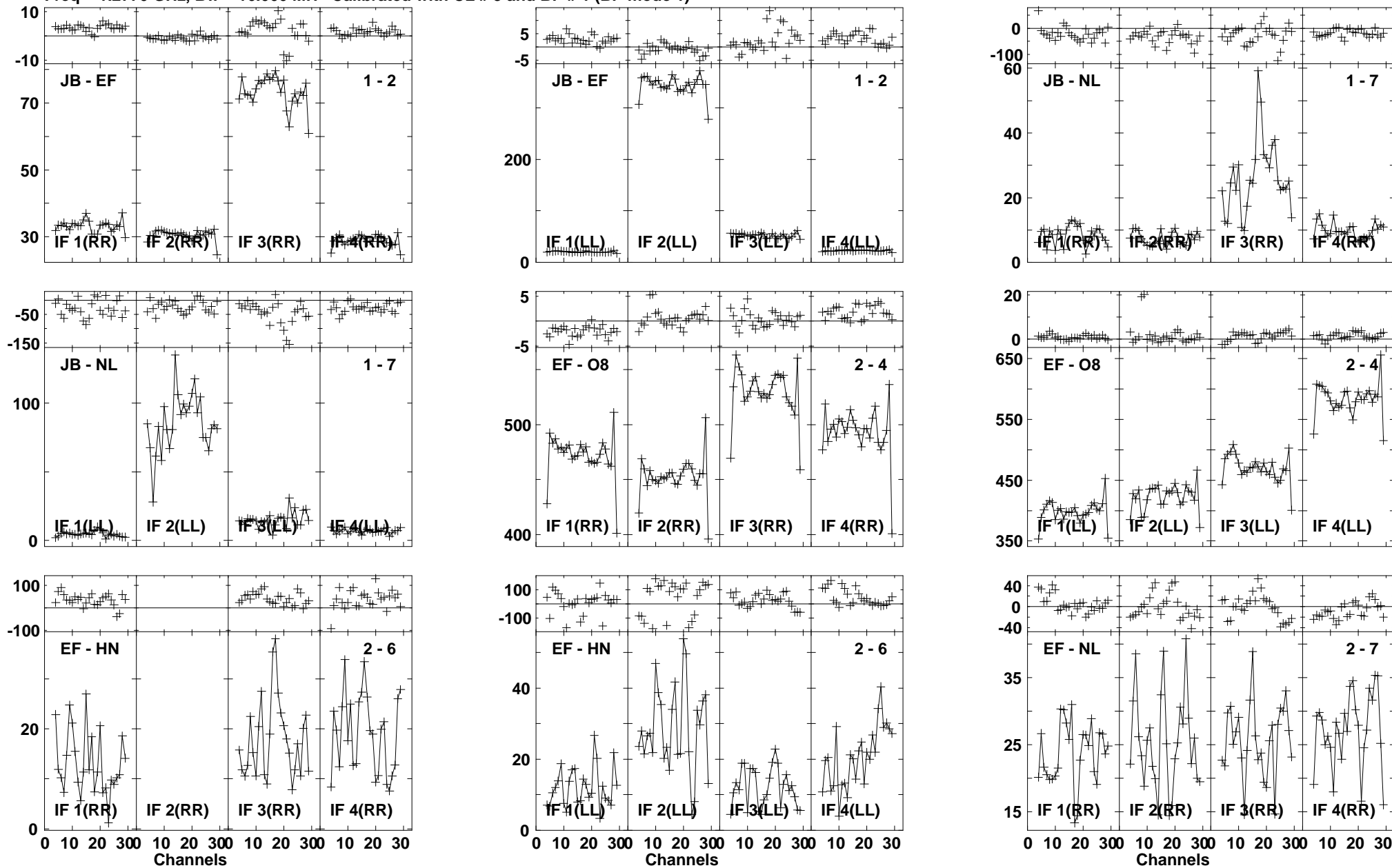

Lower frame: Milli Ampl Jy Top frame: Phas deg
 Vector averaged cross-power spectrum Baseline: JB (01) - EF (02)
 Timerange: 01/03:36:56 to 01/03:39:44

Plot file version1425 created 03-MAR-2016 01:16:06

4C52 GN002C 1.UVDATA.1

Freq = 1.2770 GHz, Bw = 16.000 MH Calibrated with CL # 3 and BP # 1 (BP mode 1)

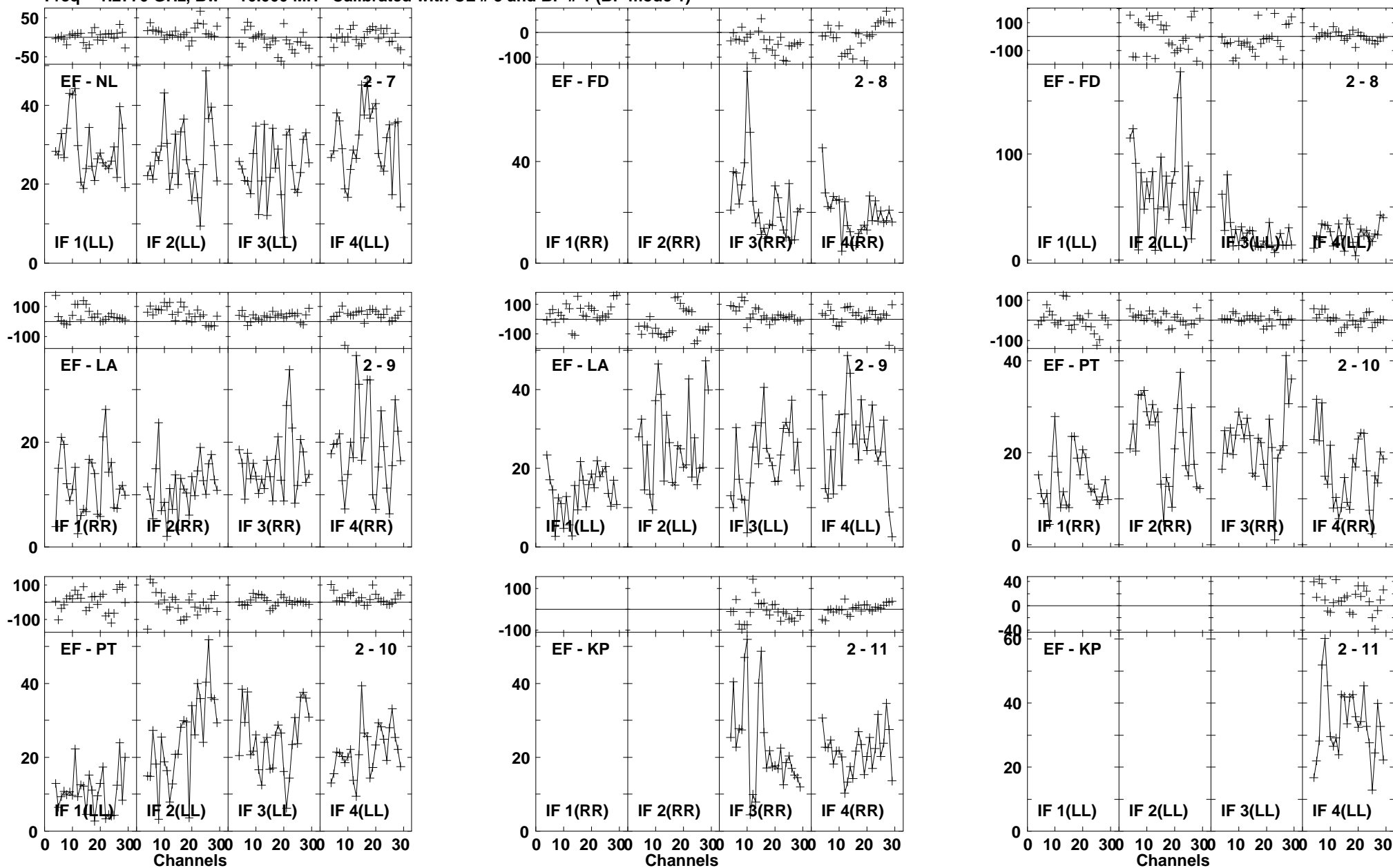

Lower frame: Milli Ampl Jy Top frame: Phas deg
Vector averaged cross-power spectrum Baseline: EF (02) - NL (07)
Timerange: 01/03:36:56 to 01/03:39:44

Plot file version1426 created 03-MAR-2016 01:16:06

4C52 GN002C 1.UVDATA.1

Freq = 1.2770 GHz, Bw = 16.000 MH Calibrated with CL # 3 and BP # 1 (BP mode 1)

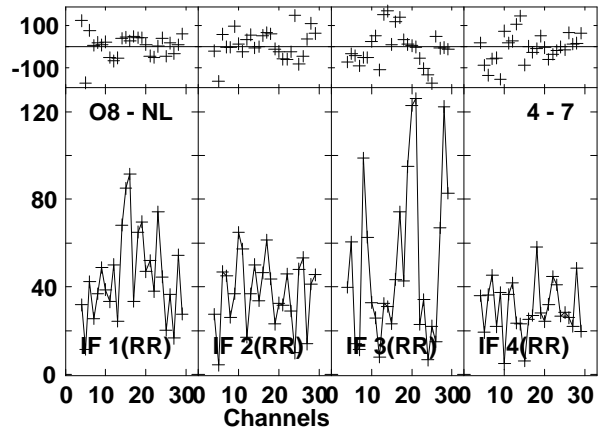
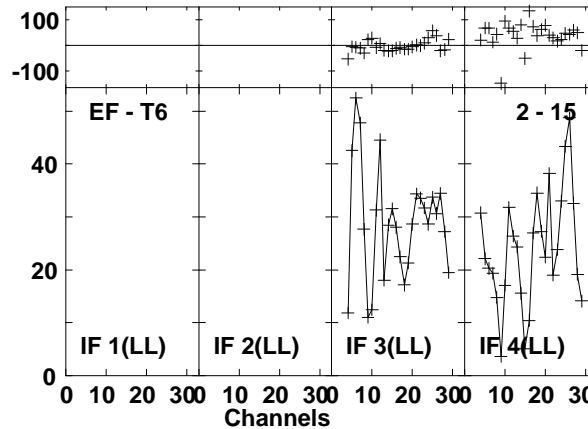
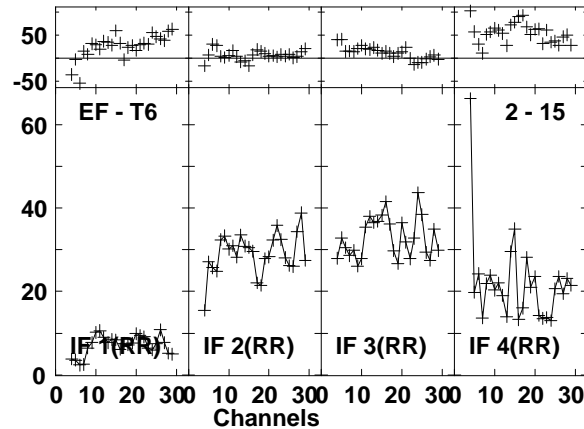
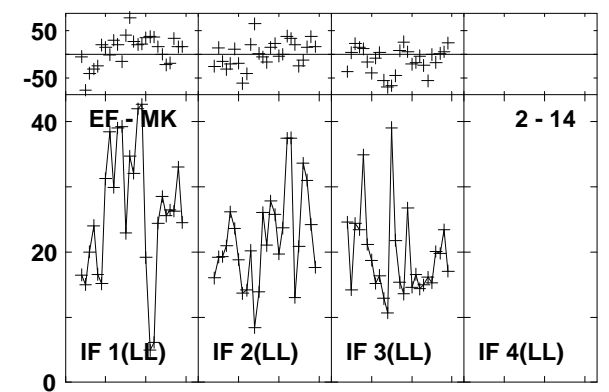
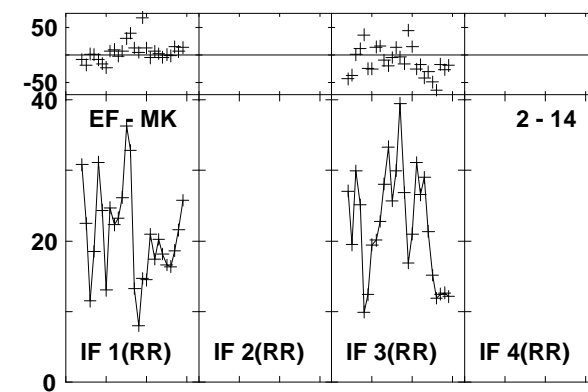
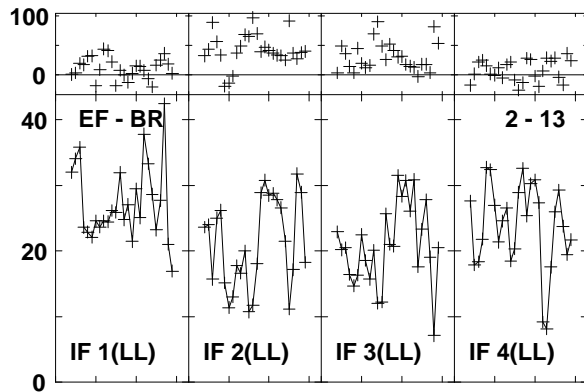
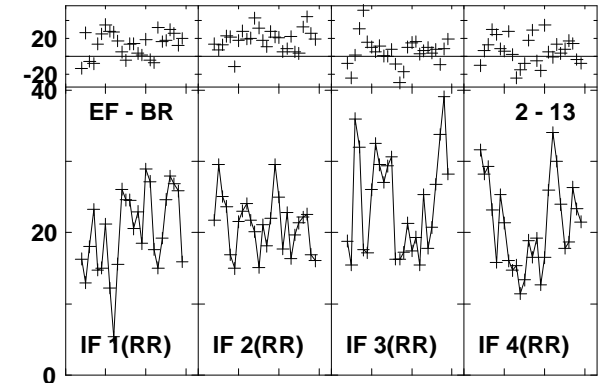
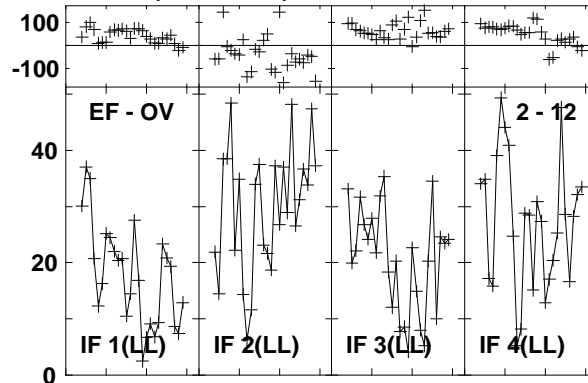
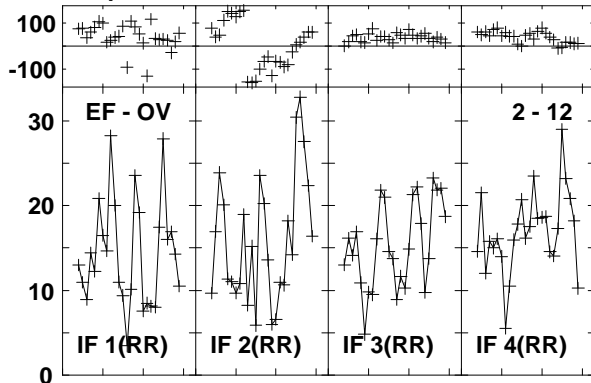

Lower frame: Milli Ampl Jy Top frame: Phas deg
Vector averaged cross-power spectrum Baseline: EF (02) - OV (12)
Timerange: 01/03:36:56 to 01/03:39:44

Plot file version1427 created 03-MAR-2016 01:16:06

4C52 GN002C 1.UVDATA.1

Freq = 1.2770 GHz, Bw = 16.000 MH Calibrated with CL # 3 and BP # 1 (BP mode 1)

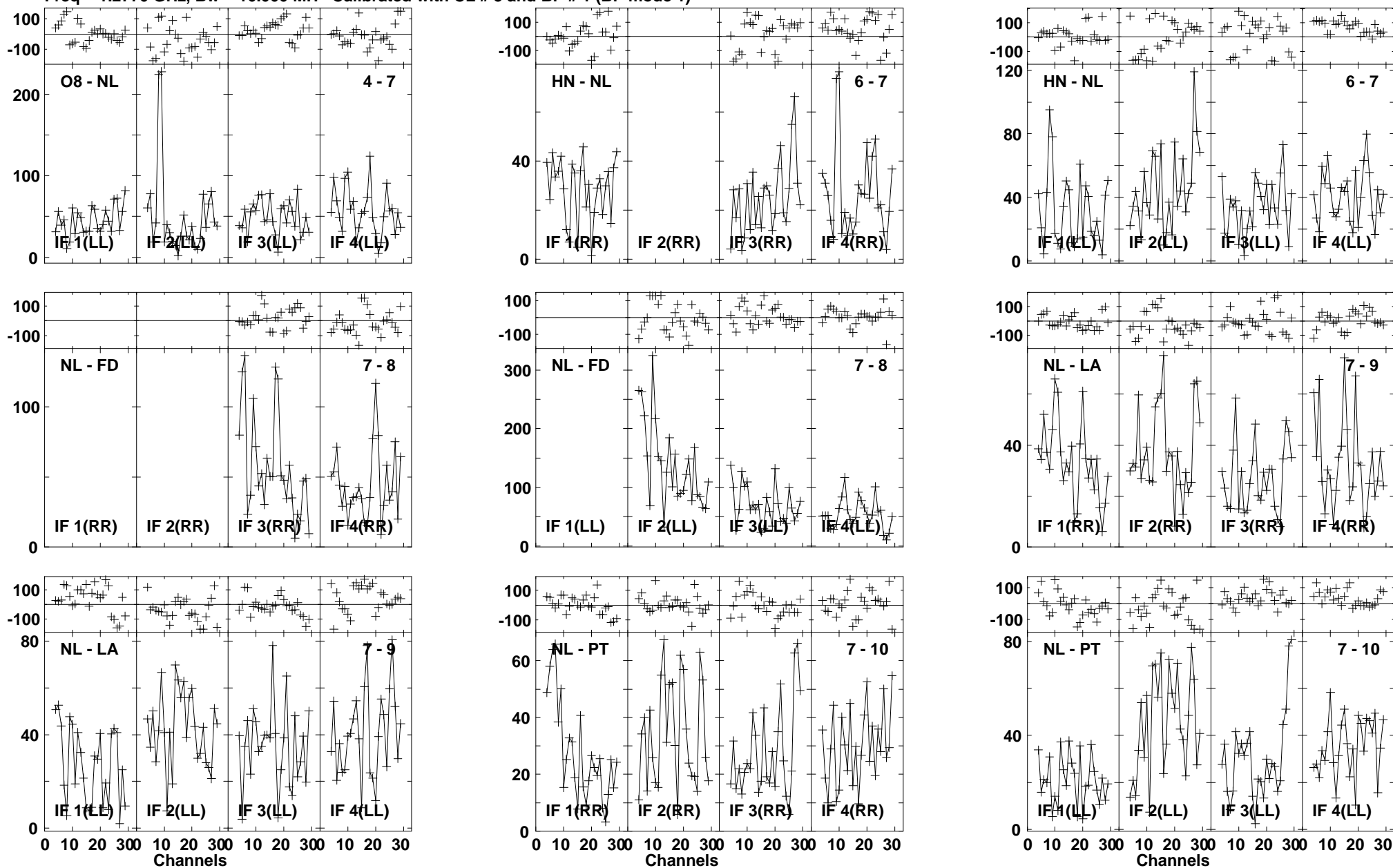

Lower frame: Milli Ampl Jy Top frame: Phas deg
Vector averaged cross-power spectrum Baseline: O8 (04) - NL (07)
Timerange: 01/03:36:56 to 01/03:39:44

Plot file version1428 created 03-MAR-2016 01:16:07

4C52 GN002C 1.UVDATA.1

Freq = 1.2770 GHz, Bw = 16.000 MH Calibrated with CL # 3 and BP # 1 (BP mode 1)

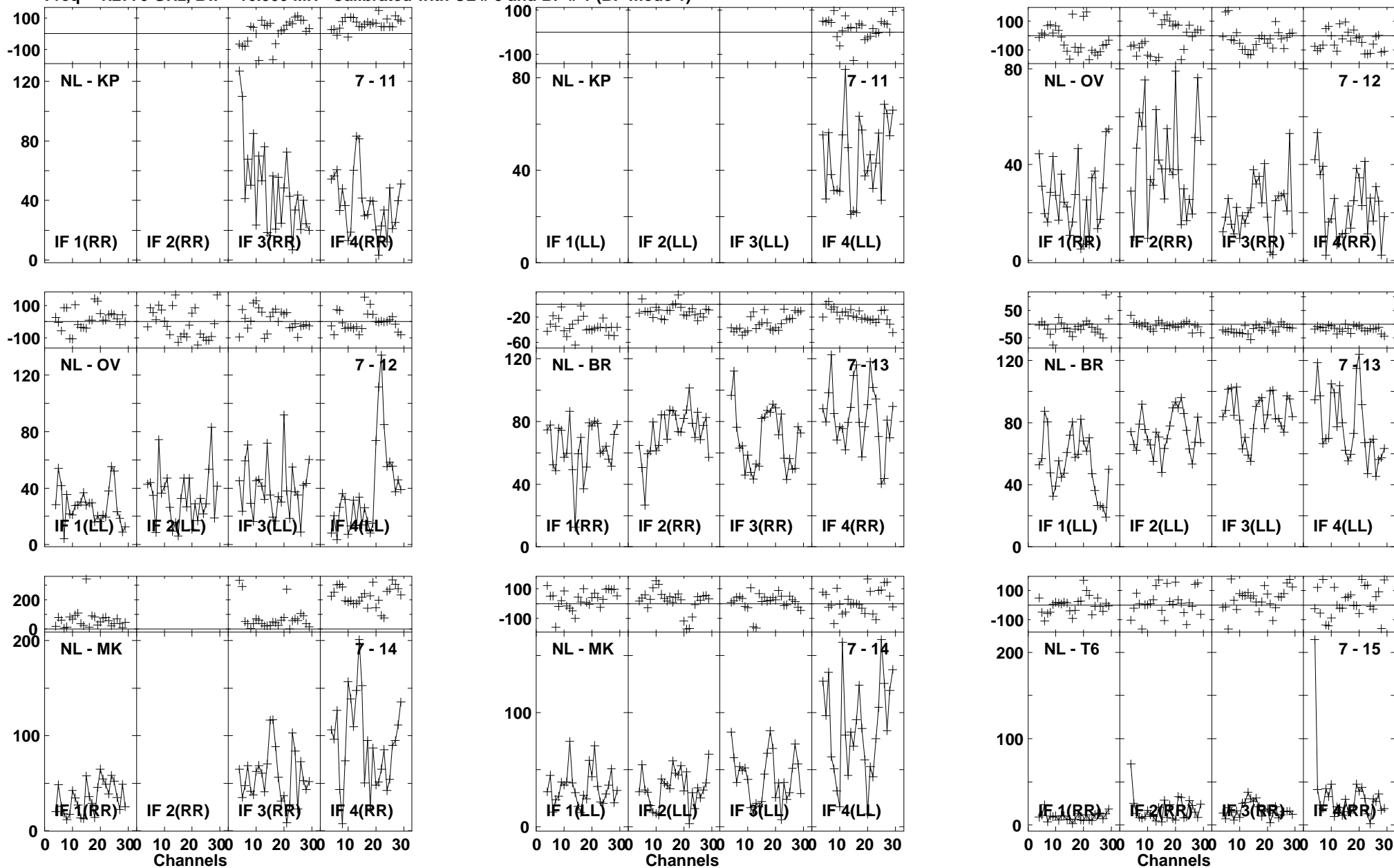

Lower frame: Milli Ampl Jy Top frame: Phas deg
Vector averaged cross-power spectrum Baseline: NL (07) - KP (11)
Timerange: 01/03:36:56 to 01/03:39:44

Plot file version1429 created 03-MAR-2016 01:16:07

4C52 GN002C 1.UVDATA.1

Freq = 1.2770 GHz, Bw = 16.000 MH Calibrated with CL # 3 and BP # 1 (BP mode 1)

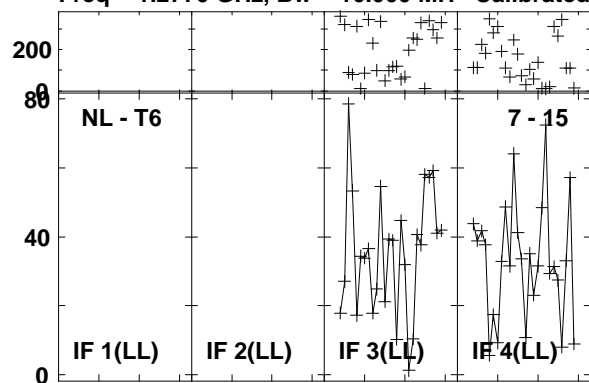

Lower frame: Milli Ampl Jy Top frame: Phas deg
Vector averaged cross-power spectrum Baseline: NL (07) - T6 (15)
Timerange: 01/03:36:56 to 01/03:39:44

Plot file version1430 created 03-MAR-2016 01:16:07
 J1545+5400 GN002C 1.UVDATA.1
 Freq = 1.2770 GHz, Bw = 16.000 MH Calibrated with CL # 3 and BP # 1 (BP mode 1)

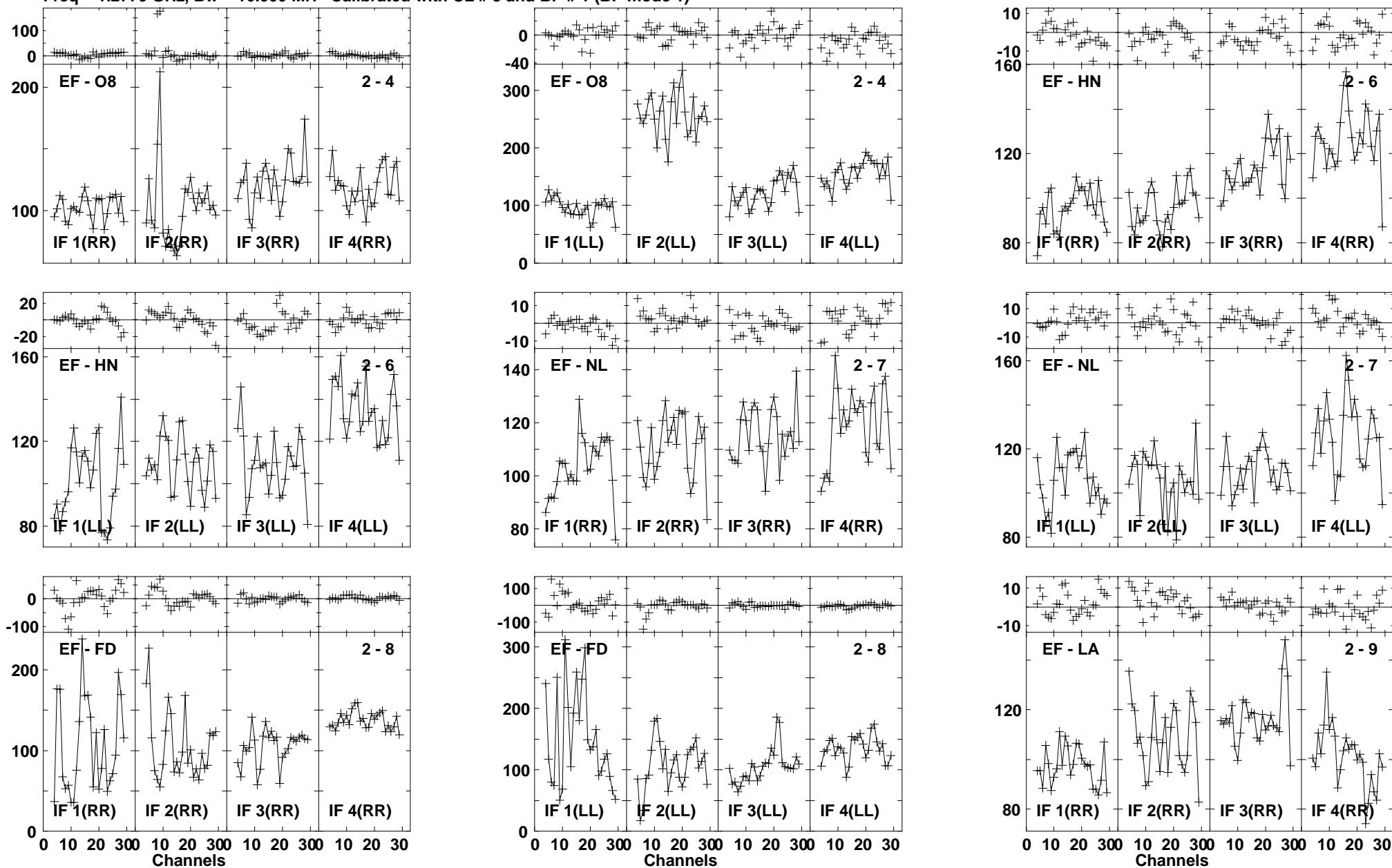

Lower frame: Milli Ampl Jy Top frame: Phas deg
 Vector averaged cross-power spectrum Baseline: EF (02) - O8 (04)
 Timerange: 01/03:40:37 to 01/03:41:35

Plot file version1431 created 03-MAR-2016 01:16:07

J1545+5400 GN002C 1.UVDATA.1

Freq = 1.2770 GHz, Bw = 16.000 MH Calibrated with CL # 3 and BP # 1 (BP mode 1)

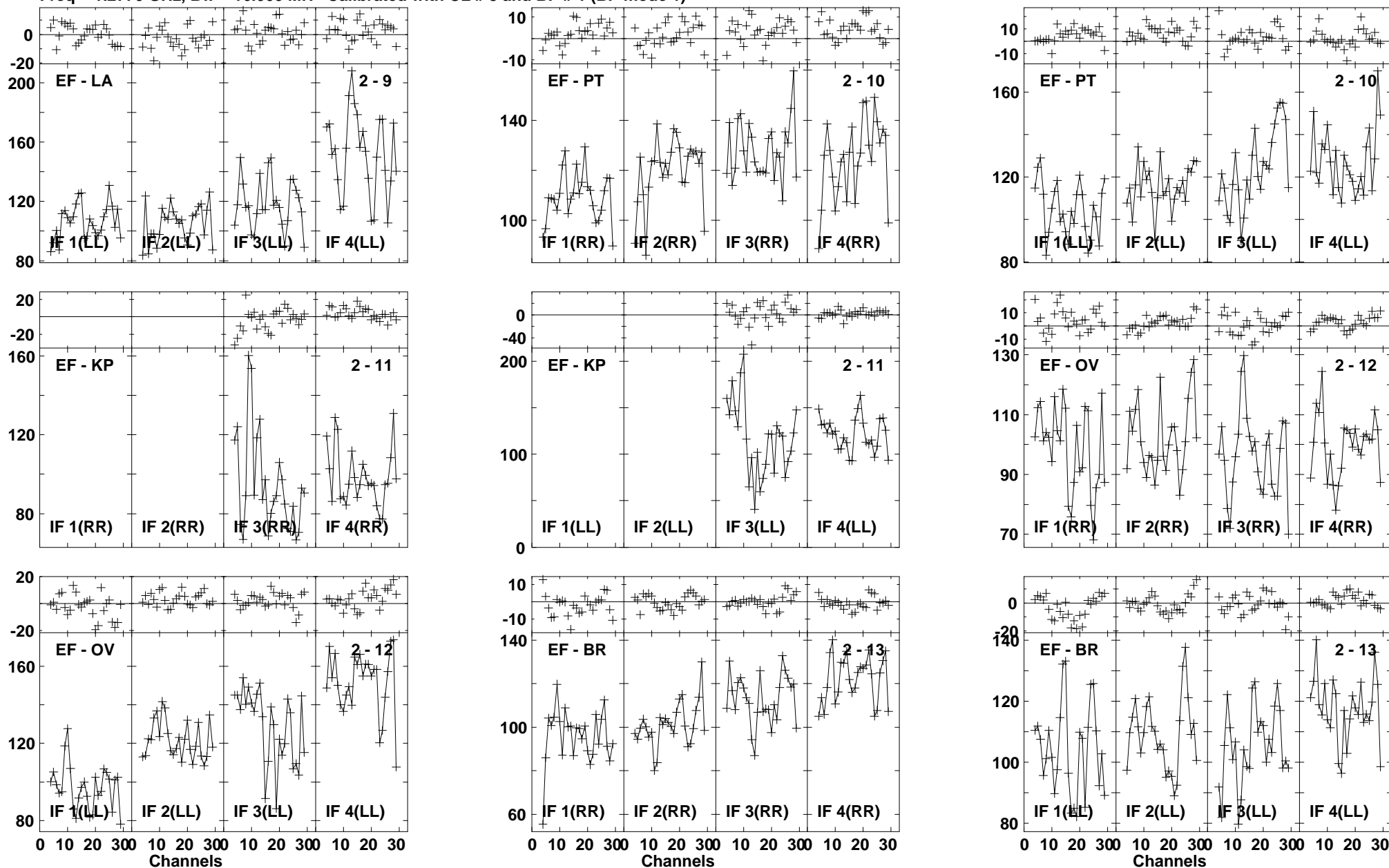

Lower frame: Milli Ampl Jy Top frame: Phas deg
Vector averaged cross-power spectrum Baseline: EF (02) - LA (09)
Timerange: 01/03:40:37 to 01/03:41:35

Plot file version1432 created 03-MAR-2016 01:16:07

J1545+5400 GN002C 1.UVDATA.1

Freq = 1.2770 GHz, Bw = 16.000 MH Calibrated with CL # 3 and BP # 1 (BP mode 1)

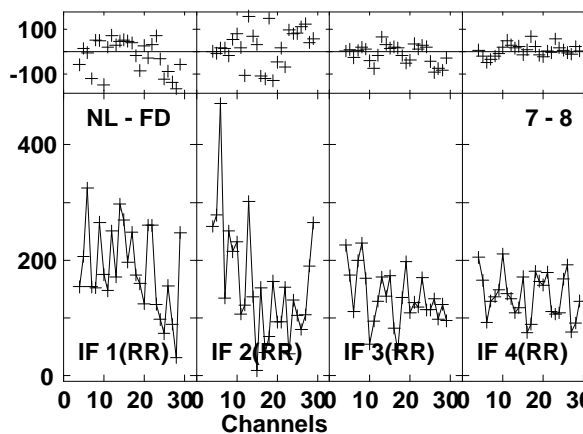
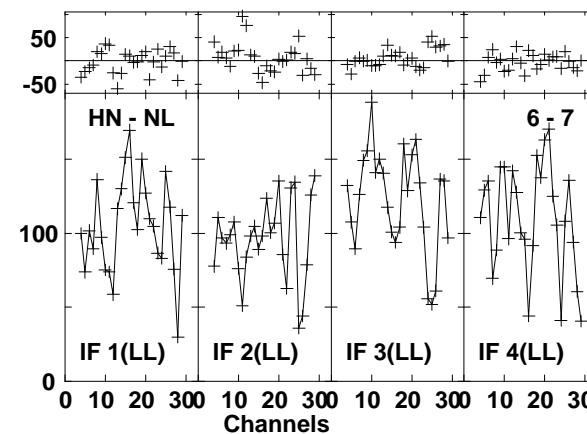
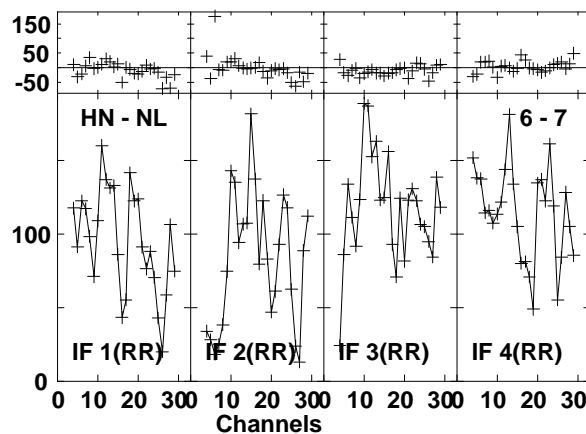
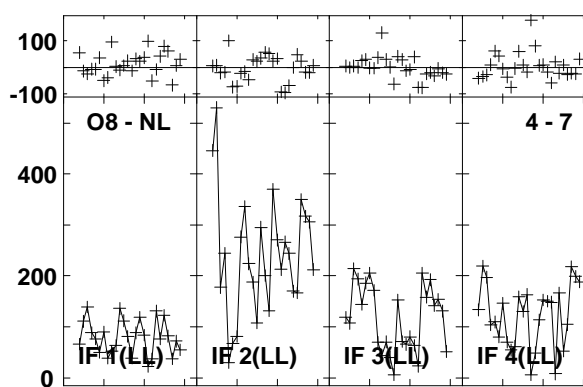
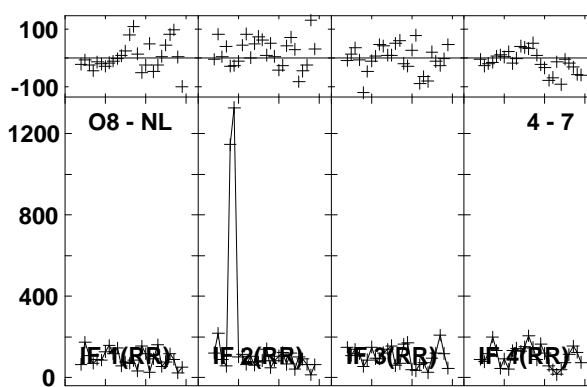
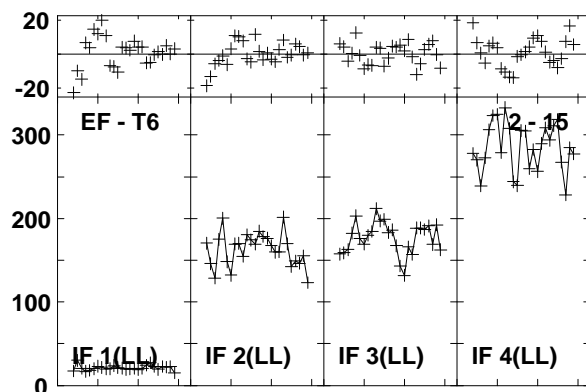
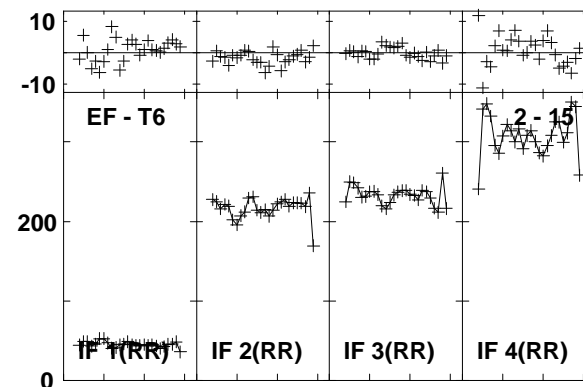
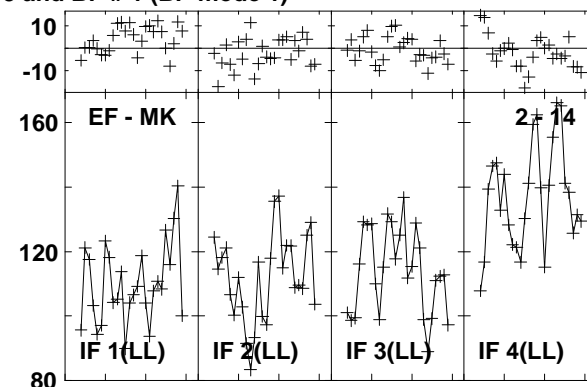
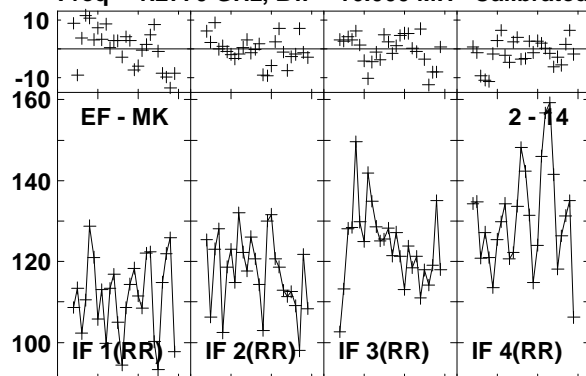

Lower frame: Milli Ampl Jy Top frame: Phas deg
Vector averaged cross-power spectrum Baseline: EF (02) - MK (14)
Timerange: 01/03:40:37 to 01/03:41:35

Plot file version1433 created 03-MAR-2016 01:16:07

J1545+5400 GN002C 1.UVDATA.1

Freq = 1.2770 GHz, Bw = 16.000 MH Calibrated with CL # 3 and BP # 1 (BP mode 1)

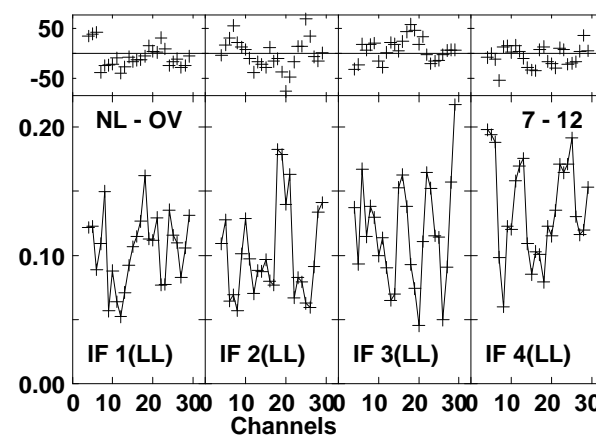
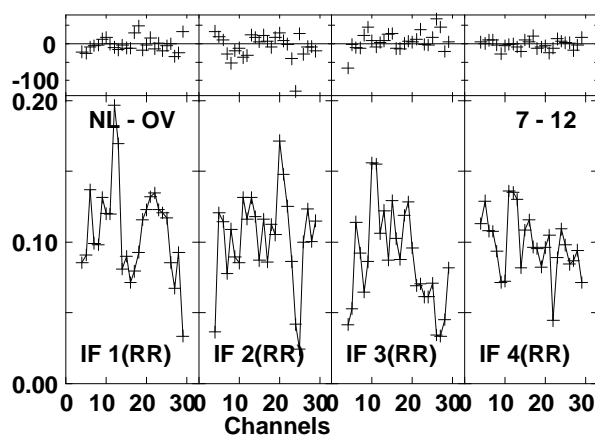
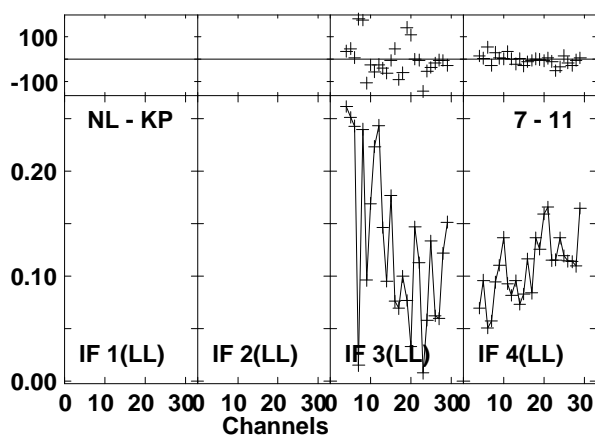
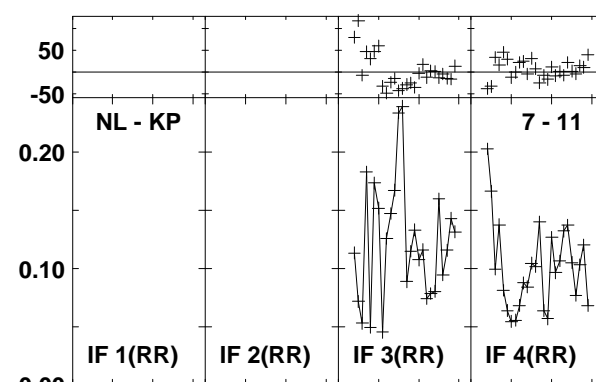
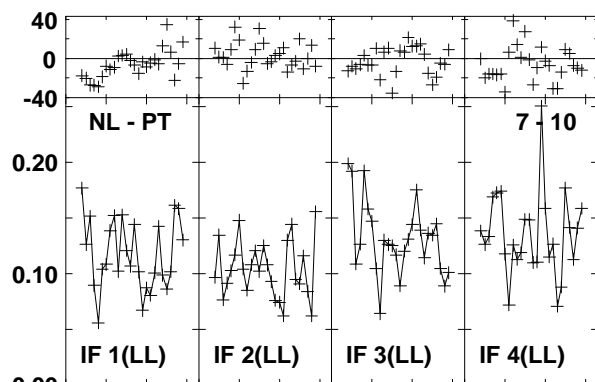
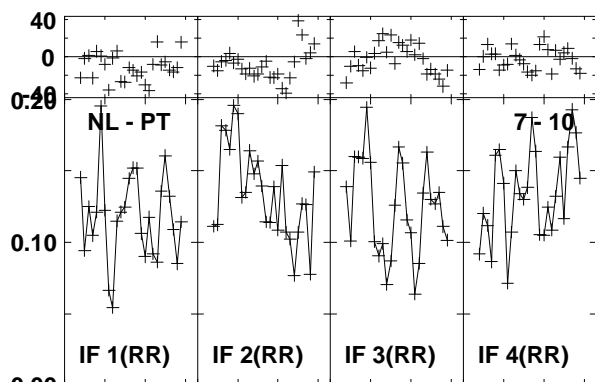
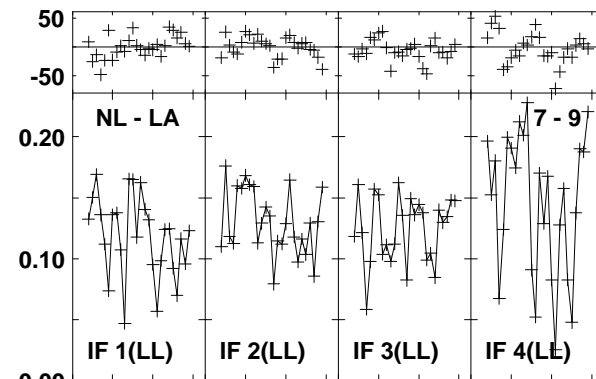
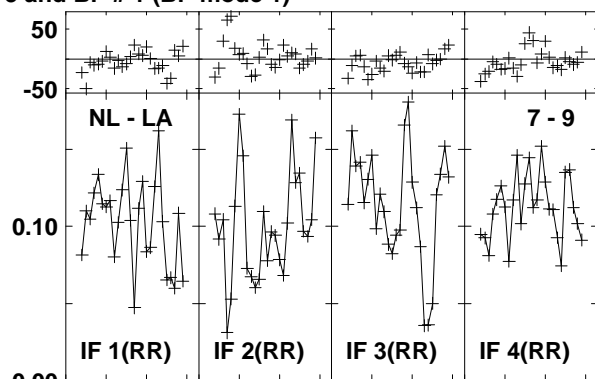
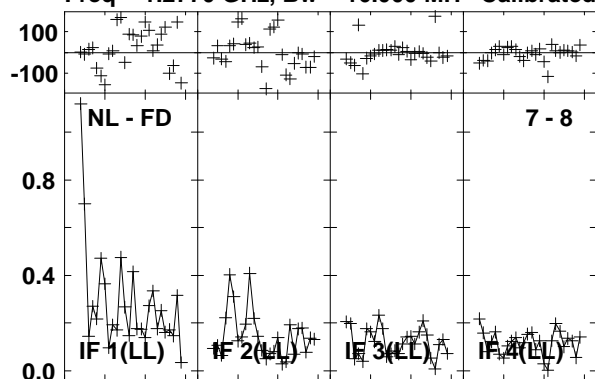

Lower frame: Ampl Jy Top frame: Phas deg
Vector averaged cross-power spectrum Baseline: NL (07) - FD (08)
Timerange: 01/03:40:37 to 01/03:41:35

Plot file version1434 created 03-MAR-2016 01:16:07

J1545+5400 GN002C 1.UVDATA.1

Freq = 1.2770 GHz, Bw = 16.000 MH Calibrated with CL # 3 and BP # 1 (BP mode 1)

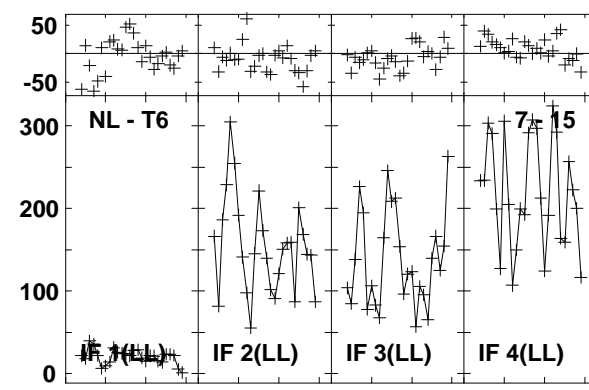
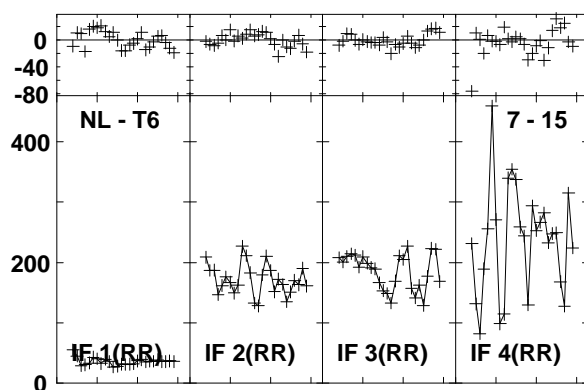
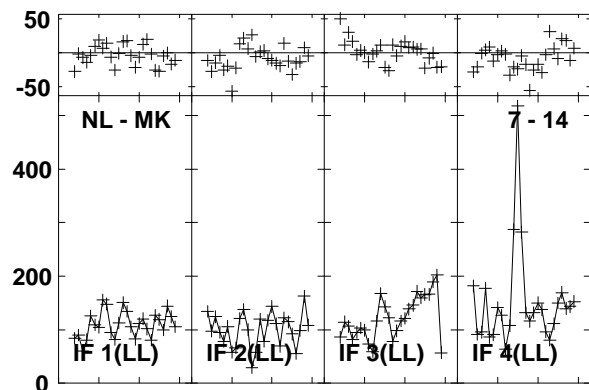
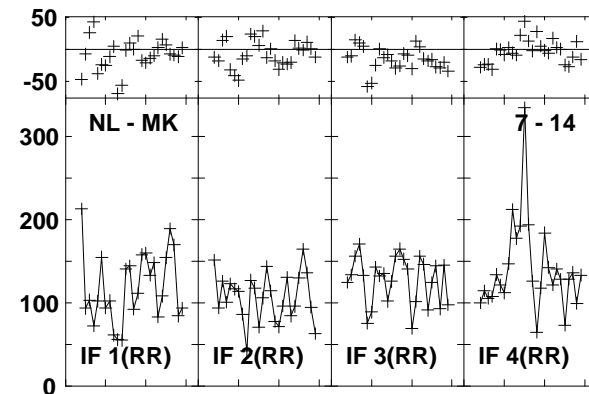
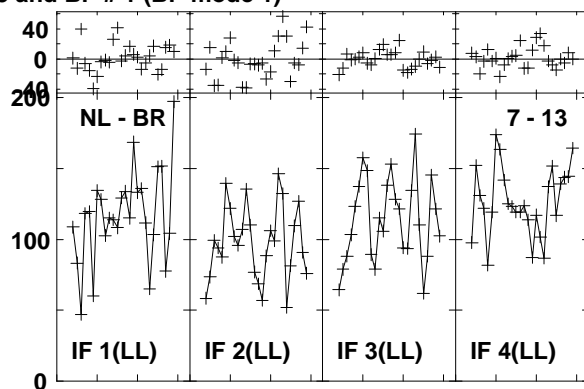
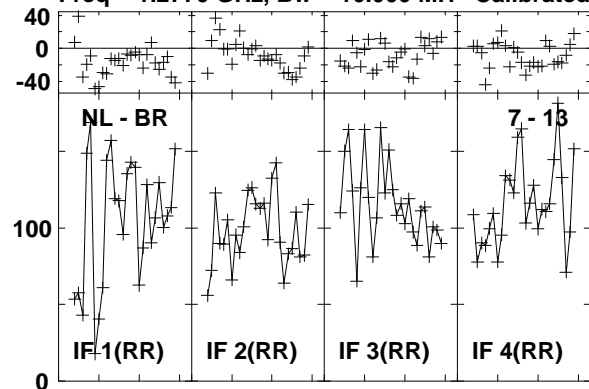

Lower frame: Milli Ampl Jy Top frame: Phas deg
Vector averaged cross-power spectrum Baseline: NL (07) - BR (13)
Timerange: 01/03:40:37 to 01/03:41:35

Plot file version1435 created 03-MAR-2016 01:16:08

4C52 GN002C 1.UVDATA.1

Freq = 1.2770 GHz, Bw = 16.000 MH Calibrated with CL # 3 and BP # 1 (BP mode 1)

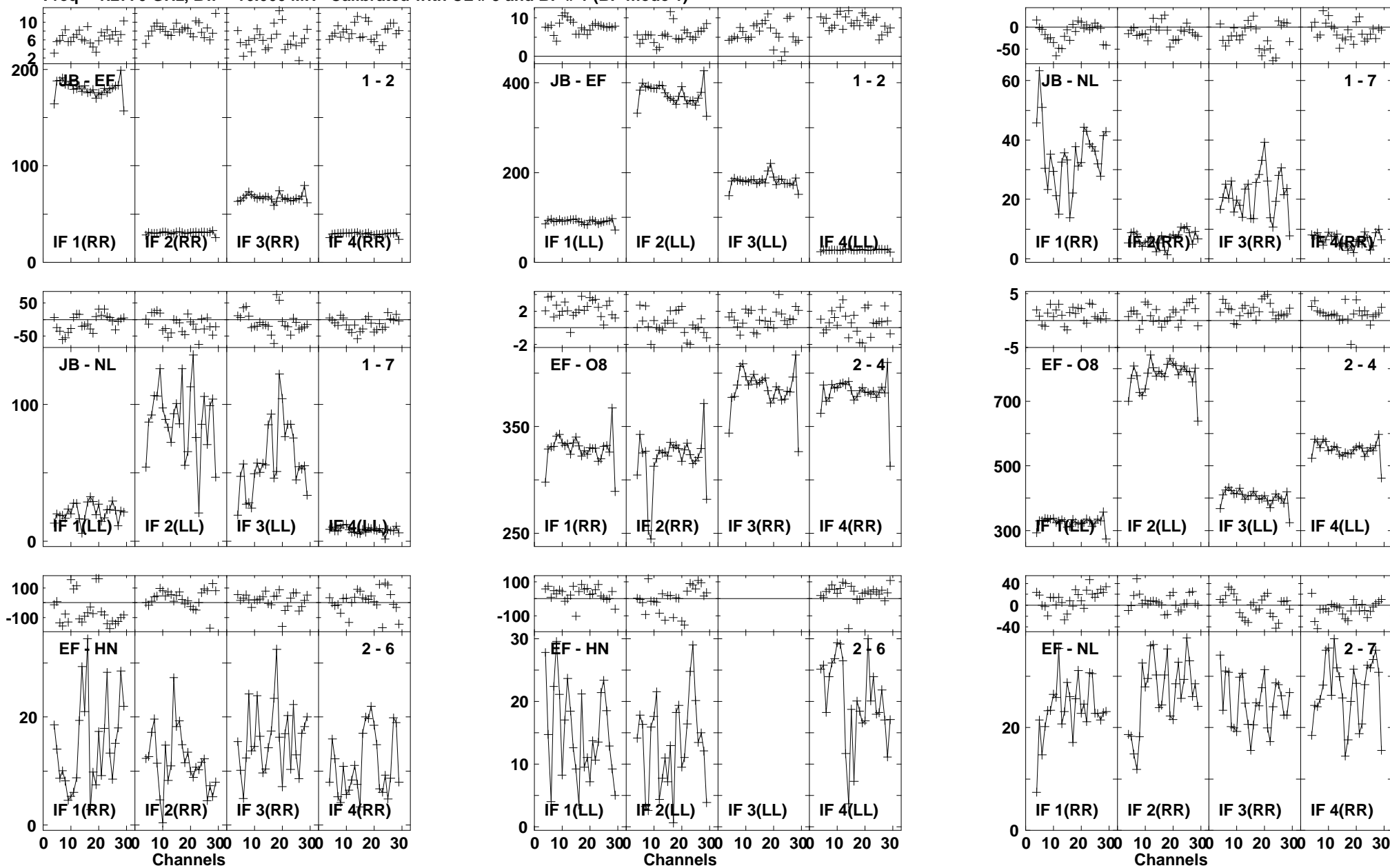

Lower frame: Milli Ampl Jy Top frame: Phas deg
Vector averaged cross-power spectrum Baseline: JB (01) - EF (02)
Timerange: 01/03:41:40 to 01/03:44:34

Plot file version1436 created 03-MAR-2016 01:16:08

4C52 GN002C 1.UVDATA.1

Freq = 1.2770 GHz, Bw = 16.000 MH Calibrated with CL # 3 and BP # 1 (BP mode 1)

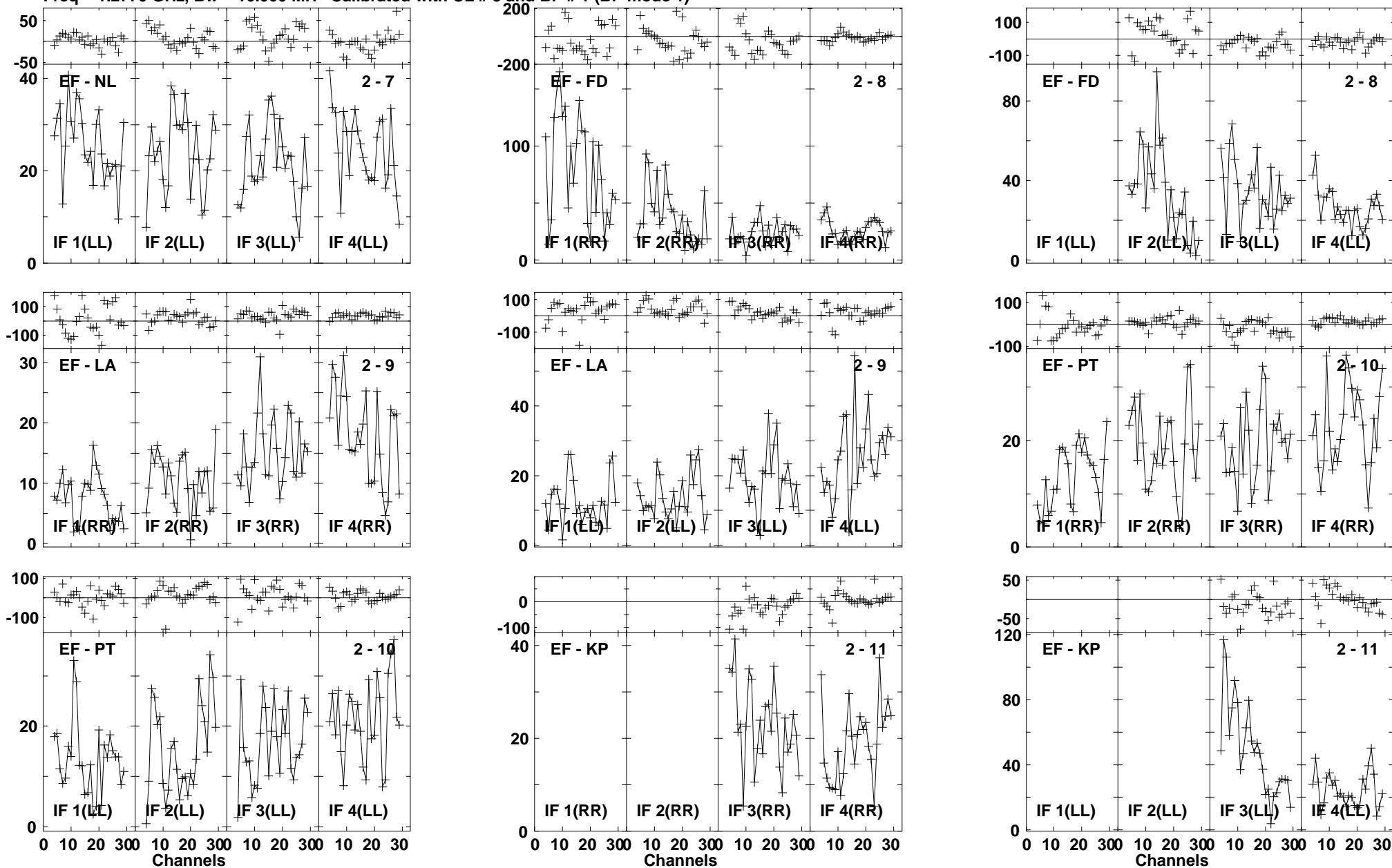

Lower frame: Milli Ampl Jy Top frame: Phas deg
Vector averaged cross-power spectrum Baseline: EF (02) - NL (07)
Timerange: 01/03:41:40 to 01/03:44:34

Plot file version1437 created 03-MAR-2016 01:16:08

4C52 GN002C 1.UVDATA.1

Freq = 1.2770 GHz, Bw = 16.000 MH Calibrated with CL # 3 and BP # 1 (BP mode 1)

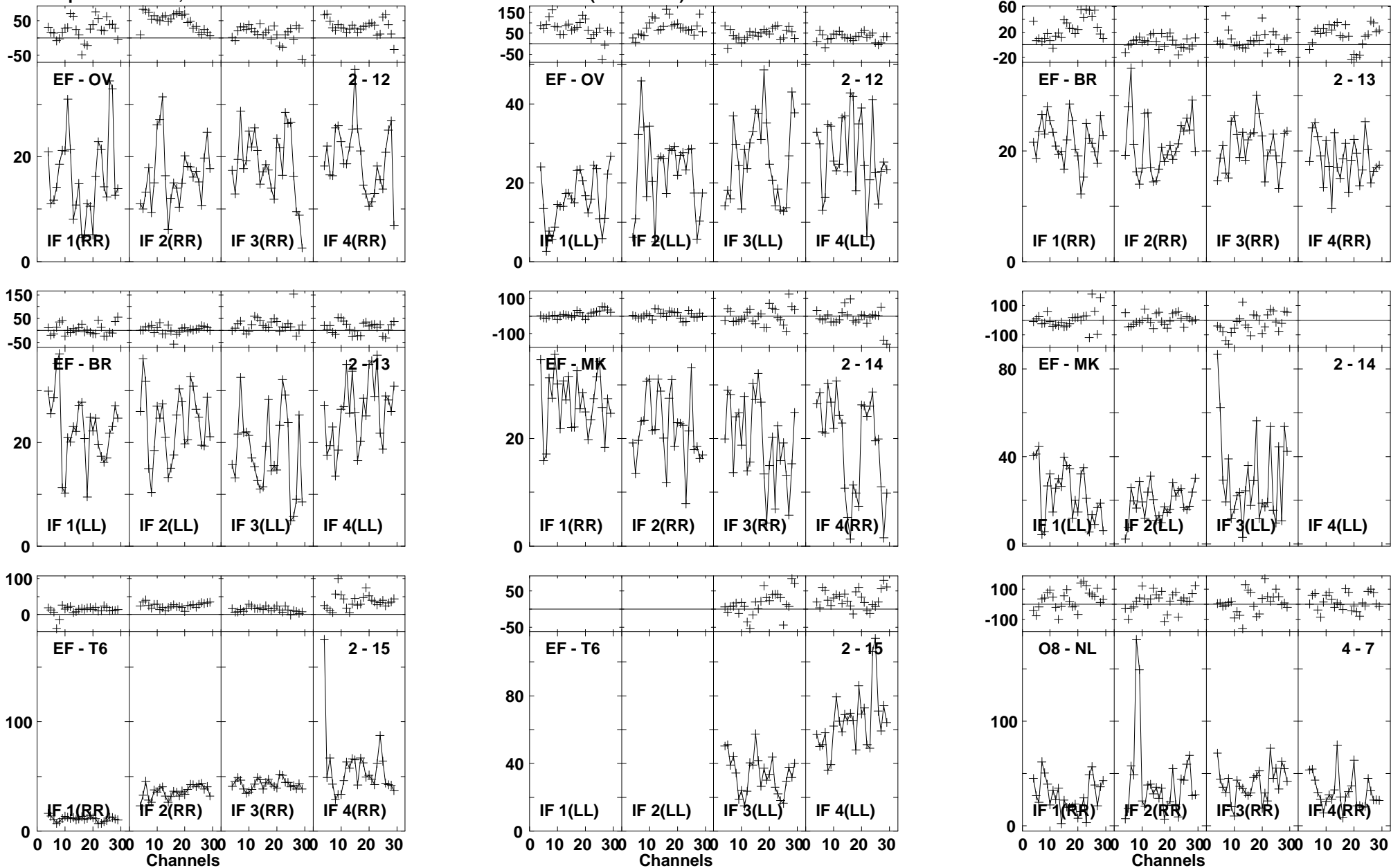

Lower frame: Milli Ampl Jy Top frame: Phas deg
Vector averaged cross-power spectrum Baseline: EF (02) - OV (12)
Timerange: 01/03:41:40 to 01/03:44:34

Plot file version1438 created 03-MAR-2016 01:16:08

4C52 GN002C 1.UVDATA.1

Freq = 1.2770 GHz, Bw = 16.000 MH Calibrated with CL # 3 and BP # 1 (BP mode 1)

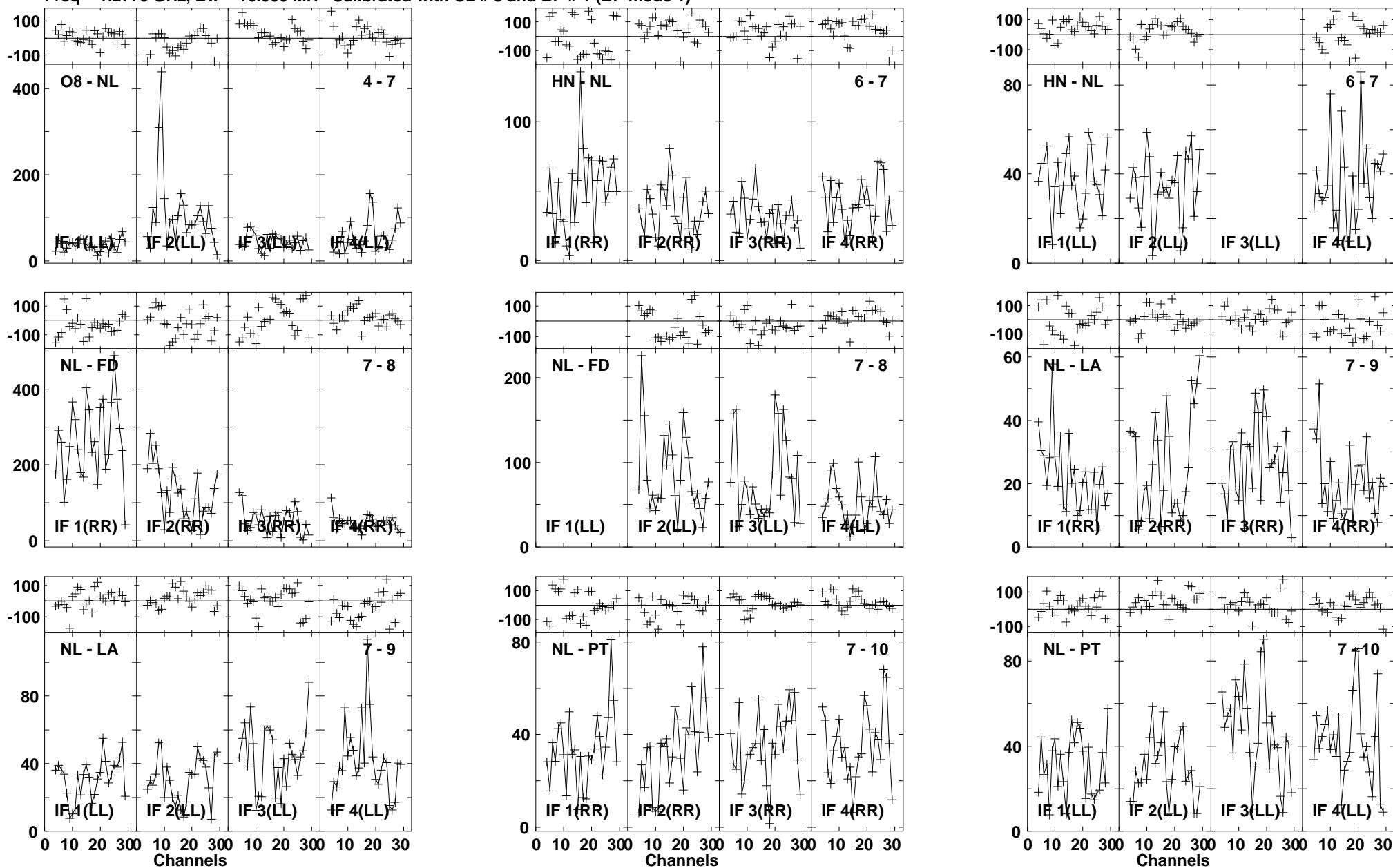

Lower frame: Milli Ampl Jy Top frame: Phas deg
Vector averaged cross-power spectrum Baseline: O8 (04) - NL (07)
Timerange: 01/03:41:40 to 01/03:44:34

Plot file version1439 created 03-MAR-2016 01:16:08
 4C52 GN002C 1.UVDATA.1
 Freq = 1.2770 GHz, Bw = 16.000 MH Calibrated with CL # 3 and BP # 1 (BP mode 1)

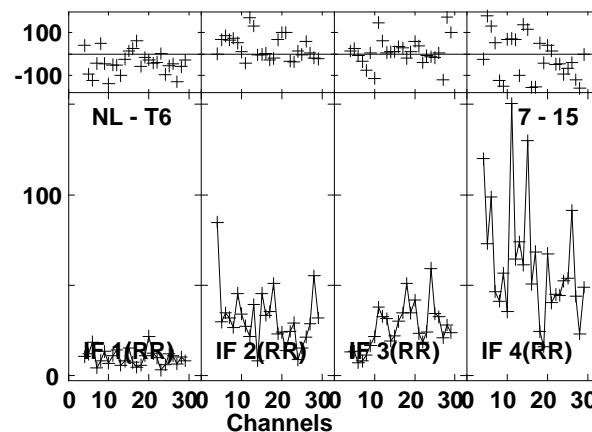
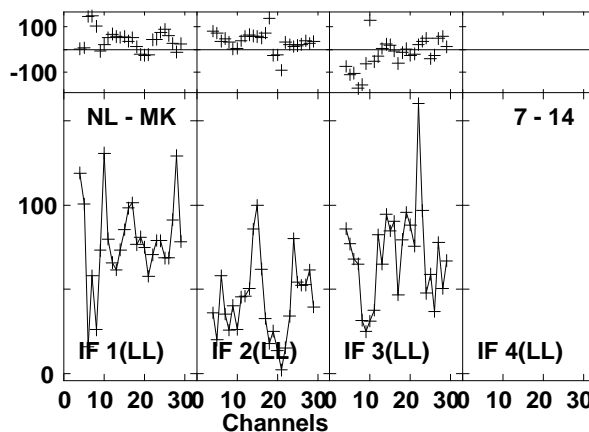
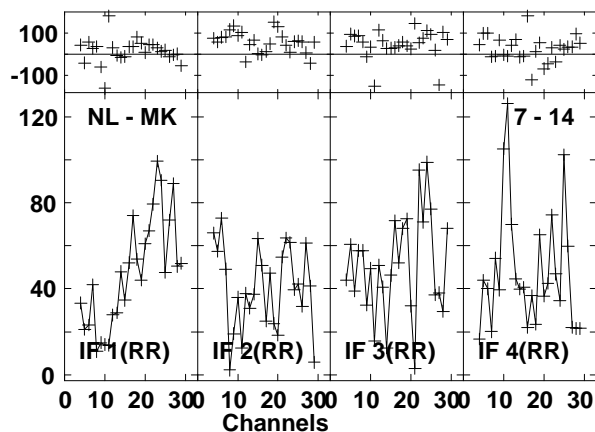
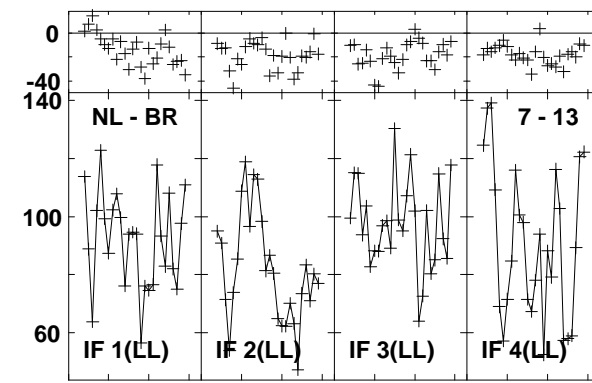
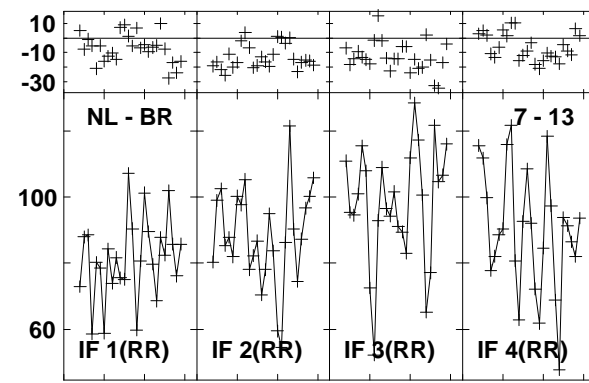
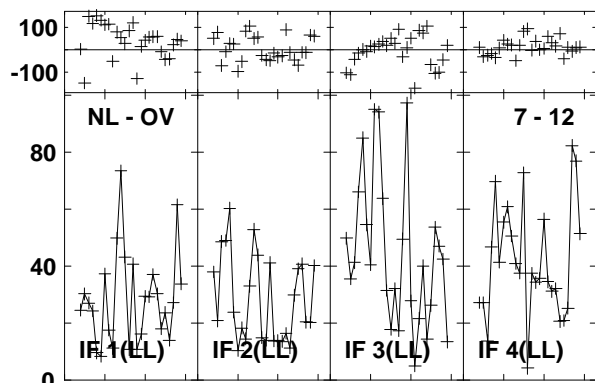
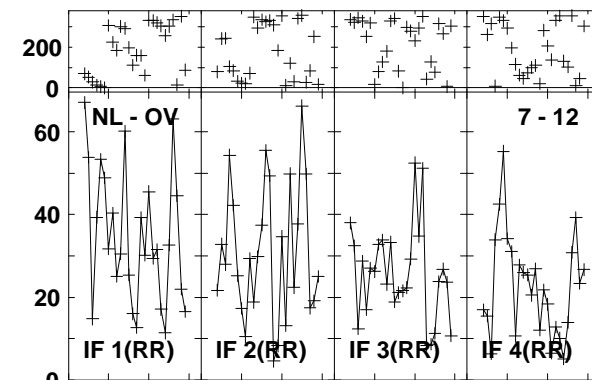
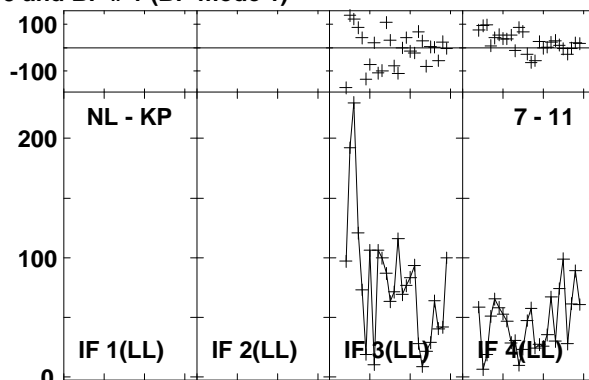
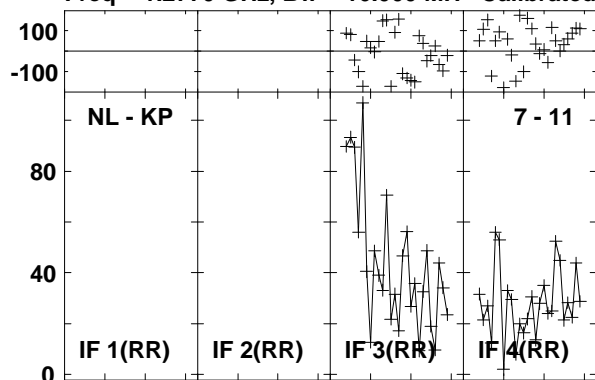

Lower frame: Milli Ampl Jy Top frame: Phas deg
 Vector averaged cross-power spectrum Baseline: NL (07) - KP (11)
 Timerange: 01/03:41:40 to 01/03:44:34

Plot file version1440 created 03-MAR-2016 01:16:09
4C52 GN002C 1.UVDATA.1
Freq = 1.2770 GHz, Bw = 16.000 MH Calibrated with CL # 3 and BP # 1 (BP mode 1)

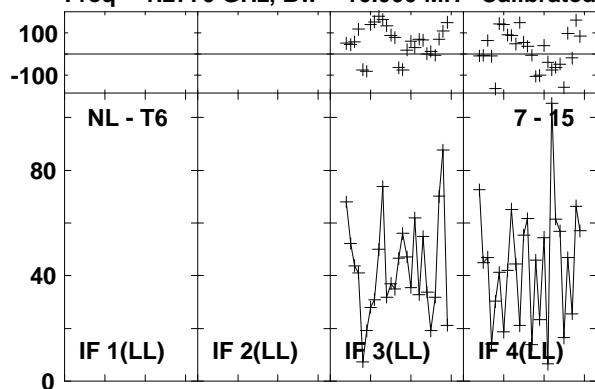

Lower frame: Milli Ampl Jy Top frame: Phas deg
Vector averaged cross-power spectrum Baseline: NL (07) - T6 (15)
Timerange: 01/03:41:40 to 01/03:44:34

Plot file version1441 created 03-MAR-2016 01:16:09

J1545+5400 GN002C 1.UVDATA.1

Freq = 1.2770 GHz, Bw = 16.000 MH Calibrated with CL # 3 and BP # 1 (BP mode 1)

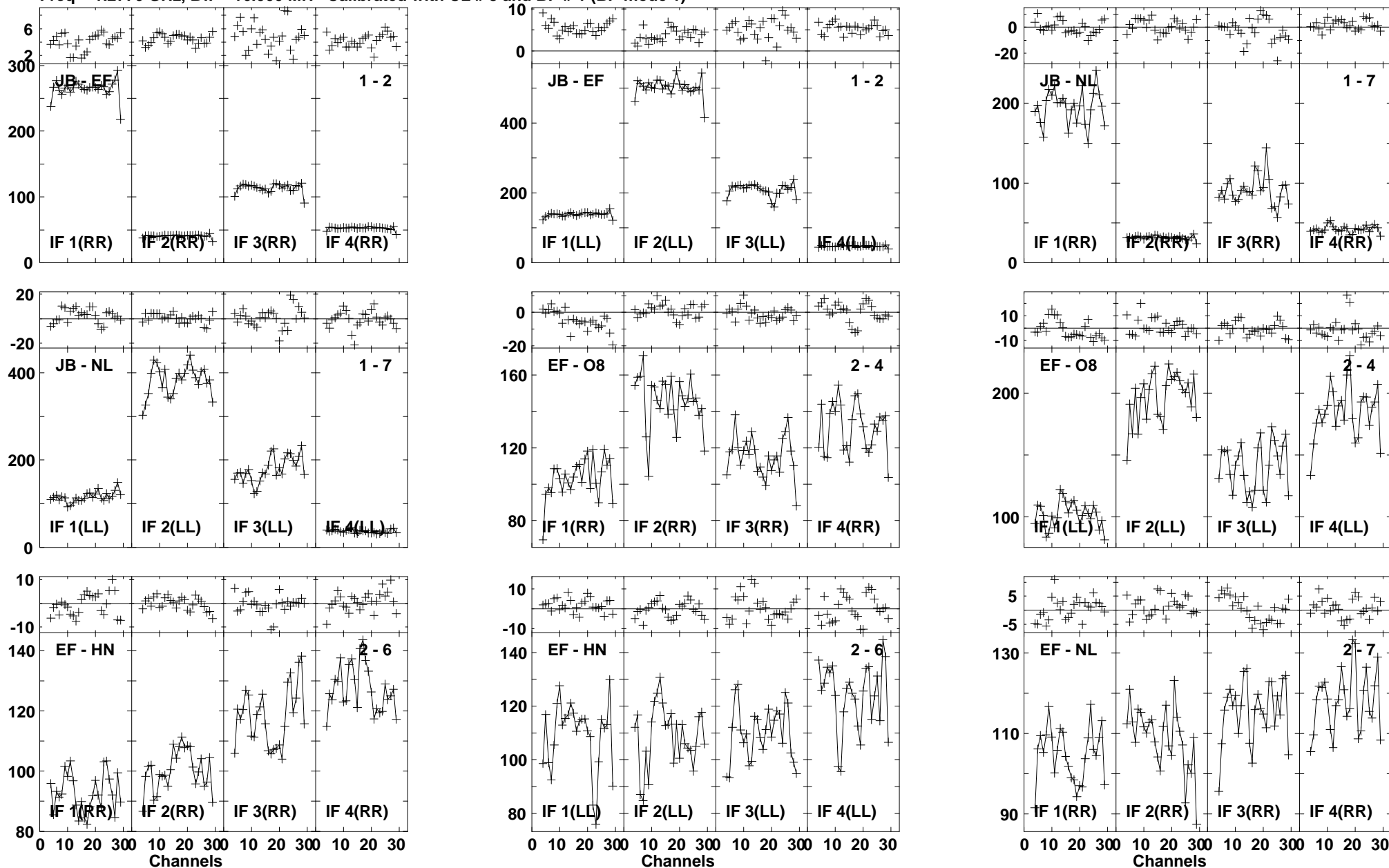

Lower frame: Milli Ampl Jy Top frame: Phas deg
Vector averaged cross-power spectrum Baseline: JB (01) - EF (02)
Timerange: 01/03:45:27 to 01/03:47:25

Plot file version1442 created 03-MAR-2016 01:16:09

J1545+5400 GN002C 1.UVDATA.1

Freq = 1.2770 GHz, Bw = 16.000 MH Calibrated with CL # 3 and BP # 1 (BP mode 1)

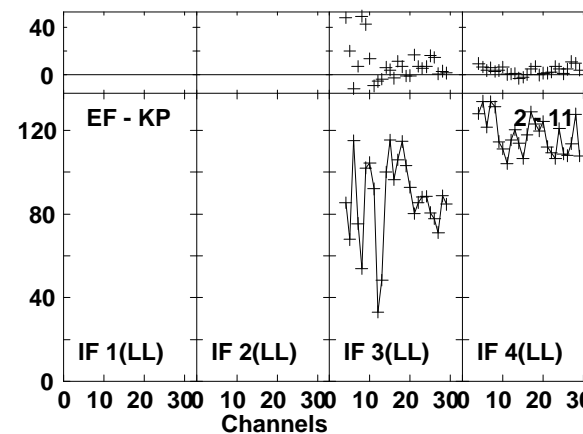
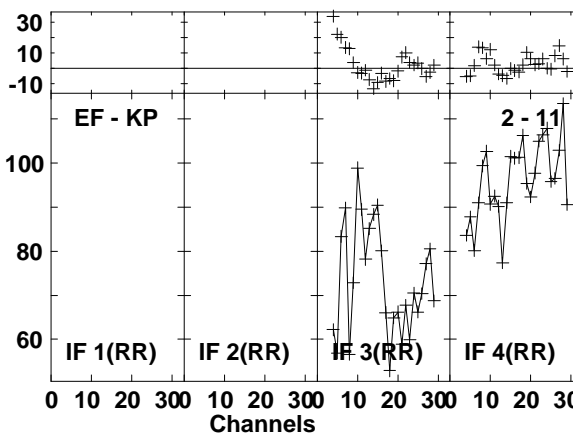
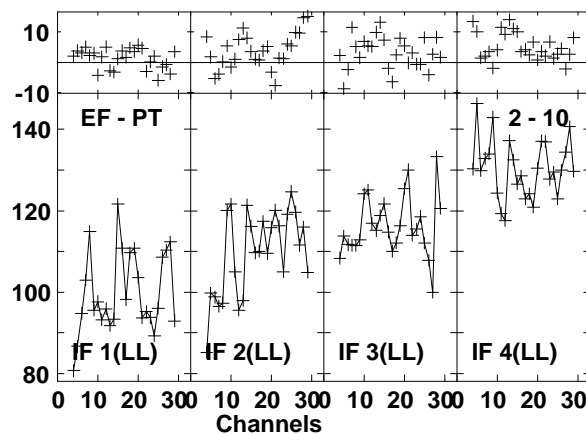
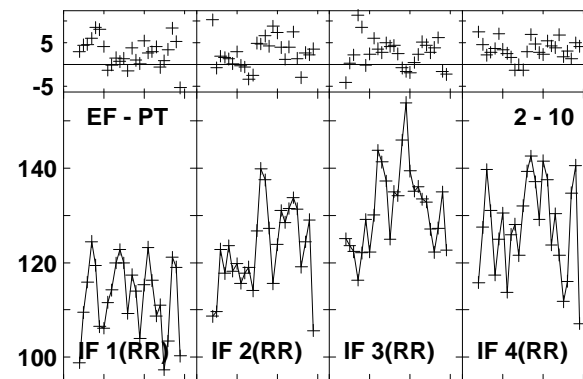
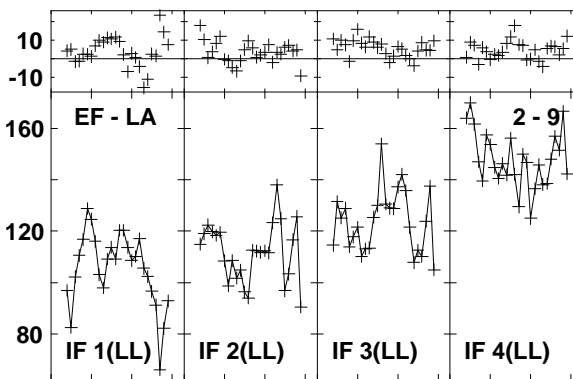
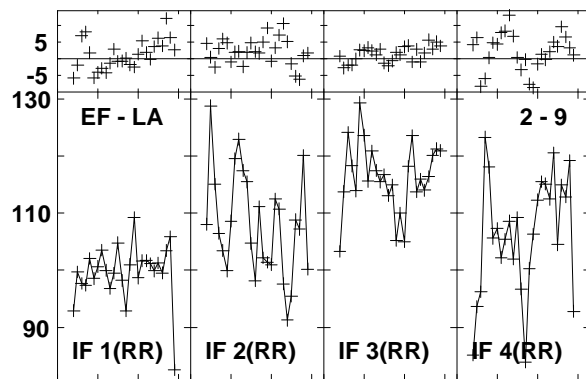
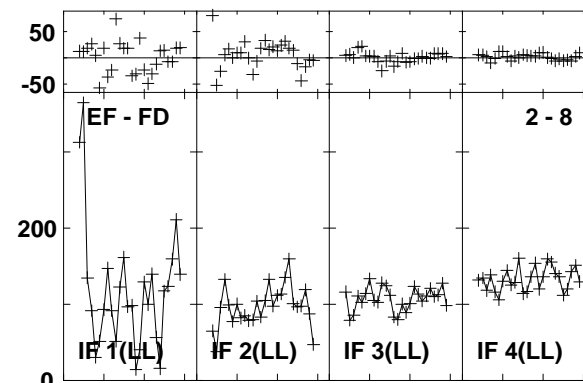
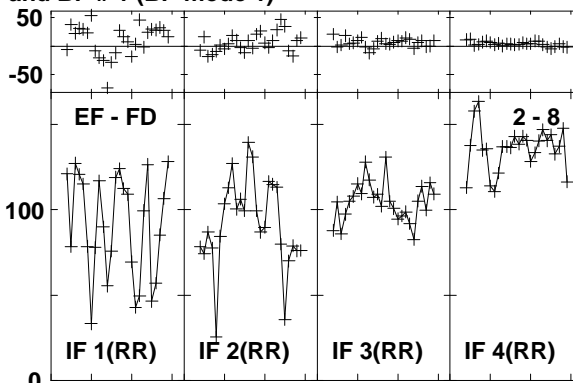
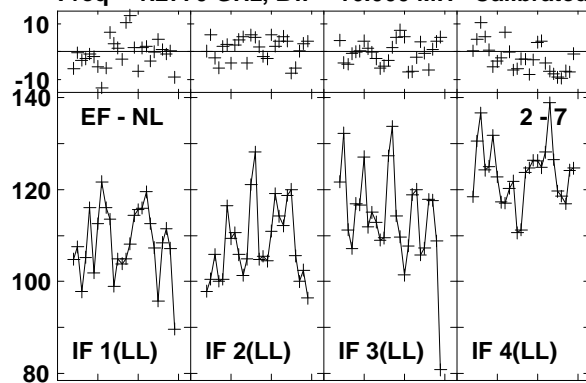

Lower frame: Milli Ampl Jy Top frame: Phas deg
Vector averaged cross-power spectrum Baseline: EF (02) - NL (07)
Timerange: 01/03:45:27 to 01/03:47:25

Plot file version1443 created 03-MAR-2016 01:16:09

J1545+5400 GN002C 1.UVDATA.1

Freq = 1.2770 GHz, Bw = 16.000 MH Calibrated with CL # 3 and BP # 1 (BP mode 1)

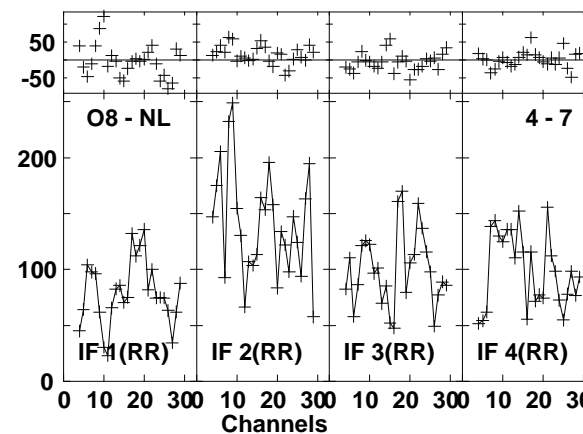
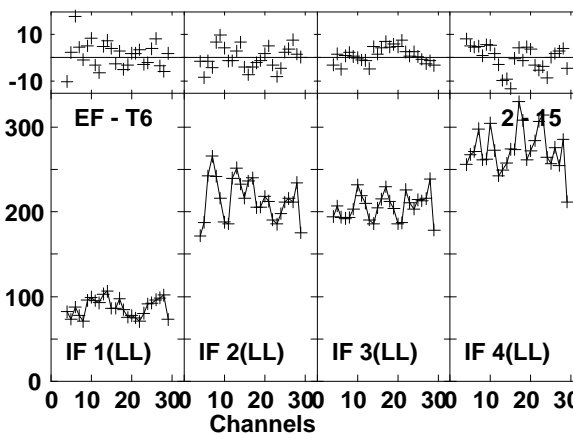
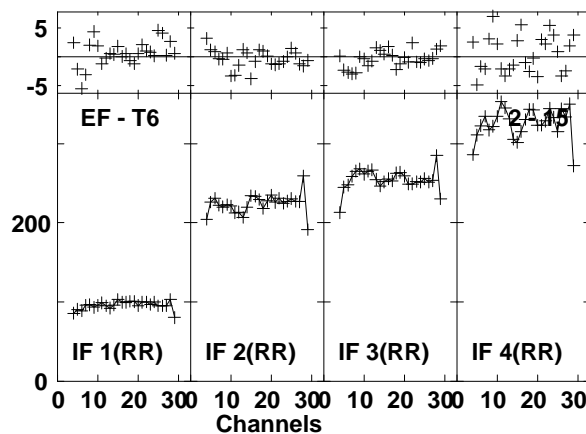
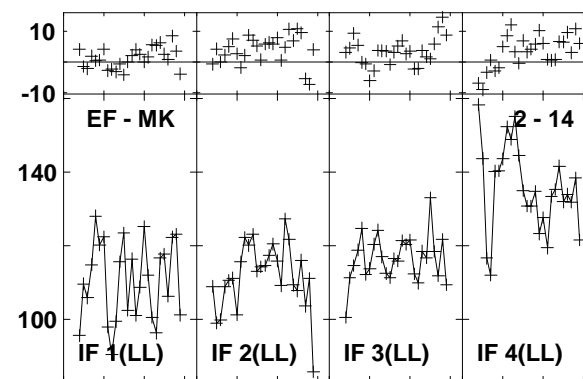
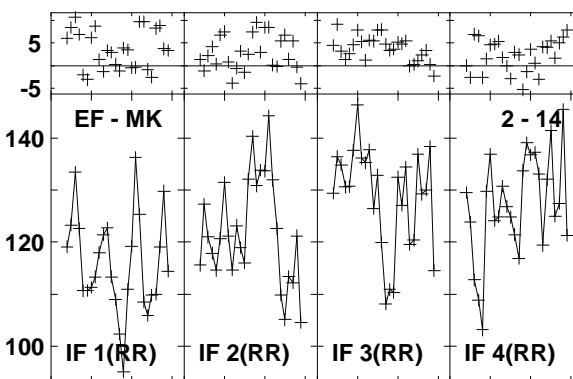
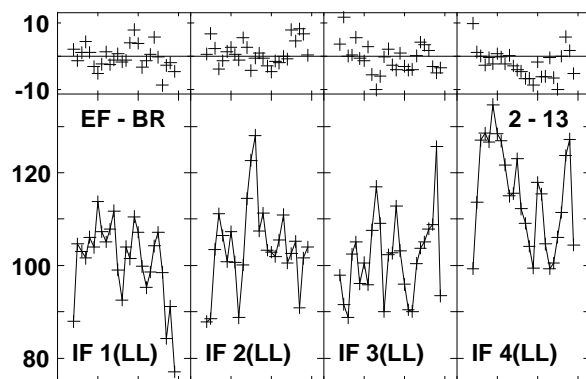
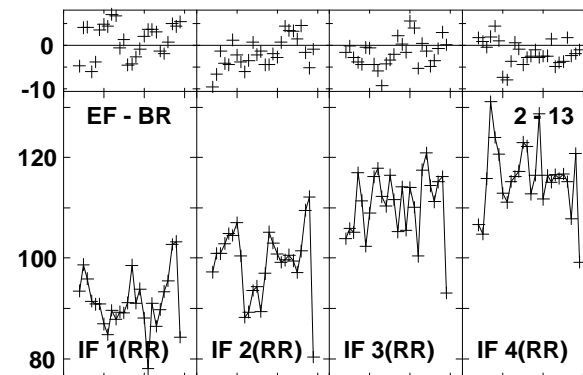
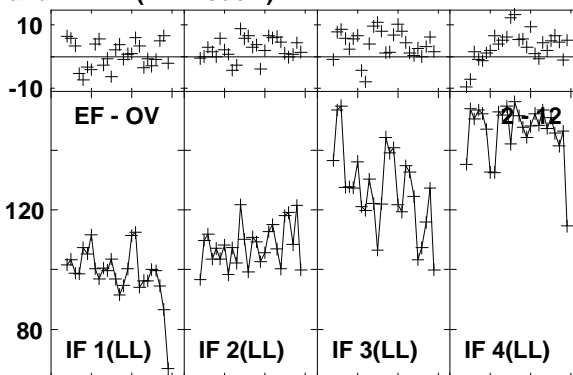
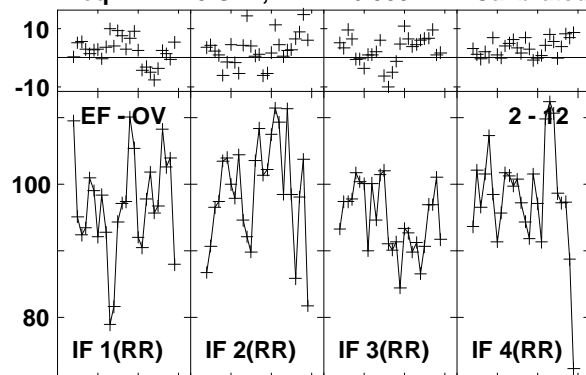

Lower frame: Milli Ampl Jy Top frame: Phas deg
Vector averaged cross-power spectrum Baseline: EF (02) - OV (12)
Timerange: 01/03:45:27 to 01/03:47:25

Plot file version1444 created 03-MAR-2016 01:16:09

J1545+5400 GN002C 1.UVDATA.1

Freq = 1.2770 GHz, Bw = 16.000 MH Calibrated with CL # 3 and BP # 1 (BP mode 1)

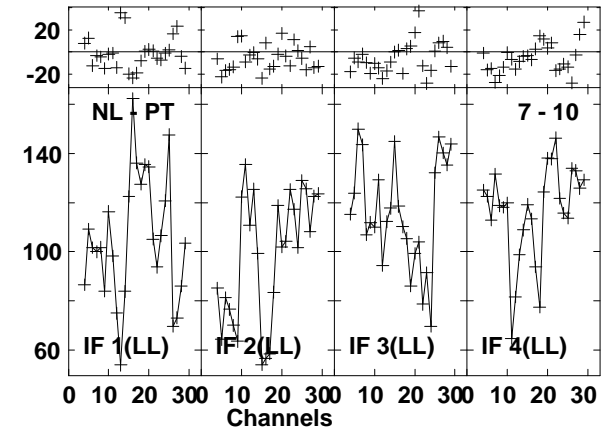
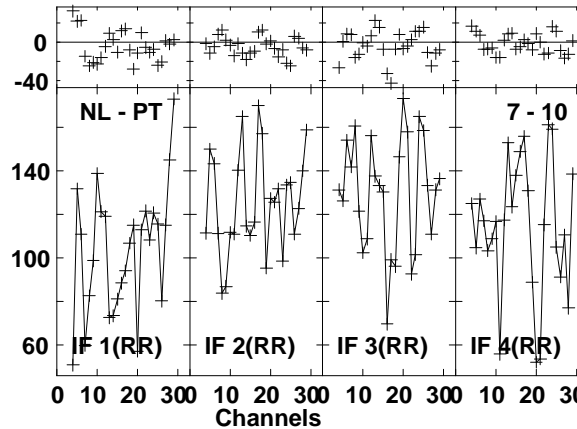
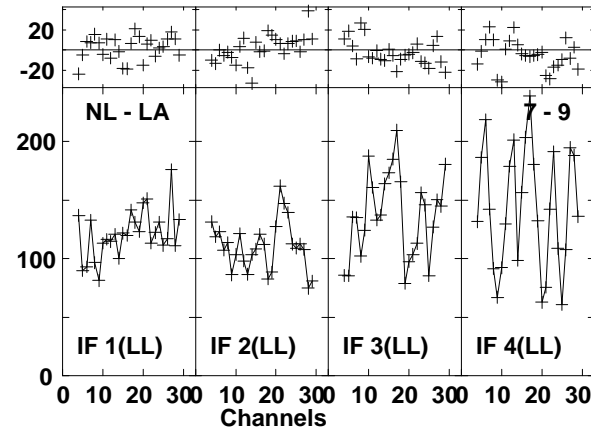
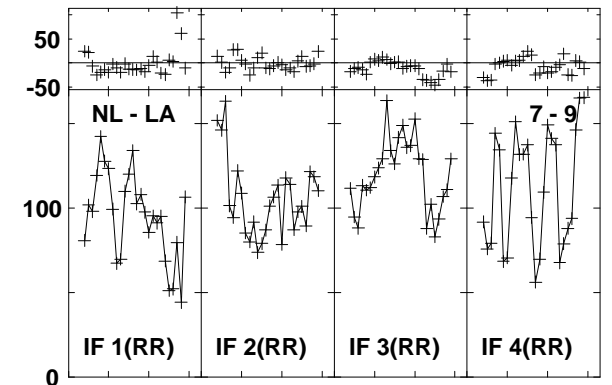
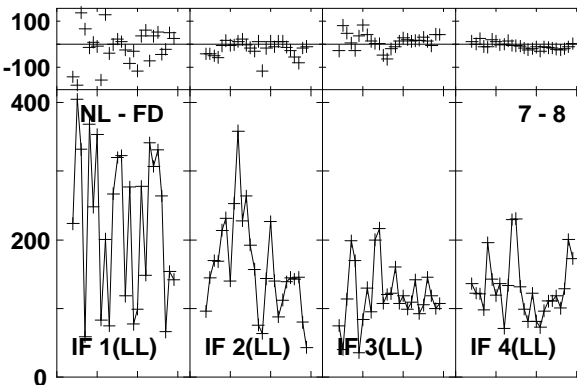
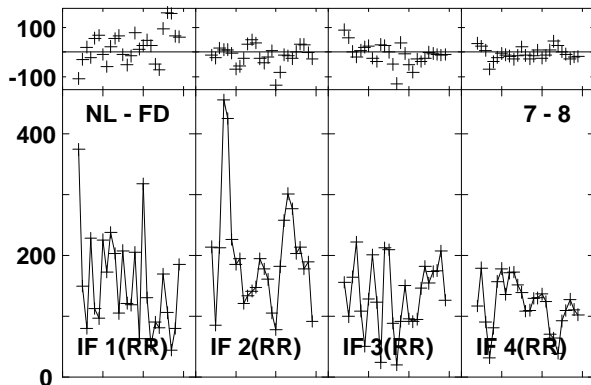
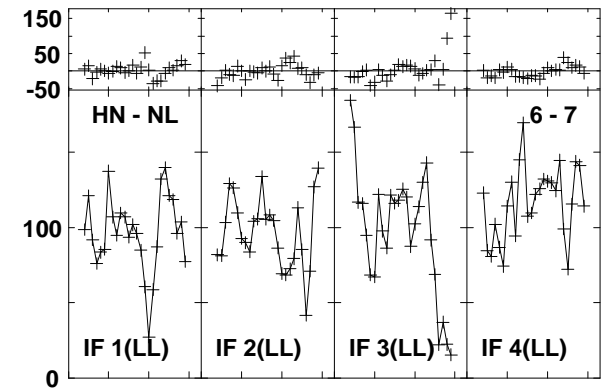
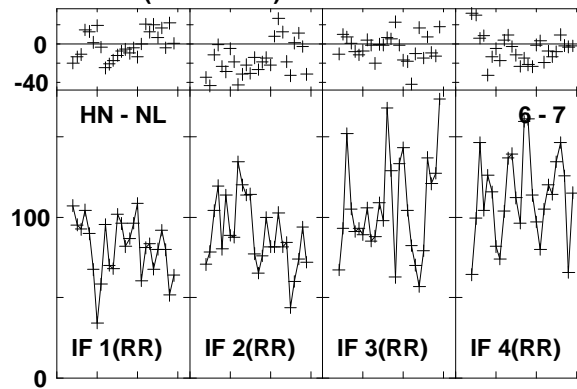
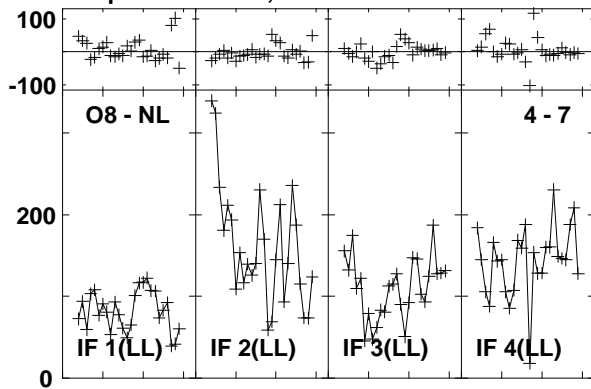

Lower frame: Milli Ampl Jy Top frame: Phas deg

Vector averaged cross-power spectrum Baseline: O8 (04) - NL (07)

Timerange: 01/03:45:27 to 01/03:47:25

Plot file version1445 created 03-MAR-2016 01:16:09

J1545+5400 GN002C 1.UVDATA.1

Freq = 1.2770 GHz, Bw = 16.000 MH Calibrated with CL # 3 and BP # 1 (BP mode 1)

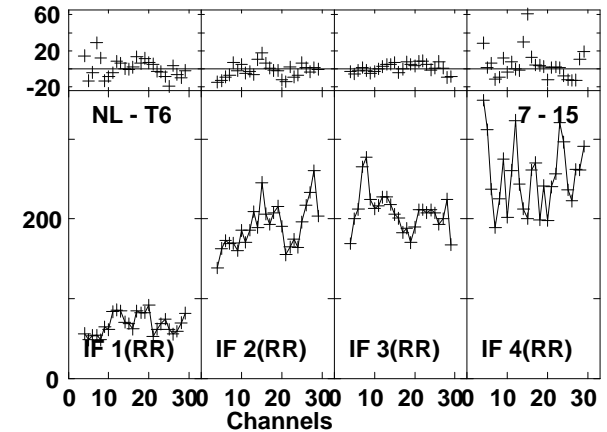
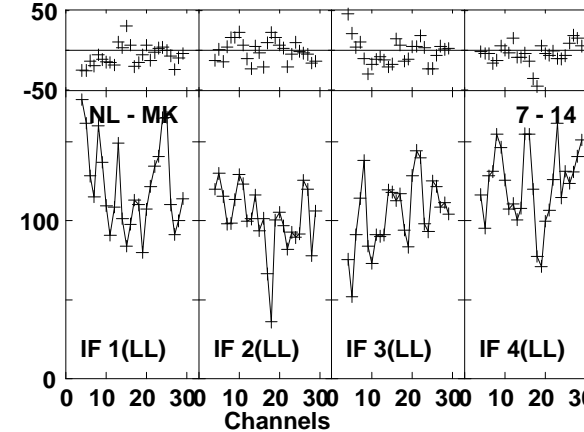
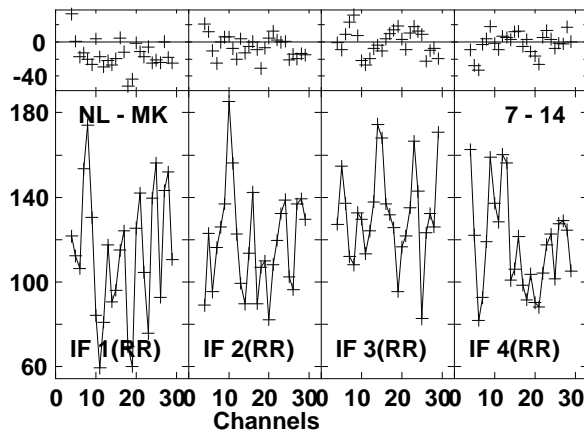
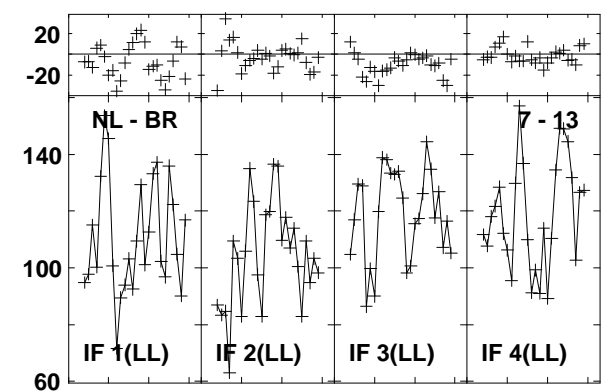
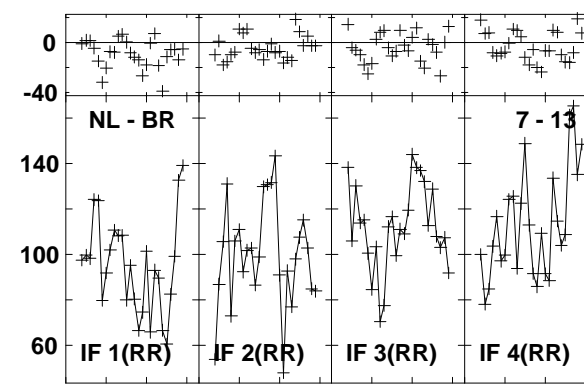
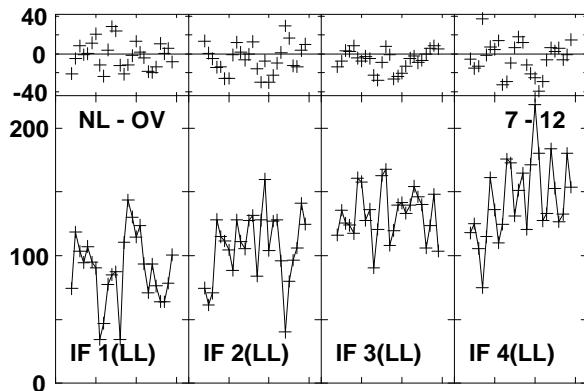
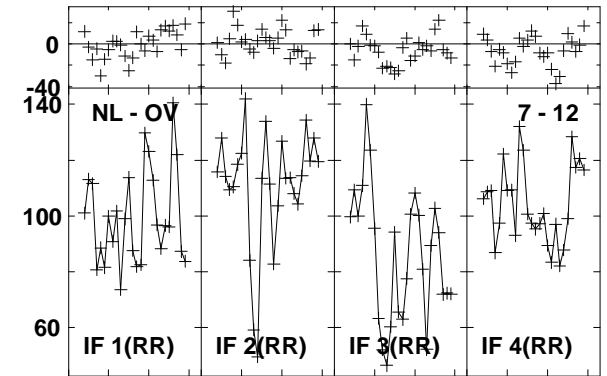
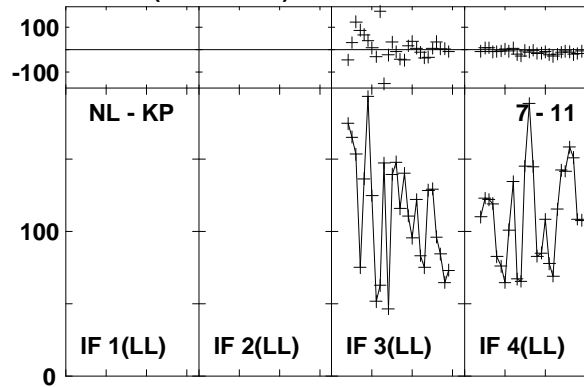
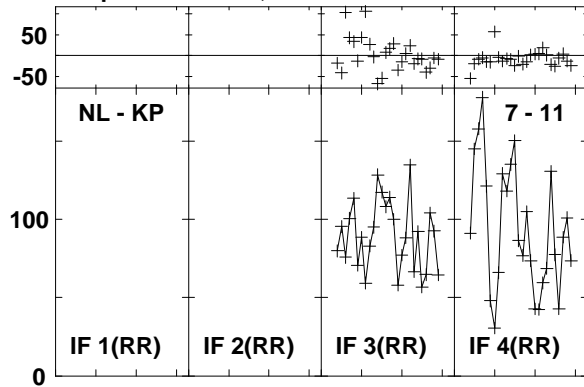

Lower frame: Milli Ampl Jy Top frame: Phas deg

Vector averaged cross-power spectrum Baseline: NL (07) - KP (11)

Timerange: 01/03:45:27 to 01/03:47:25

Plot file version1446 created 03-MAR-2016 01:16:09
J1545+5400 GN002C 1.UVDATA.1
Freq = 1.2770 GHz, Bw = 16.000 MH Calibrated with CL # 3 and BP # 1 (BP mode 1)

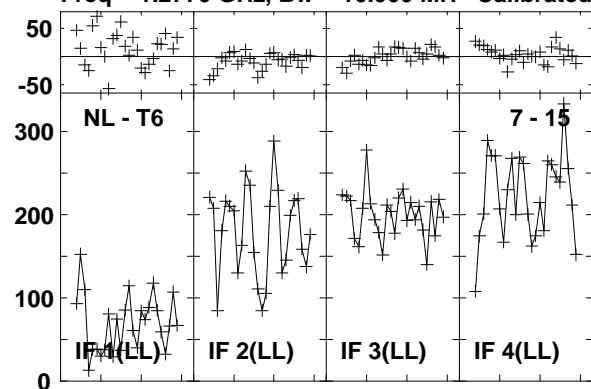

Lower frame: Milli Ampl Jy Top frame: Phas deg
Vector averaged cross-power spectrum Baseline: NL (07) - T6 (15)
Timerange: 01/03:45:27 to 01/03:47:25

Plot file version1447 created 03-MAR-2016 01:16:10
 J1638+5720 GN002C 1.UVDATA.1
 Freq = 1.2770 GHz, Bw = 16.000 MH Calibrated with CL # 3 and BP # 1 (BP mode 1)

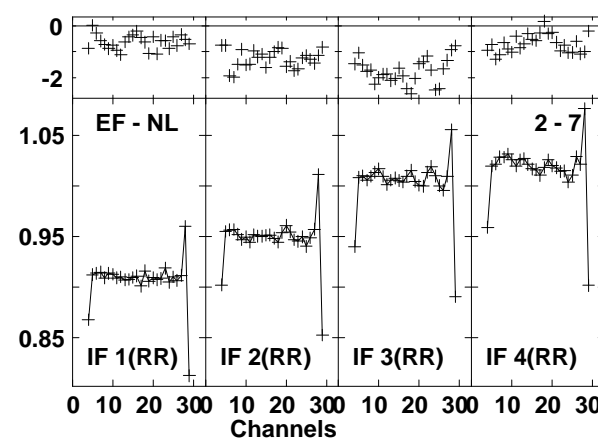
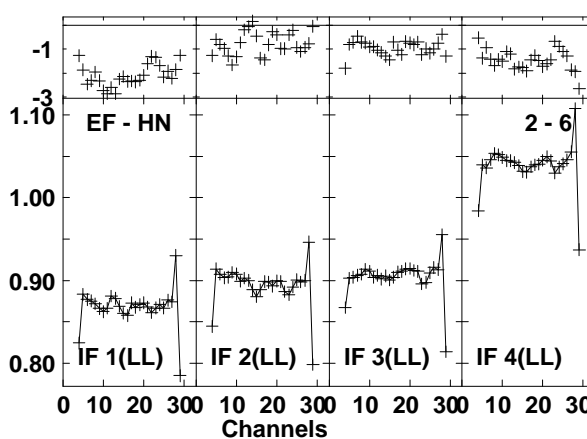
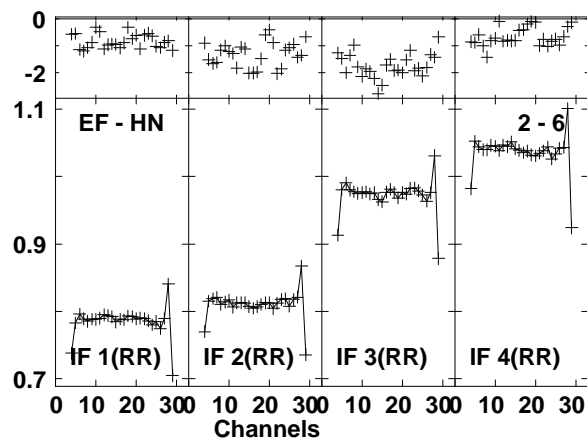
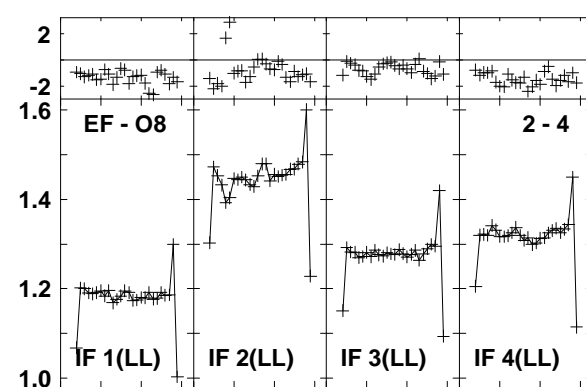
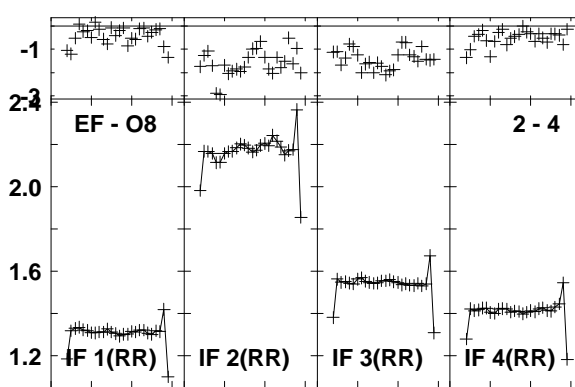
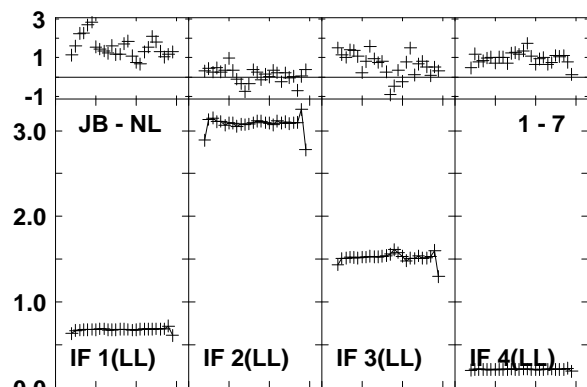
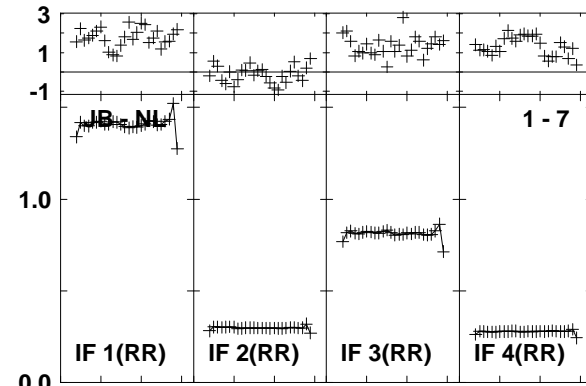
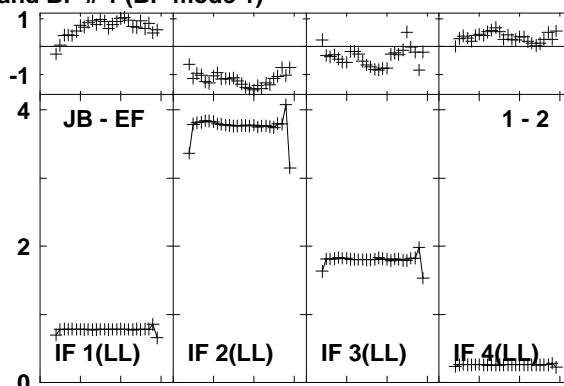
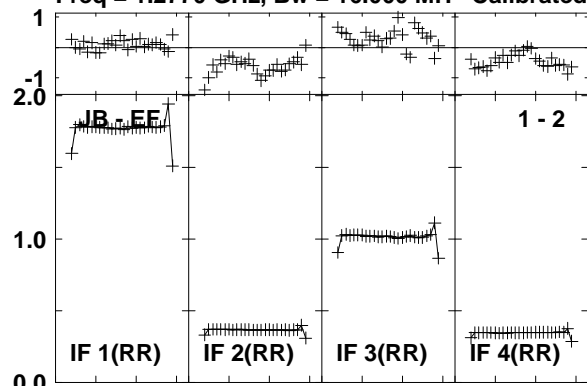

Lower frame: Ampl Jy Top frame: Phas deg
 Vector averaged cross-power spectrum Baseline: JB (01) - EF (02)
 Timerange: 01/03:48:30 to 01/03:52:18

Plot file version1448 created 03-MAR-2016 01:16:10

J1638+5720 GN002C 1.UVDATA.1

Freq = 1.2770 GHz, Bw = 16.000 MH Calibrated with CL # 3 and BP # 1 (BP mode 1)

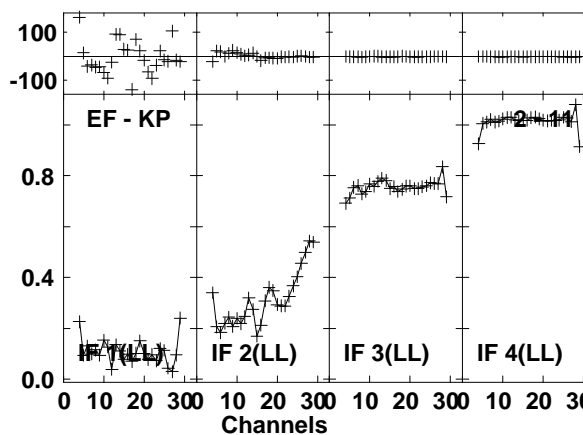
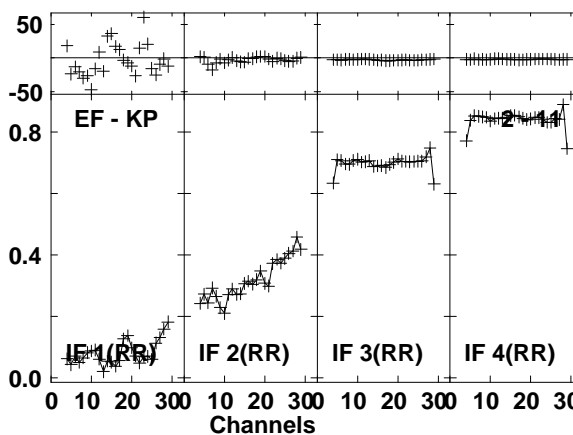
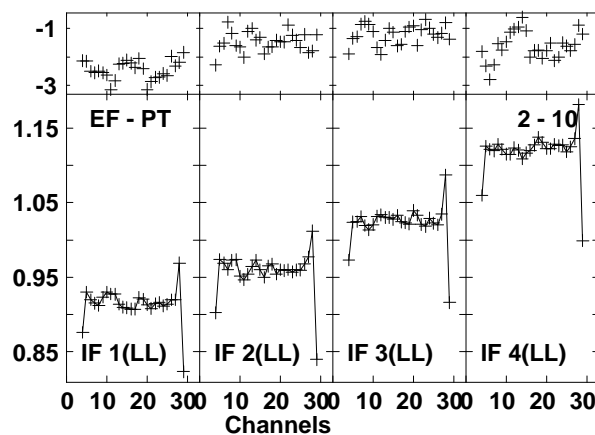
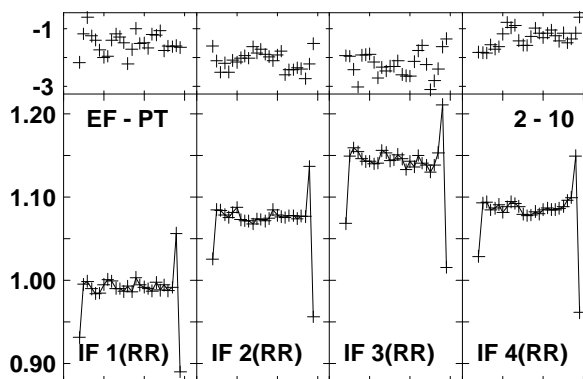
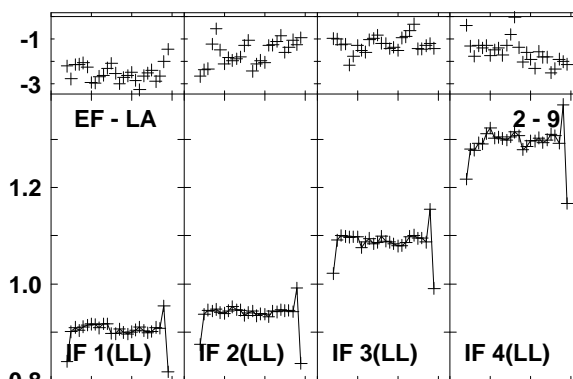
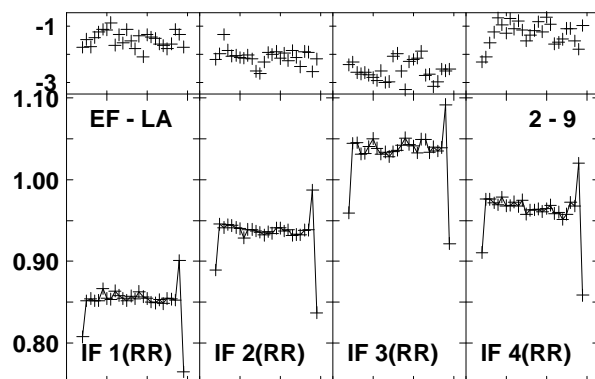
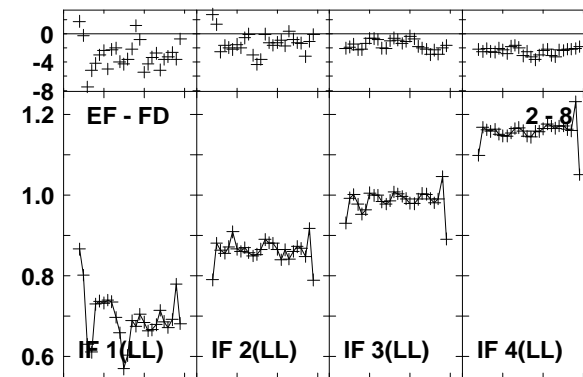
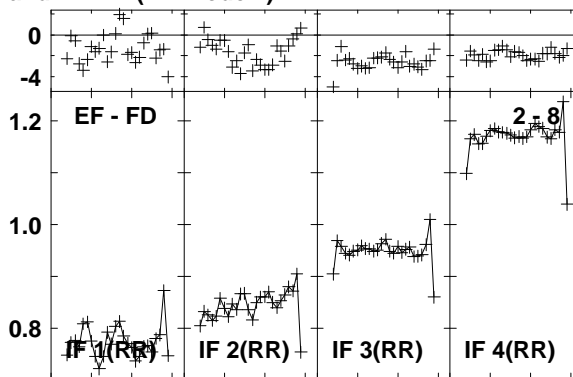
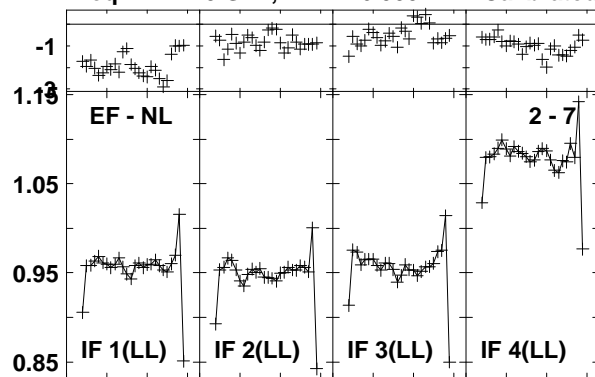

Lower frame: Ampl Jy Top frame: Phas deg
Vector averaged cross-power spectrum Baseline: EF (02) - NL (07)
Timerange: 01/03:48:30 to 01/03:52:18

Plot file version1449 created 03-MAR-2016 01:16:10

J1638+5720 GN002C 1.UVDATA.1

Freq = 1.2770 GHz, Bw = 16.000 MH Calibrated with CL # 3 and BP # 1 (BP mode 1)

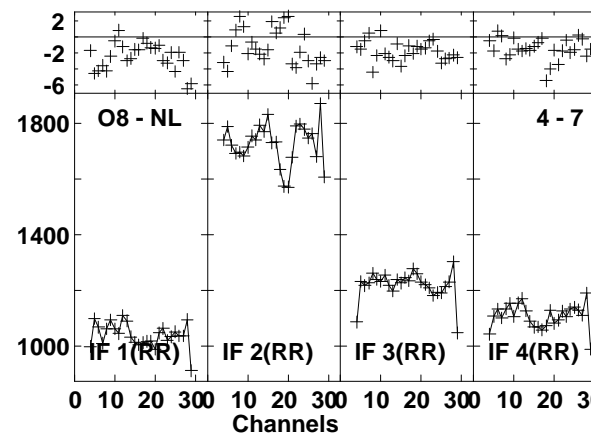
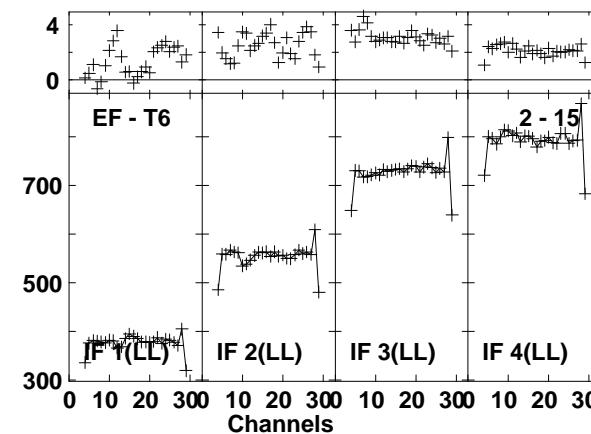
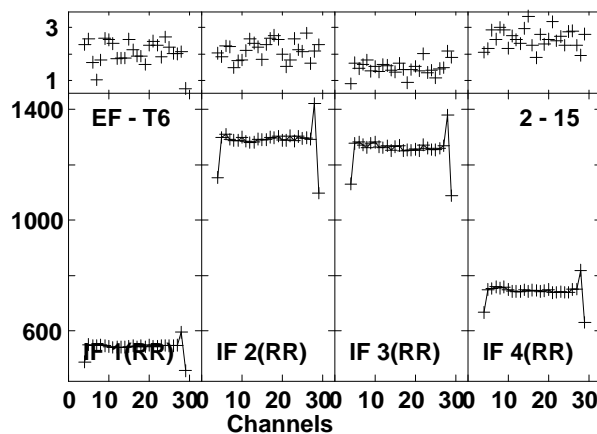
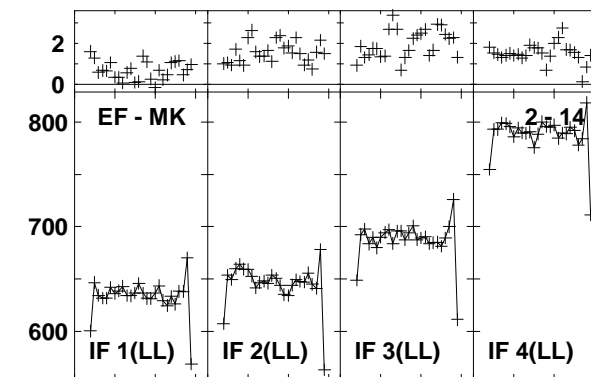
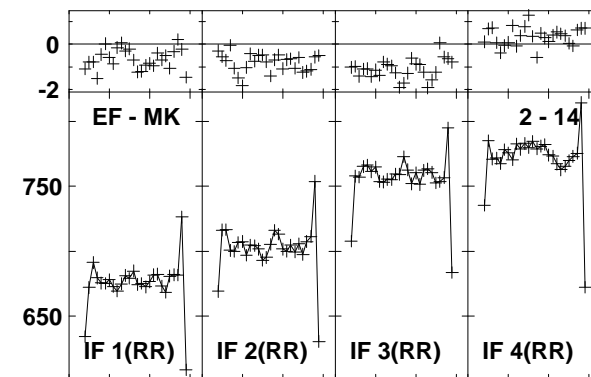
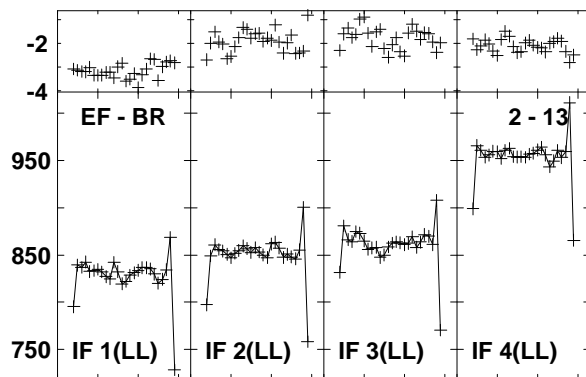
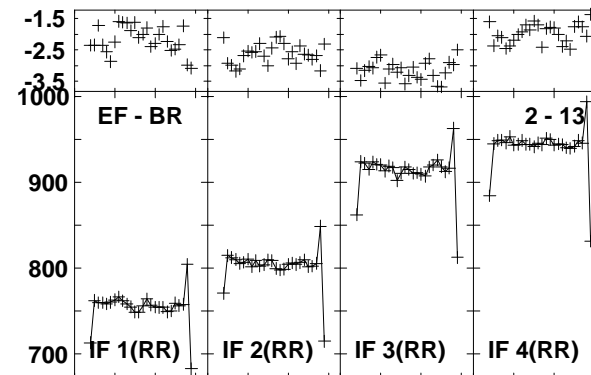
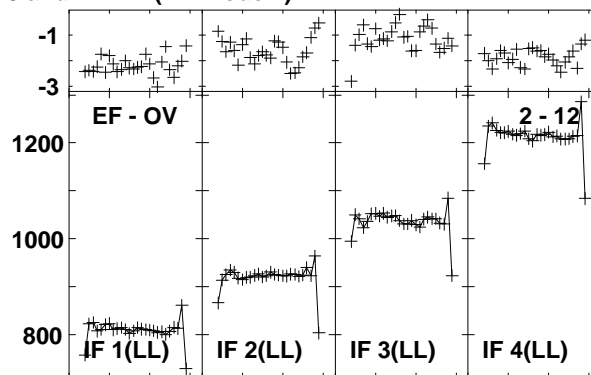
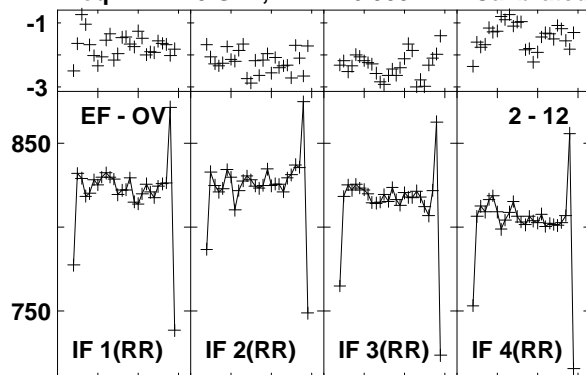

Lower frame: Milli Ampl Jy Top frame: Phas deg
Vector averaged cross-power spectrum Baseline: EF (02) - OV (12)
Timerange: 01/03:48:30 to 01/03:52:18

Plot file version1450 created 03-MAR-2016 01:16:10
 J1638+5720 GN002C 1.UVDATA.1
 Freq = 1.2770 GHz, Bw = 16.000 MH Calibrated with CL # 3 and BP # 1 (BP mode 1)

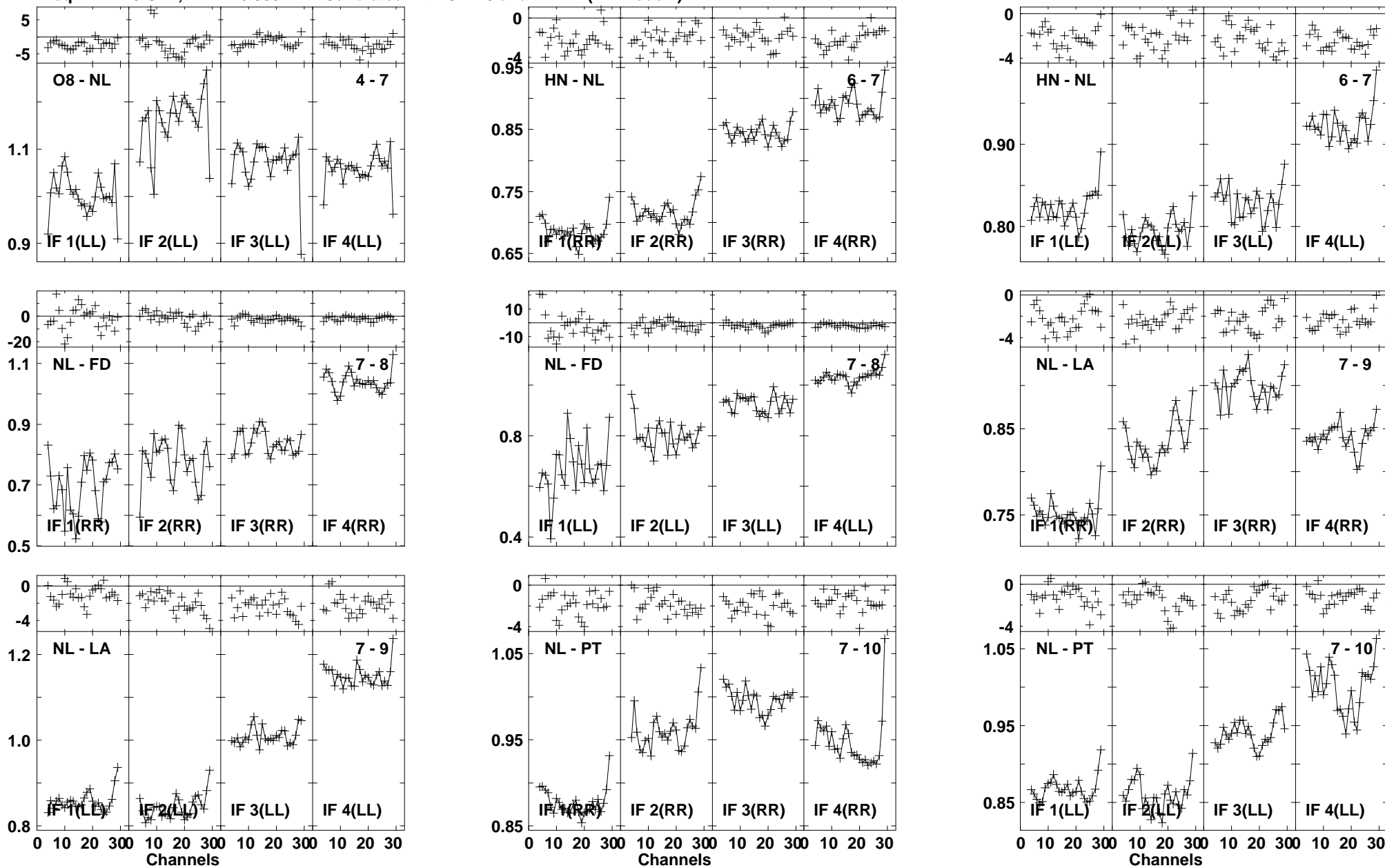

Lower frame: Ampl Jy Top frame: Phas deg
 Vector averaged cross-power spectrum Baseline: O8 (04) - NL (07)
 Timerange: 01/03:48:30 to 01/03:52:18

Plot file version1451 created 03-MAR-2016 01:16:10

J1638+5720 GN002C 1.UVDATA.1

Freq = 1.2770 GHz, Bw = 16.000 MH Calibrated with CL # 3 and BP # 1 (BP mode 1)

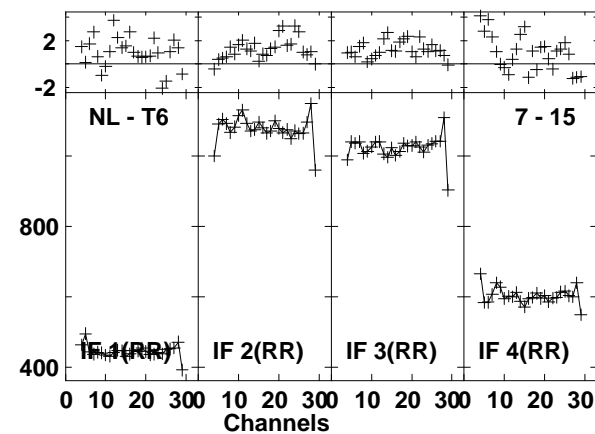
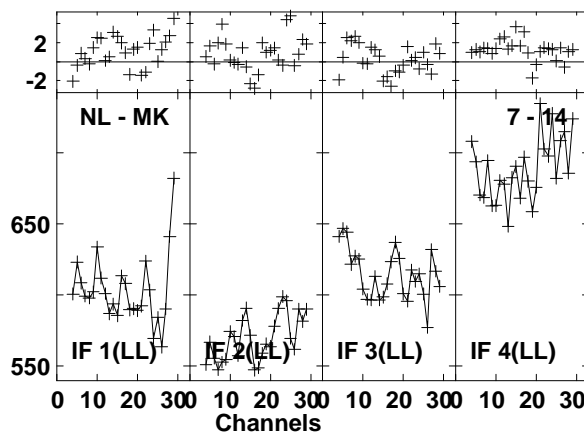
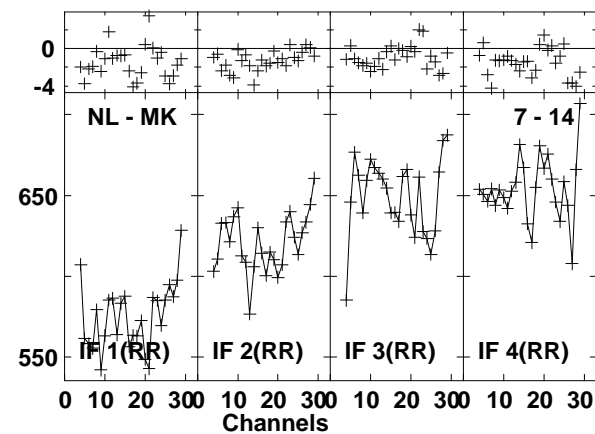
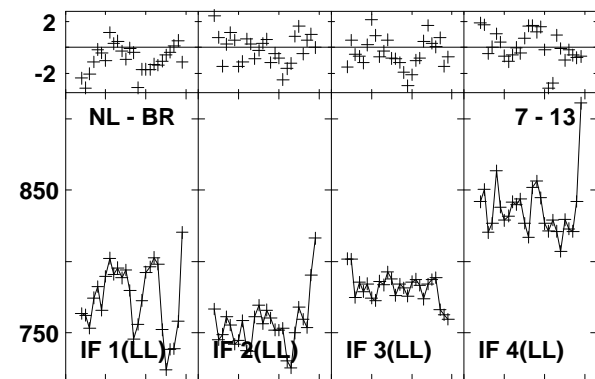
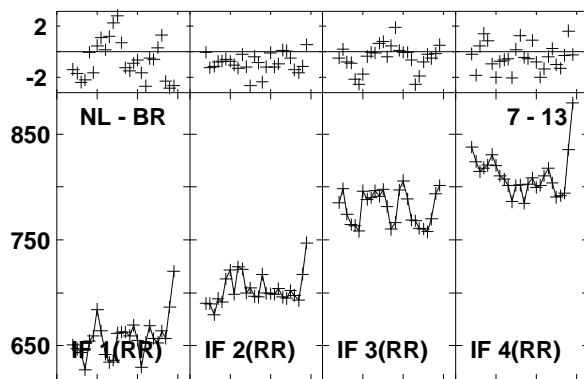
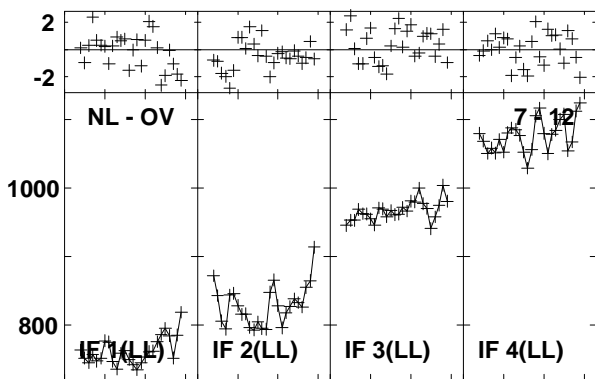
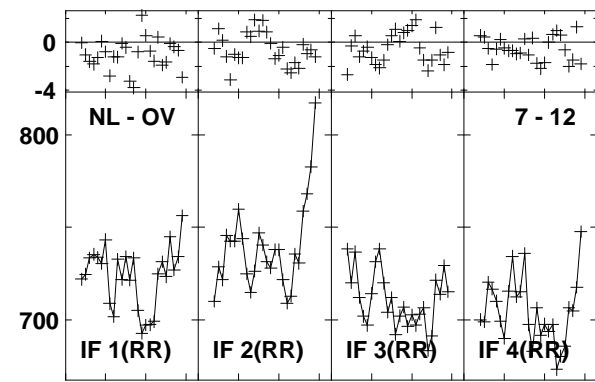
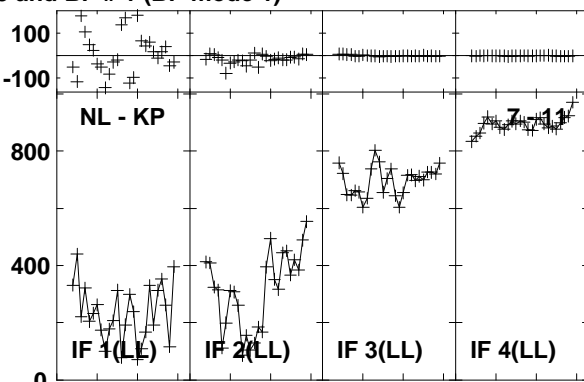
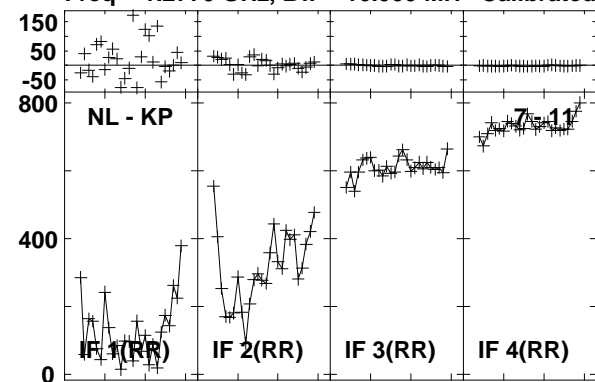

Lower frame: Milli Ampl Jy Top frame: Phas deg
Vector averaged cross-power spectrum Baseline: NL (07) - KP (11)
Timerange: 01/03:48:30 to 01/03:52:18

Plot file version1452 created 03-MAR-2016 01:16:11
J1638+5720 GN002C 1.UVDATA.1
Freq = 1.2770 GHz, Bw = 16.000 MH Calibrated with CL # 3 and BP # 1 (BP mode 1)

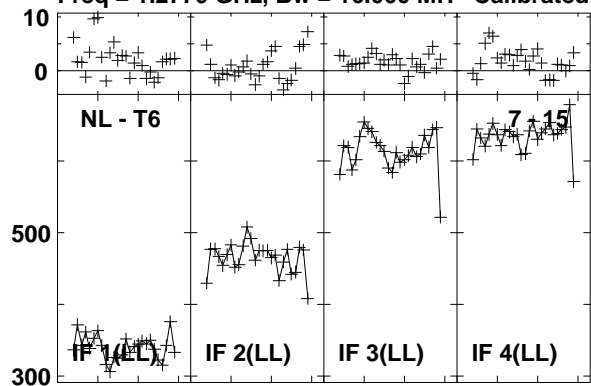

Lower frame: Milli Ampl Jy Top frame: Phas deg
Vector averaged cross-power spectrum Baseline: NL (07) - T6 (15)
Timerange: 01/03:48:30 to 01/03:52:18

Plot file version1453 created 03-MAR-2016 01:16:11

J1545+5400 GN002C 1.UVDATA.1

Freq = 1.2770 GHz, Bw = 16.000 MH Calibrated with CL # 3 and BP # 1 (BP mode 1)

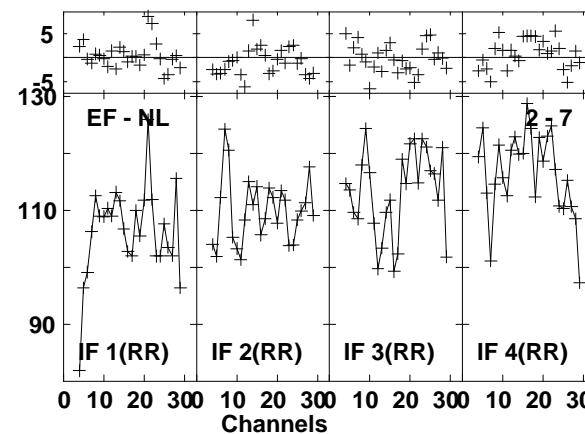
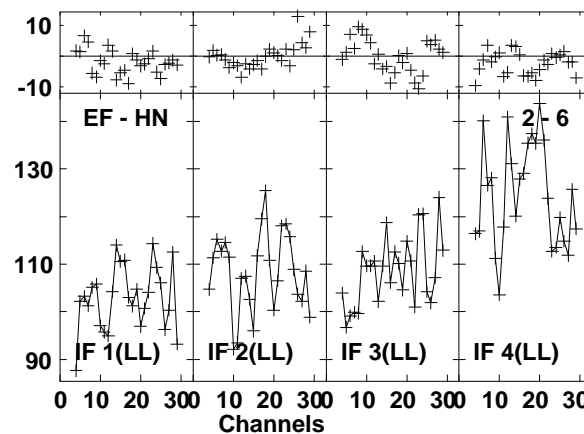
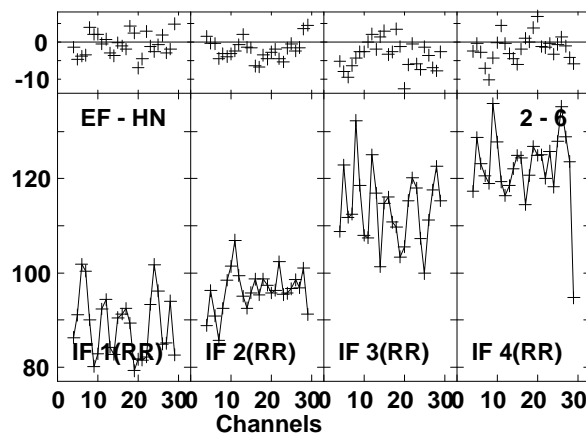
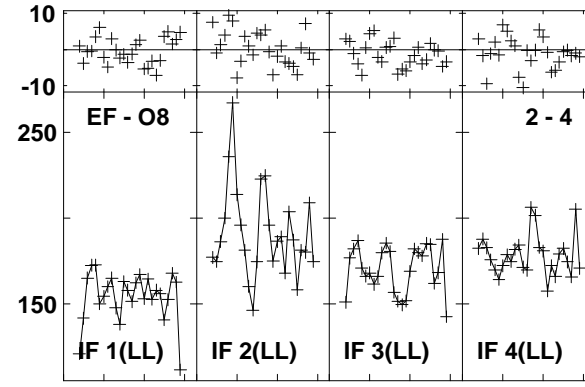
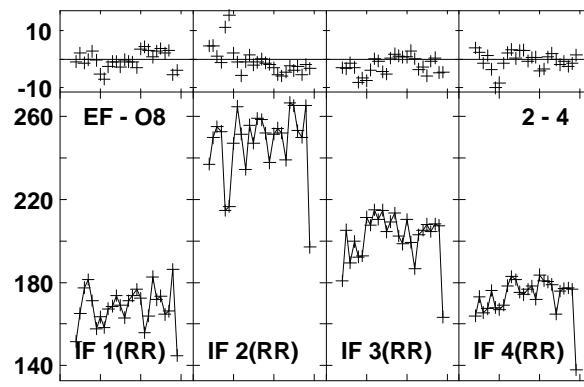
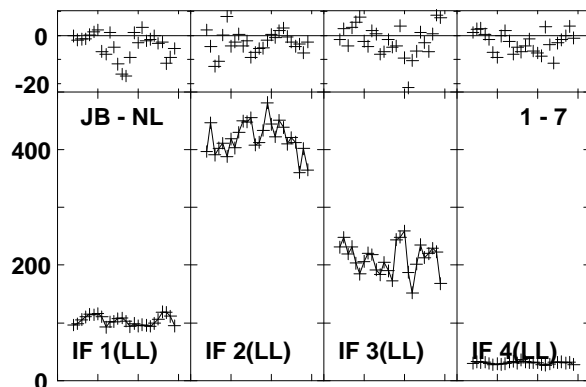
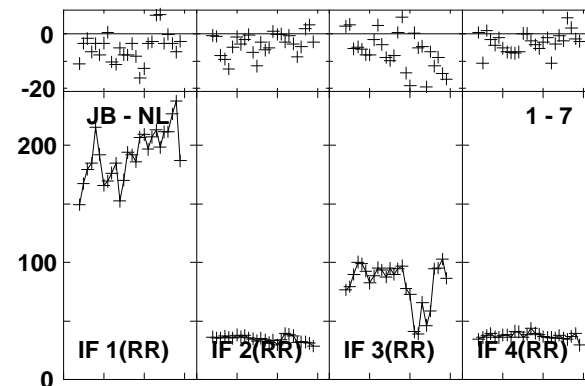
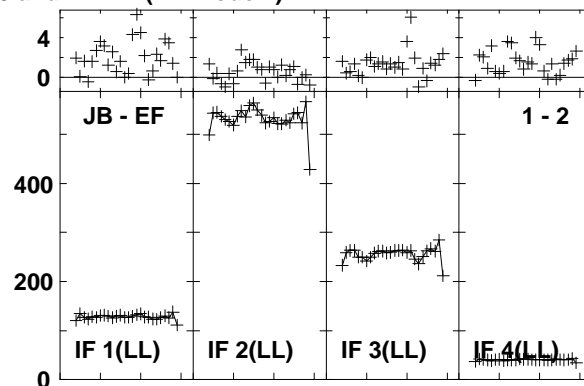
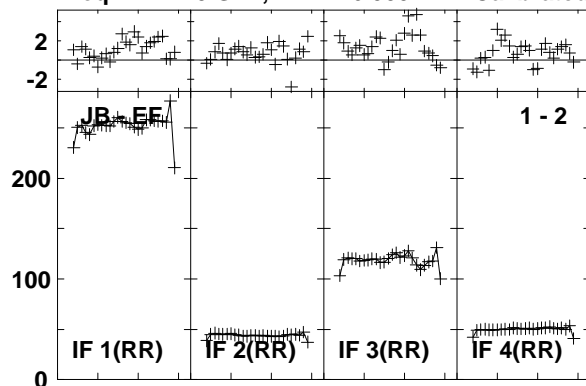

Lower frame: Milli Ampl Jy Top frame: Phas deg
Vector averaged cross-power spectrum Baseline: JB (01) - EF (02)
Timerange: 01/03:53:25 to 01/03:56:13

Plot file version1454 created 03-MAR-2016 01:16:11

J1545+5400 GN002C 1.UVDATA.1

Freq = 1.2770 GHz, Bw = 16.000 MH Calibrated with CL # 3 and BP # 1 (BP mode 1)

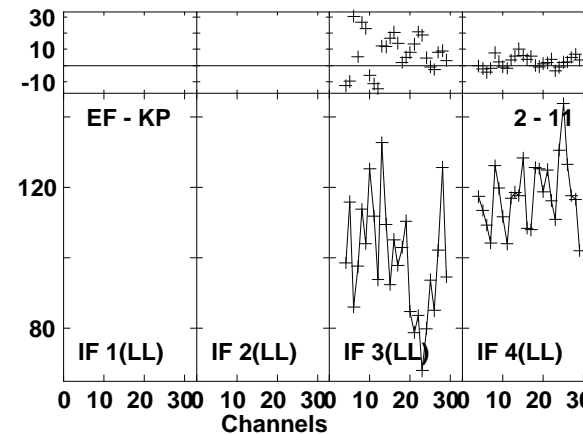
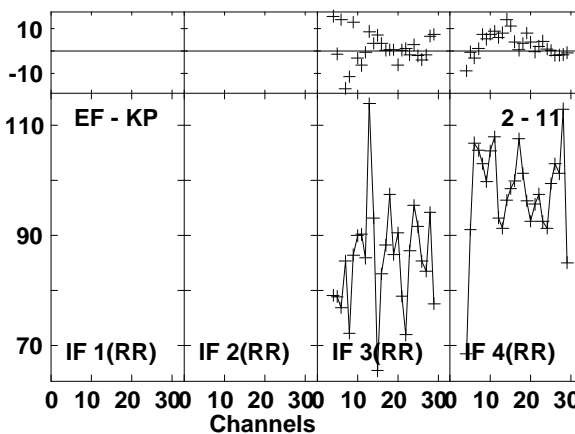
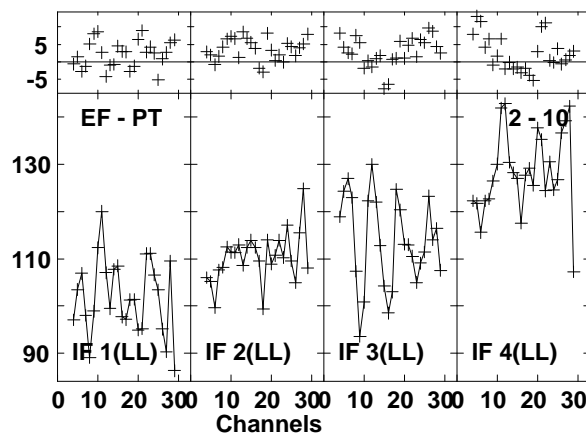
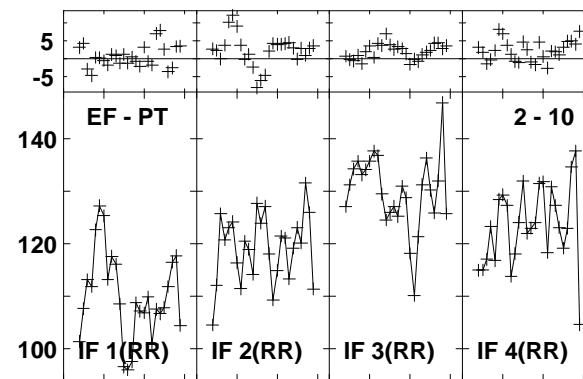
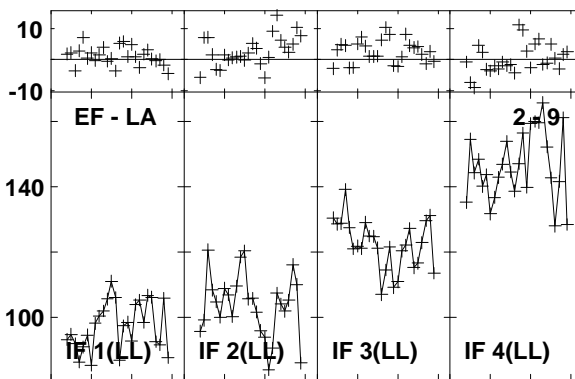
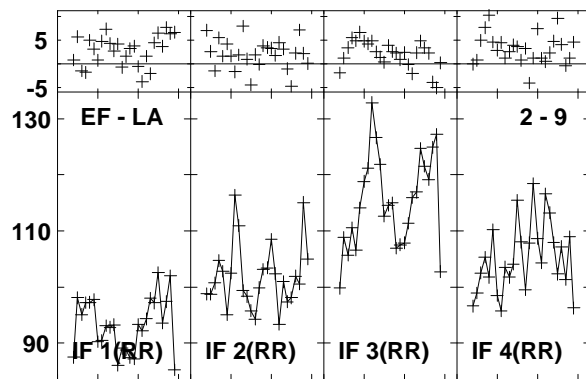
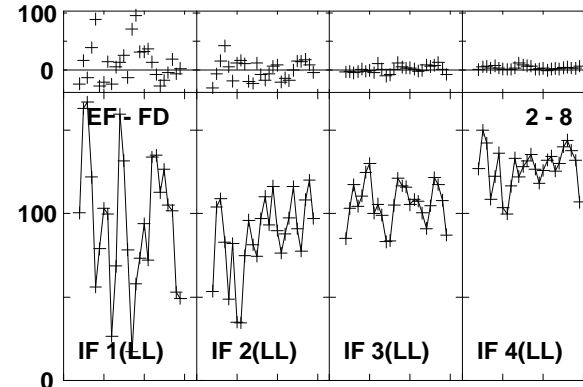
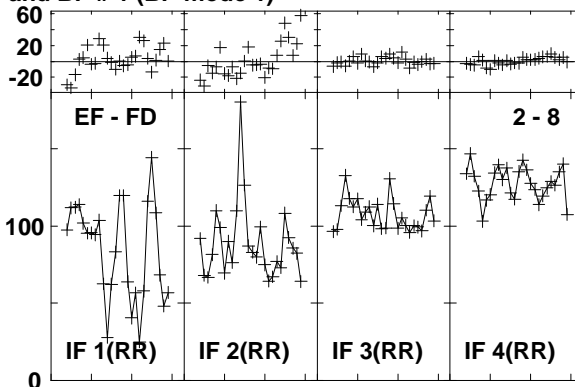
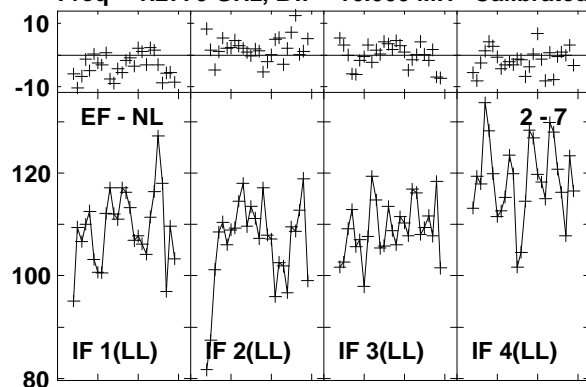

Lower frame: Milli Ampl Jy Top frame: Phas deg
Vector averaged cross-power spectrum Baseline: EF (02) - NL (07)
Timerange: 01/03:53:25 to 01/03:56:13

Plot file version1455 created 03-MAR-2016 01:16:11

J1545+5400 GN002C 1.UVDATA.1

Freq = 1.2770 GHz, Bw = 16.000 MH Calibrated with CL # 3 and BP # 1 (BP mode 1)

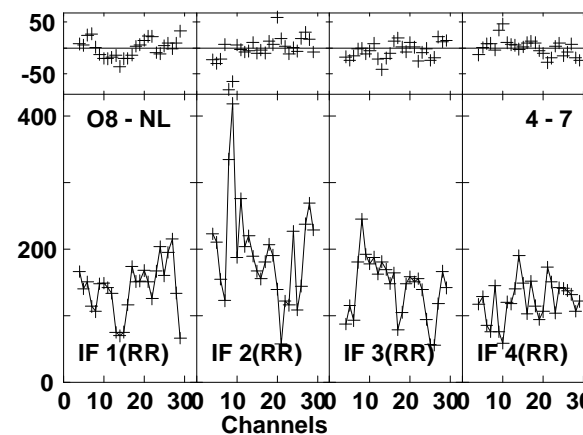
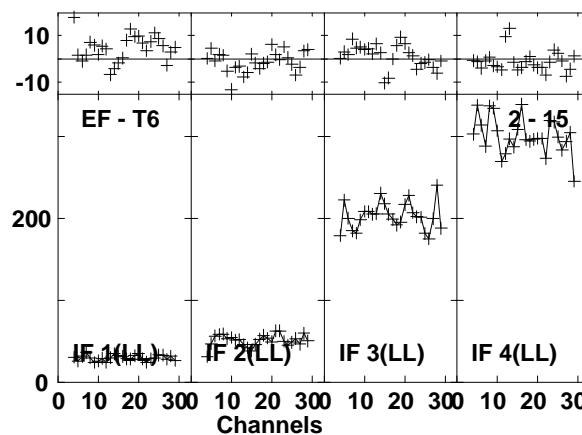
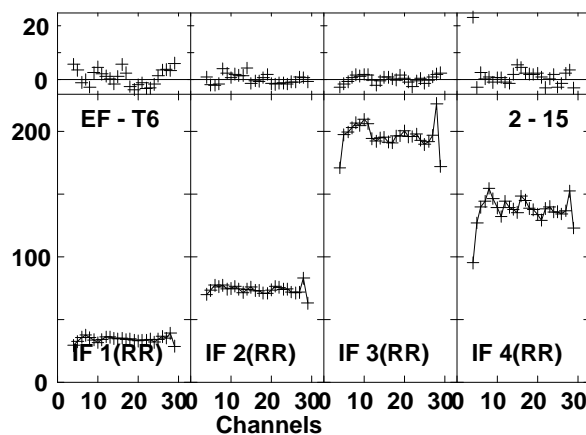
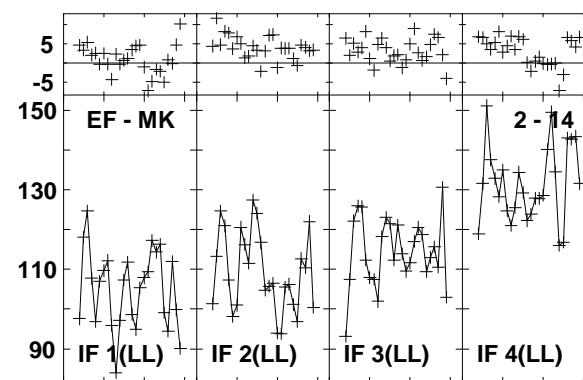
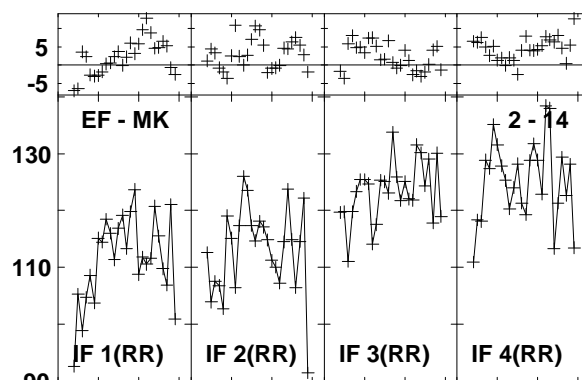
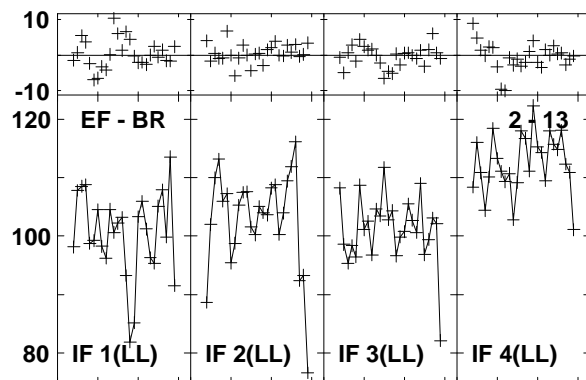
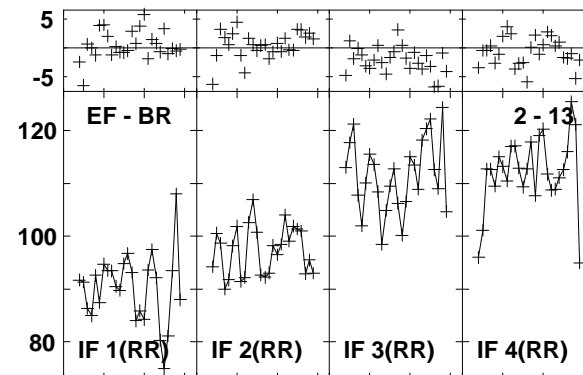
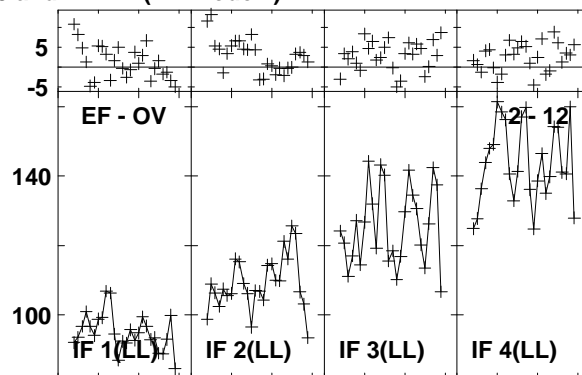
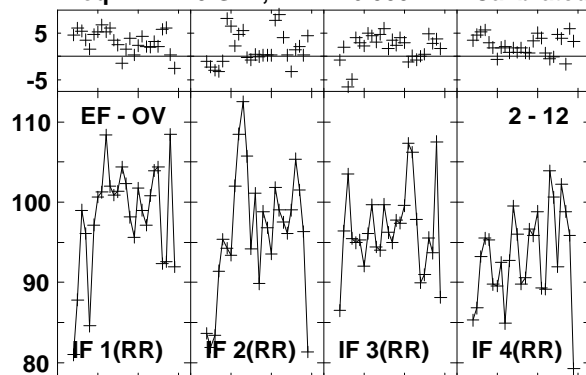

Lower frame: Milli Ampl Jy Top frame: Phas deg
Vector averaged cross-power spectrum Baseline: EF (02) - OV (12)
Timerange: 01/03:53:25 to 01/03:56:13

Plot file version1456 created 03-MAR-2016 01:16:11

J1545+5400 GN002C 1.UVDATA.1

Freq = 1.2770 GHz, Bw = 16.000 MH Calibrated with CL # 3 and BP # 1 (BP mode 1)

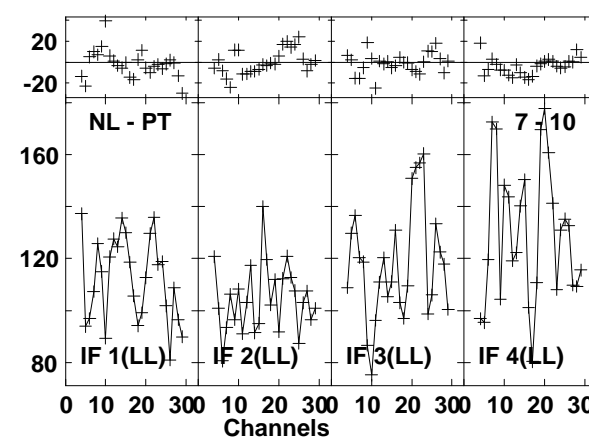
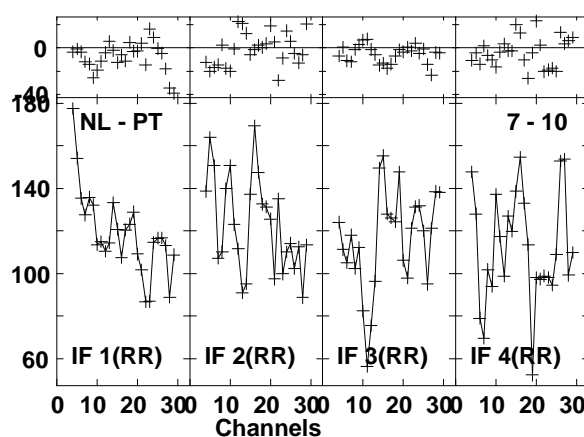
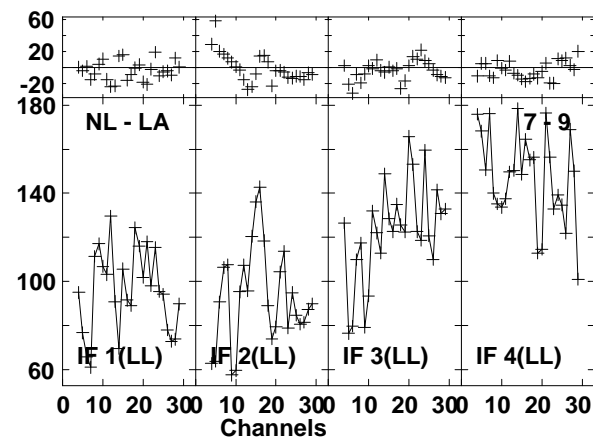
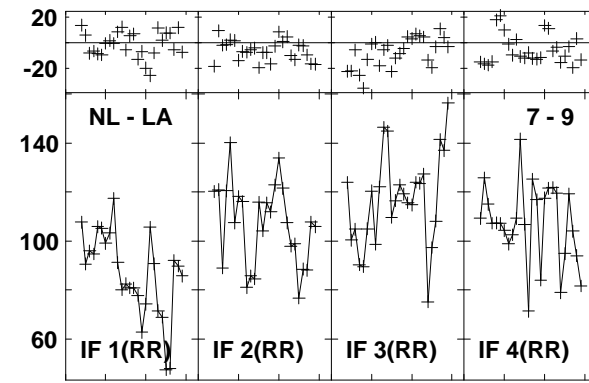
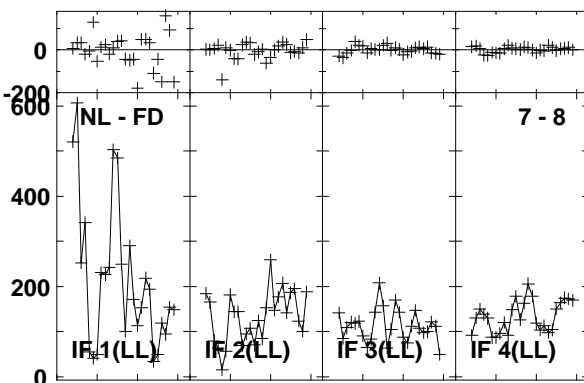
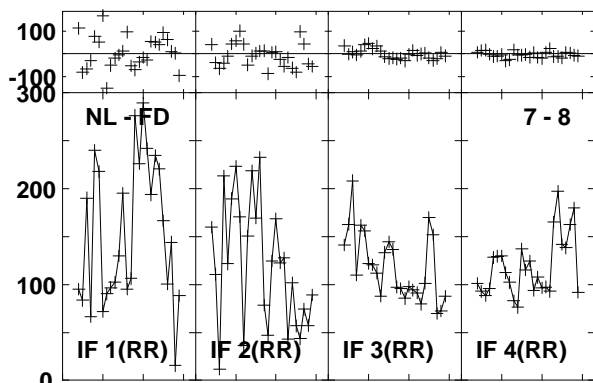
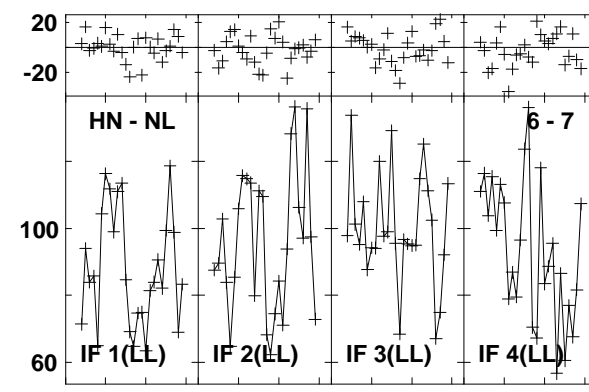
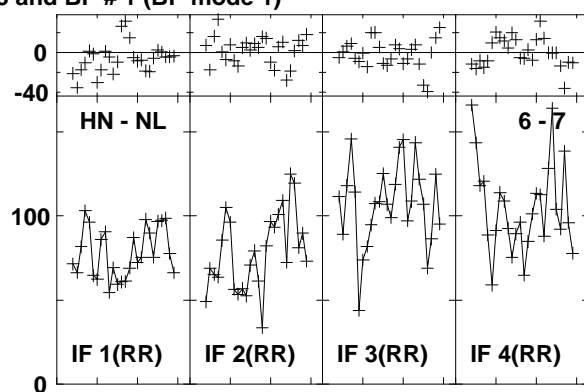
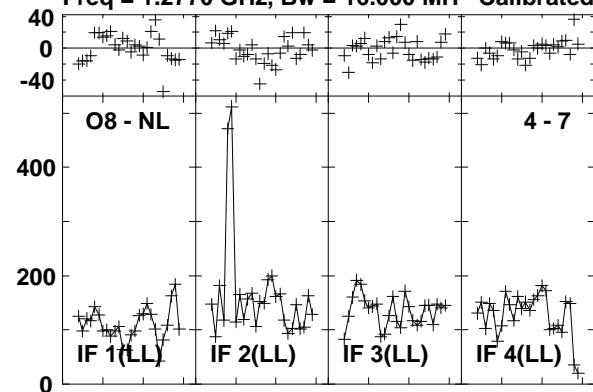

Lower frame: Milli Ampl Jy Top frame: Phas deg
Vector averaged cross-power spectrum Baseline: O8 (04) - NL (07)
Timerange: 01/03:53:25 to 01/03:56:13

Plot file version1457 created 03-MAR-2016 01:16:11

J1545+5400 GN002C 1.UVDATA.1

Freq = 1.2770 GHz, Bw = 16.000 MH Calibrated with CL # 3 and BP # 1 (BP mode 1)

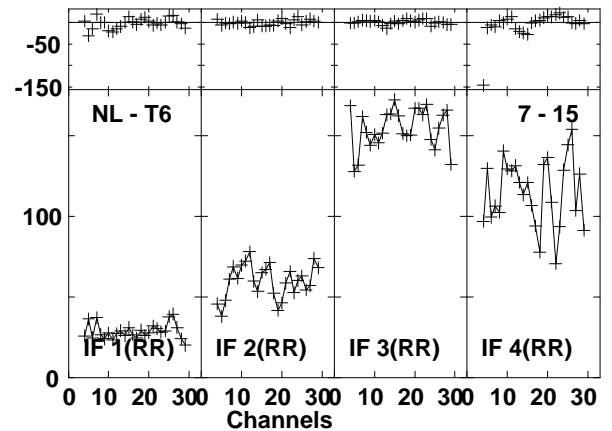
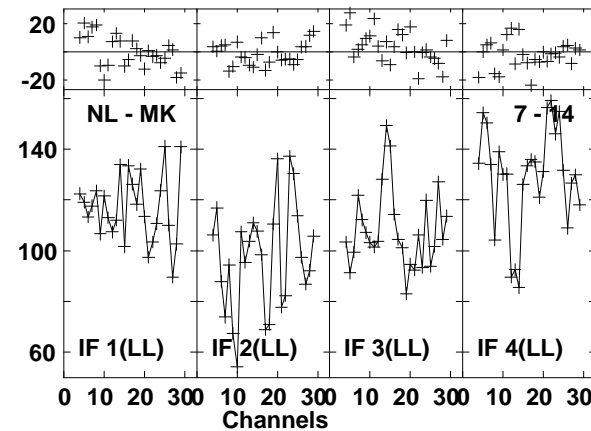
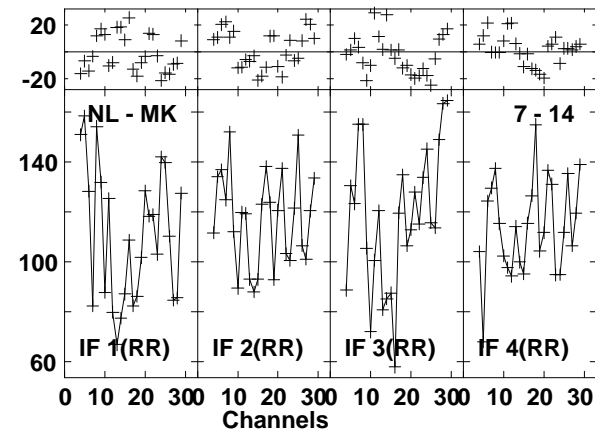
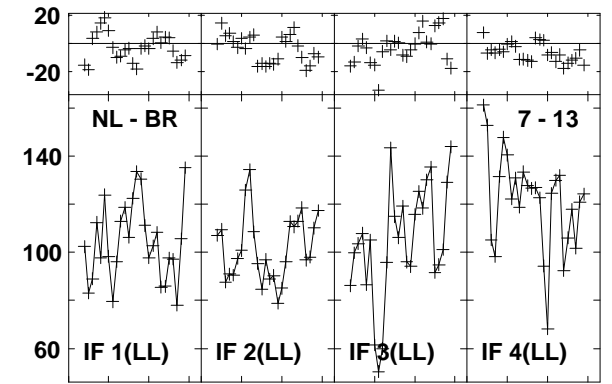
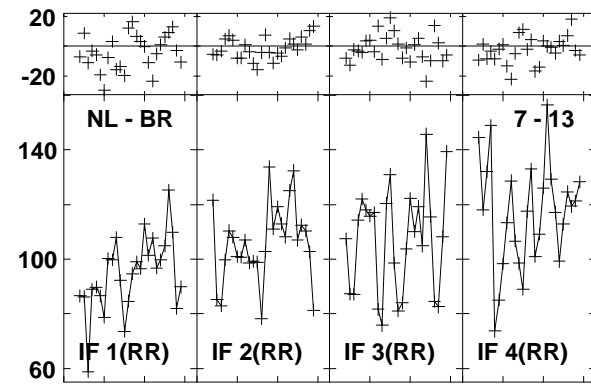
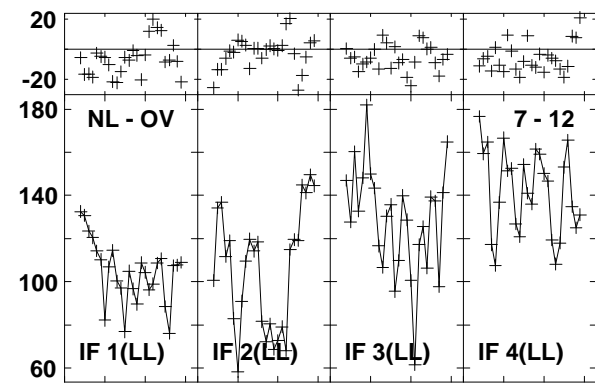
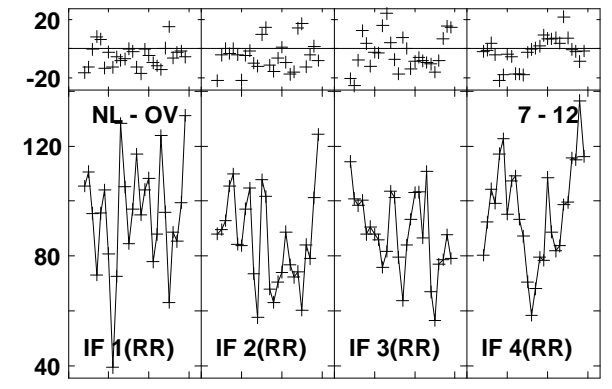
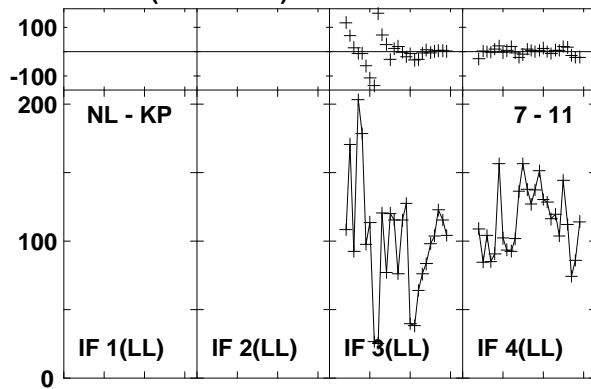
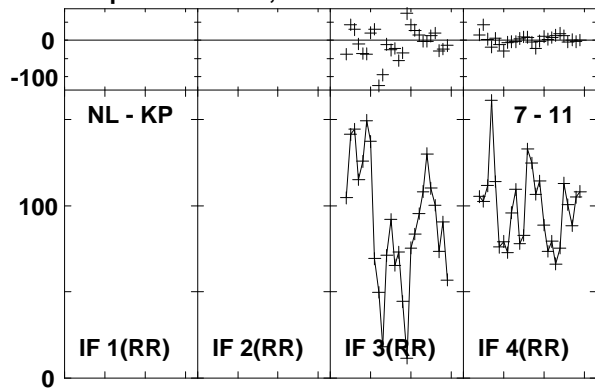

Lower frame: Milli Ampl Jy Top frame: Phas deg

Vector averaged cross-power spectrum Baseline: NL (07) - KP (11)

Timerange: 01/03:53:25 to 01/03:56:13

Plot file version1458 created 03-MAR-2016 01:16:12
J1545+5400 GN002C 1.UVDATA.1
Freq = 1.2770 GHz, Bw = 16.000 MH Calibrated with CL # 3 and BP # 1 (BP mode 1)

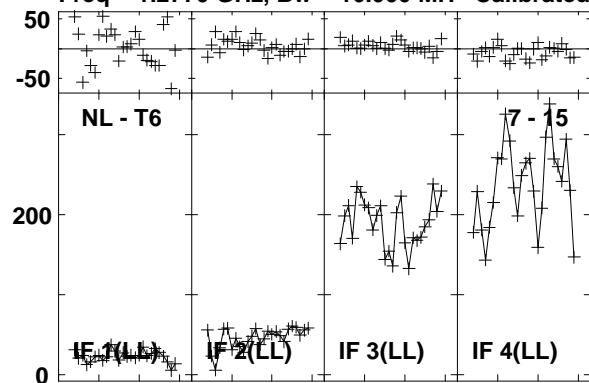

Lower frame: Milli Ampl Jy Top frame: Phas deg
Vector averaged cross-power spectrum Baseline: NL (07) - T6 (15)
Timerange: 01/03:53:25 to 01/03:56:13

Plot file version1459 created 03-MAR-2016 01:16:12

4C52 GN002C 1.UVDATA.1

Freq = 1.2770 GHz, Bw = 16.000 MH Calibrated with CL # 3 and BP # 1 (BP mode 1)

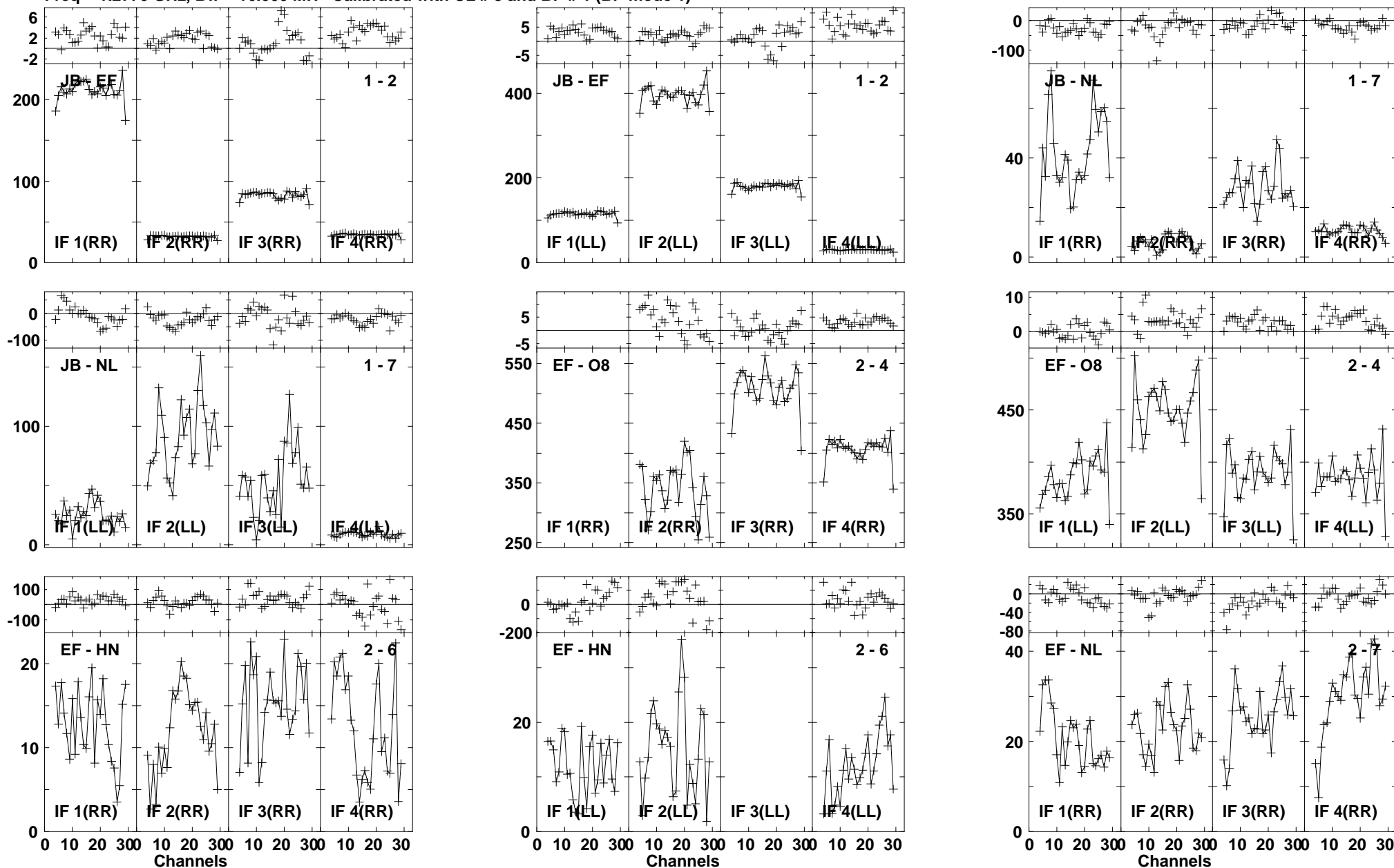

Plot file version1460 created 03-MAR-2016 01:16:12

4C52 GN002C 1.UVDATA.1

Freq = 1.2770 GHz, Bw = 16.000 MH Calibrated with CL # 3 and BP # 1 (BP mode 1)

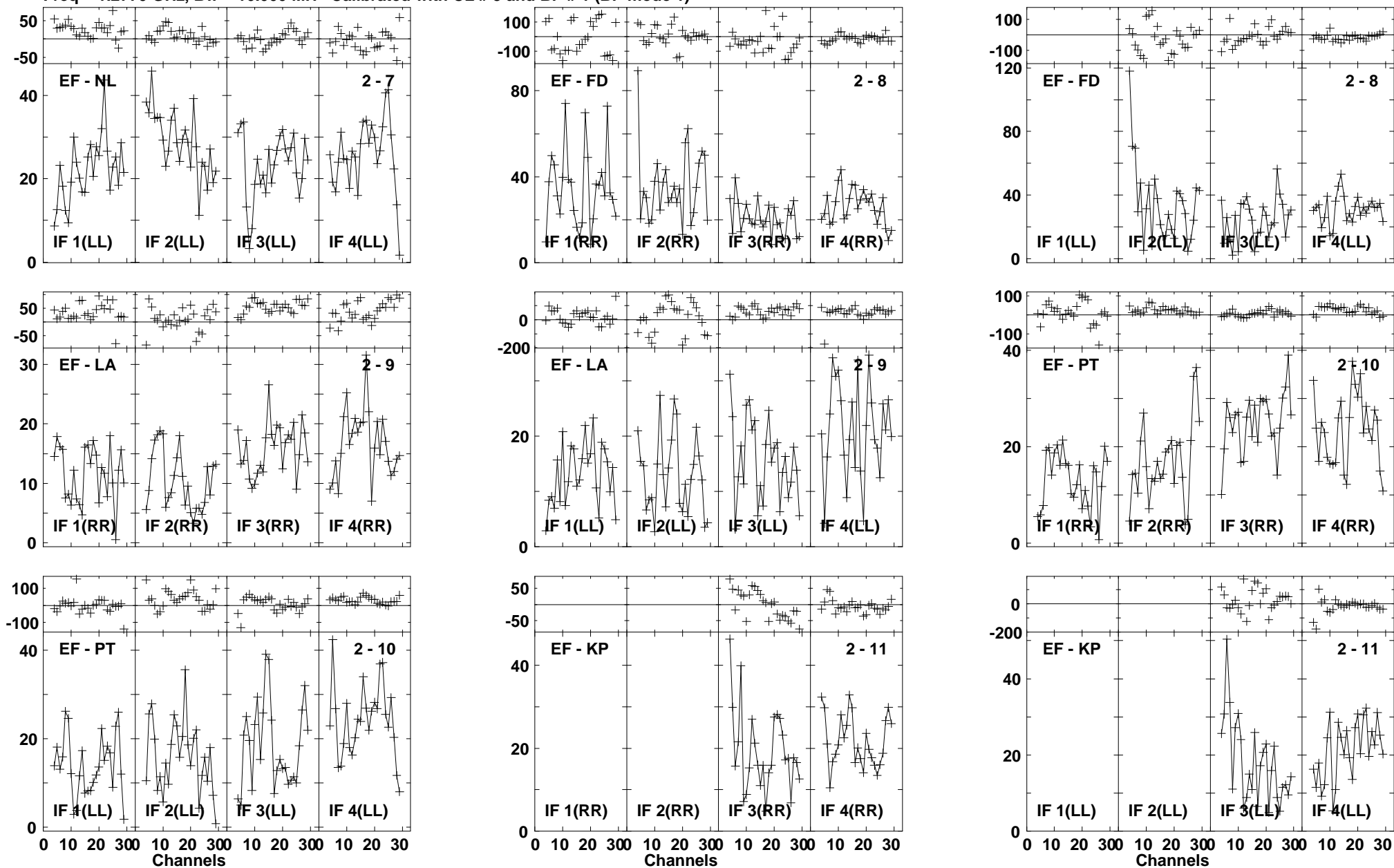

Lower frame: Milli Ampl Jy Top frame: Phas deg
Vector averaged cross-power spectrum Baseline: EF (02) - NL (07)
Timerange: 01/03:56:25 to 01/03:59:43

Plot file version1461 created 03-MAR-2016 01:16:12
 4C52 GN002C 1.UVDATA.1

Freq = 1.2770 GHz, Bw = 16.000 MH Calibrated with CL # 3 and BP # 1 (BP mode 1)

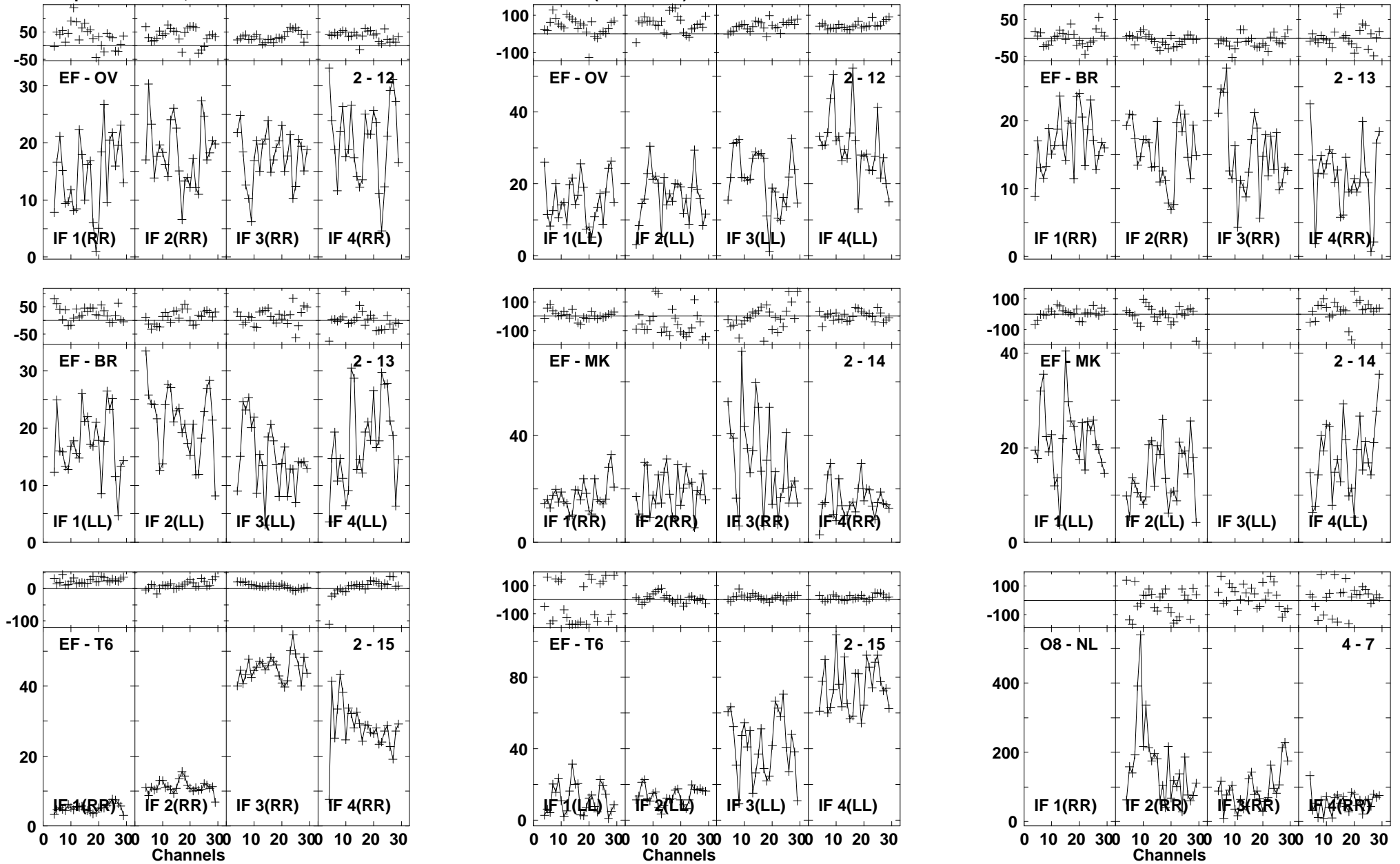

Lower frame: Milli Ampl Jy Top frame: Phas deg
 Vector averaged cross-power spectrum Baseline: EF (02) - OV (12)
 Timerange: 01/03:56:25 to 01/03:59:43

Plot file version1462 created 03-MAR-2016 01:16:12

4C52 GN002C 1.UVDATA.1

Freq = 1.2770 GHz, Bw = 16.000 MH Calibrated with CL # 3 and BP # 1 (BP mode 1)

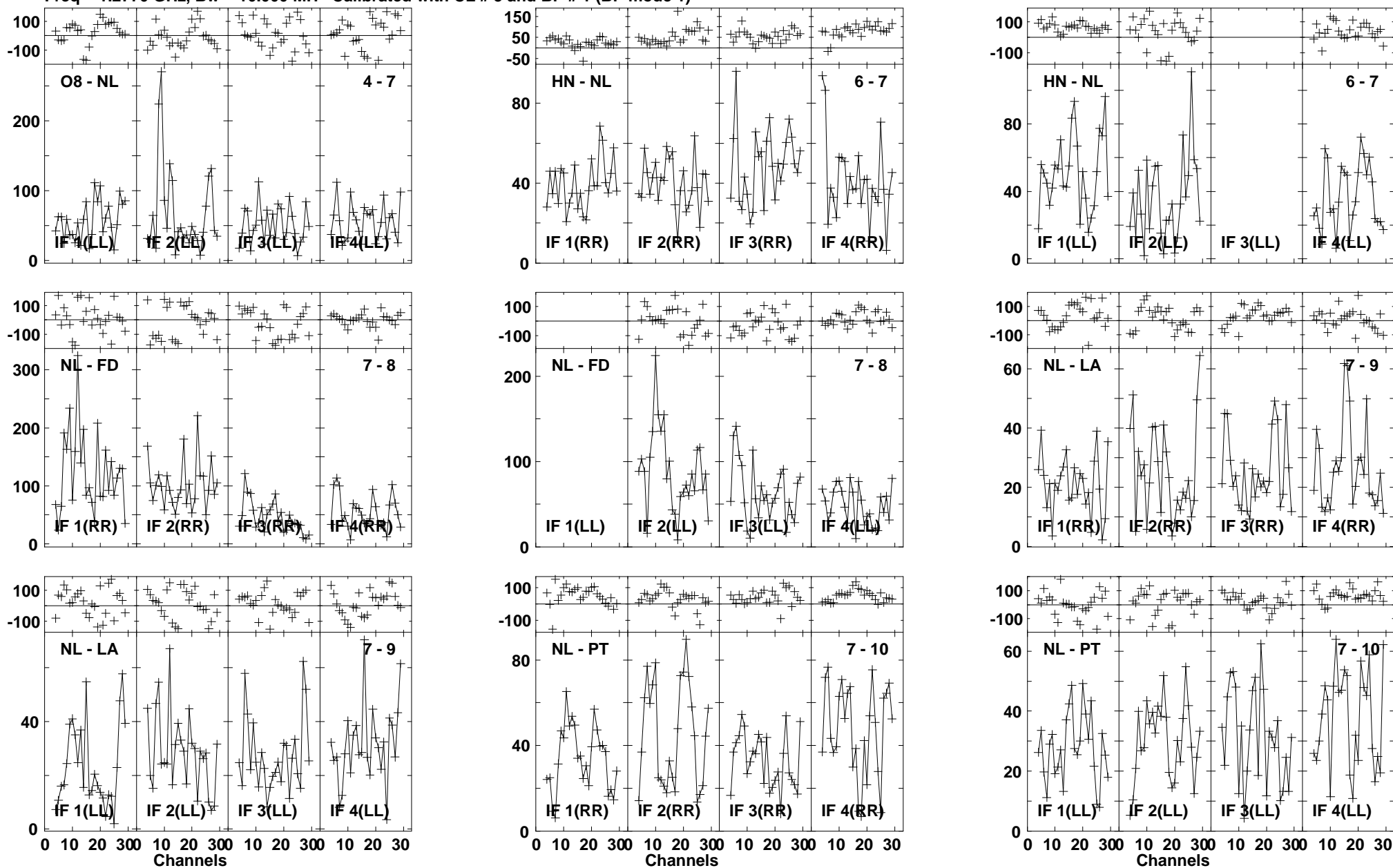

Lower frame: Milli Ampl Jy Top frame: Phas deg
Vector averaged cross-power spectrum Baseline: O8 (04) - NL (07)
Timerange: 01/03:56:25 to 01/03:59:43

Plot file version1463 created 03-MAR-2016 01:16:13

4C52 GN002C 1.UVDATA.1

Freq = 1.2770 GHz, Bw = 16.000 MH Calibrated with CL # 3 and BP # 1 (BP mode 1)

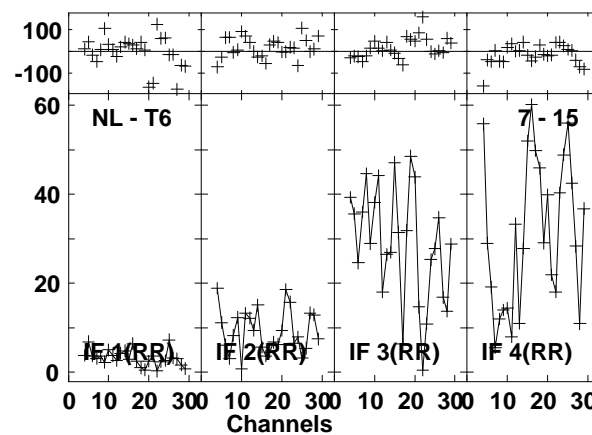
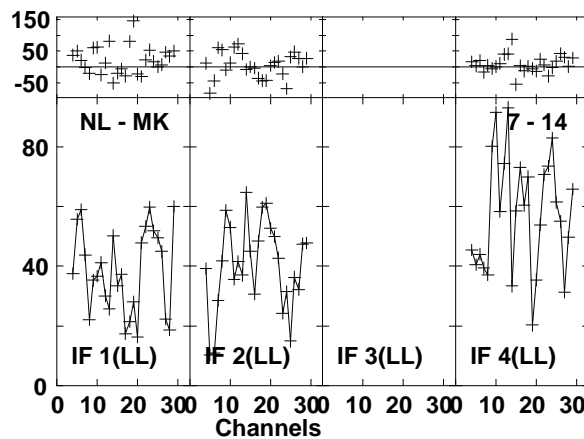
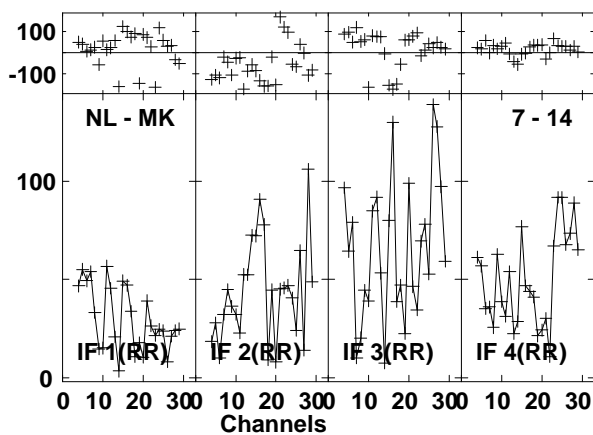
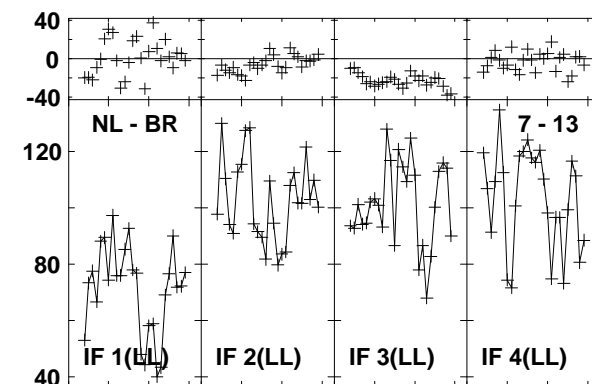
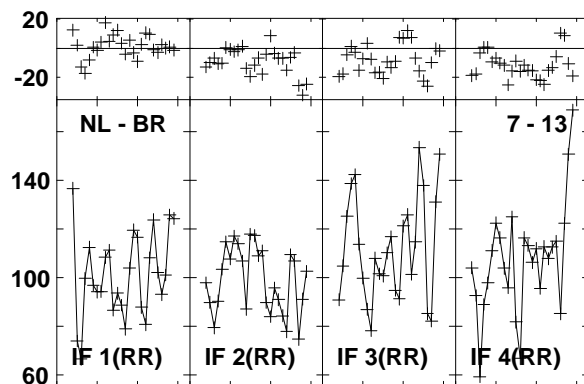
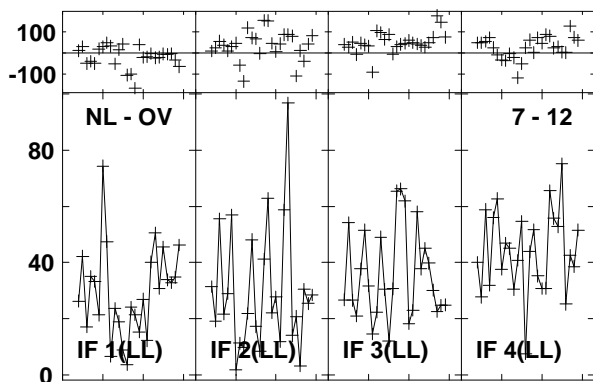
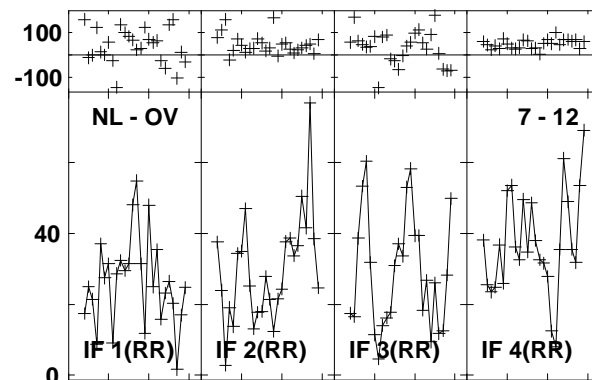
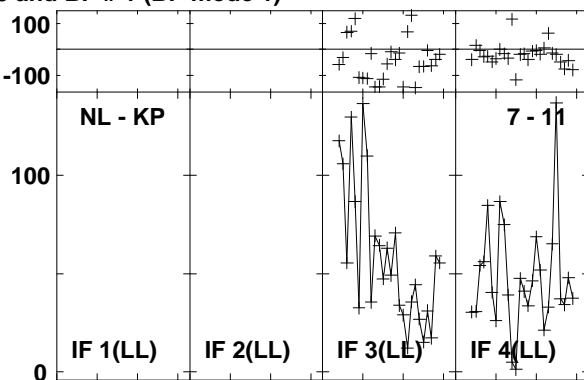
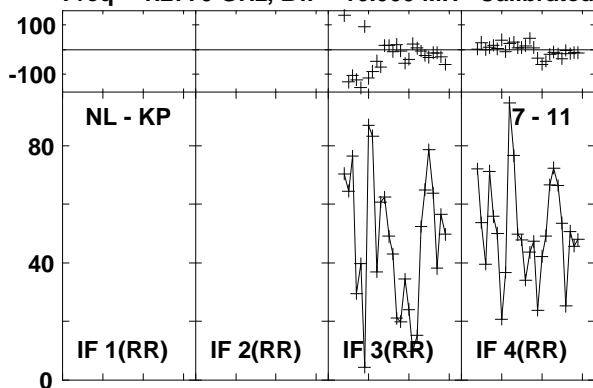

Lower frame: Milli Ampl Jy Top frame: Phas deg
Vector averaged cross-power spectrum Baseline: NL (07) - KP (11)
Timerange: 01/03:56:25 to 01/03:59:43

Plot file version1464 created 03-MAR-2016 01:16:13

4C52 GN002C 1.UVDATA.1

Freq = 1.2770 GHz, Bw = 16.000 MH Calibrated with CL # 3 and BP # 1 (BP mode 1)

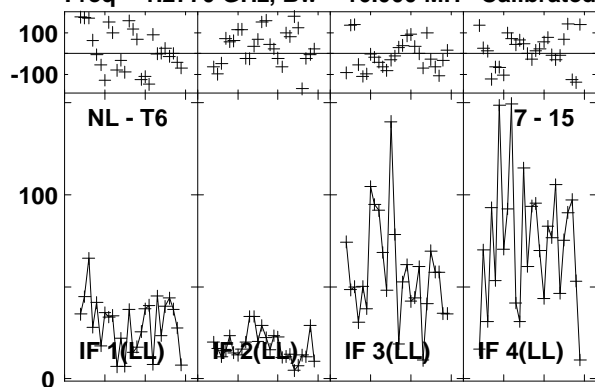

Lower frame: Milli Ampl Jy Top frame: Phas deg
Vector averaged cross-power spectrum Baseline: NL (07) - T6 (15)
Timerange: 01/03:56:25 to 01/03:59:43

Plot file version1465 created 03-MAR-2016 01:16:13

J1545+5400 GN002C 1.UVDATA.1

Freq = 1.2770 GHz, Bw = 16.000 MH Calibrated with CL # 3 and BP # 1 (BP mode 1)

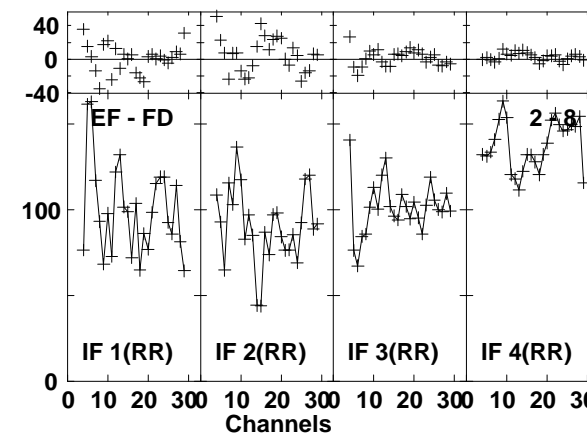
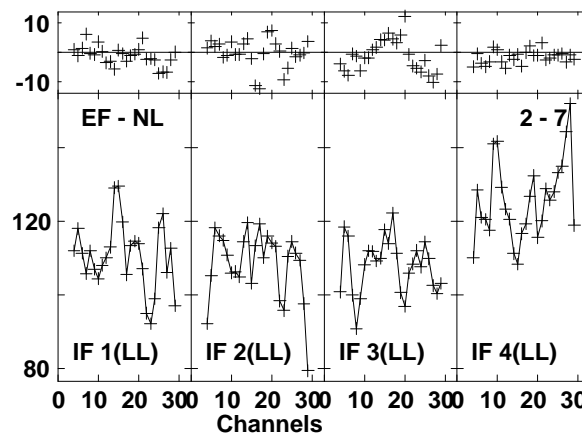
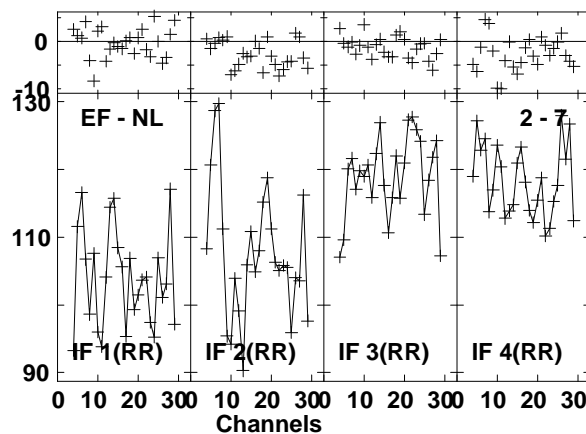
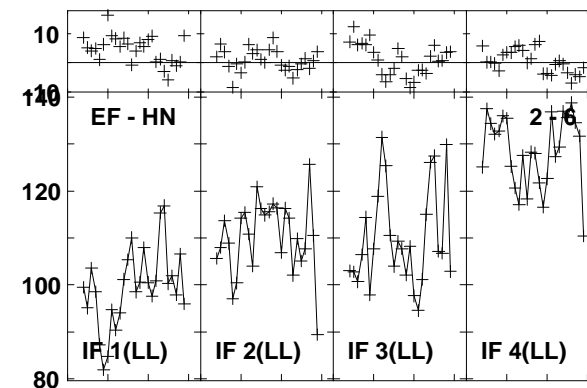
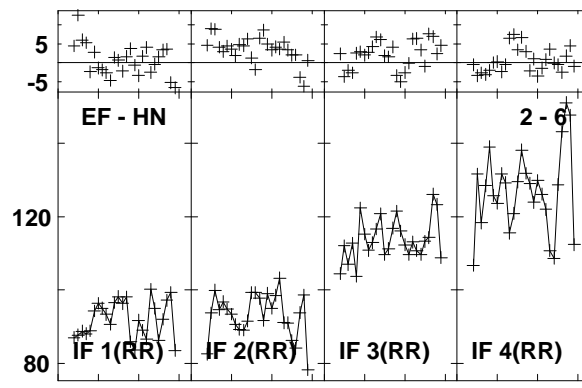
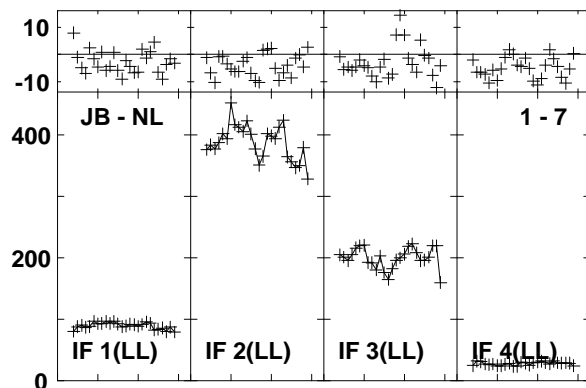
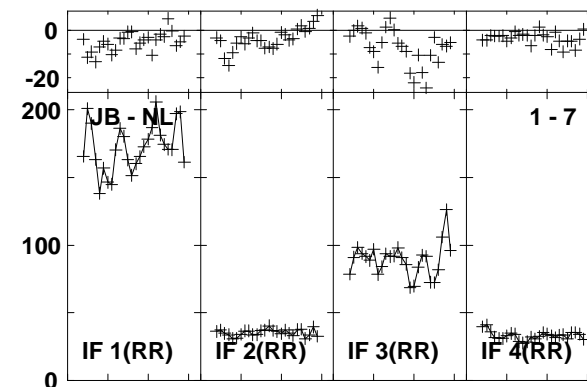
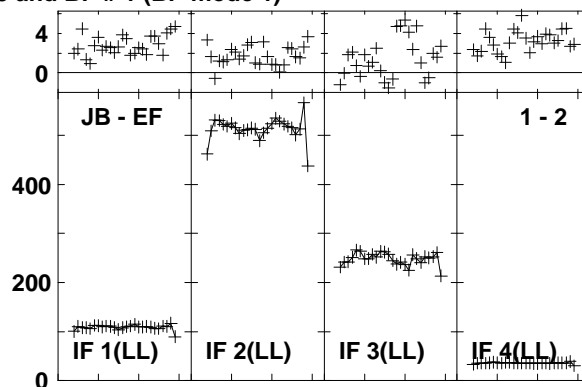
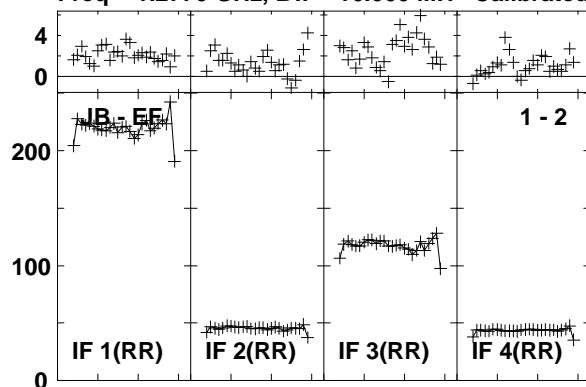

Lower frame: Milli Ampl Jy Top frame: Phas deg
Vector averaged cross-power spectrum Baseline: JB (01) - EF (02)
Timerange: 01/04:00:35 to 01/04:03:23

Plot file version1466 created 03-MAR-2016 01:16:13

J1545+5400 GN002C 1.UVDATA.1

Freq = 1.2770 GHz, Bw = 16.000 MH Calibrated with CL # 3 and BP # 1 (BP mode 1)

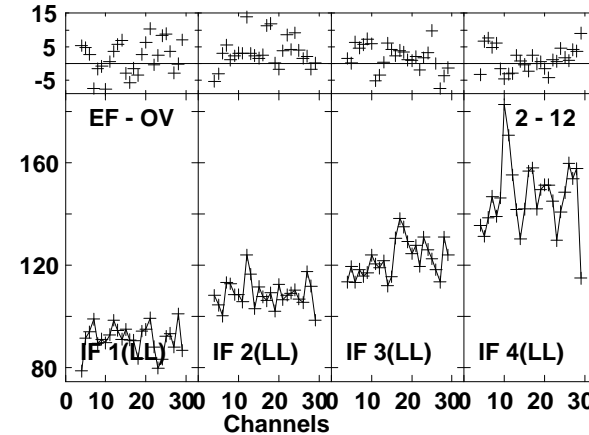
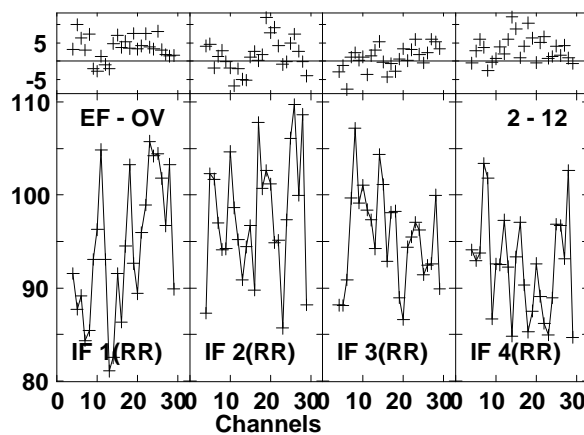
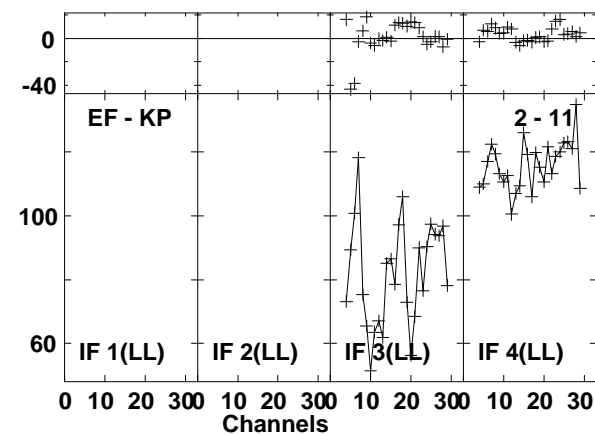
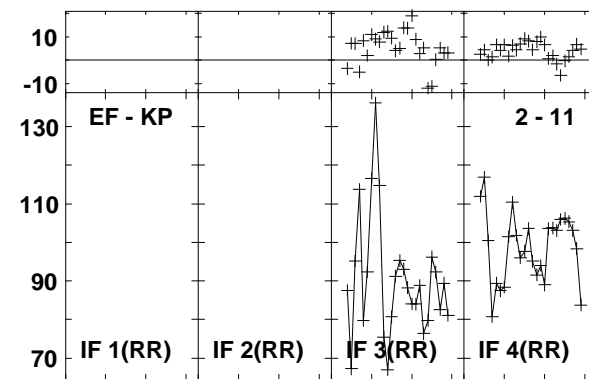
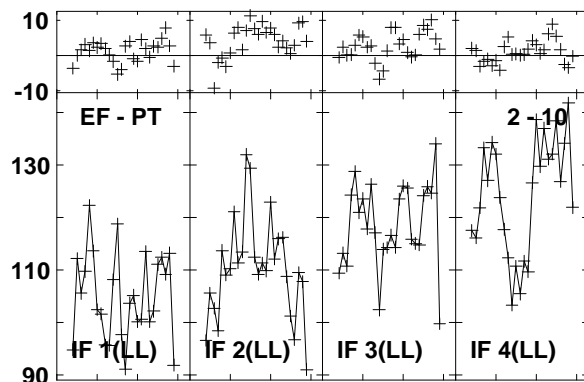
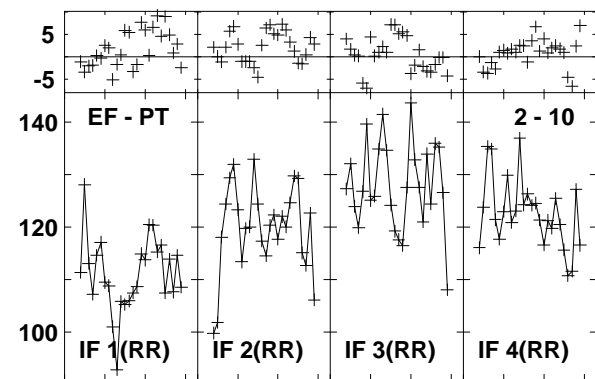
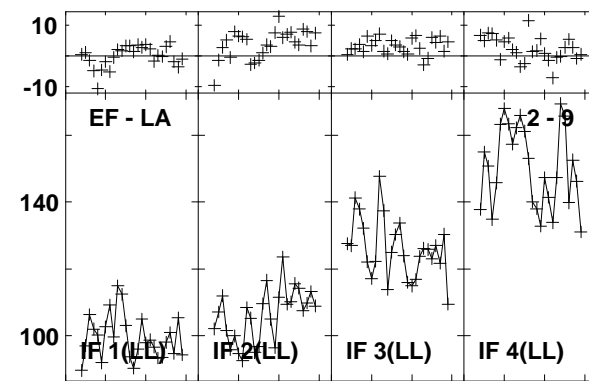
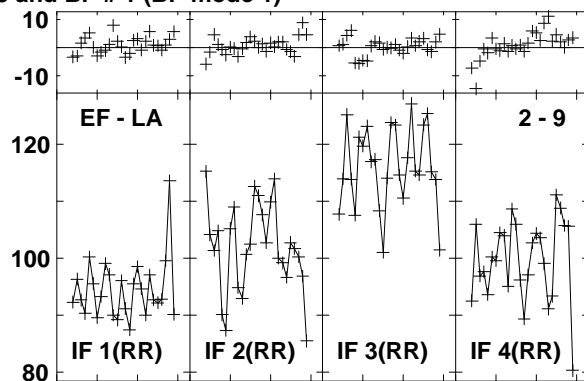
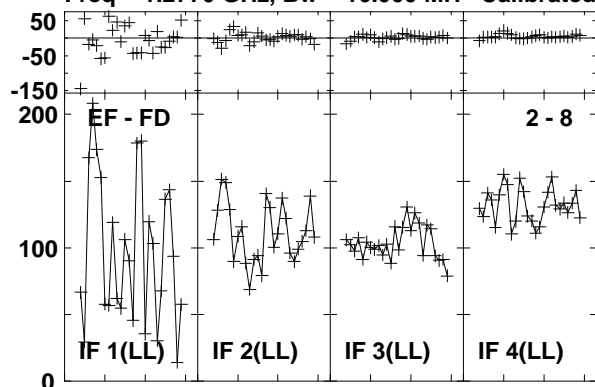

Lower frame: Milli Ampl Jy Top frame: Phas deg
Vector averaged cross-power spectrum Baseline: EF (02) - FD (08)
Timerange: 01/04:00:35 to 01/04:03:23

Plot file version1467 created 03-MAR-2016 01:16:13

J1545+5400 GN002C 1.UVDATA.1

Freq = 1.2770 GHz, Bw = 16.000 MH Calibrated with CL # 3 and BP # 1 (BP mode 1)

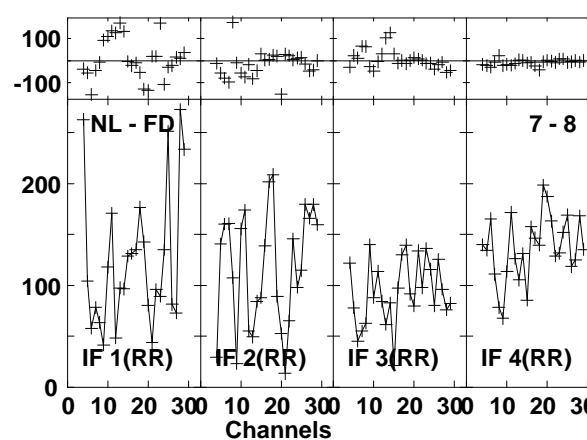
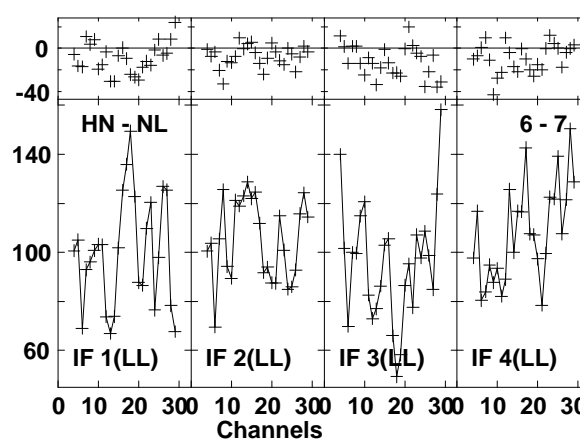
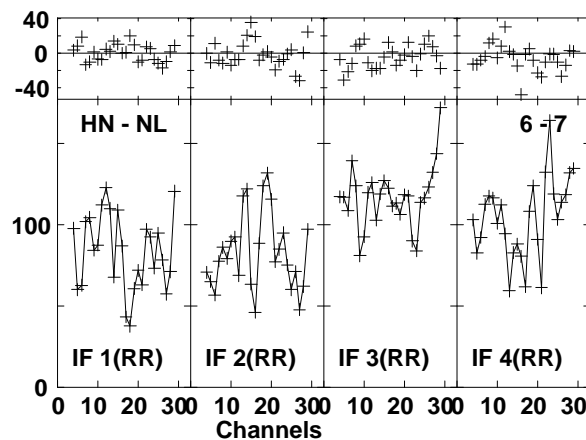
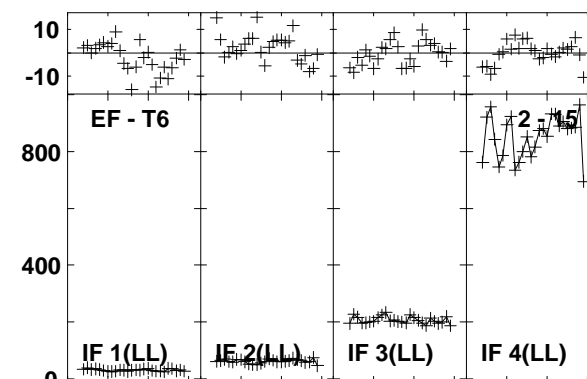
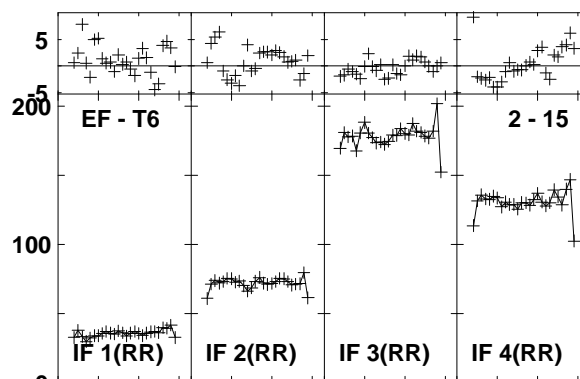
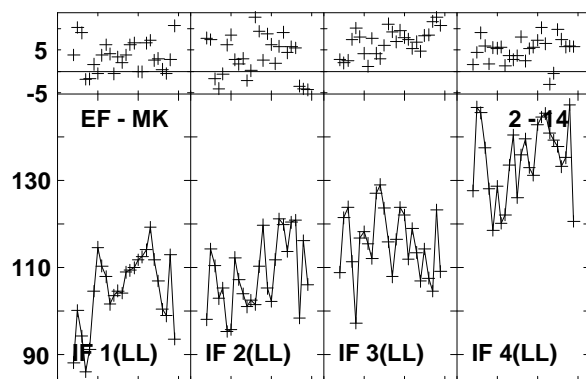
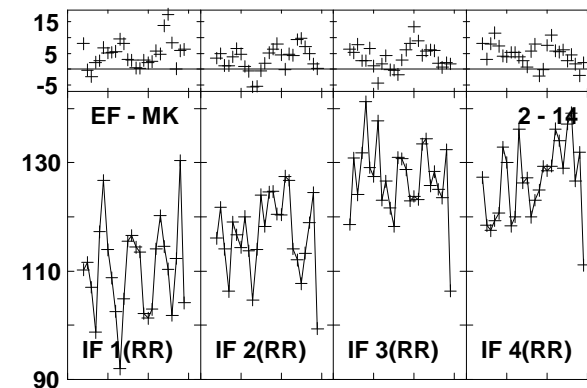
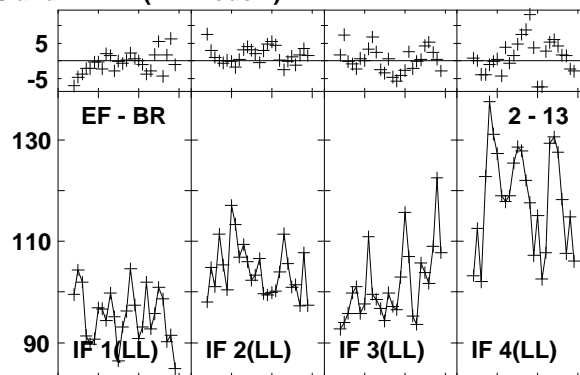
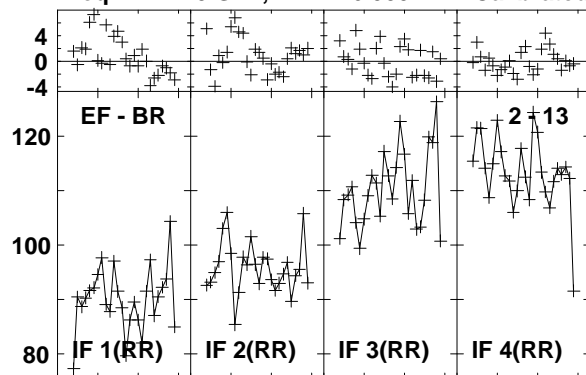

Lower frame: Milli Ampl Jy Top frame: Phas deg
Vector averaged cross-power spectrum Baseline: EF (02) - BR (13)
Timerange: 01/04:00:35 to 01/04:03:23

Plot file version1468 created 03-MAR-2016 01:16:14
 J1545+5400 GN002C 1.UVDATA.1
 Freq = 1.2770 GHz, Bw = 16.000 MH Calibrated with CL # 3 and BP # 1 (BP mode 1)

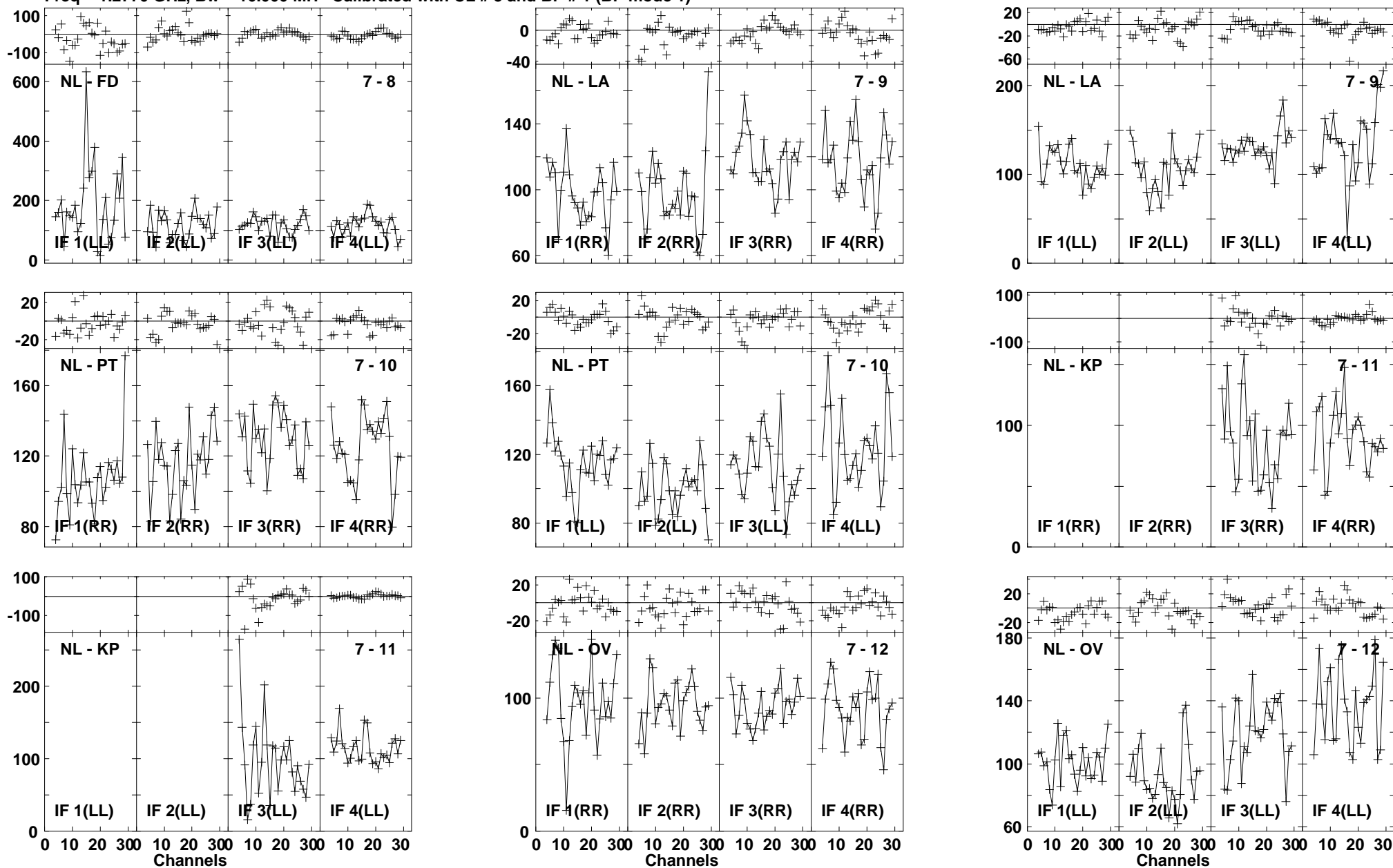

Lower frame: Milli Ampl Jy Top frame: Phas deg
 Vector averaged cross-power spectrum Baseline: NL (07) - FD (08)
 Timerange: 01/04:00:35 to 01/04:03:23

Plot file version1469 created 03-MAR-2016 01:16:14
 J1545+5400 GN002C 1.UVDATA.1
 Freq = 1.2770 GHz, Bw = 16.000 MH Calibrated with CL # 3 and BP # 1 (BP mode 1)

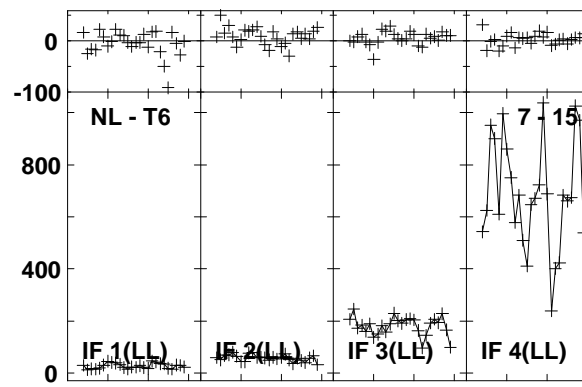
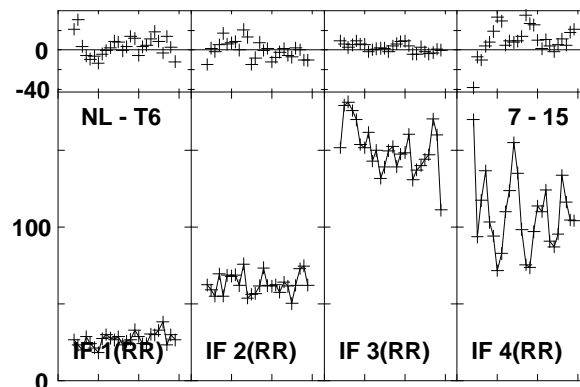
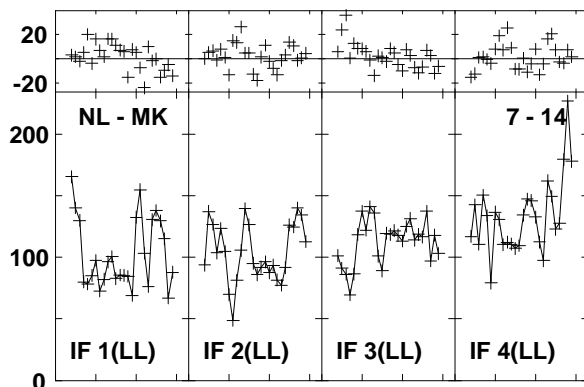
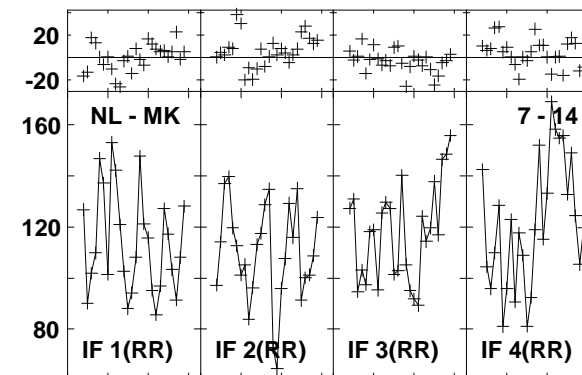
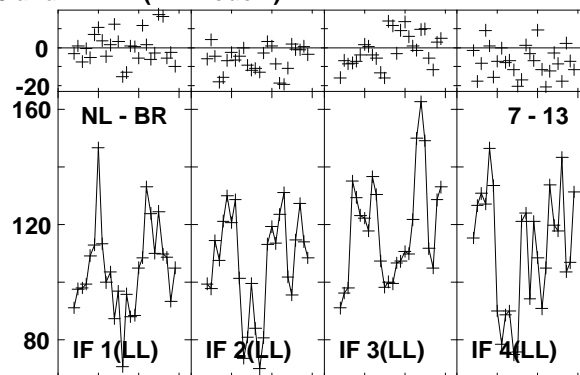
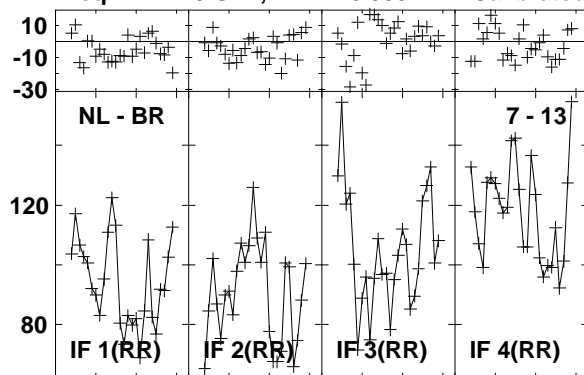

Lower frame: Milli Ampl Jy Top frame: Phas deg
 Vector averaged cross-power spectrum Baseline: NL (07) - BR (13)
 Timerange: 01/04:00:35 to 01/04:03:23

Plot file version1470 created 03-MAR-2016 01:16:14

4C52 GN002C 1.UVDATA.1

Freq = 1.2770 GHz, Bw = 16.000 MH Calibrated with CL # 3 and BP # 1 (BP mode 1)

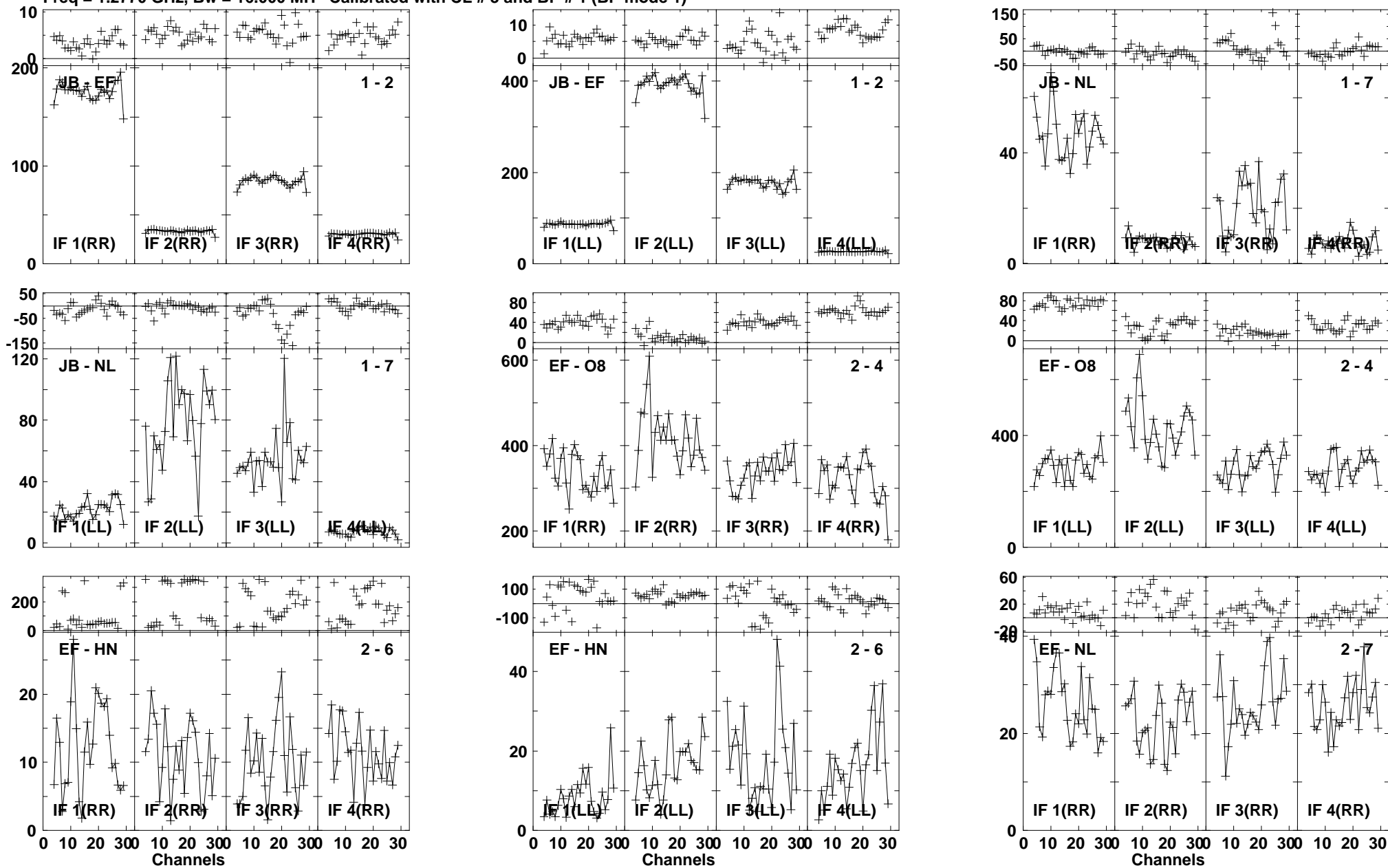

Plot file version1471 created 03-MAR-2016 01:16:14

4C52 GN002C 1.UVDATA.1

Freq = 1.2770 GHz, Bw = 16.000 MH Calibrated with CL # 3 and BP # 1 (BP mode 1)

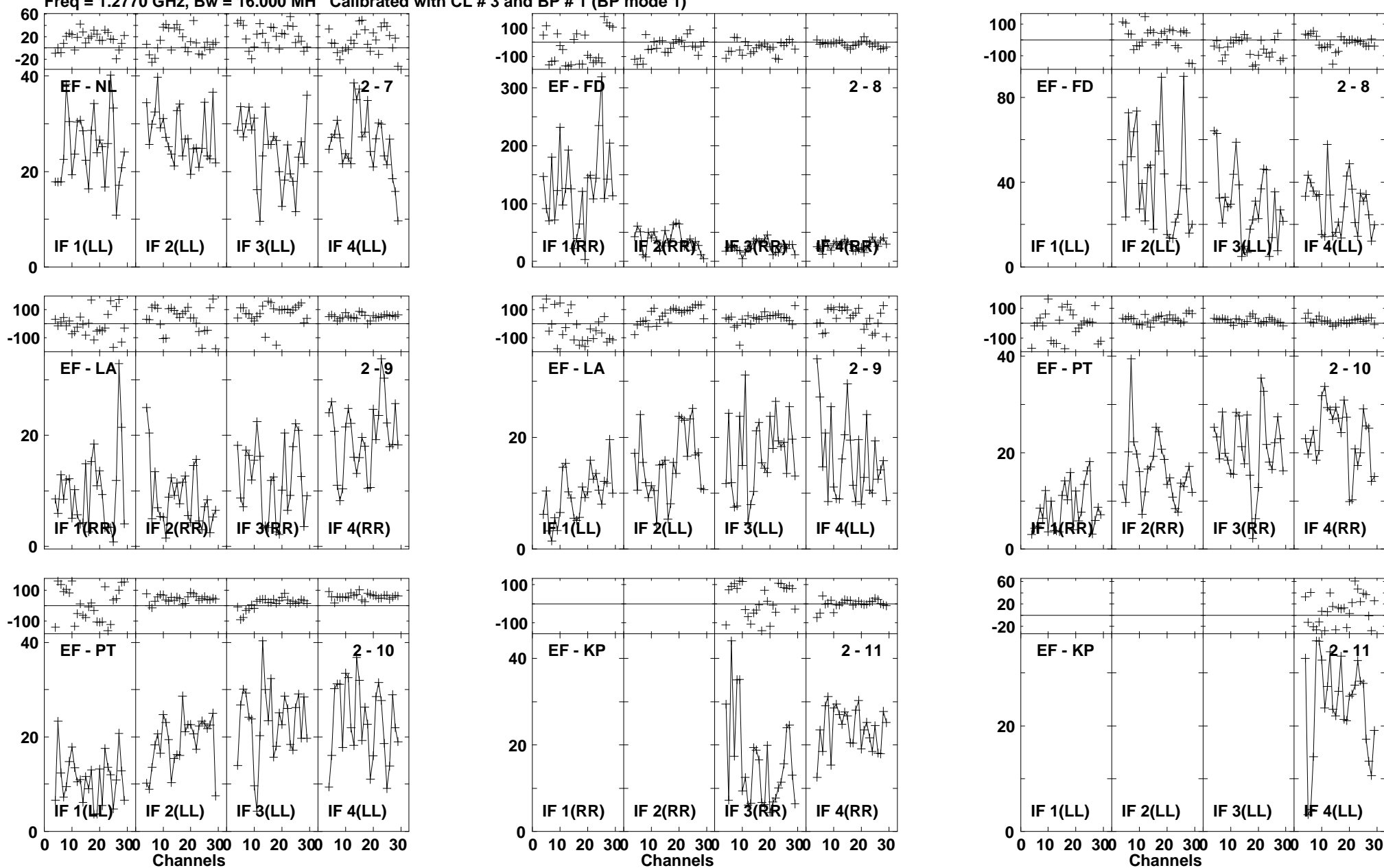

Lower frame: Milli Ampl Jy Top frame: Phas deg
Vector averaged cross-power spectrum Baseline: EF (02) - NL (07)
Timerange: 01/04:03:35 to 01/04:06:53

Plot file version1472 created 03-MAR-2016 01:16:14

4C52 GN002C 1.UVDATA.1

Freq = 1.2770 GHz, Bw = 16.000 MH Calibrated with CL # 3 and BP # 1 (BP mode 1)

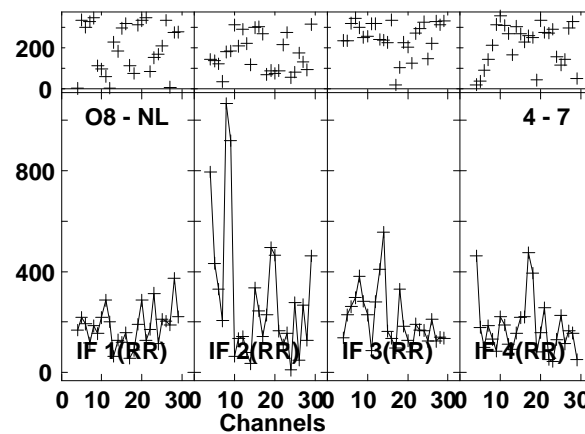
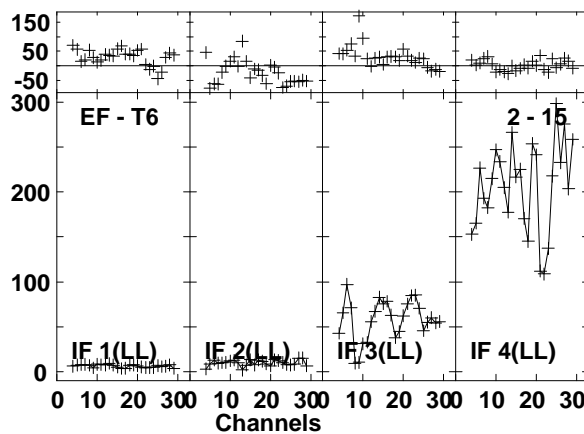
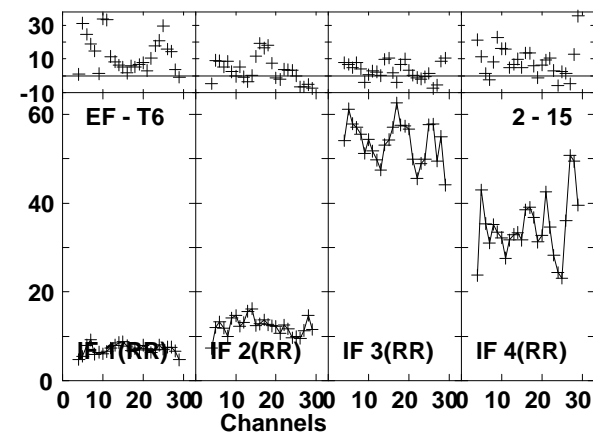
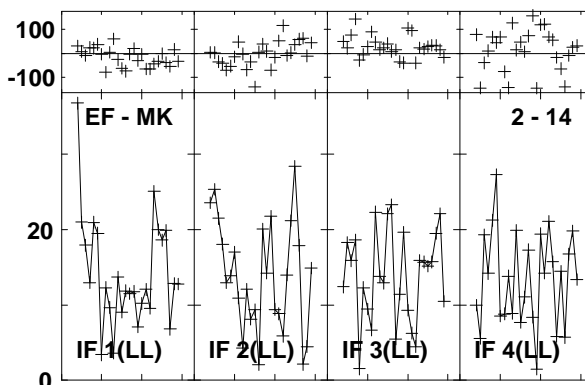
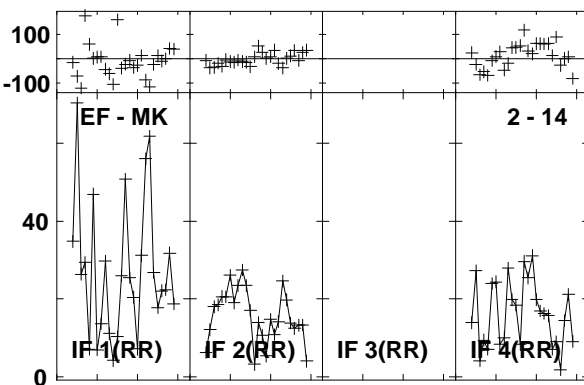
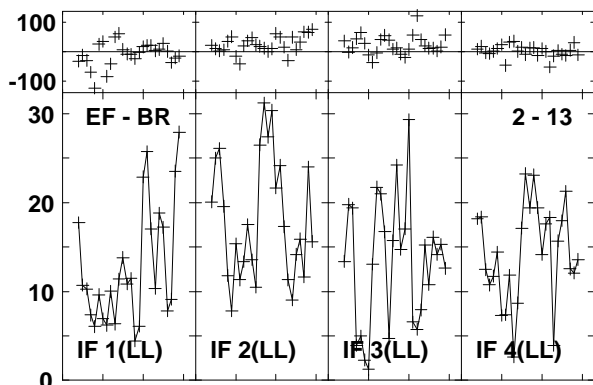
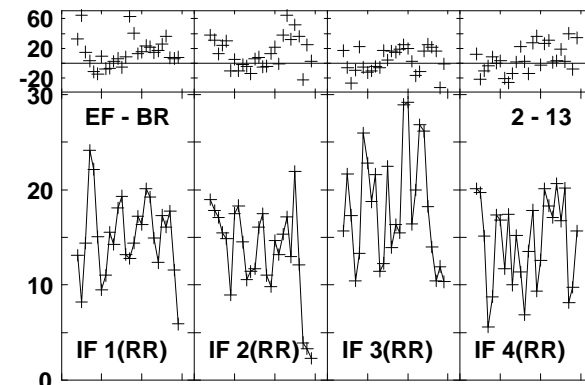
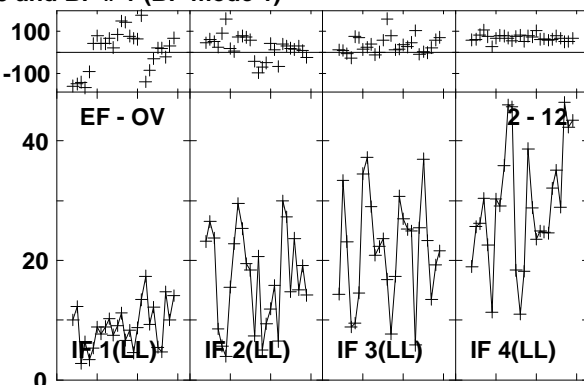
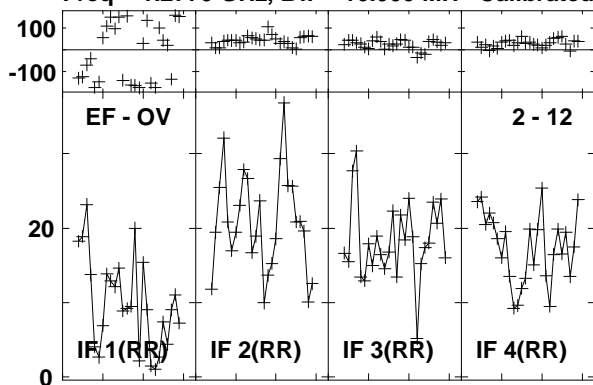

Lower frame: Milli Ampl Jy Top frame: Phas deg
Vector averaged cross-power spectrum Baseline: EF (02) - OV (12)
Timerange: 01/04:03:35 to 01/04:06:53

Plot file version1473 created 03-MAR-2016 01:16:14

4C52 GN002C 1.UVDATA.1

Freq = 1.2770 GHz, Bw = 16.000 MH Calibrated with CL # 3 and BP # 1 (BP mode 1)

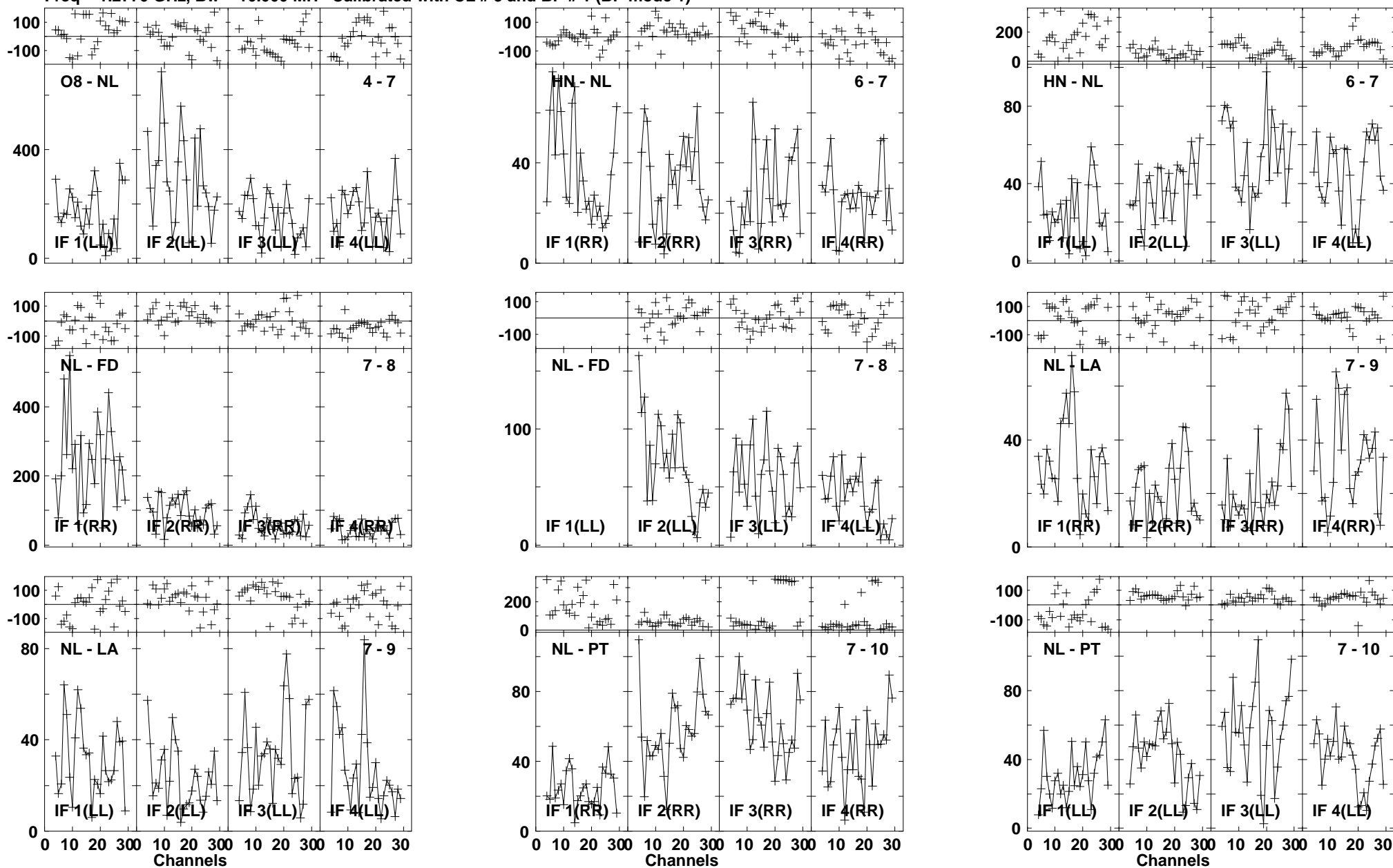

Lower frame: Milli Ampl Jy Top frame: Phas deg
Vector averaged cross-power spectrum Baseline: O8 (04) - NL (07)
Timerange: 01/04:03:35 to 01/04:06:53

Plot file version1474 created 03-MAR-2016 01:16:15
 4C52 GN002C 1.UVDATA.1
 Freq = 1.2770 GHz, Bw = 16.000 MH Calibrated with CL # 3 and BP # 1 (BP mode 1)

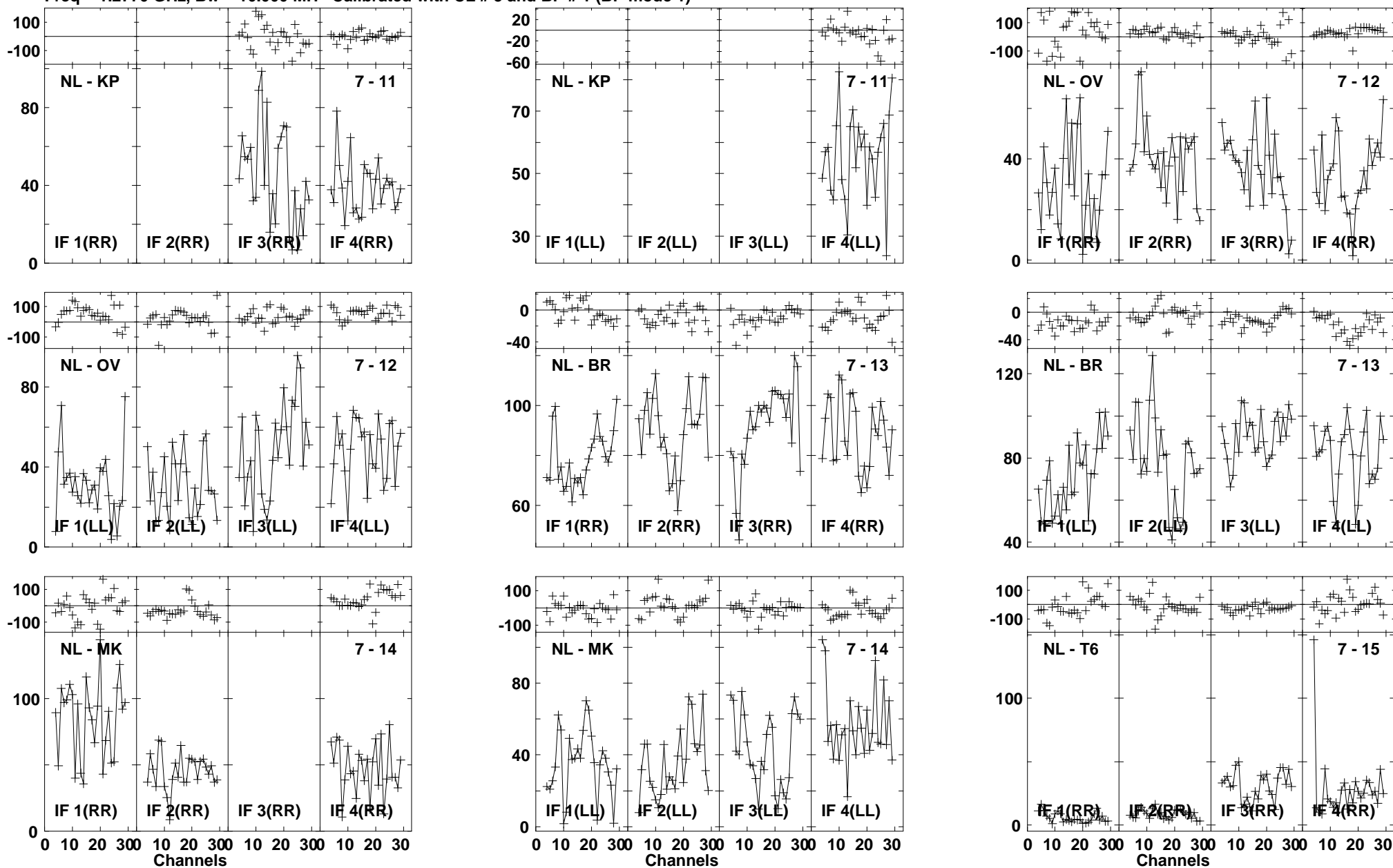

Lower frame: Milli Ampl Jy Top frame: Phas deg
 Vector averaged cross-power spectrum Baseline: NL (07) - KP (11)
 Timerange: 01/04:03:35 to 01/04:06:53

Plot file version1475 created 03-MAR-2016 01:16:15
4C52 GN002C 1.UVDATA.1
Freq = 1.2770 GHz, Bw = 16.000 MH Calibrated with CL # 3 and BP # 1 (BP mode 1)

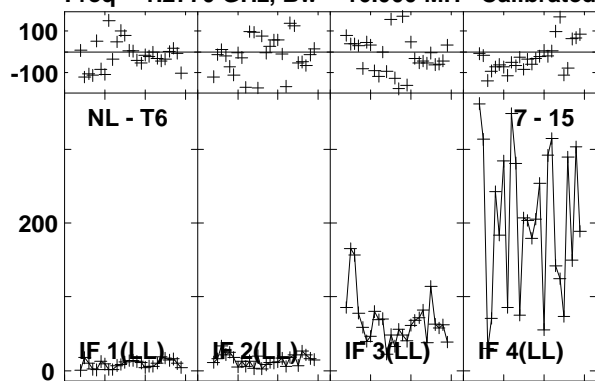

Lower frame: Milli Ampl Jy Top frame: Phas deg
Vector averaged cross-power spectrum Baseline: NL (07) - T6 (15)
Timerange: 01/04:03:35 to 01/04:06:53

Plot file version1476 created 03-MAR-2016 01:16:15

J1545+5400 GN002C 1.UVDATA.1

Freq = 1.2770 GHz, Bw = 16.000 MH Calibrated with CL # 3 and BP # 1 (BP mode 1)

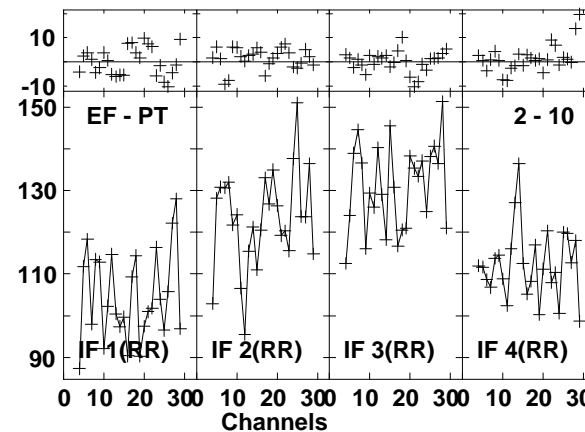
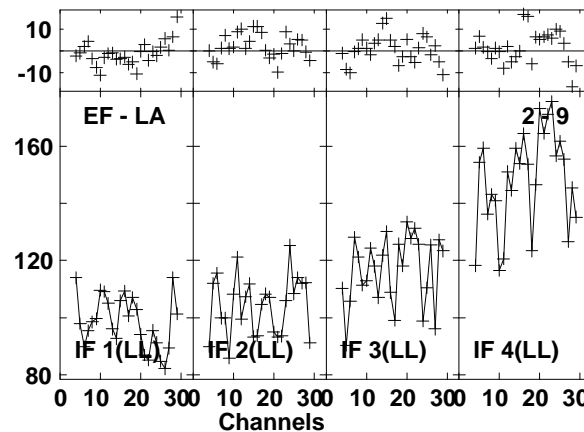
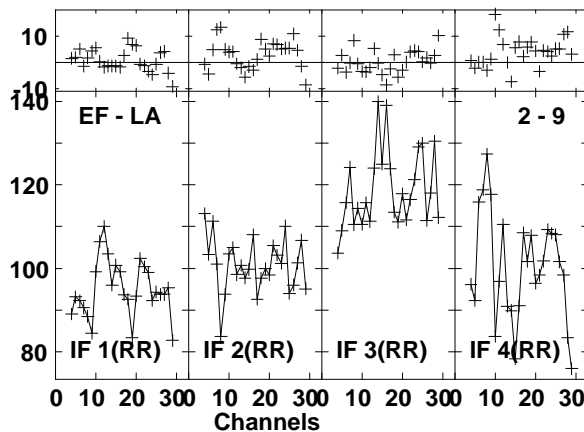
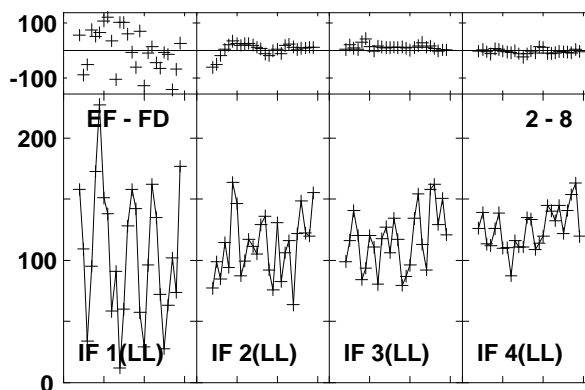
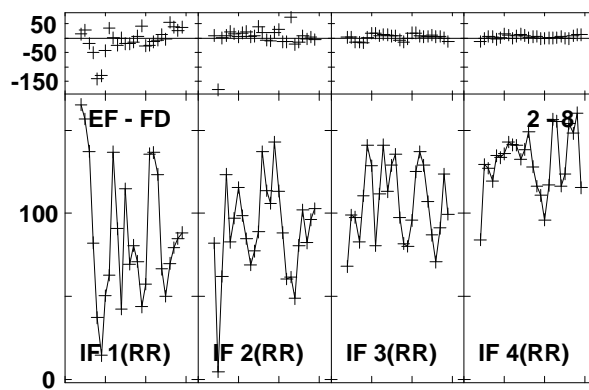
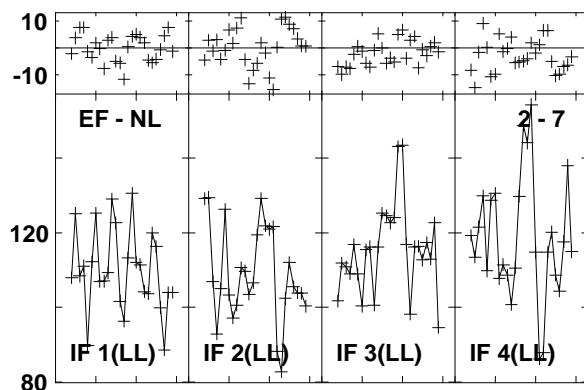
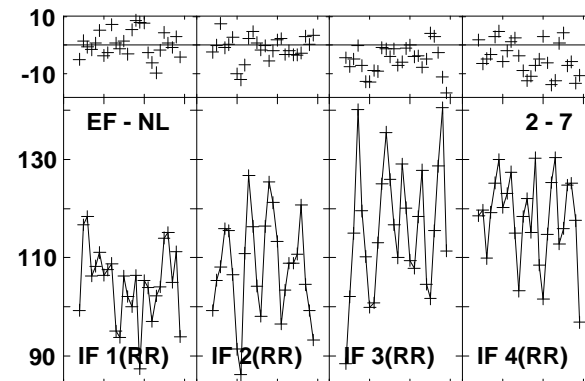
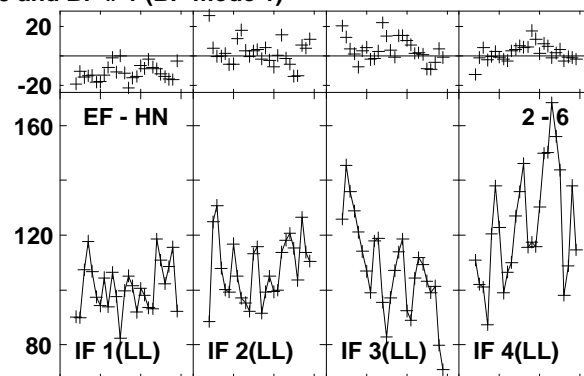
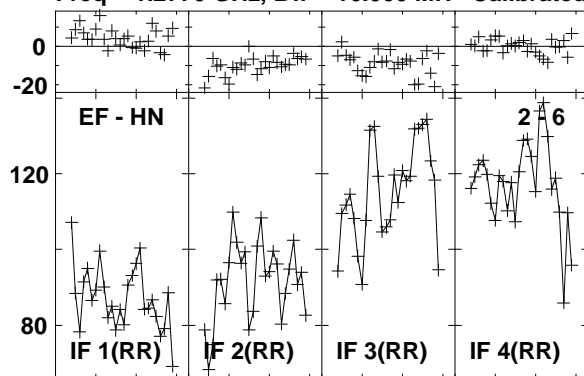

Lower frame: Milli Ampl Jy Top frame: Phas deg
Vector averaged cross-power spectrum Baseline: EF (02) - HN (06)
Timerange: 01/04:07:45 to 01/04:09:03

Plot file version1477 created 03-MAR-2016 01:16:15
 J1545+5400 GN002C 1.UVDATA.1
 Freq = 1.2770 GHz, Bw = 16.000 MH Calibrated with CL # 3 and BP # 1 (BP mode 1)

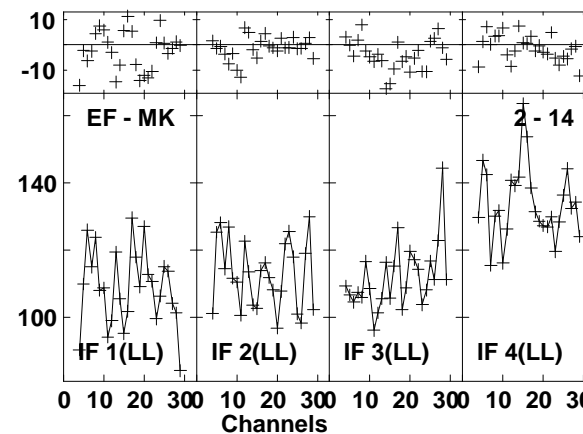
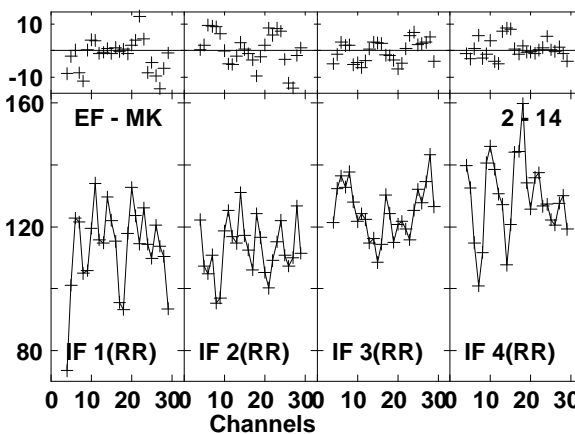
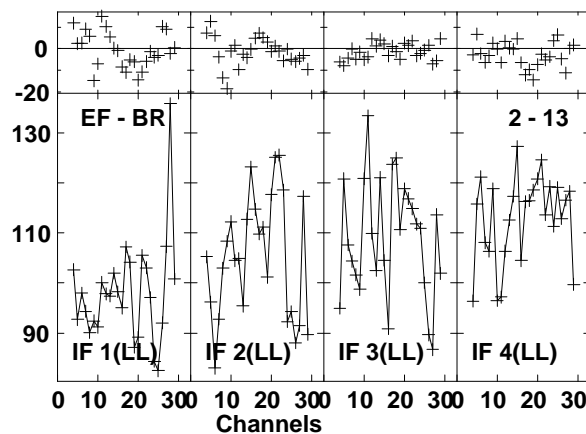
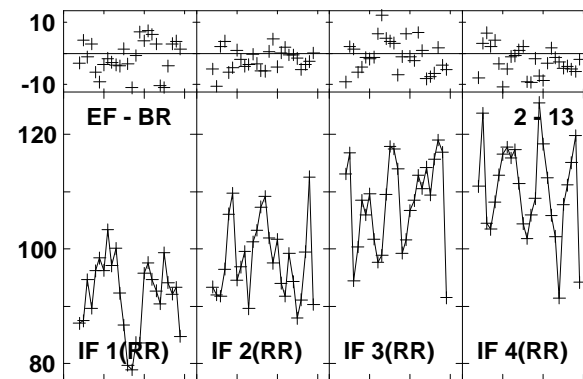
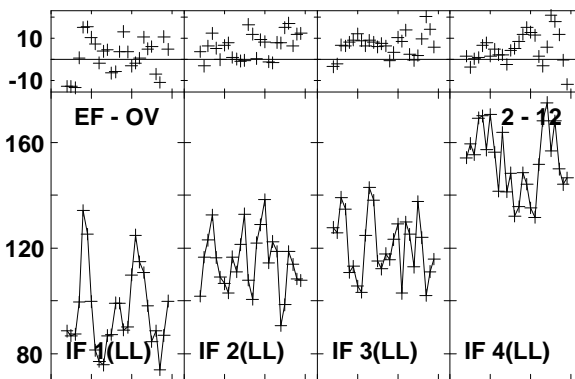
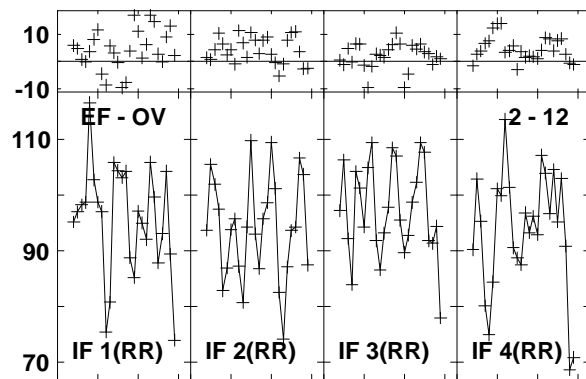
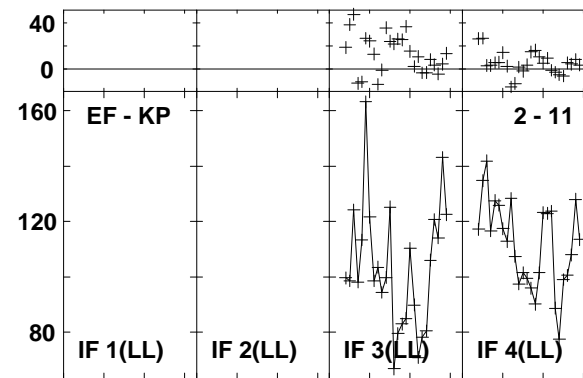
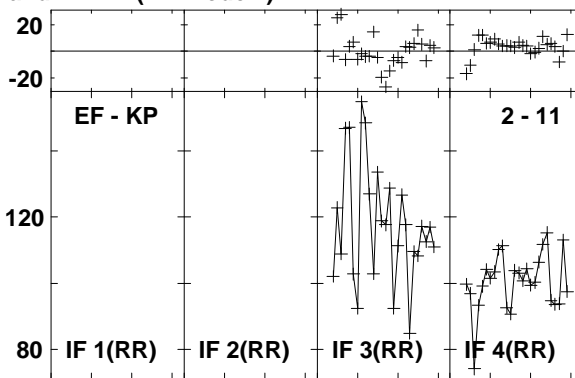
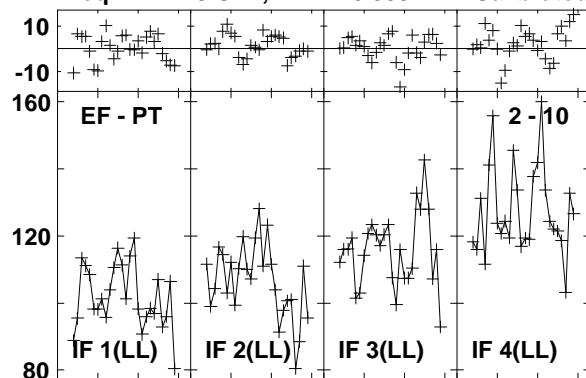

Lower frame: Milli Ampl Jy Top frame: Phas deg
 Vector averaged cross-power spectrum Baseline: EF (02) - PT (10)
 Timerange: 01/04:07:45 to 01/04:09:03

Plot file version1478 created 03-MAR-2016 01:16:15

J1545+5400 GN002C 1.UVDATA.1

Freq = 1.2770 GHz, Bw = 16.000 MH Calibrated with CL # 3 and BP # 1 (BP mode 1)

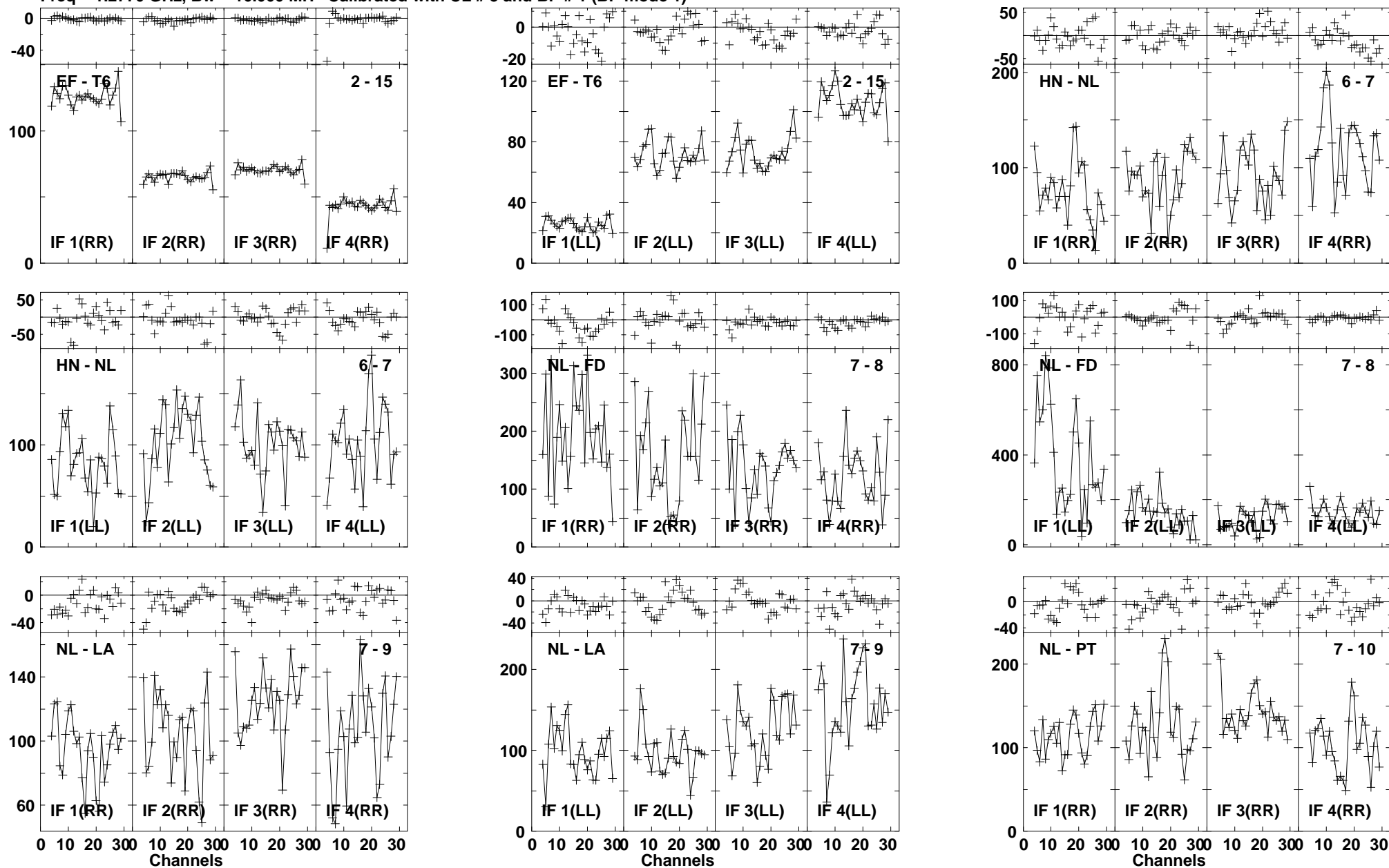

Lower frame: Milli Ampl Jy Top frame: Phas deg
Vector averaged cross-power spectrum Baseline: EF (02) - T6 (15)
Timerange: 01/04:07:45 to 01/04:09:03

Plot file version1479 created 03-MAR-2016 01:16:15

J1545+5400 GN002C 1.UVDATA.1

Freq = 1.2770 GHz, Bw = 16.000 MH Calibrated with CL # 3 and BP # 1 (BP mode 1)

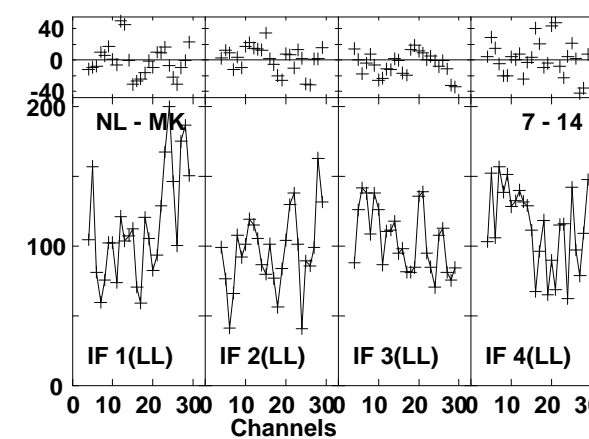
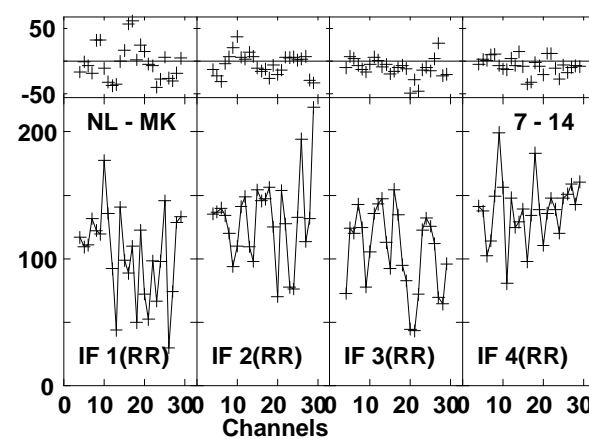
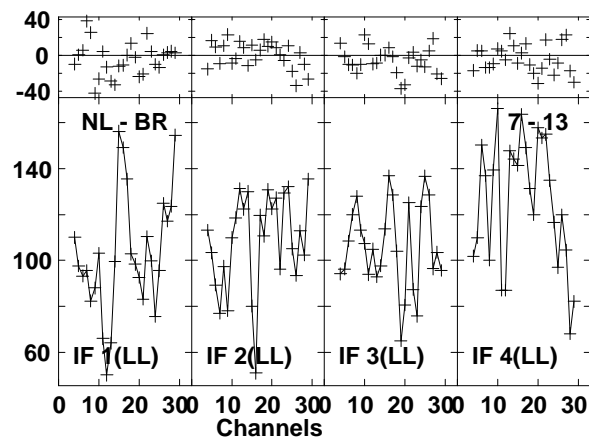
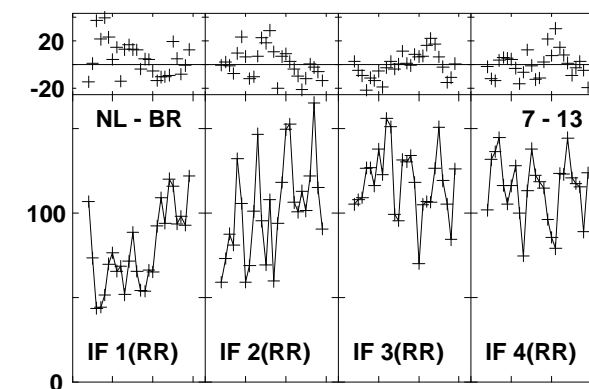
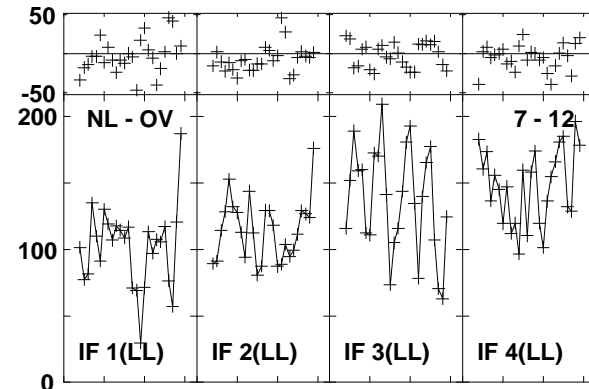
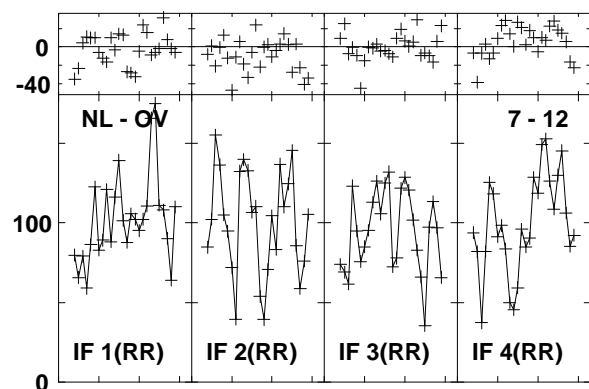
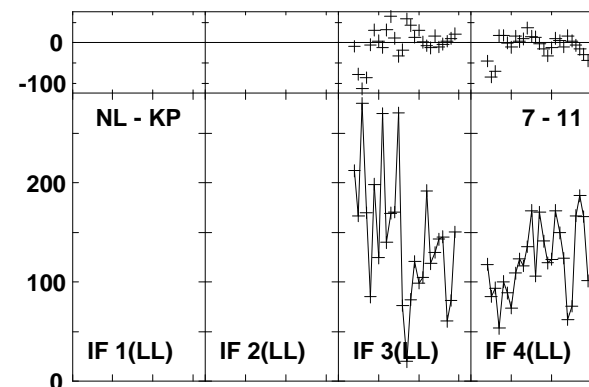
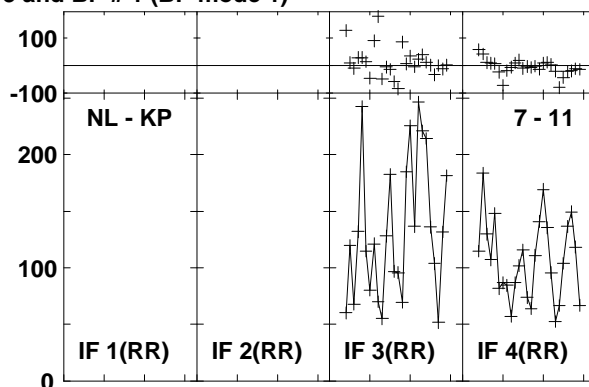
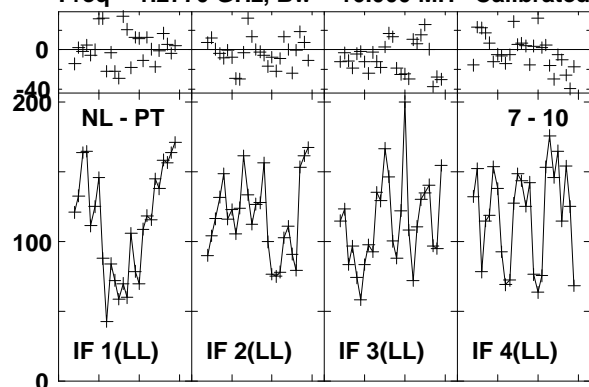

Lower frame: Milli Ampl Jy Top frame: Phas deg
Vector averaged cross-power spectrum Baseline: NL (07) - PT (10)
Timerange: 01/04:07:45 to 01/04:09:03

Plot file version1480 created 03-MAR-2016 01:16:16

J1545+5400 GN002C 1.UVDATA.1

Freq = 1.2770 GHz, Bw = 16.000 MH Calibrated with CL # 3 and BP # 1 (BP mode 1)

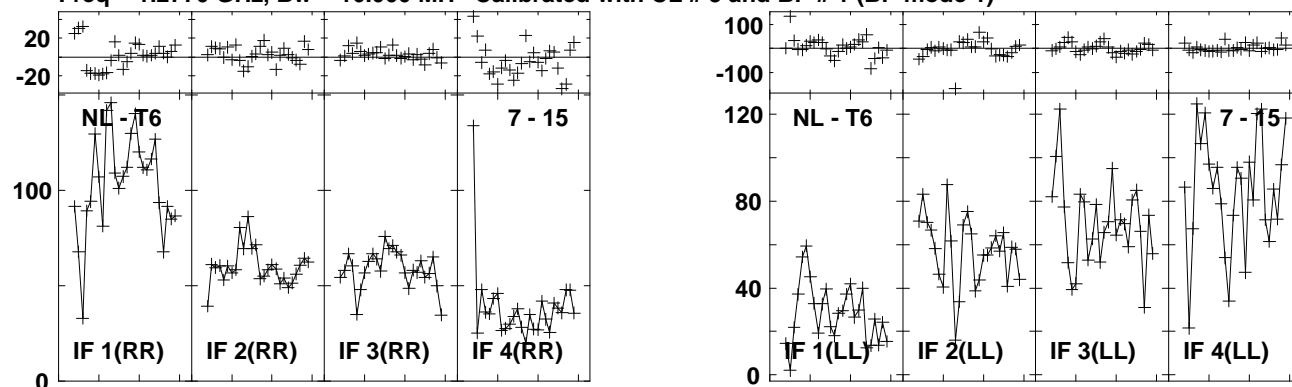

Lower frame: Milli Ampl Jy Top frame: Phas deg
Vector averaged cross-power spectrum Baseline: NL (07) - T6 (15)
Timerange: 01/04:07:45 to 01/04:09:03

Plot file version1481 created 03-MAR-2016 01:16:16

4C52 GN002C 1.UVDATA.1

Freq = 1.2770 GHz, Bw = 16.000 MH Calibrated with CL # 3 and BP # 1 (BP mode 1)

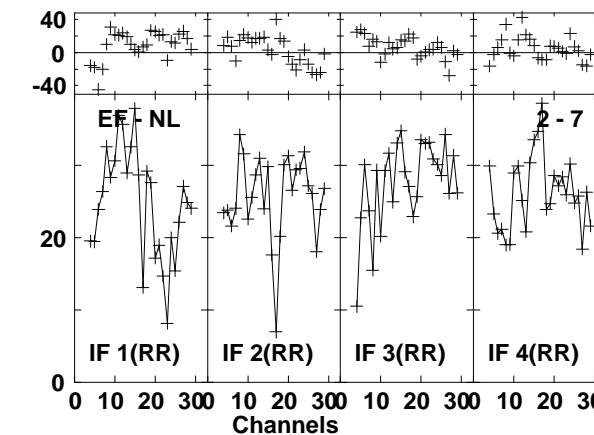
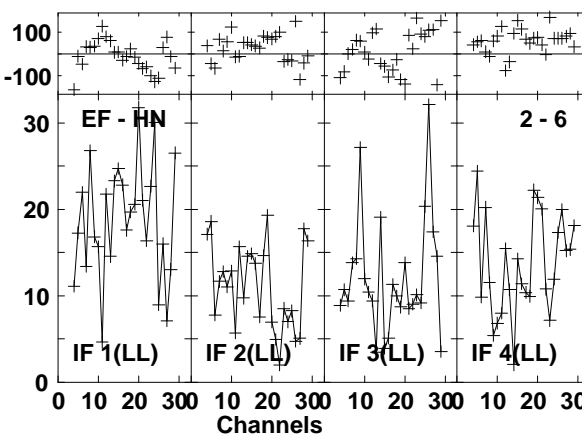
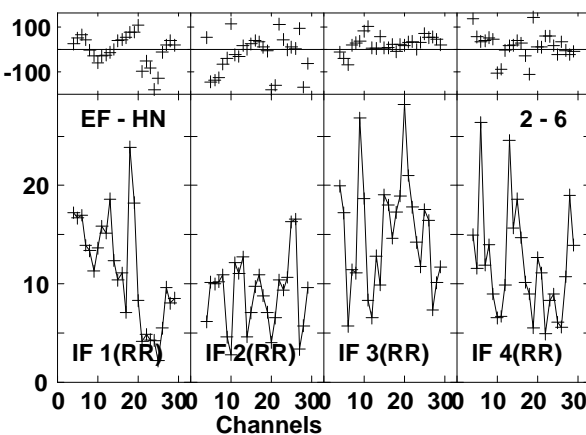
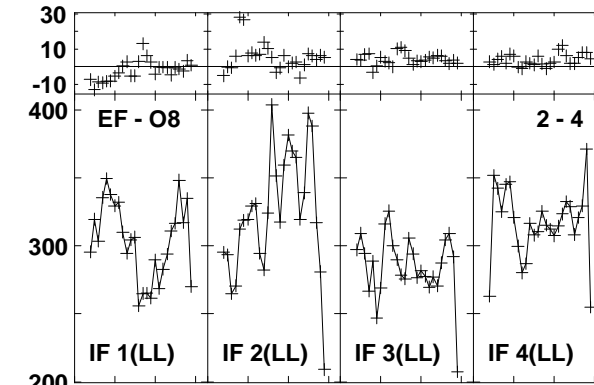
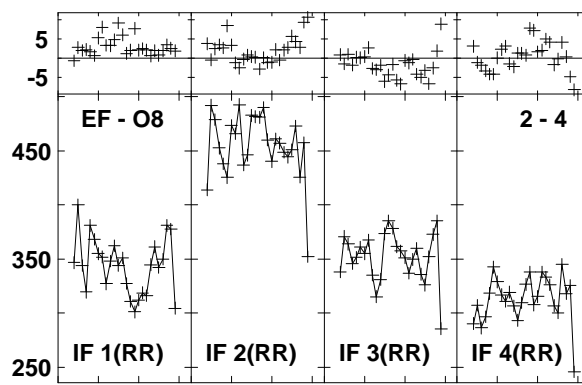
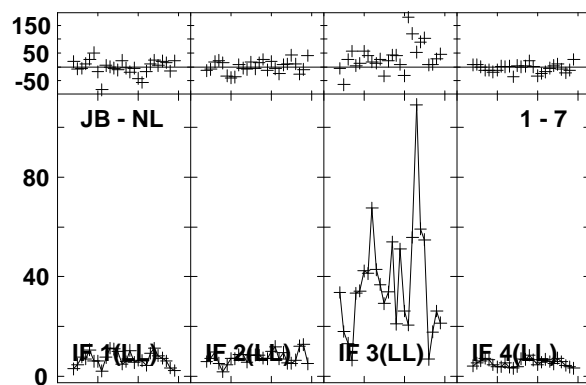
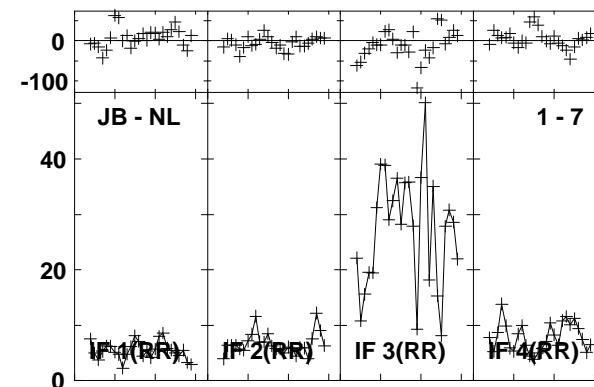
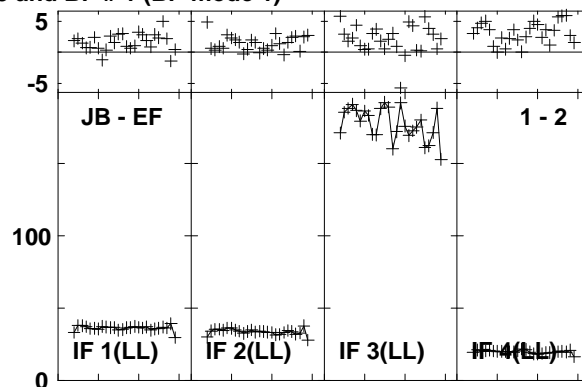
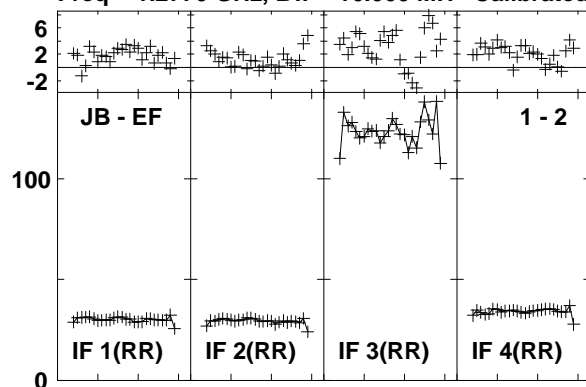

Lower frame: Milli Ampl Jy Top frame: Phas deg
Vector averaged cross-power spectrum Baseline: JB (01) - EF (02)
Timerange: 01/04:09:08 to 01/04:12:32

Plot file version1482 created 03-MAR-2016 01:16:16

4C52 GN002C 1.UVDATA.1

Freq = 1.2770 GHz, Bw = 16.000 MH Calibrated with CL # 3 and BP # 1 (BP mode 1)

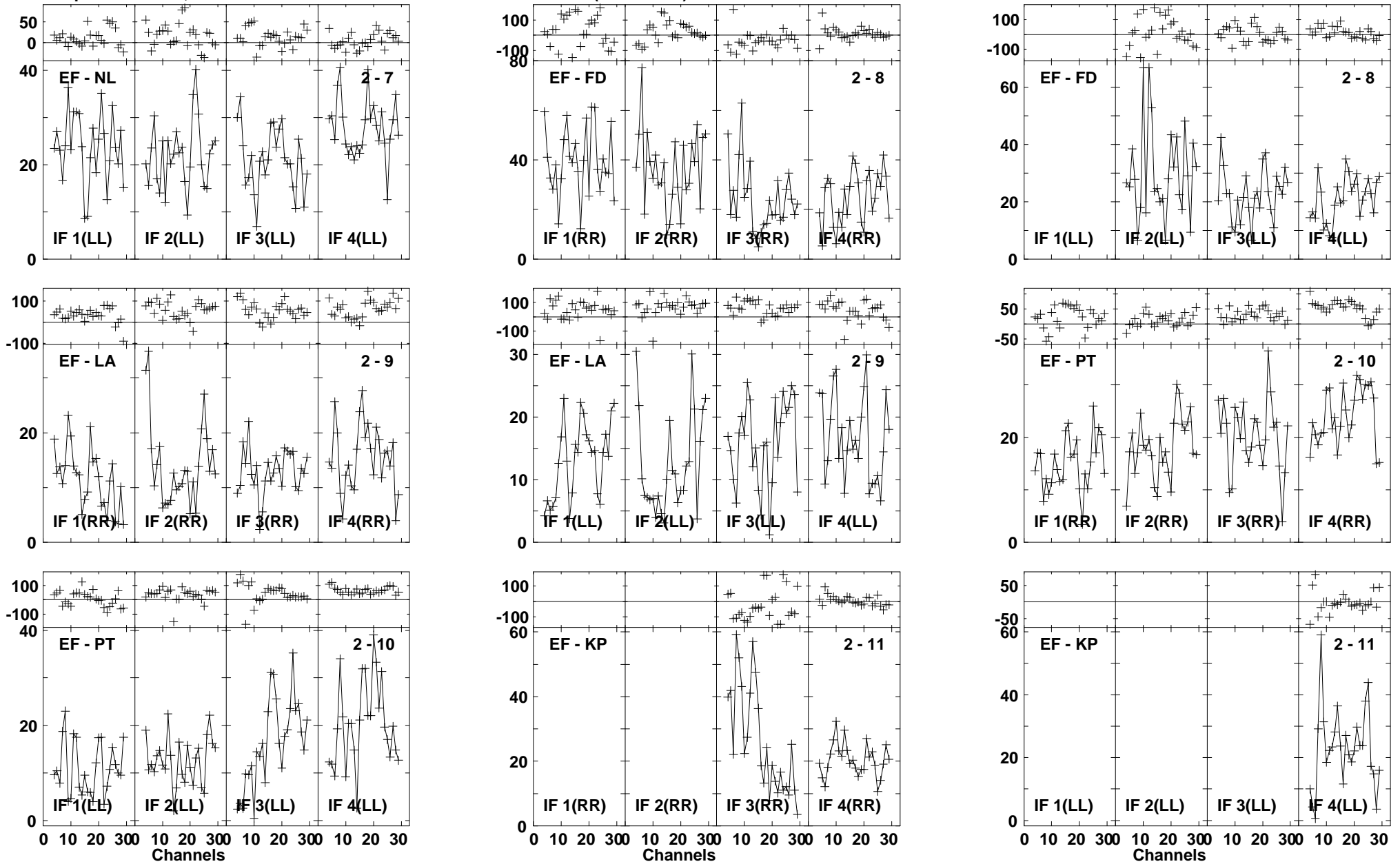

Lower frame: Milli Ampl Jy Top frame: Phas deg
Vector averaged cross-power spectrum Baseline: EF (02) - NL (07)
Timerange: 01/04:09:08 to 01/04:12:32

Plot file version1483 created 03-MAR-2016 01:16:16

4C52 GN002C 1.UVDATA.1

Freq = 1.2770 GHz, Bw = 16.000 MH Calibrated with CL # 3 and BP # 1 (BP mode 1)

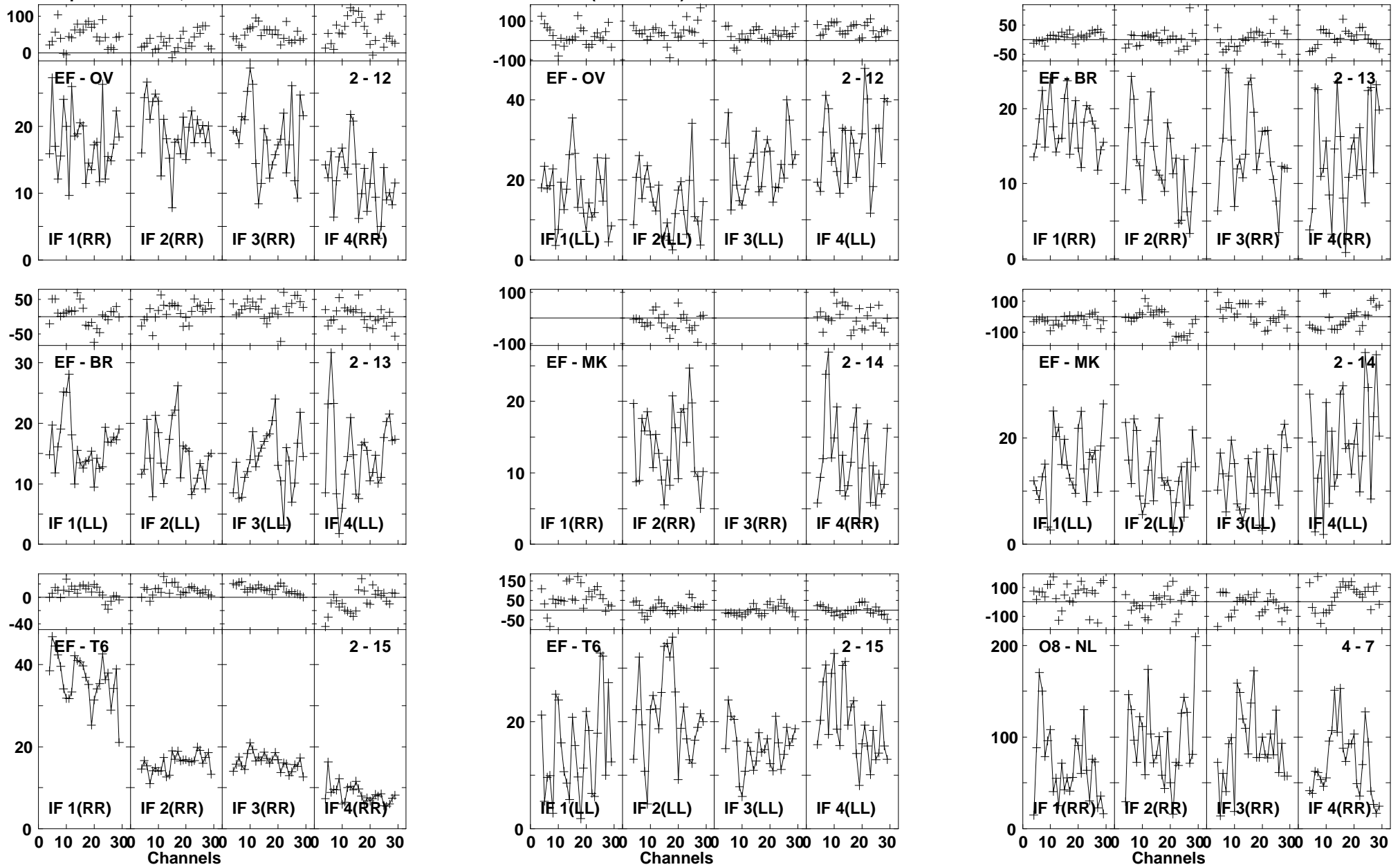

Lower frame: Milli Ampl Jy Top frame: Phas deg
Vector averaged cross-power spectrum Baseline: EF (02) - OV (12)
Timerange: 01/04:09:08 to 01/04:12:32

Plot file version1484 created 03-MAR-2016 01:16:16

4C52 GN002C 1.UVDATA.1

Freq = 1.2770 GHz, Bw = 16.000 MH Calibrated with CL # 3 and BP # 1 (BP mode 1)

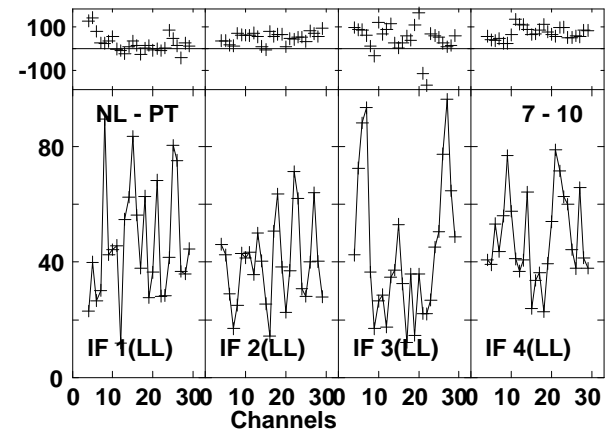
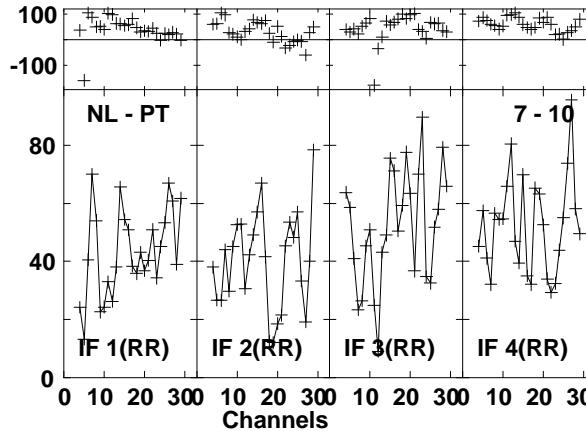
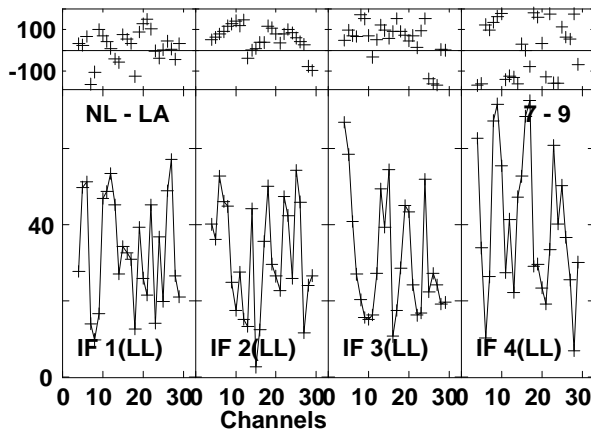
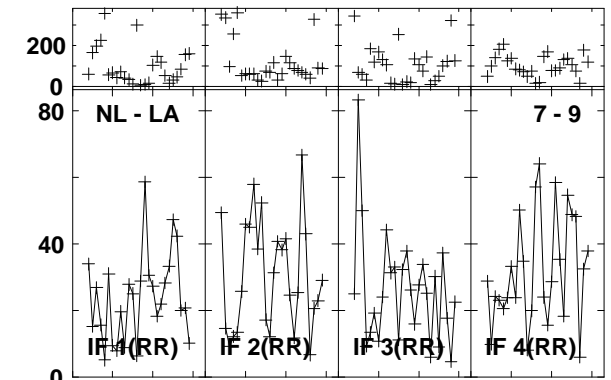
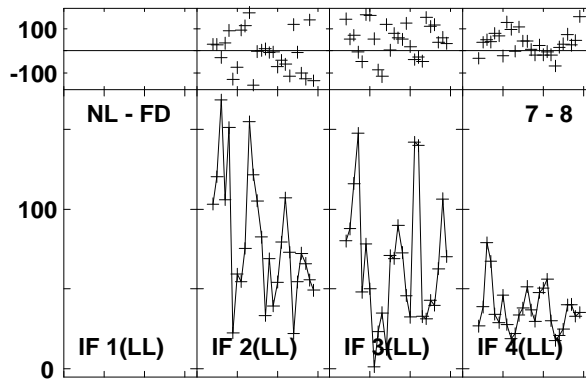
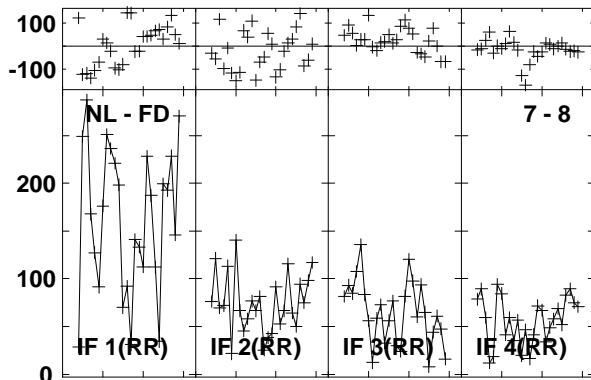
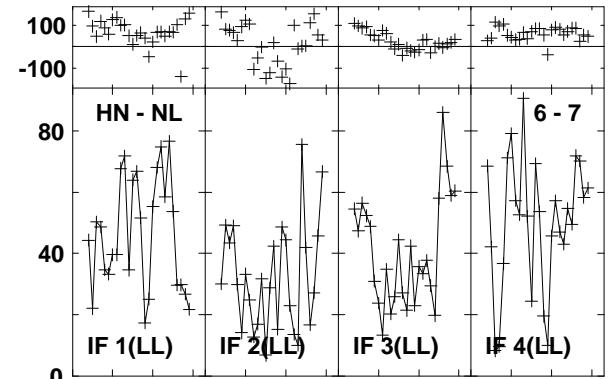
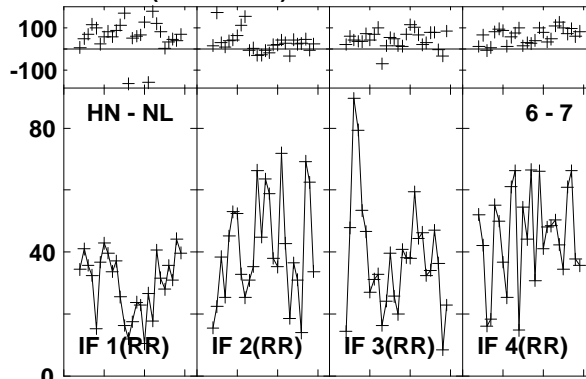
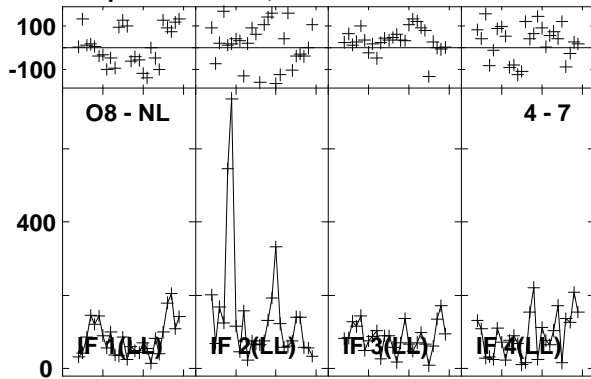

Lower frame: Milli Ampl Jy Top frame: Phas deg
Vector averaged cross-power spectrum Baseline: O8 (04) - NL (07)
Timerange: 01/04:09:08 to 01/04:12:32

Plot file version1485 created 03-MAR-2016 01:16:16
 4C52 GN002C 1.UVDATA.1
 Freq = 1.2770 GHz, Bw = 16.000 MH Calibrated with CL # 3 and BP # 1 (BP mode 1)

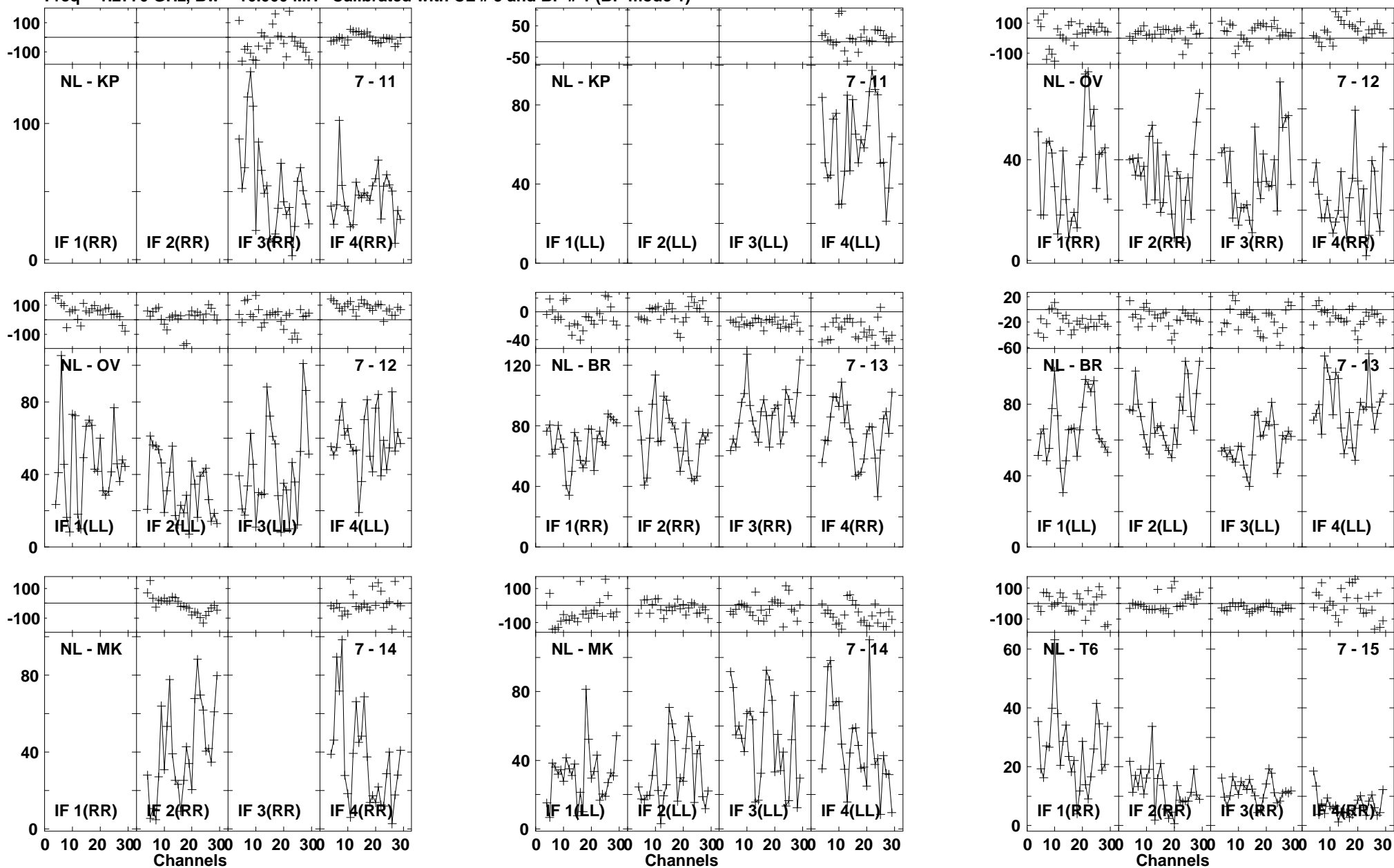

Lower frame: Milli Ampl Jy Top frame: Phas deg
 Vector averaged cross-power spectrum Baseline: NL (07) - KP (11)
 Timerange: 01/04:09:08 to 01/04:12:32

Plot file version1486 created 03-MAR-2016 01:16:17

4C52 GN002C 1.UVDATA.1

Freq = 1.2770 GHz, Bw = 16.000 MH Calibrated with CL # 3 and BP # 1 (BP mode 1)

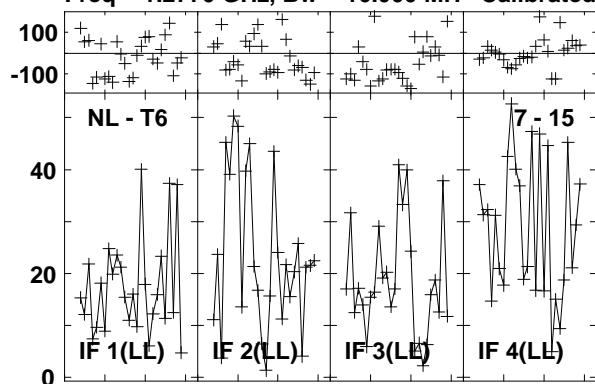

Lower frame: Milli Ampl Jy Top frame: Phas deg
Vector averaged cross-power spectrum Baseline: NL (07) - T6 (15)
Timerange: 01/04:09:08 to 01/04:12:32

Plot file version1487 created 03-MAR-2016 01:16:17

J1545+5400 GN002C 1.UVDATA.1

Freq = 1.2770 GHz, Bw = 16.000 MH Calibrated with CL # 3 and BP # 1 (BP mode 1)

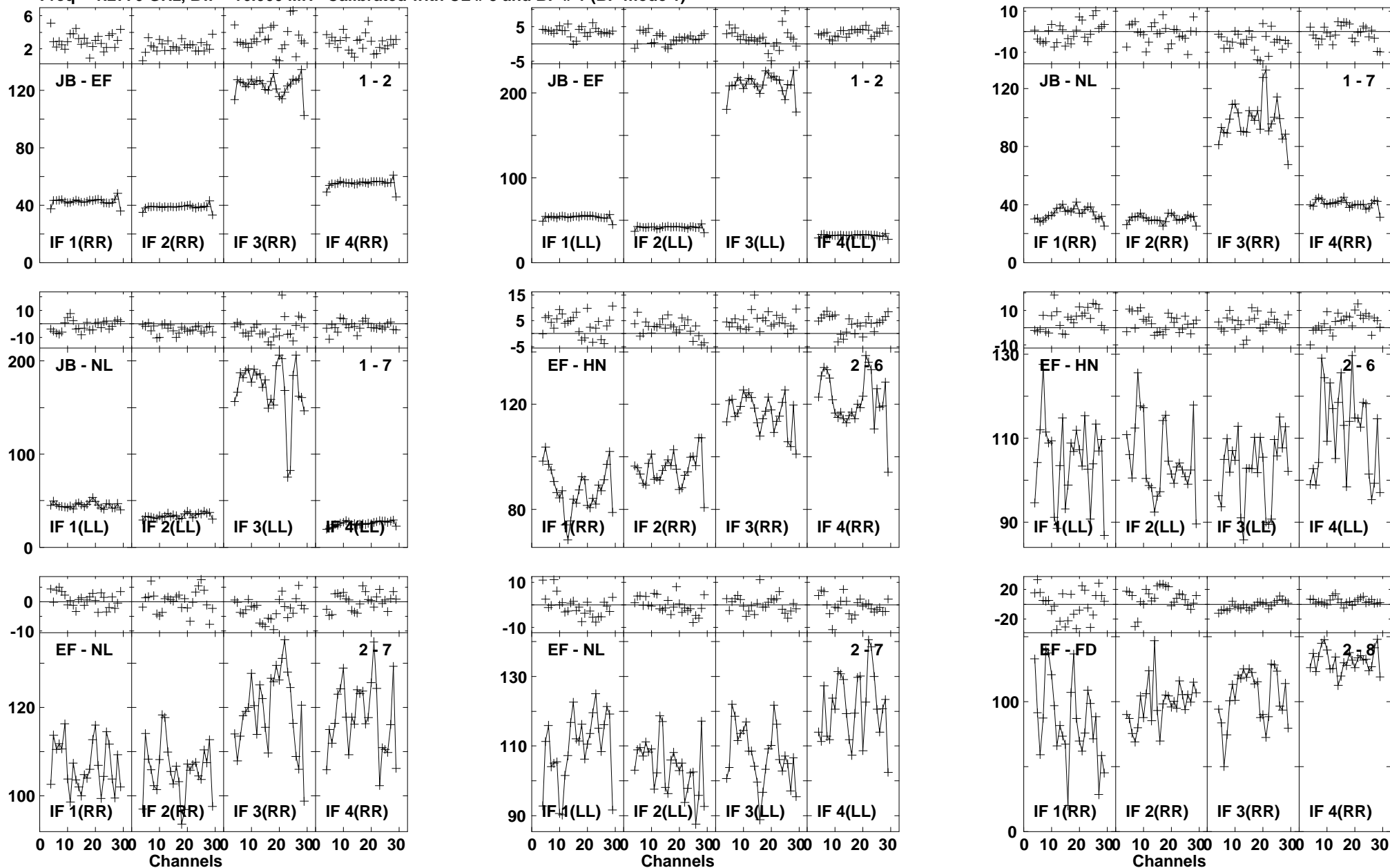

Lower frame: Milli Ampl Jy Top frame: Phas deg
Vector averaged cross-power spectrum Baseline: JB (01) - EF (02)
Timerange: 01/04:13:25 to 01/04:16:13

Plot file version1488 created 03-MAR-2016 01:16:17

J1545+5400 GN002C 1.UVDATA.1

Freq = 1.2770 GHz, Bw = 16.000 MH Calibrated with CL # 3 and BP # 1 (BP mode 1)

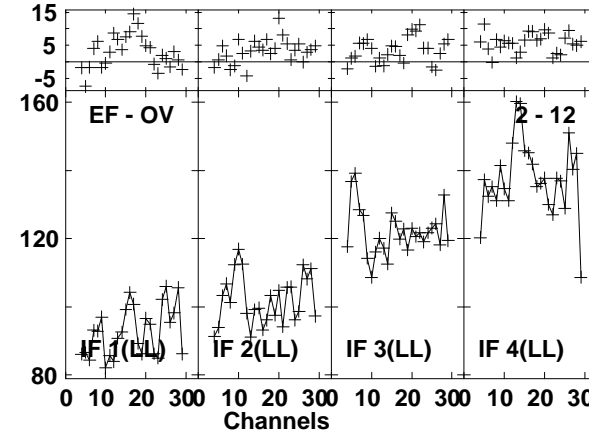
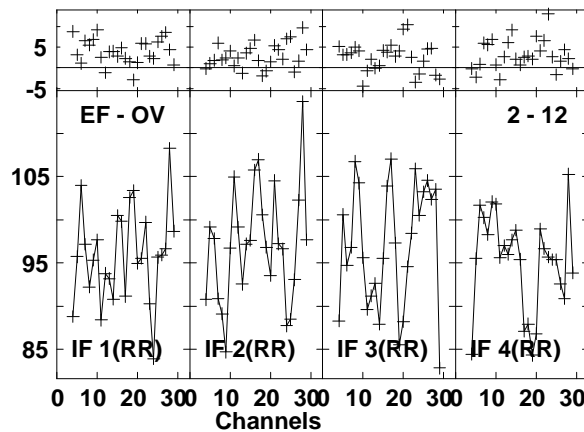
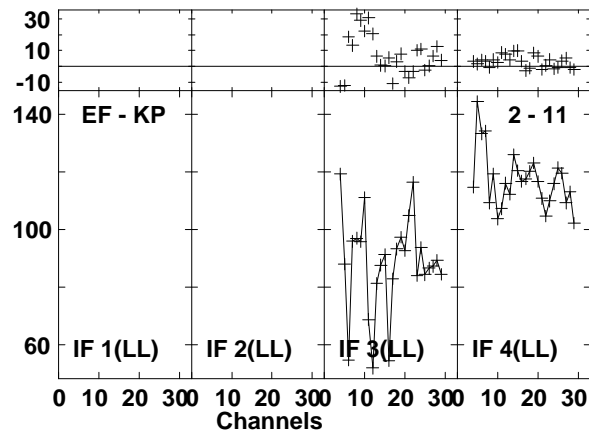
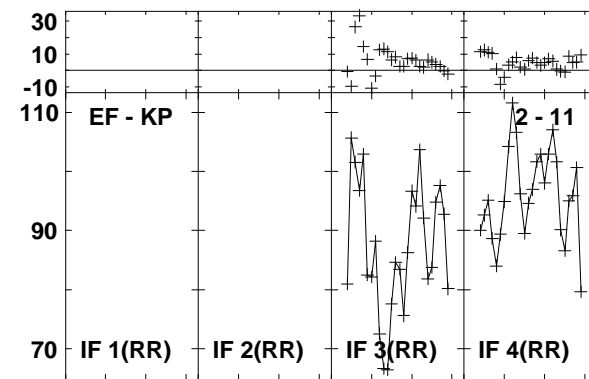
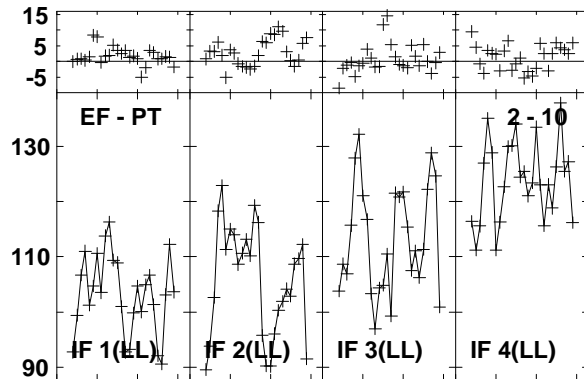
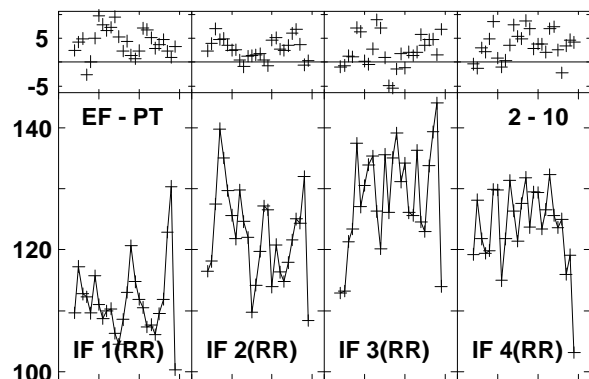
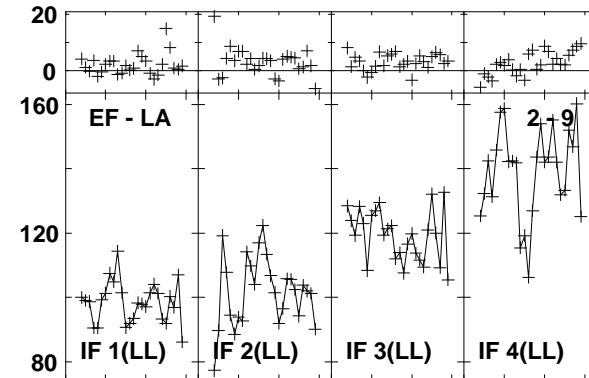
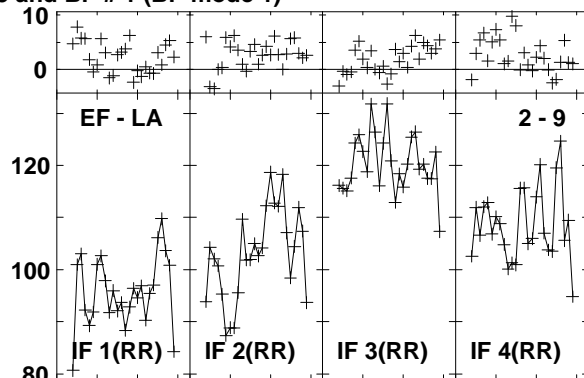
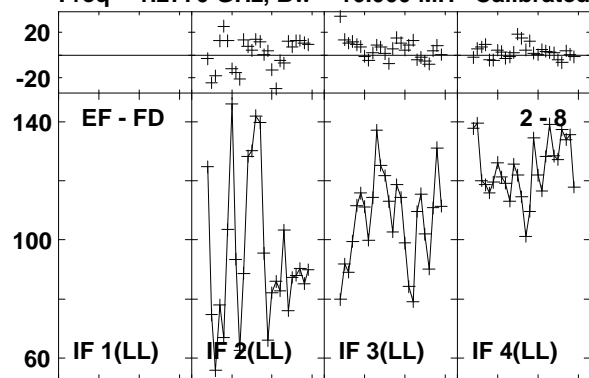

Lower frame: Milli Ampl Jy Top frame: Phas deg
Vector averaged cross-power spectrum Baseline: EF (02) - FD (08)
Timerange: 01/04:13:25 to 01/04:16:13

Plot file version1489 created 03-MAR-2016 01:16:17

J1545+5400 GN002C 1.UVDATA.1

Freq = 1.2770 GHz, Bw = 16.000 MH Calibrated with CL # 3 and BP # 1 (BP mode 1)

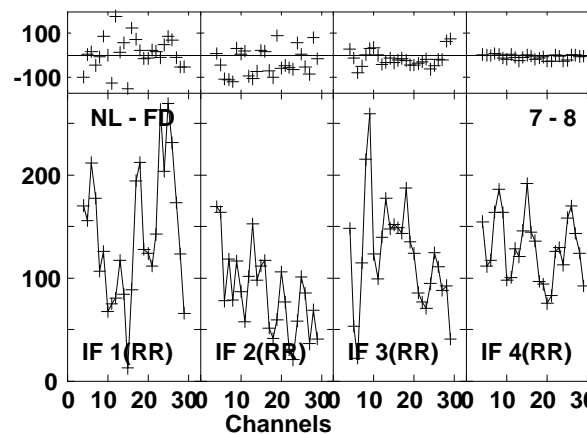
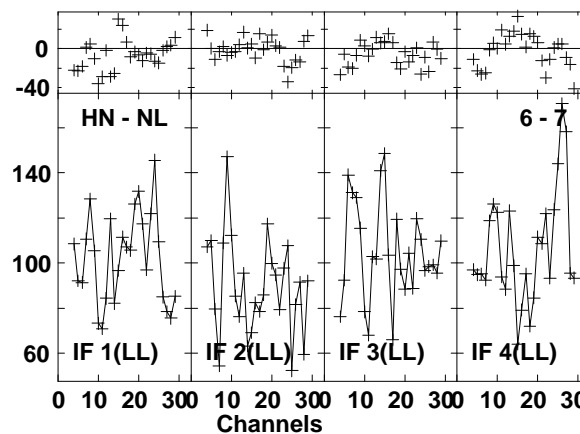
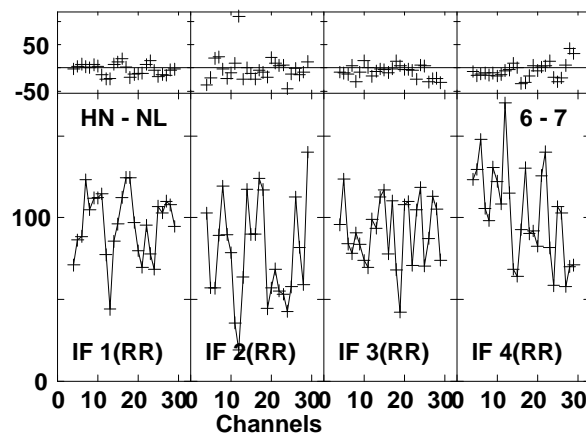
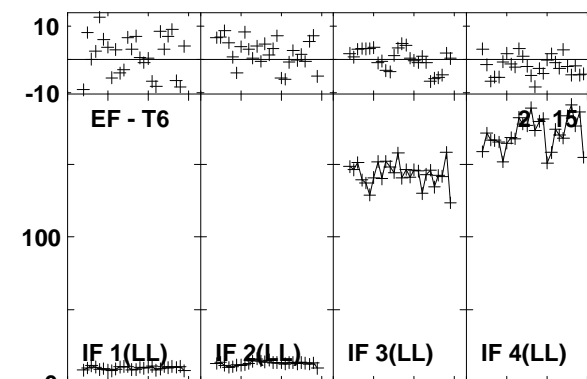
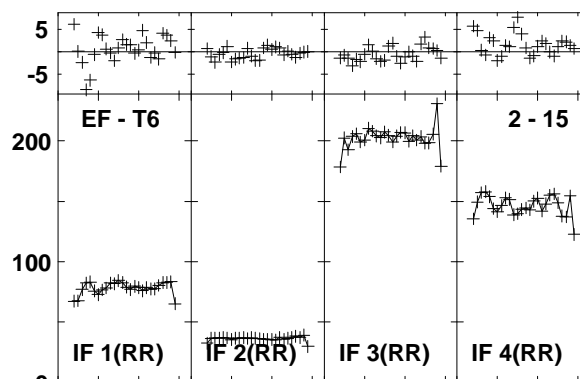
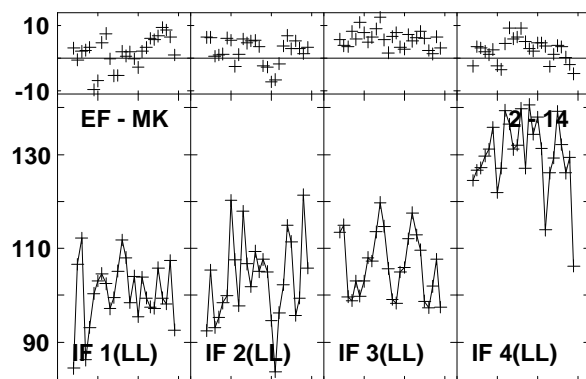
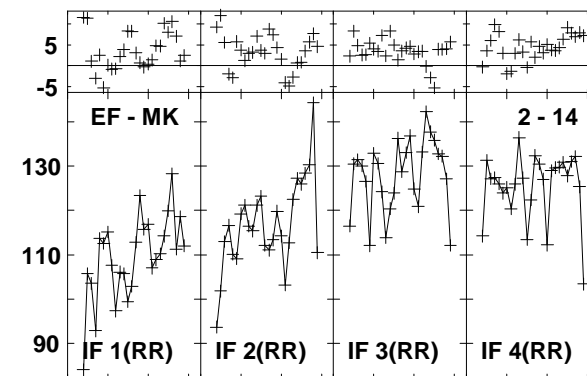
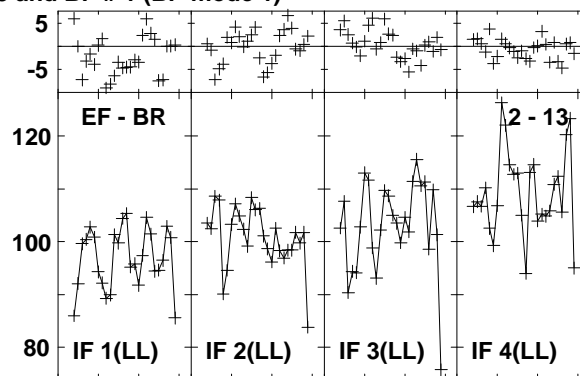
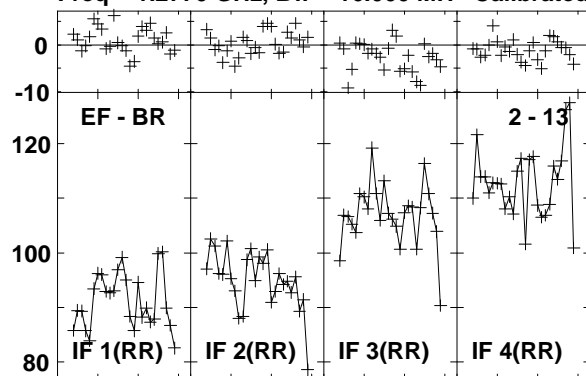

Lower frame: Milli Ampl Jy Top frame: Phas deg
Vector averaged cross-power spectrum Baseline: EF (02) - BR (13)
Timerange: 01/04:13:25 to 01/04:16:13

Plot file version1490 created 03-MAR-2016 01:16:17

J1545+5400 GN002C 1.UVDATA.1

Freq = 1.2770 GHz, Bw = 16.000 MH Calibrated with CL # 3 and BP # 1 (BP mode 1)

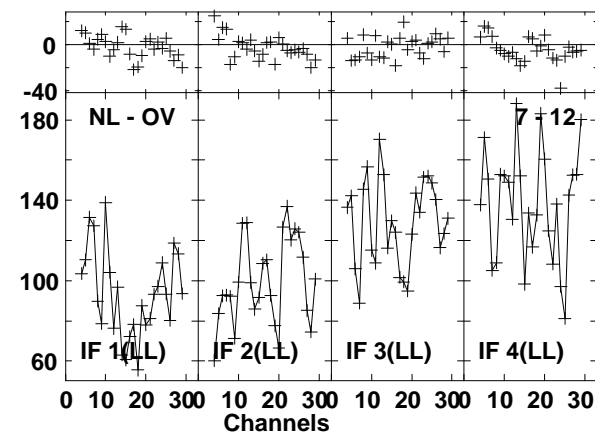
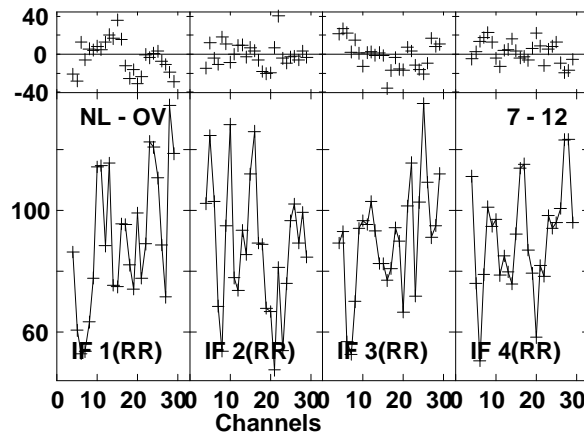
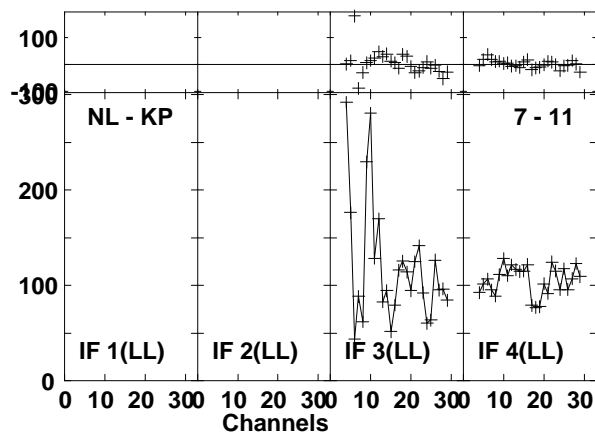
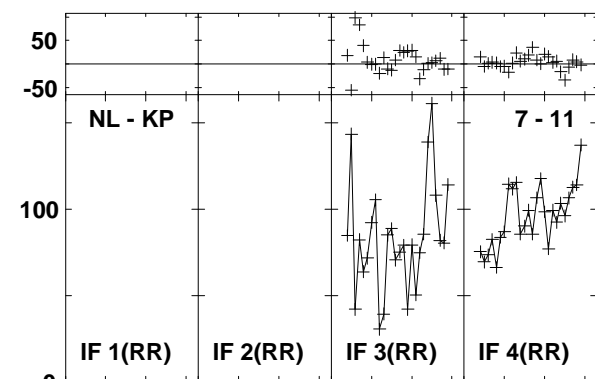
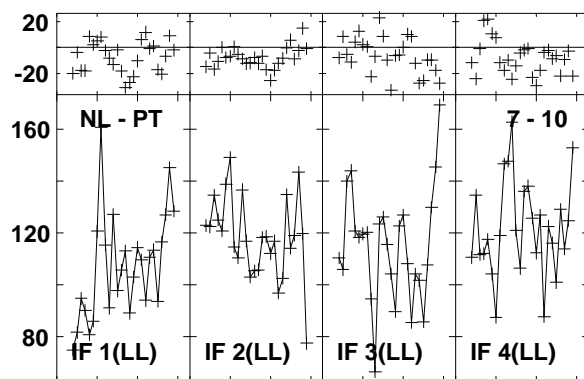
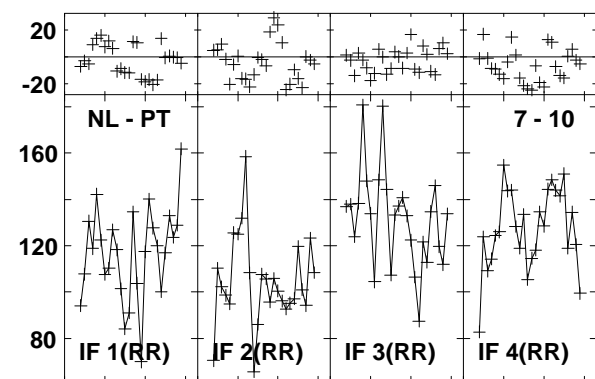
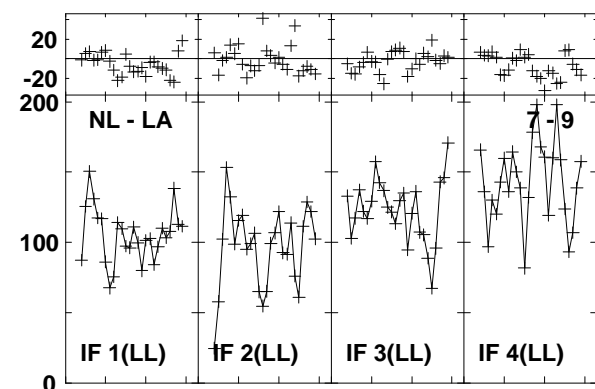
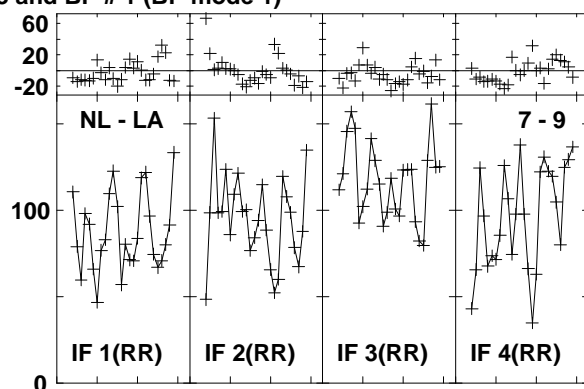
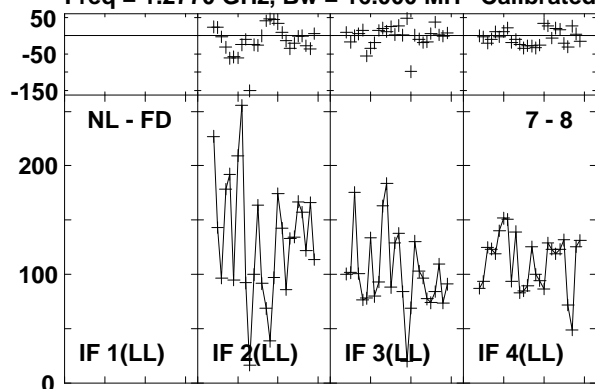

Lower frame: Milli Ampl Jy Top frame: Phas deg
Vector averaged cross-power spectrum Baseline: NL (07) - FD (08)
Timerange: 01/04:13:25 to 01/04:16:13

Plot file version1491 created 03-MAR-2016 01:16:18
 J1545+5400 GN002C 1.UVDATA.1
 Freq = 1.2770 GHz, Bw = 16.000 MH Calibrated with CL # 3 and BP # 1 (BP mode 1)

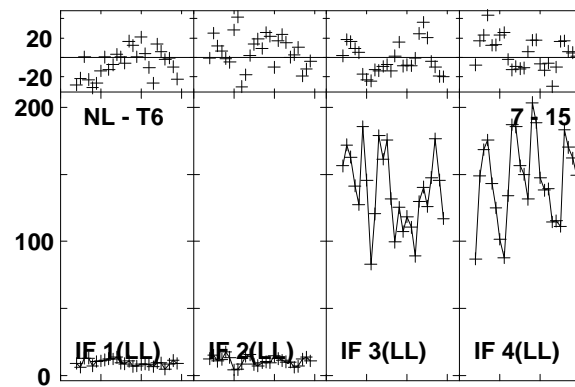
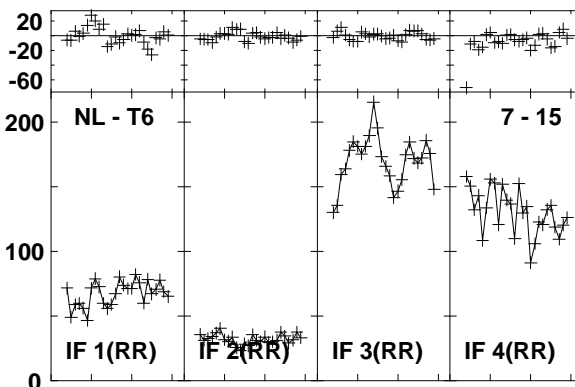
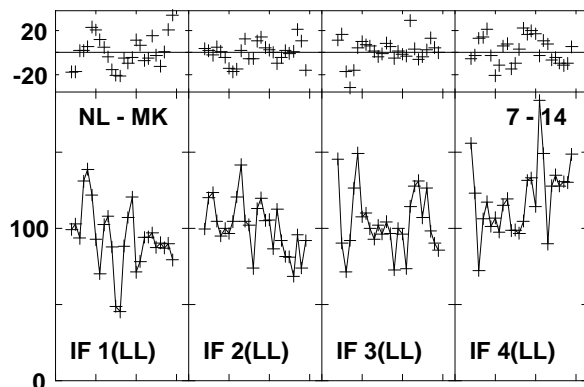
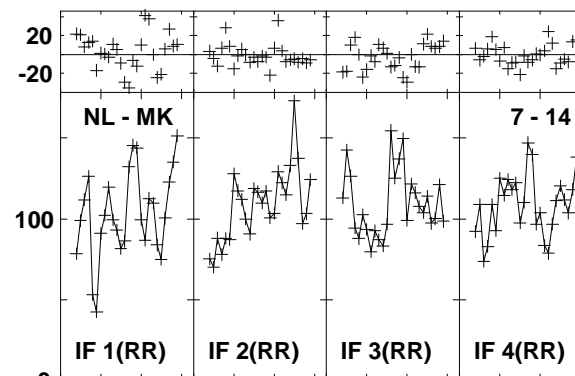
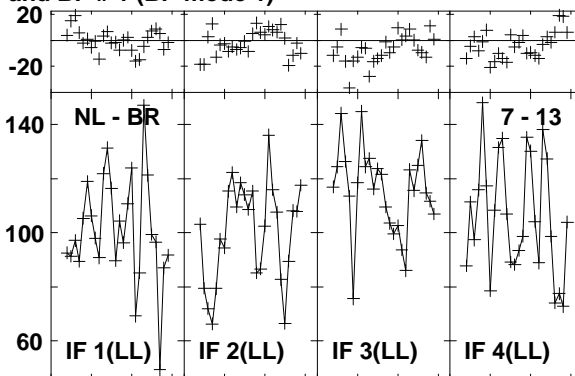
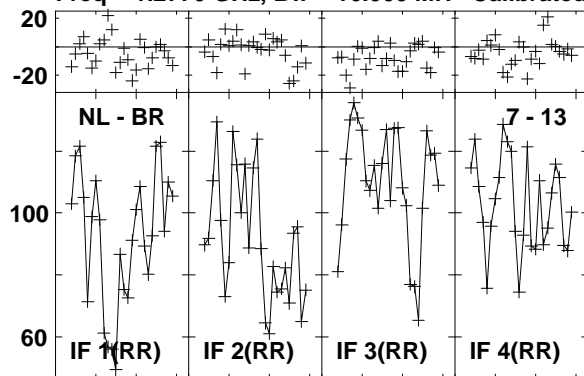

Lower frame: Milli Ampl Jy Top frame: Phas deg
 Vector averaged cross-power spectrum Baseline: NL (07) - BR (13)
 Timerange: 01/04:13:25 to 01/04:16:13

Plot file version1492 created 03-MAR-2016 01:16:18

4C52 GN002C 1.UVDATA.1

Freq = 1.2770 GHz, Bw = 16.000 MH Calibrated with CL # 3 and BP # 1 (BP mode 1)

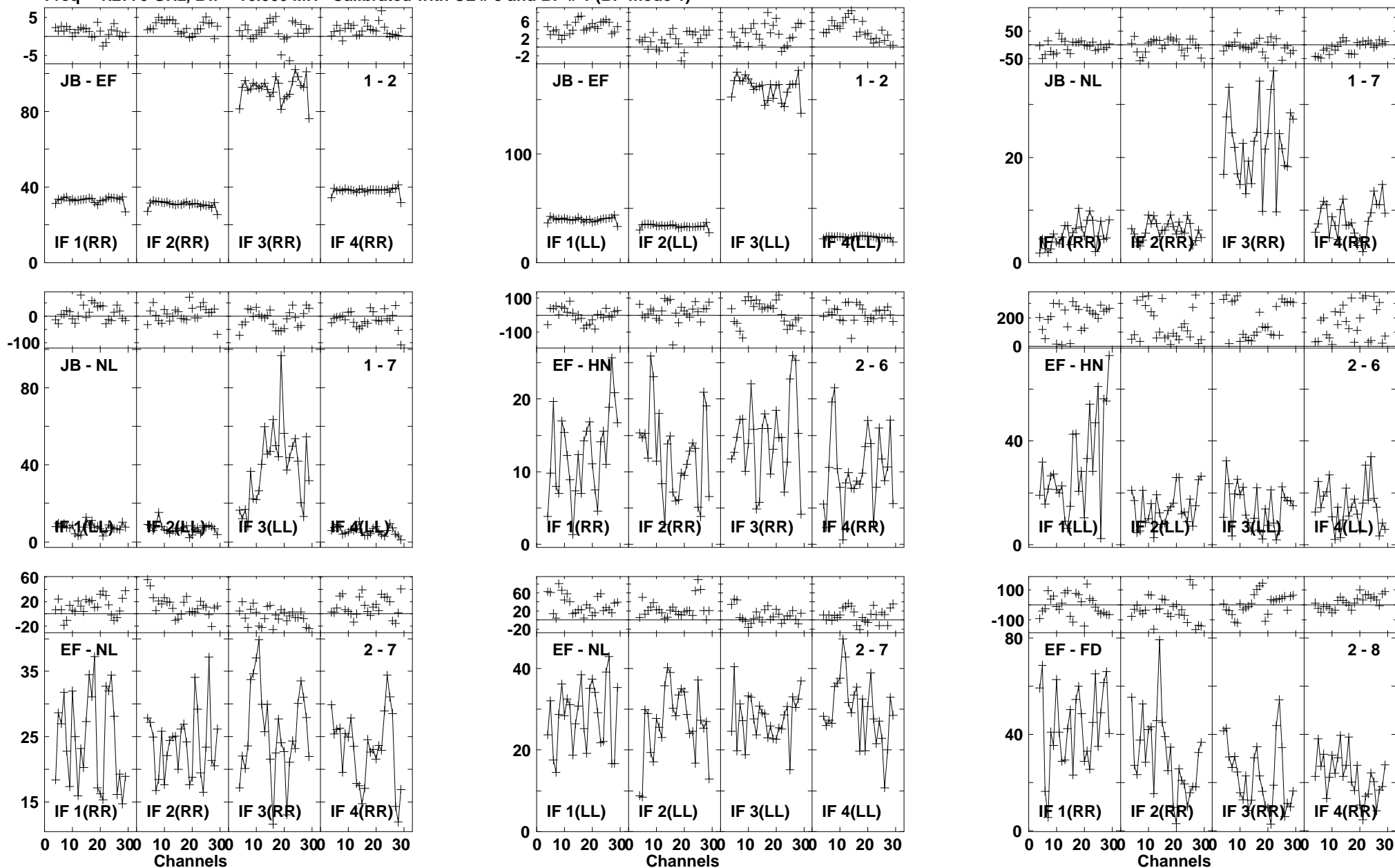

Plot file version1493 created 03-MAR-2016 01:16:18

4C52 GN002C 1.UVDATA.1

Freq = 1.2770 GHz, Bw = 16.000 MH Calibrated with CL # 3 and BP # 1 (BP mode 1)

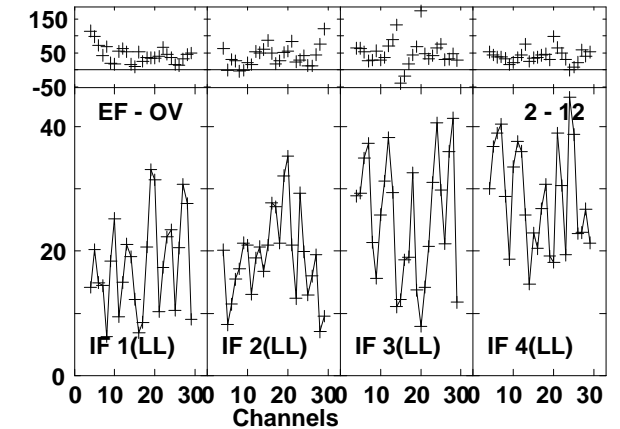
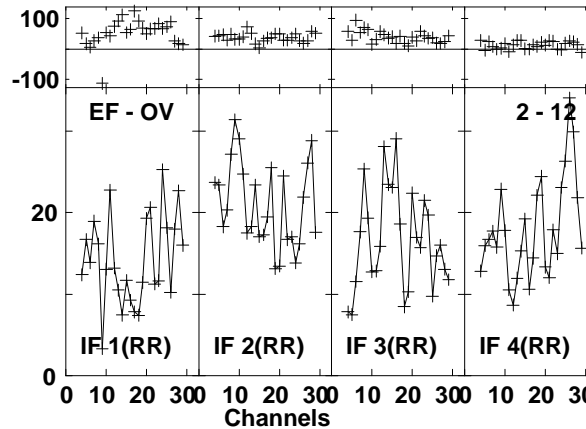
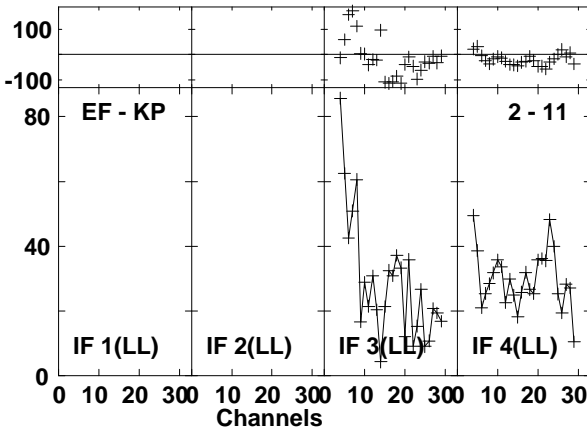
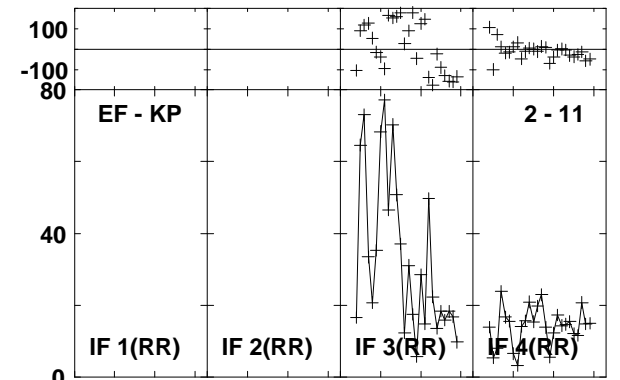
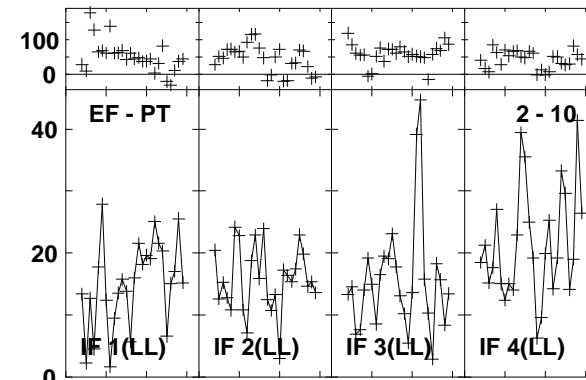
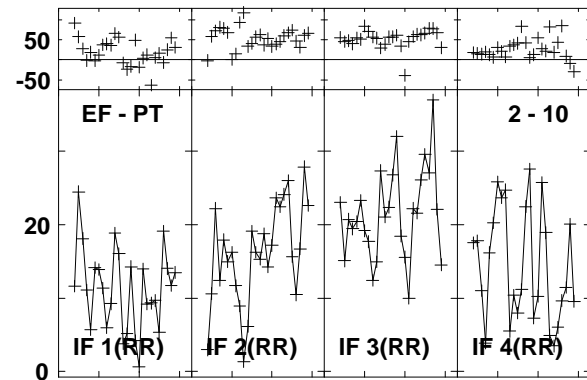
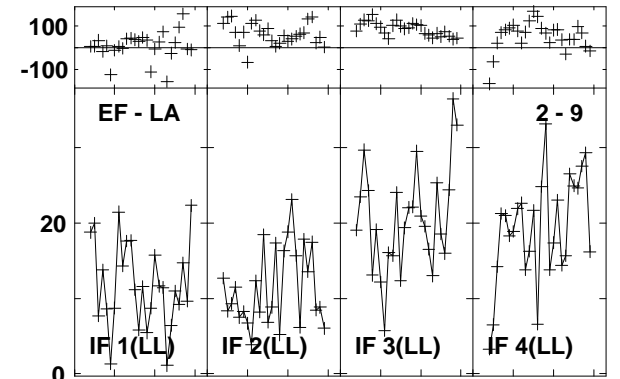
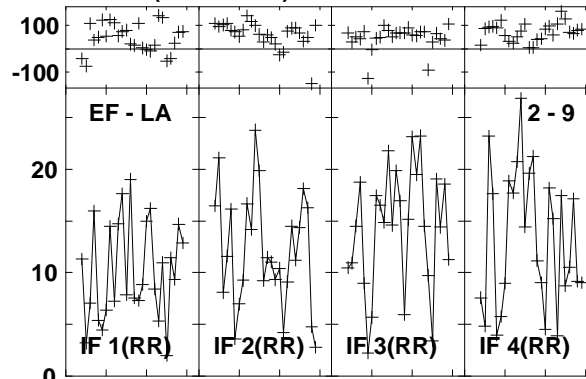
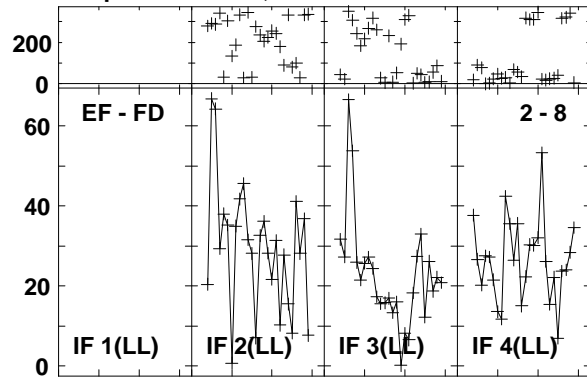

Lower frame: Milli Ampl Jy Top frame: Phas deg
Vector averaged cross-power spectrum Baseline: EF (02) - FD (08)
Timerange: 01/04:16:25 to 01/04:19:43

Plot file version1494 created 03-MAR-2016 01:16:18

4C52 GN002C 1.UVDATA.1

Freq = 1.2770 GHz, Bw = 16.000 MH Calibrated with CL # 3 and BP # 1 (BP mode 1)

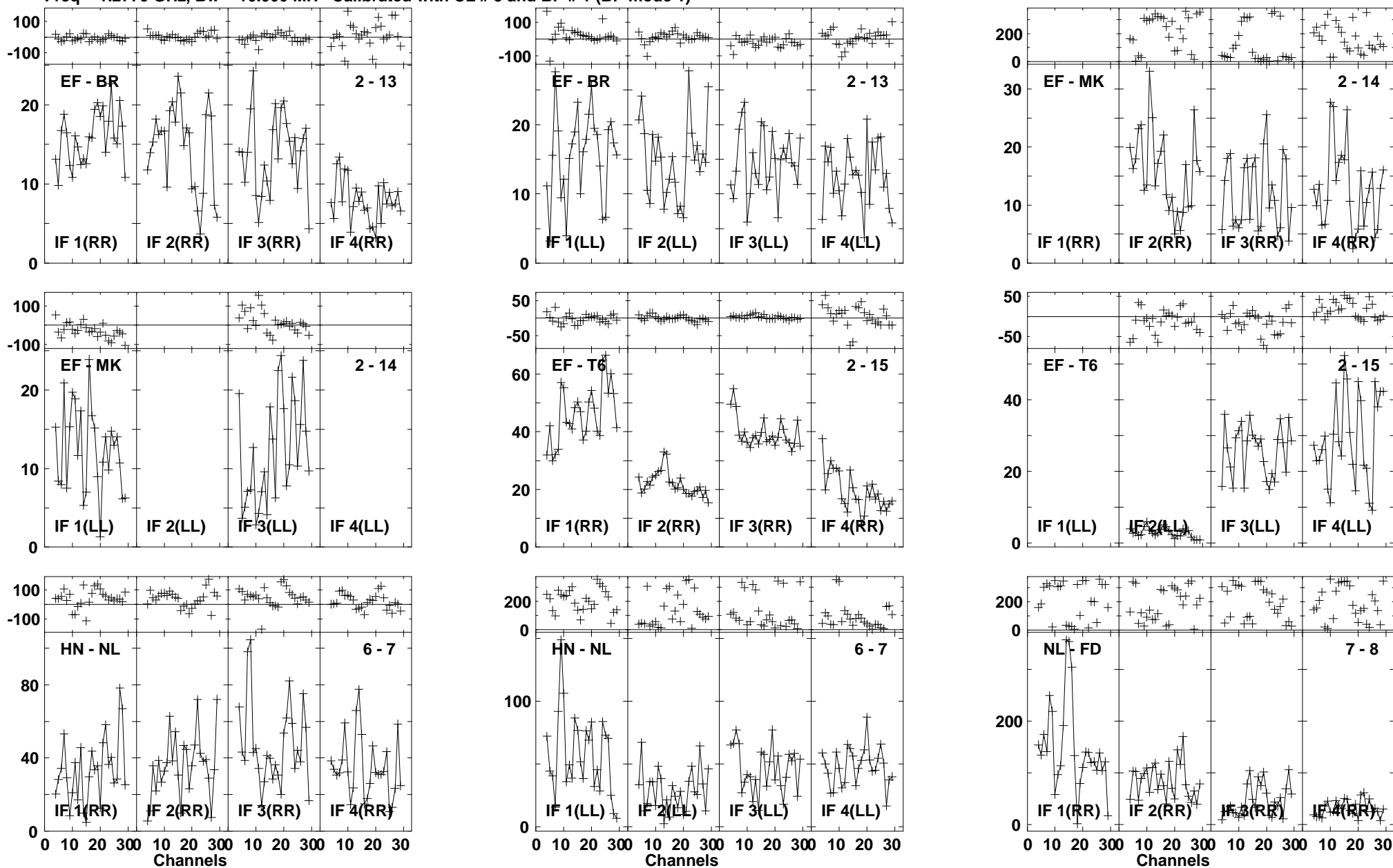

Lower frame: Milli Ampl Jy Top frame: Phas deg
Vector averaged cross-power spectrum Baseline: EF (02) - BR (13)
Timerange: 01/04:16:25 to 01/04:19:43

Plot file version1495 created 03-MAR-2016 01:16:18

4C52 GN002C 1.UVDATA.1

Freq = 1.2770 GHz, Bw = 16.000 MH Calibrated with CL # 3 and BP # 1 (BP mode 1)

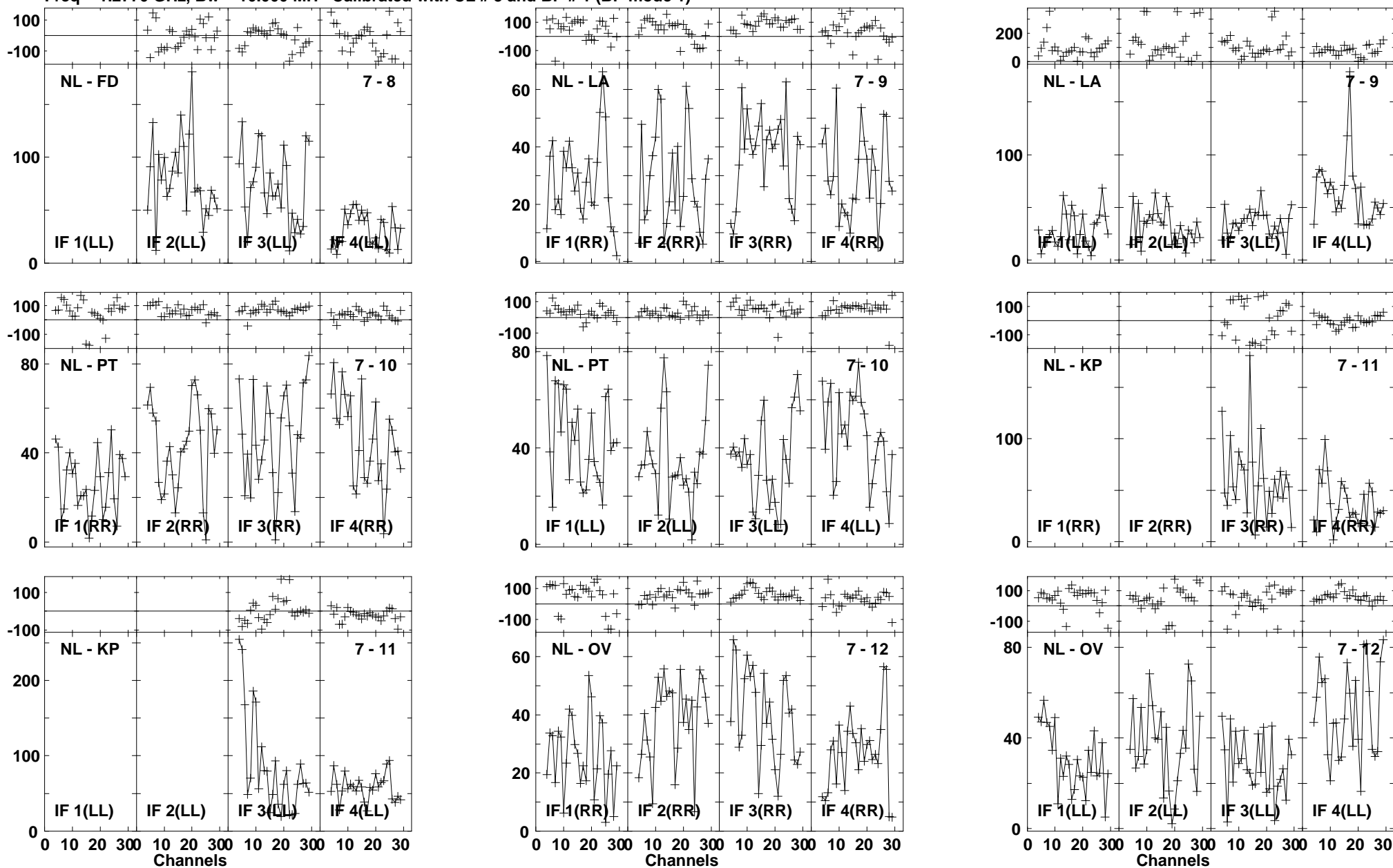

Lower frame: Milli Ampl Jy Top frame: Phas deg
Vector averaged cross-power spectrum Baseline: NL (07) - FD (08)
Timerange: 01/04:16:25 to 01/04:19:43

Plot file version1496 created 03-MAR-2016 01:16:19

4C52 GN002C 1.UVDATA.1

Freq = 1.2770 GHz, Bw = 16.000 MH Calibrated with CL # 3 and BP # 1 (BP mode 1)

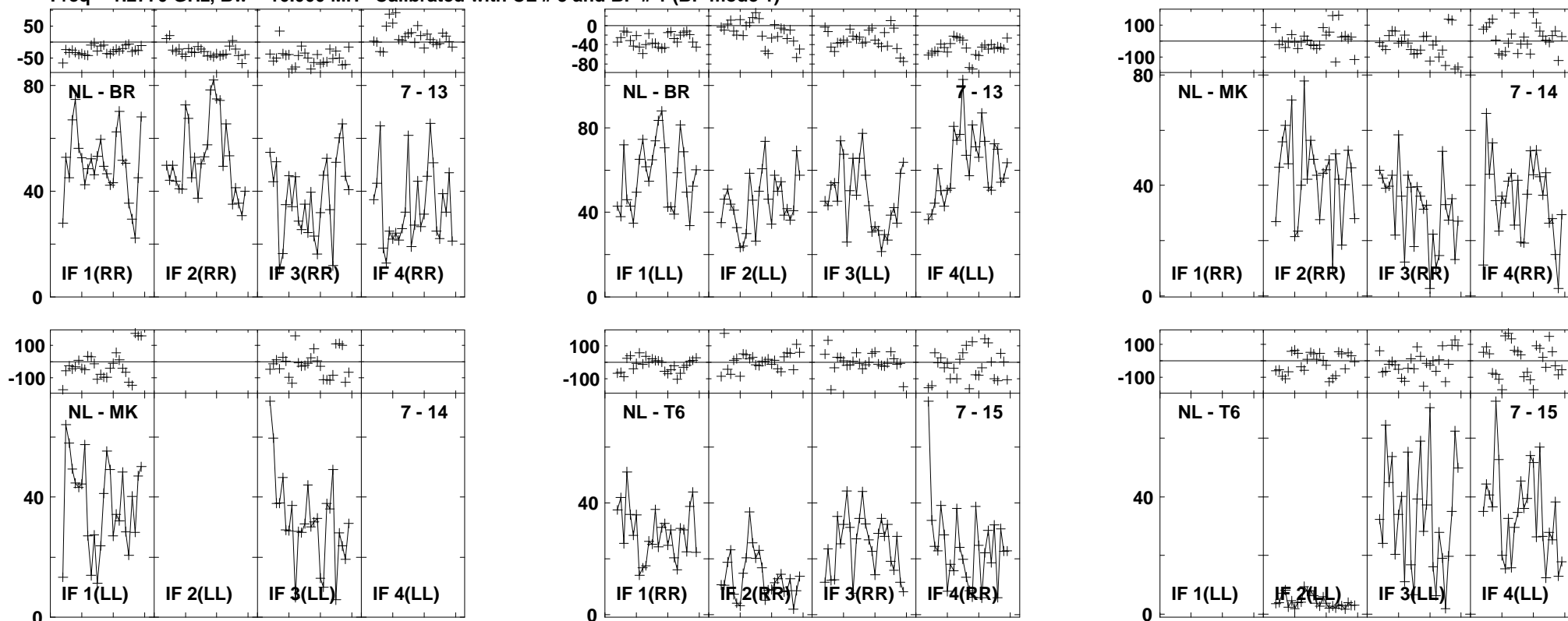

Lower frame: Milli Ampl Jy Top frame: Phas deg
Vector averaged cross-power spectrum Baseline: NL (07) - BR (13)
Timerange: 01/04:16:25 to 01/04:19:43

Plot file version1497 created 03-MAR-2016 01:16:19

J1545+5400 GN002C 1.UVDATA.1

Freq = 1.2770 GHz, Bw = 16.000 MH Calibrated with CL # 3 and BP # 1 (BP mode 1)

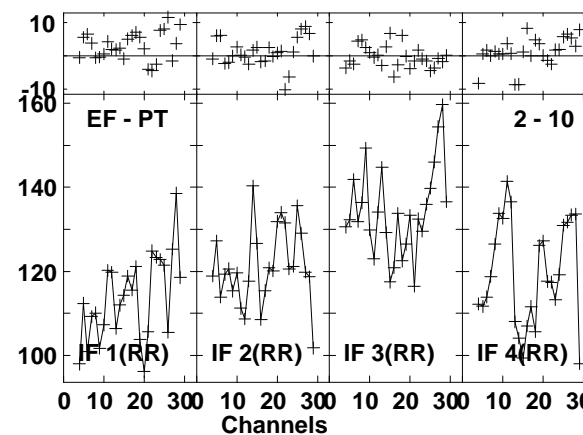
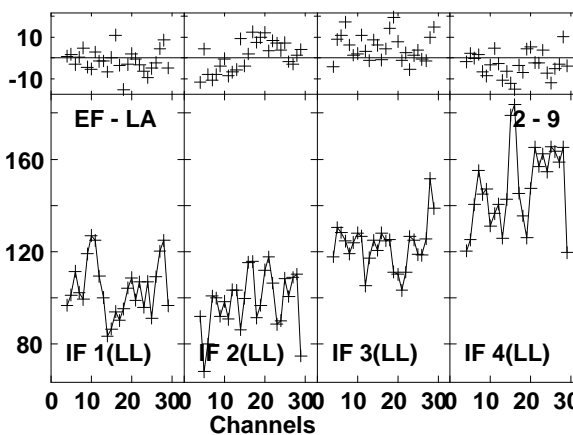
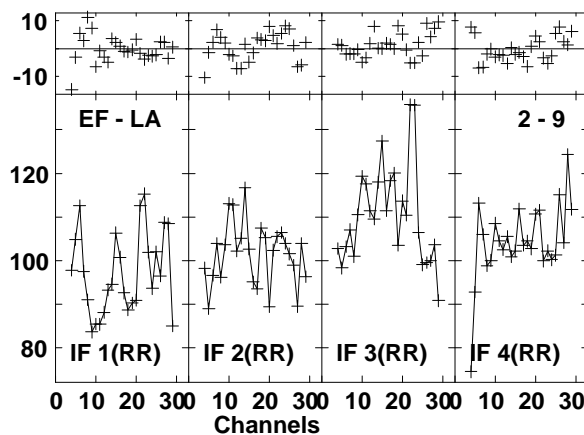
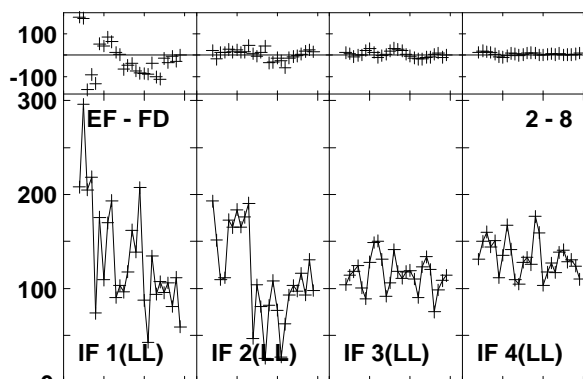
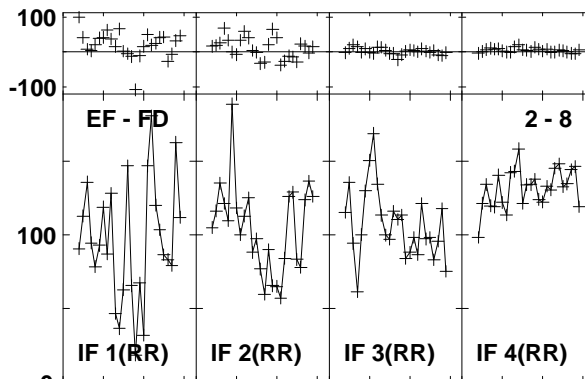
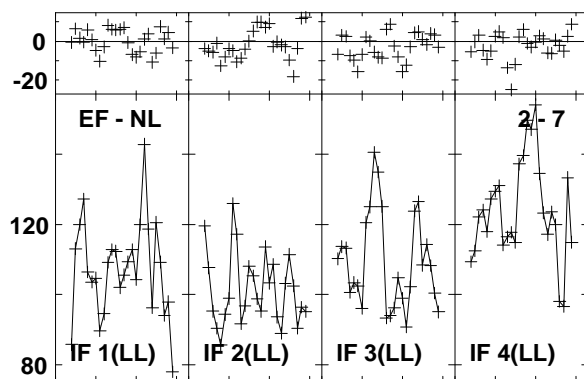
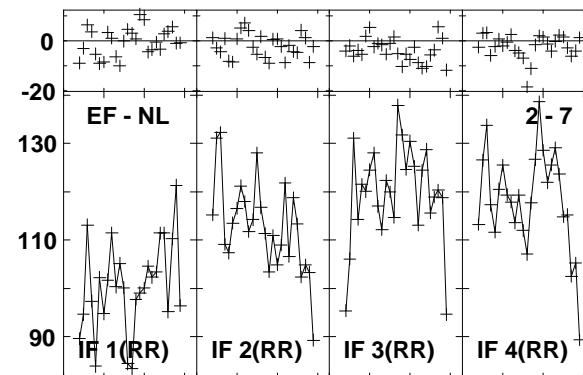
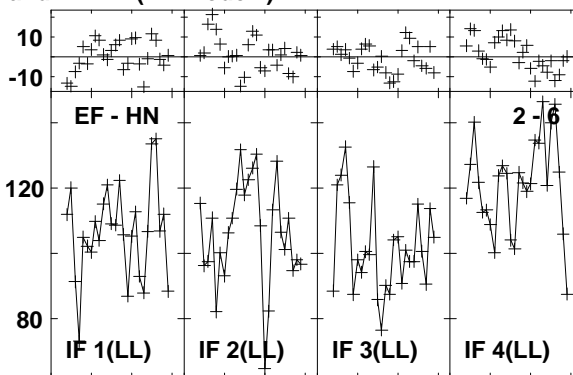
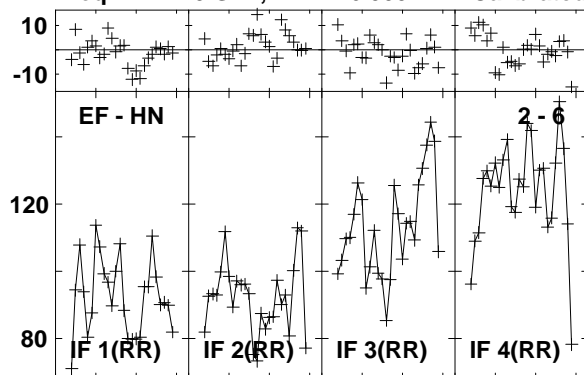

Lower frame: Milli Ampl Jy Top frame: Phas deg
Vector averaged cross-power spectrum Baseline: EF (02) - HN (06)
Timerange: 01/04:20:35 to 01/04:21:53

Plot file version1498 created 03-MAR-2016 01:16:19
 J1545+5400 GN002C 1.UVDATA.1
 Freq = 1.2770 GHz, Bw = 16.000 MH Calibrated with CL # 3 and BP # 1 (BP mode 1)

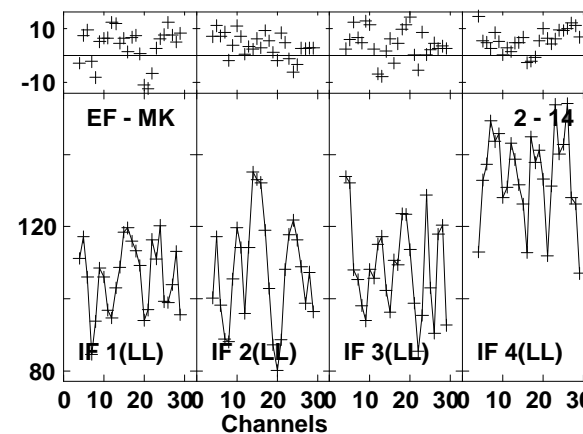
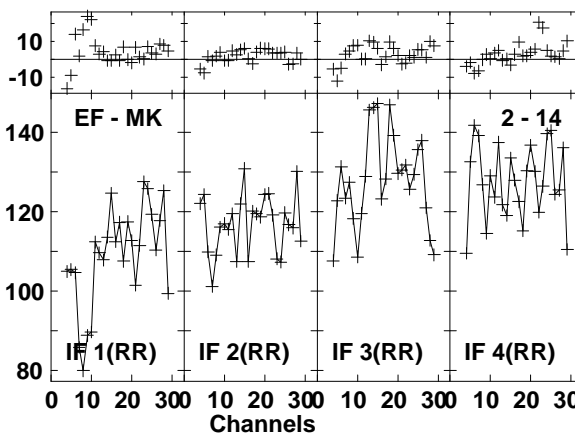
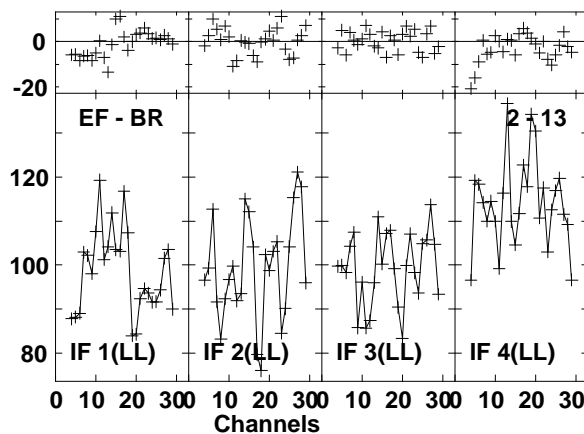
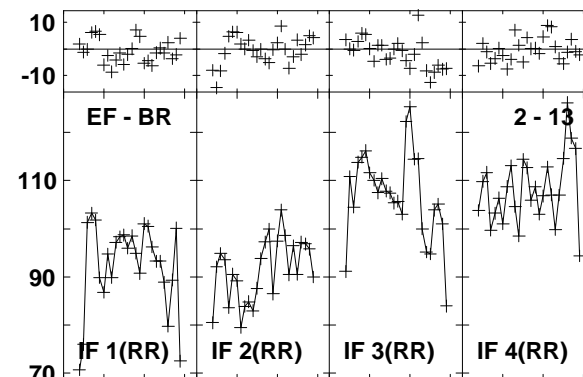
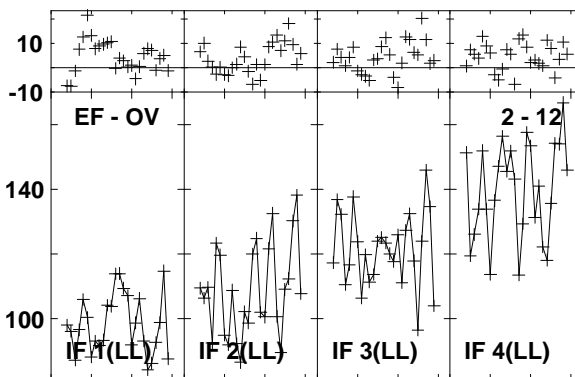
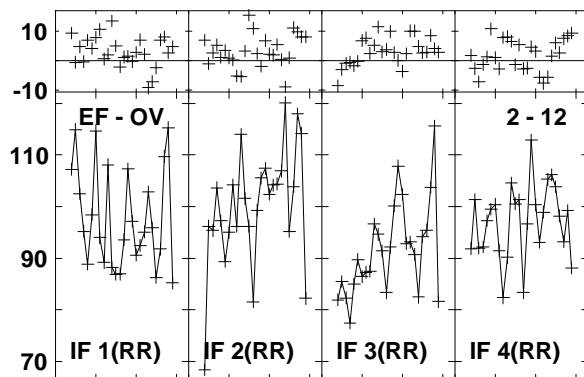
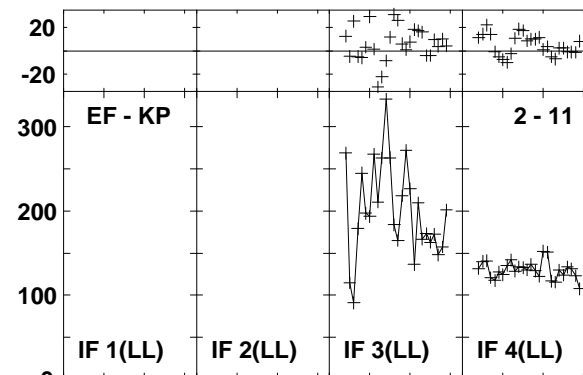
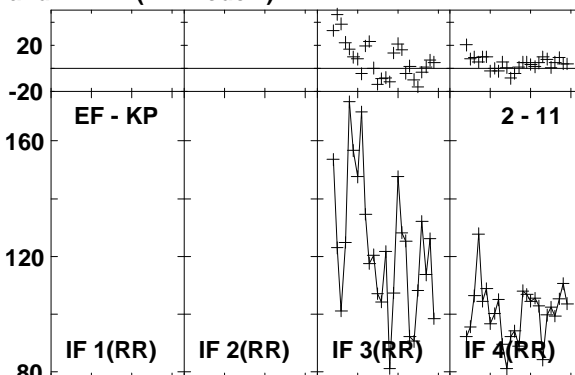
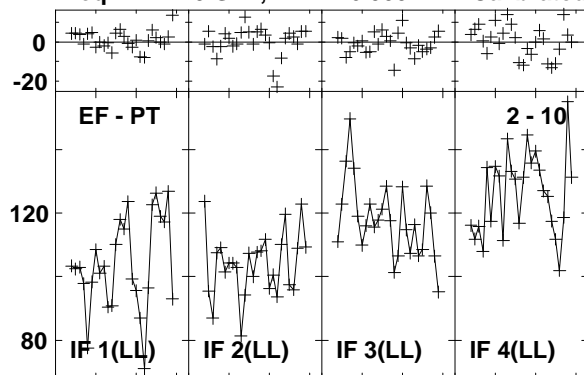

Lower frame: Milli Ampl Jy Top frame: Phas deg
 Vector averaged cross-power spectrum Baseline: EF (02) - PT (10)
 Timerange: 01/04:20:35 to 01/04:21:53

Plot file version1499 created 03-MAR-2016 01:16:19

J1545+5400 GN002C 1.UVDATA.1

Freq = 1.2770 GHz, Bw = 16.000 MH Calibrated with CL # 3 and BP # 1 (BP mode 1)

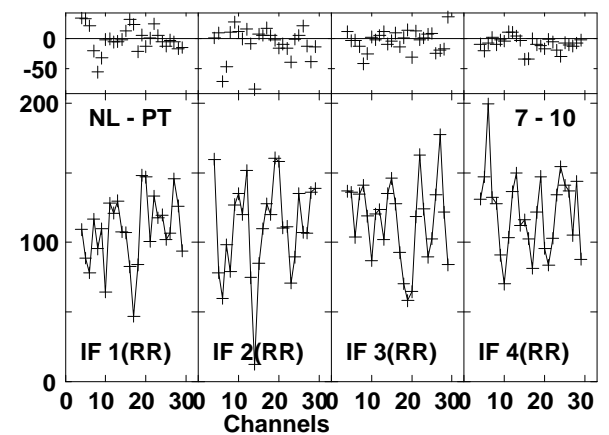
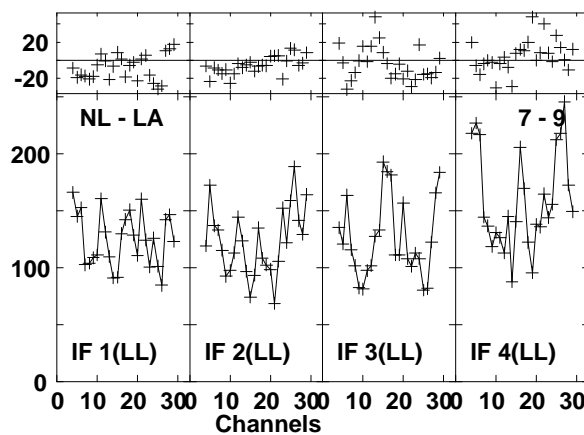
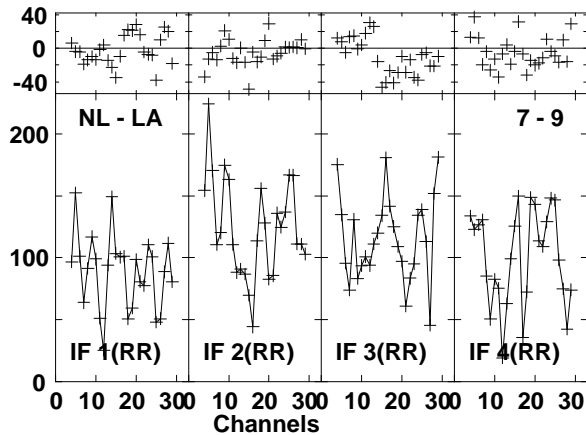
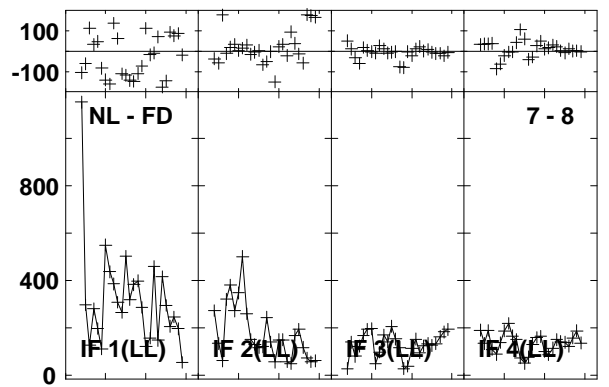
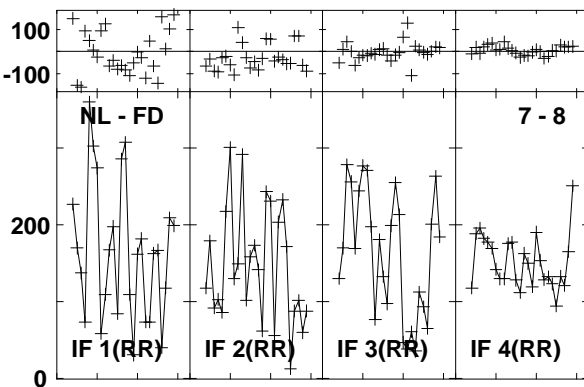
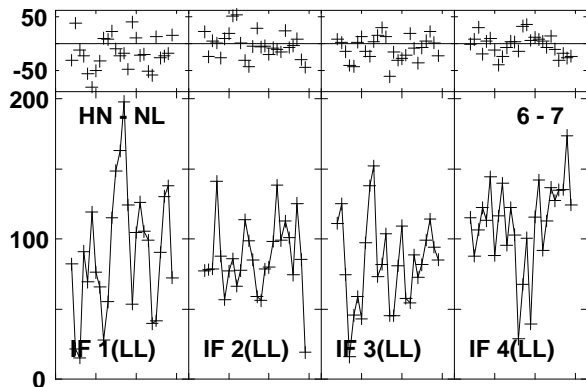
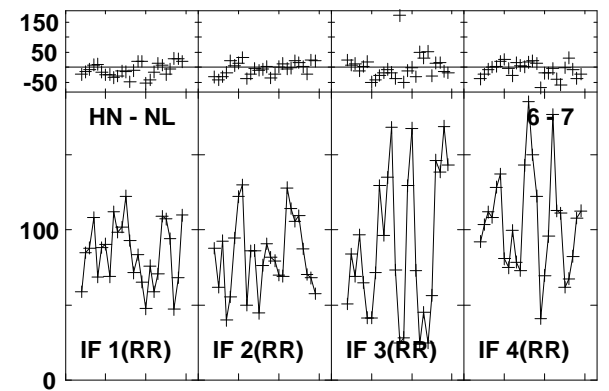
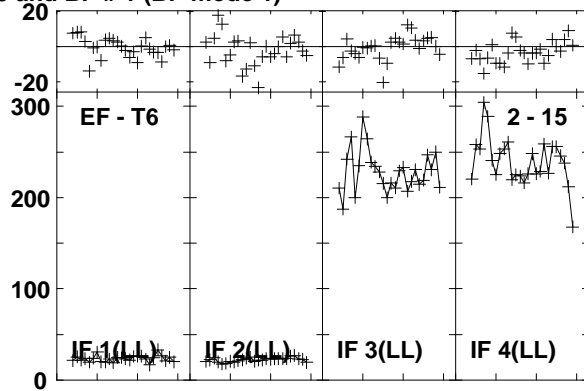
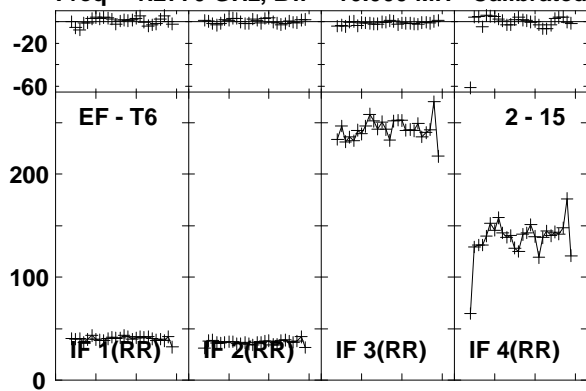

Lower frame: Milli Ampl Jy Top frame: Phas deg
Vector averaged cross-power spectrum Baseline: EF (02) - T6 (15)
Timerange: 01/04:20:35 to 01/04:21:53

Plot file version1500 created 03-MAR-2016 01:16:19

J1545+5400 GN002C 1.UVDATA.1

Freq = 1.2770 GHz, Bw = 16.000 MH Calibrated with CL # 3 and BP # 1 (BP mode 1)

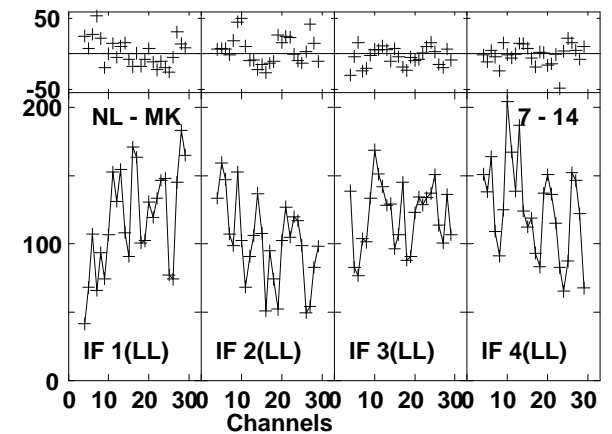
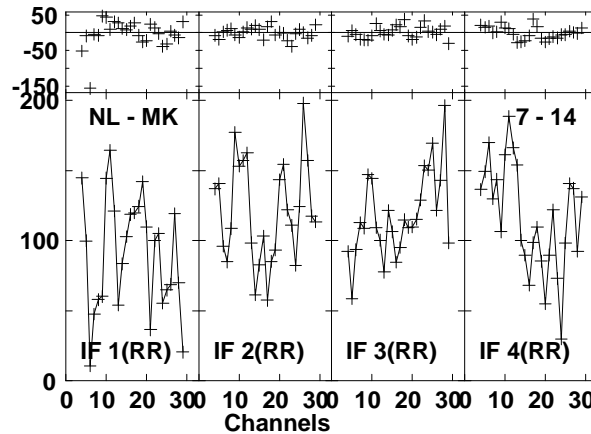
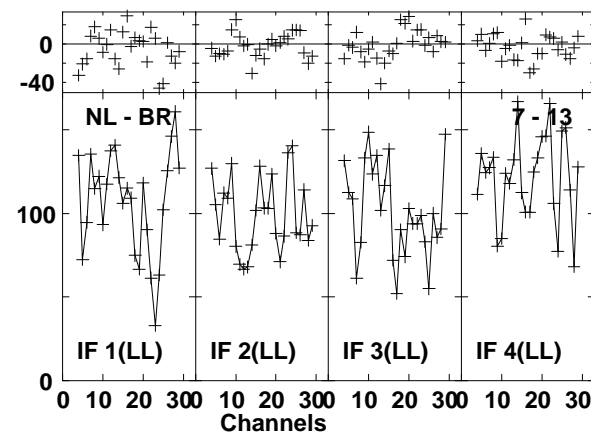
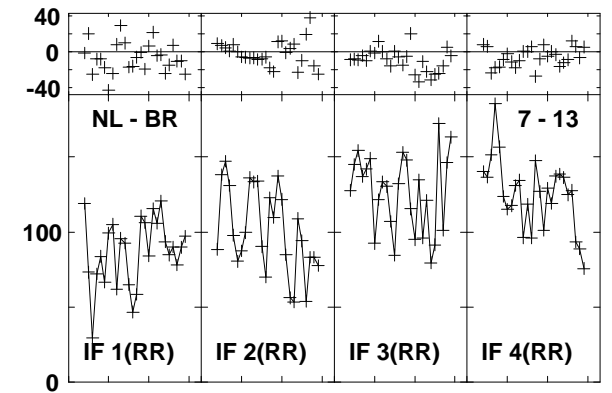
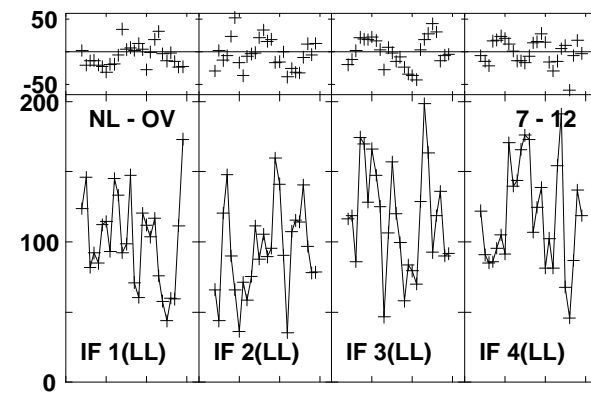
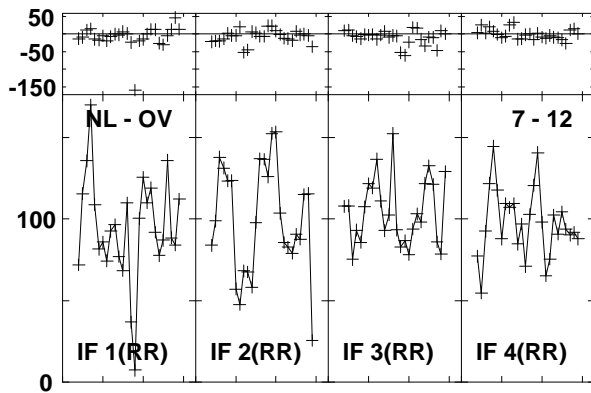
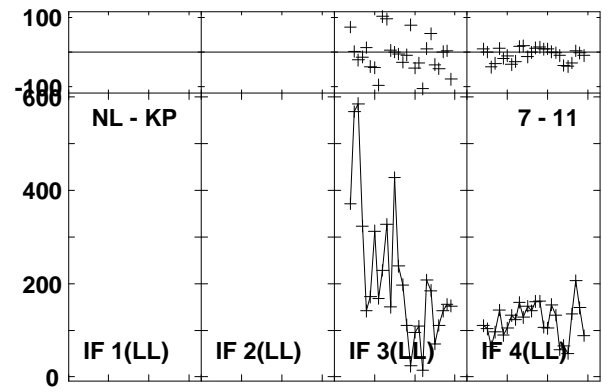
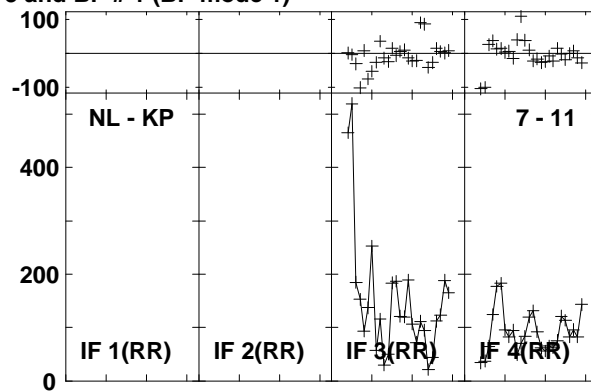
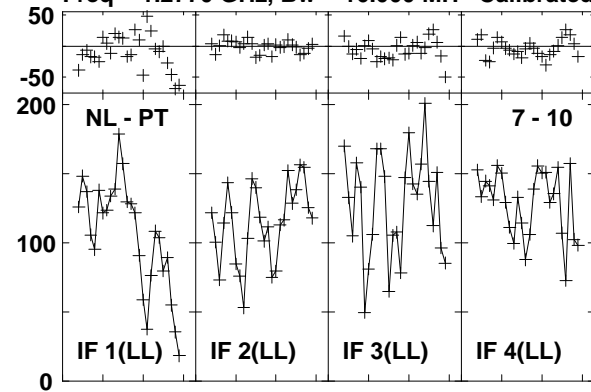

Lower frame: Milli Ampl Jy Top frame: Phas deg
Vector averaged cross-power spectrum Baseline: NL (07) - PT (10)
Timerange: 01/04:20:35 to 01/04:21:53

Plot file version1501 created 03-MAR-2016 01:16:19

J1545+5400 GN002C 1.UVDATA.1

Freq = 1.2770 GHz, Bw = 16.000 MH Calibrated with CL # 3 and BP # 1 (BP mode 1)

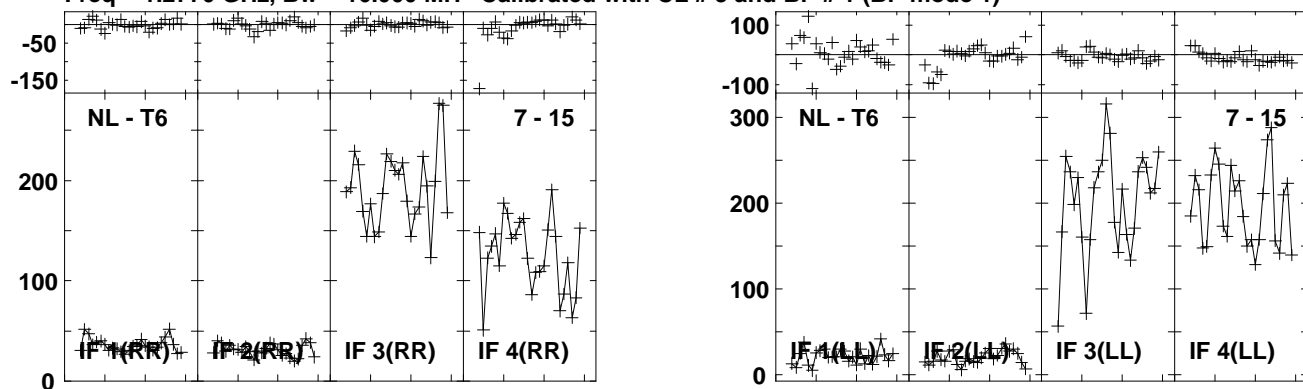

Lower frame: Milli Ampl Jy Top frame: Phas deg
Vector averaged cross-power spectrum Baseline: NL (07) - T6 (15)
Timerange: 01/04:20:35 to 01/04:21:53

Plot file version1502 created 03-MAR-2016 01:16:20

4C52 GN002C 1.UVDATA.1

Freq = 1.2770 GHz, Bw = 16.000 MH Calibrated with CL # 3 and BP # 1 (BP mode 1)

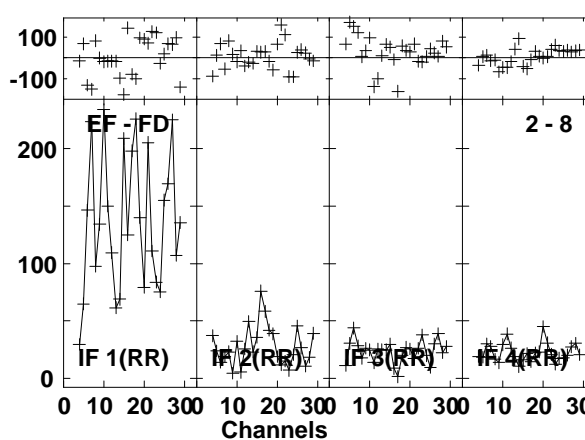
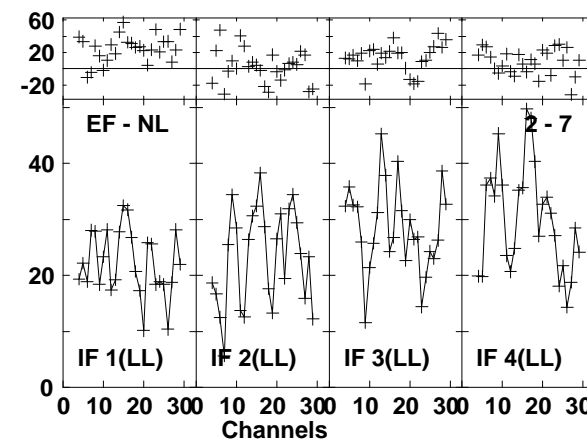
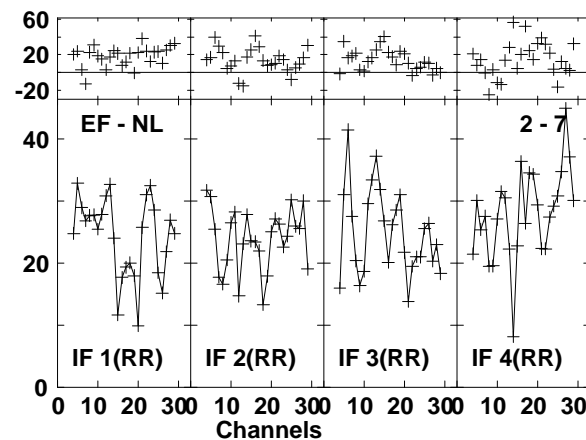
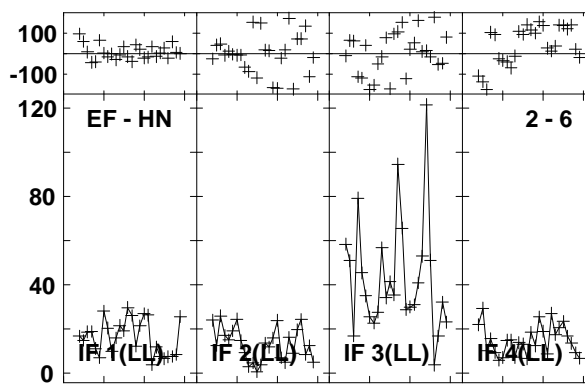
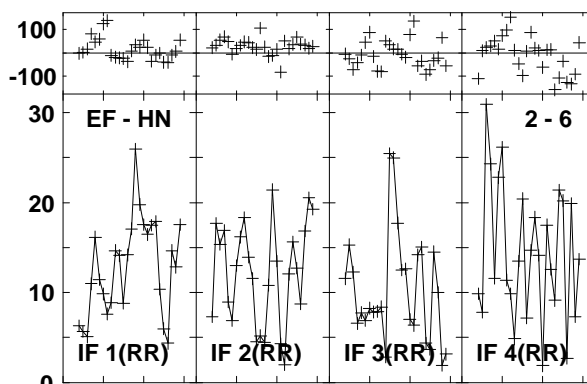
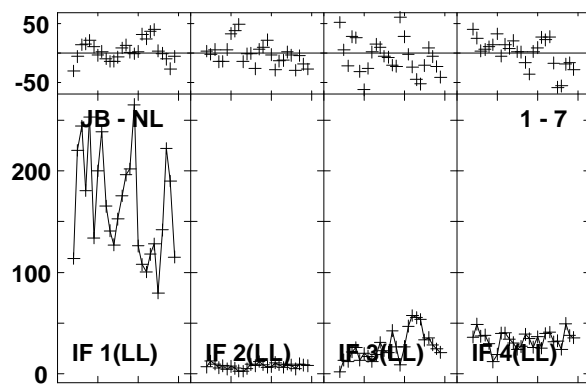
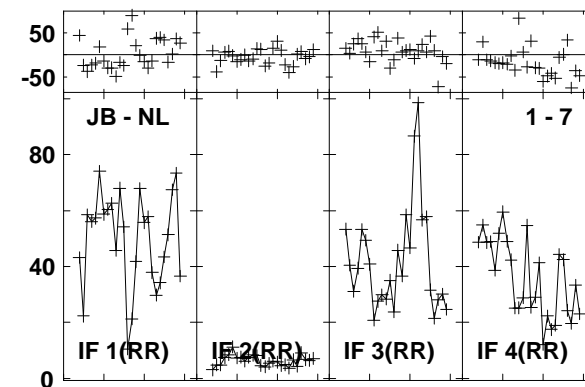
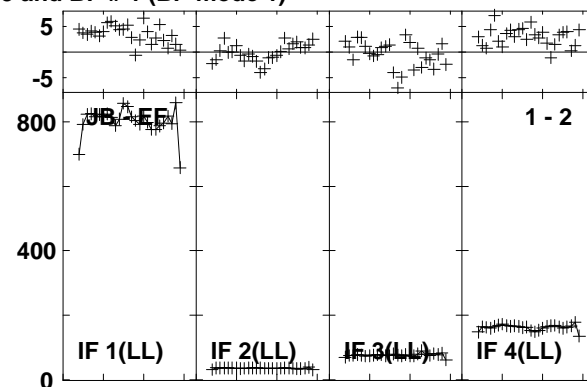
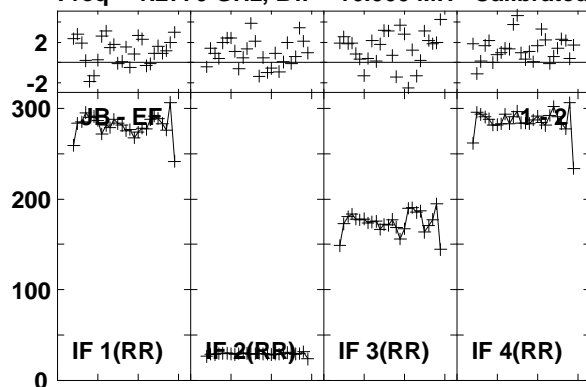

Lower frame: Milli Ampl Jy Top frame: Phas deg
Vector averaged cross-power spectrum Baseline: JB (01) - EF (02)
Timerange: 01/04:21:58 to 01/04:25:22

Plot file version1503 created 03-MAR-2016 01:16:20

4C52 GN002C 1.UVDATA.1

Freq = 1.2770 GHz, Bw = 16.000 MH Calibrated with CL # 3 and BP # 1 (BP mode 1)

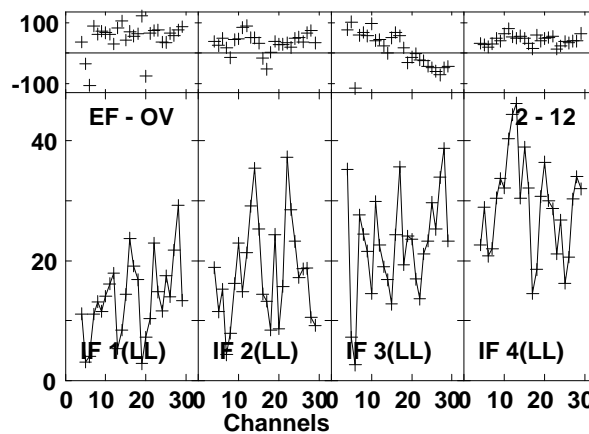
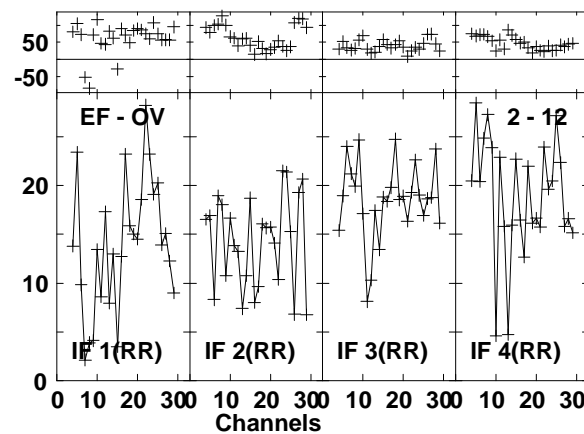
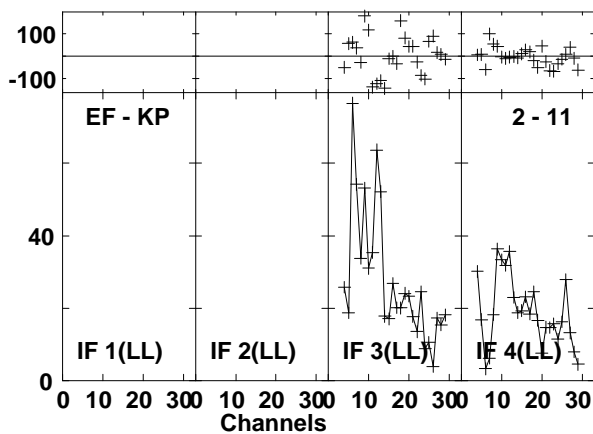
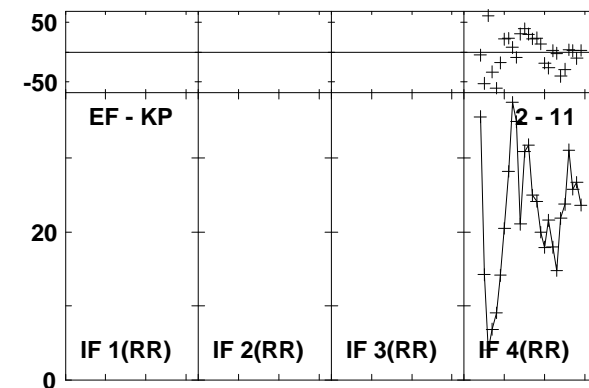
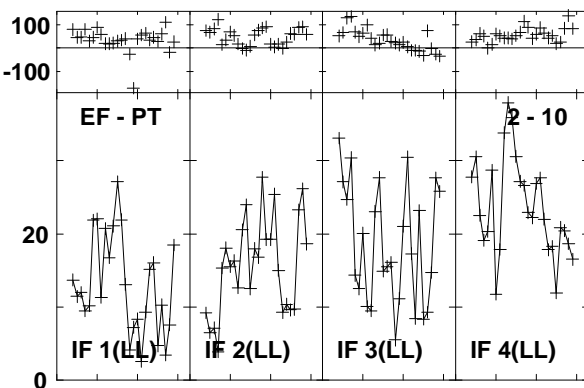
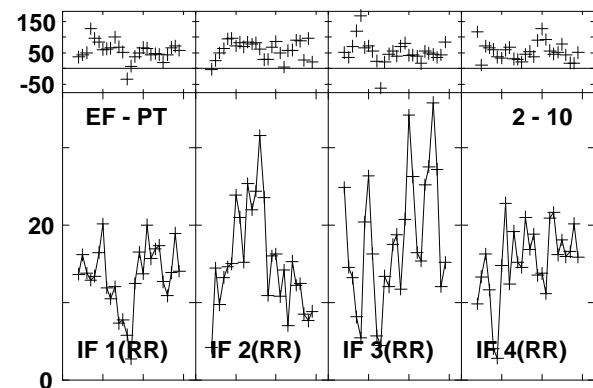
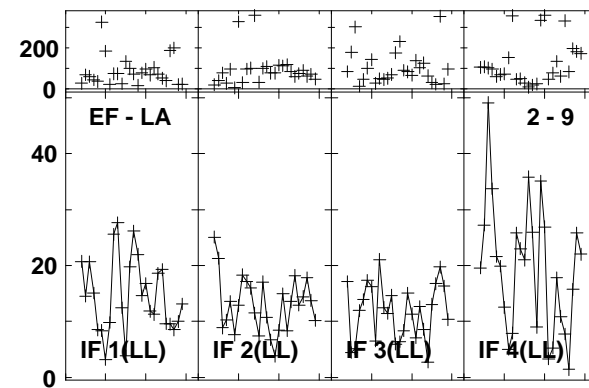
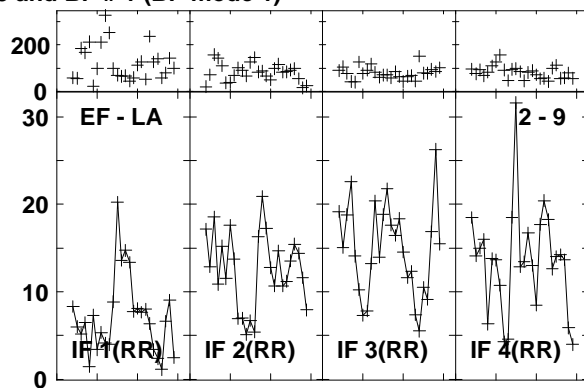
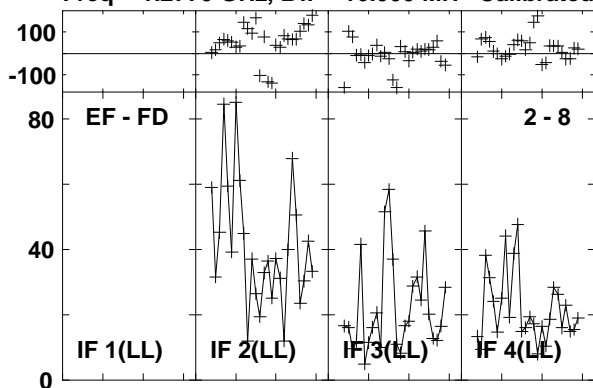

Lower frame: Milli Ampl Jy Top frame: Phas deg
Vector averaged cross-power spectrum Baseline: EF (02) - FD (08)
Timerange: 01/04:21:58 to 01/04:25:22

Plot file version1504 created 03-MAR-2016 01:16:20

4C52 GN002C 1.UVDATA.1

Freq = 1.2770 GHz, Bw = 16.000 MH Calibrated with CL # 3 and BP # 1 (BP mode 1)

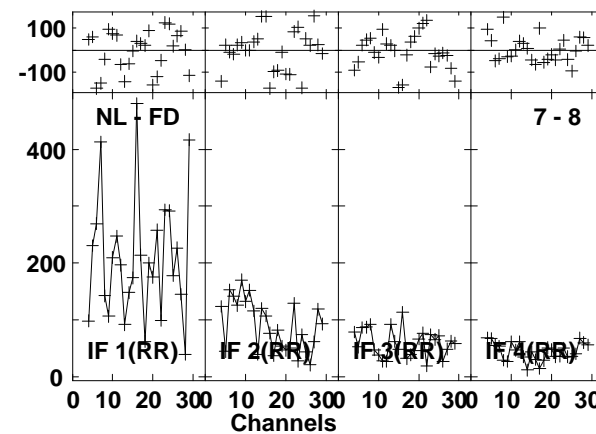
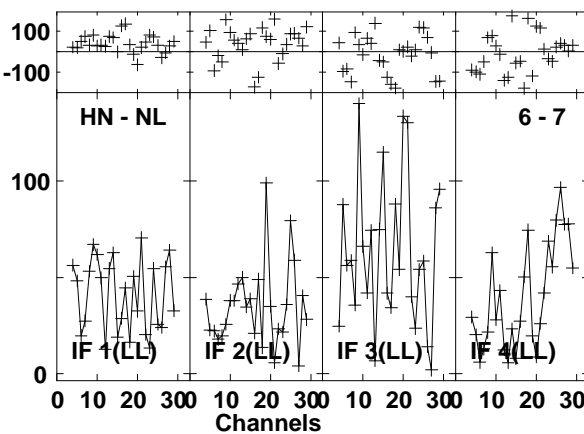
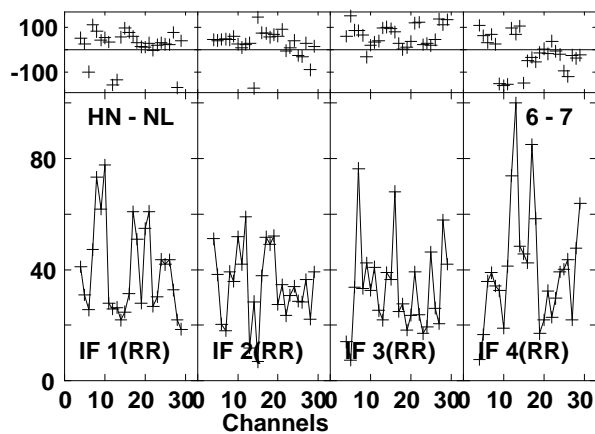
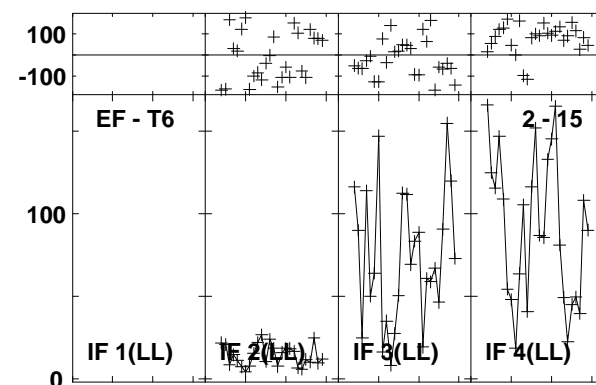
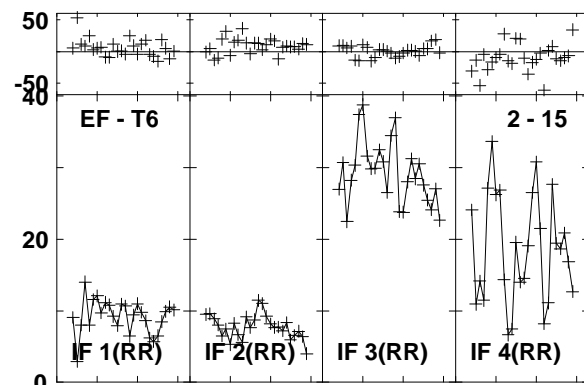
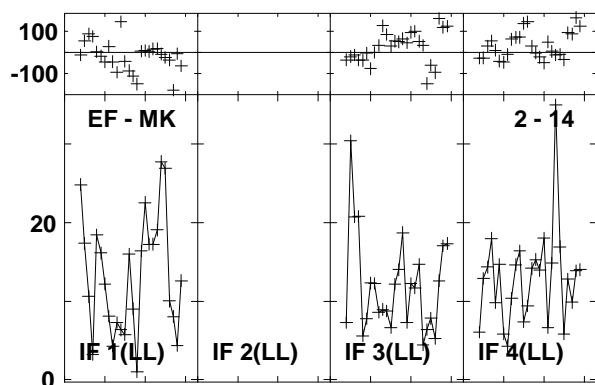
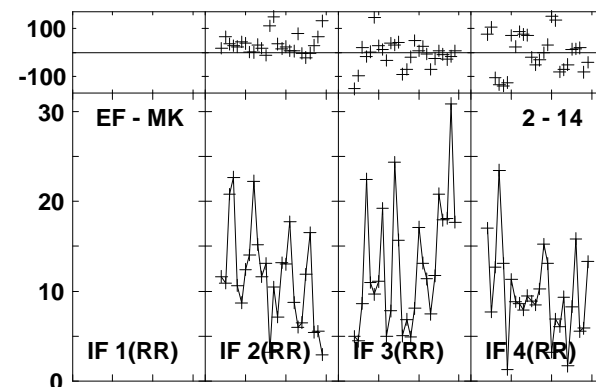
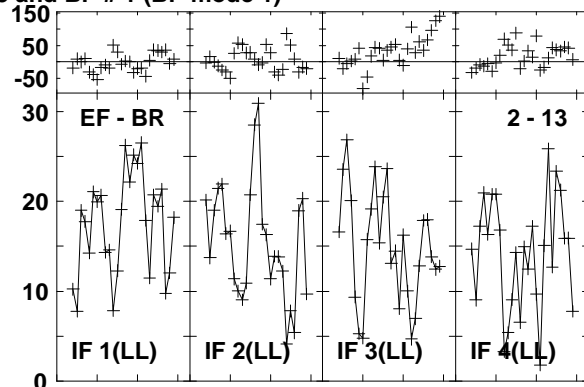
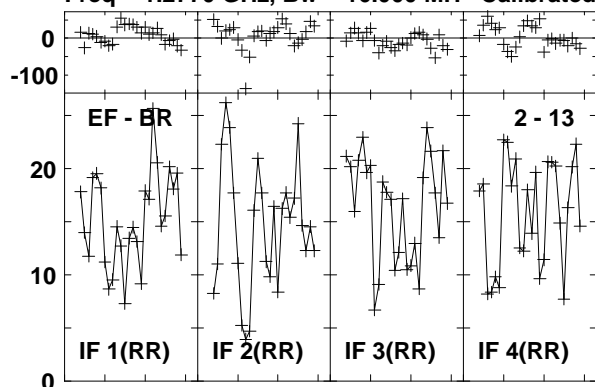

Lower frame: Milli Ampl Jy Top frame: Phas deg
Vector averaged cross-power spectrum Baseline: EF (02) - BR (13)
Timerange: 01/04:21:58 to 01/04:25:22

Plot file version1505 created 03-MAR-2016 01:16:20
 4C52 GN002C 1.UVDATA.1
 Freq = 1.2770 GHz, Bw = 16.000 MH Calibrated with CL # 3 and BP # 1 (BP mode 1)

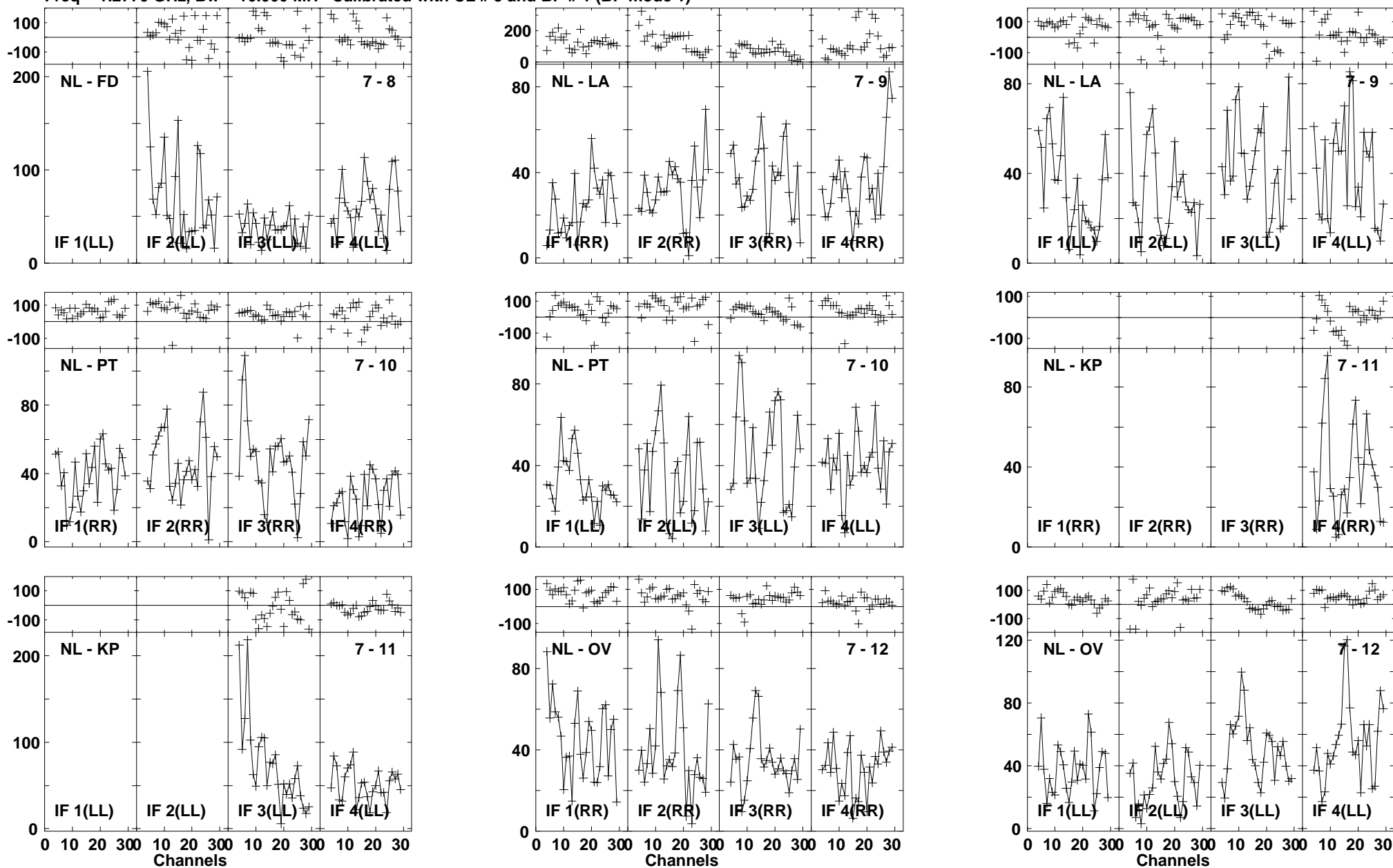

Lower frame: Milli Ampl Jy Top frame: Phas deg
 Vector averaged cross-power spectrum Baseline: NL (07) - FD (08)
 Timerange: 01/04:21:58 to 01/04:25:22

Plot file version1506 created 03-MAR-2016 01:16:20

4C52 GN002C 1.UVDATA.1

Freq = 1.2770 GHz, Bw = 16.000 MH Calibrated with CL # 3 and BP # 1 (BP mode 1)

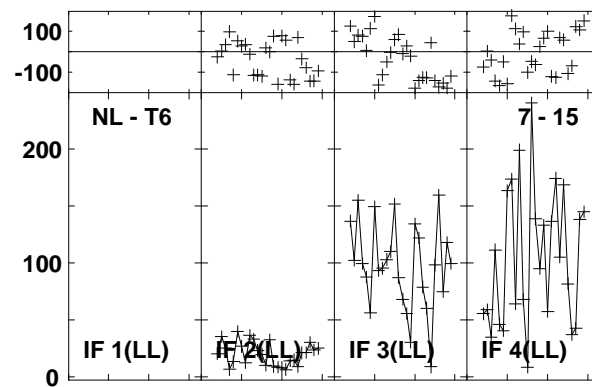
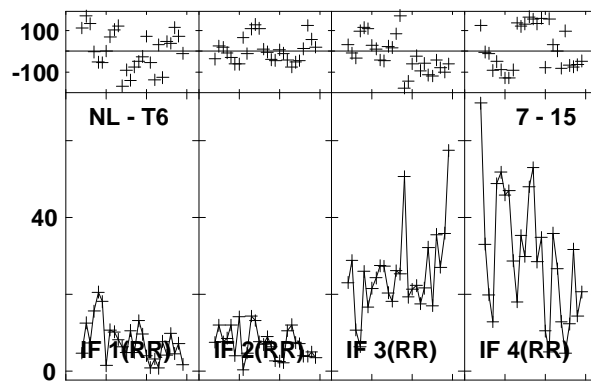
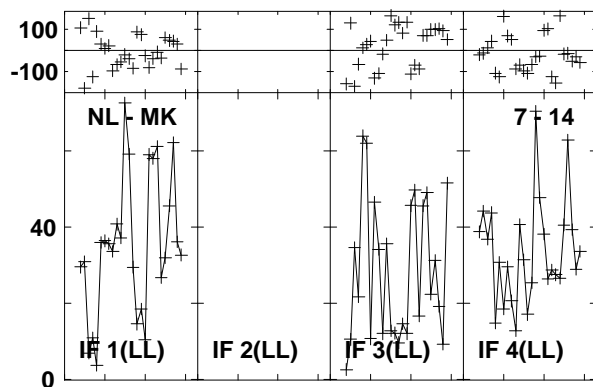
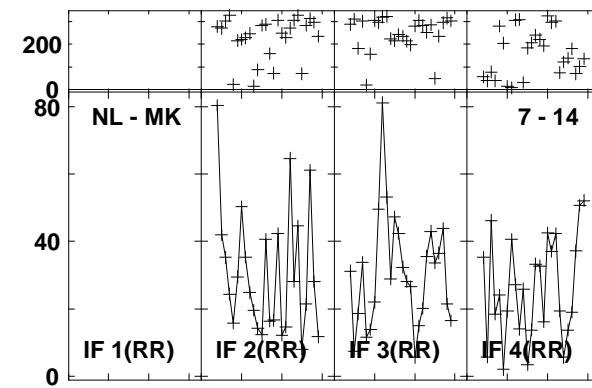
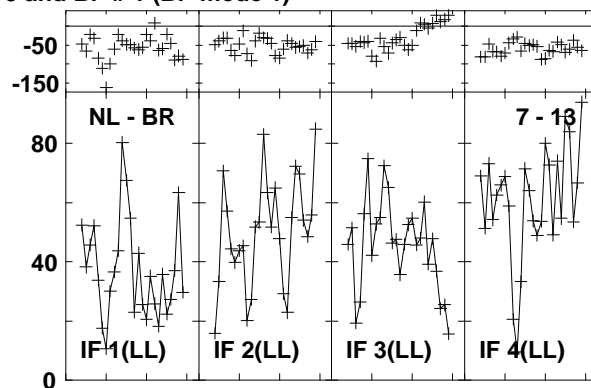
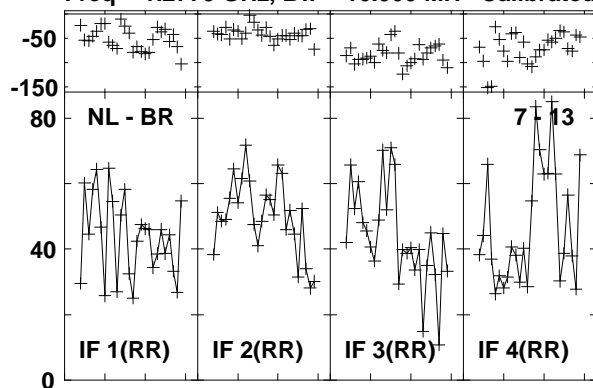

Lower frame: Milli Ampl Jy Top frame: Phas deg
Vector averaged cross-power spectrum Baseline: NL (07) - BR (13)
Timerange: 01/04:21:58 to 01/04:25:22

Plot file version1507 created 03-MAR-2016 01:16:21

J1545+5400 GN002C 1.UVDATA.1

Freq = 1.2770 GHz, Bw = 16.000 MH Calibrated with CL # 3 and BP # 1 (BP mode 1)

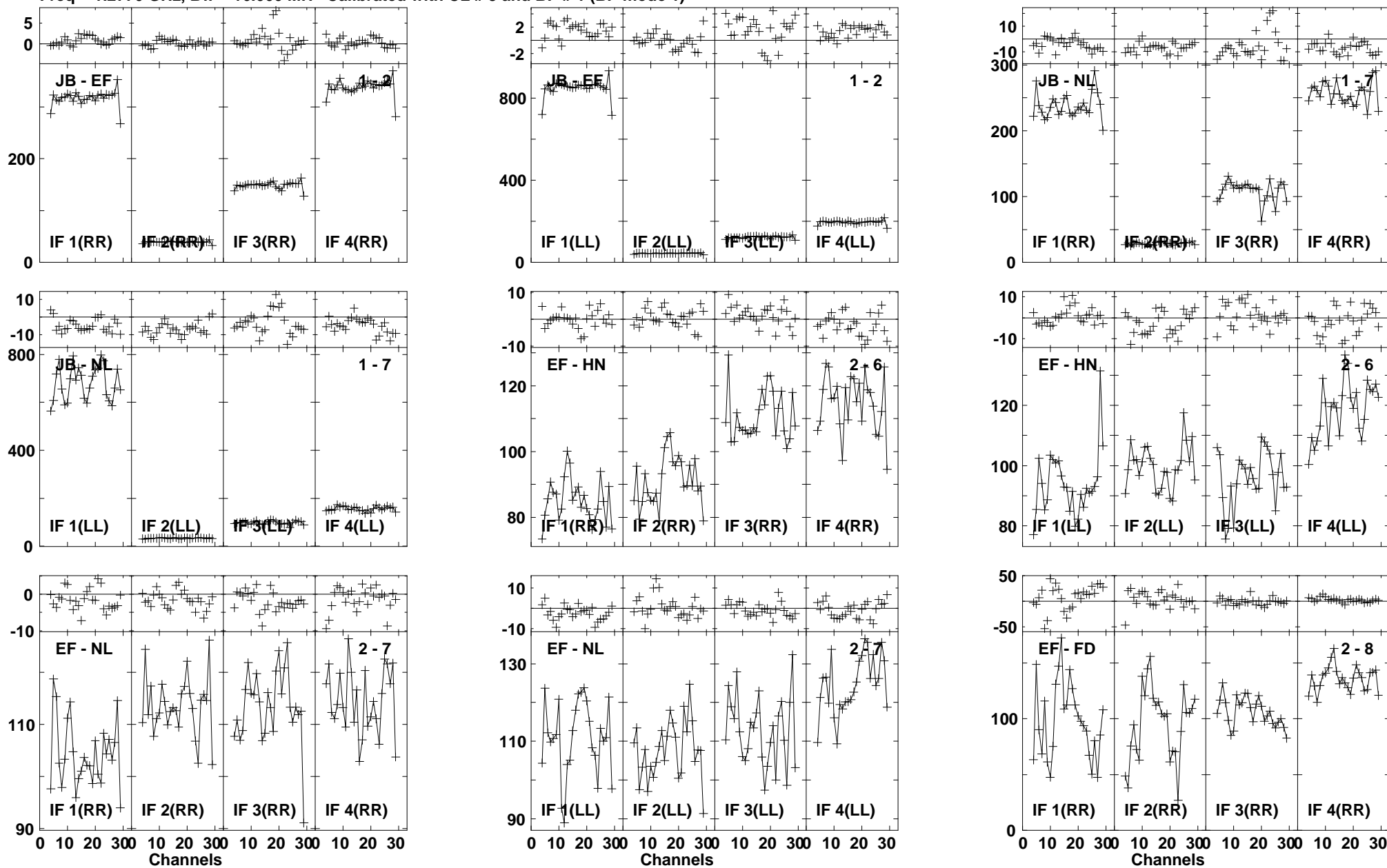

Plot file version1508 created 03-MAR-2016 01:16:21

J1545+5400 GN002C 1.UVDATA.1

Freq = 1.2770 GHz, Bw = 16.000 MH Calibrated with CL # 3 and BP # 1 (BP mode 1)

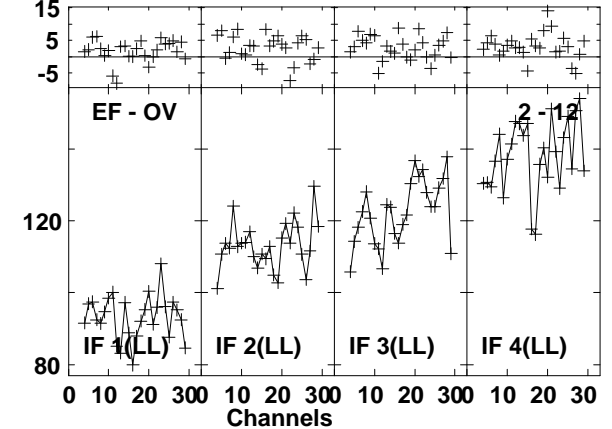
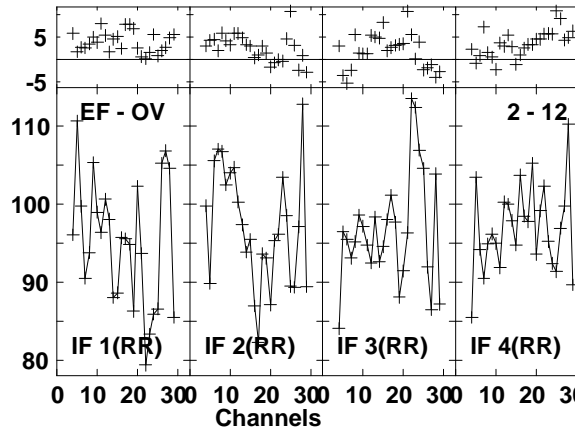
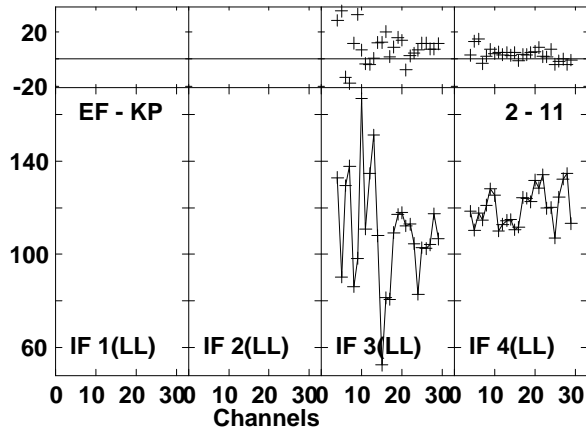
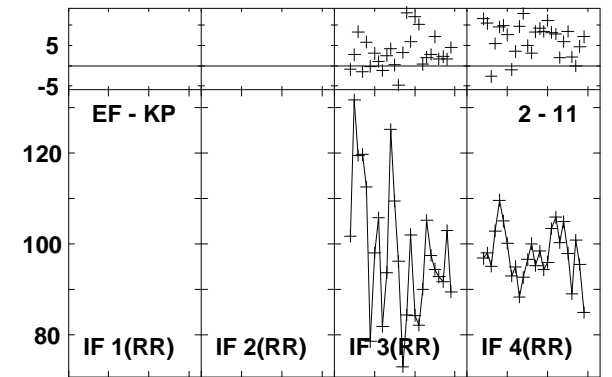
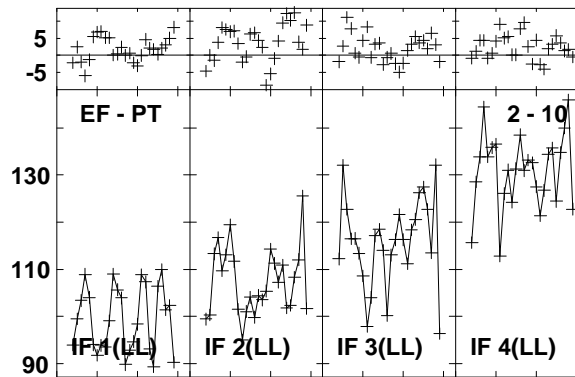
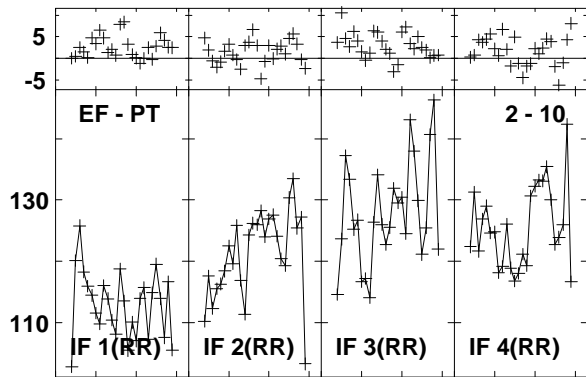
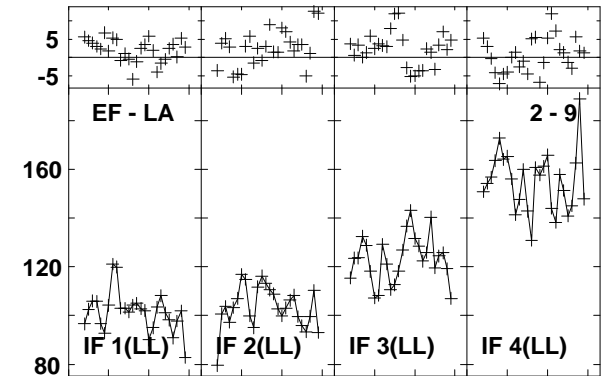
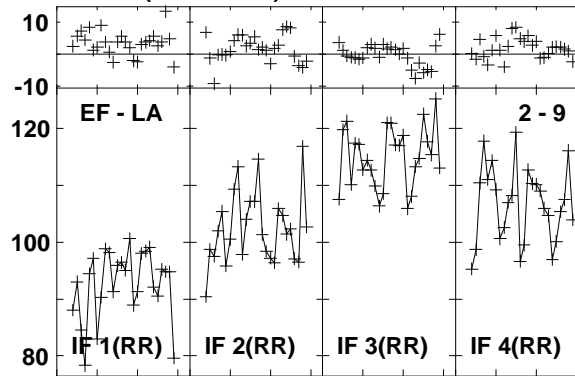
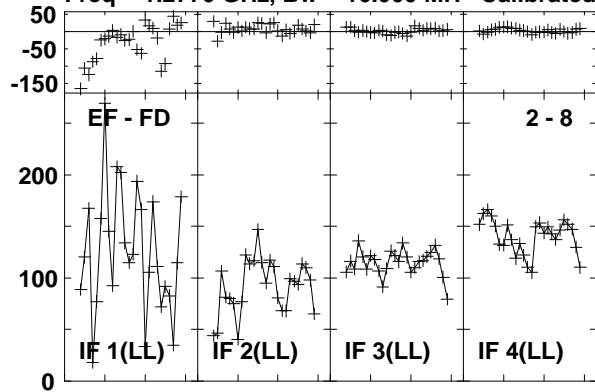

Lower frame: Milli Ampl Jy Top frame: Phas deg
Vector averaged cross-power spectrum Baseline: EF (02) - FD (08)
Timerange: 01/04:26:15 to 01/04:29:03

Plot file version1509 created 03-MAR-2016 01:16:21

J1545+5400 GN002C 1.UVDATA.1

Freq = 1.2770 GHz, Bw = 16.000 MH Calibrated with CL # 3 and BP # 1 (BP mode 1)

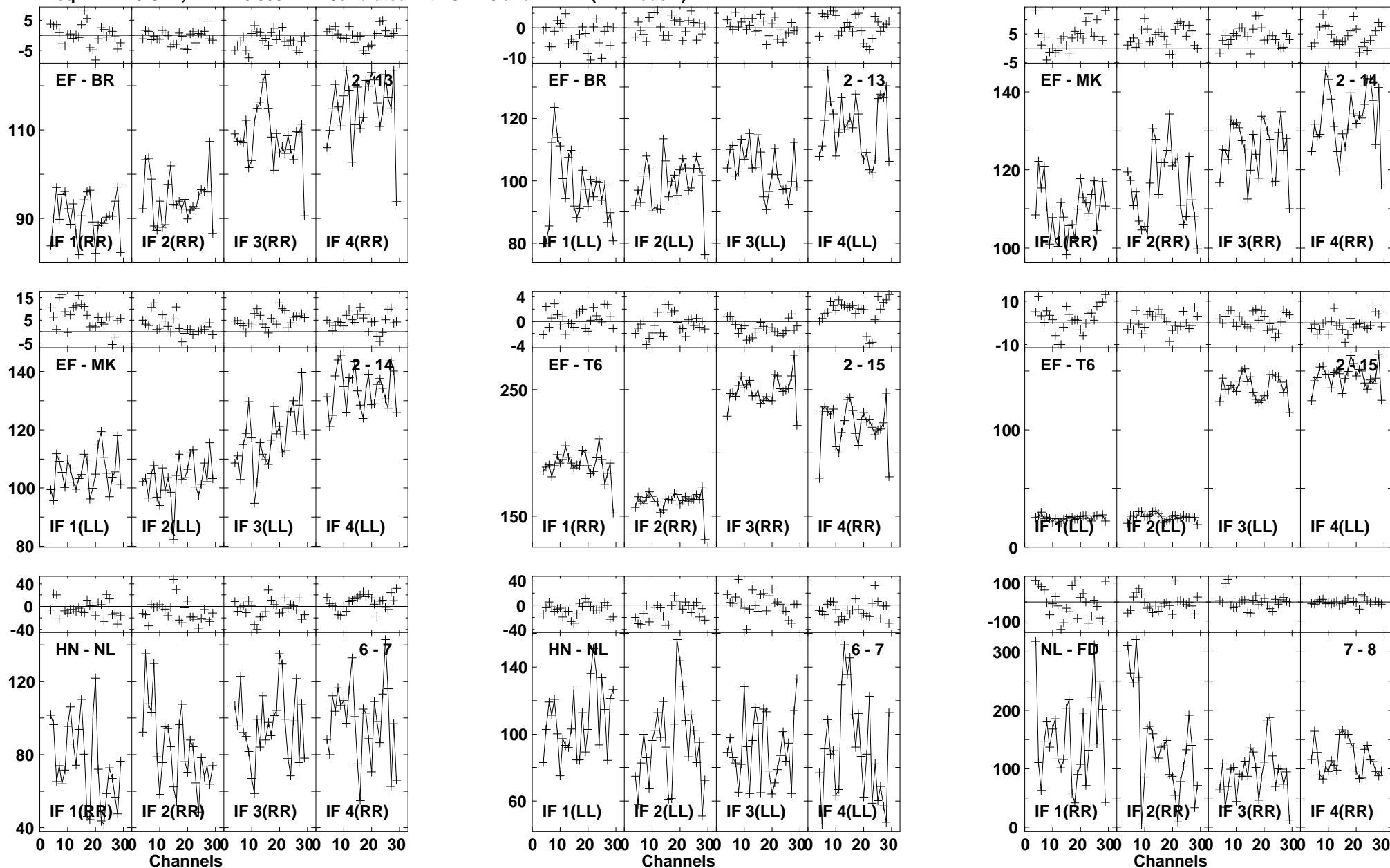

Lower frame: Milli Ampl Jy Top frame: Phas deg
Vector averaged cross-power spectrum Baseline: EF (02) - BR (13)
Timerange: 01/04:26:15 to 01/04:29:03

Plot file version1510 created 03-MAR-2016 01:16:21
 J1545+5400 GN002C 1.UVDATA.1
 Freq = 1.2770 GHz, Bw = 16.000 MH Calibrated with CL # 3 and BP # 1 (BP mode 1)

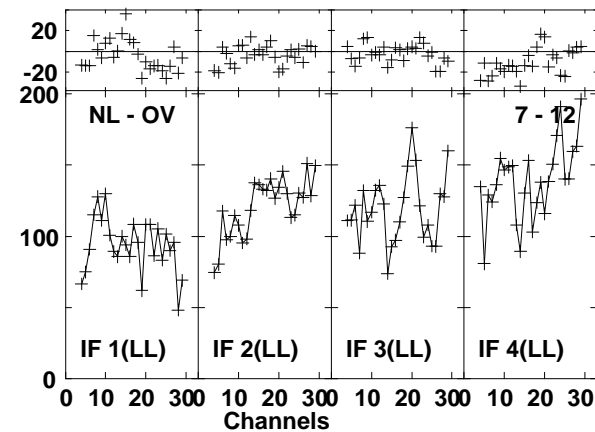
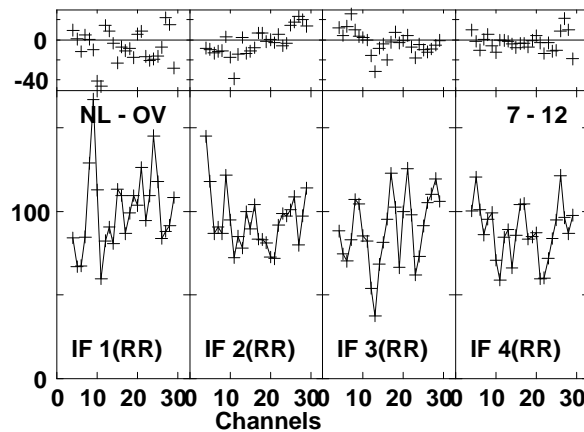
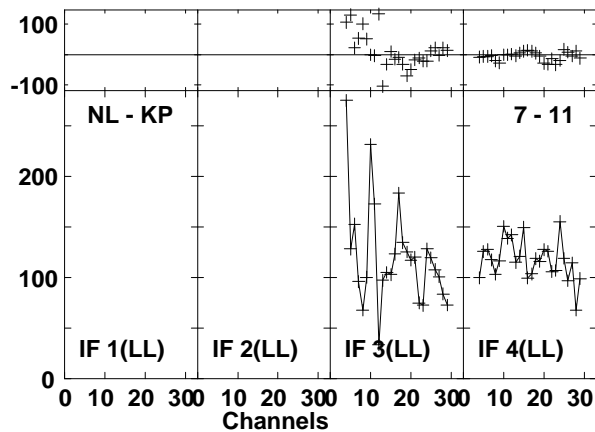
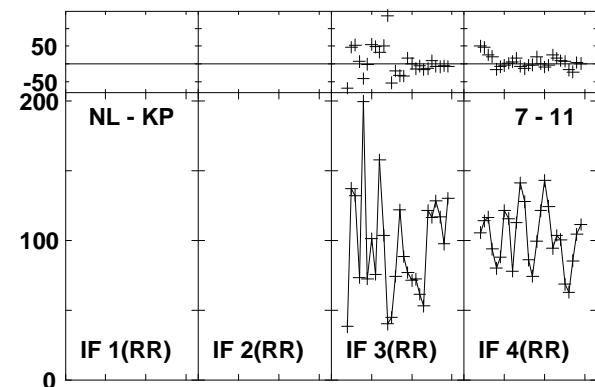
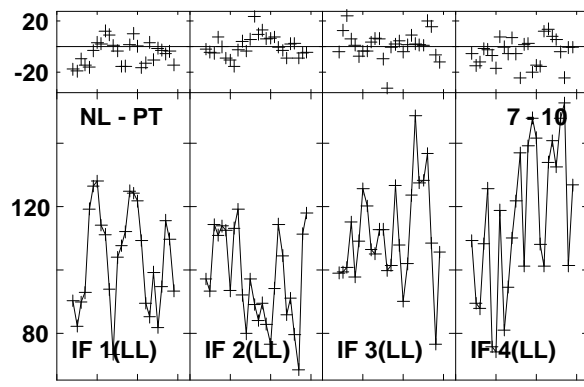
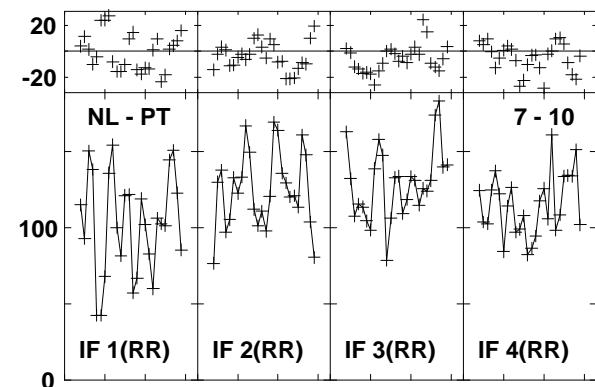
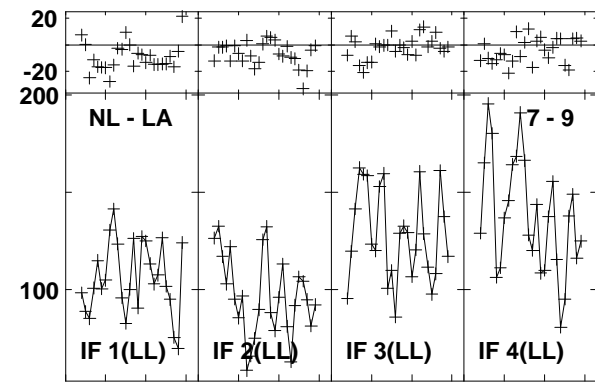
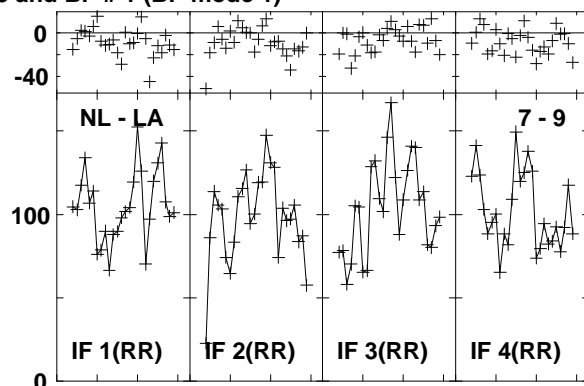
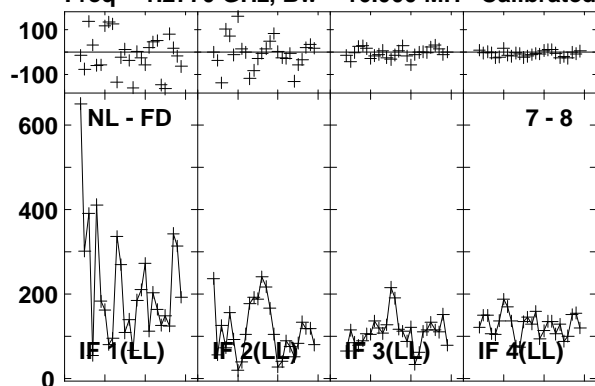

Lower frame: Milli Ampl Jy Top frame: Phas deg
 Vector averaged cross-power spectrum Baseline: NL (07) - FD (08)
 Timerange: 01/04:26:15 to 01/04:29:03

Plot file version1511 created 03-MAR-2016 01:16:21
 J1545+5400 GN002C 1.UVDATA.1
 Freq = 1.2770 GHz, Bw = 16.000 MH Calibrated with CL # 3 and BP # 1 (BP mode 1)

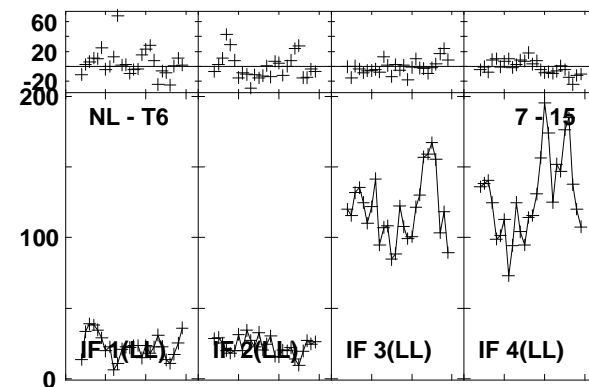
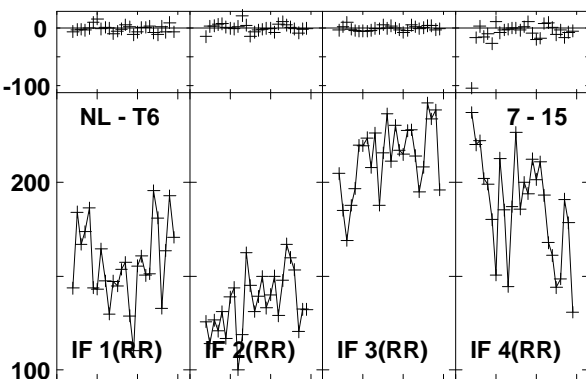
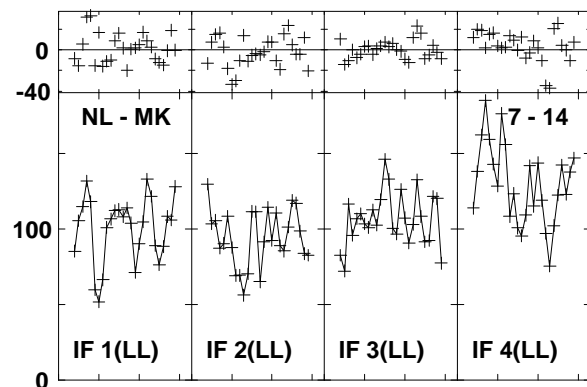
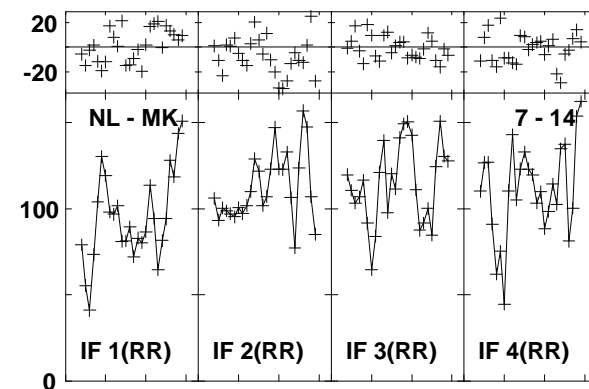
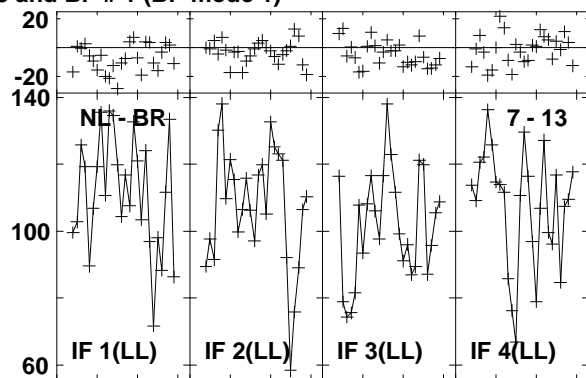
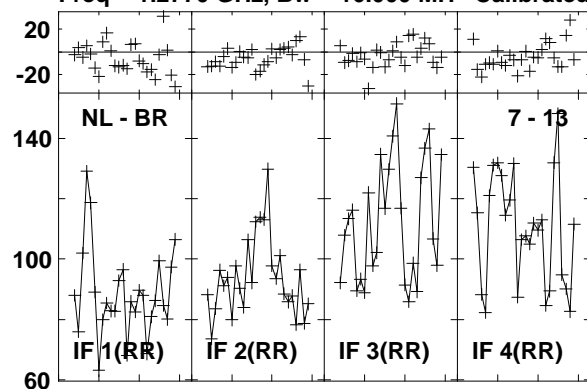

Lower frame: Milli Ampl Jy Top frame: Phas deg
 Vector averaged cross-power spectrum Baseline: NL (07) - BR (13)
 Timerange: 01/04:26:15 to 01/04:29:03

Plot file version1512 created 03-MAR-2016 01:16:22

4C52 GN002C 1.UVDATA.1

Freq = 1.2770 GHz, Bw = 16.000 MH Calibrated with CL # 3 and BP # 1 (BP mode 1)

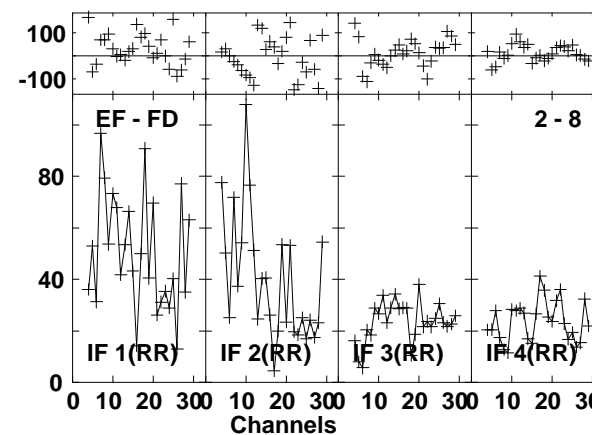
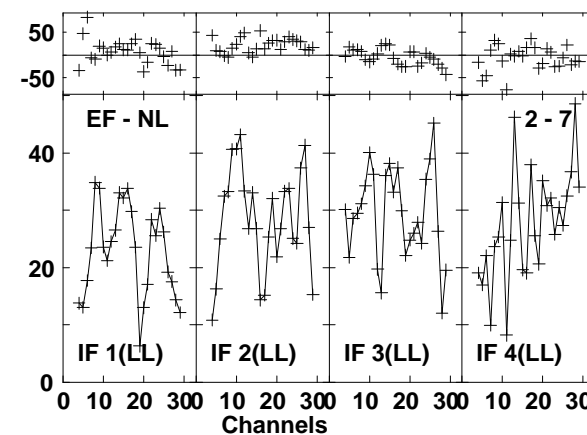
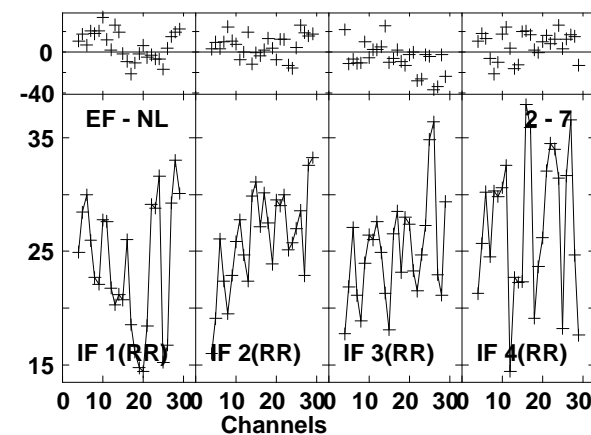
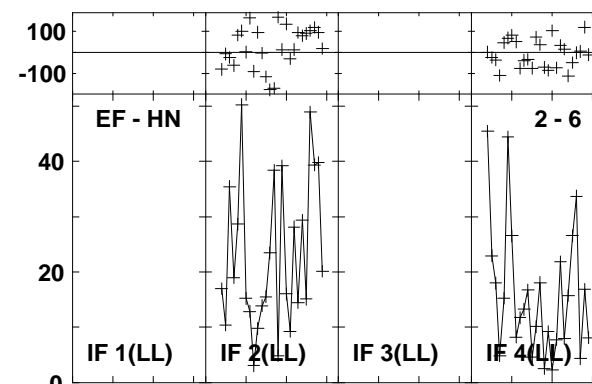
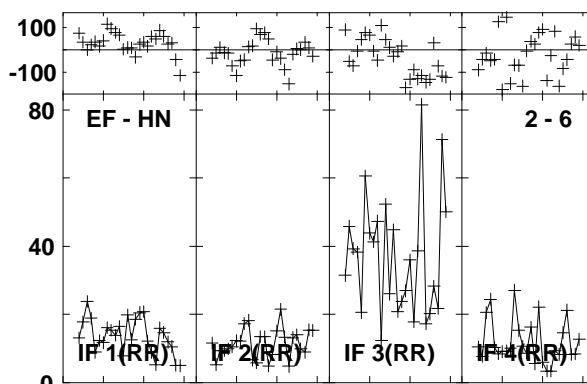
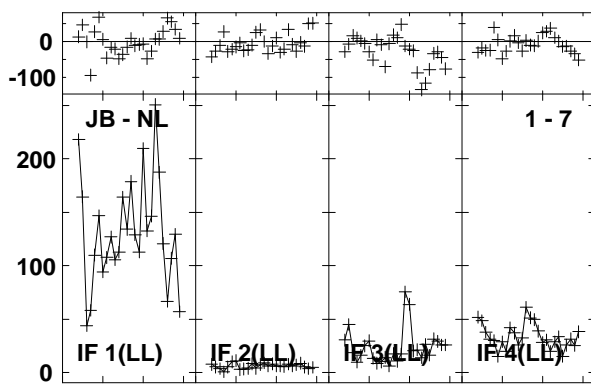
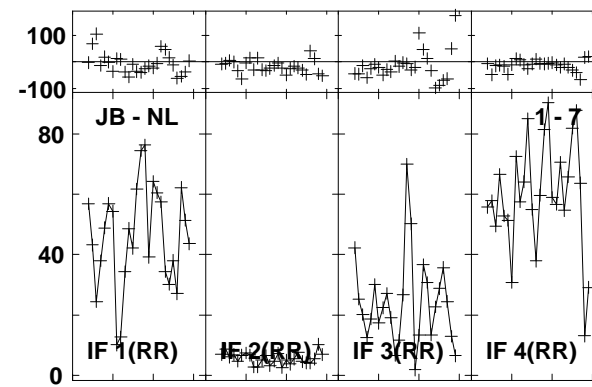
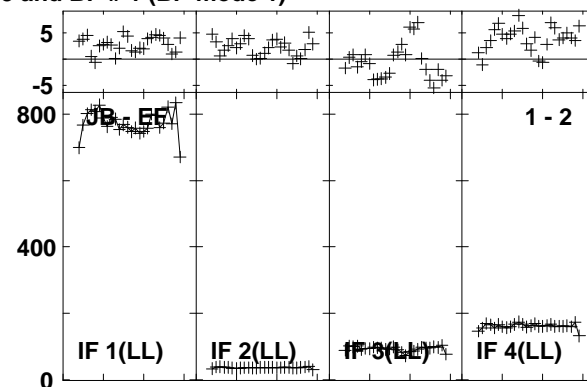
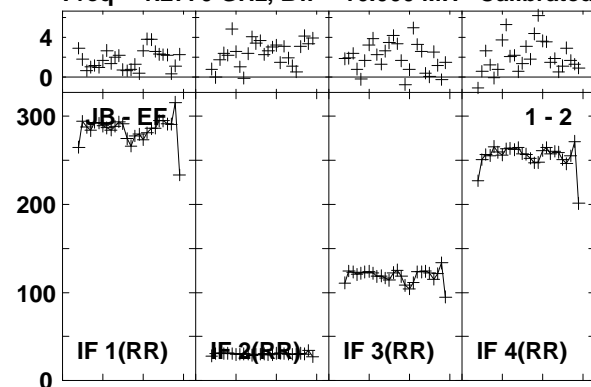

Lower frame: Milli Ampl Jy Top frame: Phas deg
Vector averaged cross-power spectrum Baseline: JB (01) - EF (02)
Timerange: 01/04:29:15 to 01/04:32:33

Plot file version1513 created 03-MAR-2016 01:16:22

4C52 GN002C 1.UVDATA.1

Freq = 1.2770 GHz, Bw = 16.000 MH Calibrated with CL # 3 and BP # 1 (BP mode 1)

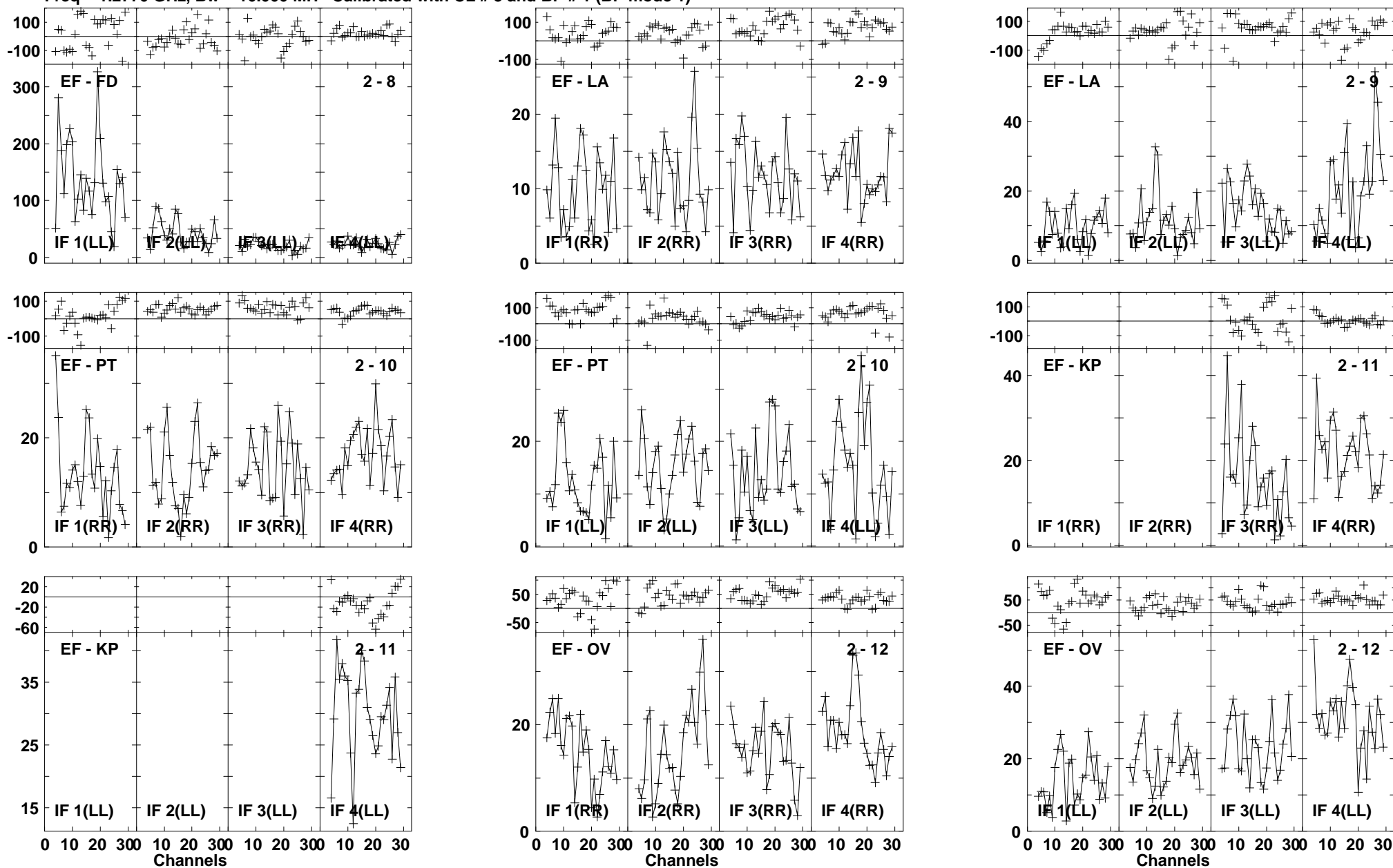

Lower frame: Milli Ampl Jy Top frame: Phas deg
Vector averaged cross-power spectrum Baseline: EF (02) - FD (08)
Timerange: 01/04:29:15 to 01/04:32:33

Plot file version1514 created 03-MAR-2016 01:16:22

4C52 GN002C 1.UVDATA.1

Freq = 1.2770 GHz, Bw = 16.000 MH Calibrated with CL # 3 and BP # 1 (BP mode 1)

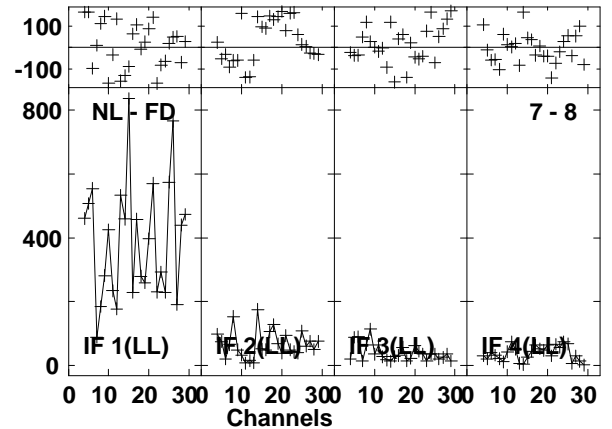
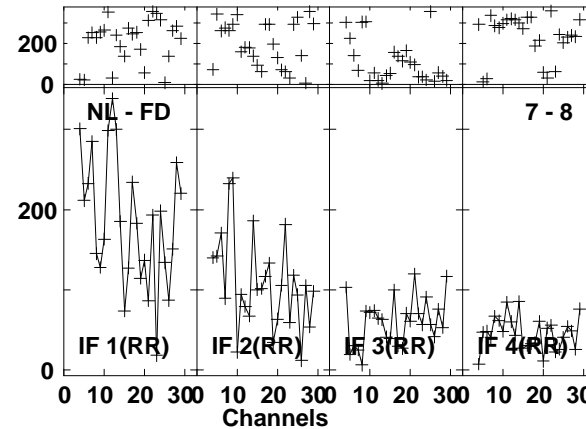
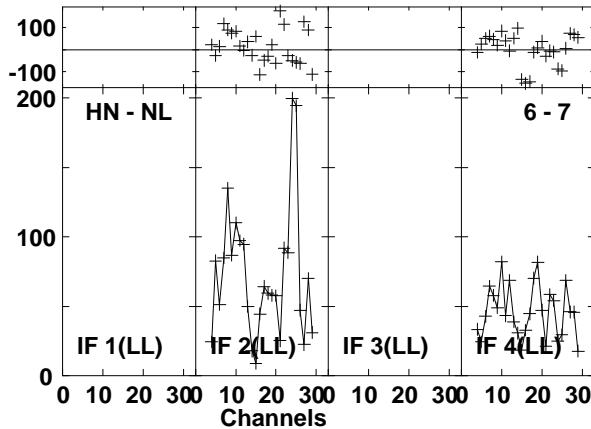
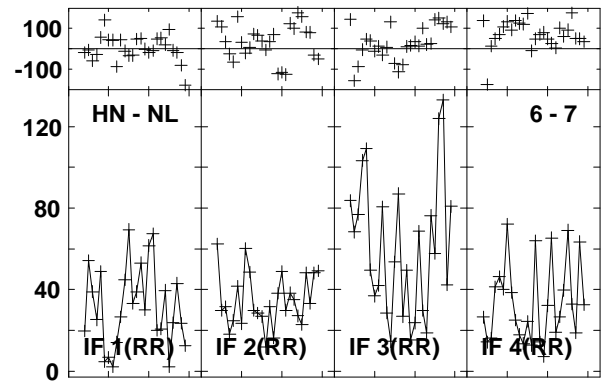
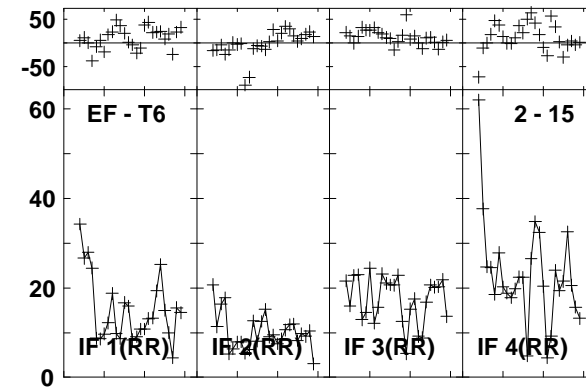
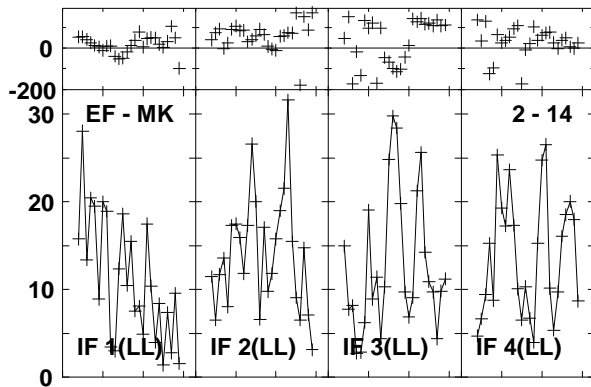
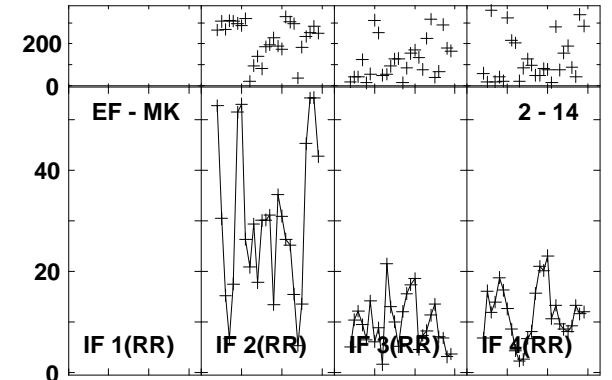
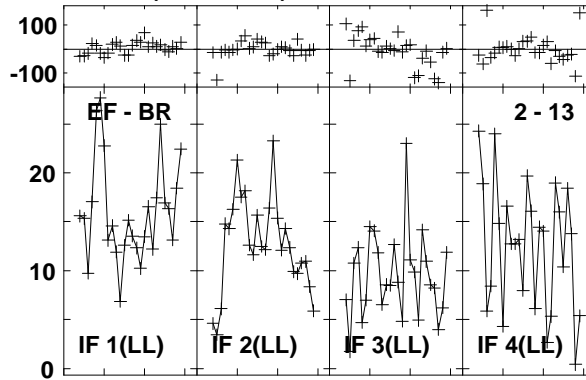
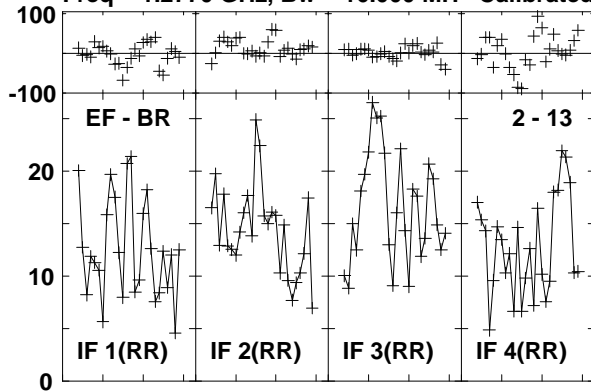

Lower frame: Milli Ampl Jy Top frame: Phas deg
Vector averaged cross-power spectrum Baseline: EF (02) - BR (13)
Timerange: 01/04:29:15 to 01/04:32:33

Plot file version1515 created 03-MAR-2016 01:16:22

4C52 GN002C 1.UVDATA.1

Freq = 1.2770 GHz, Bw = 16.000 MH Calibrated with CL # 3 and BP # 1 (BP mode 1)

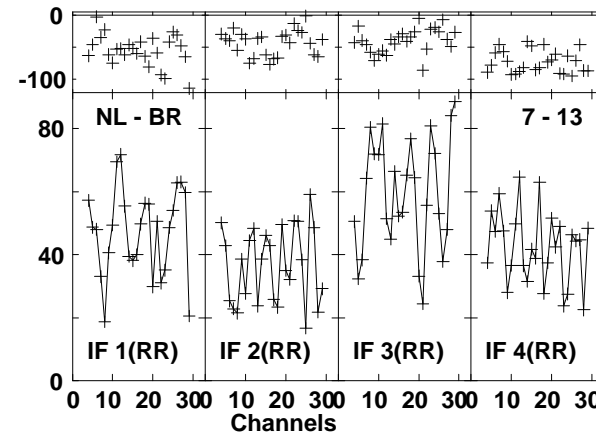
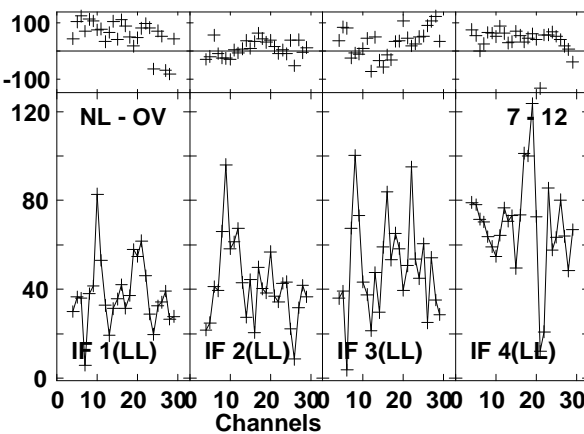
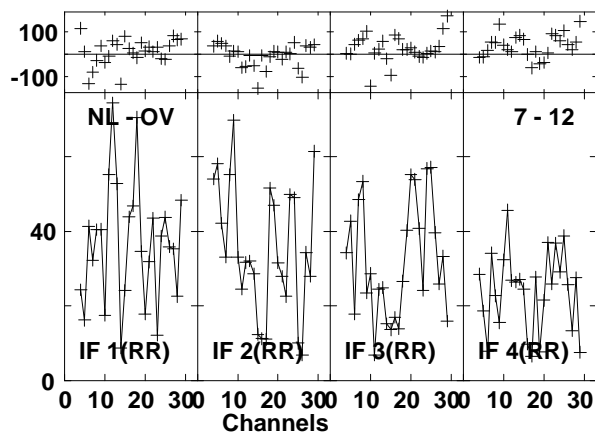
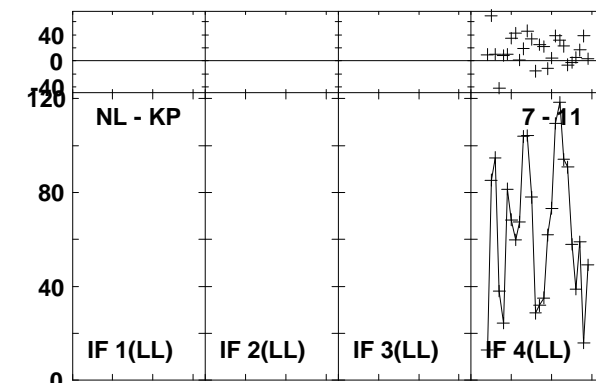
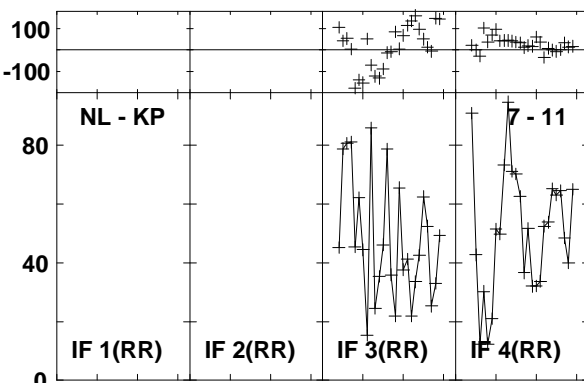
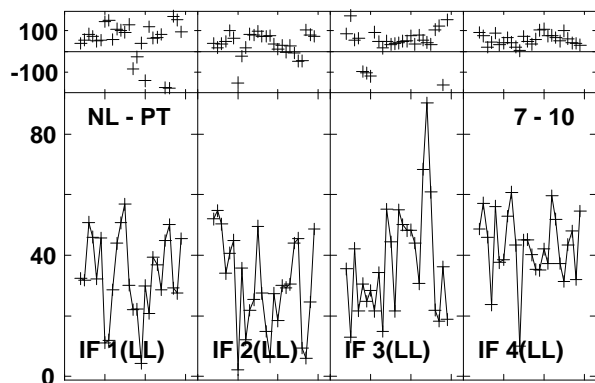
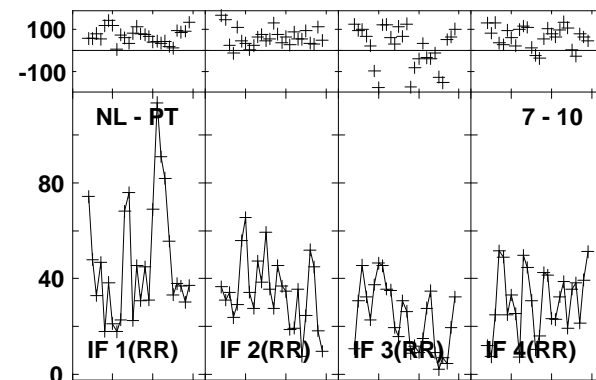
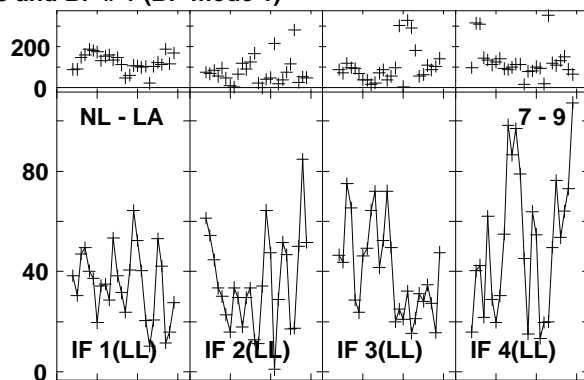
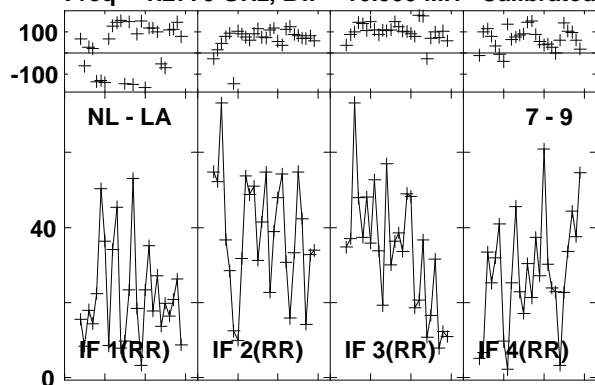

Lower frame: Milli Ampl Jy Top frame: Phas deg
Vector averaged cross-power spectrum Baseline: NL (07) - LA (09)
Timerange: 01/04:29:15 to 01/04:32:33

Plot file version1516 created 03-MAR-2016 01:16:22

4C52 GN002C 1.UVDATA.1

Freq = 1.2770 GHz, Bw = 16.000 MH Calibrated with CL # 3 and BP # 1 (BP mode 1)

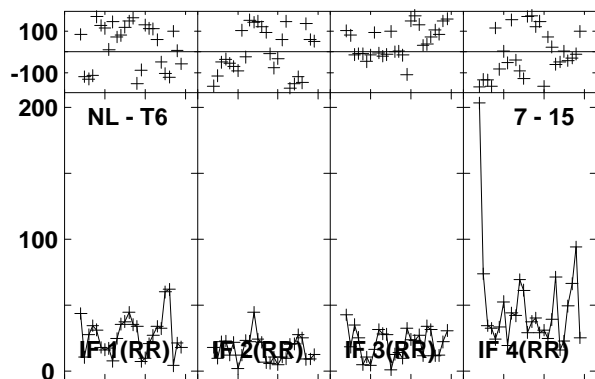
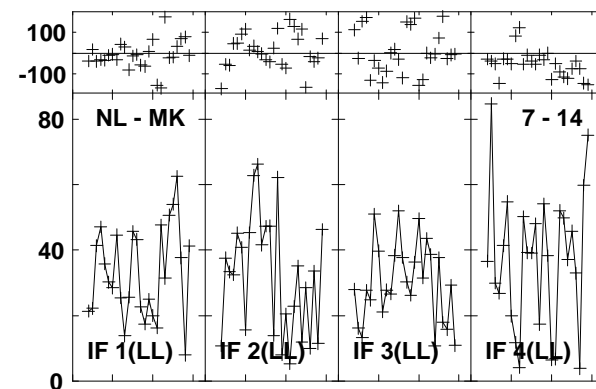
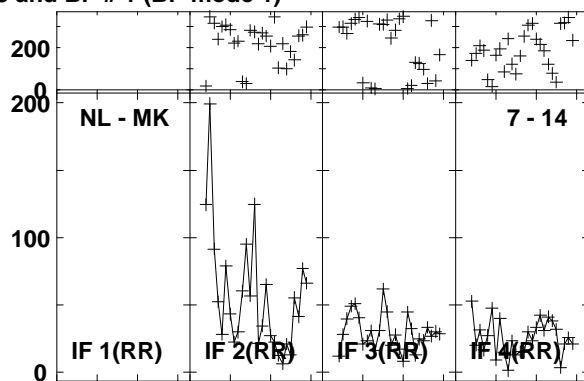
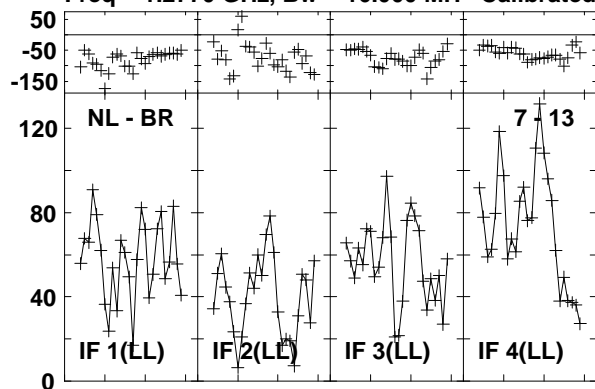

Lower frame: Milli Ampl Jy Top frame: Phas deg
Vector averaged cross-power spectrum Baseline: NL (07) - BR (13)
Timerange: 01/04:29:15 to 01/04:32:33

Plot file version1517 created 03-MAR-2016 01:16:23

J1545+5400 GN002C 1.UVDATA.1

Freq = 1.2770 GHz, Bw = 16.000 MH Calibrated with CL # 3 and BP # 1 (BP mode 1)

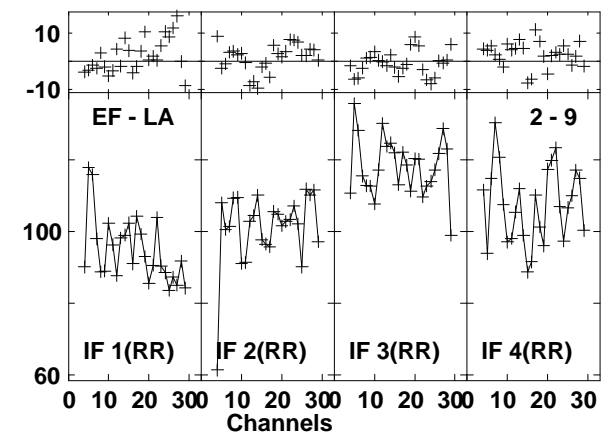
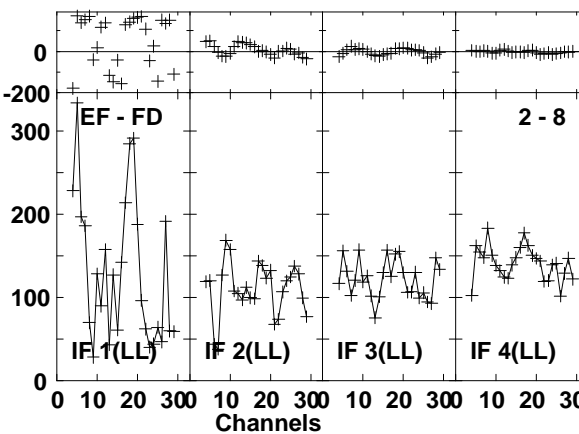
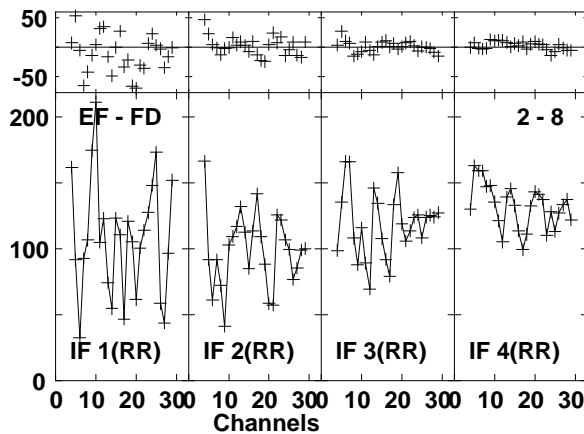
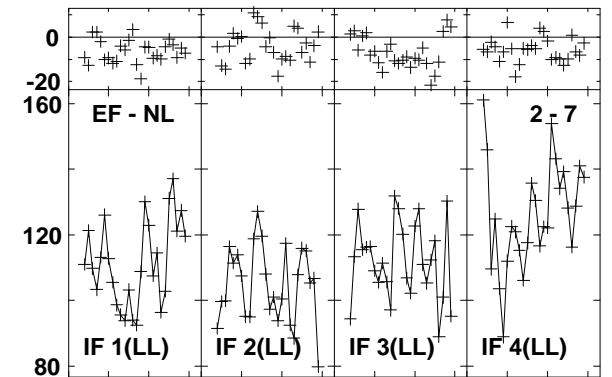
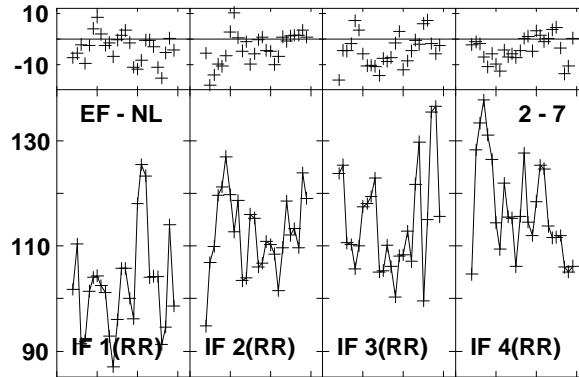
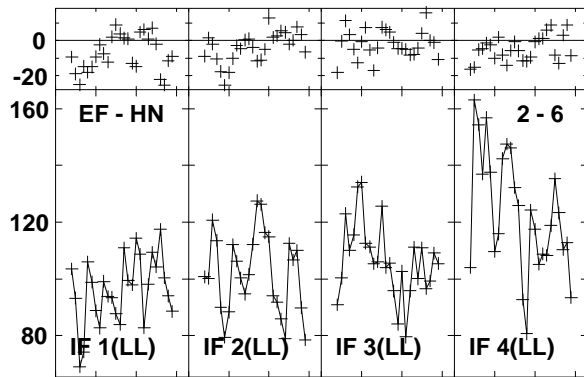
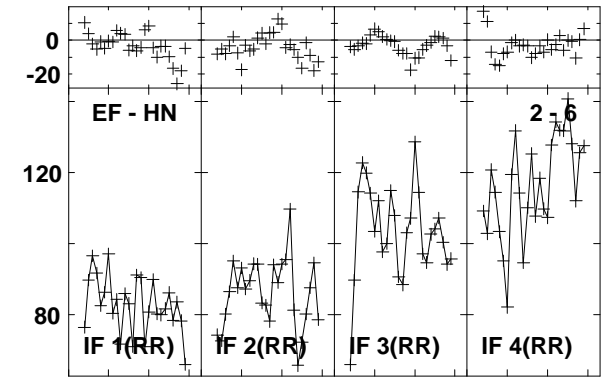
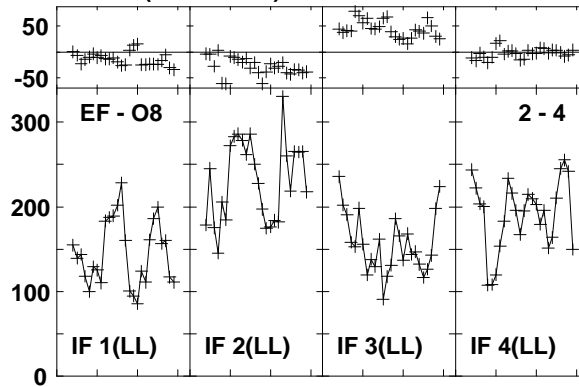
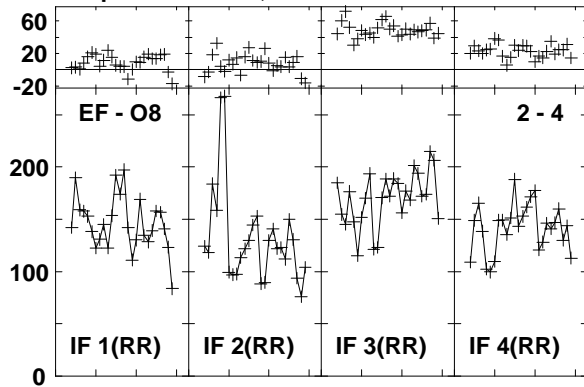

Lower frame: Milli Ampl Jy Top frame: Phas deg
Vector averaged cross-power spectrum Baseline: EF (02) - O8 (04)
Timerange: 01/04:33:25 to 01/04:34:43

Plot file version1518 created 03-MAR-2016 01:16:23

J1545+5400 GN002C 1.UVDATA.1

Freq = 1.2770 GHz, Bw = 16.000 MH Calibrated with CL # 3 and BP # 1 (BP mode 1)

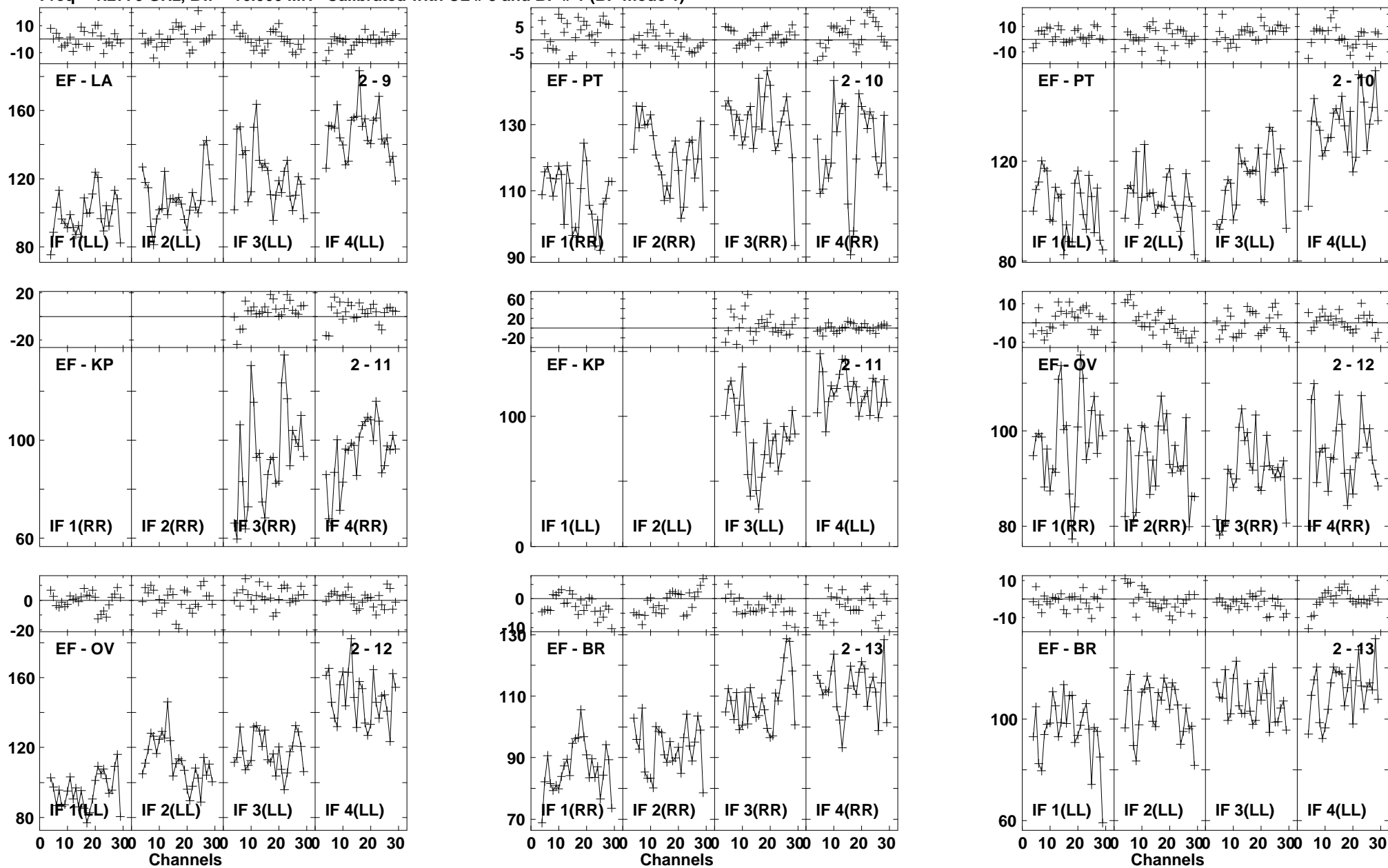

Lower frame: Milli Ampl Jy Top frame: Phas deg
Vector averaged cross-power spectrum Baseline: EF (02) - LA (09)
Timerange: 01/04:33:25 to 01/04:34:43

Plot file version1519 created 03-MAR-2016 01:16:23

J1545+5400 GN002C 1.UVDATA.1

Freq = 1.2770 GHz, Bw = 16.000 MH Calibrated with CL # 3 and BP # 1 (BP mode 1)

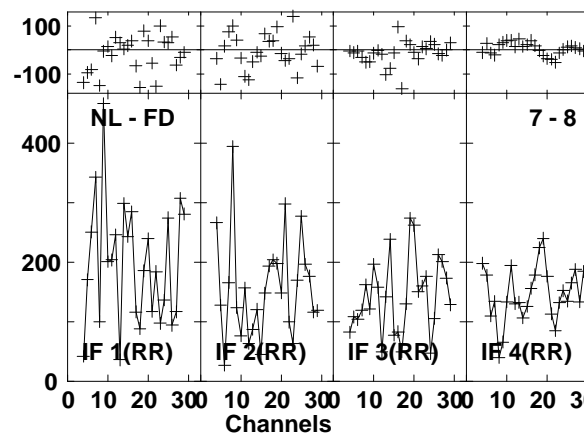
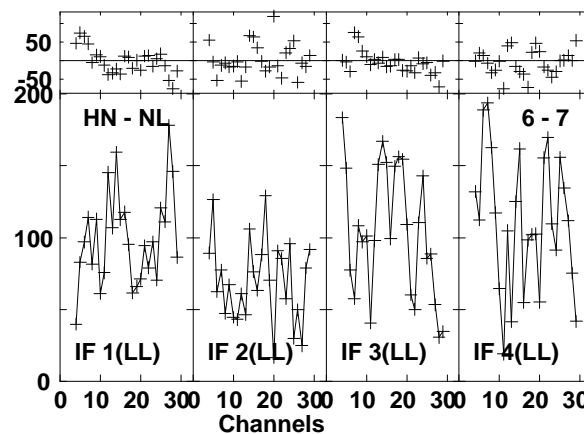
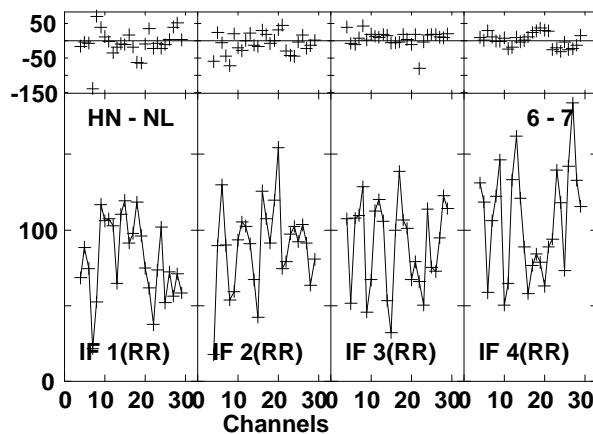
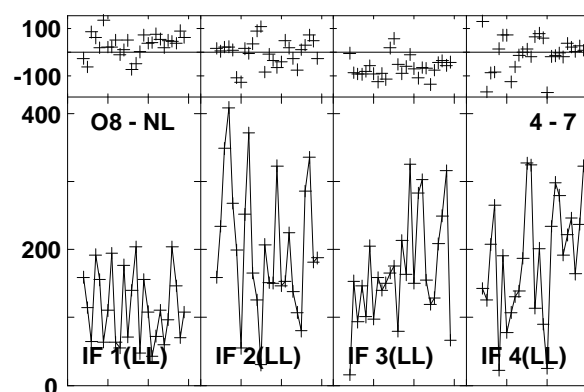
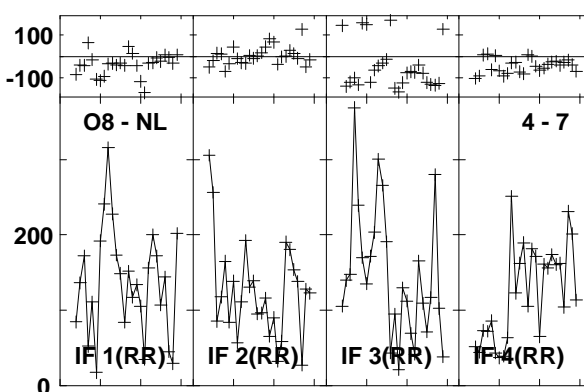
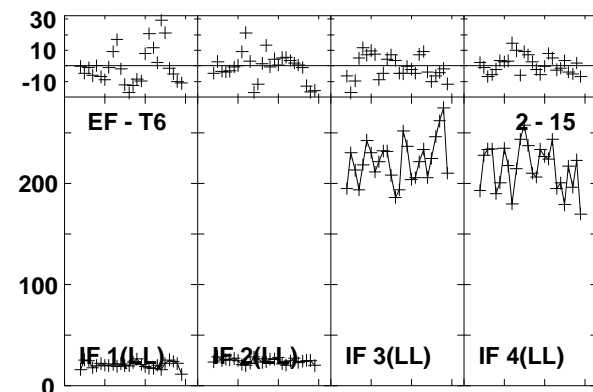
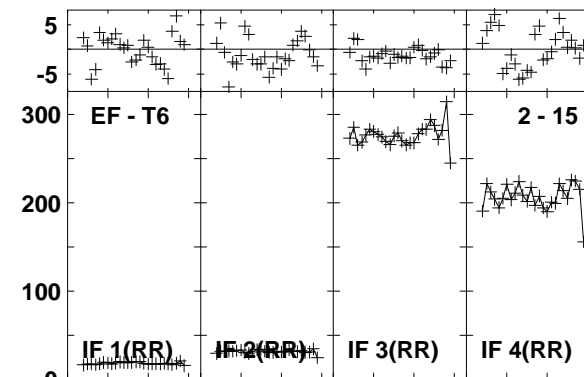
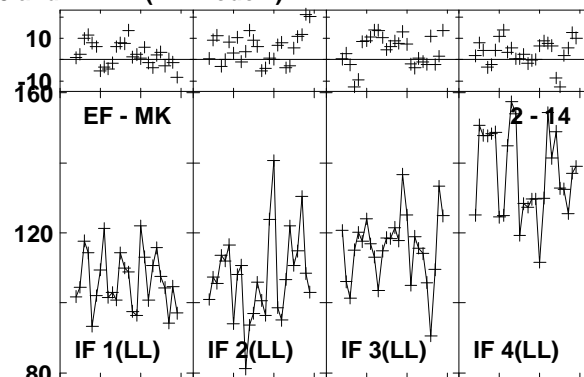
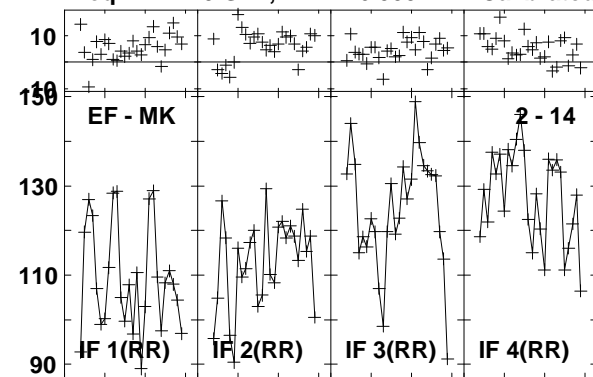

Lower frame: Milli Ampl Jy Top frame: Phas deg
Vector averaged cross-power spectrum Baseline: EF (02) - MK (14)
Timerange: 01/04:33:25 to 01/04:34:43

Plot file version1520 created 03-MAR-2016 01:16:23

J1545+5400 GN002C 1.UVDATA.1

Freq = 1.2770 GHz, Bw = 16.000 MH Calibrated with CL # 3 and BP # 1 (BP mode 1)

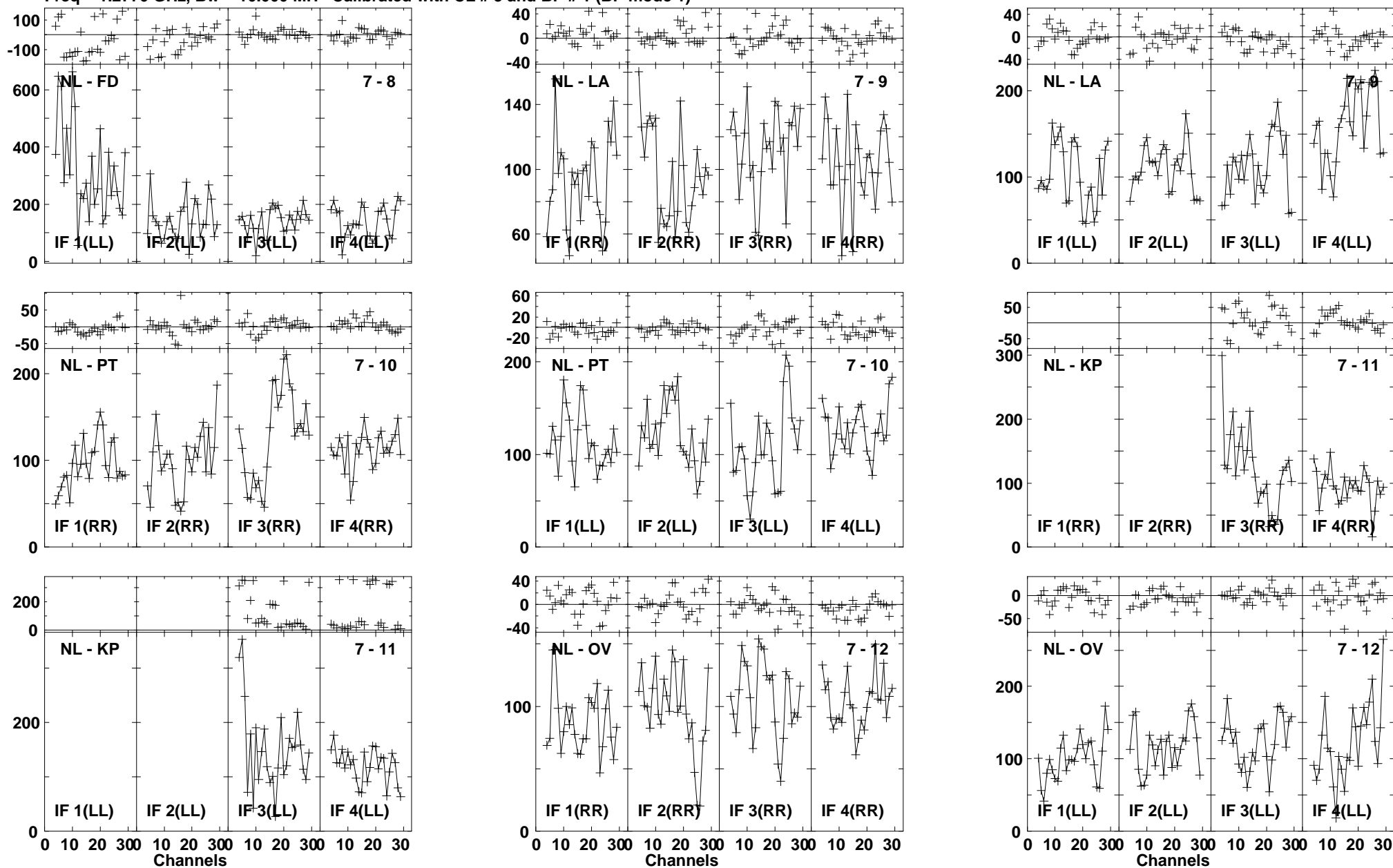

Lower frame: Milli Ampl Jy Top frame: Phas deg
Vector averaged cross-power spectrum Baseline: NL (07) - FD (08)
Timerange: 01/04:33:25 to 01/04:34:43

Plot file version1521 created 03-MAR-2016 01:16:23
 J1545+5400 GN002C 1.UVDATA.1
 Freq = 1.2770 GHz, Bw = 16.000 MH Calibrated with CL # 3 and BP # 1 (BP mode 1)

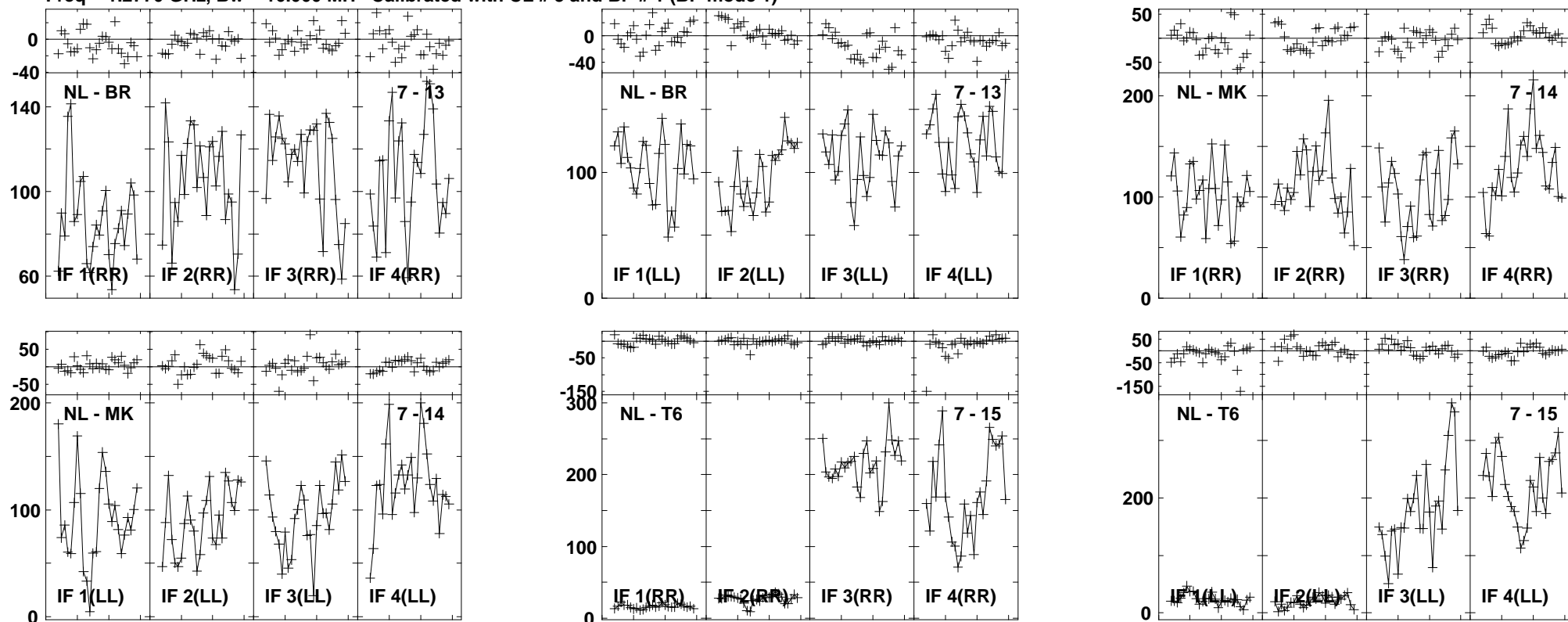

Lower frame: Milli Ampl Jy Top frame: Phas deg
 Vector averaged cross-power spectrum Baseline: NL (07) - BR (13)
 Timerange: 01/04:33:25 to 01/04:34:43

Plot file version1522 created 03-MAR-2016 01:16:23

4C52 GN002C 1.UVDATA.1

Freq = 1.2770 GHz, Bw = 16.000 MH Calibrated with CL # 3 and BP # 1 (BP mode 1)

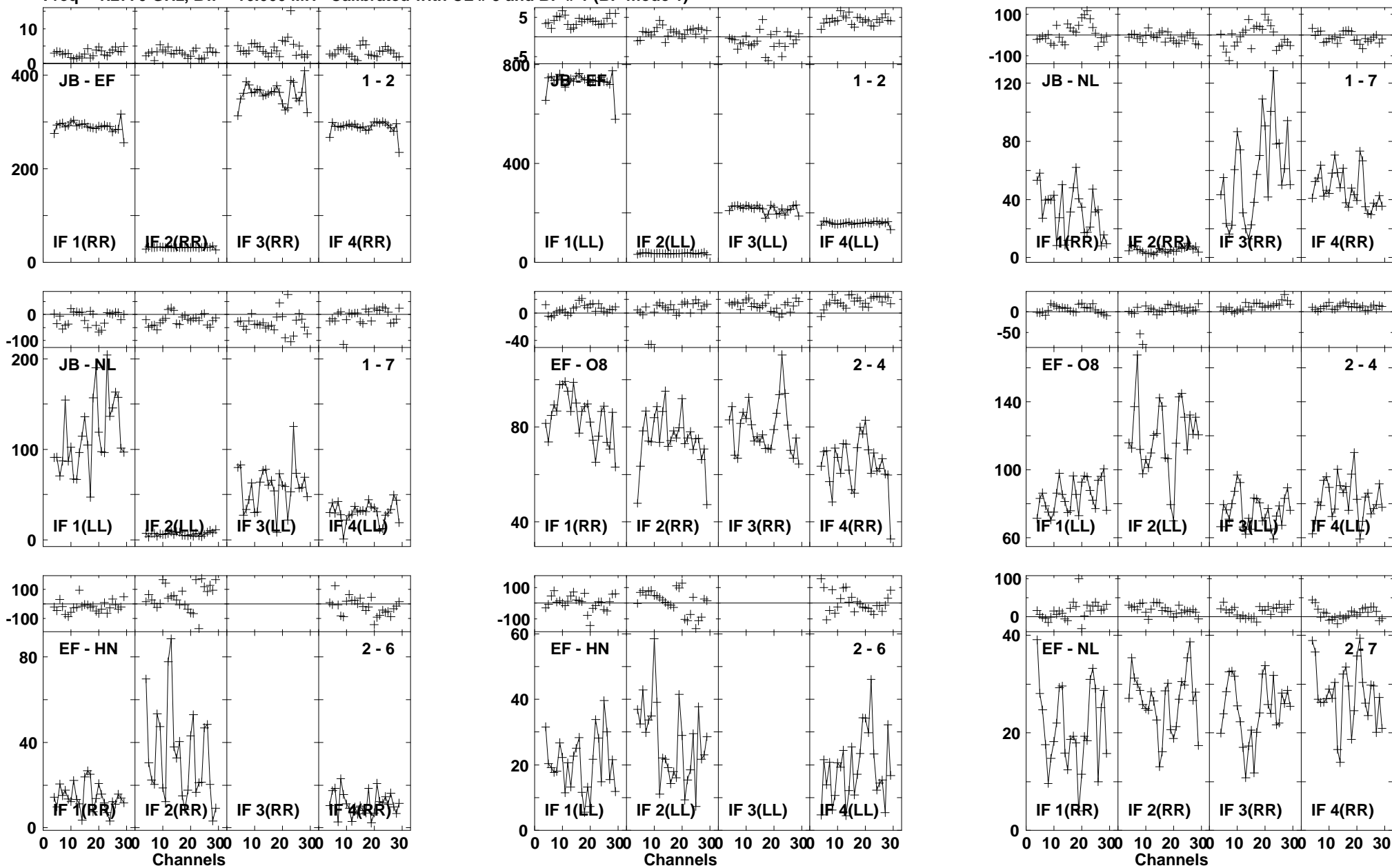

Lower frame: Milli Ampl Jy Top frame: Phas deg
Vector averaged cross-power spectrum Baseline: JB (01) - EF (02)
Timerange: 01/04:34:48 to 01/04:38:12

Plot file version1523 created 03-MAR-2016 01:16:24

4C52 GN002C 1.UVDATA.1

Freq = 1.2770 GHz, Bw = 16.000 MH Calibrated with CL # 3 and BP # 1 (BP mode 1)

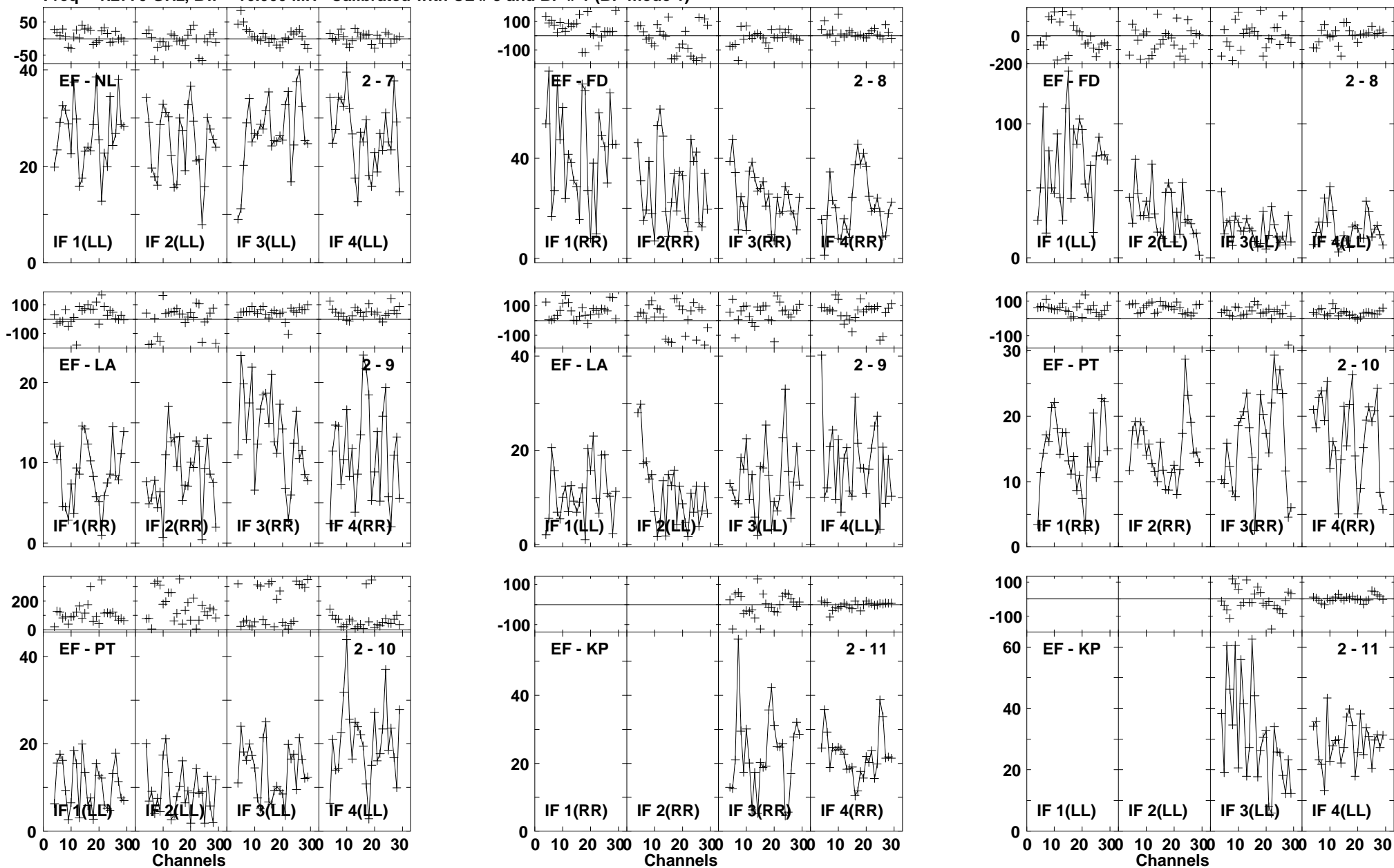

Lower frame: Milli Ampl Jy Top frame: Phas deg
Vector averaged cross-power spectrum Baseline: EF (02) - NL (07)
Timerange: 01/04:34:48 to 01/04:38:12

Plot file version1524 created 03-MAR-2016 01:16:24

4C52 GN002C 1.UVDATA.1

Freq = 1.2770 GHz, Bw = 16.000 MH Calibrated with CL # 3 and BP # 1 (BP mode 1)

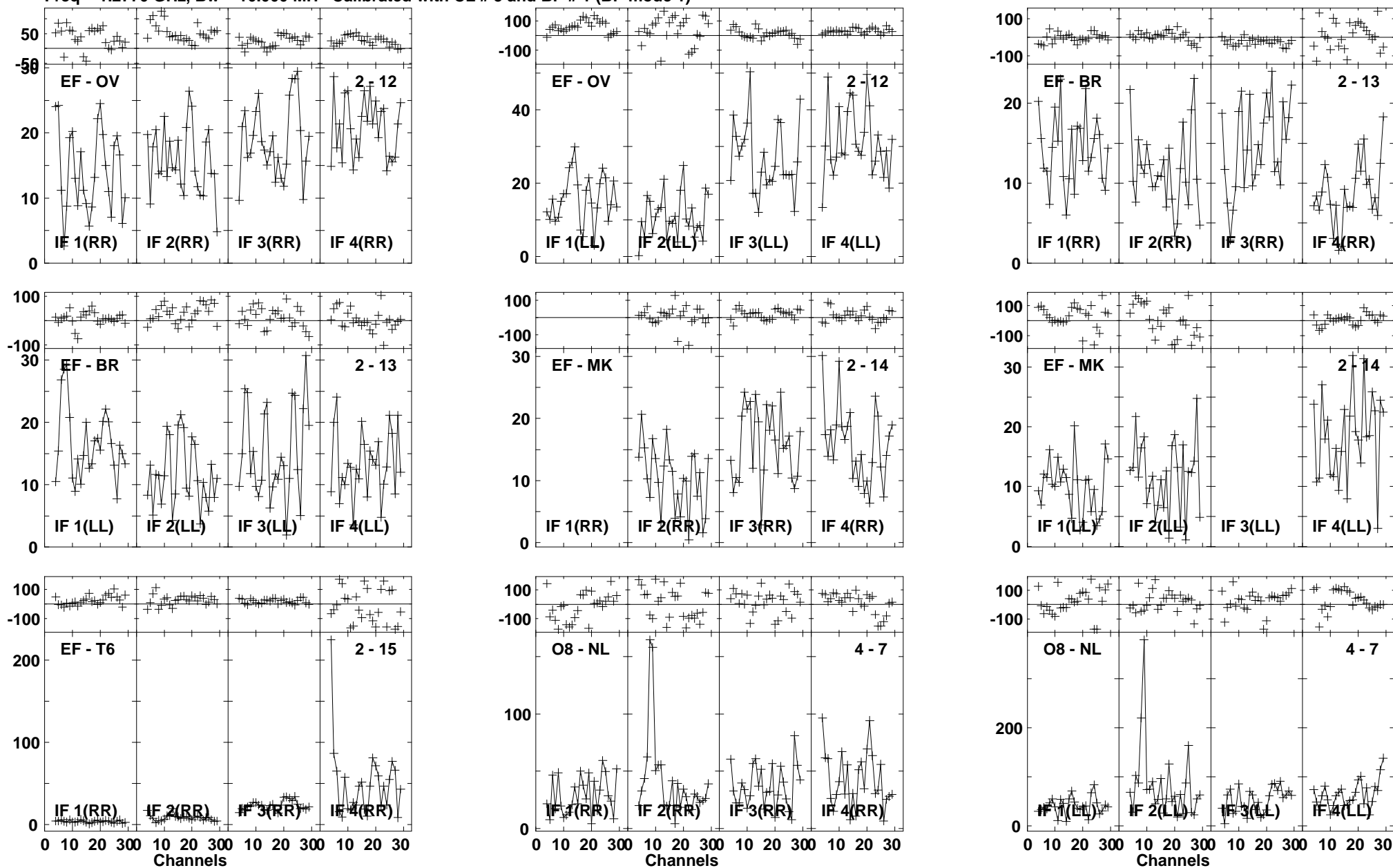

Lower frame: Milli Ampl Jy Top frame: Phas deg
Vector averaged cross-power spectrum Baseline: EF (02) - OV (12)
Timerange: 01/04:34:48 to 01/04:38:12

Plot file version1525 created 03-MAR-2016 01:16:24

4C52 GN002C 1.UVDATA.1

Freq = 1.2770 GHz, Bw = 16.000 MH Calibrated with CL # 3 and BP # 1 (BP mode 1)

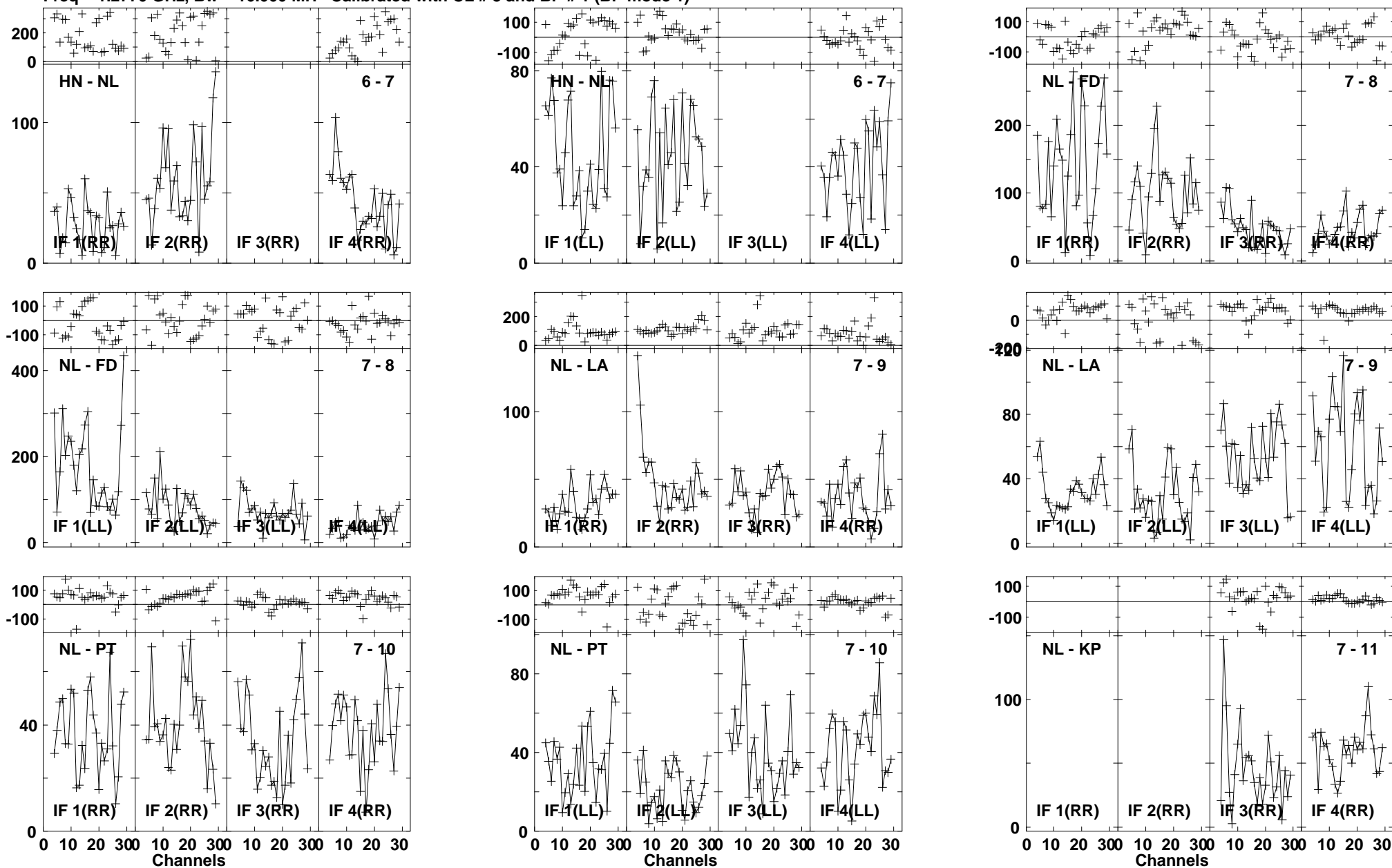

Lower frame: Milli Ampl Jy Top frame: Phas deg
Vector averaged cross-power spectrum Baseline: HN (06) - NL (07)
Timerange: 01/04:34:48 to 01/04:38:12

Plot file version1526 created 03-MAR-2016 01:16:24
 4C52 GN002C 1.UVDATA.1
 Freq = 1.2770 GHz, Bw = 16.000 MH Calibrated with CL # 3 and BP # 1 (BP mode 1)

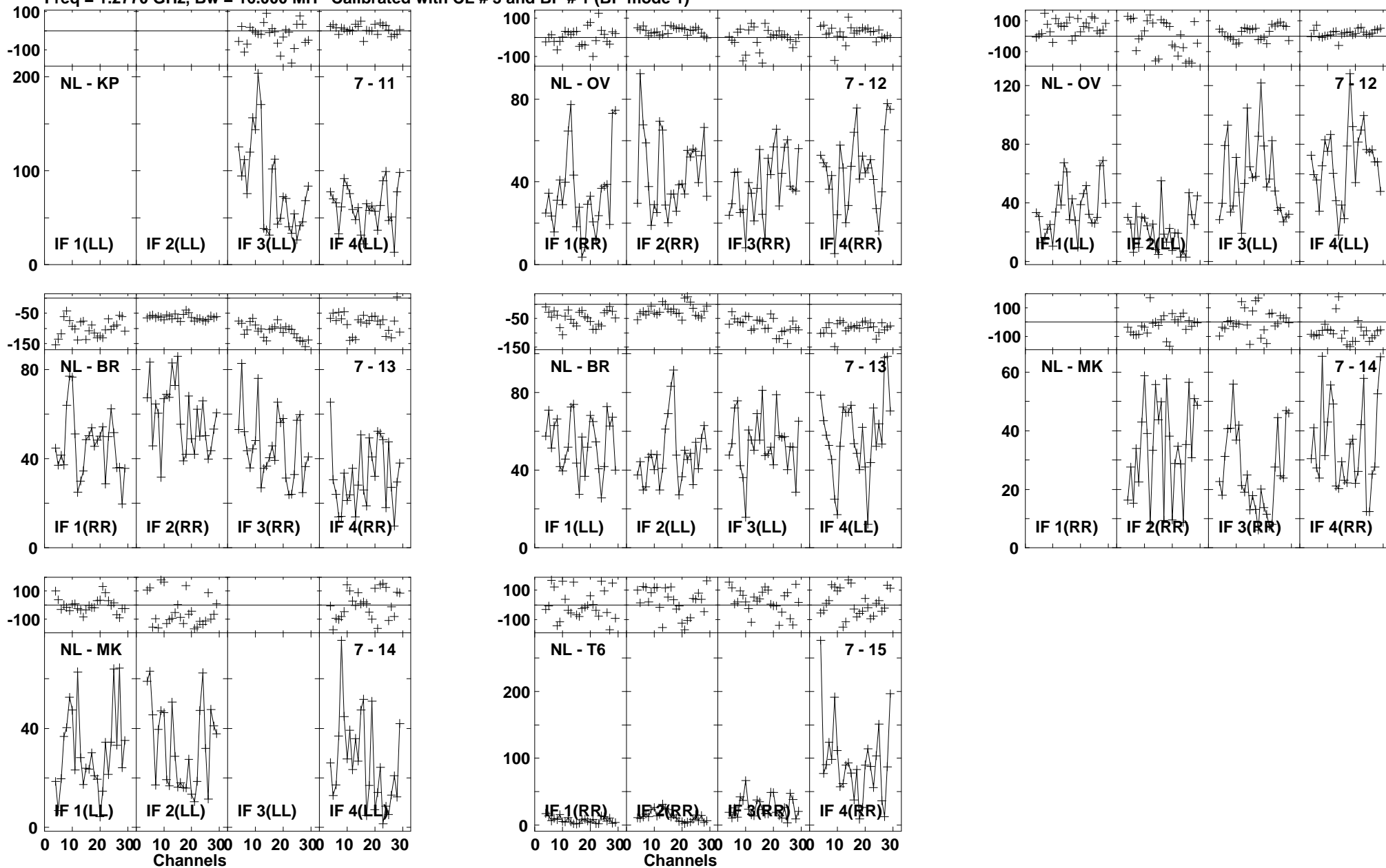

Lower frame: Milli Ampl Jy Top frame: Phas deg
 Vector averaged cross-power spectrum Baseline: NL (07) - KP (11)
 Timerange: 01/04:34:48 to 01/04:38:12

Plot file version1527 created 03-MAR-2016 01:16:24

J1545+5400 GN002C 1.UVDATA.1

Freq = 1.2770 GHz, Bw = 16.000 MH Calibrated with CL # 3 and BP # 1 (BP mode 1)

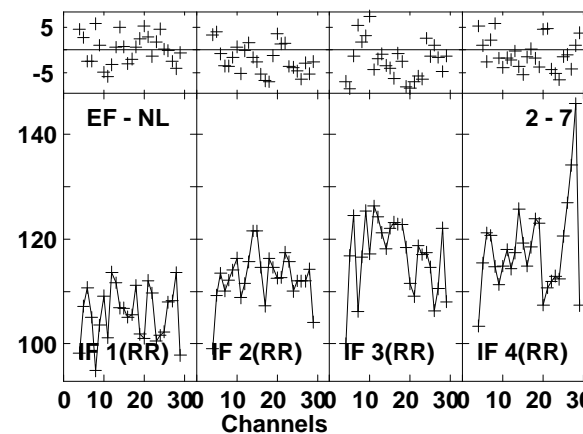
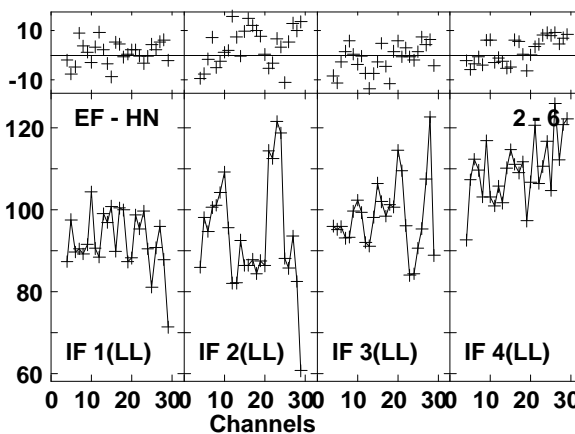
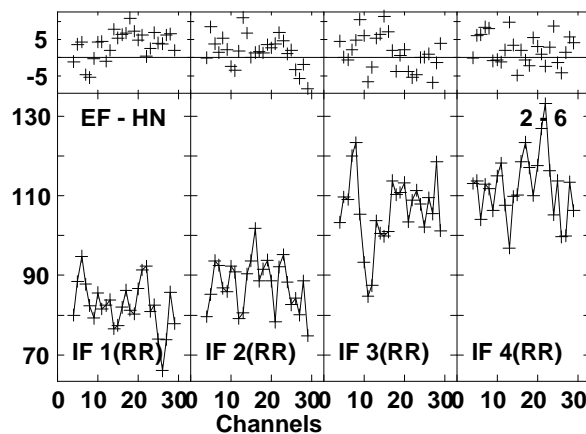
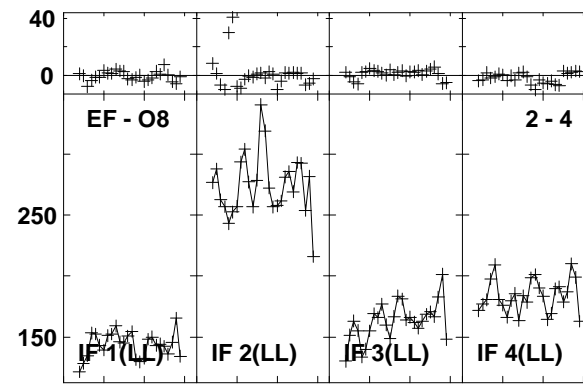
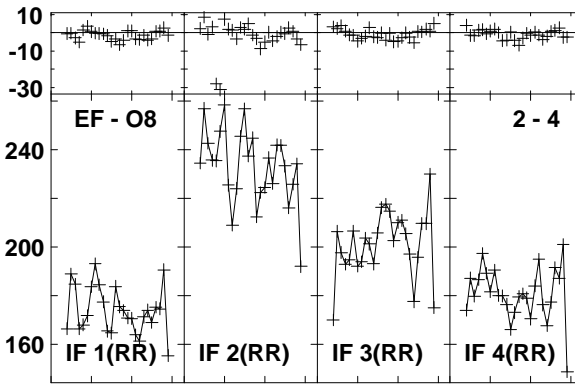
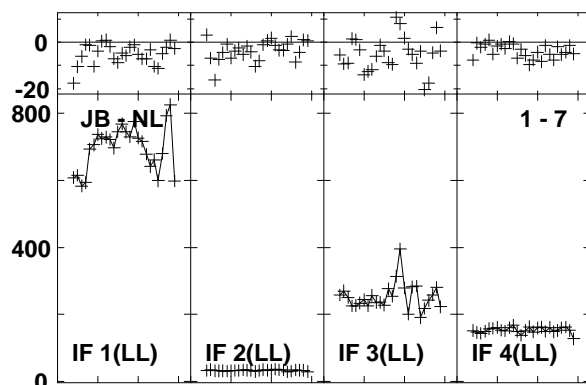
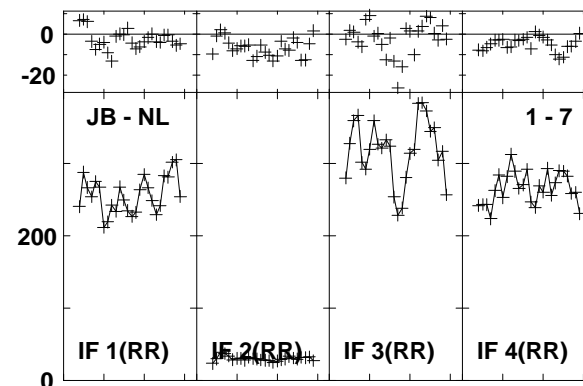
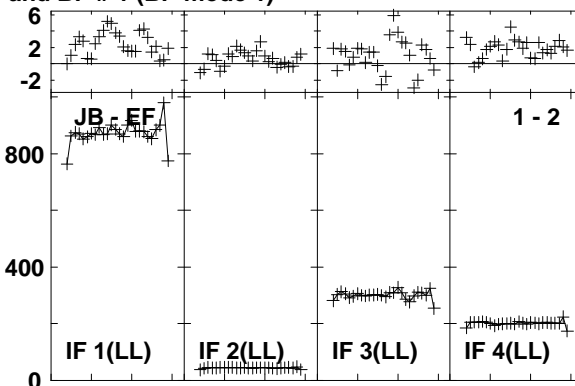
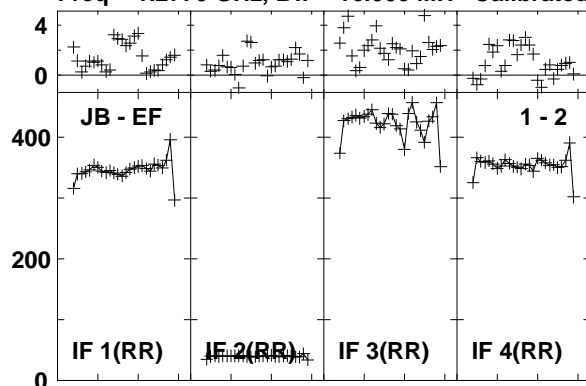

Lower frame: Milli Ampl Jy Top frame: Phas deg
Vector averaged cross-power spectrum Baseline: JB (01) - EF (02)
Timerange: 01/04:39:05 to 01/04:41:53

Plot file version1528 created 03-MAR-2016 01:16:25

J1545+5400 GN002C 1.UVDATA.1

Freq = 1.2770 GHz, Bw = 16.000 MH Calibrated with CL # 3 and BP # 1 (BP mode 1)

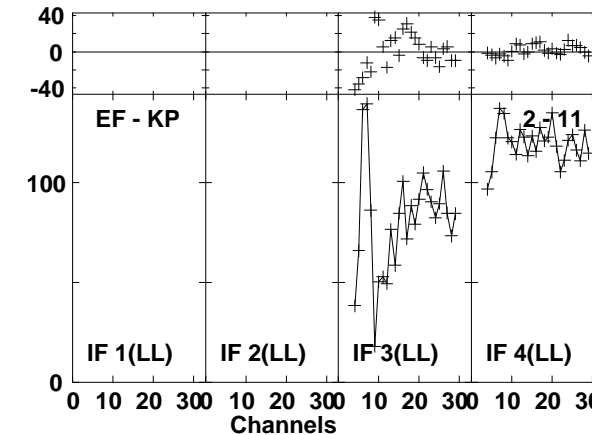
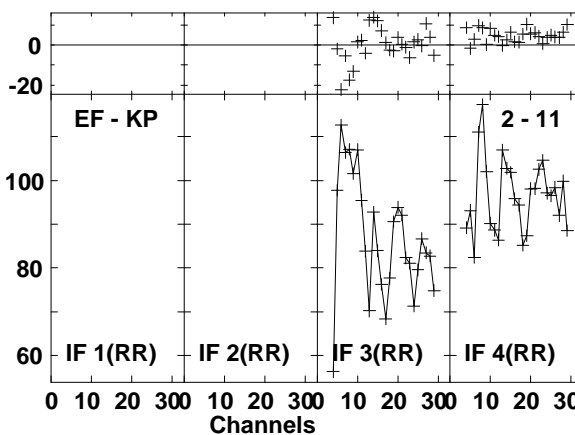
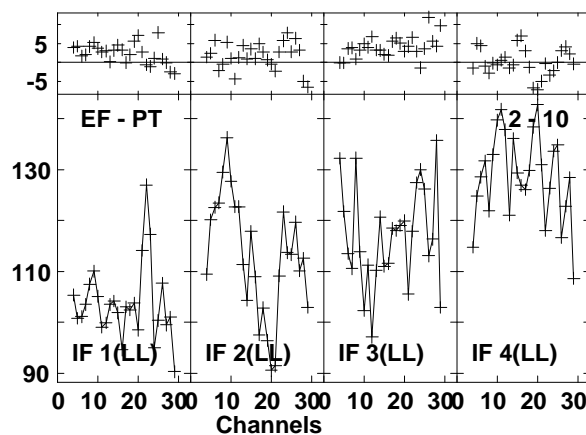
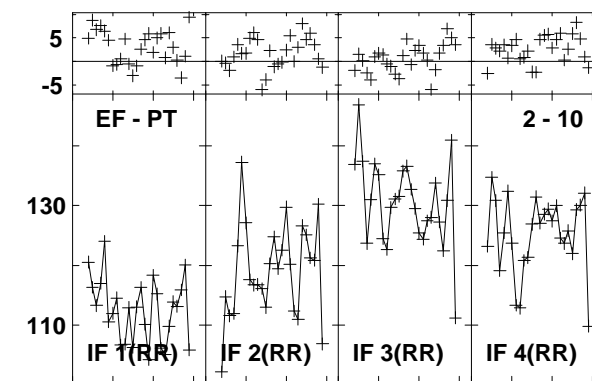
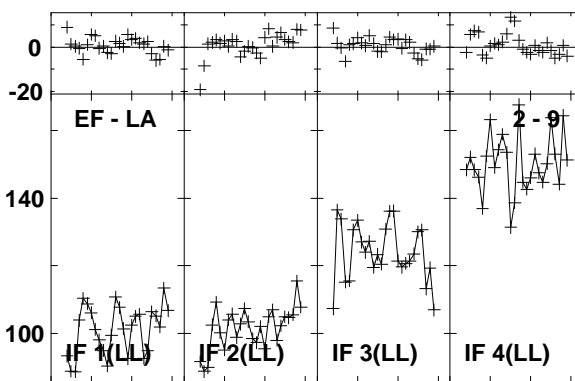
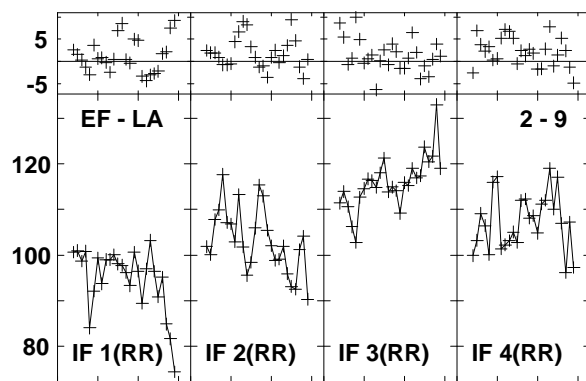
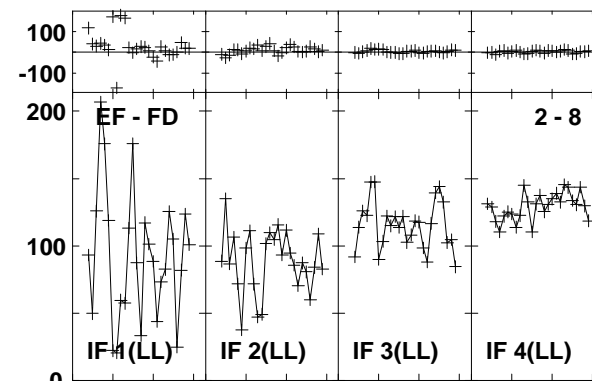
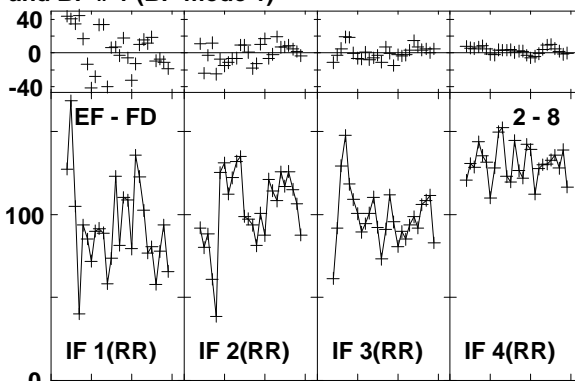
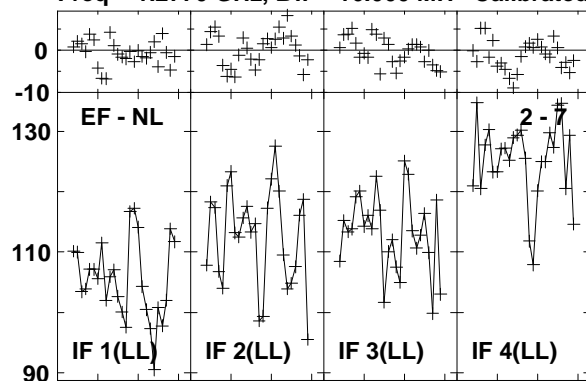

Lower frame: Milli Ampl Jy Top frame: Phas deg
Vector averaged cross-power spectrum Baseline: EF (02) - NL (07)
Timerange: 01/04:39:05 to 01/04:41:53

Plot file version1529 created 03-MAR-2016 01:16:25
 J1545+5400 GN002C 1.UVDATA.1
 Freq = 1.2770 GHz, Bw = 16.000 MH Calibrated with CL # 3 and BP # 1 (BP mode 1)

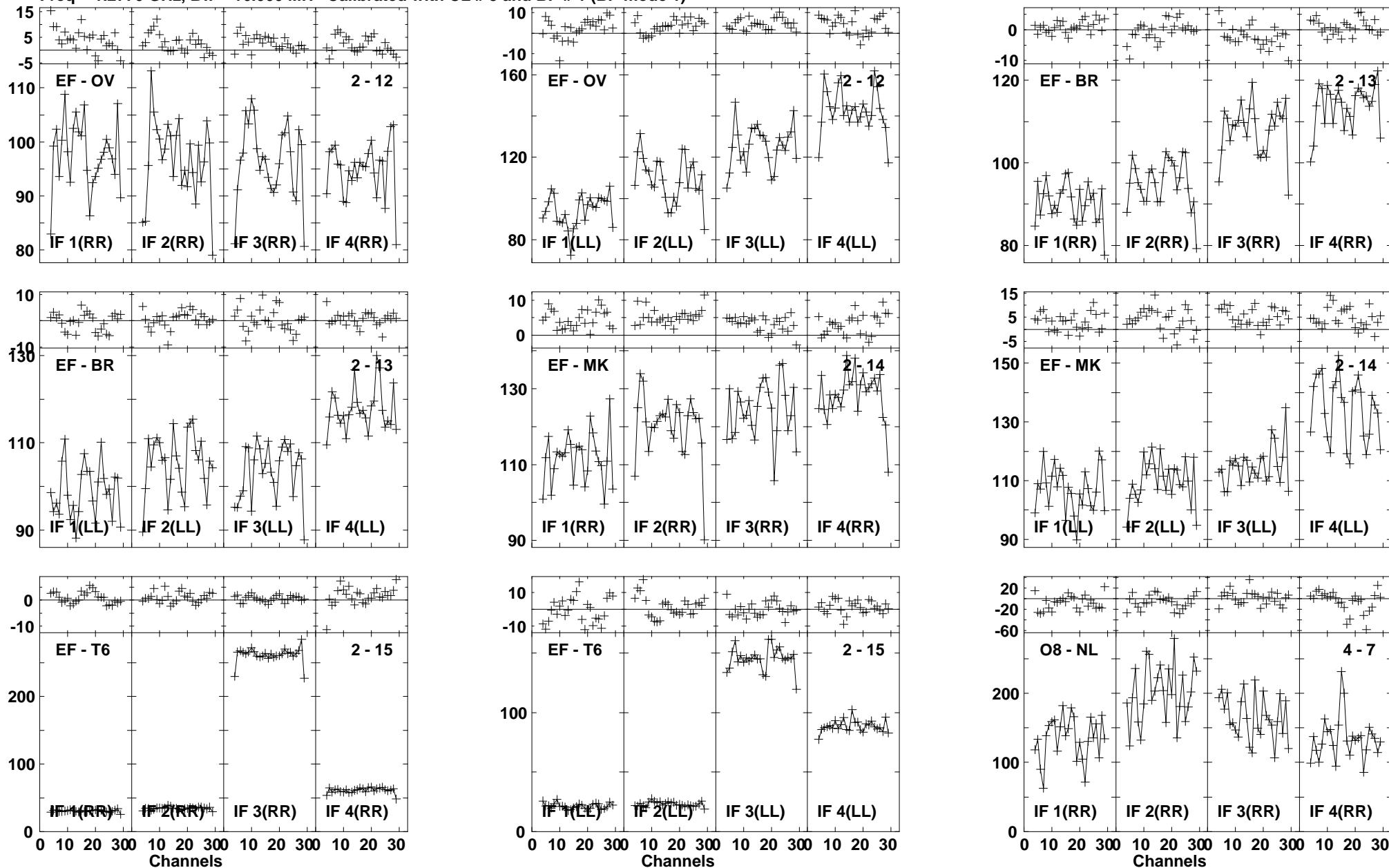

Lower frame: Milli Ampl Jy Top frame: Phas deg
 Vector averaged cross-power spectrum Baseline: EF (02) - OV (12)
 Timerange: 01/04:39:05 to 01/04:41:53

Plot file version1530 created 03-MAR-2016 01:16:25

J1545+5400 GN002C 1.UVDATA.1

Freq = 1.2770 GHz, Bw = 16.000 MH Calibrated with CL # 3 and BP # 1 (BP mode 1)

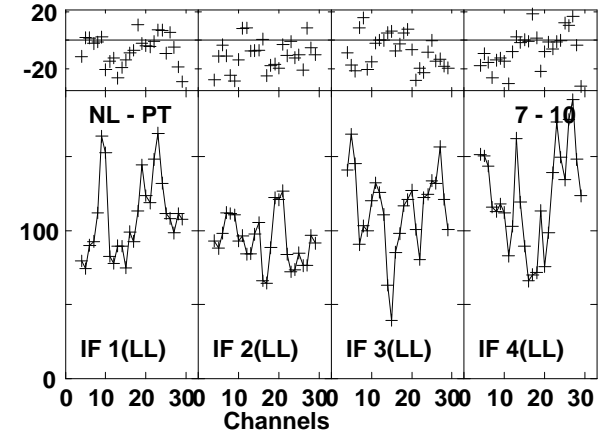
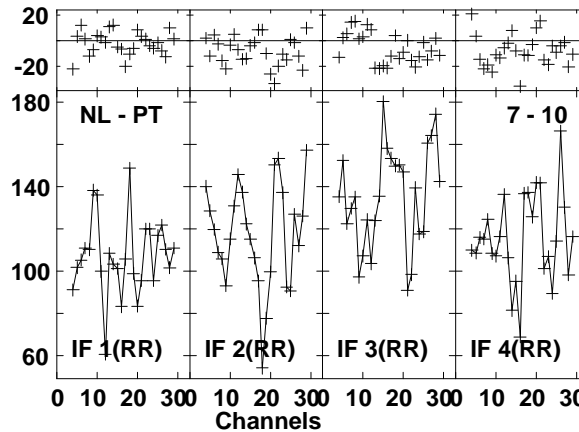
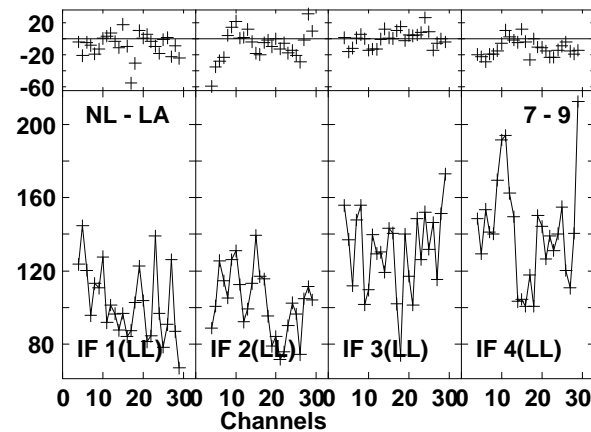
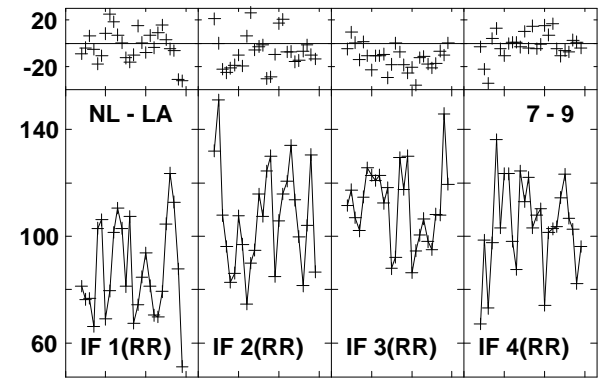
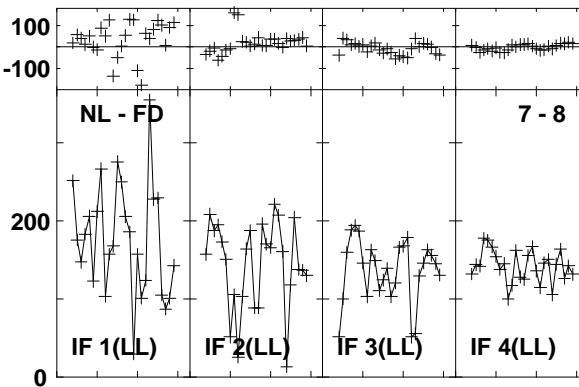
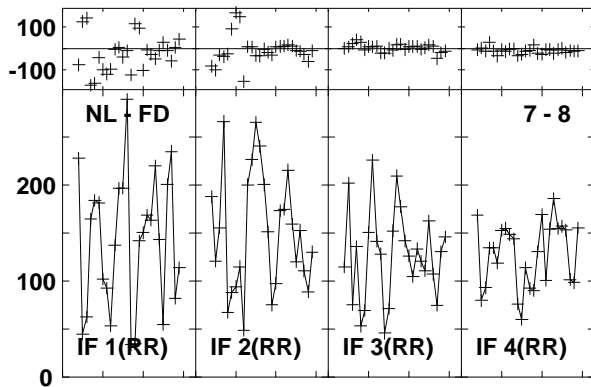
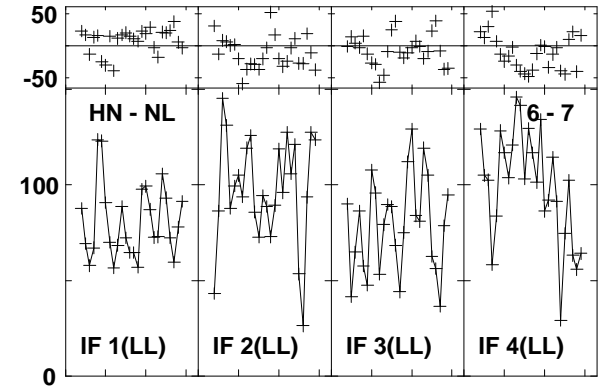
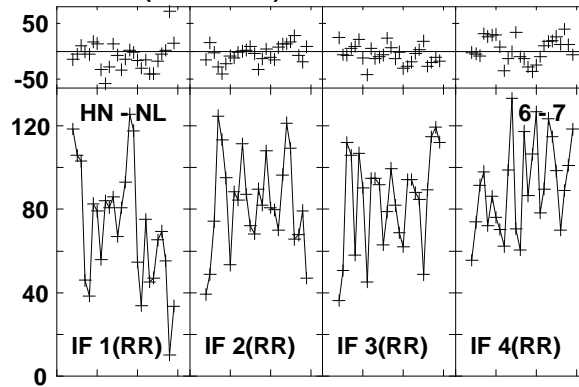
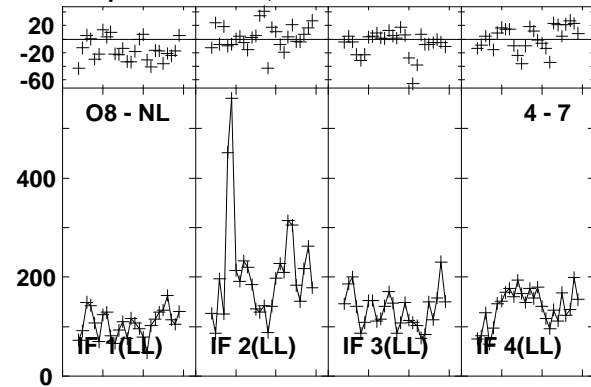

Lower frame: Milli Ampl Jy Top frame: Phas deg
Vector averaged cross-power spectrum Baseline: O8 (04) - NL (07)
Timerange: 01/04:39:05 to 01/04:41:53

Plot file version1531 created 03-MAR-2016 01:16:25
 J1545+5400 GN002C 1.UVDATA.1
 Freq = 1.2770 GHz, Bw = 16.000 MH Calibrated with CL # 3 and BP # 1 (BP mode 1)

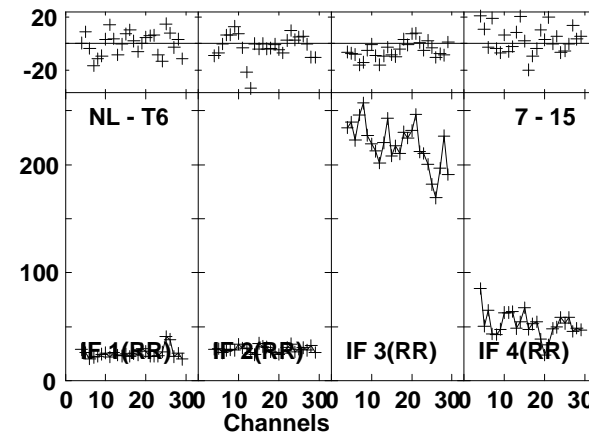
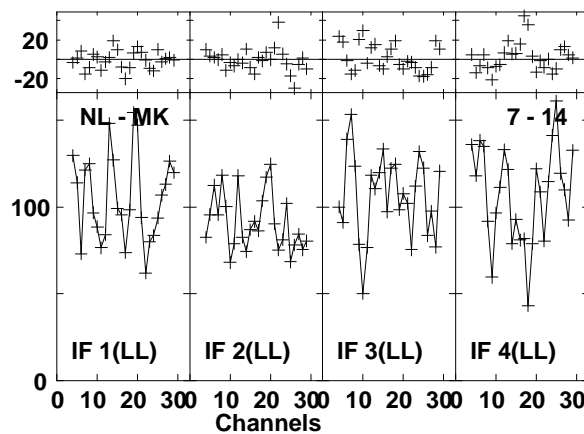
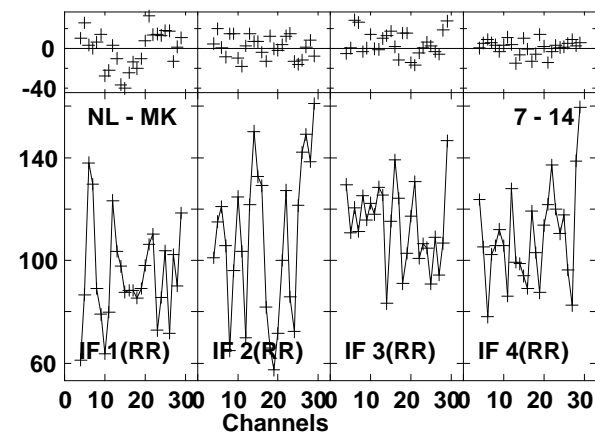
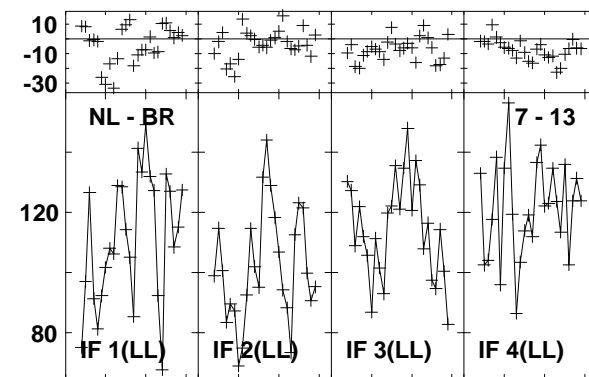
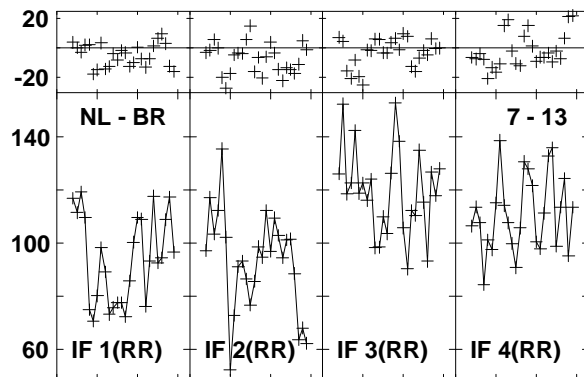
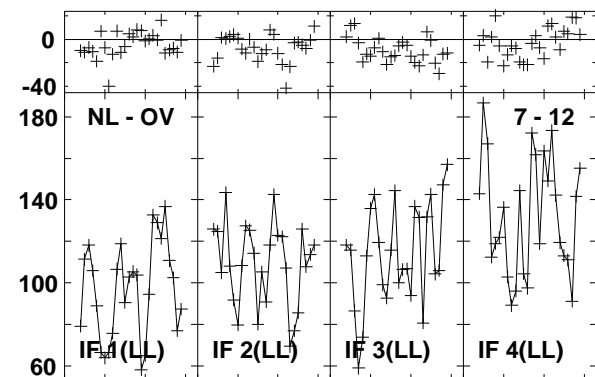
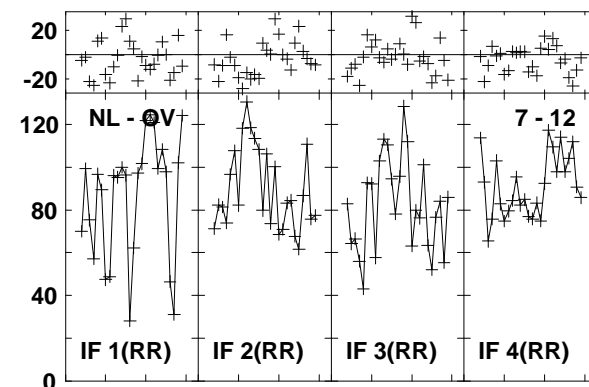
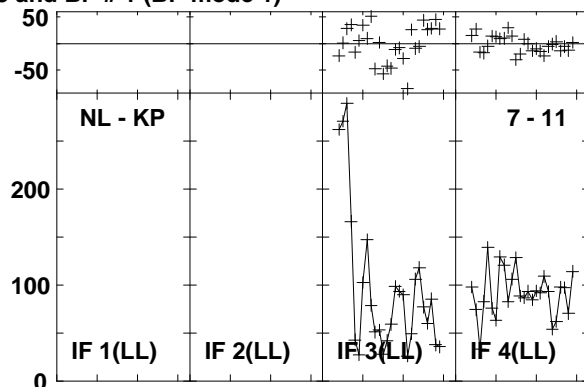
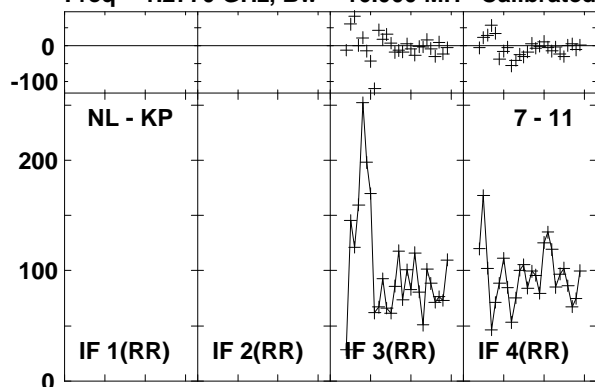

Lower frame: Milli Ampl Jy Top frame: Phas deg
 Vector averaged cross-power spectrum Baseline: NL (07) - KP (11)
 Timerange: 01/04:39:05 to 01/04:41:53

Plot file version1532 created 03-MAR-2016 01:16:25
J1545+5400 GN002C 1.UVDATA.1
Freq = 1.2770 GHz, Bw = 16.000 MH Calibrated with CL # 3 and BP # 1 (BP mode 1)

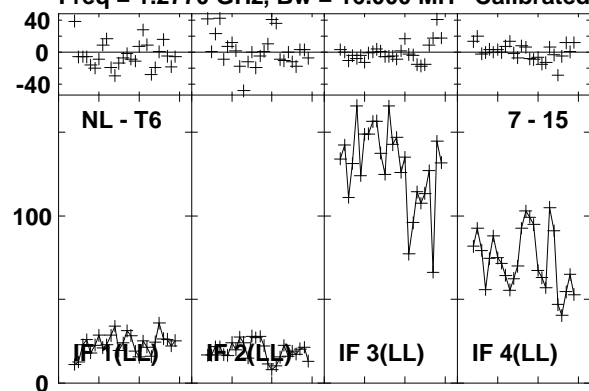

Lower frame: Milli Ampl Jy Top frame: Phas deg
Vector averaged cross-power spectrum Baseline: NL (07) - T6 (15)
Timerange: 01/04:39:05 to 01/04:41:53

Plot file version1533 created 03-MAR-2016 01:16:25

4C52 GN002C 1.UVDATA.1

Freq = 1.2770 GHz, Bw = 16.000 MH Calibrated with CL # 3 and BP # 1 (BP mode 1)

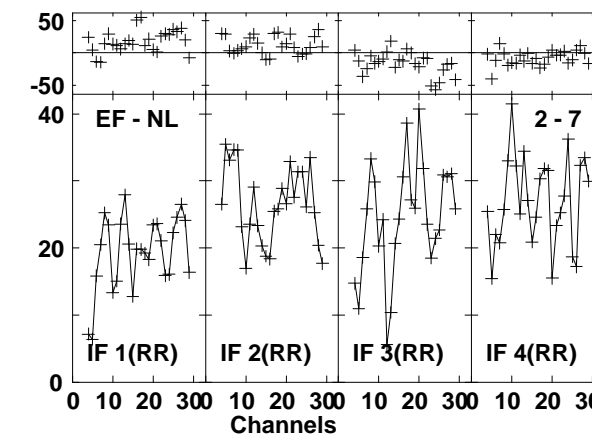
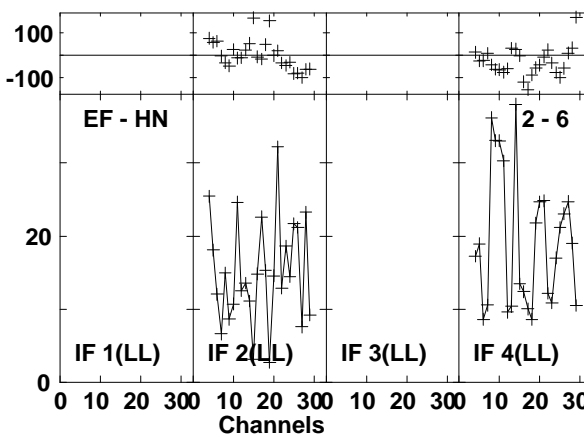
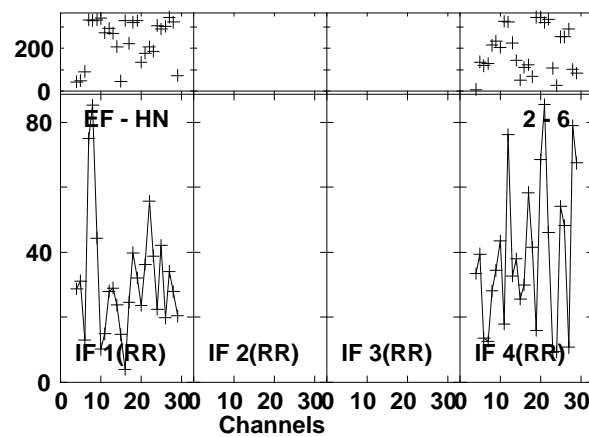
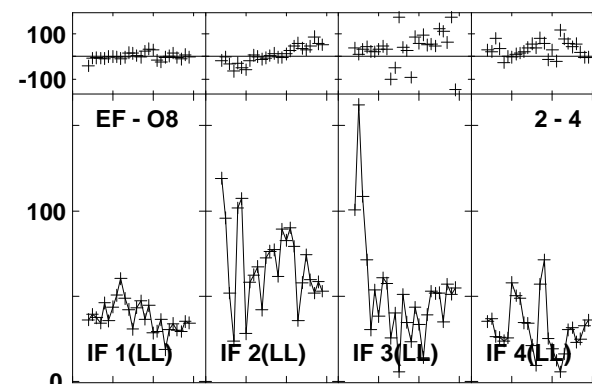
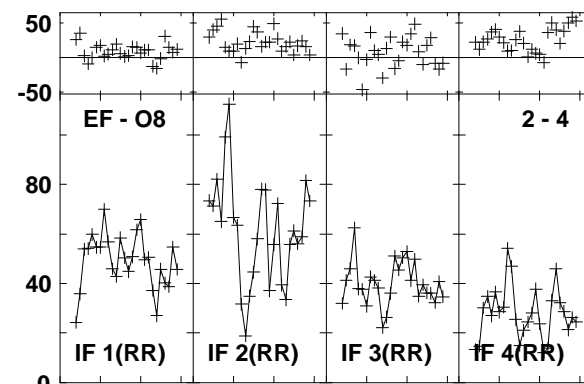
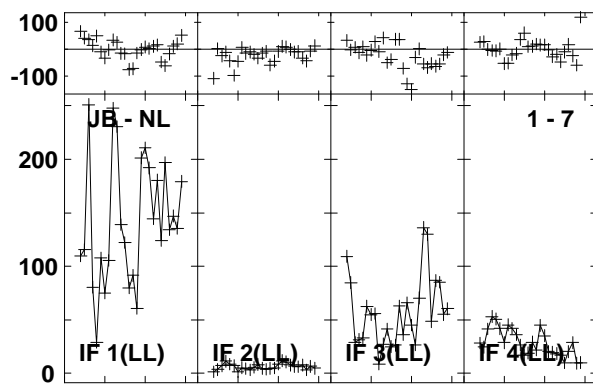
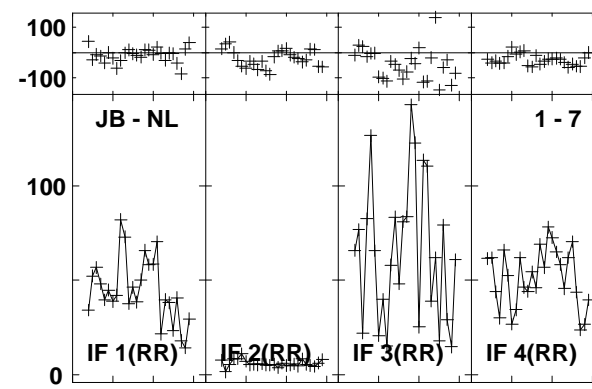
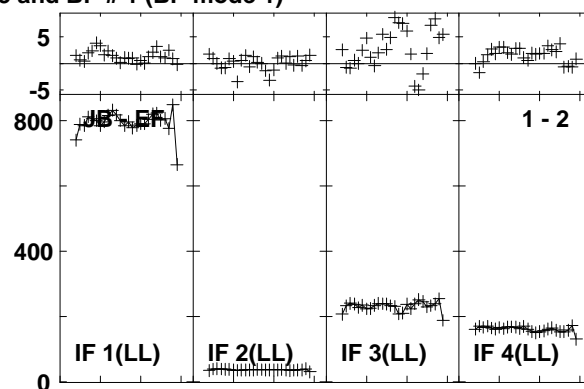
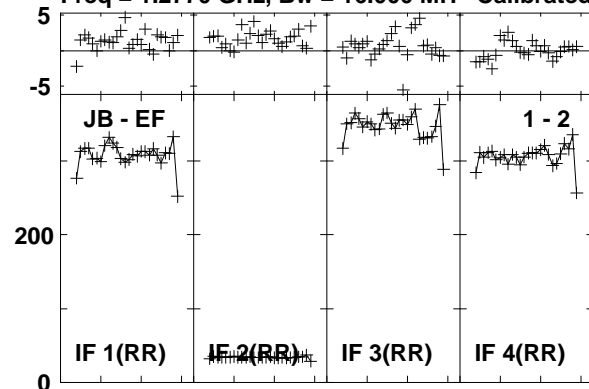

Lower frame: Milli Ampl Jy Top frame: Phas deg
Vector averaged cross-power spectrum Baseline: JB (01) - EF (02)
Timerange: 01/04:42:05 to 01/04:45:23

Plot file version1534 created 03-MAR-2016 01:16:26

4C52 GN002C 1.UVDATA.1

Freq = 1.2770 GHz, Bw = 16.000 MH Calibrated with CL # 3 and BP # 1 (BP mode 1)

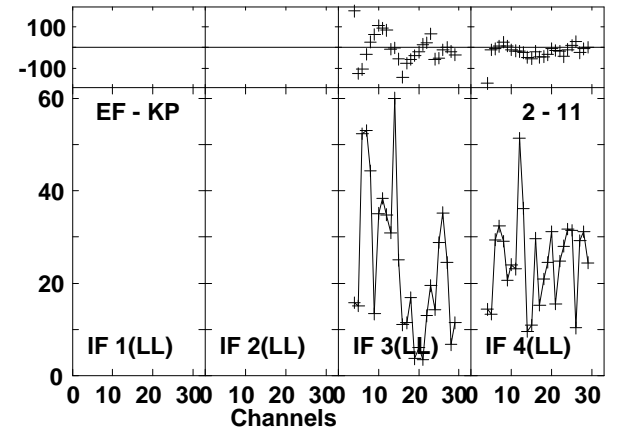
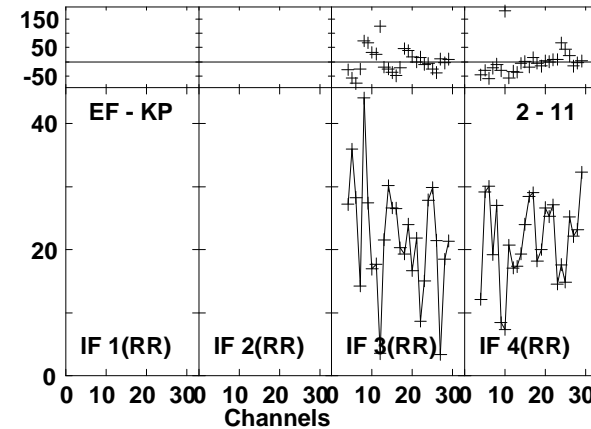
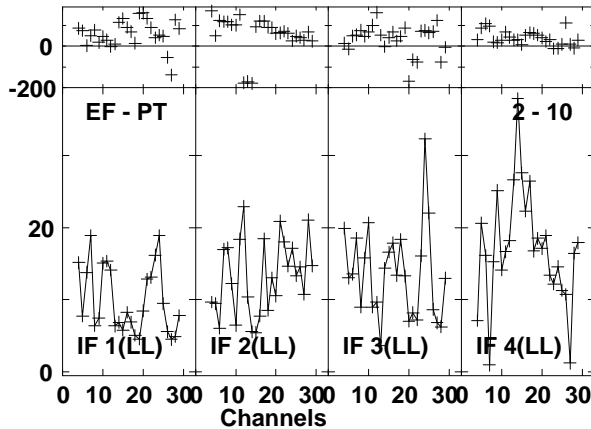
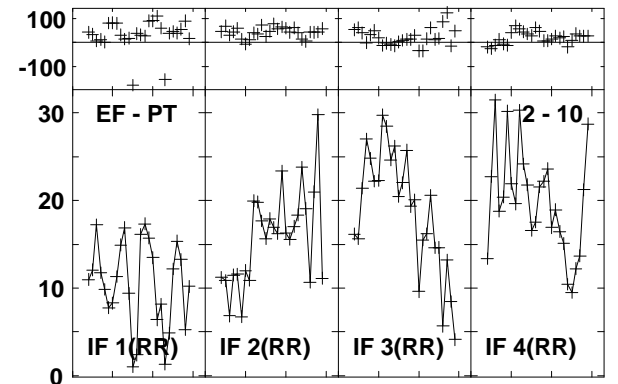
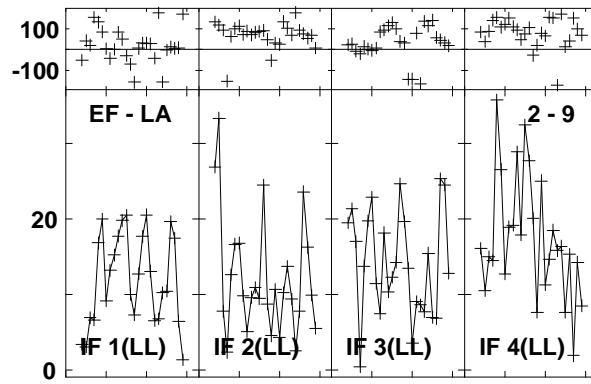
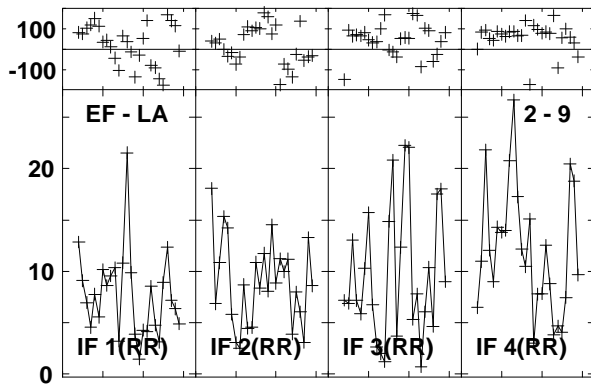
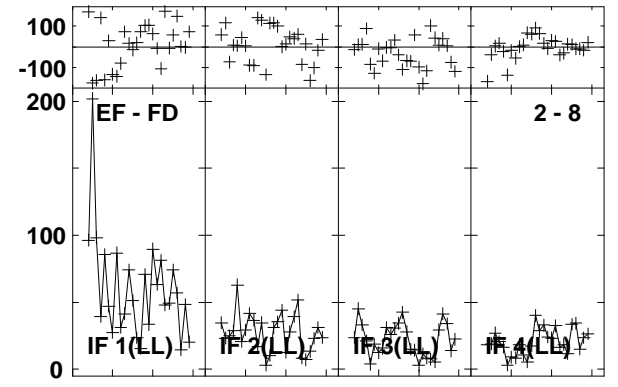
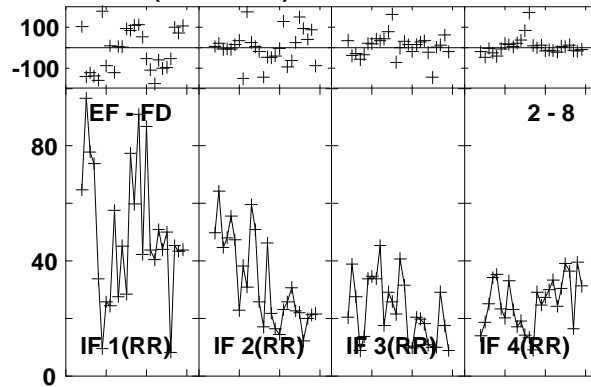
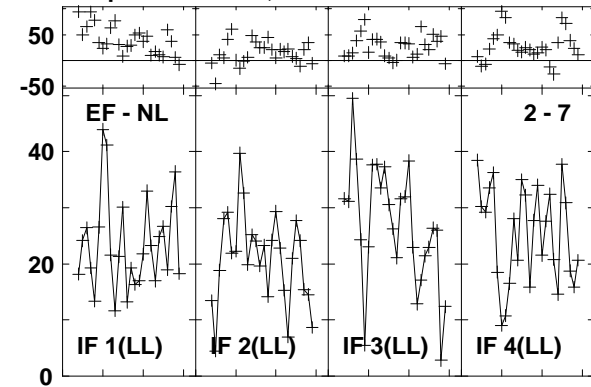

Lower frame: Milli Ampl Jy Top frame: Phas deg
Vector averaged cross-power spectrum Baseline: EF (02) - NL (07)
Timerange: 01/04:42:05 to 01/04:45:23

Plot file version1535 created 03-MAR-2016 01:16:26

4C52 GN002C 1.UVDATA.1

Freq = 1.2770 GHz, Bw = 16.000 MH Calibrated with CL # 3 and BP # 1 (BP mode 1)

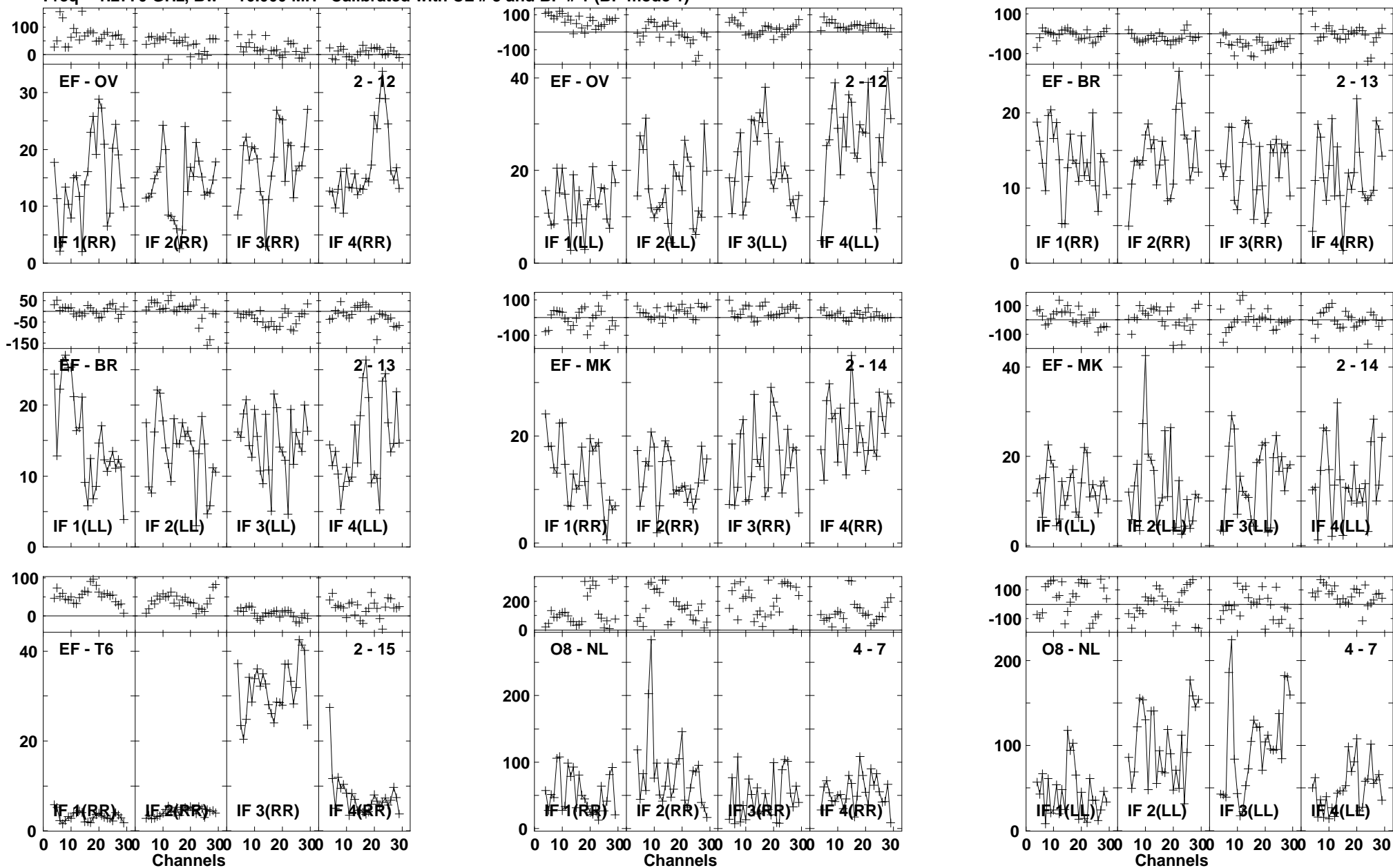

Lower frame: Milli Ampl Jy Top frame: Phas deg
Vector averaged cross-power spectrum Baseline: EF (02) - OV (12)
Timerange: 01/04:42:05 to 01/04:45:23

Plot file version1536 created 03-MAR-2016 01:16:26

4C52 GN002C 1.UVDATA.1

Freq = 1.2770 GHz, Bw = 16.000 MH Calibrated with CL # 3 and BP # 1 (BP mode 1)

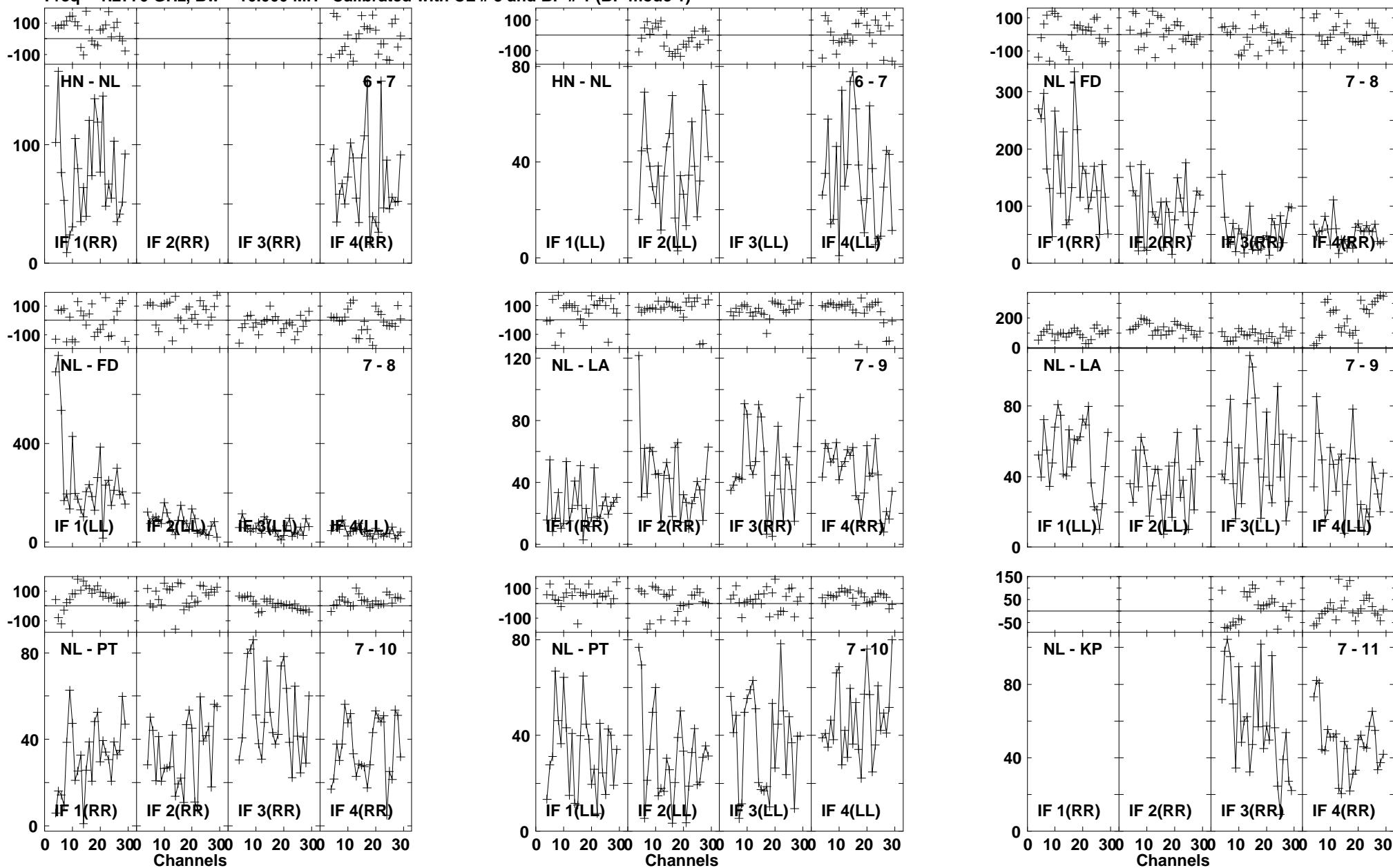

Lower frame: Milli Ampl Jy Top frame: Phas deg
Vector averaged cross-power spectrum Baseline: HN (06) - NL (07)
Timerange: 01/04:42:05 to 01/04:45:23

Plot file version1537 created 03-MAR-2016 01:16:26

4C52 GN002C 1.UVDATA.1

Freq = 1.2770 GHz, Bw = 16.000 MH Calibrated with CL # 3 and BP # 1 (BP mode 1)

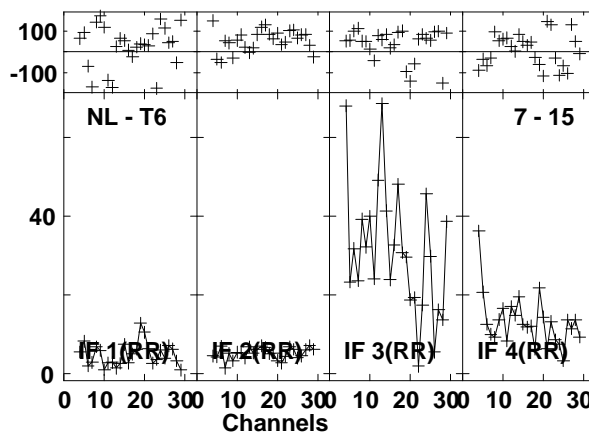
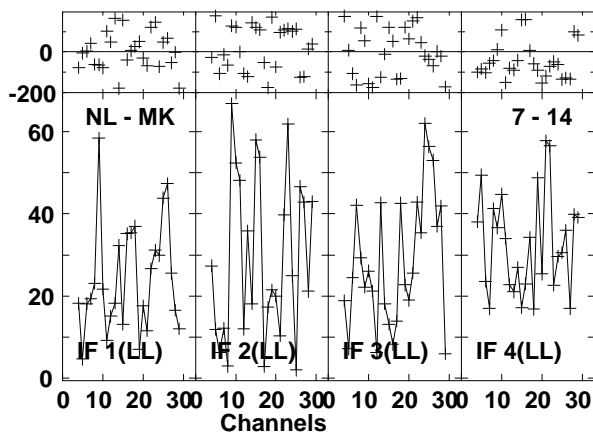
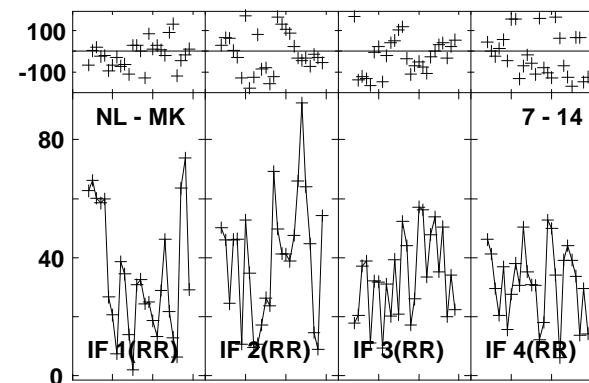
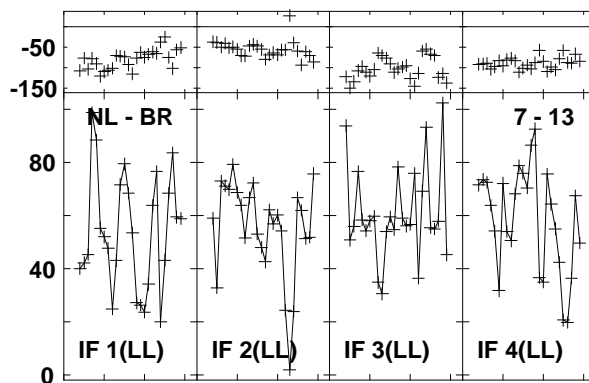
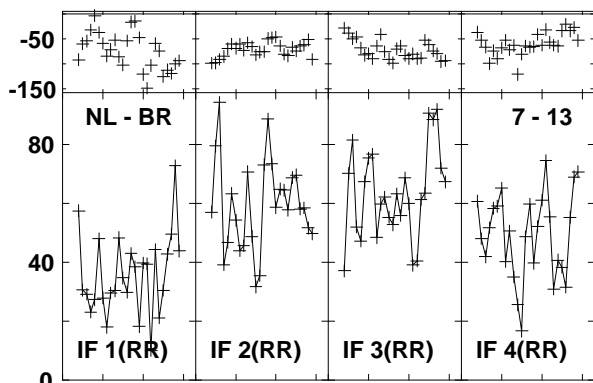
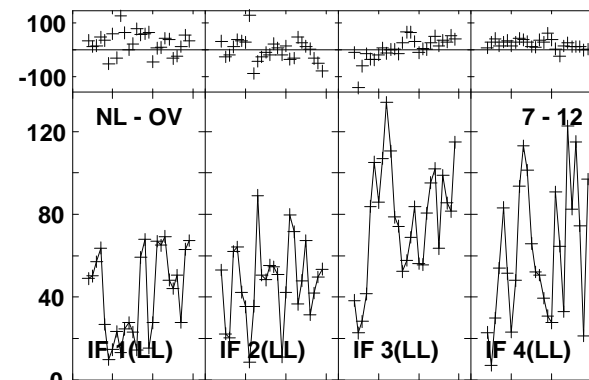
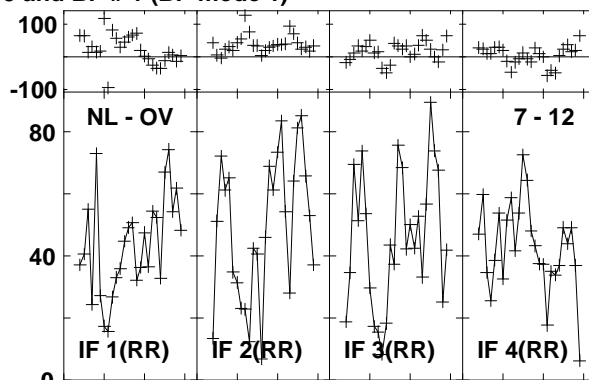
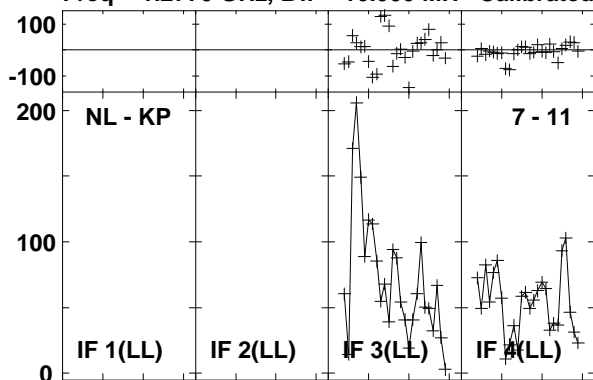

Lower frame: Milli Ampl Jy Top frame: Phas deg

Vector averaged cross-power spectrum Baseline: NL (07) - KP (11)

Timerange: 01/04:42:05 to 01/04:45:23

Plot file version1538 created 03-MAR-2016 01:16:27

J1545+5400 GN002C 1.UVDATA.1

Freq = 1.2770 GHz, Bw = 16.000 MH Calibrated with CL # 3 and BP # 1 (BP mode 1)

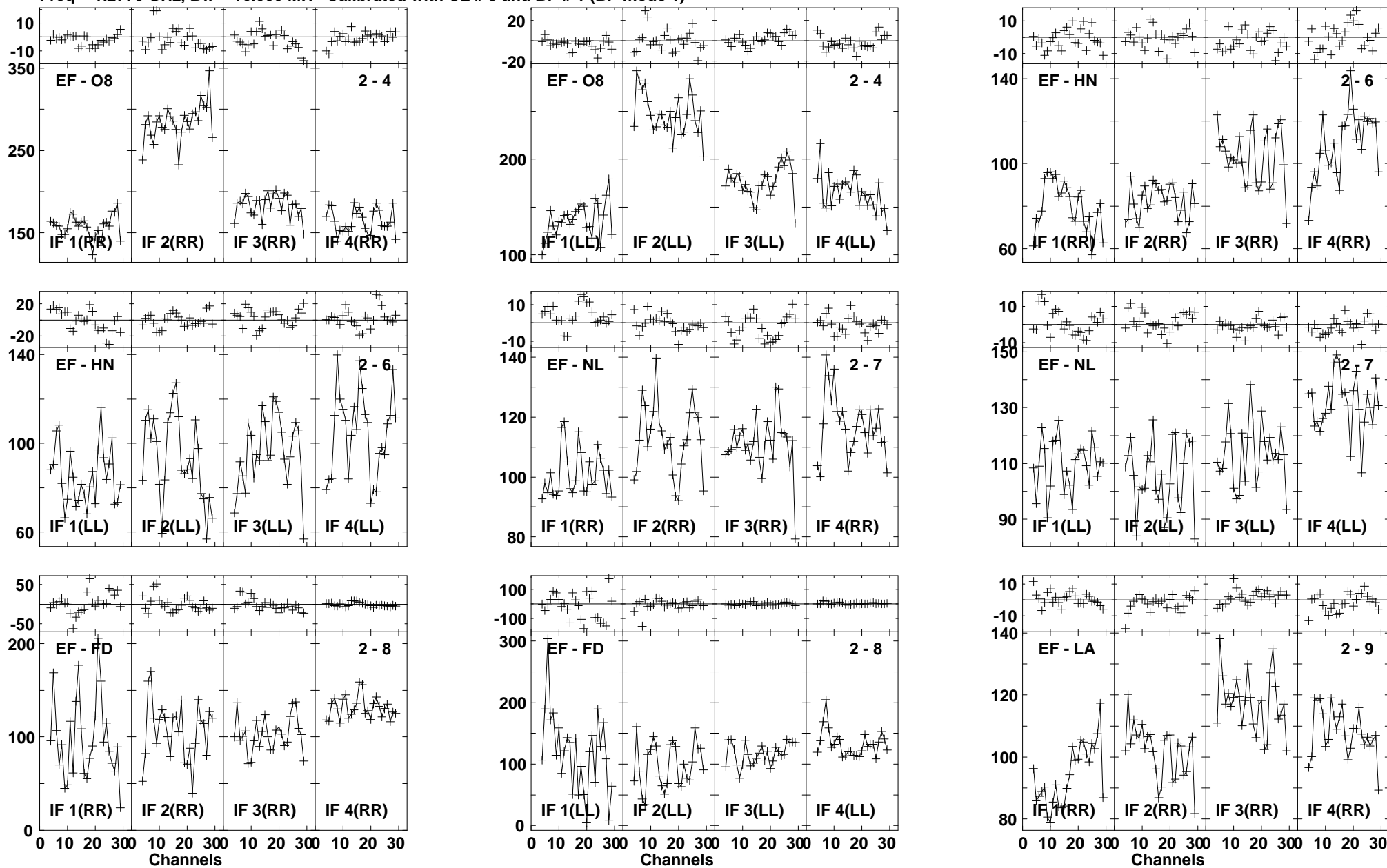

Lower frame: Milli Ampl Jy Top frame: Phas deg
Vector averaged cross-power spectrum Baseline: EF (02) - O8 (04)
Timerange: 01/04:46:15 to 01/04:47:33

Plot file version1539 created 03-MAR-2016 01:16:27

J1545+5400 GN002C 1.UVDATA.1

Freq = 1.2770 GHz, Bw = 16.000 MH Calibrated with CL # 3 and BP # 1 (BP mode 1)

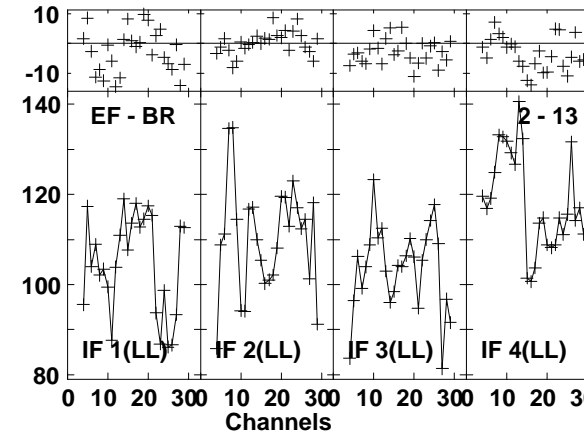
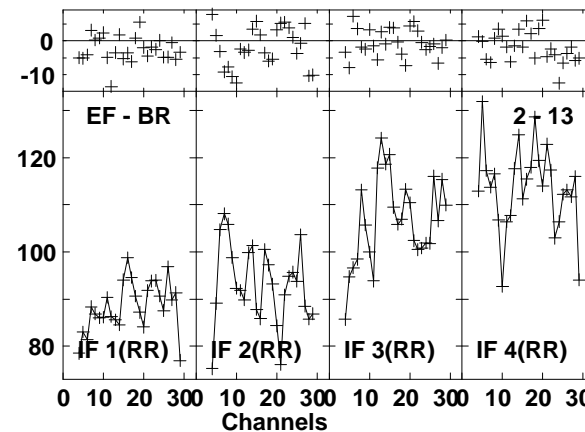
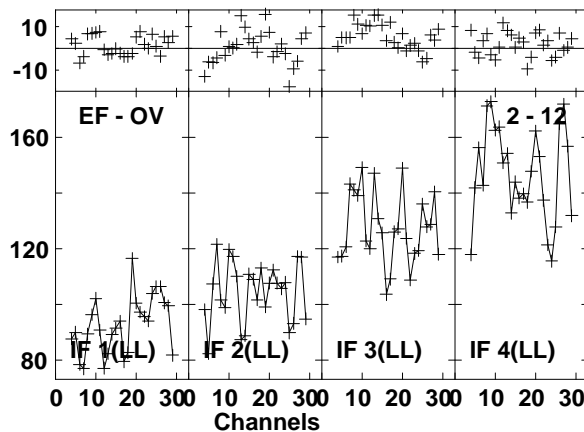
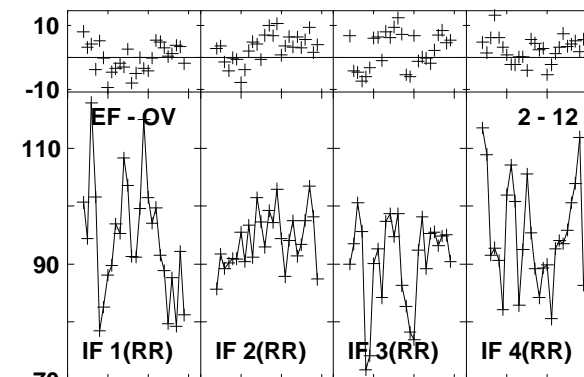
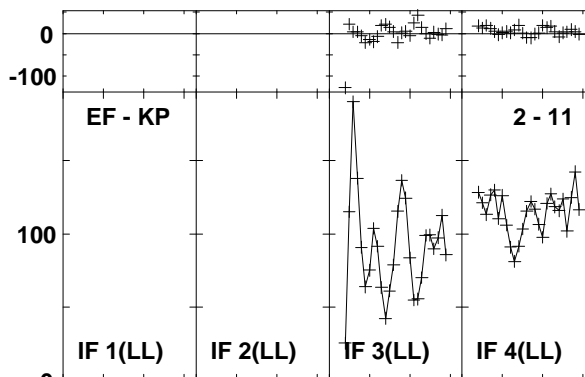
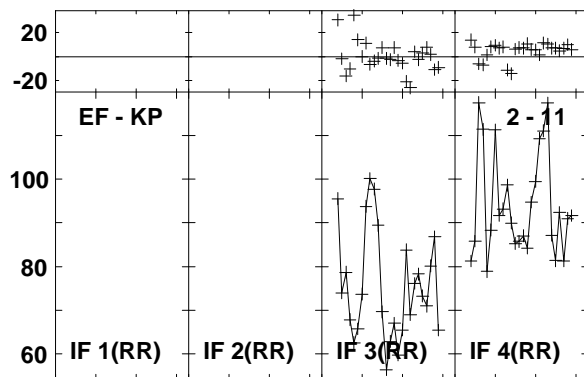
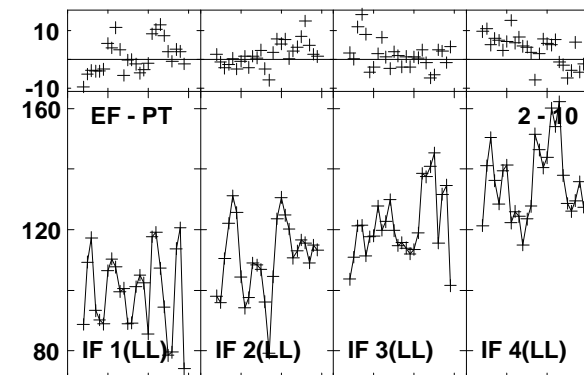
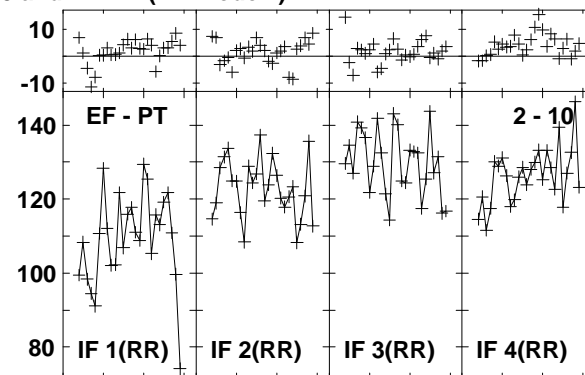
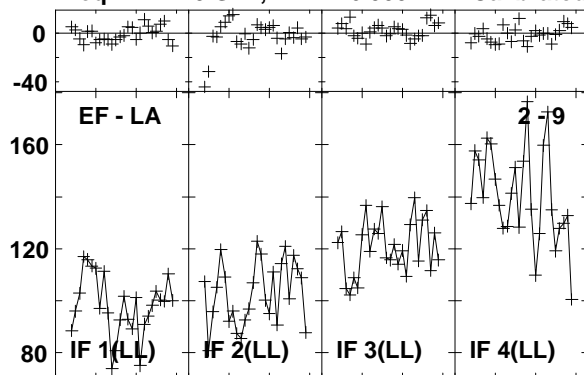

Lower frame: Milli Ampl Jy Top frame: Phas deg
Vector averaged cross-power spectrum Baseline: EF (02) - LA (09)
Timerange: 01/04:46:15 to 01/04:47:33

Plot file version1540 created 03-MAR-2016 01:16:27

J1545+5400 GN002C 1.UVDATA.1

Freq = 1.2770 GHz, Bw = 16.000 MH Calibrated with CL # 3 and BP # 1 (BP mode 1)

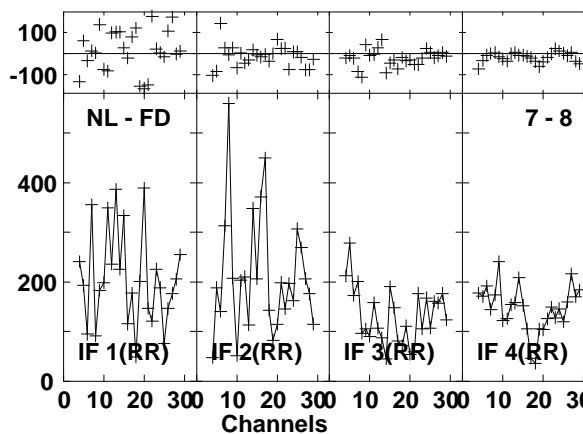
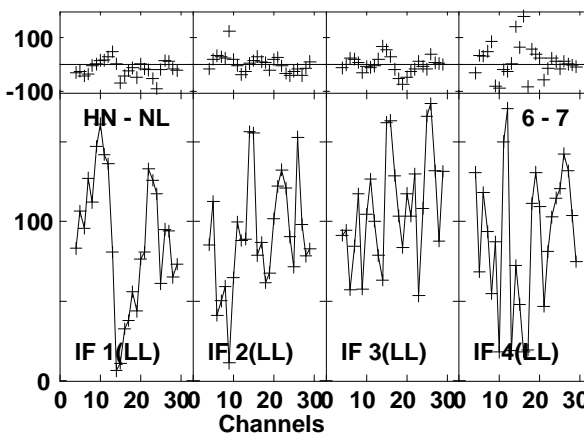
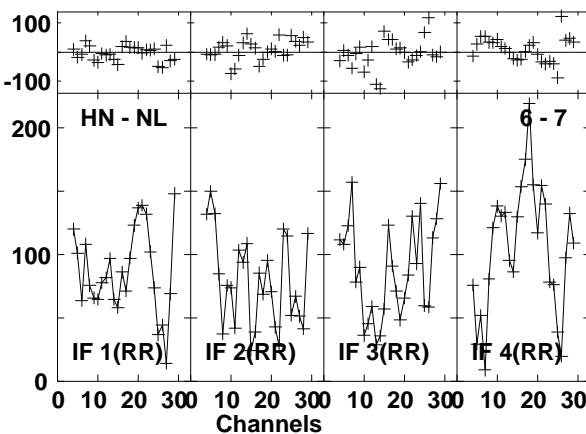
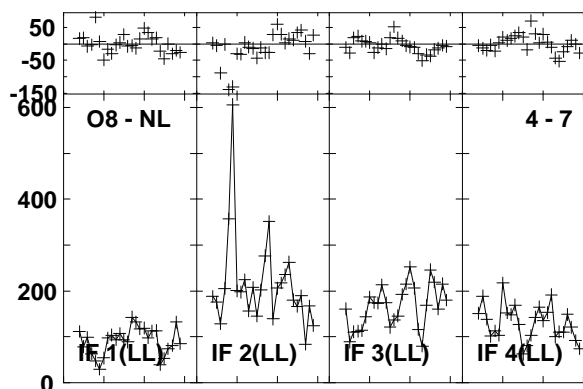
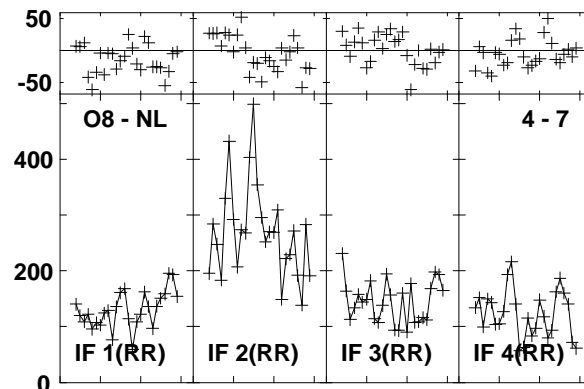
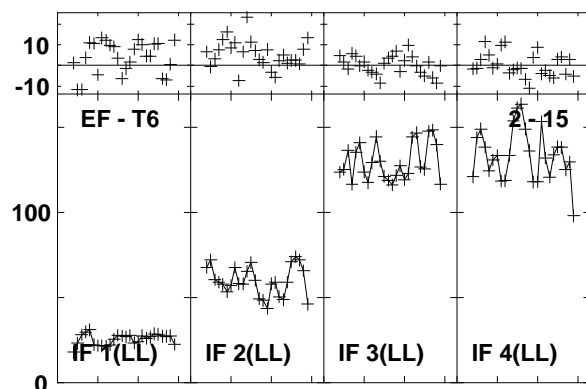
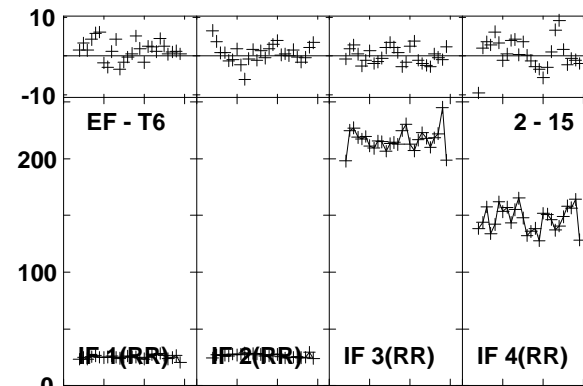
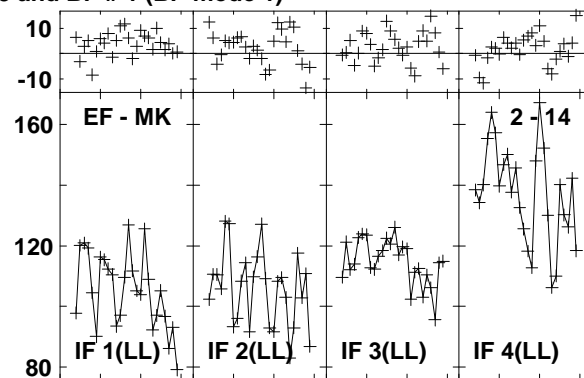
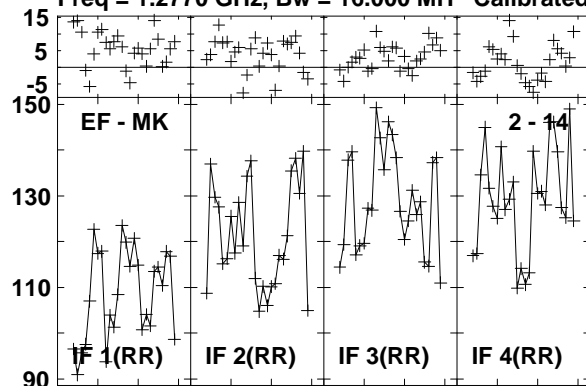

Lower frame: Milli Ampl Jy Top frame: Phas deg
Vector averaged cross-power spectrum Baseline: EF (02) - MK (14)
Timerange: 01/04:46:15 to 01/04:47:33

Plot file version1541 created 03-MAR-2016 01:16:27
 J1545+5400 GN002C 1.UVDATA.1
 Freq = 1.2770 GHz, Bw = 16.000 MH Calibrated with CL # 3 and BP # 1 (BP mode 1)

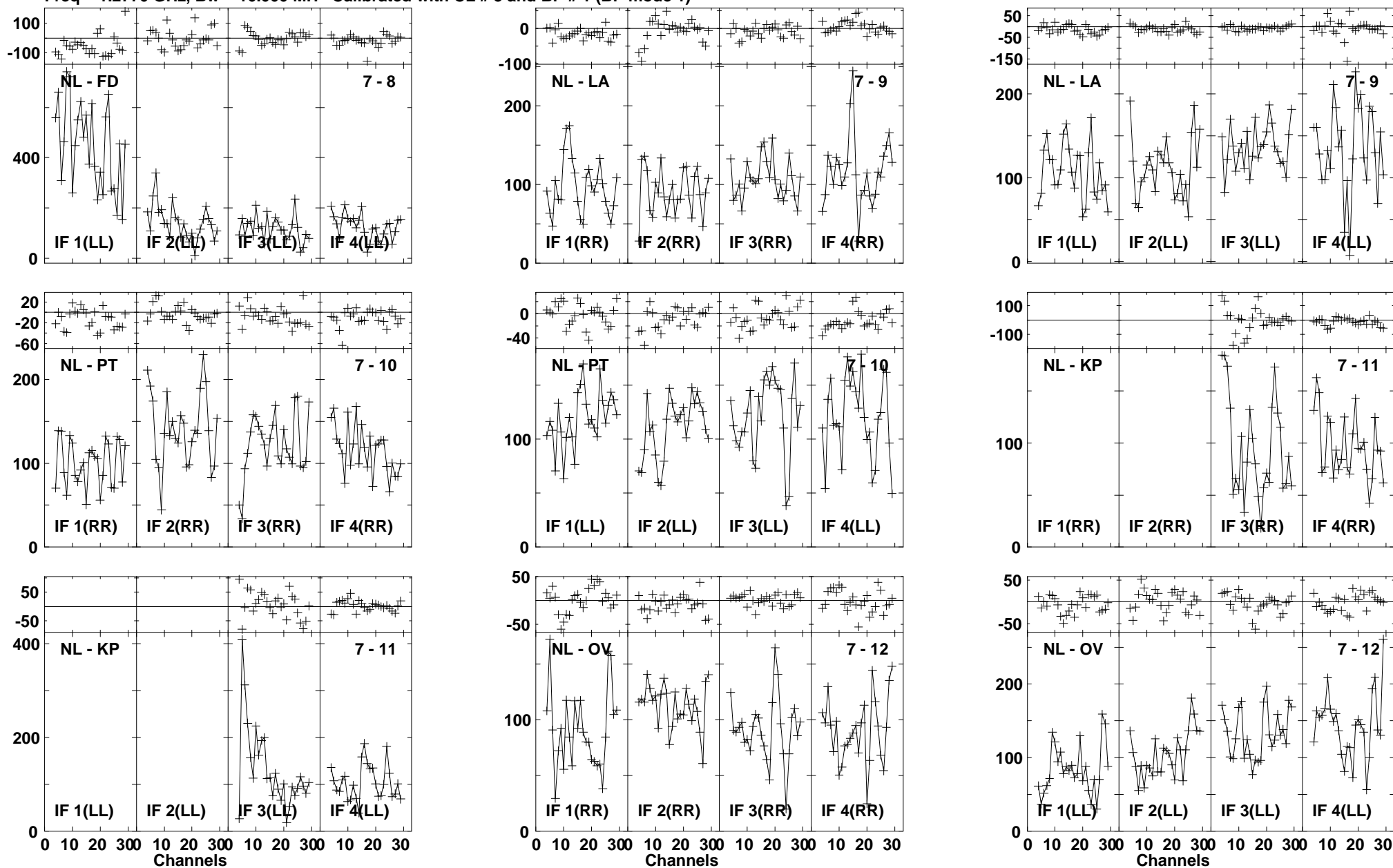

Lower frame: Milli Ampl Jy Top frame: Phas deg
 Vector averaged cross-power spectrum Baseline: NL (07) - FD (08)
 Timerange: 01/04:46:15 to 01/04:47:33

Plot file version1542 created 03-MAR-2016 01:16:27

J1545+5400 GN002C 1.UVDATA.1

Freq = 1.2770 GHz, Bw = 16.000 MH Calibrated with CL # 3 and BP # 1 (BP mode 1)

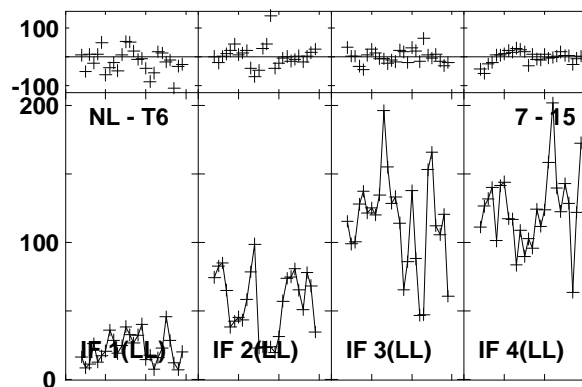
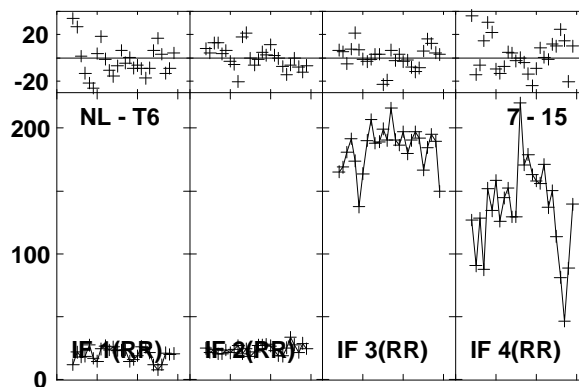
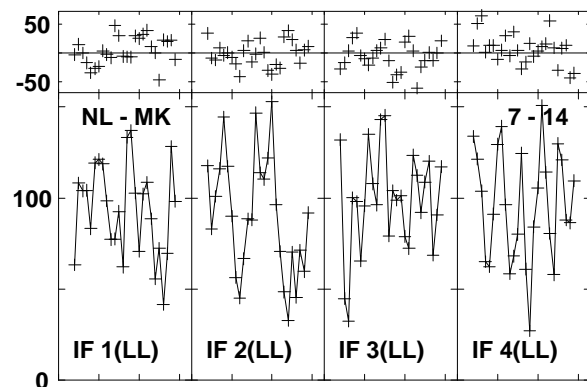
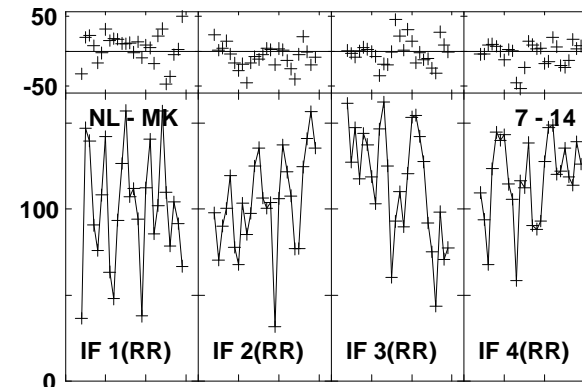
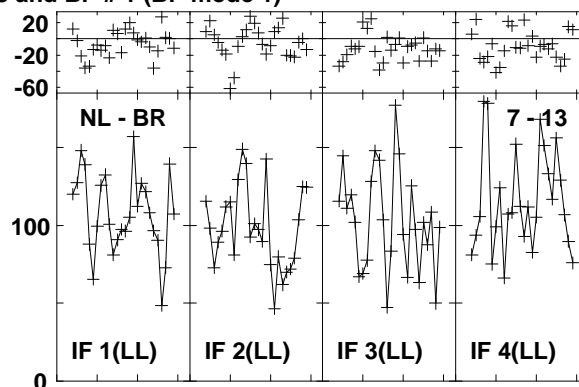
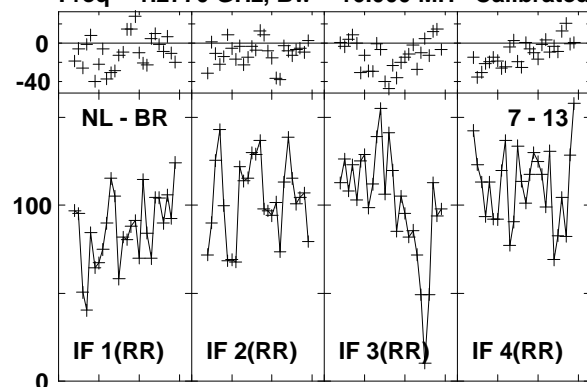

Lower frame: Milli Ampl Jy Top frame: Phas deg
Vector averaged cross-power spectrum Baseline: NL (07) - BR (13)
Timerange: 01/04:46:15 to 01/04:47:33

Plot file version1543 created 03-MAR-2016 01:16:28

4C52 GN002C 1.UVDATA.1

Freq = 1.2770 GHz, Bw = 16.000 MH Calibrated with CL # 3 and BP # 1 (BP mode 1)

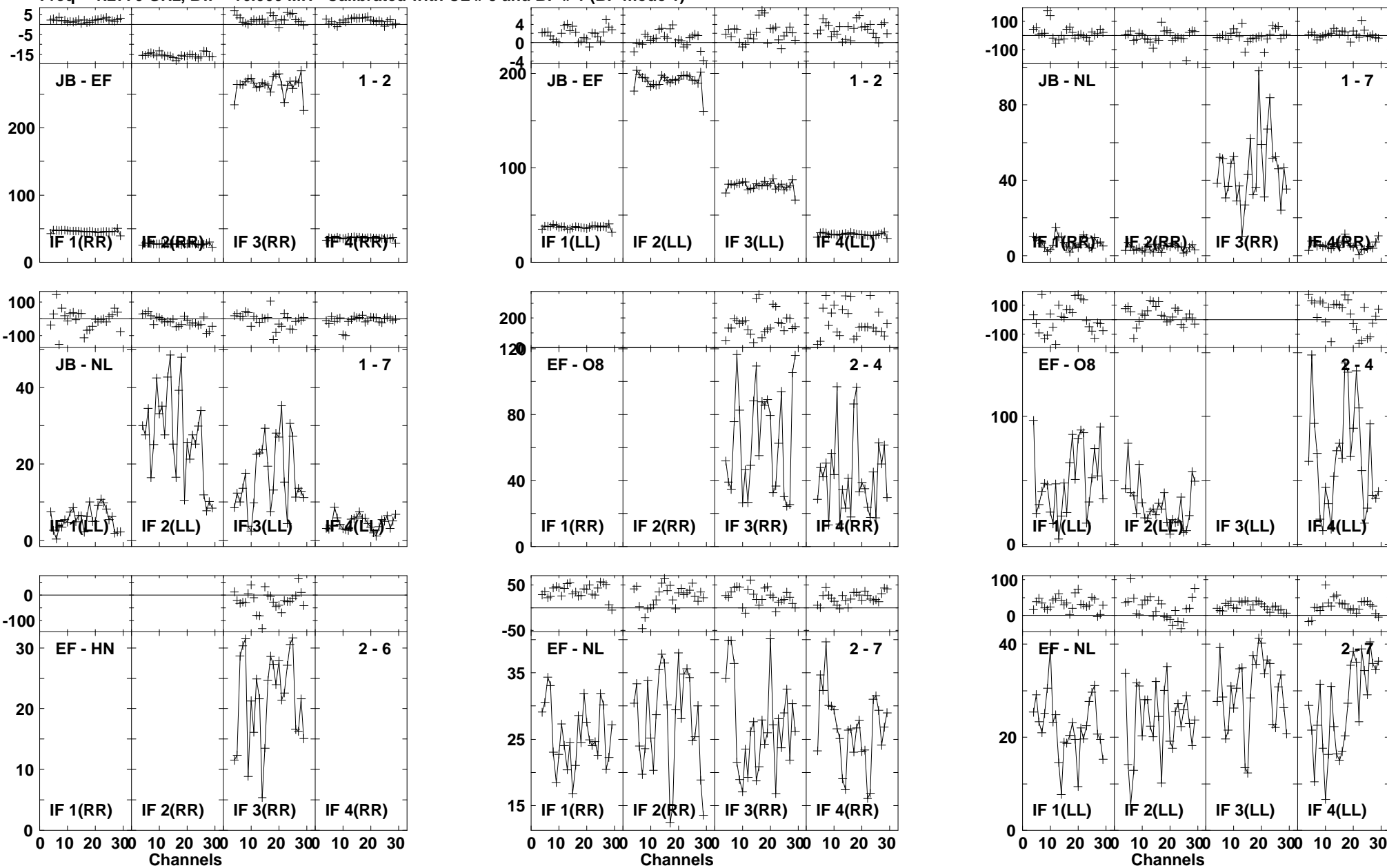

Lower frame: Milli Ampl Jy Top frame: Phas deg
Vector averaged cross-power spectrum Baseline: JB (01) - EF (02)
Timerange: 01/04:47:38 to 01/04:51:02

Plot file version1544 created 03-MAR-2016 01:16:28

4C52 GN002C 1.UVDATA.1

Freq = 1.2770 GHz, Bw = 16.000 MH Calibrated with CL # 3 and BP # 1 (BP mode 1)

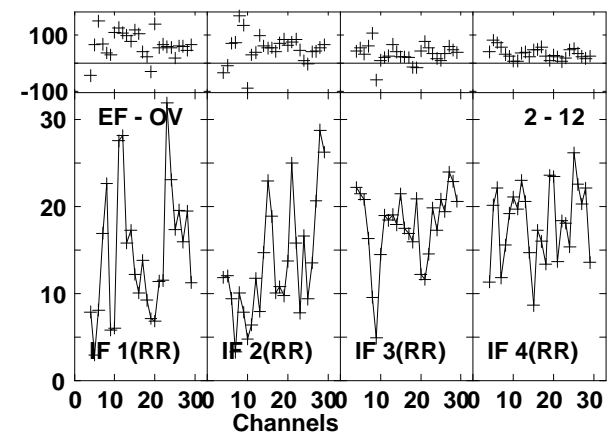
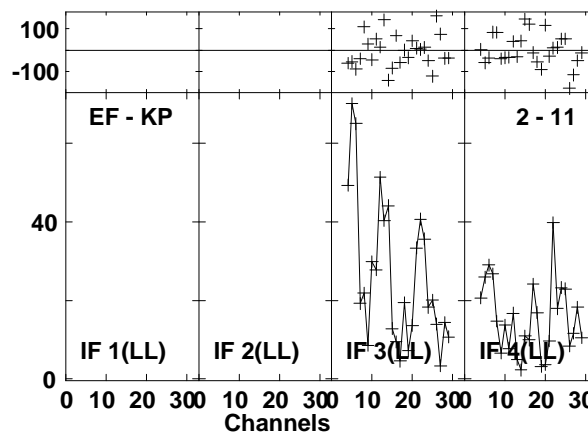
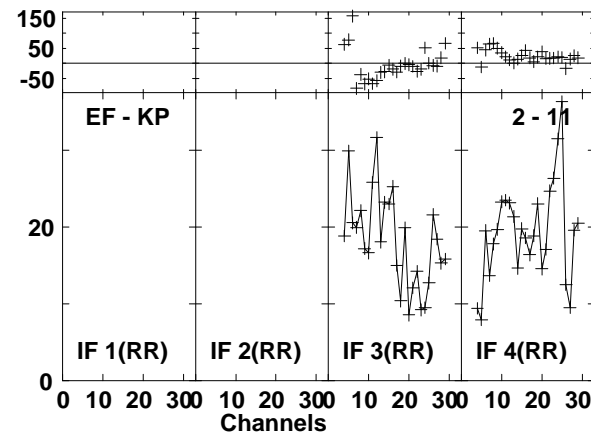
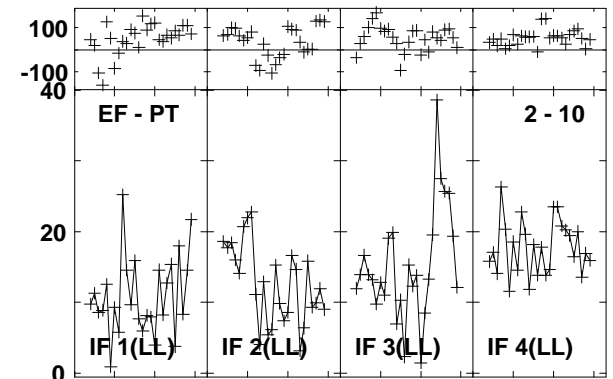
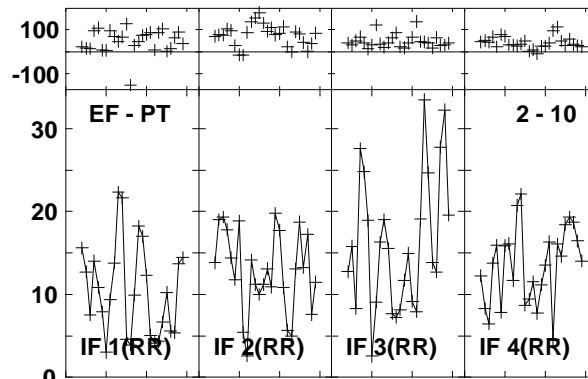
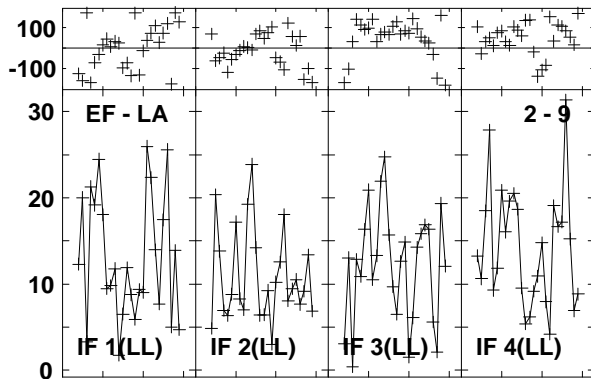
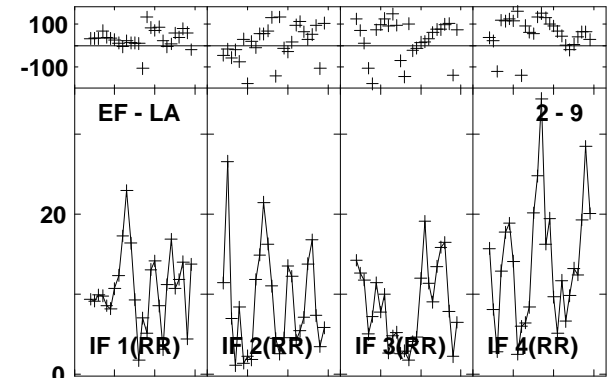
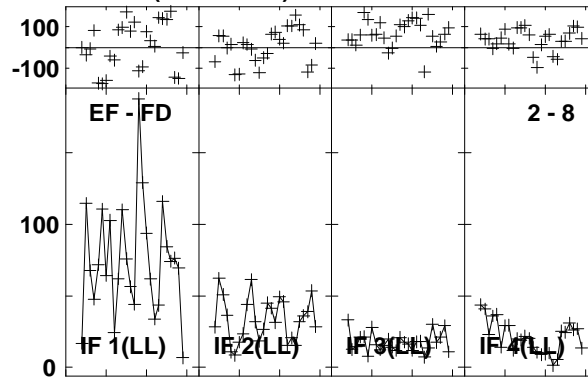
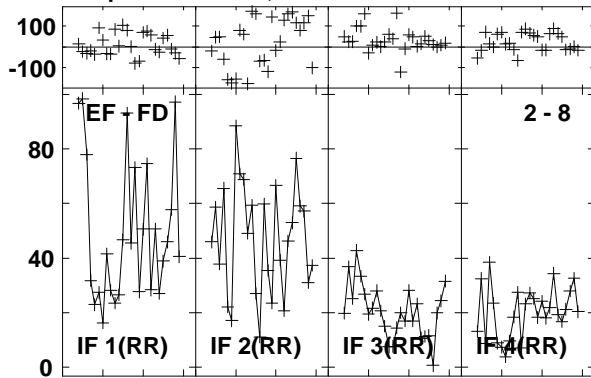

Lower frame: Milli Ampl Jy Top frame: Phas deg
Vector averaged cross-power spectrum Baseline: EF (02) - FD (08)
Timerange: 01/04:47:38 to 01/04:51:02

Plot file version1545 created 03-MAR-2016 01:16:28

4C52 GN002C 1.UVDATA.1

Freq = 1.2770 GHz, Bw = 16.000 MH Calibrated with CL # 3 and BP # 1 (BP mode 1)

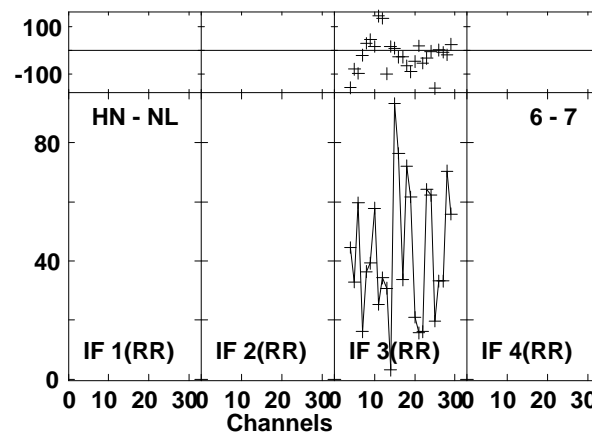
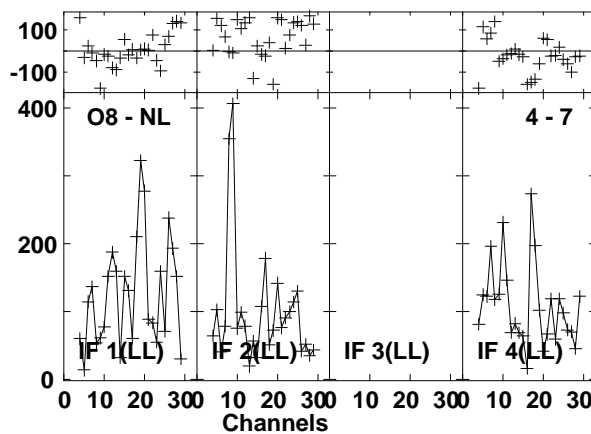
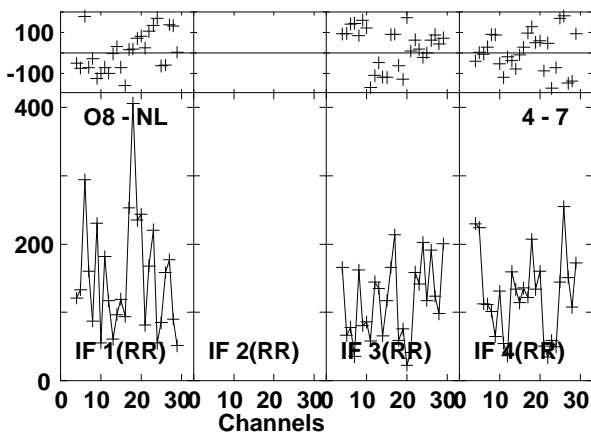
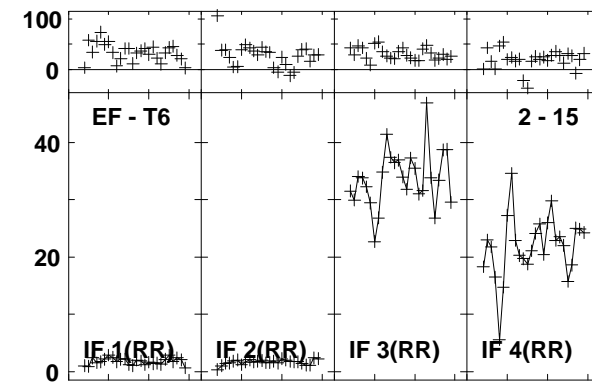
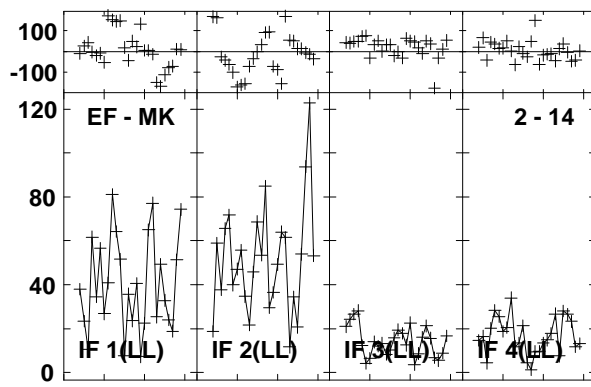
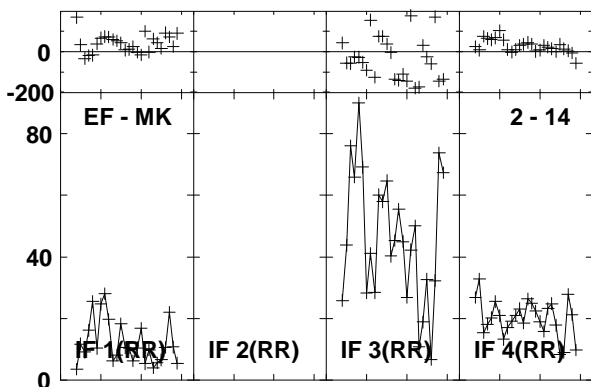
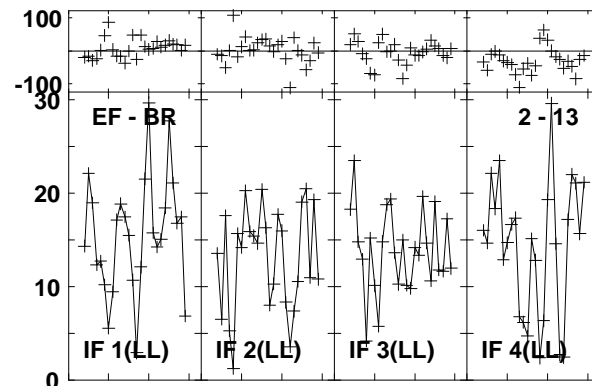
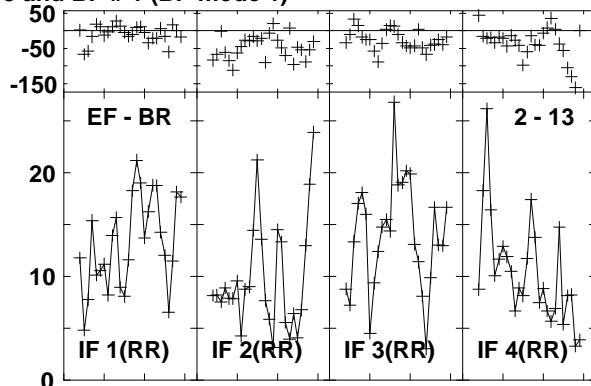
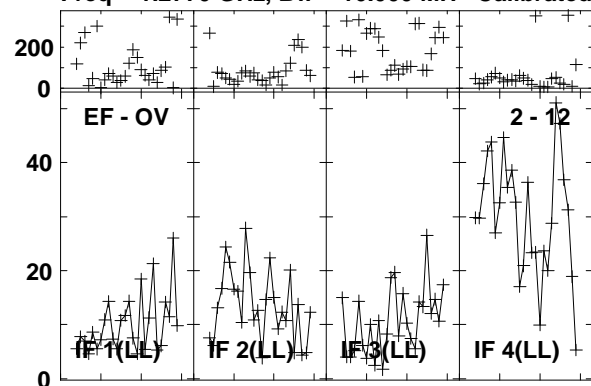

Lower frame: Milli Ampl Jy Top frame: Phas deg
Vector averaged cross-power spectrum Baseline: EF (02) - OV (12)
Timerange: 01/04:47:38 to 01/04:51:02

Plot file version1546 created 03-MAR-2016 01:16:28

4C52 GN002C 1.UVDATA.1

Freq = 1.2770 GHz, Bw = 16.000 MH Calibrated with CL # 3 and BP # 1 (BP mode 1)

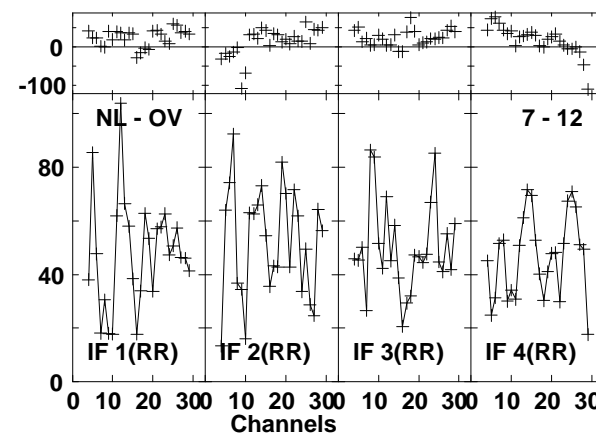
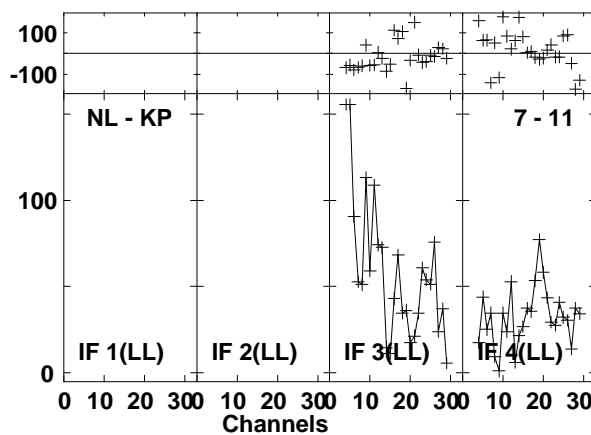
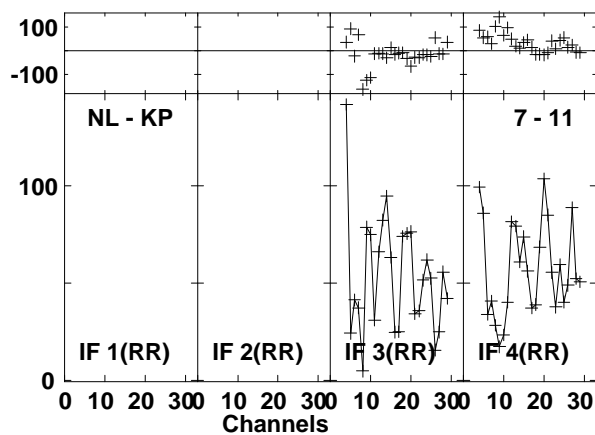
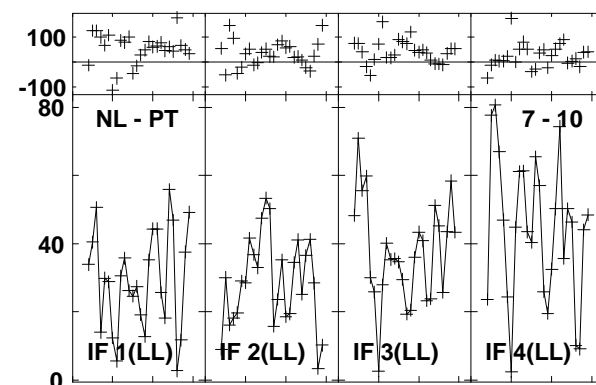
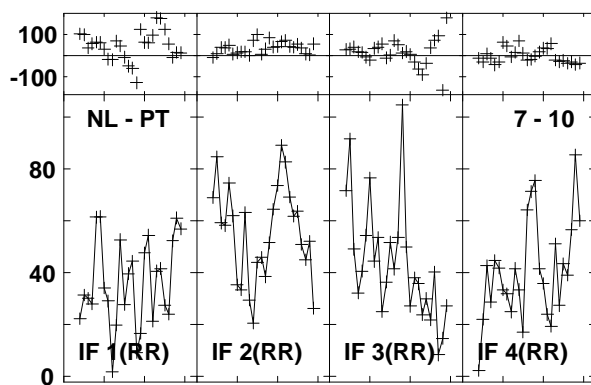
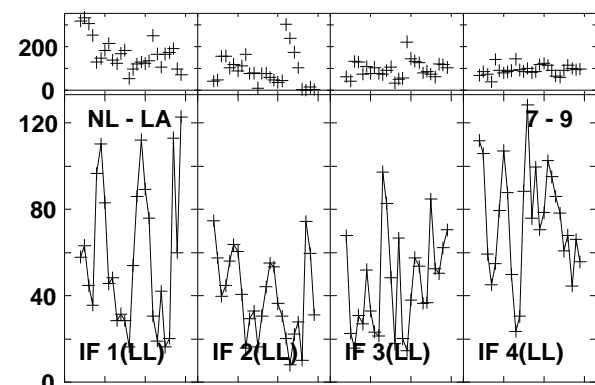
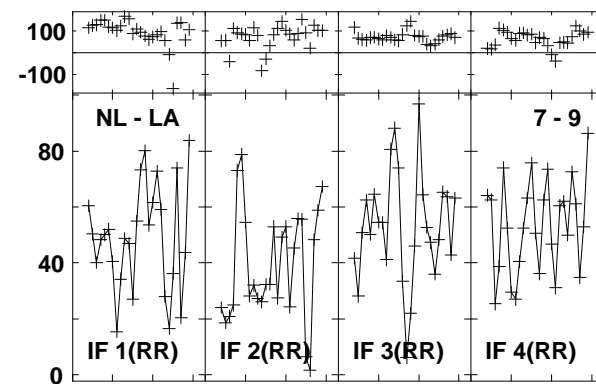
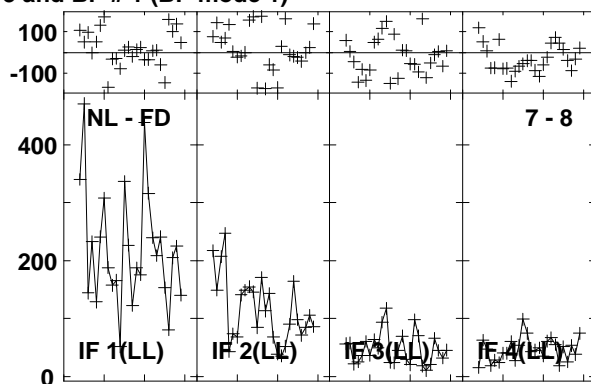
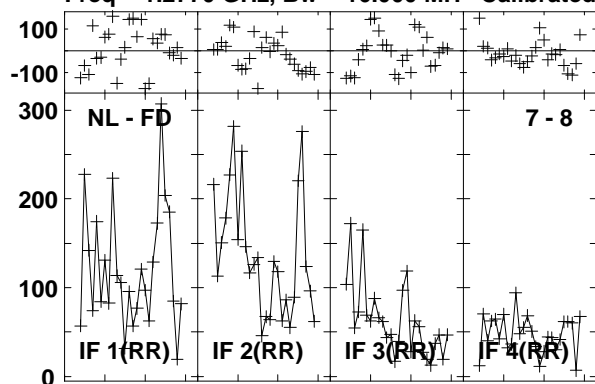

Lower frame: Milli Ampl Jy Top frame: Phas deg
Vector averaged cross-power spectrum Baseline: NL (07) - FD (08)
Timerange: 01/04:47:38 to 01/04:51:02

Plot file version1547 created 03-MAR-2016 01:16:28

4C52 GN002C 1.UVDATA.1

Freq = 1.2770 GHz, Bw = 16.000 MH Calibrated with CL # 3 and BP # 1 (BP mode 1)

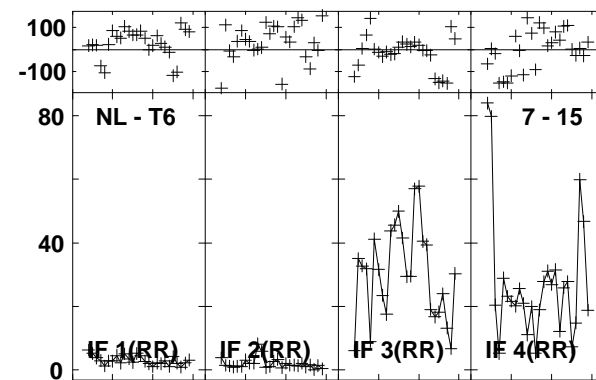
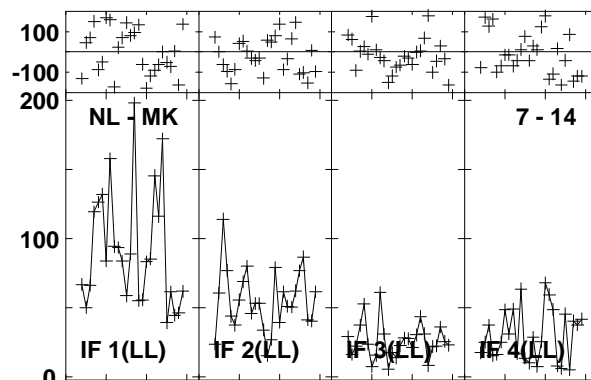
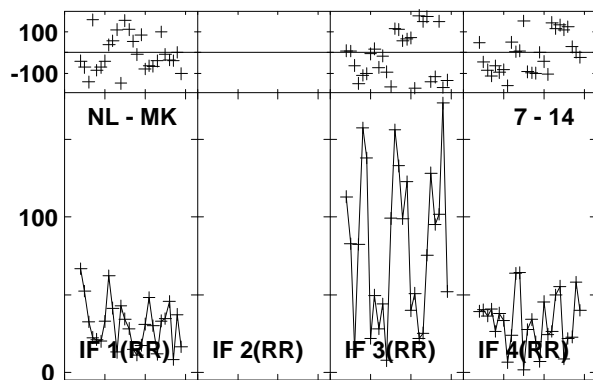
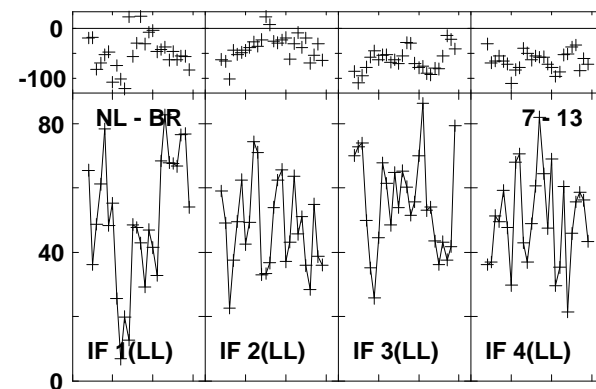
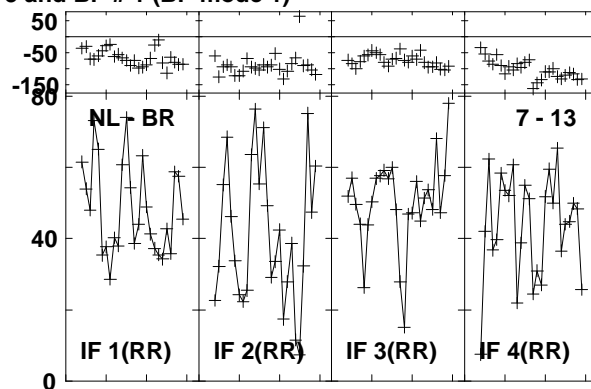
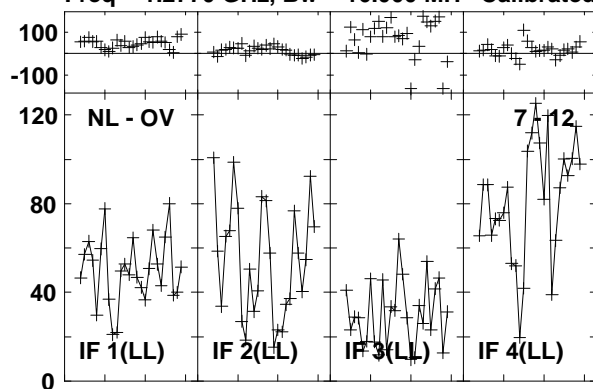

Lower frame: Milli Ampl Jy Top frame: Phas deg
Vector averaged cross-power spectrum Baseline: NL (07) - OV (12)
Timerange: 01/04:47:38 to 01/04:51:02

Plot file version1548 created 03-MAR-2016 01:16:29

J1545+5400 GN002C 1.UVDATA.1

Freq = 1.2770 GHz, Bw = 16.000 MH Calibrated with CL # 3 and BP # 1 (BP mode 1)

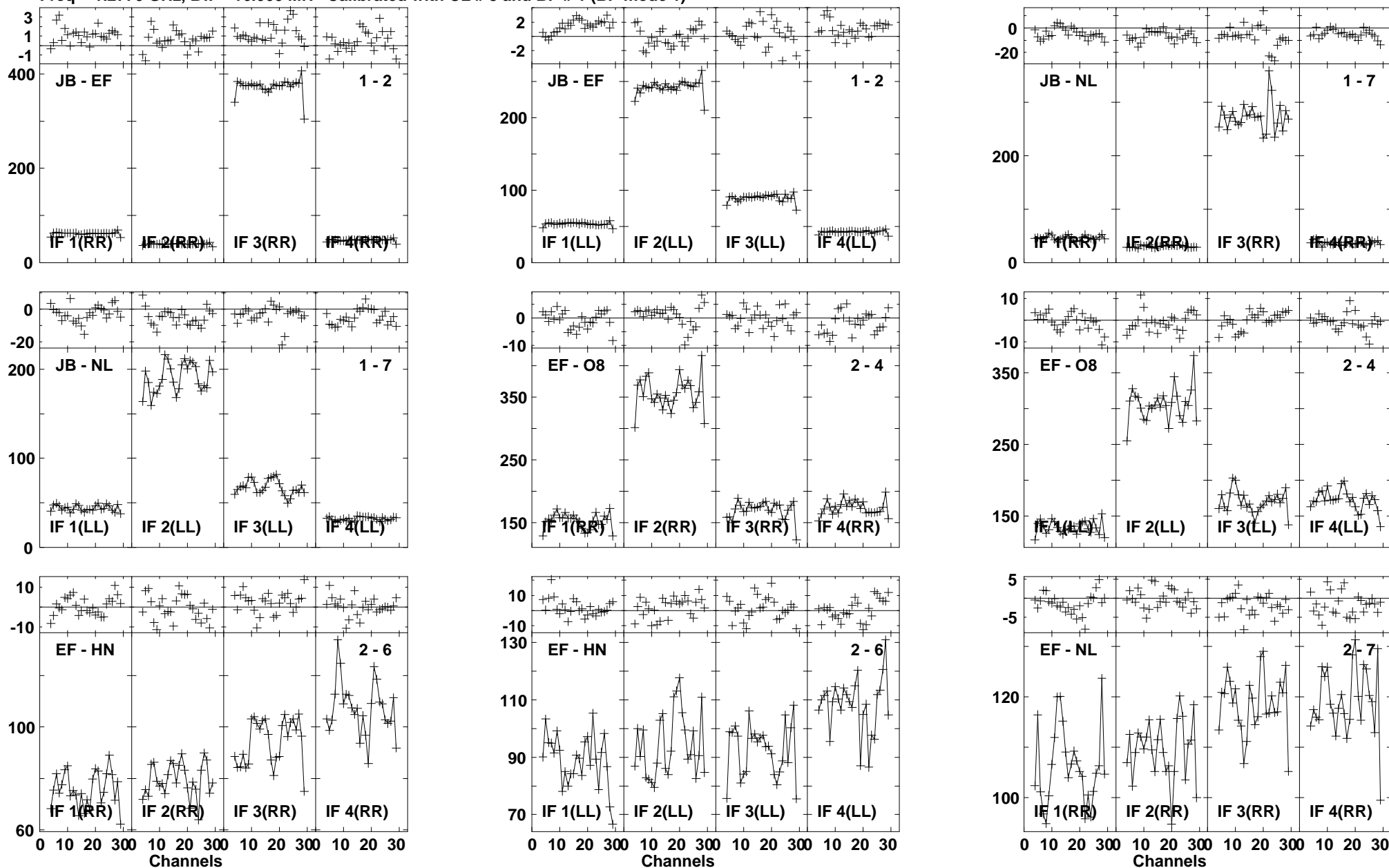

Lower frame: Milli Ampl Jy Top frame: Phas deg
Vector averaged cross-power spectrum Baseline: JB (01) - EF (02)
Timerange: 01/04:51:55 to 01/04:54:43

Plot file version1549 created 03-MAR-2016 01:16:29

J1545+5400 GN002C 1.UVDATA.1

Freq = 1.2770 GHz, Bw = 16.000 MH Calibrated with CL # 3 and BP # 1 (BP mode 1)

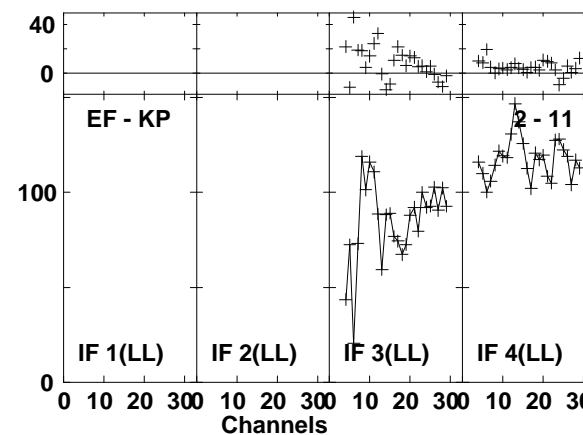
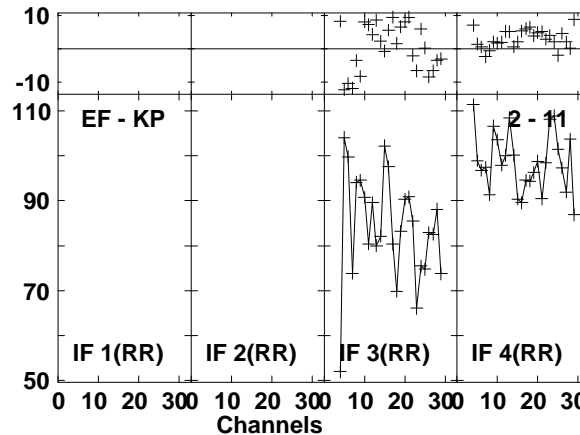
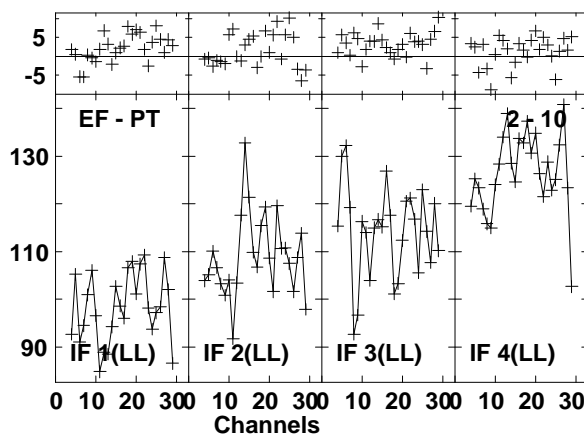
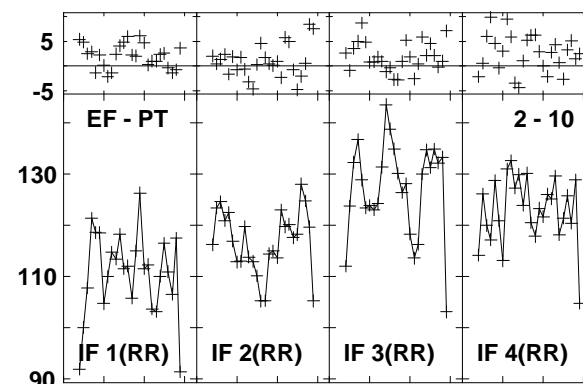
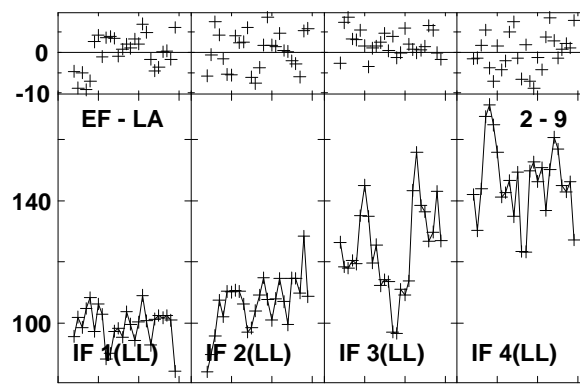
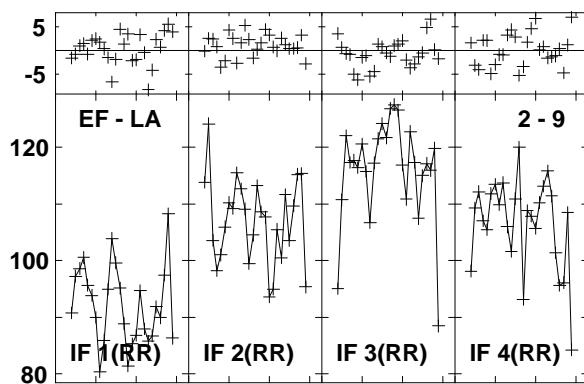
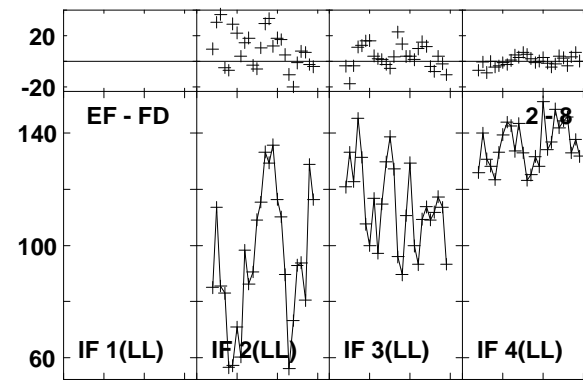
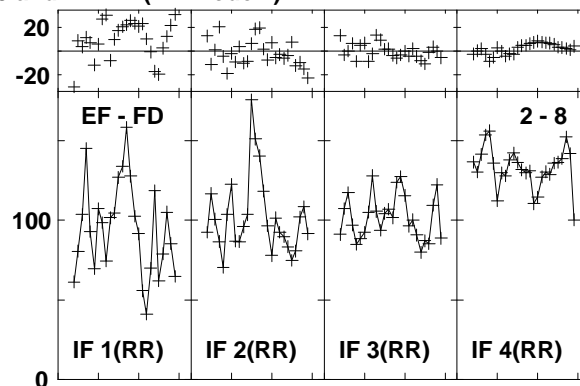
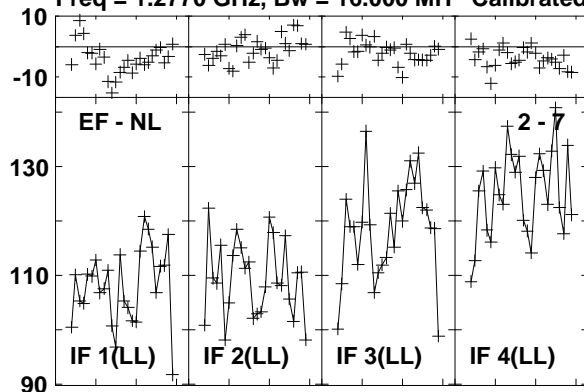

Lower frame: Milli Ampl Jy Top frame: Phas deg
Vector averaged cross-power spectrum Baseline: EF (02) - NL (07)
Timerange: 01/04:51:55 to 01/04:54:43

Plot file version1550 created 03-MAR-2016 01:16:29

J1545+5400 GN002C 1.UVDATA.1

Freq = 1.2770 GHz, Bw = 16.000 MH Calibrated with CL # 3 and BP # 1 (BP mode 1)

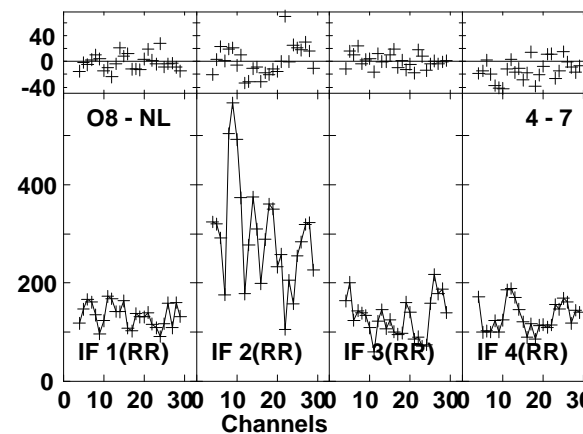
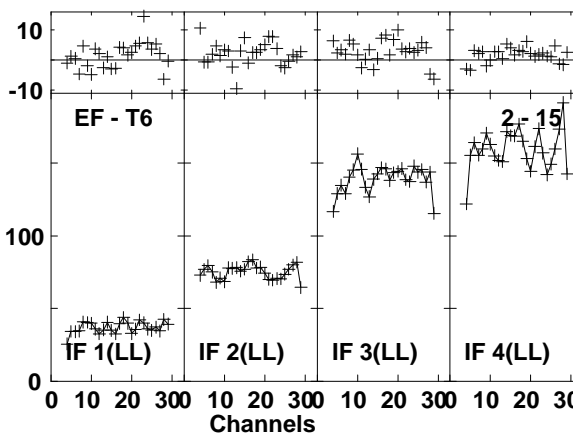
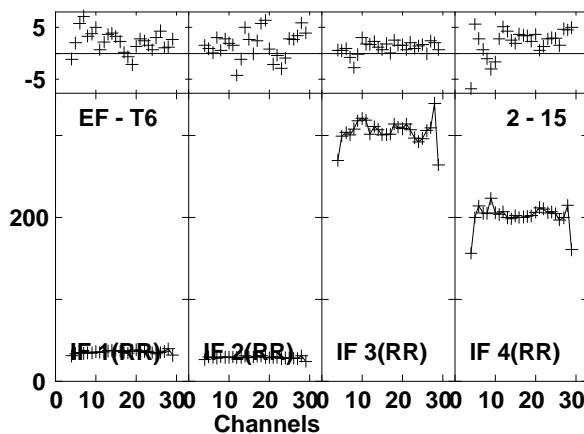
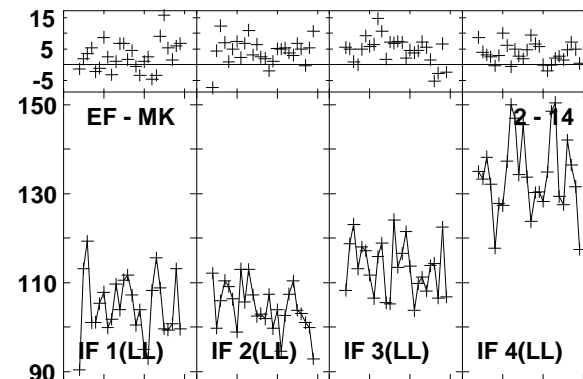
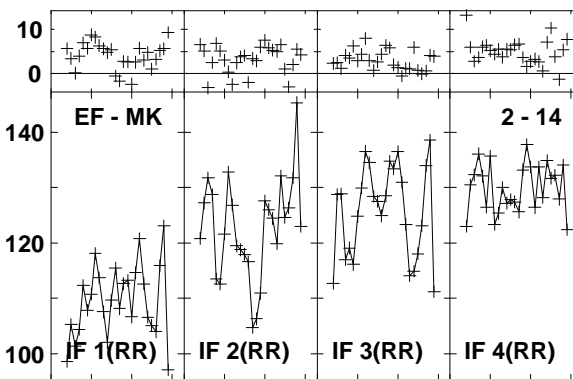
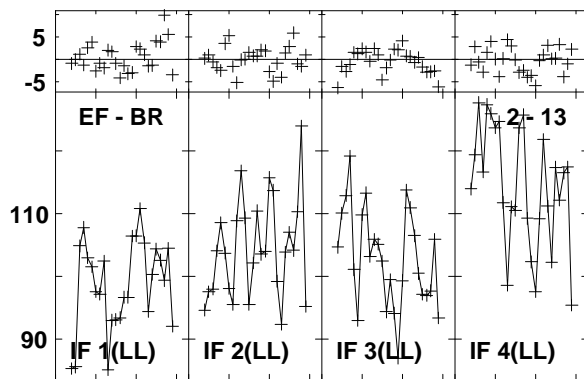
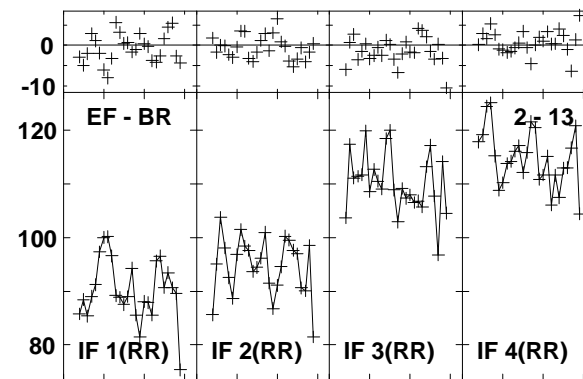
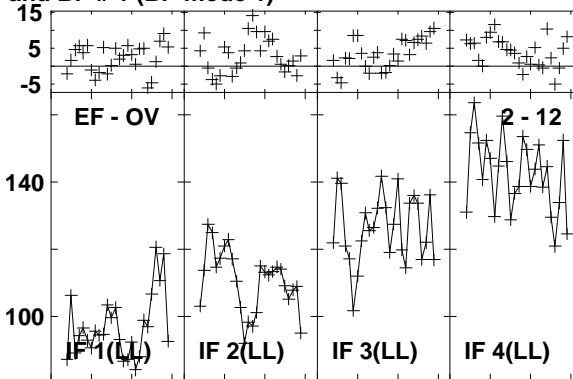
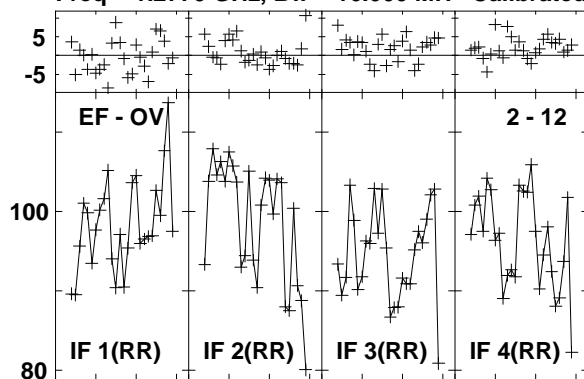

Lower frame: Milli Ampl Jy Top frame: Phas deg
Vector averaged cross-power spectrum Baseline: EF (02) - OV (12)
Timerange: 01/04:51:55 to 01/04:54:43

Plot file version1551 created 03-MAR-2016 01:16:29

J1545+5400 GN002C 1.UVDATA.1

Freq = 1.2770 GHz, Bw = 16.000 MH Calibrated with CL # 3 and BP # 1 (BP mode 1)

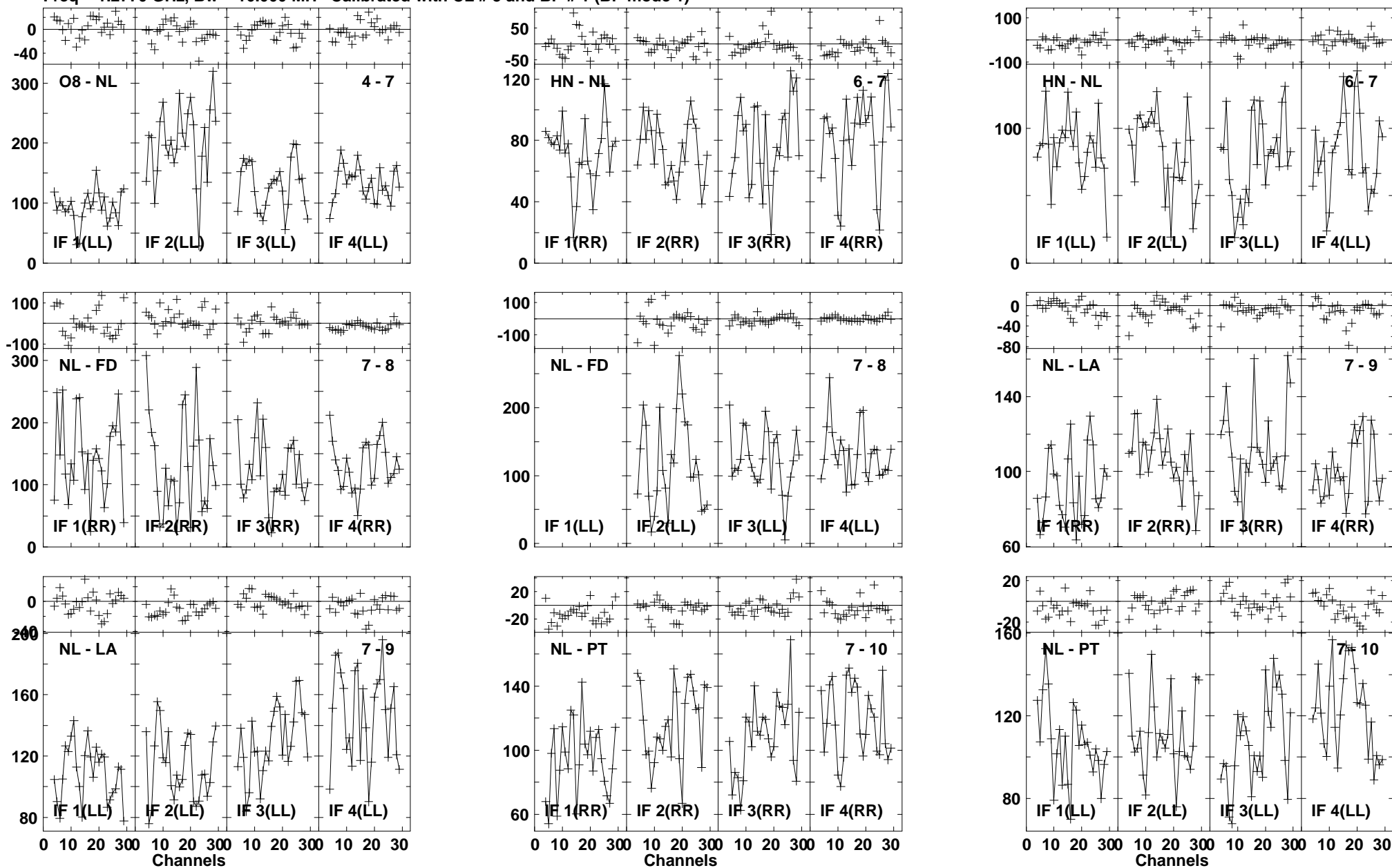

Lower frame: Milli Ampl Jy Top frame: Phas deg
Vector averaged cross-power spectrum Baseline: O8 (04) - NL (07)
Timerange: 01/04:51:55 to 01/04:54:43

Plot file version1552 created 03-MAR-2016 01:16:30
 J1545+5400 GN002C 1.UVDATA.1
 Freq = 1.2770 GHz, Bw = 16.000 MH Calibrated with CL # 3 and BP # 1 (BP mode 1)

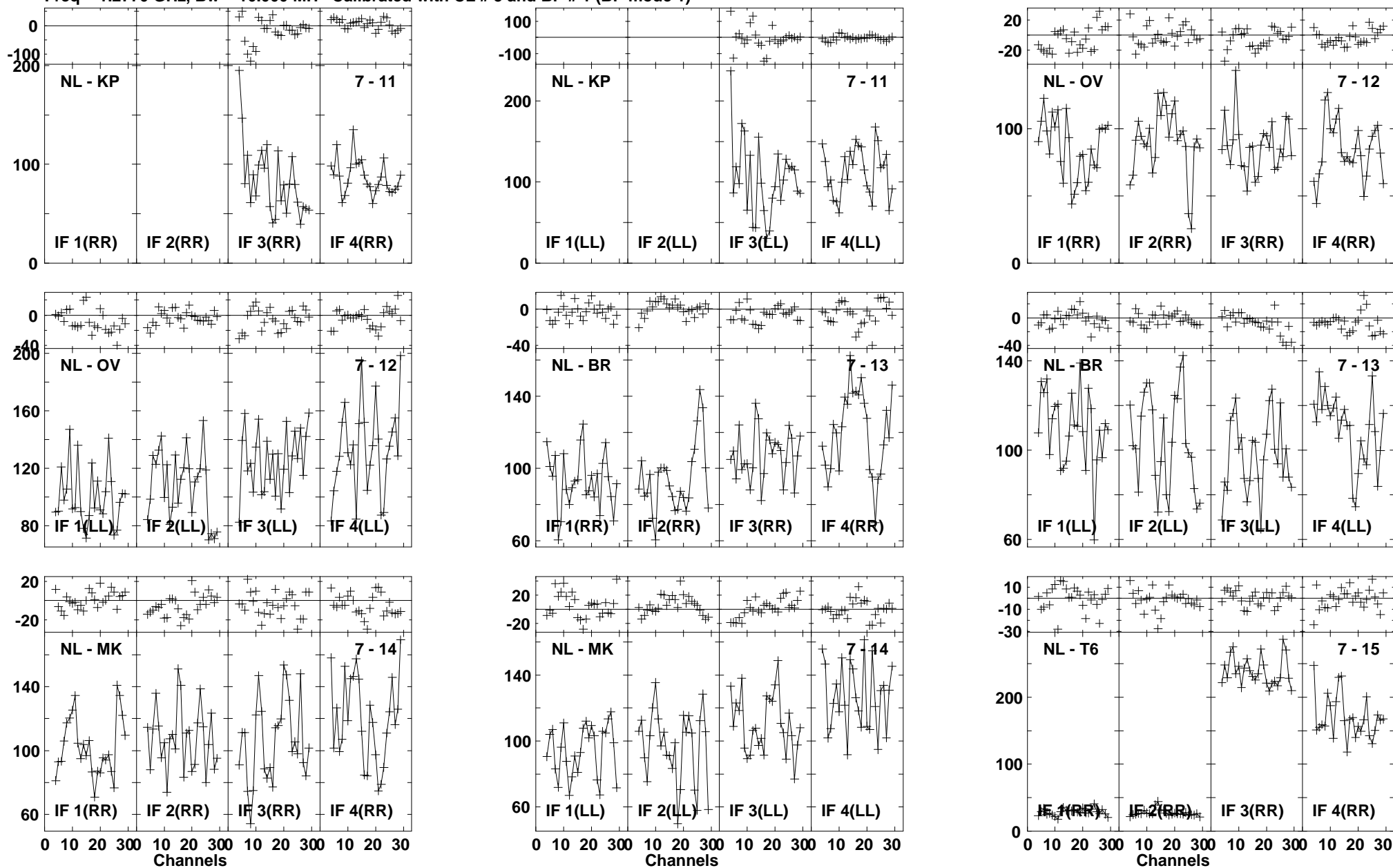

Lower frame: Milli Ampl Jy Top frame: Phas deg
 Vector averaged cross-power spectrum Baseline: NL (07) - KP (11)
 Timerange: 01/04:51:55 to 01/04:54:43

Plot file version1553 created 03-MAR-2016 01:16:30
J1545+5400 GN002C 1.UVDATA.1
Freq = 1.2770 GHz, Bw = 16.000 MH Calibrated with CL # 3 and BP # 1 (BP mode 1)

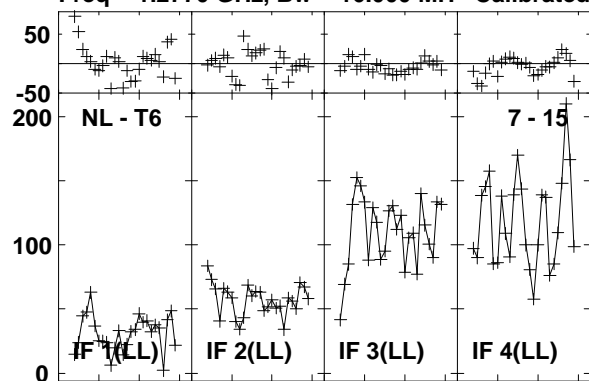

Lower frame: Milli Ampl Jy Top frame: Phas deg
Vector averaged cross-power spectrum Baseline: NL (07) - T6 (15)
Timerange: 01/04:51:55 to 01/04:54:43

Plot file version1554 created 03-MAR-2016 01:16:30

4C52 GN002C 1.UVDATA.1

Freq = 1.2770 GHz, Bw = 16.000 MH Calibrated with CL # 3 and BP # 1 (BP mode 1)

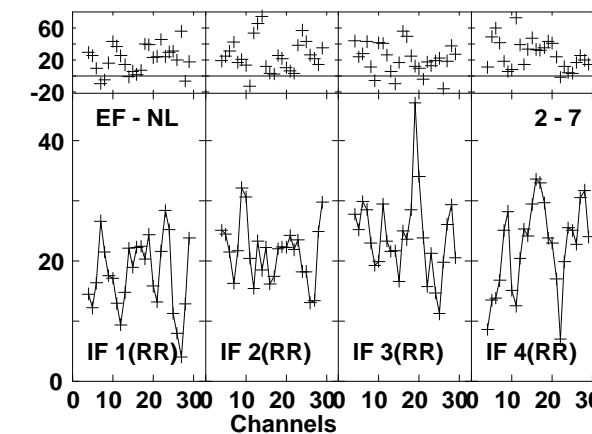
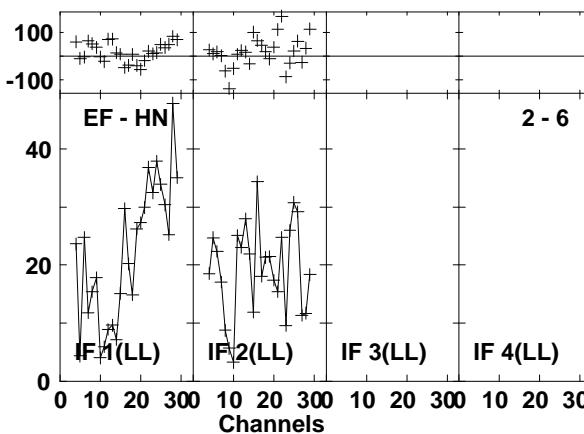
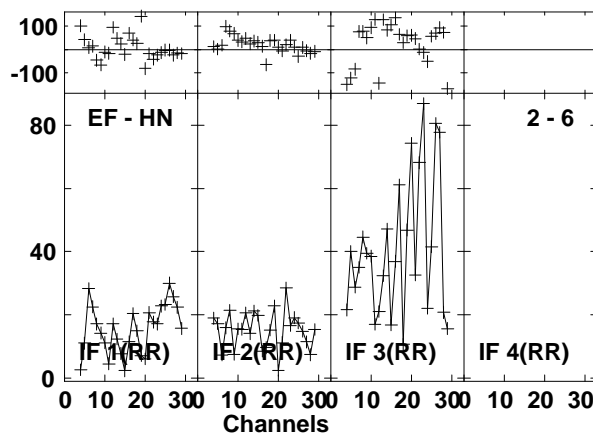
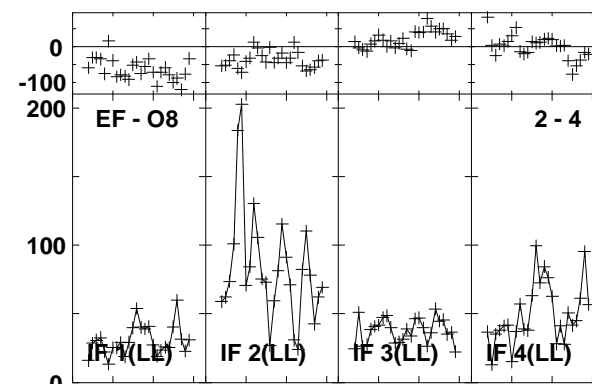
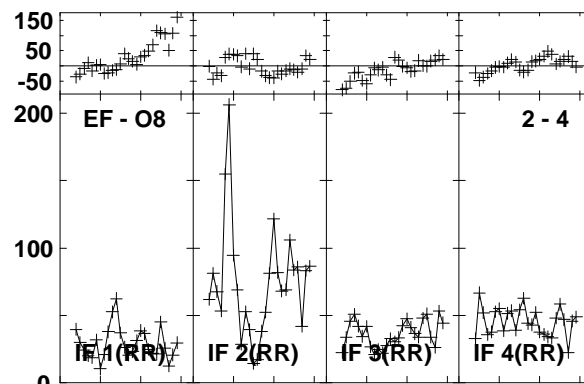
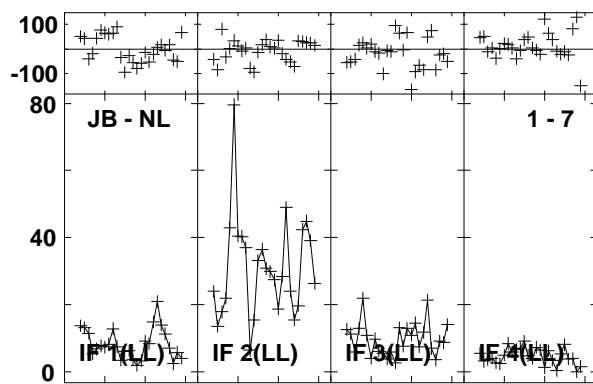
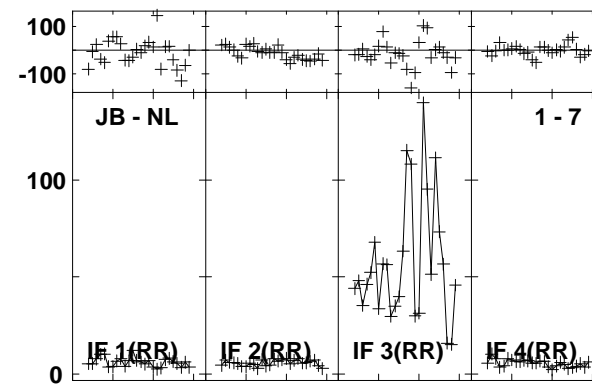
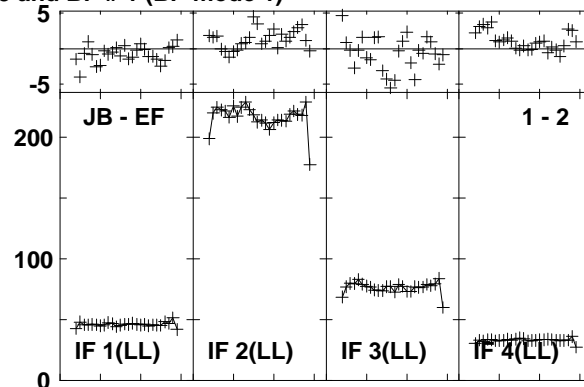
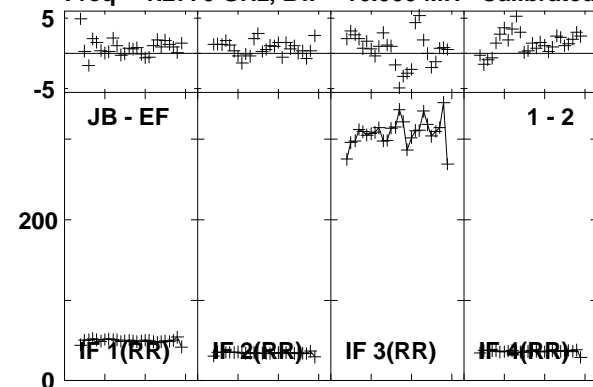

Lower frame: Milli Ampl Jy Top frame: Phas deg
Vector averaged cross-power spectrum Baseline: JB (01) - EF (02)
Timerange: 01/04:54:55 to 01/04:58:13

Plot file version1555 created 03-MAR-2016 01:16:30

4C52 GN002C 1.UVDATA.1

Freq = 1.2770 GHz, Bw = 16.000 MH Calibrated with CL # 3 and BP # 1 (BP mode 1)

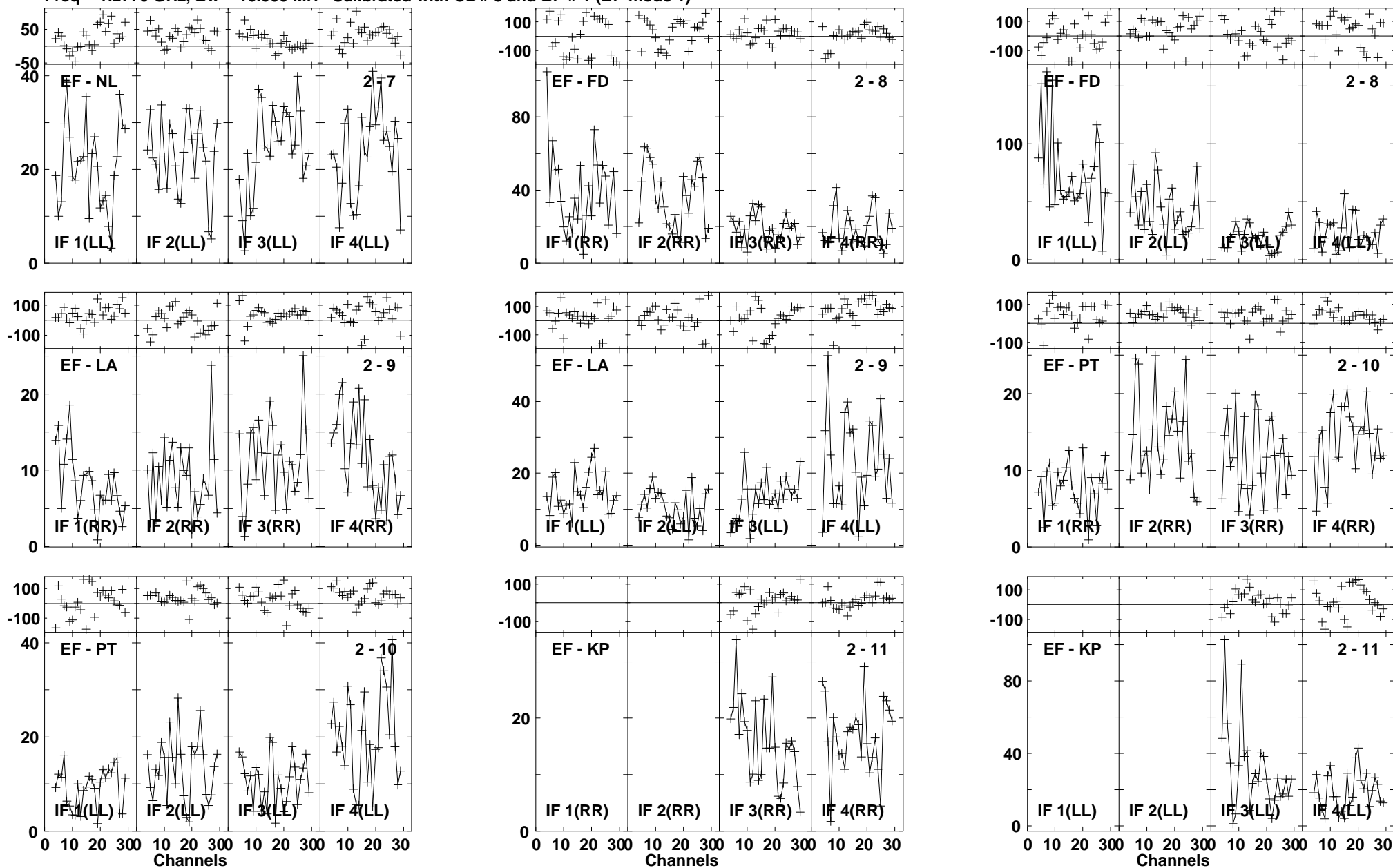

Lower frame: Milli Ampl Jy Top frame: Phas deg
Vector averaged cross-power spectrum Baseline: EF (02) - NL (07)
Timerange: 01/04:54:55 to 01/04:58:13

Plot file version1556 created 03-MAR-2016 01:16:30

4C52 GN002C 1.UVDATA.1

Freq = 1.2770 GHz, Bw = 16.000 MH Calibrated with CL # 3 and BP # 1 (BP mode 1)

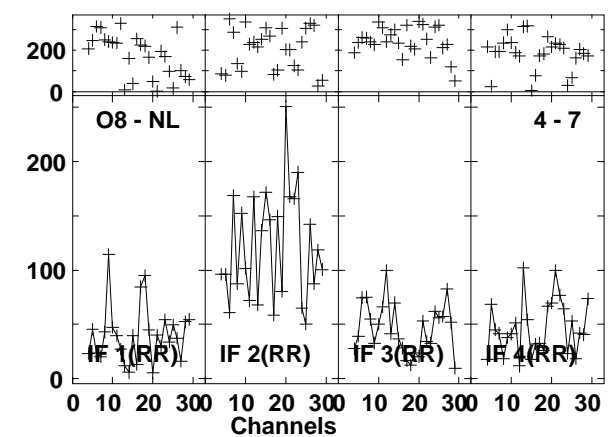
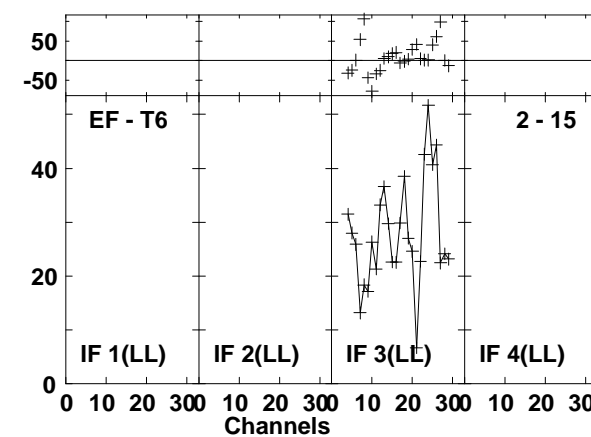
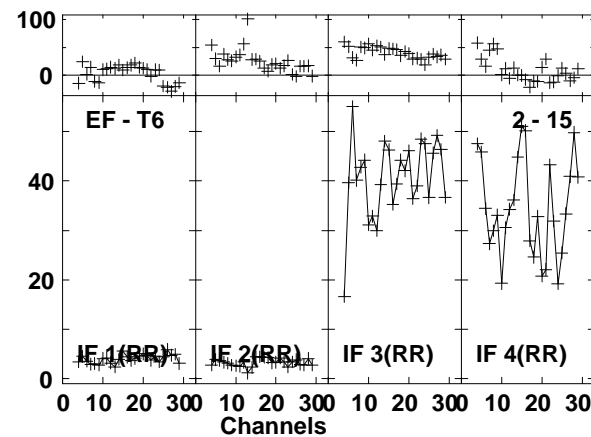
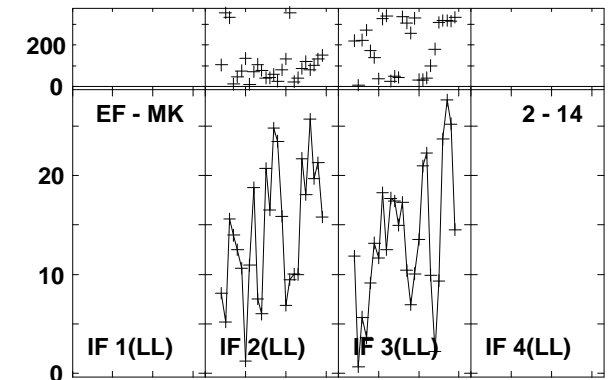
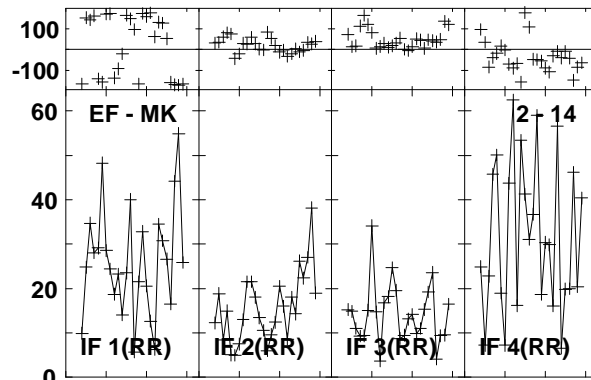
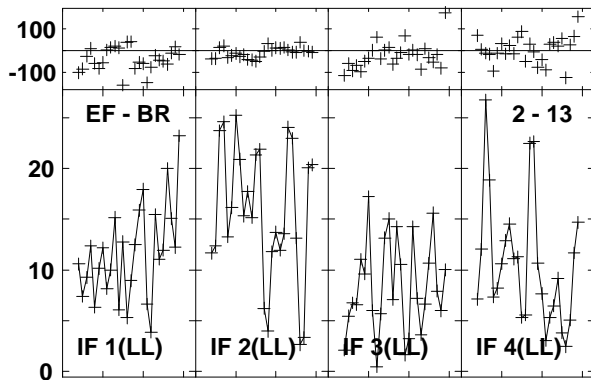
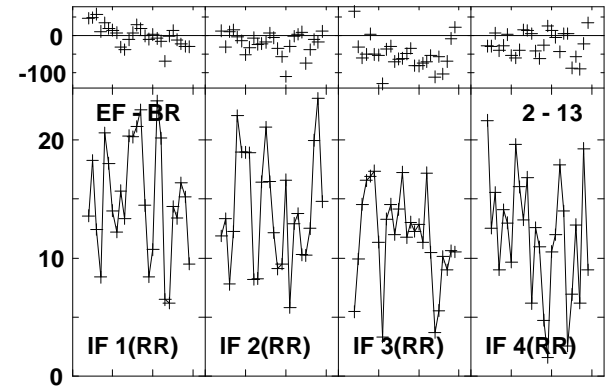
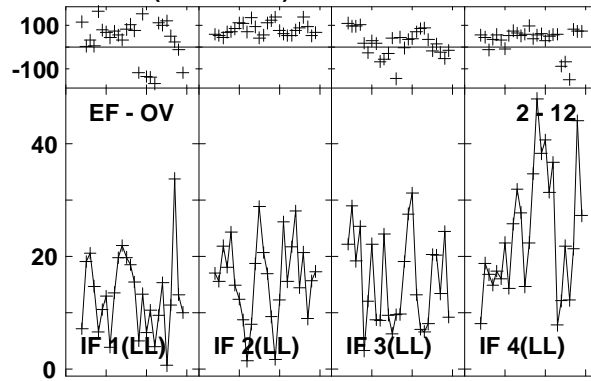
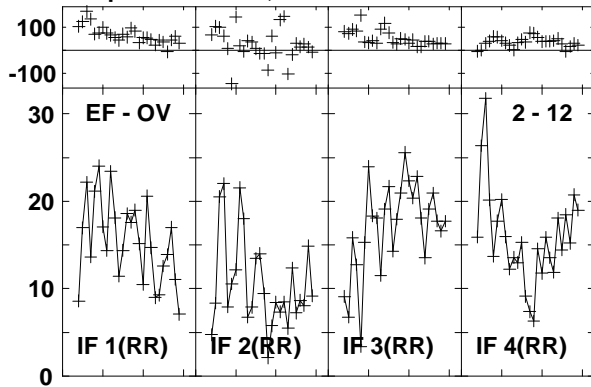

Lower frame: Milli Ampl Jy Top frame: Phas deg
Vector averaged cross-power spectrum Baseline: EF (02) - OV (12)
Timerange: 01/04:54:55 to 01/04:58:13

Plot file version1557 created 03-MAR-2016 01:16:30

4C52 GN002C 1.UVDATA.1

Freq = 1.2770 GHz, Bw = 16.000 MH Calibrated with CL # 3 and BP # 1 (BP mode 1)

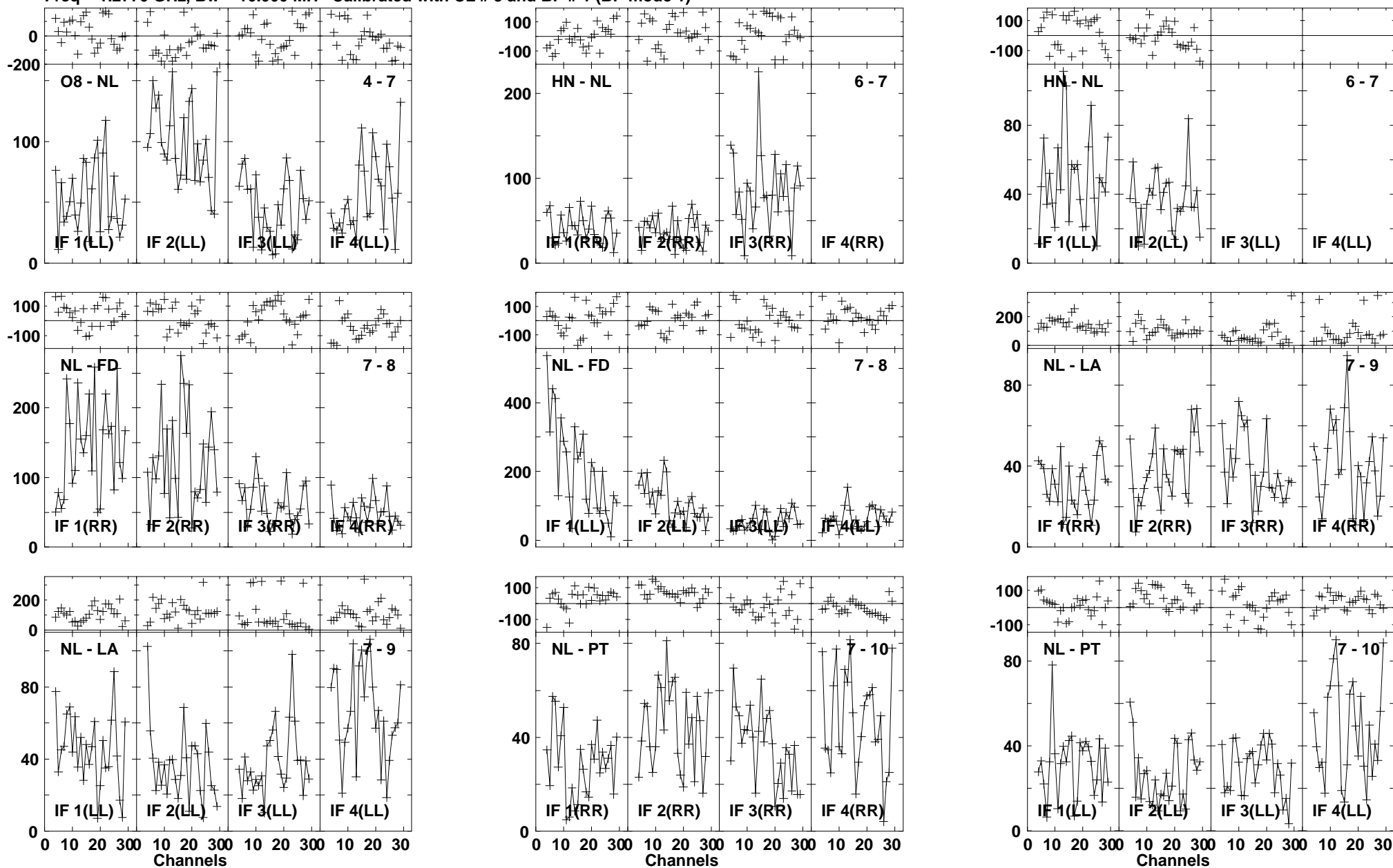

Lower frame: Milli Ampl Jy Top frame: Phas deg
Vector averaged cross-power spectrum Baseline: O8 (04) - NL (07)
Timerange: 01/04:54:55 to 01/04:58:13

Plot file version1558 created 03-MAR-2016 01:16:31
 4C52 GN002C 1.UVDATA.1
 Freq = 1.2770 GHz, Bw = 16.000 MH Calibrated with CL # 3 and BP # 1 (BP mode 1)

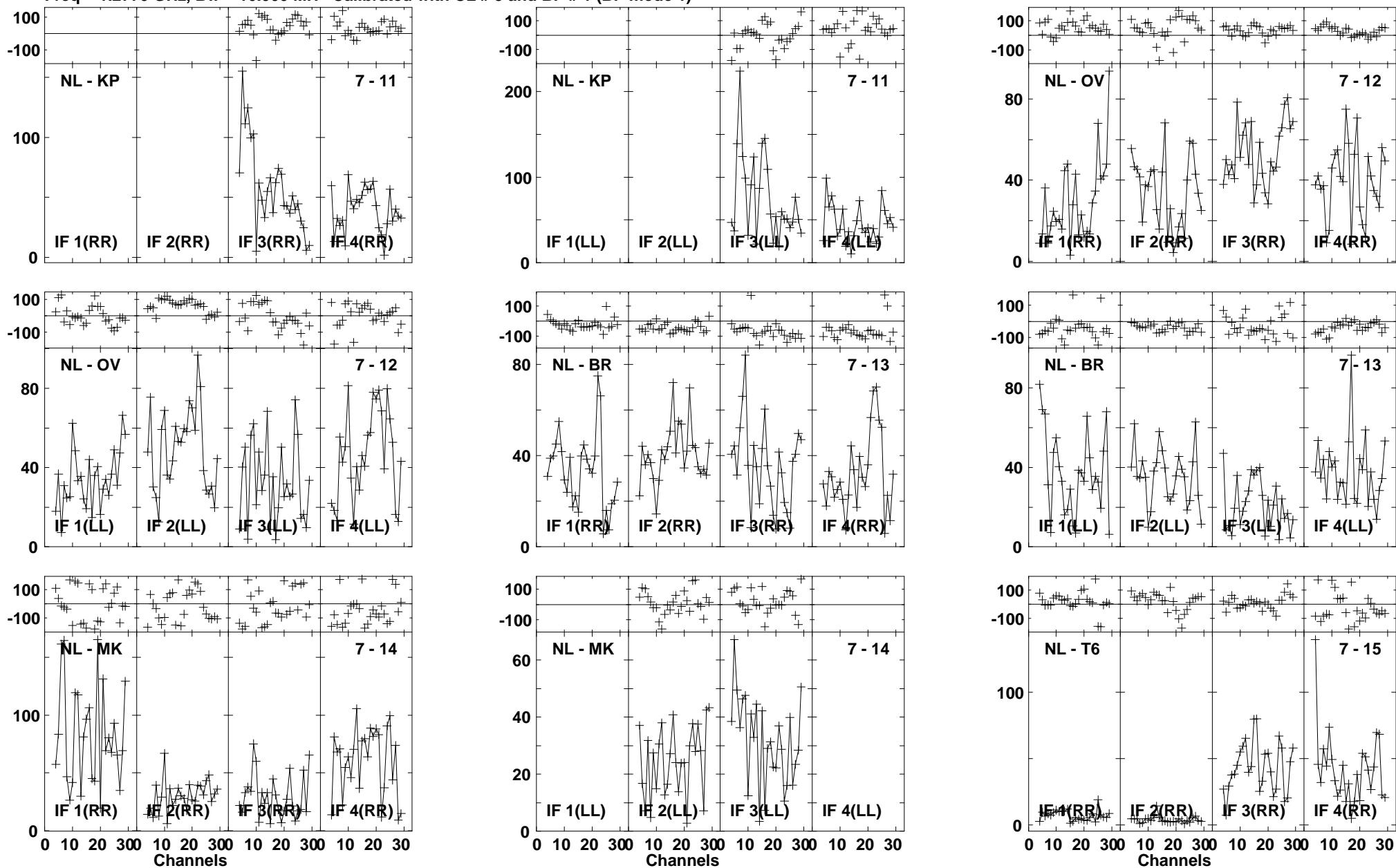

Lower frame: Milli Ampl Jy Top frame: Phas deg
 Vector averaged cross-power spectrum Baseline: NL (07) - KP (11)
 Timerange: 01/04:54:55 to 01/04:58:13

Plot file version1559 created 03-MAR-2016 01:16:31
4C52 GN002C 1.UVDATA.1
Freq = 1.2770 GHz, Bw = 16.000 MH Calibrated with CL # 3 and BP # 1 (BP mode 1)

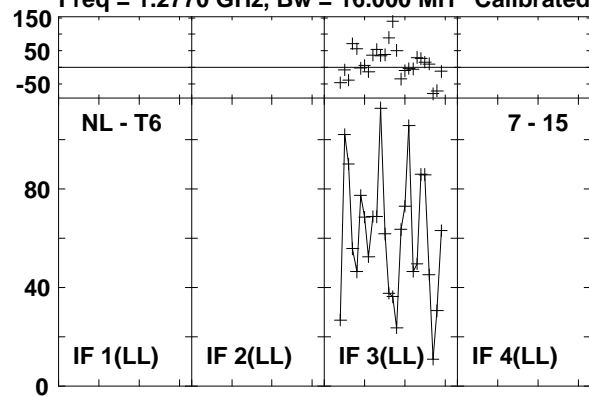

Lower frame: Milli Ampl Jy Top frame: Phas deg
Vector averaged cross-power spectrum Baseline: NL (07) - T6 (15)
Timerange: 01/04:54:55 to 01/04:58:13

Plot file version1560 created 03-MAR-2016 01:16:31

J1545+5400 GN002C 1.UVDATA.1

Freq = 1.2770 GHz, Bw = 16.000 MH Calibrated with CL # 3 and BP # 1 (BP mode 1)

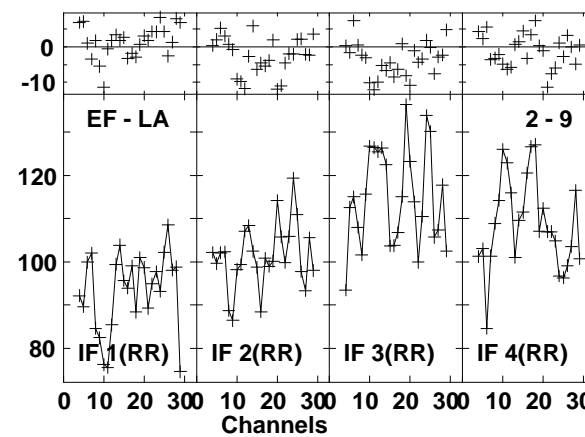
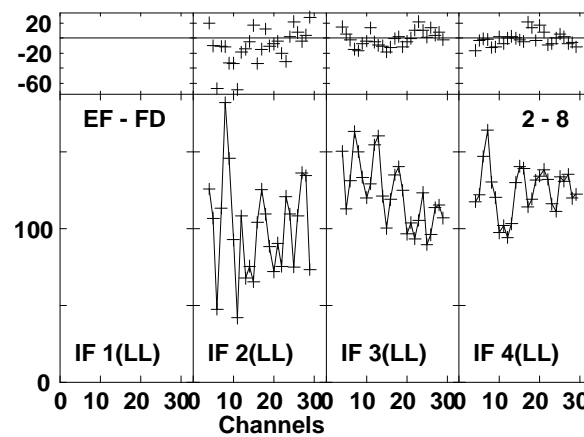
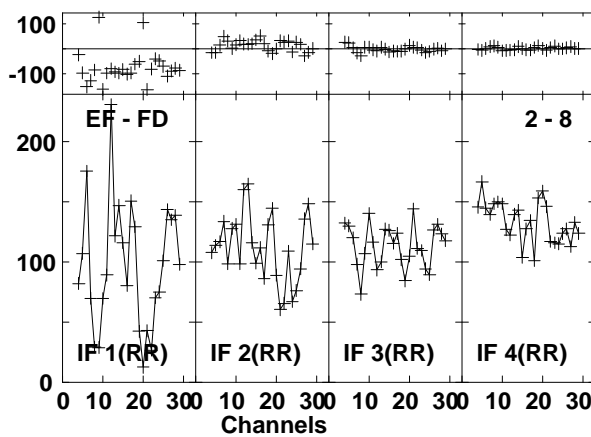
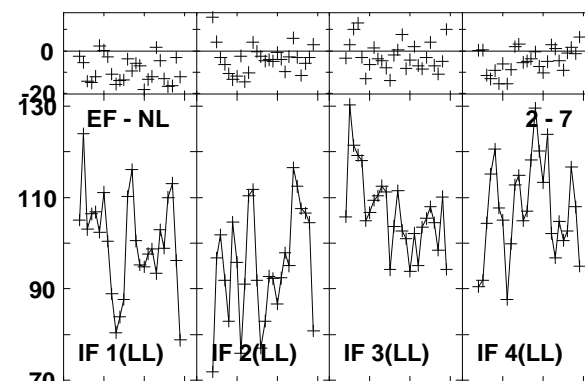
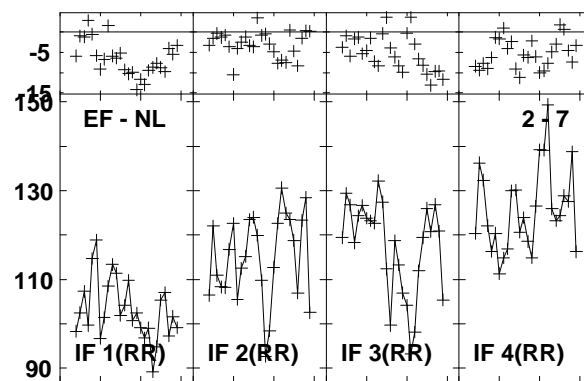
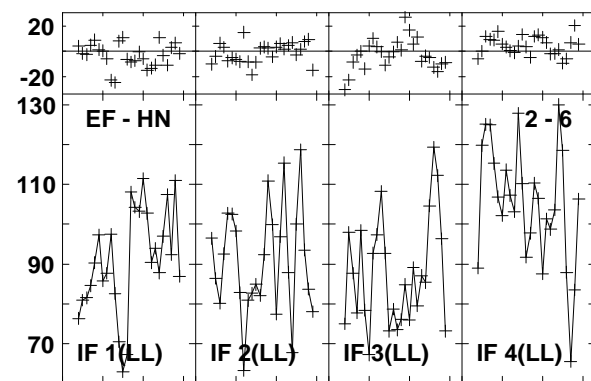
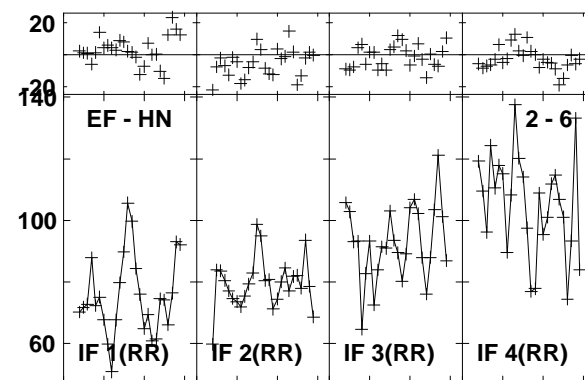
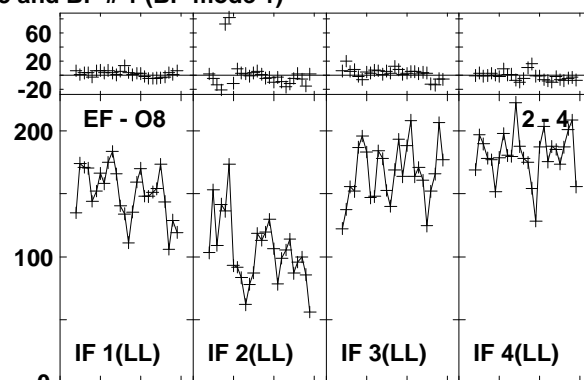
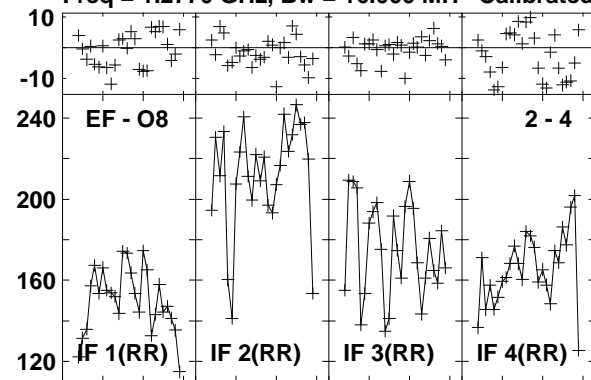

Lower frame: Milli Ampl Jy Top frame: Phas deg
Vector averaged cross-power spectrum Baseline: EF (02) - O8 (04)
Timerange: 01/04:59:05 to 01/05:00:23

Plot file version1561 created 03-MAR-2016 01:16:31

J1545+5400 GN002C 1.UVDATA.1

Freq = 1.2770 GHz, Bw = 16.000 MH Calibrated with CL # 3 and BP # 1 (BP mode 1)

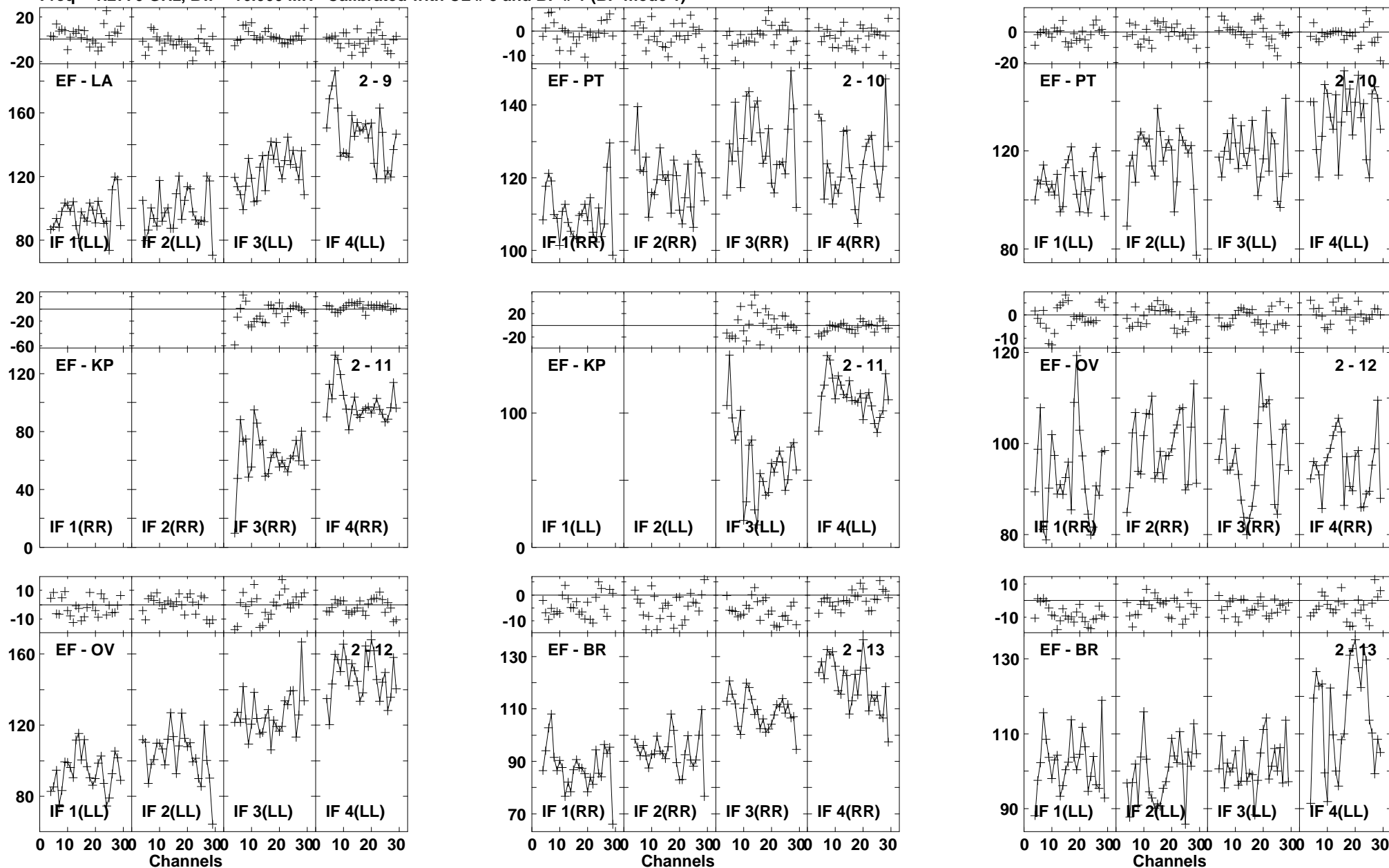

Lower frame: Milli Ampl Jy Top frame: Phas deg
Vector averaged cross-power spectrum Baseline: EF (02) - LA (09)
Timerange: 01/04:59:05 to 01/05:00:23

Plot file version1562 created 03-MAR-2016 01:16:31

J1545+5400 GN002C 1.UVDATA.1

Freq = 1.2770 GHz, Bw = 16.000 MH Calibrated with CL # 3 and BP # 1 (BP mode 1)

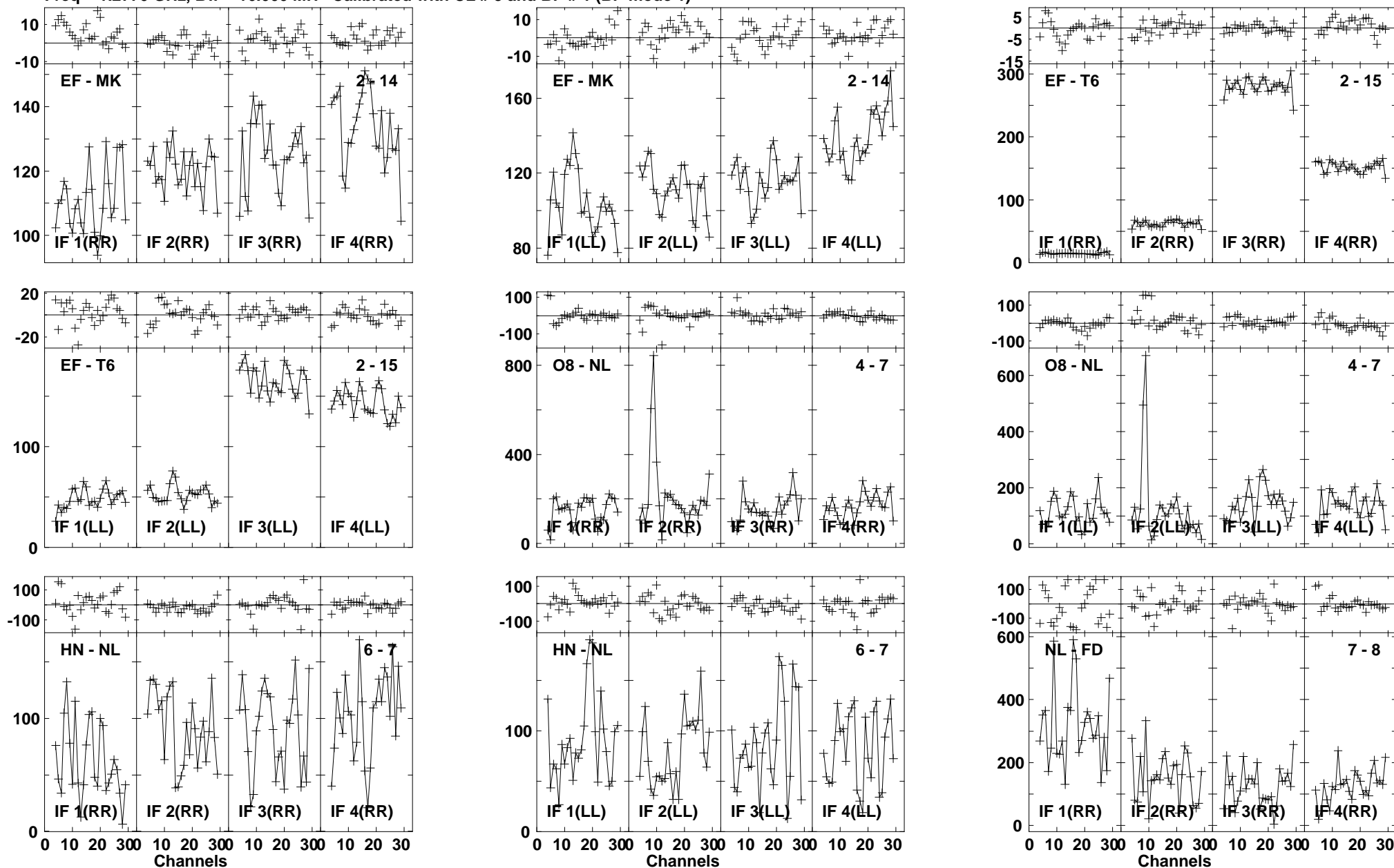

Lower frame: Milli Ampl Jy Top frame: Phas deg
Vector averaged cross-power spectrum Baseline: EF (02) - MK (14)
Timerange: 01/04:59:05 to 01/05:00:23

Plot file version1563 created 03-MAR-2016 01:16:32
 J1545+5400 GN002C 1.UVDATA.1
 Freq = 1.2770 GHz, Bw = 16.000 MH Calibrated with CL # 3 and BP # 1 (BP mode 1)

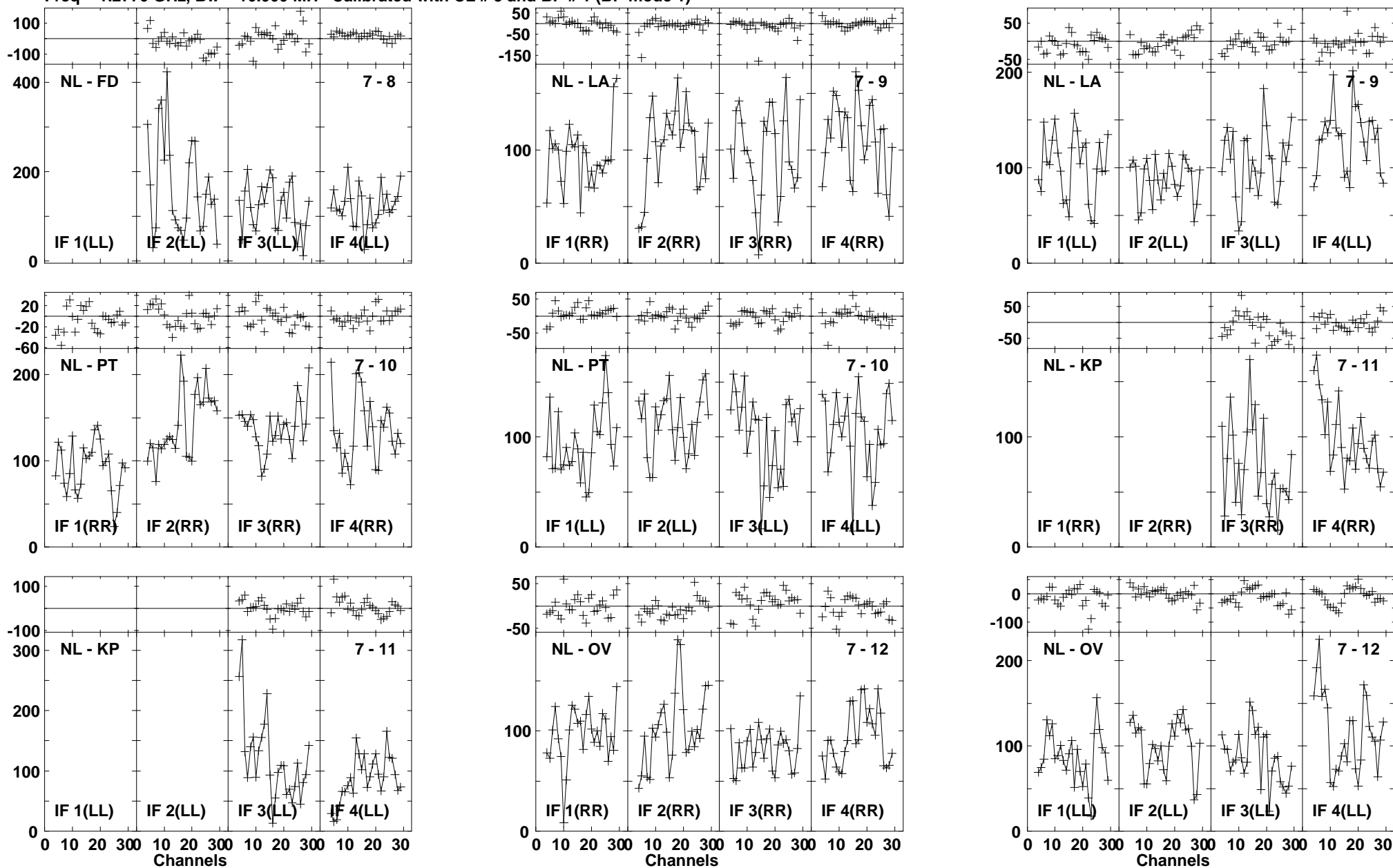

Lower frame: Milli Ampl Jy Top frame: Phas deg
 Vector averaged cross-power spectrum Baseline: NL (07) - FD (08)
 Timerange: 01/04:59:05 to 01/05:00:23

Plot file version1564 created 03-MAR-2016 01:16:32
 J1545+5400 GN002C 1.UVDATA.1
 Freq = 1.2770 GHz, Bw = 16.000 MH Calibrated with CL # 3 and BP # 1 (BP mode 1)

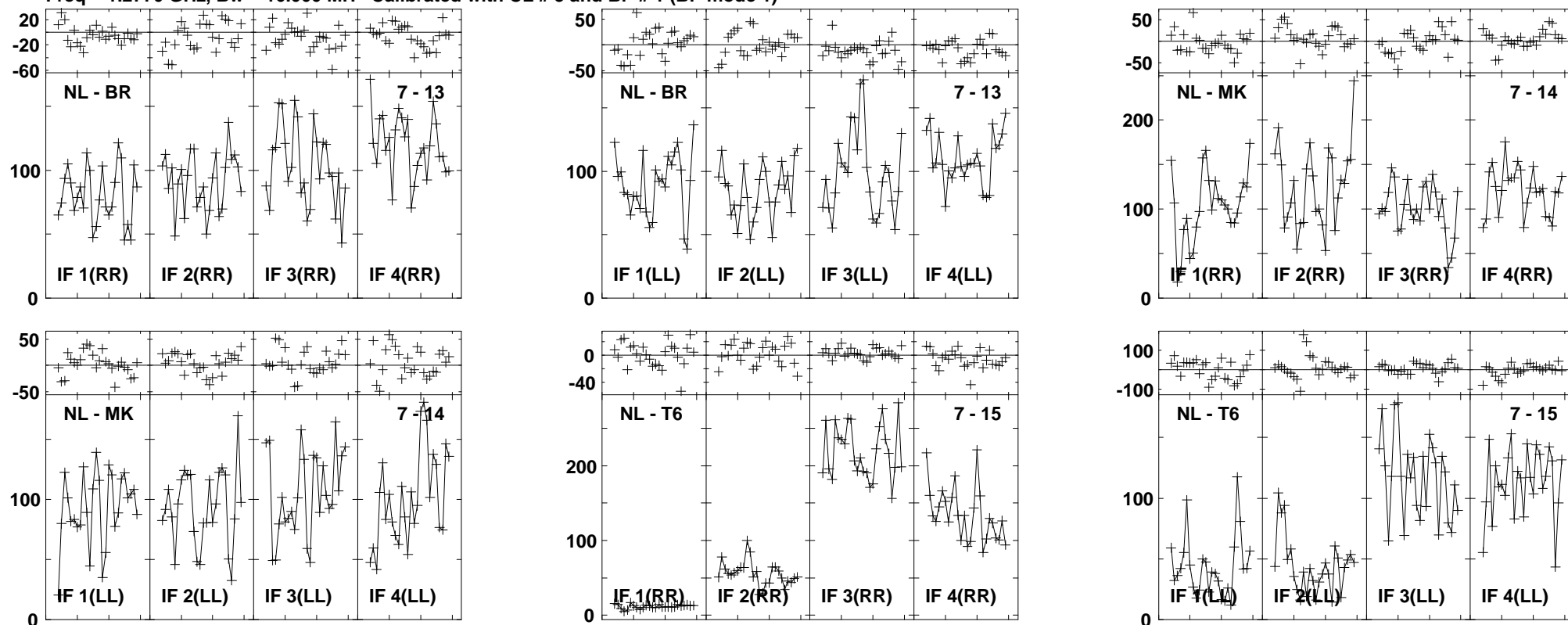

Lower frame: Milli Ampl Jy Top frame: Phas deg
 Vector averaged cross-power spectrum Baseline: NL (07) - BR (13)
 Timerange: 01/04:59:05 to 01/05:00:23

Plot file version1565 created 03-MAR-2016 01:16:32

4C52 GN002C 1.UVDATA.1

Freq = 1.2770 GHz, Bw = 16.000 MH Calibrated with CL # 3 and BP # 1 (BP mode 1)

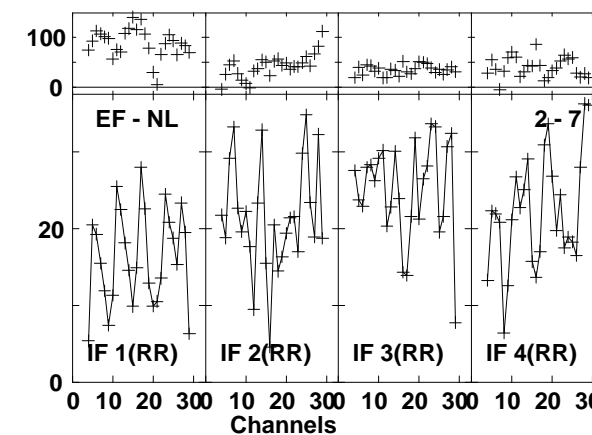
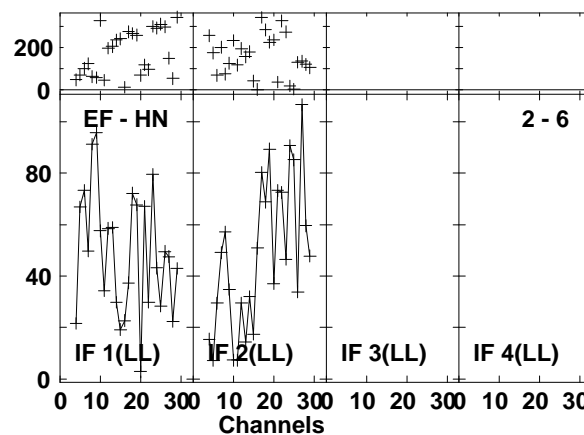
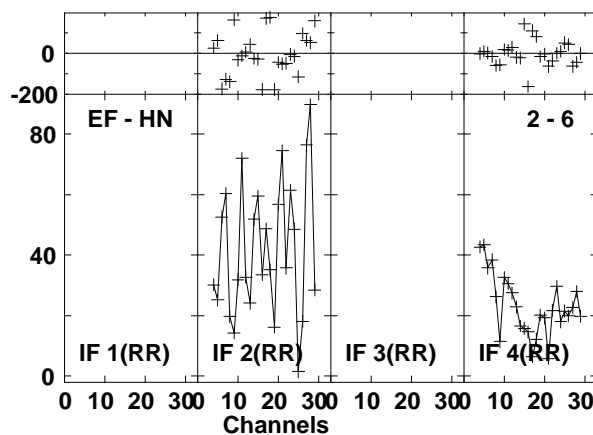
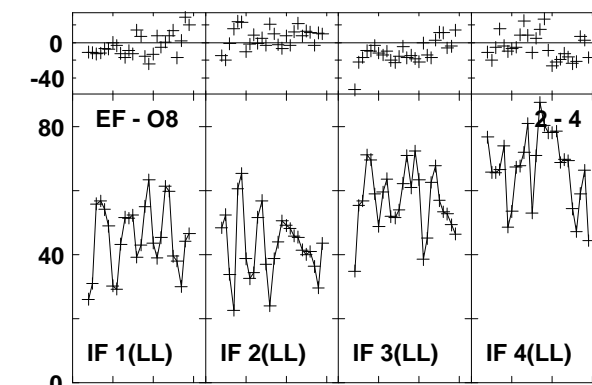
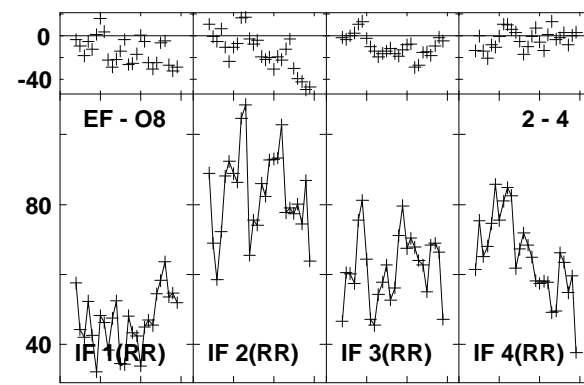
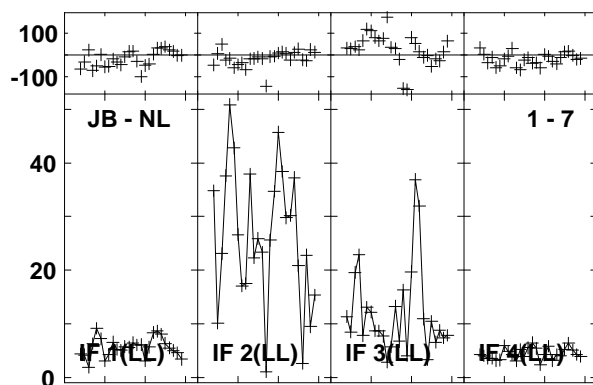
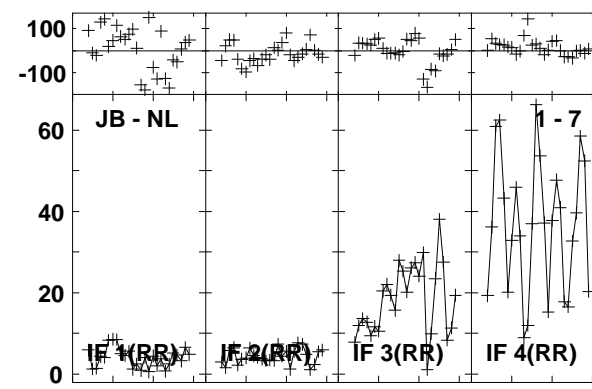
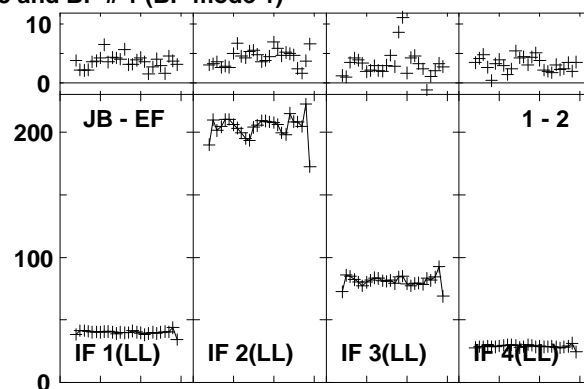
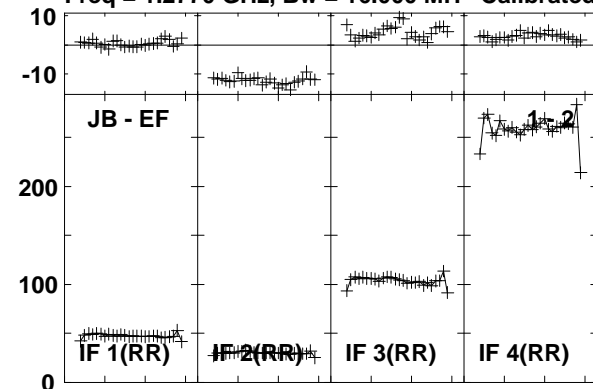

Lower frame: Milli Ampl Jy Top frame: Phas deg
Vector averaged cross-power spectrum Baseline: JB (01) - EF (02)
Timerange: 01/05:00:28 to 01/05:03:52

Plot file version1566 created 03-MAR-2016 01:16:32

4C52 GN002C 1.UVDATA.1

Freq = 1.2770 GHz, Bw = 16.000 MH Calibrated with CL # 3 and BP # 1 (BP mode 1)

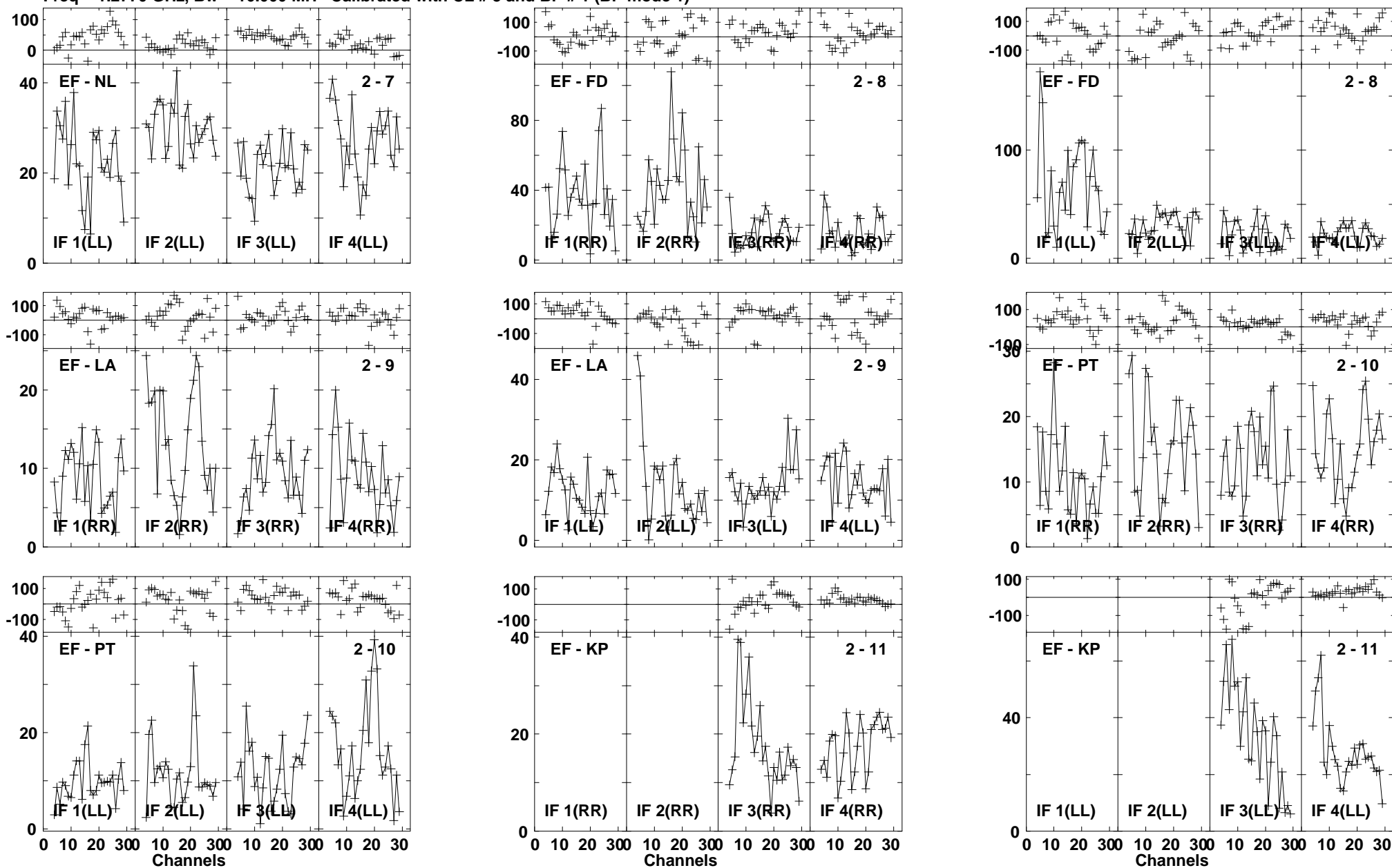

Lower frame: Milli Ampl Jy Top frame: Phas deg
Vector averaged cross-power spectrum Baseline: EF (02) - NL (07)
Timerange: 01/05:00:28 to 01/05:03:52

Plot file version1567 created 03-MAR-2016 01:16:32

4C52 GN002C 1.UVDATA.1

Freq = 1.2770 GHz, Bw = 16.000 MH Calibrated with CL # 3 and BP # 1 (BP mode 1)

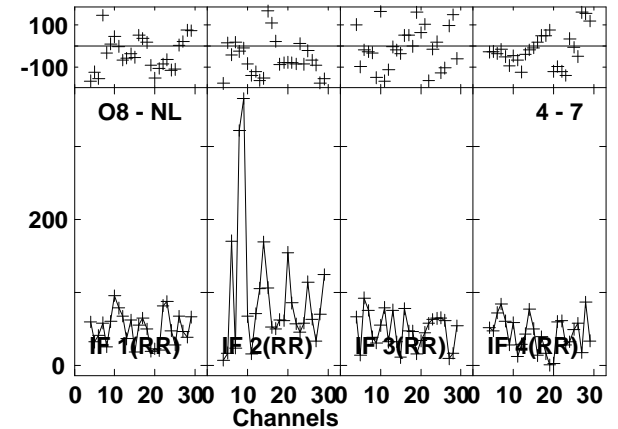
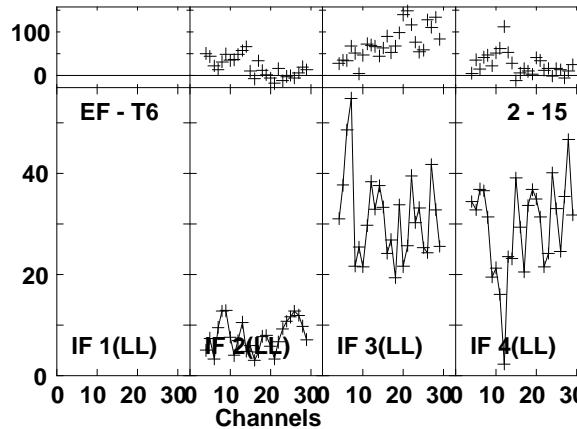
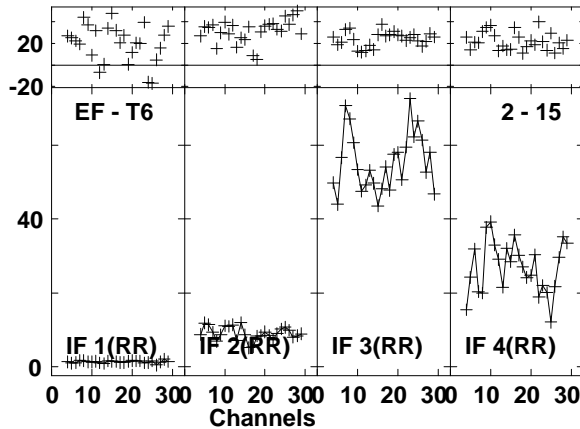
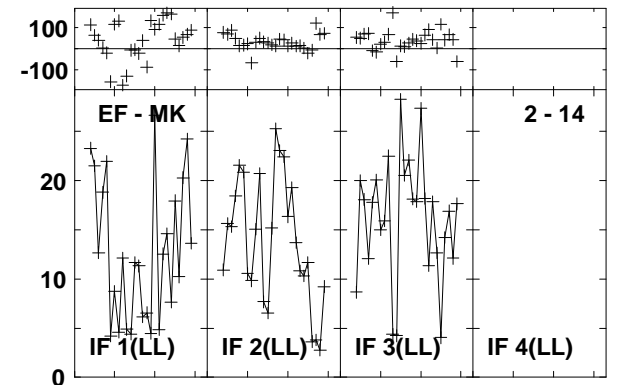
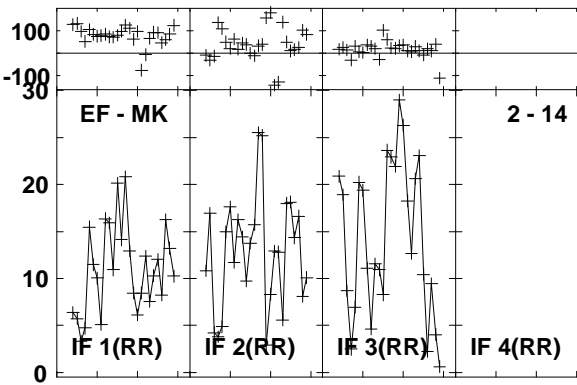
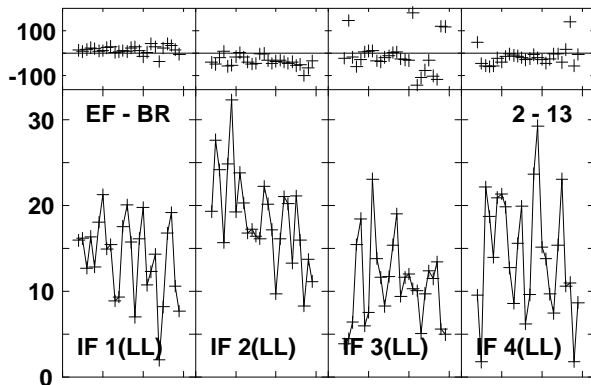
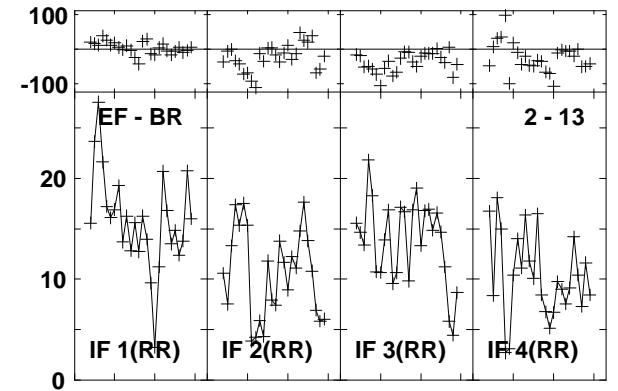
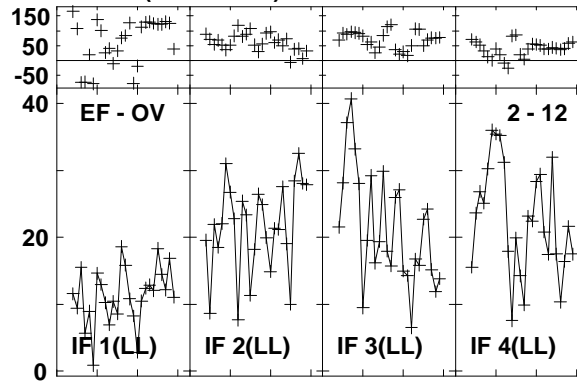
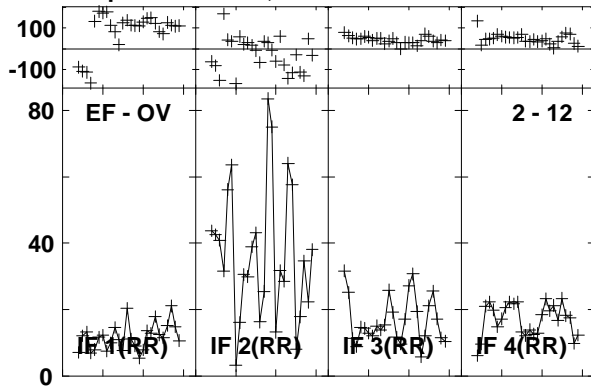

Lower frame: Milli Ampl Jy Top frame: Phas deg
Vector averaged cross-power spectrum Baseline: EF (02) - OV (12)
Timerange: 01/05:00:28 to 01/05:03:52

Plot file version1568 created 03-MAR-2016 01:16:33

4C52 GN002C 1.UVDATA.1

Freq = 1.2770 GHz, Bw = 16.000 MH Calibrated with CL # 3 and BP # 1 (BP mode 1)

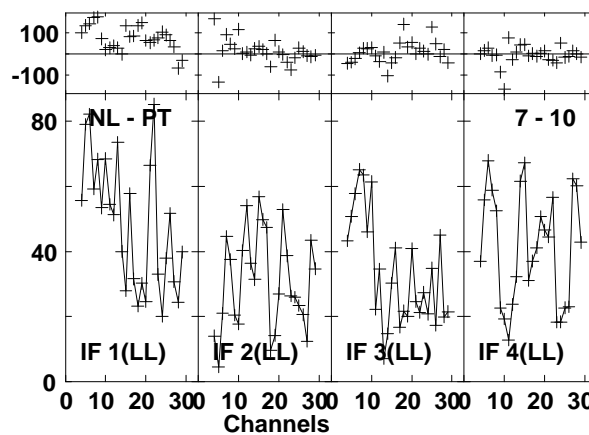
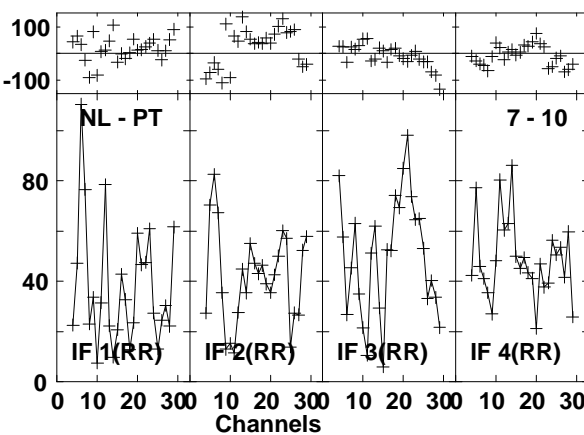
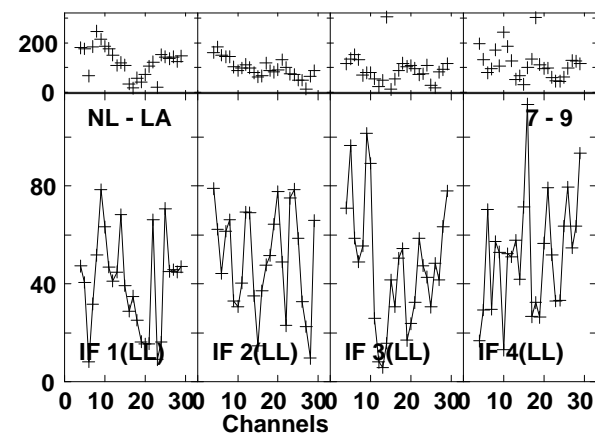
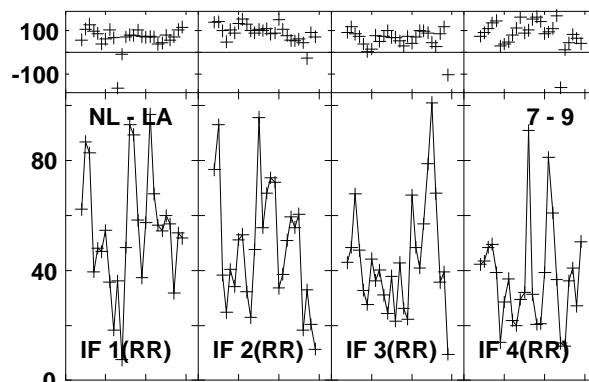
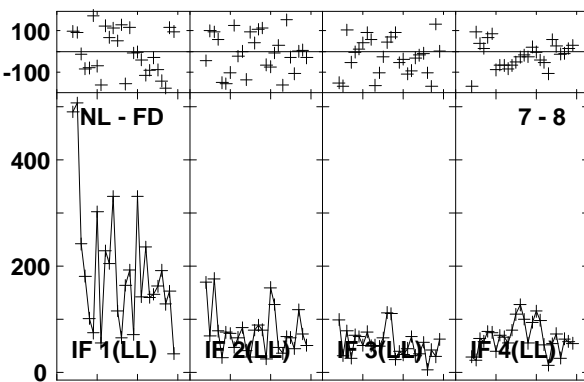
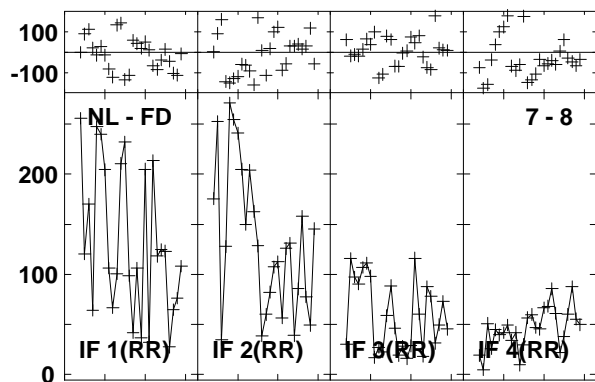
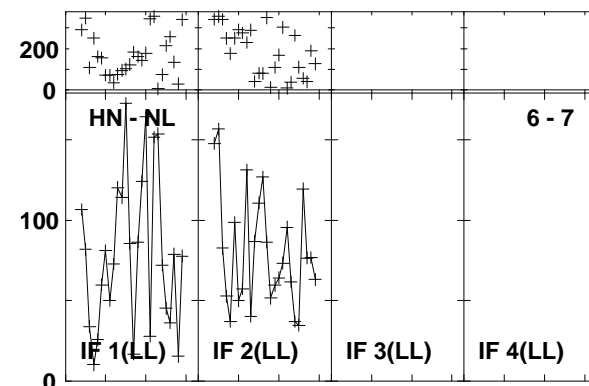
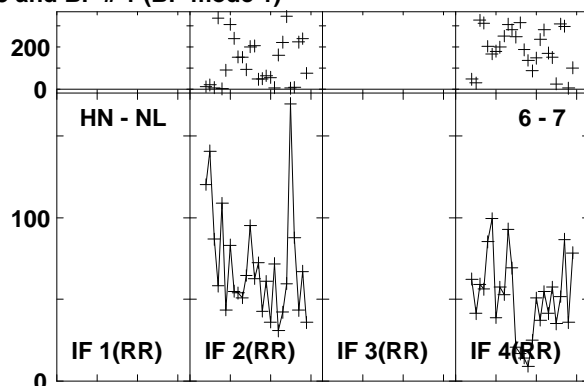
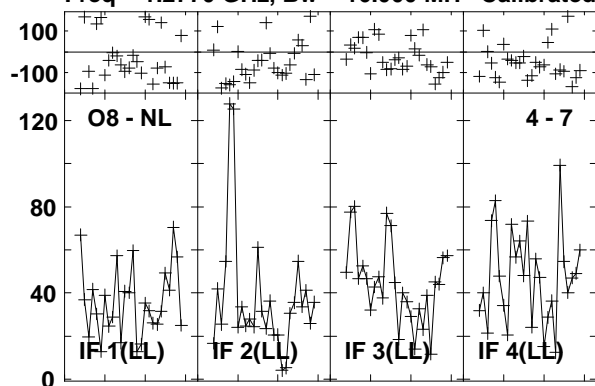

Lower frame: Milli Ampl Jy Top frame: Phas deg
Vector averaged cross-power spectrum Baseline: O8 (04) - NL (07)
Timerange: 01/05:00:28 to 01/05:03:52

Plot file version1569 created 03-MAR-2016 01:16:33

4C52 GN002C 1.UVDATA.1

Freq = 1.2770 GHz, Bw = 16.000 MH Calibrated with CL # 3 and BP # 1 (BP mode 1)

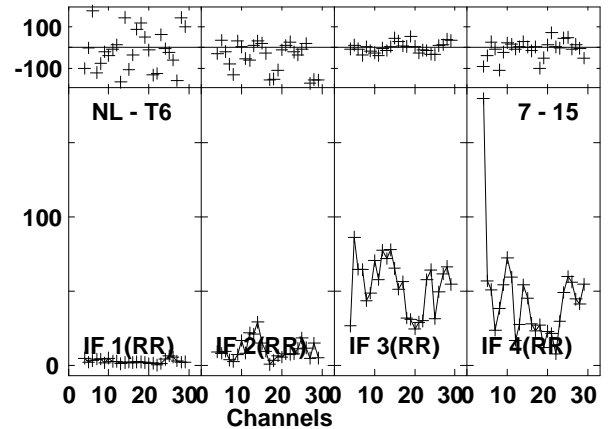
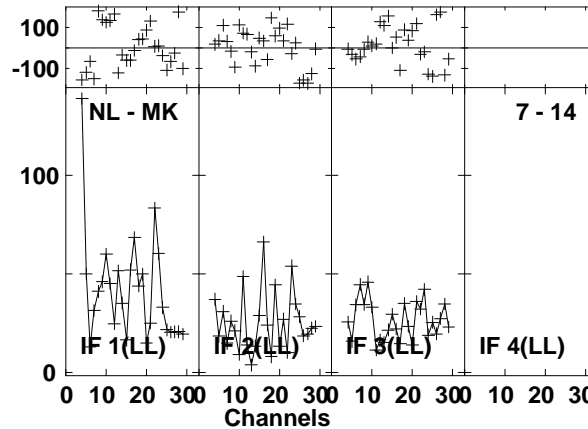
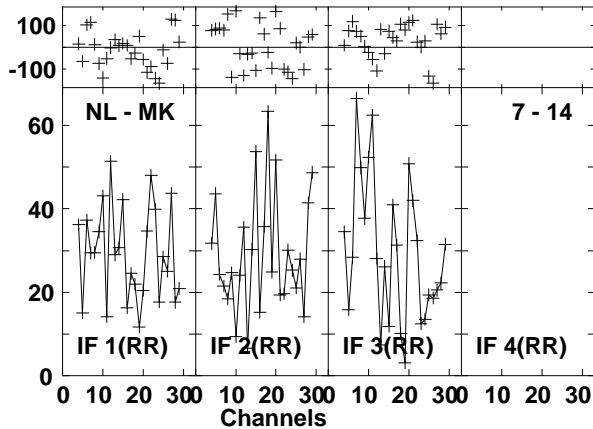
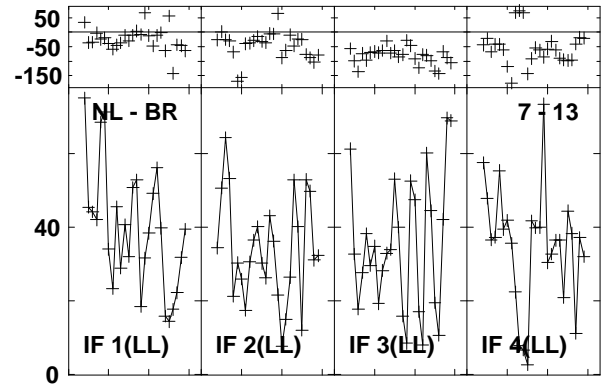
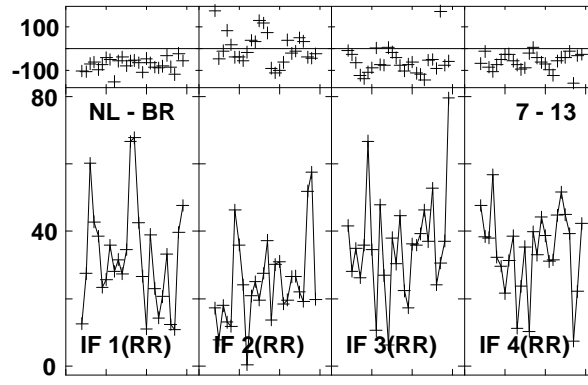
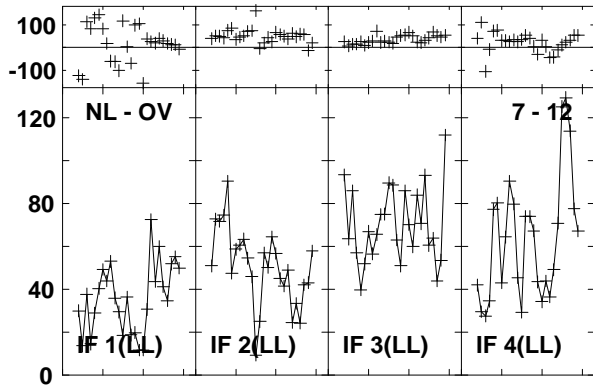
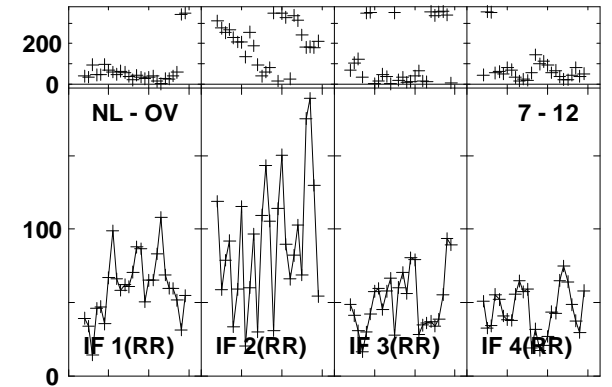
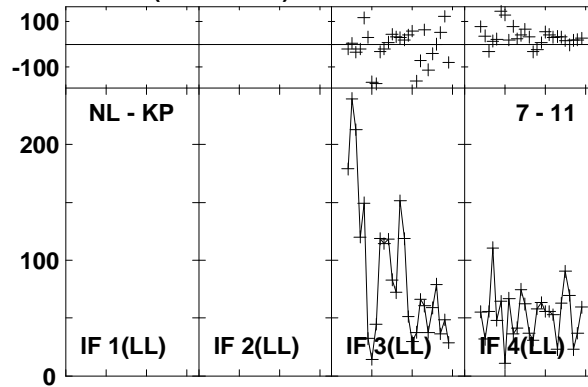
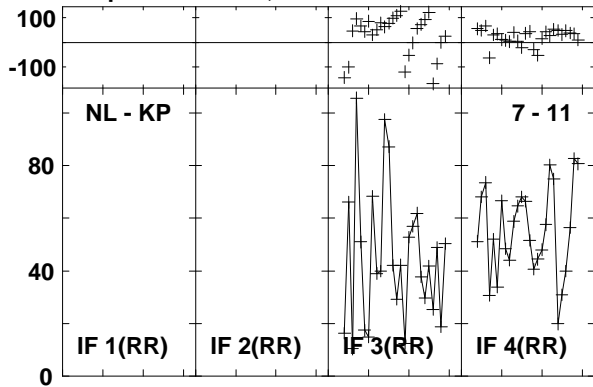

Lower frame: Milli Ampl Jy Top frame: Phas deg

Vector averaged cross-power spectrum Baseline: NL (07) - KP (11)

Timerange: 01/05:00:28 to 01/05:03:52

Plot file version1570 created 03-MAR-2016 01:16:33

4C52 GN002C 1.UVDATA.1

Freq = 1.2770 GHz, Bw = 16.000 MH Calibrated with CL # 3 and BP # 1 (BP mode 1)

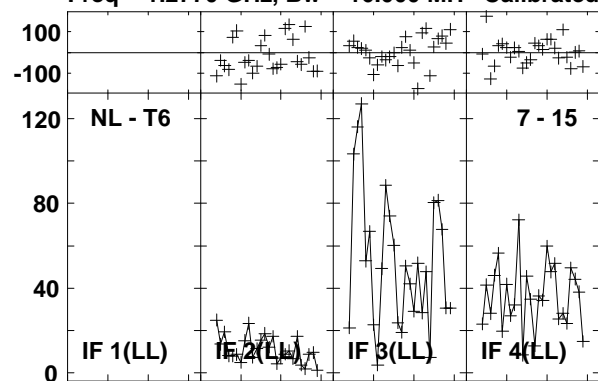

Lower frame: Milli Ampl Jy Top frame: Phas deg
Vector averaged cross-power spectrum Baseline: NL (07) - T6 (15)
Timerange: 01/05:00:28 to 01/05:03:52

Plot file version1571 created 03-MAR-2016 01:16:33

J1545+5400 GN002C 1.UVDATA.1

Freq = 1.2770 GHz, Bw = 16.000 MH Calibrated with CL # 3 and BP # 1 (BP mode 1)

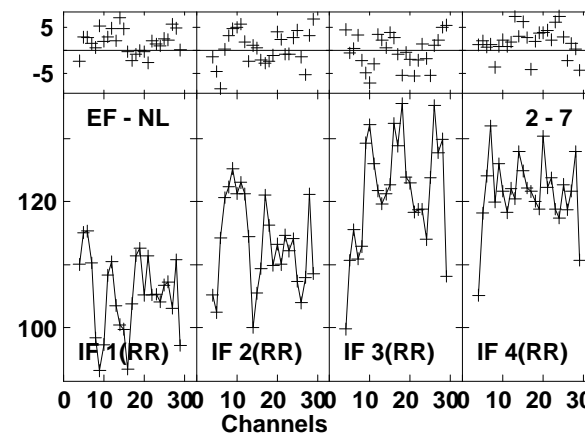
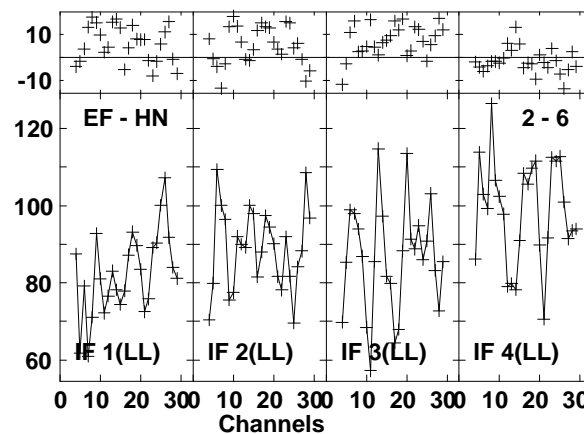
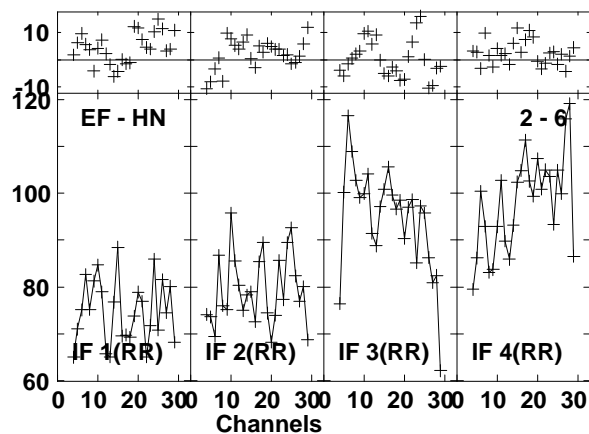
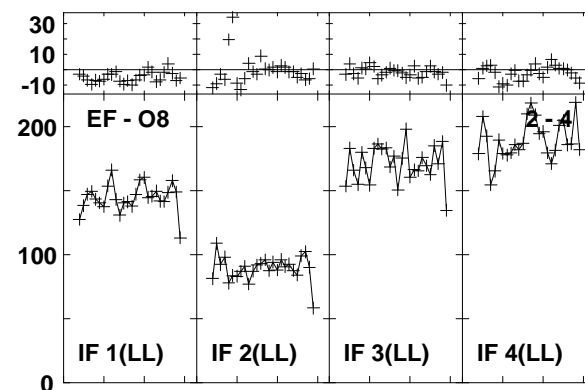
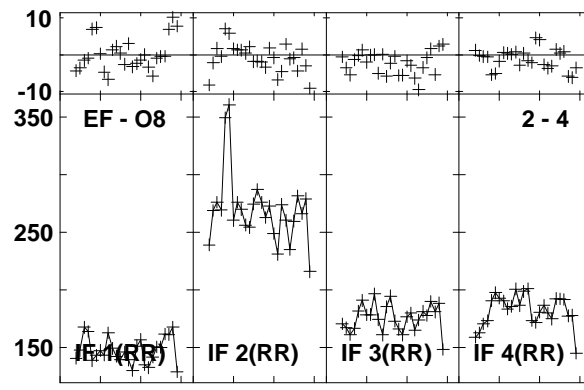
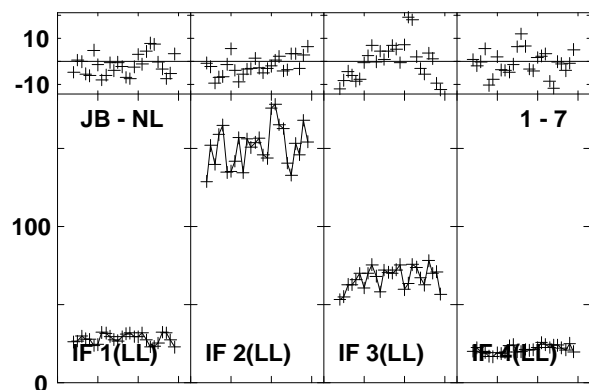
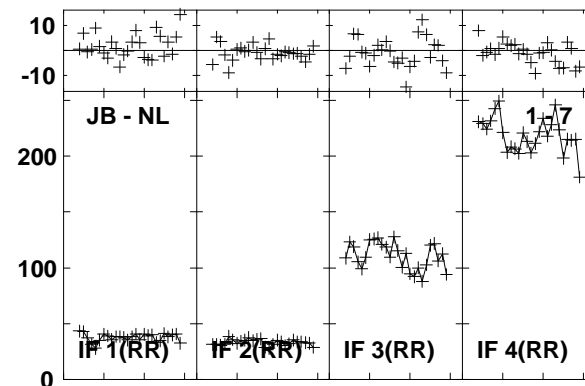
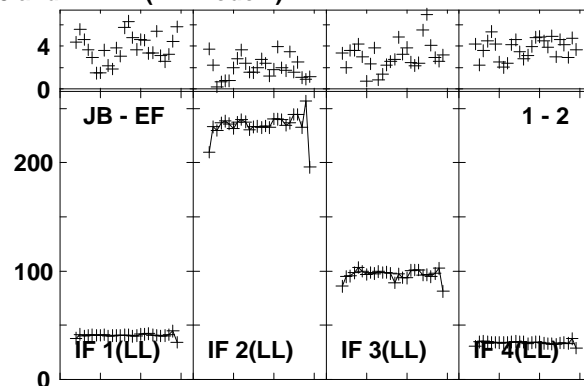
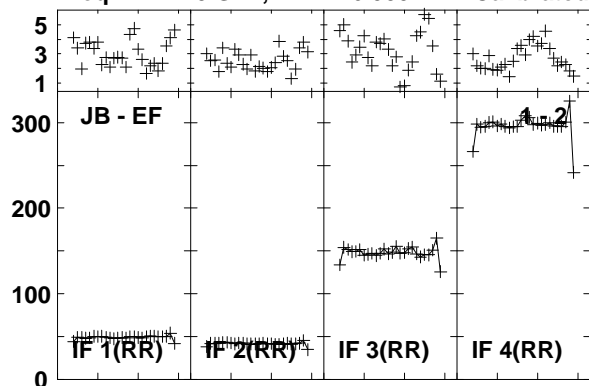

Lower frame: Milli Ampl Jy Top frame: Phas deg
Vector averaged cross-power spectrum Baseline: JB (01) - EF (02)
Timerange: 01/05:04:45 to 01/05:07:33

Plot file version1572 created 03-MAR-2016 01:16:33

J1545+5400 GN002C 1.UVDATA.1

Freq = 1.2770 GHz, Bw = 16.000 MH Calibrated with CL # 3 and BP # 1 (BP mode 1)

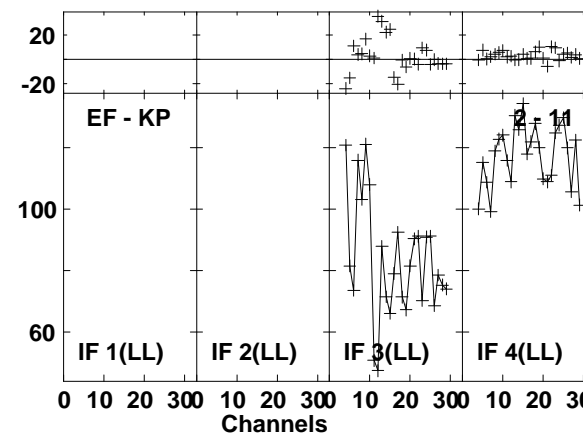
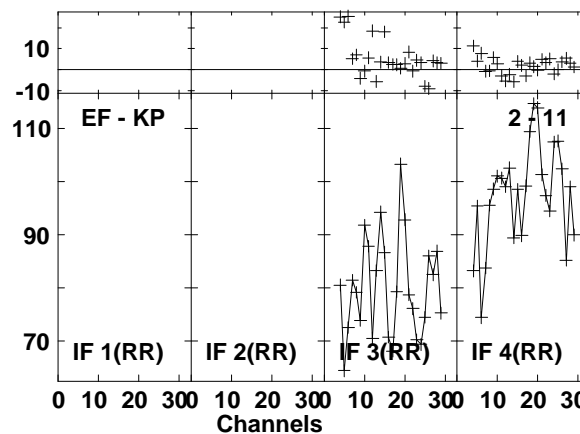
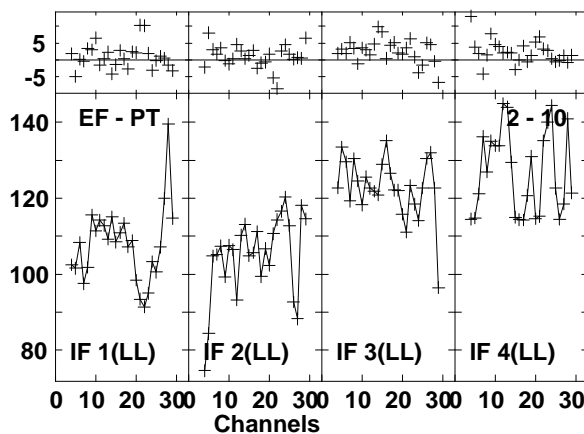
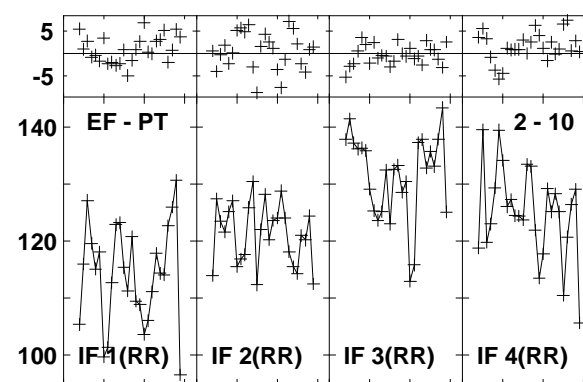
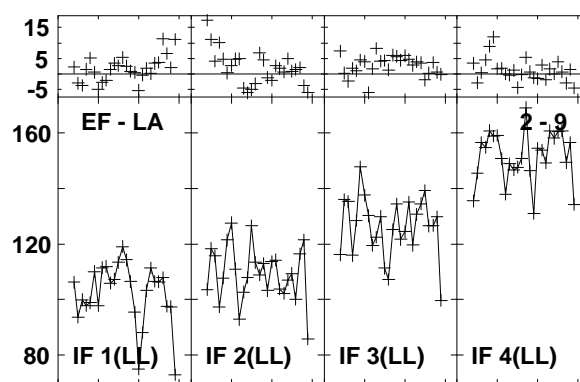
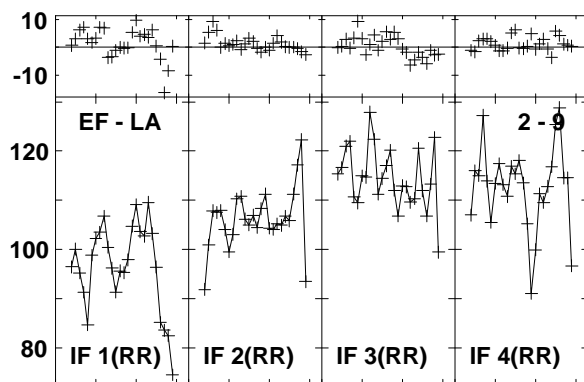
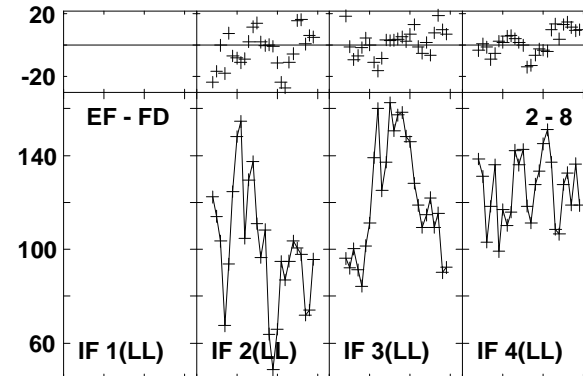
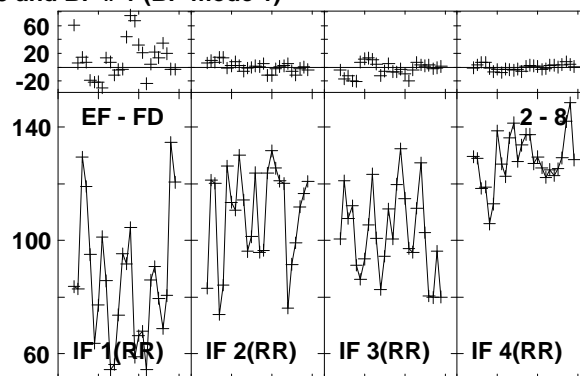
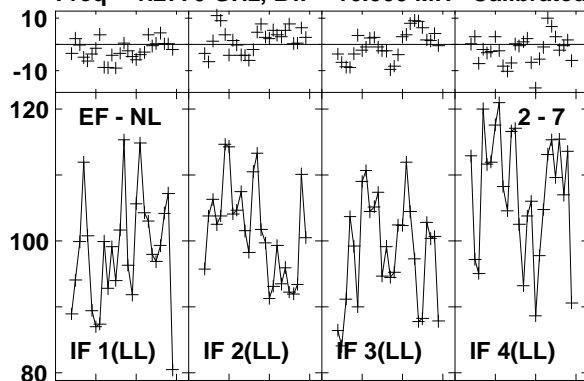

Lower frame: Milli Ampl Jy Top frame: Phas deg
Vector averaged cross-power spectrum Baseline: EF (02) - NL (07)
Timerange: 01/05:04:45 to 01/05:07:33

Plot file version1573 created 03-MAR-2016 01:16:34

J1545+5400 GN002C 1.UVDATA.1

Freq = 1.2770 GHz, Bw = 16.000 MH Calibrated with CL # 3 and BP # 1 (BP mode 1)

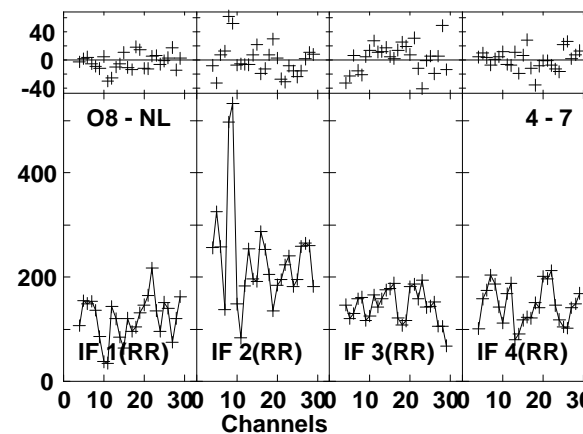
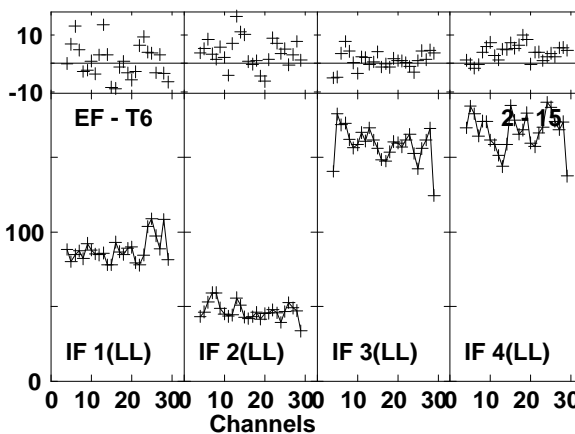
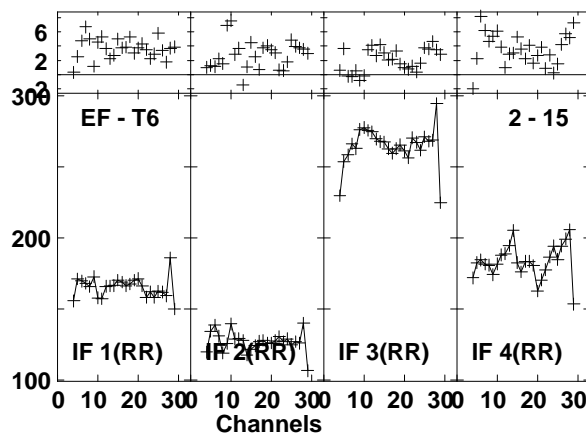
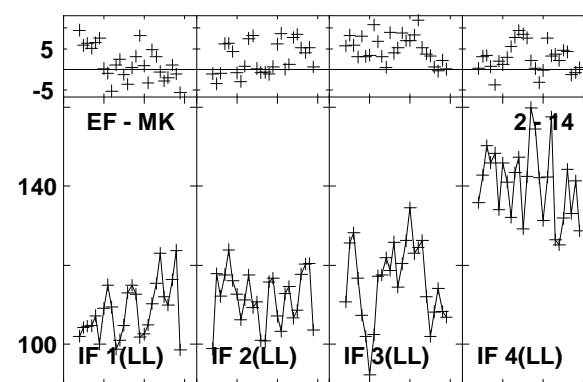
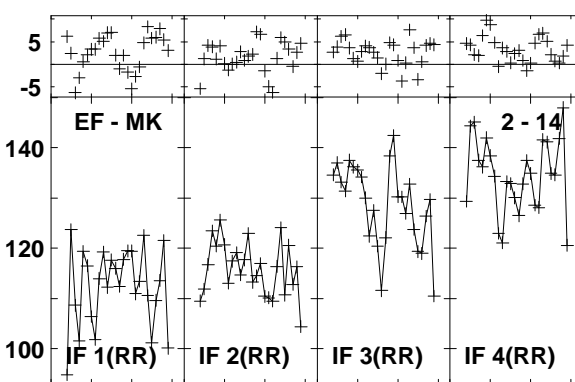
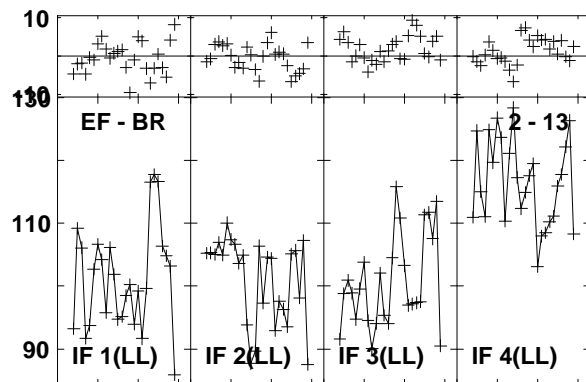
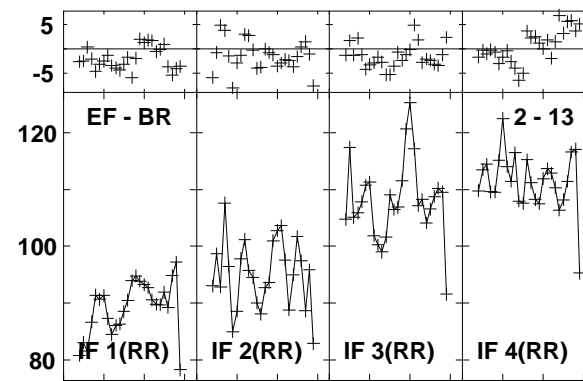
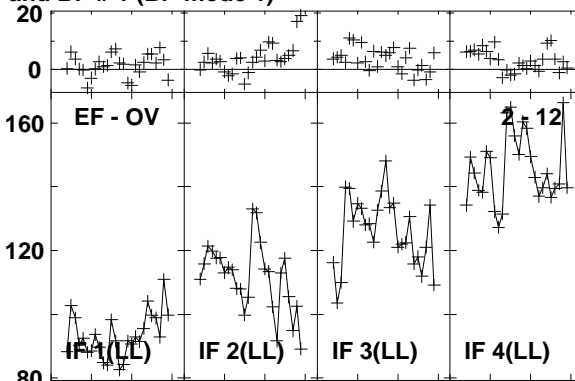
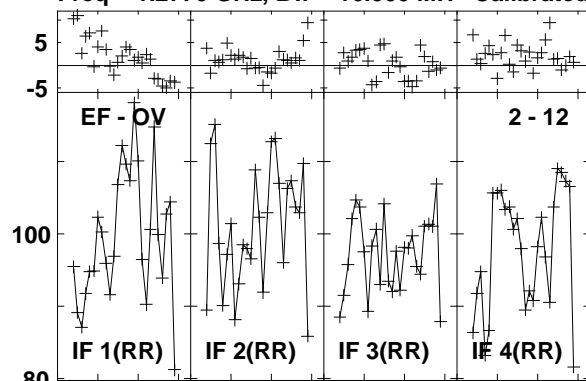

Lower frame: Milli Ampl Jy Top frame: Phas deg
Vector averaged cross-power spectrum Baseline: EF (02) - OV (12)
Timerange: 01/05:04:45 to 01/05:07:33

Plot file version1574 created 03-MAR-2016 01:16:34

J1545+5400 GN002C 1.UVDATA.1

Freq = 1.2770 GHz, Bw = 16.000 MH Calibrated with CL # 3 and BP # 1 (BP mode 1)

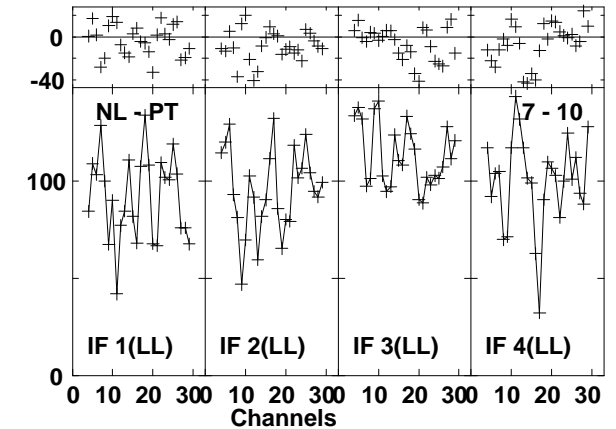
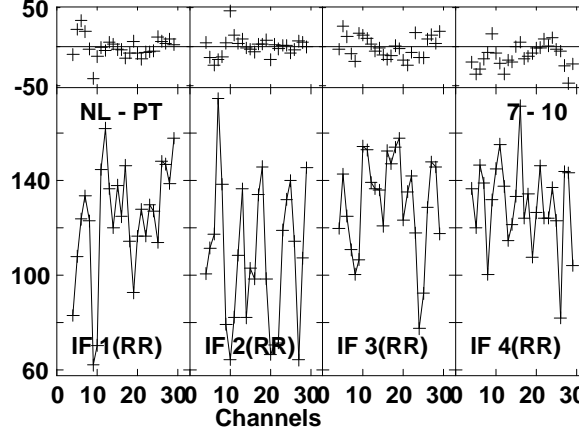
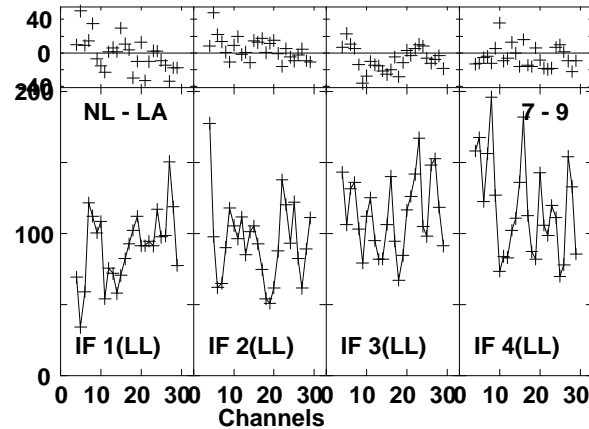
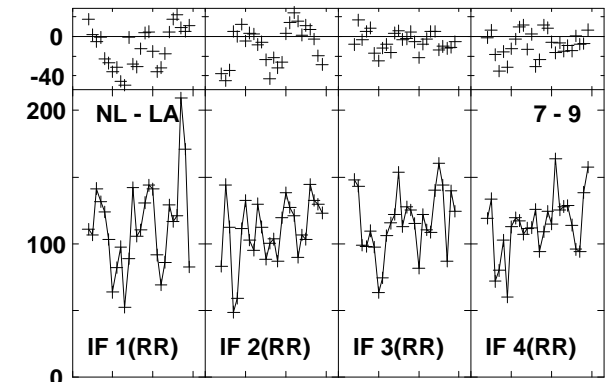
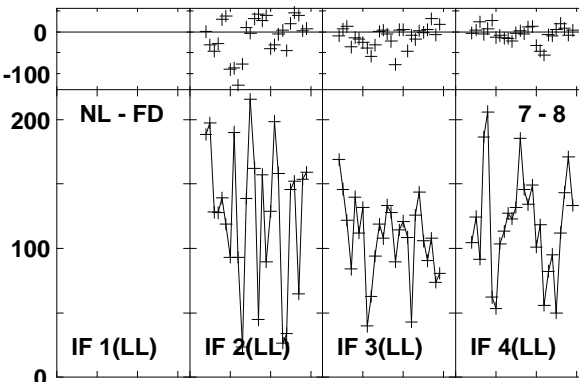
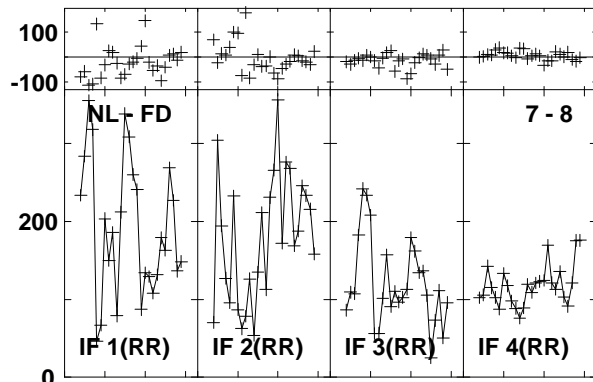
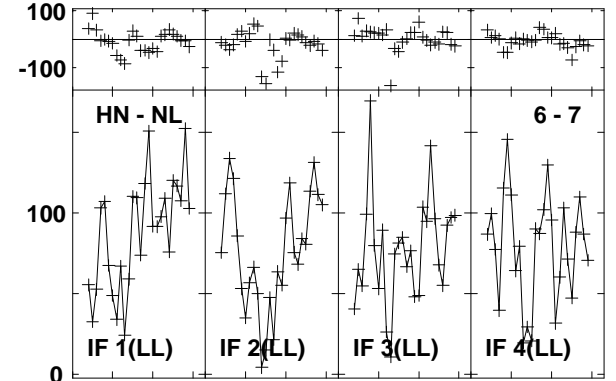
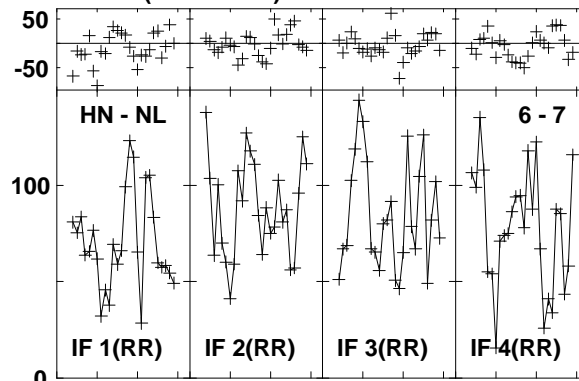
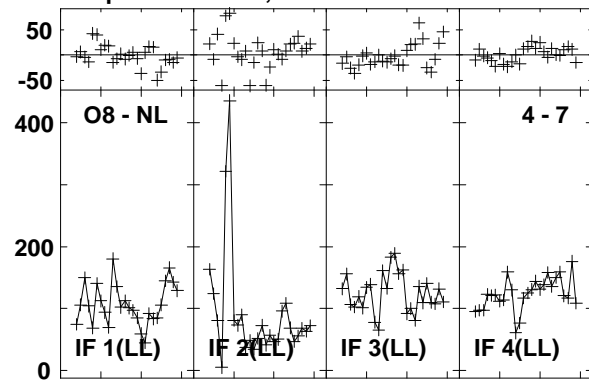

Lower frame: Milli Ampl Jy Top frame: Phas deg
Vector averaged cross-power spectrum Baseline: O8 (04) - NL (07)
Timerange: 01/05:04:45 to 01/05:07:33

Plot file version1575 created 03-MAR-2016 01:16:34
 J1545+5400 GN002C 1.UVDATA.1
 Freq = 1.2770 GHz, Bw = 16.000 MH Calibrated with CL # 3 and BP # 1 (BP mode 1)

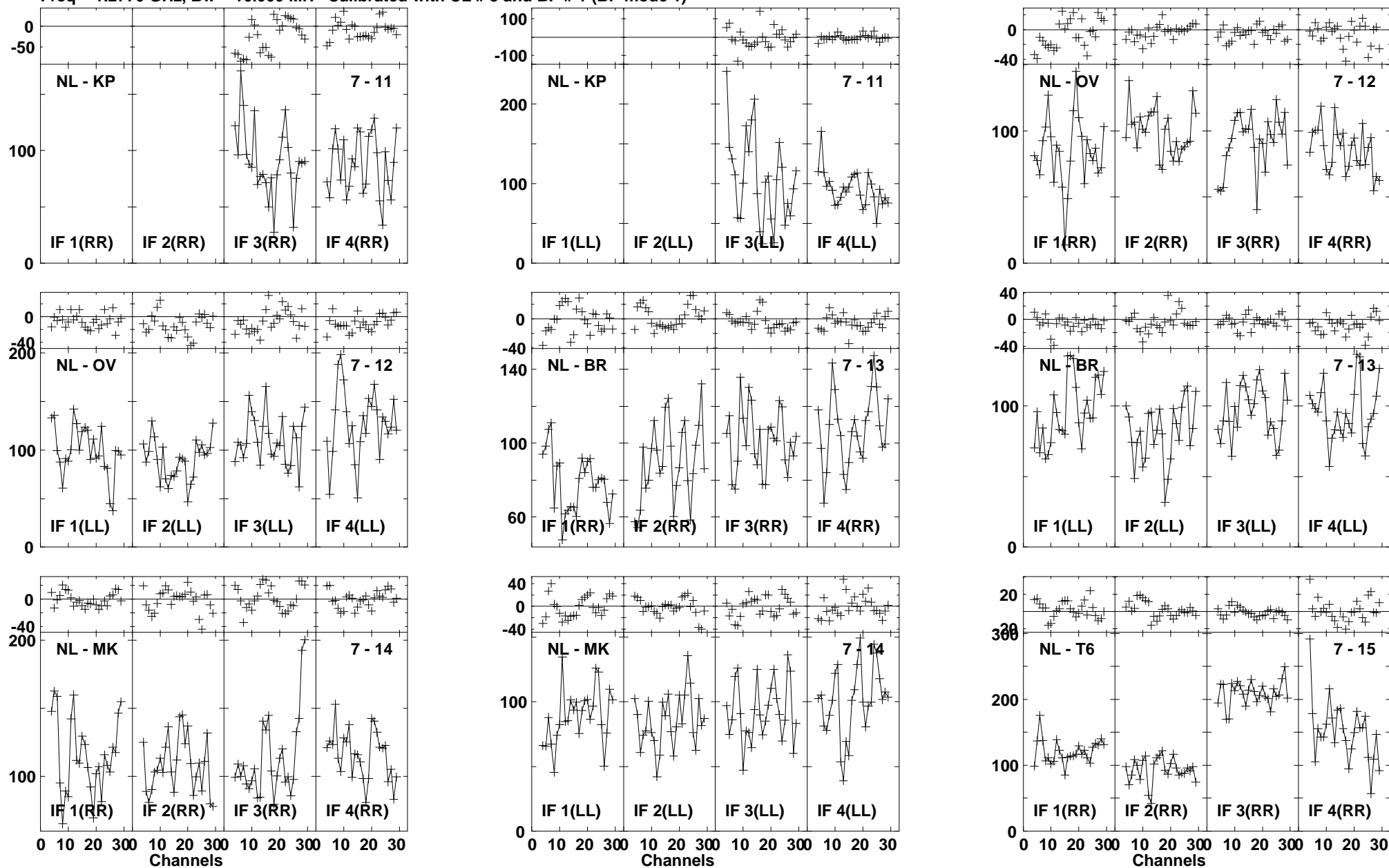

Lower frame: Milli Ampl Jy Top frame: Phas deg
 Vector averaged cross-power spectrum Baseline: NL (07) - KP (11)
 Timerange: 01/05:04:45 to 01/05:07:33

Plot file version1576 created 03-MAR-2016 01:16:34
J1545+5400 GN002C 1.UVDATA.1
Freq = 1.2770 GHz, Bw = 16.000 MH Calibrated with CL # 3 and BP # 1 (BP mode 1)

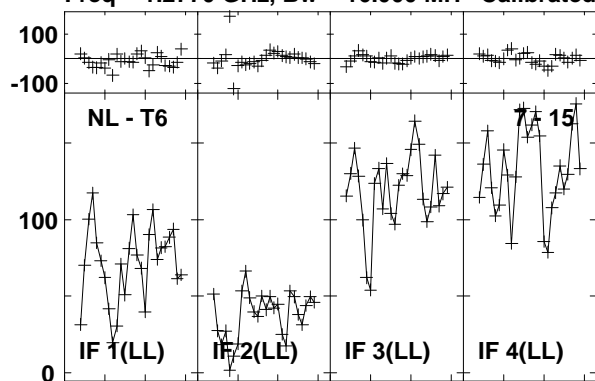

Lower frame: Milli Ampl Jy Top frame: Phas deg
Vector averaged cross-power spectrum Baseline: NL (07) - T6 (15)
Timerange: 01/05:04:45 to 01/05:07:33

Plot file version1577 created 03-MAR-2016 01:16:34

4C52 GN002C 1.UVDATA.1

Freq = 1.2770 GHz, Bw = 16.000 MH Calibrated with CL # 3 and BP # 1 (BP mode 1)

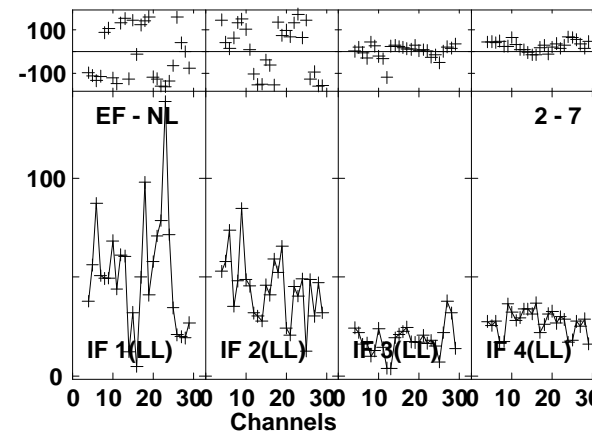
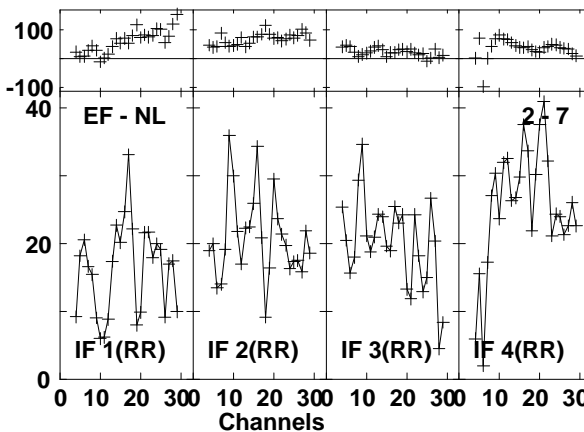
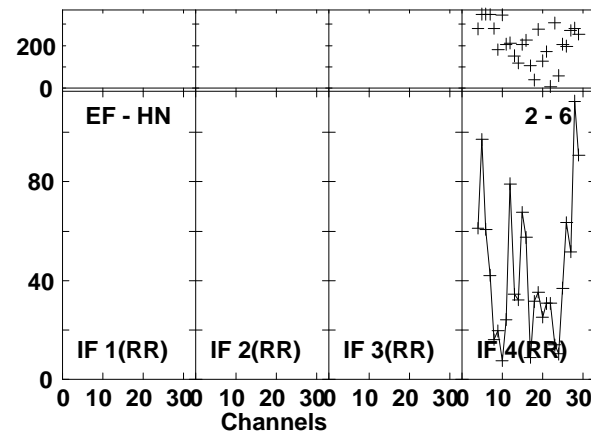
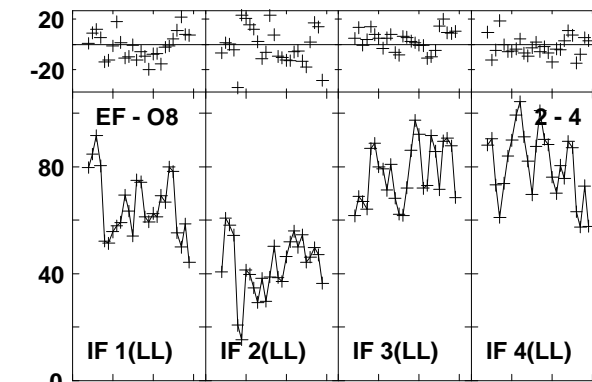
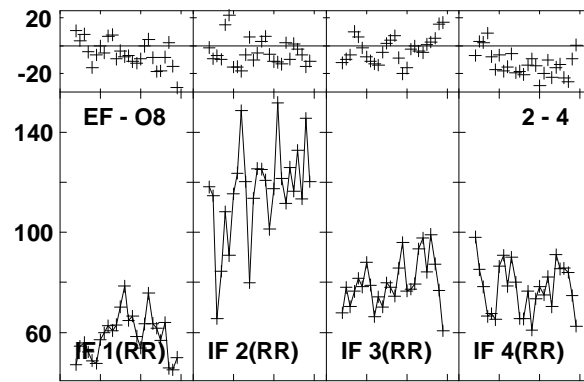
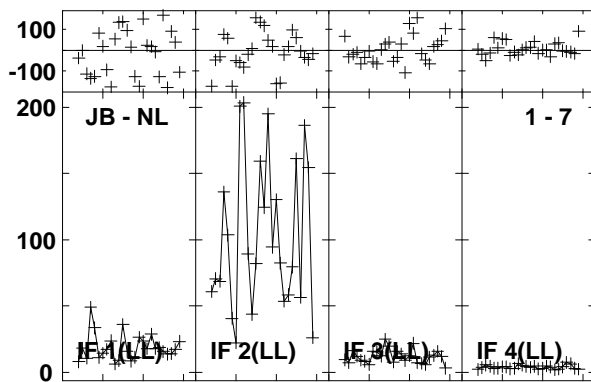
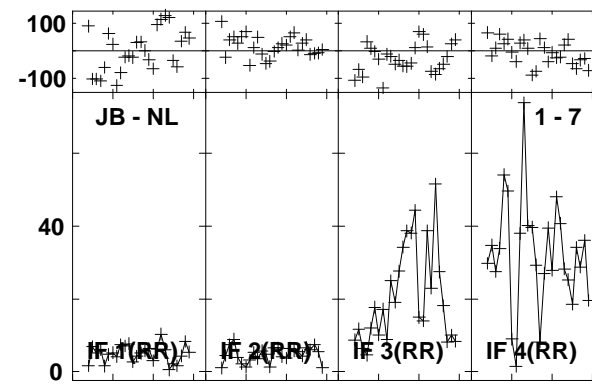
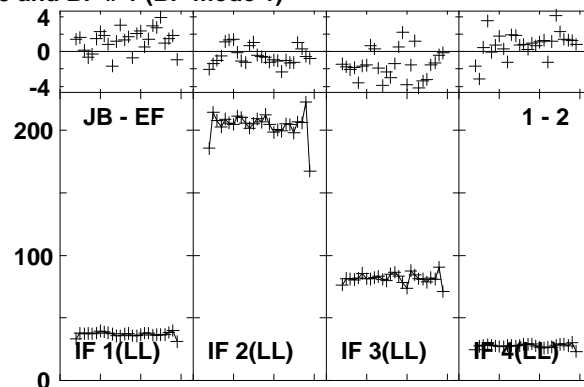
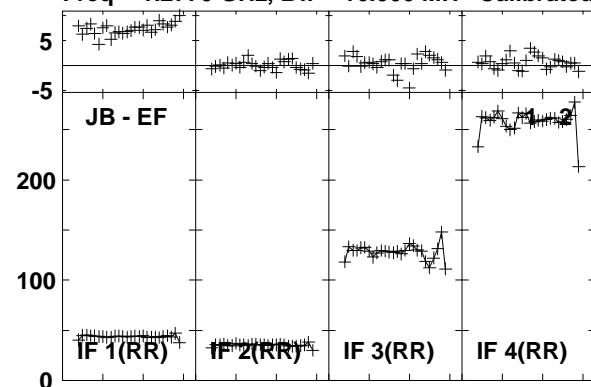

Lower frame: Milli Ampl Jy Top frame: Phas deg
Vector averaged cross-power spectrum Baseline: JB (01) - EF (02)
Timerange: 01/05:07:45 to 01/05:11:03

Plot file version1578 created 03-MAR-2016 01:16:35

4C52 GN002C 1.UVDATA.1

Freq = 1.2770 GHz, Bw = 16.000 MH Calibrated with CL # 3 and BP # 1 (BP mode 1)

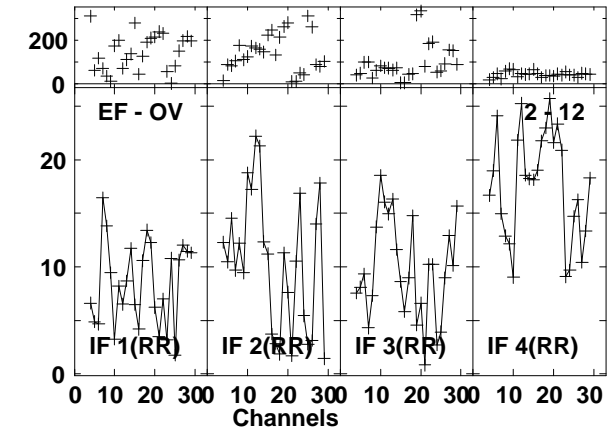
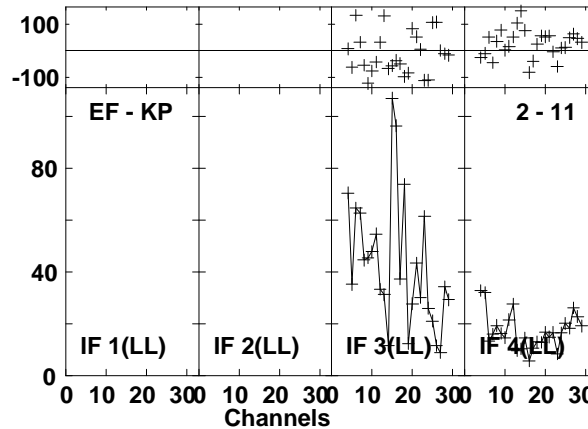
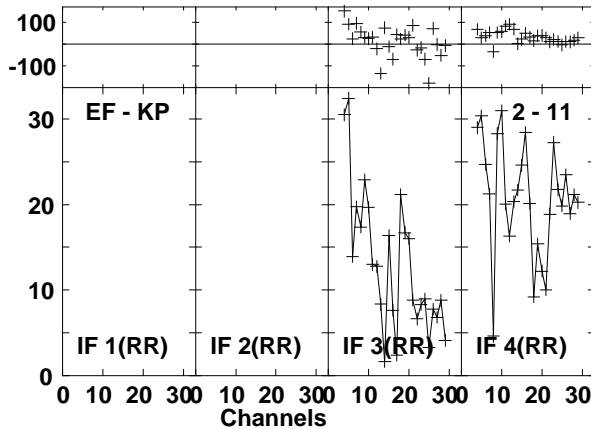
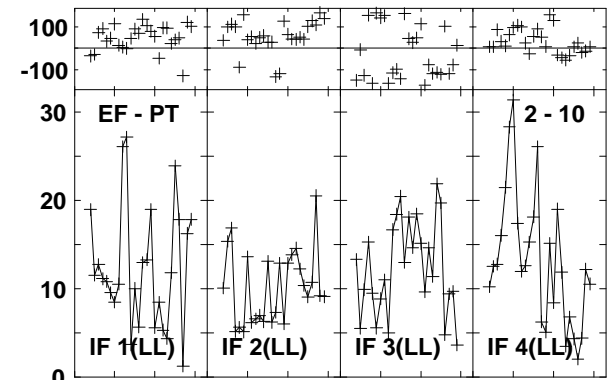
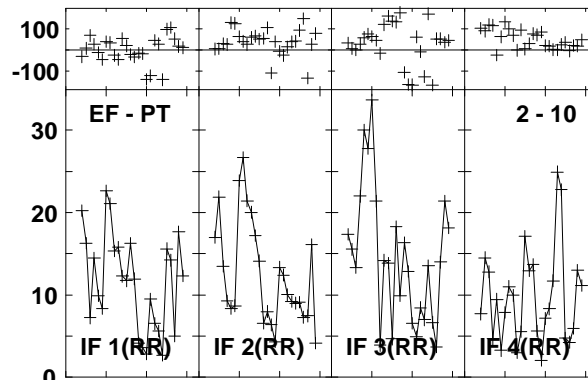
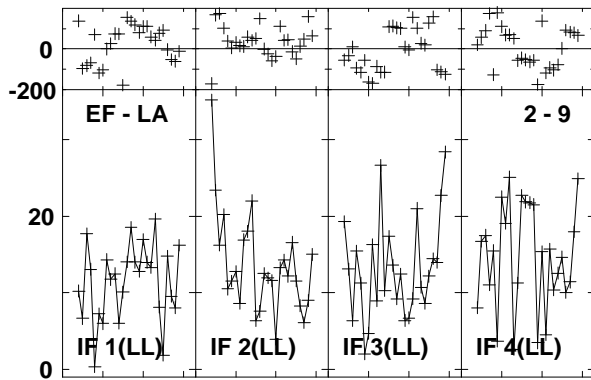
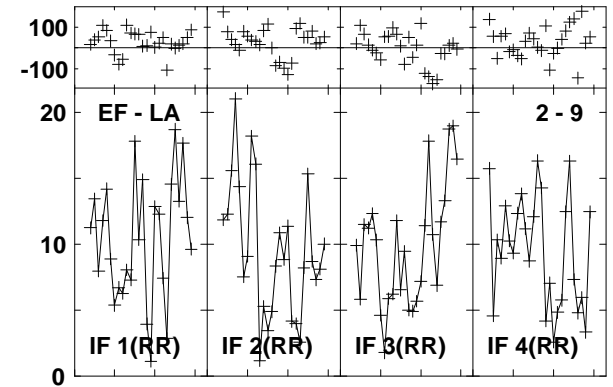
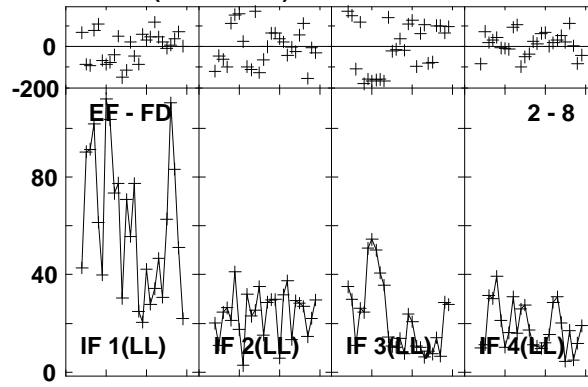
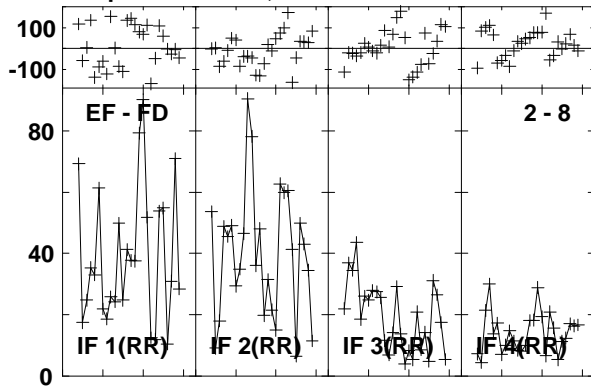

Lower frame: Milli Ampl Jy Top frame: Phas deg
Vector averaged cross-power spectrum Baseline: EF (02) - FD (08)
Timerange: 01/05:07:45 to 01/05:11:03

Plot file version1579 created 03-MAR-2016 01:16:35

4C52 GN002C 1.UVDATA.1

Freq = 1.2770 GHz, Bw = 16.000 MH Calibrated with CL # 3 and BP # 1 (BP mode 1)

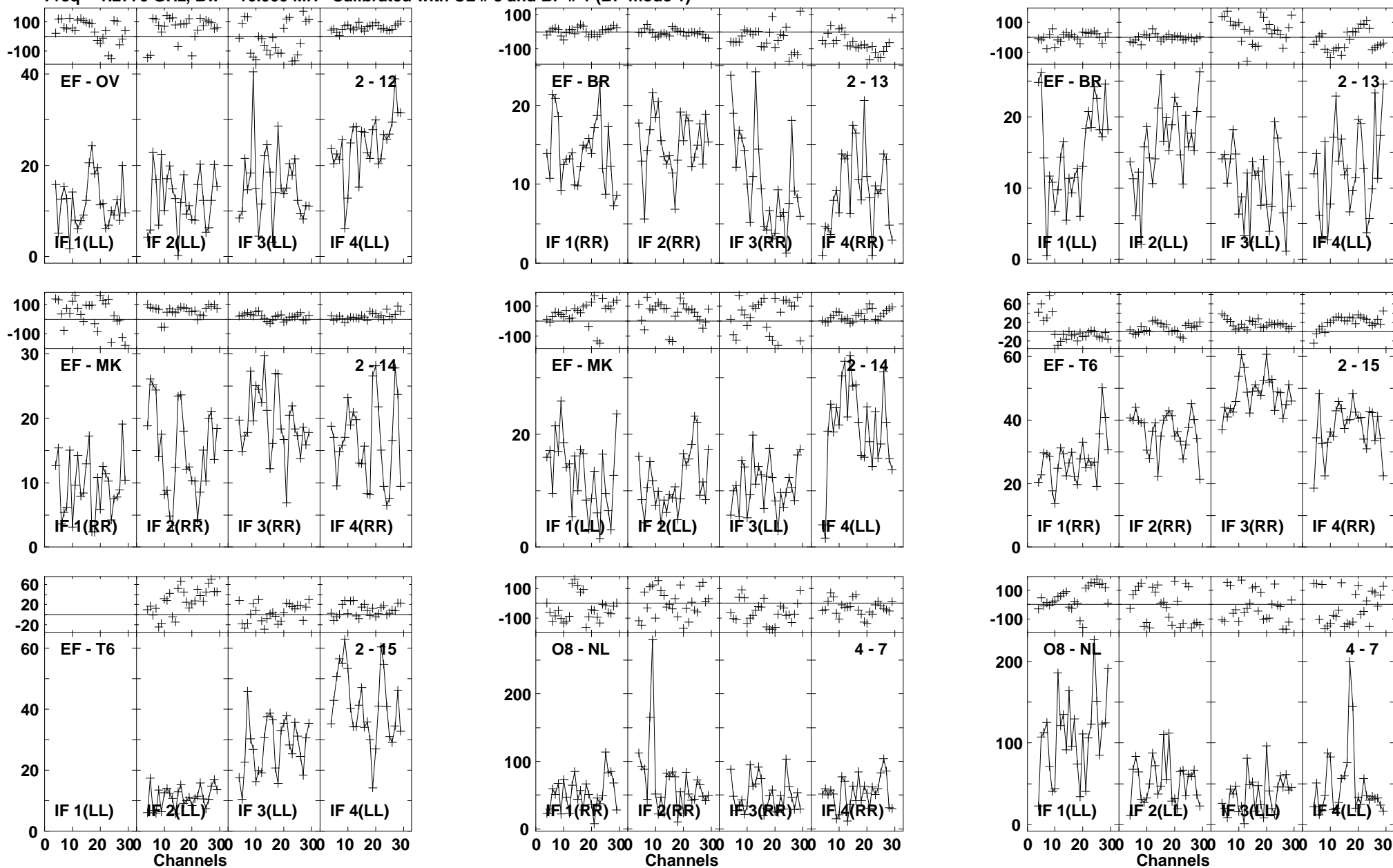

Plot file version1580 created 03-MAR-2016 01:16:35

4C52 GN002C 1.UVDATA.1

Freq = 1.2770 GHz, Bw = 16.000 MH Calibrated with CL # 3 and BP # 1 (BP mode 1)

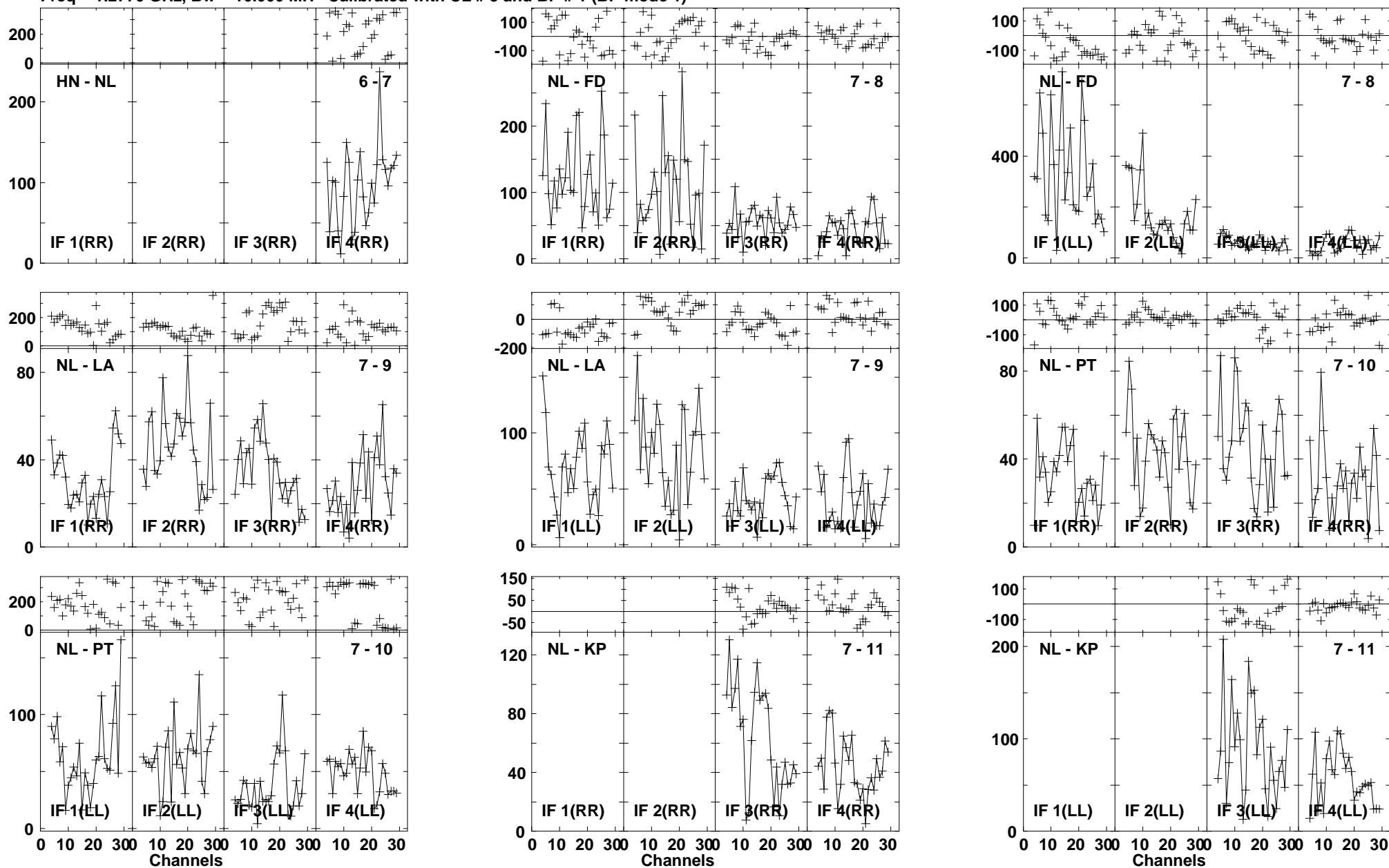

Lower frame: Milli Ampl Jy Top frame: Phas deg
Vector averaged cross-power spectrum Baseline: HN (06) - NL (07)
Timerange: 01/05:07:45 to 01/05:11:03

Plot file version1581 created 03-MAR-2016 01:16:35

4C52 GN002C 1.UVDATA.1

Freq = 1.2770 GHz, Bw = 16.000 MH Calibrated with CL # 3 and BP # 1 (BP mode 1)

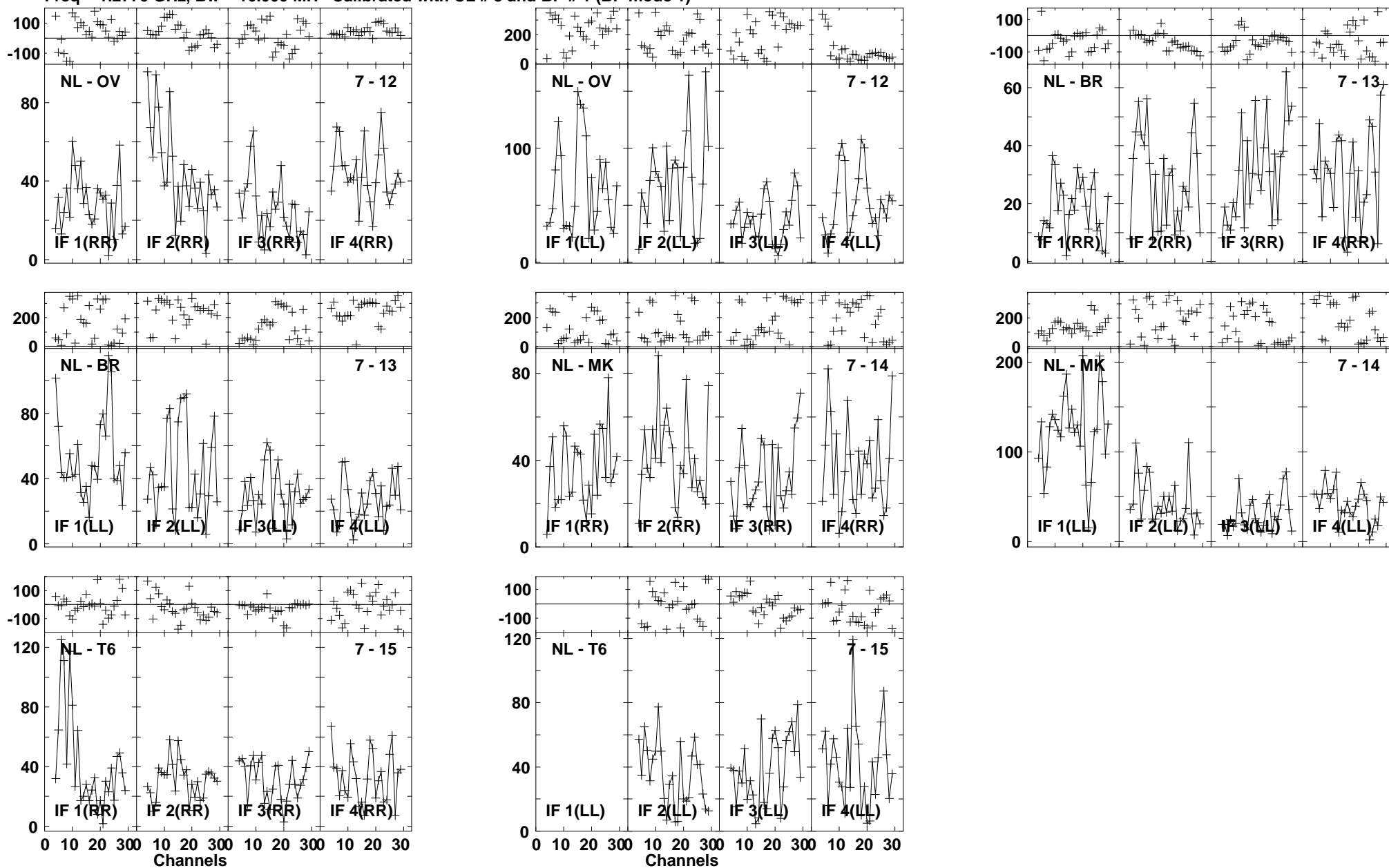

Lower frame: Milli Ampl Jy Top frame: Phas deg
Vector averaged cross-power spectrum Baseline: NL (07) - OV (12)
Timerange: 01/05:07:45 to 01/05:11:03

Plot file version1582 created 03-MAR-2016 01:16:35
 J1545+5400 GN002C 1.UVDATA.1
 Freq = 1.2770 GHz, Bw = 16.000 MH Calibrated with CL # 3 and BP # 1 (BP mode 1)

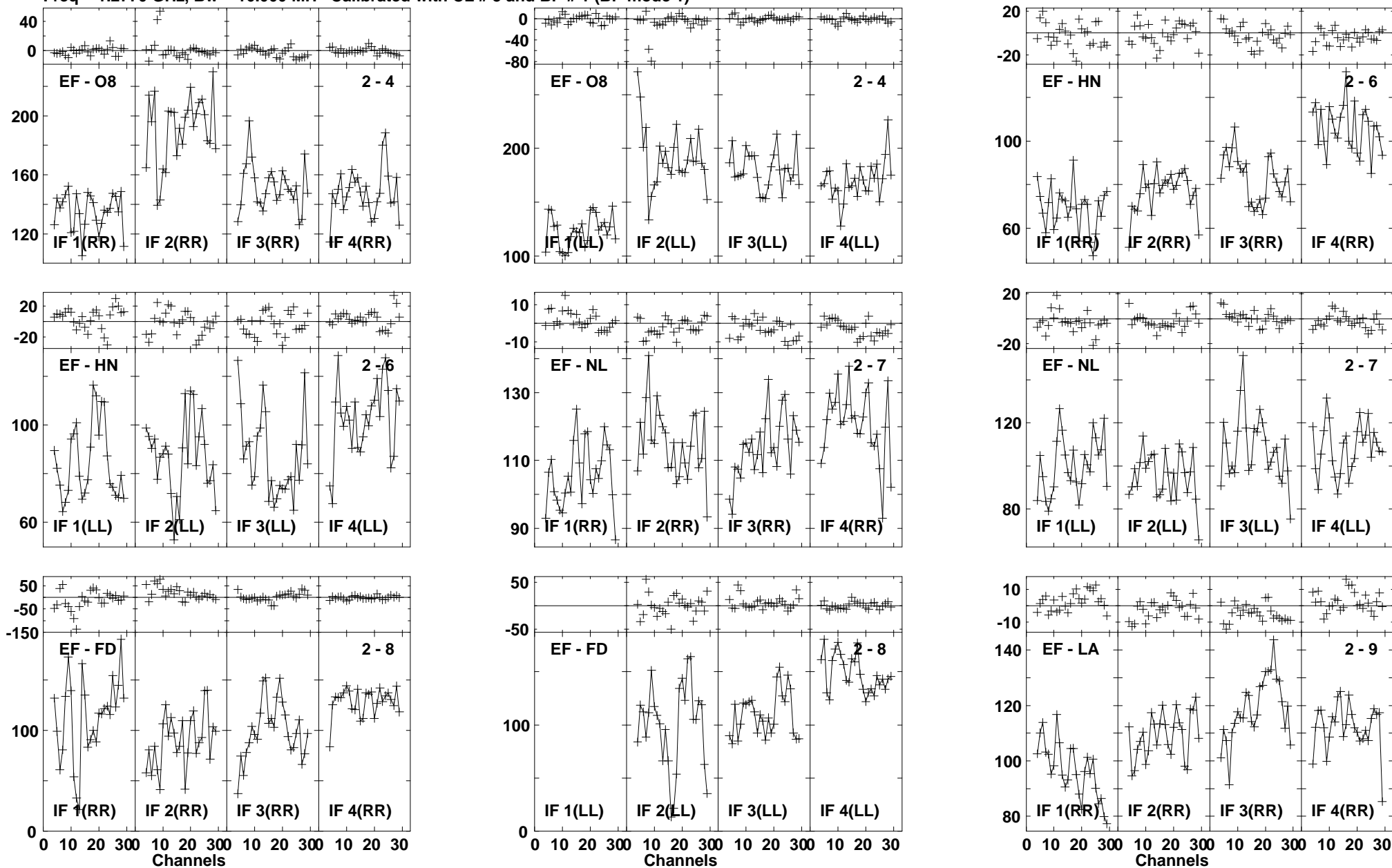

Lower frame: Milli Ampl Jy Top frame: Phas deg
 Vector averaged cross-power spectrum Baseline: EF (02) - O8 (04)
 Timerange: 01/05:11:55 to 01/05:13:13

Plot file version1583 created 03-MAR-2016 01:16:36

J1545+5400 GN002C 1.UVDATA.1

Freq = 1.2770 GHz, Bw = 16.000 MH Calibrated with CL # 3 and BP # 1 (BP mode 1)

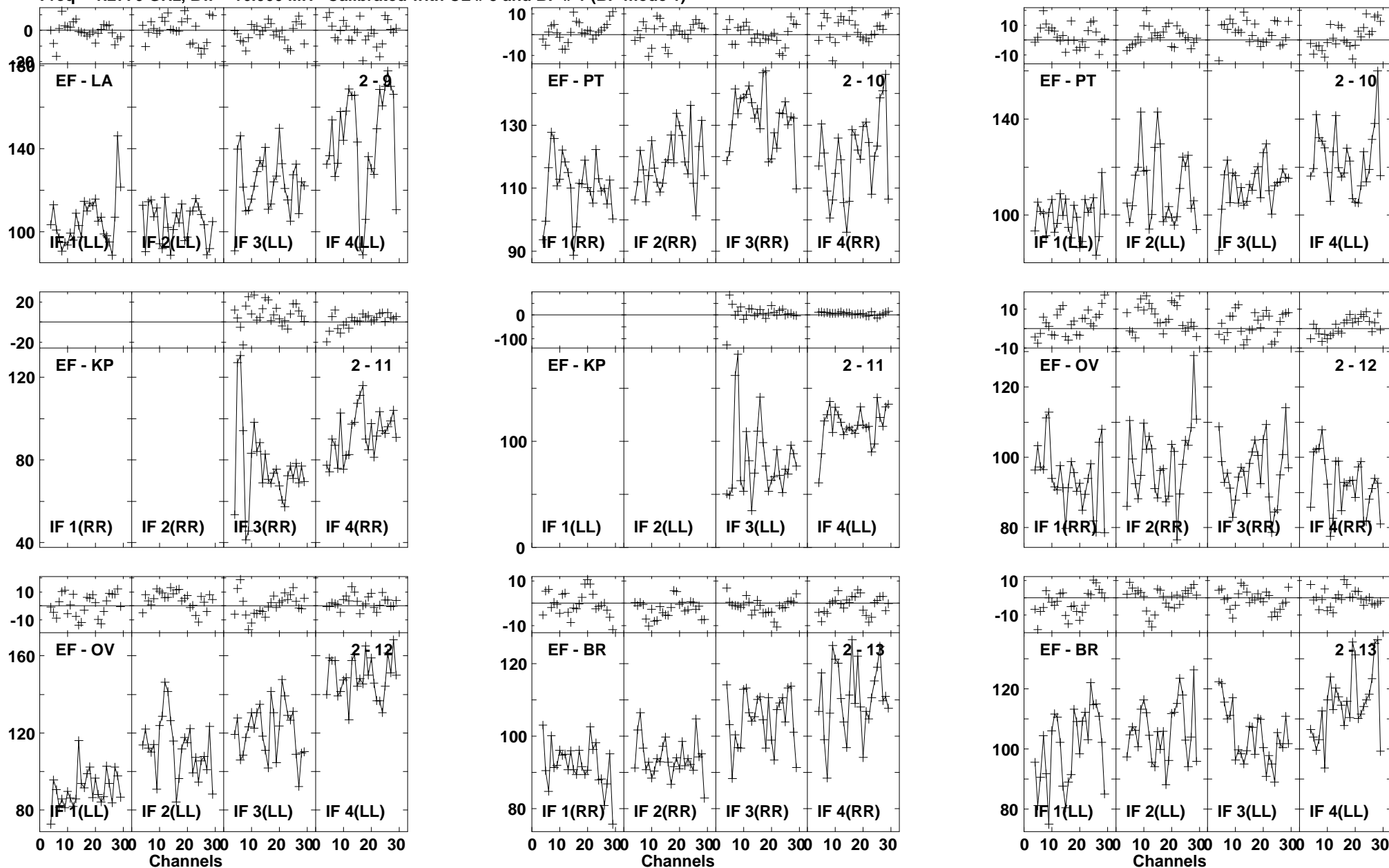

Lower frame: Milli Ampl Jy Top frame: Phas deg
Vector averaged cross-power spectrum Baseline: EF (02) - LA (09)
Timerange: 01/05:11:55 to 01/05:13:13

Plot file version1584 created 03-MAR-2016 01:16:36

J1545+5400 GN002C 1.UVDATA.1

Freq = 1.2770 GHz, Bw = 16.000 MH Calibrated with CL # 3 and BP # 1 (BP mode 1)

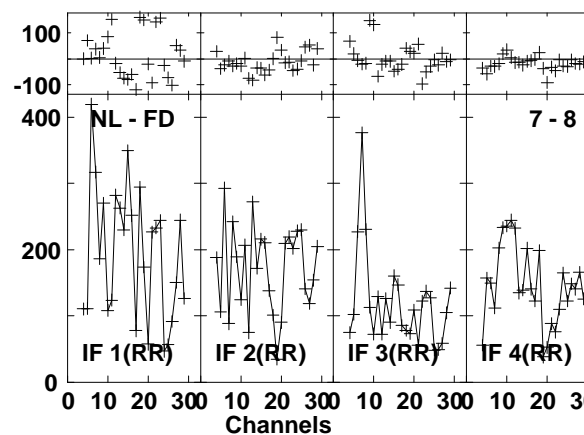
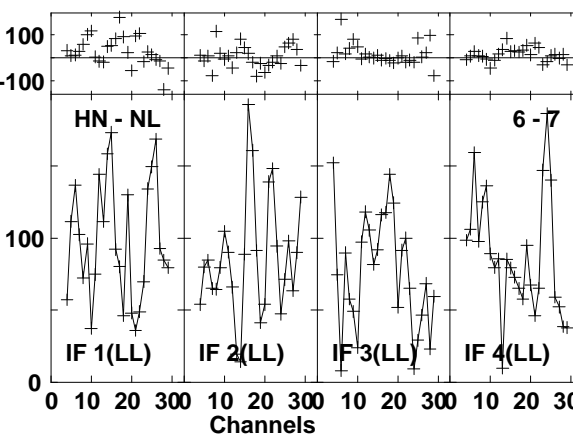
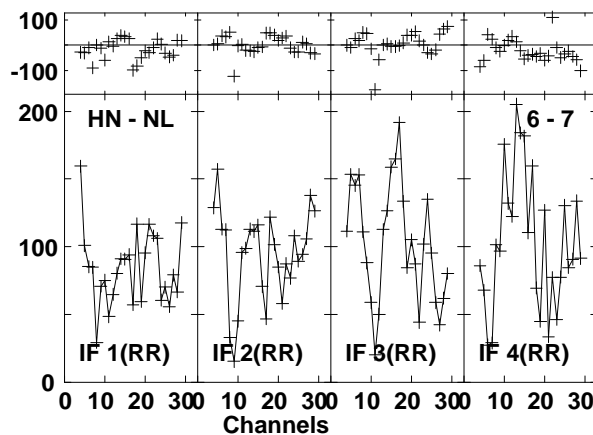
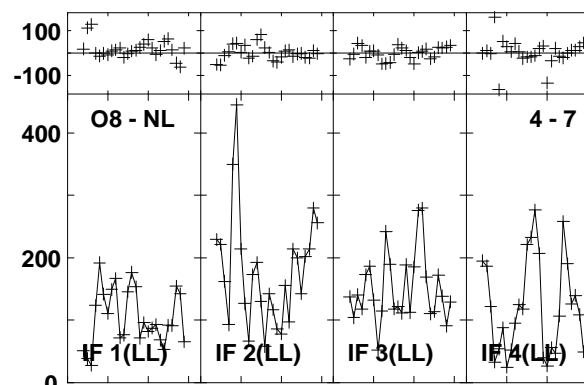
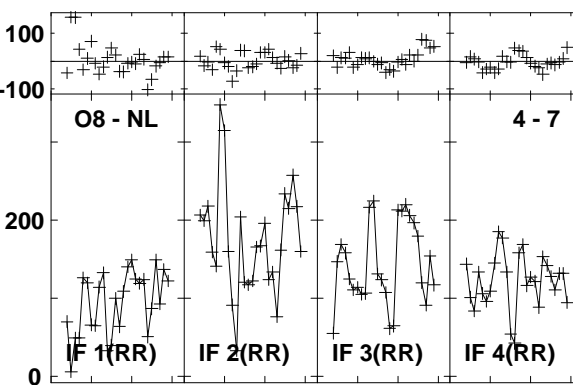
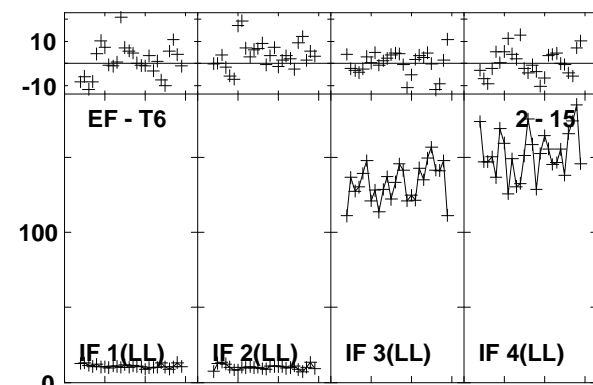
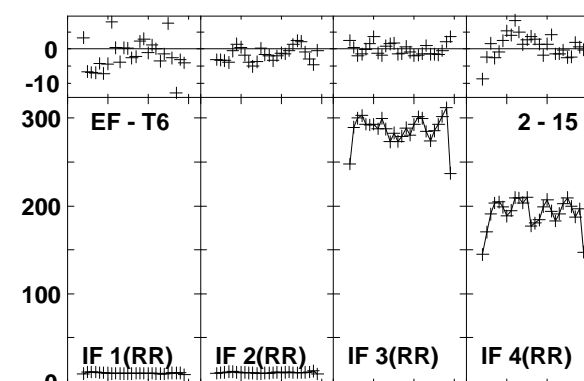
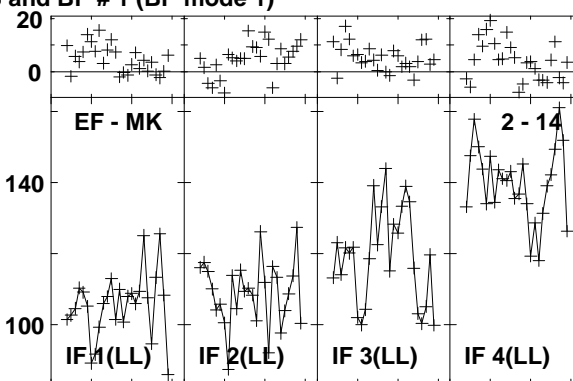
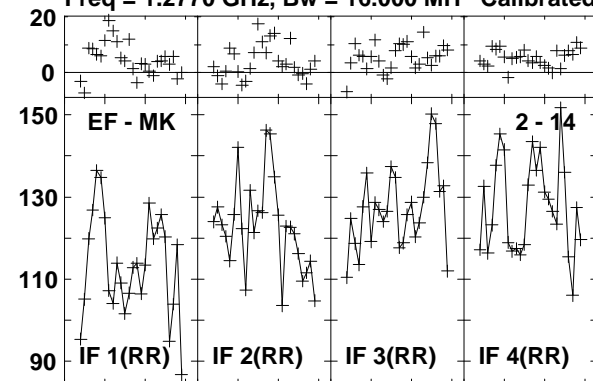

Lower frame: Milli Ampl Jy Top frame: Phas deg
Vector averaged cross-power spectrum Baseline: EF (02) - MK (14)
Timerange: 01/05:11:55 to 01/05:13:13

Plot file version1585 created 03-MAR-2016 01:16:36

J1545+5400 GN002C 1.UVDATA.1

Freq = 1.2770 GHz, Bw = 16.000 MH Calibrated with CL # 3 and BP # 1 (BP mode 1)

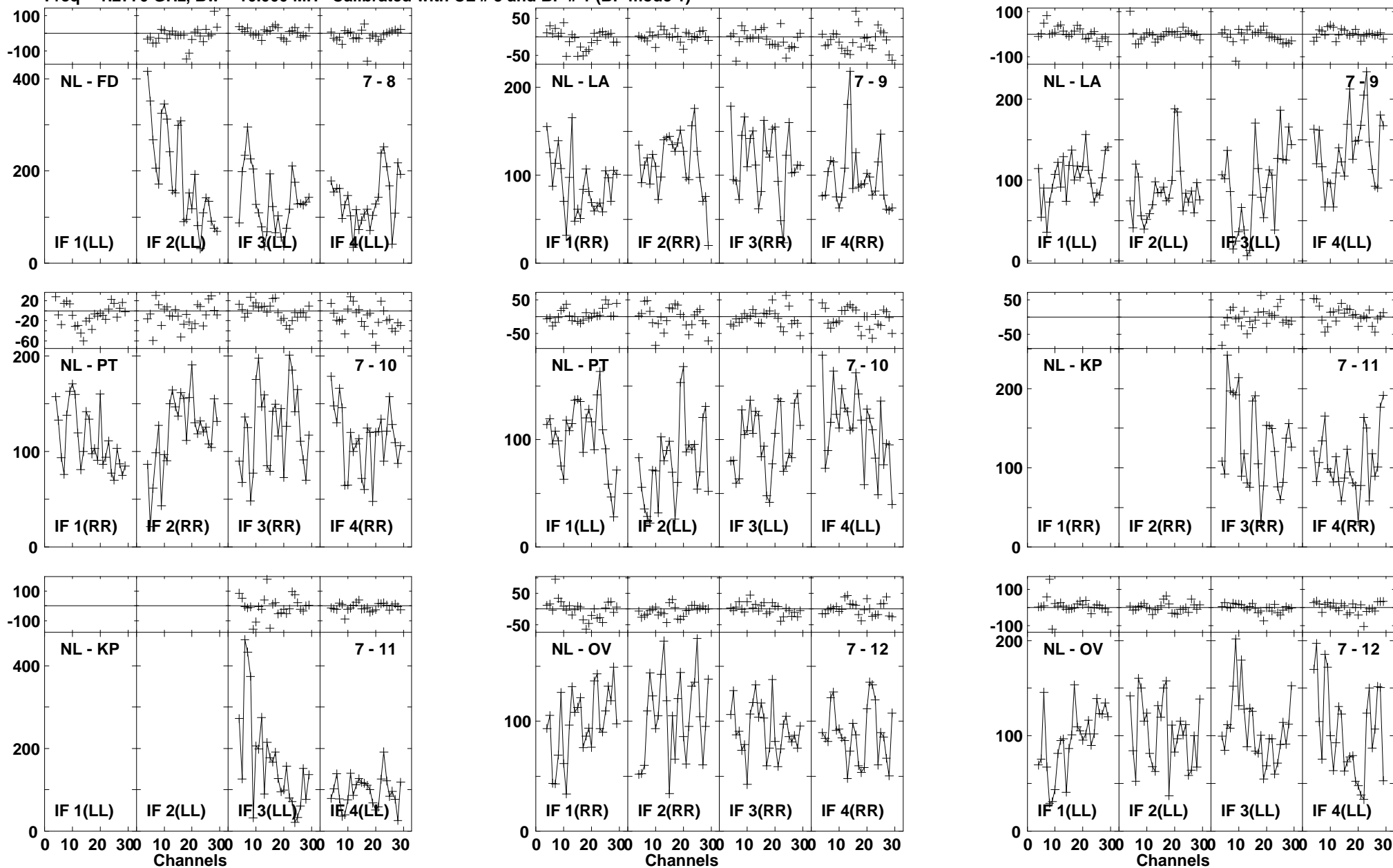

Lower frame: Milli Ampl Jy Top frame: Phas deg
Vector averaged cross-power spectrum Baseline: NL (07) - FD (08)
Timerange: 01/05:11:55 to 01/05:13:13

Plot file version1586 created 03-MAR-2016 01:16:36

J1545+5400 GN002C 1.UVDATA.1

Freq = 1.2770 GHz, Bw = 16.000 MH Calibrated with CL # 3 and BP # 1 (BP mode 1)

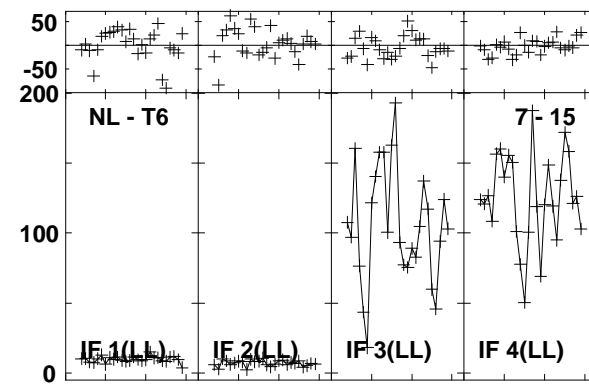
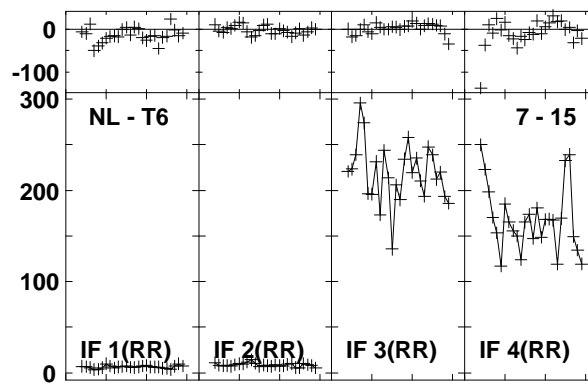
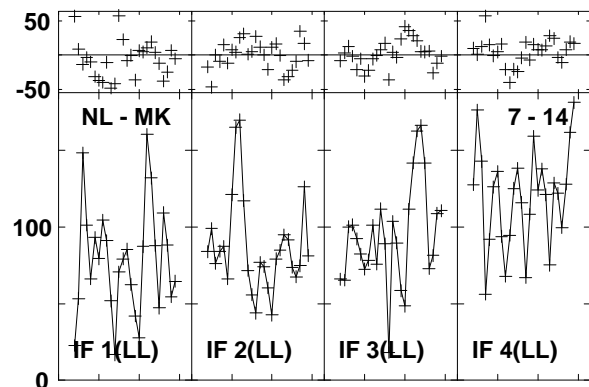
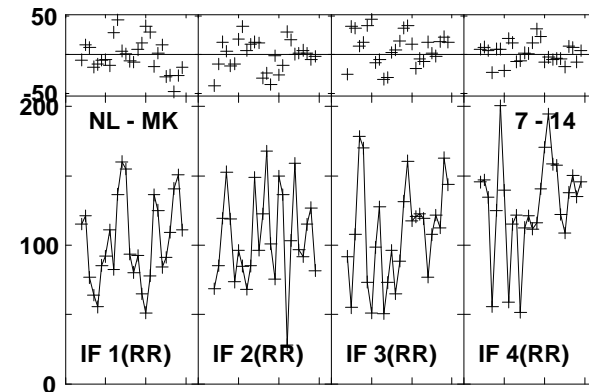
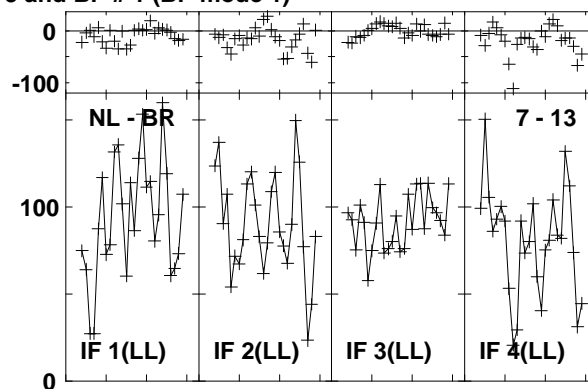
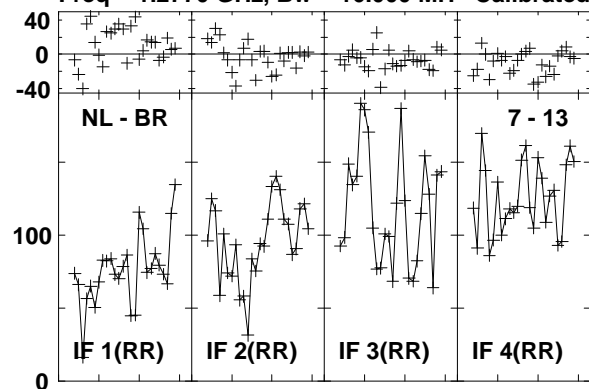

Lower frame: Milli Ampl Jy Top frame: Phas deg
Vector averaged cross-power spectrum Baseline: NL (07) - BR (13)
Timerange: 01/05:11:55 to 01/05:13:13

Plot file version1587 created 03-MAR-2016 01:16:36

4C52 GN002C 1.UVDATA.1

Freq = 1.2770 GHz, Bw = 16.000 MH Calibrated with CL # 3 and BP # 1 (BP mode 1)

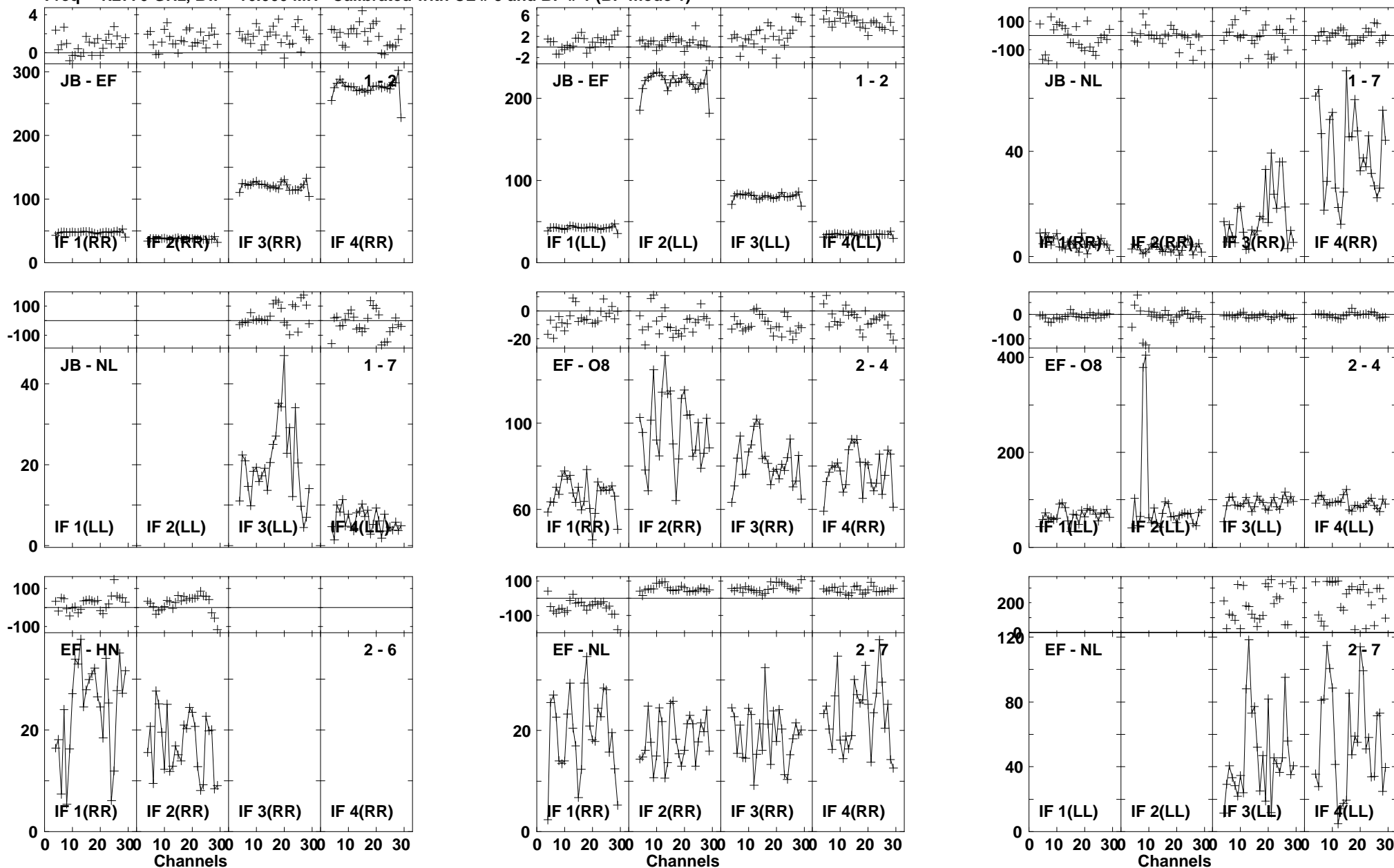

Lower frame: Milli Ampl Jy Top frame: Phas deg
Vector averaged cross-power spectrum Baseline: JB (01) - EF (02)
Timerange: 01/05:13:18 to 01/05:16:42

Plot file version1588 created 03-MAR-2016 01:16:37

4C52 GN002C 1.UVDATA.1

Freq = 1.2770 GHz, Bw = 16.000 MH Calibrated with CL # 3 and BP # 1 (BP mode 1)

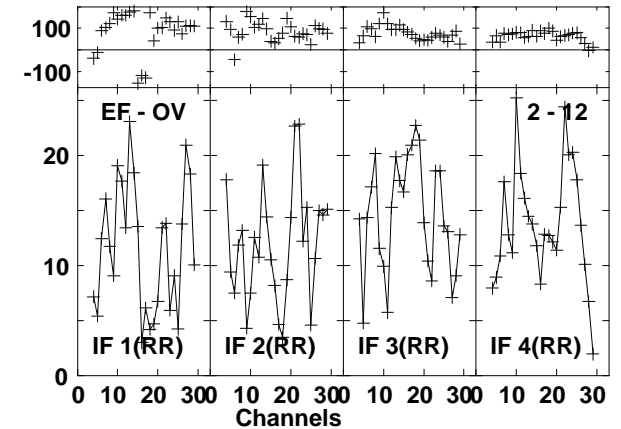
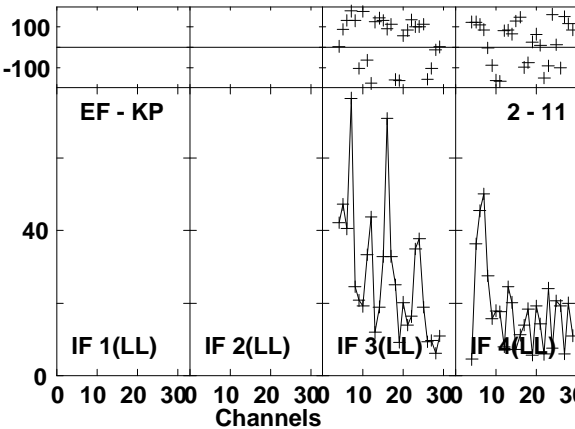
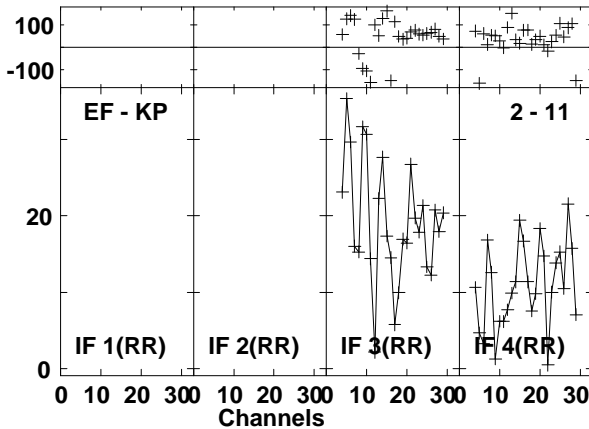
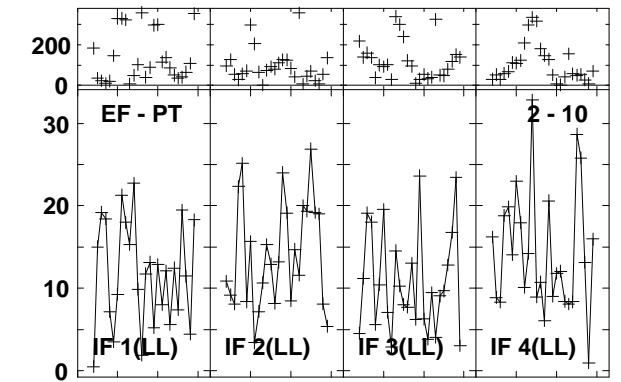
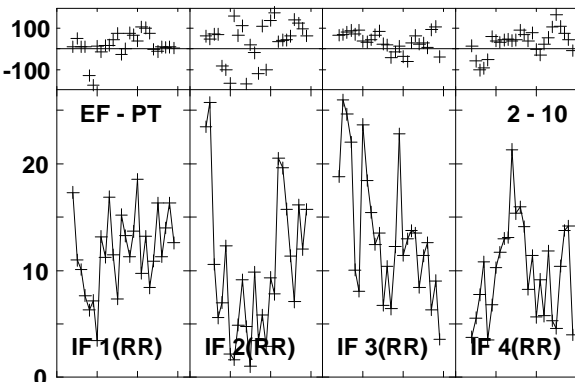
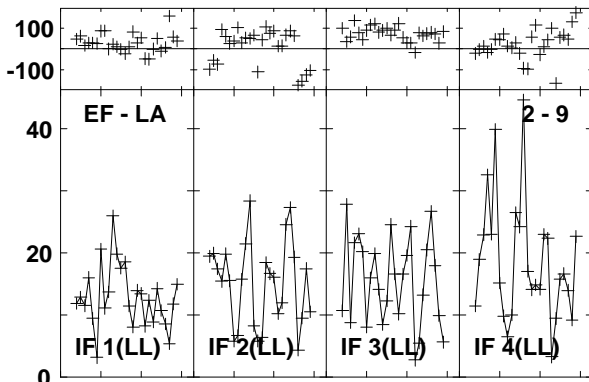
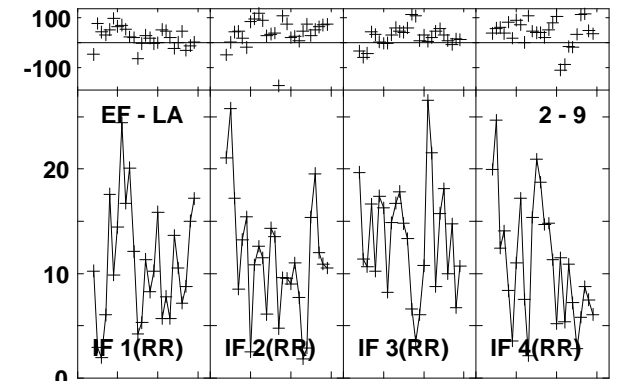
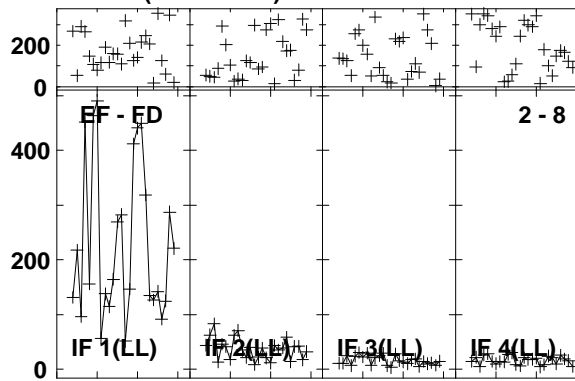
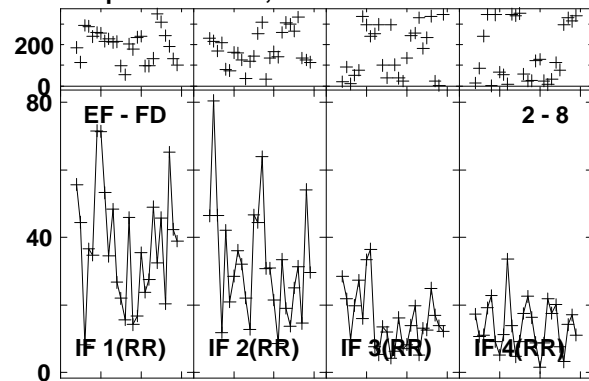

Lower frame: Milli Ampl Jy Top frame: Phas deg
Vector averaged cross-power spectrum Baseline: EF (02) - FD (08)
Timerange: 01/05:13:18 to 01/05:16:42

Plot file version1589 created 03-MAR-2016 01:16:37

4C52 GN002C 1.UVDATA.1

Freq = 1.2770 GHz, Bw = 16.000 MH Calibrated with CL # 3 and BP # 1 (BP mode 1)

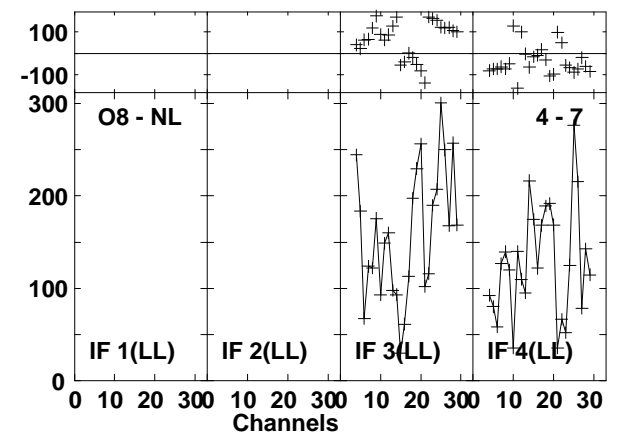
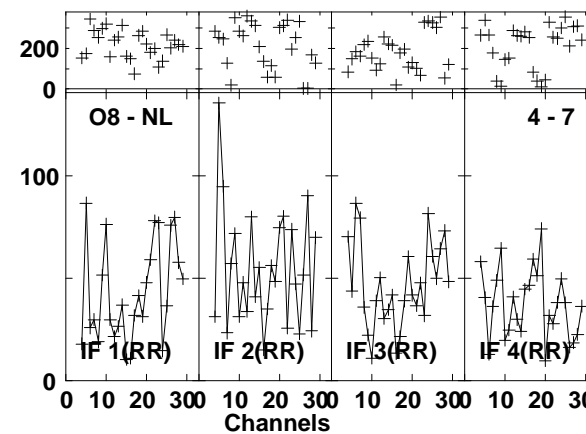
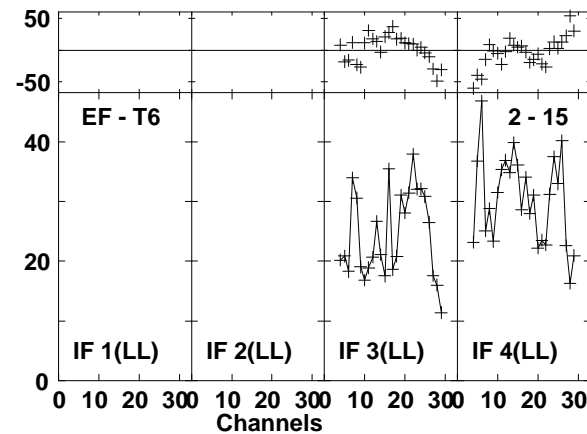
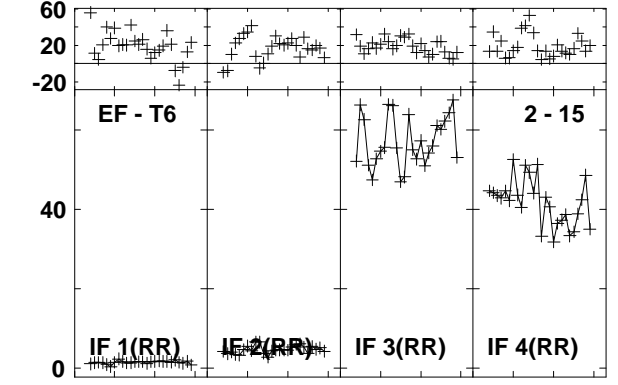
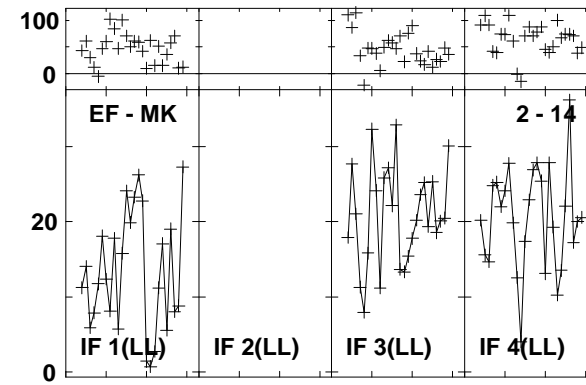
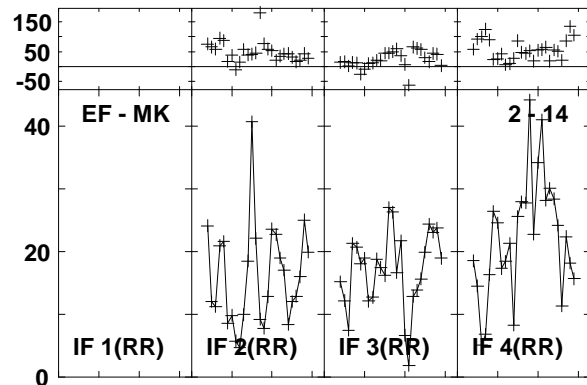
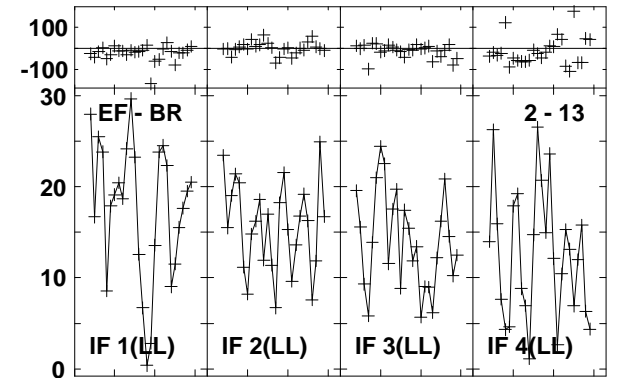
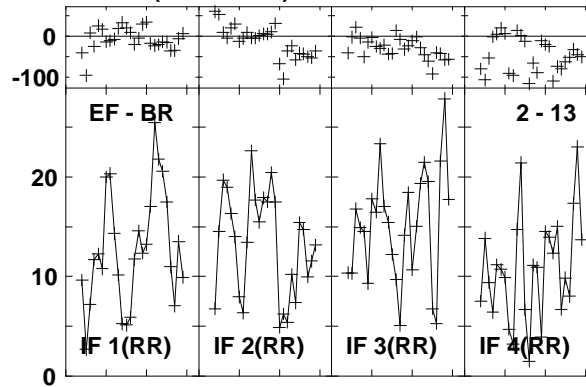
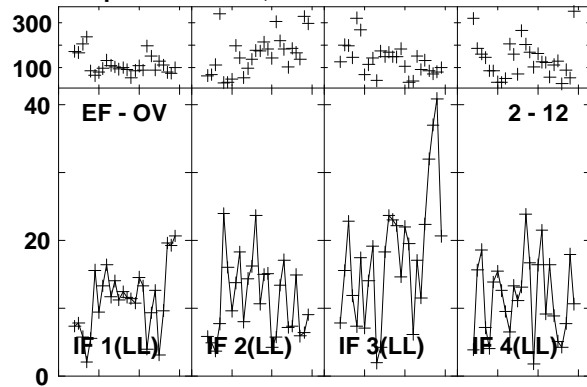

Lower frame: Milli Ampl Jy Top frame: Phas deg
Vector averaged cross-power spectrum Baseline: EF (02) - OV (12)
Timerange: 01/05:13:18 to 01/05:16:42

Plot file version1590 created 03-MAR-2016 01:16:37

4C52 GN002C 1.UVDATA.1

Freq = 1.2770 GHz, Bw = 16.000 MH Calibrated with CL # 3 and BP # 1 (BP mode 1)

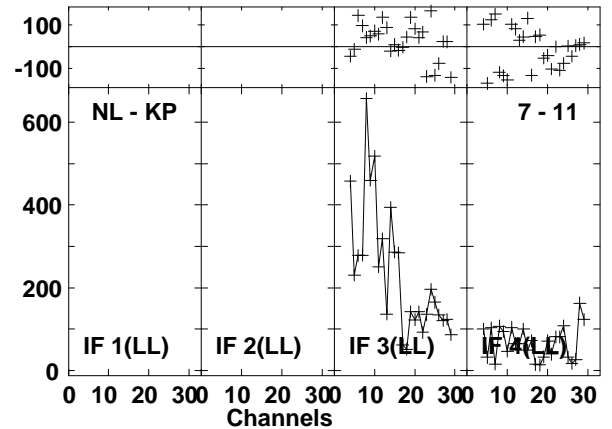
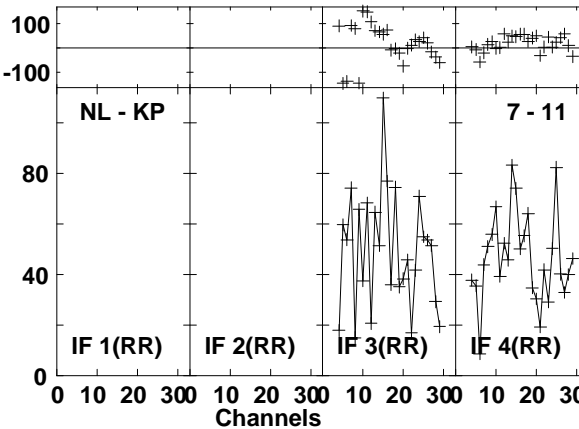
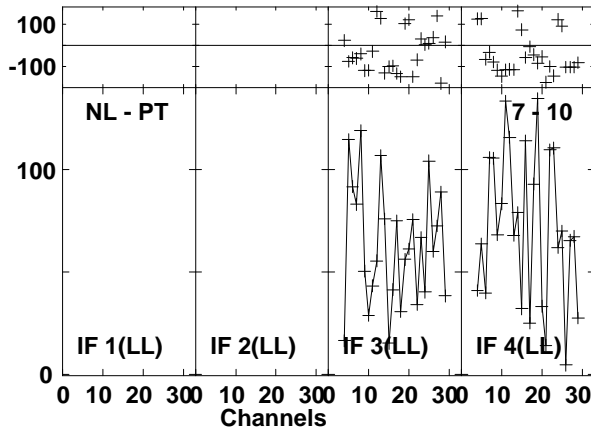
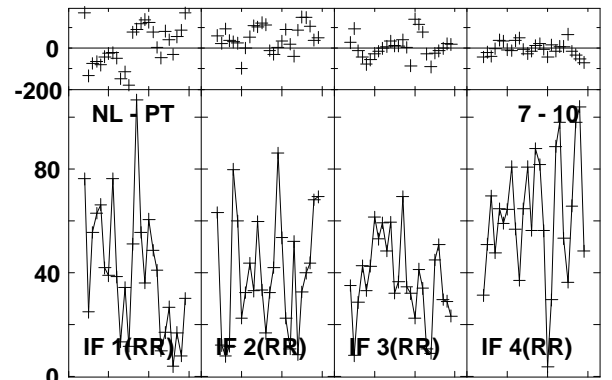
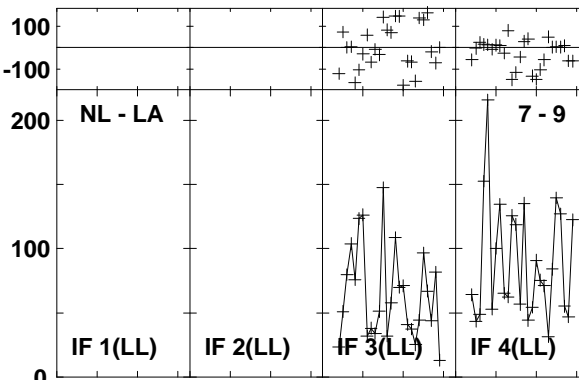
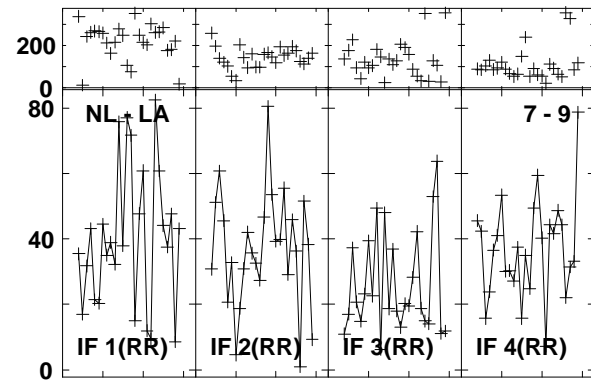
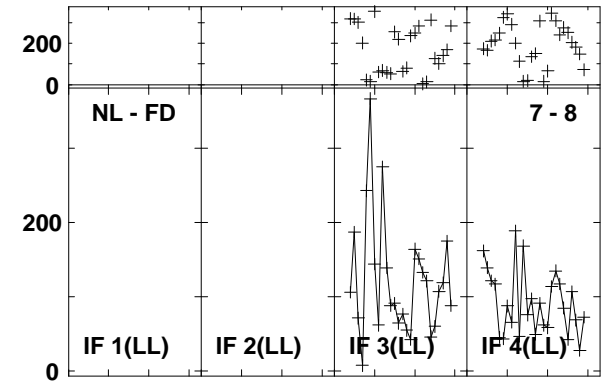
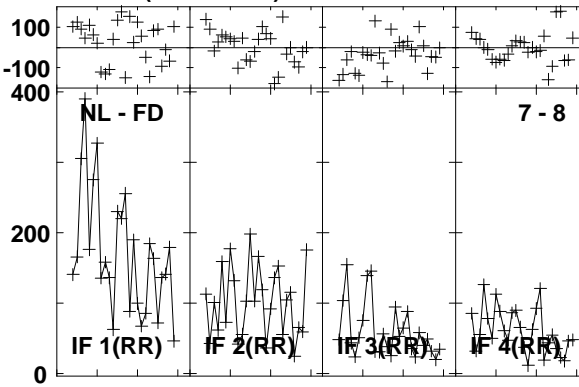
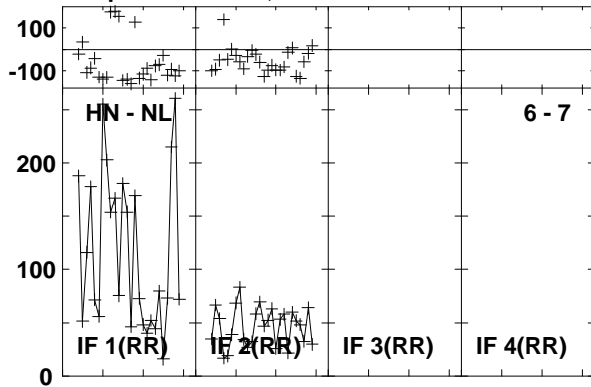

Lower frame: Milli Ampl Jy Top frame: Phas deg
Vector averaged cross-power spectrum Baseline: HN (06) - NL (07)
Timerange: 01/05:13:18 to 01/05:16:42

Plot file version1591 created 03-MAR-2016 01:16:37

4C52 GN002C 1.UVDATA.1

Freq = 1.2770 GHz, Bw = 16.000 MH Calibrated with CL # 3 and BP # 1 (BP mode 1)

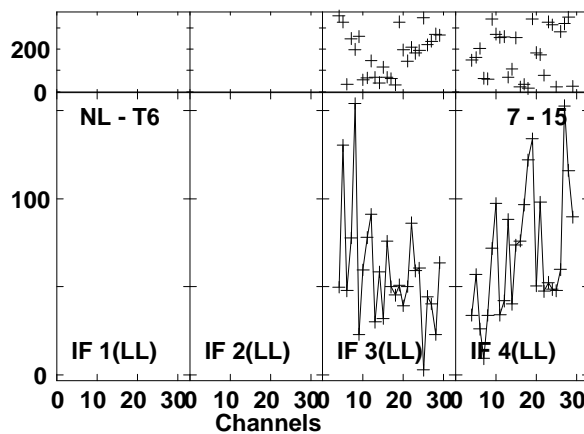
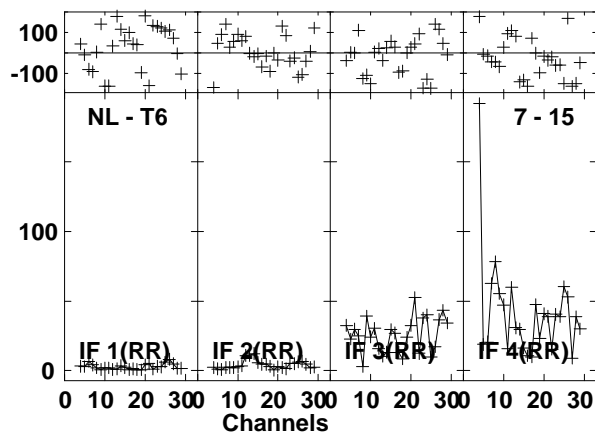
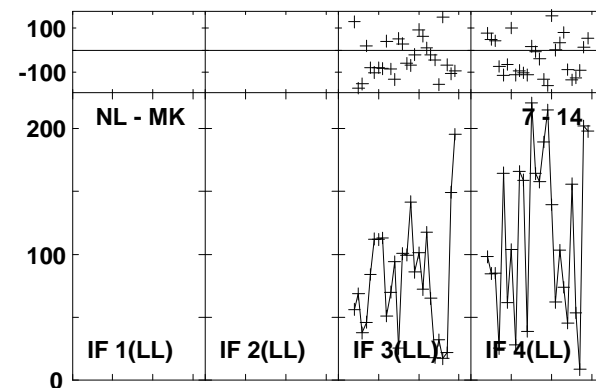
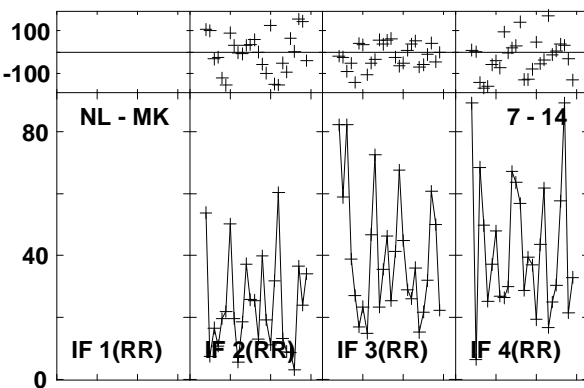
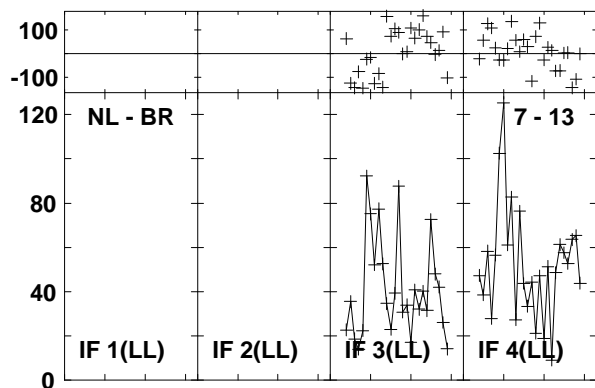
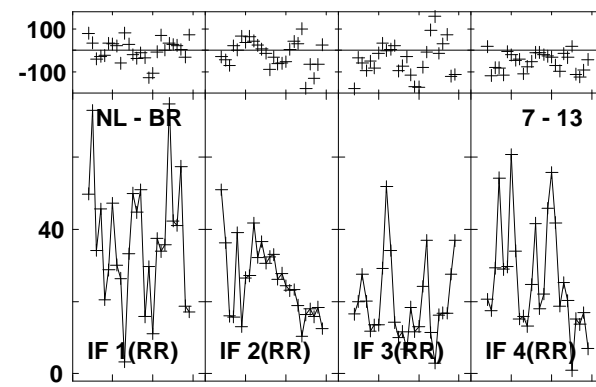
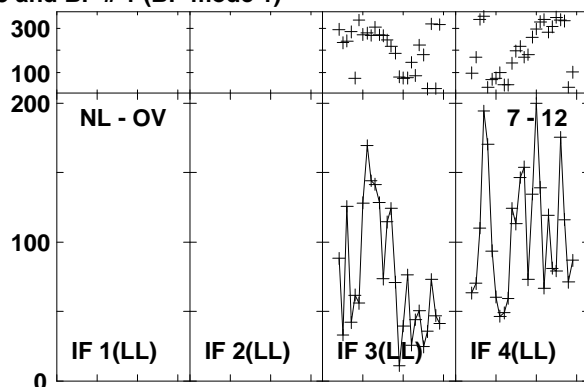
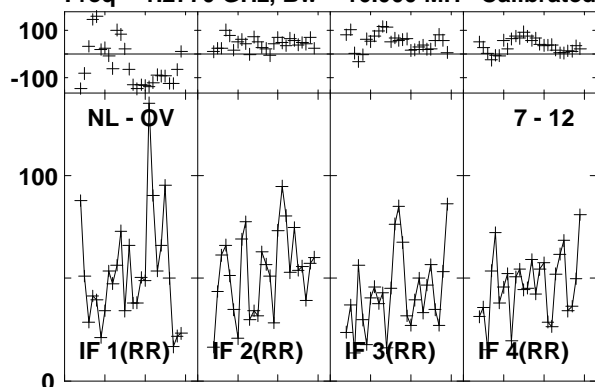

Lower frame: Milli Ampl Jy Top frame: Phas deg
Vector averaged cross-power spectrum Baseline: NL (07) - OV (12)
Timerange: 01/05:13:18 to 01/05:16:42

Plot file version1592 created 03-MAR-2016 01:16:37

J1545+5400 GN002C 1.UVDATA.1

Freq = 1.2770 GHz, Bw = 16.000 MH Calibrated with CL # 3 and BP # 1 (BP mode 1)

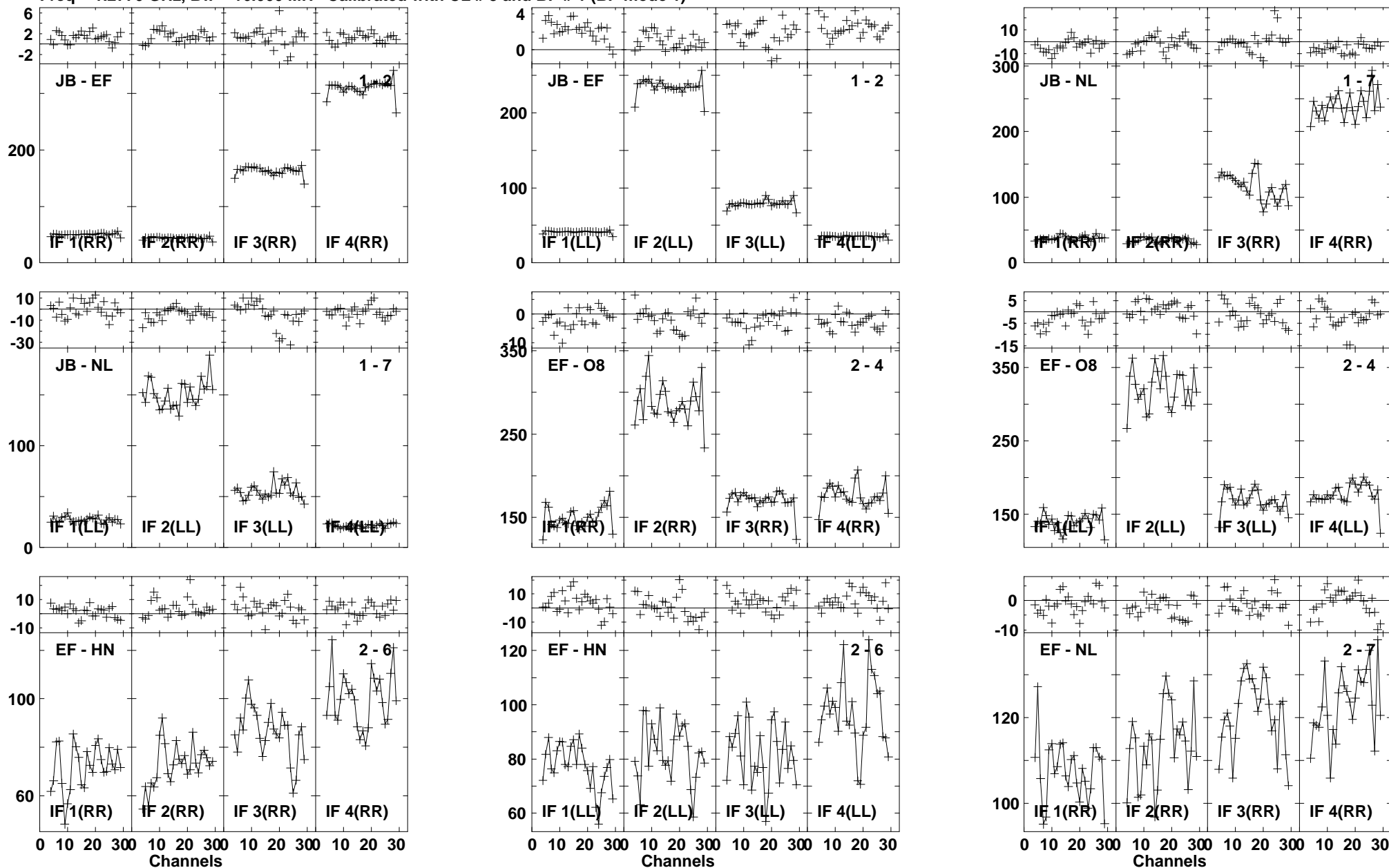

Lower frame: Milli Ampl Jy Top frame: Phas deg
Vector averaged cross-power spectrum Baseline: JB (01) - EF (02)
Timerange: 01/05:17:35 to 01/05:20:23

Plot file version1593 created 03-MAR-2016 01:16:38
 J1545+5400 GN002C 1.UVDATA.1
 Freq = 1.2770 GHz, Bw = 16.000 MH Calibrated with CL # 3 and BP # 1 (BP mode 1)

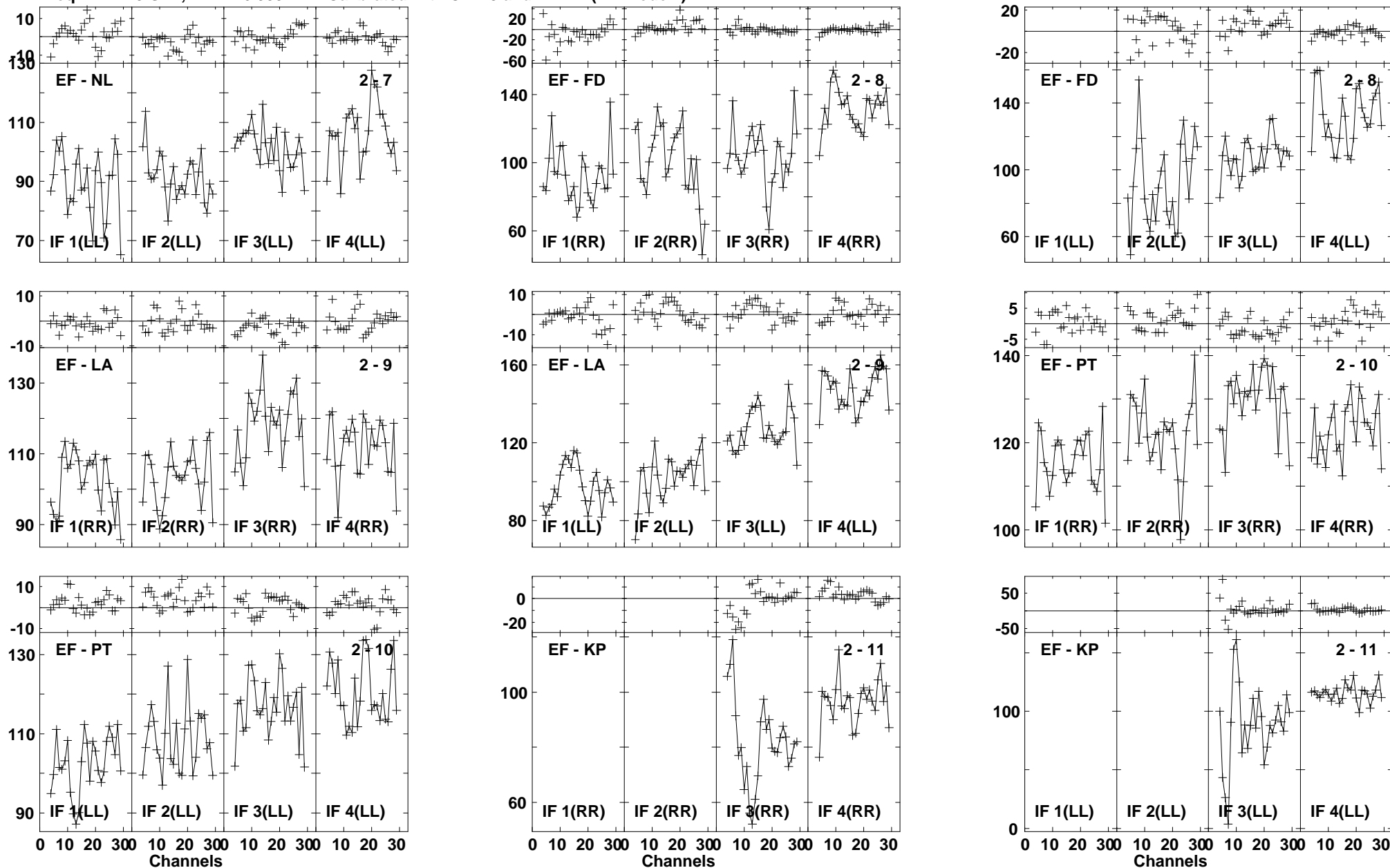

Lower frame: Milli Ampl Jy Top frame: Phas deg
 Vector averaged cross-power spectrum Baseline: EF (02) - NL (07)
 Timerange: 01/05:17:35 to 01/05:20:23

Plot file version1594 created 03-MAR-2016 01:16:38

J1545+5400 GN002C 1.UVDATA.1

Freq = 1.2770 GHz, Bw = 16.000 MH Calibrated with CL # 3 and BP # 1 (BP mode 1)

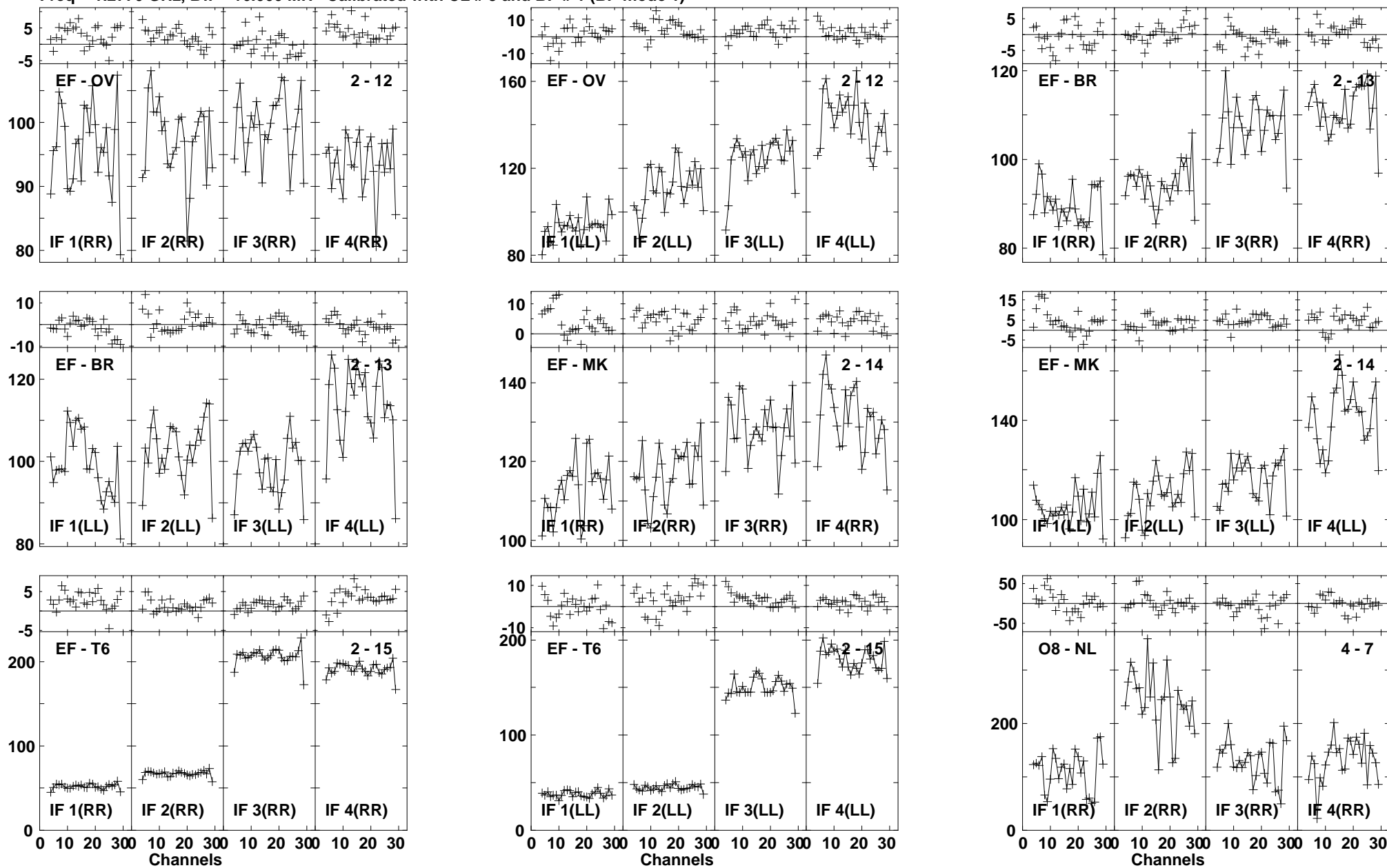

Plot file version1595 created 03-MAR-2016 01:16:38
 J1545+5400 GN002C 1.UVDATA.1
 Freq = 1.2770 GHz, Bw = 16.000 MH Calibrated with CL # 3 and BP # 1 (BP mode 1)

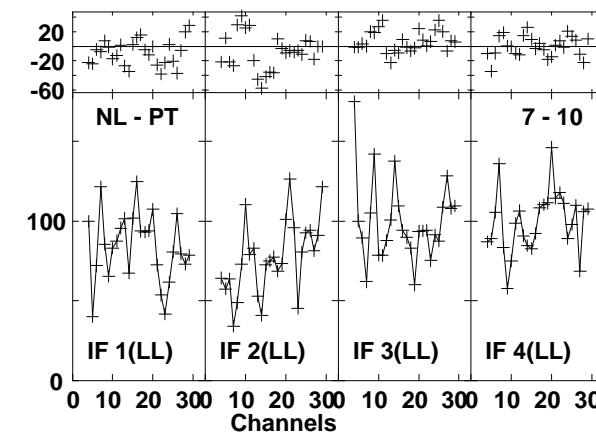
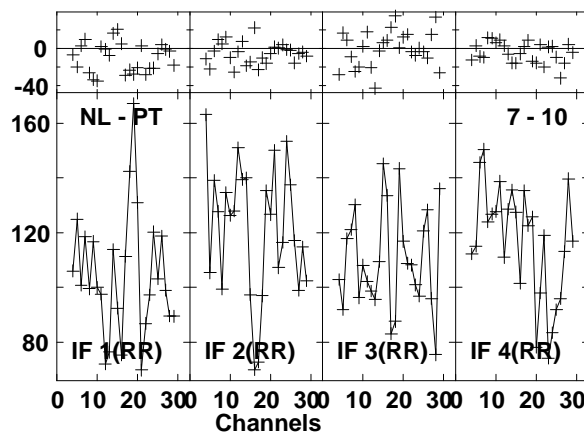
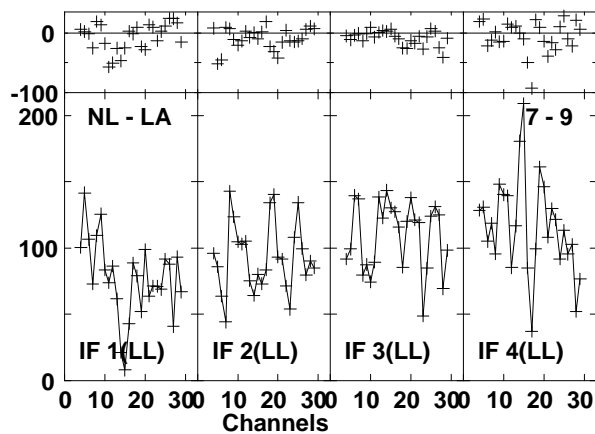
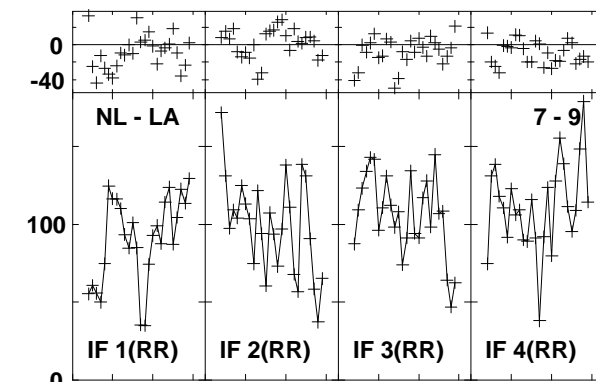
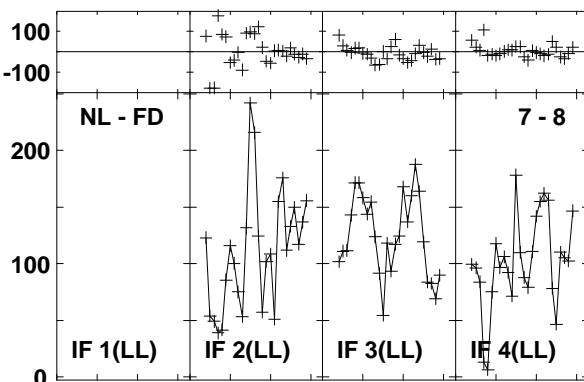
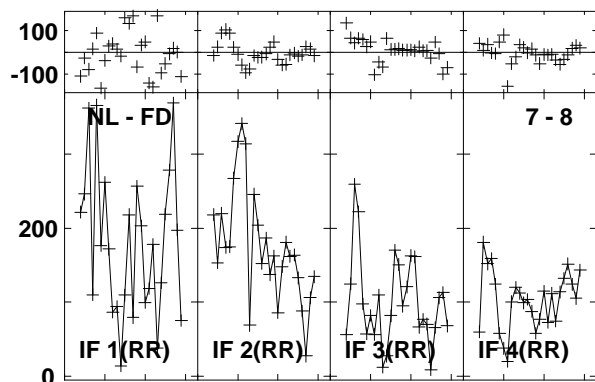
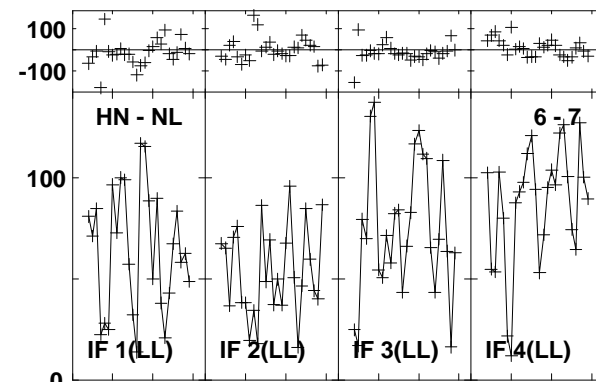
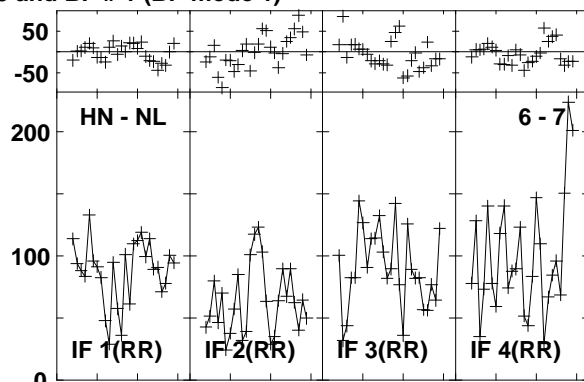
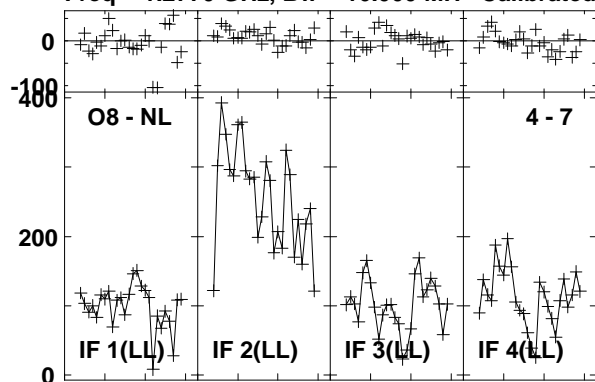

Lower frame: Milli Ampl Jy Top frame: Phas deg
 Vector averaged cross-power spectrum Baseline: O8 (04) - NL (07)
 Timerange: 01/05:17:35 to 01/05:20:23

Plot file version1596 created 03-MAR-2016 01:16:38
 J1545+5400 GN002C 1.UVDATA.1
 Freq = 1.2770 GHz, Bw = 16.000 MH Calibrated with CL # 3 and BP # 1 (BP mode 1)

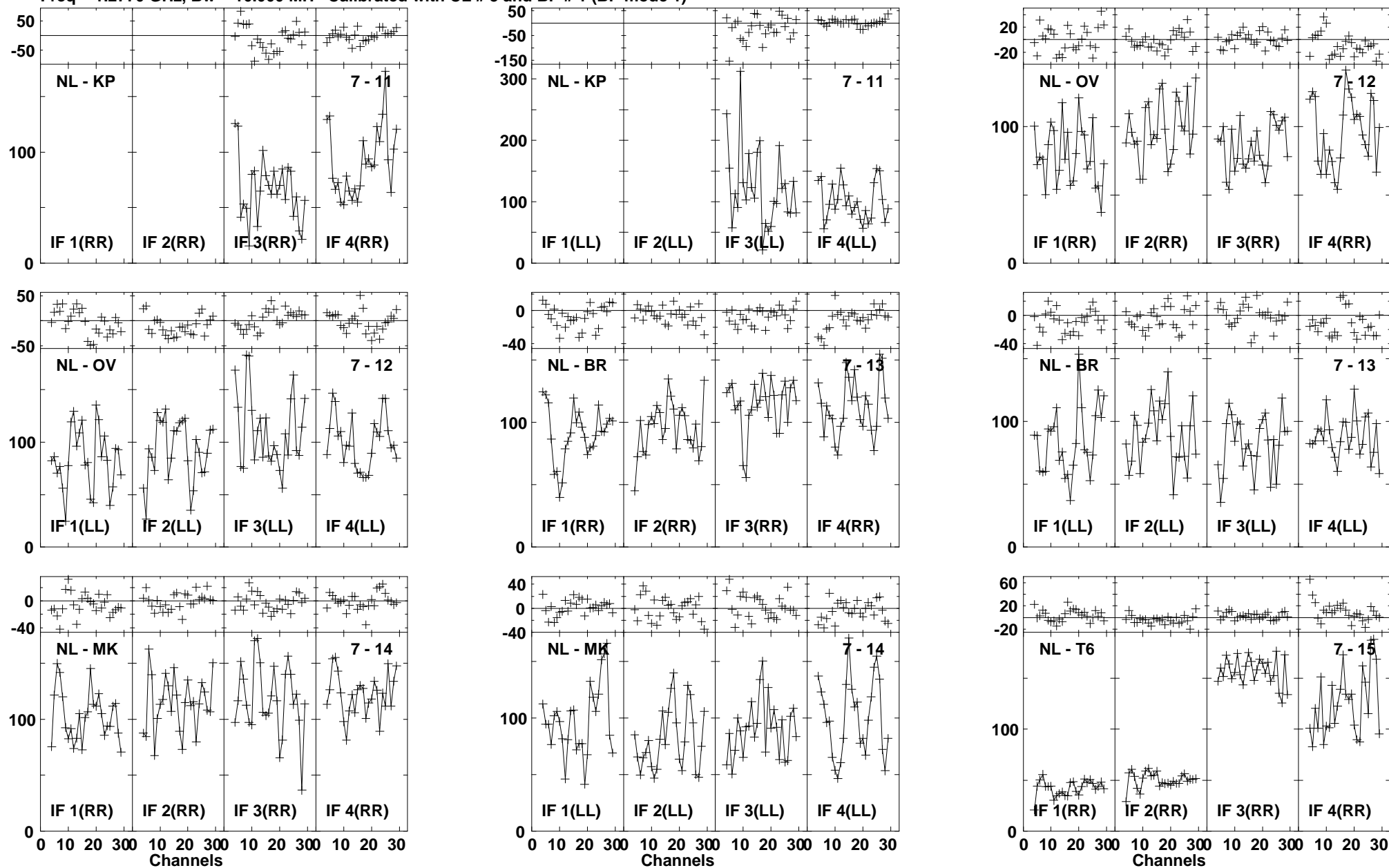

Lower frame: Milli Ampl Jy Top frame: Phas deg
 Vector averaged cross-power spectrum Baseline: NL (07) - KP (11)
 Timerange: 01/05:17:35 to 01/05:20:23

Plot file version1597 created 03-MAR-2016 01:16:39
J1545+5400 GN002C 1.UVDATA.1
Freq = 1.2770 GHz, Bw = 16.000 MH Calibrated with CL # 3 and BP # 1 (BP mode 1)

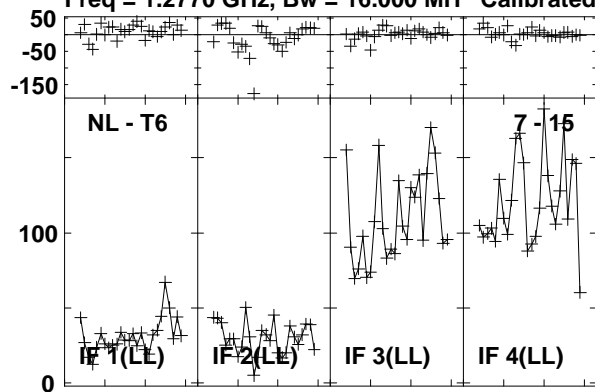

Lower frame: Milli Ampl Jy Top frame: Phas deg
Vector averaged cross-power spectrum Baseline: NL (07) - T6 (15)
Timerange: 01/05:17:35 to 01/05:20:23

Plot file version1598 created 03-MAR-2016 01:16:39

J1638+5720 GN002C 1.UVDATA.1

Freq = 1.2770 GHz, Bw = 16.000 MH Calibrated with CL # 3 and BP # 1 (BP mode 1)

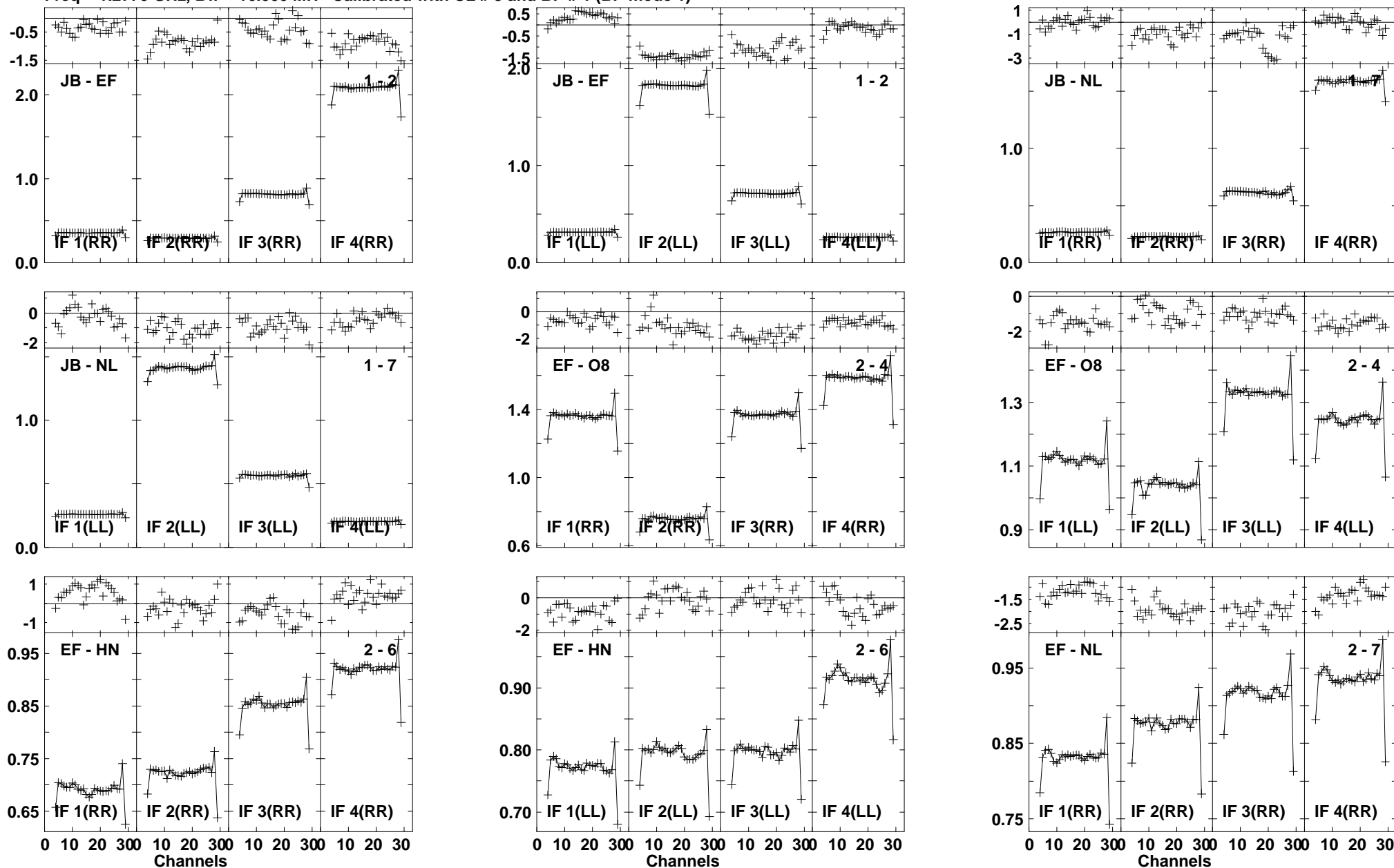

Lower frame: Ampl Jy Top frame: Phas deg
Vector averaged cross-power spectrum Baseline: JB (01) - EF (02)
Timerange: 01/05:21:28 to 01/05:25:16

Plot file version1599 created 03-MAR-2016 01:16:39

J1638+5720 GN002C 1.UVDATA.1

Freq = 1.2770 GHz, Bw = 16.000 MH Calibrated with CL # 3 and BP # 1 (BP mode 1)

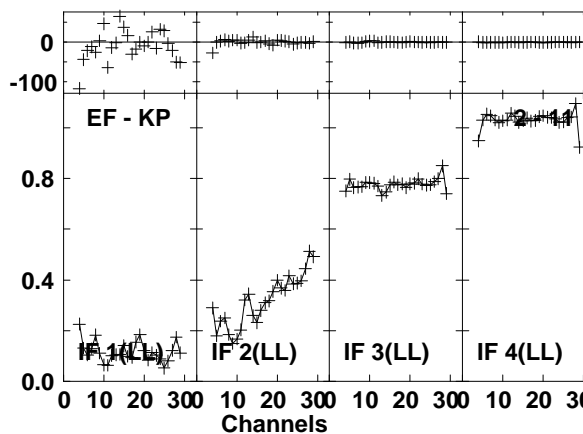
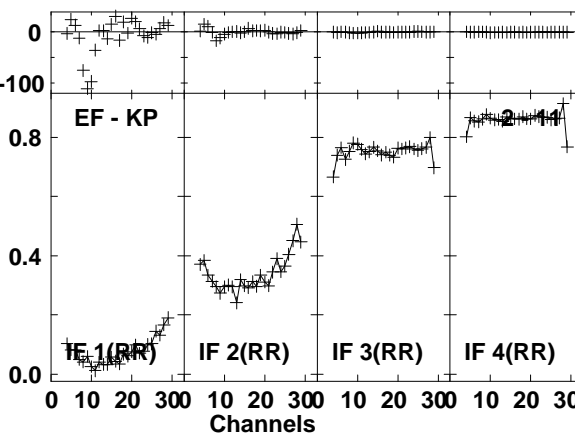
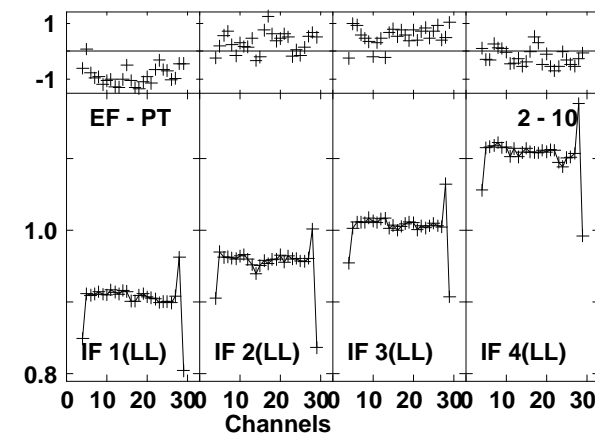
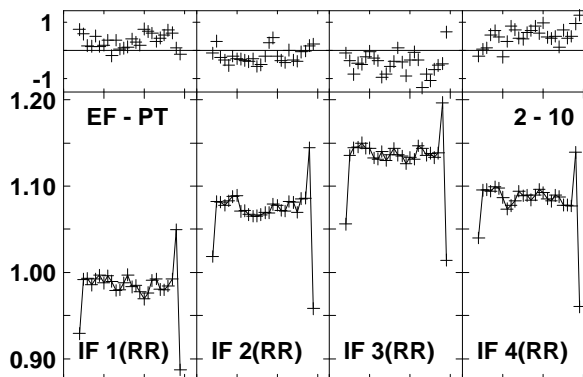
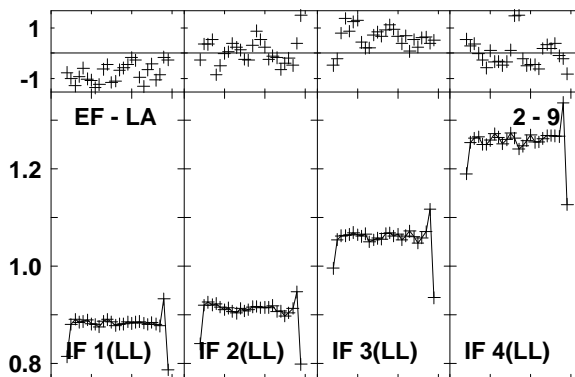
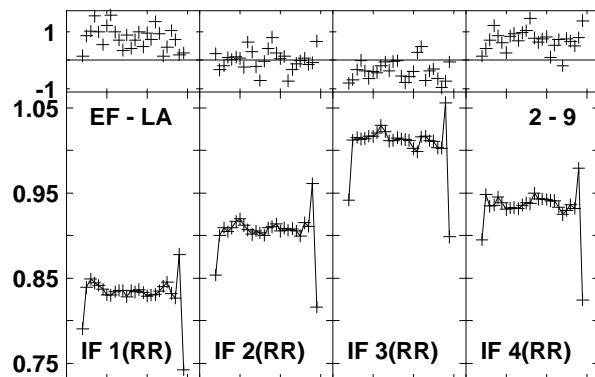
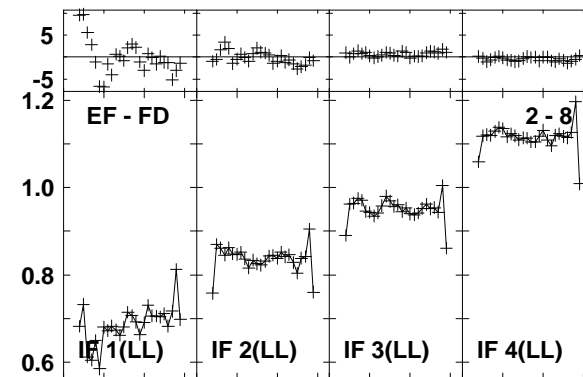
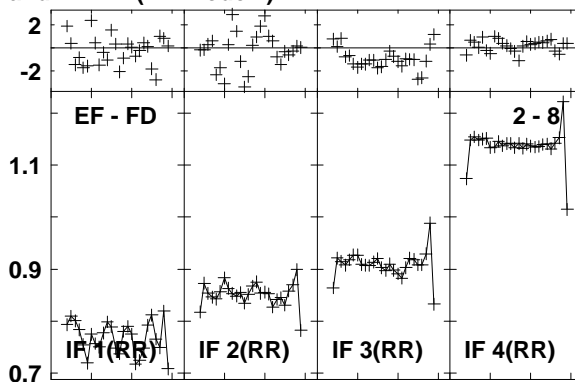
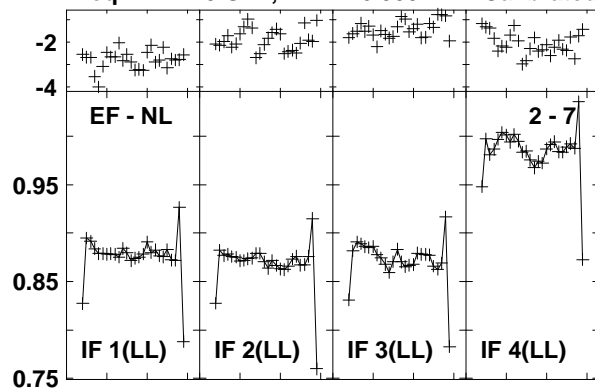

Lower frame: Ampl Jy Top frame: Phas deg
Vector averaged cross-power spectrum Baseline: EF (02) - NL (07)
Timerange: 01/05:21:28 to 01/05:25:16

Plot file version1600 created 03-MAR-2016 01:16:39
 J1638+5720 GN002C 1.UVDATA.1
 Freq = 1.2770 GHz, Bw = 16.000 MH Calibrated with CL # 3 and BP # 1 (BP mode 1)

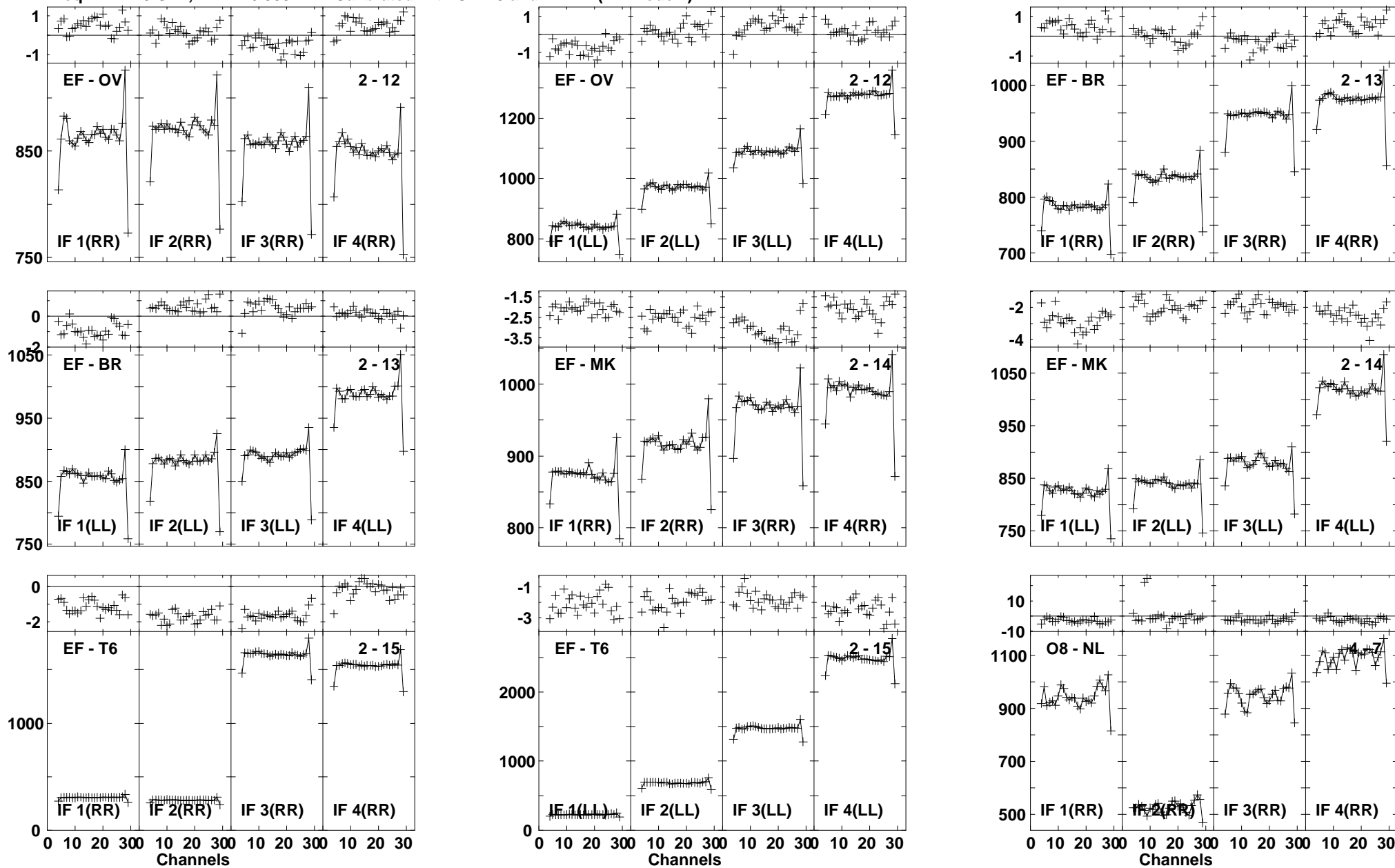

Lower frame: Milli Ampl Jy Top frame: Phas deg
 Vector averaged cross-power spectrum Baseline: EF (02) - OV (12)
 Timerange: 01/05:21:28 to 01/05:25:16

Plot file version1601 created 03-MAR-2016 01:16:39

J1638+5720 GN002C 1.UVDATA.1

Freq = 1.2770 GHz, Bw = 16.000 MH Calibrated with CL # 3 and BP # 1 (BP mode 1)

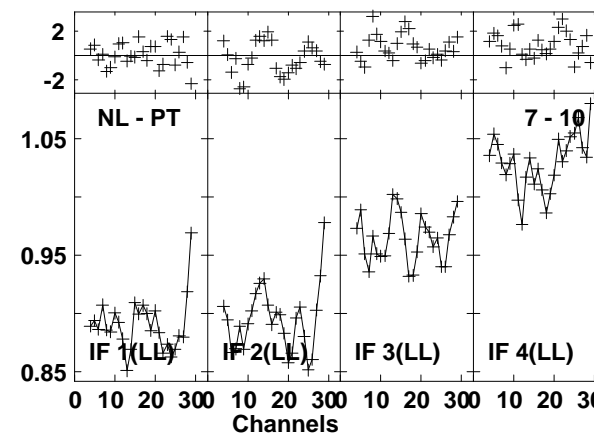
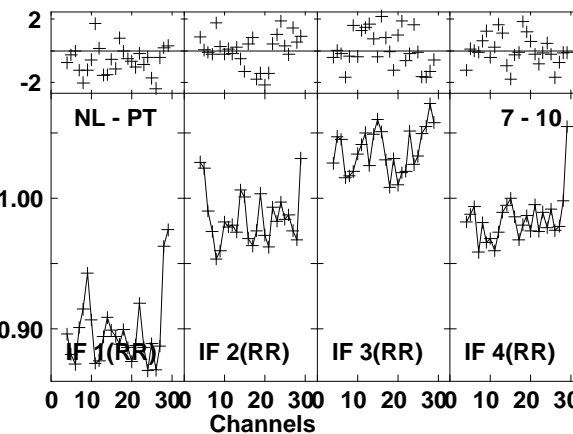
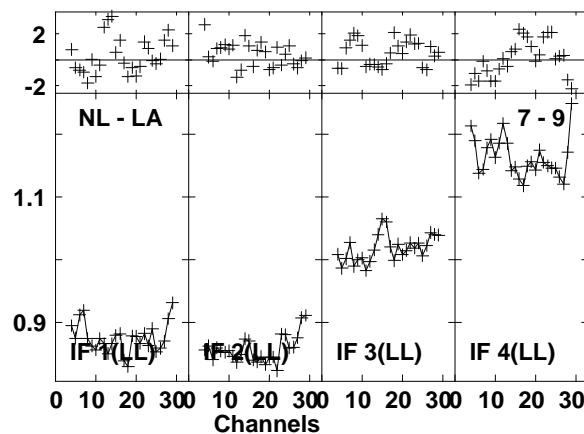
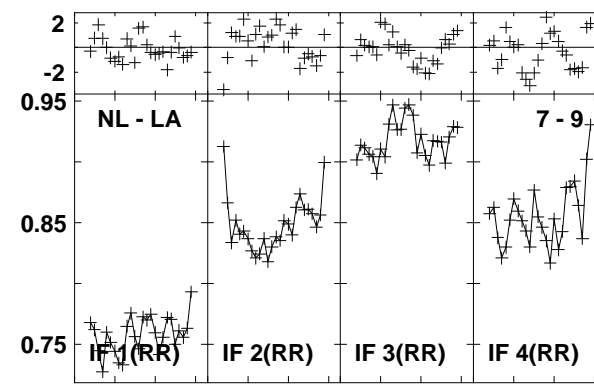
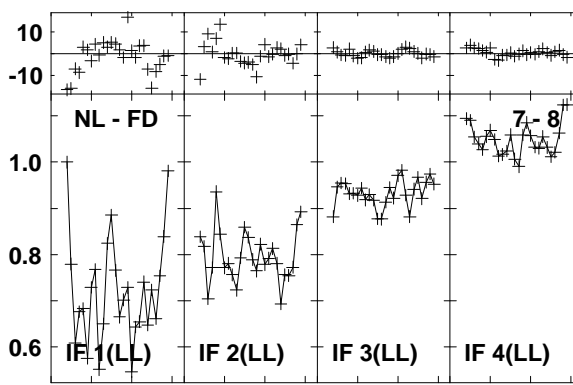
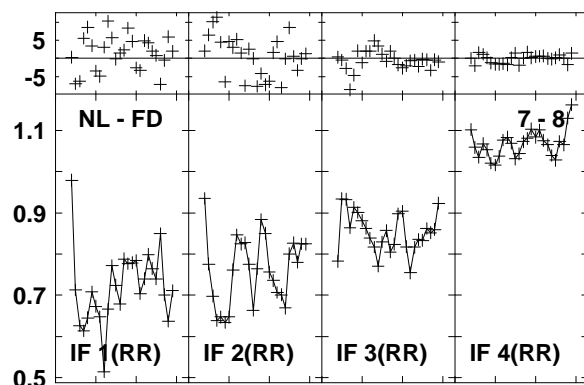
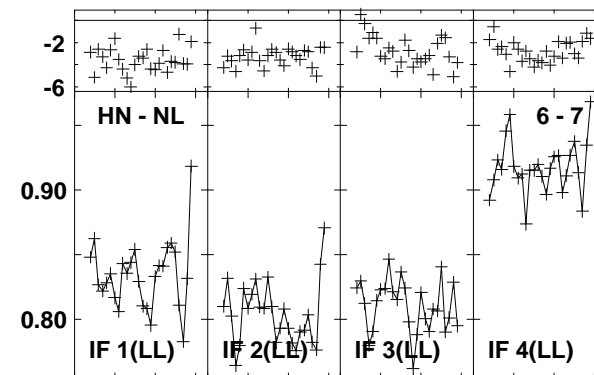
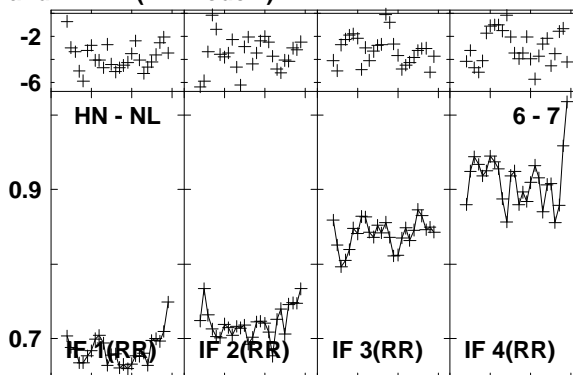
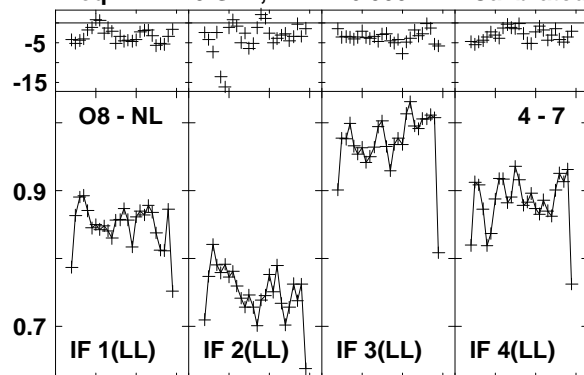

Lower frame: Ampl Jy Top frame: Phas deg
Vector averaged cross-power spectrum Baseline: O8 (04) - NL (07)
Timerange: 01/05:21:28 to 01/05:25:16

Plot file version1602 created 03-MAR-2016 01:16:39

J1638+5720 GN002C 1.UVDATA.1

Freq = 1.2770 GHz, Bw = 16.000 MH Calibrated with CL # 3 and BP # 1 (BP mode 1)

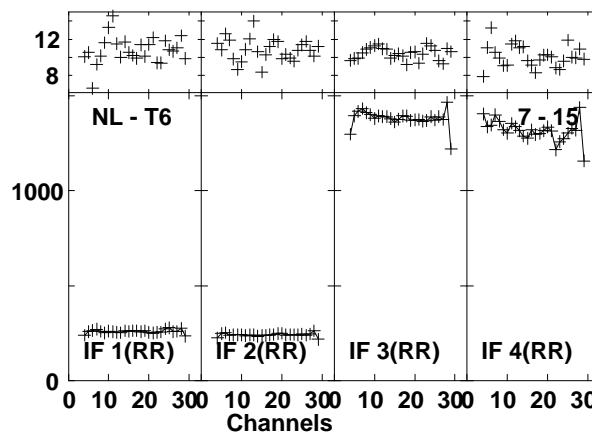
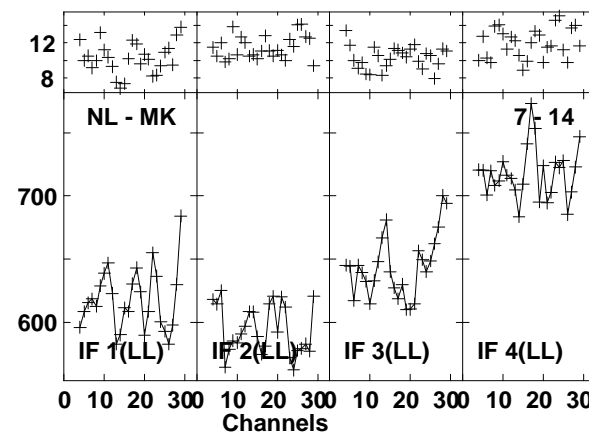
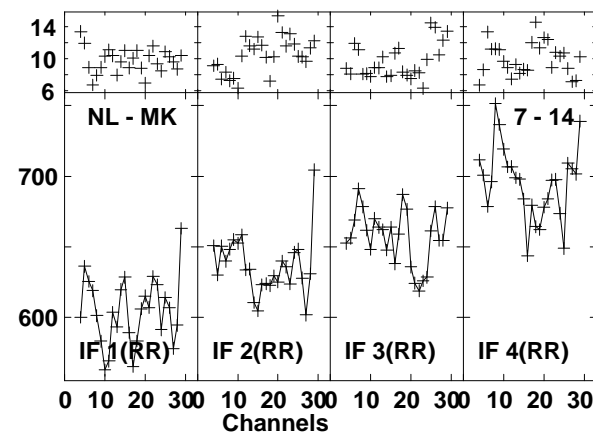
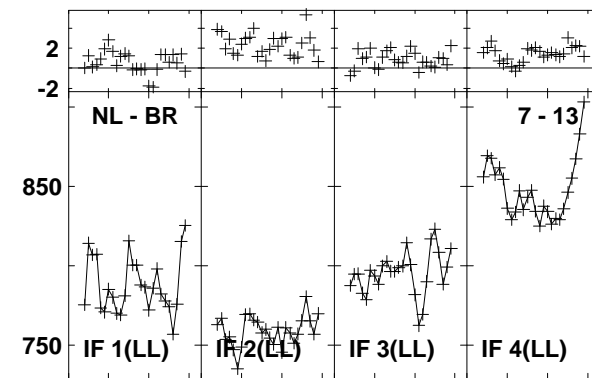
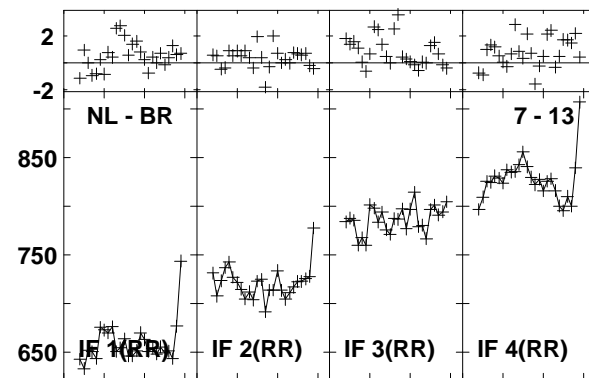
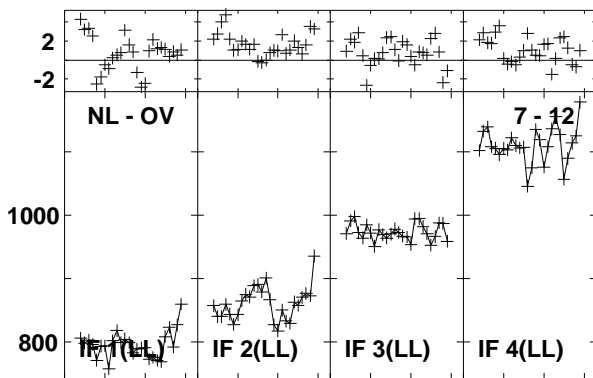
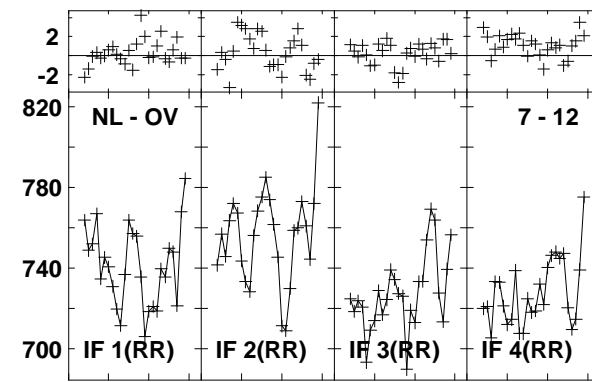
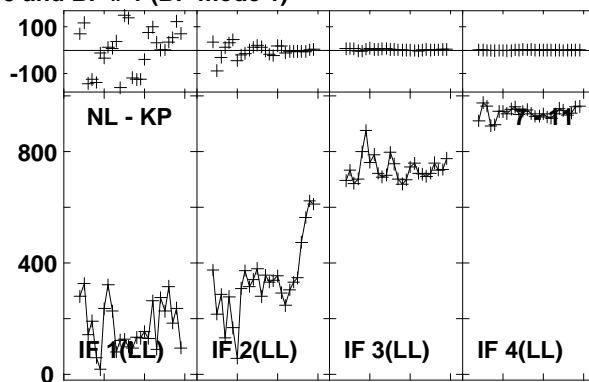
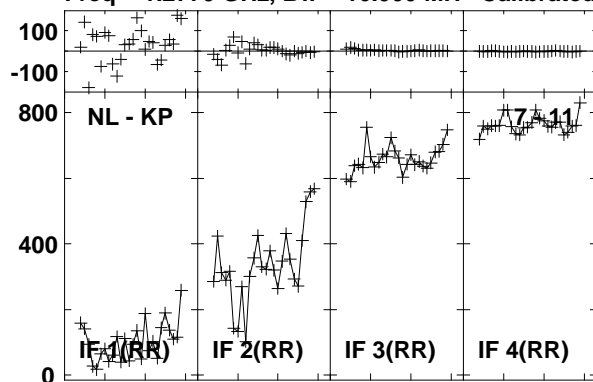

Lower frame: Milli Ampl Jy Top frame: Phas deg
Vector averaged cross-power spectrum Baseline: NL (07) - KP (11)
Timerange: 01/05:21:28 to 01/05:25:16

Plot file version1603 created 03-MAR-2016 01:16:40
J1638+5720 GN002C 1.UVDATA.1
Freq = 1.2770 GHz, Bw = 16.000 MH Calibrated with CL # 3 and BP # 1 (BP mode 1)

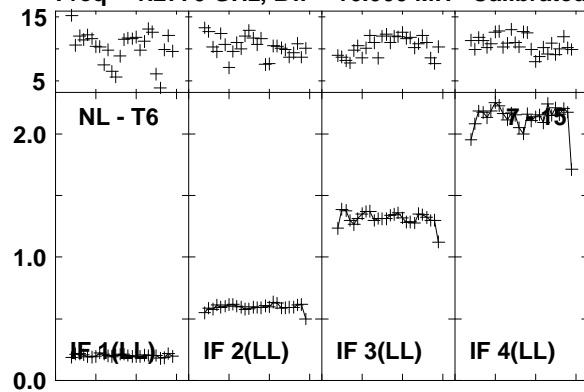

Lower frame: Ampl Jy Top frame: Phas deg
Vector averaged cross-power spectrum Baseline: NL (07) - T6 (15)
Timerange: 01/05:21:28 to 01/05:25:16

Plot file version1604 created 03-MAR-2016 01:16:40
 J1545+5400 GN002C 1.UVDATA.1
 Freq = 1.2770 GHz, Bw = 16.000 MH Calibrated with CL # 3 and BP # 1 (BP mode 1)

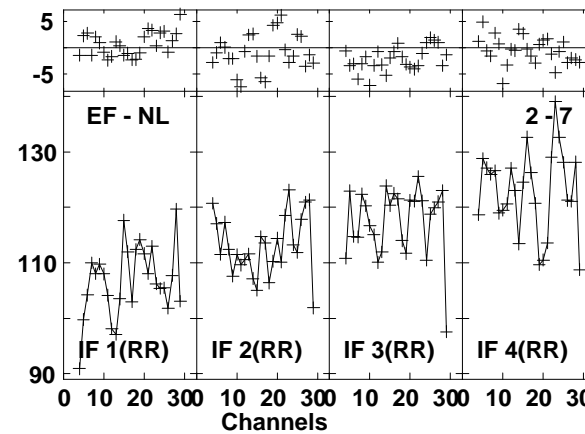
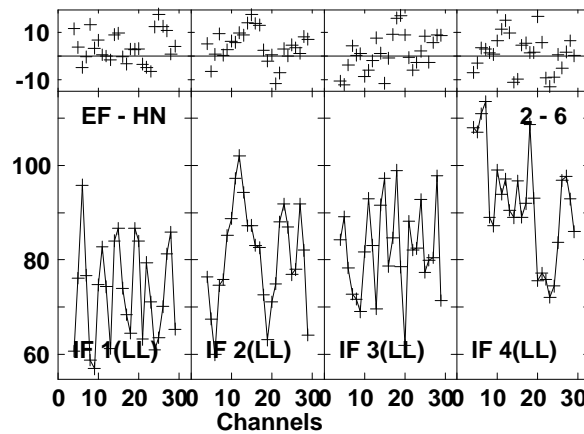
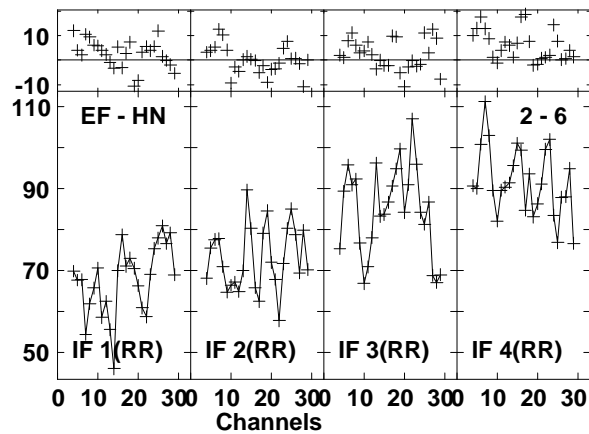
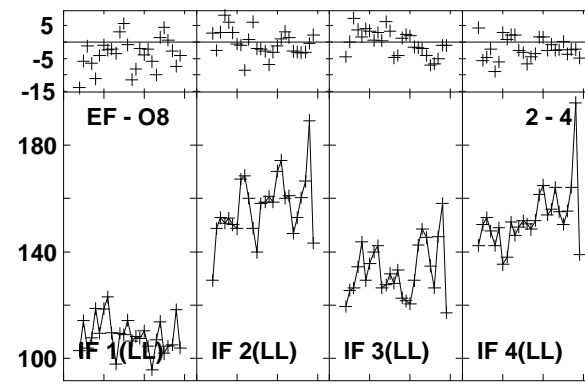
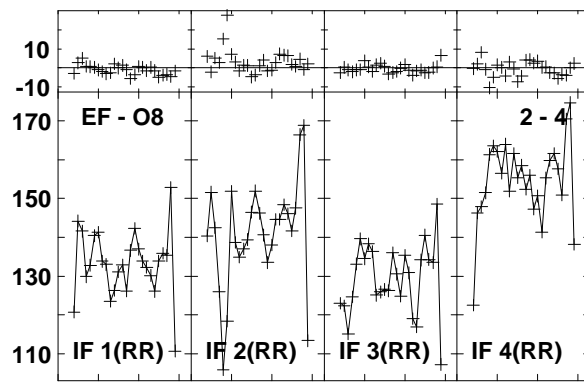
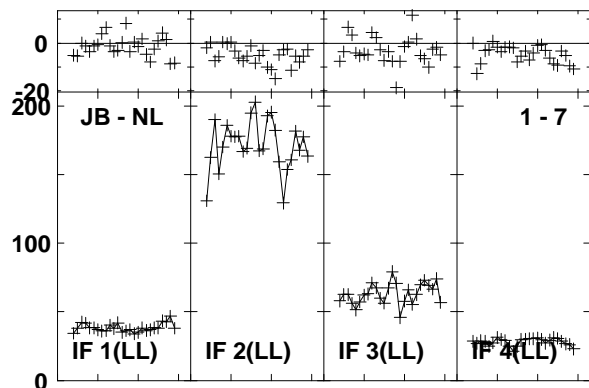
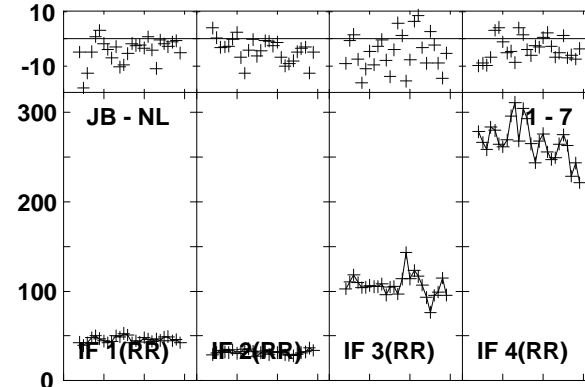
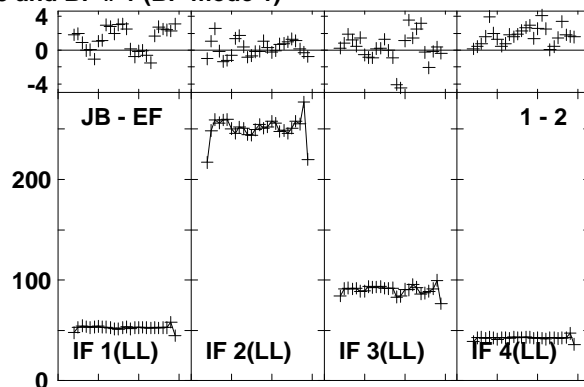
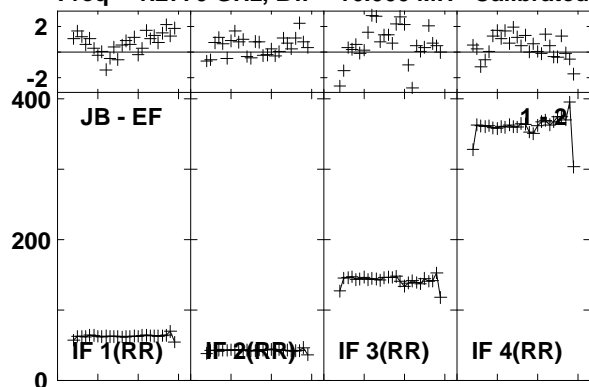

Lower frame: Milli Ampl Jy Top frame: Phas deg
 Vector averaged cross-power spectrum Baseline: JB (01) - EF (02)
 Timerange: 01/05:26:22 to 01/05:29:50

Plot file version1605 created 03-MAR-2016 01:16:40

J1545+5400 GN002C 1.UVDATA.1

Freq = 1.2770 GHz, Bw = 16.000 MH Calibrated with CL # 3 and BP # 1 (BP mode 1)

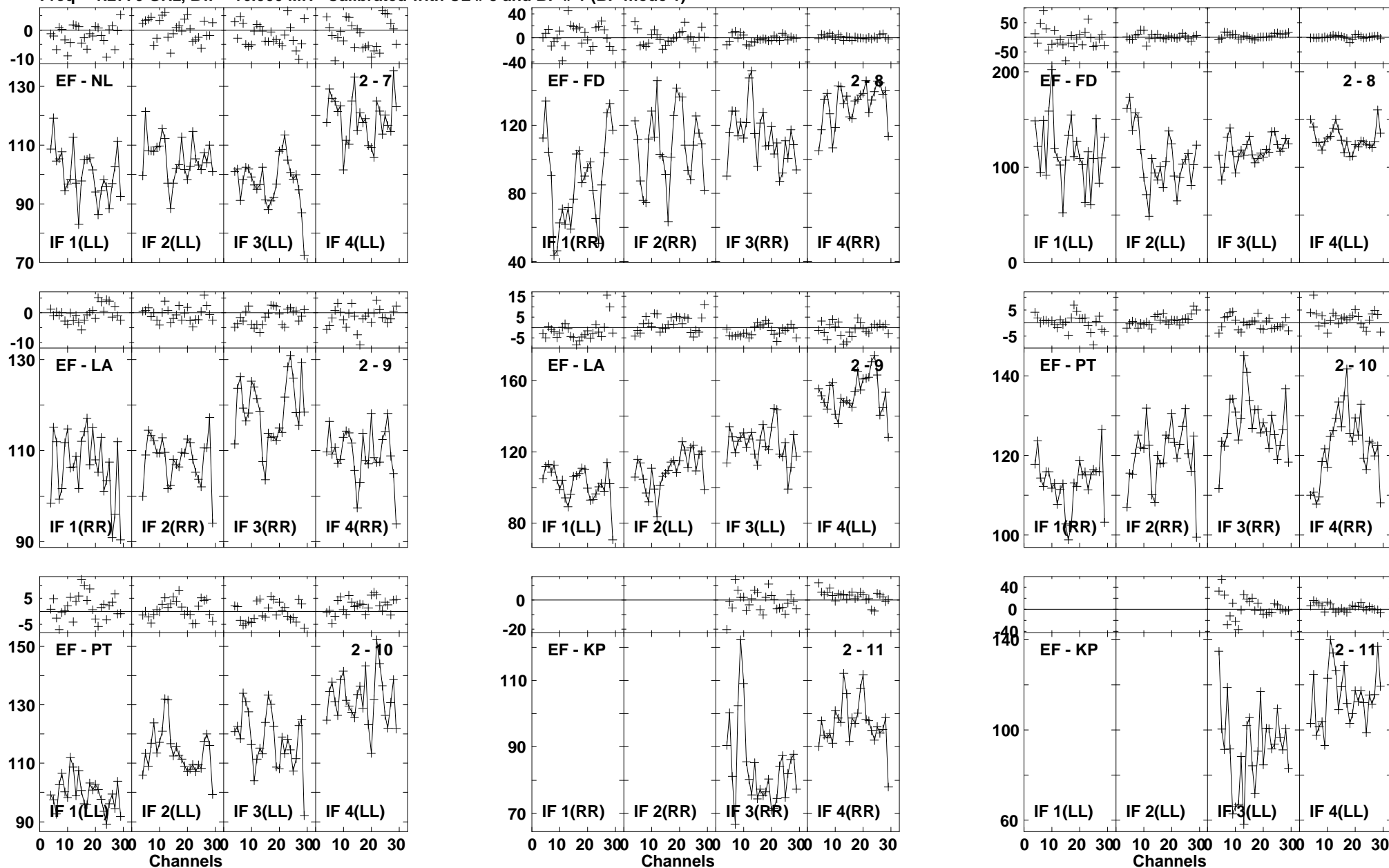

Lower frame: Milli Ampl Jy Top frame: Phas deg
Vector averaged cross-power spectrum Baseline: EF (02) - NL (07)
Timerange: 01/05:26:22 to 01/05:29:50

Plot file version1606 created 03-MAR-2016 01:16:40

J1545+5400 GN002C 1.UVDATA.1

Freq = 1.2770 GHz, Bw = 16.000 MH Calibrated with CL # 3 and BP # 1 (BP mode 1)

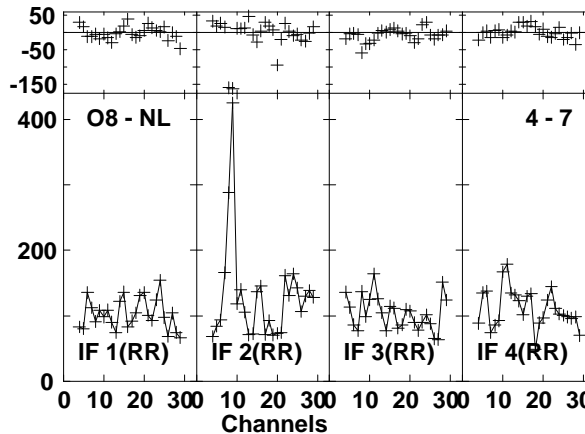
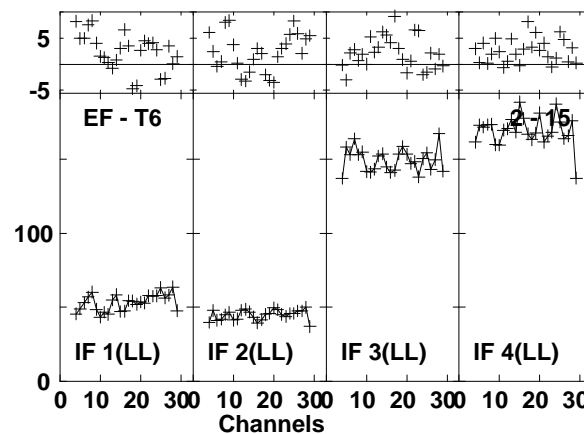
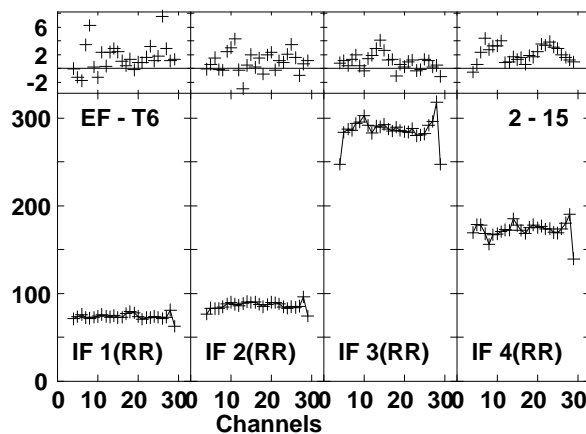
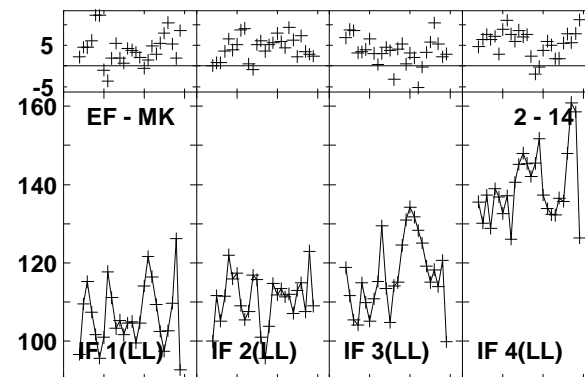
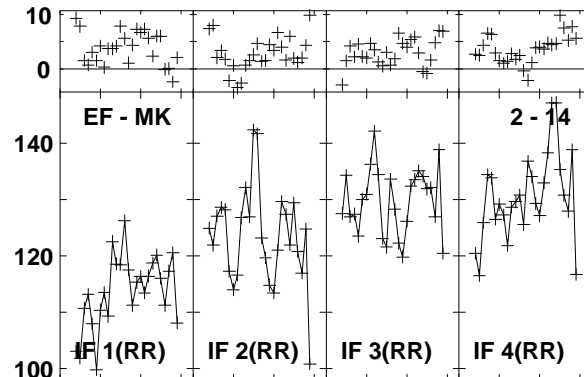
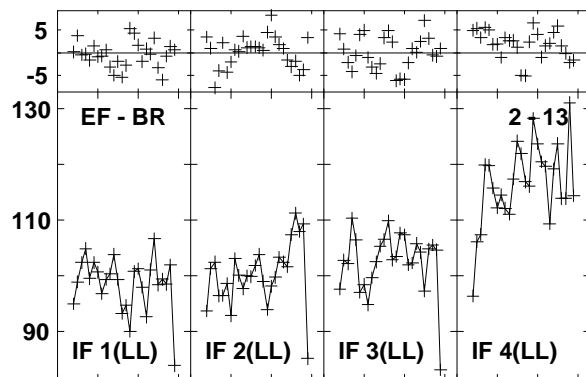
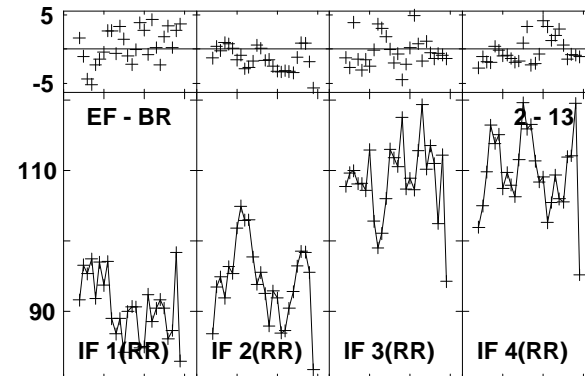
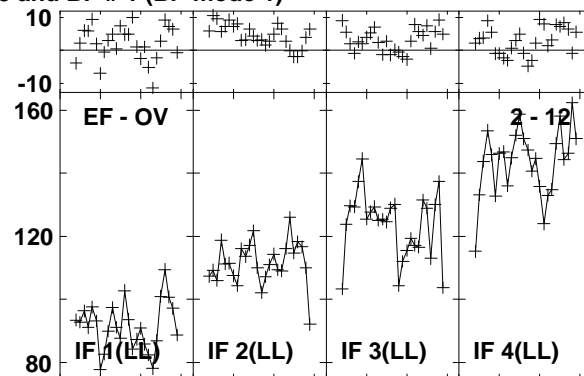
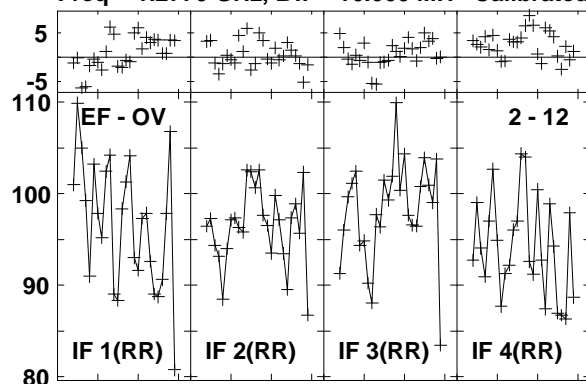

Lower frame: Milli Ampl Jy Top frame: Phas deg
Vector averaged cross-power spectrum Baseline: EF (02) - OV (12)
Timerange: 01/05:26:22 to 01/05:29:50

Plot file version1607 created 03-MAR-2016 01:16:40

J1545+5400 GN002C 1.UVDATA.1

Freq = 1.2770 GHz, Bw = 16.000 MH Calibrated with CL # 3 and BP # 1 (BP mode 1)

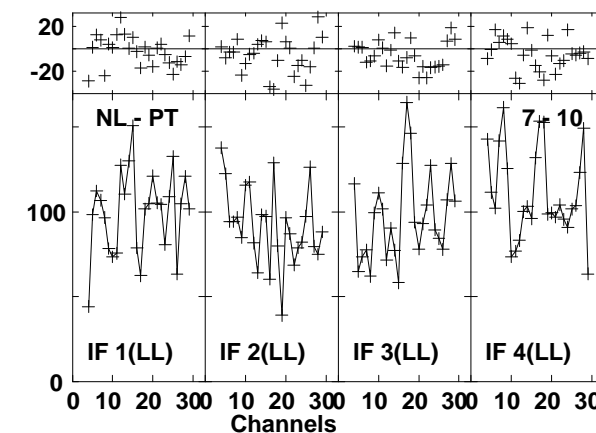
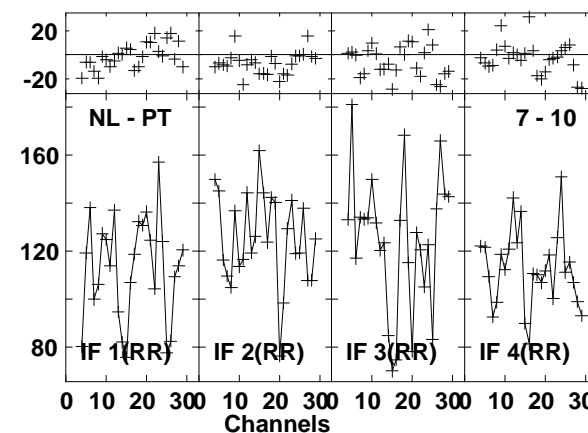
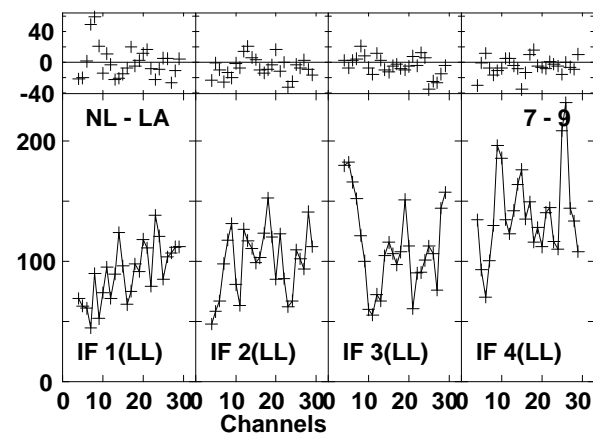
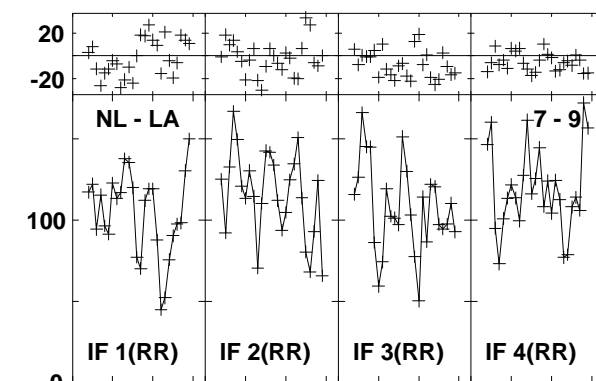
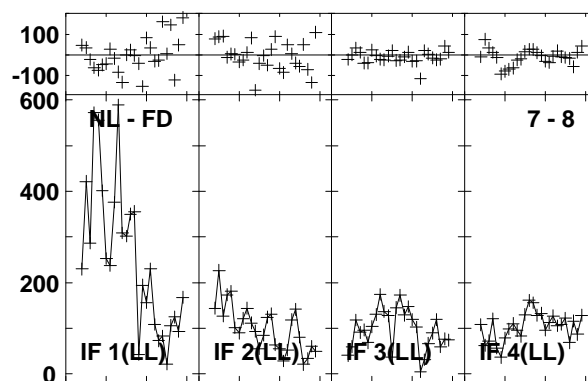
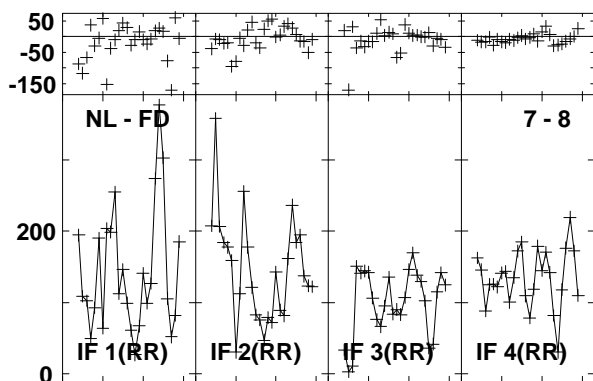
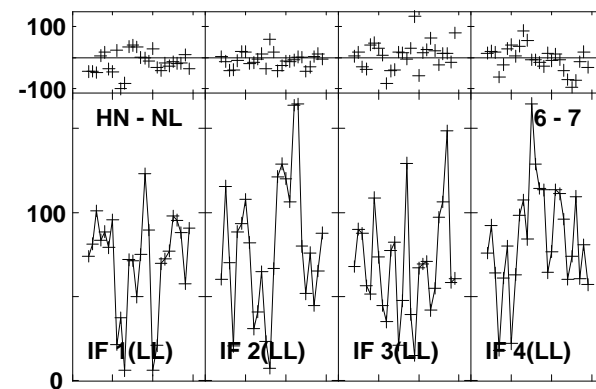
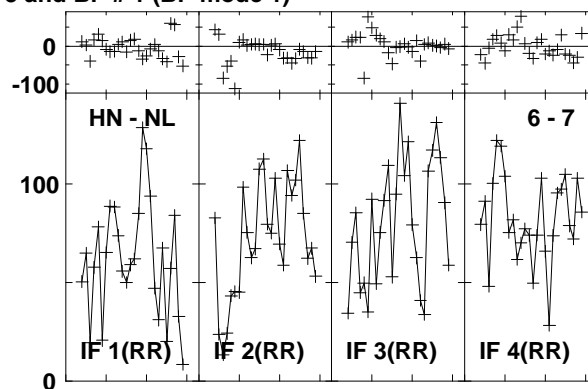
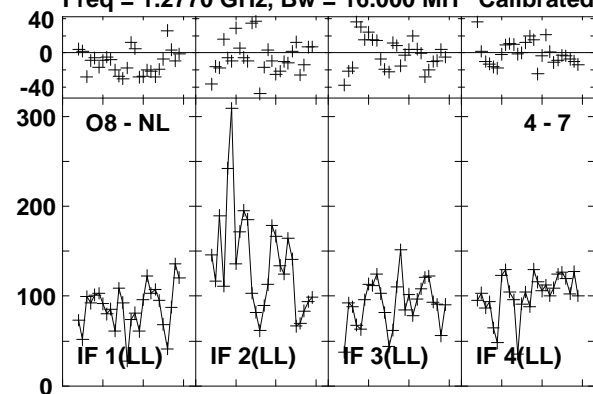

Lower frame: Milli Ampl Jy Top frame: Phas deg
Vector averaged cross-power spectrum Baseline: O8 (04) - NL (07)
Timerange: 01/05:26:22 to 01/05:29:50

Plot file version1608 created 03-MAR-2016 01:16:41

J1545+5400 GN002C 1.UVDATA.1

Freq = 1.2770 GHz, Bw = 16.000 MH Calibrated with CL # 3 and BP # 1 (BP mode 1)

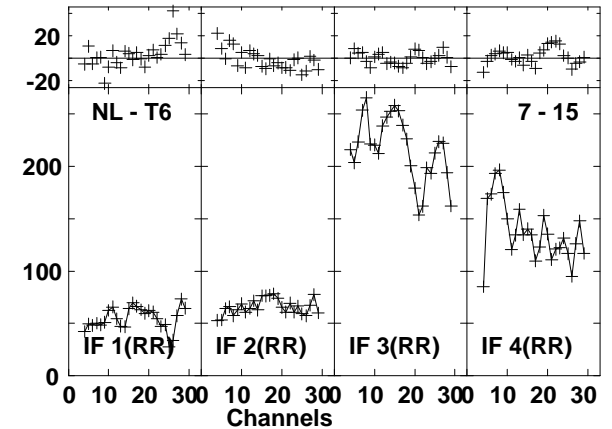
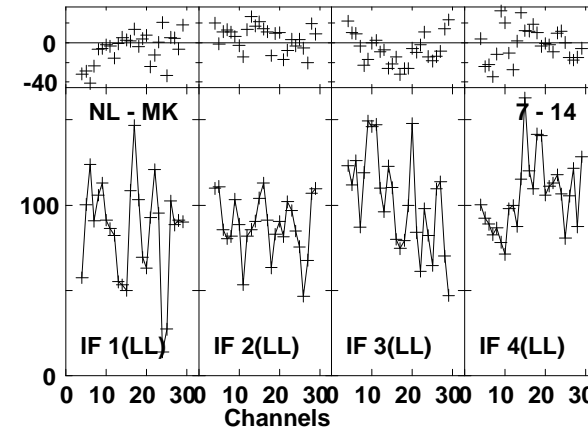
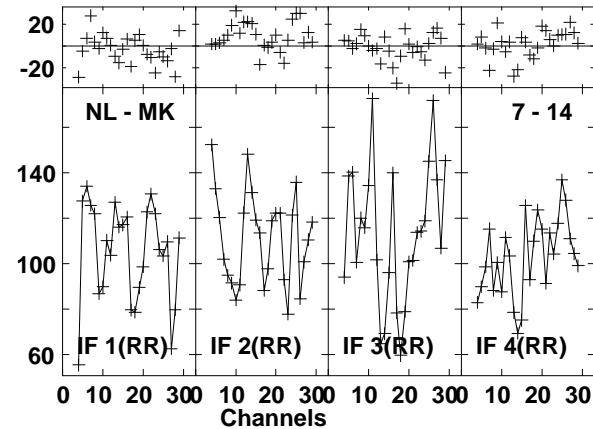
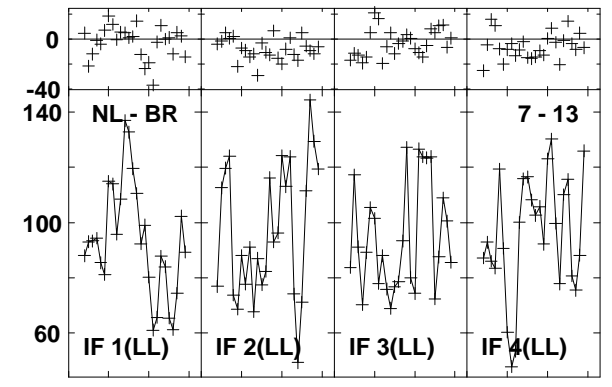
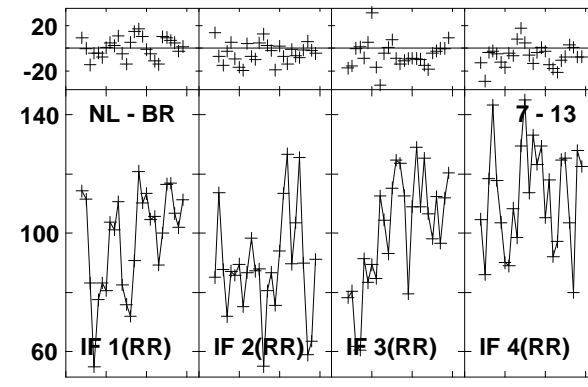
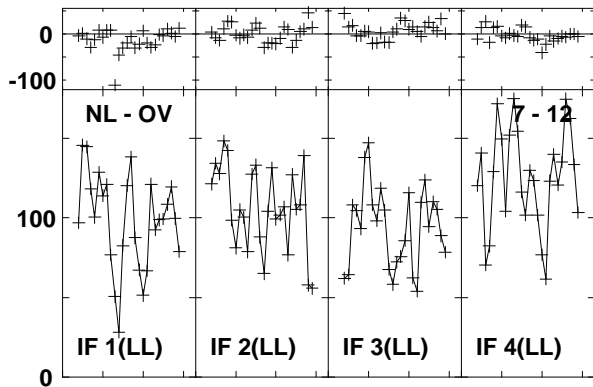
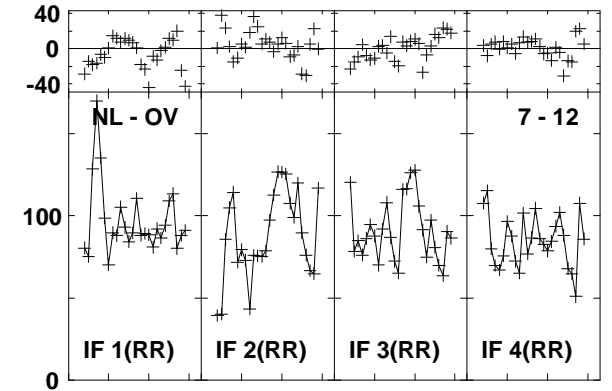
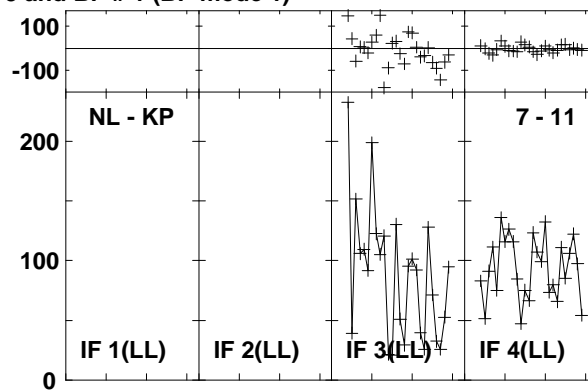
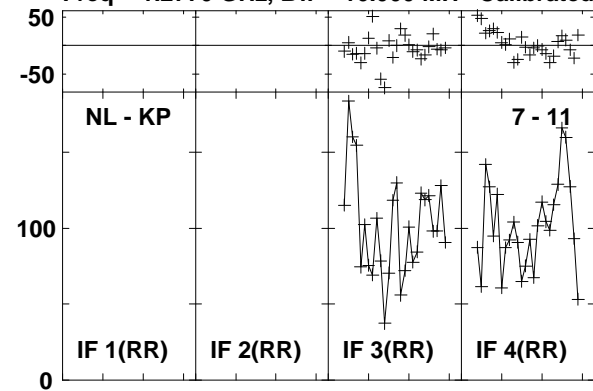

Lower frame: Milli Ampl Jy Top frame: Phas deg
Vector averaged cross-power spectrum Baseline: NL (07) - KP (11)
Timerange: 01/05:26:22 to 01/05:29:50

Plot file version1609 created 03-MAR-2016 01:16:41
J1545+5400 GN002C 1.UVDATA.1
Freq = 1.2770 GHz, Bw = 16.000 MH Calibrated with CL # 3 and BP # 1 (BP mode 1)

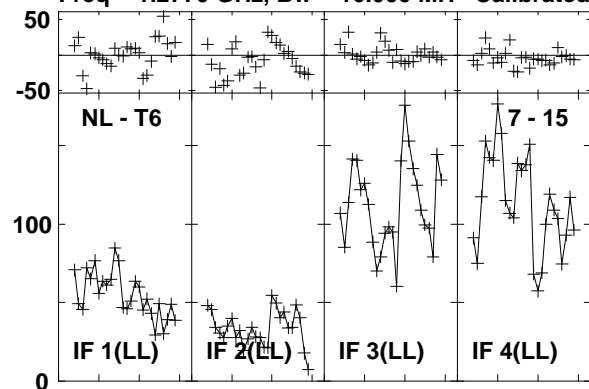

Lower frame: Milli Ampl Jy Top frame: Phas deg
Vector averaged cross-power spectrum Baseline: NL (07) - T6 (15)
Timerange: 01/05:26:22 to 01/05:29:50