

Plot file version 1 created 11-APR-2016 17:08:14
 4C39.25 GP053G 3.UVDATA.1

Freq = 4.9253 GHz, Bw = 16.000 MH No calibration applied and no bandpass applied

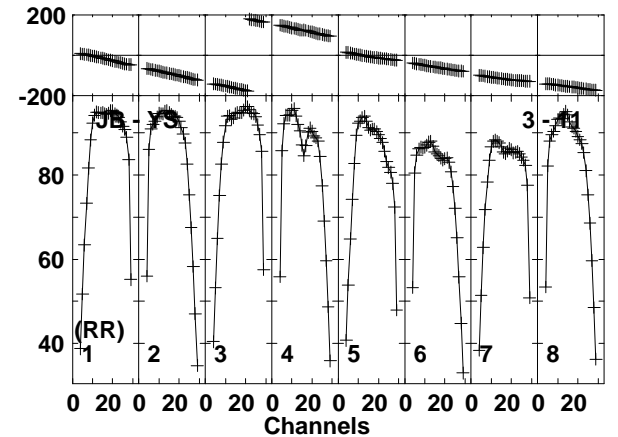
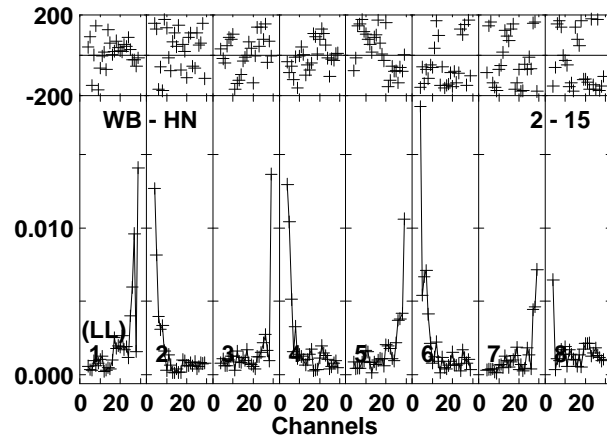
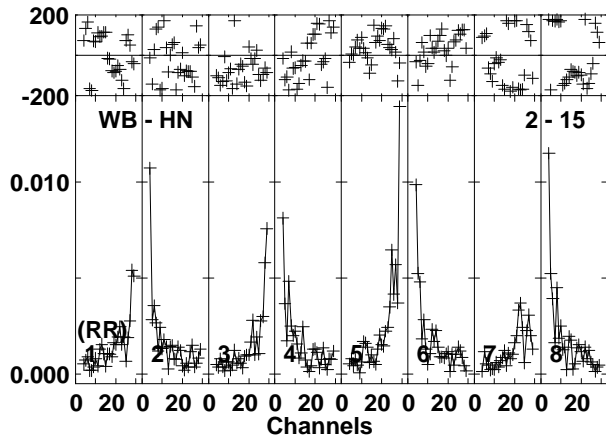
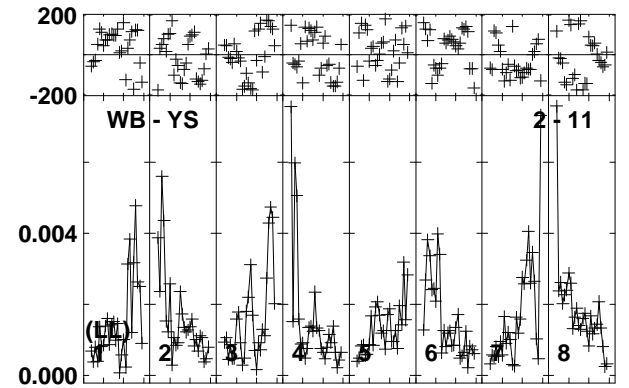
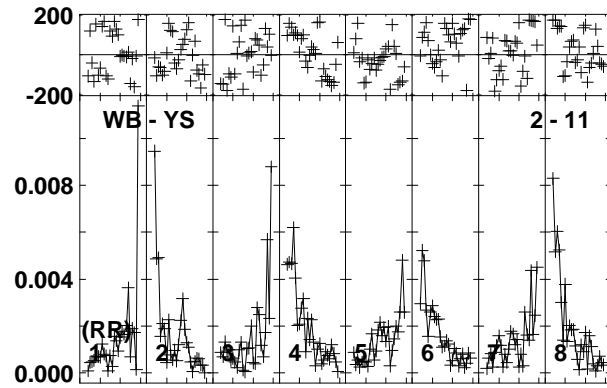
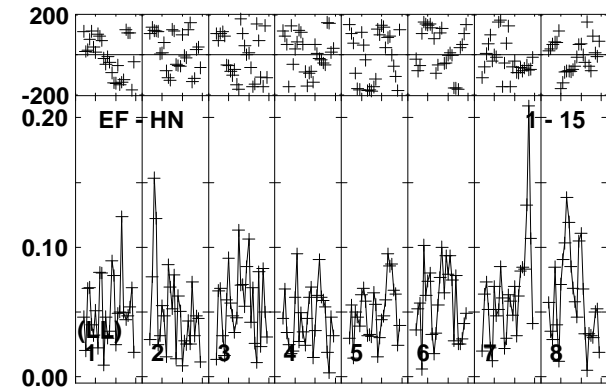
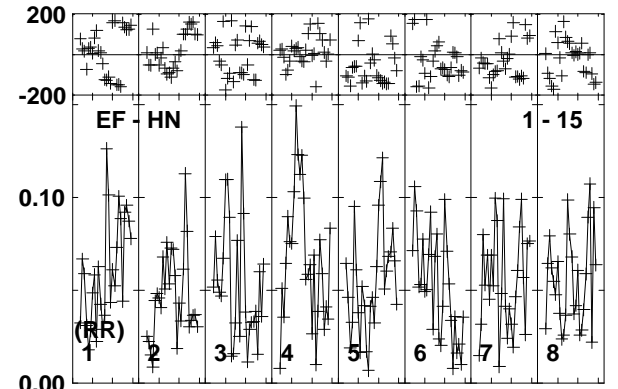
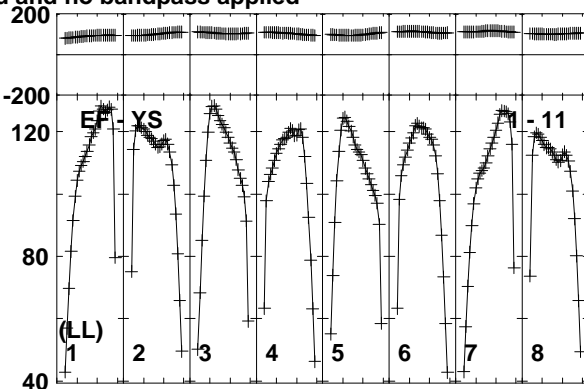
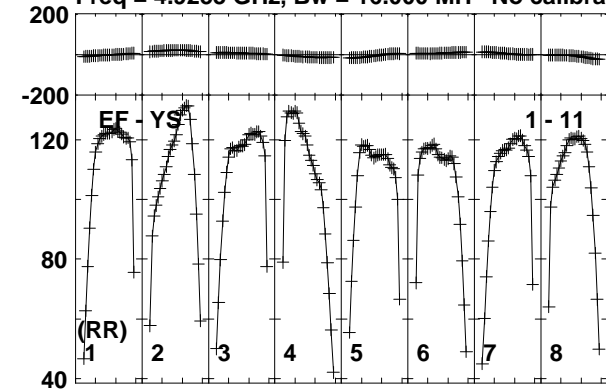

Lower frame: Milli Ampl Jy Top frame: Phas deg
 Vector averaged cross-power spectrum Baseline: EF (01) - YS (11)
 Timerange: 00/20:30:01 to 00/20:34:56

Plot file version 2 created 11-APR-2016 17:08:14
 4C39.25 GP053G 3.UVDATA.1

Freq = 4.9253 GHz, Bw = 16.000 MH No calibration applied and no bandpass applied

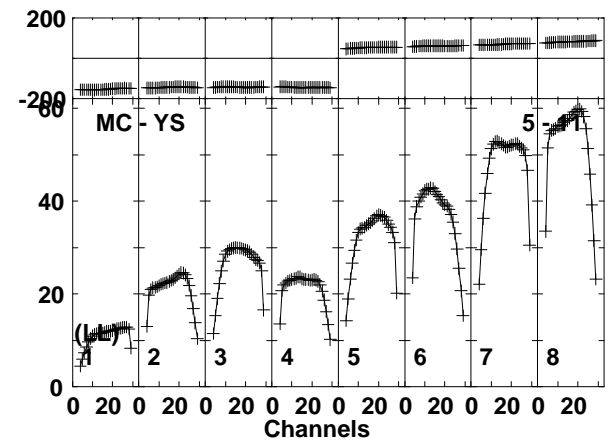
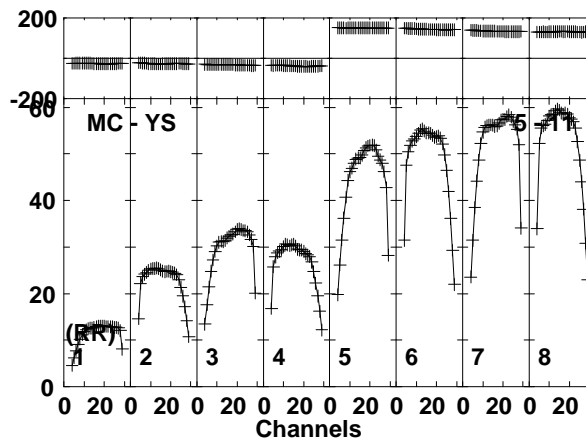
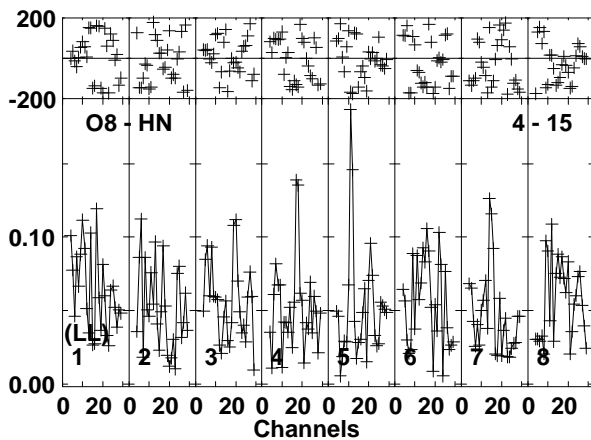
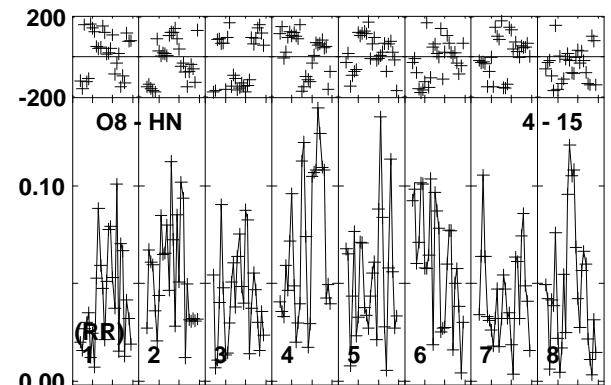
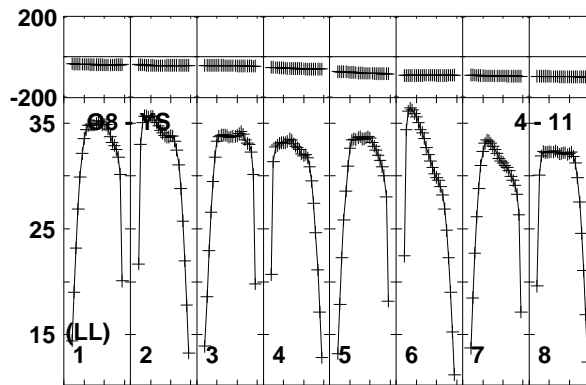
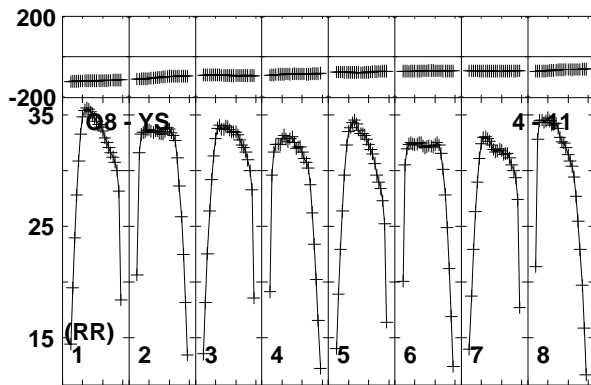
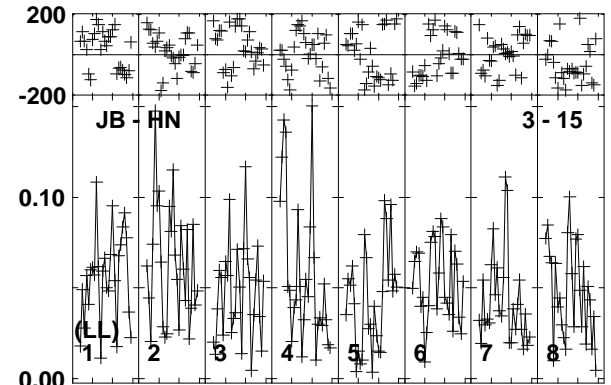
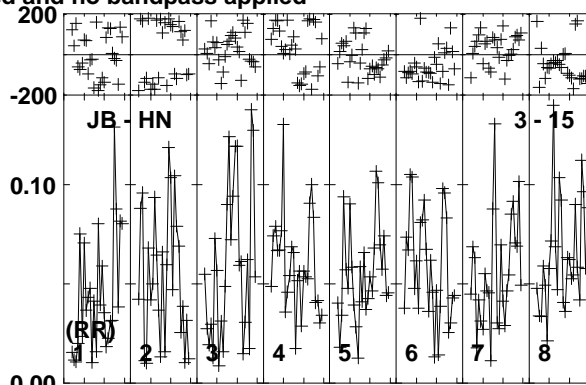
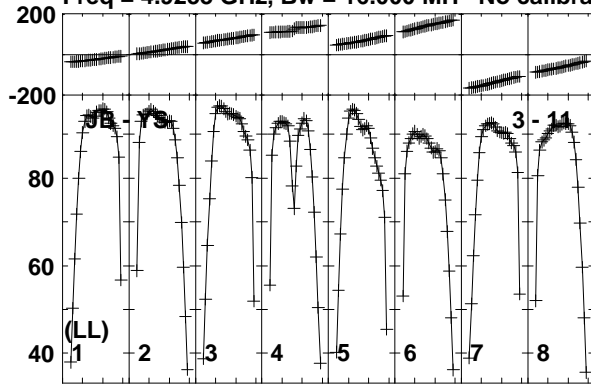

Lower frame: Milli Ampl Jy Top frame: Phas deg
 Vector averaged cross-power spectrum Baseline: JB (03) - YS (11)
 Timerange: 00/20:30:01 to 00/20:34:56

Plot file version 3 created 11-APR-2016 17:08:14
 4C39.25 GP053G 3.UVDATA.1

Freq = 4.9253 GHz, Bw = 16.000 MH No calibration applied and no bandpass applied

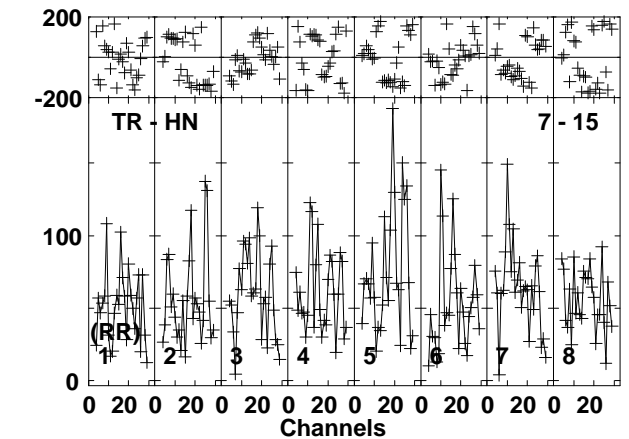
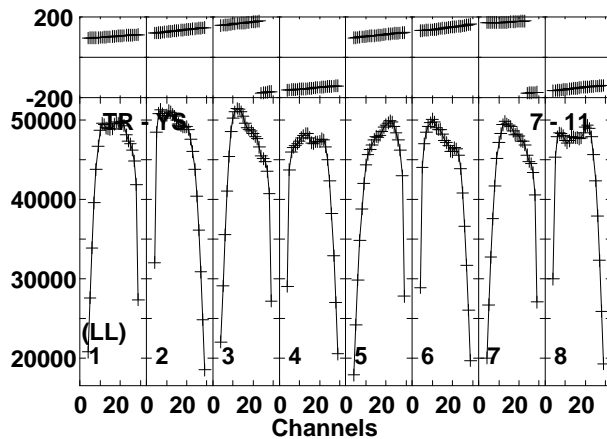
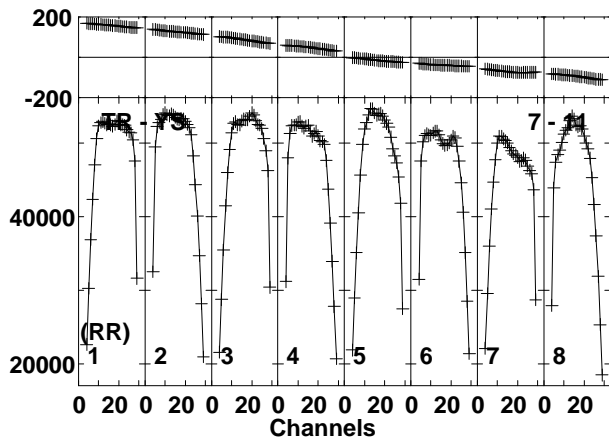
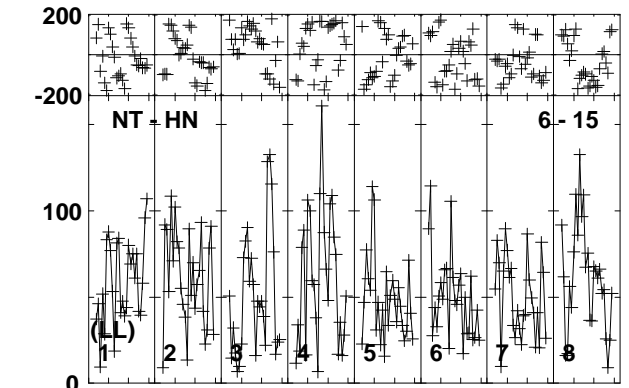
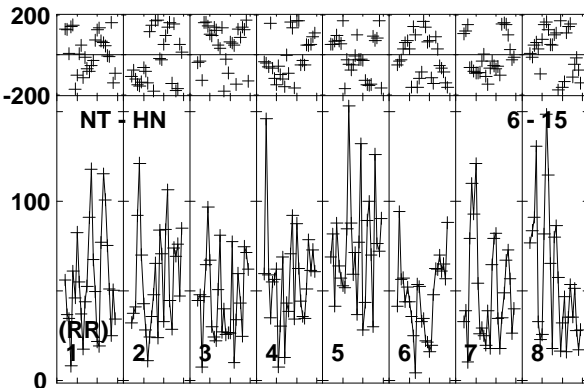
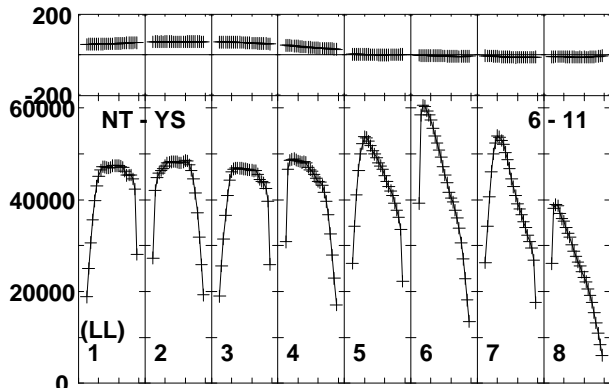
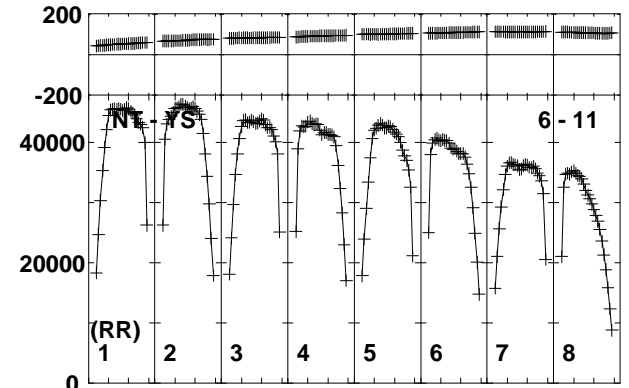
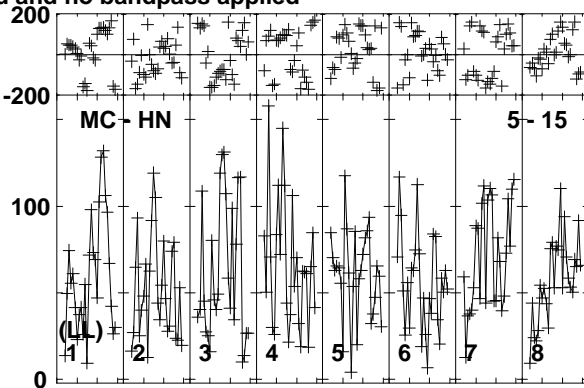
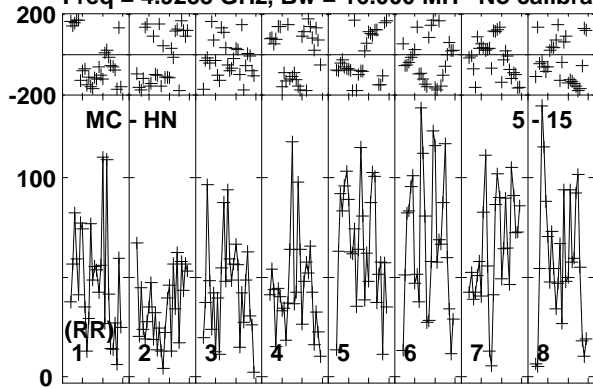

Lower frame: Micro Ampl Jy Top frame: Phas deg
 Vector averaged cross-power spectrum Baseline: MC (05) - HN (15)
 Timerange: 00/20:30:01 to 00/20:34:56

Plot file version 4 created 11-APR-2016 17:08:14
 4C39.25 GP053G 3.UVDATA.1

Freq = 4.9253 GHz, Bw = 16.000 MH No calibration applied and no bandpass applied

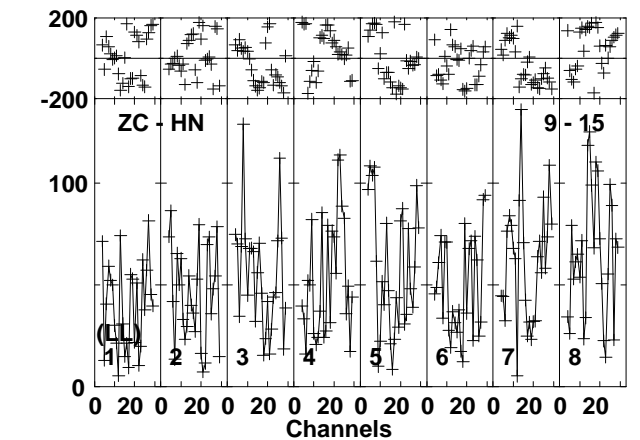
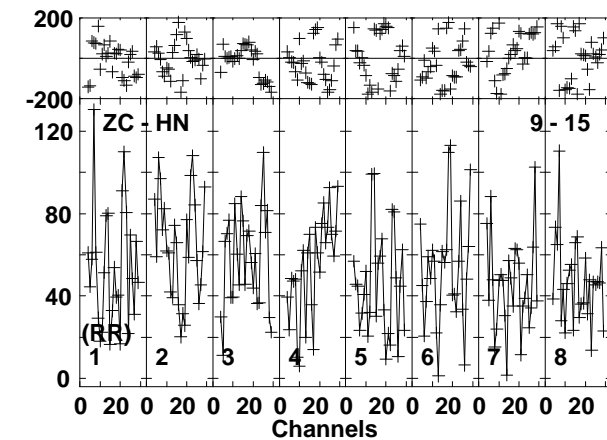
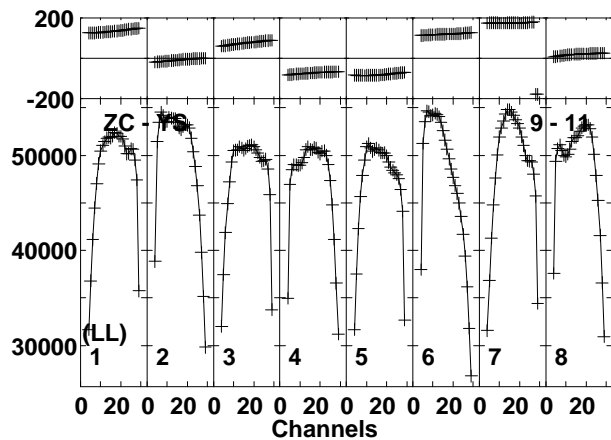
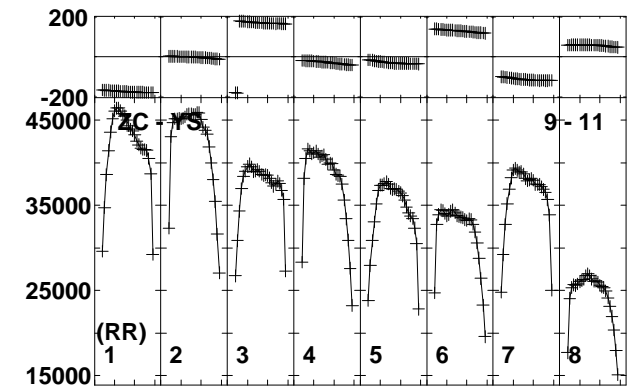
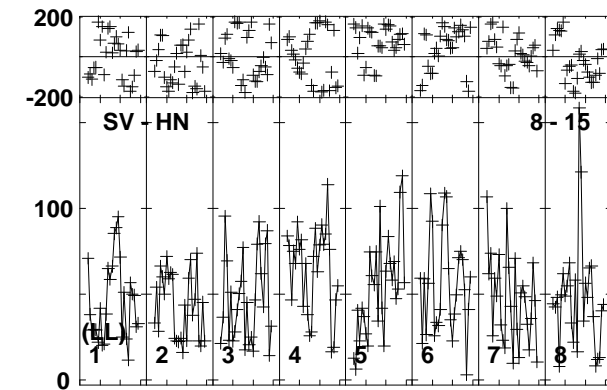
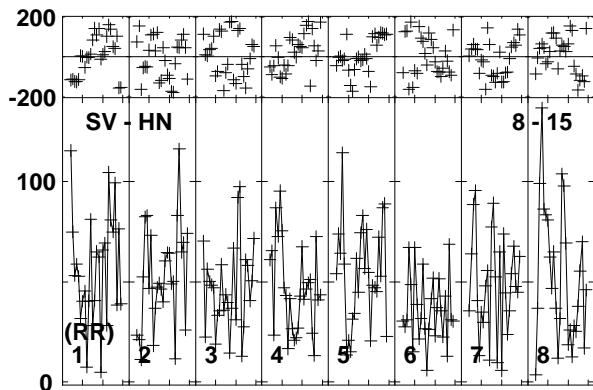
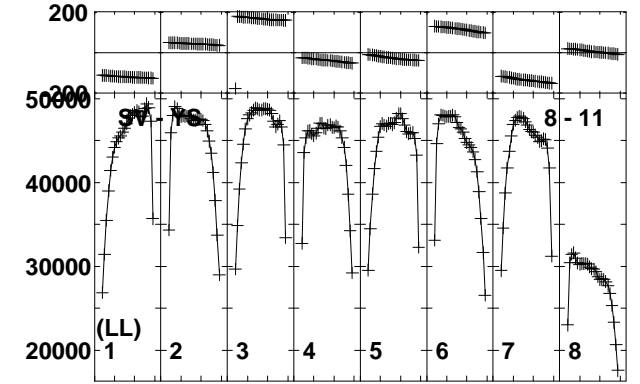
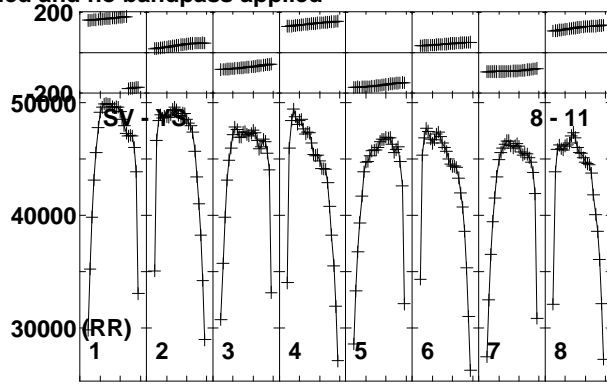
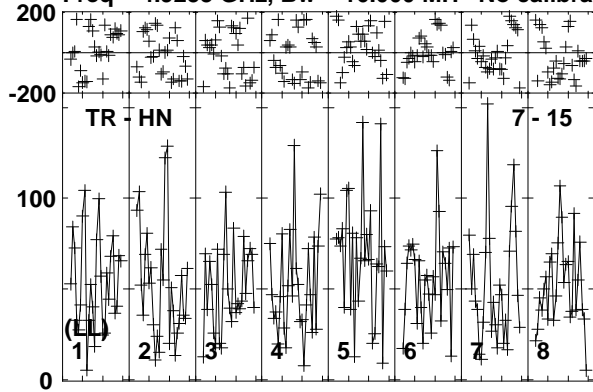

Lower frame: Micro Ampl Jy Top frame: Phas deg
 Vector averaged cross-power spectrum Baseline: TR (07) - HN (15)
 Timerange: 00/20:30:01 to 00/20:34:56

Plot file version 5 created 11-APR-2016 17:08:15

4C39.25 GP053G 3.UVDATA.1

Freq = 4.9253 GHz, Bw = 16.000 MH No calibration applied and no bandpass applied

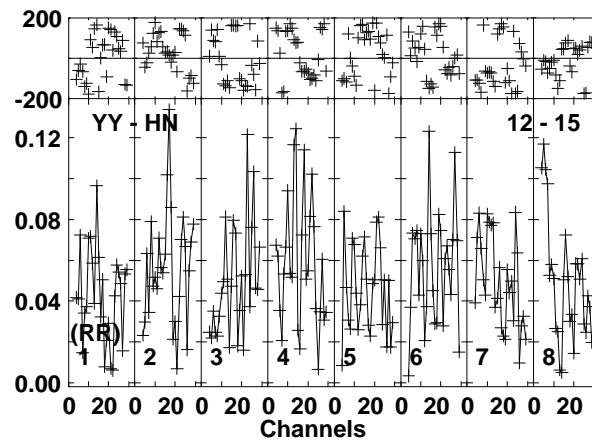
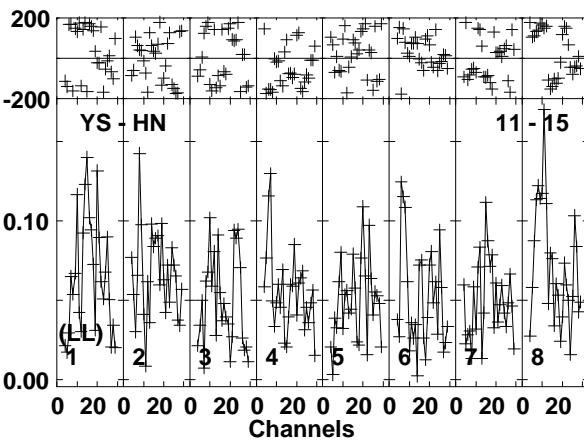
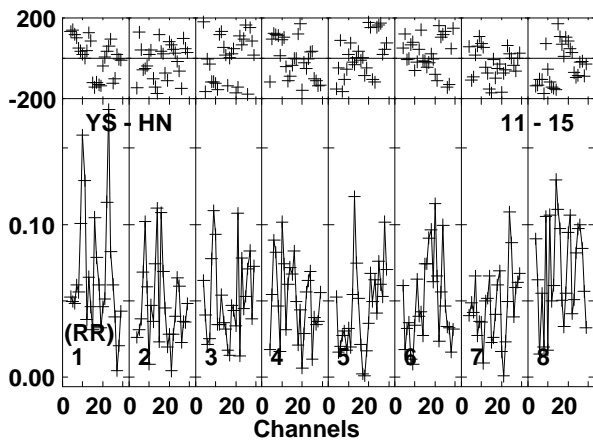
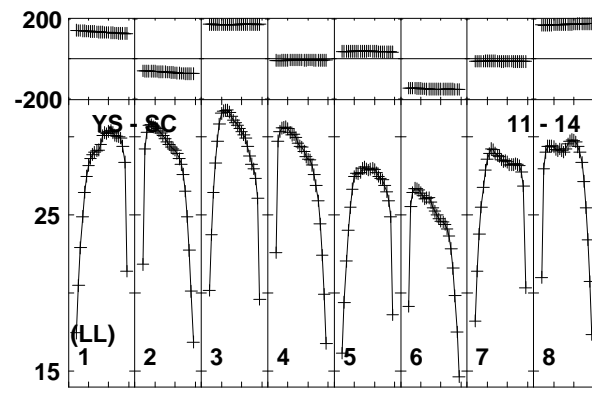
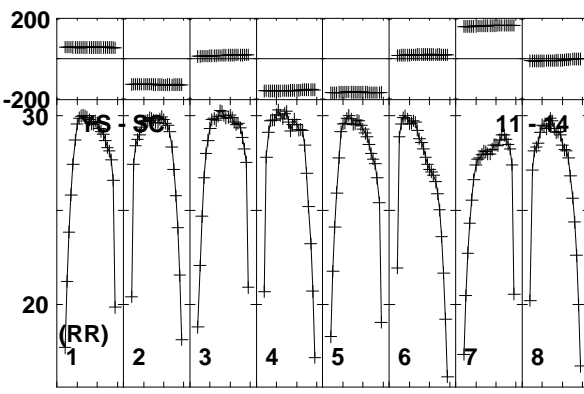
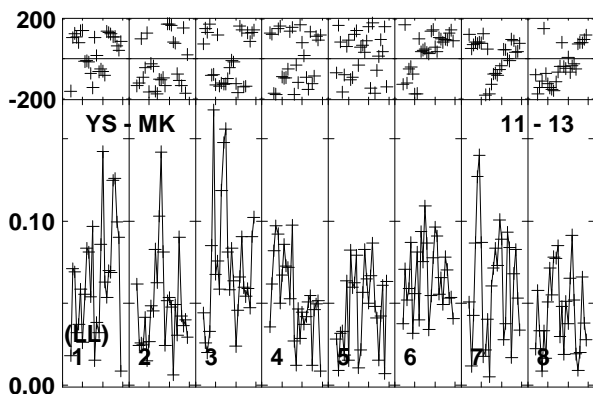
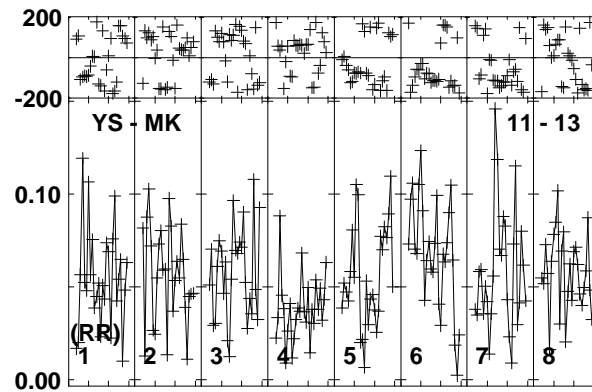
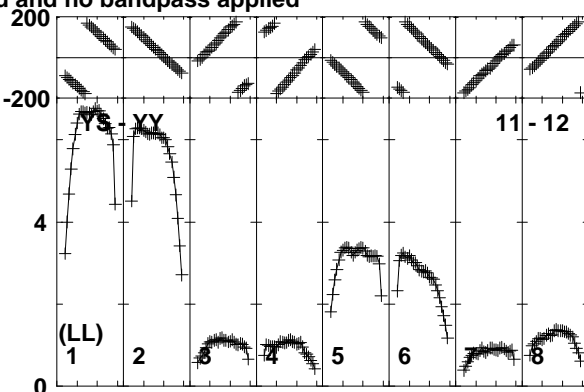
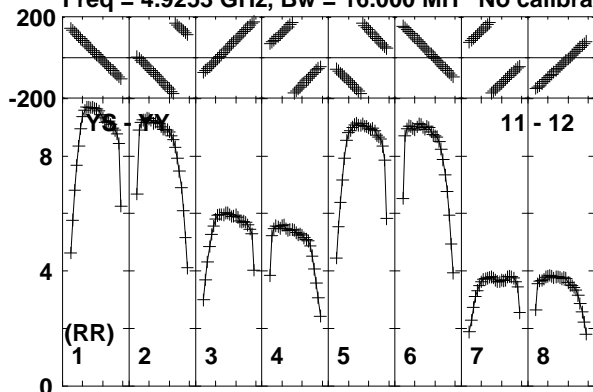

Lower frame: Milli Ampl Jy Top frame: Phas deg
Vector averaged cross-power spectrum Baseline: YS (11) - YY (12)
Timerange: 00/20:30:01 to 00/20:34:56

Plot file version 6 created 11-APR-2016 17:08:15

4C39.25 GP053G 3.UVDATA.1

Freq = 4.9253 GHz, Bw = 16.000 MH No calibration applied and no bandpass applied

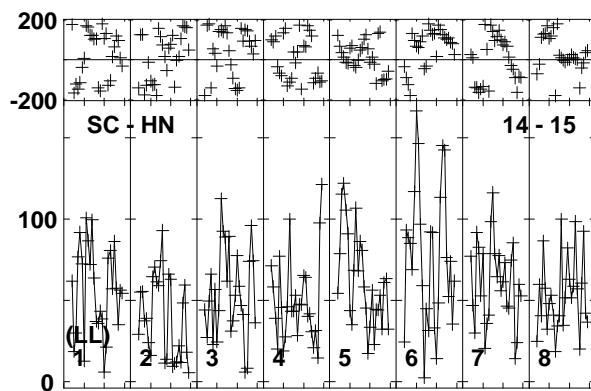
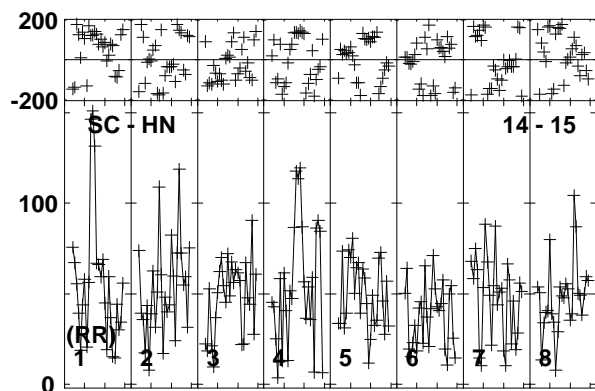
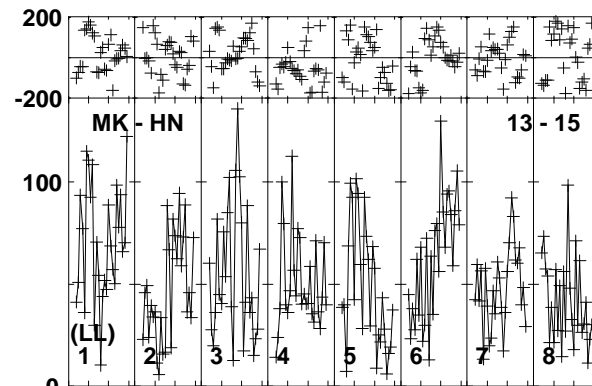
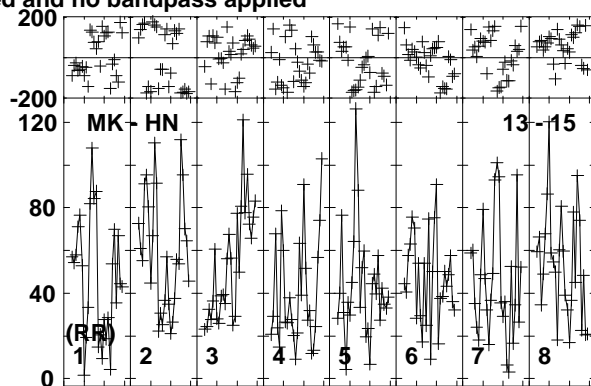
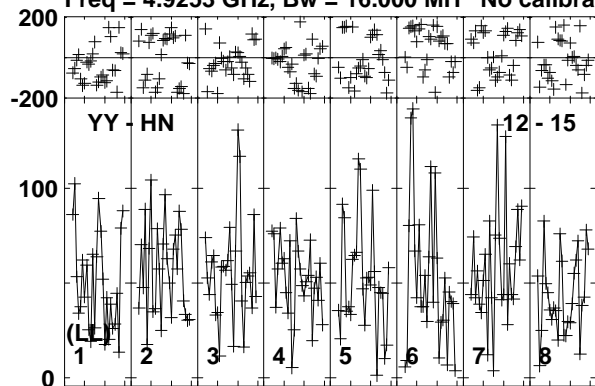

Lower frame: Micro Ampl Jy Top frame: Phas deg
Vector averaged cross-power spectrum Baseline: YY (12) - HN (15)
Timerange: 00/20:30:01 to 00/20:34:56

Plot file version 7 created 11-APR-2016 17:08:15

J1128+5925 GP053G 3.UV DATA.1

Freq = 4.9253 GHz, Bw = 16.000 MH No calibration applied and no bandpass applied

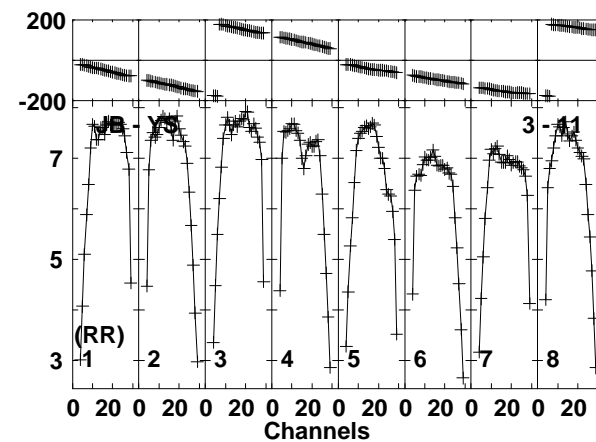
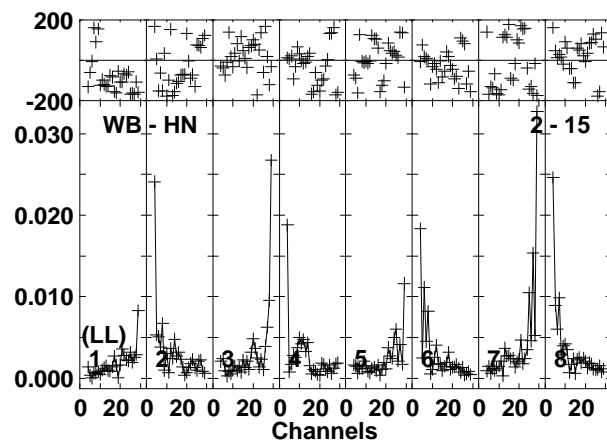
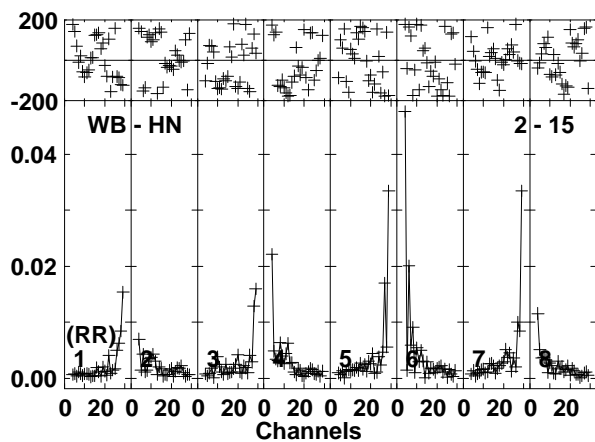
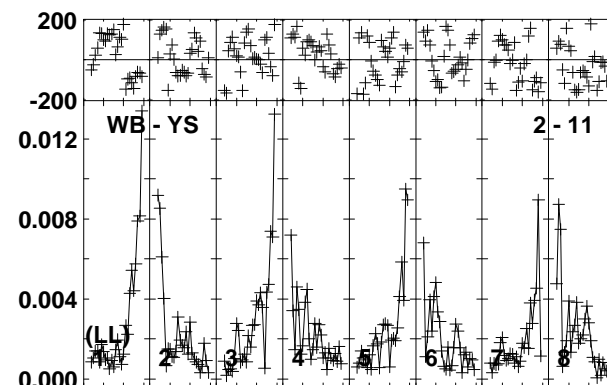
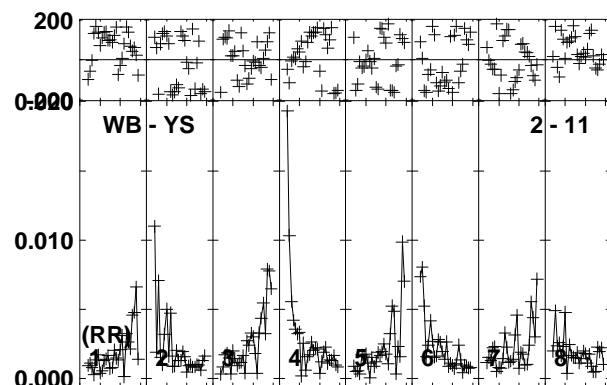
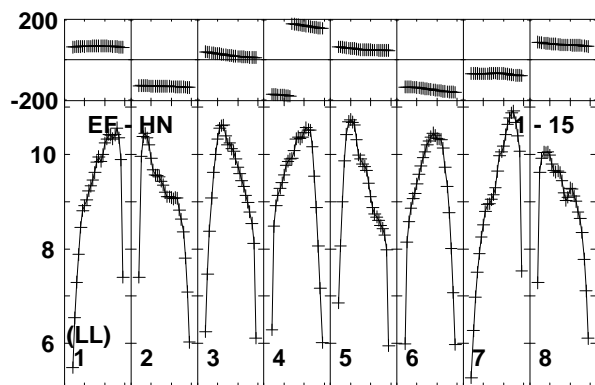
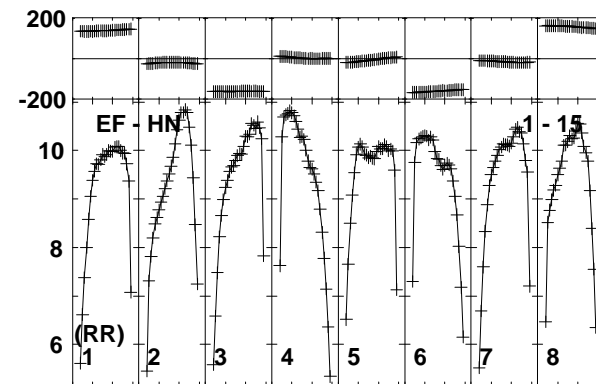
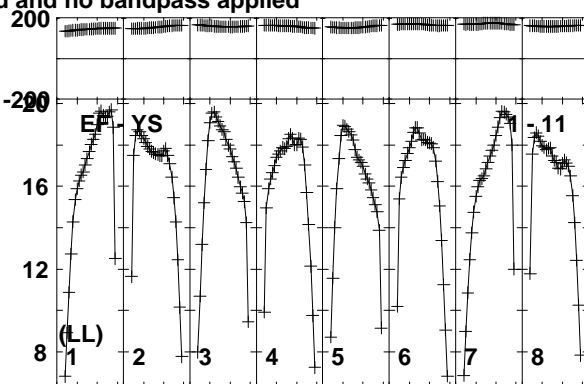
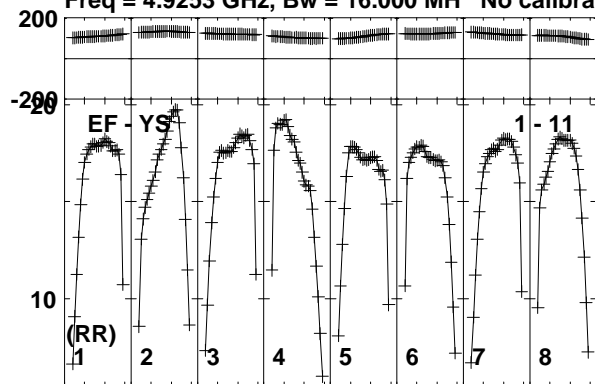

Lower frame: Milli Ampl Jy Top frame: Phas deg
Vector averaged cross-power spectrum Baseline: EF (01) - YS (11)
Timerange: 00/20:35:18 to 00/20:39:13

Plot file version 8 created 11-APR-2016 17:08:15

J1128+5925 GP053G 3.UVDATA.1

Freq = 4.9253 GHz, Bw = 16.000 MH No calibration applied and no bandpass applied

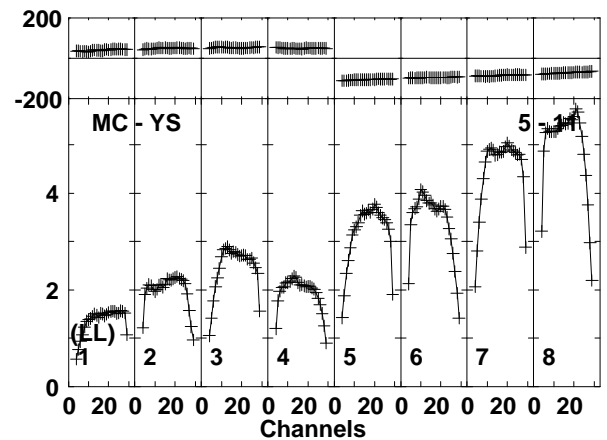
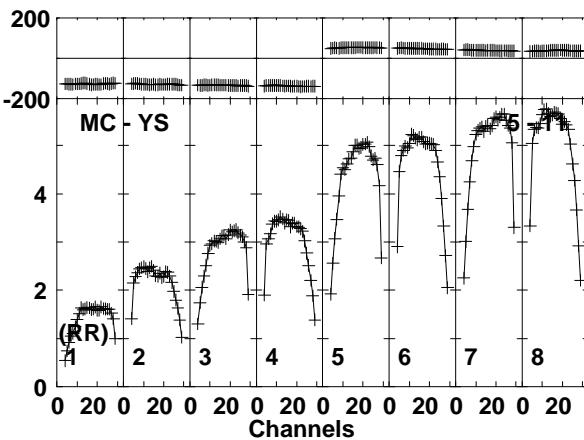
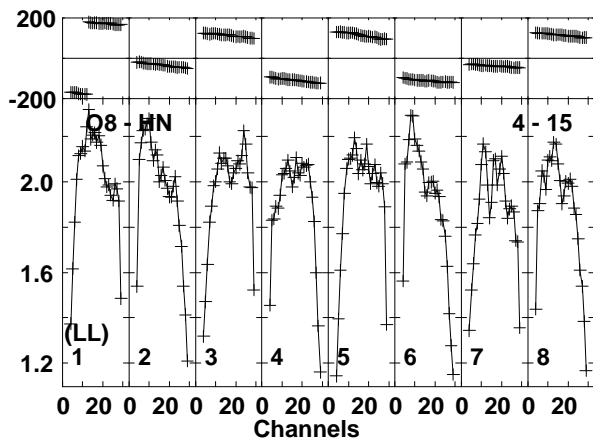
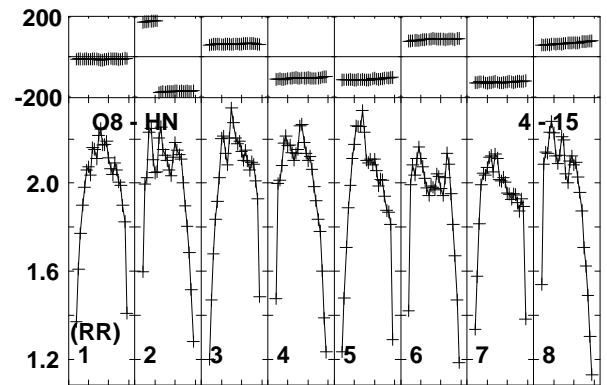
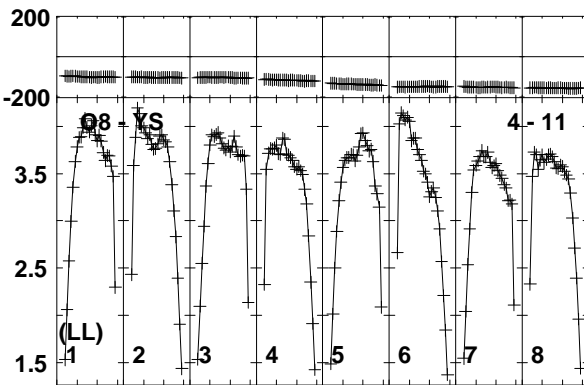
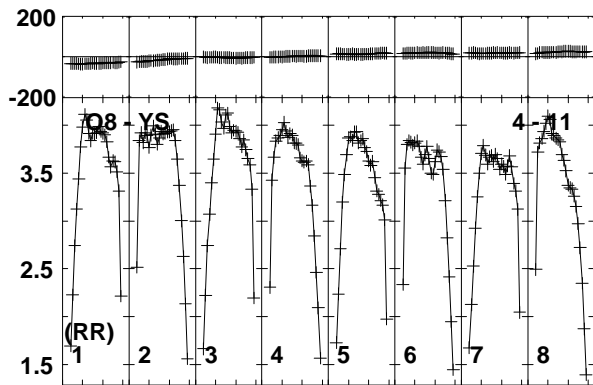
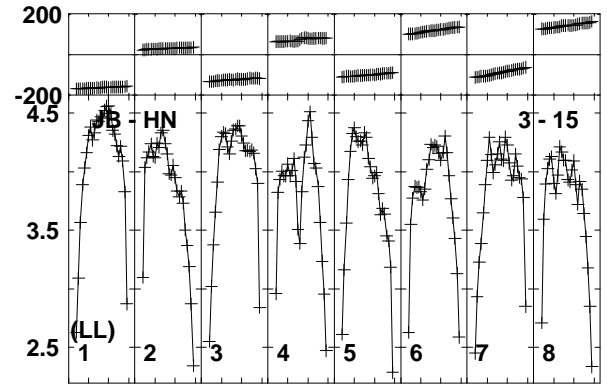
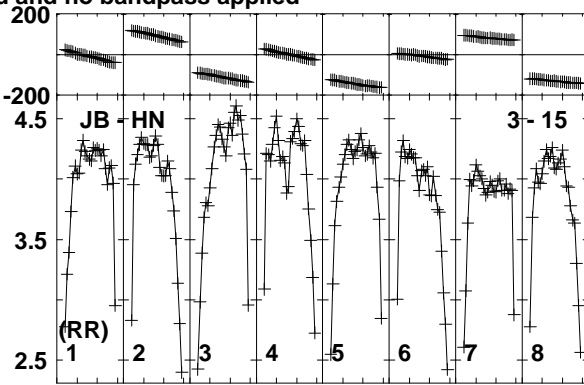
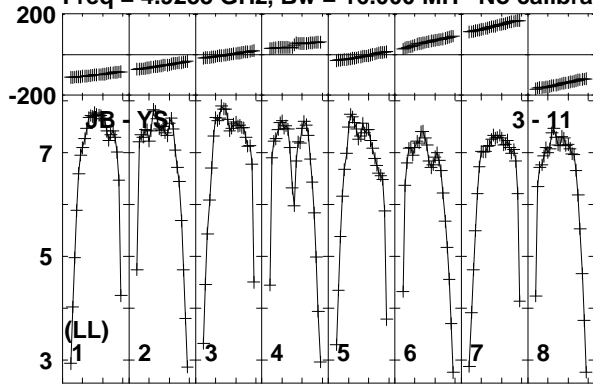

Lower frame: Milli Ampl Jy Top frame: Phas deg
Vector averaged cross-power spectrum Baseline: JB (03) - YS (11)
Timerange: 00/20:35:18 to 00/20:39:13

Plot file version 9 created 11-APR-2016 17:08:15

J1128+5925 GP053G 3.UVDATA.1

Freq = 4.9253 GHz, Bw = 16.000 MH No calibration applied and no bandpass applied

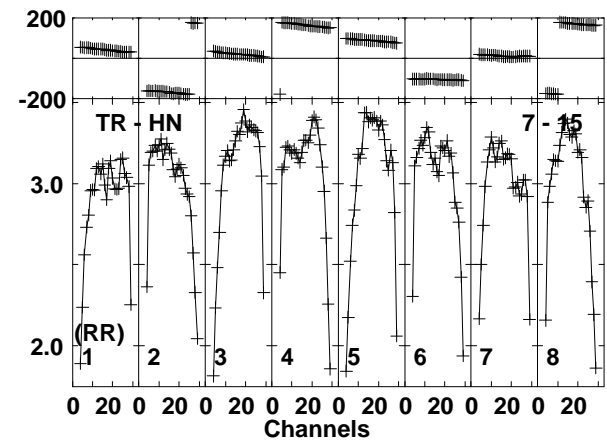
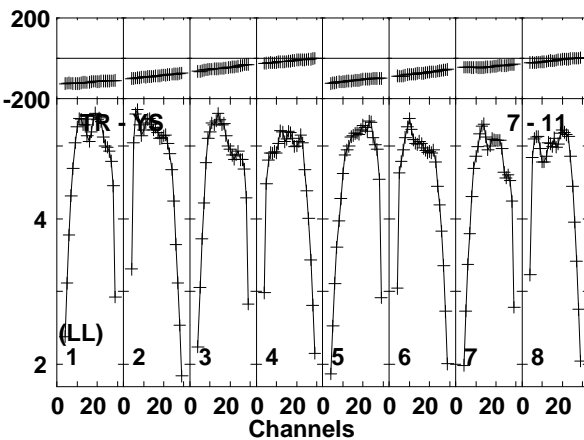
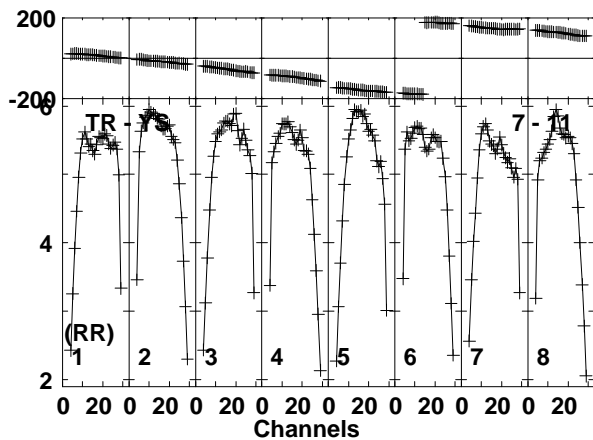
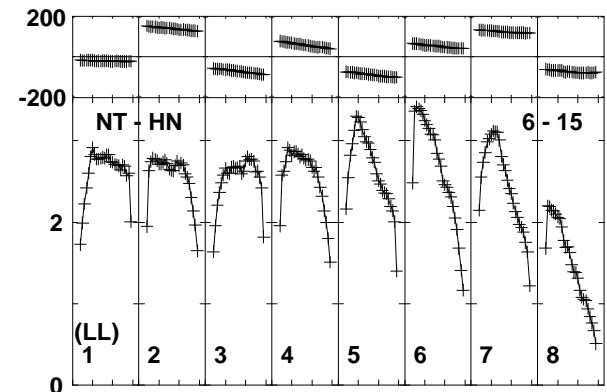
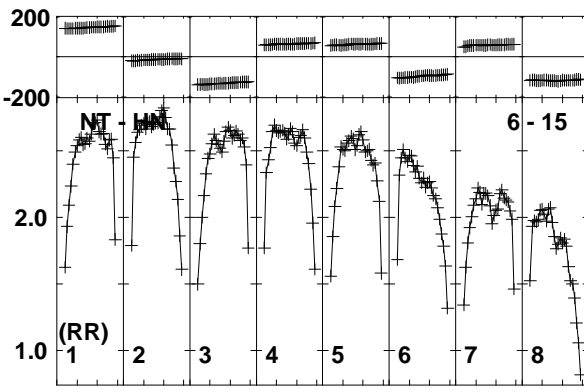
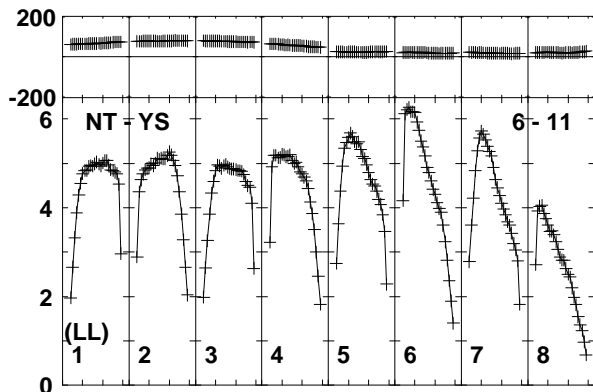
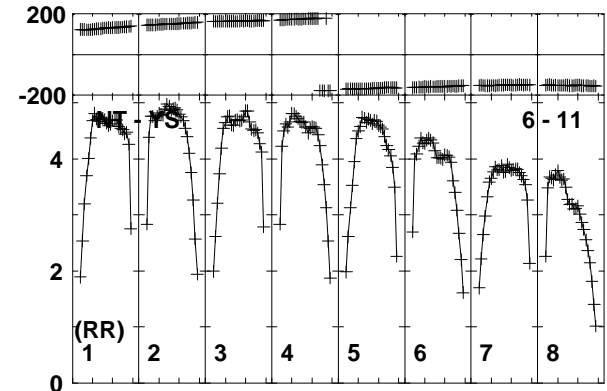
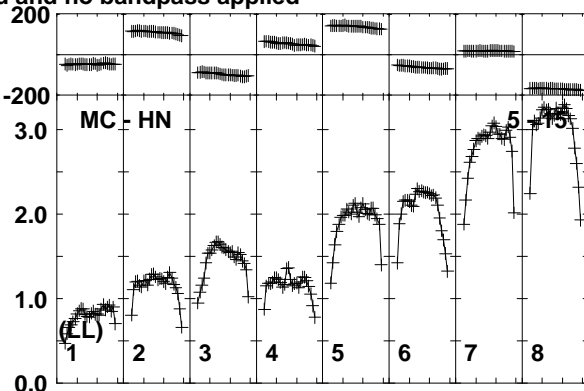
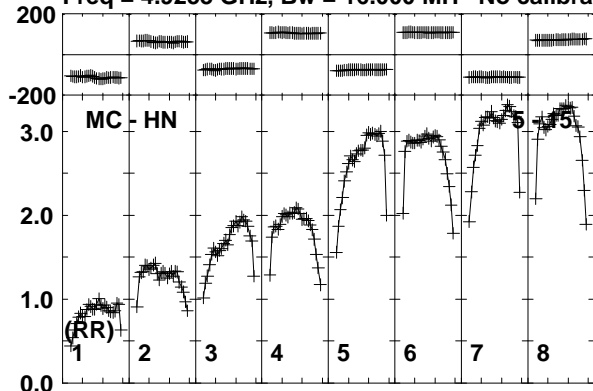

Lower frame: Milli Ampl Jy Top frame: Phas deg
Vector averaged cross-power spectrum Baseline: MC (05) - HN (15)
Timerange: 00/20:35:18 to 00/20:39:13

Plot file version 10 created 11-APR-2016 17:08:15

J1128+5925 GP053G 3.UVDATA.1

Freq = 4.9253 GHz, Bw = 16.000 MH No calibration applied and no bandpass applied

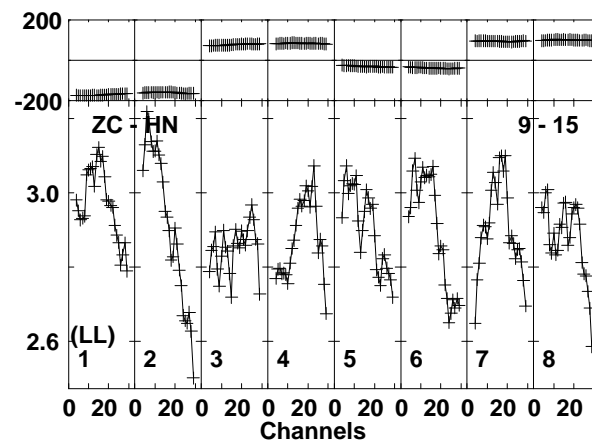
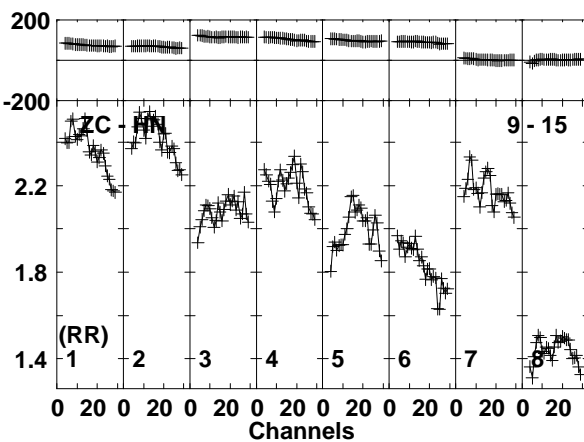
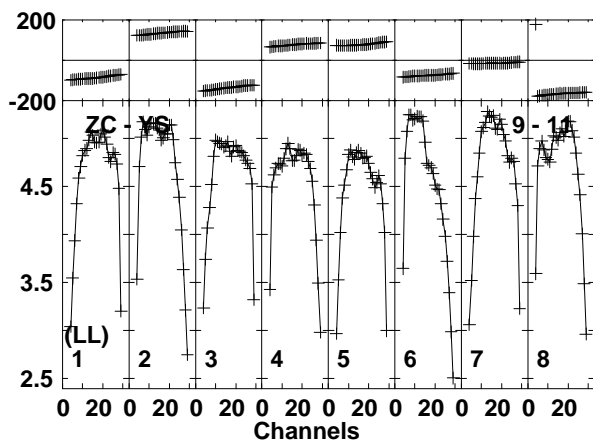
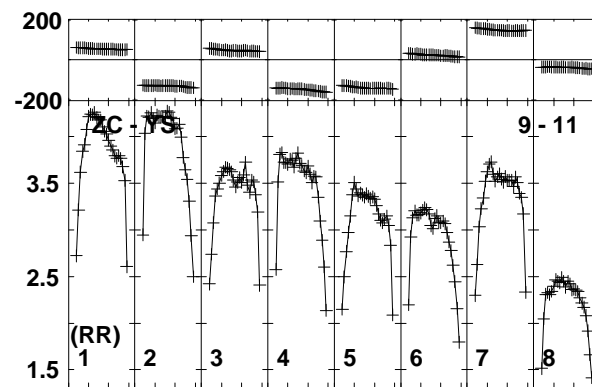
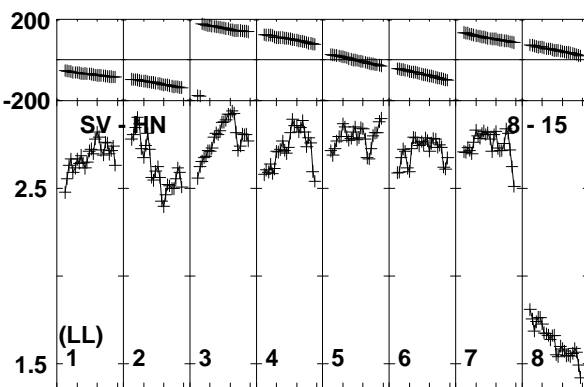
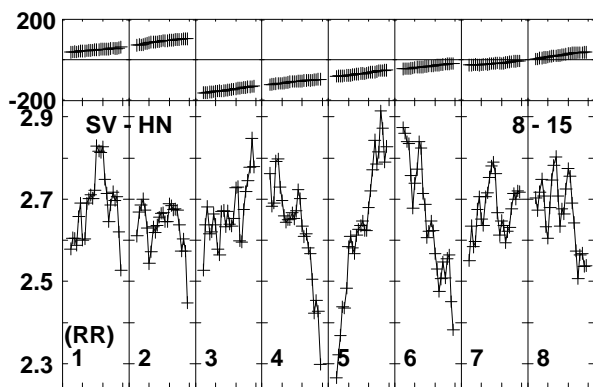
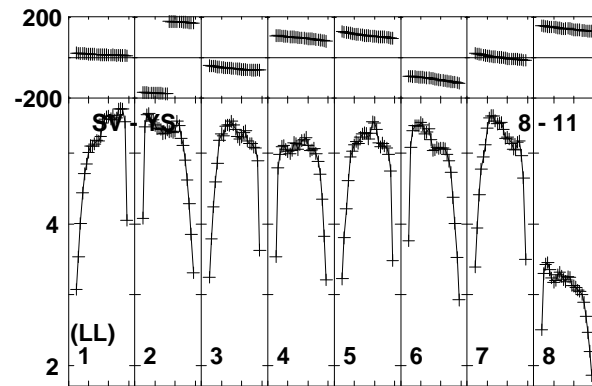
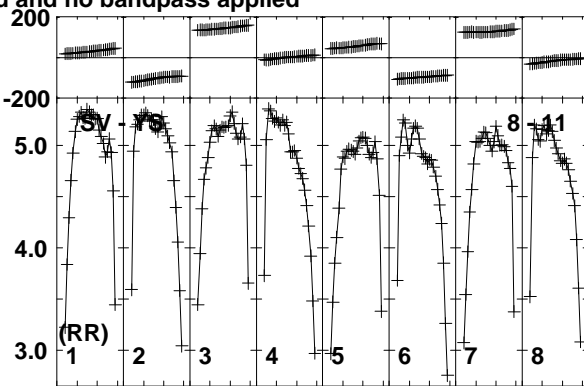
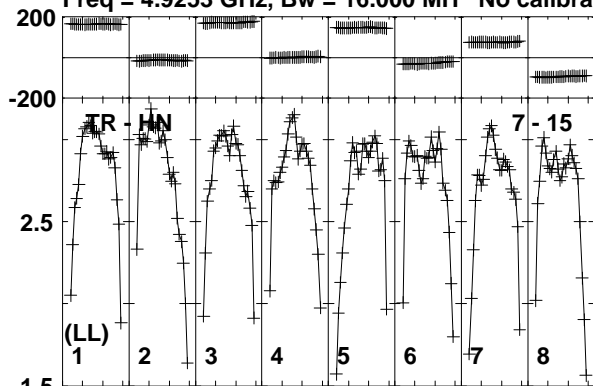

Lower frame: Milli Ampl Jy Top frame: Phas deg
Vector averaged cross-power spectrum Baseline: TR (07) - HN (15)
Timerange: 00/20:35:18 to 00/20:39:13

Plot file version 11 created 11-APR-2016 17:08:16

J1128+5925 GP053G 3.UVDATA.1

Freq = 4.9253 GHz, Bw = 16.000 MH No calibration applied and no bandpass applied

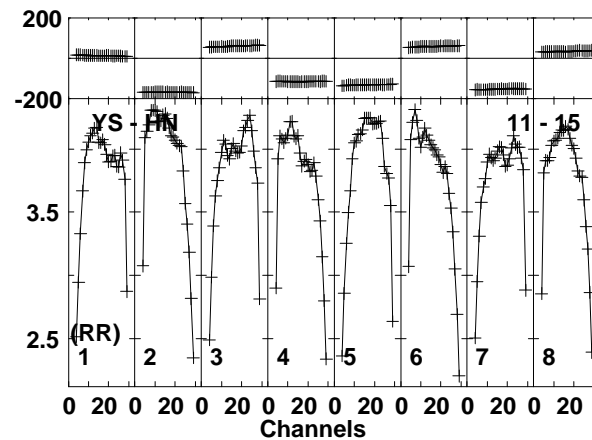
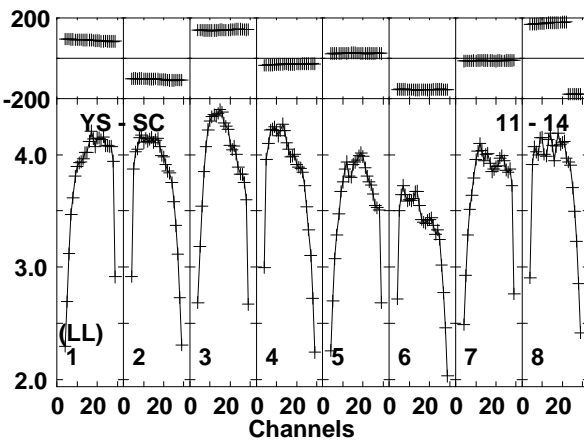
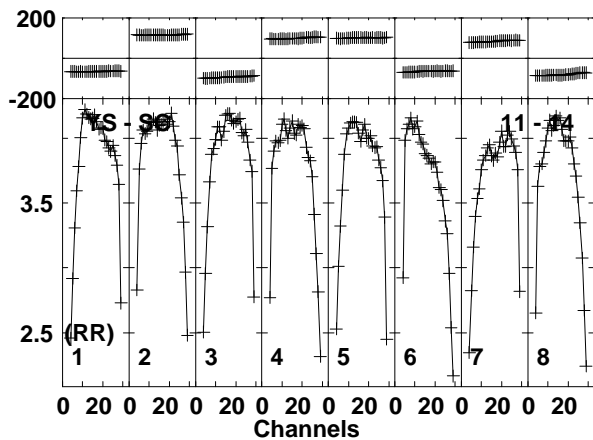
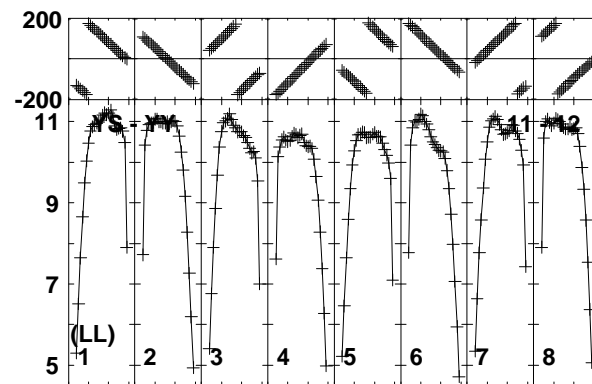
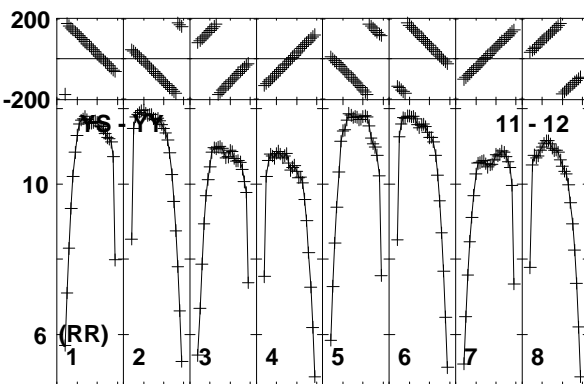
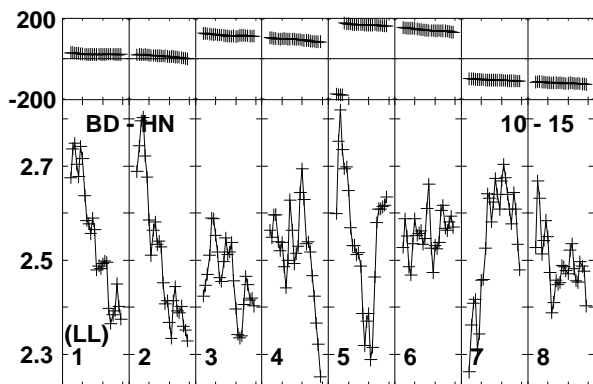
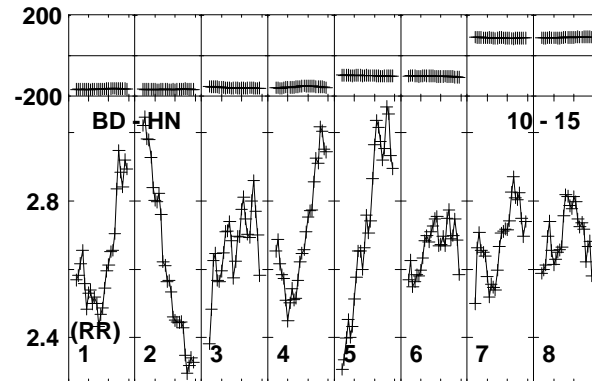
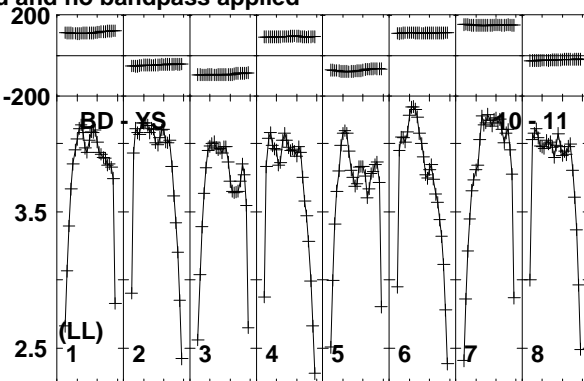
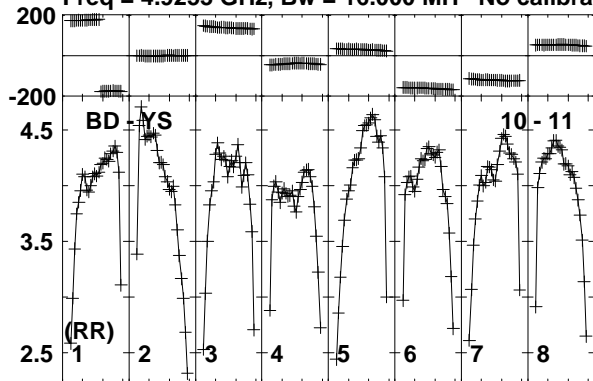

Lower frame: Milli Ampl Jy Top frame: Phas deg
Vector averaged cross-power spectrum Baseline: BD (10) - YS (11)
Timerange: 00/20:35:18 to 00/20:39:13

Plot file version 12 created 11-APR-2016 17:08:16

J1128+5925 GP053G 3.UVDATA.1

Freq = 4.9253 GHz, Bw = 16.000 MH No calibration applied and no bandpass applied

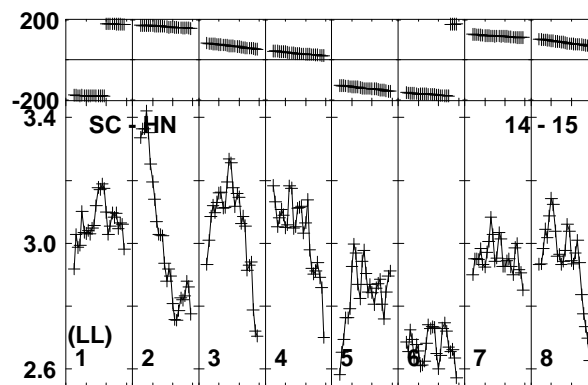
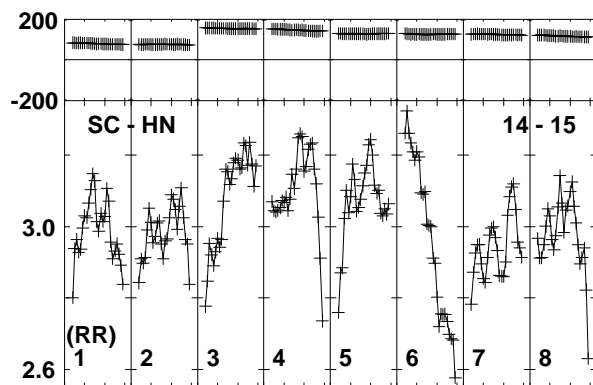
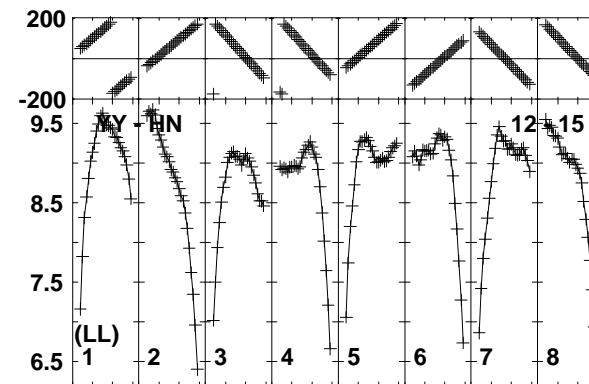
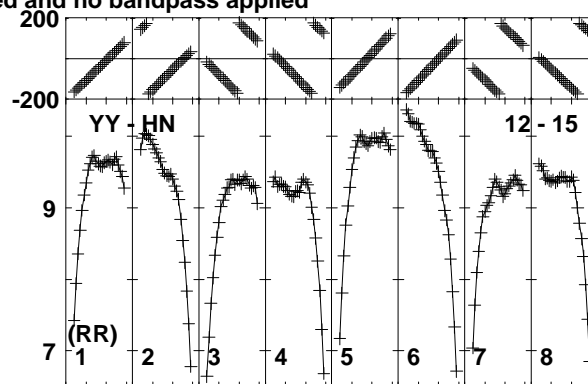
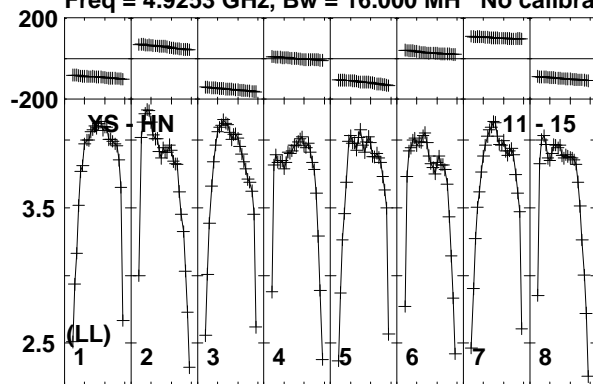

Lower frame: Milli Ampl Jy Top frame: Phas deg
Vector averaged cross-power spectrum Baseline: YS (11) - HN (15)
Timerange: 00/20:35:18 to 00/20:39:13

Plot file version 13 created 11-APR-2016 17:08:16

ARP299C GP053G 3.UVDATA.1

Freq = 4.9253 GHz, Bw = 16.000 MH No calibration applied and no bandpass applied

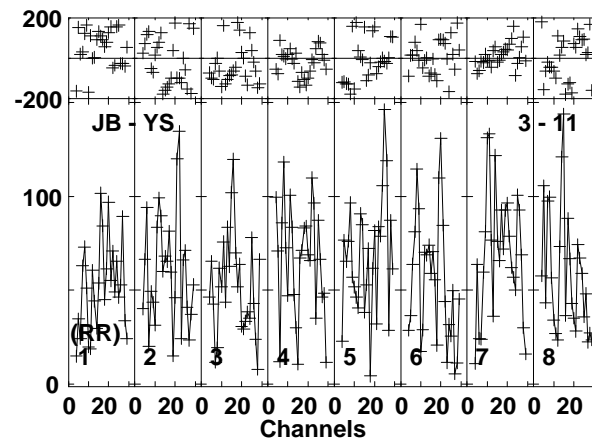
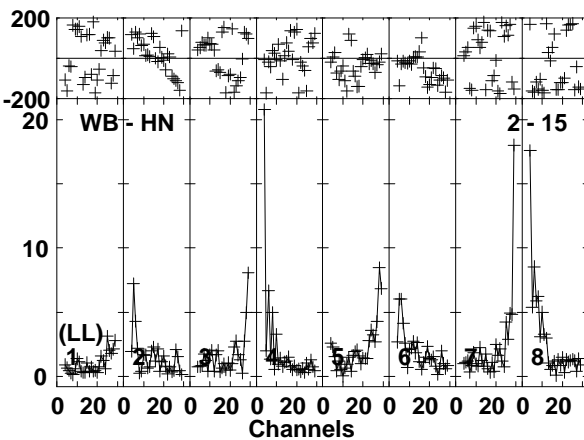
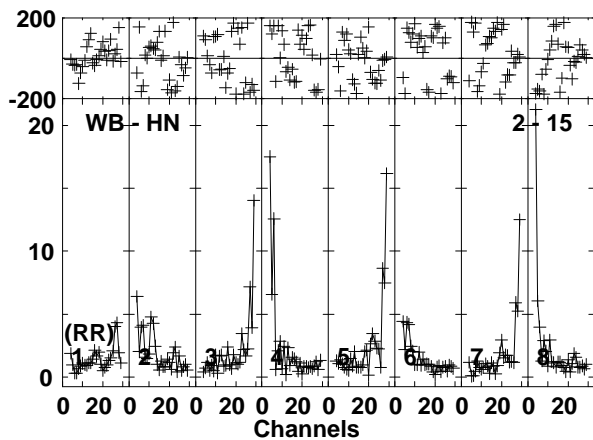
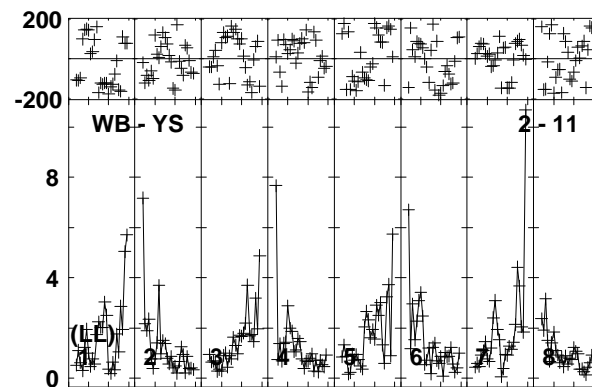
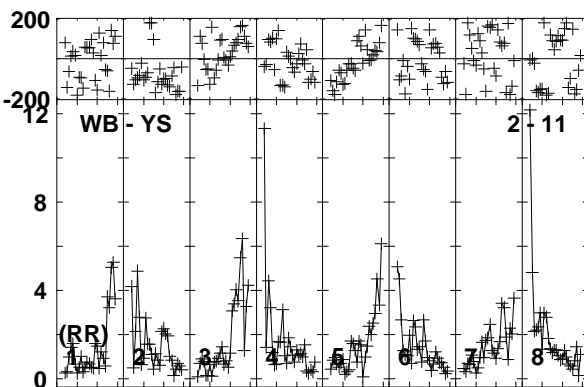
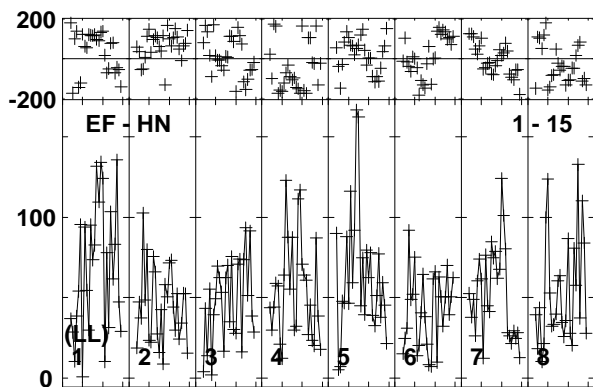
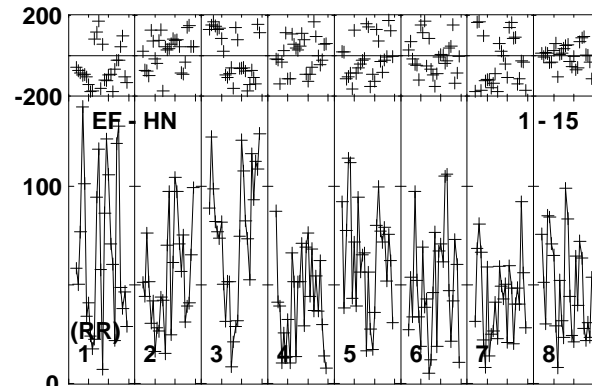
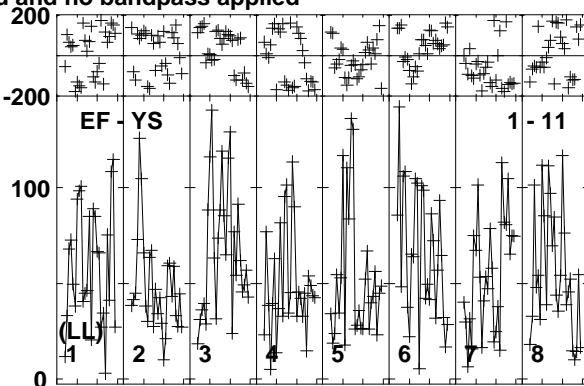
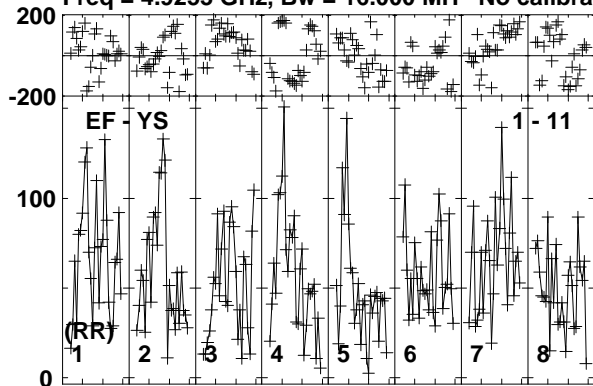

Lower frame: Micro Ampl Jy Top frame: Phas deg
Vector averaged cross-power spectrum Baseline: EF (01) - YS (11)
Timerange: 00/20:39:19 to 00/20:44:31

Plot file version 14 created 11-APR-2016 17:08:16

ARP299C GP053G 3.UVDATA.1

Freq = 4.9253 GHz, Bw = 16.000 MH No calibration applied and no bandpass applied

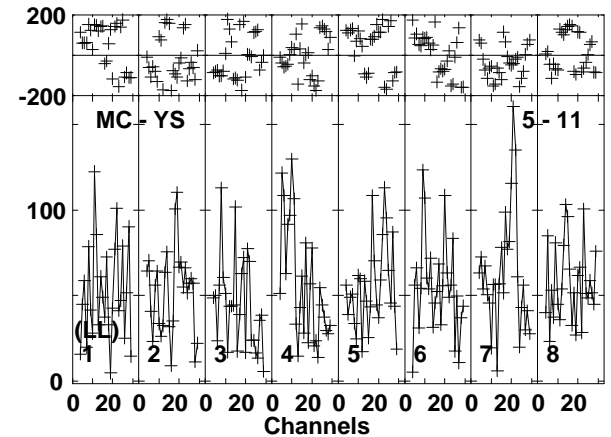
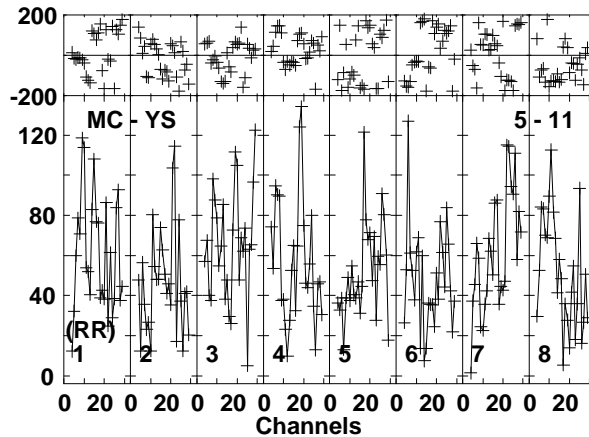
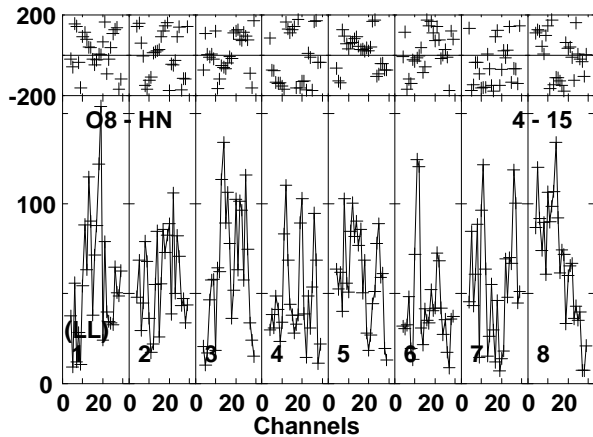
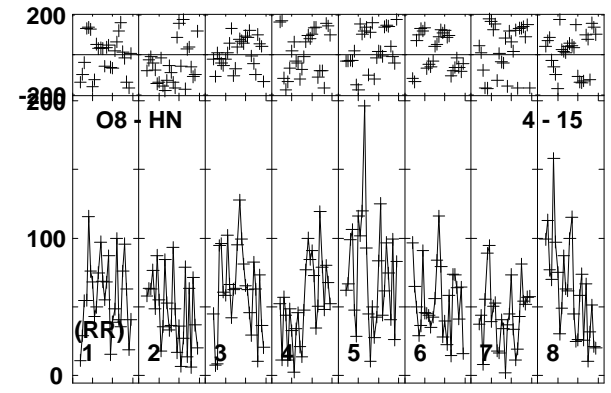
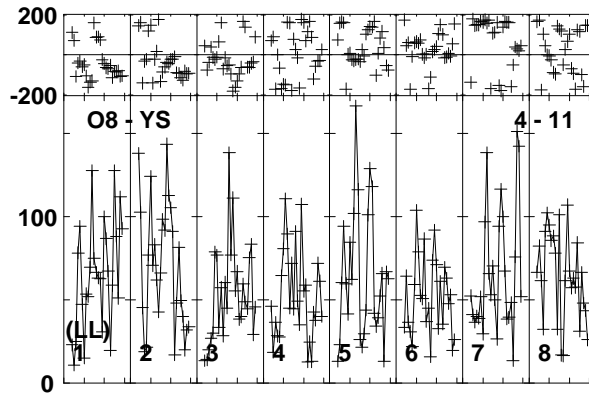
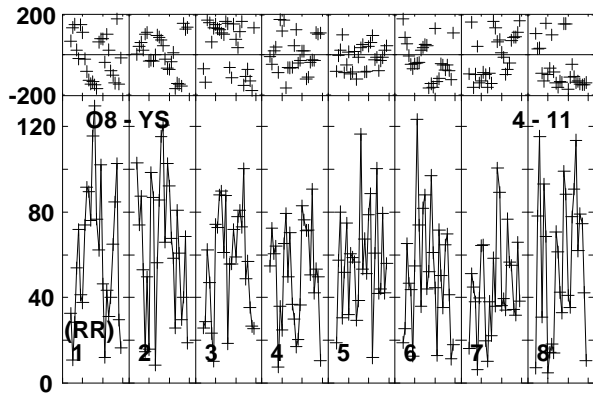
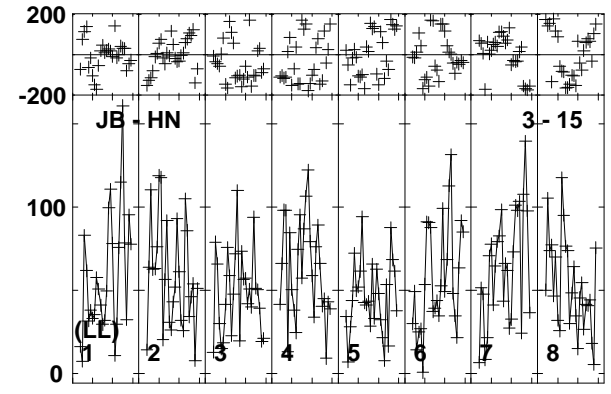
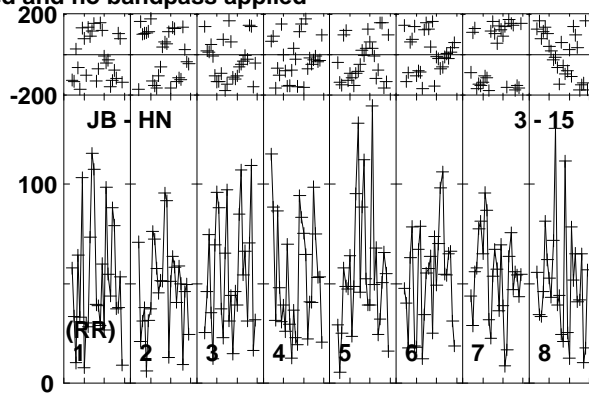
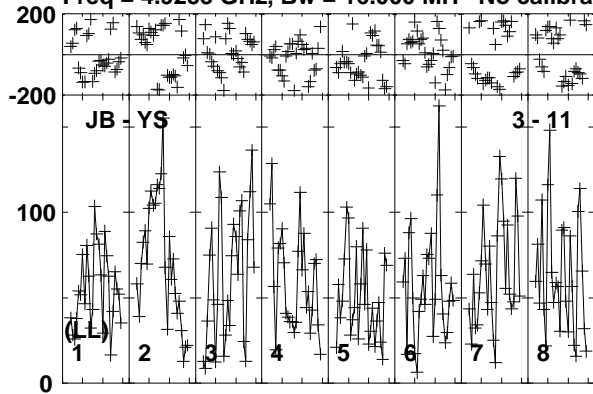

Lower frame: Micro Ampl Jy Top frame: Phas deg
Vector averaged cross-power spectrum Baseline: JB (03) - YS (11)
Timerange: 00/20:39:19 to 00/20:44:31

Plot file version 15 created 11-APR-2016 17:08:16

ARP299C GP053G 3.UVDATA.1

Freq = 4.9253 GHz, Bw = 16.000 MH No calibration applied and no bandpass applied

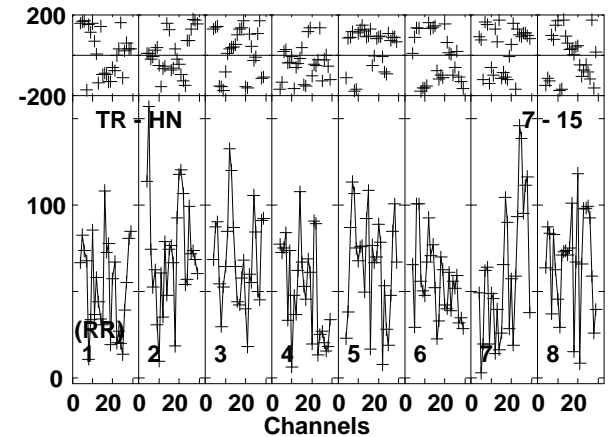
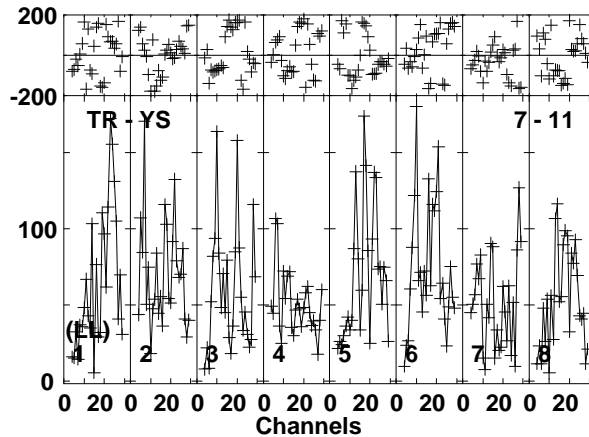
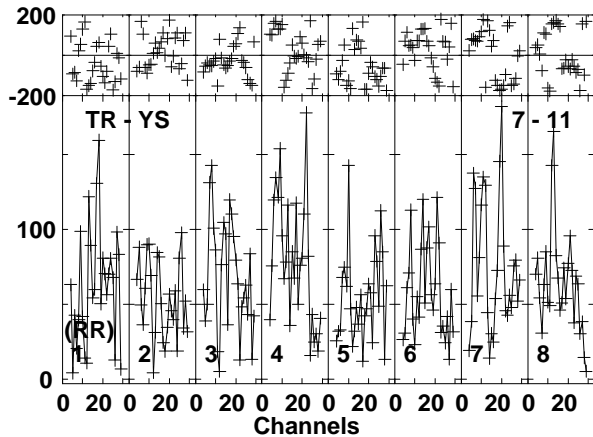
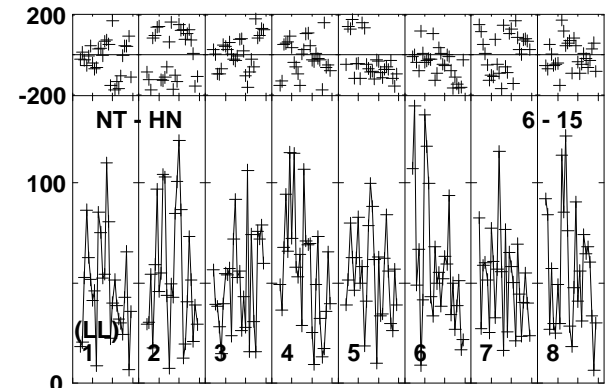
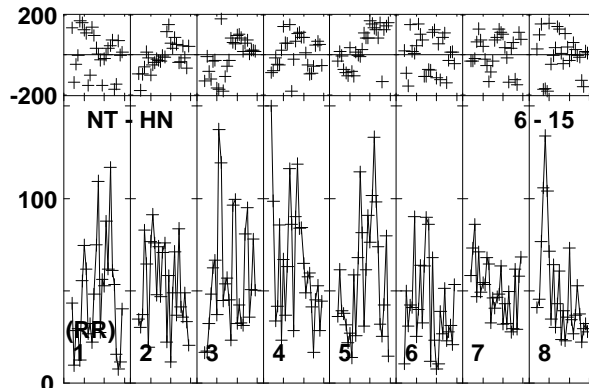
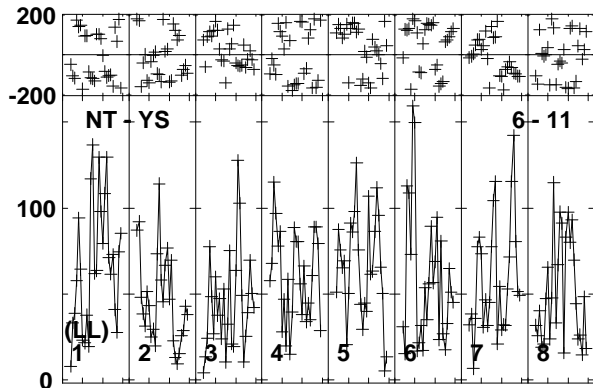
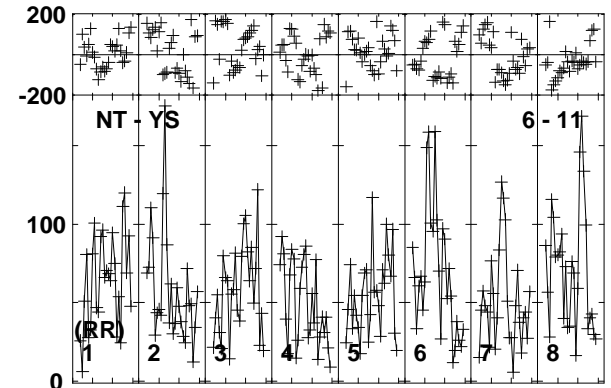
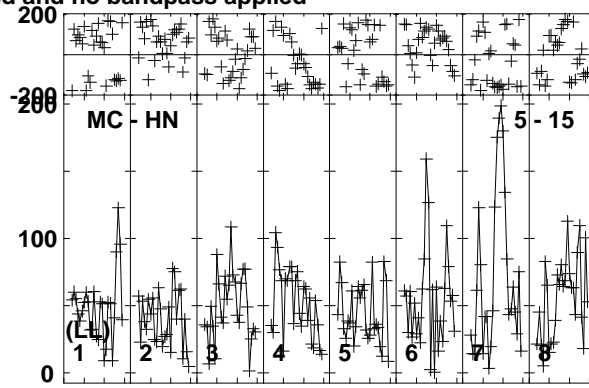
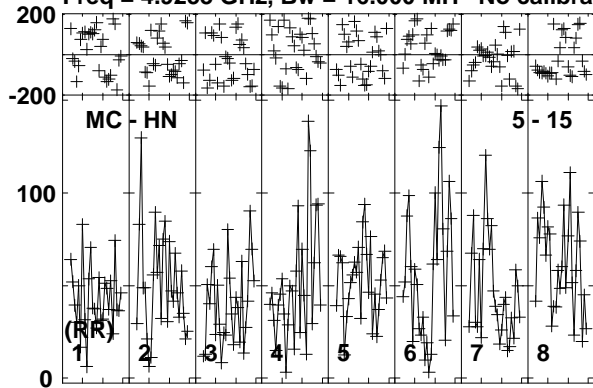

Lower frame: Micro Ampl Jy Top frame: Phas deg
Vector averaged cross-power spectrum Baseline: MC (05) - HN (15)
Timerange: 00/20:39:19 to 00/20:44:31

Plot file version 16 created 11-APR-2016 17:08:16

ARP299C GP053G 3.UVDATA.1

Freq = 4.9253 GHz, Bw = 16.000 MH No calibration applied and no bandpass applied

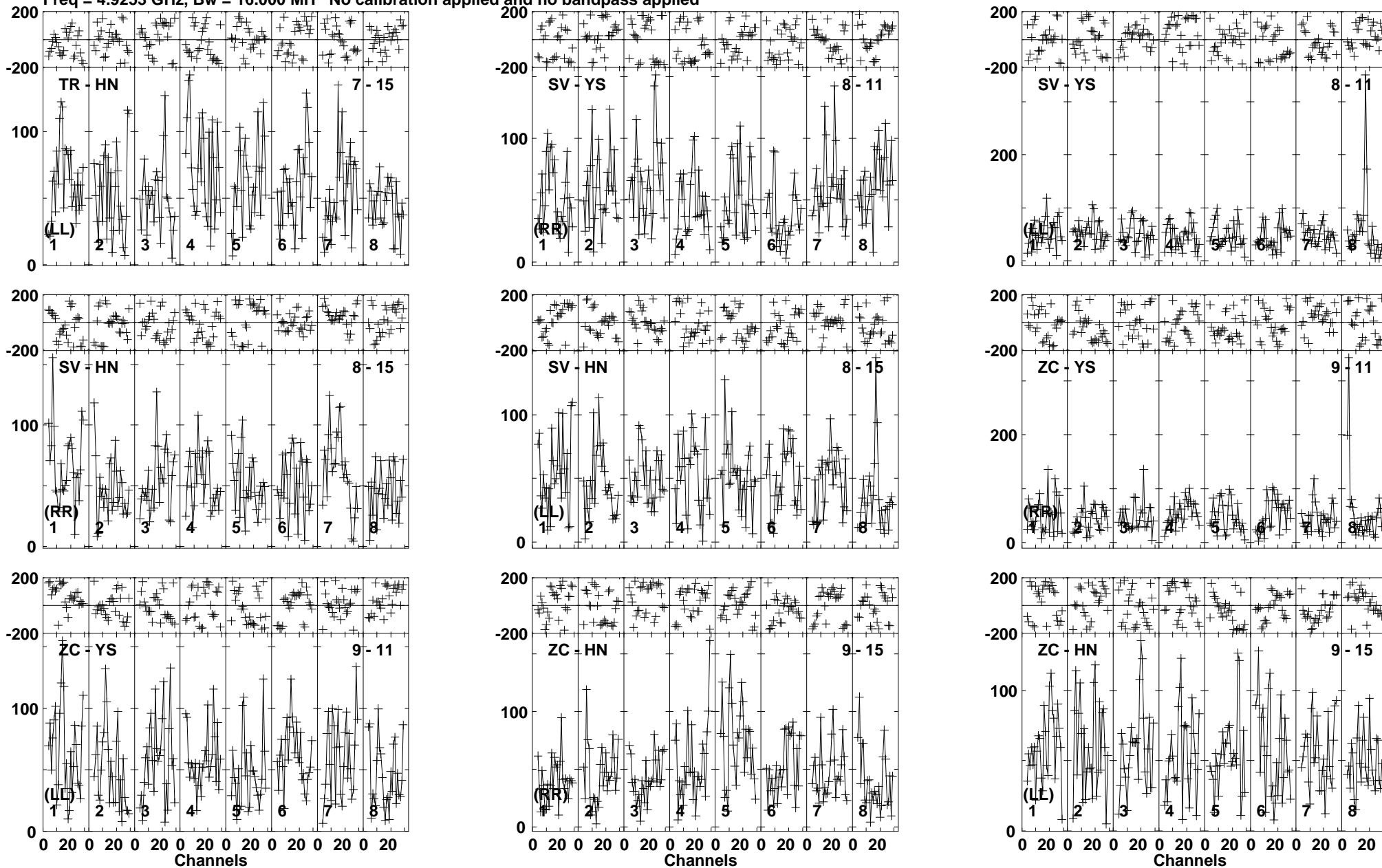

Lower frame: Micro Ampl Jy Top frame: Phas deg
Vector averaged cross-power spectrum Baseline: TR (07) - HN (15)
Timerange: 00/20:39:19 to 00/20:44:31

Plot file version 17 created 11-APR-2016 17:08:16

ARP299C GP053G 3.UVDATA.1

Freq = 4.9253 GHz, Bw = 16.000 MH No calibration applied and no bandpass applied

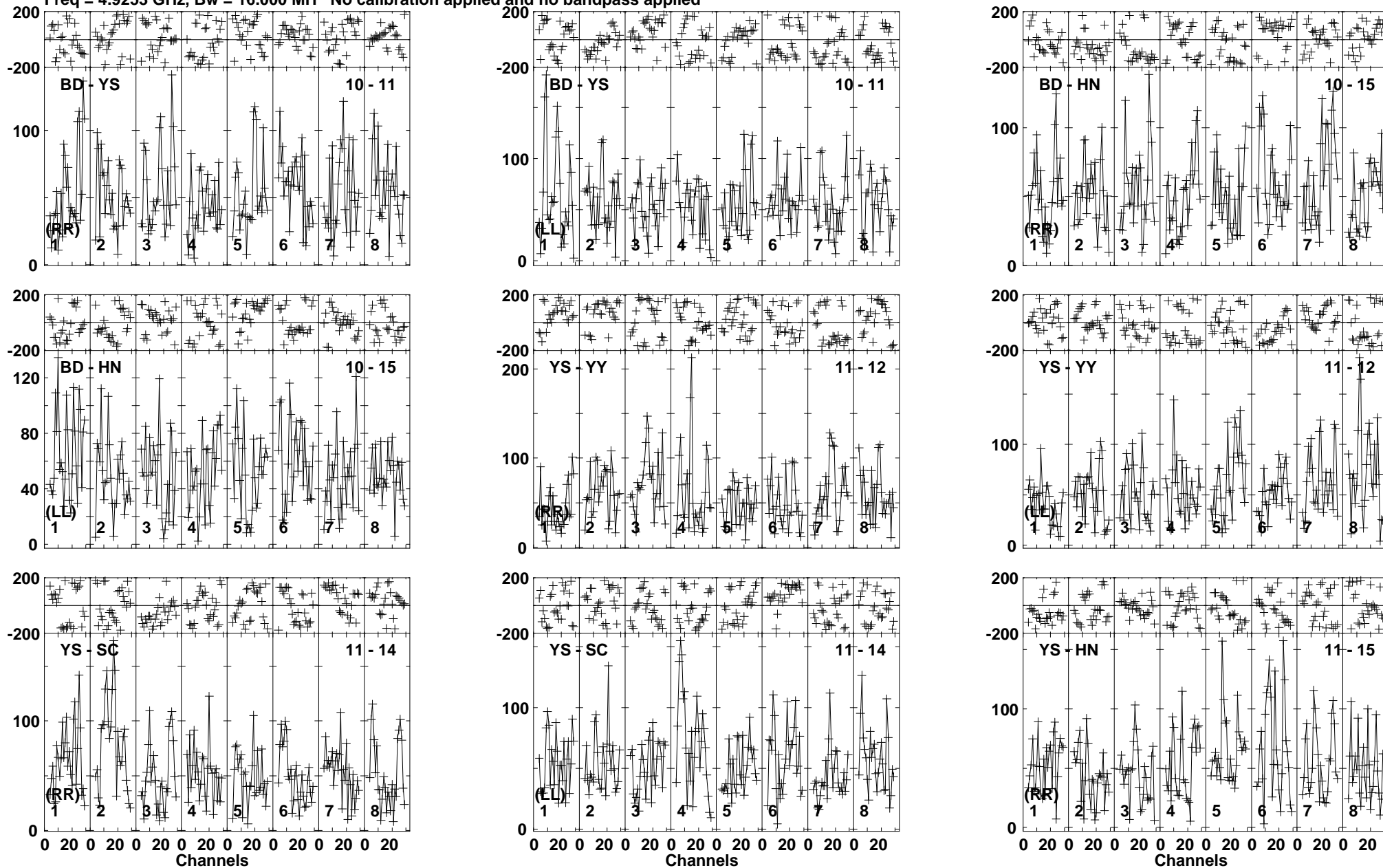

Lower frame: Micro Ampl Jy Top frame: Phas deg
Vector averaged cross-power spectrum Baseline: BD (10) - YS (11)
Timerange: 00/20:39:19 to 00/20:44:31

Plot file version 18 created 11-APR-2016 17:08:17

ARP299C GP053G 3.UVDATA.1

Freq = 4.9253 GHz, Bw = 16.000 MH No calibration applied and no bandpass applied

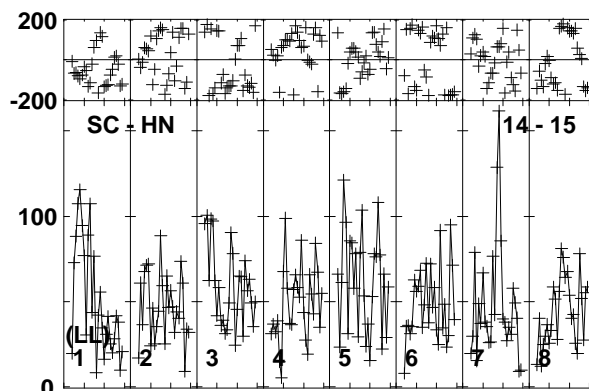
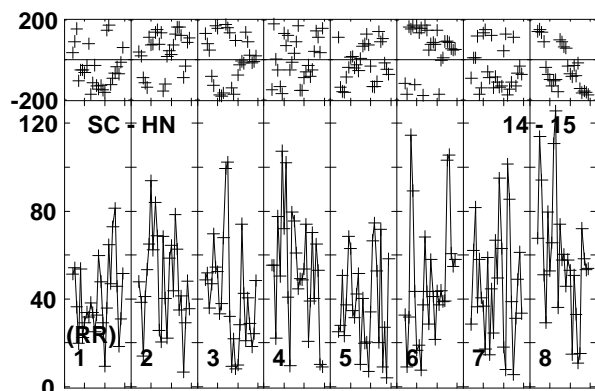
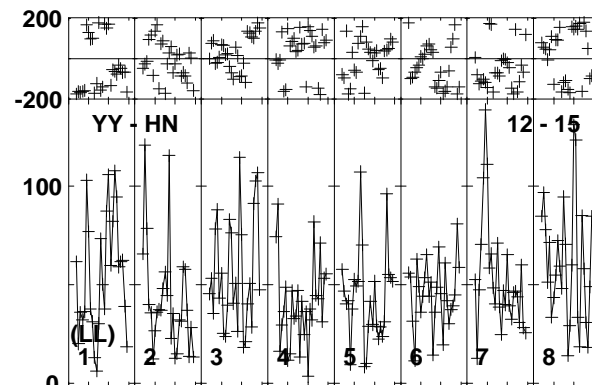
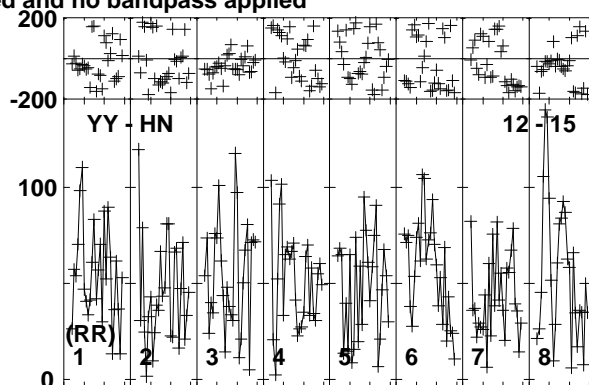
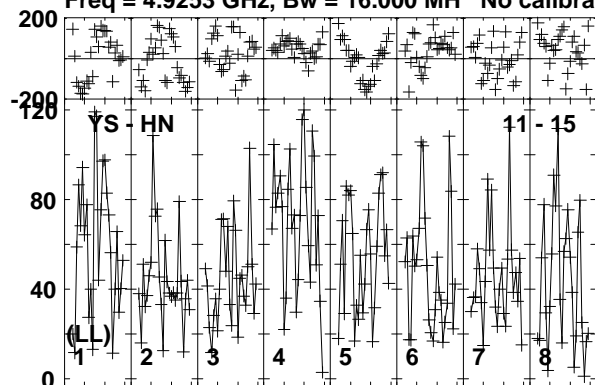

Lower frame: Micro Ampl Jy Top frame: Phas deg
Vector averaged cross-power spectrum Baseline: YS (11) - HN (15)
Timerange: 00/20:39:19 to 00/20:44:31

Plot file version 19 created 11-APR-2016 17:08:17

J1128+5925 GP053G 3.UVDATA.1

Freq = 4.9253 GHz, Bw = 16.000 MH No calibration applied and no bandpass applied

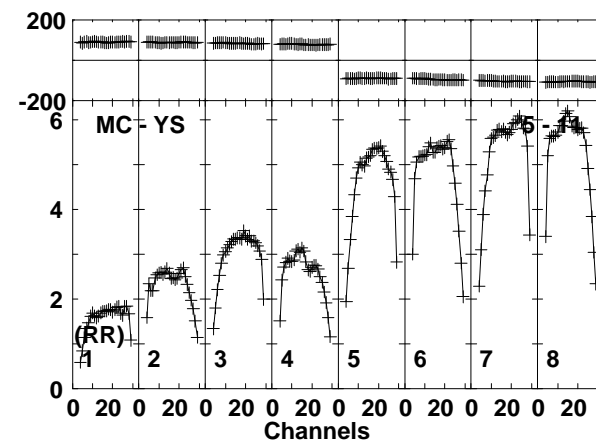
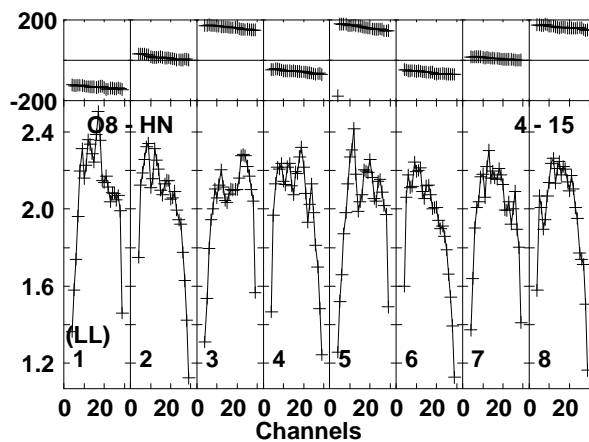
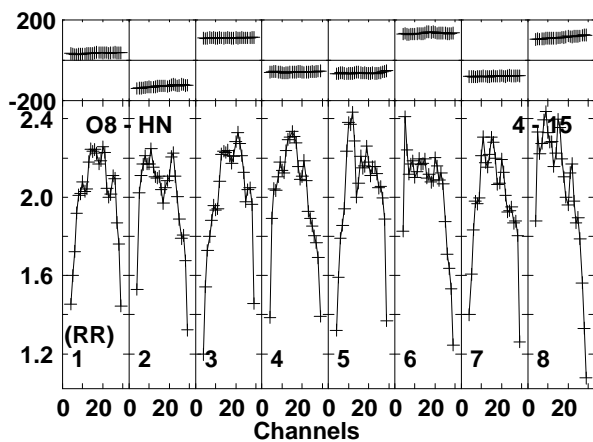
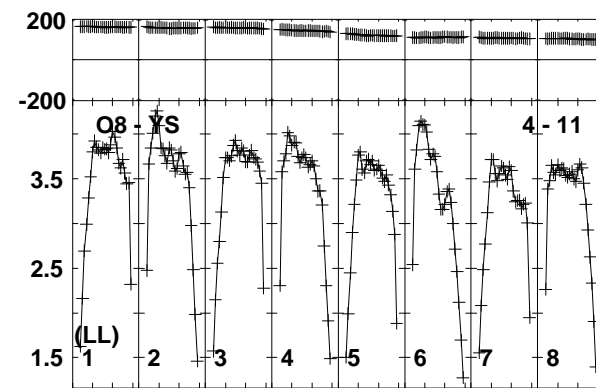
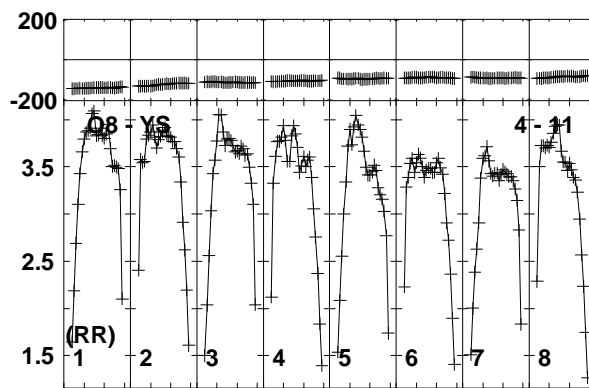
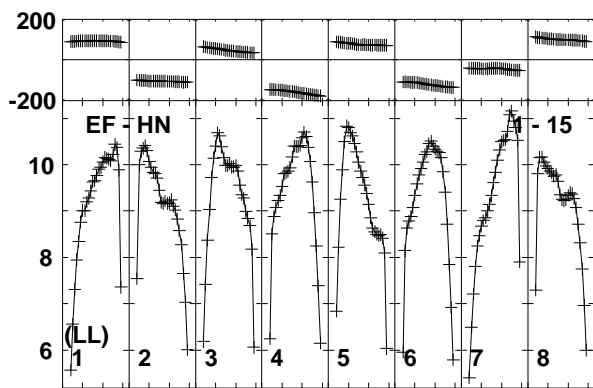
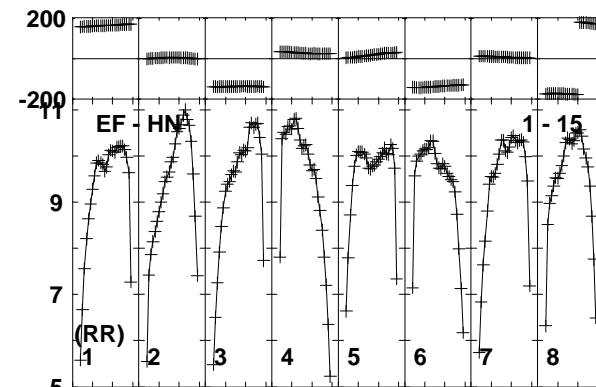
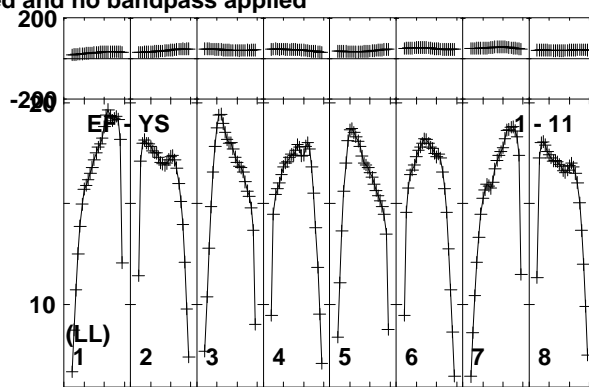
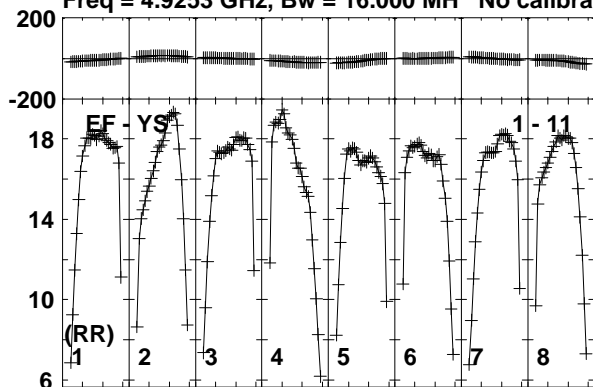

Lower frame: Milli Ampl Jy Top frame: Phas deg
Vector averaged cross-power spectrum Baseline: EF (01) - YS (11)
Timerange: 00/20:44:37 to 00/20:46:28

Plot file version 20 created 11-APR-2016 17:08:17

J1128+5925 GP053G 3.UVDATA.1

Freq = 4.9253 GHz, Bw = 16.000 MH No calibration applied and no bandpass applied

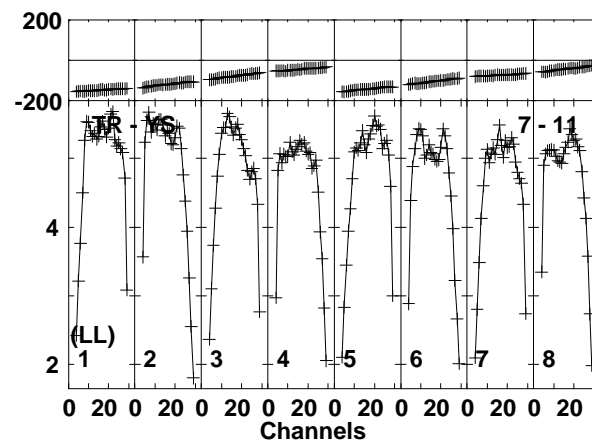
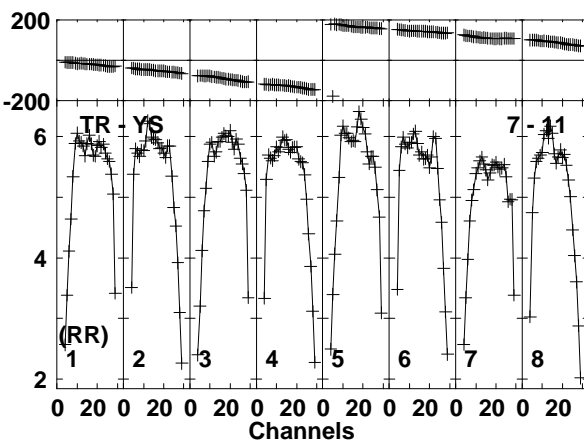
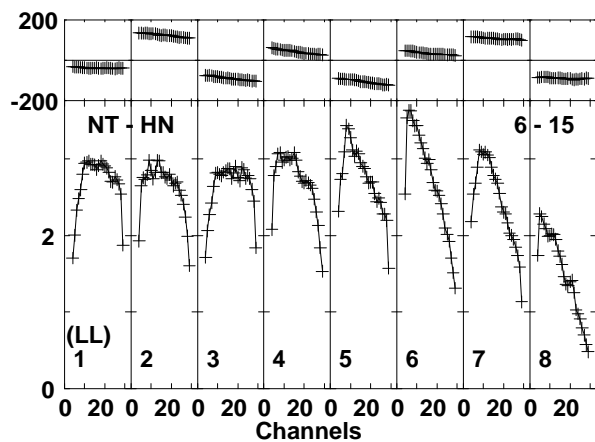
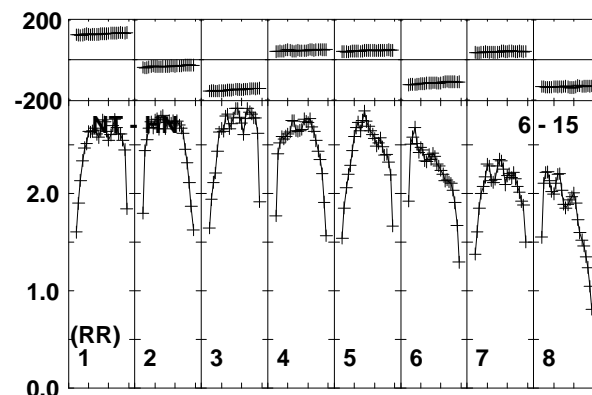
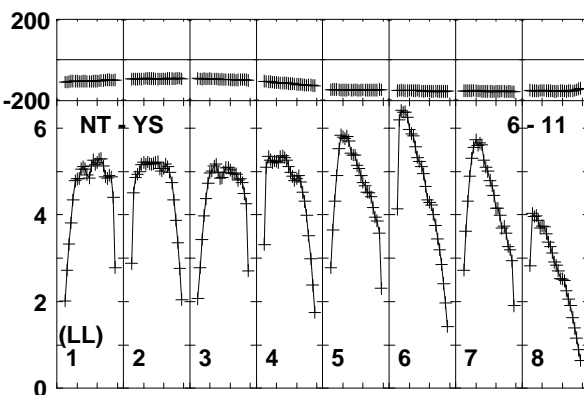
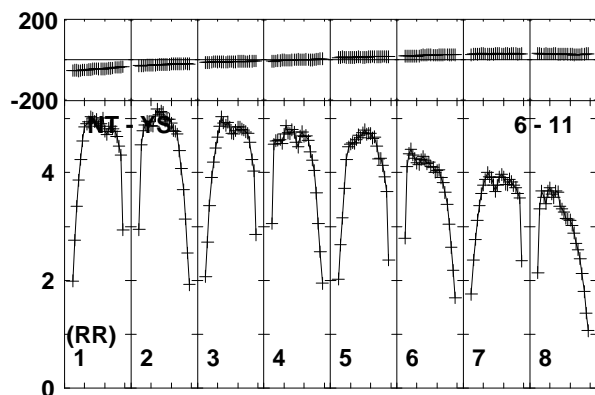
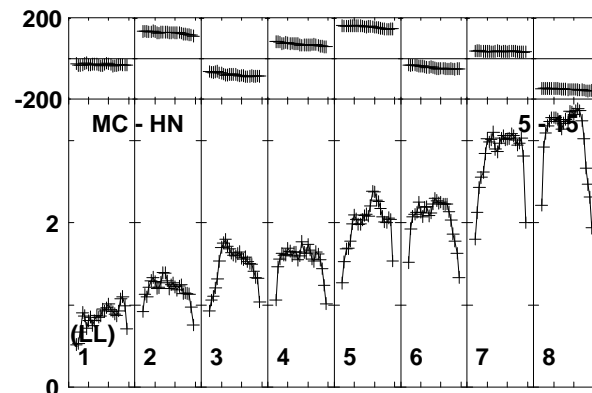
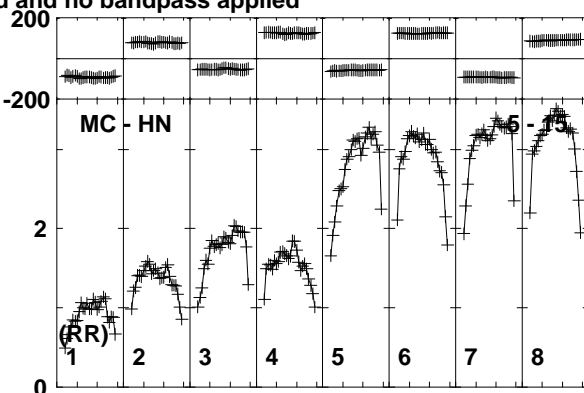
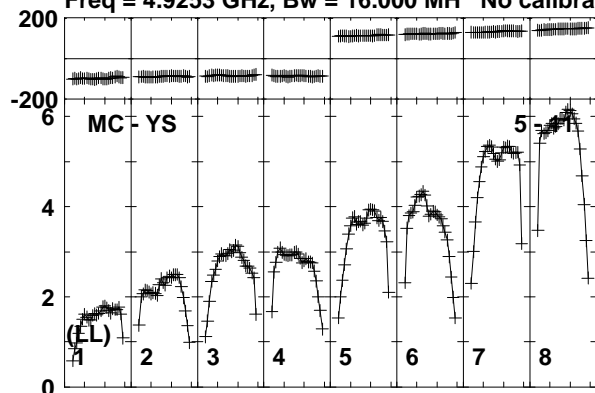

Lower frame: Milli Ampl Jy Top frame: Phas deg

Vector averaged cross-power spectrum Baseline: MC (05) - YS (11)

Timerange: 00/20:44:37 to 00/20:46:28

Plot file version 21 created 11-APR-2016 17:08:17

J1128+5925 GP053G 3.UVDATA.1

Freq = 4.9253 GHz, Bw = 16.000 MH No calibration applied and no bandpass applied

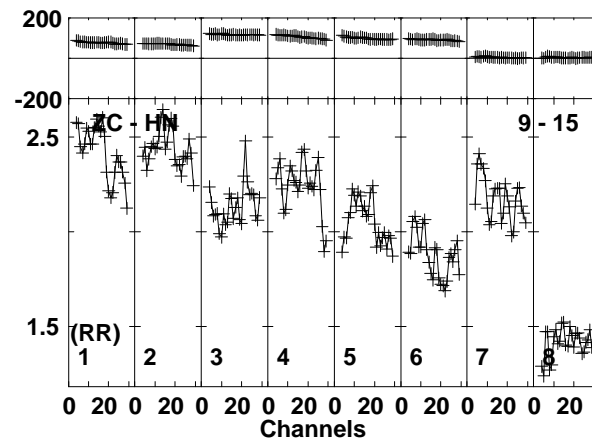
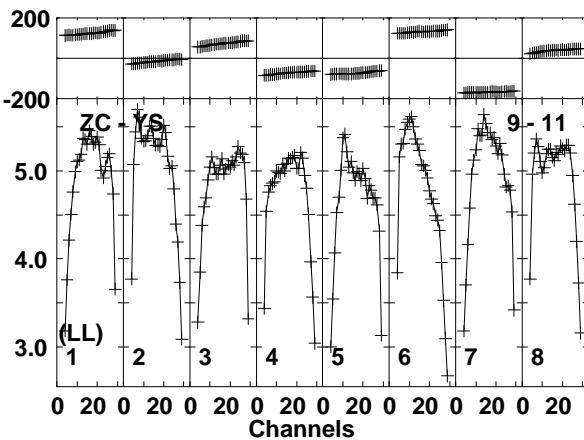
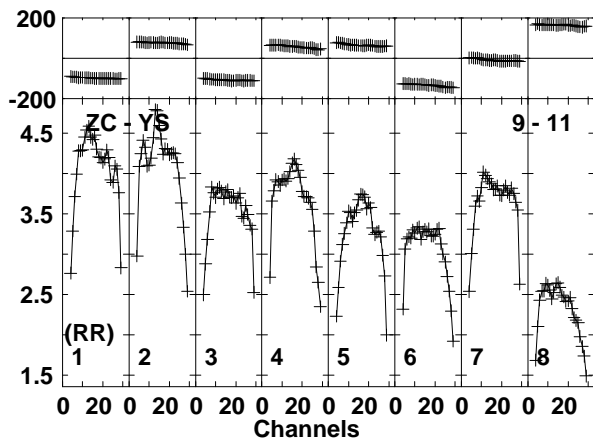
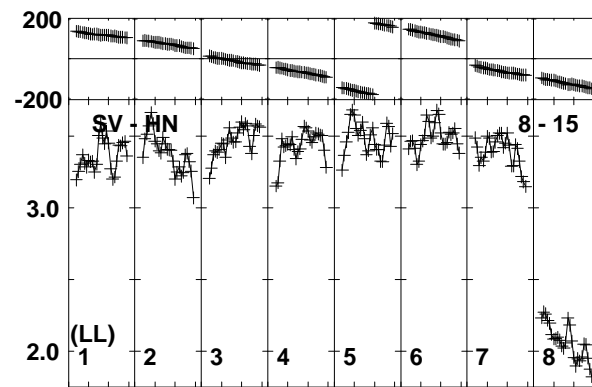
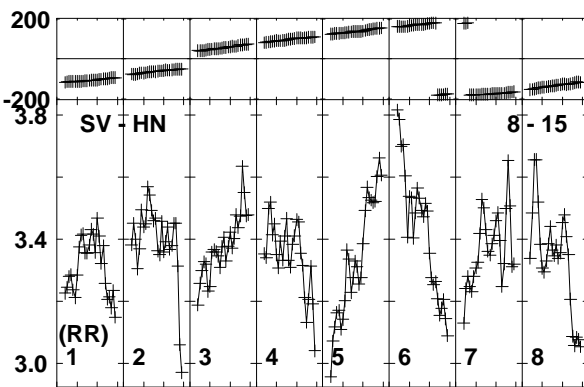
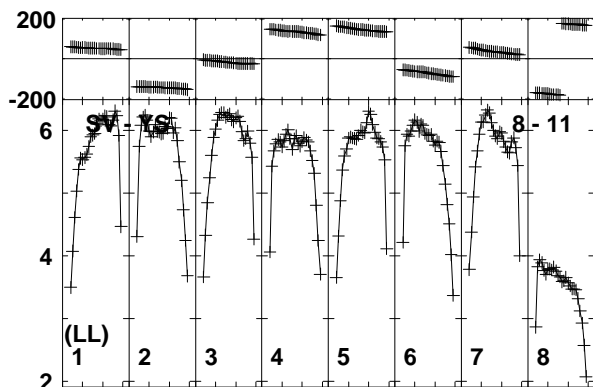
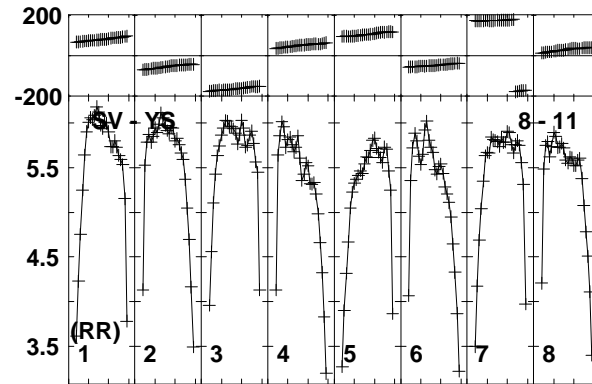
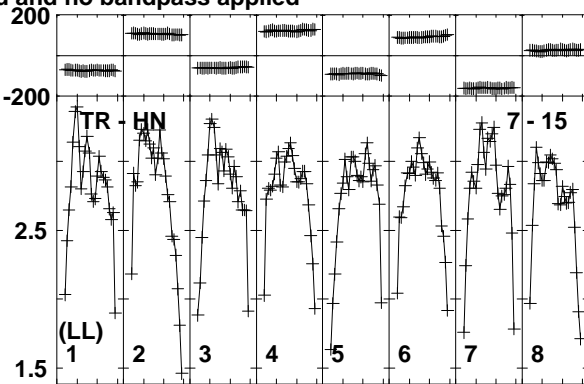
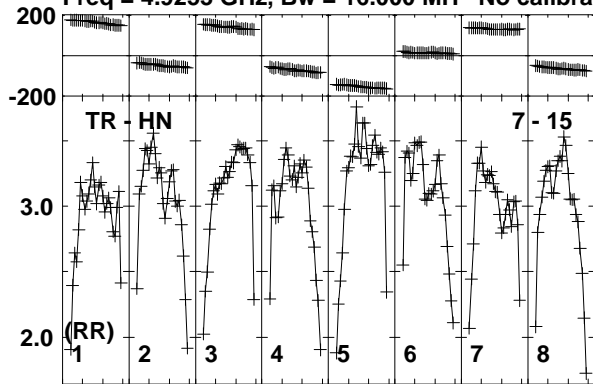

Lower frame: Milli Ampl Jy Top frame: Phas deg
Vector averaged cross-power spectrum Baseline: TR (07) - HN (15)
Timerange: 00/20:44:37 to 00/20:46:28

Plot file version 22 created 11-APR-2016 17:08:17

J1128+5925 GP053G 3.UVDATA.1

Freq = 4.9253 GHz, Bw = 16.000 MH No calibration applied and no bandpass applied

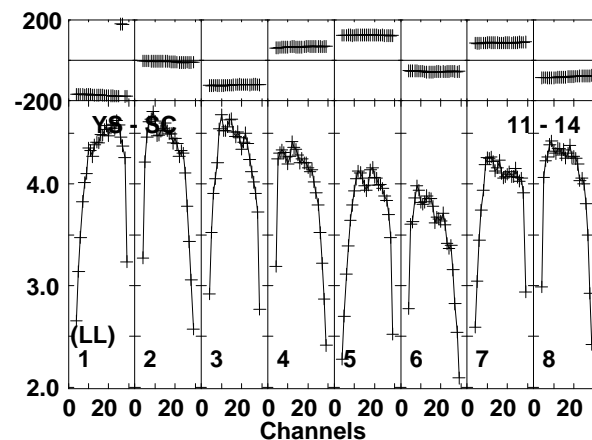
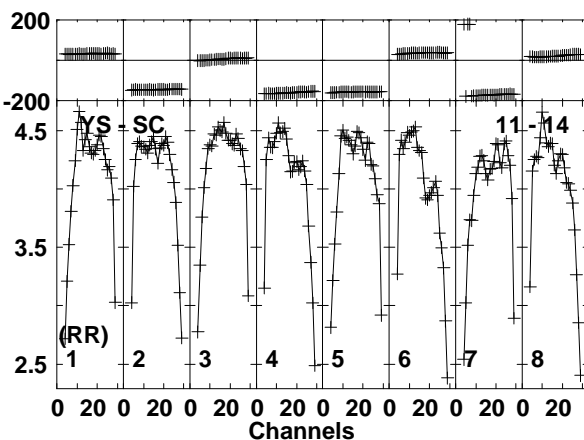
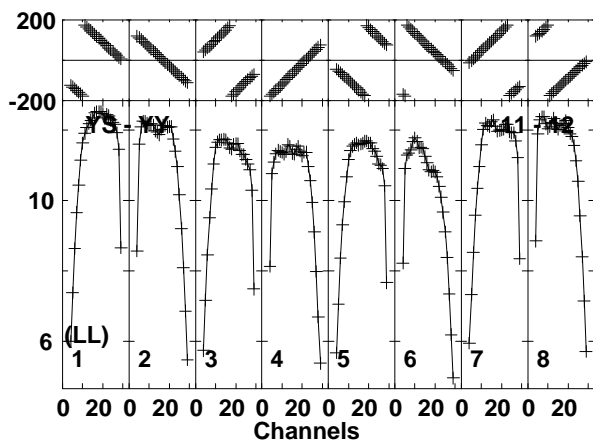
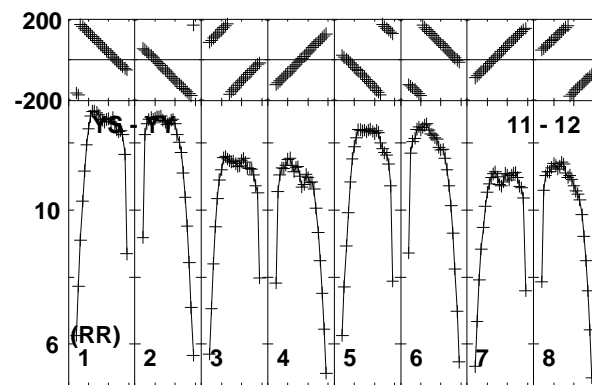
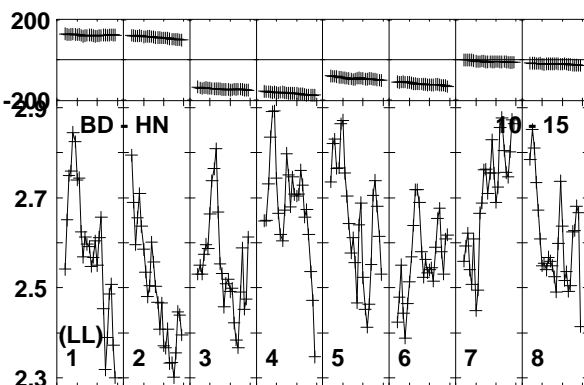
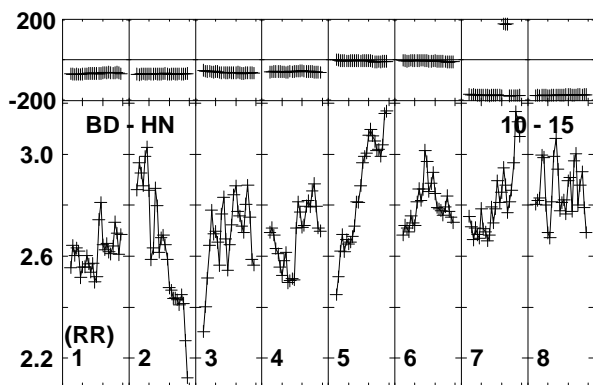
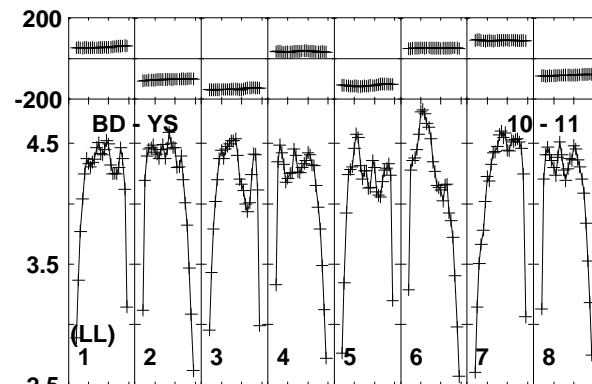
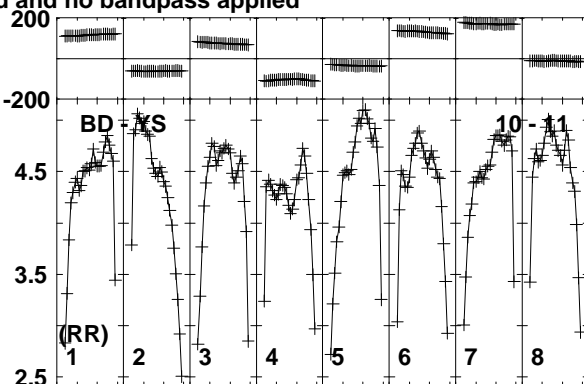
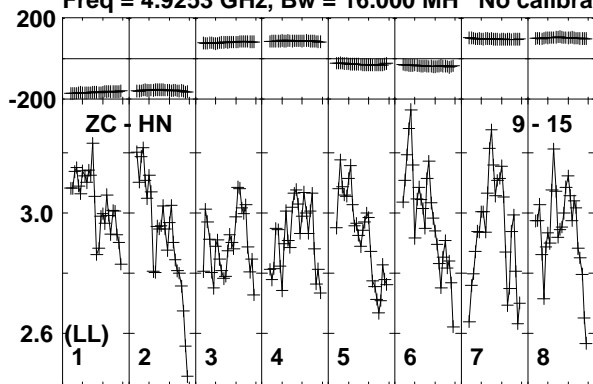

Lower frame: Milli Ampl Jy Top frame: Phas deg
Vector averaged cross-power spectrum Baseline: ZC (09) - HN (15)
Timerange: 00/20:44:37 to 00/20:46:28

Plot file version 23 created 11-APR-2016 17:08:17

J1128+5925 GP053G 3.UVDATA.1

Freq = 4.9253 GHz, Bw = 16.000 MH No calibration applied and no bandpass applied

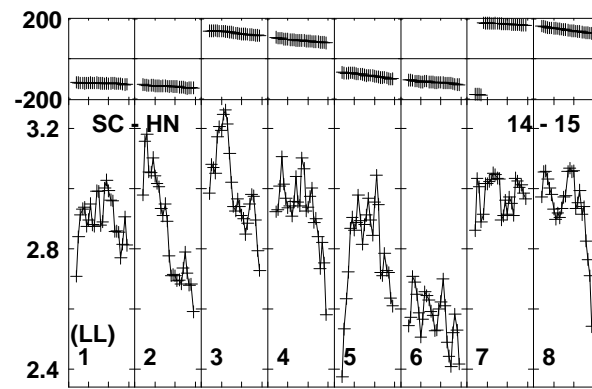
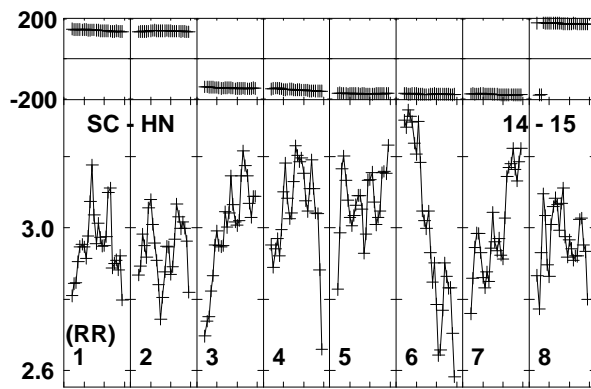
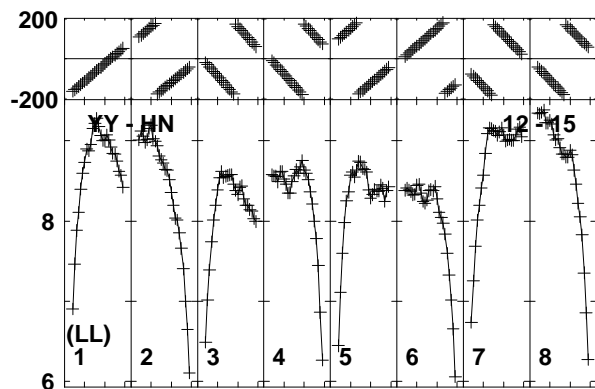
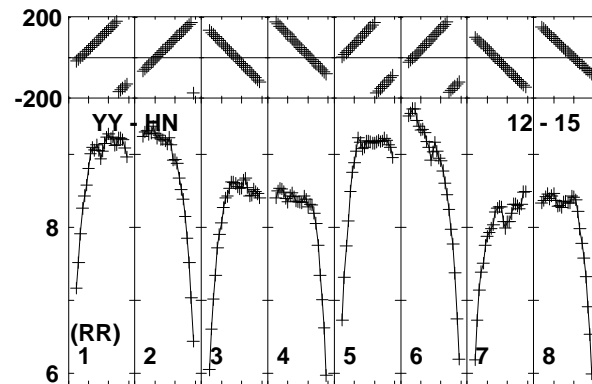
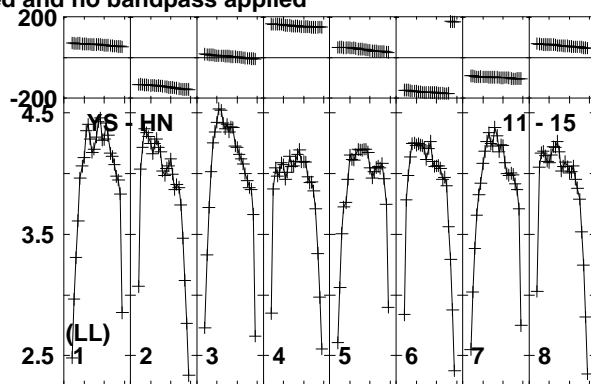
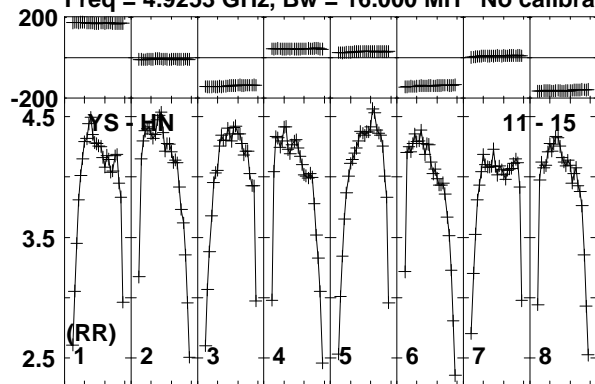

Lower frame: Milli Ampl Jy Top frame: Phas deg
Vector averaged cross-power spectrum Baseline: YS (11) - HN (15)
Timerange: 00/20:44:37 to 00/20:46:28

Plot file version 24 created 11-APR-2016 17:08:18

ARP299C GP053G 3.UVDATA.1

Freq = 4.9253 GHz, Bw = 16.000 MH No calibration applied and no bandpass applied

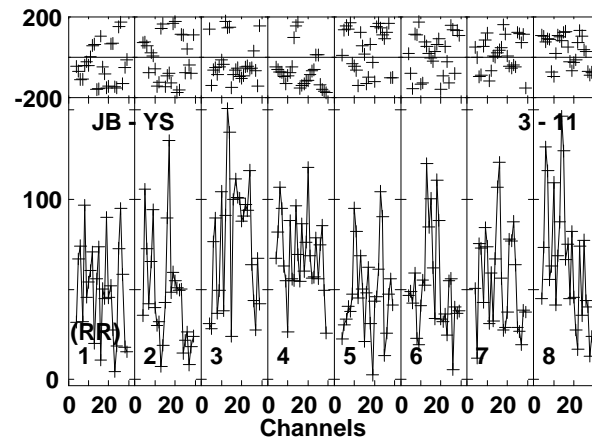
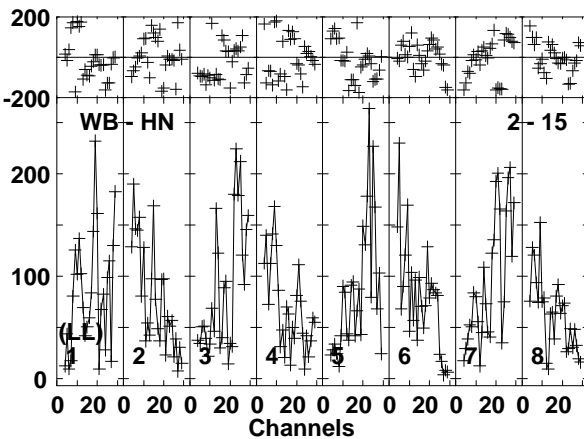
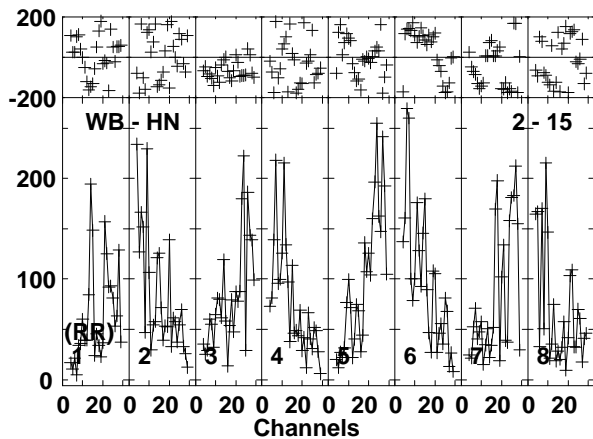
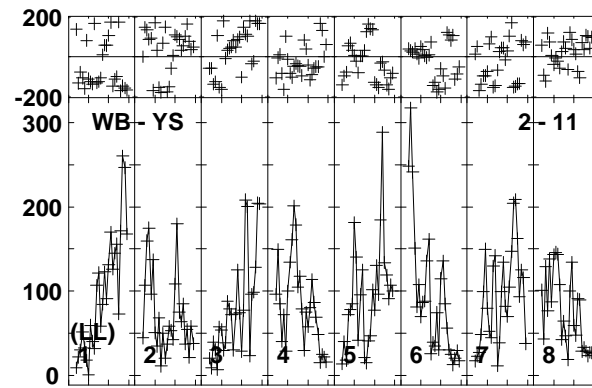
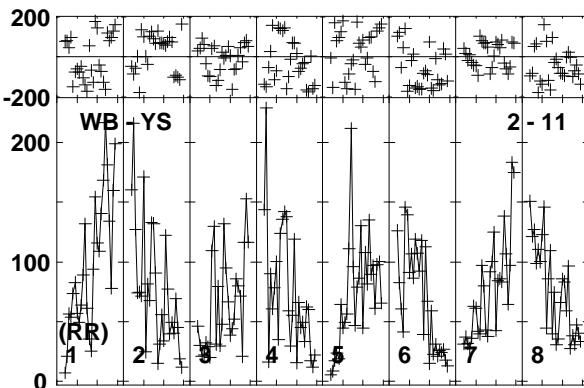
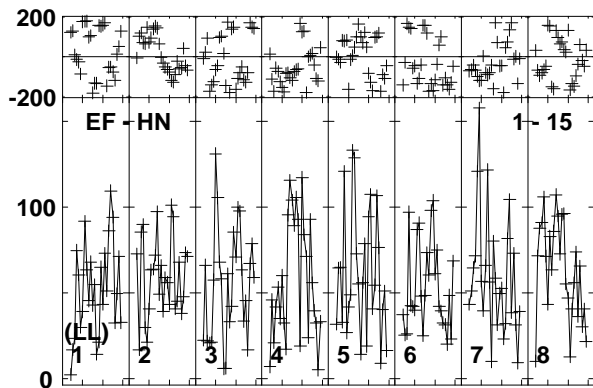
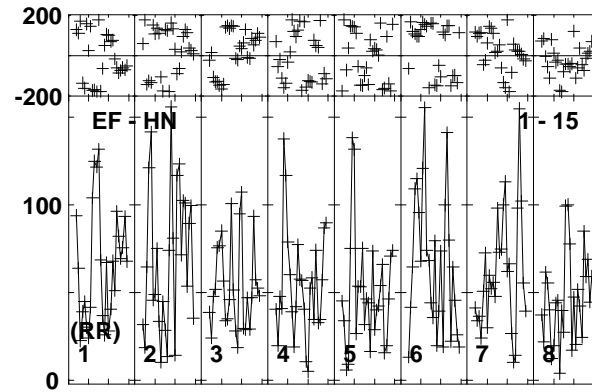
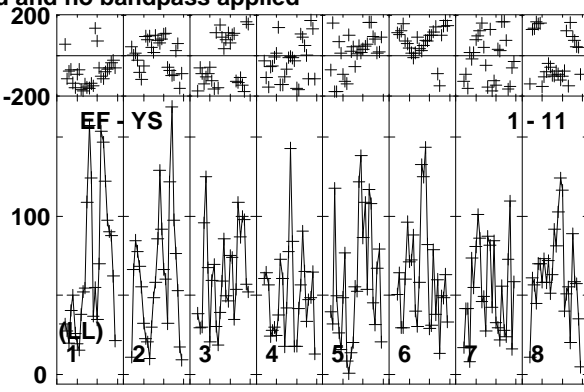
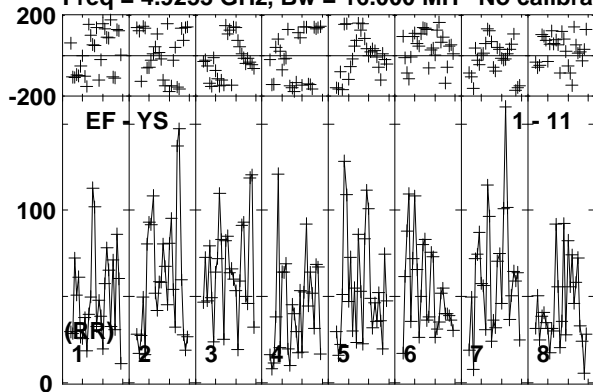

Lower frame: Micro Ampl Jy Top frame: Phas deg
Vector averaged cross-power spectrum Baseline: EF (01) - YS (11)
Timerange: 00/20:46:33 to 00/20:51:47

Plot file version 25 created 11-APR-2016 17:08:18

ARP299C GP053G 3.UVDATA.1

Freq = 4.9253 GHz, Bw = 16.000 MH No calibration applied and no bandpass applied

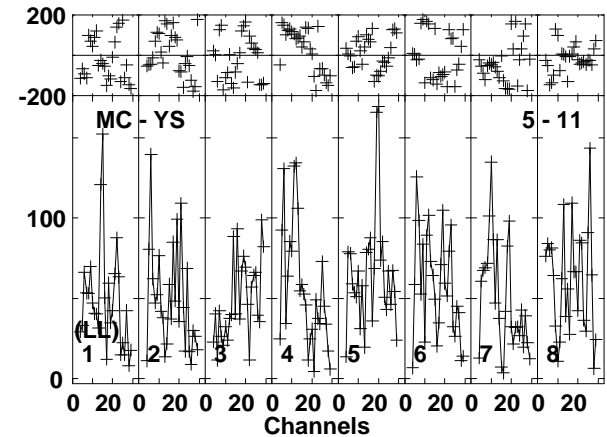
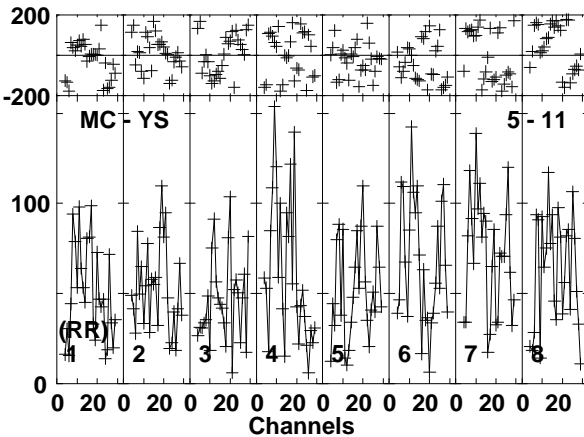
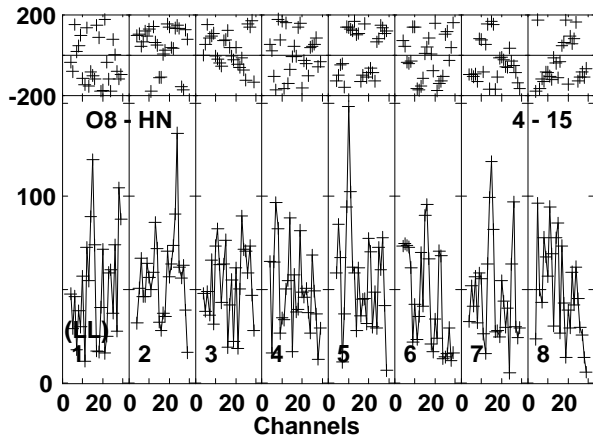
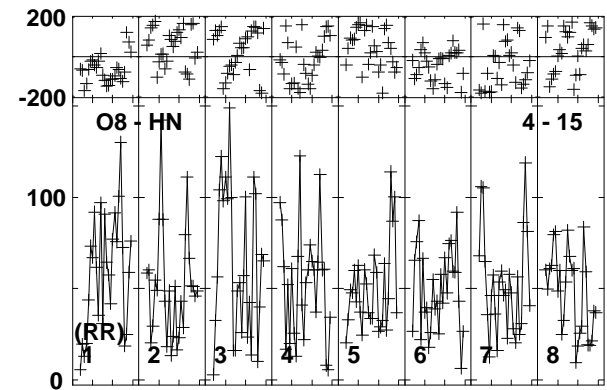
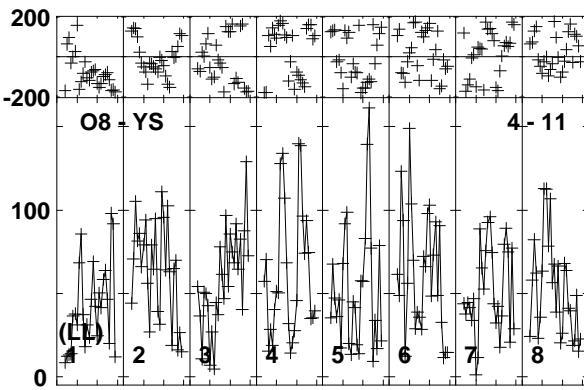
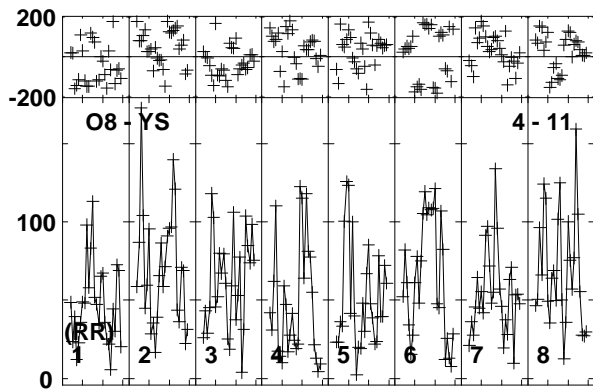
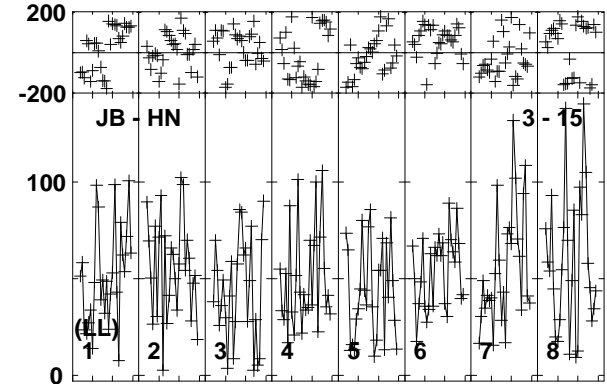
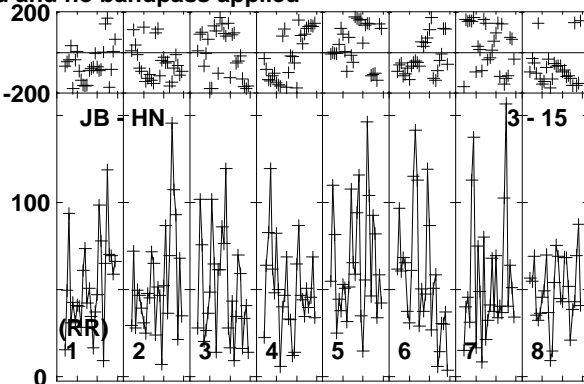
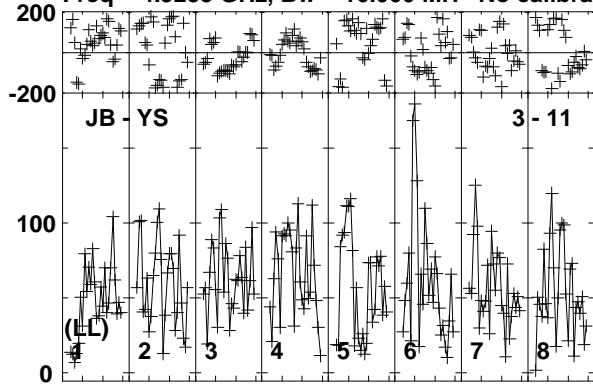

Lower frame: Micro Ampl Jy Top frame: Phas deg
Vector averaged cross-power spectrum Baseline: JB (03) - YS (11)
Timerange: 00/20:46:33 to 00/20:51:47

Plot file version 26 created 11-APR-2016 17:08:18

ARP299C GP053G 3.UVDATA.1

Freq = 4.9253 GHz, Bw = 16.000 MH No calibration applied and no bandpass applied

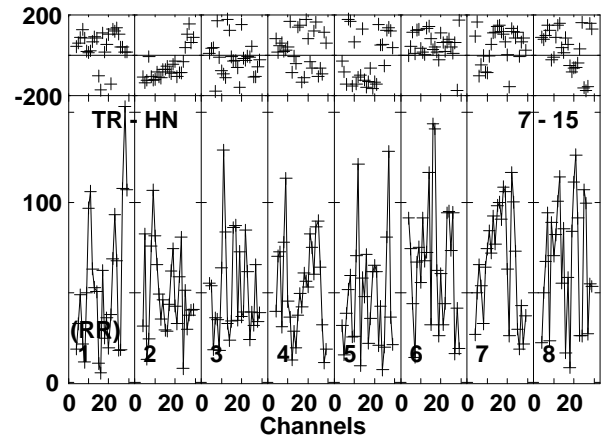
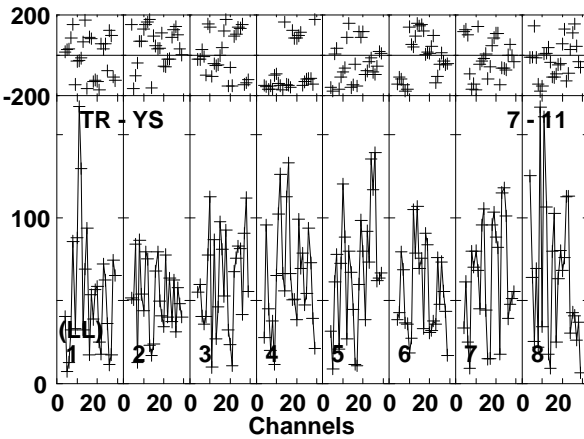
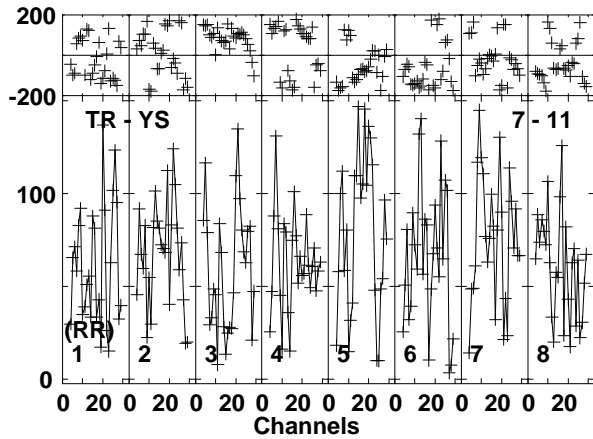
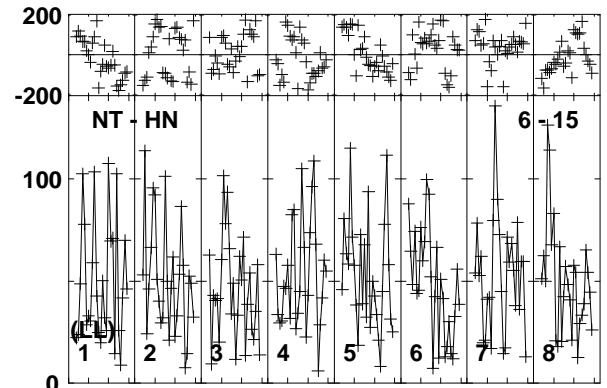
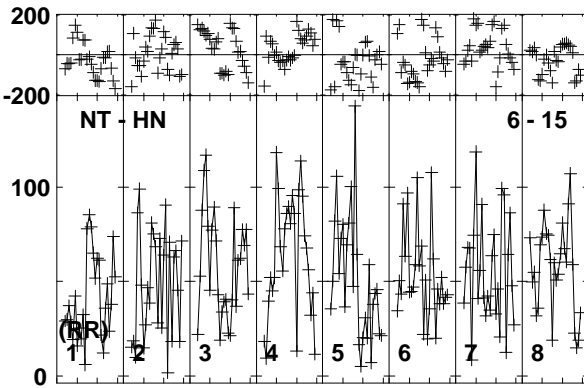
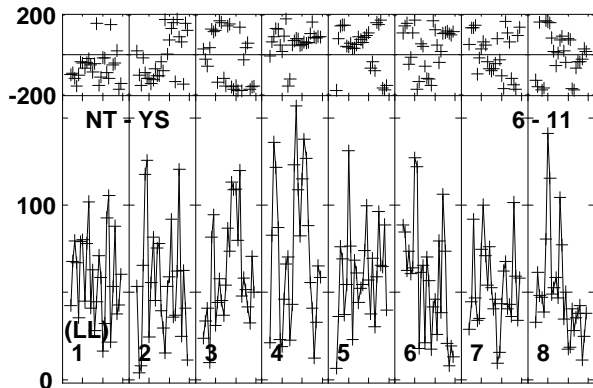
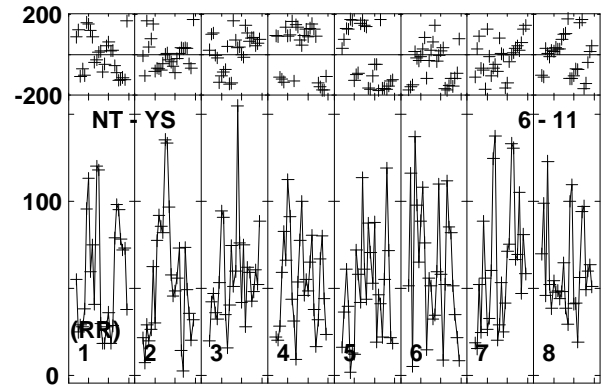
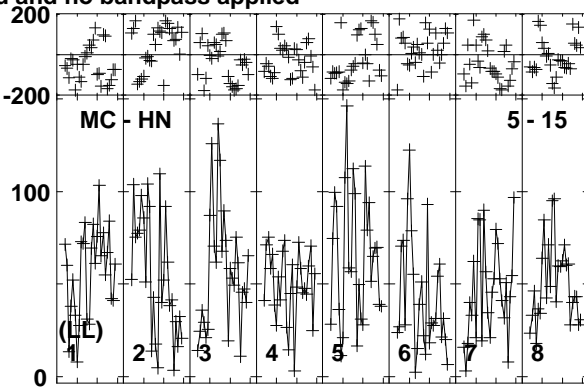
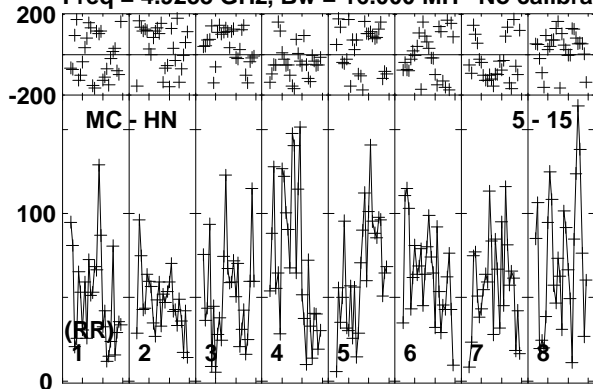

Lower frame: Micro Ampl Jy Top frame: Phas deg
Vector averaged cross-power spectrum Baseline: MC (05) - HN (15)
Timerange: 00/20:46:33 to 00/20:51:47

Plot file version 27 created 11-APR-2016 17:08:18

ARP299C GP053G 3.UVDATA.1

Freq = 4.9253 GHz, Bw = 16.000 MH No calibration applied and no bandpass applied

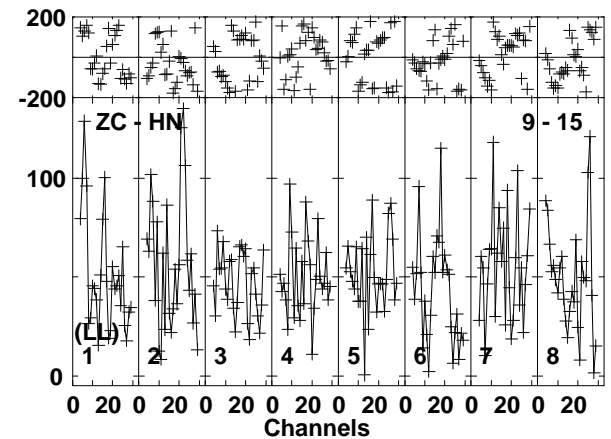
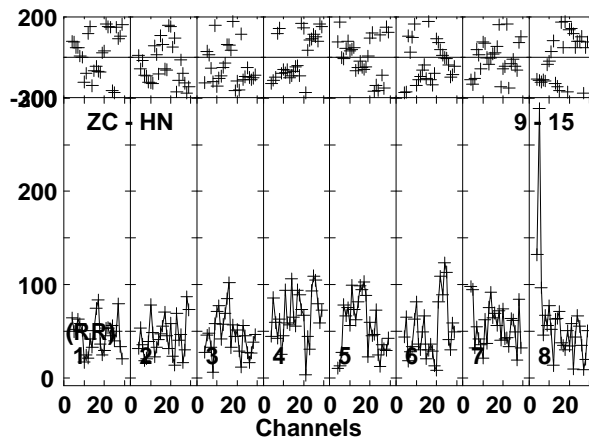
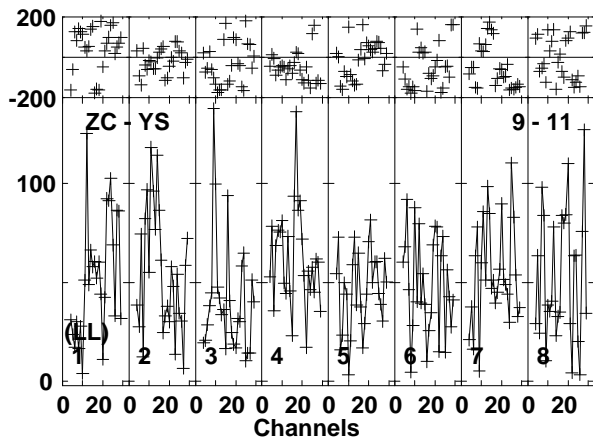
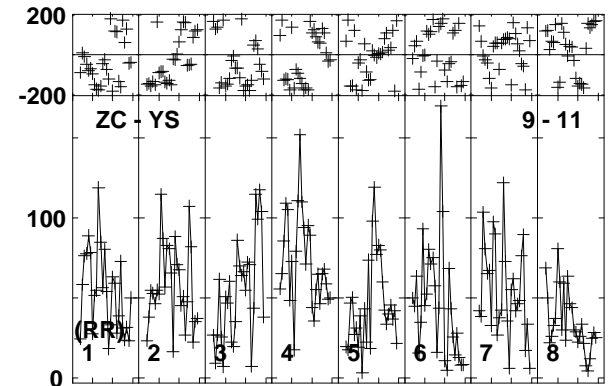
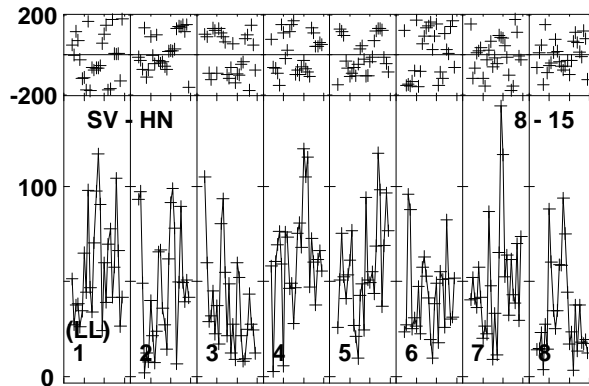
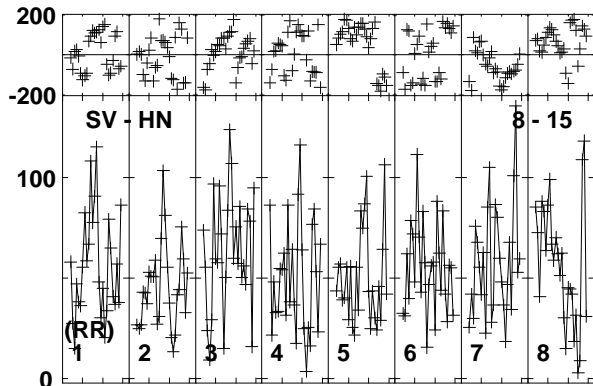
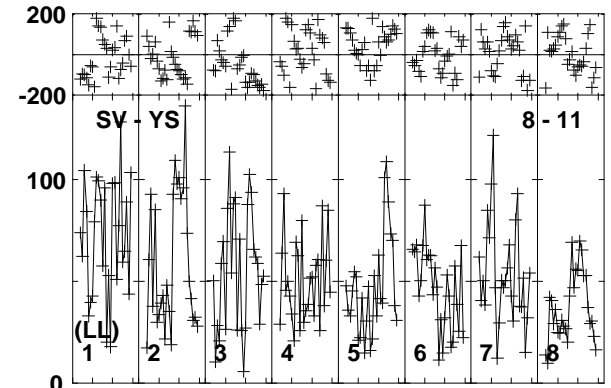
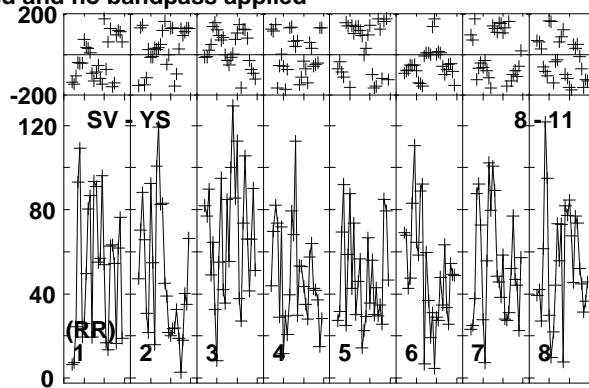
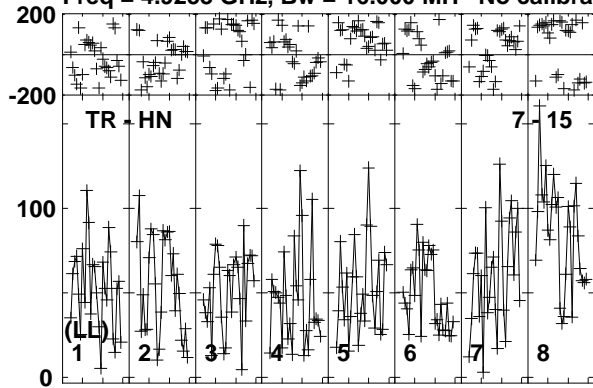

Lower frame: Micro Ampl Jy Top frame: Phas deg
Vector averaged cross-power spectrum Baseline: TR (07) - HN (15)
Timerange: 00/20:46:33 to 00/20:51:47

Plot file version 28 created 11-APR-2016 17:08:18

ARP299C GP053G 3.UVDATA.1

Freq = 4.9253 GHz, Bw = 16.000 MH No calibration applied and no bandpass applied

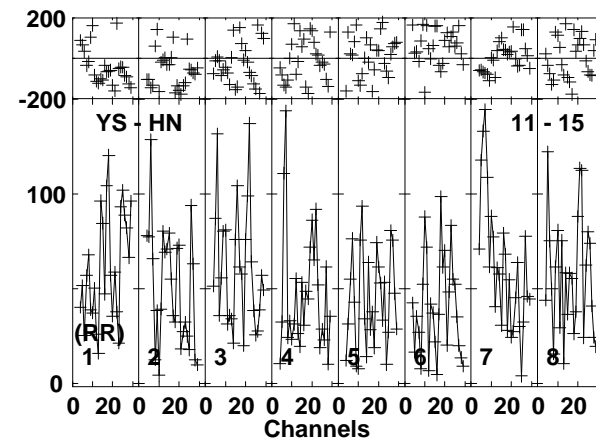
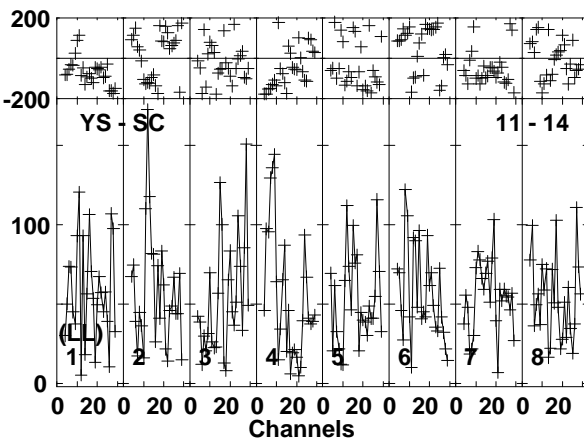
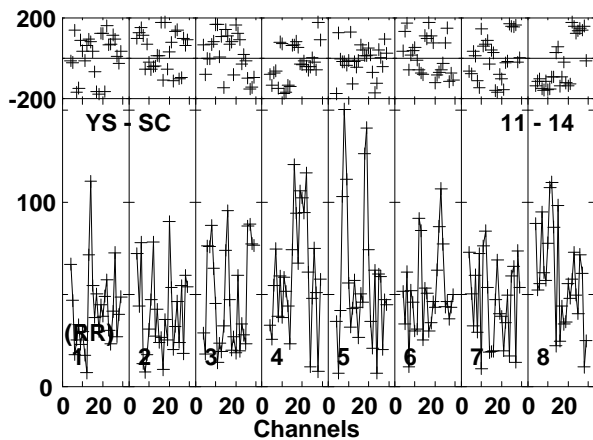
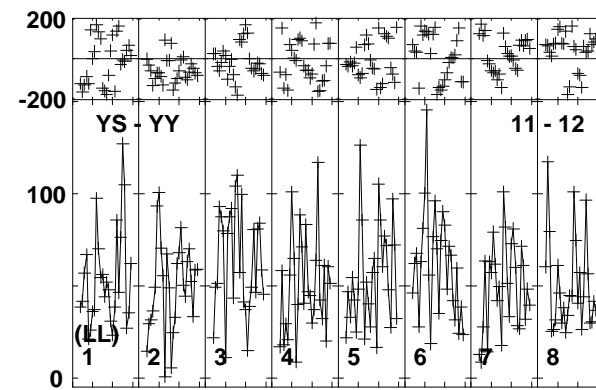
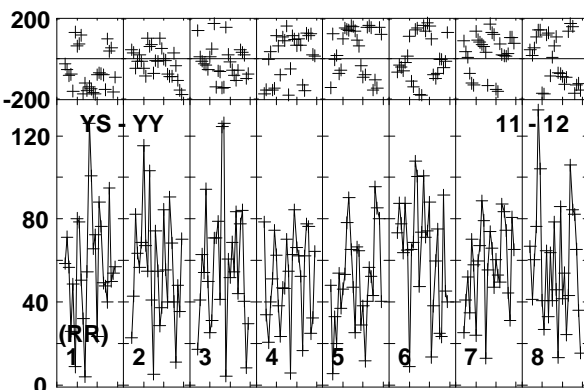
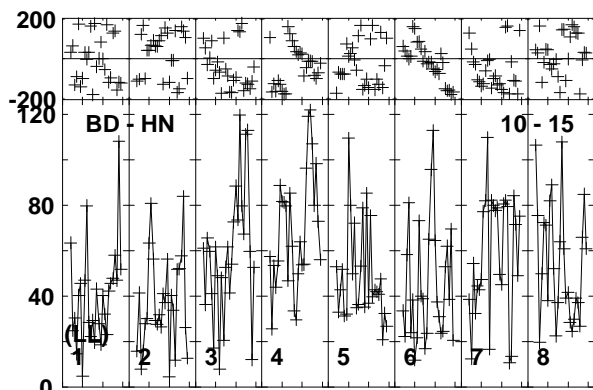
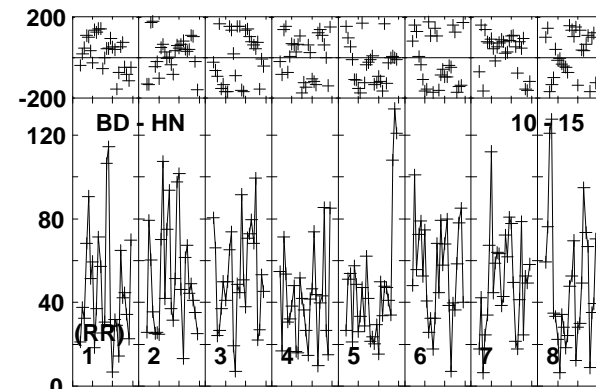
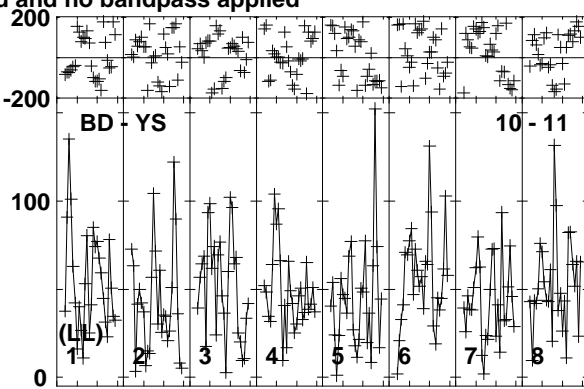
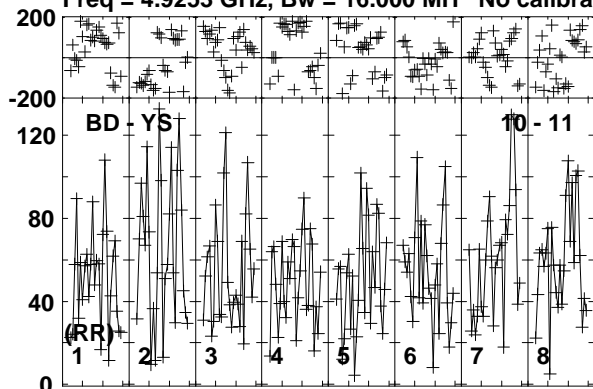

Lower frame: Micro Ampl Jy Top frame: Phas deg
Vector averaged cross-power spectrum Baseline: BD (10) - YS (11)
Timerange: 00/20:46:33 to 00/20:51:47

Plot file version 29 created 11-APR-2016 17:08:18

ARP299C GP053G 3.UVDATA.1

Freq = 4.9253 GHz, Bw = 16.000 MH No calibration applied and no bandpass applied

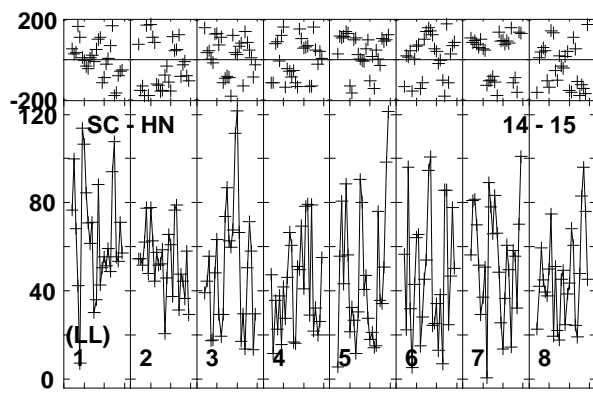
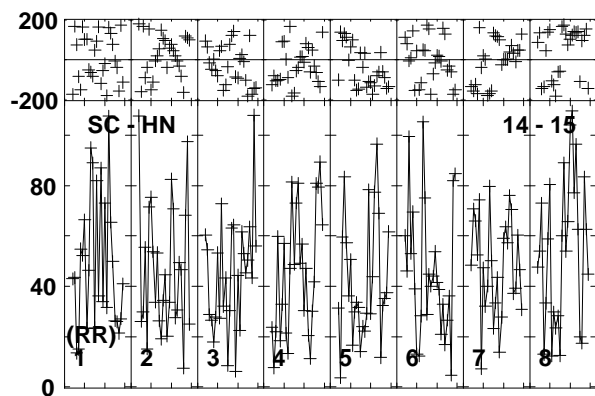
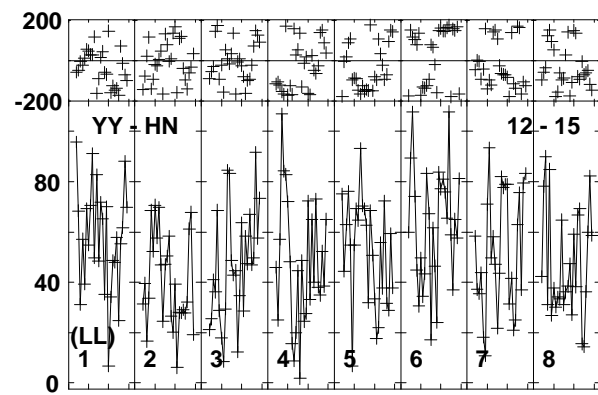
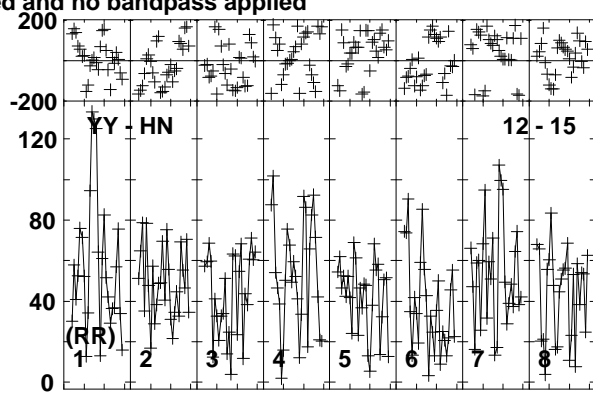
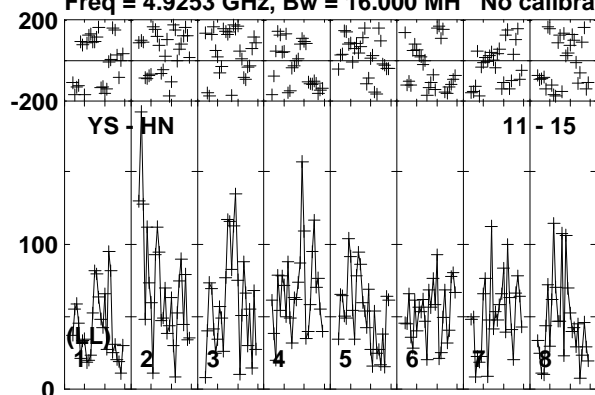

Lower frame: Micro Ampl Jy Top frame: Phas deg
Vector averaged cross-power spectrum Baseline: YS (11) - HN (15)
Timerange: 00/20:46:33 to 00/20:51:47

Plot file version 30 created 11-APR-2016 17:08:19

J1128+5925 GP053G 3.UVDATA.1

Freq = 4.9253 GHz, Bw = 16.000 MH No calibration applied and no bandpass applied

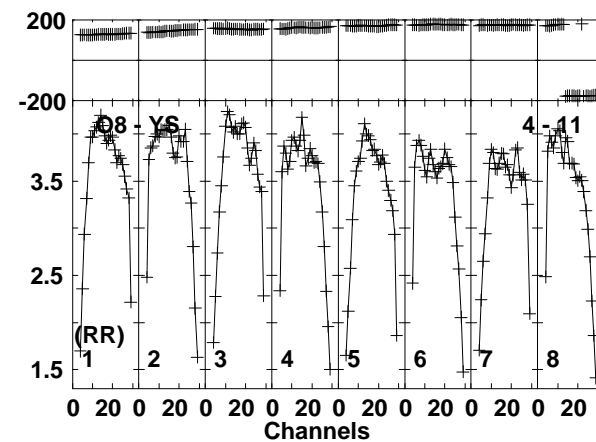
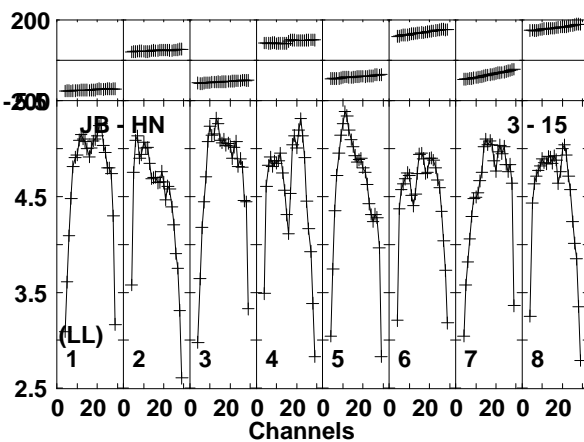
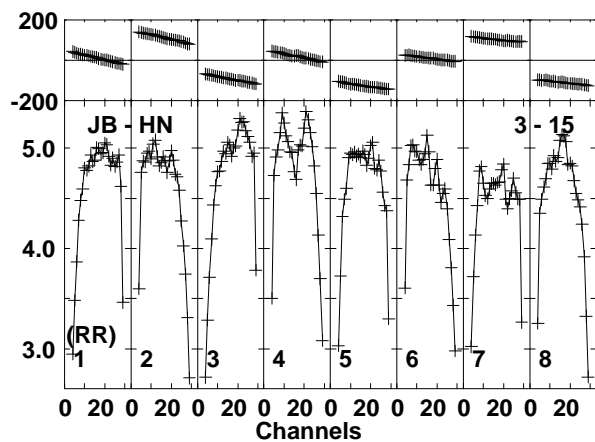
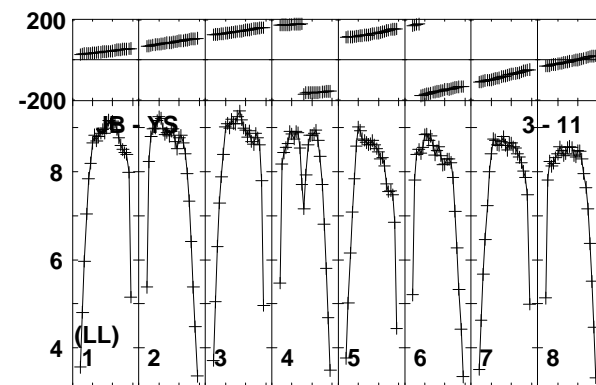
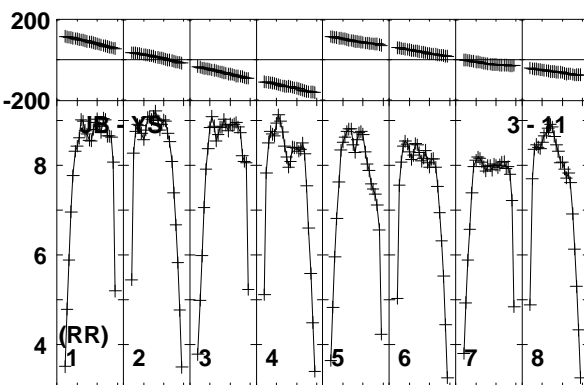
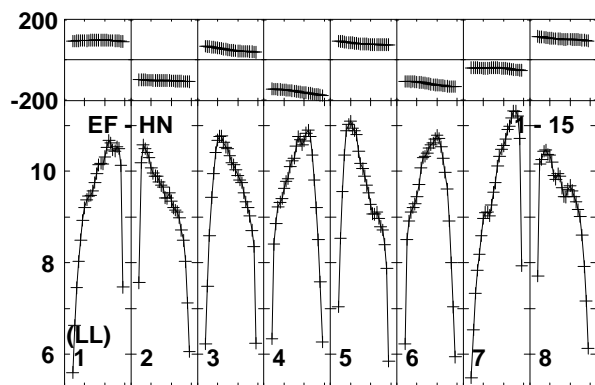
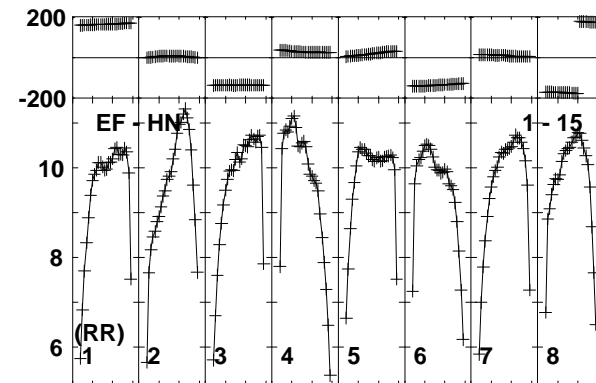
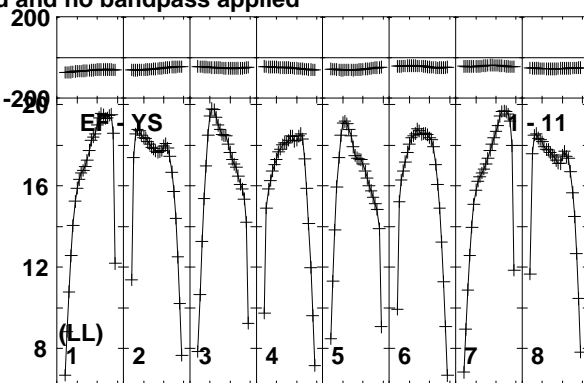
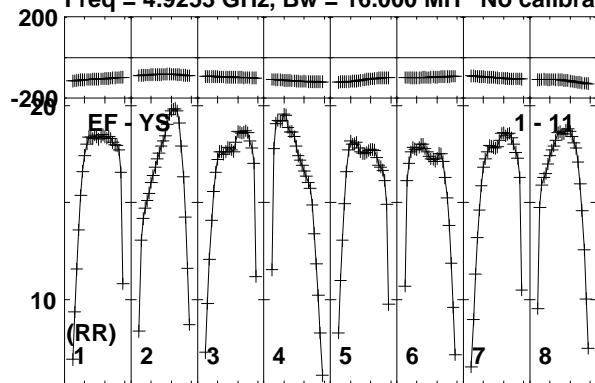

Lower frame: Milli Ampl Jy Top frame: Phas deg
Vector averaged cross-power spectrum Baseline: EF (01) - YS (11)
Timerange: 00/20:51:50 to 00/20:53:37

Plot file version 31 created 11-APR-2016 17:08:19

J1128+5925 GP053G 3.UVDATA.1

Freq = 4.9253 GHz, Bw = 16.000 MH No calibration applied and no bandpass applied

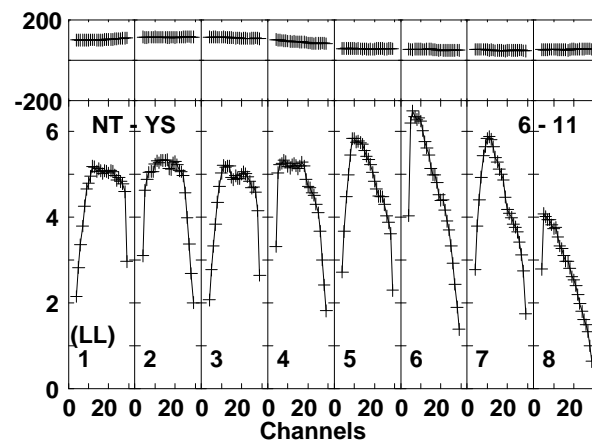
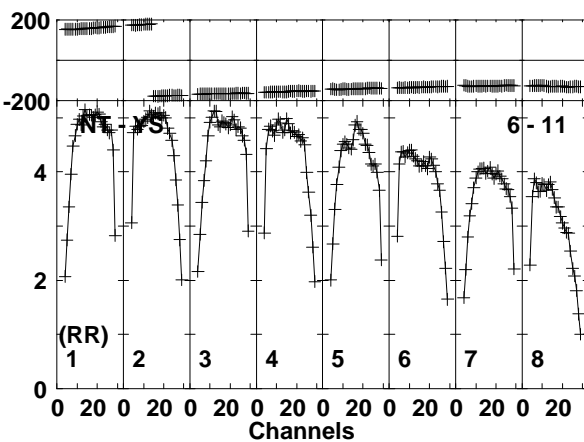
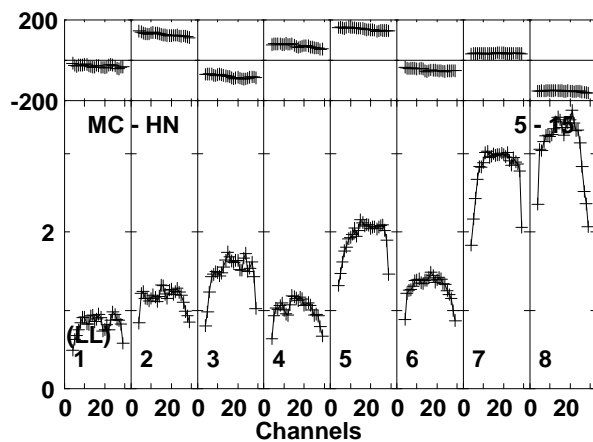
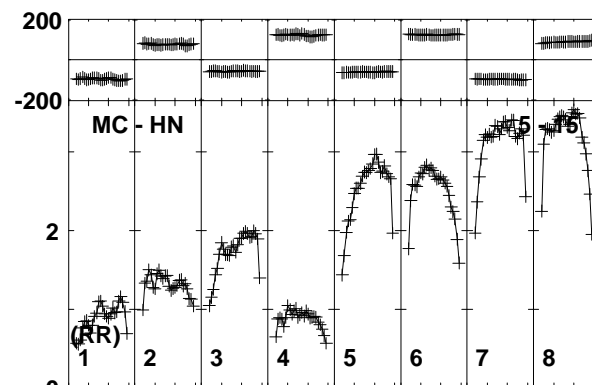
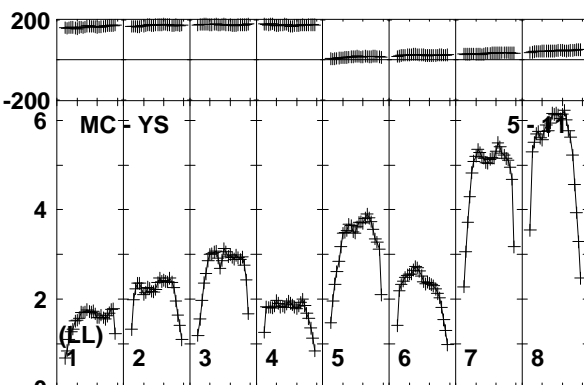
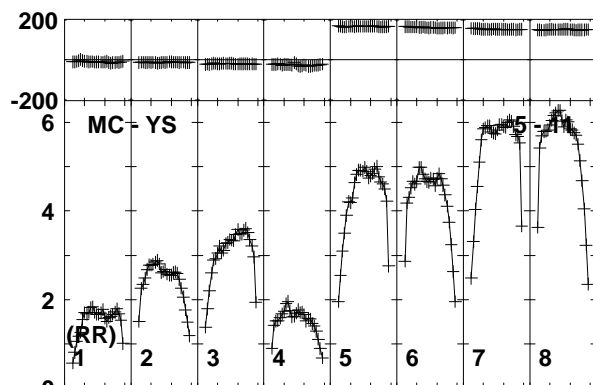
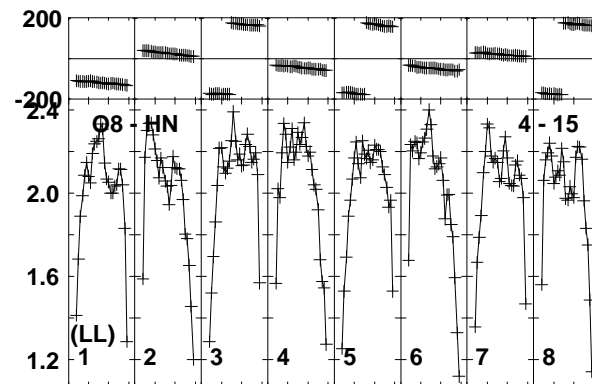
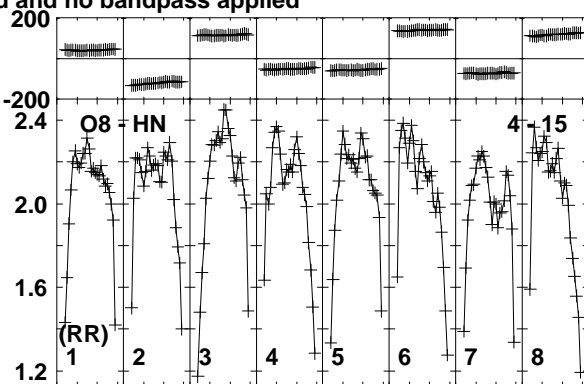
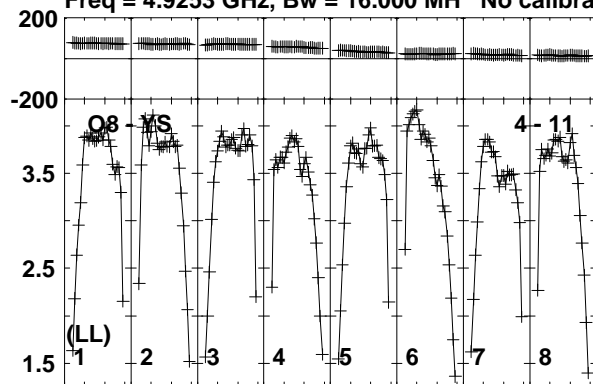

Lower frame: Milli Ampl Jy Top frame: Phas deg
Vector averaged cross-power spectrum Baseline: O8 (04) - YS (11)
Timerange: 00/20:51:50 to 00/20:53:37

Plot file version 32 created 11-APR-2016 17:08:19

J1128+5925 GP053G 3.UVDATA.1

Freq = 4.9253 GHz, Bw = 16.000 MH No calibration applied and no bandpass applied

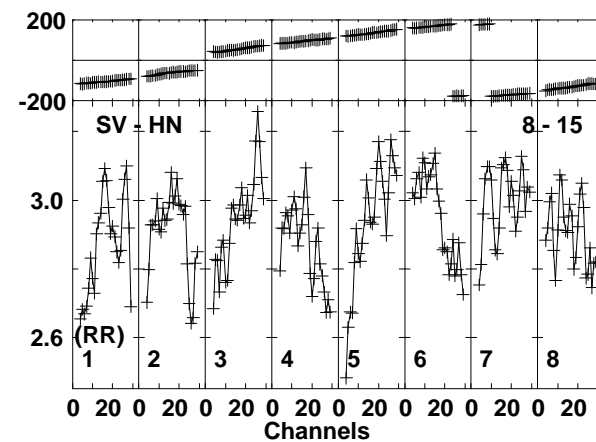
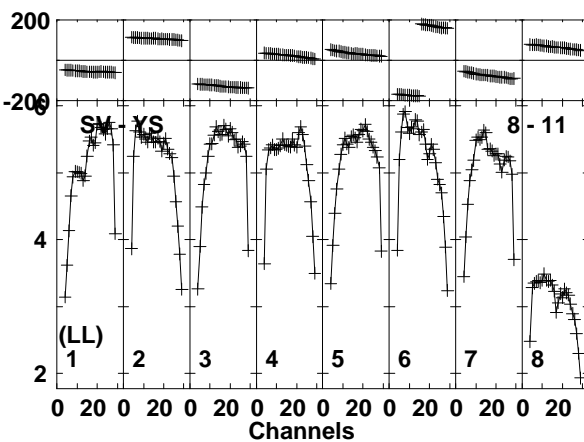
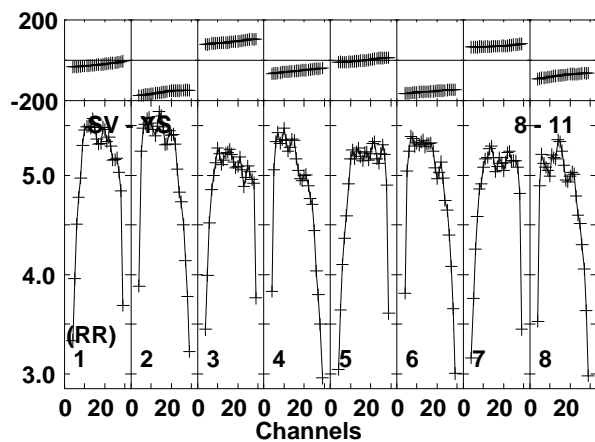
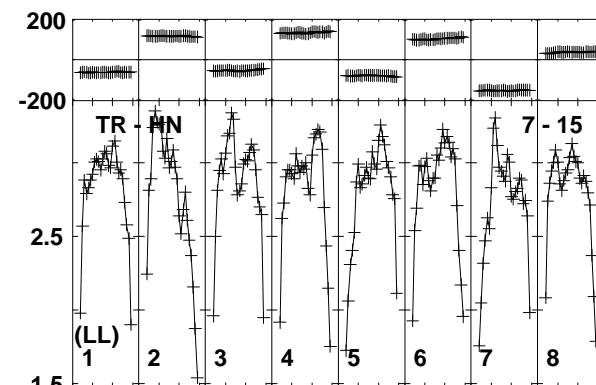
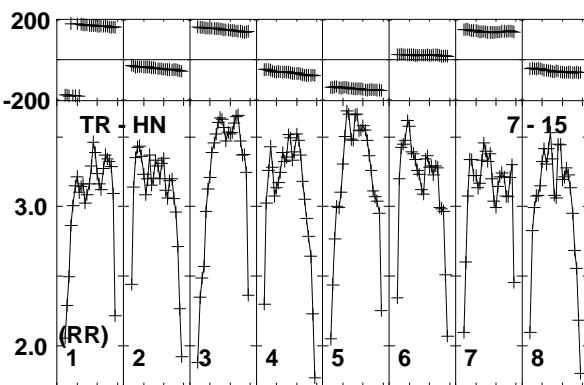
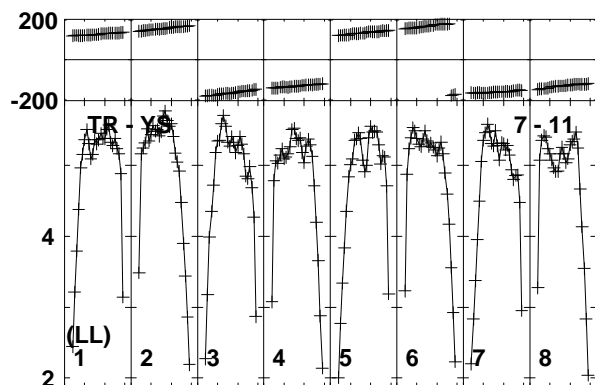
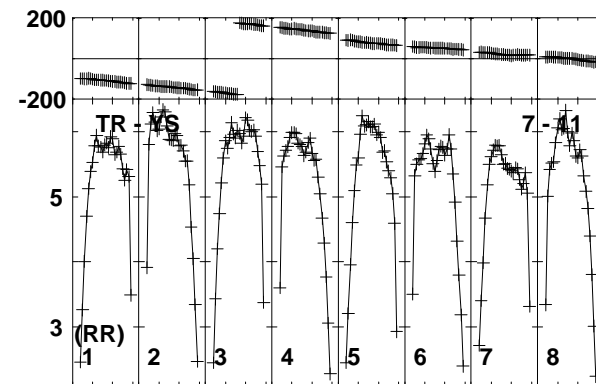
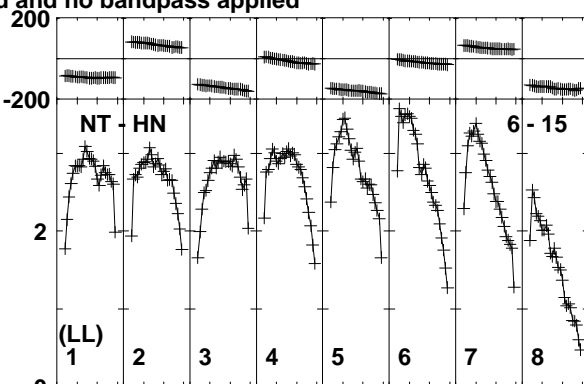
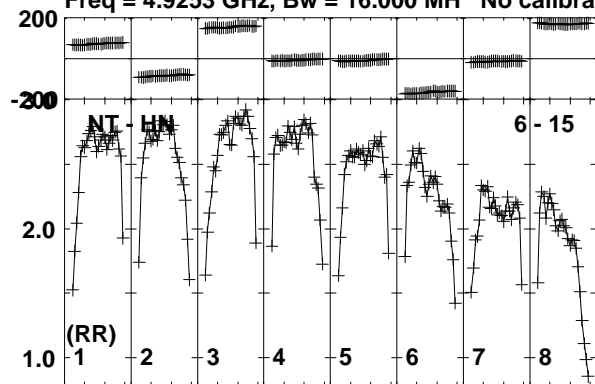

Lower frame: Milli Ampl Jy Top frame: Phas deg
Vector averaged cross-power spectrum Baseline: NT (06) - HN (15)
Timerange: 00/20:51:50 to 00/20:53:37

Plot file version 33 created 11-APR-2016 17:08:19

J1128+5925 GP053G 3.UVDATA.1

Freq = 4.9253 GHz, Bw = 16.000 MH No calibration applied and no bandpass applied

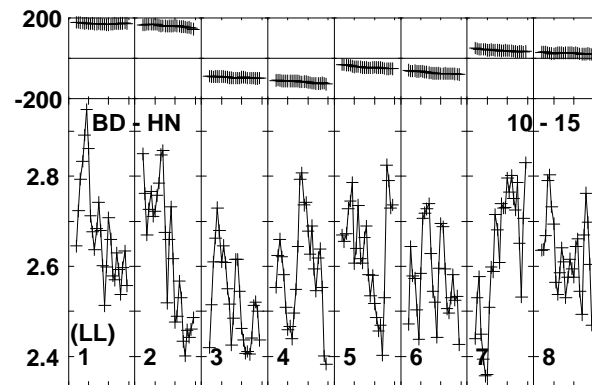
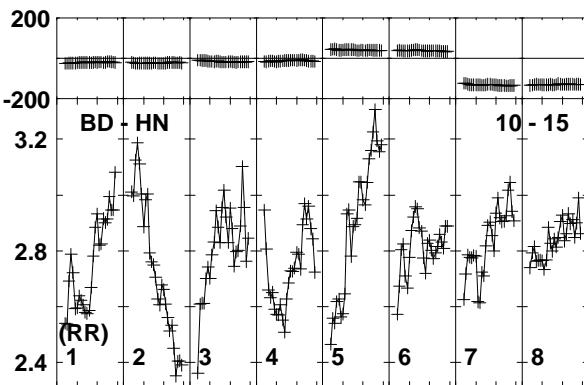
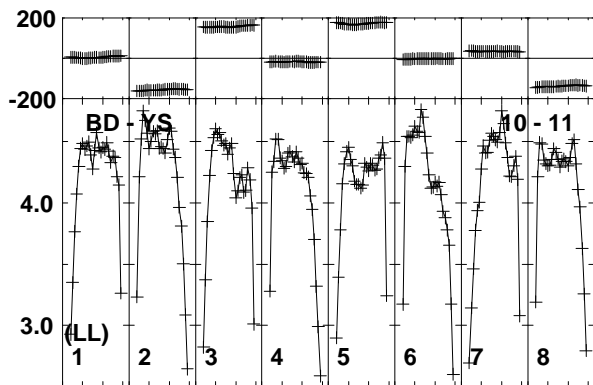
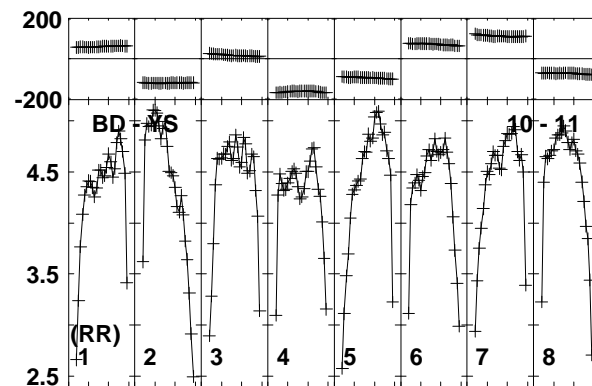
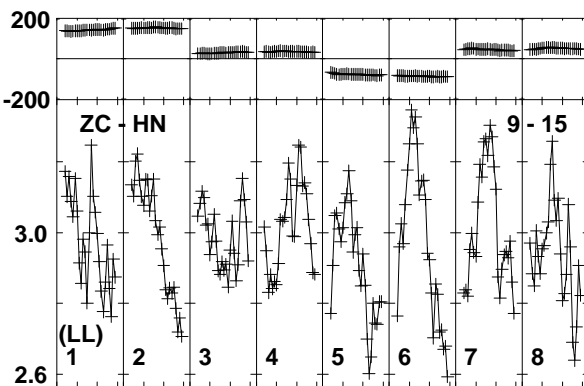
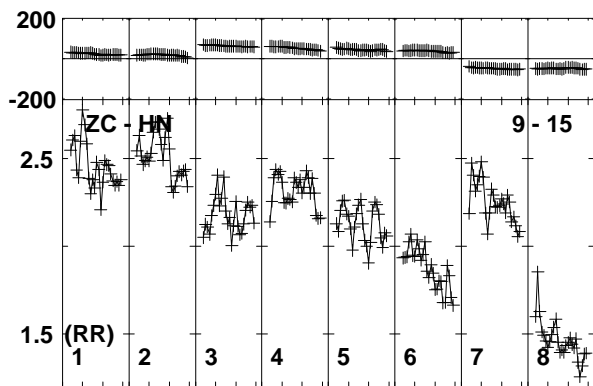
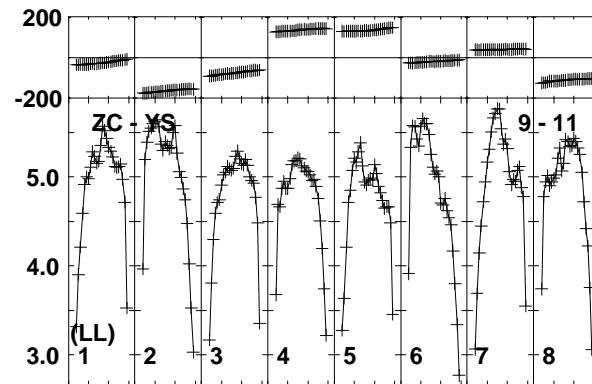
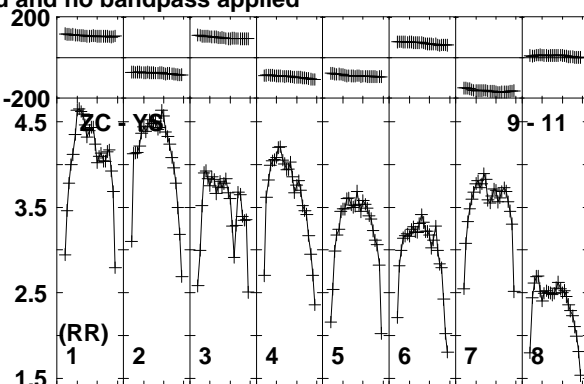
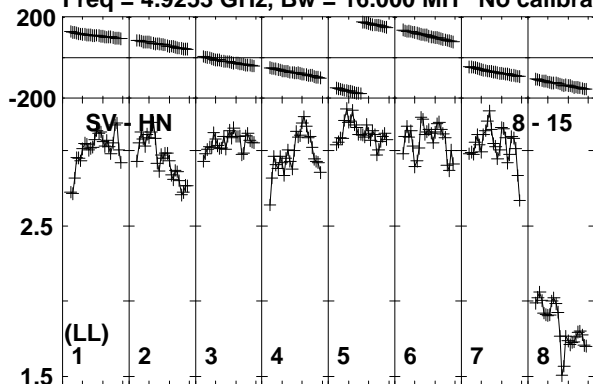

Lower frame: Milli Ampl Jy Top frame: Phas deg

Vector averaged cross-power spectrum Baseline: SV (08) - HN (15)

Timerange: 00/20:51:50 to 00/20:53:37

Plot file version 34 created 11-APR-2016 17:08:19

J1128+5925 GP053G 3.UVDATA.1

Freq = 4.9253 GHz, Bw = 16.000 MH No calibration applied and no bandpass applied

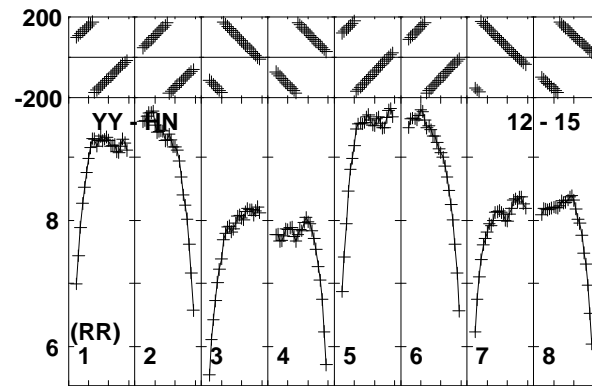
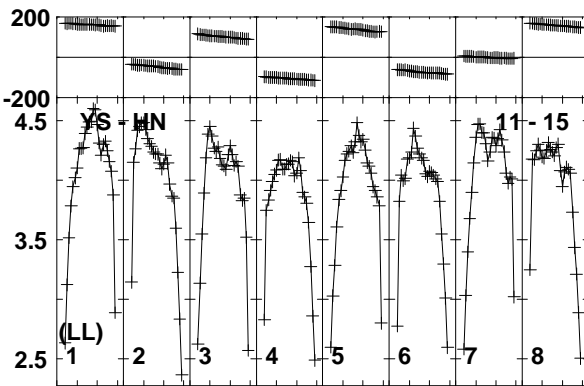
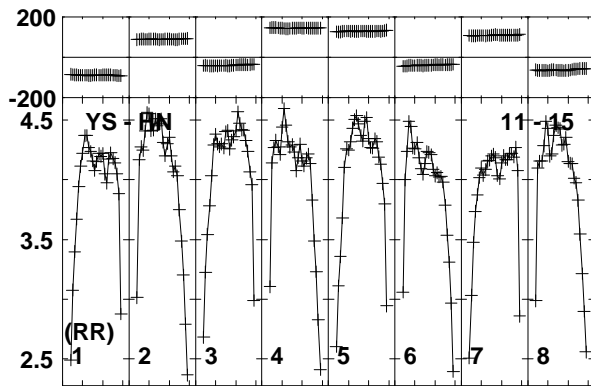
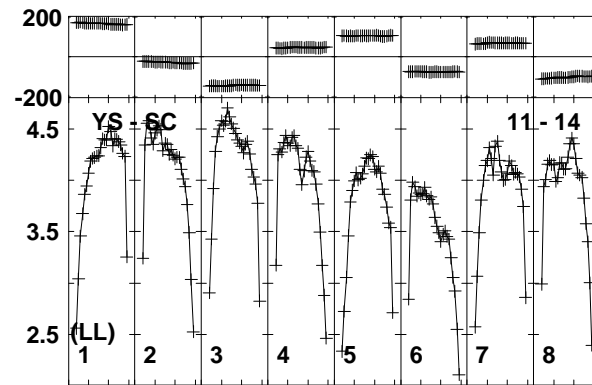
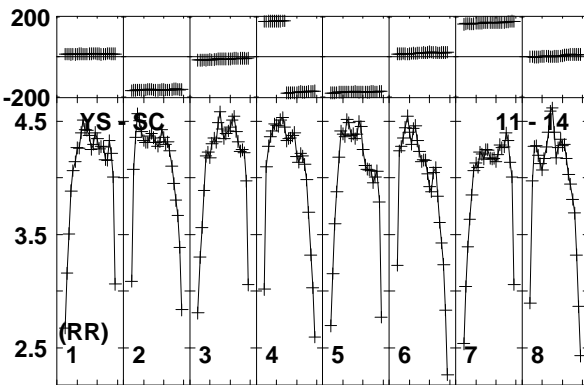
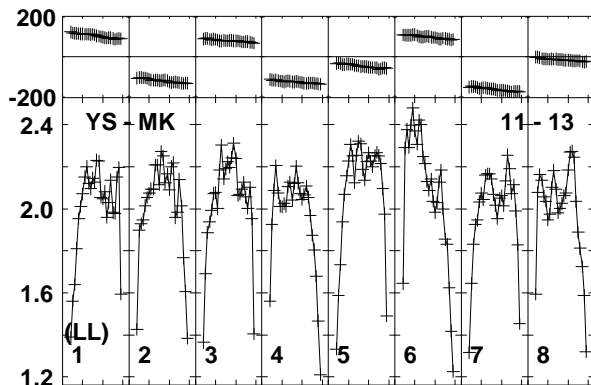
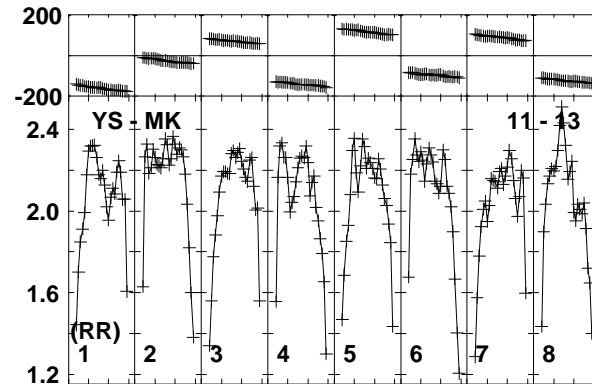
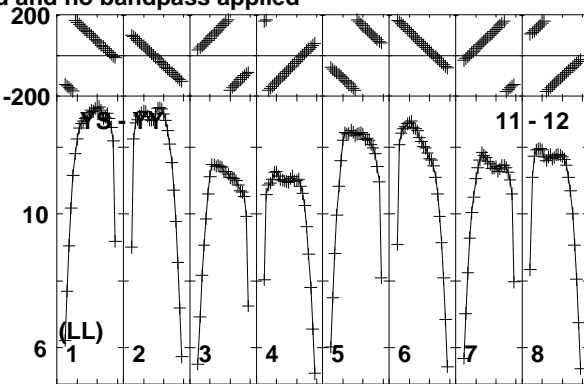
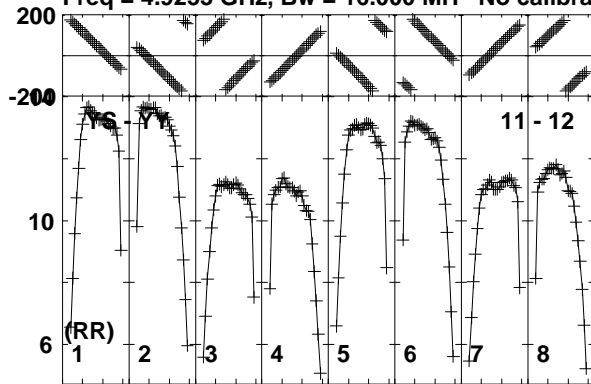

Lower frame: Milli Ampl Jy Top frame: Phas deg
Vector averaged cross-power spectrum Baseline: YS (11) - YY (12)
Timerange: 00/20:51:50 to 00/20:53:37

Plot file version 35 created 11-APR-2016 17:08:19

J1128+5925 GP053G 3.UVDATA.1

Freq = 4.9253 GHz, Bw = 16.000 MH No calibration applied and no bandpass applied

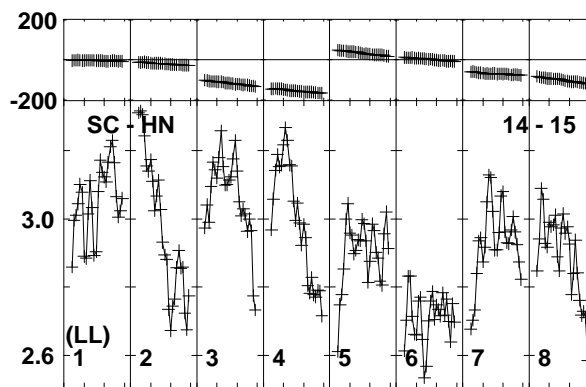
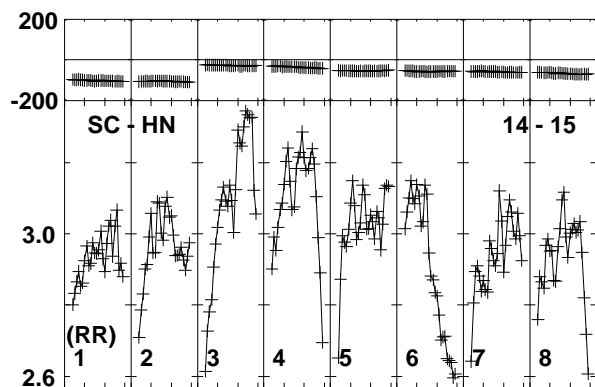
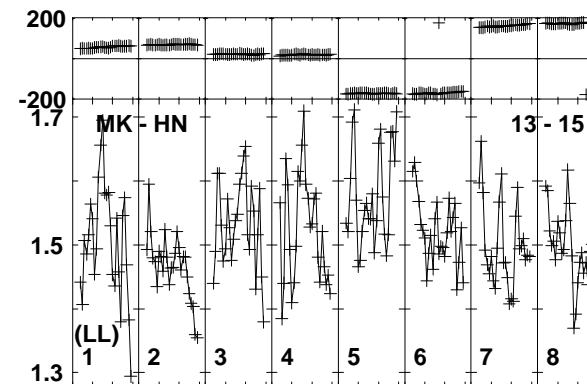
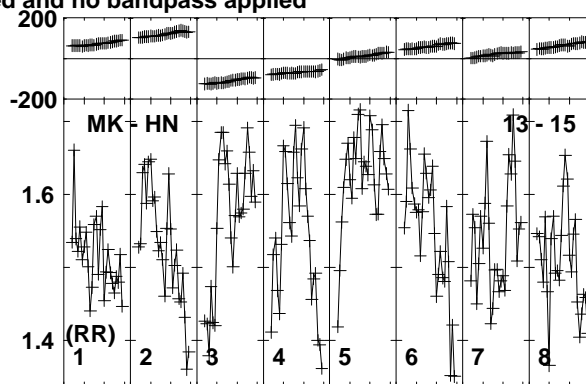
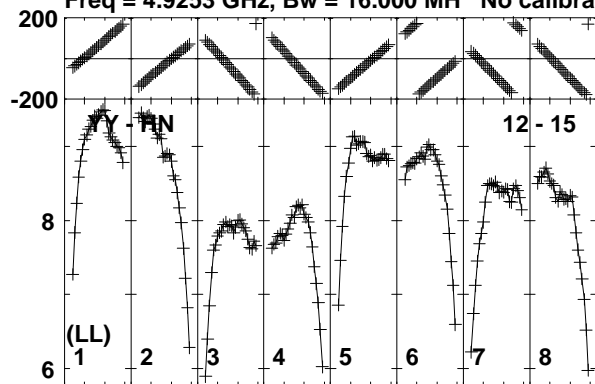

Lower frame: Milli Ampl Jy Top frame: Phas deg
Vector averaged cross-power spectrum Baseline: YY (12) - HN (15)
Timerange: 00/20:51:50 to 00/20:53:37

Plot file version 36 created 11-APR-2016 17:08:19

ARP299C GP053G 3.UVDATA.1

Freq = 4.9253 GHz, Bw = 16.000 MH No calibration applied and no bandpass applied

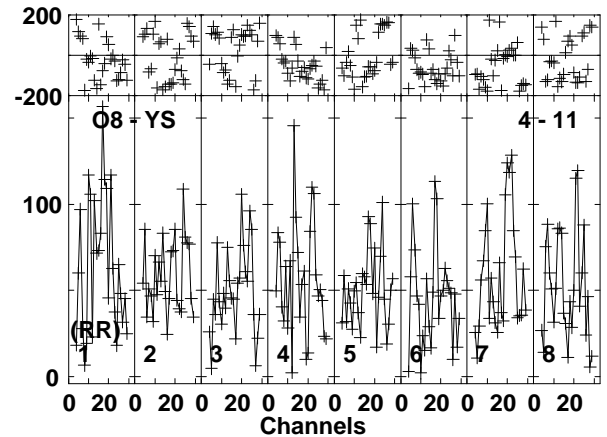
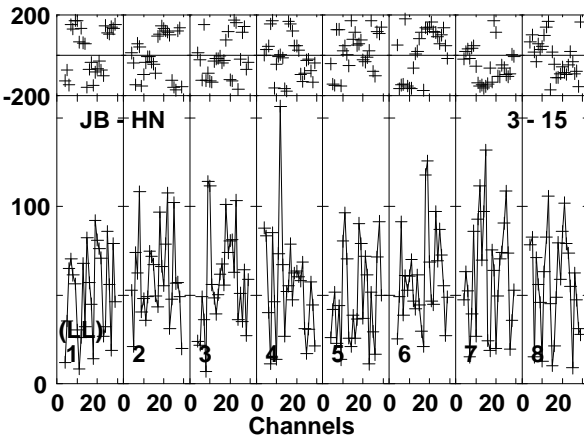
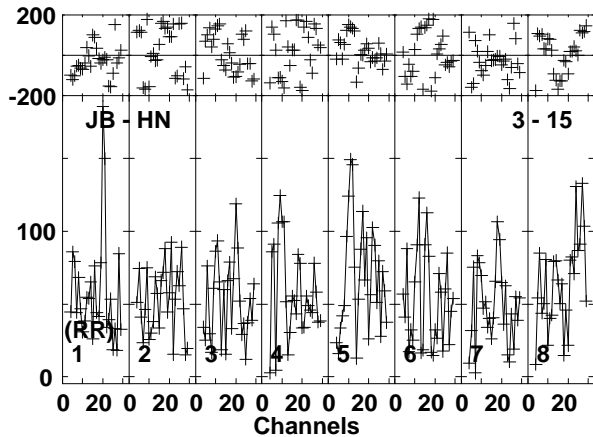
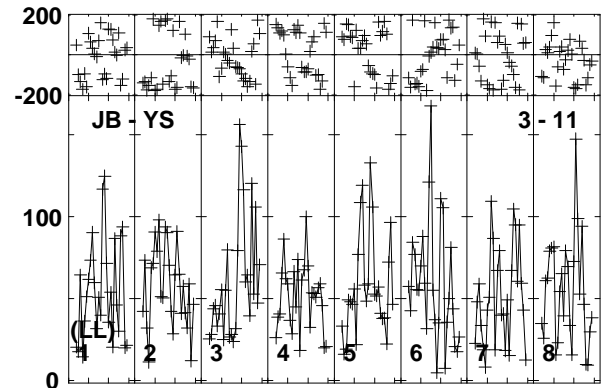
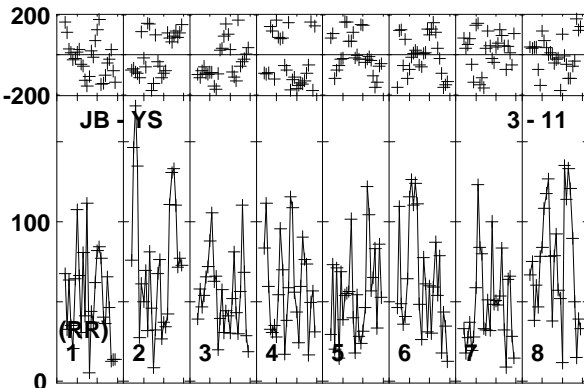
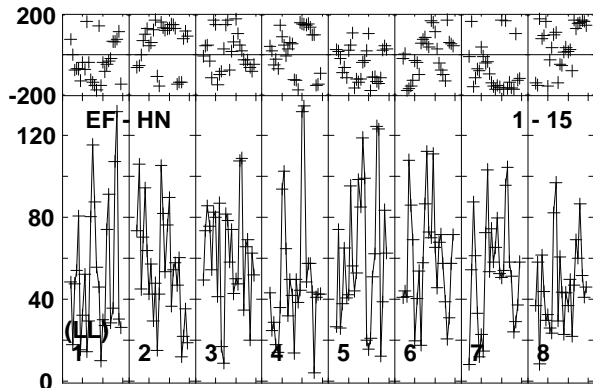
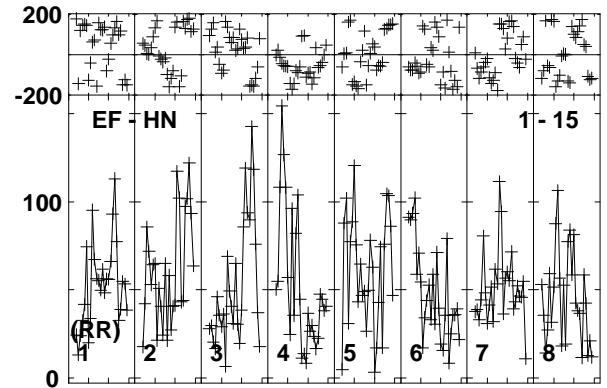
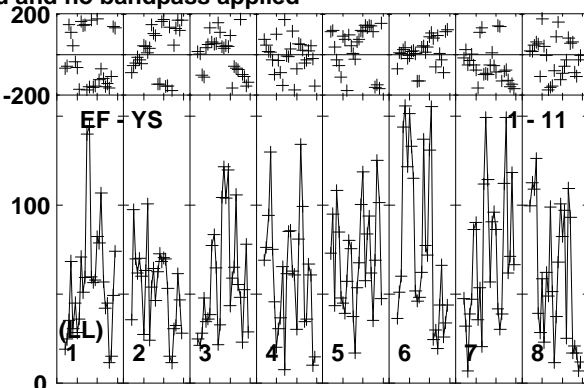
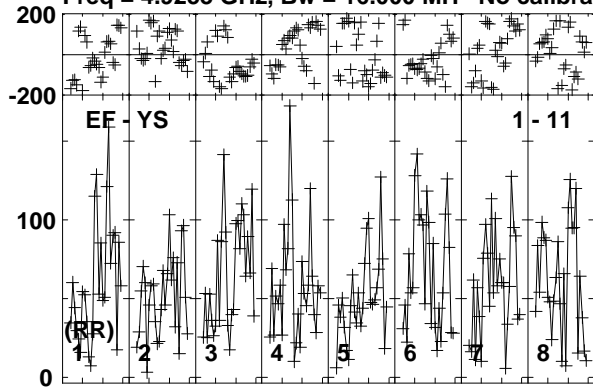

Lower frame: Micro Ampl Jy Top frame: Phas deg
Vector averaged cross-power spectrum Baseline: EF (01) - YS (11)
Timerange: 00/20:53:44 to 00/20:58:56

Plot file version 37 created 11-APR-2016 17:08:19

ARP299C GP053G 3.UVDATA.1

Freq = 4.9253 GHz, Bw = 16.000 MH No calibration applied and no bandpass applied

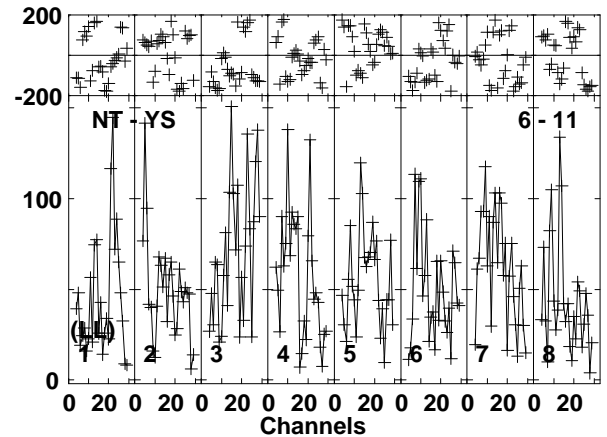
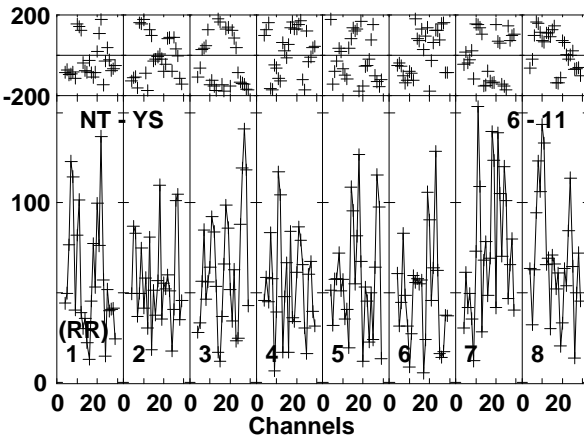
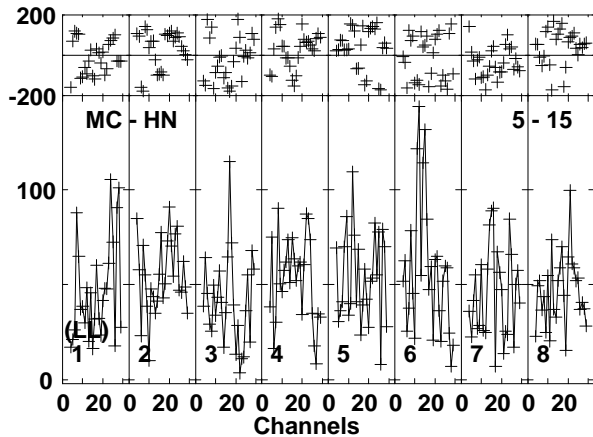
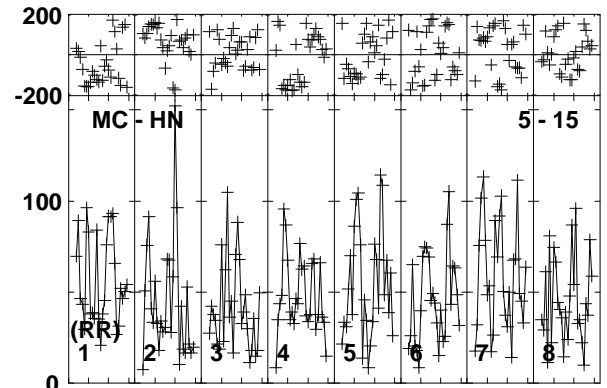
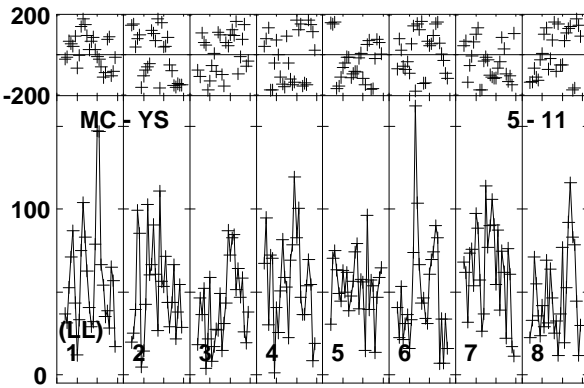
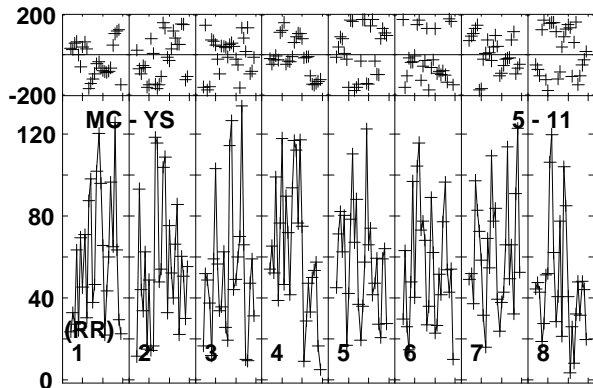
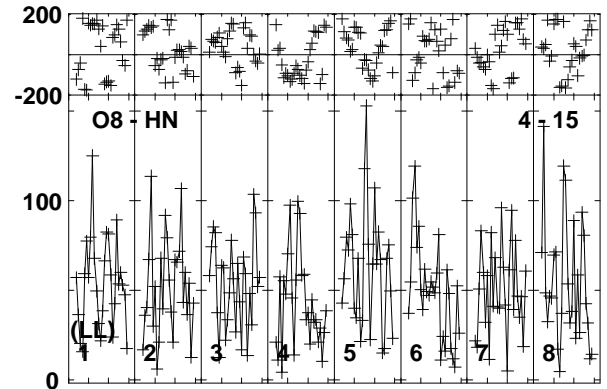
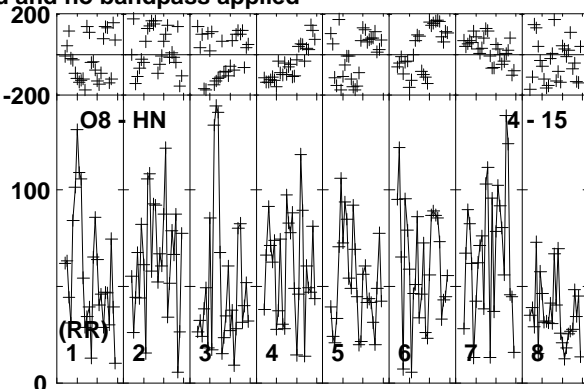
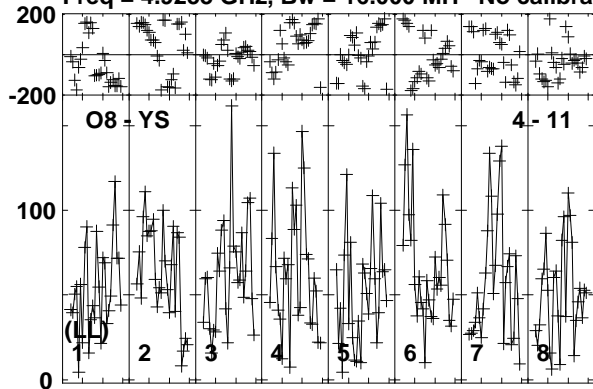

Lower frame: Micro Ampl Jy Top frame: Phas deg
Vector averaged cross-power spectrum Baseline: O8 (04) - YS (11)
Timerange: 00/20:53:44 to 00/20:58:56

Plot file version 38 created 11-APR-2016 17:08:20

ARP299C GP053G 3.UVDATA.1

Freq = 4.9253 GHz, Bw = 16.000 MH No calibration applied and no bandpass applied

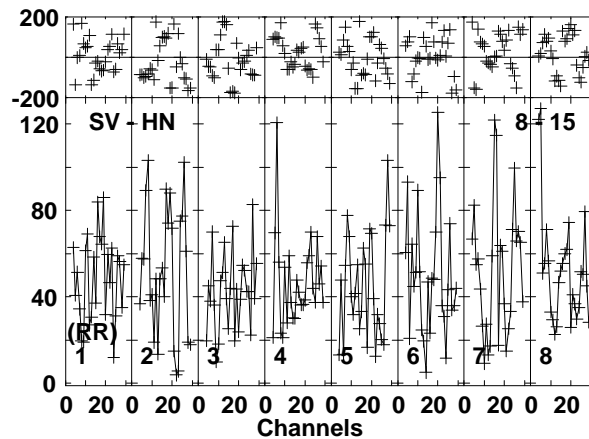
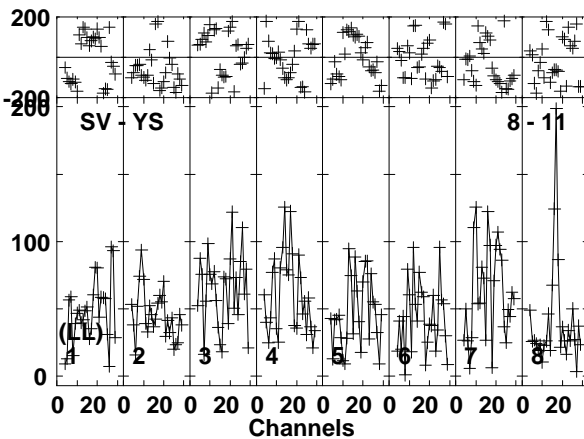
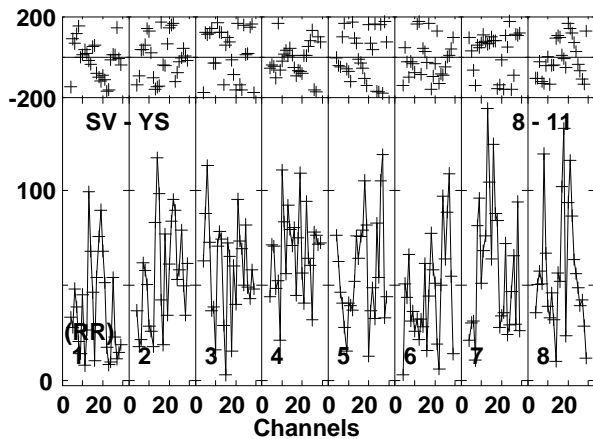
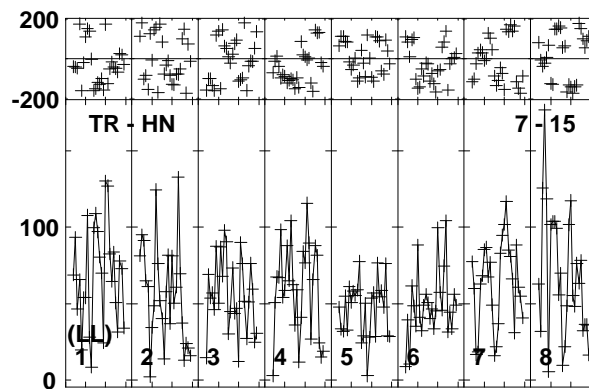
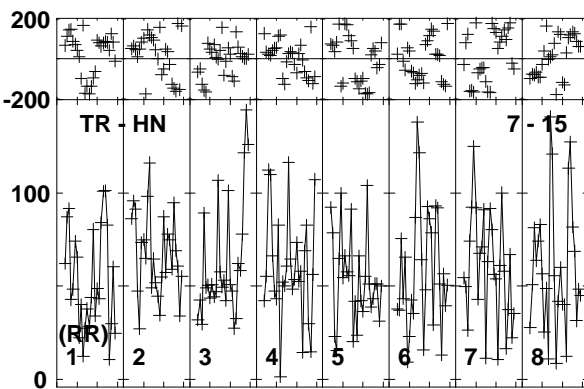
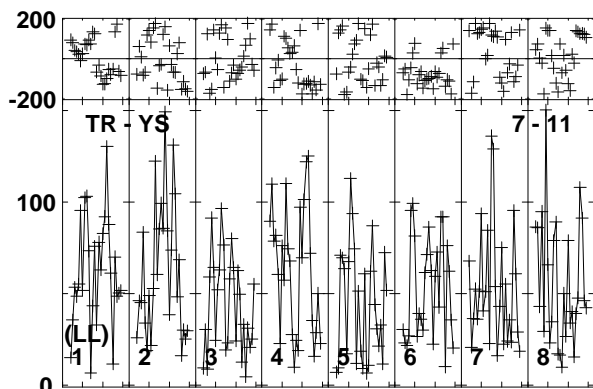
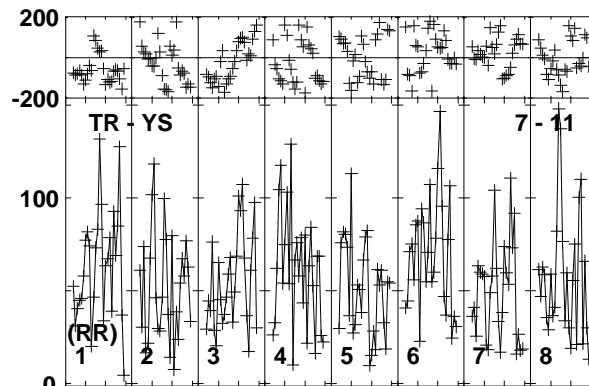
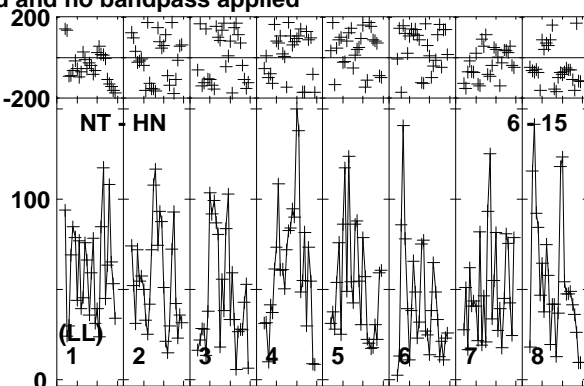
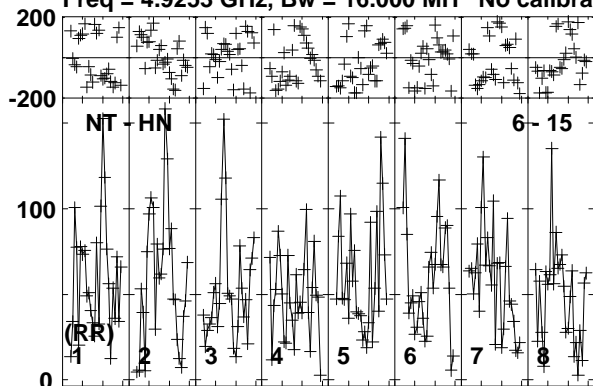

Lower frame: Micro Ampl Jy Top frame: Phas deg
Vector averaged cross-power spectrum Baseline: NT (06) - HN (15)
Timerange: 00/20:53:44 to 00/20:58:56

Plot file version 39 created 11-APR-2016 17:08:20

ARP299C GP053G 3.UVDATA.1

Freq = 4.9253 GHz, Bw = 16.000 MH No calibration applied and no bandpass applied

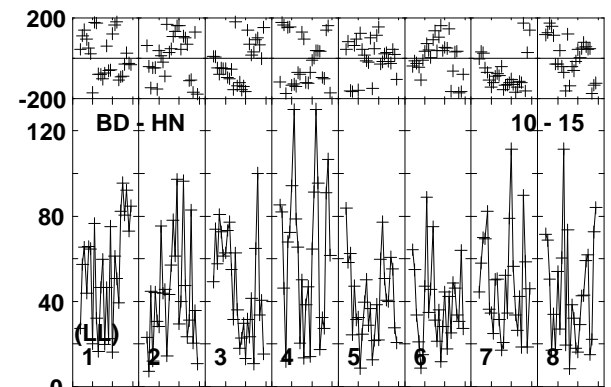
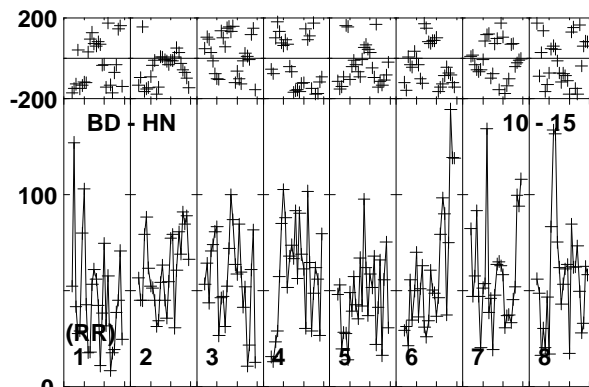
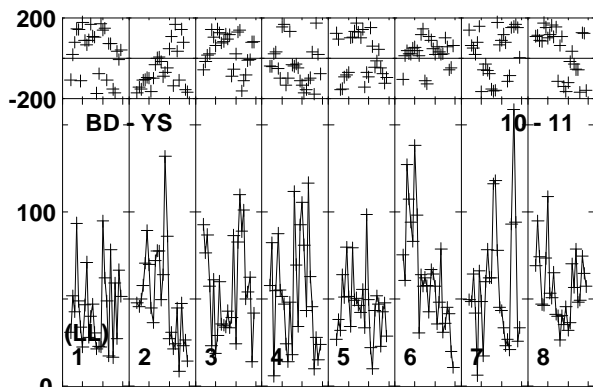
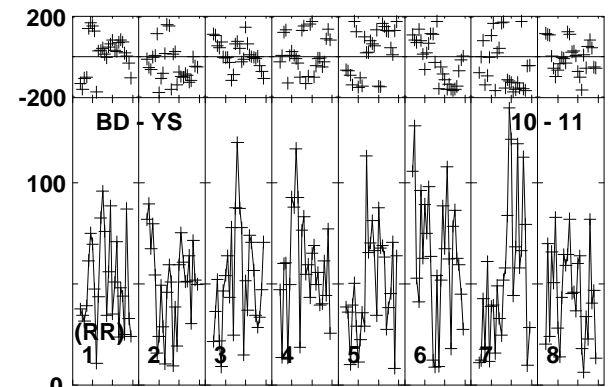
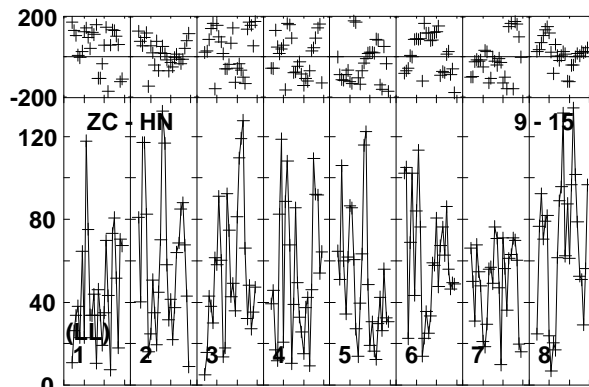
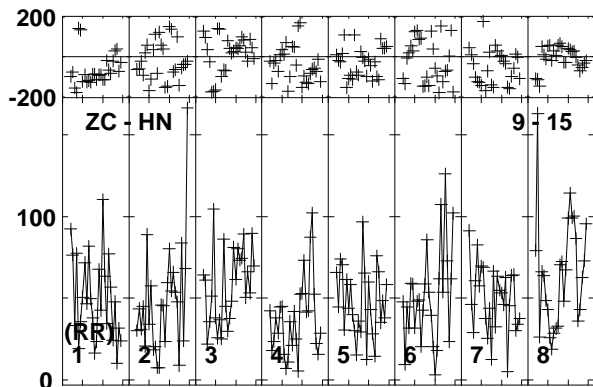
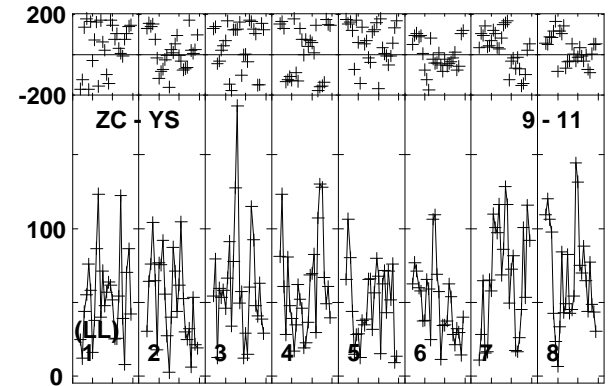
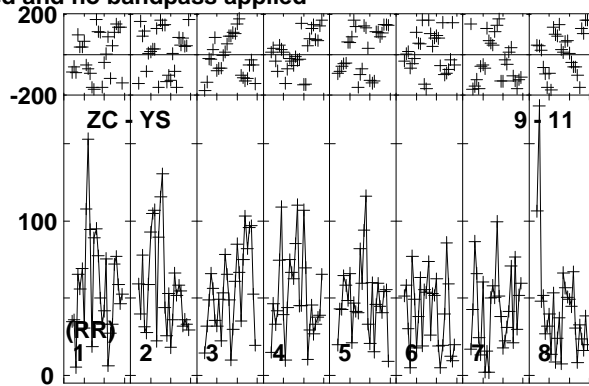
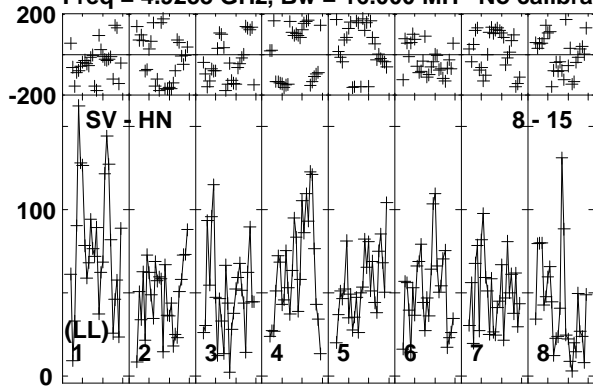

Lower frame: Micro Ampl Jy Top frame: Phas deg
Vector averaged cross-power spectrum Baseline: SV (08) - HN (15)
Timerange: 00/20:53:44 to 00/20:58:56

Plot file version 40 created 11-APR-2016 17:08:20

ARP299C GP053G 3.UVDATA.1

Freq = 4.9253 GHz, Bw = 16.000 MH No calibration applied and no bandpass applied

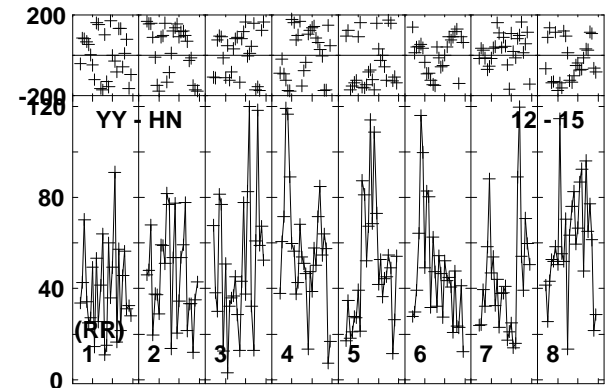
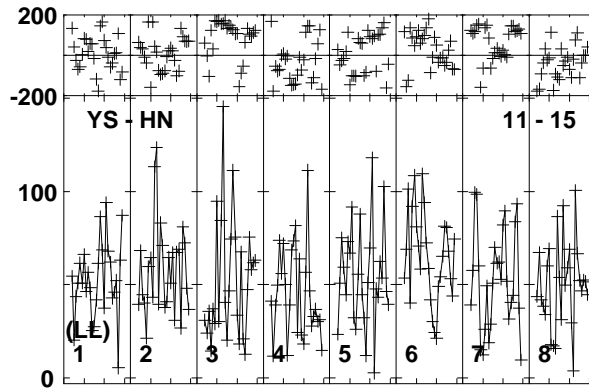
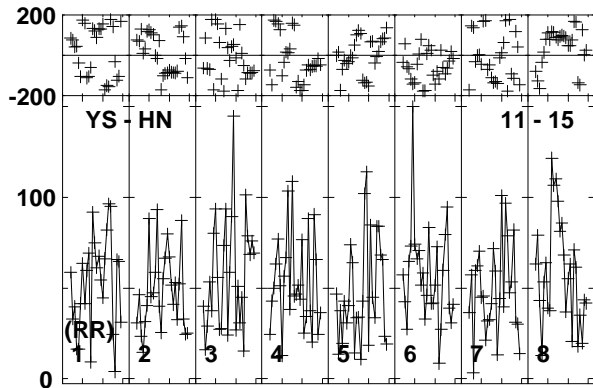
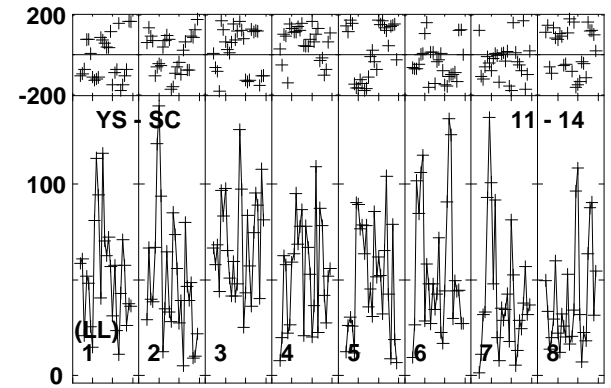
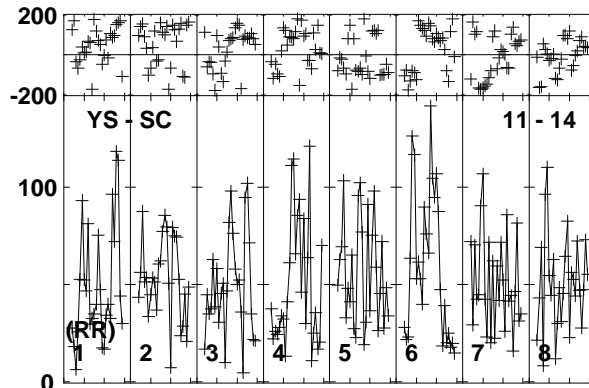
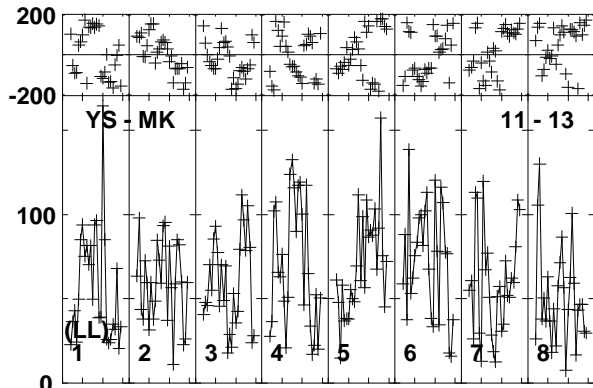
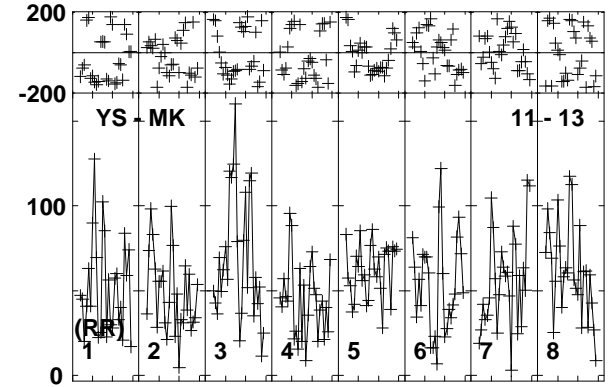
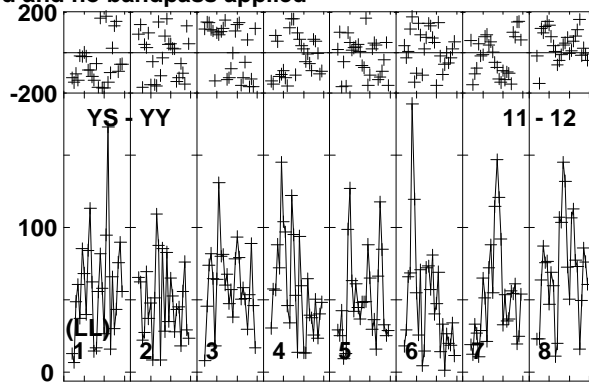
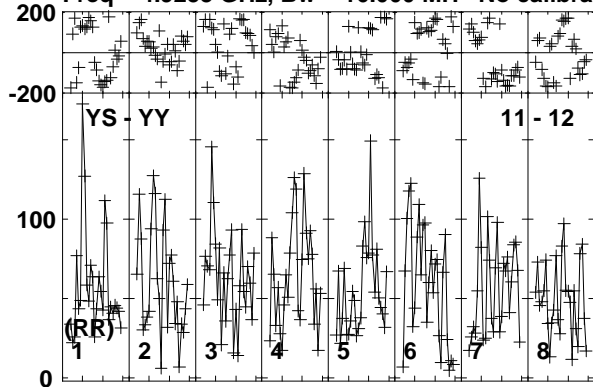

Lower frame: Micro Ampl Jy Top frame: Phas deg
Vector averaged cross-power spectrum Baseline: YS (11) - YY (12)
Timerange: 00/20:53:44 to 00/20:58:56

Plot file version 41 created 11-APR-2016 17:08:20

ARP299C GP053G 3.UVDATA.1

Freq = 4.9253 GHz, Bw = 16.000 MH No calibration applied and no bandpass applied

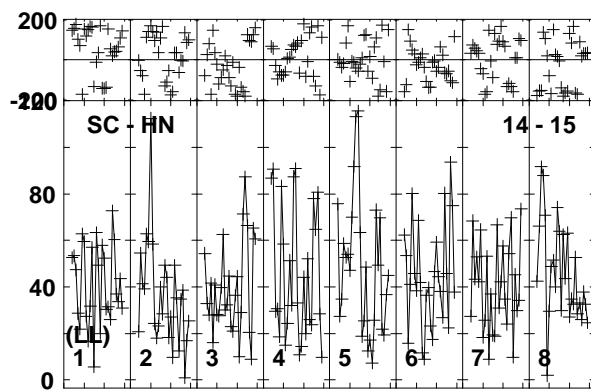
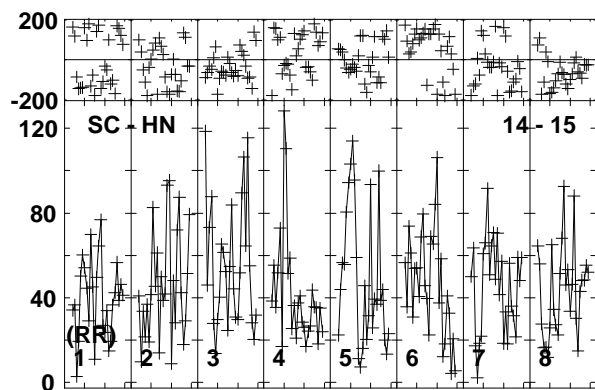
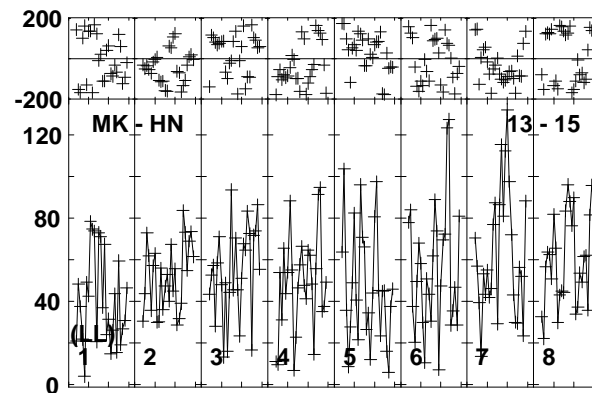
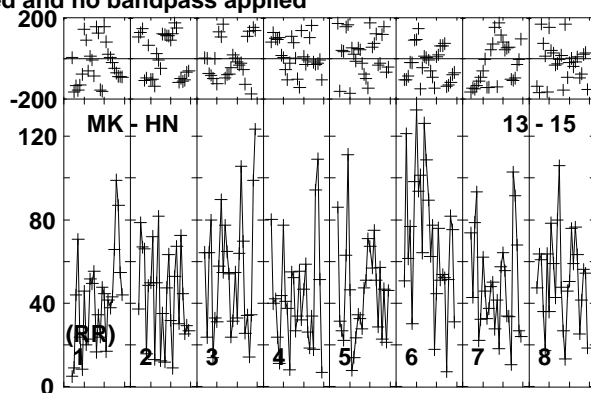
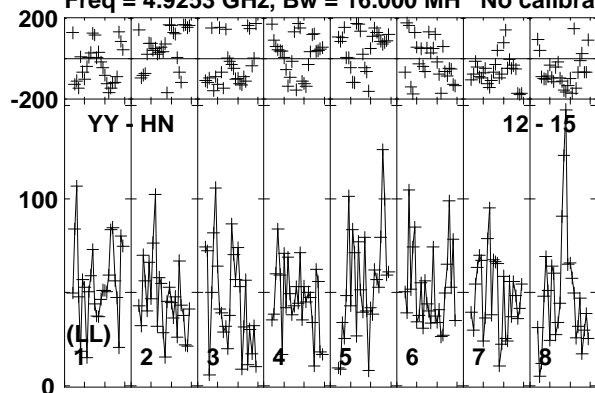

Lower frame: Micro Ampl Jy Top frame: Phas deg
Vector averaged cross-power spectrum Baseline: YY (12) - HN (15)
Timerange: 00/20:53:44 to 00/20:58:56

Plot file version 42 created 11-APR-2016 17:08:20

J1128+5925 GP053G 3.UVDATA.1

Freq = 4.9253 GHz, Bw = 16.000 MH No calibration applied and no bandpass applied

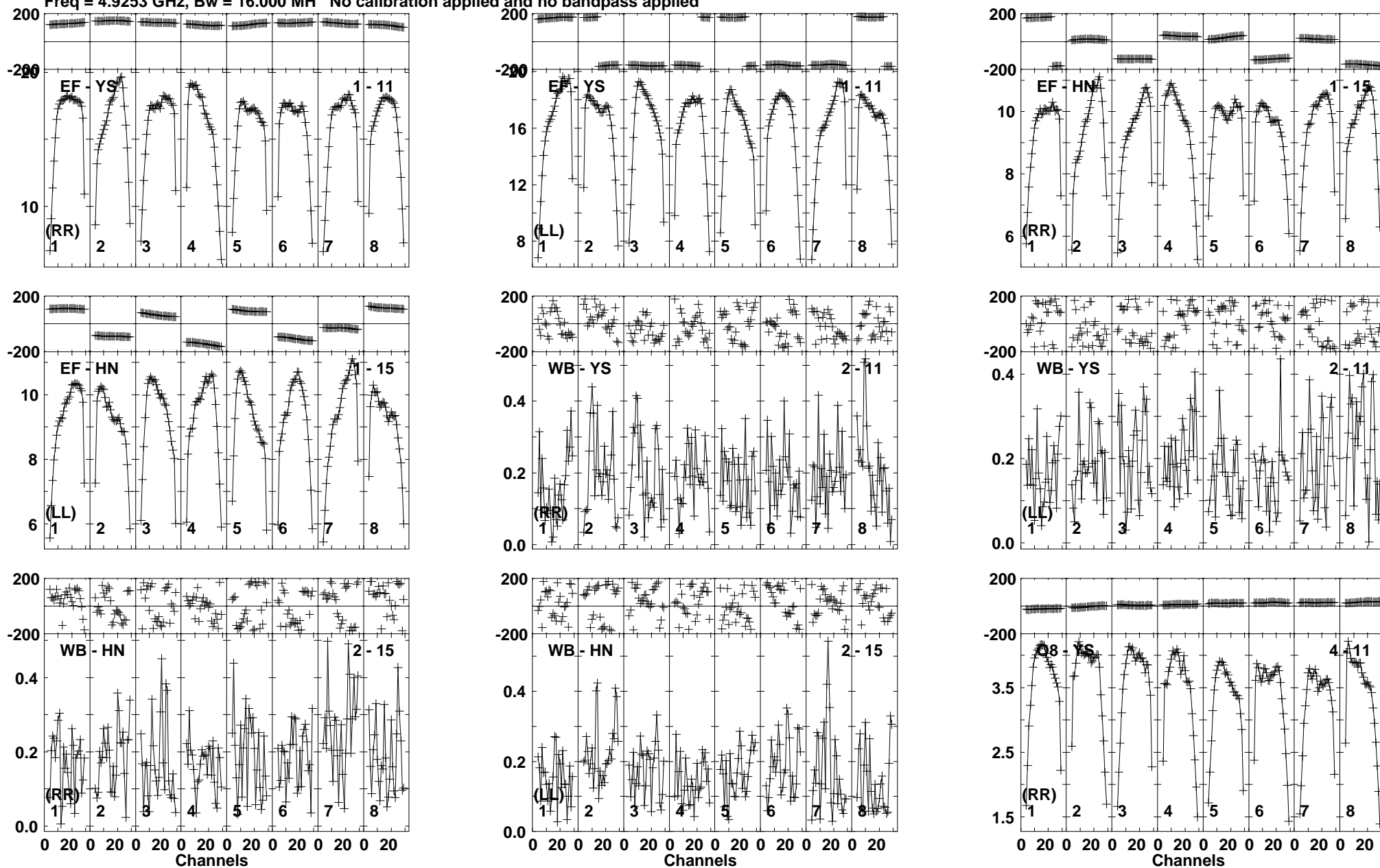

Lower frame: Milli Ampl Jy Top frame: Phas deg
Vector averaged cross-power spectrum Baseline: EF (01) - YS (11)
Timerange: 00/20:59:02 to 00/21:00:53

Plot file version 43 created 11-APR-2016 17:08:20

J1128+5925 GP053G 3.UVDATA.1

Freq = 4.9253 GHz, Bw = 16.000 MH No calibration applied and no bandpass applied

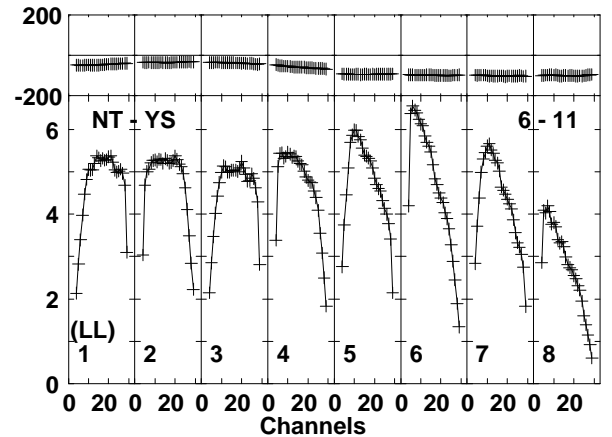
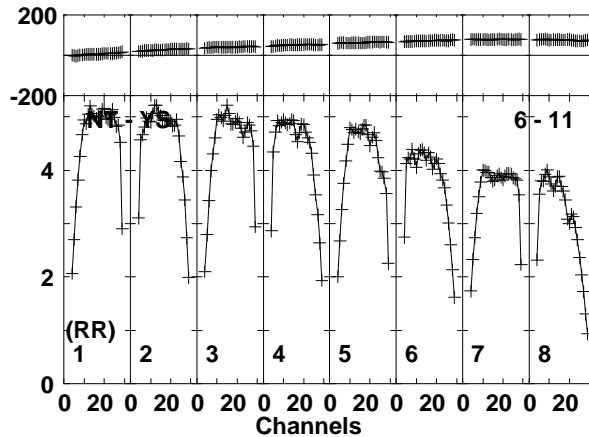
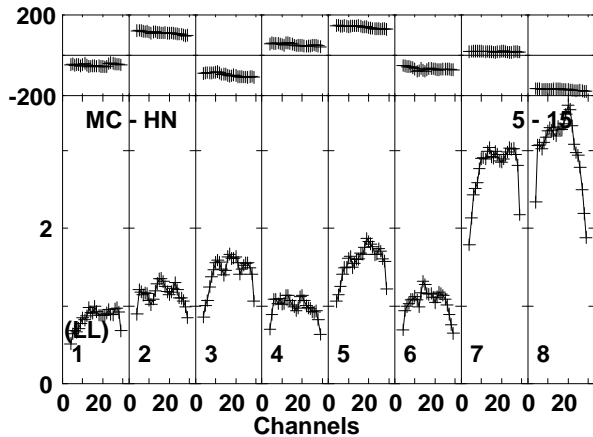
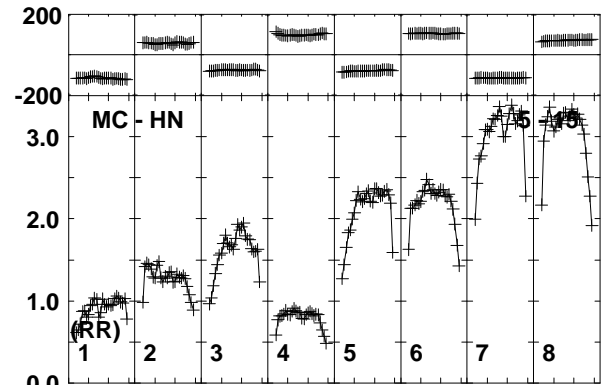
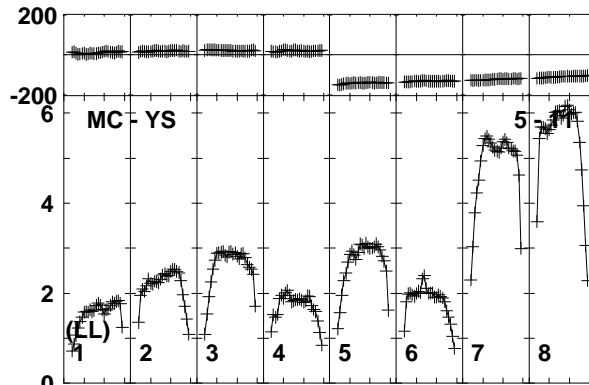
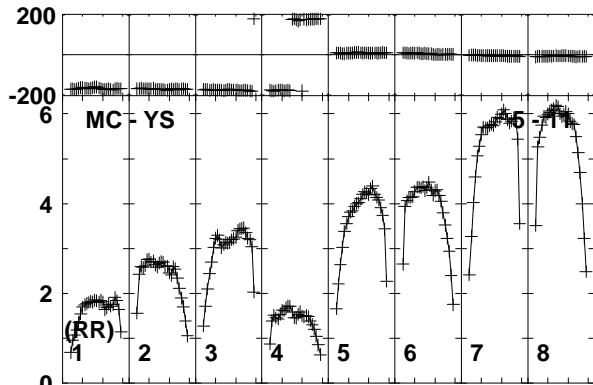
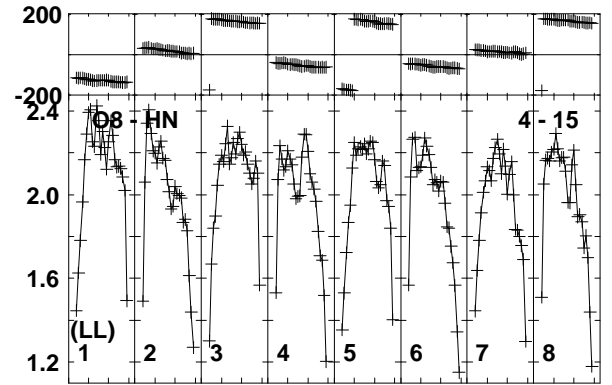
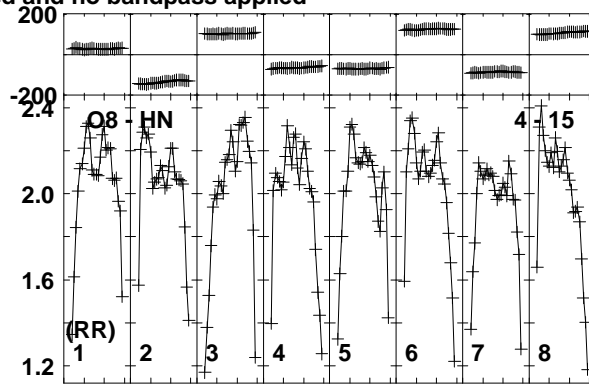
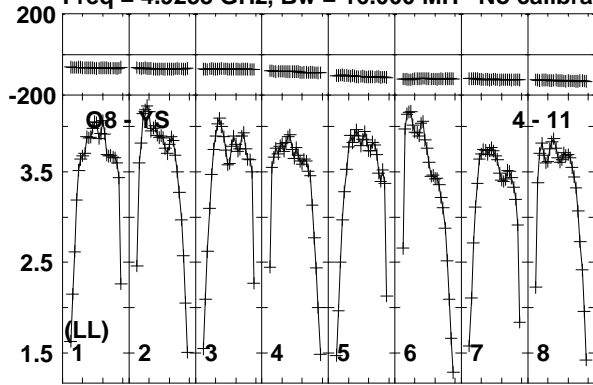

Lower frame: Milli Ampl Jy Top frame: Phas deg
Vector averaged cross-power spectrum Baseline: O8 (04) - YS (11)
Timerange: 00/20:59:02 to 00/21:00:53

Plot file version 44 created 11-APR-2016 17:08:21

J1128+5925 GP053G 3.UVDATA.1

Freq = 4.9253 GHz, Bw = 16.000 MH No calibration applied and no bandpass applied

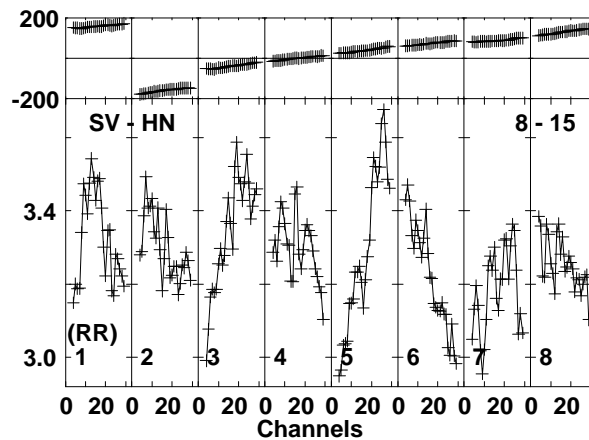
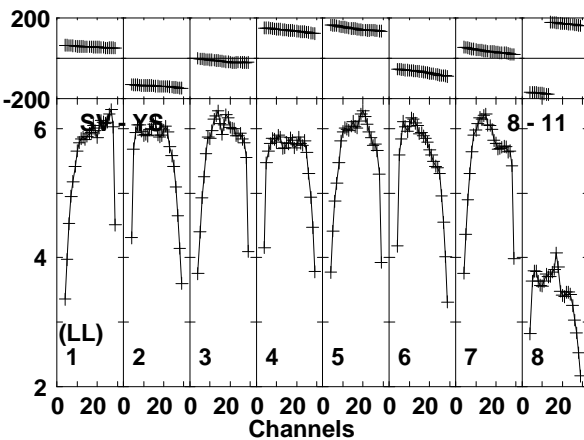
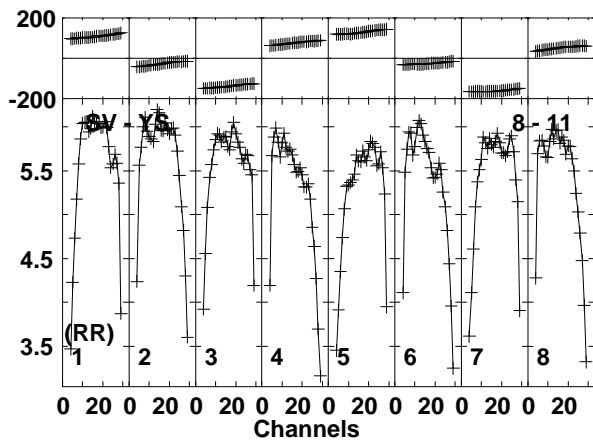
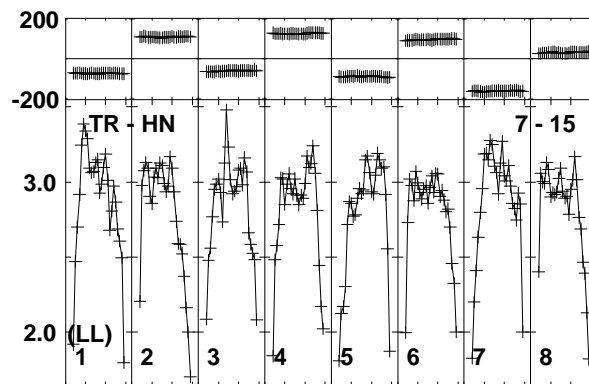
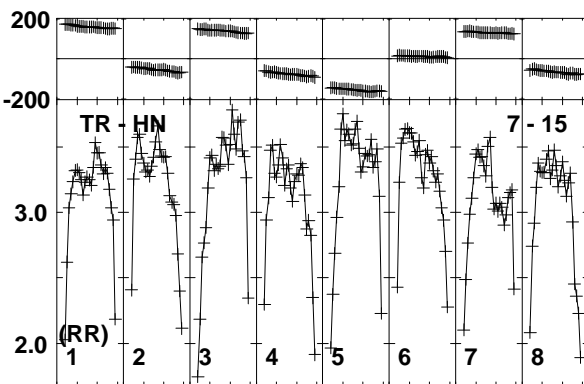
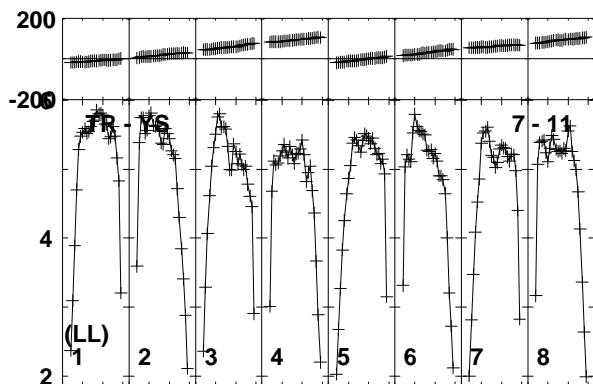
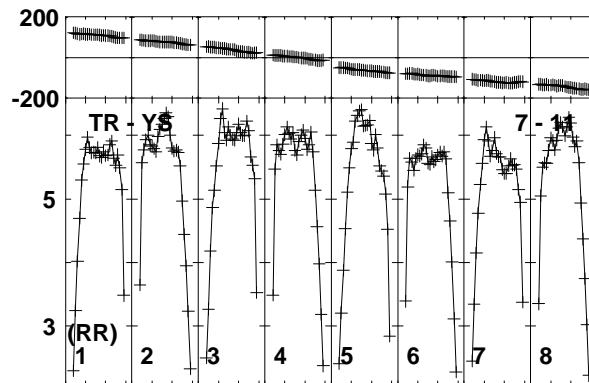
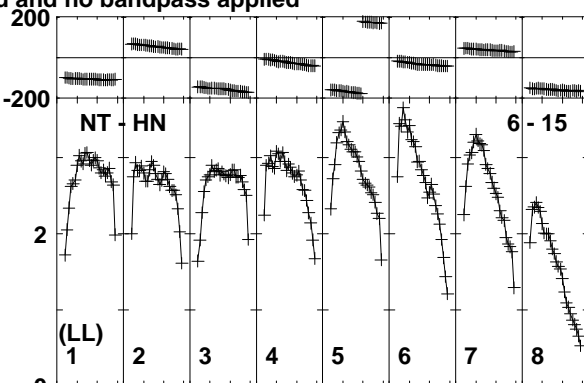
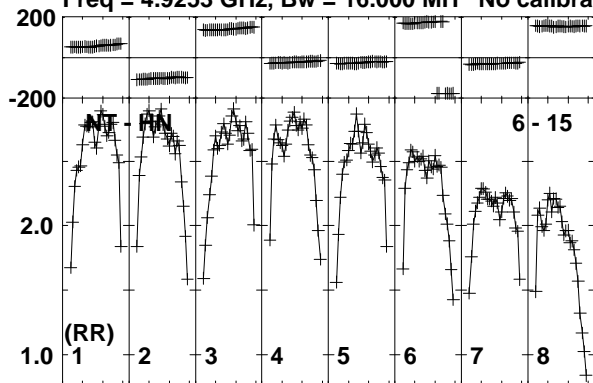

Lower frame: Milli Ampl Jy Top frame: Phas deg
Vector averaged cross-power spectrum Baseline: NT (06) - HN (15)
Timerange: 00/20:59:02 to 00/21:00:53

Plot file version 45 created 11-APR-2016 17:08:21

J1128+5925 GP053G 3.UVDATA.1

Freq = 4.9253 GHz, Bw = 16.000 MH No calibration applied and no bandpass applied

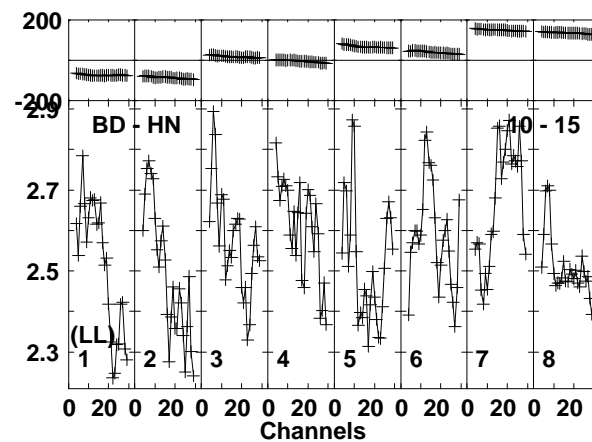
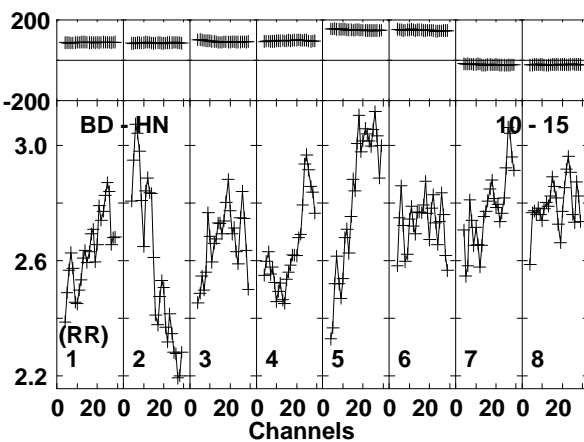
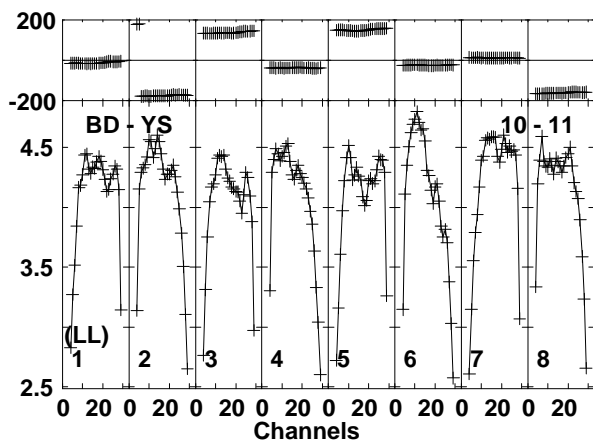
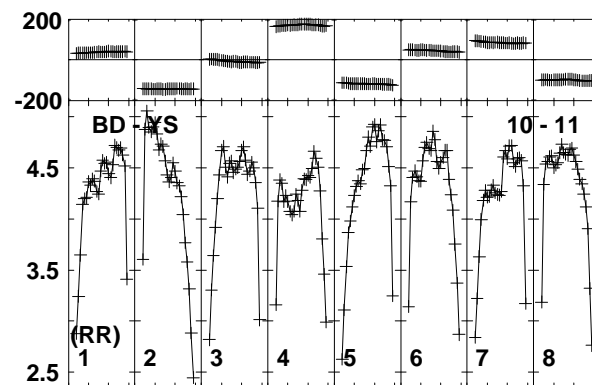
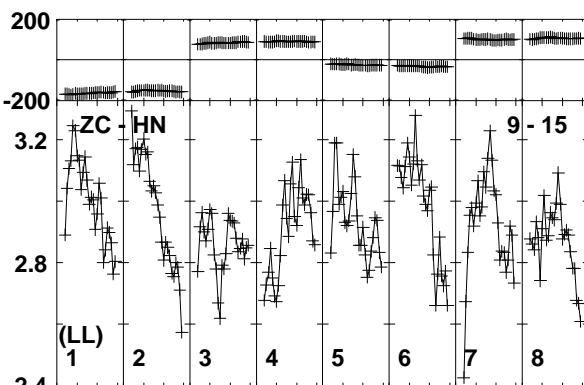
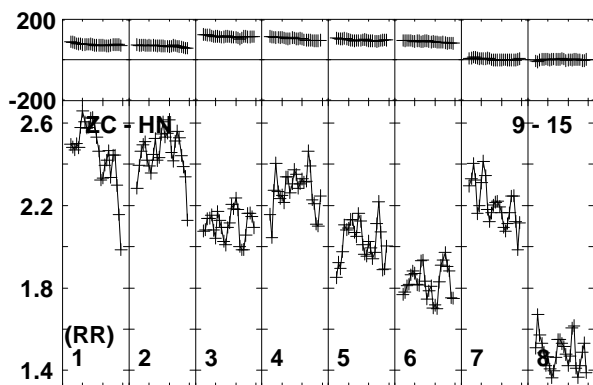
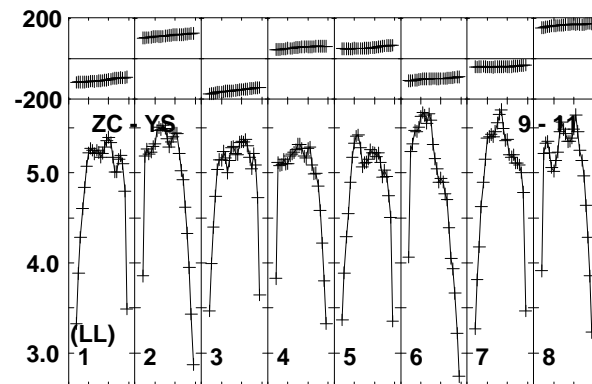
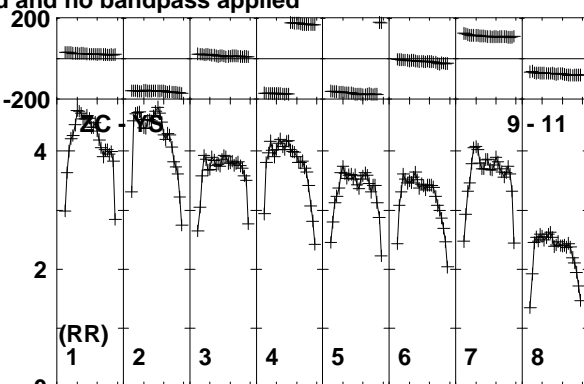
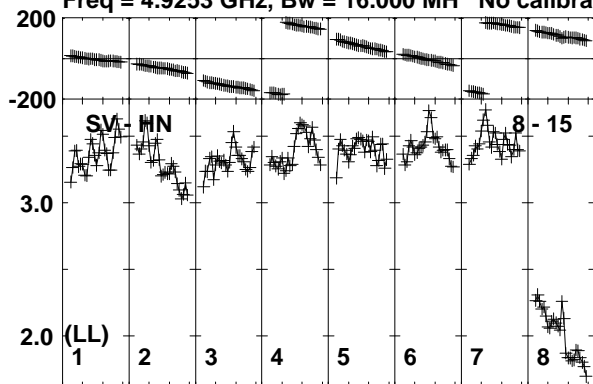

Lower frame: Milli Ampl Jy Top frame: Phas deg
Vector averaged cross-power spectrum Baseline: SV (08) - HN (15)
Timerange: 00/20:59:02 to 00/21:00:53

Plot file version 46 created 11-APR-2016 17:08:21

J1128+5925 GP053G 3.UVDATA.1

Freq = 4.9253 GHz, Bw = 16.000 MH No calibration applied and no bandpass applied

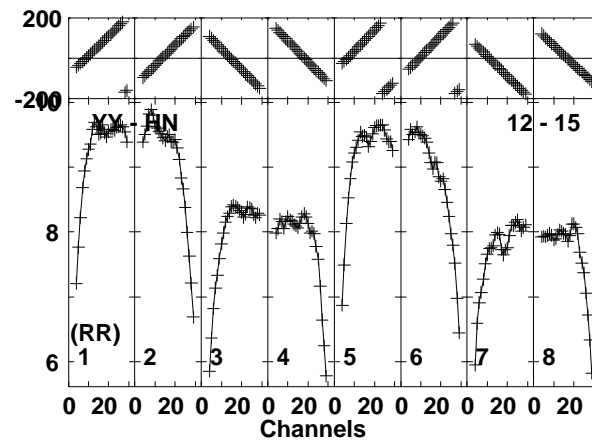
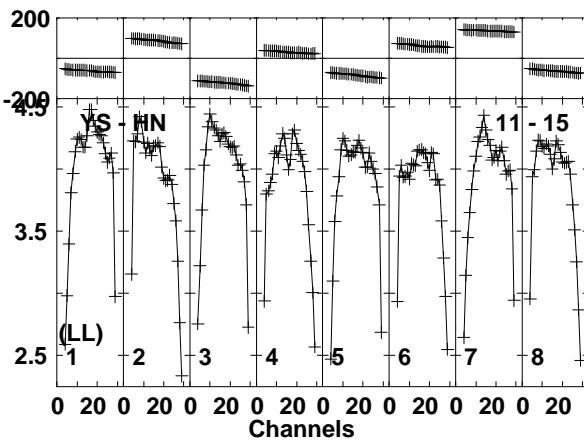
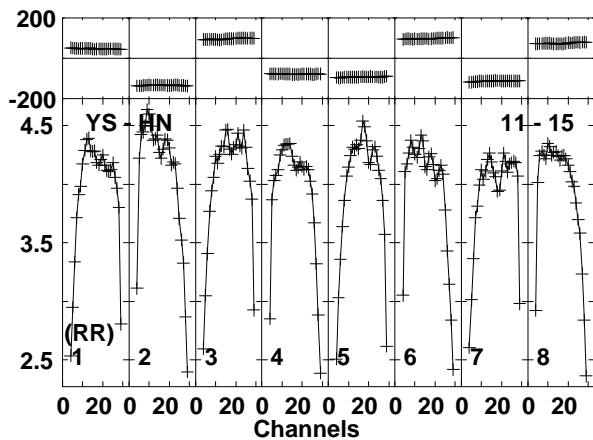
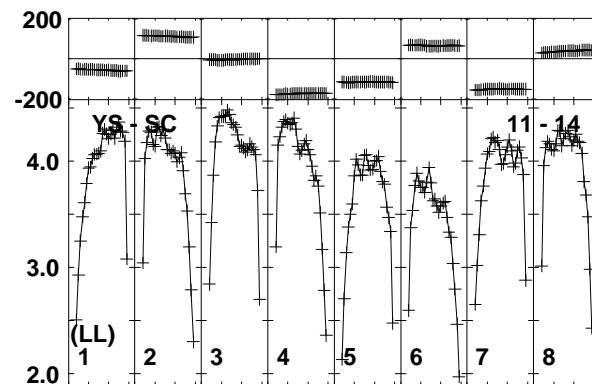
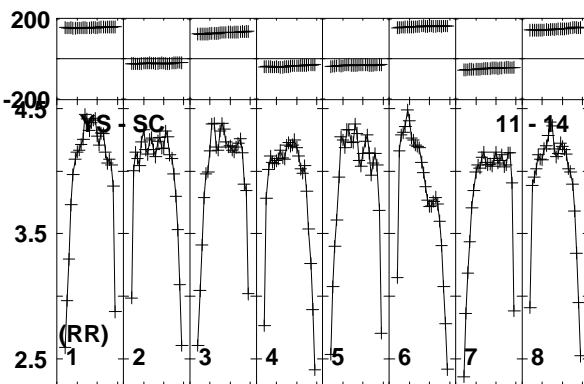
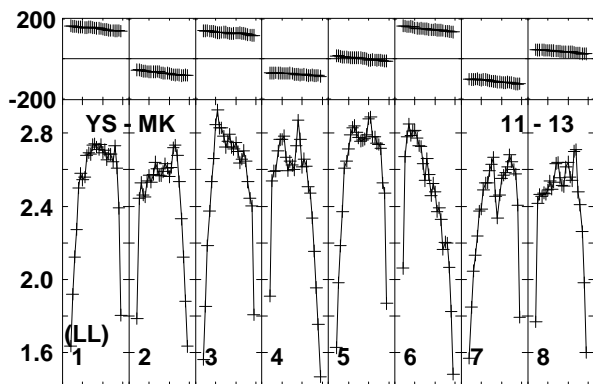
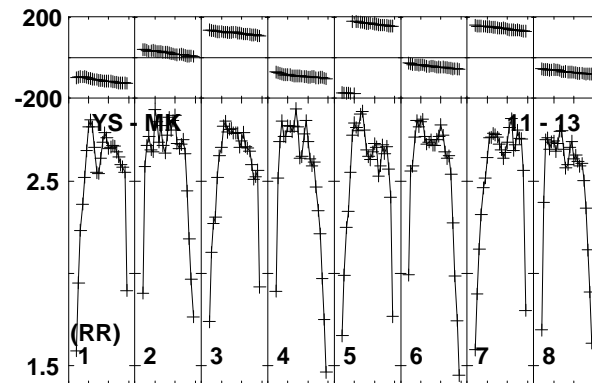
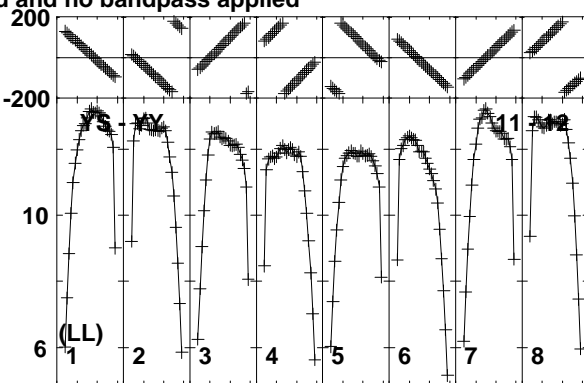
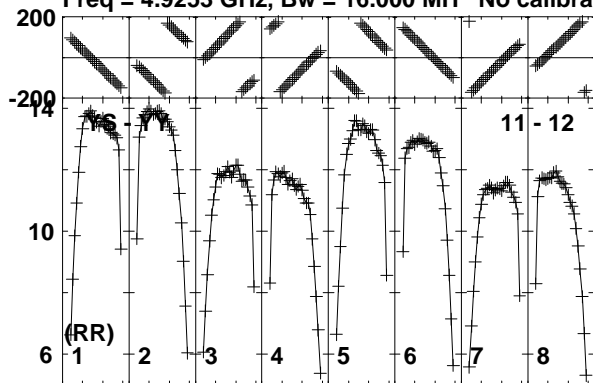

Lower frame: Milli Ampl Jy Top frame: Phas deg
Vector averaged cross-power spectrum Baseline: YS (11) - YY (12)
Timerange: 00/20:59:02 to 00/21:00:53

Plot file version 47 created 11-APR-2016 17:08:21

J1128+5925 GP053G 3.UVDATA.1

Freq = 4.9253 GHz, Bw = 16.000 MH No calibration applied and no bandpass applied

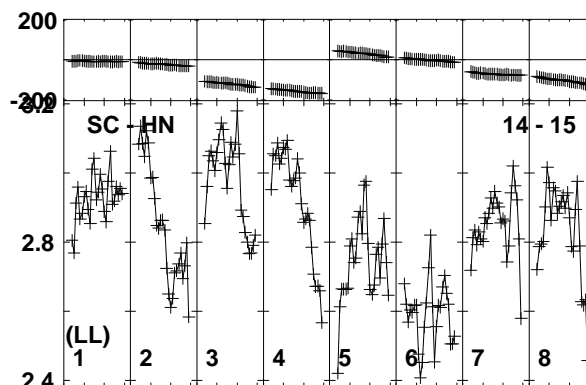
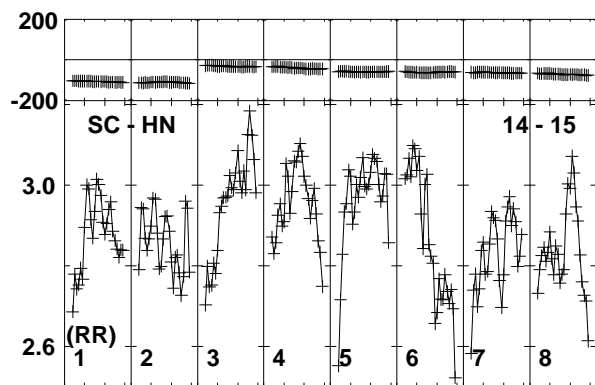
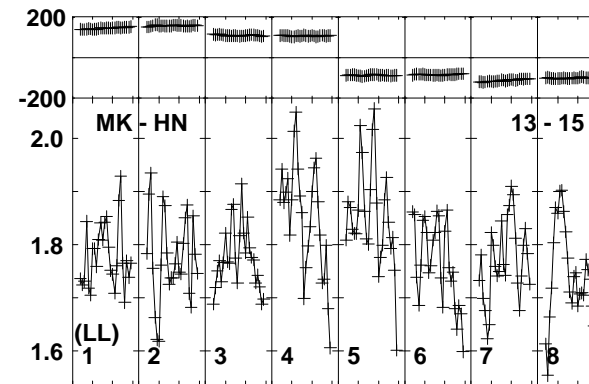
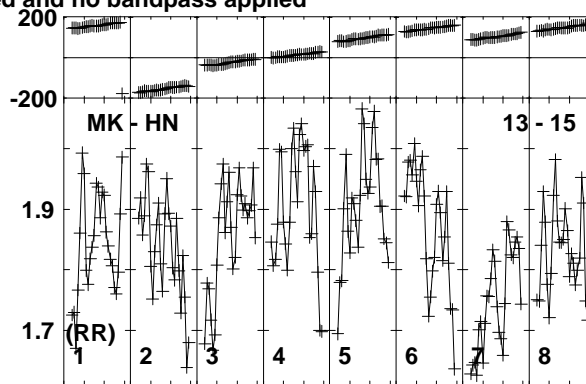
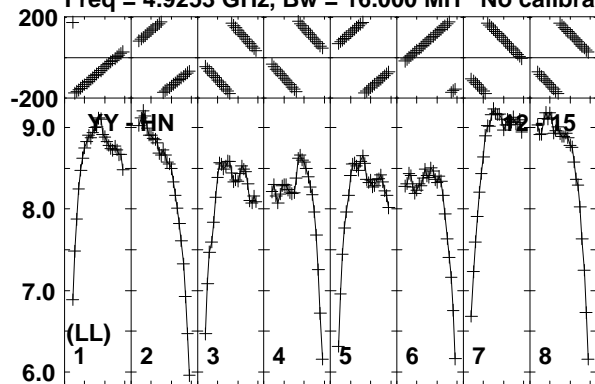

Lower frame: Milli Ampl Jy Top frame: Phas deg
Vector averaged cross-power spectrum Baseline: YY (12) - HN (15)
Timerange: 00/20:59:02 to 00/21:00:53

Plot file version 48 created 11-APR-2016 17:08:21

ARP299C GP053G 3.UVDATA.1

Freq = 4.9253 GHz, Bw = 16.000 MH No calibration applied and no bandpass applied

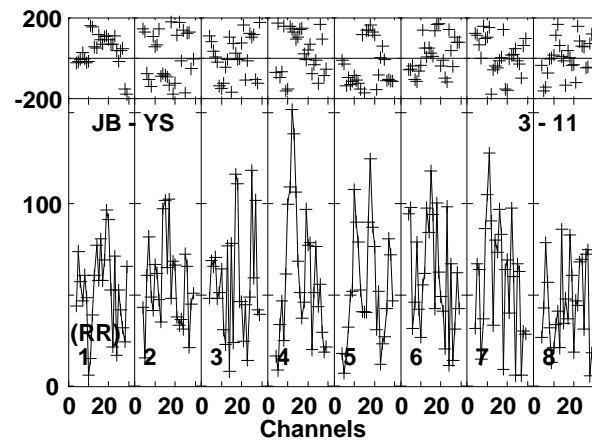
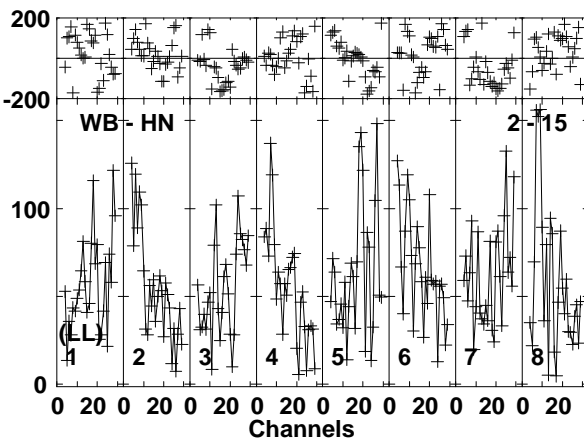
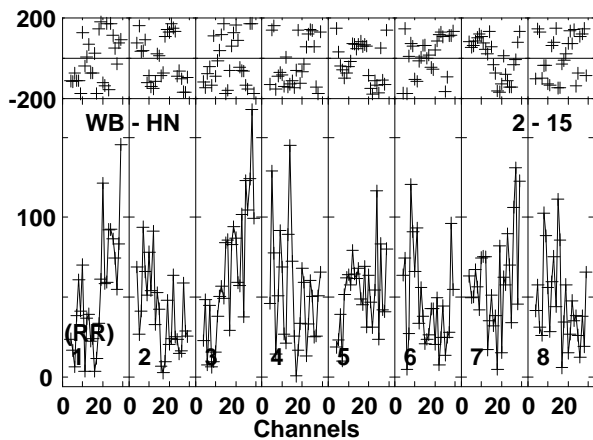
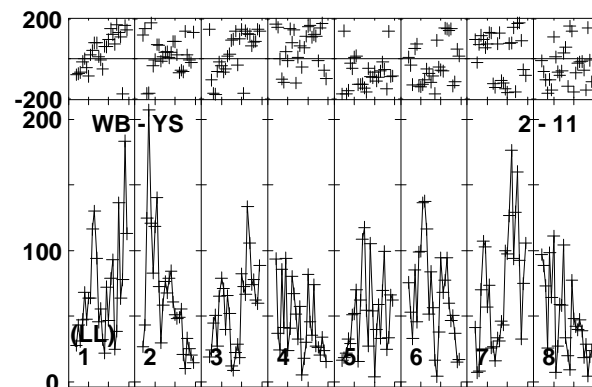
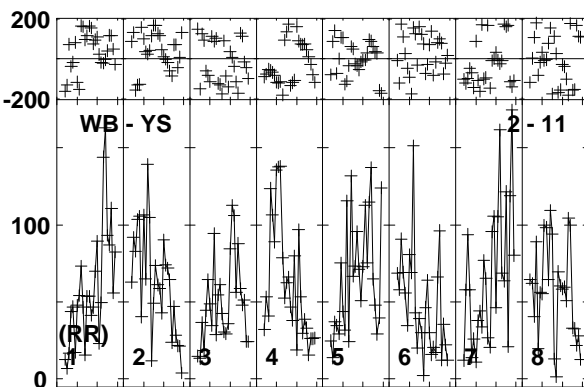
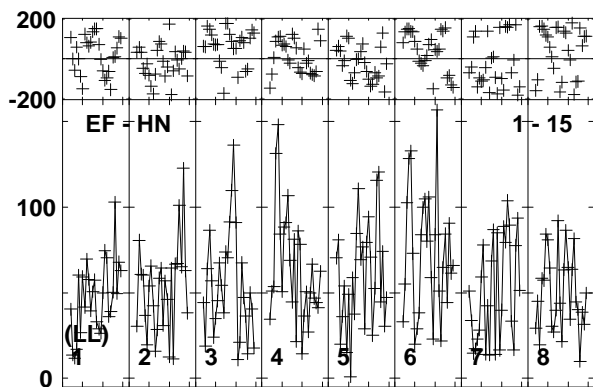
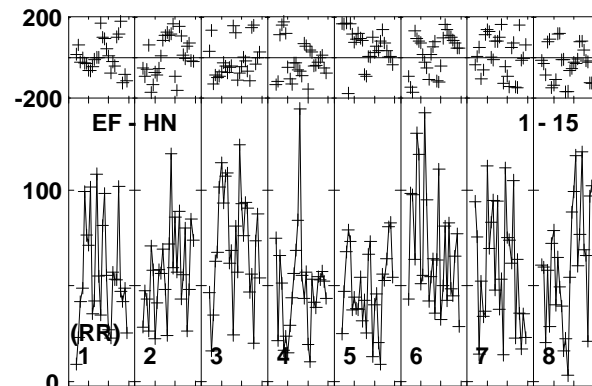
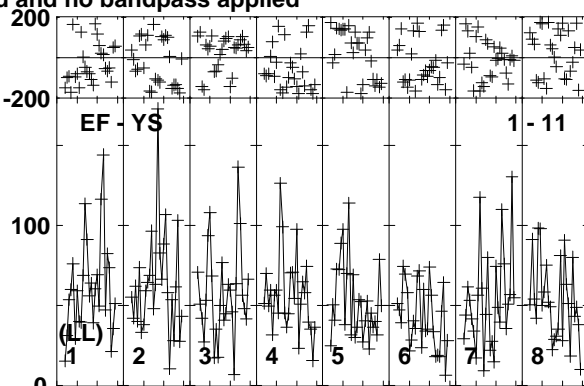
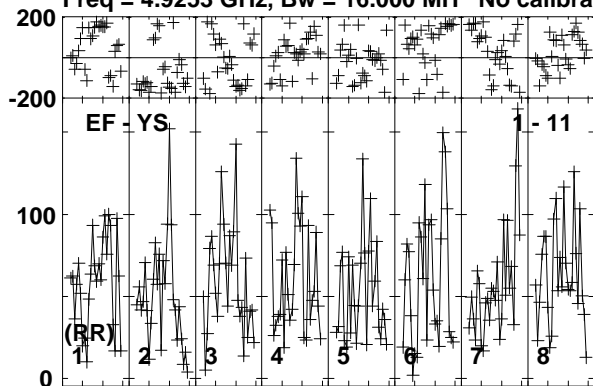

Lower frame: Micro Ampl Jy Top frame: Phas deg
Vector averaged cross-power spectrum Baseline: EF (01) - YS (11)
Timerange: 00/21:00:58 to 00/21:06:12

Plot file version 49 created 11-APR-2016 17:08:21

ARP299C GP053G 3.UVDATA.1

Freq = 4.9253 GHz, Bw = 16.000 MH No calibration applied and no bandpass applied

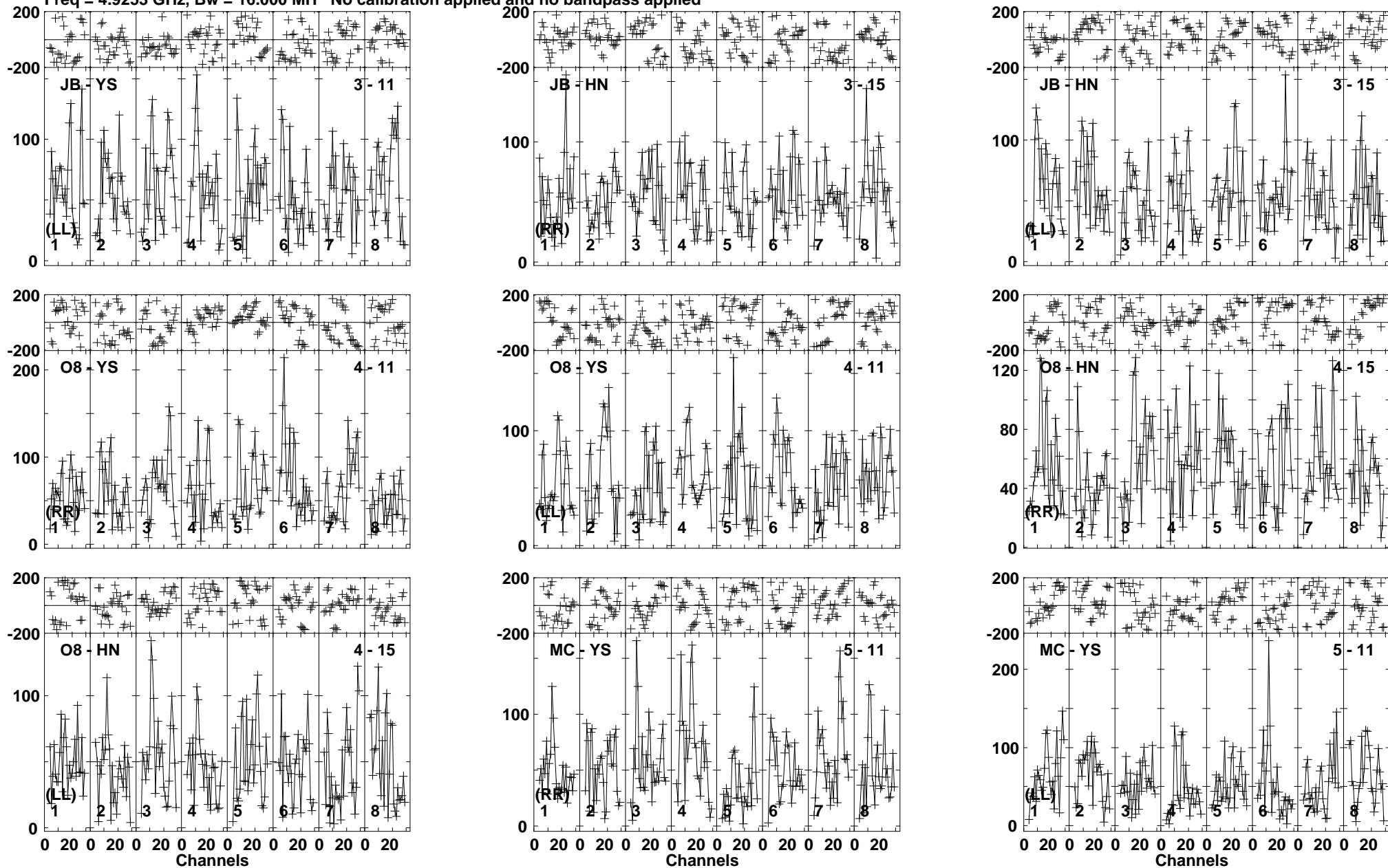

Lower frame: Micro Ampl Jy Top frame: Phas deg
Vector averaged cross-power spectrum Baseline: JB (03) - YS (11)
Timerange: 00/21:00:58 to 00/21:06:12

Plot file version 50 created 11-APR-2016 17:08:22

ARP299C GP053G 3.UVDATA.1

Freq = 4.9253 GHz, Bw = 16.000 MH No calibration applied and no bandpass applied

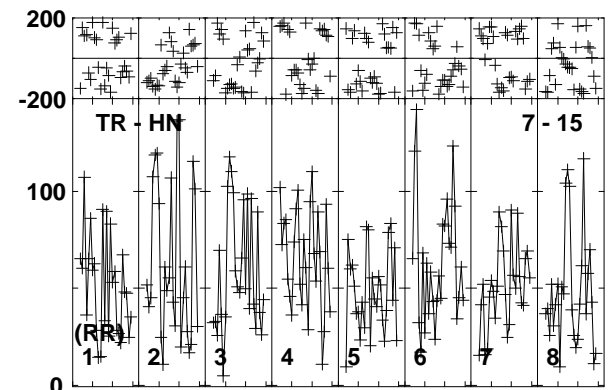
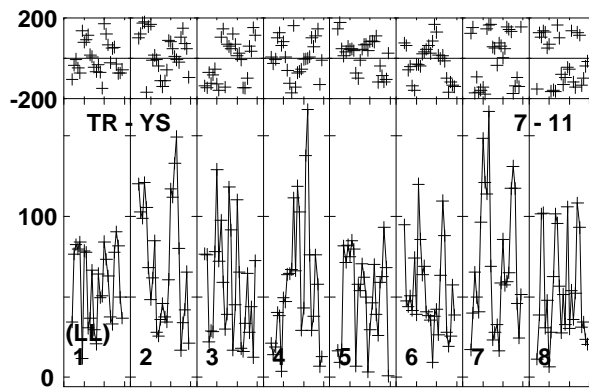
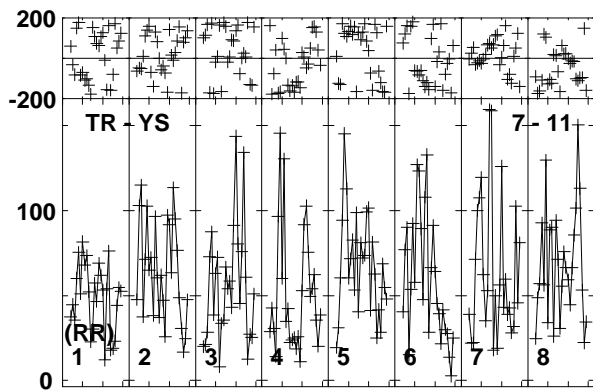
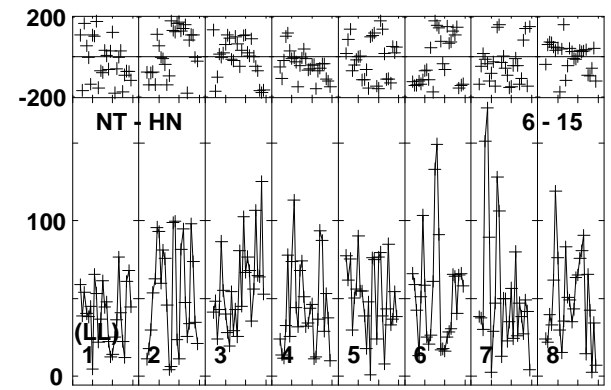
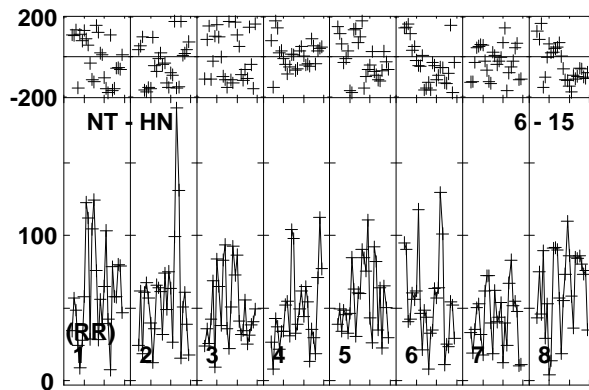
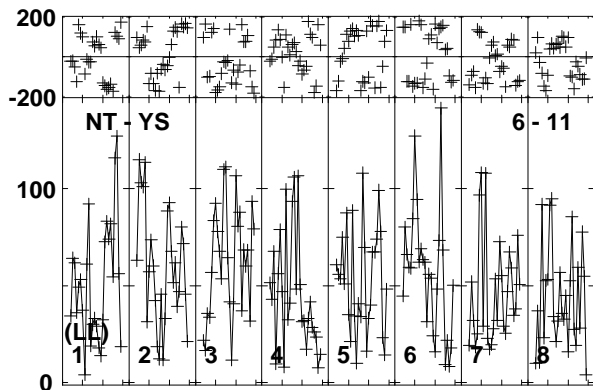
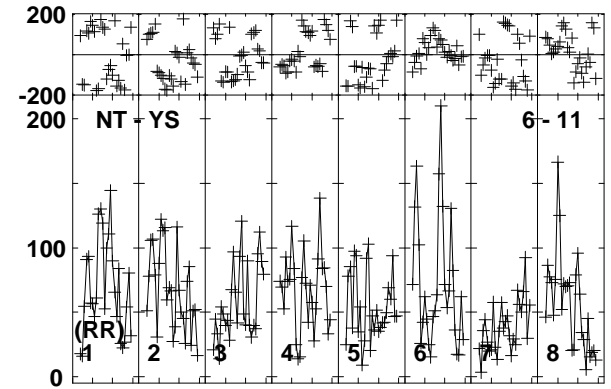
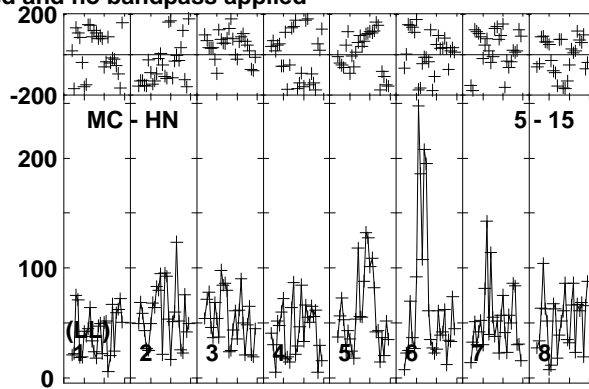
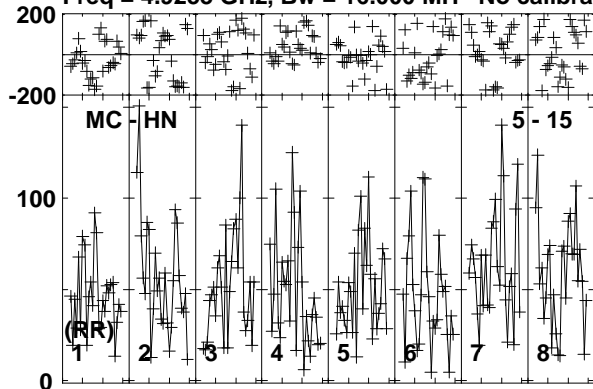

Lower frame: Micro Ampl Jy Top frame: Phas deg
Vector averaged cross-power spectrum Baseline: MC (05) - HN (15)
Timerange: 00/21:00:58 to 00/21:06:12

Plot file version 51 created 11-APR-2016 17:08:22

ARP299C GP053G 3.UVDATA.1

Freq = 4.9253 GHz, Bw = 16.000 MH No calibration applied and no bandpass applied

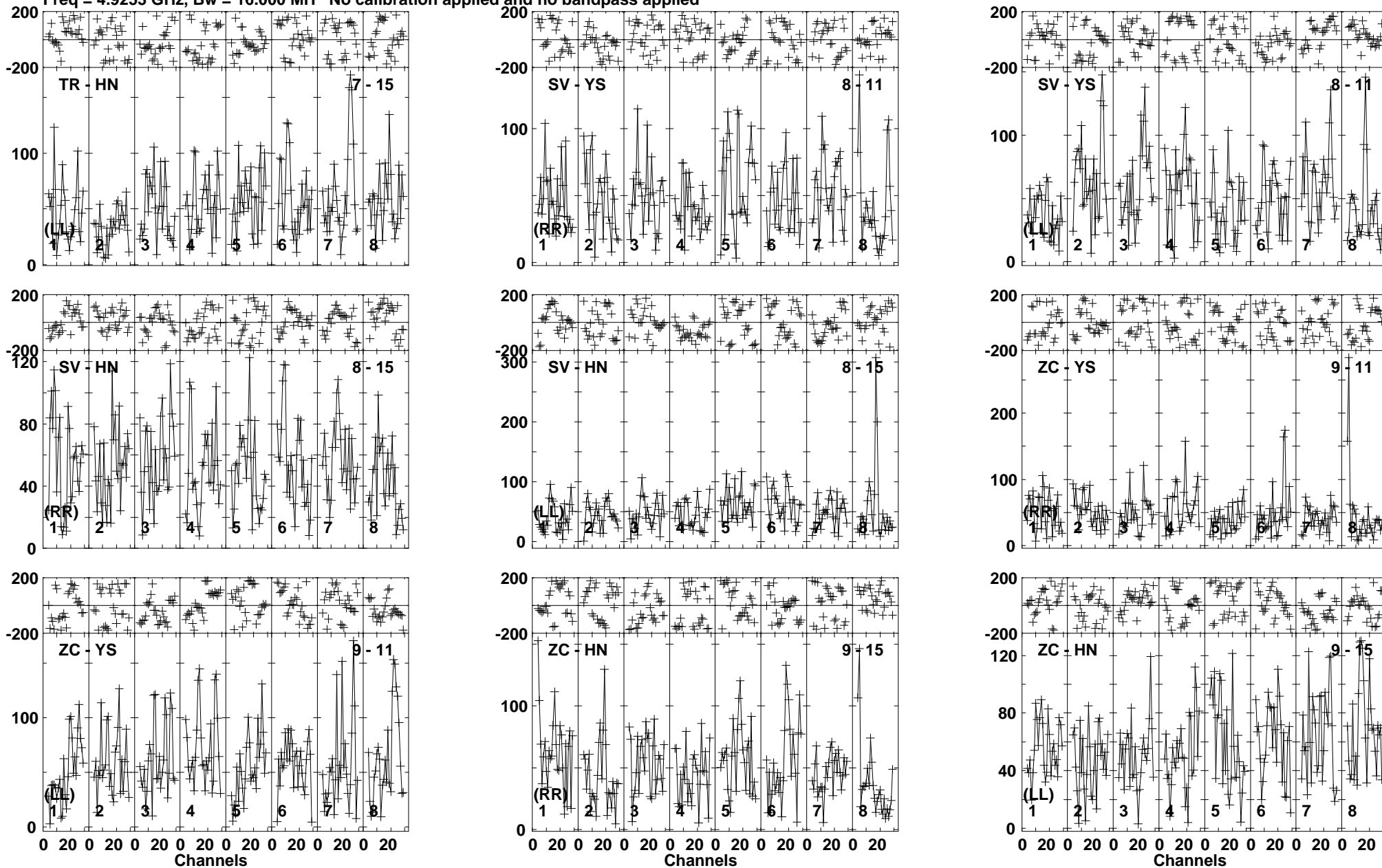

Lower frame: Micro Ampl Jy Top frame: Phas deg
Vector averaged cross-power spectrum Baseline: TR (07) - HN (15)
Timerange: 00/21:00:58 to 00/21:06:12

Plot file version 52 created 11-APR-2016 17:08:22

ARP299C GP053G 3.UVDATA.1

Freq = 4.9253 GHz, Bw = 16.000 MH No calibration applied and no bandpass applied

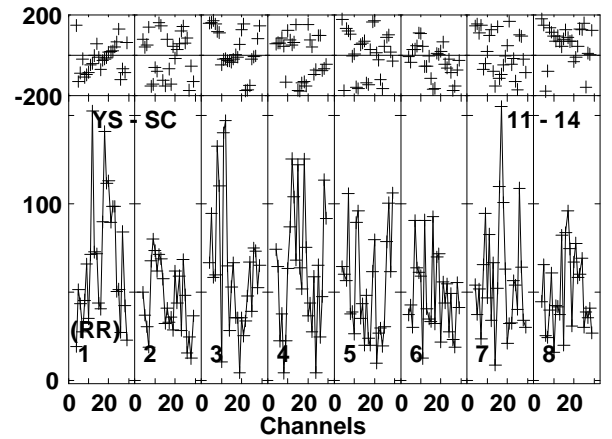
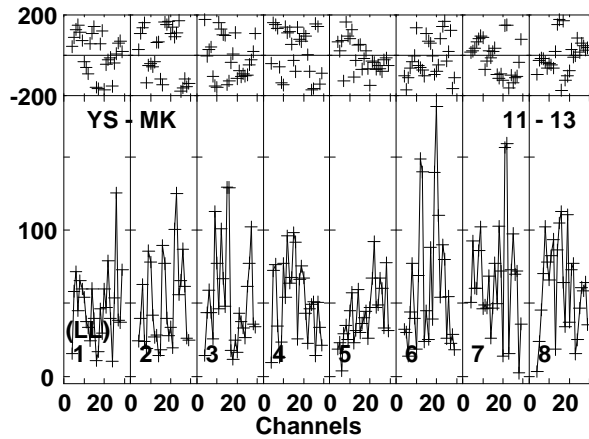
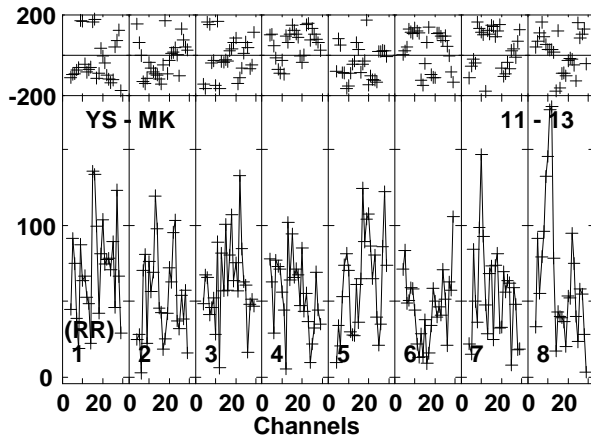
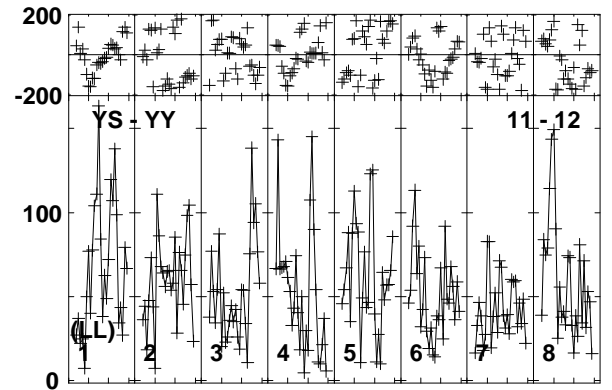
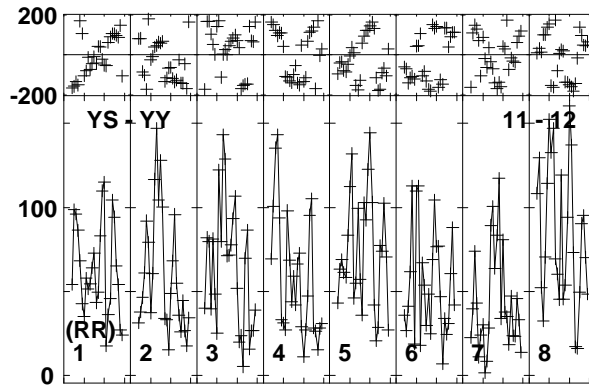
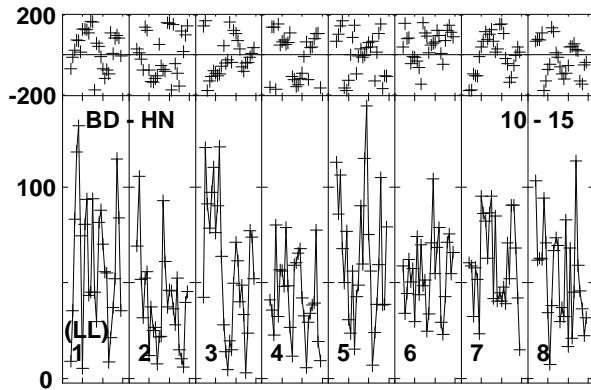
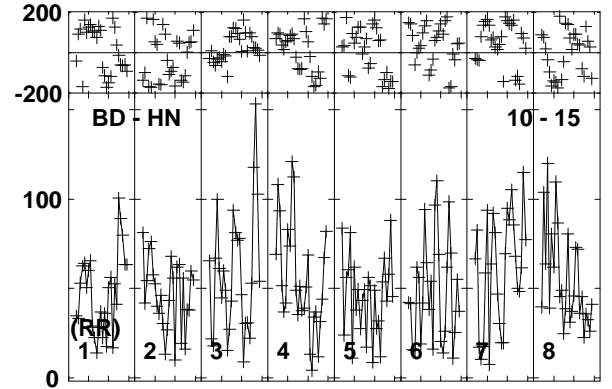
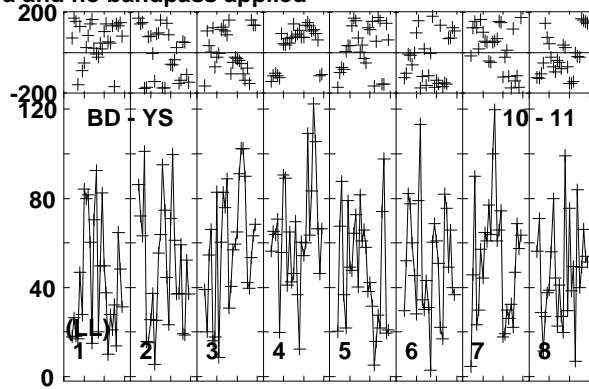
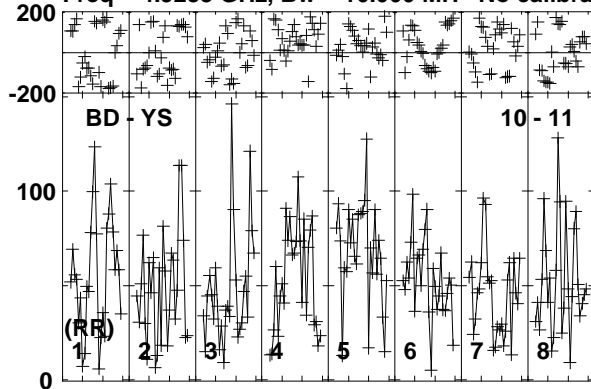

Lower frame: Micro Ampl Jy Top frame: Phas deg
Vector averaged cross-power spectrum Baseline: BD (10) - YS (11)
Timerange: 00/21:00:58 to 00/21:06:12

Plot file version 53 created 11-APR-2016 17:08:22

ARP299C GP053G 3.UVDATA.1

Freq = 4.9253 GHz, Bw = 16.000 MH No calibration applied and no bandpass applied

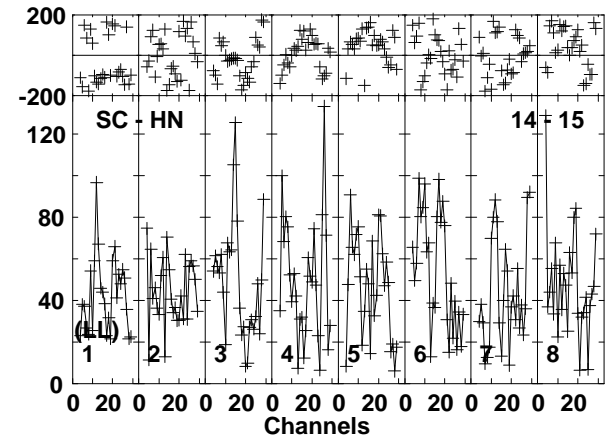
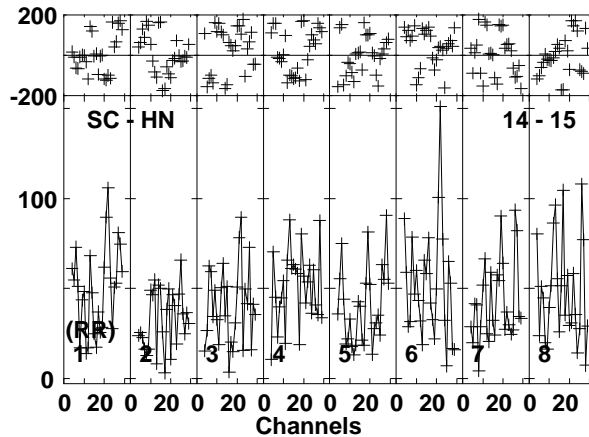
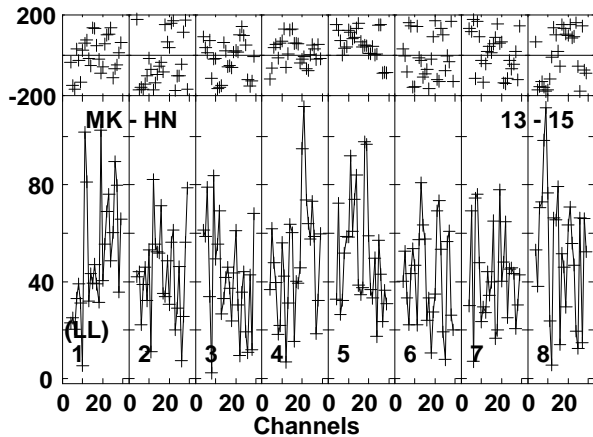
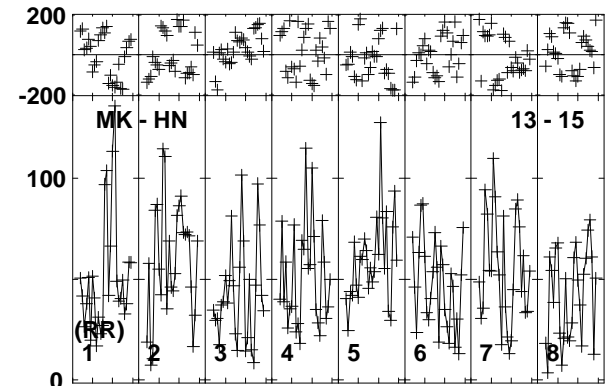
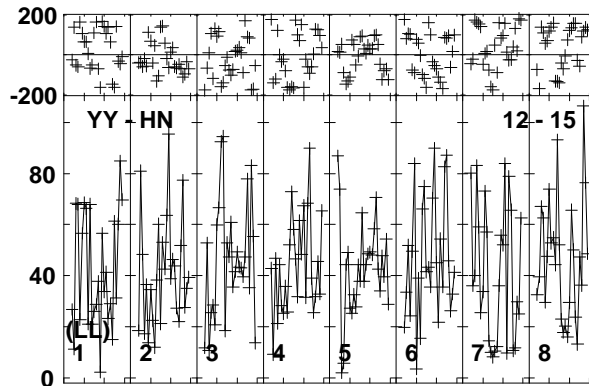
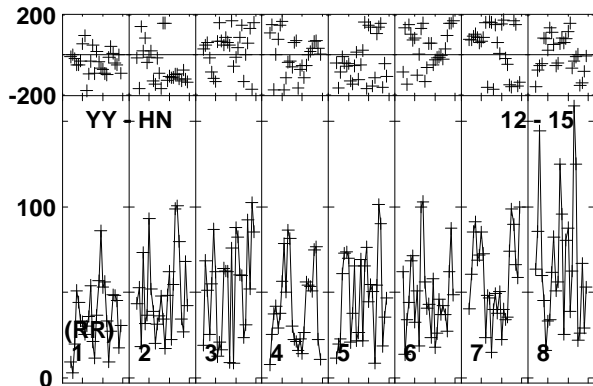
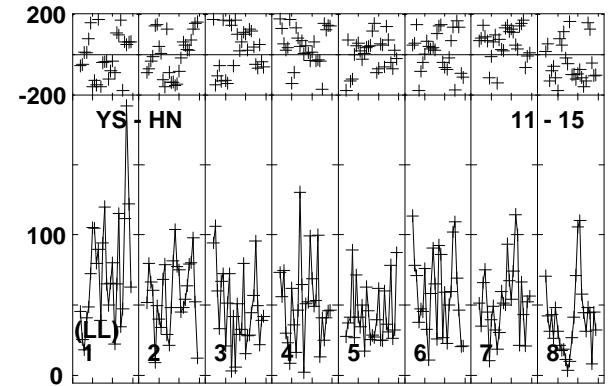
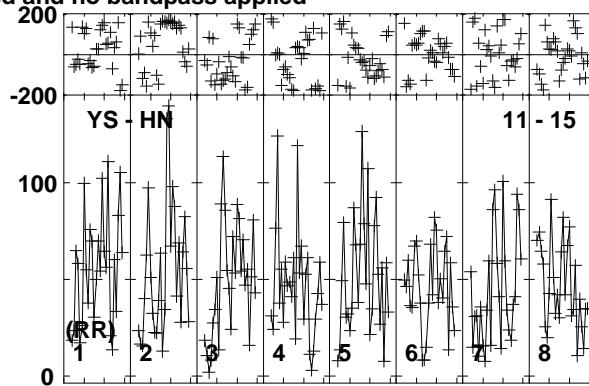
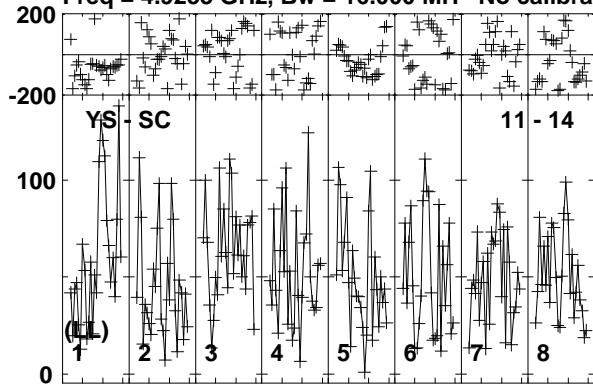

Lower frame: Micro Ampl Jy Top frame: Phas deg
Vector averaged cross-power spectrum Baseline: YS (11) - SC (14)
Timerange: 00/21:00:58 to 00/21:06:12

Plot file version 54 created 11-APR-2016 17:08:22

J1128+5925 GP053G 3.UVDATA.1

Freq = 4.9253 GHz, Bw = 16.000 MH No calibration applied and no bandpass applied

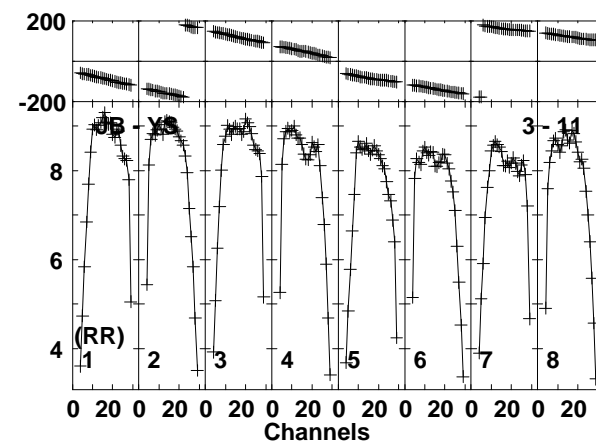
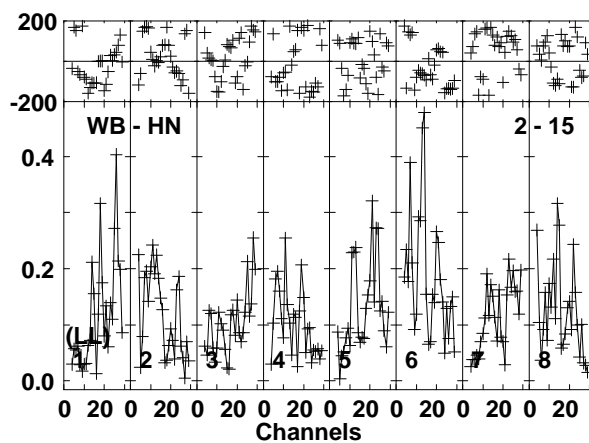
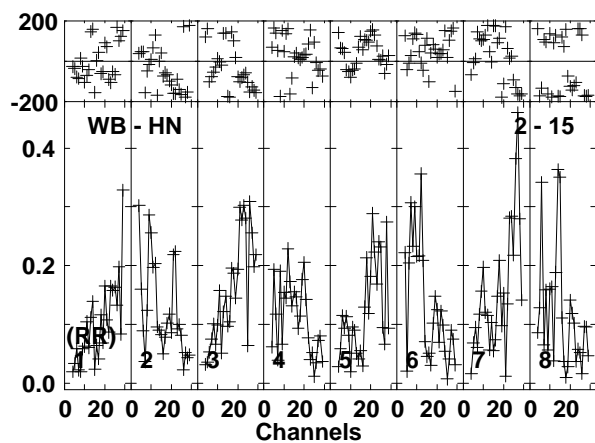
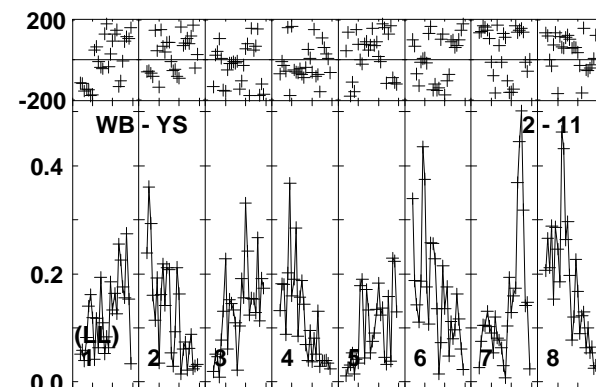
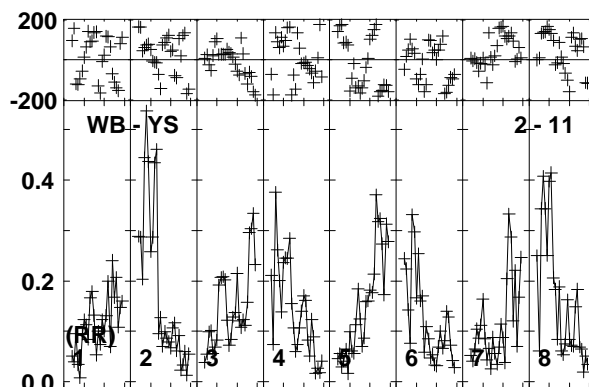
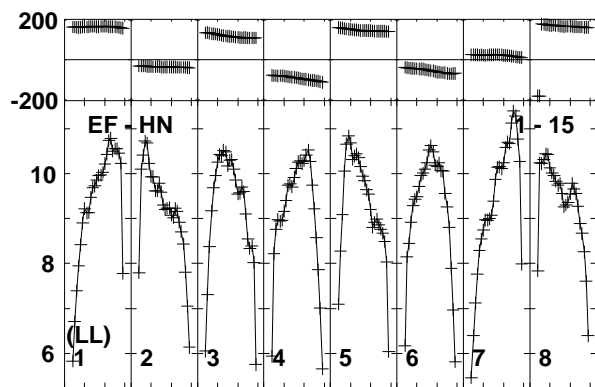
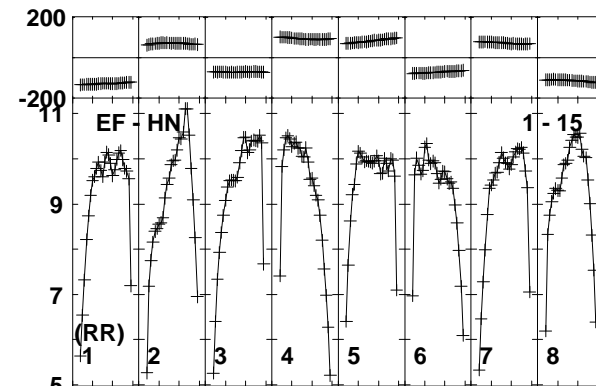
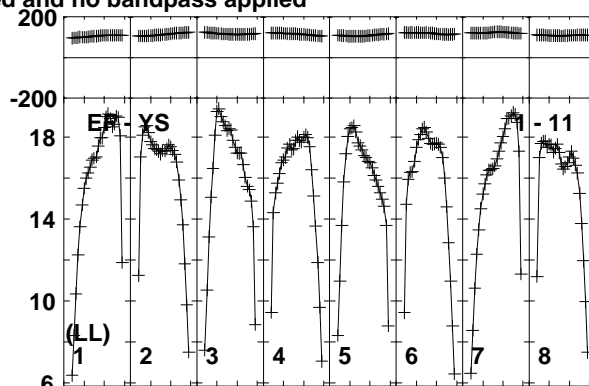
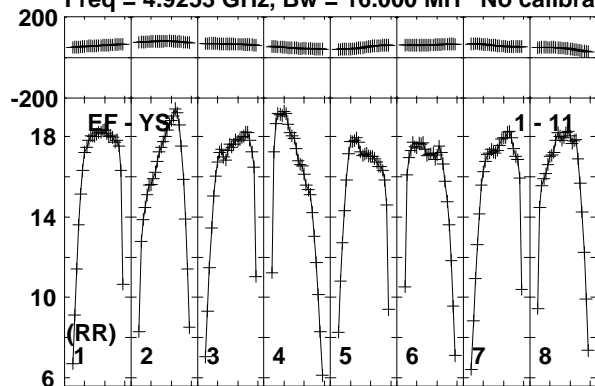

Lower frame: Milli Ampl Jy Top frame: Phas deg
Vector averaged cross-power spectrum Baseline: EF (01) - YS (11)
Timerange: 00/21:06:19 to 00/21:08:02

Plot file version 55 created 11-APR-2016 17:08:22

J1128+5925 GP053G 3.UVDATA.1

Freq = 4.9253 GHz, Bw = 16.000 MH No calibration applied and no bandpass applied

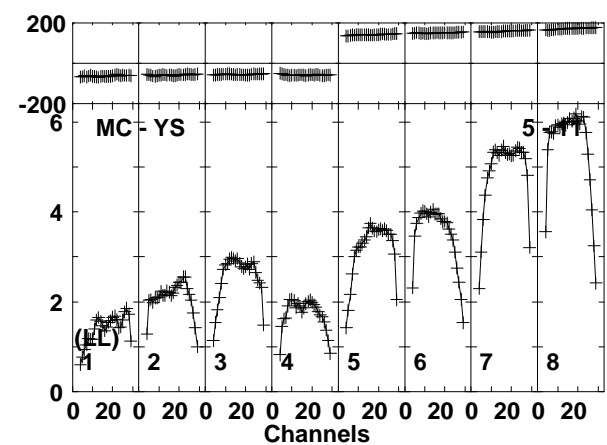
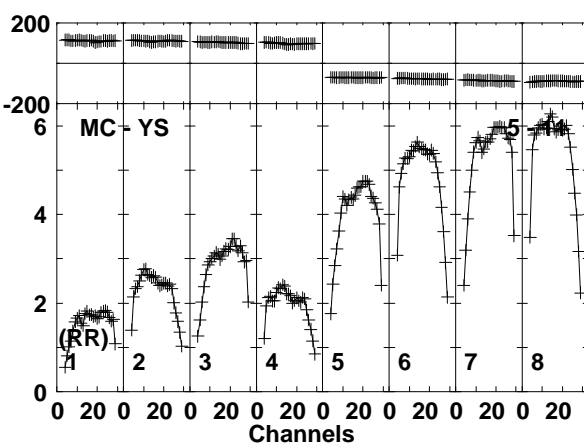
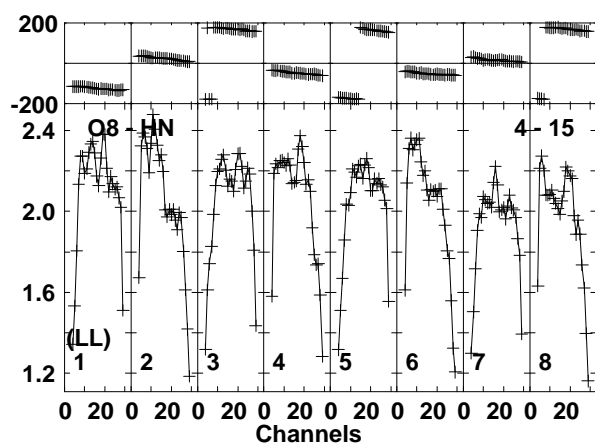
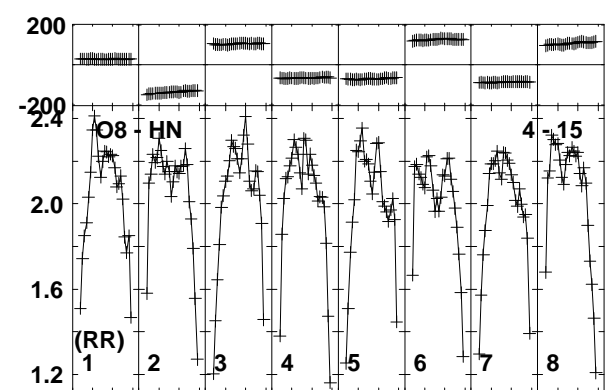
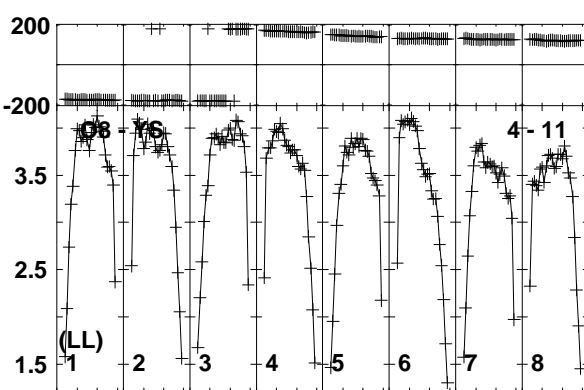
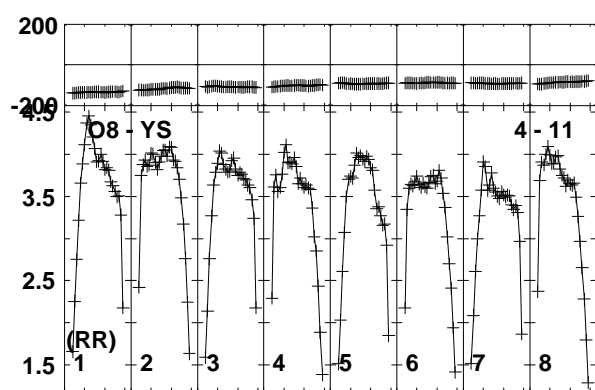
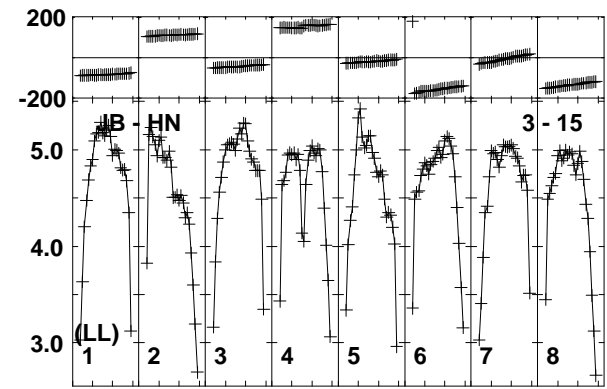
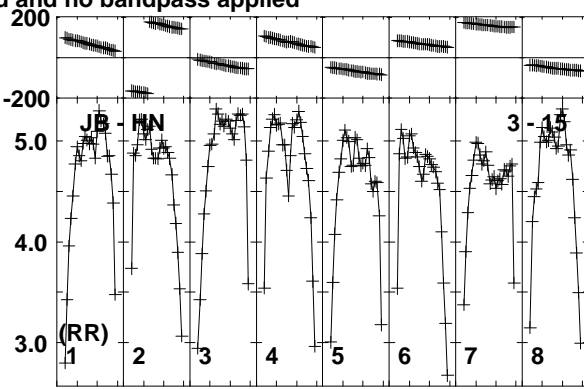
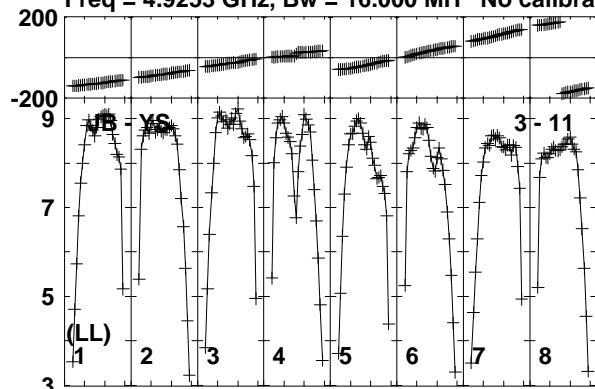

Lower frame: Milli Ampl Jy Top frame: Phas deg
Vector averaged cross-power spectrum Baseline: JB (03) - YS (11)
Timerange: 00/21:06:19 to 00/21:08:02

Plot file version 56 created 11-APR-2016 17:08:22

J1128+5925 GP053G 3.UVDATA.1

Freq = 4.9253 GHz, Bw = 16.000 MH No calibration applied and no bandpass applied

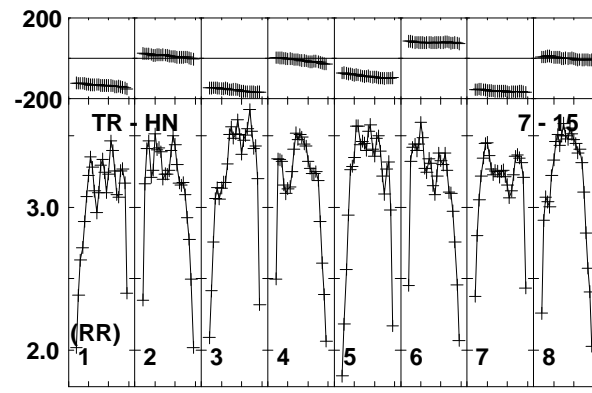
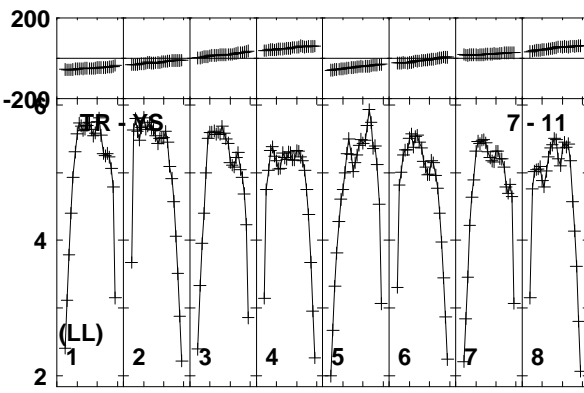
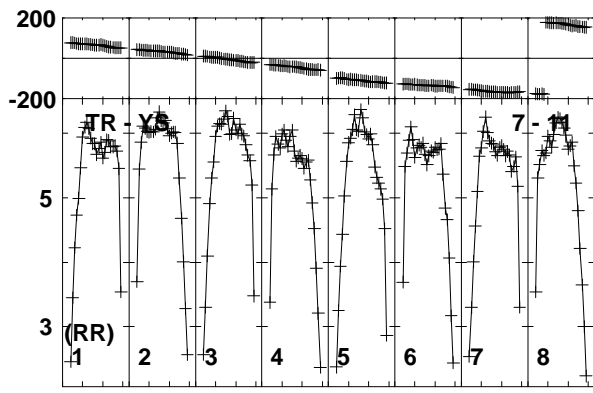
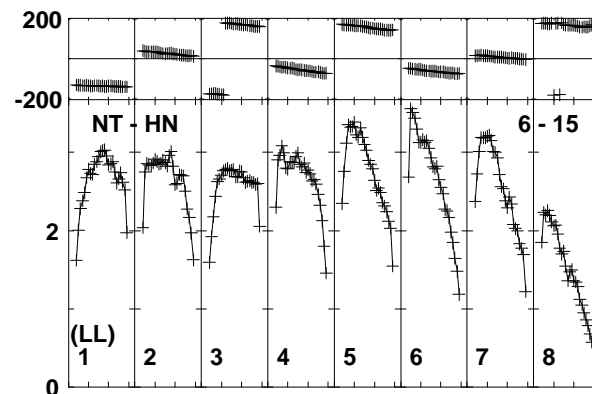
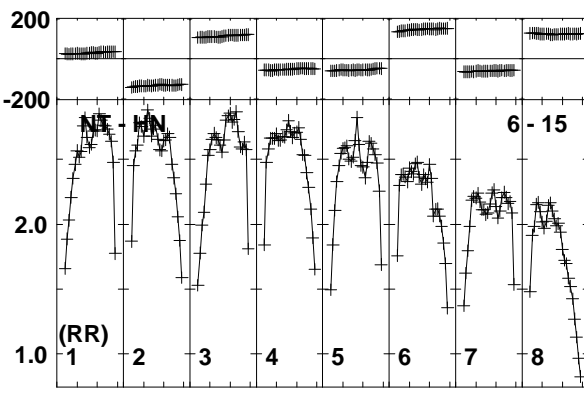
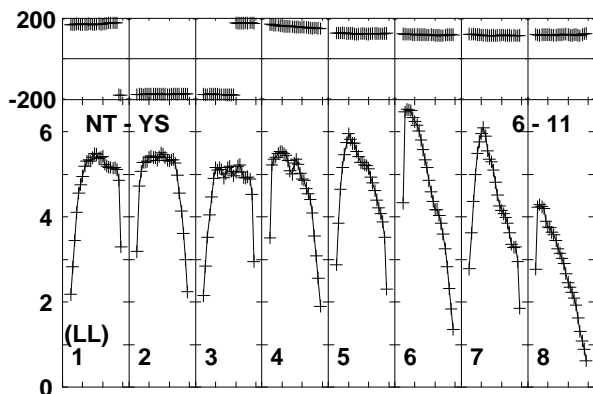
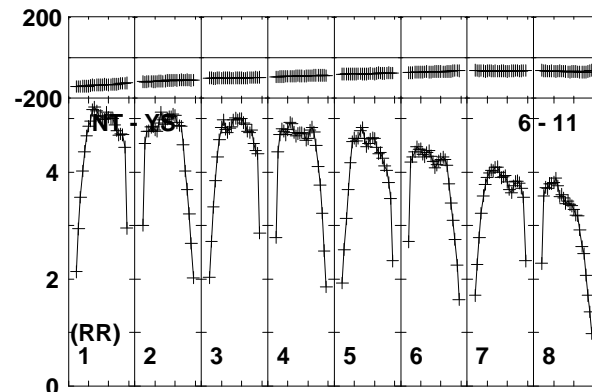
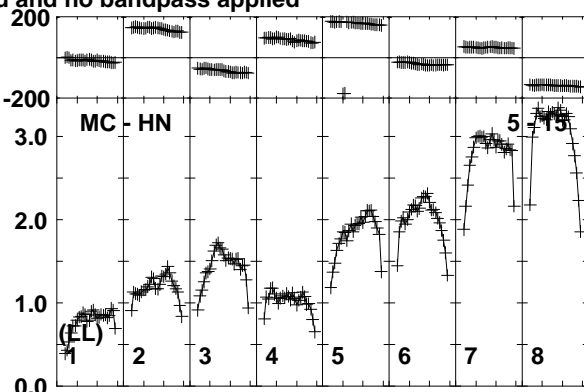
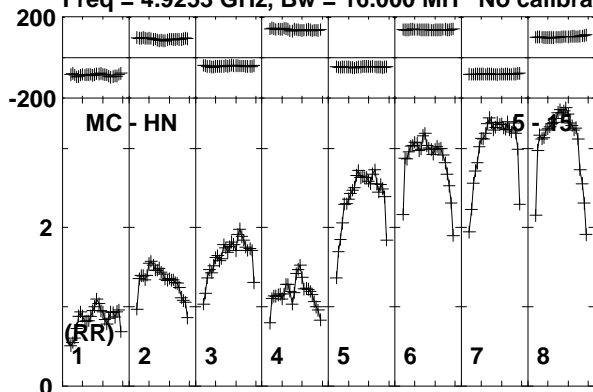

Lower frame: Milli Ampl Jy Top frame: Phas deg

Vector averaged cross-power spectrum Baseline: MC (05) - HN (15)

Timerange: 00/21:06:19 to 00/21:08:02

Plot file version 57 created 11-APR-2016 17:08:22

J1128+5925 GP053G 3.UVDATA.1

Freq = 4.9253 GHz, Bw = 16.000 MH No calibration applied and no bandpass applied

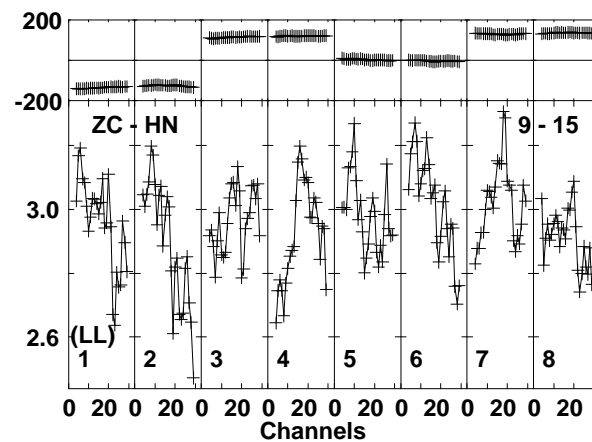
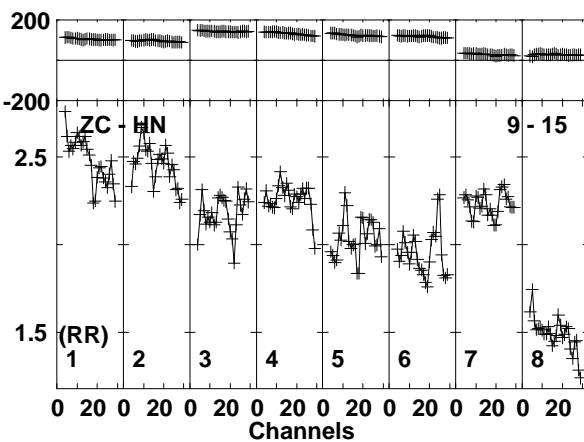
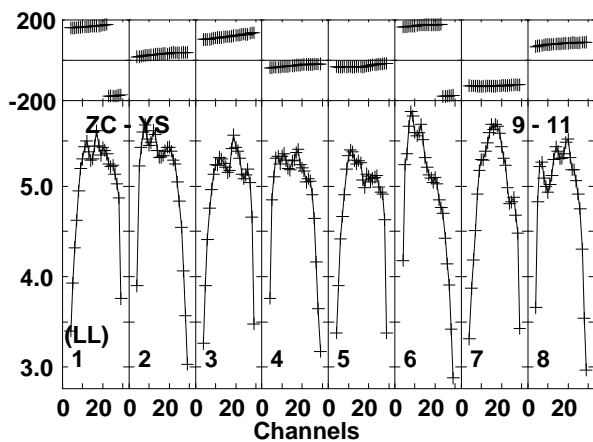
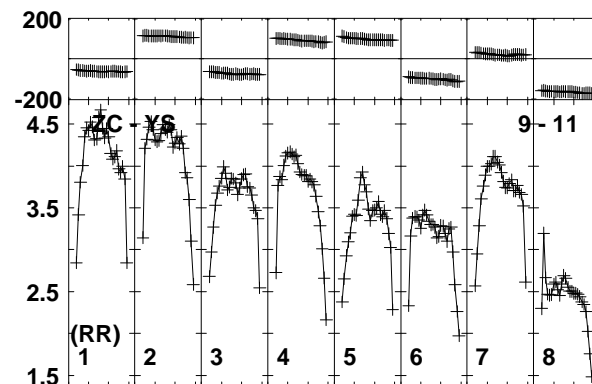
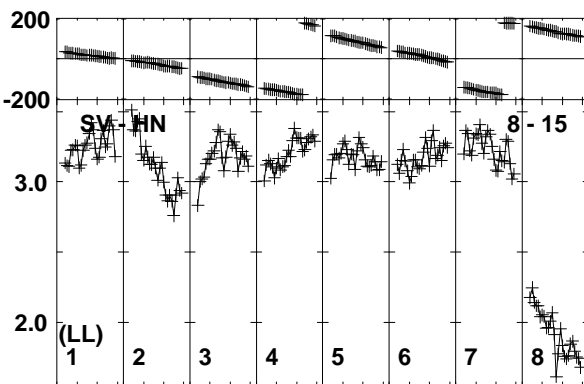
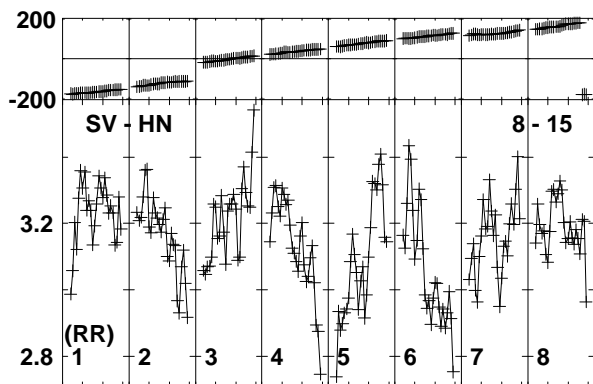
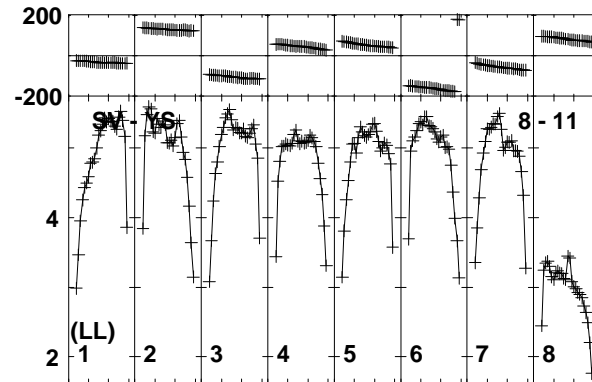
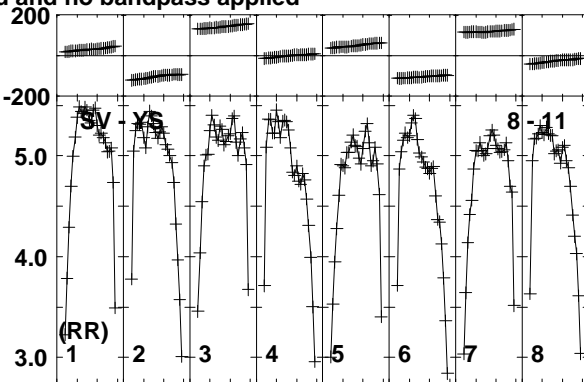
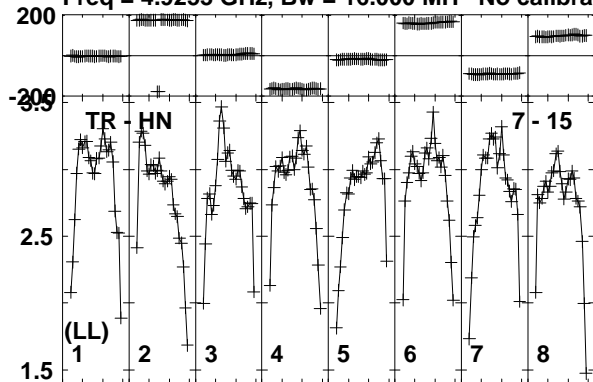

Lower frame: Milli Ampl Jy Top frame: Phas deg
Vector averaged cross-power spectrum Baseline: TR (07) - HN (15)
Timerange: 00/21:06:19 to 00/21:08:02

Plot file version 58 created 11-APR-2016 17:08:23

J1128+5925 GP053G 3.UVDATA.1

Freq = 4.9253 GHz, Bw = 16.000 MH No calibration applied and no bandpass applied

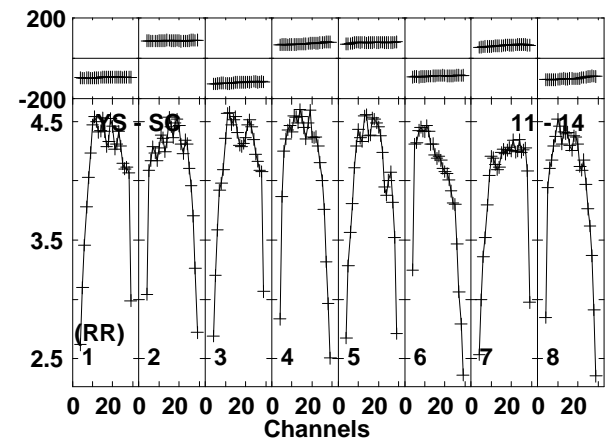
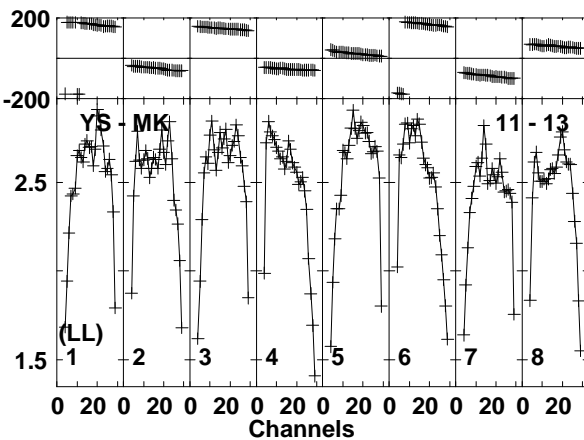
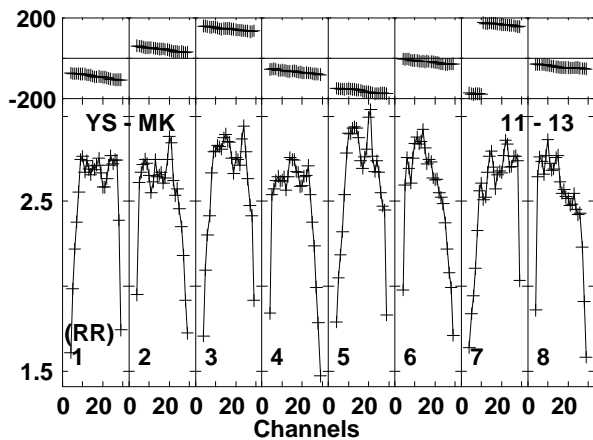
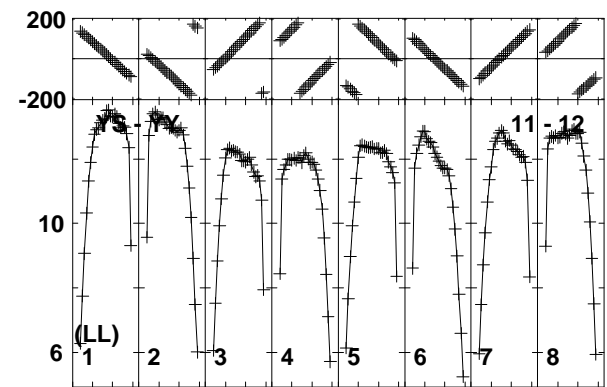
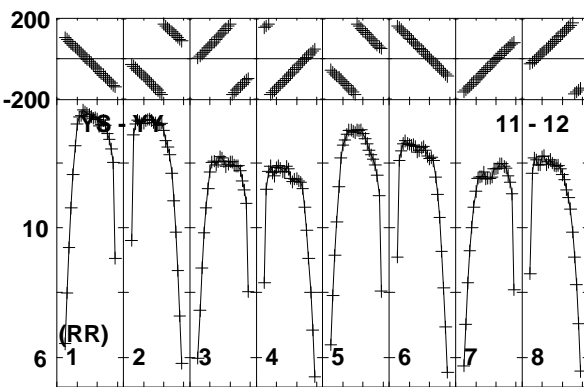
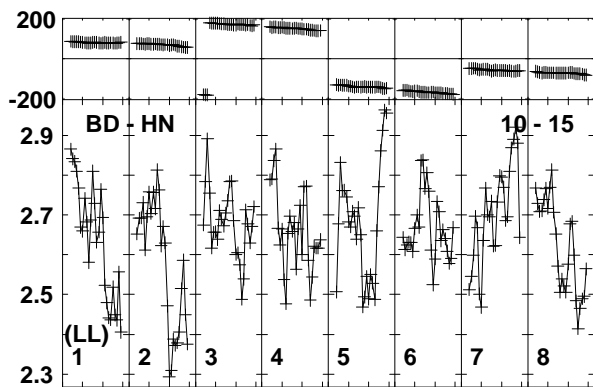
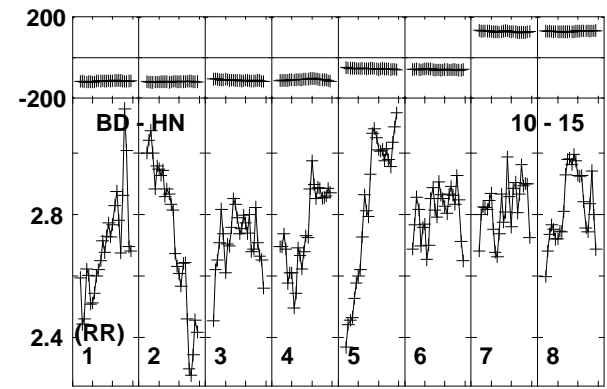
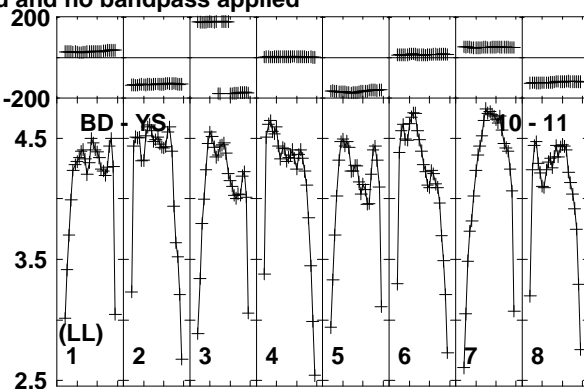
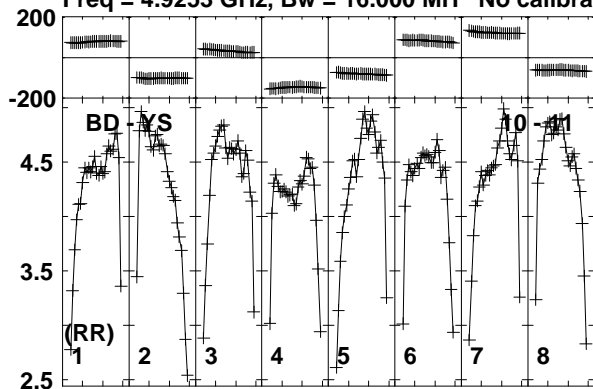

Lower frame: Milli Ampl Jy Top frame: Phas deg
Vector averaged cross-power spectrum Baseline: BD (10) - YS (11)
Timerange: 00/21:06:19 to 00/21:08:02

Plot file version 59 created 11-APR-2016 17:08:23

J1128+5925 GP053G 3.UVDATA.1

Freq = 4.9253 GHz, Bw = 16.000 MH No calibration applied and no bandpass applied

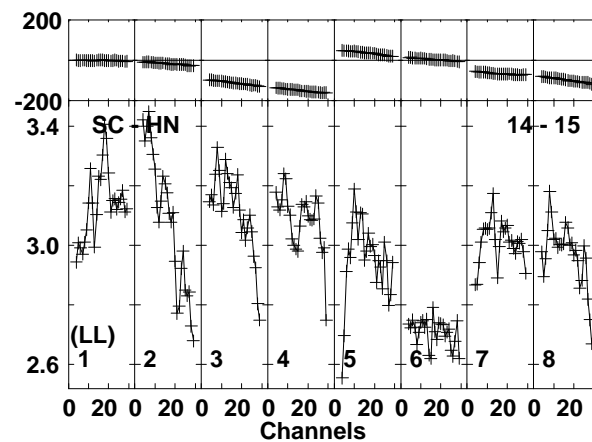
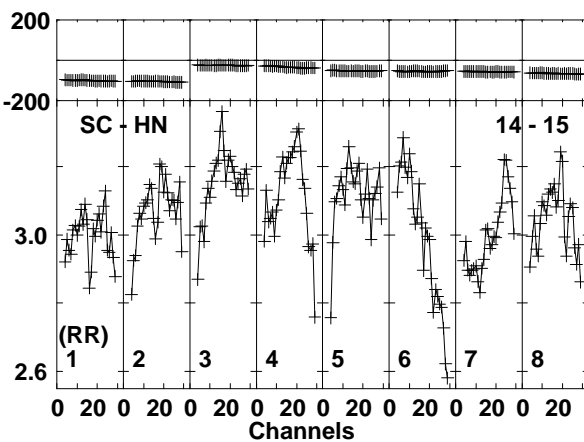
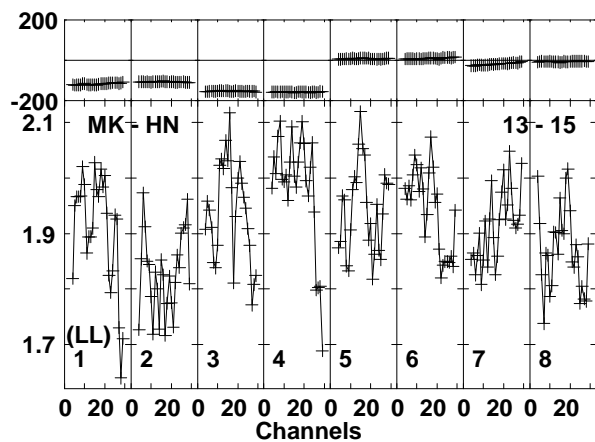
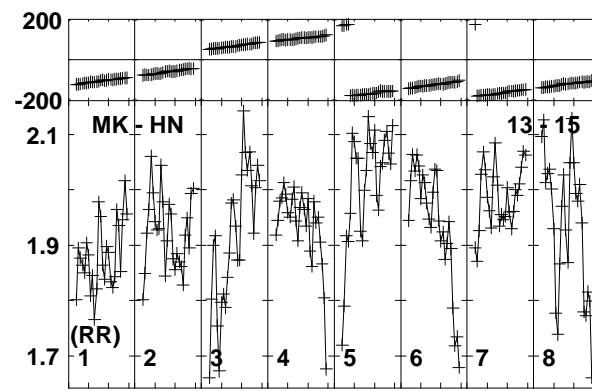
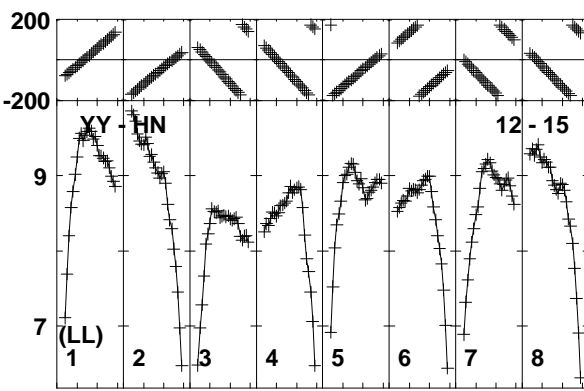
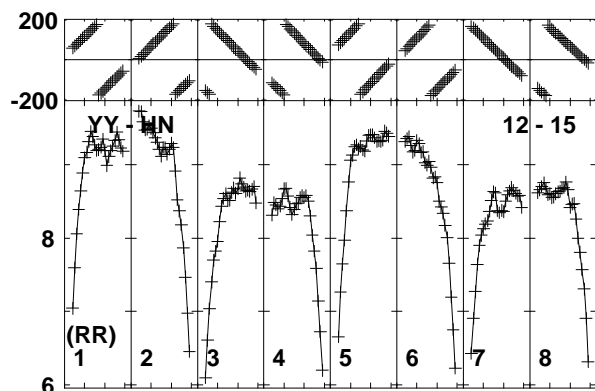
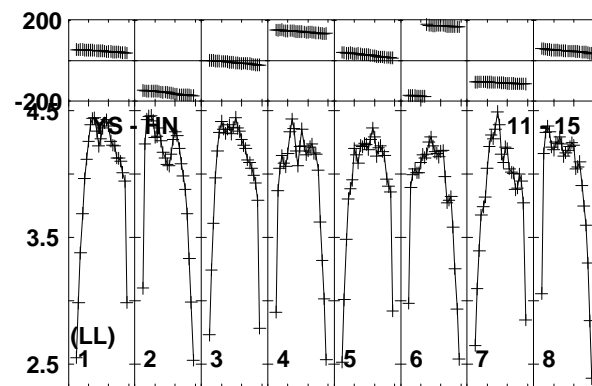
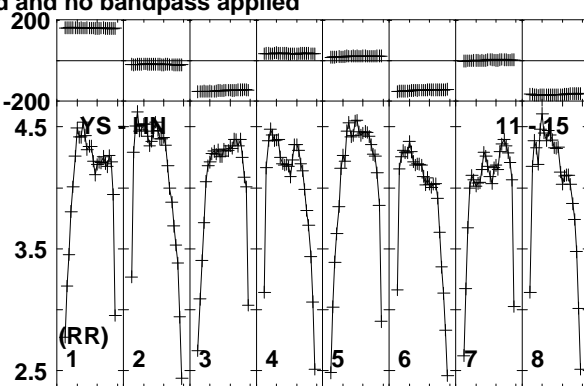
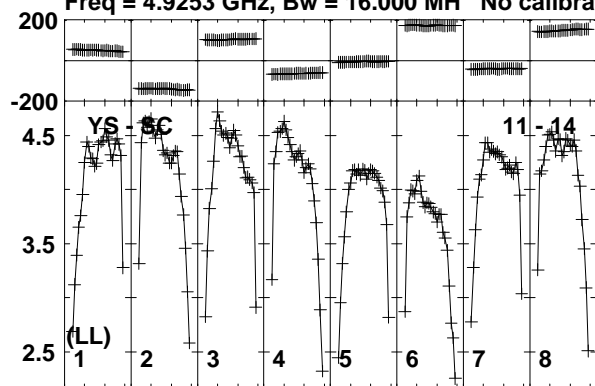

Lower frame: Milli Ampl Jy Top frame: Phas deg
Vector averaged cross-power spectrum Baseline: YS (11) - SC (14)
Timerange: 00/21:06:19 to 00/21:08:02

Plot file version 60 created 11-APR-2016 17:08:23

ARP299C GP053G 3.UVDATA.1

Freq = 4.9253 GHz, Bw = 16.000 MH No calibration applied and no bandpass applied

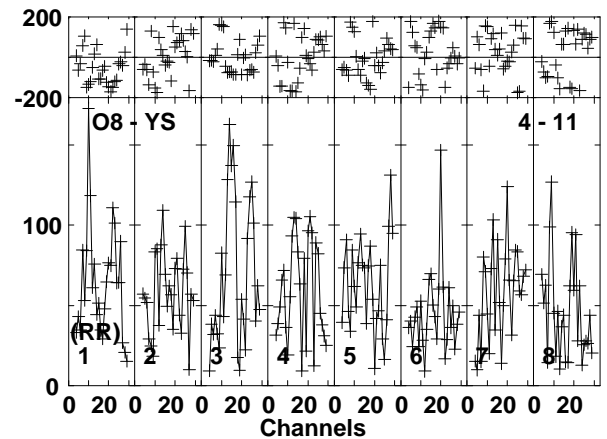
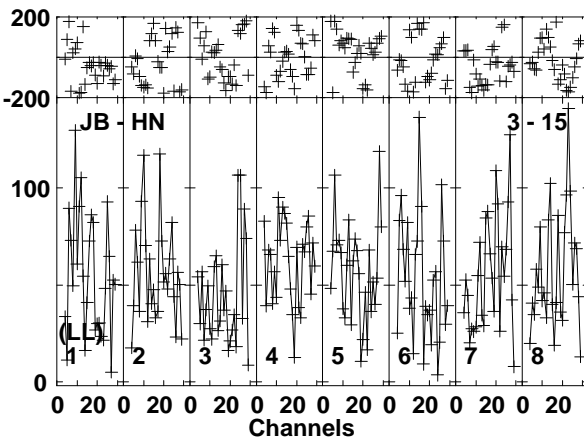
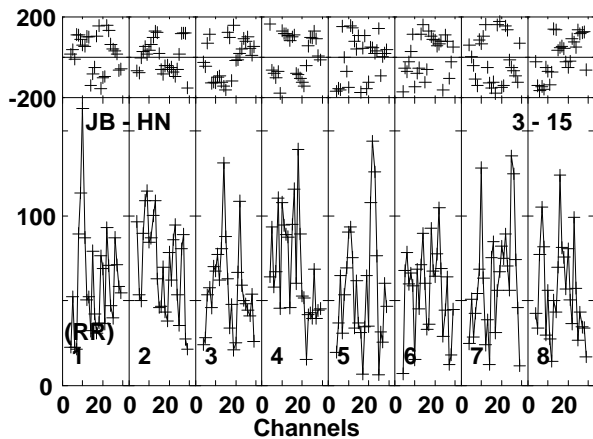
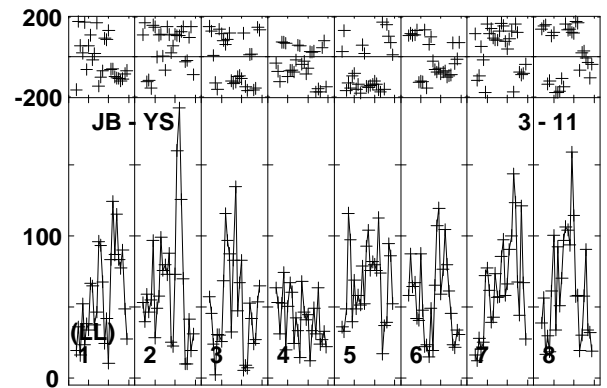
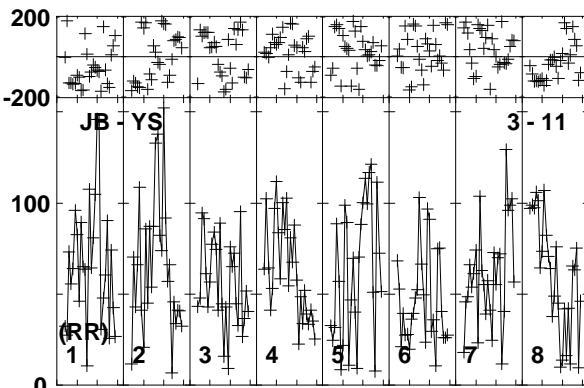
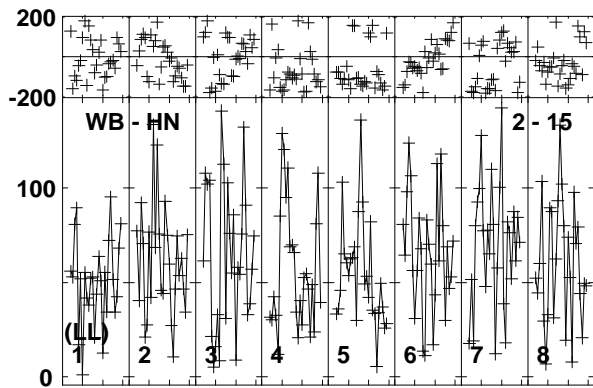
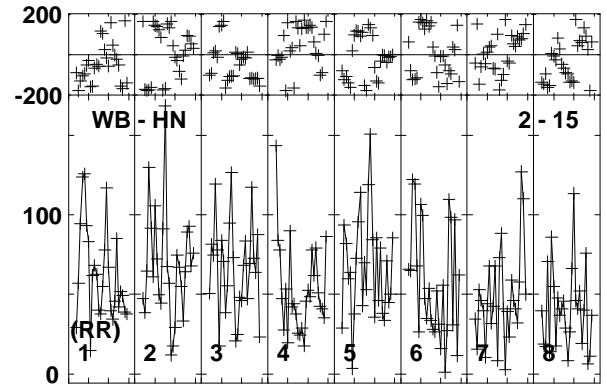
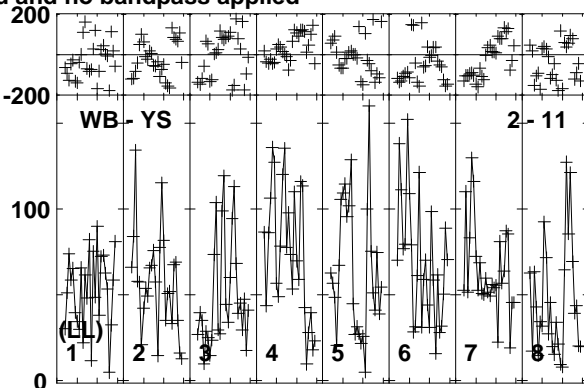
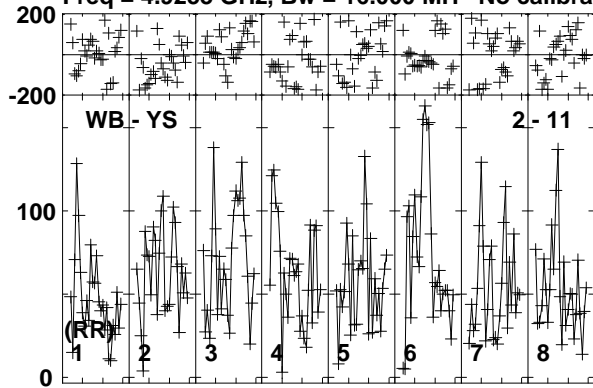

Lower frame: Micro Ampl Jy Top frame: Phas deg
Vector averaged cross-power spectrum Baseline: WB (02) - YS (11)
Timerange: 00/21:08:09 to 00/21:13:21

Plot file version 61 created 11-APR-2016 17:08:23

ARP299C GP053G 3.UVDATA.1

Freq = 4.9253 GHz, Bw = 16.000 MH No calibration applied and no bandpass applied

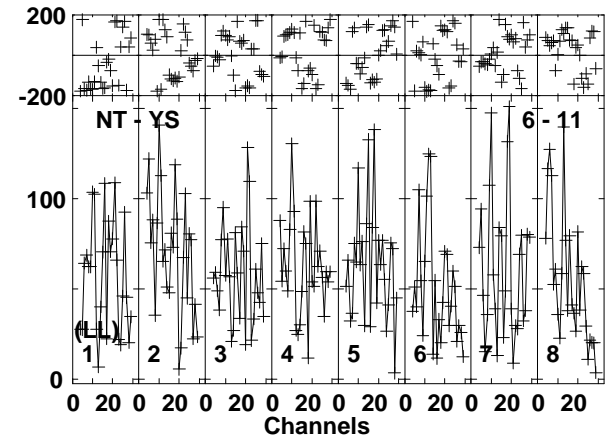
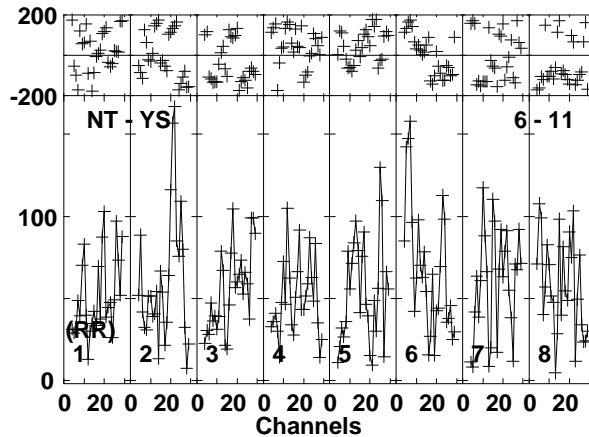
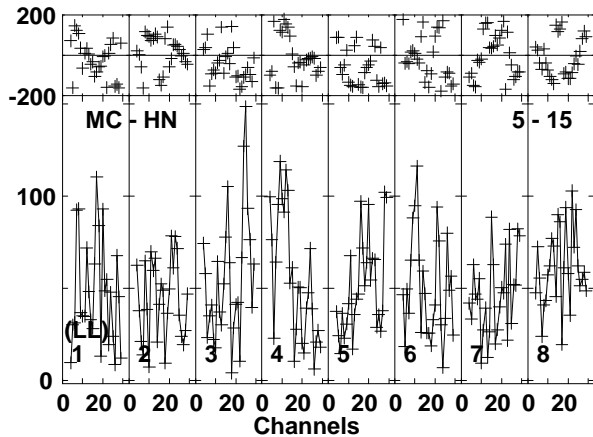
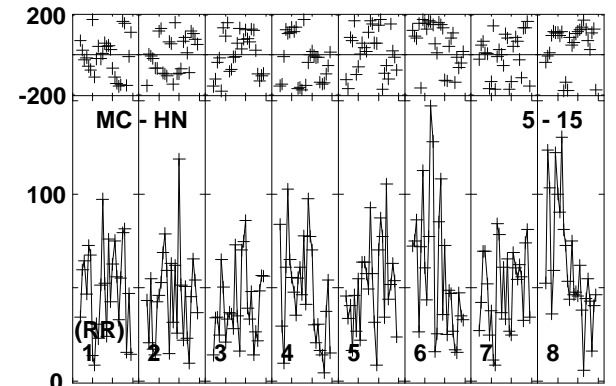
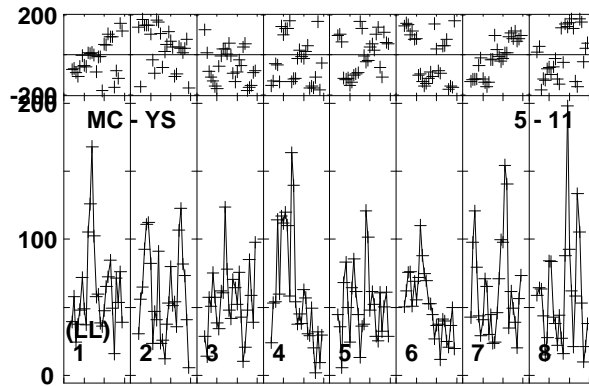
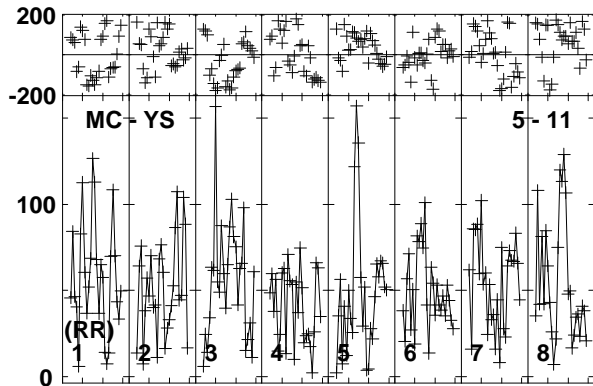
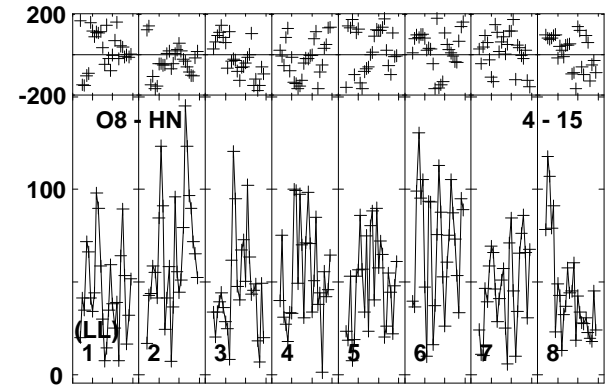
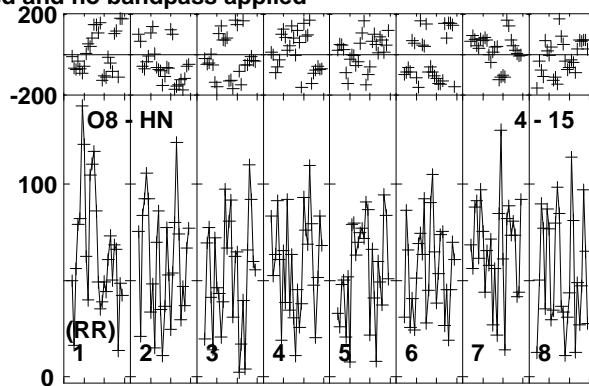
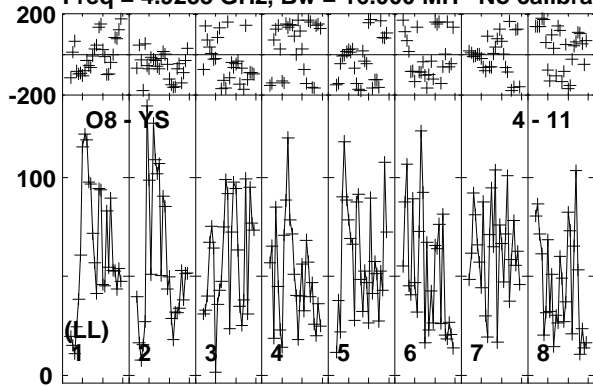

Lower frame: Micro Ampl Jy Top frame: Phas deg
Vector averaged cross-power spectrum Baseline: O8 (04) - YS (11)
Timerange: 00/21:08:09 to 00/21:13:21

Plot file version 62 created 11-APR-2016 17:08:23

ARP299C GP053G 3.UVDATA.1

Freq = 4.9253 GHz, Bw = 16.000 MH No calibration applied and no bandpass applied

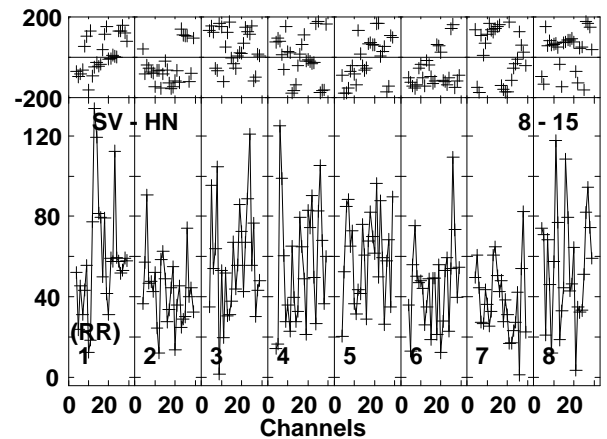
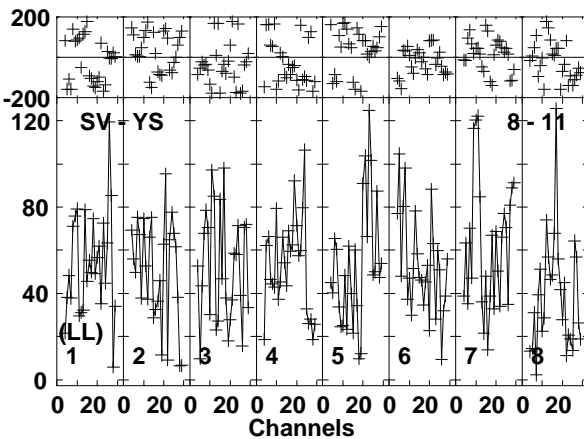
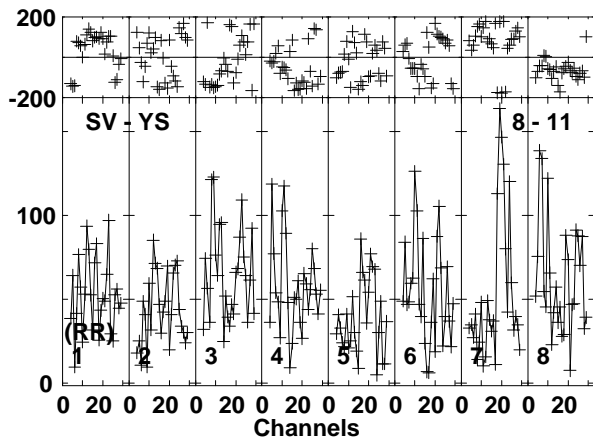
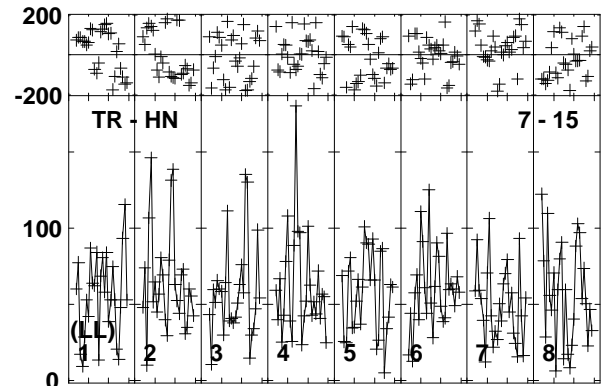
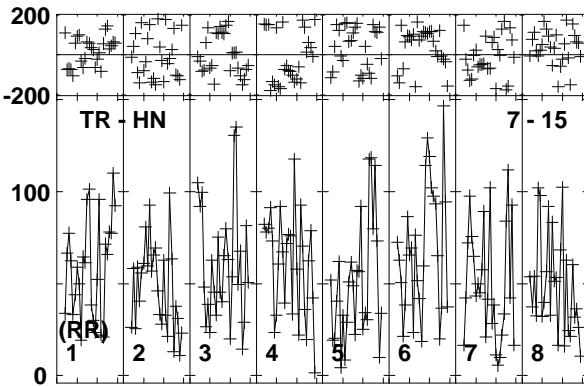
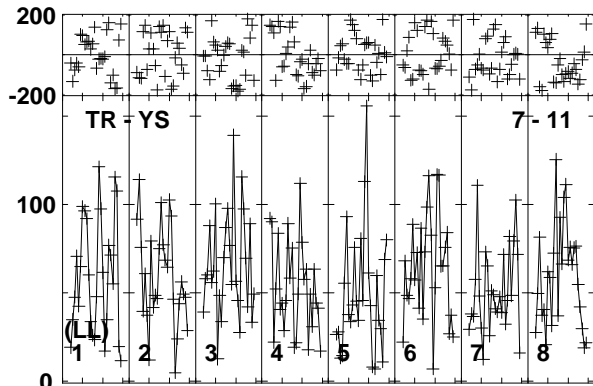
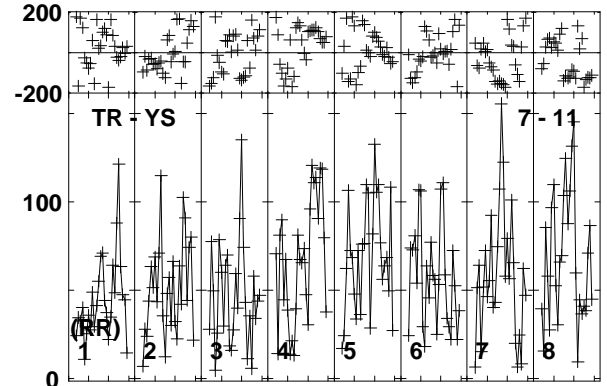
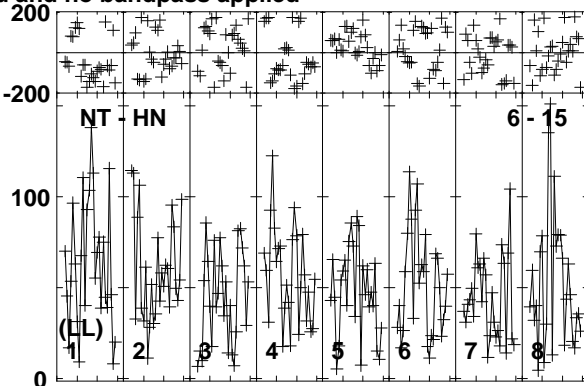
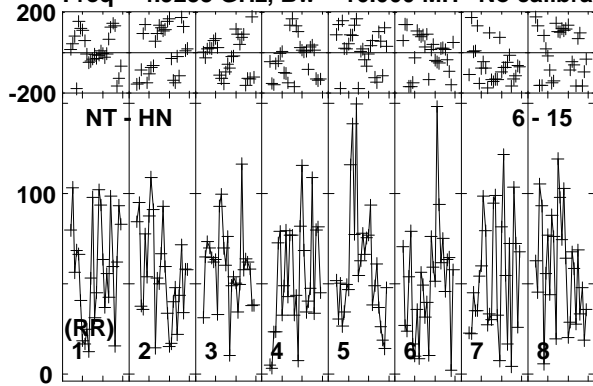

Lower frame: Micro Ampl Jy Top frame: Phas deg
Vector averaged cross-power spectrum Baseline: NT (06) - HN (15)
Timerange: 00/21:08:09 to 00/21:13:21

Plot file version 63 created 11-APR-2016 17:08:24

ARP299C GP053G 3.UVDATA.1

Freq = 4.9253 GHz, Bw = 16.000 MH No calibration applied and no bandpass applied

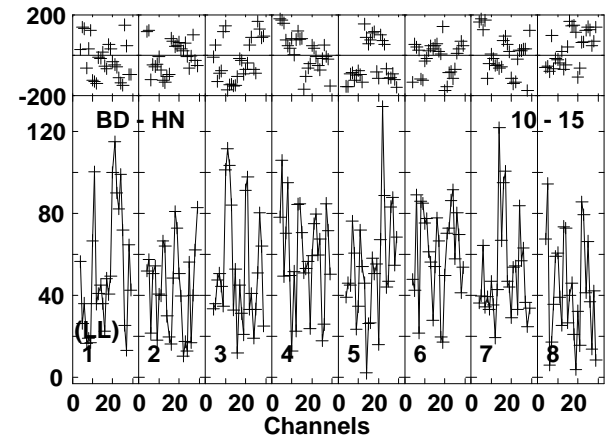
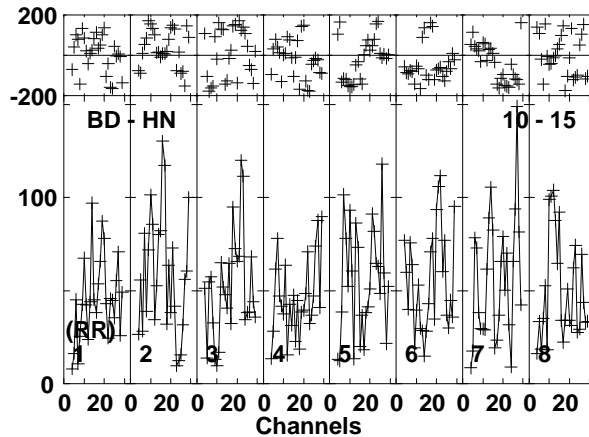
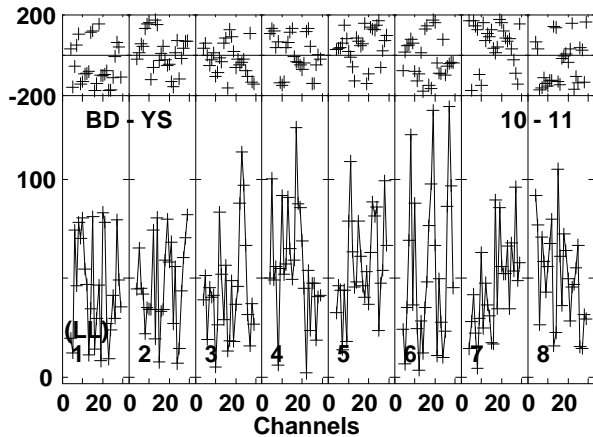
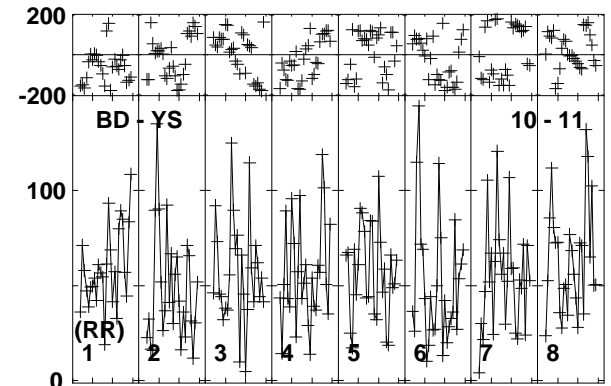
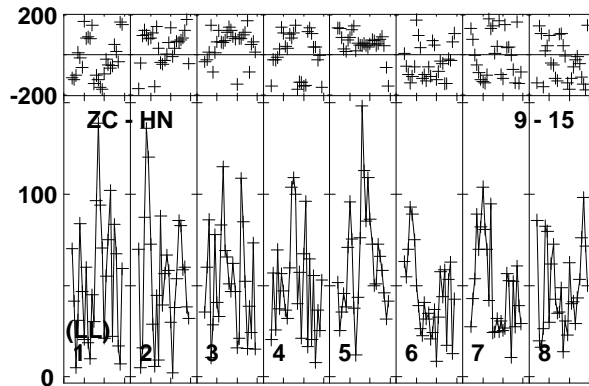
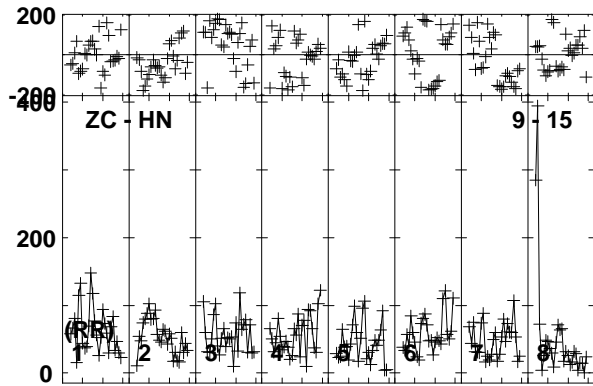
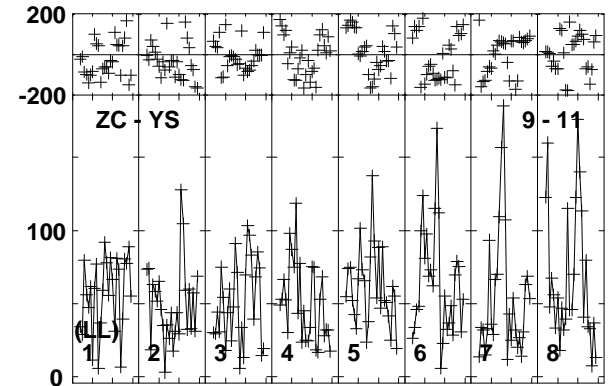
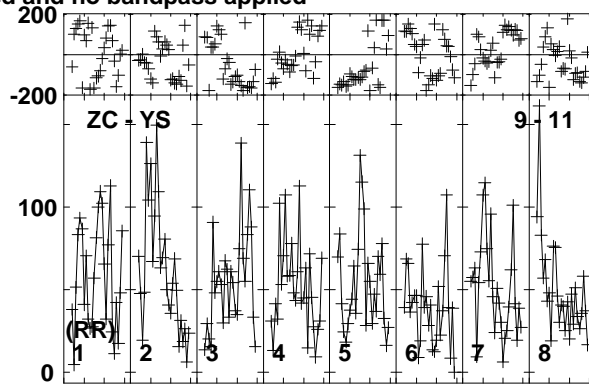
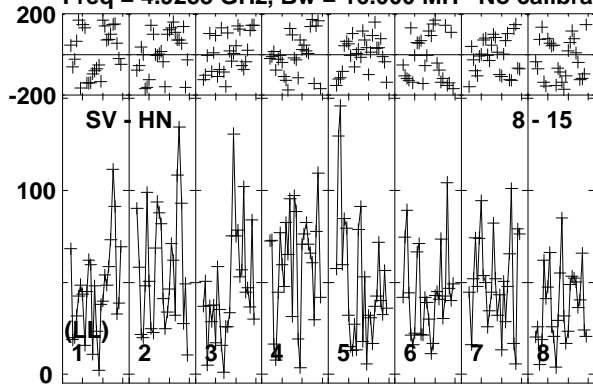

Lower frame: Micro Ampl Jy Top frame: Phas deg
Vector averaged cross-power spectrum Baseline: SV (08) - HN (15)
Timerange: 00/21:08:09 to 00/21:13:21

Plot file version 64 created 11-APR-2016 17:08:24

ARP299C GP053G 3.UVDATA.1

Freq = 4.9253 GHz, Bw = 16.000 MH No calibration applied and no bandpass applied

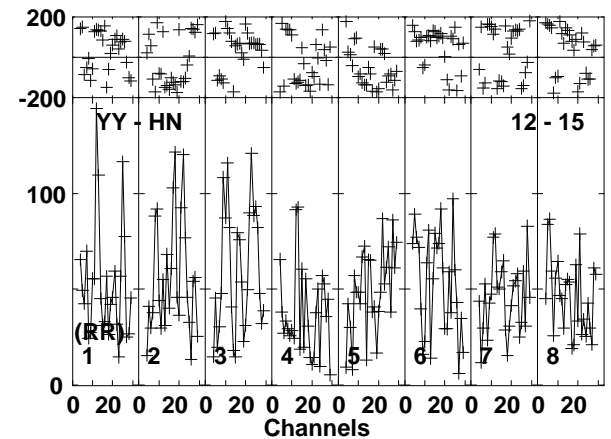
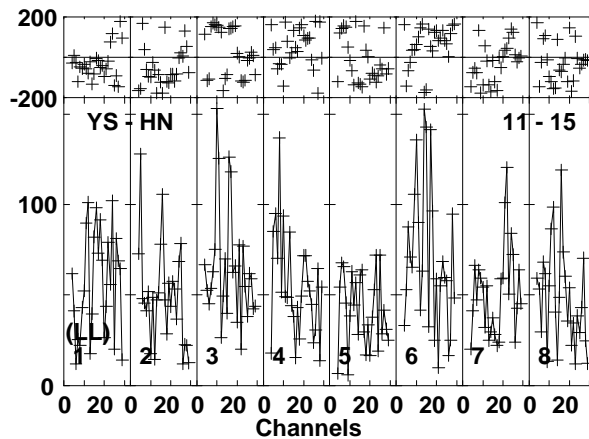
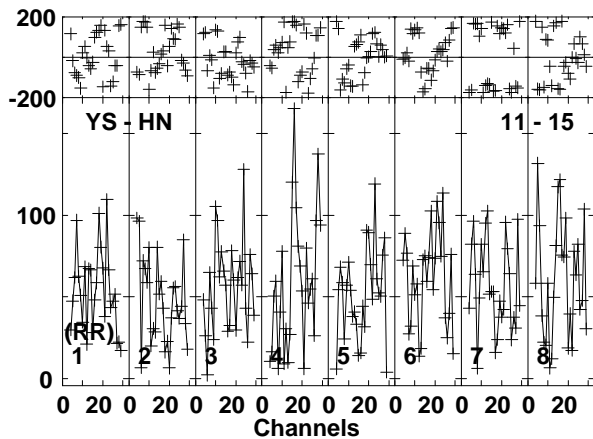
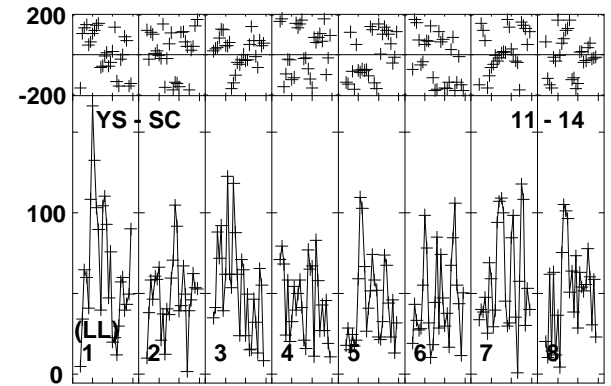
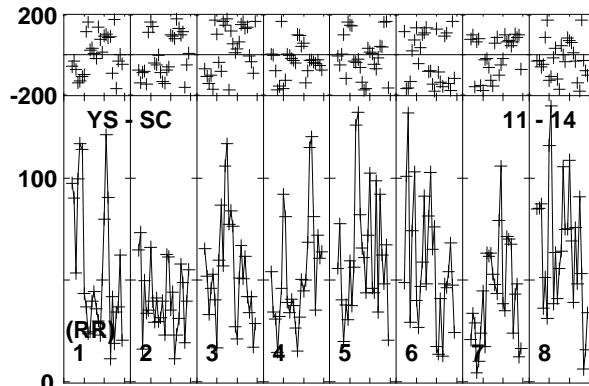
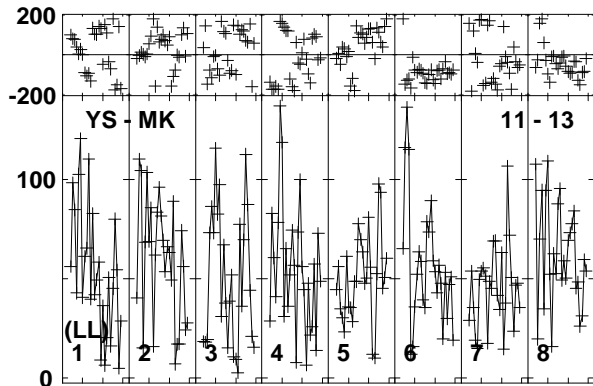
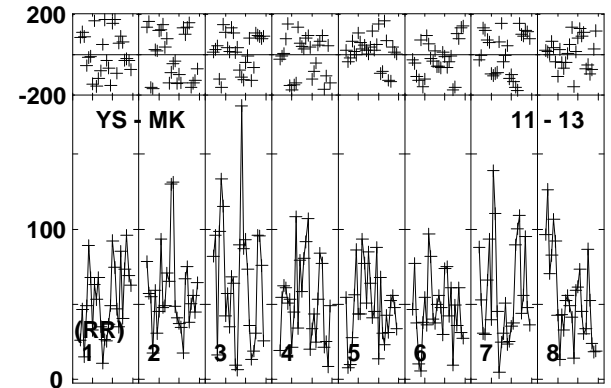
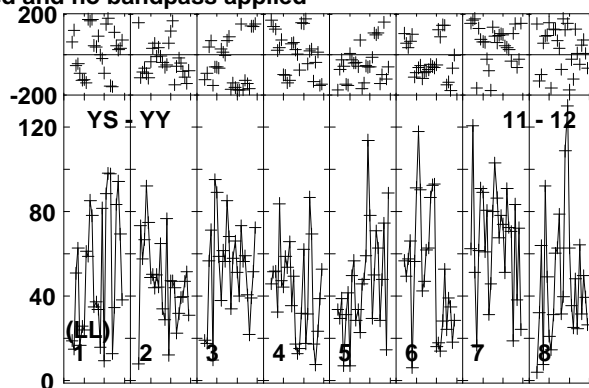
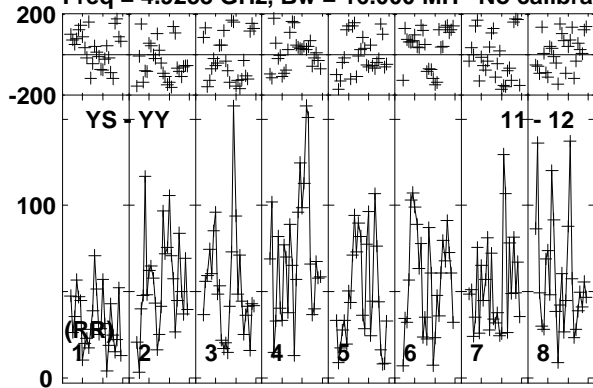

Lower frame: Micro Ampl Jy Top frame: Phas deg
Vector averaged cross-power spectrum Baseline: YS (11) - YY (12)
Timerange: 00/21:08:09 to 00/21:13:21

Plot file version 65 created 11-APR-2016 17:08:24

ARP299C GP053G 3.UVDATA.1

Freq = 4.9253 GHz, Bw = 16.000 MH No calibration applied and no bandpass applied

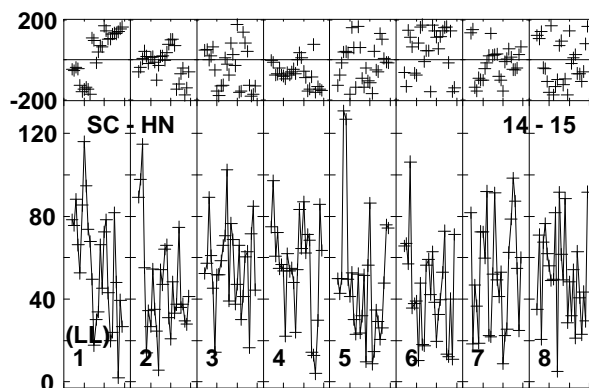
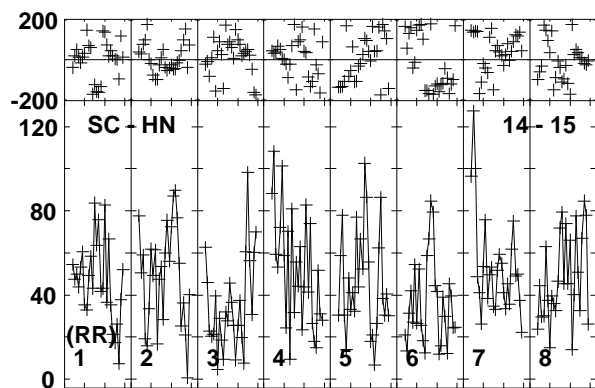
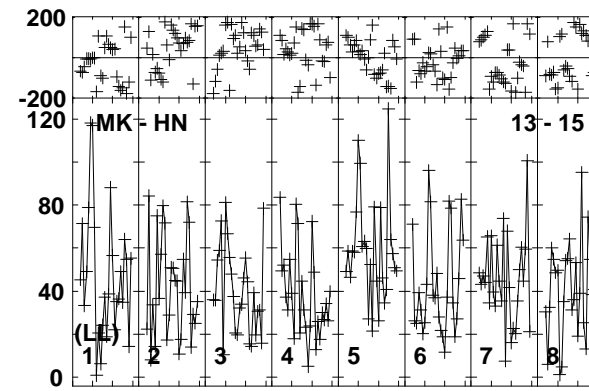
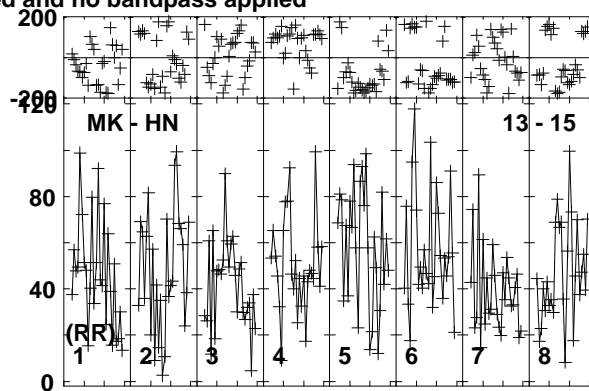
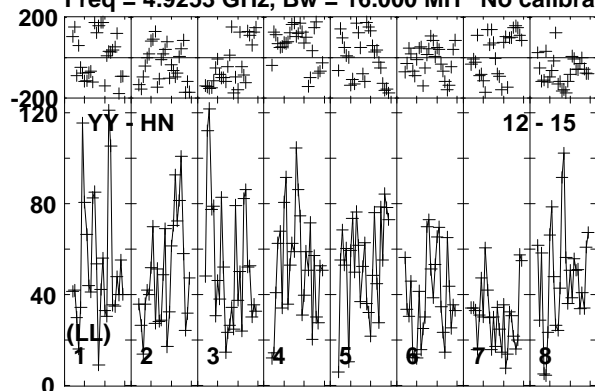

Lower frame: Micro Ampl Jy Top frame: Phas deg
Vector averaged cross-power spectrum Baseline: YY (12) - HN (15)
Timerange: 00/21:08:09 to 00/21:13:21

Plot file version 66 created 11-APR-2016 17:08:24

J1128+5925 GP053G 3.UVDATA.1

Freq = 4.9253 GHz, Bw = 16.000 MH No calibration applied and no bandpass applied

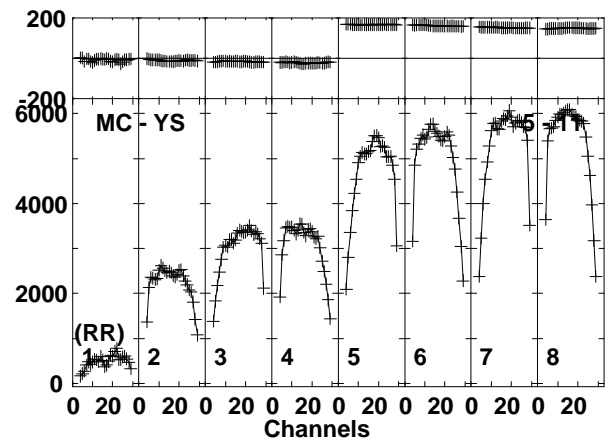
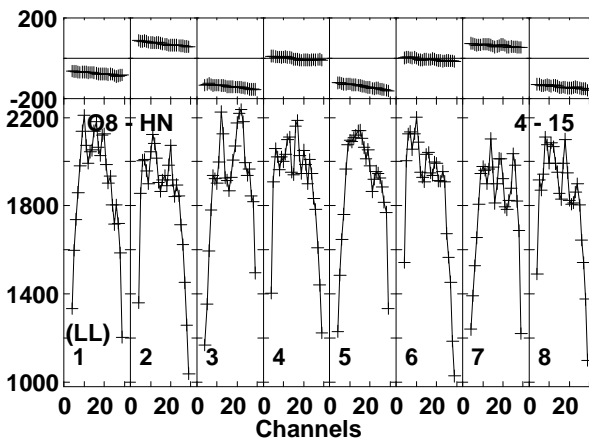
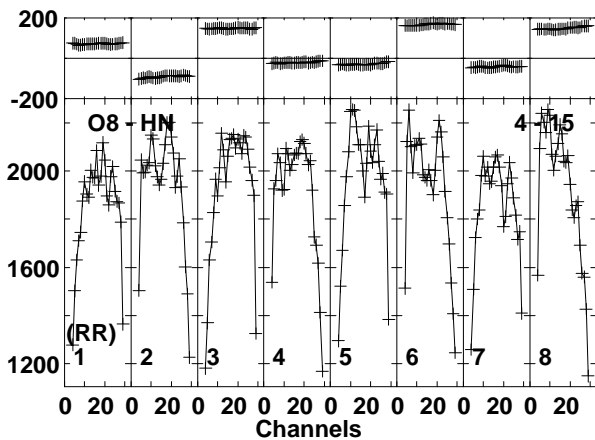
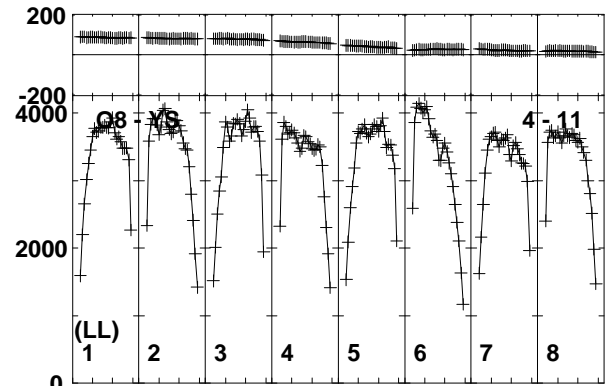
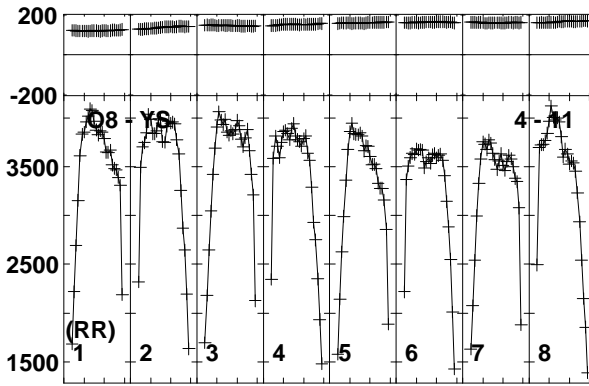
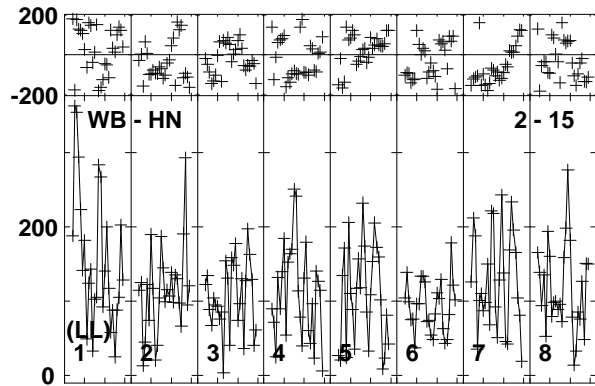
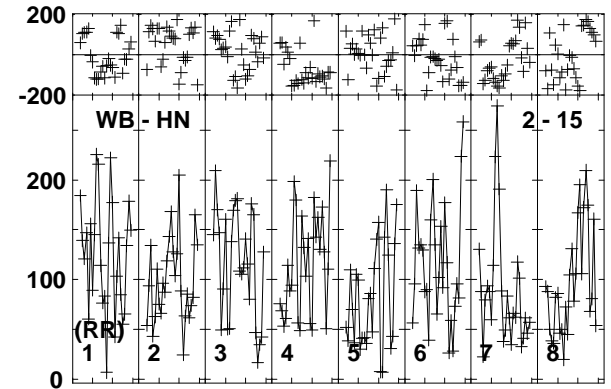
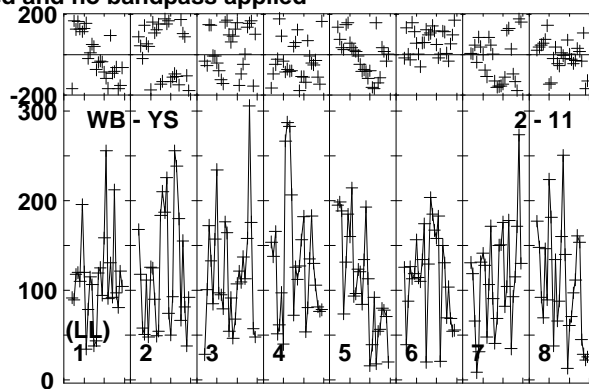
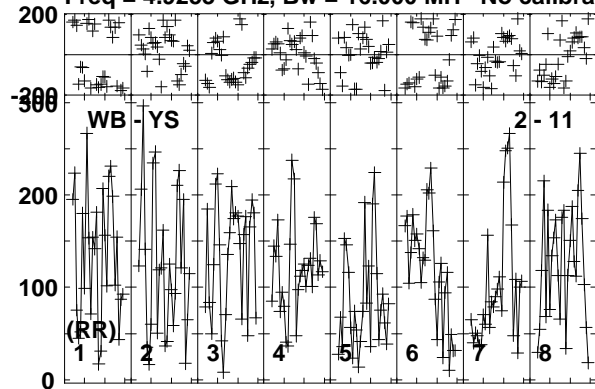

Lower frame: Micro Ampl Jy Top frame: Phas deg
Vector averaged cross-power spectrum Baseline: WB (02) - YS (11)
Timerange: 00/21:13:27 to 00/21:15:18

Plot file version 67 created 11-APR-2016 17:08:24

J1128+5925 GP053G 3.UVDATA.1

Freq = 4.9253 GHz, Bw = 16.000 MH No calibration applied and no bandpass applied

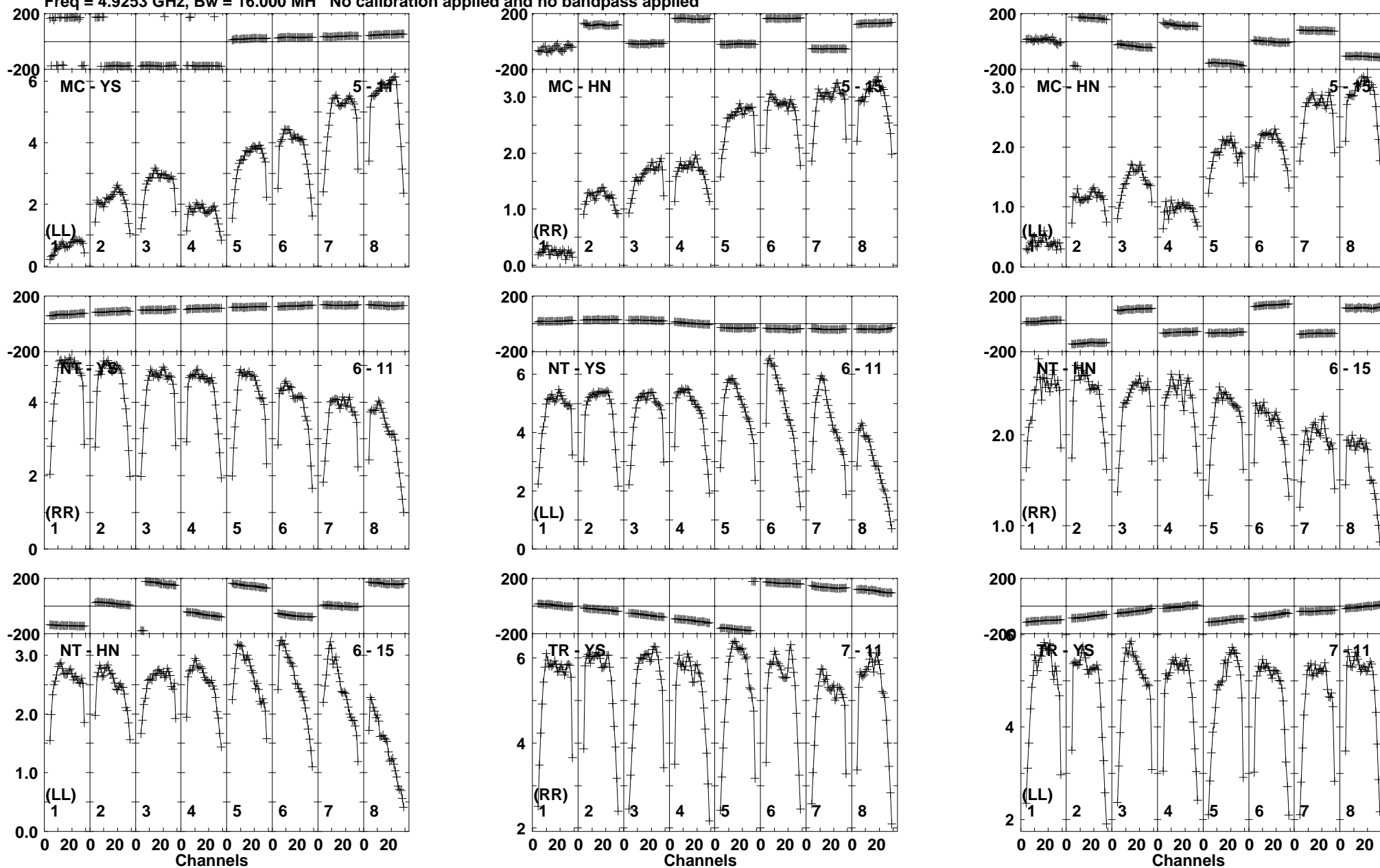

Lower frame: Milli Ampl Jy Top frame: Phas deg
Vector averaged cross-power spectrum Baseline: MC (05) - YS (11)
Timerange: 00/21:13:27 to 00/21:15:18

Plot file version 68 created 11-APR-2016 17:08:25

J1128+5925 GP053G 3.UVDATA.1

Freq = 4.9253 GHz, Bw = 16.000 MH No calibration applied and no bandpass applied

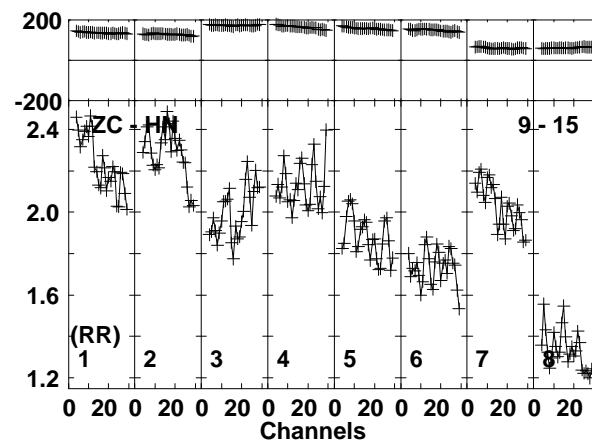
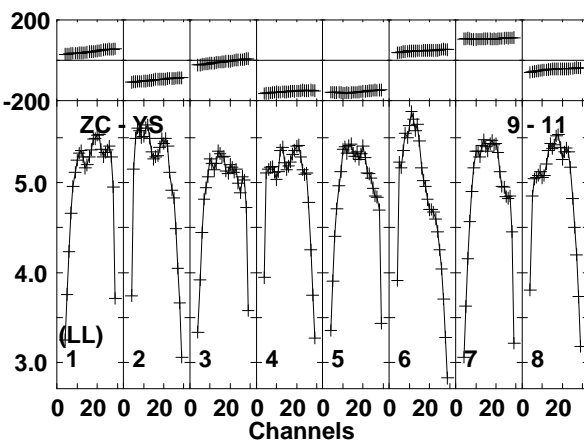
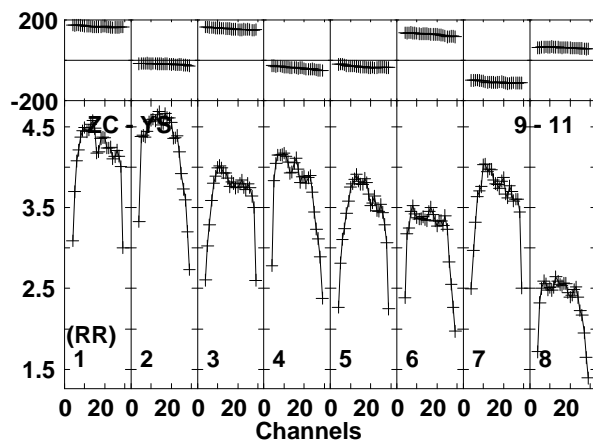
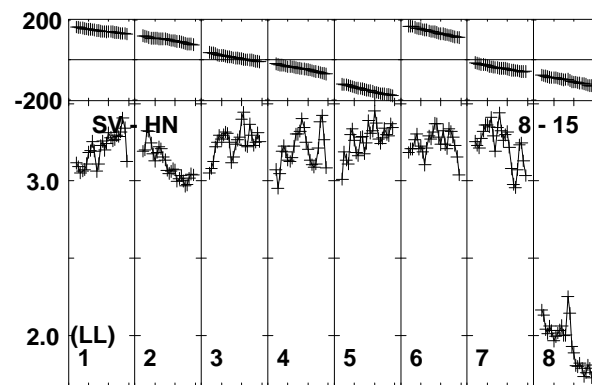
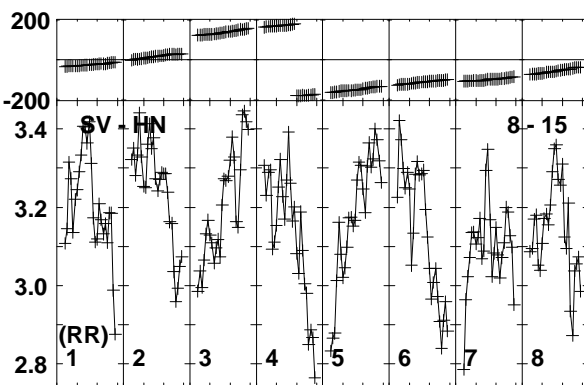
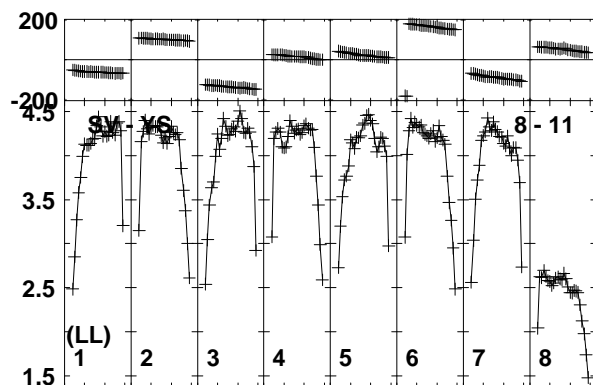
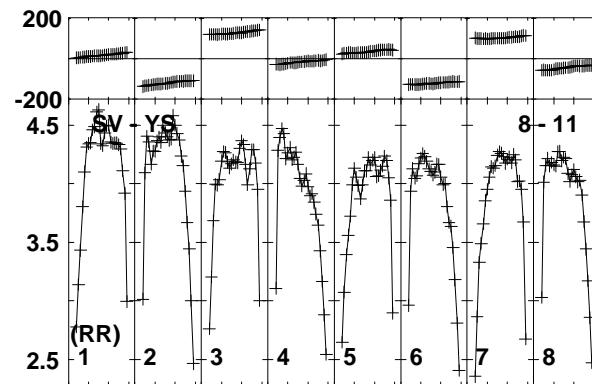
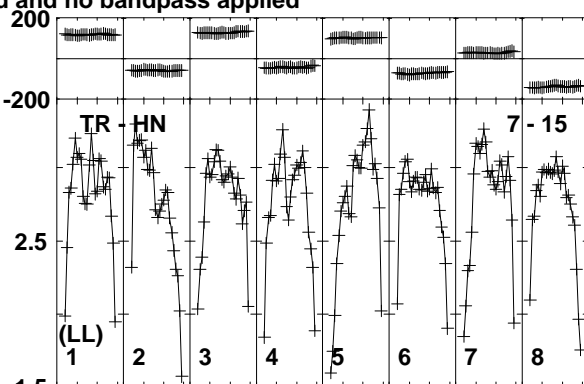
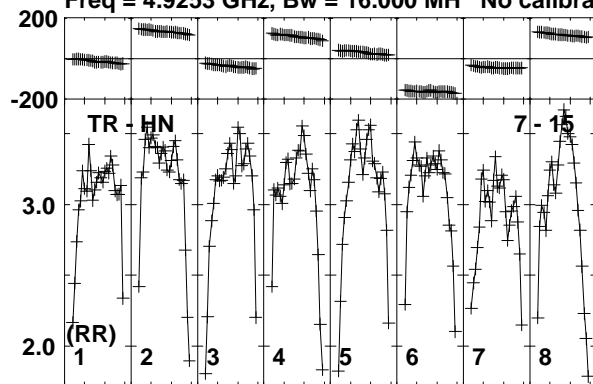

Lower frame: Milli Ampl Jy Top frame: Phas deg
Vector averaged cross-power spectrum Baseline: TR (07) - HN (15)
Timerange: 00/21:13:27 to 00/21:15:18

Plot file version 69 created 11-APR-2016 17:08:25

J1128+5925 GP053G 3.UVDATA.1

Freq = 4.9253 GHz, Bw = 16.000 MH No calibration applied and no bandpass applied

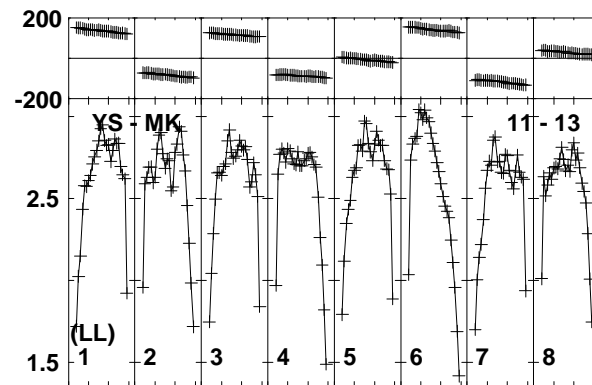
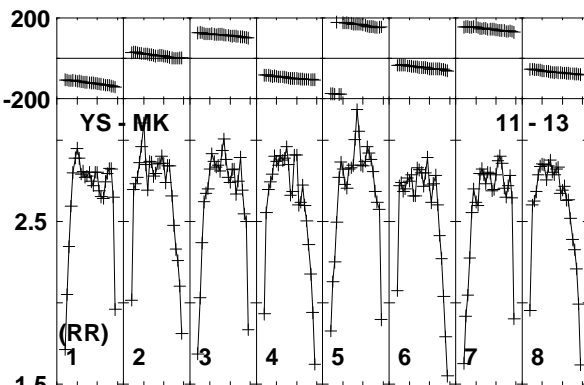
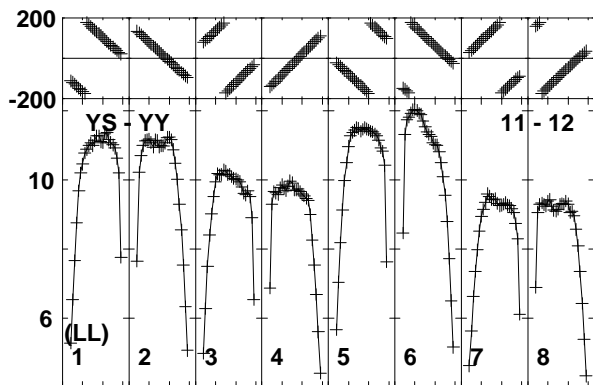
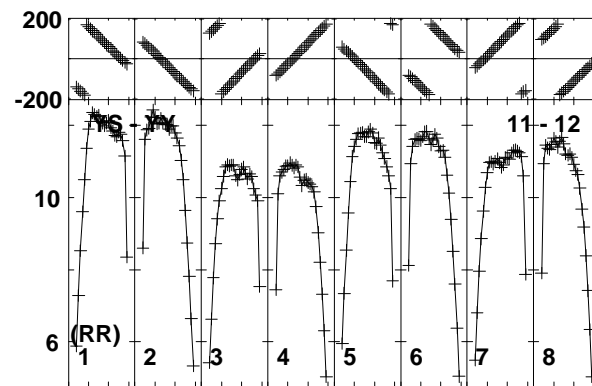
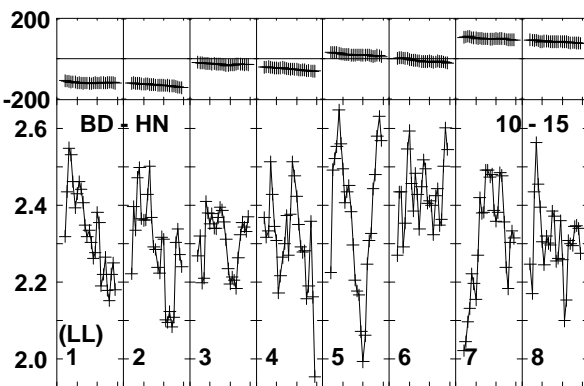
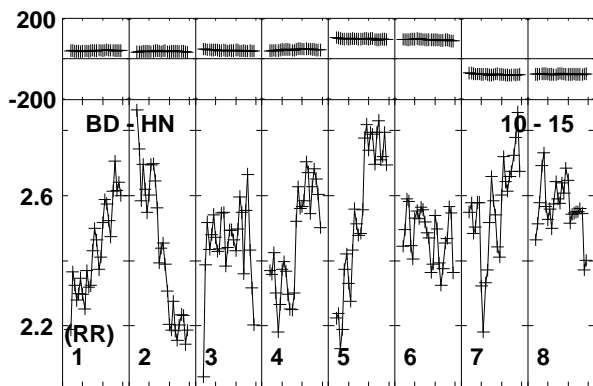
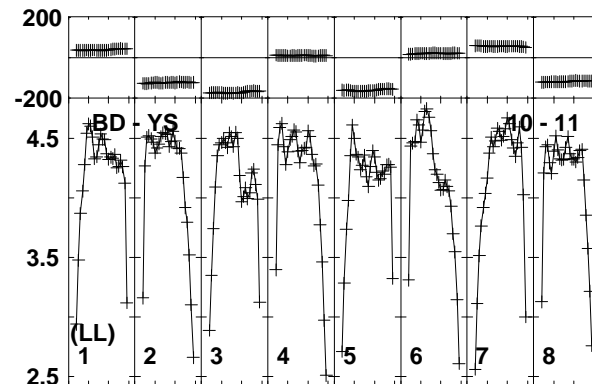
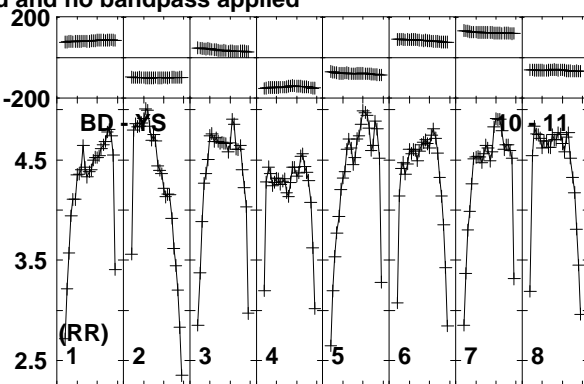
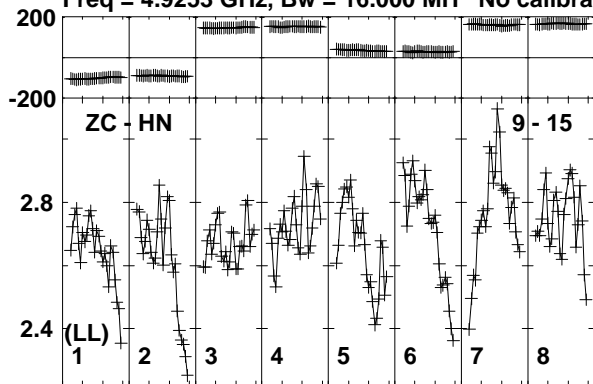

Lower frame: Milli Ampl Jy Top frame: Phas deg
Vector averaged cross-power spectrum Baseline: ZC (09) - HN (15)
Timerange: 00/21:13:27 to 00/21:15:18

Plot file version 70 created 11-APR-2016 17:08:25

J1128+5925 GP053G 3.UVDATA.1

Freq = 4.9253 GHz, Bw = 16.000 MH No calibration applied and no bandpass applied

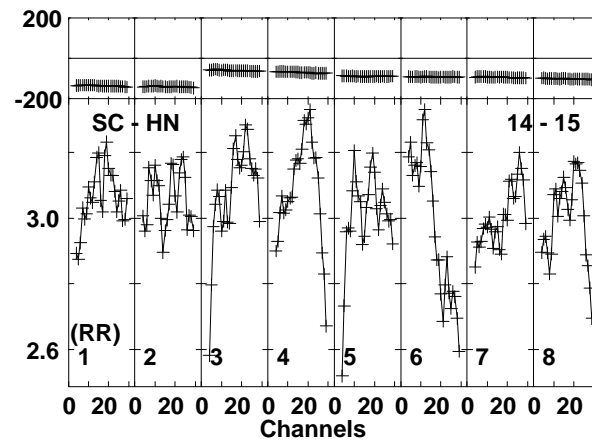
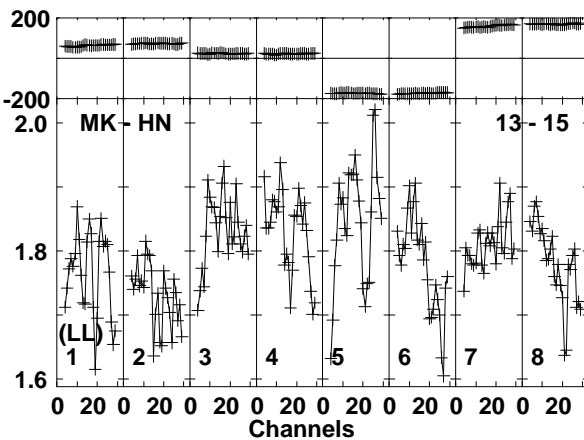
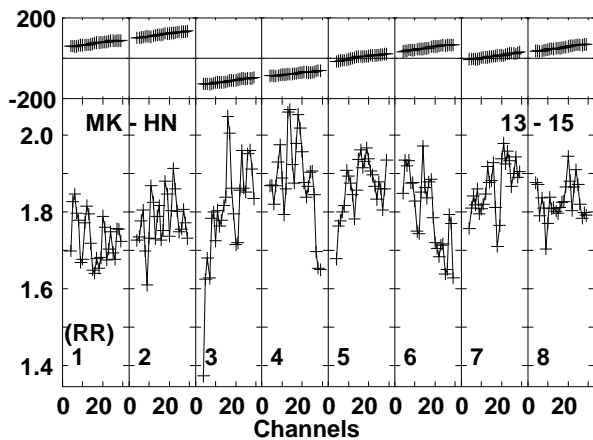
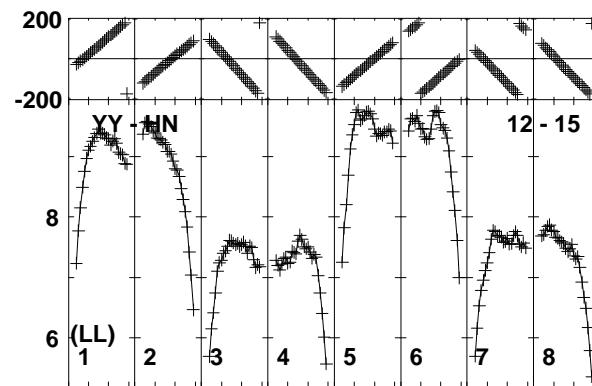
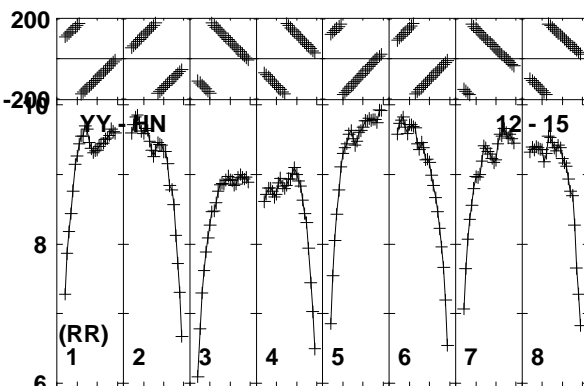
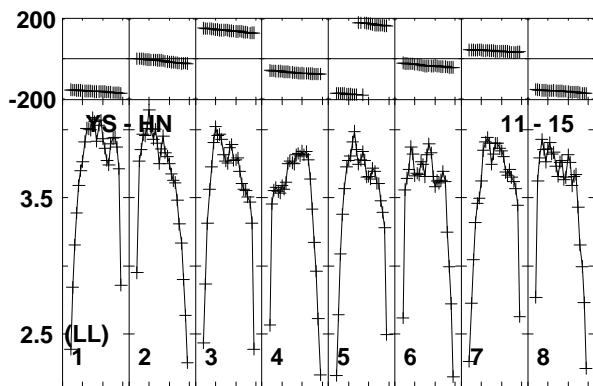
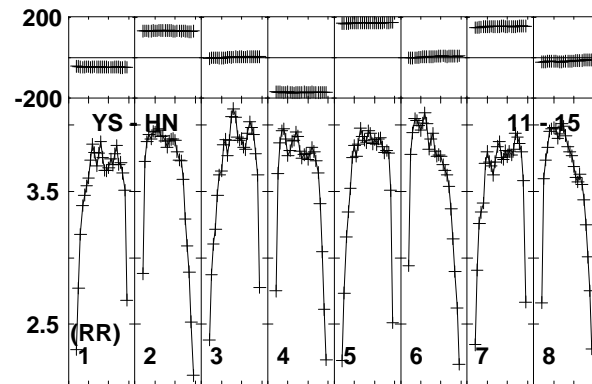
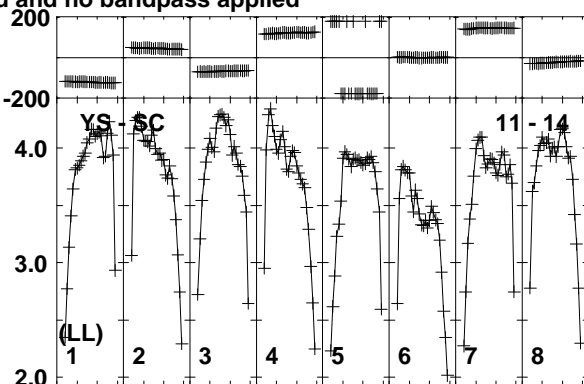
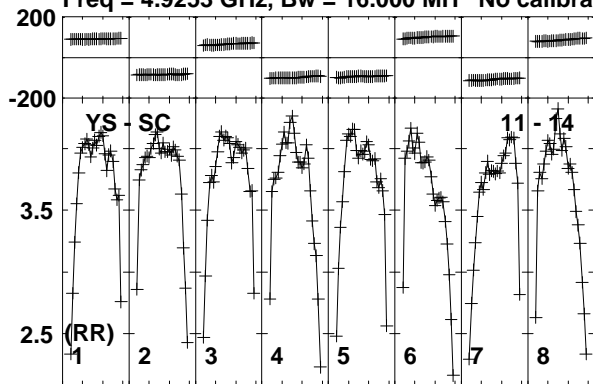

Lower frame: Milli Ampl Jy Top frame: Phas deg
Vector averaged cross-power spectrum Baseline: YS (11) - SC (14)
Timerange: 00/21:13:27 to 00/21:15:18

Plot file version 71 created 11-APR-2016 17:08:25
J1128+5925 GP053G 3.UVDATA.1
Freq = 4.9253 GHz, Bw = 16.000 MH No calibration applied and no bandpass applied

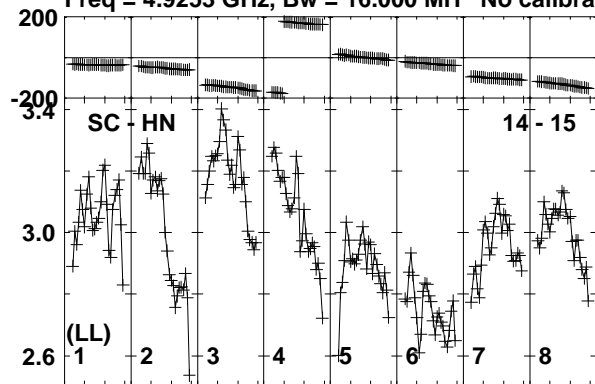

Lower frame: Milli Ampl Jy Top frame: Phas deg
Vector averaged cross-power spectrum Baseline: SC (14) - HN (15)
Timerange: 00/21:13:27 to 00/21:15:18

Plot file version 72 created 11-APR-2016 17:08:25

ARP299C GP053G 3.UVDATA.1

Freq = 4.9253 GHz, Bw = 16.000 MH No calibration applied and no bandpass applied

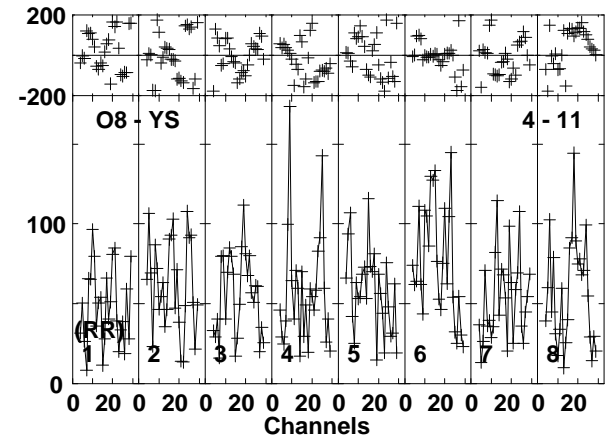
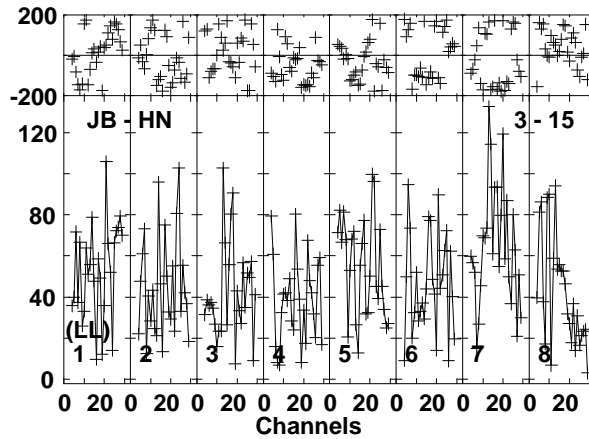
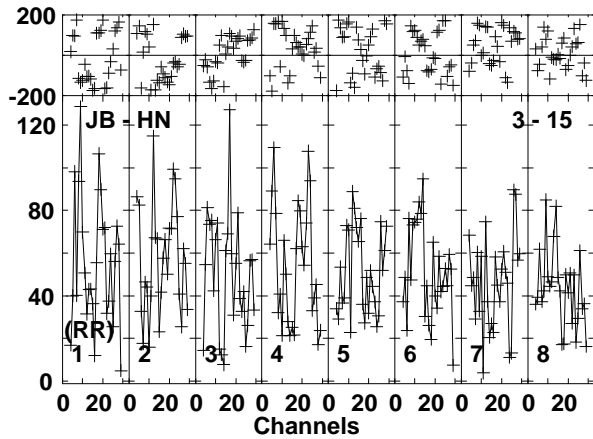
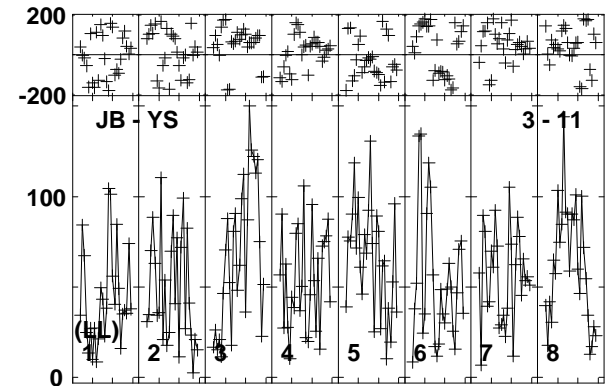
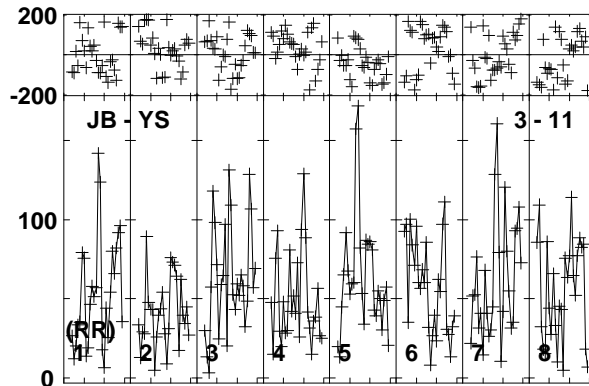
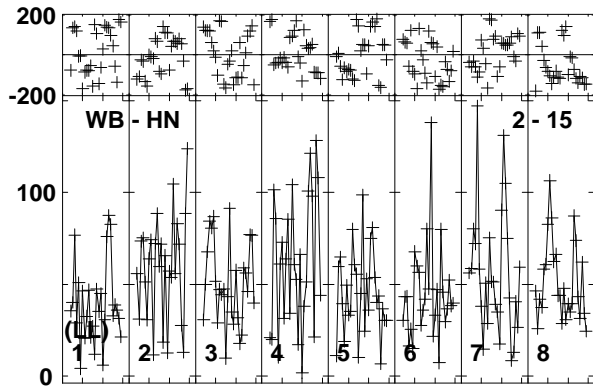
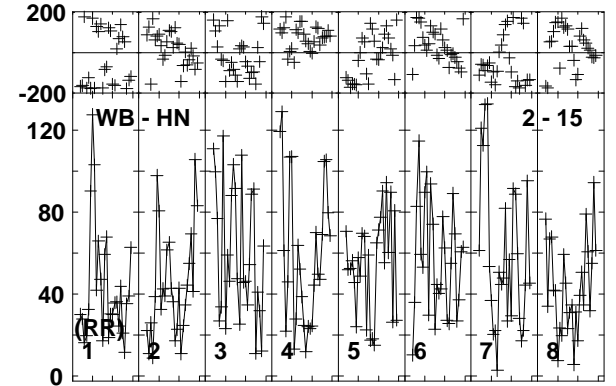
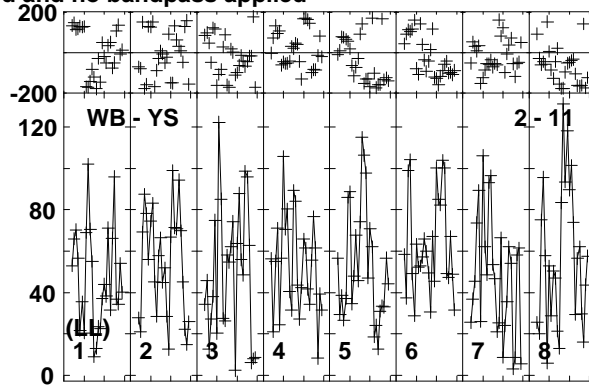
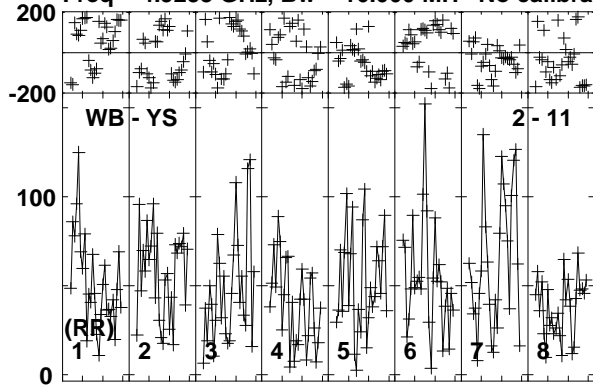

Lower frame: Micro Ampl Jy Top frame: Phas deg
Vector averaged cross-power spectrum Baseline: WB (02) - YS (11)
Timerange: 00/21:15:23 to 00/21:20:37

Plot file version 73 created 11-APR-2016 17:08:25

ARP299C GP053G 3.UVDATA.1

Freq = 4.9253 GHz, Bw = 16.000 MH No calibration applied and no bandpass applied

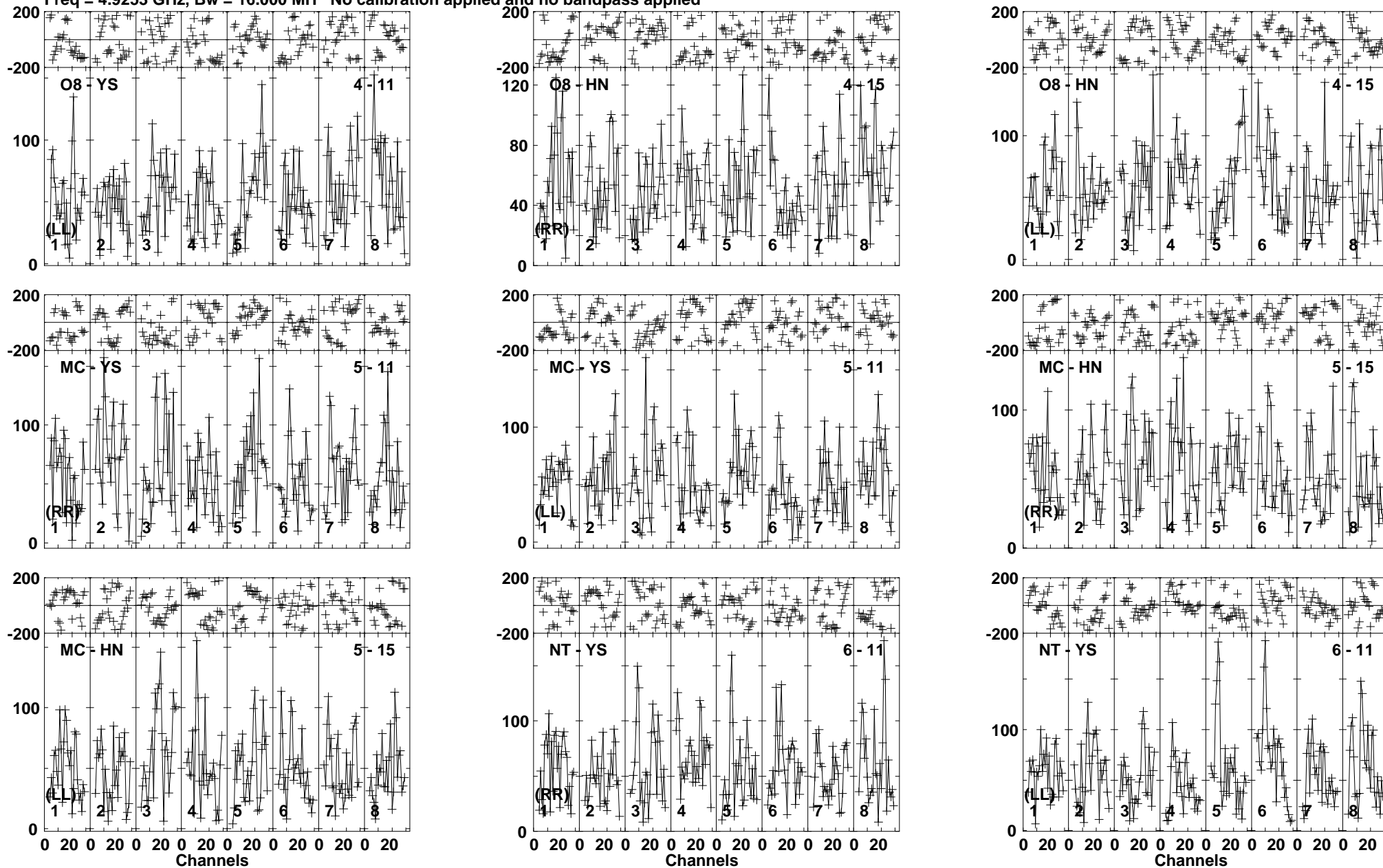

Lower frame: Micro Ampl Jy Top frame: Phas deg
Vector averaged cross-power spectrum Baseline: O8 (04) - YS (11)
Timerange: 00/21:15:23 to 00/21:20:37

Plot file version 74 created 11-APR-2016 17:08:25

ARP299C GP053G 3.UVDATA.1

Freq = 4.9253 GHz, Bw = 16.000 MH No calibration applied and no bandpass applied

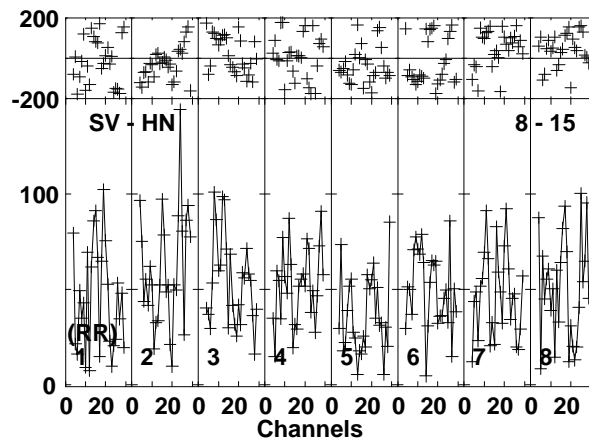
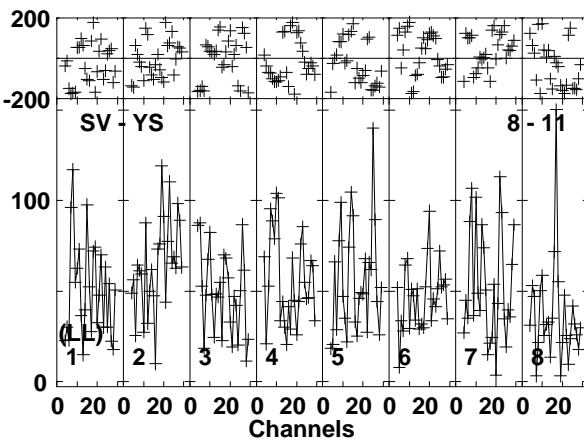
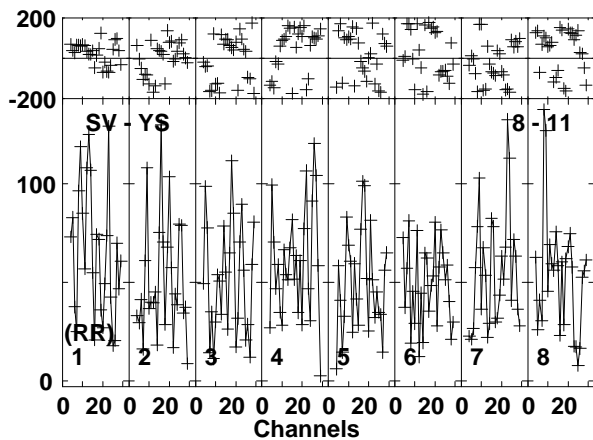
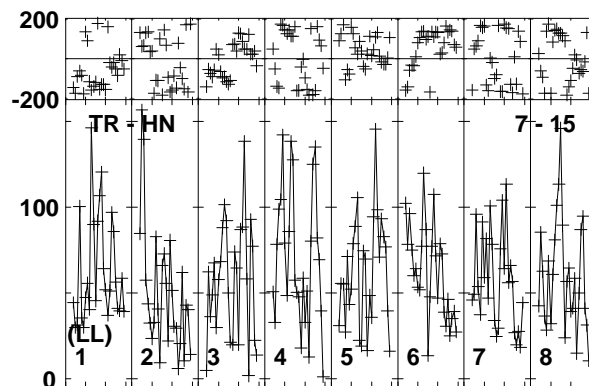
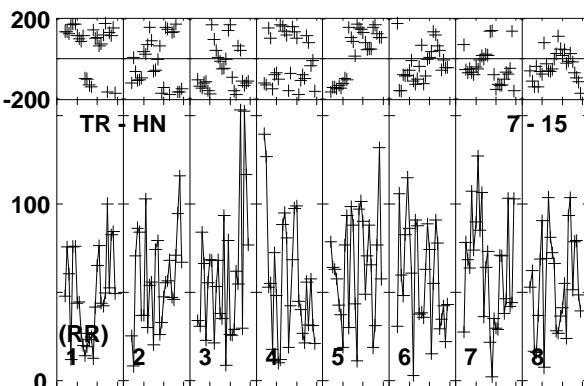
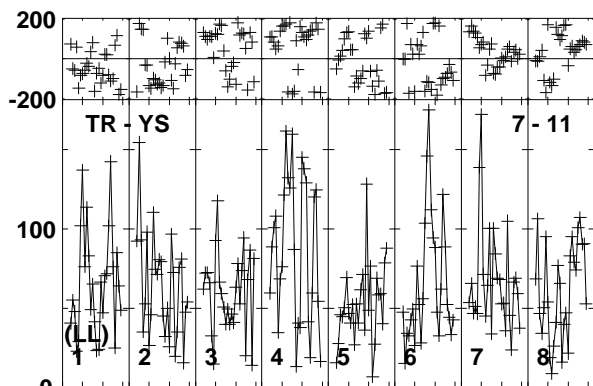
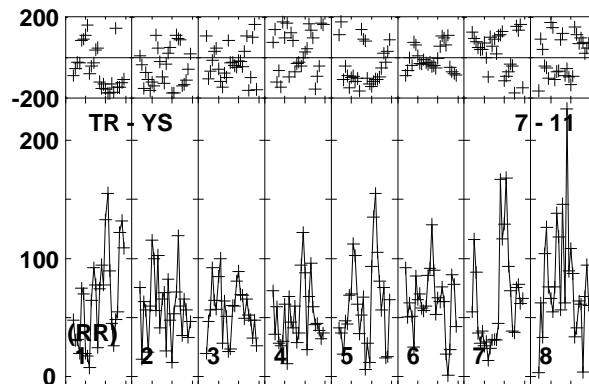
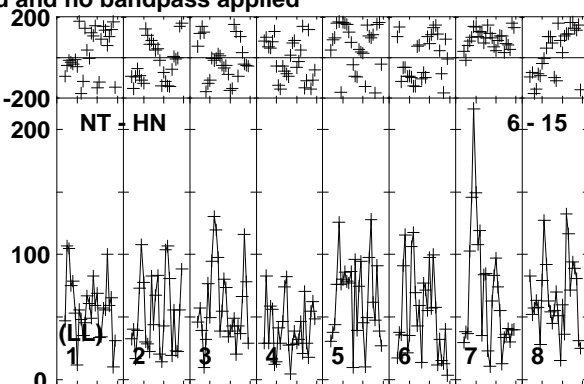
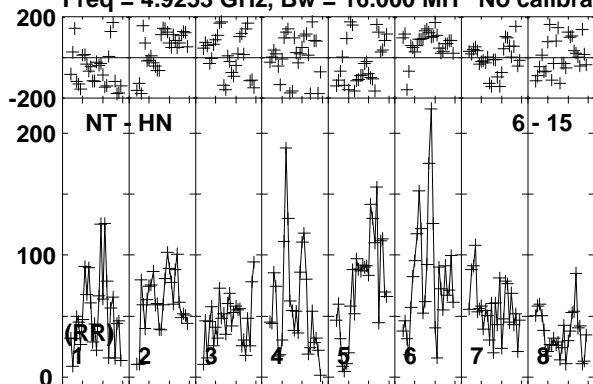

Lower frame: Micro Ampl Jy Top frame: Phas deg
Vector averaged cross-power spectrum Baseline: NT (06) - HN (15)
Timerange: 00/21:15:23 to 00/21:20:37

Plot file version 75 created 11-APR-2016 17:08:26

ARP299C GP053G 3.UVDATA.1

Freq = 4.9253 GHz, Bw = 16.000 MH No calibration applied and no bandpass applied

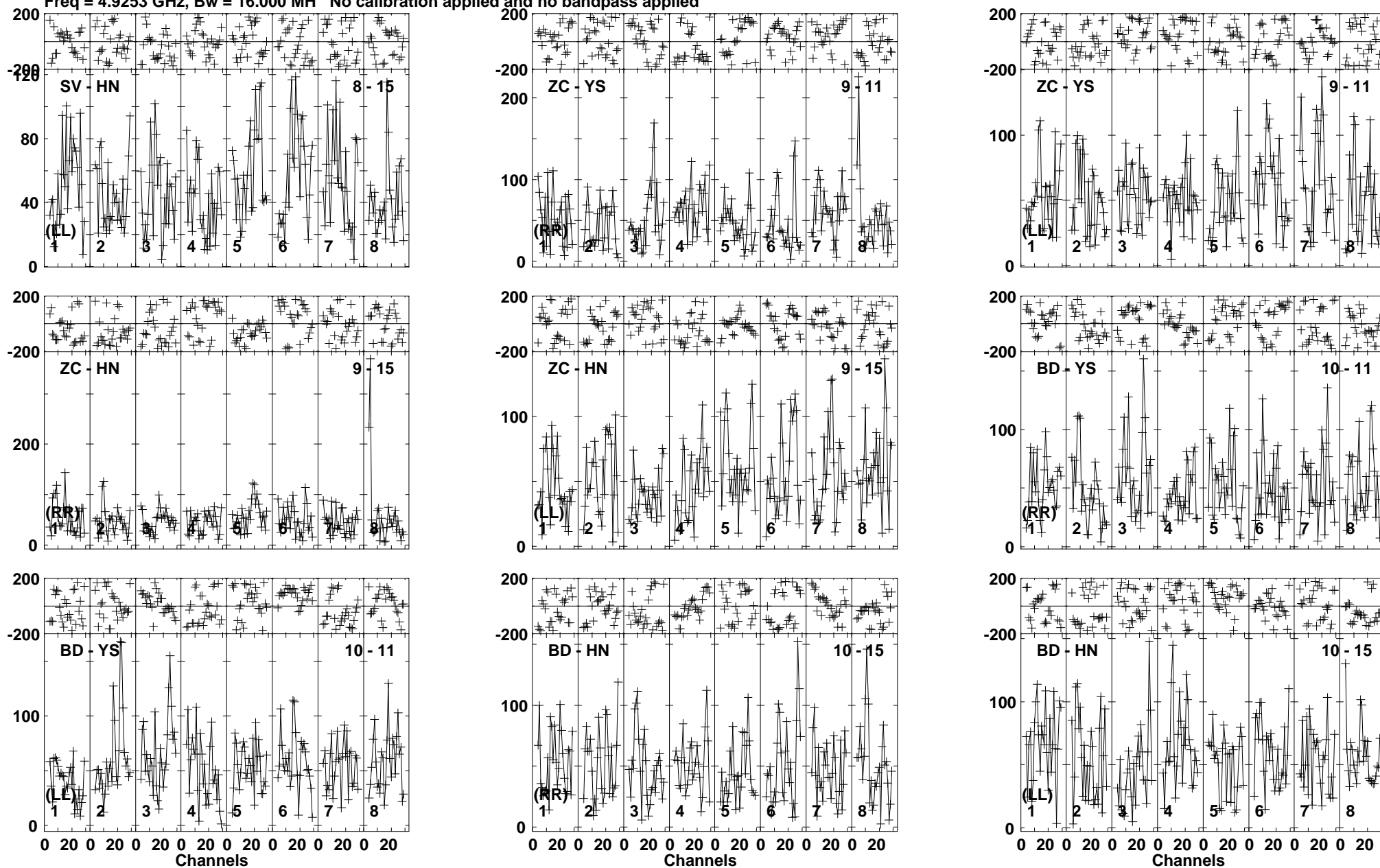

Lower frame: Micro Ampl Jy Top frame: Phas deg
Vector averaged cross-power spectrum Baseline: SV (08) - HN (15)
Timerange: 00/21:15:23 to 00/21:20:37

Plot file version 76 created 11-APR-2016 17:08:26

ARP299C GP053G 3.UVDATA.1

Freq = 4.9253 GHz, Bw = 16.000 MH No calibration applied and no bandpass applied

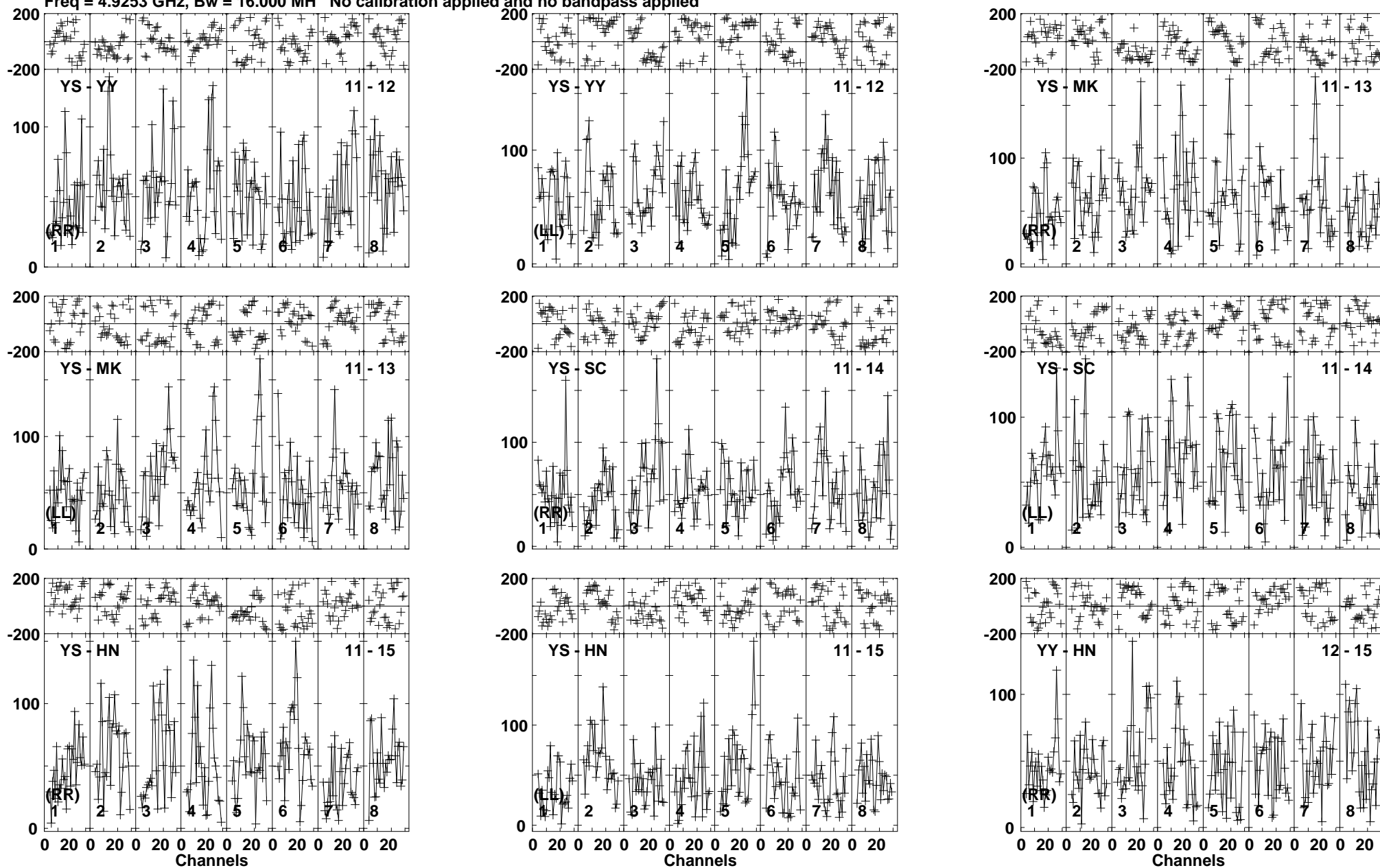

Lower frame: Micro Ampl Jy Top frame: Phas deg
Vector averaged cross-power spectrum Baseline: YS (11) - YY (12)
Timerange: 00/21:15:23 to 00/21:20:37

Plot file version 77 created 11-APR-2016 17:08:26

ARP299C GP053G 3.UVDATA.1

Freq = 4.9253 GHz, Bw = 16.000 MH No calibration applied and no bandpass applied

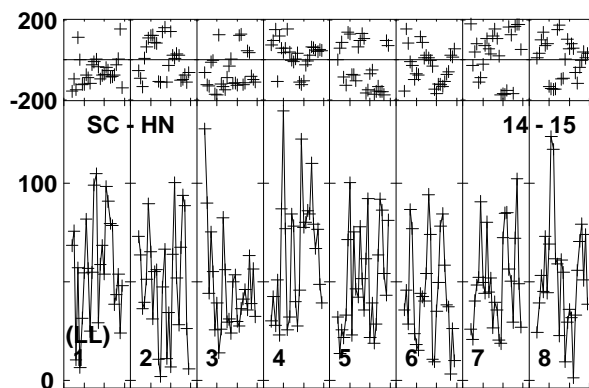
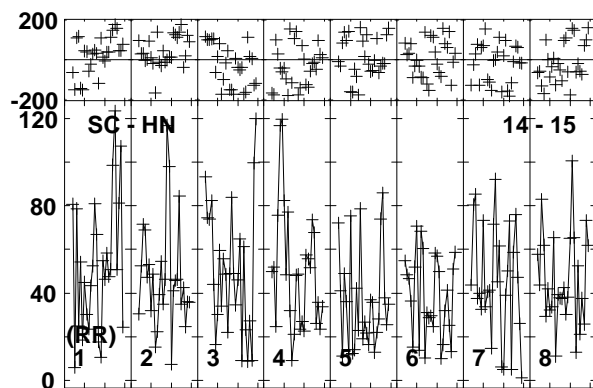
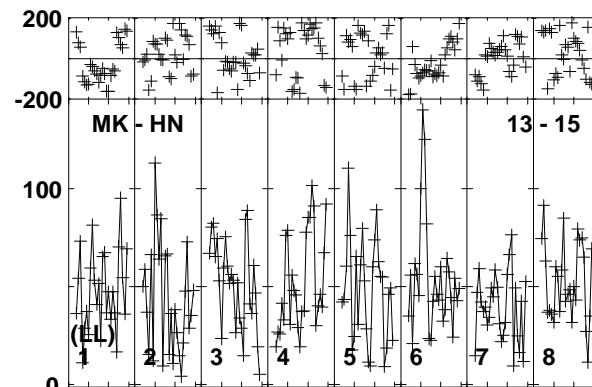
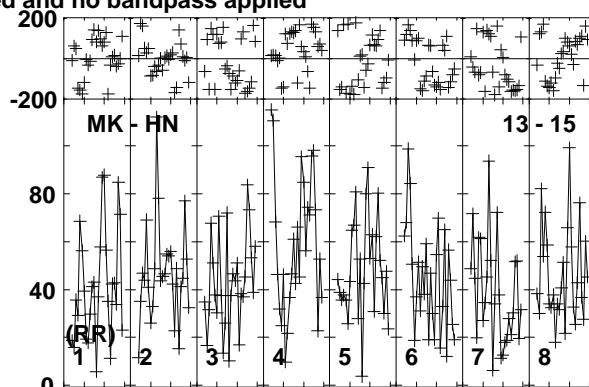
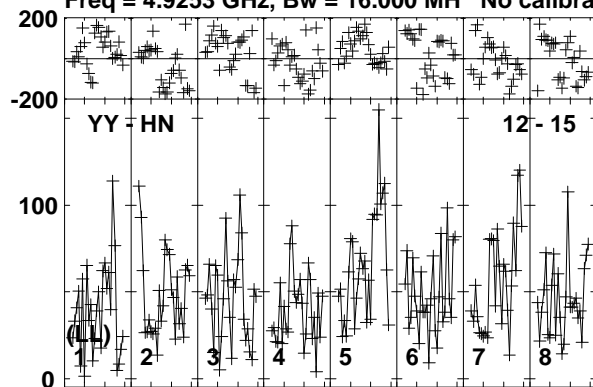

Lower frame: Micro Ampl Jy Top frame: Phas deg
Vector averaged cross-power spectrum Baseline: YY (12) - HN (15)
Timerange: 00/21:15:23 to 00/21:20:37

Plot file version 78 created 11-APR-2016 17:08:26

J1128+5925 GP053G 3.UVDATA.1

Freq = 4.9253 GHz, Bw = 16.000 MH No calibration applied and no bandpass applied

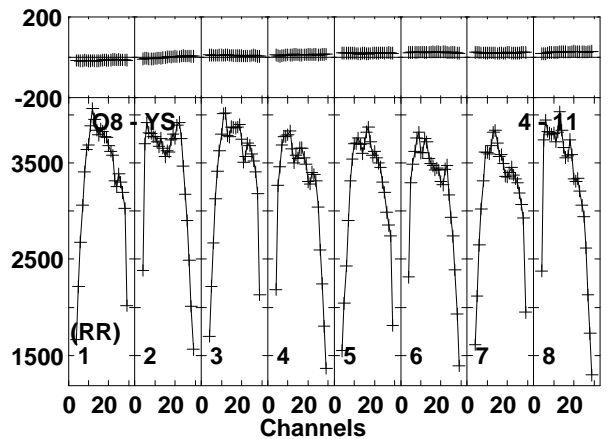
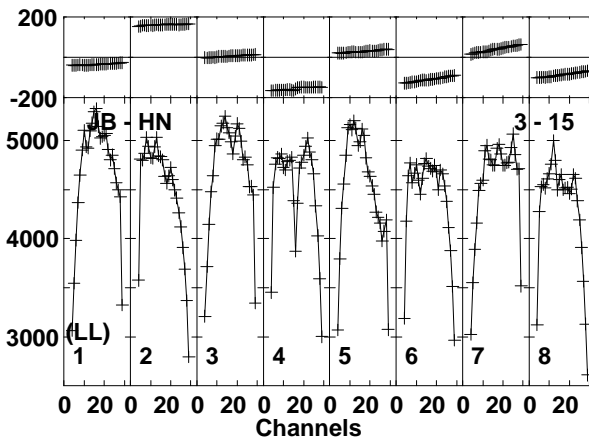
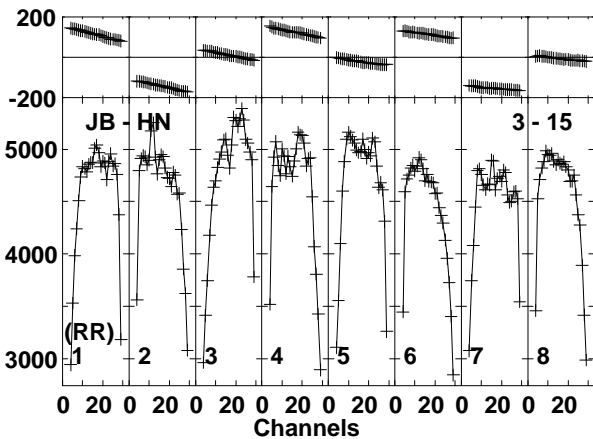
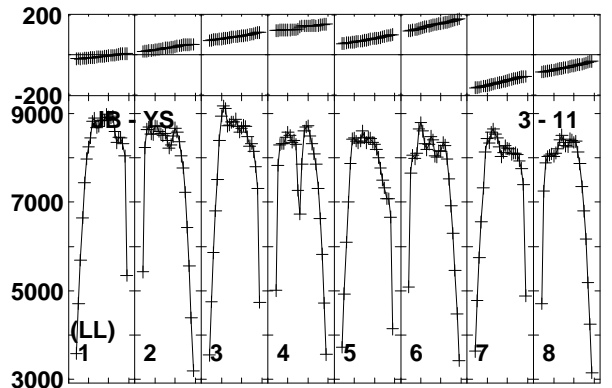
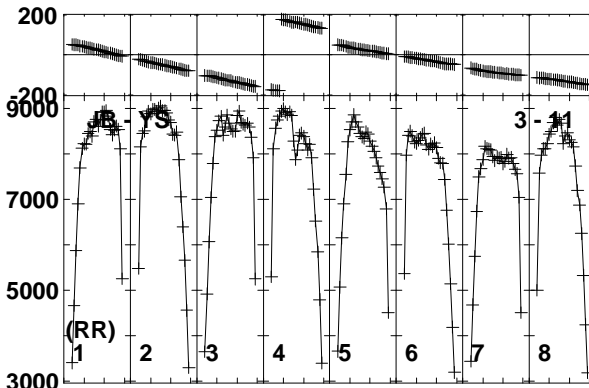
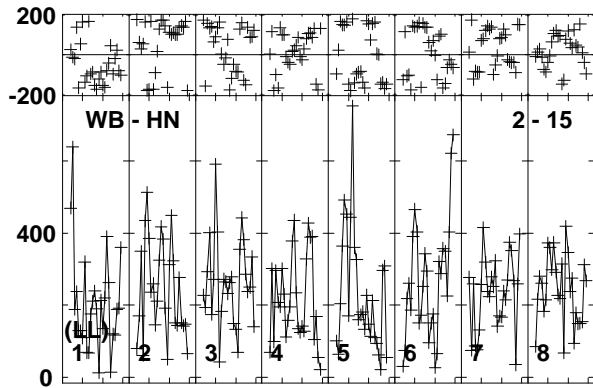
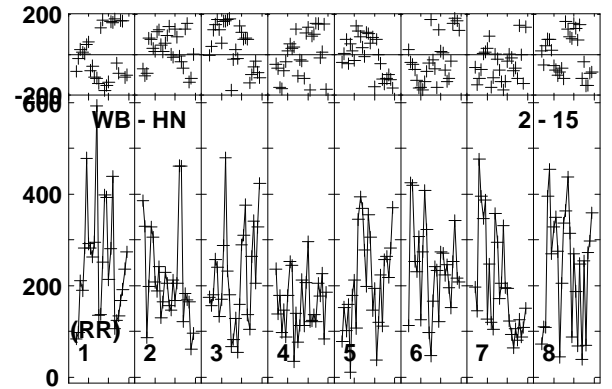
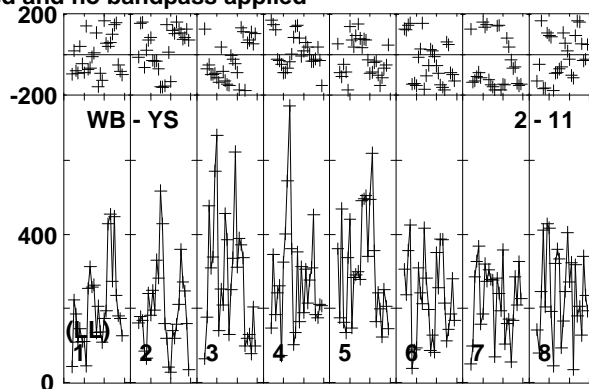
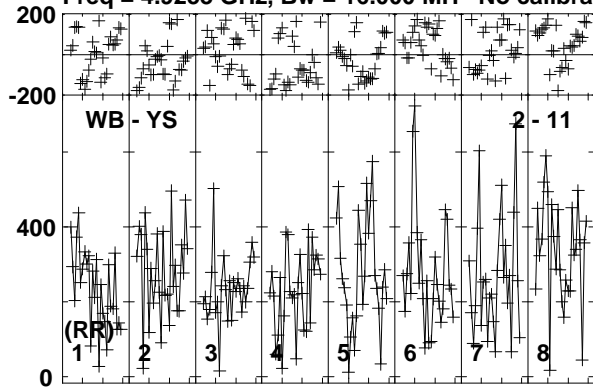

Lower frame: Micro Ampl Jy Top frame: Phas deg
Vector averaged cross-power spectrum Baseline: WB (02) - YS (11)
Timerange: 00/21:20:44 to 00/21:22:27

Plot file version 79 created 11-APR-2016 17:08:26

J1128+5925 GP053G 3.UVDATA.1

Freq = 4.9253 GHz, Bw = 16.000 MH No calibration applied and no bandpass applied

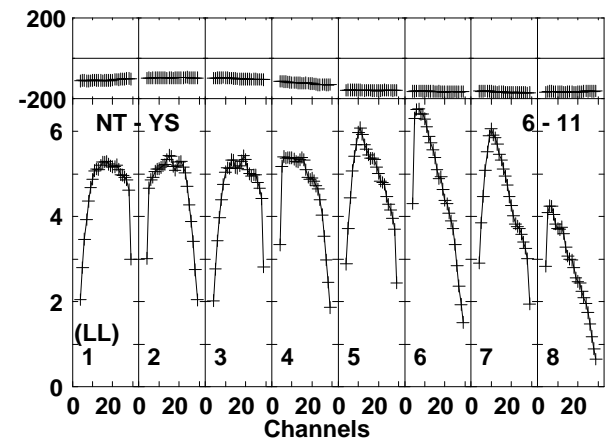
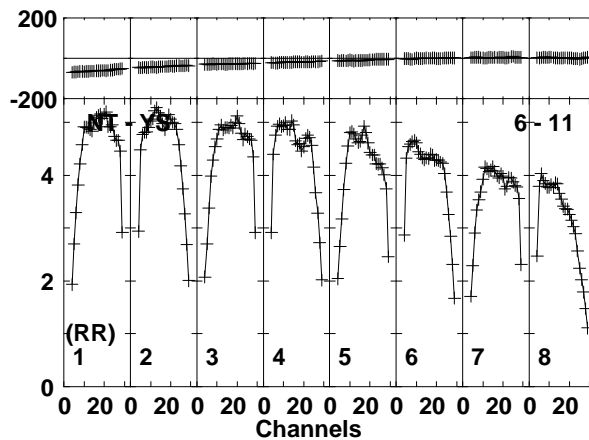
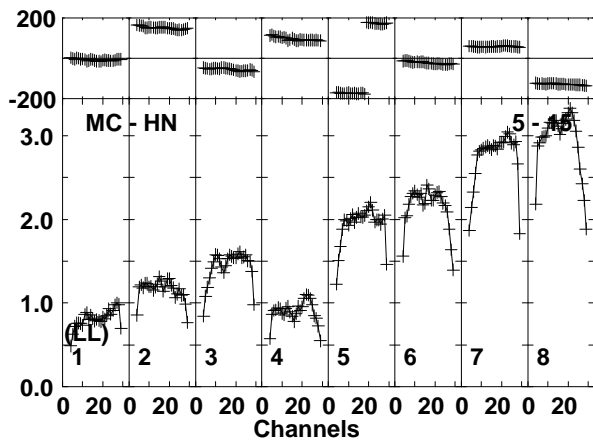
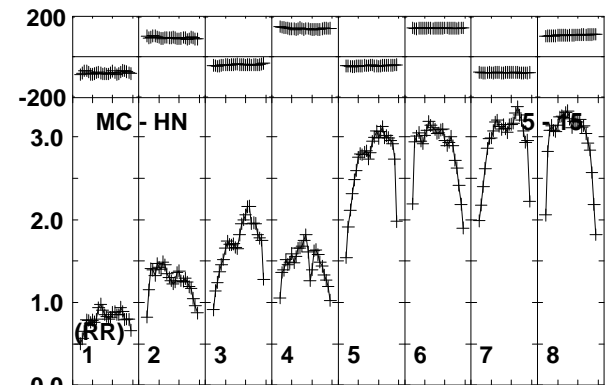
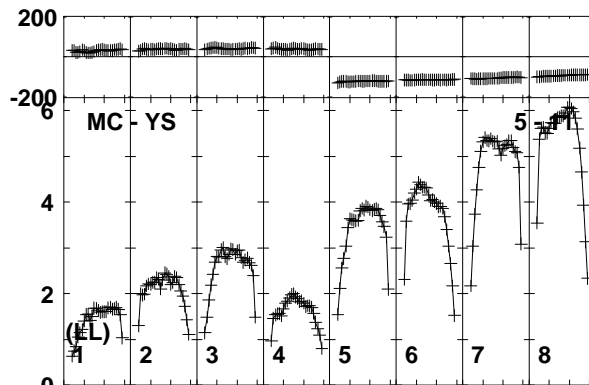
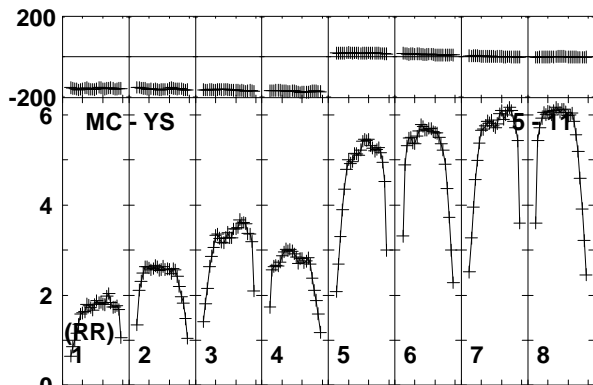
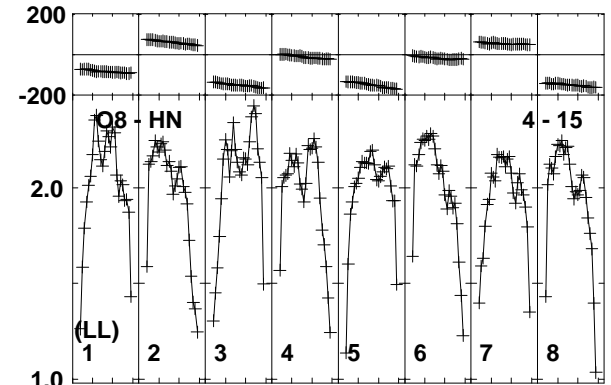
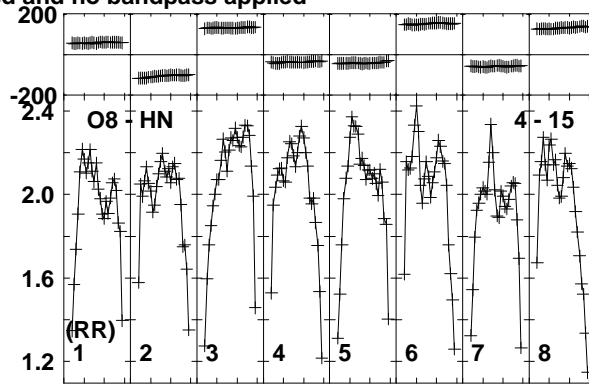
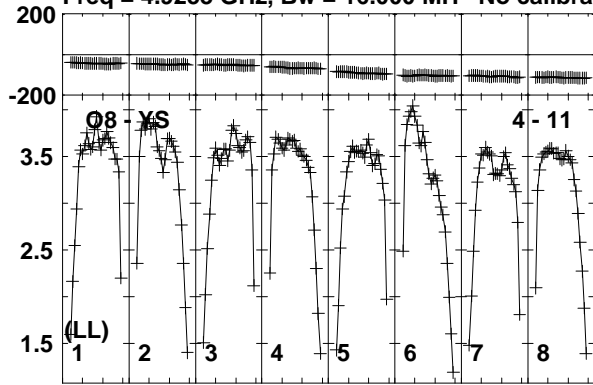

Lower frame: Milli Ampl Jy Top frame: Phas deg
Vector averaged cross-power spectrum Baseline: O8 (04) - YS (11)
Timerange: 00/21:20:44 to 00/21:22:27

Plot file version 80 created 11-APR-2016 17:08:27

J1128+5925 GP053G 3.UVDATA.1

Freq = 4.9253 GHz, Bw = 16.000 MH No calibration applied and no bandpass applied

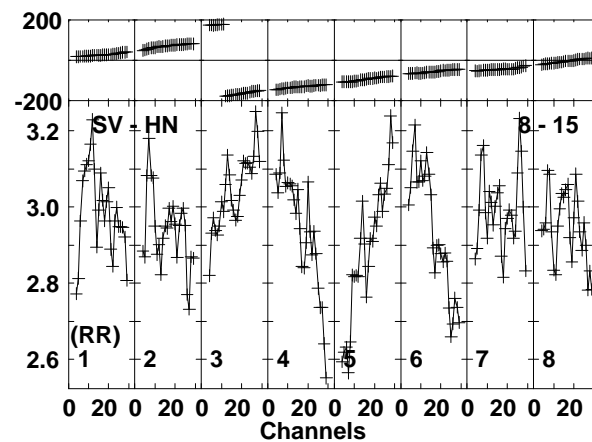
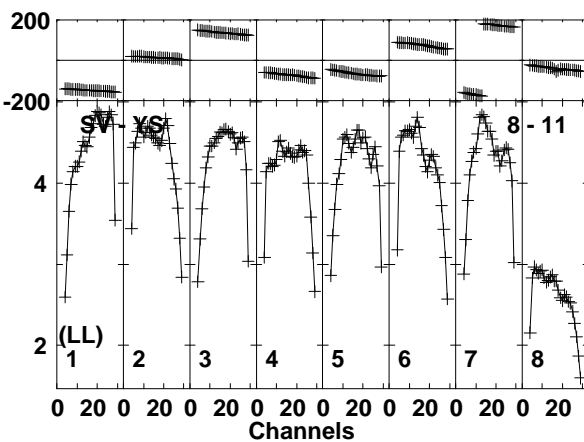
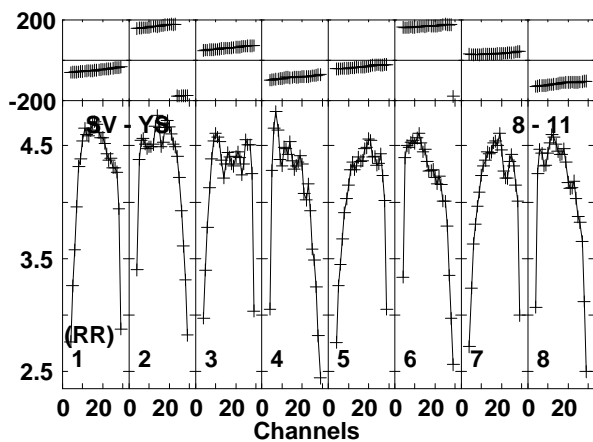
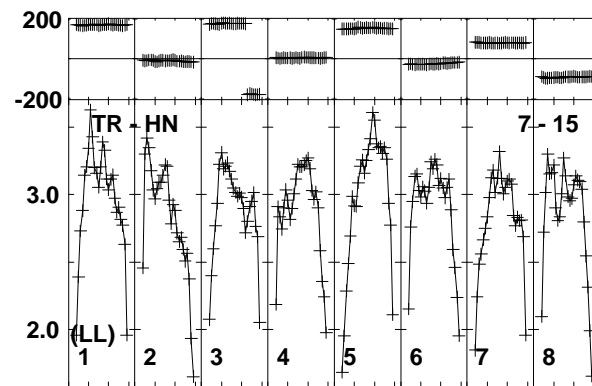
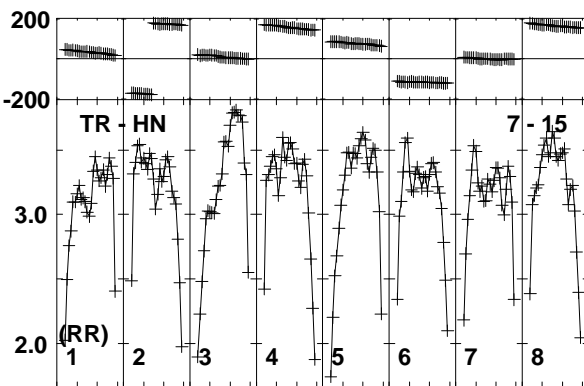
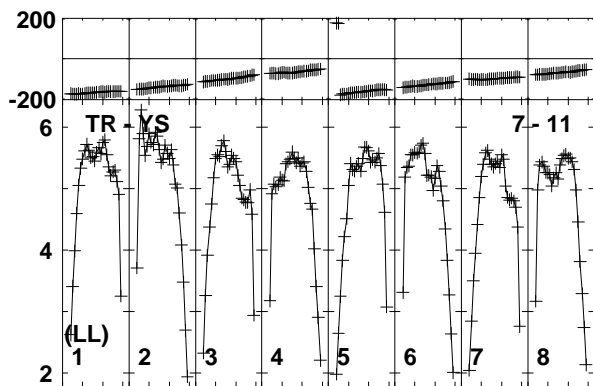
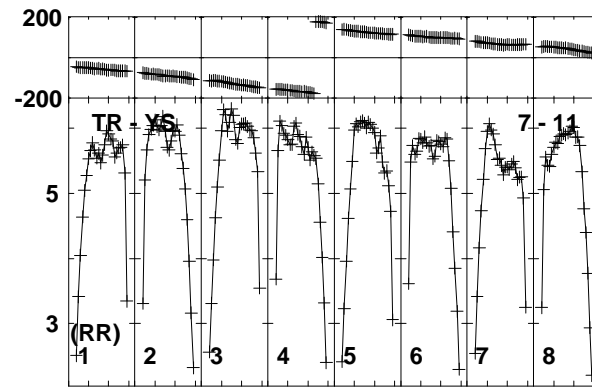
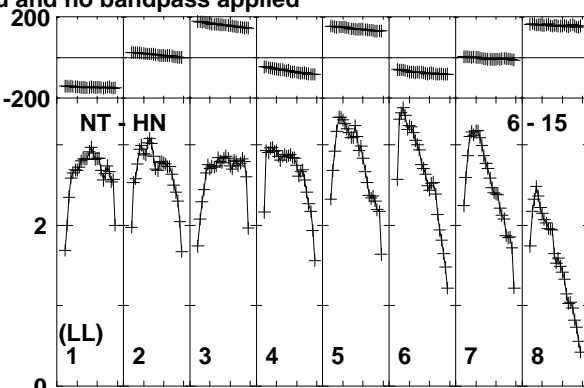
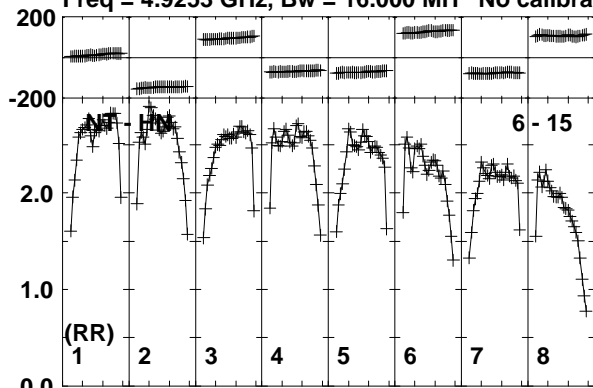

Lower frame: Milli Ampl Jy Top frame: Phas deg
Vector averaged cross-power spectrum Baseline: NT (06) - HN (15)
Timerange: 00/21:20:44 to 00/21:22:27

Plot file version 81 created 11-APR-2016 17:08:27

J1128+5925 GP053G 3.UVDATA.1

Freq = 4.9253 GHz, Bw = 16.000 MH No calibration applied and no bandpass applied

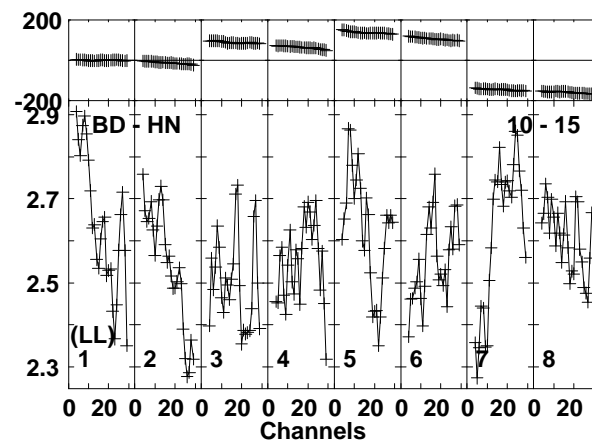
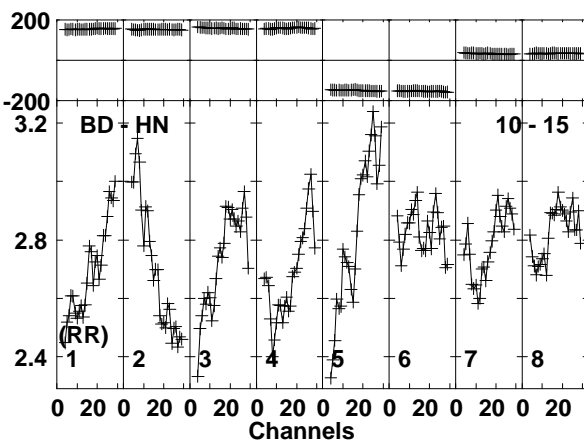
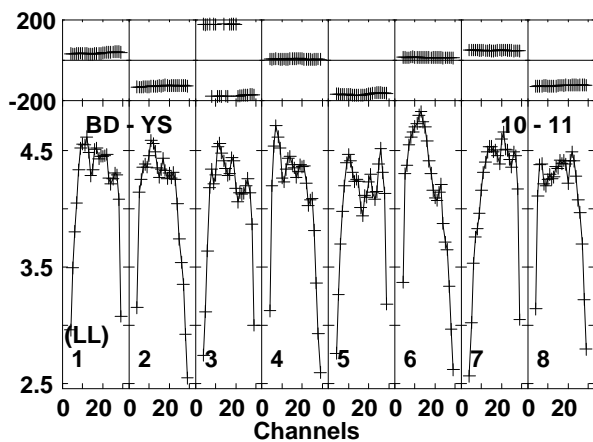
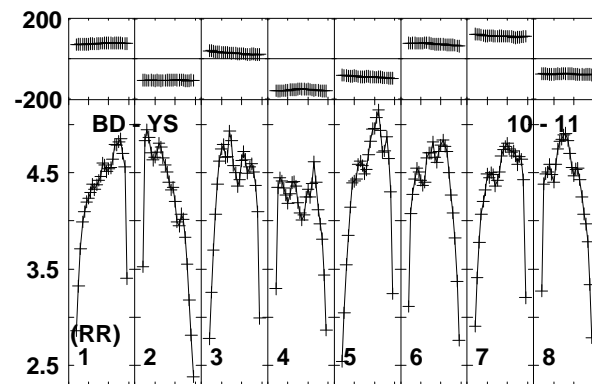
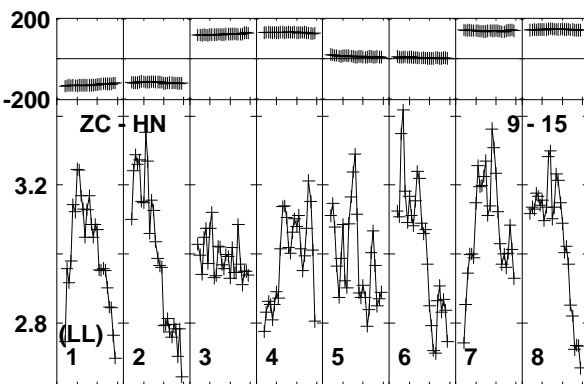
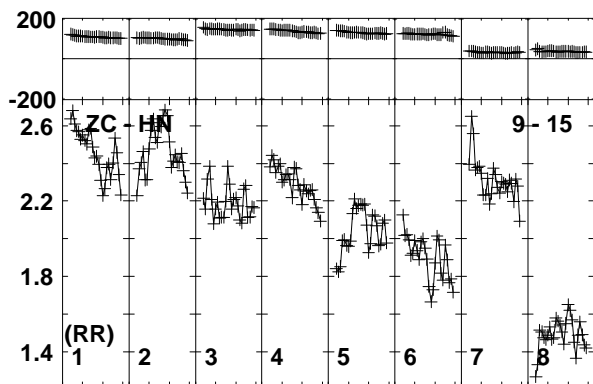
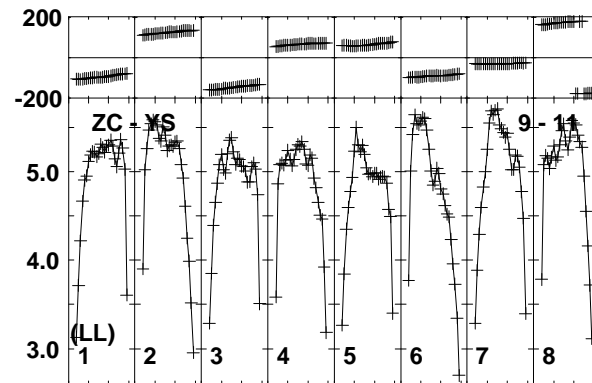
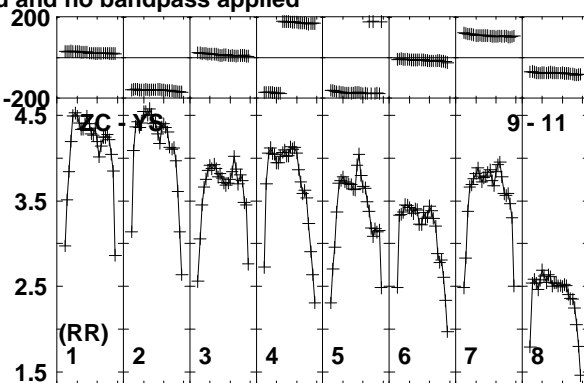
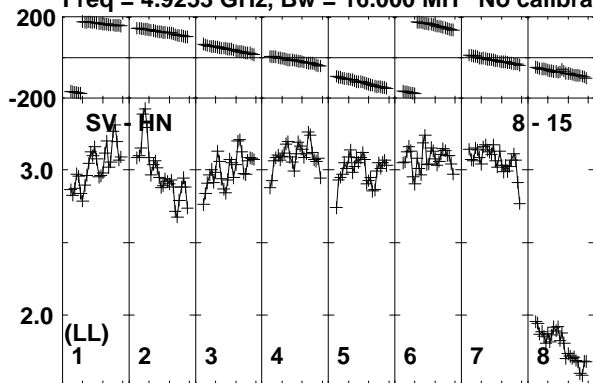

Lower frame: Milli Ampl Jy Top frame: Phas deg
Vector averaged cross-power spectrum Baseline: SV (08) - HN (15)
Timerange: 00/21:20:44 to 00/21:22:27

Plot file version 82 created 11-APR-2016 17:08:27

J1128+5925 GP053G 3.UVDATA.1

Freq = 4.9253 GHz, Bw = 16.000 MH No calibration applied and no bandpass applied

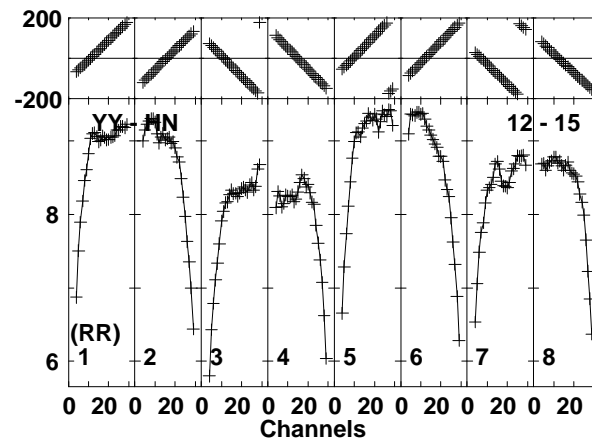
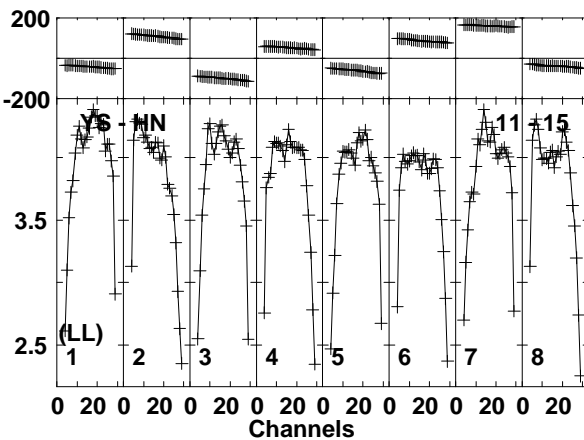
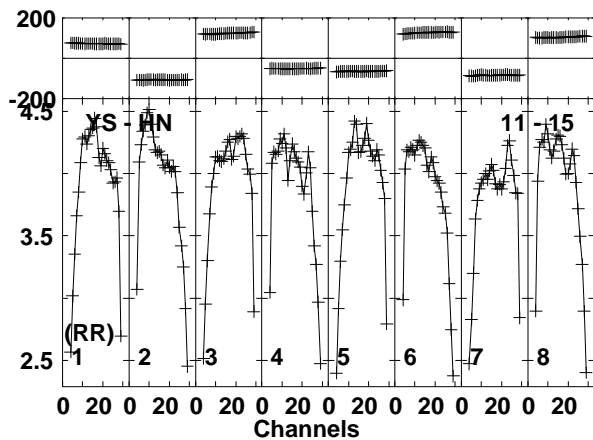
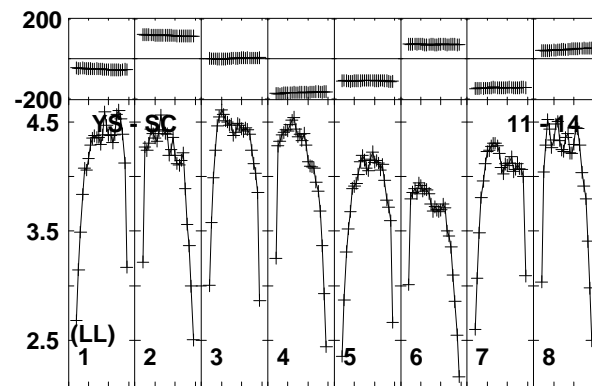
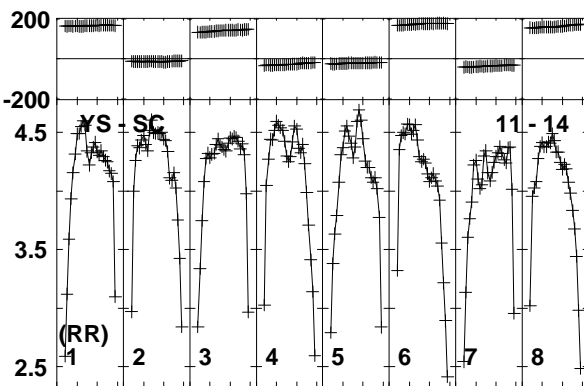
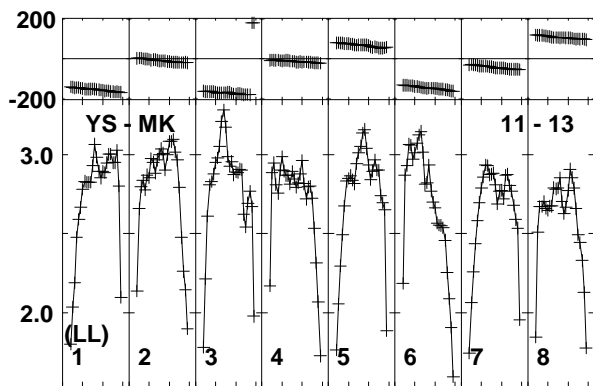
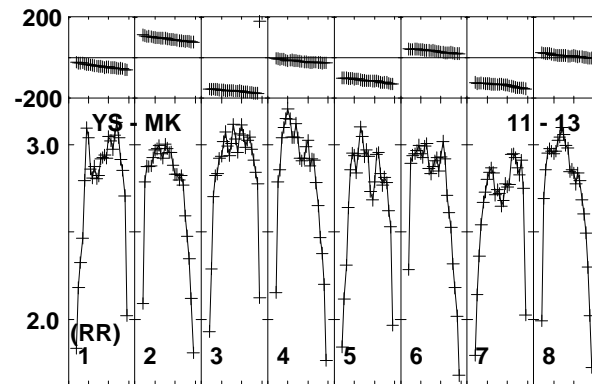
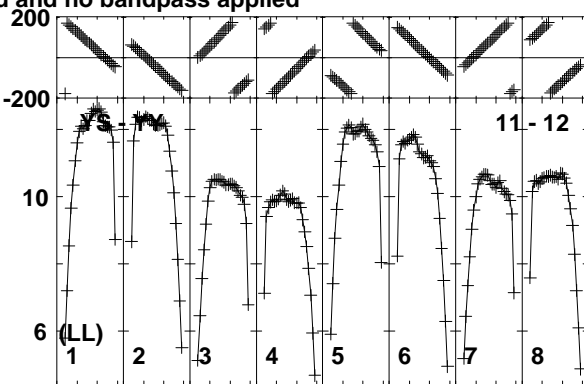
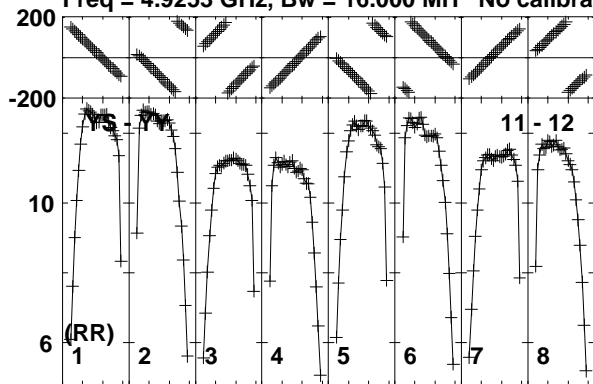

Lower frame: Milli Ampl Jy Top frame: Phas deg
Vector averaged cross-power spectrum Baseline: YS (11) - YY (12)
Timerange: 00/21:20:44 to 00/21:22:27

Plot file version 83 created 11-APR-2016 17:08:27

J1128+5925 GP053G 3.UVDATA.1

Freq = 4.9253 GHz, Bw = 16.000 MH No calibration applied and no bandpass applied

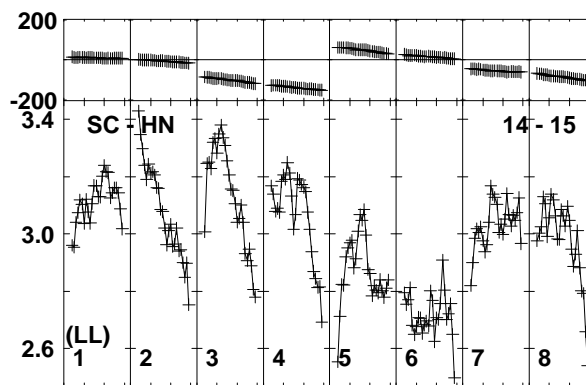
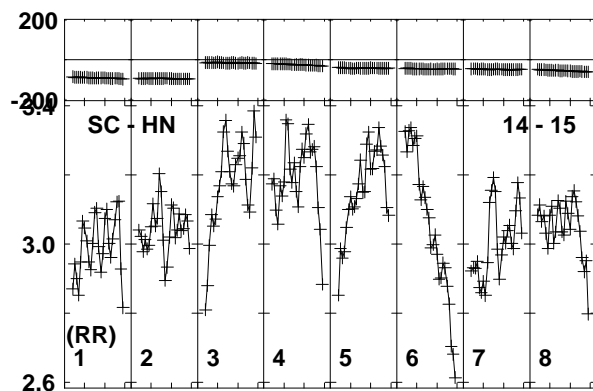
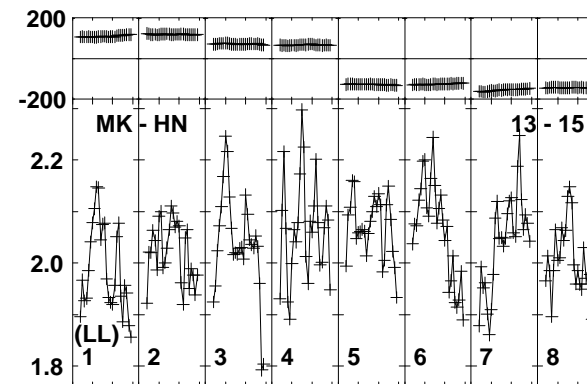
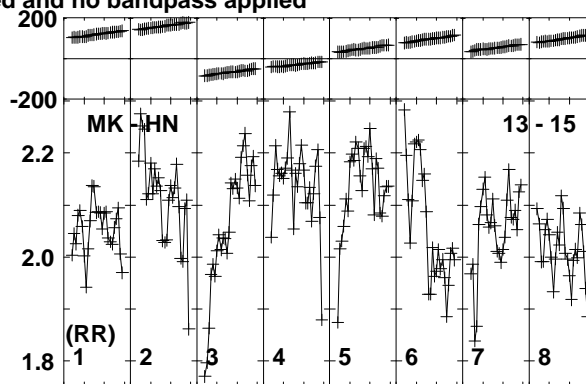
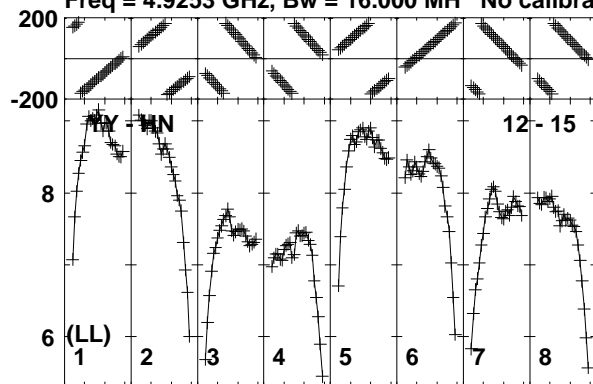

Lower frame: Milli Ampl Jy Top frame: Phas deg
Vector averaged cross-power spectrum Baseline: YY (12) - HN (15)
Timerange: 00/21:20:44 to 00/21:22:27

Plot file version 84 created 11-APR-2016 17:08:27

ARP299C GP053G 3.UVDATA.1

Freq = 4.9253 GHz, Bw = 16.000 MH No calibration applied and no bandpass applied

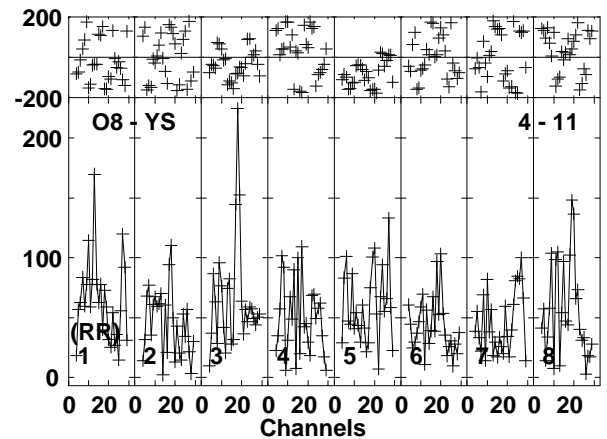
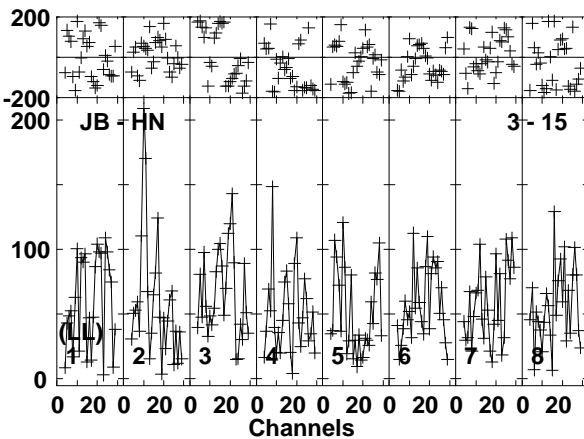
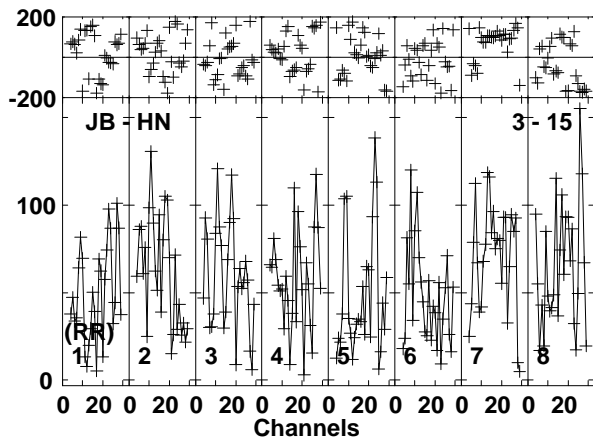
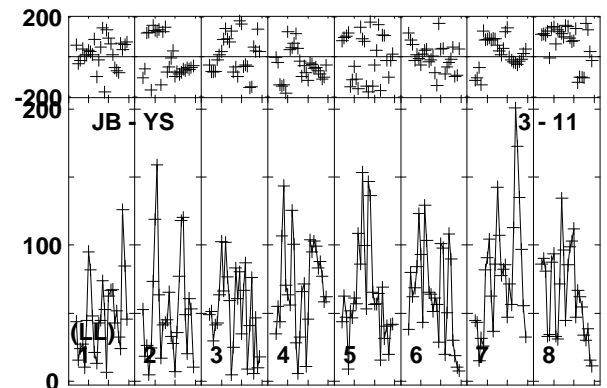
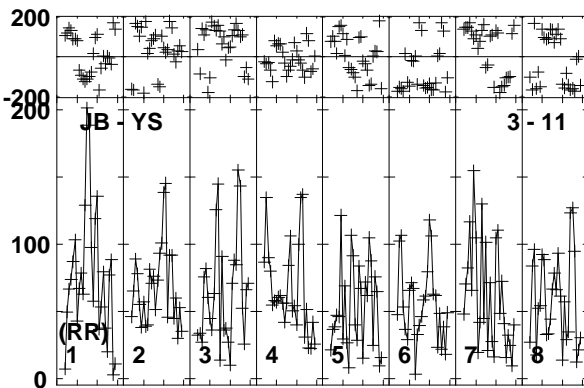
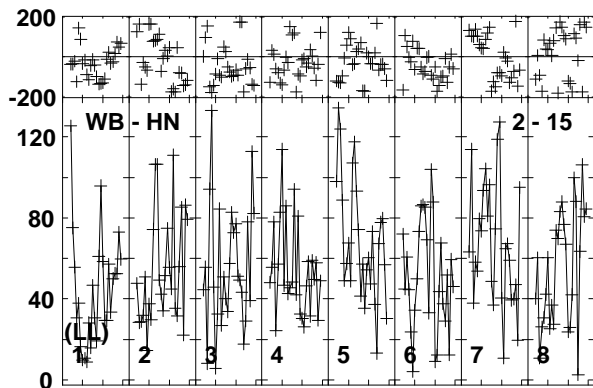
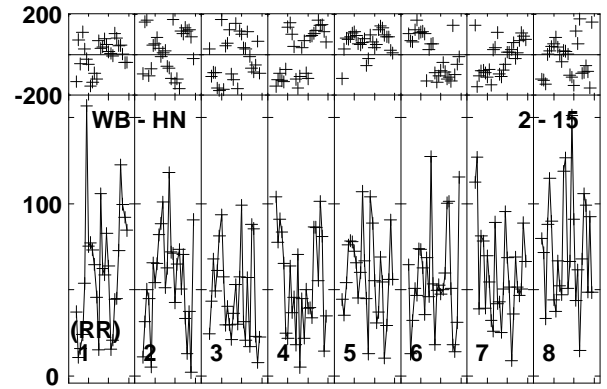
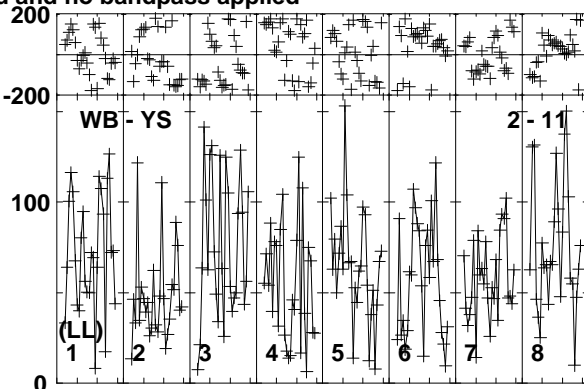
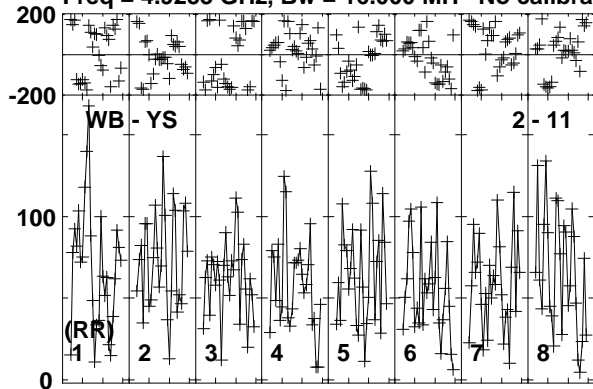

Lower frame: Micro Ampl Jy Top frame: Phas deg
Vector averaged cross-power spectrum Baseline: WB (02) - YS (11)
Timerange: 00/21:22:34 to 00/21:27:46

Plot file version 85 created 11-APR-2016 17:08:27

ARP299C GP053G 3.UVDATA.1

Freq = 4.9253 GHz, Bw = 16.000 MH No calibration applied and no bandpass applied

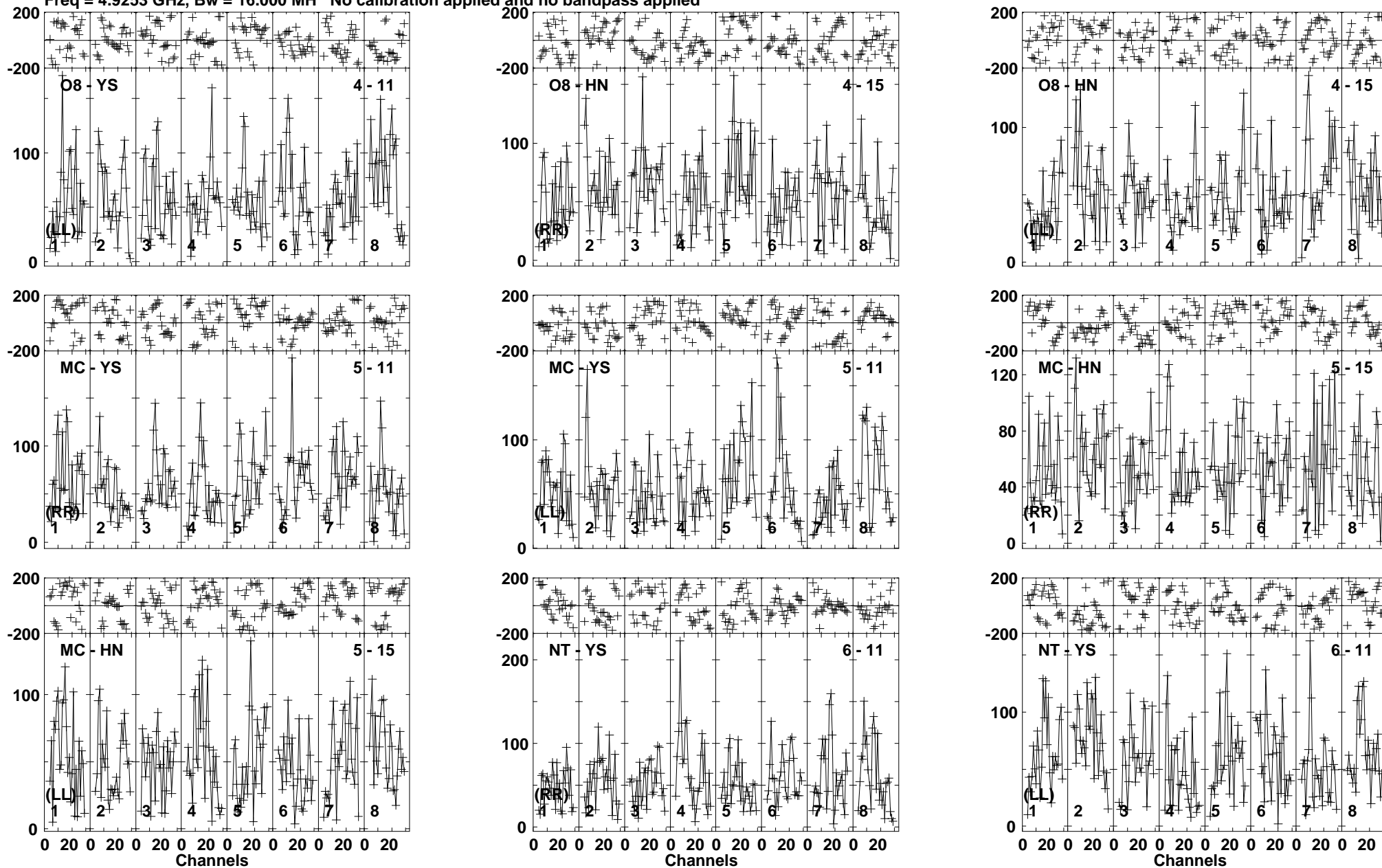

Lower frame: Micro Ampl Jy Top frame: Phas deg
Vector averaged cross-power spectrum Baseline: O8 (04) - YS (11)
Timerange: 00/21:22:34 to 00/21:27:46

Plot file version 86 created 11-APR-2016 17:08:28

ARP299C GP053G 3.UVDATA.1

Freq = 4.9253 GHz, Bw = 16.000 MH No calibration applied and no bandpass applied

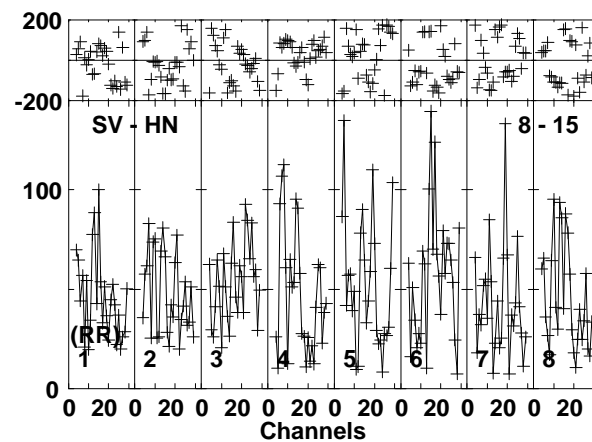
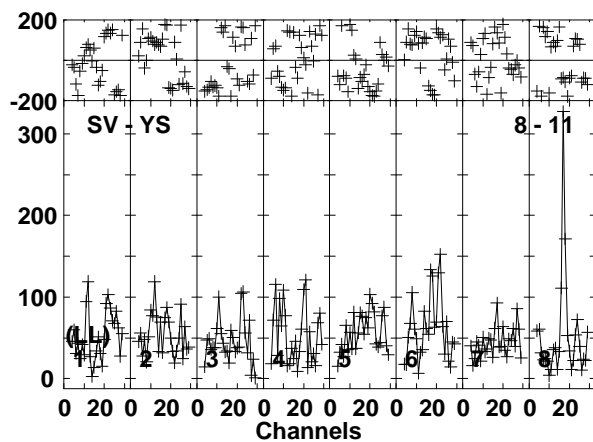
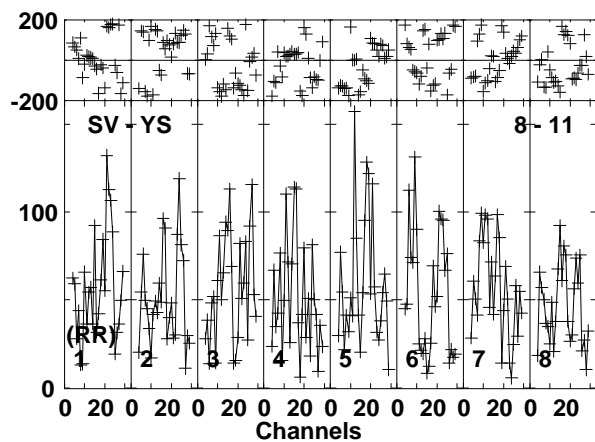
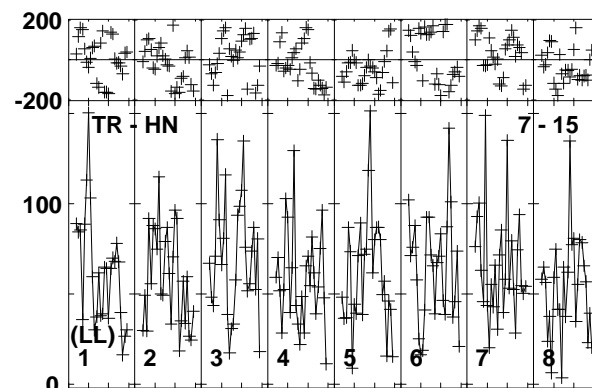
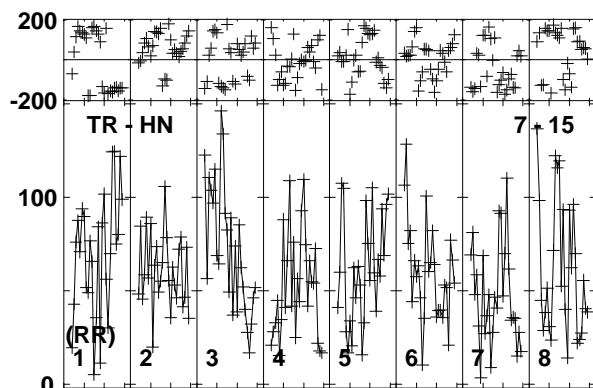
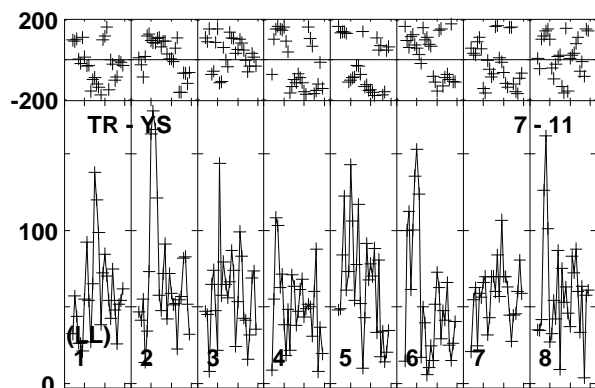
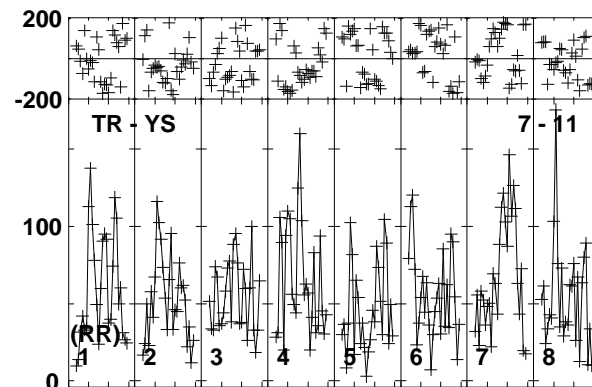
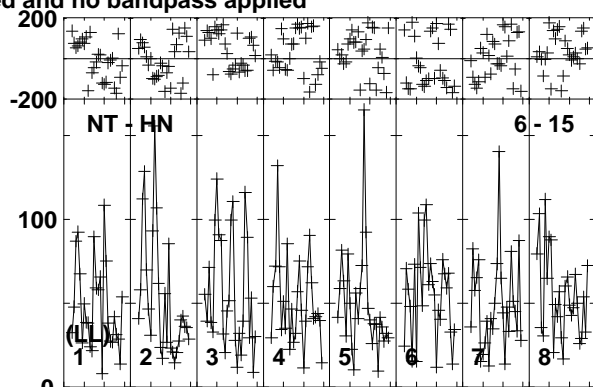
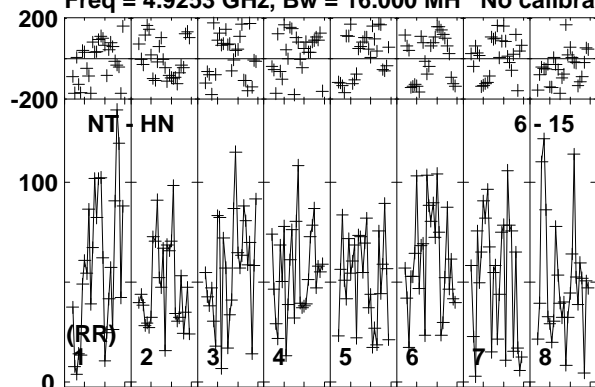

Lower frame: Micro Ampl Jy Top frame: Phas deg
Vector averaged cross-power spectrum Baseline: NT (06) - HN (15)
Timerange: 00/21:22:34 to 00/21:27:46

Plot file version 87 created 11-APR-2016 17:08:28

ARP299C GP053G 3.UVDATA.1

Freq = 4.9253 GHz, Bw = 16.000 MH No calibration applied and no bandpass applied

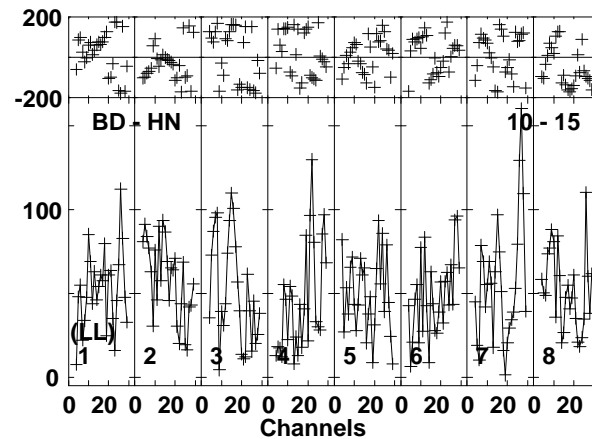
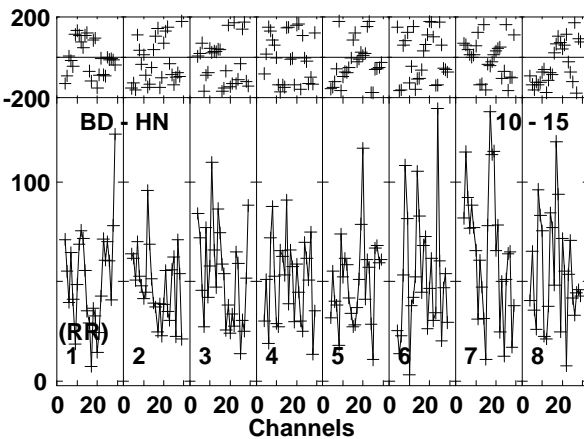
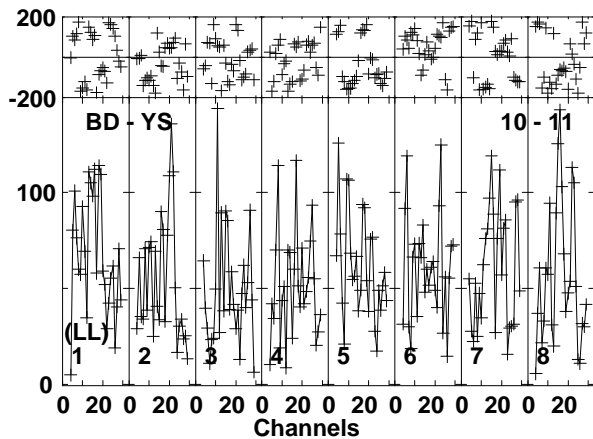
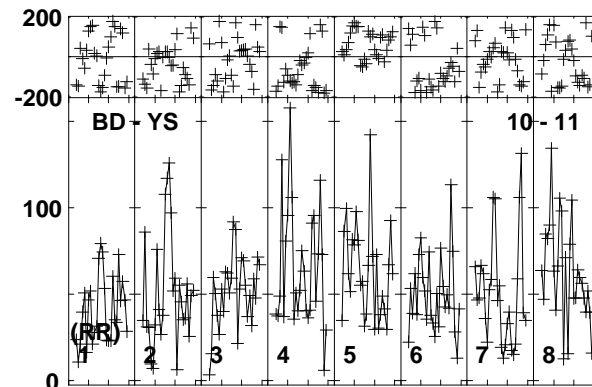
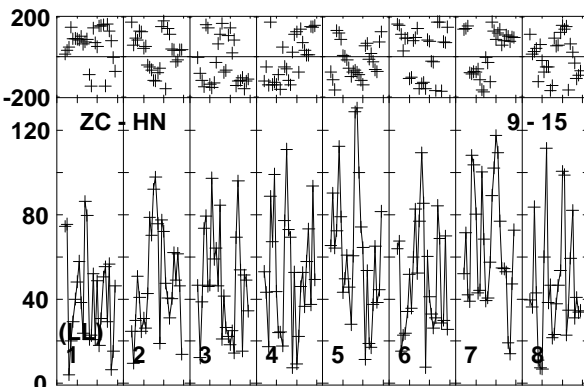
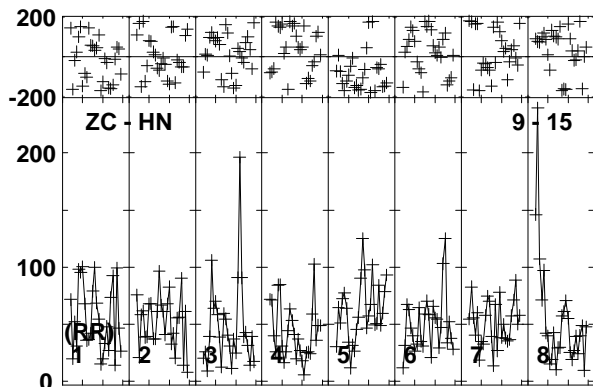
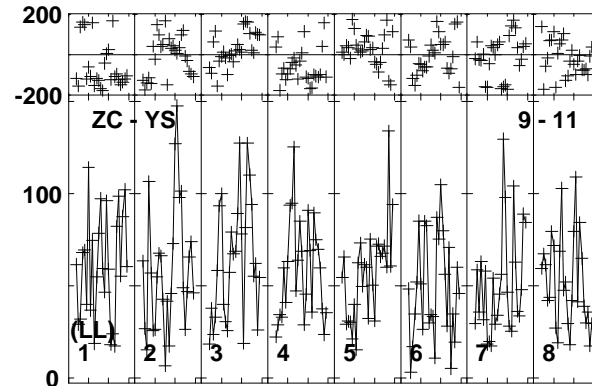
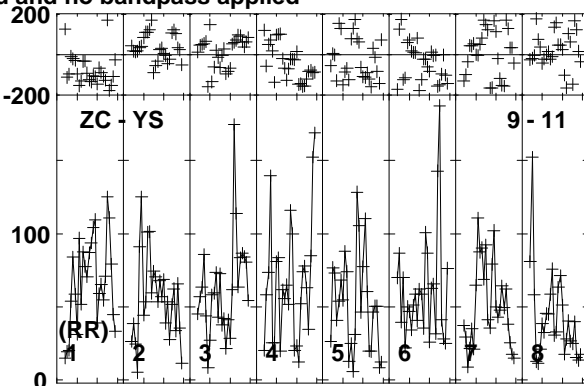
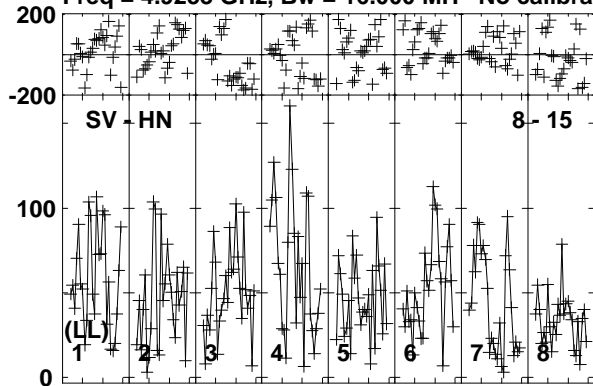

Lower frame: Micro Ampl Jy Top frame: Phas deg
Vector averaged cross-power spectrum Baseline: SV (08) - HN (15)
Timerange: 00/21:22:34 to 00/21:27:46

Plot file version 88 created 11-APR-2016 17:08:28

ARP299C GP053G 3.UVDATA.1

Freq = 4.9253 GHz, Bw = 16.000 MH No calibration applied and no bandpass applied

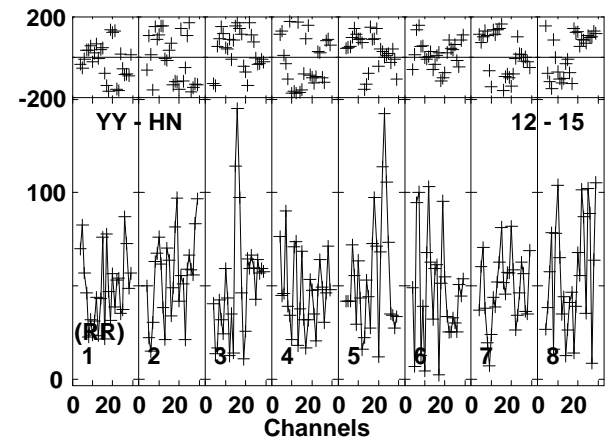
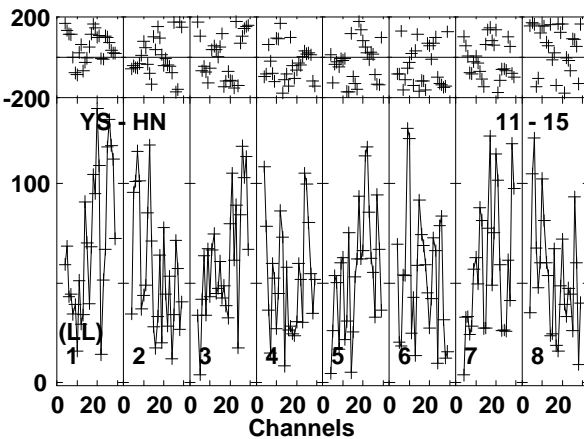
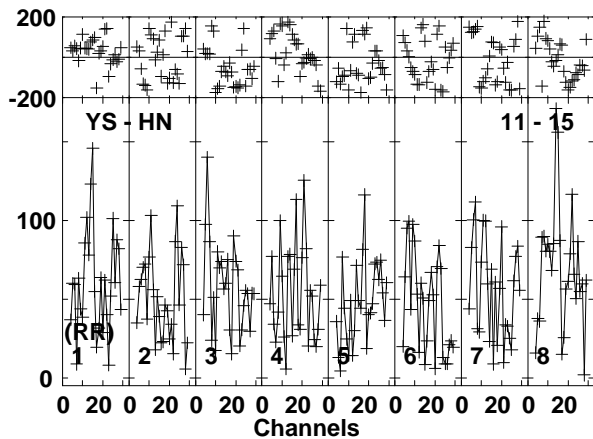
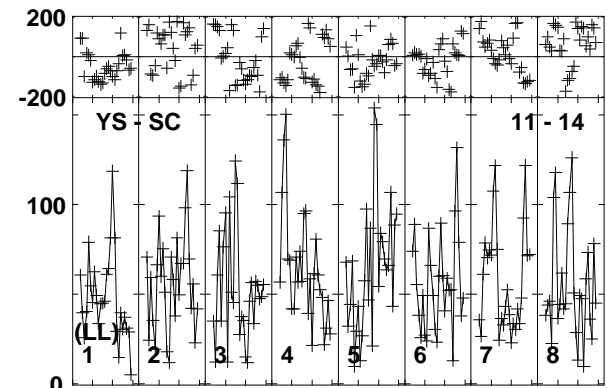
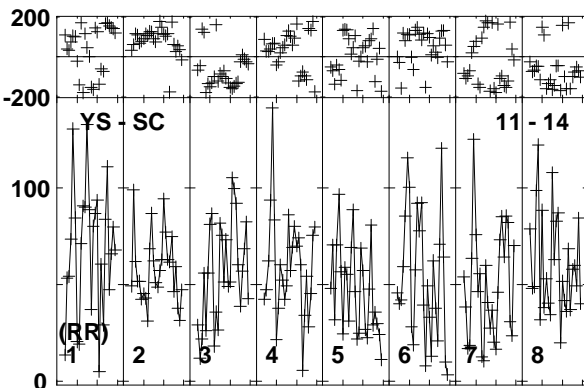
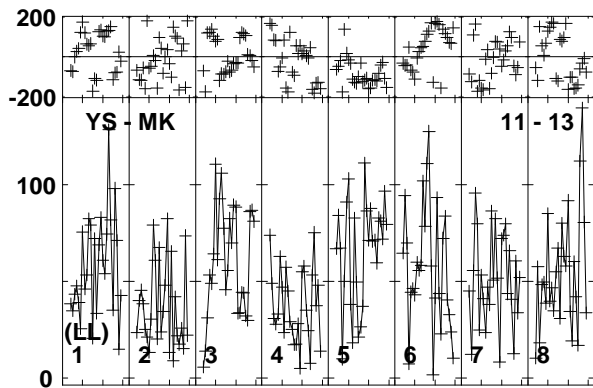
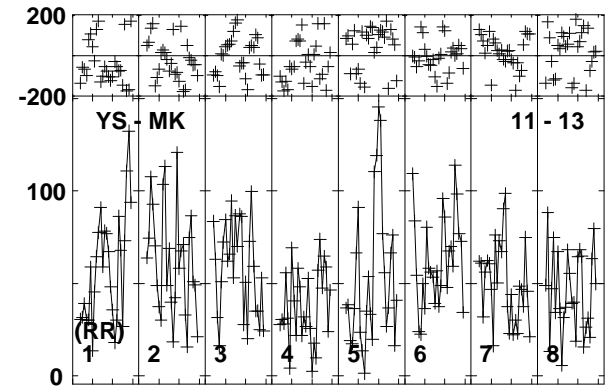
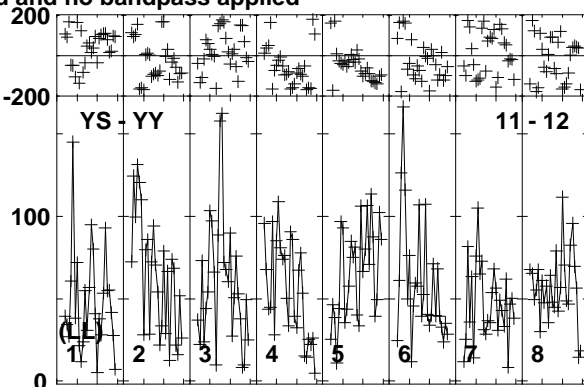
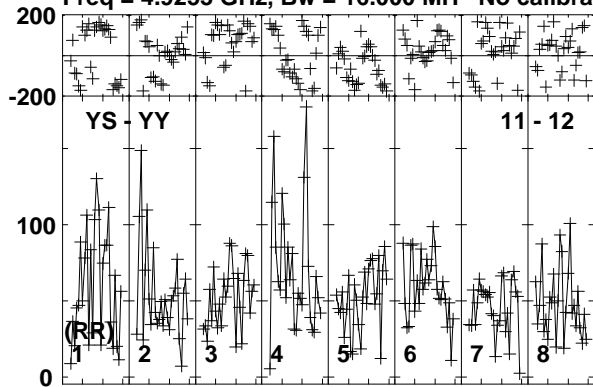

Lower frame: Micro Ampl Jy Top frame: Phas deg
Vector averaged cross-power spectrum Baseline: YS (11) - YY (12)
Timerange: 00/21:22:34 to 00/21:27:46

Plot file version 89 created 11-APR-2016 17:08:28

ARP299C GP053G 3.UVDATA.1

Freq = 4.9253 GHz, Bw = 16.000 MH No calibration applied and no bandpass applied

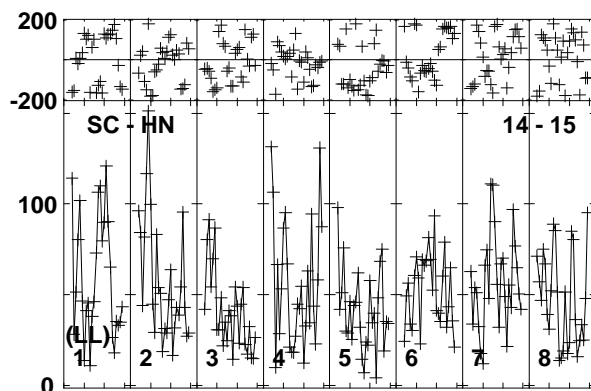
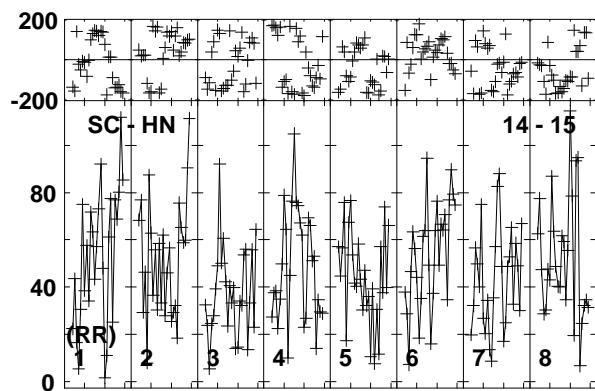
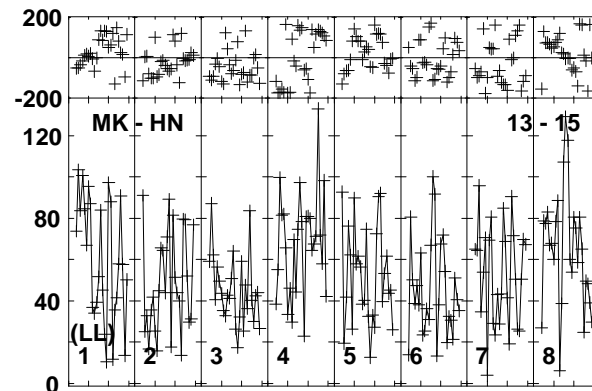
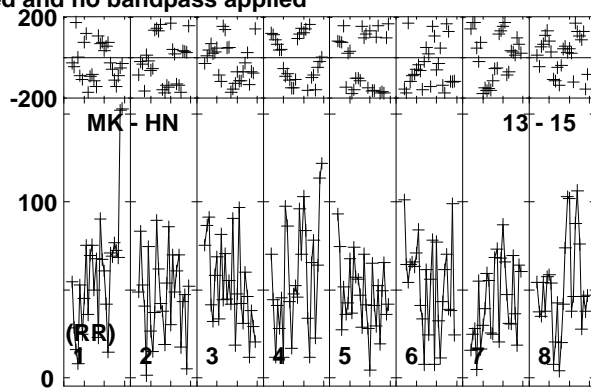
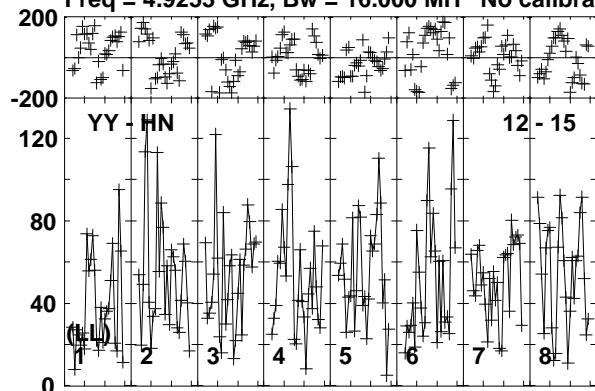

Lower frame: Micro Ampl Jy Top frame: Phas deg
Vector averaged cross-power spectrum Baseline: YY (12) - HN (15)
Timerange: 00/21:22:34 to 00/21:27:46

Plot file version 90 created 11-APR-2016 17:08:28

J1128+5925 GP053G 3.UVDATA.1

Freq = 4.9253 GHz, Bw = 16.000 MH No calibration applied and no bandpass applied

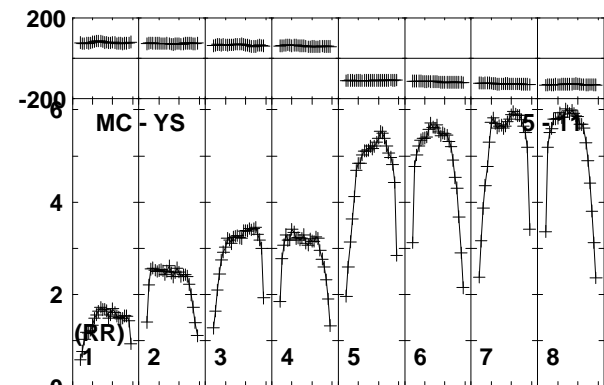
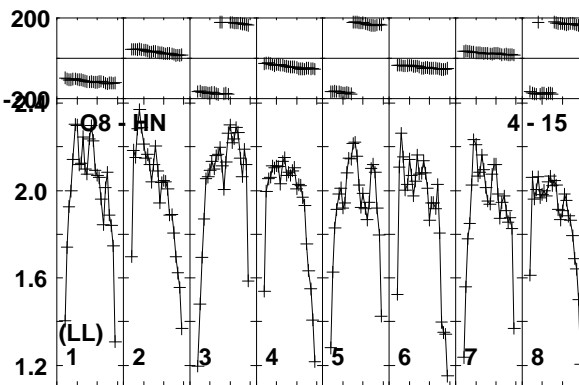
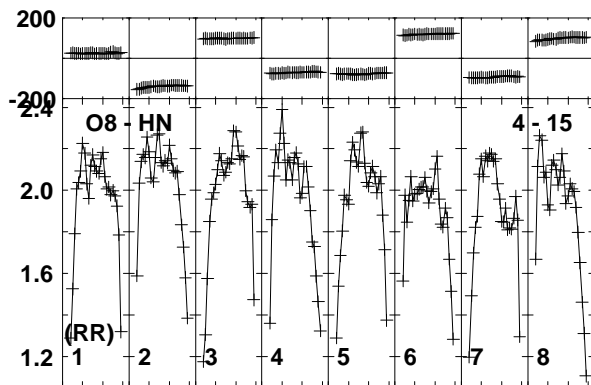
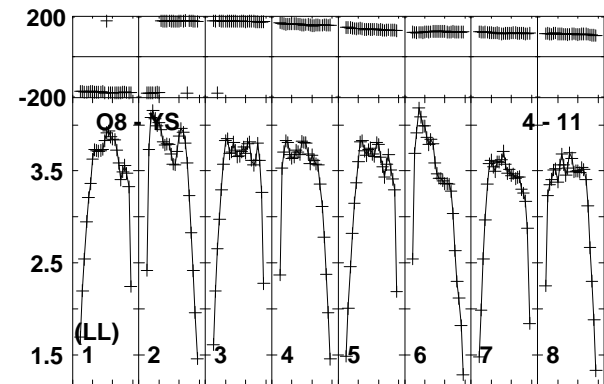
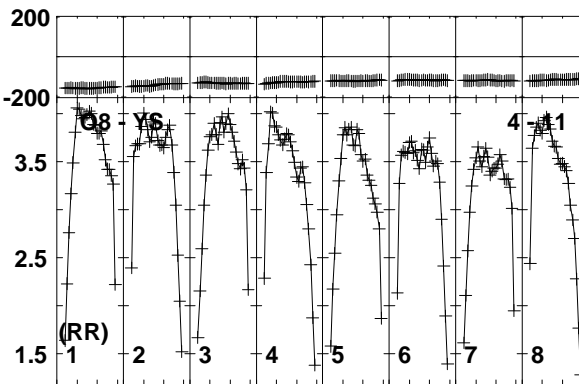
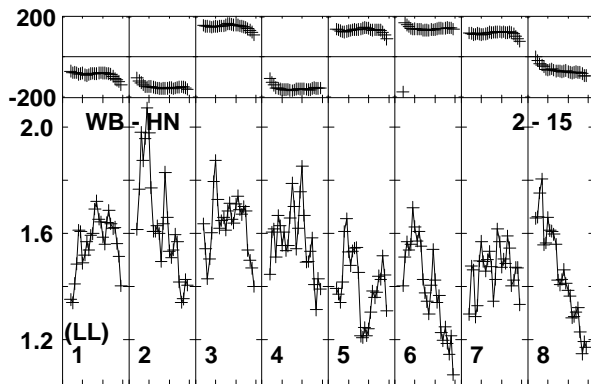
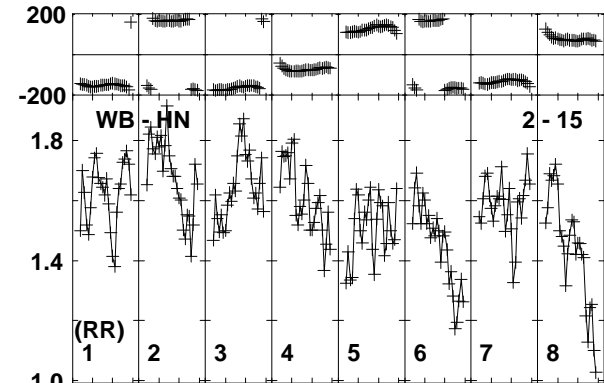
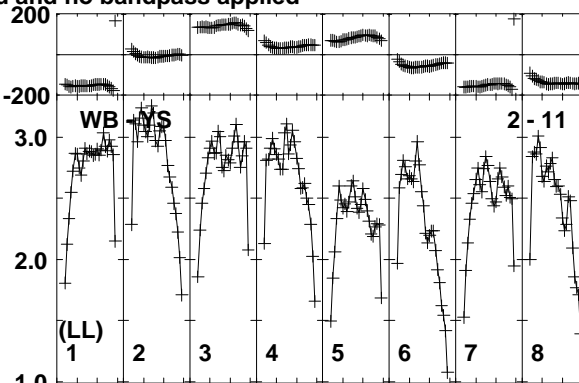
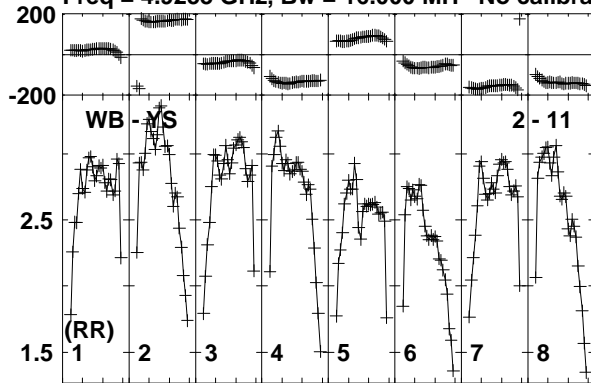

Lower frame: Milli Ampl Jy Top frame: Phas deg
Vector averaged cross-power spectrum Baseline: WB (02) - YS (11)
Timerange: 00/21:27:52 to 00/21:29:43

Plot file version 91 created 11-APR-2016 17:08:28

J1128+5925 GP053G 3.UVDATA.1

Freq = 4.9253 GHz, Bw = 16.000 MH No calibration applied and no bandpass applied

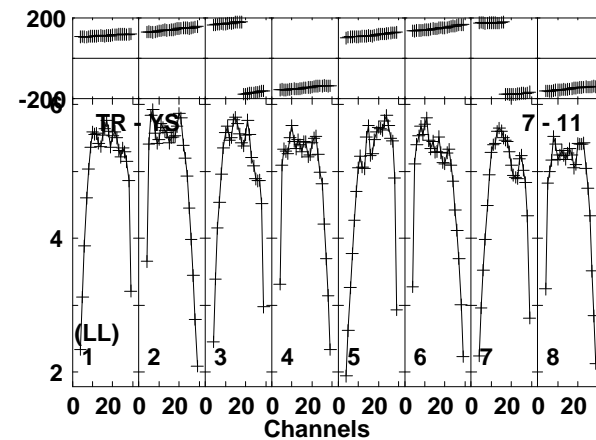
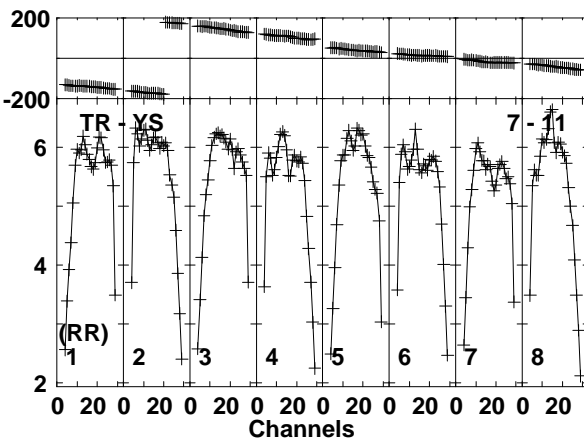
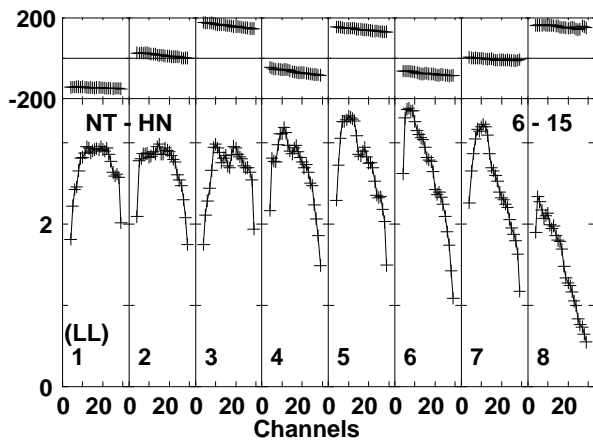
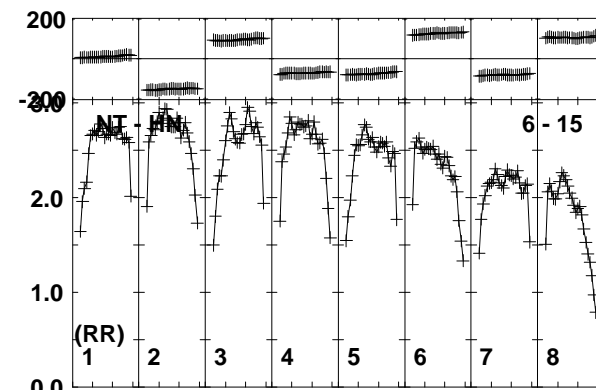
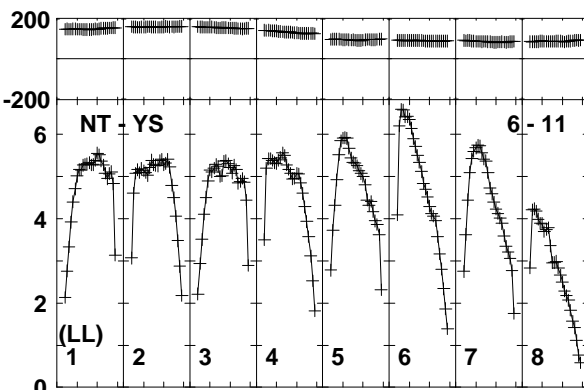
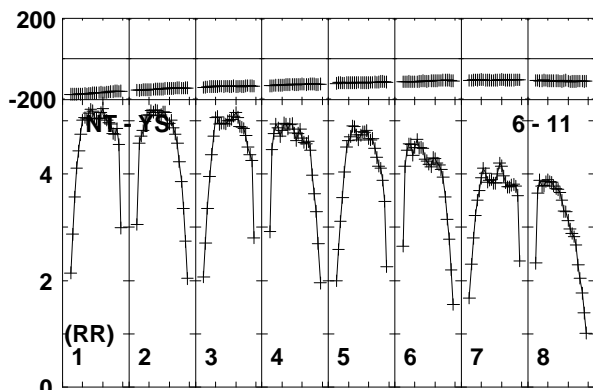
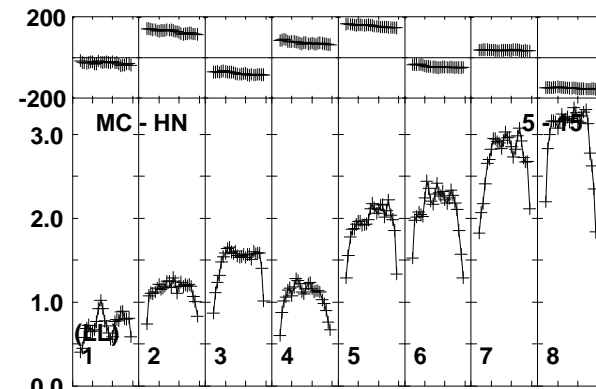
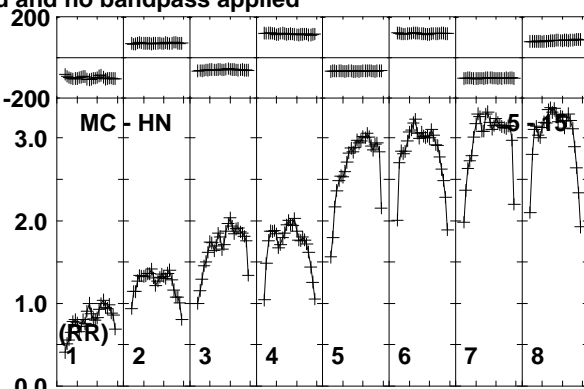
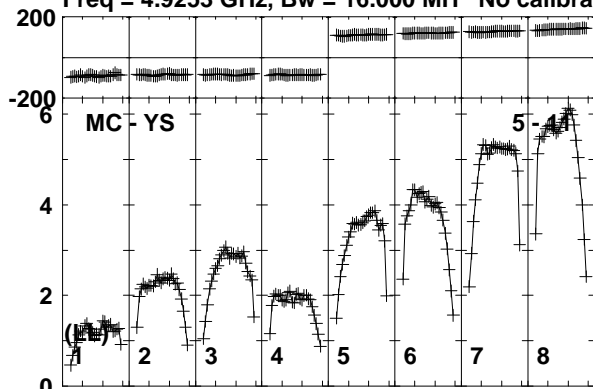

Lower frame: Milli Ampl Jy Top frame: Phas deg
Vector averaged cross-power spectrum Baseline: MC (05) - YS (11)
Timerange: 00/21:27:52 to 00/21:29:43

Plot file version 92 created 11-APR-2016 17:08:29

J1128+5925 GP053G 3.UVDATA.1

Freq = 4.9253 GHz, Bw = 16.000 MH No calibration applied and no bandpass applied

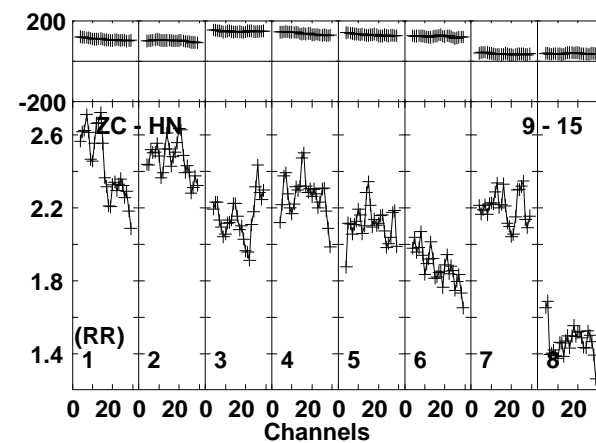
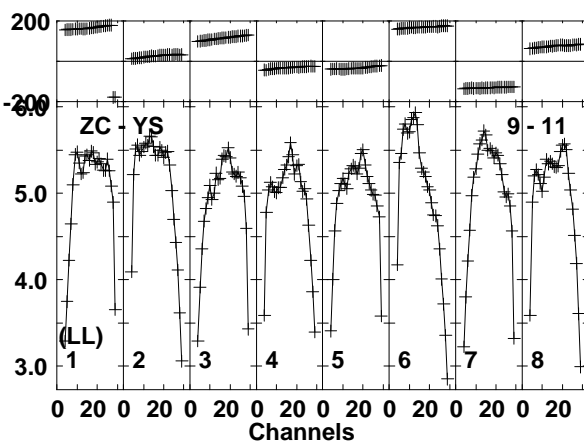
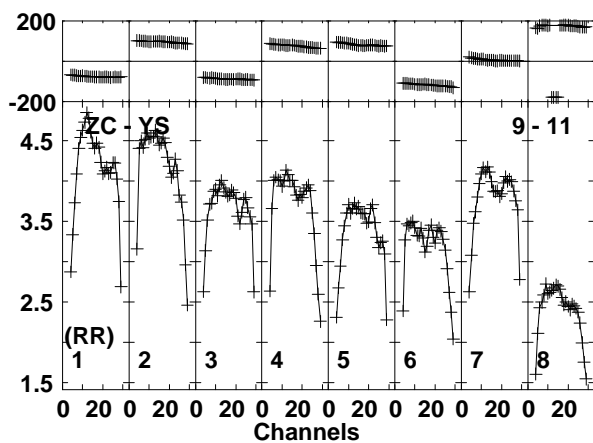
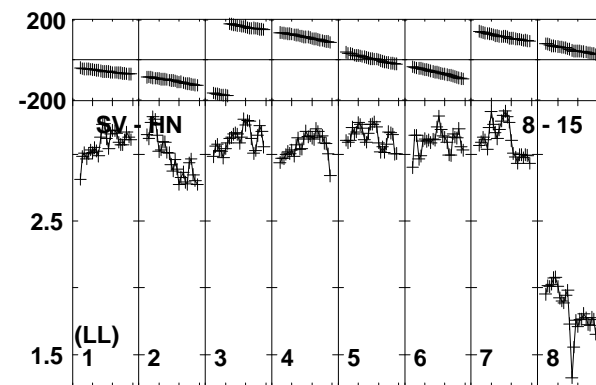
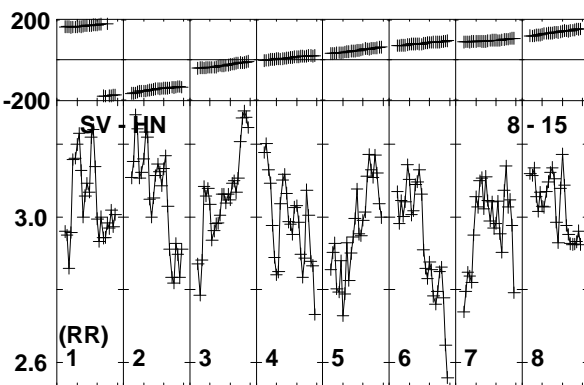
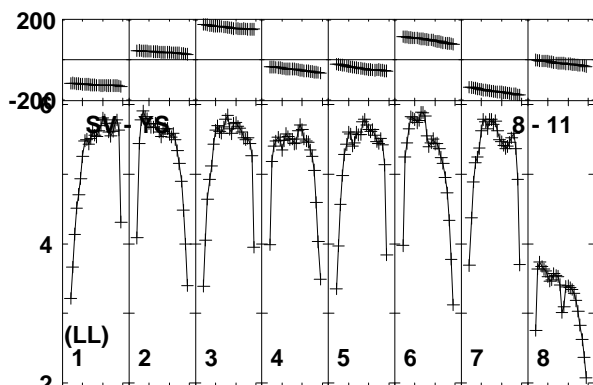
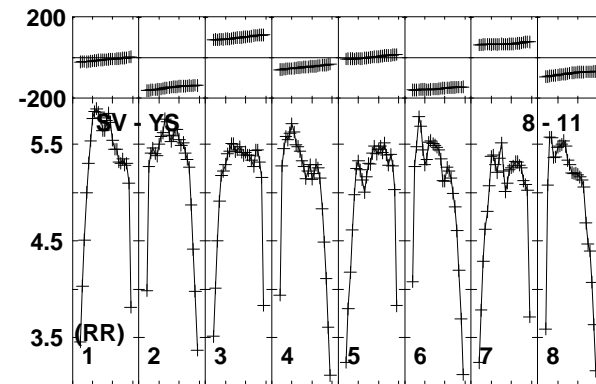
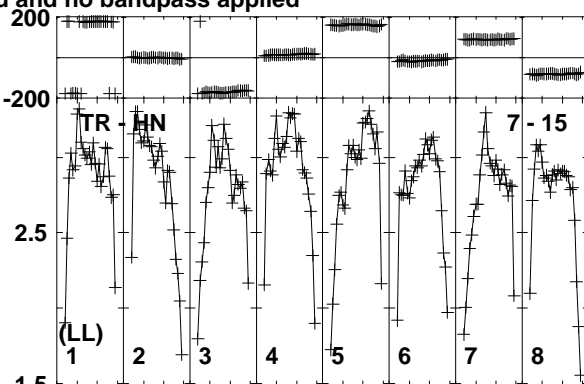
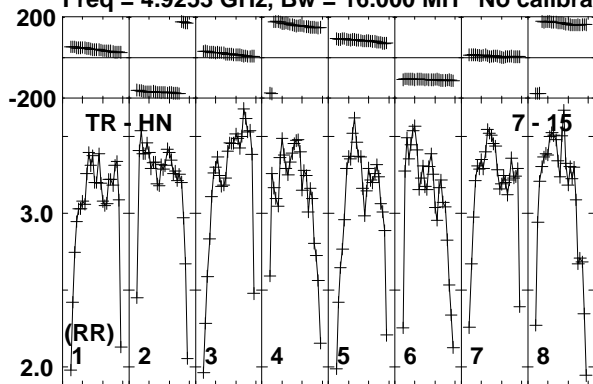

Lower frame: Milli Ampl Jy Top frame: Phas deg
Vector averaged cross-power spectrum Baseline: TR (07) - HN (15)
Timerange: 00/21:27:52 to 00/21:29:43

Plot file version 93 created 11-APR-2016 17:08:29

J1128+5925 GP053G 3.UVDATA.1

Freq = 4.9253 GHz, Bw = 16.000 MH No calibration applied and no bandpass applied

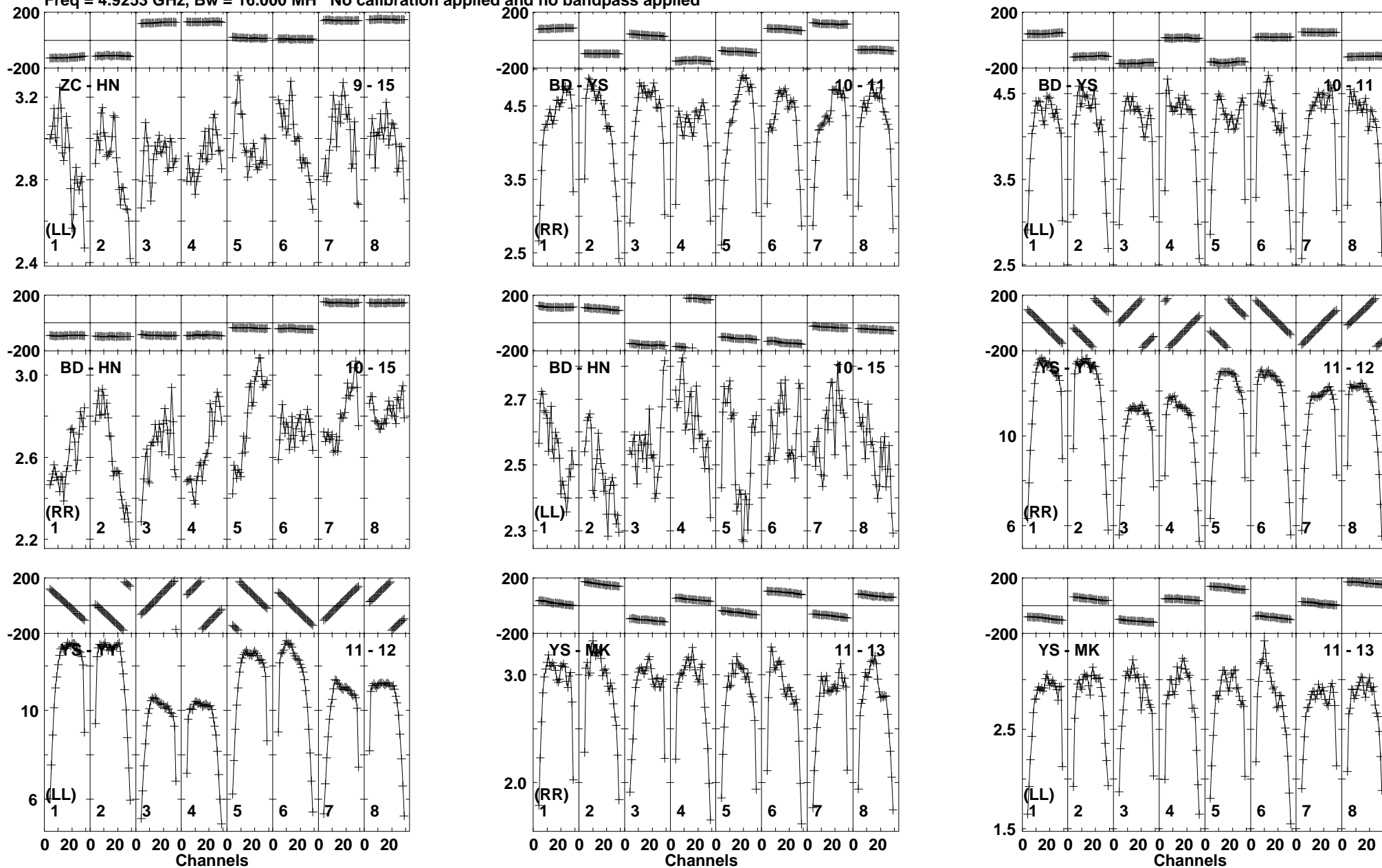

Lower frame: Milli Ampl Jy Top frame: Phas deg
Vector averaged cross-power spectrum Baseline: ZC (09) - HN (15)
Timerange: 00/21:27:52 to 00/21:29:43

Plot file version 94 created 11-APR-2016 17:08:29

J1128+5925 GP053G 3.UVDATA.1

Freq = 4.9253 GHz, Bw = 16.000 MH No calibration applied and no bandpass applied

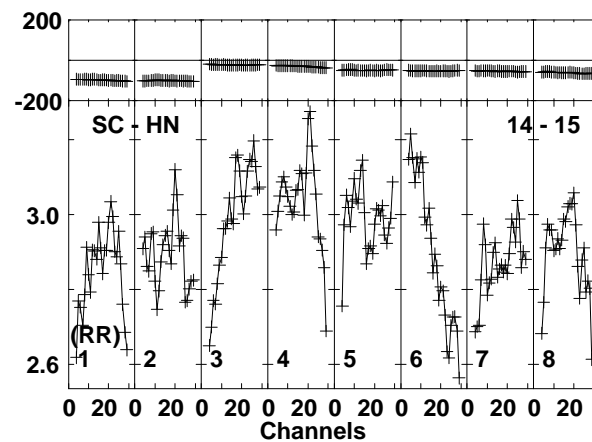
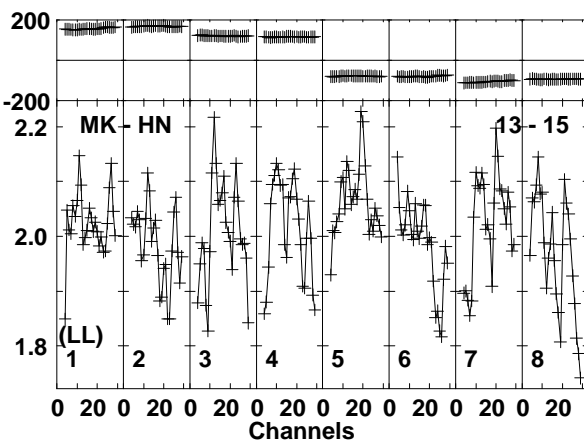
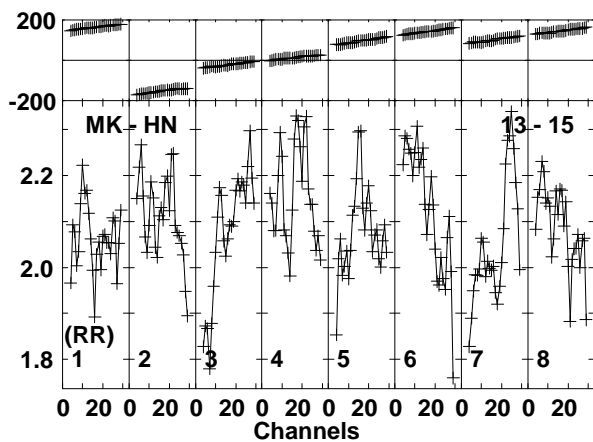
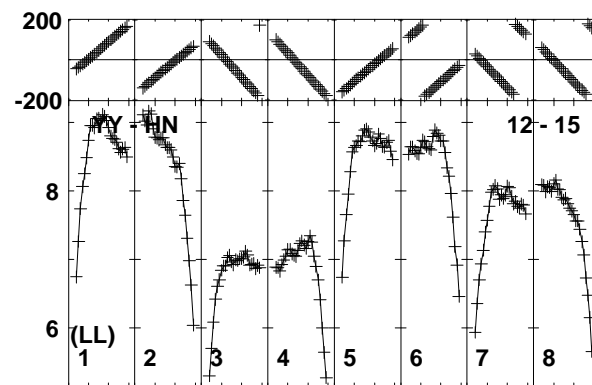
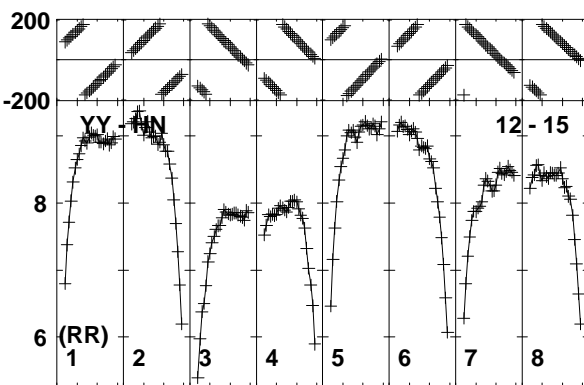
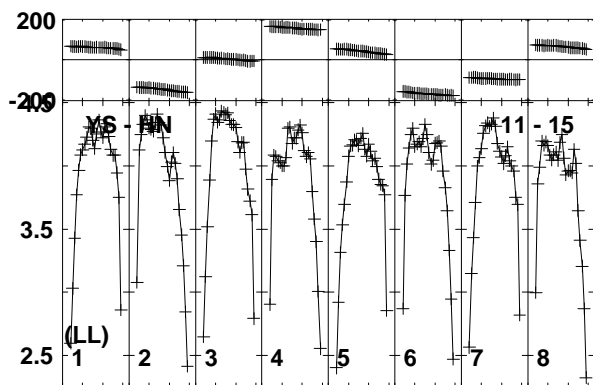
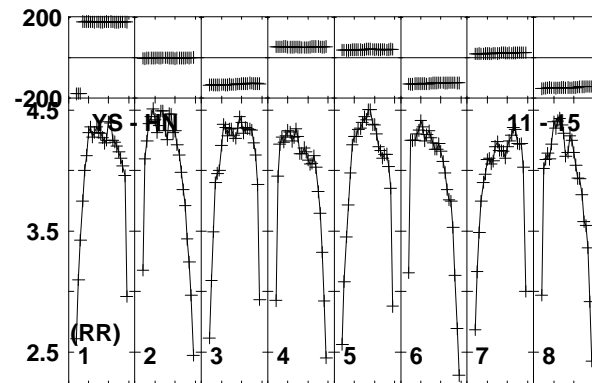
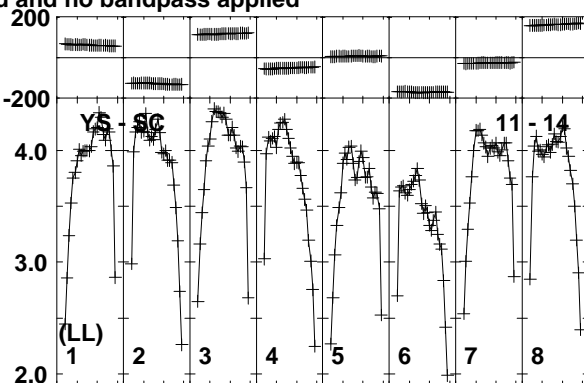
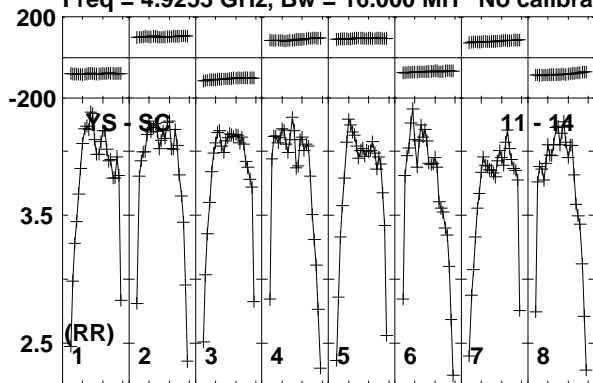

Lower frame: Milli Ampl Jy Top frame: Phas deg
Vector averaged cross-power spectrum Baseline: YS (11) - SC (14)
Timerange: 00/21:27:52 to 00/21:29:43

Plot file version 95 created 11-APR-2016 17:08:29
J1128+5925 GP053G 3.UVDATA.1
Freq = 4.9253 GHz, Bw = 16.000 MH No calibration applied and no bandpass applied

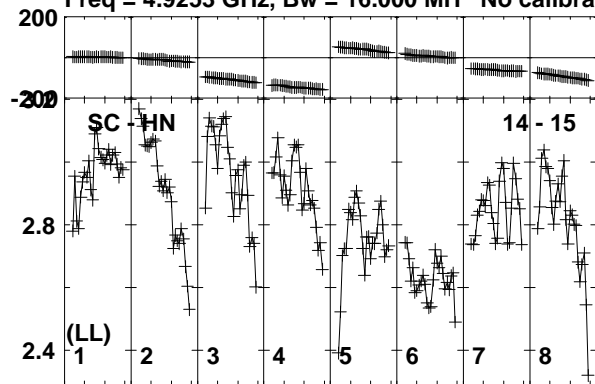

Lower frame: Milli Ampl Jy Top frame: Phas deg
Vector averaged cross-power spectrum Baseline: SC (14) - HN (15)
Timerange: 00/21:27:52 to 00/21:29:43

Plot file version 96 created 11-APR-2016 17:08:29

ARP299C GP053G 3.UVDATA.1

Freq = 4.9253 GHz, Bw = 16.000 MH No calibration applied and no bandpass applied

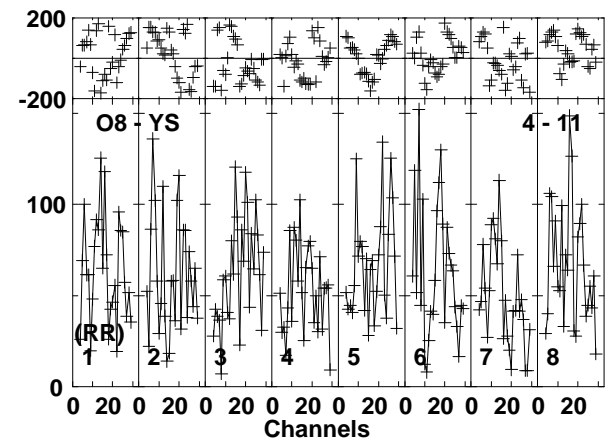
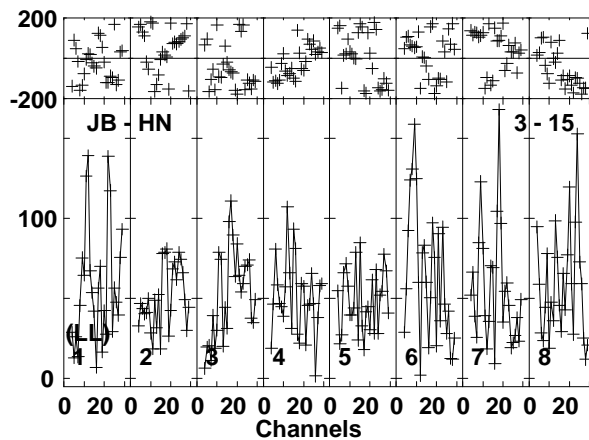
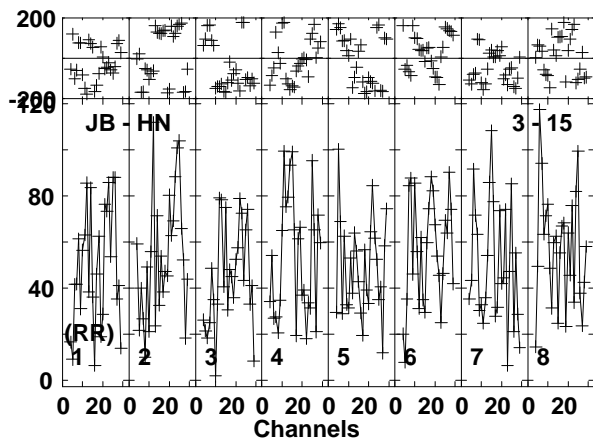
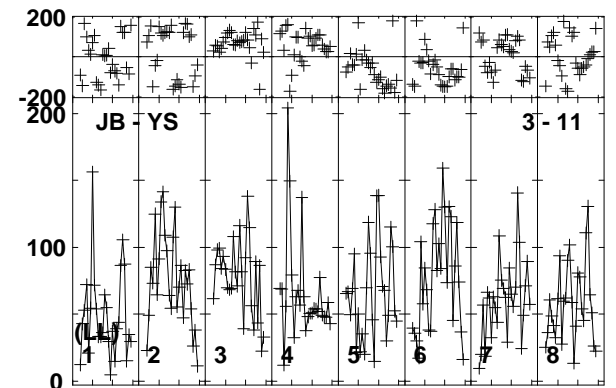
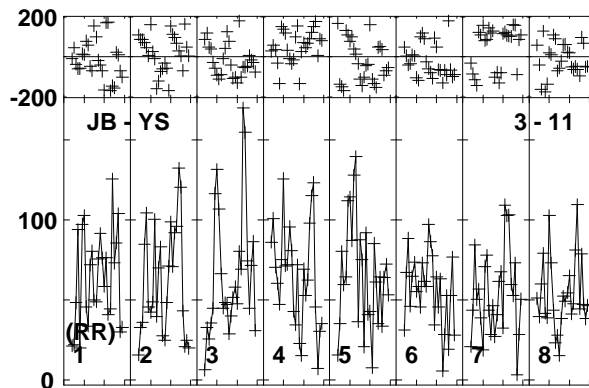
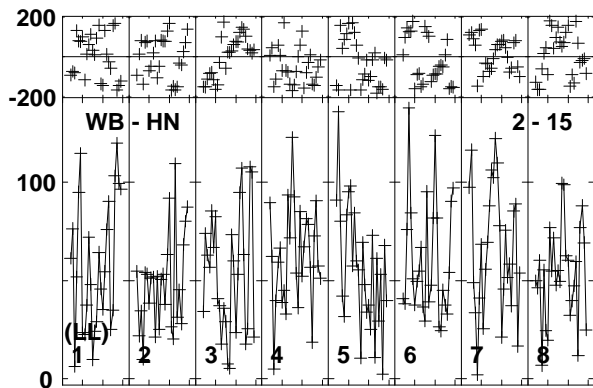
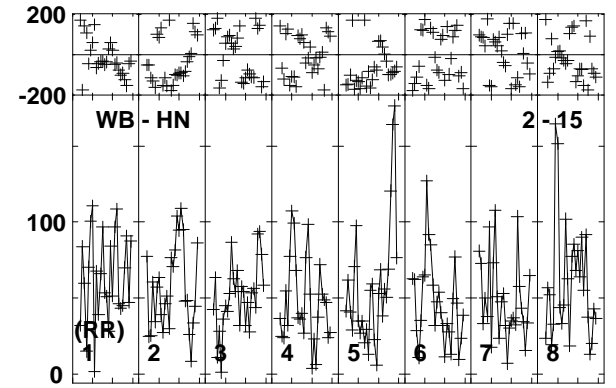
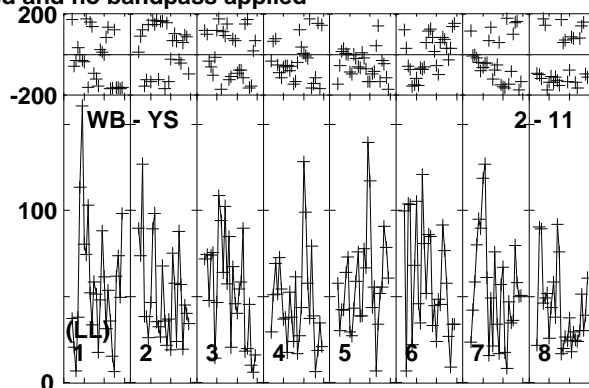
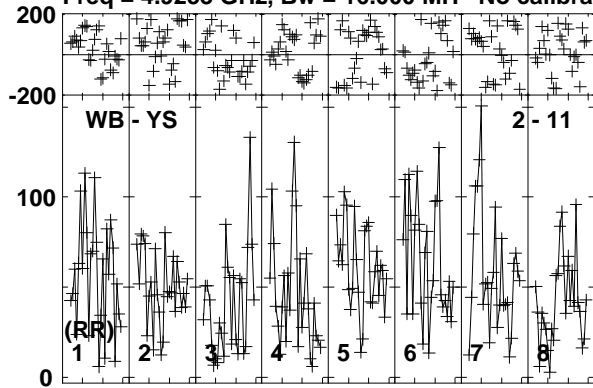

Lower frame: Micro Ampl Jy Top frame: Phas deg
Vector averaged cross-power spectrum Baseline: WB (02) - YS (11)
Timerange: 00/21:29:48 to 00/21:35:02

Plot file version 97 created 11-APR-2016 17:08:29

ARP299C GP053G 3.UVDATA.1

Freq = 4.9253 GHz, Bw = 16.000 MH No calibration applied and no bandpass applied

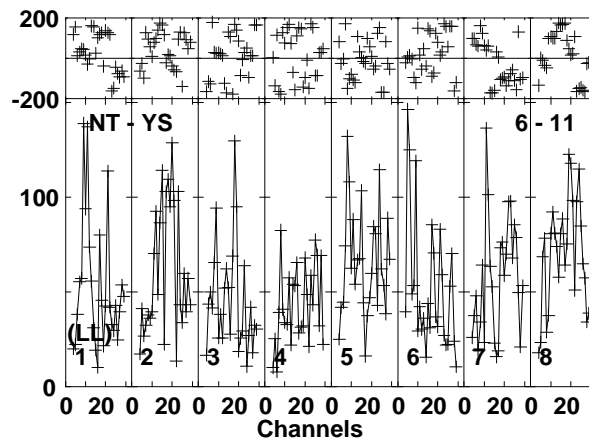
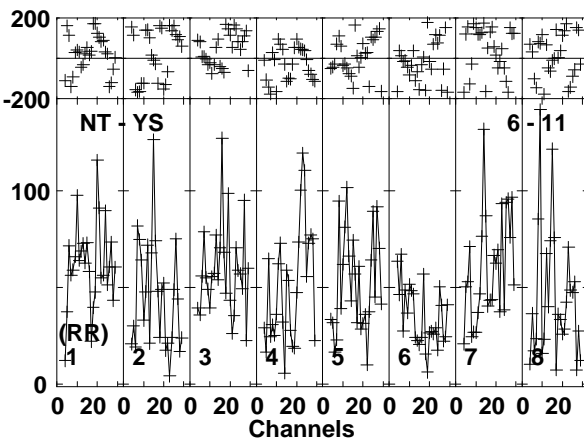
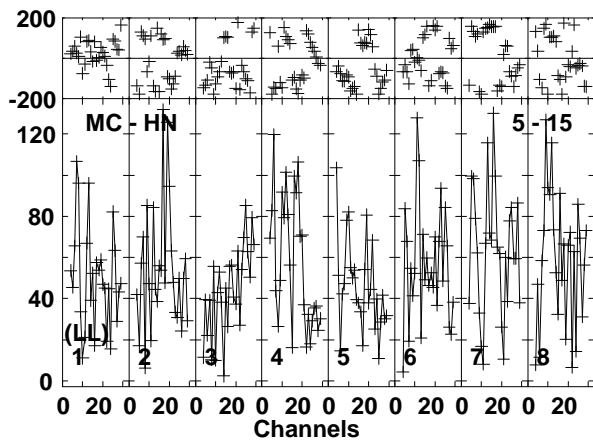
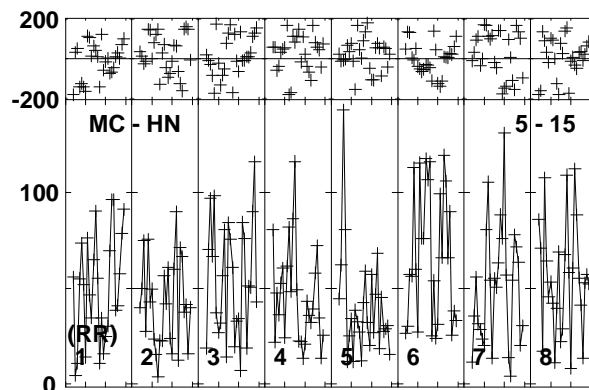
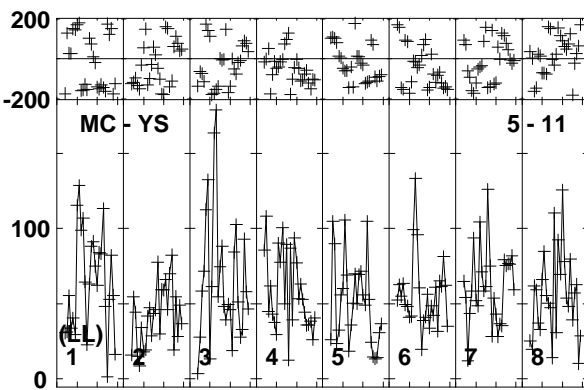
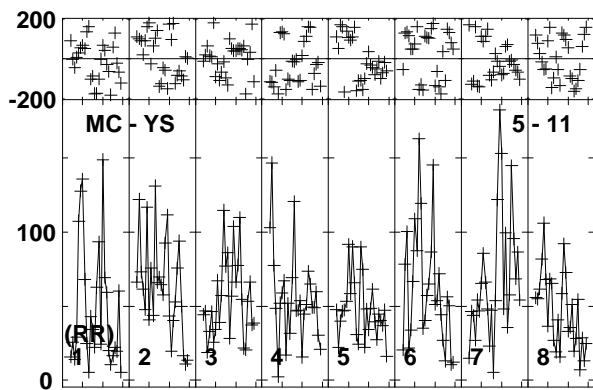
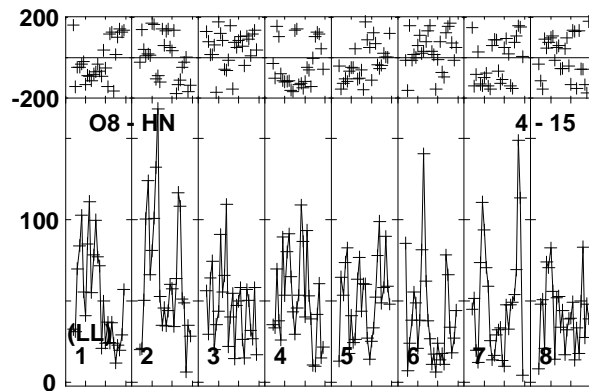
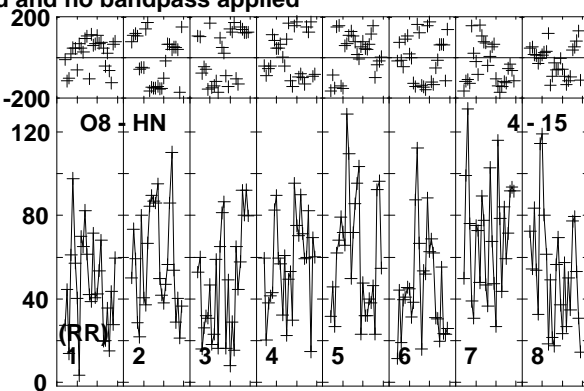
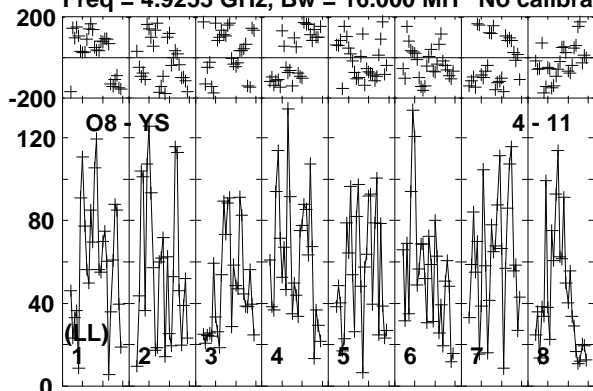

Lower frame: Micro Ampl Jy Top frame: Phas deg
Vector averaged cross-power spectrum Baseline: O8 (04) - YS (11)
Timerange: 00/21:29:48 to 00/21:35:02

Plot file version 98 created 11-APR-2016 17:08:30

ARP299C GP053G 3.UVDATA.1

Freq = 4.9253 GHz, Bw = 16.000 MH No calibration applied and no bandpass applied

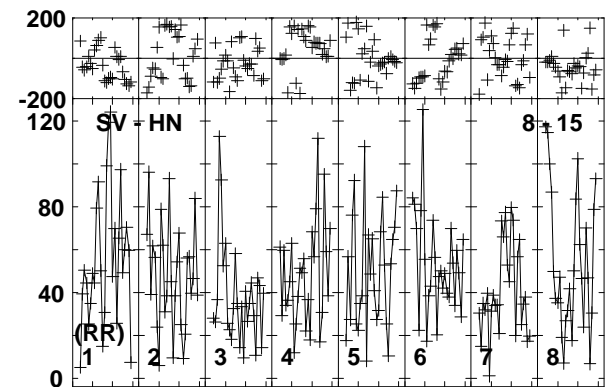
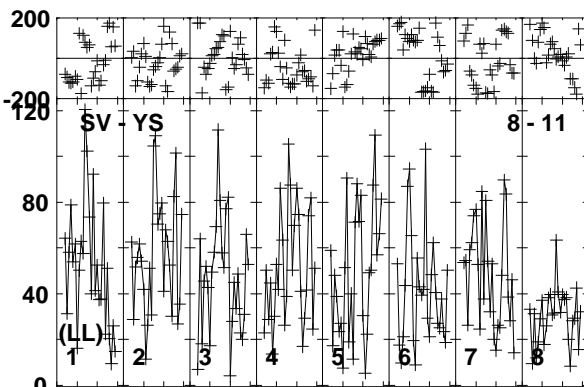
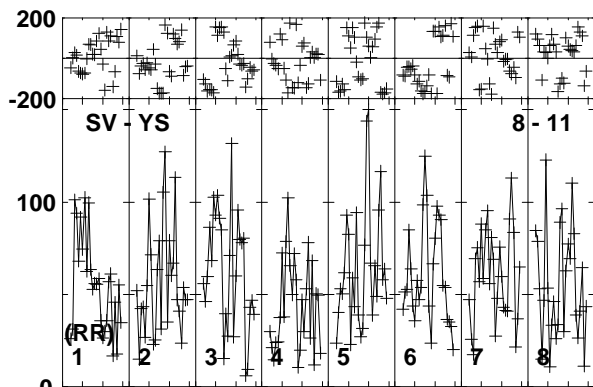
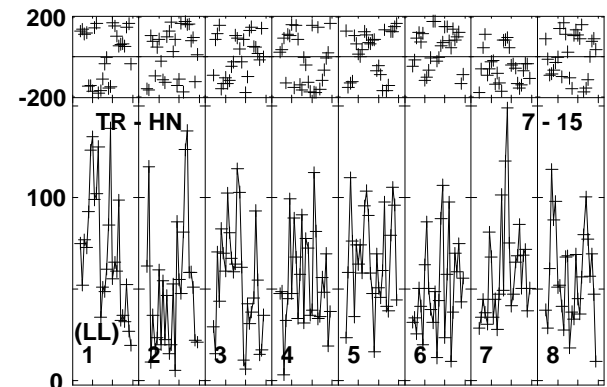
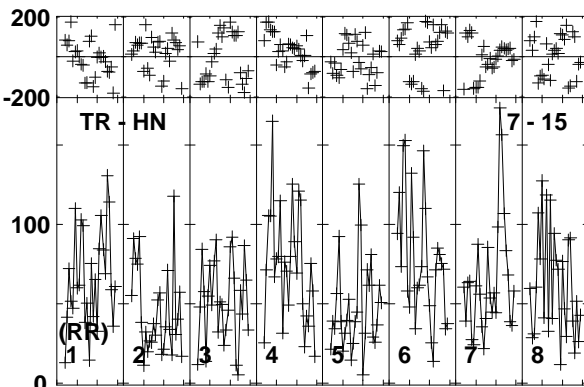
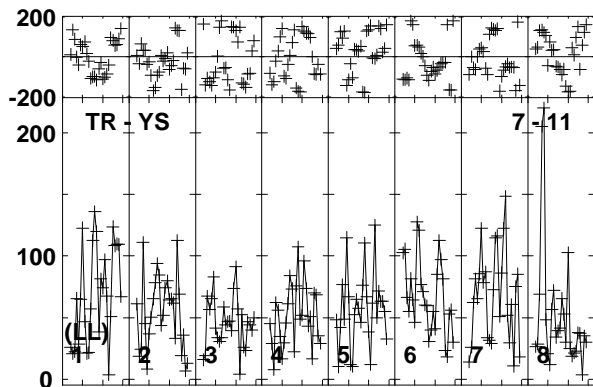
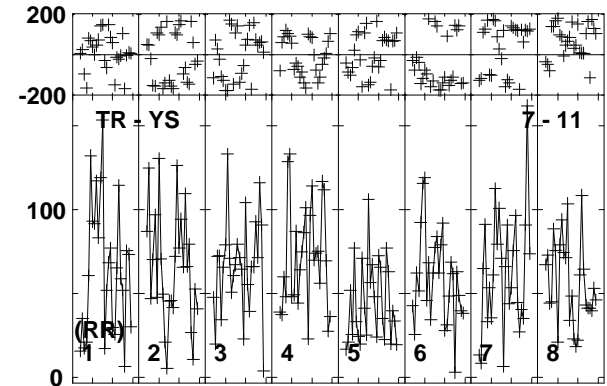
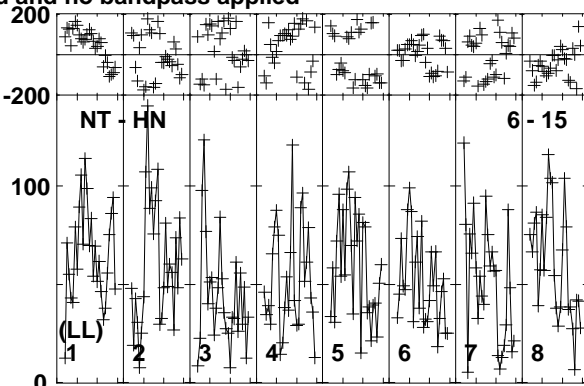
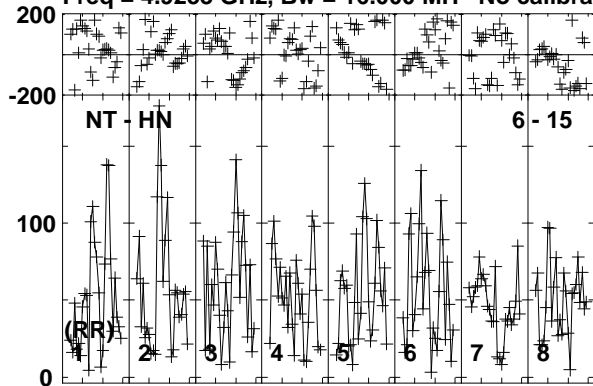

Lower frame: Micro Ampl Jy Top frame: Phas deg
Vector averaged cross-power spectrum Baseline: NT (06) - HN (15)
Timerange: 00/21:29:48 to 00/21:35:02

Plot file version 99 created 11-APR-2016 17:08:30

ARP299C GP053G 3.UVDATA.1

Freq = 4.9253 GHz, Bw = 16.000 MH No calibration applied and no bandpass applied

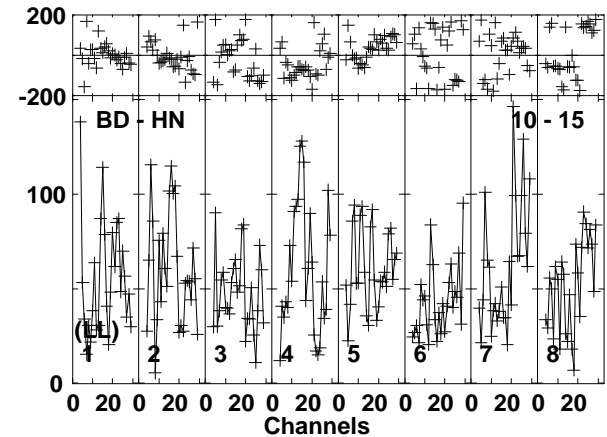
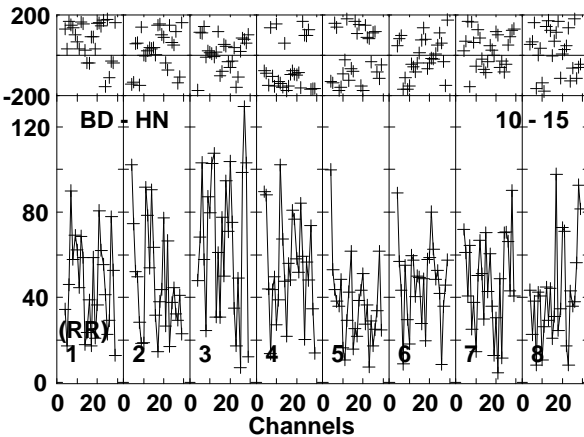
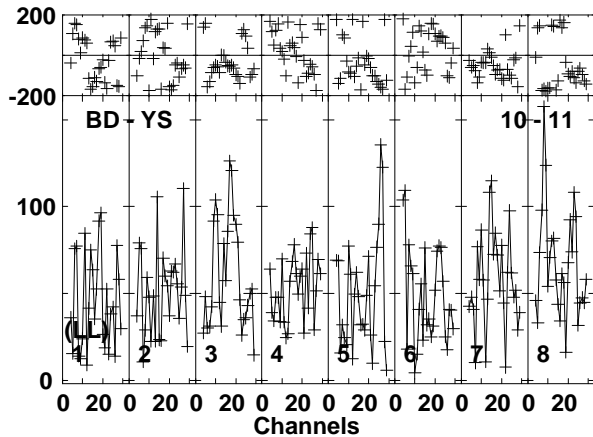
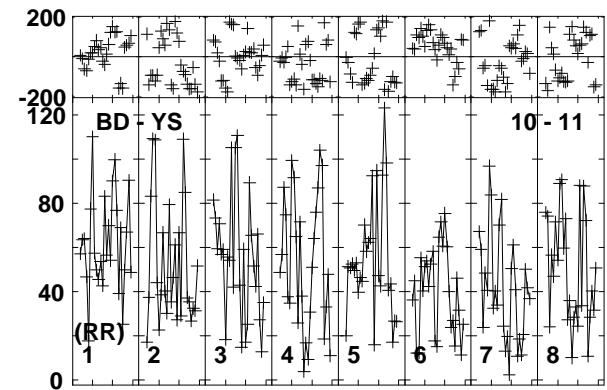
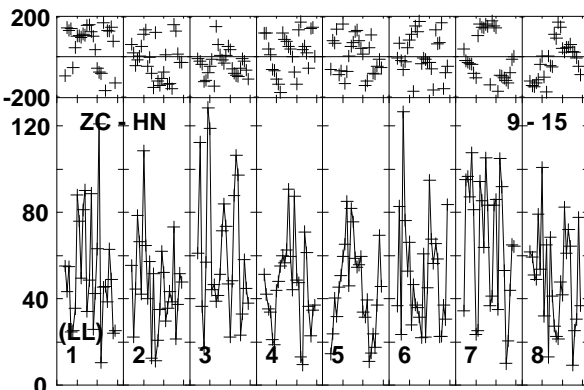
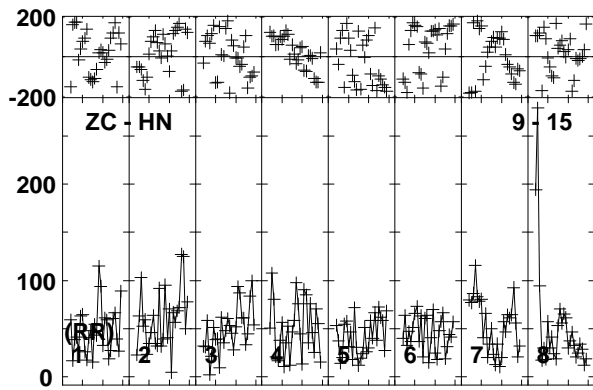
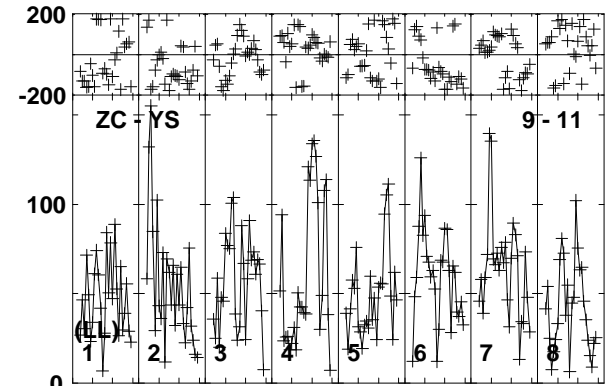
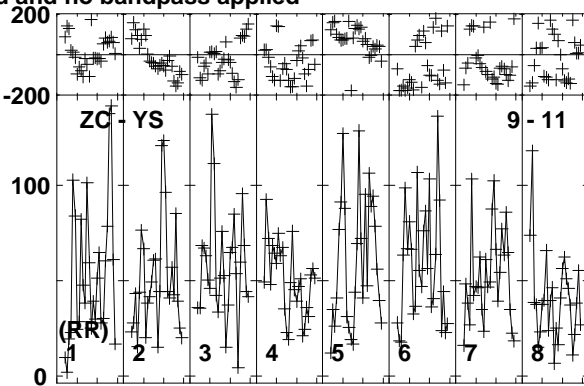
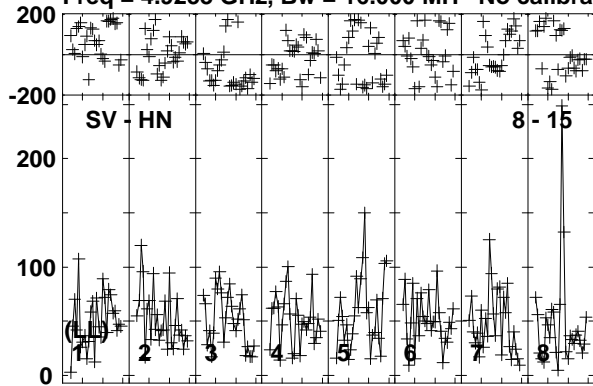

Lower frame: Micro Ampl Jy Top frame: Phas deg
Vector averaged cross-power spectrum Baseline: SV (08) - HN (15)
Timerange: 00/21:29:48 to 00/21:35:02

Plot file version 100 created 11-APR-2016 17:08:30

ARP299C GP053G 3.UVDATA.1

Freq = 4.9253 GHz, Bw = 16.000 MH No calibration applied and no bandpass applied

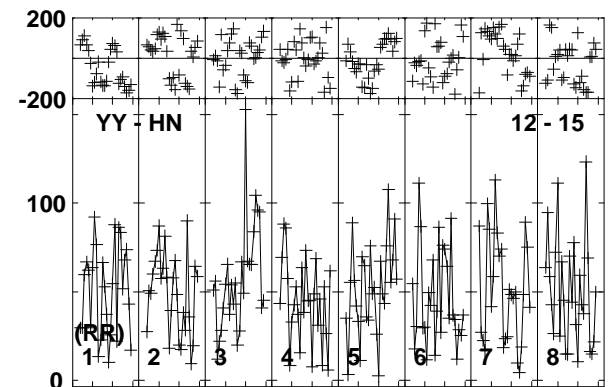
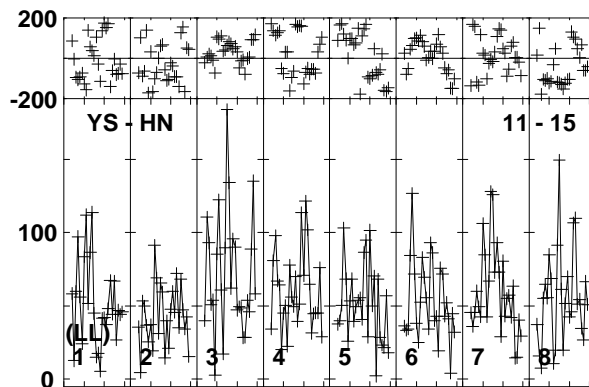
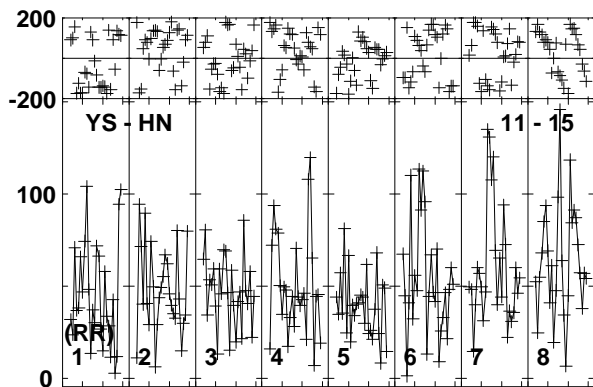
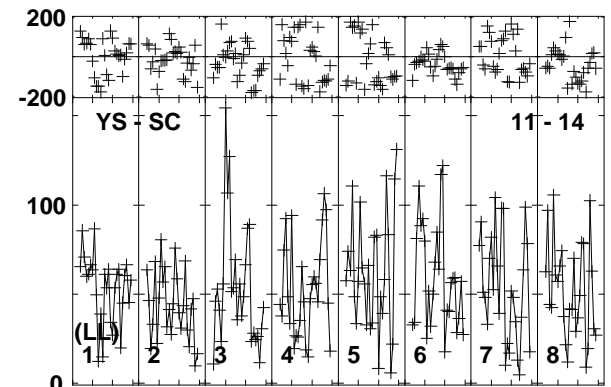
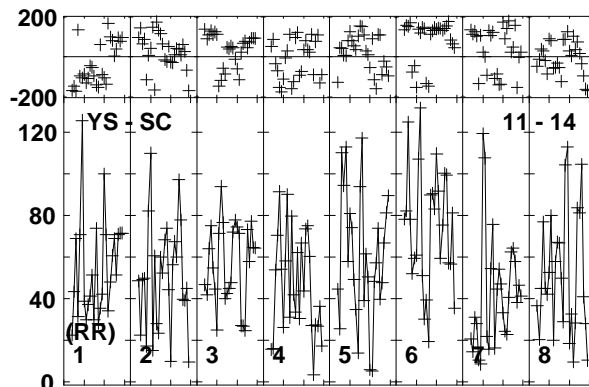
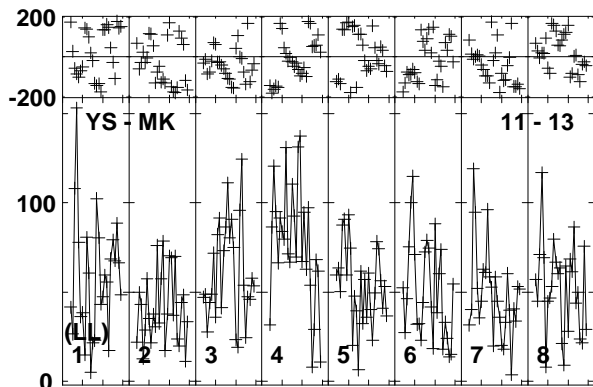
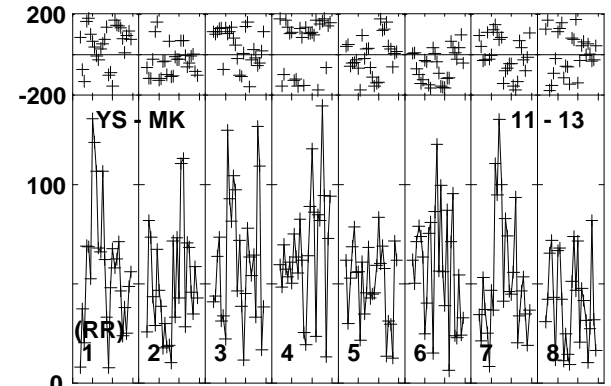
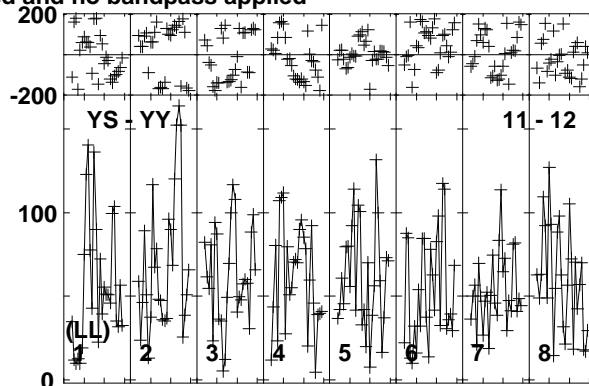
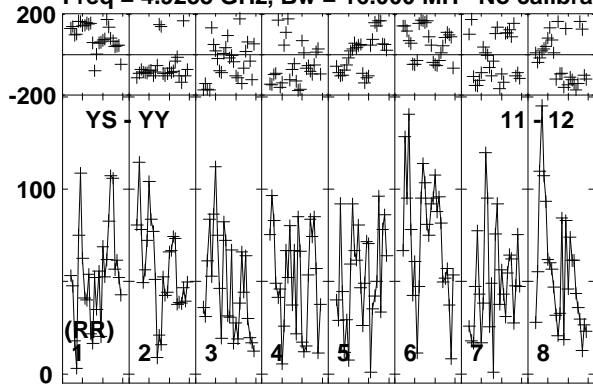

Lower frame: Micro Ampl Jy Top frame: Phas deg
Vector averaged cross-power spectrum Baseline: YS (11) - YY (12)
Timerange: 00/21:29:48 to 00/21:35:02

Plot file version 101 created 11-APR-2016 17:08:30

ARP299C GP053G 3.UVDATA.1

Freq = 4.9253 GHz, Bw = 16.000 MH No calibration applied and no bandpass applied

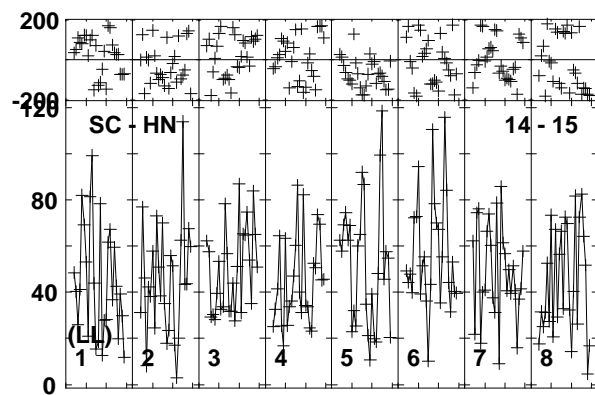
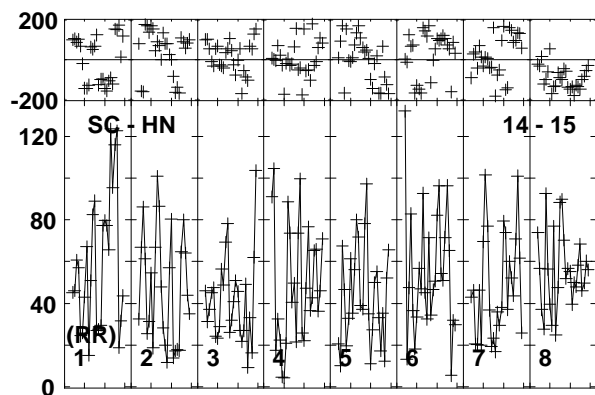
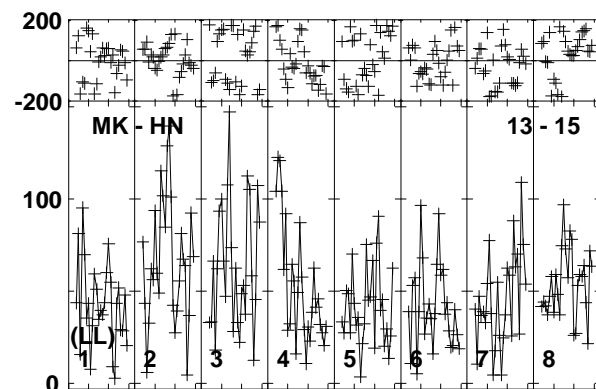
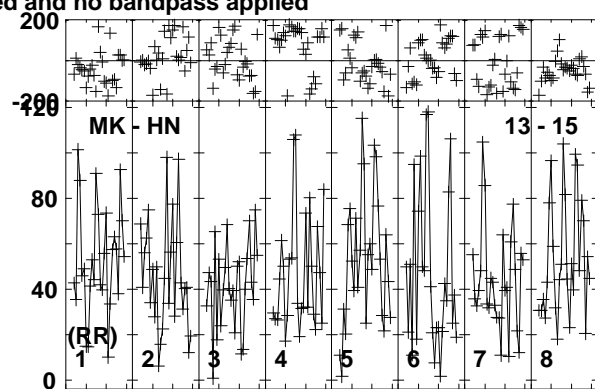
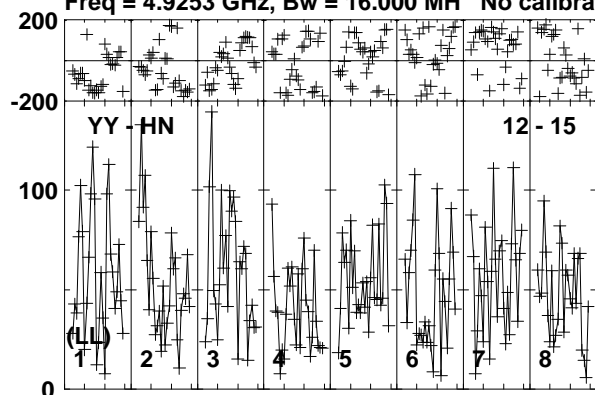

Lower frame: Micro Ampl Jy Top frame: Phas deg
Vector averaged cross-power spectrum Baseline: YY (12) - HN (15)
Timerange: 00/21:29:48 to 00/21:35:02

Plot file version 102 created 11-APR-2016 17:08:30

J1128+5925 GP053G 3.UVDATA.1

Freq = 4.9253 GHz, Bw = 16.000 MH No calibration applied and no bandpass applied

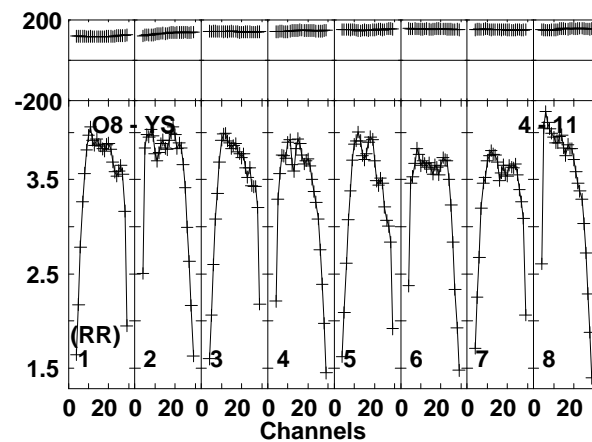
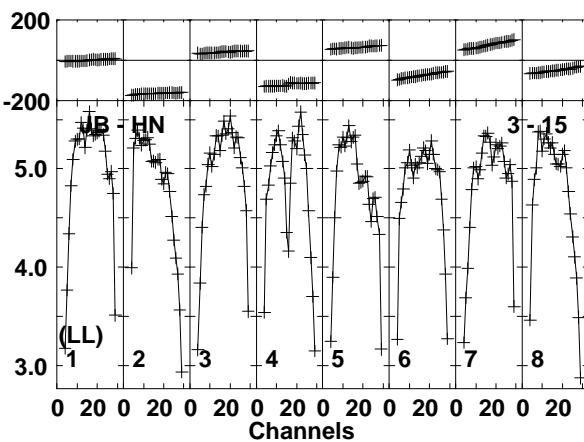
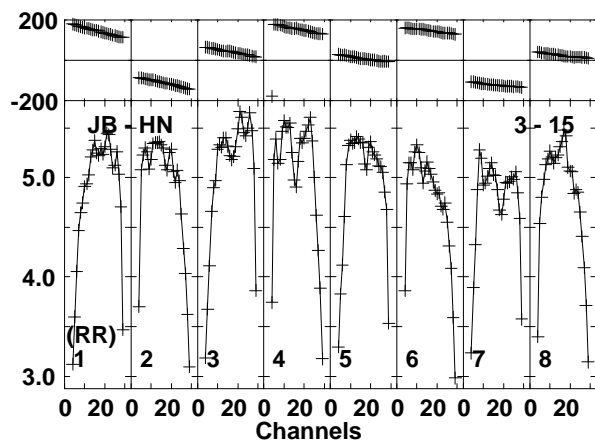
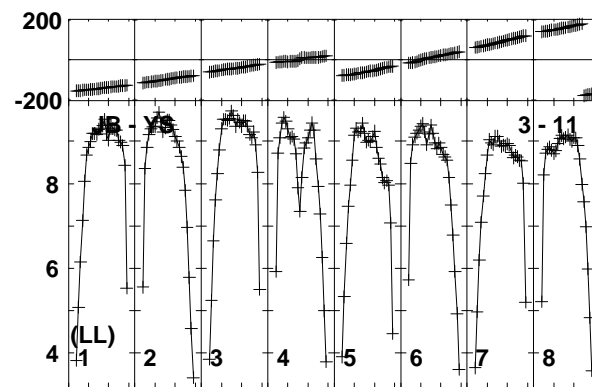
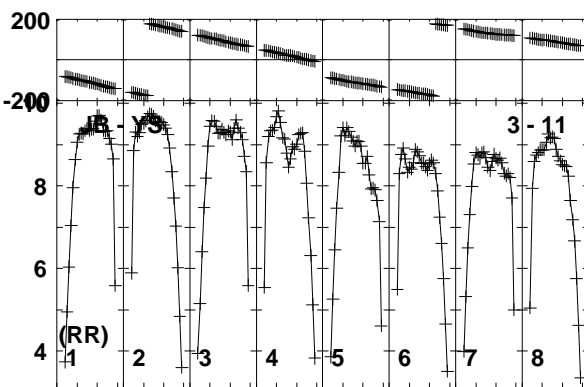
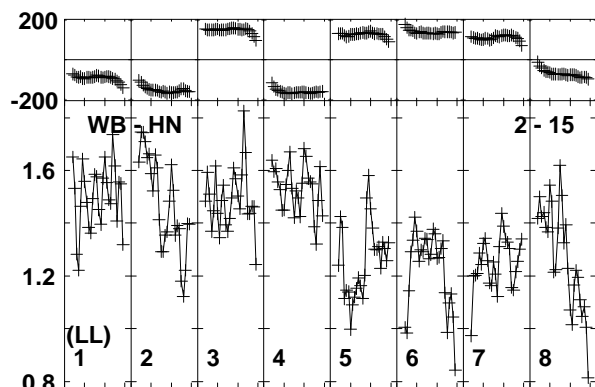
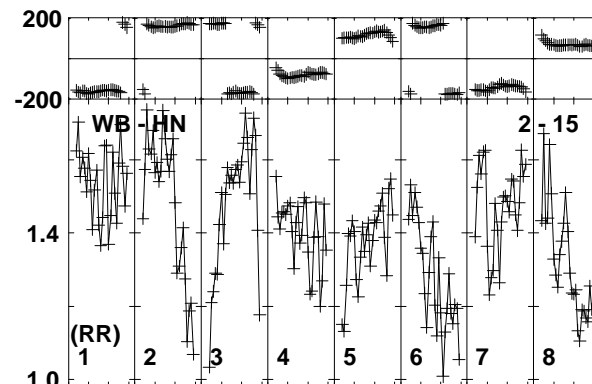
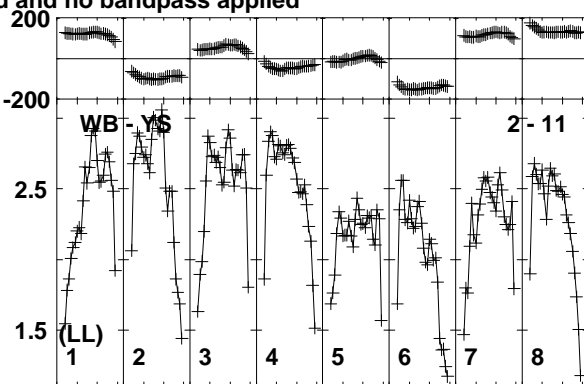
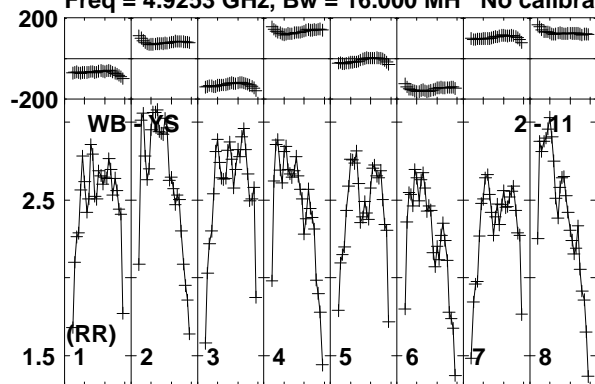

Lower frame: Milli Ampl Jy Top frame: Phas deg
Vector averaged cross-power spectrum Baseline: WB (02) - YS (11)
Timerange: 00/21:35:09 to 00/21:36:52

Plot file version 103 created 11-APR-2016 17:08:30

J1128+5925 GP053G 3.UVDATA.1

Freq = 4.9253 GHz, Bw = 16.000 MH No calibration applied and no bandpass applied

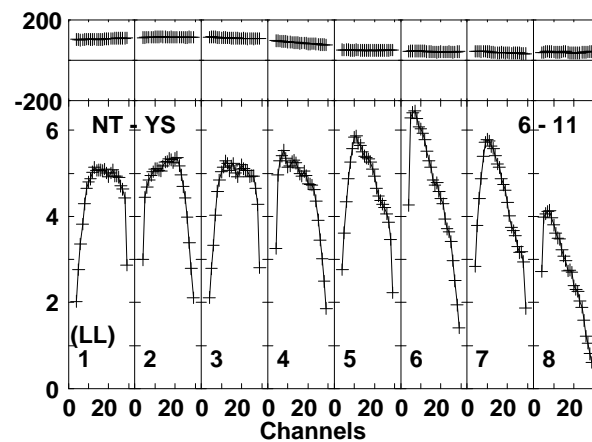
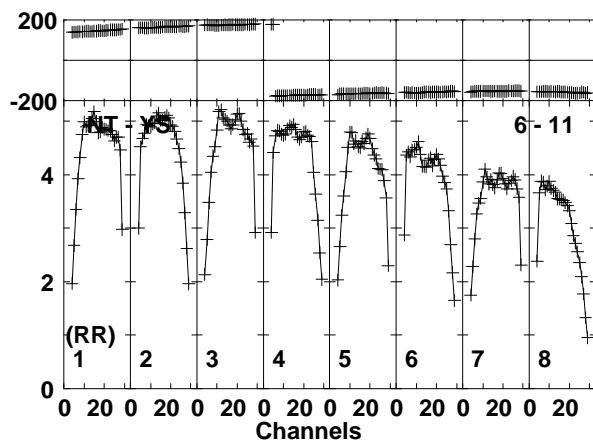
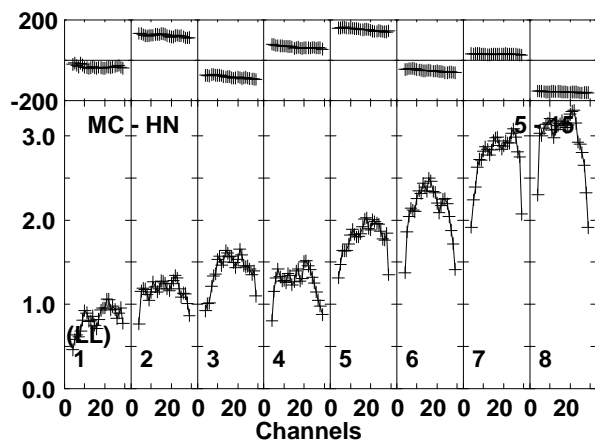
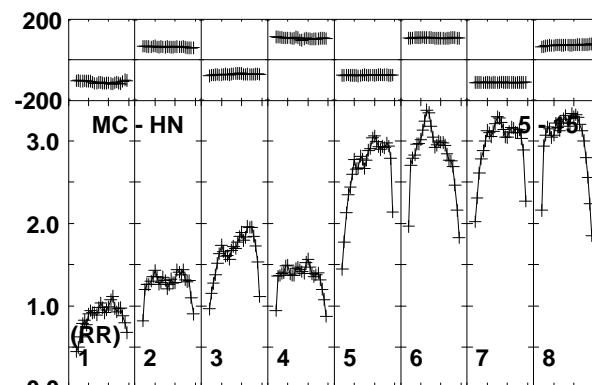
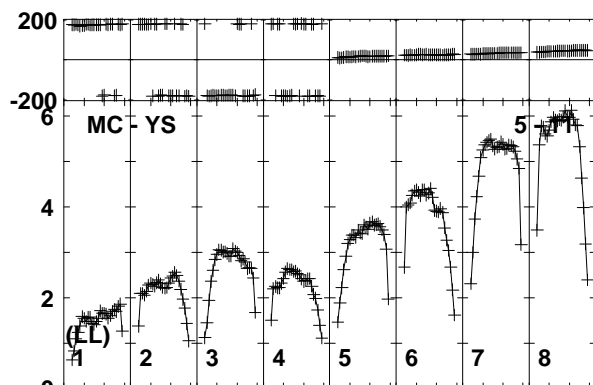
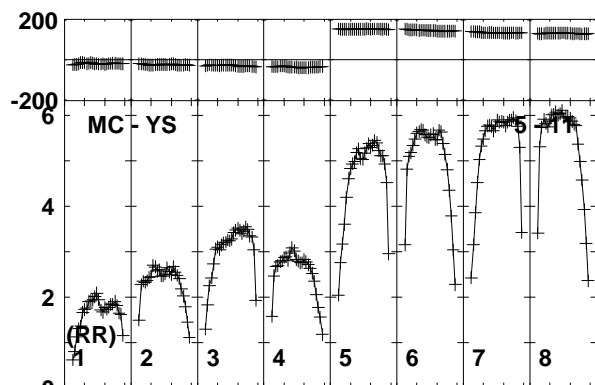
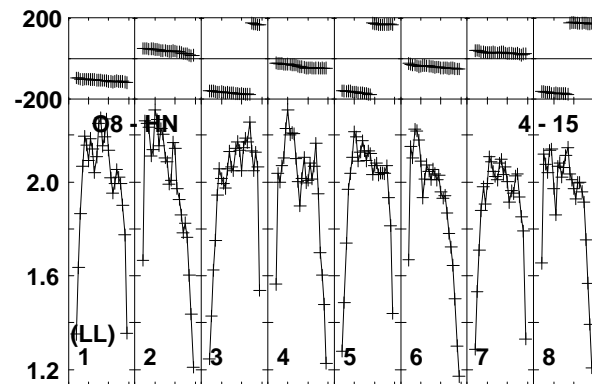
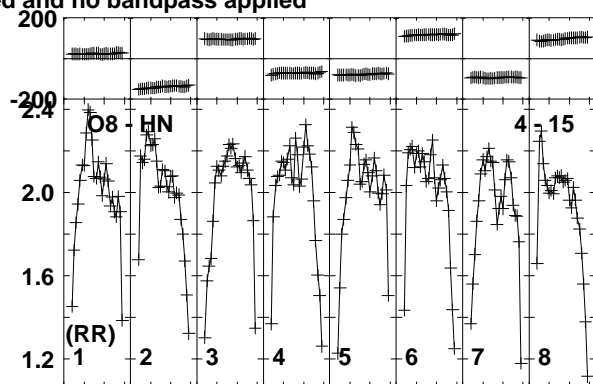
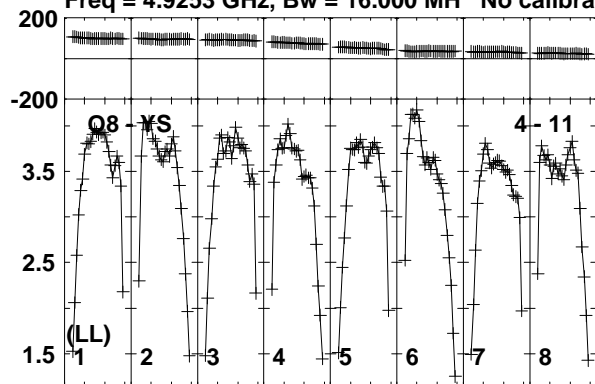

Lower frame: Milli Ampl Jy Top frame: Phas deg
Vector averaged cross-power spectrum Baseline: O8 (04) - YS (11)
Timerange: 00/21:35:09 to 00/21:36:52

Plot file version 104 created 11-APR-2016 17:08:31

J1128+5925 GP053G 3.UVDATA.1

Freq = 4.9253 GHz, Bw = 16.000 MH No calibration applied and no bandpass applied

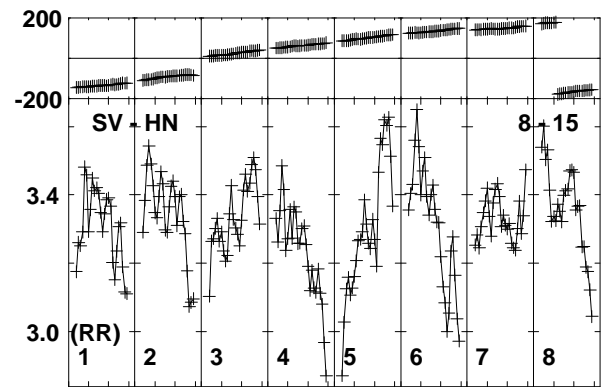
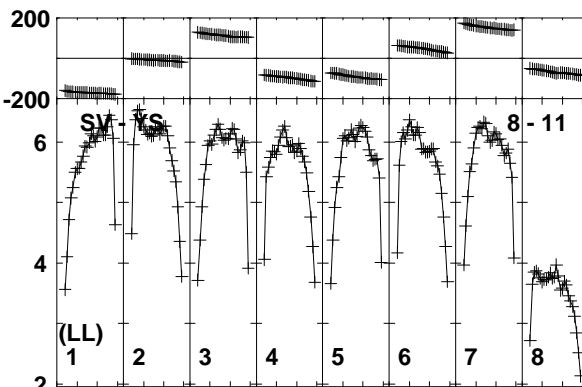
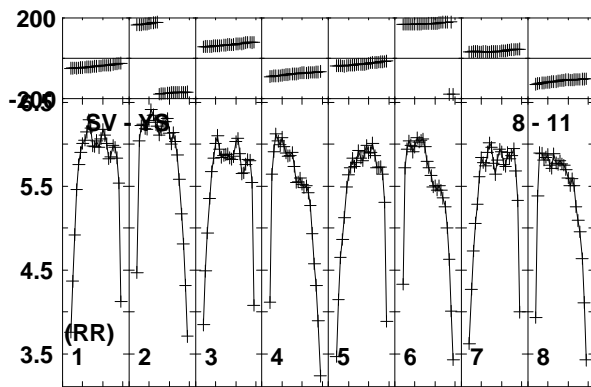
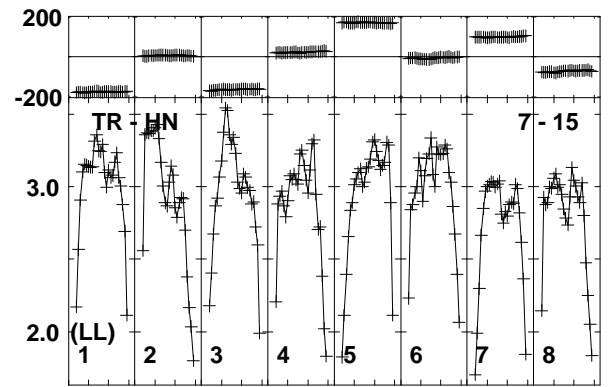
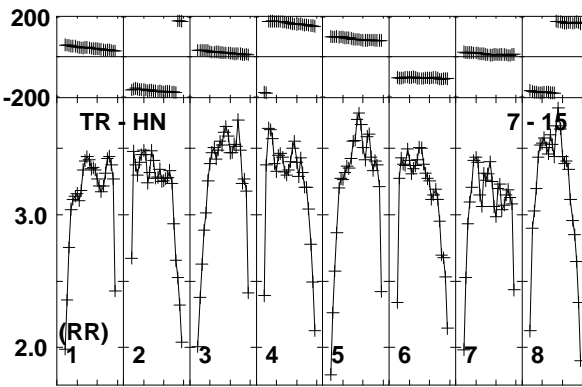
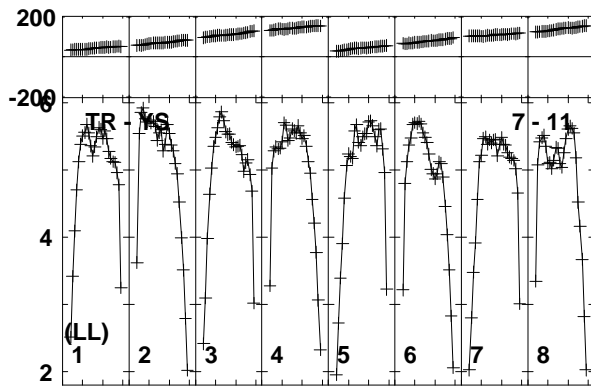
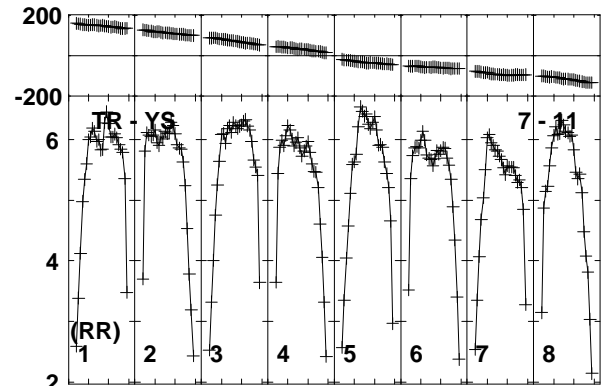
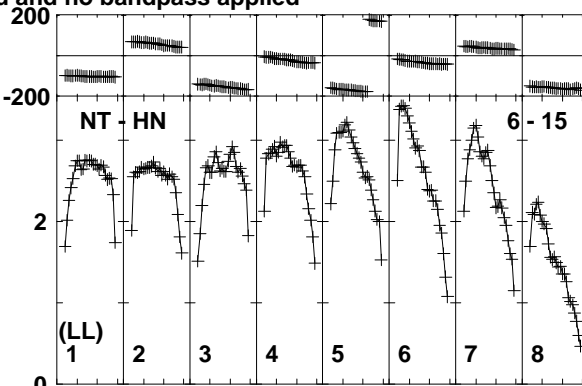
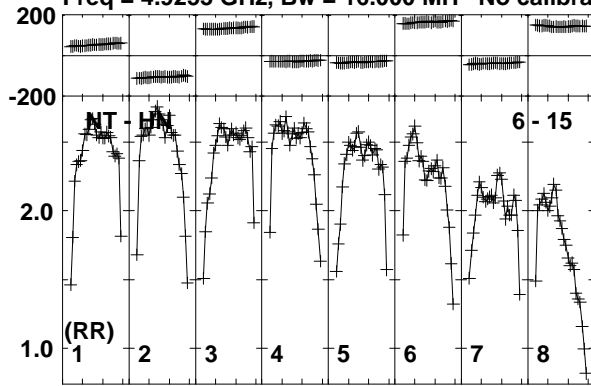

Lower frame: Milli Ampl Jy Top frame: Phas deg

Vector averaged cross-power spectrum Baseline: NT (06) - HN (15)

Timerange: 00/21:35:09 to 00/21:36:52

Plot file version 105 created 11-APR-2016 17:08:31

J1128+5925 GP053G 3.UVDATA.1

Freq = 4.9253 GHz, Bw = 16.000 MH No calibration applied and no bandpass applied

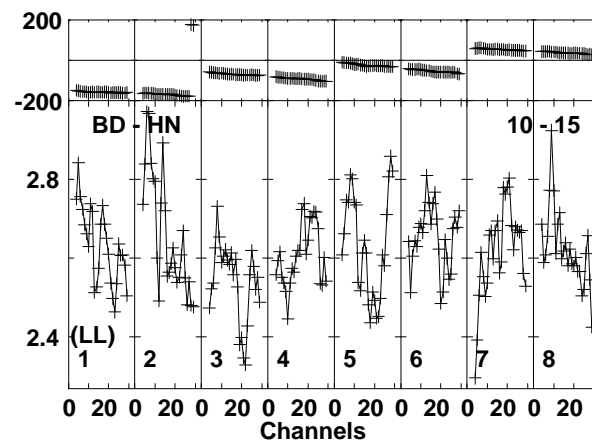
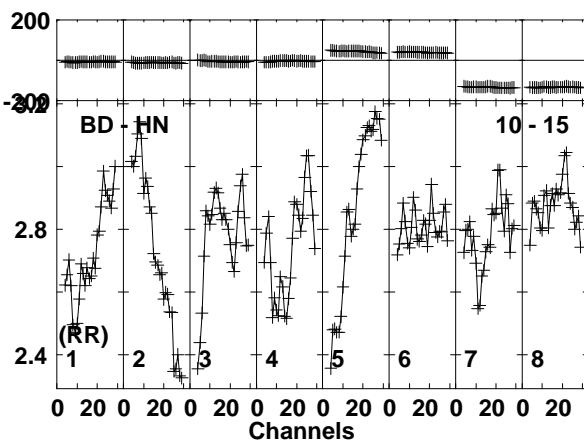
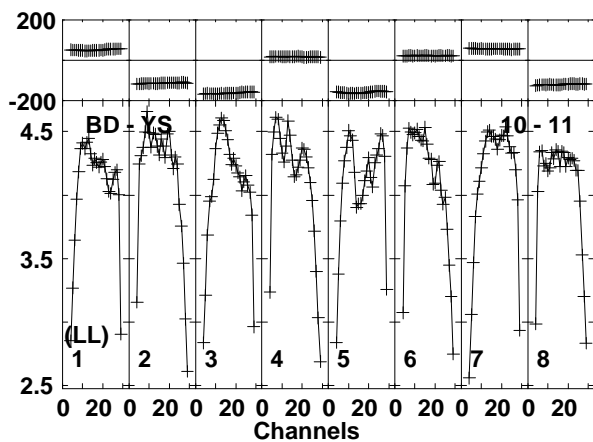
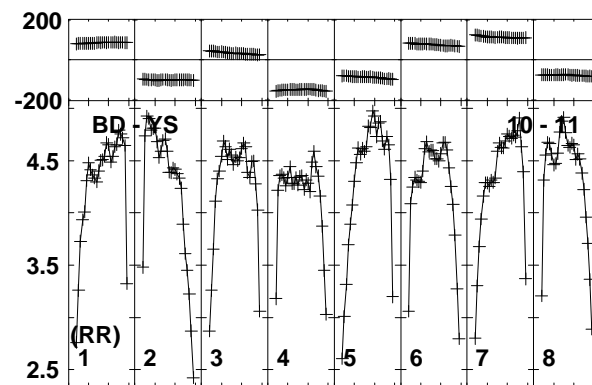
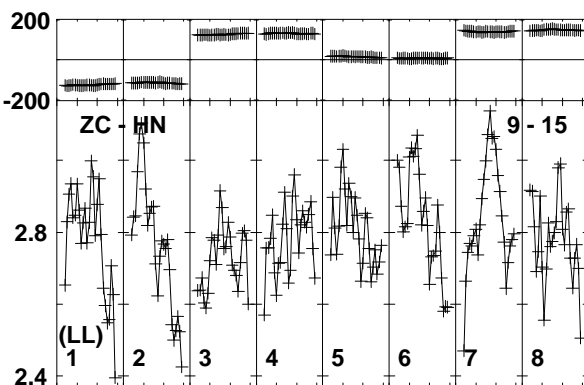
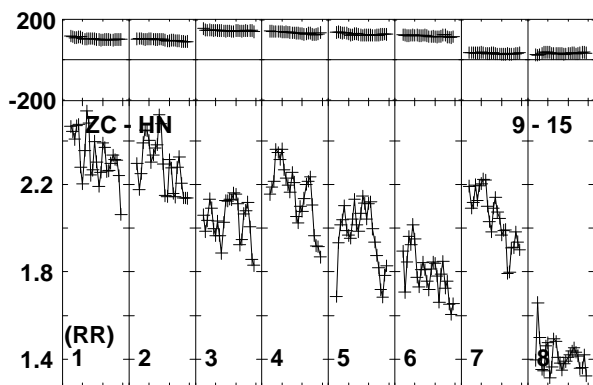
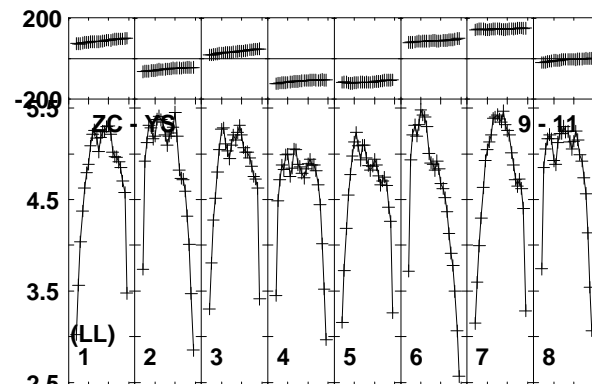
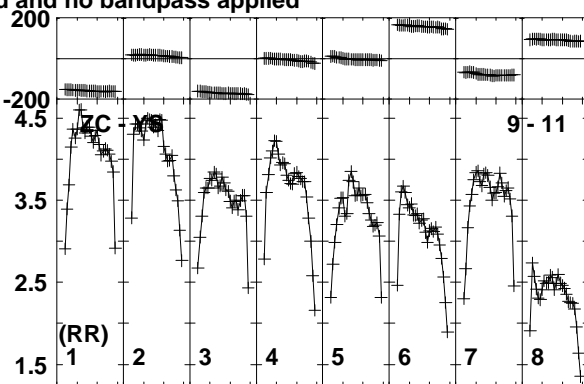
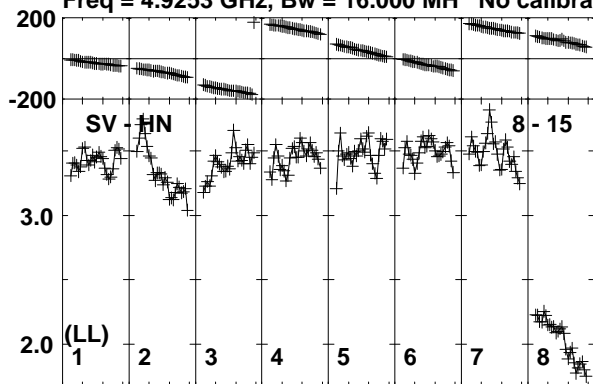

Lower frame: Milli Ampl Jy Top frame: Phas deg
Vector averaged cross-power spectrum Baseline: SV (08) - HN (15)
Timerange: 00/21:35:09 to 00/21:36:52

Plot file version 106 created 11-APR-2016 17:08:31

J1128+5925 GP053G 3.UVDATA.1

Freq = 4.9253 GHz, Bw = 16.000 MH No calibration applied and no bandpass applied

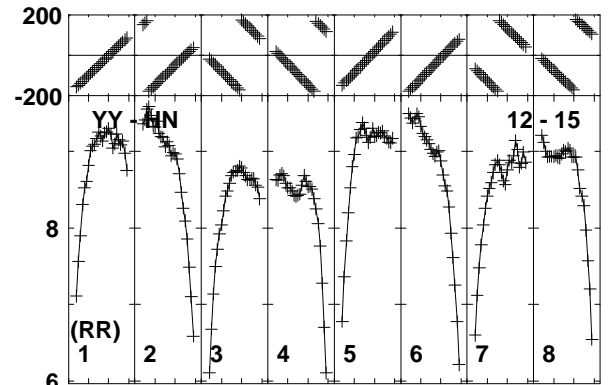
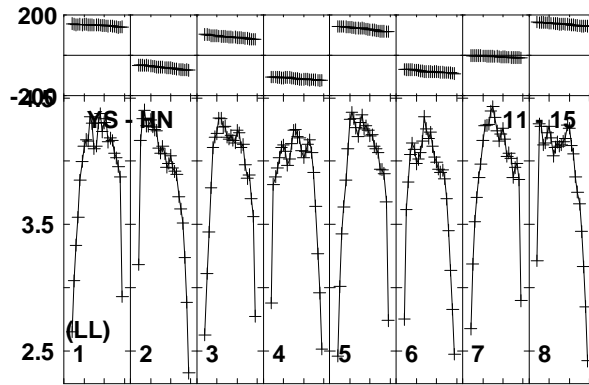
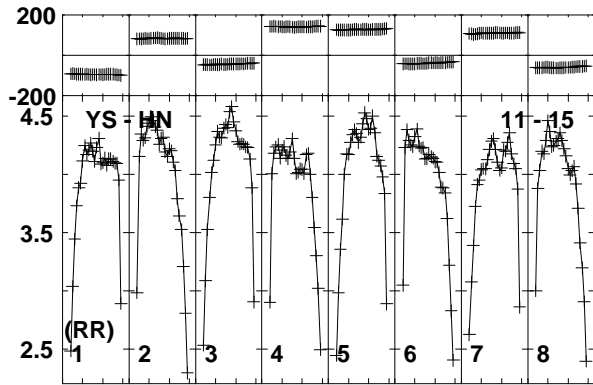
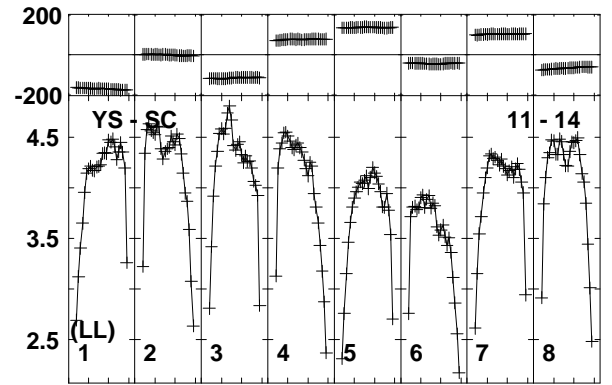
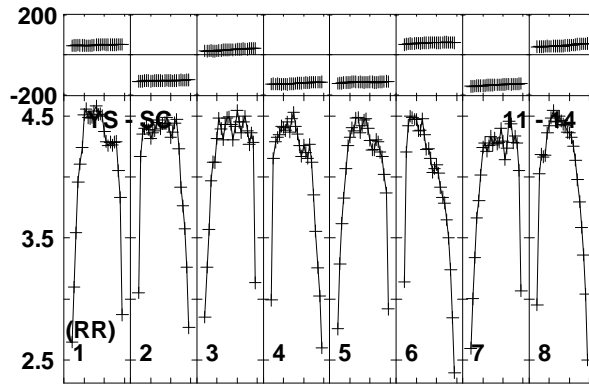
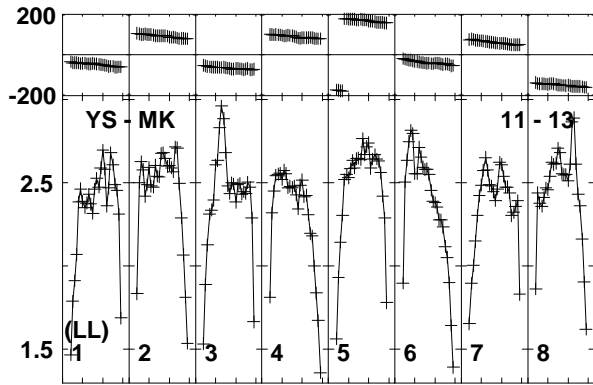
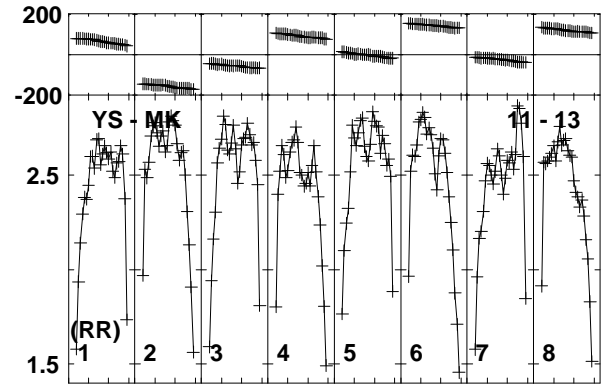
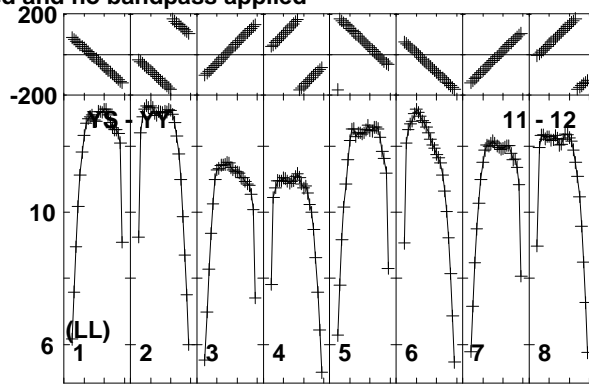
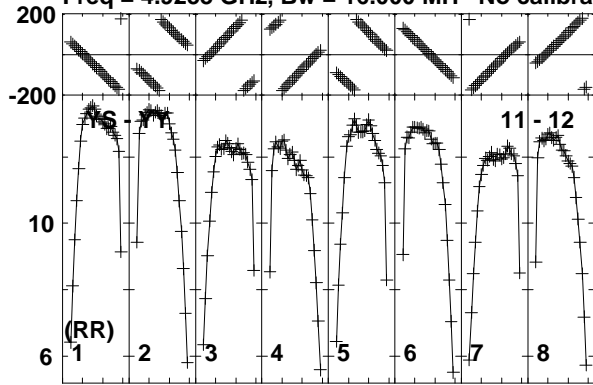

Lower frame: Milli Ampl Jy Top frame: Phas deg
Vector averaged cross-power spectrum Baseline: YS (11) - YY (12)
Timerange: 00/21:35:09 to 00/21:36:52

Plot file version 107 created 11-APR-2016 17:08:31

J1128+5925 GP053G 3.UVDATA.1

Freq = 4.9253 GHz, Bw = 16.000 MH No calibration applied and no bandpass applied

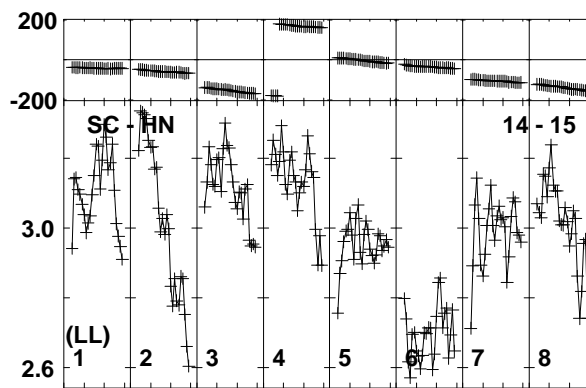
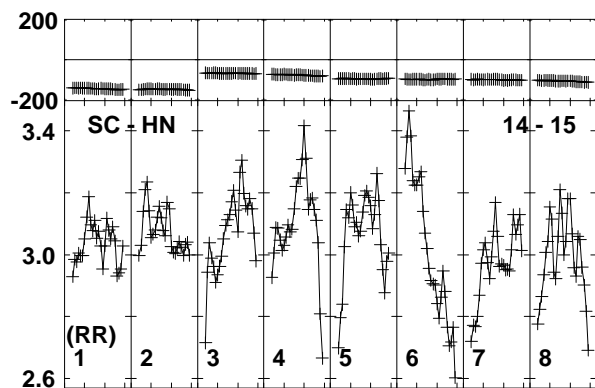
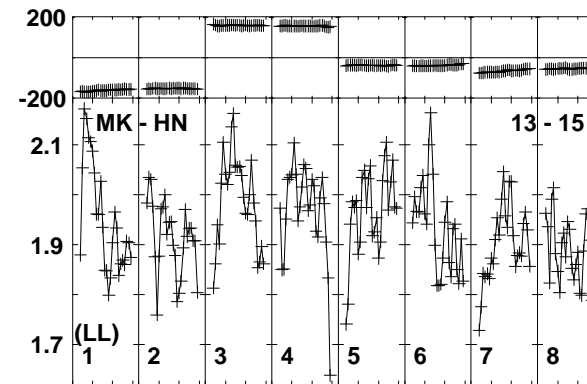
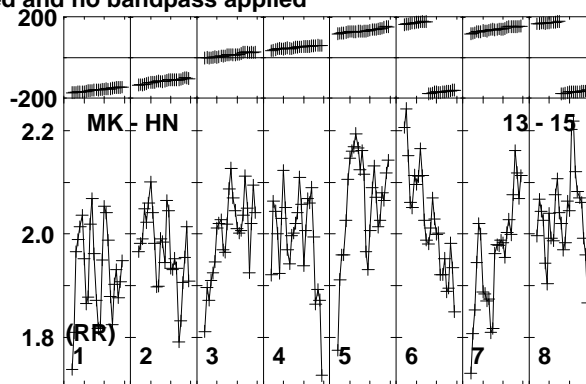
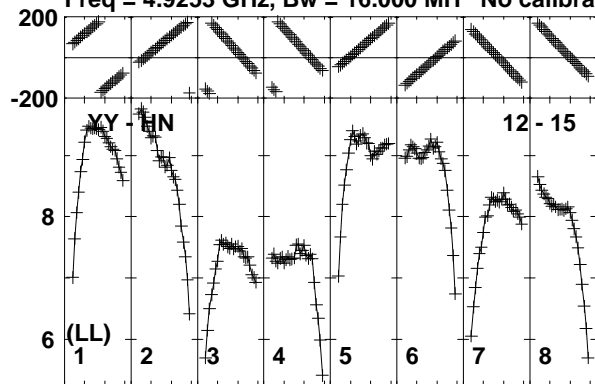

Lower frame: Milli Ampl Jy Top frame: Phas deg
Vector averaged cross-power spectrum Baseline: YY (12) - HN (15)
Timerange: 00/21:35:09 to 00/21:36:52

Plot file version 108 created 11-APR-2016 17:08:31

ARP299C GP053G 3.UVDATA.1

Freq = 4.9253 GHz, Bw = 16.000 MH No calibration applied and no bandpass applied

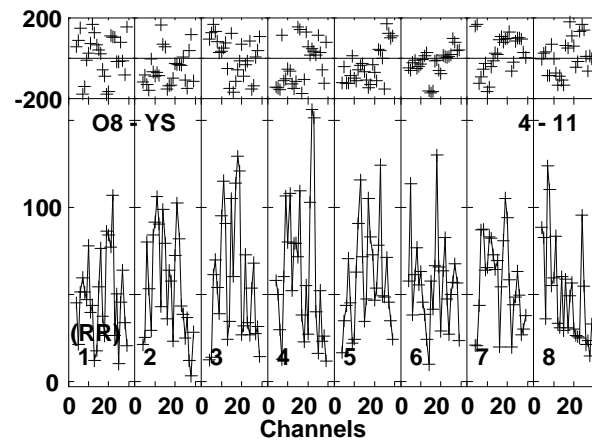
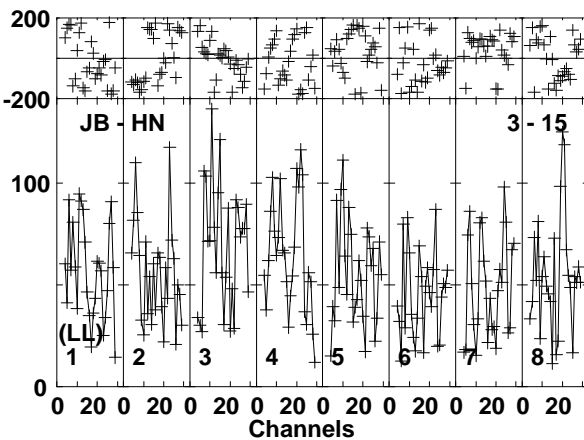
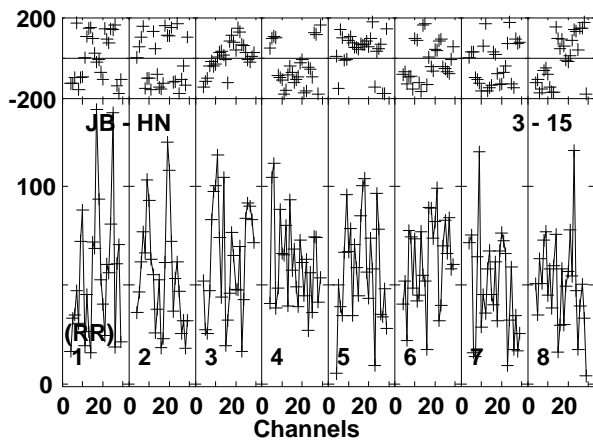
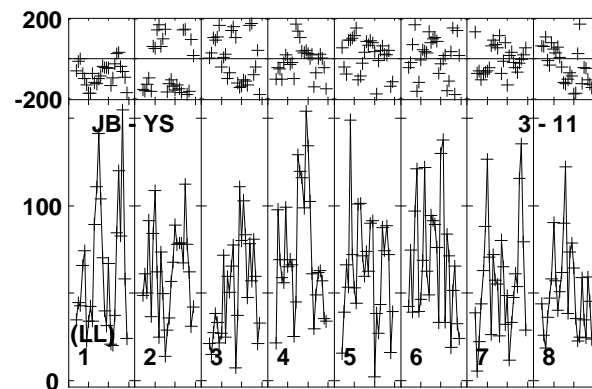
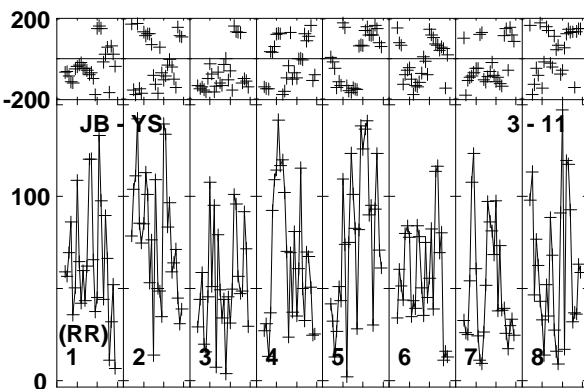
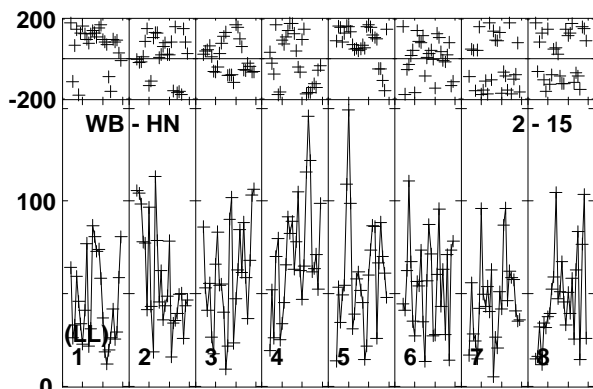
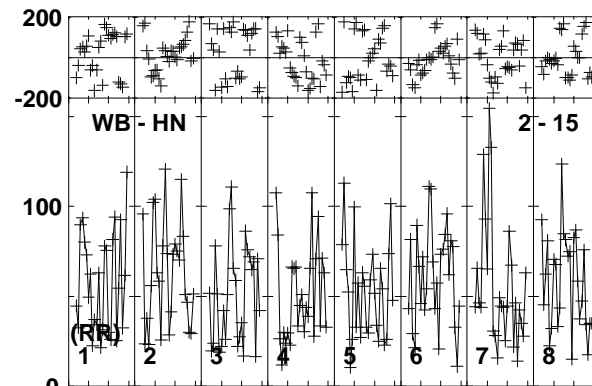
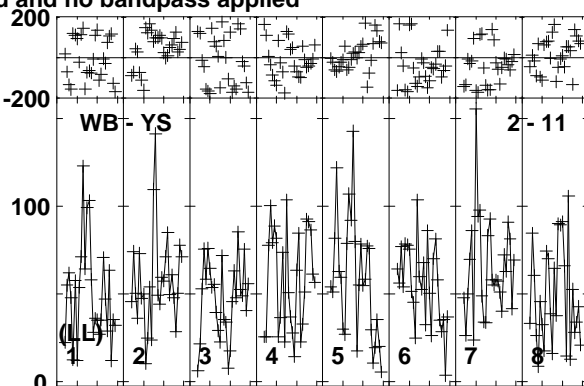
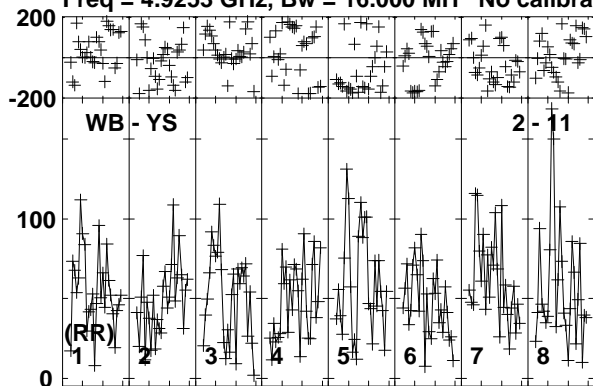

Lower frame: Micro Ampl Jy Top frame: Phas deg
Vector averaged cross-power spectrum Baseline: WB (02) - YS (11)
Timerange: 00/21:36:59 to 00/21:42:11

Plot file version 109 created 11-APR-2016 17:08:31

ARP299C GP053G 3.UVDATA.1

Freq = 4.9253 GHz, Bw = 16.000 MH No calibration applied and no bandpass applied

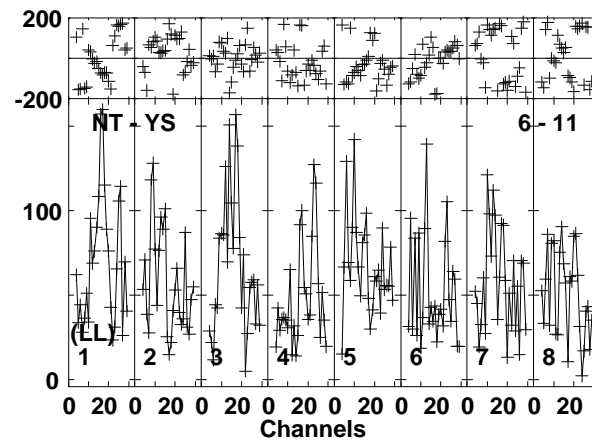
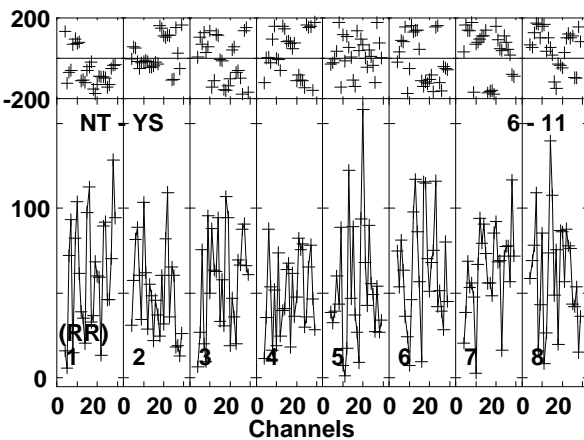
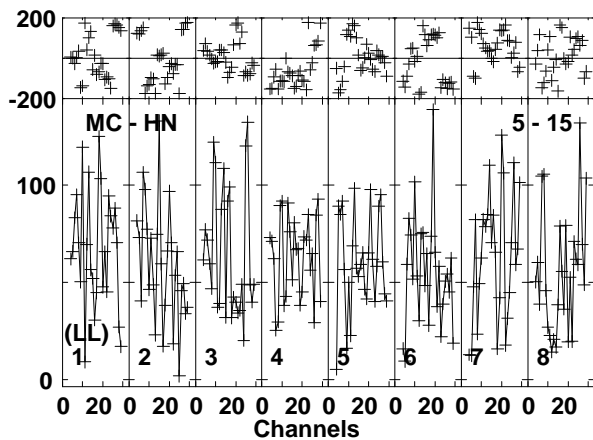
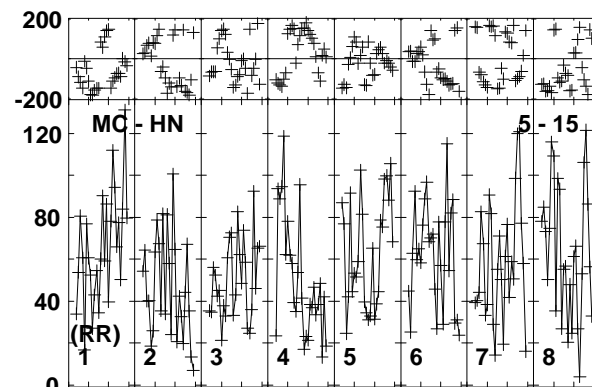
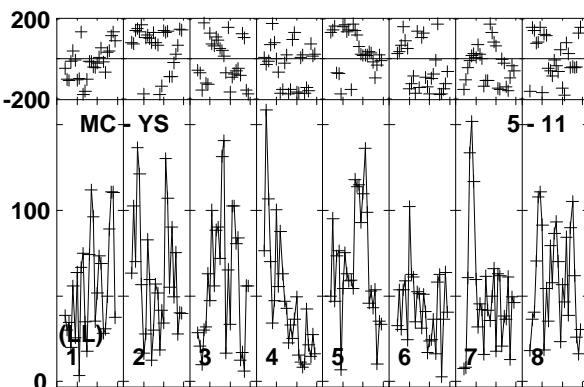
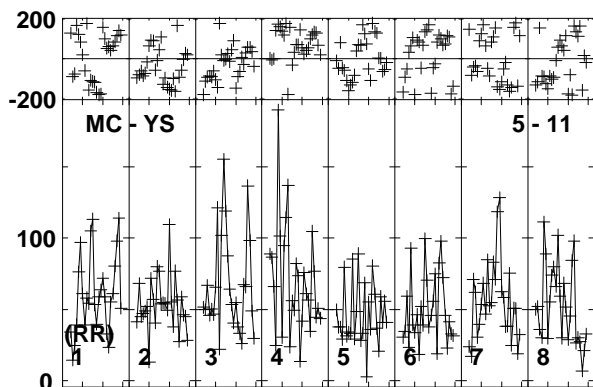
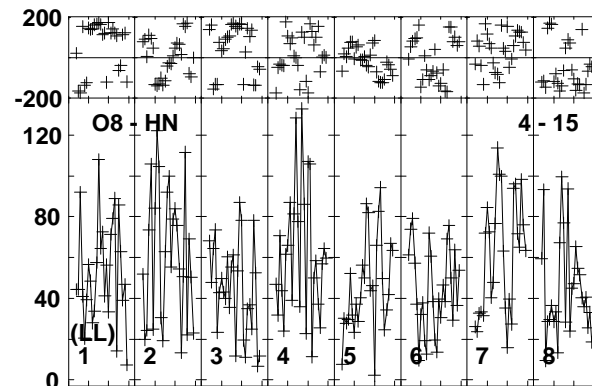
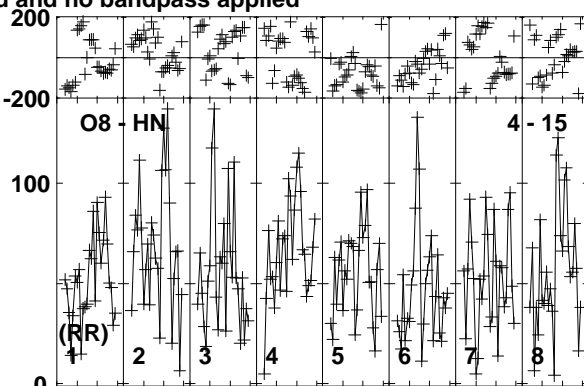
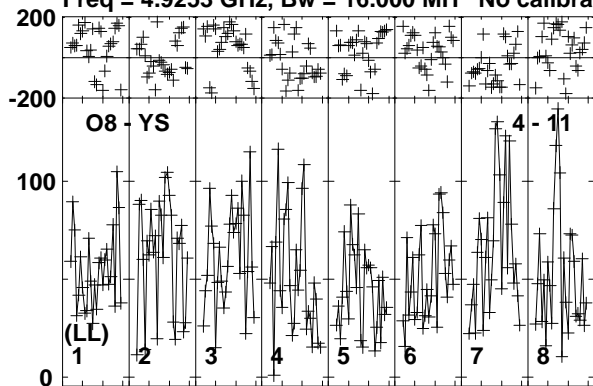

Lower frame: Micro Ampl Jy Top frame: Phas deg
Vector averaged cross-power spectrum Baseline: O8 (04) - YS (11)
Timerange: 00/21:36:59 to 00/21:42:11

Plot file version 110 created 11-APR-2016 17:08:32

ARP299C GP053G 3.UVDATA.1

Freq = 4.9253 GHz, Bw = 16.000 MH No calibration applied and no bandpass applied

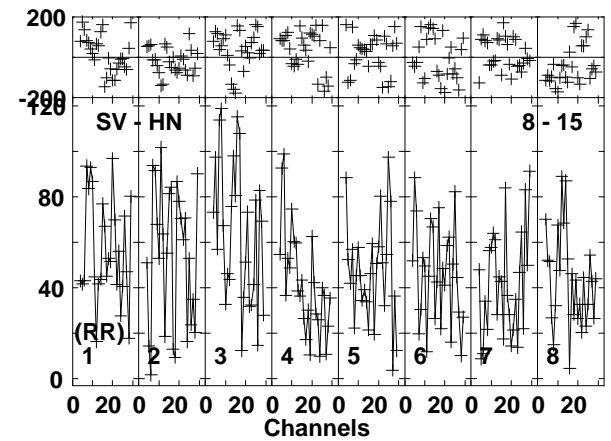
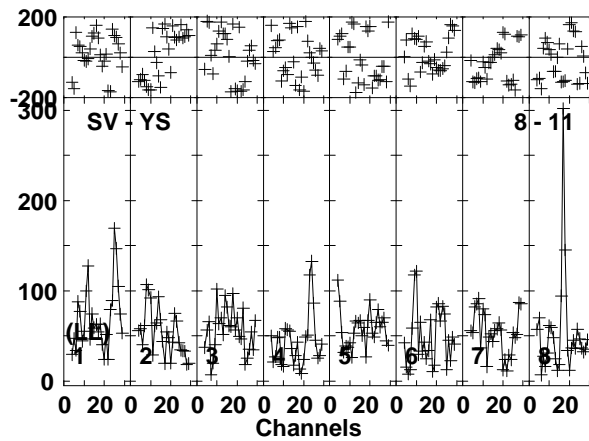
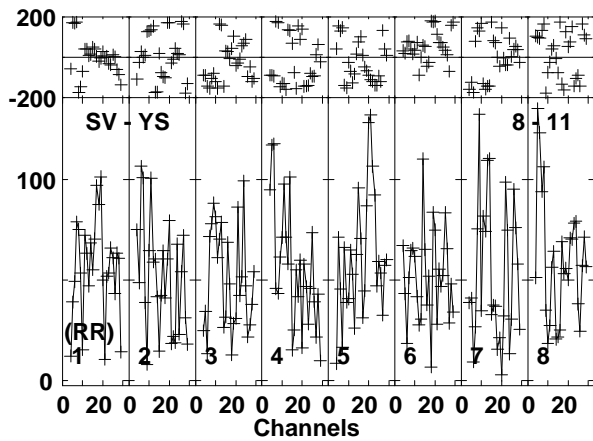
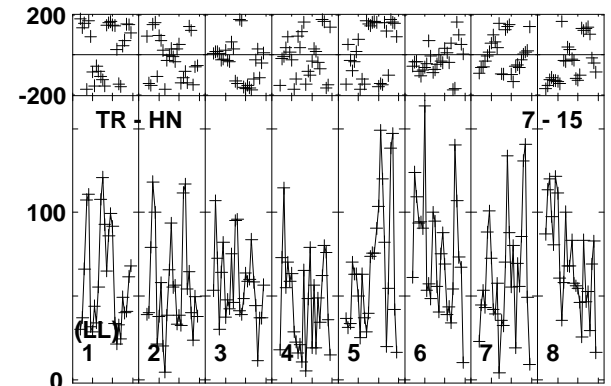
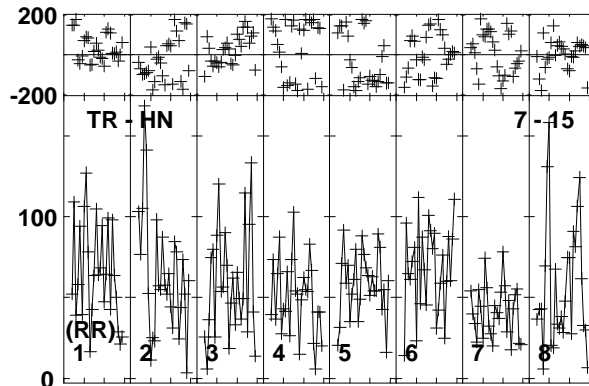
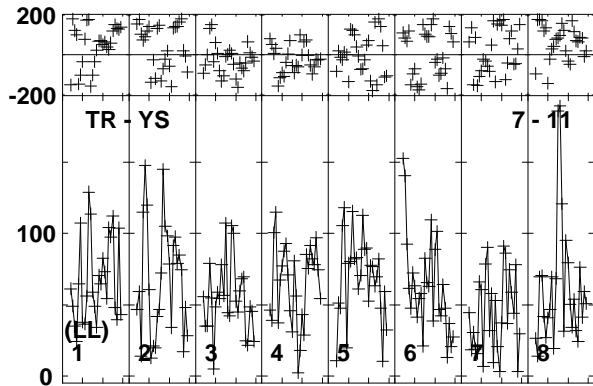
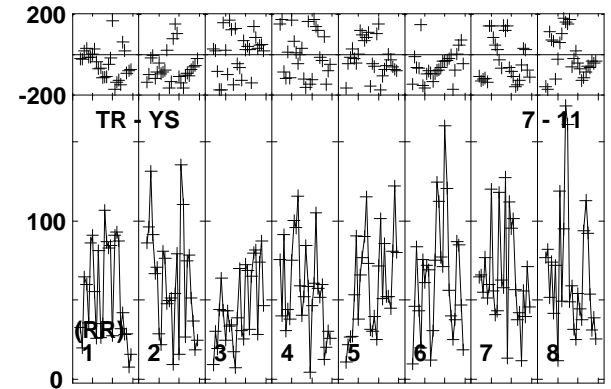
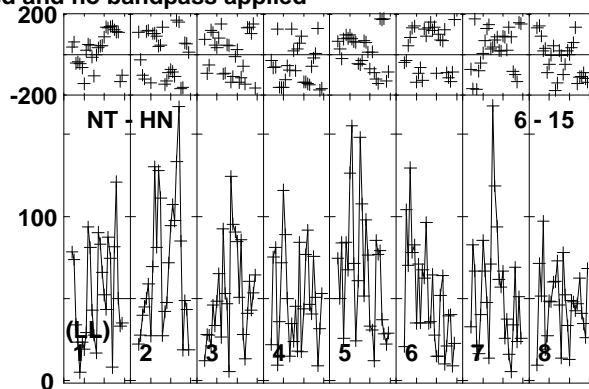
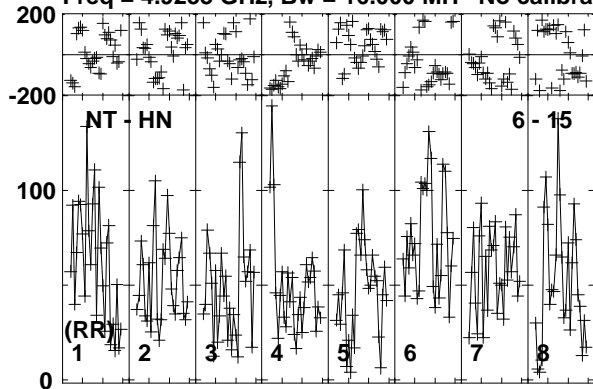

Lower frame: Micro Ampl Jy Top frame: Phas deg
Vector averaged cross-power spectrum Baseline: NT (06) - HN (15)
Timerange: 00/21:36:59 to 00/21:42:11

Plot file version 111 created 11-APR-2016 17:08:32

ARP299C GP053G 3.UVDATA.1

Freq = 4.9253 GHz, Bw = 16.000 MH No calibration applied and no bandpass applied

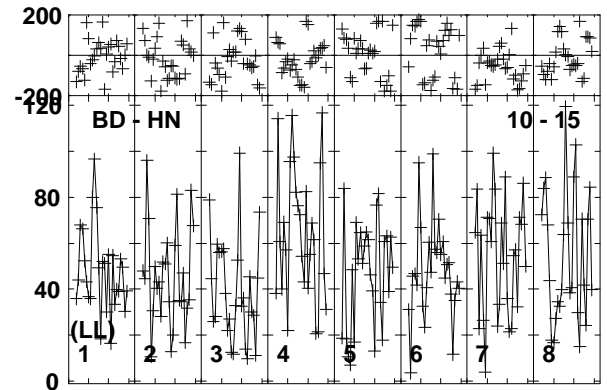
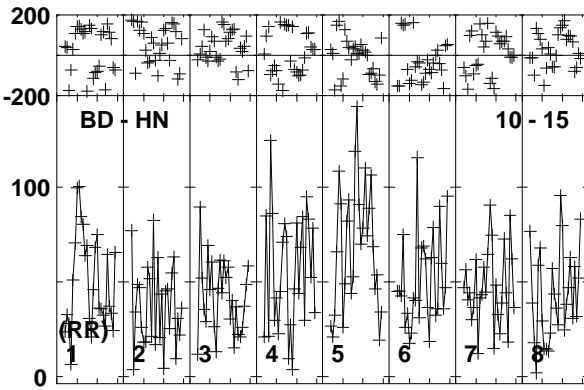
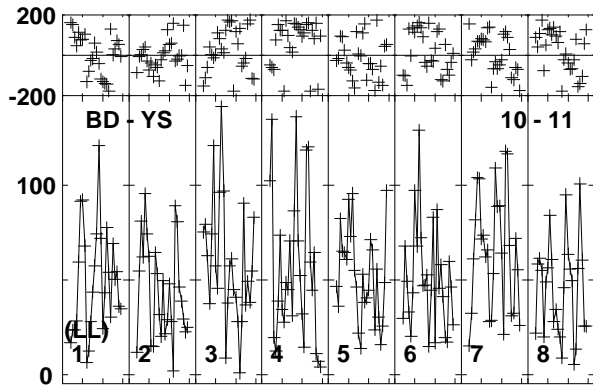
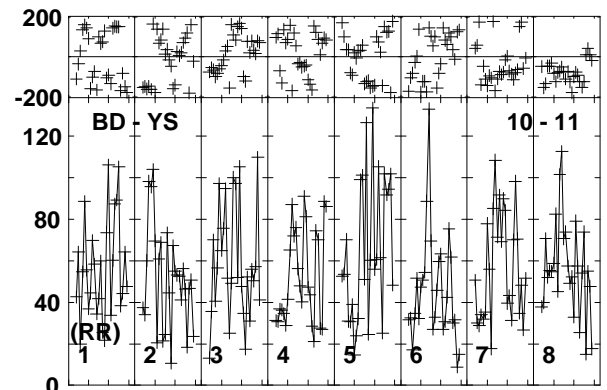
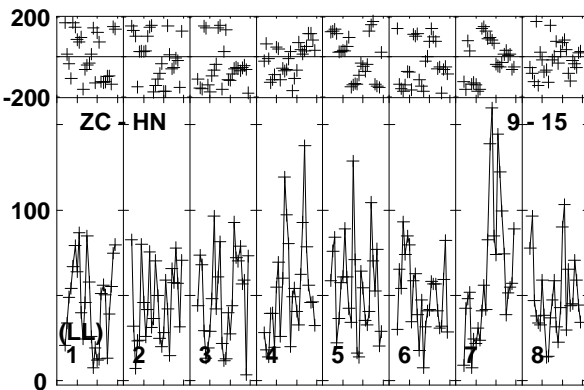
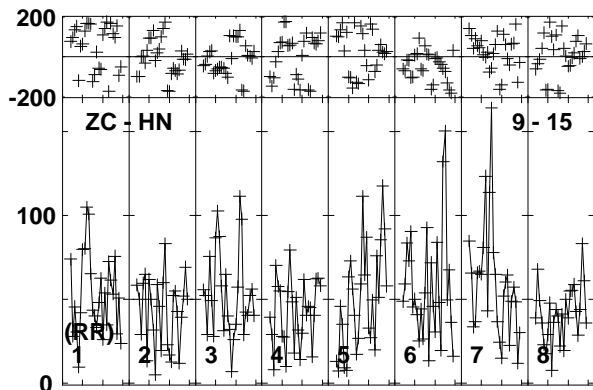
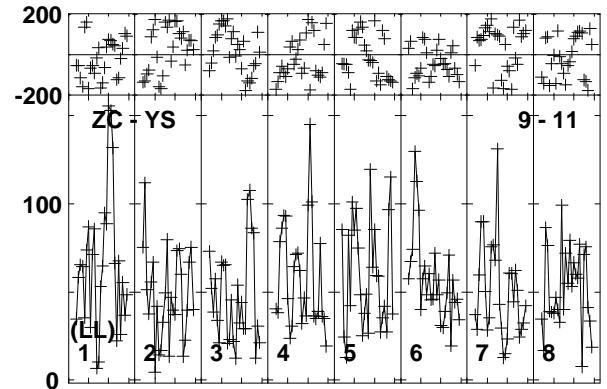
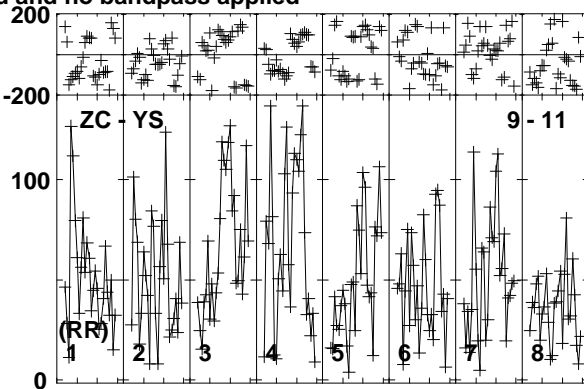
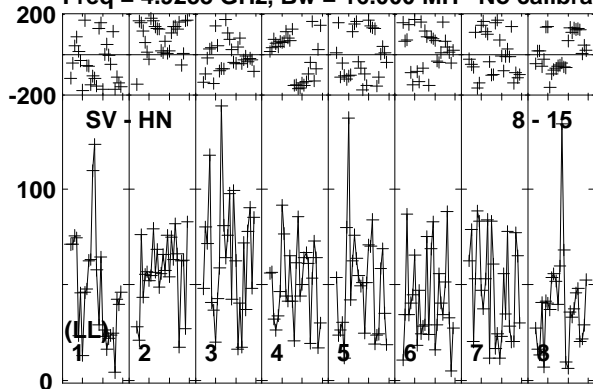

Lower frame: Micro Ampl Jy Top frame: Phas deg
Vector averaged cross-power spectrum Baseline: SV (08) - HN (15)
Timerange: 00/21:36:59 to 00/21:42:11

Plot file version 112 created 11-APR-2016 17:08:32

ARP299C GP053G 3.UVDATA.1

Freq = 4.9253 GHz, Bw = 16.000 MH No calibration applied and no bandpass applied

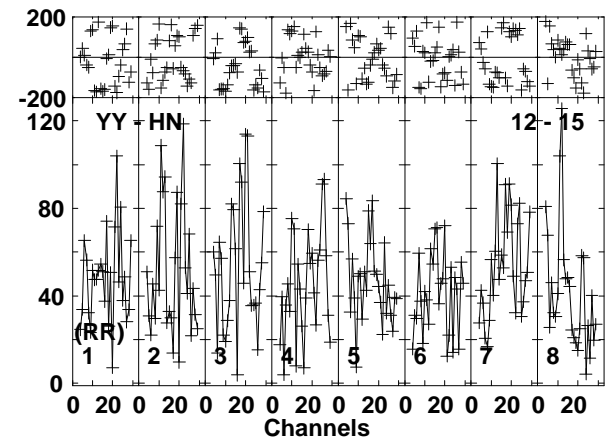
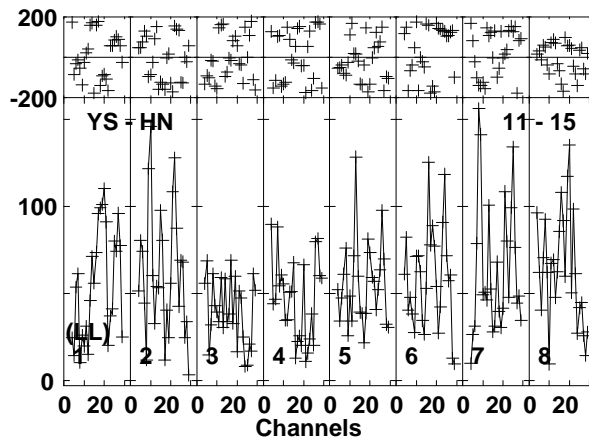
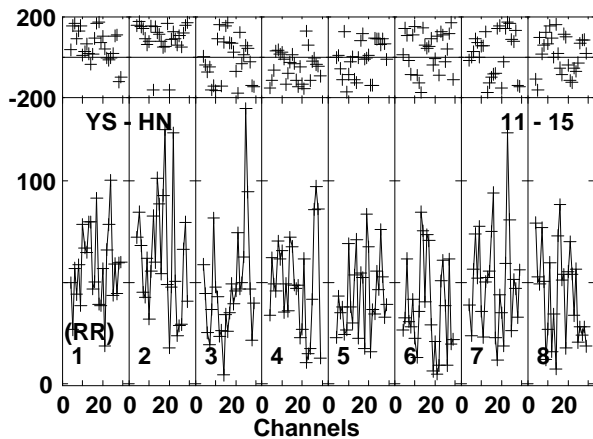
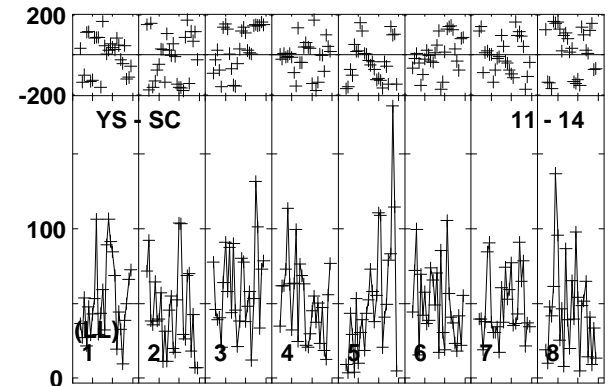
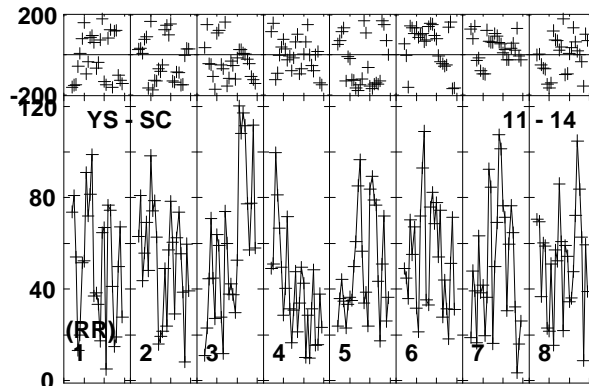
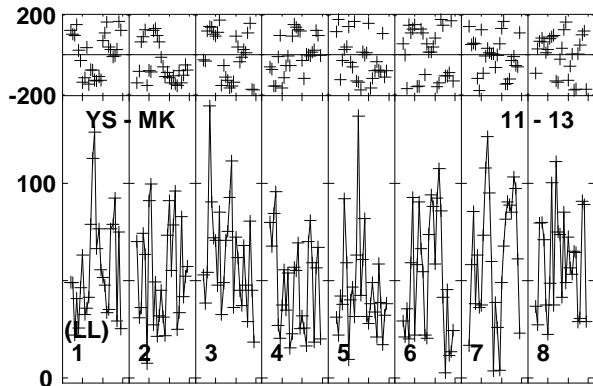
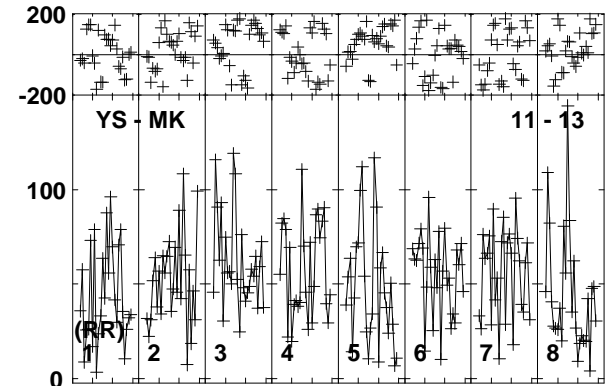
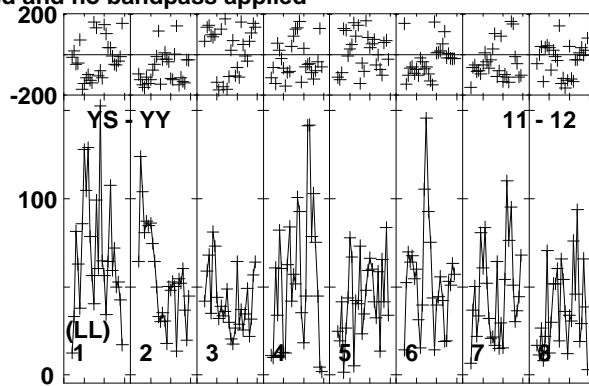
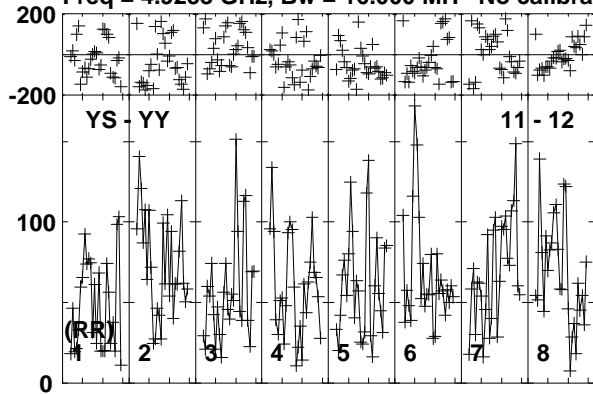

Lower frame: Micro Ampl Jy Top frame: Phas deg
Vector averaged cross-power spectrum Baseline: YS (11) - YY (12)
Timerange: 00/21:36:59 to 00/21:42:11

Plot file version 113 created 11-APR-2016 17:08:32

ARP299C GP053G 3.UVDATA.1

Freq = 4.9253 GHz, Bw = 16.000 MH No calibration applied and no bandpass applied

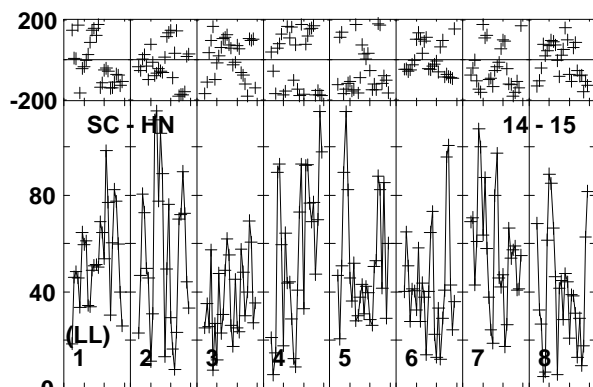
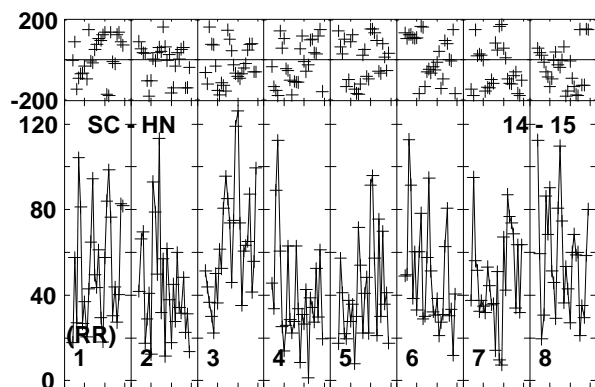
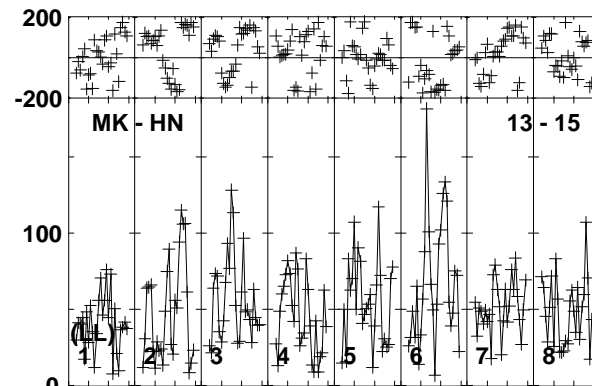
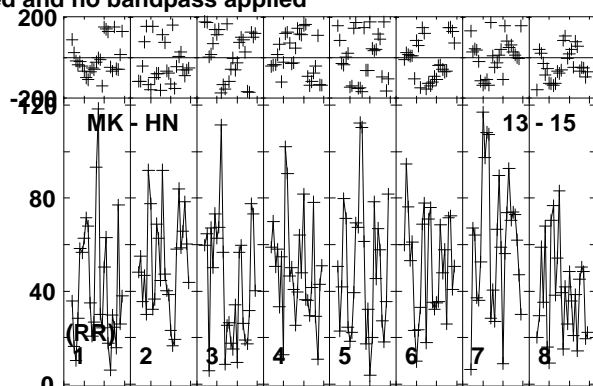
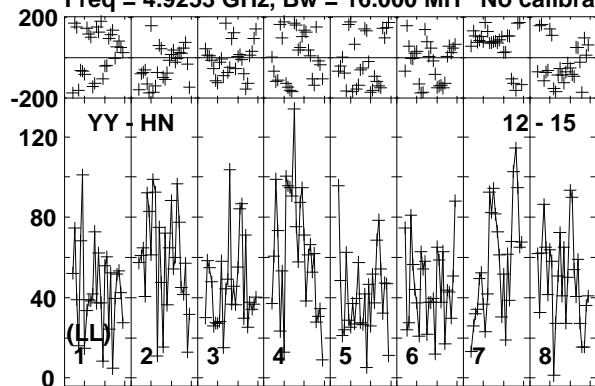

Lower frame: Micro Ampl Jy Top frame: Phas deg
Vector averaged cross-power spectrum Baseline: YY (12) - HN (15)
Timerange: 00/21:36:59 to 00/21:42:11

Plot file version 114 created 11-APR-2016 17:08:32

J1128+5925 GP053G 3.UVDATA.1

Freq = 4.9253 GHz, Bw = 16.000 MH No calibration applied and no bandpass applied

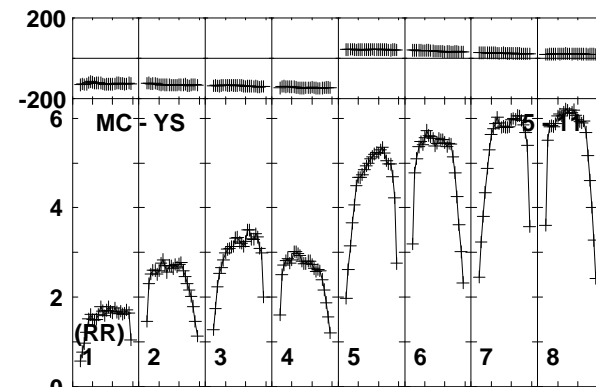
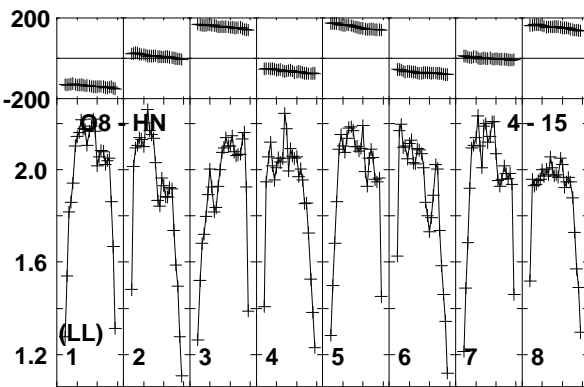
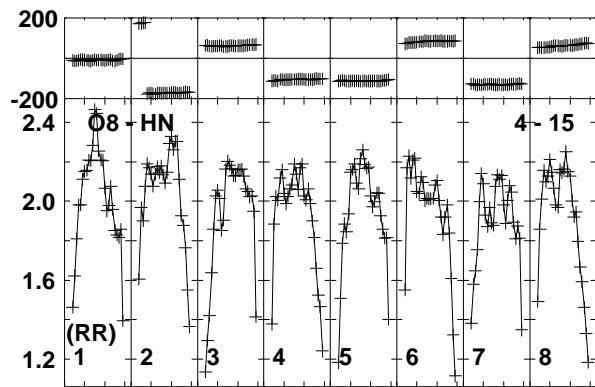
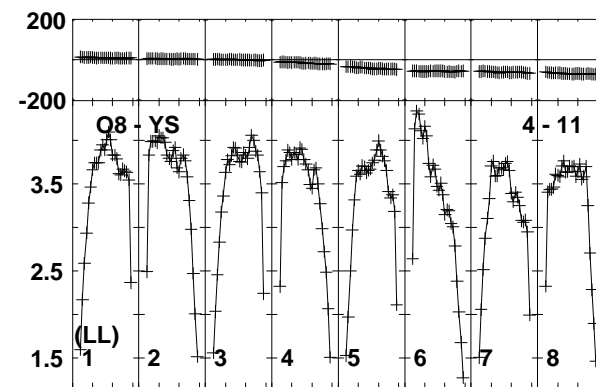
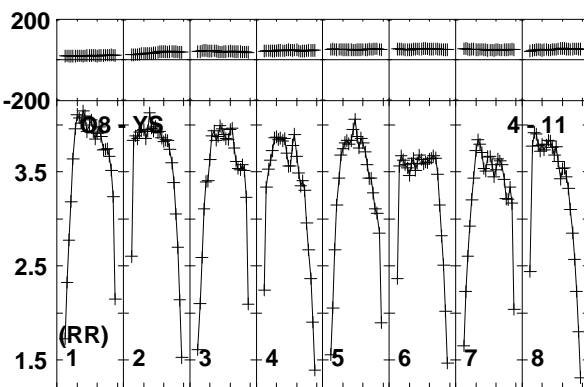
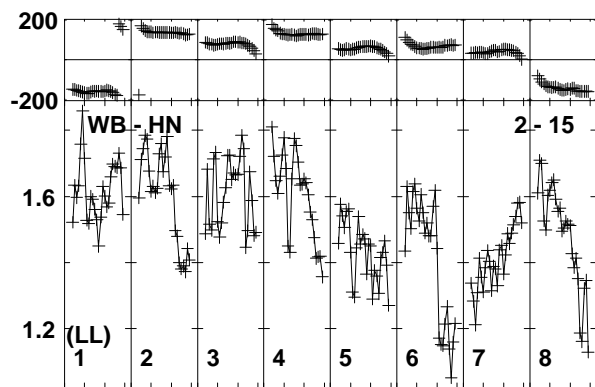
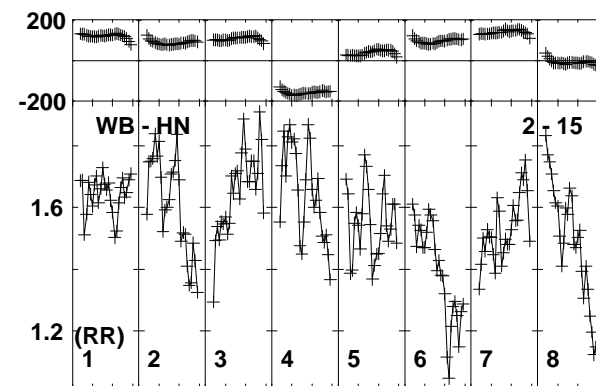
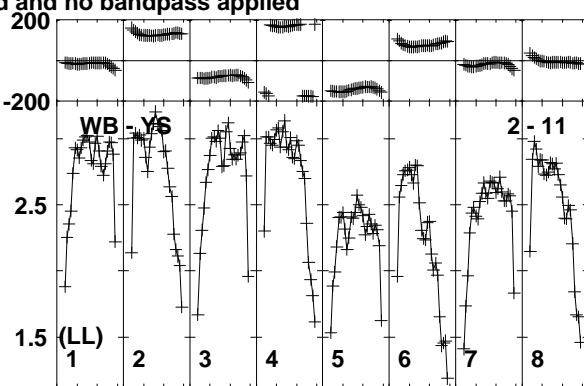
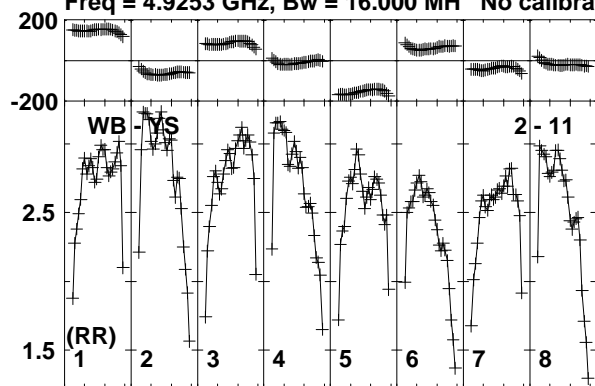

Lower frame: Milli Ampl Jy Top frame: Phas deg
Vector averaged cross-power spectrum Baseline: WB (02) - YS (11)
Timerange: 00/21:42:17 to 00/21:44:08

Plot file version 115 created 11-APR-2016 17:08:33

J1128+5925 GP053G 3.UVDATA.1

Freq = 4.9253 GHz, Bw = 16.000 MH No calibration applied and no bandpass applied

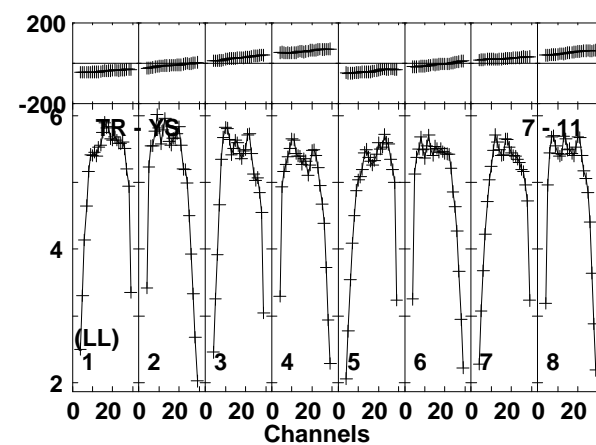
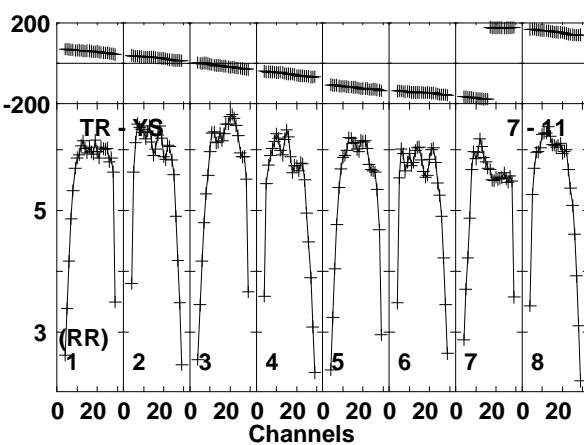
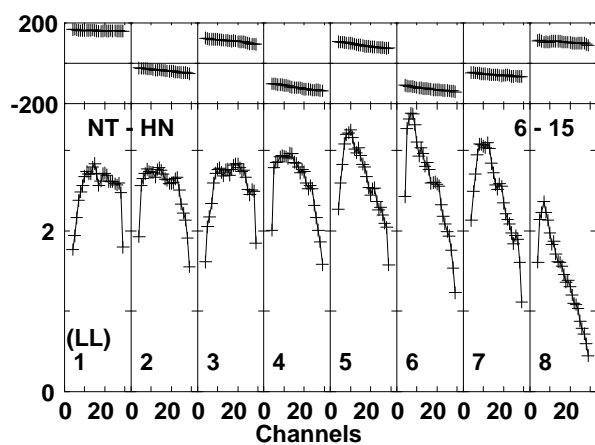
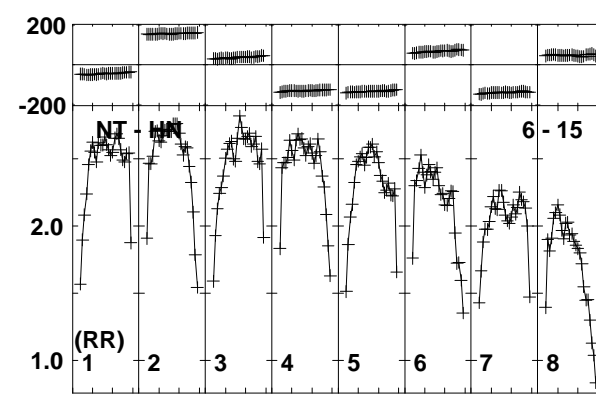
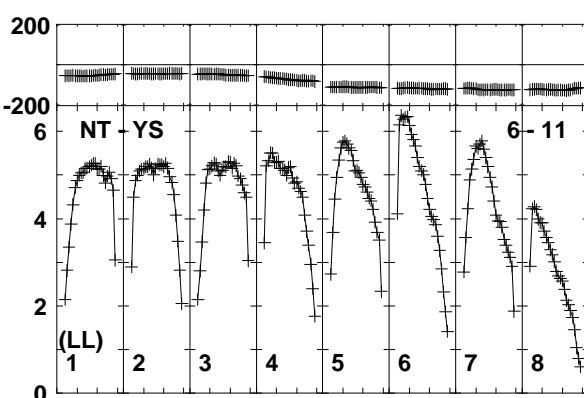
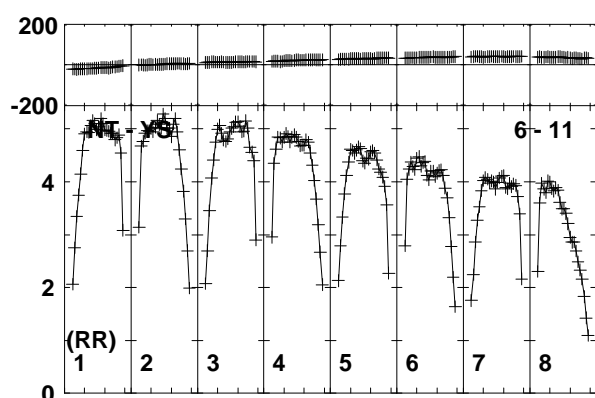
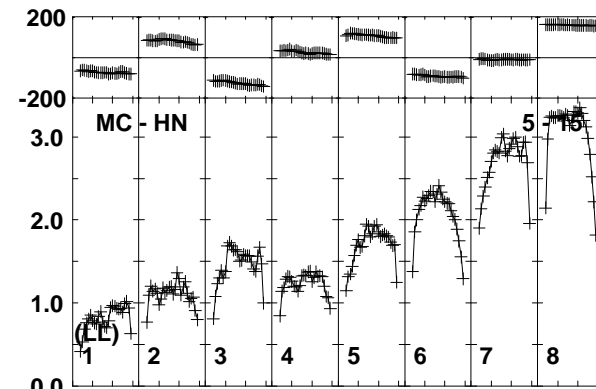
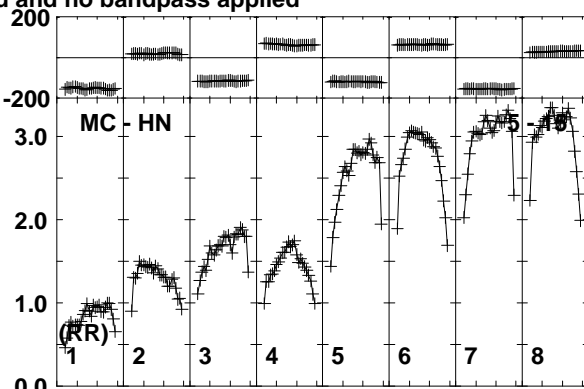
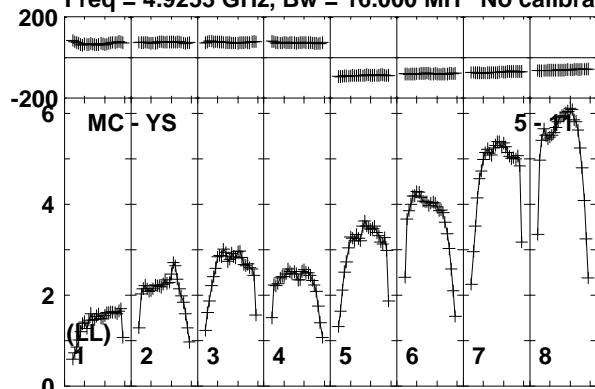

Lower frame: Milli Ampl Jy Top frame: Phas deg
Vector averaged cross-power spectrum Baseline: MC (05) - YS (11)
Timerange: 00/21:42:17 to 00/21:44:08

Plot file version 116 created 11-APR-2016 17:08:33

J1128+5925 GP053G 3.UVDATA.1

Freq = 4.9253 GHz, Bw = 16.000 MH No calibration applied and no bandpass applied

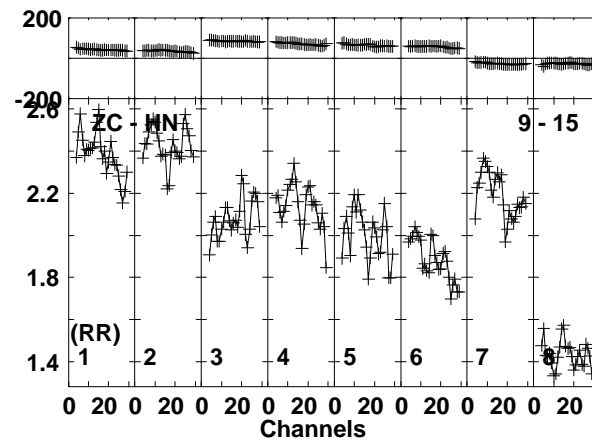
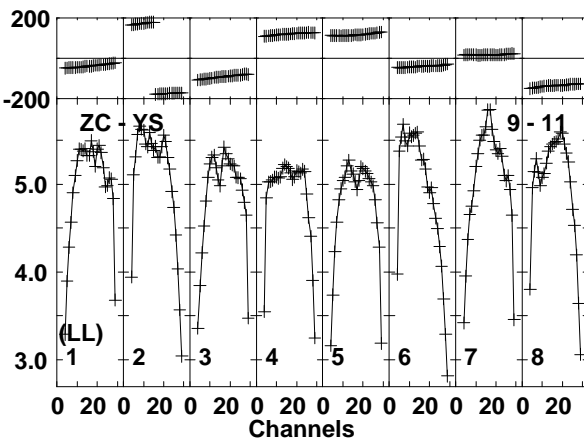
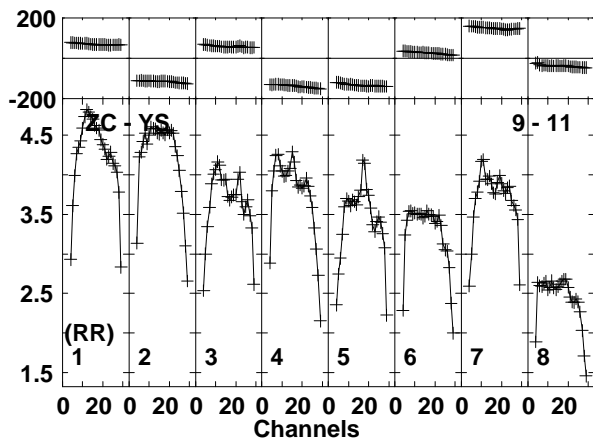
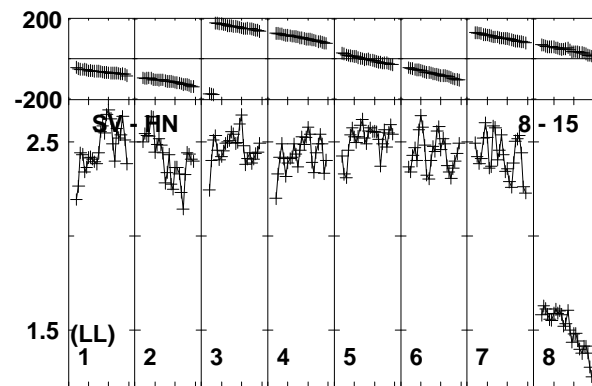
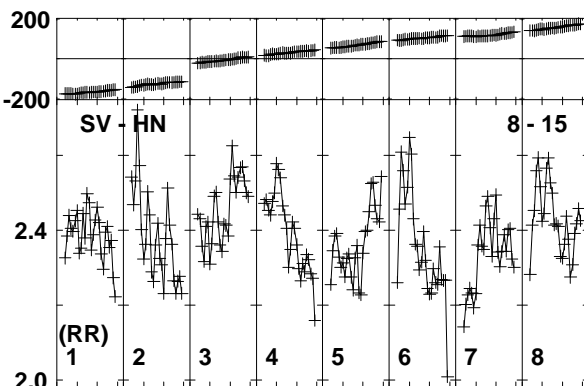
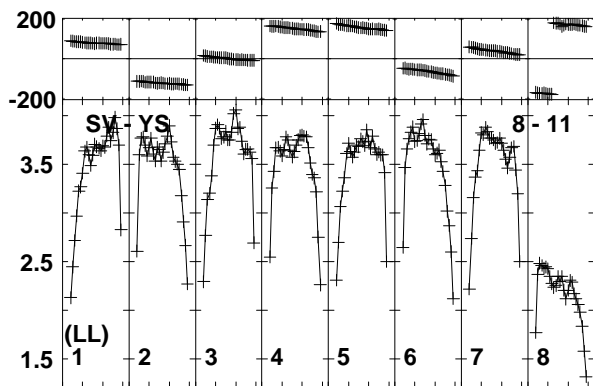
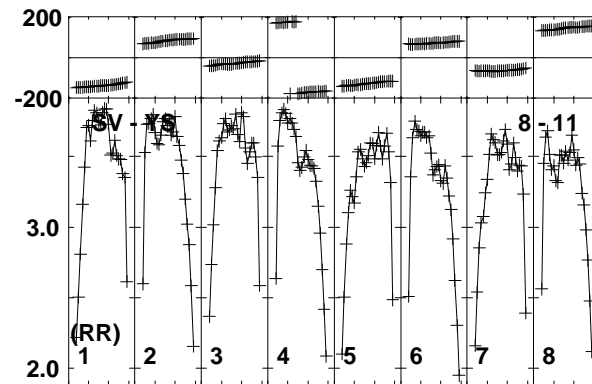
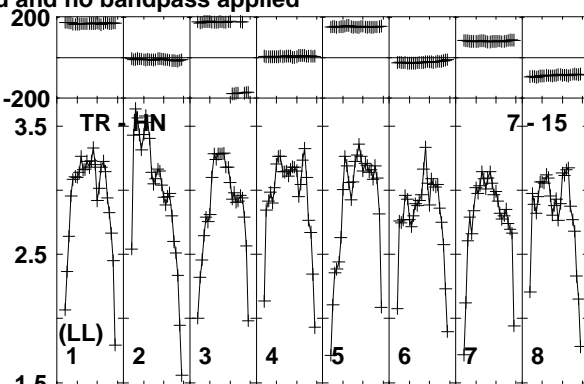
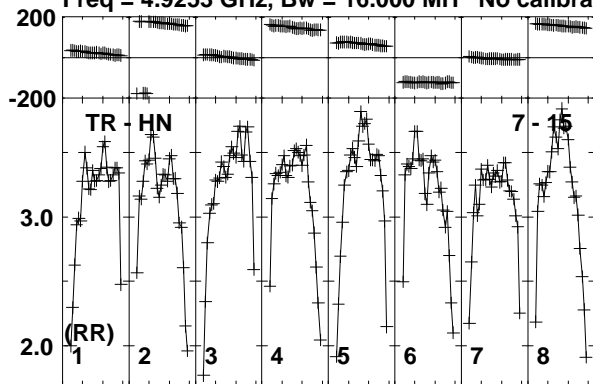

Lower frame: Milli Ampl Jy Top frame: Phas deg
Vector averaged cross-power spectrum Baseline: TR (07) - HN (15)
Timerange: 00/21:42:17 to 00/21:44:08

Plot file version 117 created 11-APR-2016 17:08:33

J1128+5925 GP053G 3.UVDATA.1

Freq = 4.9253 GHz, Bw = 16.000 MH No calibration applied and no bandpass applied

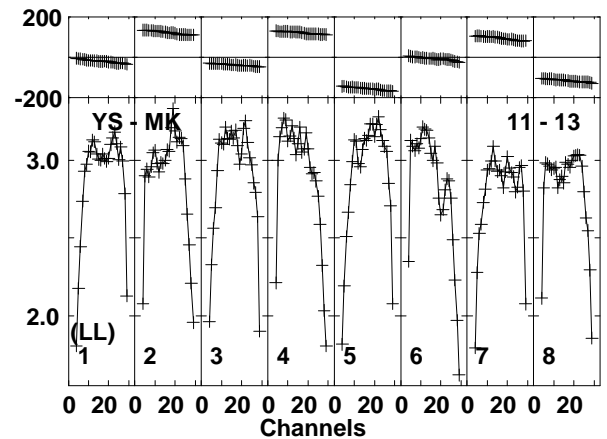
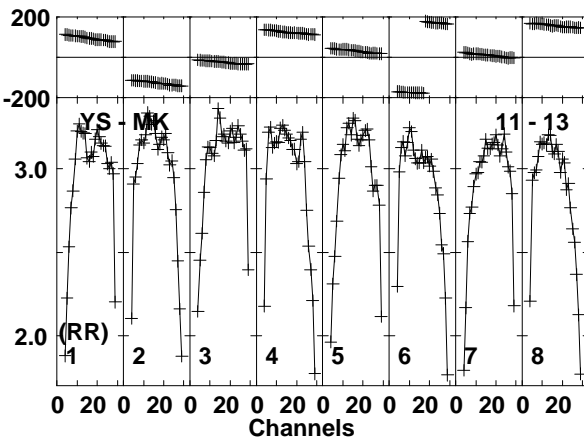
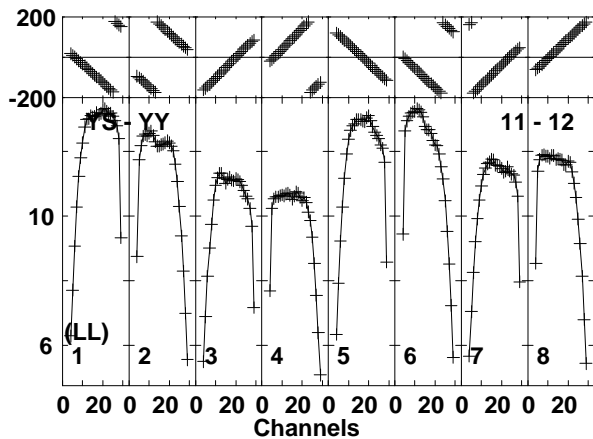
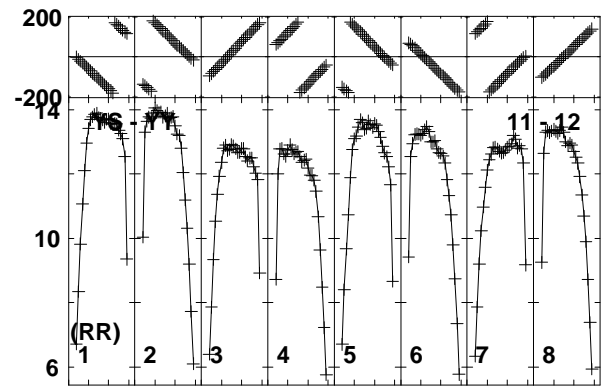
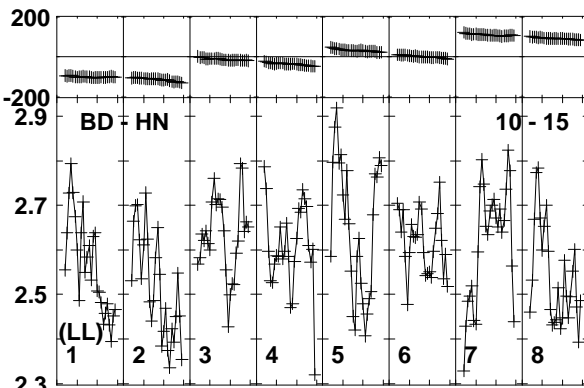
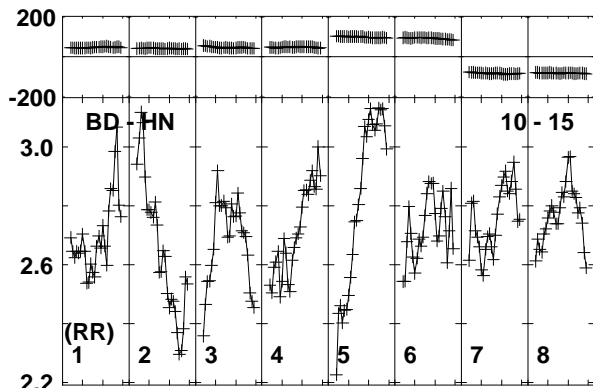
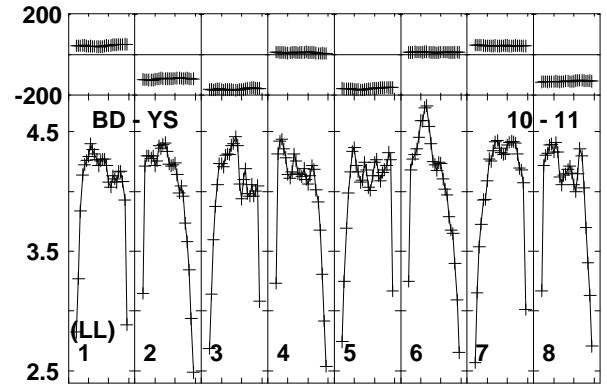
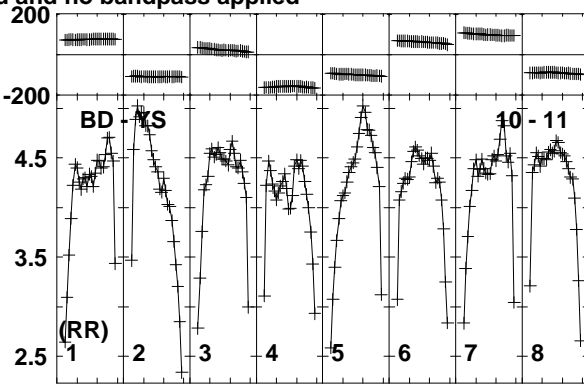
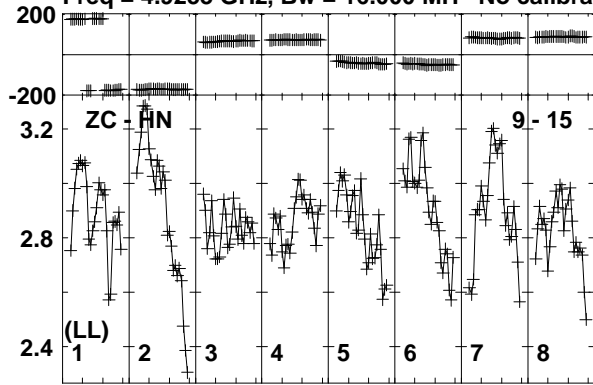

Lower frame: Milli Ampl Jy Top frame: Phas deg
Vector averaged cross-power spectrum Baseline: ZC (09) - HN (15)
Timerange: 00/21:42:17 to 00/21:44:08

Plot file version 118 created 11-APR-2016 17:08:33

J1128+5925 GP053G 3.UVDATA.1

Freq = 4.9253 GHz, Bw = 16.000 MH No calibration applied and no bandpass applied

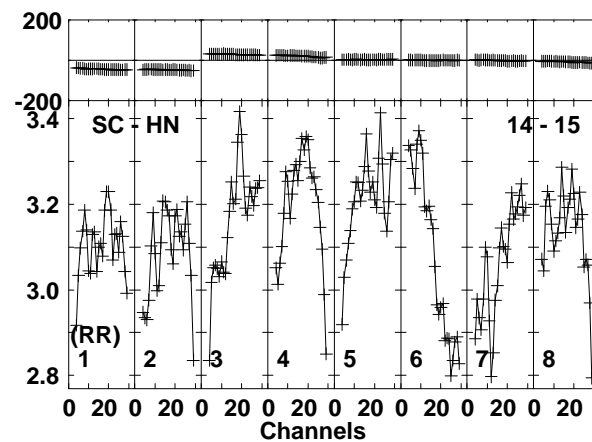
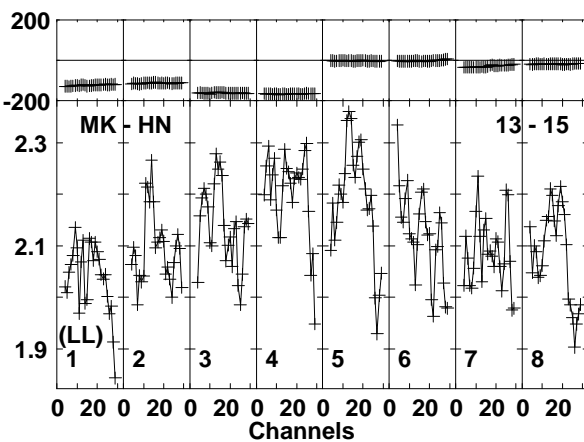
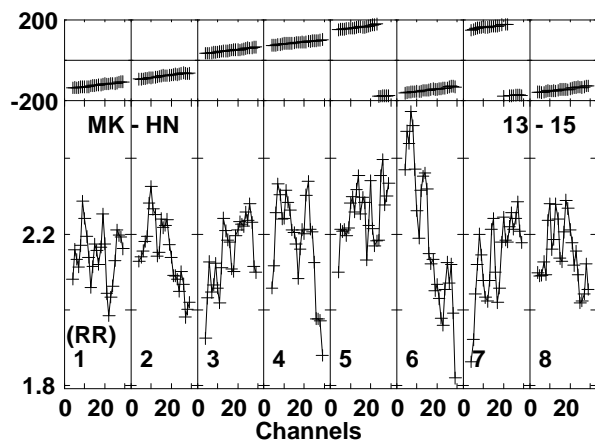
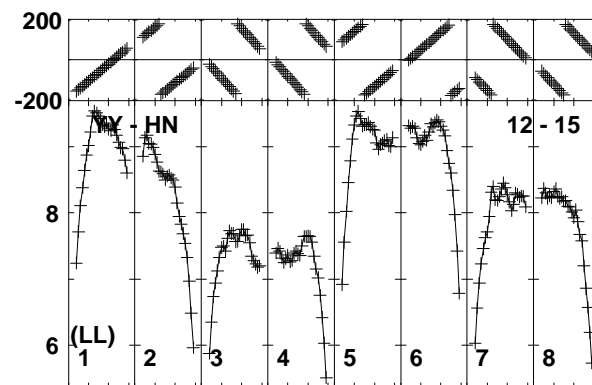
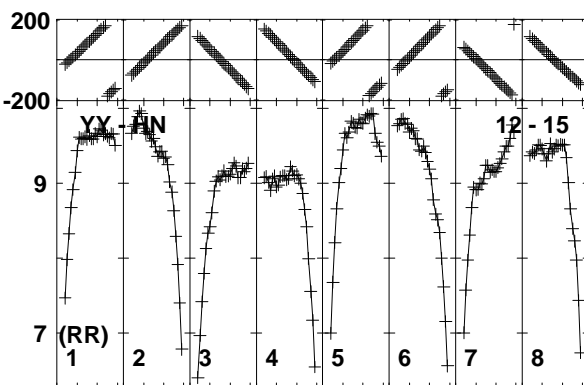
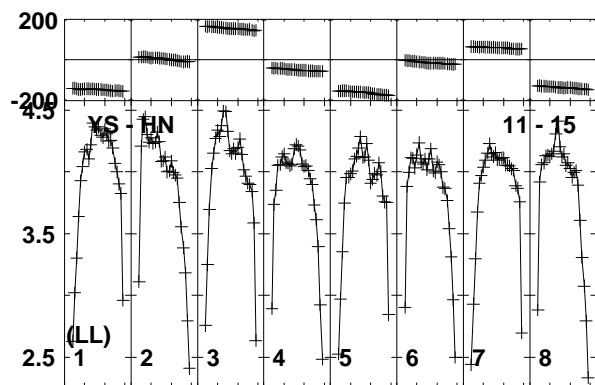
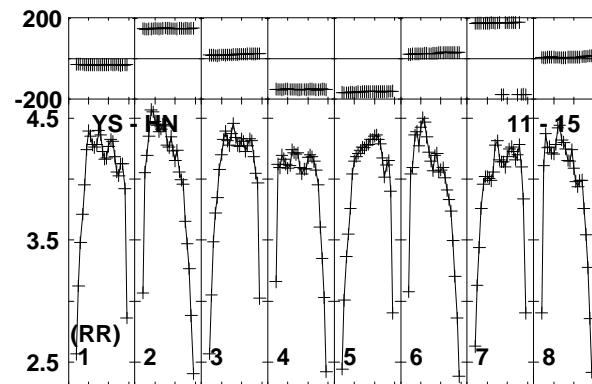
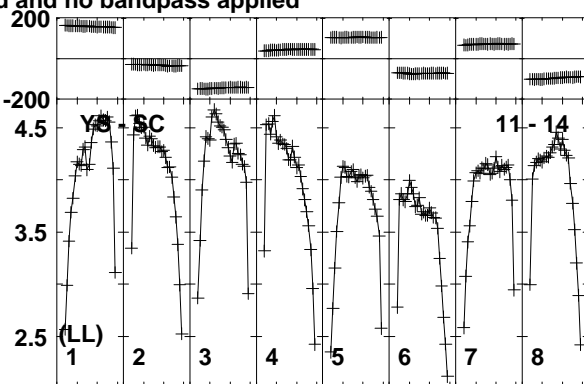
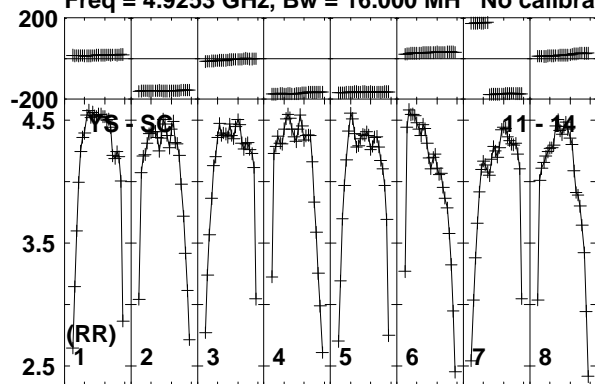

Lower frame: Milli Ampl Jy Top frame: Phas deg
Vector averaged cross-power spectrum Baseline: YS (11) - SC (14)
Timerange: 00/21:42:17 to 00/21:44:08

Plot file version 119 created 11-APR-2016 17:08:33
J1128+5925 GP053G 3.UVDATA.1
Freq = 4.9253 GHz, Bw = 16.000 MH No calibration applied and no bandpass applied

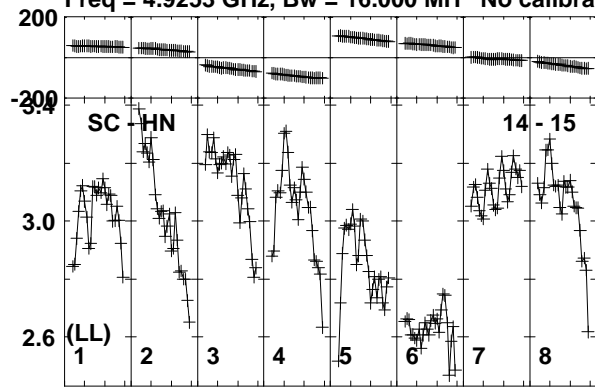

Lower frame: Milli Ampl Jy Top frame: Phas deg
Vector averaged cross-power spectrum Baseline: SC (14) - HN (15)
Timerange: 00/21:42:17 to 00/21:44:08

Plot file version 120 created 11-APR-2016 17:08:33

ARP299C GP053G 3.UVDATA.1

Freq = 4.9253 GHz, Bw = 16.000 MH No calibration applied and no bandpass applied

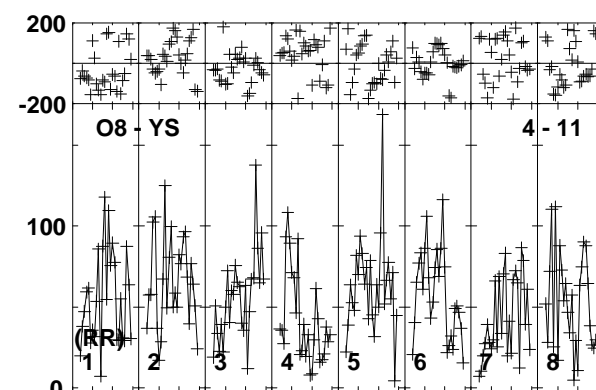
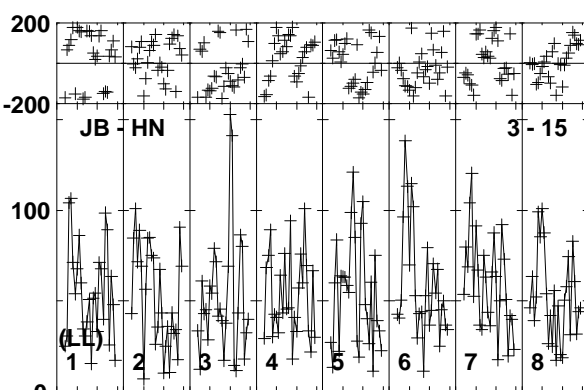
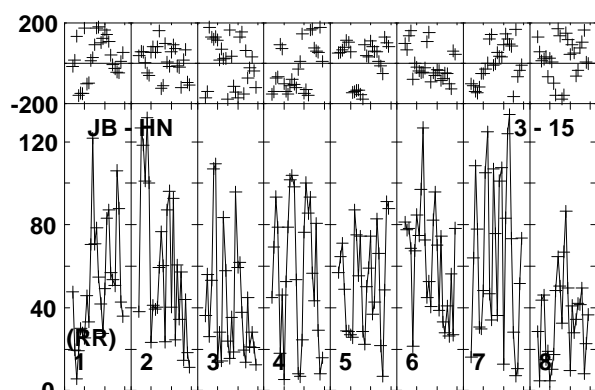
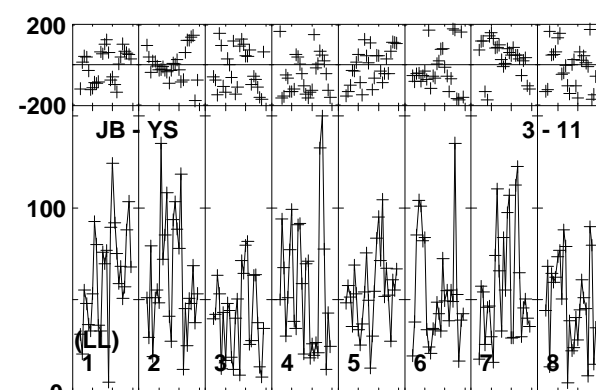
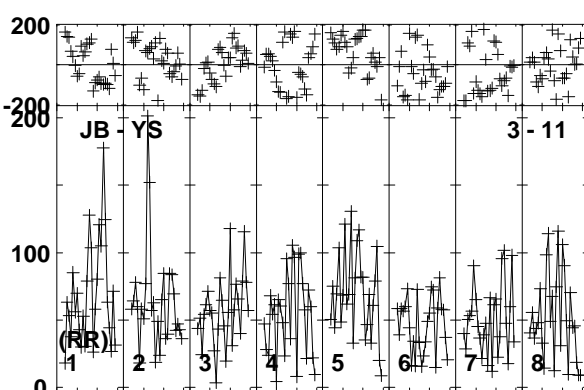
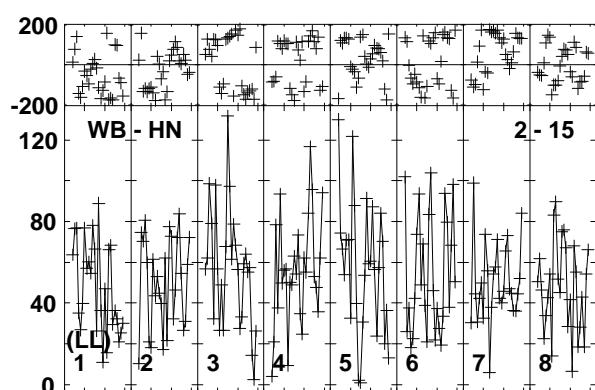
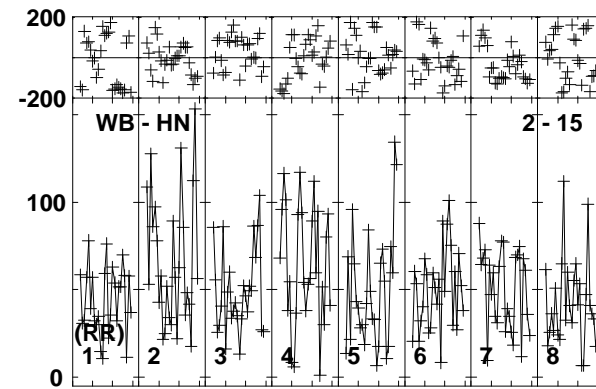
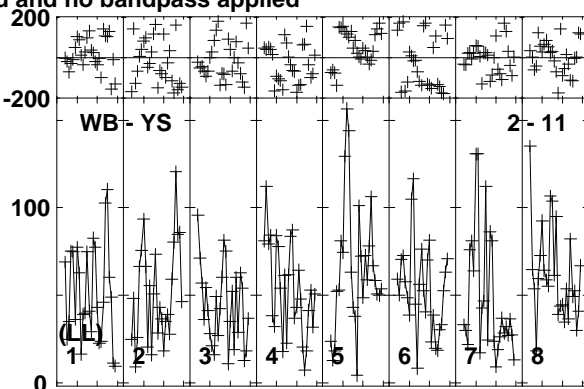
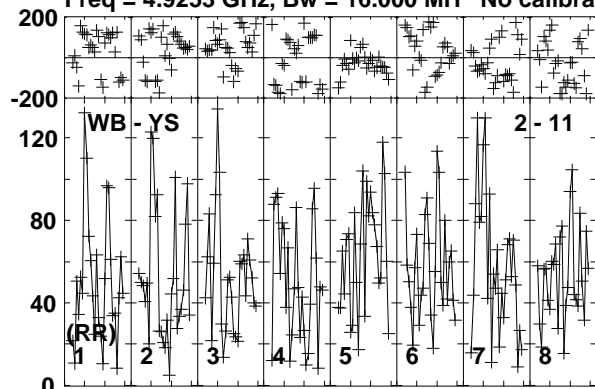

Lower frame: Micro Ampl Jy Top frame: Phas deg
Vector averaged cross-power spectrum Baseline: WB (02) - YS (11)
Timerange: 00/21:44:13 to 00/21:49:27

Plot file version 121 created 11-APR-2016 17:08:33

ARP299C GP053G 3.UVDATA.1

Freq = 4.9253 GHz, Bw = 16.000 MH No calibration applied and no bandpass applied

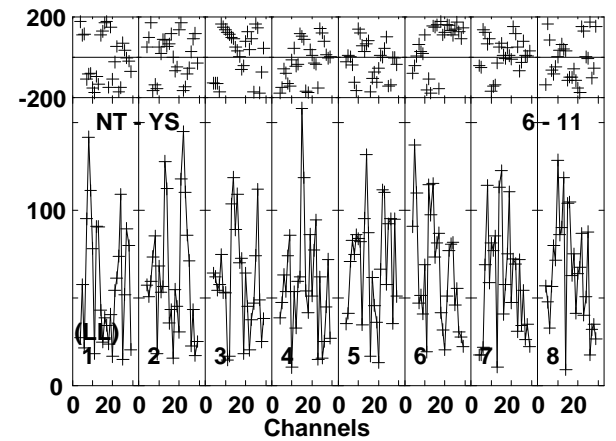
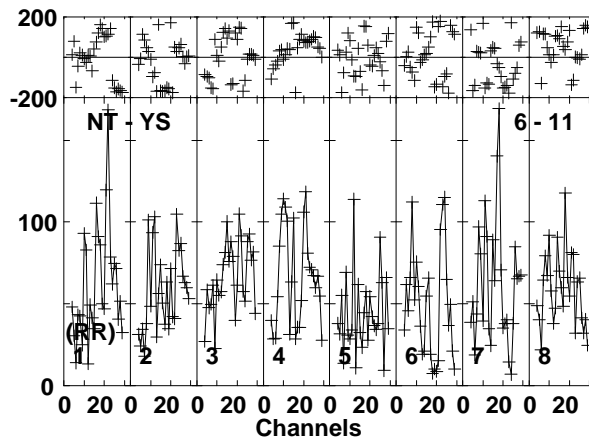
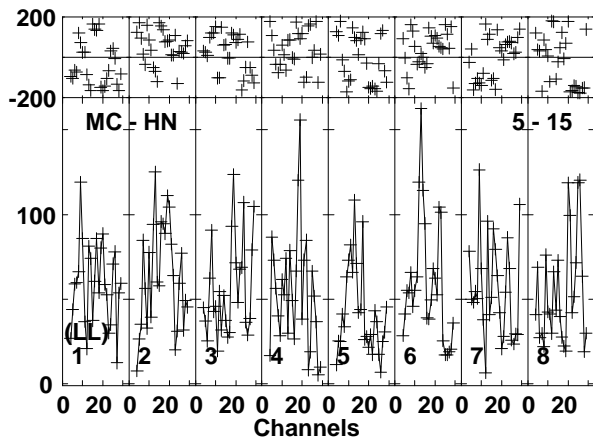
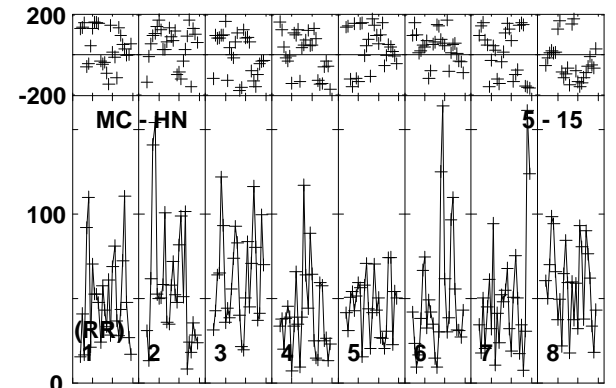
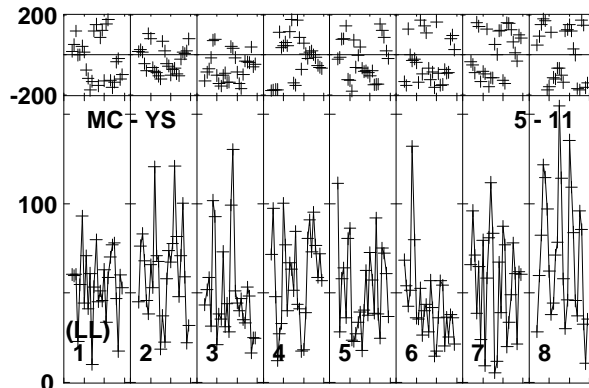
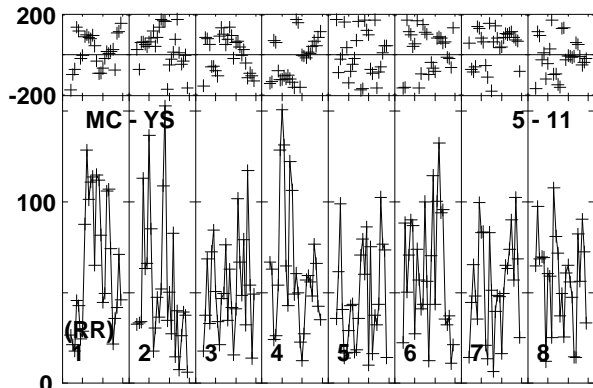
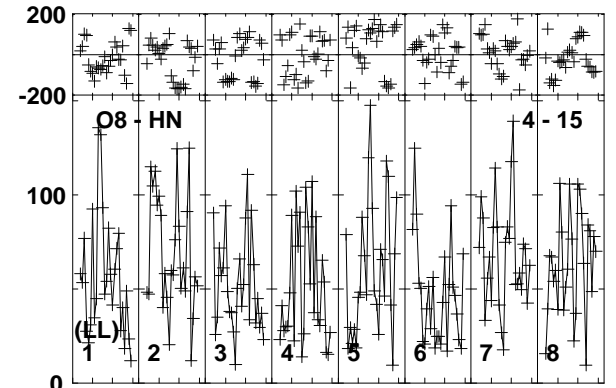
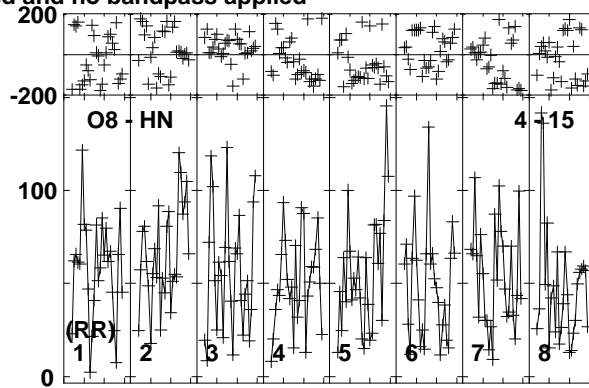
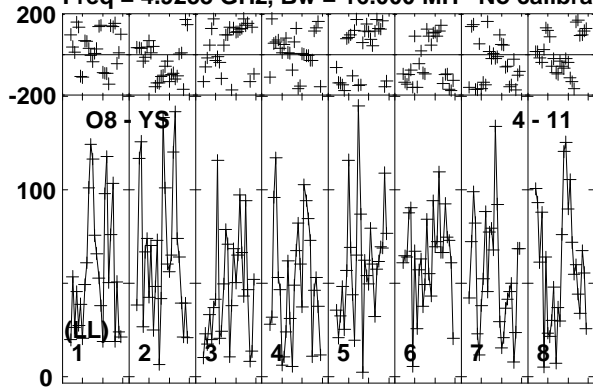

Lower frame: Micro Ampl Jy Top frame: Phas deg
Vector averaged cross-power spectrum Baseline: O8 (04) - YS (11)
Timerange: 00/21:44:13 to 00/21:49:27

Plot file version 122 created 11-APR-2016 17:08:34

ARP299C GP053G 3.UVDATA.1

Freq = 4.9253 GHz, Bw = 16.000 MH No calibration applied and no bandpass applied

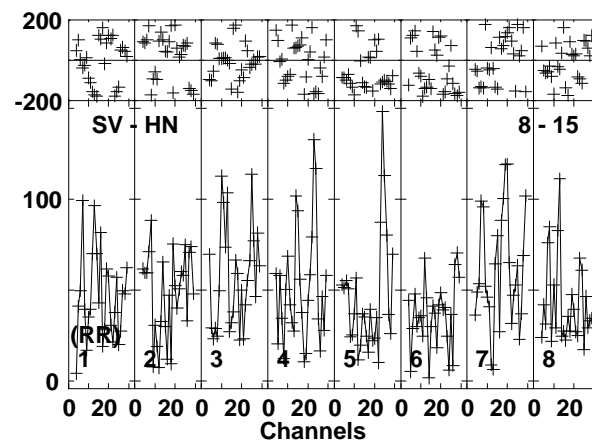
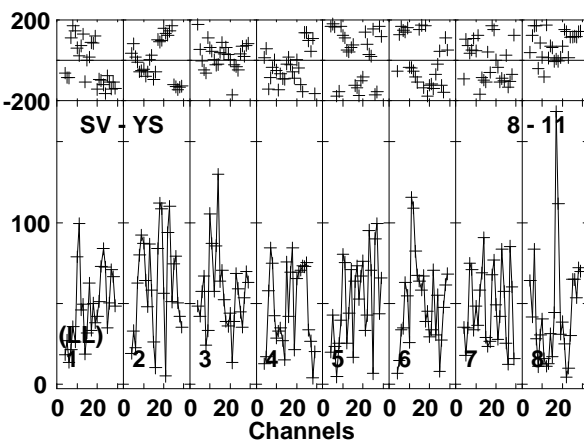
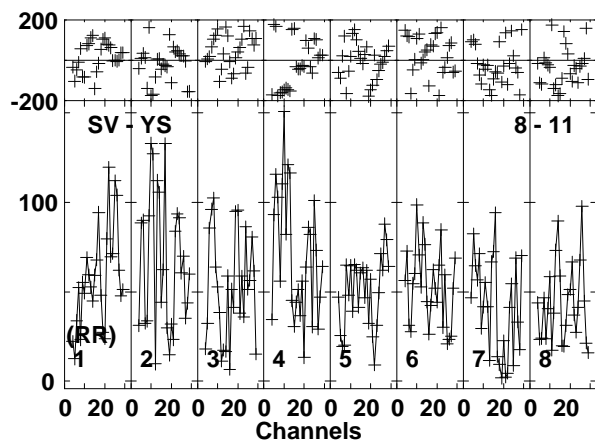
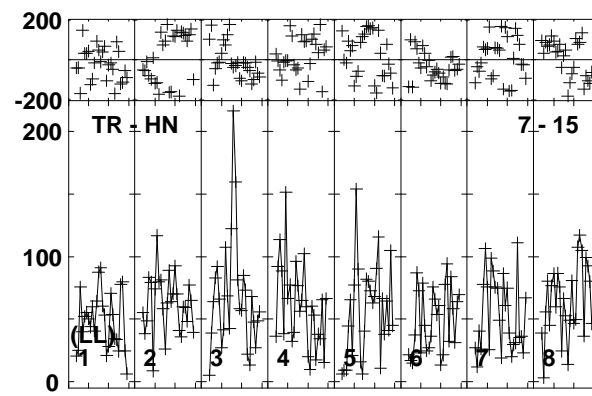
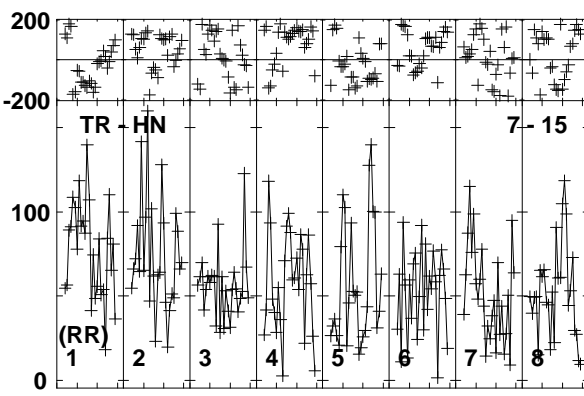
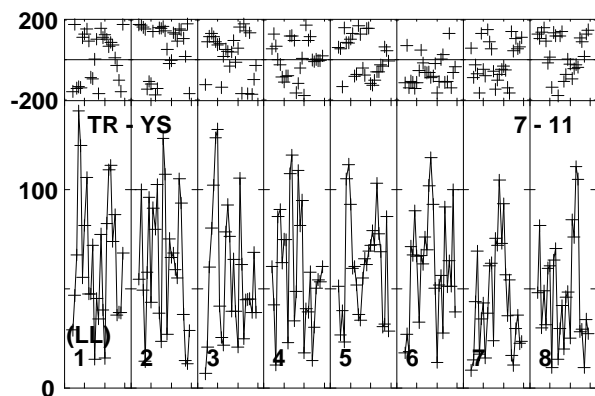
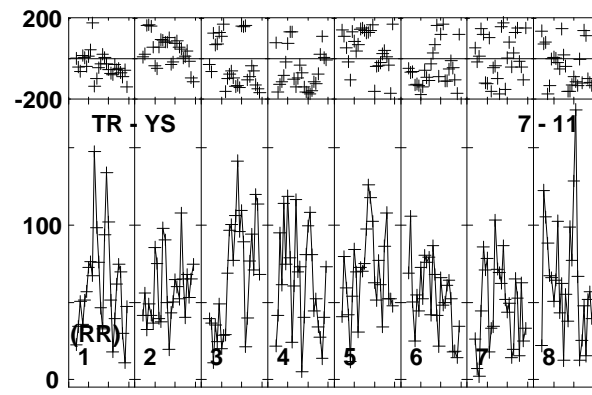
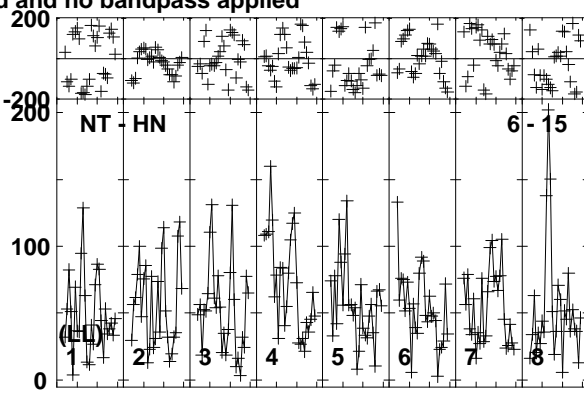
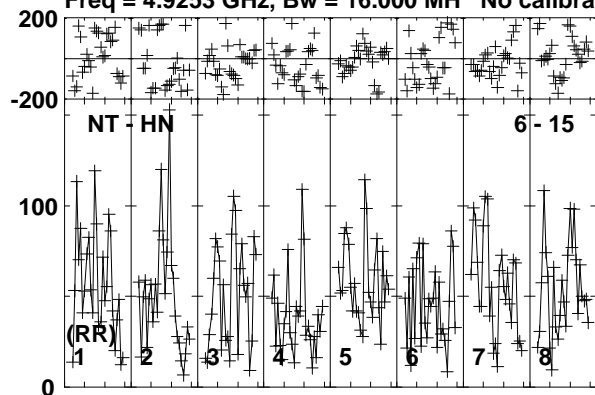

Lower frame: Micro Ampl Jy Top frame: Phas deg
Vector averaged cross-power spectrum Baseline: NT (06) - HN (15)
Timerange: 00/21:44:13 to 00/21:49:27

Plot file version 123 created 11-APR-2016 17:08:34

ARP299C GP053G 3.UVDATA.1

Freq = 4.9253 GHz, Bw = 16.000 MH No calibration applied and no bandpass applied

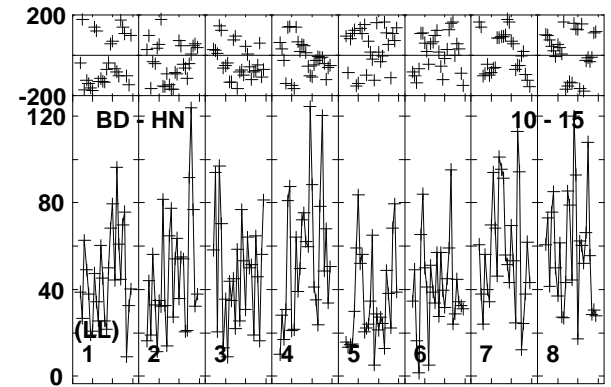
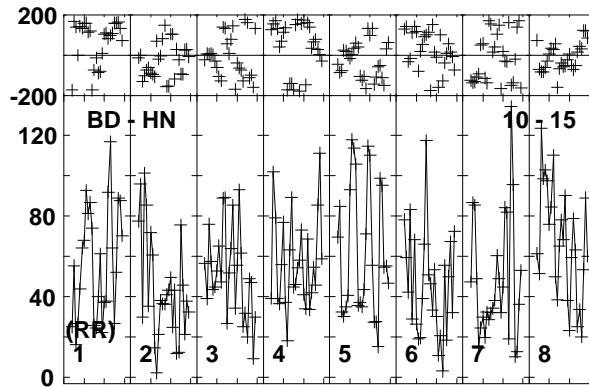
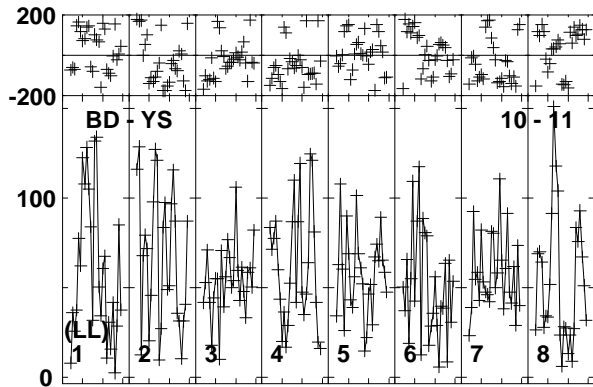
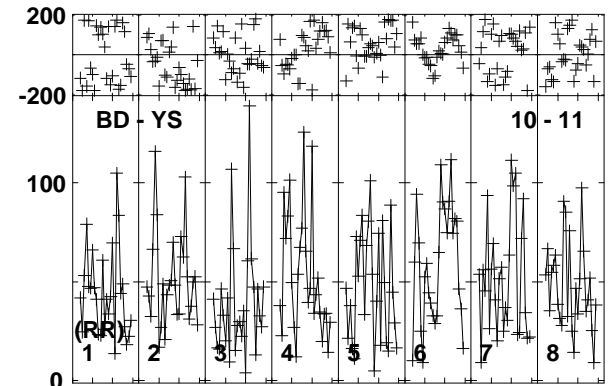
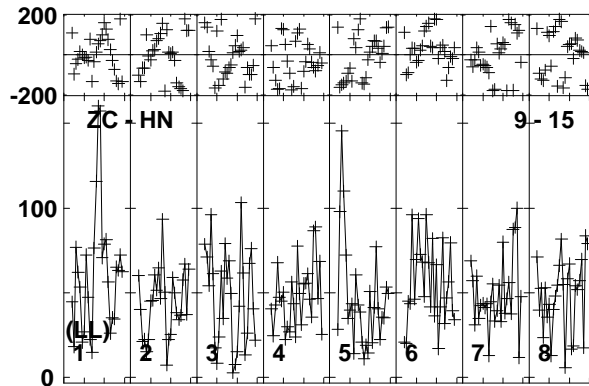
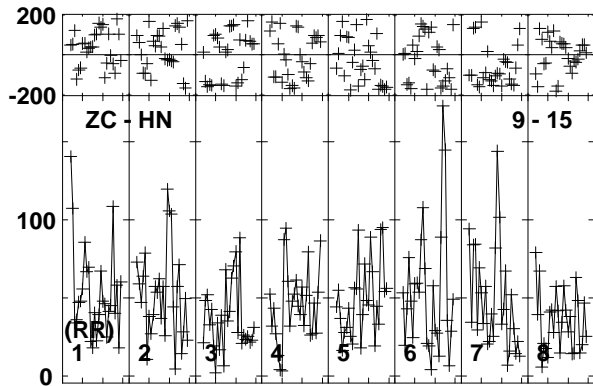
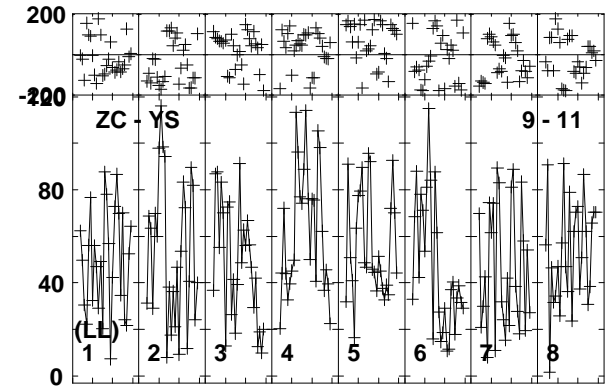
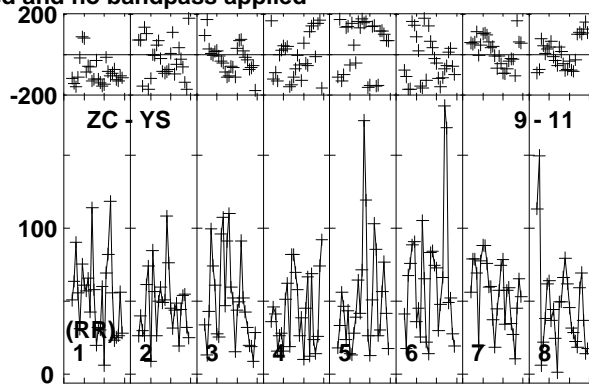
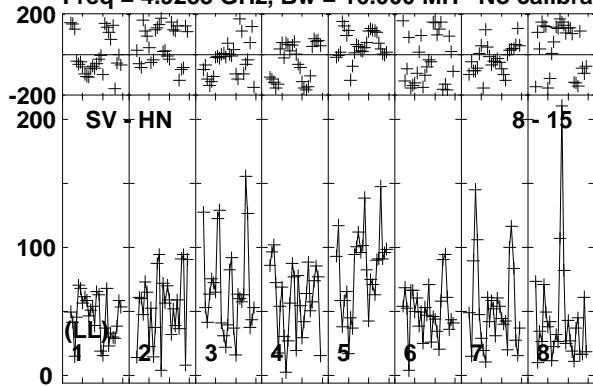

Lower frame: Micro Ampl Jy Top frame: Phas deg
Vector averaged cross-power spectrum Baseline: SV (08) - HN (15)
Timerange: 00/21:44:13 to 00/21:49:27

Plot file version 124 created 11-APR-2016 17:08:34

ARP299C GP053G 3.UVDATA.1

Freq = 4.9253 GHz, Bw = 16.000 MH No calibration applied and no bandpass applied

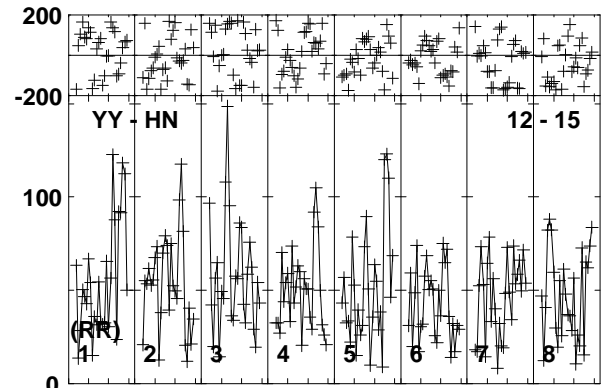
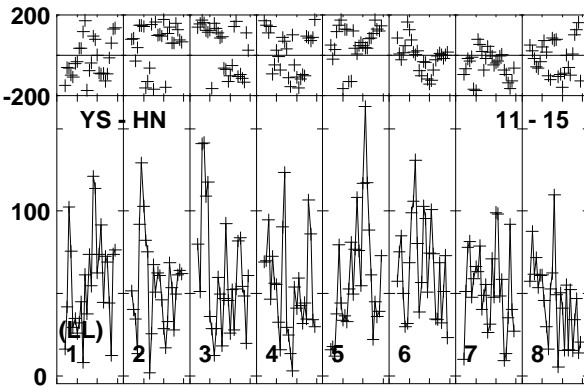
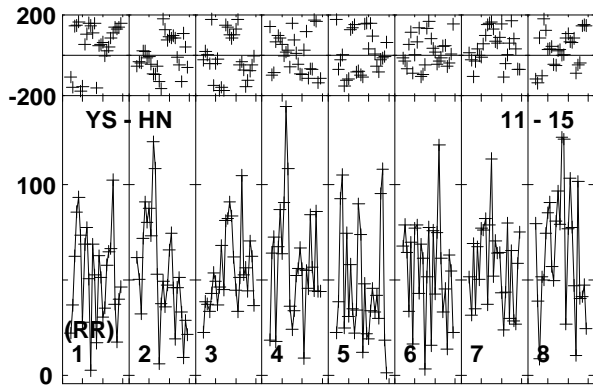
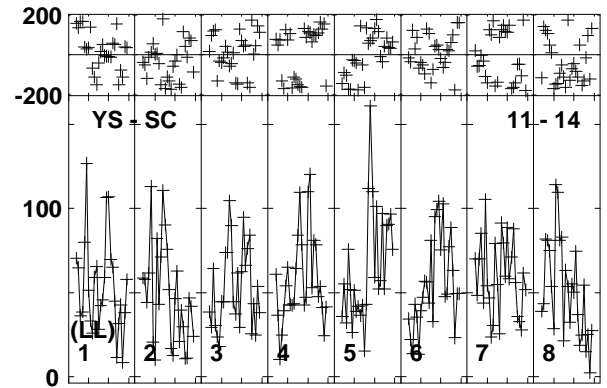
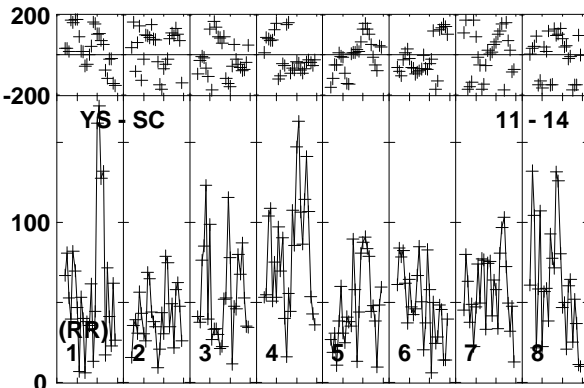
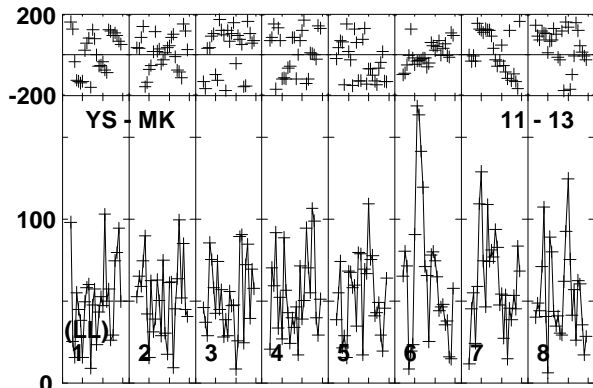
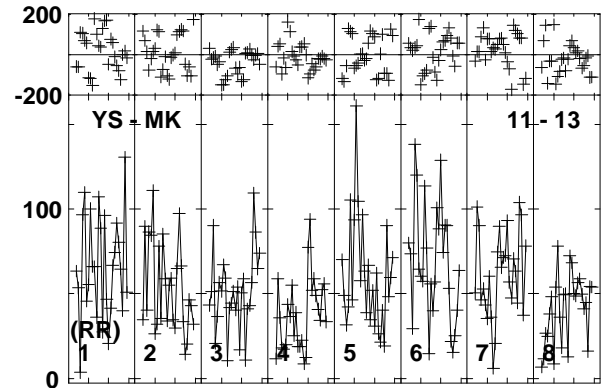
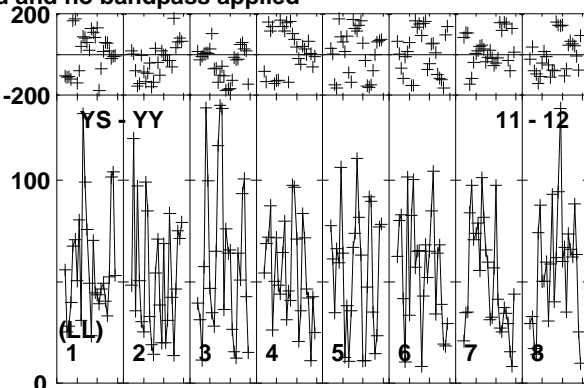
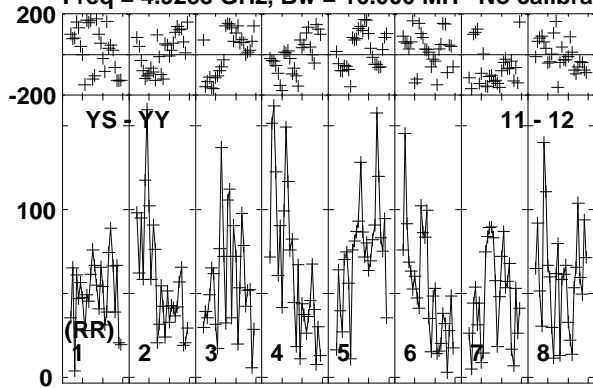

Lower frame: Micro Ampl Jy Top frame: Phas deg
Vector averaged cross-power spectrum Baseline: YS (11) - YY (12)
Timerange: 00/21:44:13 to 00/21:49:27

Plot file version 125 created 11-APR-2016 17:08:34

ARP299C GP053G 3.UVDATA.1

Freq = 4.9253 GHz, Bw = 16.000 MH No calibration applied and no bandpass applied

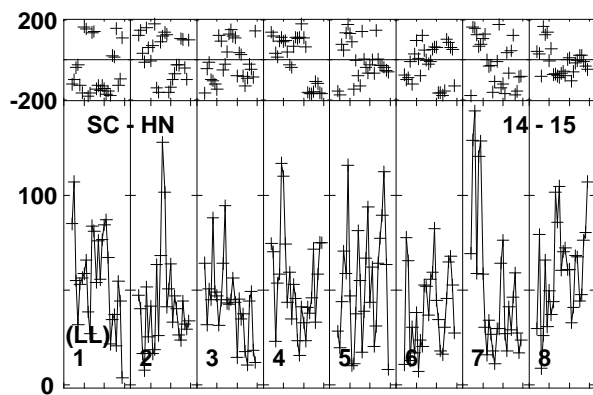
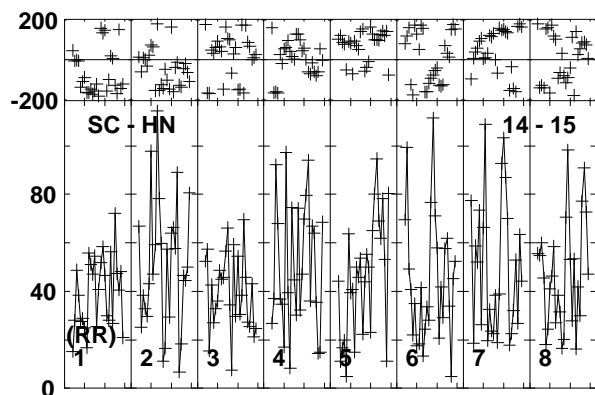
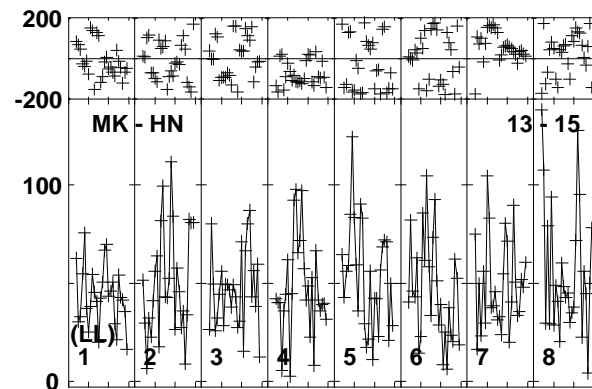
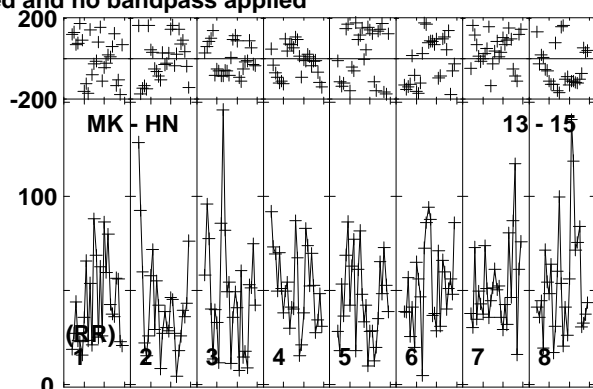
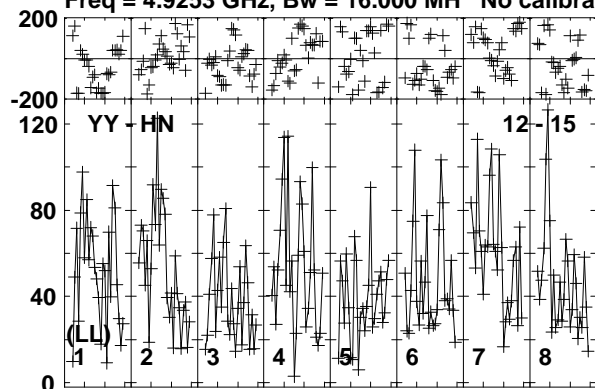

Lower frame: Micro Ampl Jy Top frame: Phas deg
Vector averaged cross-power spectrum Baseline: YY (12) - HN (15)
Timerange: 00/21:44:13 to 00/21:49:27

Plot file version 126 created 11-APR-2016 17:08:34

J1128+5925 GP053G 3.UVDATA.1

Freq = 4.9253 GHz, Bw = 16.000 MH No calibration applied and no bandpass applied

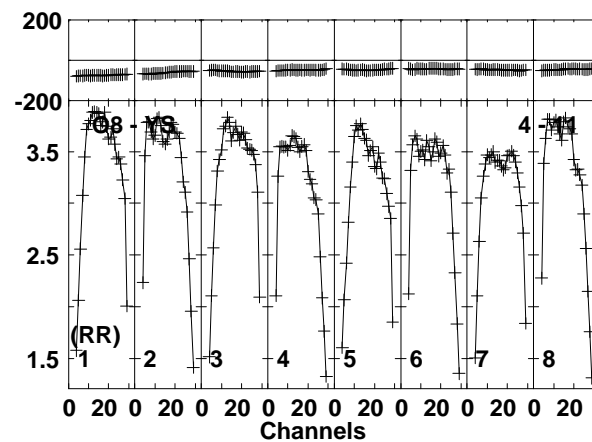
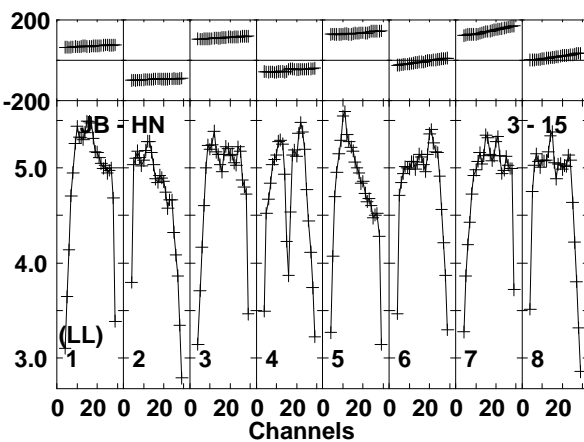
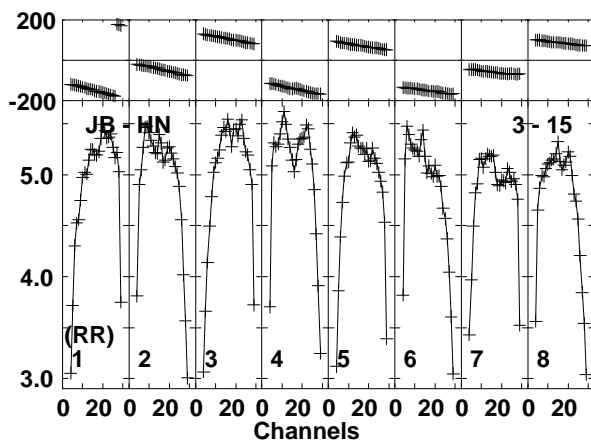
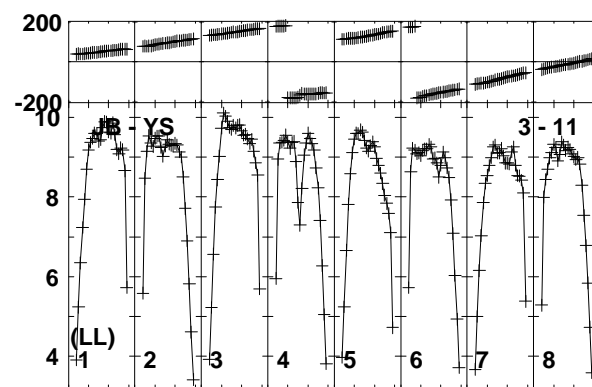
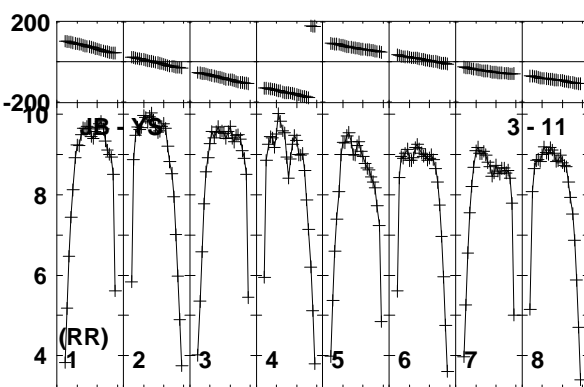
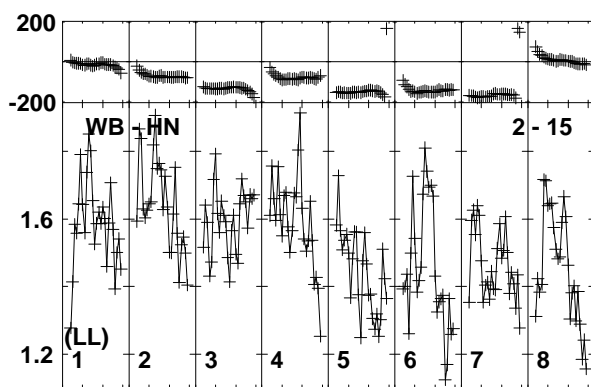
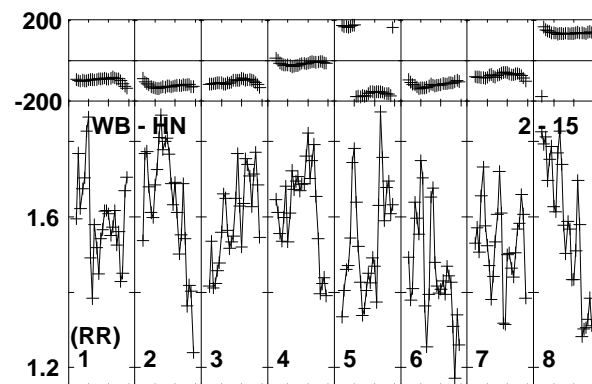
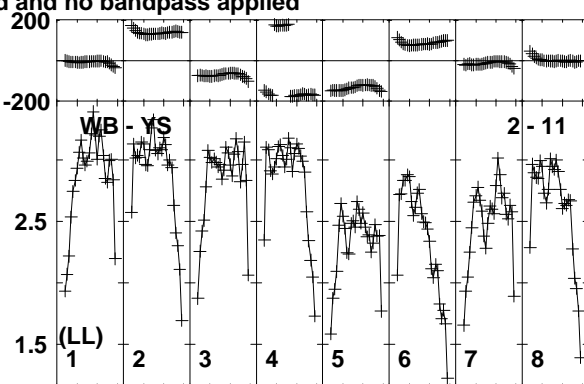
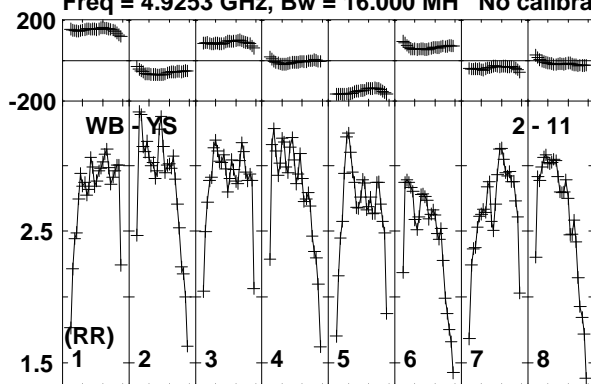

Lower frame: Milli Ampl Jy Top frame: Phas deg
Vector averaged cross-power spectrum Baseline: WB (02) - YS (11)
Timerange: 00:21:49:34 to 00:21:51:17

Plot file version 127 created 11-APR-2016 17:08:34

J1128+5925 GP053G 3.UVDATA.1

Freq = 4.9253 GHz, Bw = 16.000 MH No calibration applied and no bandpass applied

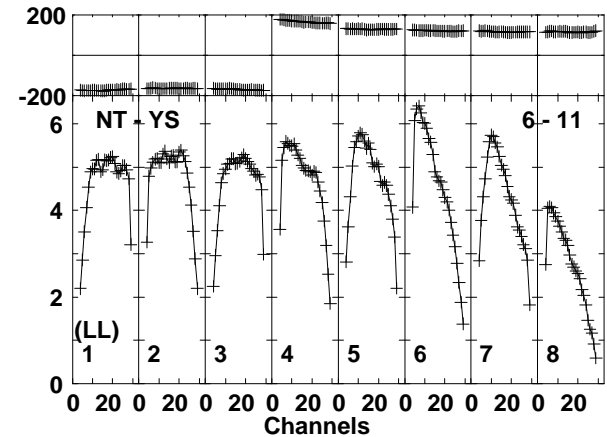
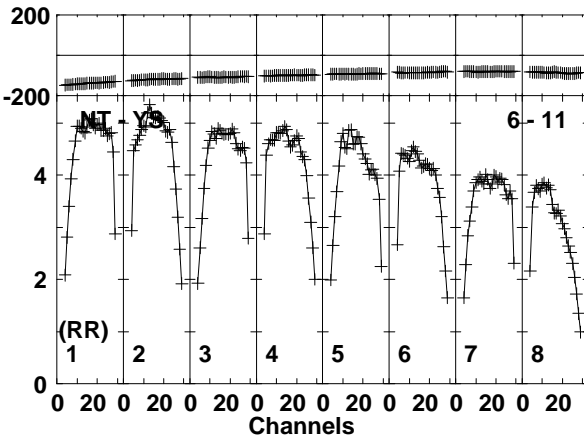
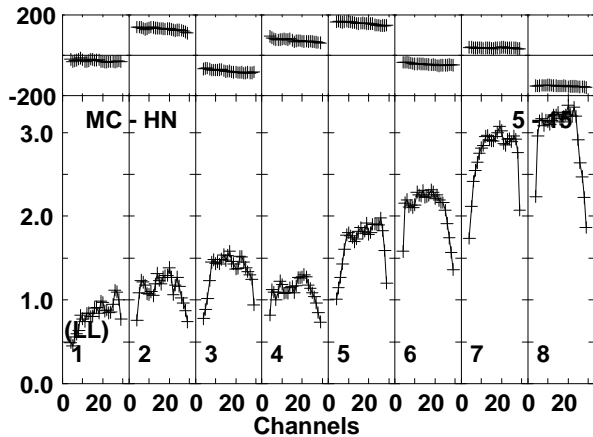
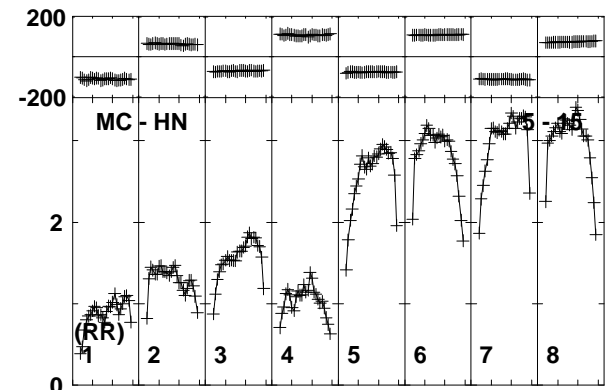
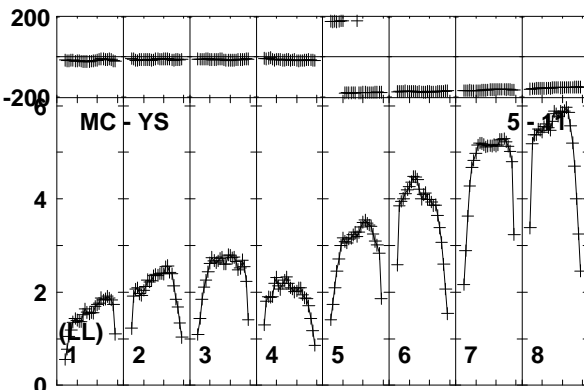
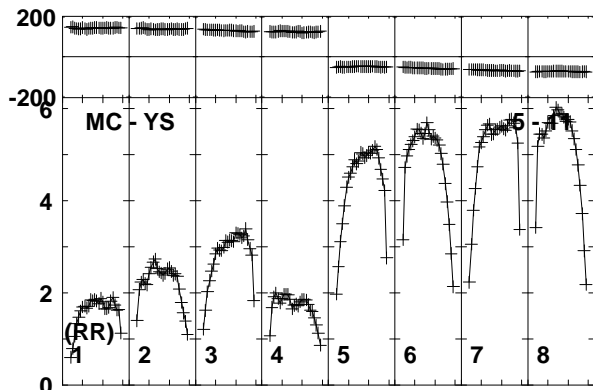
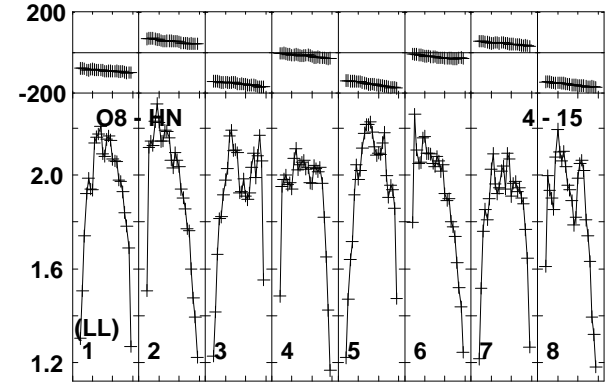
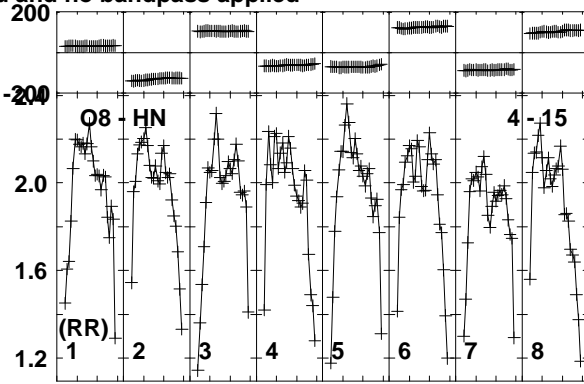
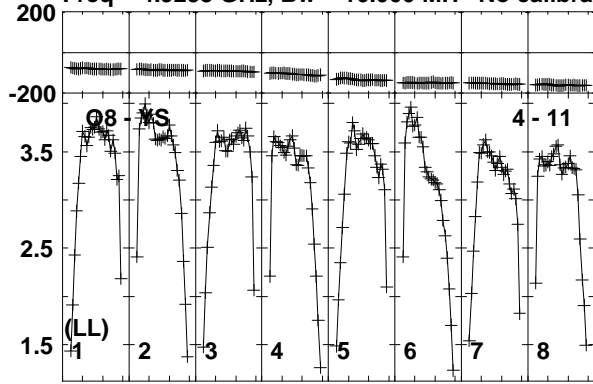

Lower frame: Milli Ampl Jy Top frame: Phas deg
Vector averaged cross-power spectrum Baseline: O8 (04) - YS (11)
Timerange: 00/21:49:34 to 00/21:51:17

Plot file version 128 created 11-APR-2016 17:08:35

J1128+5925 GP053G 3.UVDATA.1

Freq = 4.9253 GHz, Bw = 16.000 MH No calibration applied and no bandpass applied

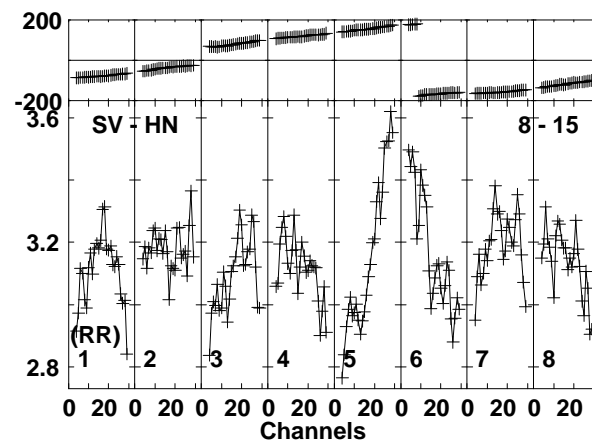
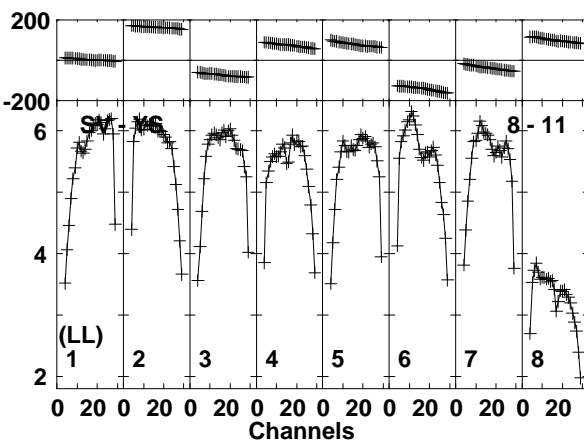
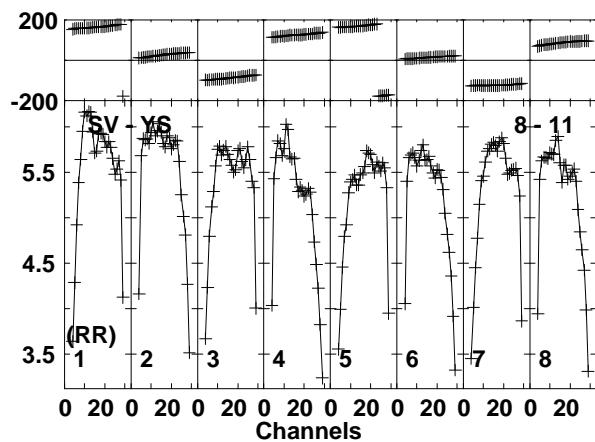
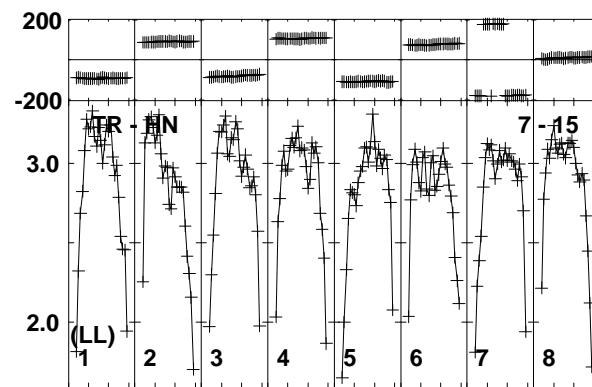
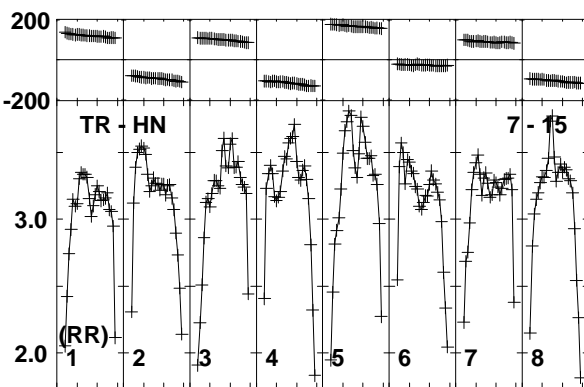
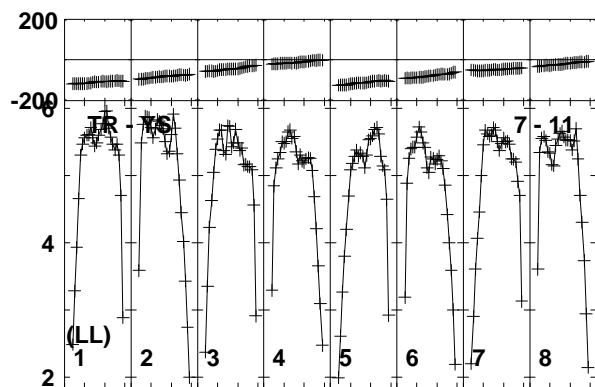
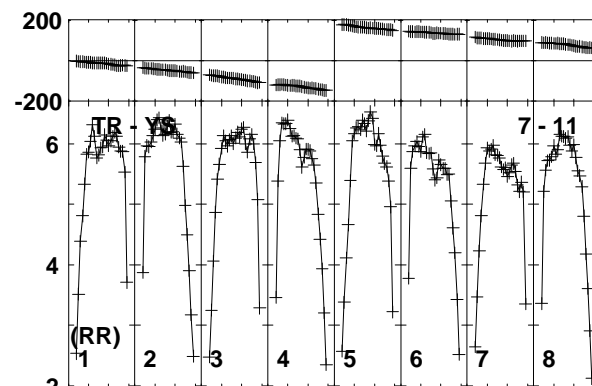
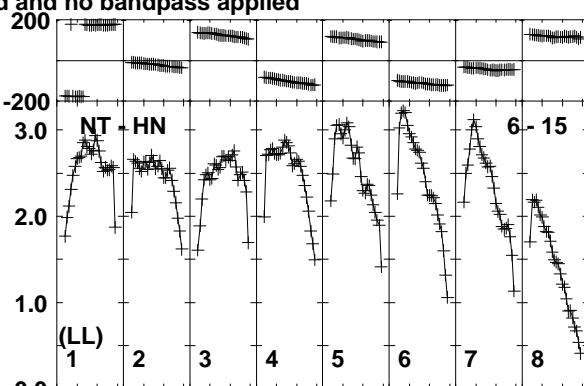
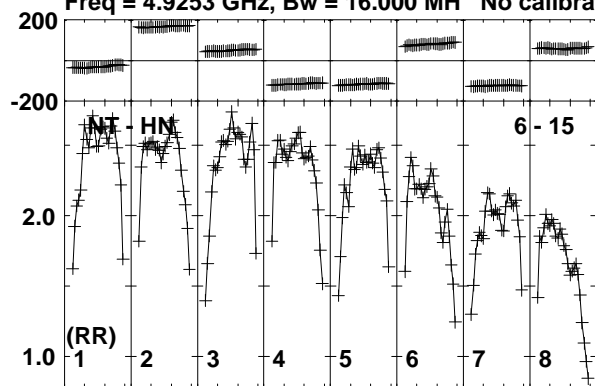

Lower frame: Milli Ampl Jy Top frame: Phas deg
Vector averaged cross-power spectrum Baseline: NT (06) - HN (15)
Timerange: 00/21:49:34 to 00/21:51:17

Plot file version 129 created 11-APR-2016 17:08:35

J1128+5925 GP053G 3.UVDATA.1

Freq = 4.9253 GHz, Bw = 16.000 MH No calibration applied and no bandpass applied

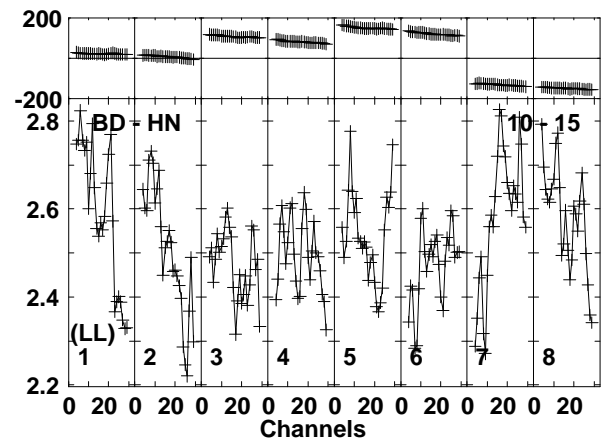
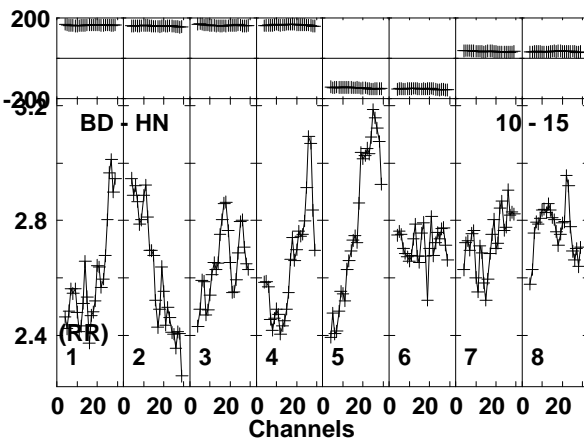
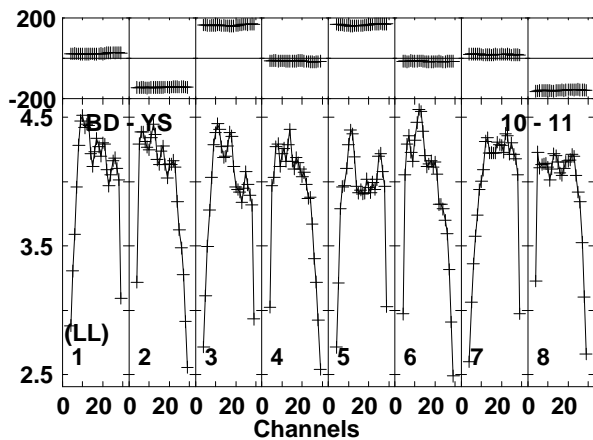
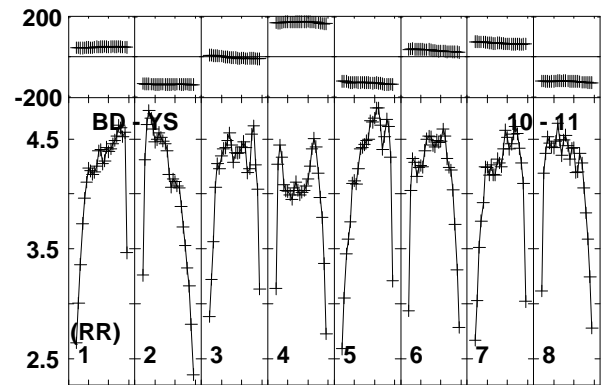
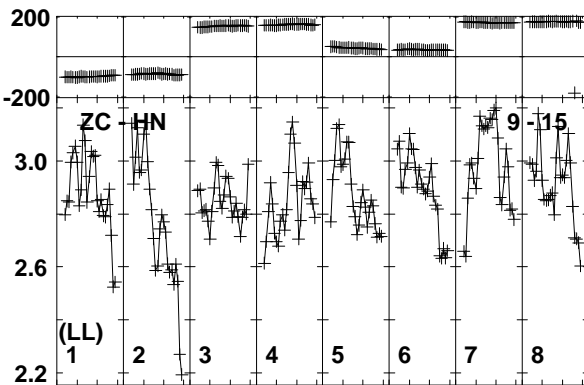
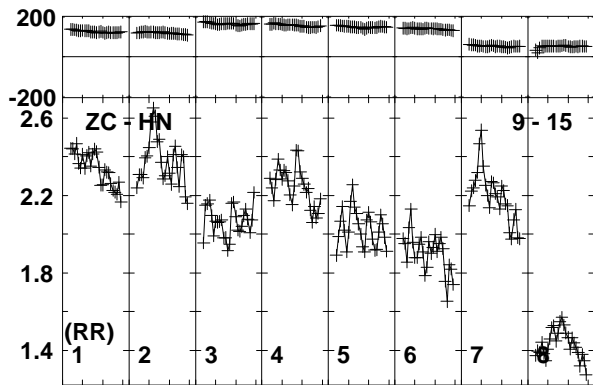
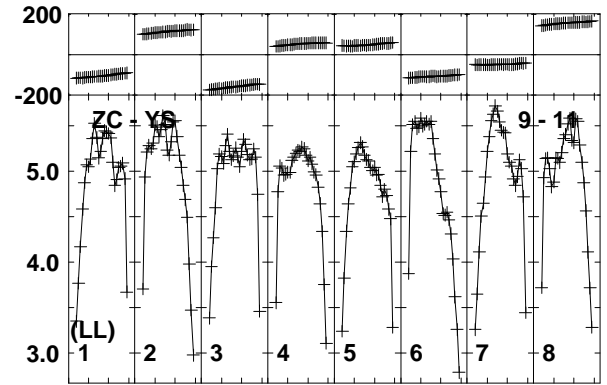
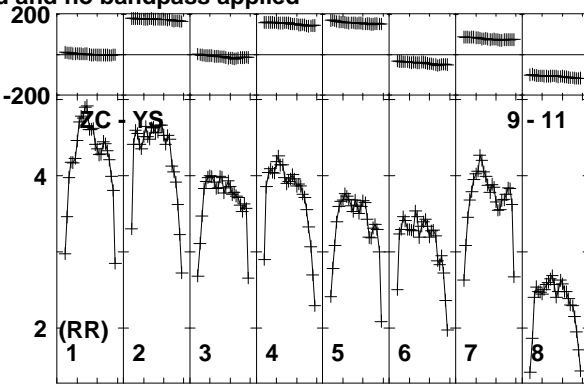
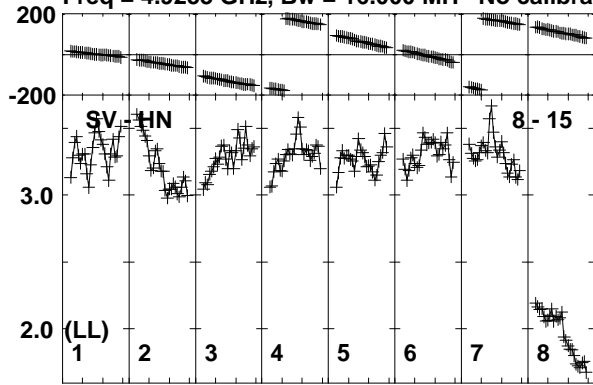

Lower frame: Milli Ampl Jy Top frame: Phas deg
Vector averaged cross-power spectrum Baseline: SV (08) - HN (15)
Timerange: 00/21:49:34 to 00/21:51:17

Plot file version 130 created 11-APR-2016 17:08:35

J1128+5925 GP053G 3.UVDATA.1

Freq = 4.9253 GHz, Bw = 16.000 MH No calibration applied and no bandpass applied

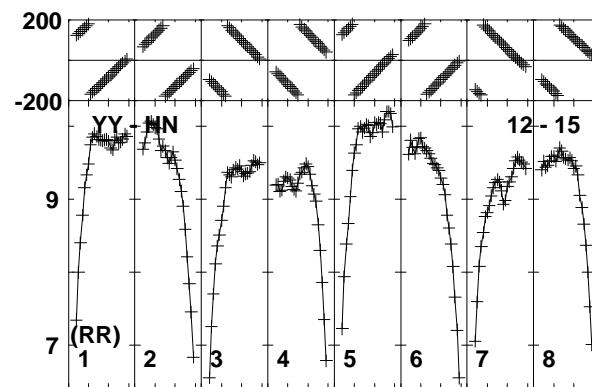
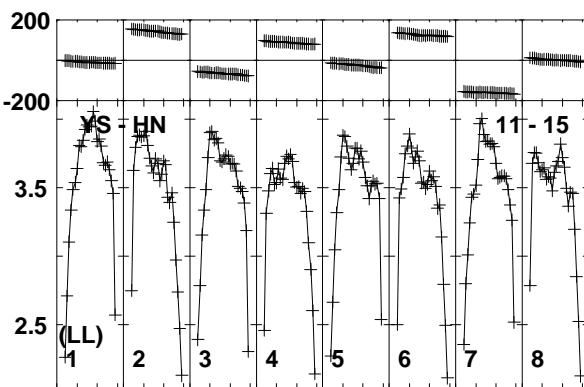
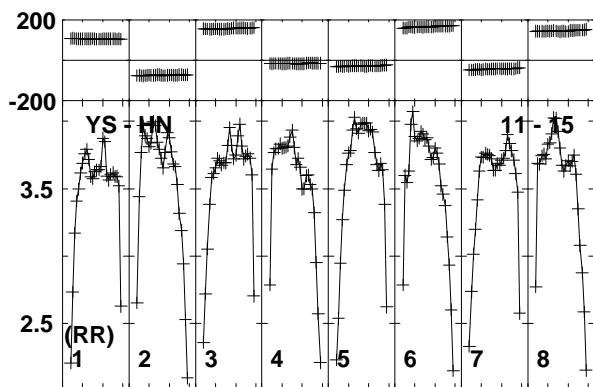
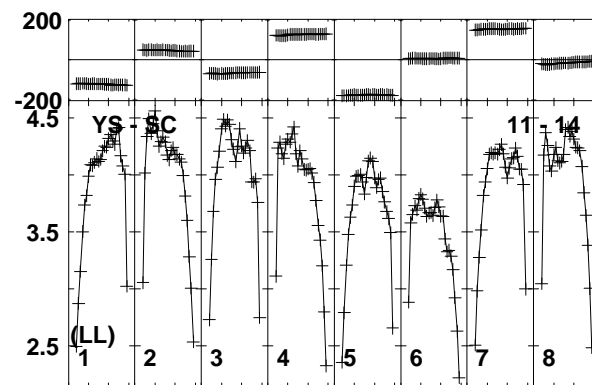
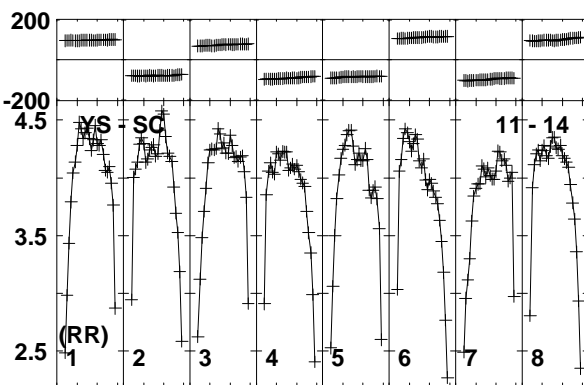
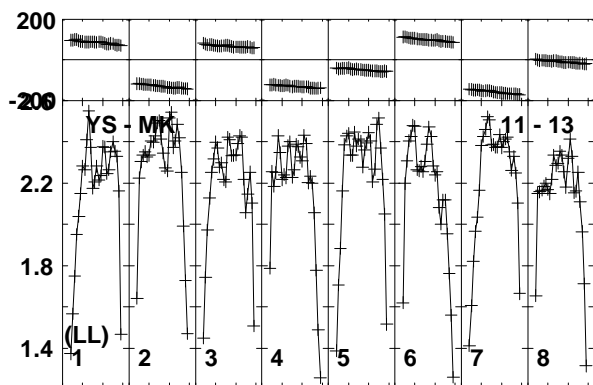
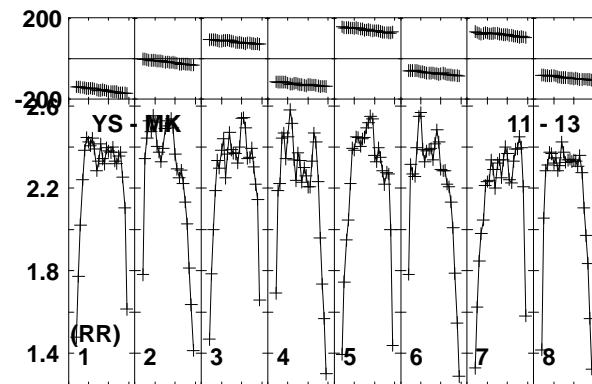
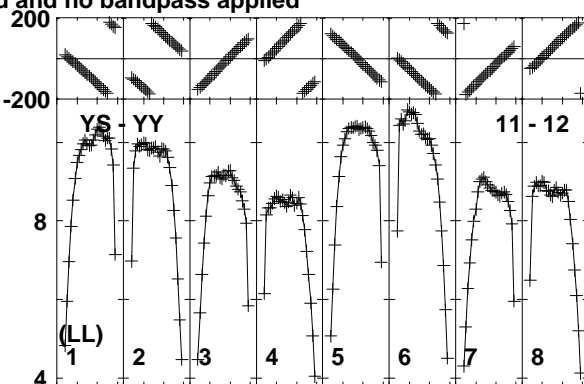
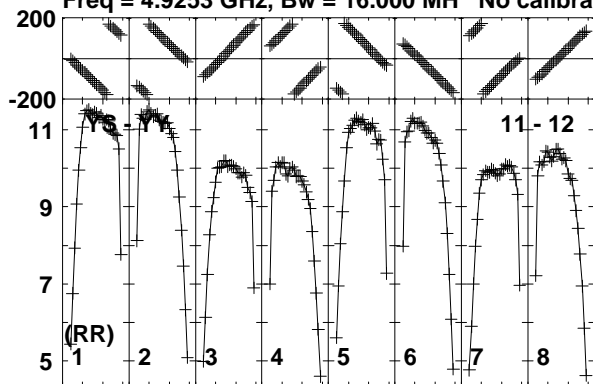

Lower frame: Milli Ampl Jy Top frame: Phas deg
Vector averaged cross-power spectrum Baseline: YS (11) - YY (12)
Timerange: 00/21:49:34 to 00/21:51:17

Plot file version 131 created 11-APR-2016 17:08:35

J1128+5925 GP053G 3.UVDATA.1

Freq = 4.9253 GHz, Bw = 16.000 MH No calibration applied and no bandpass applied

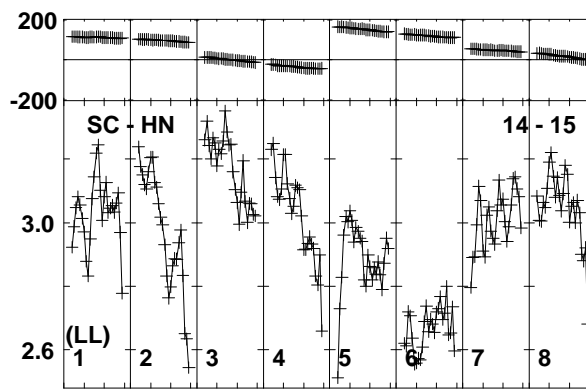
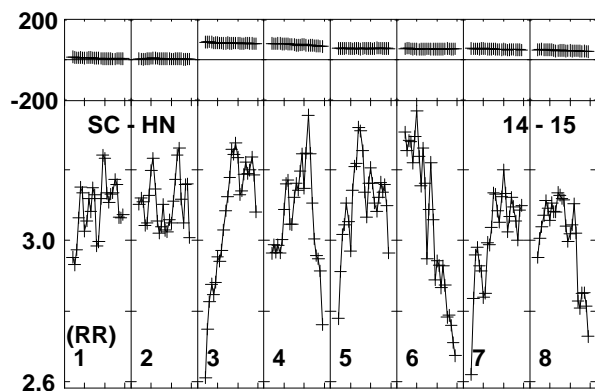
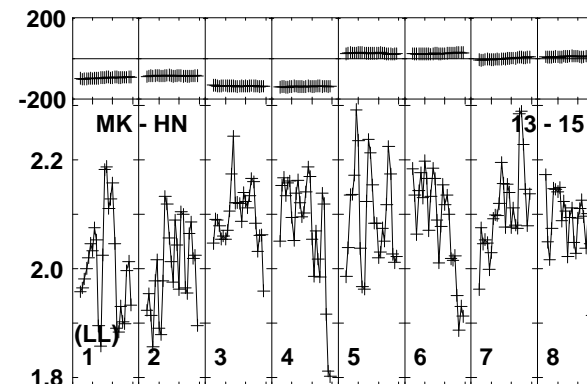
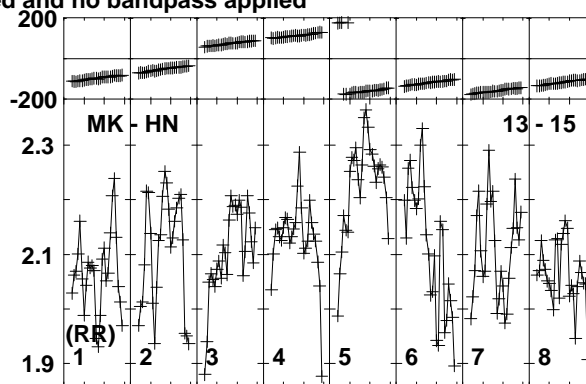
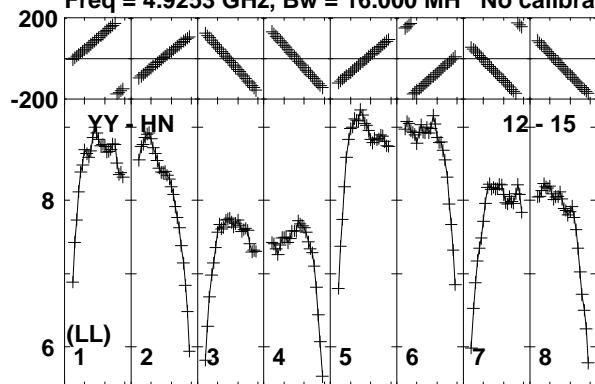

Lower frame: Milli Ampl Jy Top frame: Phas deg
Vector averaged cross-power spectrum Baseline: YY (12) - HN (15)
Timerange: 00/21:49:34 to 00/21:51:17

Plot file version 132 created 11-APR-2016 17:08:35

ARP299C GP053G 3.UVDATA.1

Freq = 4.9253 GHz, Bw = 16.000 MH No calibration applied and no bandpass applied

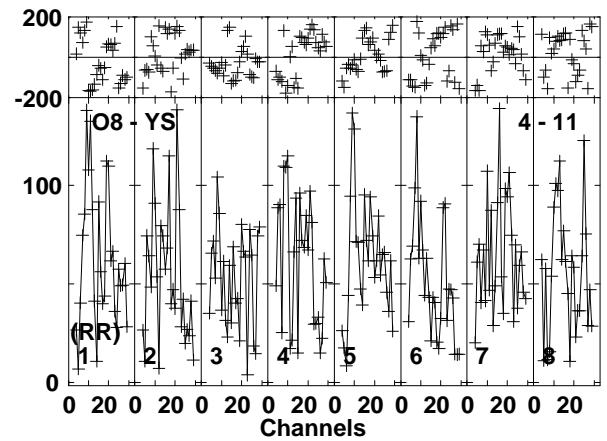
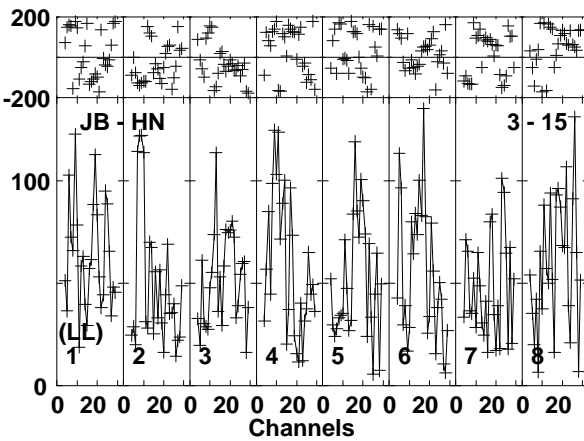
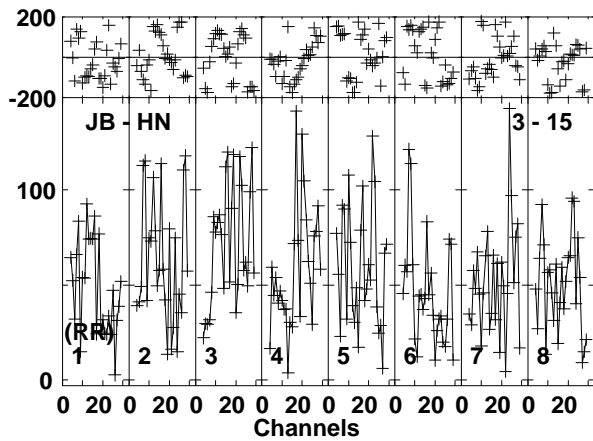
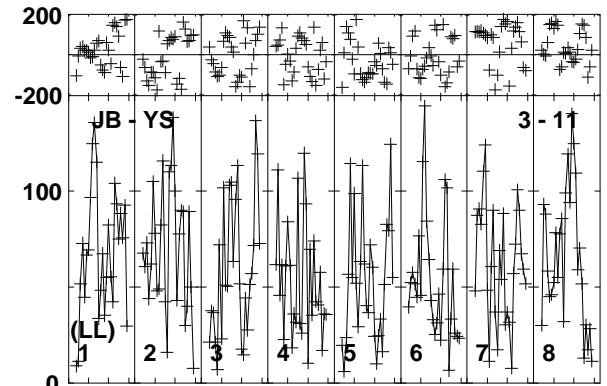
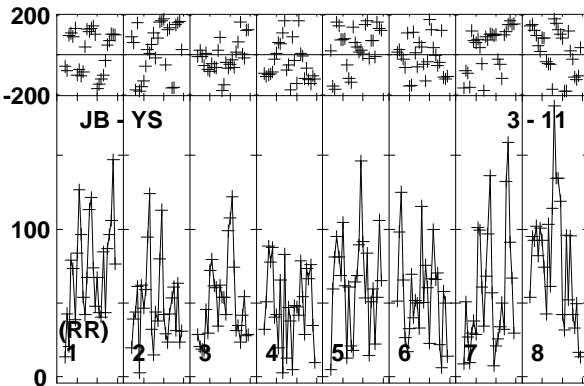
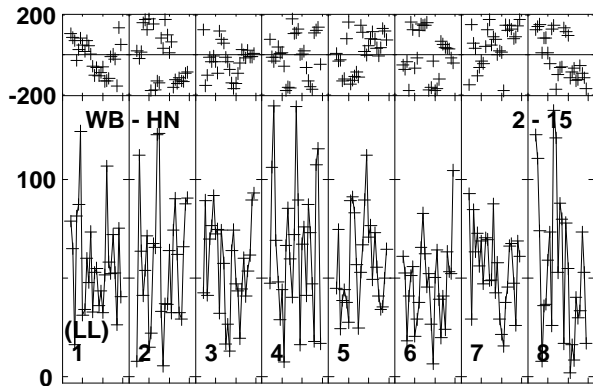
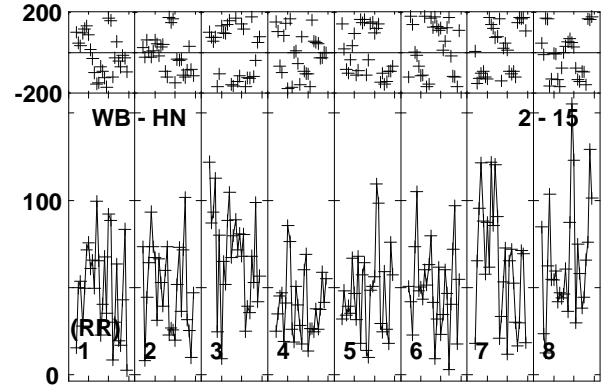
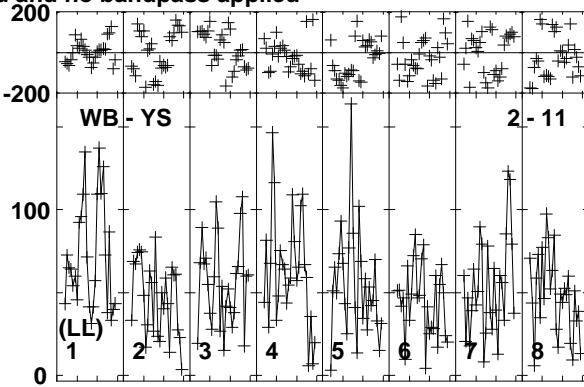
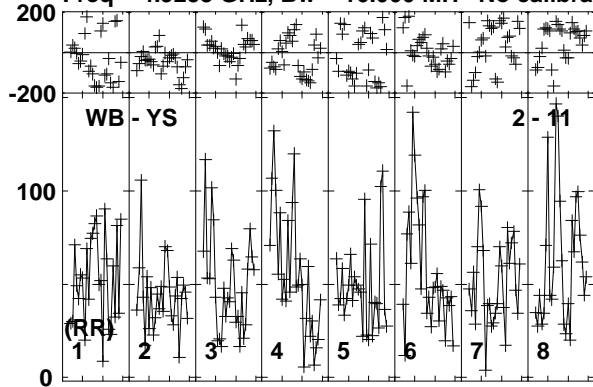

Lower frame: Micro Ampl Jy Top frame: Phas deg
Vector averaged cross-power spectrum Baseline: WB (02) - YS (11)
Timerange: 00/21:51:24 to 00/21:56:36

Plot file version 133 created 11-APR-2016 17:08:35

ARP299C GP053G 3.UVDATA.1

Freq = 4.9253 GHz, Bw = 16.000 MH No calibration applied and no bandpass applied

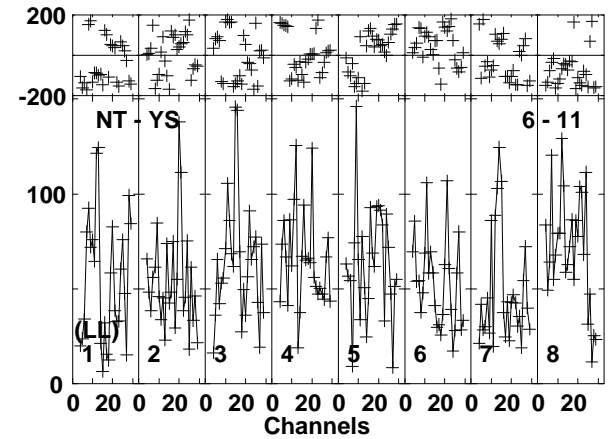
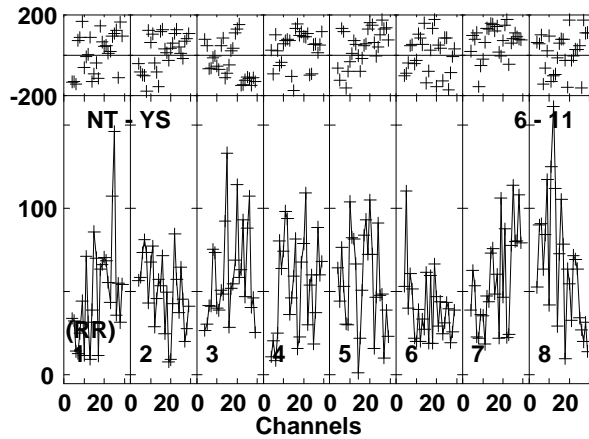
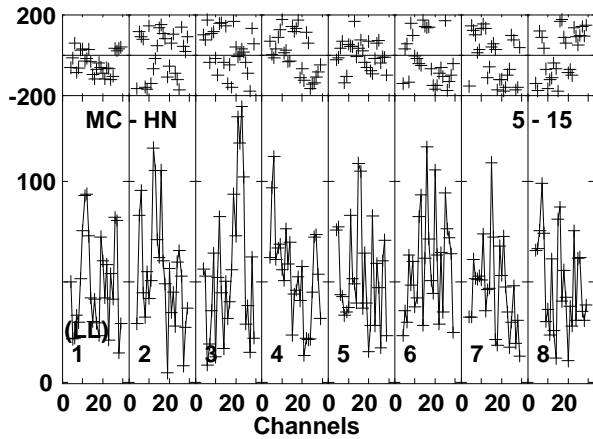
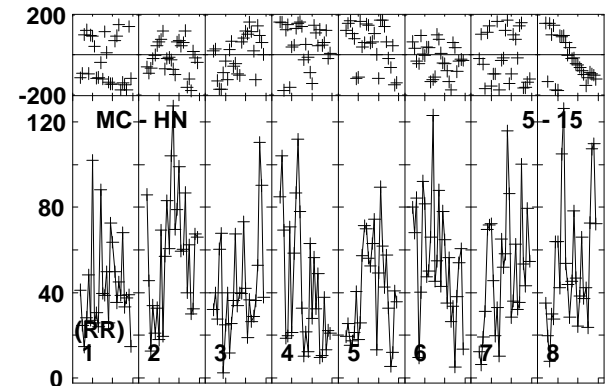
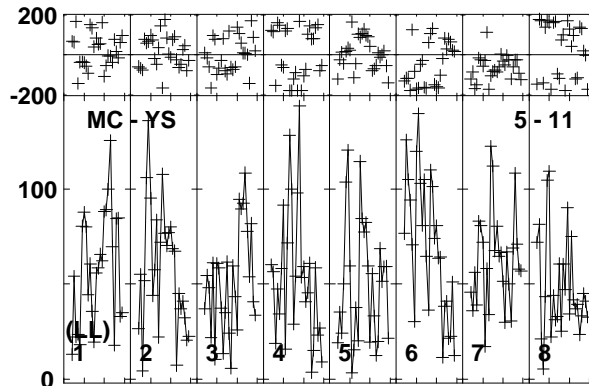
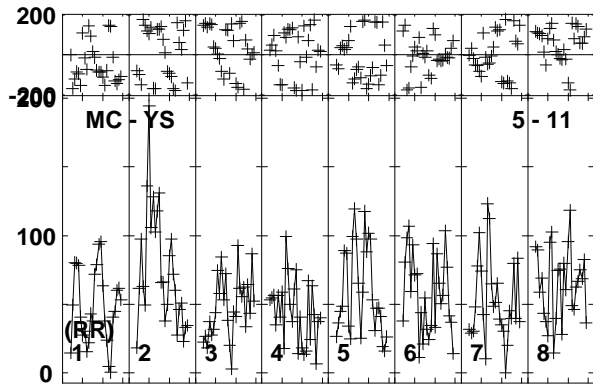
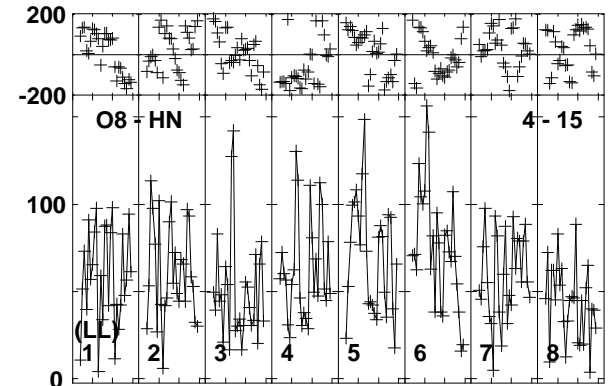
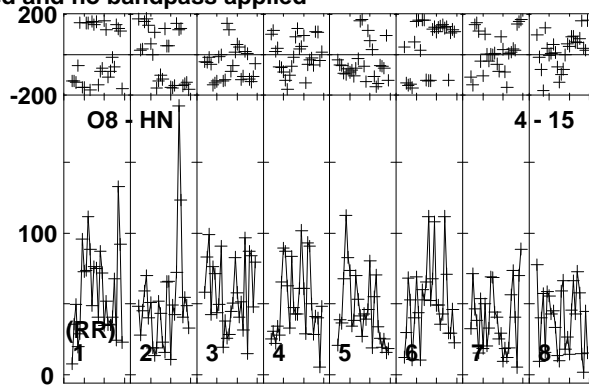
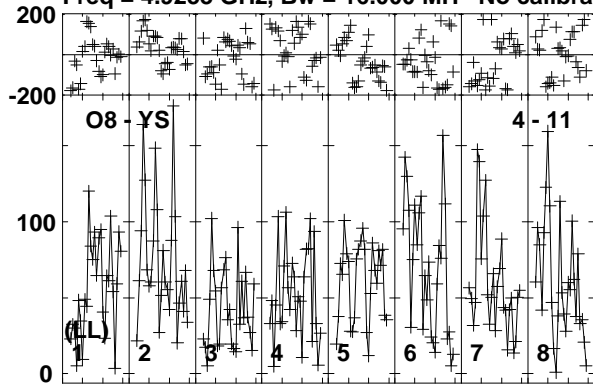

Lower frame: Micro Ampl Jy Top frame: Phas deg
Vector averaged cross-power spectrum Baseline: O8 (04) - YS (11)
Timerange: 00/21:51:24 to 00/21:56:36

Plot file version 134 created 11-APR-2016 17:08:36

ARP299C GP053G 3.UVDATA.1

Freq = 4.9253 GHz, Bw = 16.000 MH No calibration applied and no bandpass applied

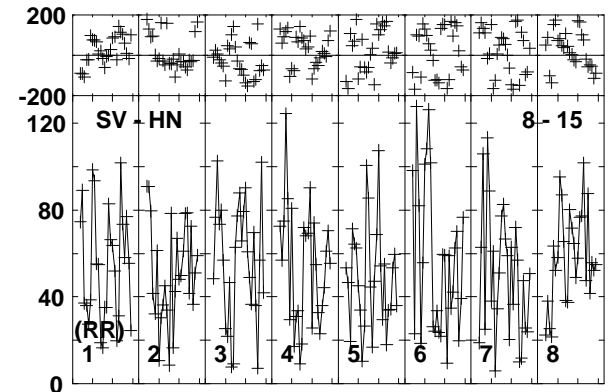
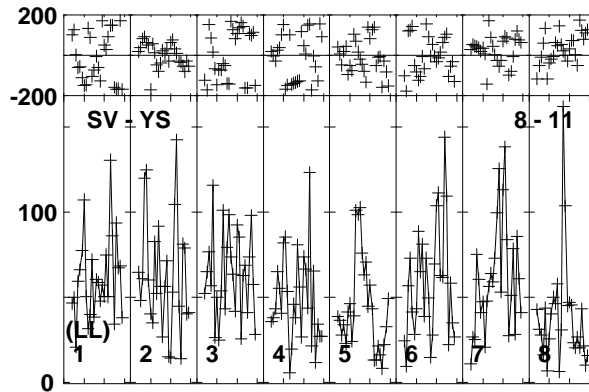
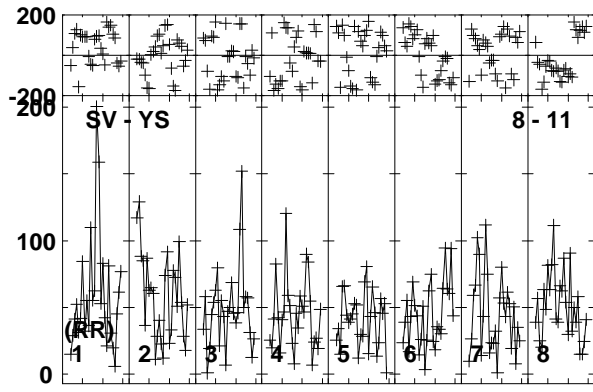
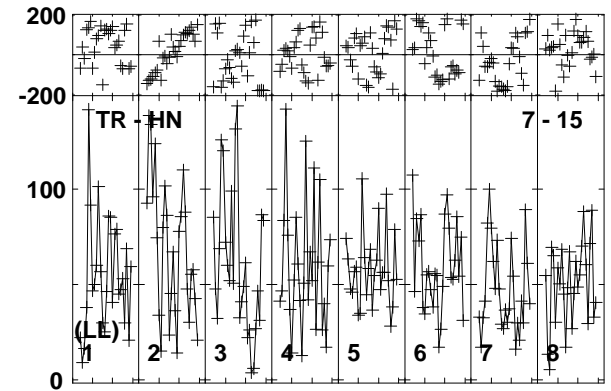
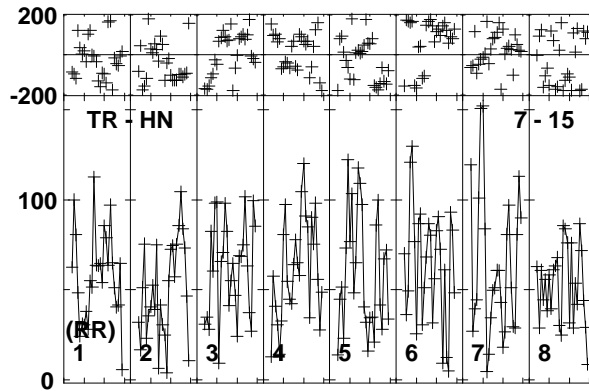
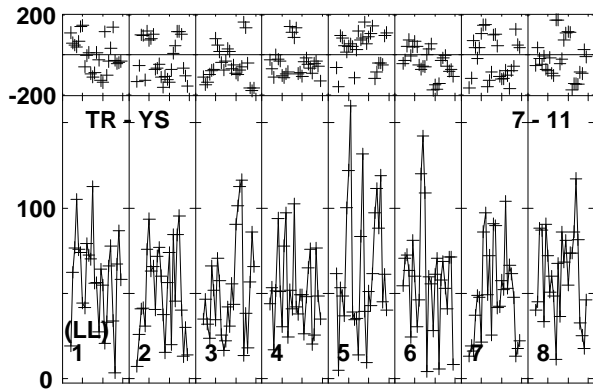
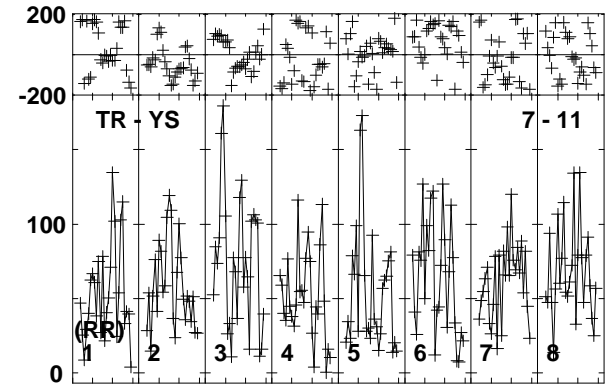
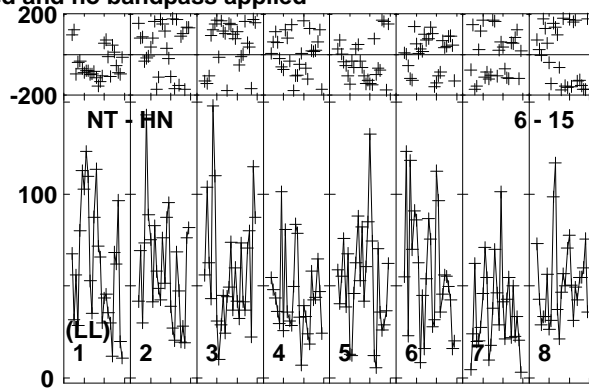
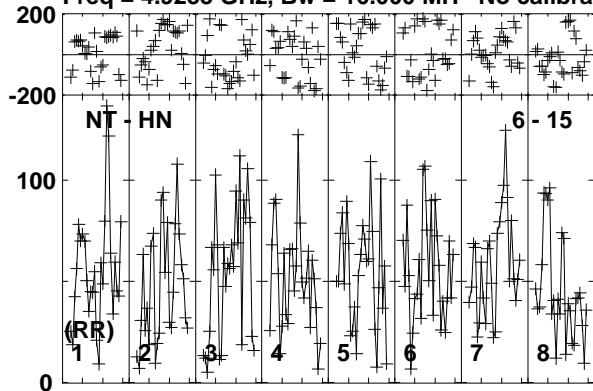

Lower frame: Micro Ampl Jy Top frame: Phas deg
Vector averaged cross-power spectrum Baseline: NT (06) - HN (15)
Timerange: 00/21:51:24 to 00/21:56:36

Plot file version 135 created 11-APR-2016 17:08:36

ARP299C GP053G 3.UVDATA.1

Freq = 4.9253 GHz, Bw = 16.000 MH No calibration applied and no bandpass applied

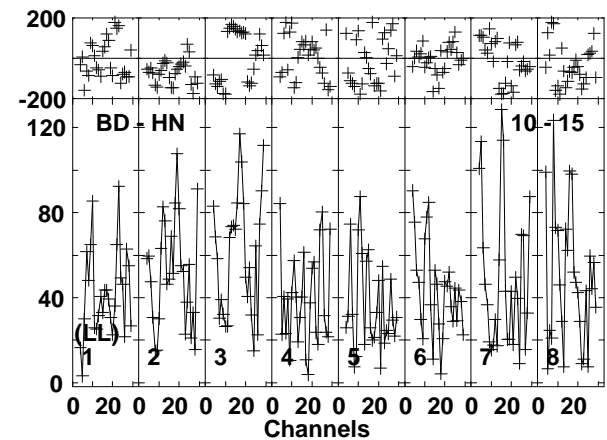
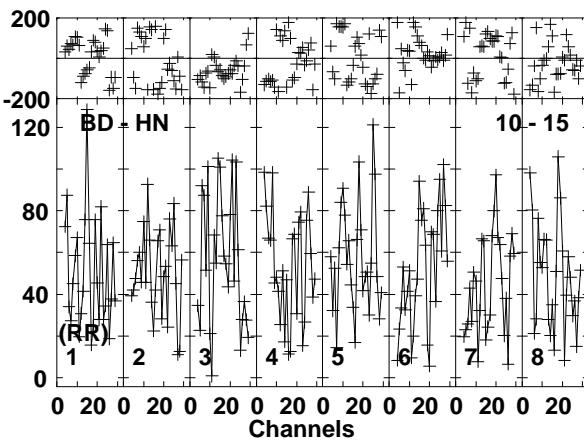
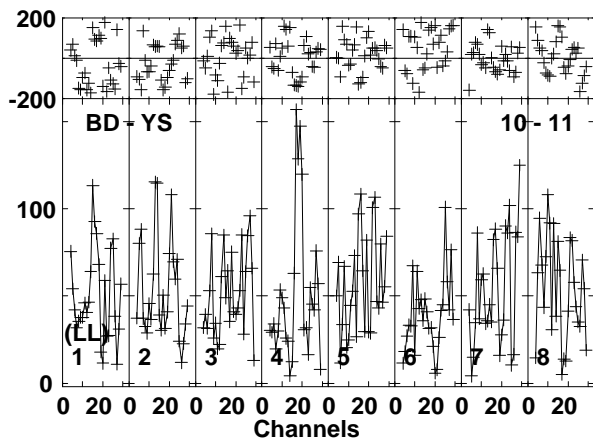
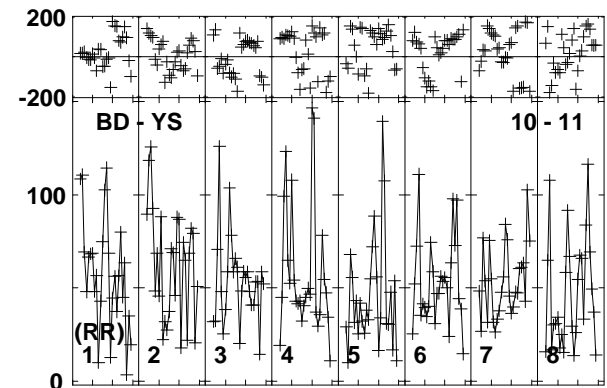
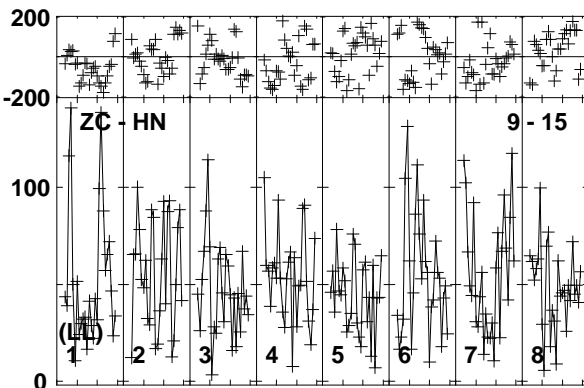
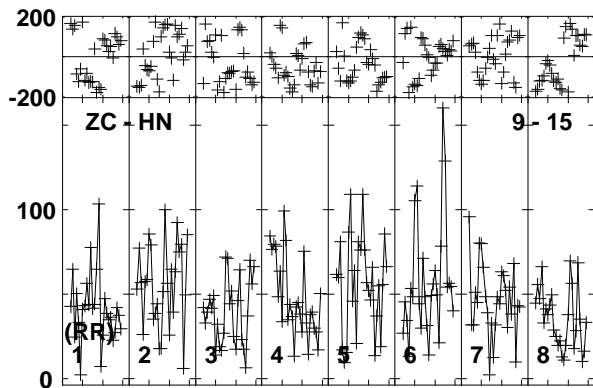
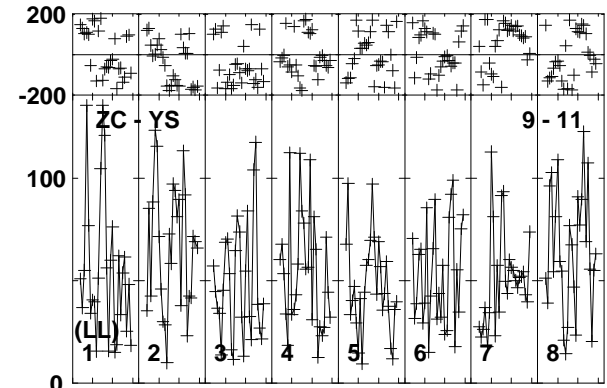
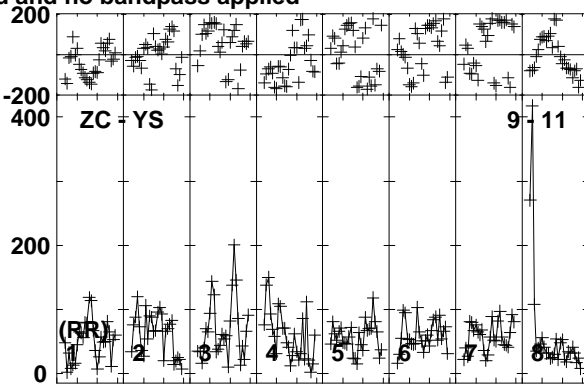
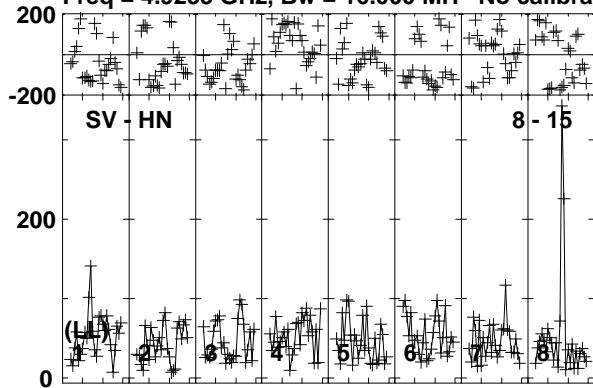

Lower frame: Micro Ampl Jy Top frame: Phas deg
Vector averaged cross-power spectrum Baseline: SV (08) - HN (15)
Timerange: 00/21:51:24 to 00/21:56:36

Plot file version 136 created 11-APR-2016 17:08:36

ARP299C GP053G 3.UVDATA.1

Freq = 4.9253 GHz, Bw = 16.000 MH No calibration applied and no bandpass applied

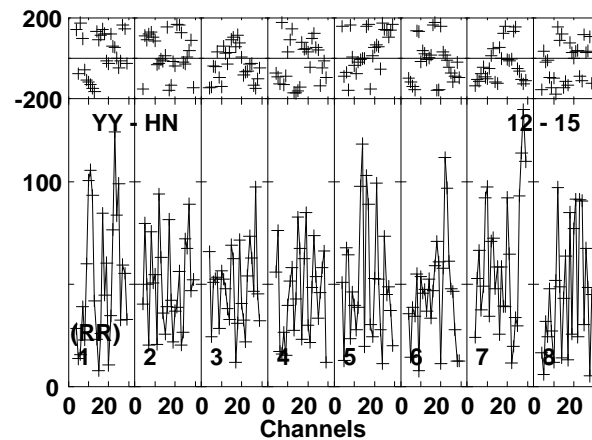
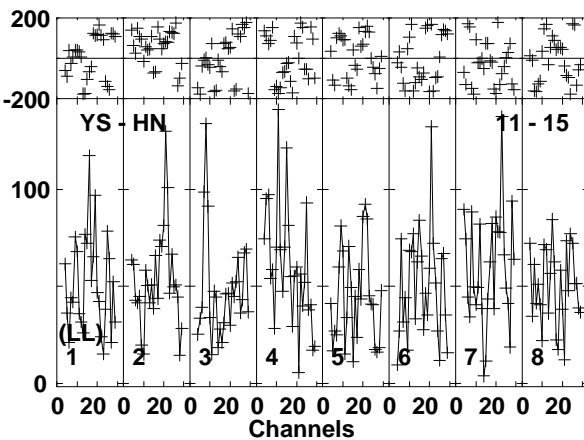
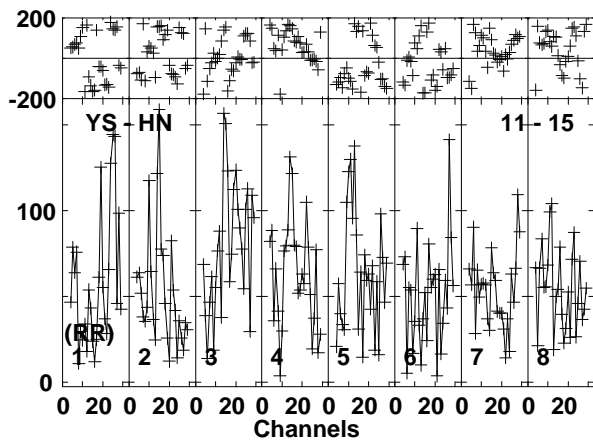
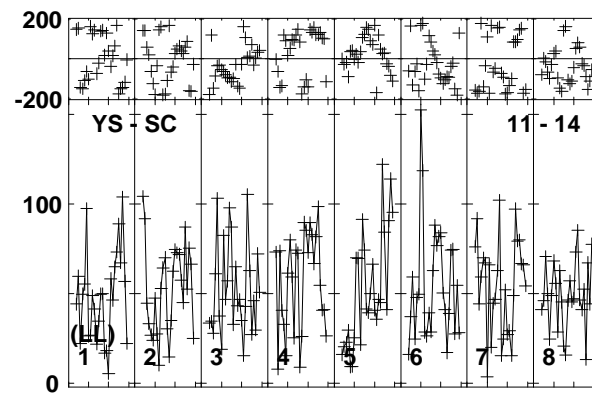
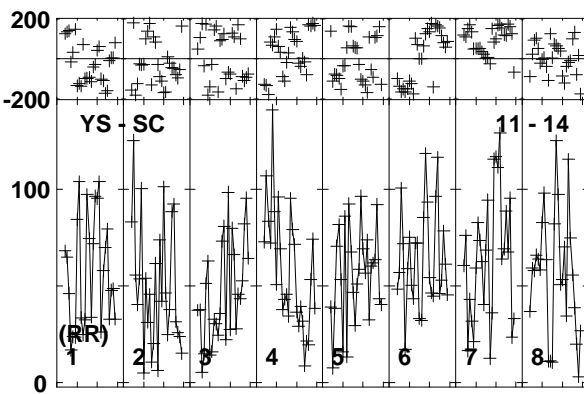
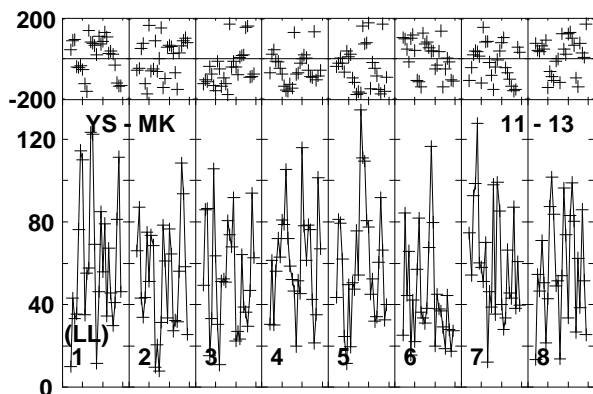
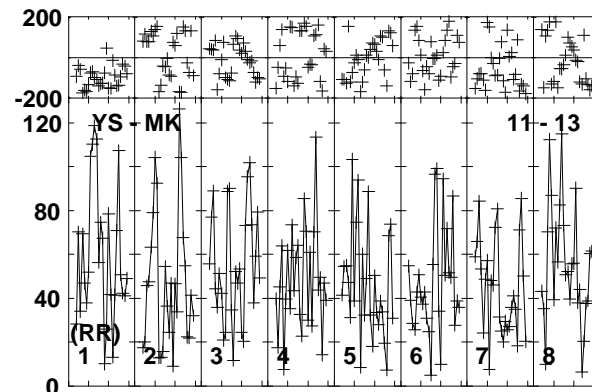
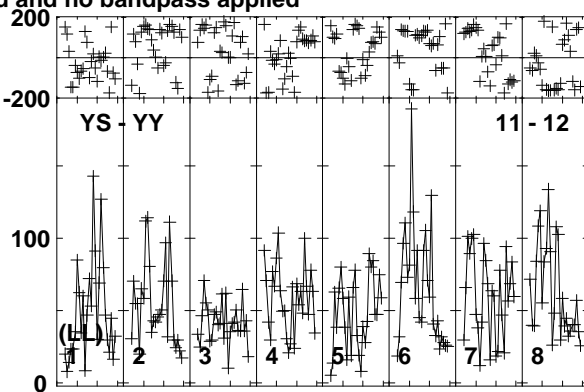
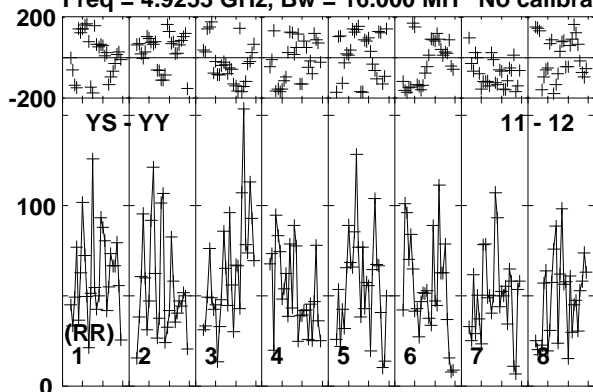

Lower frame: Micro Ampl Jy Top frame: Phas deg
Vector averaged cross-power spectrum Baseline: YS (11) - YY (12)
Timerange: 00/21:51:24 to 00/21:56:36

Plot file version 137 created 11-APR-2016 17:08:36

ARP299C GP053G 3.UVDATA.1

Freq = 4.9253 GHz, Bw = 16.000 MH No calibration applied and no bandpass applied

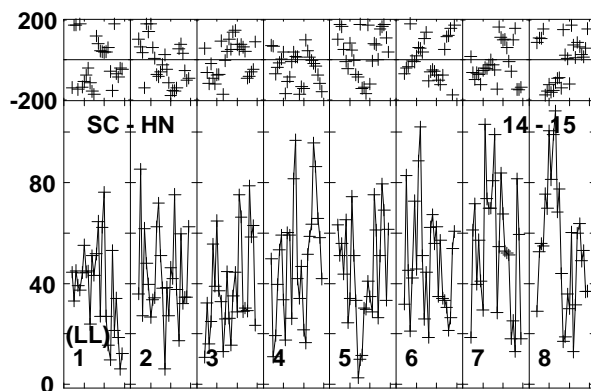
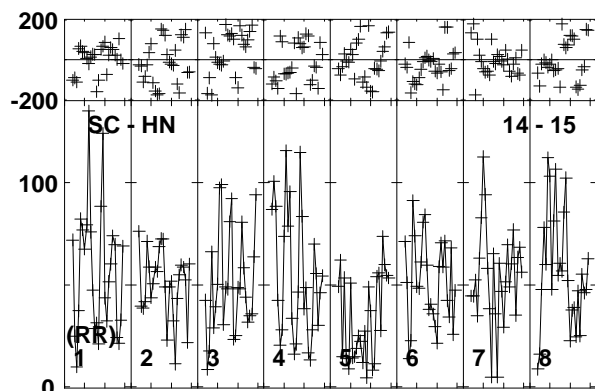
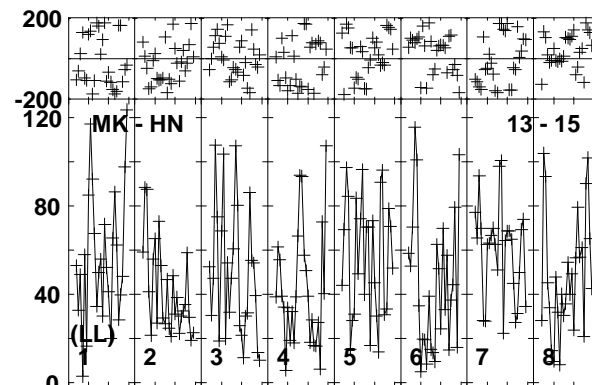
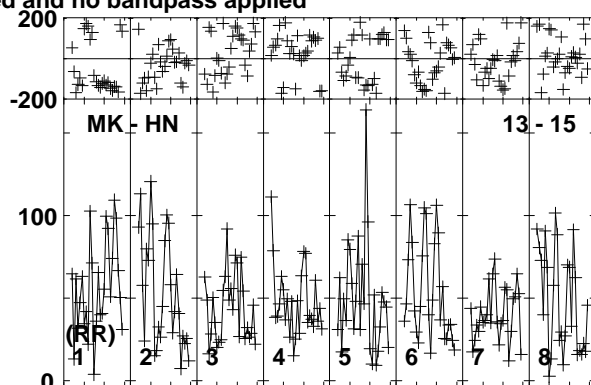
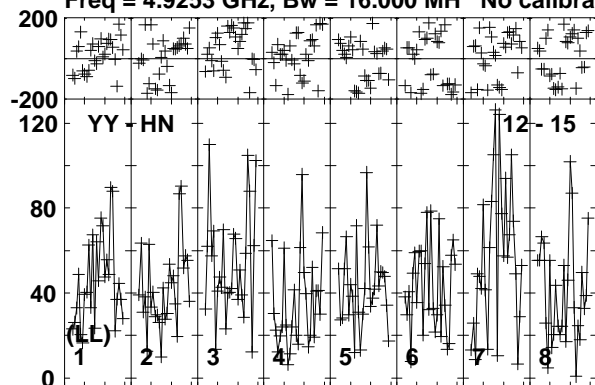

Lower frame: Micro Ampl Jy Top frame: Phas deg
Vector averaged cross-power spectrum Baseline: YY (12) - HN (15)
Timerange: 00/21:51:24 to 00/21:56:36

Plot file version 138 created 11-APR-2016 17:08:36

J1128+5925 GP053G 3.UVDATA.1

Freq = 4.9253 GHz, Bw = 16.000 MH No calibration applied and no bandpass applied

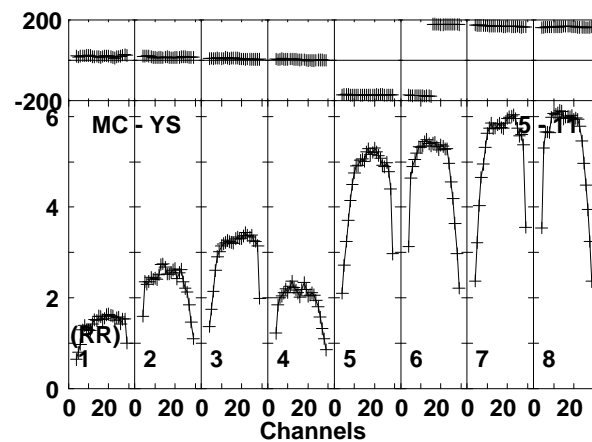
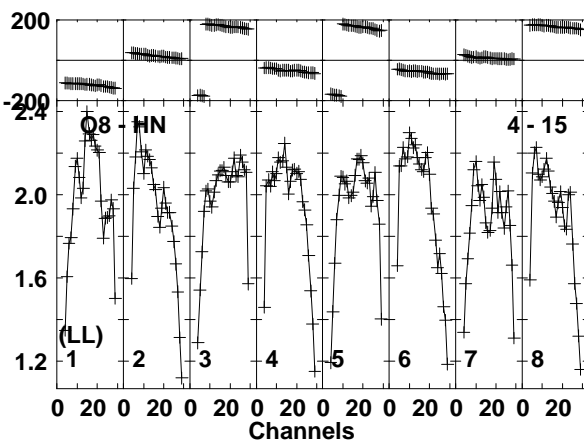
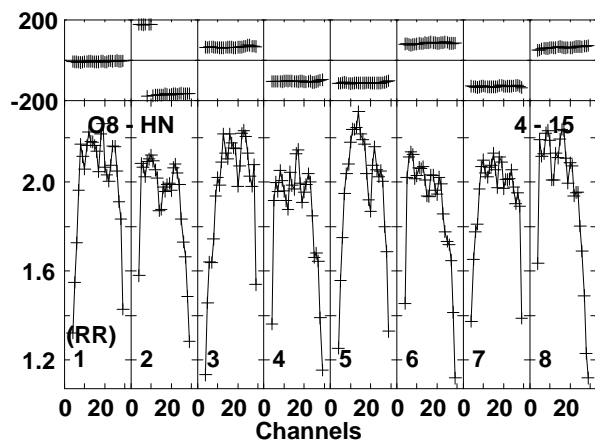
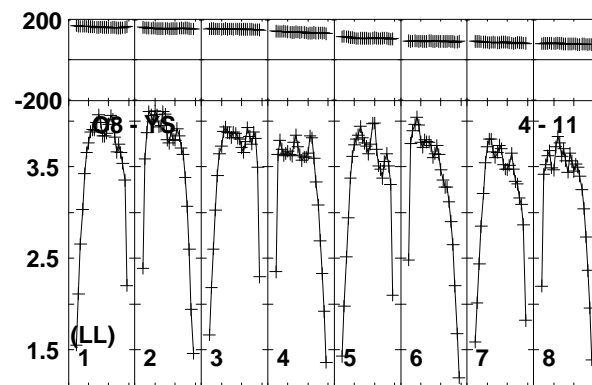
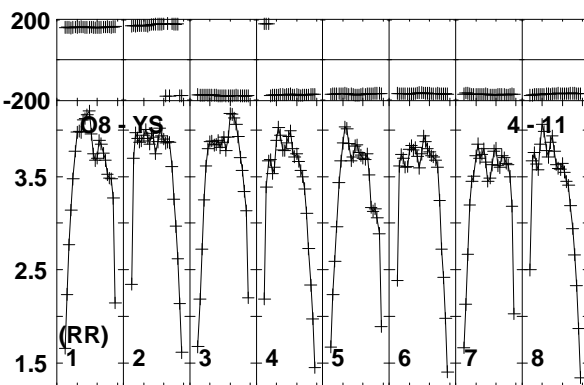
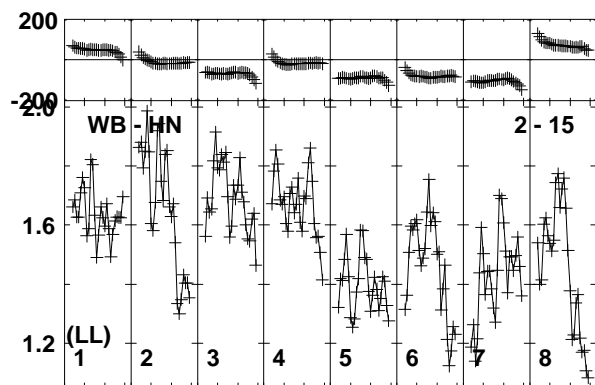
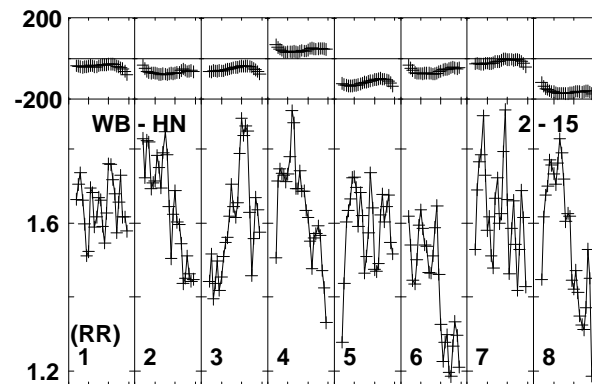
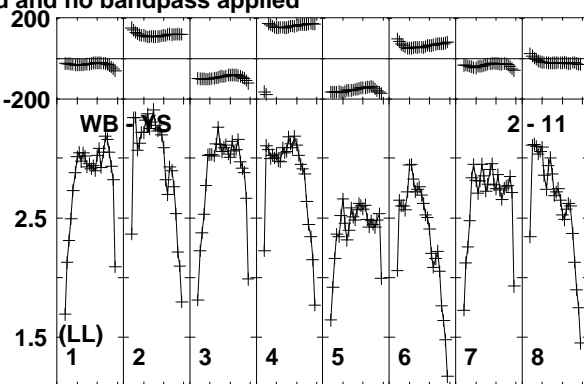
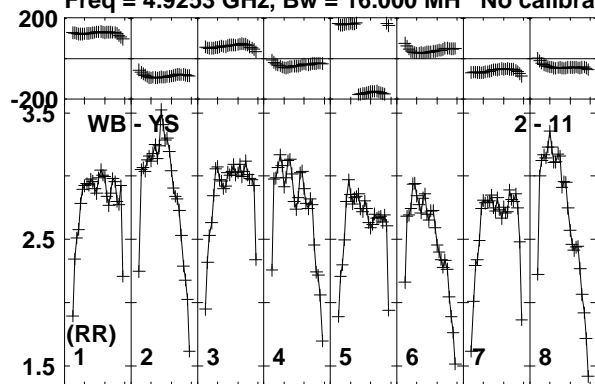

Lower frame: Milli Ampl Jy Top frame: Phas deg
Vector averaged cross-power spectrum Baseline: WB (02) - YS (11)
Timerange: 00/21:56:42 to 00/21:58:33

Plot file version 139 created 11-APR-2016 17:08:37

J1128+5925 GP053G 3.UVDATA.1

Freq = 4.9253 GHz, Bw = 16.000 MH No calibration applied and no bandpass applied

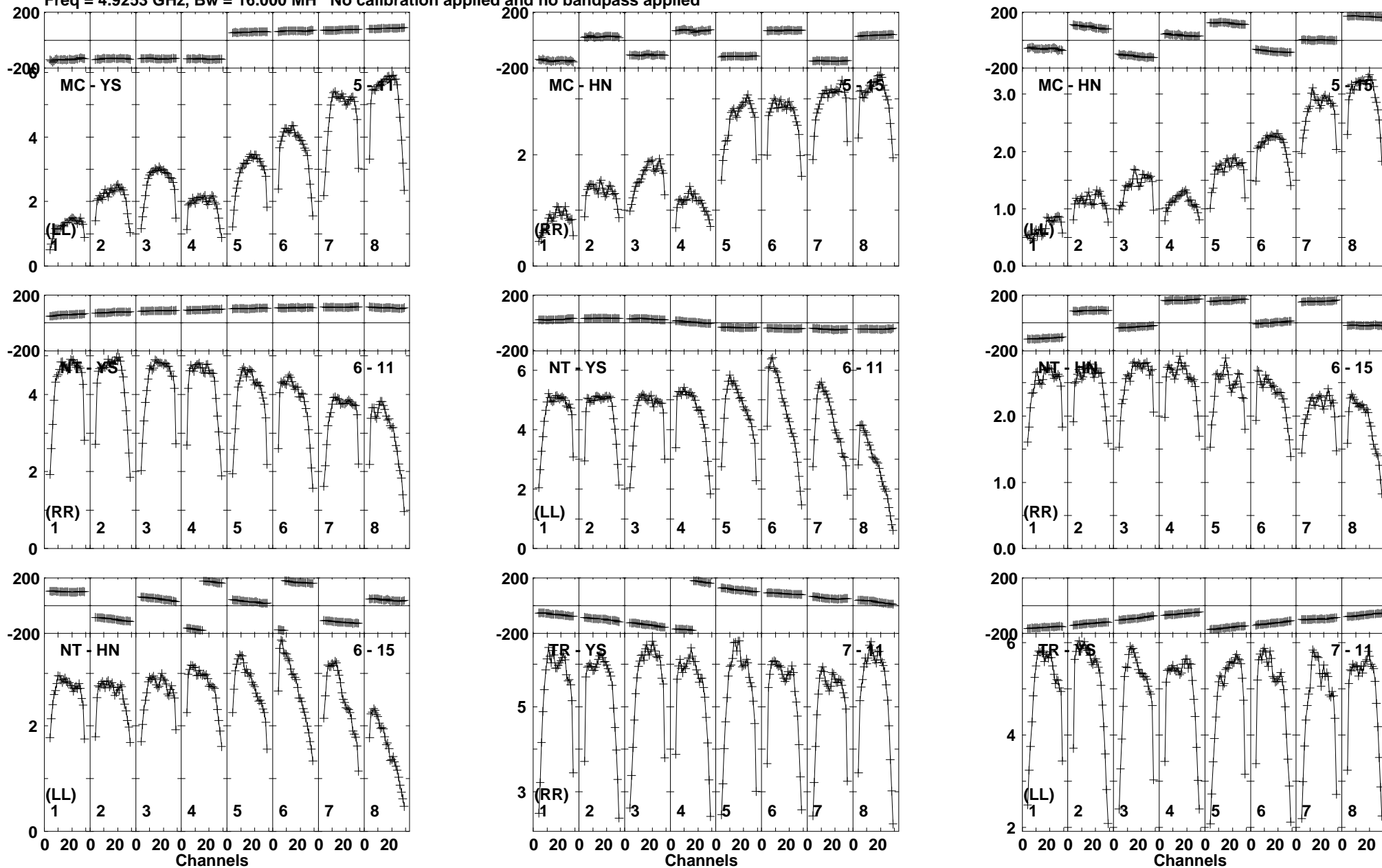

Lower frame: Milli Ampl Jy Top frame: Phas deg
Vector averaged cross-power spectrum Baseline: MC (05) - YS (11)
Timerange: 00/21:56:42 to 00/21:58:33

Plot file version 140 created 11-APR-2016 17:08:37

J1128+5925 GP053G 3.UVDATA.1

Freq = 4.9253 GHz, Bw = 16.000 MH No calibration applied and no bandpass applied

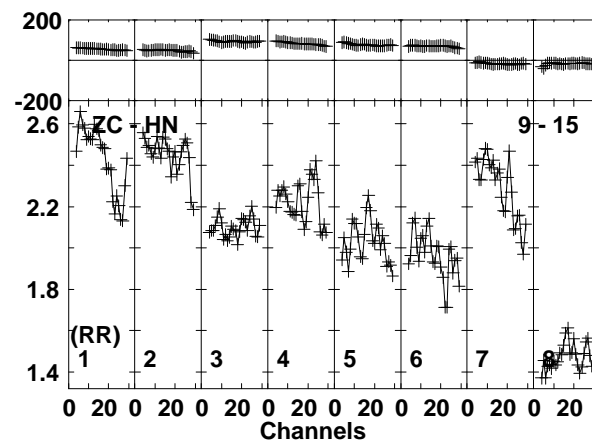
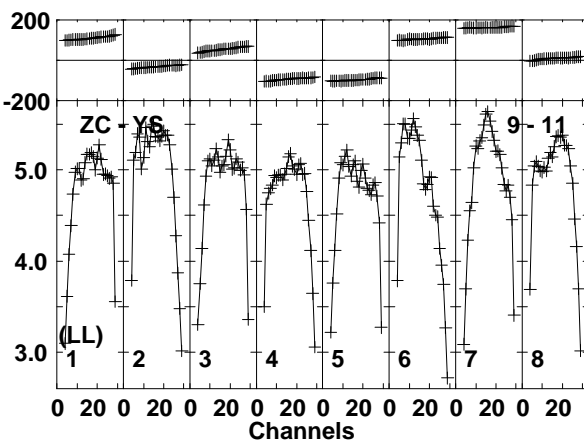
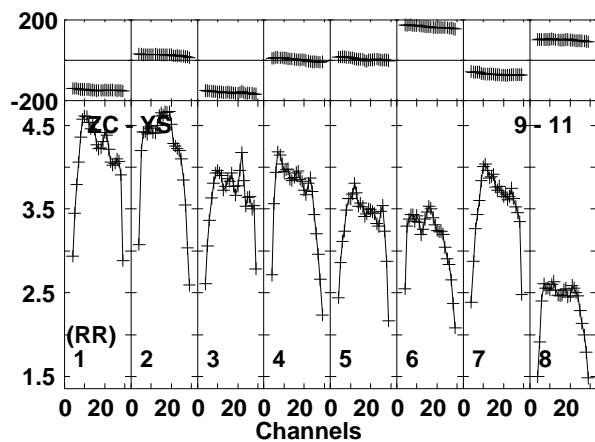
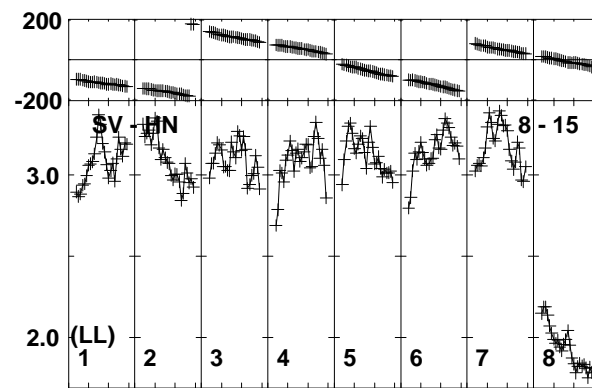
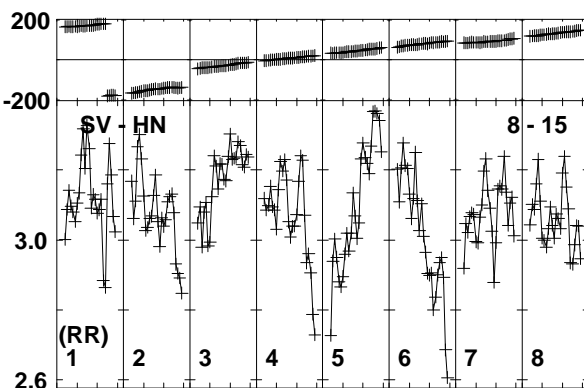
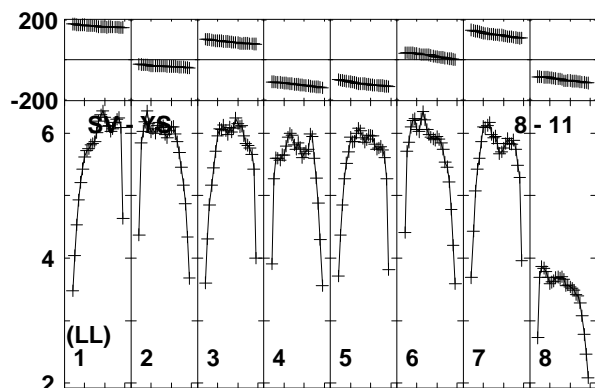
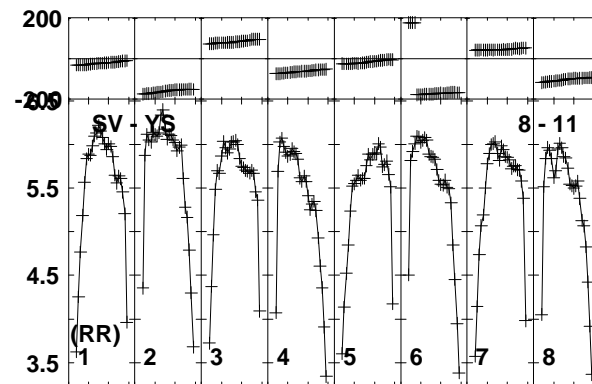
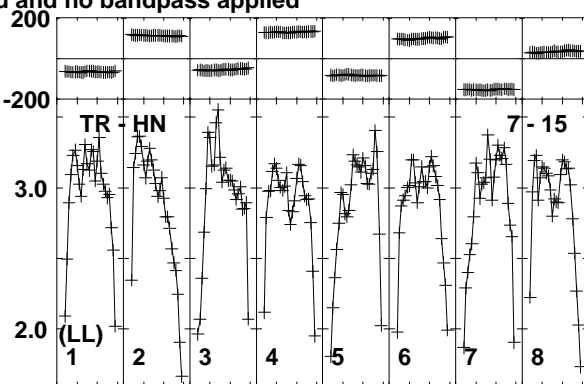
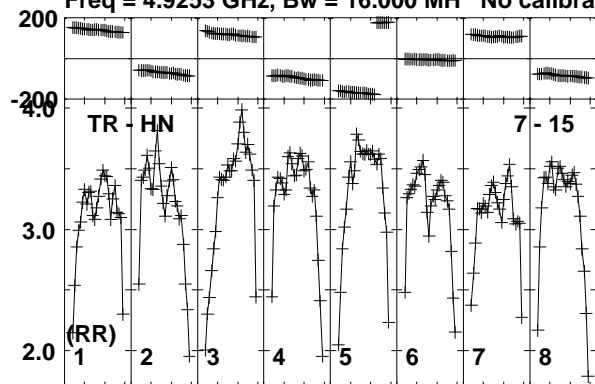

Lower frame: Milli Ampl Jy Top frame: Phas deg
Vector averaged cross-power spectrum Baseline: TR (07) - HN (15)
Timerange: 00/21:56:42 to 00/21:58:33

Plot file version 141 created 11-APR-2016 17:08:37

J1128+5925 GP053G 3.UVDATA.1

Freq = 4.9253 GHz, Bw = 16.000 MH No calibration applied and no bandpass applied

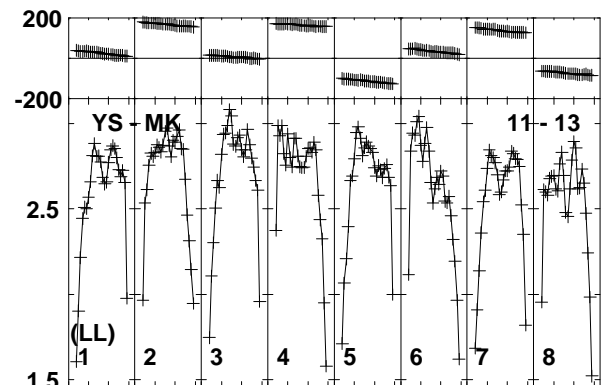
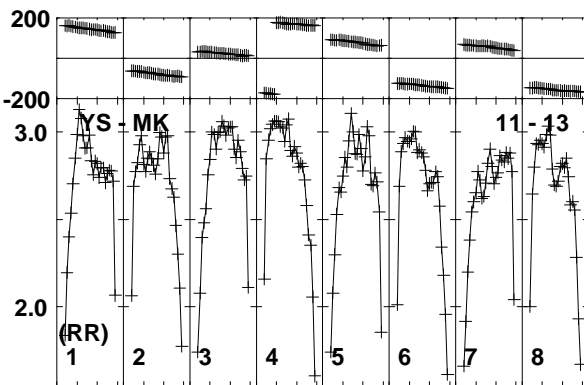
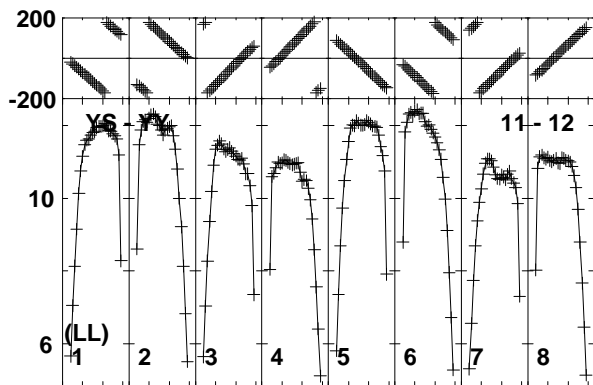
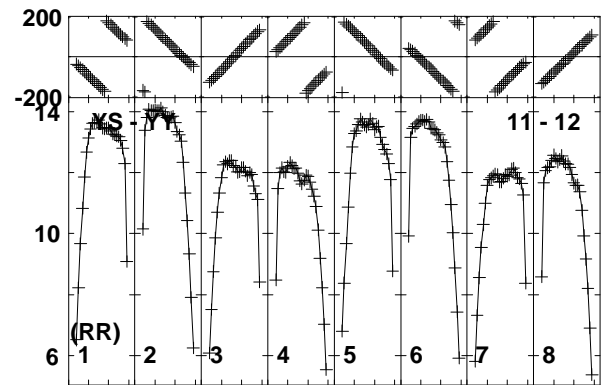
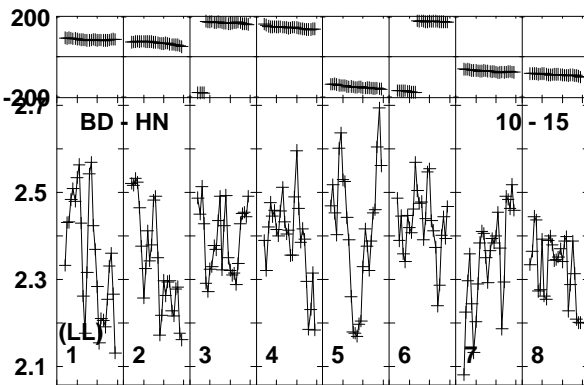
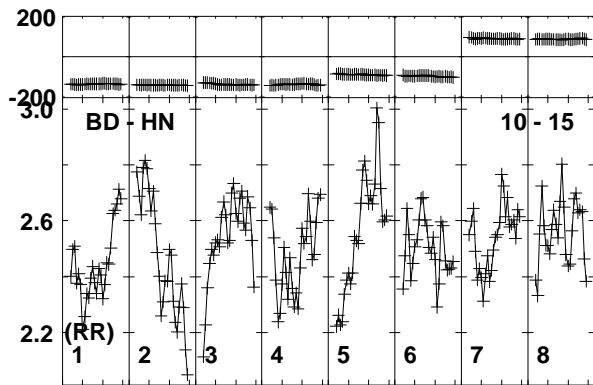
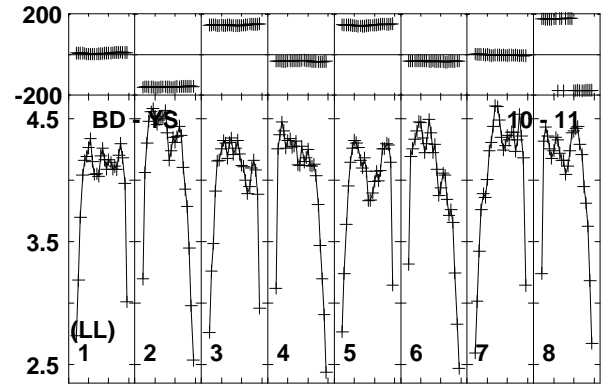
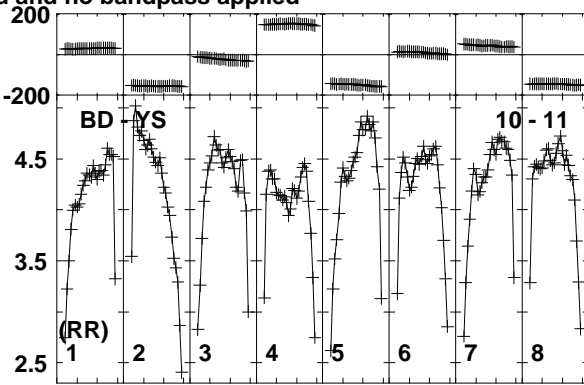
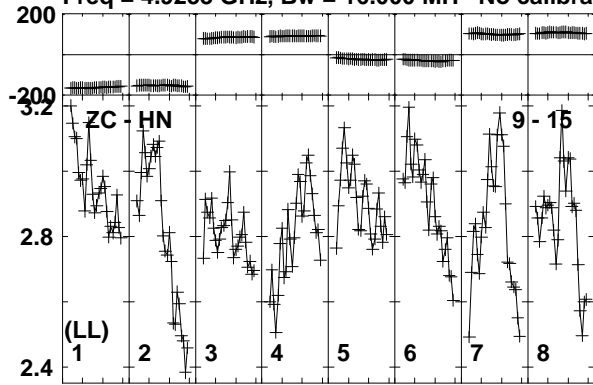

Lower frame: Milli Ampl Jy Top frame: Phas deg
Vector averaged cross-power spectrum Baseline: ZC (09) - HN (15)
Timerange: 00/21:56:42 to 00/21:58:33

Plot file version 142 created 11-APR-2016 17:08:37

J1128+5925 GP053G 3.UVDATA.1

Freq = 4.9253 GHz, Bw = 16.000 MH No calibration applied and no bandpass applied

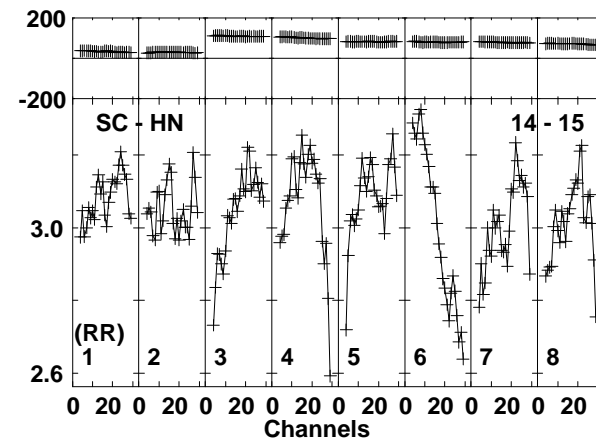
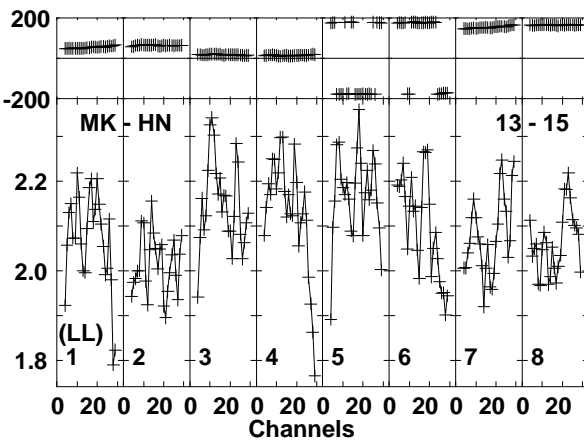
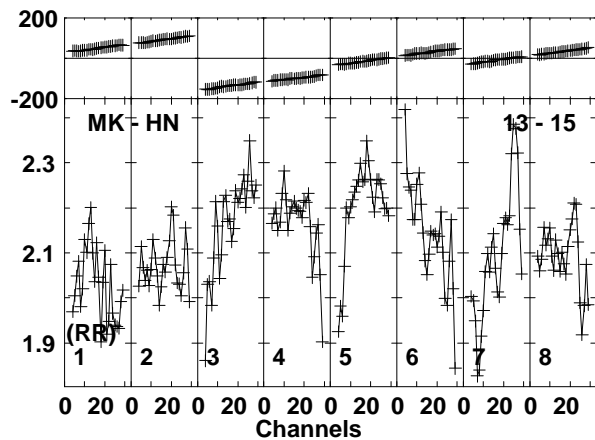
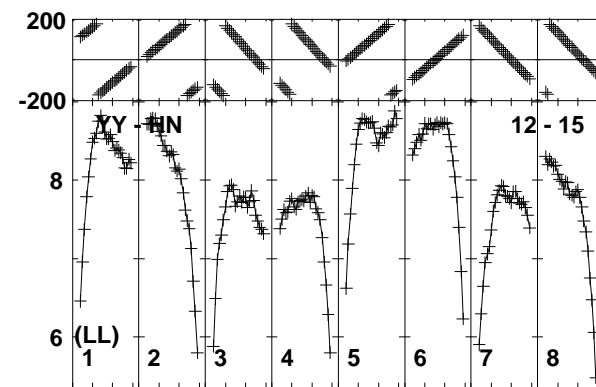
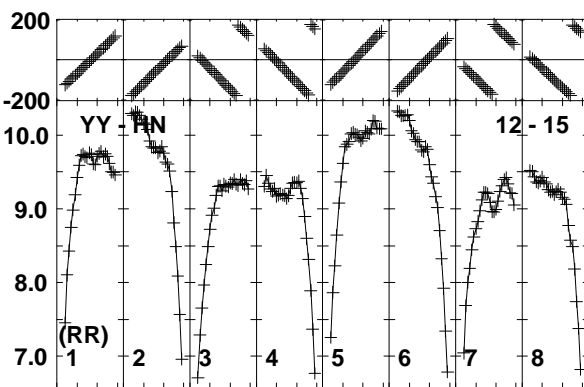
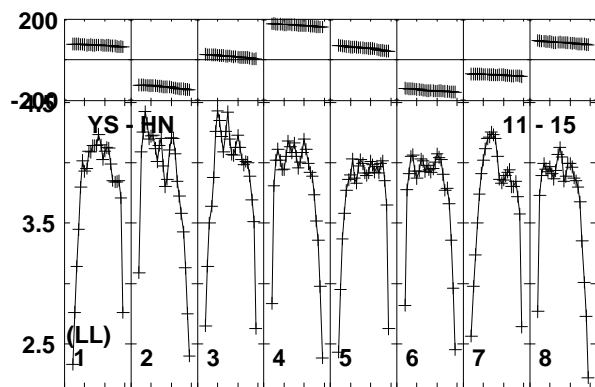
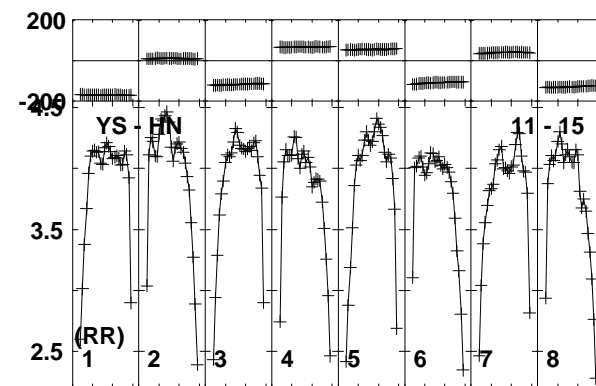
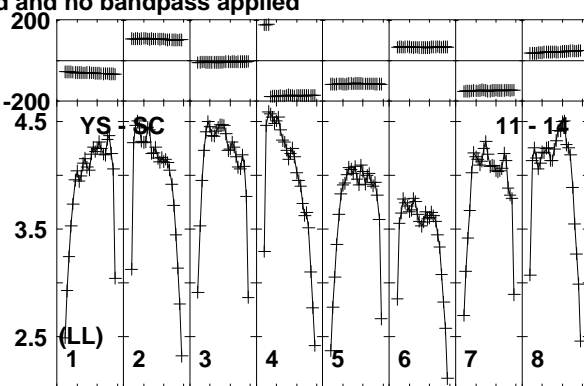
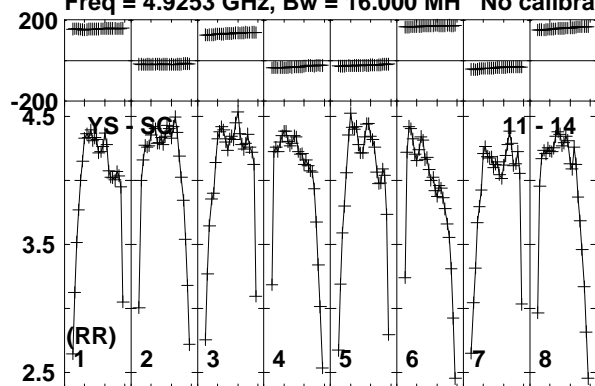

Lower frame: Milli Ampl Jy Top frame: Phas deg
Vector averaged cross-power spectrum Baseline: YS (11) - SC (14)
Timerange: 00/21:56:42 to 00/21:58:33

Plot file version 143 created 11-APR-2016 17:08:37
J1128+5925 GP053G 3.UVDATA.1
Freq = 4.9253 GHz, Bw = 16.000 MH No calibration applied and no bandpass applied

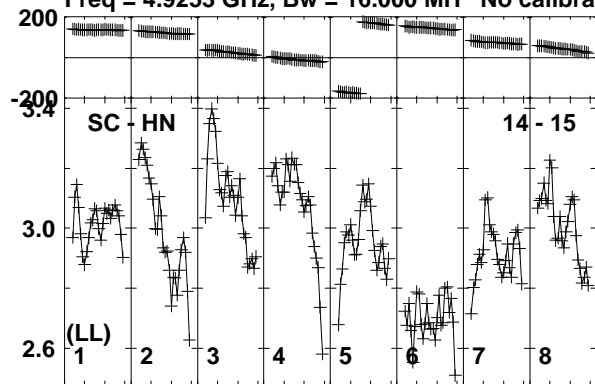

Lower frame: Milli Ampl Jy Top frame: Phas deg
Vector averaged cross-power spectrum Baseline: SC (14) - HN (15)
Timerange: 00/21:56:42 to 00/21:58:33

Plot file version 144 created 11-APR-2016 17:08:37

ARP299C GP053G 3.UVDATA.1

Freq = 4.9253 GHz, Bw = 16.000 MH No calibration applied and no bandpass applied

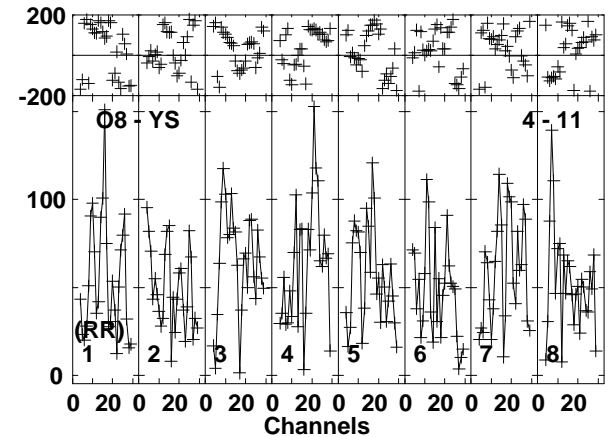
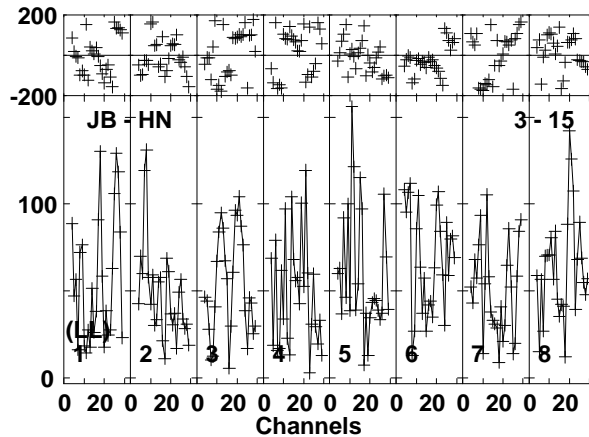
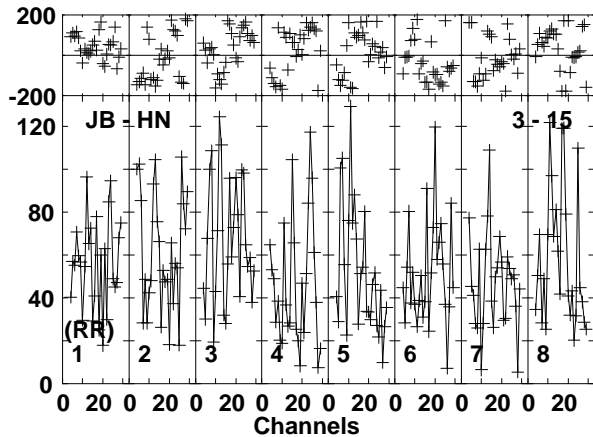
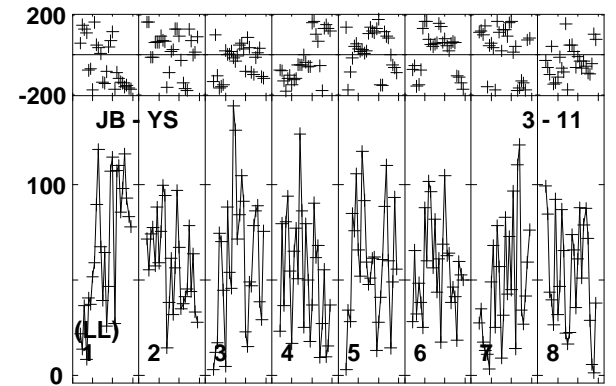
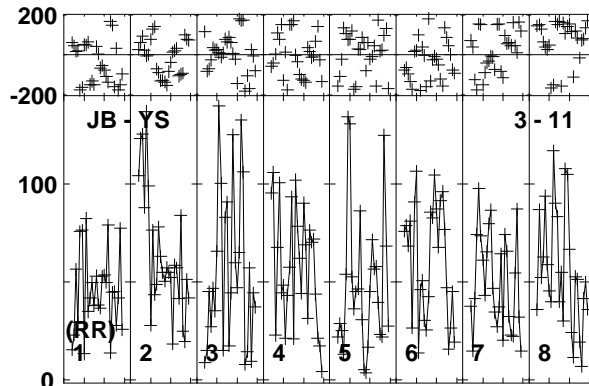
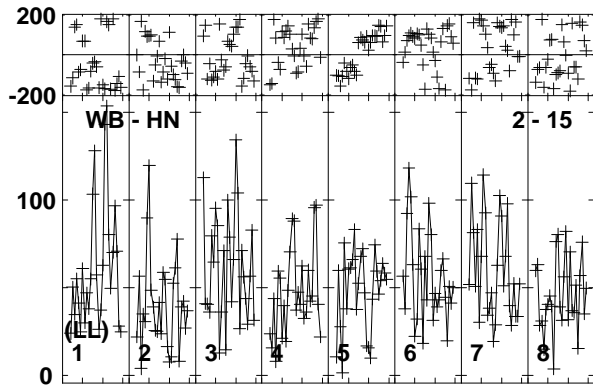
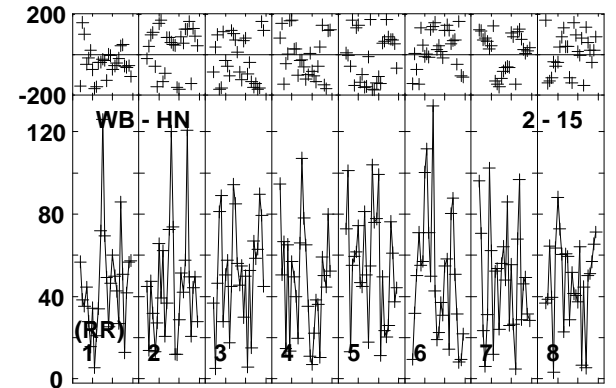
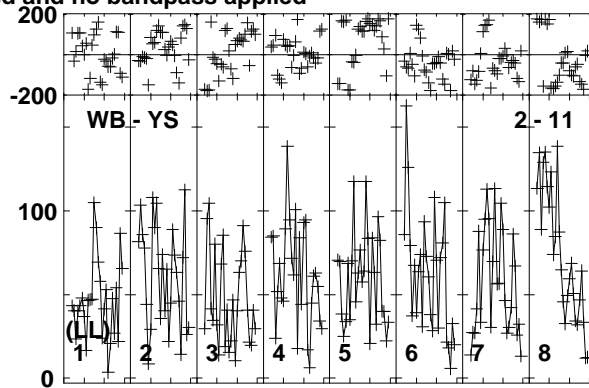
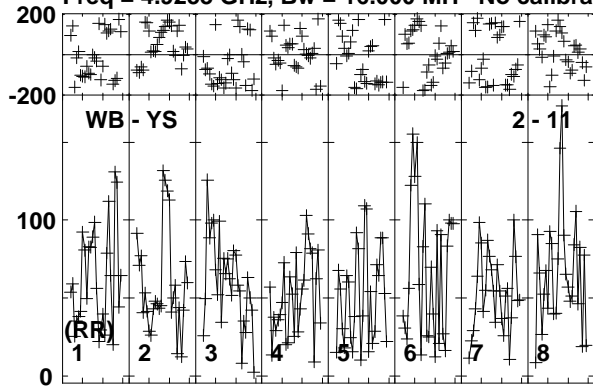

Lower frame: Micro Ampl Jy Top frame: Phas deg
Vector averaged cross-power spectrum Baseline: WB (02) - YS (11)
Timerange: 00/21:58:38 to 00/22:03:52

Plot file version 145 created 11-APR-2016 17:08:38

ARP299C GP053G 3.UVDATA.1

Freq = 4.9253 GHz, Bw = 16.000 MH No calibration applied and no bandpass applied

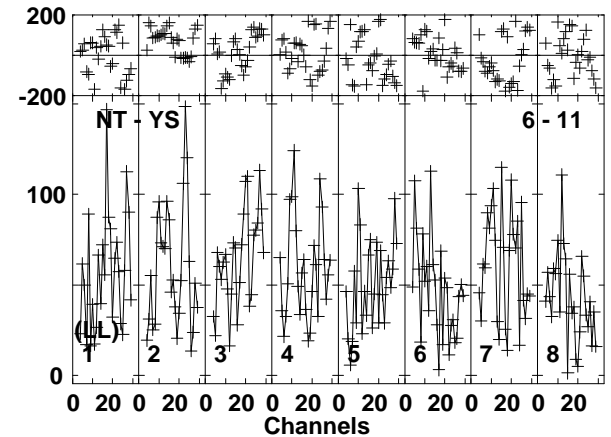
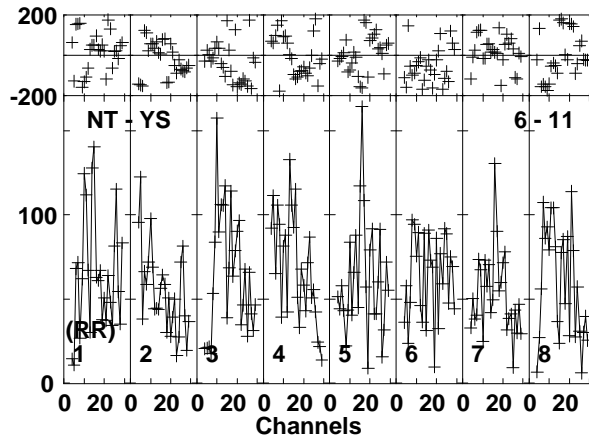
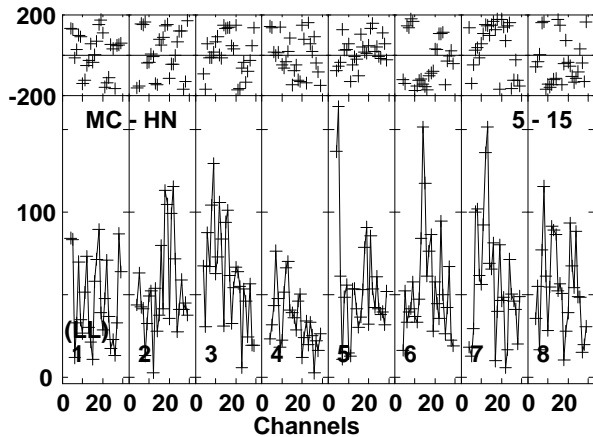
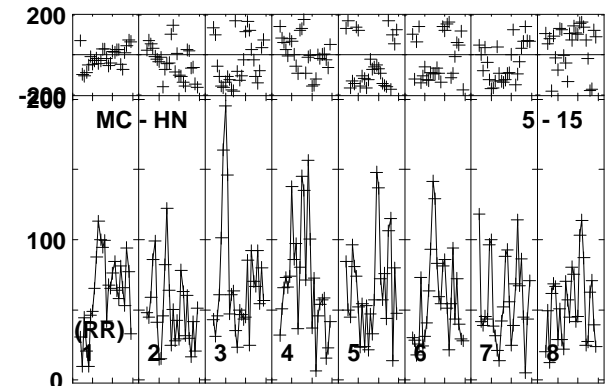
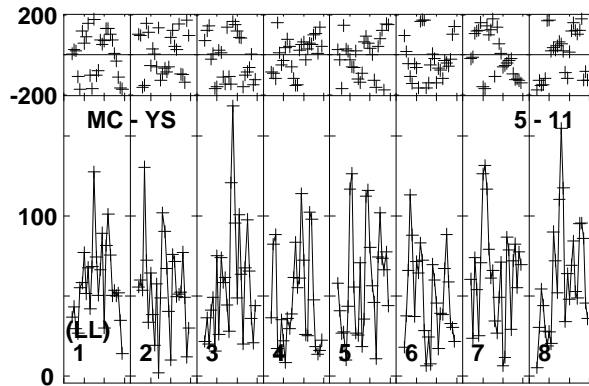
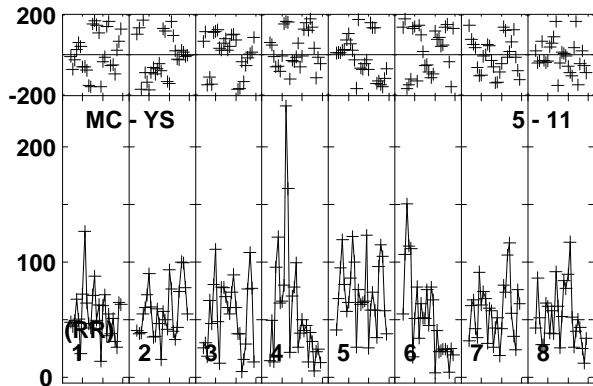
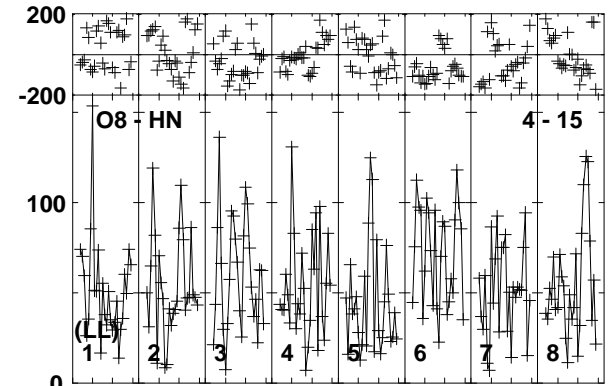
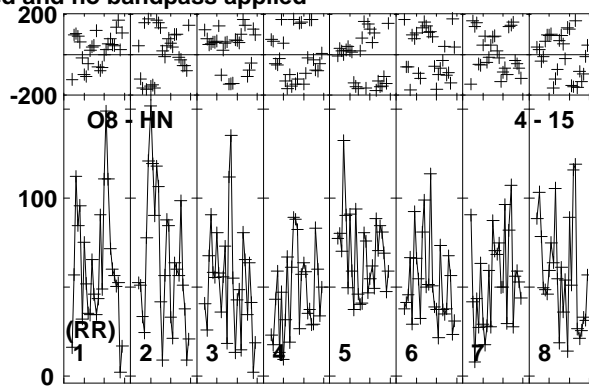
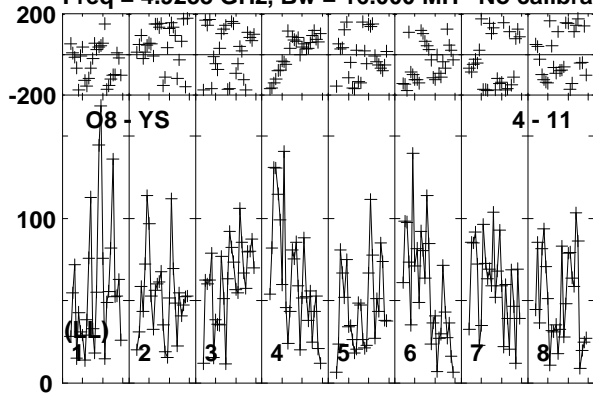

Lower frame: Micro Ampl Jy Top frame: Phas deg
Vector averaged cross-power spectrum Baseline: O8 (04) - YS (11)
Timerange: 00/21:58:38 to 00/22:03:52

Plot file version 146 created 11-APR-2016 17:08:38

ARP299C GP053G 3.UVDATA.1

Freq = 4.9253 GHz, Bw = 16.000 MH No calibration applied and no bandpass applied

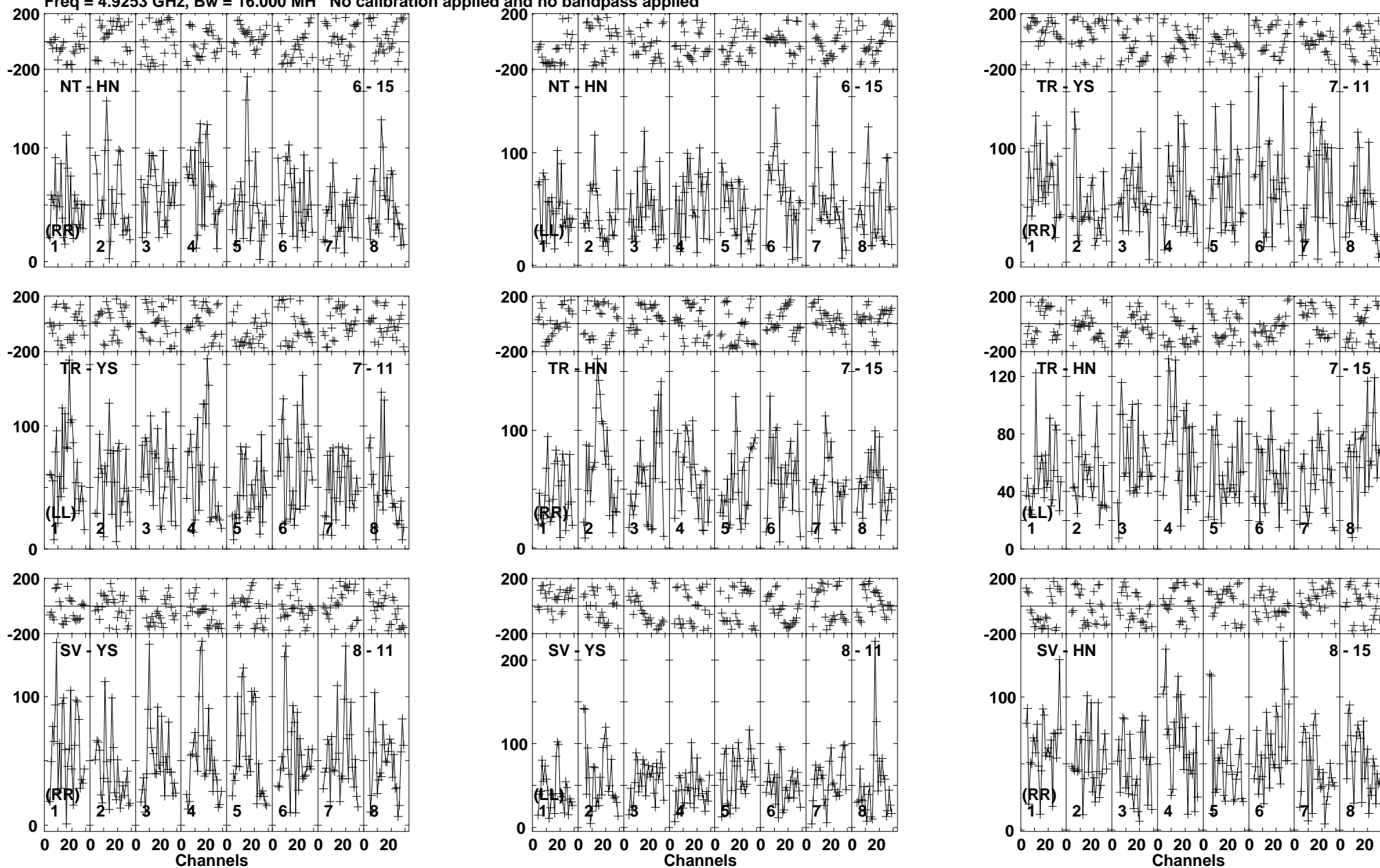

Lower frame: Micro Ampl Jy Top frame: Phas deg
Vector averaged cross-power spectrum Baseline: NT (06) - HN (15)
Timerange: 00/21:58:38 to 00/22:03:52

Plot file version 147 created 11-APR-2016 17:08:38

ARP299C GP053G 3.UVDATA.1

Freq = 4.9253 GHz, Bw = 16.000 MH No calibration applied and no bandpass applied

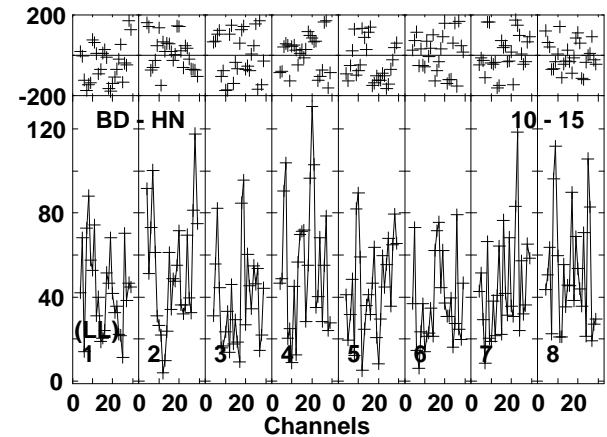
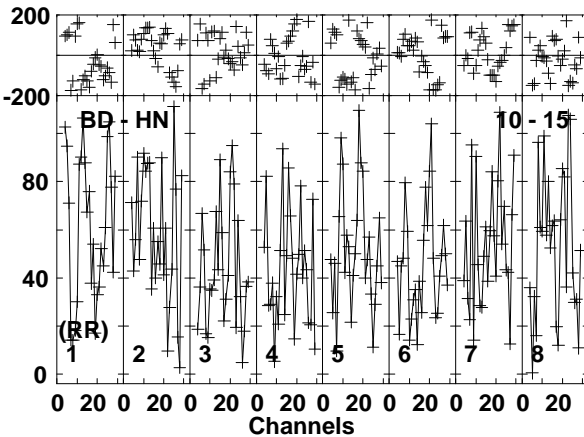
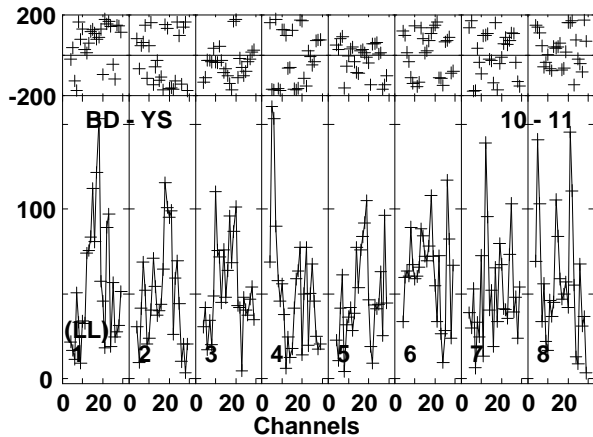
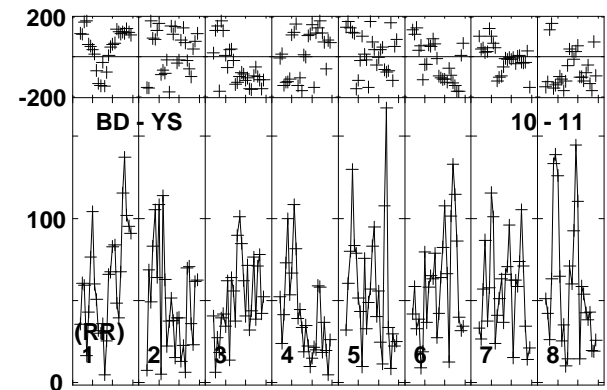
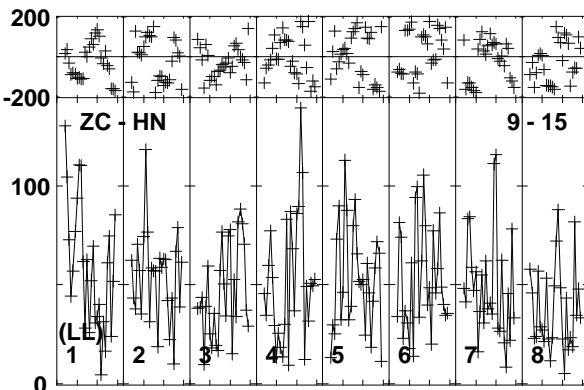
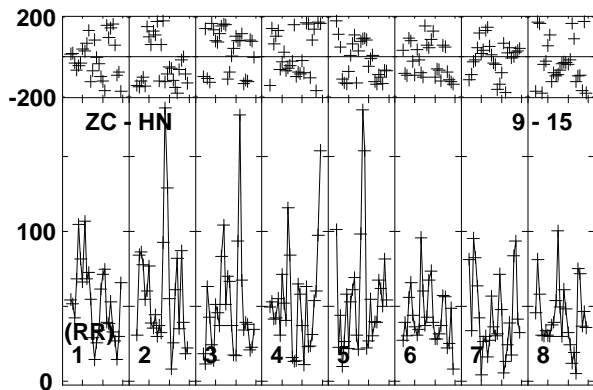
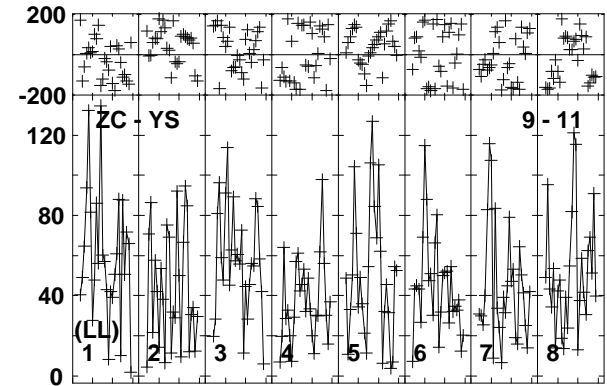
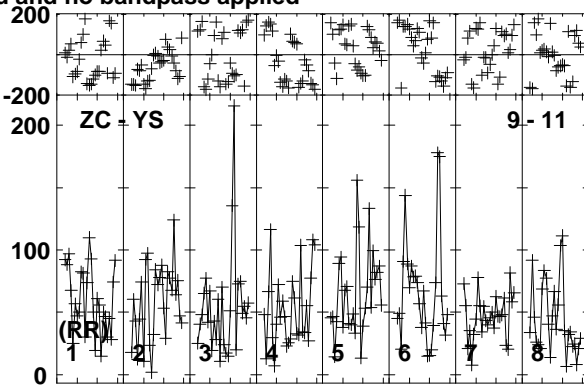
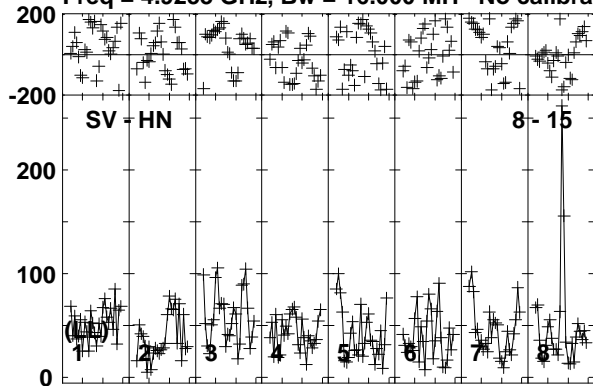

Lower frame: Micro Ampl Jy Top frame: Phas deg
Vector averaged cross-power spectrum Baseline: SV (08) - HN (15)
Timerange: 00/21:58:38 to 00/22:03:52

Plot file version 148 created 11-APR-2016 17:08:38

ARP299C GP053G 3.UVDATA.1

Freq = 4.9253 GHz, Bw = 16.000 MH No calibration applied and no bandpass applied

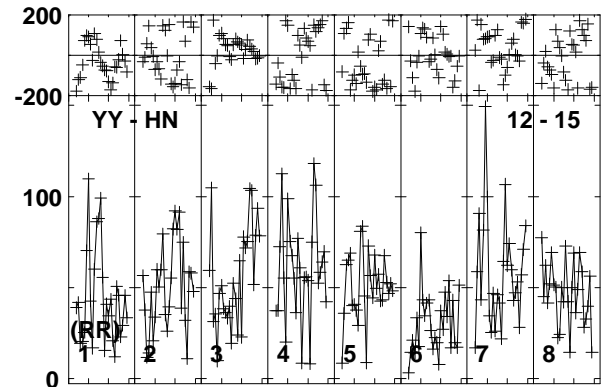
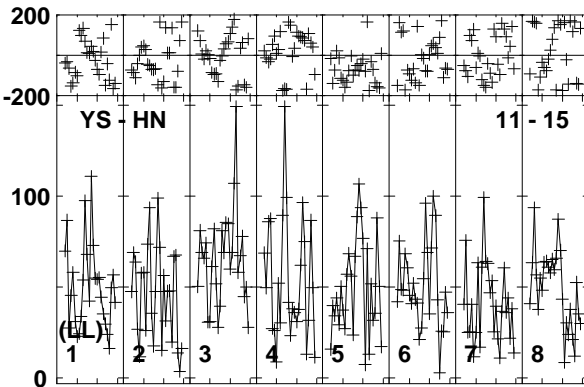
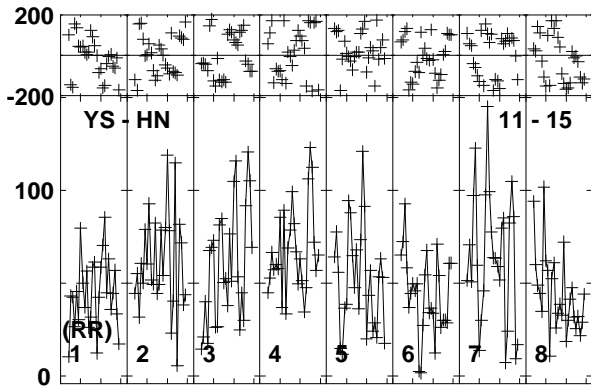
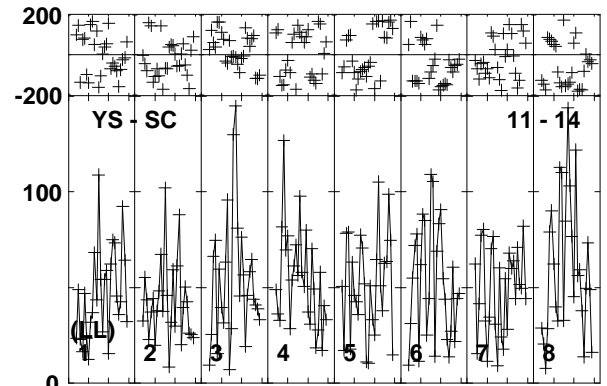
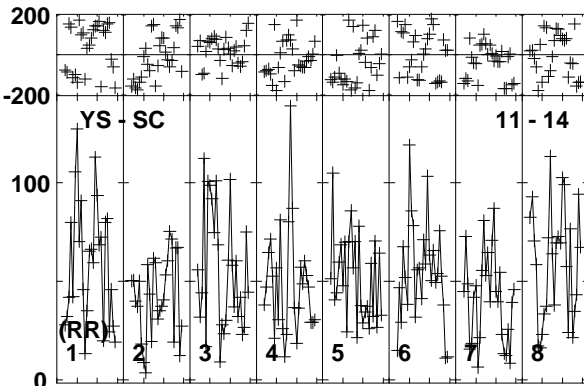
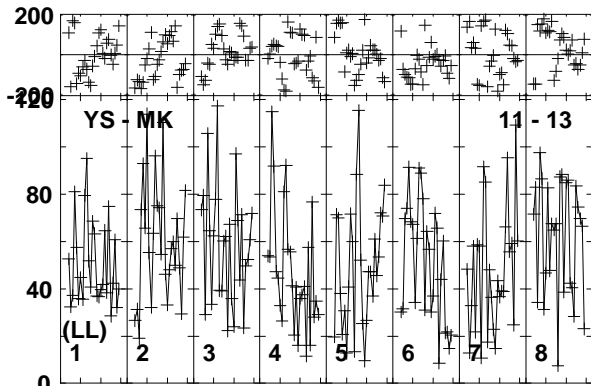
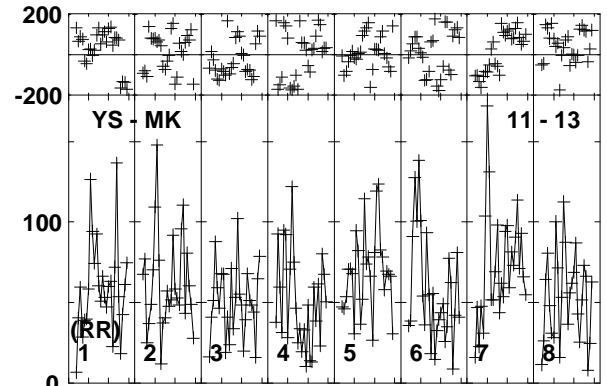
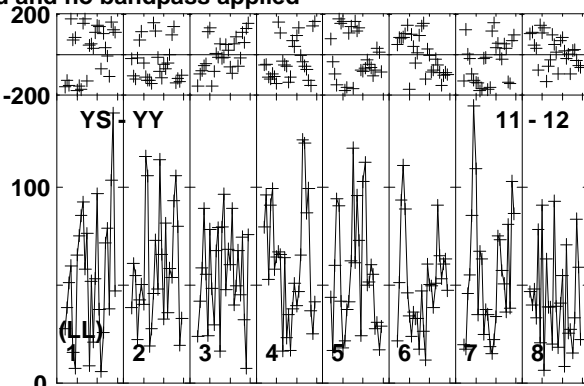
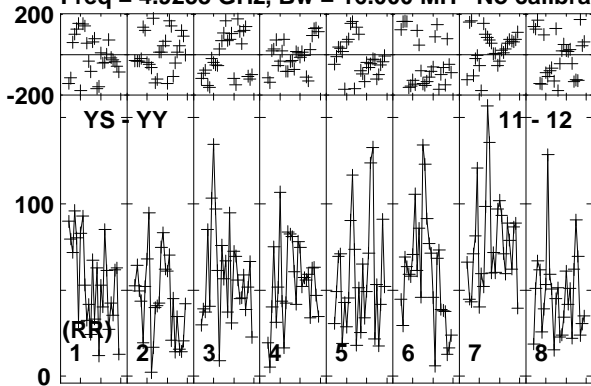

Lower frame: Micro Ampl Jy Top frame: Phas deg
Vector averaged cross-power spectrum Baseline: YS (11) - YY (12)
Timerange: 00/21:58:38 to 00/22:03:52

Plot file version 149 created 11-APR-2016 17:08:38

ARP299C GP053G 3.UVDATA.1

Freq = 4.9253 GHz, Bw = 16.000 MH No calibration applied and no bandpass applied

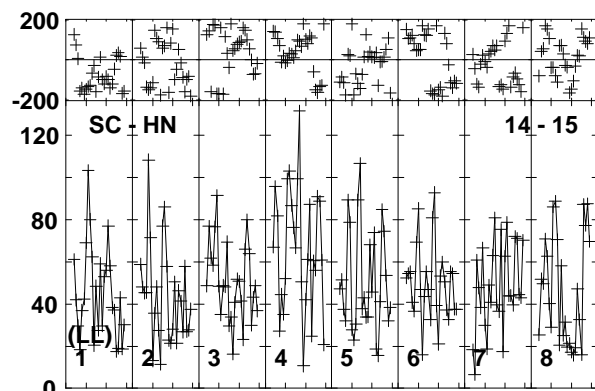
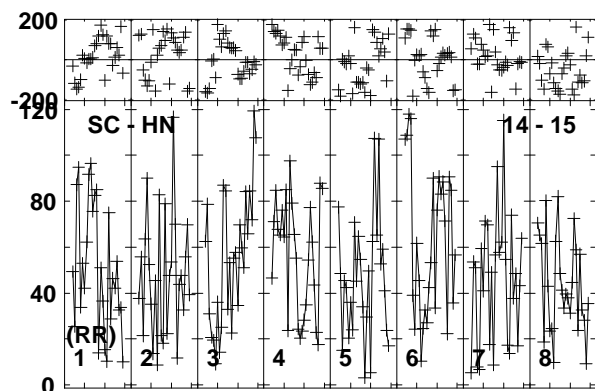
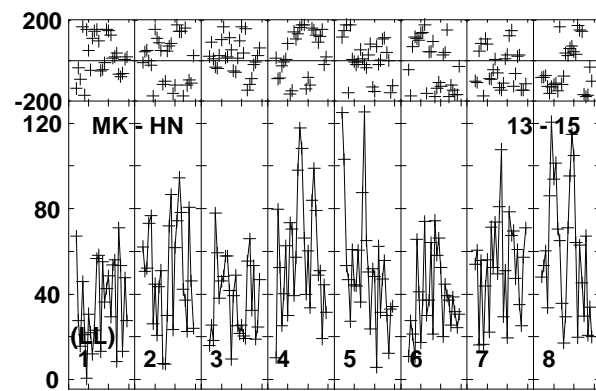
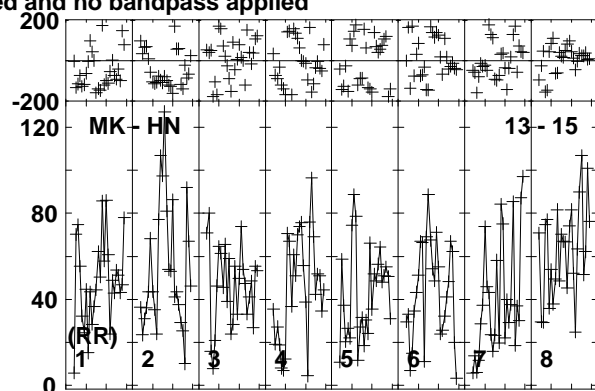
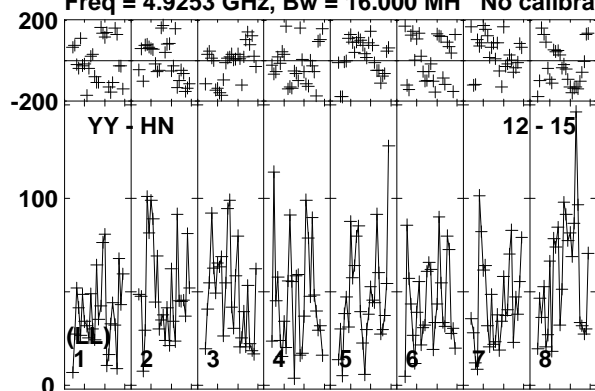

Lower frame: Micro Ampl Jy Top frame: Phas deg
Vector averaged cross-power spectrum Baseline: YY (12) - HN (15)
Timerange: 00/21:58:38 to 00/22:03:52

Plot file version 150 created 11-APR-2016 17:08:39

J1128+5925 GP053G 3.UVDATA.1

Freq = 4.9253 GHz, Bw = 16.000 MH No calibration applied and no bandpass applied

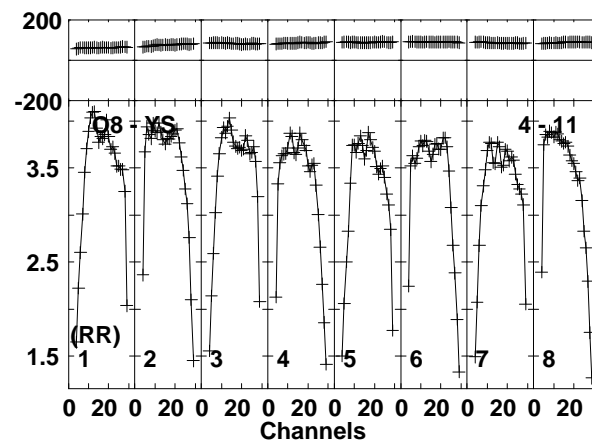
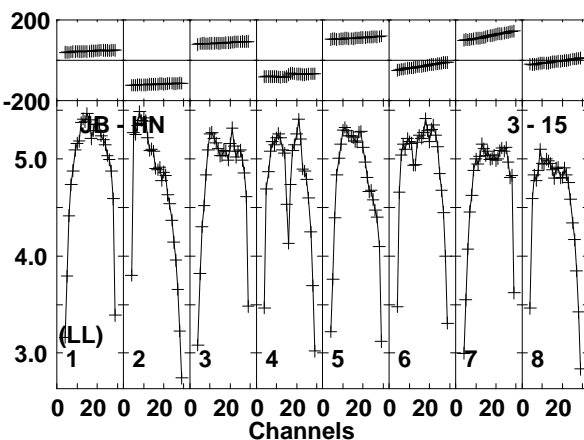
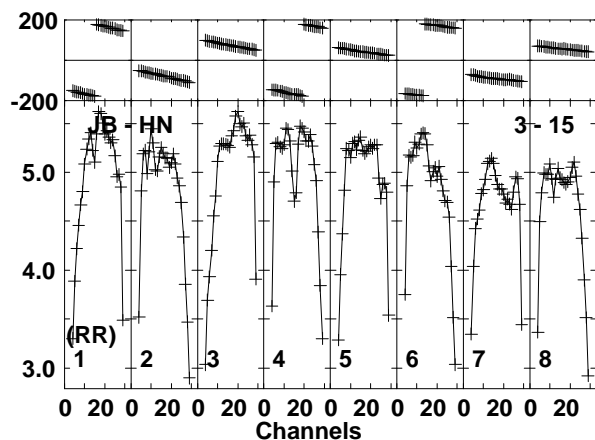
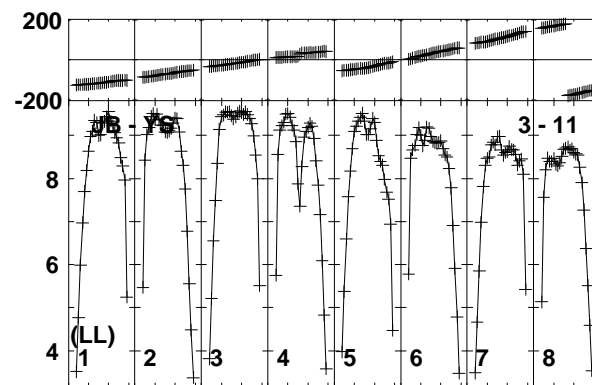
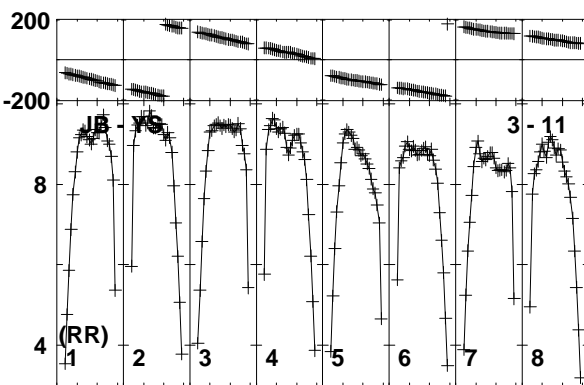
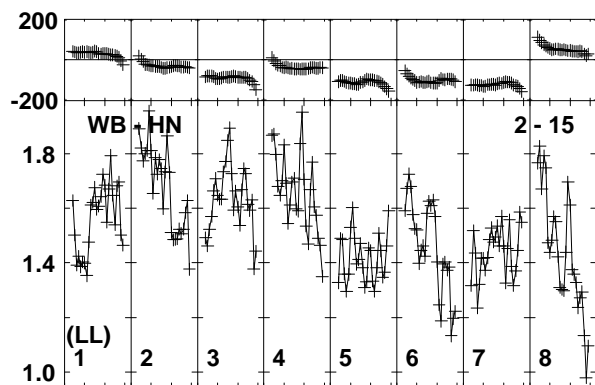
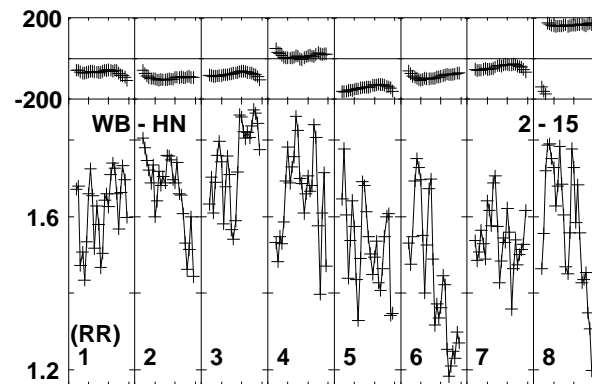
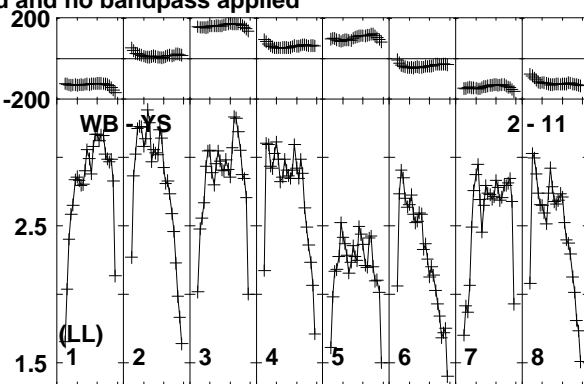
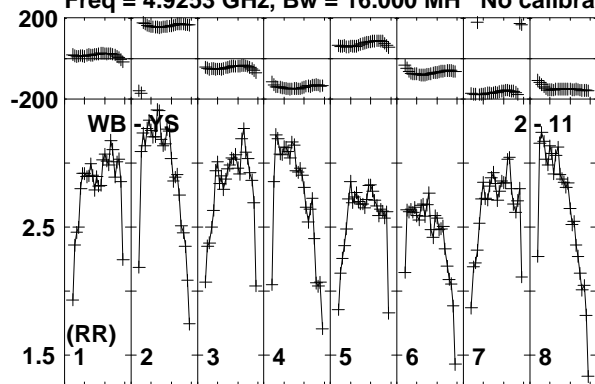

Lower frame: Milli Ampl Jy Top frame: Phas deg
Vector averaged cross-power spectrum Baseline: WB (02) - YS (11)
Timerange: 00/22:03:59 to 00/22:05:42

Plot file version 151 created 11-APR-2016 17:08:39

J1128+5925 GP053G 3.UVDATA.1

Freq = 4.9253 GHz, Bw = 16.000 MH No calibration applied and no bandpass applied

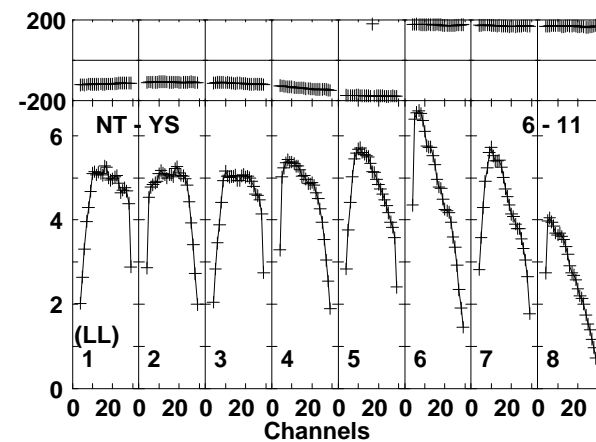
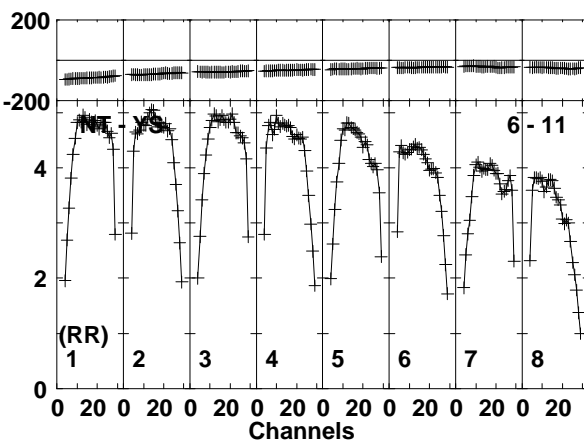
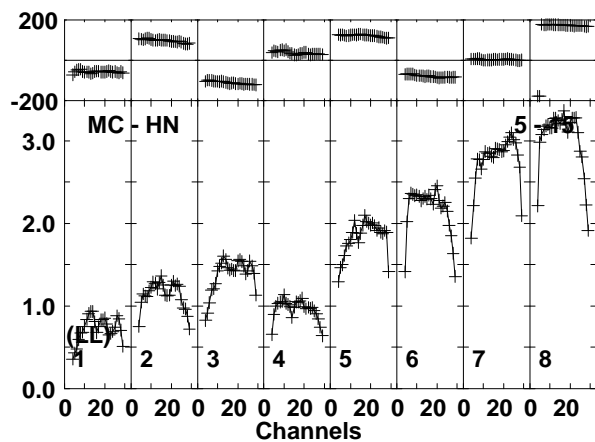
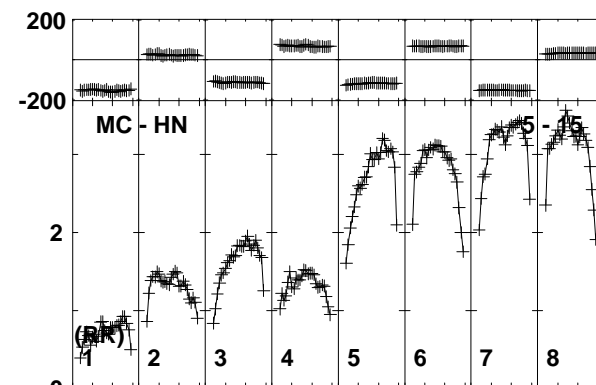
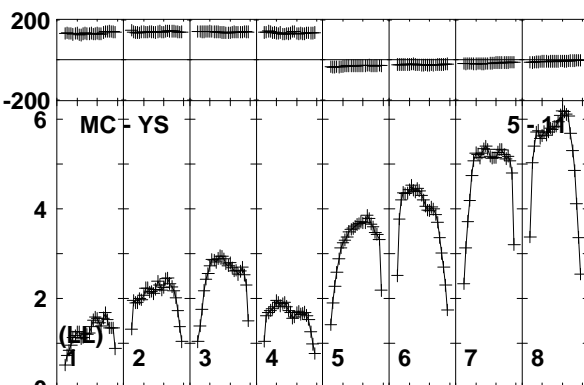
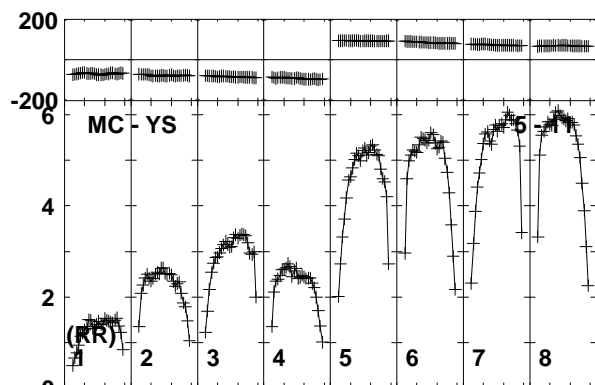
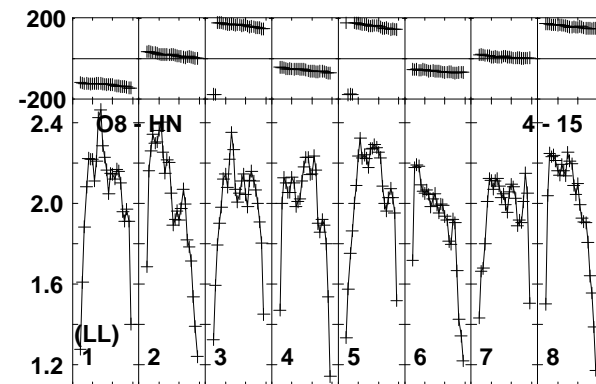
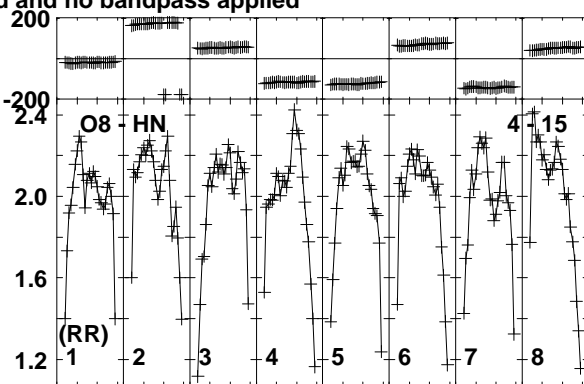
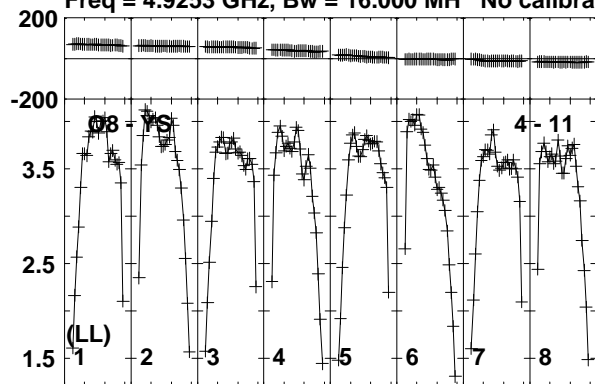

Lower frame: Milli Ampl Jy Top frame: Phas deg
Vector averaged cross-power spectrum Baseline: O8 (04) - YS (11)
Timerange: 00/22:03:59 to 00/22:05:42

Plot file version 152 created 11-APR-2016 17:08:39

J1128+5925 GP053G 3.UVDATA.1

Freq = 4.9253 GHz, Bw = 16.000 MH No calibration applied and no bandpass applied

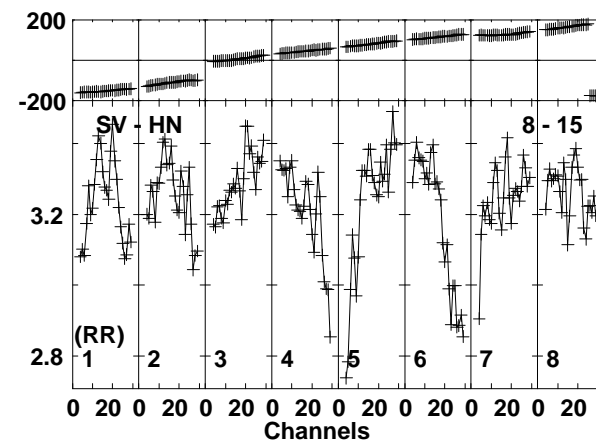
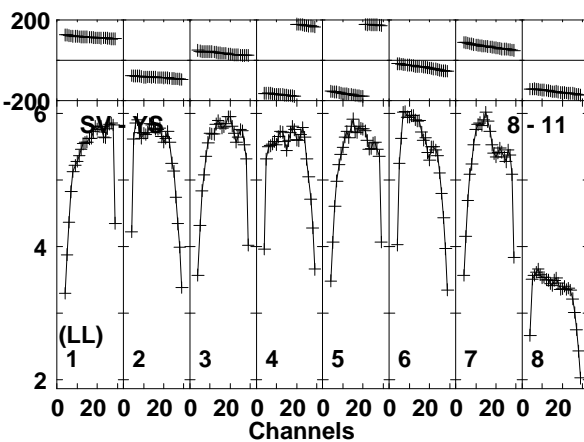
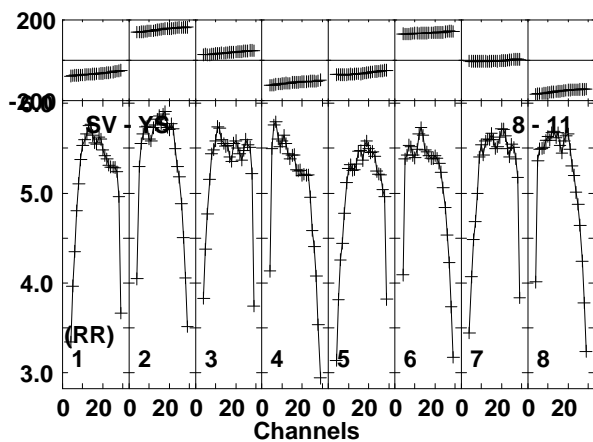
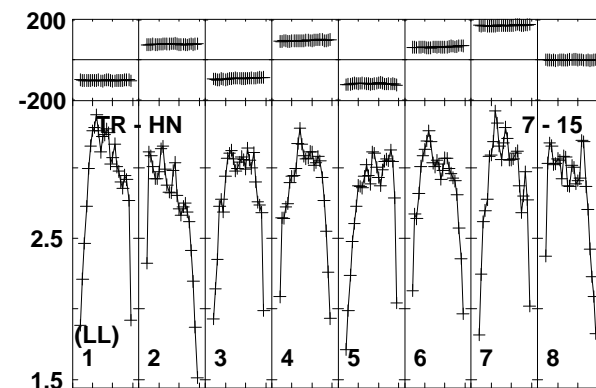
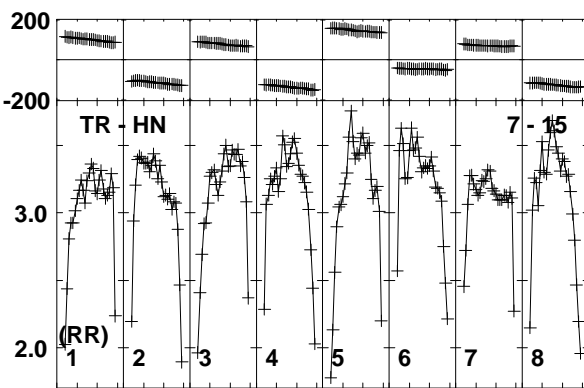
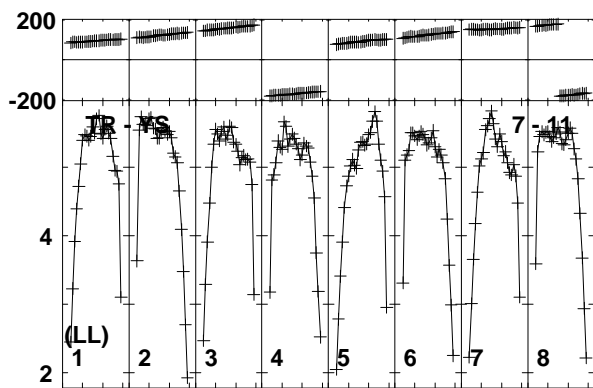
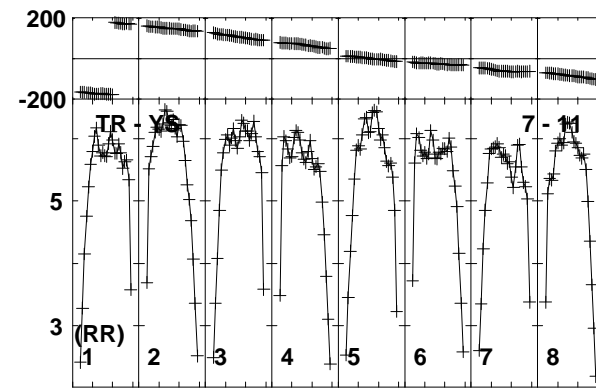
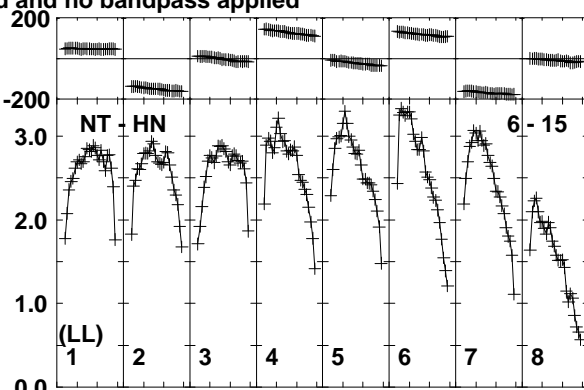
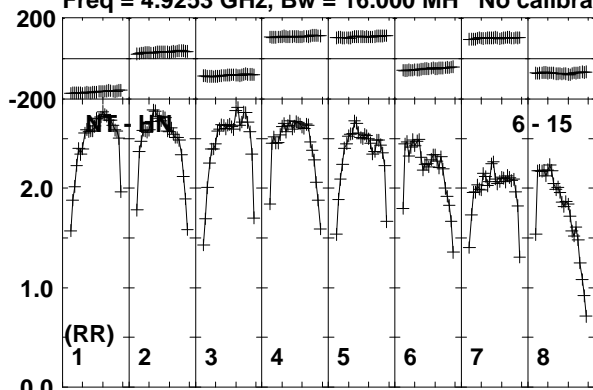

Lower frame: Milli Ampl Jy Top frame: Phas deg
Vector averaged cross-power spectrum Baseline: NT (06) - HN (15)
Timerange: 00/22:03:59 to 00/22:05:42

Plot file version 153 created 11-APR-2016 17:08:39

J1128+5925 GP053G 3.UVDATA.1

Freq = 4.9253 GHz, Bw = 16.000 MH No calibration applied and no bandpass applied

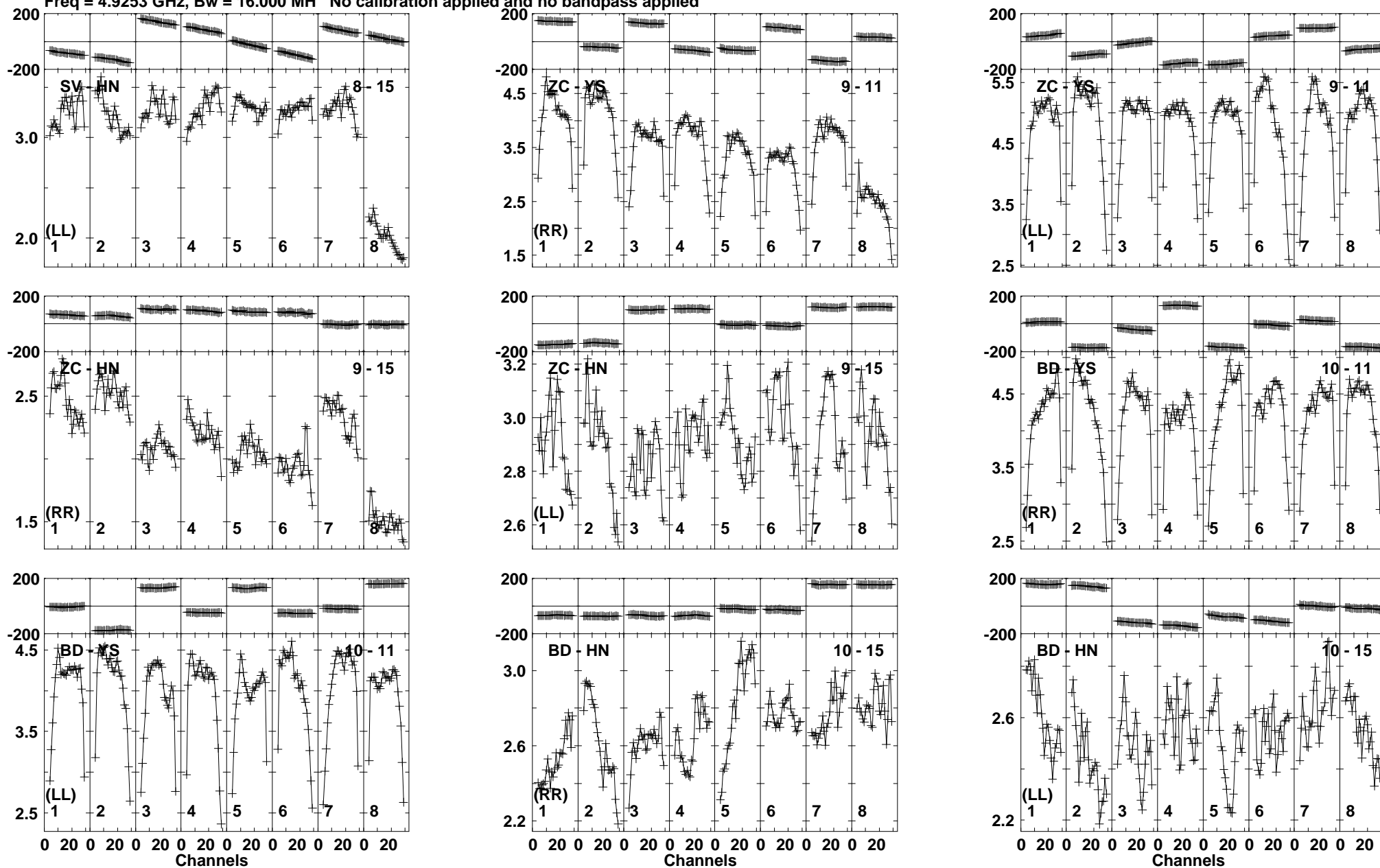

Lower frame: Milli Ampl Jy Top frame: Phas deg
Vector averaged cross-power spectrum Baseline: SV (08) - HN (15)
Timerange: 00/22:03:59 to 00/22:05:42

Plot file version 154 created 11-APR-2016 17:08:39

J1128+5925 GP053G 3.UVDATA.1

Freq = 4.9253 GHz, Bw = 16.000 MH No calibration applied and no bandpass applied

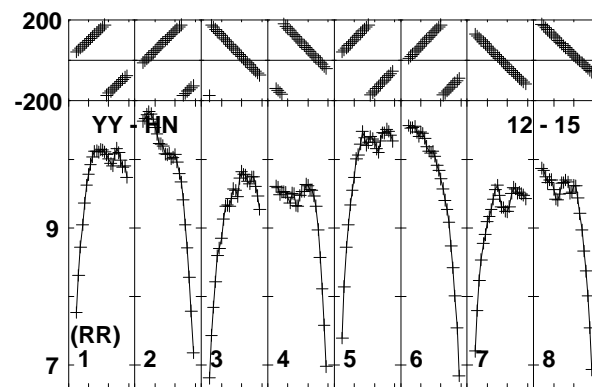
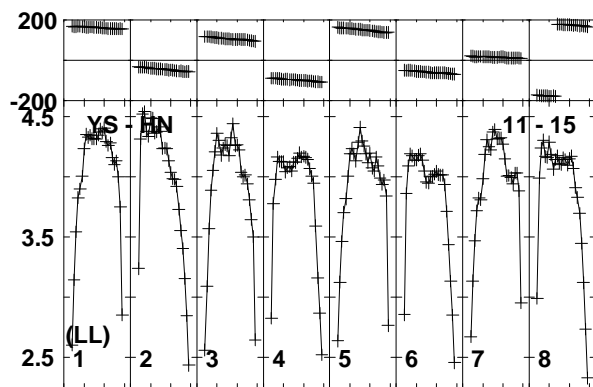
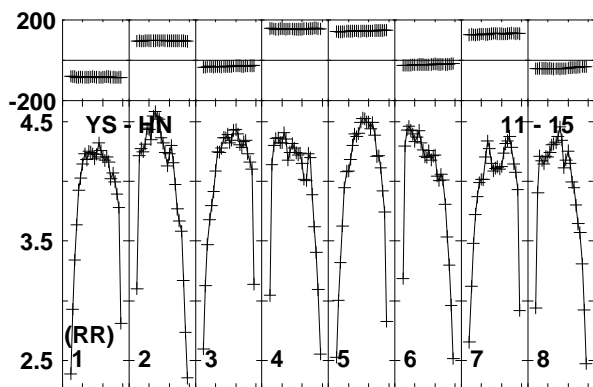
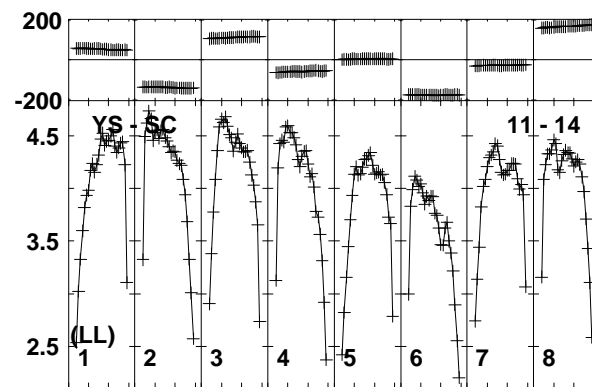
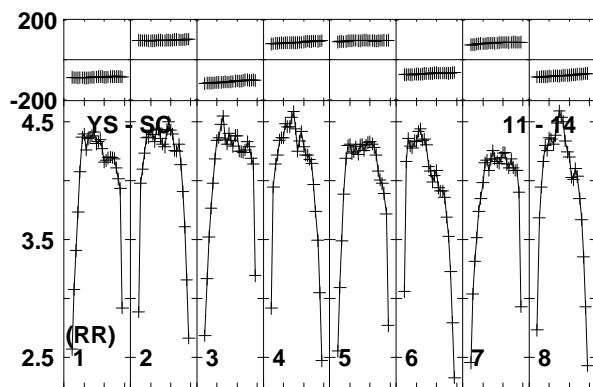
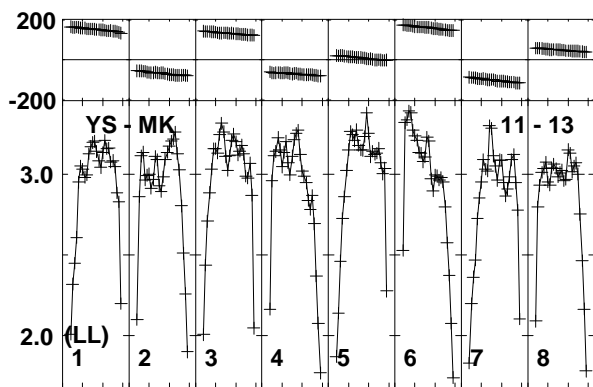
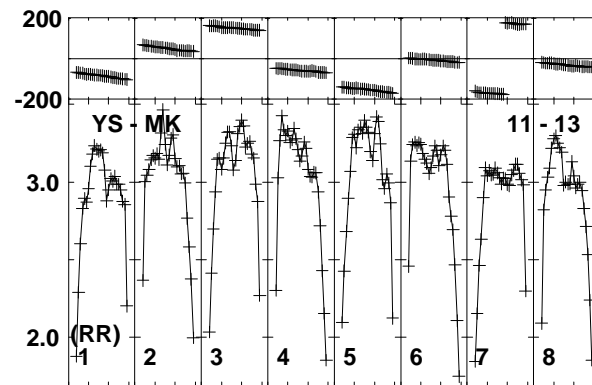
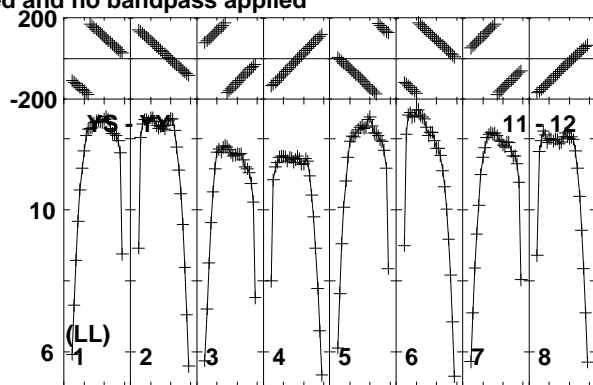
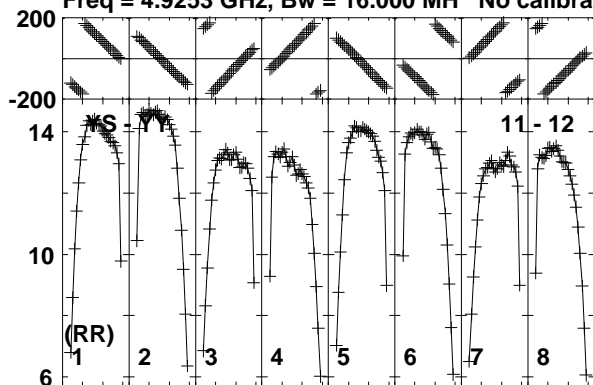

Lower frame: Milli Ampl Jy Top frame: Phas deg
Vector averaged cross-power spectrum Baseline: YS (11) - YY (12)
Timerange: 00/22:03:59 to 00/22:05:42

Plot file version 155 created 11-APR-2016 17:08:39

J1128+5925 GP053G 3.UVDATA.1

Freq = 4.9253 GHz, Bw = 16.000 MH No calibration applied and no bandpass applied

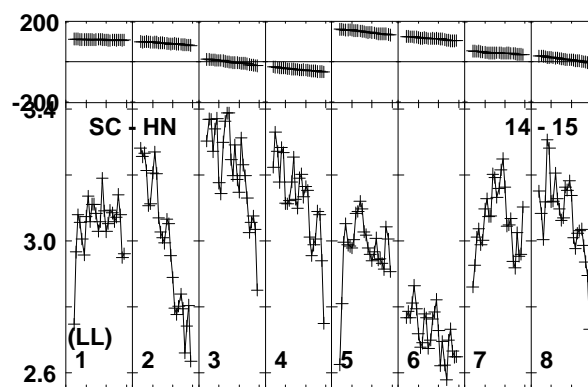
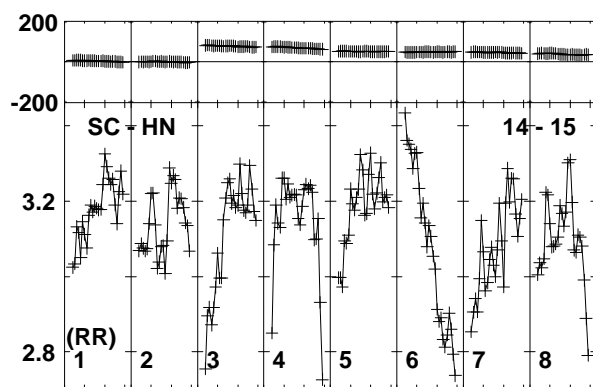
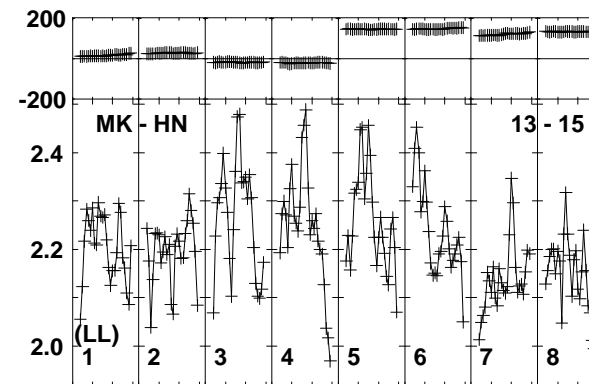
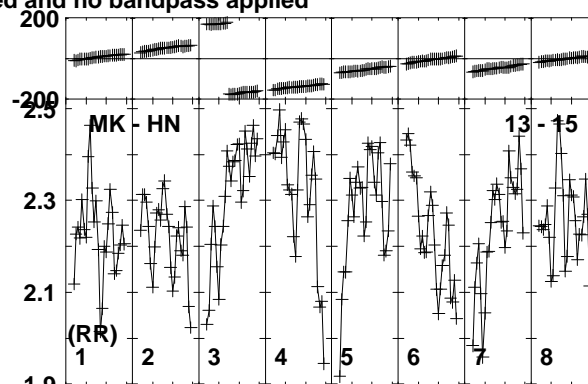
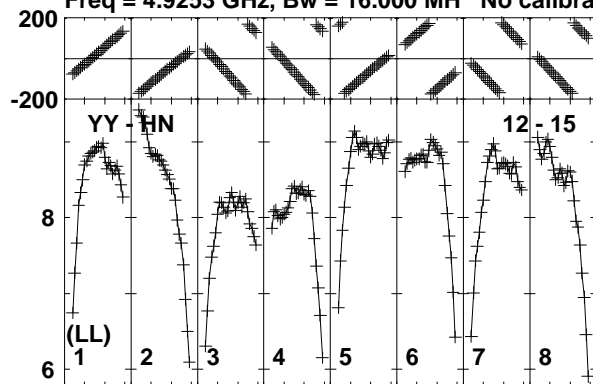

Lower frame: Milli Ampl Jy Top frame: Phas deg
Vector averaged cross-power spectrum Baseline: YY (12) - HN (15)
Timerange: 00/22:03:59 to 00/22:05:42

Plot file version 156 created 11-APR-2016 17:08:40

ARP299C GP053G 3.UVDATA.1

Freq = 4.9253 GHz, Bw = 16.000 MH No calibration applied and no bandpass applied

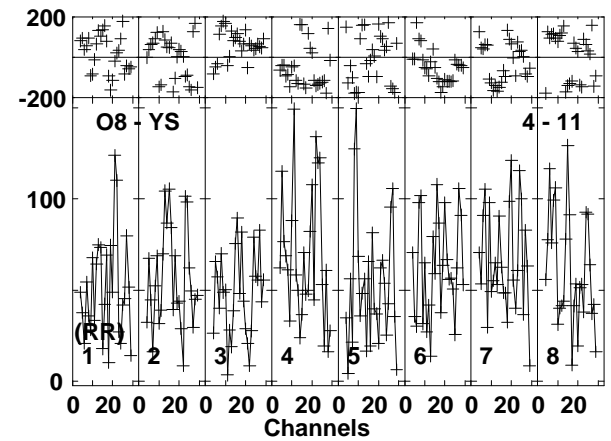
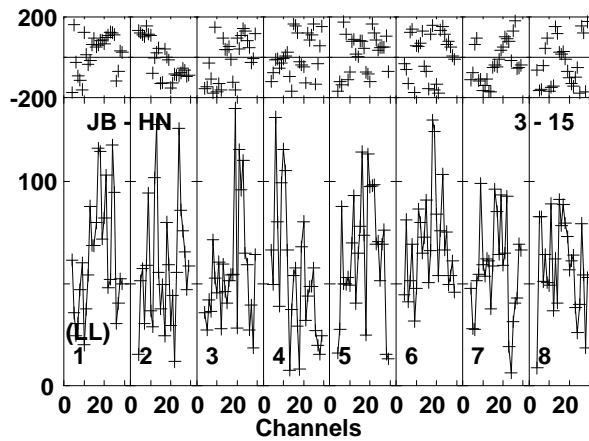
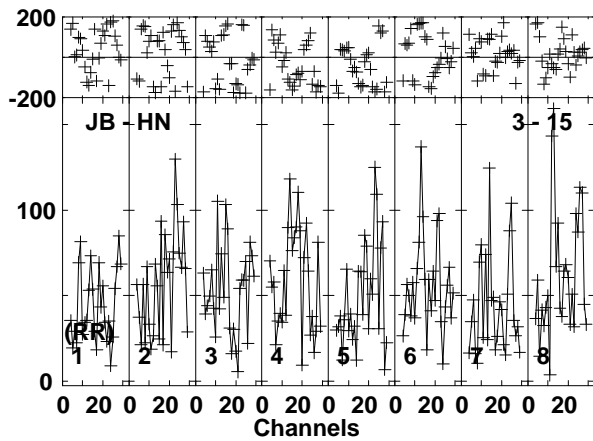
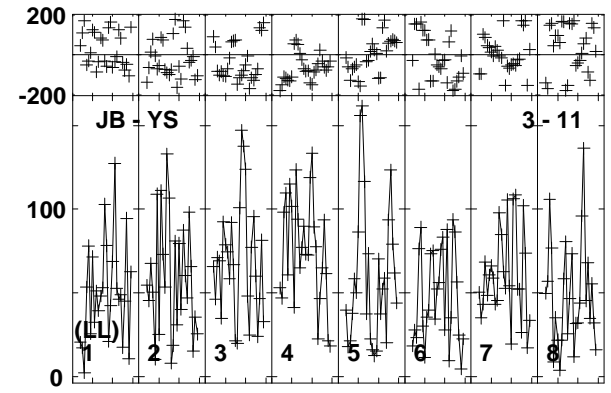
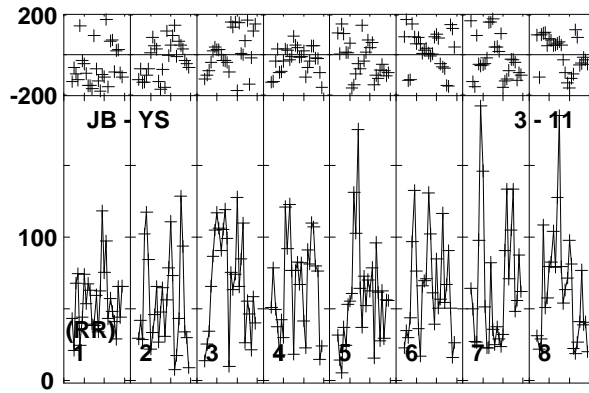
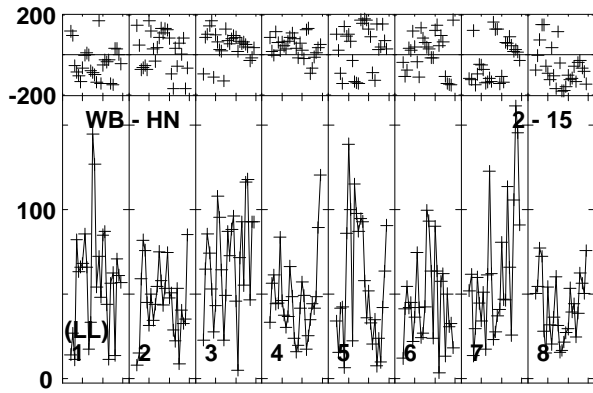
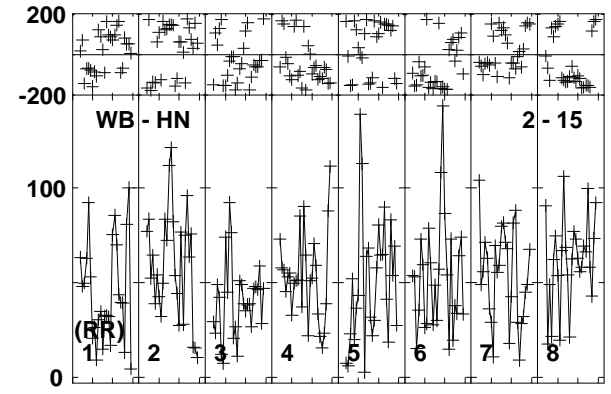
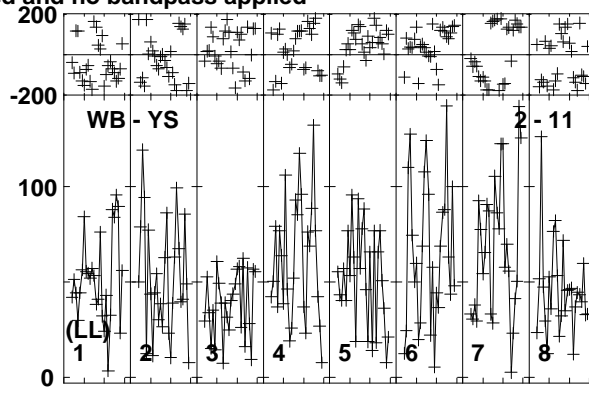
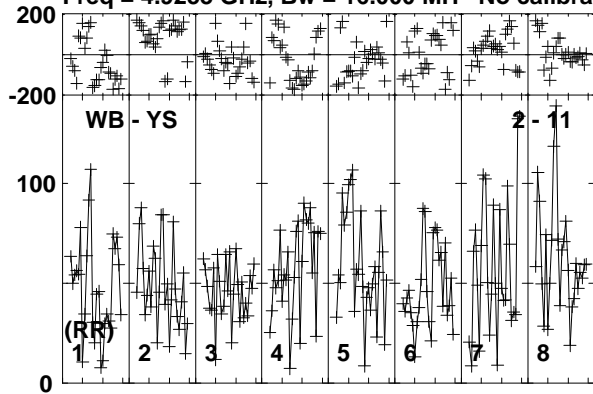

Lower frame: Micro Ampl Jy Top frame: Phas deg
Vector averaged cross-power spectrum Baseline: WB (02) - YS (11)
Timerange: 00:22:05:49 to 00:22:11:01

Plot file version 157 created 11-APR-2016 17:08:40

ARP299C GP053G 3.UVDATA.1

Freq = 4.9253 GHz, Bw = 16.000 MH No calibration applied and no bandpass applied

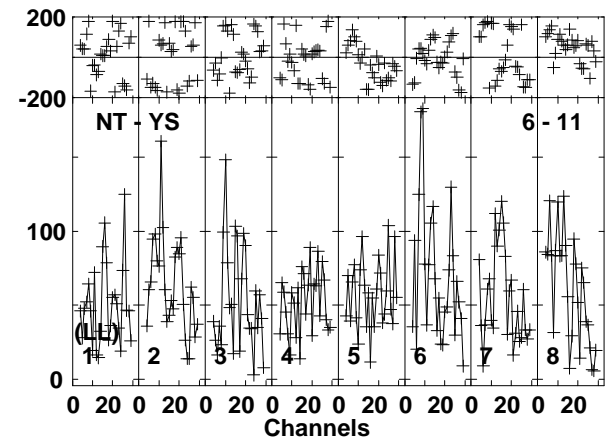
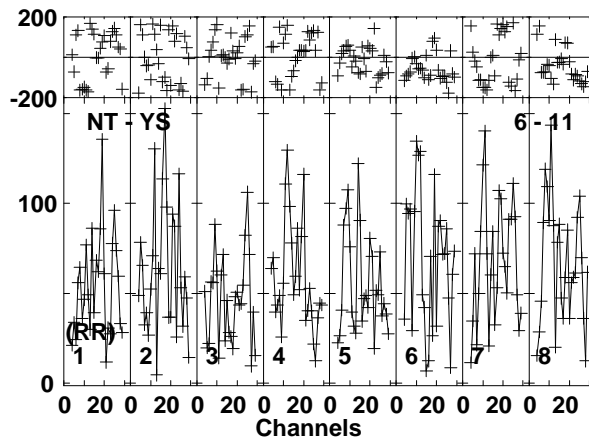
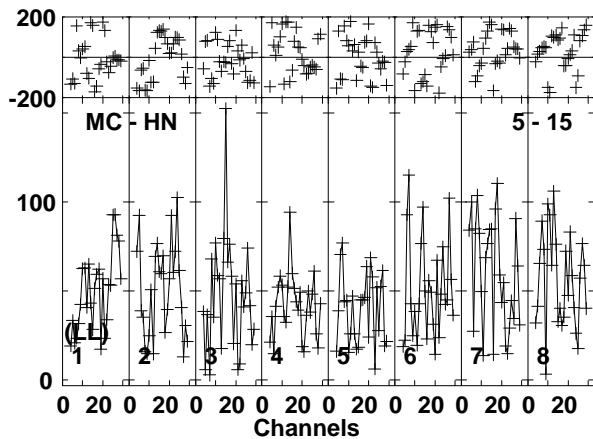
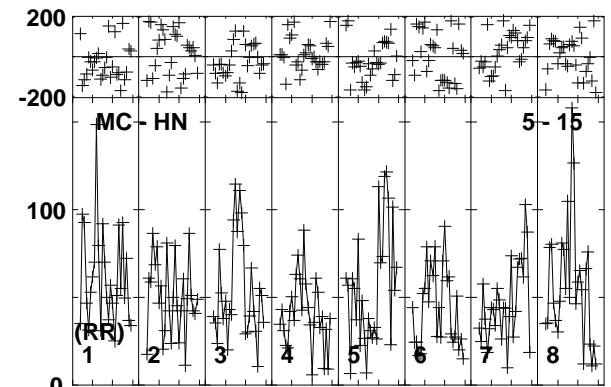
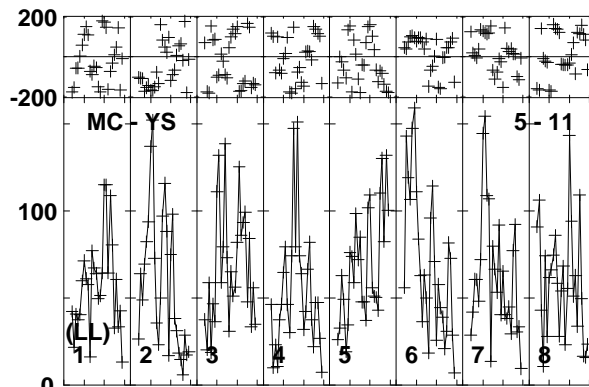
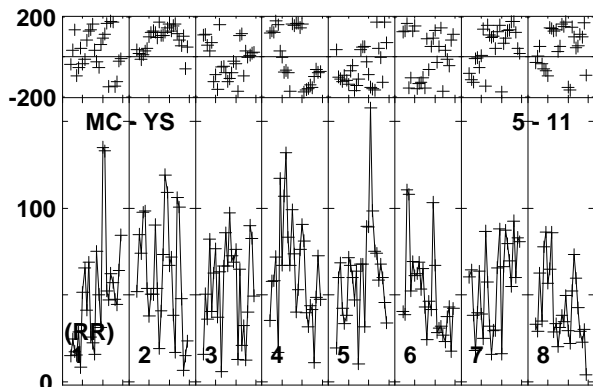
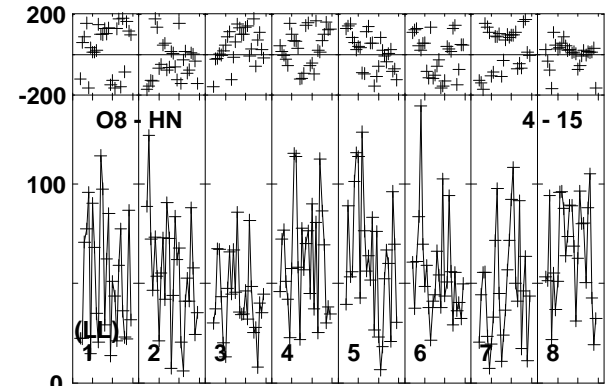
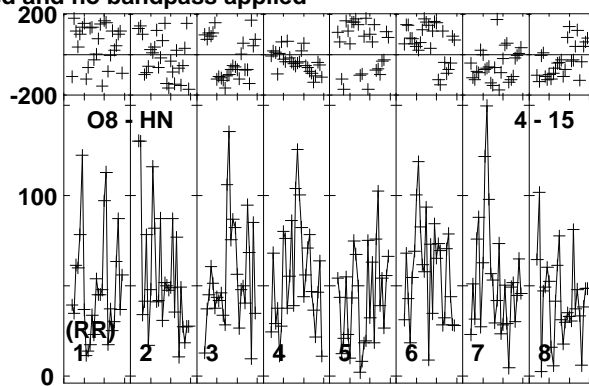
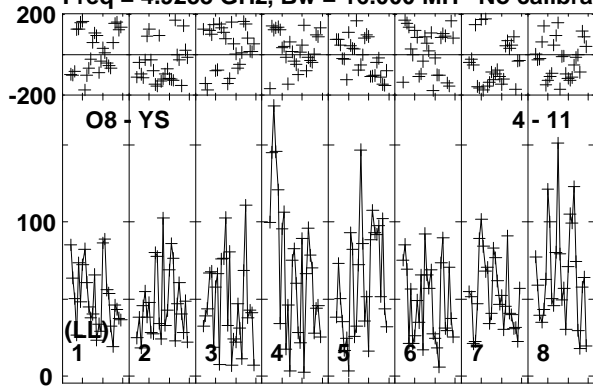

Lower frame: Micro Ampl Jy Top frame: Phas deg
Vector averaged cross-power spectrum Baseline: O8 (04) - YS (11)
Timerange: 00/22:05:49 to 00/22:11:01

Plot file version 158 created 11-APR-2016 17:08:40

ARP299C GP053G 3.UVDATA.1

Freq = 4.9253 GHz, Bw = 16.000 MH No calibration applied and no bandpass applied

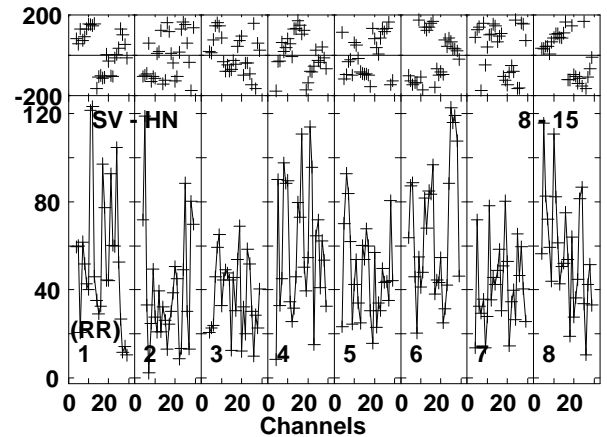
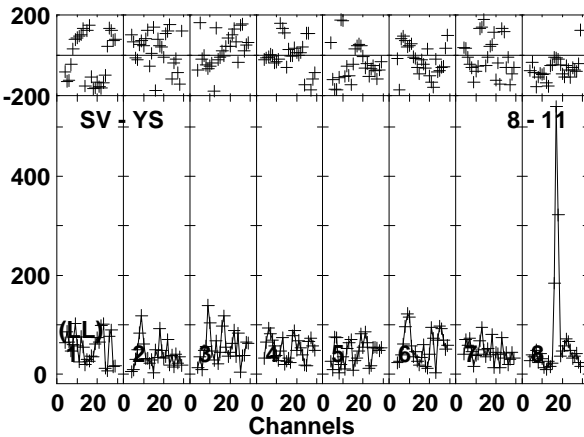
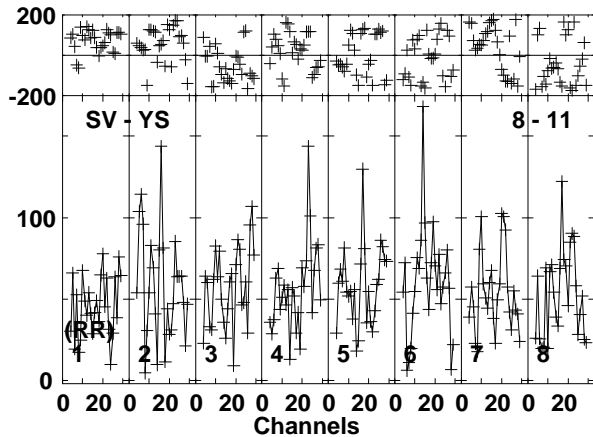
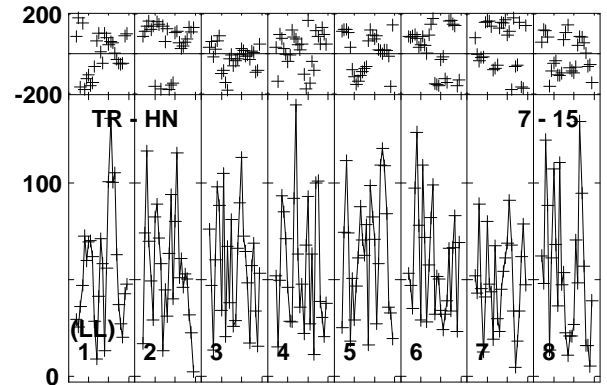
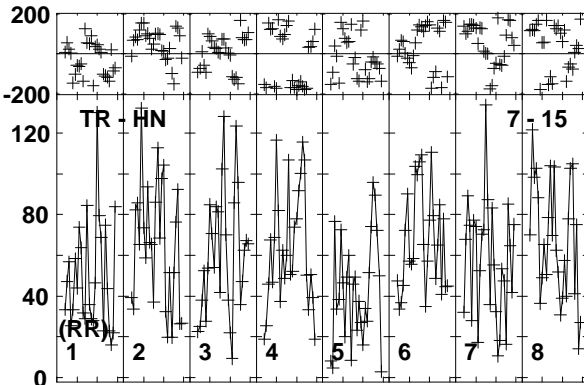
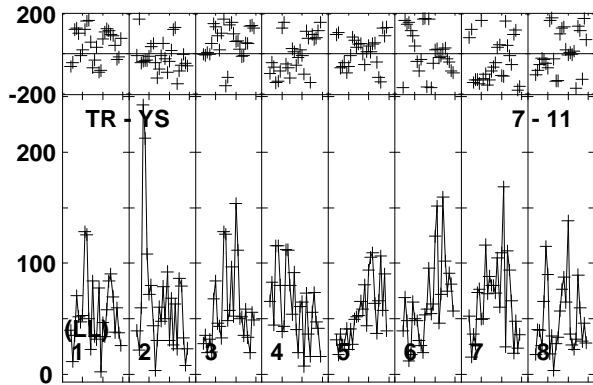
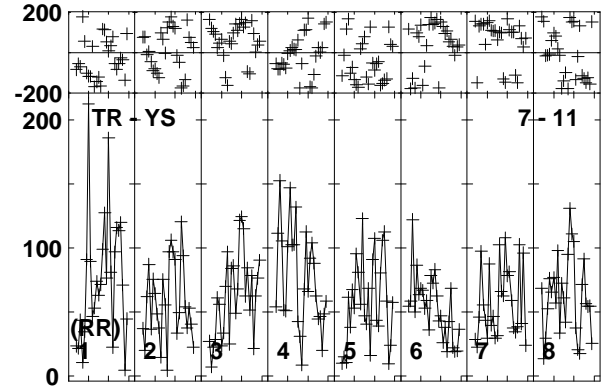
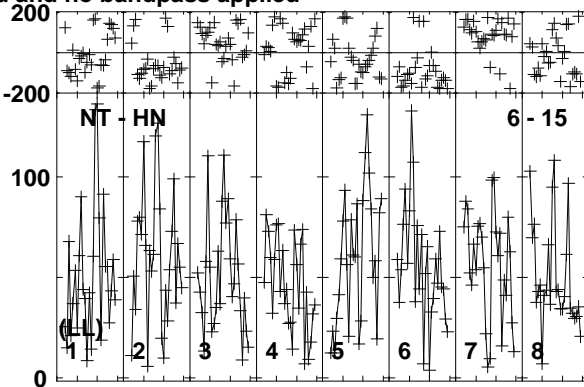
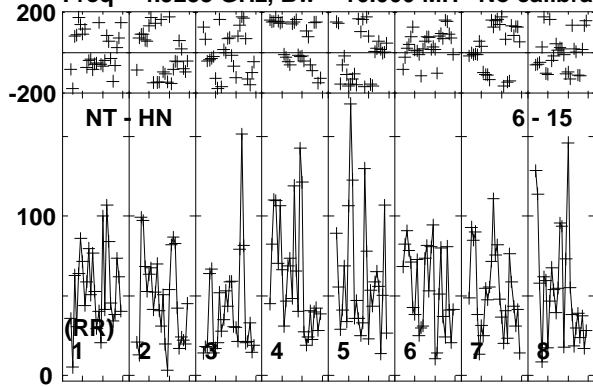

Lower frame: Micro Ampl Jy Top frame: Phas deg
Vector averaged cross-power spectrum Baseline: NT (06) - HN (15)
Timerange: 00:22:05:49 to 00:22:11:01

Plot file version 159 created 11-APR-2016 17:08:40

ARP299C GP053G 3.UVDATA.1

Freq = 4.9253 GHz, Bw = 16.000 MH No calibration applied and no bandpass applied

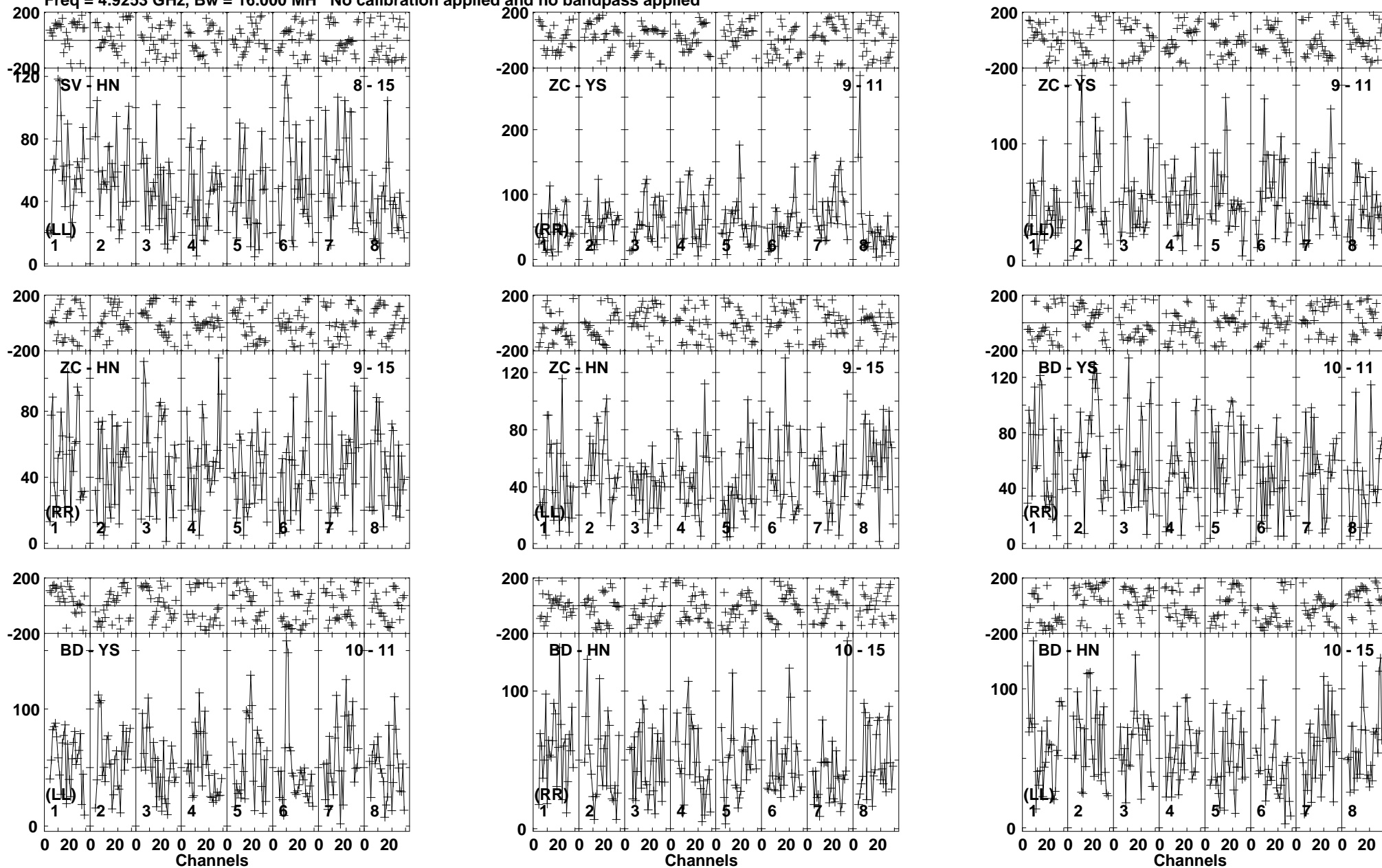

Lower frame: Micro Ampl Jy Top frame: Phas deg
Vector averaged cross-power spectrum Baseline: SV (08) - HN (15)
Timerange: 00:22:05:49 to 00:22:11:01

Plot file version 160 created 11-APR-2016 17:08:40

ARP299C GP053G 3.UVDATA.1

Freq = 4.9253 GHz, Bw = 16.000 MH No calibration applied and no bandpass applied

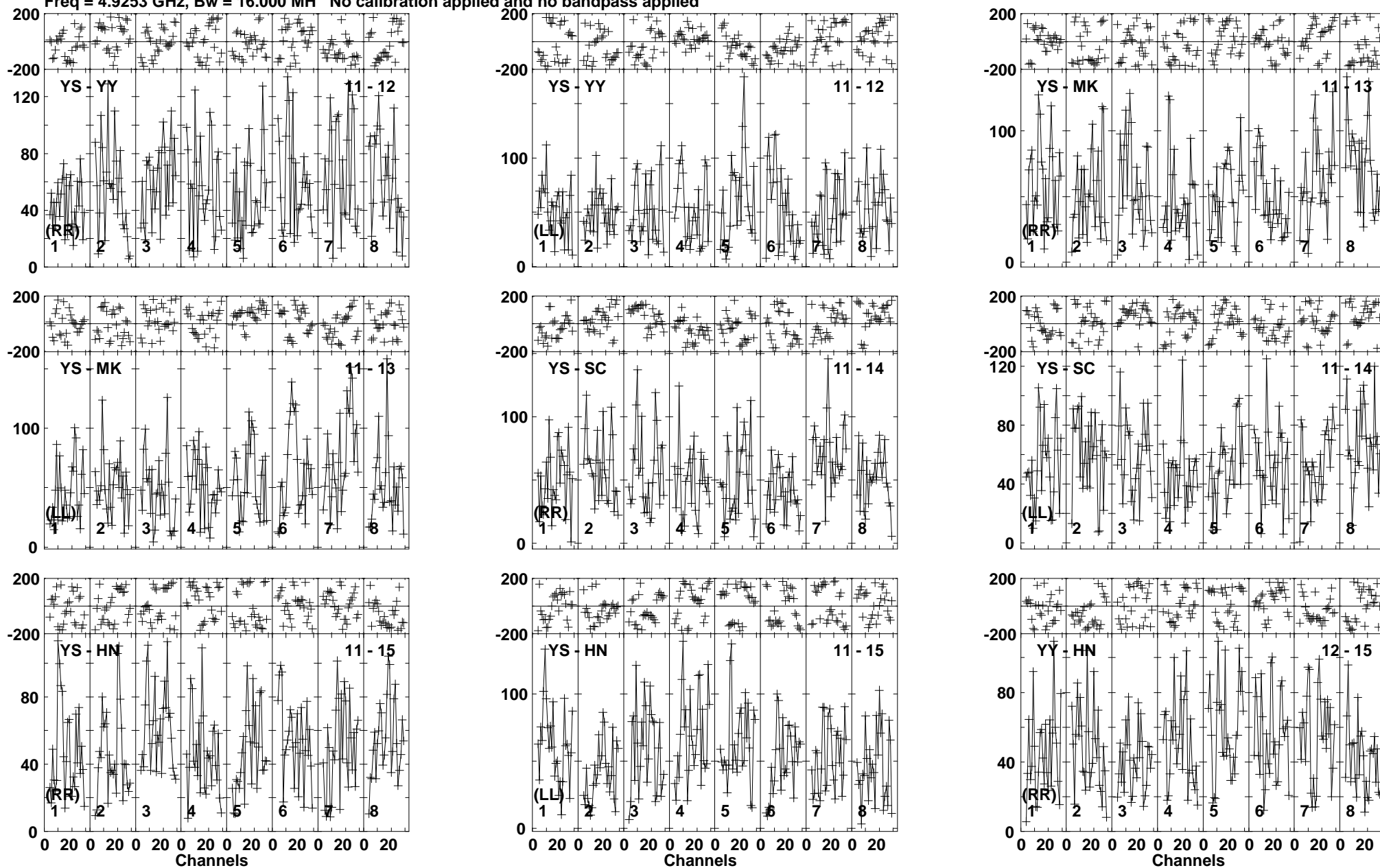

Lower frame: Micro Ampl Jy Top frame: Phas deg
Vector average cross-power spectrum Baseline: YS (11) - YY (12)
Timerange: 00:22:05:49 to 00:22:11:01

Plot file version 161 created 11-APR-2016 17:08:41

ARP299C GP053G 3.UVDATA.1

Freq = 4.9253 GHz, Bw = 16.000 MH No calibration applied and no bandpass applied

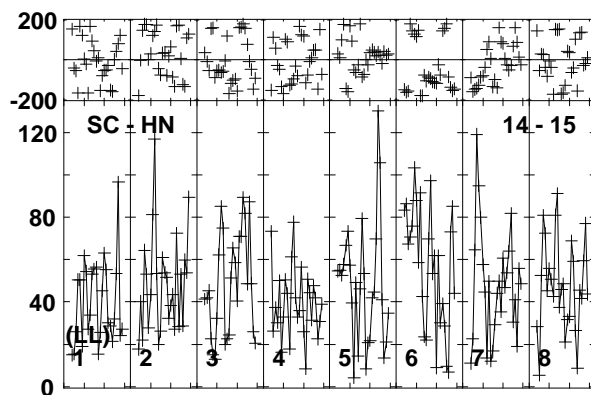
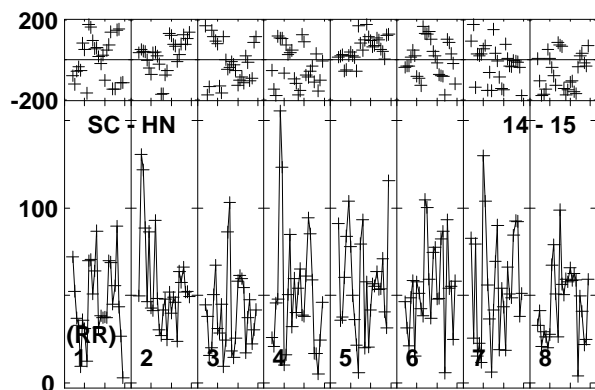
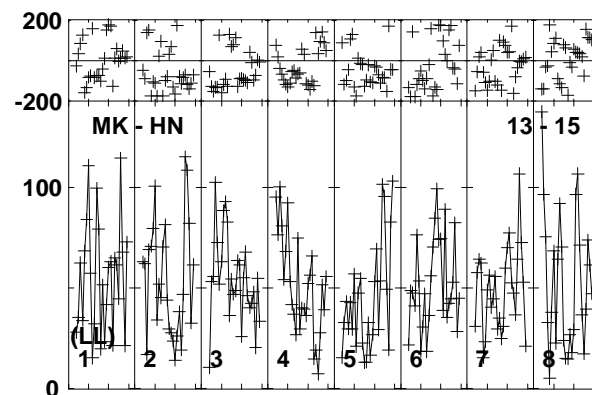
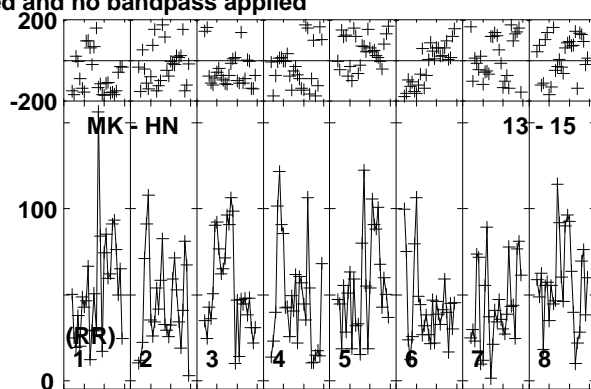
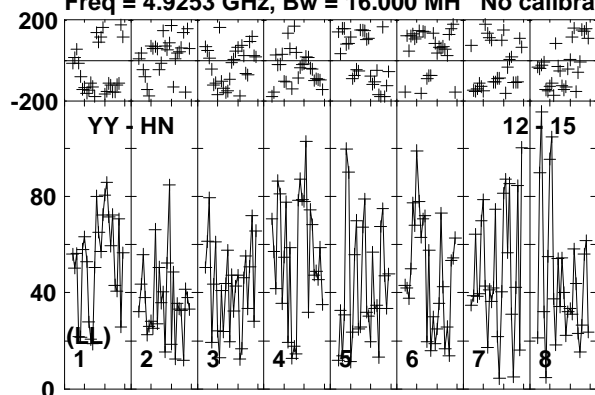

Lower frame: Micro Ampl Jy Top frame: Phas deg
Vector averaged cross-power spectrum Baseline: YY (12) - HN (15)
Timerange: 00/22:05:49 to 00/22:11:01

Plot file version 162 created 11-APR-2016 17:08:41

J1128+5925 GP053G 3.UVDATA.1

Freq = 4.9253 GHz, Bw = 16.000 MH No calibration applied and no bandpass applied

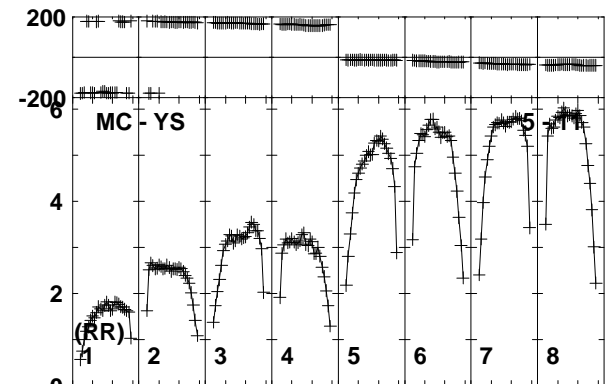
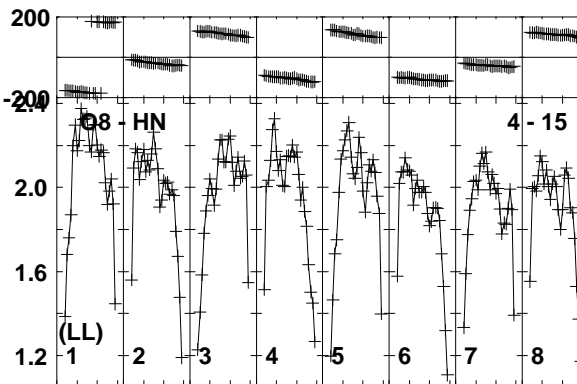
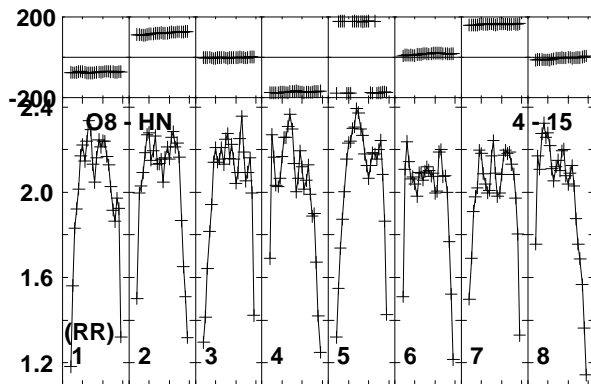
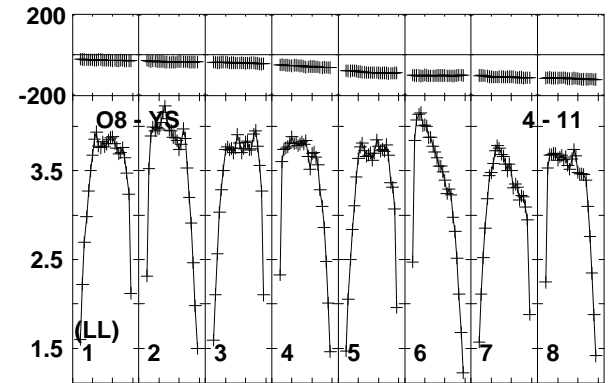
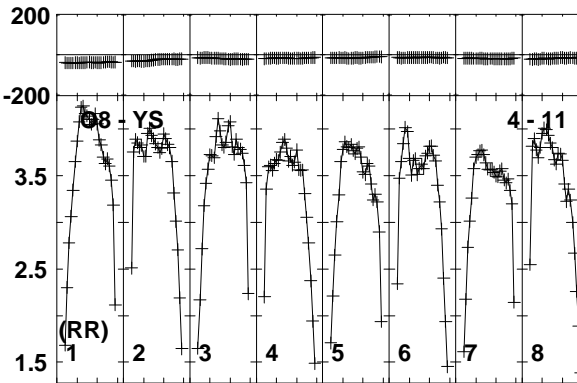
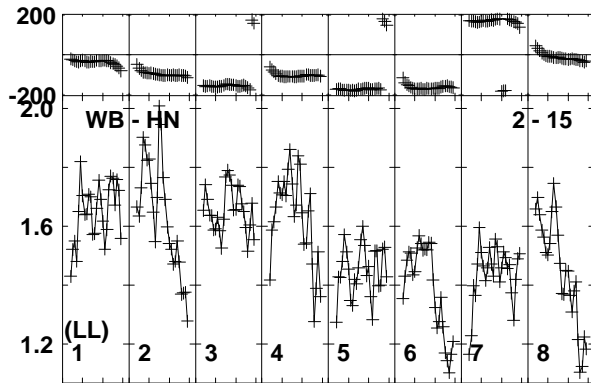
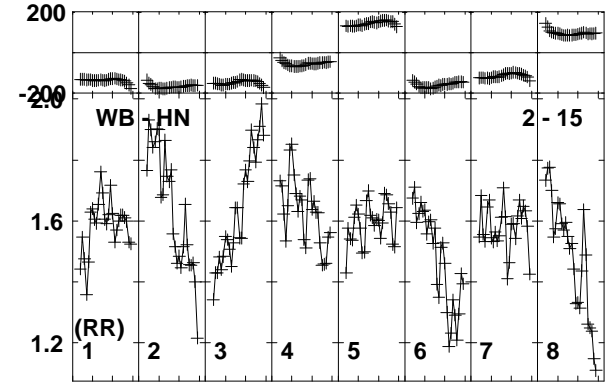
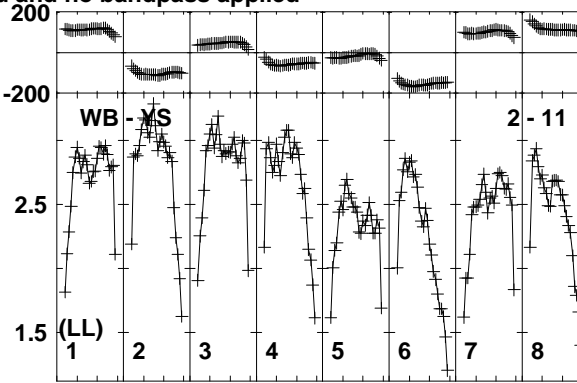
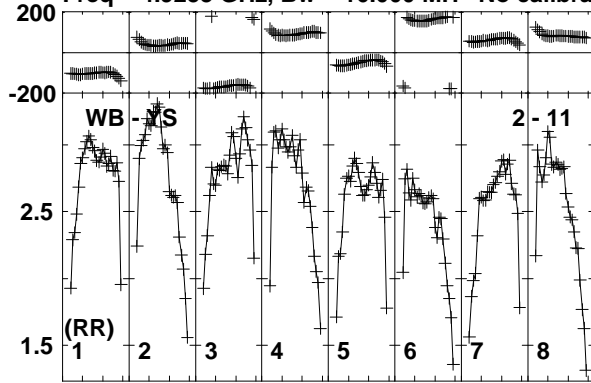

Lower frame: Milli Ampl Jy Top frame: Phas deg

Vector averaged cross-power spectrum Baseline: WB (02) - YS (11)

Timerange: 00/22:11:07 to 00/22:12:58

Plot file version 163 created 11-APR-2016 17:08:41
 J1128+5925 GP053G 3.UVDATA.1

Freq = 4.9253 GHz, Bw = 16.000 MH No calibration applied and no bandpass applied

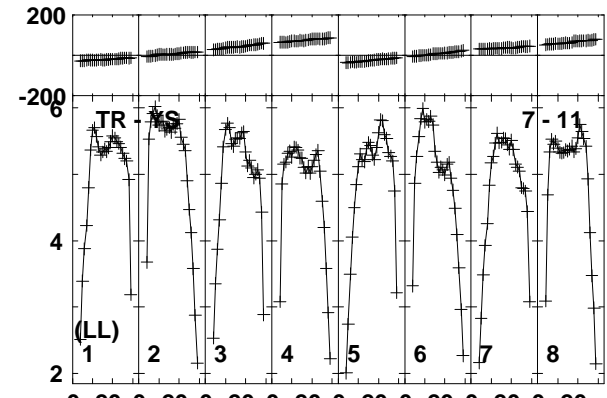
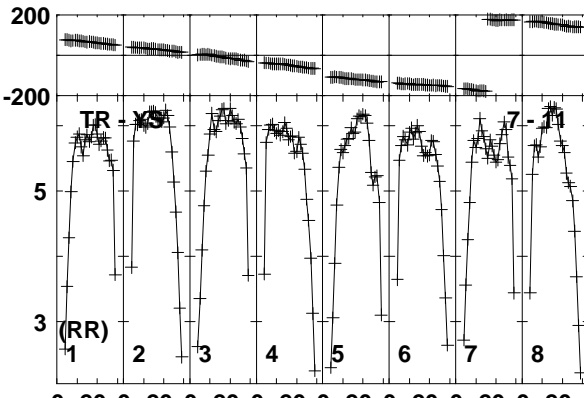
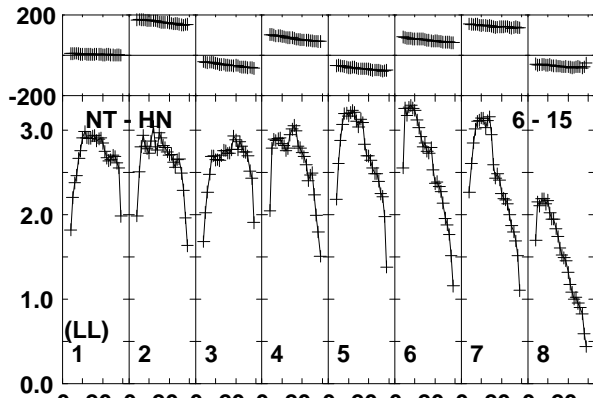
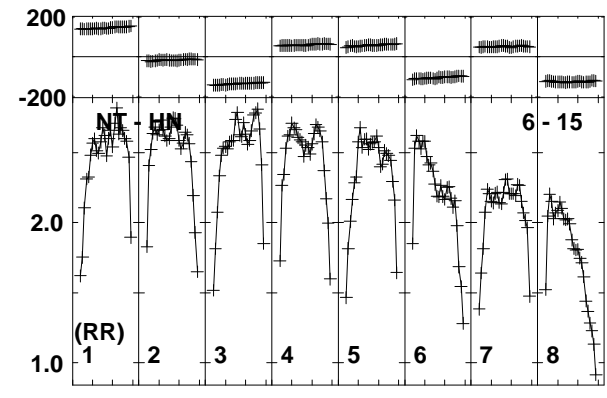
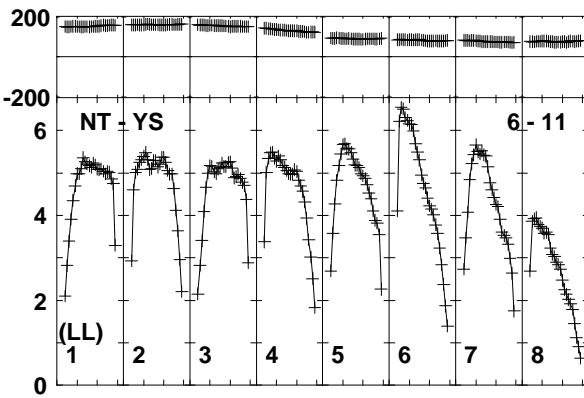
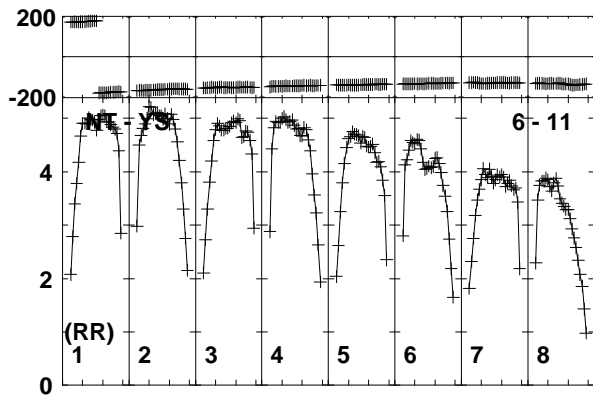
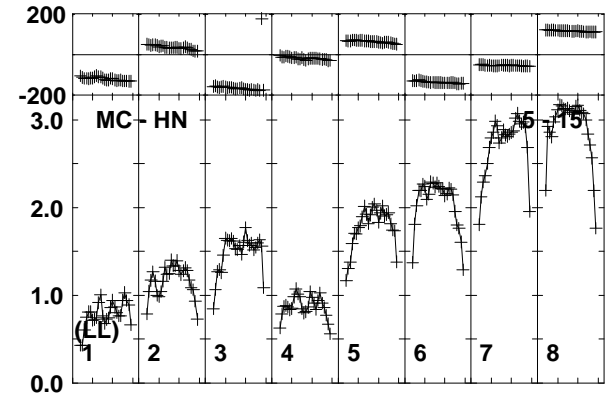
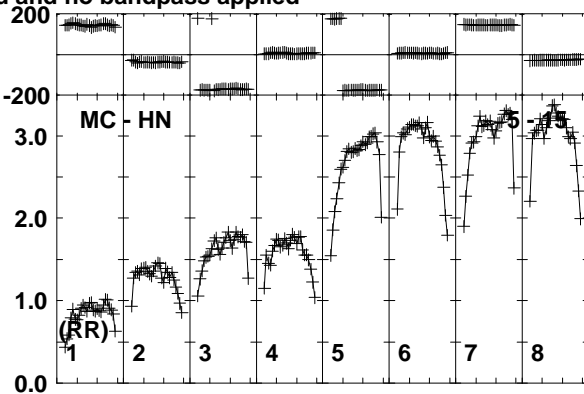
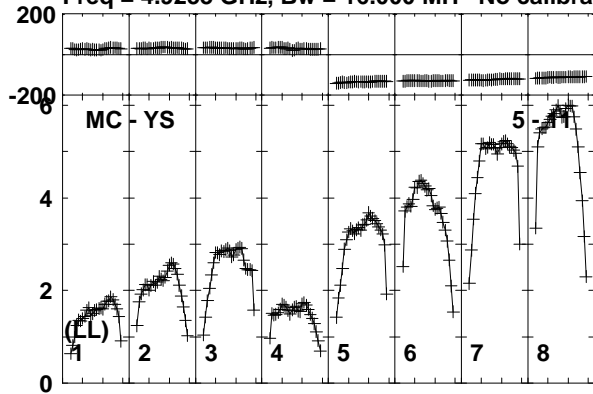

Lower frame: Milli Ampl Jy Top frame: Phas deg
 Vector averaged cross-power spectrum Baseline: MC (05) - YS (11)
 Timerange: 00:22:11:07 to 00:22:12:58

Plot file version 164 created 11-APR-2016 17:08:41

J1128+5925 GP053G 3.UVDATA.1

Freq = 4.9253 GHz, Bw = 16.000 MH No calibration applied and no bandpass applied

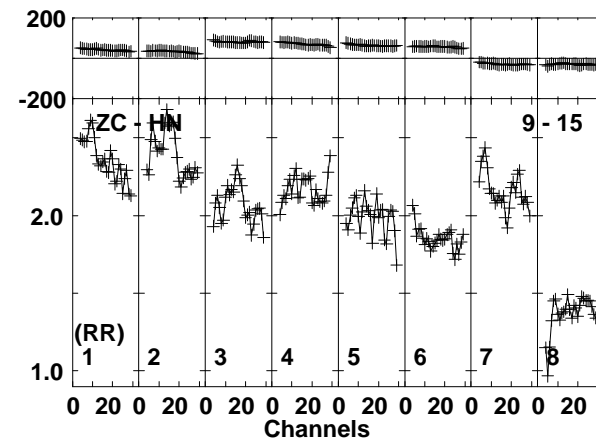
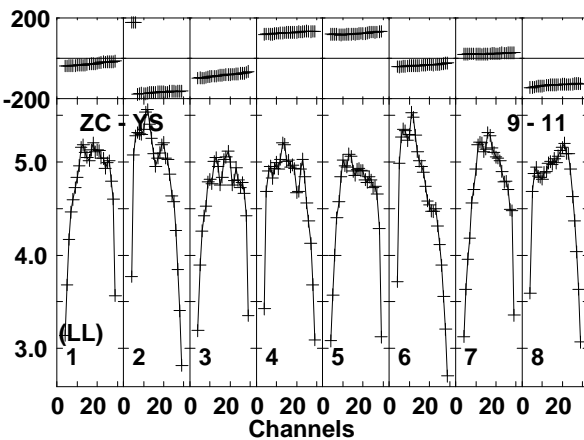
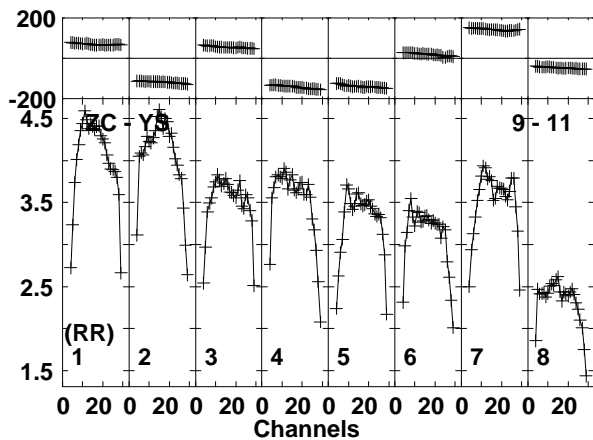
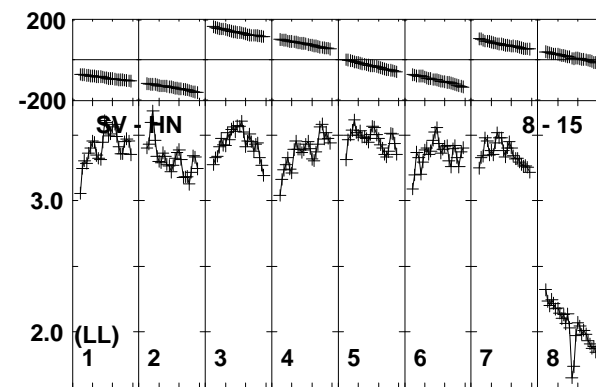
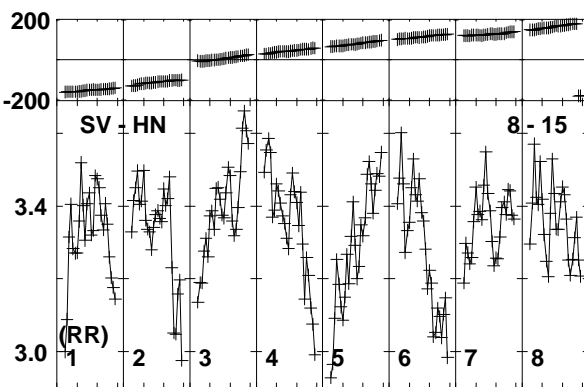
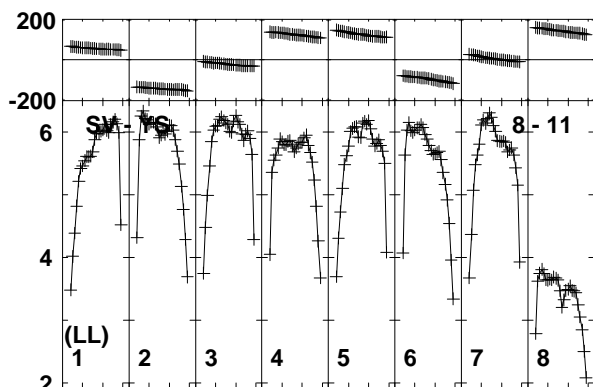
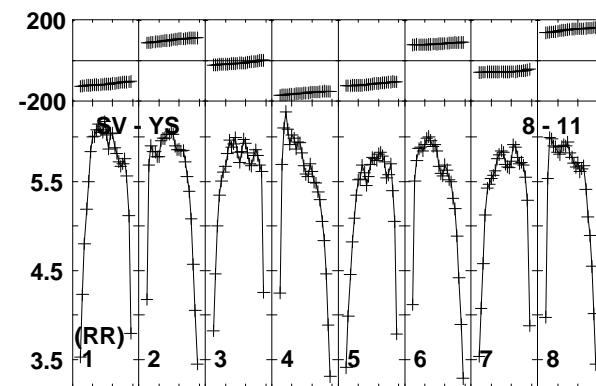
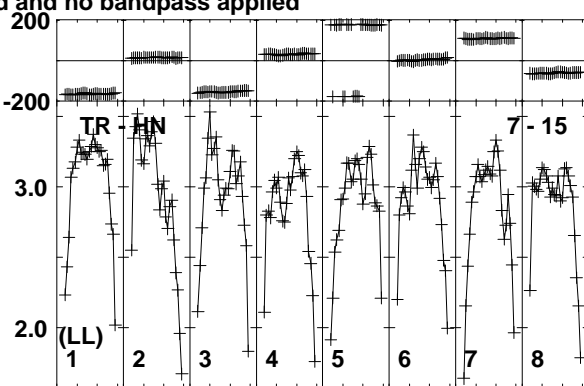
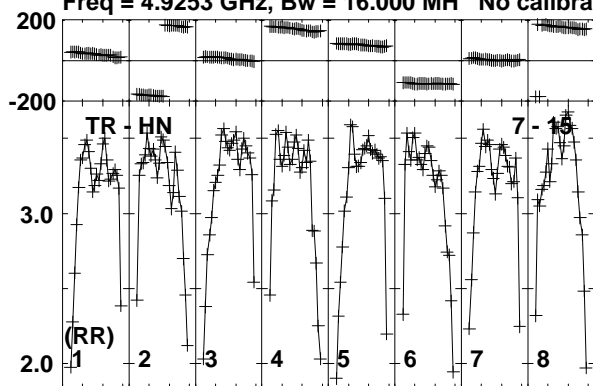

Lower frame: Milli Ampl Jy Top frame: Phas deg
Vector averaged cross-power spectrum Baseline: TR (07) - HN (15)
Timerange: 00/22:11:07 to 00/22:12:58

Plot file version 165 created 11-APR-2016 17:08:41

J1128+5925 GP053G 3.UVDATA.1

Freq = 4.9253 GHz, Bw = 16.000 MH No calibration applied and no bandpass applied

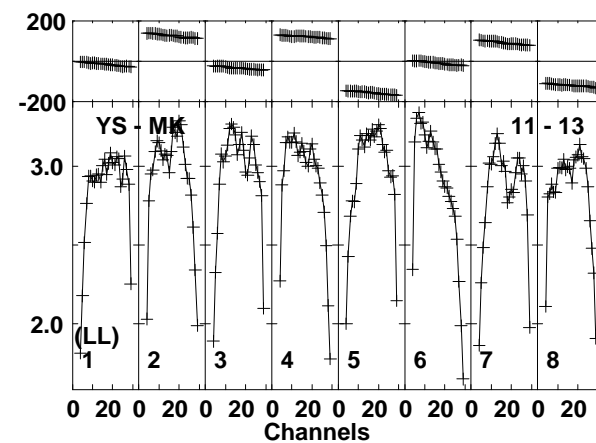
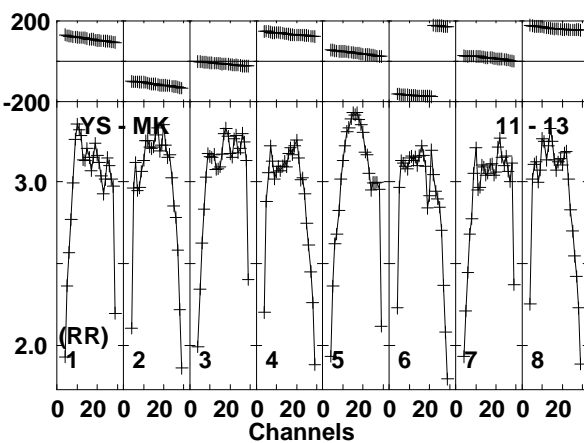
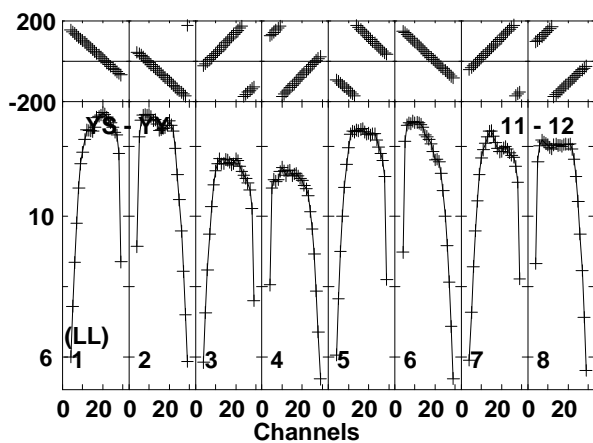
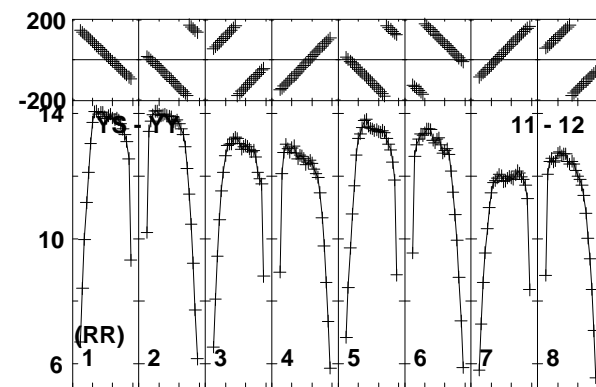
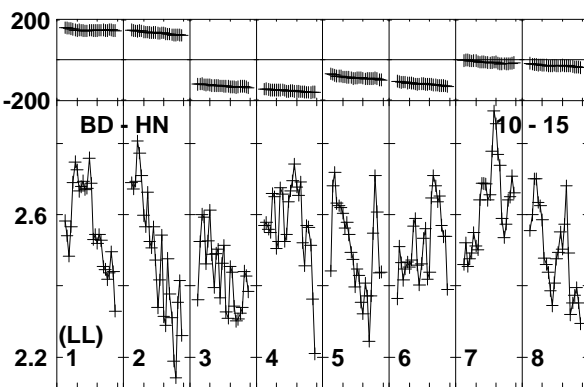
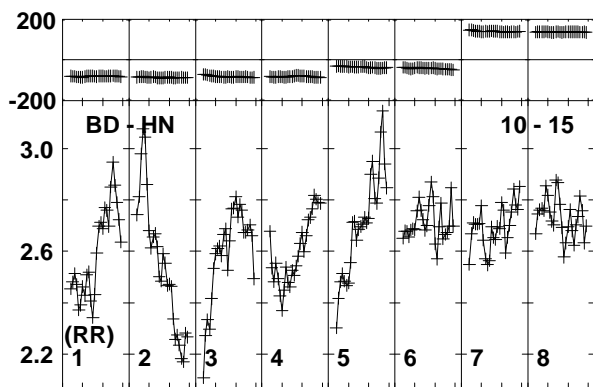
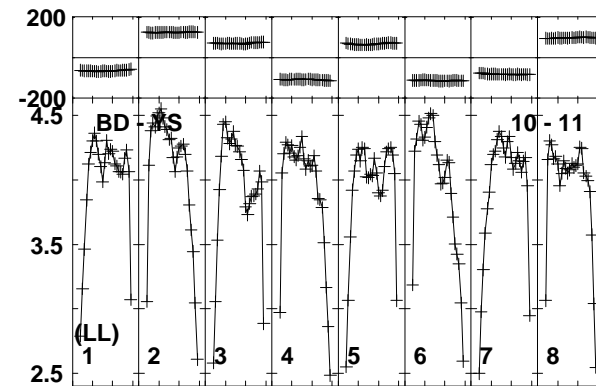
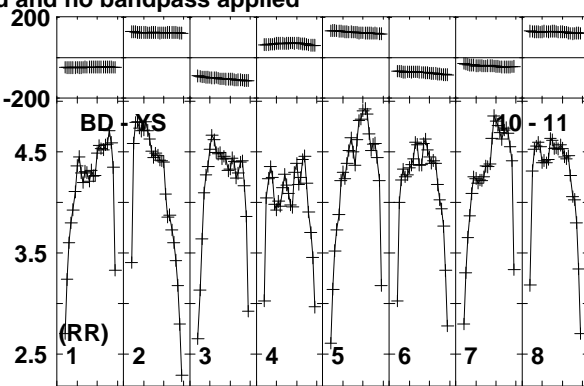
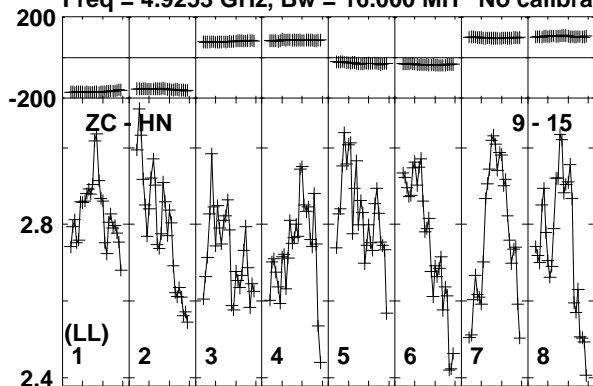

Lower frame: Milli Ampl Jy Top frame: Phas deg
Vector averaged cross-power spectrum Baseline: ZC (09) - HN (15)
Timerange: 00/22:11:07 to 00/22:12:58

Plot file version 166 created 11-APR-2016 17:08:41

J1128+5925 GP053G 3.UVDATA.1

Freq = 4.9253 GHz, Bw = 16.000 MH No calibration applied and no bandpass applied

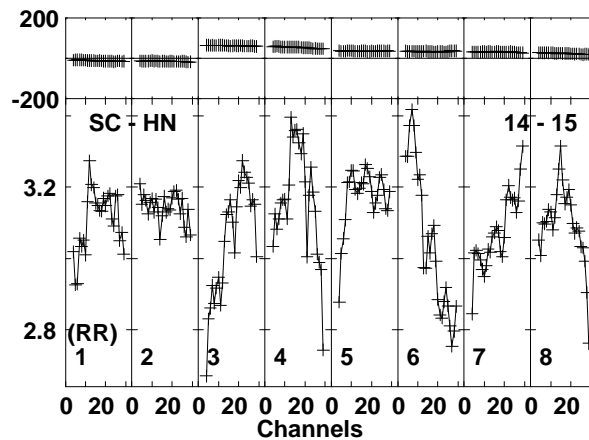
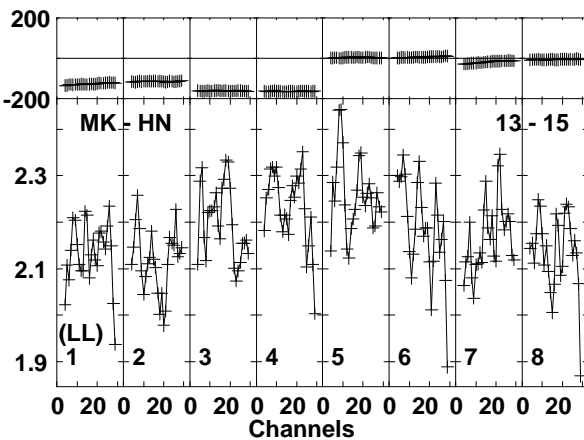
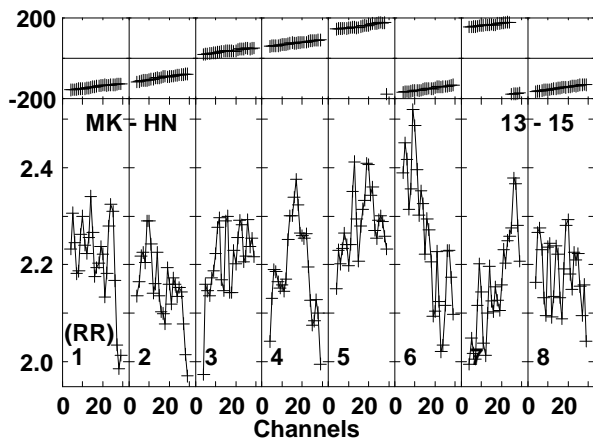
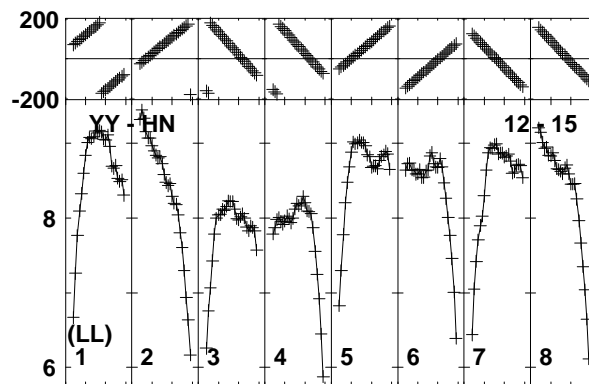
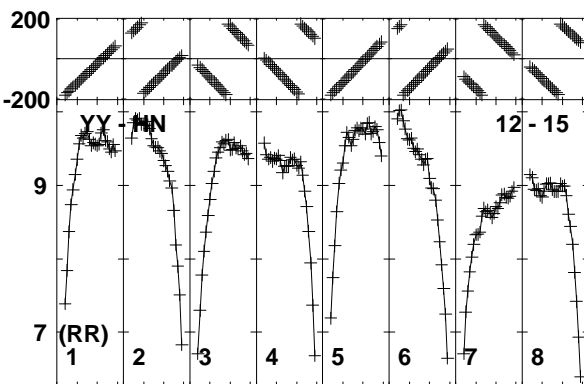
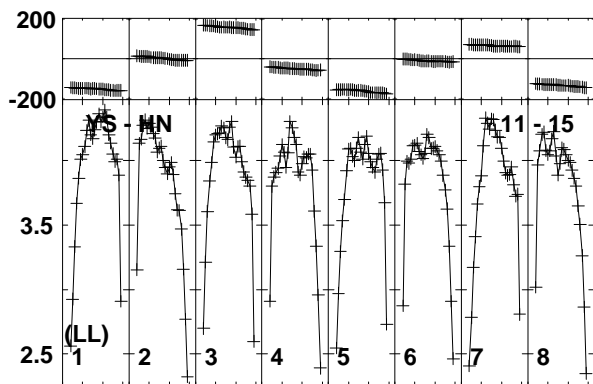
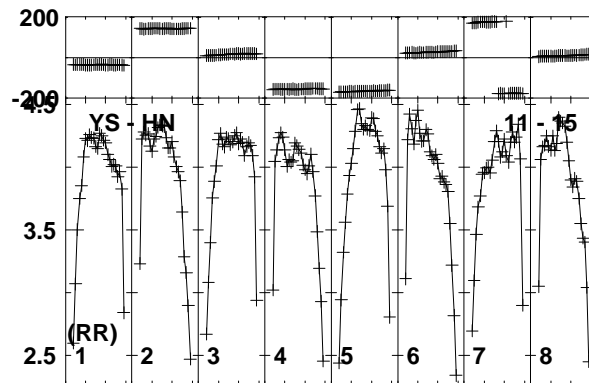
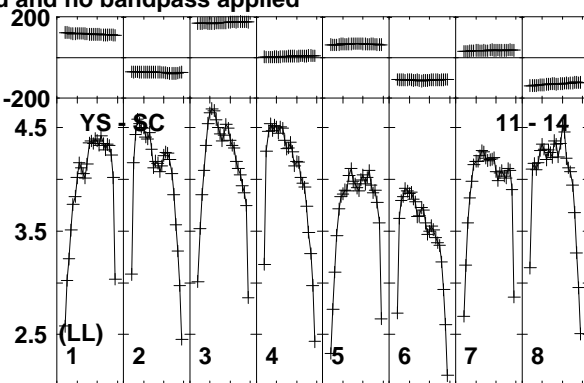
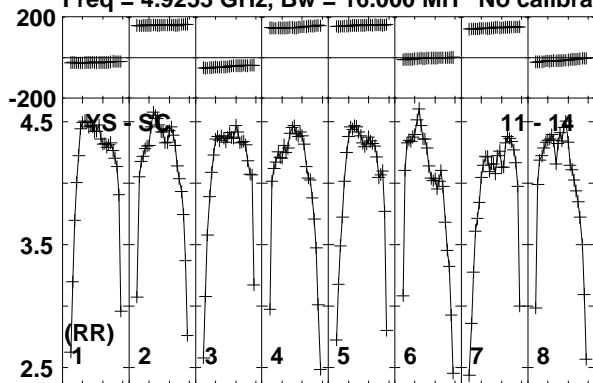

Lower frame: Milli Ampl Jy Top frame: Phas deg
Vector averaged cross-power spectrum Baseline: YS (11) - SC (14)
Timerange: 00:22:11:07 to 00:22:12:58

Plot file version 167 created 11-APR-2016 17:08:42
J1128+5925 GP053G 3.UVDATA.1
Freq = 4.9253 GHz, Bw = 16.000 MH No calibration applied and no bandpass applied

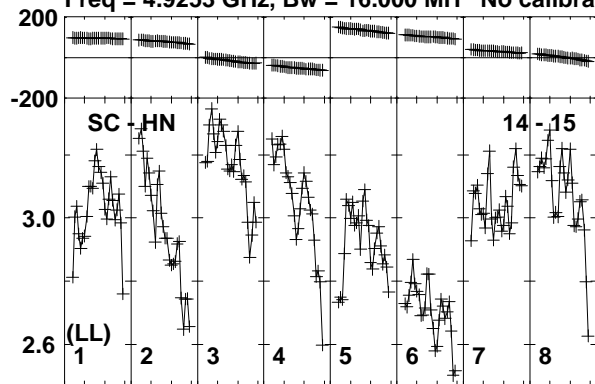

Lower frame: Milli Ampl Jy Top frame: Phas deg
Vector averaged cross-power spectrum Baseline: SC (14) - HN (15)
Timerange: 00/22:11:07 to 00/22:12:58

Plot file version 168 created 11-APR-2016 17:08:42
ARP299C GP053G 3.UVDATA.1

Freq = 4.9253 GHz, Bw = 16.000 MH No calibration applied and no bandpass applied

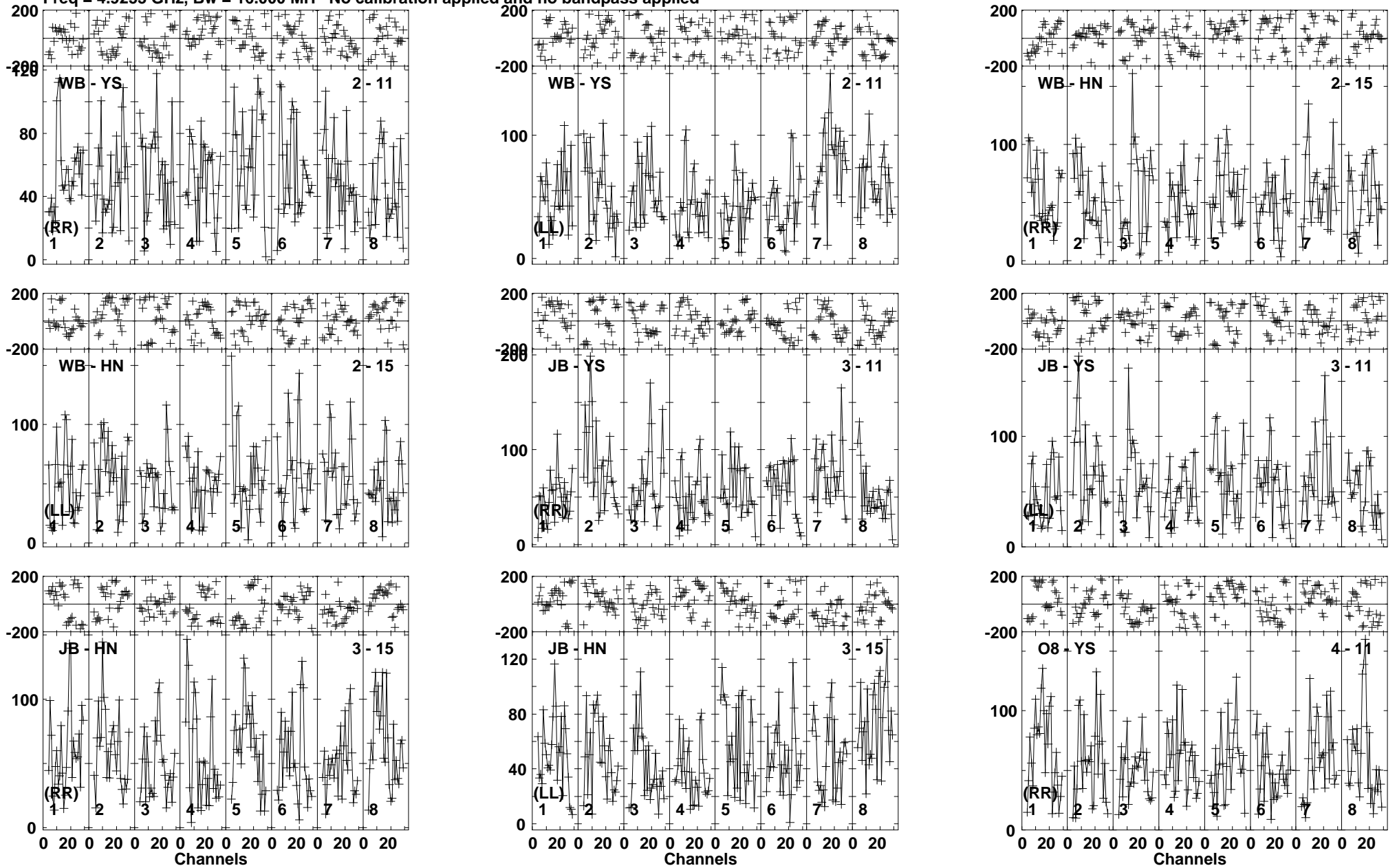

Lower frame: Micro Ampl Jy Top frame: Phas deg
Vector averaged cross-power spectrum Baseline: WB (02) - YS (11)
Timerange: 00/22:13:03 to 00/22:18:17

Plot file version 169 created 11-APR-2016 17:08:42

ARP299C GP053G 3.UVDATA.1

Freq = 4.9253 GHz, Bw = 16.000 MH No calibration applied and no bandpass applied

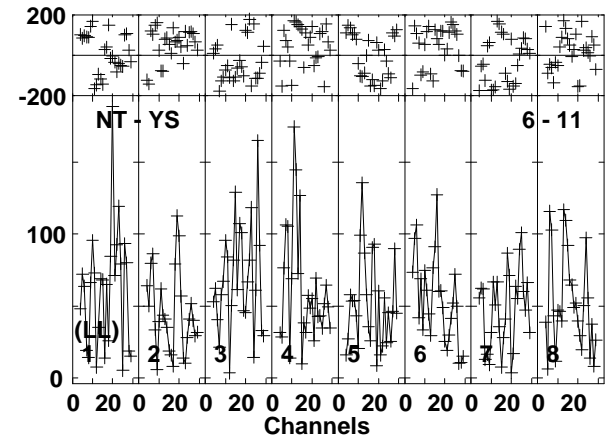
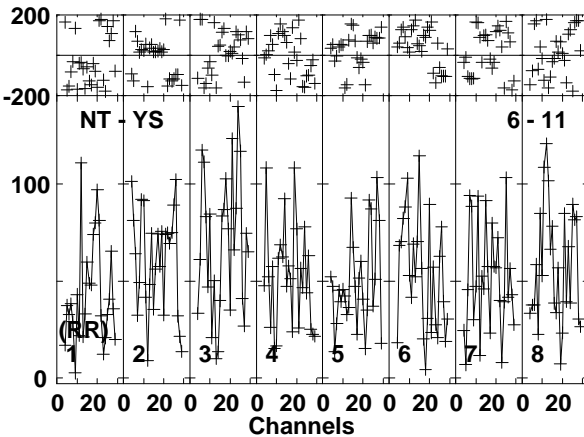
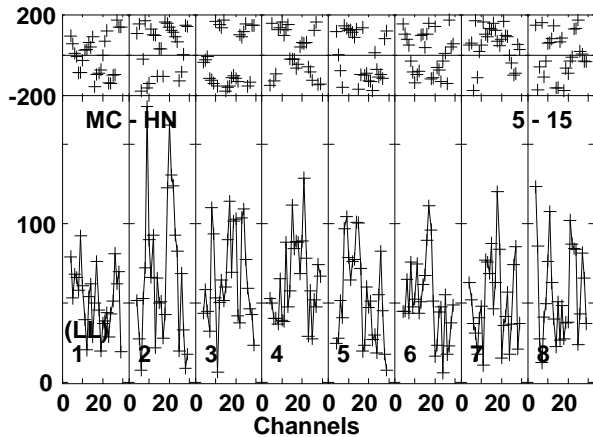
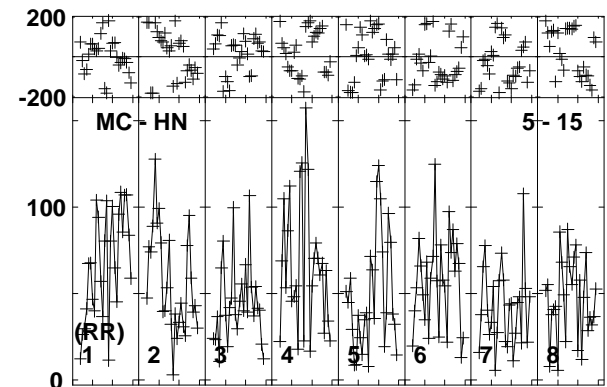
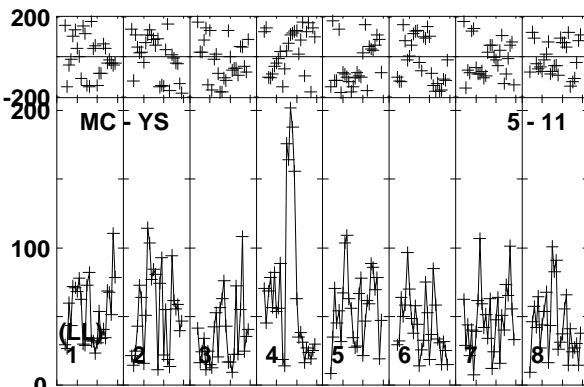
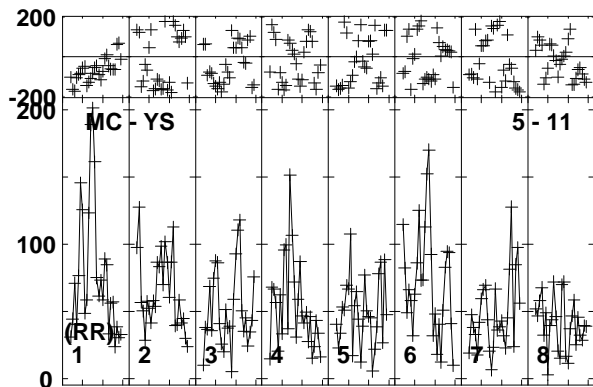
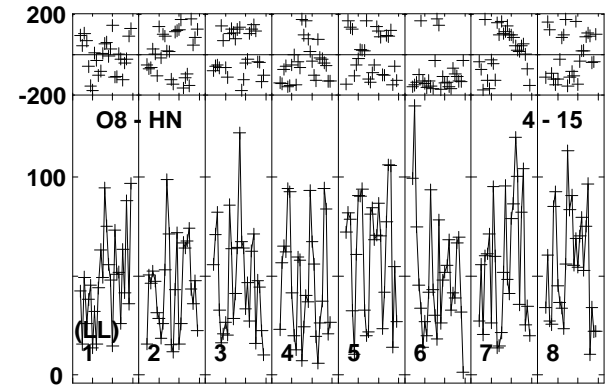
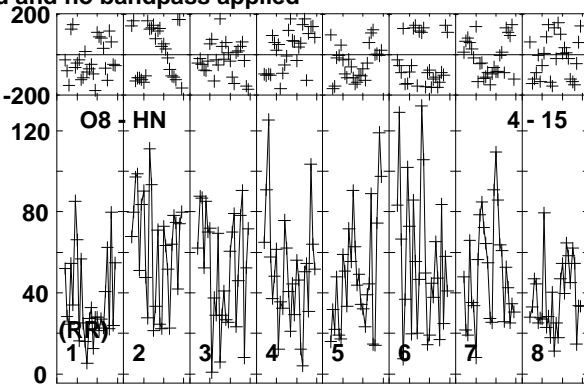
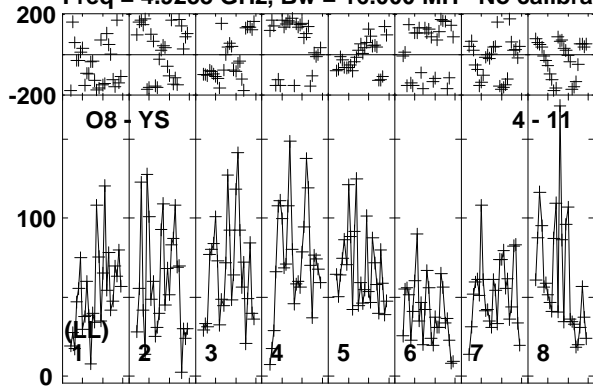

Lower frame: Micro Ampl Jy Top frame: Phas deg
Vector averaged cross-power spectrum Baseline: O8 (04) - YS (11)
Timerange: 00/22:13:03 to 00/22:18:17

Plot file version 170 created 11-APR-2016 17:08:42

ARP299C GP053G 3.UVDATA.1

Freq = 4.9253 GHz, Bw = 16.000 MH No calibration applied and no bandpass applied

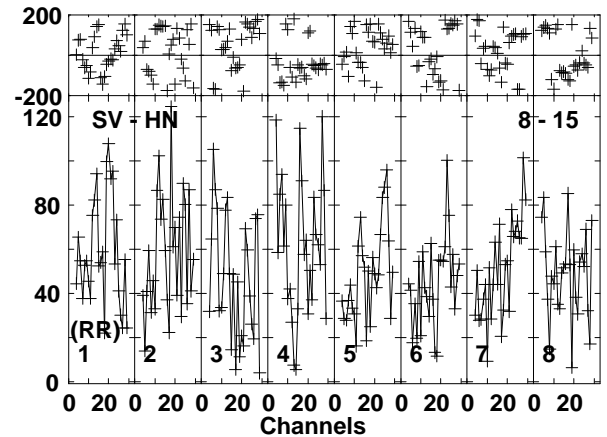
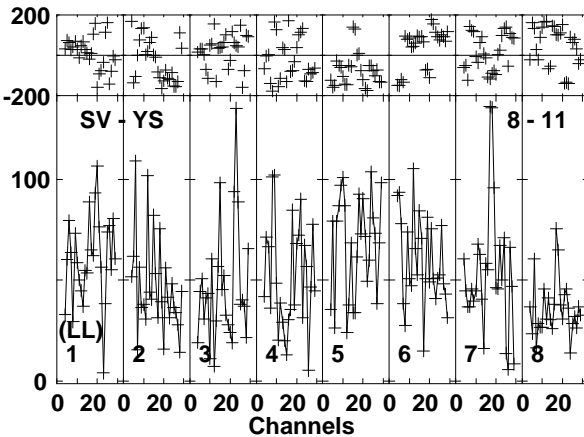
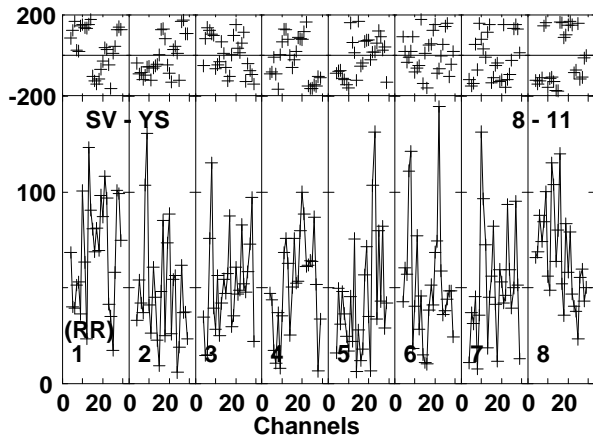
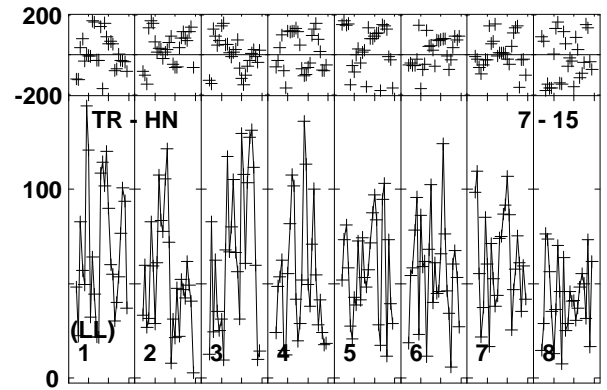
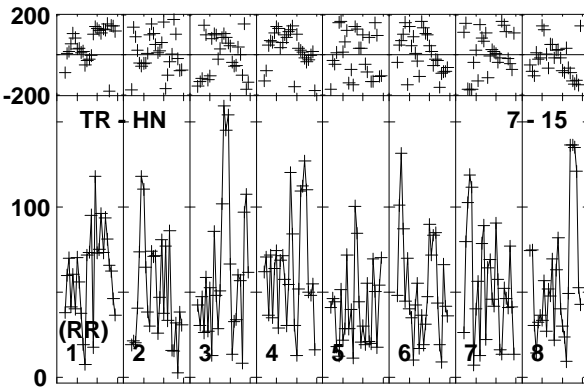
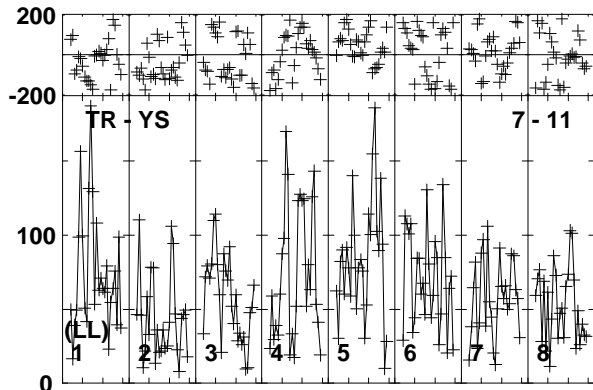
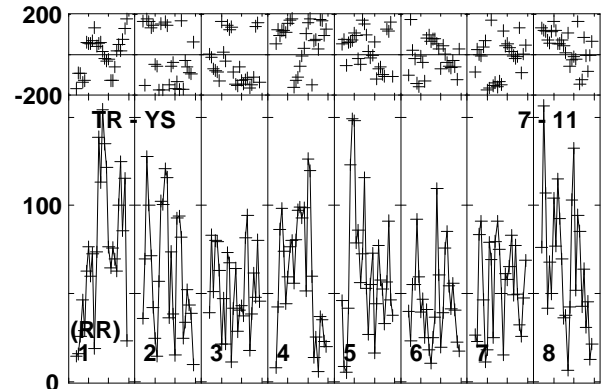
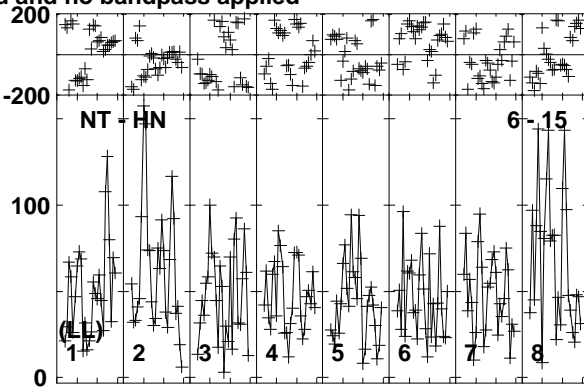
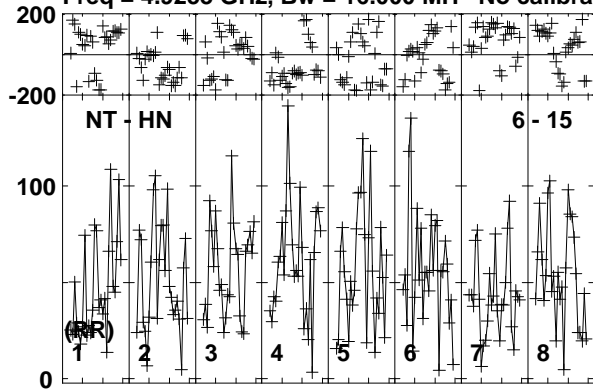

Lower frame: Micro Ampl Jy Top frame: Phas deg
Vector averaged cross-power spectrum Baseline: NT (06) - HN (15)
Timerange: 00/22:13:03 to 00/22:18:17

Plot file version 171 created 11-APR-2016 17:08:42

ARP299C GP053G 3.UVDATA.1

Freq = 4.9253 GHz, Bw = 16.000 MH No calibration applied and no bandpass applied

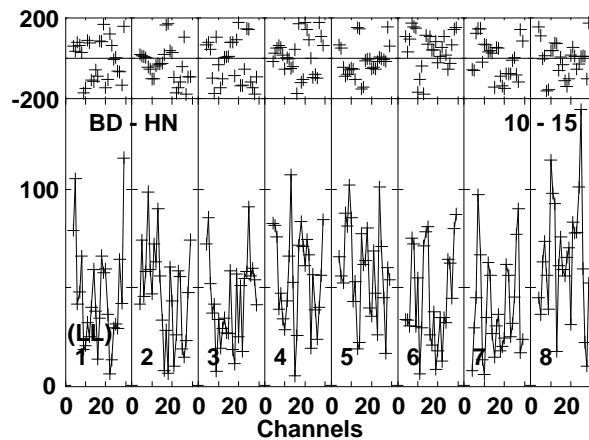
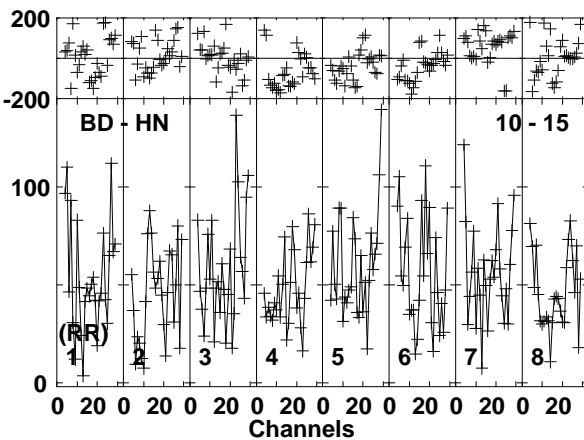
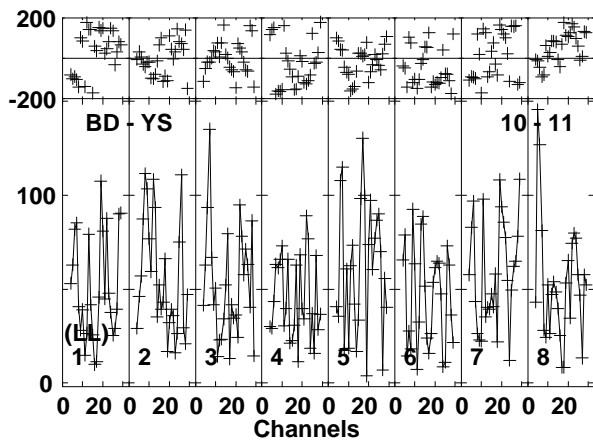
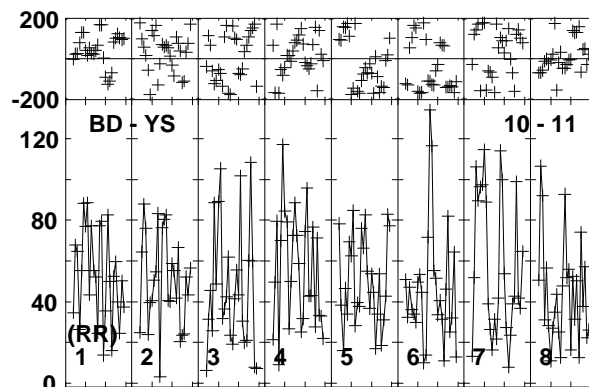
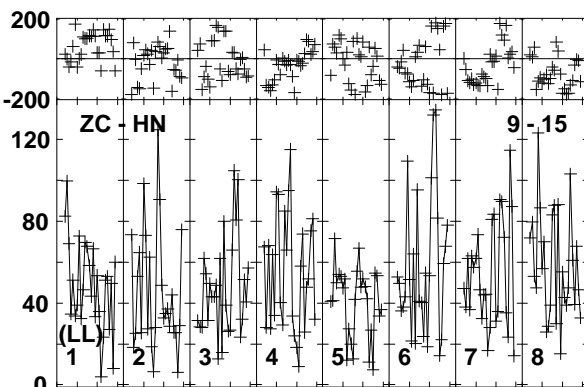
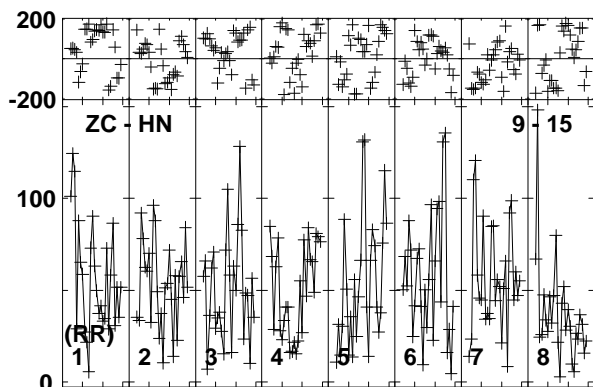
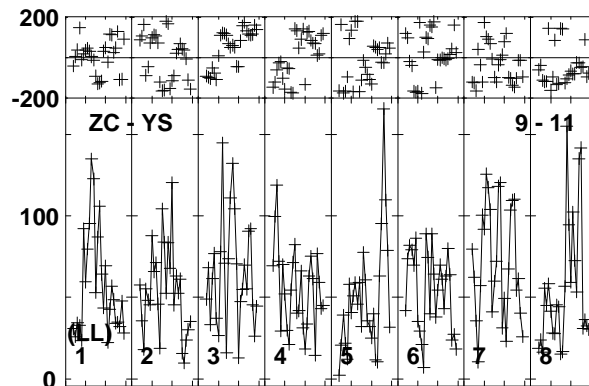
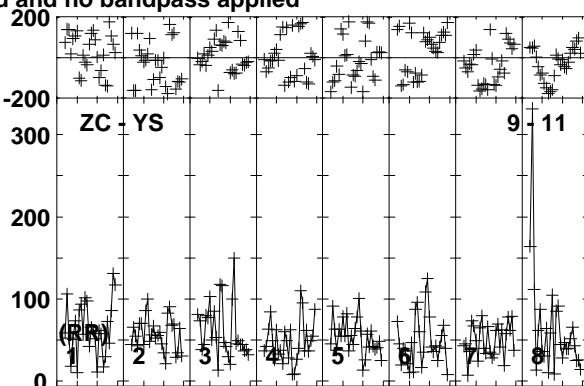
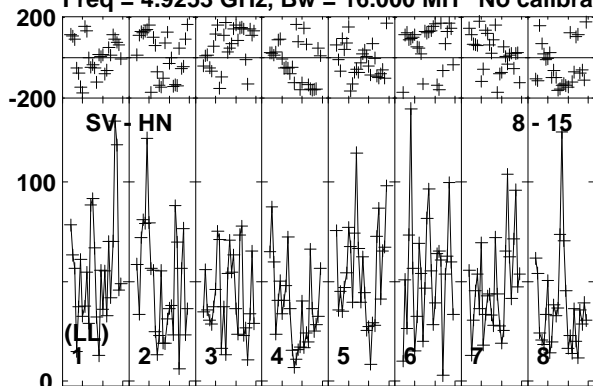

Lower frame: Micro Ampl Jy Top frame: Phas deg
Vector averaged cross-power spectrum Baseline: SV (08) - HN (15)
Timerange: 00/22:13:03 to 00/22:18:17

Plot file version 172 created 11-APR-2016 17:08:43

ARP299C GP053G 3.UVDATA.1

Freq = 4.9253 GHz, Bw = 16.000 MH No calibration applied and no bandpass applied

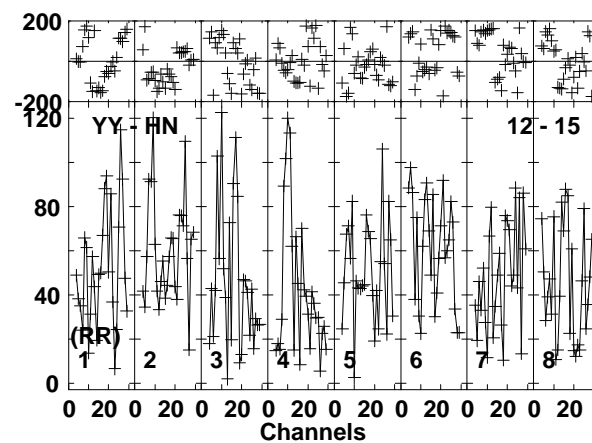
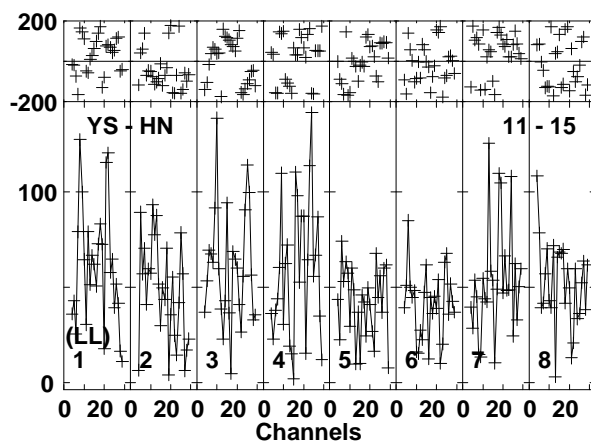
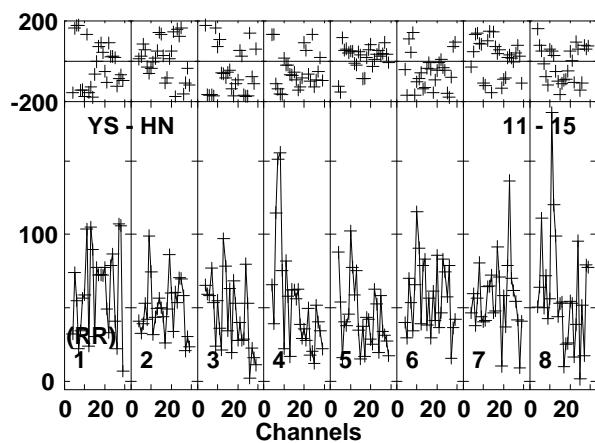
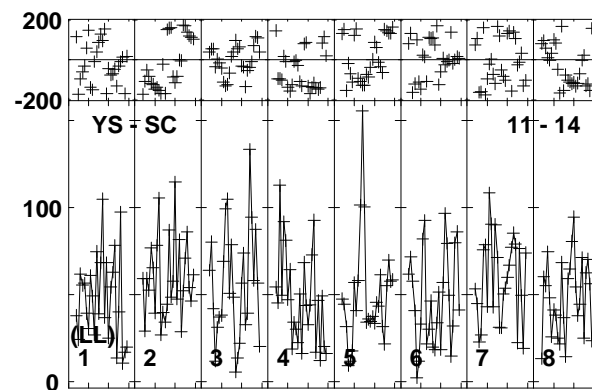
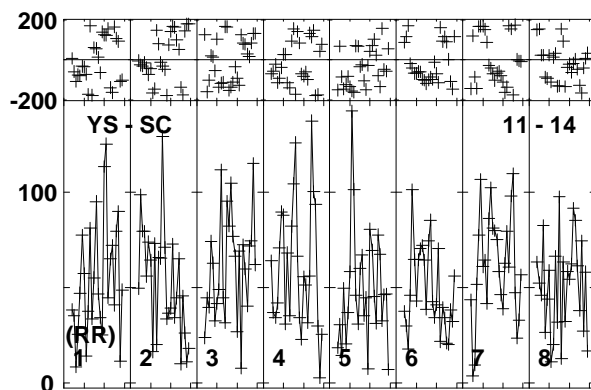
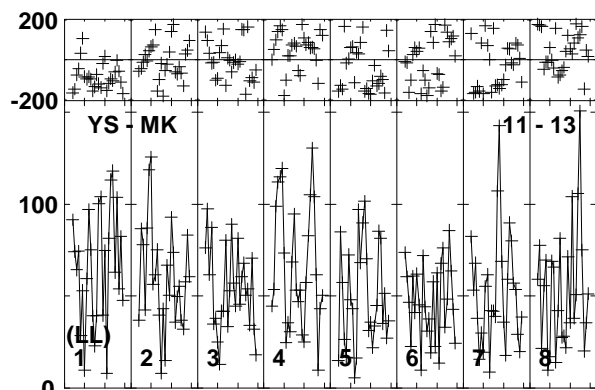
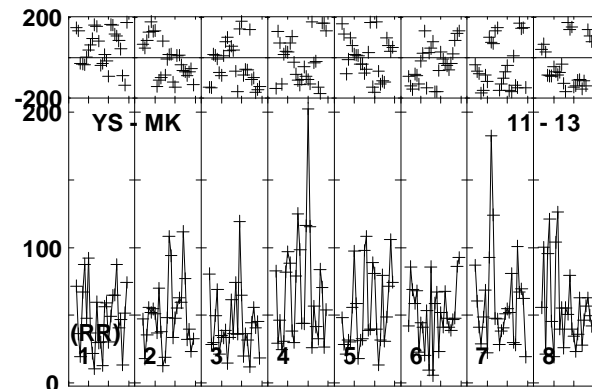
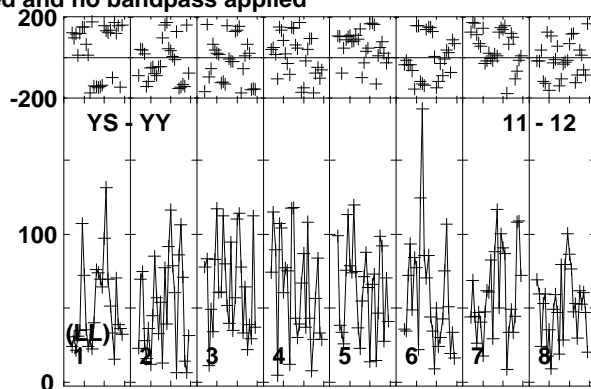
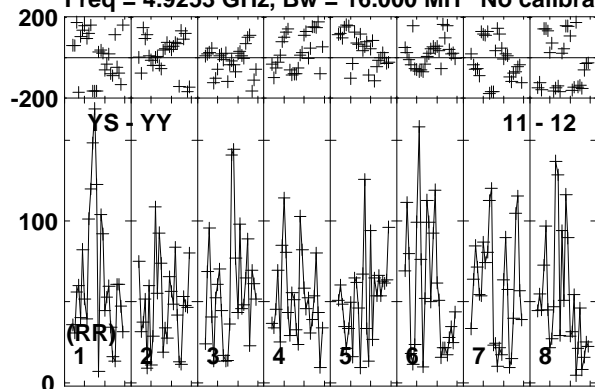

Lower frame: Micro Ampl Jy Top frame: Phas deg
Vector averaged cross-power spectrum Baseline: YS (11) - YY (12)
Timerange: 00/22:13:03 to 00/22:18:17

Plot file version 173 created 11-APR-2016 17:08:43

ARP299C GP053G 3.UVDATA.1

Freq = 4.9253 GHz, Bw = 16.000 MH No calibration applied and no bandpass applied

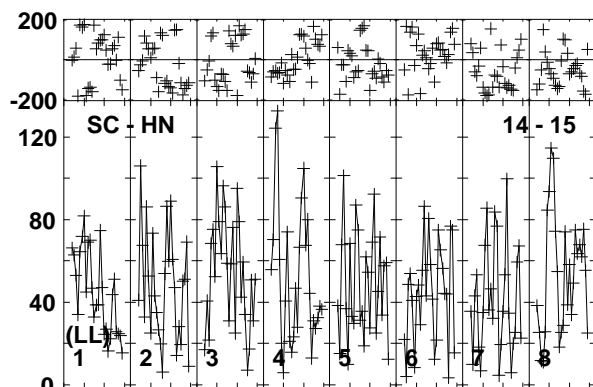
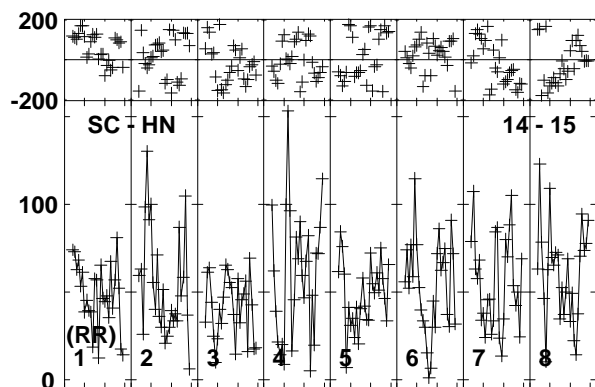
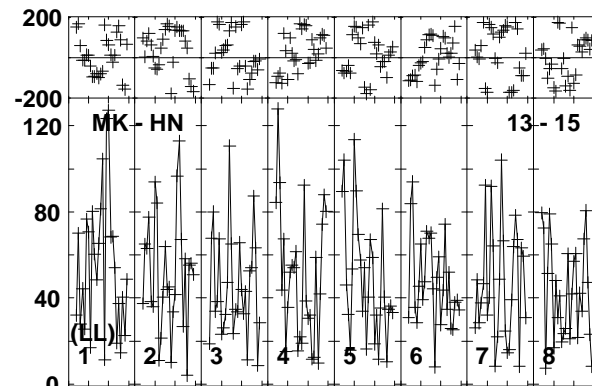
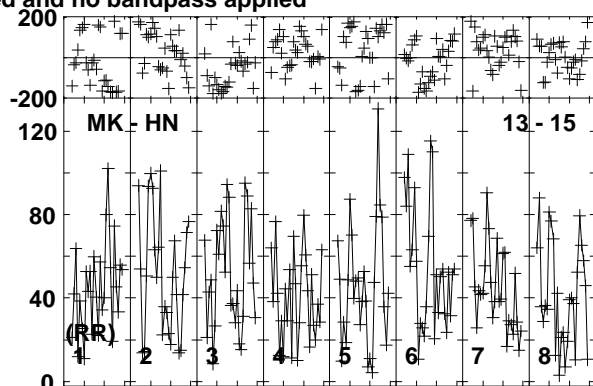
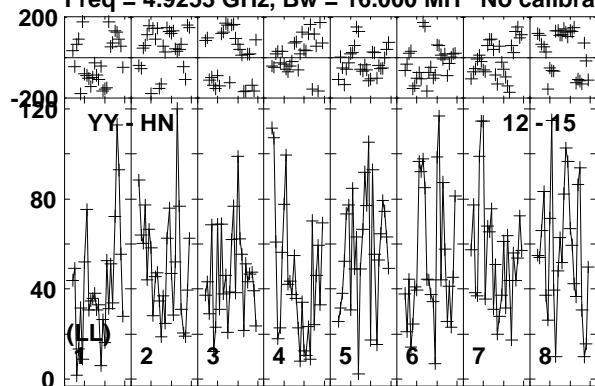

Lower frame: Micro Ampl Jy Top frame: Phas deg
Vector averaged cross-power spectrum Baseline: YY (12) - HN (15)
Timerange: 00/22:13:03 to 00/22:18:17

Plot file version 174 created 11-APR-2016 17:08:43

J1128+5925 GP053G 3.UVDATA.1

Freq = 4.9253 GHz, Bw = 16.000 MH No calibration applied and no bandpass applied

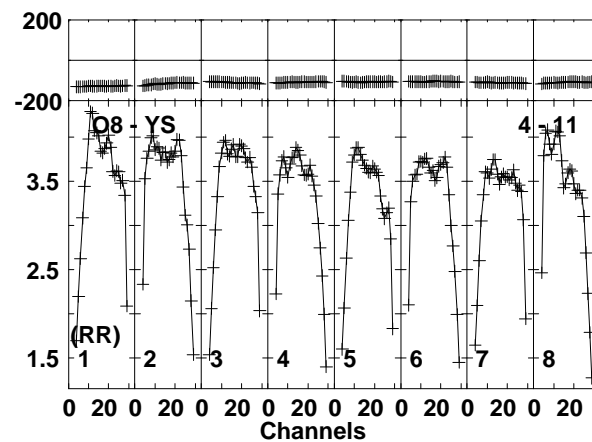
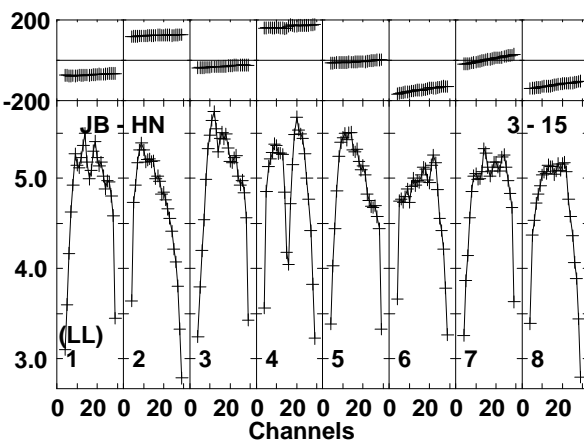
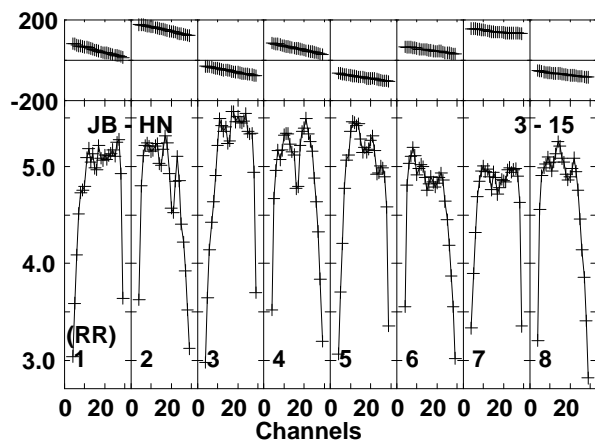
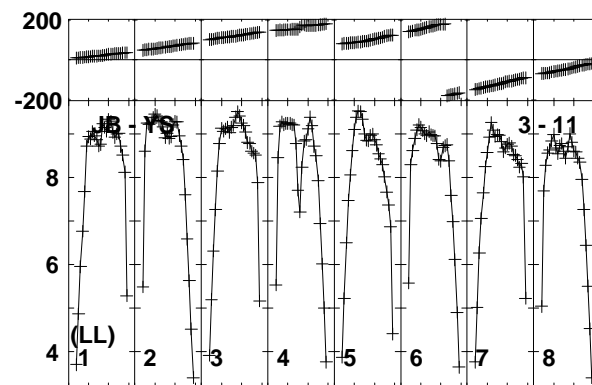
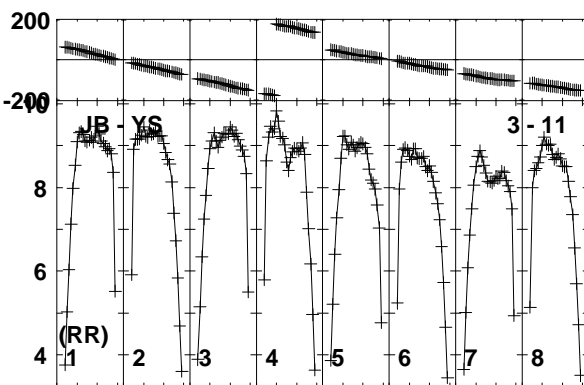
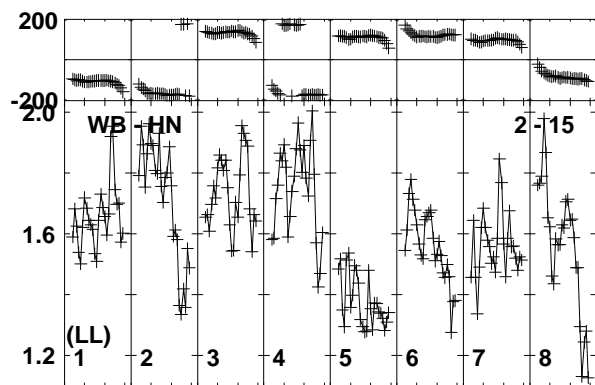
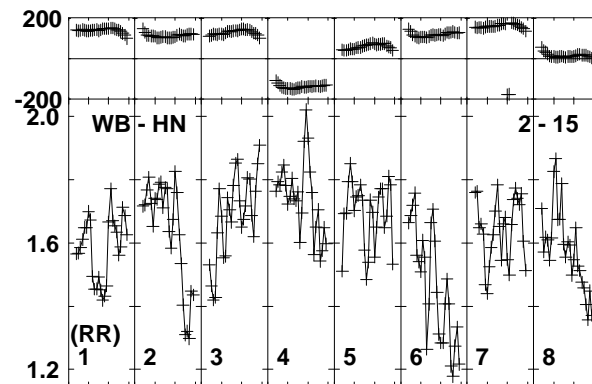
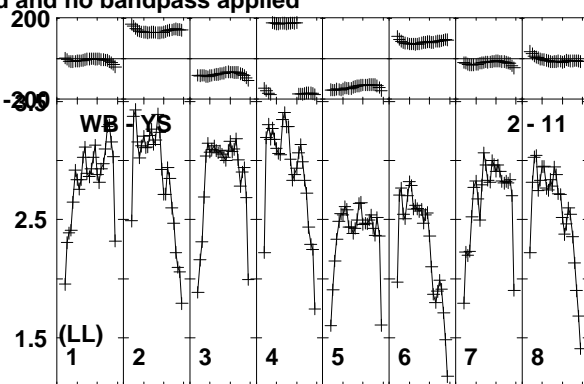
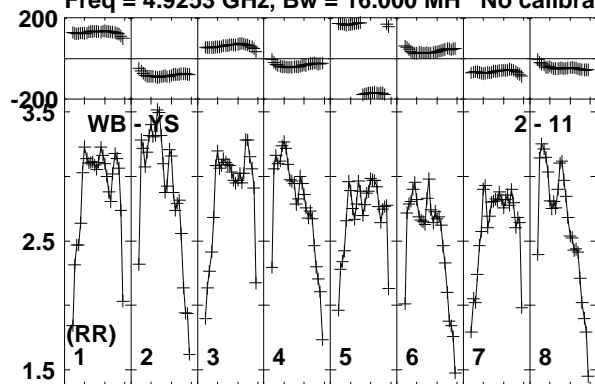

Lower frame: Milli Ampl Jy Top frame: Phas deg
Vector averaged cross-power spectrum Baseline: WB (02) - YS (11)
Timerange: 00/22:18:24 to 00/22:20:07

Plot file version 175 created 11-APR-2016 17:08:43

J1128+5925 GP053G 3.UVDATA.1

Freq = 4.9253 GHz, Bw = 16.000 MH No calibration applied and no bandpass applied

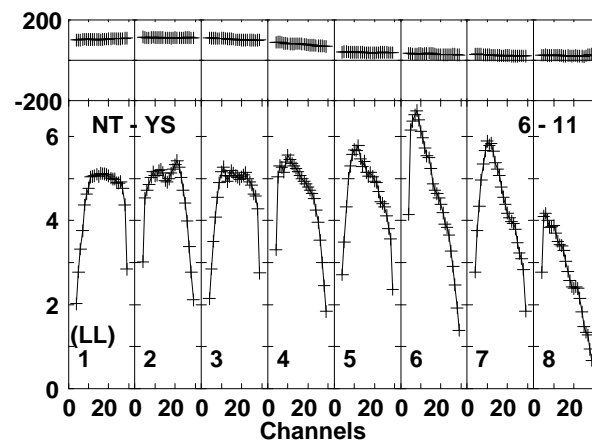
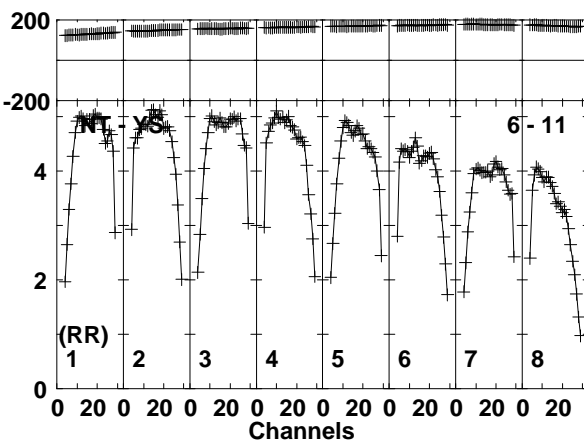
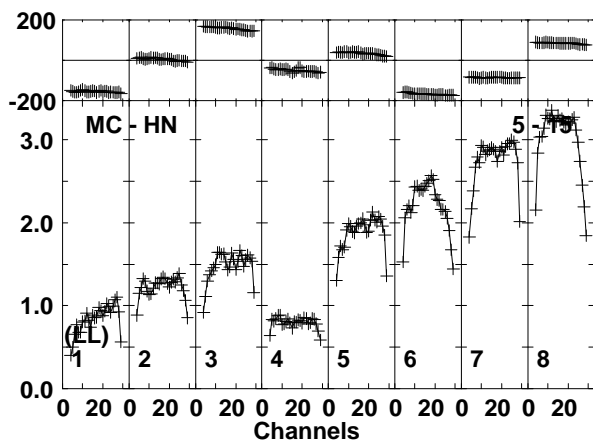
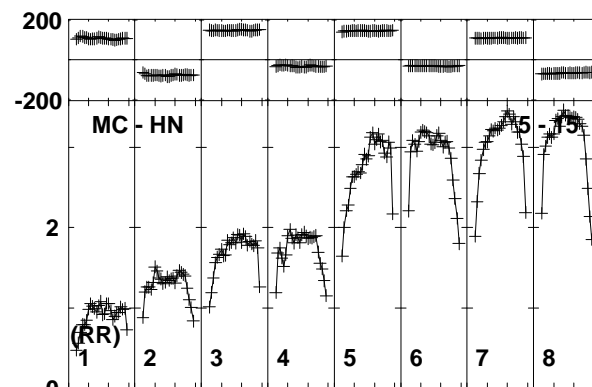
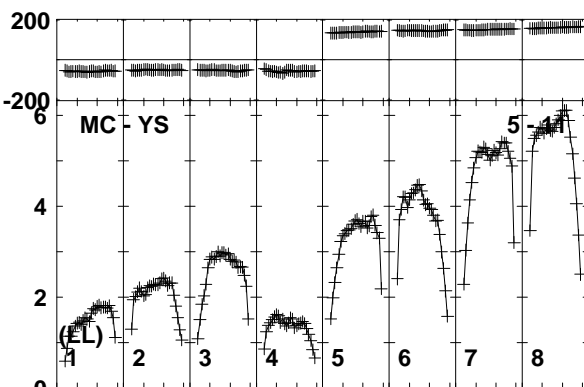
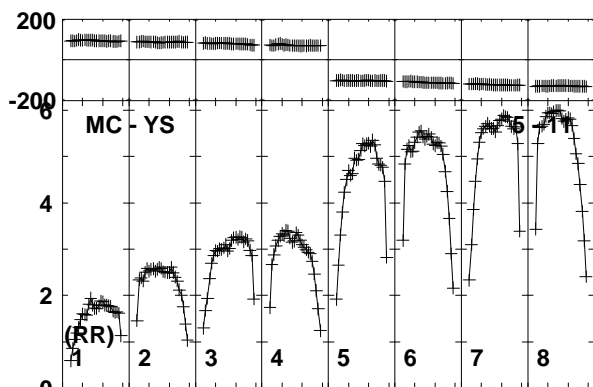
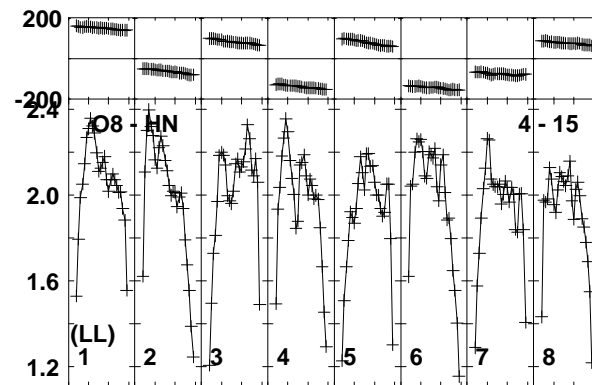
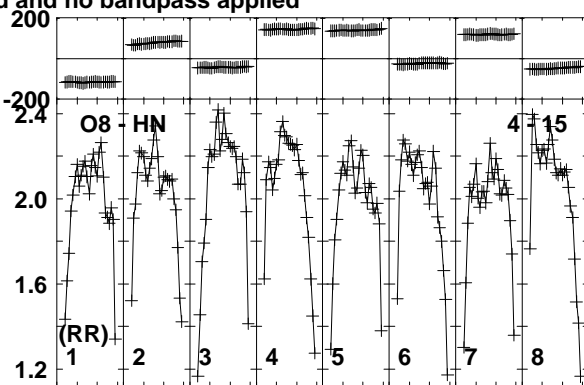
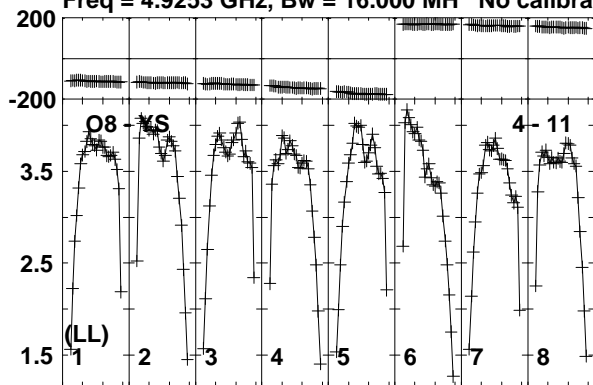

Lower frame: Milli Ampl Jy Top frame: Phas deg
Vector averaged cross-power spectrum Baseline: O8 (04) - YS (11)
Timerange: 00/22:18:24 to 00/22:20:07

Plot file version 176 created 11-APR-2016 17:08:43

J1128+5925 GP053G 3.UVDATA.1

Freq = 4.9253 GHz, Bw = 16.000 MH No calibration applied and no bandpass applied

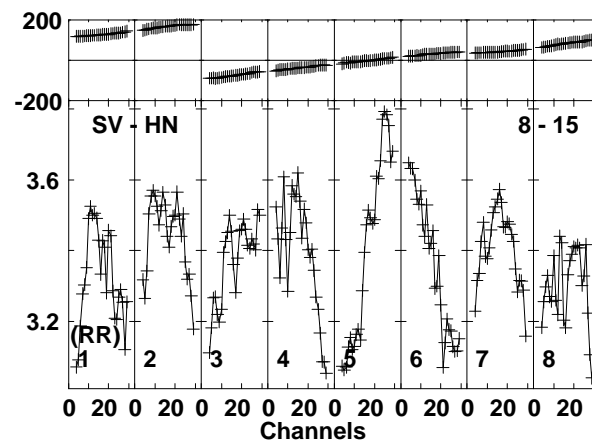
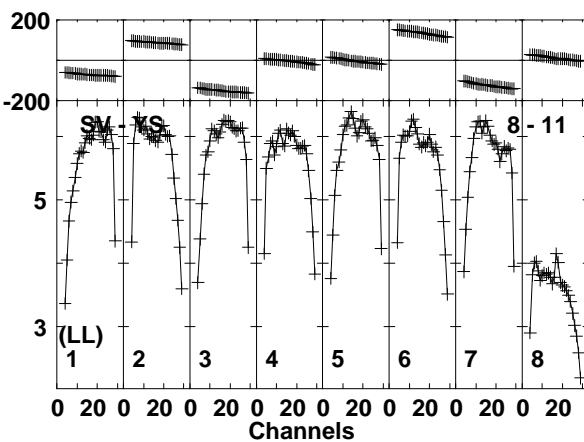
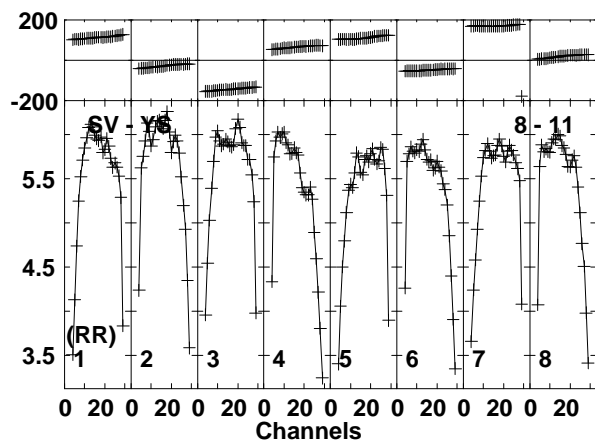
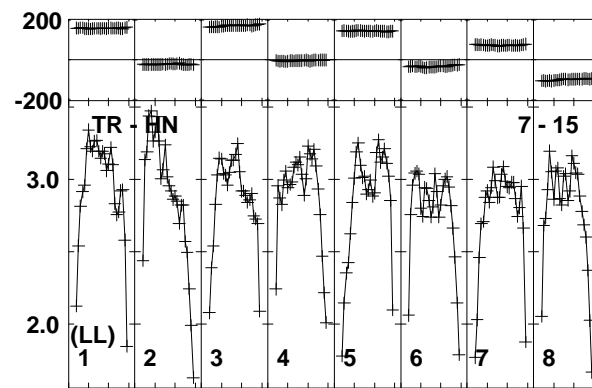
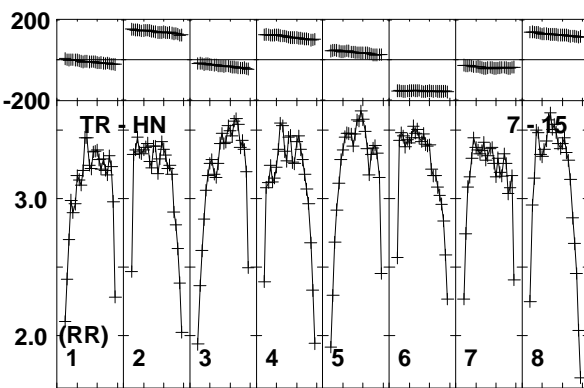
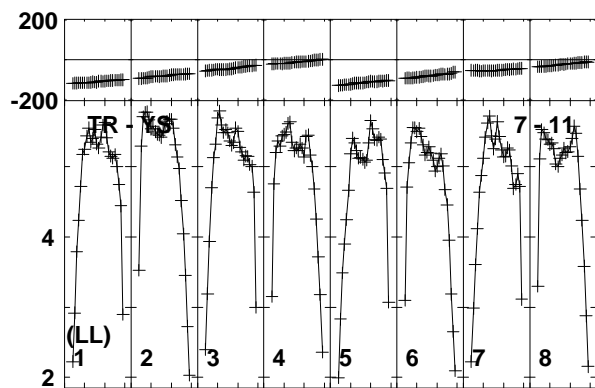
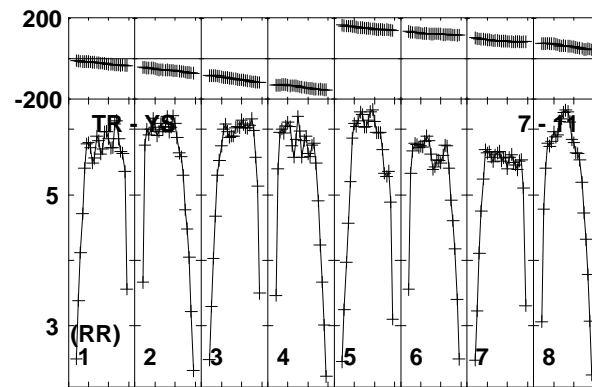
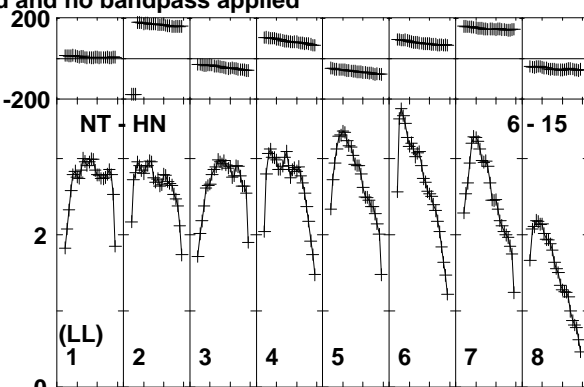
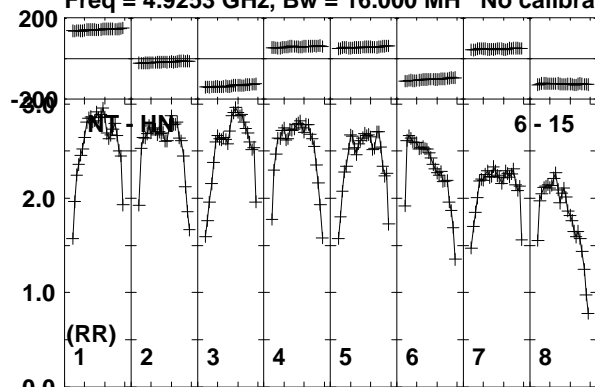

Lower frame: Milli Ampl Jy Top frame: Phas deg
Vector averaged cross-power spectrum Baseline: NT (06) - HN (15)
Timerange: 00/22:18:24 to 00/22:20:07

Plot file version 177 created 11-APR-2016 17:08:43

J1128+5925 GP053G 3.UVDATA.1

Freq = 4.9253 GHz, Bw = 16.000 MH No calibration applied and no bandpass applied

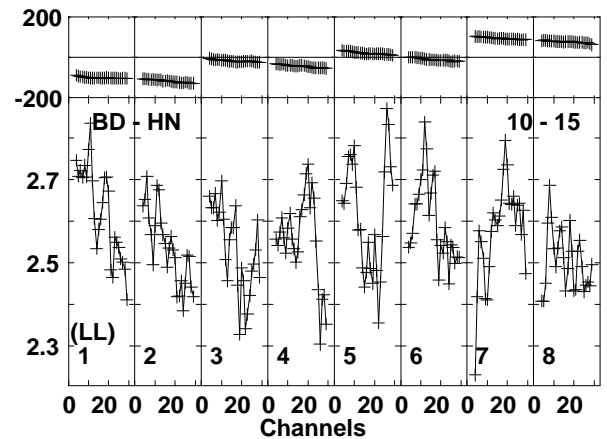
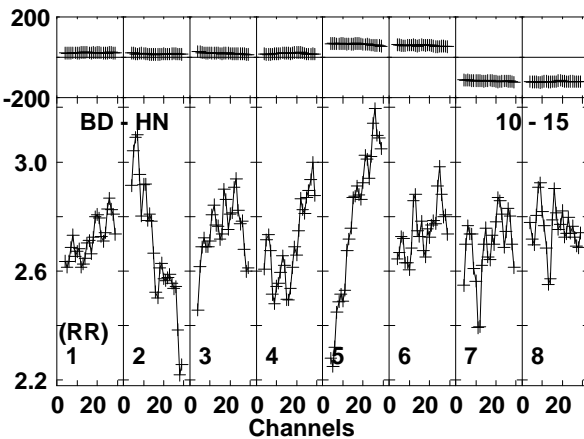
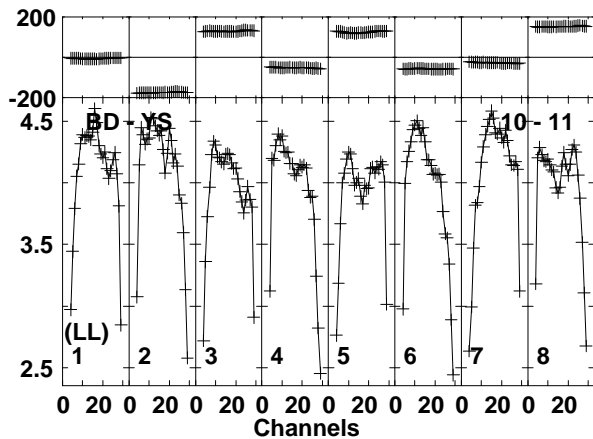
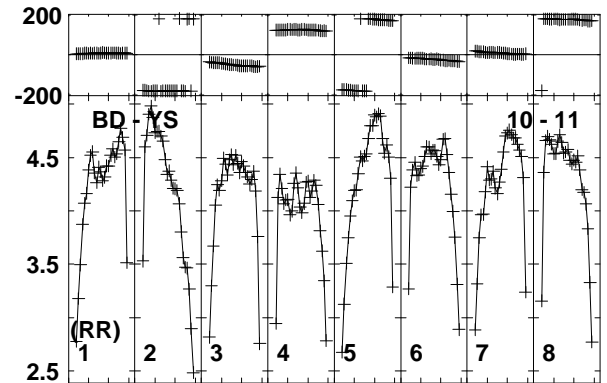
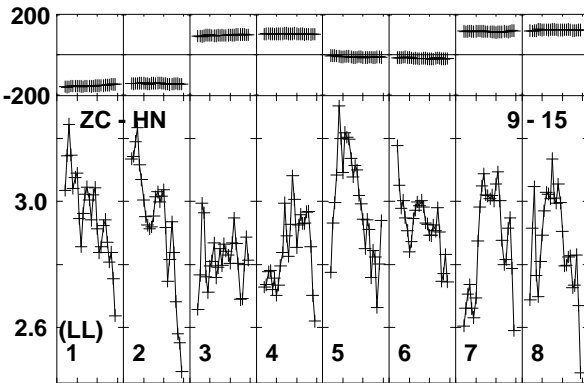
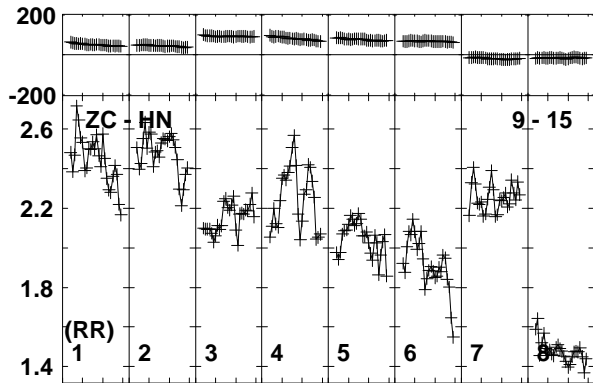
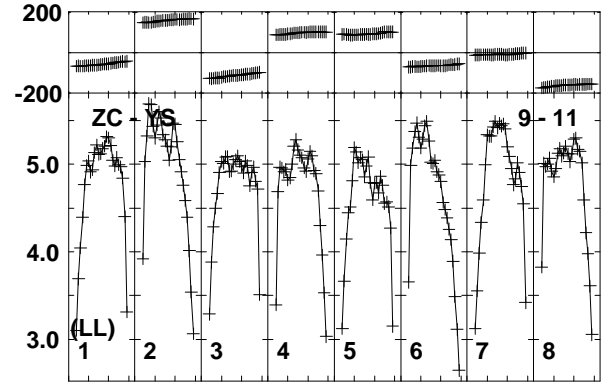
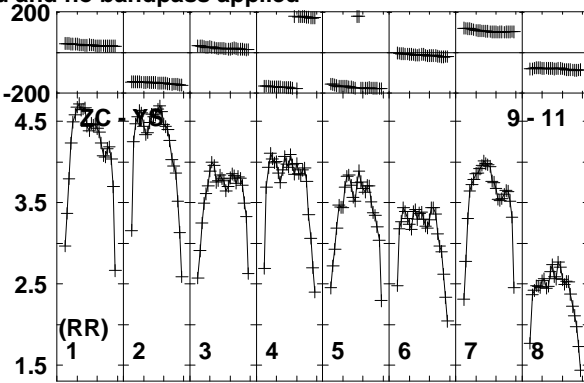
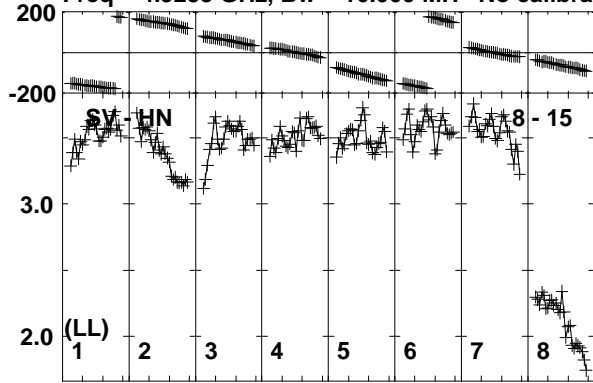

Lower frame: Milli Ampl Jy Top frame: Phas deg
Vector averaged cross-power spectrum Baseline: SV (08) - HN (15)
Timerange: 00/22:18:24 to 00/22:20:07

Plot file version 178 created 11-APR-2016 17:08:44
 J1128+5925 GP053G 3.UVDATA.1

Freq = 4.9253 GHz, Bw = 16.000 MH No calibration applied and no bandpass applied

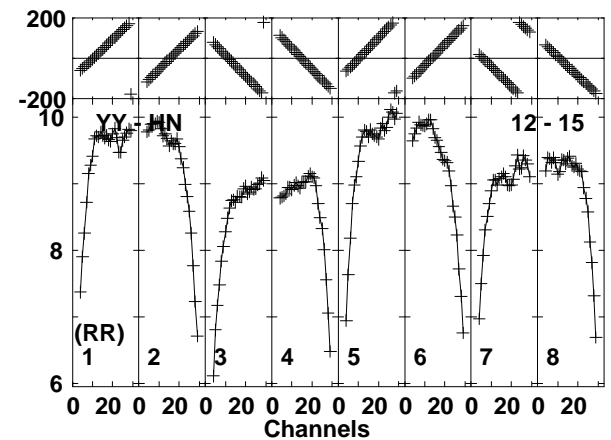
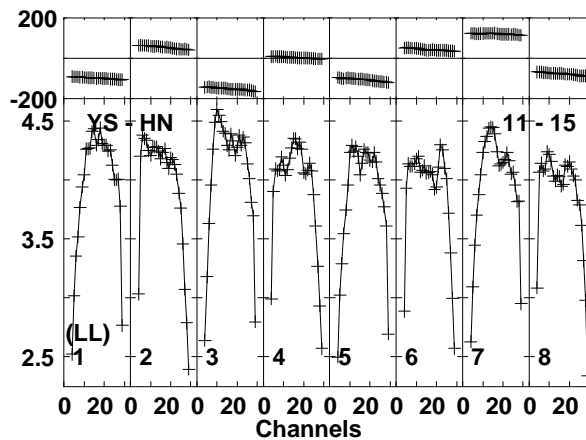
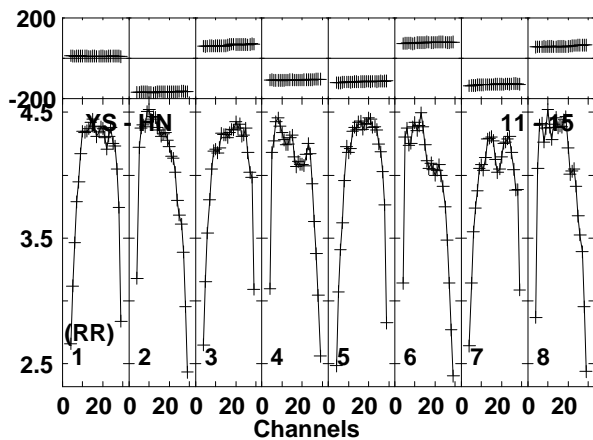
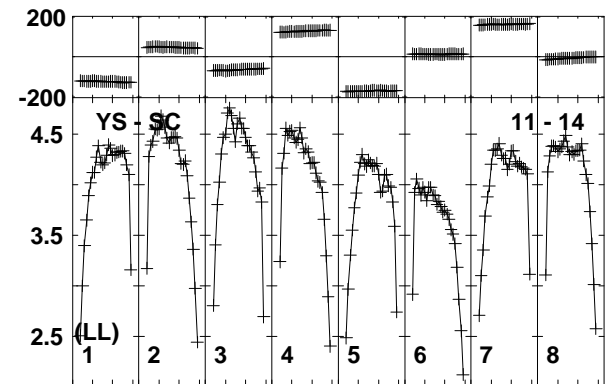
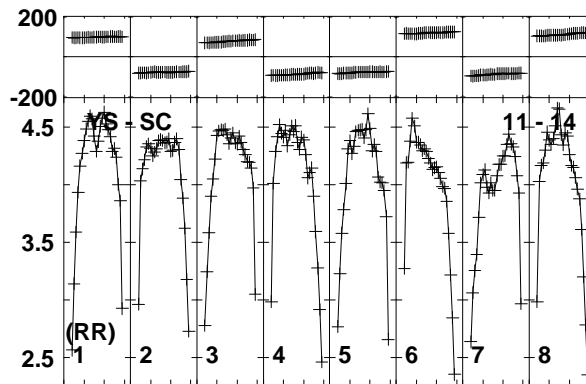
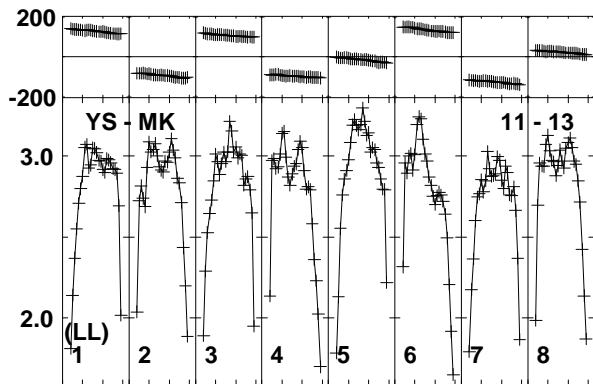
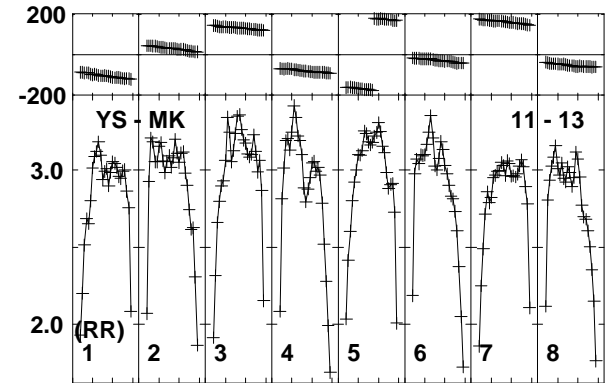
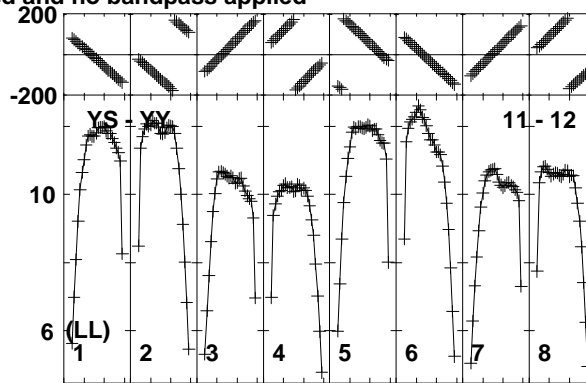
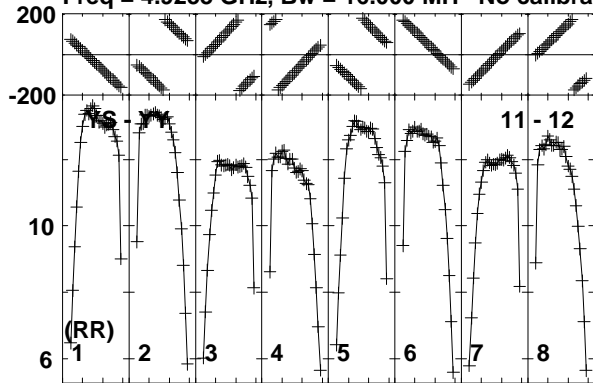

Lower frame: Milli Ampl Jy Top frame: Phas deg
 Vector averaged cross-power spectrum Baseline: YS (11) - YY (12)
 Timerange: 00/22:18:24 to 00/22:20:07

Plot file version 179 created 11-APR-2016 17:08:44

J1128+5925 GP053G 3.UVDATA.1

Freq = 4.9253 GHz, Bw = 16.000 MH No calibration applied and no bandpass applied

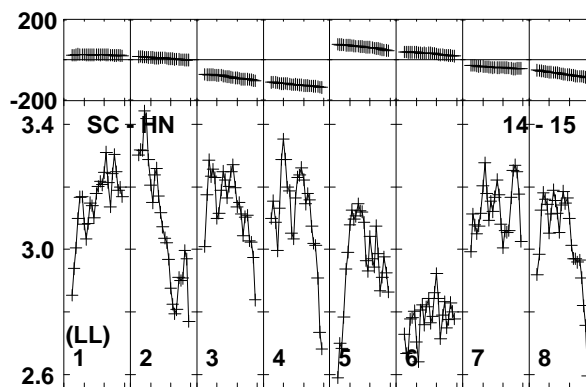
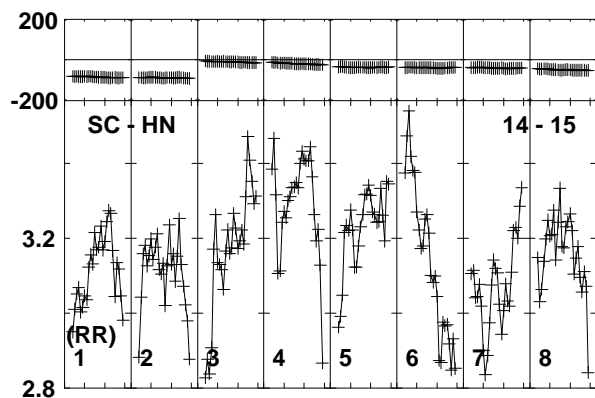
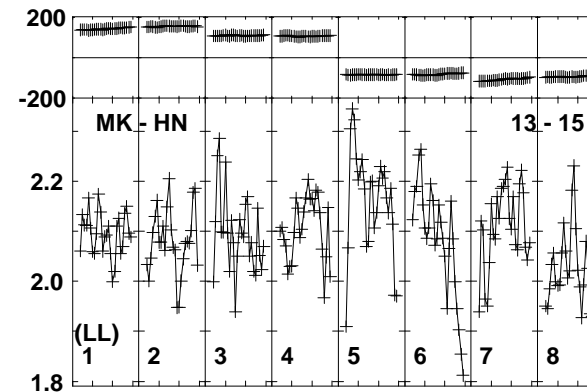
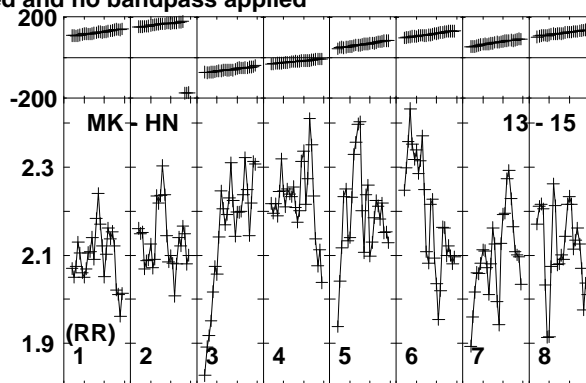
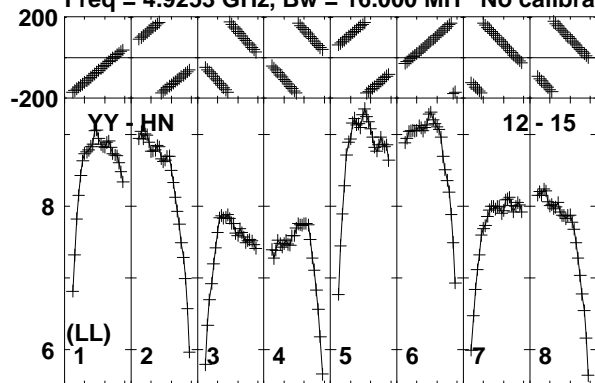

Lower frame: Milli Ampl Jy Top frame: Phas deg
Vector averaged cross-power spectrum Baseline: YY (12) - HN (15)
Timerange: 00/22:18:24 to 00/22:20:07

Plot file version 180 created 11-APR-2016 17:08:44

ARP299C GP053G 3.UVDATA.1

Freq = 4.9253 GHz, Bw = 16.000 MH No calibration applied and no bandpass applied

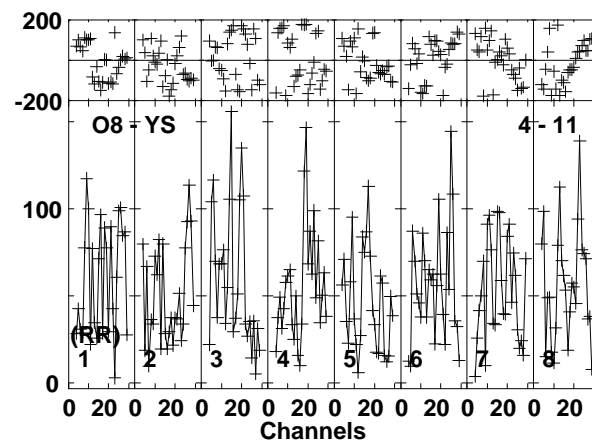
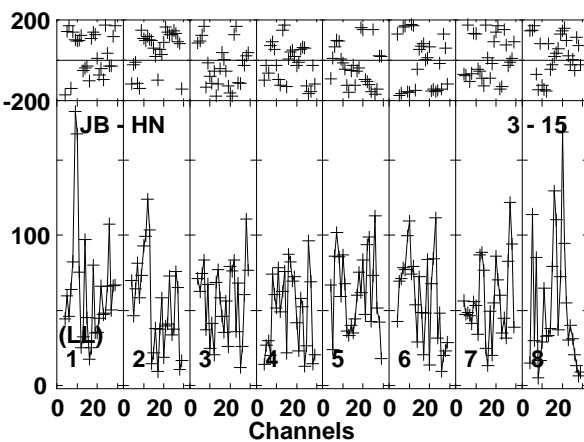
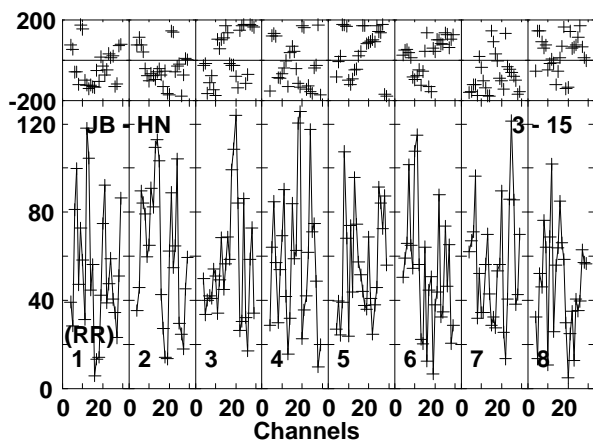
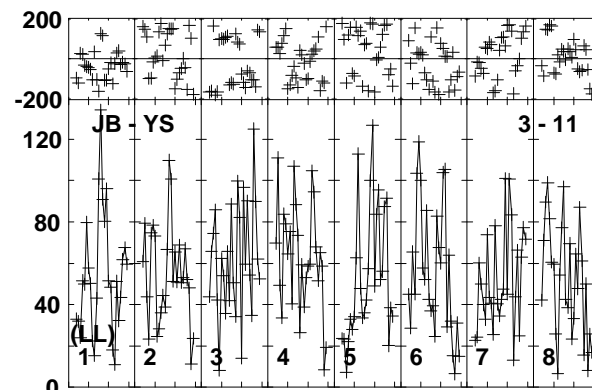
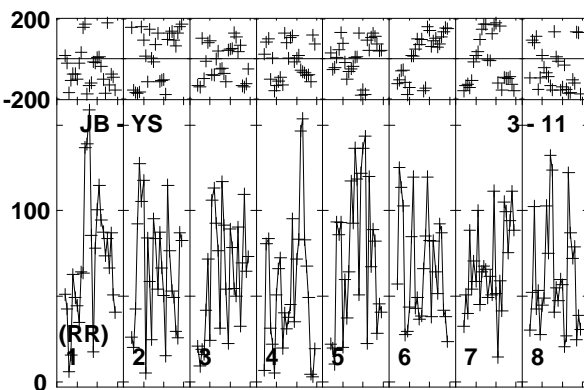
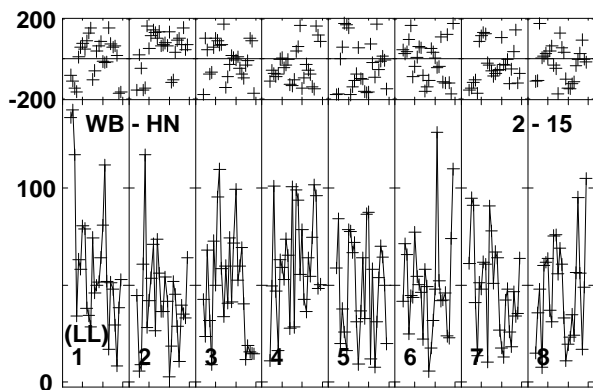
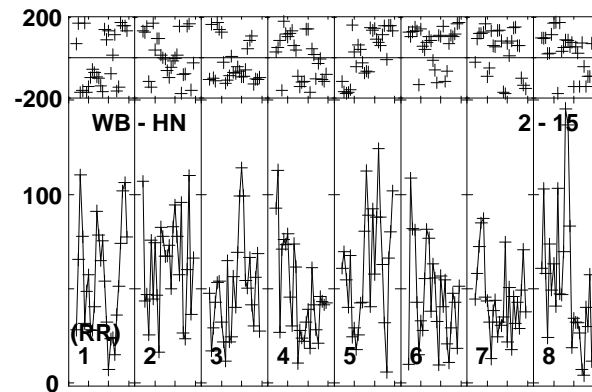
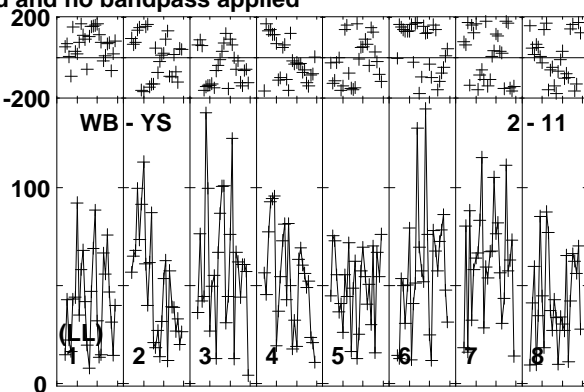
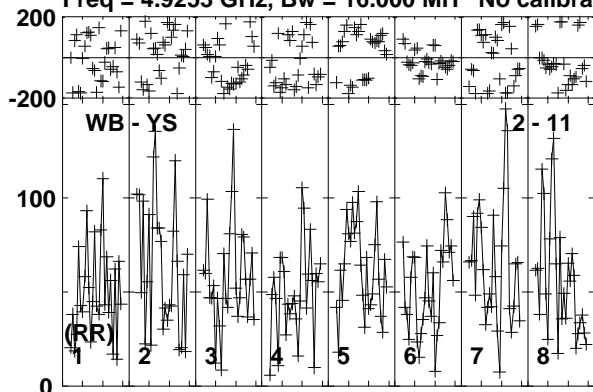

Lower frame: Micro Ampl Jy Top frame: Phas deg
Vector averaged cross-power spectrum Baseline: WB (02) - YS (11)
Timerange: 00:22:20:14 to 00:22:25:26

Plot file version 181 created 11-APR-2016 17:08:44

ARP299C GP053G 3.UVDATA.1

Freq = 4.9253 GHz, Bw = 16.000 MH No calibration applied and no bandpass applied

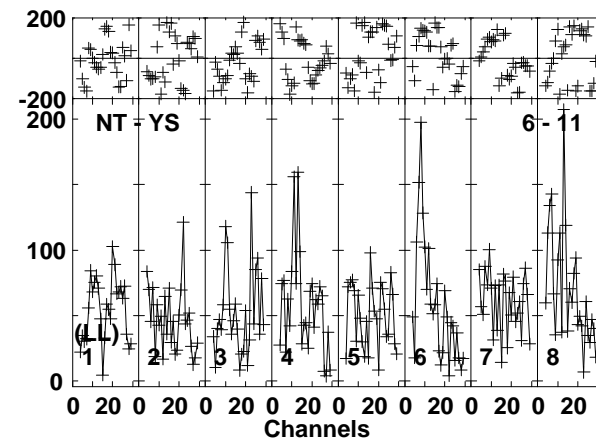
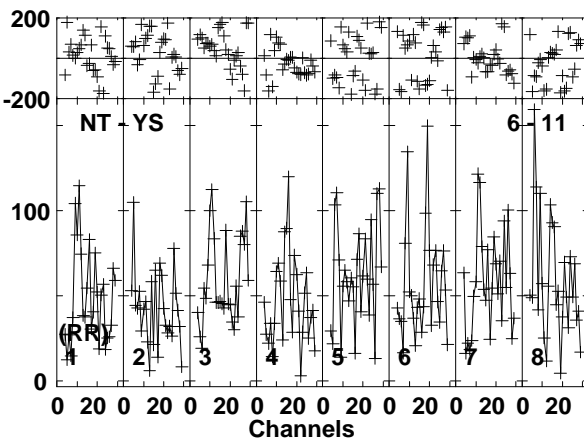
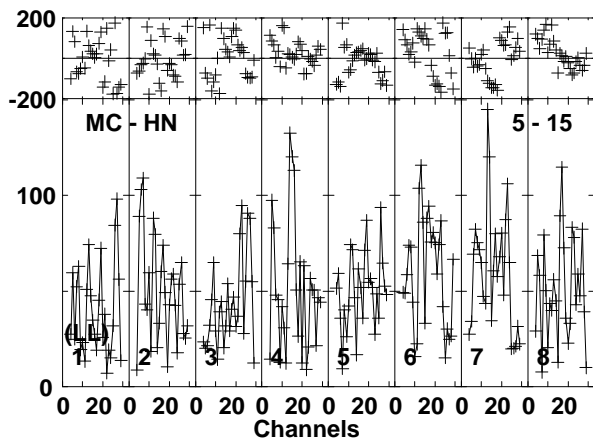
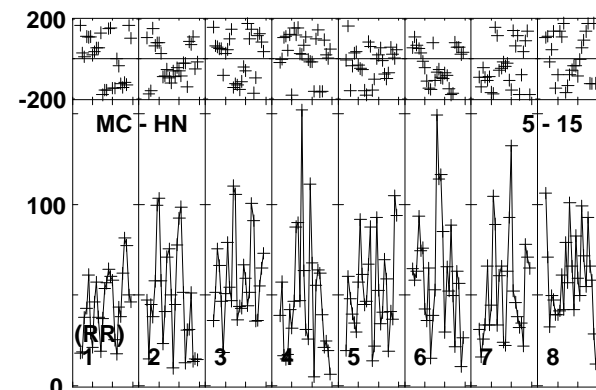
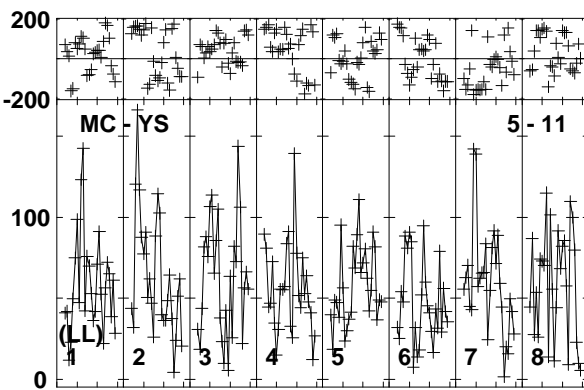
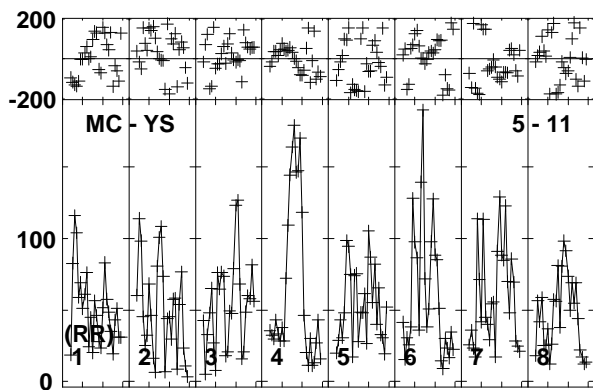
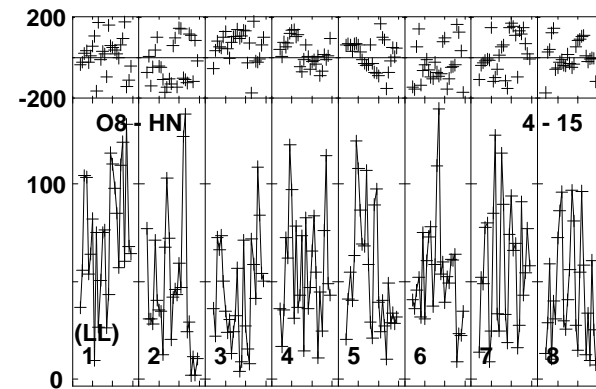
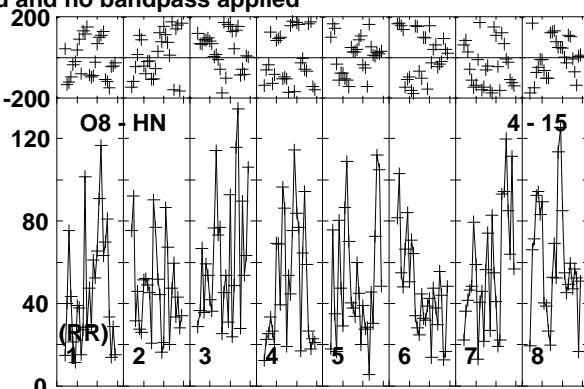
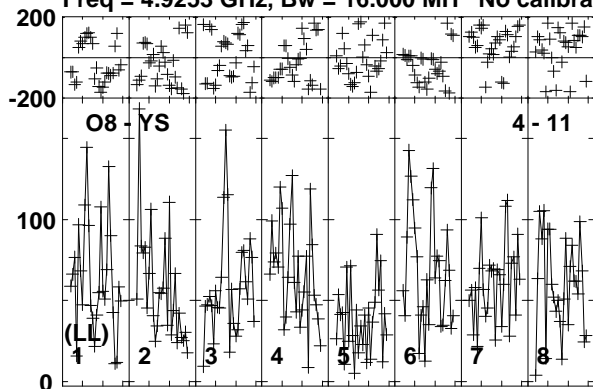

Lower frame: Micro Ampl Jy Top frame: Phas deg
Vector averaged cross-power spectrum Baseline: O8 (04) - YS (11)
Timerange: 00/22:20:14 to 00/22:25:26

Plot file version 182 created 11-APR-2016 17:08:44

ARP299C GP053G 3.UVDATA.1

Freq = 4.9253 GHz, Bw = 16.000 MH No calibration applied and no bandpass applied

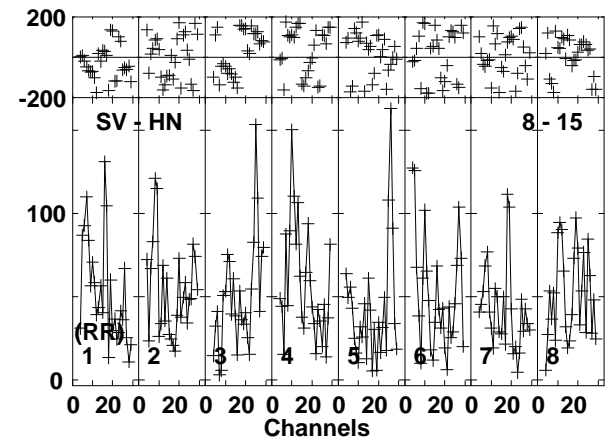
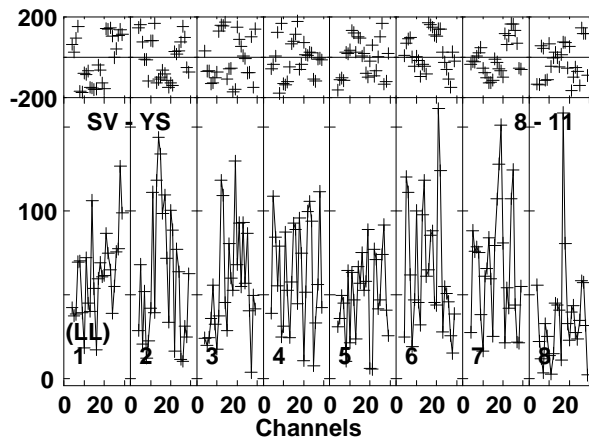
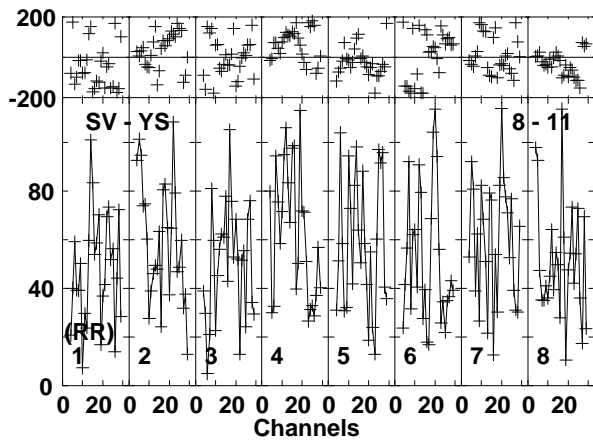
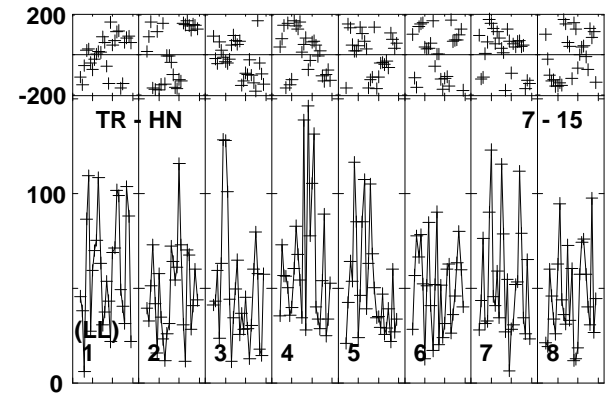
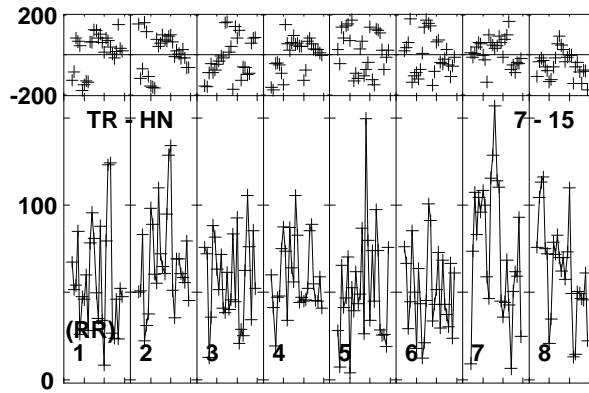
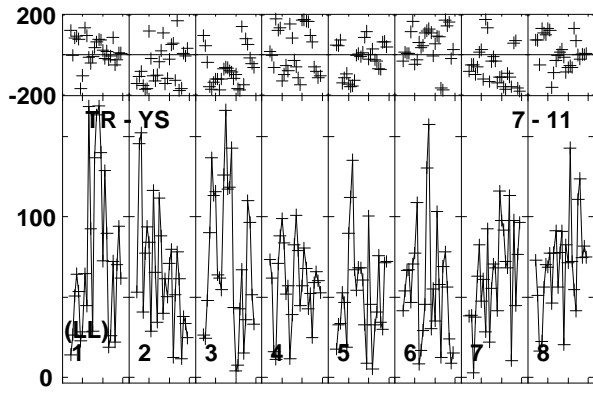
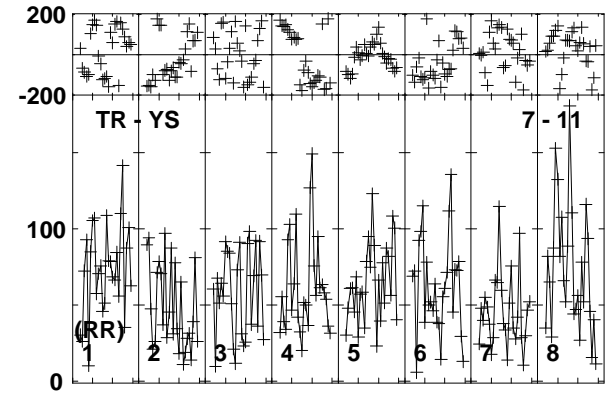
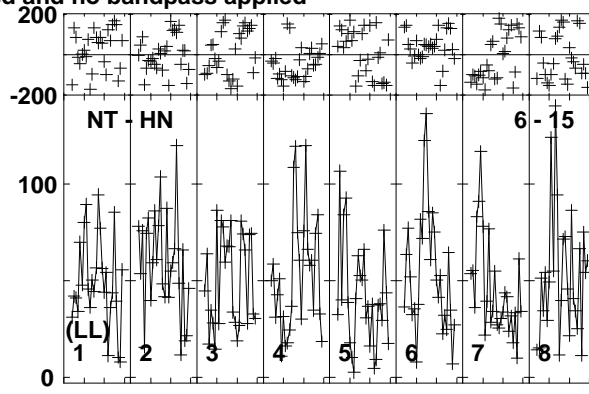
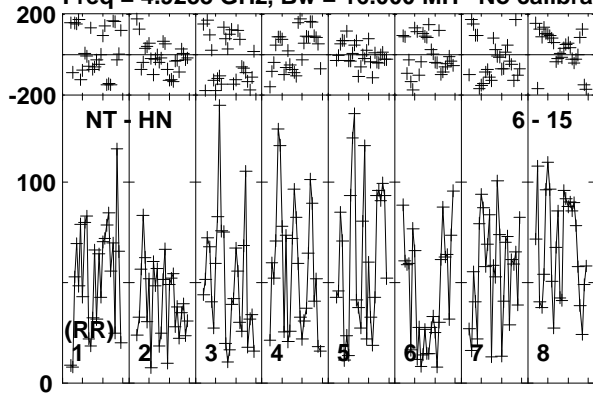

Lower frame: Micro Ampl Jy Top frame: Phas deg
Vector averaged cross-power spectrum Baseline: NT (06) - HN (15)
Timerange: 00/22:20:14 to 00/22:25:26

Plot file version 183 created 11-APR-2016 17:08:45

ARP299C GP053G 3.UVDATA.1

Freq = 4.9253 GHz, Bw = 16.000 MH No calibration applied and no bandpass applied

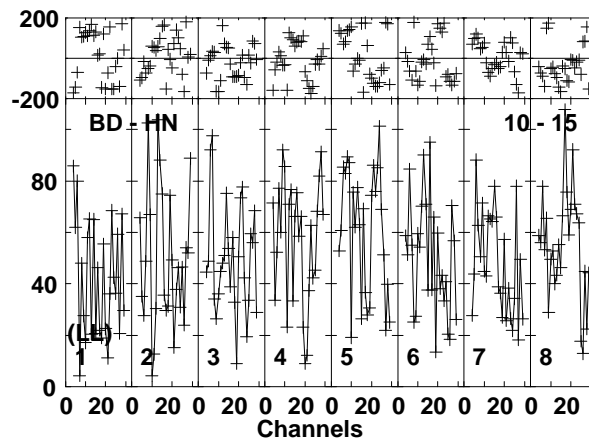
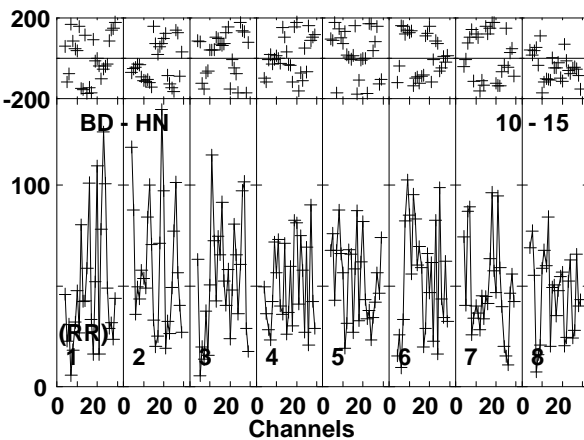
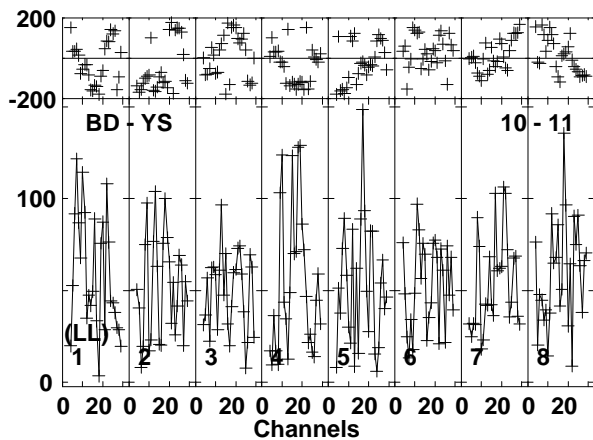
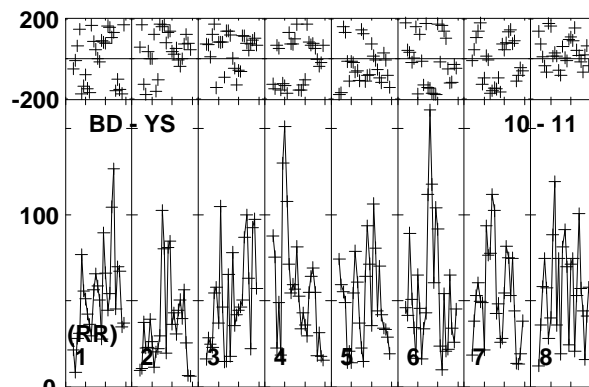
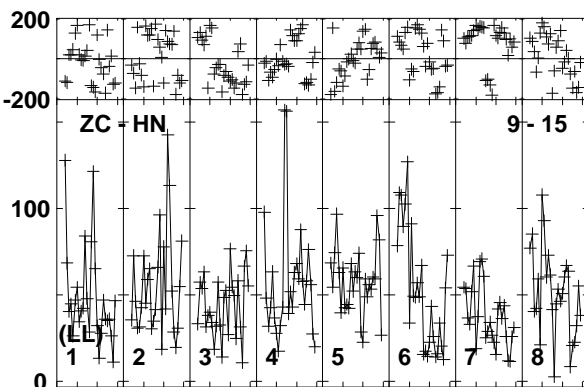
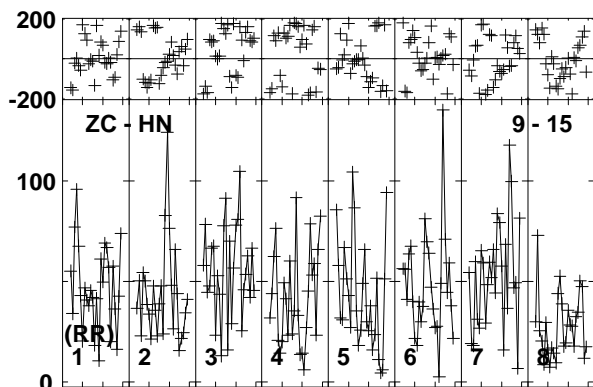
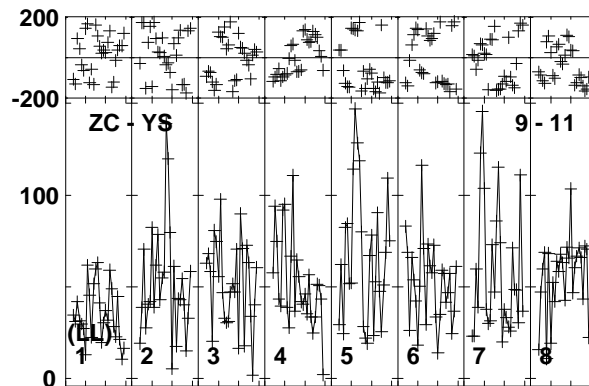
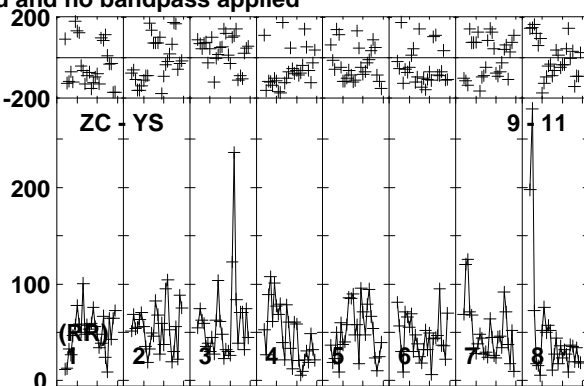
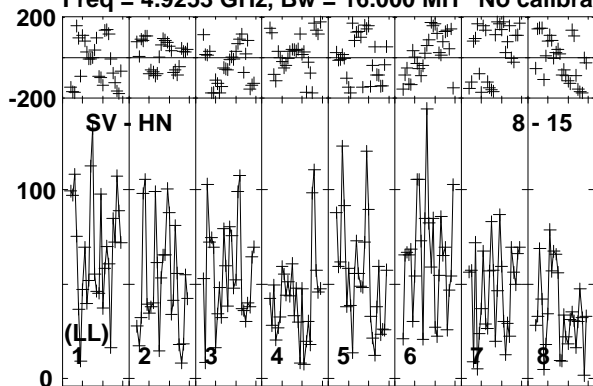

Lower frame: Micro Ampl Jy Top frame: Phas deg
Vector averaged cross-power spectrum Baseline: SV (08) - HN (15)
Timerange: 00:22:20:14 to 00:22:25:26

Plot file version 184 created 11-APR-2016 17:08:45

ARP299C GP053G 3.UVDATA.1

Freq = 4.9253 GHz, Bw = 16.000 MH No calibration applied and no bandpass applied

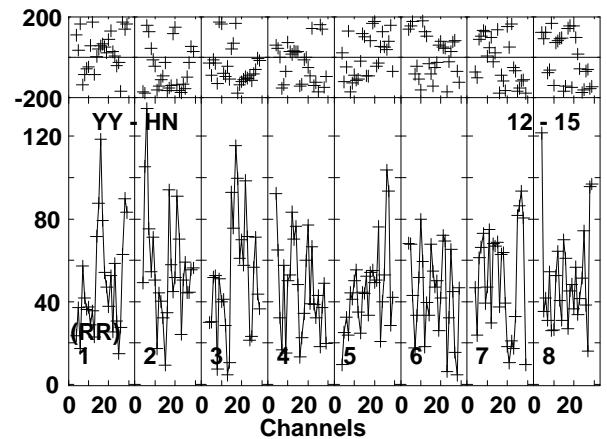
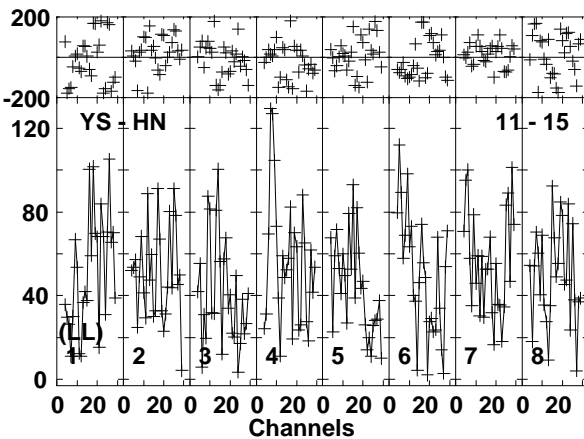
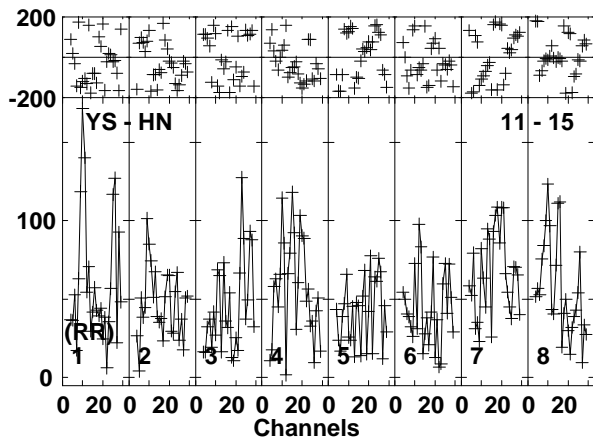
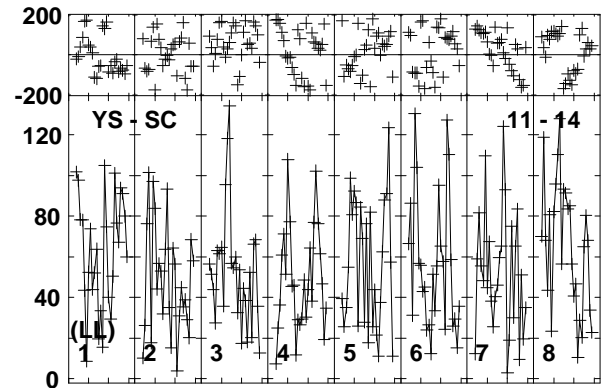
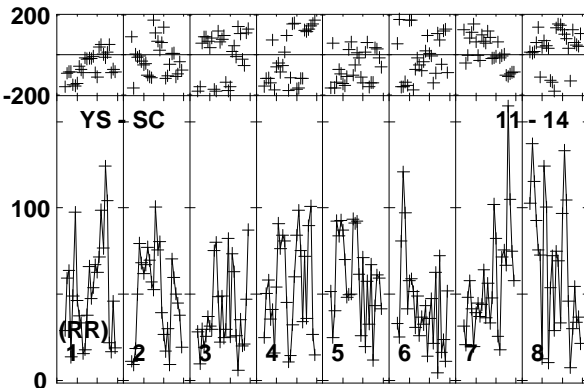
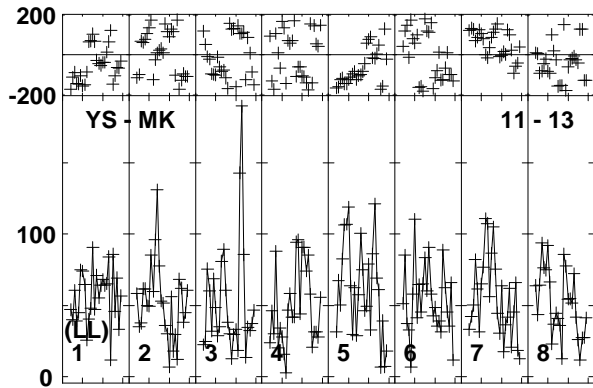
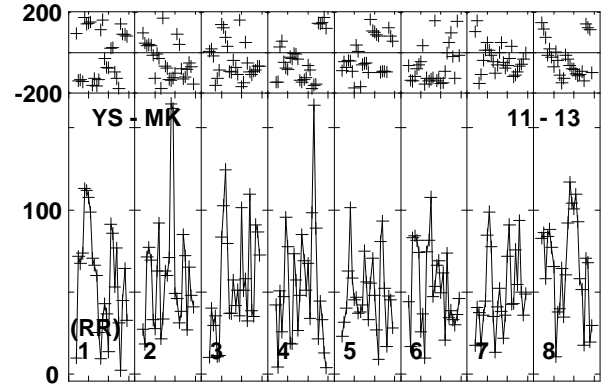
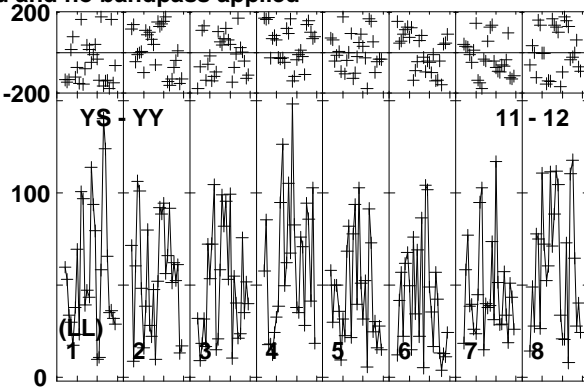
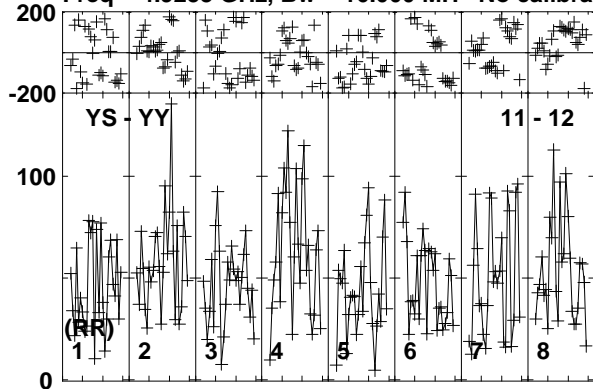

Lower frame: Micro Ampl Jy Top frame: Phas deg
Vector averaged cross-power spectrum Baseline: YS (11) - YY (12)
Timerange: 00/22:20:14 to 00/22:25:26

Plot file version 185 created 11-APR-2016 17:08:45

ARP299C GP053G 3.UVDATA.1

Freq = 4.9253 GHz, Bw = 16.000 MH No calibration applied and no bandpass applied

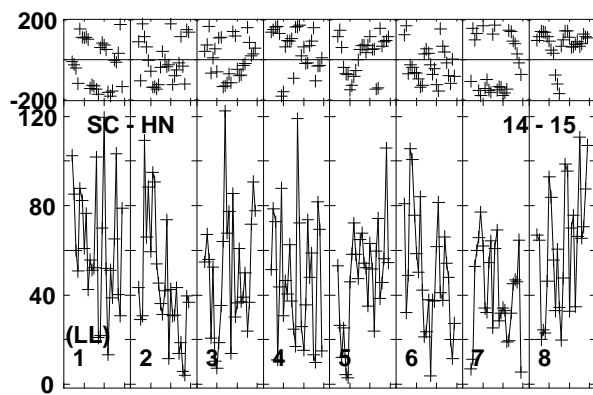
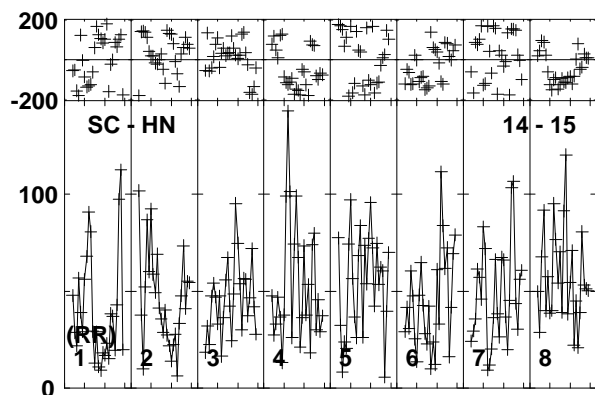
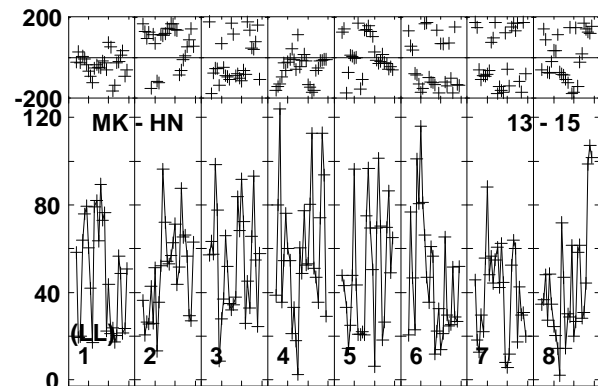
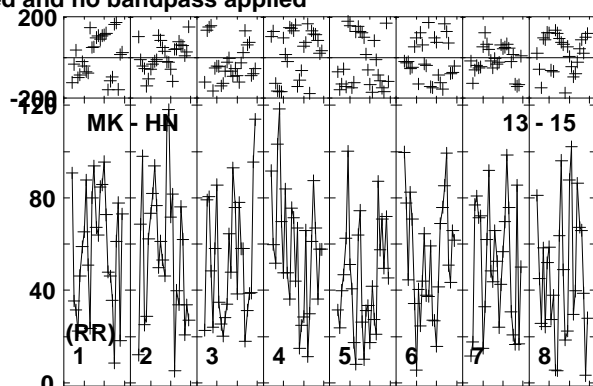
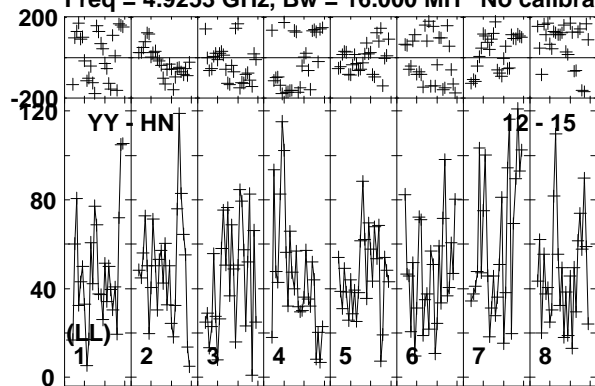

Lower frame: Micro Ampl Jy Top frame: Phas deg
Vector averaged cross-power spectrum Baseline: YY (12) - HN (15)
Timerange: 00/22:20:14 to 00/22:25:26

Plot file version 186 created 11-APR-2016 17:08:45

J1128+5925 GP053G 3.UVDATA.1

Freq = 4.9253 GHz, Bw = 16.000 MH No calibration applied and no bandpass applied

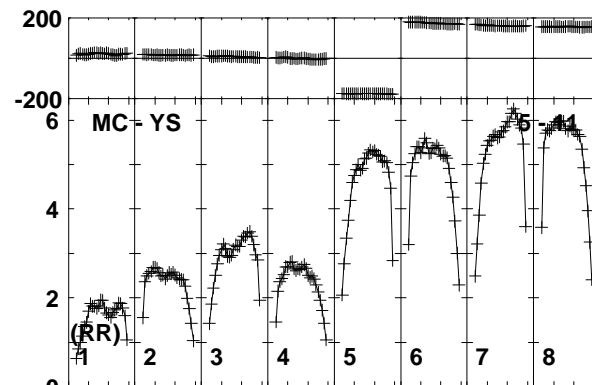
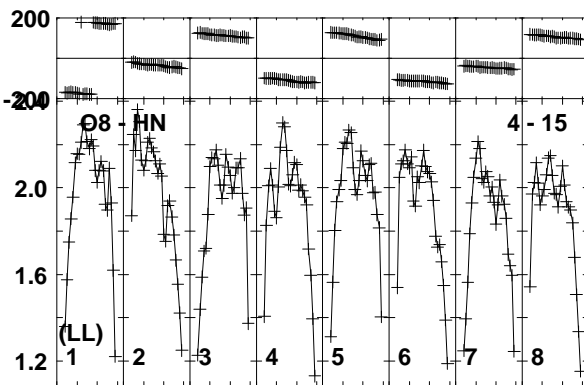
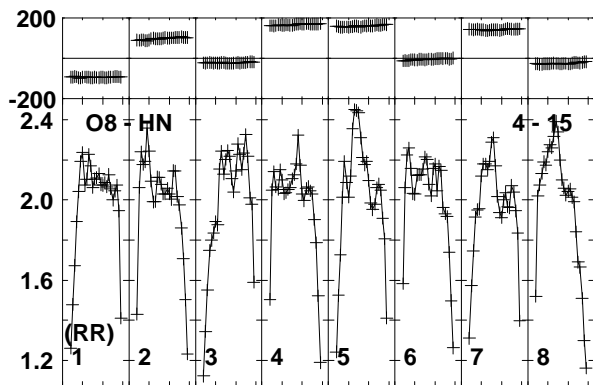
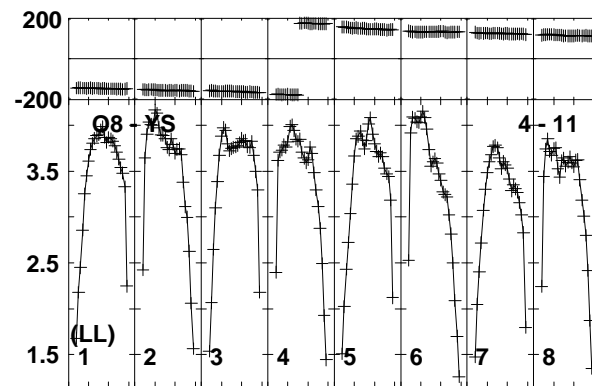
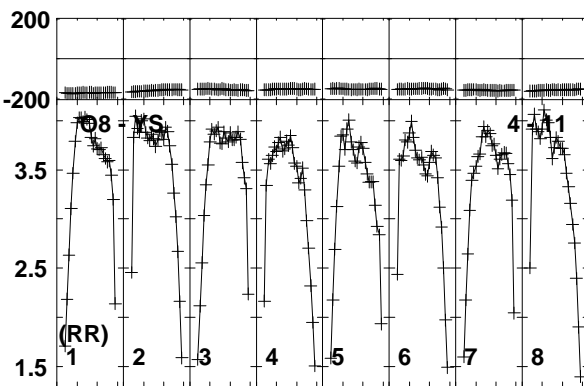
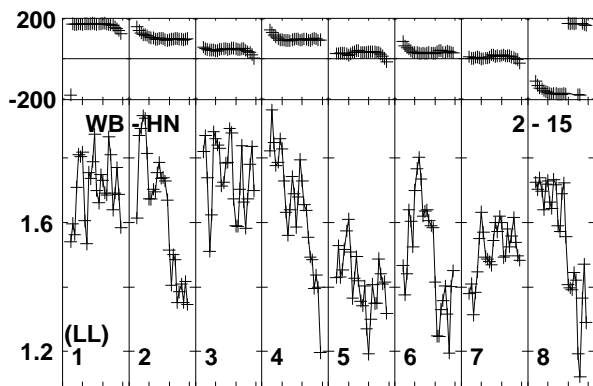
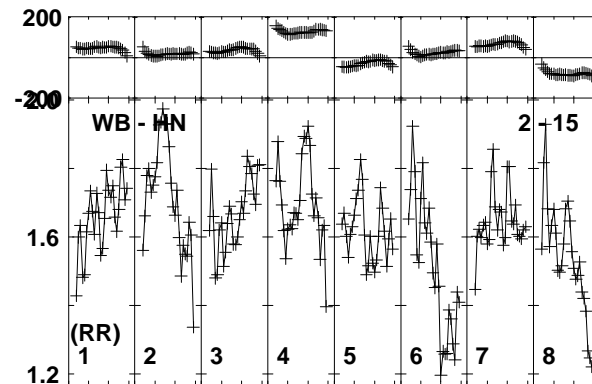
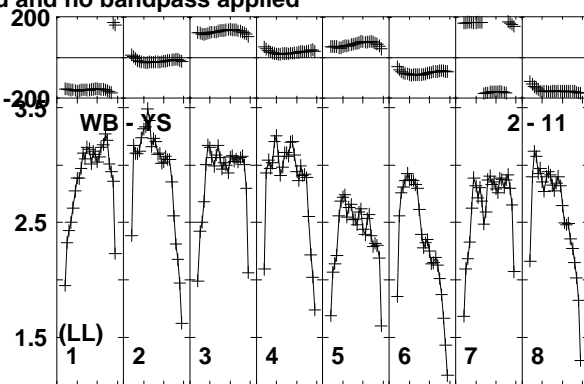
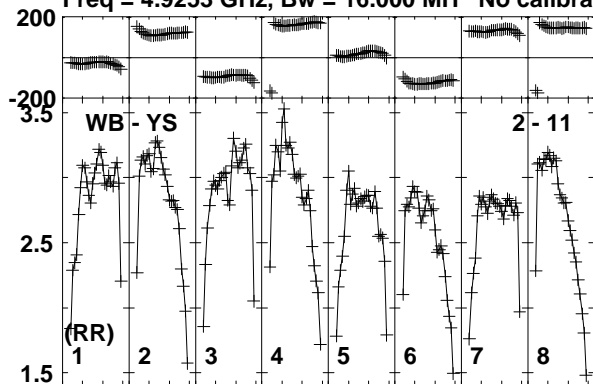

Lower frame: Milli Ampl Jy Top frame: Phas deg

Vector averaged cross-power spectrum Baseline: WB (02) - YS (11)

Timerange: 00/22:25:32 to 00/22:27:23

Plot file version 187 created 11-APR-2016 17:08:45

J1128+5925 GP053G 3.UVDATA.1

Freq = 4.9253 GHz, Bw = 16.000 MH No calibration applied and no bandpass applied

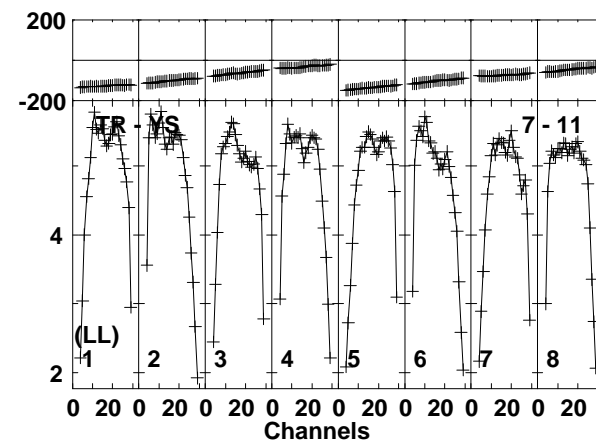
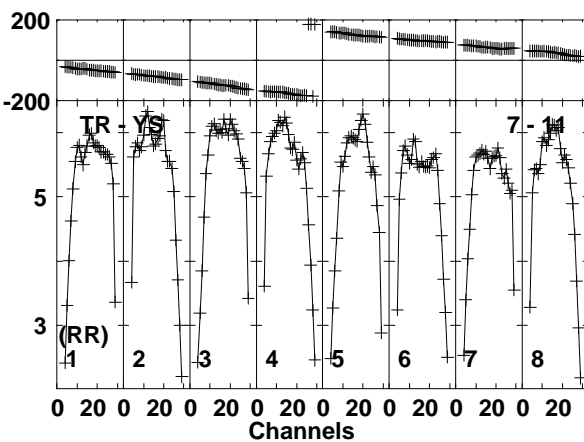
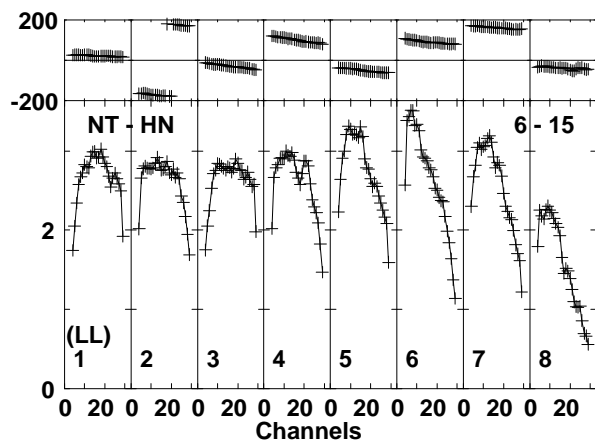
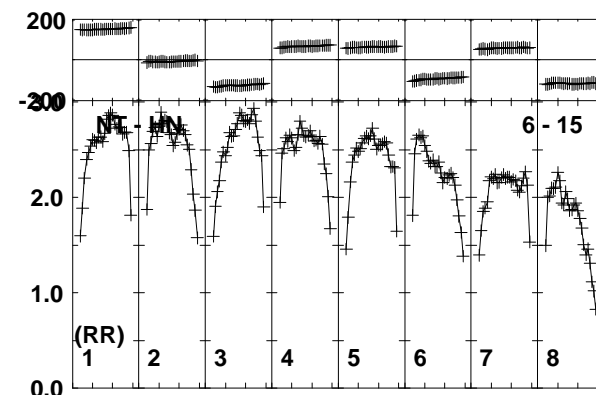
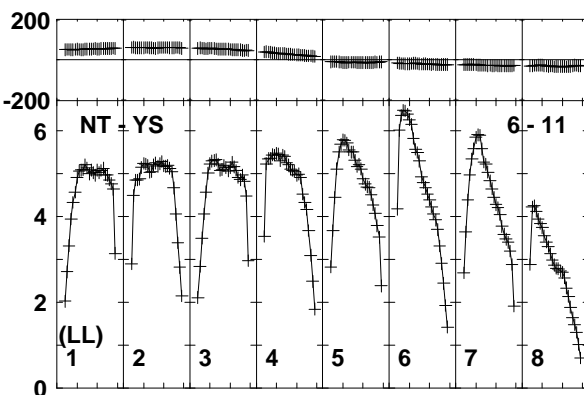
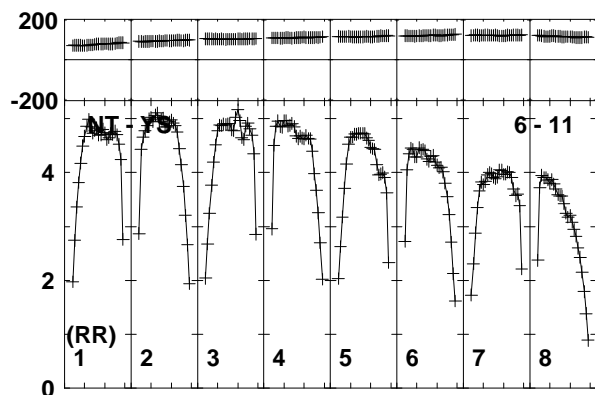
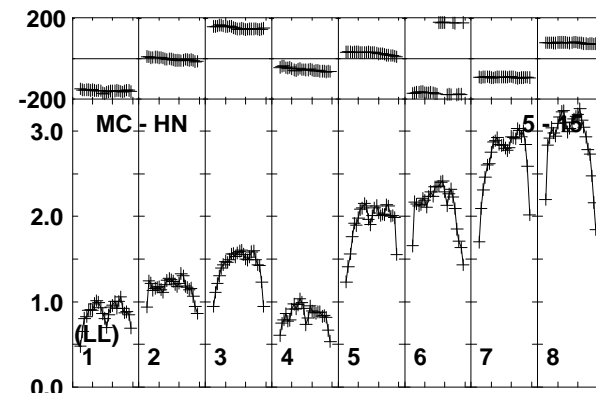
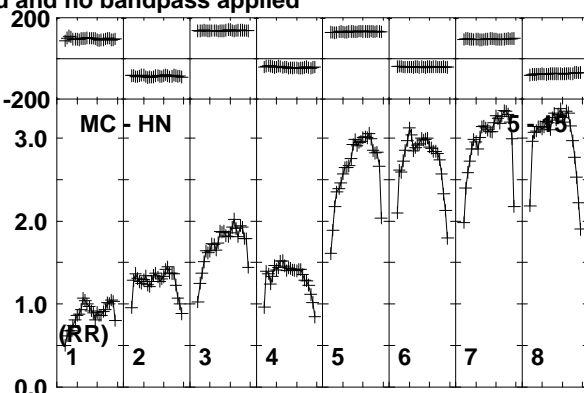
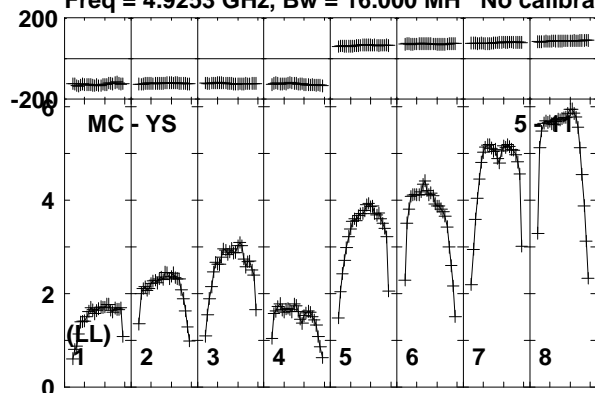

Lower frame: Milli Ampl Jy Top frame: Phas deg
Vector averaged cross-power spectrum Baseline: MC (05) - YS (11)
Timerange: 00/22:25:32 to 00/22:27:23

Plot file version 188 created 11-APR-2016 17:08:46
 J1128+5925 GP053G 3.UVDATA.1

Freq = 4.9253 GHz, Bw = 16.000 MH No calibration applied and no bandpass applied

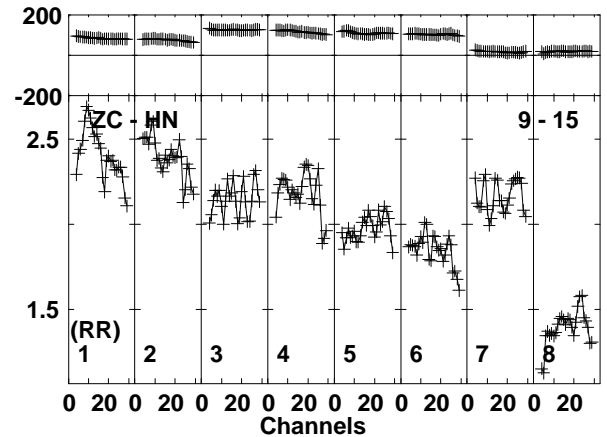
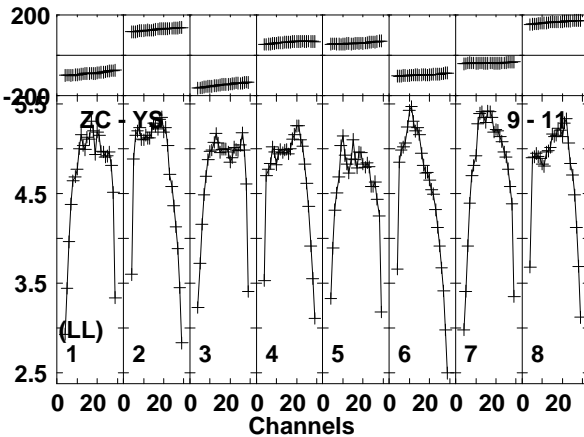
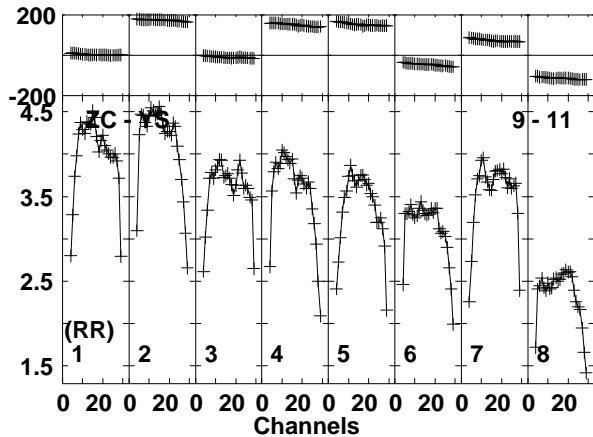
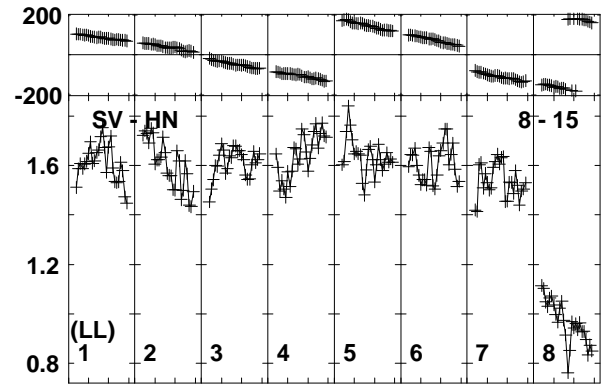
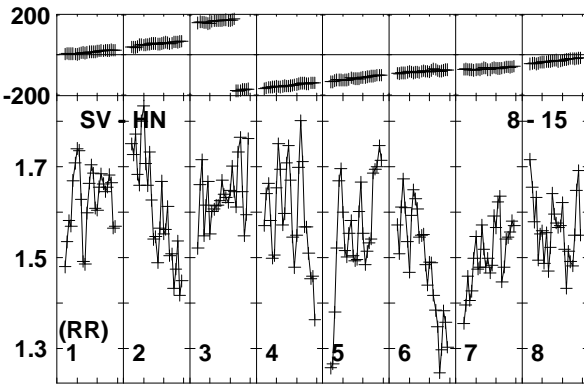
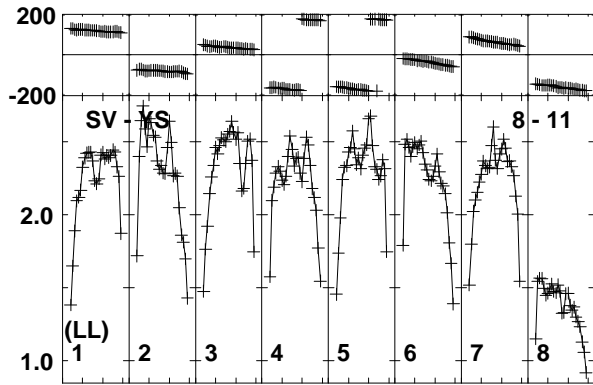
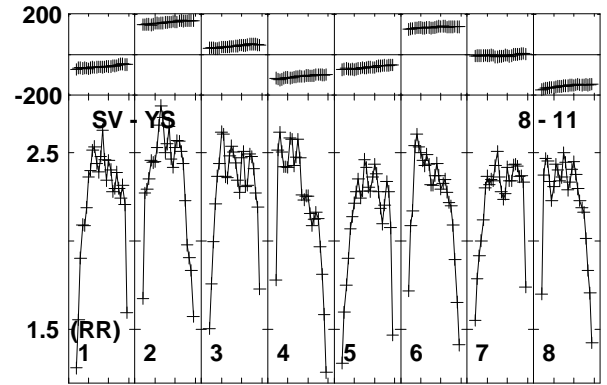
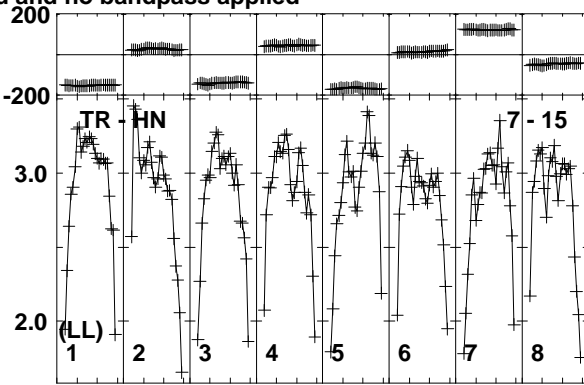
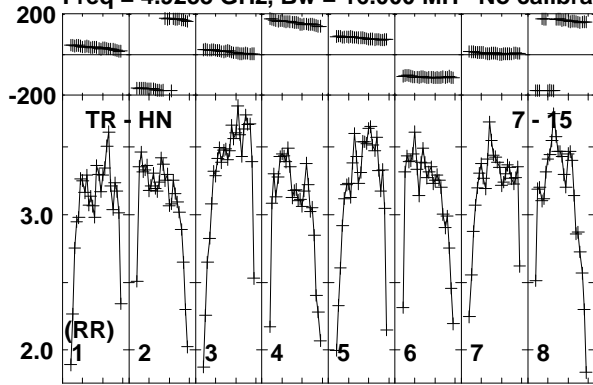

Lower frame: Milli Ampl Jy Top frame: Phas deg
 Vector averaged cross-power spectrum Baseline: TR (07) - HN (15)
 Timerange: 00/22:25:32 to 00/22:27:23

Plot file version 189 created 11-APR-2016 17:08:46

J1128+5925 GP053G 3.UVDATA.1

Freq = 4.9253 GHz, Bw = 16.000 MH No calibration applied and no bandpass applied

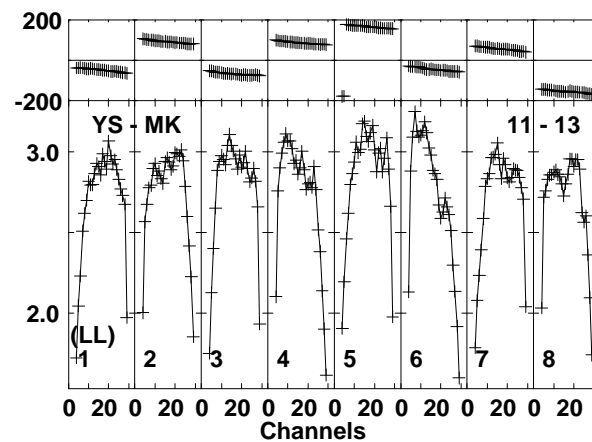
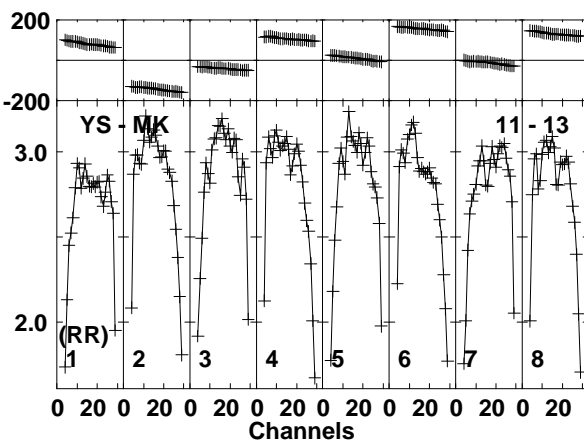
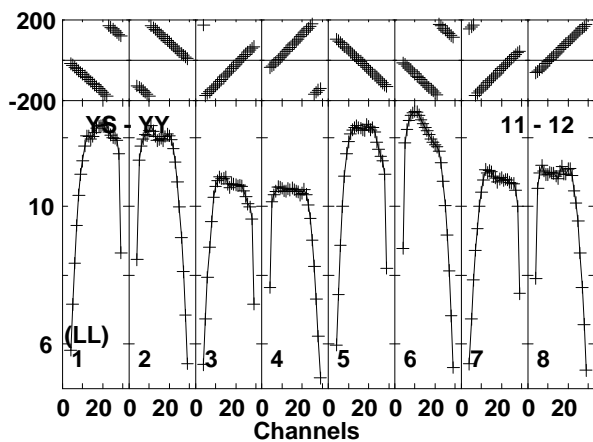
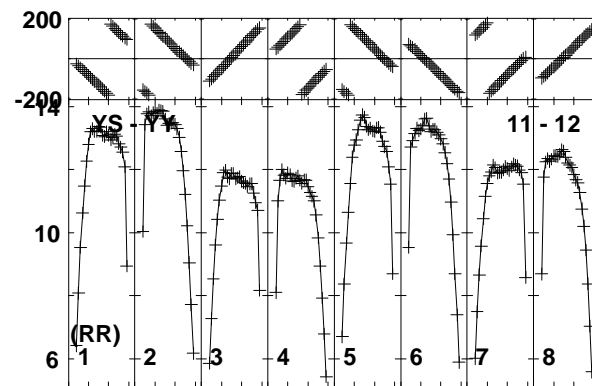
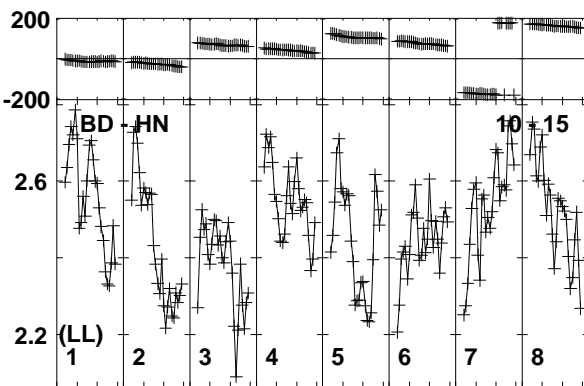
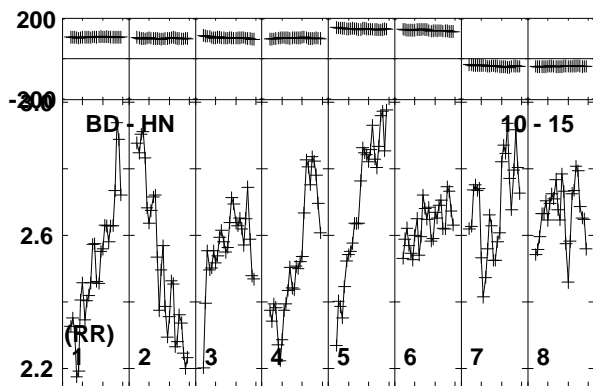
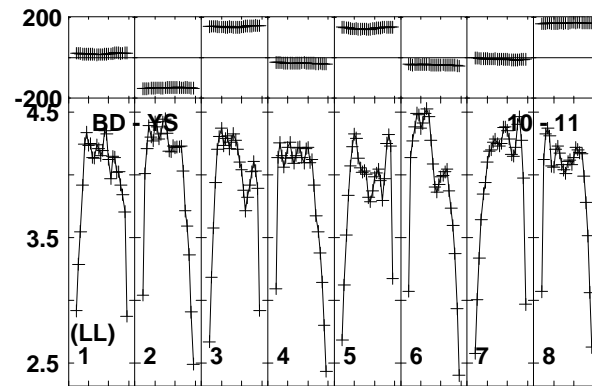
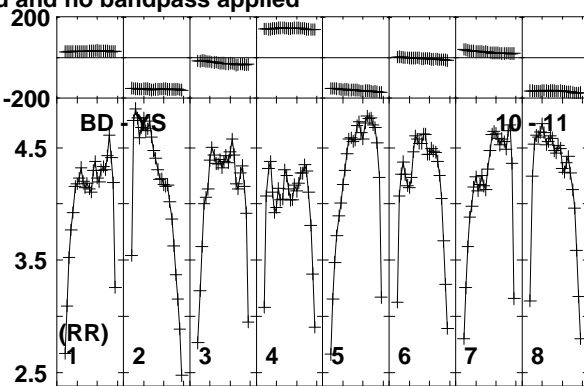
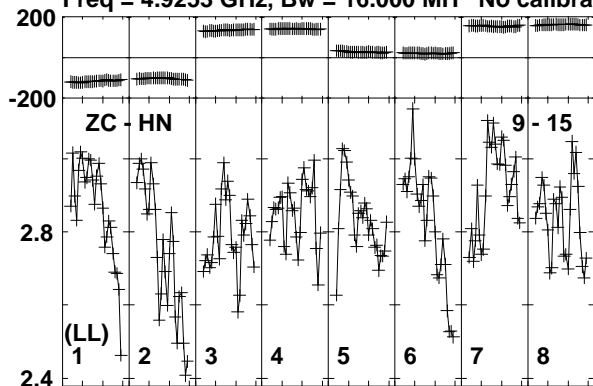

Lower frame: Milli Ampl Jy Top frame: Phas deg
Vector averaged cross-power spectrum Baseline: ZC (09) - HN (15)
Timerange: 00/22:25:32 to 00/22:27:23

Plot file version 190 created 11-APR-2016 17:08:46

J1128+5925 GP053G 3.UVDATA.1

Freq = 4.9253 GHz, Bw = 16.000 MH No calibration applied and no bandpass applied

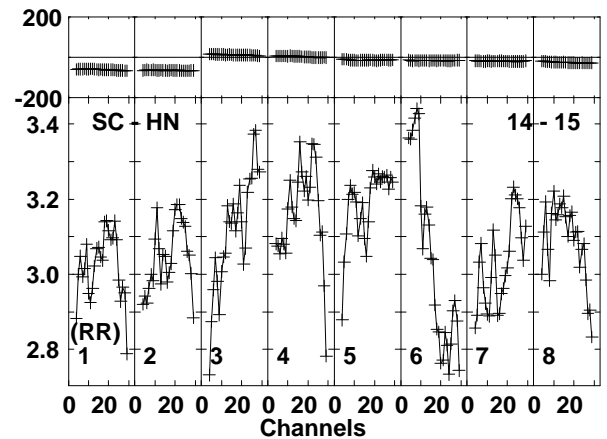
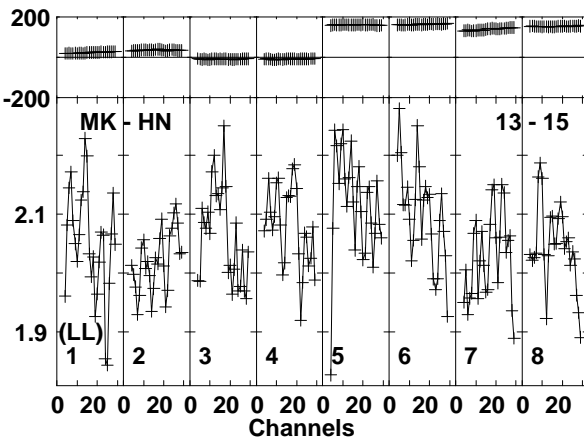
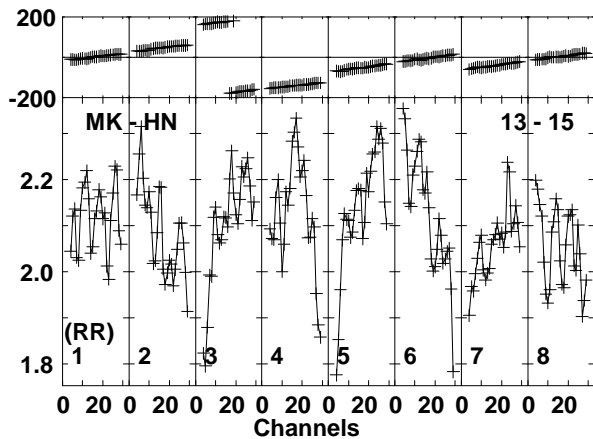
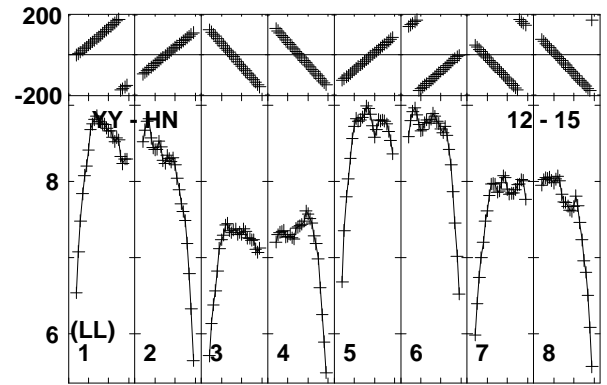
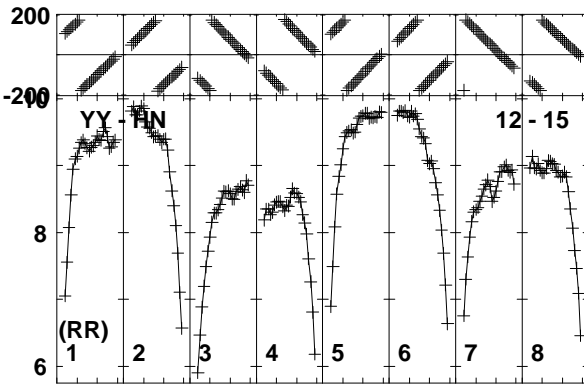
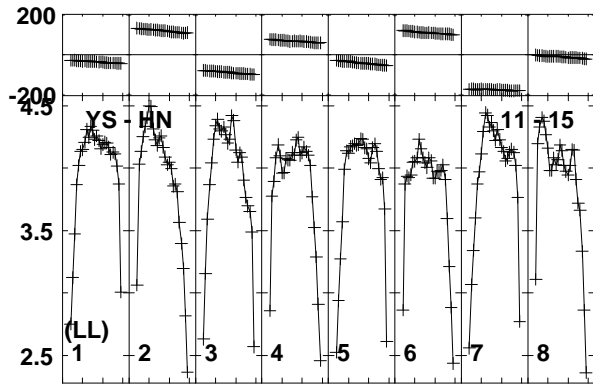
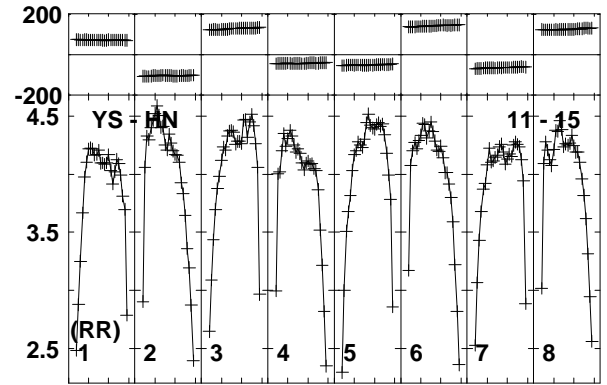
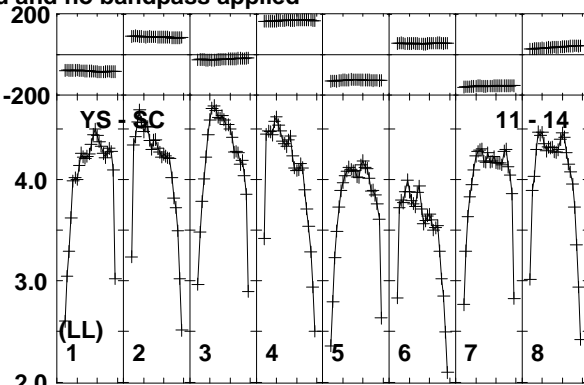
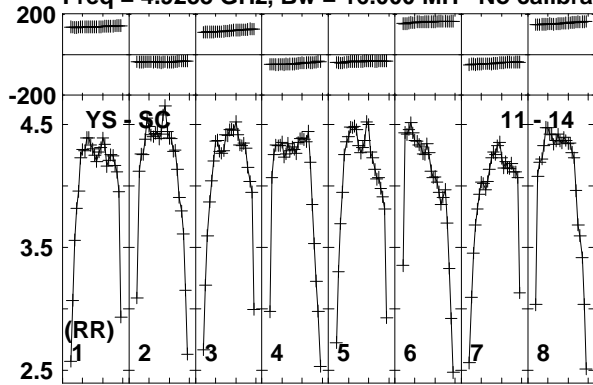

Lower frame: Milli Ampl Jy Top frame: Phas deg
Vector averaged cross-power spectrum Baseline: YS (11) - SC (14)
Timerange: 00/22:25:32 to 00/22:27:23

Plot file version 191 created 11-APR-2016 17:08:46
J1128+5925 GP053G 3.UVDATA.1
Freq = 4.9253 GHz, Bw = 16.000 MH No calibration applied and no bandpass applied

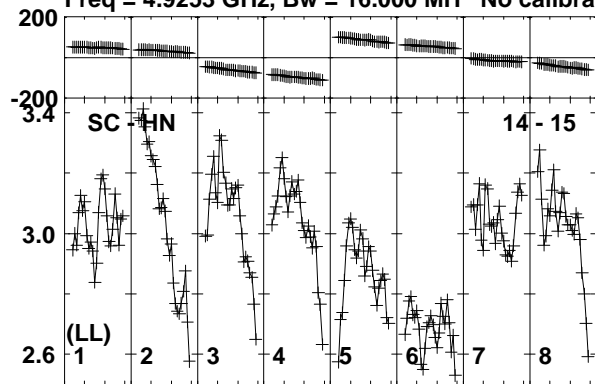

Lower frame: Milli Ampl Jy Top frame: Phas deg
Vector averaged cross-power spectrum Baseline: SC (14) - HN (15)
Timerange: 00/22:25:32 to 00/22:27:23

Plot file version 192 created 11-APR-2016 17:08:46

ARP299C GP053G 3.UVDATA.1

Freq = 4.9253 GHz, Bw = 16.000 MH No calibration applied and no bandpass applied

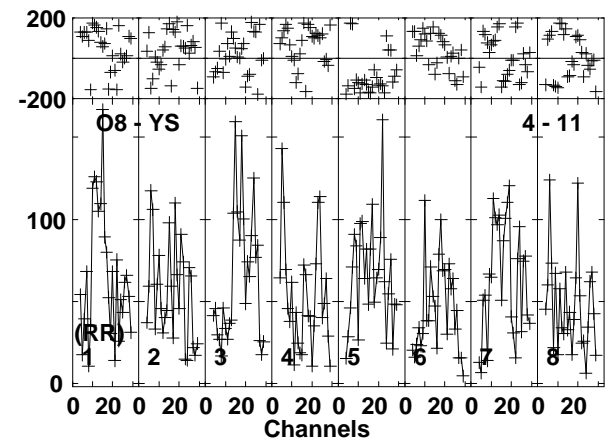
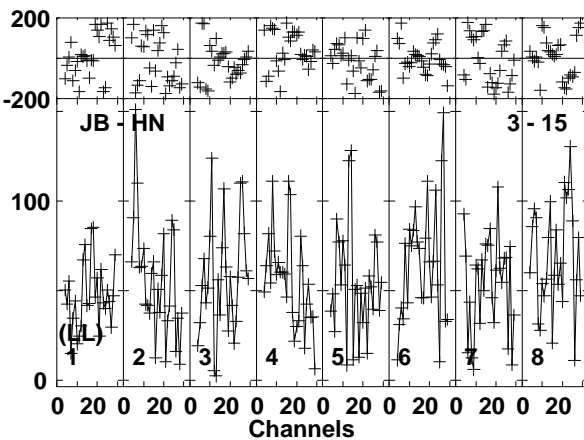
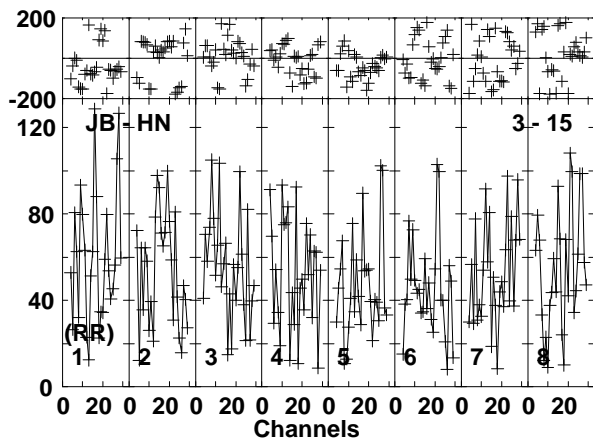
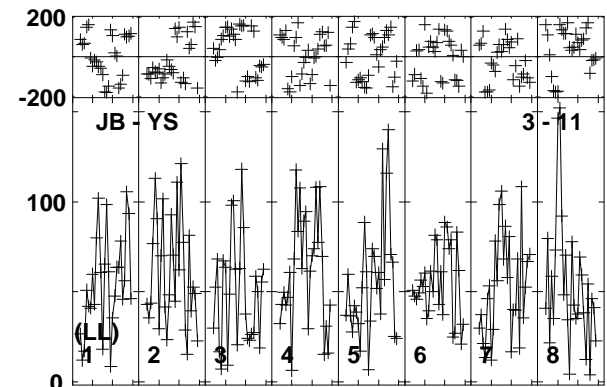
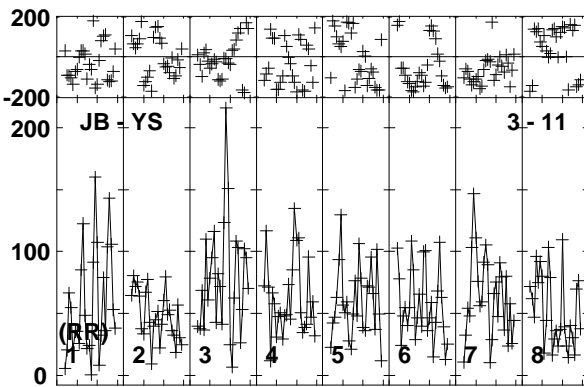
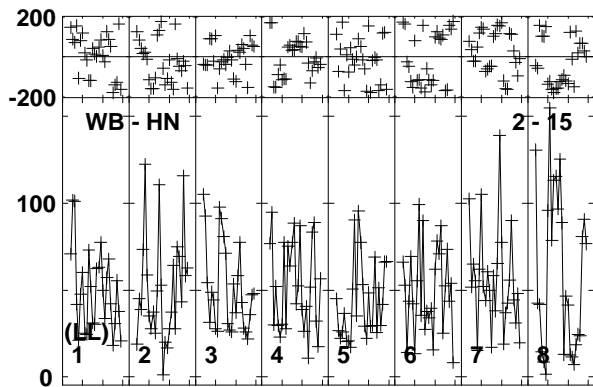
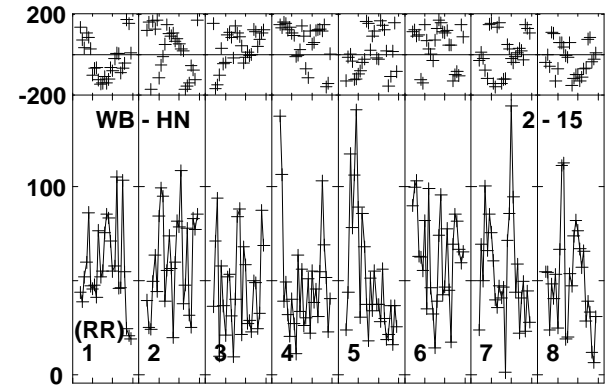
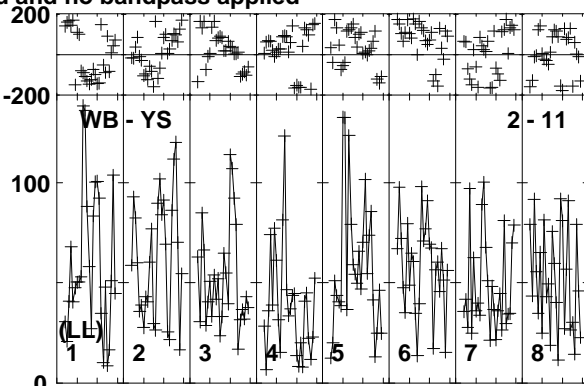
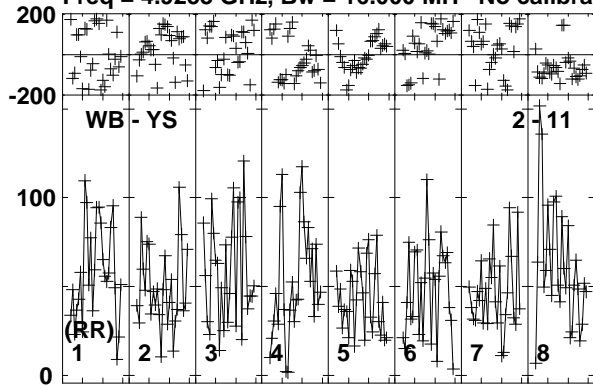

Lower frame: Micro Ampl Jy Top frame: Phas deg
Vector averaged cross-power spectrum Baseline: WB (02) - YS (11)
Timerange: 00/22:27:28 to 00/22:32:42

Plot file version 193 created 11-APR-2016 17:08:46

ARP299C GP053G 3.UVDATA.1

Freq = 4.9253 GHz, Bw = 16.000 MH No calibration applied and no bandpass applied

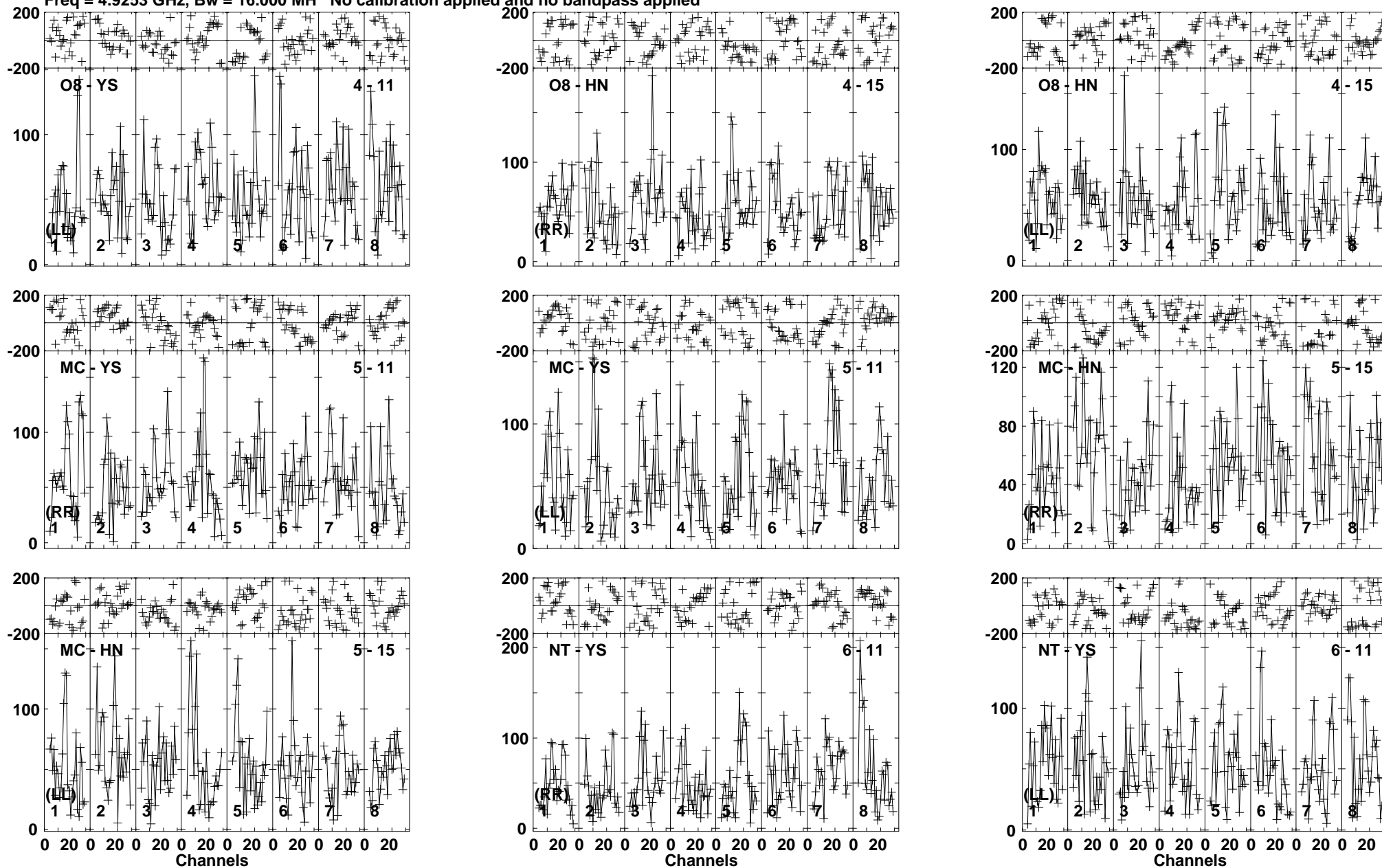

Lower frame: Micro Ampl Jy Top frame: Phas deg
Vector averaged cross-power spectrum Baseline: O8 (04) - YS (11)
Timerange: 00/22:27:28 to 00/22:32:42

Plot file version 194 created 11-APR-2016 17:08:47

ARP299C GP053G 3.UVDATA.1

Freq = 4.9253 GHz, Bw = 16.000 MH No calibration applied and no bandpass applied

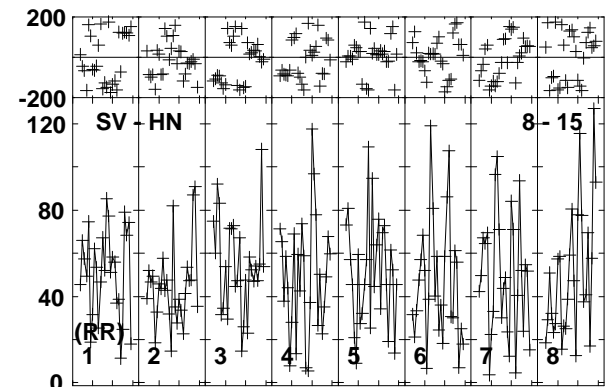
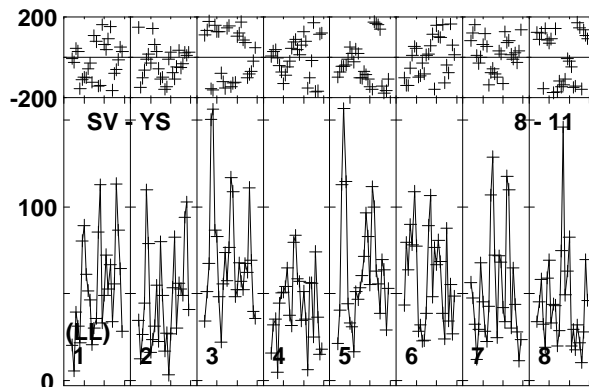
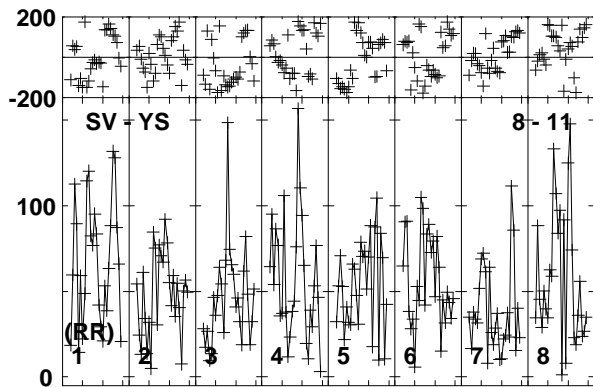
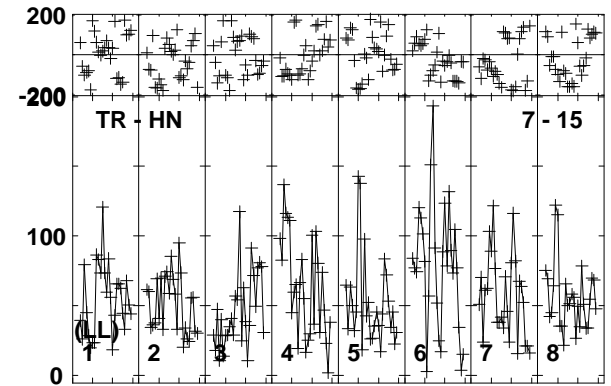
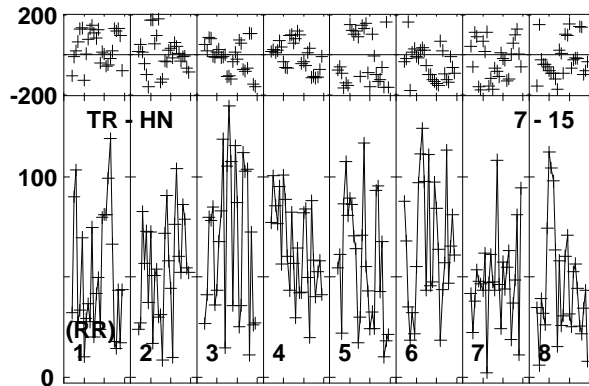
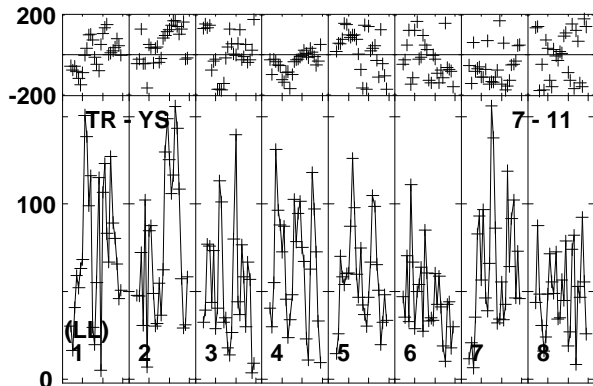
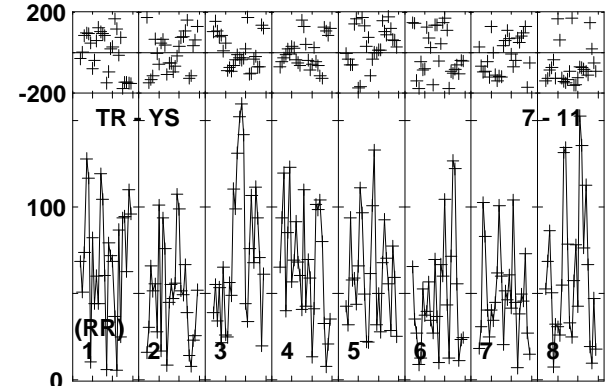
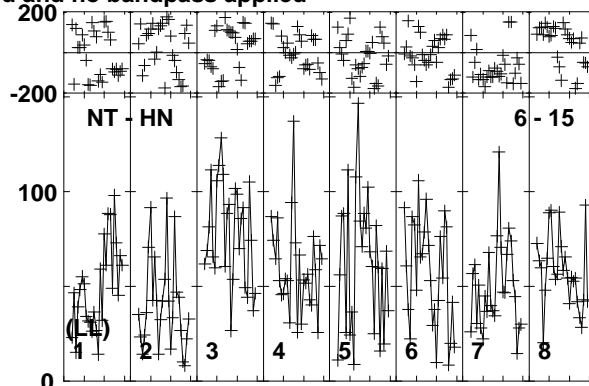
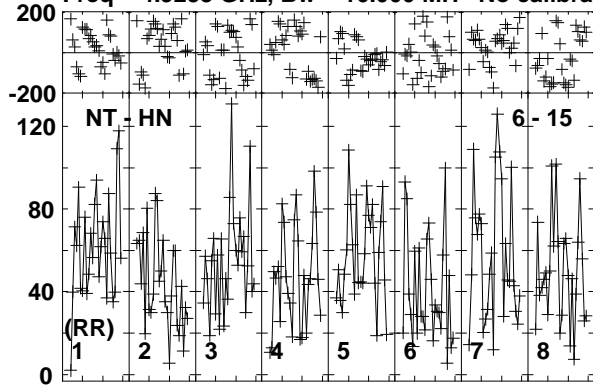

Lower frame: Micro Ampl Jy Top frame: Phas deg
Vector averaged cross-power spectrum Baseline: NT (06) - HN (15)
Timerange: 00/22:27:28 to 00/22:32:42

Plot file version 195 created 11-APR-2016 17:08:47

ARP299C GP053G 3.UVDATA.1

Freq = 4.9253 GHz, Bw = 16.000 MH No calibration applied and no bandpass applied

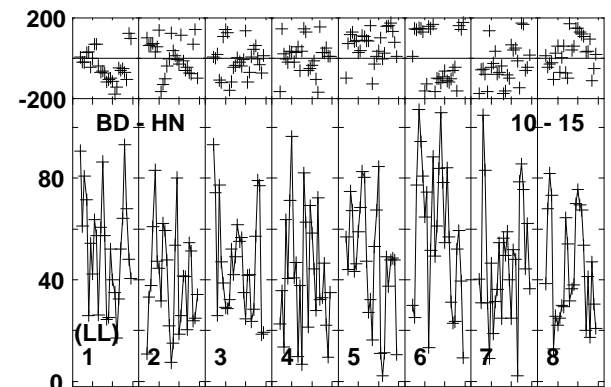
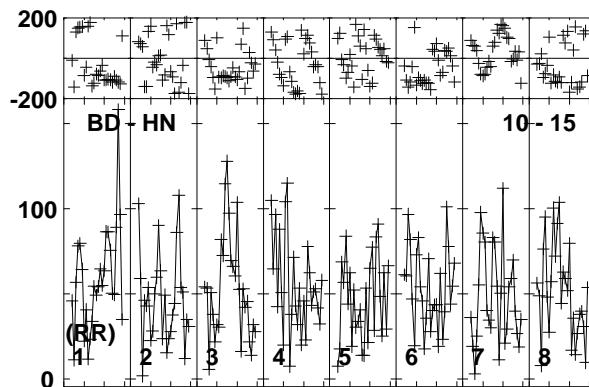
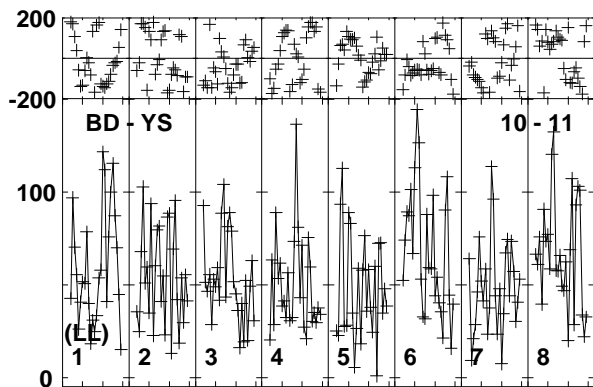
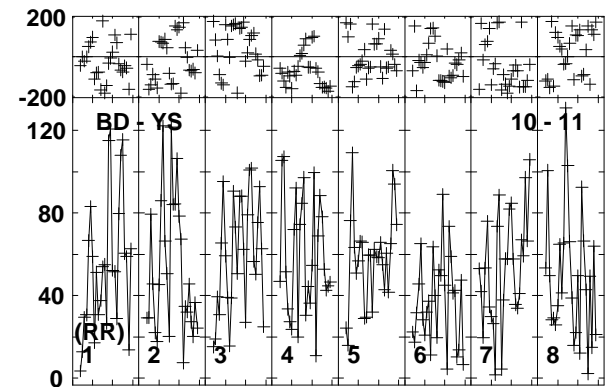
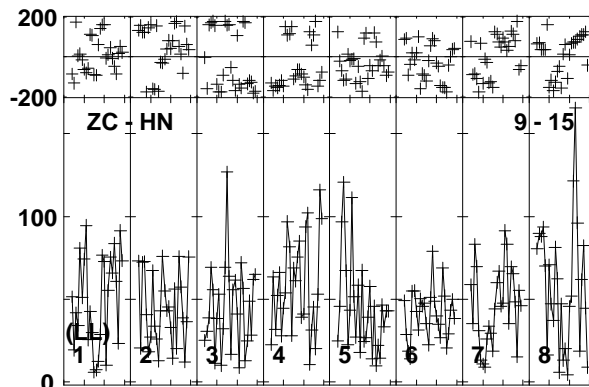
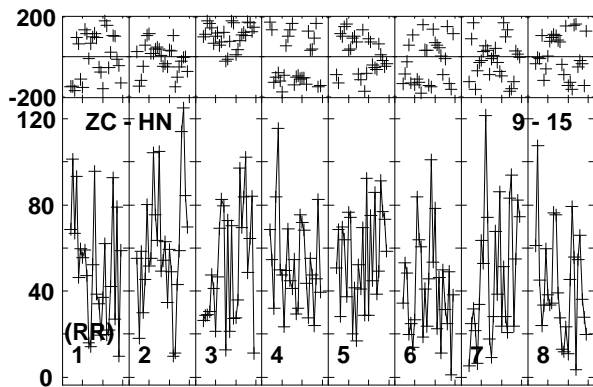
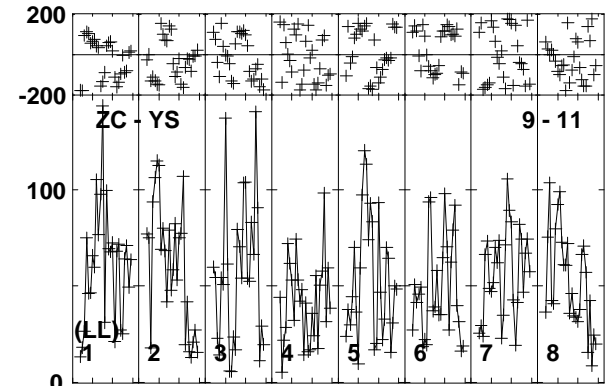
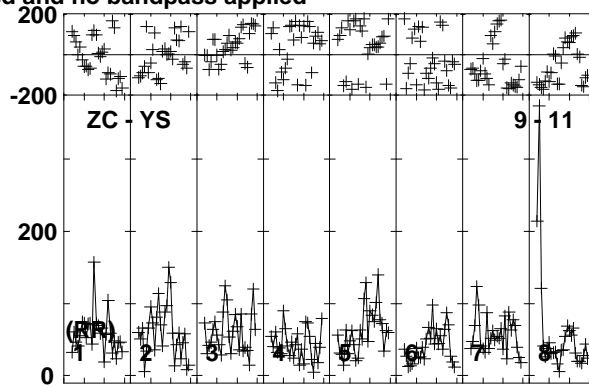
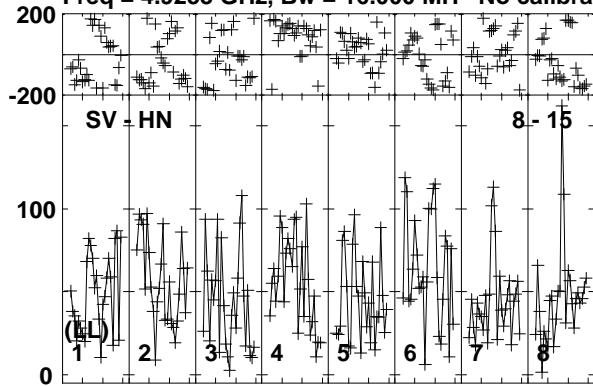

Lower frame: Micro Ampl Jy Top frame: Phas deg
Vector averaged cross-power spectrum Baseline: SV (08) - HN (15)
Timerange: 00/22:27:28 to 00/22:32:42

Plot file version 196 created 11-APR-2016 17:08:47

ARP299C GP053G 3.UVDATA.1

Freq = 4.9253 GHz, Bw = 16.000 MH No calibration applied and no bandpass applied

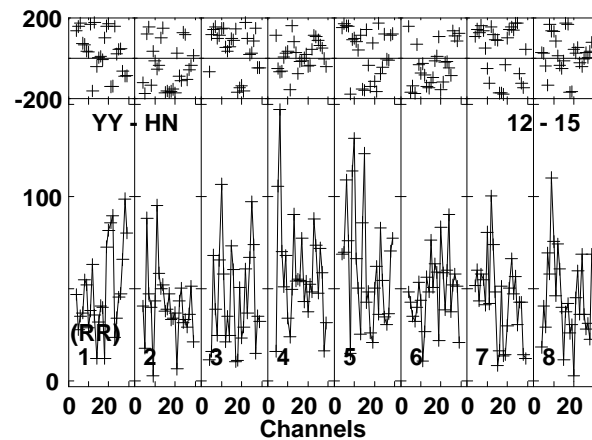
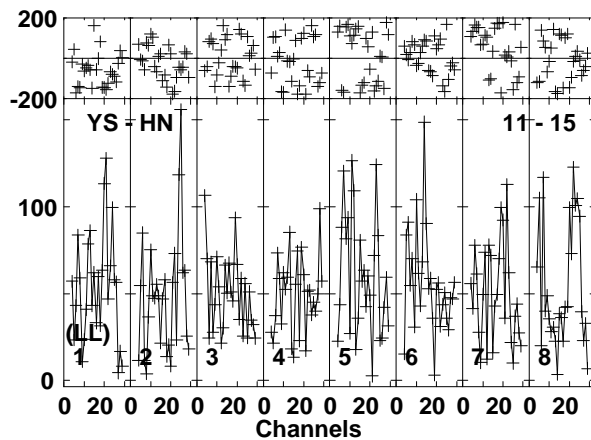
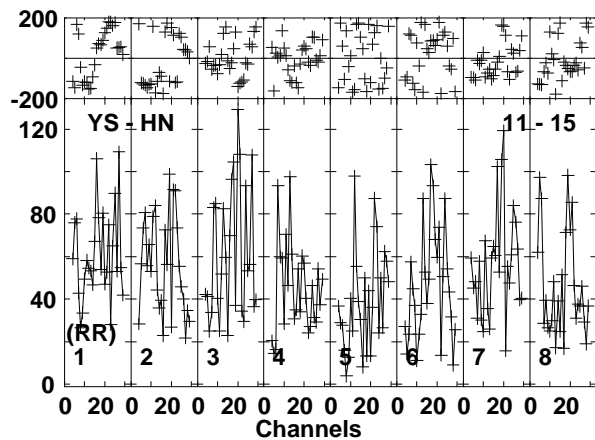
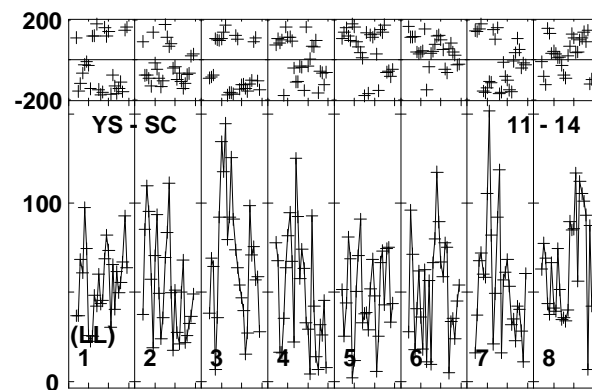
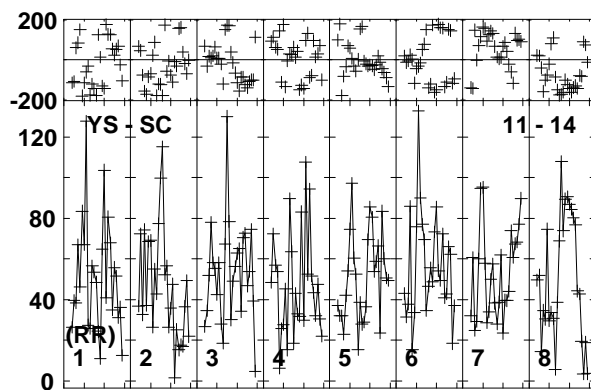
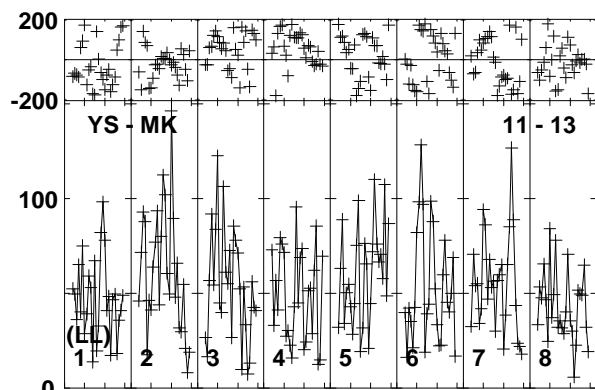
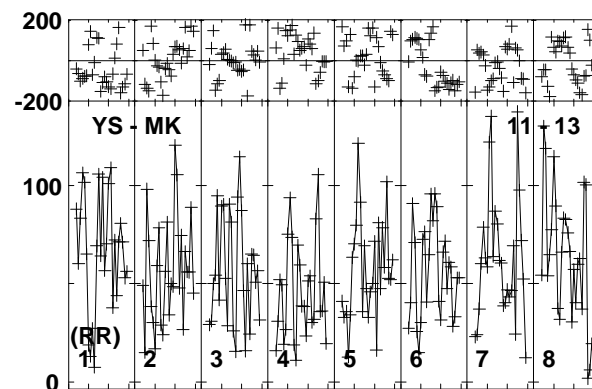
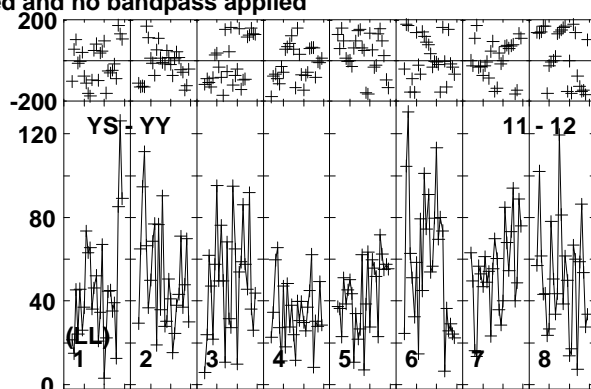
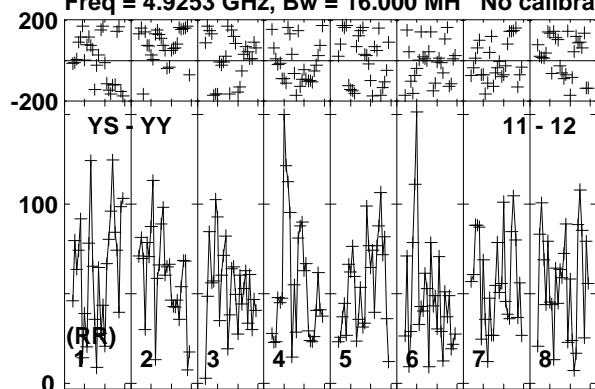

Lower frame: Micro Ampl Jy Top frame: Phas deg
Vector averaged cross-power spectrum Baseline: YS (11) - YY (12)
Timerange: 00/22:27:28 to 00/22:32:42

Plot file version 197 created 11-APR-2016 17:08:47

ARP299C GP053G 3.UVDATA.1

Freq = 4.9253 GHz, Bw = 16.000 MH No calibration applied and no bandpass applied

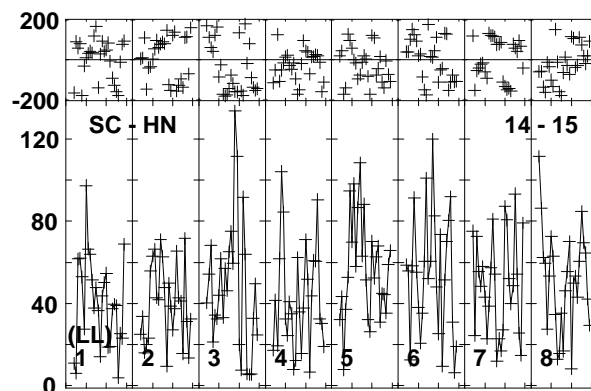
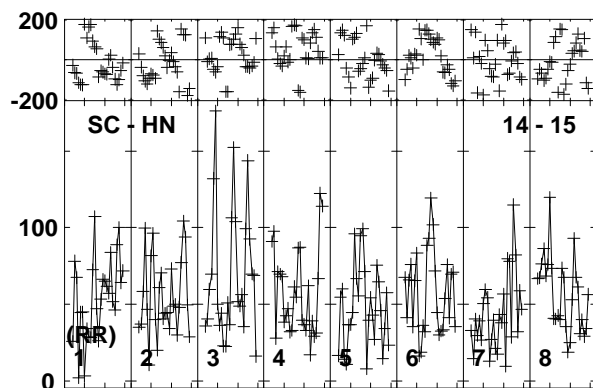
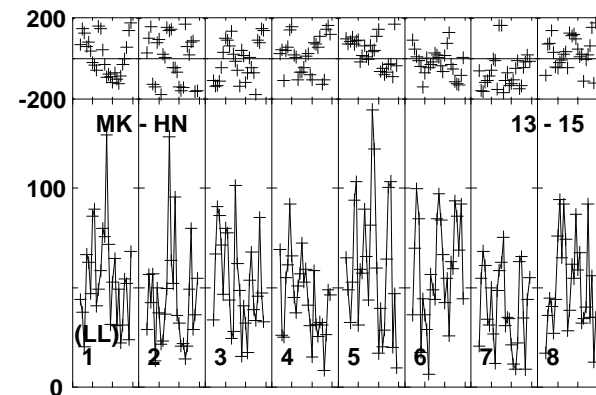
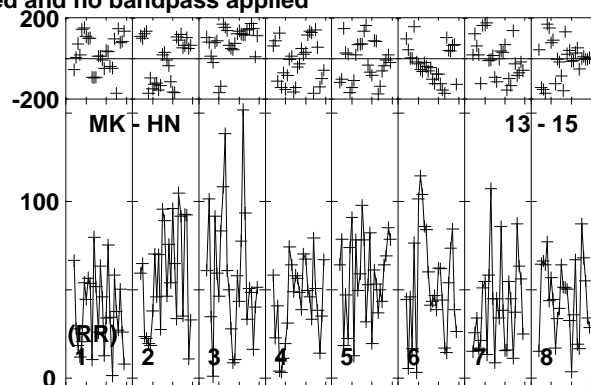
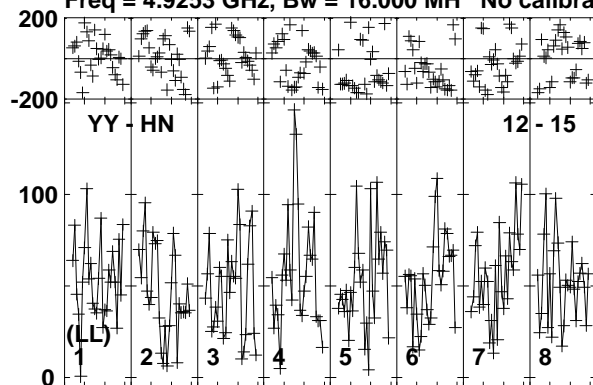

Lower frame: Micro Ampl Jy Top frame: Phas deg
Vector averaged cross-power spectrum Baseline: YY (12) - HN (15)
Timerange: 00/22:27:28 to 00/22:32:42

Plot file version 198 created 11-APR-2016 17:08:47

J1128+5925 GP053G 3.UVDATA.1

Freq = 4.9253 GHz, Bw = 16.000 MH No calibration applied and no bandpass applied

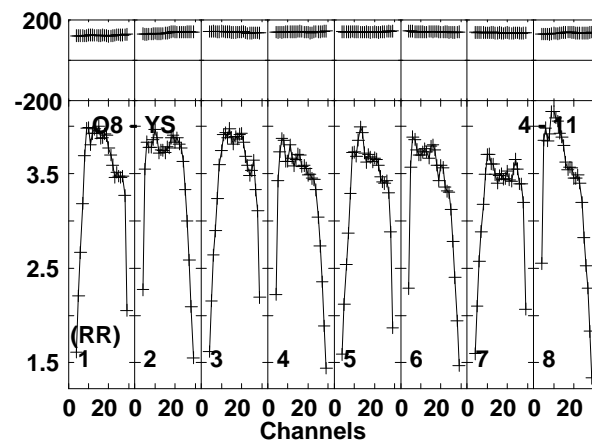
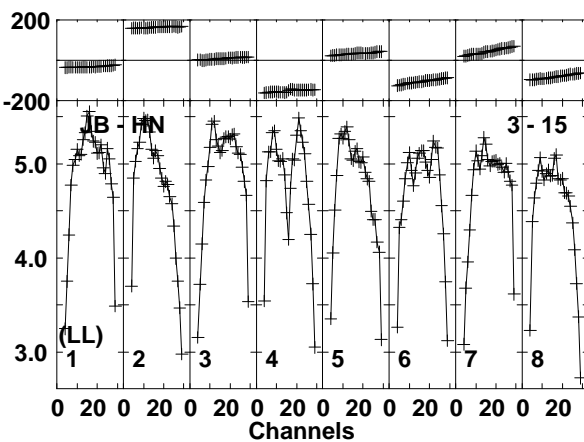
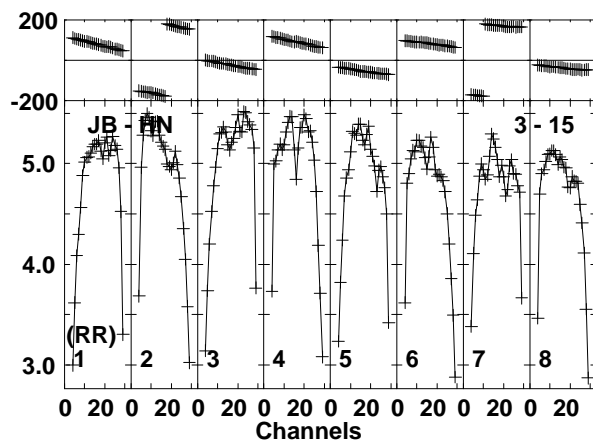
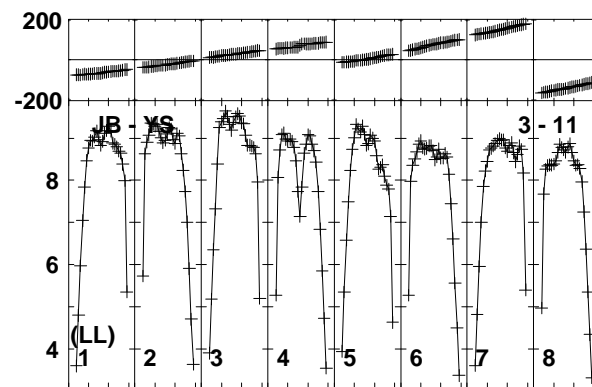
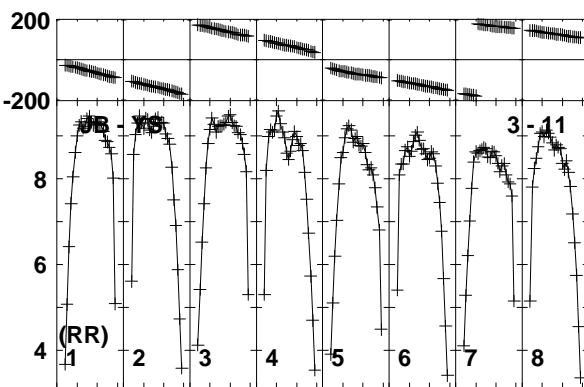
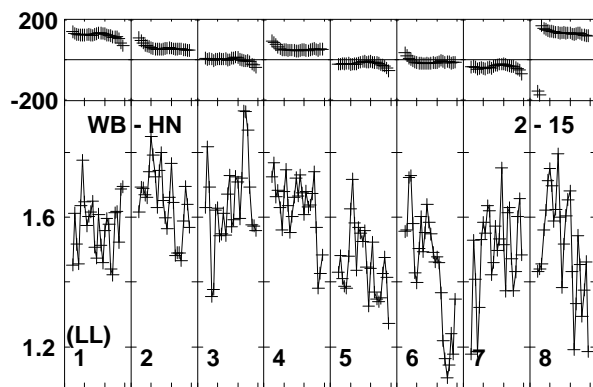
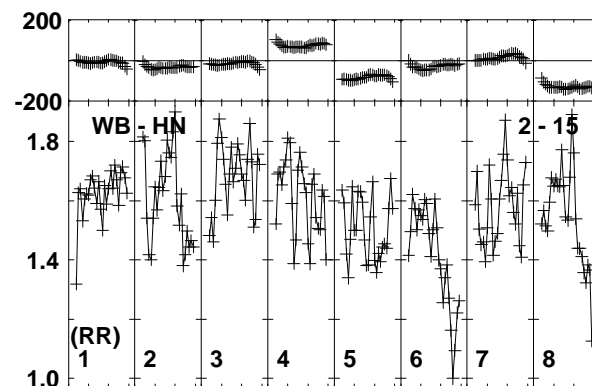
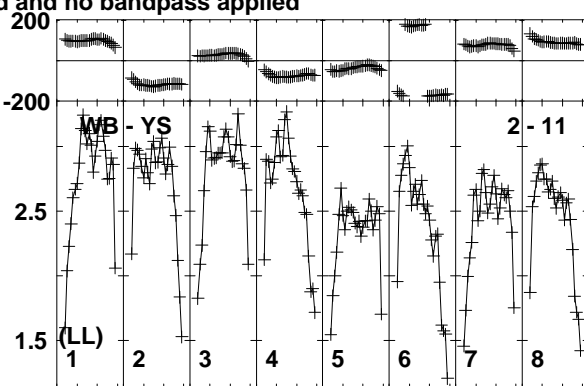
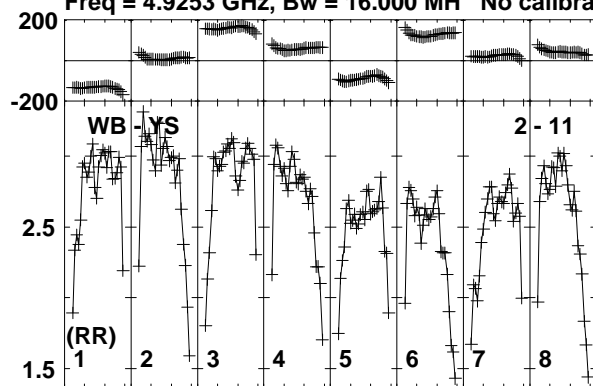

Lower frame: Milli Ampl Jy Top frame: Phas deg
Vector averaged cross-power spectrum Baseline: WB (02) - YS (11)
Timerange: 00:22:32:49 to 00:22:34:32

Plot file version 199 created 11-APR-2016 17:08:48

J1128+5925 GP053G 3.UVDATA.1

Freq = 4.9253 GHz, Bw = 16.000 MH No calibration applied and no bandpass applied

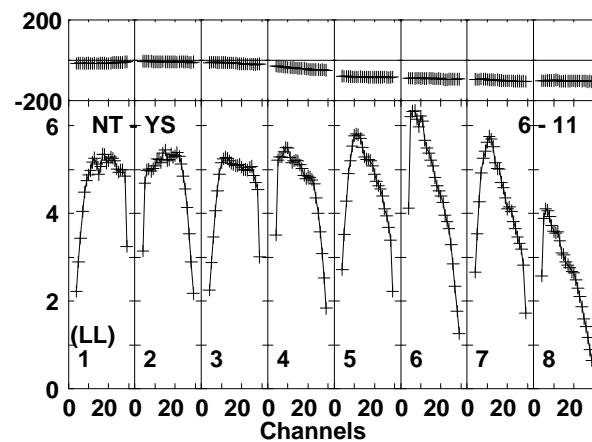
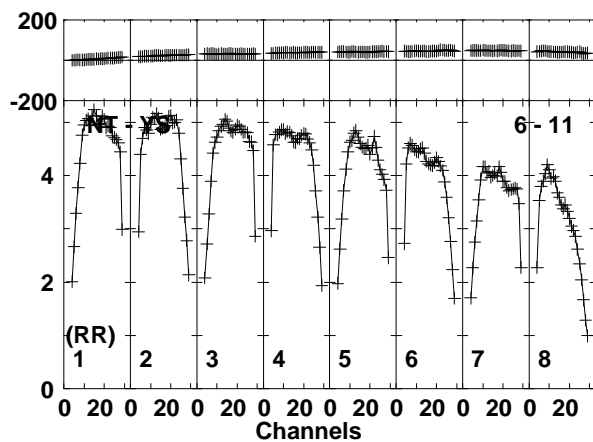
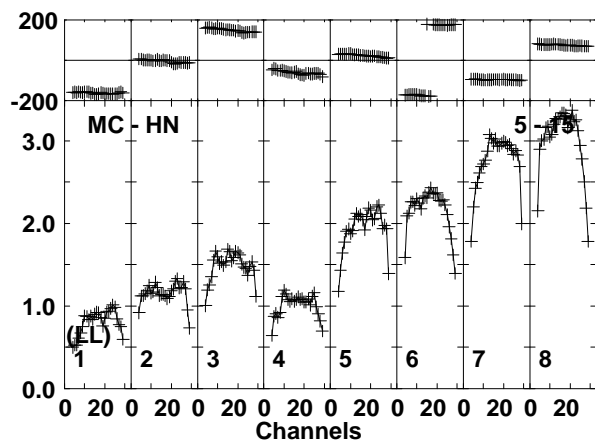
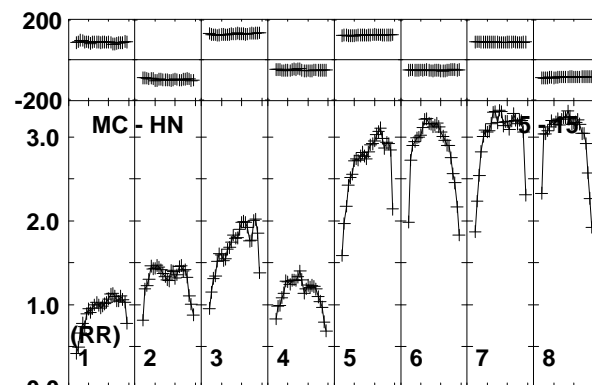
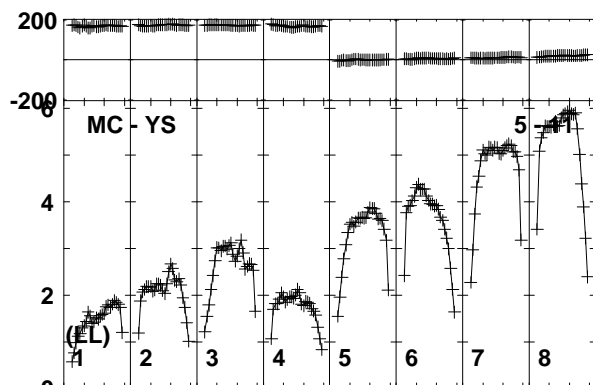
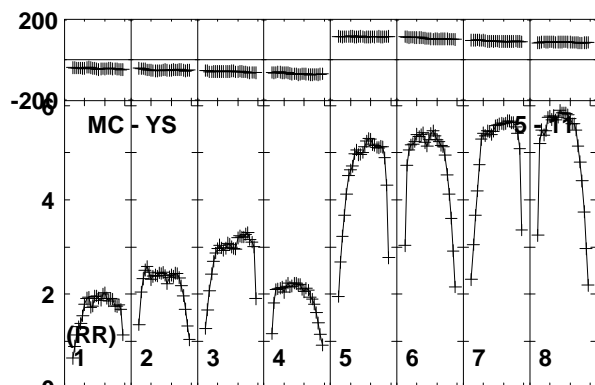
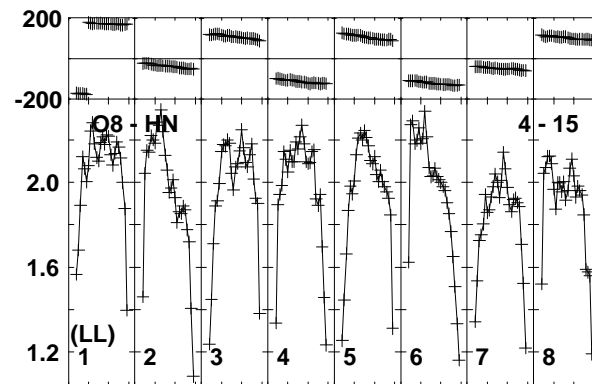
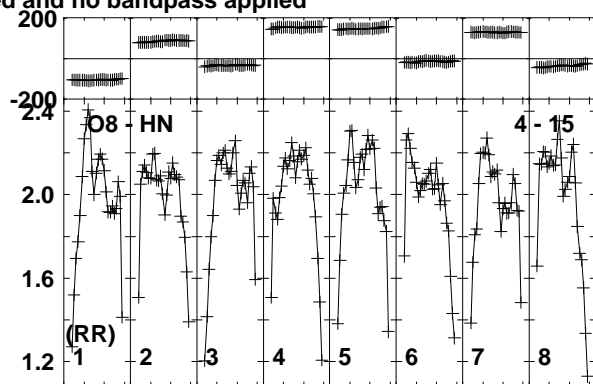
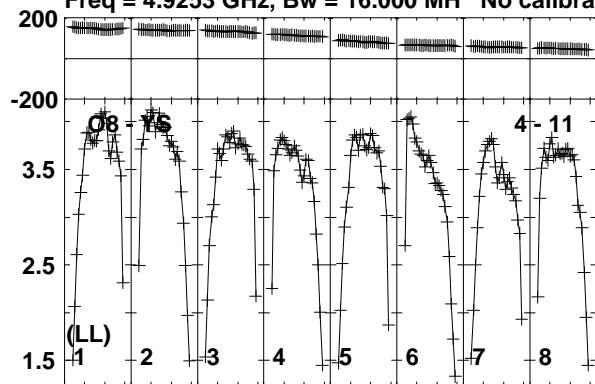

Lower frame: Milli Ampl Jy Top frame: Phas deg
Vector averaged cross-power spectrum Baseline: O8 (04) - YS (11)
Timerange: 00:22:32:49 to 00:22:34:32

Plot file version 200 created 11-APR-2016 17:08:48

J1128+5925 GP053G 3.UVDATA.1

Freq = 4.9253 GHz, Bw = 16.000 MH No calibration applied and no bandpass applied

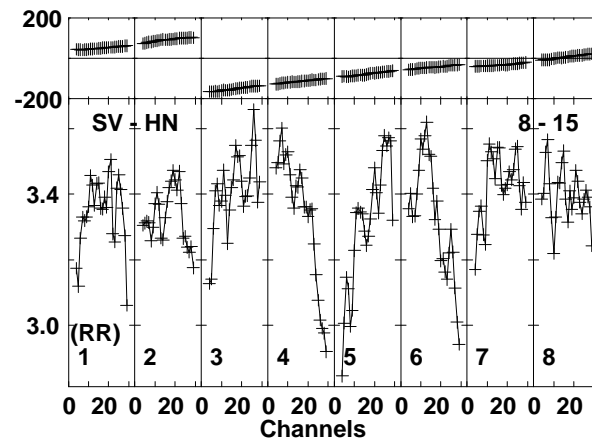
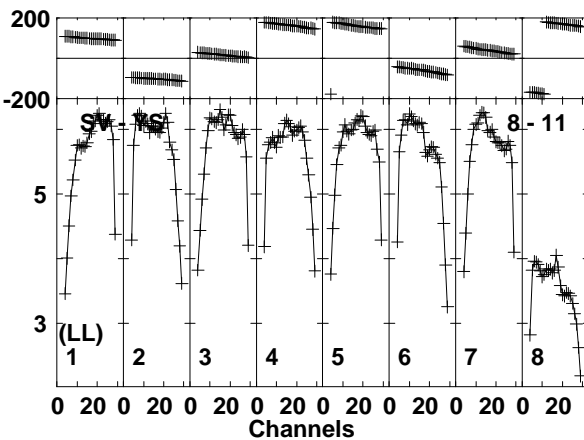
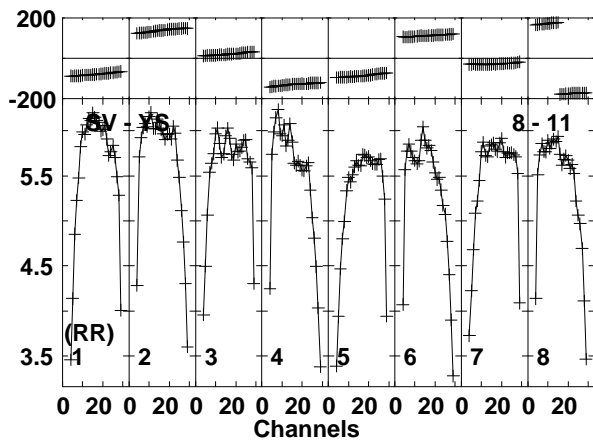
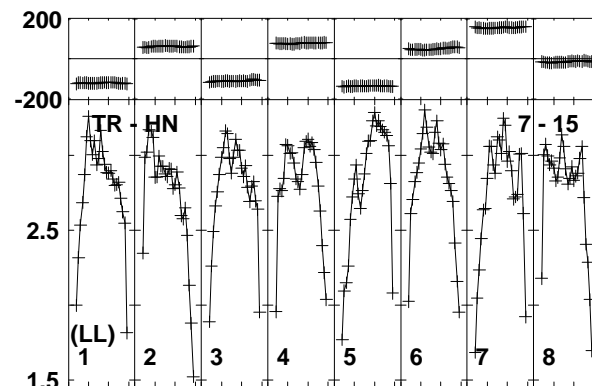
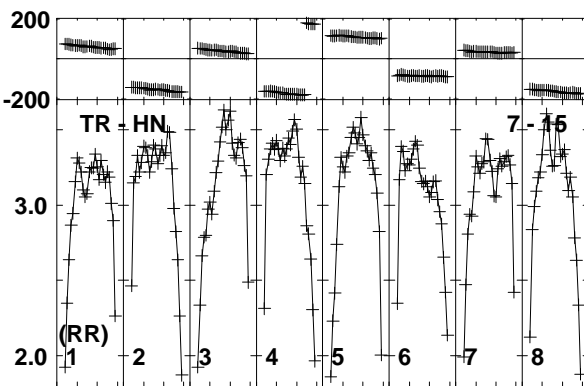
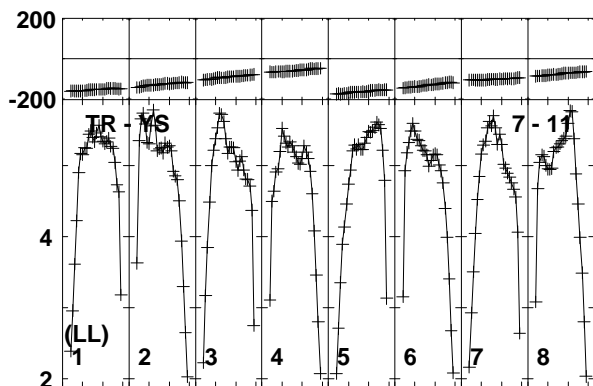
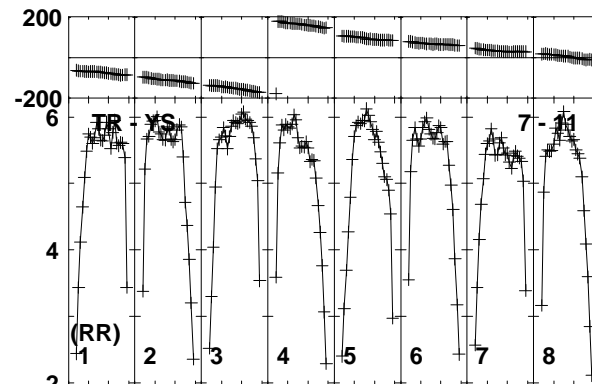
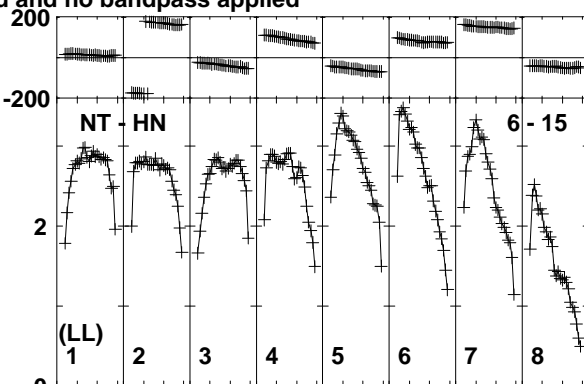
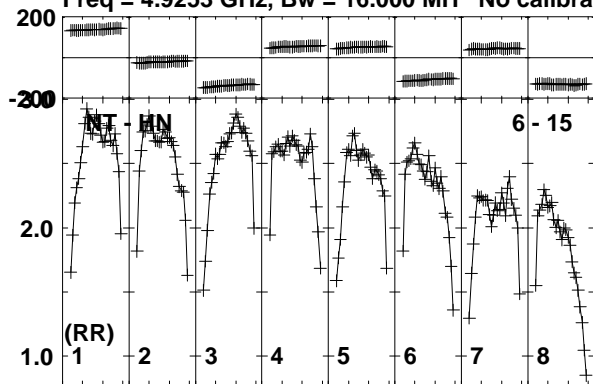

Lower frame: Milli Ampl Jy Top frame: Phas deg
Vector averaged cross-power spectrum Baseline: NT (06) - HN (15)
Timerange: 00/22:32:49 to 00/22:34:32

Plot file version 201 created 11-APR-2016 17:08:48

J1128+5925 GP053G 3.UVDATA.1

Freq = 4.9253 GHz, Bw = 16.000 MH No calibration applied and no bandpass applied

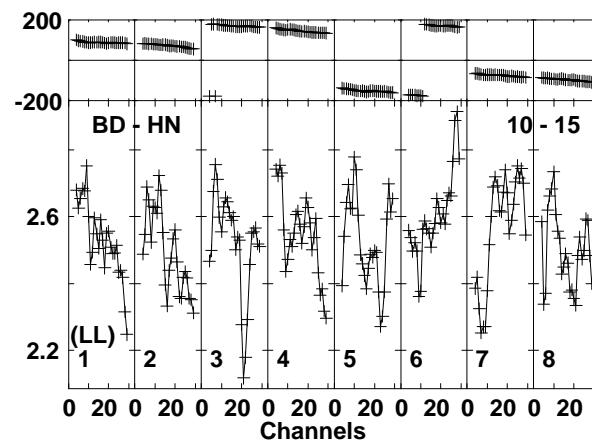
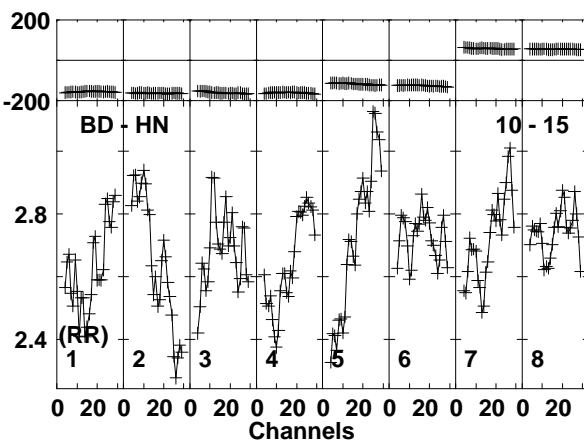
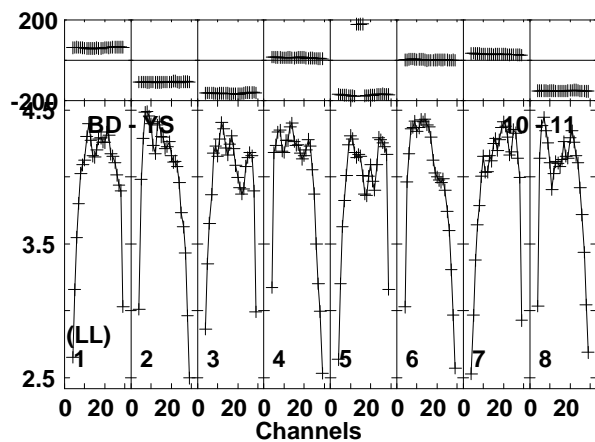
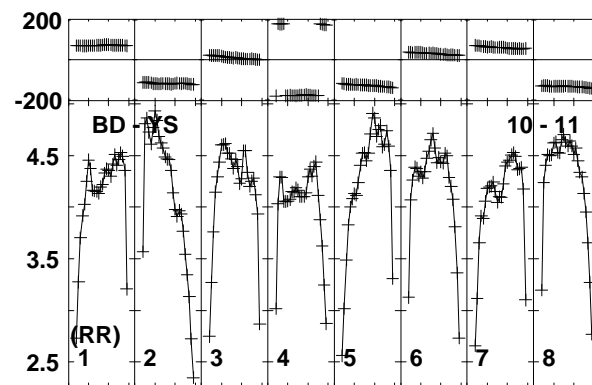
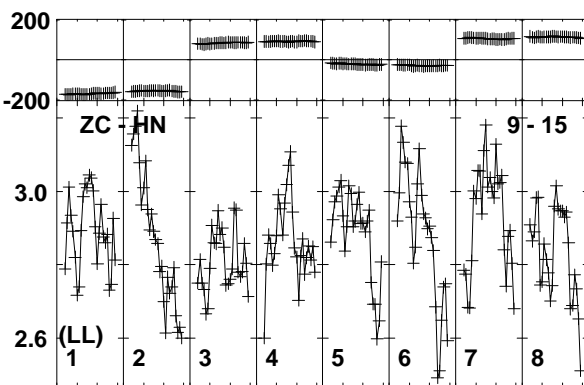
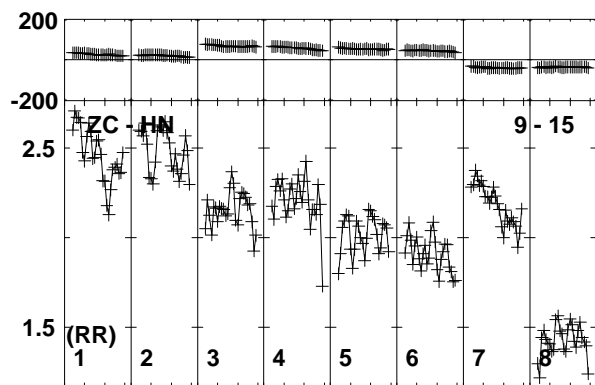
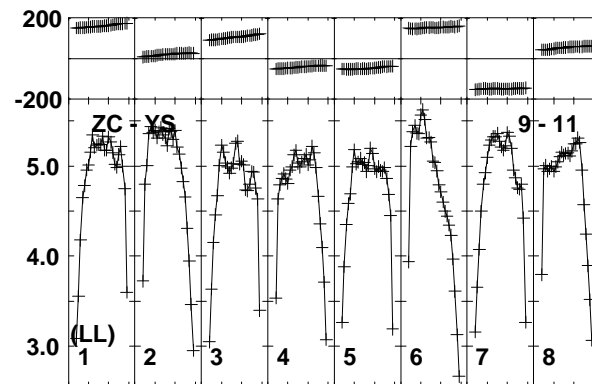
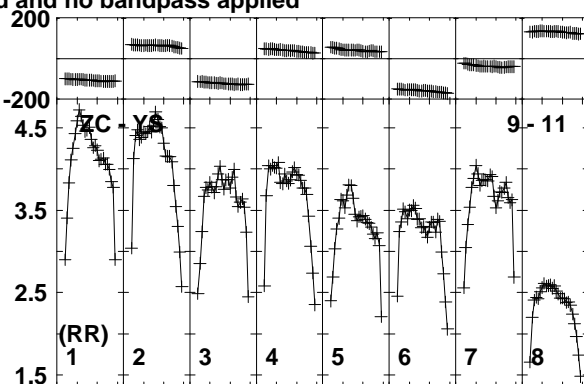
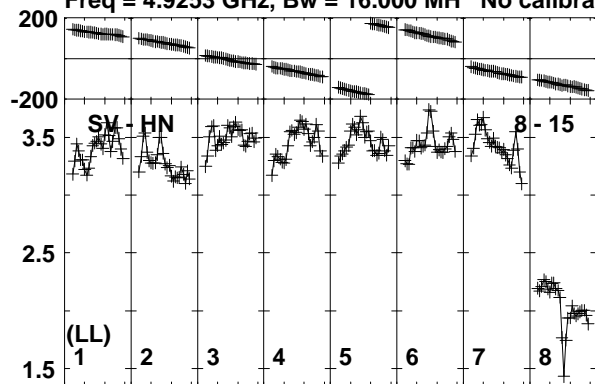

Lower frame: Milli Ampl Jy Top frame: Phas deg
Vector averaged cross-power spectrum Baseline: SV (08) - HN (15)
Timerange: 00/22:32:49 to 00/22:34:32

Plot file version 202 created 11-APR-2016 17:08:48

J1128+5925 GP053G 3.UVDATA.1

Freq = 4.9253 GHz, Bw = 16.000 MH No calibration applied and no bandpass applied

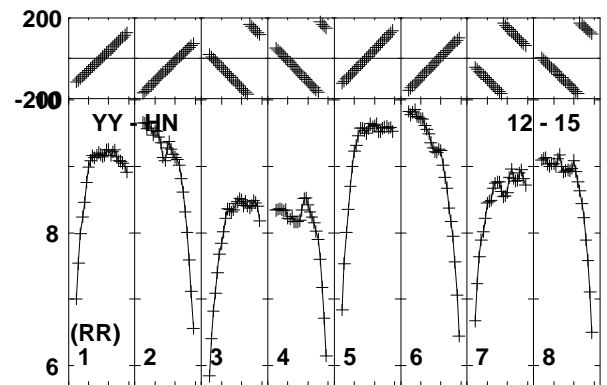
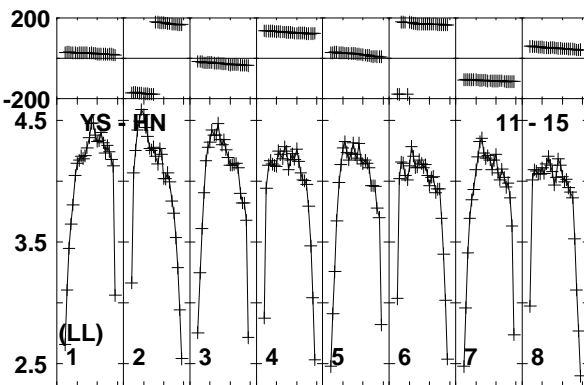
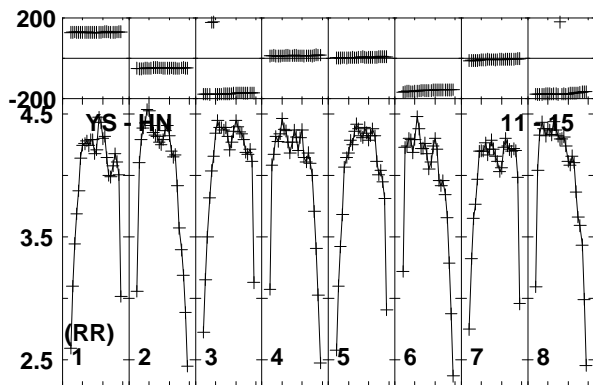
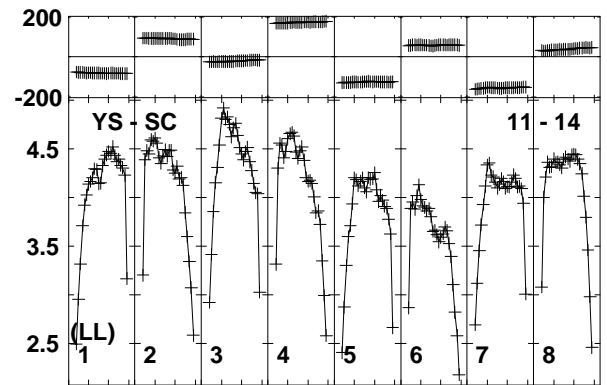
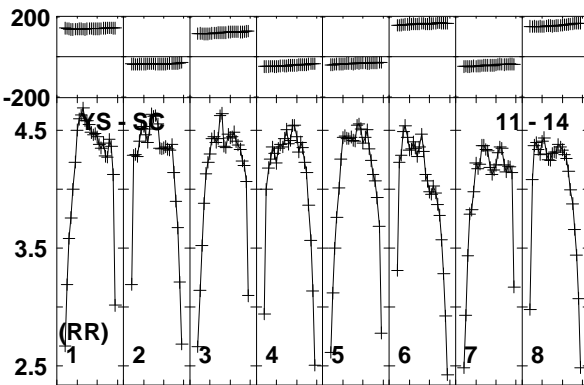
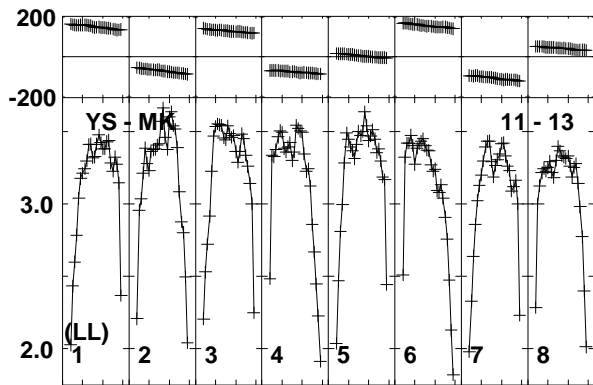
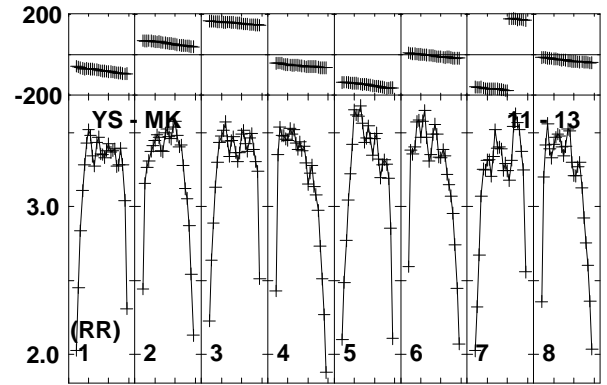
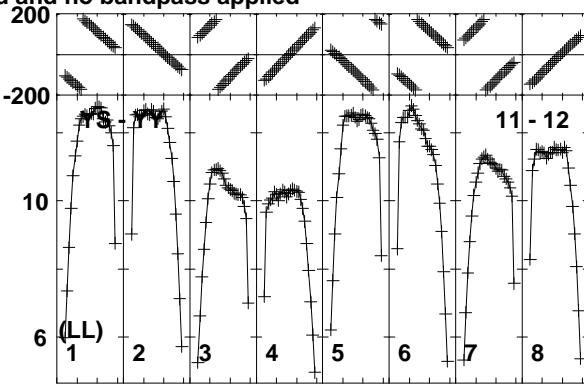
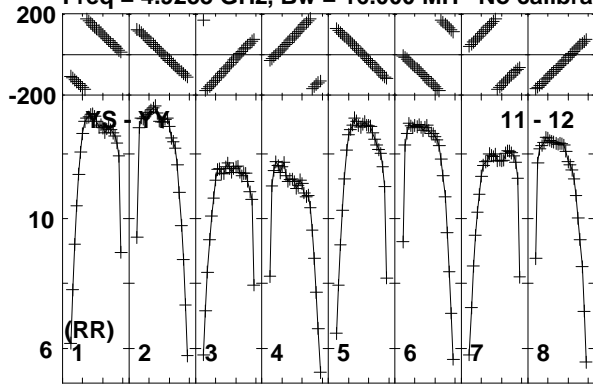

Lower frame: Milli Ampl Jy Top frame: Phas deg
Vector averaged cross-power spectrum Baseline: YS (11) - YY (12)
Timerange: 00/22:32:49 to 00/22:34:32

Plot file version 203 created 11-APR-2016 17:08:48

J1128+5925 GP053G 3.UVDATA.1

Freq = 4.9253 GHz, Bw = 16.000 MH No calibration applied and no bandpass applied

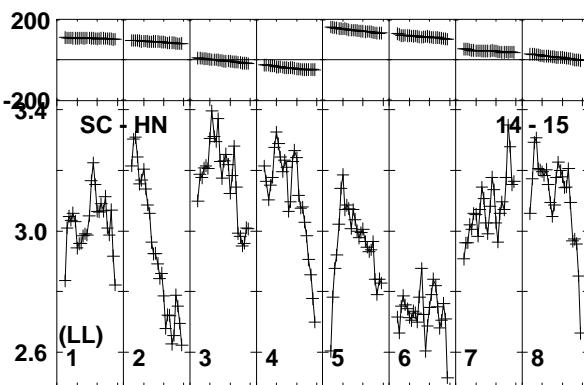
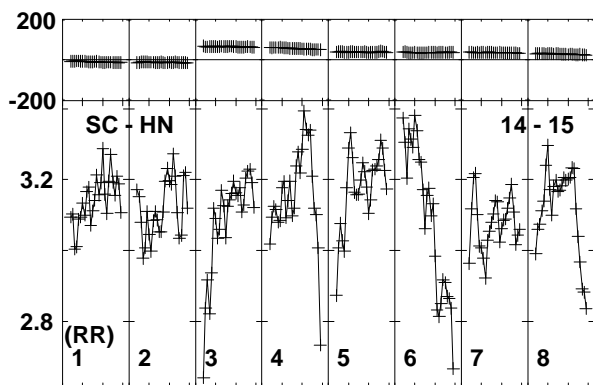
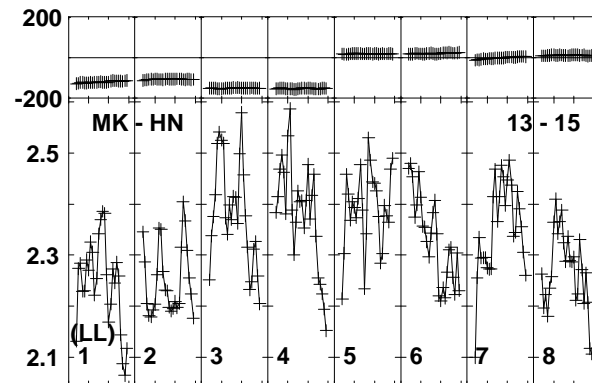
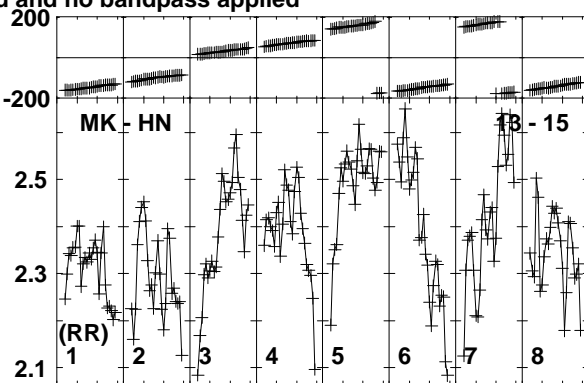
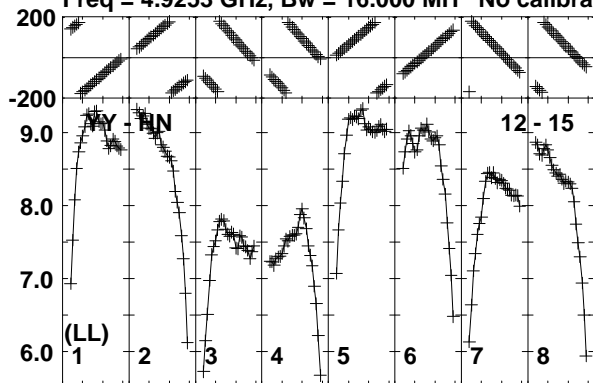

Lower frame: Milli Ampl Jy Top frame: Phas deg
Vector averaged cross-power spectrum Baseline: YY (12) - HN (15)
Timerange: 00/22:32:49 to 00/22:34:32

Plot file version 204 created 11-APR-2016 17:08:48

ARP299C GP053G 3.UVDATA.1

Freq = 4.9253 GHz, Bw = 16.000 MH No calibration applied and no bandpass applied

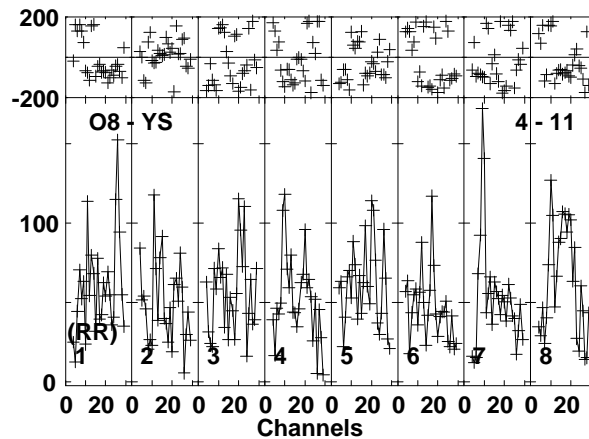
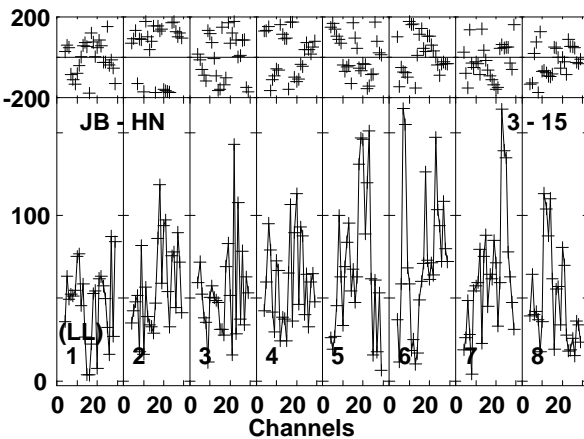
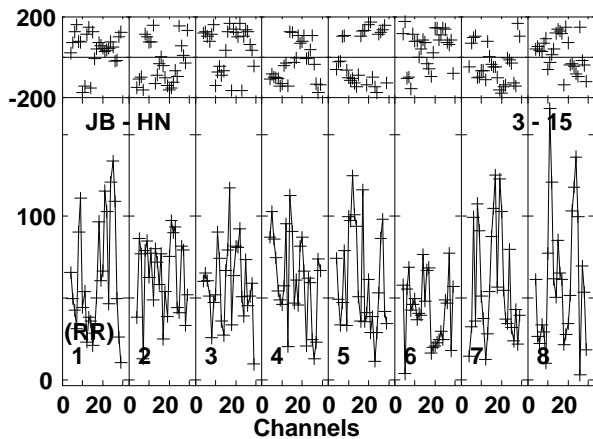
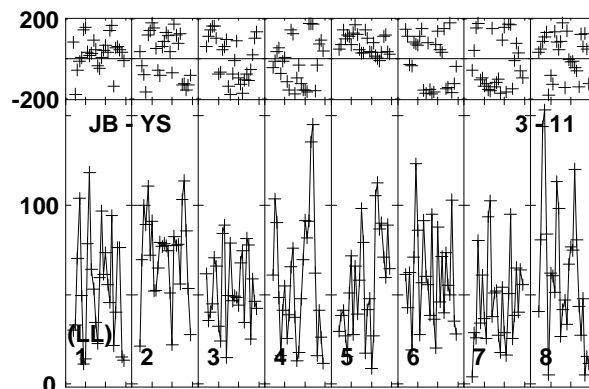
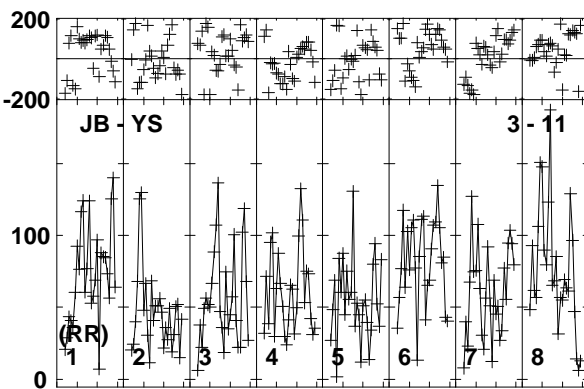
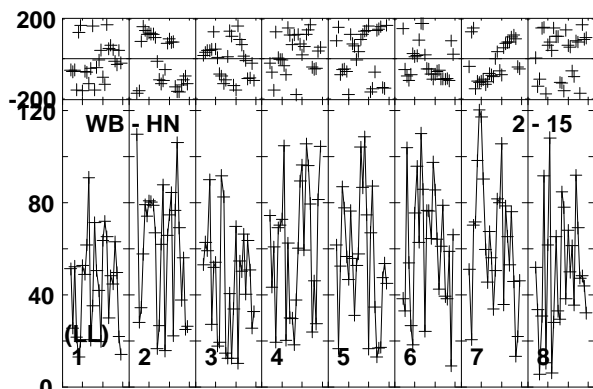
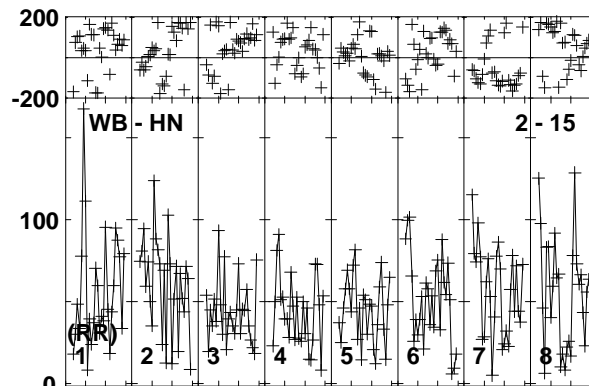
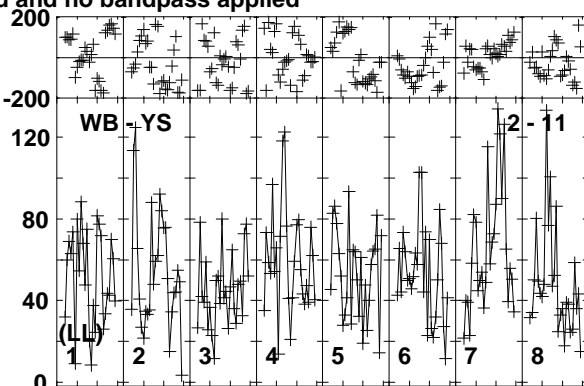
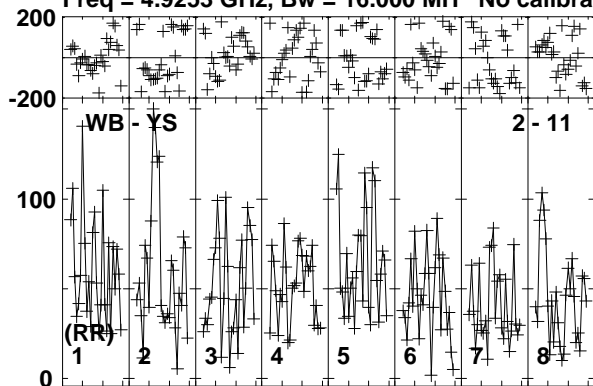

Lower frame: Micro Ampl Jy Top frame: Phas deg
Vector averaged cross-power spectrum Baseline: WB (02) - YS (11)
Timerange: 00/22:34:39 to 00/22:39:51

Plot file version 205 created 11-APR-2016 17:08:49

ARP299C GP053G 3.UVDATA.1

Freq = 4.9253 GHz, Bw = 16.000 MH No calibration applied and no bandpass applied

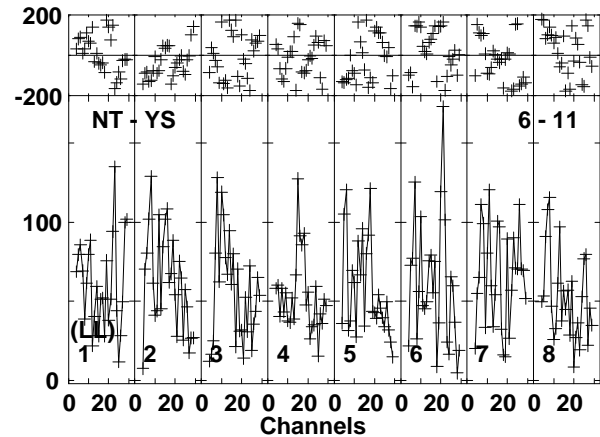
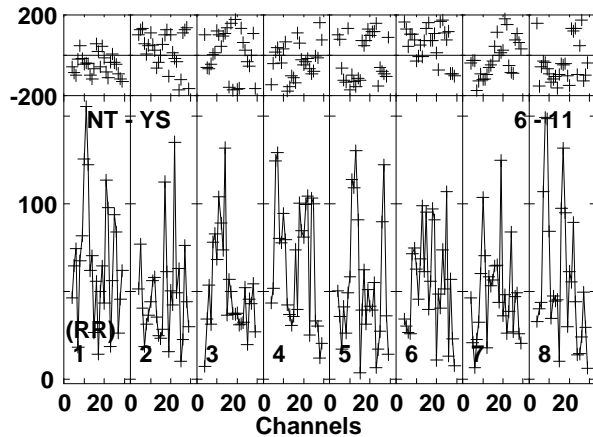
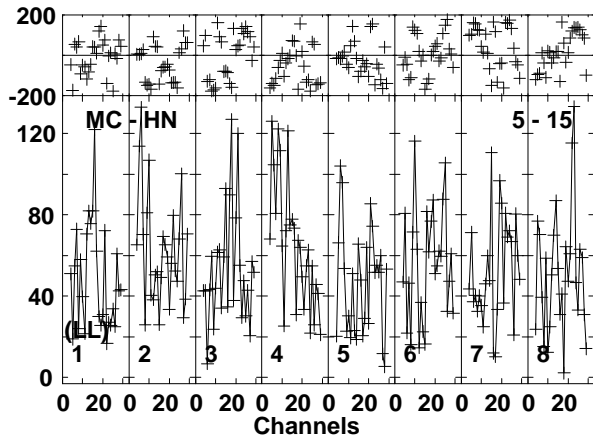
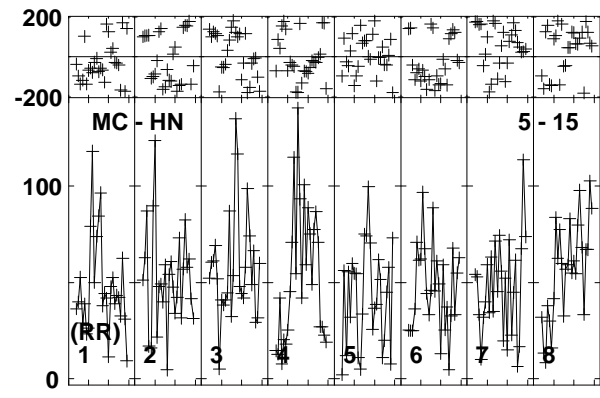
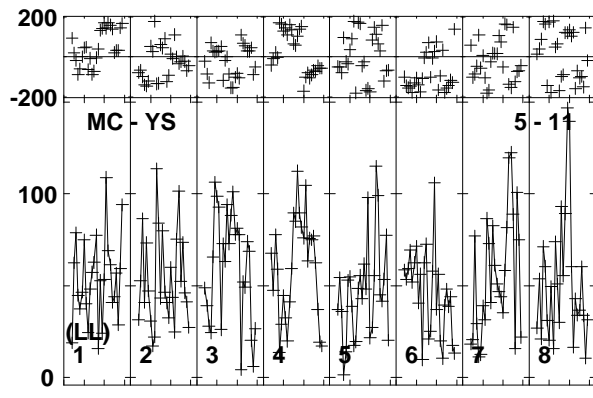
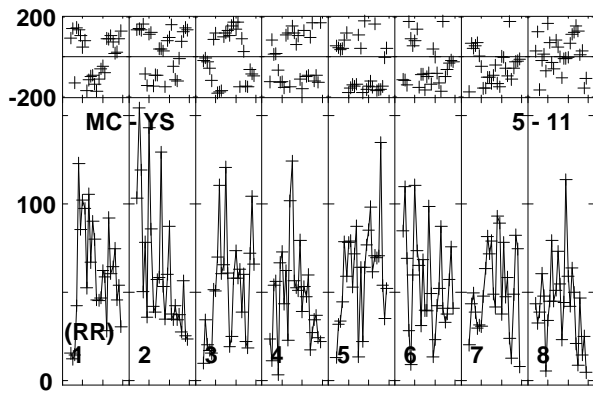
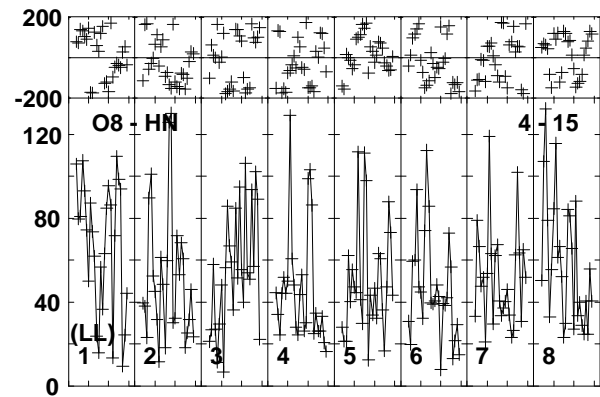
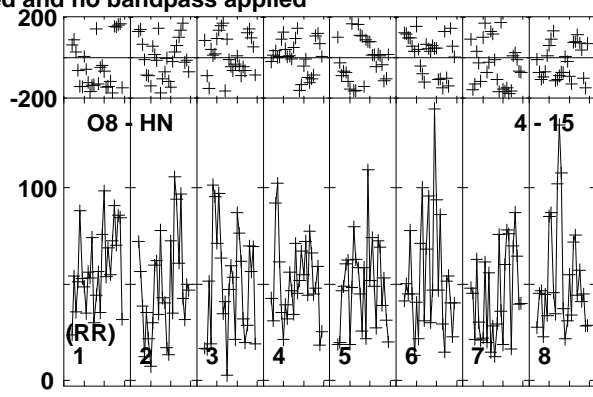
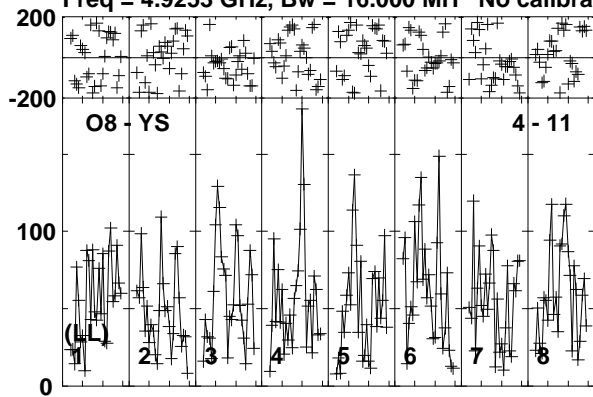

Lower frame: Micro Ampl Jy Top frame: Phas deg
Vector averaged cross-power spectrum Baseline: O8 (04) - YS (11)
Timerange: 00/22:34:39 to 00/22:39:51

Plot file version 206 created 11-APR-2016 17:08:49

ARP299C GP053G 3.UVDATA.1

Freq = 4.9253 GHz, Bw = 16.000 MH No calibration applied and no bandpass applied

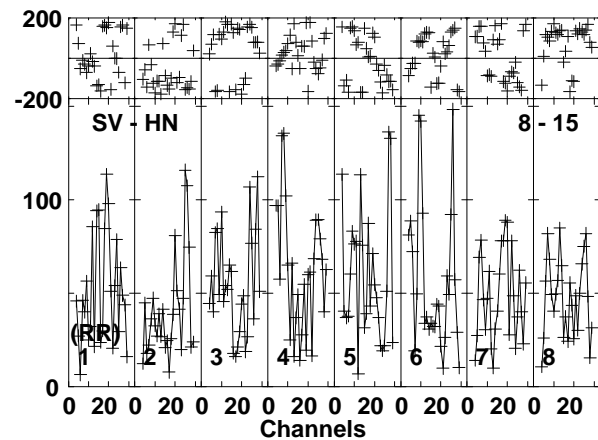
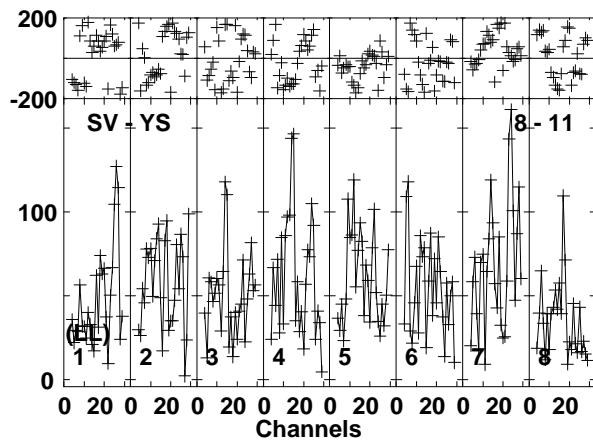
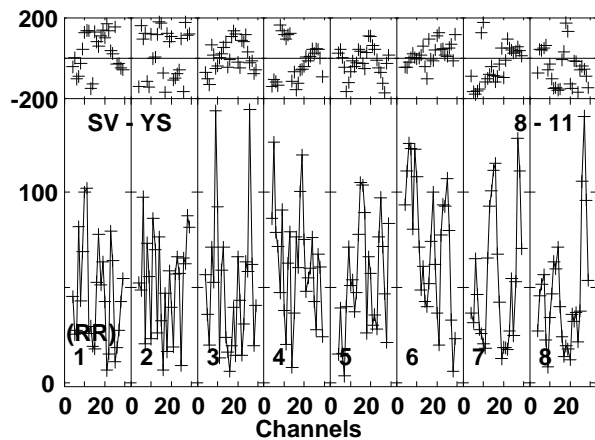
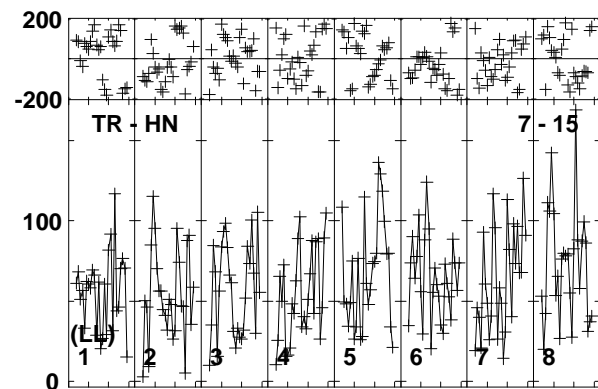
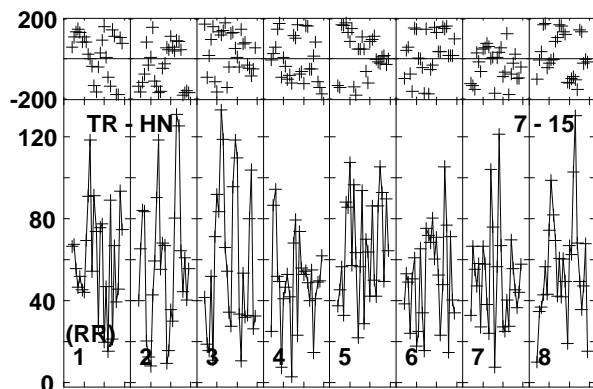
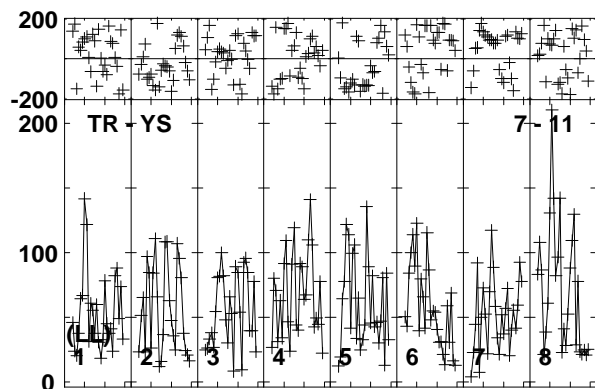
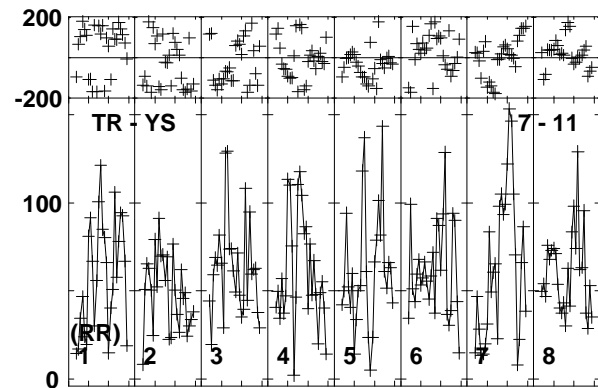
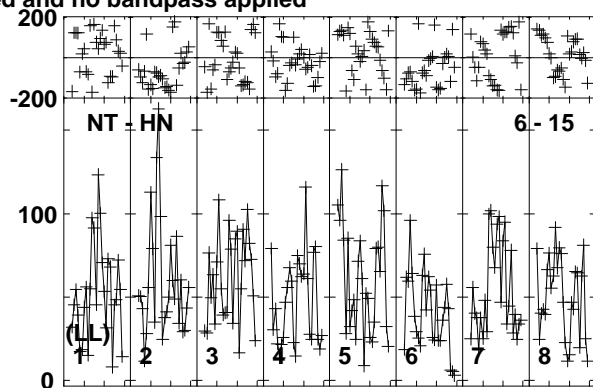
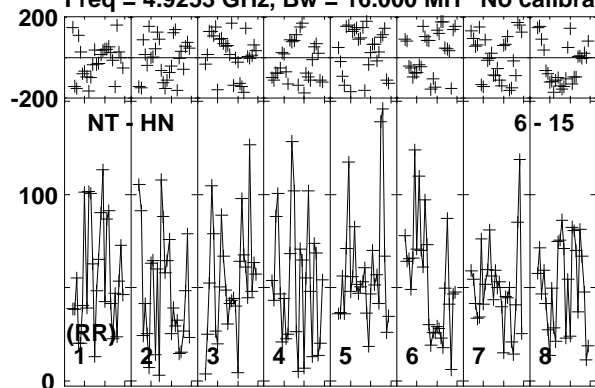

Lower frame: Micro Ampl Jy Top frame: Phas deg
Vector averaged cross-power spectrum Baseline: NT (06) - HN (15)
Timerange: 00/22:34:39 to 00/22:39:51

Plot file version 207 created 11-APR-2016 17:08:49

ARP299C GP053G 3.UVDATA.1

Freq = 4.9253 GHz, Bw = 16.000 MH No calibration applied and no bandpass applied

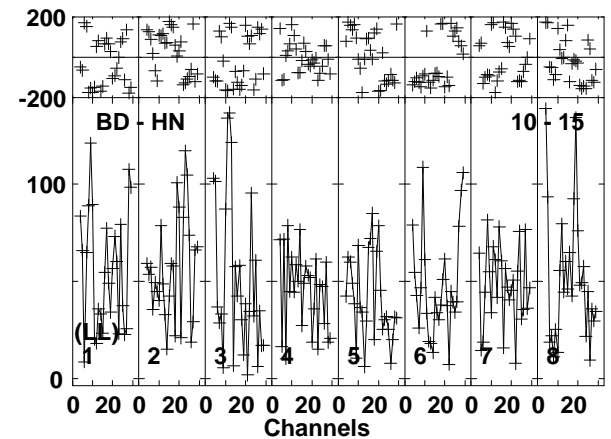
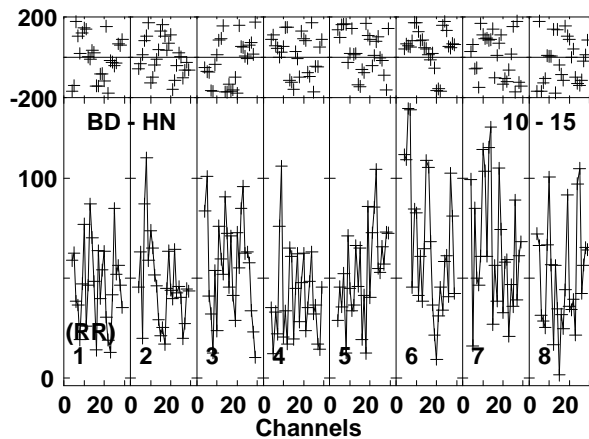
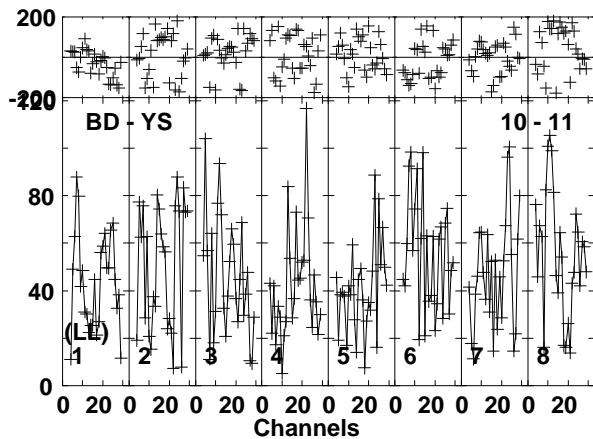
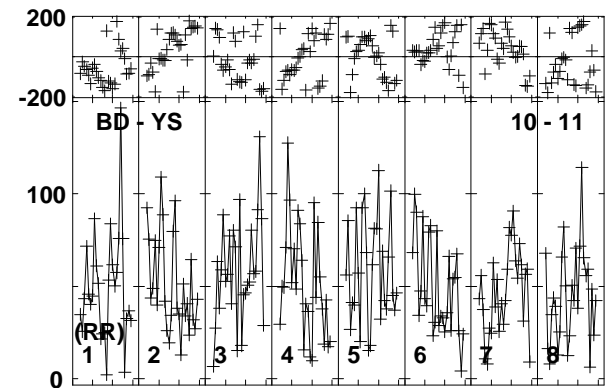
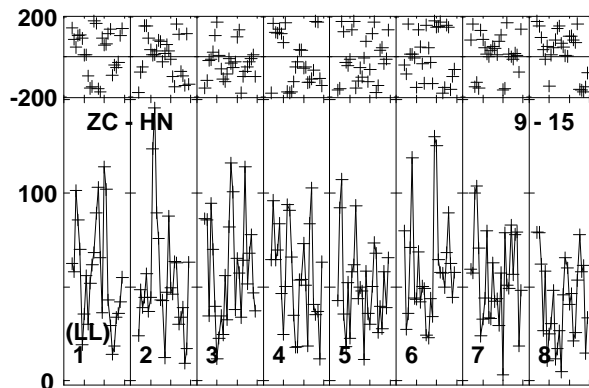
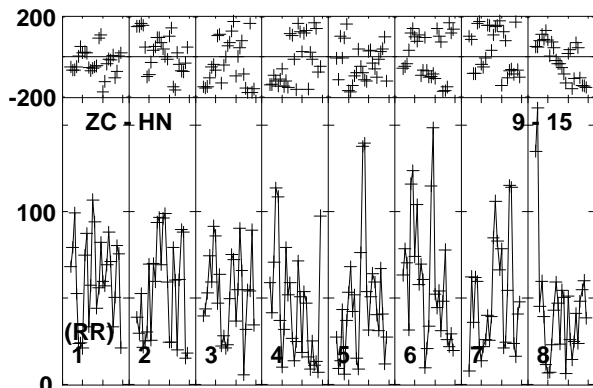
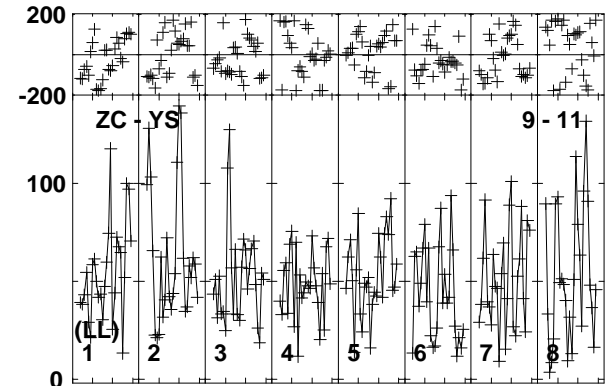
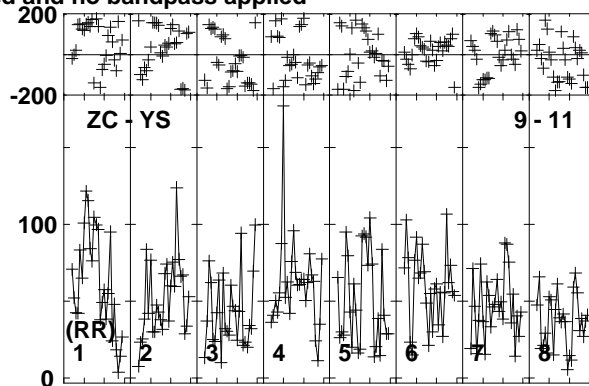
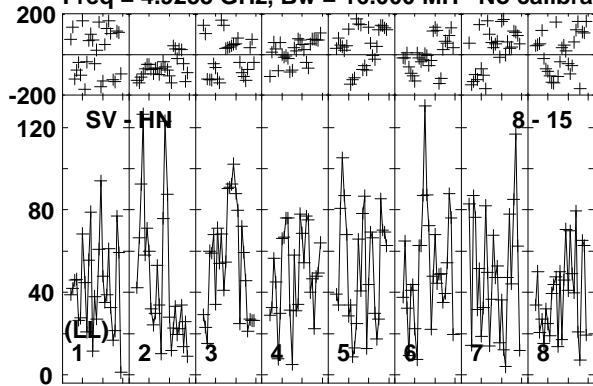

Lower frame: Micro Ampl Jy Top frame: Phas deg
Vector averaged cross-power spectrum Baseline: SV (08) - HN (15)
Timerange: 00/22:34:39 to 00/22:39:51

Plot file version 208 created 11-APR-2016 17:08:49

ARP299C GP053G 3.UVDATA.1

Freq = 4.9253 GHz, Bw = 16.000 MH No calibration applied and no bandpass applied

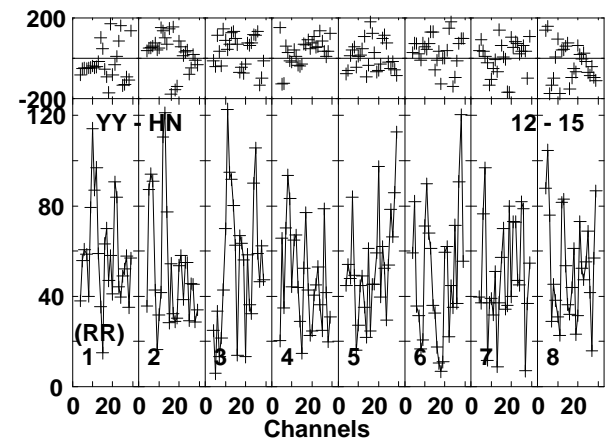
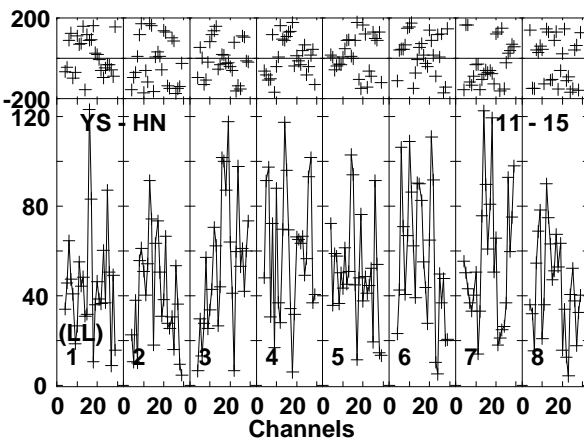
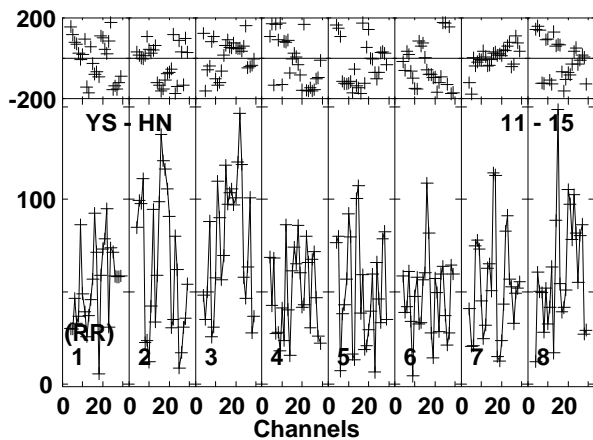
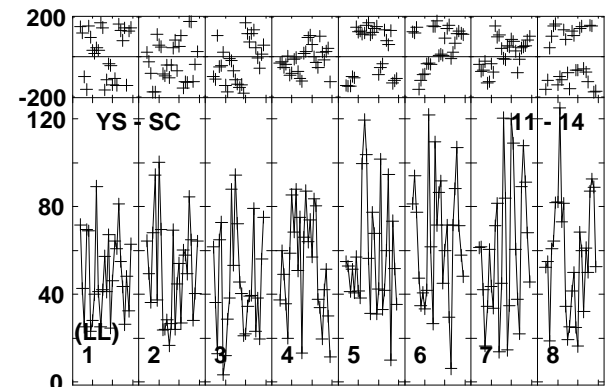
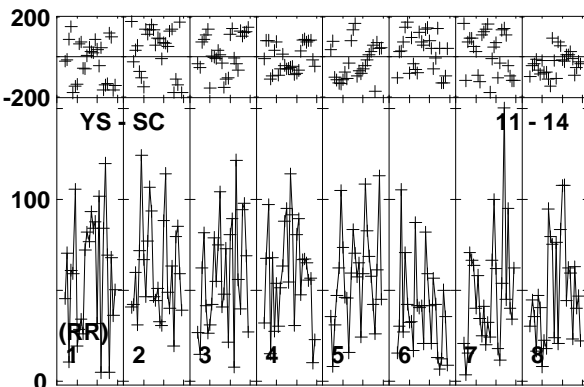
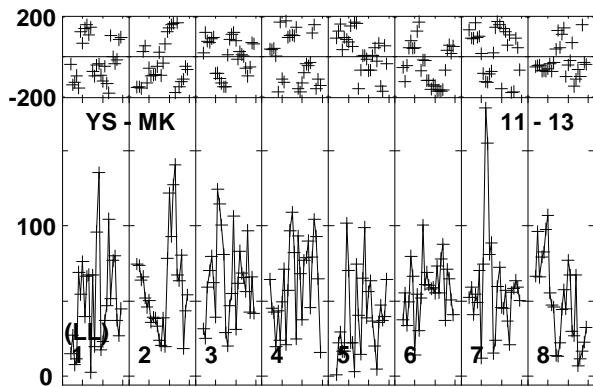
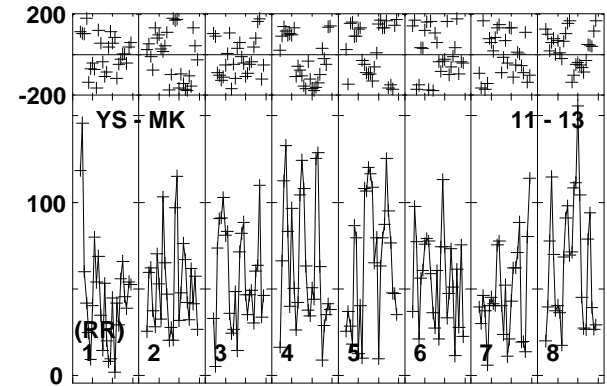
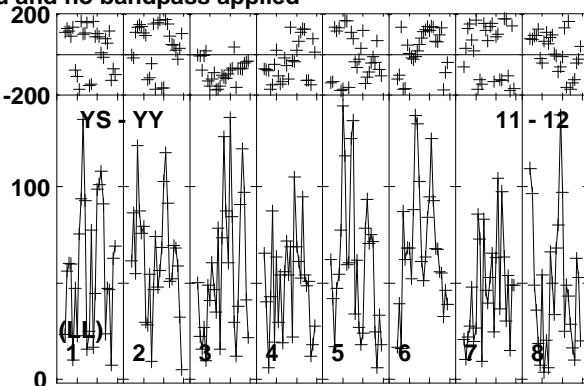
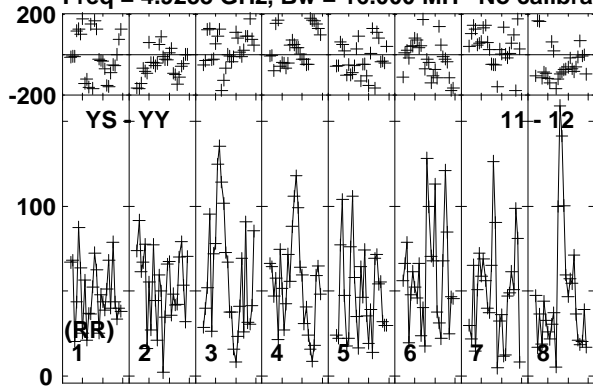

Lower frame: Micro Ampl Jy Top frame: Phas deg
Vector averaged cross-power spectrum Baseline: YS (11) - YY (12)
Timerange: 00/22:34:39 to 00/22:39:51

Plot file version 209 created 11-APR-2016 17:08:49

ARP299C GP053G 3.UVDATA.1

Freq = 4.9253 GHz, Bw = 16.000 MH No calibration applied and no bandpass applied

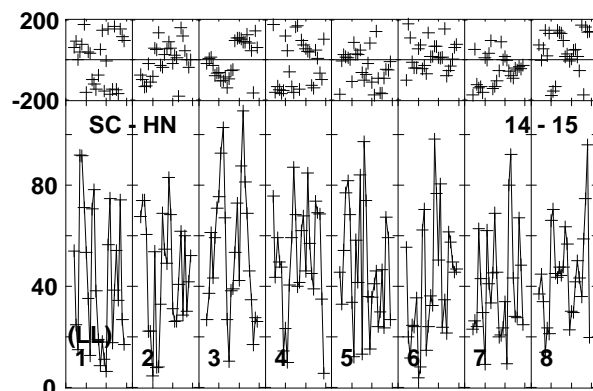
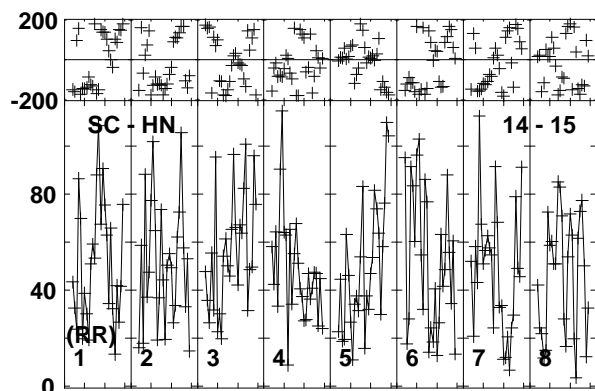
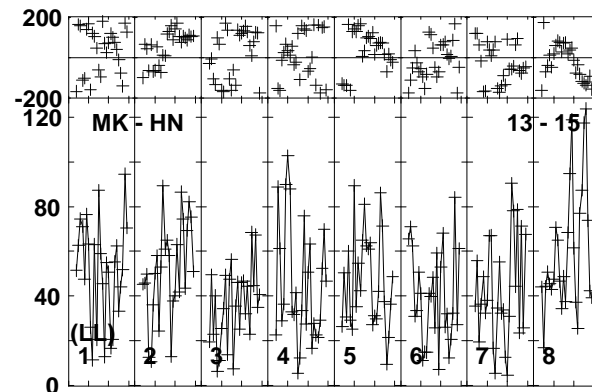
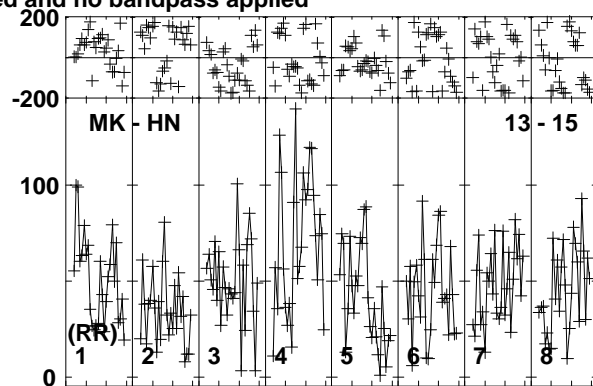
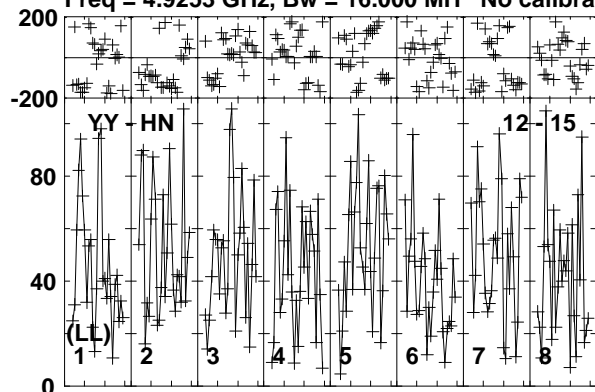

Lower frame: Micro Ampl Jy Top frame: Phas deg
Vector averaged cross-power spectrum Baseline: YY (12) - HN (15)
Timerange: 00/22:34:39 to 00/22:39:51

Plot file version 210 created 11-APR-2016 17:08:50

J1128+5925 GP053G 3.UVDATA.1

Freq = 4.9253 GHz, Bw = 16.000 MH No calibration applied and no bandpass applied

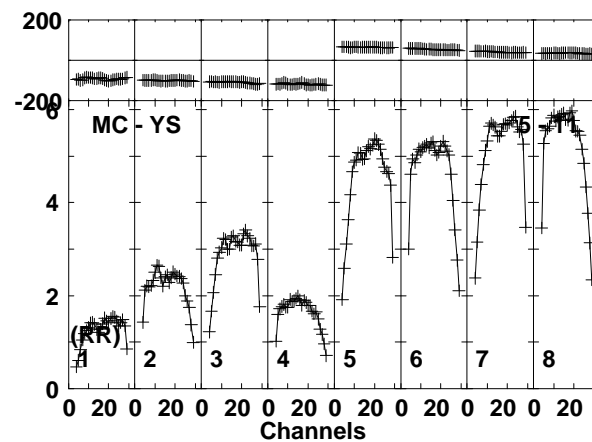
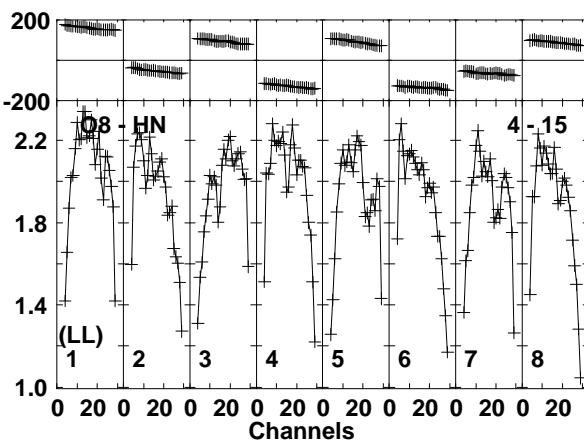
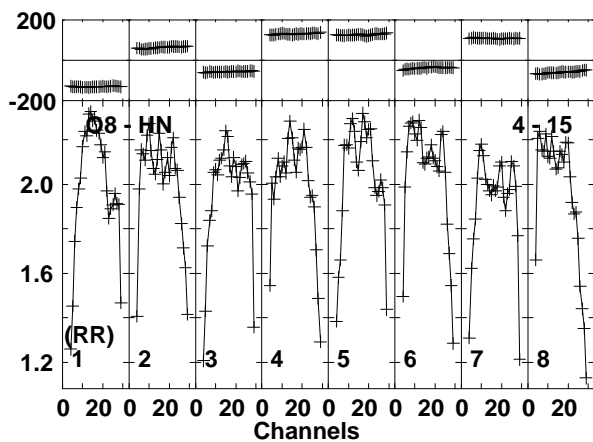
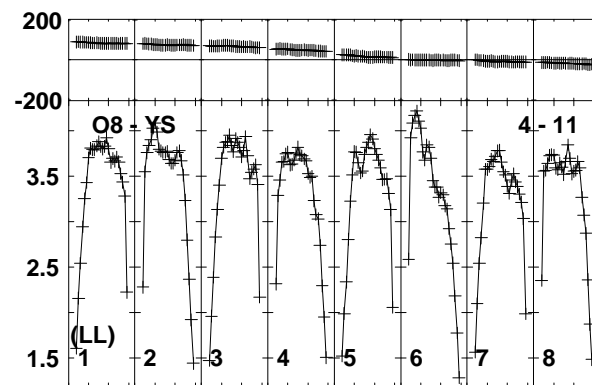
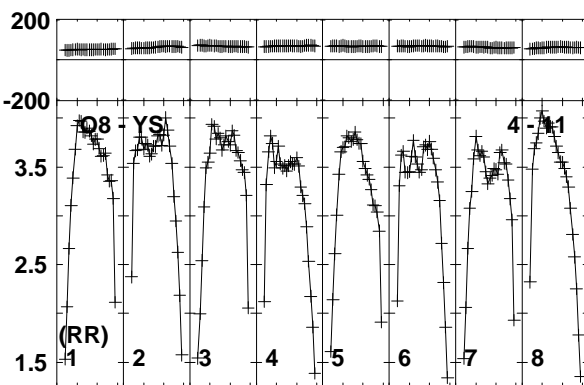
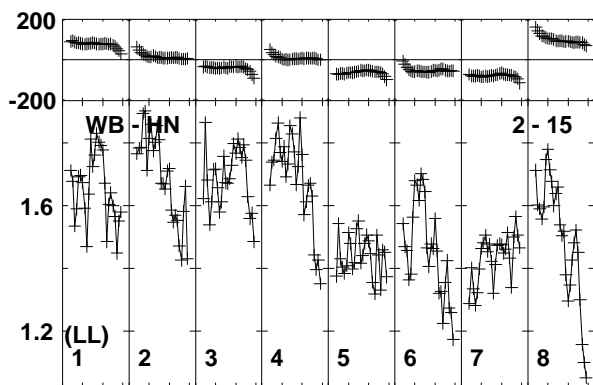
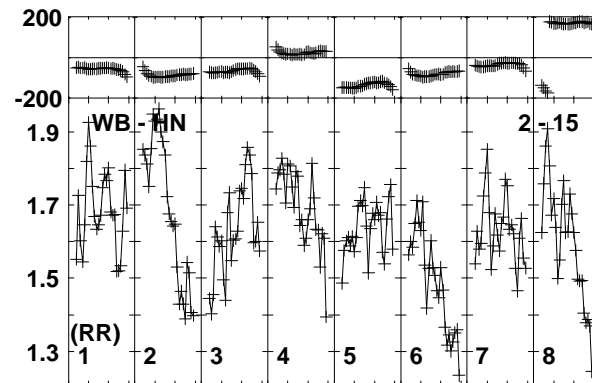
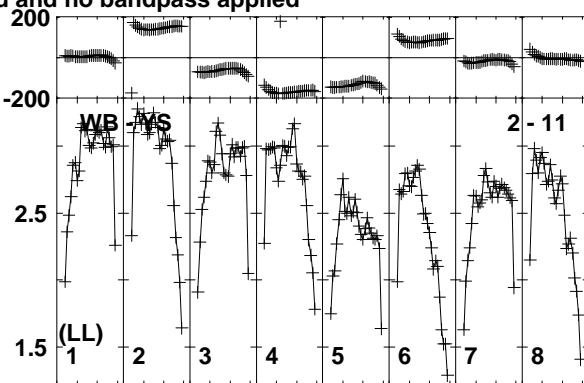
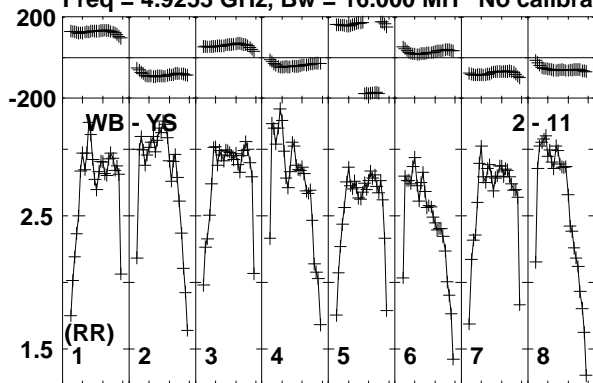

Lower frame: Milli Ampl Jy Top frame: Phas deg
Vector averaged cross-power spectrum Baseline: WB (02) - YS (11)
Timerange: 00/22:39:56 to 00/22:41:48

Plot file version 211 created 11-APR-2016 17:08:50

J1128+5925 GP053G 3.UVDATA.1

Freq = 4.9253 GHz, Bw = 16.000 MH No calibration applied and no bandpass applied

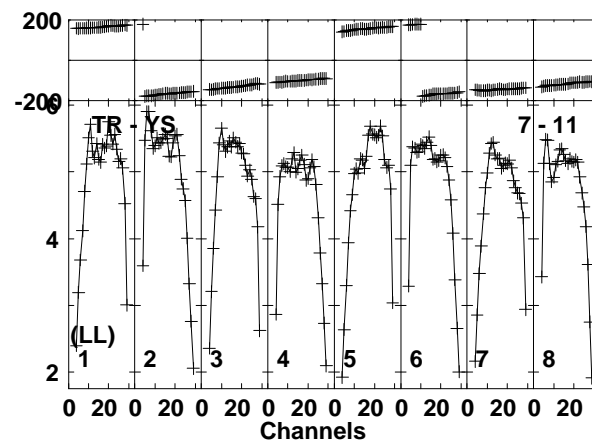
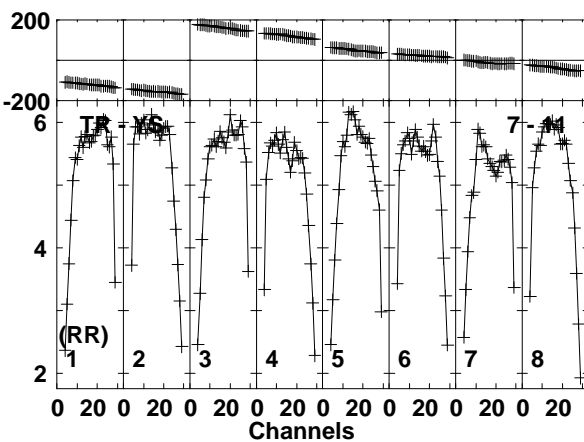
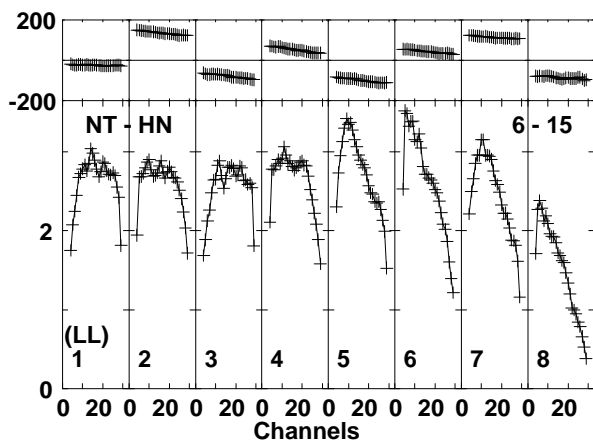
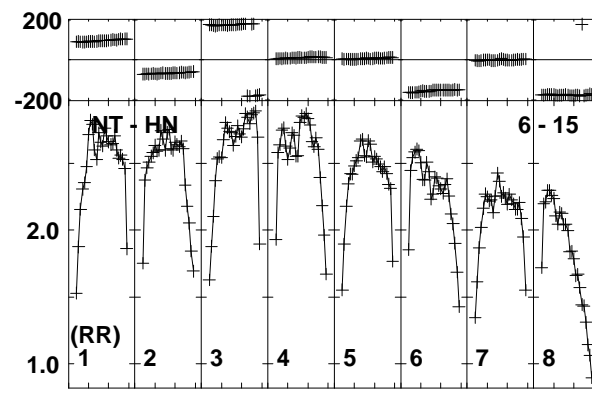
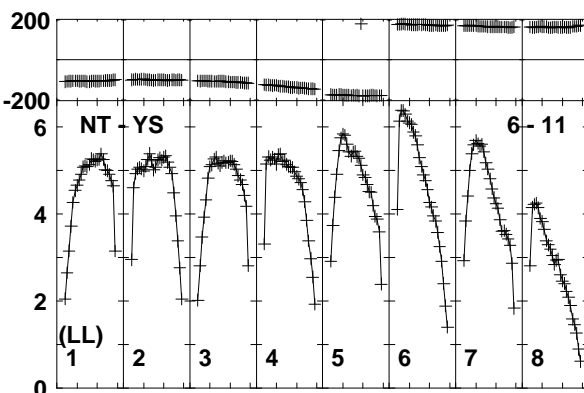
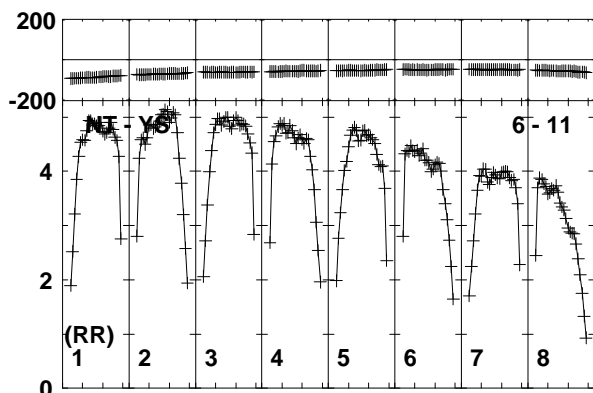
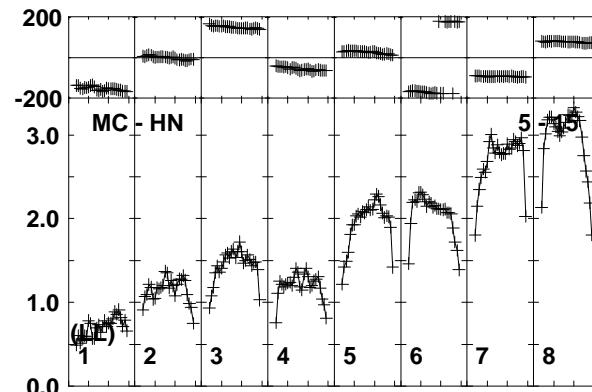
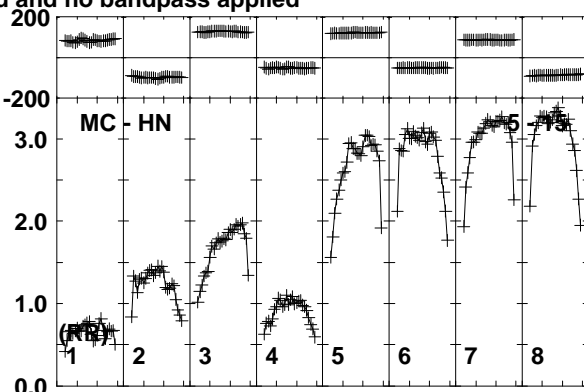
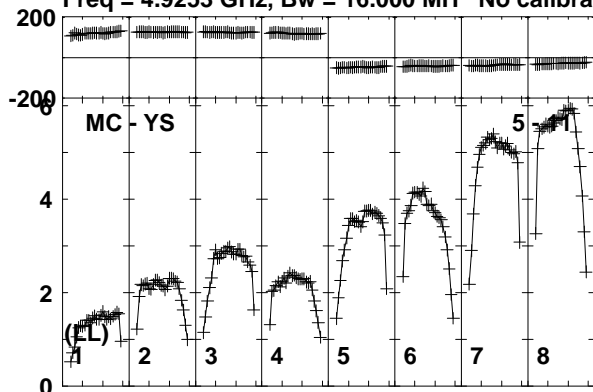

Lower frame: Milli Ampl Jy Top frame: Phas deg

Vector averaged cross-power spectrum Baseline: MC (05) - YS (11)

Timerange: 00:22:39:56 to 00:22:41:48

Plot file version 212 created 11-APR-2016 17:08:50

J1128+5925 GP053G 3.UVDATA.1

Freq = 4.9253 GHz, Bw = 16.000 MH No calibration applied and no bandpass applied

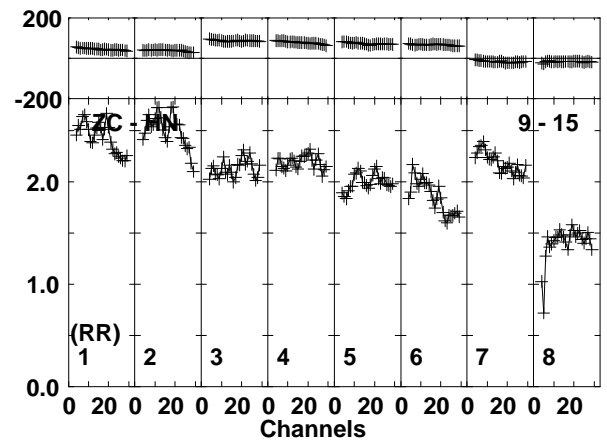
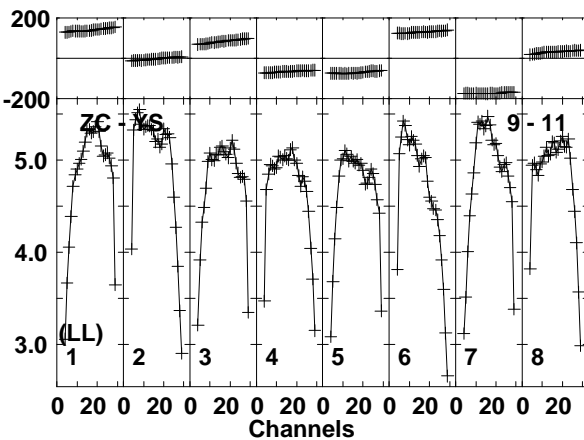
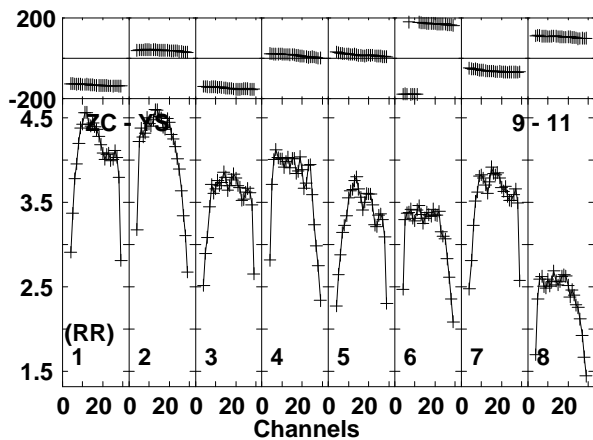
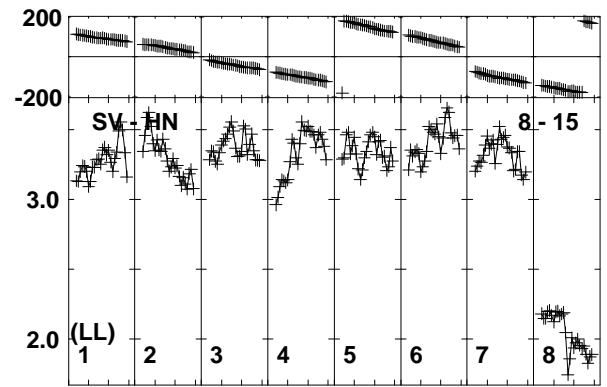
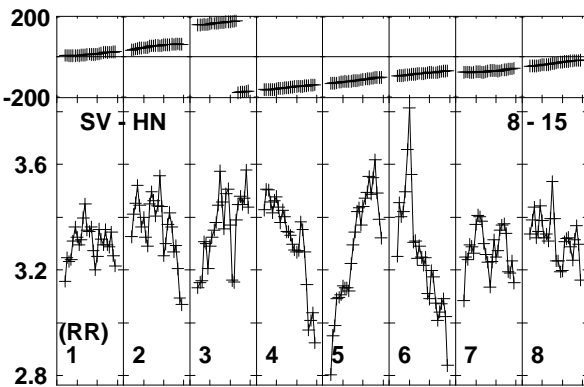
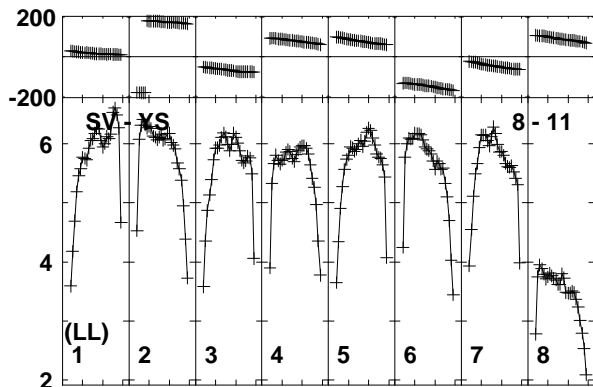
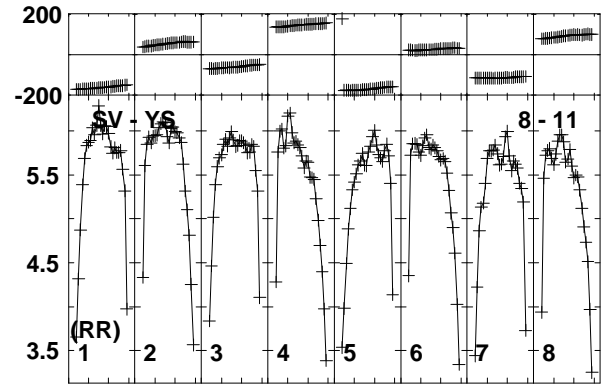
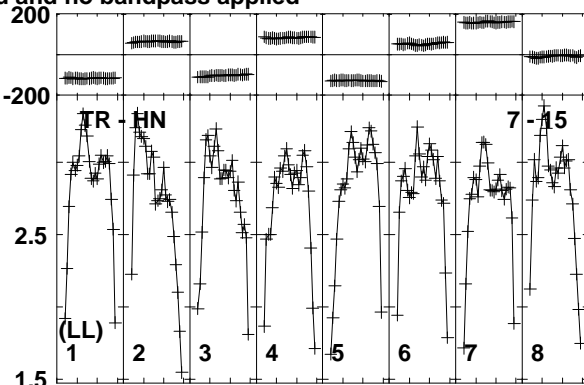
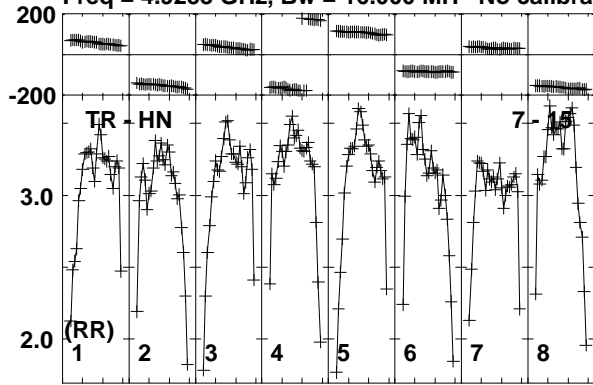

Lower frame: Milli Ampl Jy Top frame: Phas deg
Vector averaged cross-power spectrum Baseline: TR (07) - HN (15)
Timerange: 00:22:39:56 to 00:22:41:48

Plot file version 213 created 11-APR-2016 17:08:50

J1128+5925 GP053G 3.UVDATA.1

Freq = 4.9253 GHz, Bw = 16.000 MH No calibration applied and no bandpass applied

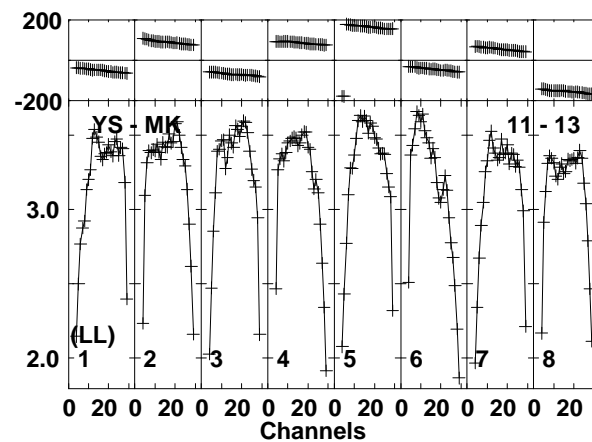
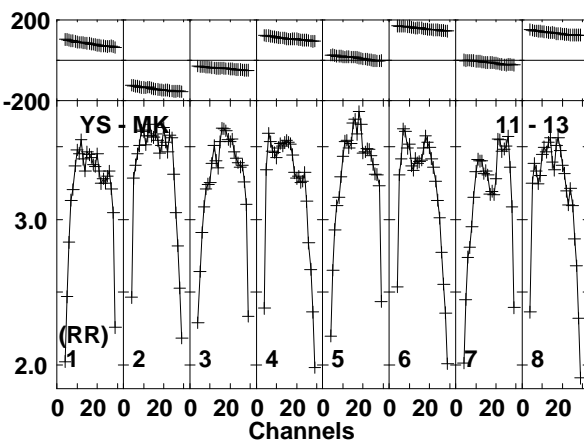
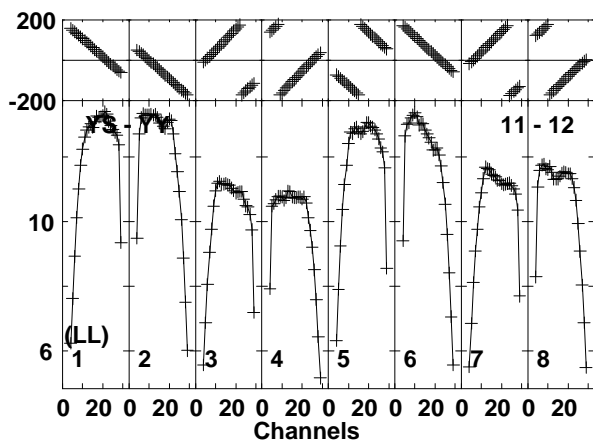
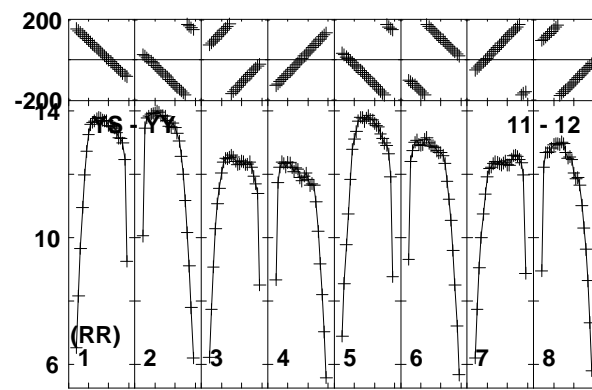
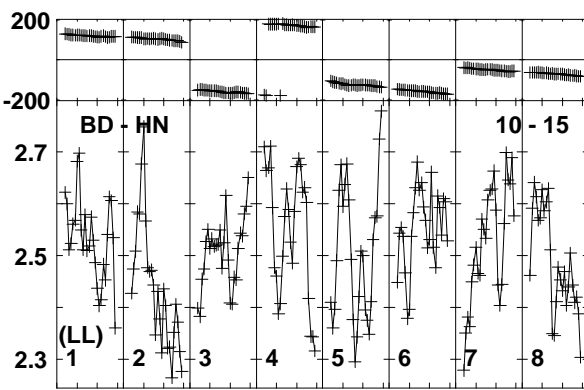
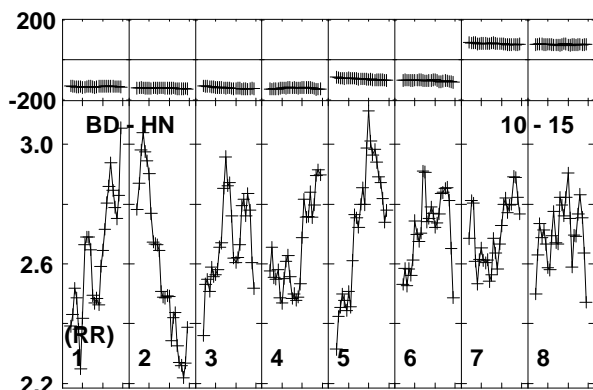
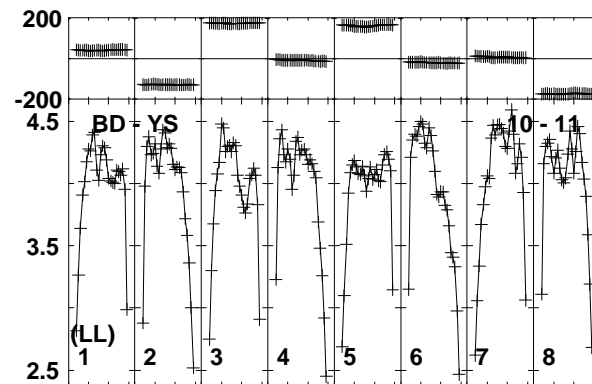
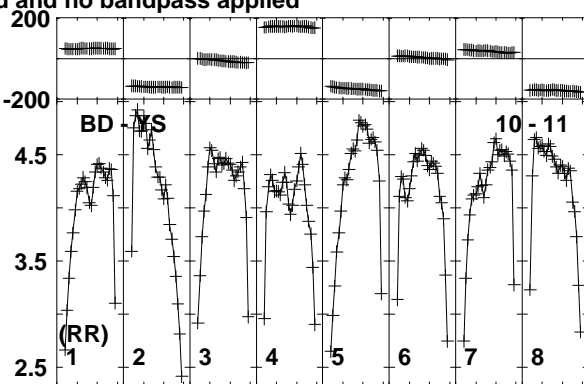
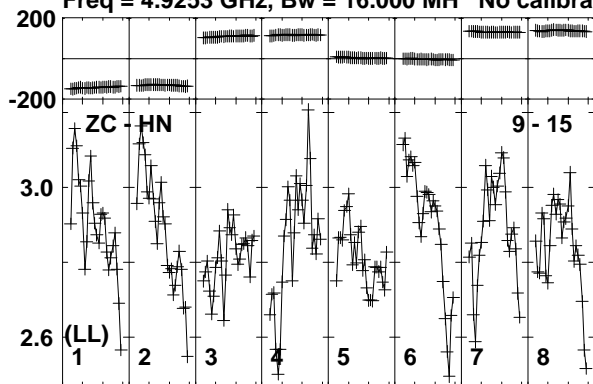

Lower frame: Milli Ampl Jy Top frame: Phas deg
Vector averaged cross-power spectrum Baseline: ZC (09) - HN (15)
Timerange: 00/22:39:56 to 00/22:41:48

Plot file version 214 created 11-APR-2016 17:08:50

J1128+5925 GP053G 3.UVDATA.1

Freq = 4.9253 GHz, Bw = 16.000 MH No calibration applied and no bandpass applied

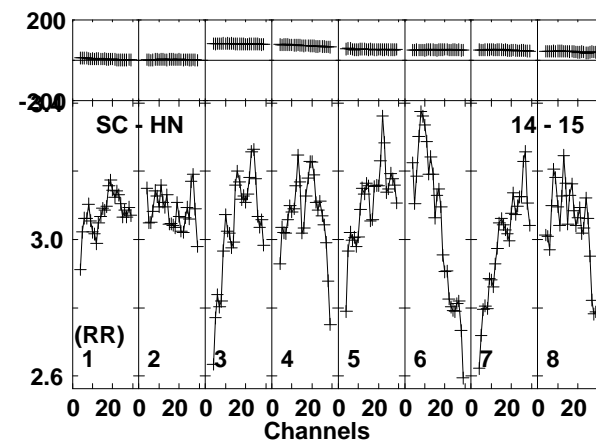
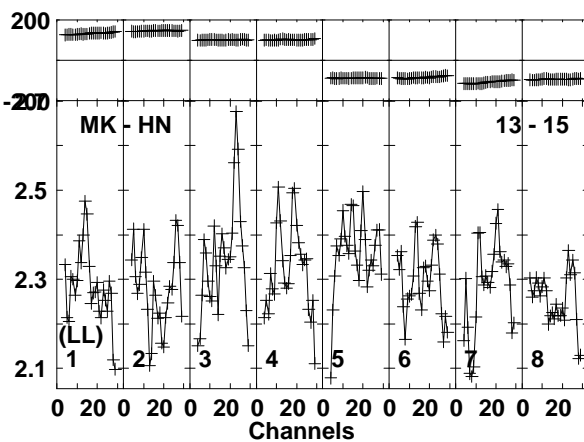
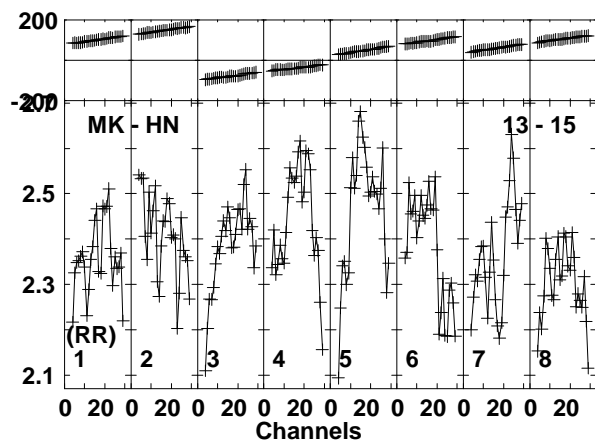
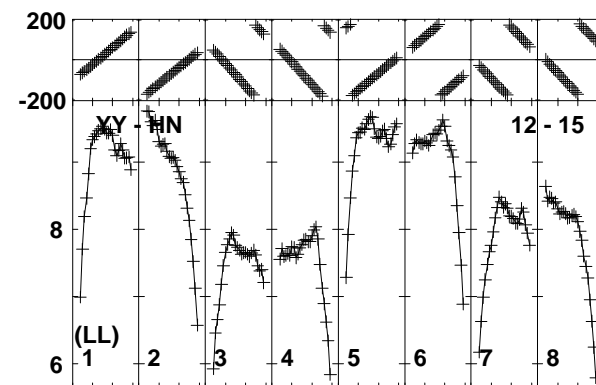
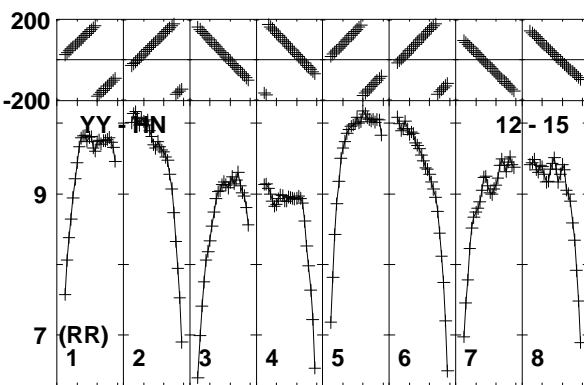
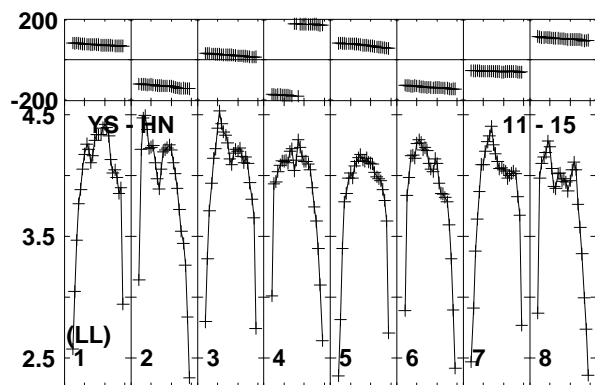
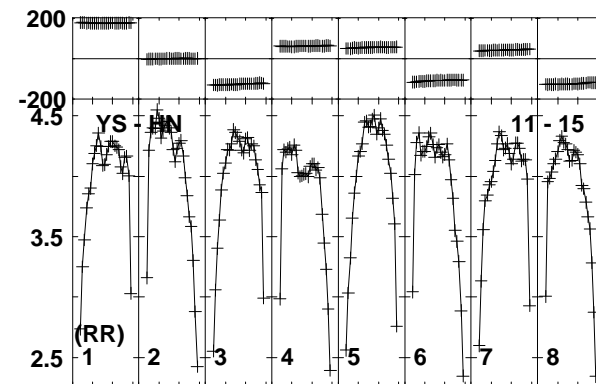
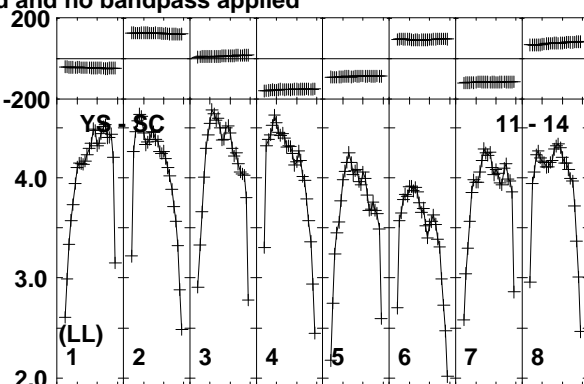
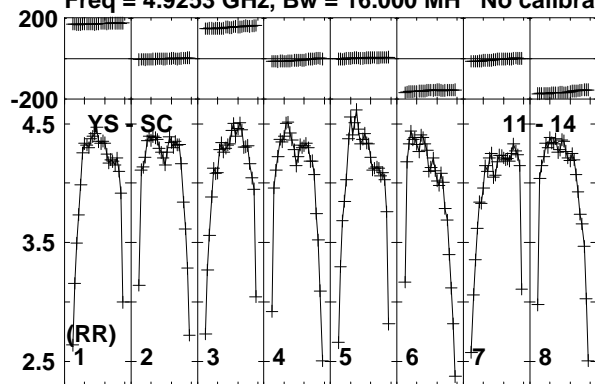

Lower frame: Milli Ampl Jy Top frame: Phas deg
Vector averaged cross-power spectrum Baseline: YS (11) - SC (14)
Timerange: 00:22:39:56 to 00:22:41:48

Plot file version 215 created 11-APR-2016 17:08:50
J1128+5925 GP053G 3.UVDATA.1
Freq = 4.9253 GHz, Bw = 16.000 MH No calibration applied and no bandpass applied

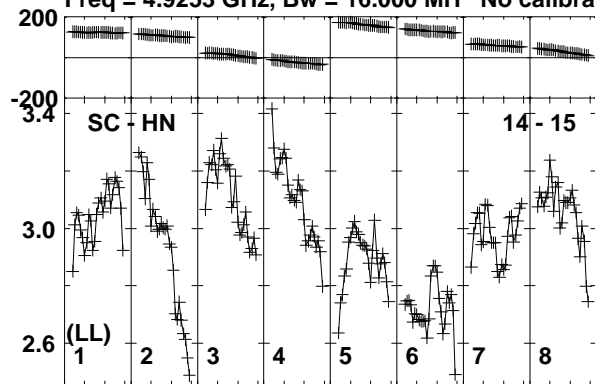

Lower frame: Milli Ampl Jy Top frame: Phas deg
Vector averaged cross-power spectrum Baseline: SC (14) - HN (15)
Timerange: 00/22:39:56 to 00/22:41:48

Plot file version 216 created 11-APR-2016 17:08:50

ARP299C GP053G 3.UVDATA.1

Freq = 4.9253 GHz, Bw = 16.000 MH No calibration applied and no bandpass applied

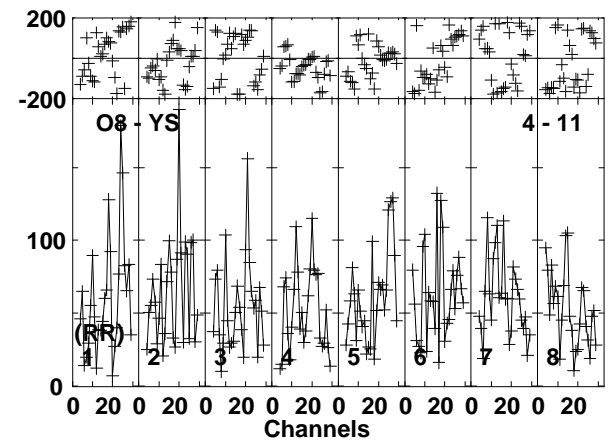
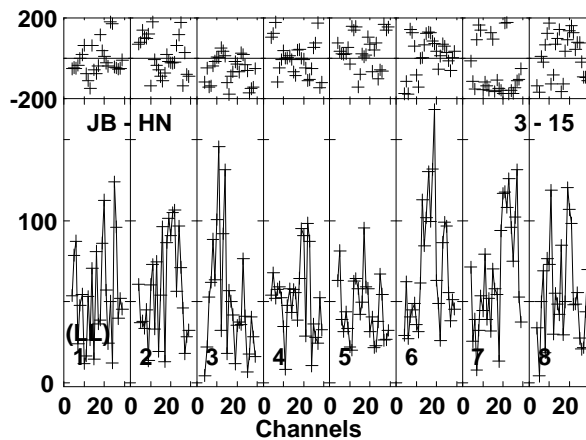
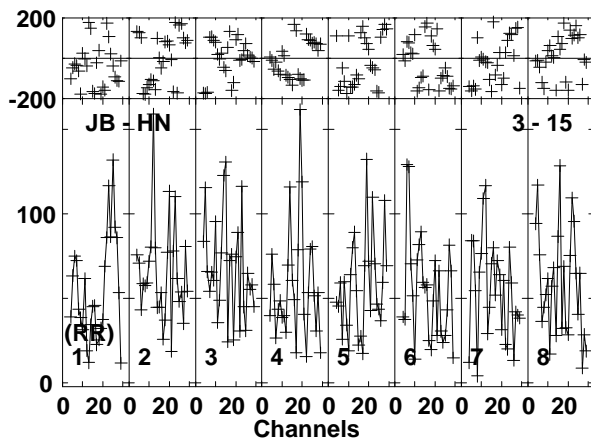
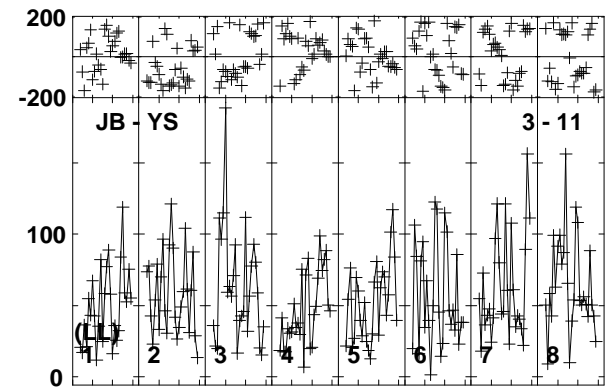
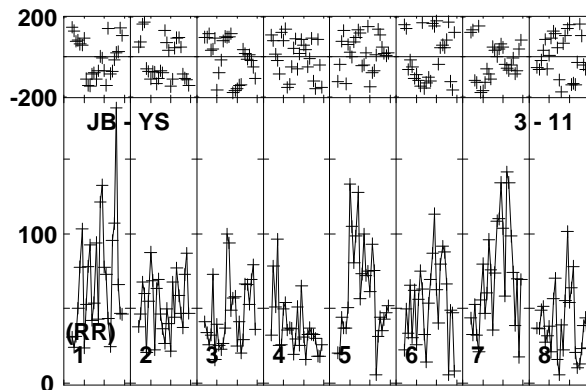
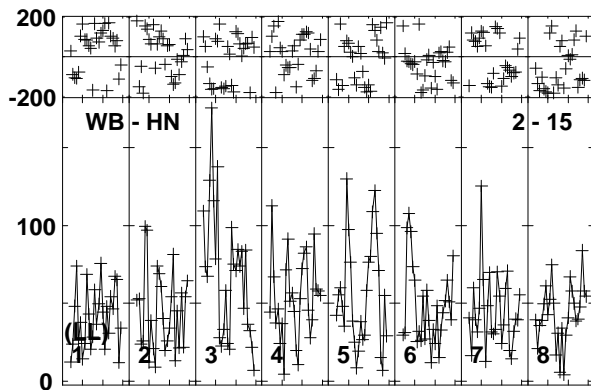
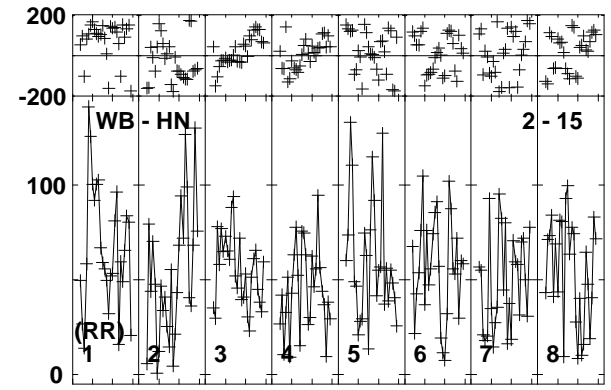
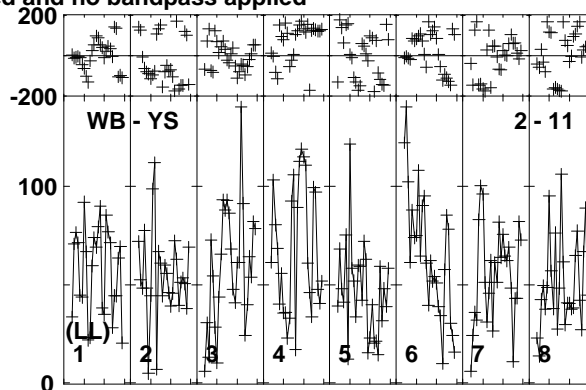
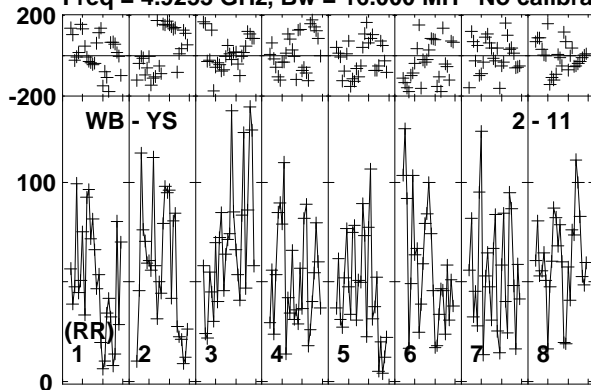

Lower frame: Micro Ampl Jy Top frame: Phas deg
Vector averaged cross-power spectrum Baseline: WB (02) - YS (11)
Timerange: 00/22:41:53 to 00/22:47:07

Plot file version 217 created 11-APR-2016 17:08:51

ARP299C GP053G 3.UVDATA.1

Freq = 4.9253 GHz, Bw = 16.000 MH No calibration applied and no bandpass applied

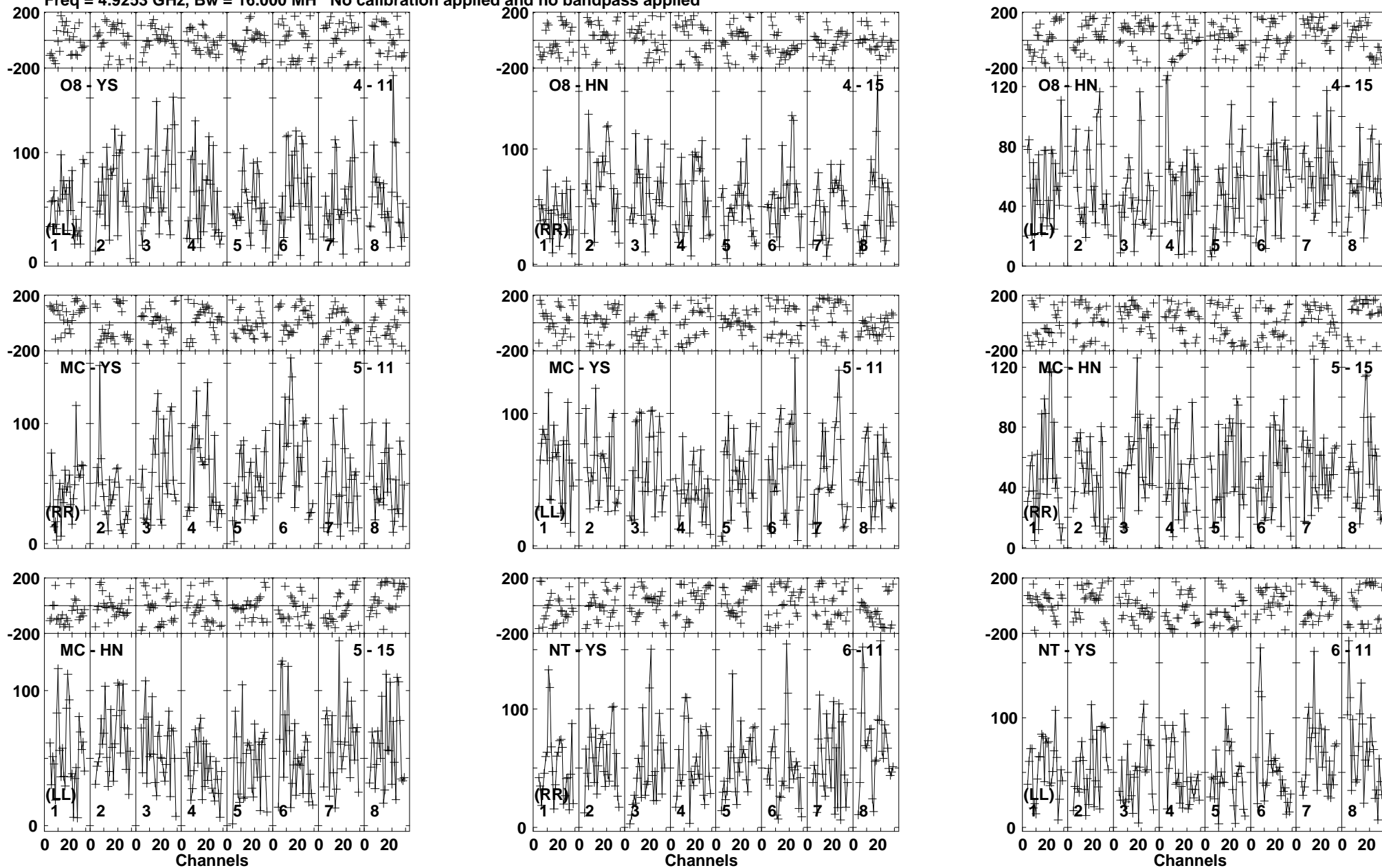

Lower frame: Micro Ampl Jy Top frame: Phas deg
Vector averaged cross-power spectrum Baseline: O8 (04) - YS (11)
Timerange: 00/22:41:53 to 00/22:47:07

Plot file version 218 created 11-APR-2016 17:08:51

ARP299C GP053G 3.UVDATA.1

Freq = 4.9253 GHz, Bw = 16.000 MH No calibration applied and no bandpass applied

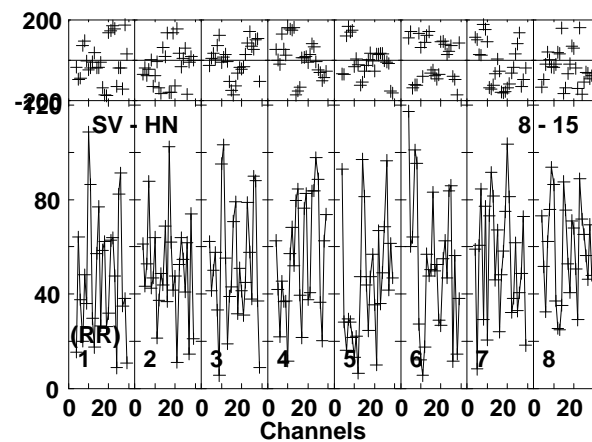
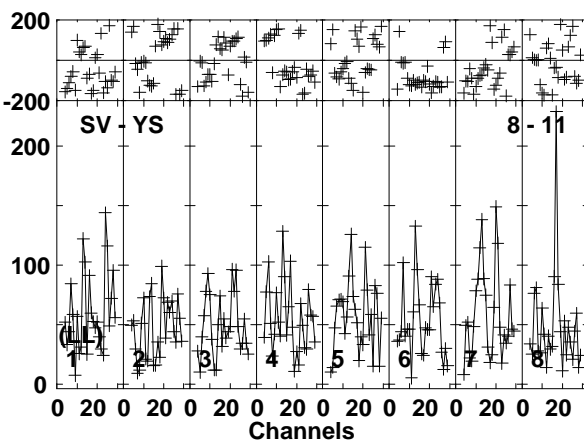
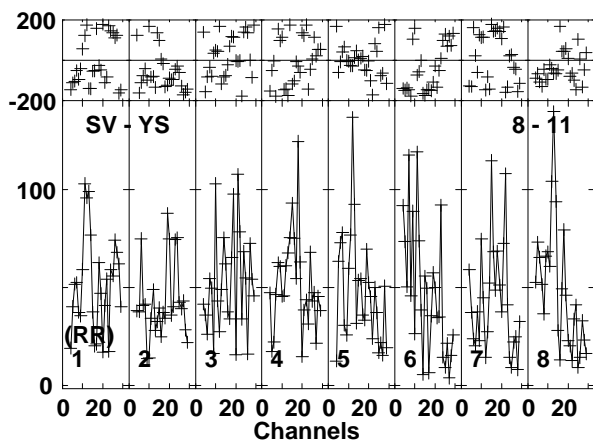
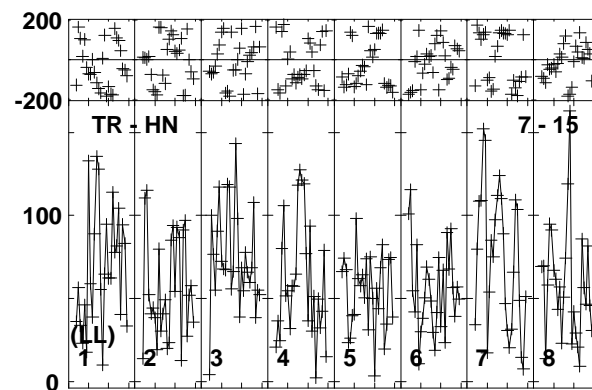
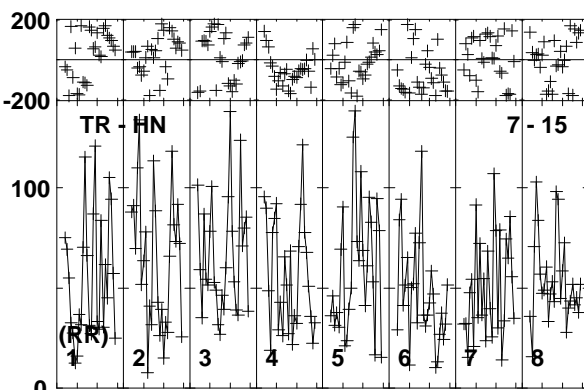
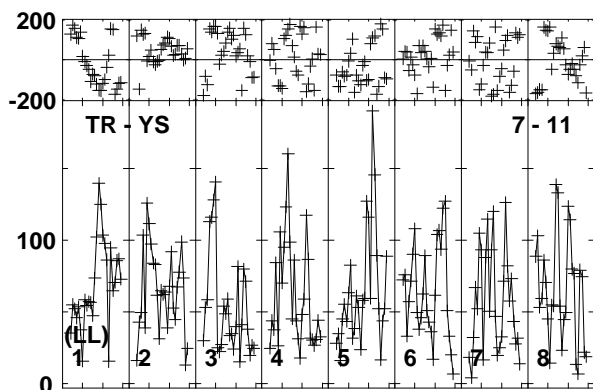
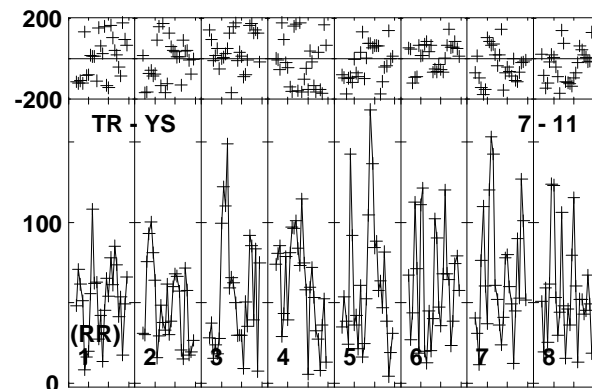
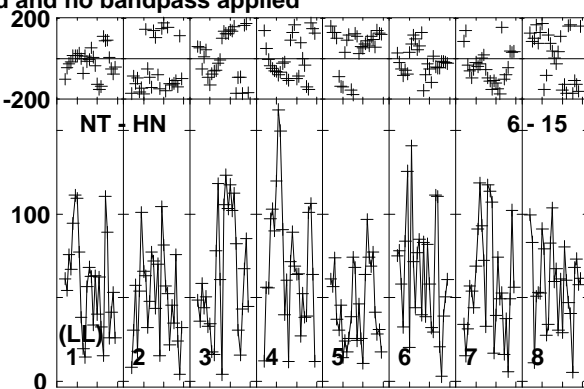
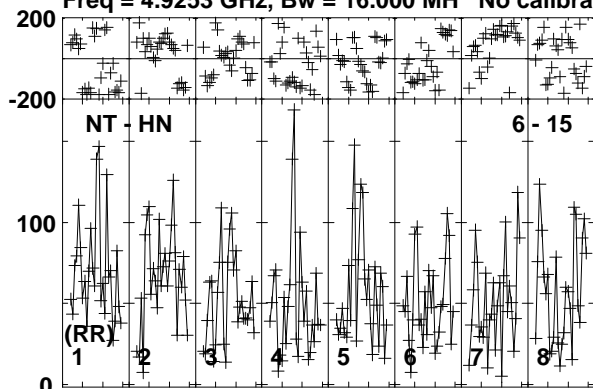

Lower frame: Micro Ampl Jy Top frame: Phas deg

Vector averaged cross-power spectrum Baseline: NT (06) - HN (15)

Timerange: 00/22:41:53 to 00/22:47:07

Plot file version 219 created 11-APR-2016 17:08:51

ARP299C GP053G 3.UVDATA.1

Freq = 4.9253 GHz, Bw = 16.000 MH No calibration applied and no bandpass applied

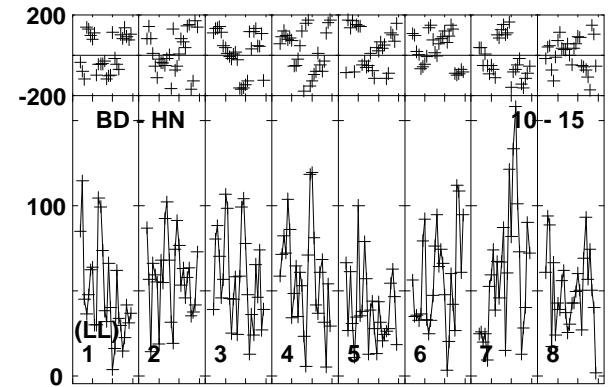
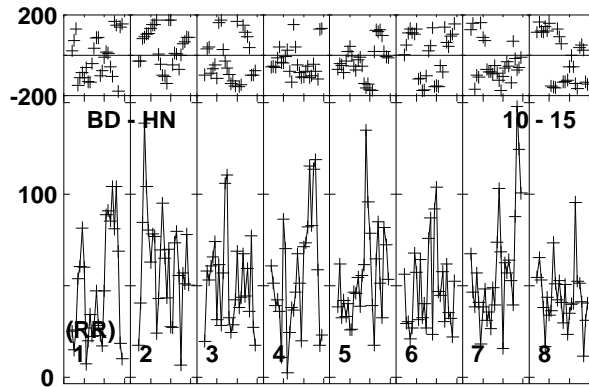
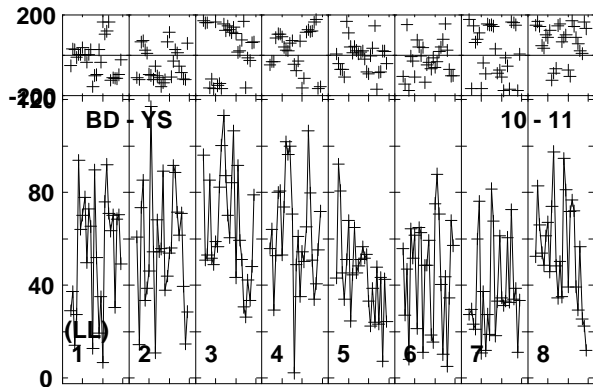
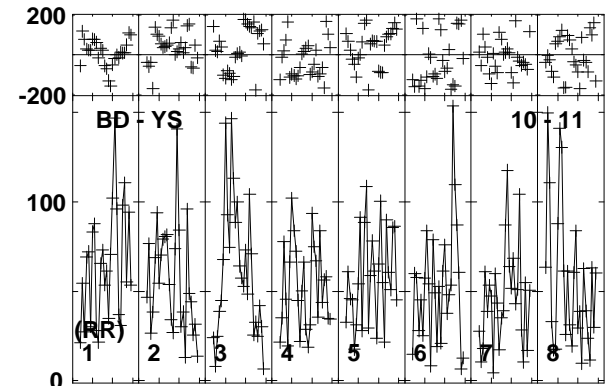
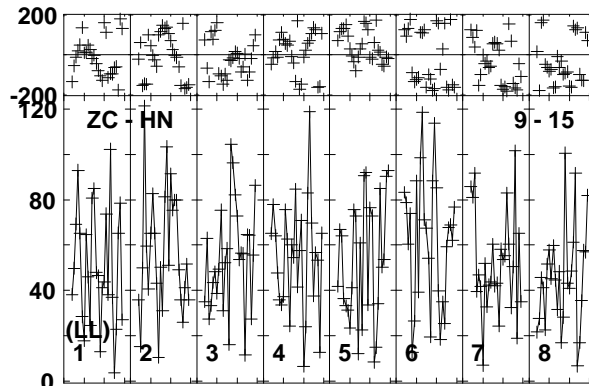
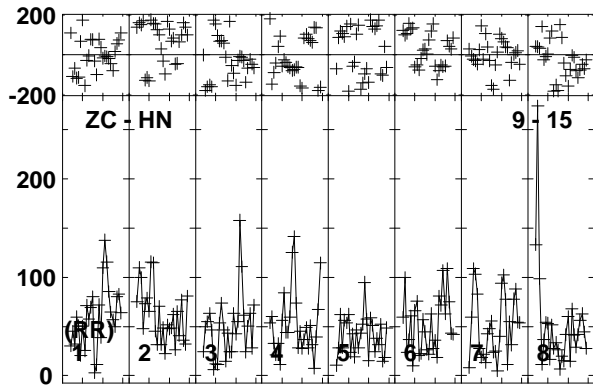
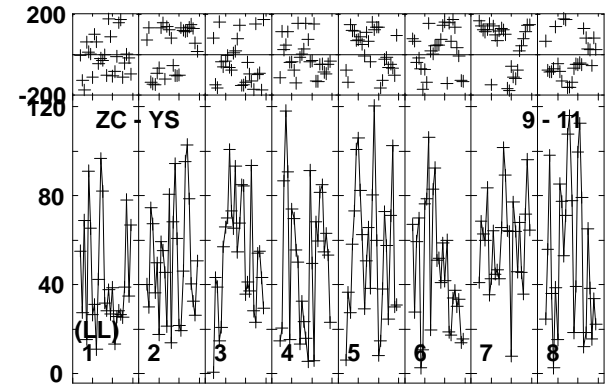
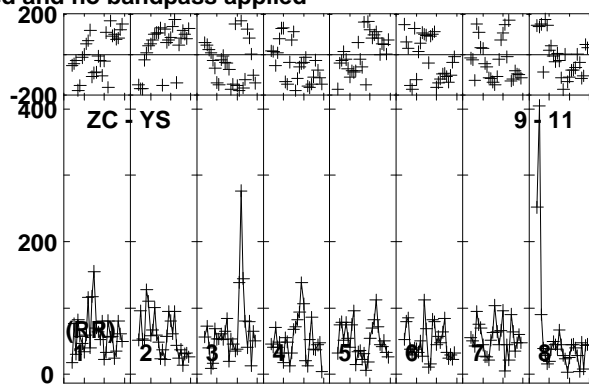
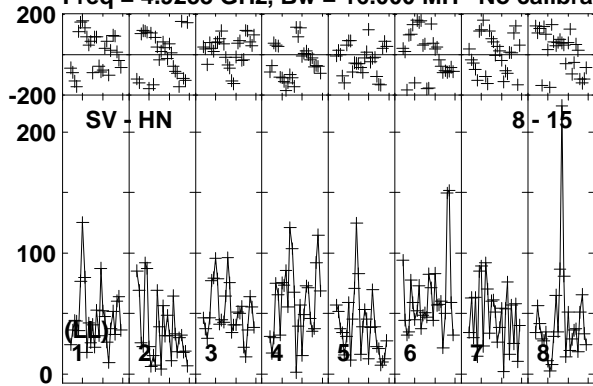

Lower frame: Micro Ampl Jy Top frame: Phas deg
Vector averaged cross-power spectrum Baseline: SV (08) - HN (15)
Timerange: 00:22:41:53 to 00:22:47:07

Plot file version 220 created 11-APR-2016 17:08:51

ARP299C GP053G 3.UVDATA.1

Freq = 4.9253 GHz, Bw = 16.000 MH No calibration applied and no bandpass applied

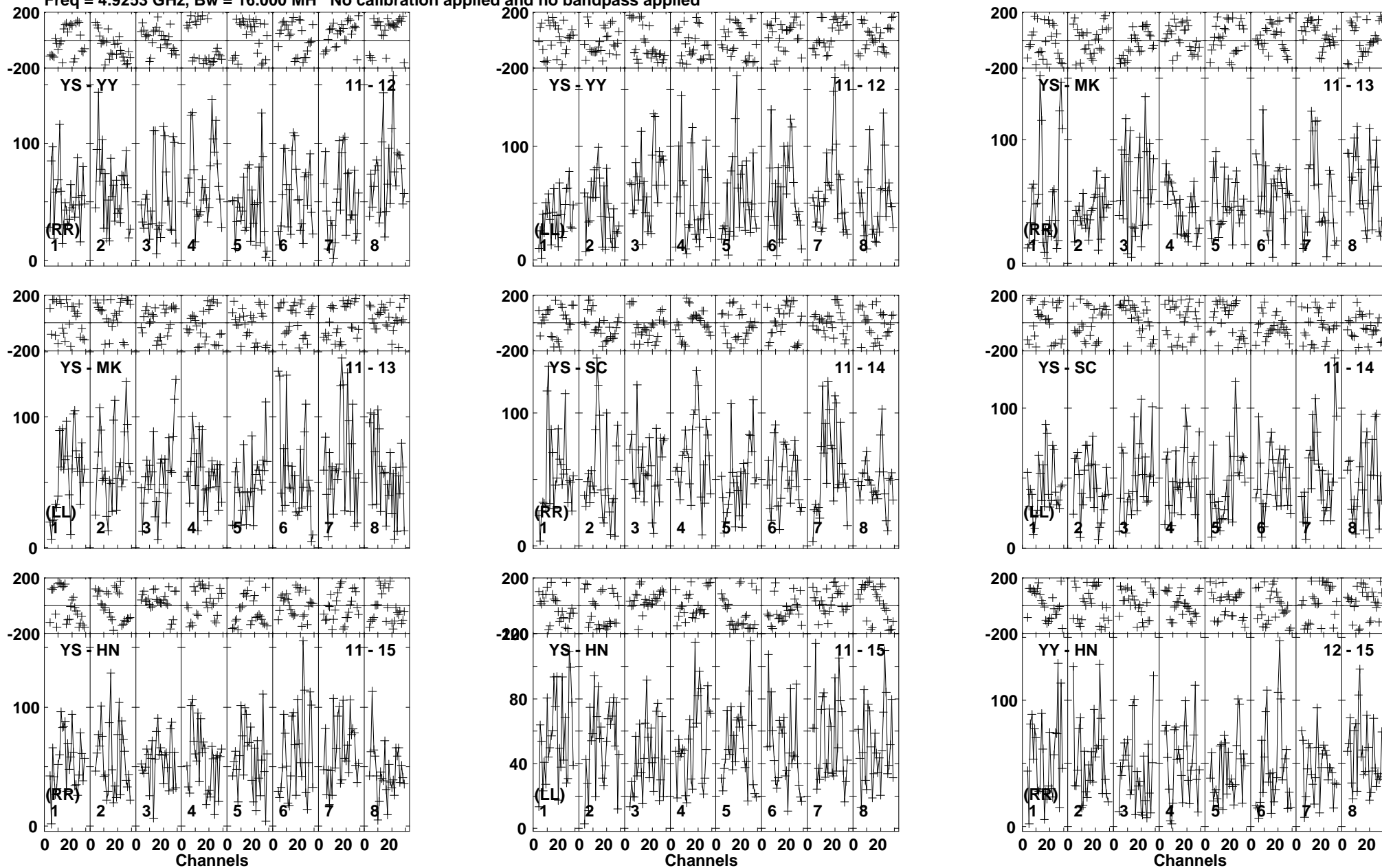

Lower frame: Micro Ampl Jy Top frame: Phas deg
Vector averaged cross-power spectrum Baseline: YS (11) - YY (12)
Timerange: 00/22:41:53 to 00/22:47:07

Plot file version 221 created 11-APR-2016 17:08:51

ARP299C GP053G 3.UVDATA.1

Freq = 4.9253 GHz, Bw = 16.000 MH No calibration applied and no bandpass applied

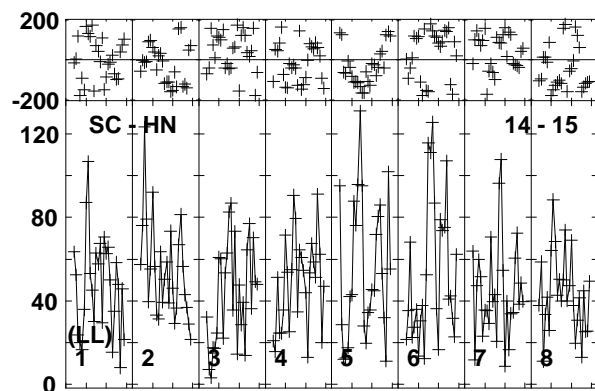
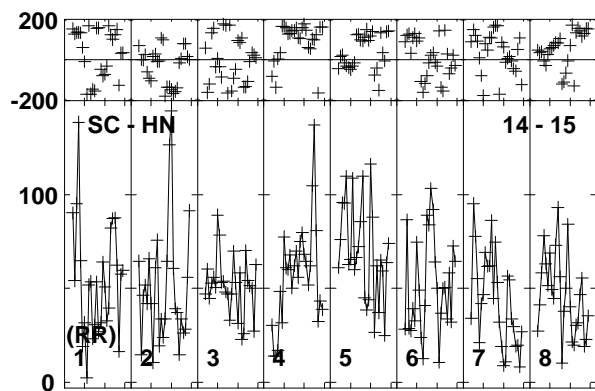
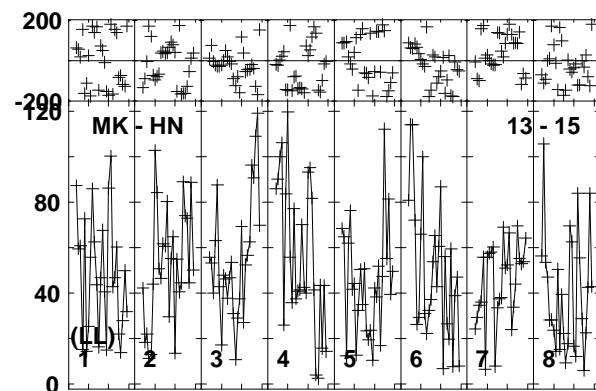
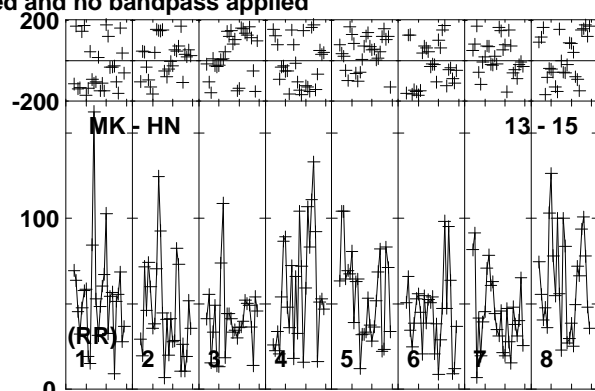
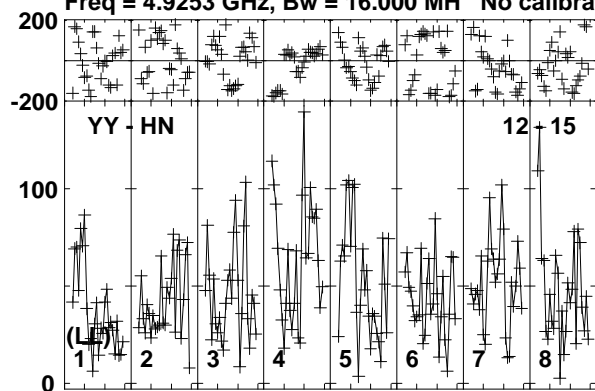

Lower frame: Micro Ampl Jy Top frame: Phas deg
Vector averaged cross-power spectrum Baseline: YY (12) - HN (15)
Timerange: 00/22:41:53 to 00/22:47:07

Plot file version 222 created 11-APR-2016 17:08:52

J1128+5925 GP053G 3.UVDATA.1

Freq = 4.9253 GHz, Bw = 16.000 MH No calibration applied and no bandpass applied

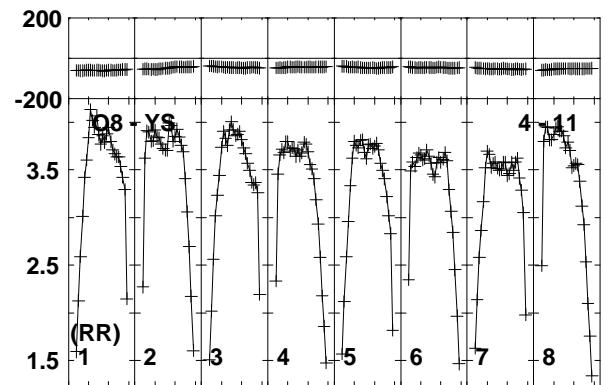
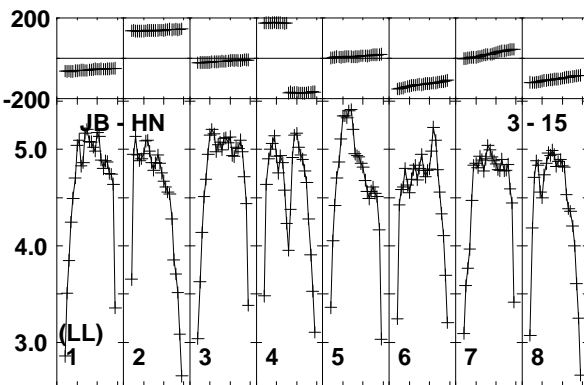
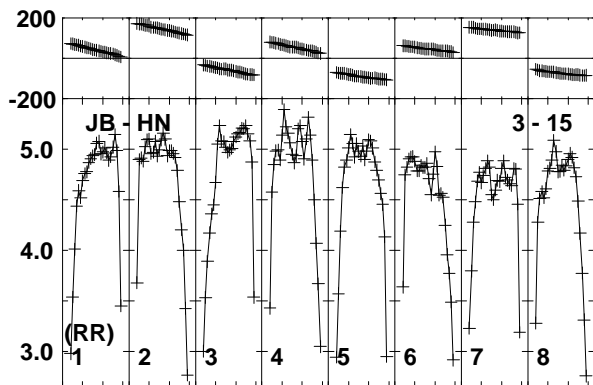
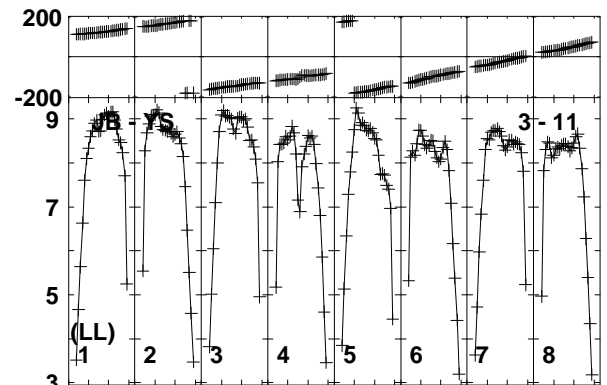
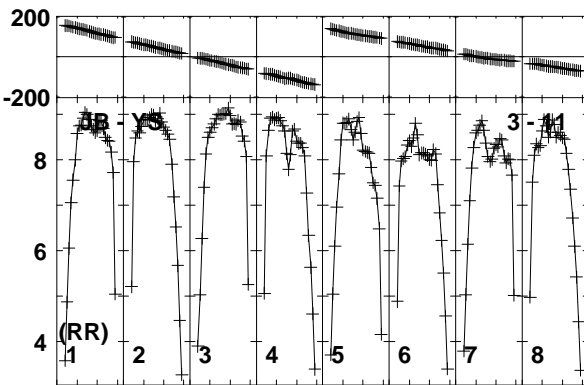
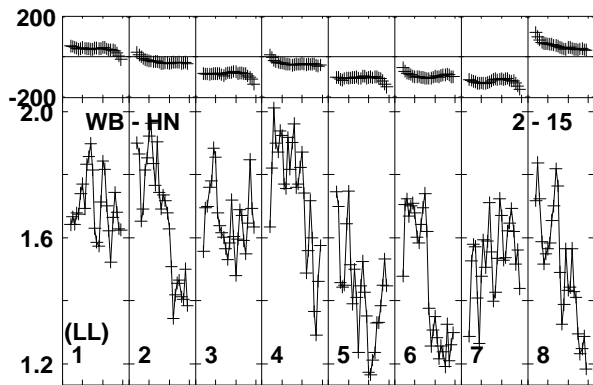
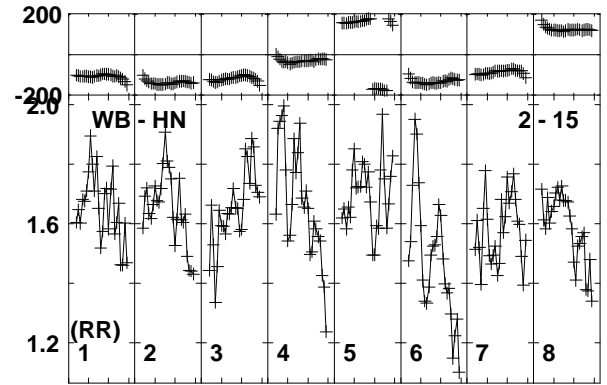
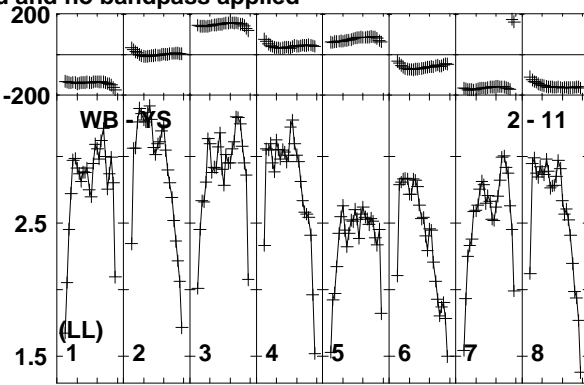
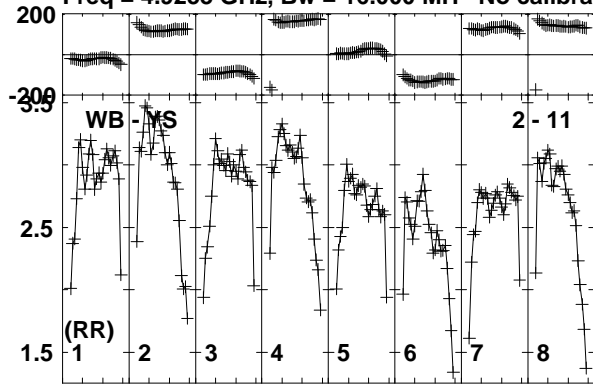

Lower frame: Milli Ampl Jy Top frame: Phas deg

Vector averaged cross-power spectrum Baseline: WB (02) - YS (11)

Timerange: 00/22:47:13 to 00/22:48:57

Plot file version 223 created 11-APR-2016 17:08:52

J1128+5925 GP053G 3.UVDATA.1

Freq = 4.9253 GHz, Bw = 16.000 MH No calibration applied and no bandpass applied

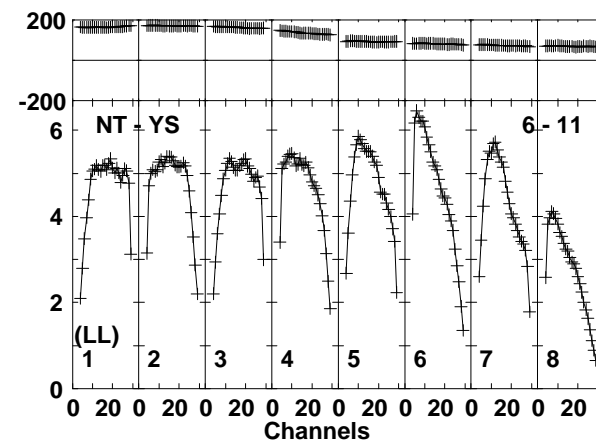
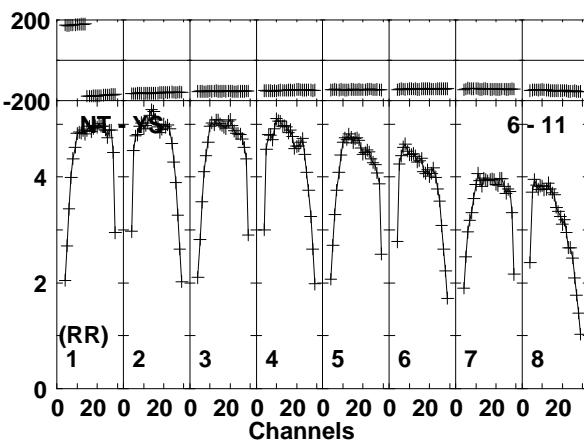
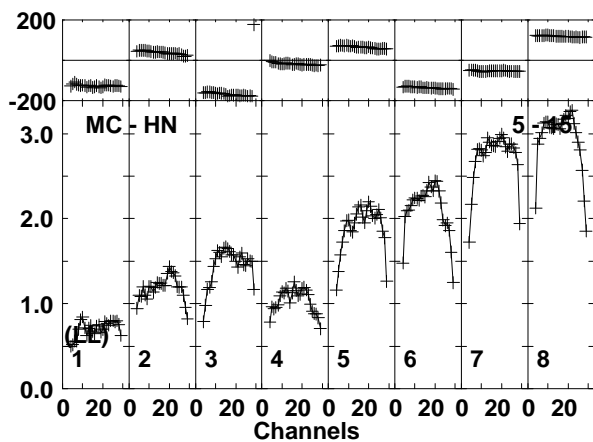
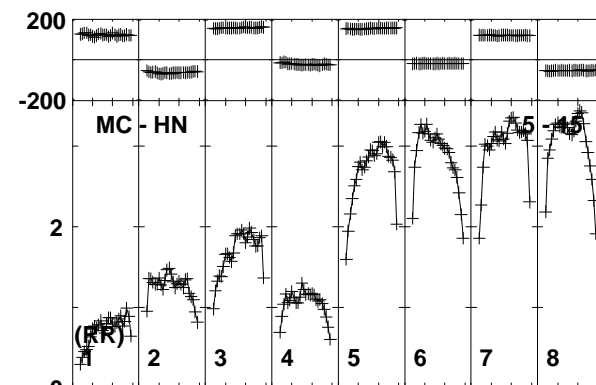
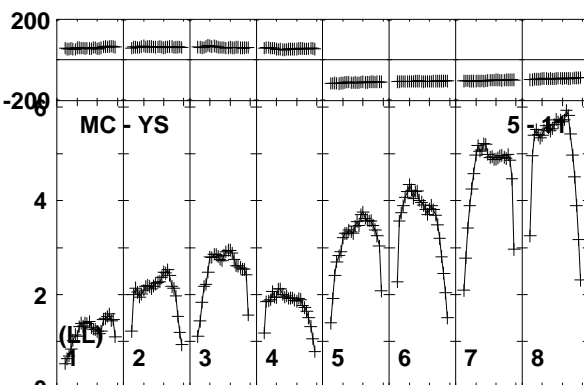
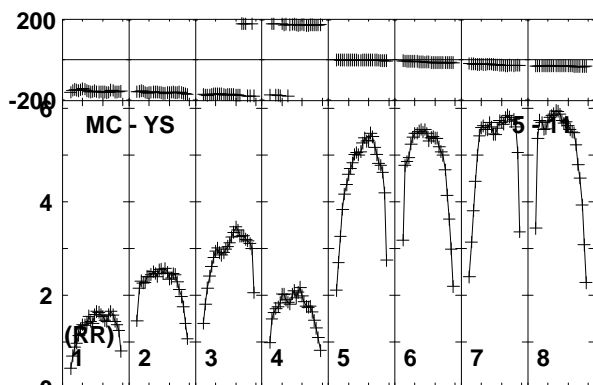
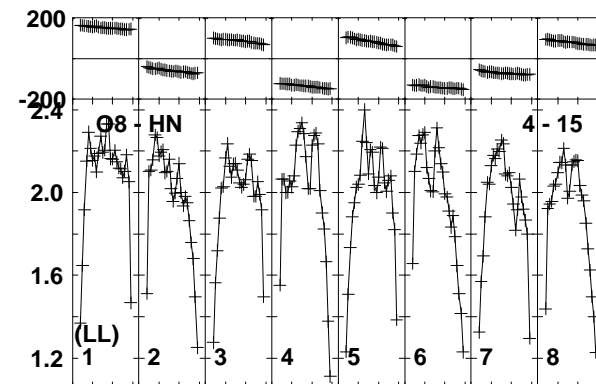
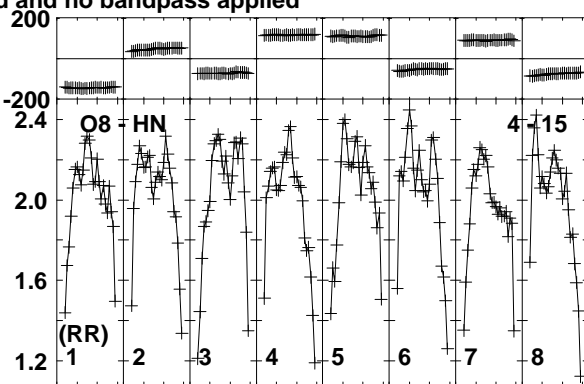
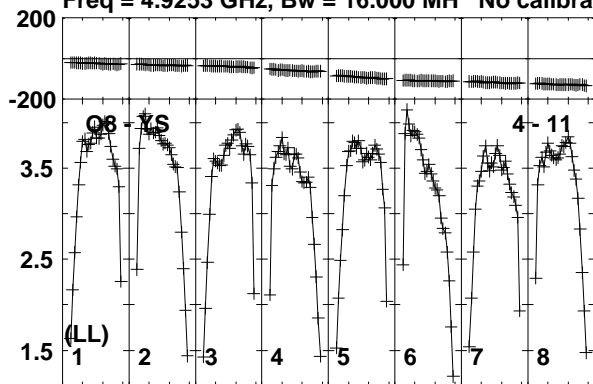

Lower frame: Milli Ampl Jy Top frame: Phas deg
Vector averaged cross-power spectrum Baseline: O8 (04) - YS (11)
Timerange: 00/22:47:13 to 00/22:48:57

Plot file version 224 created 11-APR-2016 17:08:52

J1128+5925 GP053G 3.UVDATA.1

Freq = 4.9253 GHz, Bw = 16.000 MH No calibration applied and no bandpass applied

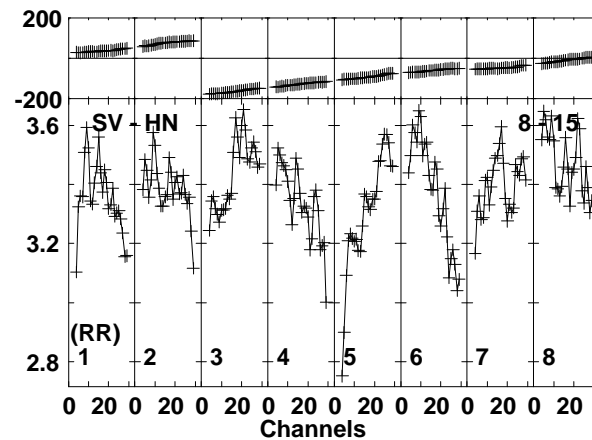
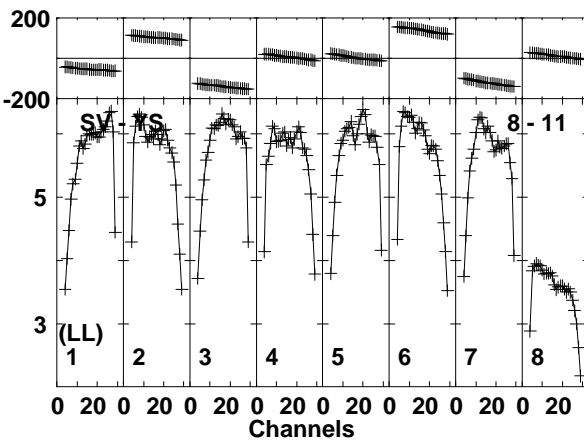
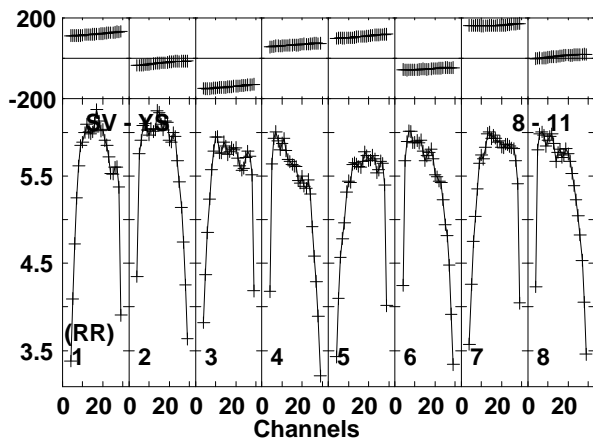
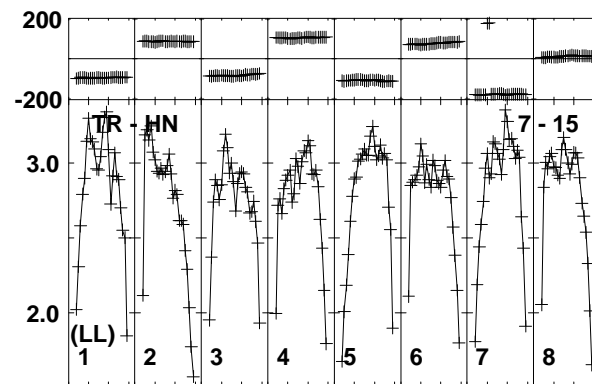
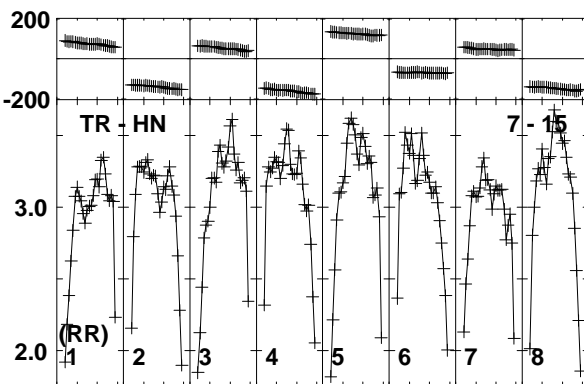
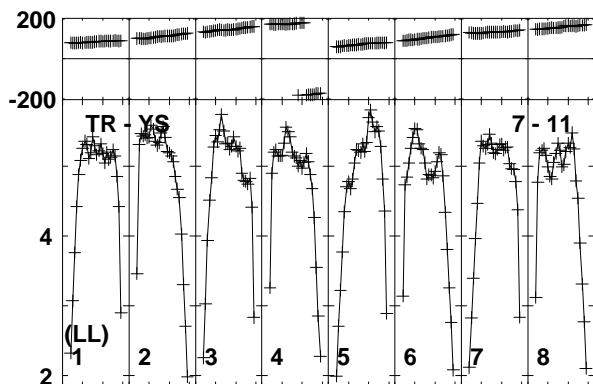
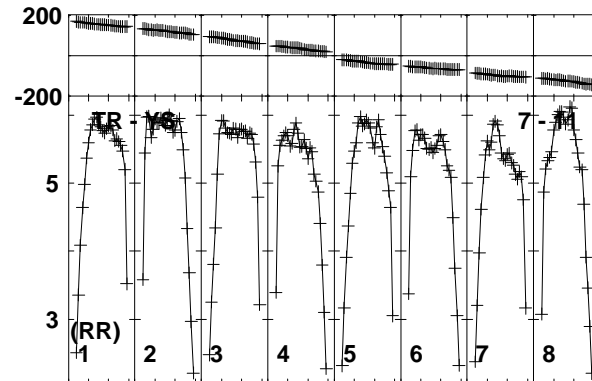
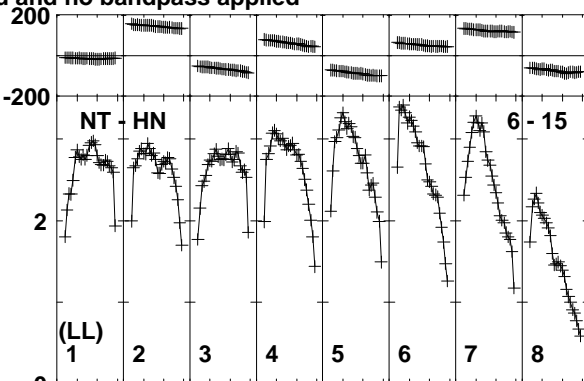
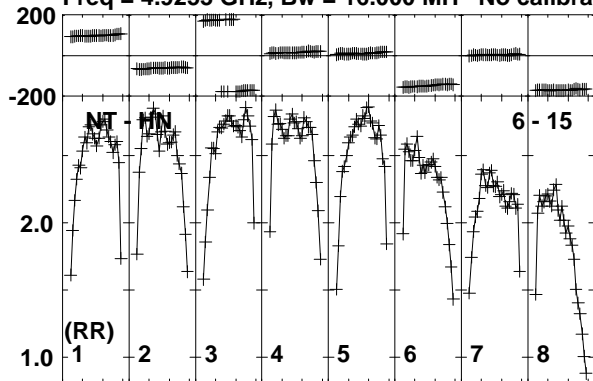

Lower frame: Milli Ampl Jy Top frame: Phas deg
Vector averaged cross-power spectrum Baseline: NT (06) - HN (15)
Timerange: 00:22:47:13 to 00:22:48:57

Plot file version 225 created 11-APR-2016 17:08:52

J1128+5925 GP053G 3.UVDATA.1

Freq = 4.9253 GHz, Bw = 16.000 MH No calibration applied and no bandpass applied

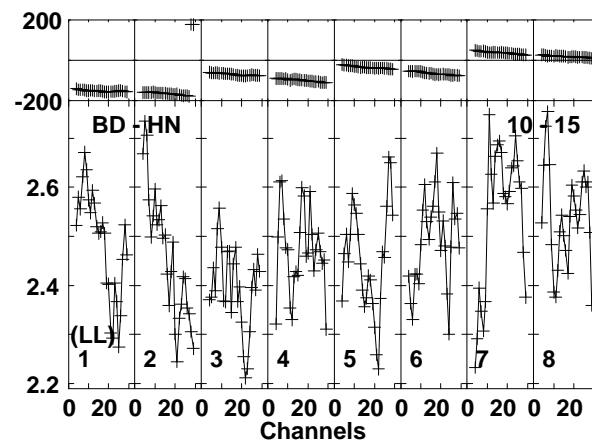
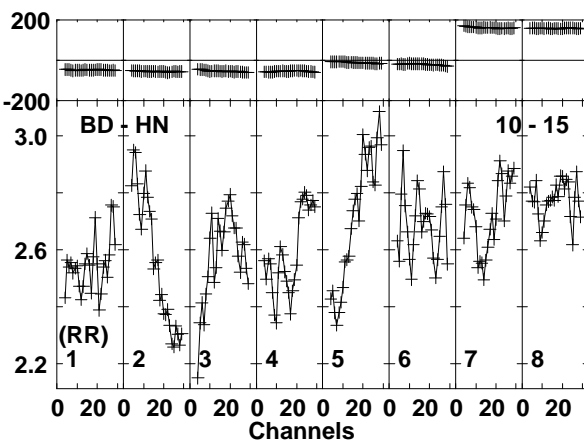
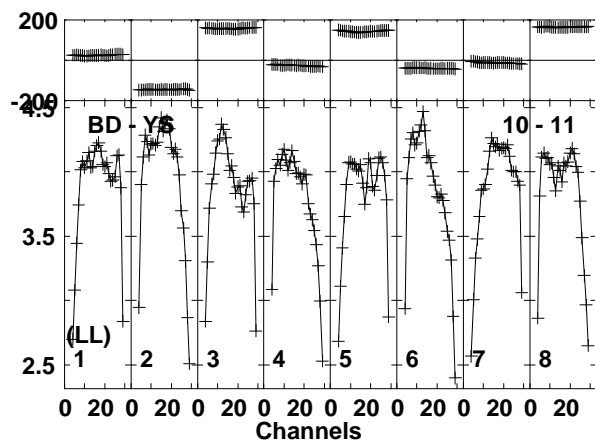
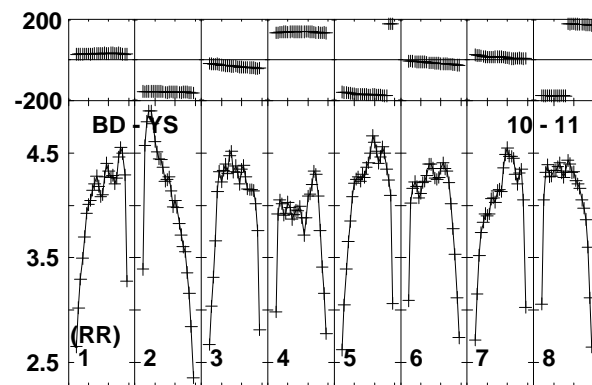
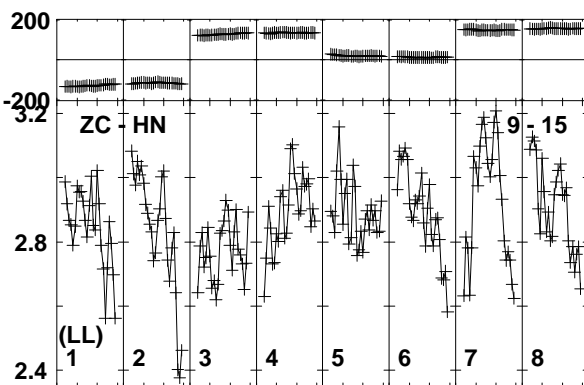
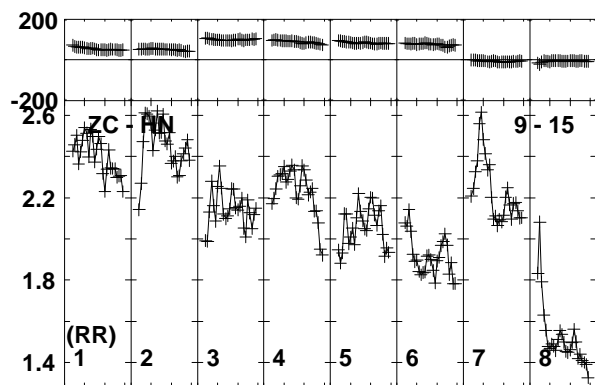
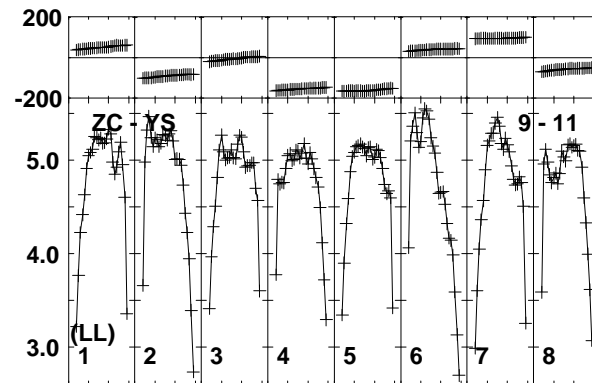
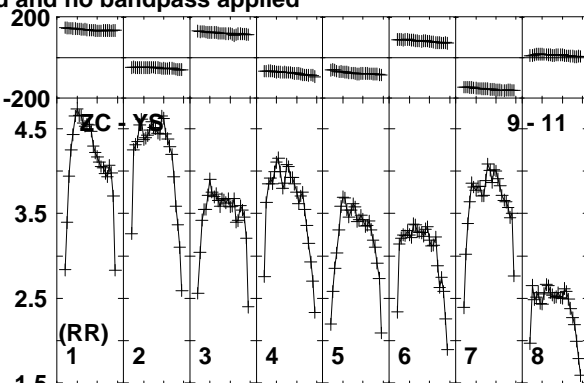
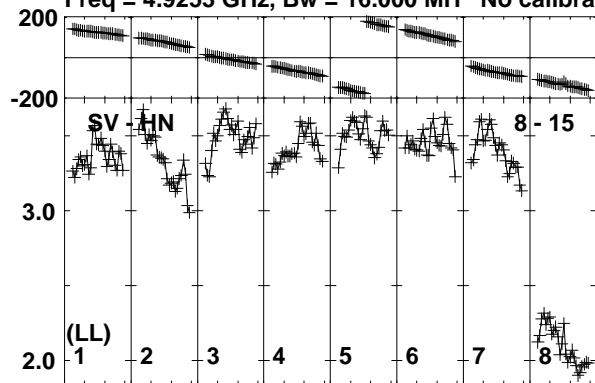

Lower frame: Milli Ampl Jy Top frame: Phas deg
Vector averaged cross-power spectrum Baseline: SV (08) - HN (15)
Timerange: 00/22:47:13 to 00/22:48:57

Plot file version 226 created 11-APR-2016 17:08:52

J1128+5925 GP053G 3.UVDATA.1

Freq = 4.9253 GHz, Bw = 16.000 MH No calibration applied and no bandpass applied

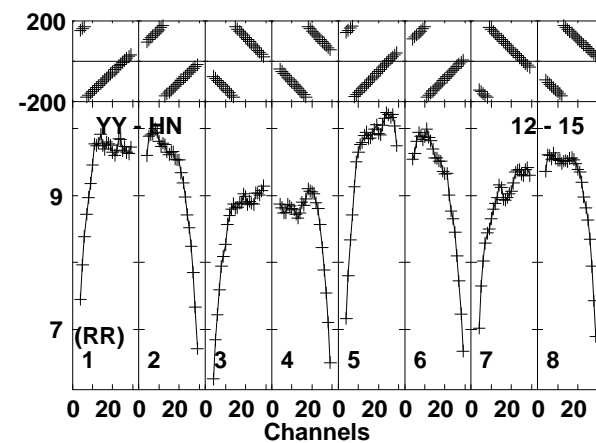
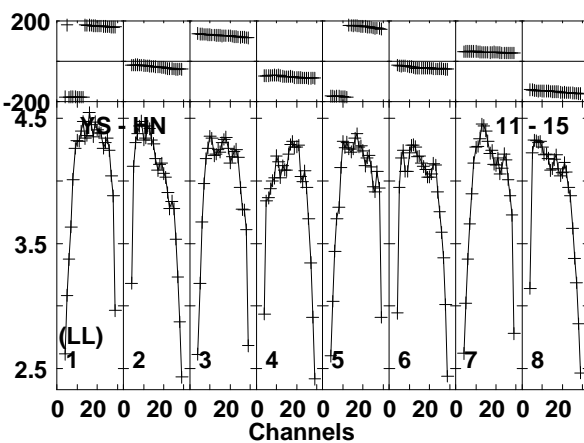
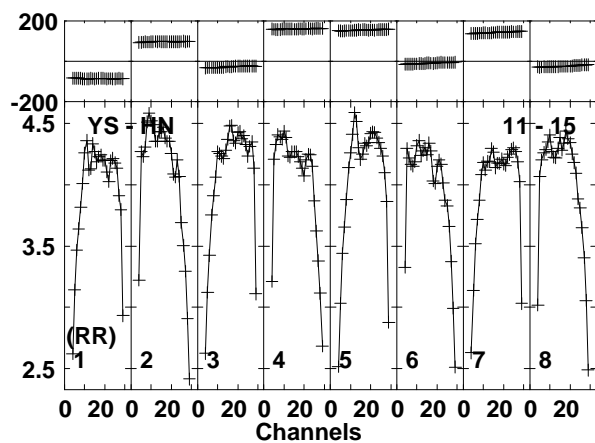
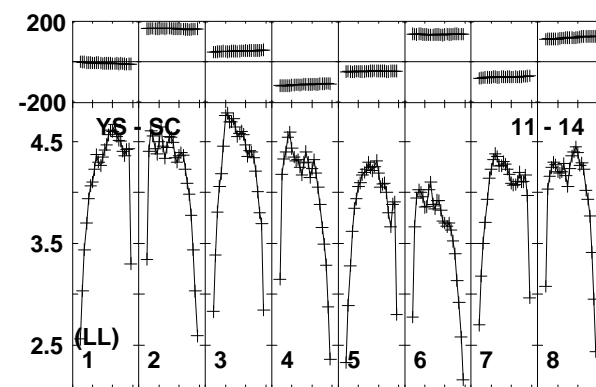
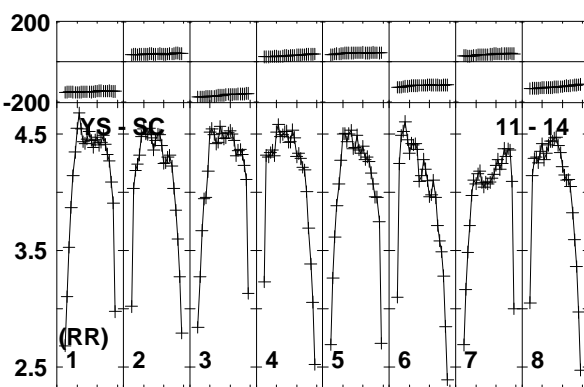
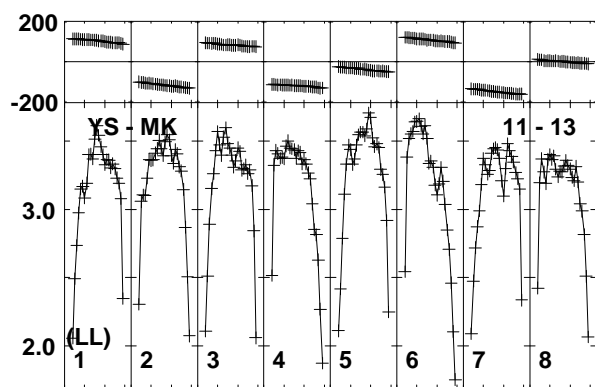
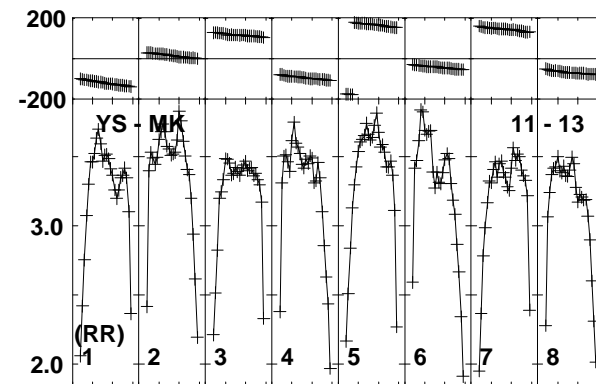
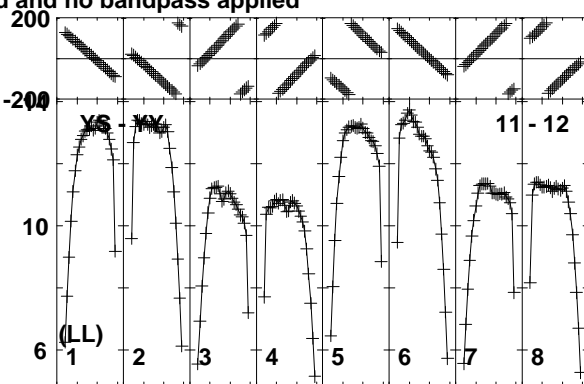
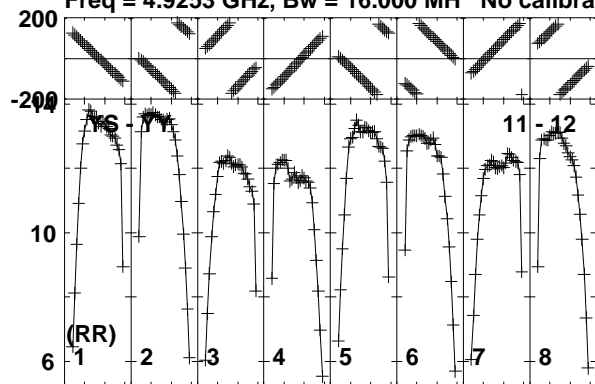

Lower frame: Milli Ampl Jy Top frame: Phas deg
Vector averaged cross-power spectrum Baseline: YS (11) - YY (12)
Timerange: 00/22:47:13 to 00/22:48:57

Plot file version 227 created 11-APR-2016 17:08:52

J1128+5925 GP053G 3.UVDATA.1

Freq = 4.9253 GHz, Bw = 16.000 MH No calibration applied and no bandpass applied

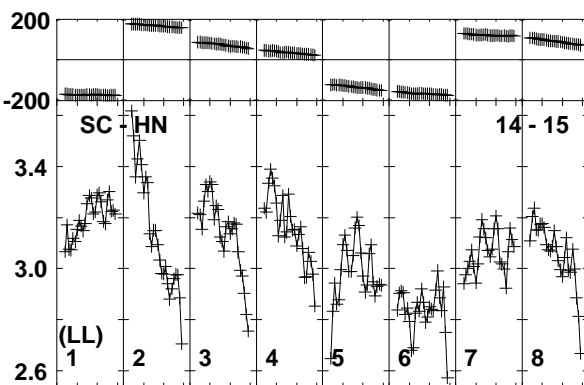
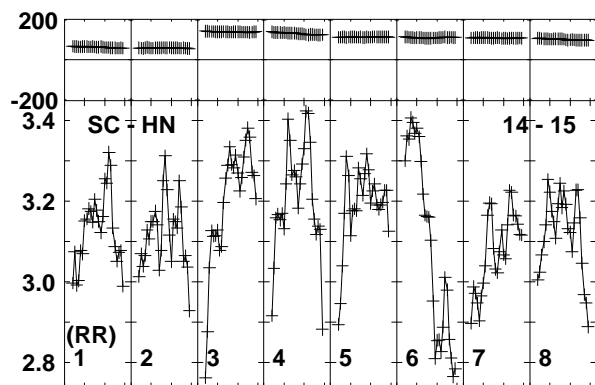
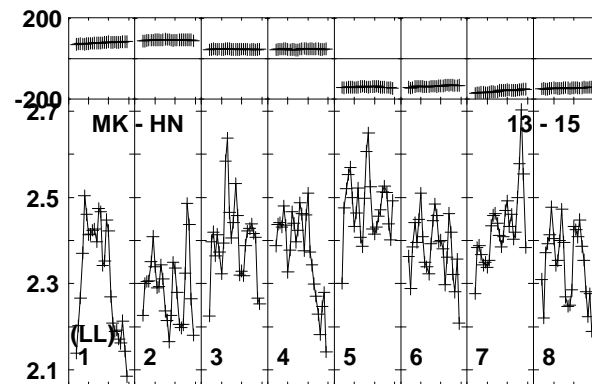
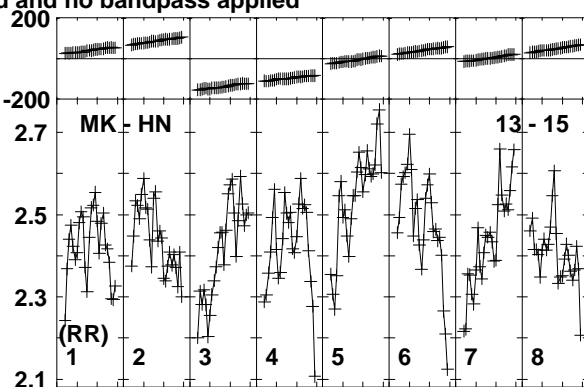
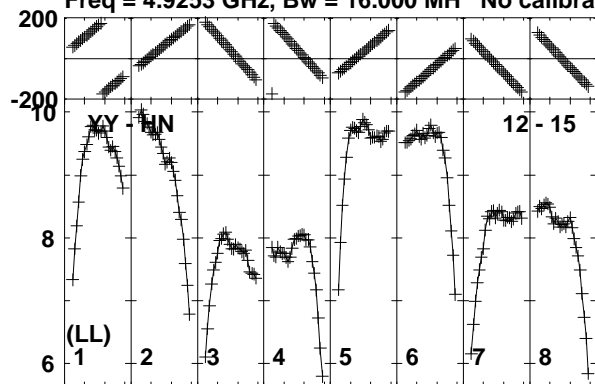

Lower frame: Milli Ampl Jy Top frame: Phas deg
Vector averaged cross-power spectrum Baseline: YY (12) - HN (15)
Timerange: 00/22:47:13 to 00/22:48:57

Plot file version 228 created 11-APR-2016 17:08:52

ARP299C GP053G 3.UVDATA.1

Freq = 4.9253 GHz, Bw = 16.000 MH No calibration applied and no bandpass applied

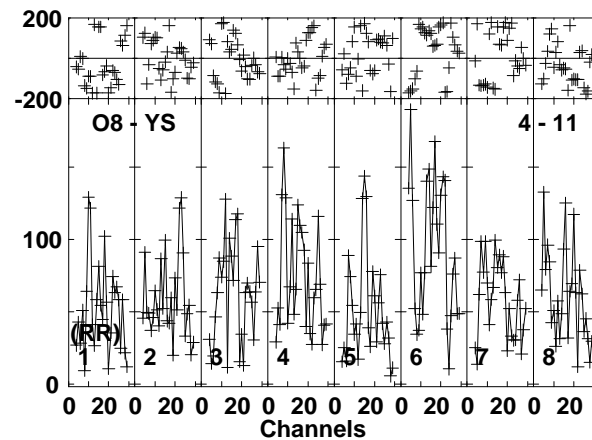
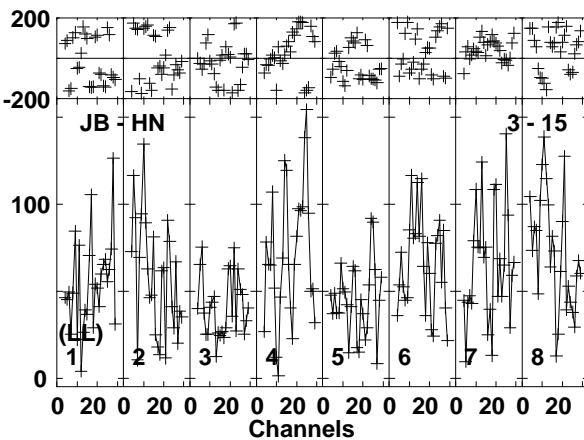
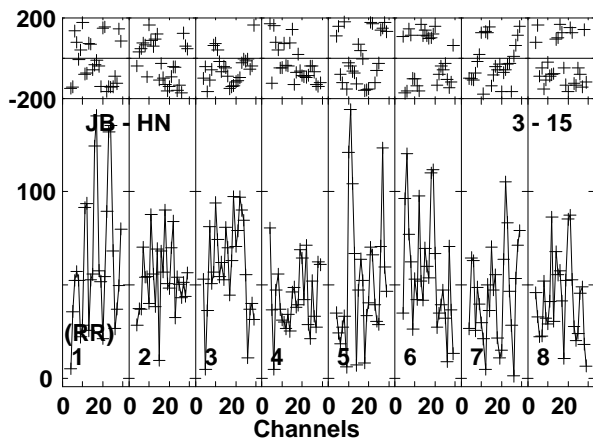
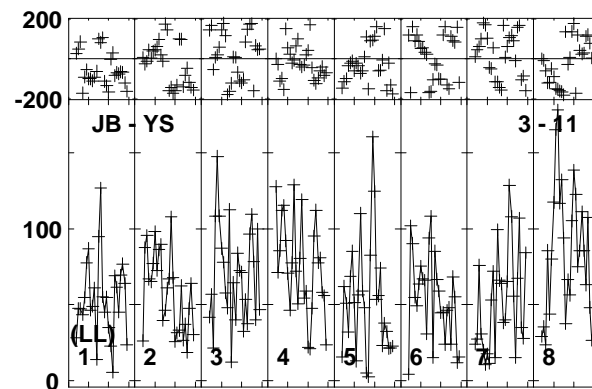
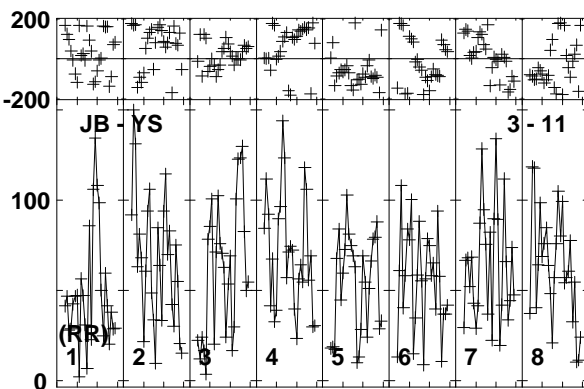
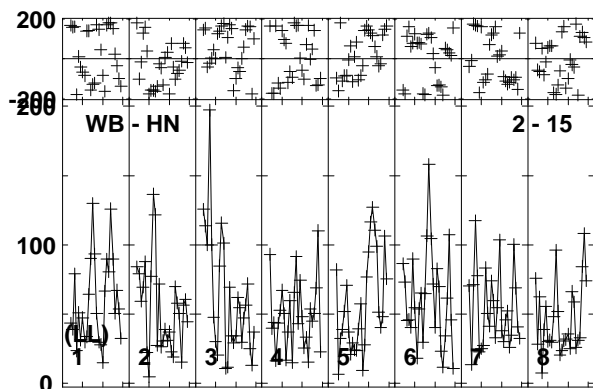
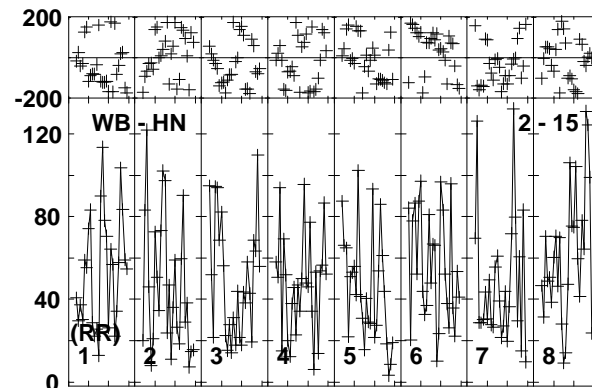
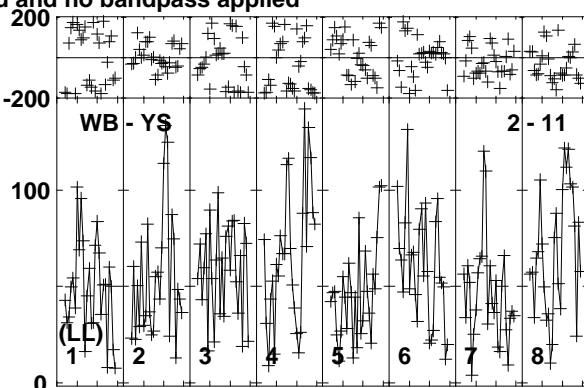
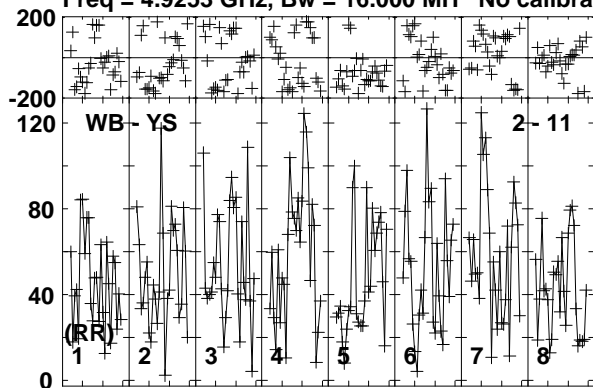

Lower frame: Micro Ampl Jy Top frame: Phas deg
Vector averaged cross-power spectrum Baseline: WB (02) - YS (11)
Timerange: 00/22:49:03 to 00/22:54:15

Plot file version 229 created 11-APR-2016 17:08:53

ARP299C GP053G 3.UVDATA.1

Freq = 4.9253 GHz, Bw = 16.000 MH No calibration applied and no bandpass applied

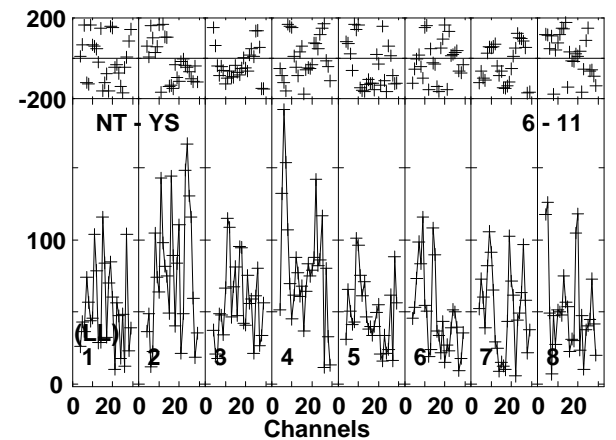
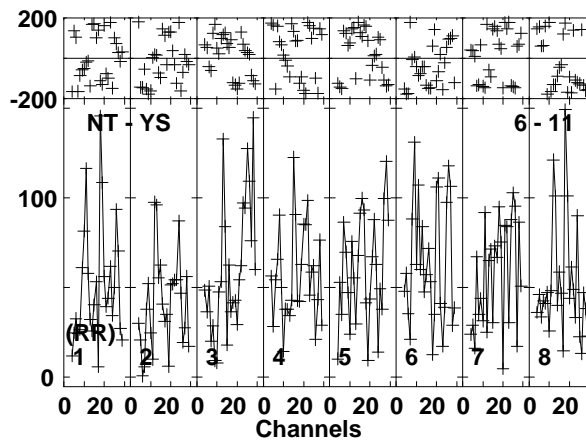
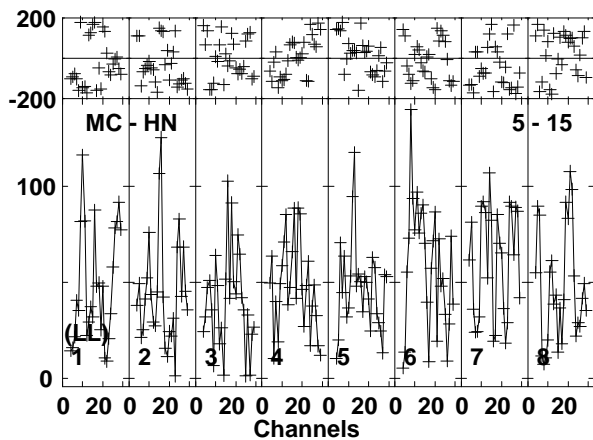
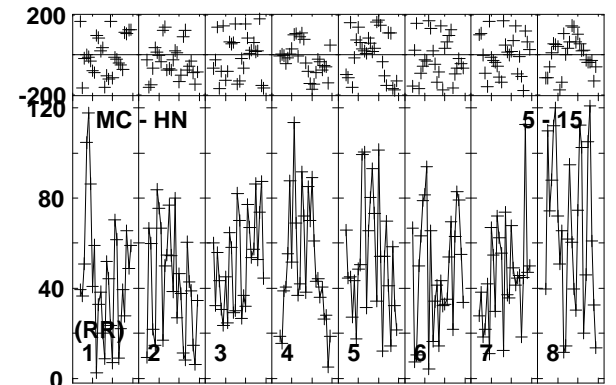
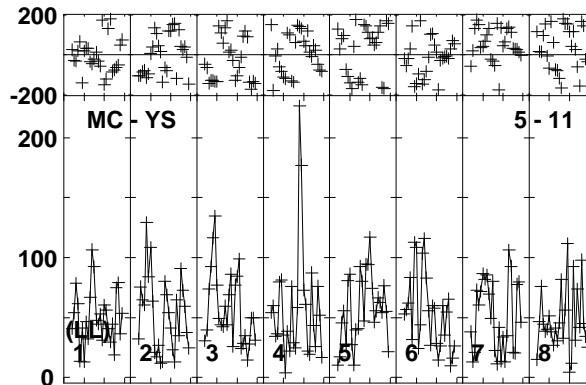
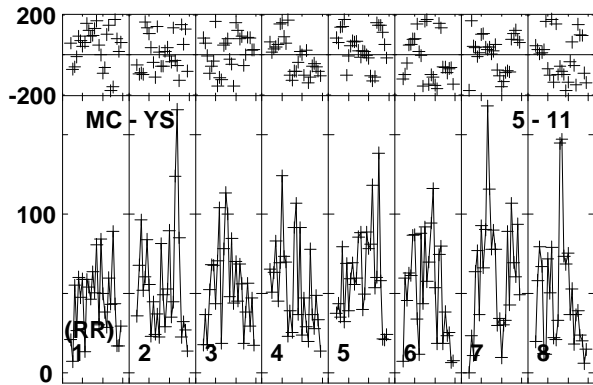
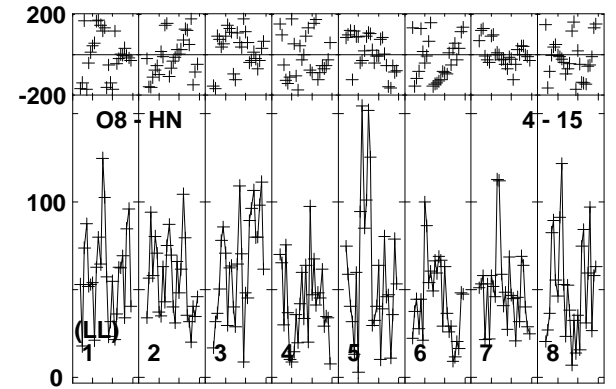
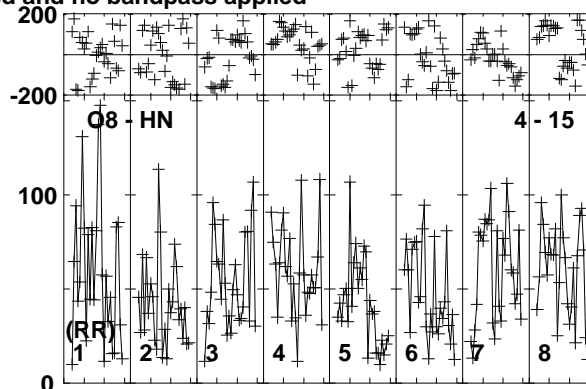
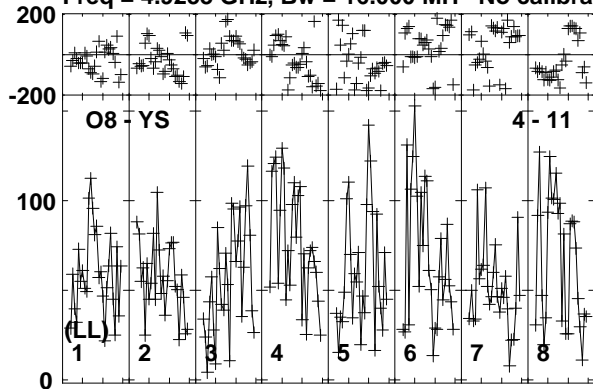

Lower frame: Micro Ampl Jy Top frame: Phas deg
Vector averaged cross-power spectrum Baseline: O8 (04) - YS (11)
Timerange: 00/22:49:03 to 00/22:54:15

Plot file version 230 created 11-APR-2016 17:08:53

ARP299C GP053G 3.UVDATA.1

Freq = 4.9253 GHz, Bw = 16.000 MH No calibration applied and no bandpass applied

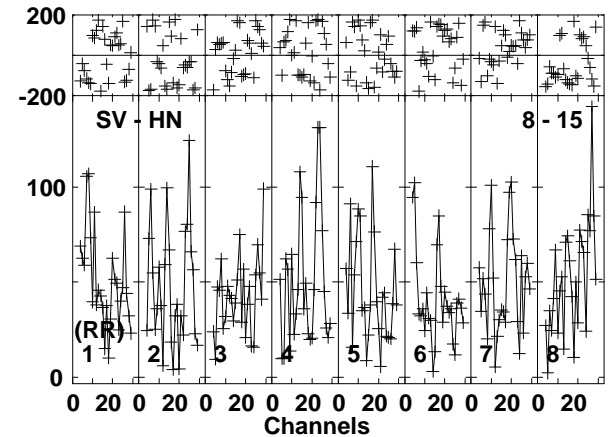
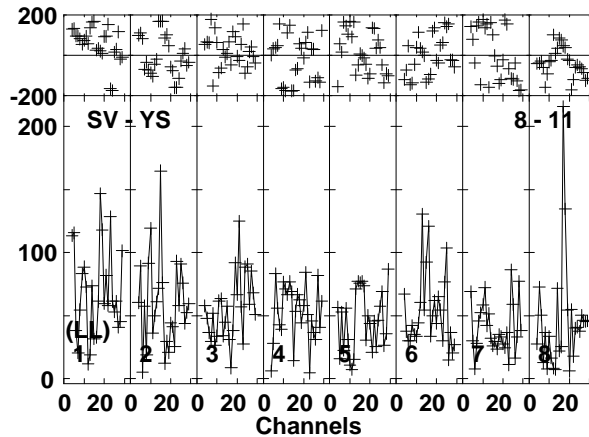
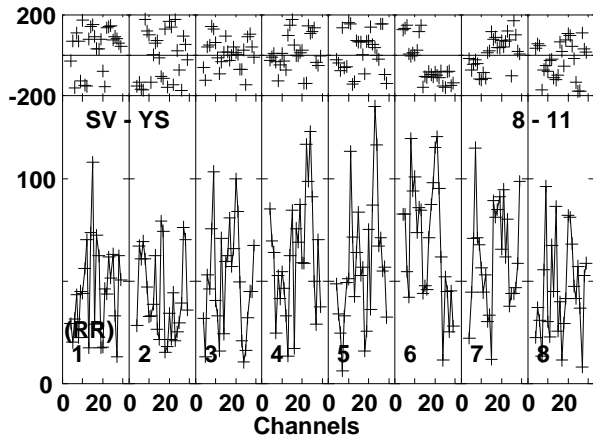
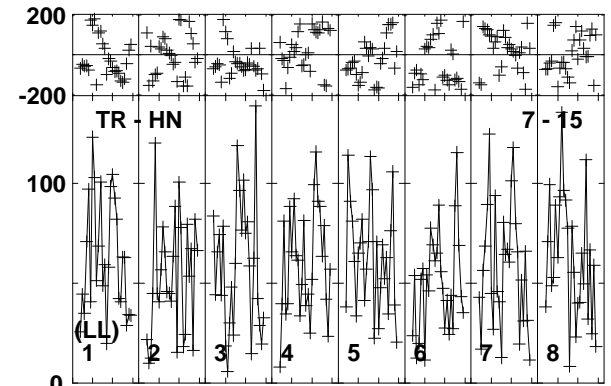
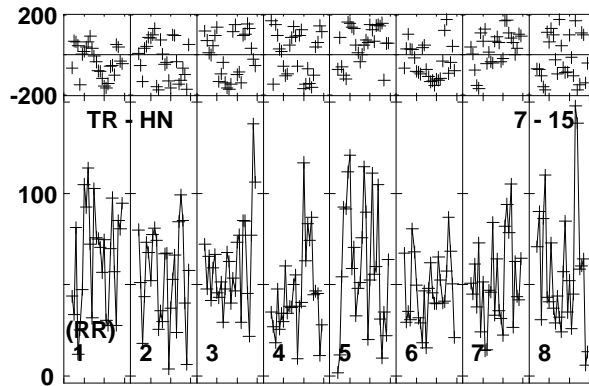
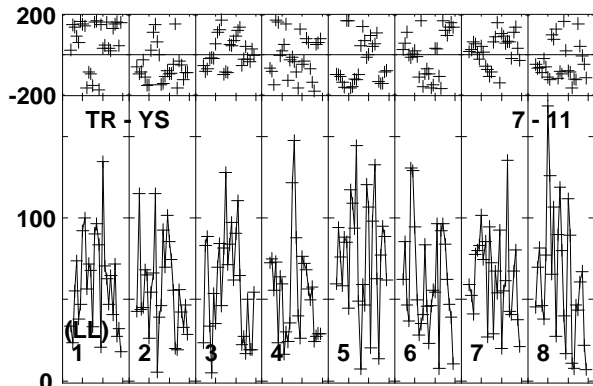
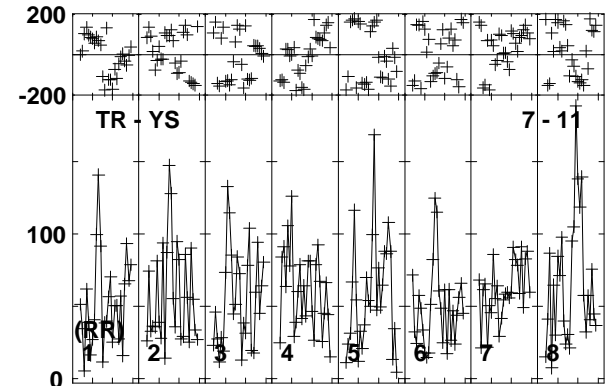
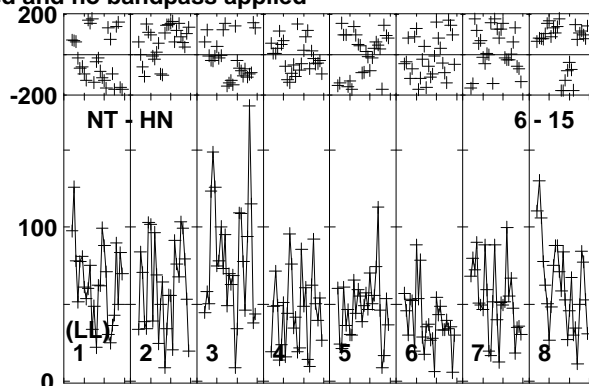
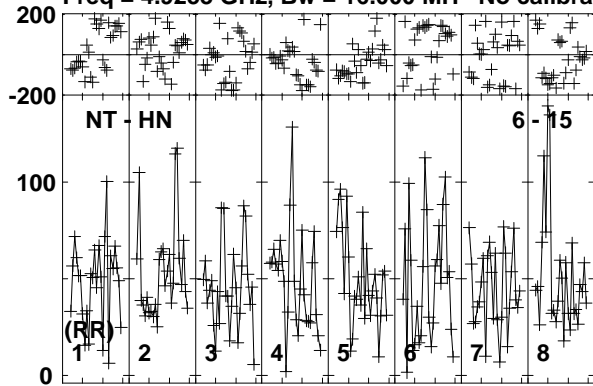

Lower frame: Micro Ampl Jy Top frame: Phas deg
Vector averaged cross-power spectrum Baseline: NT (06) - HN (15)
Timerange: 00:22:49:03 to 00:22:54:15

Plot file version 231 created 11-APR-2016 17:08:53

ARP299C GP053G 3.UVDATA.1

Freq = 4.9253 GHz, Bw = 16.000 MH No calibration applied and no bandpass applied

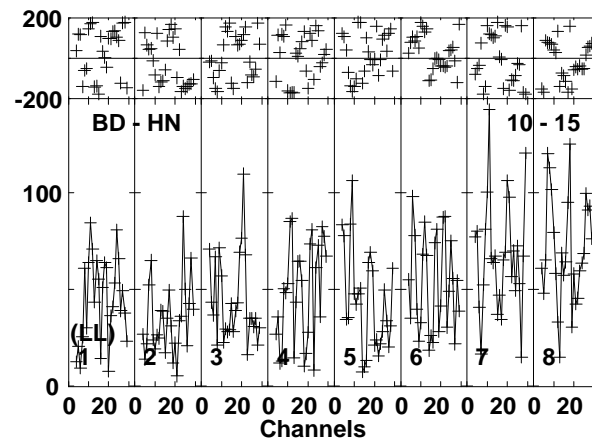
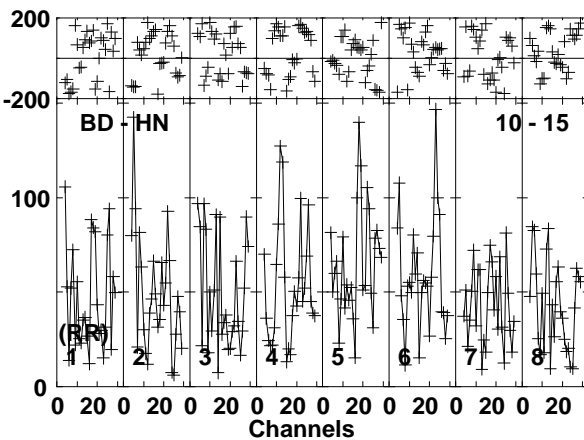
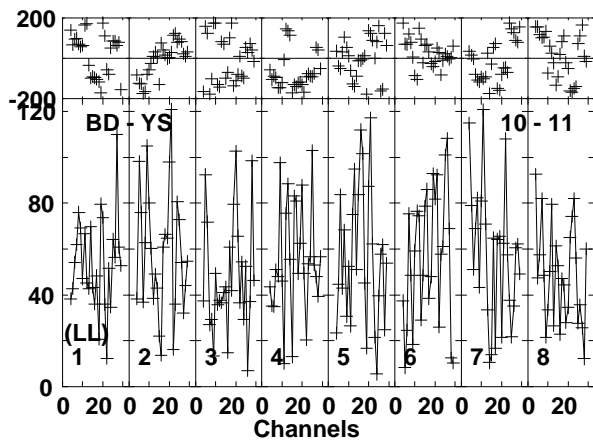
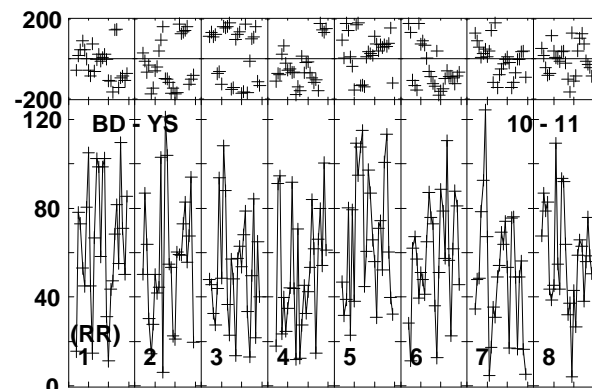
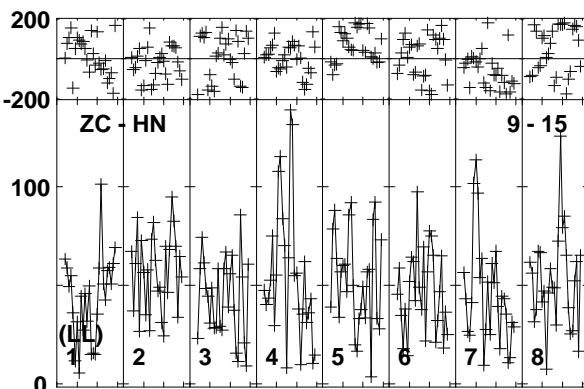
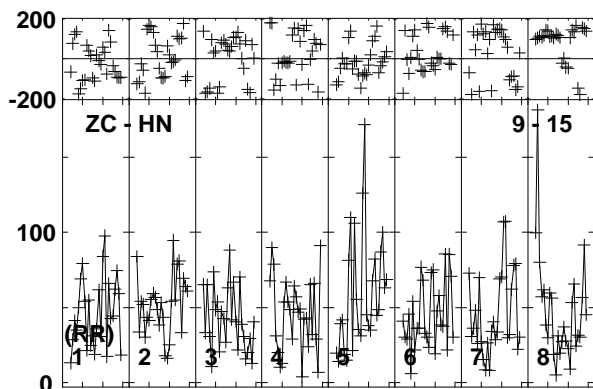
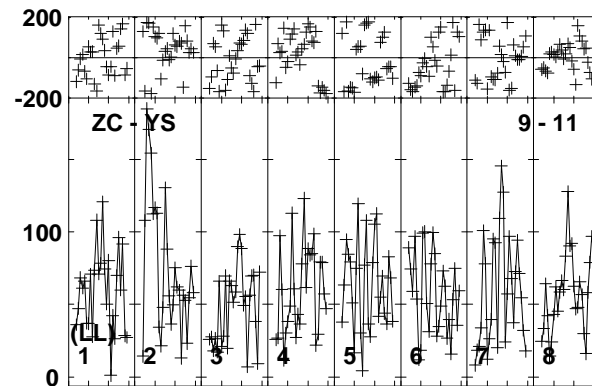
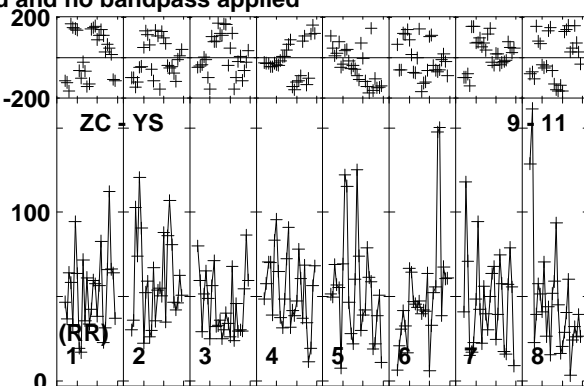
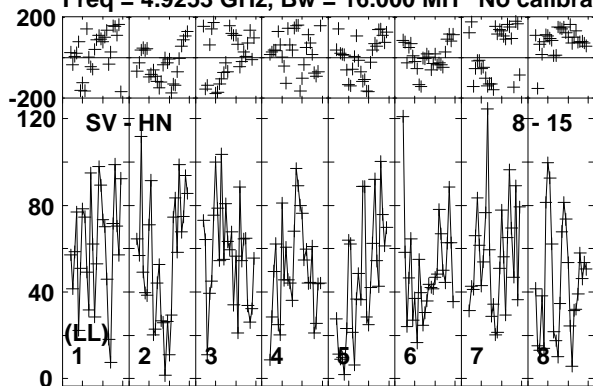

Lower frame: Micro Ampl Jy Top frame: Phas deg
Vector averaged cross-power spectrum Baseline: SV (08) - HN (15)
Timerange: 00/22:49:03 to 00/22:54:15

Plot file version 232 created 11-APR-2016 17:08:53

ARP299C GP053G 3.UVDATA.1

Freq = 4.9253 GHz, Bw = 16.000 MH No calibration applied and no bandpass applied

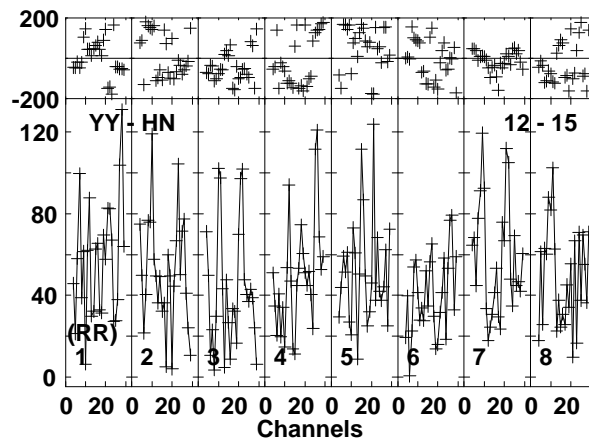
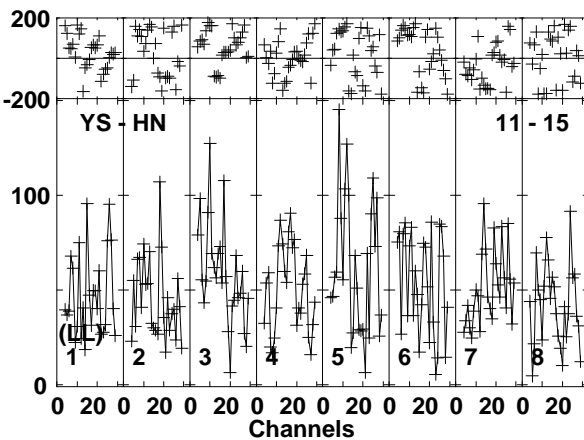
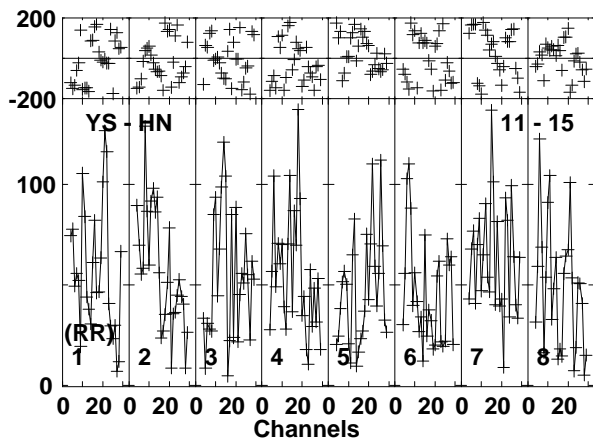
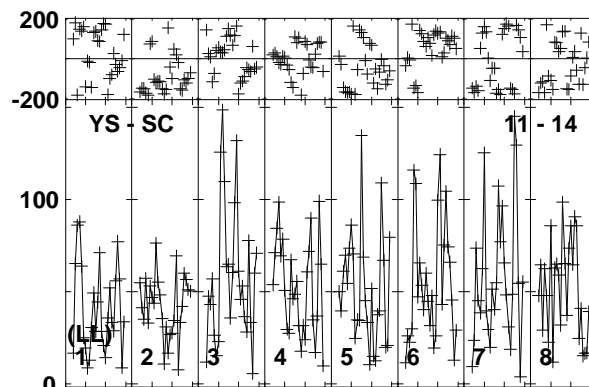
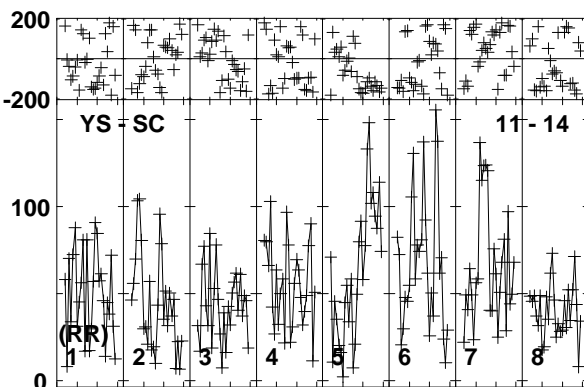
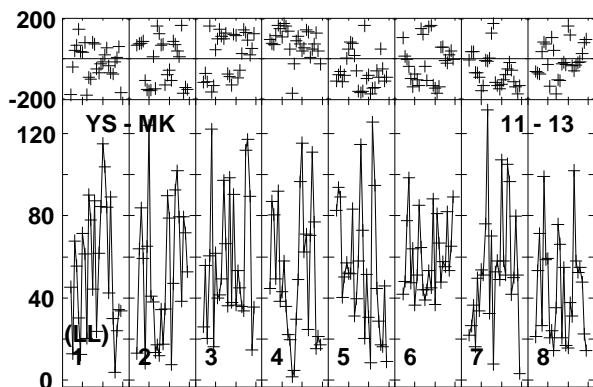
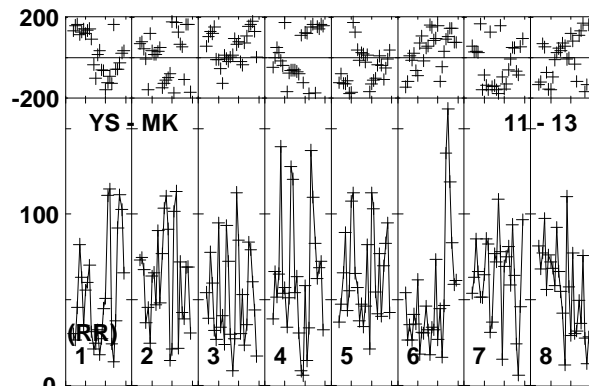
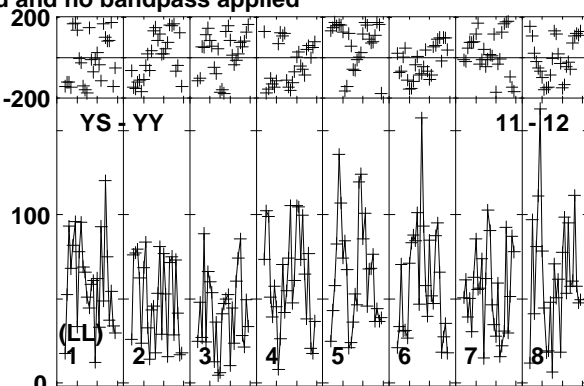
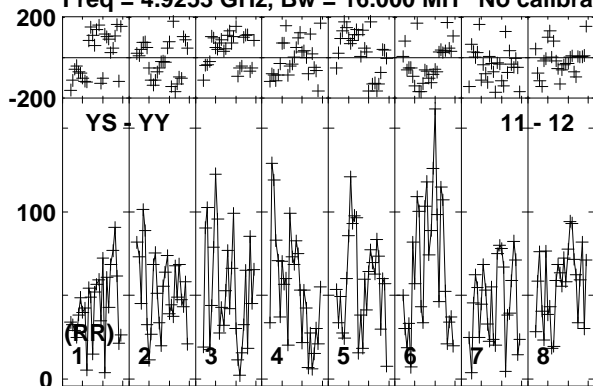

Lower frame: Micro Ampl Jy Top frame: Phas deg
Vector averaged cross-power spectrum Baseline: YS (11) - YY (12)
Timerange: 00/22:49:03 to 00/22:54:15

Plot file version 233 created 11-APR-2016 17:08:53

ARP299C GP053G 3.UVDATA.1

Freq = 4.9253 GHz, Bw = 16.000 MH No calibration applied and no bandpass applied

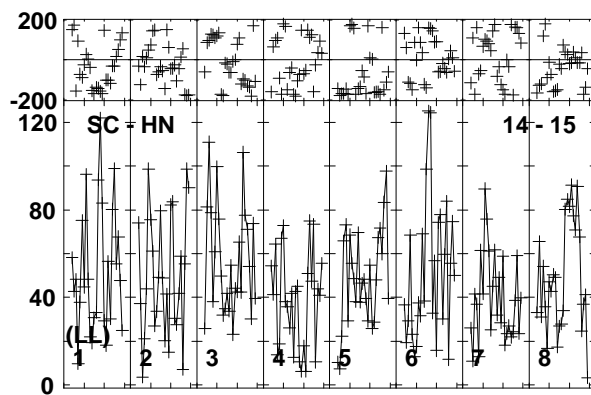
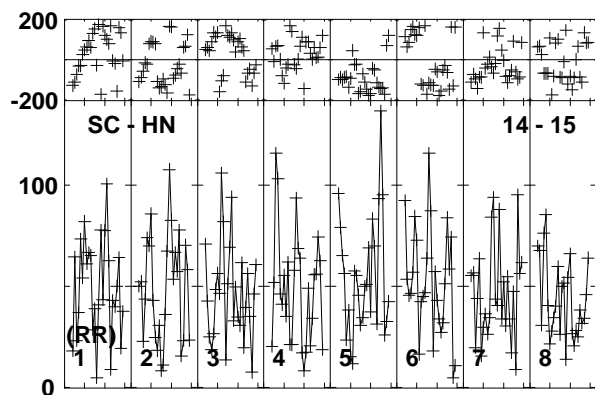
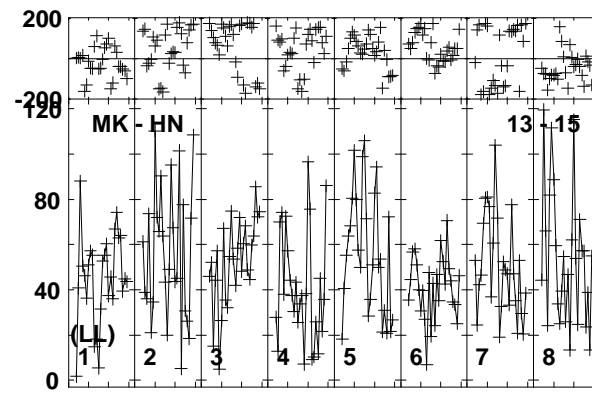
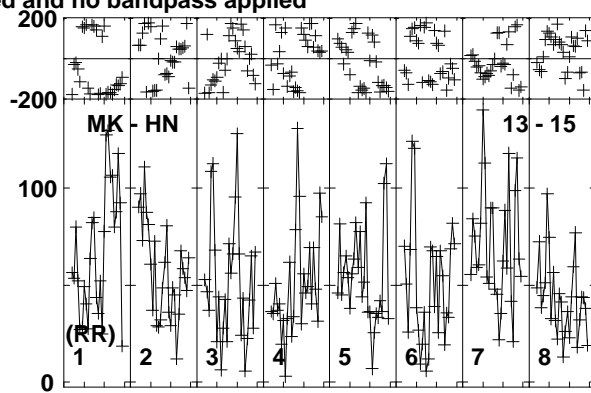
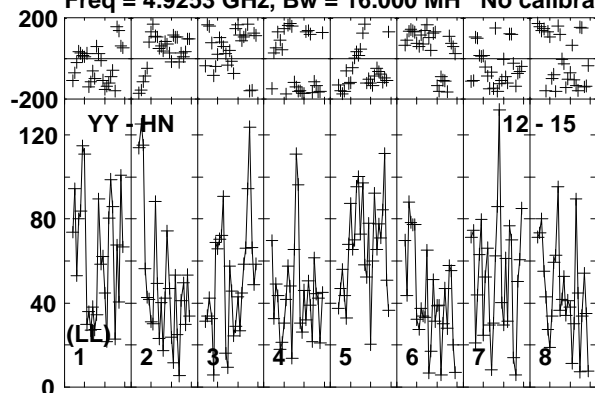

Lower frame: Micro Ampl Jy Top frame: Phas deg
Vector averaged cross-power spectrum Baseline: YY (12) - HN (15)
Timerange: 00/22:49:03 to 00/22:54:15

Plot file version 234 created 11-APR-2016 17:08:54

J1128+5925 GP053G 3.UVDATA.1

Freq = 4.9253 GHz, Bw = 16.000 MH No calibration applied and no bandpass applied

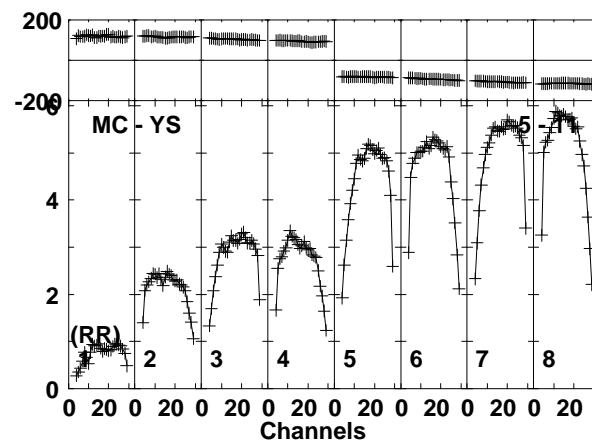
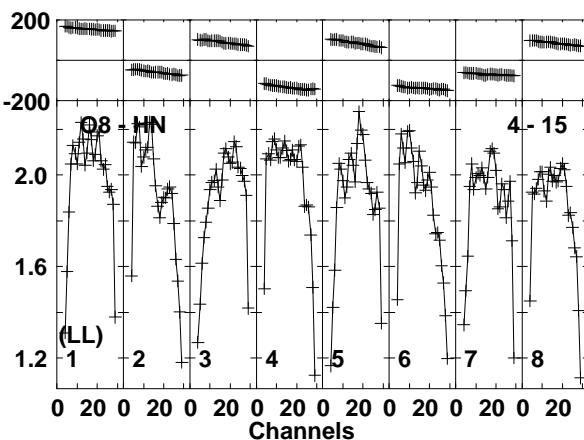
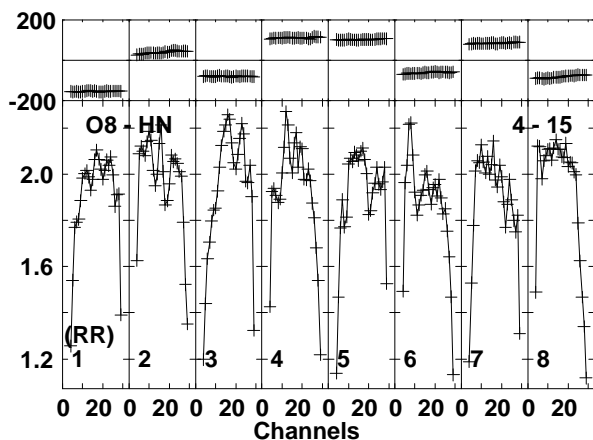
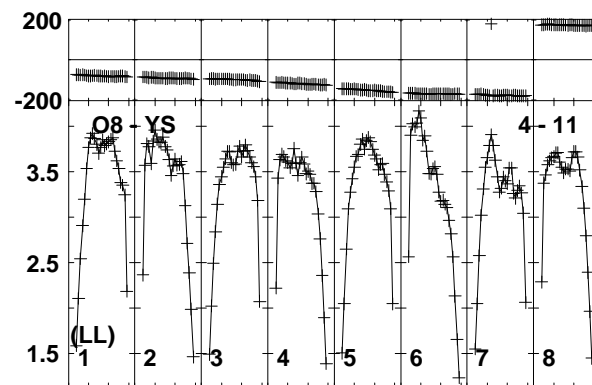
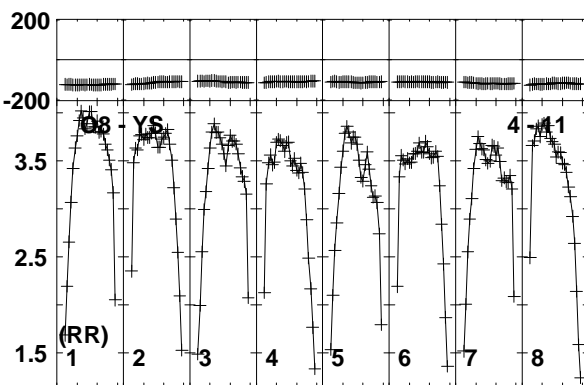
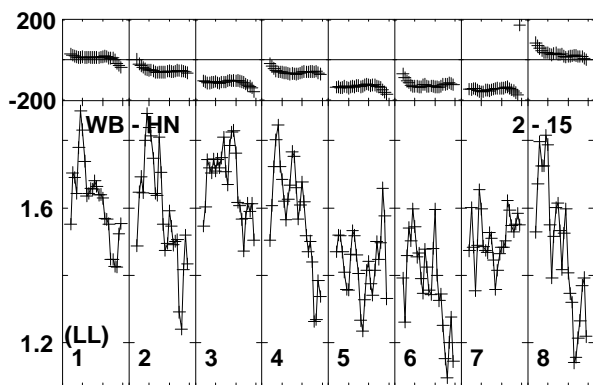
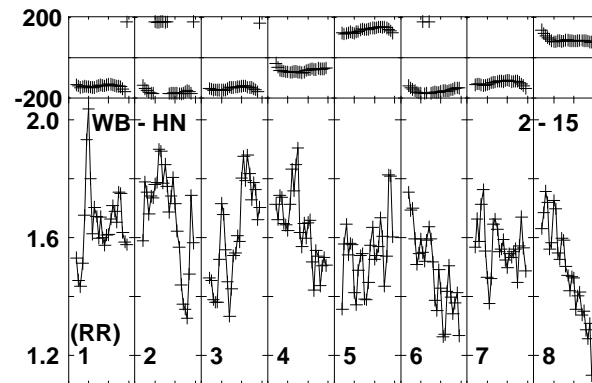
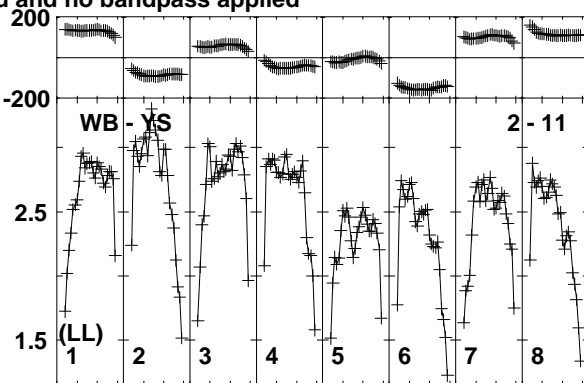
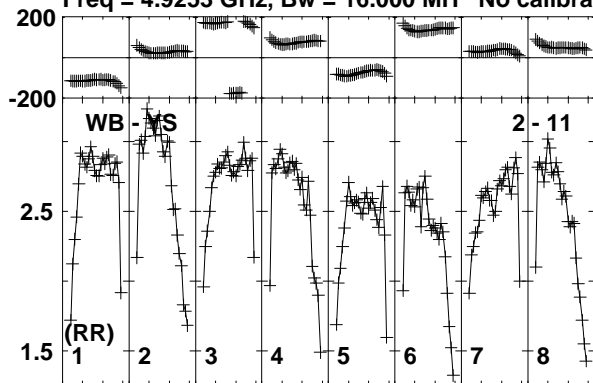

Lower frame: Milli Ampl Jy Top frame: Phas deg
Vector averaged cross-power spectrum Baseline: WB (02) - YS (11)
Timerange: 00/22:54:21 to 00/22:56:13

Plot file version 235 created 11-APR-2016 17:08:54

J1128+5925 GP053G 3.UVDATA.1

Freq = 4.9253 GHz, Bw = 16.000 MH No calibration applied and no bandpass applied

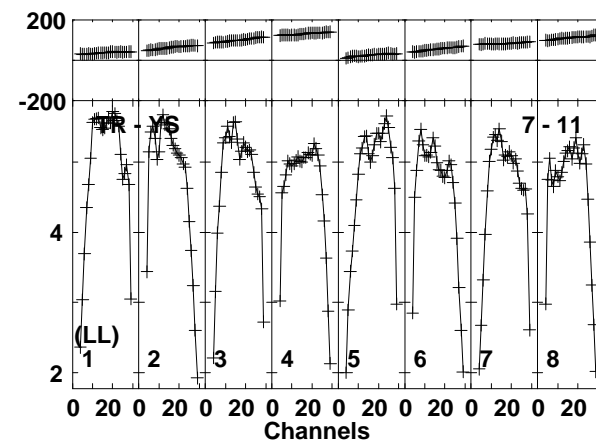
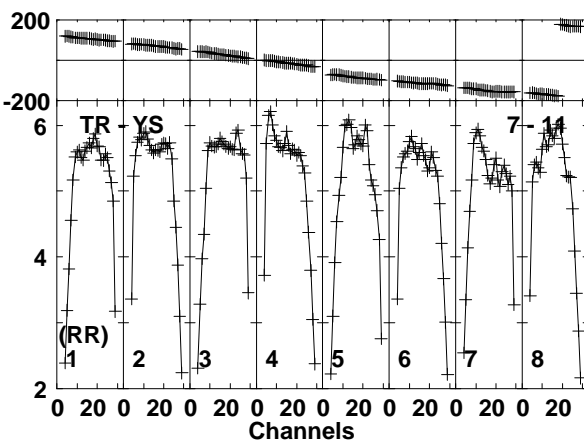
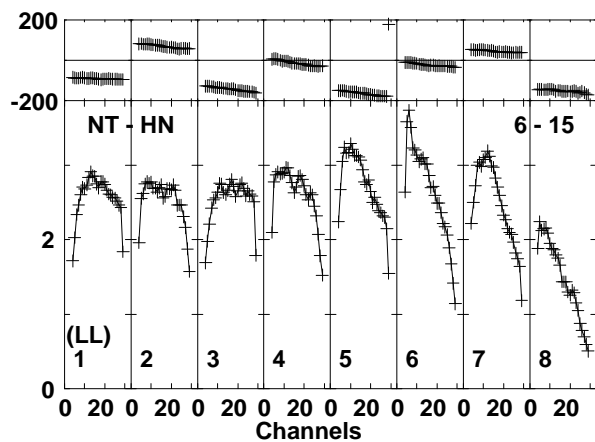
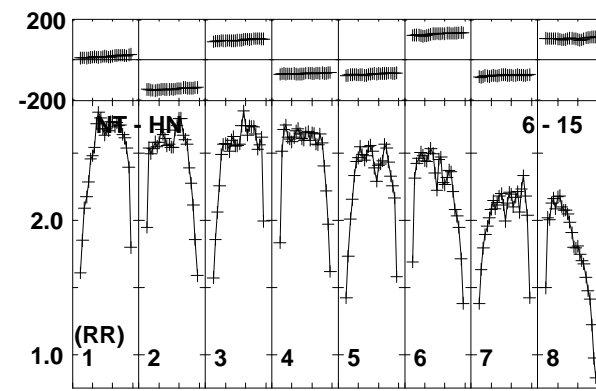
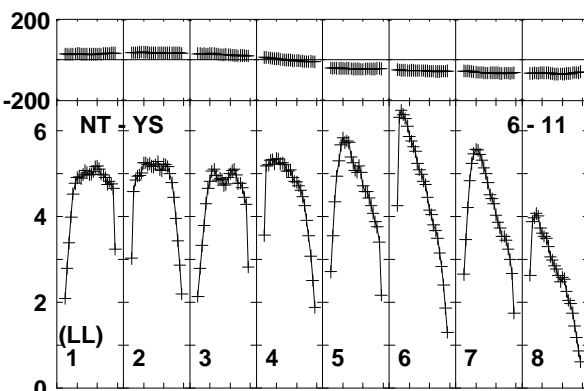
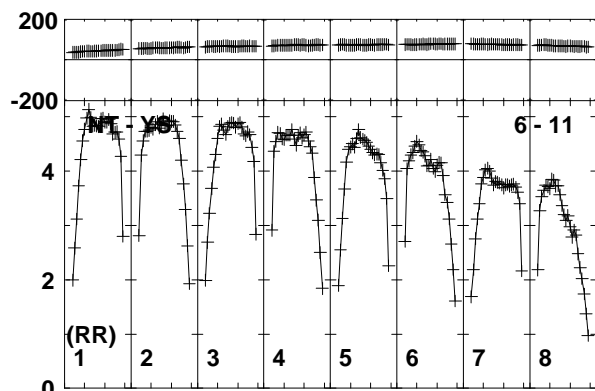
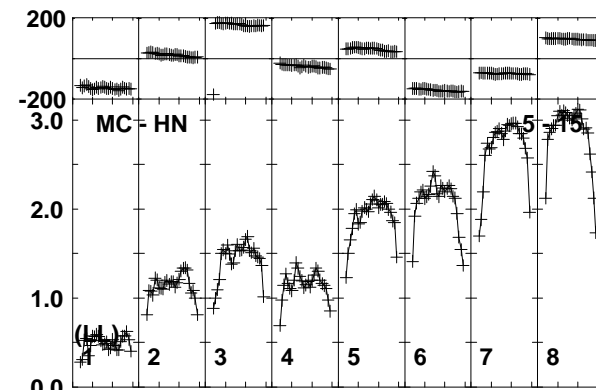
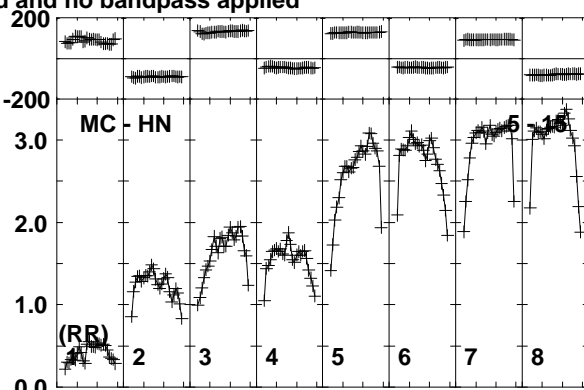
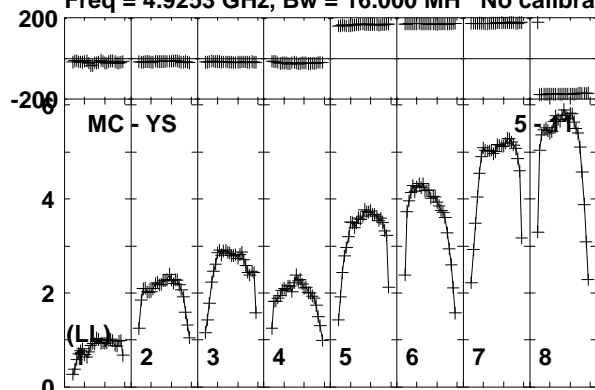

Lower frame: Milli Ampl Jy Top frame: Phas deg
Vector averaged cross-power spectrum Baseline: MC (05) - YS (11)
Timerange: 00/22:54:21 to 00/22:56:13

Plot file version 236 created 11-APR-2016 17:08:54

J1128+5925 GP053G 3.UVDATA.1

Freq = 4.9253 GHz, Bw = 16.000 MH No calibration applied and no bandpass applied

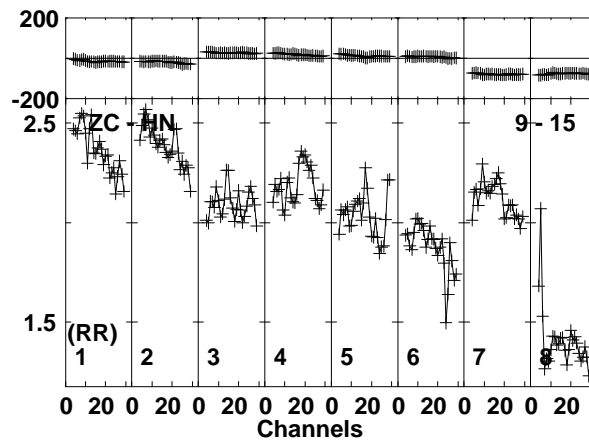
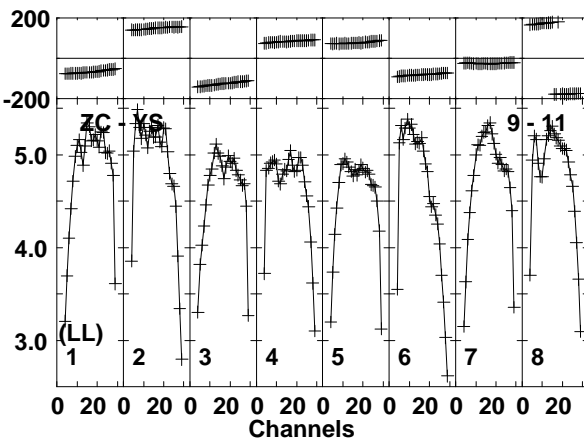
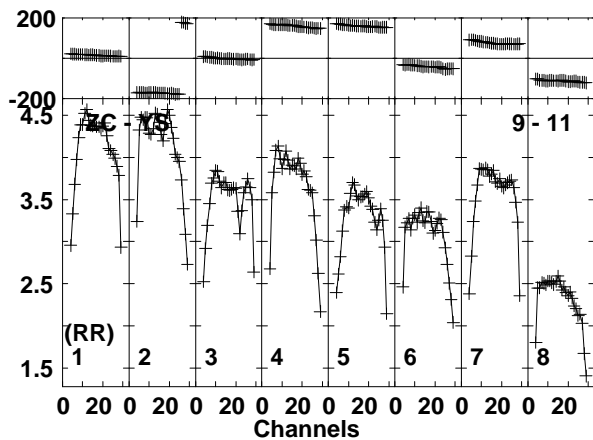
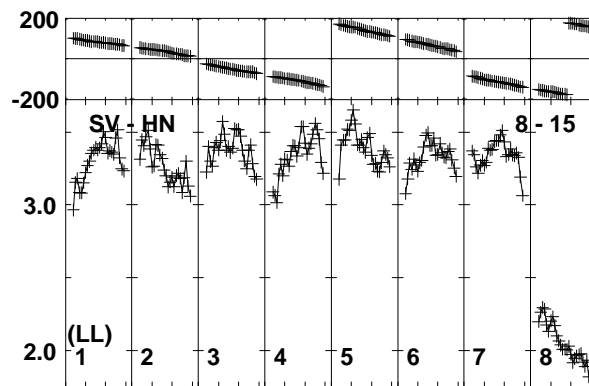
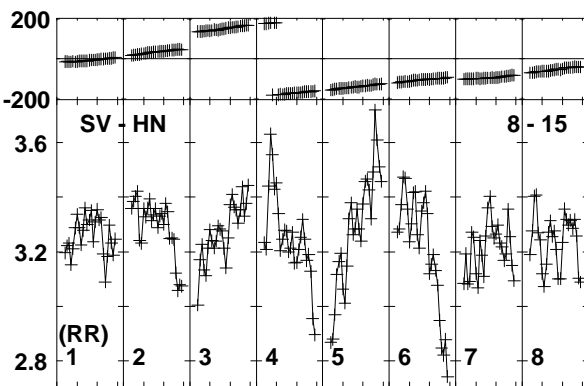
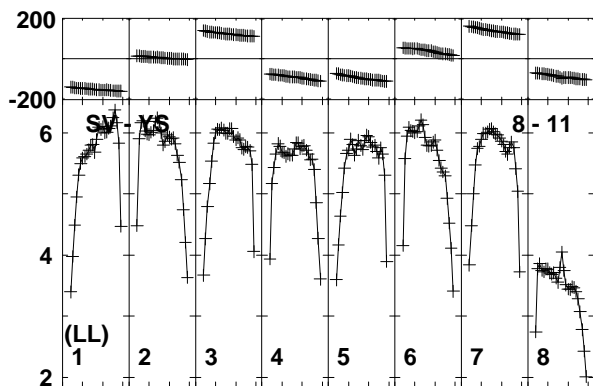
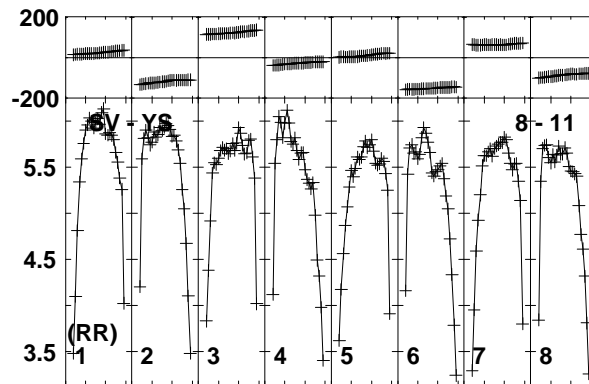
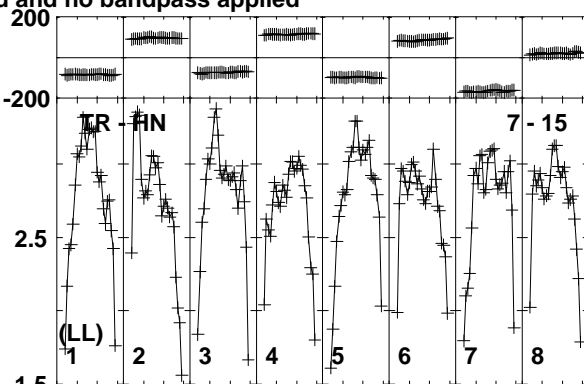
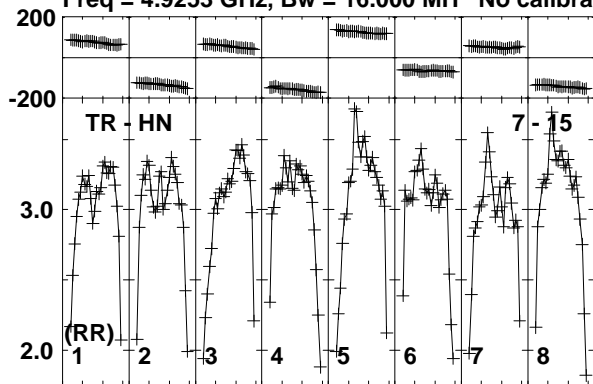

Lower frame: Milli Ampl Jy Top frame: Phas deg
Vector averaged cross-power spectrum Baseline: TR (07) - HN (15)
Timerange: 00/22:54:21 to 00/22:56:13

Plot file version 237 created 11-APR-2016 17:08:54

J1128+5925 GP053G 3.UVDATA.1

Freq = 4.9253 GHz, Bw = 16.000 MH No calibration applied and no bandpass applied

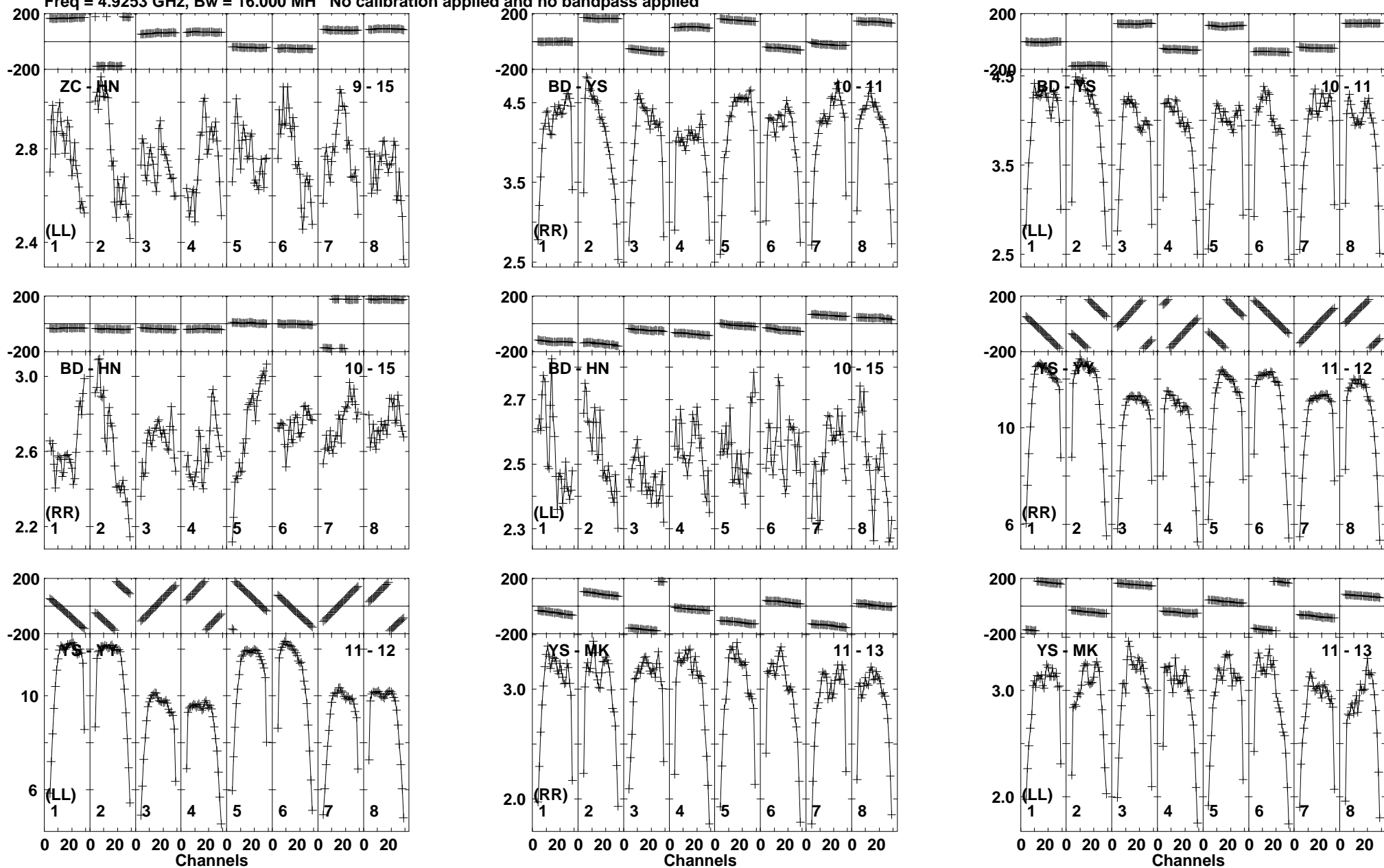

Lower frame: Milli Ampl Jy Top frame: Phas deg
Vector averaged cross-power spectrum Baseline: ZC (09) - HN (15)
Timerange: 00/22:54:21 to 00/22:56:13

Plot file version 238 created 11-APR-2016 17:08:54

J1128+5925 GP053G 3.UVDATA.1

Freq = 4.9253 GHz, Bw = 16.000 MH No calibration applied and no bandpass applied

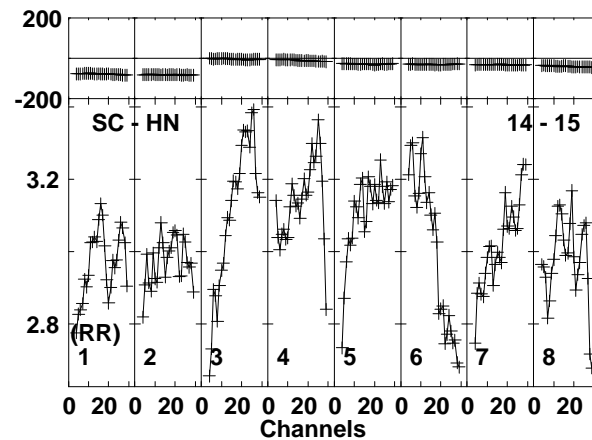
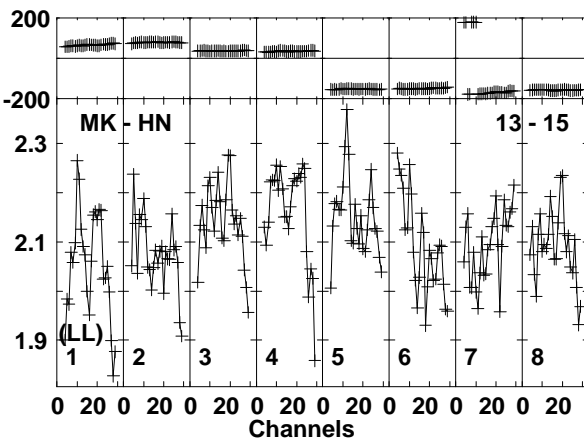
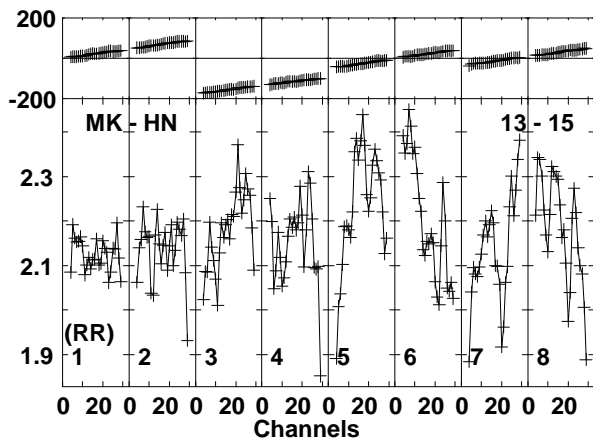
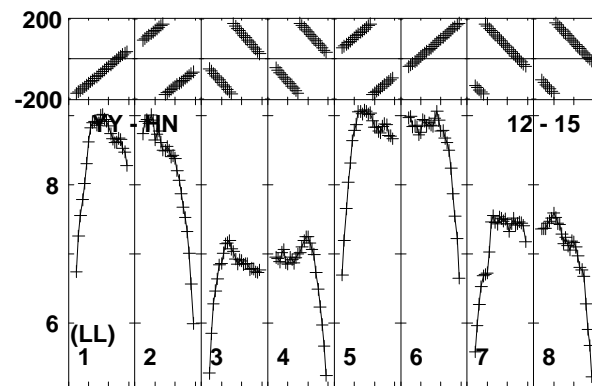
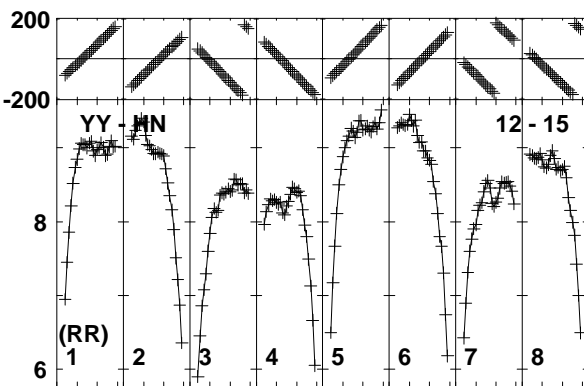
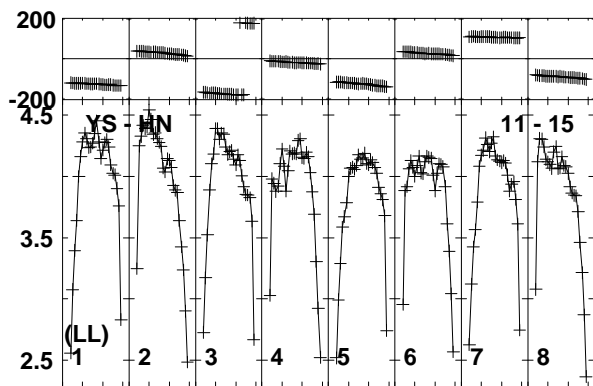
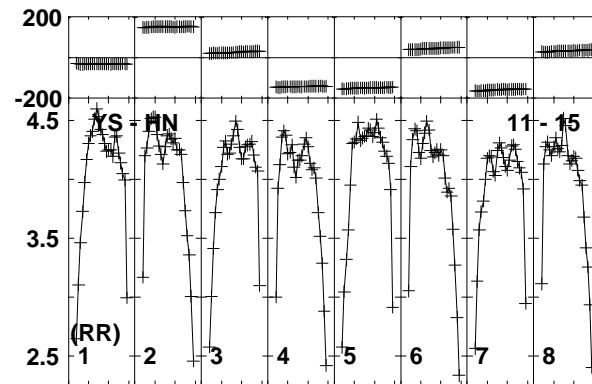
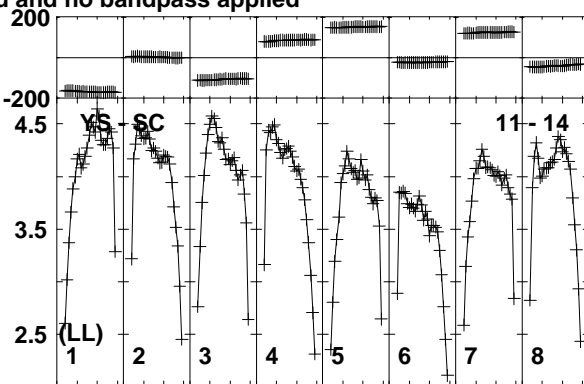
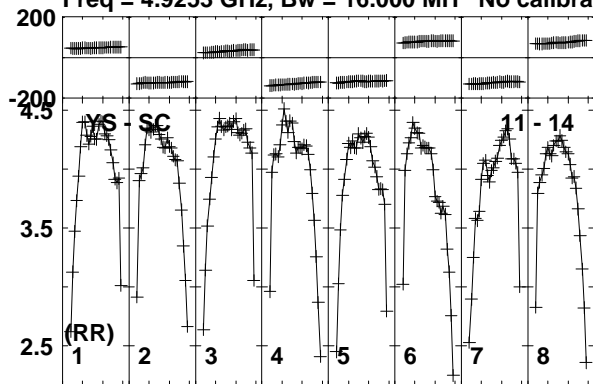

Lower frame: Milli Ampl Jy Top frame: Phas deg
Vector averaged cross-power spectrum Baseline: YS (11) - SC (14)
Timerange: 00/22:54:21 to 00/22:56:13

Plot file version 239 created 11-APR-2016 17:08:54
J1128+5925 GP053G 3.UVDATA.1
Freq = 4.9253 GHz, Bw = 16.000 MH No calibration applied and no bandpass applied

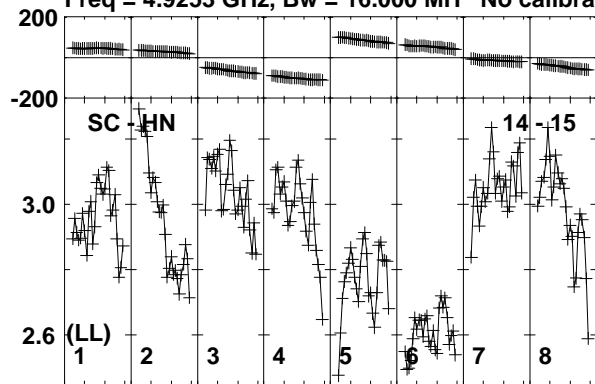

Lower frame: Milli Ampl Jy Top frame: Phas deg
Vector averaged cross-power spectrum Baseline: SC (14) - HN (15)
Timerange: 00/22:54:21 to 00/22:56:13

Plot file version 240 created 11-APR-2016 17:08:54

ARP299C GP053G 3.UVDATA.1

Freq = 4.9253 GHz, Bw = 16.000 MH No calibration applied and no bandpass applied

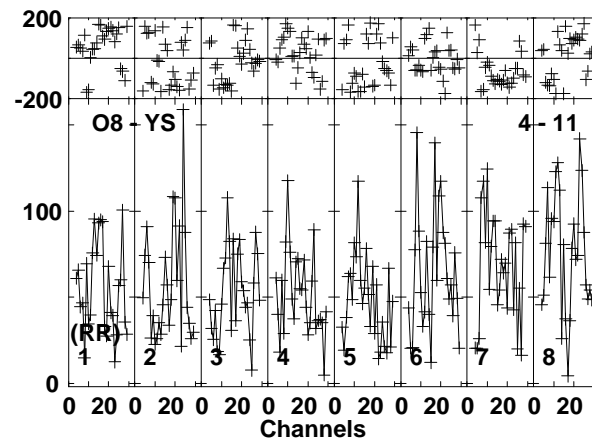
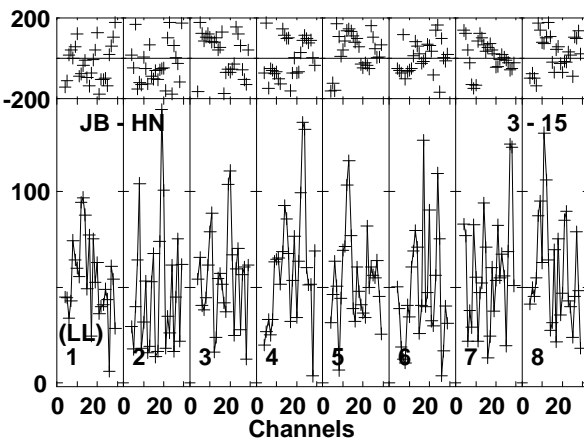
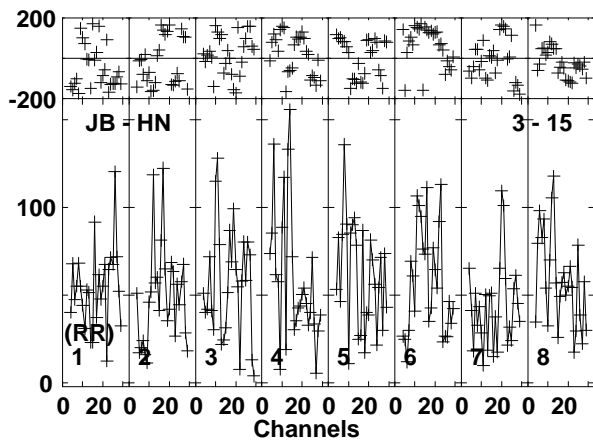
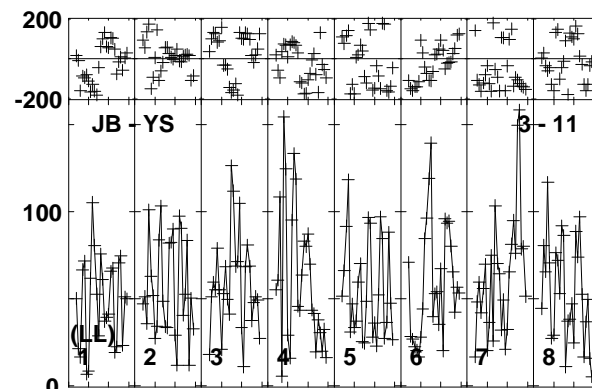
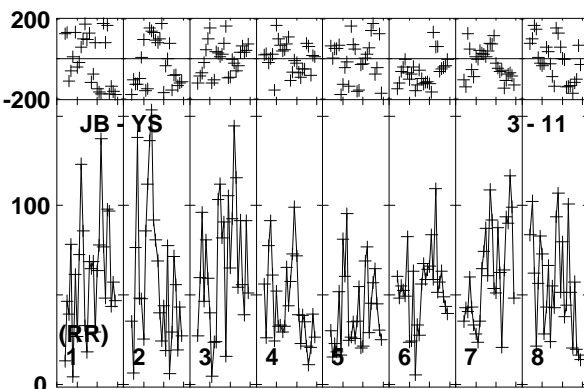
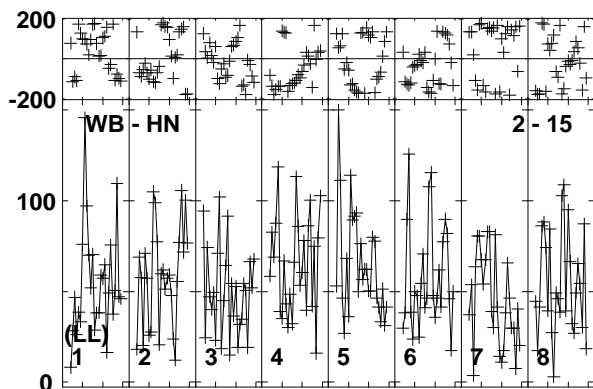
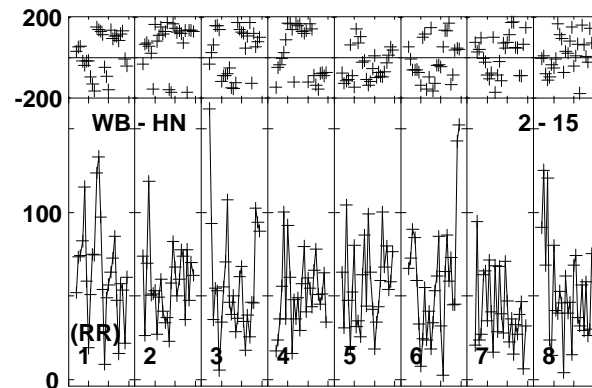
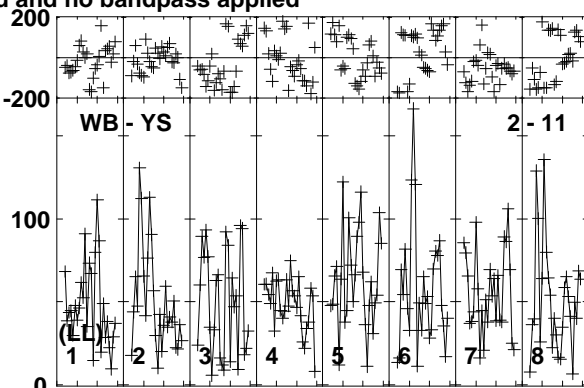
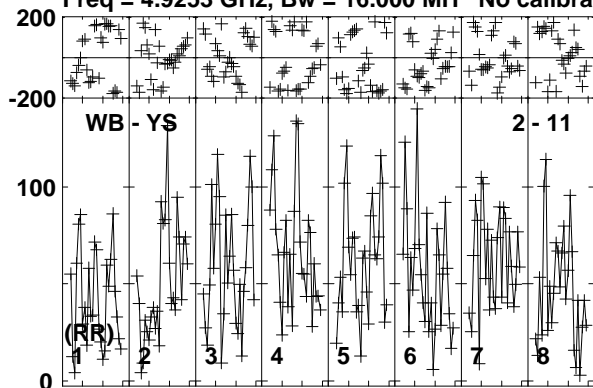

Lower frame: Micro Ampl Jy Top frame: Phas deg
Vector averaged cross-power spectrum Baseline: WB (02) - YS (11)
Timerange: 00/22:56:18 to 00/23:01:32

Plot file version 241 created 11-APR-2016 17:08:55

ARP299C GP053G 3.UVDATA.1

Freq = 4.9253 GHz, Bw = 16.000 MH No calibration applied and no bandpass applied

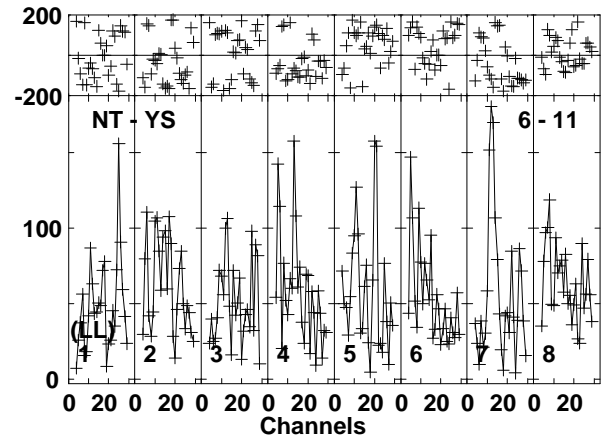
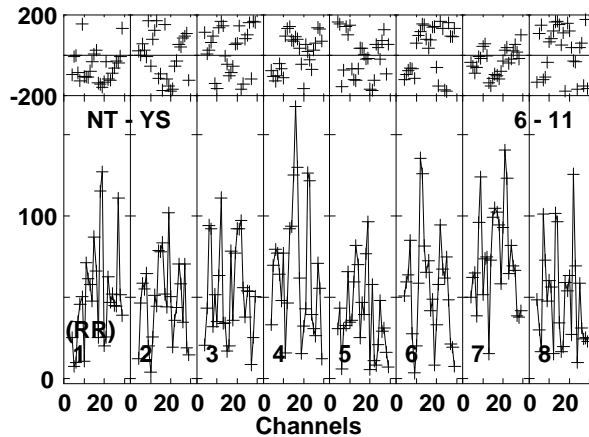
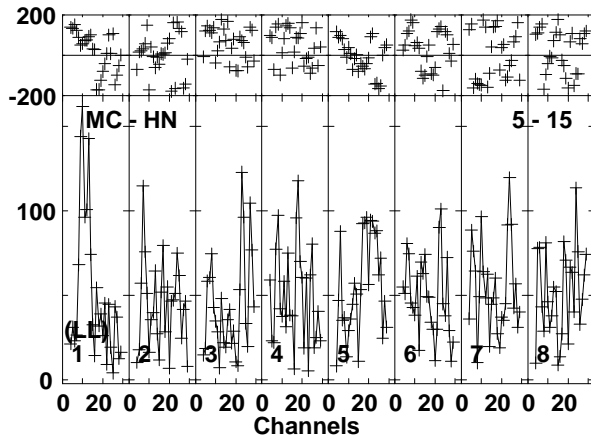
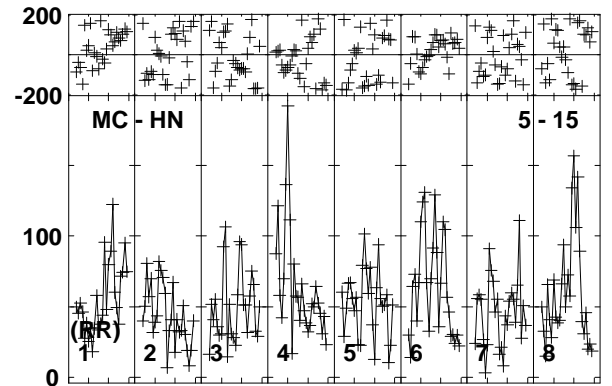
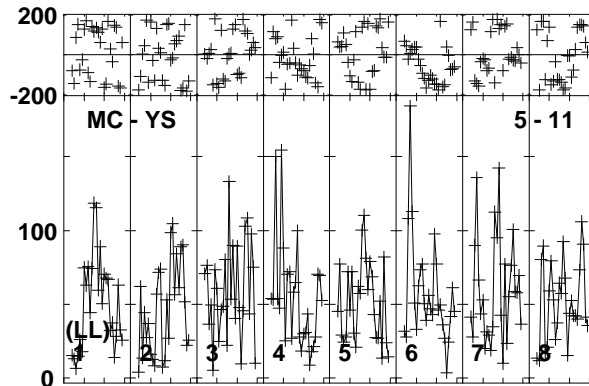
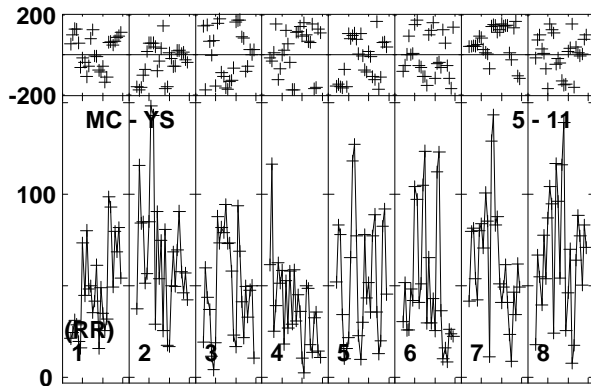
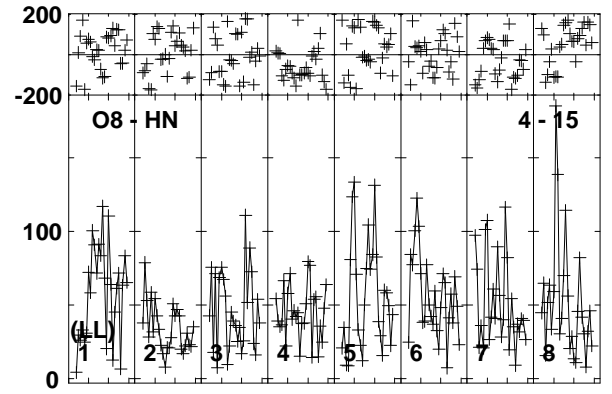
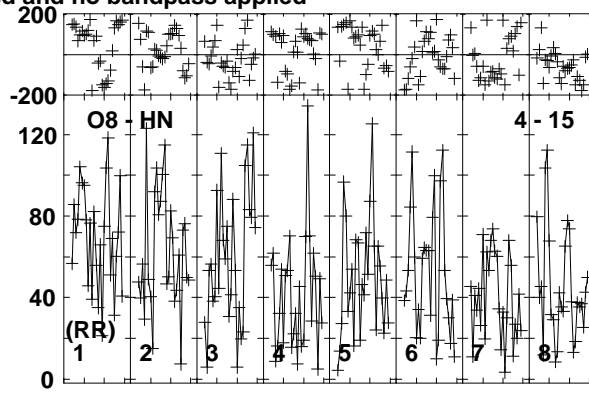
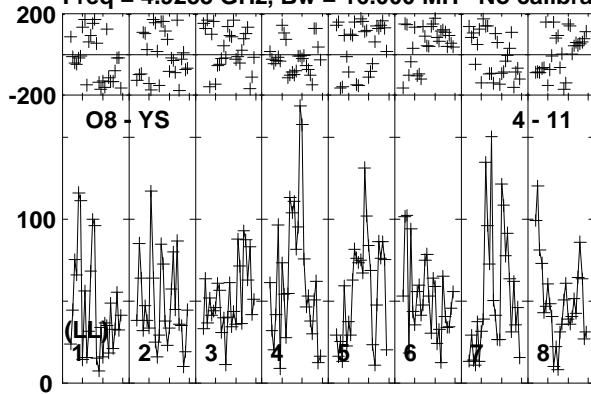

Lower frame: Micro Ampl Jy Top frame: Phas deg
Vector averaged cross-power spectrum Baseline: O8 (04) - YS (11)
Timerange: 00/22:56:18 to 00/23:01:32

Plot file version 242 created 11-APR-2016 17:08:55

ARP299C GP053G 3.UVDATA.1

Freq = 4.9253 GHz, Bw = 16.000 MH No calibration applied and no bandpass applied

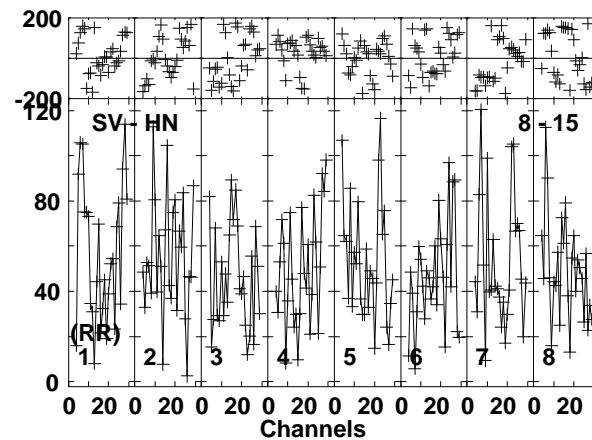
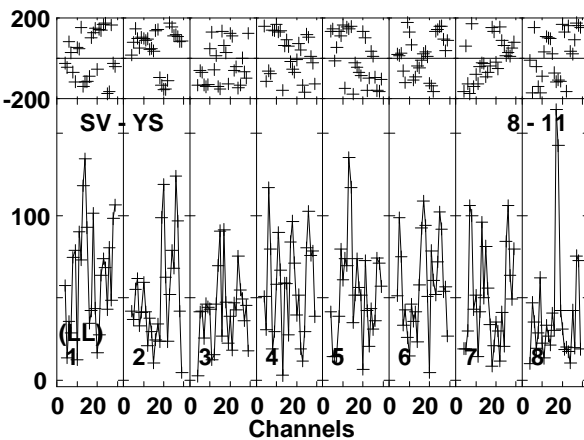
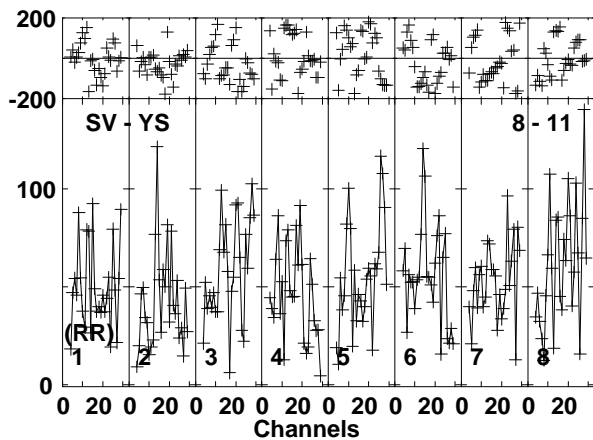
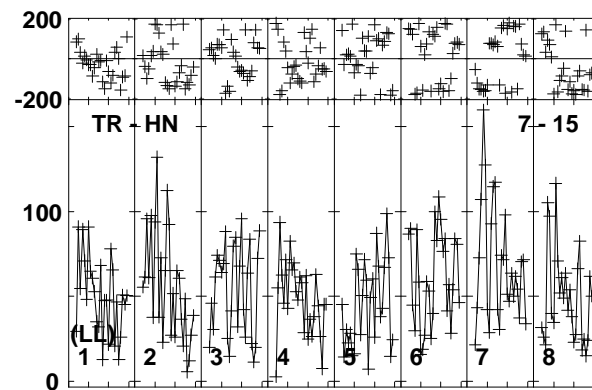
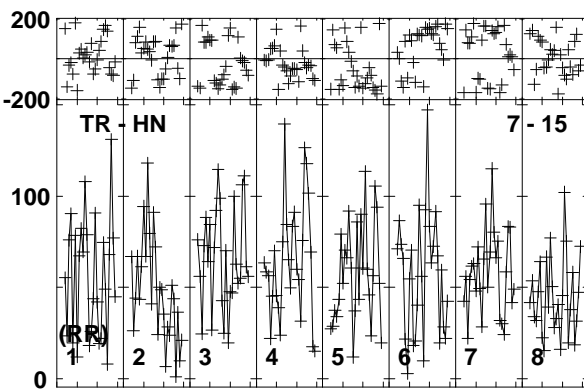
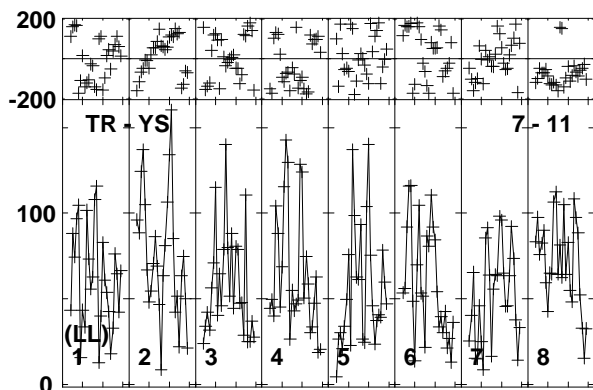
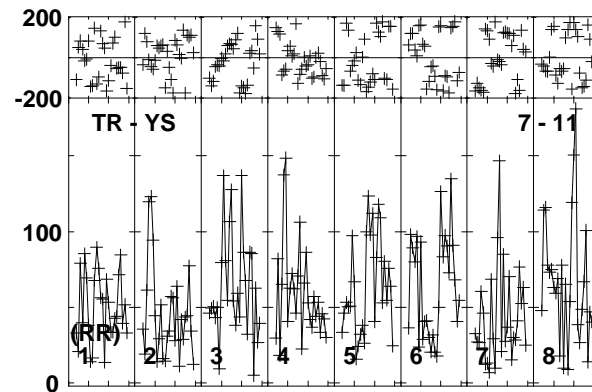
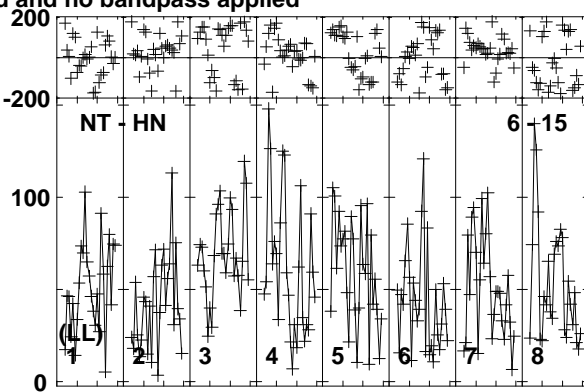
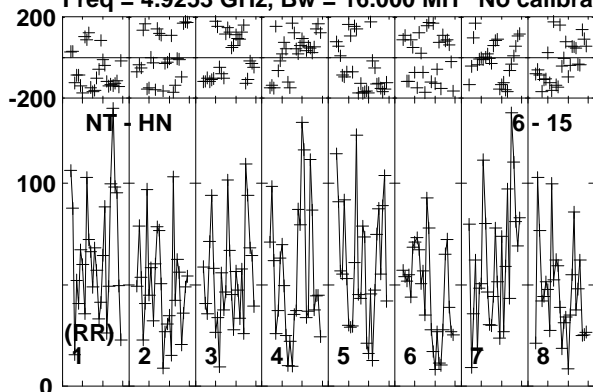

Lower frame: Micro Ampl Jy Top frame: Phas deg
Vector averaged cross-power spectrum Baseline: NT (06) - HN (15)
Timerange: 00/22:56:18 to 00/23:01:32

Plot file version 243 created 11-APR-2016 17:08:55

ARP299C GP053G 3.UVDATA.1

Freq = 4.9253 GHz, Bw = 16.000 MH No calibration applied and no bandpass applied

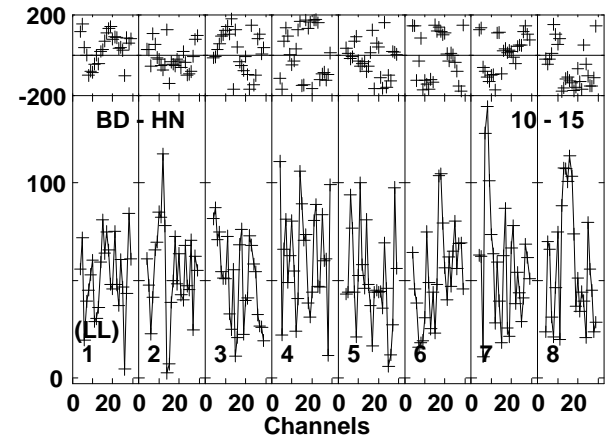
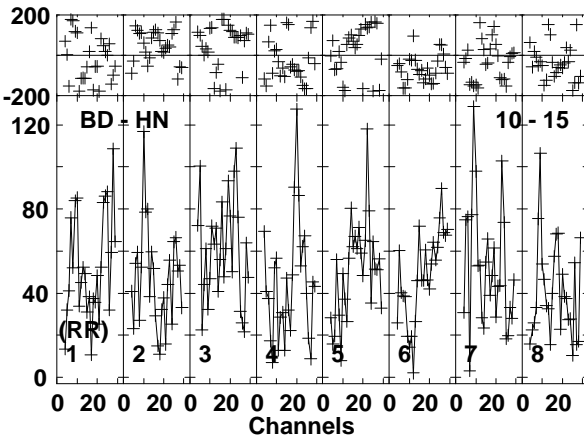
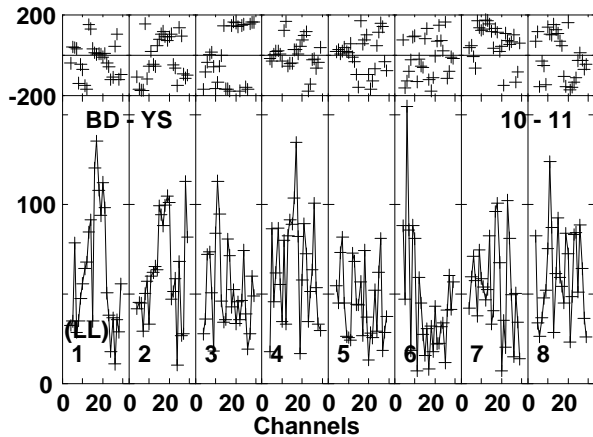
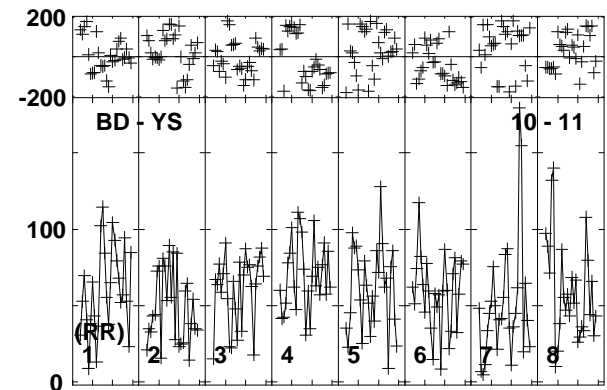
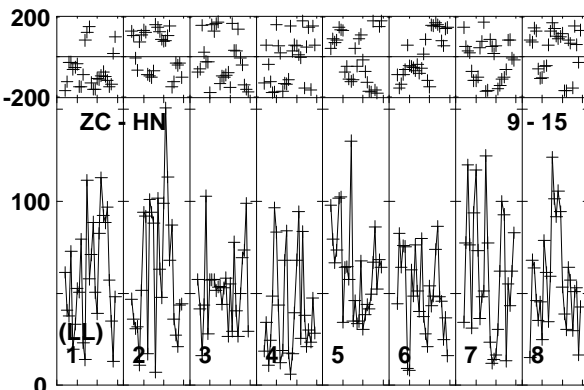
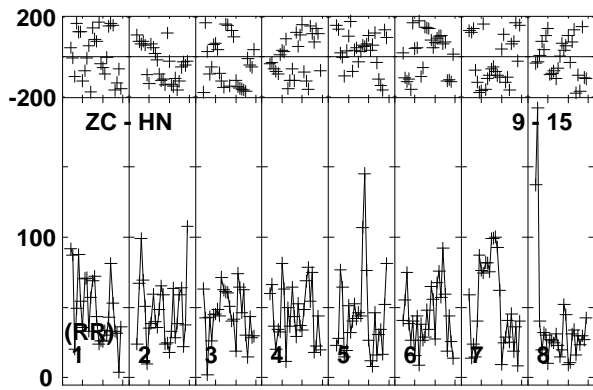
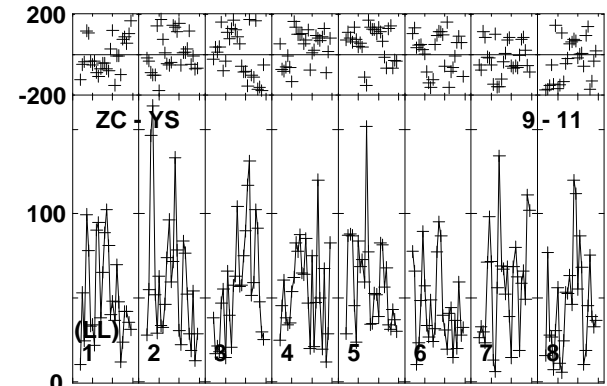
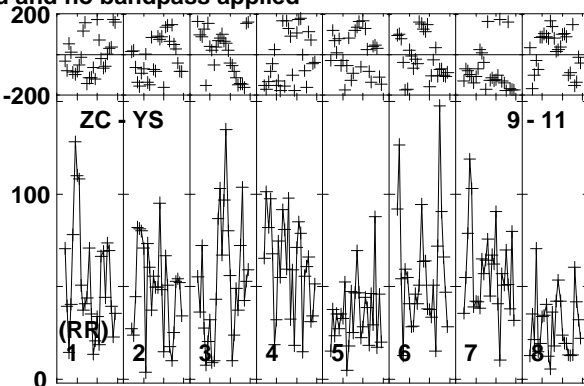
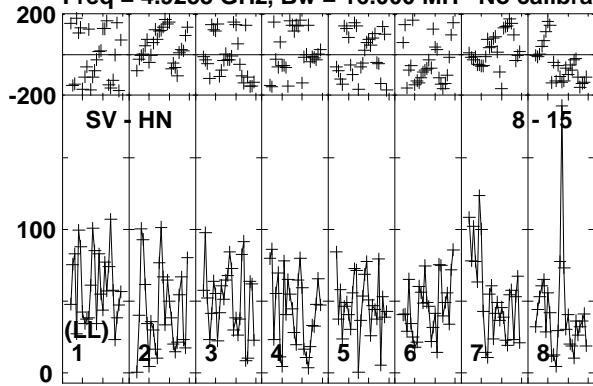

Lower frame: Micro Ampl Jy Top frame: Phas deg
Vector averaged cross-power spectrum Baseline: SV (08) - HN (15)
Timerange: 00/22:56:18 to 00/23:01:32

Plot file version 244 created 11-APR-2016 17:08:55

ARP299C GP053G 3.UVDATA.1

Freq = 4.9253 GHz, Bw = 16.000 MH No calibration applied and no bandpass applied

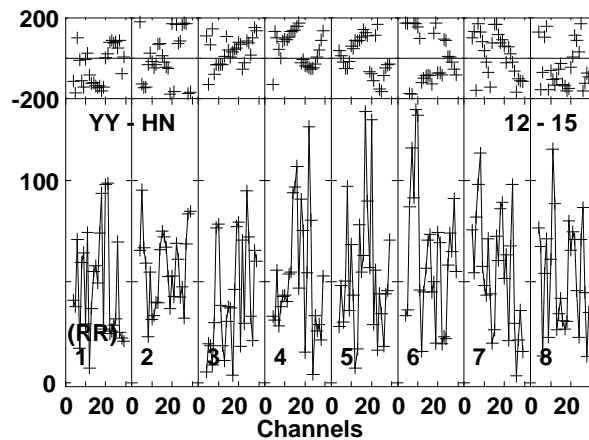
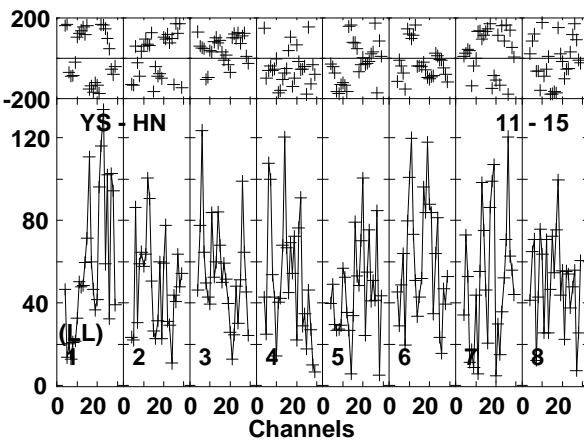
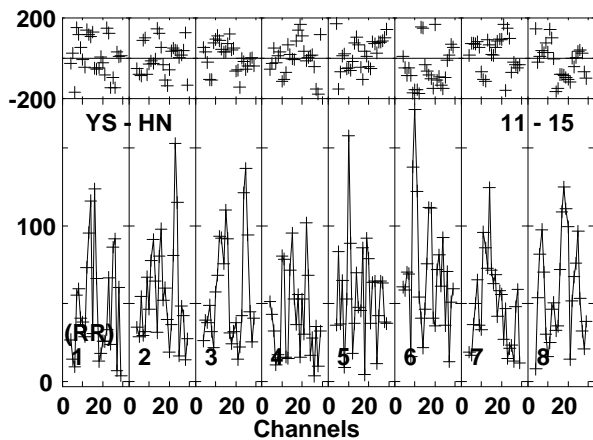
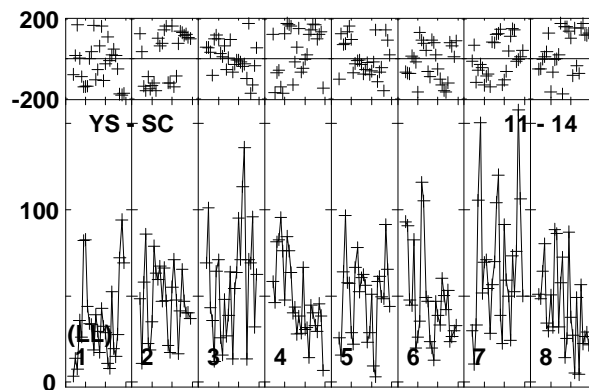
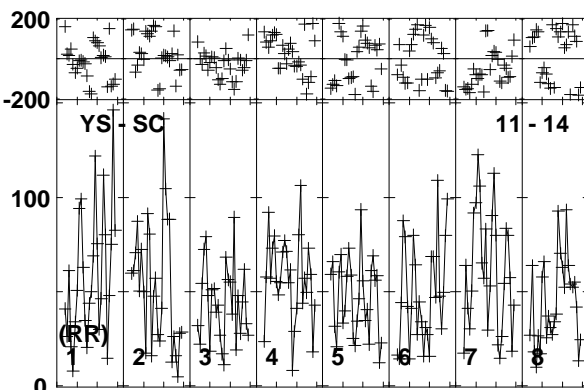
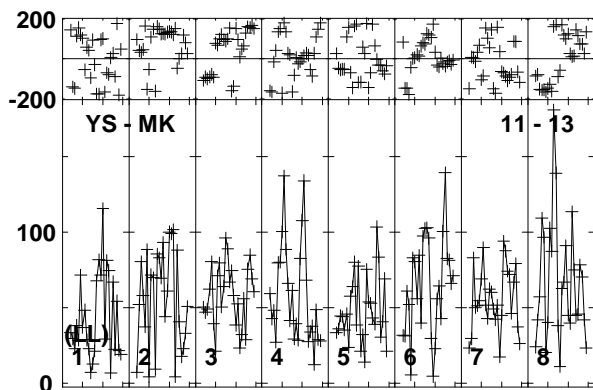
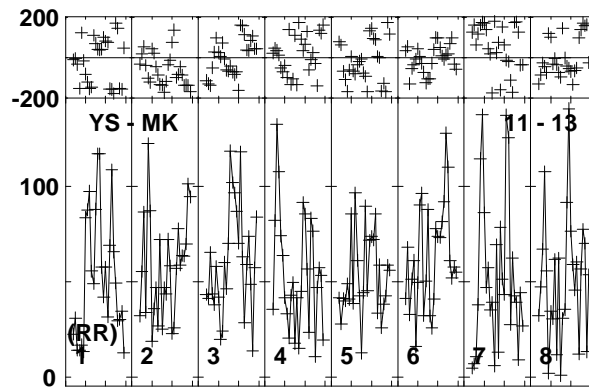
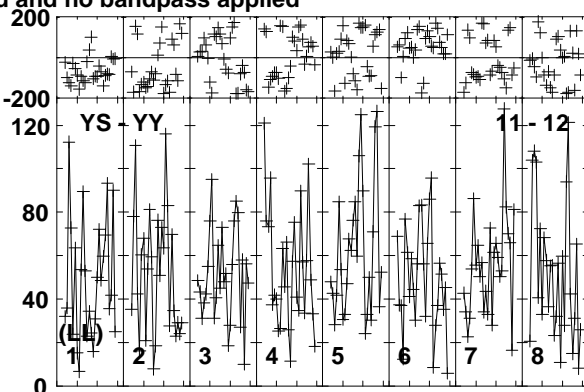
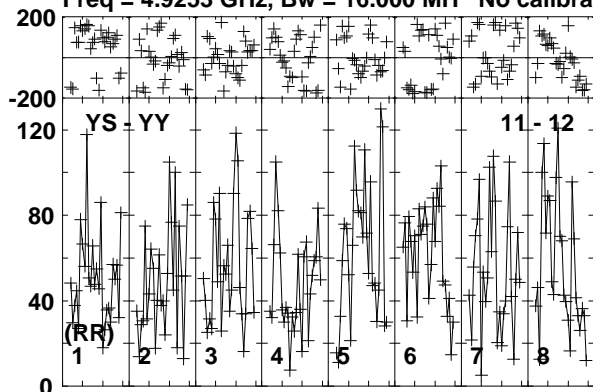

Lower frame: Micro Ampl Jy Top frame: Phas deg
Vector averaged cross-power spectrum Baseline: YS (11) - YY (12)
Timerange: 00/22:56:18 to 00/23:01:32

Plot file version 245 created 11-APR-2016 17:08:55

ARP299C GP053G 3.UVDATA.1

Freq = 4.9253 GHz, Bw = 16.000 MH No calibration applied and no bandpass applied

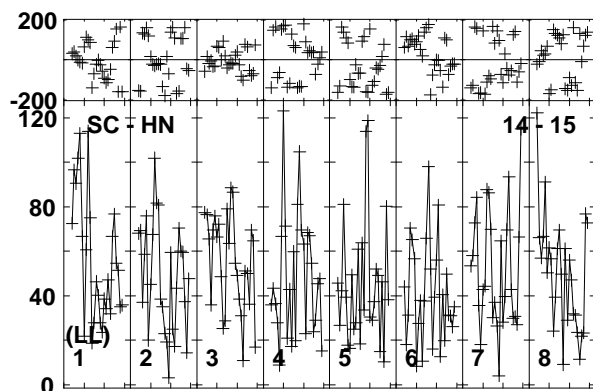
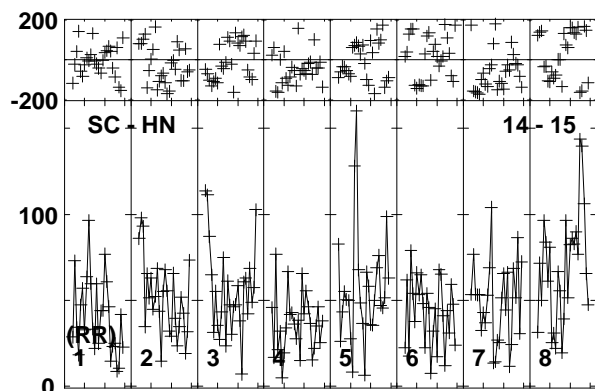
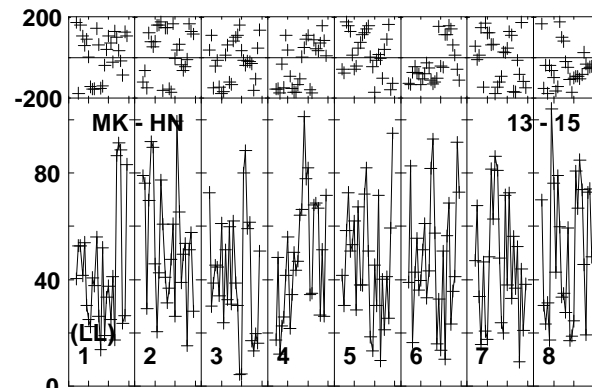
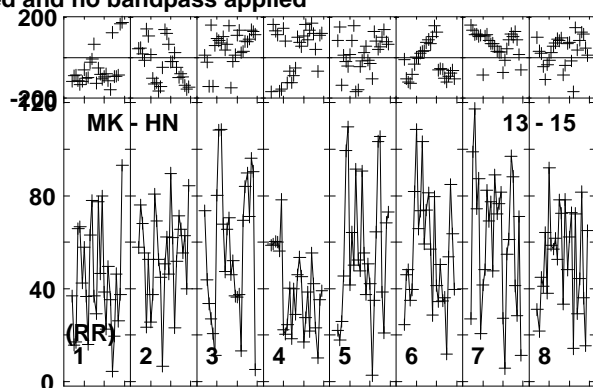
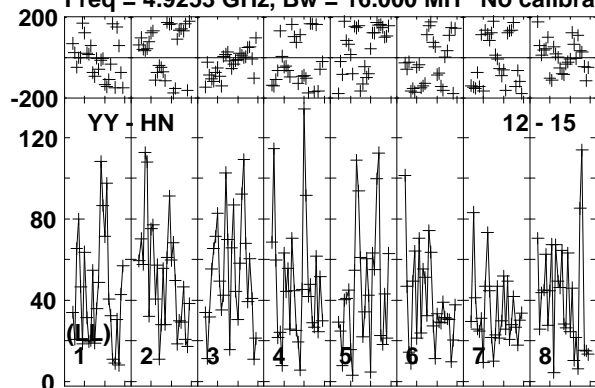

Lower frame: Micro Ampl Jy Top frame: Phas deg
Vector averaged cross-power spectrum Baseline: YY (12) - HN (15)
Timerange: 00/22:56:18 to 00/23:01:32

Plot file version 246 created 11-APR-2016 17:08:56

J1128+5925 GP053G 3.UVDATA.1

Freq = 4.9253 GHz, Bw = 16.000 MH No calibration applied and no bandpass applied

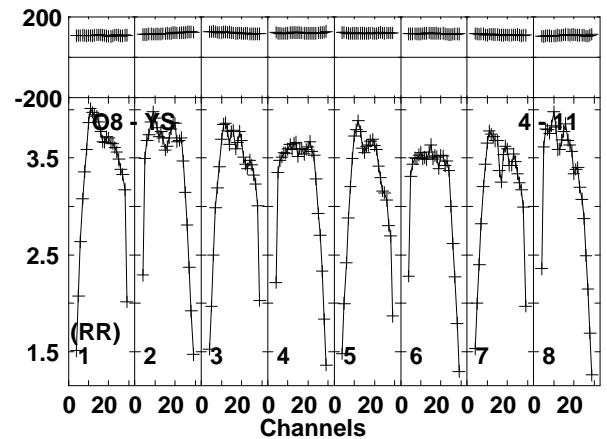
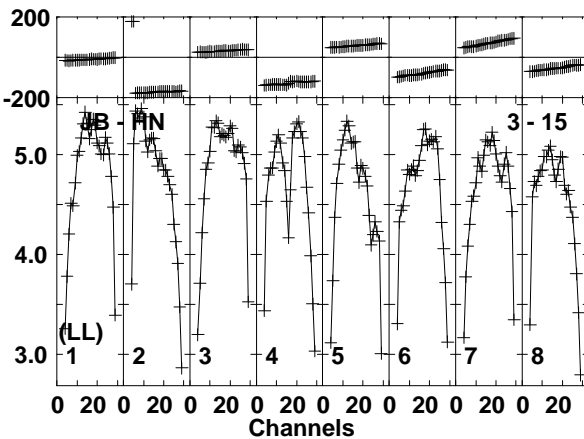
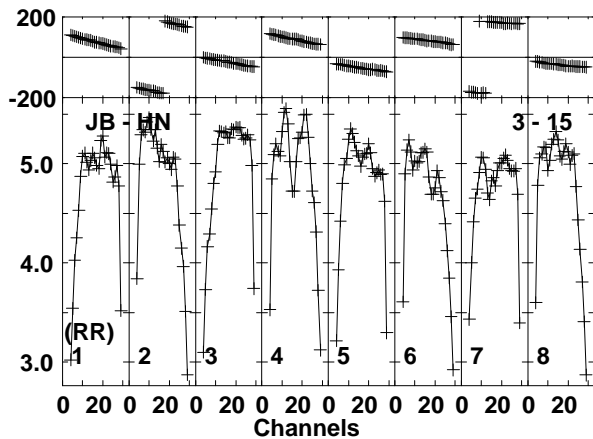
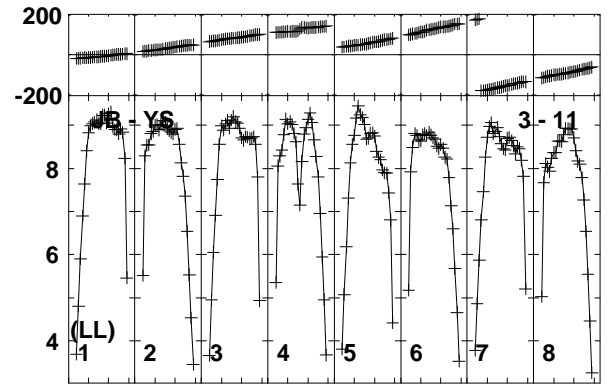
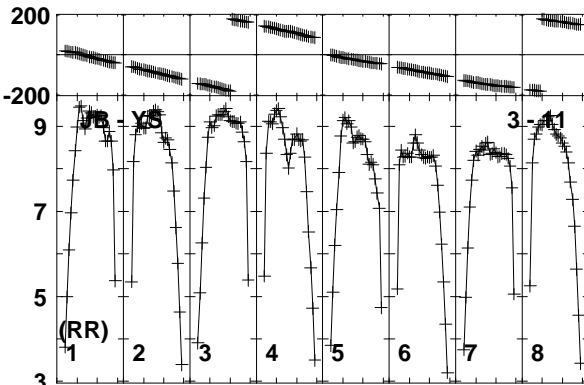
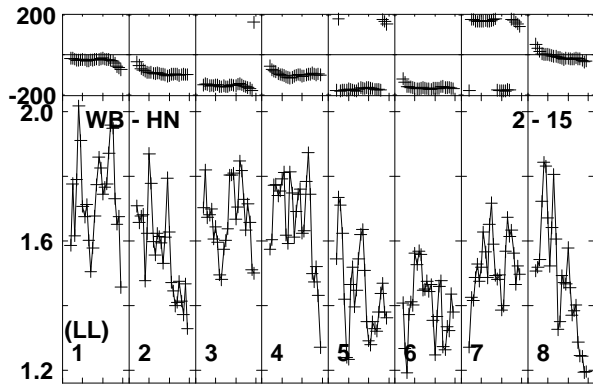
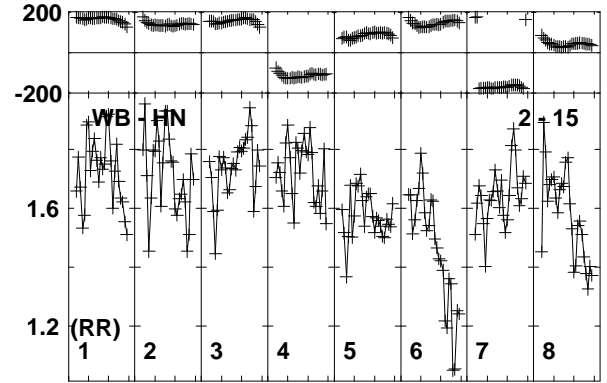
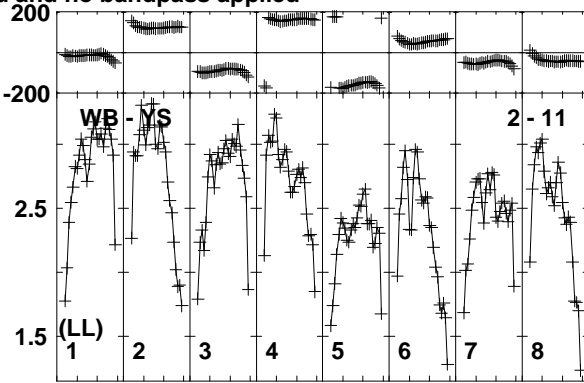
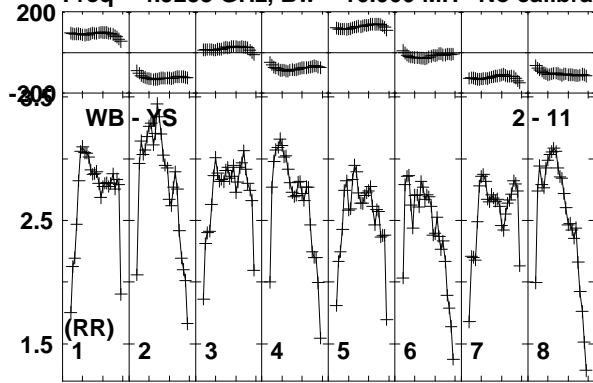

Lower frame: Milli Ampl Jy Top frame: Phas deg

Vector averaged cross-power spectrum Baseline: WB (02) - YS (11)

Timerange: 00/23:01:38 to 00/23:03:22

Plot file version 247 created 11-APR-2016 17:08:56

J1128+5925 GP053G 3.UVDATA.1

Freq = 4.9253 GHz, Bw = 16.000 MH No calibration applied and no bandpass applied

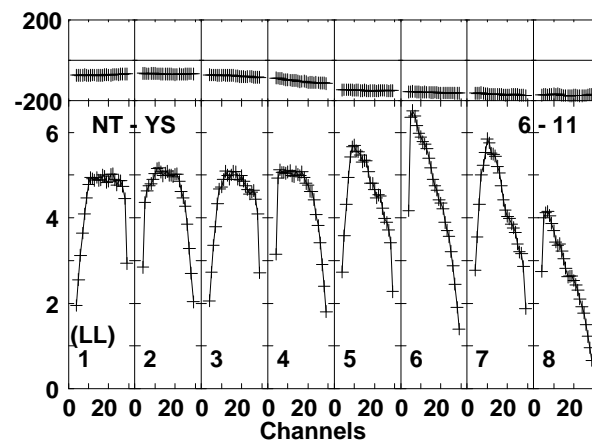
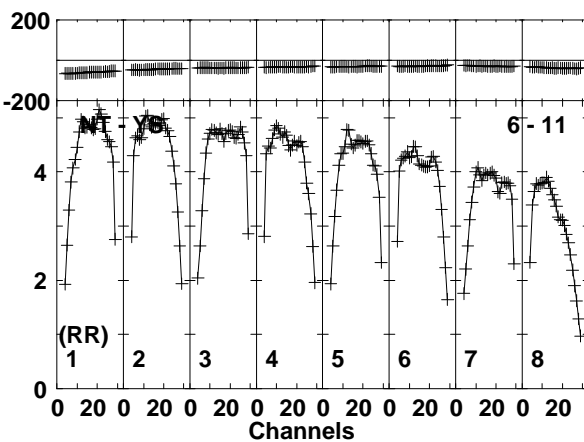
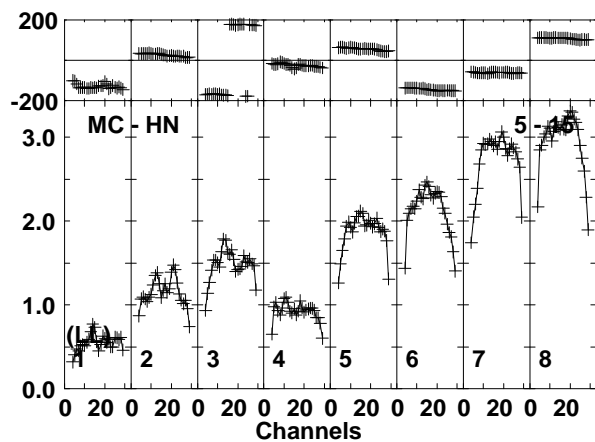
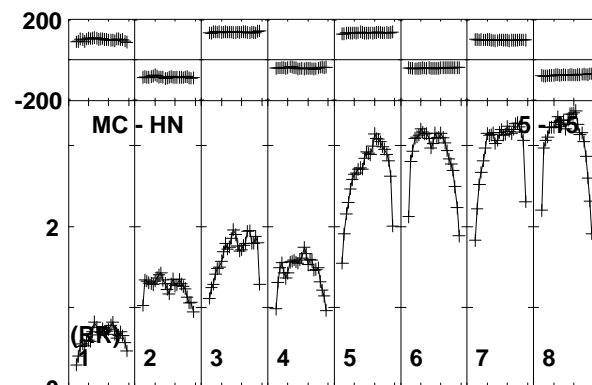
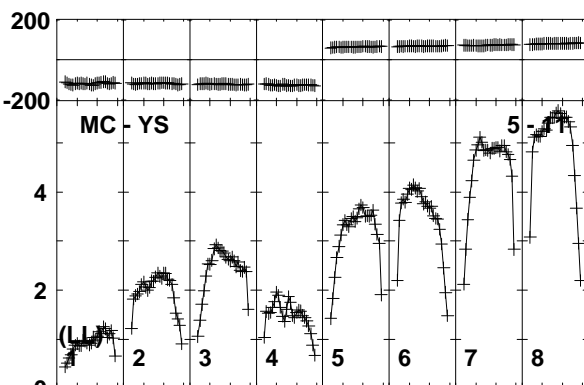
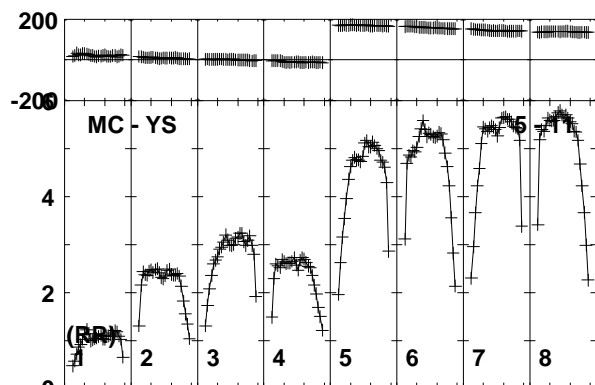
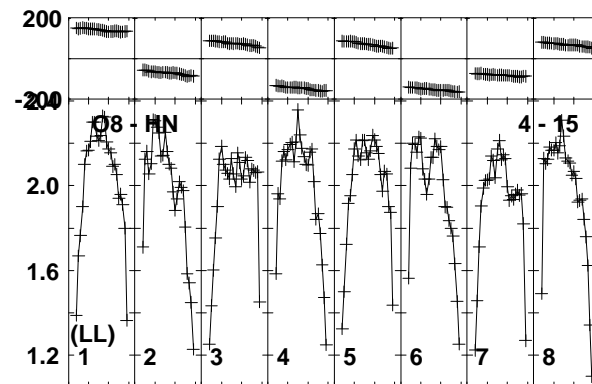
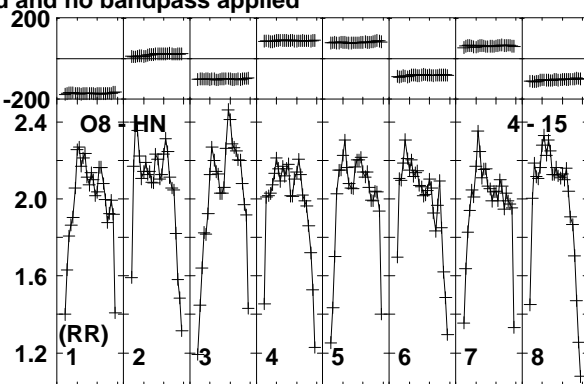
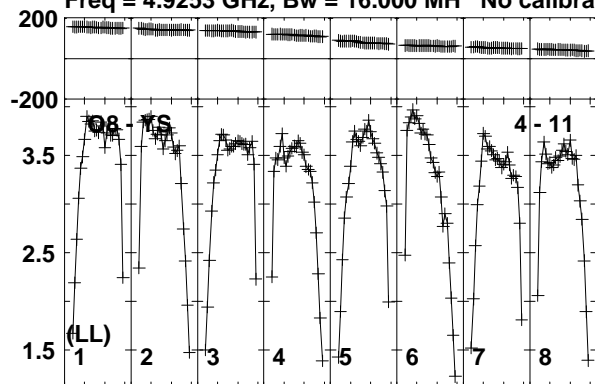

Lower frame: Milli Ampl Jy Top frame: Phas deg
Vector averaged cross-power spectrum Baseline: O8 (04) - YS (11)
Timerange: 00/23:01:38 to 00/23:03:22

Plot file version 248 created 11-APR-2016 17:08:56

J1128+5925 GP053G 3.UVDATA.1

Freq = 4.9253 GHz, Bw = 16.000 MH No calibration applied and no bandpass applied

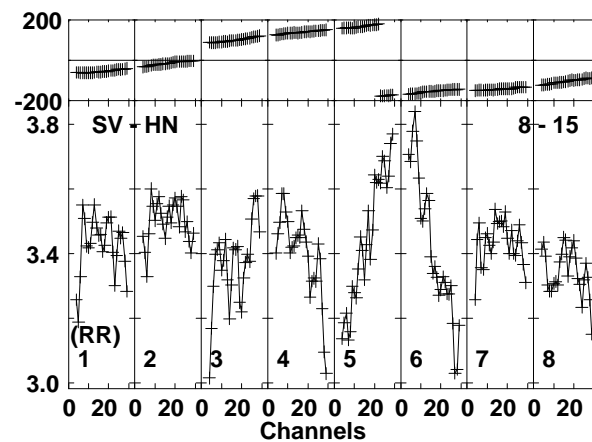
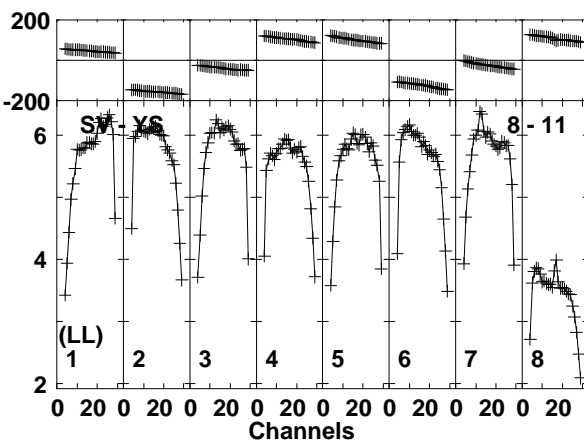
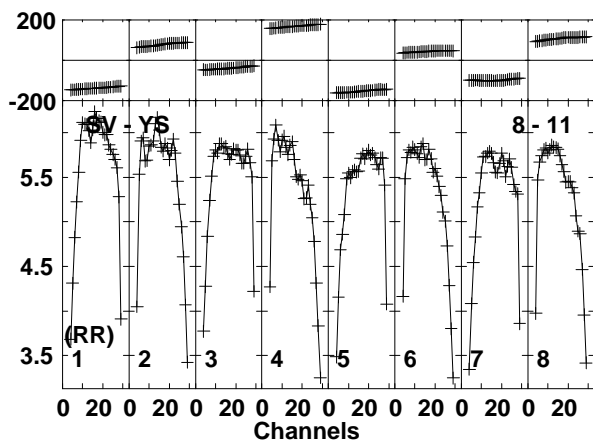
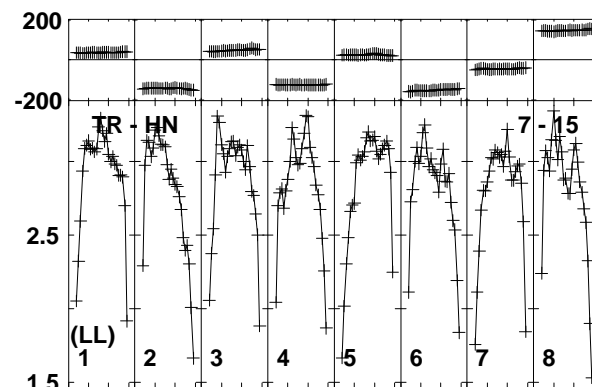
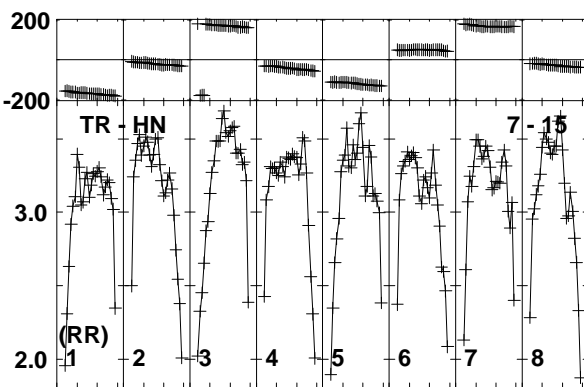
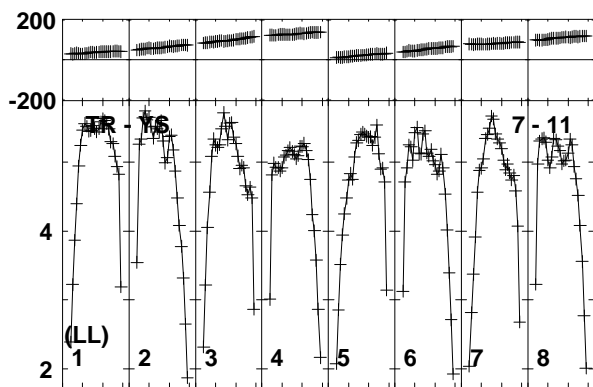
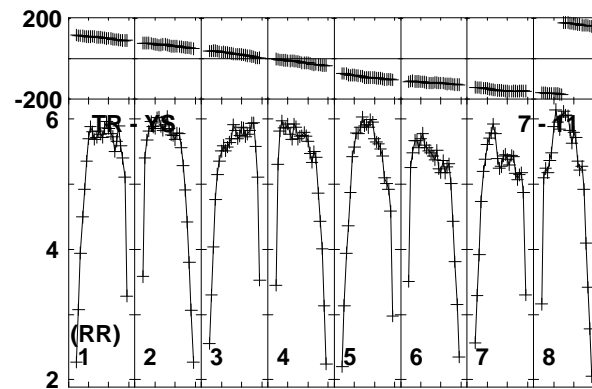
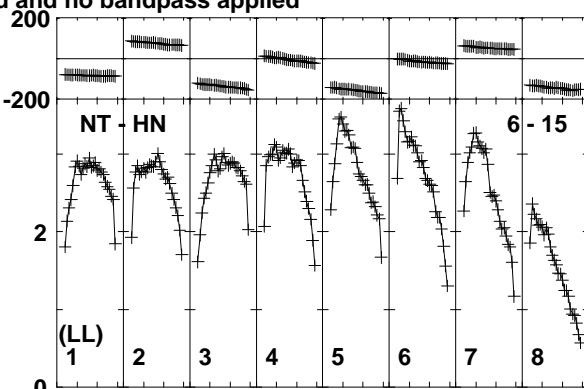
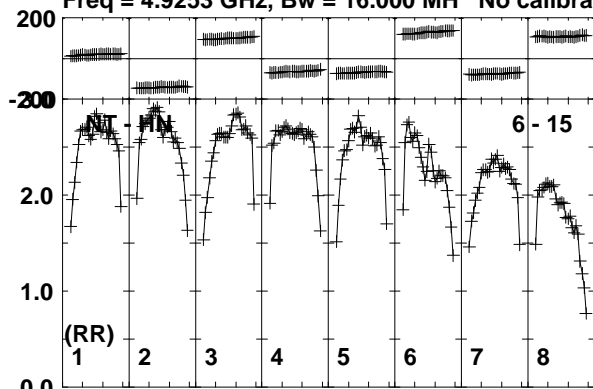

Lower frame: Milli Ampl Jy Top frame: Phas deg
Vector averaged cross-power spectrum Baseline: NT (06) - HN (15)
Timerange: 00/23:01:38 to 00/23:03:22

Plot file version 249 created 11-APR-2016 17:08:56

J1128+5925 GP053G 3.UVDATA.1

Freq = 4.9253 GHz, Bw = 16.000 MH No calibration applied and no bandpass applied

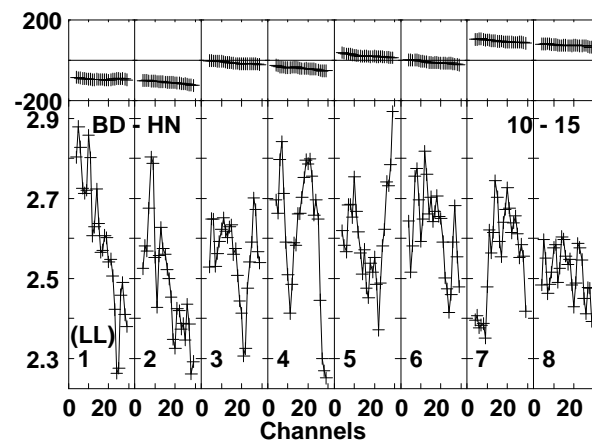
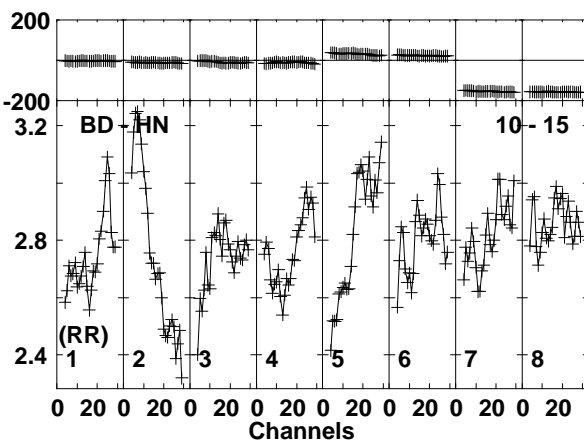
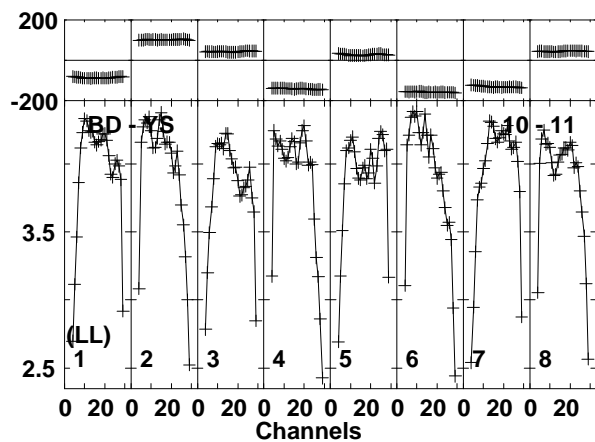
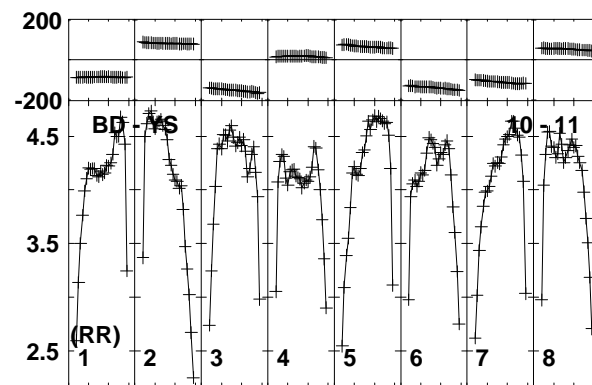
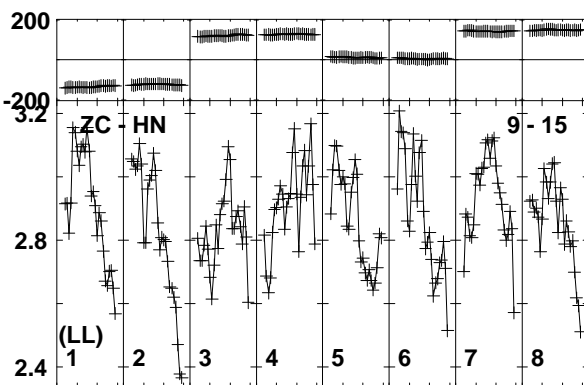
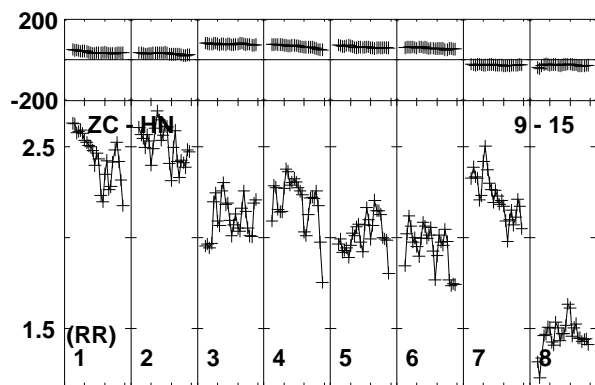
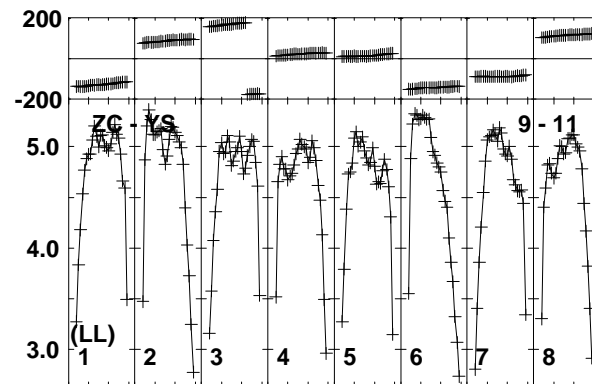
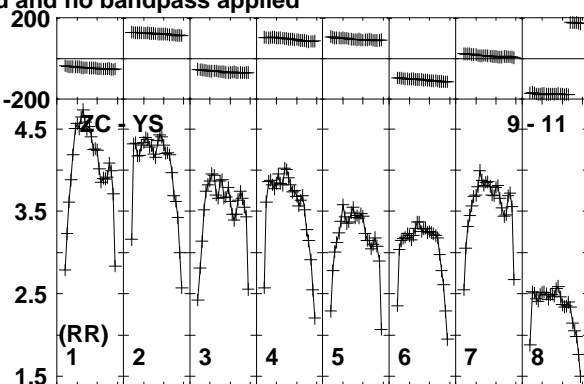
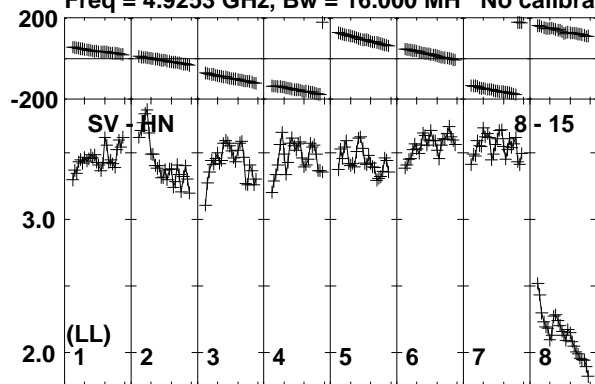

Lower frame: Milli Ampl Jy Top frame: Phas deg
Vector averaged cross-power spectrum Baseline: SV (08) - HN (15)
Timerange: 00/23:01:38 to 00/23:03:22

Plot file version 250 created 11-APR-2016 17:08:56

J1128+5925 GP053G 3.UVDATA.1

Freq = 4.9253 GHz, Bw = 16.000 MH No calibration applied and no bandpass applied

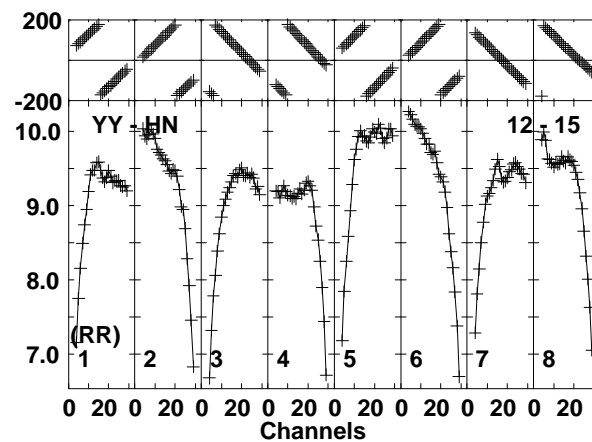
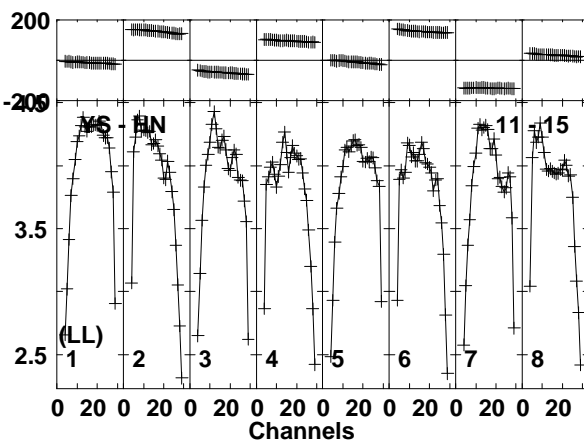
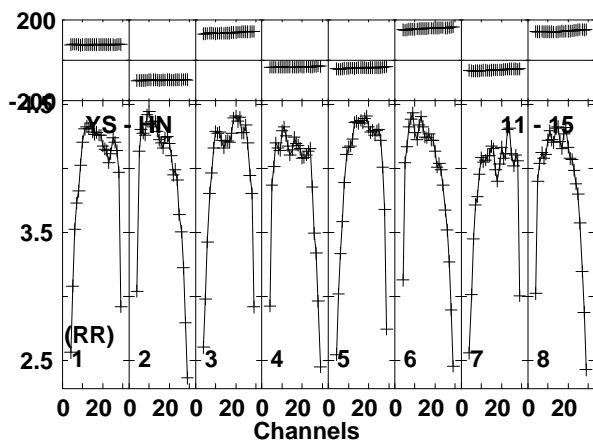
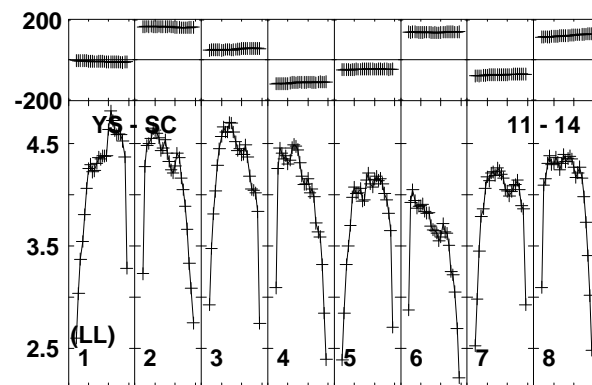
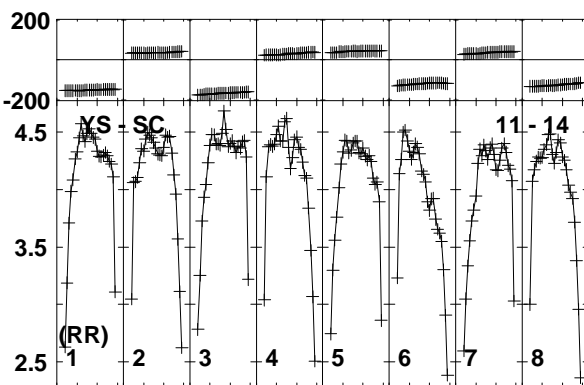
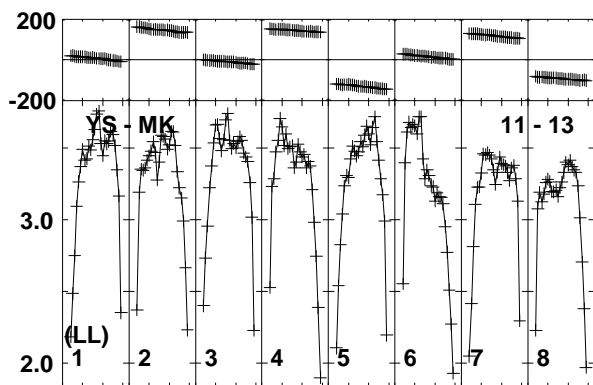
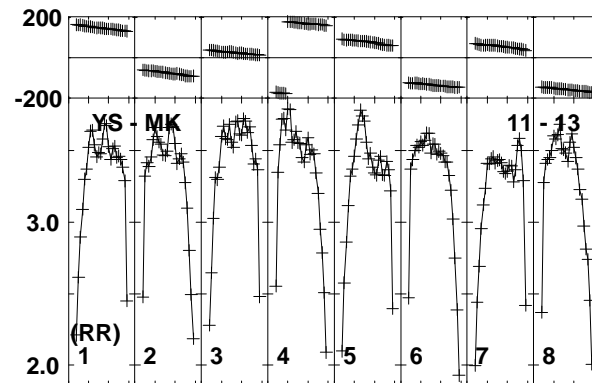
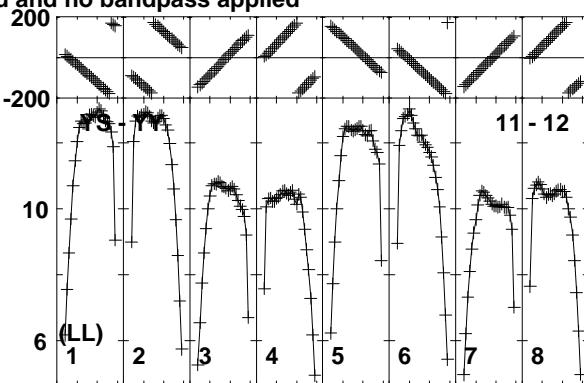
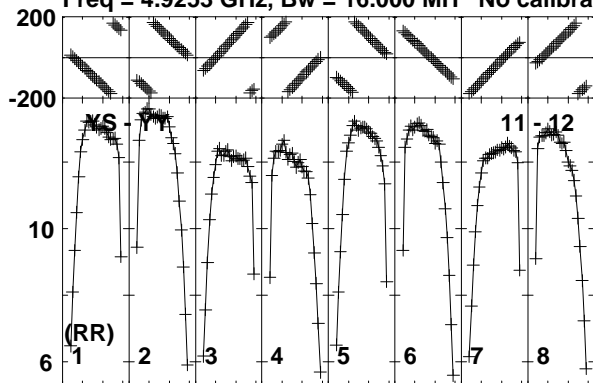

Lower frame: Milli Ampl Jy Top frame: Phas deg
Vector averaged cross-power spectrum Baseline: YS (11) - YY (12)
Timerange: 00/23:01:38 to 00/23:03:22

Plot file version 251 created 11-APR-2016 17:08:56

J1128+5925 GP053G 3.UVDATA.1

Freq = 4.9253 GHz, Bw = 16.000 MH No calibration applied and no bandpass applied

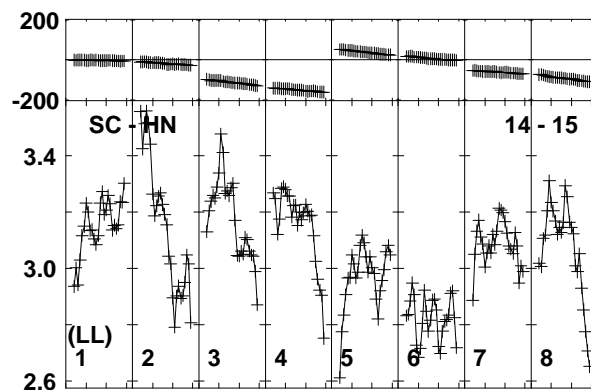
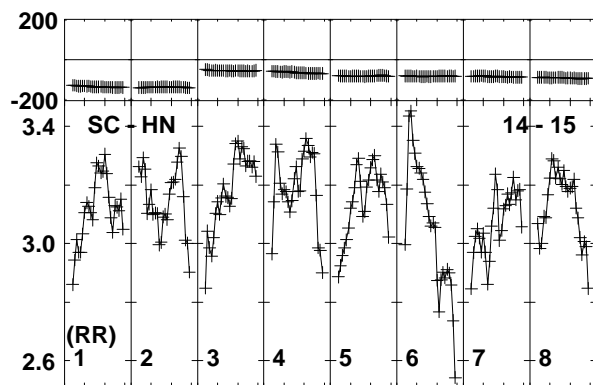
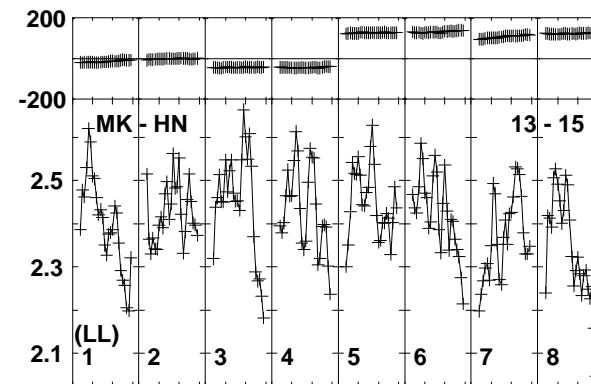
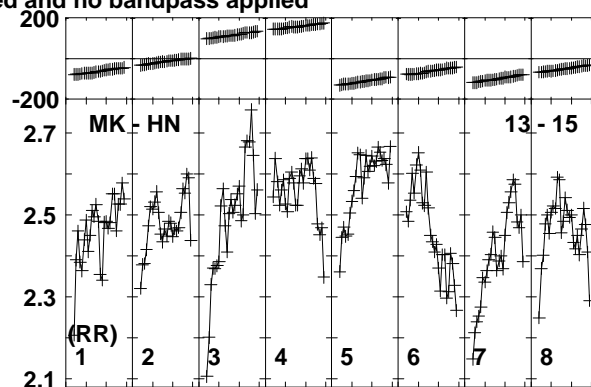
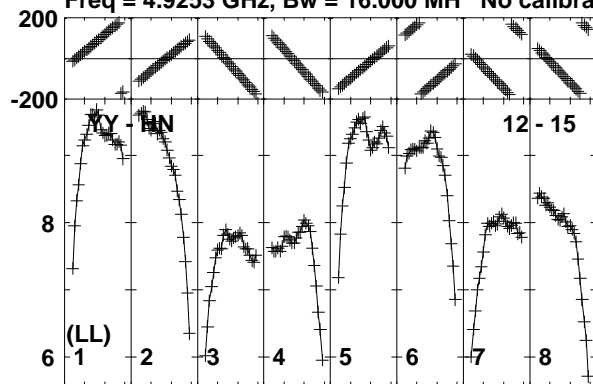

Lower frame: Milli Ampl Jy Top frame: Phas deg
Vector averaged cross-power spectrum Baseline: YY (12) - HN (15)
Timerange: 00/23:01:38 to 00/23:03:22

Plot file version 252 created 11-APR-2016 17:08:57

ARP299C GP053G 3.UVDATA.1

Freq = 4.9253 GHz, Bw = 16.000 MH No calibration applied and no bandpass applied

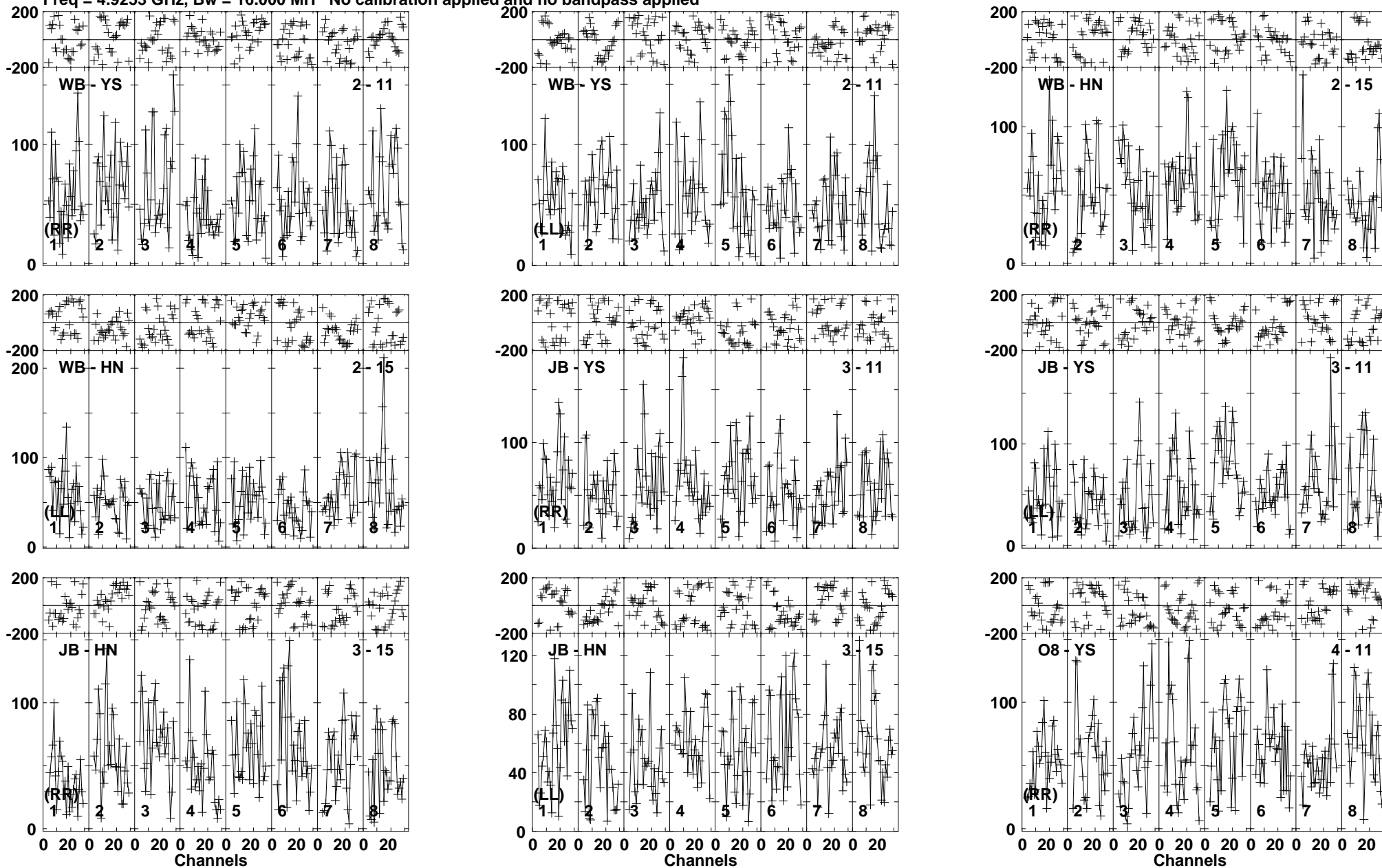

Lower frame: Micro Ampl Jy Top frame: Phas deg
Vector averaged cross-power spectrum Baseline: WB (02) - YS (11)
Timerange: 00/23:03:28 to 00/23:08:40

Plot file version 253 created 11-APR-2016 17:08:57

ARP299C GP053G 3.UVDATA.1

Freq = 4.9253 GHz, Bw = 16.000 MH No calibration applied and no bandpass applied

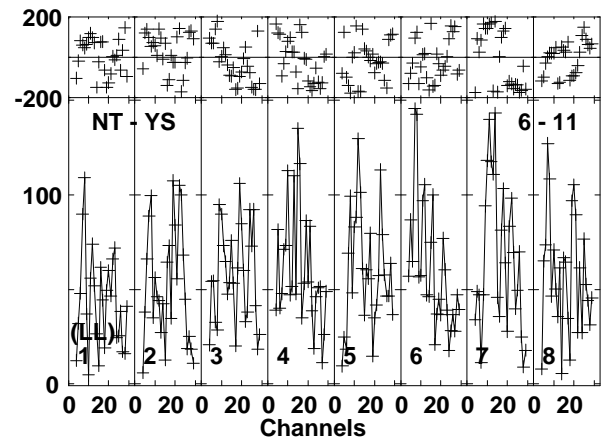
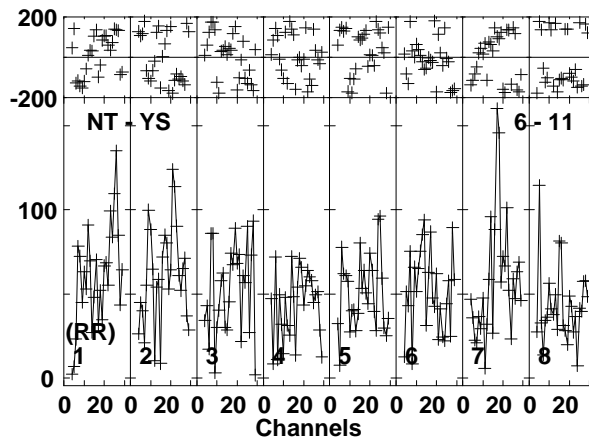
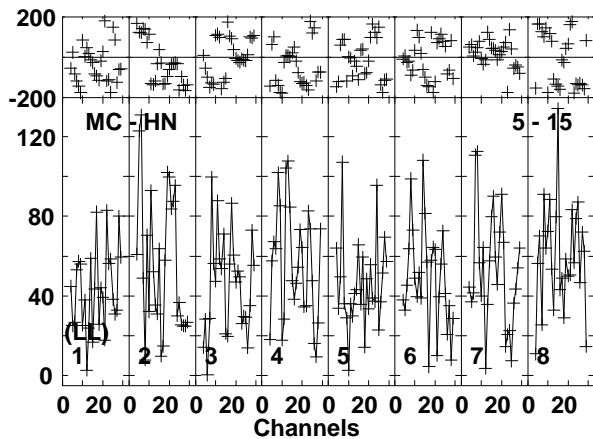
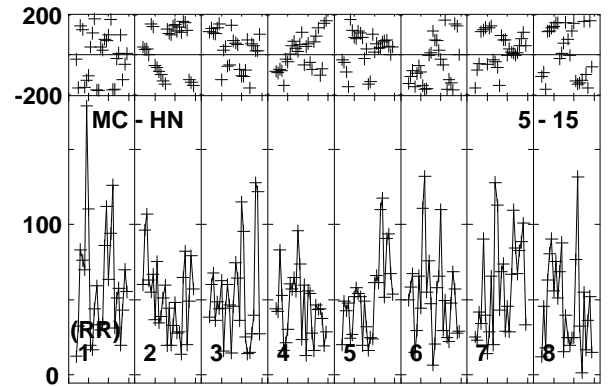
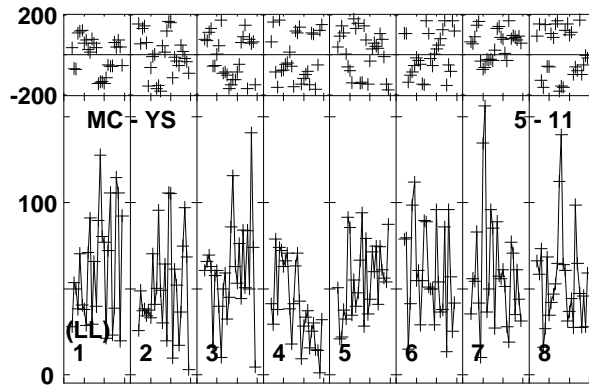
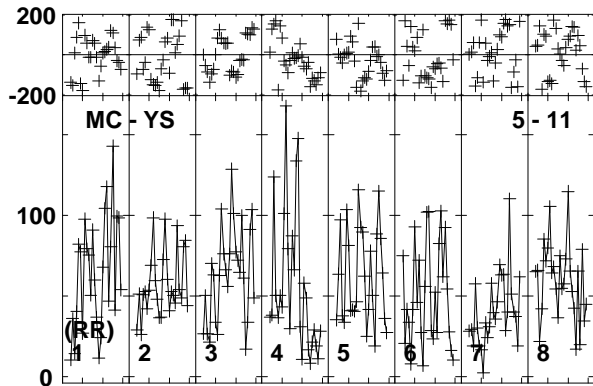
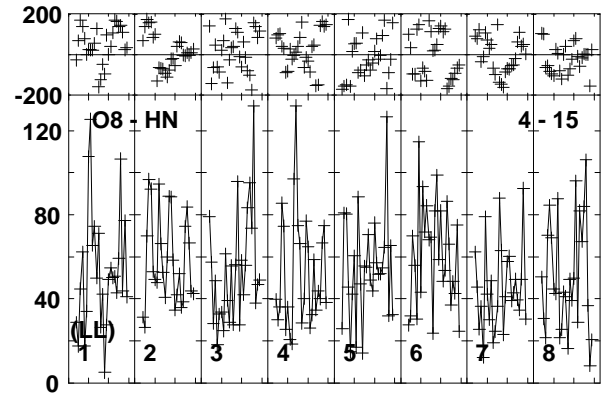
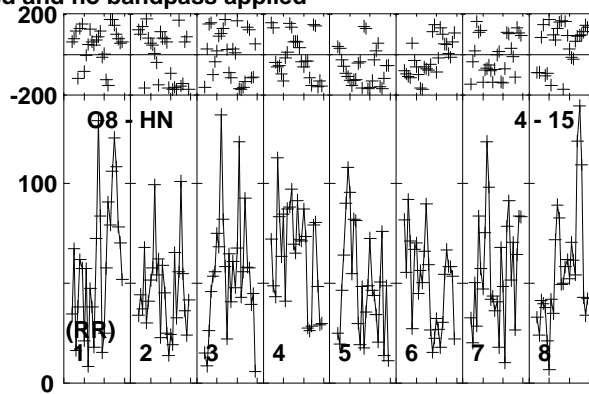
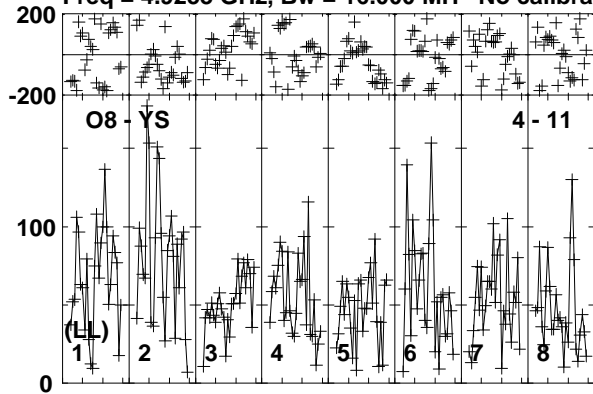

Lower frame: Micro Ampl Jy Top frame: Phas deg
Vector averaged cross-power spectrum Baseline: O8 (04) - YS (11)
Timerange: 00/23:03:28 to 00/23:08:40

Plot file version 254 created 11-APR-2016 17:08:57

ARP299C GP053G 3.UVDATA.1

Freq = 4.9253 GHz, Bw = 16.000 MH No calibration applied and no bandpass applied

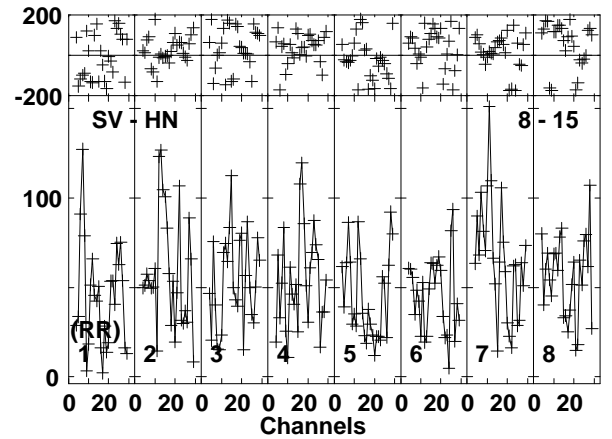
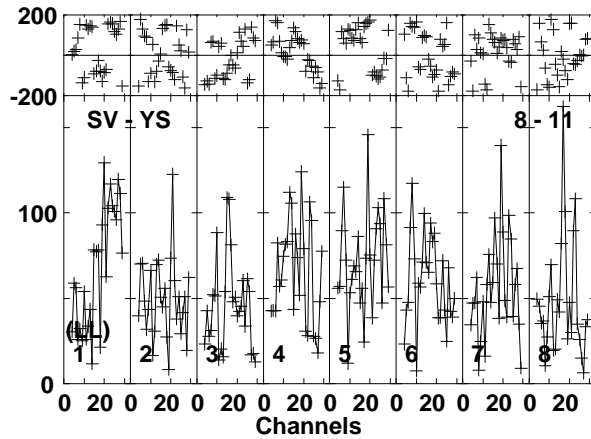
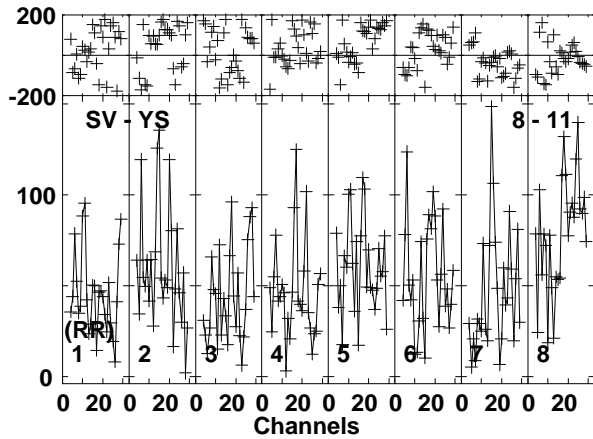
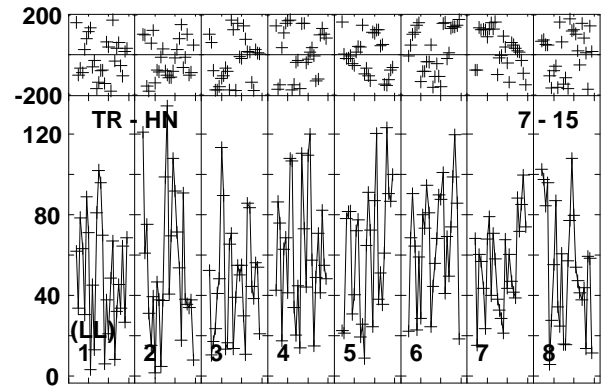
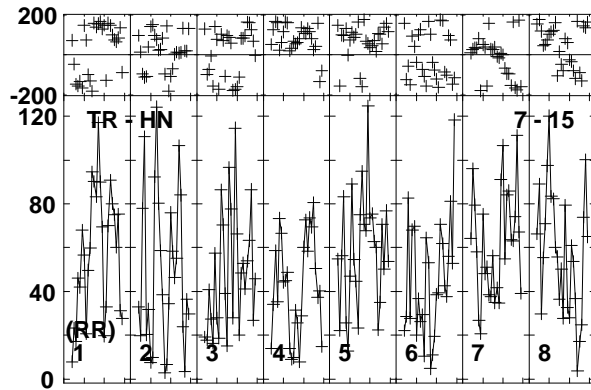
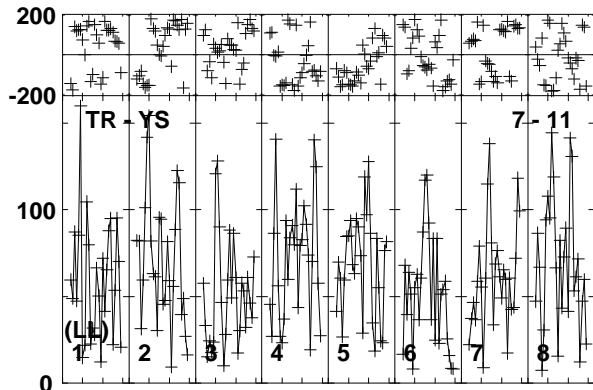
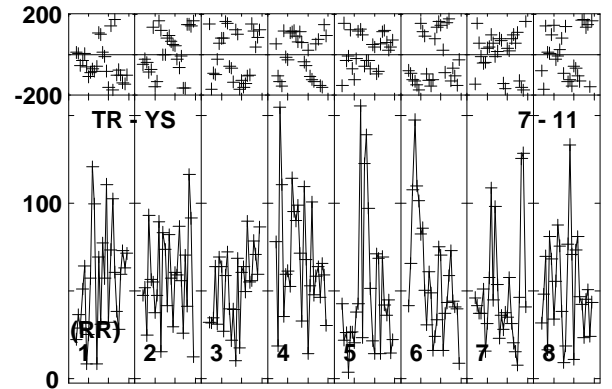
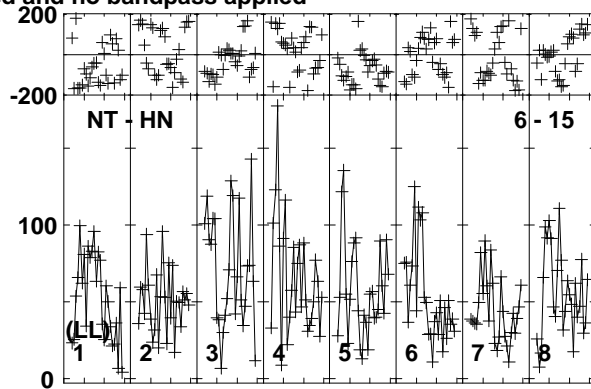
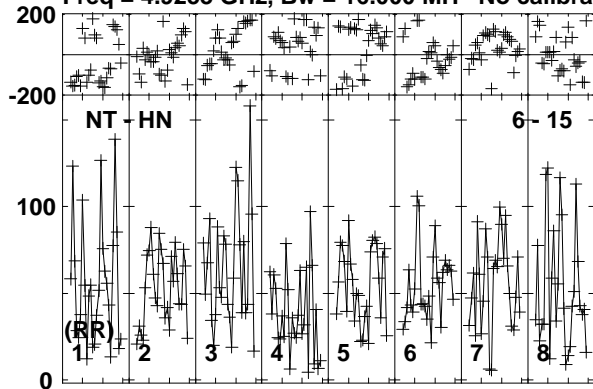

Lower frame: Micro Ampl Jy Top frame: Phas deg
Vector averaged cross-power spectrum Baseline: NT (06) - HN (15)
Timerange: 00/23:03:28 to 00/23:08:40

Plot file version 255 created 11-APR-2016 17:08:57

ARP299C GP053G 3.UVDATA.1

Freq = 4.9253 GHz, Bw = 16.000 MH No calibration applied and no bandpass applied

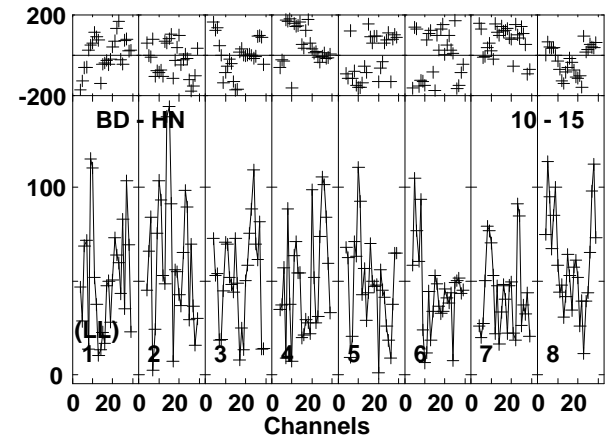
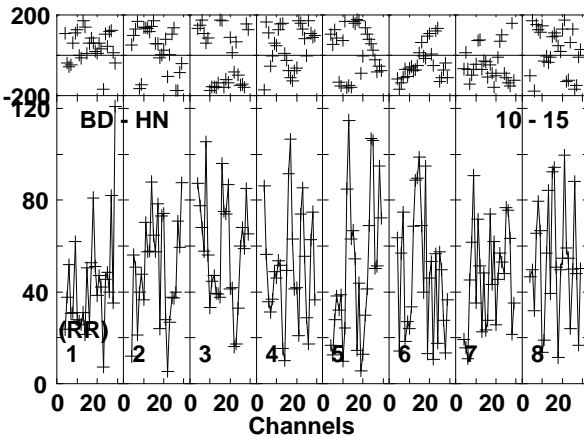
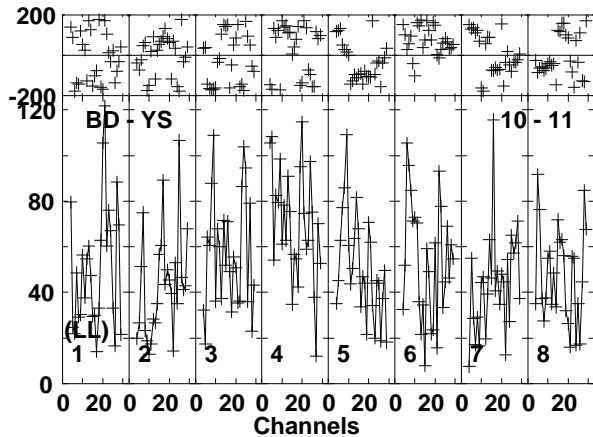
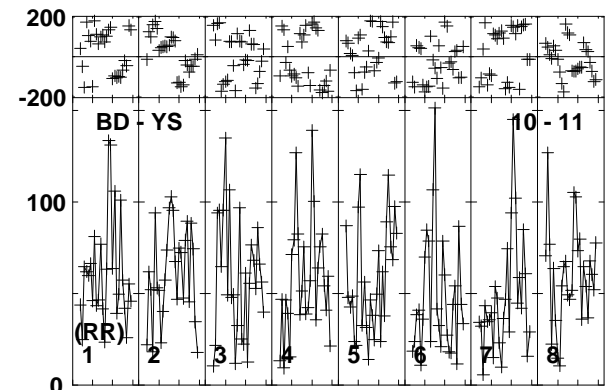
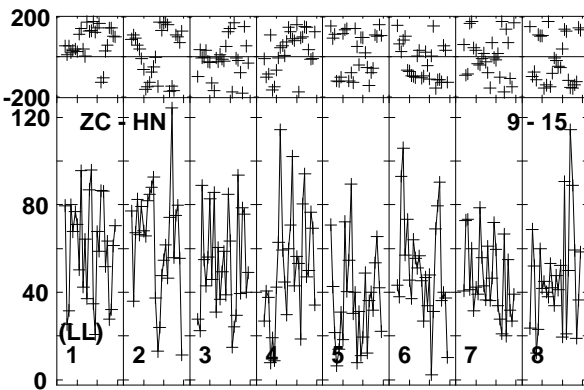
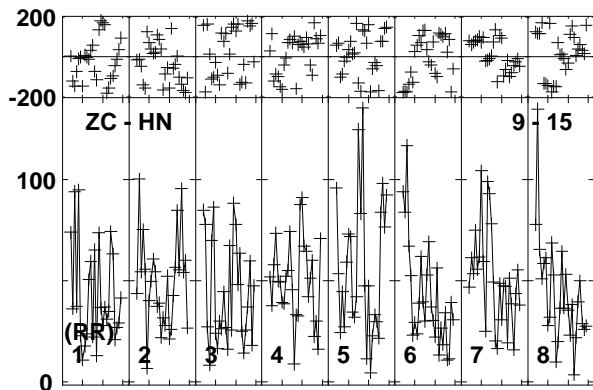
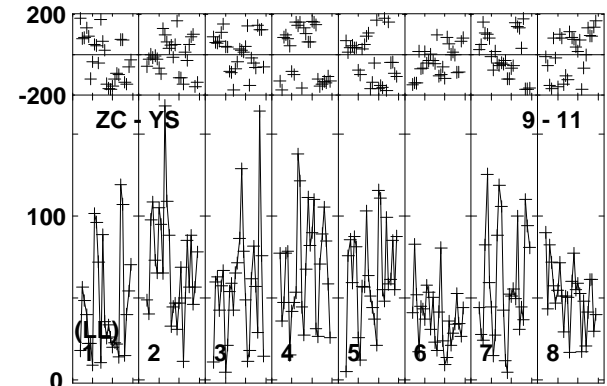
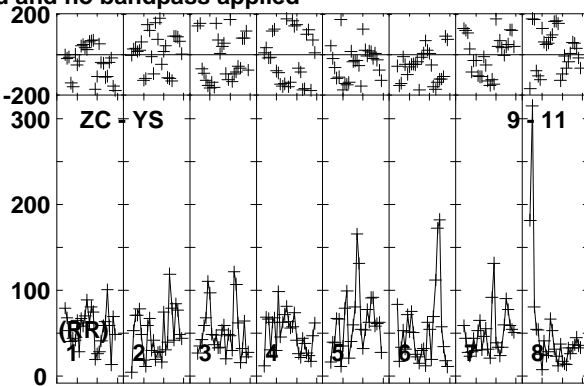
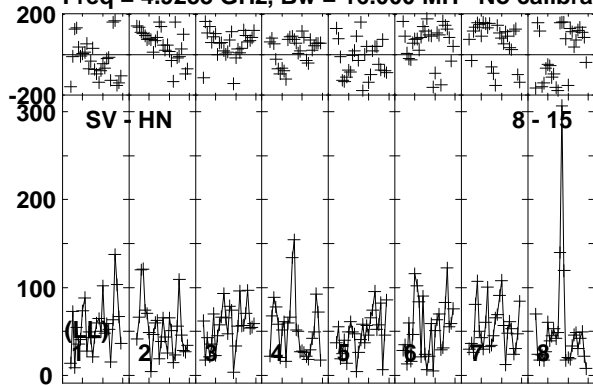

Lower frame: Micro Ampl Jy Top frame: Phas deg
Vector averaged cross-power spectrum Baseline: SV (08) - HN (15)
Timerange: 00/23:03:28 to 00/23:08:40

Plot file version 256 created 11-APR-2016 17:08:57

ARP299C GP053G 3.UVDATA.1

Freq = 4.9253 GHz, Bw = 16.000 MH No calibration applied and no bandpass applied

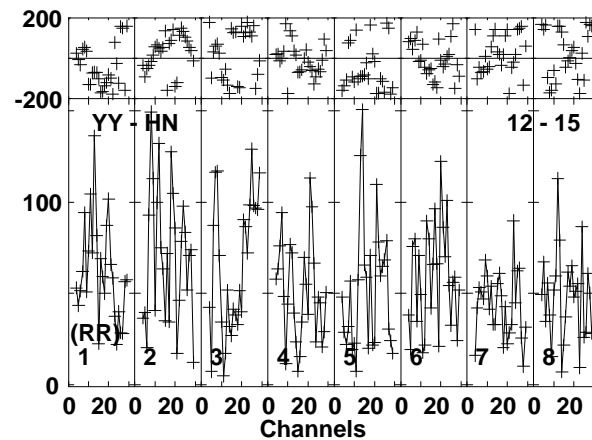
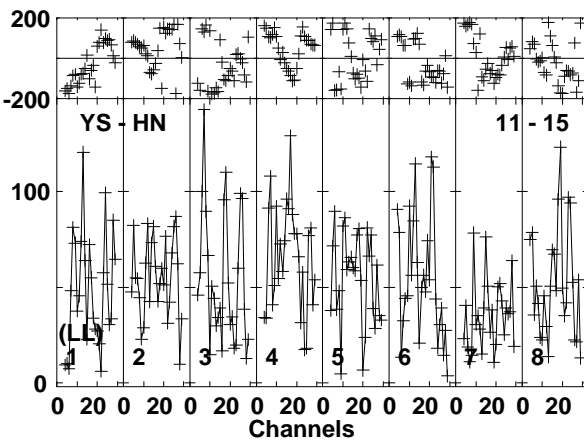
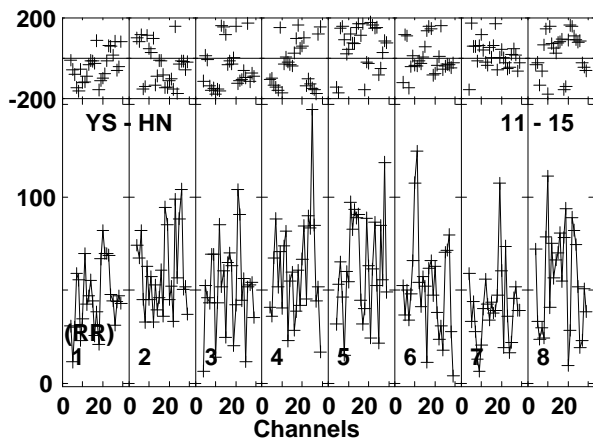
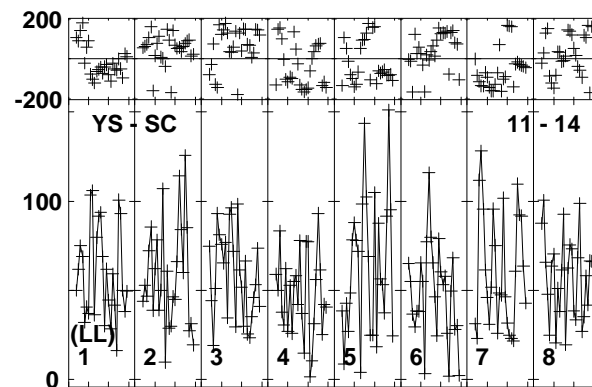
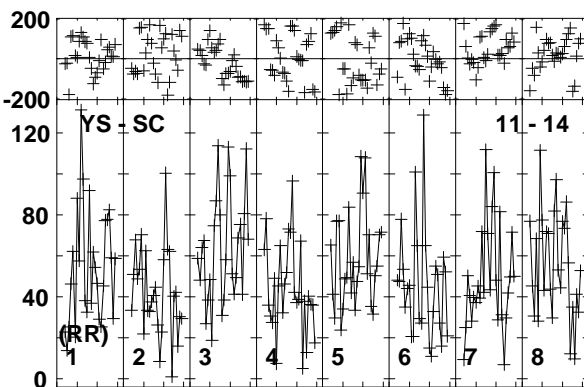
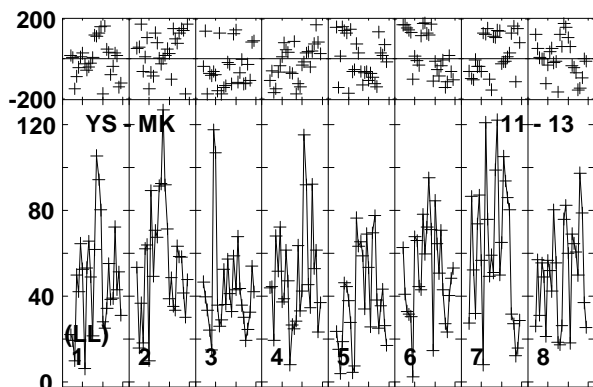
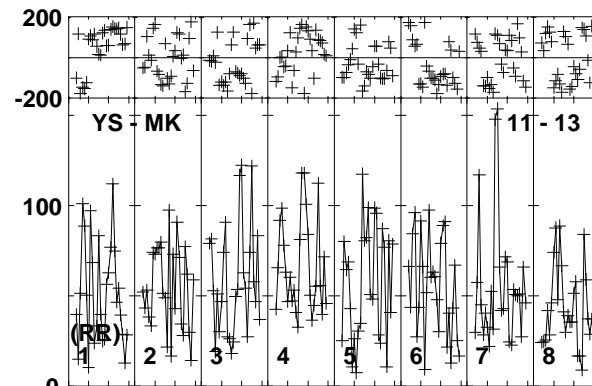
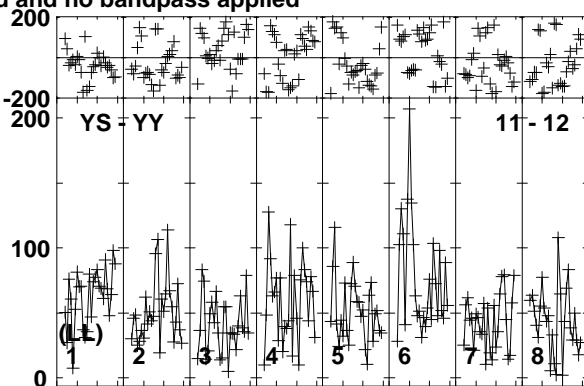
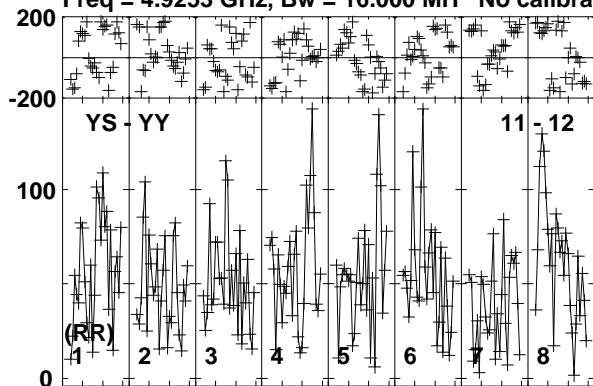

Lower frame: Micro Ampl Jy Top frame: Phas deg
Vector averaged cross-power spectrum Baseline: YS (11) - YY (12)
Timerange: 00/23:03:28 to 00/23:08:40

Plot file version 257 created 11-APR-2016 17:08:57

ARP299C GP053G 3.UVDATA.1

Freq = 4.9253 GHz, Bw = 16.000 MH No calibration applied and no bandpass applied

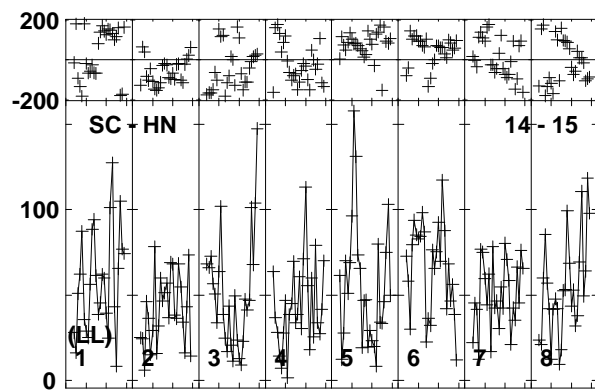
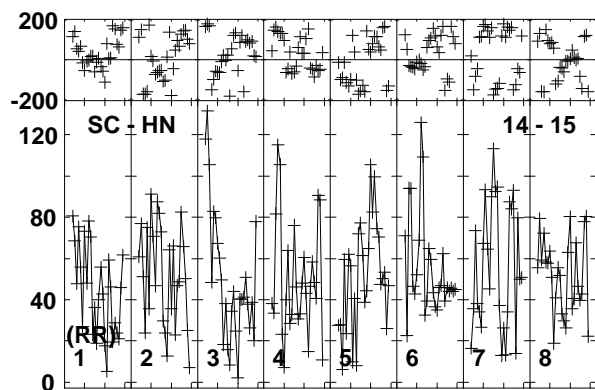
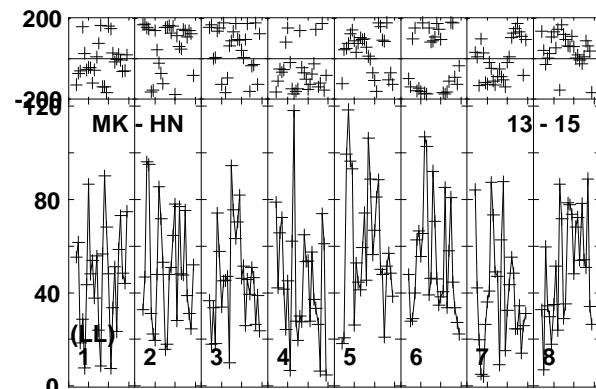
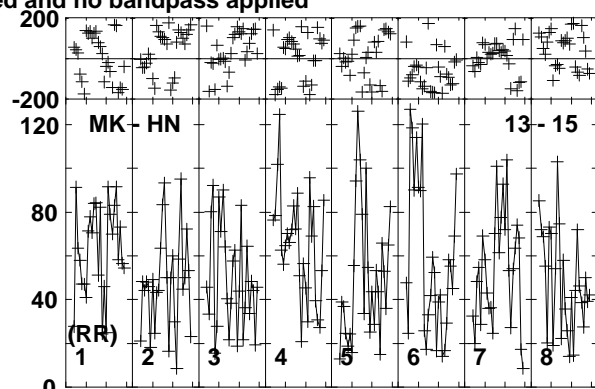
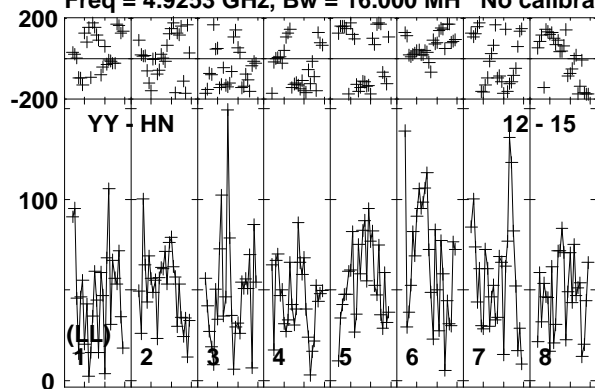

Lower frame: Micro Ampl Jy Top frame: Phas deg
Vector averaged cross-power spectrum Baseline: YY (12) - HN (15)
Timerange: 00/23:03:28 to 00/23:08:40

Plot file version 258 created 11-APR-2016 17:08:58

J1128+5925 GP053G 3.UVDATA.1

Freq = 4.9253 GHz, Bw = 16.000 MH No calibration applied and no bandpass applied

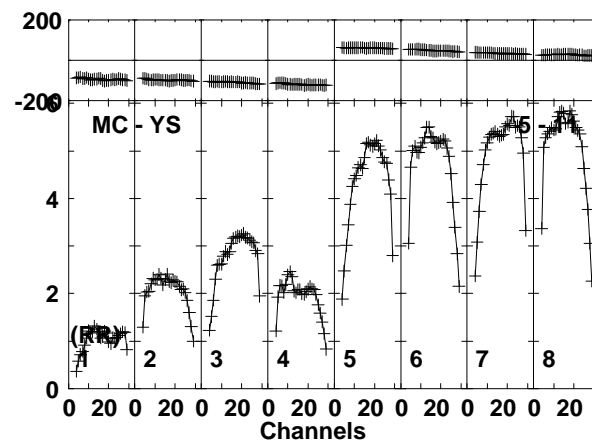
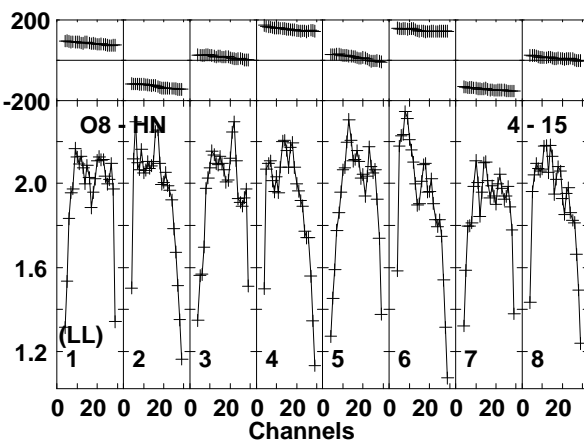
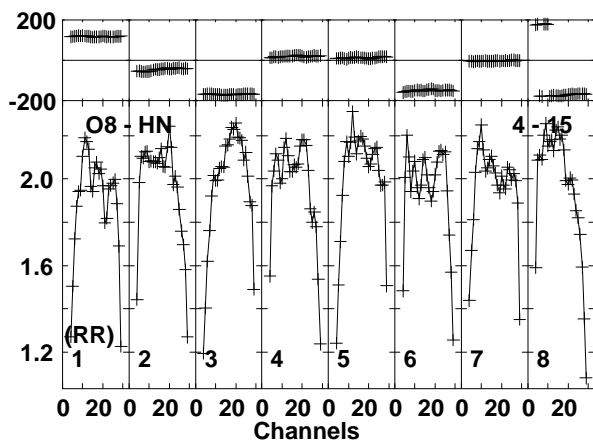
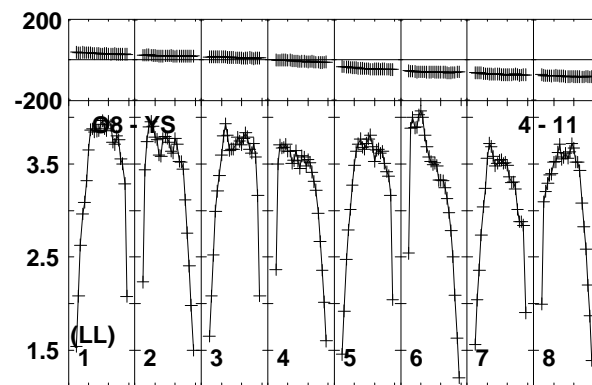
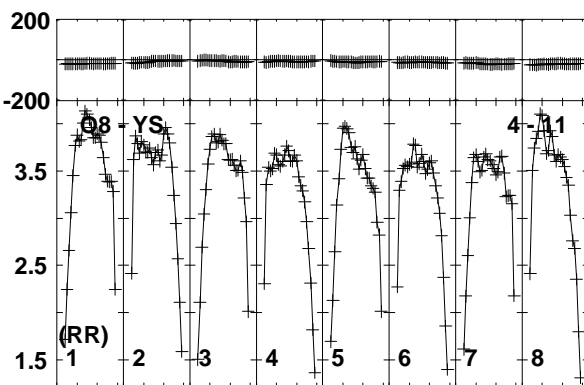
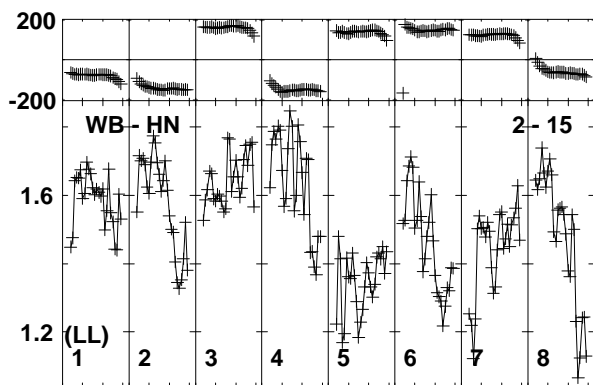
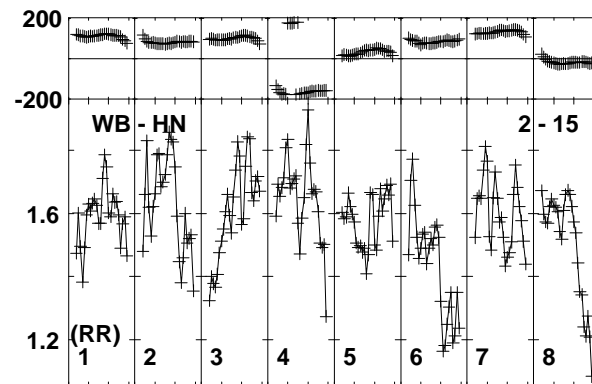
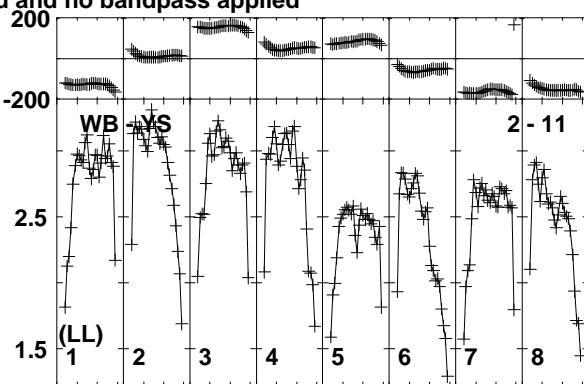
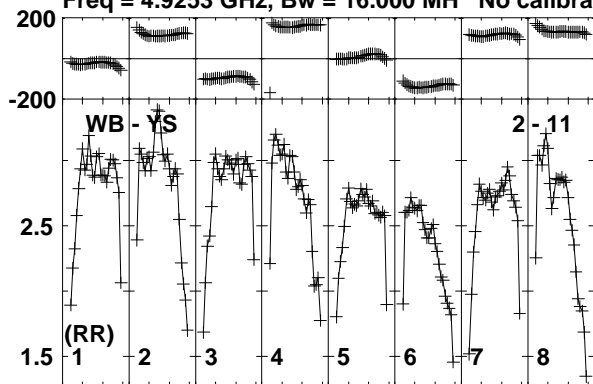

Lower frame: Milli Ampl Jy Top frame: Phas deg
Vector averaged cross-power spectrum Baseline: WB (02) - YS (11)
Timerange: 00/23:08:46 to 00/23:10:38

Plot file version 259 created 11-APR-2016 17:08:58

J1128+5925 GP053G 3.UVDATA.1

Freq = 4.9253 GHz, Bw = 16.000 MH No calibration applied and no bandpass applied

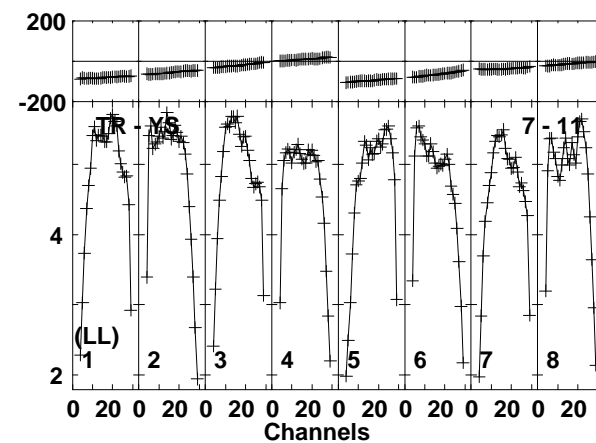
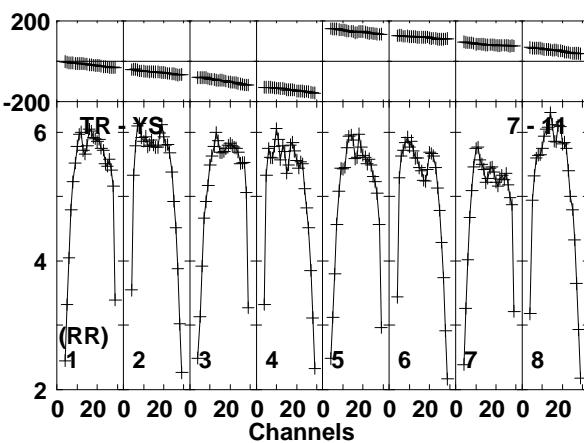
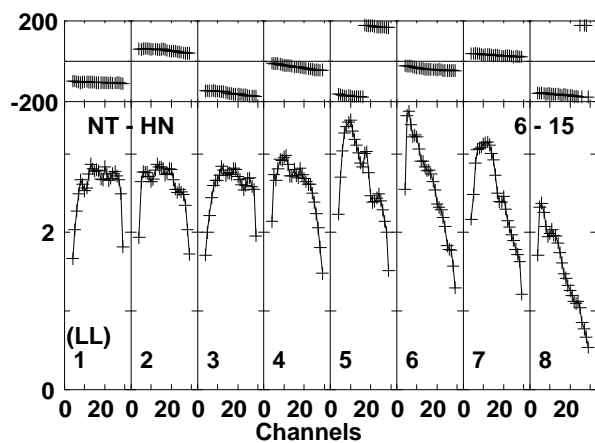
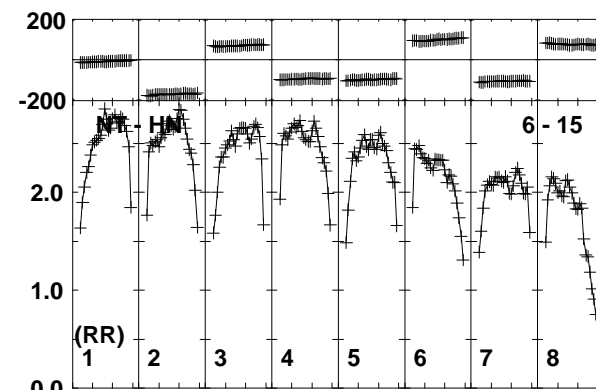
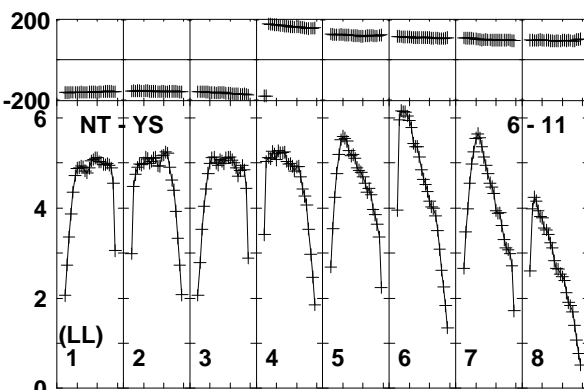
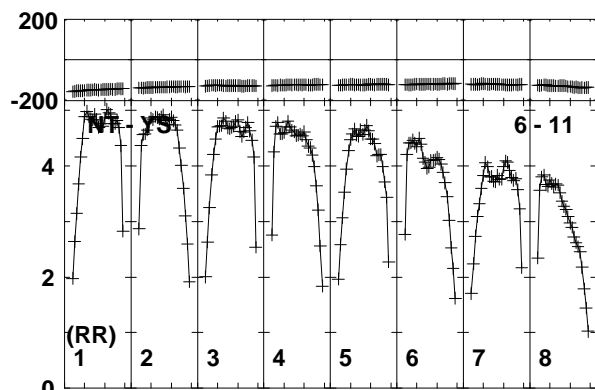
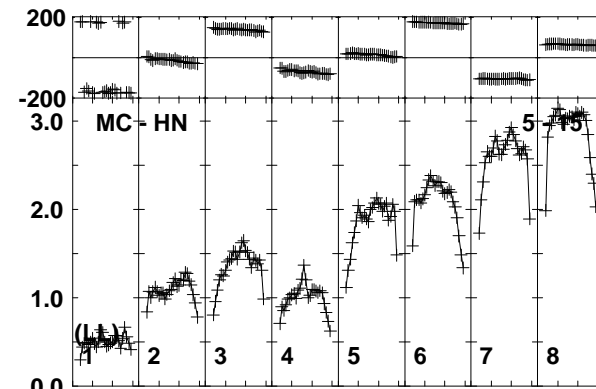
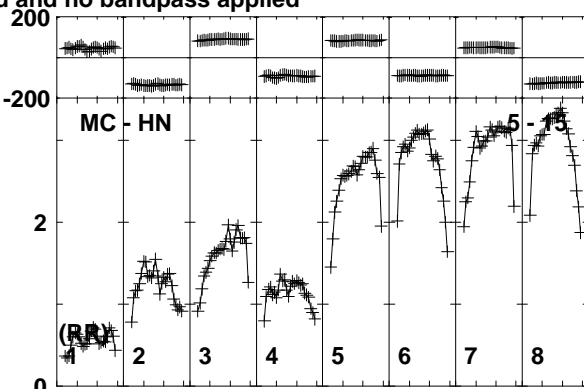
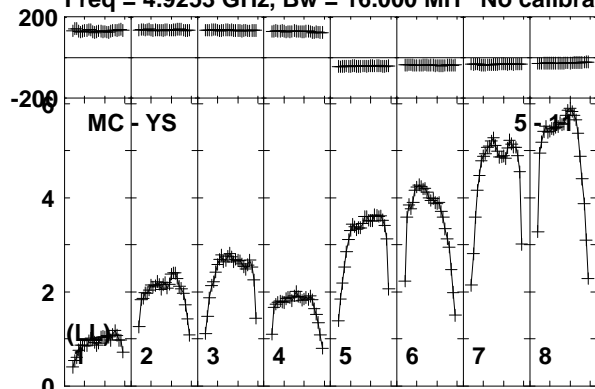

Lower frame: Milli Ampl Jy Top frame: Phas deg
Vector averaged cross-power spectrum Baseline: MC (05) - YS (11)
Timerange: 00/23:08:46 to 00/23:10:38

Plot file version 260 created 11-APR-2016 17:08:58

J1128+5925 GP053G 3.UVDATA.1

Freq = 4.9253 GHz, Bw = 16.000 MH No calibration applied and no bandpass applied

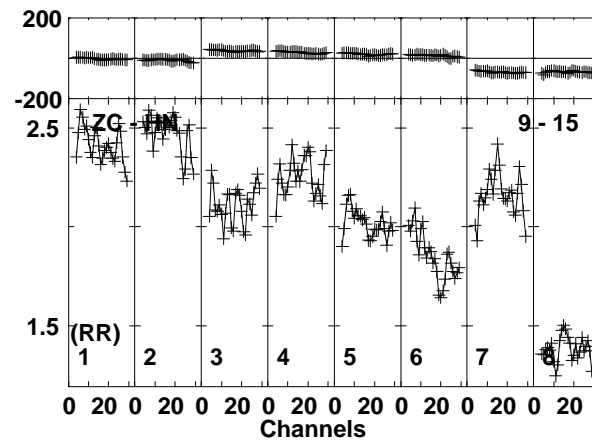
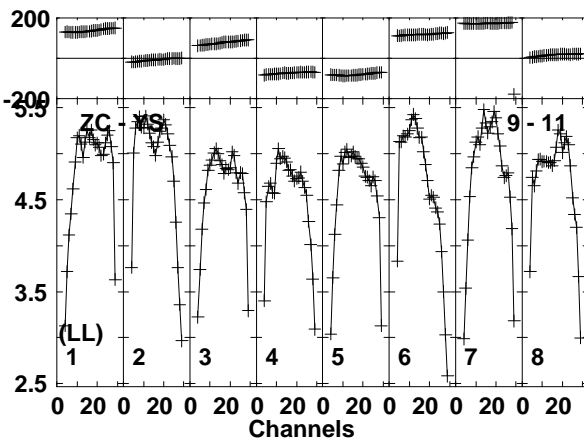
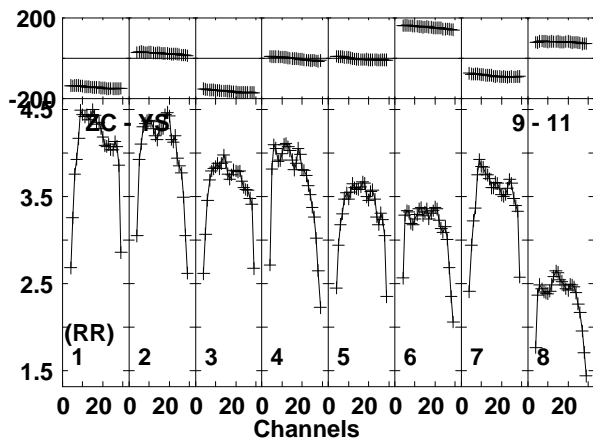
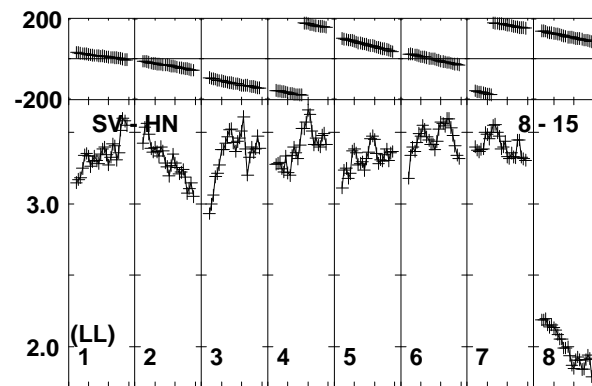
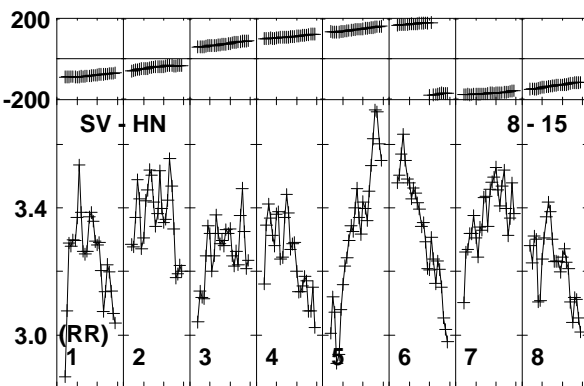
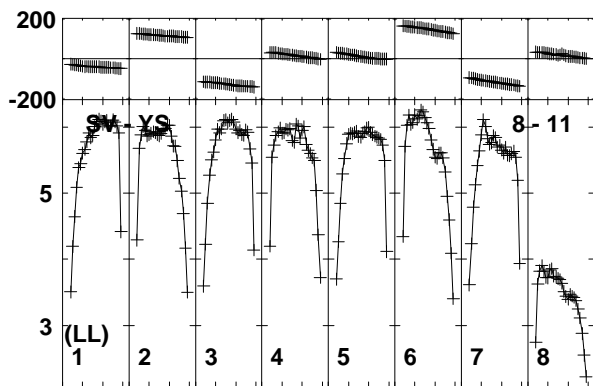
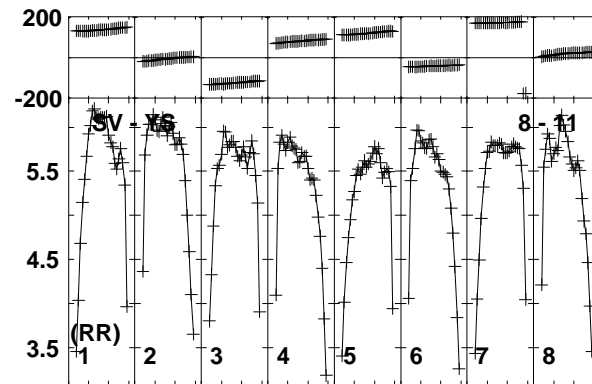
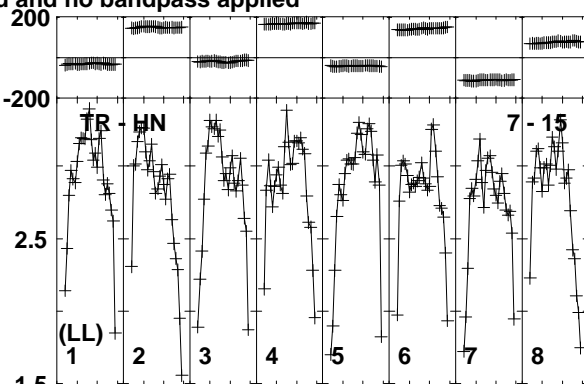
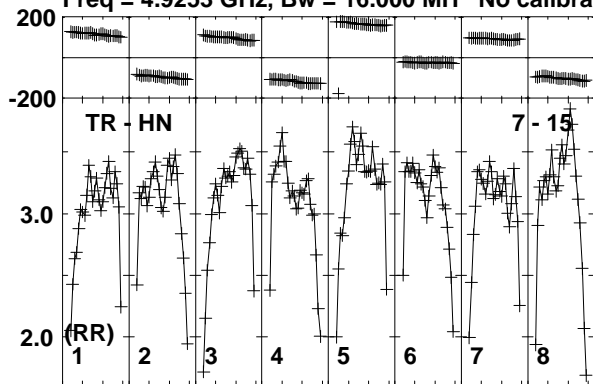

Lower frame: Milli Ampl Jy Top frame: Phas deg
Vector averaged cross-power spectrum Baseline: TR (07) - HN (15)
Timerange: 00/23:08:46 to 00/23:10:38

Plot file version 261 created 11-APR-2016 17:08:58

J1128+5925 GP053G 3.UVDATA.1

Freq = 4.9253 GHz, Bw = 16.000 MH No calibration applied and no bandpass applied

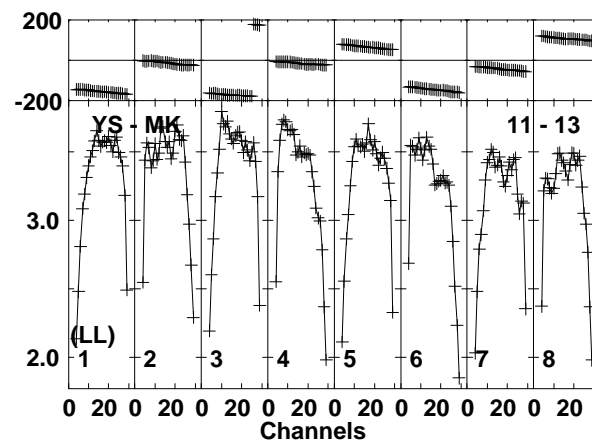
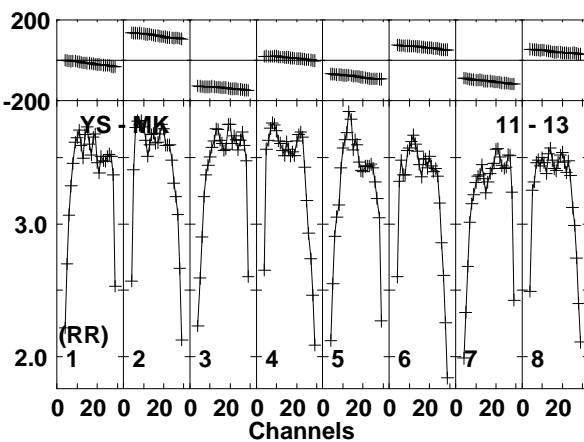
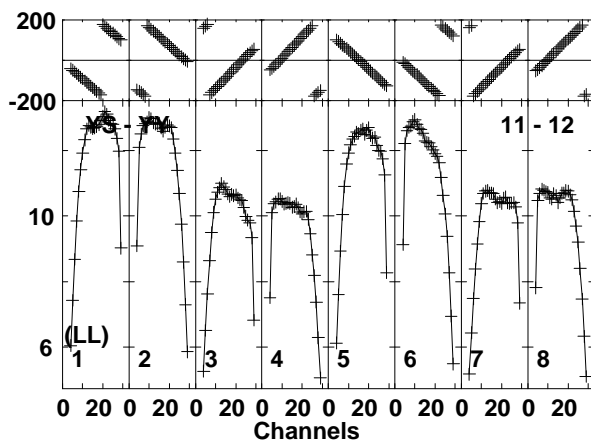
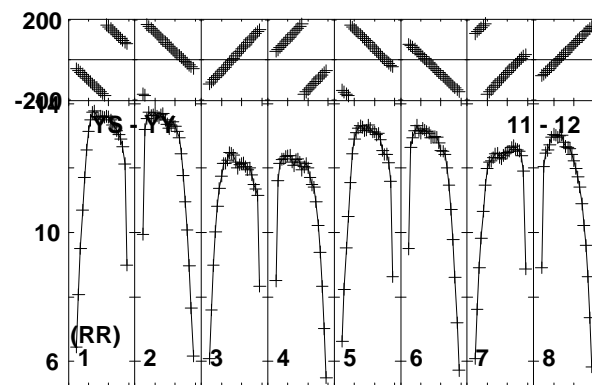
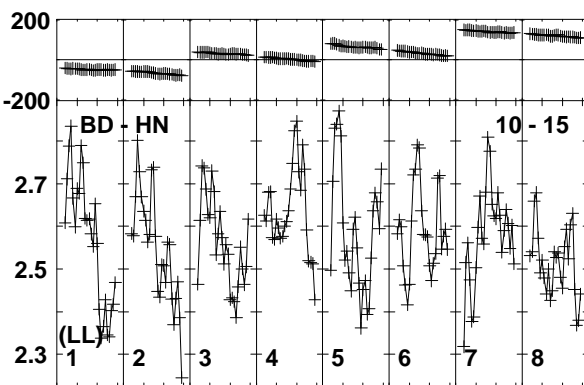
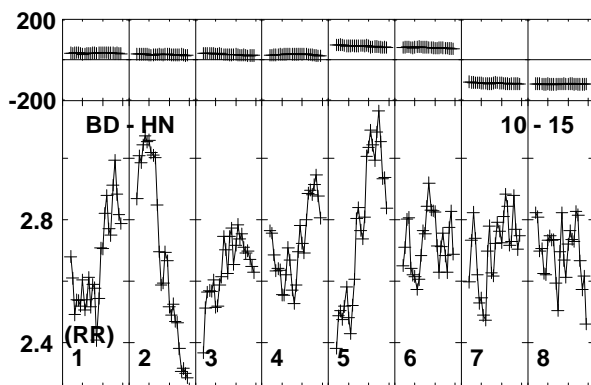
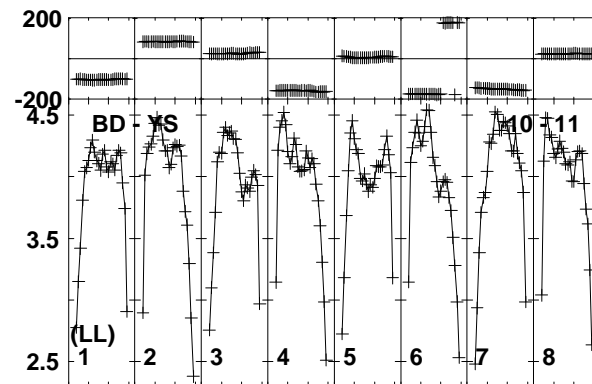
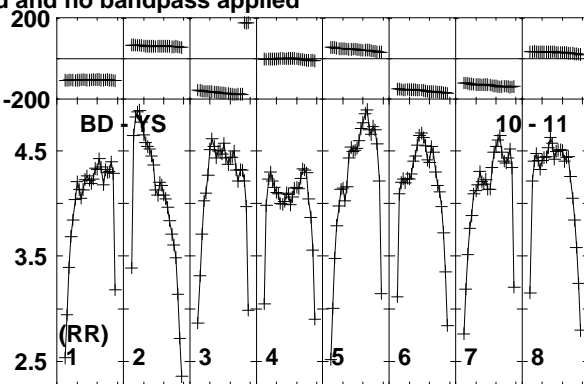
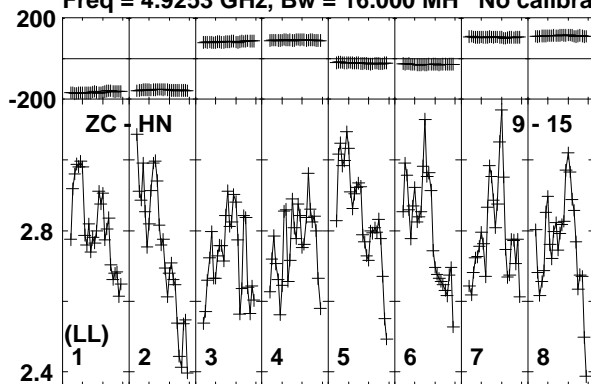

Lower frame: Milli Ampl Jy Top frame: Phas deg
Vector averaged cross-power spectrum Baseline: ZC (09) - HN (15)
Timerange: 00/23:08:46 to 00/23:10:38

Plot file version 262 created 11-APR-2016 17:08:58

J1128+5925 GP053G 3.UVDATA.1

Freq = 4.9253 GHz, Bw = 16.000 MH No calibration applied and no bandpass applied

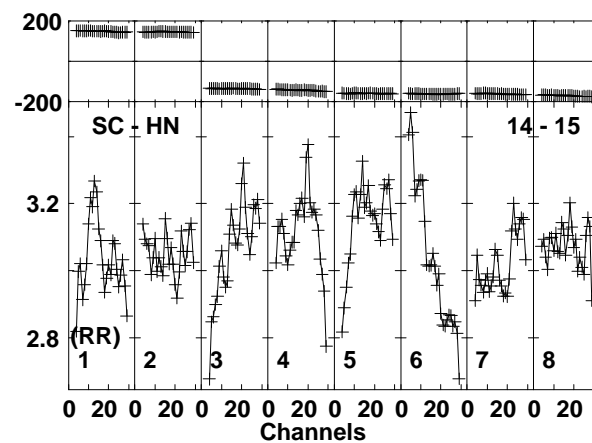
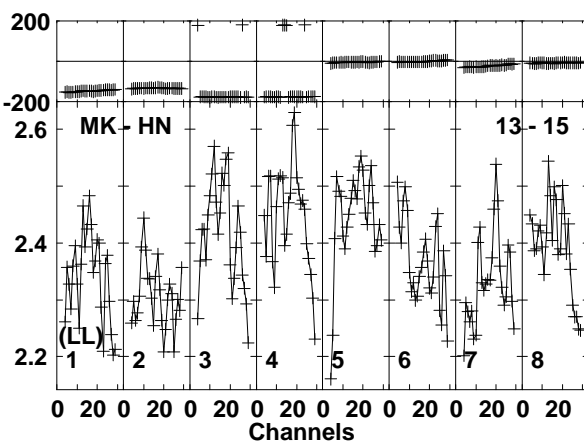
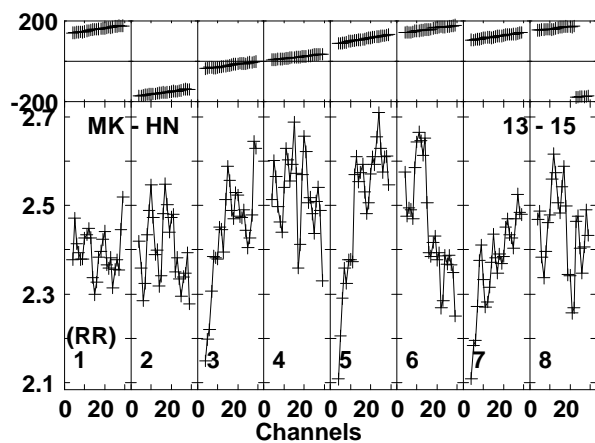
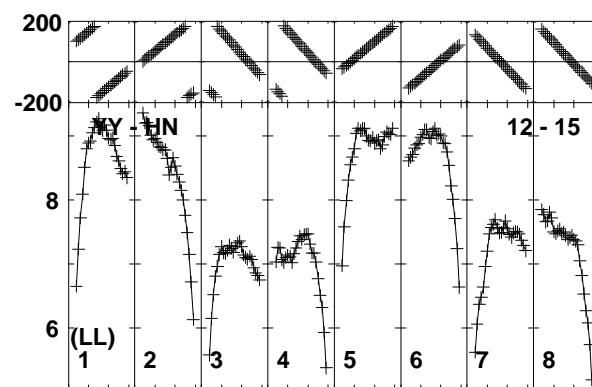
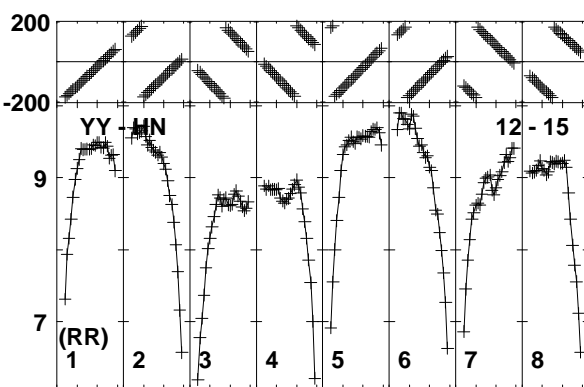
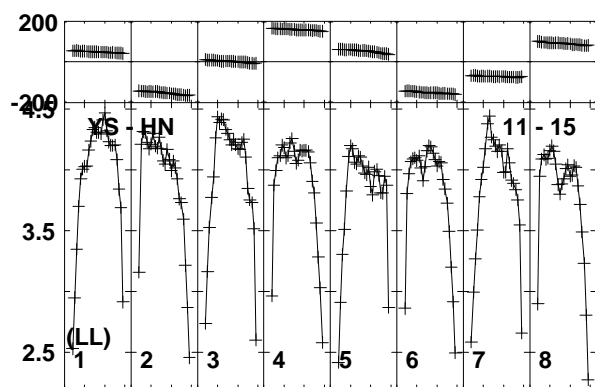
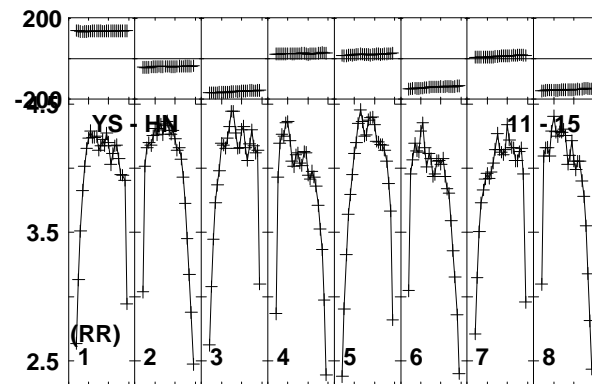
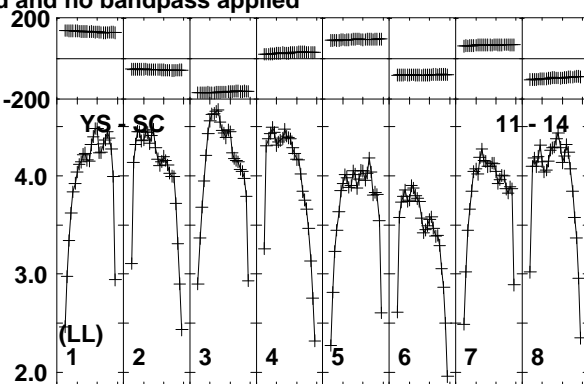
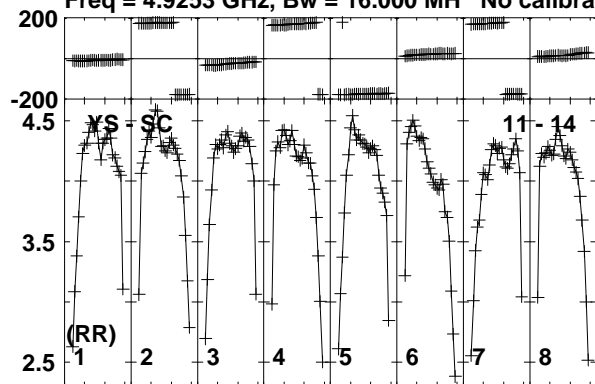

Lower frame: Milli Ampl Jy Top frame: Phas deg
Vector averaged cross-power spectrum Baseline: YS (11) - SC (14)
Timerange: 00/23:08:46 to 00/23:10:38

Plot file version 263 created 11-APR-2016 17:08:58
J1128+5925 GP053G 3.UVDATA.1
Freq = 4.9253 GHz, Bw = 16.000 MH No calibration applied and no bandpass applied

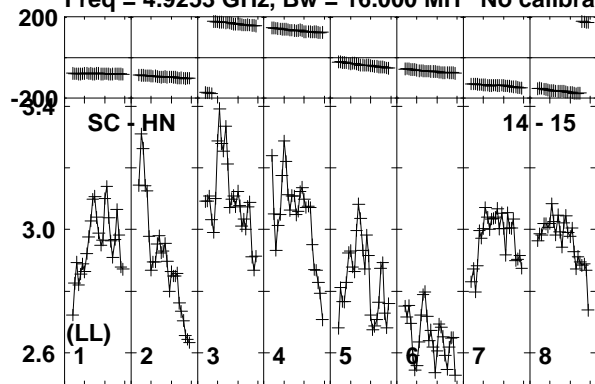

Lower frame: Milli Ampl Jy Top frame: Phas deg
Vector averaged cross-power spectrum Baseline: SC (14) - HN (15)
Timerange: 00/23:08:46 to 00/23:10:38

Plot file version 264 created 11-APR-2016 17:08:58

ARP299C GP053G 3.UVDATA.1

Freq = 4.9253 GHz, Bw = 16.000 MH No calibration applied and no bandpass applied

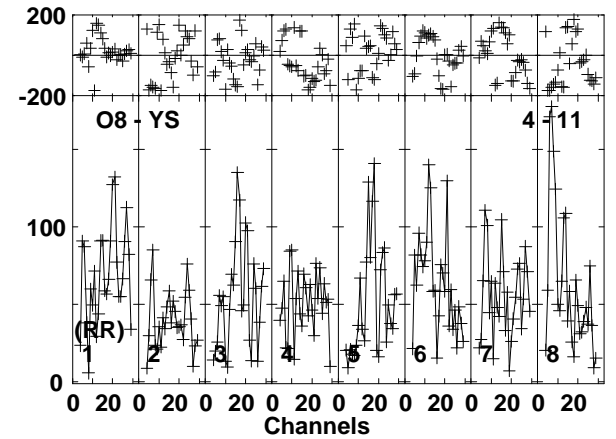
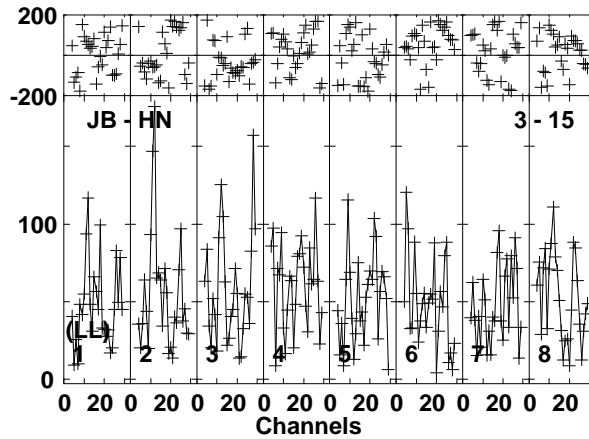
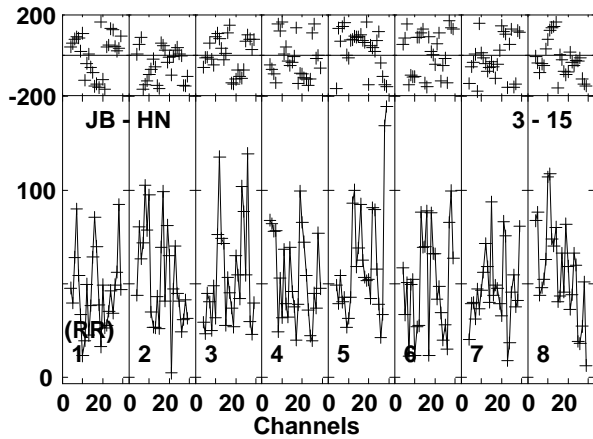
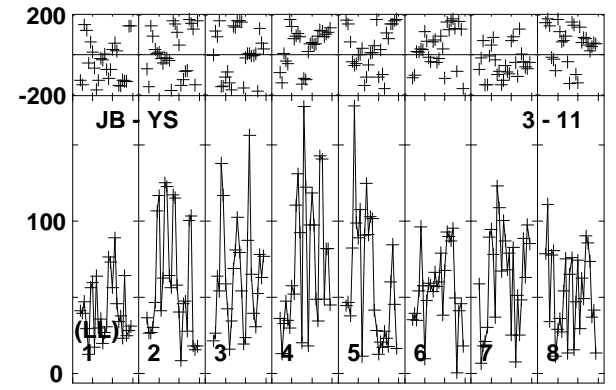
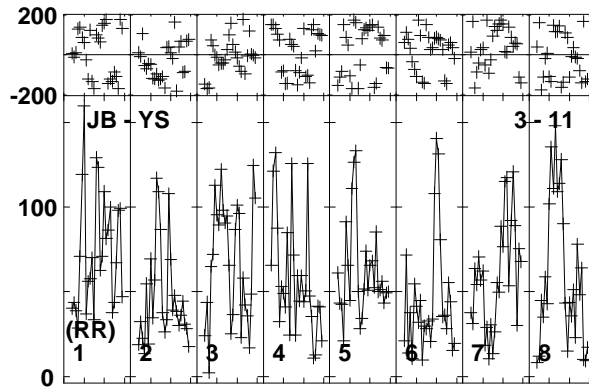
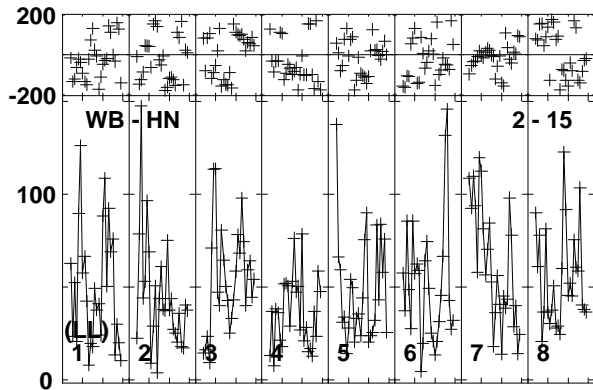
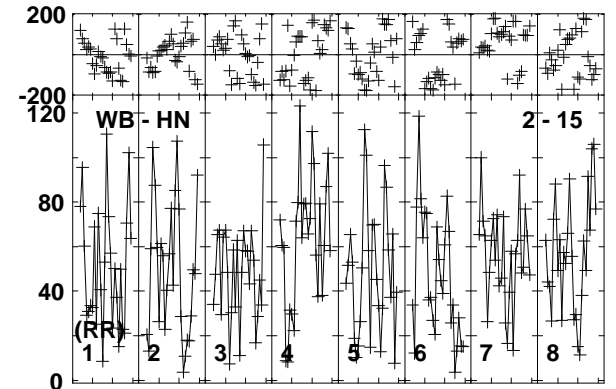
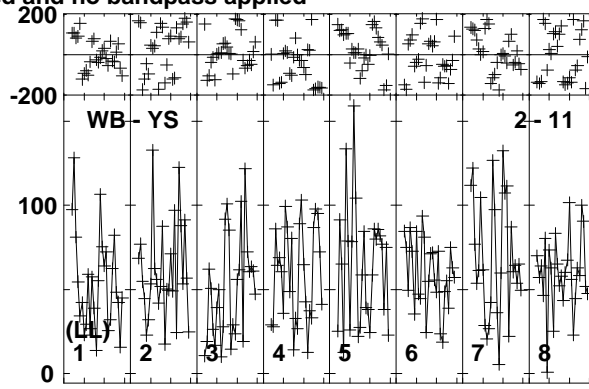
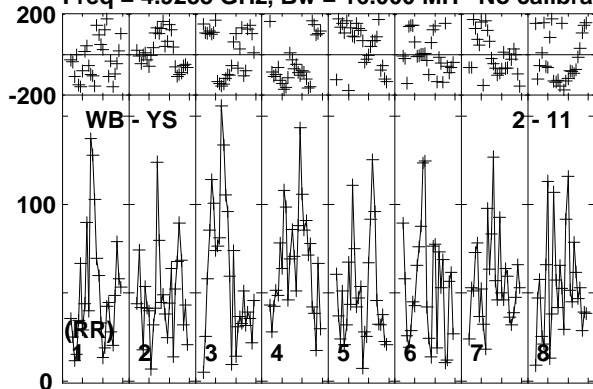

Lower frame: Micro Ampl Jy Top frame: Phas deg
Vector averaged cross-power spectrum Baseline: WB (02) - YS (11)
Timerange: 00/23:10:43 to 00/23:15:57

Plot file version 265 created 11-APR-2016 17:08:59

ARP299C GP053G 3.UVDATA.1

Freq = 4.9253 GHz, Bw = 16.000 MH No calibration applied and no bandpass applied

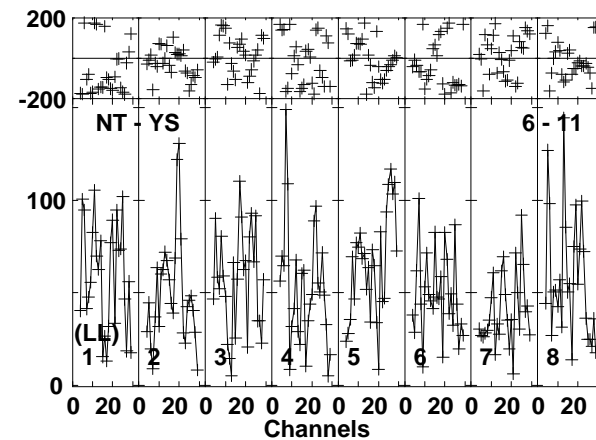
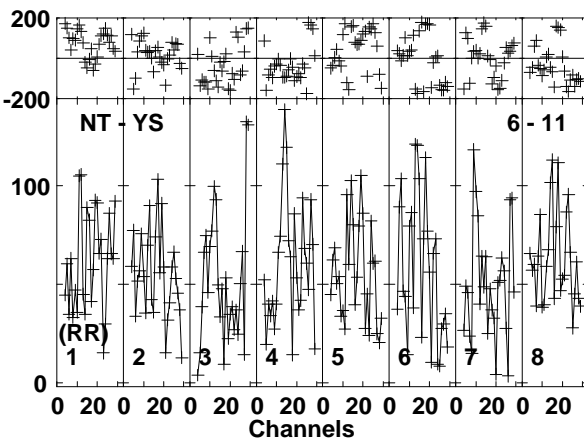
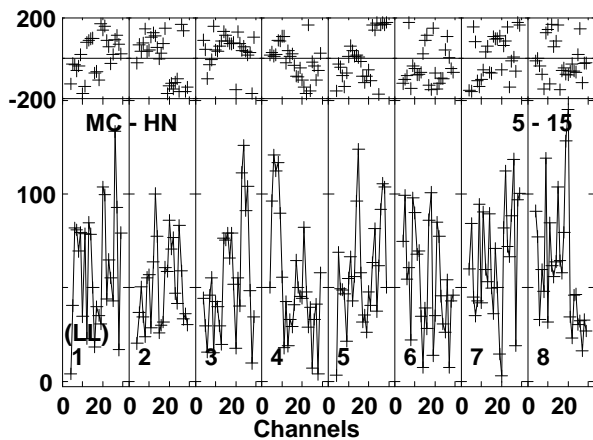
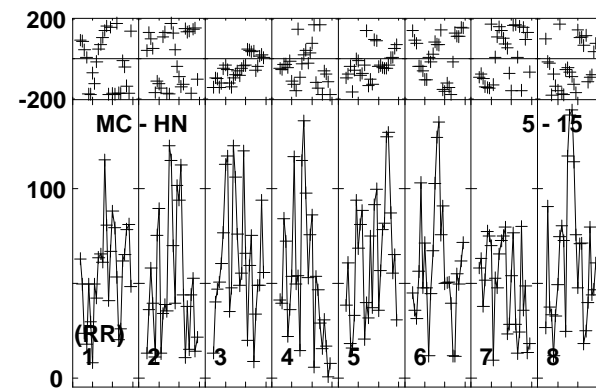
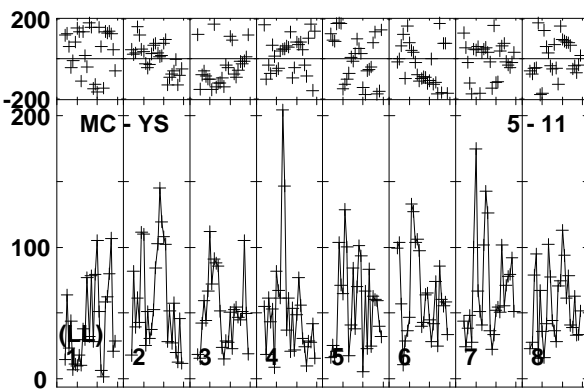
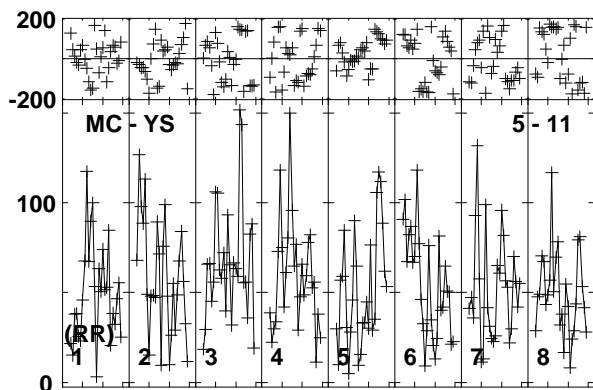
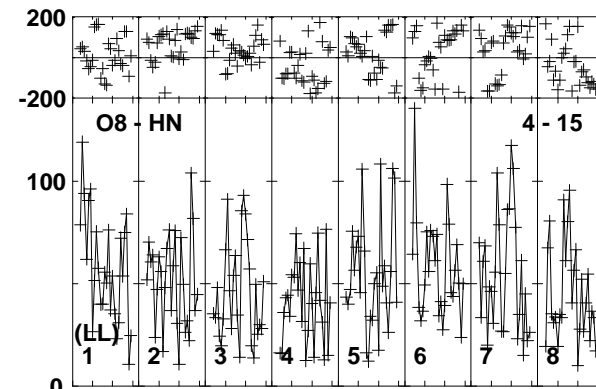
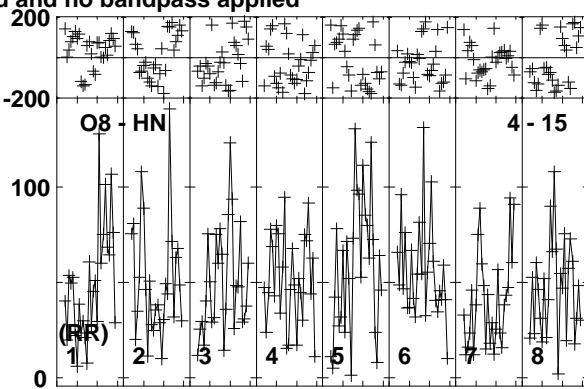
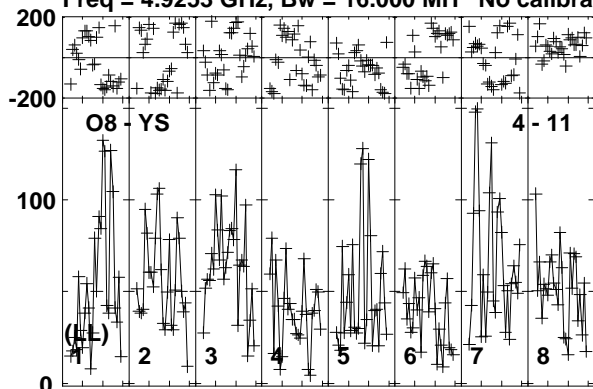

Lower frame: Micro Ampl Jy Top frame: Phas deg
Vector averaged cross-power spectrum Baseline: O8 (04) - YS (11)
Timerange: 00/23:10:43 to 00/23:15:57

Plot file version 266 created 11-APR-2016 17:08:59

ARP299C GP053G 3.UVDATA.1

Freq = 4.9253 GHz, Bw = 16.000 MH No calibration applied and no bandpass applied

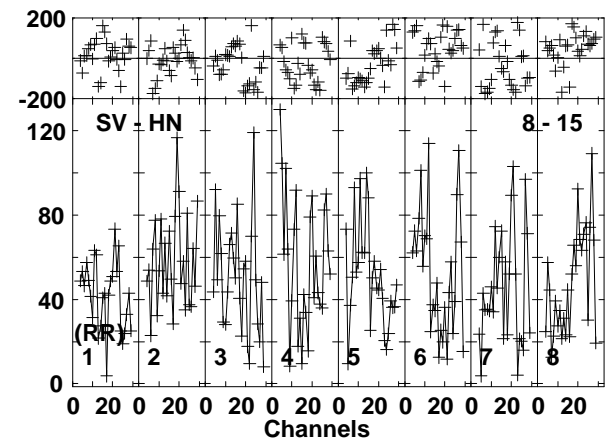
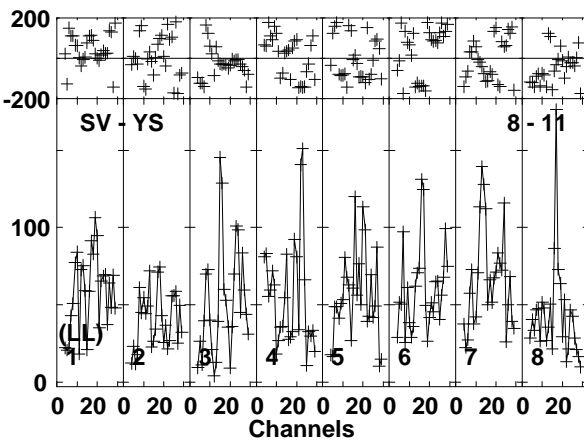
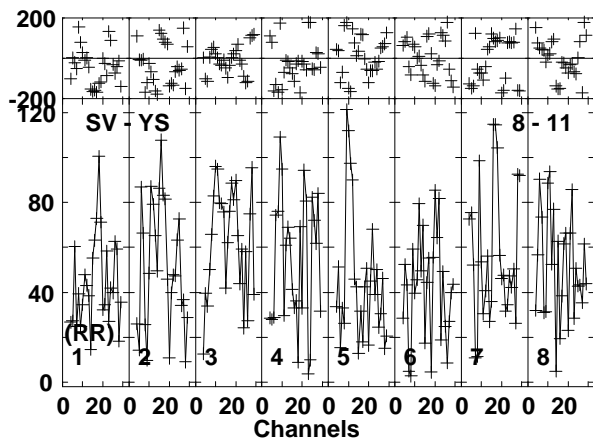
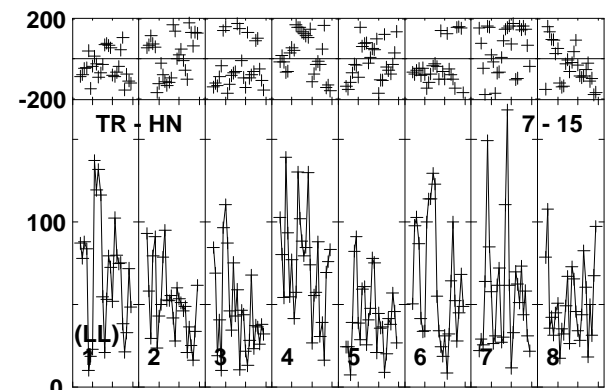
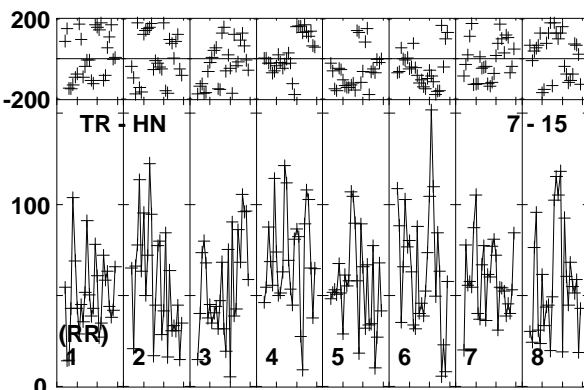
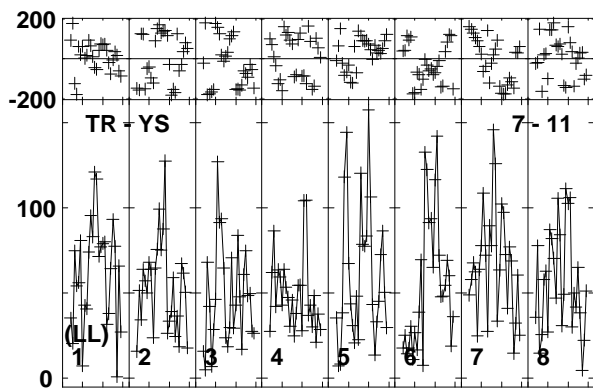
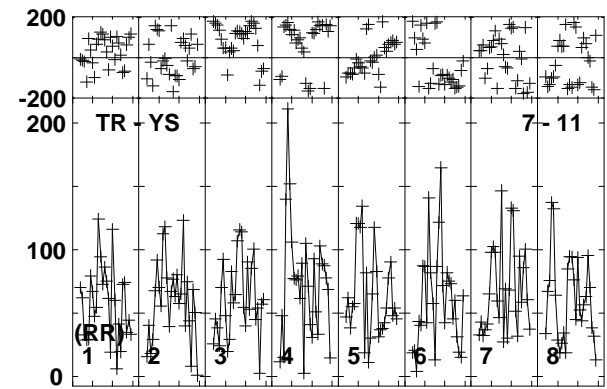
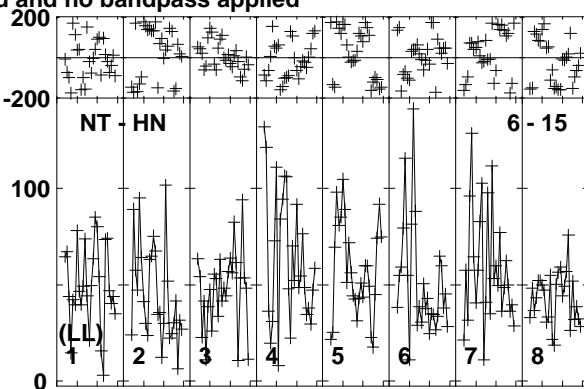
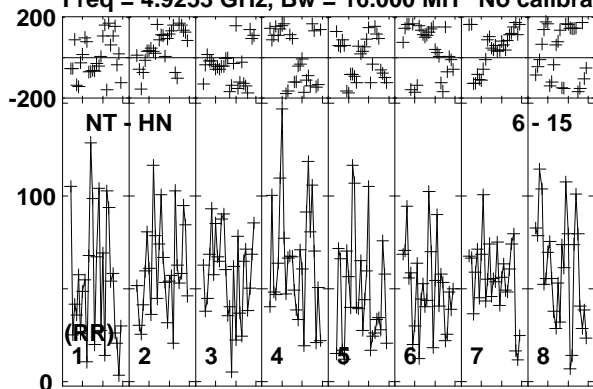

Lower frame: Micro Ampl Jy Top frame: Phas deg
 Vector averaged cross-power spectrum Baseline: NT (06) - HN (15)
 Timerange: 00/23:10:43 to 00/23:15:57

Plot file version 267 created 11-APR-2016 17:08:59

ARP299C GP053G 3.UVDATA.1

Freq = 4.9253 GHz, Bw = 16.000 MH No calibration applied and no bandpass applied

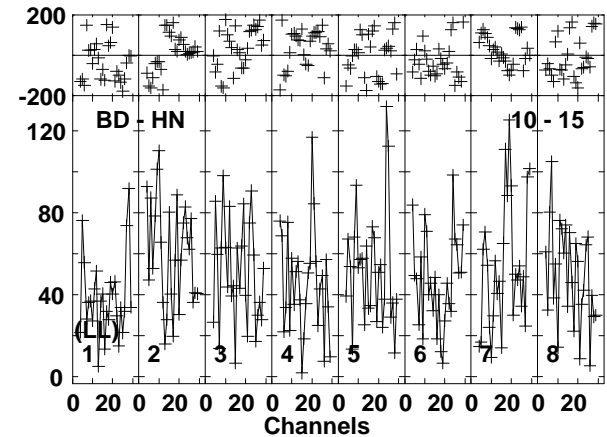
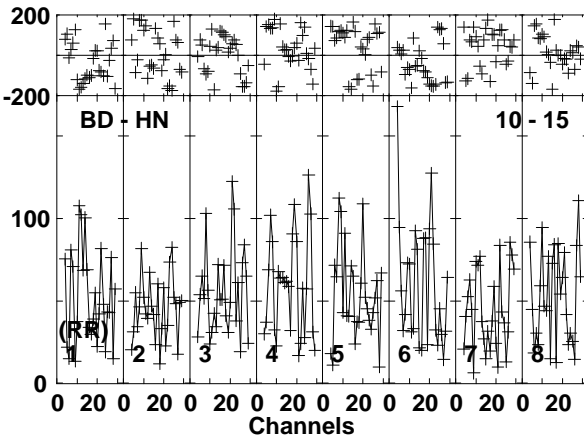
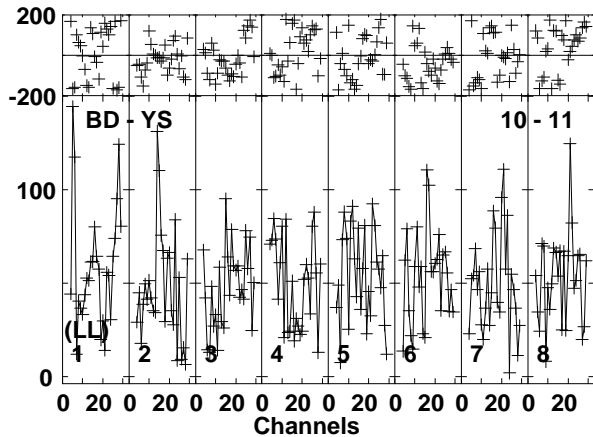
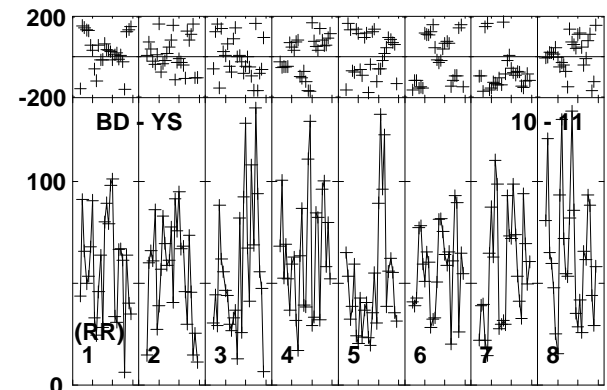
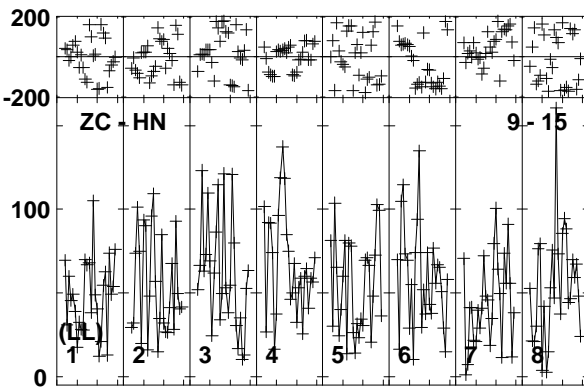
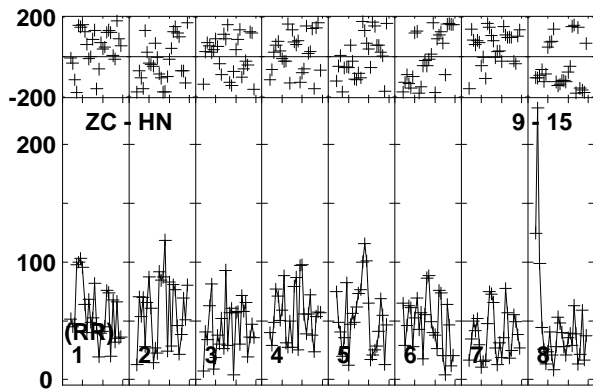
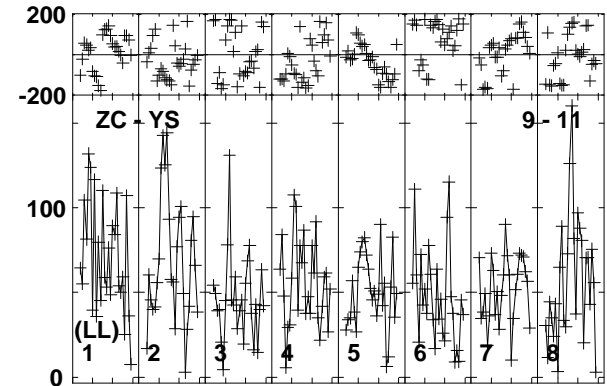
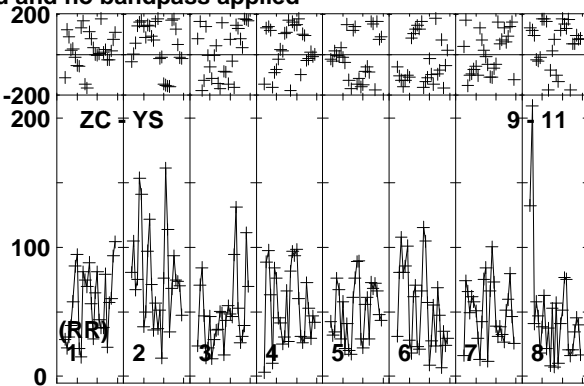
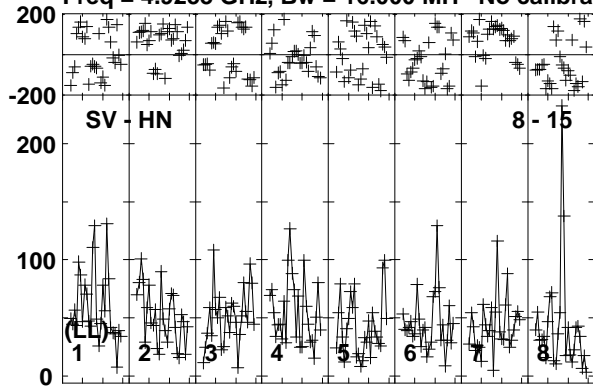

Lower frame: Micro Ampl Jy Top frame: Phas deg
Vector averaged cross-power spectrum Baseline: SV (08) - HN (15)
Timerange: 00/23:10:43 to 00/23:15:57

Plot file version 268 created 11-APR-2016 17:08:59

ARP299C GP053G 3.UVDATA.1

Freq = 4.9253 GHz, Bw = 16.000 MH No calibration applied and no bandpass applied

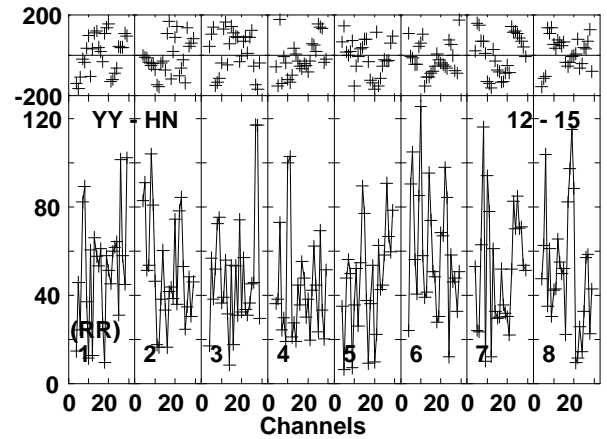
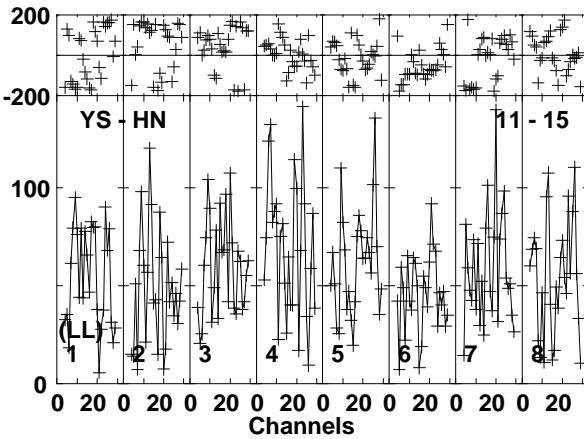
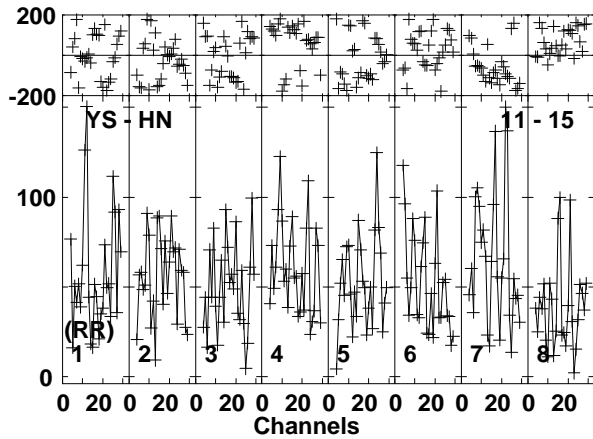
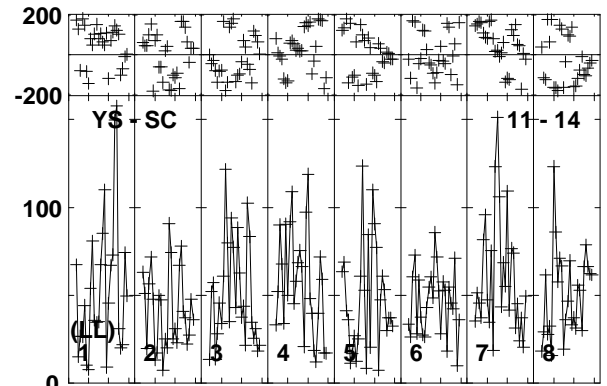
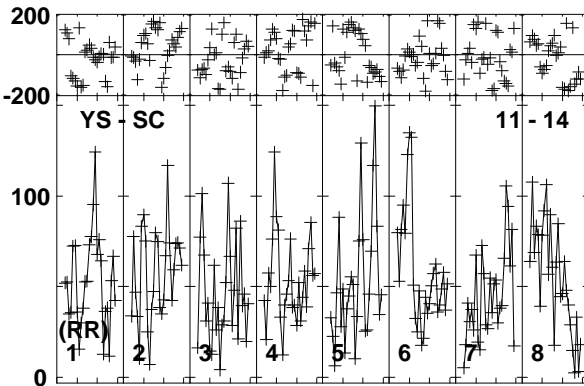
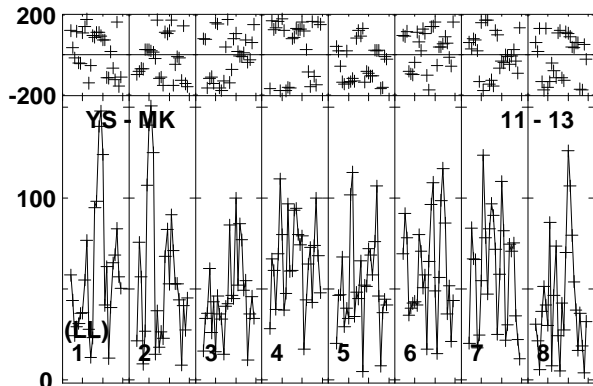
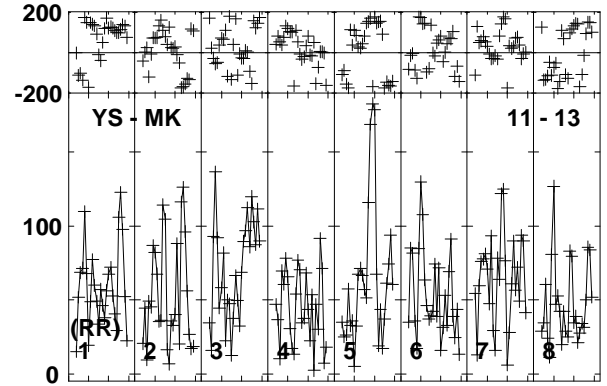
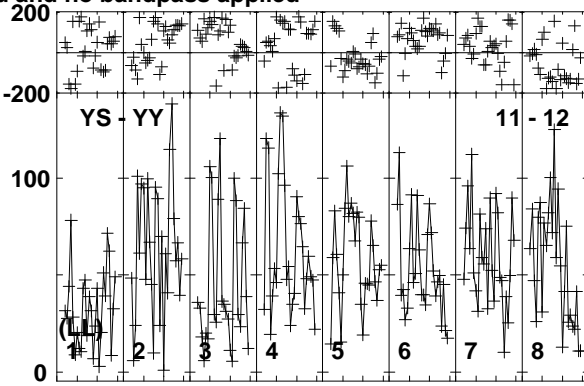
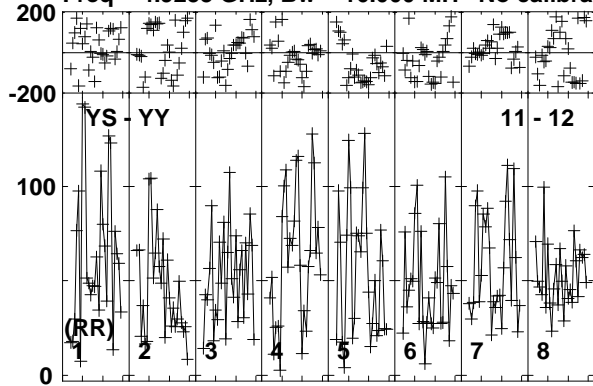

Lower frame: Micro Ampl Jy Top frame: Phas deg
Vector averaged cross-power spectrum Baseline: YS (11) - YY (12)
Timerange: 00/23:10:43 to 00/23:15:57

Plot file version 269 created 11-APR-2016 17:08:59

ARP299C GP053G 3.UVDATA.1

Freq = 4.9253 GHz, Bw = 16.000 MH No calibration applied and no bandpass applied

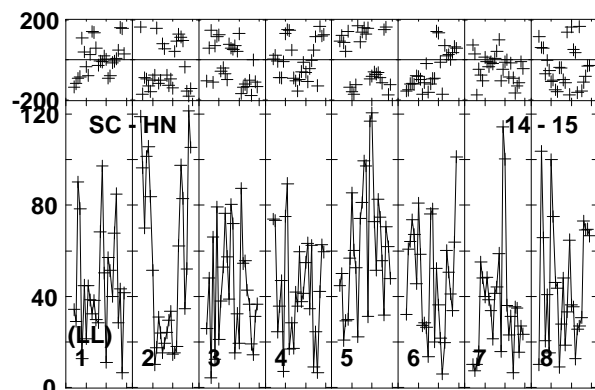
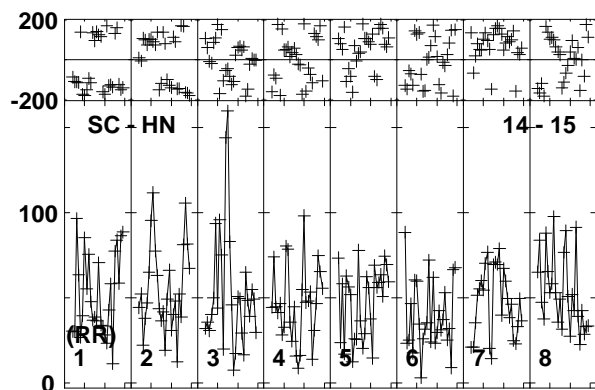
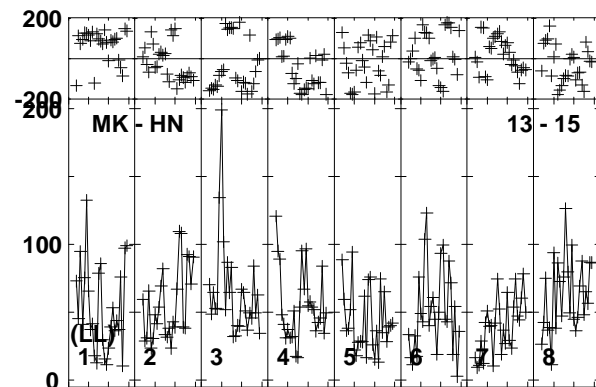
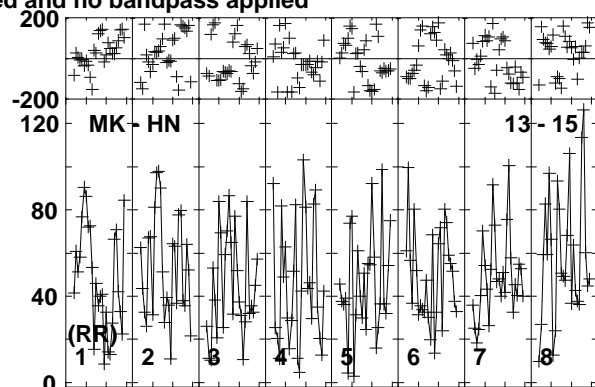
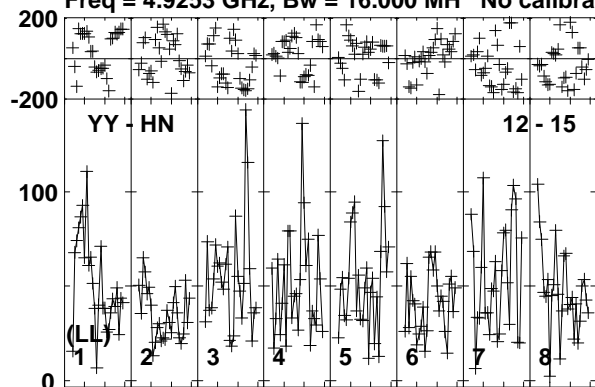

Lower frame: Micro Ampl Jy Top frame: Phas deg
Vector averaged cross-power spectrum Baseline: YY (12) - HN (15)
Timerange: 00/23:10:43 to 00/23:15:57

Plot file version 270 created 11-APR-2016 17:09:00

J1128+5925 GP053G 3.UVDATA.1

Freq = 4.9253 GHz, Bw = 16.000 MH No calibration applied and no bandpass applied

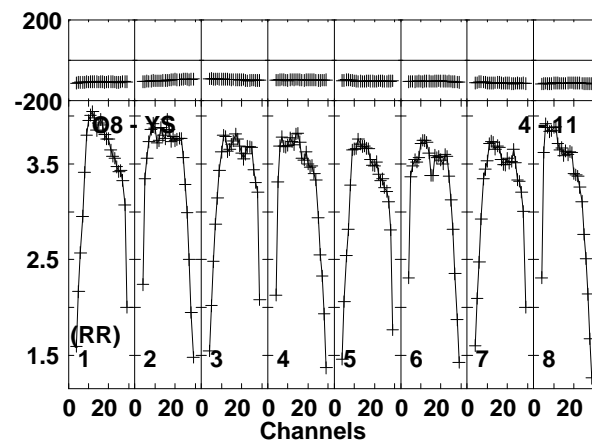
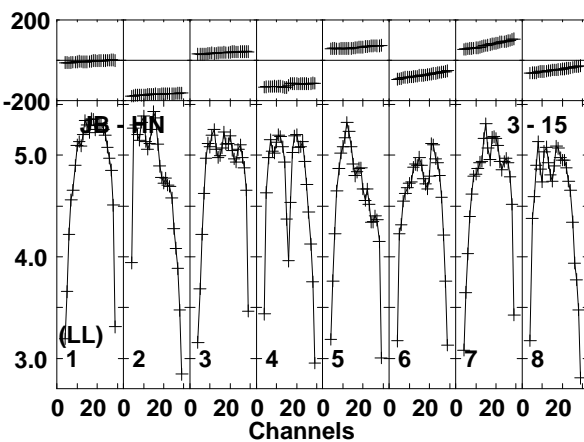
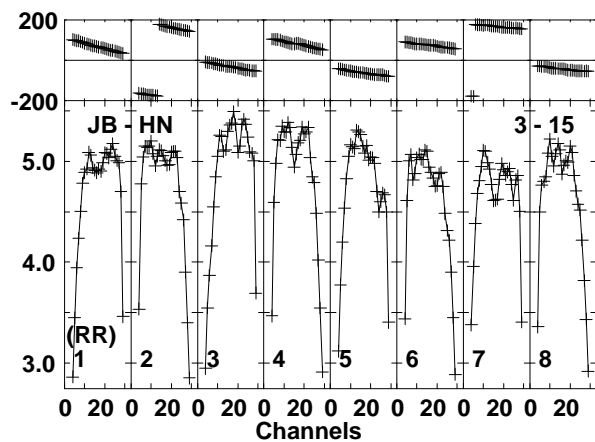
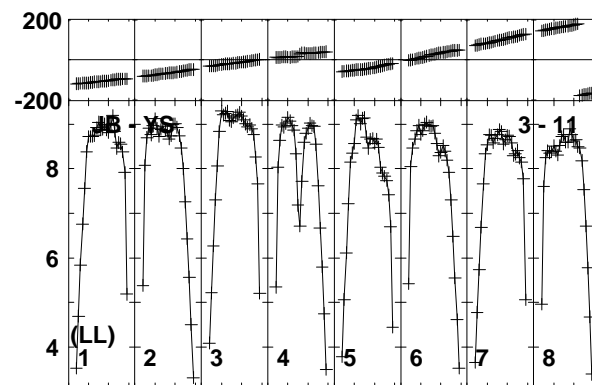
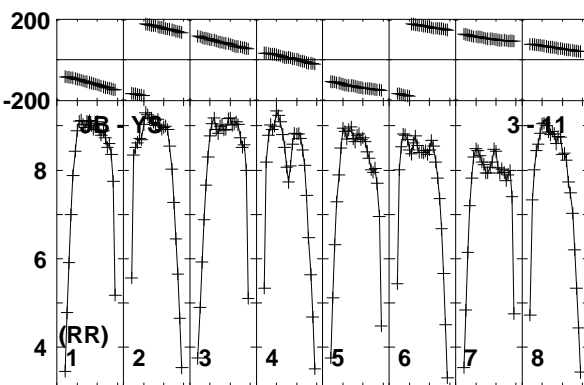
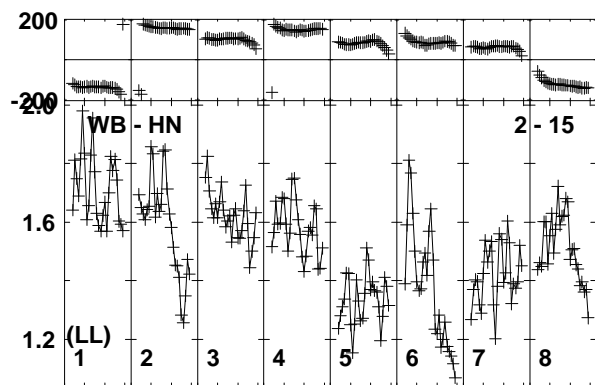
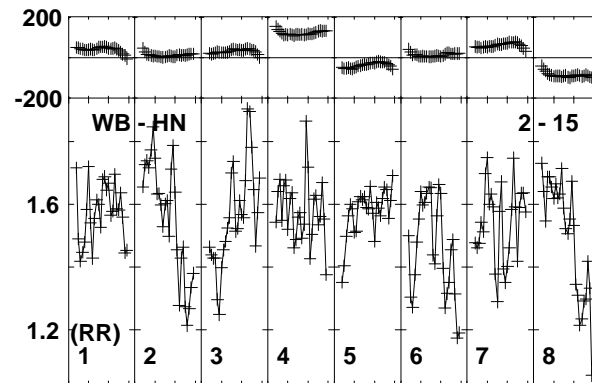
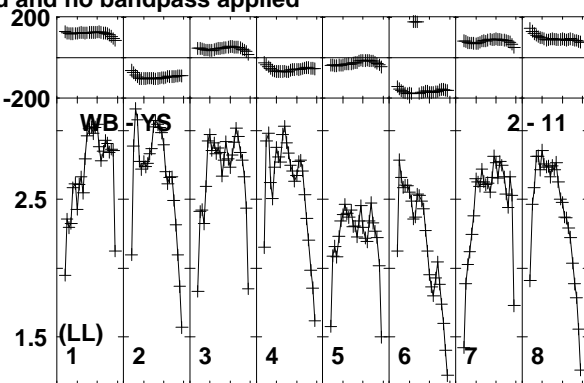
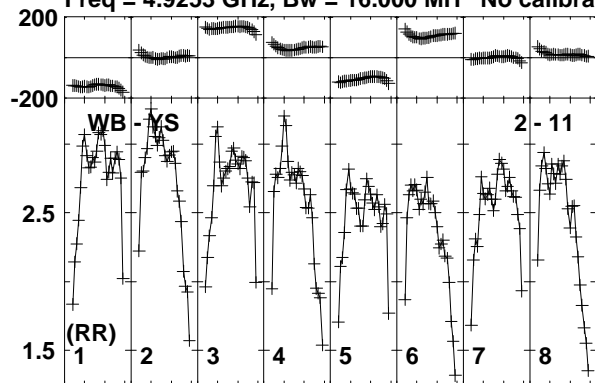

Lower frame: Milli Ampl Jy Top frame: Phas deg
Vector averaged cross-power spectrum Baseline: WB (02) - YS (11)
Timerange: 00/23:16:03 to 00/23:17:47

Plot file version 271 created 11-APR-2016 17:09:00

J1128+5925 GP053G 3.UVDATA.1

Freq = 4.9253 GHz, Bw = 16.000 MH No calibration applied and no bandpass applied

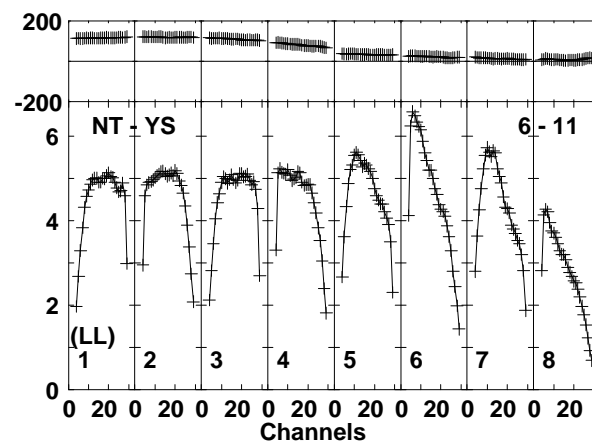
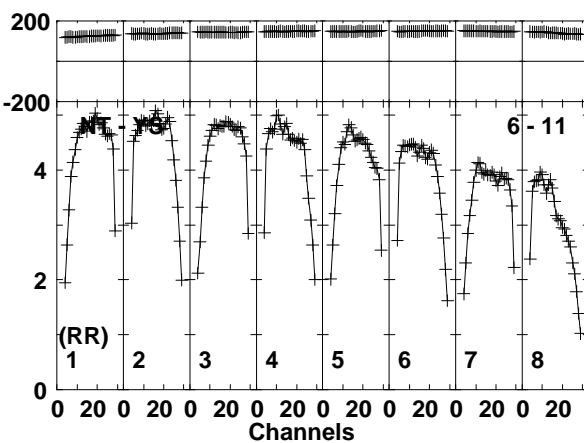
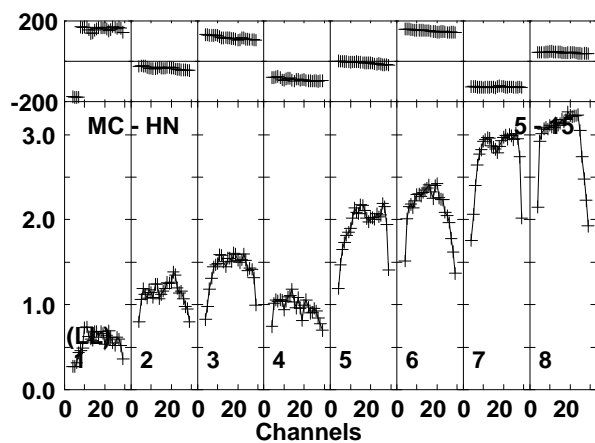
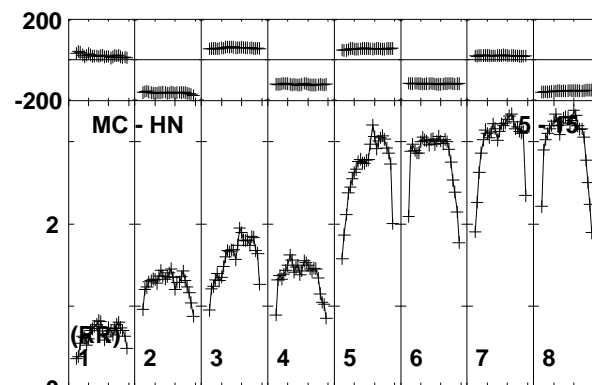
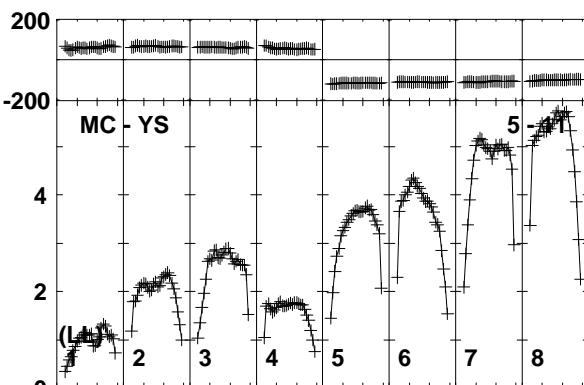
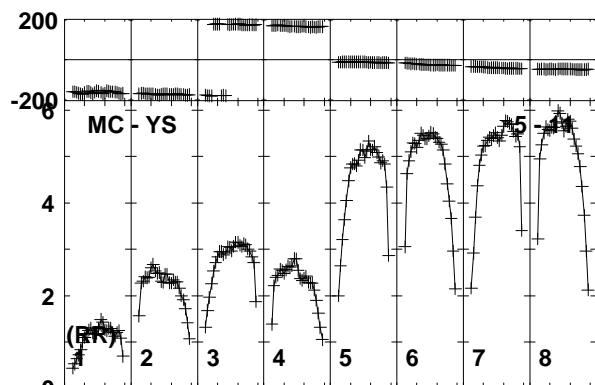
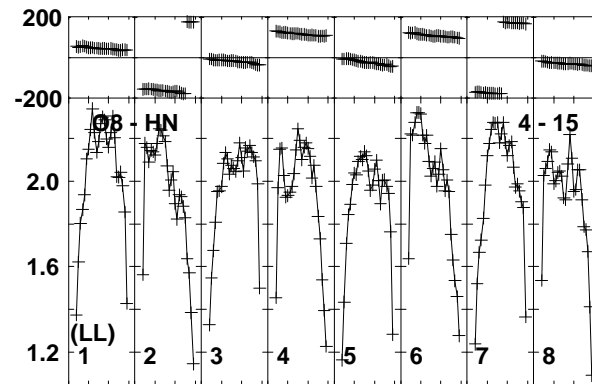
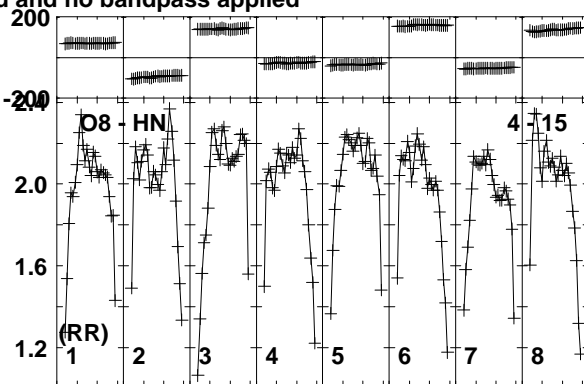
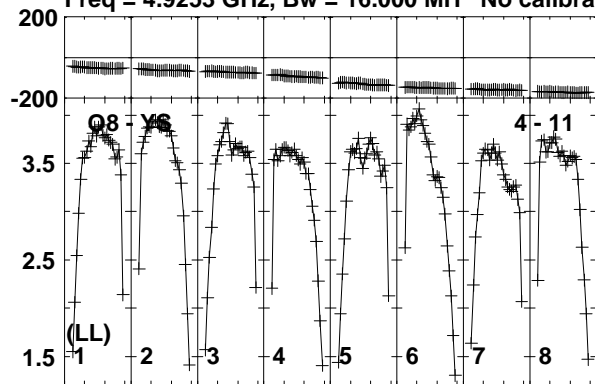

Lower frame: Milli Ampl Jy Top frame: Phas deg
Vector averaged cross-power spectrum Baseline: O8 (04) - YS (11)
Timerange: 00/23:16:03 to 00/23:17:47

Plot file version 272 created 11-APR-2016 17:09:00

J1128+5925 GP053G 3.UVDATA.1

Freq = 4.9253 GHz, Bw = 16.000 MH No calibration applied and no bandpass applied

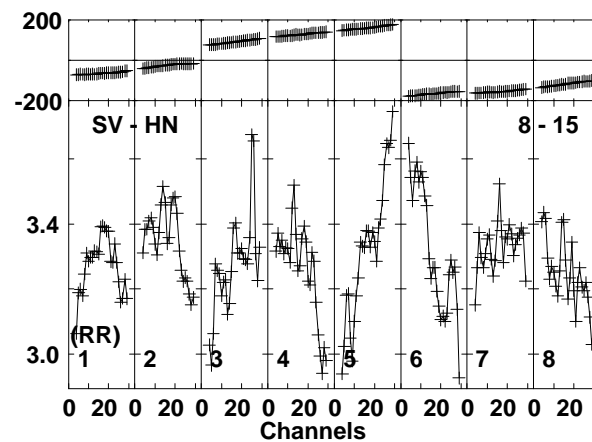
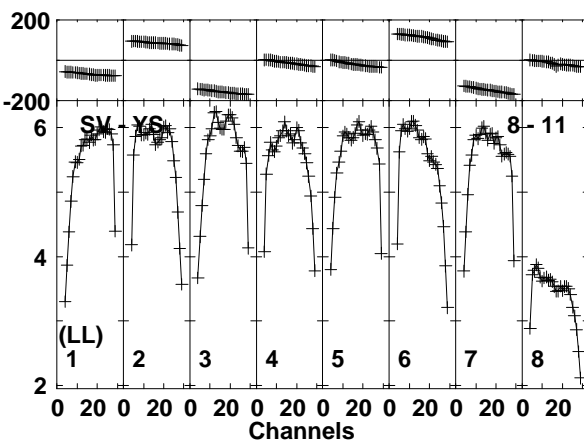
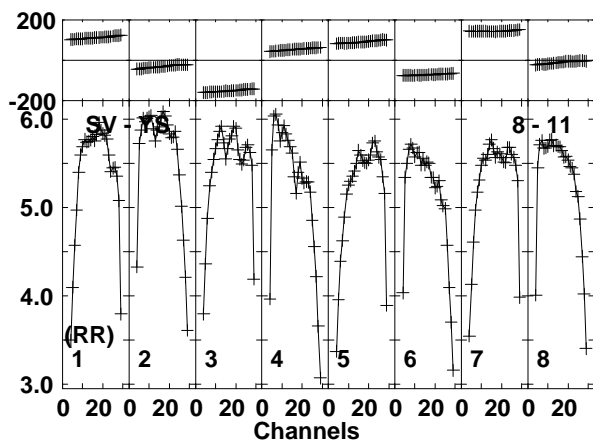
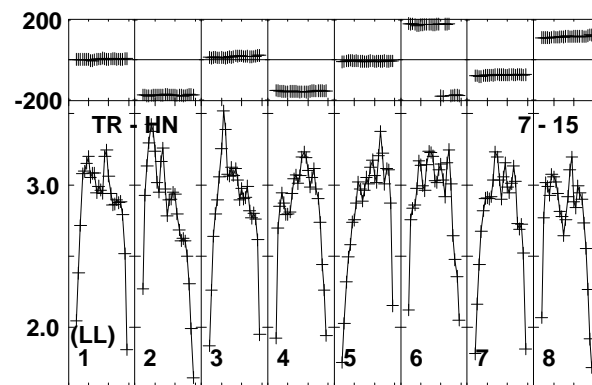
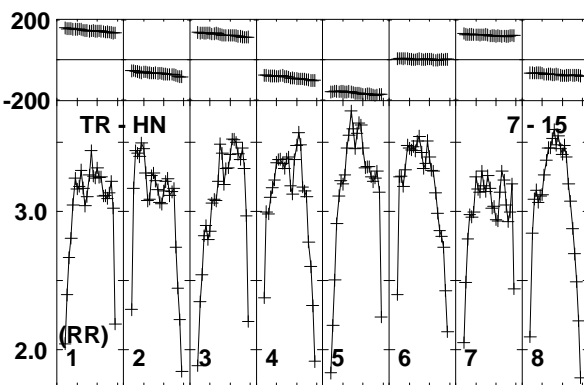
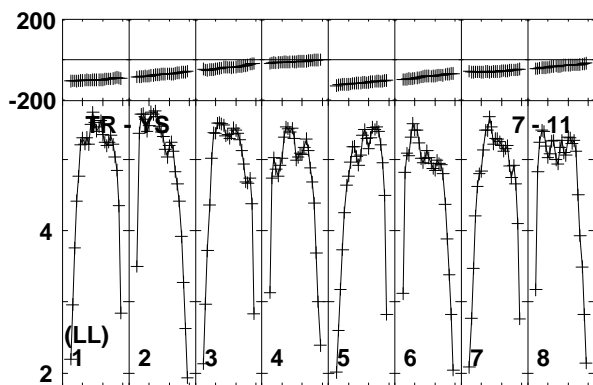
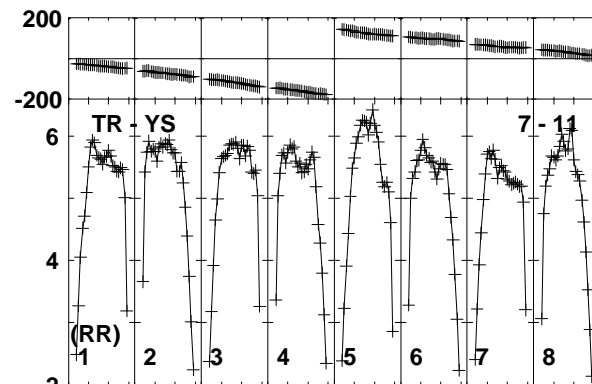
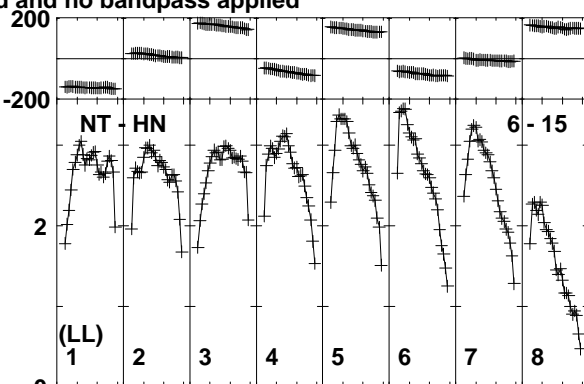
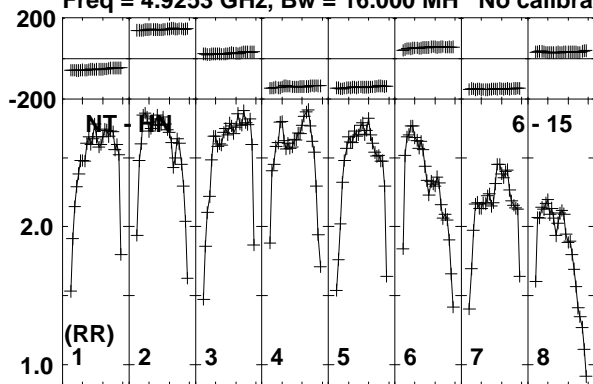

Lower frame: Milli Ampl Jy Top frame: Phas deg
Vector averaged cross-power spectrum Baseline: NT (06) - HN (15)
Timerange: 00/23:16:03 to 00/23:17:47

Plot file version 273 created 11-APR-2016 17:09:00

J1128+5925 GP053G 3.UVDATA.1

Freq = 4.9253 GHz, Bw = 16.000 MH No calibration applied and no bandpass applied

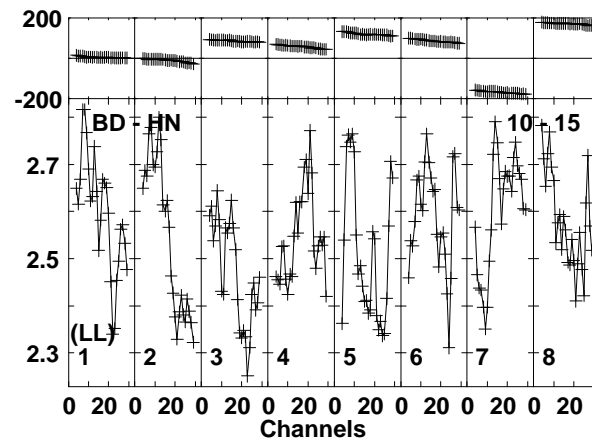
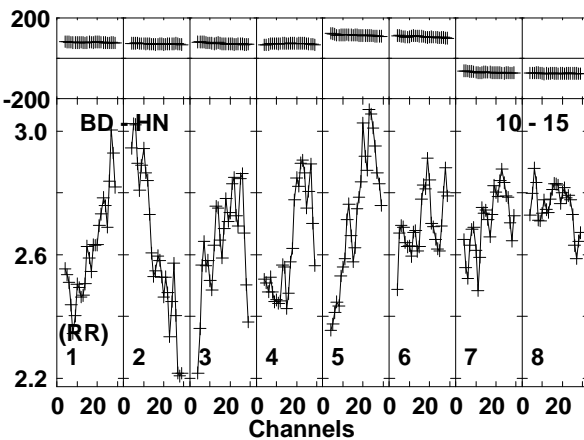
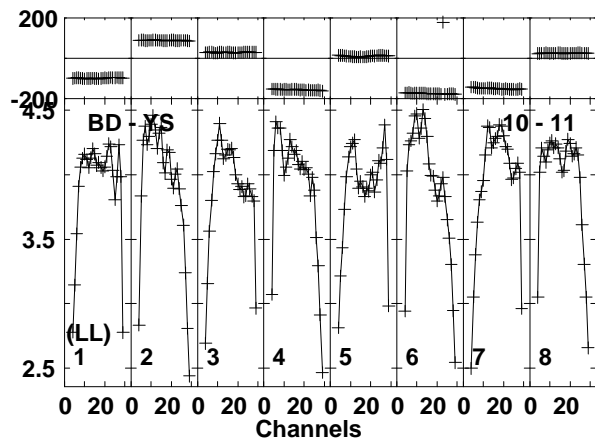
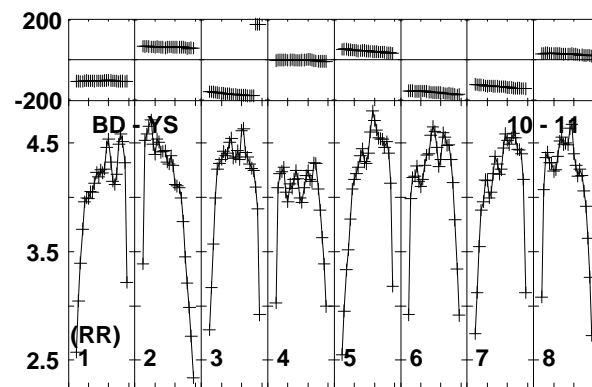
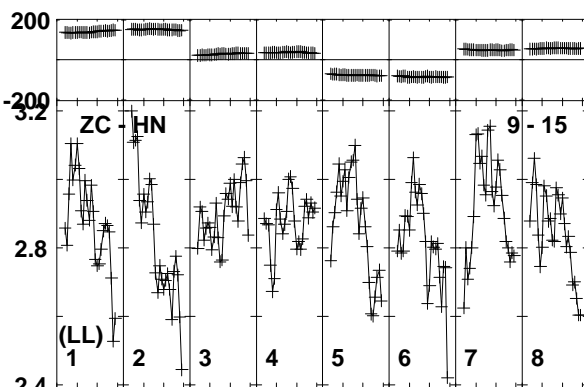
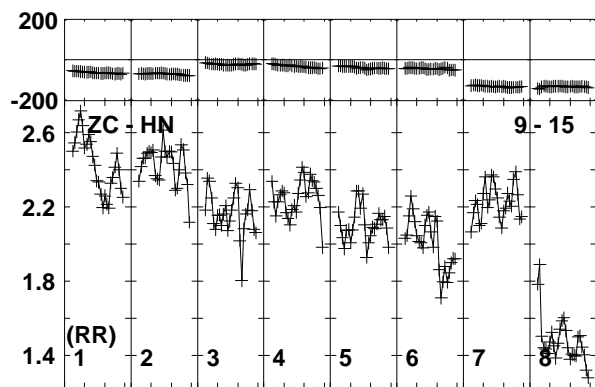
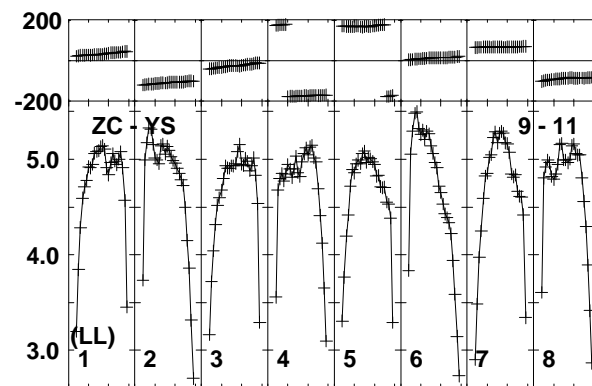
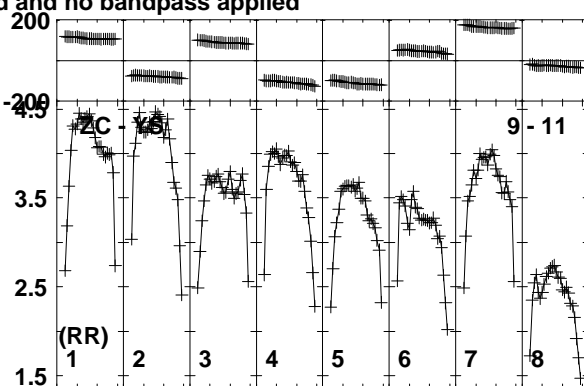
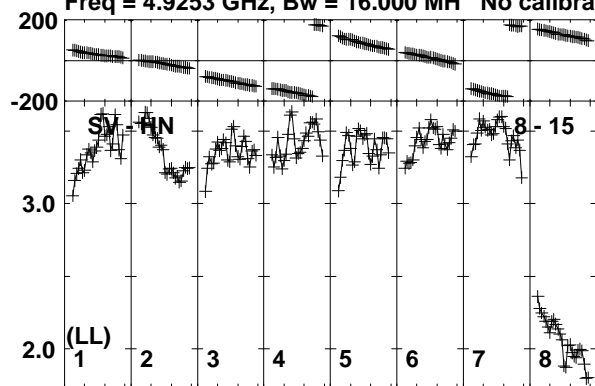

Lower frame: Milli Ampl Jy Top frame: Phas deg
Vector averaged cross-power spectrum Baseline: SV (08) - HN (15)
Timerange: 00/23:16:03 to 00/23:17:47

Plot file version 274 created 11-APR-2016 17:09:00
J1128+5925 GP053G 3.UVDATA.1

Freq = 4.9253 GHz, Bw = 16.000 MH No calibration applied and no bandpass applied

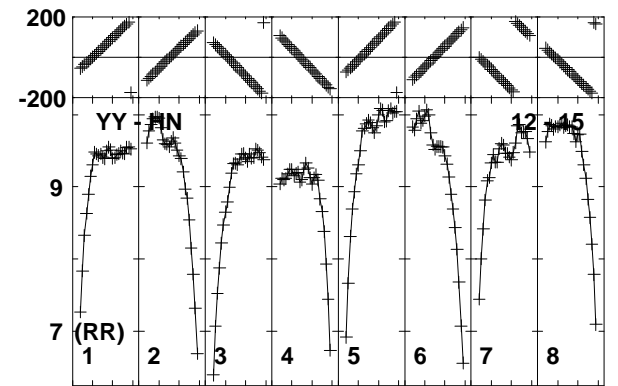
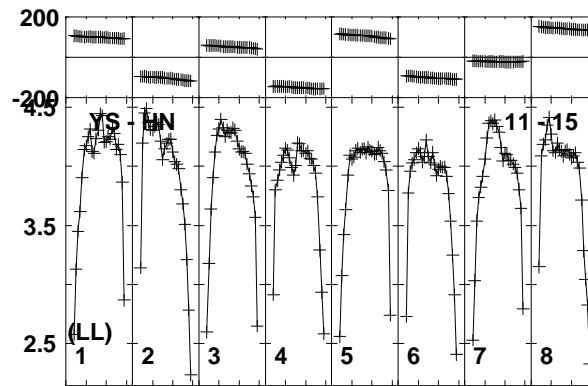
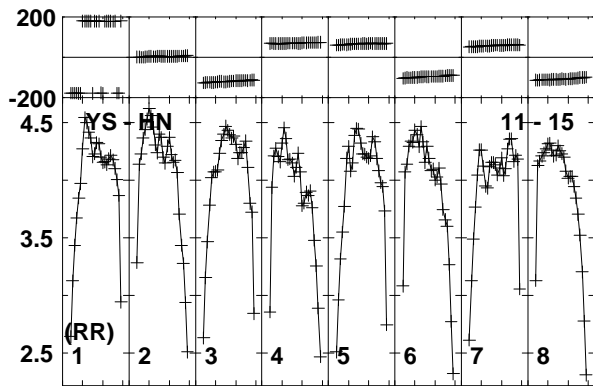
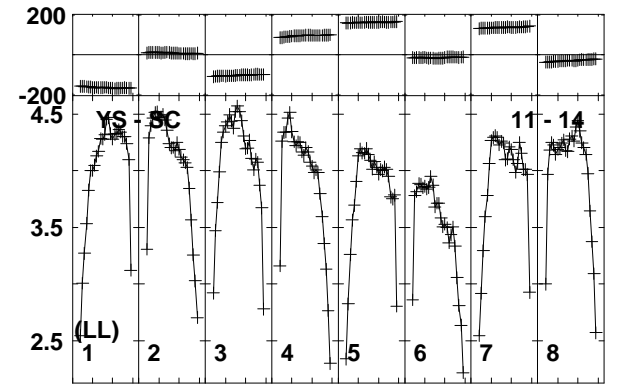
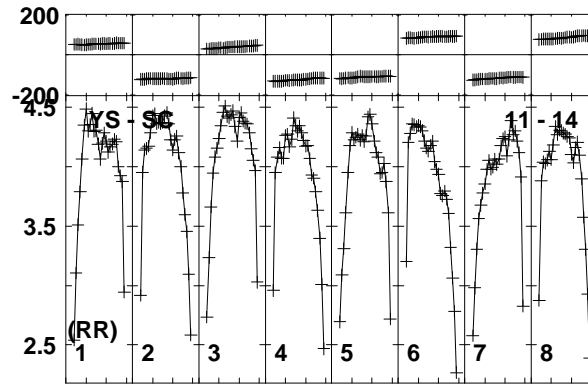
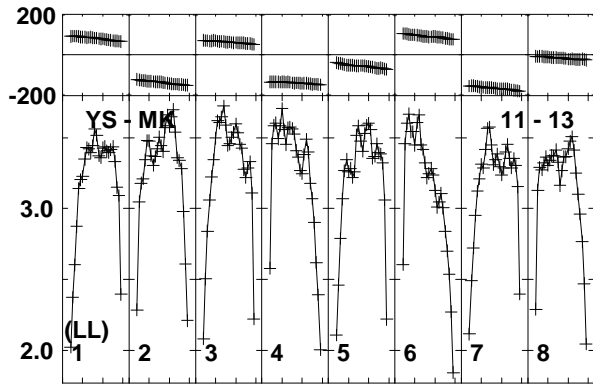
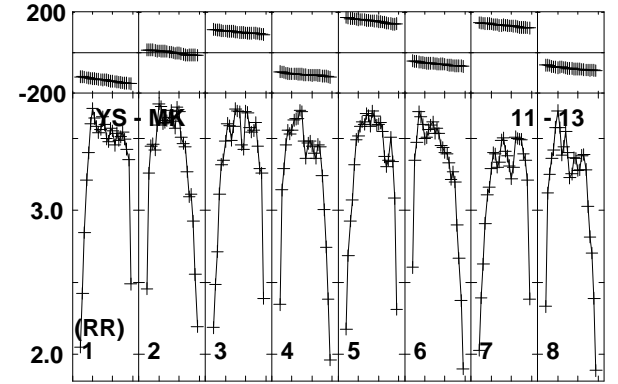
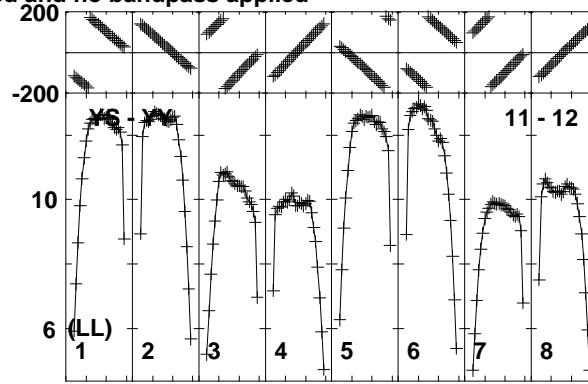
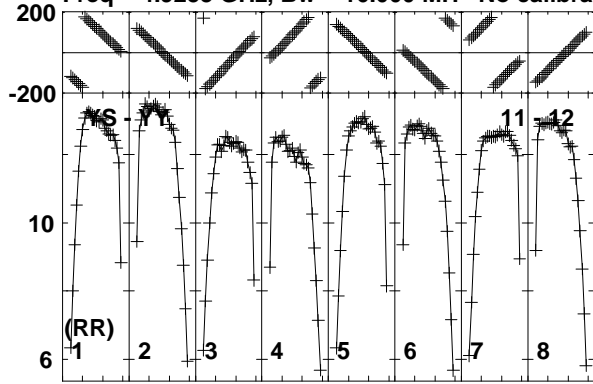

Lower frame: Milli Ampl Jy Top frame: Phas deg
Vector averaged cross-power spectrum Baseline: YS (11) - YY (12)
Timerange: 00/23:16:03 to 00/23:17:47

Plot file version 275 created 11-APR-2016 17:09:00

J1128+5925 GP053G 3.UVDATA.1

Freq = 4.9253 GHz, Bw = 16.000 MH No calibration applied and no bandpass applied

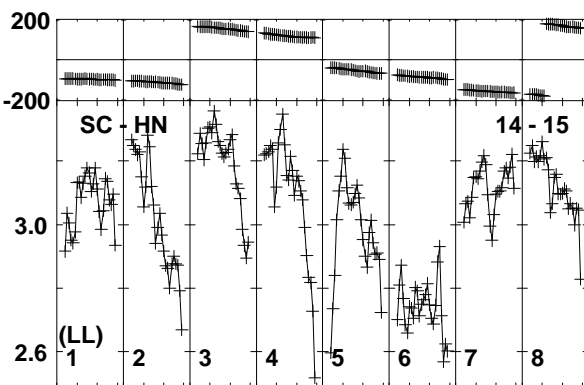
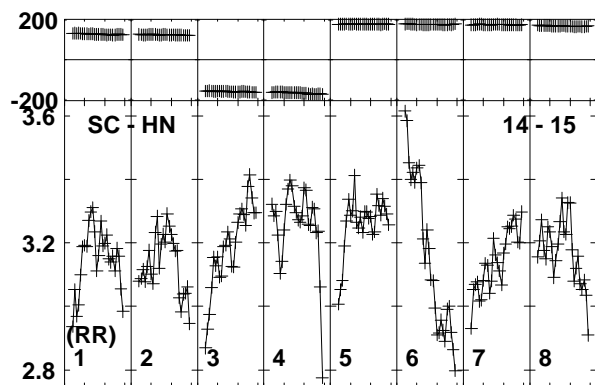
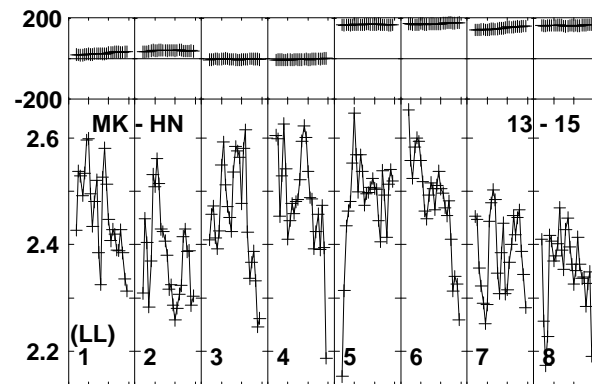
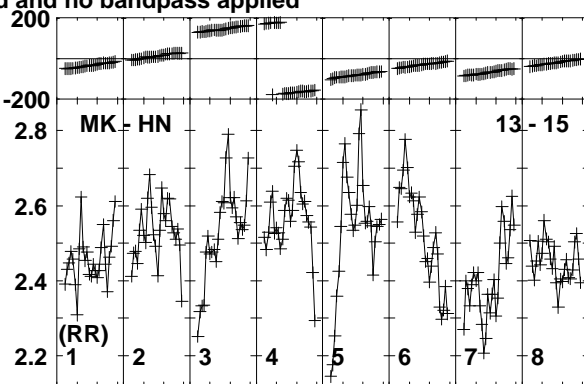
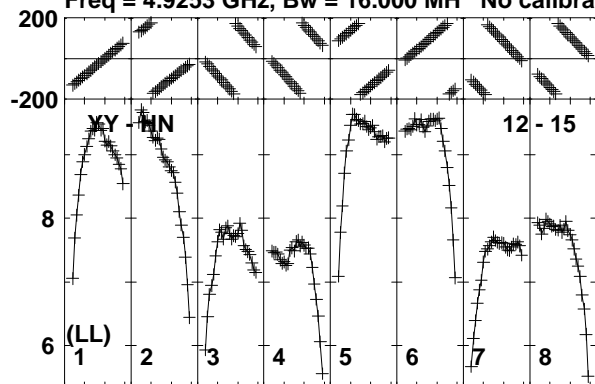

Lower frame: Milli Ampl Jy Top frame: Phas deg
Vector averaged cross-power spectrum Baseline: YY (12) - HN (15)
Timerange: 00/23:16:03 to 00/23:17:47

Plot file version 276 created 11-APR-2016 17:09:01

ARP299C GP053G 3.UVDATA.1

Freq = 4.9253 GHz, Bw = 16.000 MH No calibration applied and no bandpass applied

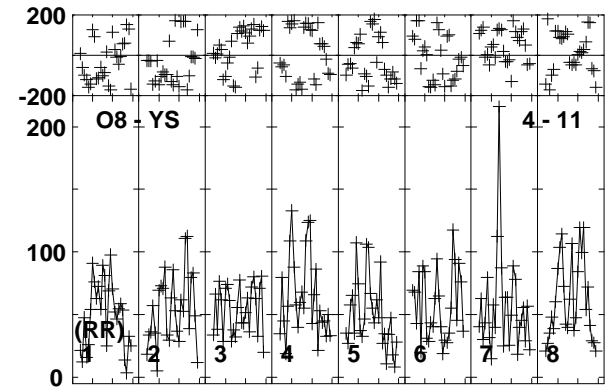
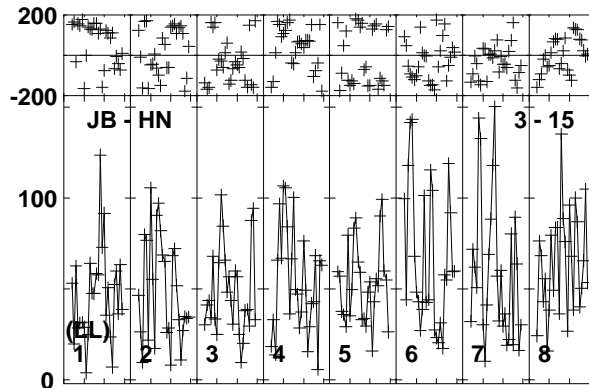
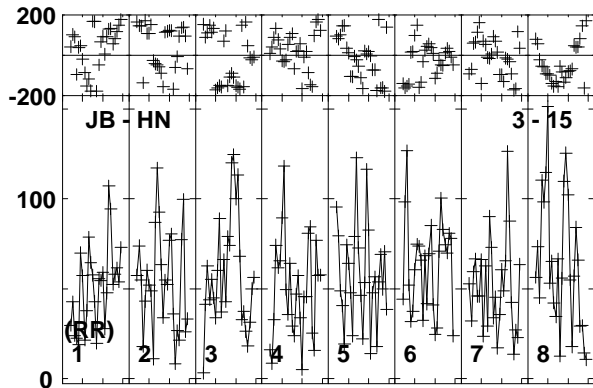
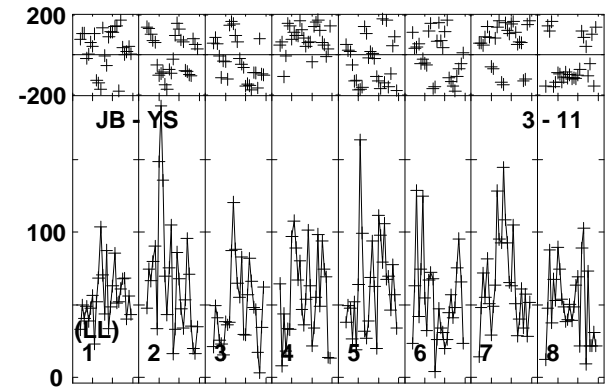
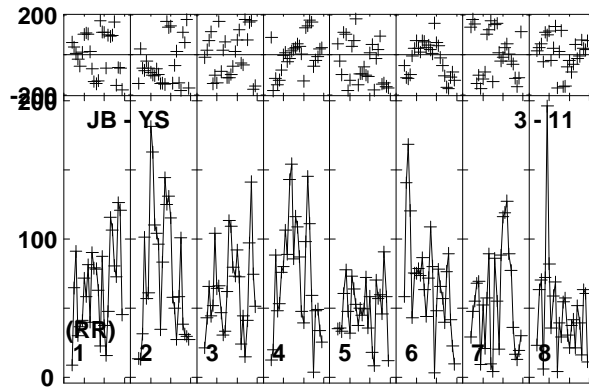
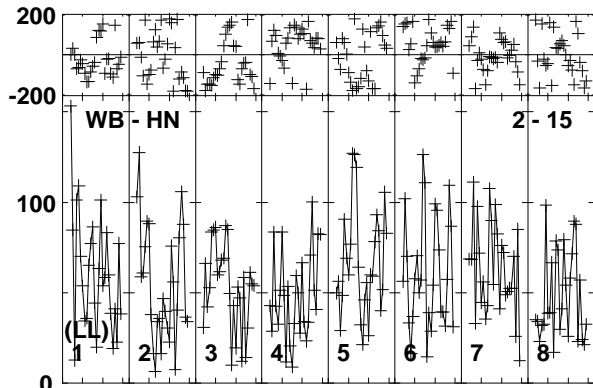
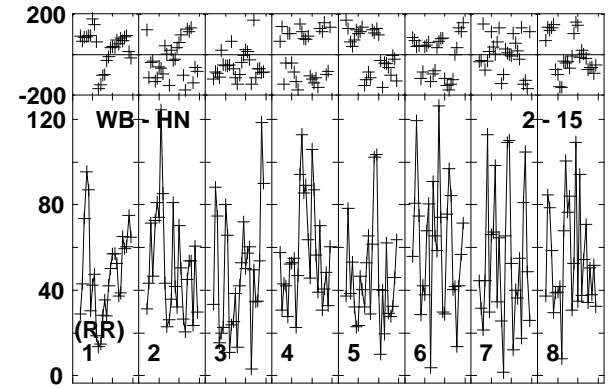
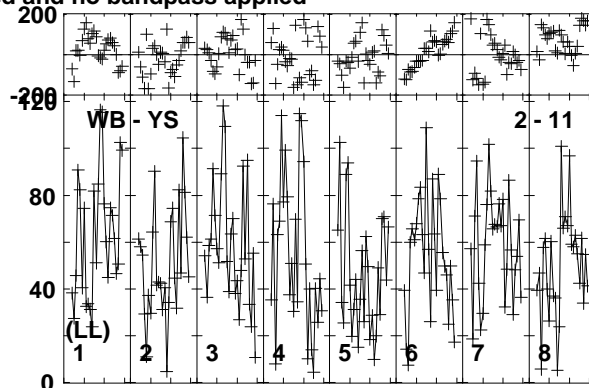
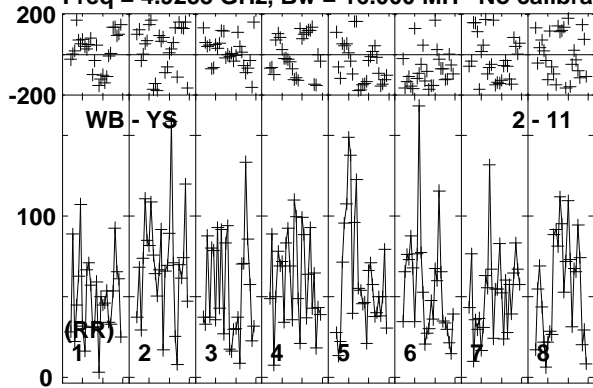

Lower frame: Micro Ampl Jy Top frame: Phas deg
Vector averaged cross-power spectrum Baseline: WB (02) - YS (11)
Timerange: 00/23:17:53 to 00/23:23:05

Plot file version 277 created 11-APR-2016 17:09:01

ARP299C GP053G 3.UVDATA.1

Freq = 4.9253 GHz, Bw = 16.000 MH No calibration applied and no bandpass applied

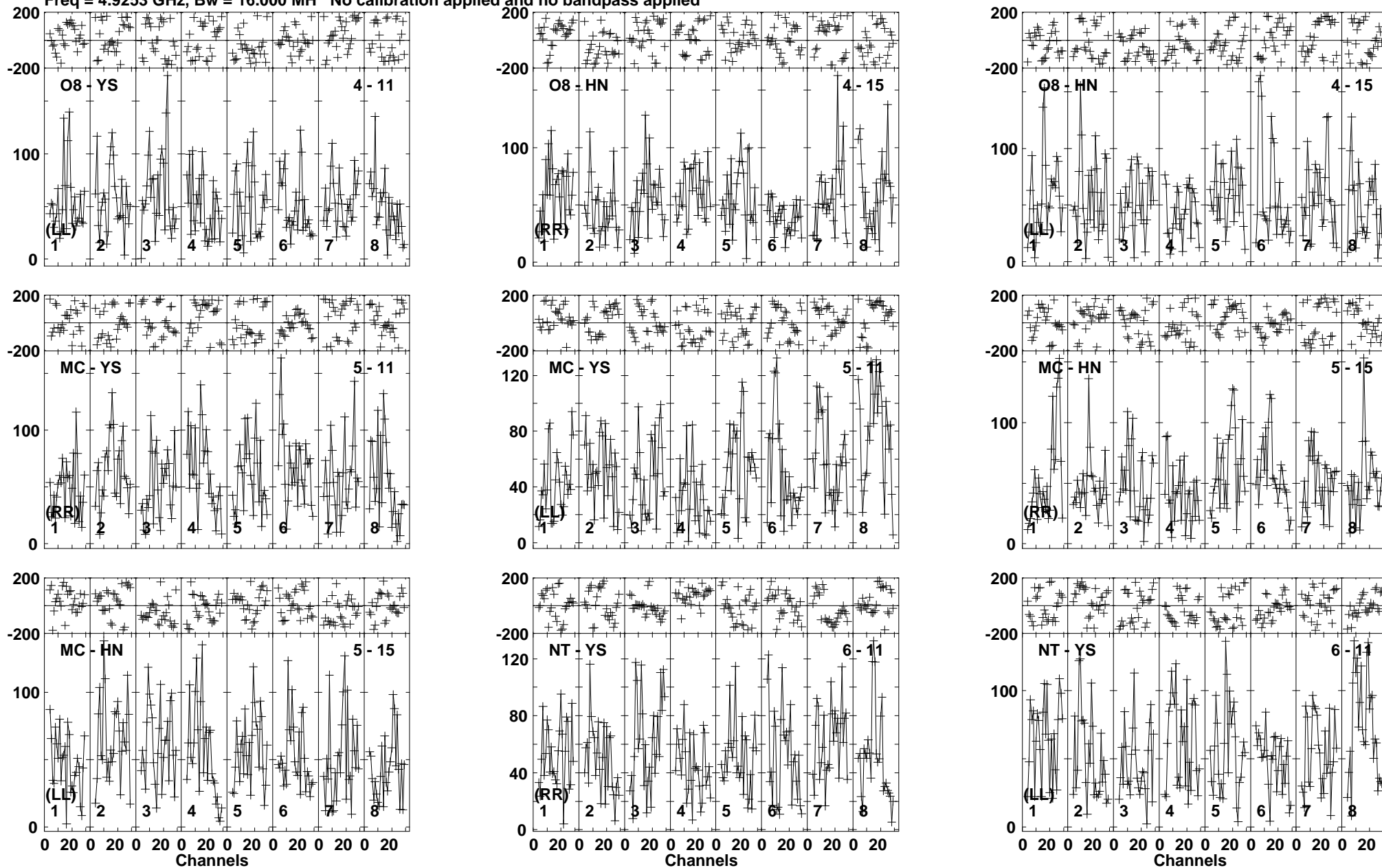

Lower frame: Micro Ampl Jy Top frame: Phas deg
Vector averaged cross-power spectrum Baseline: O8 (04) - YS (11)
Timerange: 00/23:17:53 to 00/23:23:05

Plot file version 278 created 11-APR-2016 17:09:01

ARP299C GP053G 3.UVDATA.1

Freq = 4.9253 GHz, Bw = 16.000 MH No calibration applied and no bandpass applied

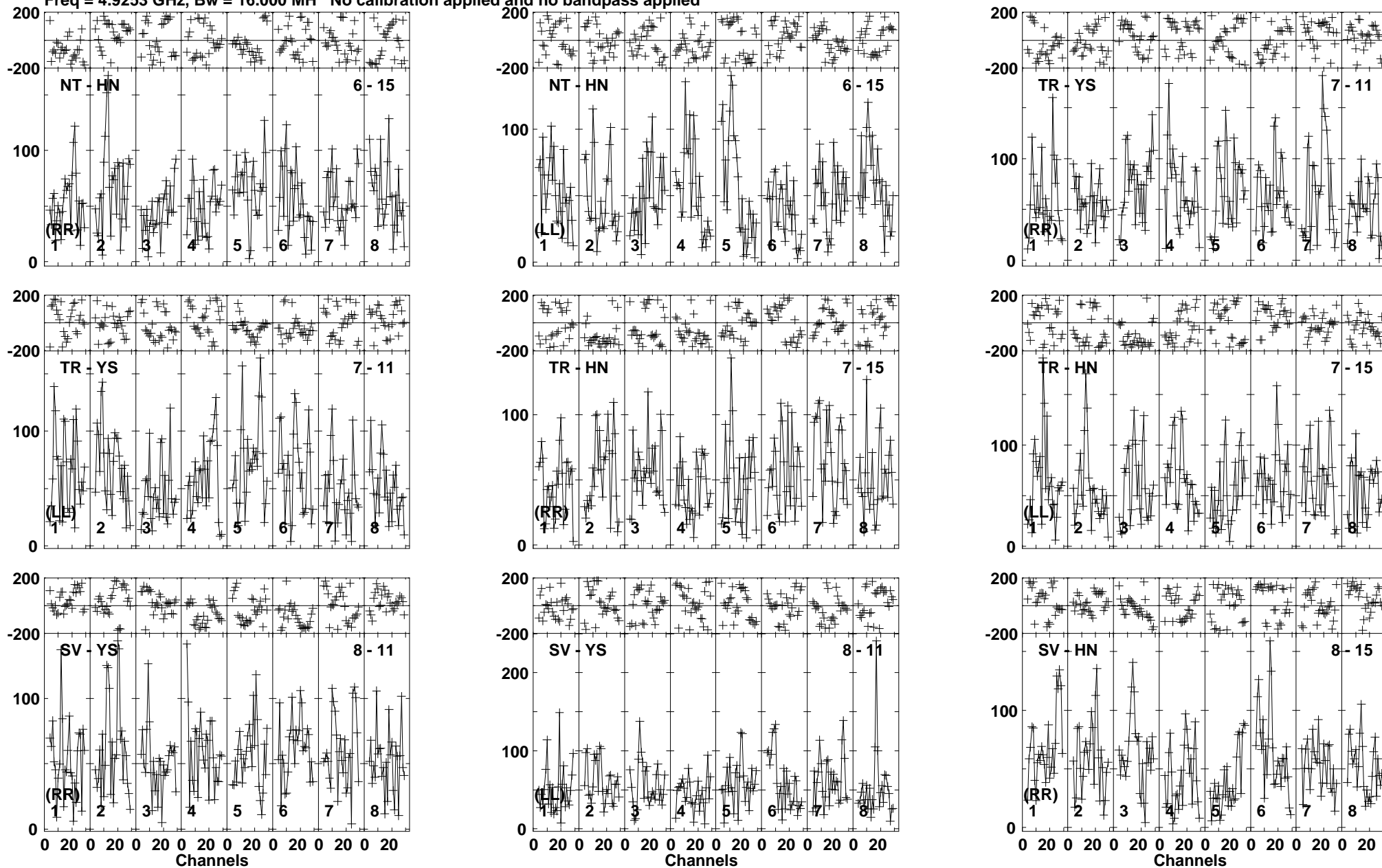

Lower frame: Micro Ampl Jy Top frame: Phas deg
Vector averaged cross-power spectrum Baseline: NT (06) - HN (15)
Timerange: 00/23:17:53 to 00/23:23:05

Plot file version 279 created 11-APR-2016 17:09:01

ARP299C GP053G 3.UVDATA.1

Freq = 4.9253 GHz, Bw = 16.000 MH No calibration applied and no bandpass applied

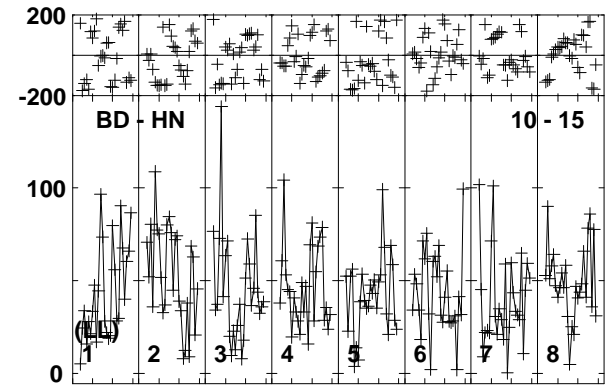
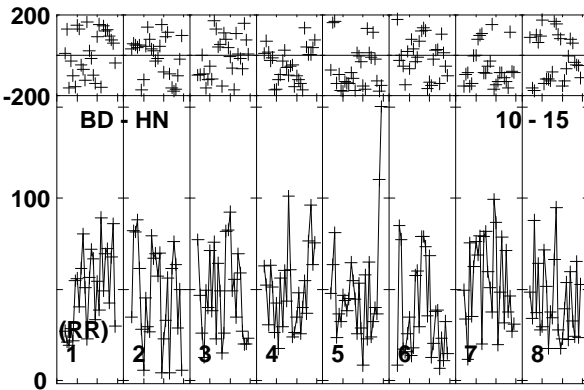
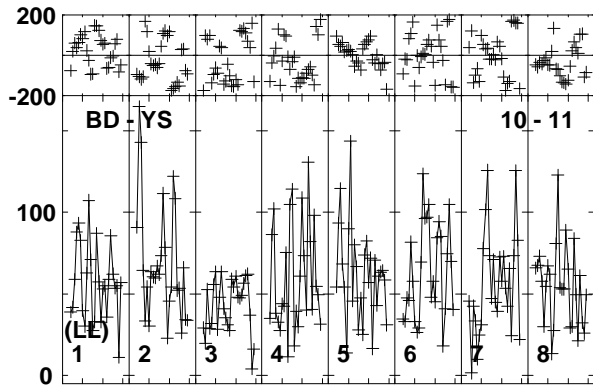
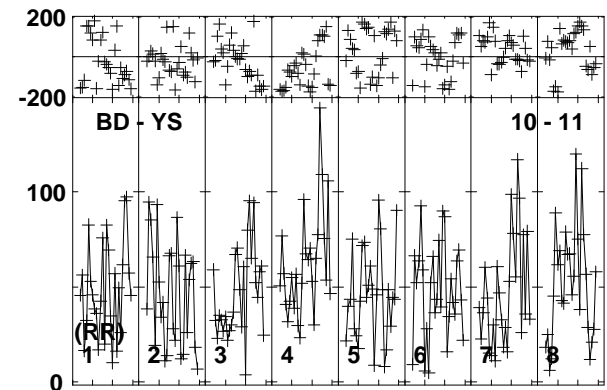
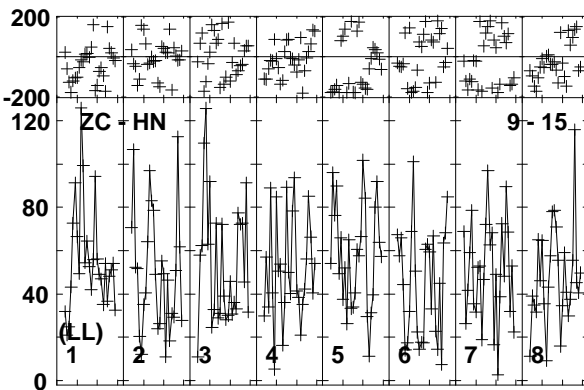
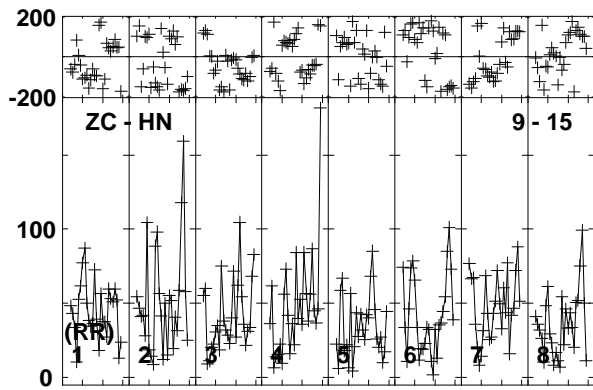
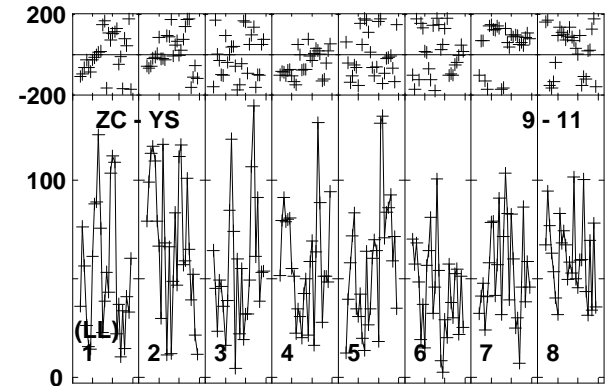
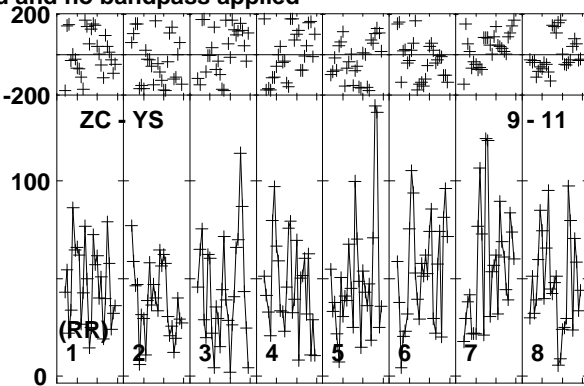
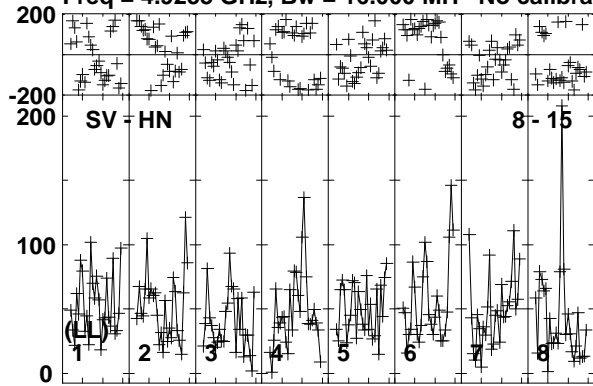

Lower frame: Micro Ampl Jy Top frame: Phas deg
Vector averaged cross-power spectrum Baseline: SV (08) - HN (15)
Timerange: 00/23:17:53 to 00/23:23:05

Plot file version 280 created 11-APR-2016 17:09:01

ARP299C GP053G 3.UVDATA.1

Freq = 4.9253 GHz, Bw = 16.000 MH No calibration applied and no bandpass applied

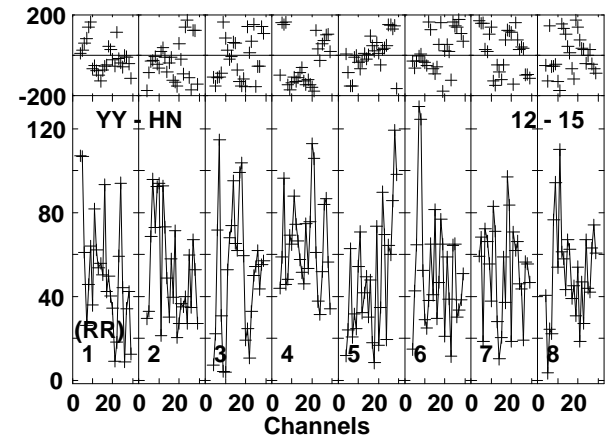
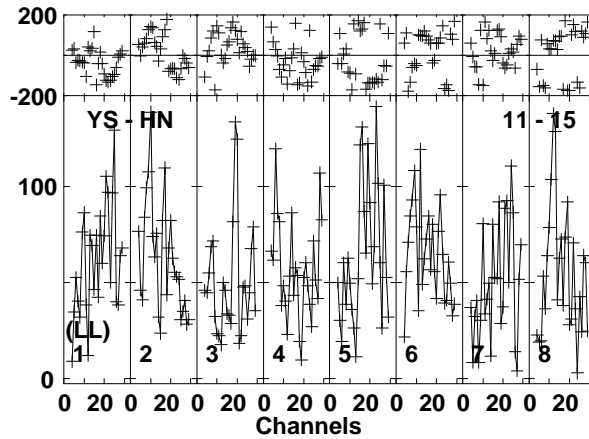
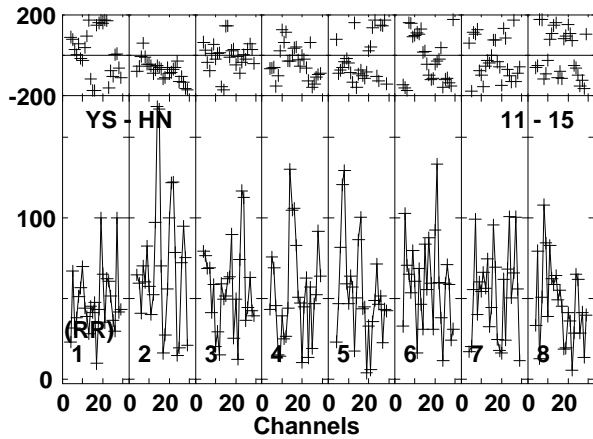
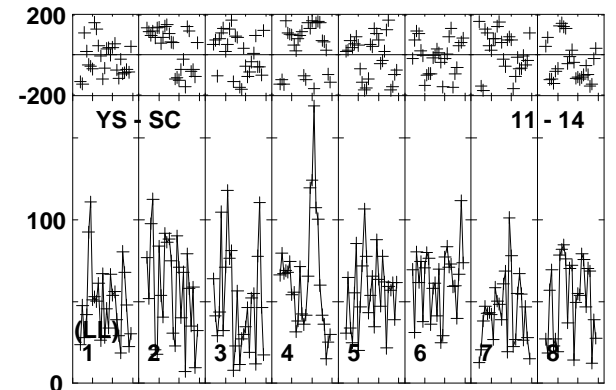
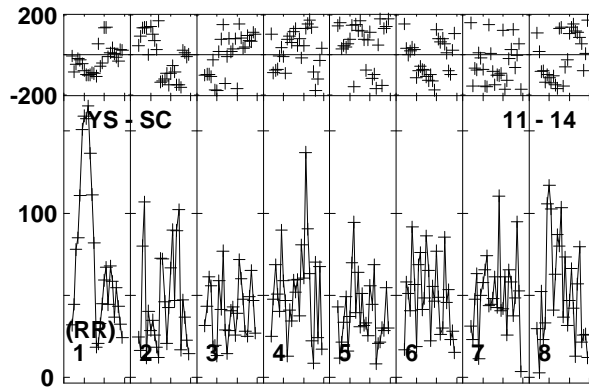
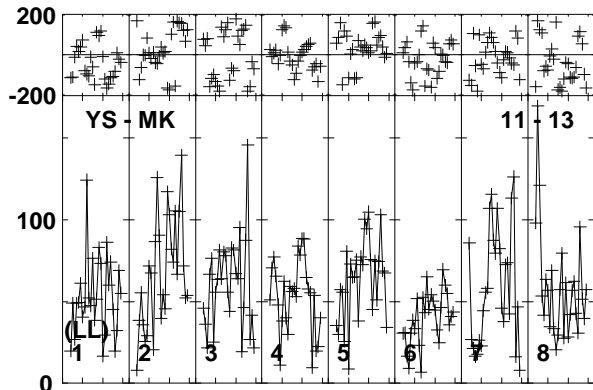
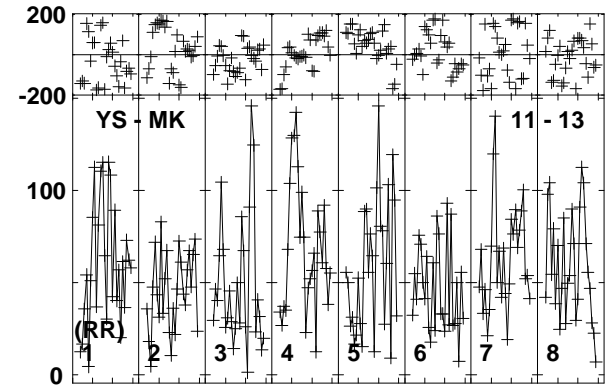
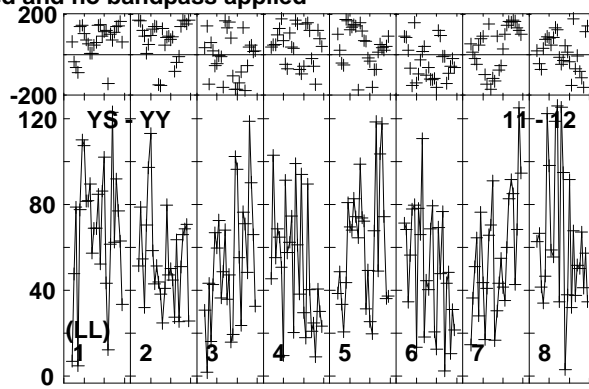
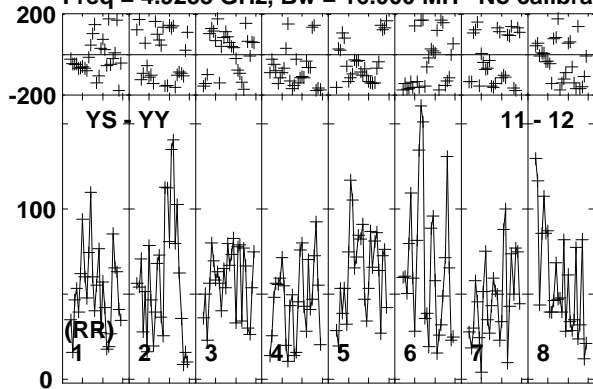

Lower frame: Micro Ampl Jy Top frame: Phas deg
Vector averaged cross-power spectrum Baseline: YS (11) - YY (12)
Timerange: 00/23:17:53 to 00/23:23:05

Plot file version 281 created 11-APR-2016 17:09:01

ARP299C GP053G 3.UVDATA.1

Freq = 4.9253 GHz, Bw = 16.000 MH No calibration applied and no bandpass applied

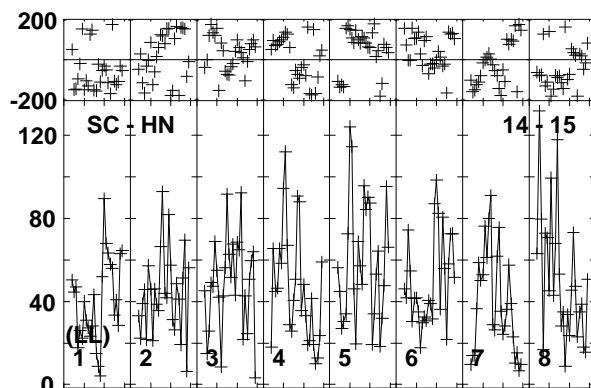
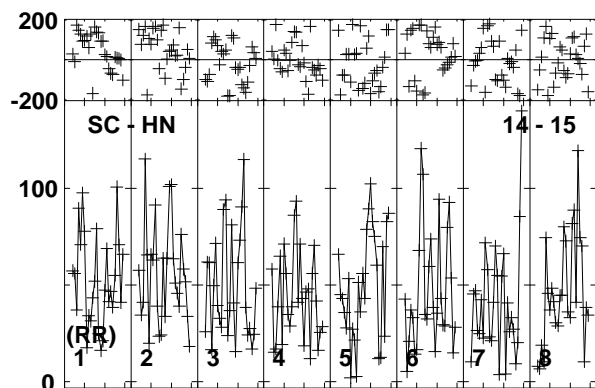
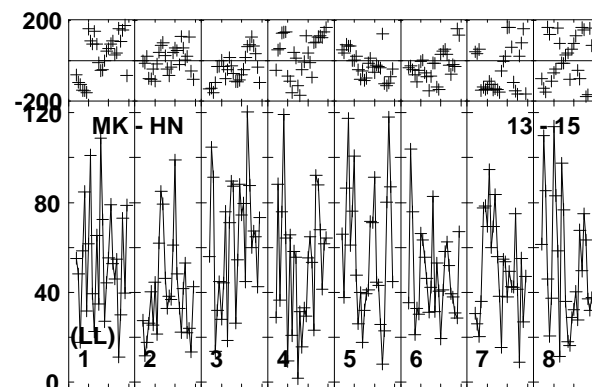
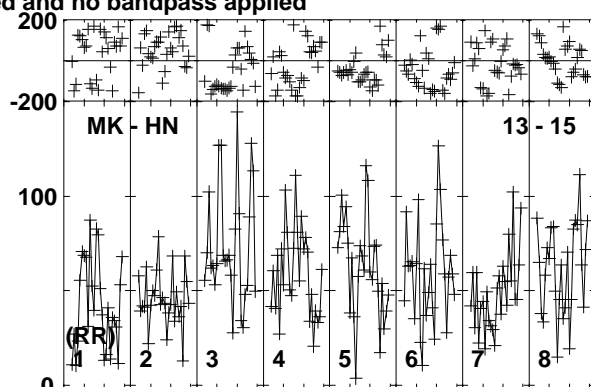
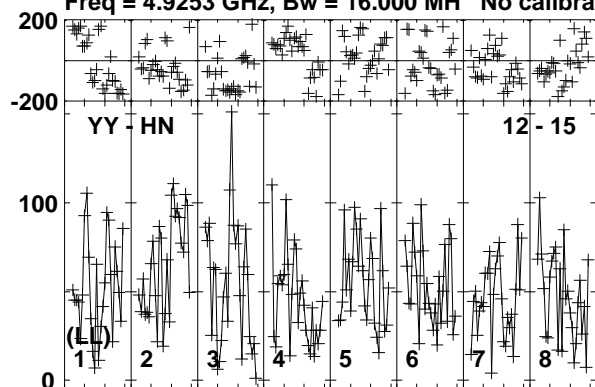

Lower frame: Micro Ampl Jy Top frame: Phas deg
Vector averaged cross-power spectrum Baseline: YY (12) - HN (15)
Timerange: 00/23:17:53 to 00/23:23:05

Plot file version 282 created 11-APR-2016 17:09:02

J1128+5925 GP053G 3.UVDATA.1

Freq = 4.9253 GHz, Bw = 16.000 MH No calibration applied and no bandpass applied

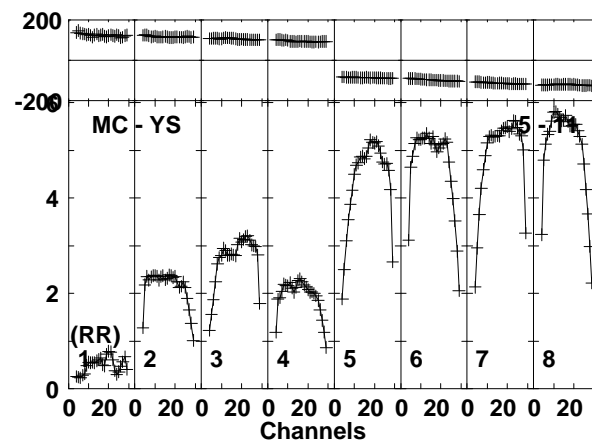
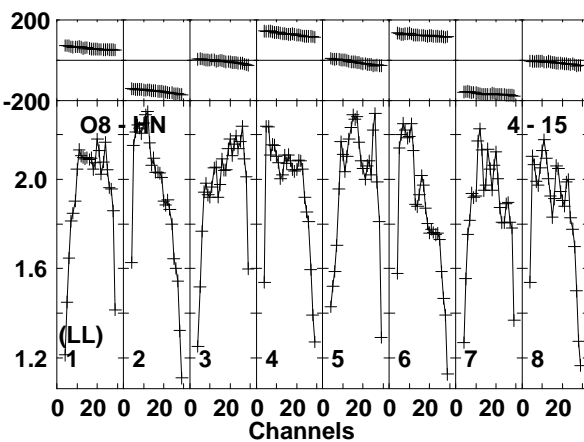
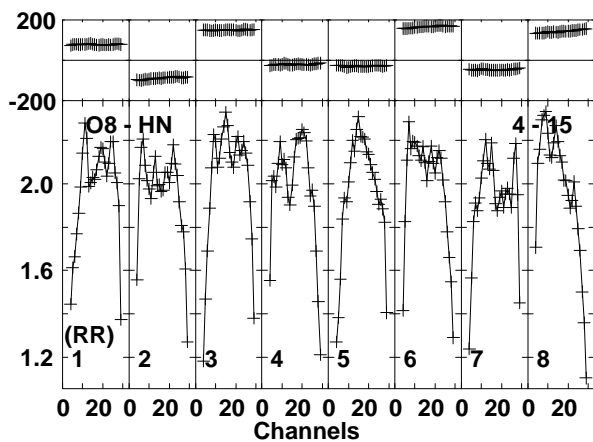
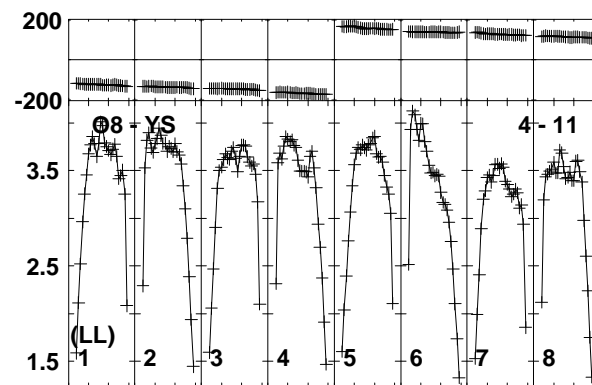
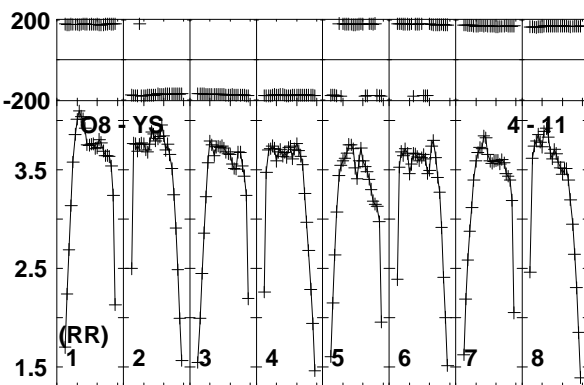
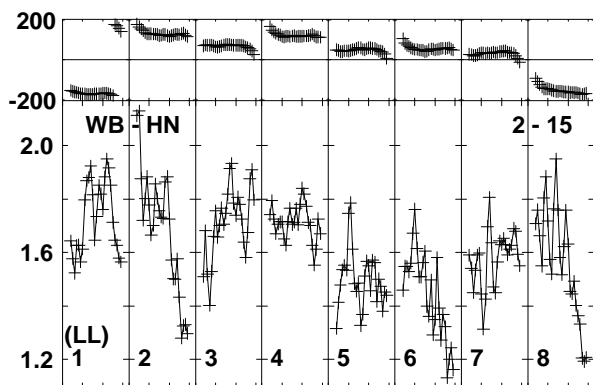
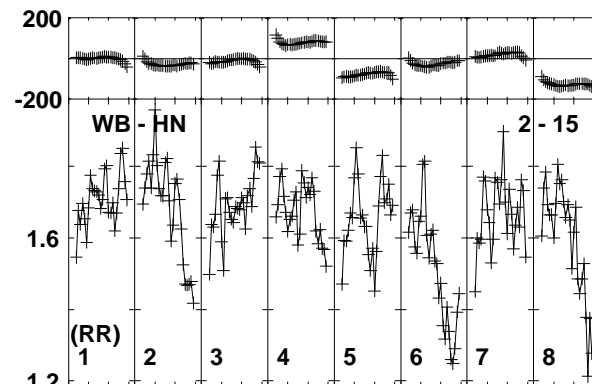
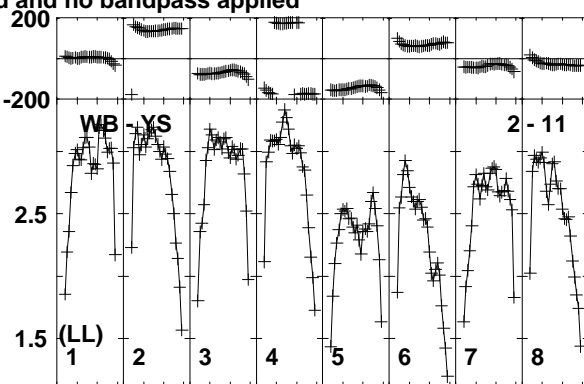
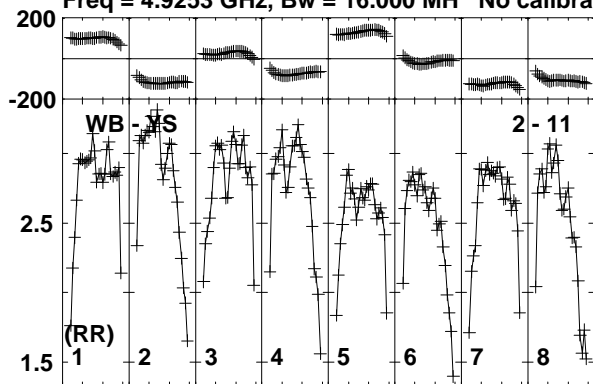

Lower frame: Milli Ampl Jy Top frame: Phas deg
Vector averaged cross-power spectrum Baseline: WB (02) - YS (11)
Timerange: 00/23:23:11 to 00/23:25:03

Plot file version 283 created 11-APR-2016 17:09:02

J1128+5925 GP053G 3.UVDATA.1

Freq = 4.9253 GHz, Bw = 16.000 MH No calibration applied and no bandpass applied

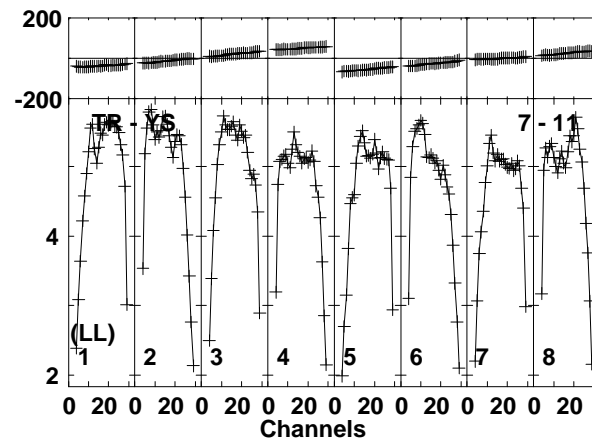
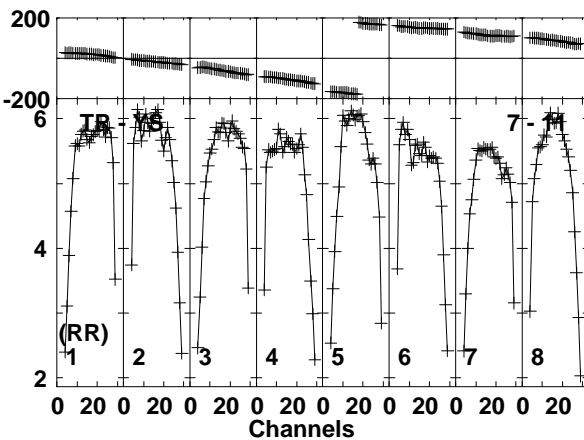
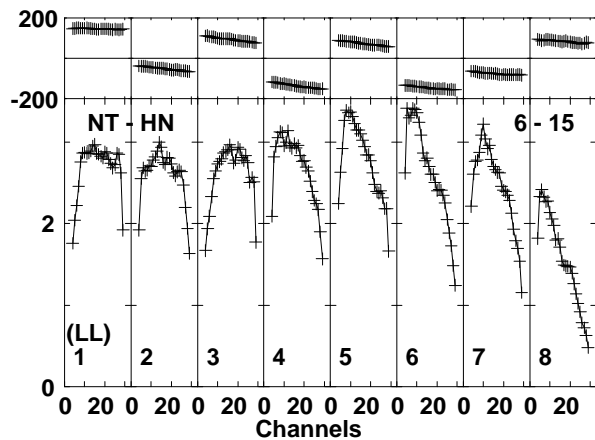
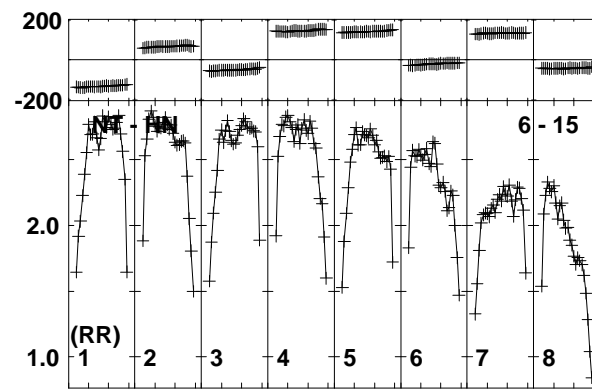
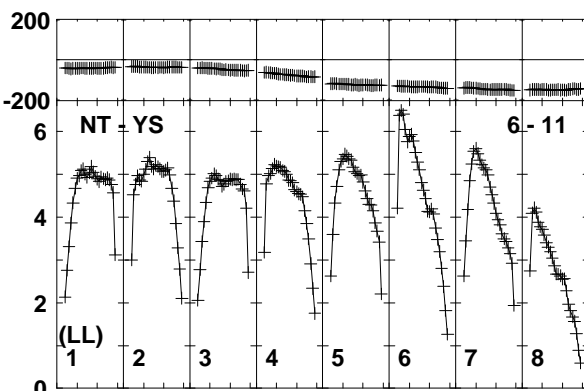
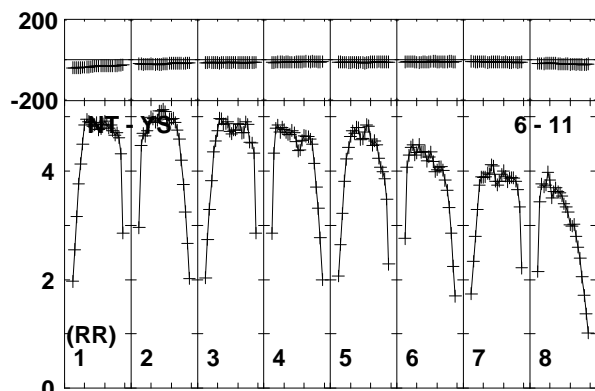
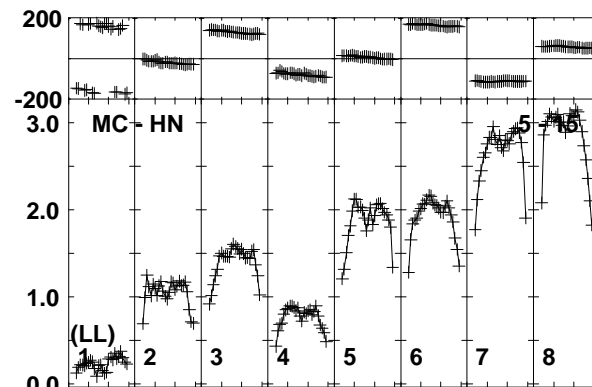
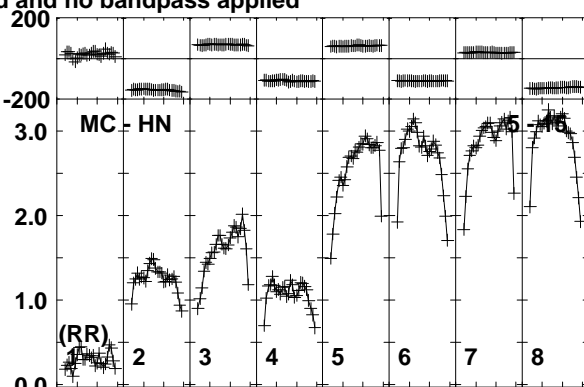
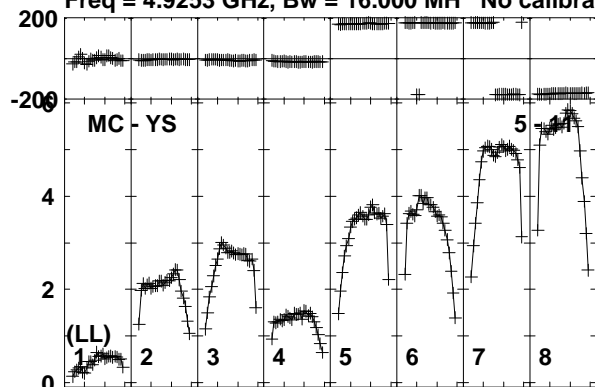

Lower frame: Milli Ampl Jy Top frame: Phas deg
Vector averaged cross-power spectrum Baseline: MC (05) - YS (11)
Timerange: 00/23:23:11 to 00/23:25:03

Plot file version 284 created 11-APR-2016 17:09:02

J1128+5925 GP053G 3.UVDATA.1

Freq = 4.9253 GHz, Bw = 16.000 MH No calibration applied and no bandpass applied

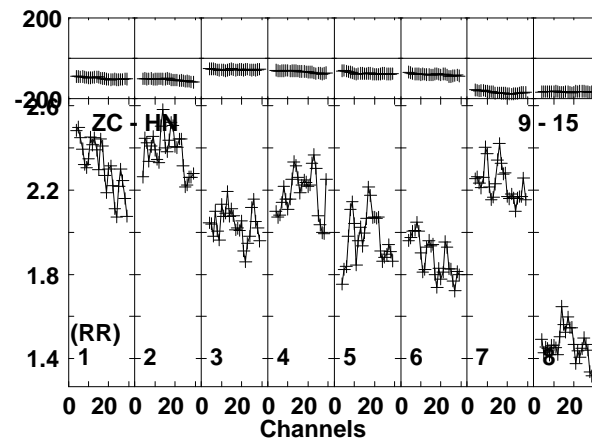
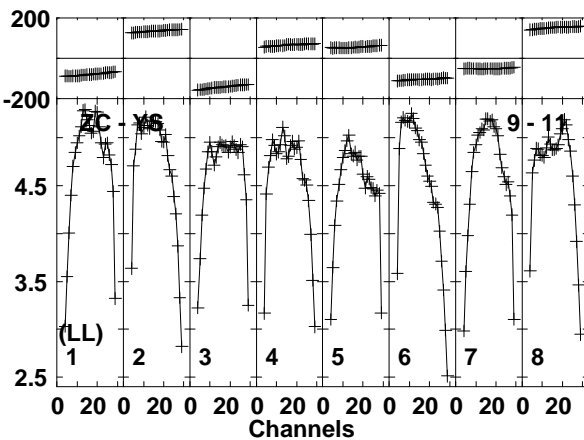
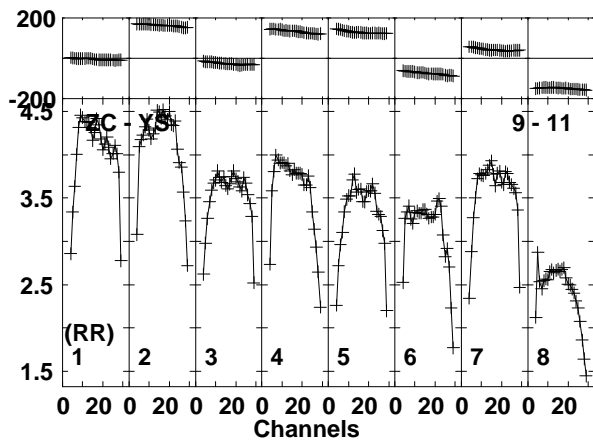
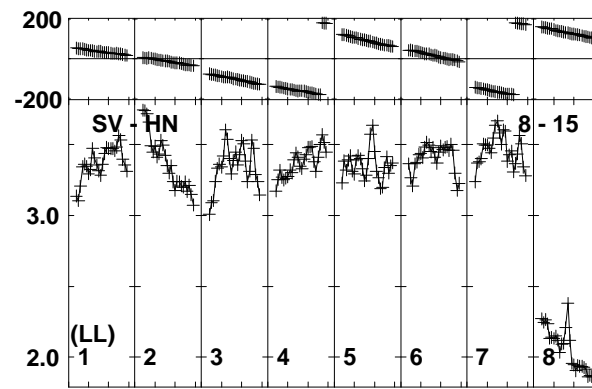
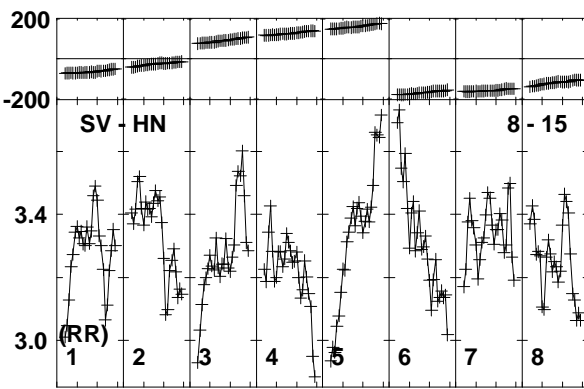
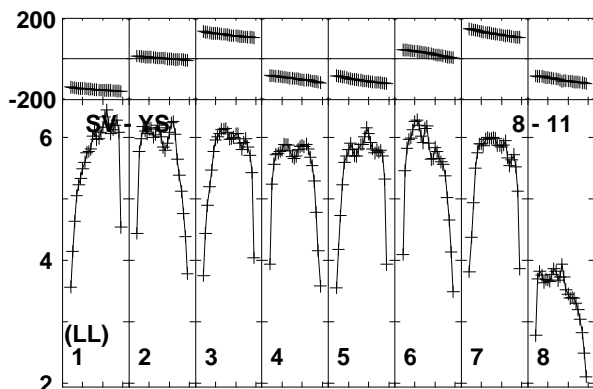
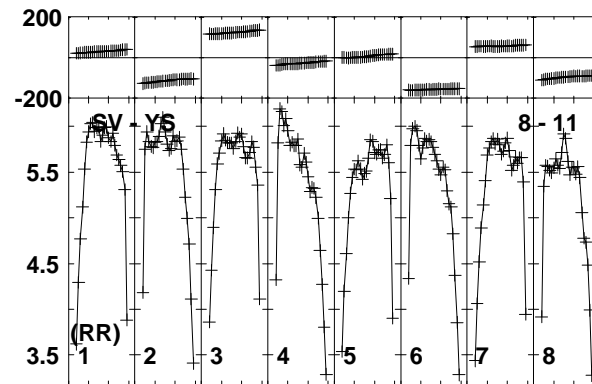
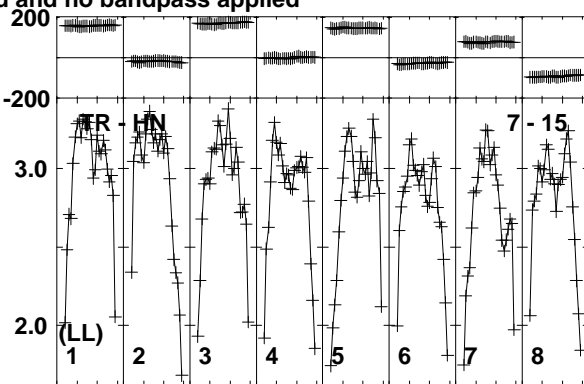
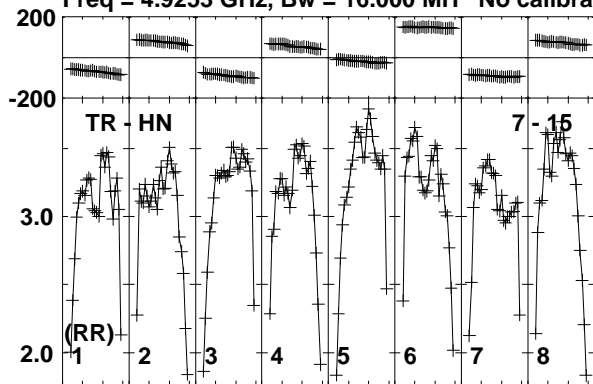

Lower frame: Milli Ampl Jy Top frame: Phas deg
Vector averaged cross-power spectrum Baseline: TR (07) - HN (15)
Timerange: 00/23:23:11 to 00/23:25:03

Plot file version 285 created 11-APR-2016 17:09:02

J1128+5925 GP053G 3.UVDATA.1

Freq = 4.9253 GHz, Bw = 16.000 MH No calibration applied and no bandpass applied

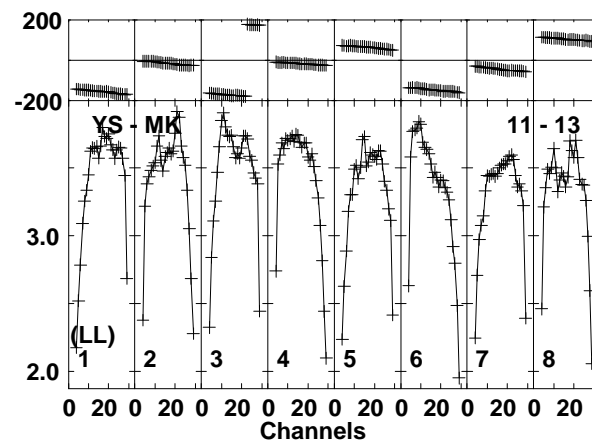
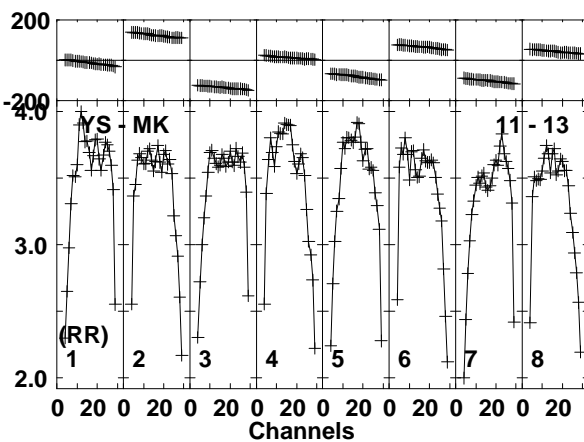
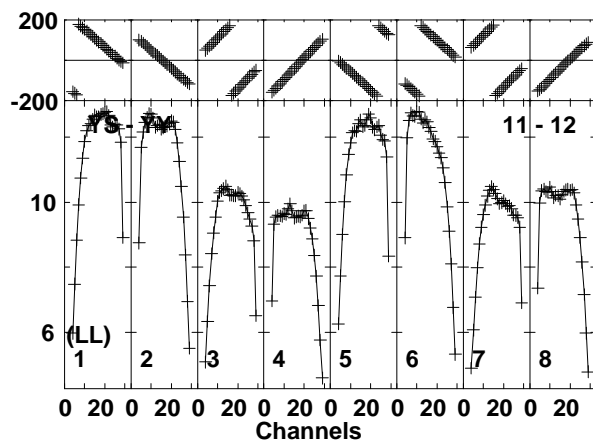
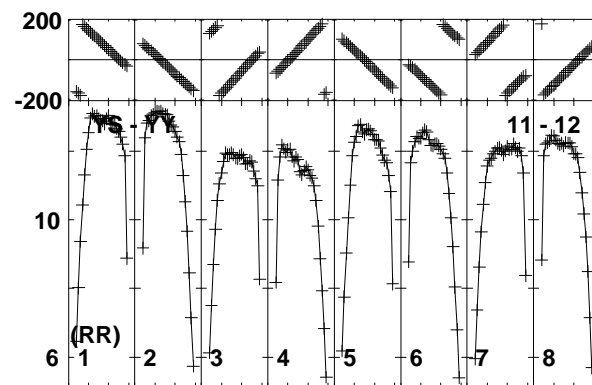
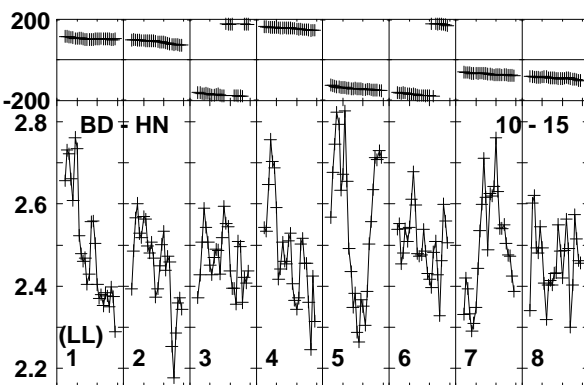
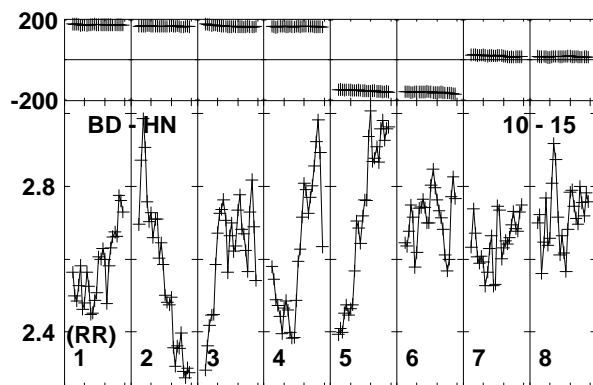
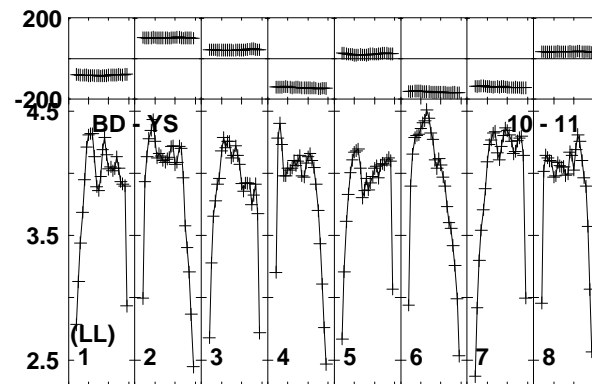
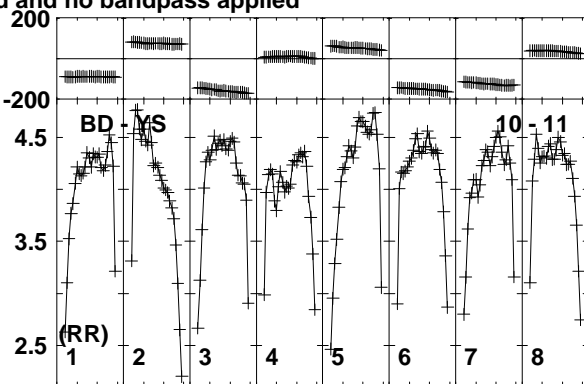
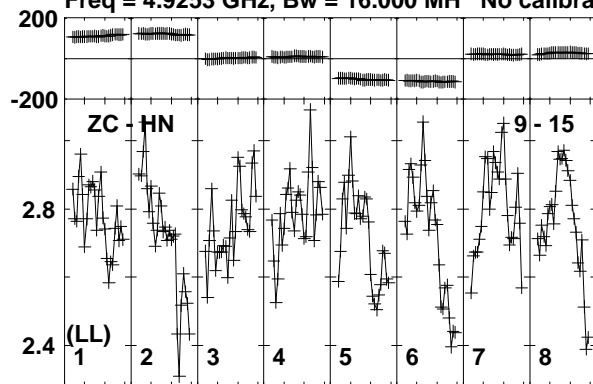

Lower frame: Milli Ampl Jy Top frame: Phas deg
Vector averaged cross-power spectrum Baseline: ZC (09) - HN (15)
Timerange: 00/23:23:11 to 00/23:25:03

Plot file version 286 created 11-APR-2016 17:09:02

J1128+5925 GP053G 3.UVDATA.1

Freq = 4.9253 GHz, Bw = 16.000 MH No calibration applied and no bandpass applied

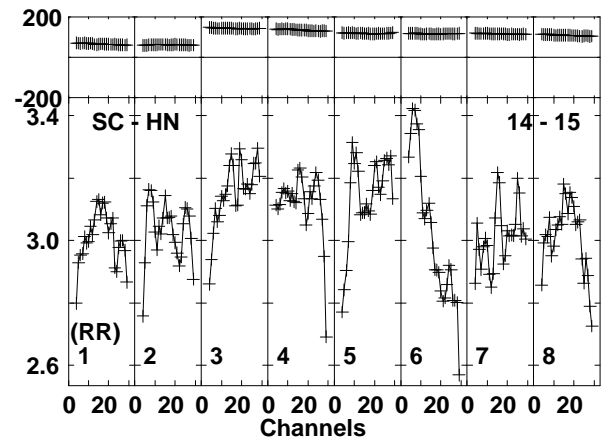
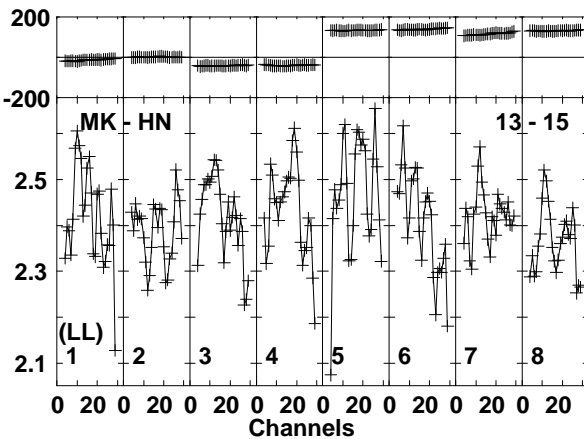
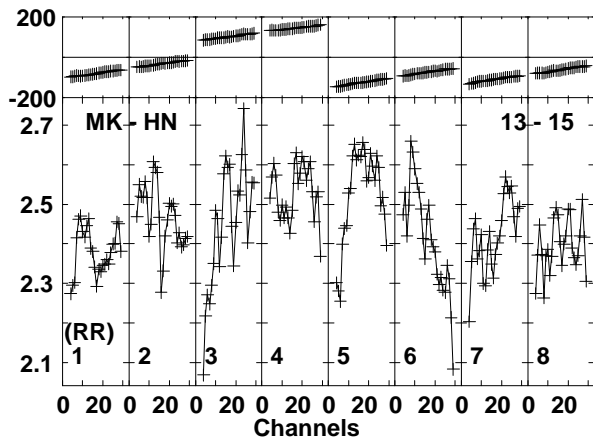
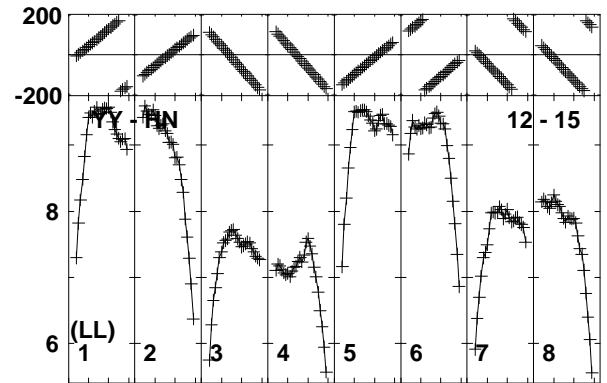
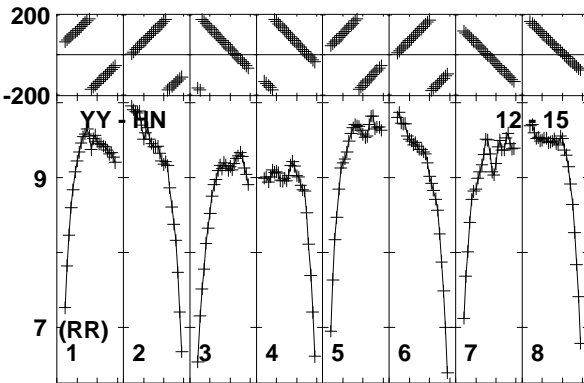
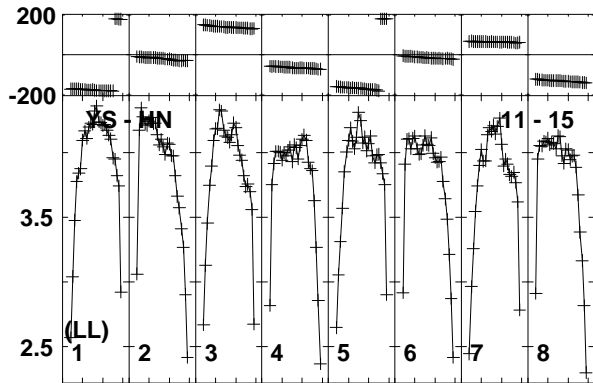
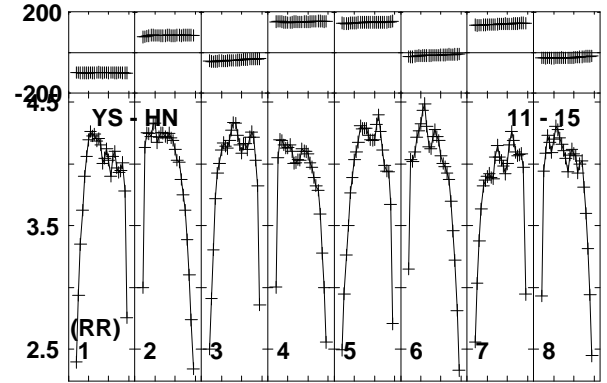
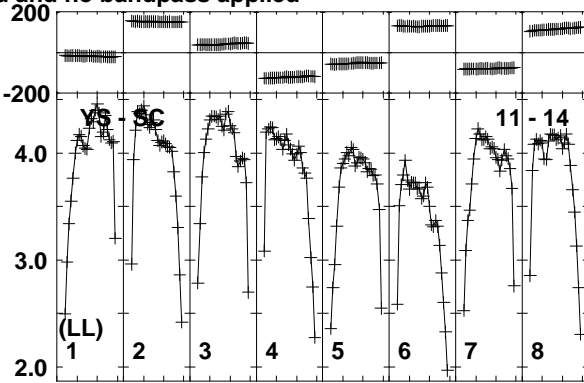
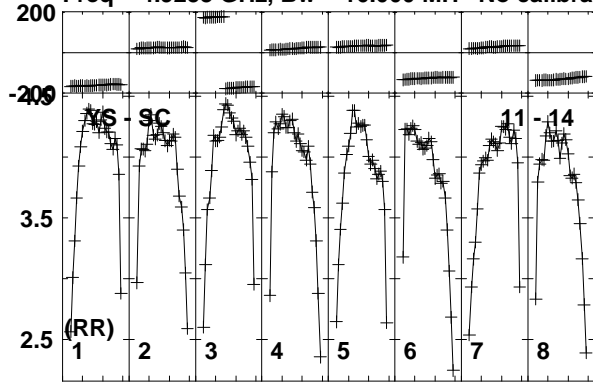

Lower frame: Milli Ampl Jy Top frame: Phas deg
Vector averaged cross-power spectrum Baseline: YS (11) - SC (14)
Timerange: 00/23:23:11 to 00/23:25:03

Plot file version 287 created 11-APR-2016 17:09:02
J1128+5925 GP053G 3.UVDATA.1
Freq = 4.9253 GHz, Bw = 16.000 MH No calibration applied and no bandpass applied

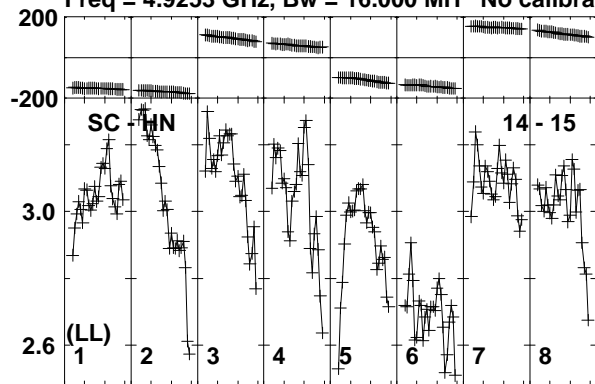

Lower frame: Milli Ampl Jy Top frame: Phas deg
Vector averaged cross-power spectrum Baseline: SC (14) - HN (15)
Timerange: 00/23:23:11 to 00/23:25:03

Plot file version 288 created 11-APR-2016 17:09:03

ARP299C GP053G 3.UVDATA.1

Freq = 4.9253 GHz, Bw = 16.000 MH No calibration applied and no bandpass applied

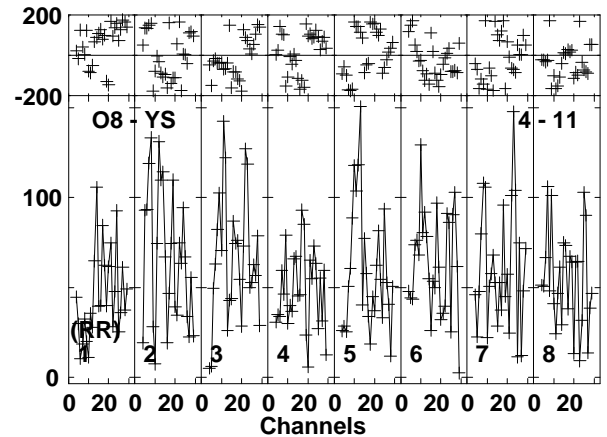
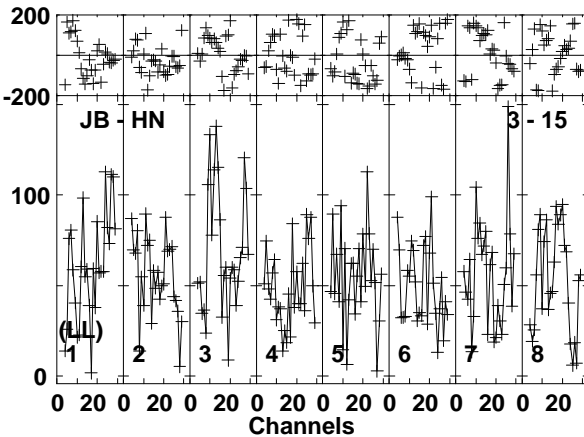
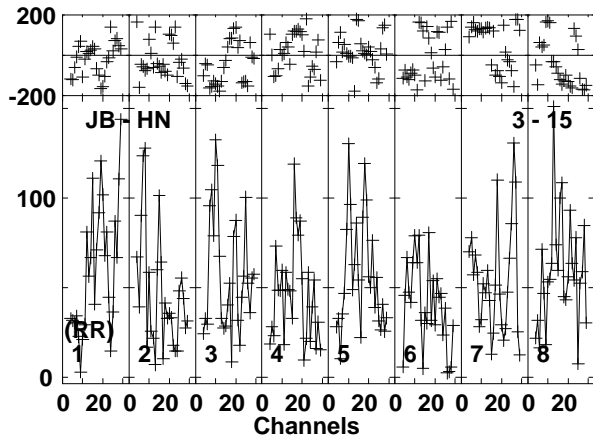
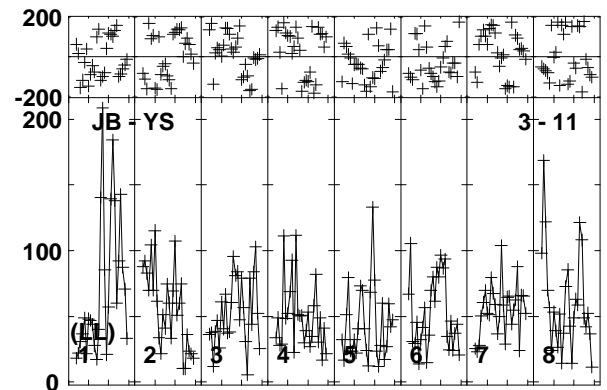
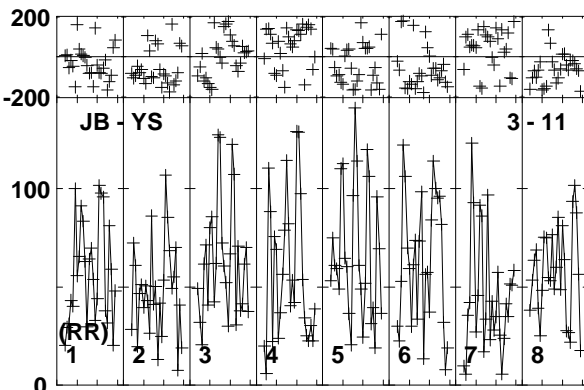
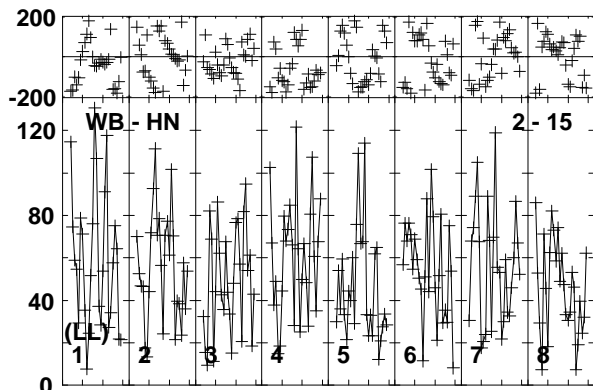
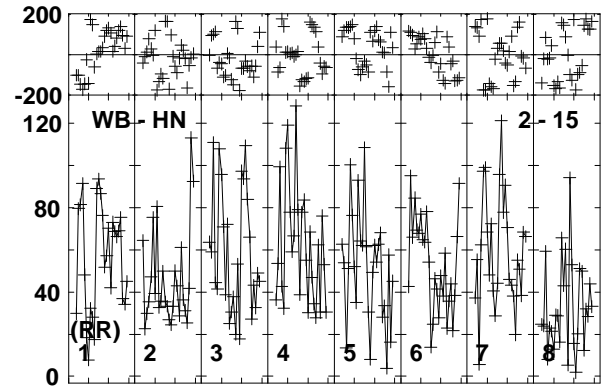
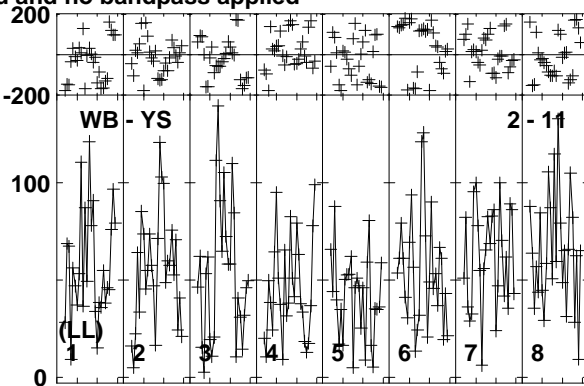
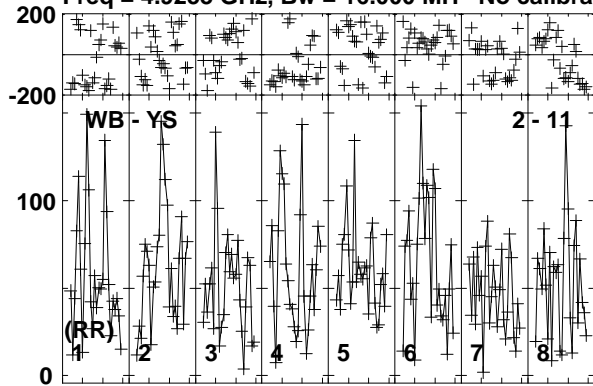

Lower frame: Micro Ampl Jy Top frame: Phas deg
Vector averaged cross-power spectrum Baseline: WB (02) - YS (11)
Timerange: 00/23:25:08 to 00/23:30:22

Plot file version 289 created 11-APR-2016 17:09:03

ARP299C GP053G 3.UVDATA.1

Freq = 4.9253 GHz, Bw = 16.000 MH No calibration applied and no bandpass applied

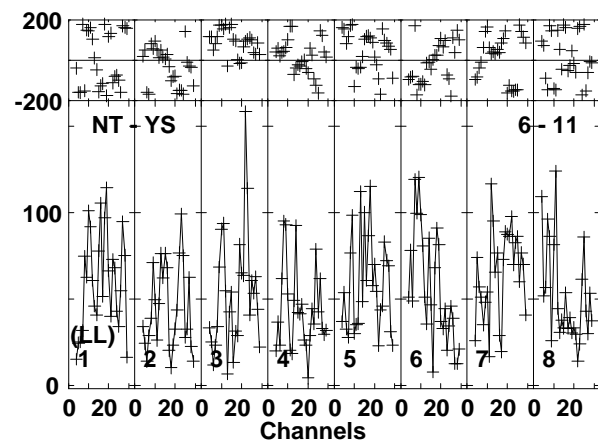
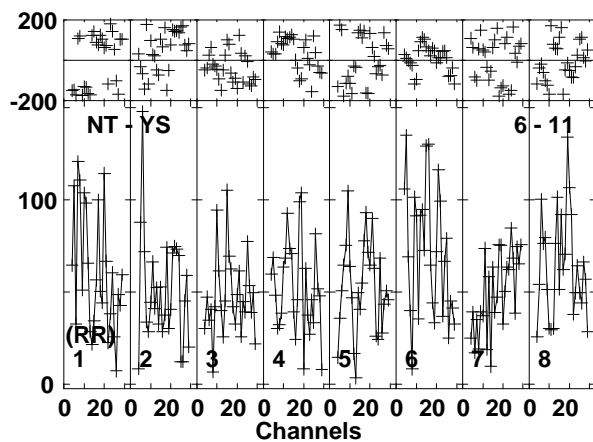
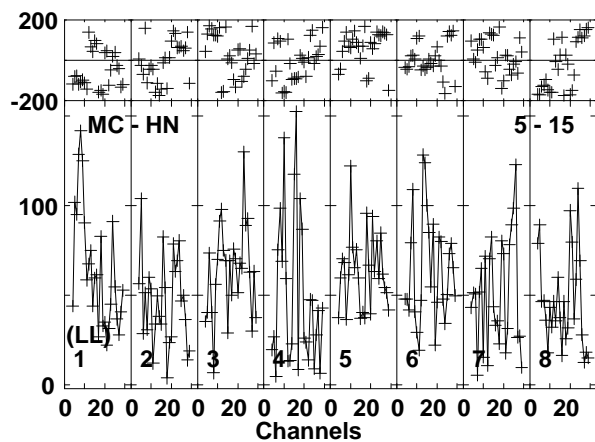
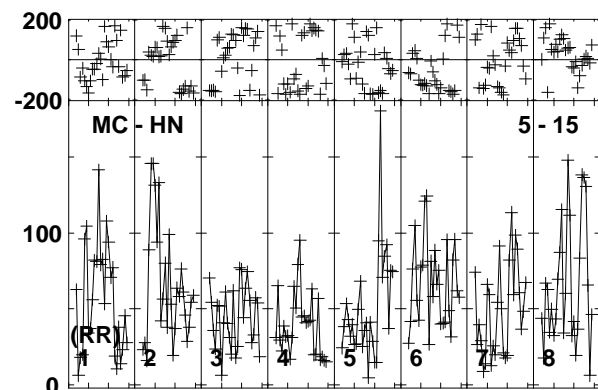
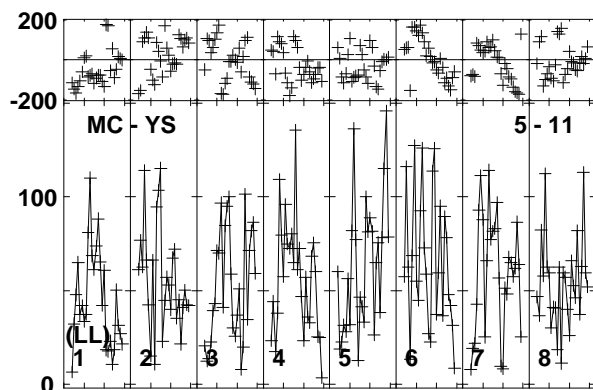
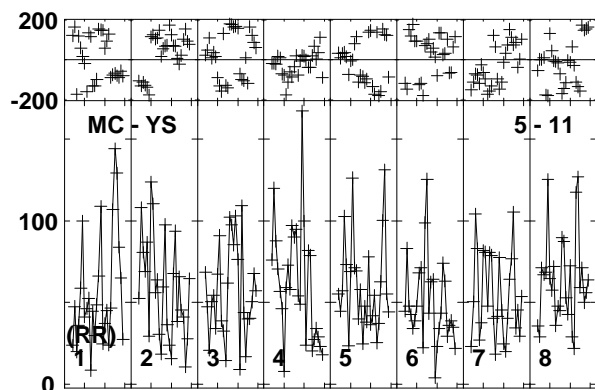
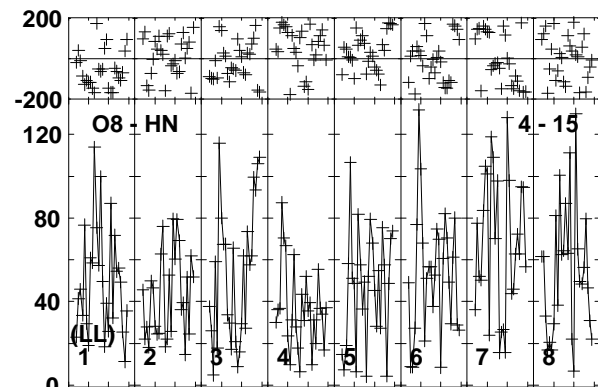
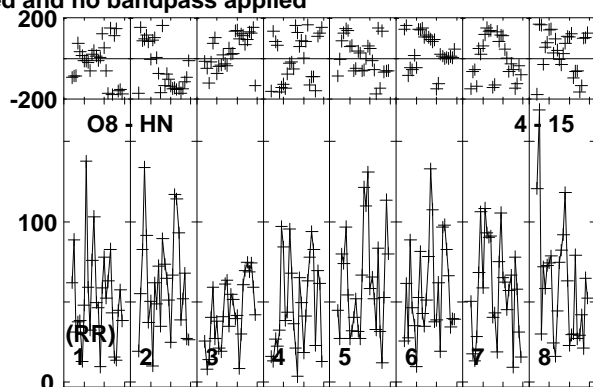
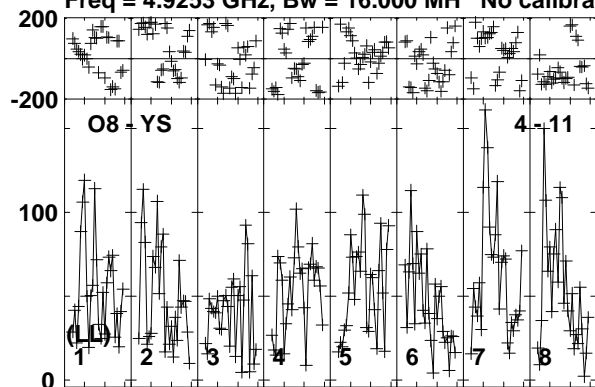

Lower frame: Micro Ampl Jy Top frame: Phas deg
Vector averaged cross-power spectrum Baseline: O8 (04) - YS (11)
Timerange: 00/23:25:08 to 00/23:30:22

Plot file version 290 created 11-APR-2016 17:09:03

ARP299C GP053G 3.UVDATA.1

Freq = 4.9253 GHz, Bw = 16.000 MH No calibration applied and no bandpass applied

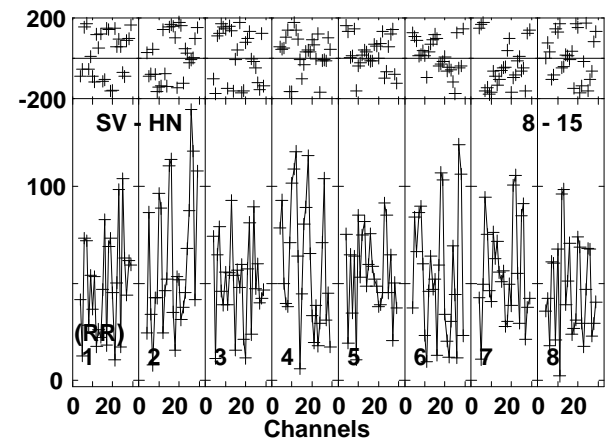
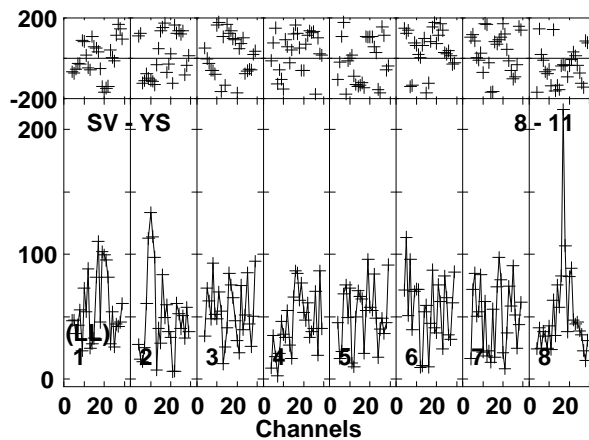
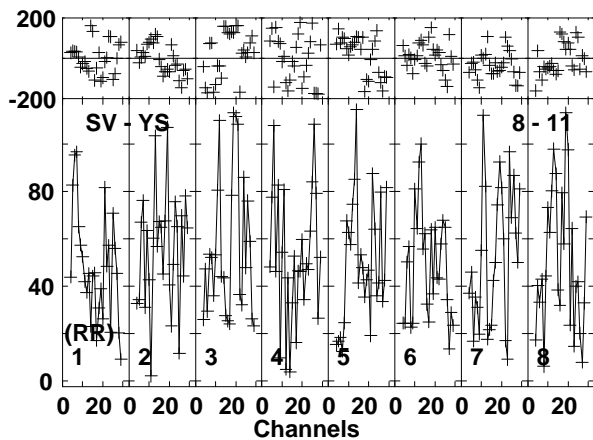
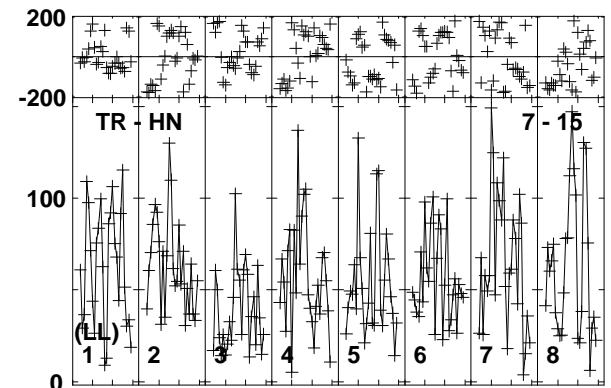
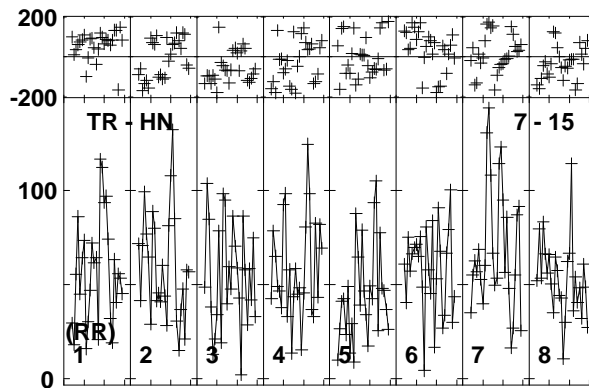
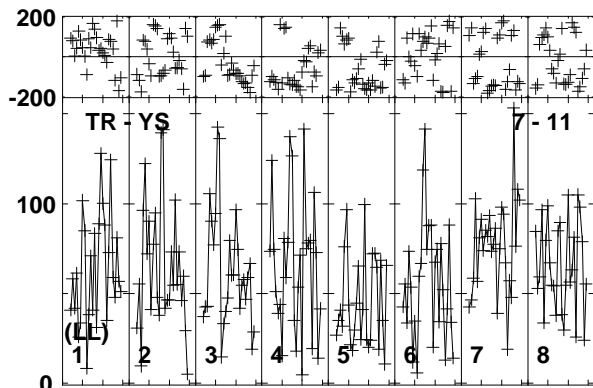
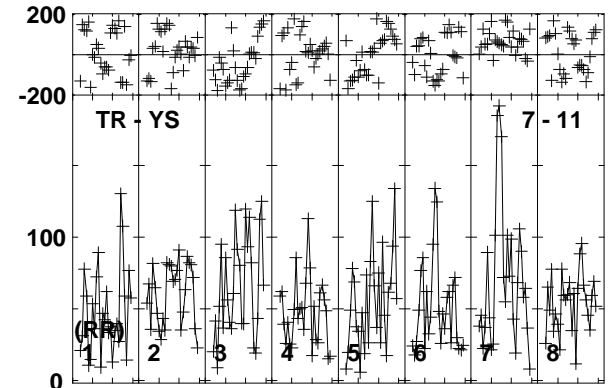
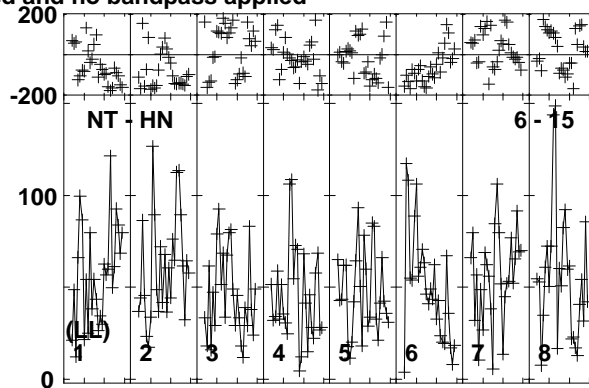
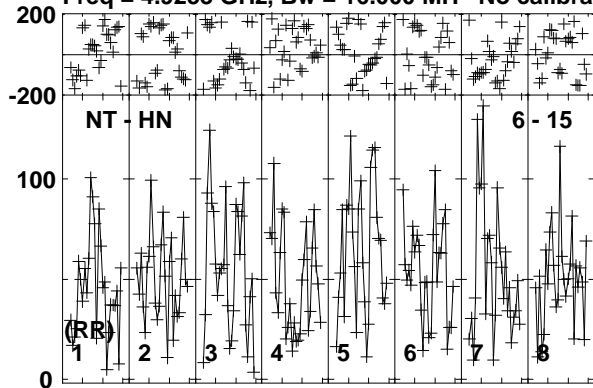

Lower frame: Micro Ampl Jy Top frame: Phas deg
Vector averaged cross-power spectrum Baseline: NT (06) - HN (15)
Timerange: 00/23:25:08 to 00/23:30:22

Plot file version 291 created 11-APR-2016 17:09:03

ARP299C GP053G 3.UVDATA.1

Freq = 4.9253 GHz, Bw = 16.000 MH No calibration applied and no bandpass applied

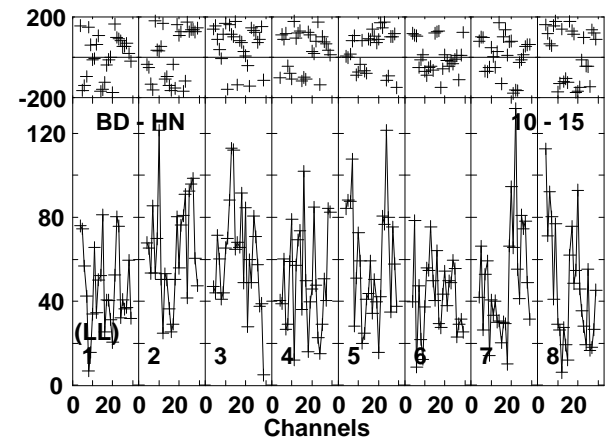
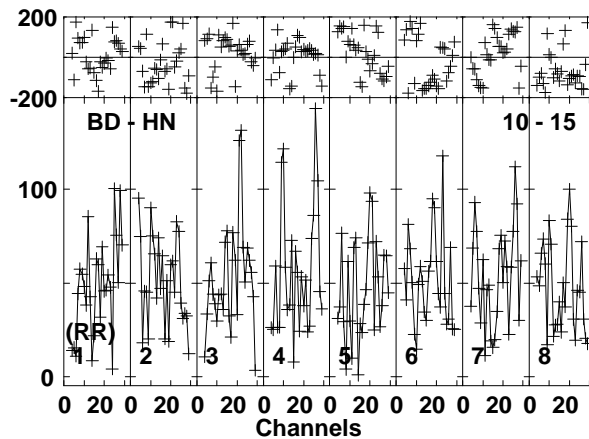
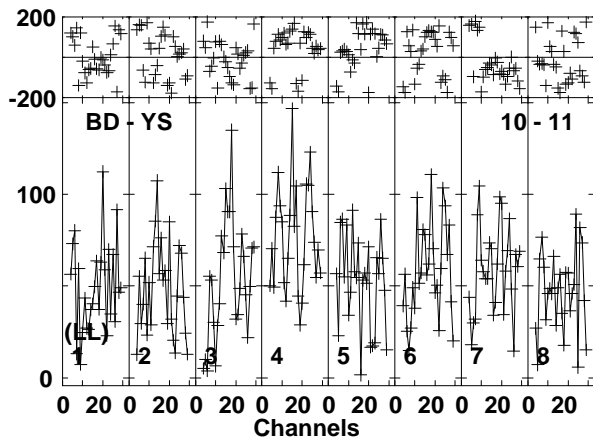
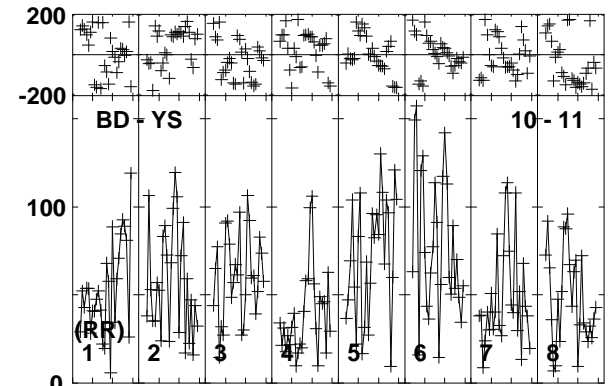
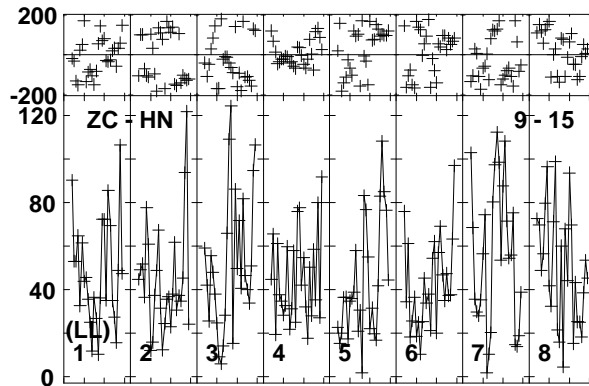
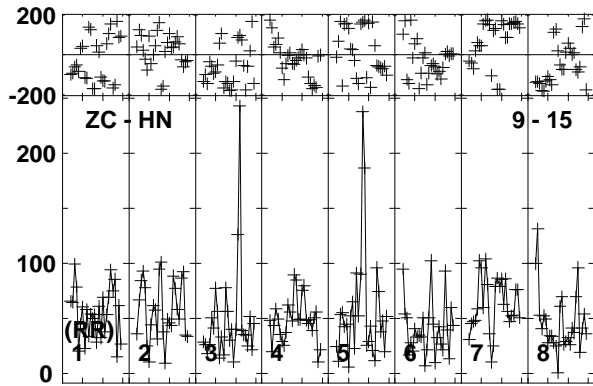
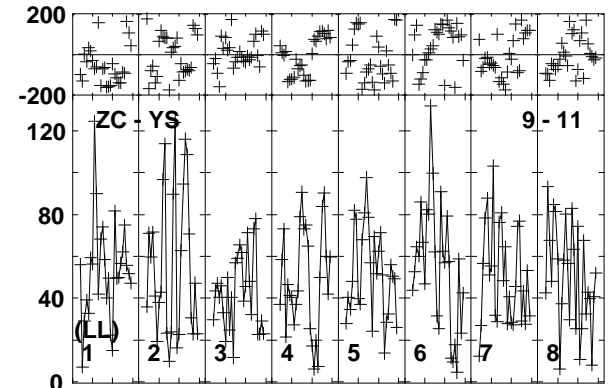
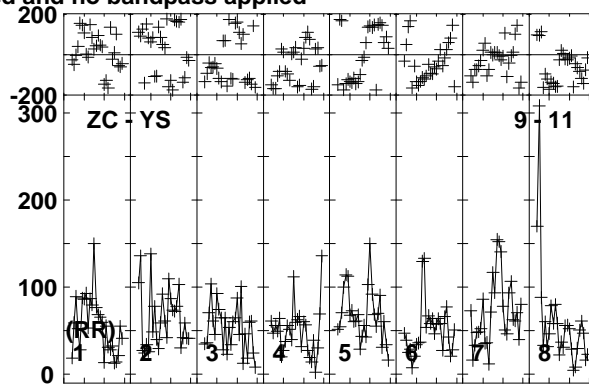
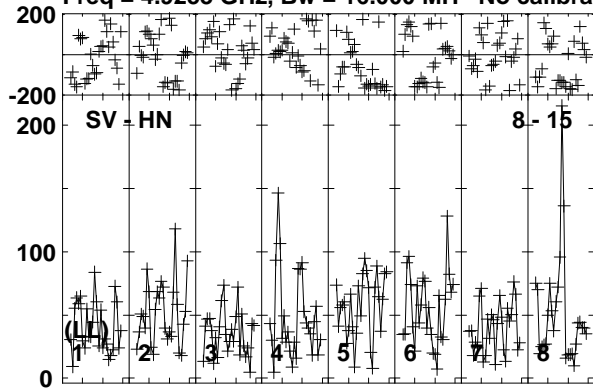

Lower frame: Micro Ampl Jy Top frame: Phas deg
Vector averaged cross-power spectrum Baseline: SV (08) - HN (15)
Timerange: 00/23:25:08 to 00/23:30:22

Plot file version 292 created 11-APR-2016 17:09:03

ARP299C GP053G 3.UVDATA.1

Freq = 4.9253 GHz, Bw = 16.000 MH No calibration applied and no bandpass applied

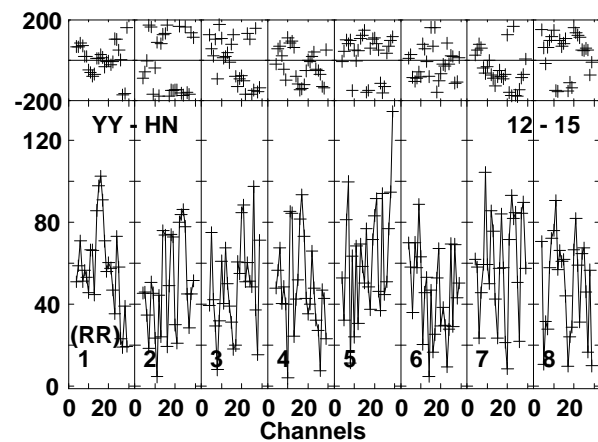
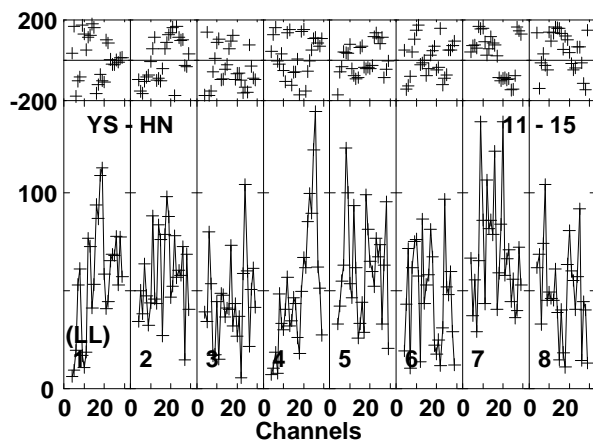
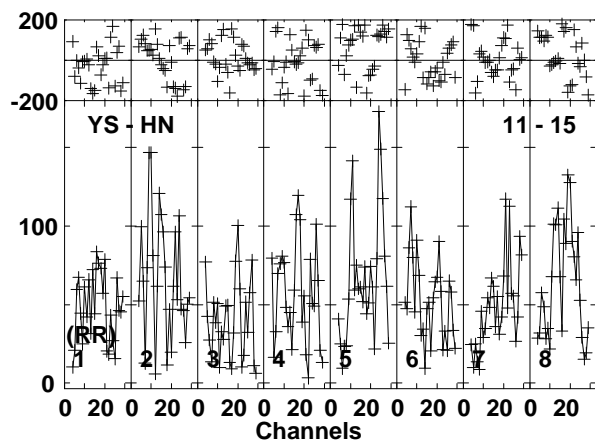
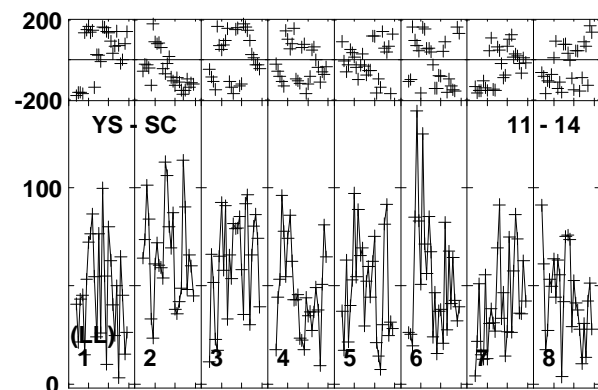
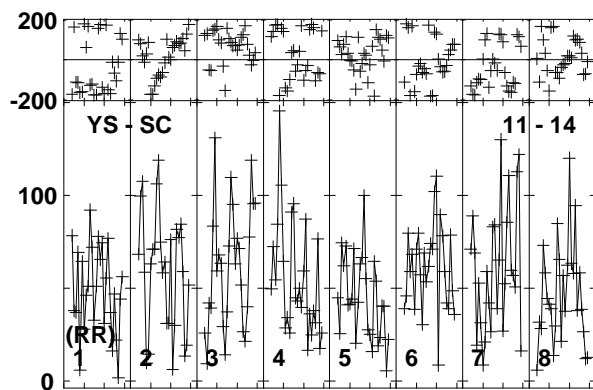
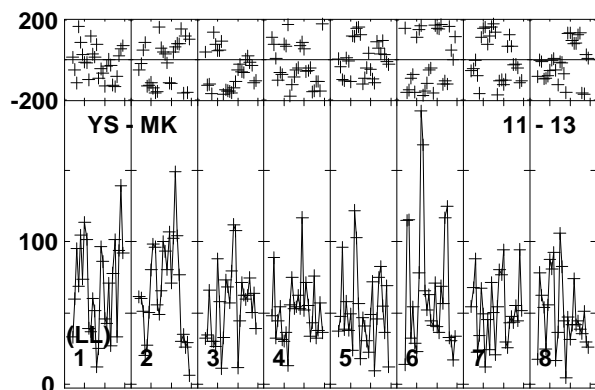
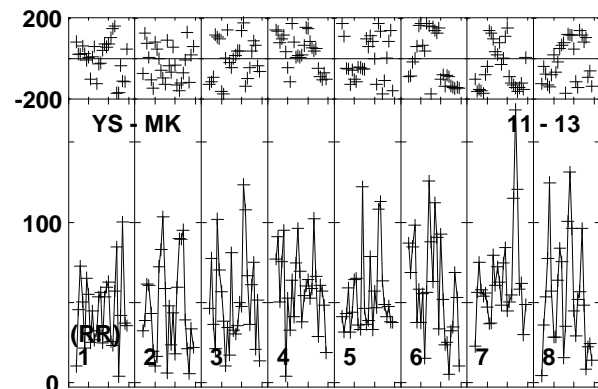
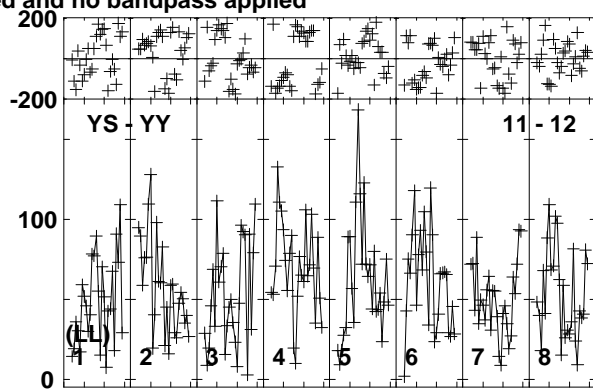
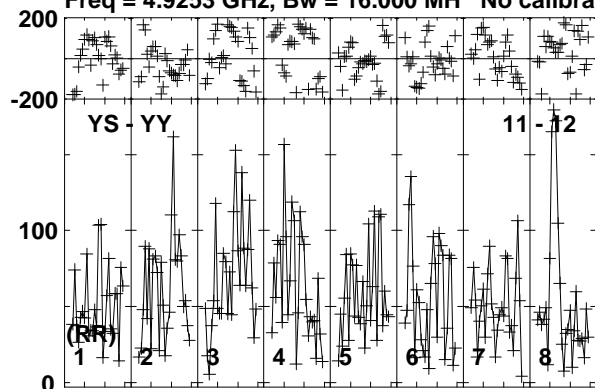

Lower frame: Micro Ampl Jy Top frame: Phas deg
Vector averaged cross-power spectrum Baseline: YS (11) - YY (12)
Timerange: 00/23:25:08 to 00/23:30:22

Plot file version 293 created 11-APR-2016 17:09:04

ARP299C GP053G 3.UVDATA.1

Freq = 4.9253 GHz, Bw = 16.000 MH No calibration applied and no bandpass applied

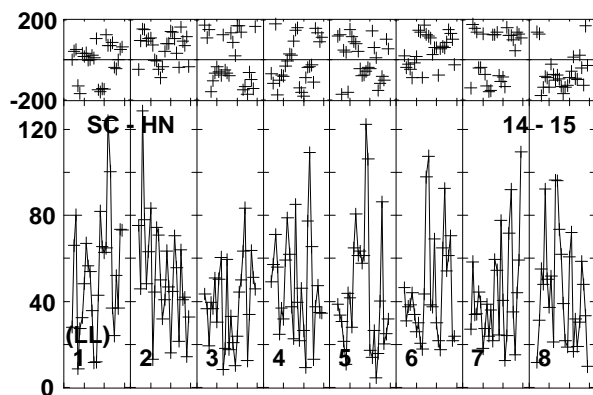
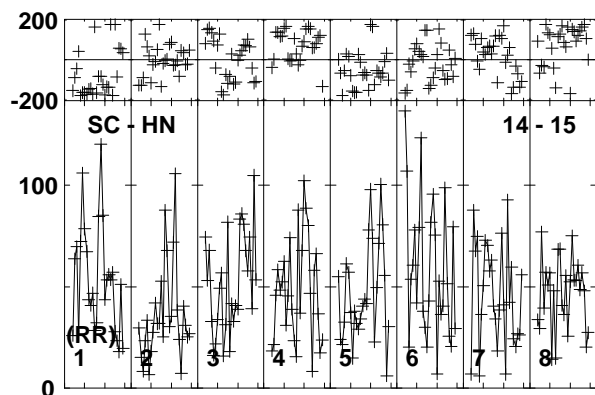
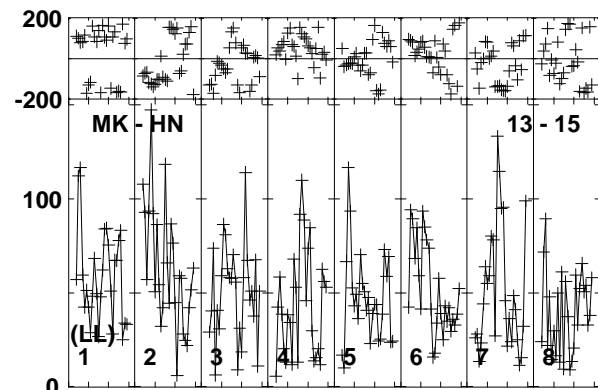
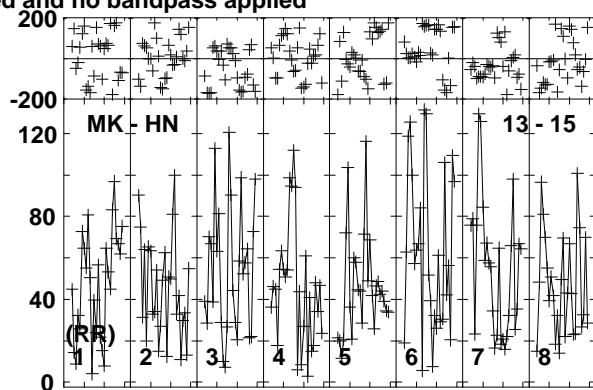
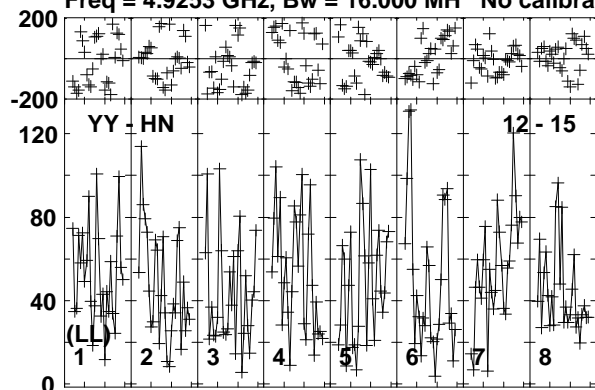

Lower frame: Micro Ampl Jy Top frame: Phas deg
Vector averaged cross-power spectrum Baseline: YY (12) - HN (15)
Timerange: 00/23:25:08 to 00/23:30:22

Plot file version 294 created 11-APR-2016 17:09:04

J1128+5925 GP053G 3.UVDATA.1

Freq = 4.9253 GHz, Bw = 16.000 MH No calibration applied and no bandpass applied

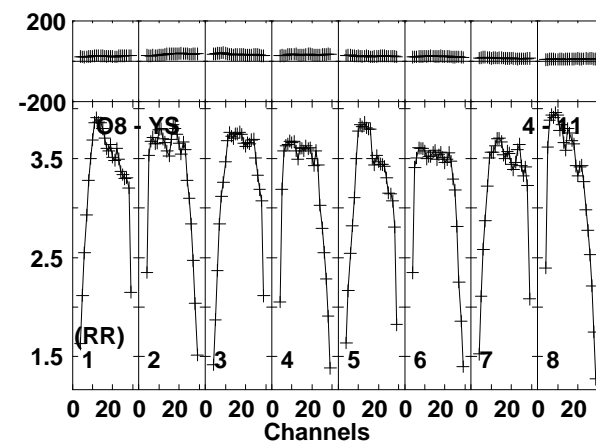
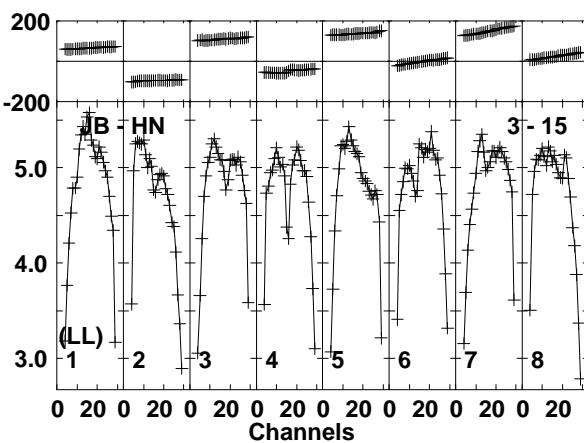
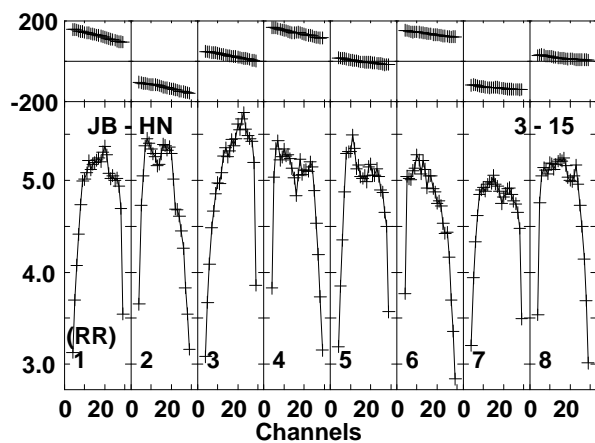
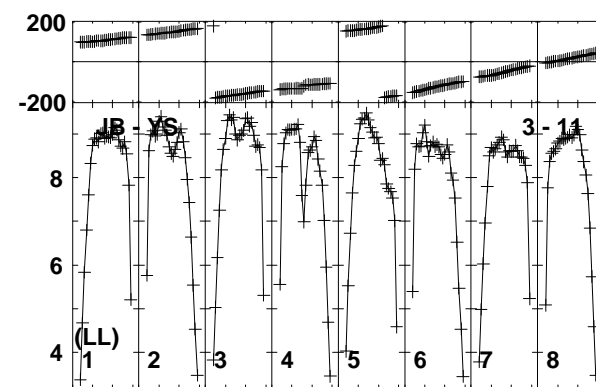
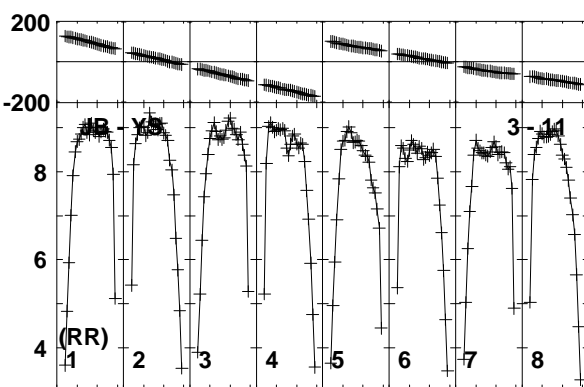
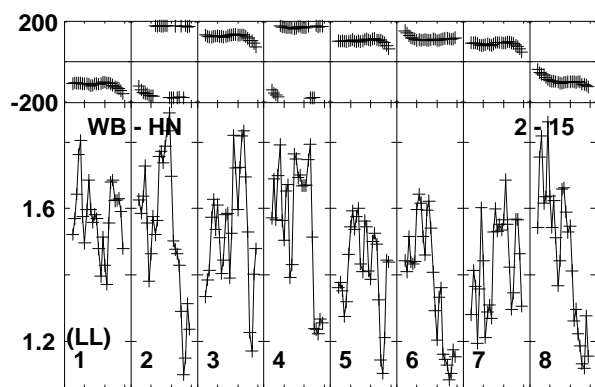
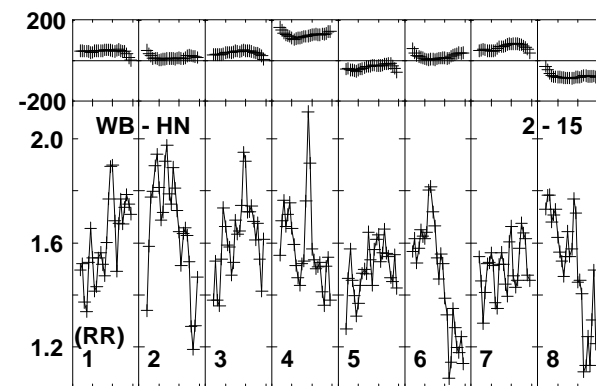
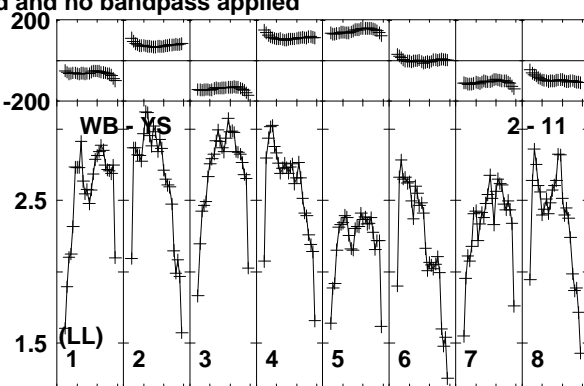
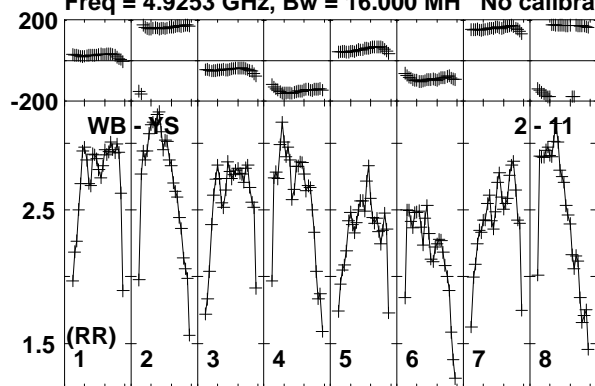

Lower frame: Milli Ampl Jy Top frame: Phas deg
Vector averaged cross-power spectrum Baseline: WB (02) - YS (11)
Timerange: 00/23:30:28 to 00/23:32:12

Plot file version 295 created 11-APR-2016 17:09:04

J1128+5925 GP053G 3.UVDATA.1

Freq = 4.9253 GHz, Bw = 16.000 MH No calibration applied and no bandpass applied

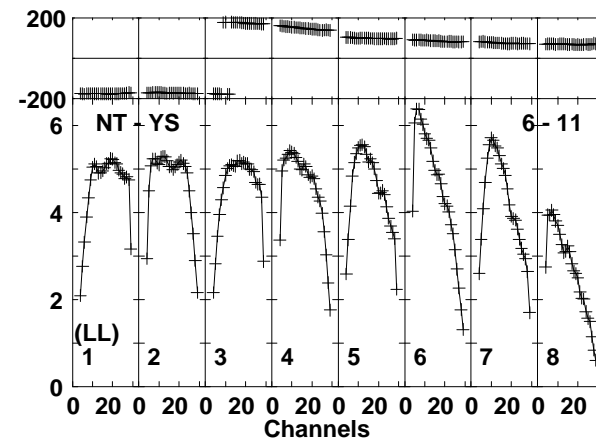
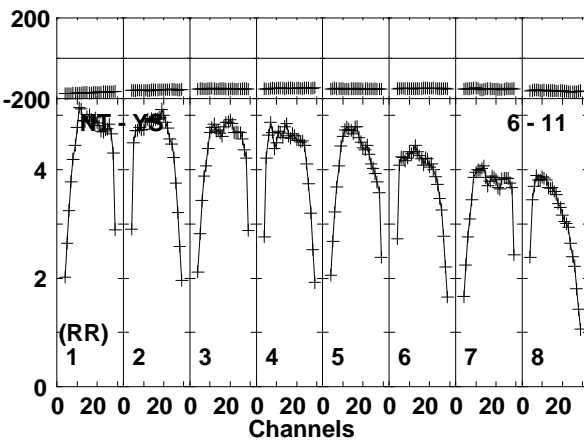
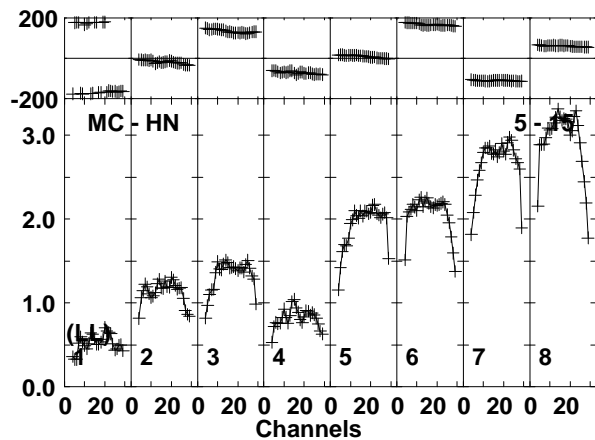
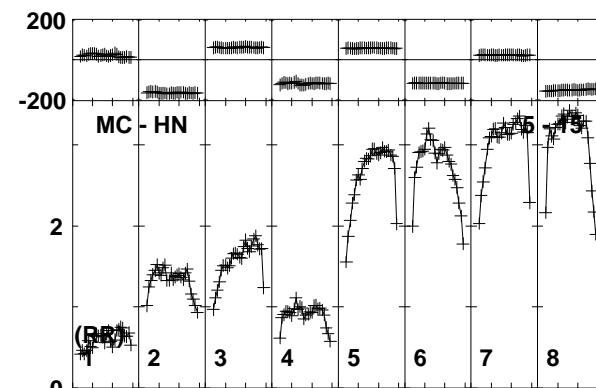
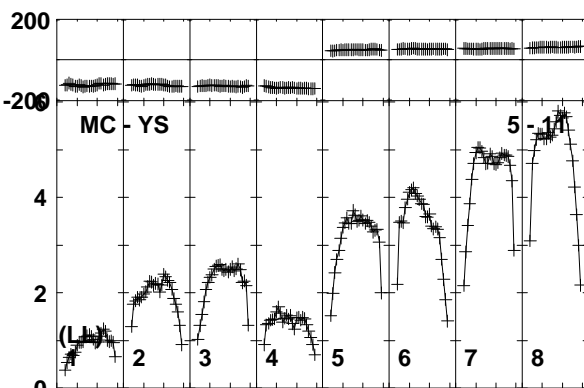
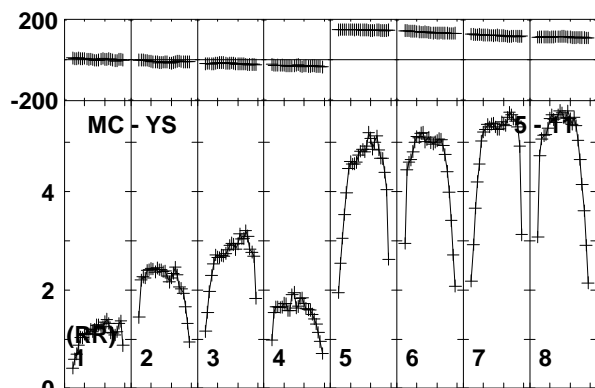
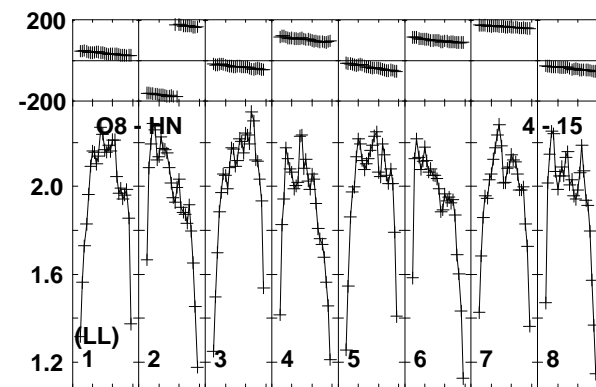
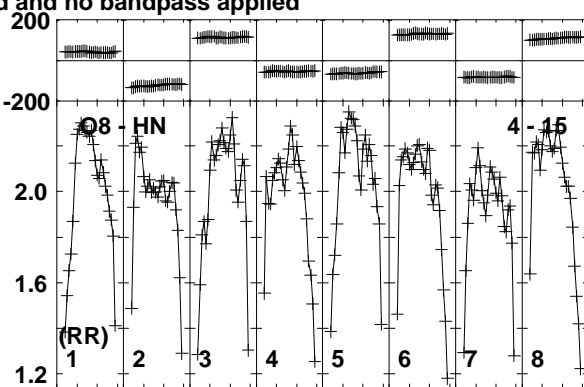
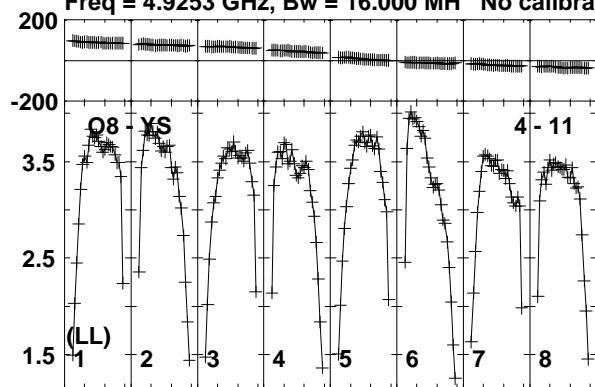

Lower frame: Milli Ampl Jy Top frame: Phas deg
Vector averaged cross-power spectrum Baseline: O8 (04) - YS (11)
Timerange: 00/23:30:28 to 00/23:32:12

Plot file version 296 created 11-APR-2016 17:09:04

J1128+5925 GP053G 3.UVDATA.1

Freq = 4.9253 GHz, Bw = 16.000 MH No calibration applied and no bandpass applied

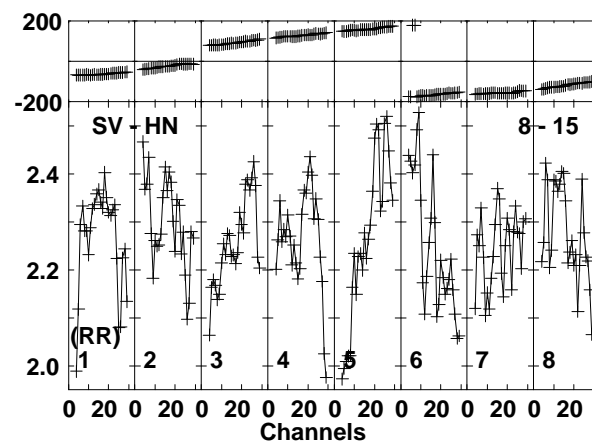
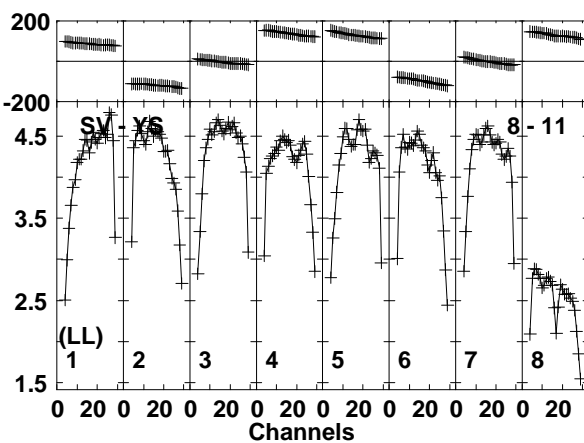
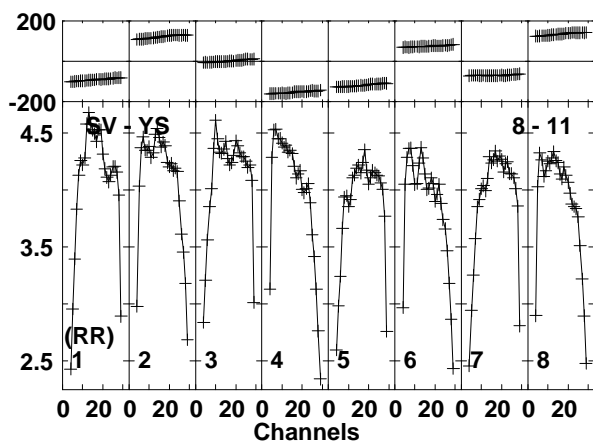
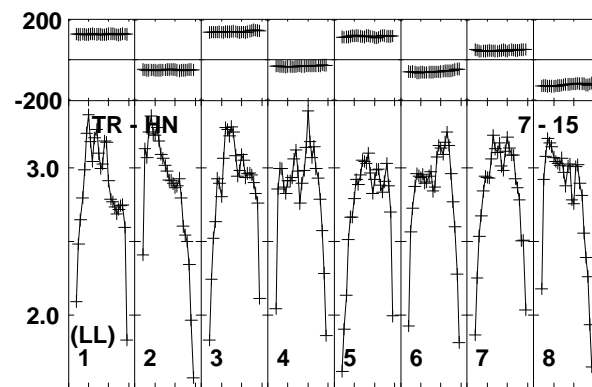
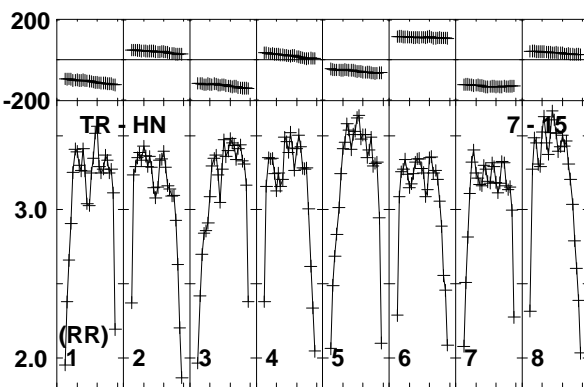
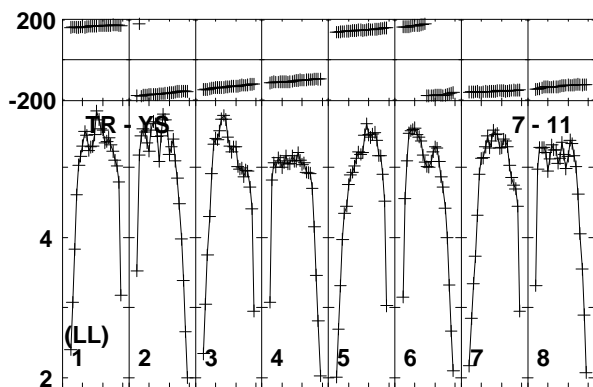
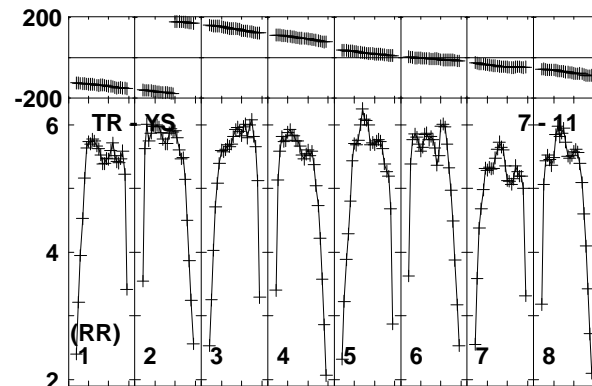
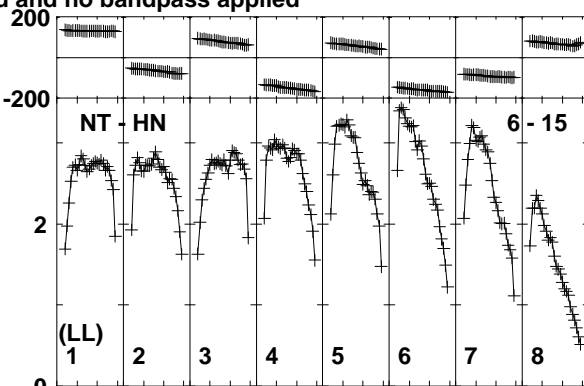
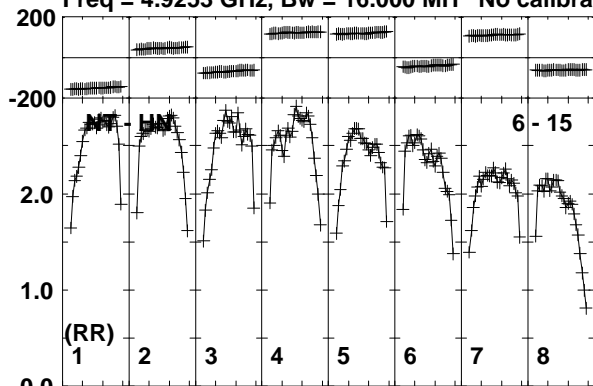

Lower frame: Milli Ampl Jy Top frame: Phas deg
Vector averaged cross-power spectrum Baseline: NT (06) - HN (15)
Timerange: 00/23:30:28 to 00/23:32:12

Plot file version 297 created 11-APR-2016 17:09:04

J1128+5925 GP053G 3.UVDATA.1

Freq = 4.9253 GHz, Bw = 16.000 MH No calibration applied and no bandpass applied

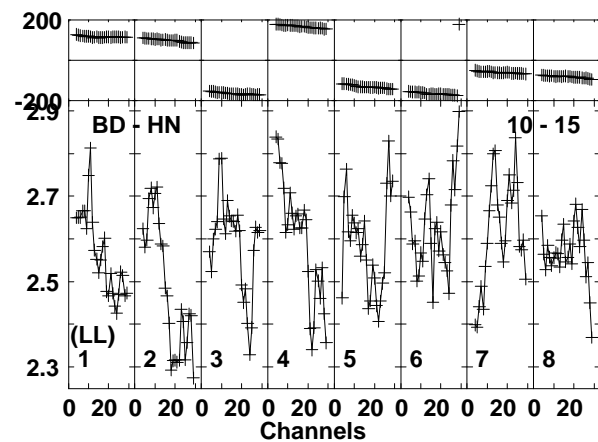
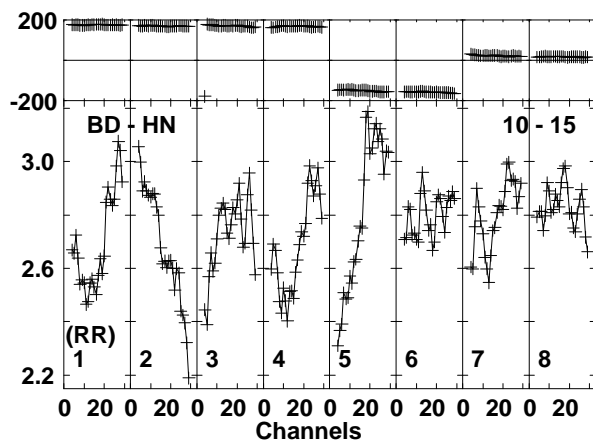
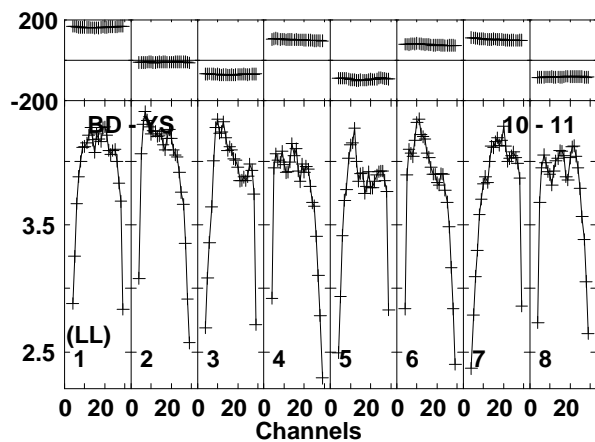
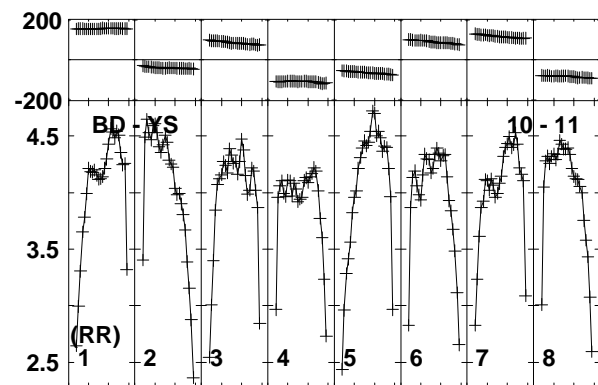
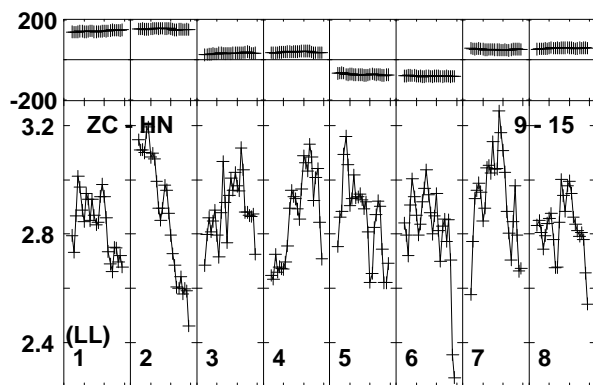
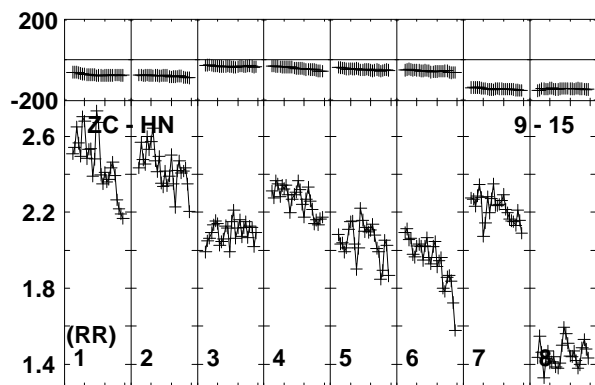
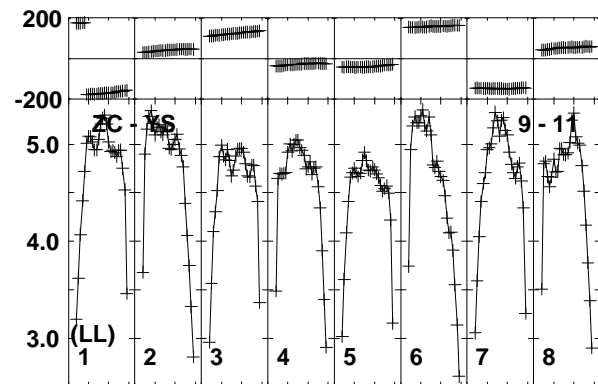
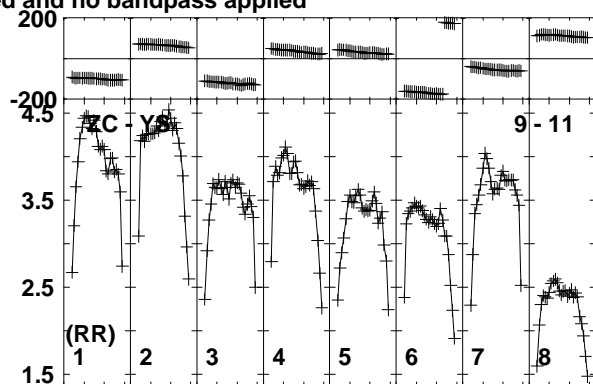
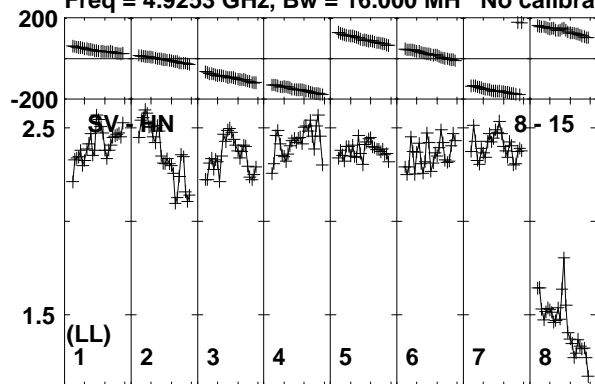

Lower frame: Milli Ampl Jy Top frame: Phas deg
Vector averaged cross-power spectrum Baseline: SV (08) - HN (15)
Timerange: 00/23:30:28 to 00/23:32:12

Plot file version 298 created 11-APR-2016 17:09:04

J1128+5925 GP053G 3.UVDATA.1

Freq = 4.9253 GHz, Bw = 16.000 MH No calibration applied and no bandpass applied

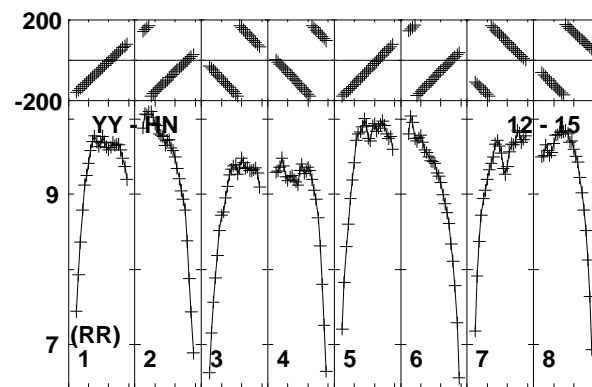
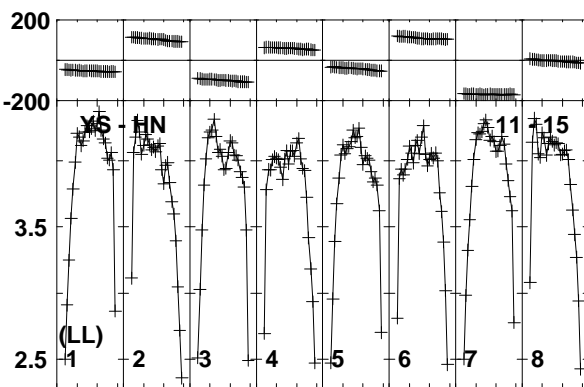
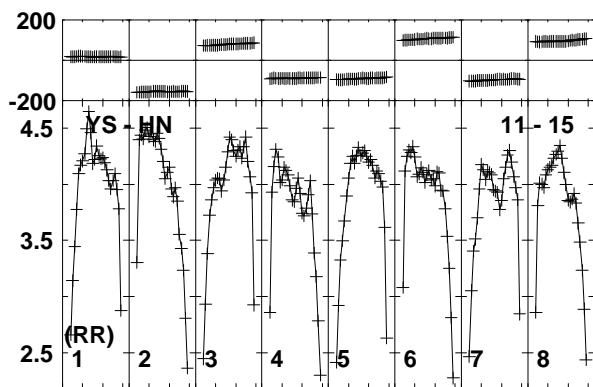
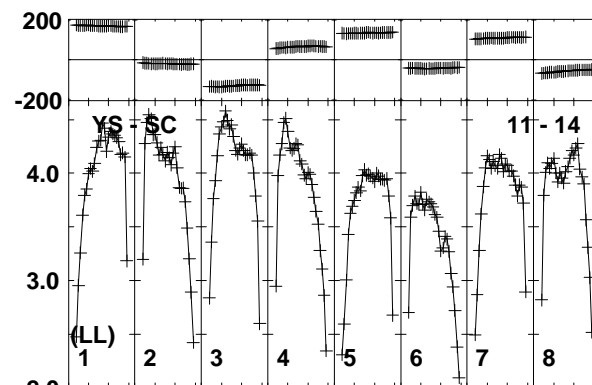
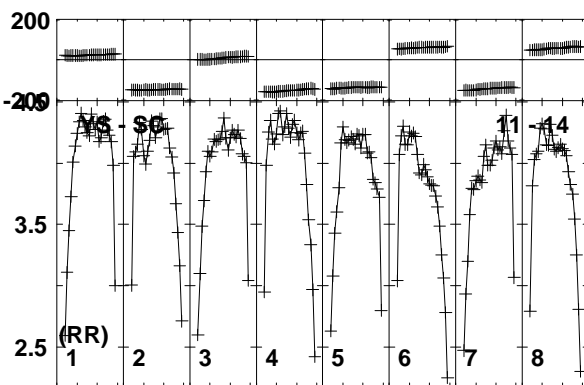
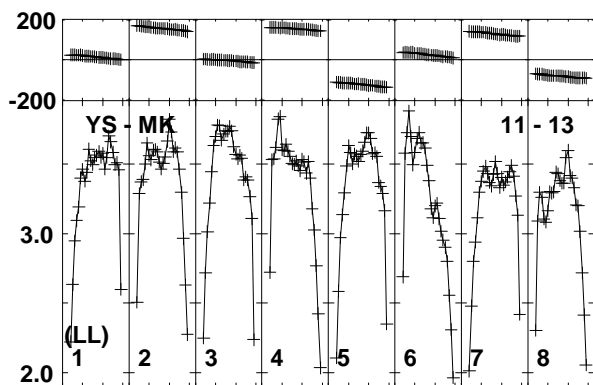
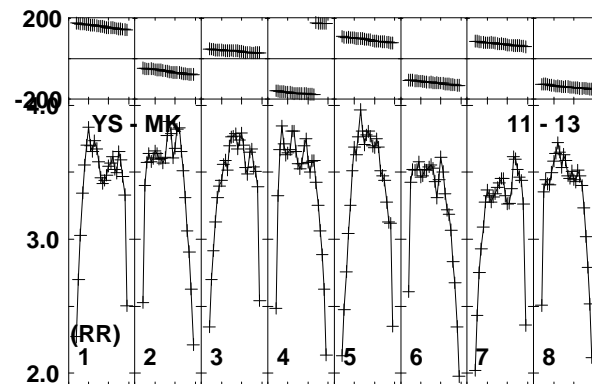
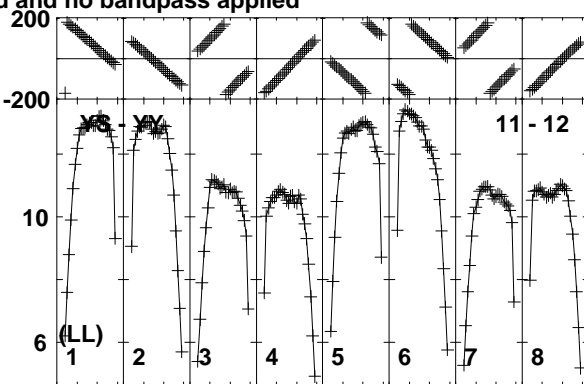
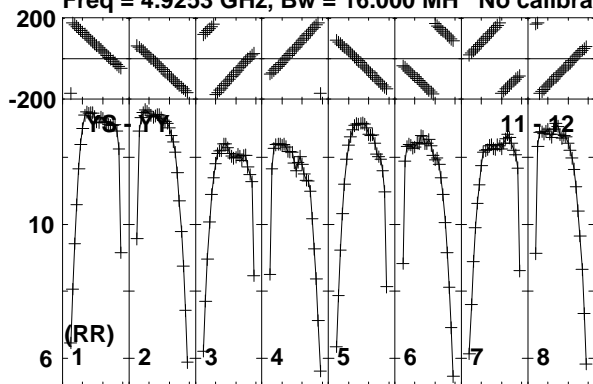

Lower frame: Milli Ampl Jy Top frame: Phas deg
Vector averaged cross-power spectrum Baseline: YS (11) - YY (12)
Timerange: 00/23:30:28 to 00/23:32:12

Plot file version 299 created 11-APR-2016 17:09:04

J1128+5925 GP053G 3.UVDATA.1

Freq = 4.9253 GHz, Bw = 16.000 MH No calibration applied and no bandpass applied

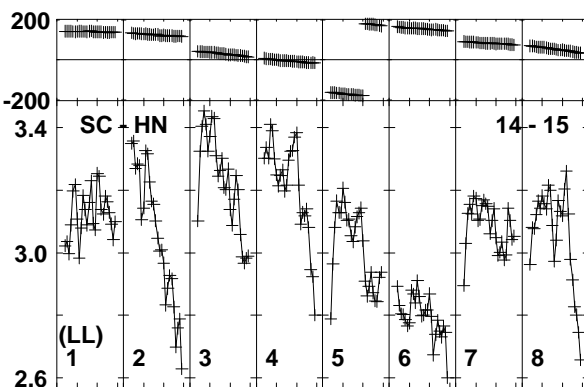
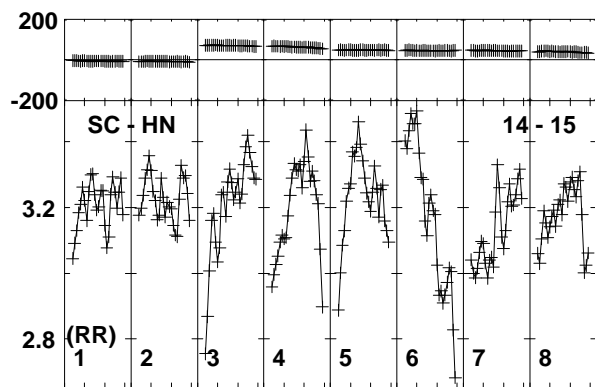
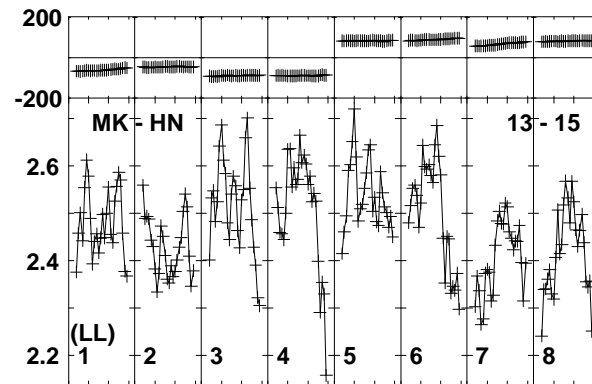
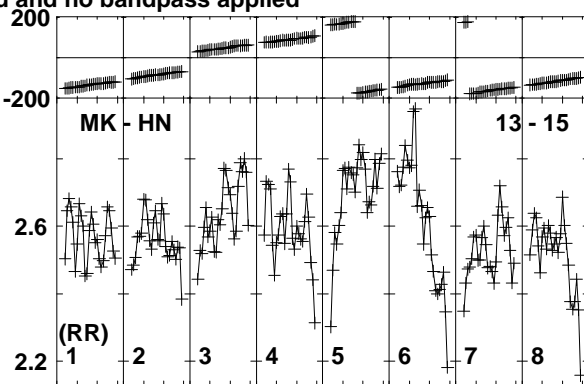
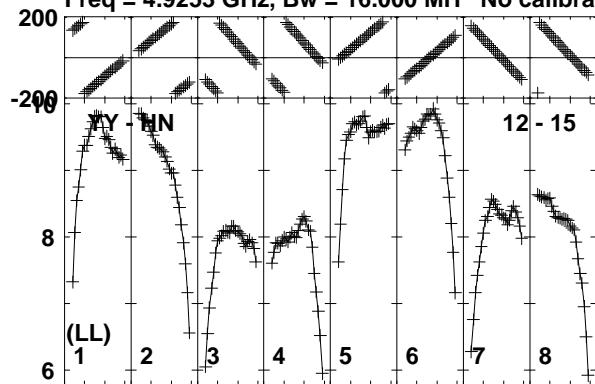

Lower frame: Milli Ampl Jy Top frame: Phas deg
Vector averaged cross-power spectrum Baseline: YY (12) - HN (15)
Timerange: 00/23:30:28 to 00/23:32:12

Plot file version 300 created 11-APR-2016 17:09:05

ARP299C GP053G 3.UVDATA.1

Freq = 4.9253 GHz, Bw = 16.000 MH No calibration applied and no bandpass applied

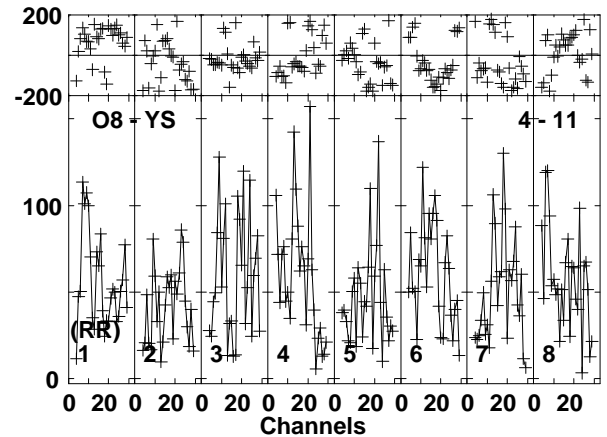
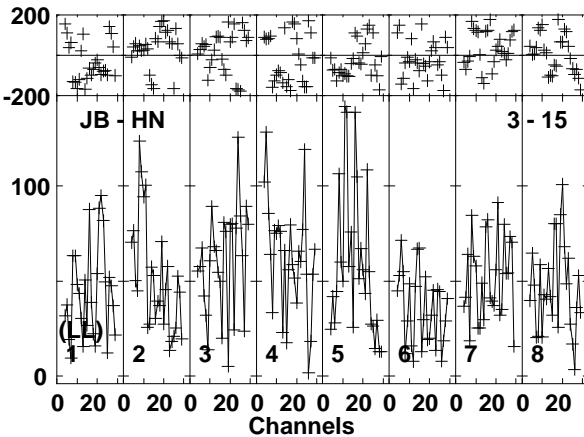
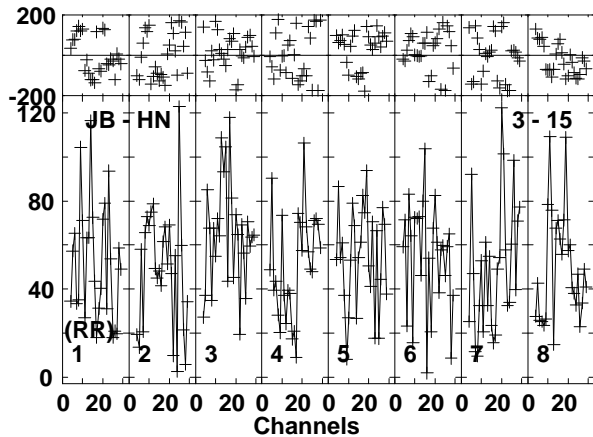
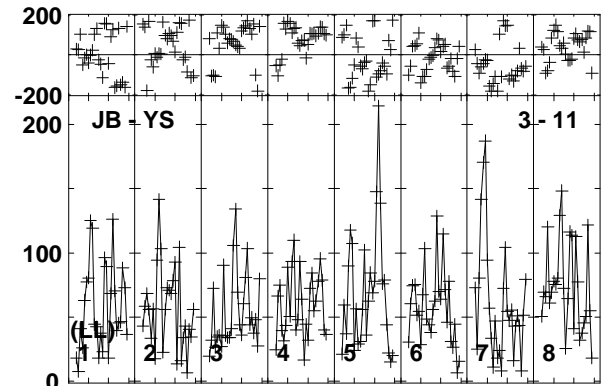
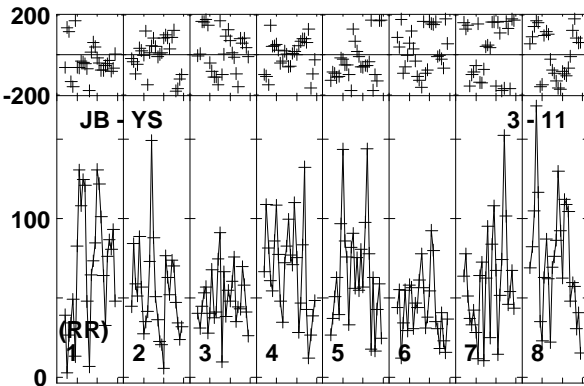
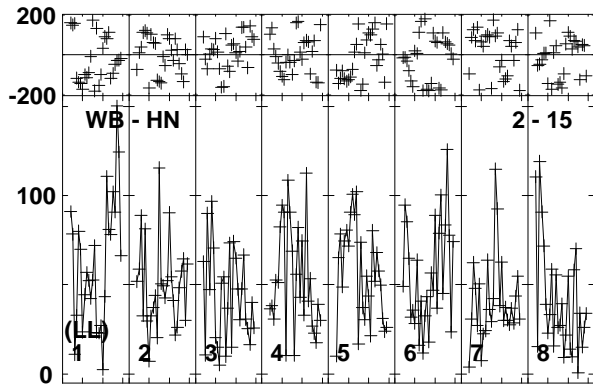
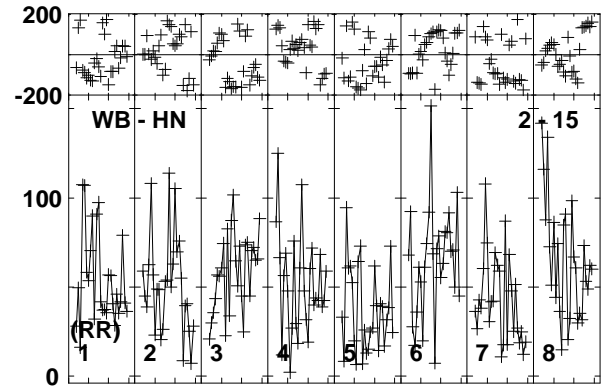
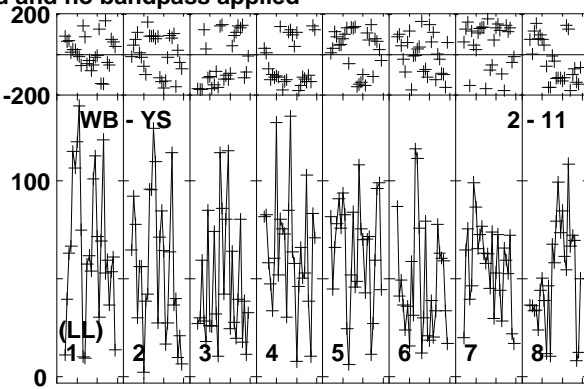
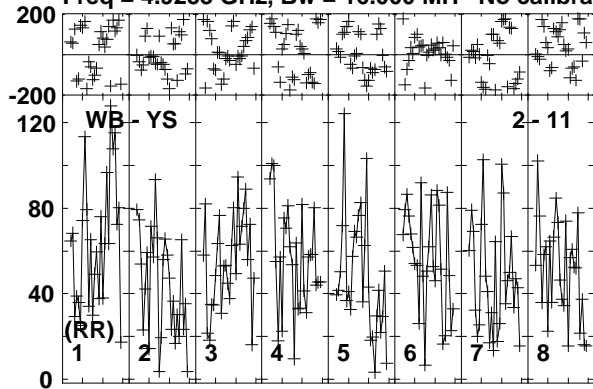

Lower frame: Micro Ampl Jy Top frame: Phas deg
Vector averaged cross-power spectrum Baseline: WB (02) - YS (11)
Timerange: 00/23:32:18 to 00/23:37:30

Plot file version 301 created 11-APR-2016 17:09:05

ARP299C GP053G 3.UVDATA.1

Freq = 4.9253 GHz, Bw = 16.000 MH No calibration applied and no bandpass applied

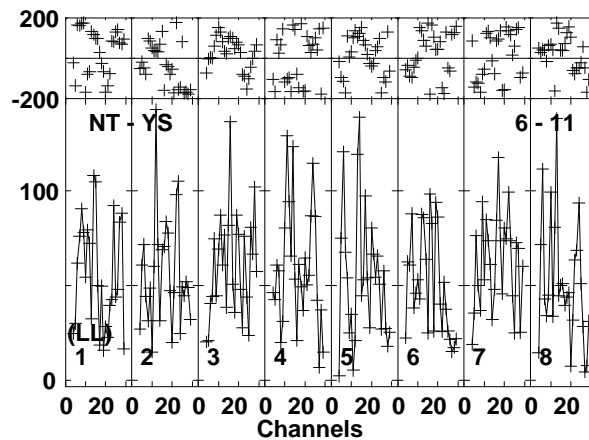
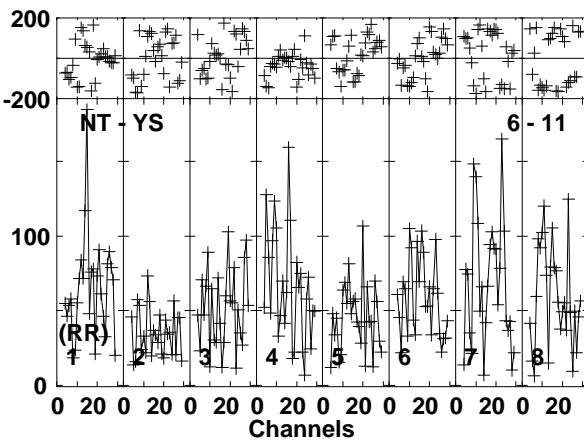
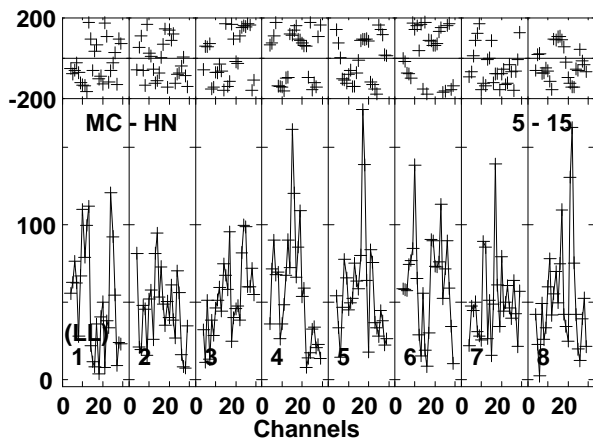
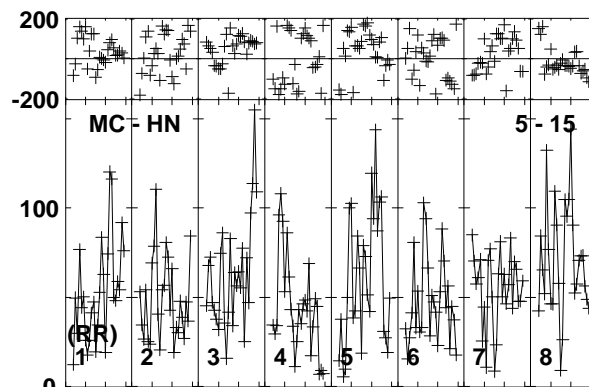
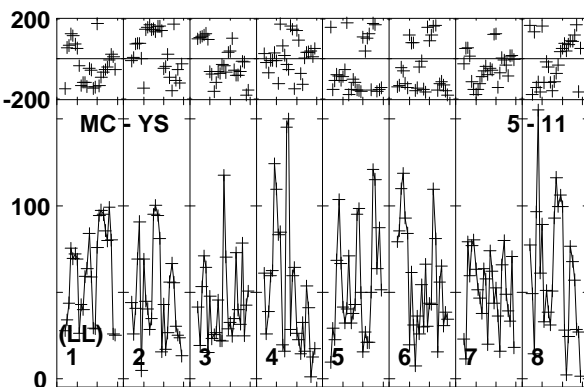
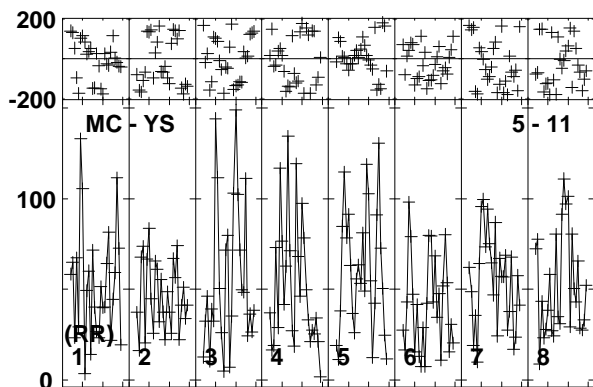
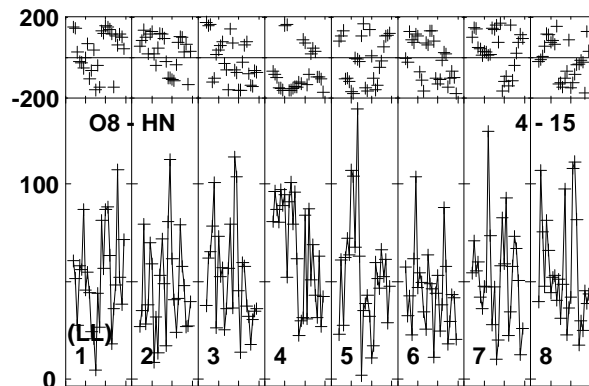
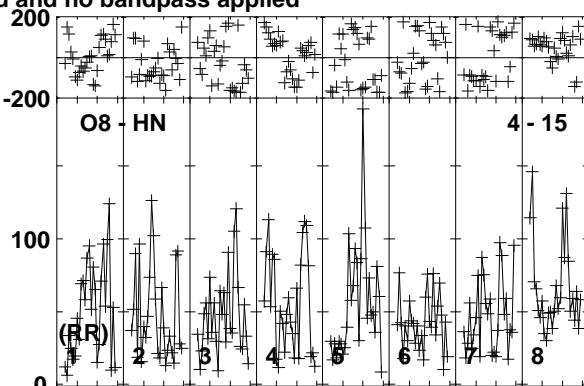
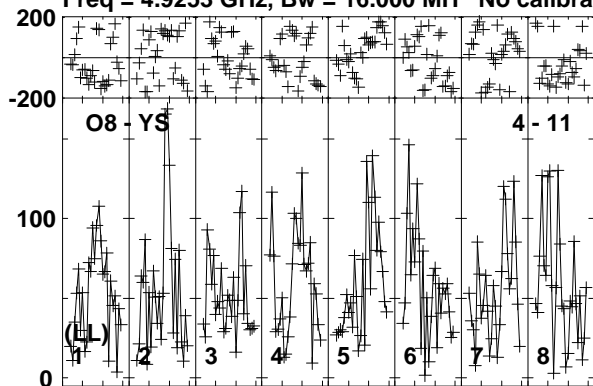

Lower frame: Micro Ampl Jy Top frame: Phas deg
Vector averaged cross-power spectrum Baseline: O8 (04) - YS (11)
Timerange: 00/23:32:18 to 00/23:37:30

Plot file version 302 created 11-APR-2016 17:09:05
 ARP299C GP053G 3.UVDATA.1
 Freq = 4.9253 GHz, Bw = 16.000 MH No calibration applied and no bandpass applied

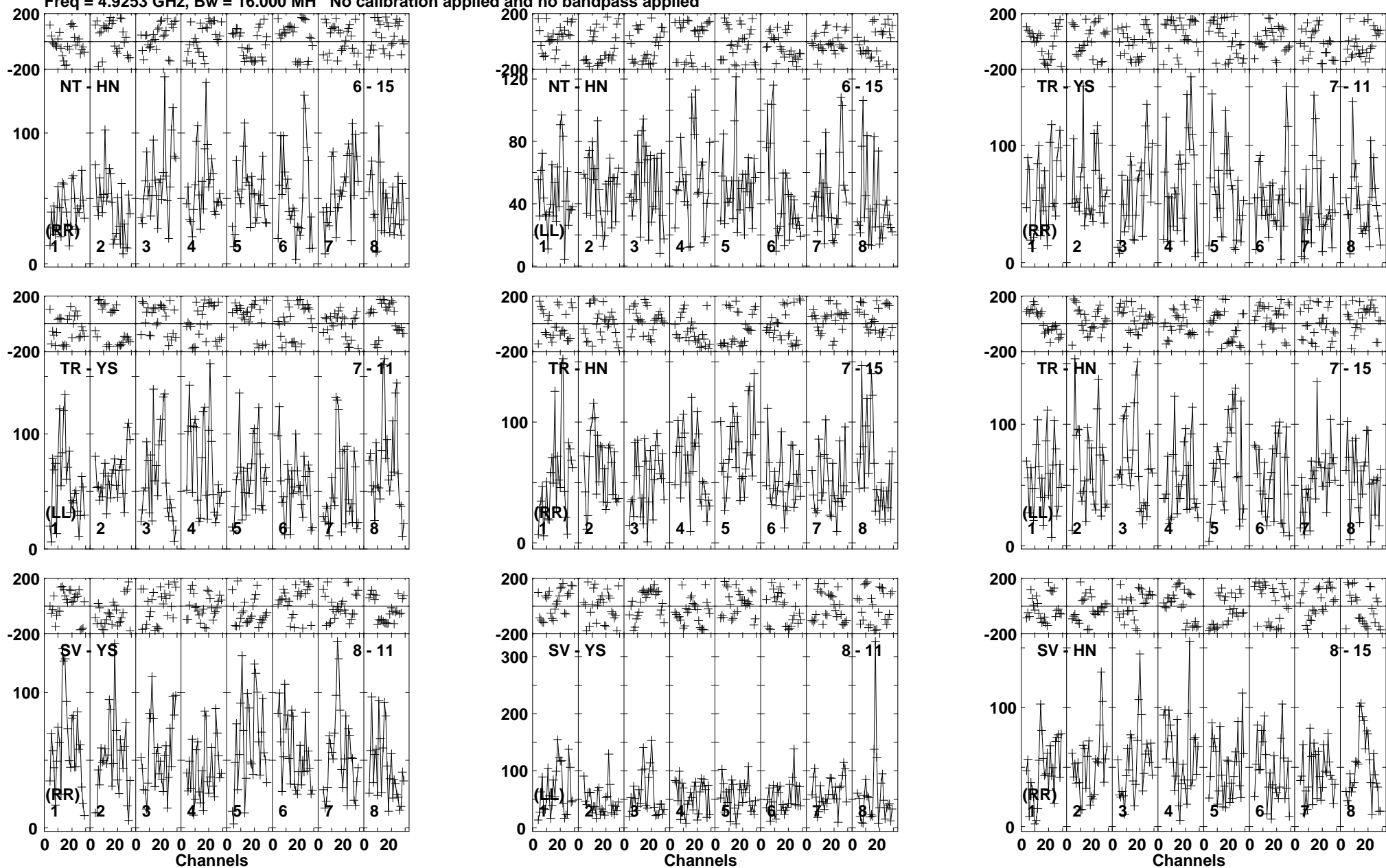

Lower frame: Micro Ampl Jy Top frame: Phas deg
 Vector averaged cross-power spectrum Baseline: NT (06) - HN (15)
 Timerange: 00/23:32:18 to 00/23:37:30

Plot file version 303 created 11-APR-2016 17:09:05

ARP299C GP053G 3.UVDATA.1

Freq = 4.9253 GHz, Bw = 16.000 MH No calibration applied and no bandpass applied

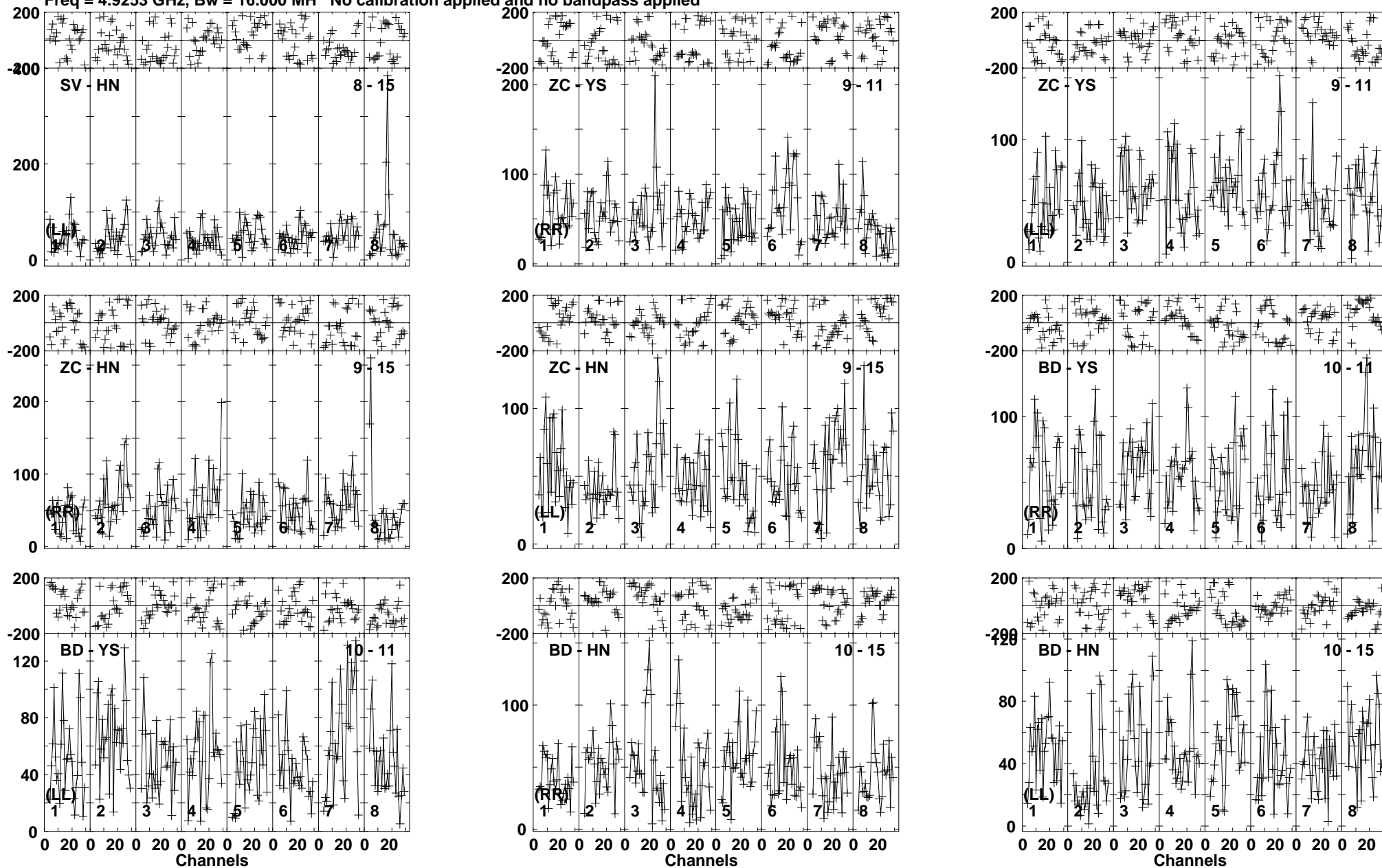

Lower frame: Micro Ampl Jy Top frame: Phas deg
Vector averaged cross-power spectrum Baseline: SV (08) - HN (15)
Timerange: 00/23:32:18 to 00/23:37:30

Plot file version 304 created 11-APR-2016 17:09:05

ARP299C GP053G 3.UVDATA.1

Freq = 4.9253 GHz, Bw = 16.000 MH No calibration applied and no bandpass applied

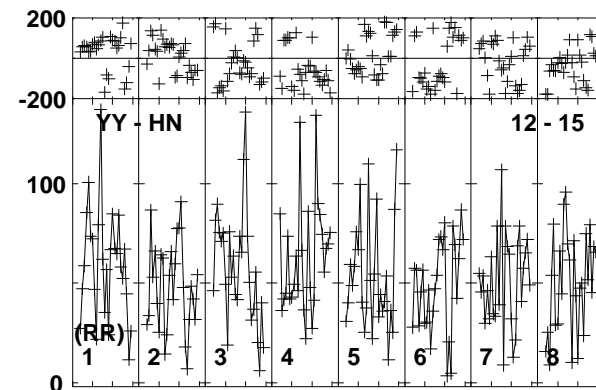
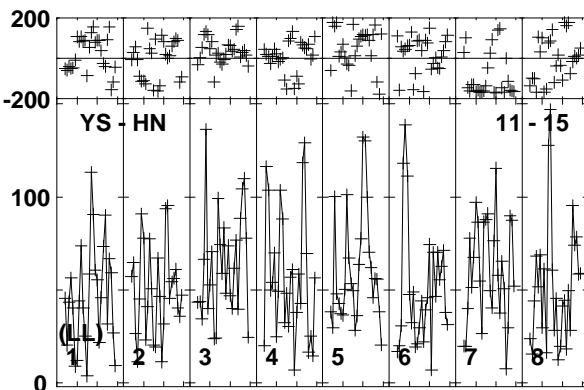
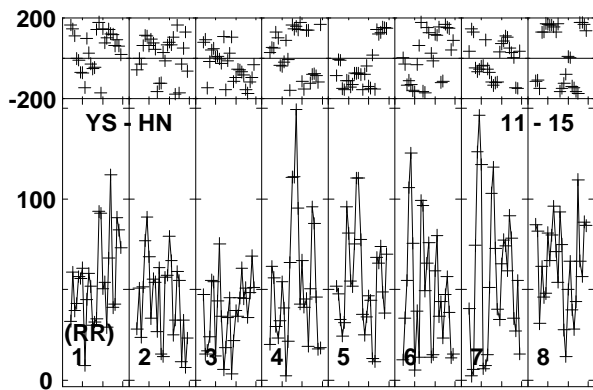
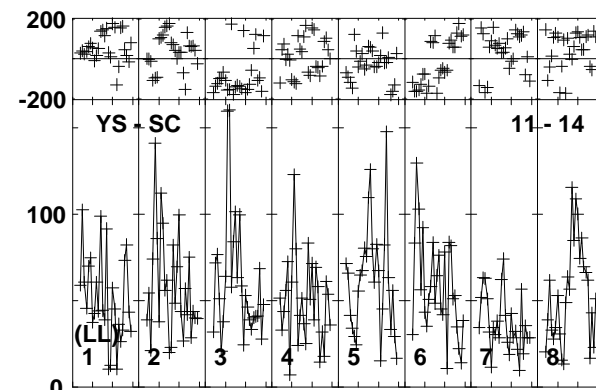
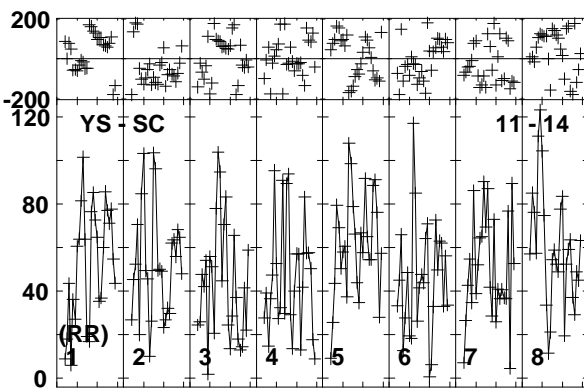
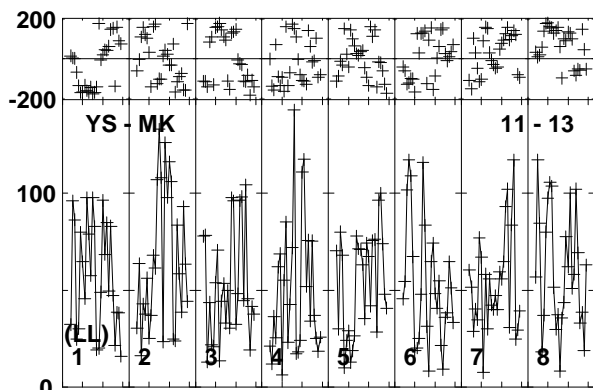
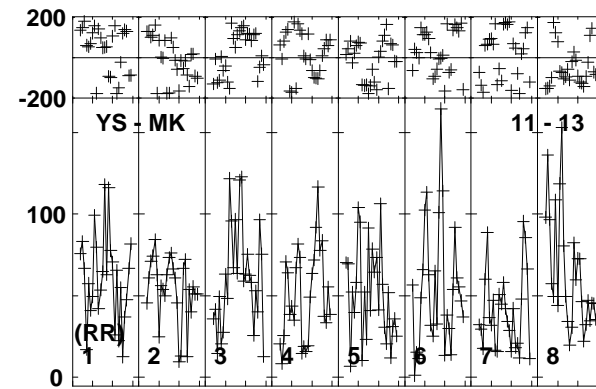
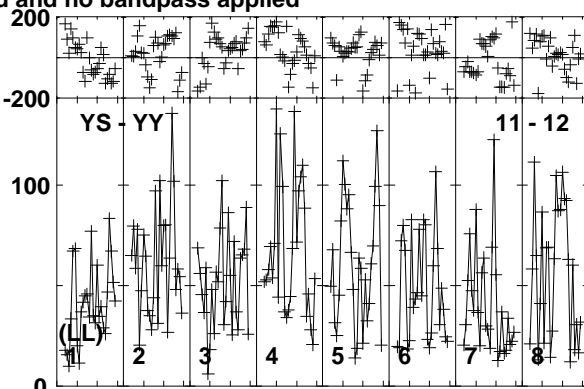
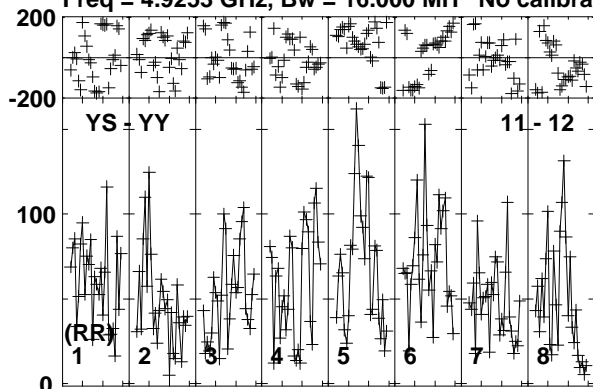

Lower frame: Micro Ampl Jy Top frame: Phas deg
Vector averaged cross-power spectrum Baseline: YS (11) - YY (12)
Timerange: 00/23:32:18 to 00/23:37:30

Plot file version 305 created 11-APR-2016 17:09:06

ARP299C GP053G 3.UVDATA.1

Freq = 4.9253 GHz, Bw = 16.000 MH No calibration applied and no bandpass applied

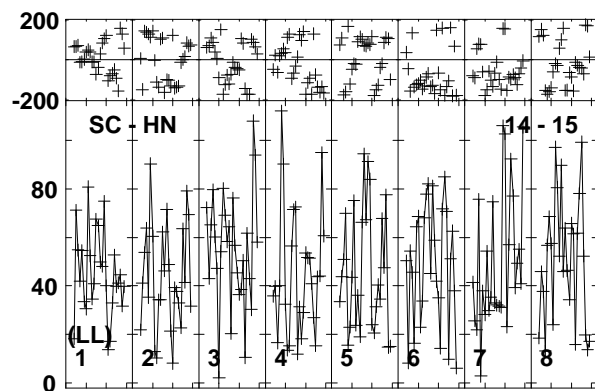
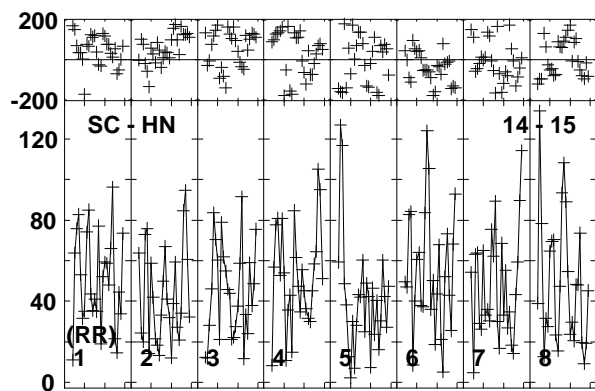
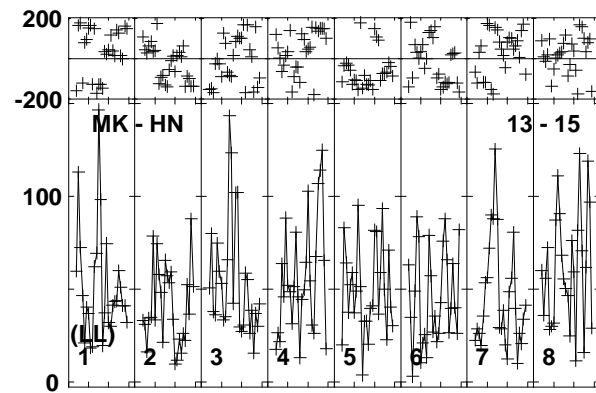
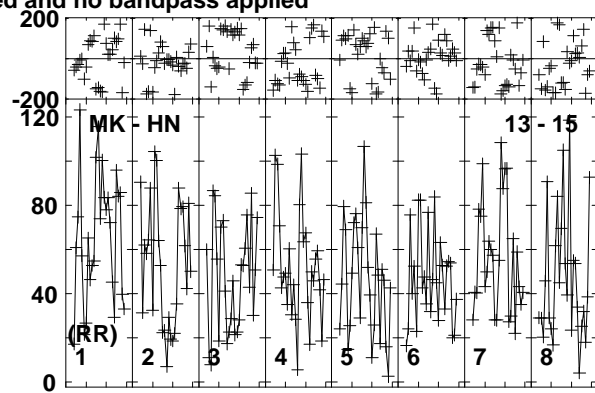
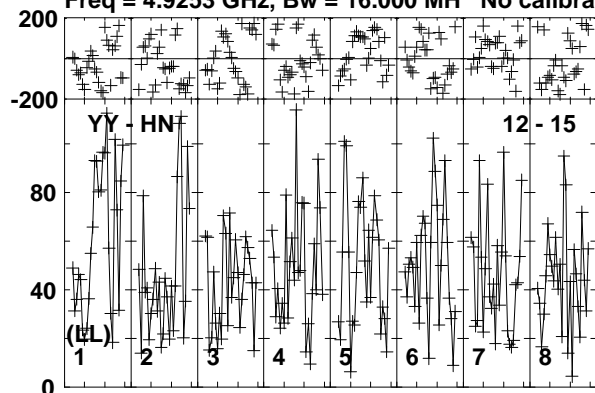

Lower frame: Micro Ampl Jy Top frame: Phas deg
Vector averaged cross-power spectrum Baseline: YY (12) - HN (15)
Timerange: 00/23:32:18 to 00/23:37:30

Plot file version 306 created 11-APR-2016 17:09:06

J1128+5925 GP053G 3.UVDATA.1

Freq = 4.9253 GHz, Bw = 16.000 MH No calibration applied and no bandpass applied

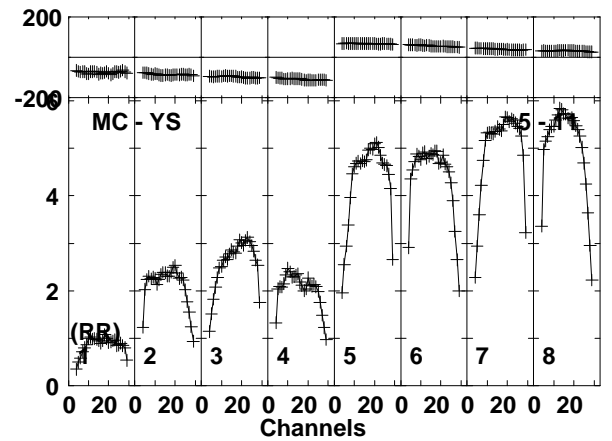
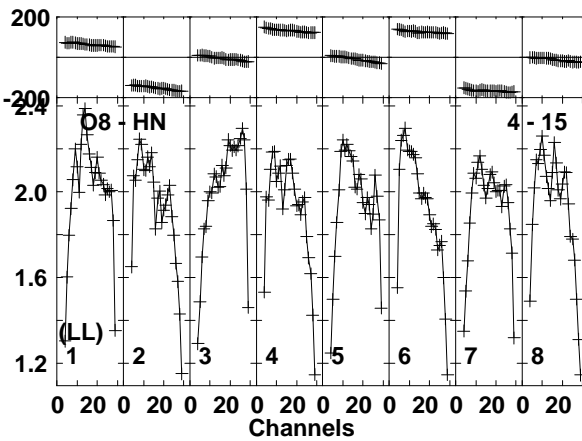
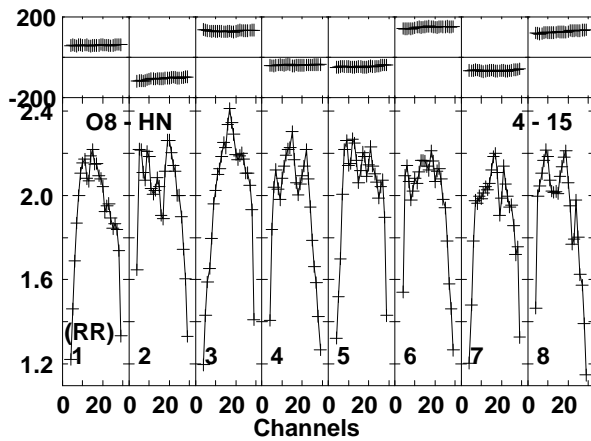
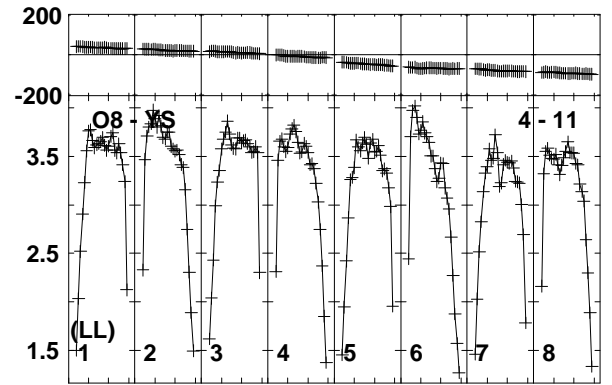
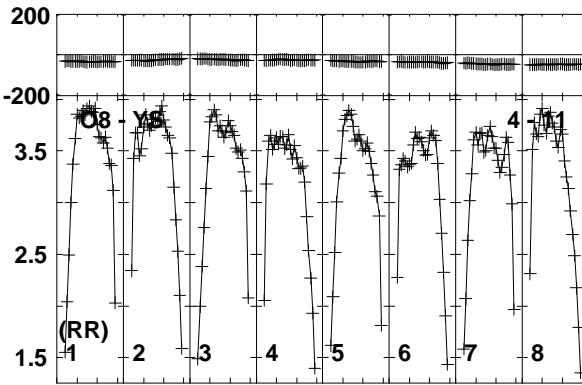
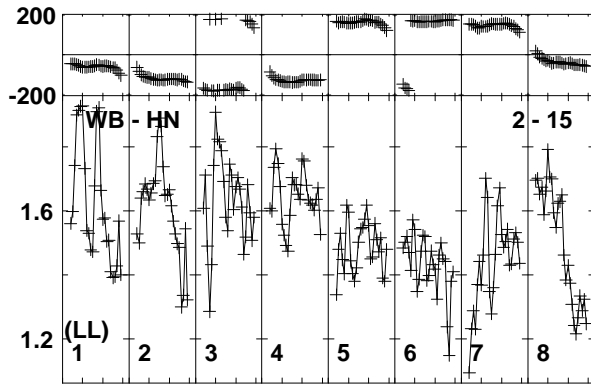
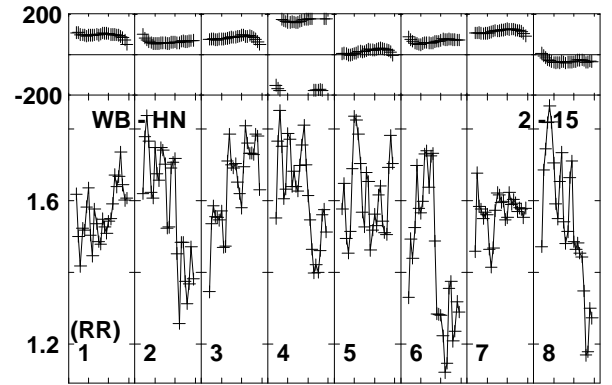
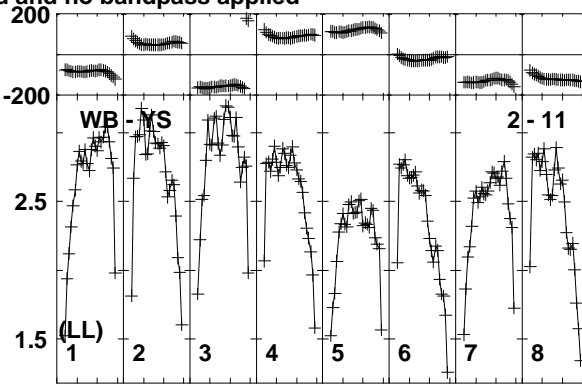
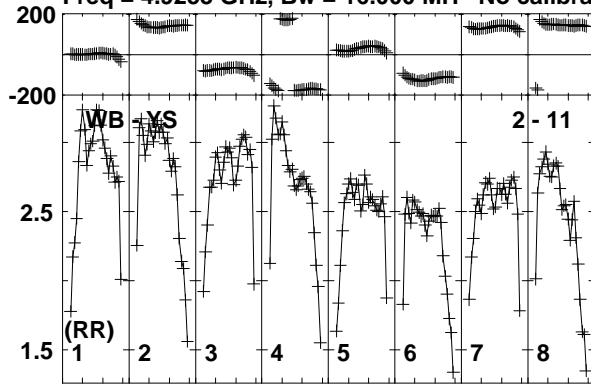

Lower frame: Milli Ampl Jy Top frame: Phas deg
Vector averaged cross-power spectrum Baseline: WB (02) - YS (11)
Timerange: 00/23:37:36 to 00/23:39:28

Plot file version 307 created 11-APR-2016 17:09:06

J1128+5925 GP053G 3.UVDATA.1

Freq = 4.9253 GHz, Bw = 16.000 MH No calibration applied and no bandpass applied

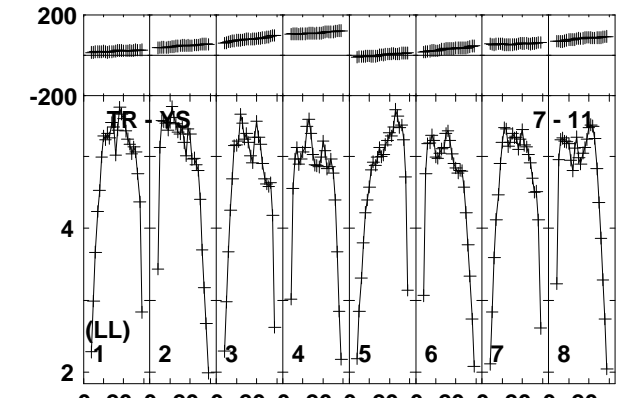
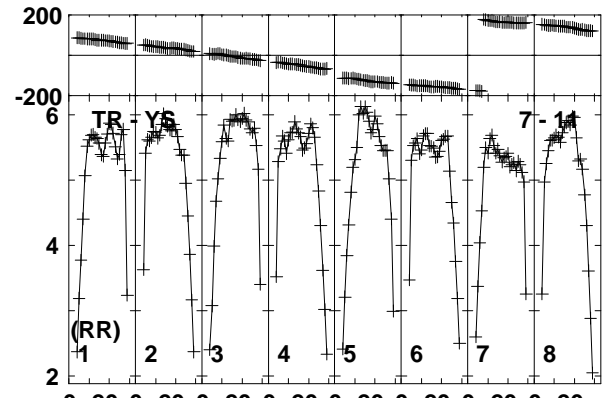
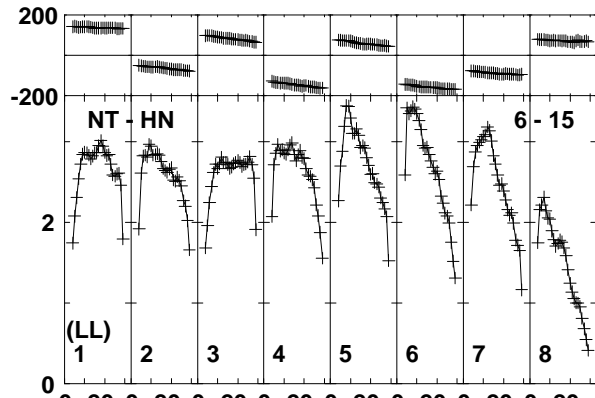
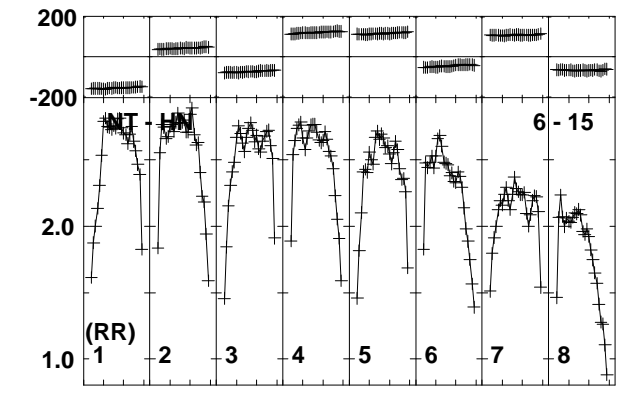
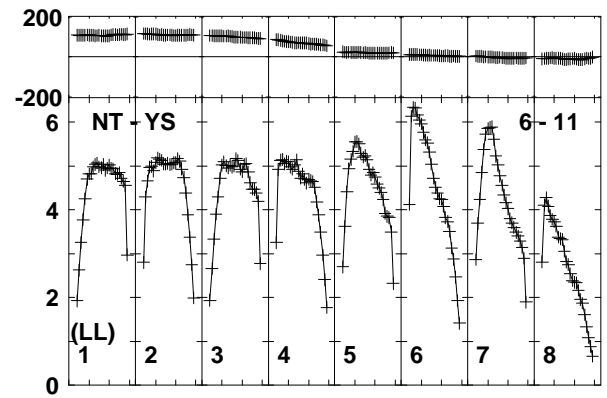
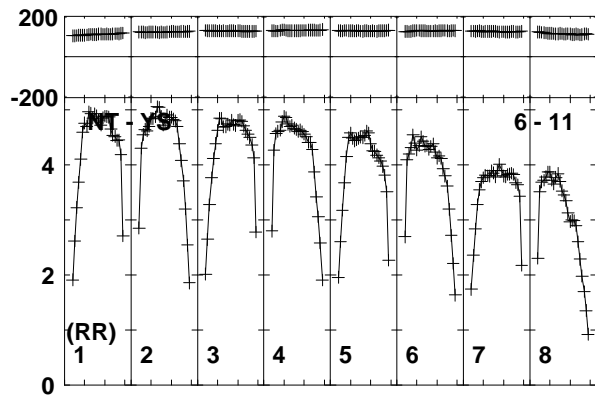
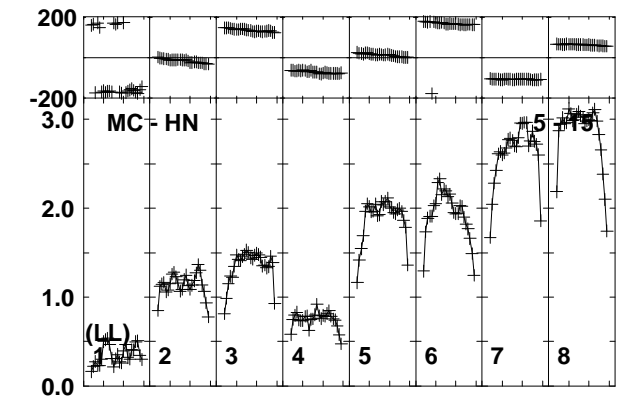
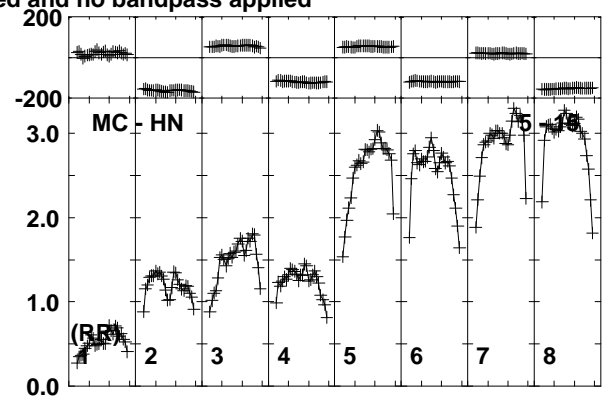
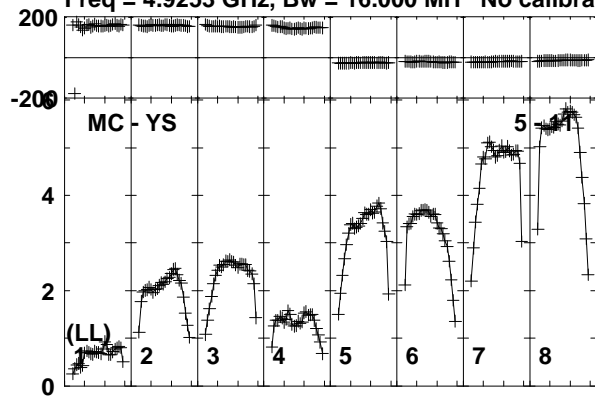

Lower frame: Milli Ampl Jy Top frame: Phas deg
Vector averaged cross-power spectrum Baseline: MC (05) - YS (11)
Timerange: 00/23:37:36 to 00/23:39:28

Plot file version 308 created 11-APR-2016 17:09:06

J1128+5925 GP053G 3.UVDATA.1

Freq = 4.9253 GHz, Bw = 16.000 MH No calibration applied and no bandpass applied

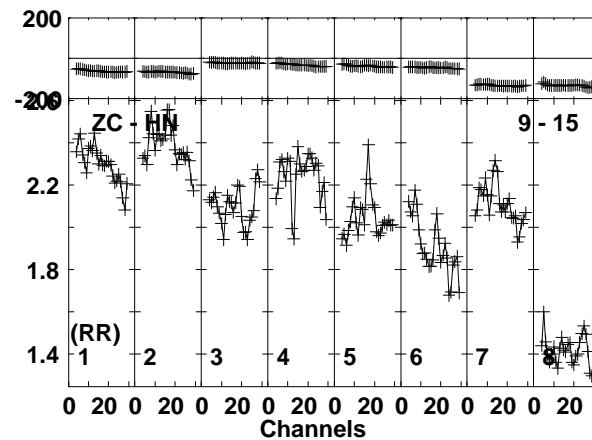
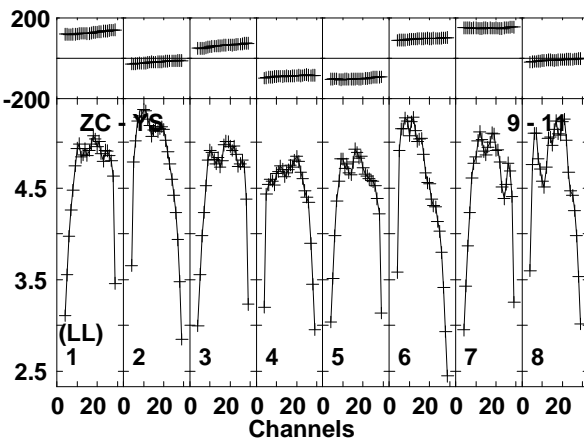
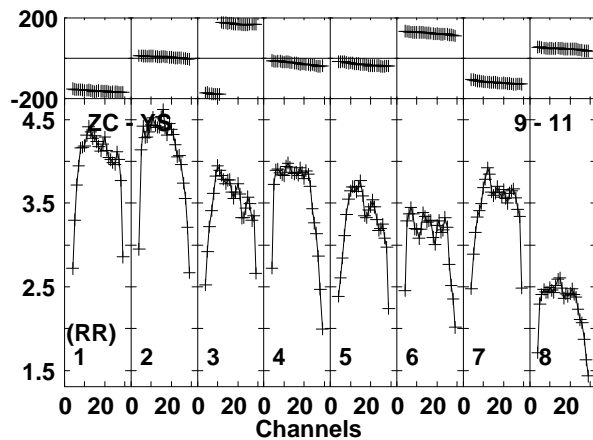
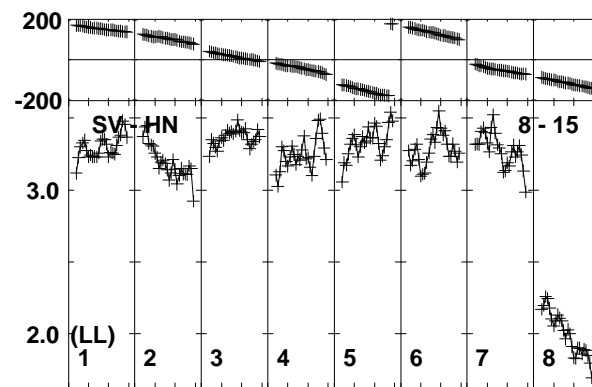
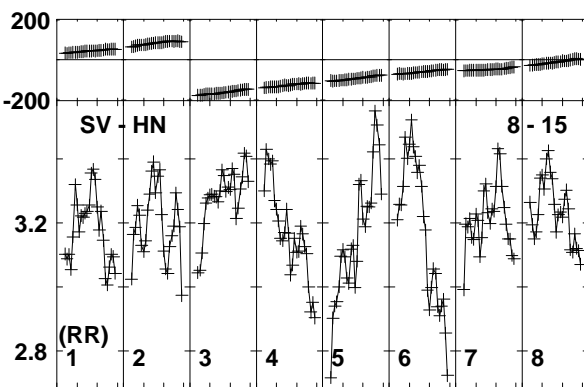
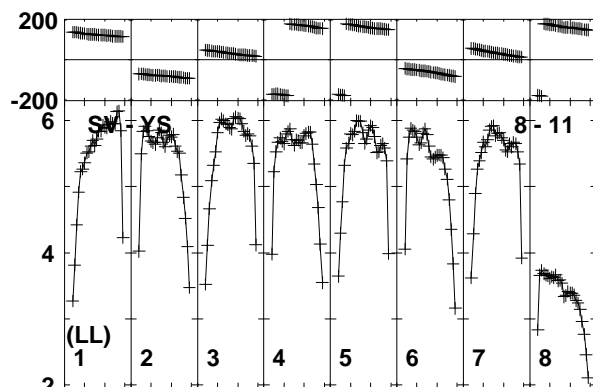
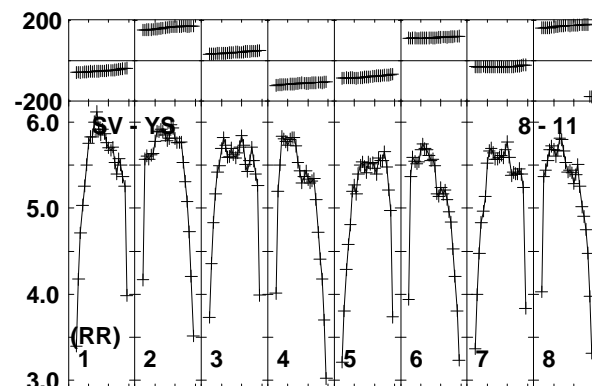
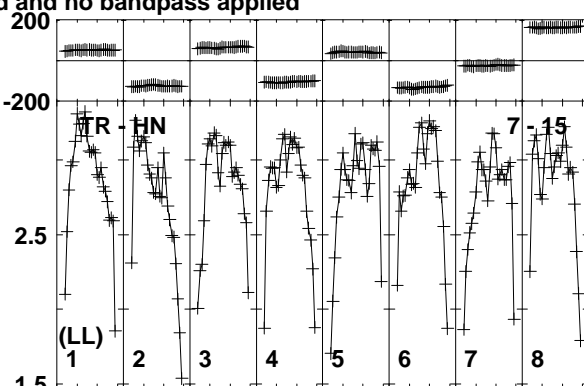
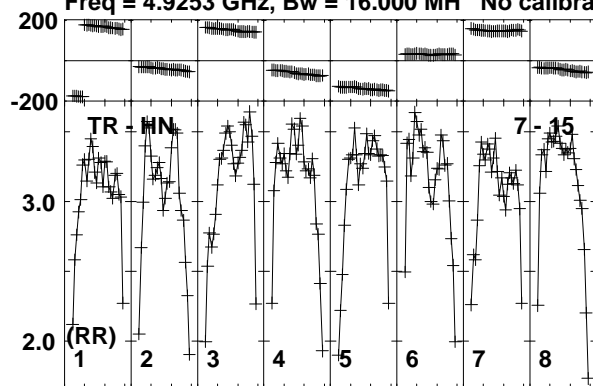

Lower frame: Milli Ampl Jy Top frame: Phas deg
Vector averaged cross-power spectrum Baseline: TR (07) - HN (15)
Timerange: 00/23:37:36 to 00/23:39:28

Plot file version 309 created 11-APR-2016 17:09:06

J1128+5925 GP053G 3.UVDATA.1

Freq = 4.9253 GHz, Bw = 16.000 MH No calibration applied and no bandpass applied

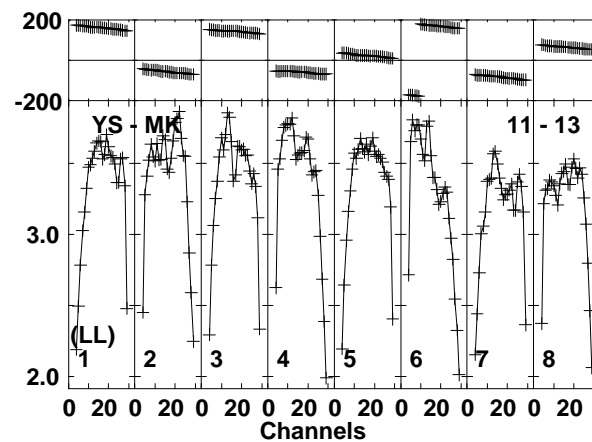
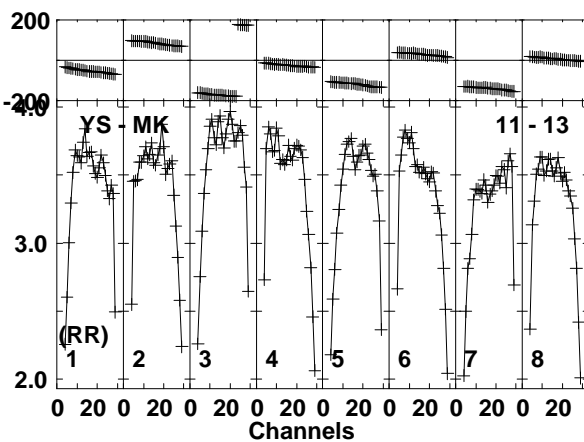
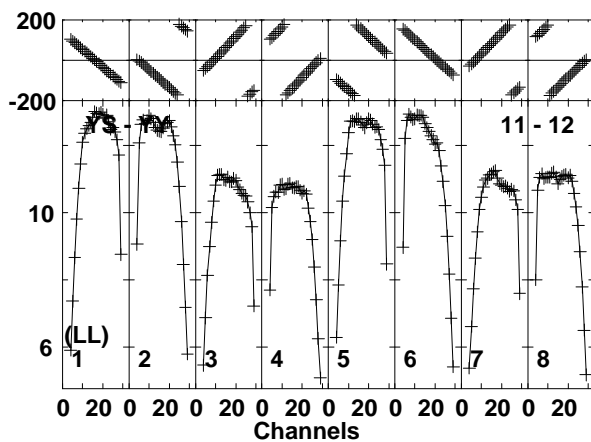
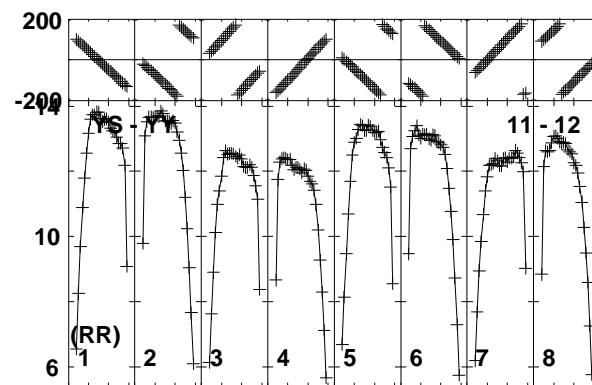
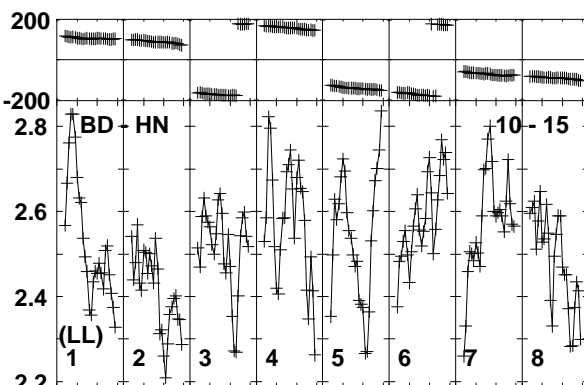
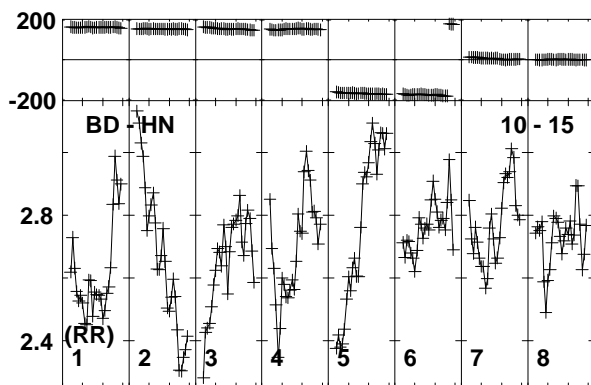
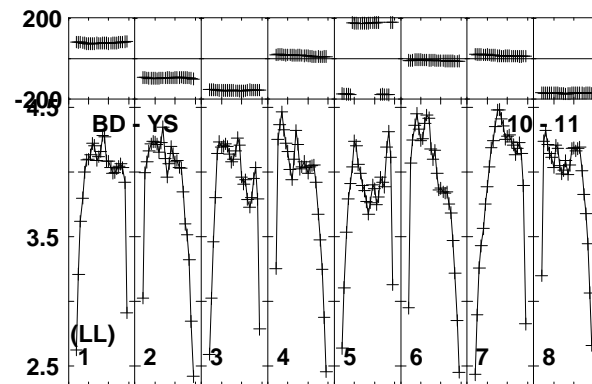
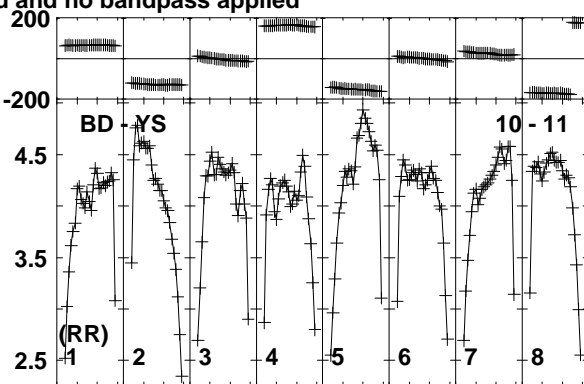
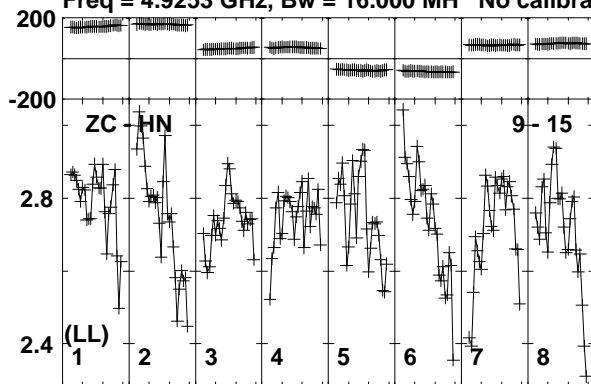

Lower frame: Milli Ampl Jy Top frame: Phas deg
Vector averaged cross-power spectrum Baseline: ZC (09) - HN (15)
Timerange: 00/23:37:36 to 00/23:39:28

Plot file version 310 created 11-APR-2016 17:09:06

J1128+5925 GP053G 3.UV DATA.1

Freq = 4.9253 GHz, Bw = 16.000 MH No calibration applied and no bandpass applied

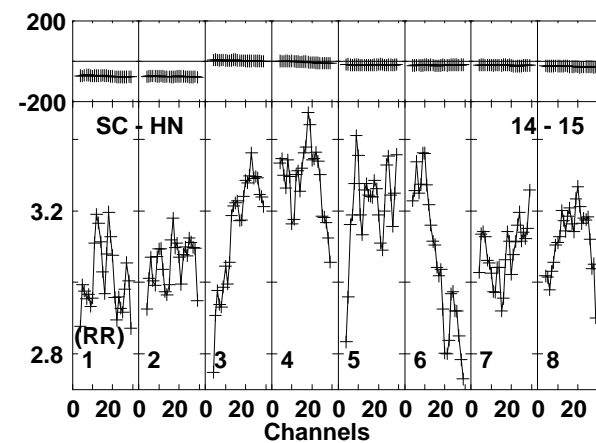
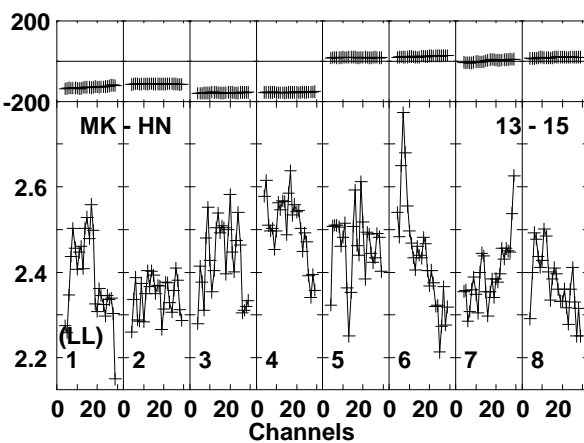
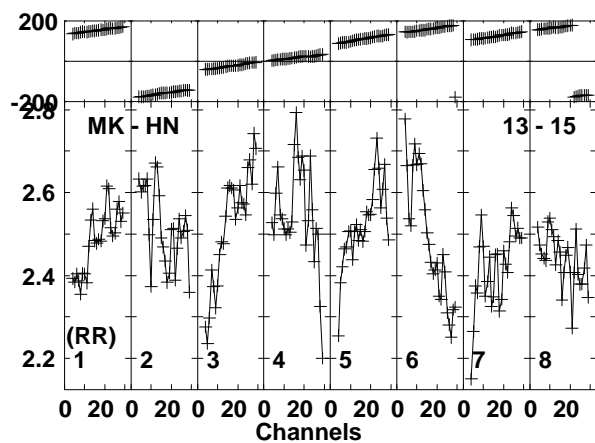
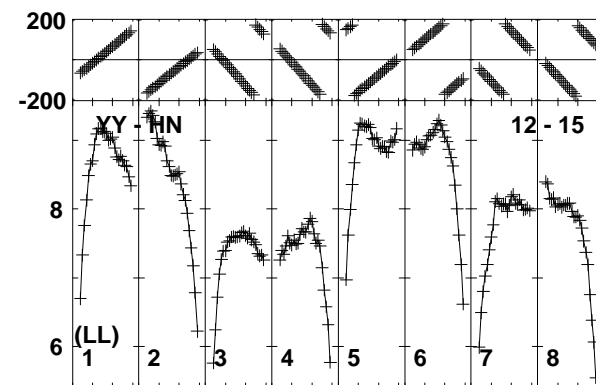
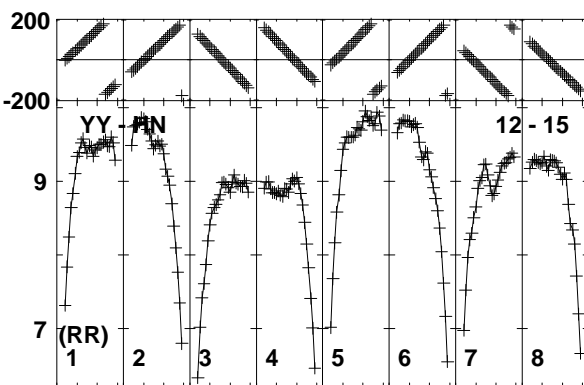
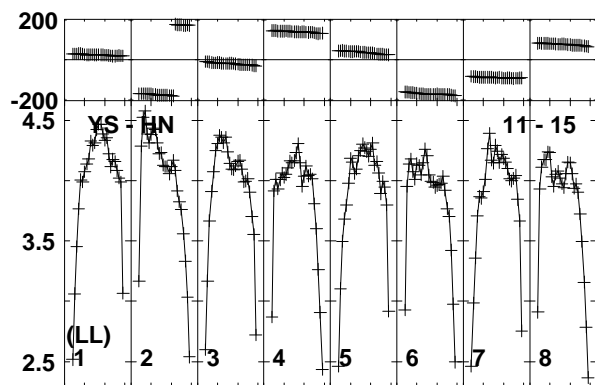
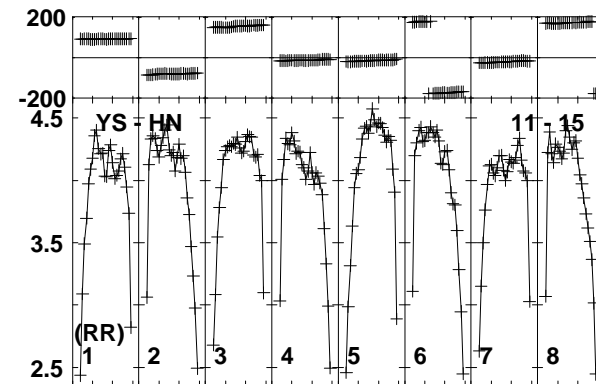
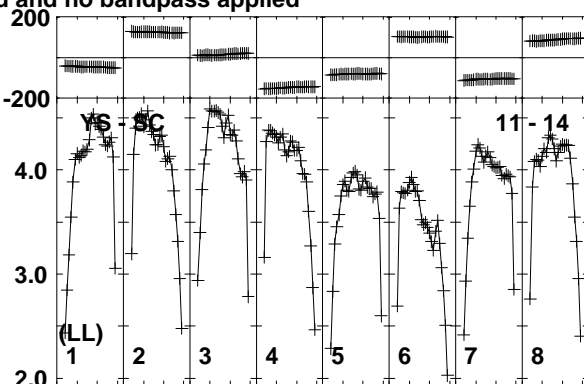
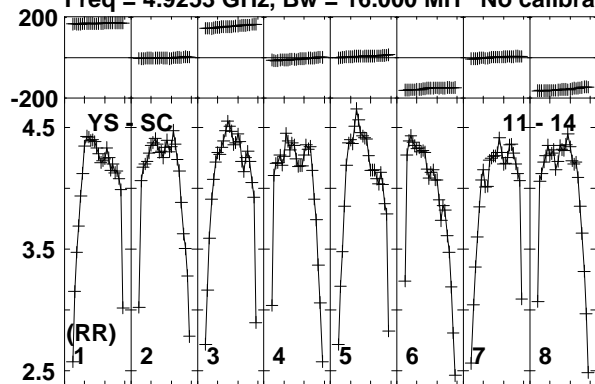

Lower frame: Milli Ampl Jy Top frame: Phas deg
Vector averaged cross-power spectrum Baseline: YS (11) - SC (14)
Timerange: 00/23:37:36 to 00/23:39:28

Plot file version 311 created 11-APR-2016 17:09:07
J1128+5925 GP053G 3.UVDATA.1
Freq = 4.9253 GHz, Bw = 16.000 MH No calibration applied and no bandpass applied

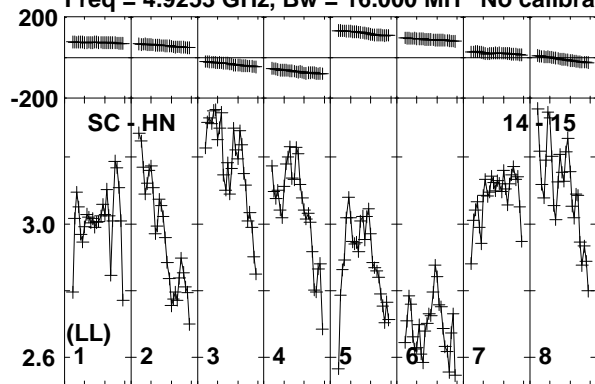

Lower frame: Milli Ampl Jy Top frame: Phas deg
Vector averaged cross-power spectrum Baseline: SC (14) - HN (15)
Timerange: 00/23:37:36 to 00/23:39:28

Plot file version 312 created 11-APR-2016 17:09:07

ARP299C GP053G 3.UVDATA.1

Freq = 4.9253 GHz, Bw = 16.000 MH No calibration applied and no bandpass applied

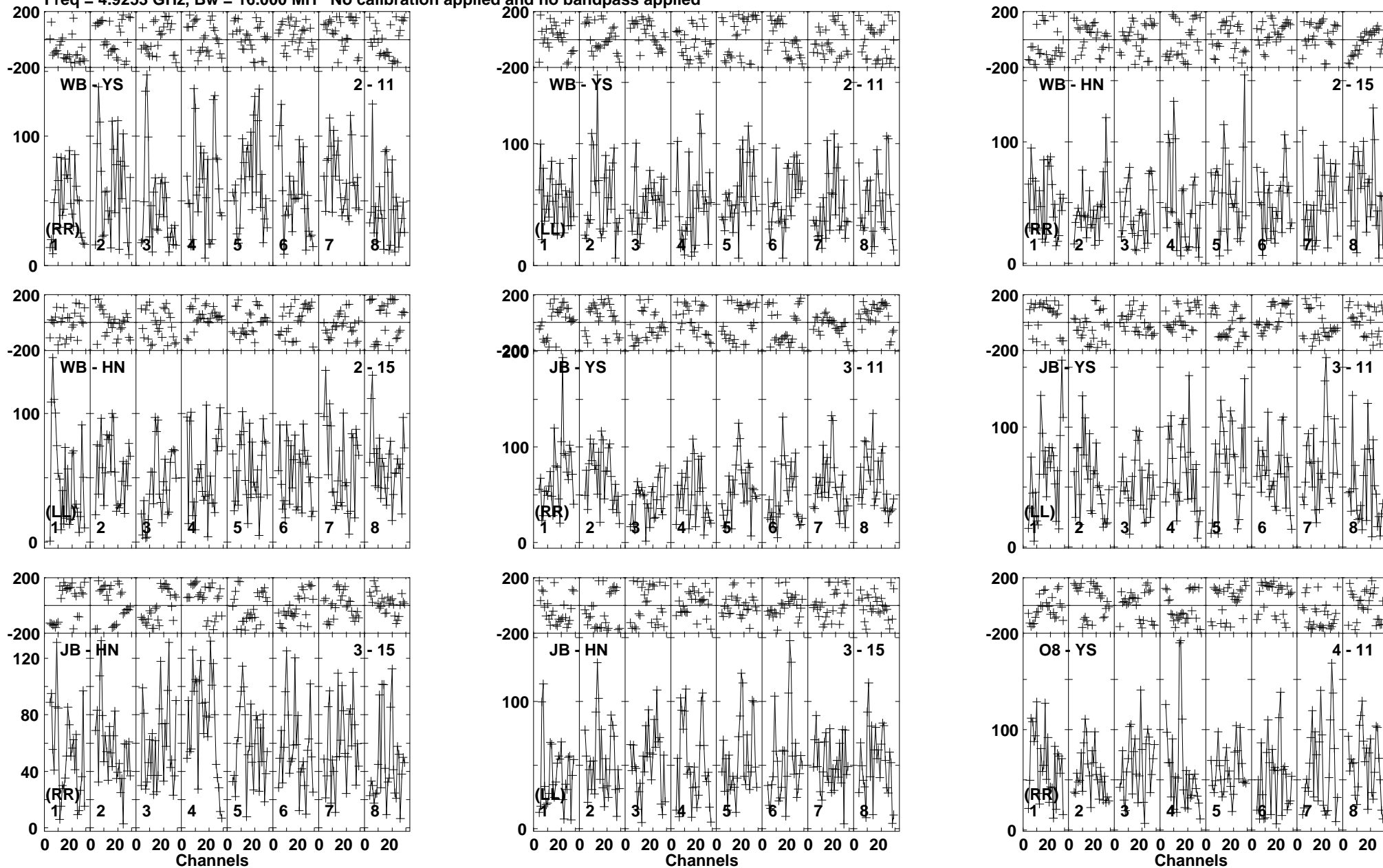

Lower frame: Micro Ampl Jy Top frame: Phas deg
Vector averaged cross-power spectrum Baseline: WB (02) - YS (11)
Timerange: 00/23:39:33 to 00/23:44:47

Plot file version 313 created 11-APR-2016 17:09:07

ARP299C GP053G 3.UVDATA.1

Freq = 4.9253 GHz, Bw = 16.000 MH No calibration applied and no bandpass applied

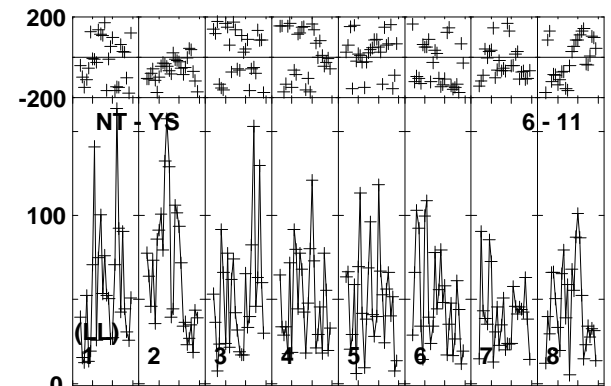
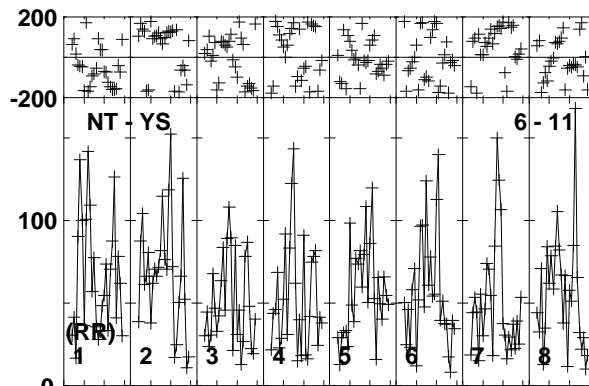
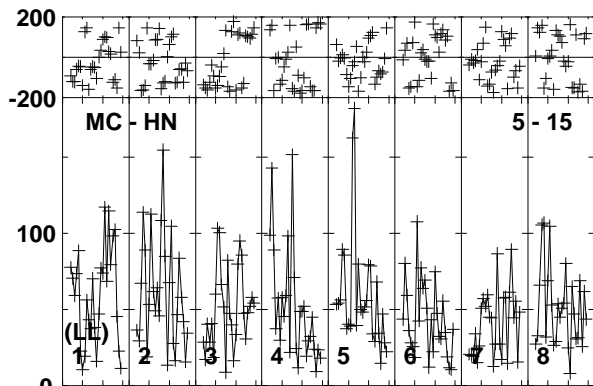
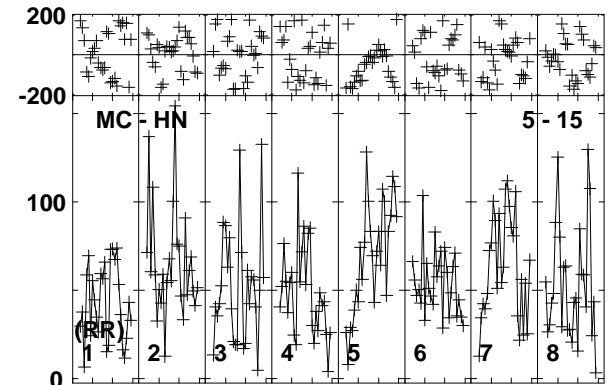
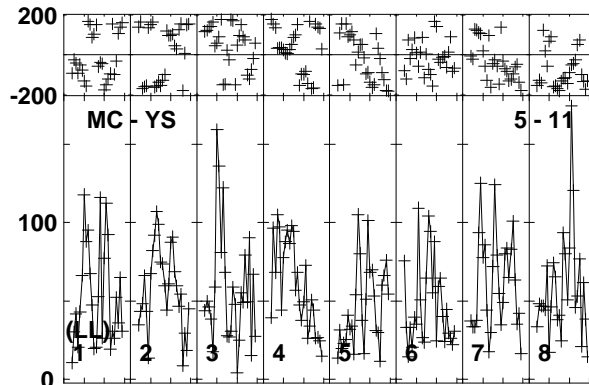
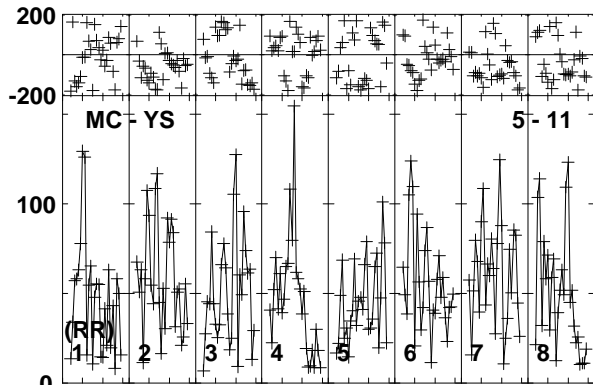
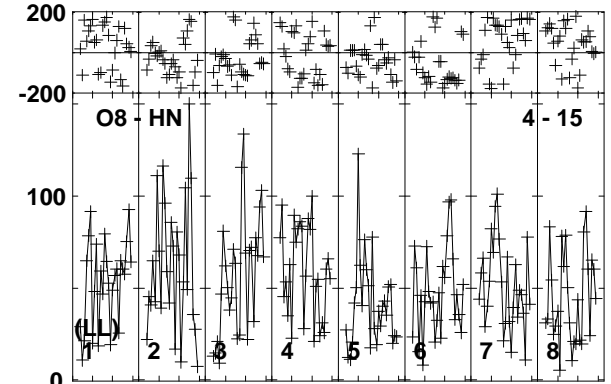
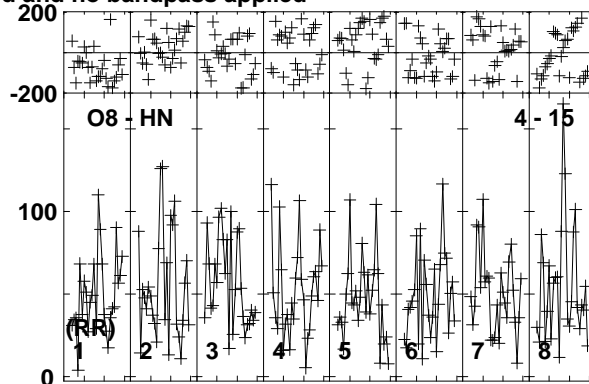
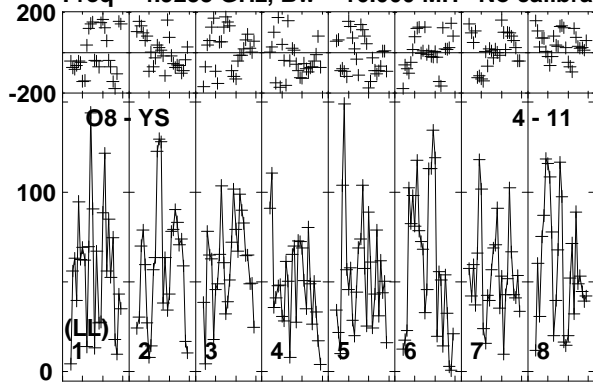

Lower frame: Micro Ampl Jy Top frame: Phas deg
Vector averaged cross-power spectrum Baseline: O8 (04) - YS (11)
Timerange: 00/23:39:33 to 00/23:44:47

Plot file version 314 created 11-APR-2016 17:09:07

ARP299C GP053G 3.UVDATA.1

Freq = 4.9253 GHz, Bw = 16.000 MH No calibration applied and no bandpass applied

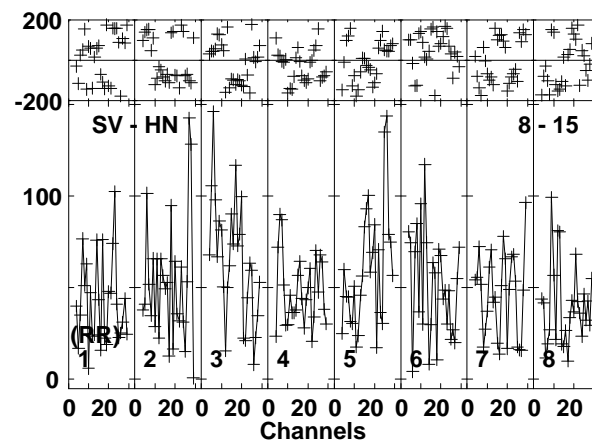
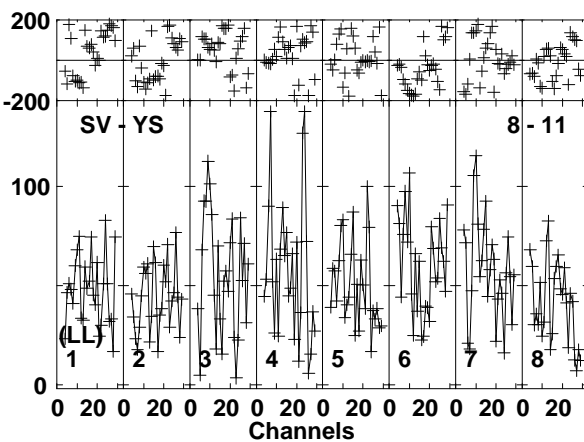
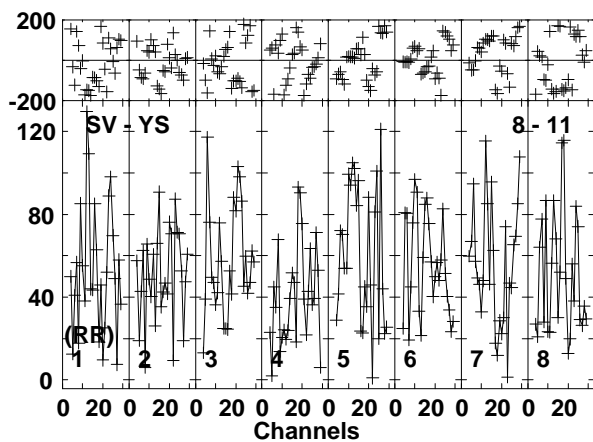
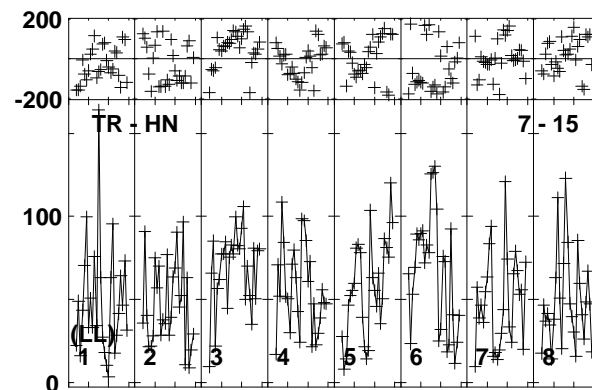
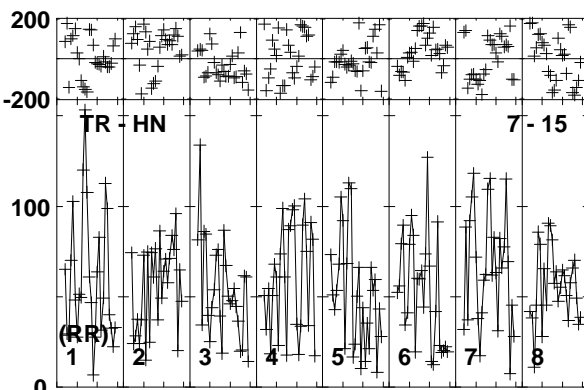
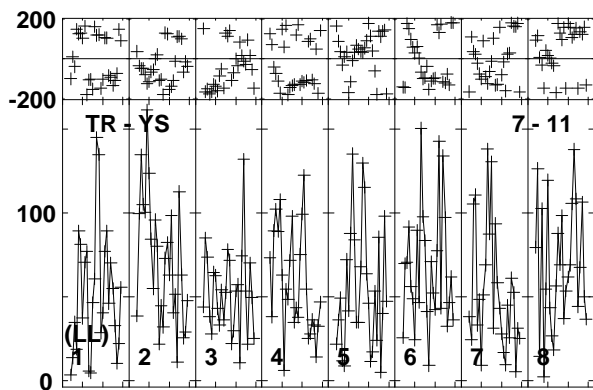
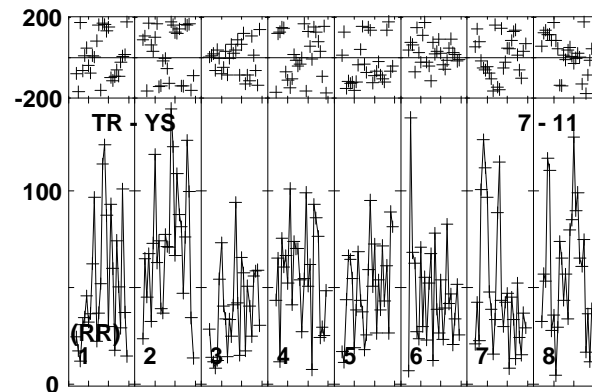
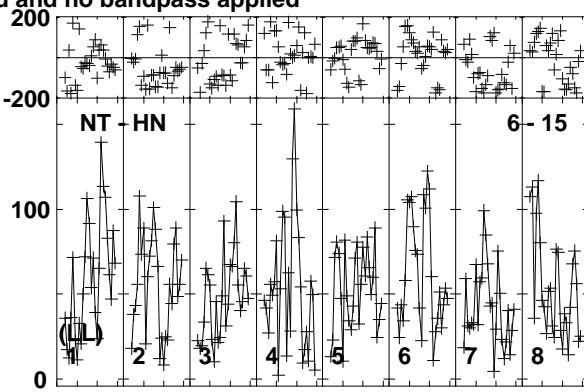
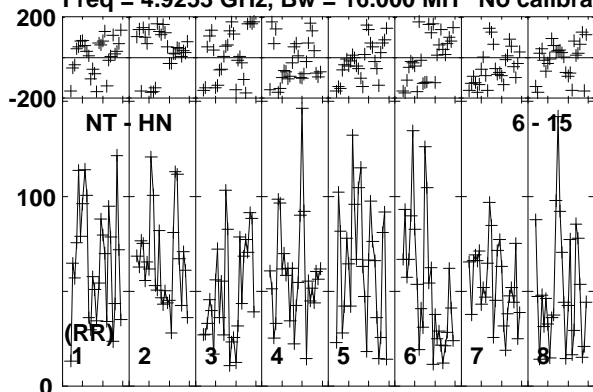

Lower frame: Micro Ampl Jy Top frame: Phas deg
Vector averaged cross-power spectrum Baseline: NT (06) - HN (15)
Timerange: 00/23:39:33 to 00/23:44:47

Plot file version 315 created 11-APR-2016 17:09:07

ARP299C GP053G 3.UVDATA.1

Freq = 4.9253 GHz, Bw = 16.000 MH No calibration applied and no bandpass applied

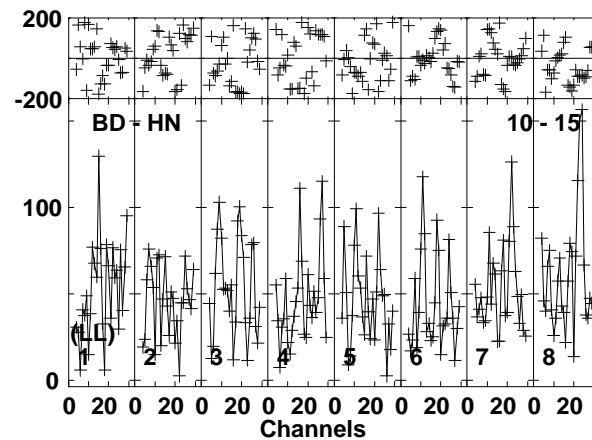
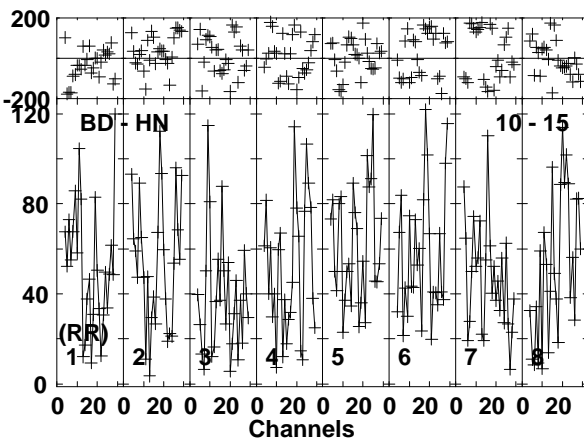
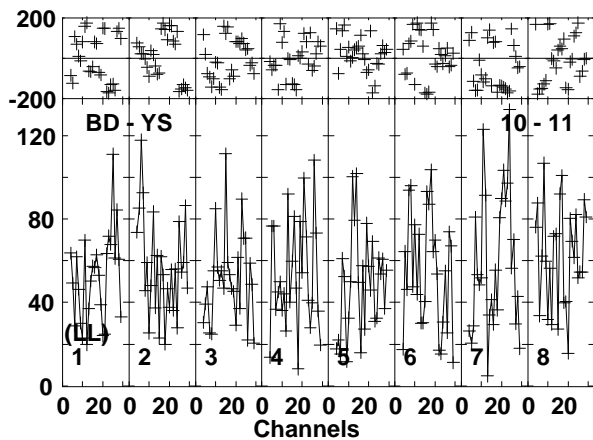
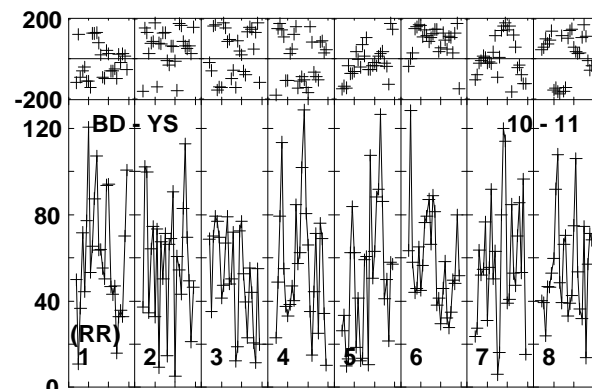
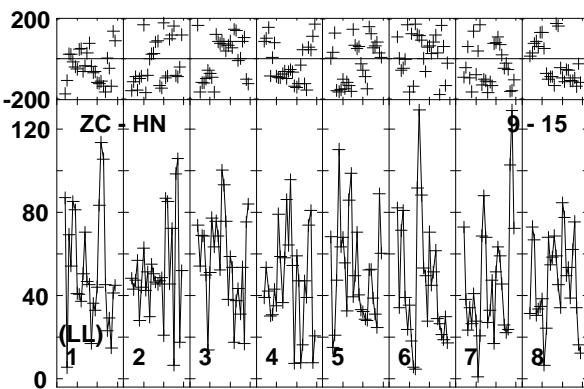
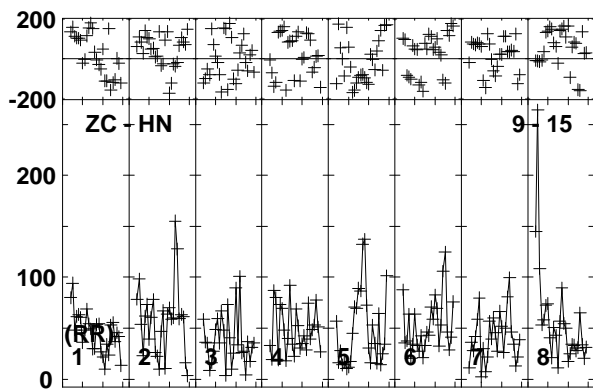
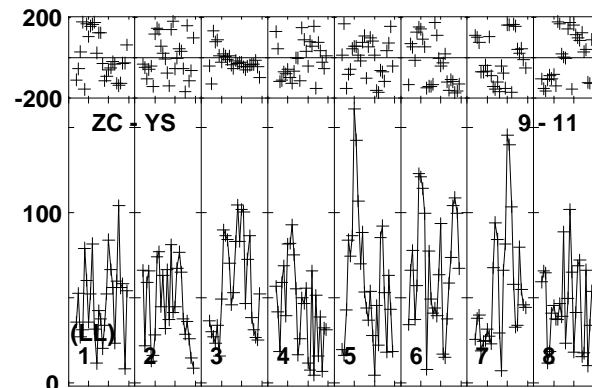
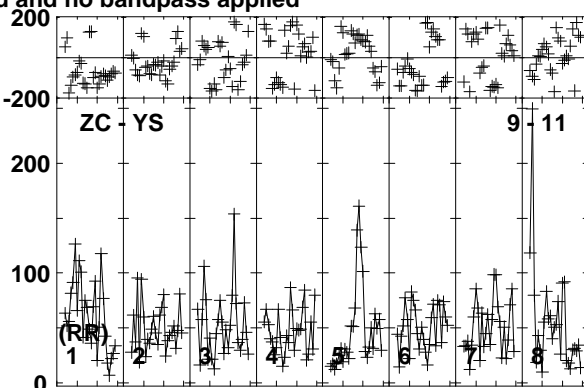
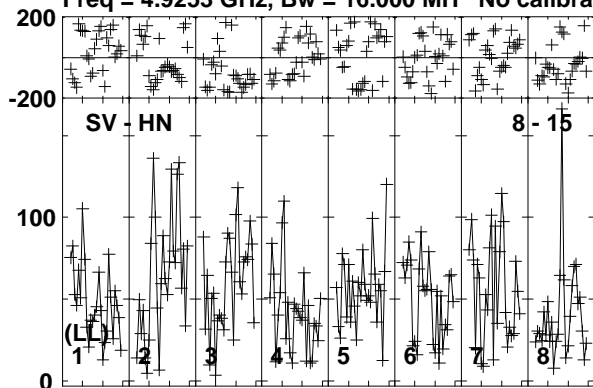

Lower frame: Micro Ampl Jy Top frame: Phas deg
Vector averaged cross-power spectrum Baseline: SV (08) - HN (15)
Timerange: 00/23:39:33 to 00/23:44:47

Plot file version 316 created 11-APR-2016 17:09:07

ARP299C GP053G 3.UVDATA.1

Freq = 4.9253 GHz, Bw = 16.000 MH No calibration applied and no bandpass applied

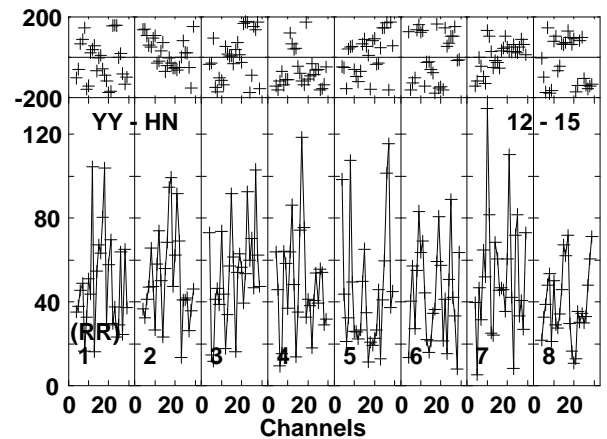
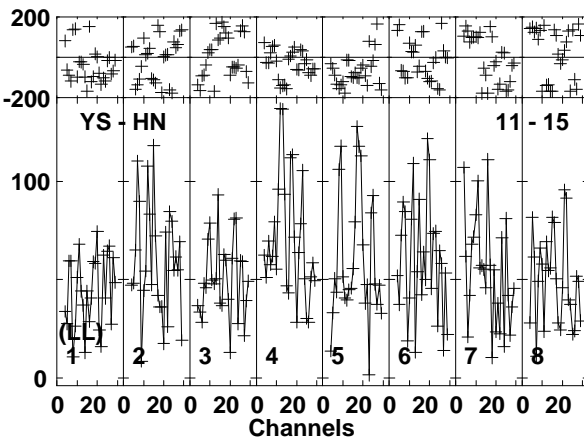
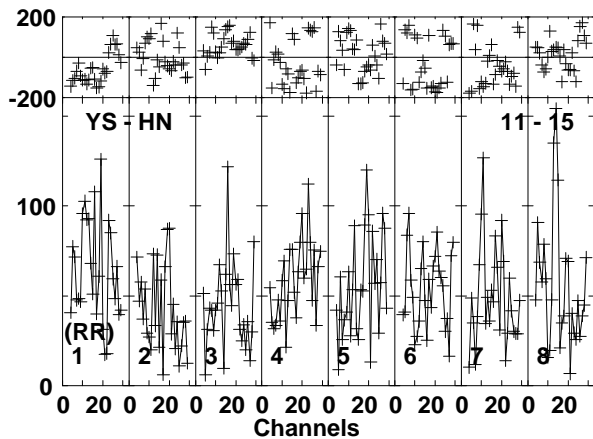
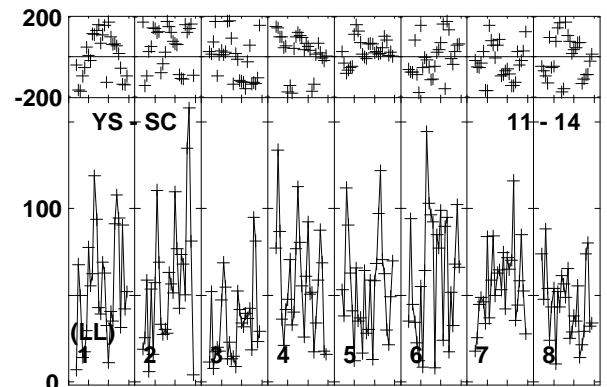
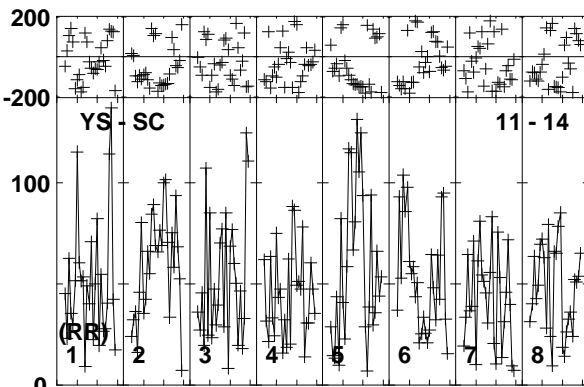
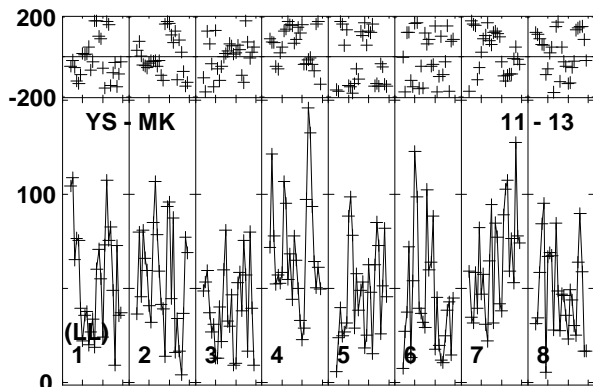
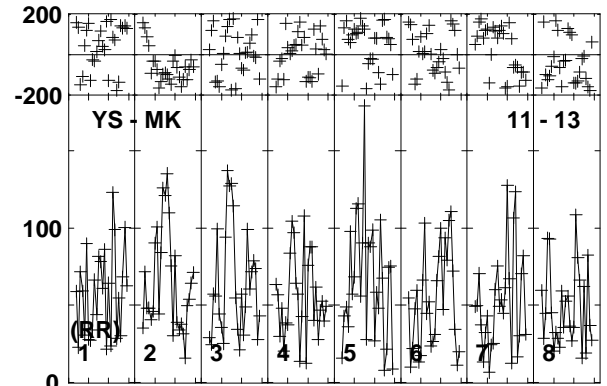
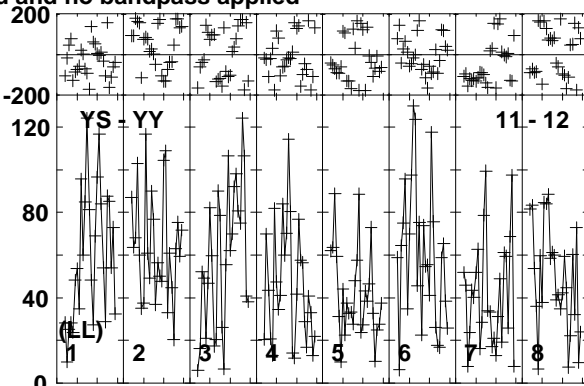
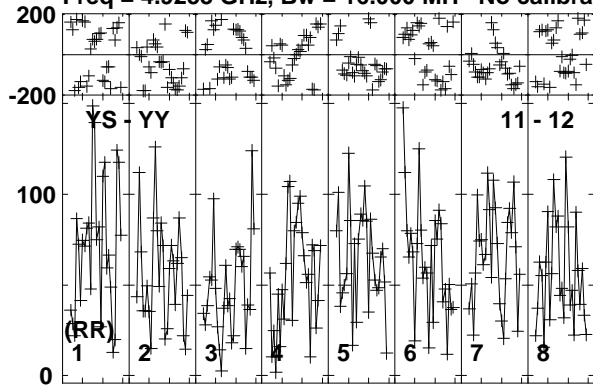

Lower frame: Micro Ampl Jy Top frame: Phas deg
Vector averaged cross-power spectrum Baseline: YS (11) - YY (12)
Timerange: 00/23:39:33 to 00/23:44:47

Plot file version 317 created 11-APR-2016 17:09:08

ARP299C GP053G 3.UVDATA.1

Freq = 4.9253 GHz, Bw = 16.000 MH No calibration applied and no bandpass applied

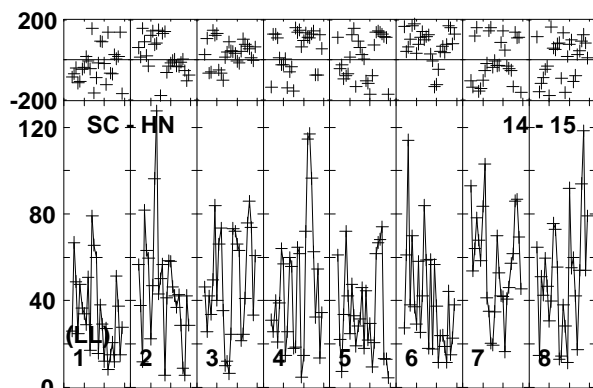
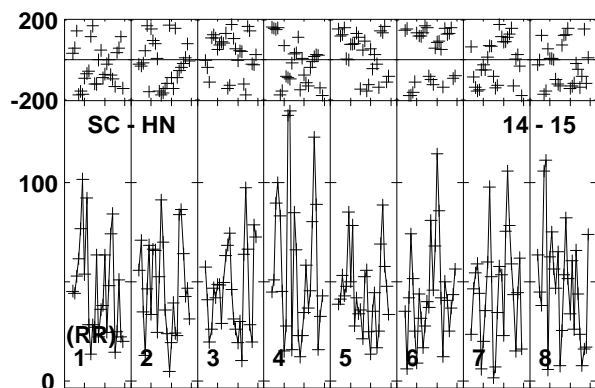
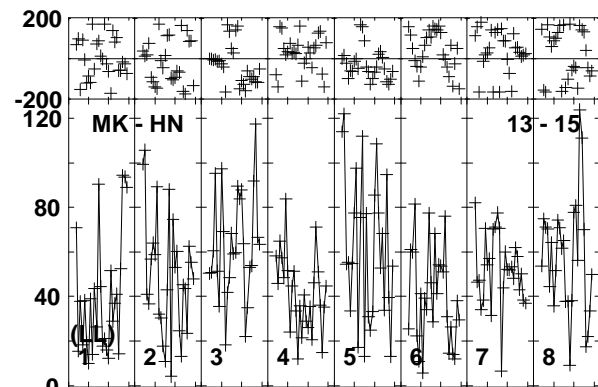
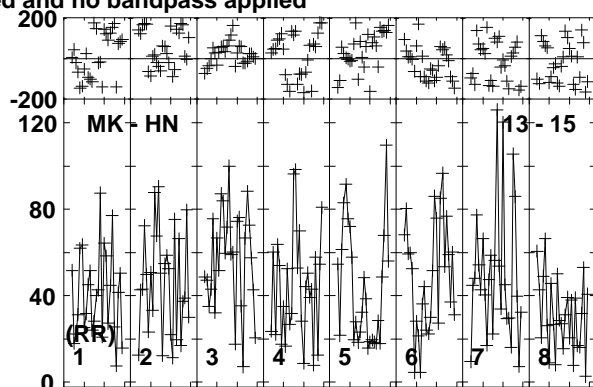
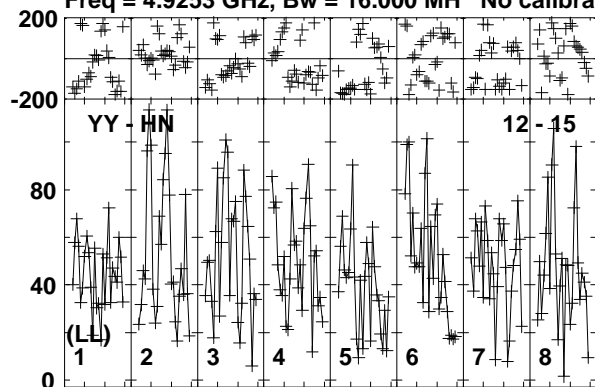

Lower frame: Micro Ampl Jy Top frame: Phas deg
Vector averaged cross-power spectrum Baseline: YY (12) - HN (15)
Timerange: 00/23:39:33 to 00/23:44:47

Plot file version 318 created 11-APR-2016 17:09:08
 J1128+5925 GP053G 3.UVDATA.1

Freq = 4.9253 GHz, Bw = 16.000 MH No calibration applied and no bandpass applied

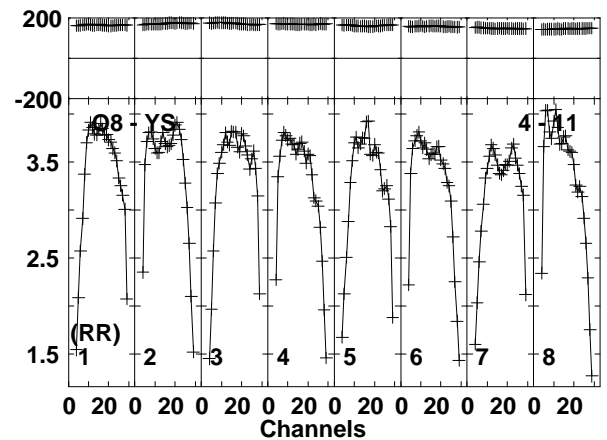
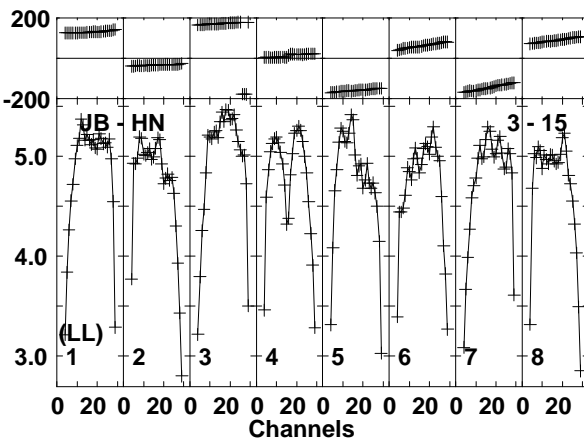
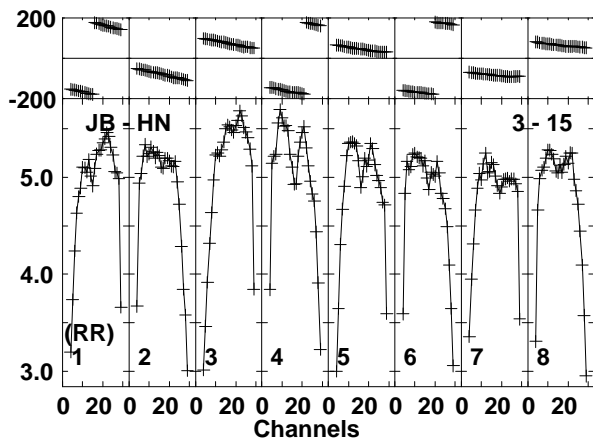
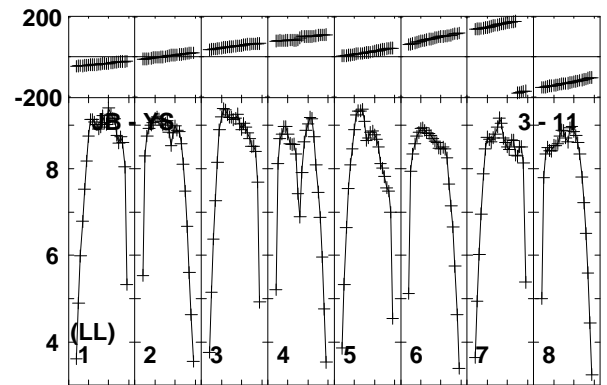
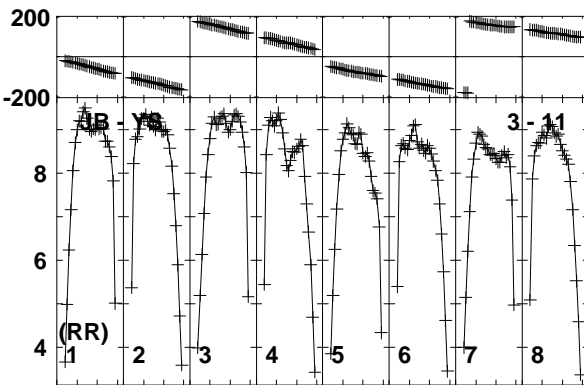
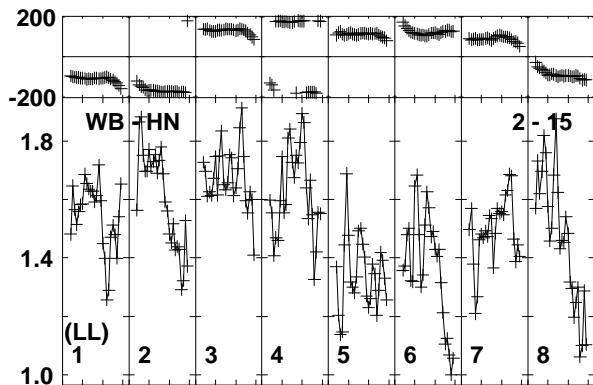
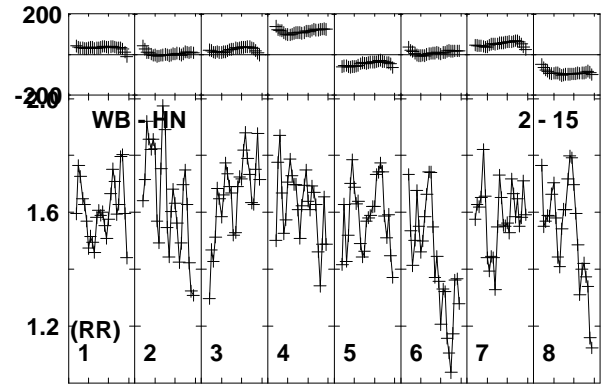
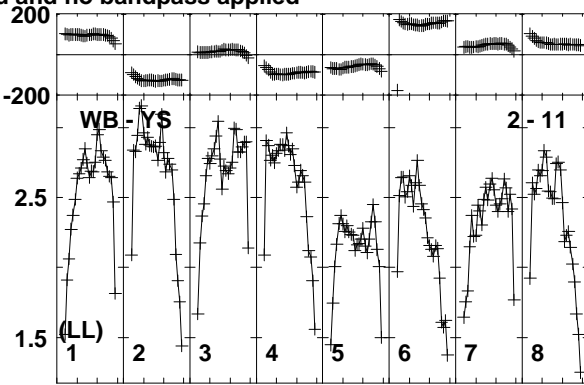
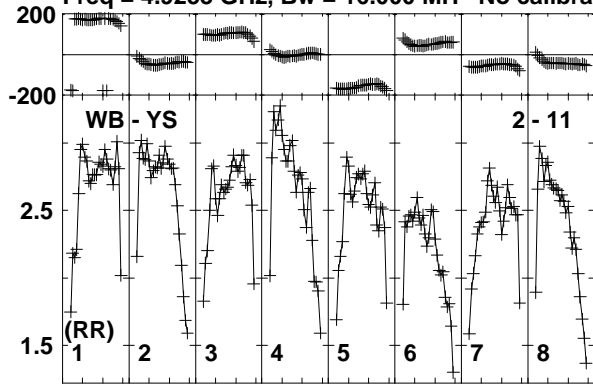

Lower frame: Milli Ampl Jy Top frame: Phas deg
 Vector averaged cross-power spectrum Baseline: WB (02) - YS (11)
 Timerange: 00/23:44:53 to 00/23:46:37

Plot file version 319 created 11-APR-2016 17:09:08

J1128+5925 GP053G 3.UVDATA.1

Freq = 4.9253 GHz, Bw = 16.000 MH No calibration applied and no bandpass applied

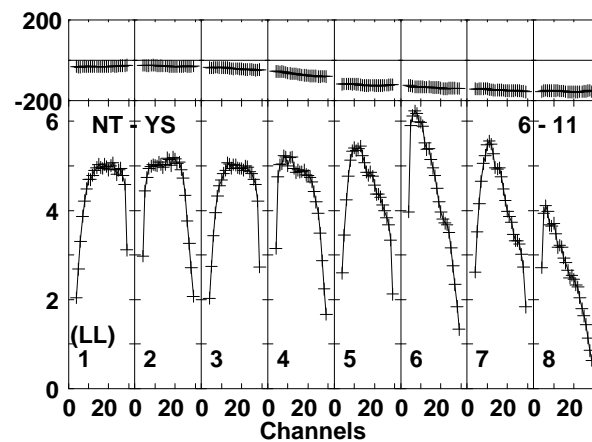
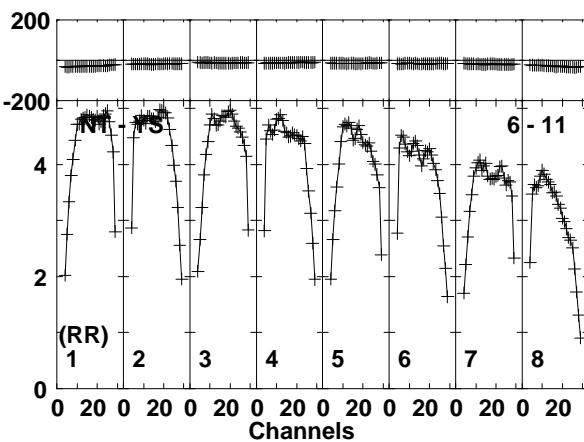
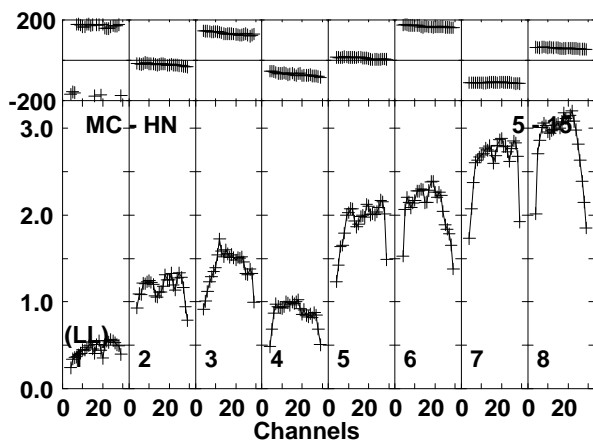
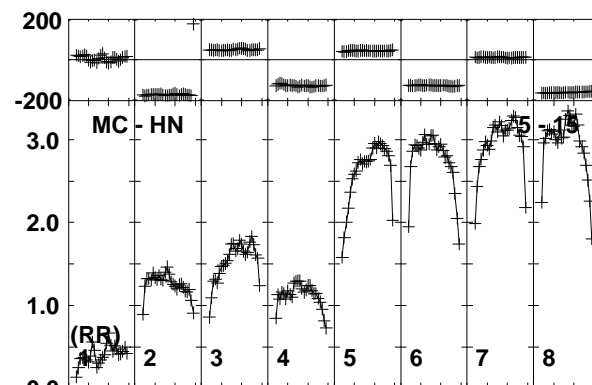
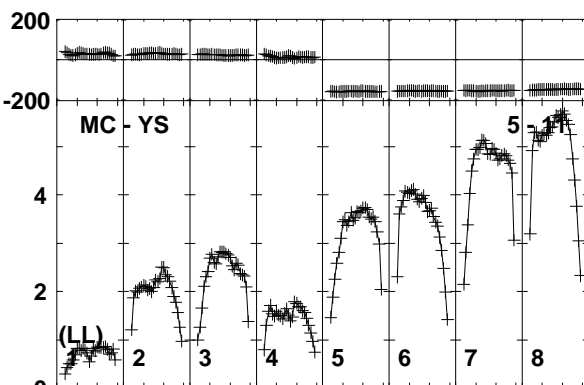
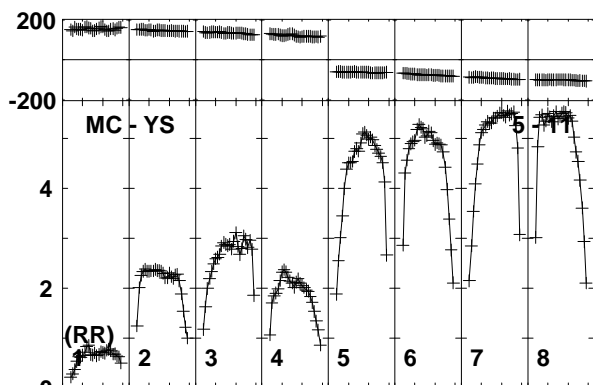
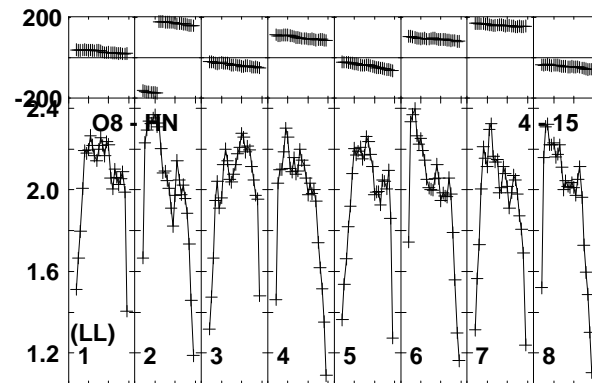
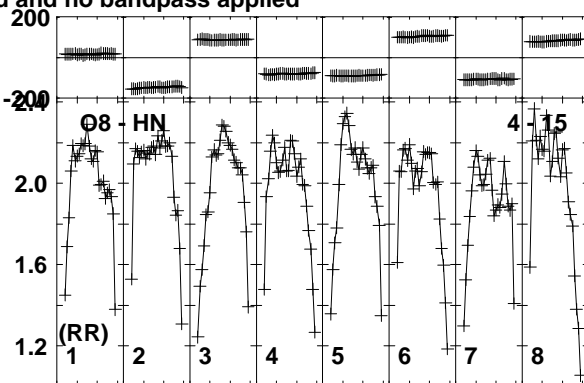
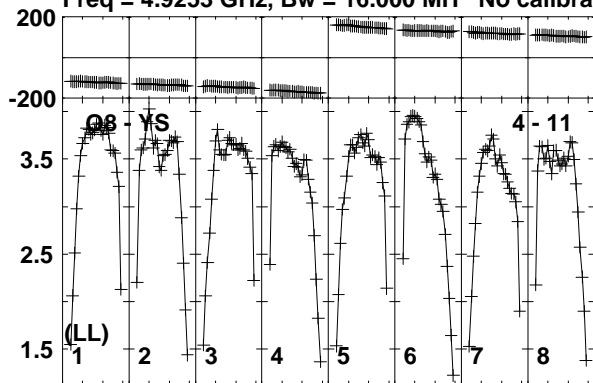

Lower frame: Milli Ampl Jy Top frame: Phas deg
Vector averaged cross-power spectrum Baseline: O8 (04) - YS (11)
Timerange: 00/23:44:53 to 00/23:46:37

Plot file version 320 created 11-APR-2016 17:09:08

J1128+5925 GP053G 3.UVDATA.1

Freq = 4.9253 GHz, Bw = 16.000 MH No calibration applied and no bandpass applied

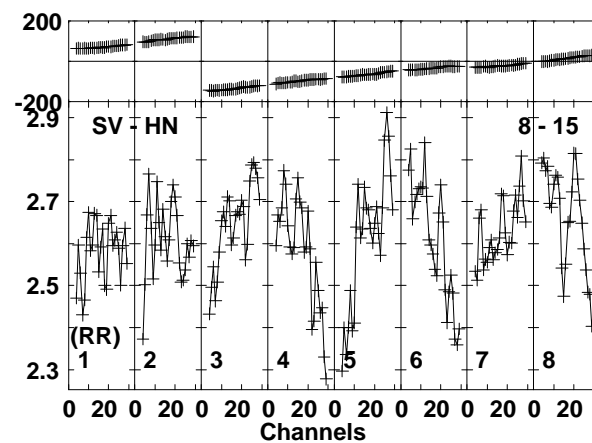
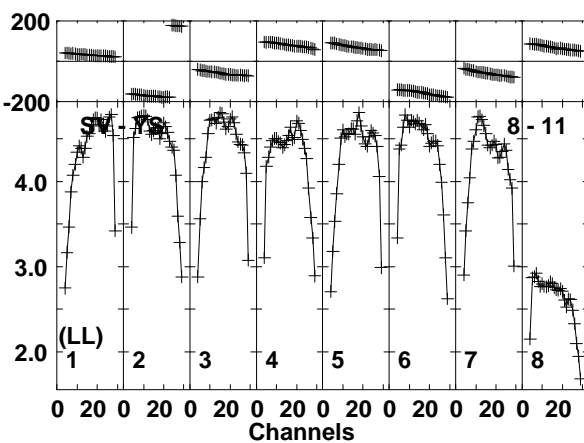
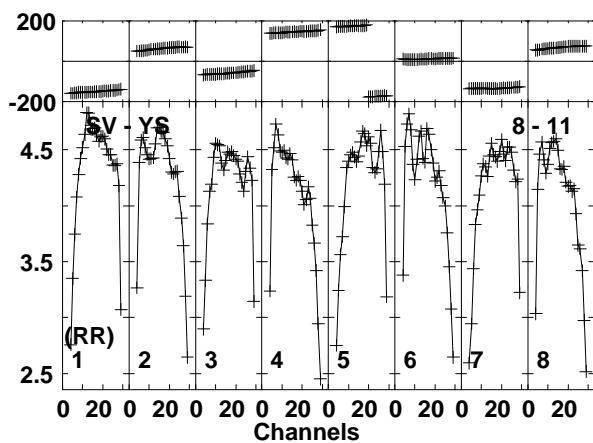
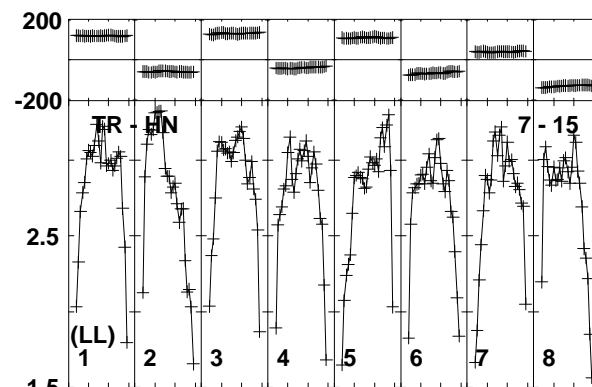
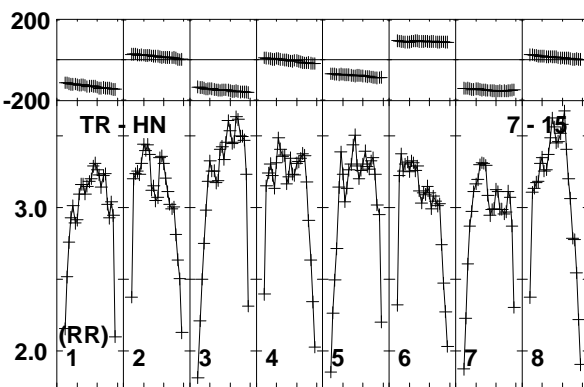
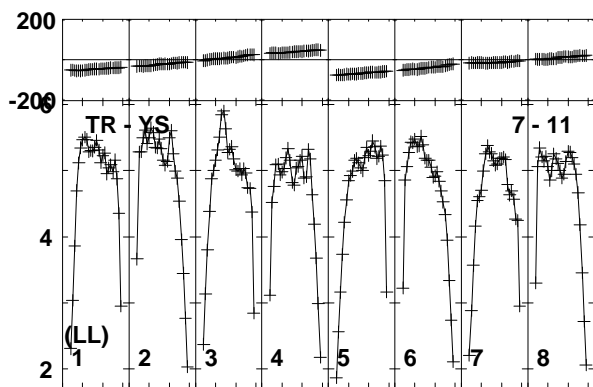
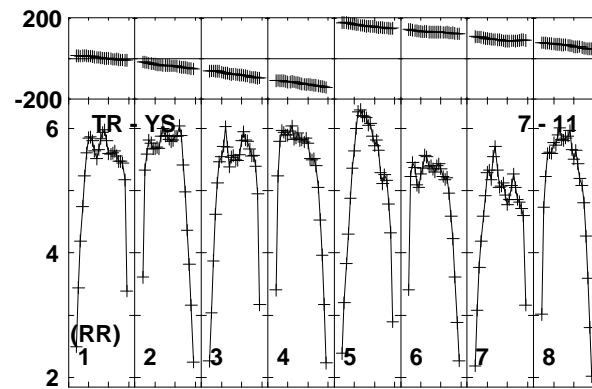
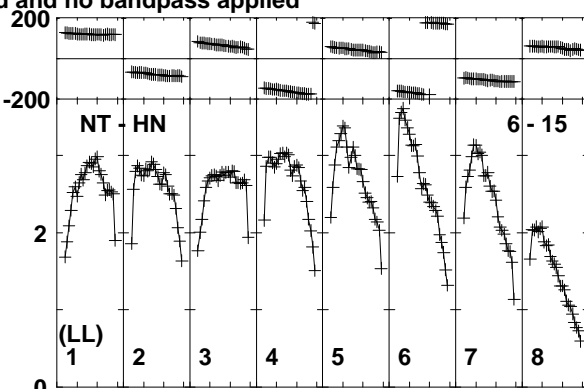
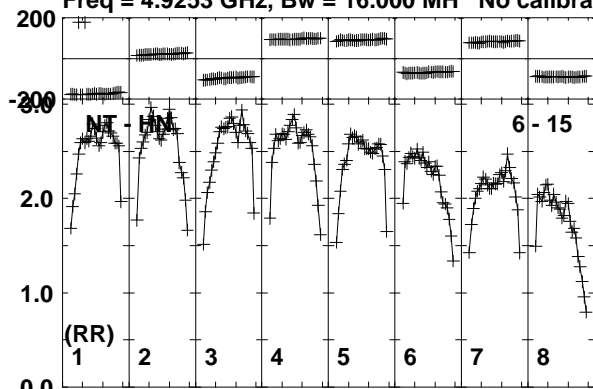

Lower frame: Milli Ampl Jy Top frame: Phas deg
Vector averaged cross-power spectrum Baseline: NT (06) - HN (15)
Timerange: 00/23:44:53 to 00/23:46:37

Plot file version 321 created 11-APR-2016 17:09:08

J1128+5925 GP053G 3.UVDATA.1

Freq = 4.9253 GHz, Bw = 16.000 MH No calibration applied and no bandpass applied

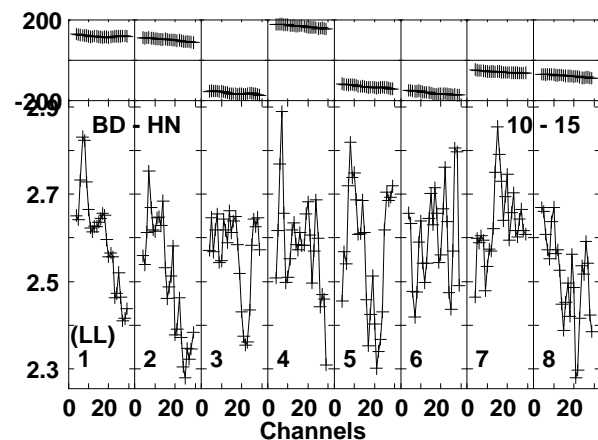
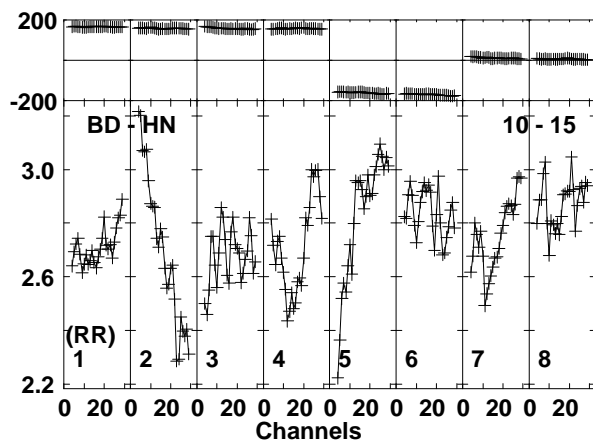
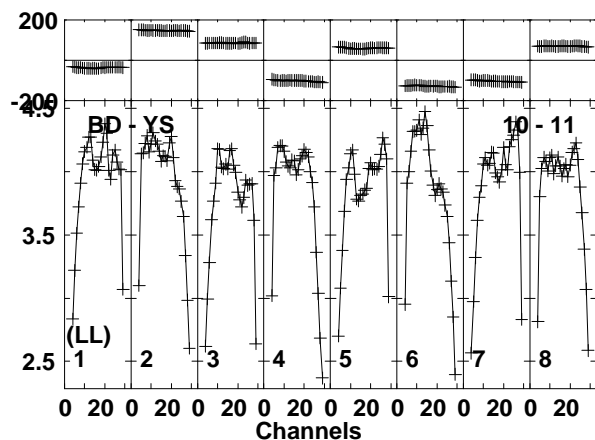
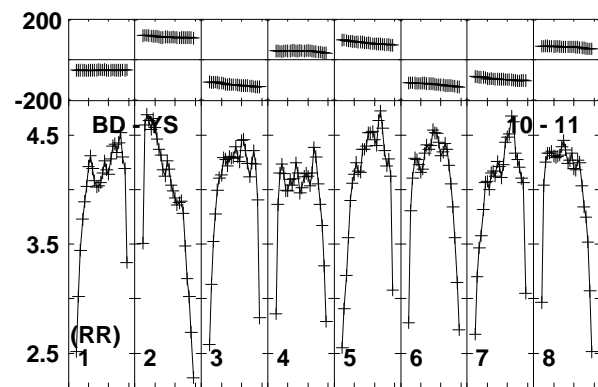
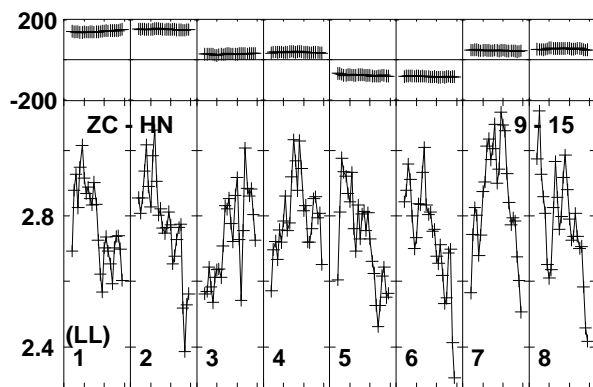
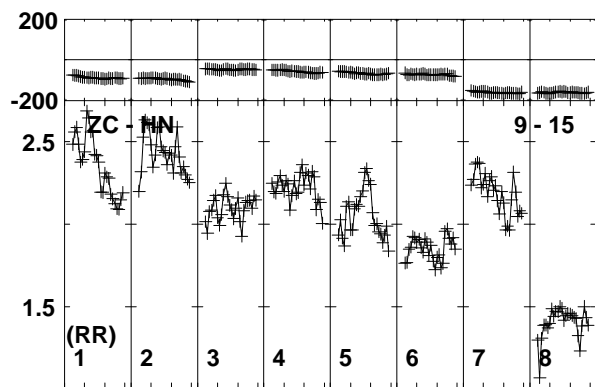
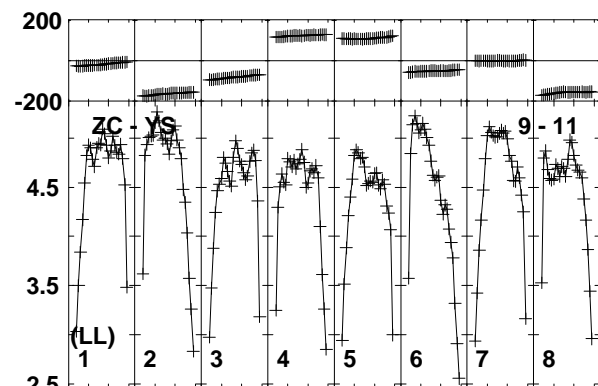
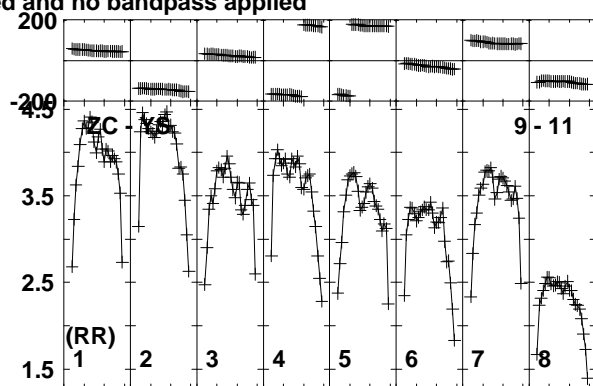
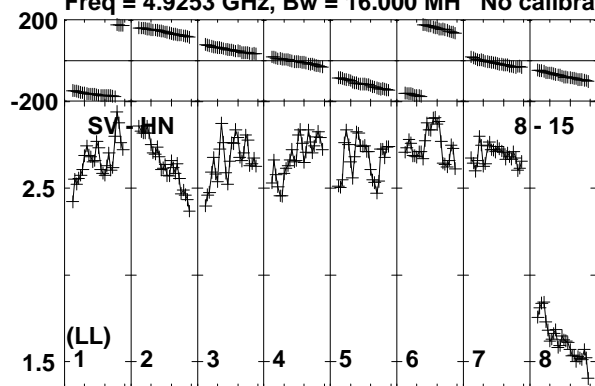

Lower frame: Milli Ampl Jy Top frame: Phas deg
Vector averaged cross-power spectrum Baseline: SV (08) - HN (15)
Timerange: 00/23:44:53 to 00/23:46:37

Plot file version 322 created 11-APR-2016 17:09:08

J1128+5925 GP053G 3.UVDATA.1

Freq = 4.9253 GHz, Bw = 16.000 MH No calibration applied and no bandpass applied

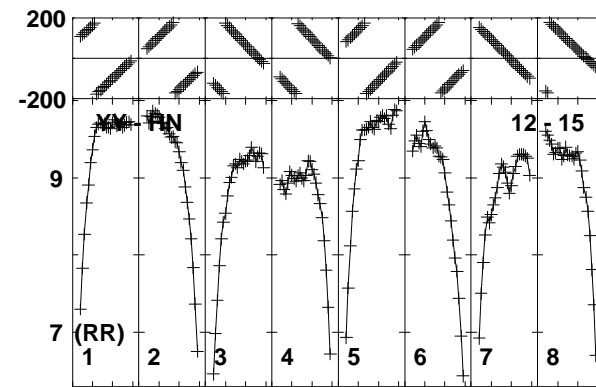
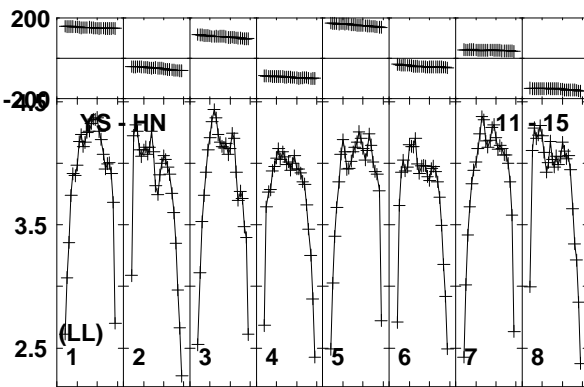
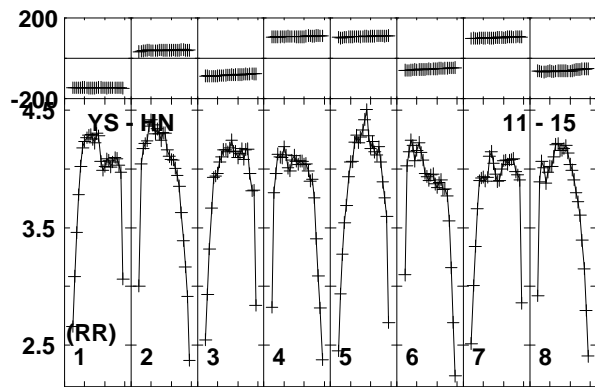
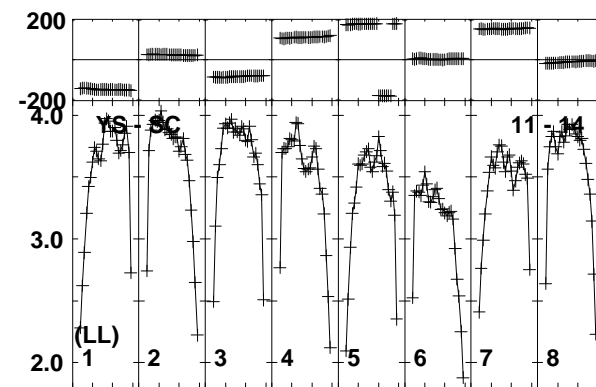
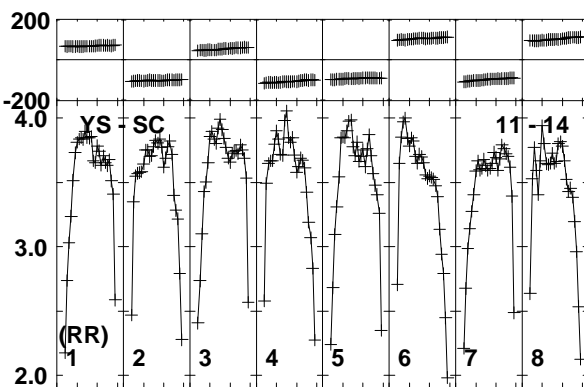
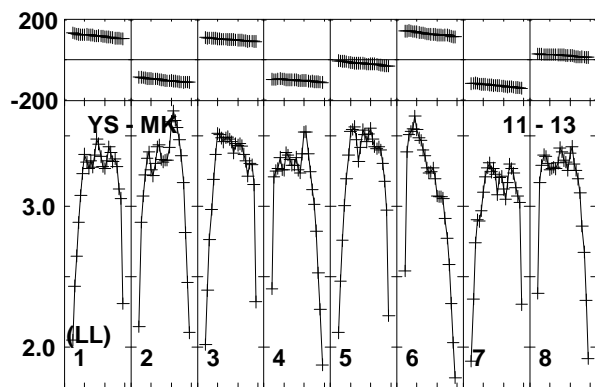
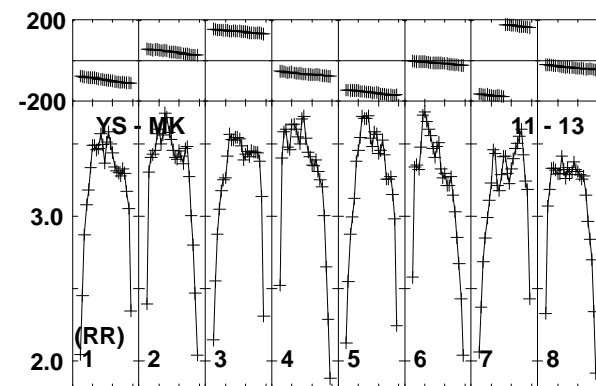
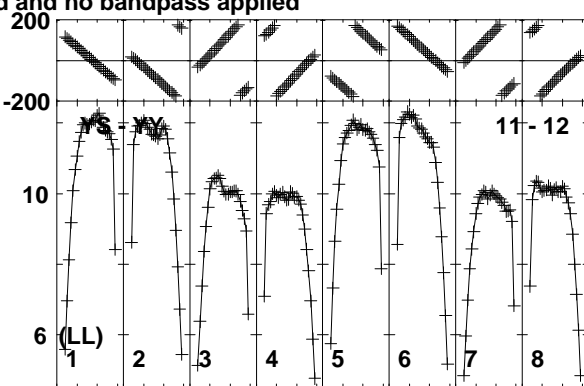
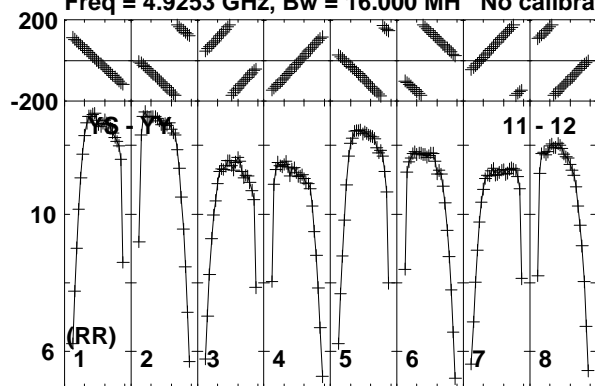

Lower frame: Milli Ampl Jy Top frame: Phas deg
Vector averaged cross-power spectrum Baseline: YS (11) - YY (12)
Timerange: 00/23:44:53 to 00/23:46:37

Plot file version 323 created 11-APR-2016 17:09:09

J1128+5925 GP053G 3.UVDATA.1

Freq = 4.9253 GHz, Bw = 16.000 MH No calibration applied and no bandpass applied

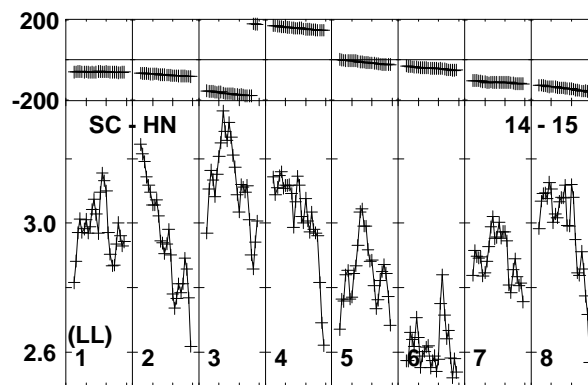
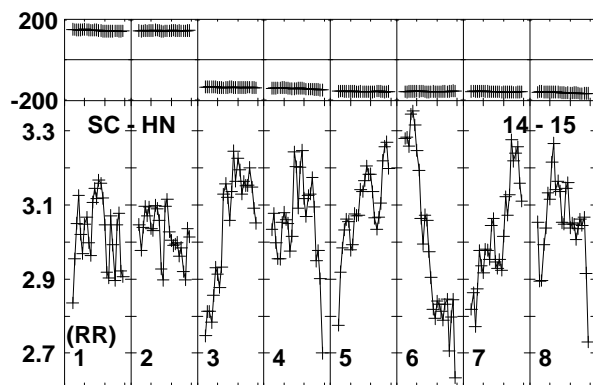
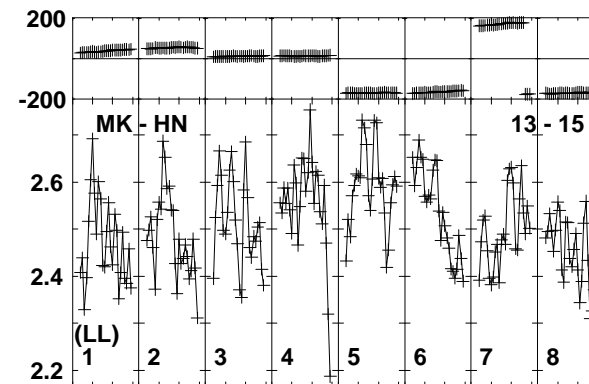
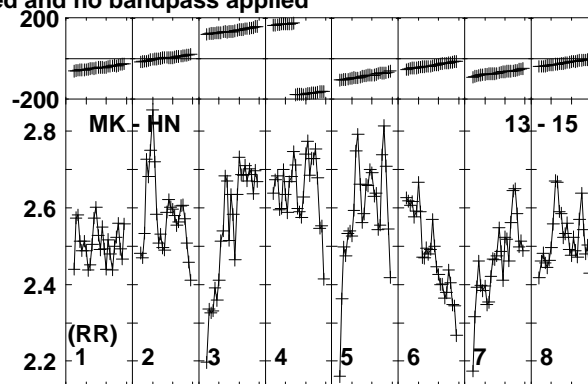
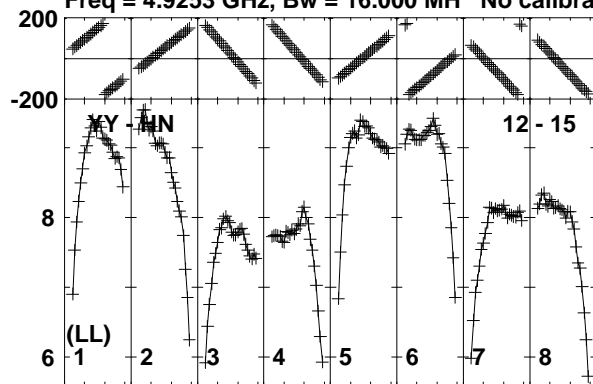

Lower frame: Milli Ampl Jy Top frame: Phas deg
Vector averaged cross-power spectrum Baseline: YY (12) - HN (15)
Timerange: 00/23:44:53 to 00/23:46:37

Plot file version 324 created 11-APR-2016 17:09:09

ARP299C GP053G 3.UVDATA.1

Freq = 4.9253 GHz, Bw = 16.000 MH No calibration applied and no bandpass applied

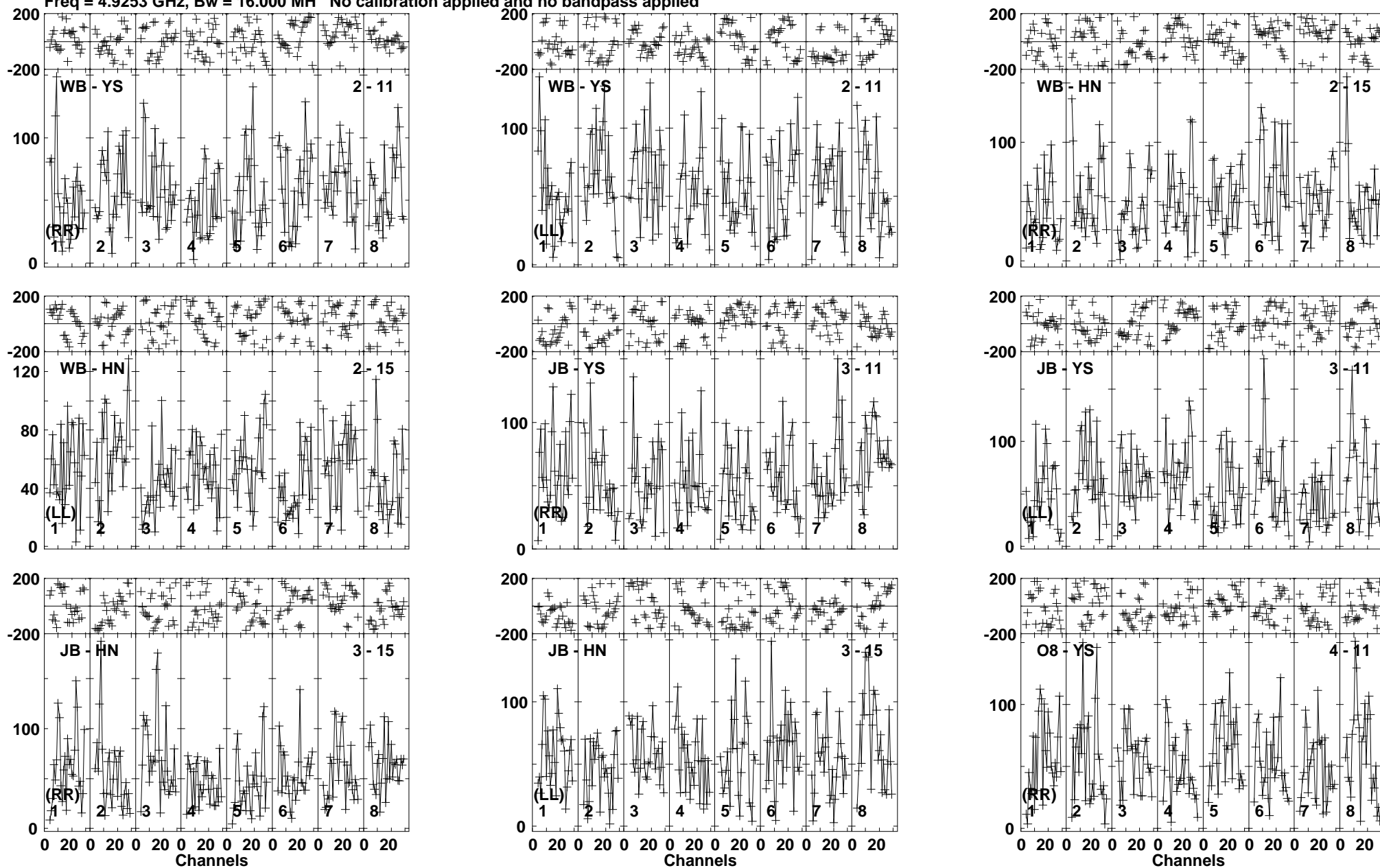

Lower frame: Micro Ampl Jy Top frame: Phas deg
Vector averaged cross-power spectrum Baseline: WB (02) - YS (11)
Timerange: 00/23:46:43 to 00/23:51:55

Plot file version 325 created 11-APR-2016 17:09:09

ARP299C GP053G 3.UVDATA.1

Freq = 4.9253 GHz, Bw = 16.000 MH No calibration applied and no bandpass applied

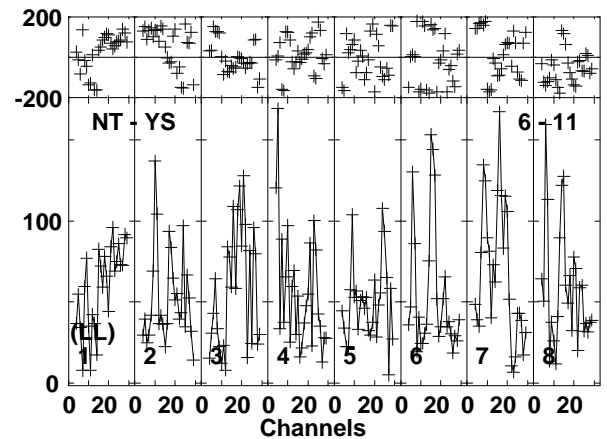
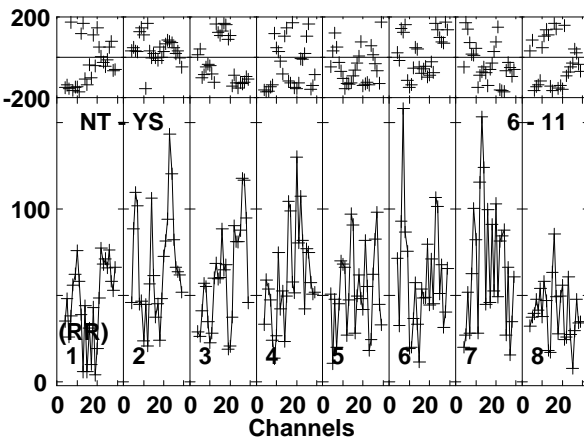
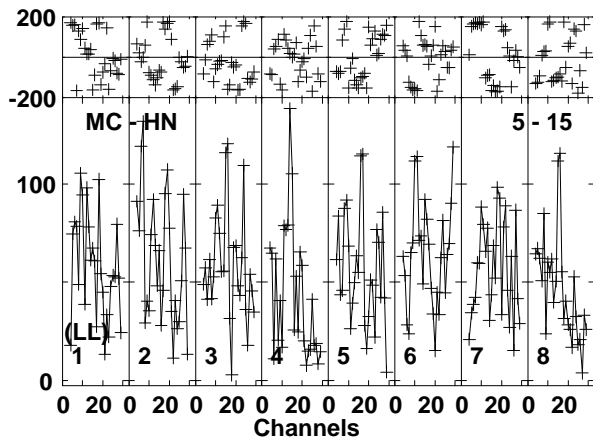
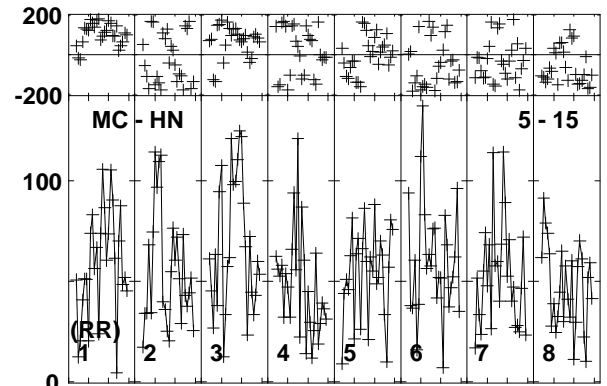
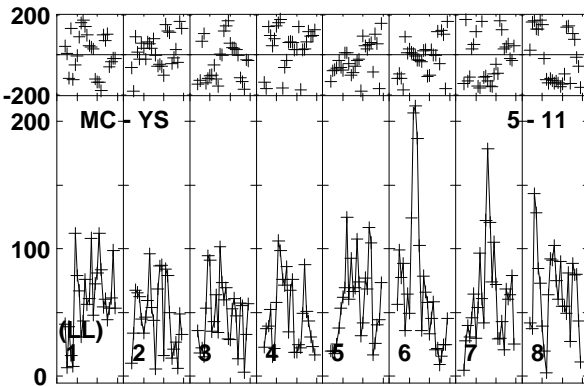
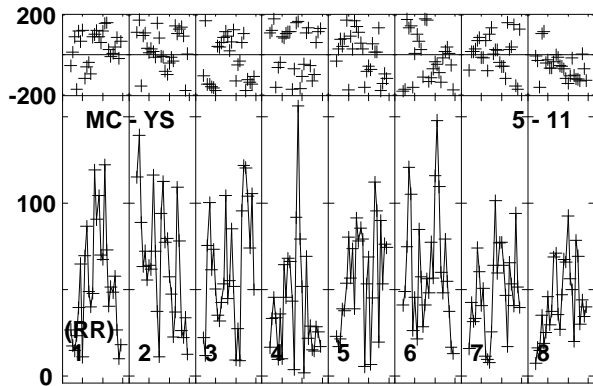
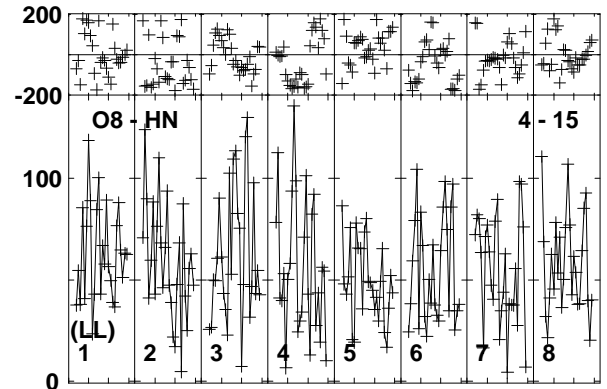
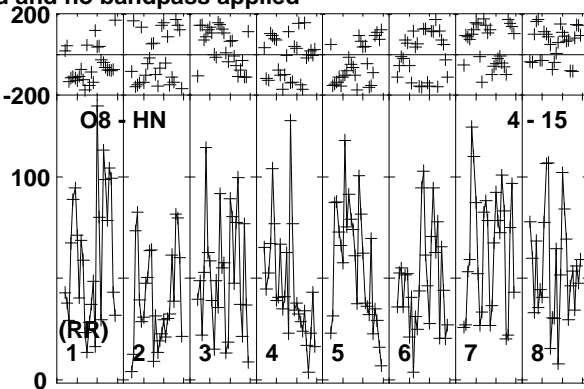
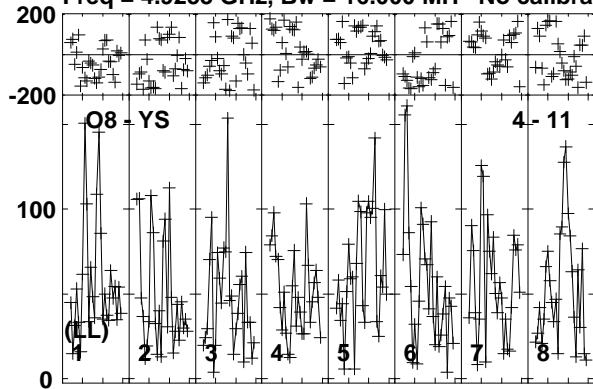

Lower frame: Micro Ampl Jy Top frame: Phas deg
Vector averaged cross-power spectrum Baseline: O8 (04) - YS (11)
Timerange: 00/23:46:43 to 00/23:51:55

Plot file version 326 created 11-APR-2016 17:09:09

ARP299C GP053G 3.UVDATA.1

Freq = 4.9253 GHz, Bw = 16.000 MH No calibration applied and no bandpass applied

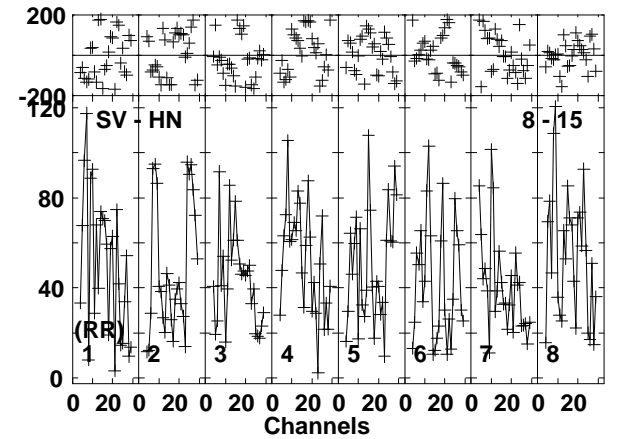
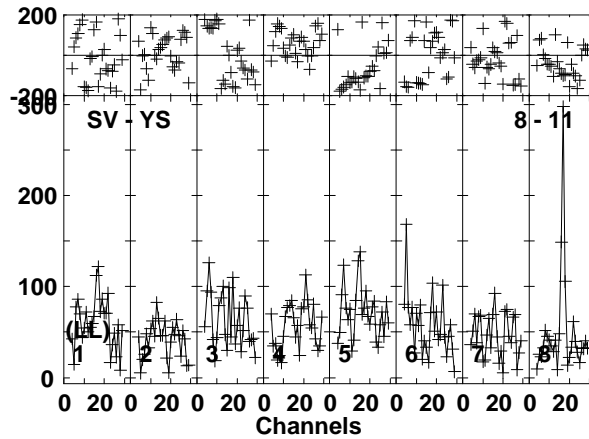
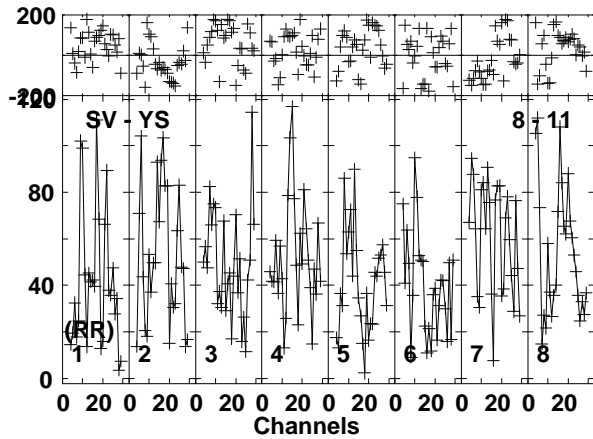
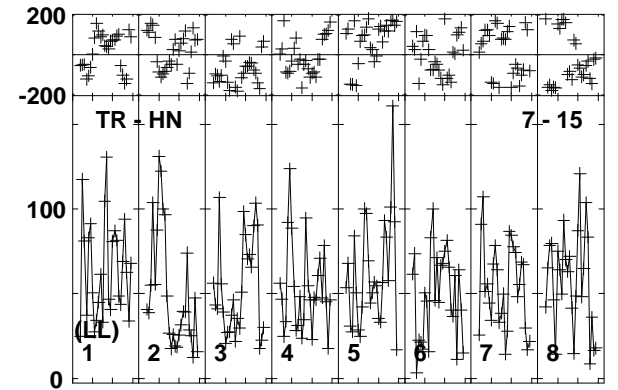
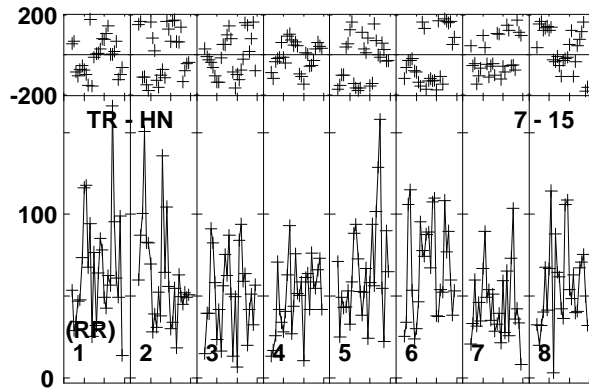
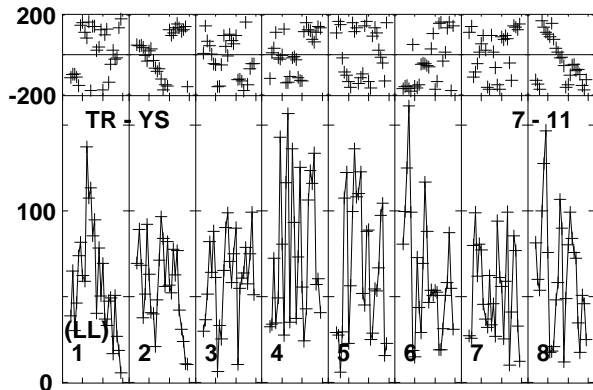
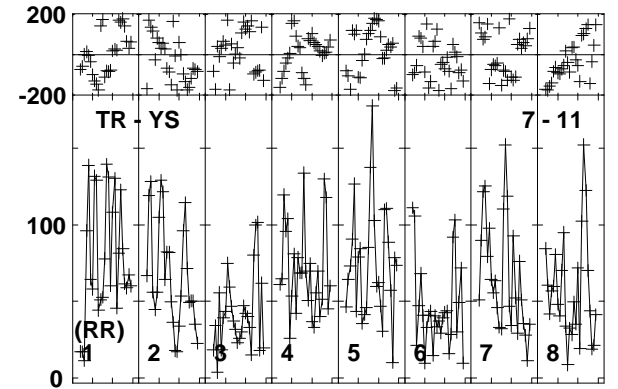
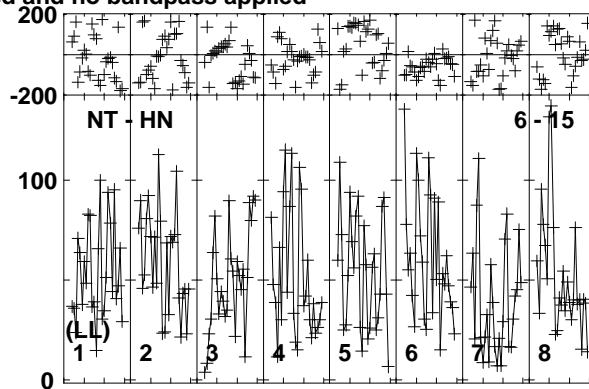
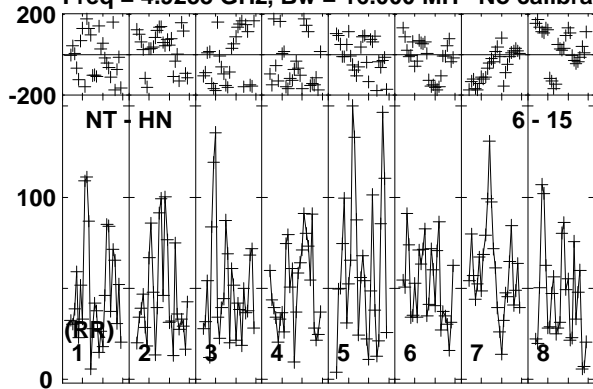

Lower frame: Micro Ampl Jy Top frame: Phas deg
Vector averaged cross-power spectrum Baseline: NT (06) - HN (15)
Timerange: 00/23:46:43 to 00/23:51:55

Plot file version 327 created 11-APR-2016 17:09:09

ARP299C GP053G 3.UVDATA.1

Freq = 4.9253 GHz, Bw = 16.000 MH No calibration applied and no bandpass applied

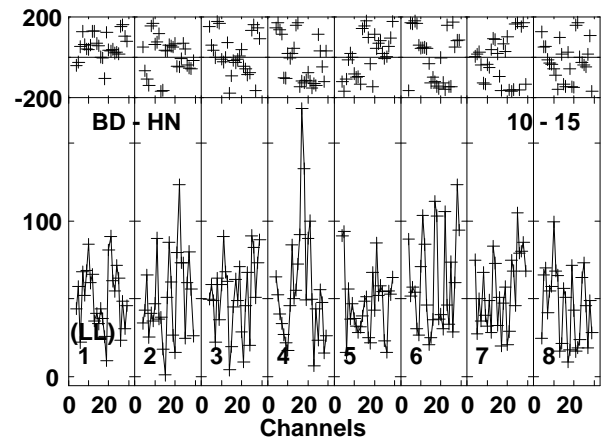
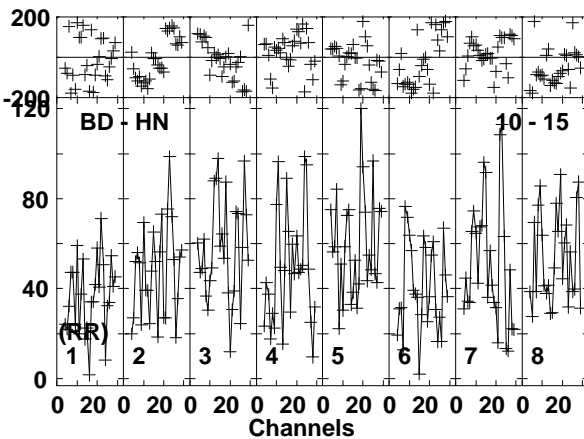
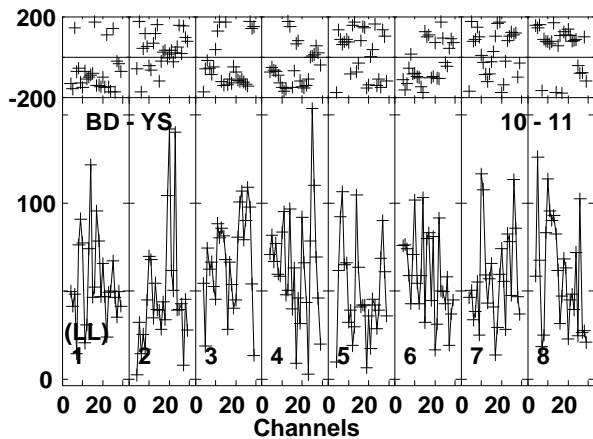
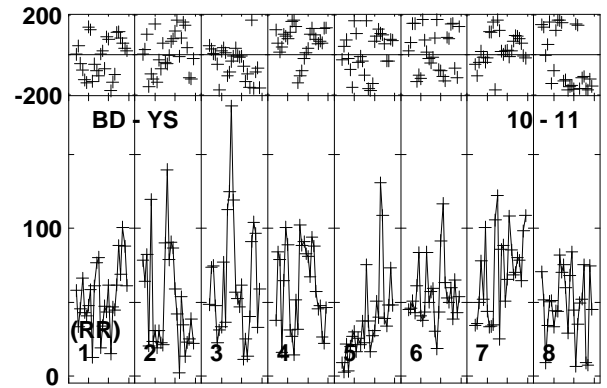
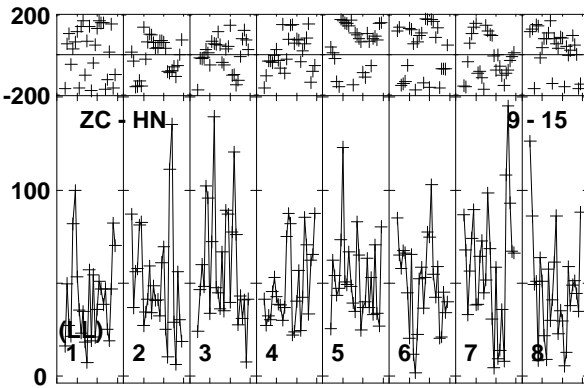
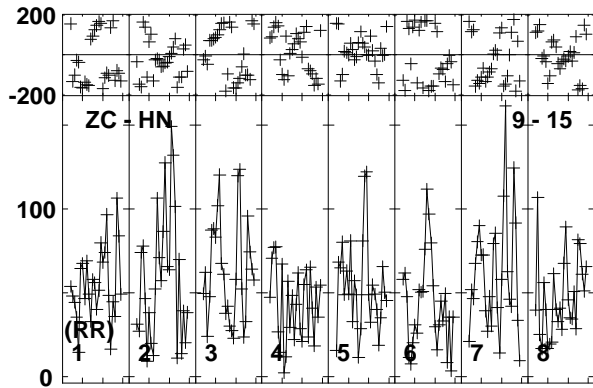
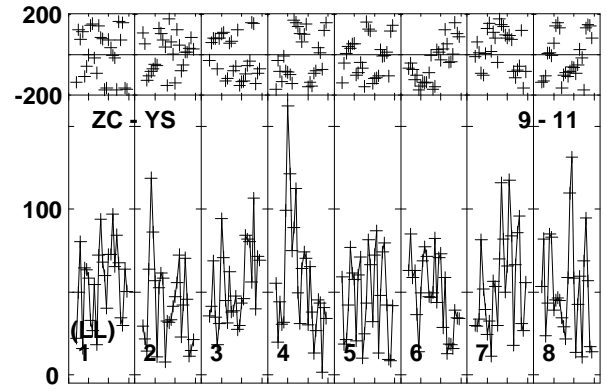
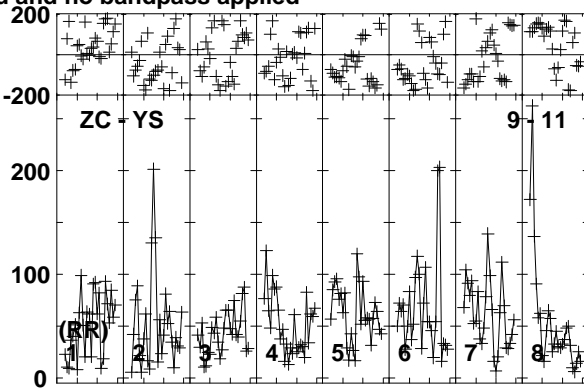
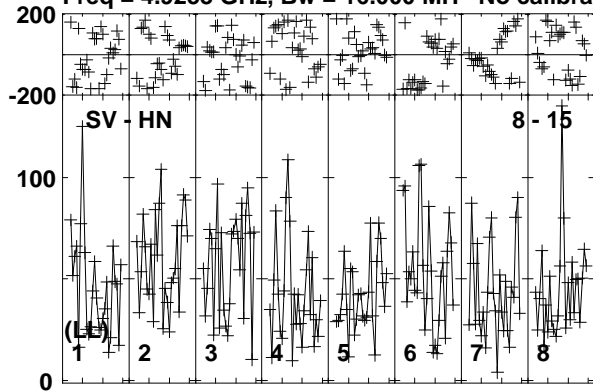

Lower frame: Micro Ampl Jy Top frame: Phas deg
Vector averaged cross-power spectrum Baseline: SV (08) - HN (15)
Timerange: 00/23:46:43 to 00/23:51:55

Plot file version 328 created 11-APR-2016 17:09:10

ARP299C GP053G 3.UVDATA.1

Freq = 4.9253 GHz, Bw = 16.000 MH No calibration applied and no bandpass applied

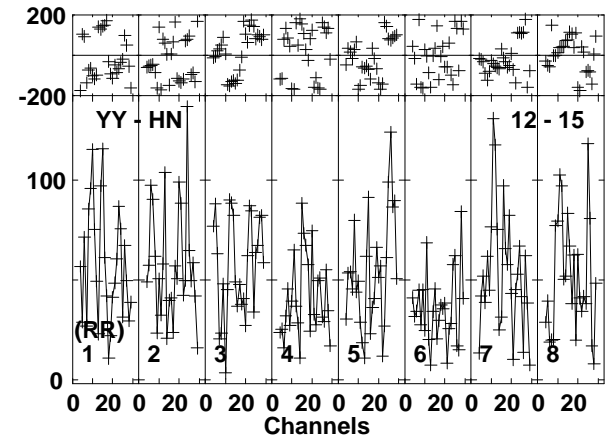
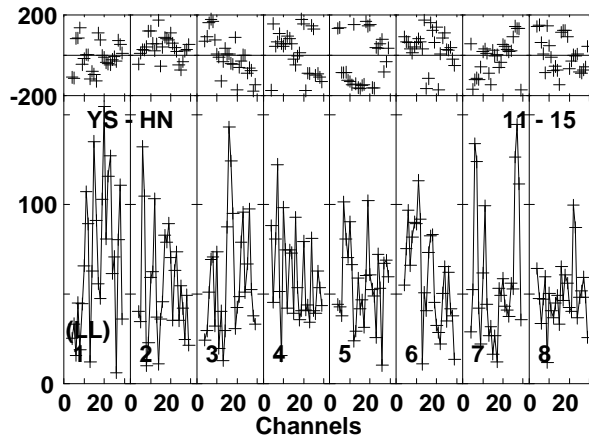
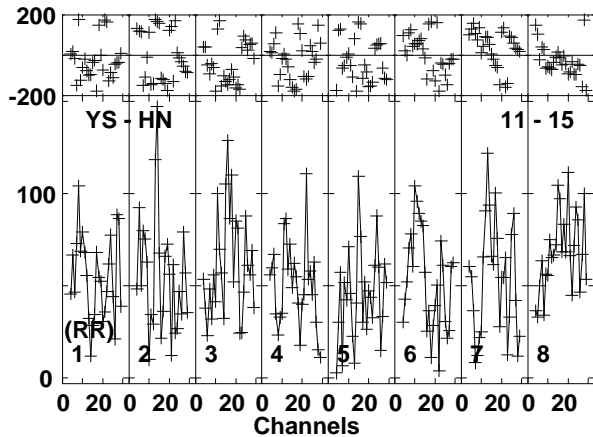
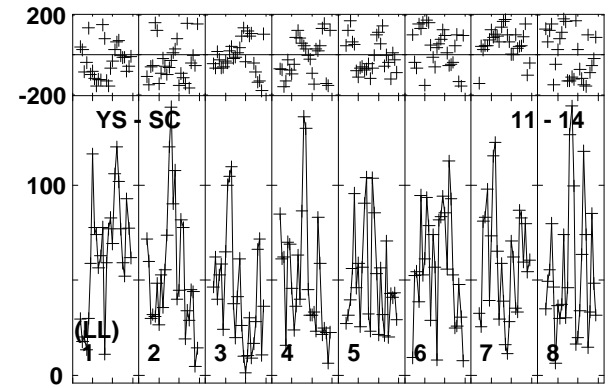
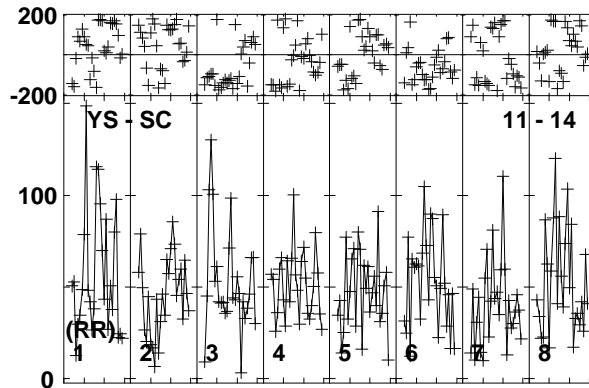
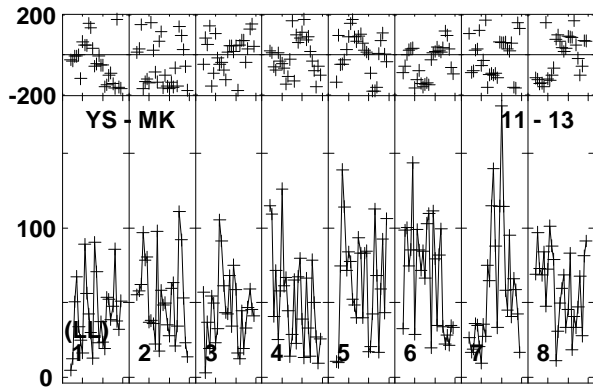
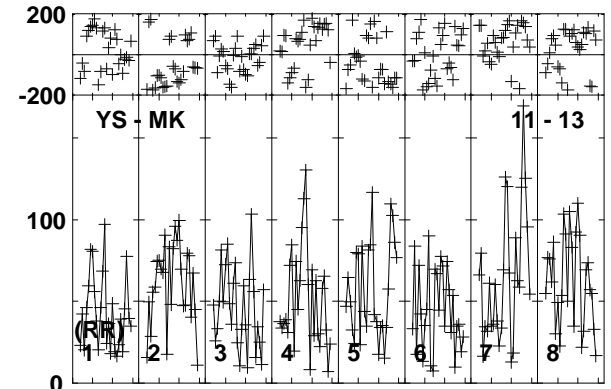
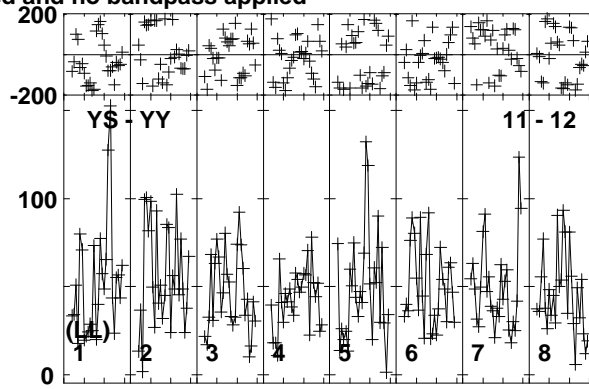
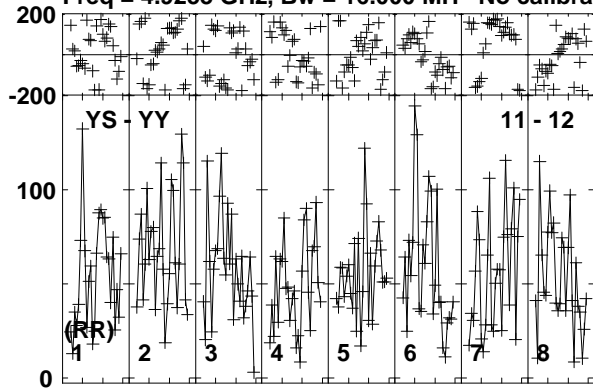

Lower frame: Micro Ampl Jy Top frame: Phas deg
Vector averaged cross-power spectrum Baseline: YS (11) - YY (12)
Timerange: 00/23:46:43 to 00/23:51:55

Plot file version 329 created 11-APR-2016 17:09:10

ARP299C GP053G 3.UVDATA.1

Freq = 4.9253 GHz, Bw = 16.000 MH No calibration applied and no bandpass applied

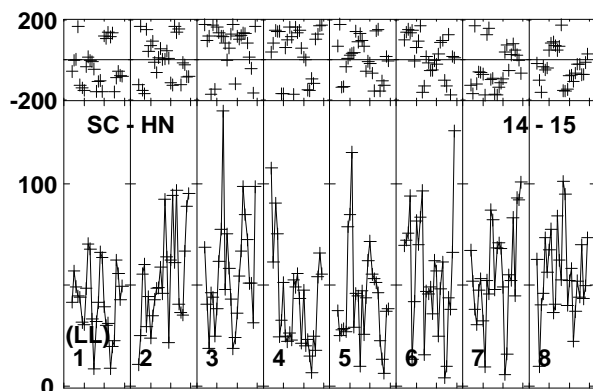
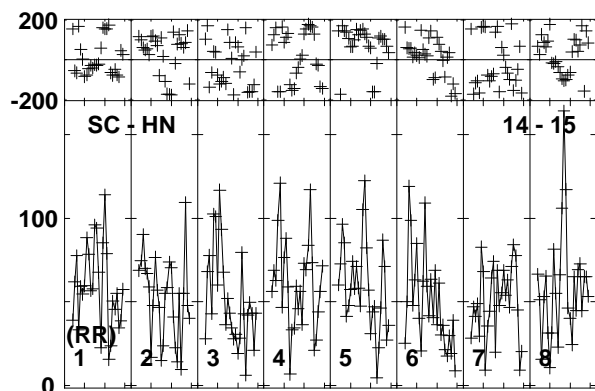
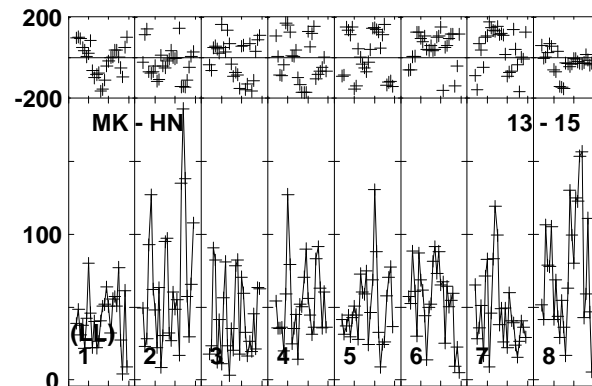
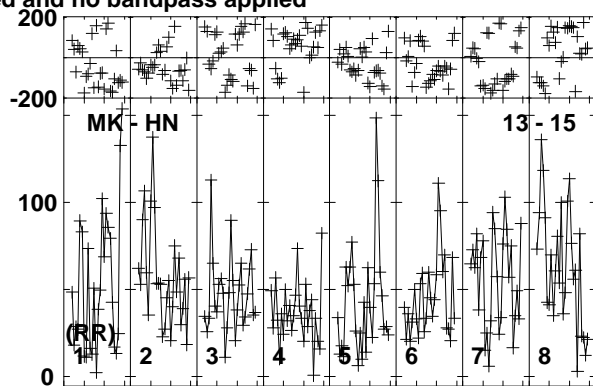
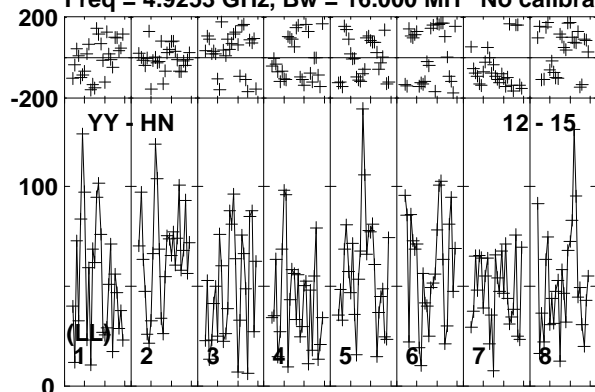

Lower frame: Micro Ampl Jy Top frame: Phas deg
Vector averaged cross-power spectrum Baseline: YY (12) - HN (15)
Timerange: 00/23:46:43 to 00/23:51:55

Plot file version 330 created 11-APR-2016 17:09:10

J1128+5925 GP053G 3.UVDATA.1

Freq = 4.9253 GHz, Bw = 16.000 MH No calibration applied and no bandpass applied

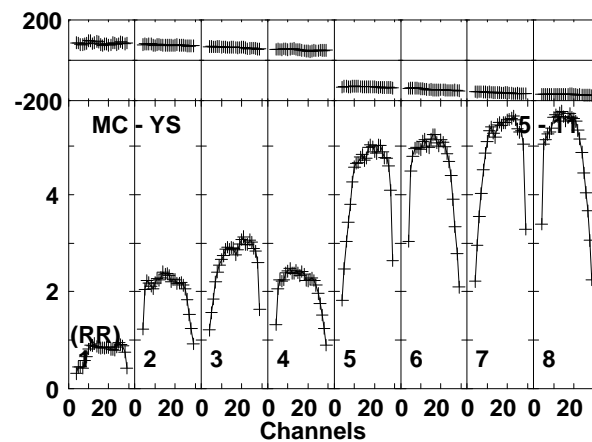
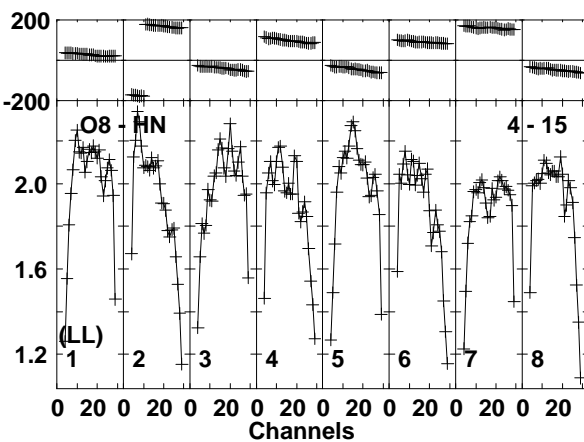
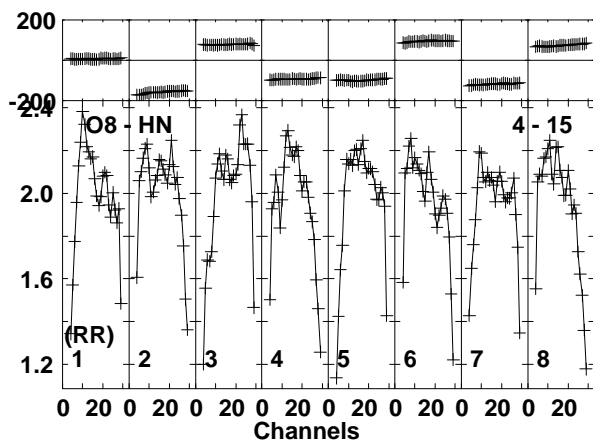
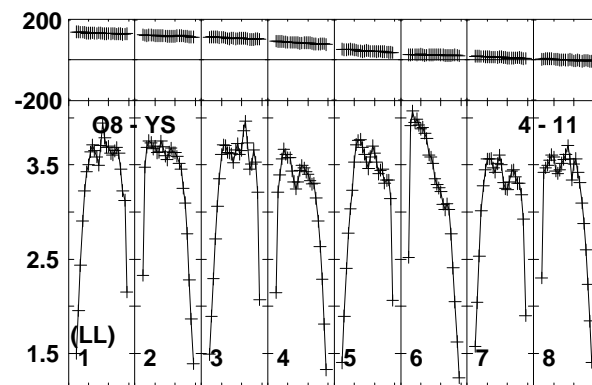
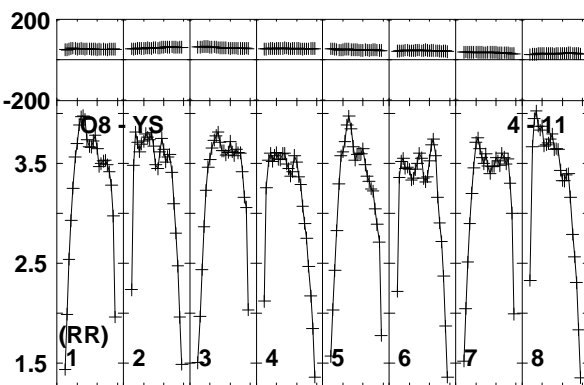
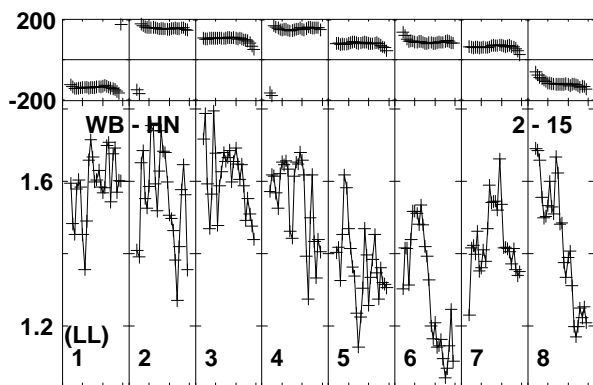
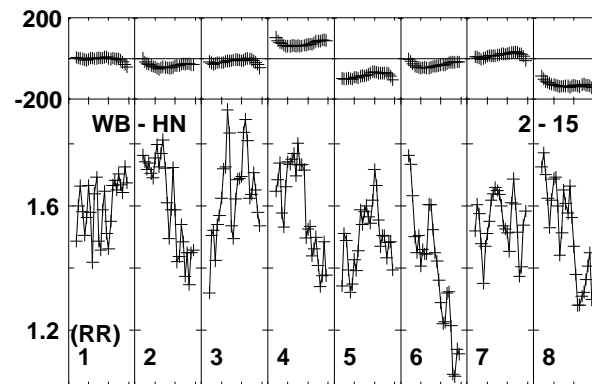
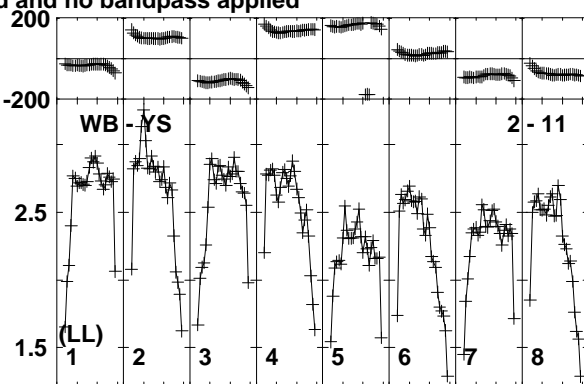
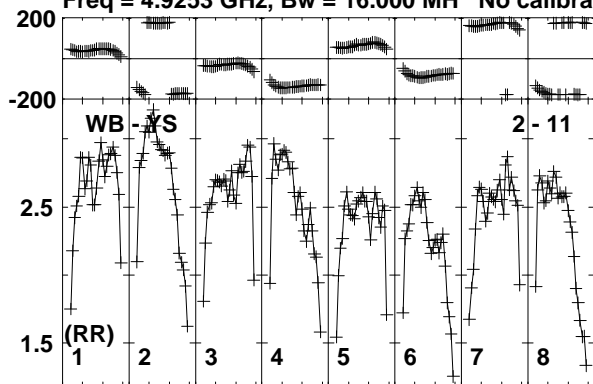

Lower frame: Milli Ampl Jy Top frame: Phas deg
Vector averaged cross-power spectrum Baseline: WB (02) - YS (11)
Timerange: 00/23:52:01 to 00/23:53:53

Plot file version 331 created 11-APR-2016 17:09:10

J1128+5925 GP053G 3.UVDATA.1

Freq = 4.9253 GHz, Bw = 16.000 MH No calibration applied and no bandpass applied

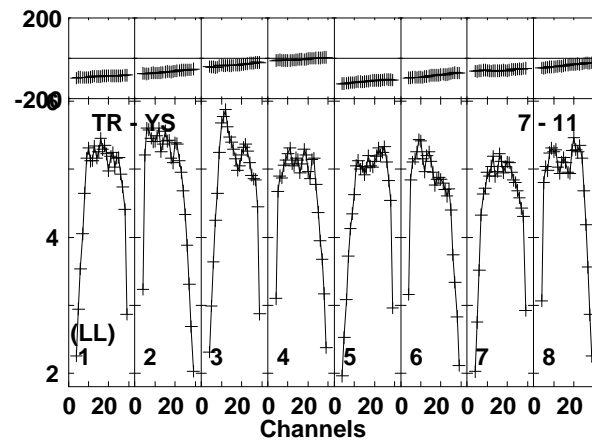
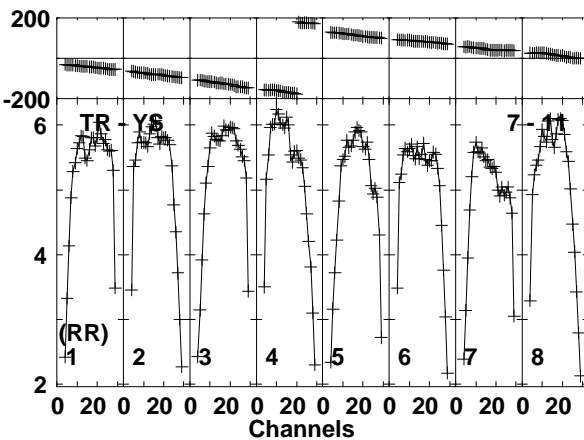
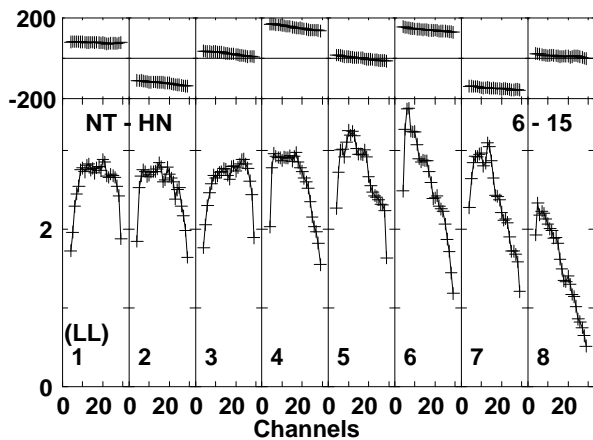
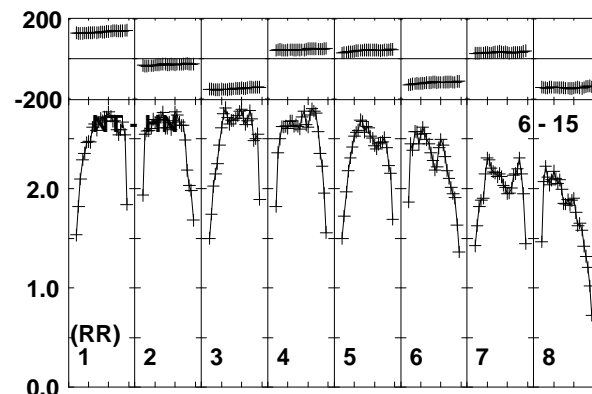
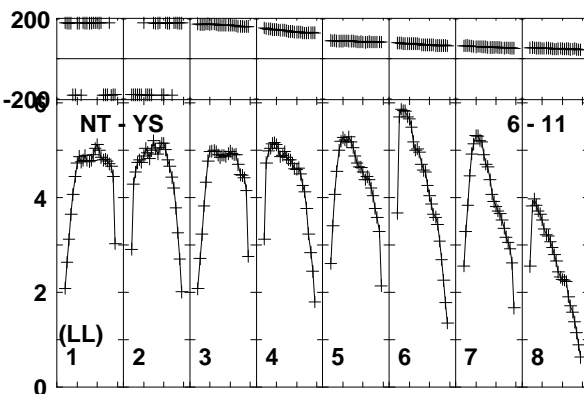
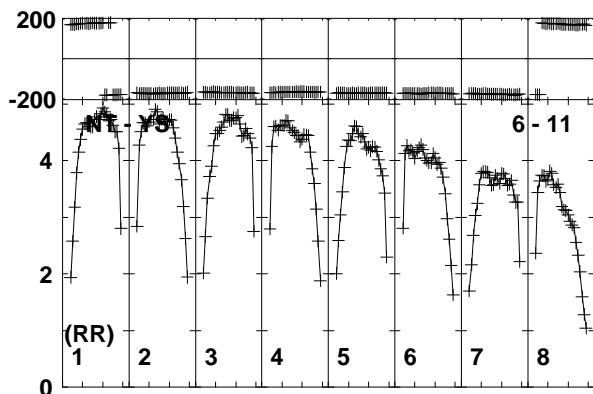
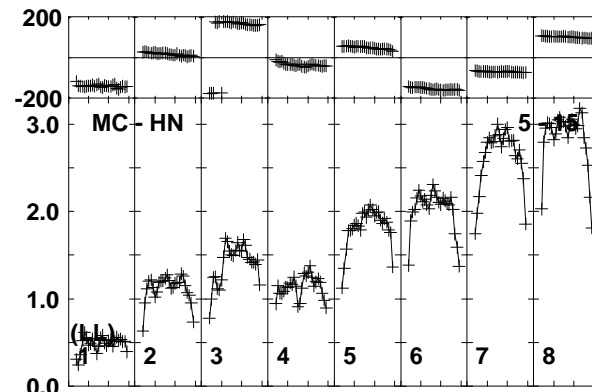
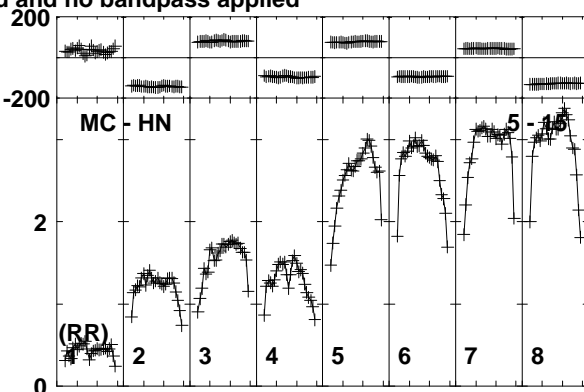
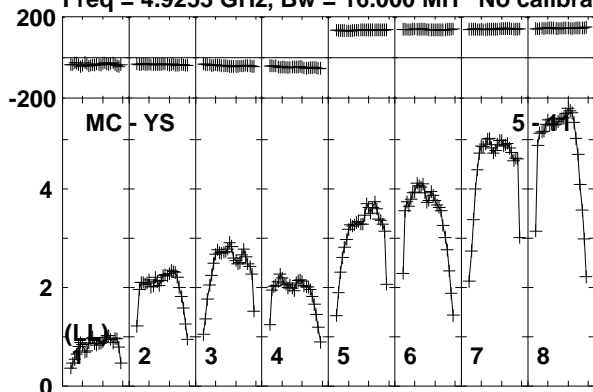

Lower frame: Milli Ampl Jy Top frame: Phas deg
Vector averaged cross-power spectrum Baseline: MC (05) - YS (11)
Timerange: 00/23:52:01 to 00/23:53:53

Plot file version 332 created 11-APR-2016 17:09:10

J1128+5925 GP053G 3.UVDATA.1

Freq = 4.9253 GHz, Bw = 16.000 MH No calibration applied and no bandpass applied

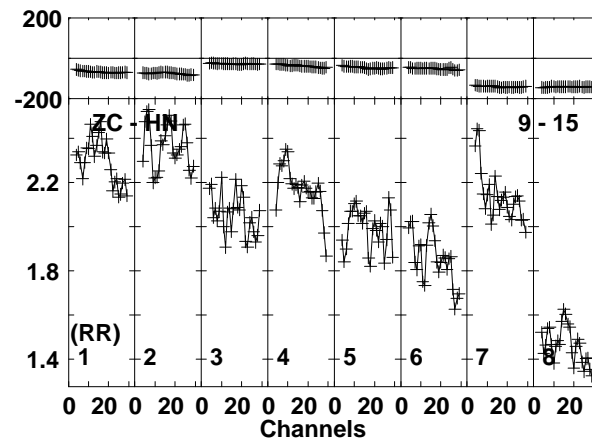
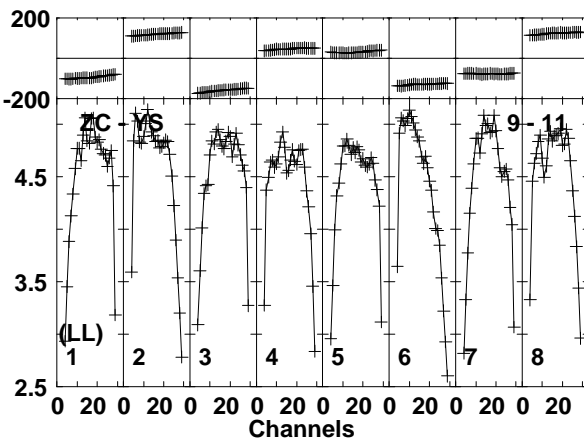
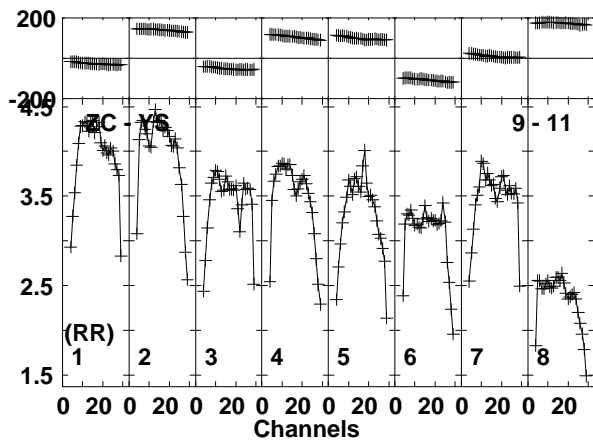
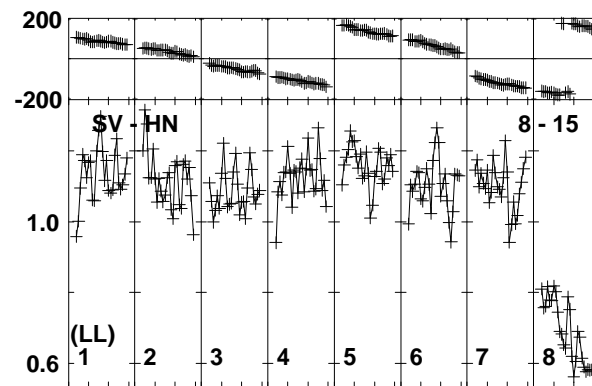
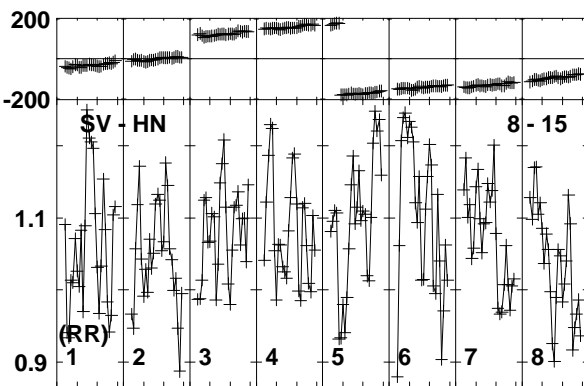
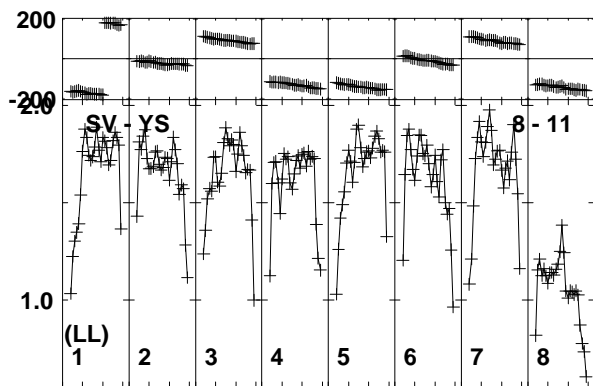
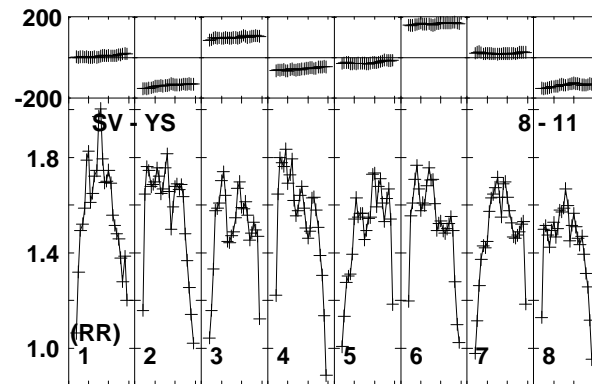
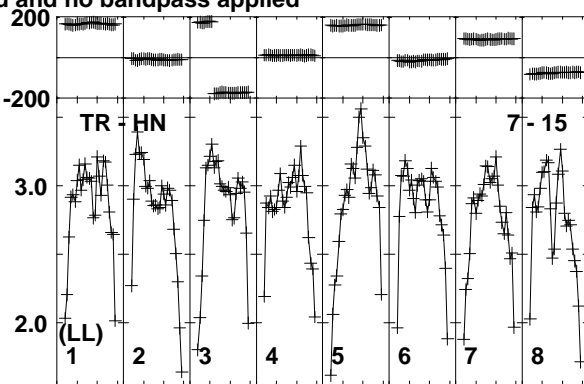
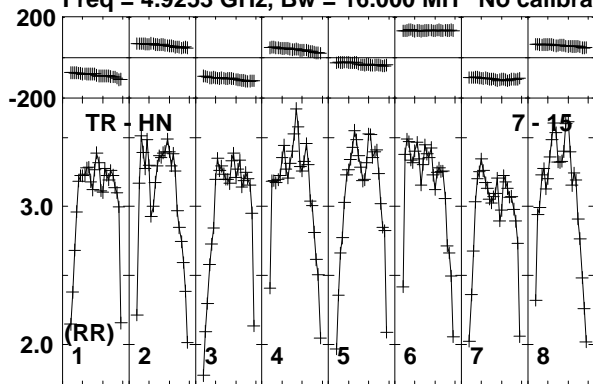

Lower frame: Milli Ampl Jy Top frame: Phas deg
Vector averaged cross-power spectrum Baseline: TR (07) - HN (15)
Timerange: 00/23:52:01 to 00/23:53:53

Plot file version 333 created 11-APR-2016 17:09:10

J1128+5925 GP053G 3.UVDATA.1

Freq = 4.9253 GHz, Bw = 16.000 MH No calibration applied and no bandpass applied

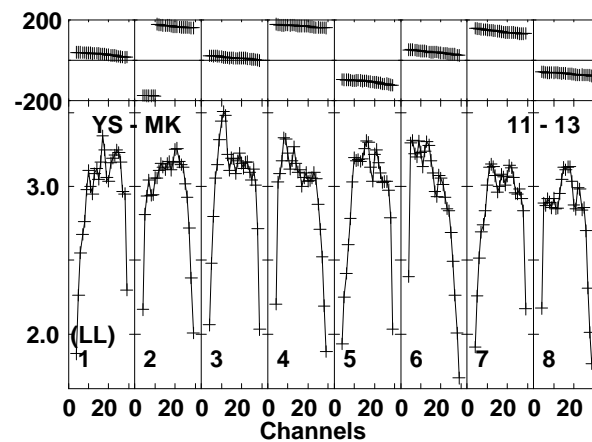
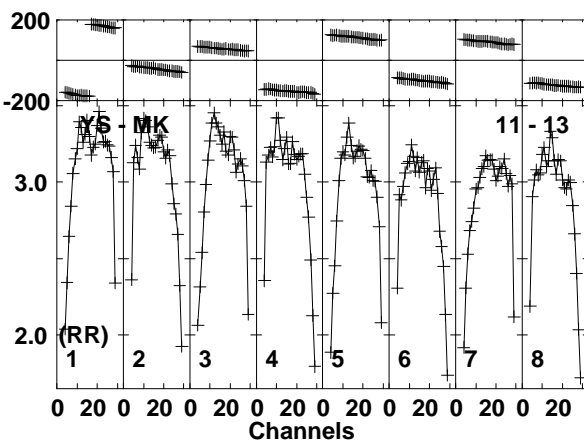
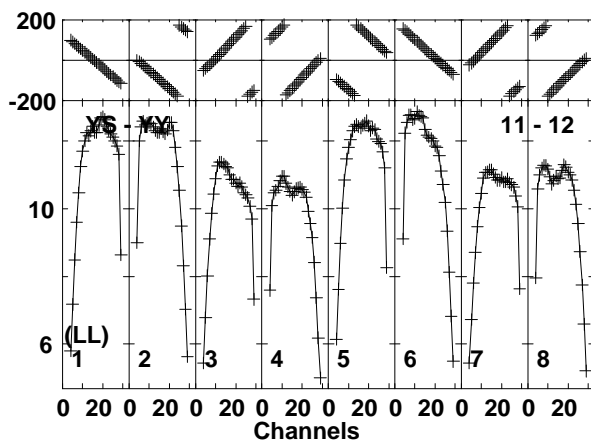
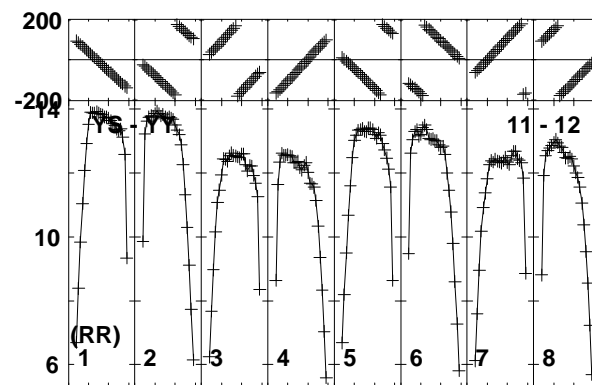
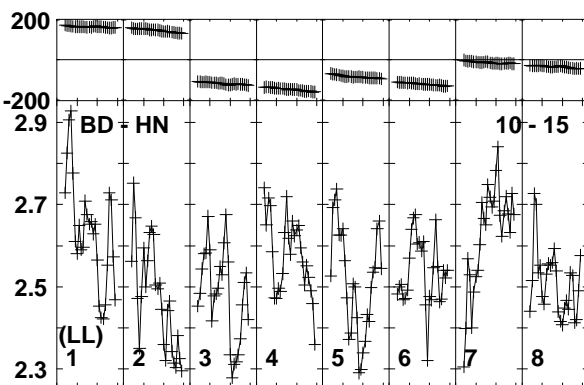
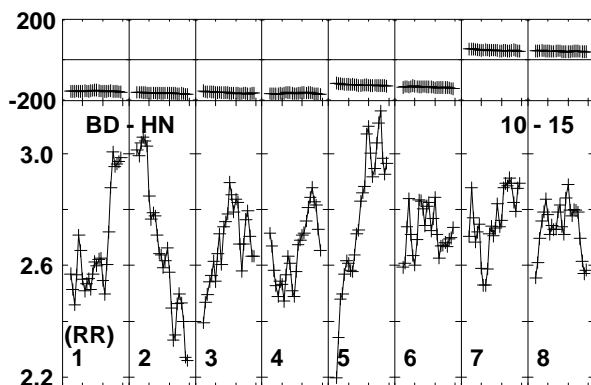
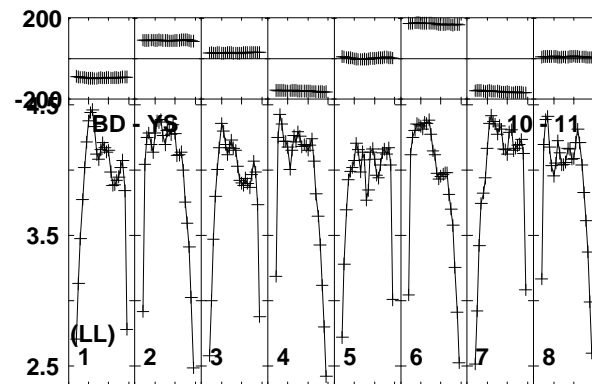
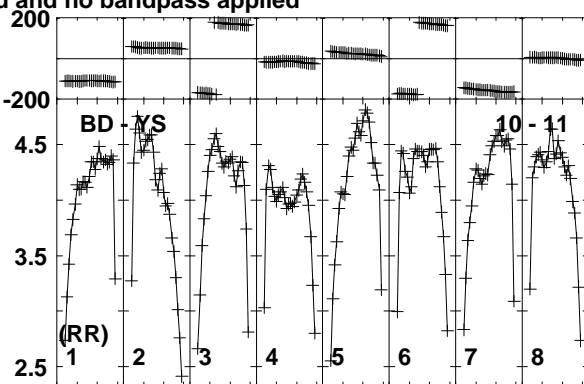
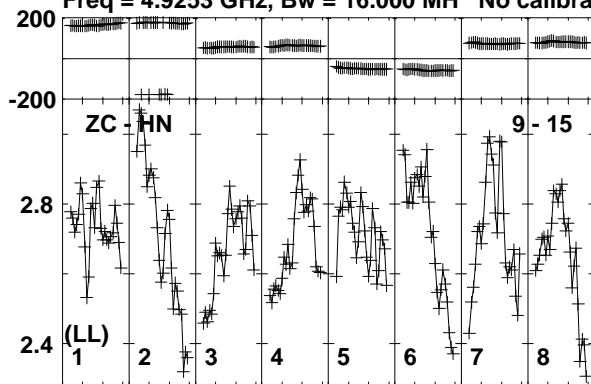

Lower frame: Milli Ampl Jy Top frame: Phas deg
Vector averaged cross-power spectrum Baseline: ZC (09) - HN (15)
Timerange: 00/23:52:01 to 00/23:53:53

Plot file version 334 created 11-APR-2016 17:09:11

J1128+5925 GP053G 3.UVDATA.1

Freq = 4.9253 GHz, Bw = 16.000 MH No calibration applied and no bandpass applied

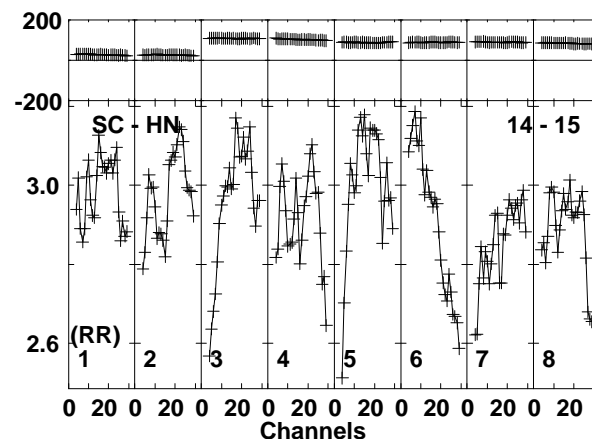
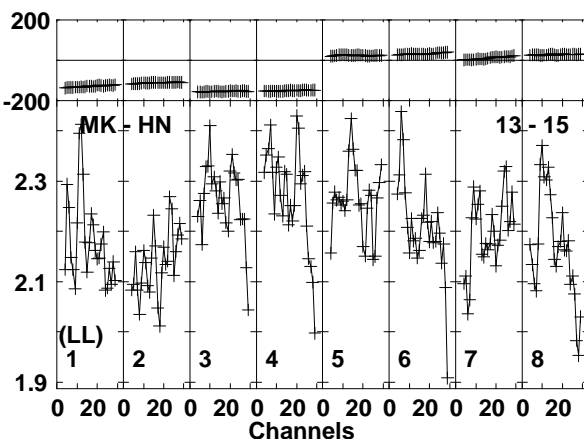
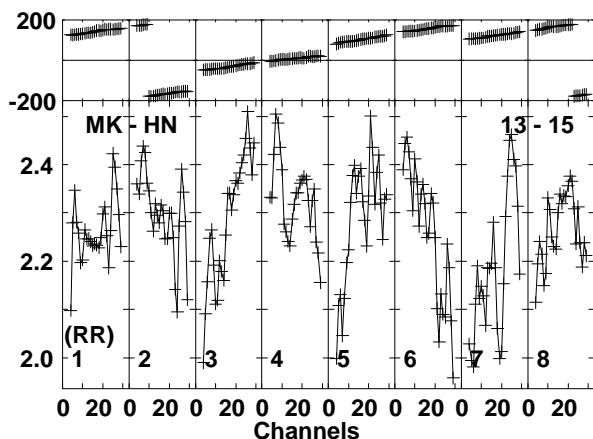
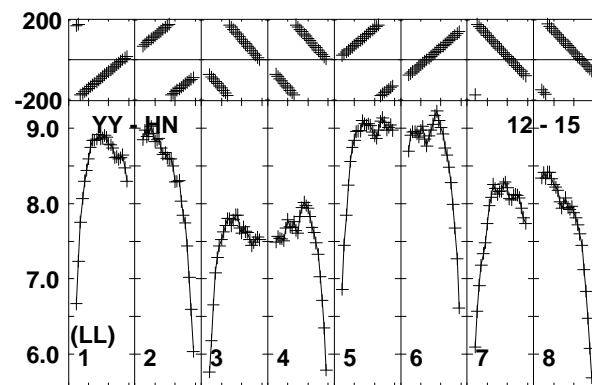
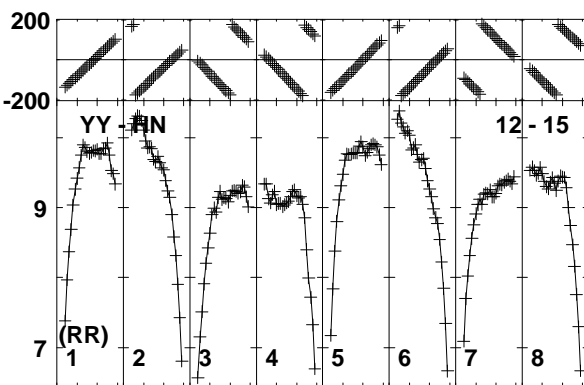
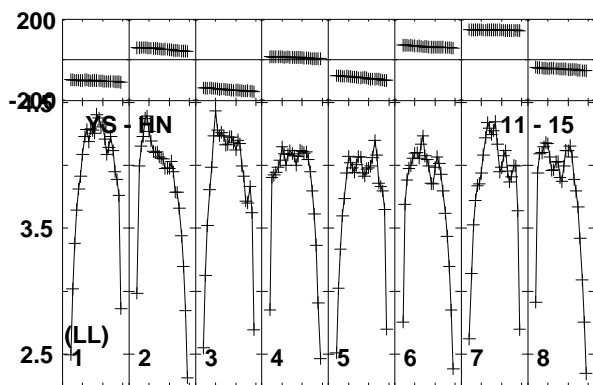
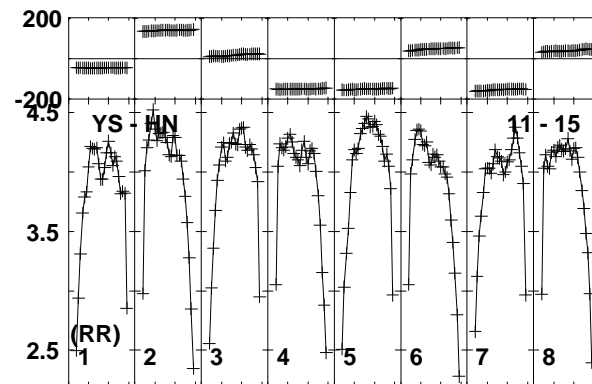
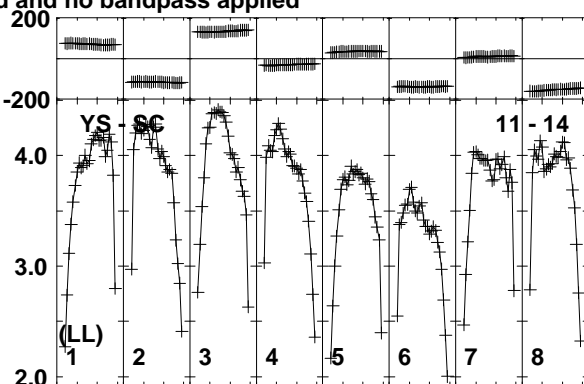
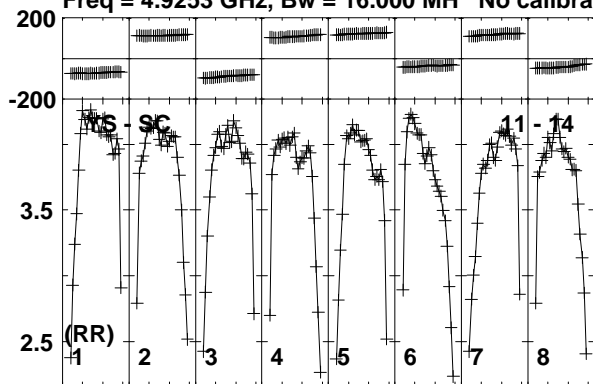

Lower frame: Milli Ampl Jy Top frame: Phas deg
Vector averaged cross-power spectrum Baseline: YS (11) - SC (14)
Timerange: 00/23:52:01 to 00/23:53:53

Plot file version 335 created 11-APR-2016 17:09:11
J1128+5925 GP053G 3.UVDATA.1
Freq = 4.9253 GHz, Bw = 16.000 MH No calibration applied and no bandpass applied

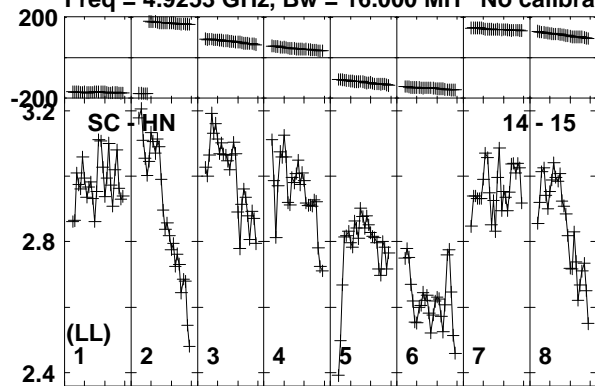

Lower frame: Milli Ampl Jy Top frame: Phas deg
Vector averaged cross-power spectrum Baseline: SC (14) - HN (15)
Timerange: 00/23:52:01 to 00/23:53:53

Plot file version 336 created 11-APR-2016 17:09:11

ARP299C GP053G 3.UVDATA.1

Freq = 4.9253 GHz, Bw = 16.000 MH No calibration applied and no bandpass applied

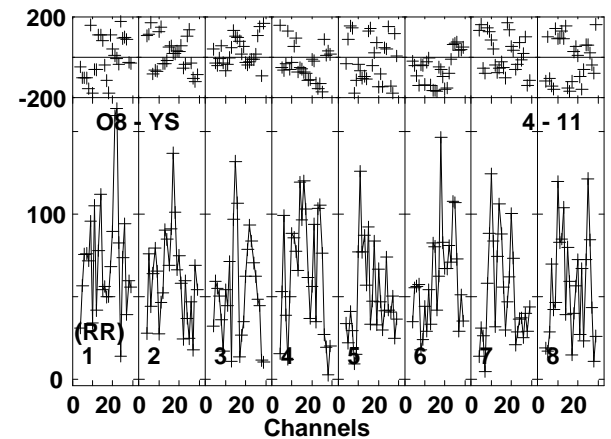
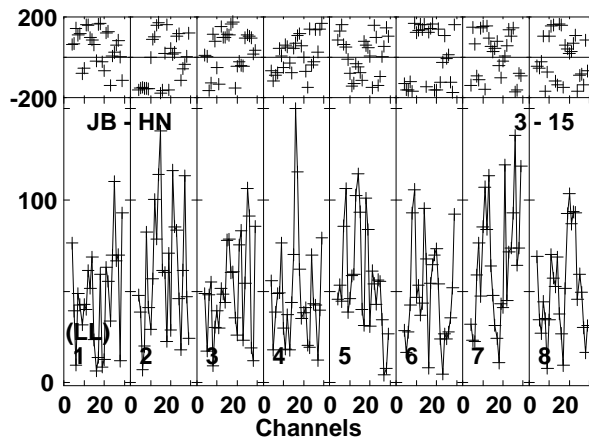
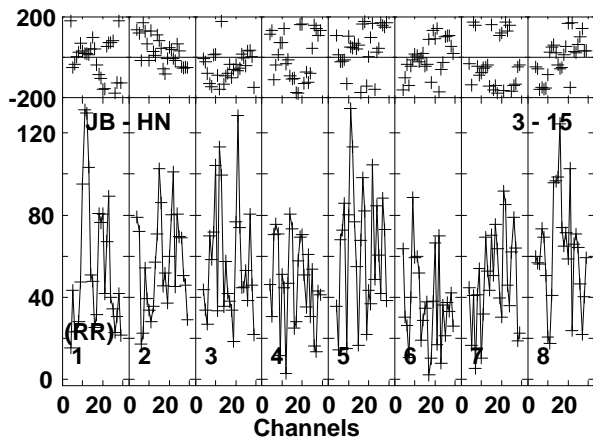
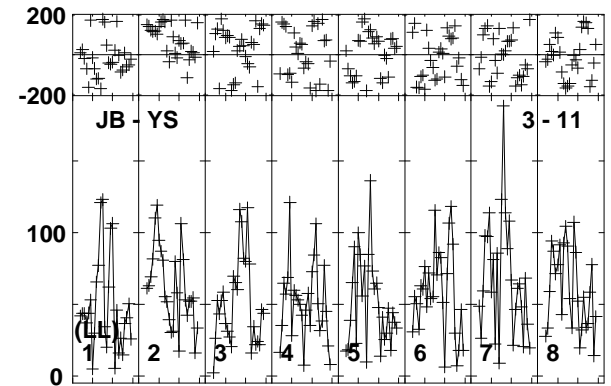
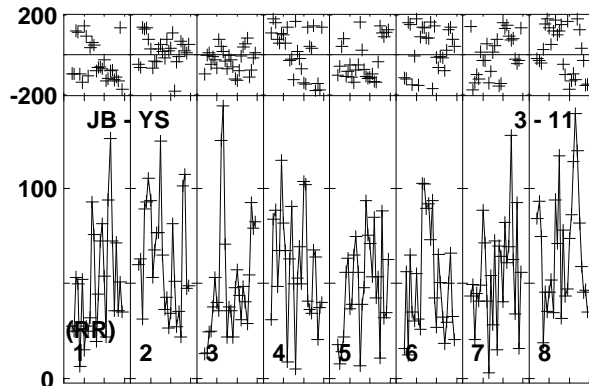
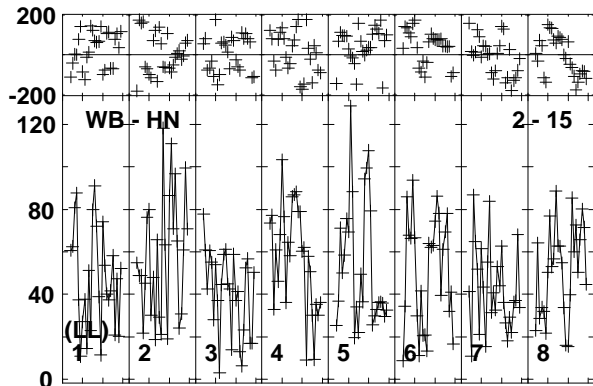
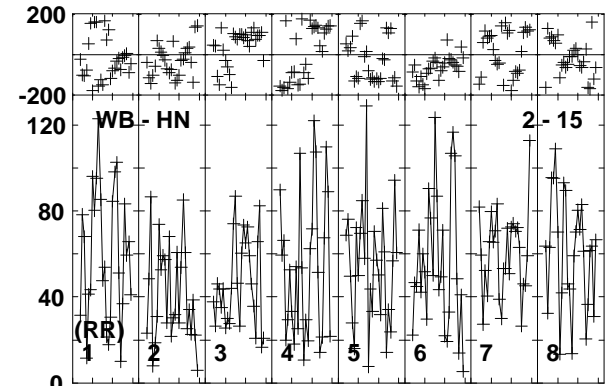
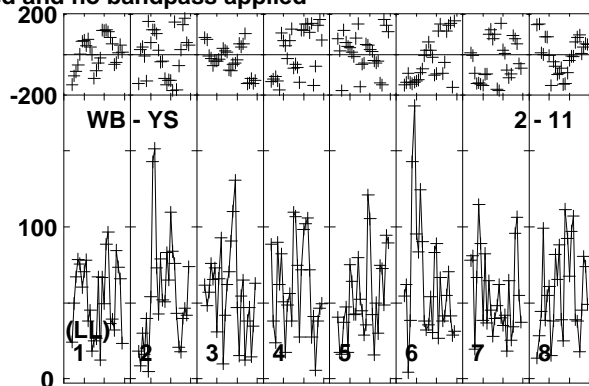
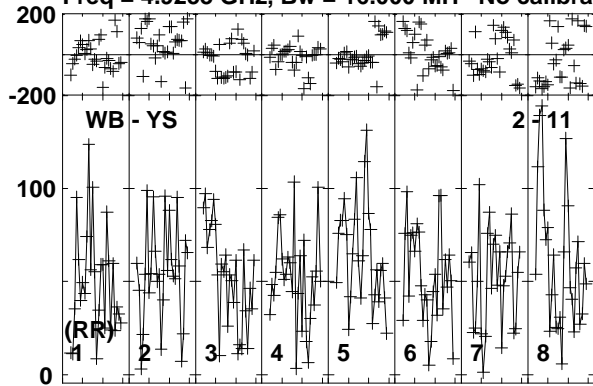

Lower frame: Micro Ampl Jy Top frame: Phas deg
Vector averaged cross-power spectrum Baseline: WB (02) - YS (11)
Timerange: 00/23:53:58 to 00/23:59:12

Plot file version 337 created 11-APR-2016 17:09:11

ARP299C GP053G 3.UVDATA.1

Freq = 4.9253 GHz, Bw = 16.000 MH No calibration applied and no bandpass applied

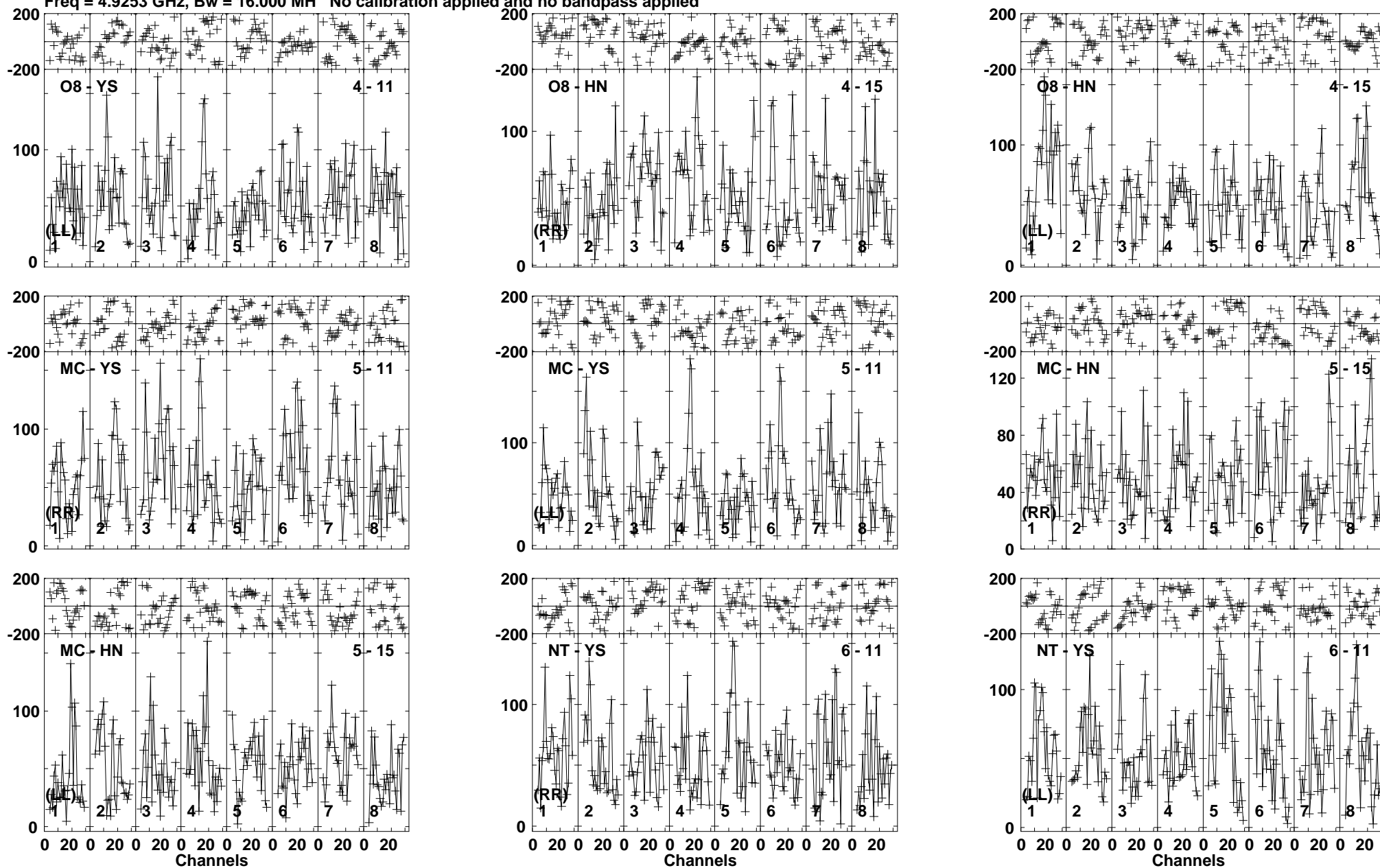

Lower frame: Micro Ampl Jy Top frame: Phas deg
Vector averaged cross-power spectrum Baseline: O8 (04) - YS (11)
Timerange: 00/23:53:58 to 00/23:59:12

Plot file version 338 created 11-APR-2016 17:09:11

ARP299C GP053G 3.UVDATA.1

Freq = 4.9253 GHz, Bw = 16.000 MH No calibration applied and no bandpass applied

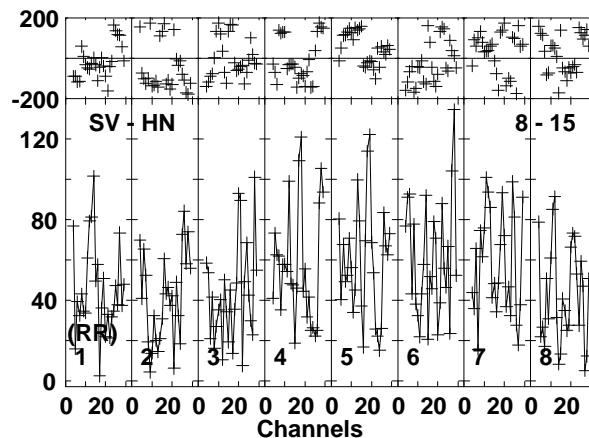
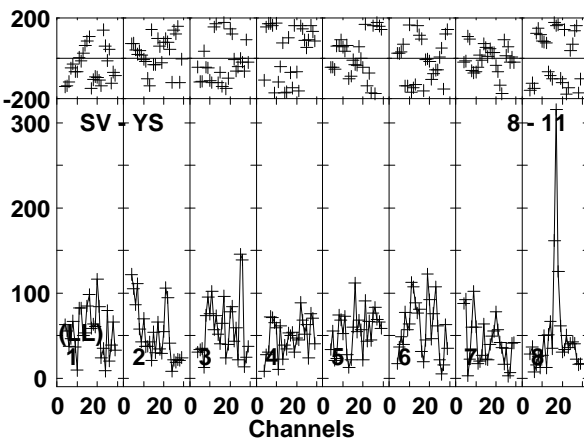
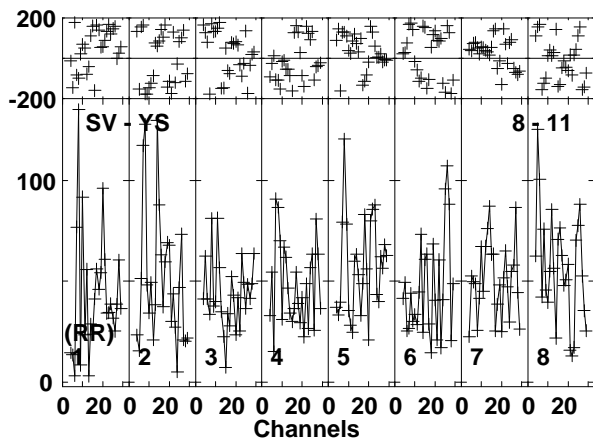
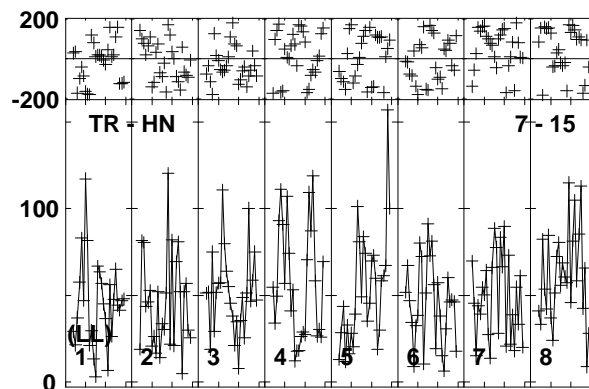
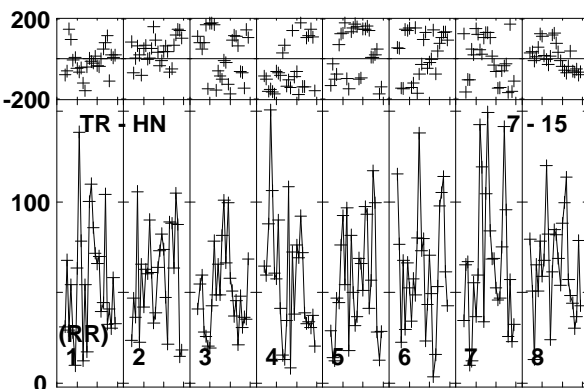
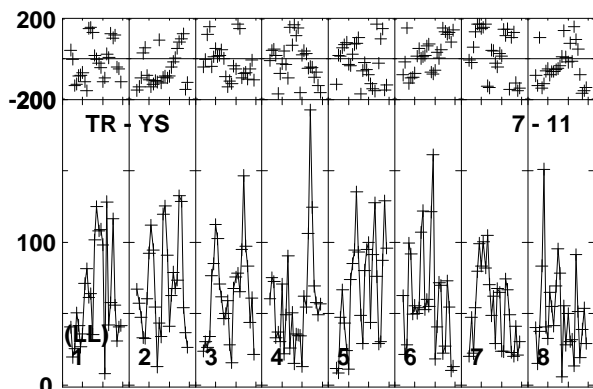
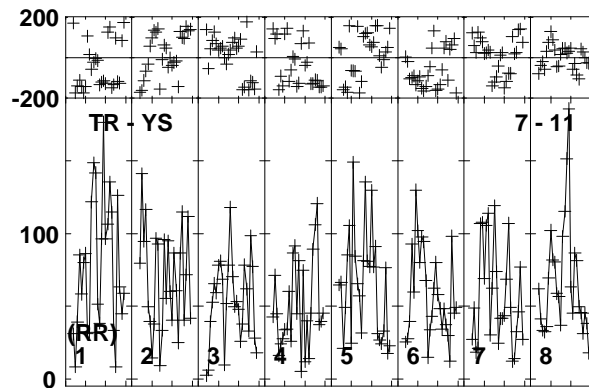
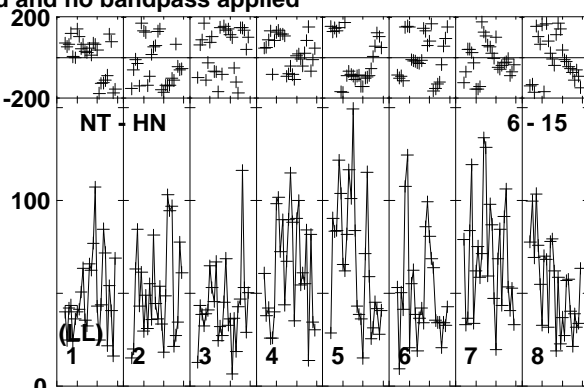
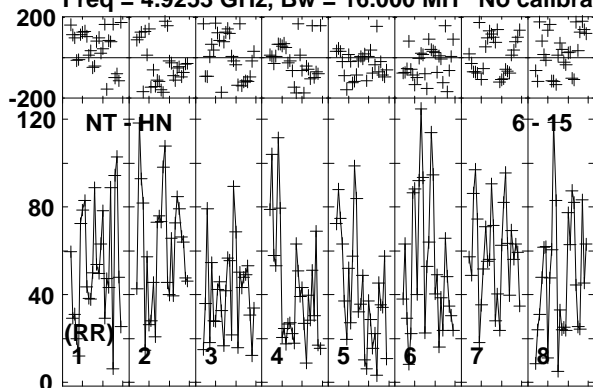

Lower frame: Micro Ampl Jy Top frame: Phas deg
Vector averaged cross-power spectrum Baseline: NT (06) - HN (15)
Timerange: 00/23:53:58 to 00/23:59:12

Plot file version 339 created 11-APR-2016 17:09:11

ARP299C GP053G 3.UVDATA.1

Freq = 4.9253 GHz, Bw = 16.000 MH No calibration applied and no bandpass applied

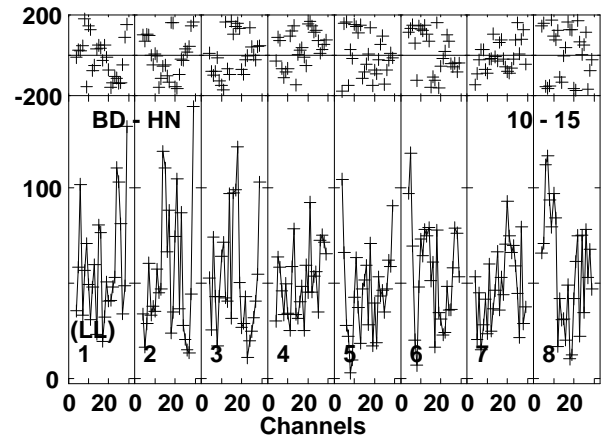
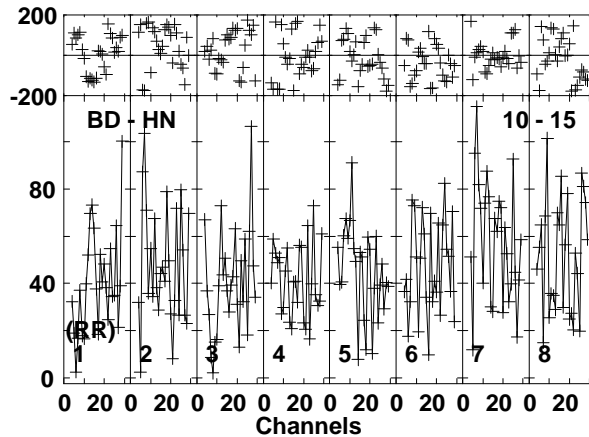
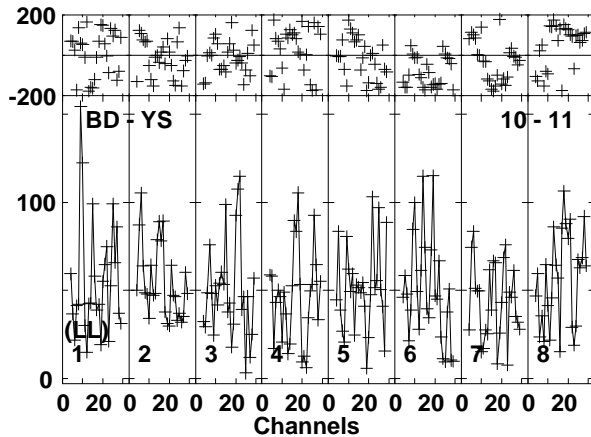
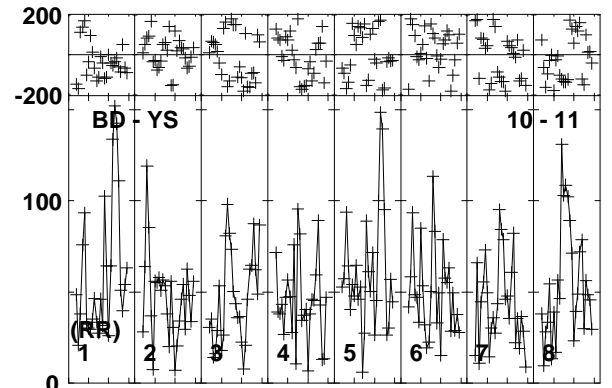
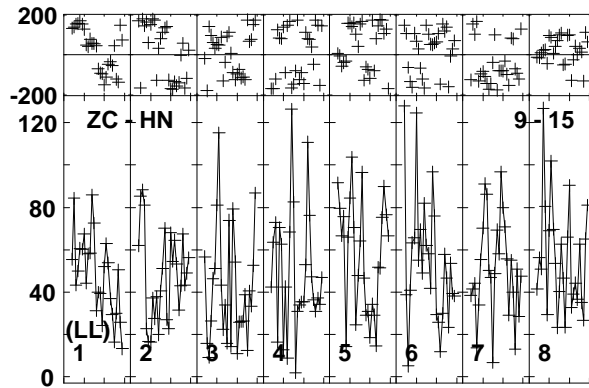
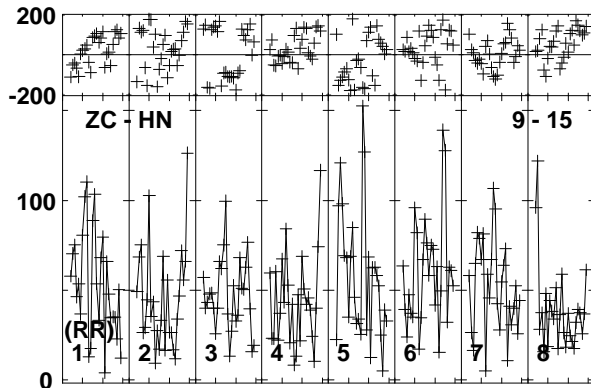
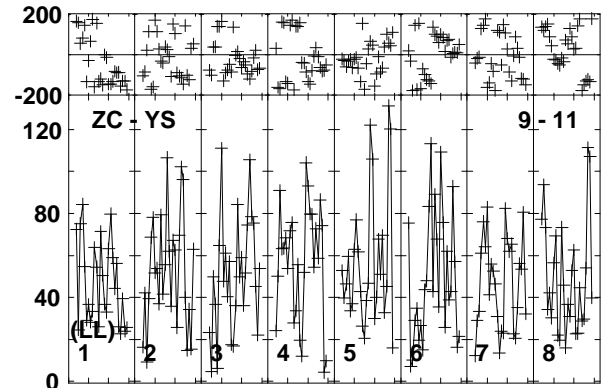
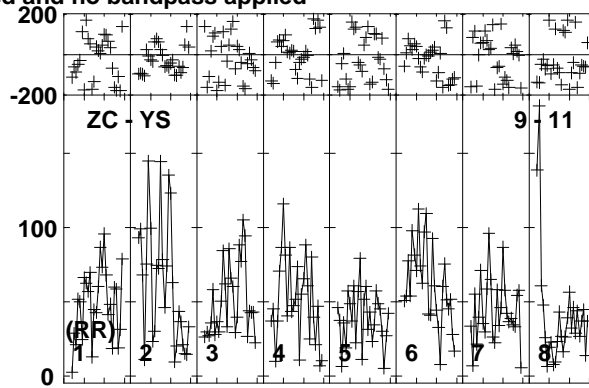
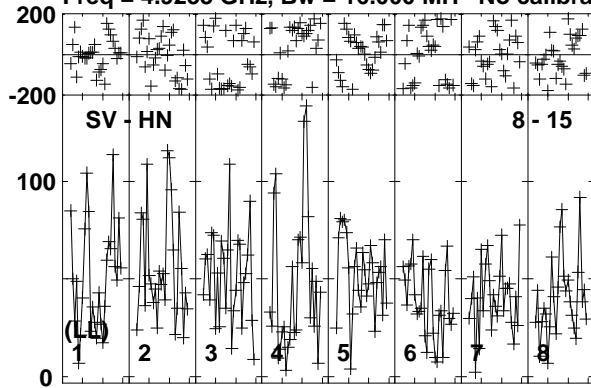

Lower frame: Micro Ampl Jy Top frame: Phas deg
Vector averaged cross-power spectrum Baseline: SV (08) - HN (15)
Timerange: 00/23:53:58 to 00/23:59:12

Plot file version 340 created 11-APR-2016 17:09:12

ARP299C GP053G 3.UVDATA.1

Freq = 4.9253 GHz, Bw = 16.000 MH No calibration applied and no bandpass applied

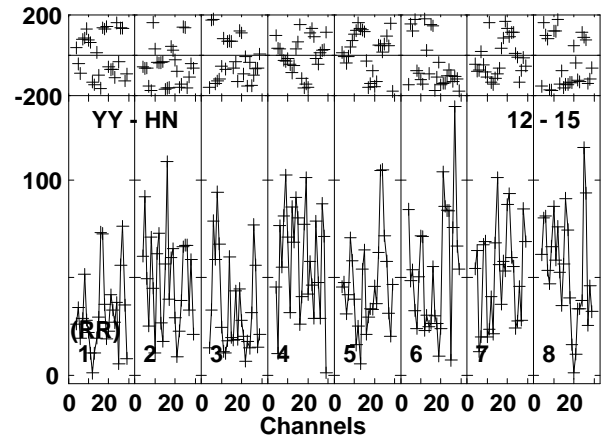
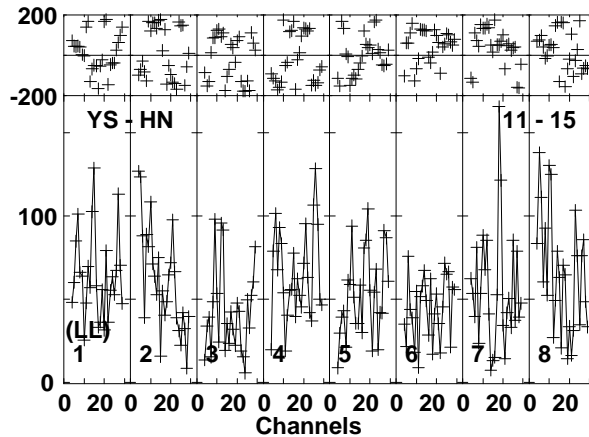
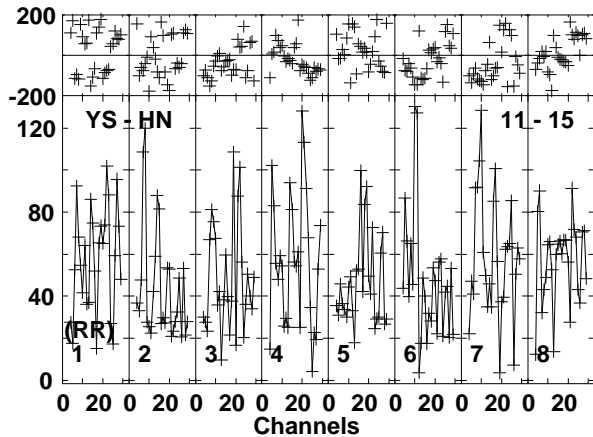
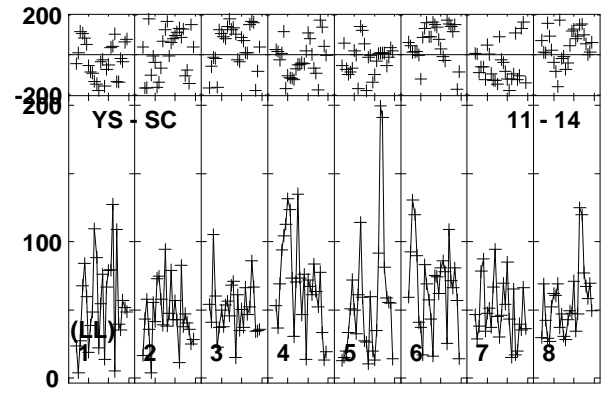
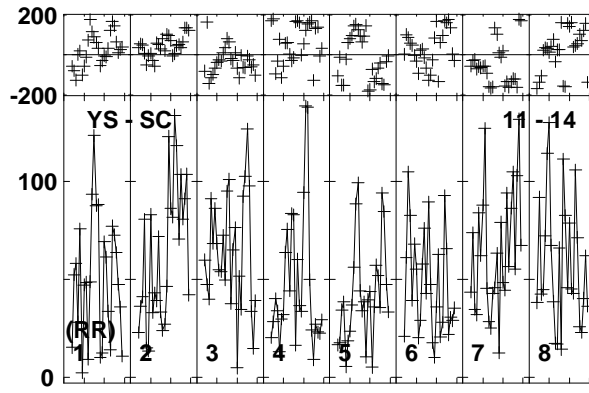
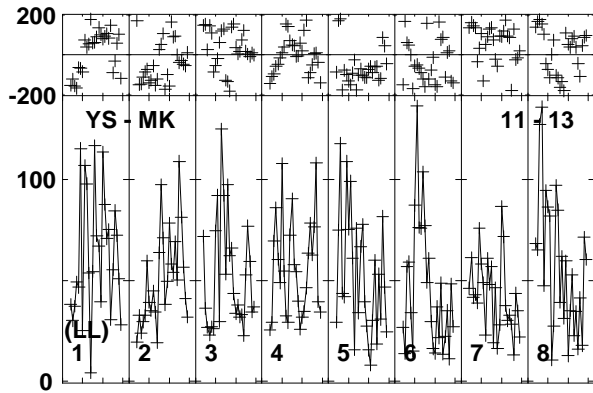
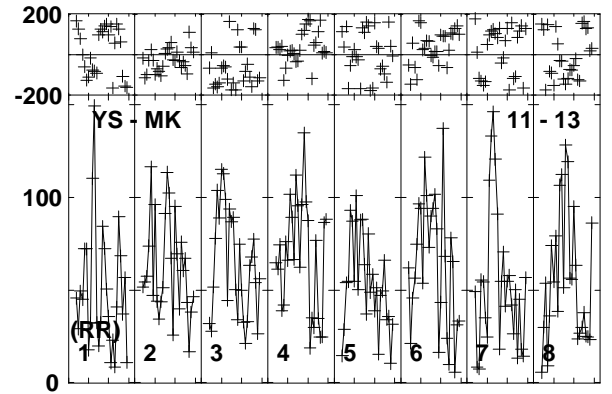
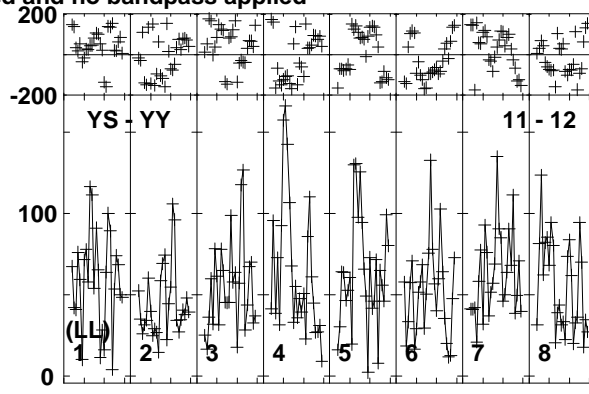
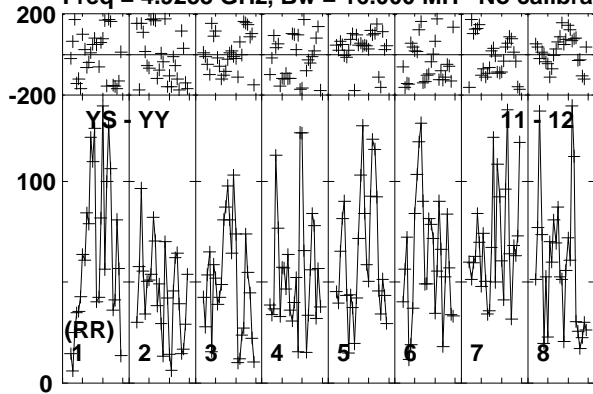

Lower frame: Micro Ampl Jy Top frame: Phas deg
Vector averaged cross-power spectrum Baseline: YS (11) - YY (12)
Timerange: 00/23:53:58 to 00/23:59:12

Plot file version 341 created 11-APR-2016 17:09:12

ARP299C GP053G 3.UVDATA.1

Freq = 4.9253 GHz, Bw = 16.000 MH No calibration applied and no bandpass applied

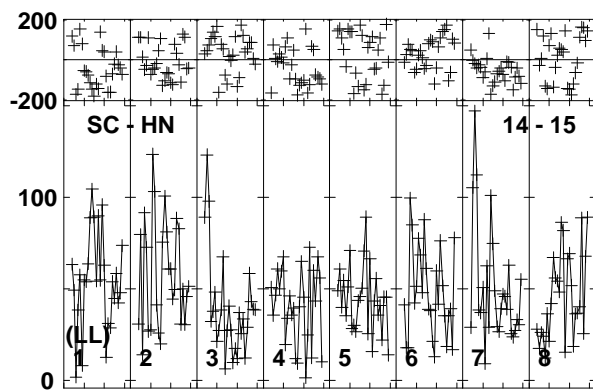
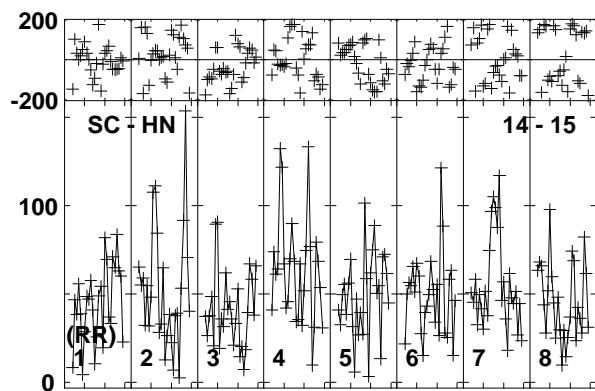
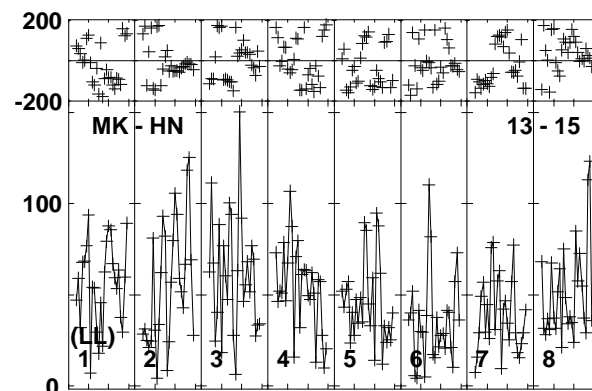
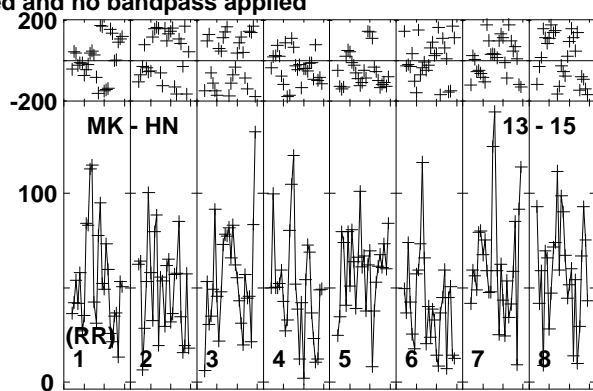
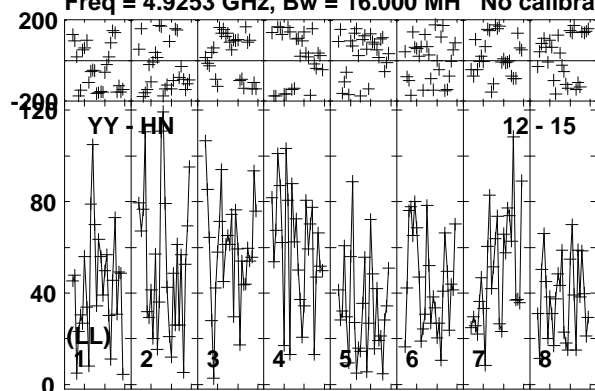

Lower frame: Micro Ampl Jy Top frame: Phas deg
Vector averaged cross-power spectrum Baseline: YY (12) - HN (15)
Timerange: 00/23:53:58 to 00/23:59:12

Plot file version 342 created 11-APR-2016 17:09:12

J1128+5925 GP053G 3.UVDATA.1

Freq = 4.9253 GHz, Bw = 16.000 MH No calibration applied and no bandpass applied

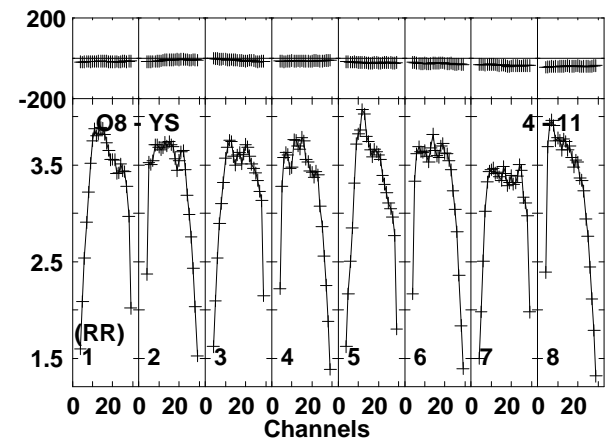
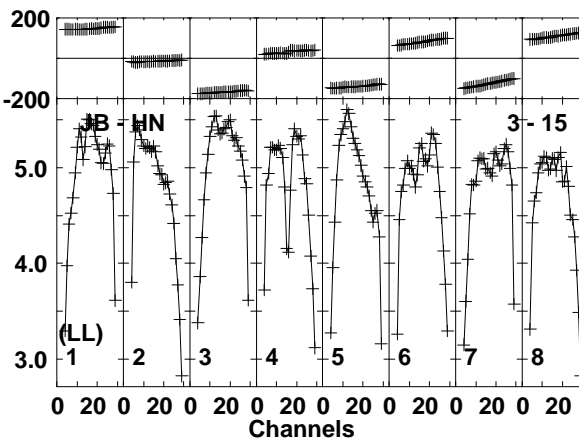
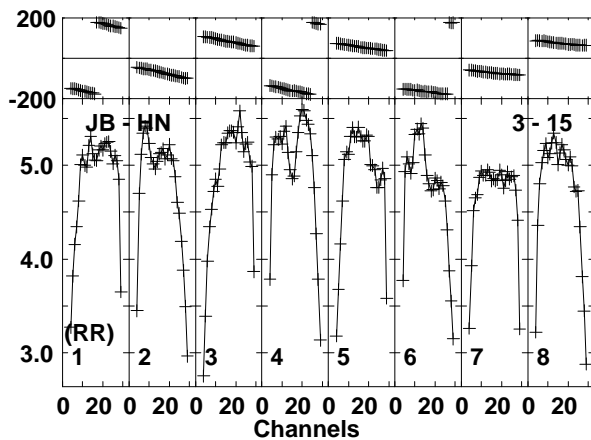
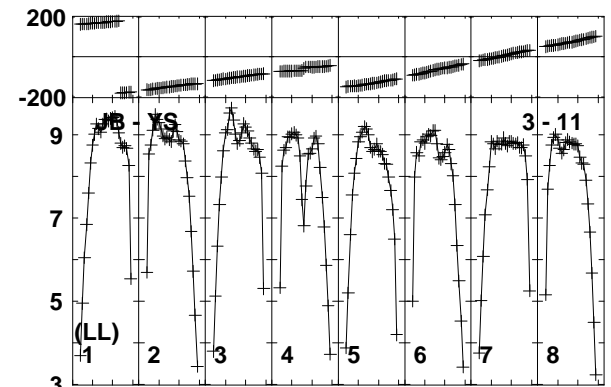
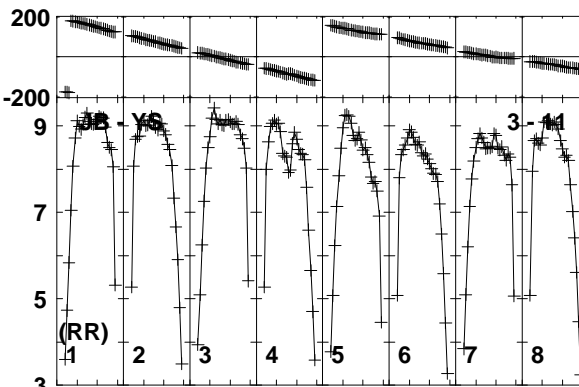
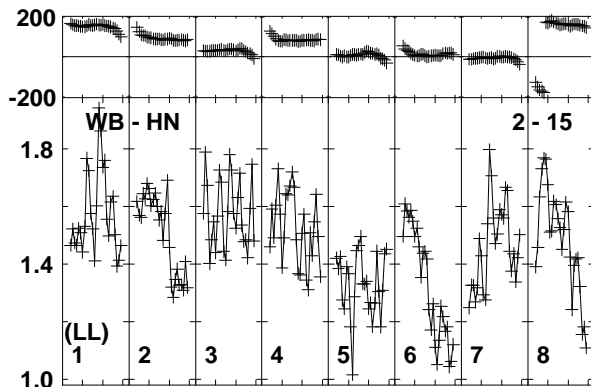
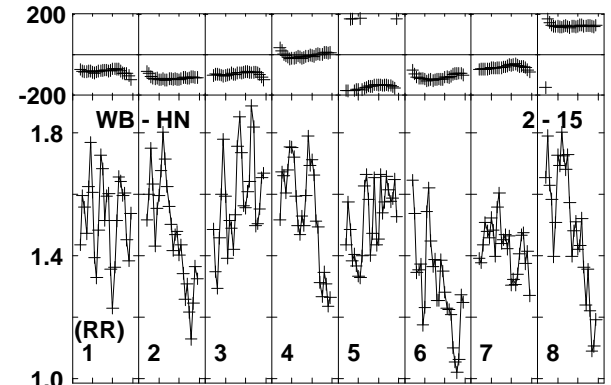
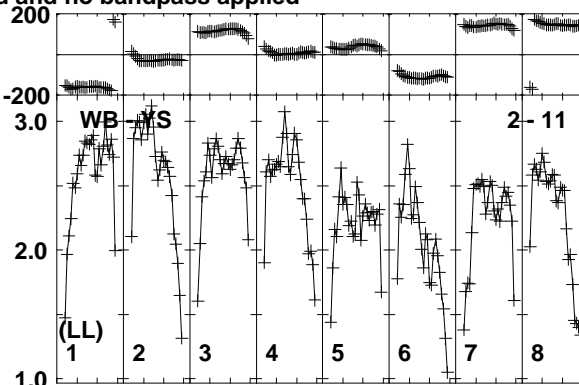
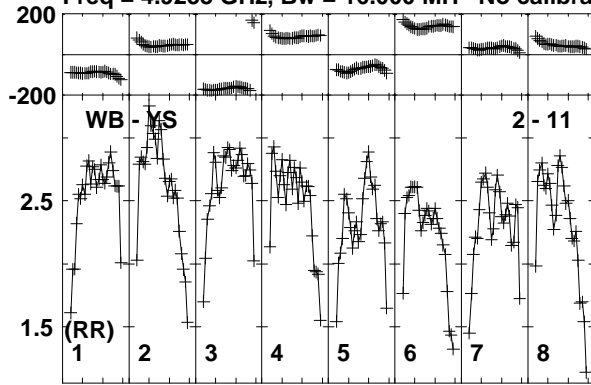

Lower frame: Milli Ampl Jy Top frame: Phas deg
Vector averaged cross-power spectrum Baseline: WB (02) - YS (11)
Timerange: 00/23:59:18 to 01/00:01:02

Plot file version 343 created 11-APR-2016 17:09:12

J1128+5925 GP053G 3.UVDATA.1

Freq = 4.9253 GHz, Bw = 16.000 MH No calibration applied and no bandpass applied

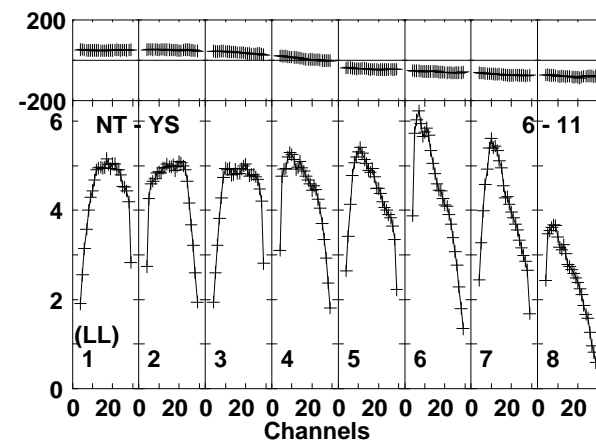
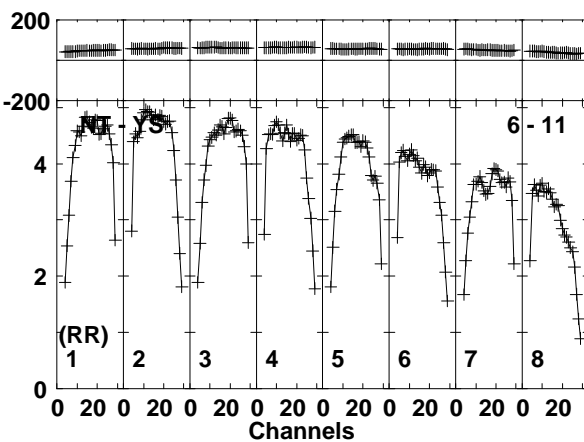
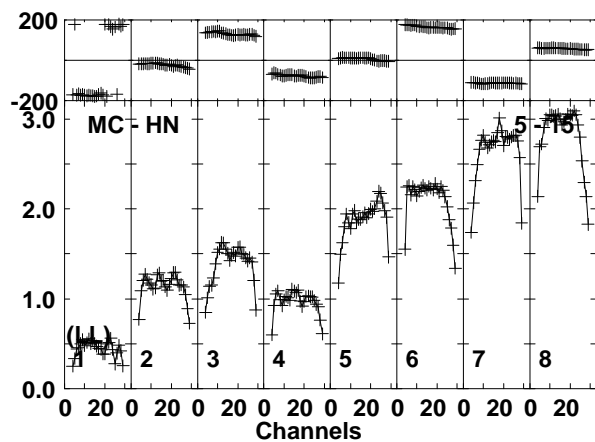
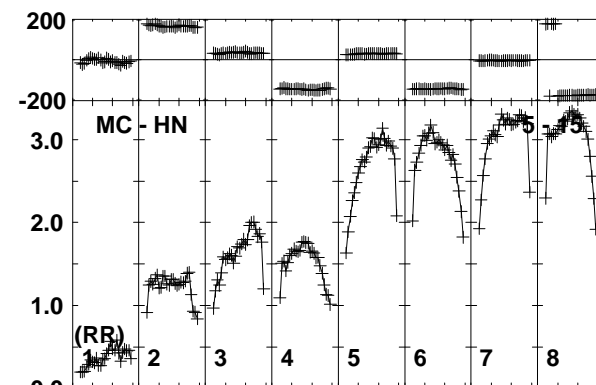
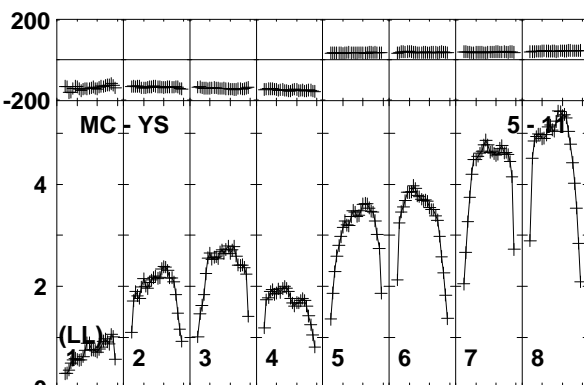
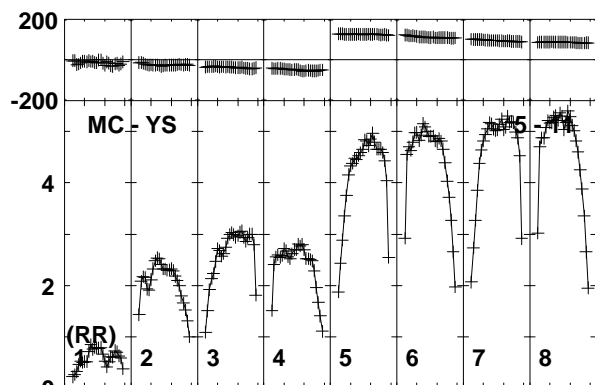
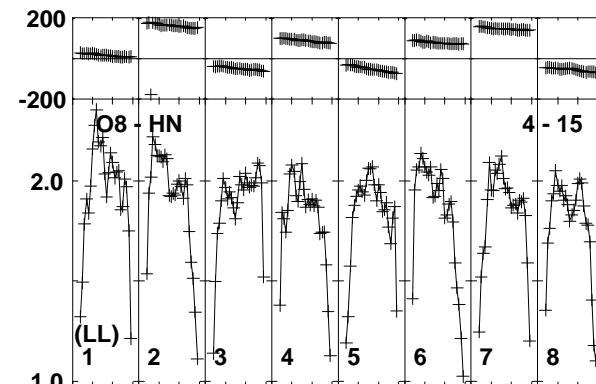
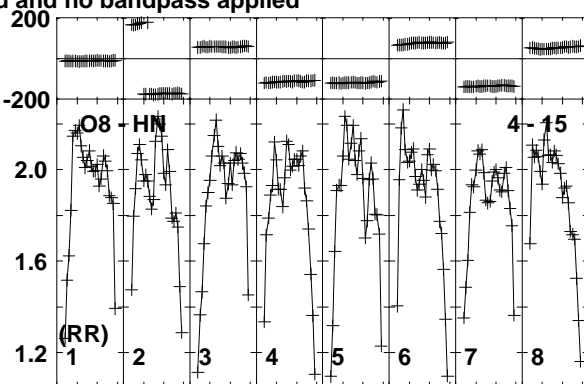
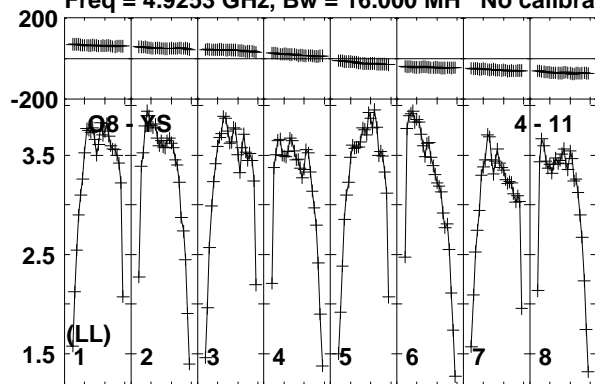

Lower frame: Milli Ampl Jy Top frame: Phas deg
Vector averaged cross-power spectrum Baseline: O8 (04) - YS (11)
Timerange: 00/23:59:18 to 01/00:01:02

Plot file version 344 created 11-APR-2016 17:09:12

J1128+5925 GP053G 3.UVDATA.1

Freq = 4.9253 GHz, Bw = 16.000 MH No calibration applied and no bandpass applied

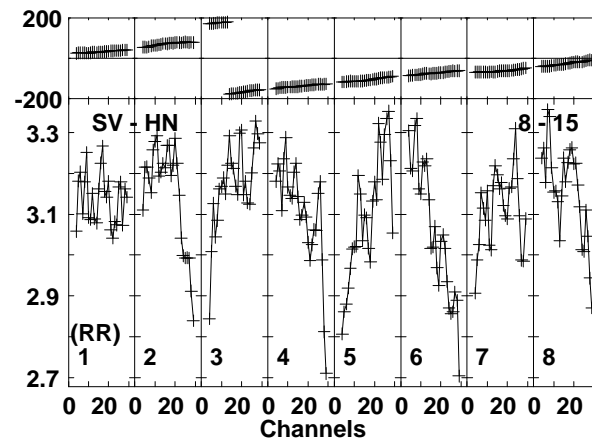
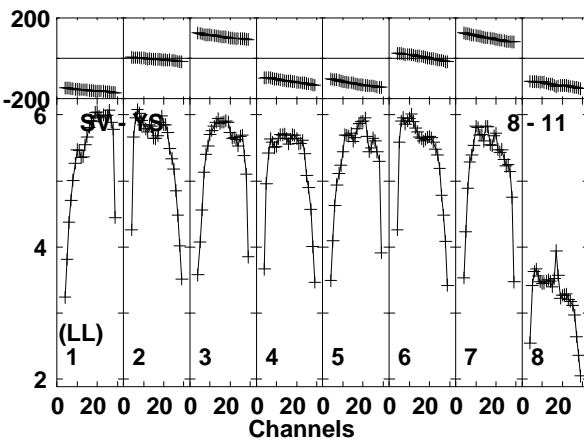
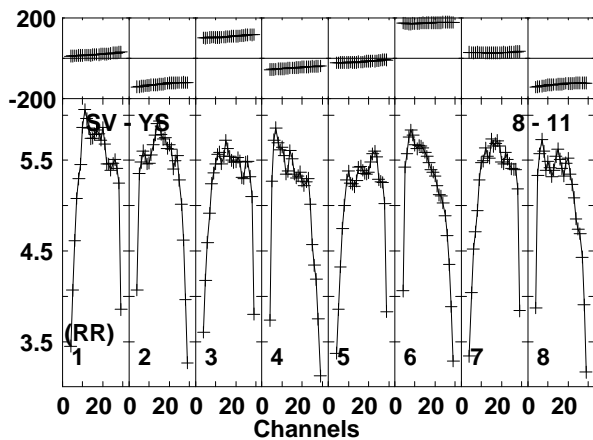
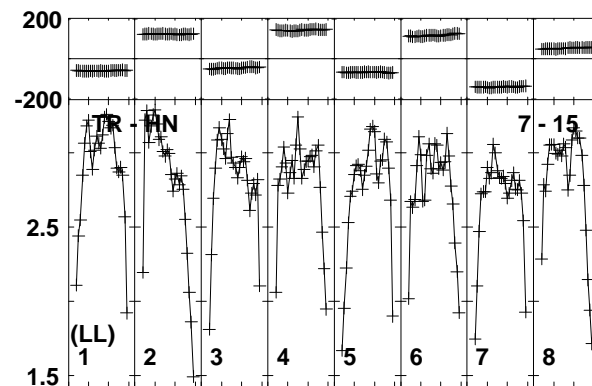
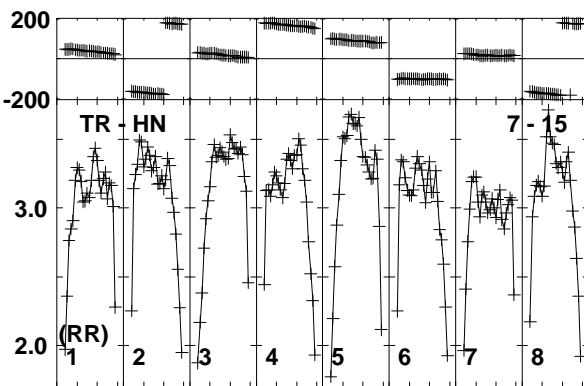
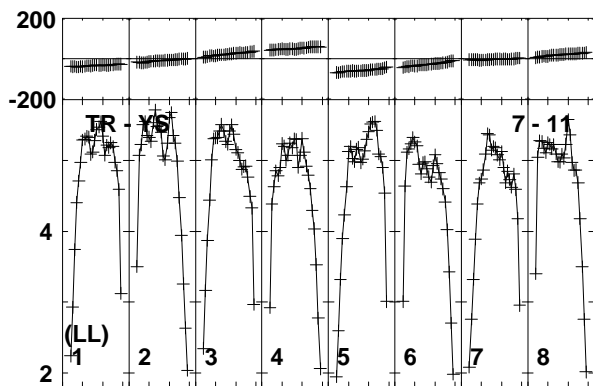
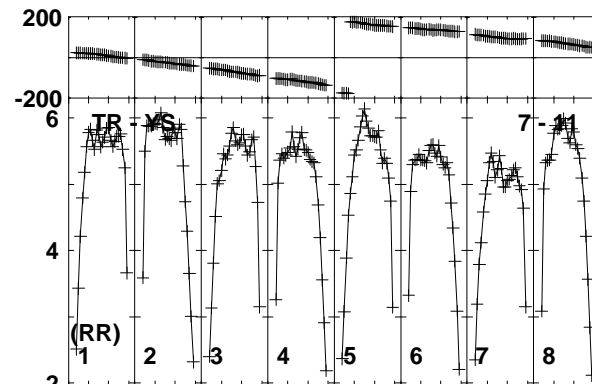
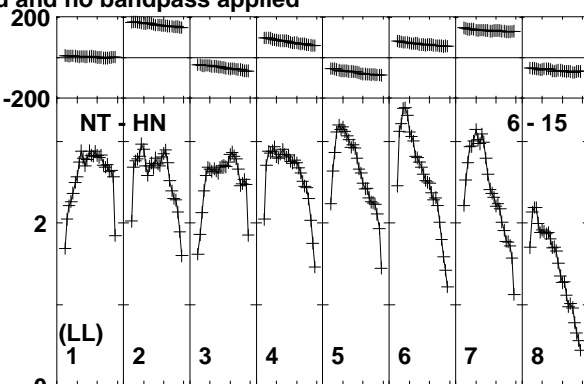
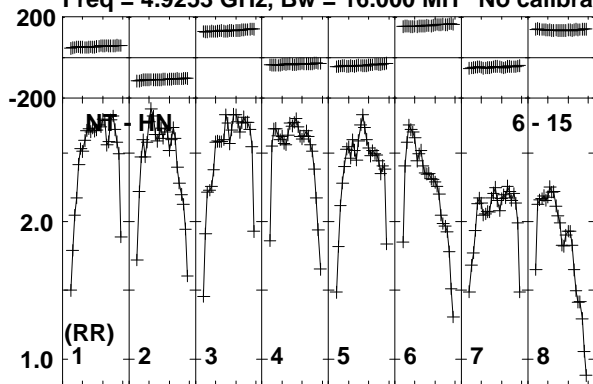

Lower frame: Milli Ampl Jy Top frame: Phas deg
Vector averaged cross-power spectrum Baseline: NT (06) - HN (15)
Timerange: 00/23:59:18 to 01/00:01:02

Plot file version 345 created 11-APR-2016 17:09:12

J1128+5925 GP053G 3.UVDATA.1

Freq = 4.9253 GHz, Bw = 16.000 MH No calibration applied and no bandpass applied

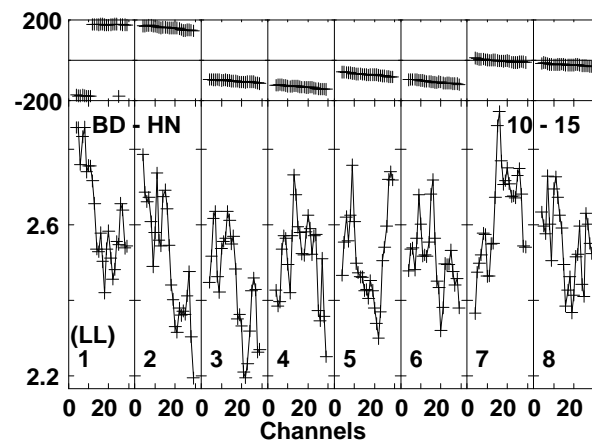
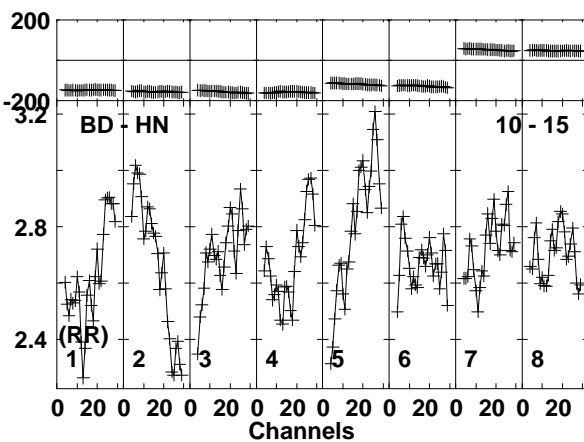
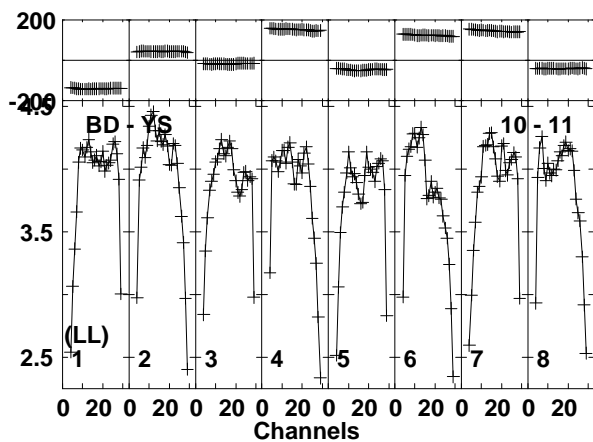
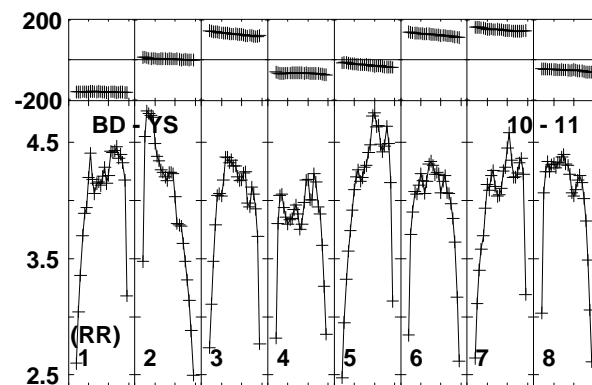
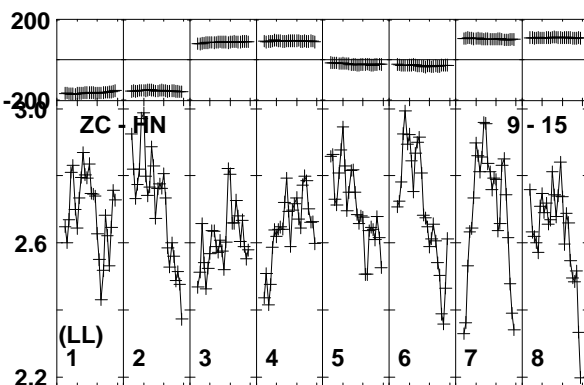
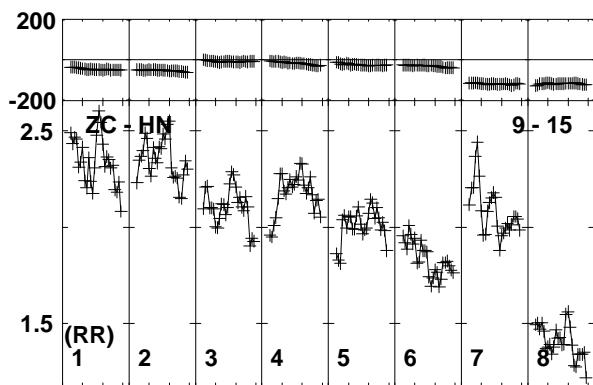
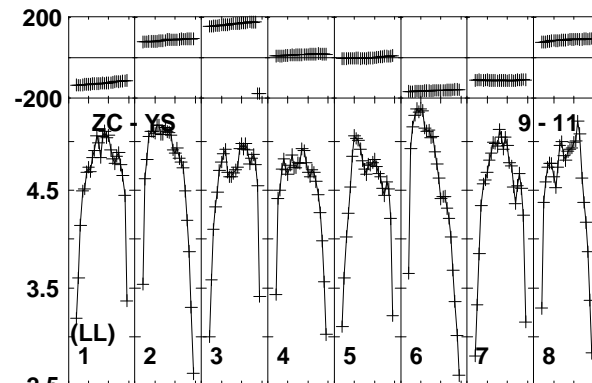
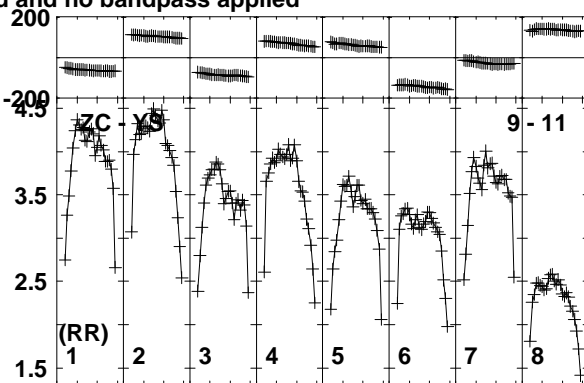
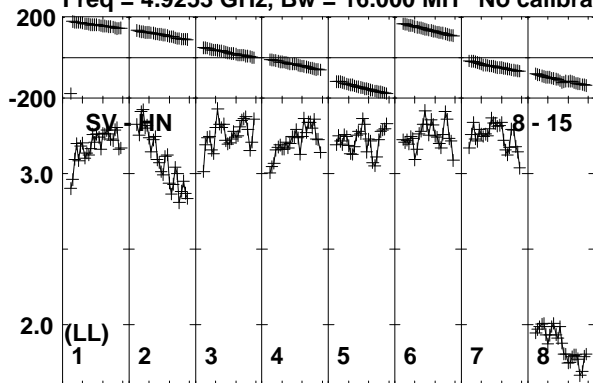

Lower frame: Milli Ampl Jy Top frame: Phas deg
Vector averaged cross-power spectrum Baseline: SV (08) - HN (15)
Timerange: 00/23:59:18 to 01/00:01:02

Plot file version 346 created 11-APR-2016 17:09:13

J1128+5925 GP053G 3.UVDATA.1

Freq = 4.9253 GHz, Bw = 16.000 MH No calibration applied and no bandpass applied

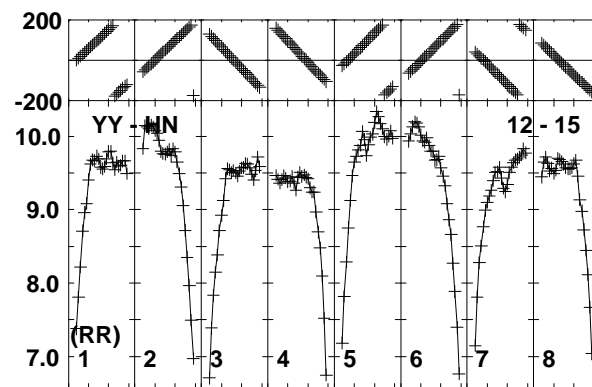
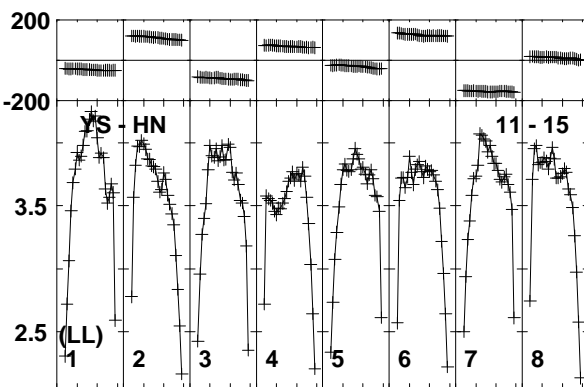
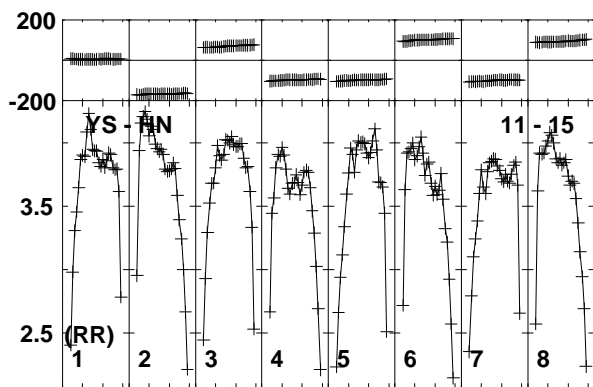
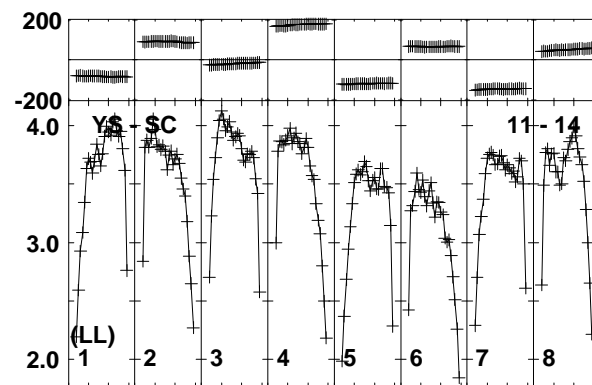
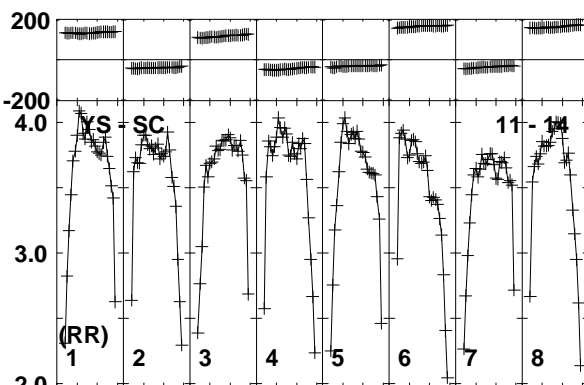
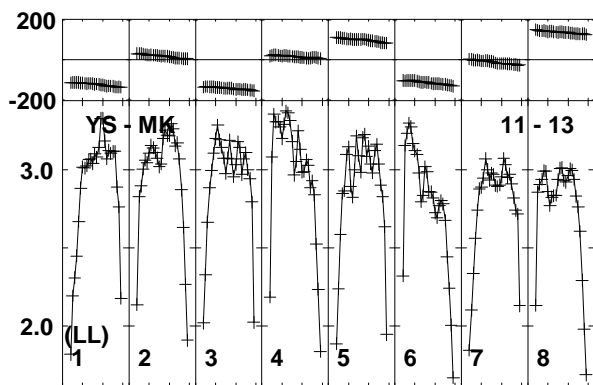
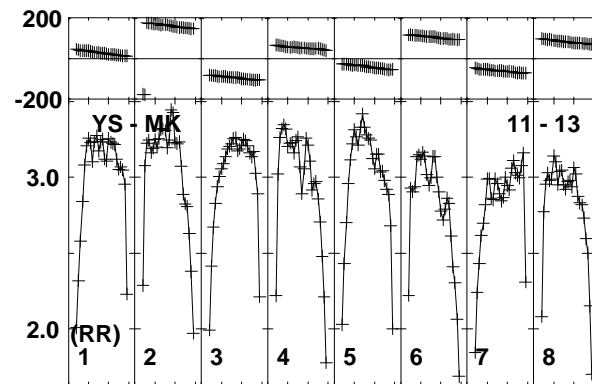
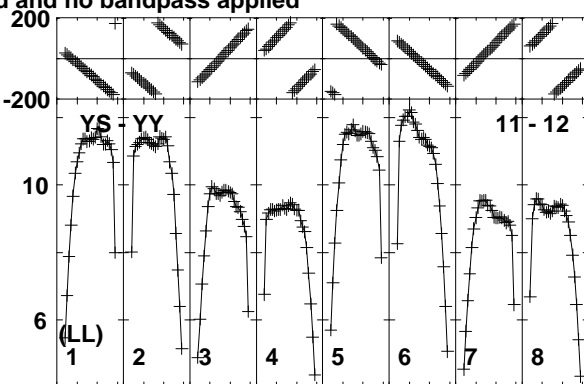
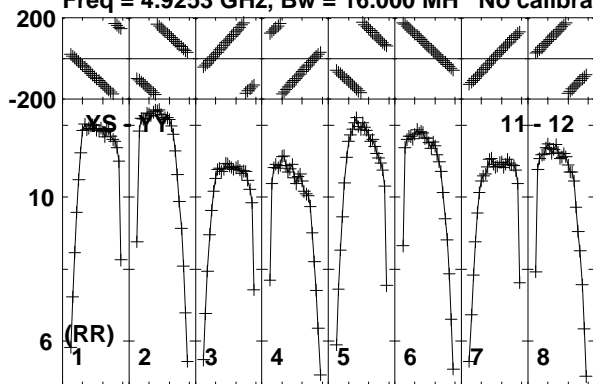

Lower frame: Milli Ampl Jy Top frame: Phas deg
Vector averaged cross-power spectrum Baseline: YS (11) - YY (12)
Timerange: 00/23:59:18 to 01/00:01:02

Plot file version 347 created 11-APR-2016 17:09:13

J1128+5925 GP053G 3.UVDATA.1

Freq = 4.9253 GHz, Bw = 16.000 MH No calibration applied and no bandpass applied

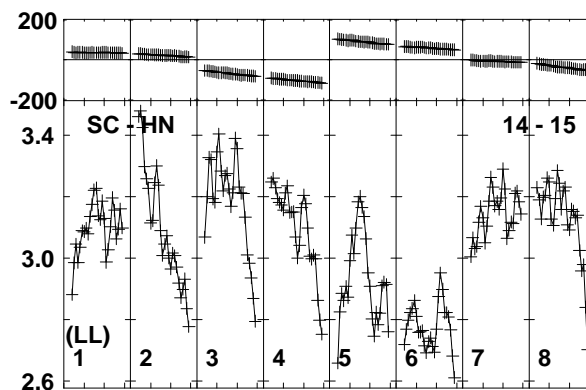
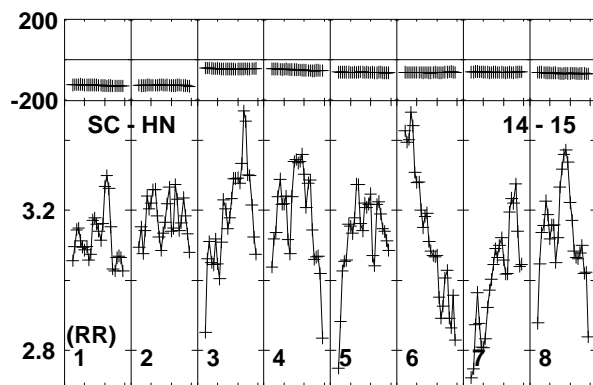
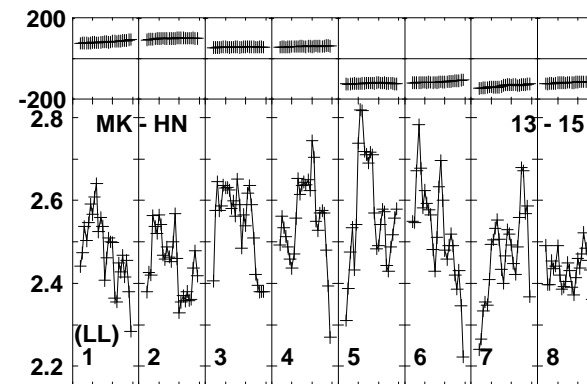
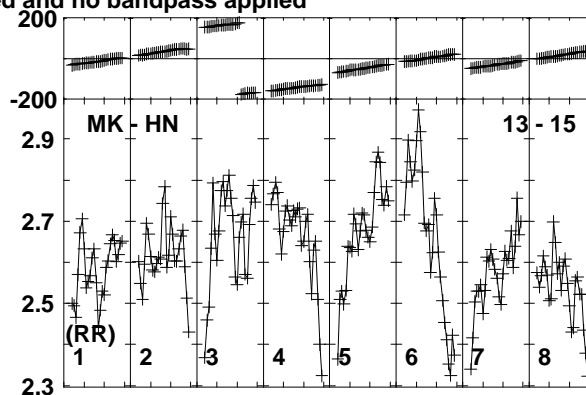
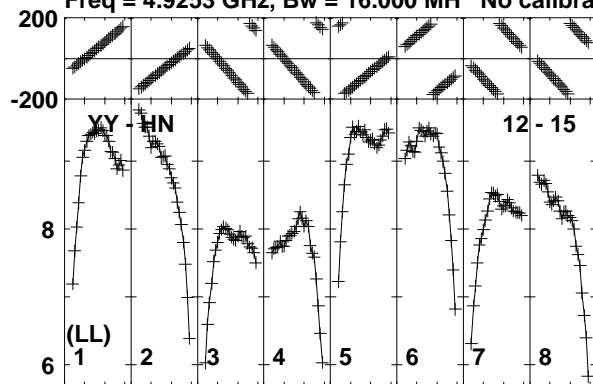

Lower frame: Milli Ampl Jy Top frame: Phas deg
Vector averaged cross-power spectrum Baseline: YY (12) - HN (15)
Timerange: 00/23:59:18 to 01/00:01:02

Plot file version 348 created 11-APR-2016 17:09:13

ARP299C GP053G 3.UVDATA.1

Freq = 4.9253 GHz, Bw = 16.000 MH No calibration applied and no bandpass applied

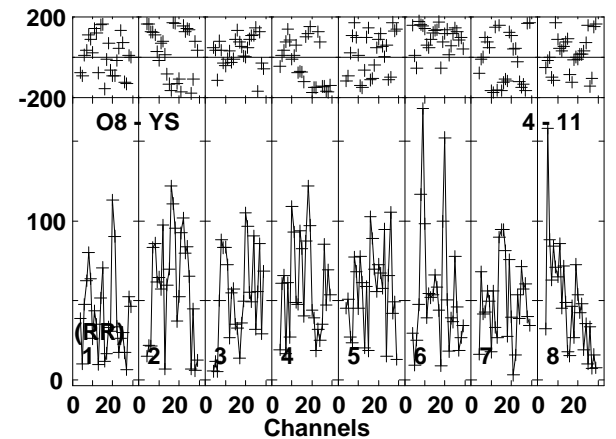
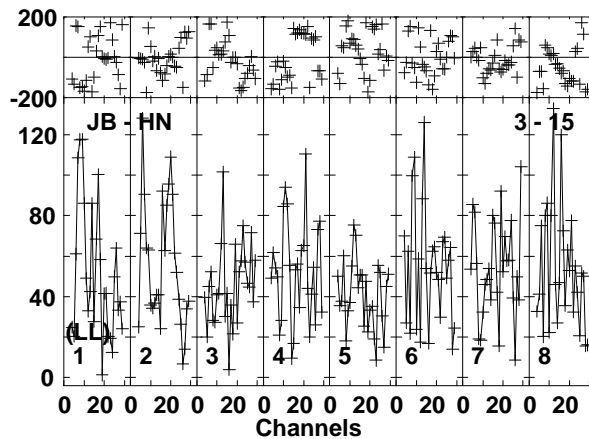
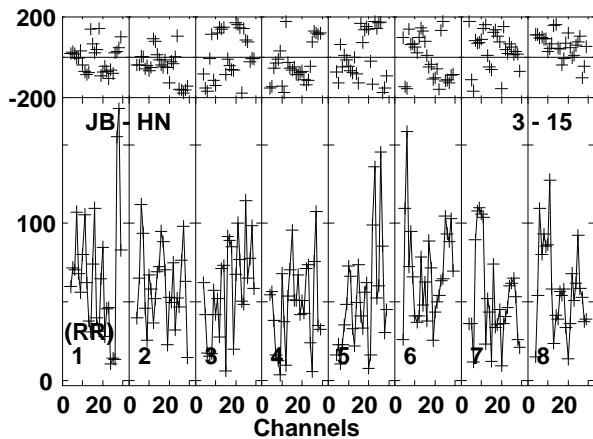
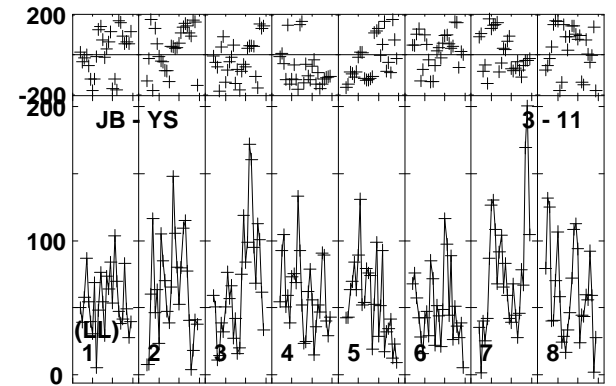
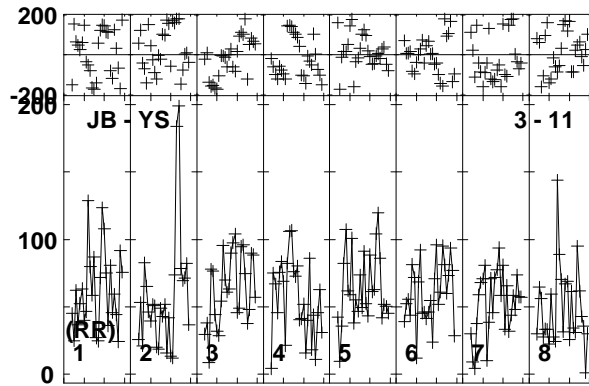
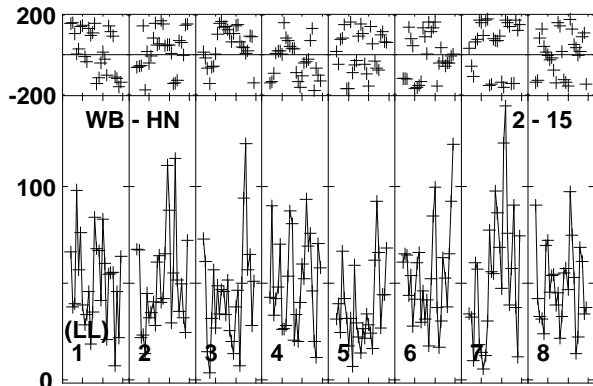
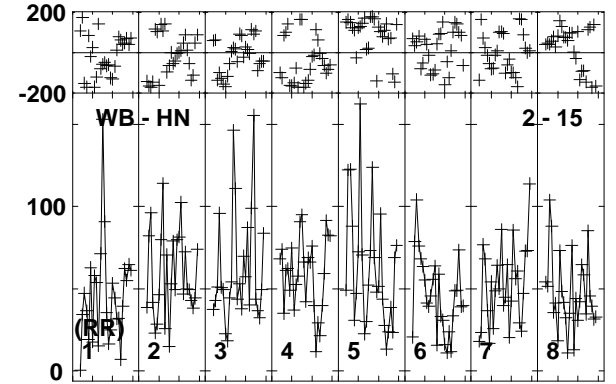
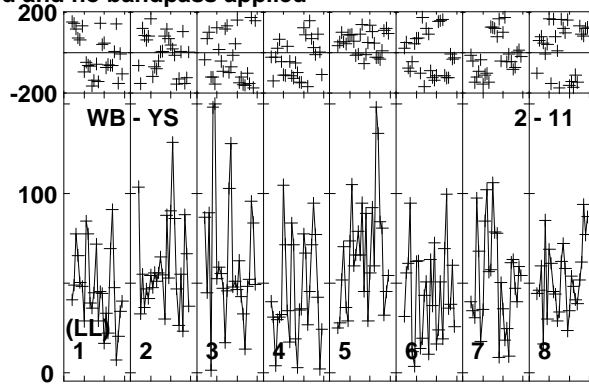
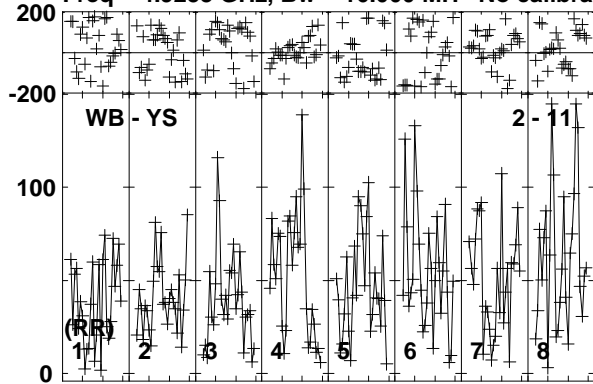

Lower frame: Micro Ampl Jy Top frame: Phas deg
Vector averaged cross-power spectrum Baseline: WB (02) - YS (11)
Timerange: 01/00:01:08 to 01/00:06:20

Plot file version 349 created 11-APR-2016 17:09:13

ARP299C GP053G 3.UVDATA.1

Freq = 4.9253 GHz, Bw = 16.000 MH No calibration applied and no bandpass applied

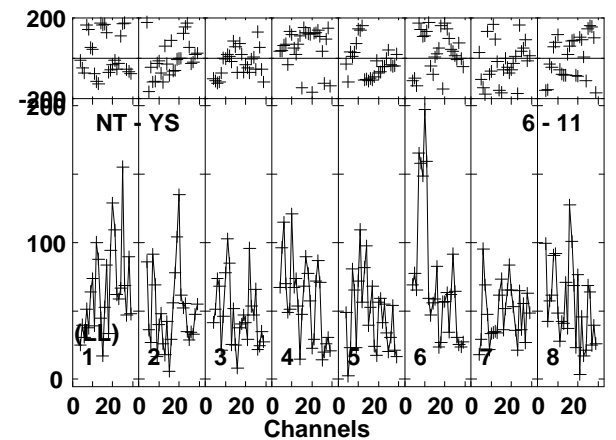
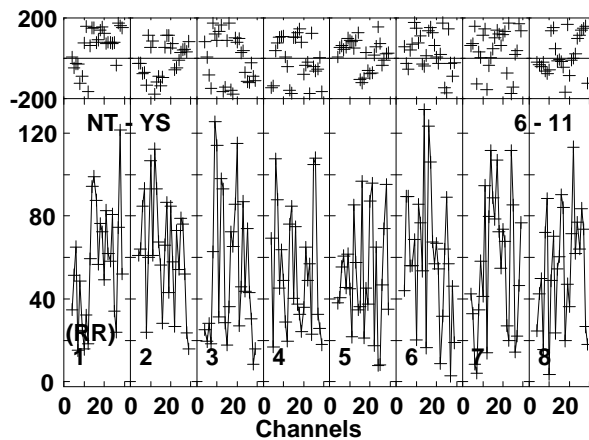
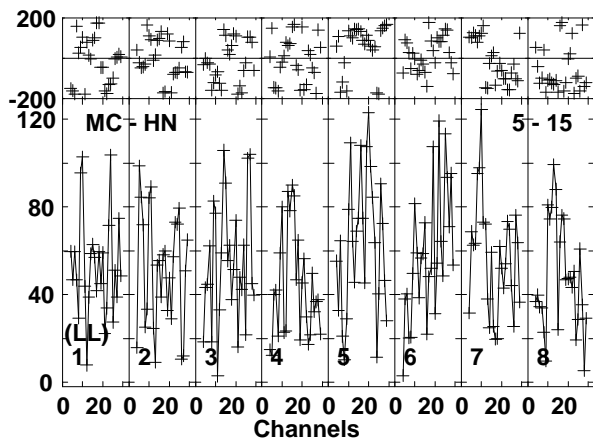
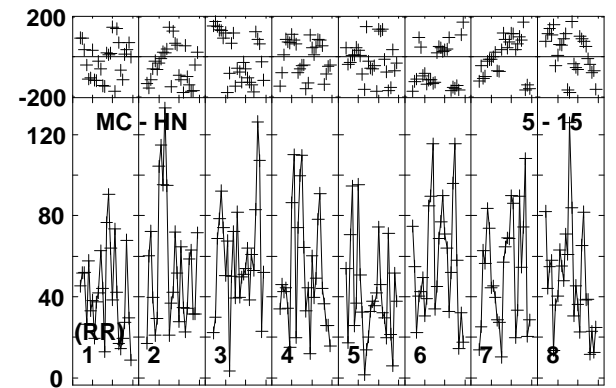
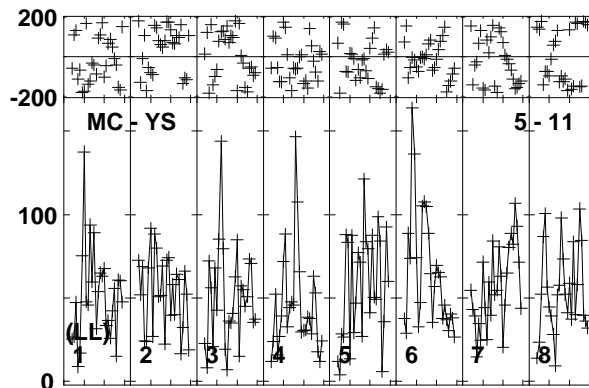
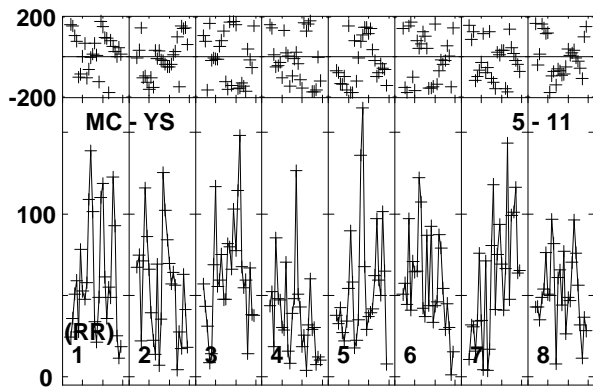
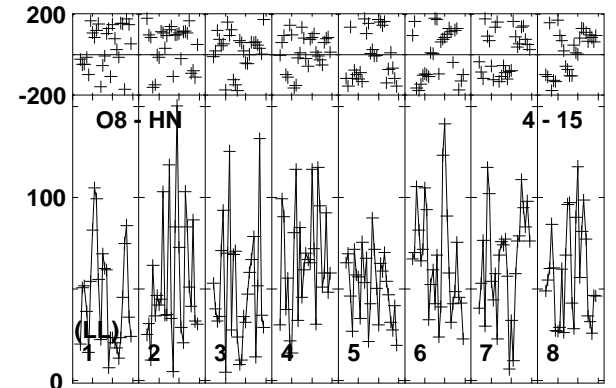
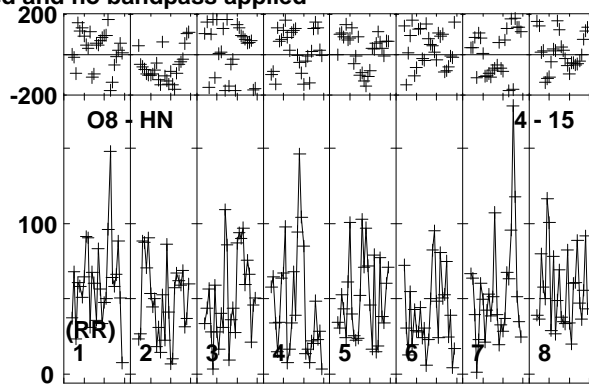
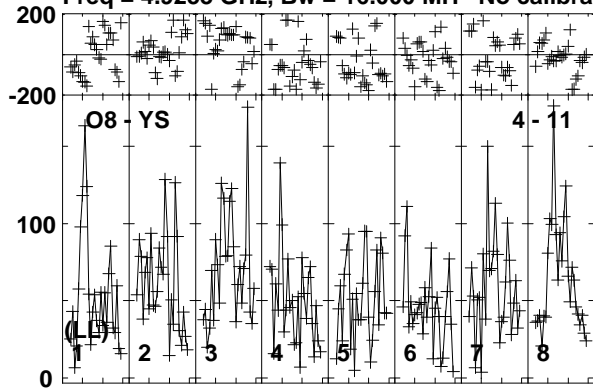

Lower frame: Micro Ampl Jy Top frame: Phas deg
Vector averaged cross-power spectrum Baseline: O8 (04) - YS (11)
Timerange: 01/00:01:08 to 01/00:06:20

Plot file version 350 created 11-APR-2016 17:09:13

ARP299C GP053G 3.UVDATA.1

Freq = 4.9253 GHz, Bw = 16.000 MH No calibration applied and no bandpass applied

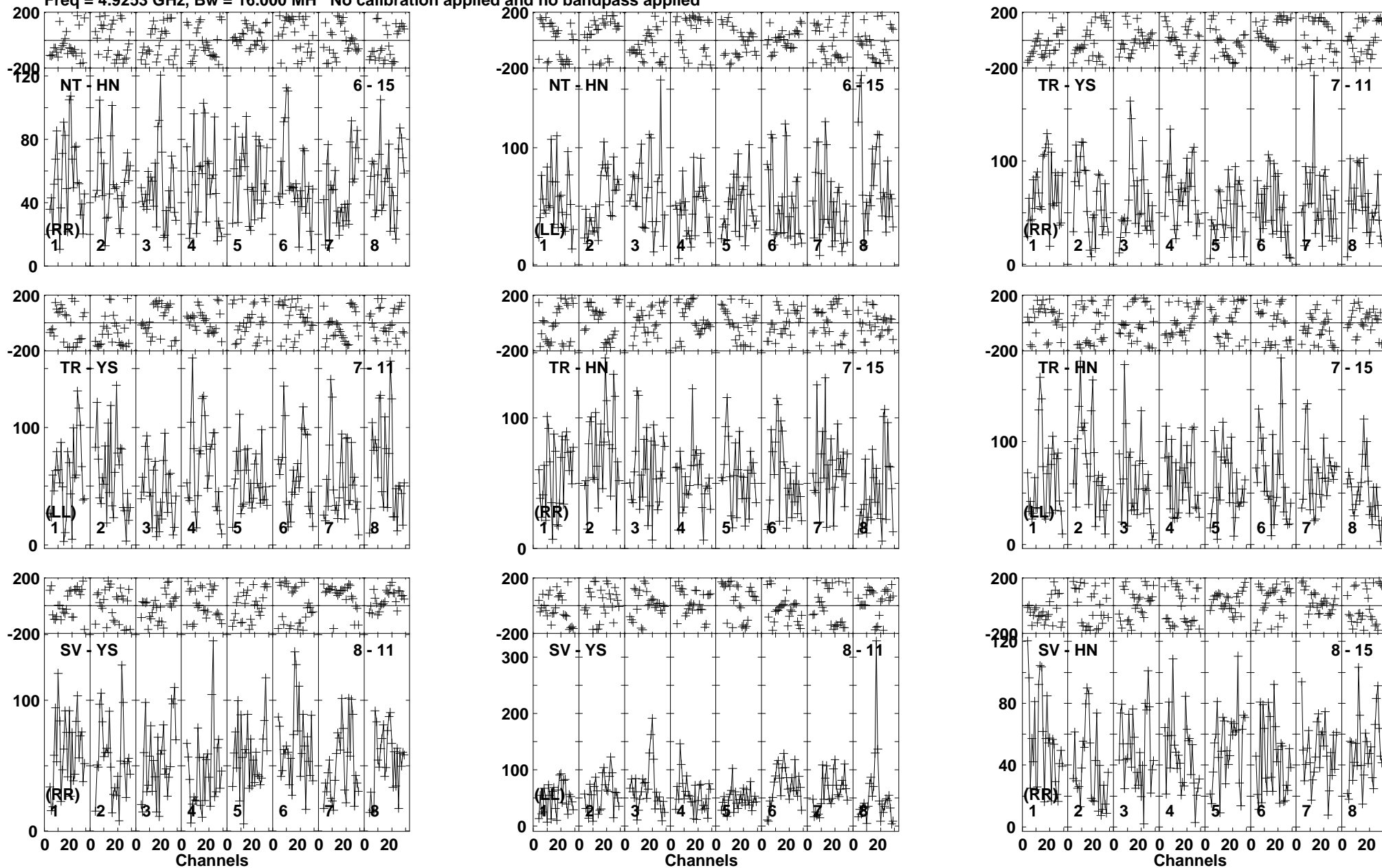

Lower frame: Micro Ampl Jy Top frame: Phas deg
Vector averaged cross-power spectrum Baseline: NT (06) - HN (15)
Timerange: 01/00:01:08 to 01/00:06:20

Plot file version 351 created 11-APR-2016 17:09:13

ARP299C GP053G 3.UVDATA.1

Freq = 4.9253 GHz, Bw = 16.000 MH No calibration applied and no bandpass applied

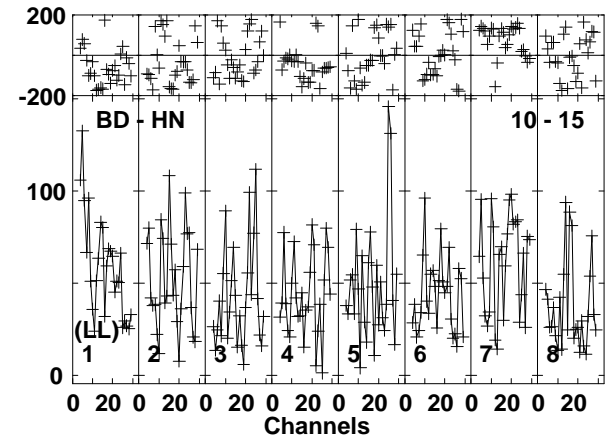
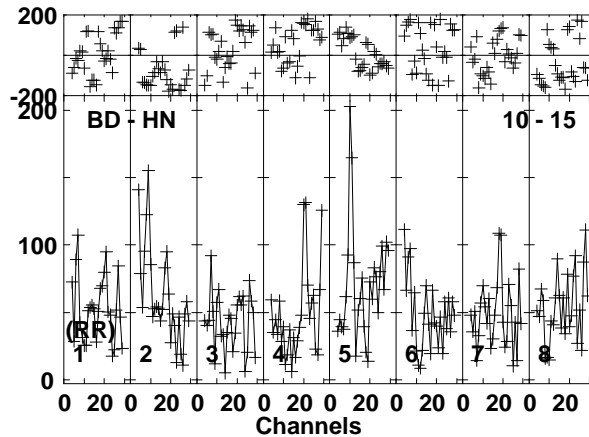
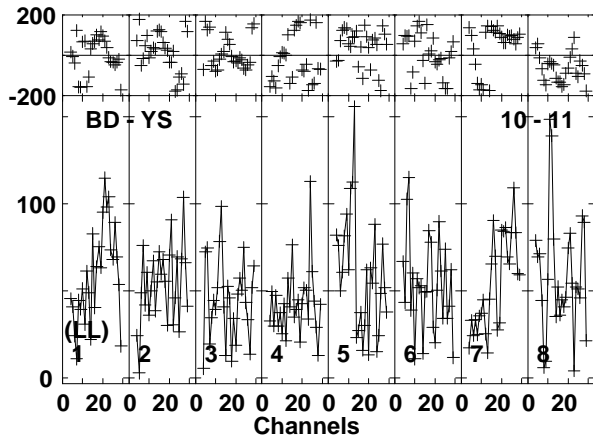
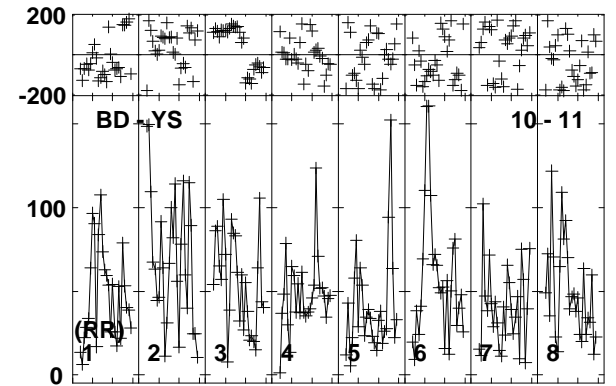
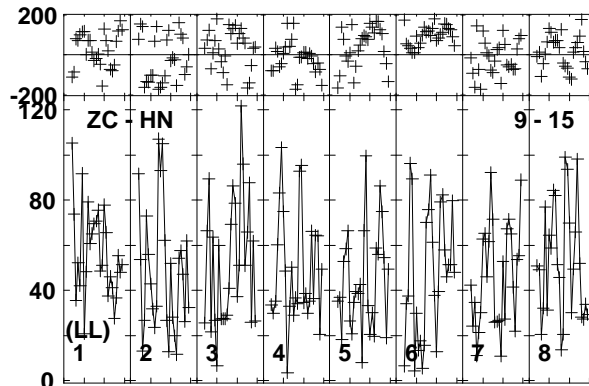
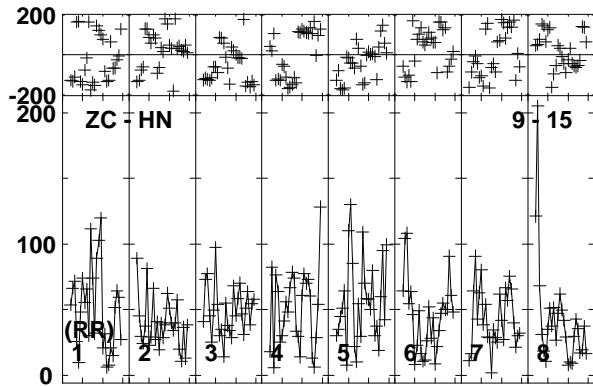
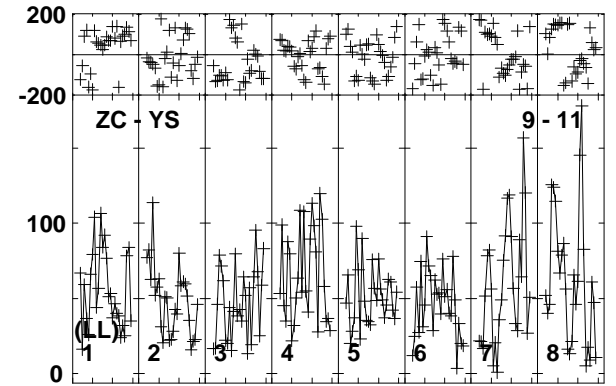
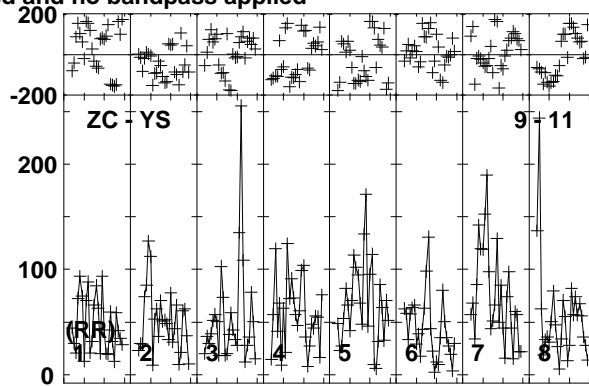
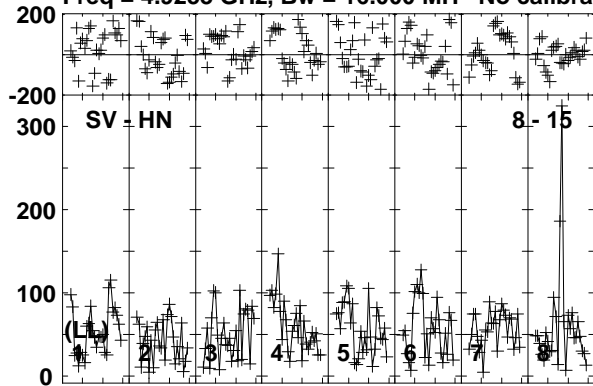

Lower frame: Micro Ampl Jy Top frame: Phas deg
Vector averaged cross-power spectrum Baseline: SV (08) - HN (15)
Timerange: 01/00:01:08 to 01/00:06:20

Plot file version 352 created 11-APR-2016 17:09:14

ARP299C GP053G 3.UVDATA.1

Freq = 4.9253 GHz, Bw = 16.000 MH No calibration applied and no bandpass applied

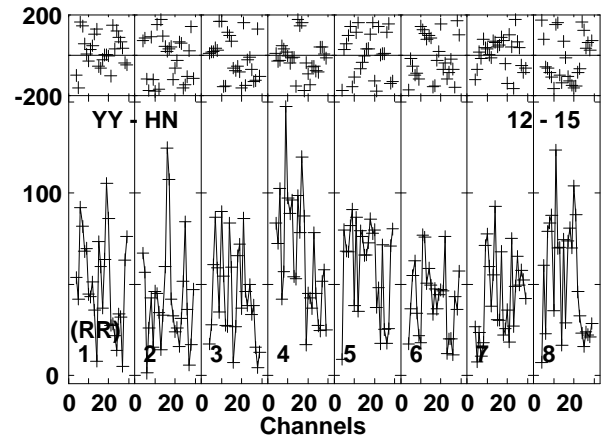
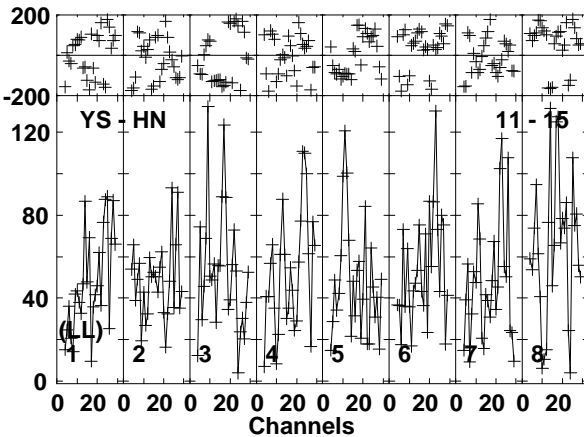
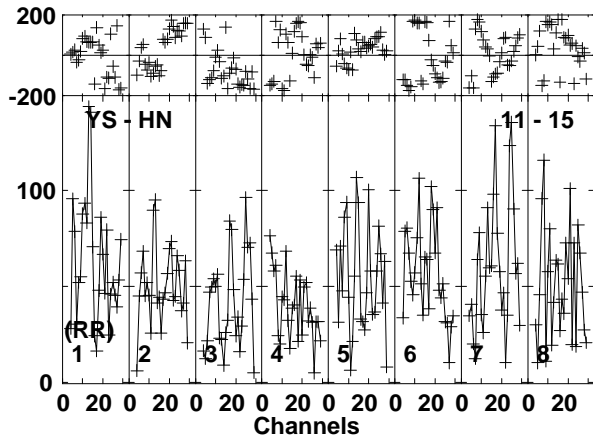
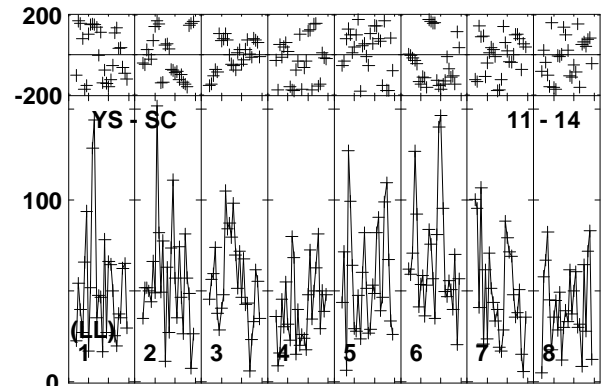
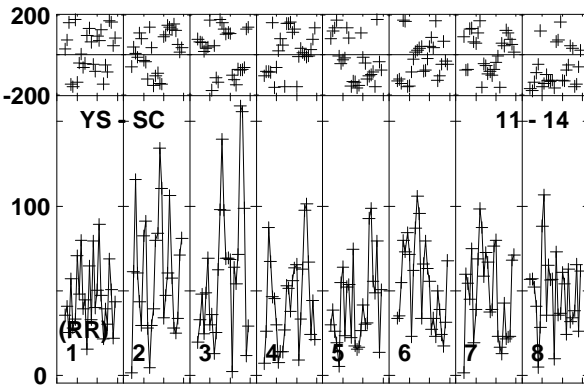
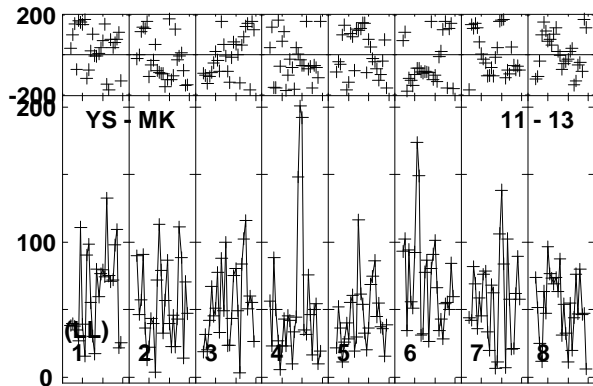
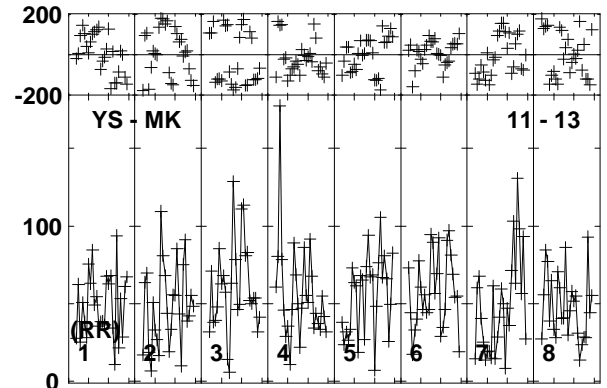
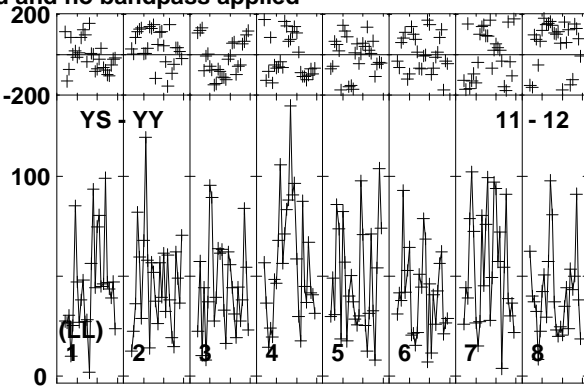
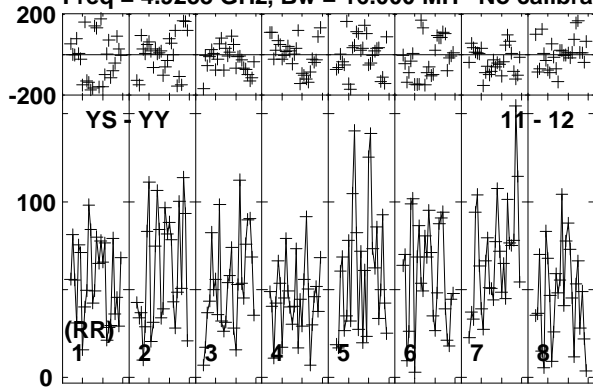

Lower frame: Micro Ampl Jy Top frame: Phas deg
Vector averaged cross-power spectrum Baseline: YS (11) - YY (12)
Timerange: 01/00:01:08 to 01/00:06:20

Plot file version 353 created 11-APR-2016 17:09:14

ARP299C GP053G 3.UVDATA.1

Freq = 4.9253 GHz, Bw = 16.000 MH No calibration applied and no bandpass applied

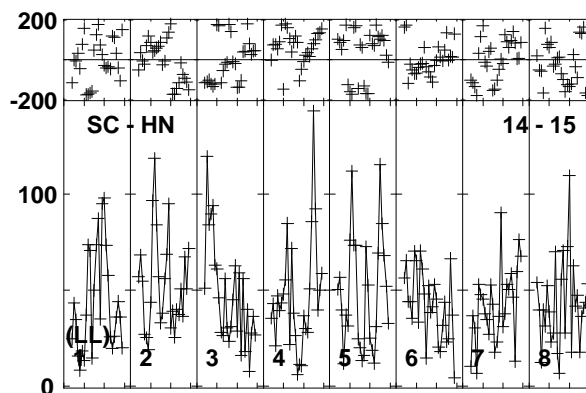
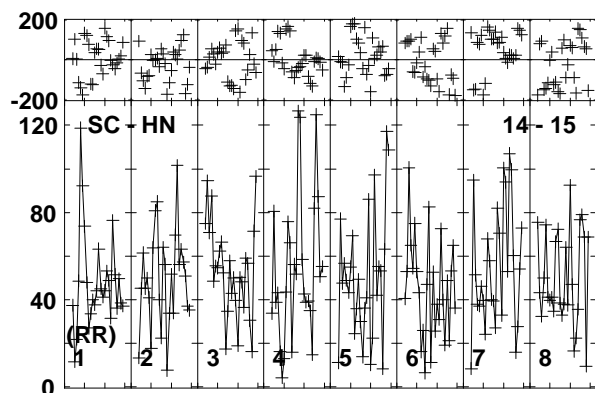
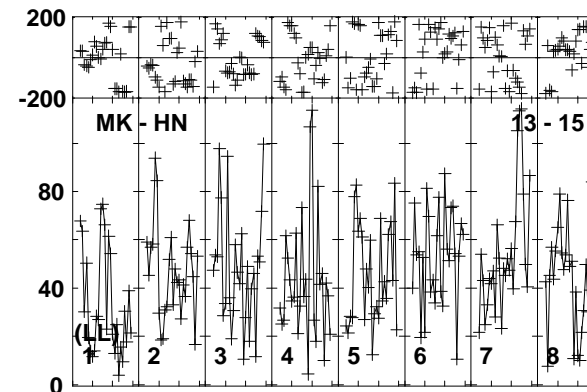
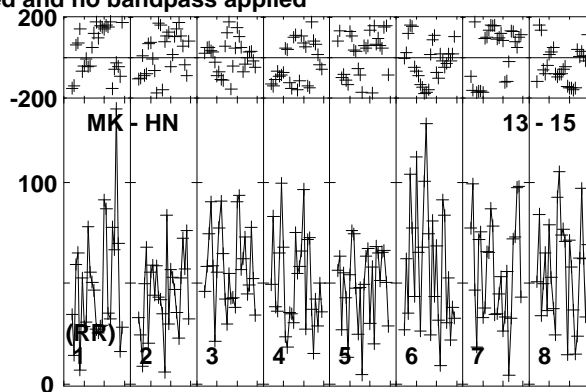
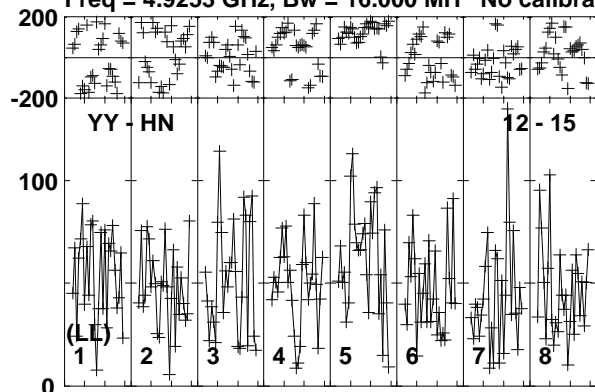

Lower frame: Micro Ampl Jy Top frame: Phas deg
Vector averaged cross-power spectrum Baseline: YY (12) - HN (15)
Timerange: 01/00:01:08 to 01/00:06:20

Plot file version 354 created 11-APR-2016 17:09:14
 J1128+5925 GP053G 3.UVDATA.1

Freq = 4.9253 GHz, Bw = 16.000 MH No calibration applied and no bandpass applied

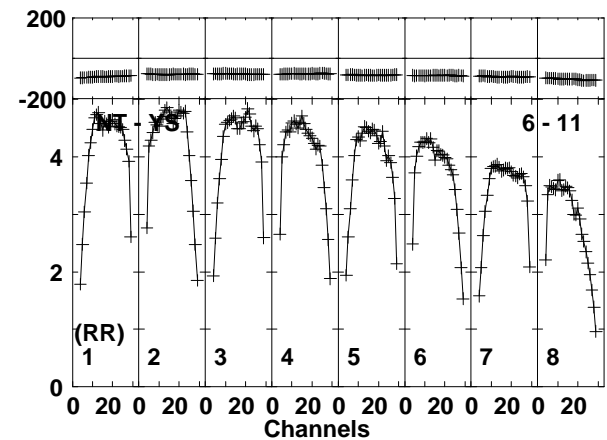
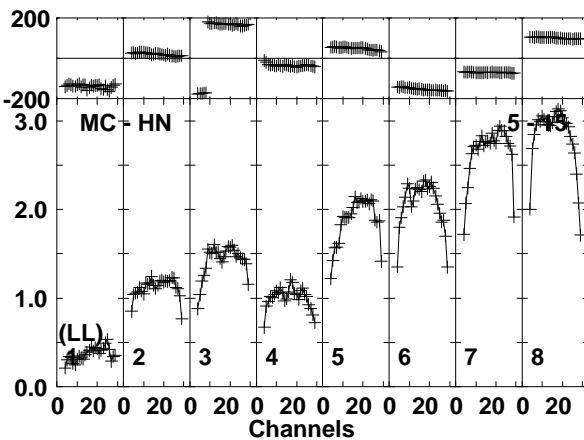
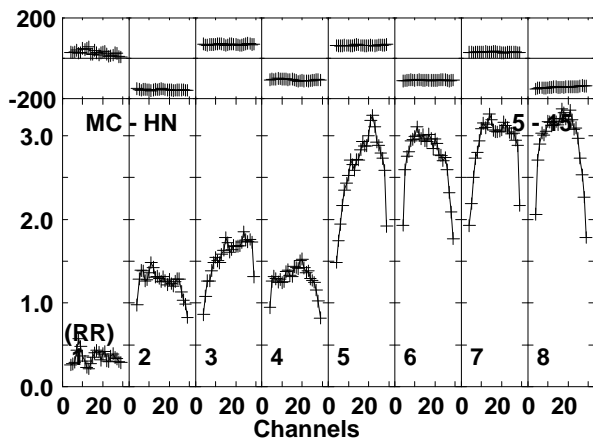
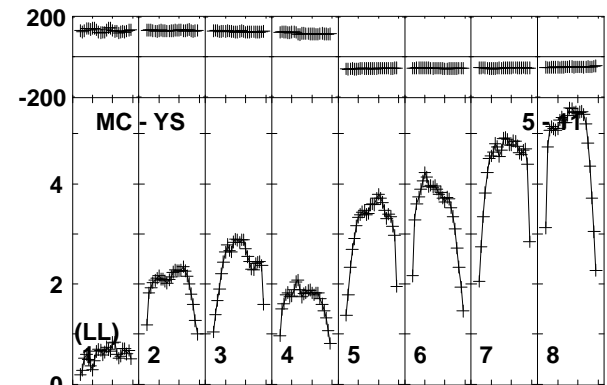
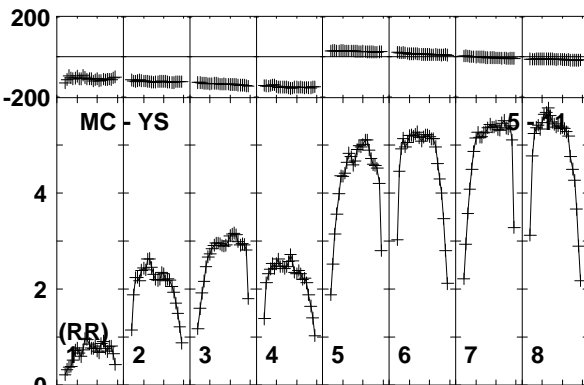
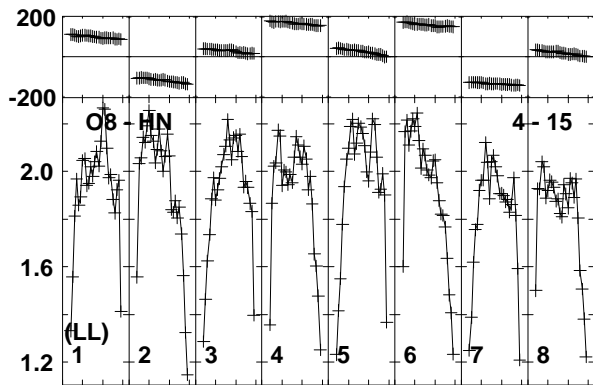
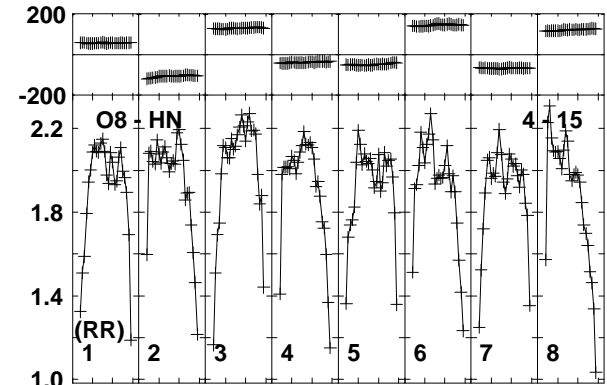
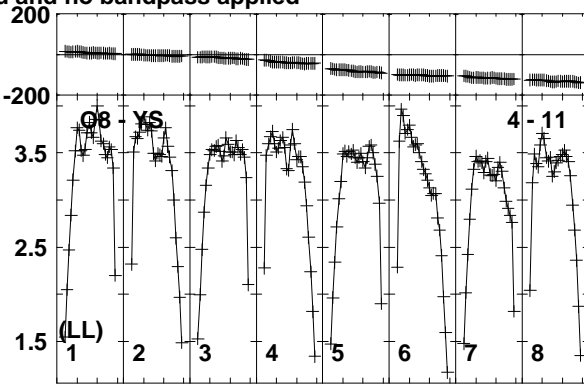
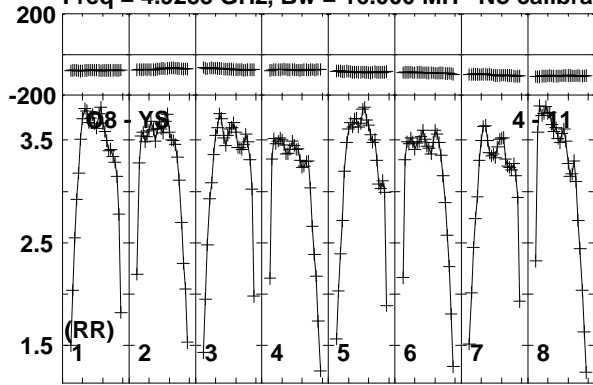

Lower frame: Milli Ampl Jy Top frame: Phas deg
 Vector averaged cross-power spectrum Baseline: O8 (04) - YS (11)
 Timerange: 01/00:06:26 to 01/00:08:18

Plot file version 355 created 11-APR-2016 17:09:14

J1128+5925 GP053G 3.UVDATA.1

Freq = 4.9253 GHz, Bw = 16.000 MH No calibration applied and no bandpass applied

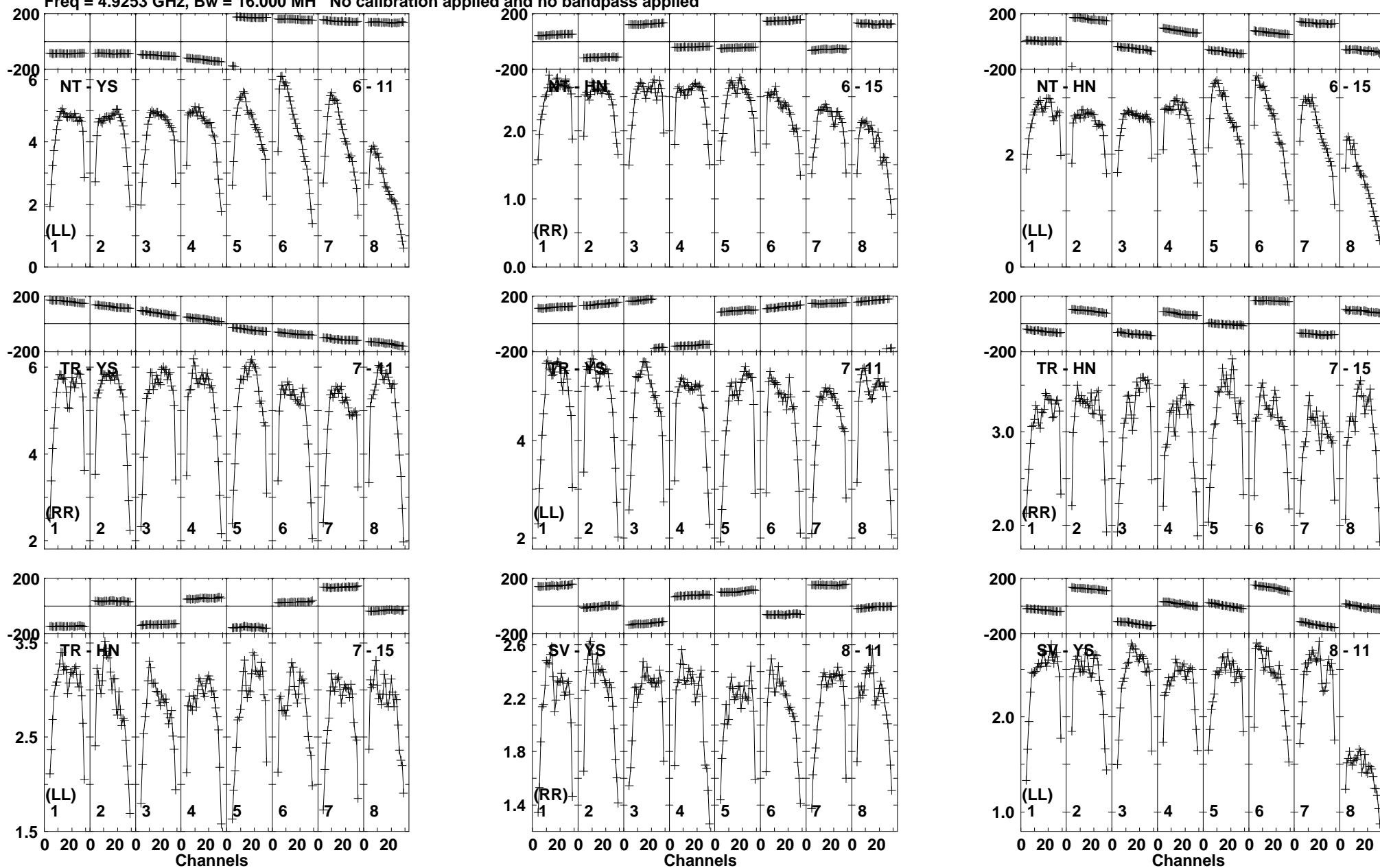

Lower frame: Milli Ampl Jy Top frame: Phas deg
Vector averaged cross-power spectrum Baseline: NT (06) - YS (11)
Timerange: 01/00:06:26 to 01/00:08:18

Plot file version 356 created 11-APR-2016 17:09:14

J1128+5925 GP053G 3.UVDATA.1

Freq = 4.9253 GHz, Bw = 16.000 MH No calibration applied and no bandpass applied

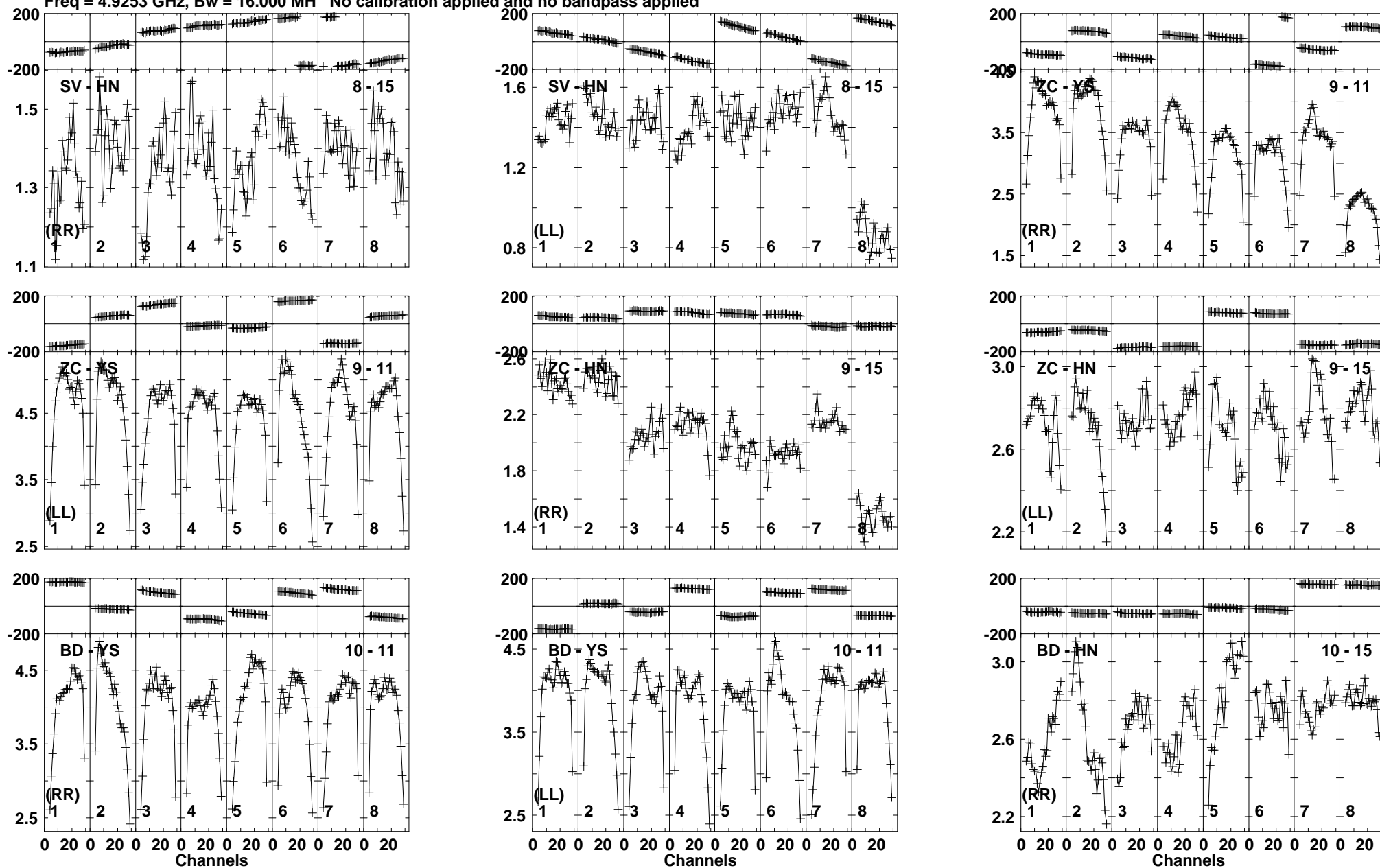

Lower frame: Milli Ampl Jy Top frame: Phas deg
Vector averaged cross-power spectrum Baseline: SV (08) - HN (15)
Timerange: 01/00:06:26 to 01/00:08:18

Plot file version 357 created 11-APR-2016 17:09:14

J1128+5925 GP053G 3.UVDATA.1

Freq = 4.9253 GHz, Bw = 16.000 MH No calibration applied and no bandpass applied

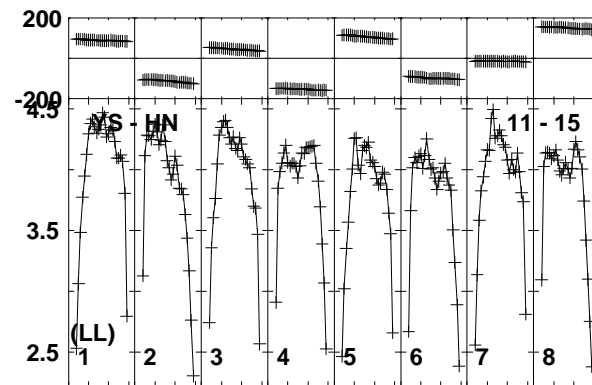
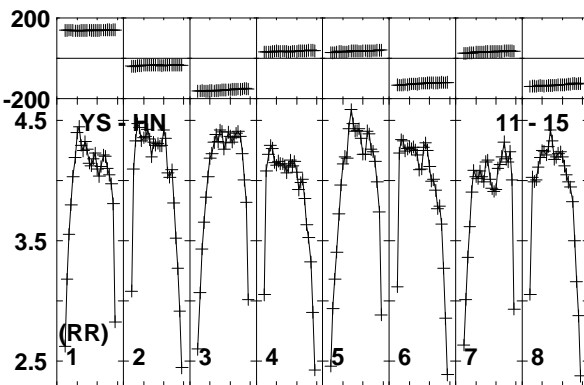
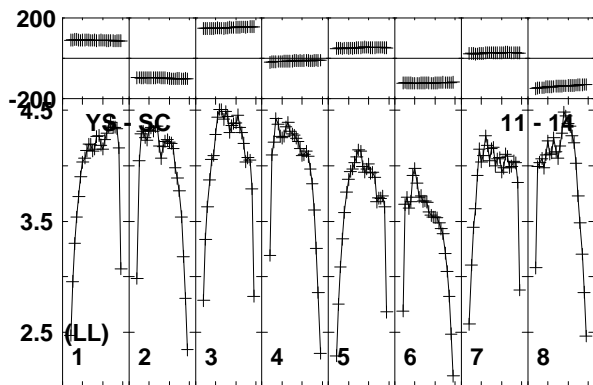
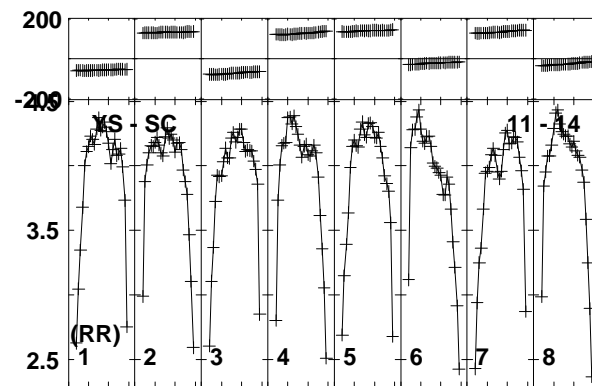
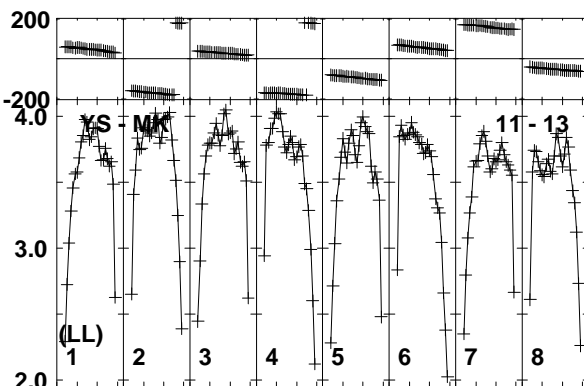
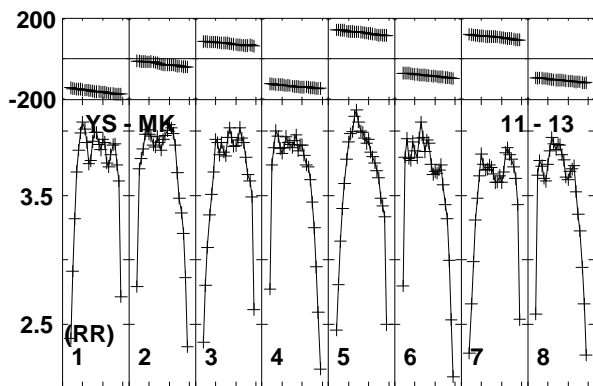
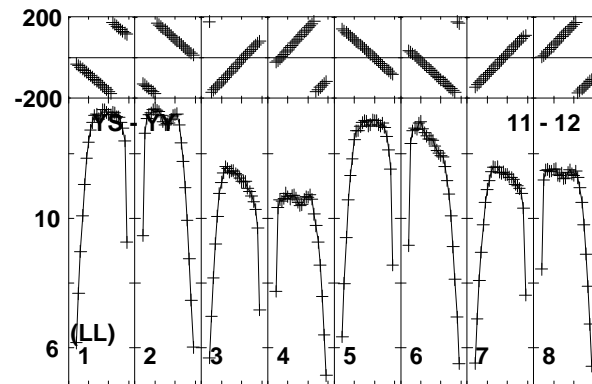
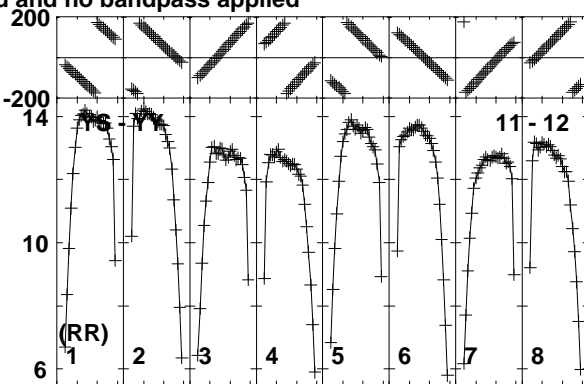
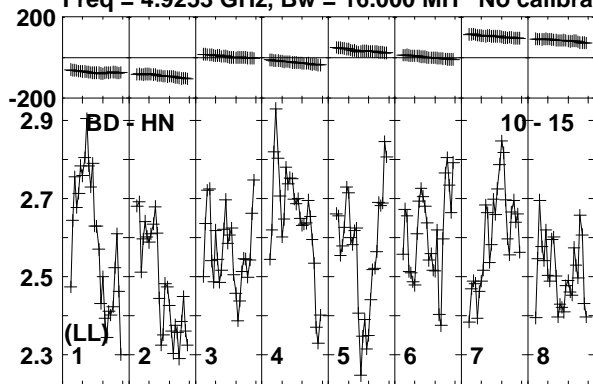

Lower frame: Milli Ampl Jy Top frame: Phas deg
Vector averaged cross-power spectrum Baseline: BD (10) - HN (15)
Timerange: 01/00:06:26 to 01/00:08:18

Plot file version 358 created 11-APR-2016 17:09:15

J1128+5925 GP053G 3.UVDATA.1

Freq = 4.9253 GHz, Bw = 16.000 MH No calibration applied and no bandpass applied

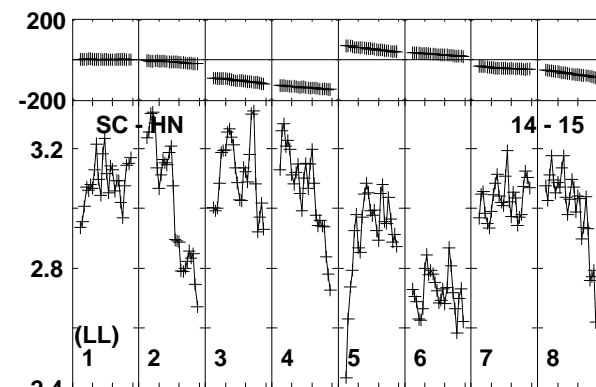
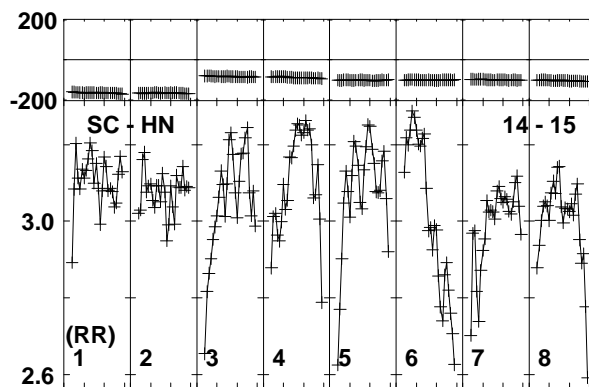
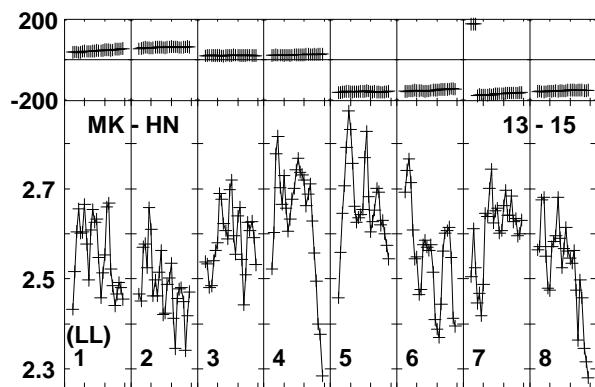
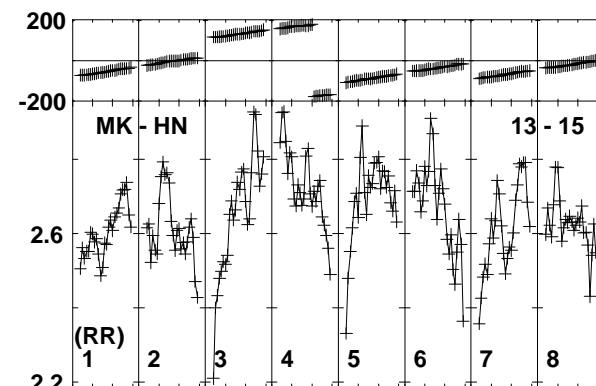
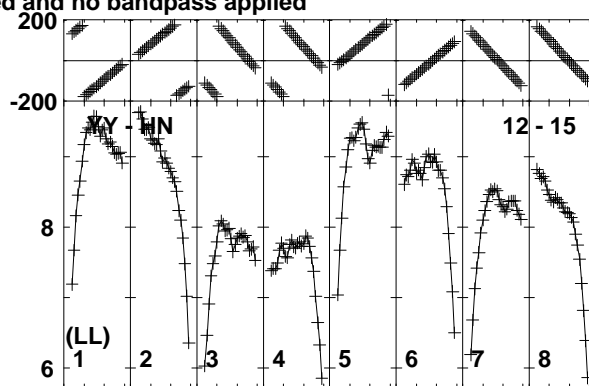
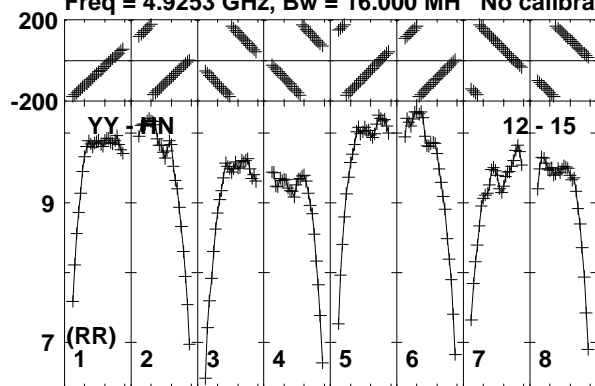

Lower frame: Milli Ampl Jy Top frame: Phas deg
Vector averaged cross-power spectrum Baseline: YY (12) - HN (15)
Timerange: 01/00:06:26 to 01/00:08:18

Plot file version 359 created 11-APR-2016 17:09:15

ARP299C GP053G 3.UVDATA.1

Freq = 4.9253 GHz, Bw = 16.000 MH No calibration applied and no bandpass applied

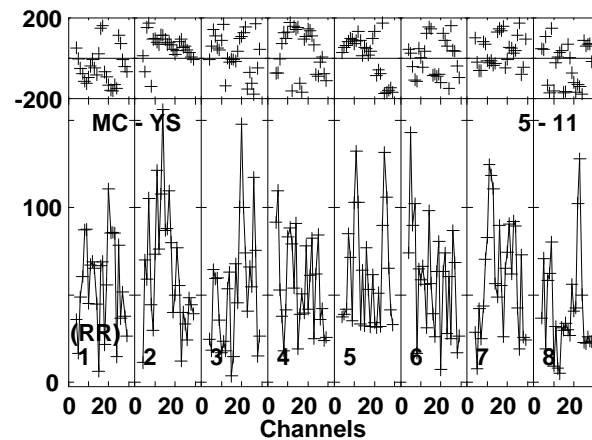
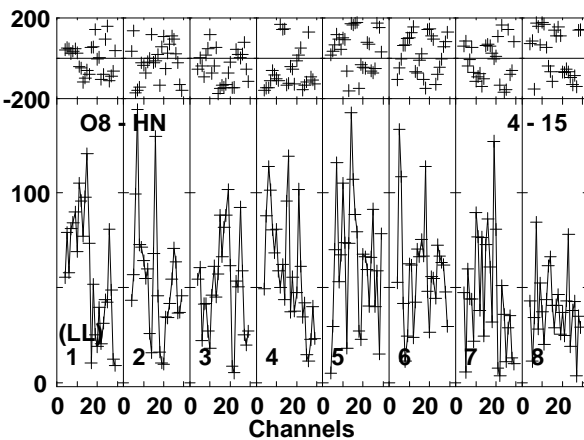
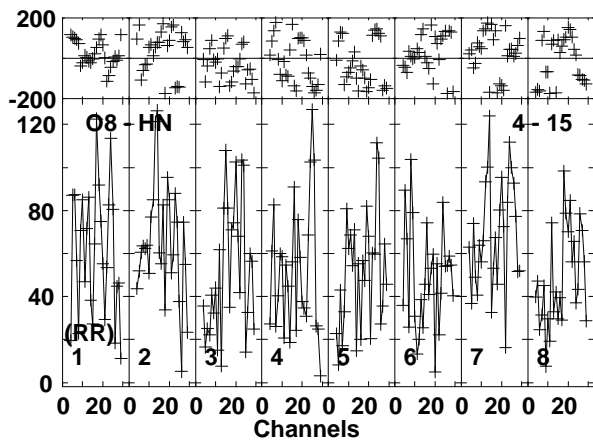
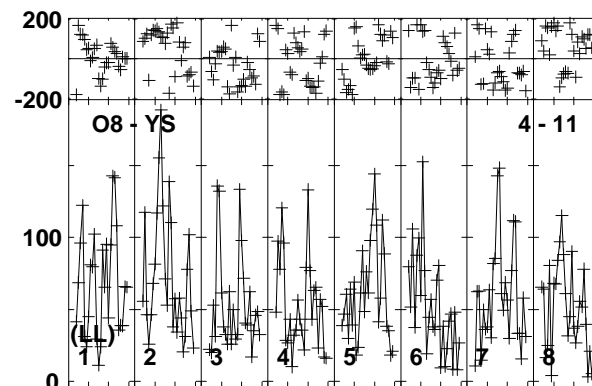
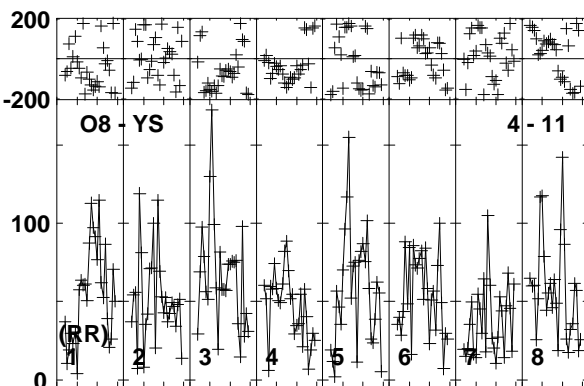
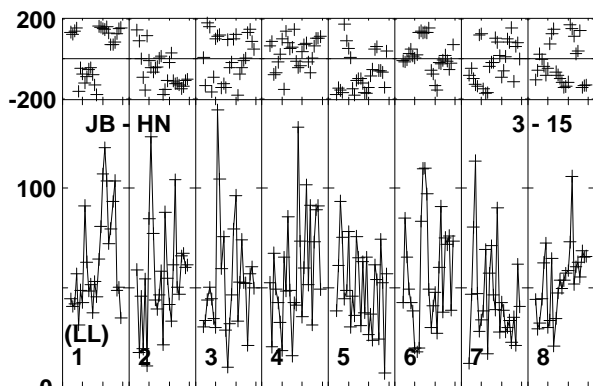
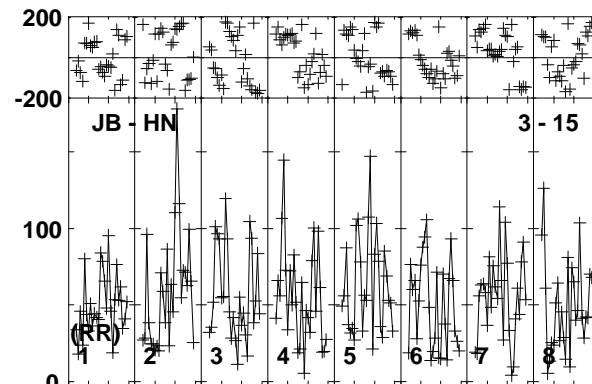
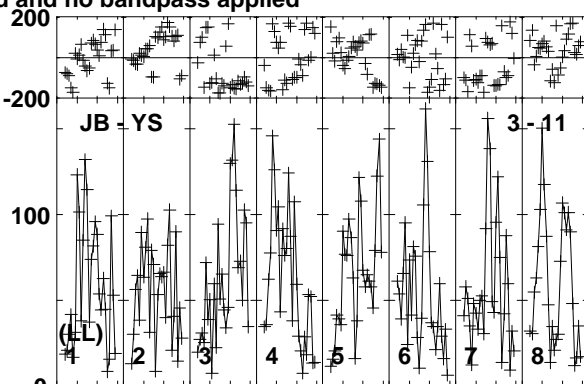
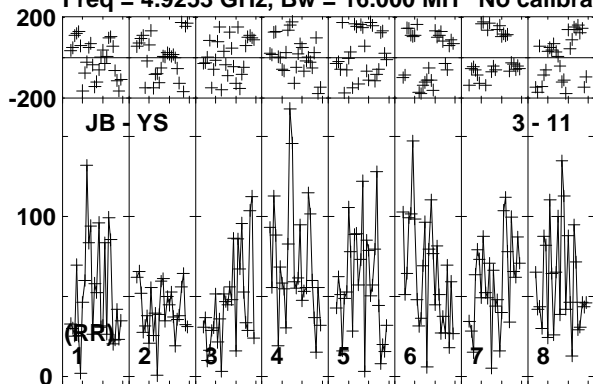

Lower frame: Micro Ampl Jy Top frame: Phas deg
Vector averaged cross-power spectrum Baseline: JB (03) - YS (11)
Timerange: 01/00:08:23 to 01/00:13:37

Plot file version 360 created 11-APR-2016 17:09:15

ARP299C GP053G 3.UVDATA.1

Freq = 4.9253 GHz, Bw = 16.000 MH No calibration applied and no bandpass applied

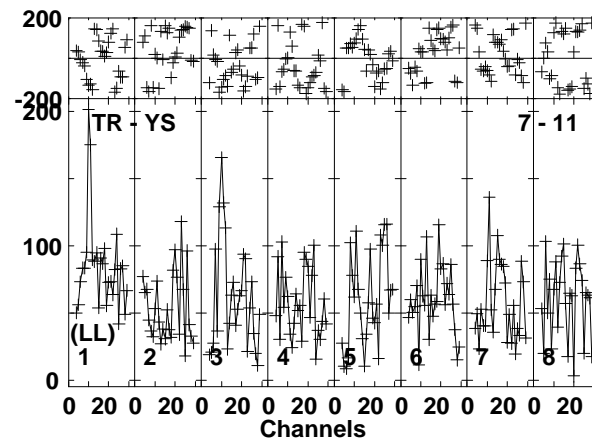
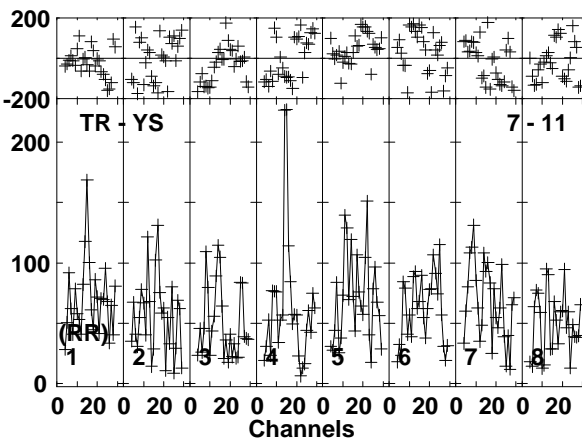
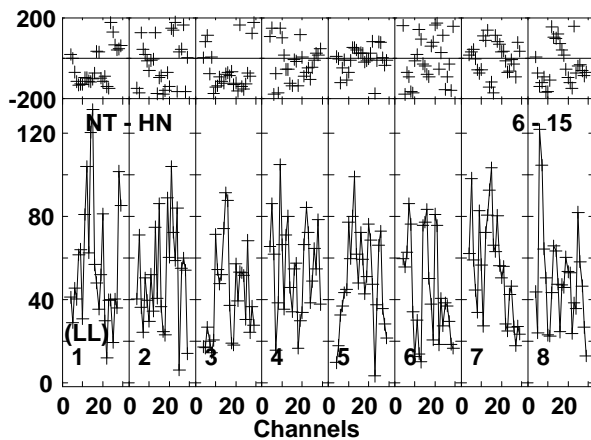
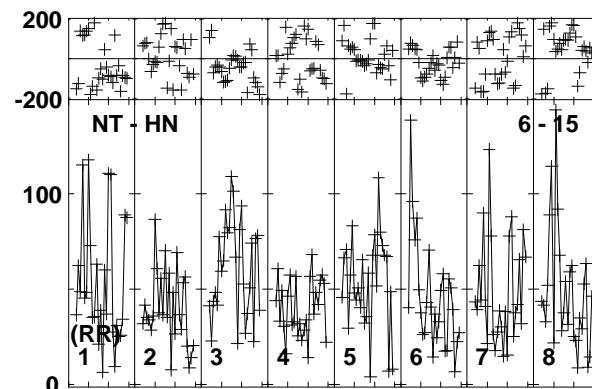
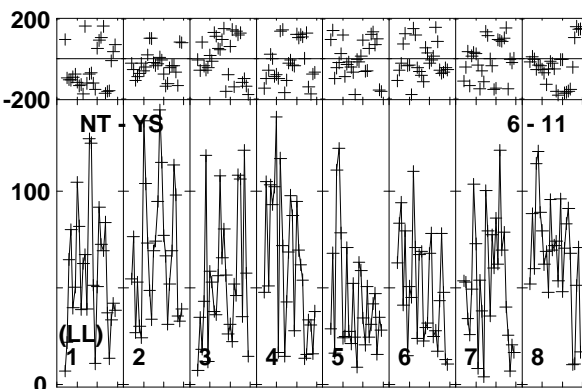
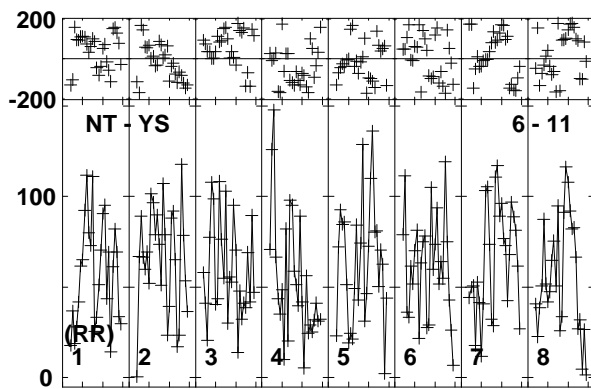
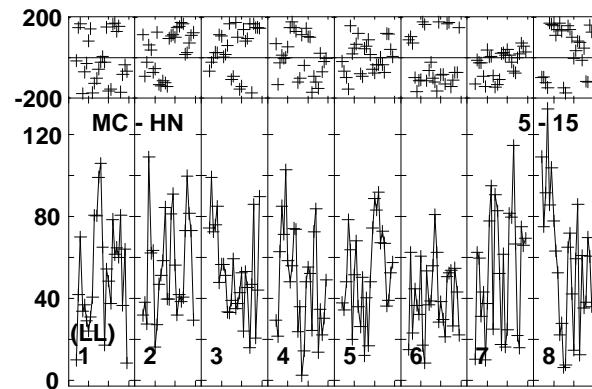
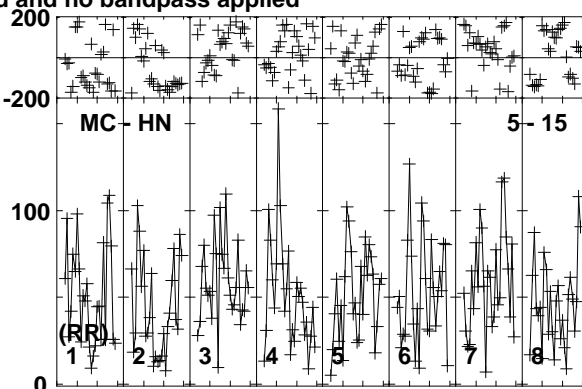
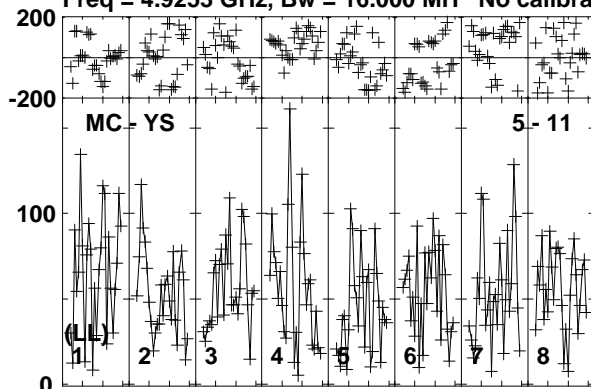

Lower frame: Micro Ampl Jy Top frame: Phas deg
Vector averaged cross-power spectrum Baseline: MC (05) - YS (11)
Timerange: 01/00:08:23 to 01/00:13:37

Plot file version 361 created 11-APR-2016 17:09:15

ARP299C GP053G 3.UVDATA.1

Freq = 4.9253 GHz, Bw = 16.000 MH No calibration applied and no bandpass applied

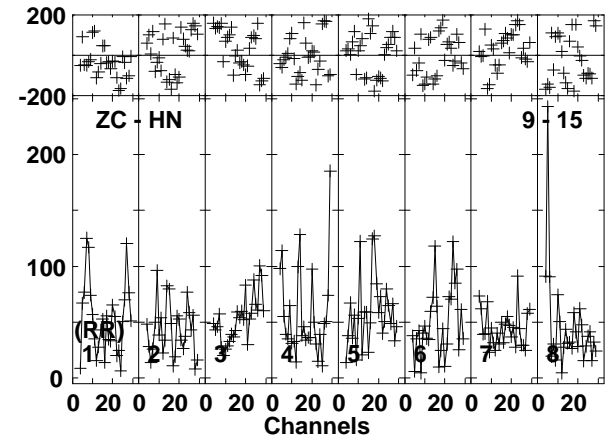
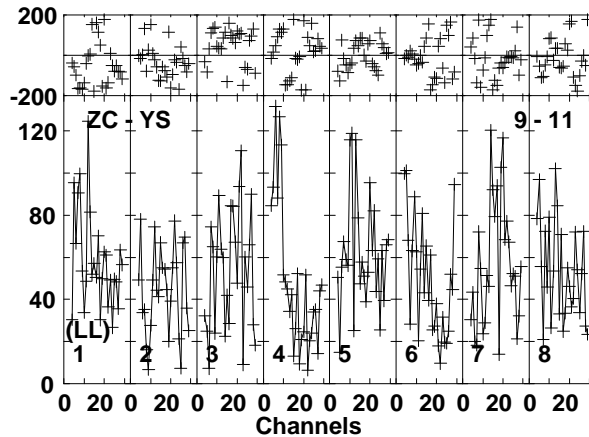
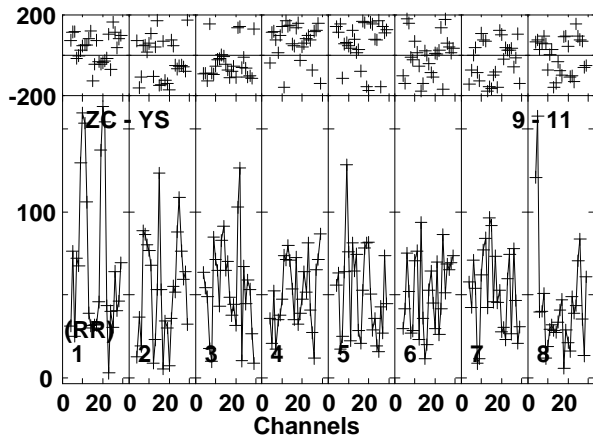
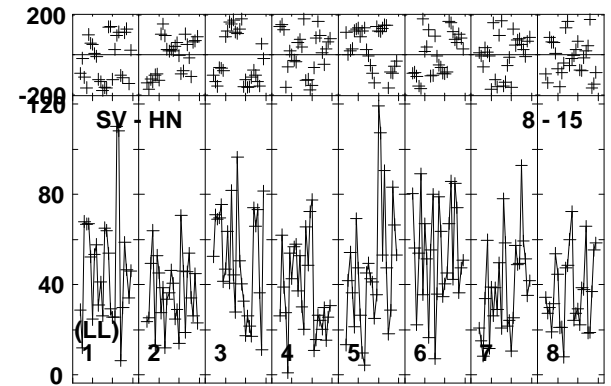
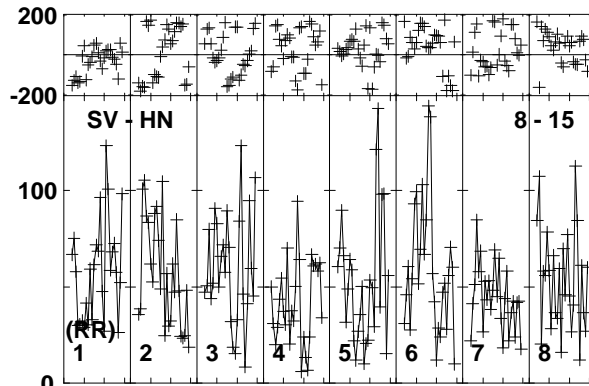
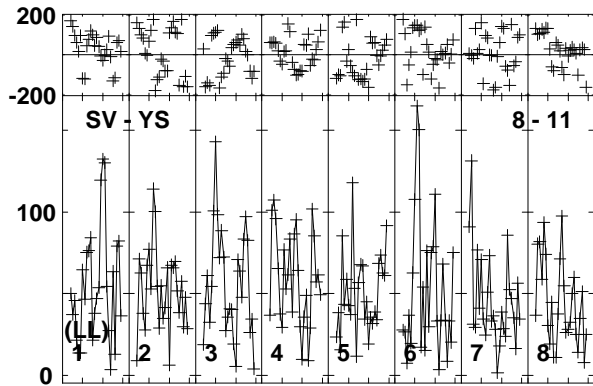
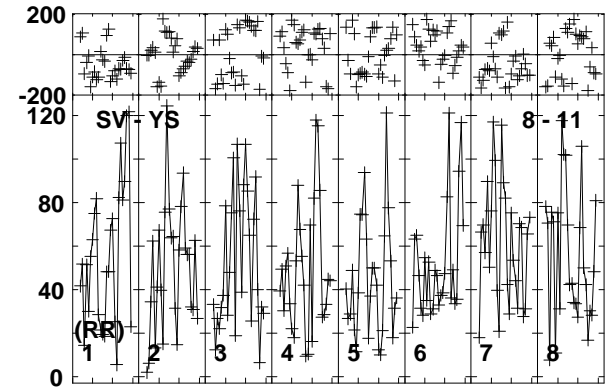
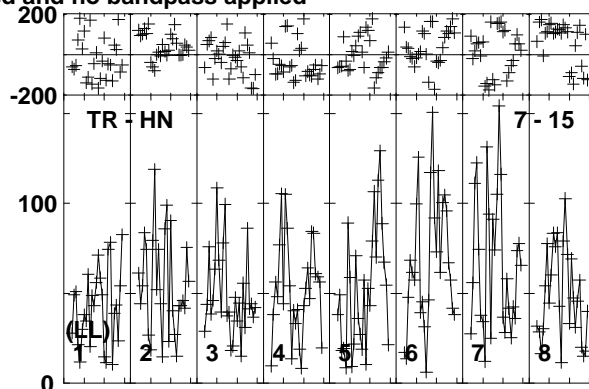
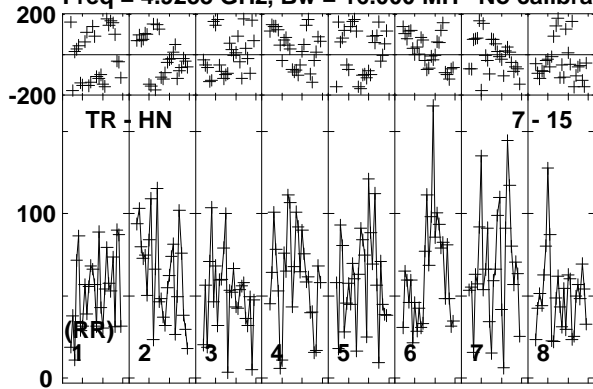

Lower frame: Micro Ampl Jy Top frame: Phas deg
Vector averaged cross-power spectrum Baseline: TR (07) - HN (15)
Timerange: 01/00:08:23 to 01/00:13:37

Plot file version 362 created 11-APR-2016 17:09:15

ARP299C GP053G 3.UVDATA.1

Freq = 4.9253 GHz, Bw = 16.000 MH No calibration applied and no bandpass applied

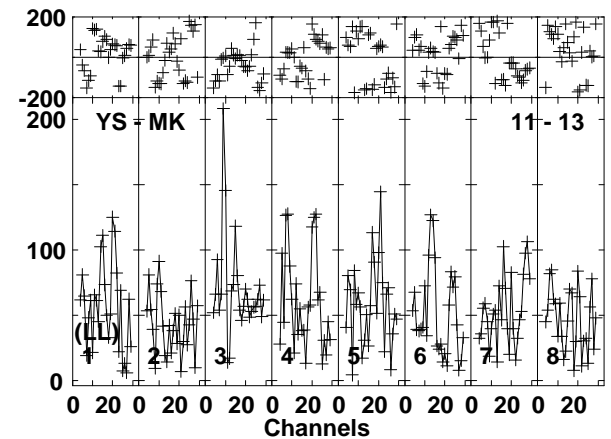
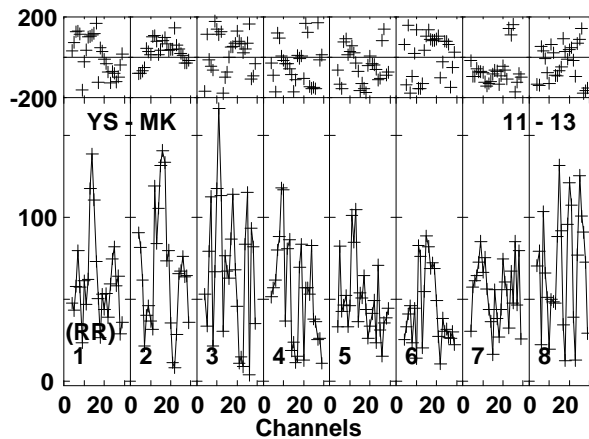
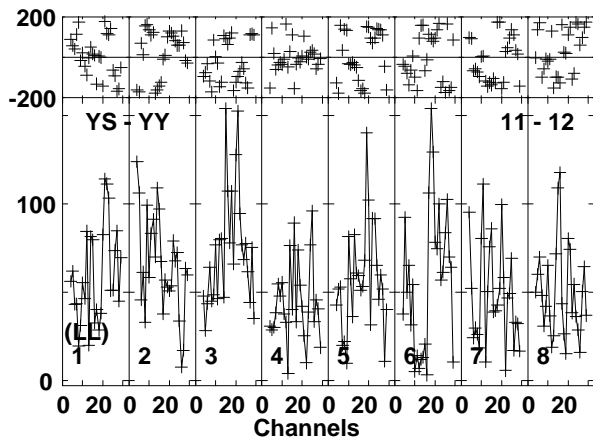
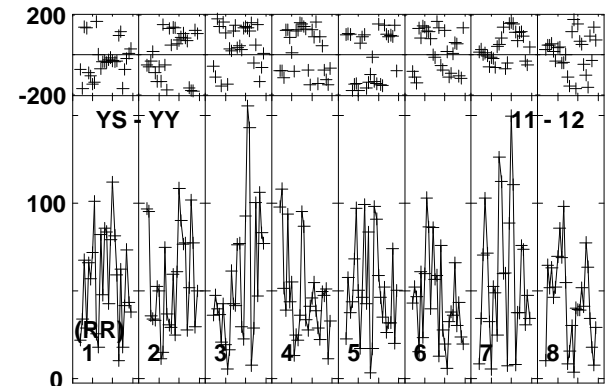
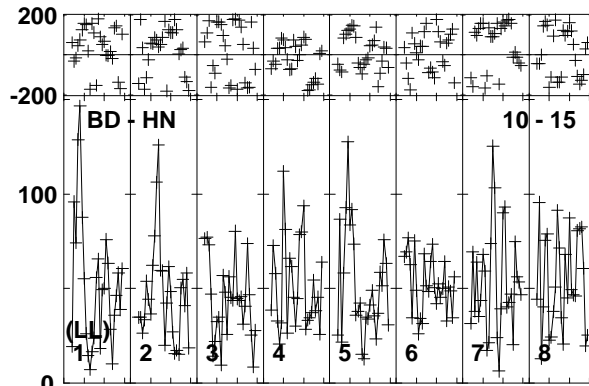
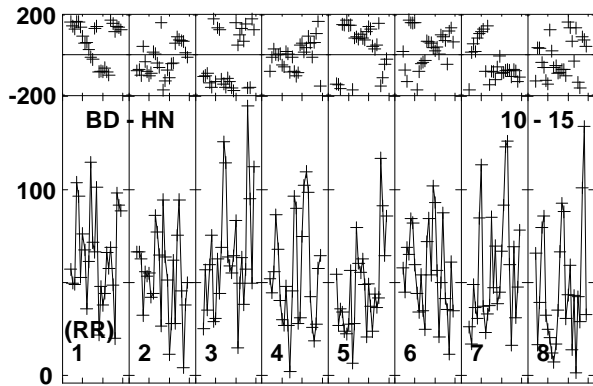
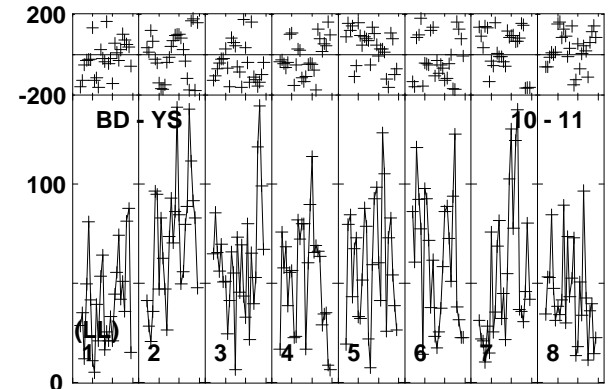
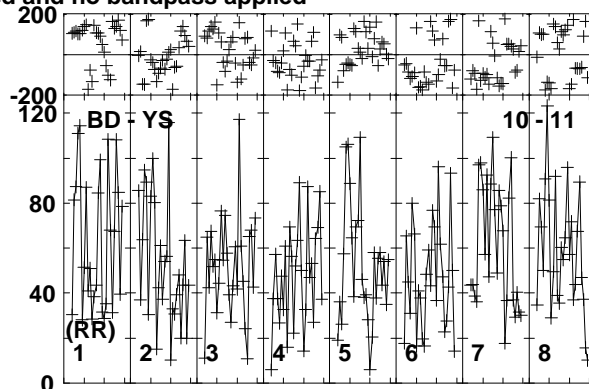
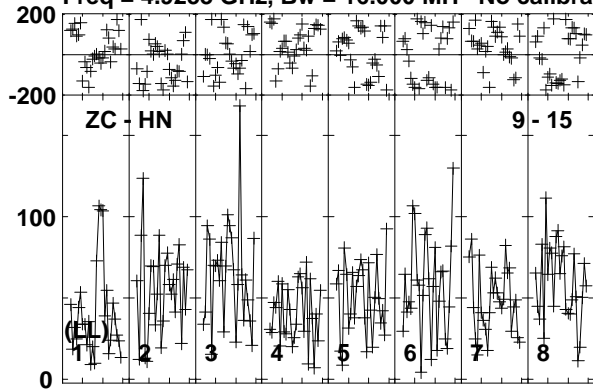

Lower frame: Micro Ampl Jy Top frame: Phas deg
Vector averaged cross-power spectrum Baseline: ZC (09) - HN (15)
Timerange: 01/00:08:23 to 01/00:13:37

Plot file version 363 created 11-APR-2016 17:09:16

ARP299C GP053G 3.UVDATA.1

Freq = 4.9253 GHz, Bw = 16.000 MH No calibration applied and no bandpass applied

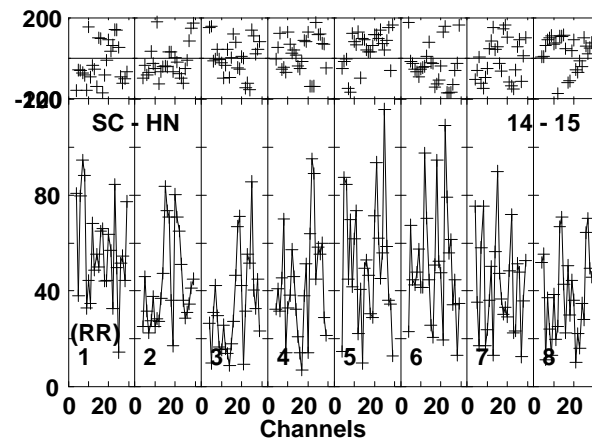
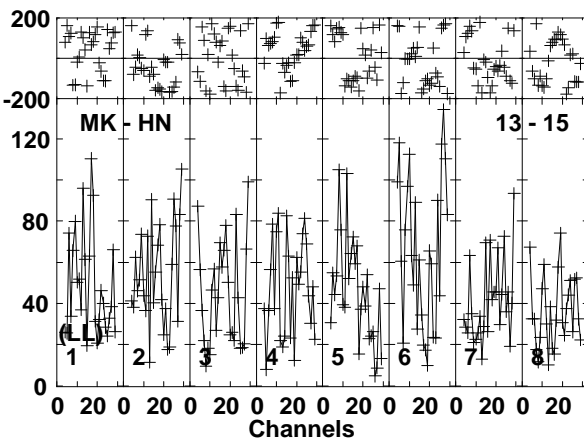
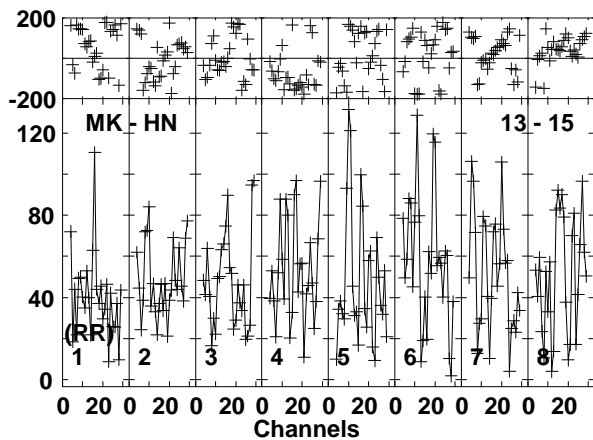
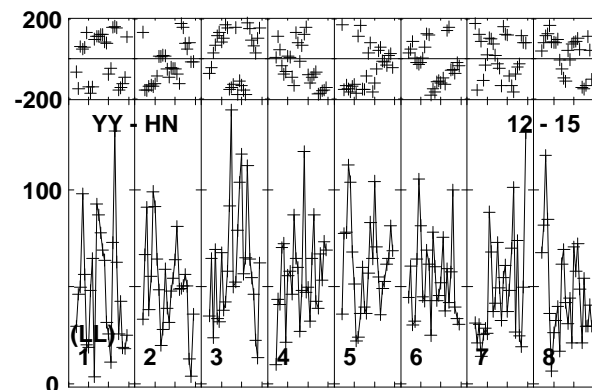
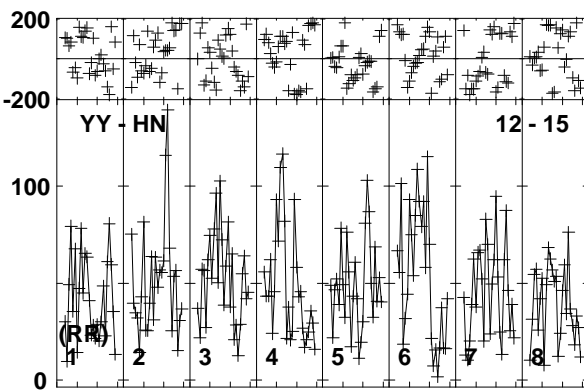
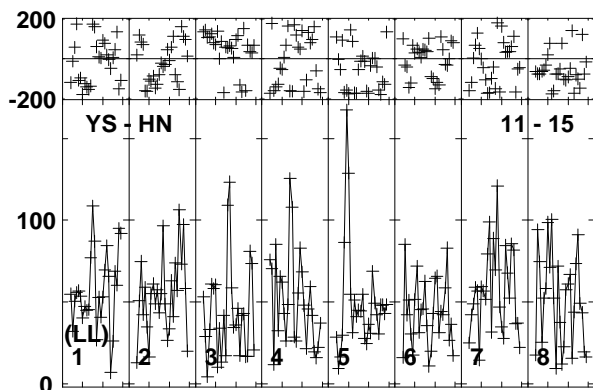
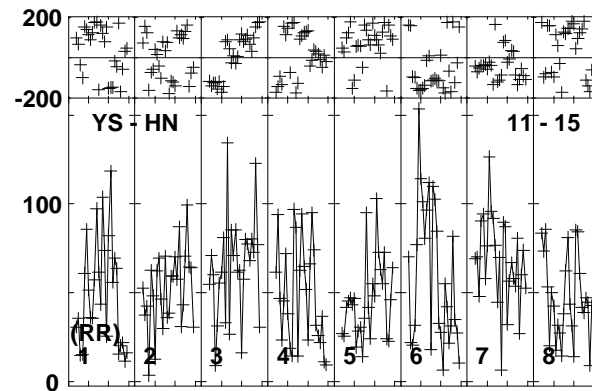
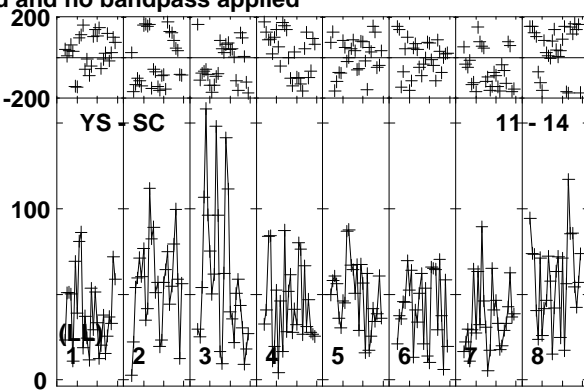
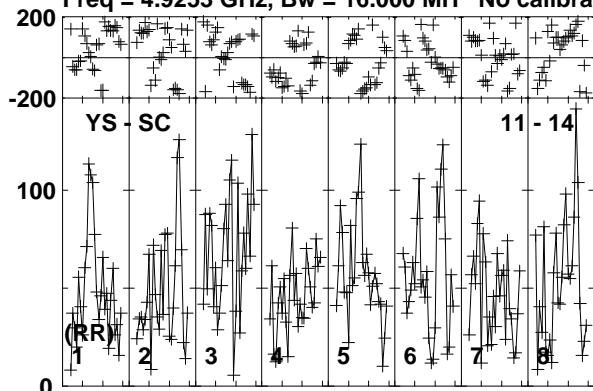

Lower frame: Micro Ampl Jy Top frame: Phas deg
Vector averaged cross-power spectrum Baseline: YS (11) - SC (14)
Timerange: 01/00:08:23 to 01/00:13:37

Plot file version 364 created 11-APR-2016 17:09:16

ARP299C GP053G 3.UVDATA.1

Freq = 4.9253 GHz, Bw = 16.000 MH No calibration applied and no bandpass applied

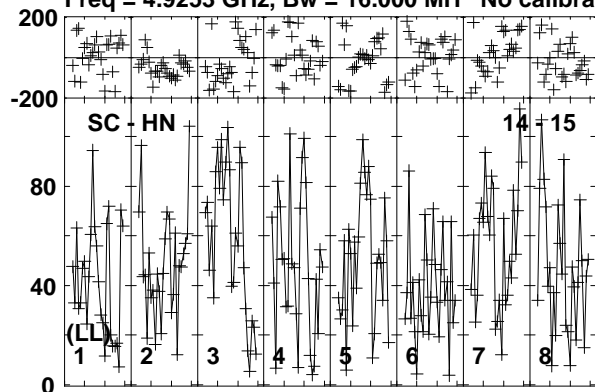

Lower frame: Micro Ampl Jy Top frame: Phas deg
Vector averaged cross-power spectrum Baseline: SC (14) - HN (15)
Timerange: 01/00:08:23 to 01/00:13:37

Plot file version 365 created 11-APR-2016 17:09:16

J1128+5925 GP053G 3.UVDATA.1

Freq = 4.9253 GHz, Bw = 16.000 MH No calibration applied and no bandpass applied

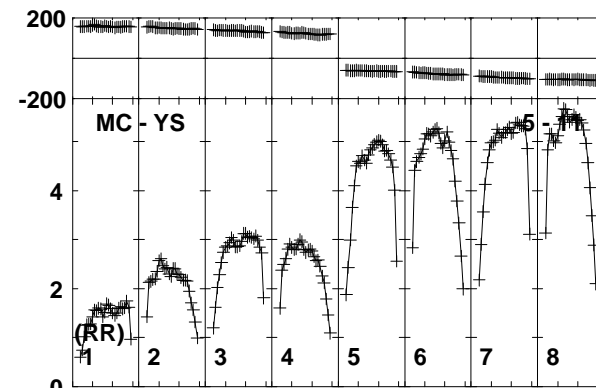
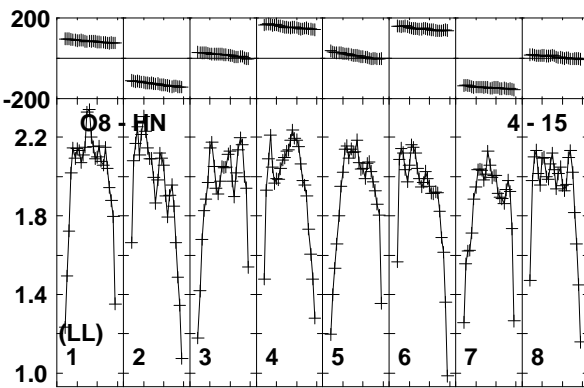
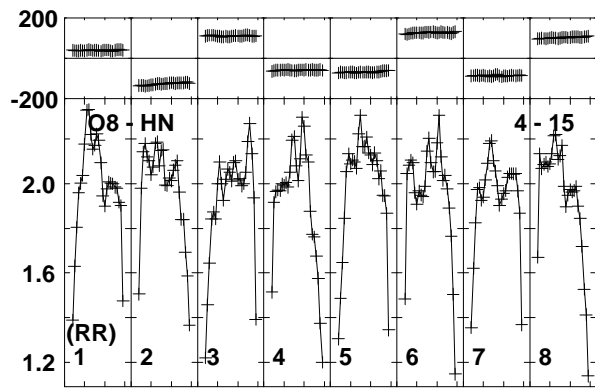
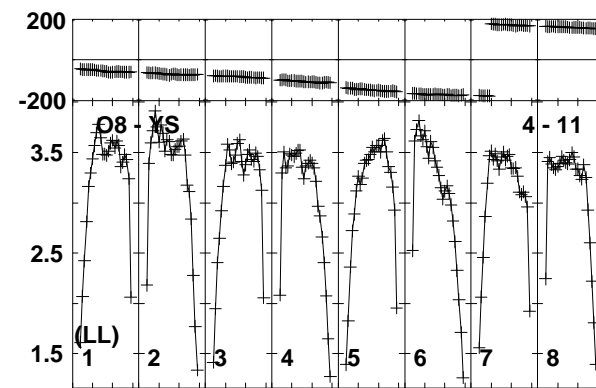
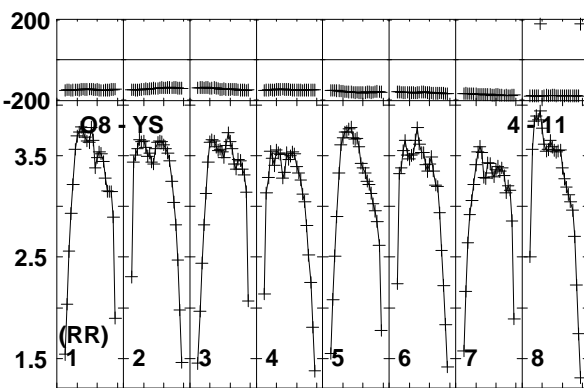
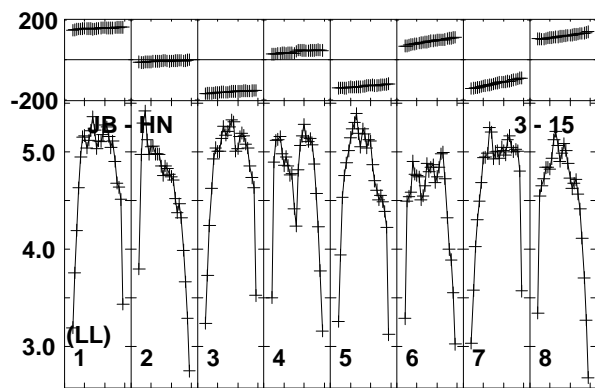
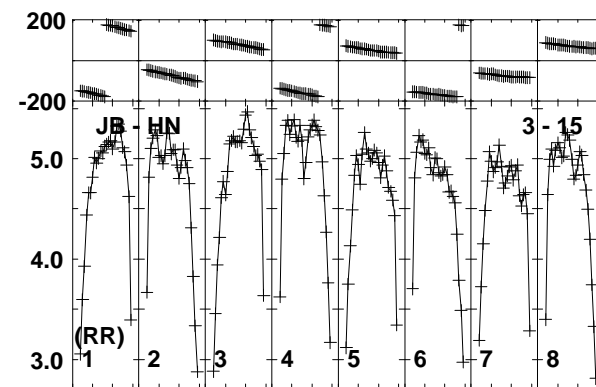
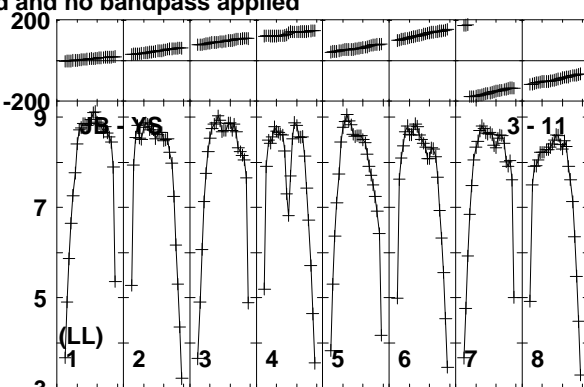
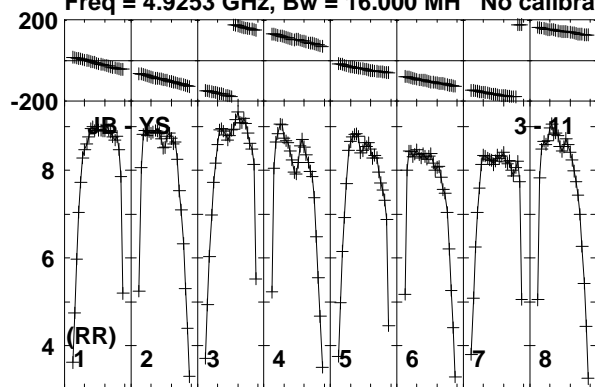

Lower frame: Milli Ampl Jy Top frame: Phas deg
Vector averaged cross-power spectrum Baseline: JB (03) - YS (11)
Timerange: 01/00:13:43 to 01/00:15:27

Plot file version 366 created 11-APR-2016 17:09:16

J1128+5925 GP053G 3.UVDATA.1

Freq = 4.9253 GHz, Bw = 16.000 MH No calibration applied and no bandpass applied

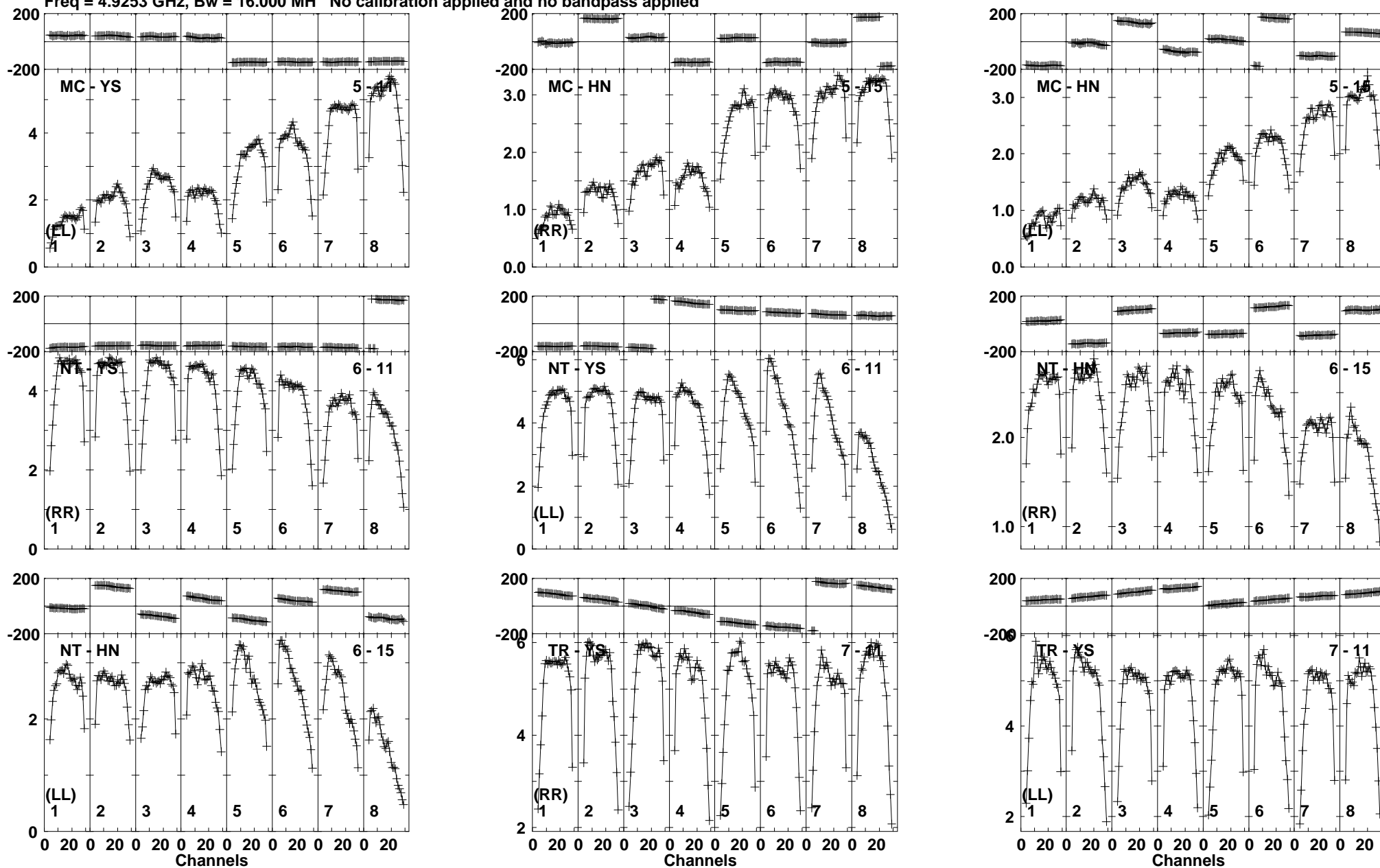

Lower frame: Milli Ampl Jy Top frame: Phas deg
Vector averaged cross-power spectrum Baseline: MC (05) - YS (11)
Timerange: 01/00:13:43 to 01/00:15:27

Plot file version 367 created 11-APR-2016 17:09:16

J1128+5925 GP053G 3.UVDATA.1

Freq = 4.9253 GHz, Bw = 16.000 MH No calibration applied and no bandpass applied

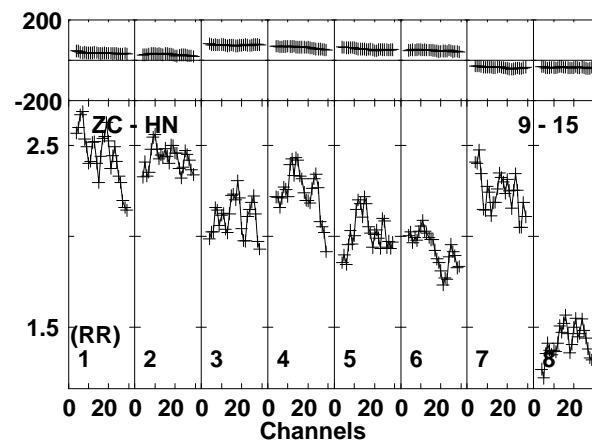
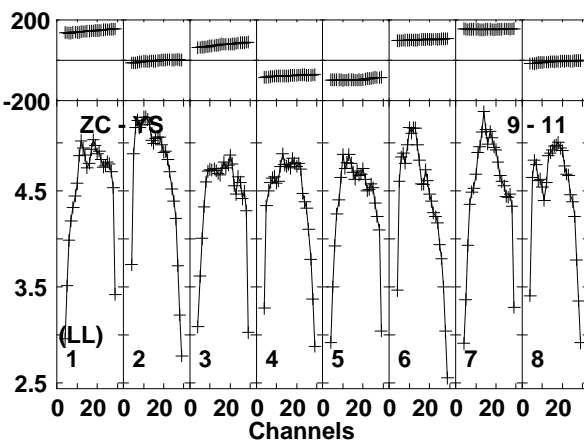
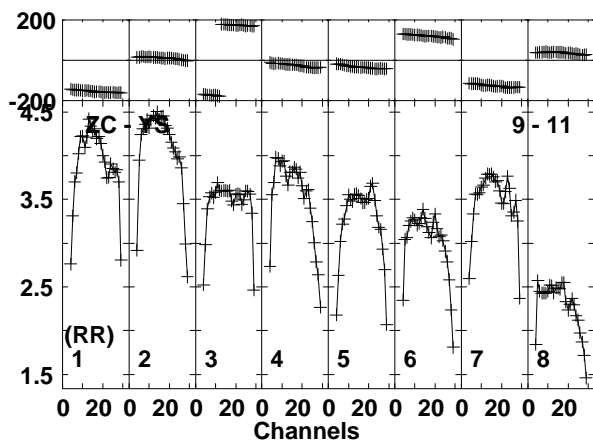
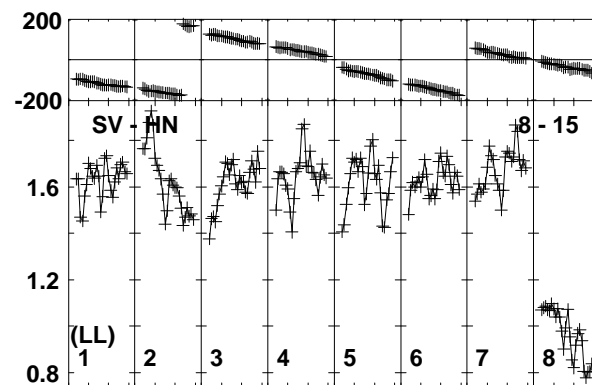
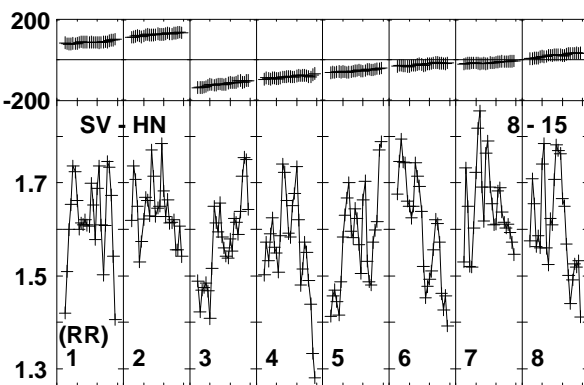
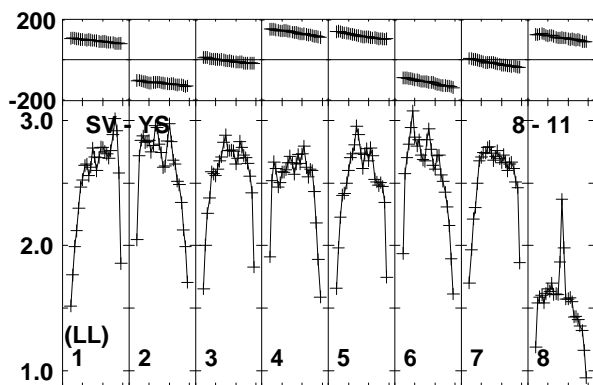
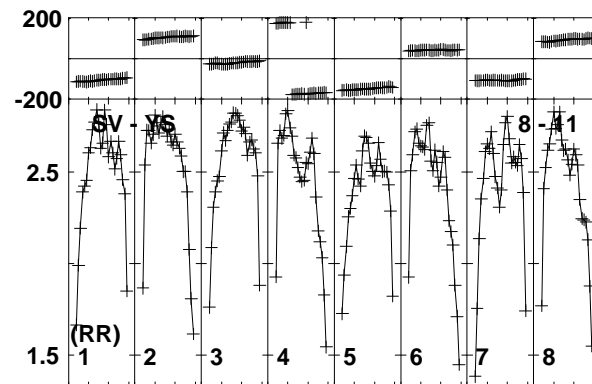
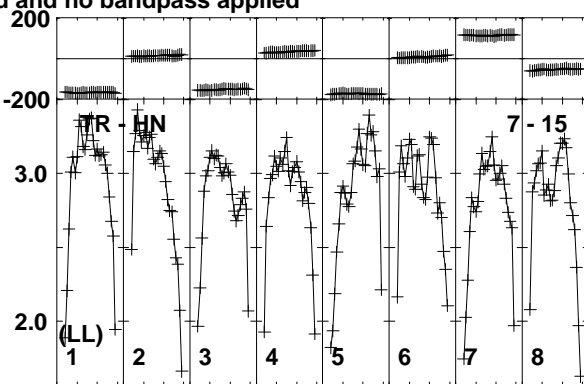
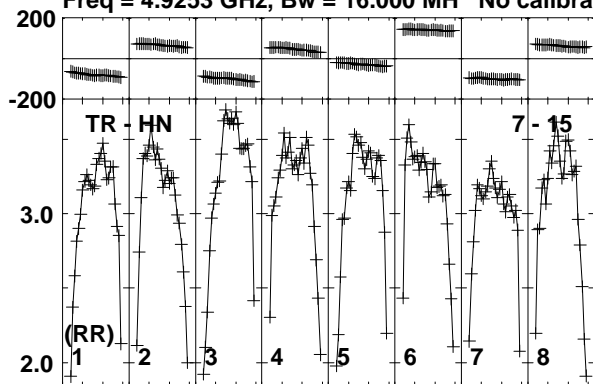

Lower frame: Milli Ampl Jy Top frame: Phas deg
Vector averaged cross-power spectrum Baseline: TR (07) - HN (15)
Timerange: 01/00:13:43 to 01/00:15:27

Plot file version 368 created 11-APR-2016 17:09:16

J1128+5925 GP053G 3.UVDATA.1

Freq = 4.9253 GHz, Bw = 16.000 MH No calibration applied and no bandpass applied

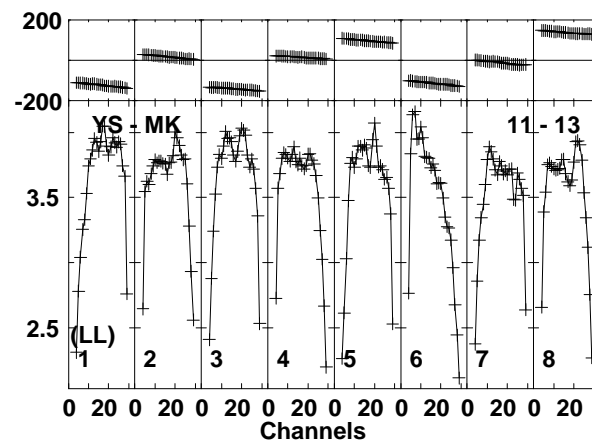
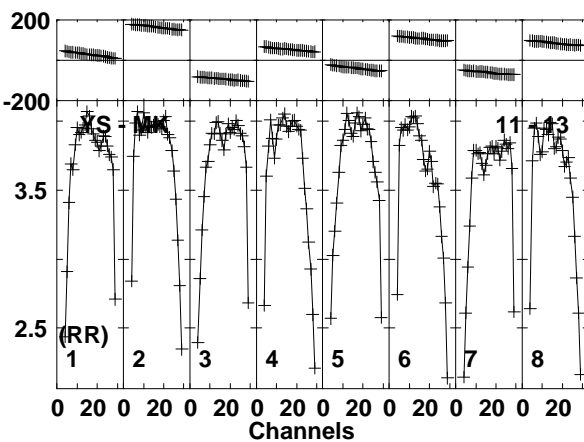
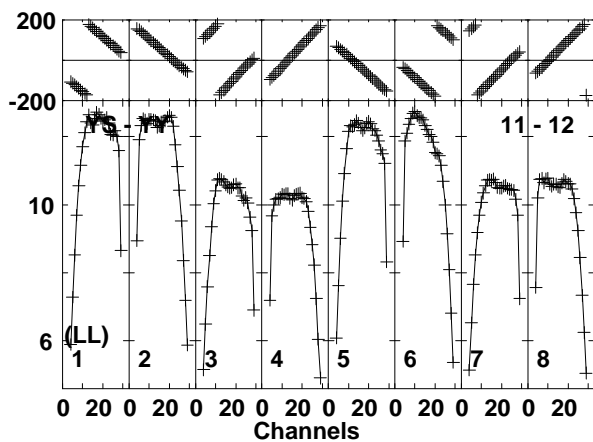
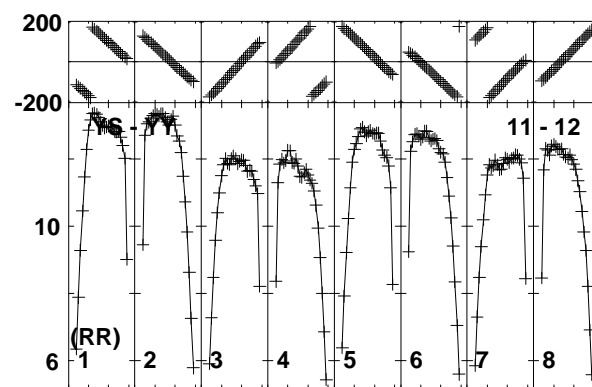
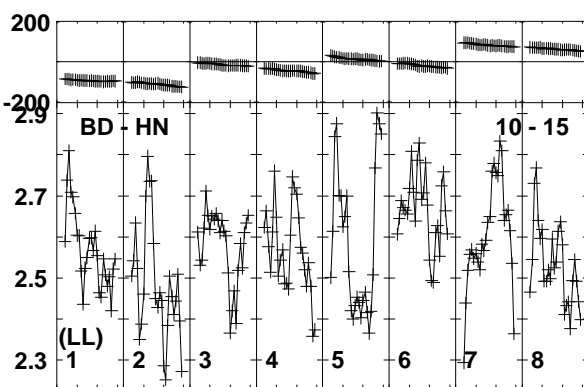
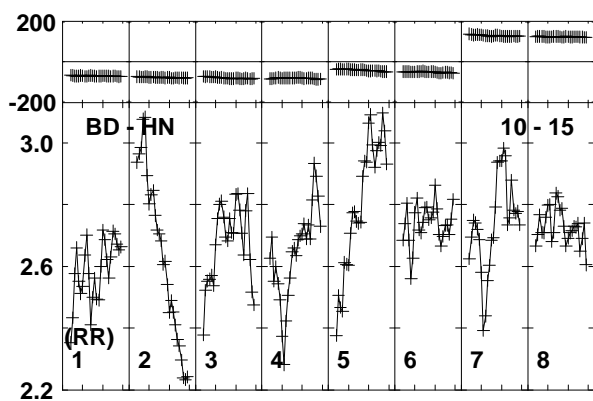
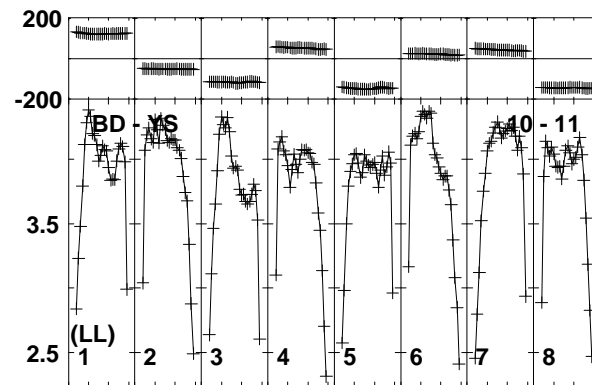
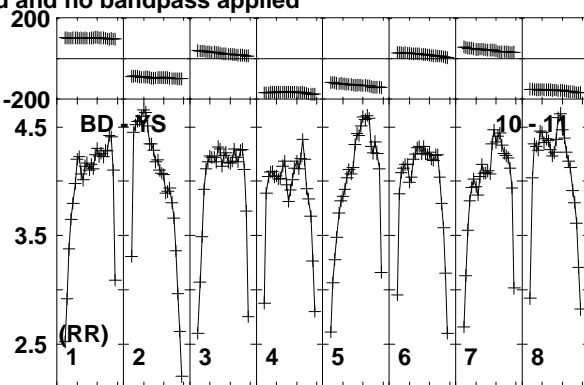
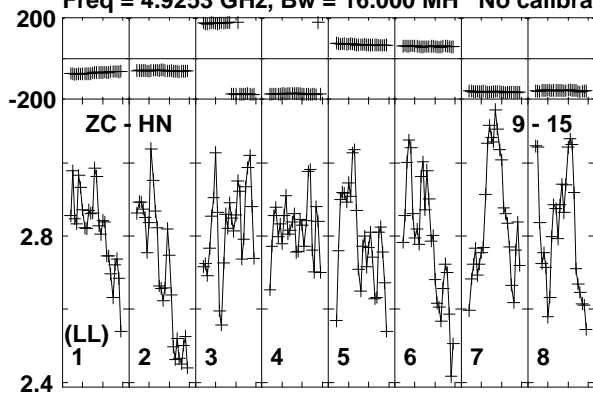

Lower frame: Milli Ampl Jy Top frame: Phas deg
Vector averaged cross-power spectrum Baseline: ZC (09) - HN (15)
Timerange: 01/00:13:43 to 01/00:15:27

Plot file version 369 created 11-APR-2016 17:09:16

J1128+5925 GP053G 3.UVDATA.1

Freq = 4.9253 GHz, Bw = 16.000 MH No calibration applied and no bandpass applied

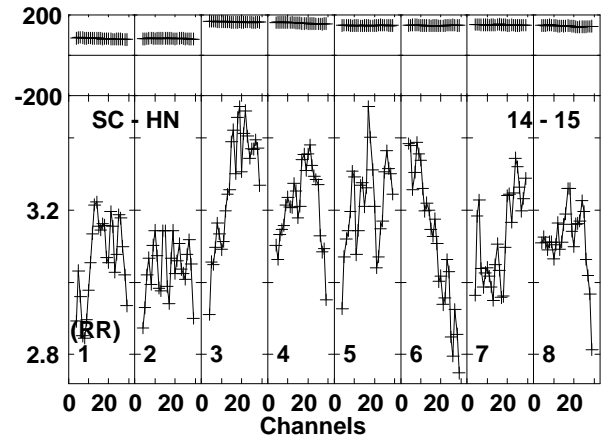
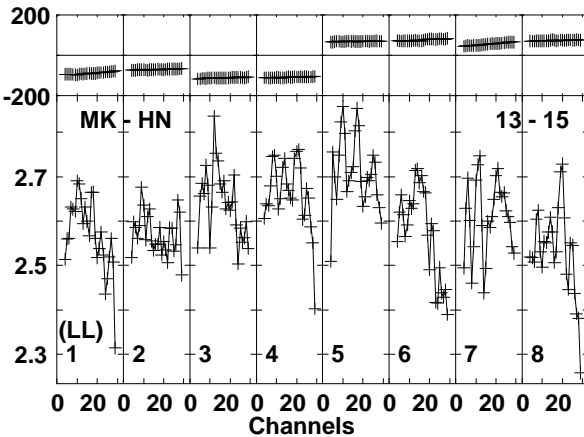
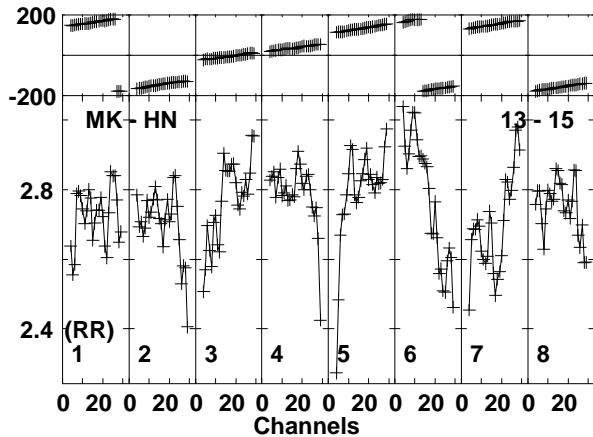
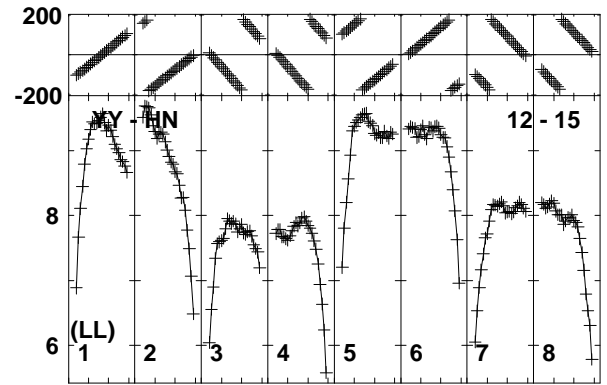
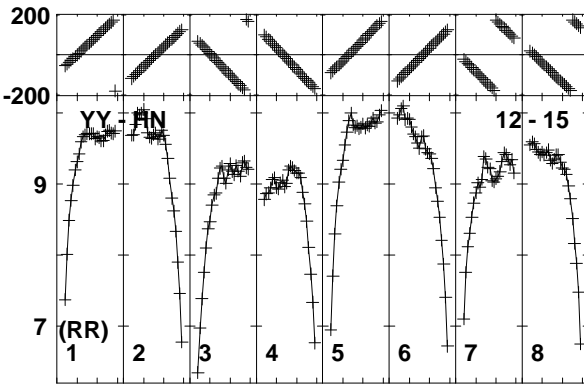
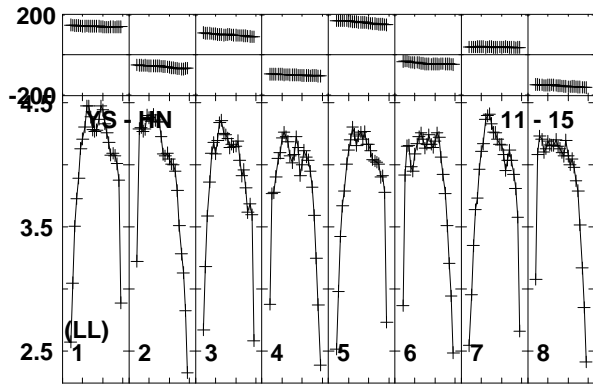
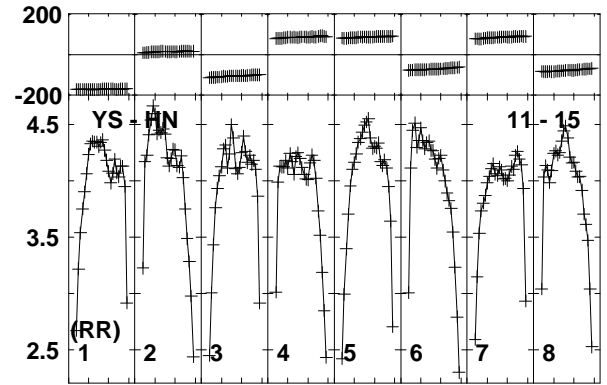
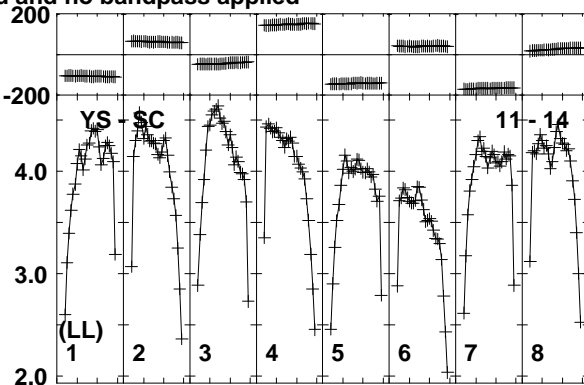
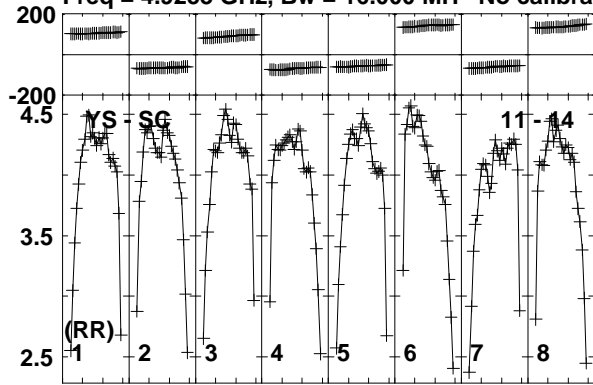

Lower frame: Milli Ampl Jy Top frame: Phas deg
 Vector averaged cross-power spectrum Baseline: YS (11) - SC (14)
 Timerange: 01/00:13:43 to 01/00:15:27

Plot file version 370 created 11-APR-2016 17:09:17
J1128+5925 GP053G 3.UVDATA.1
Freq = 4.9253 GHz, Bw = 16.000 MH No calibration applied and no bandpass applied

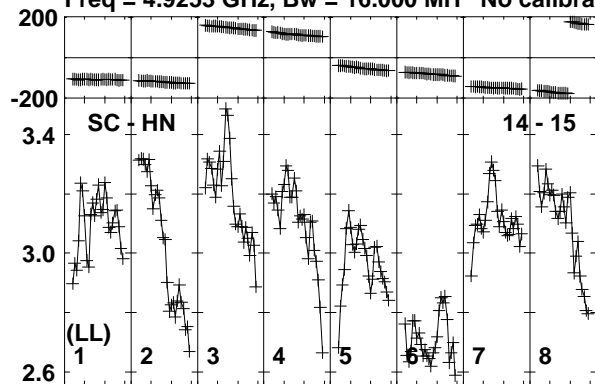

Lower frame: Milli Ampl Jy Top frame: Phas deg
Vector averaged cross-power spectrum Baseline: SC (14) - HN (15)
Timerange: 01/00:13:43 to 01/00:15:27

Plot file version 371 created 11-APR-2016 17:09:17

ARP299C GP053G 3.UVDATA.1

Freq = 4.9253 GHz, Bw = 16.000 MH No calibration applied and no bandpass applied

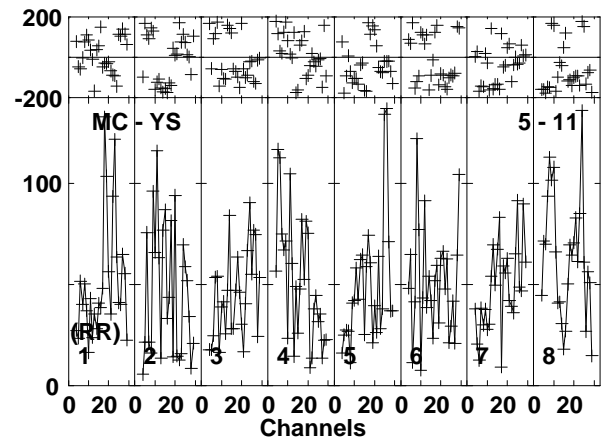
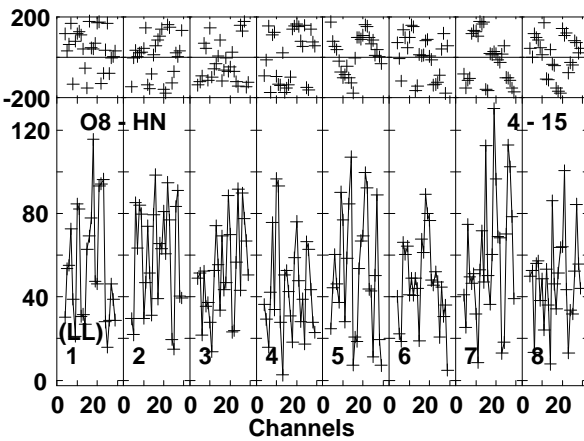
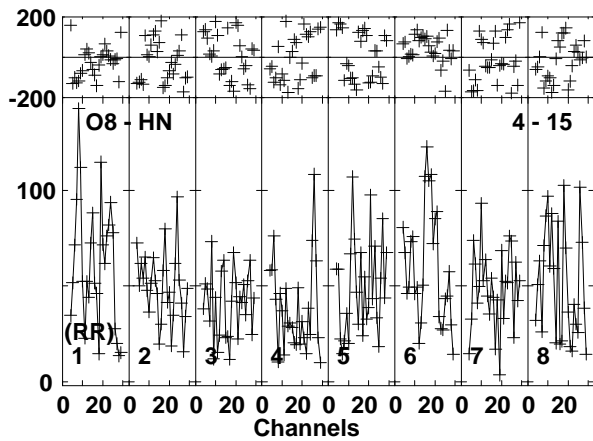
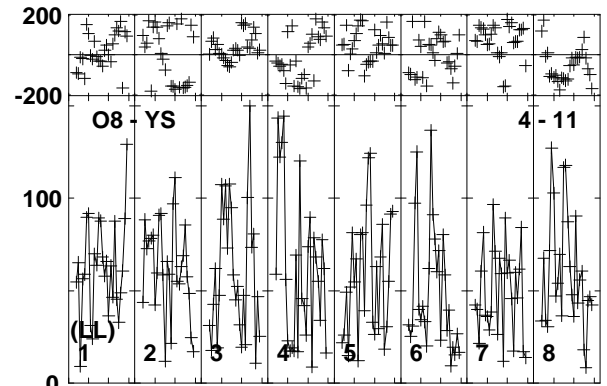
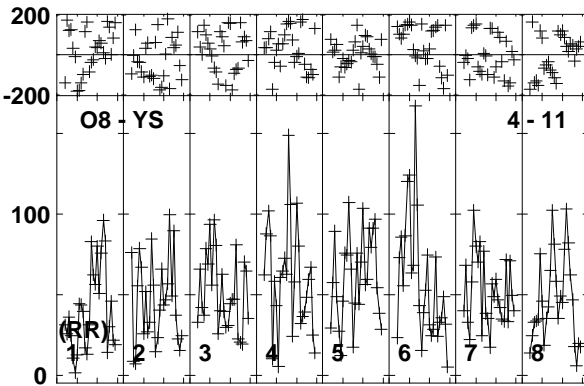
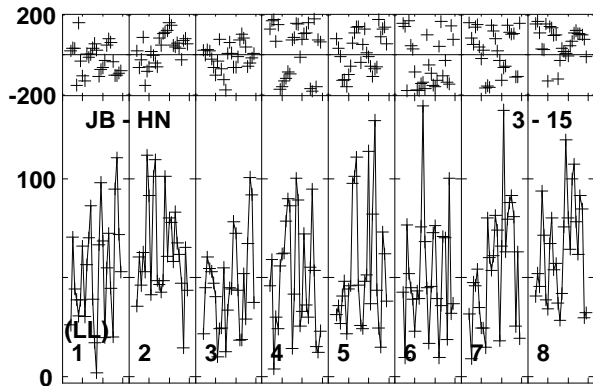
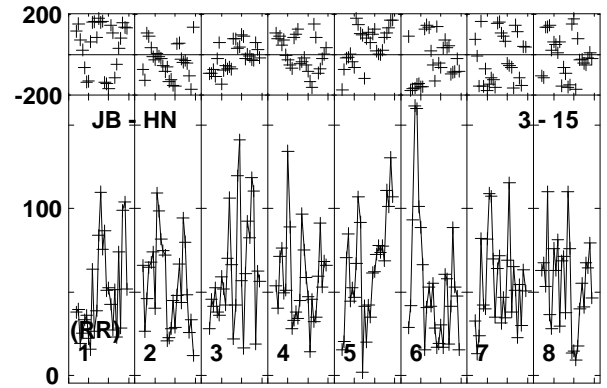
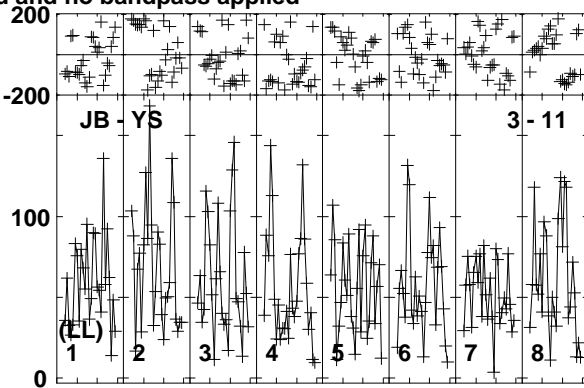
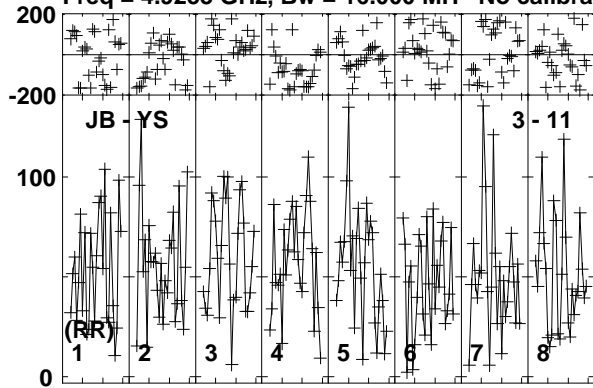

Lower frame: Micro Ampl Jy Top frame: Phas deg
Vector averaged cross-power spectrum Baseline: JB (03) - YS (11)
Timerange: 01/00:15:33 to 01/00:20:45

Plot file version 372 created 11-APR-2016 17:09:17

ARP299C GP053G 3.UVDATA.1

Freq = 4.9253 GHz, Bw = 16.000 MH No calibration applied and no bandpass applied

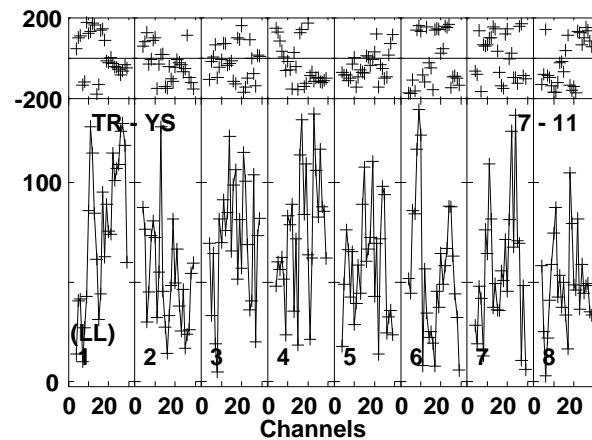
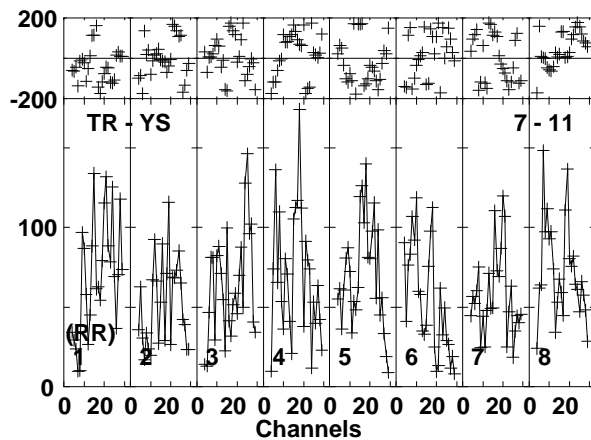
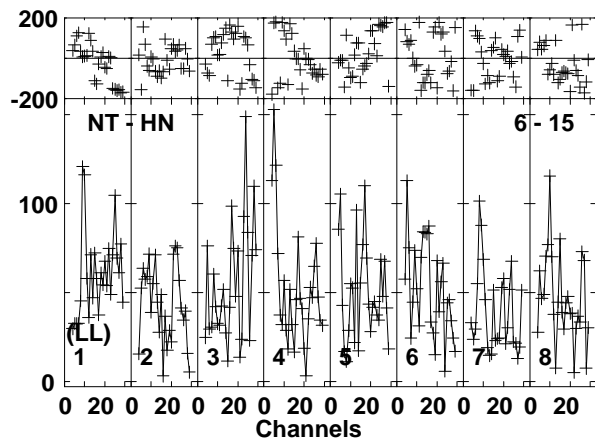
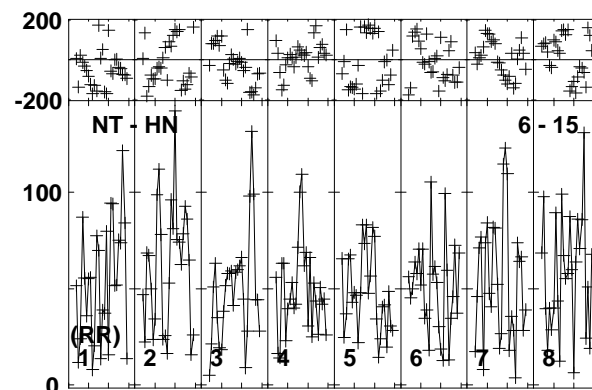
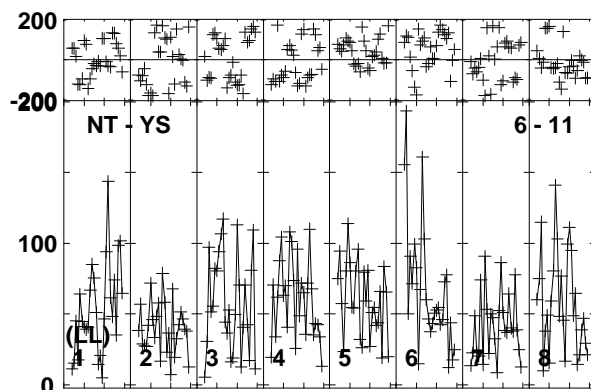
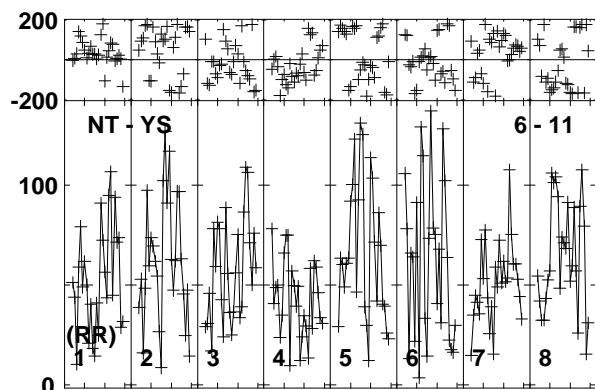
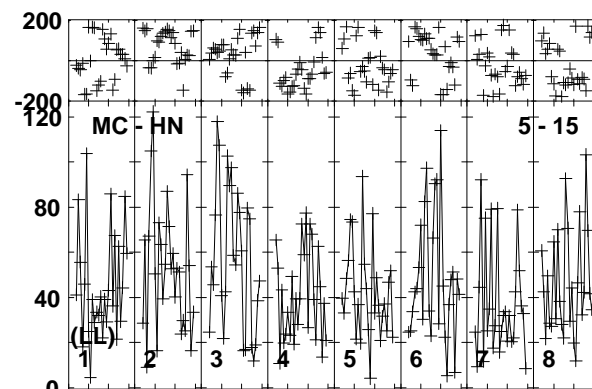
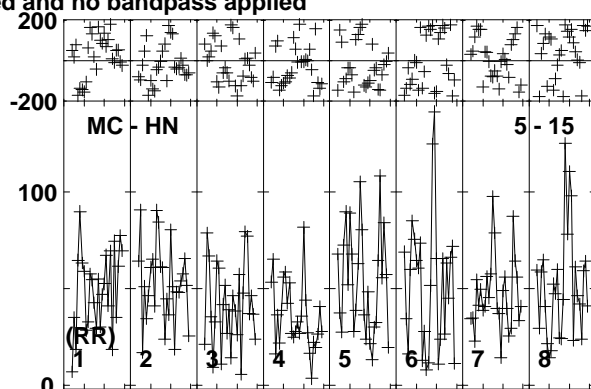
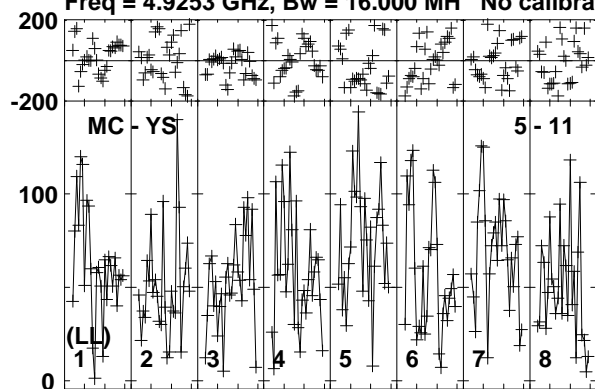

Lower frame: Micro Ampl Jy Top frame: Phas deg
Vector averaged cross-power spectrum Baseline: MC (05) - YS (11)
Timerange: 01/00:15:33 to 01/00:20:45

Plot file version 373 created 11-APR-2016 17:09:17

ARP299C GP053G 3.UVDATA.1

Freq = 4.9253 GHz, Bw = 16.000 MH No calibration applied and no bandpass applied

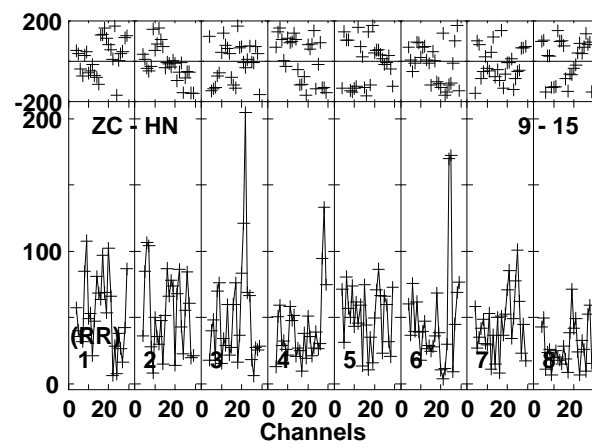
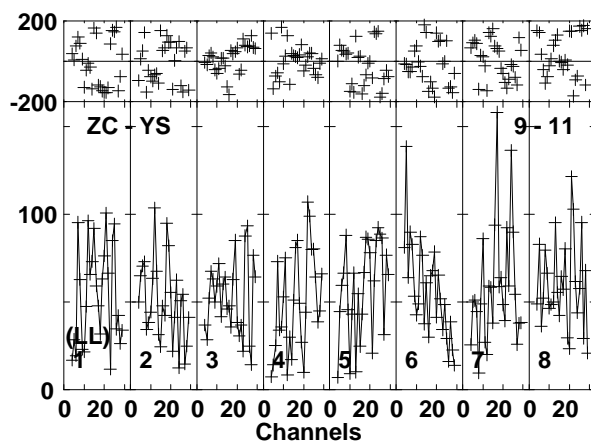
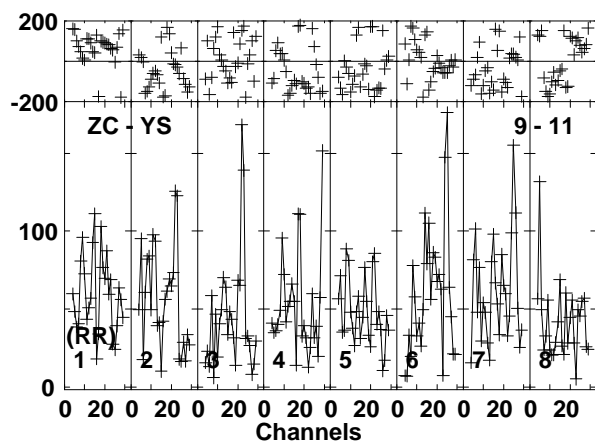
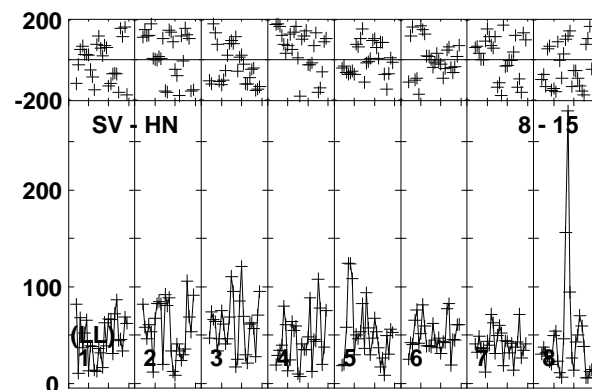
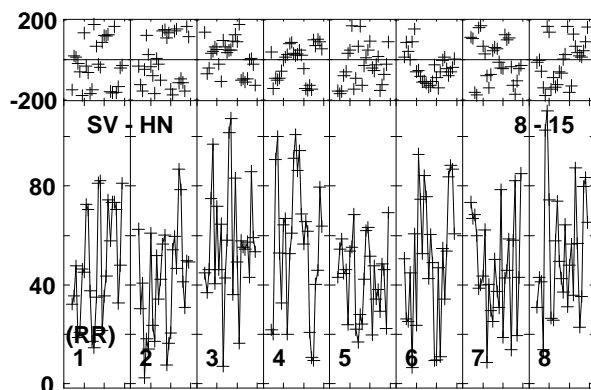
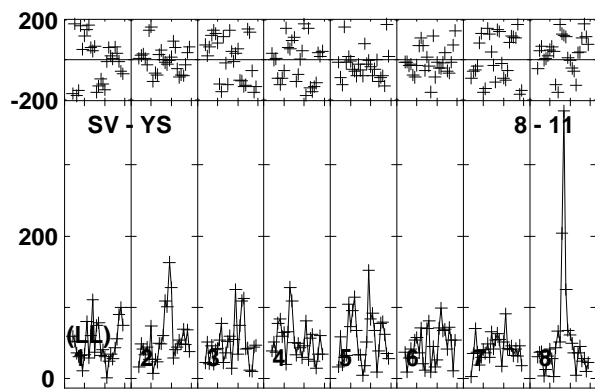
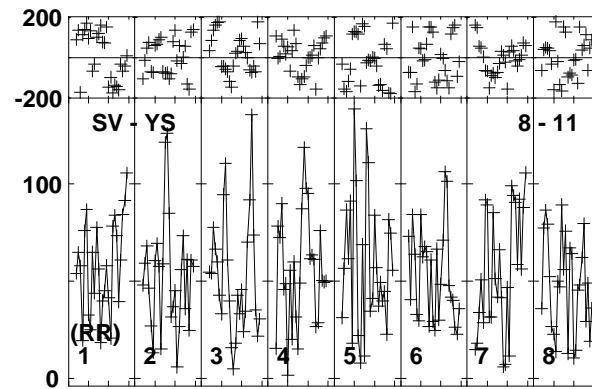
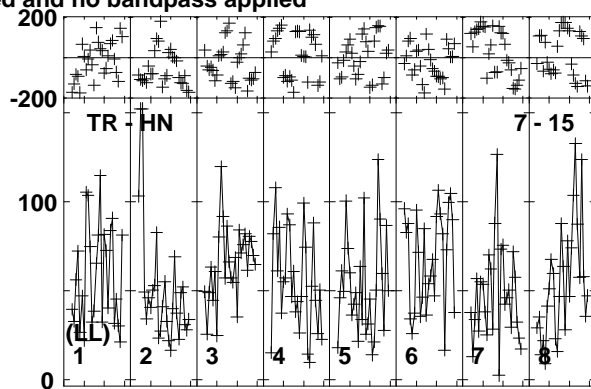
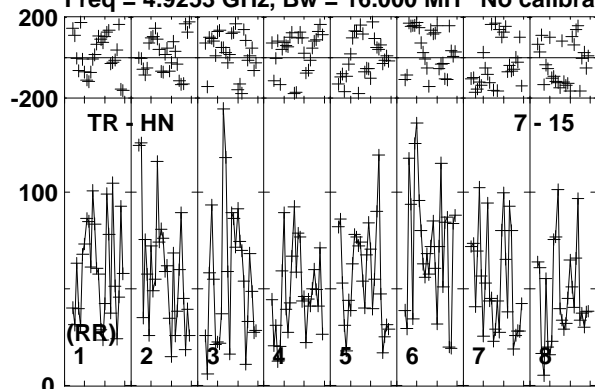

Lower frame: Micro Ampl Jy Top frame: Phas deg
Vector averaged cross-power spectrum Baseline: TR (07) - HN (15)
Timerange: 01/00:15:33 to 01/00:20:45

Plot file version 374 created 11-APR-2016 17:09:17

ARP299C GP053G 3.UVDATA.1

Freq = 4.9253 GHz, Bw = 16.000 MH No calibration applied and no bandpass applied

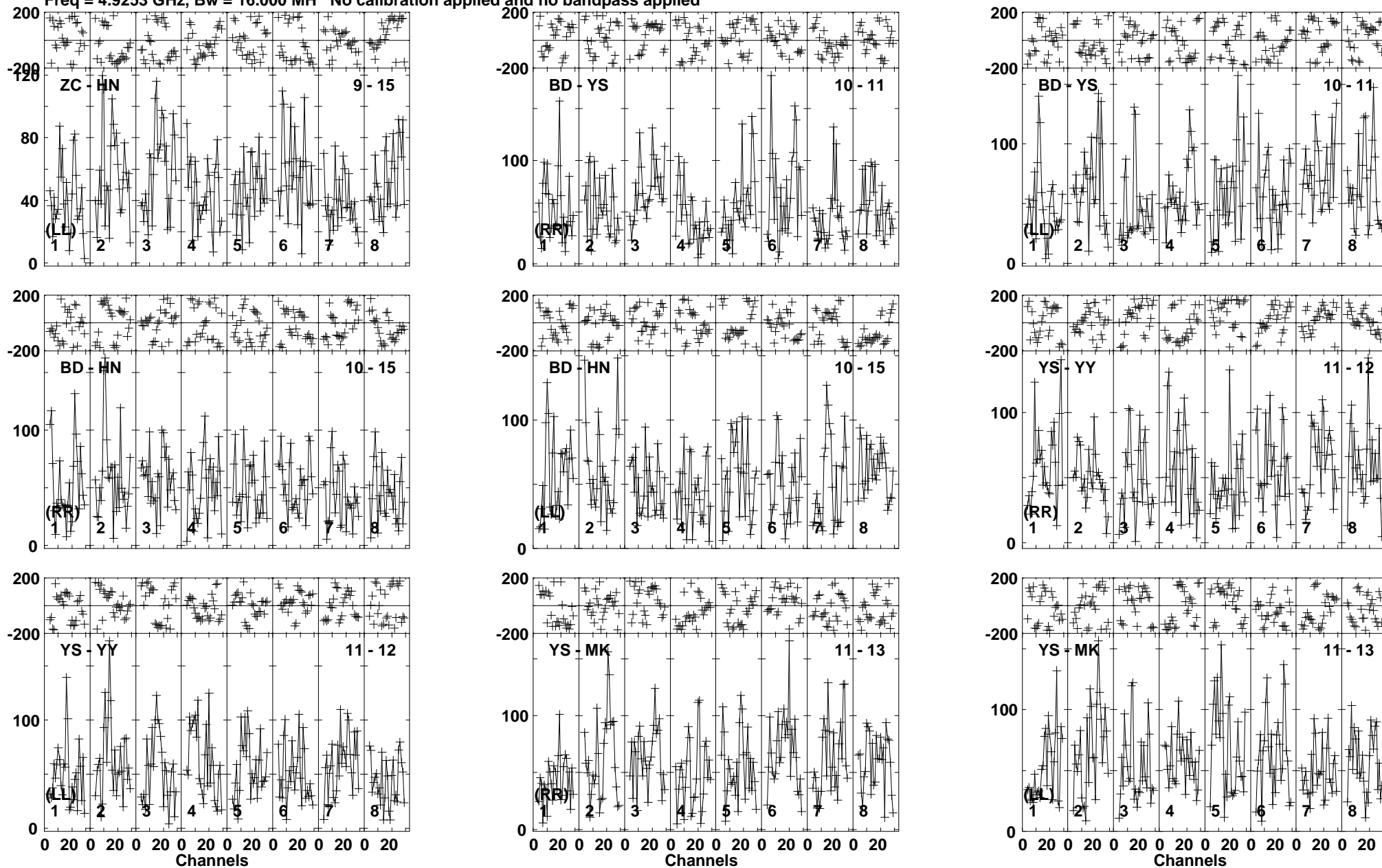

Lower frame: Micro Ampl Jy Top frame: Phas deg
Vector averaged cross-power spectrum Baseline: ZC (09) - HN (15)
Timerange: 01/00:15:33 to 01/00:20:45

Plot file version 375 created 11-APR-2016 17:09:17

ARP299C GP053G 3.UVDATA.1

Freq = 4.9253 GHz, Bw = 16.000 MH No calibration applied and no bandpass applied

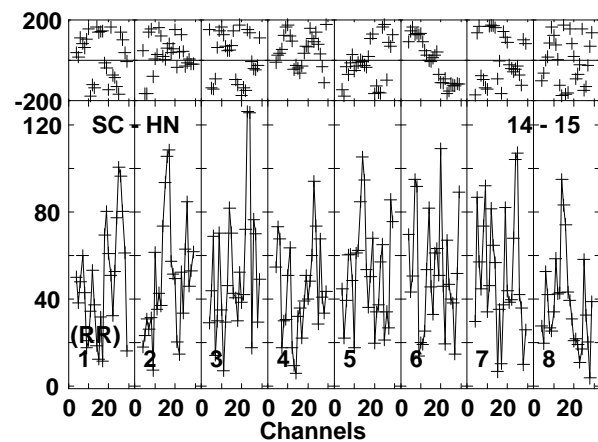
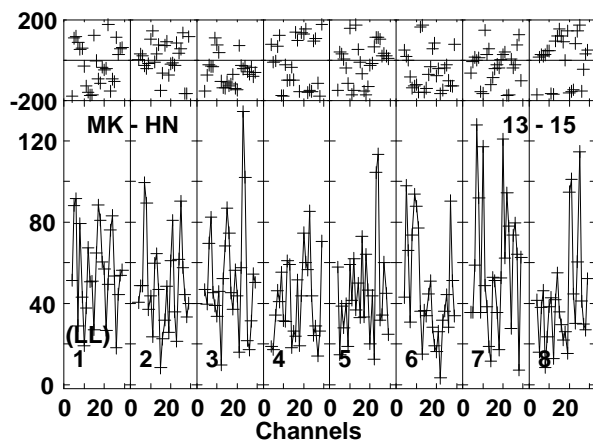
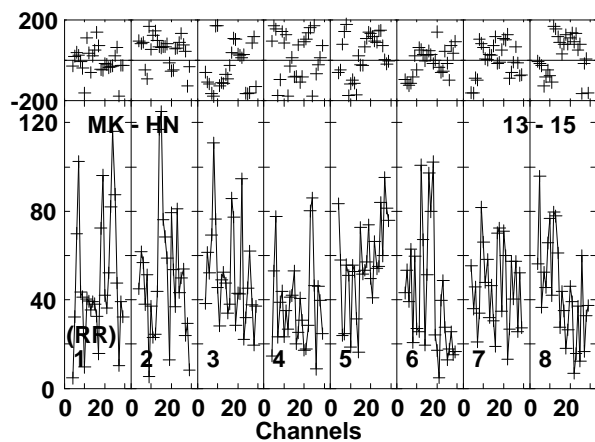
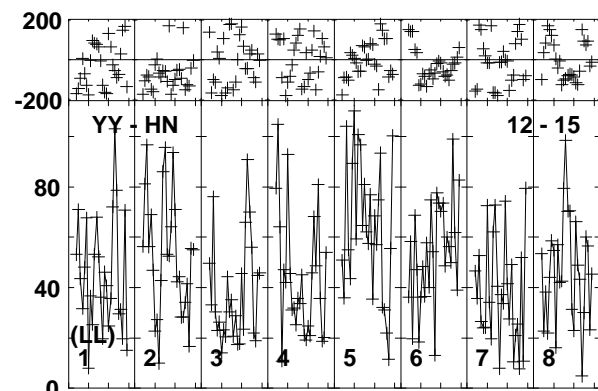
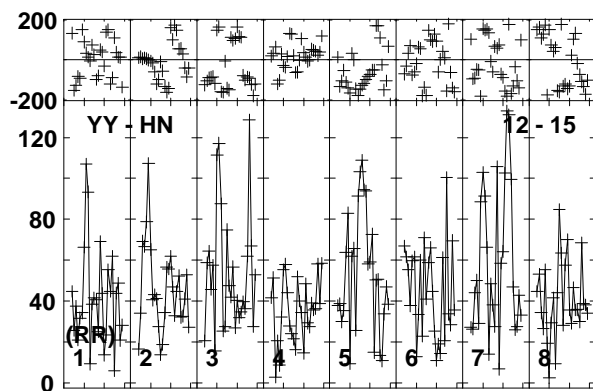
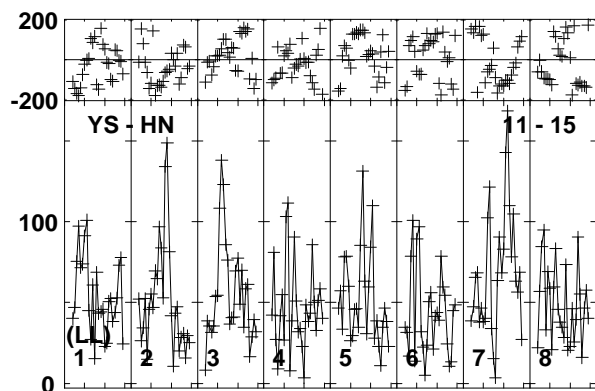
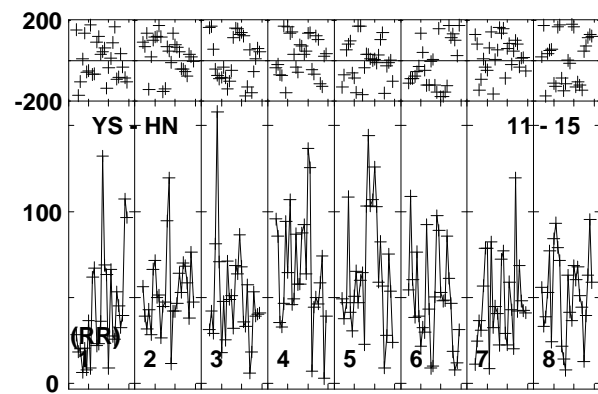
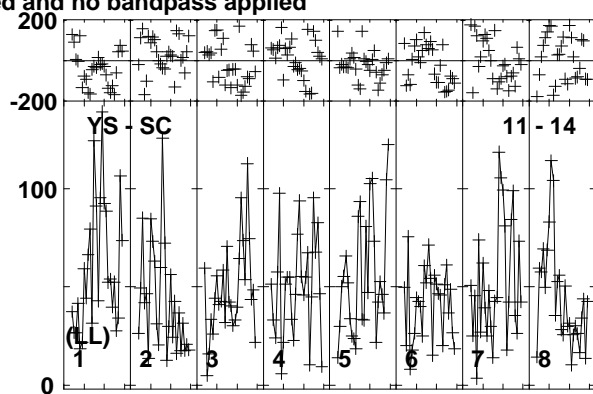
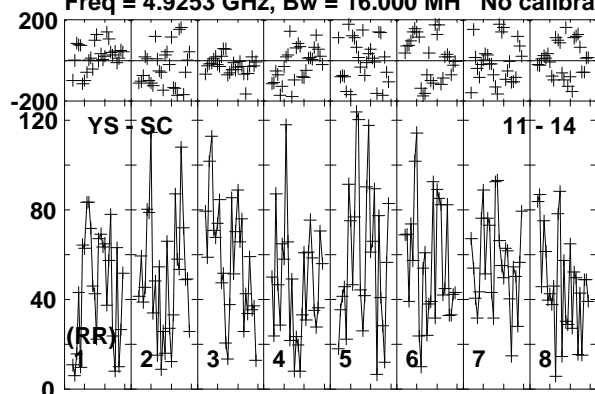

Lower frame: Micro Ampl Jy Top frame: Phas deg
Vector averaged cross-power spectrum Baseline: YS (11) - SC (14)
Timerange: 01/00:15:33 to 01/00:20:45

Plot file version 376 created 11-APR-2016 17:09:18
ARP299C GP053G 3.UVDATA.1
Freq = 4.9253 GHz, Bw = 16.000 MH No calibration applied and no bandpass applied

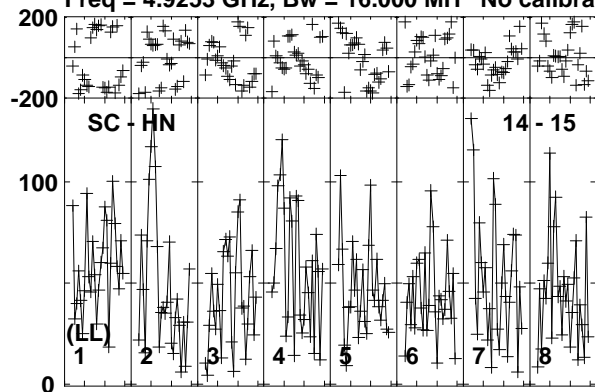

Lower frame: Micro Ampl Jy Top frame: Phas deg
Vector averaged cross-power spectrum Baseline: SC (14) - HN (15)
Timerange: 01/00:15:33 to 01/00:20:45

Plot file version 377 created 11-APR-2016 17:09:18

J1128+5925 GP053G 3.UVDATA.1

Freq = 4.9253 GHz, Bw = 16.000 MH No calibration applied and no bandpass applied

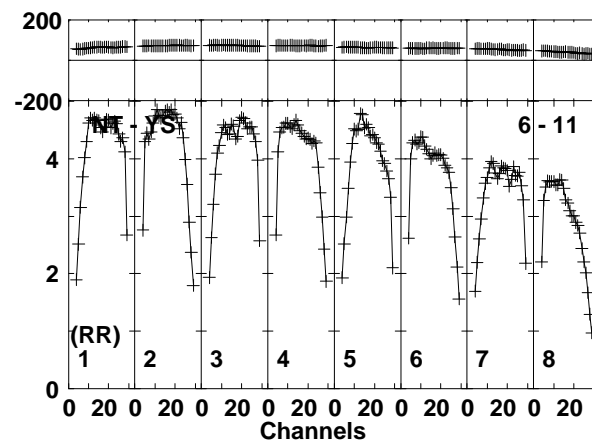
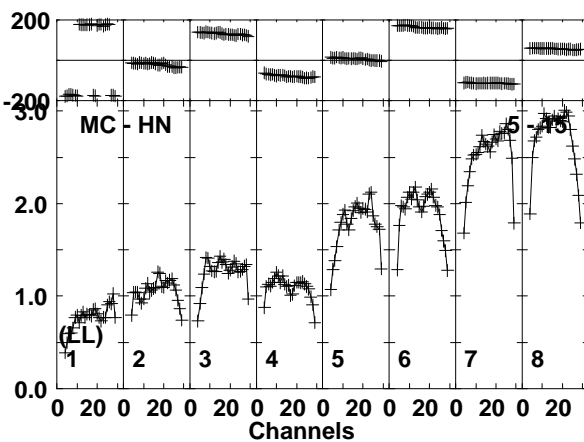
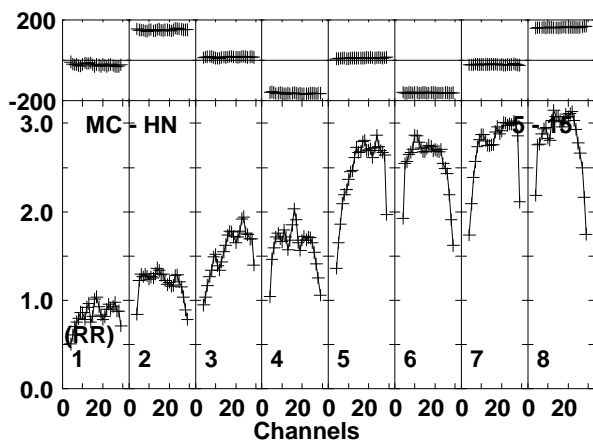
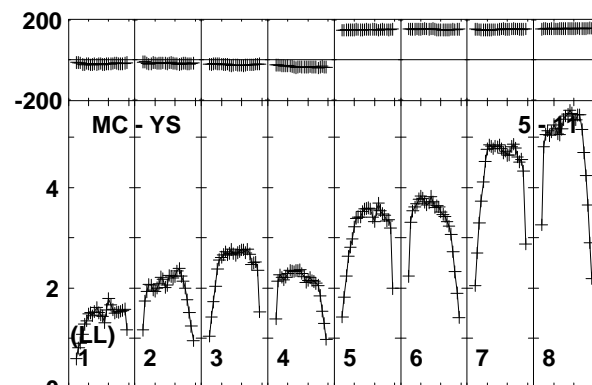
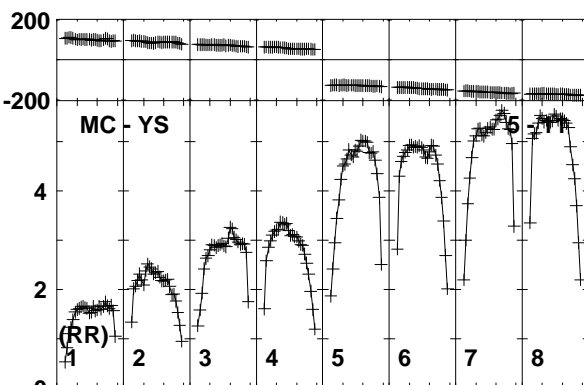
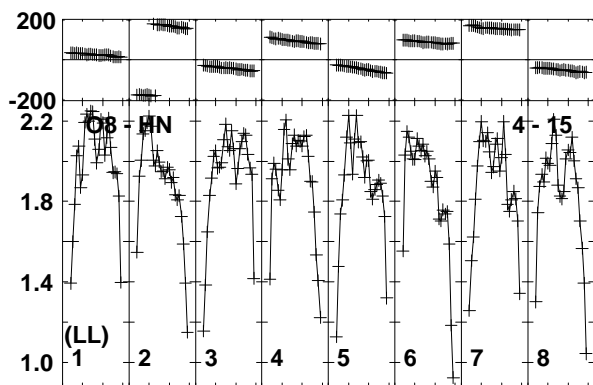
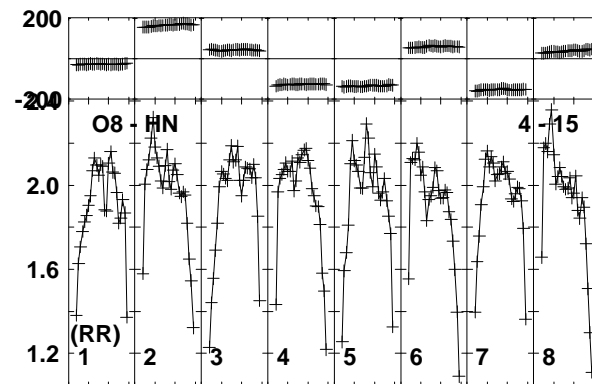
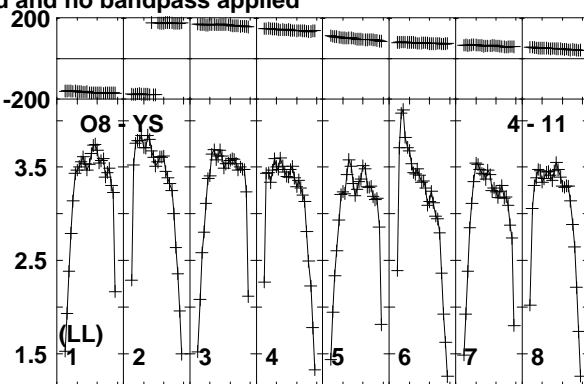
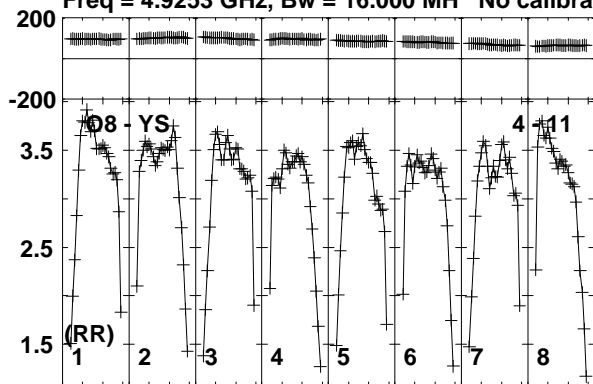

Lower frame: Milli Ampl Jy Top frame: Phas deg
Vector averaged cross-power spectrum Baseline: O8 (04) - YS (11)
Timerange: 01/00:20:51 to 01/00:22:43

Plot file version 378 created 11-APR-2016 17:09:18

J1128+5925 GP053G 3.UVDATA.1

Freq = 4.9253 GHz, Bw = 16.000 MH No calibration applied and no bandpass applied

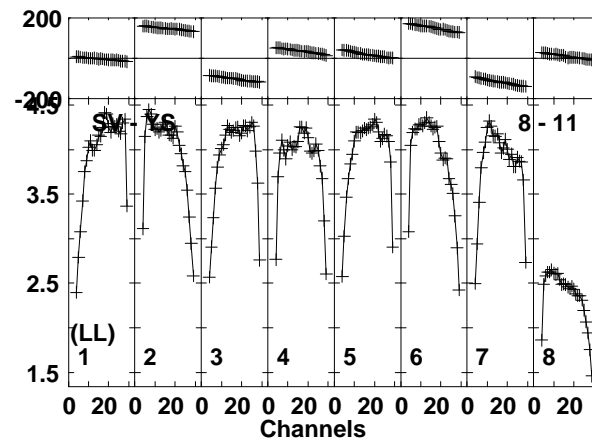
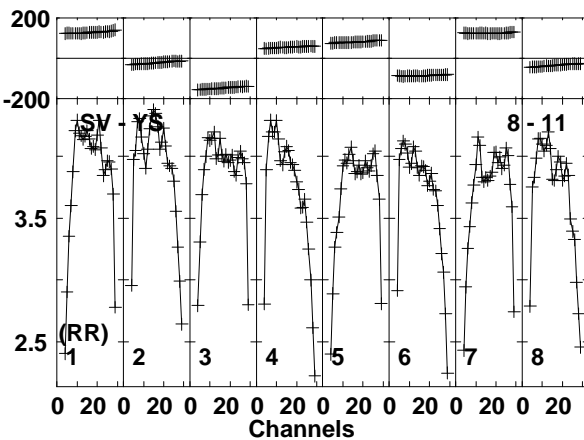
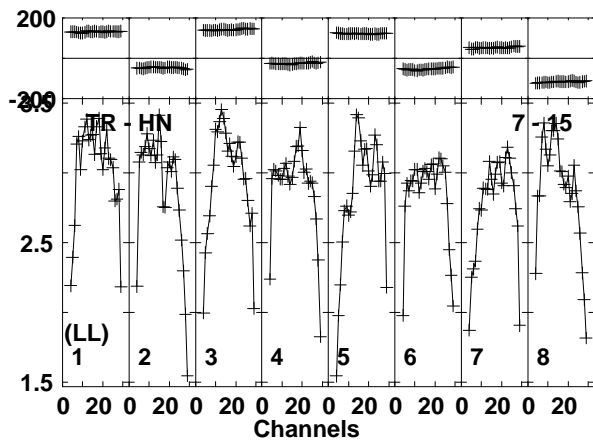
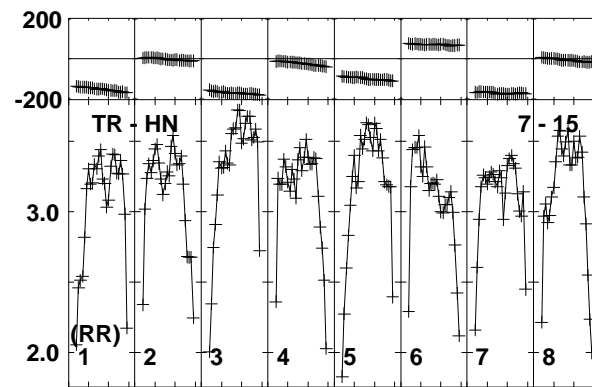
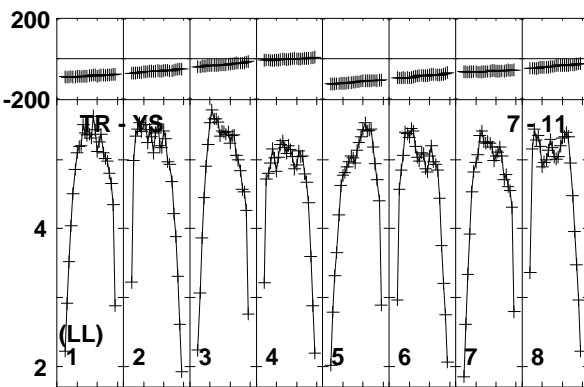
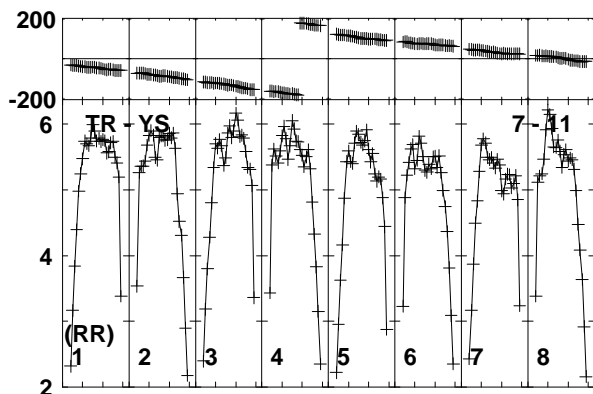
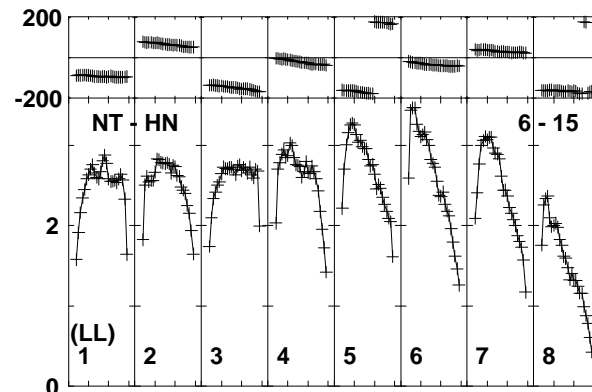
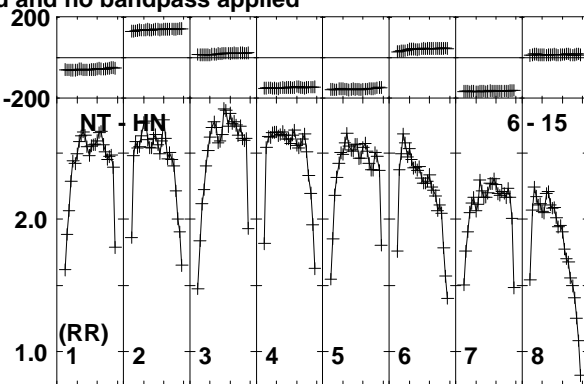
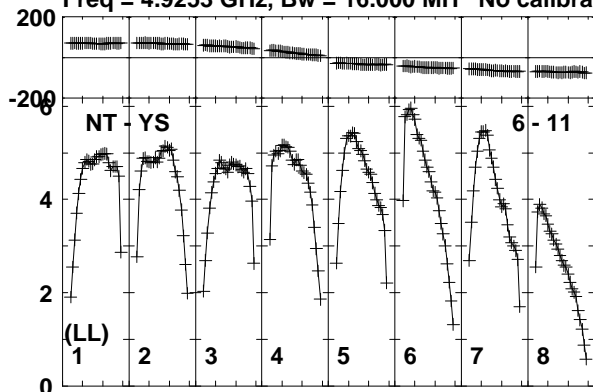

Lower frame: Milli Ampl Jy Top frame: Phas deg
Vector averaged cross-power spectrum Baseline: NT (06) - YS (11)
Timerange: 01/00:20:51 to 01/00:22:43

Plot file version 379 created 11-APR-2016 17:09:18

J1128+5925 GP053G 3.UVDATA.1

Freq = 4.9253 GHz, Bw = 16.000 MH No calibration applied and no bandpass applied

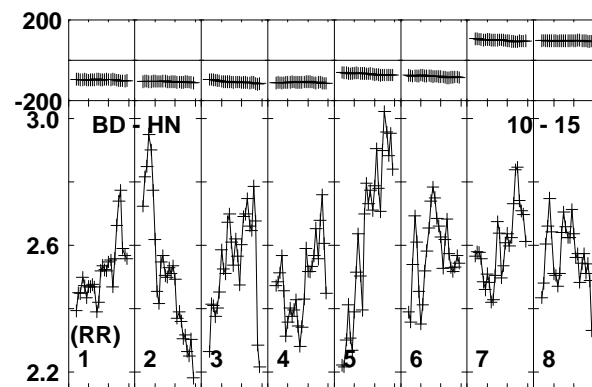
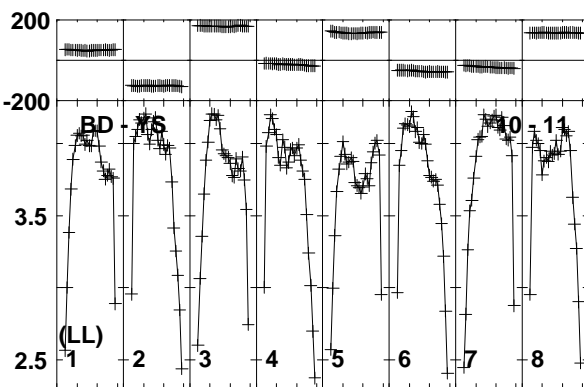
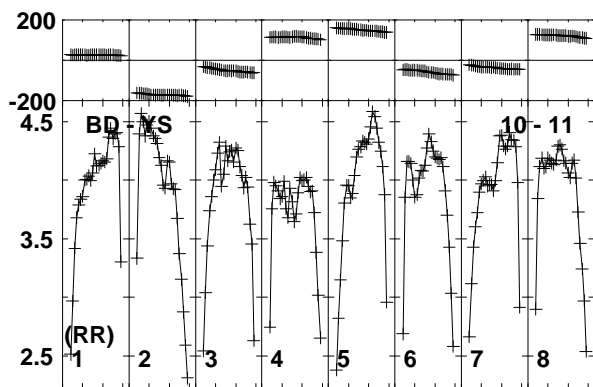
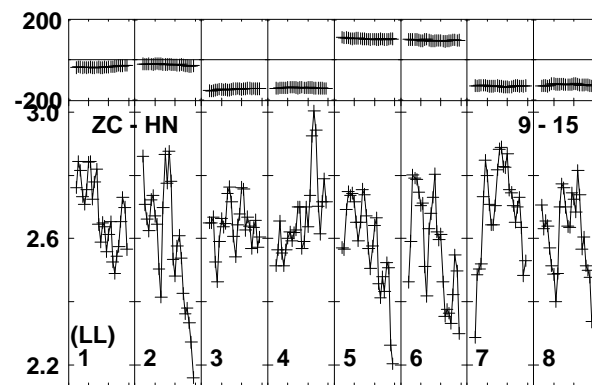
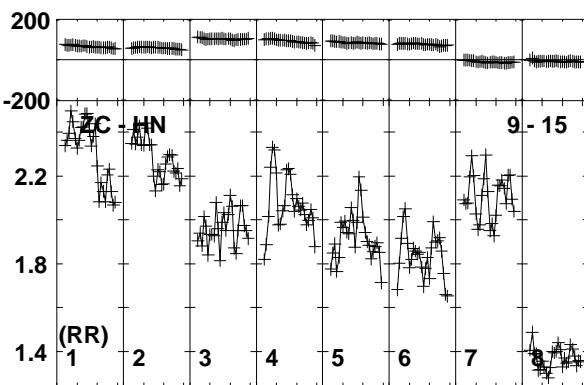
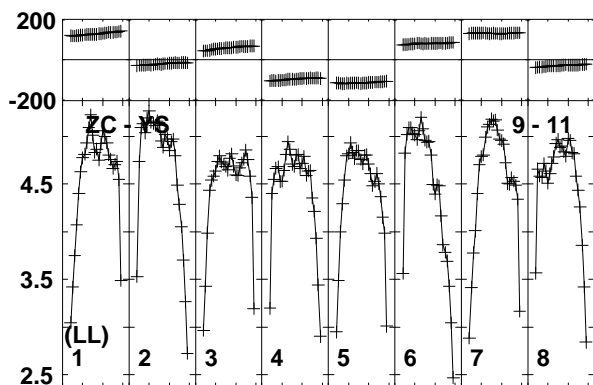
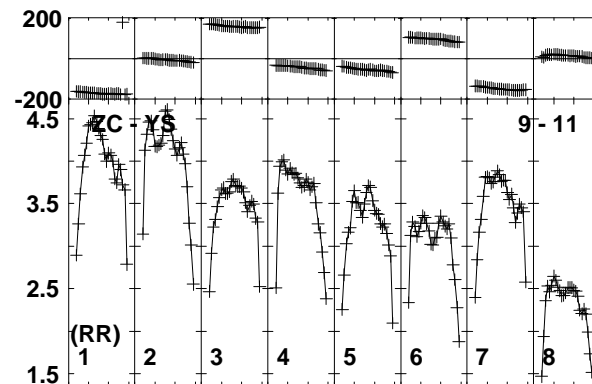
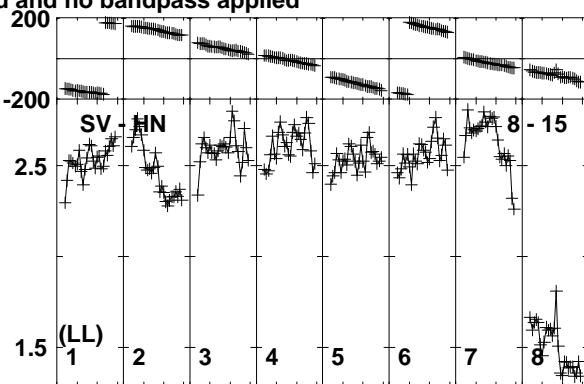
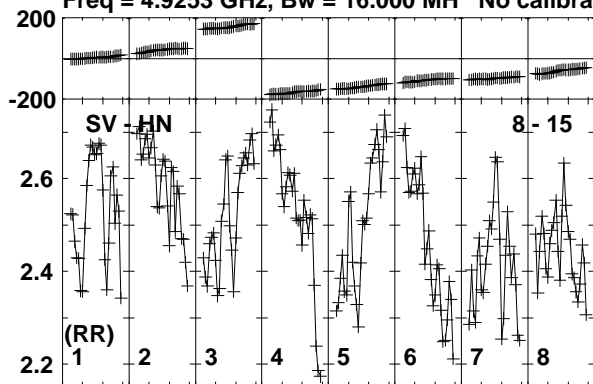

Lower frame: Milli Ampl Jy Top frame: Phas deg
Vector averaged cross-power spectrum Baseline: SV (08) - HN (15)
Timerange: 01/00:20:51 to 01/00:22:43

Plot file version 380 created 11-APR-2016 17:09:18

J1128+5925 GP053G 3.UVDATA.1

Freq = 4.9253 GHz, Bw = 16.000 MH No calibration applied and no bandpass applied

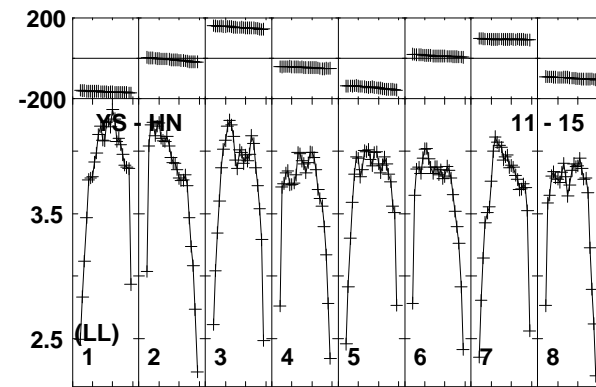
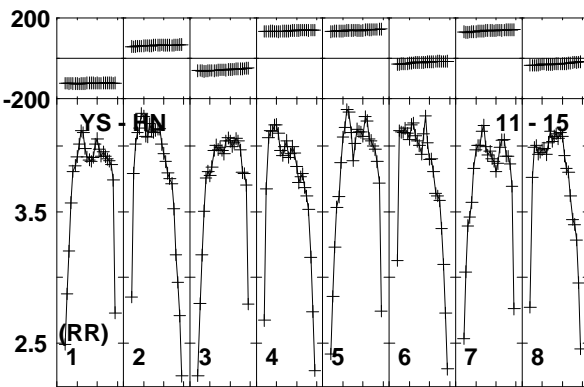
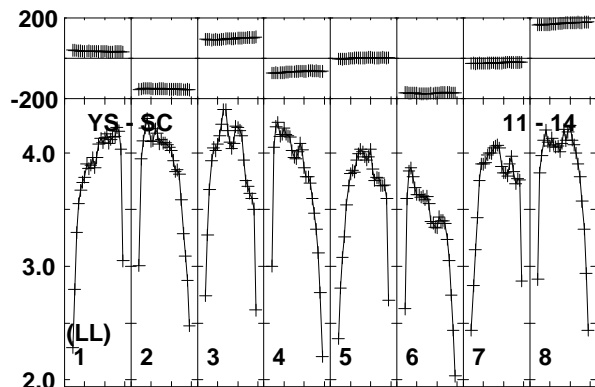
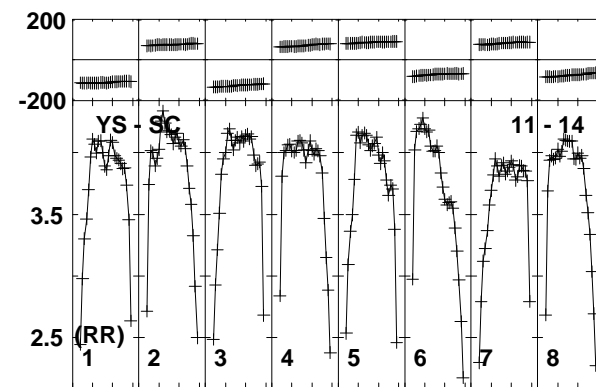
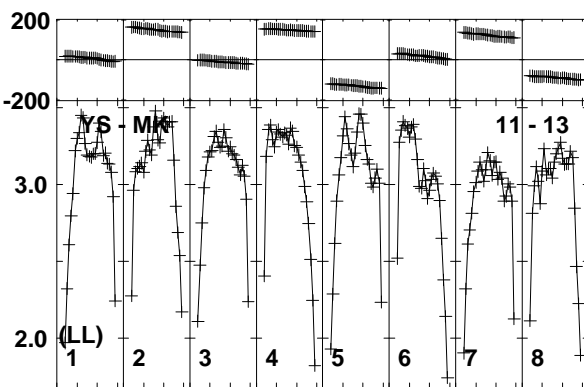
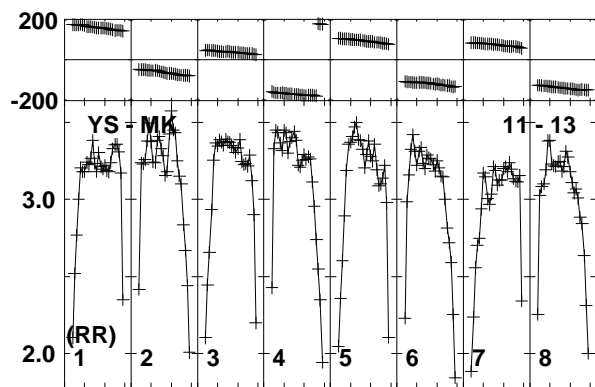
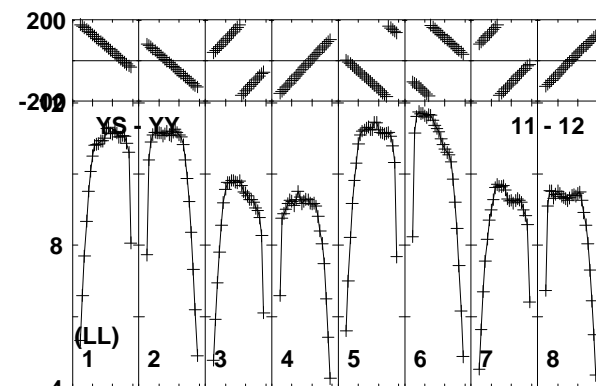
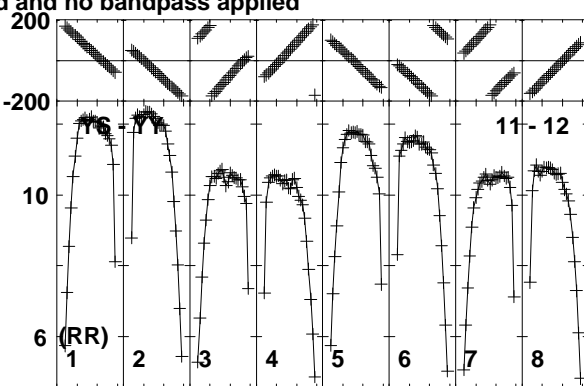
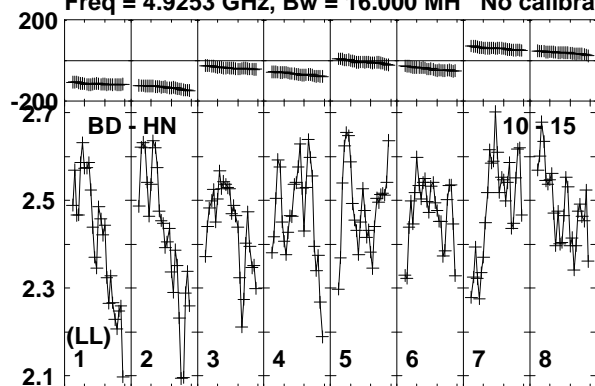

Lower frame: Milli Ampl Jy Top frame: Phas deg
Vector averaged cross-power spectrum Baseline: BD (10) - HN (15)
Timerange: 01/00:20:51 to 01/00:22:43

Plot file version 381 created 11-APR-2016 17:09:18

J1128+5925 GP053G 3.UVDATA.1

Freq = 4.9253 GHz, Bw = 16.000 MH No calibration applied and no bandpass applied

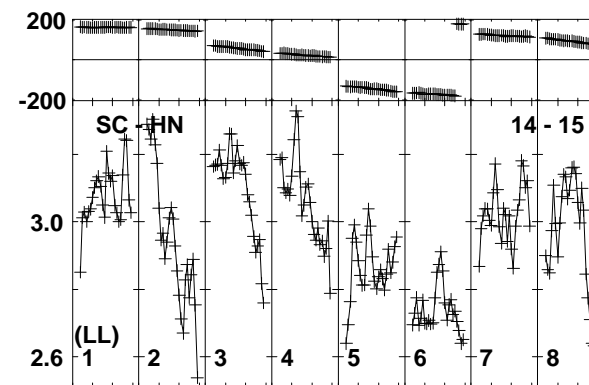
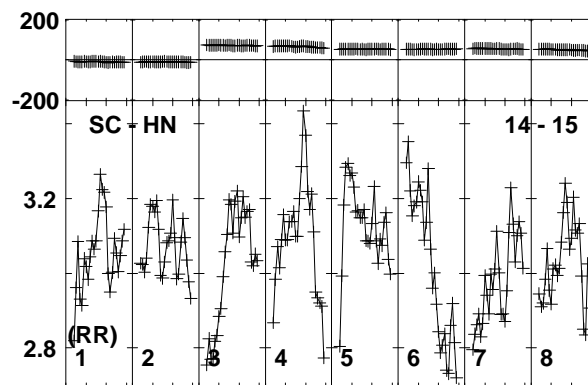
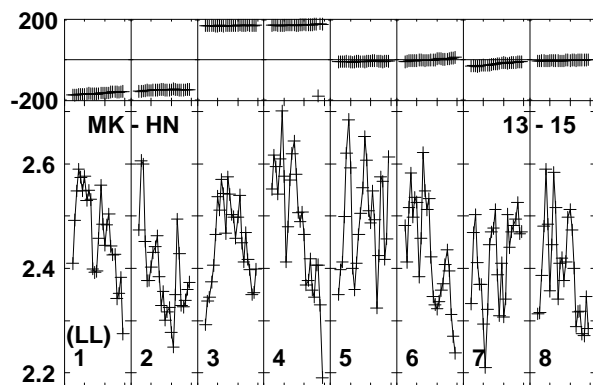
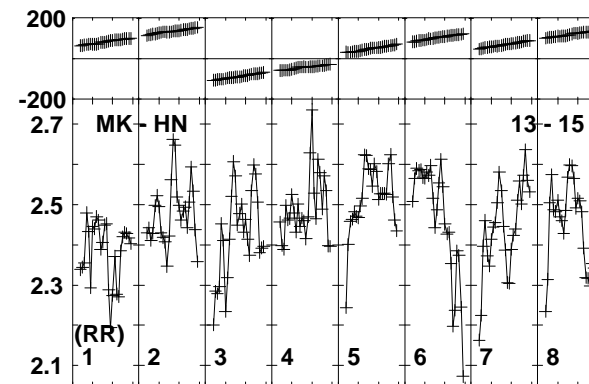
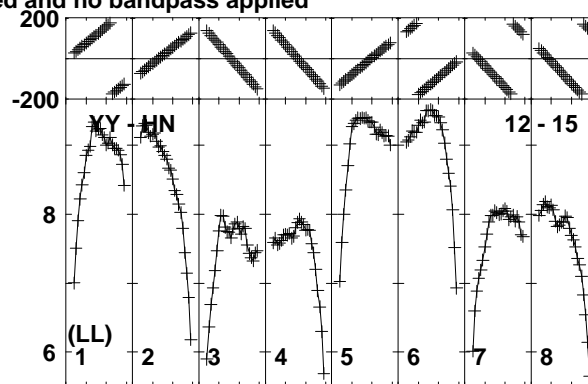
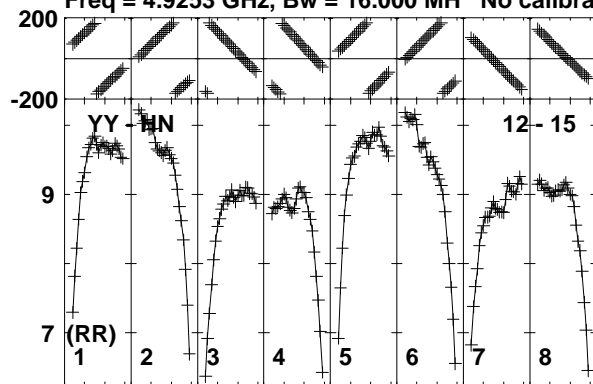

Lower frame: Milli Ampl Jy Top frame: Phas deg
Vector averaged cross-power spectrum Baseline: YY (12) - HN (15)
Timerange: 01/00:20:51 to 01/00:22:43

Plot file version 382 created 11-APR-2016 17:09:19

ARP299C GP053G 3.UVDATA.1

Freq = 4.9253 GHz, Bw = 16.000 MH No calibration applied and no bandpass applied

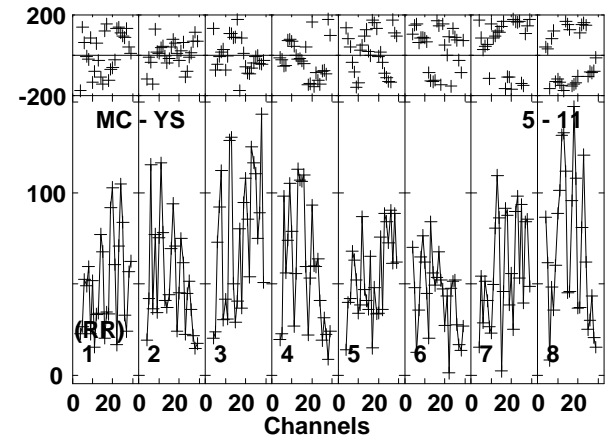
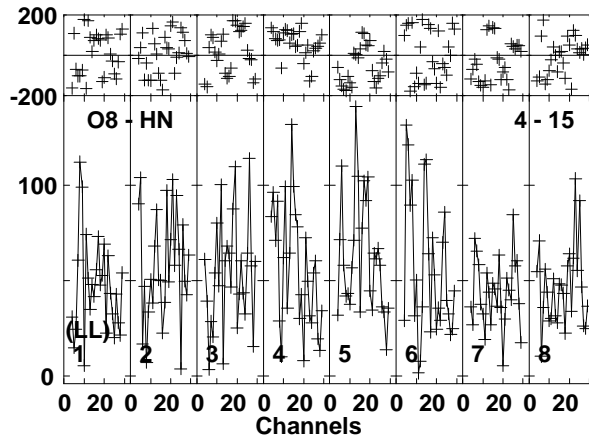
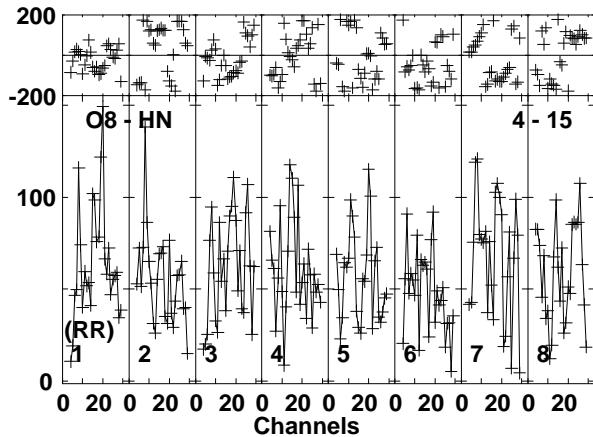
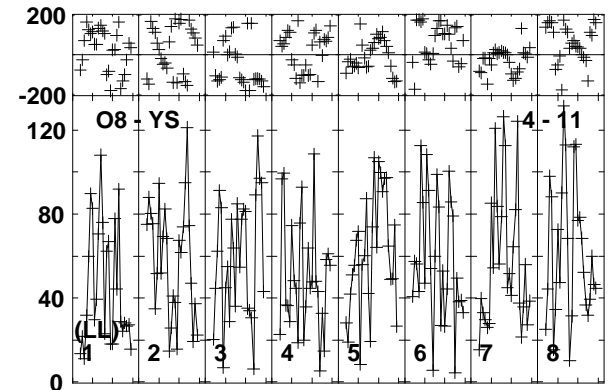
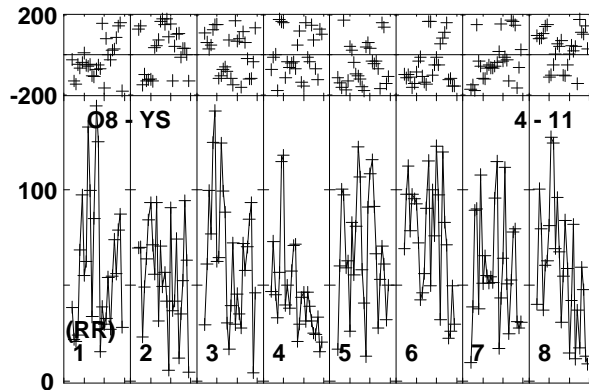
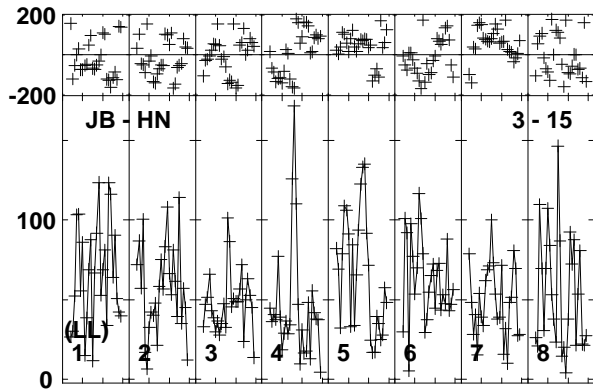
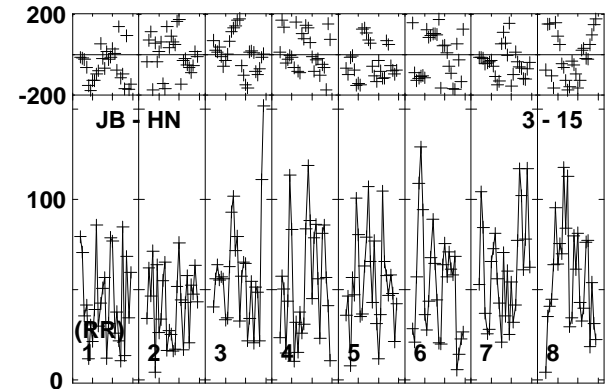
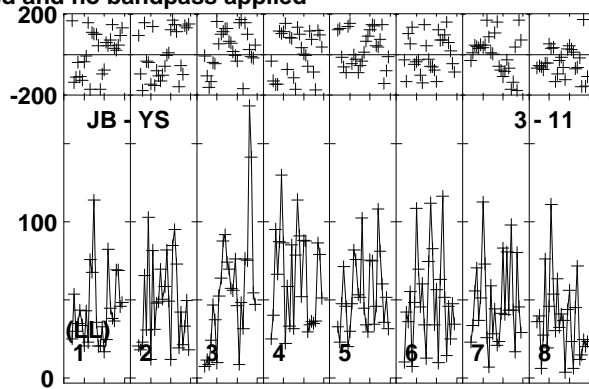
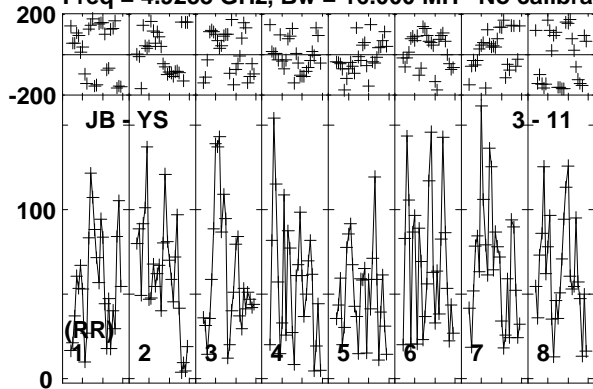

Lower frame: Micro Ampl Jy Top frame: Phas deg
Vector averaged cross-power spectrum Baseline: JB (03) - YS (11)
Timerange: 01/00:22:48 to 01/00:28:02

Plot file version 383 created 11-APR-2016 17:09:19

ARP299C GP053G 3.UVDATA.1

Freq = 4.9253 GHz, Bw = 16.000 MH No calibration applied and no bandpass applied

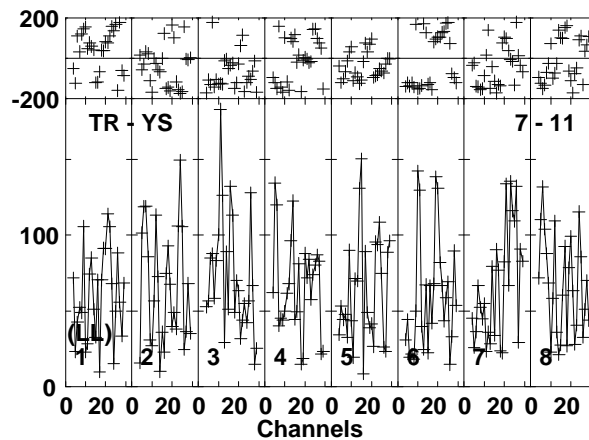
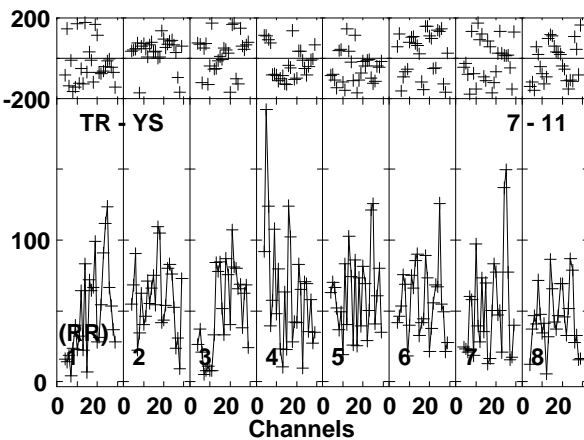
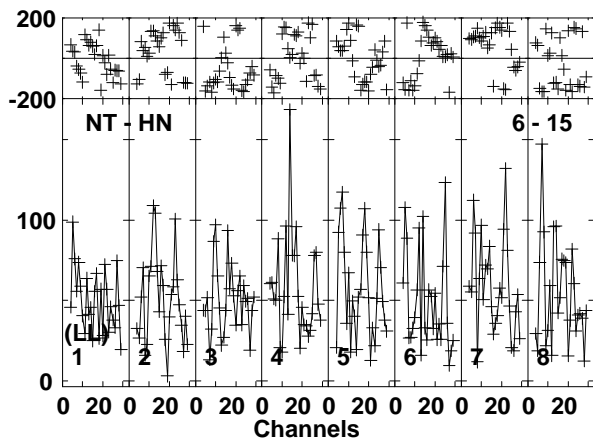
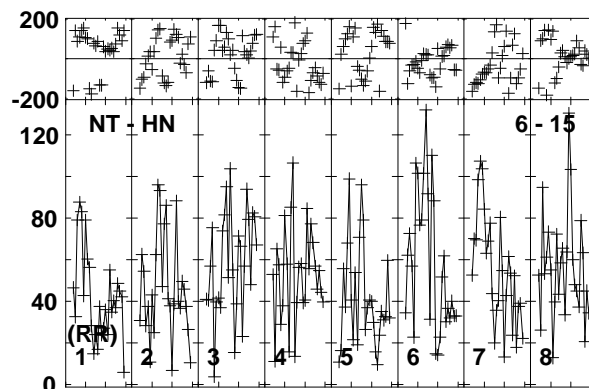
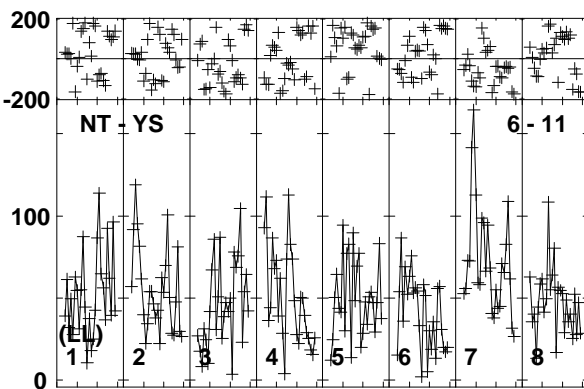
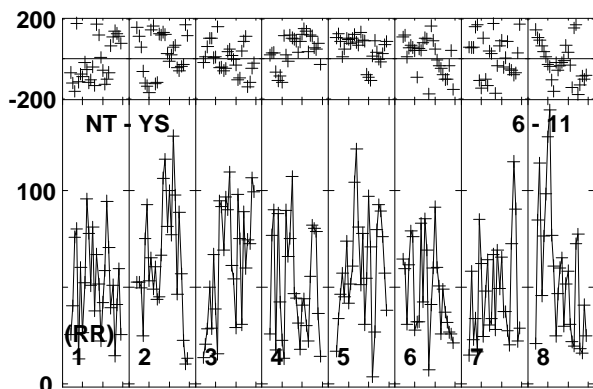
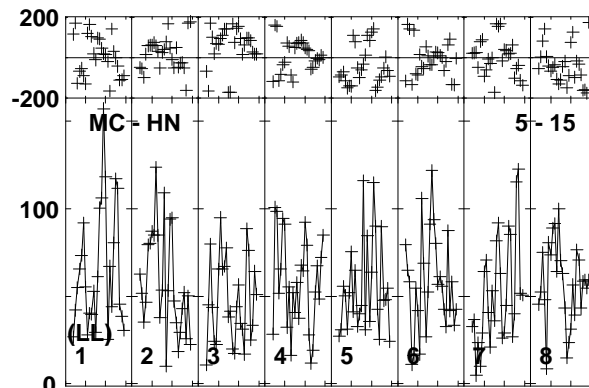
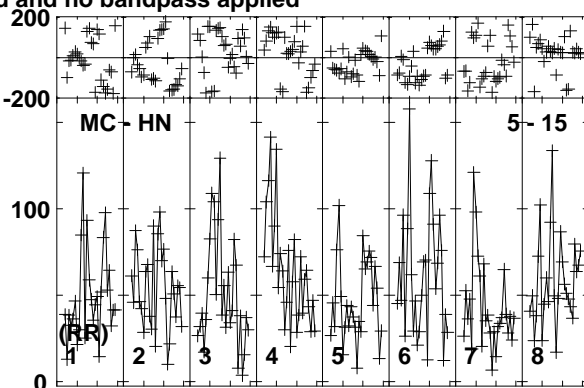
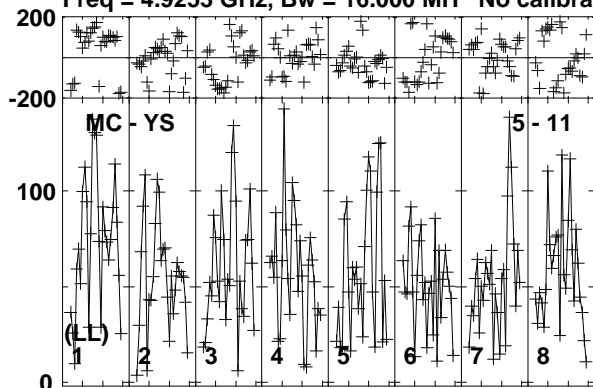

Lower frame: Micro Ampl Jy Top frame: Phas deg
Vector averaged cross-power spectrum Baseline: MC (05) - YS (11)
Timerange: 01/00:22:48 to 01/00:28:02

Plot file version 384 created 11-APR-2016 17:09:19

ARP299C GP053G 3.UVDATA.1

Freq = 4.9253 GHz, Bw = 16.000 MH No calibration applied and no bandpass applied

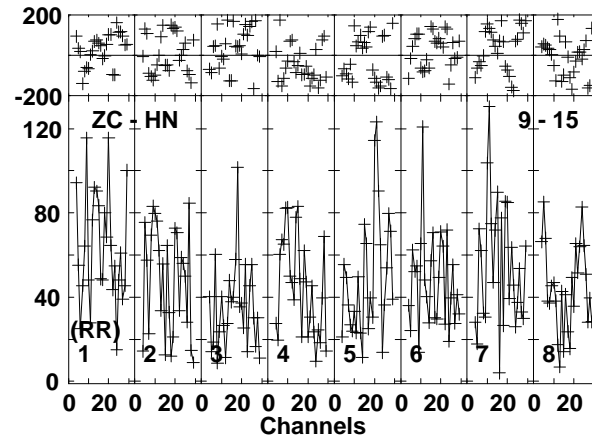
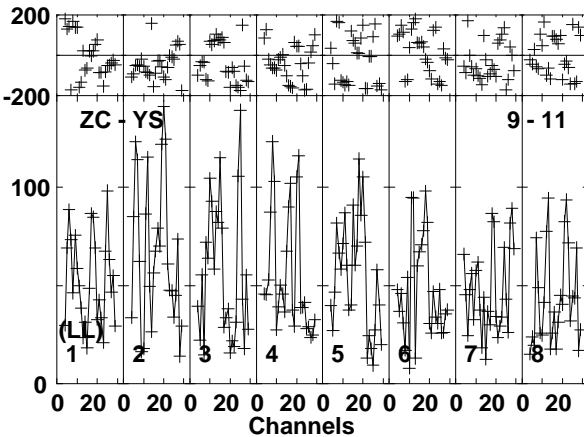
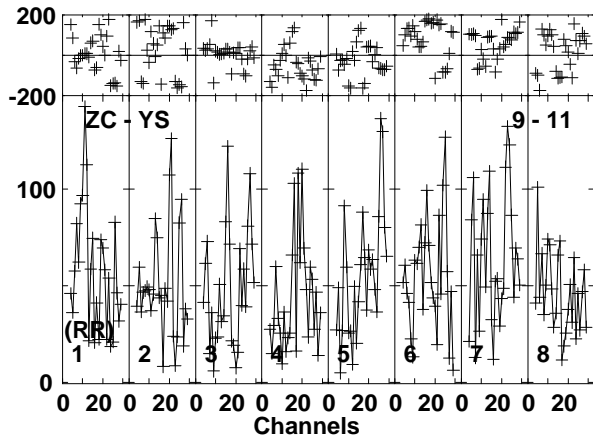
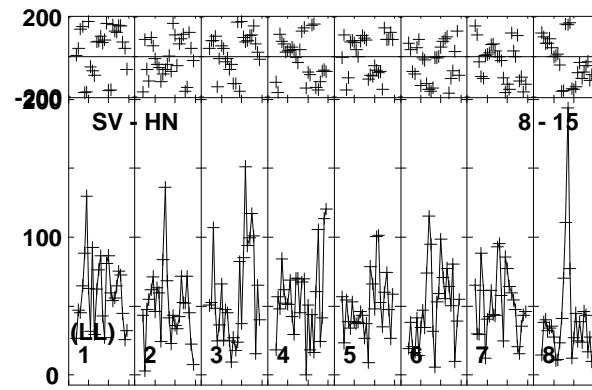
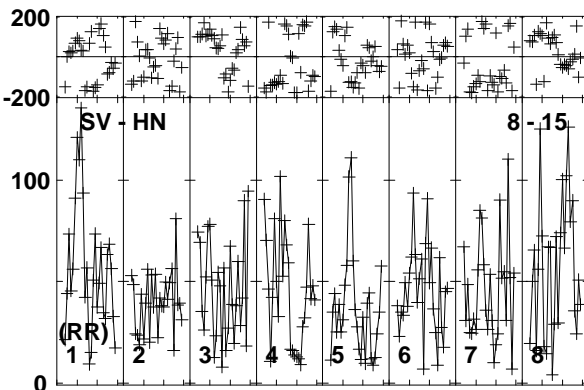
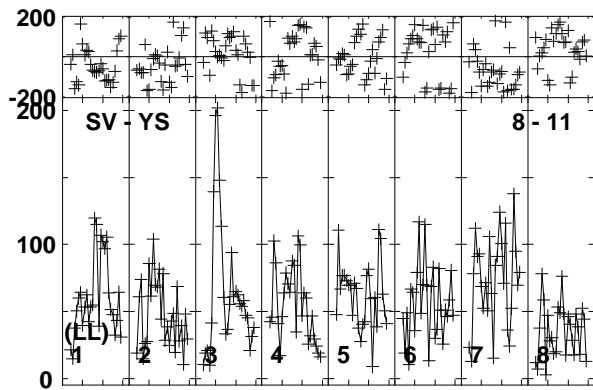
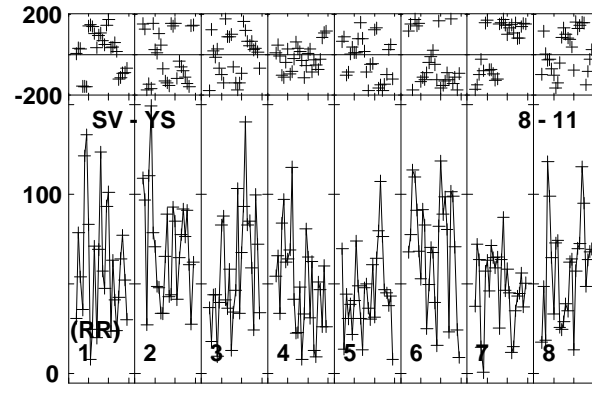
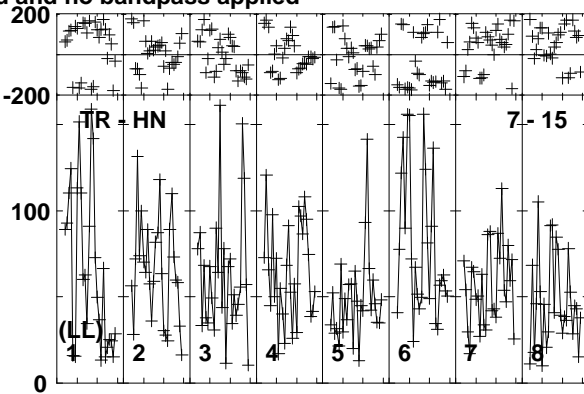
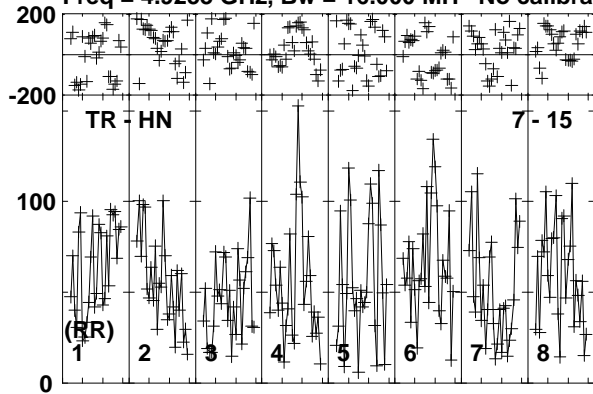

Lower frame: Micro Ampl Jy Top frame: Phas deg
Vector averaged cross-power spectrum Baseline: TR (07) - HN (15)
Timerange: 01/00:22:48 to 01/00:28:02

Plot file version 385 created 11-APR-2016 17:09:19

ARP299C GP053G 3.UVDATA.1

Freq = 4.9253 GHz, Bw = 16.000 MH No calibration applied and no bandpass applied

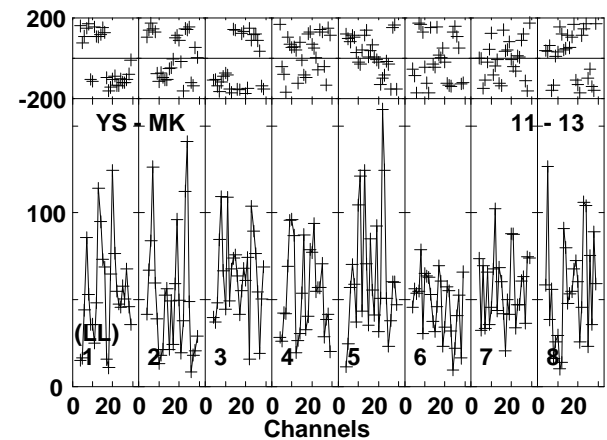
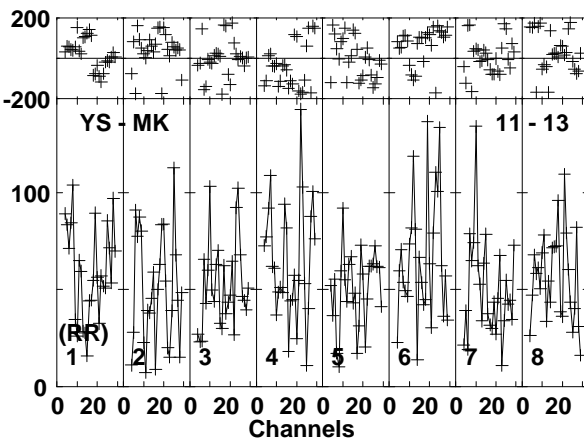
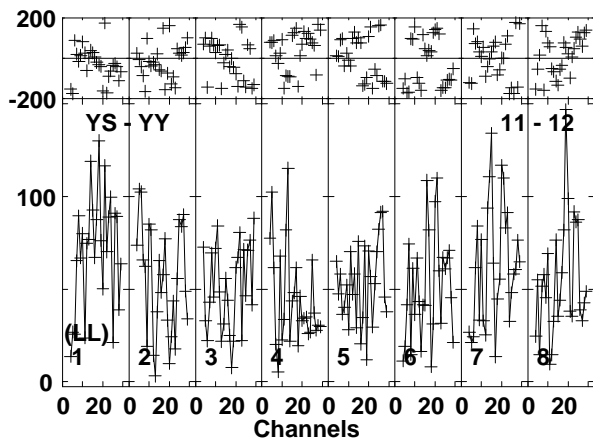
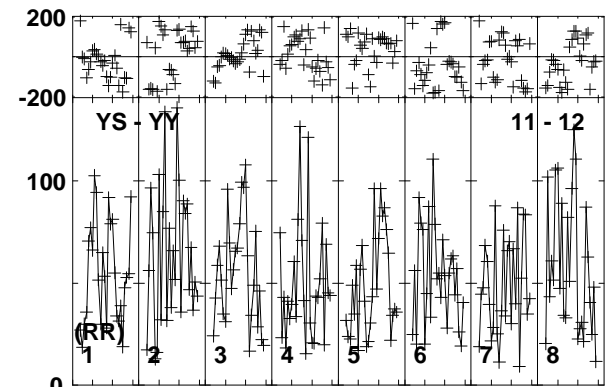
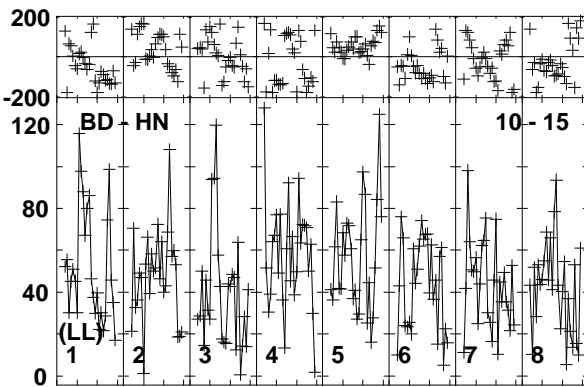
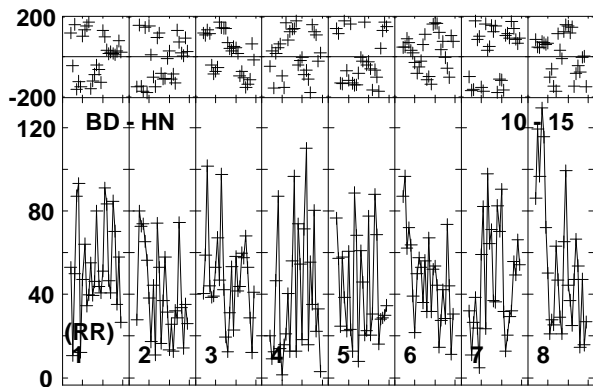
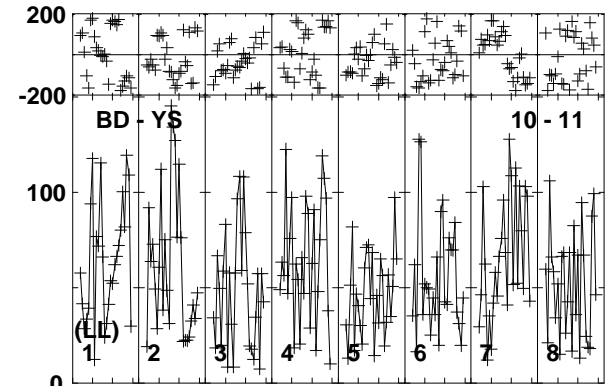
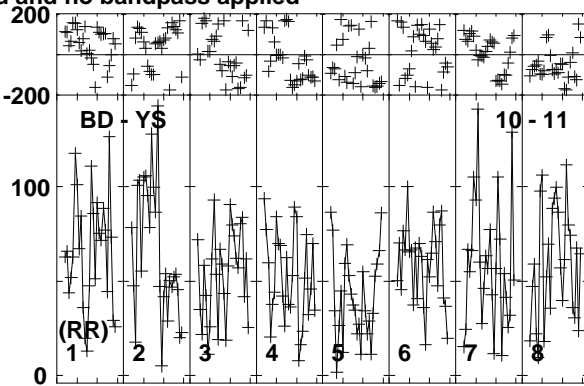
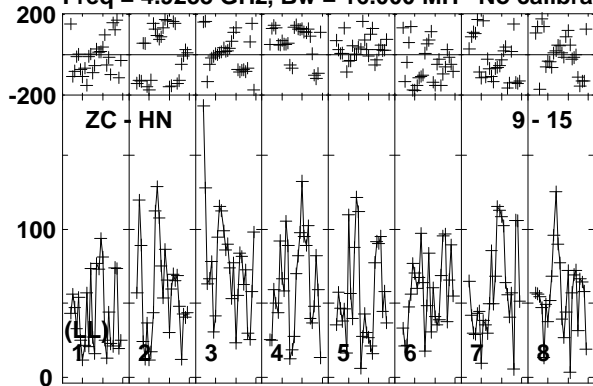

Lower frame: Micro Ampl Jy Top frame: Phas deg
Vector averaged cross-power spectrum Baseline: ZC (09) - HN (15)
Timerange: 01/00:22:48 to 01/00:28:02

Plot file version 386 created 11-APR-2016 17:09:19

ARP299C GP053G 3.UVDATA.1

Freq = 4.9253 GHz, Bw = 16.000 MH No calibration applied and no bandpass applied

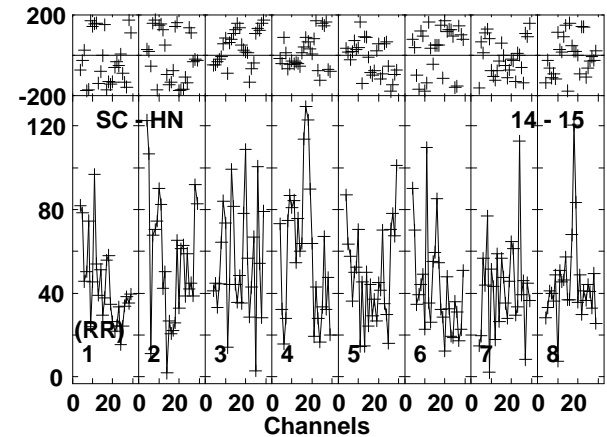
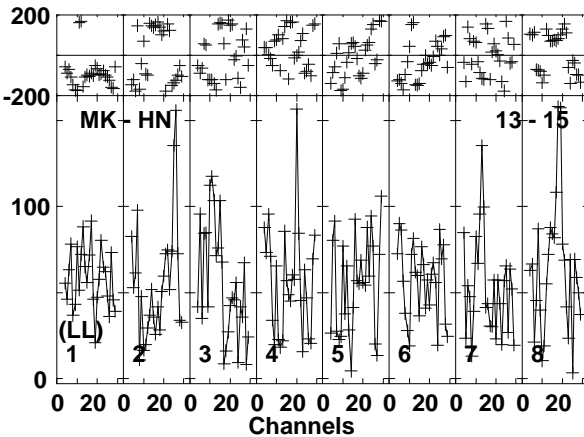
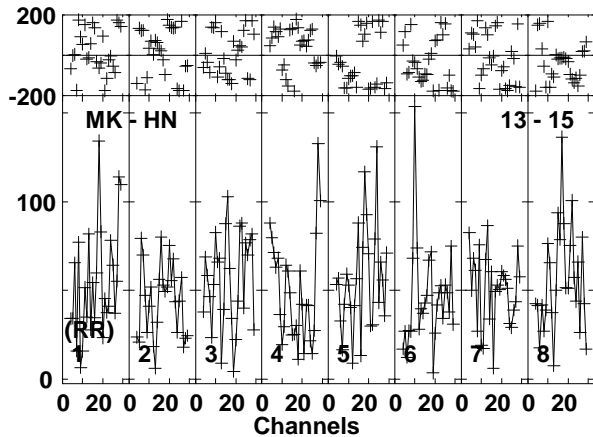
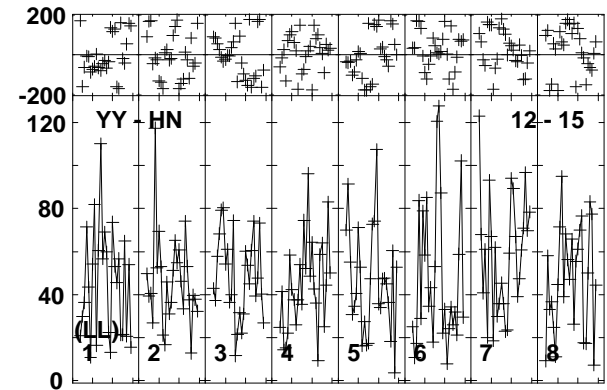
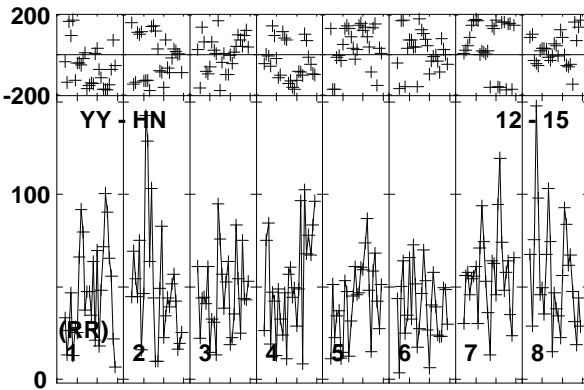
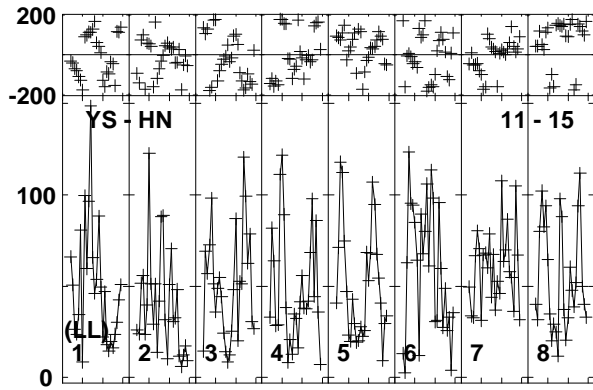
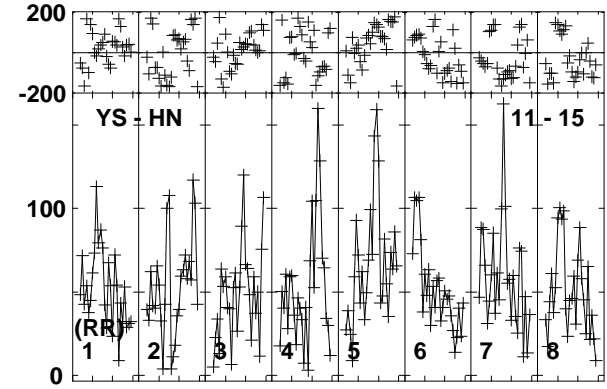
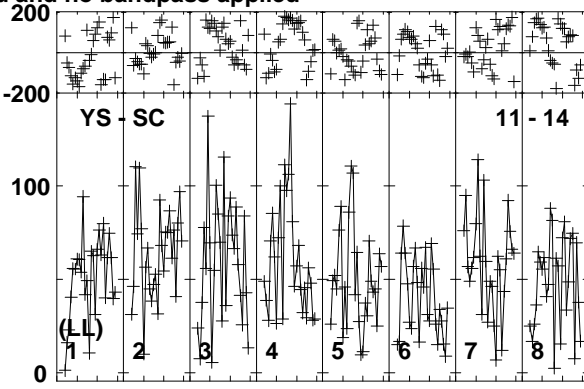
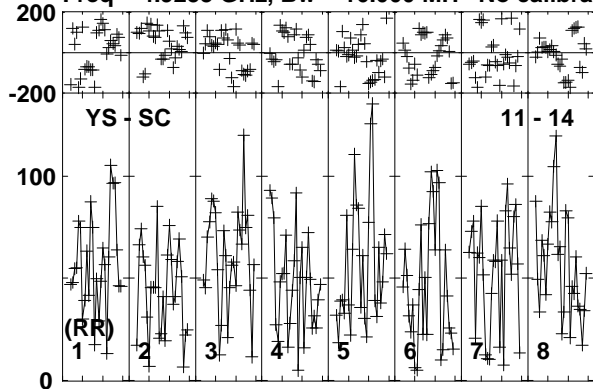

Lower frame: Micro Ampl Jy Top frame: Phas deg
Vector averaged cross-power spectrum Baseline: YS (11) - SC (14)
Timerange: 01/00:22:48 to 01/00:28:02

Plot file version 387 created 11-APR-2016 17:09:19

ARP299C GP053G 3.UVDATA.1

Freq = 4.9253 GHz, Bw = 16.000 MH No calibration applied and no bandpass applied

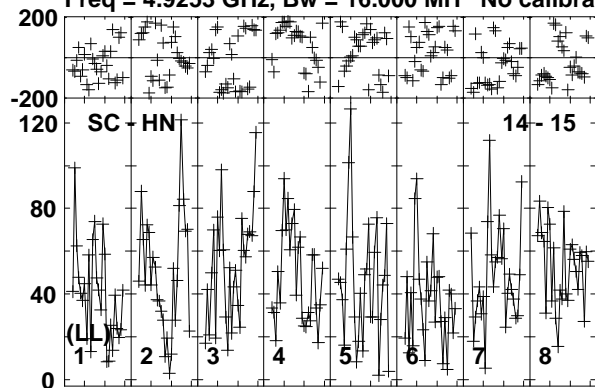

Lower frame: Micro Ampl Jy Top frame: Phas deg
Vector averaged cross-power spectrum Baseline: SC (14) - HN (15)
Timerange: 01/00:22:48 to 01/00:28:02

Plot file version 388 created 11-APR-2016 17:09:20

J1128+5925 GP053G 3.UVDATA.1

Freq = 4.9253 GHz, Bw = 16.000 MH No calibration applied and no bandpass applied

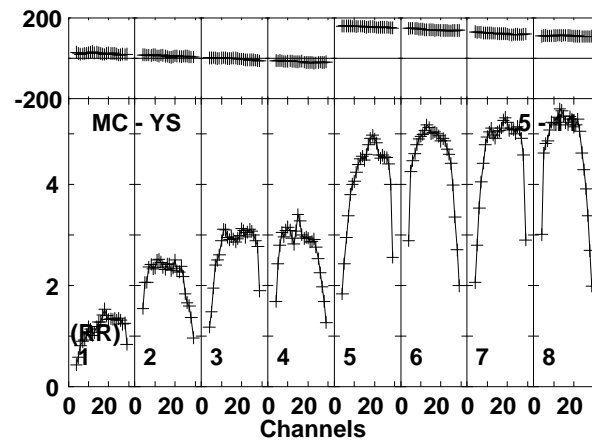
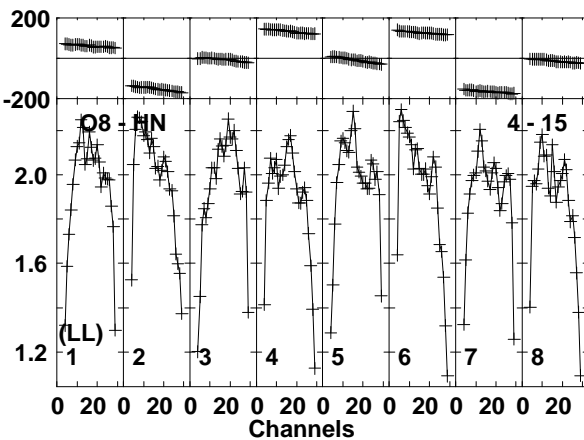
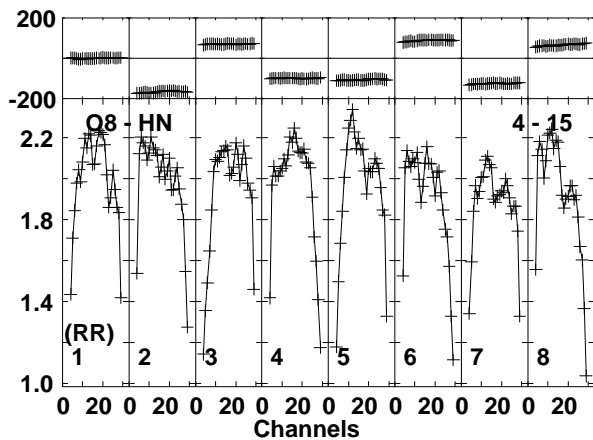
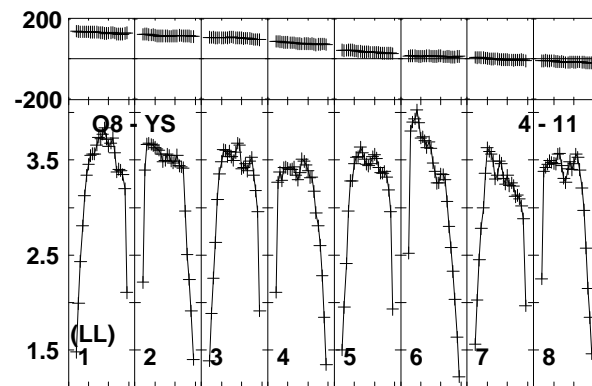
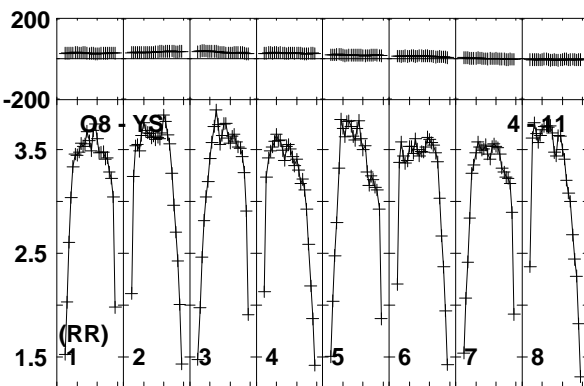
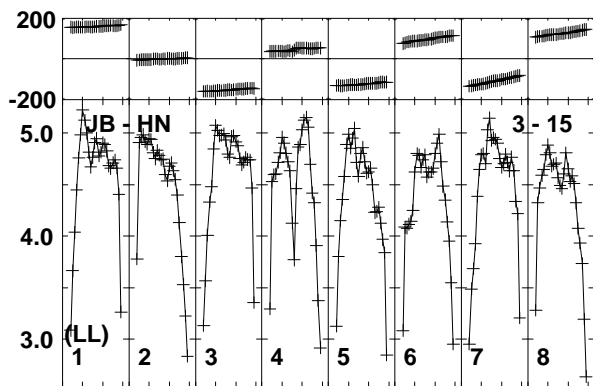
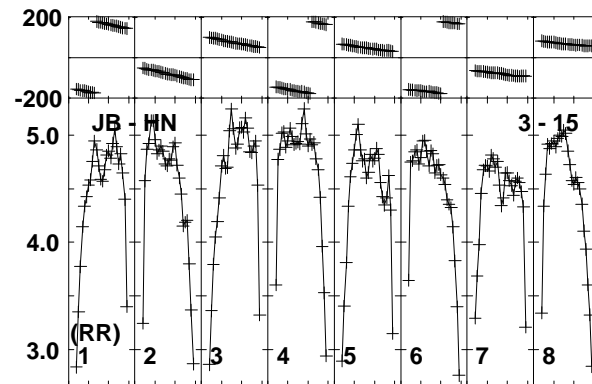
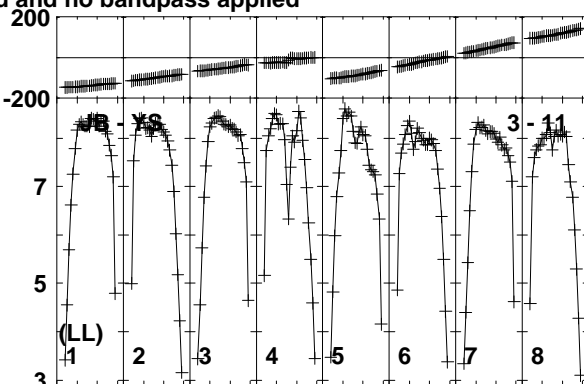
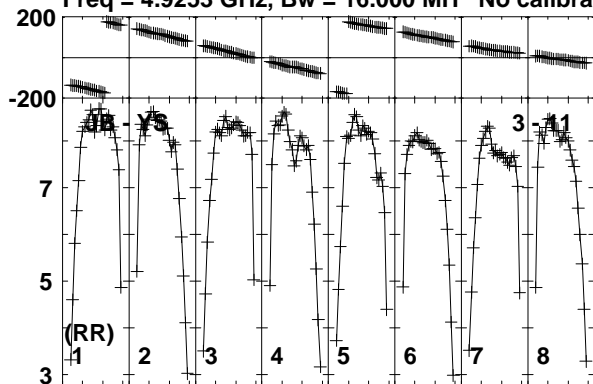

Lower frame: Milli Ampl Jy Top frame: Phas deg
Vector averaged cross-power spectrum Baseline: JB (03) - YS (11)
Timerange: 01/00:28:08 to 01/00:29:52

Plot file version 389 created 11-APR-2016 17:09:20

J1128+5925 GP053G 3.UVDATA.1

Freq = 4.9253 GHz, Bw = 16.000 MH No calibration applied and no bandpass applied

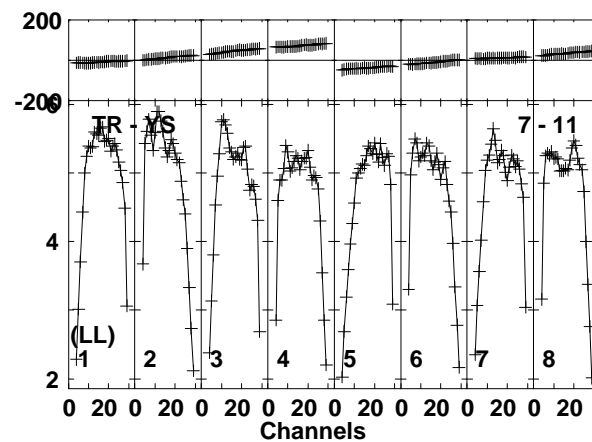
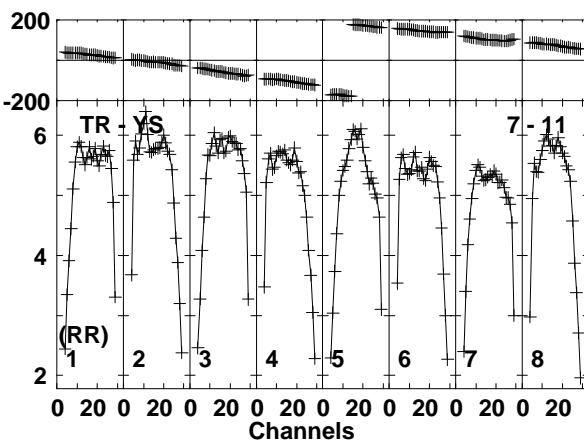
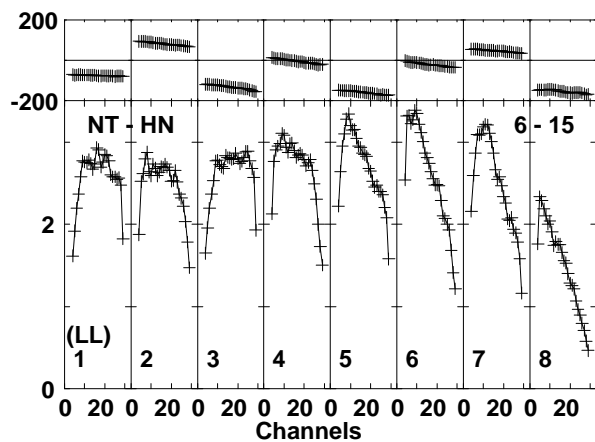
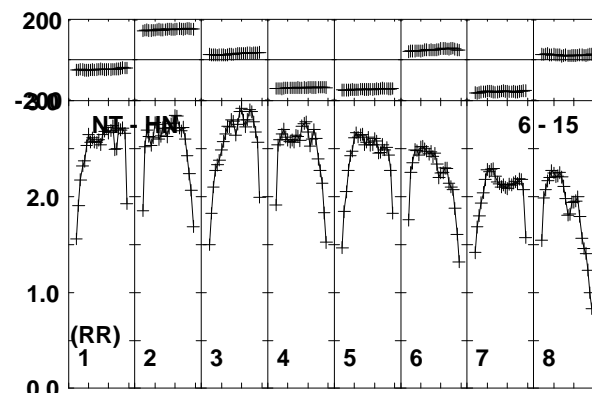
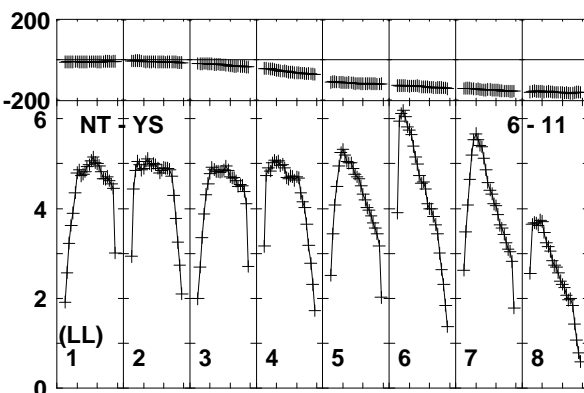
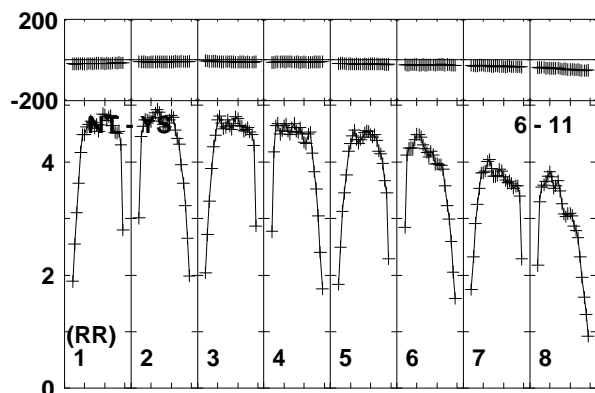
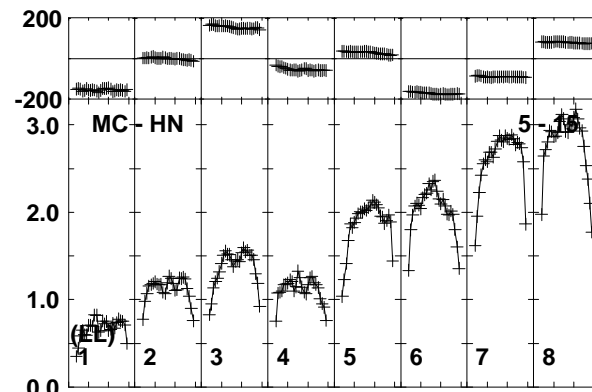
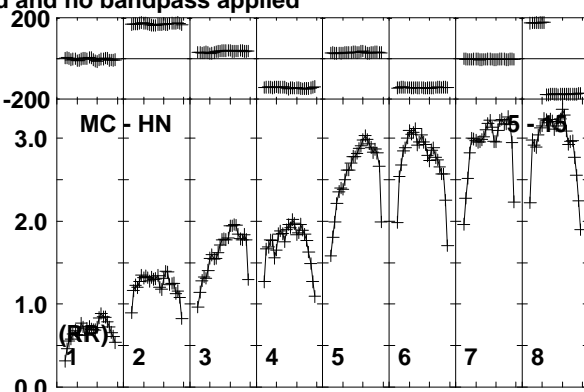
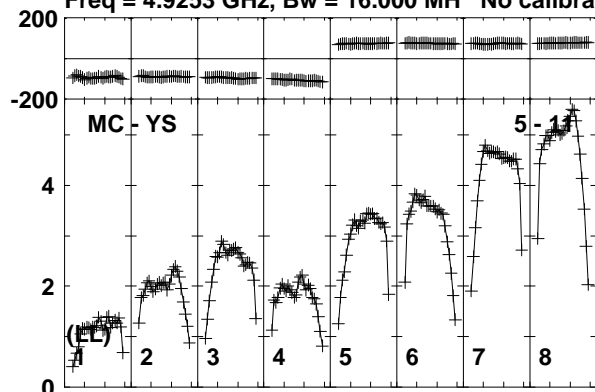

Lower frame: Milli Ampl Jy Top frame: Phas deg

Vector averaged cross-power spectrum Baseline: MC (05) - YS (11)

Timerange: 01/00:28:08 to 01/00:29:52

Plot file version 390 created 11-APR-2016 17:09:20

J1128+5925 GP053G 3.UVDATA.1

Freq = 4.9253 GHz, Bw = 16.000 MH No calibration applied and no bandpass applied

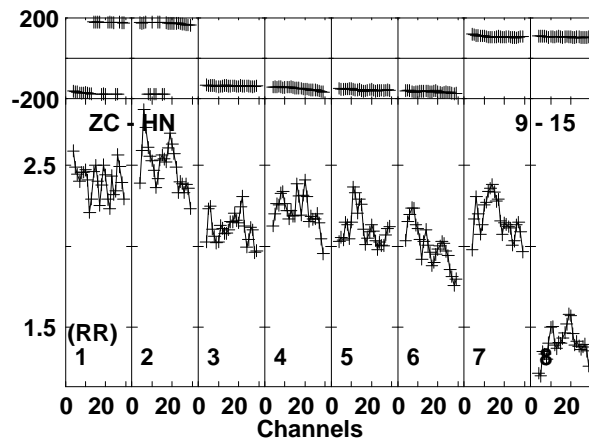
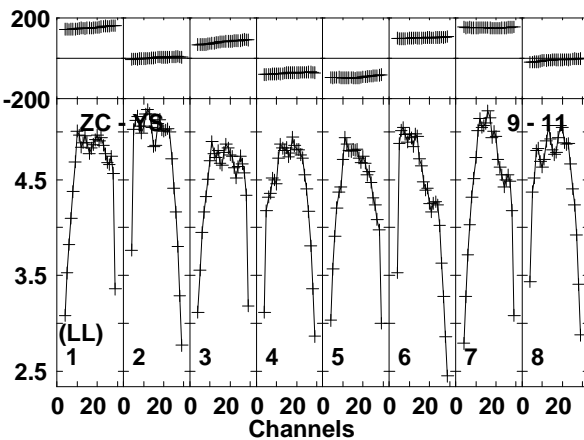
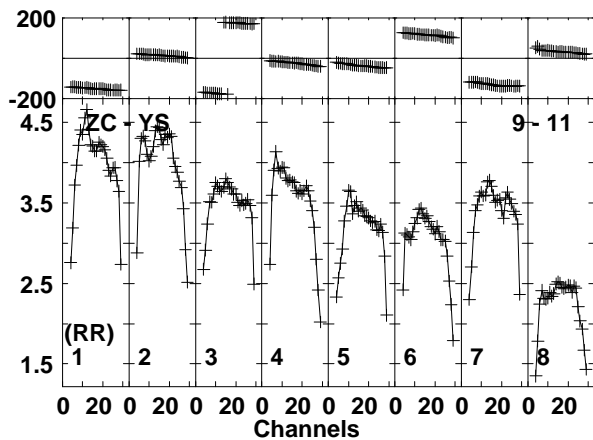
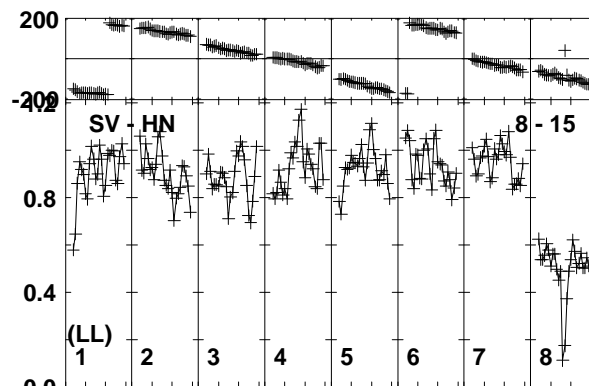
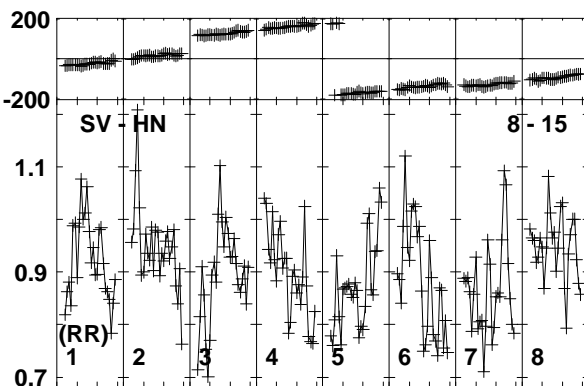
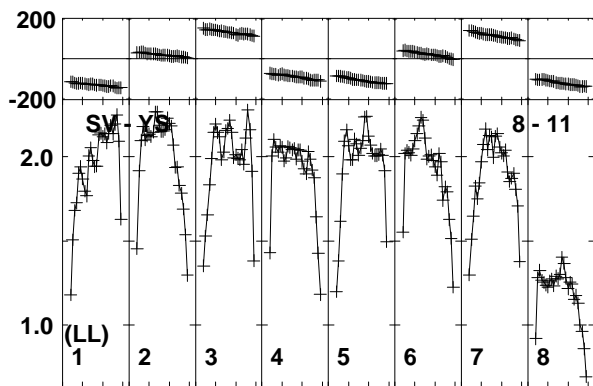
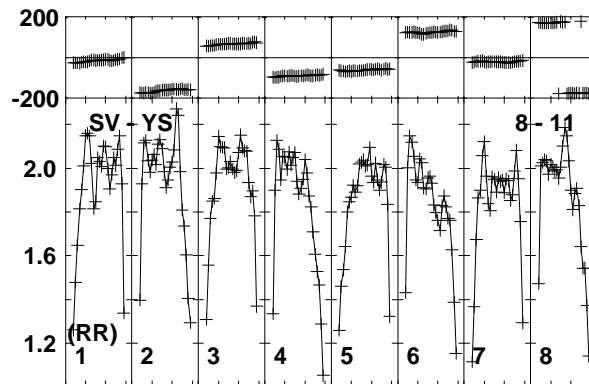
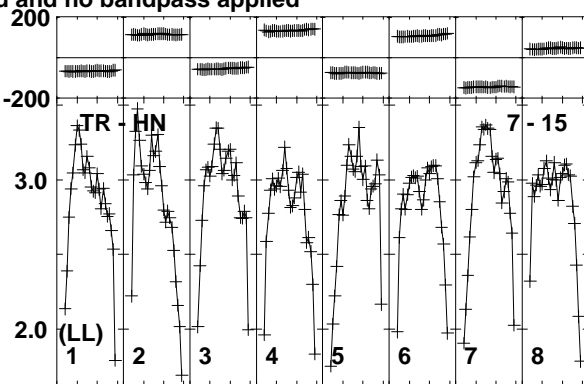
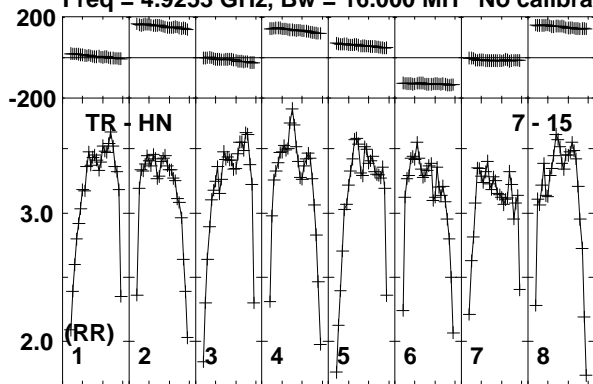

Lower frame: Milli Ampl Jy Top frame: Phas deg
Vector averaged cross-power spectrum Baseline: TR (07) - HN (15)
Timerange: 01/00:28:08 to 01/00:29:52

Plot file version 391 created 11-APR-2016 17:09:20
 J1128+5925 GP053G 3.UVDATA.1

Freq = 4.9253 GHz, Bw = 16.000 MH No calibration applied and no bandpass applied

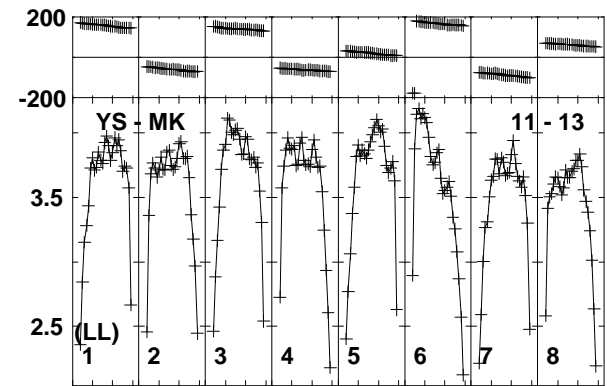
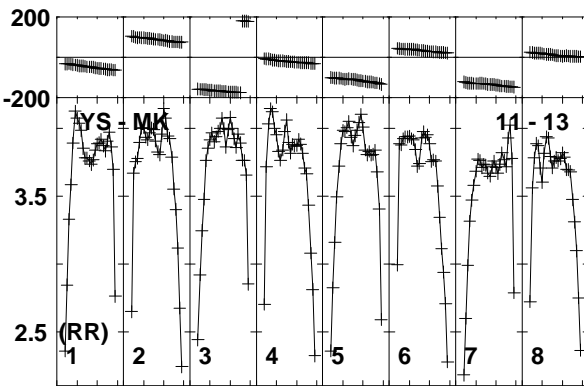
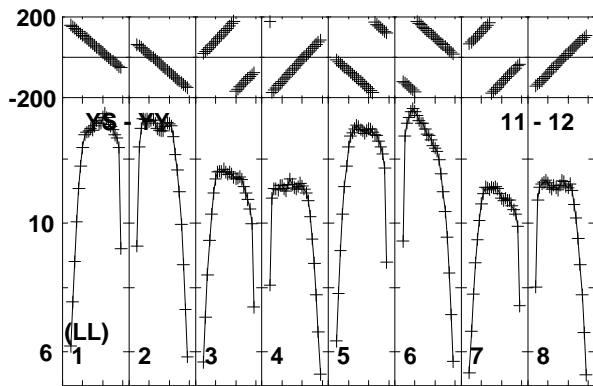
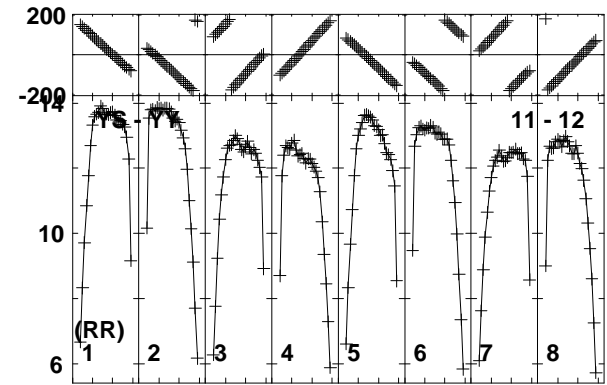
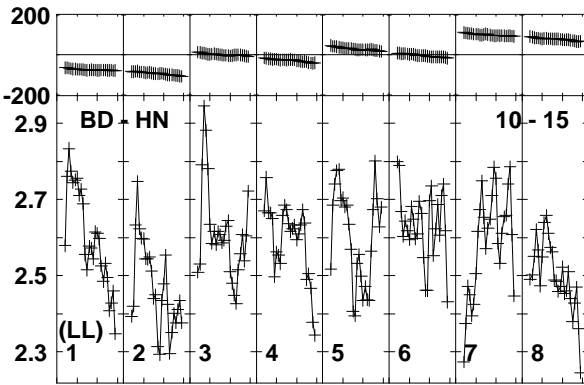
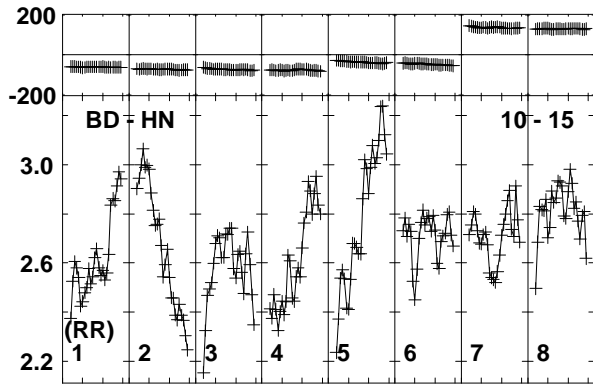
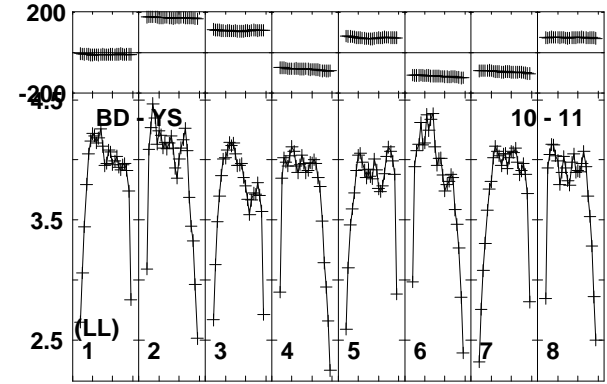
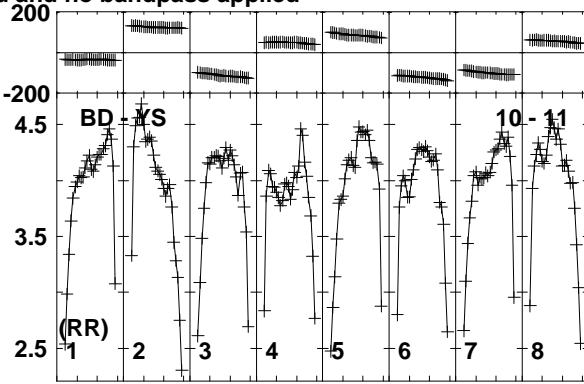
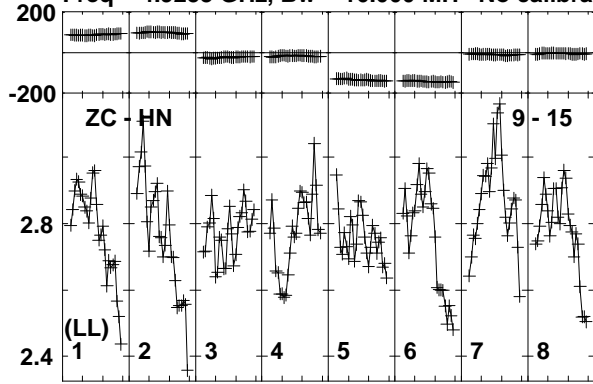

Lower frame: Milli Ampl Jy Top frame: Phas deg
 Vector averaged cross-power spectrum Baseline: ZC (09) - HN (15)
 Timerange: 01/00:28:08 to 01/00:29:52

Plot file version 392 created 11-APR-2016 17:09:20

J1128+5925 GP053G 3.UVDATA.1

Freq = 4.9253 GHz, Bw = 16.000 MH No calibration applied and no bandpass applied

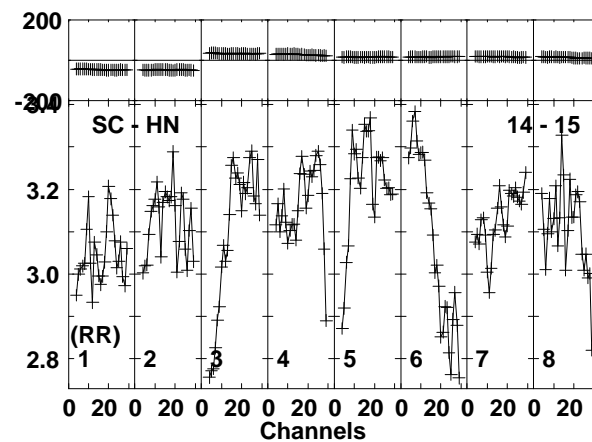
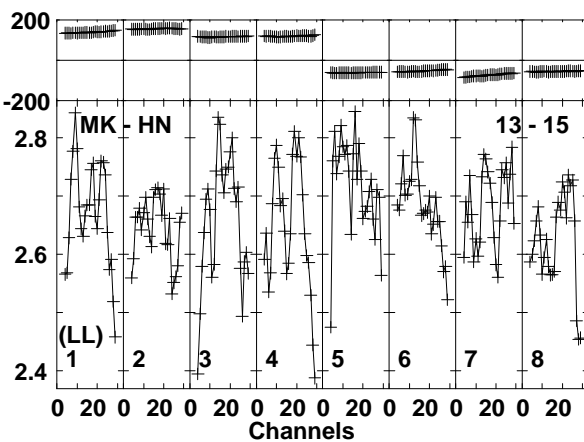
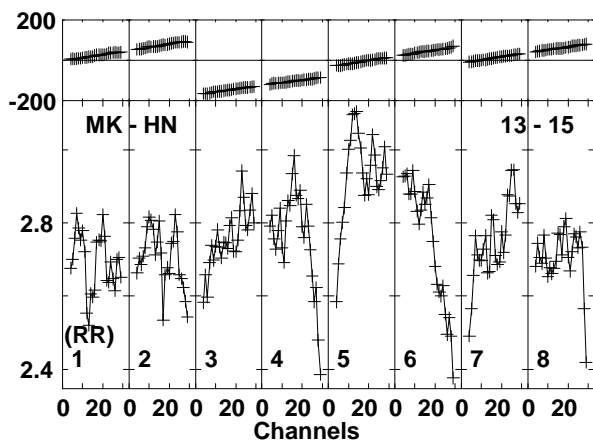
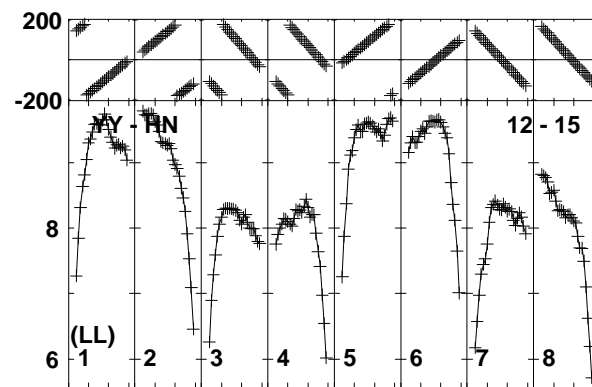
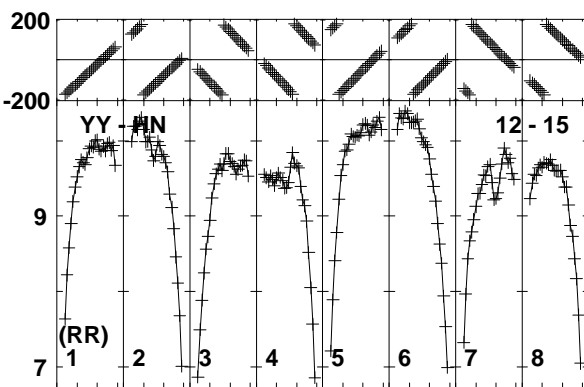
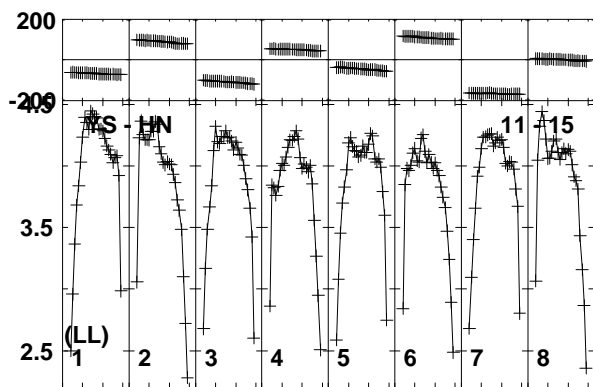
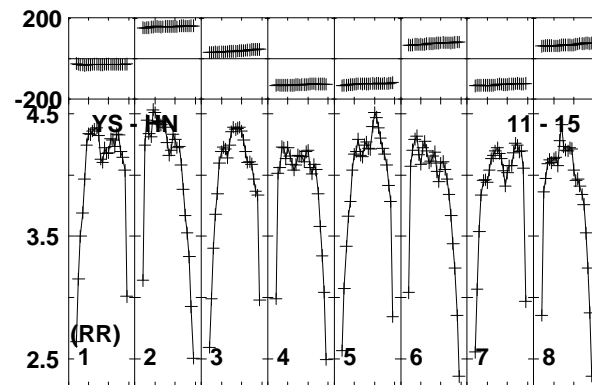
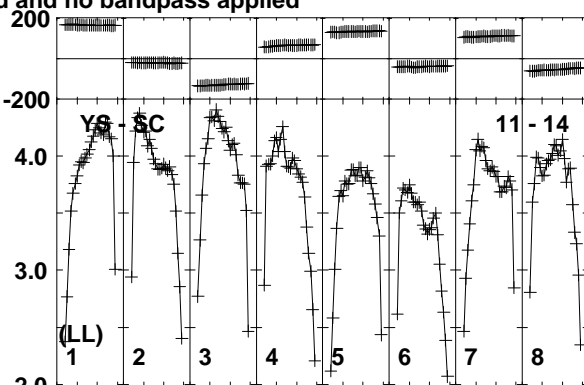
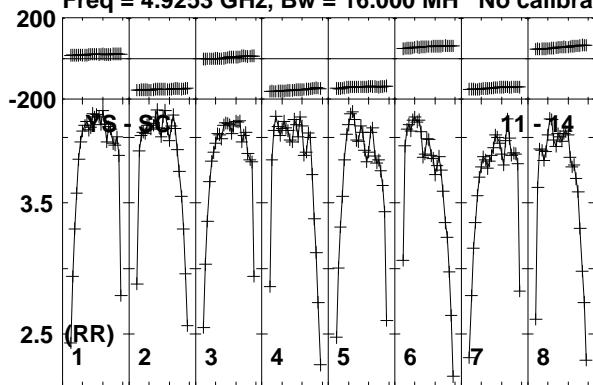

Lower frame: Milli Ampl Jy Top frame: Phas deg
Vector averaged cross-power spectrum Baseline: YS (11) - SC (14)
Timerange: 01/00:28:08 to 01/00:29:52

Plot file version 393 created 11-APR-2016 17:09:20
J1128+5925 GP053G 3.UVDATA.1
Freq = 4.9253 GHz, Bw = 16.000 MH No calibration applied and no bandpass applied

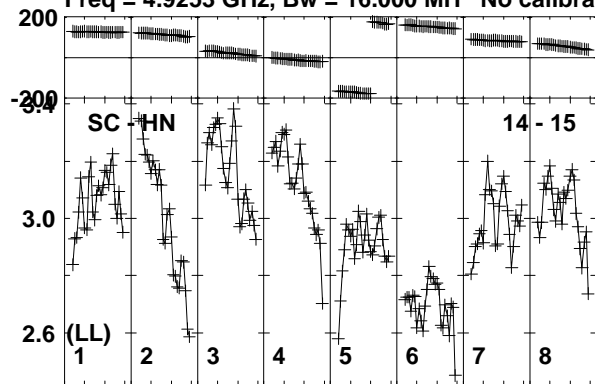

Lower frame: Milli Ampl Jy Top frame: Phas deg
Vector averaged cross-power spectrum Baseline: SC (14) - HN (15)
Timerange: 01/00:28:08 to 01/00:29:52

Plot file version 394 created 11-APR-2016 17:09:20

ARP299C GP053G 3.UVDATA.1

Freq = 4.9253 GHz, Bw = 16.000 MH No calibration applied and no bandpass applied

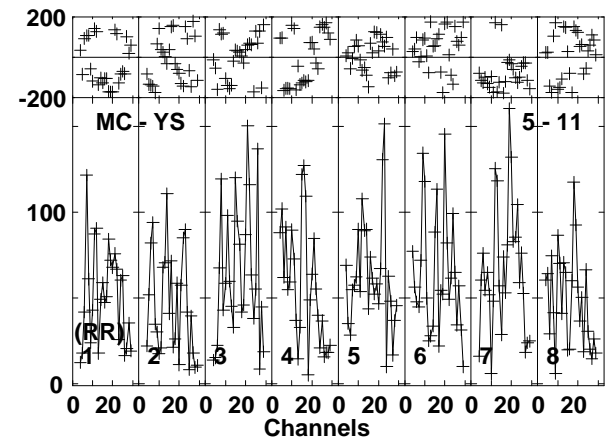
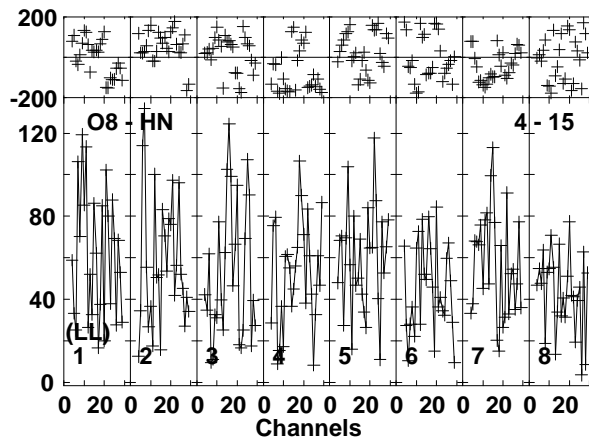
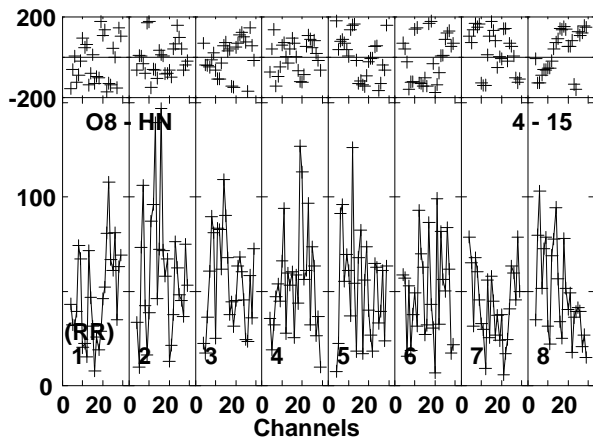
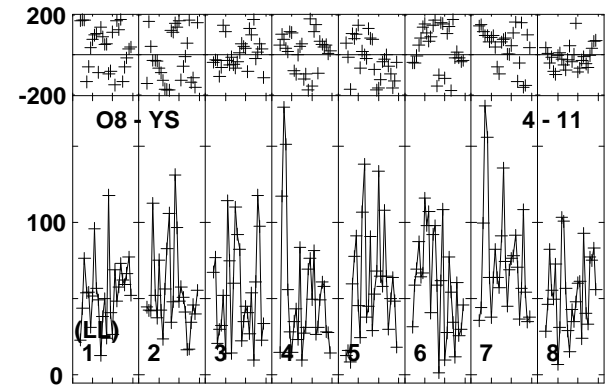
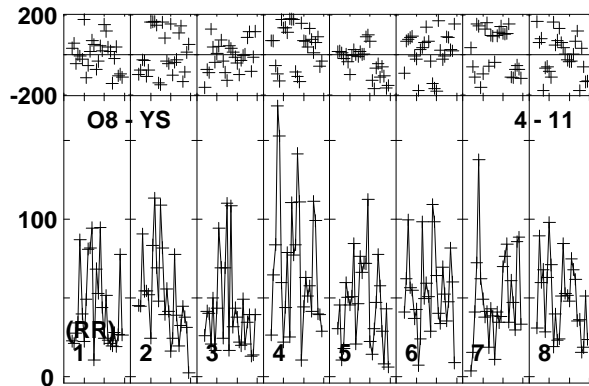
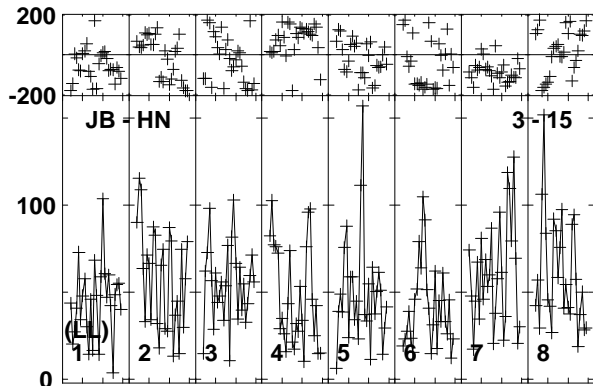
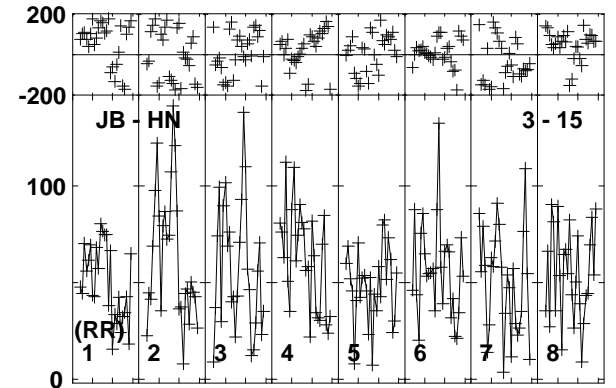
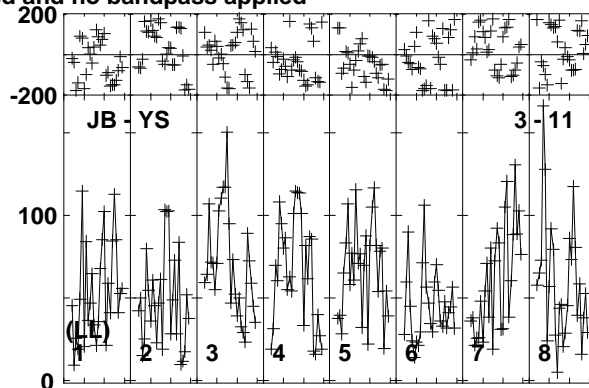
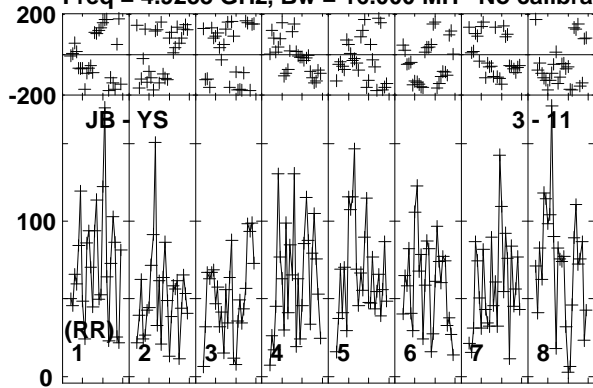

Lower frame: Micro Ampl Jy Top frame: Phas deg
Vector averaged cross-power spectrum Baseline: JB (03) - YS (11)
Timerange: 01/00:29:58 to 01/00:35:10

Plot file version 395 created 11-APR-2016 17:09:21

ARP299C GP053G 3.UVDATA.1

Freq = 4.9253 GHz, Bw = 16.000 MH No calibration applied and no bandpass applied

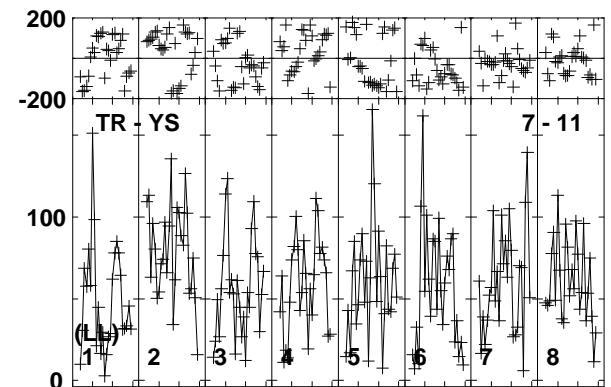
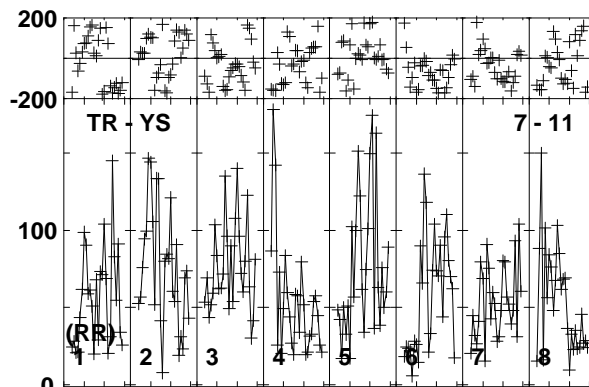
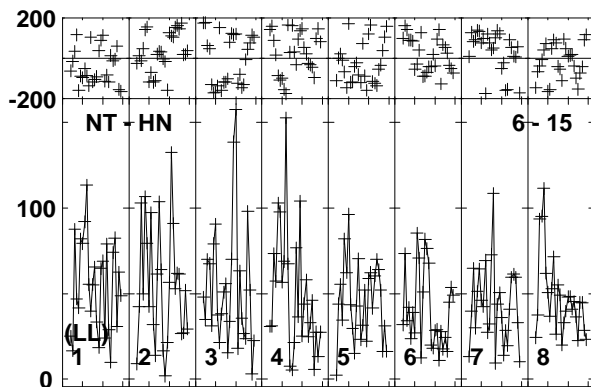
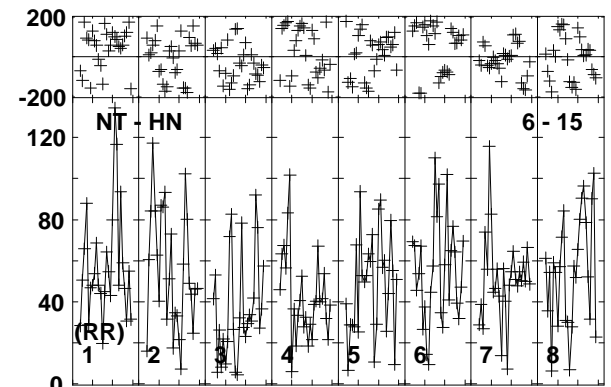
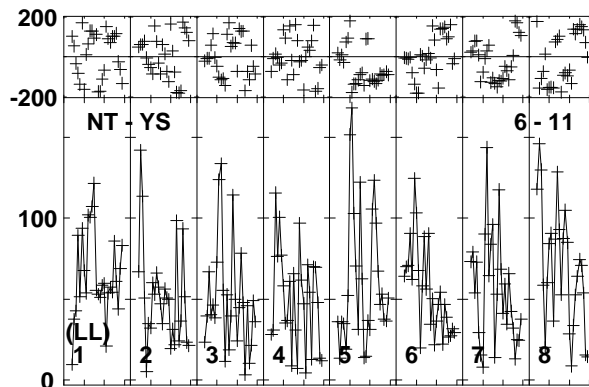
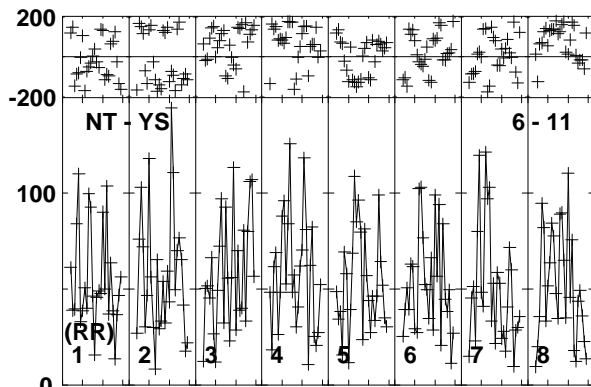
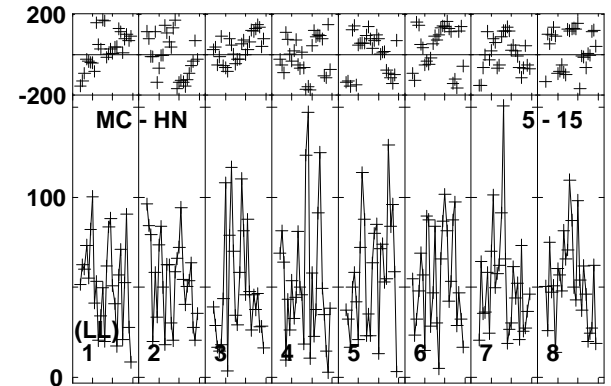
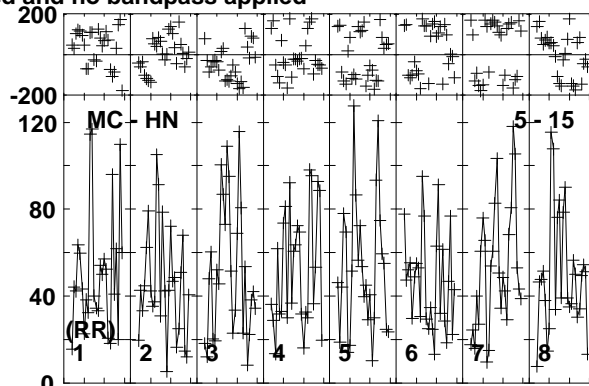
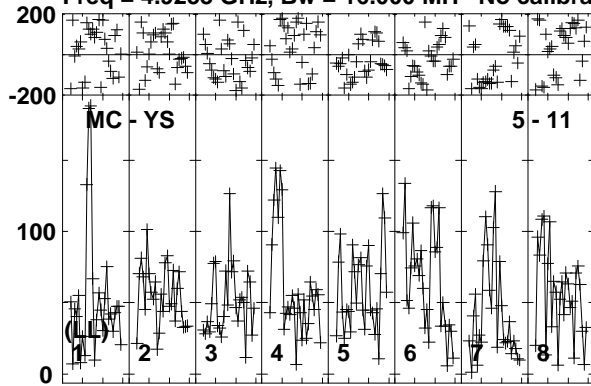

Lower frame: Micro Ampl Jy Top frame: Phas deg
Vector averaged cross-power spectrum Baseline: MC (05) - YS (11)
Timerange: 01/00:29:58 to 01/00:35:10

Plot file version 396 created 11-APR-2016 17:09:21

ARP299C GP053G 3.UVDATA.1

Freq = 4.9253 GHz, Bw = 16.000 MH No calibration applied and no bandpass applied

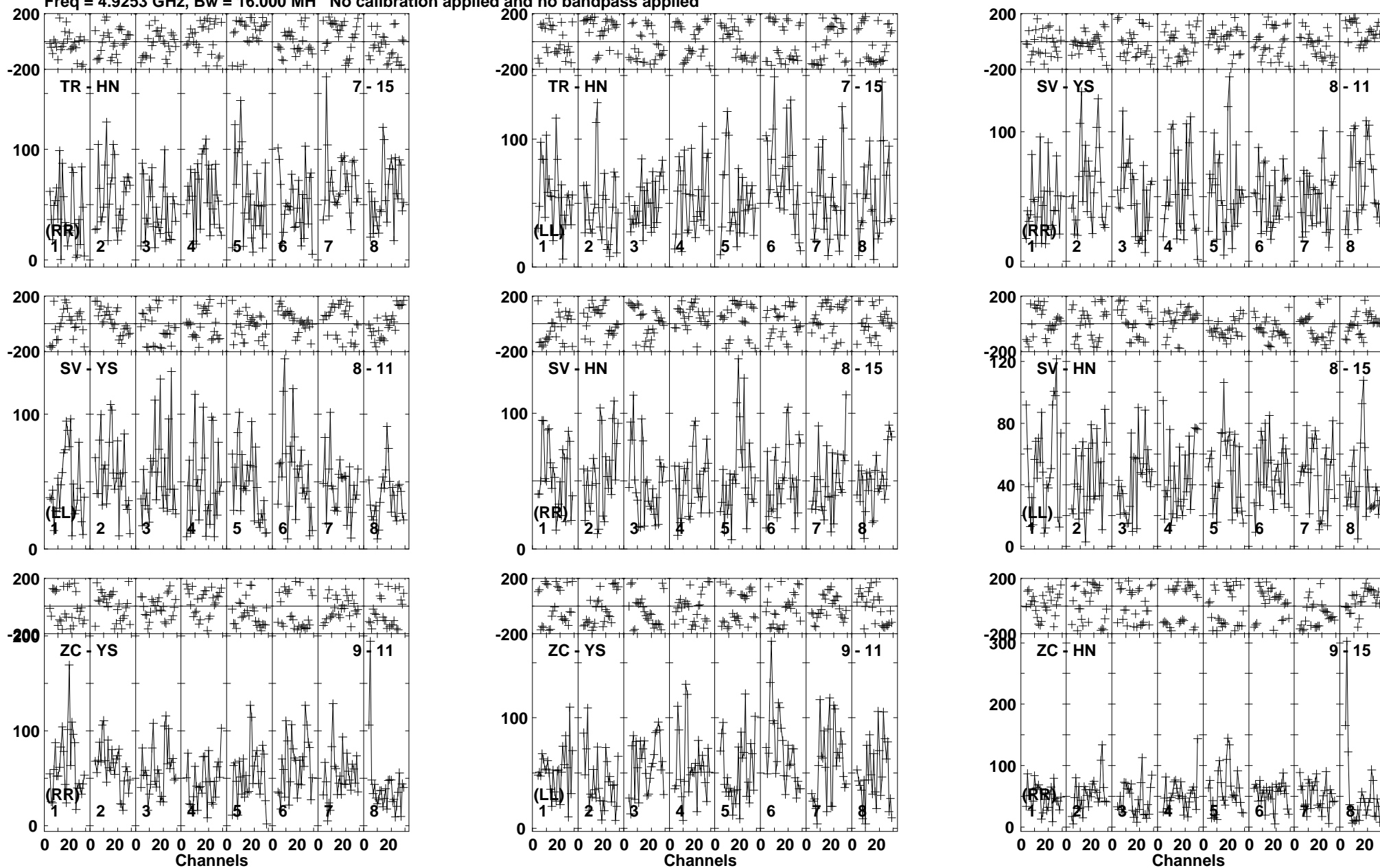

Lower frame: Micro Ampl Jy Top frame: Phas deg
Vector averaged cross-power spectrum Baseline: TR (07) - HN (15)
Timerange: 01/00:29:58 to 01/00:35:10

Plot file version 397 created 11-APR-2016 17:09:21

ARP299C GP053G 3.UVDATA.1

Freq = 4.9253 GHz, Bw = 16.000 MH No calibration applied and no bandpass applied

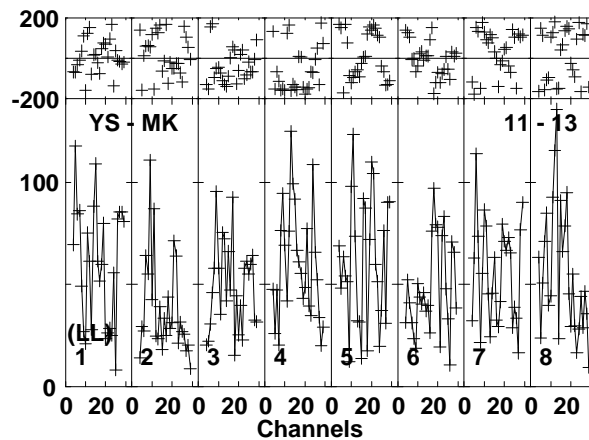
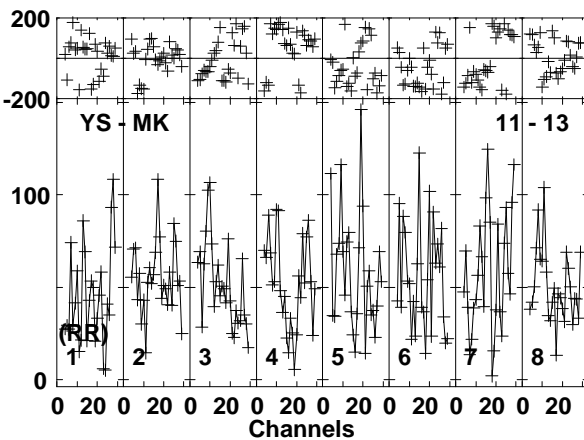
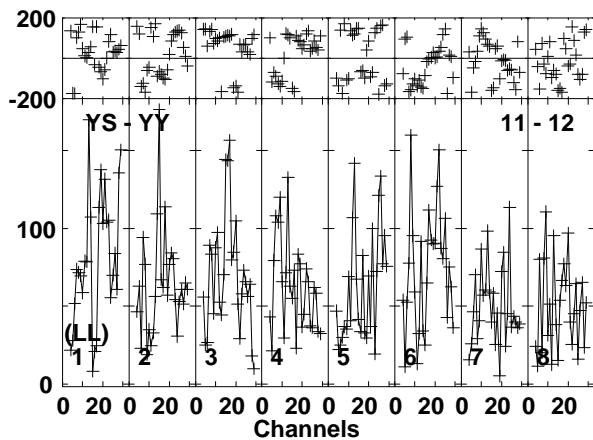
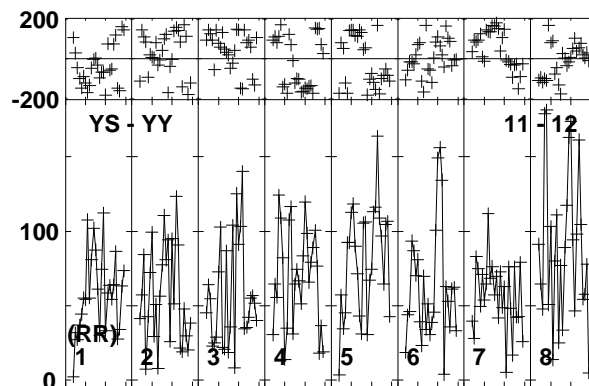
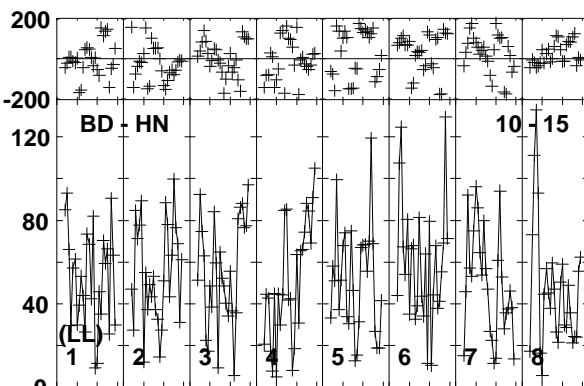
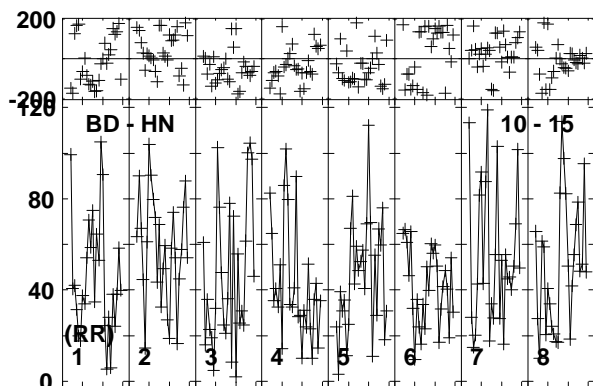
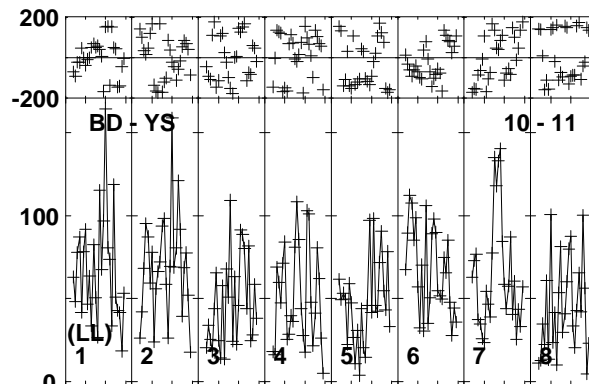
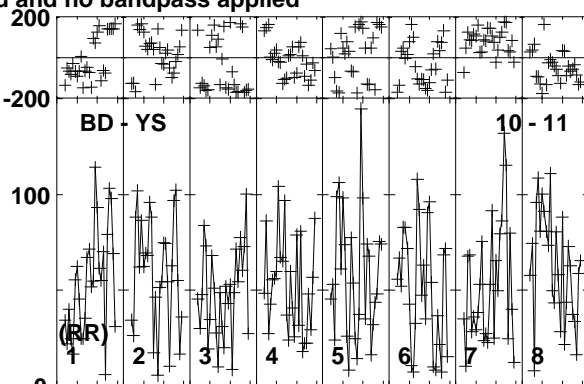
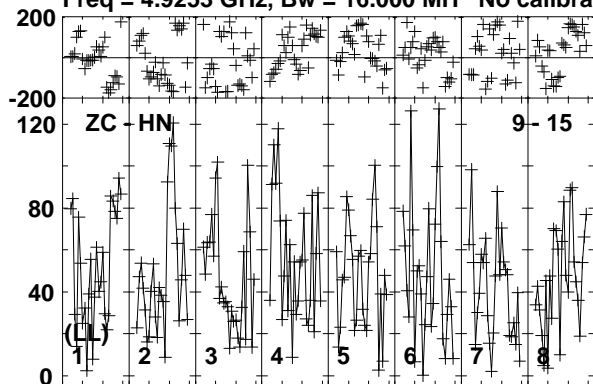

Lower frame: Micro Ampl Jy Top frame: Phas deg
Vector averaged cross-power spectrum Baseline: ZC (09) - HN (15)
Timerange: 01/00:29:58 to 01/00:35:10

Plot file version 398 created 11-APR-2016 17:09:21

ARP299C GP053G 3.UVDATA.1

Freq = 4.9253 GHz, Bw = 16.000 MH No calibration applied and no bandpass applied

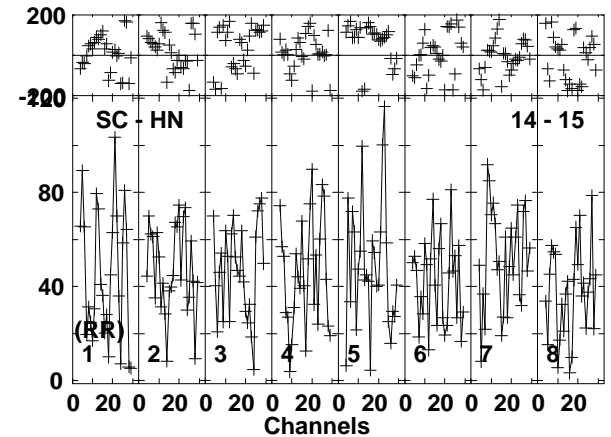
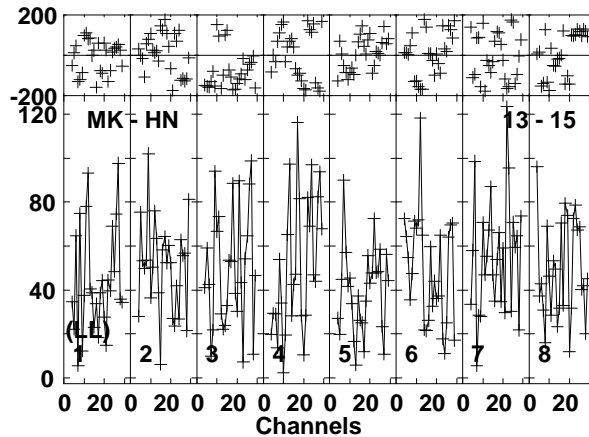
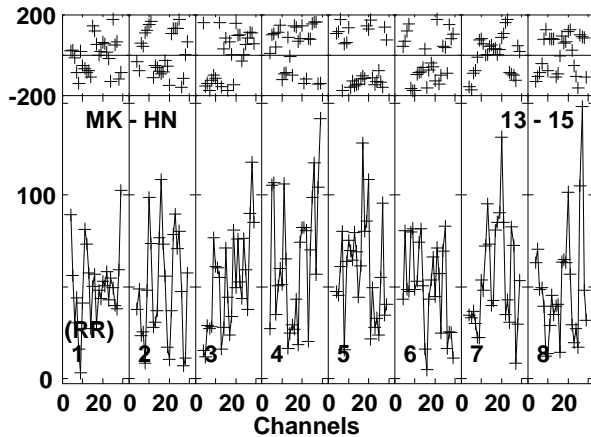
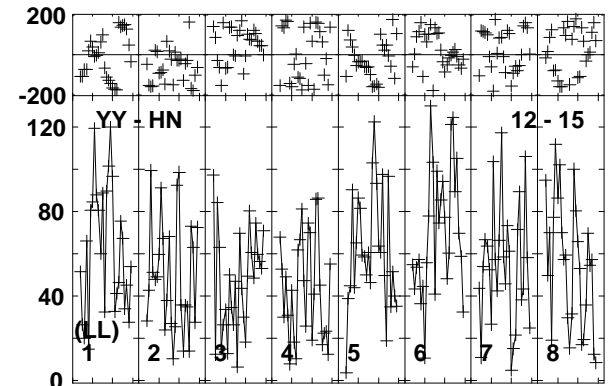
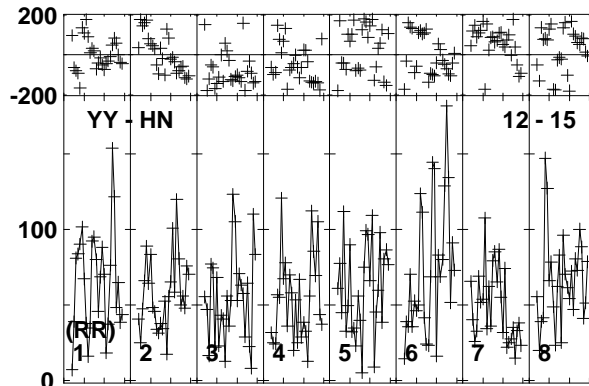
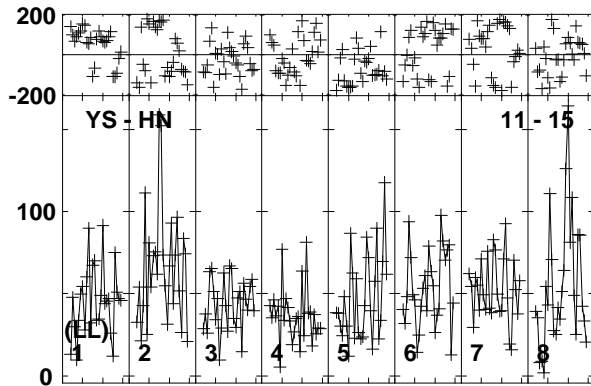
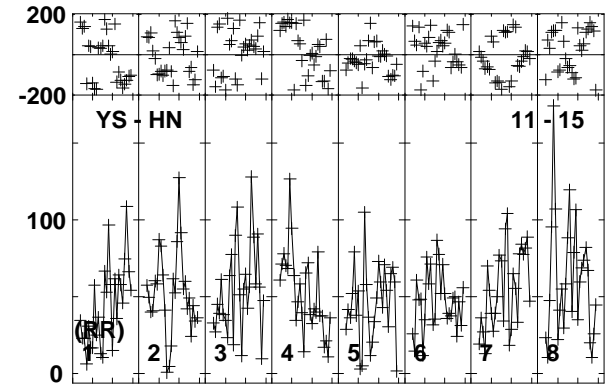
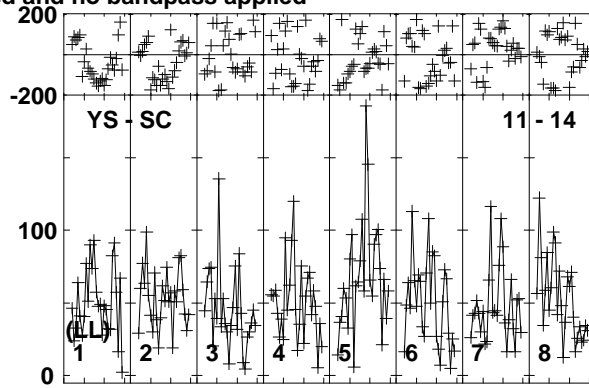
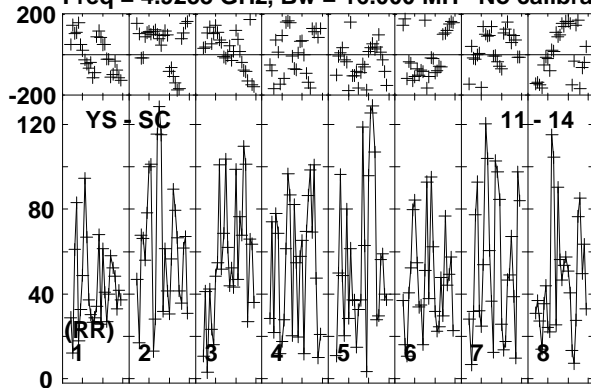

Lower frame: Micro Ampl Jy Top frame: Phas deg
Vector averaged cross-power spectrum Baseline: YS (11) - SC (14)
Timerange: 01/00:29:58 to 01/00:35:10

Plot file version 399 created 11-APR-2016 17:09:21

ARP299C GP053G 3.UVDATA.1

Freq = 4.9253 GHz, Bw = 16.000 MH No calibration applied and no bandpass applied

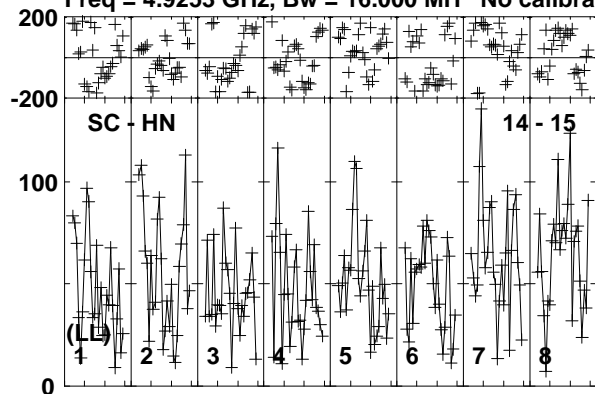

Lower frame: Micro Ampl Jy Top frame: Phas deg
Vector averaged cross-power spectrum Baseline: SC (14) - HN (15)
Timerange: 01/00:29:58 to 01/00:35:10

Plot file version 400 created 11-APR-2016 17:09:22

J1128+5925 GP053G 3.UVDATA.1

Freq = 4.9253 GHz, Bw = 16.000 MH No calibration applied and no bandpass applied

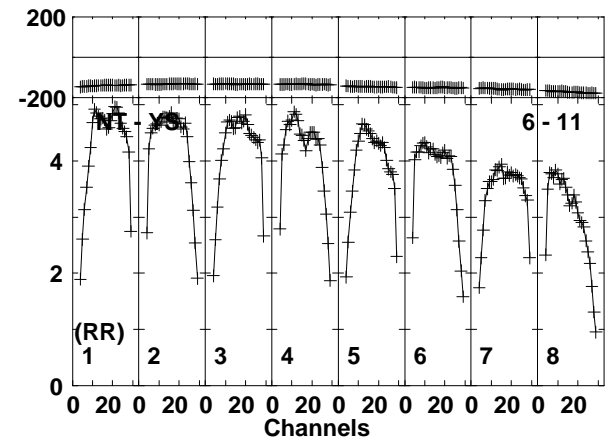
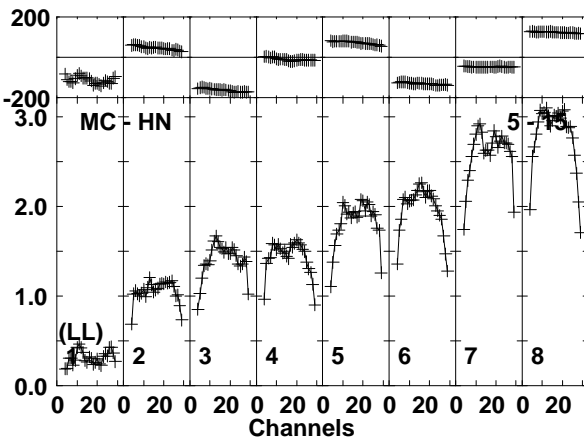
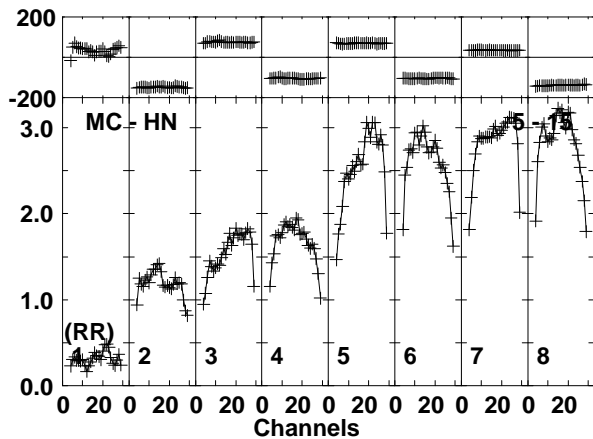
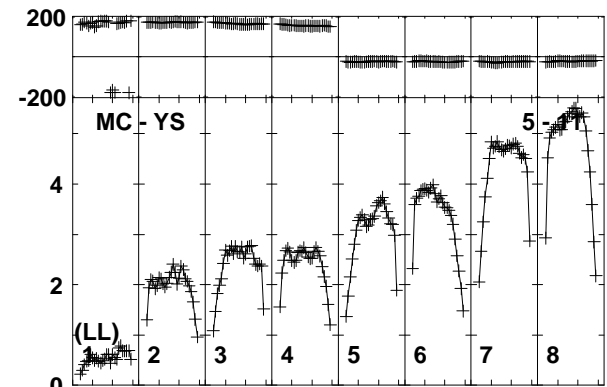
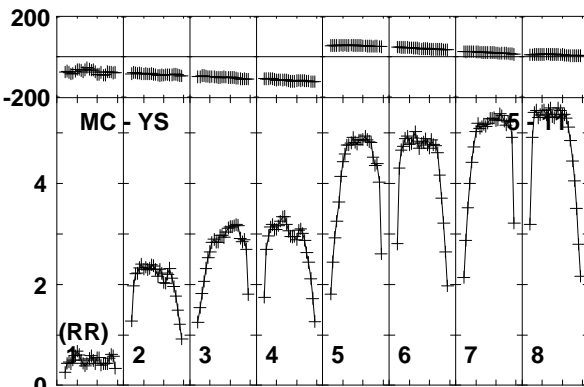
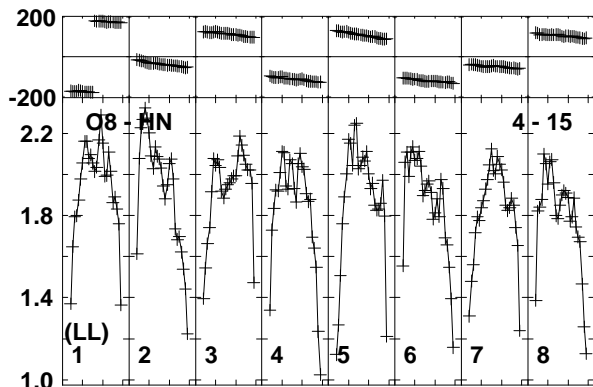
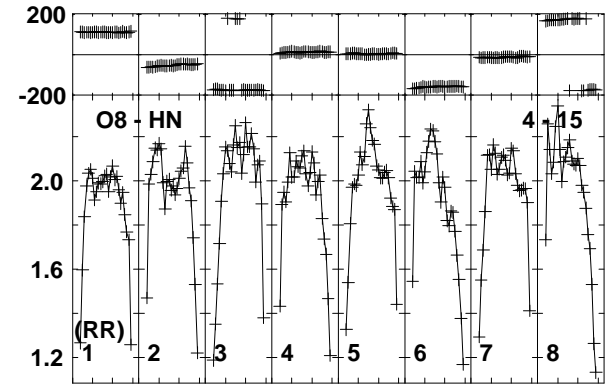
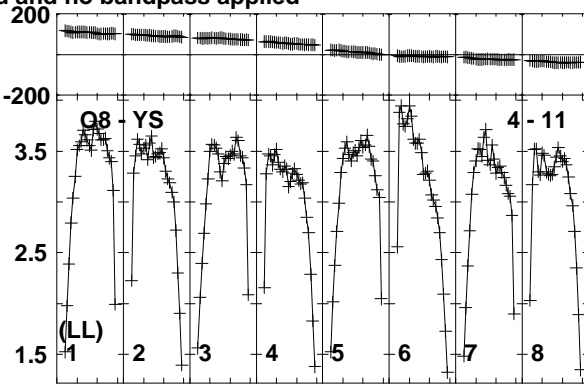
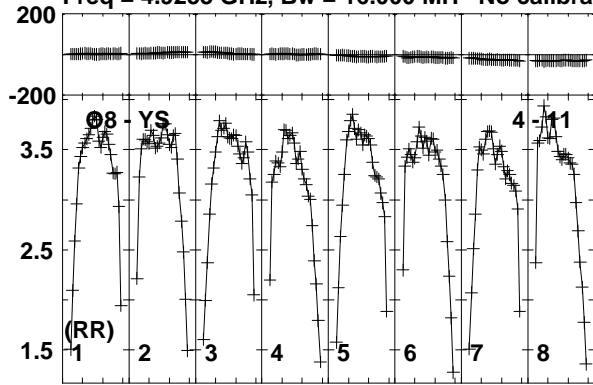

Lower frame: Milli Ampl Jy Top frame: Phas deg
Vector averaged cross-power spectrum Baseline: O8 (04) - YS (11)
Timerange: 01/00:35:16 to 01/00:37:08

Plot file version 401 created 11-APR-2016 17:09:22

J1128+5925 GP053G 3.UVDATA.1

Freq = 4.9253 GHz, Bw = 16.000 MH No calibration applied and no bandpass applied

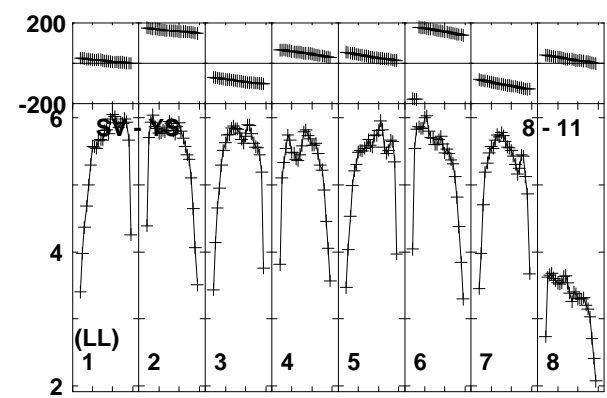
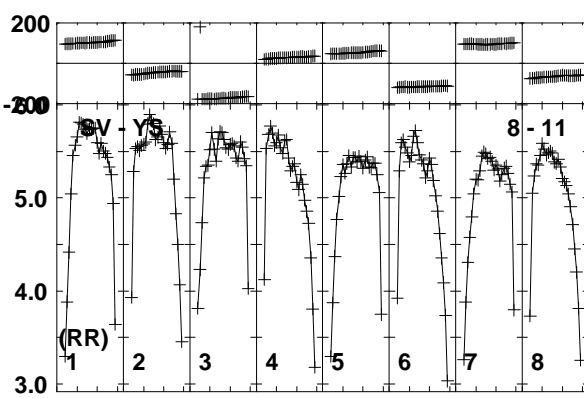
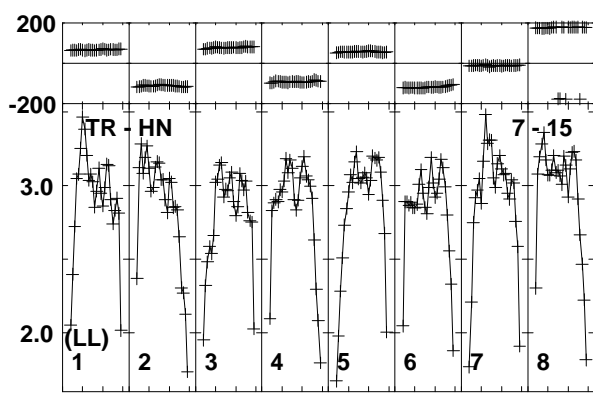
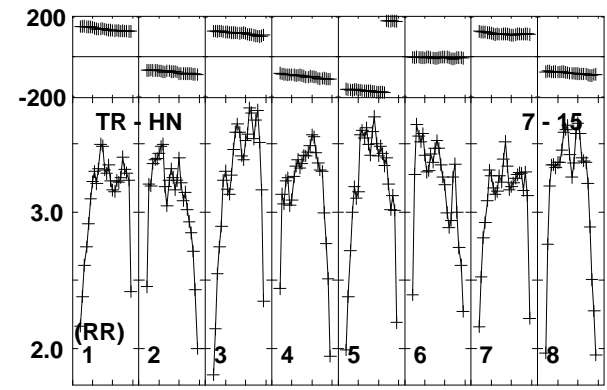
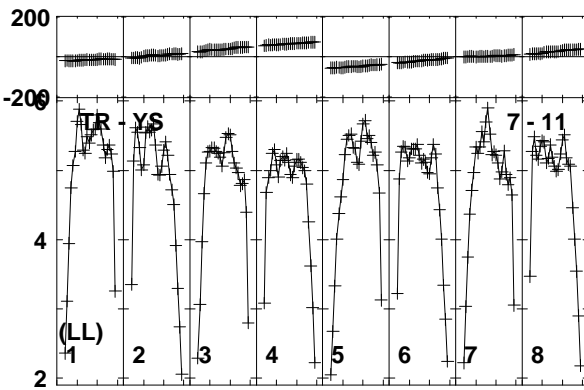
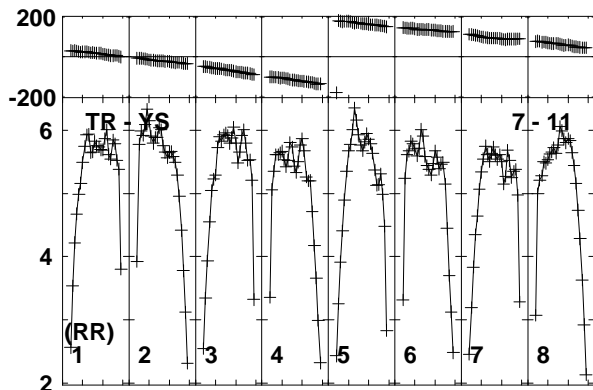
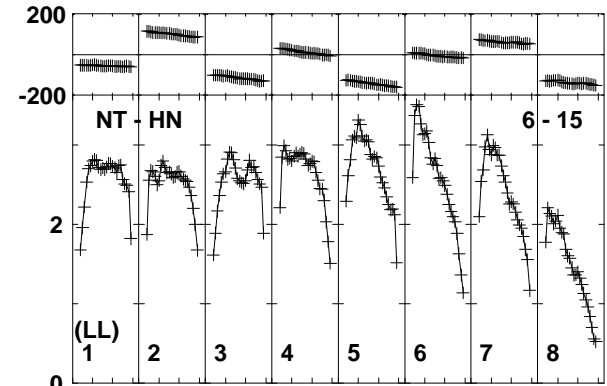
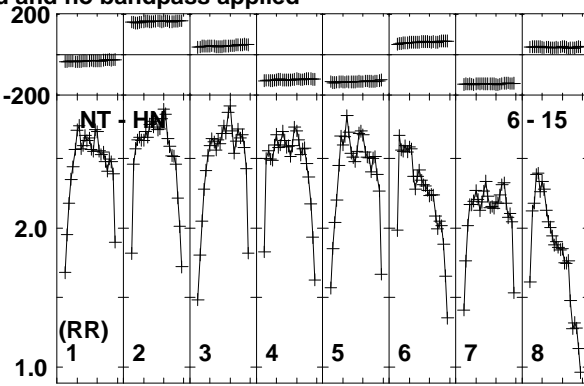
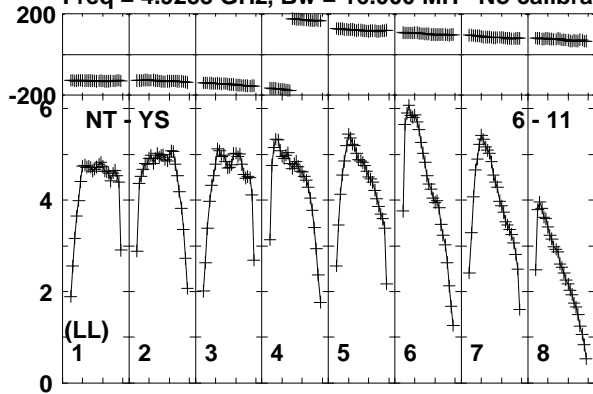

Lower frame: Milli Ampl Jy Top frame: Phas deg
Vector averaged cross-power spectrum Baseline: NT (06) - YS (11)
Timerange: 01/00:35:16 to 01/00:37:08

Plot file version 402 created 11-APR-2016 17:09:22

J1128+5925 GP053G 3.UVDATA.1

Freq = 4.9253 GHz, Bw = 16.000 MH No calibration applied and no bandpass applied

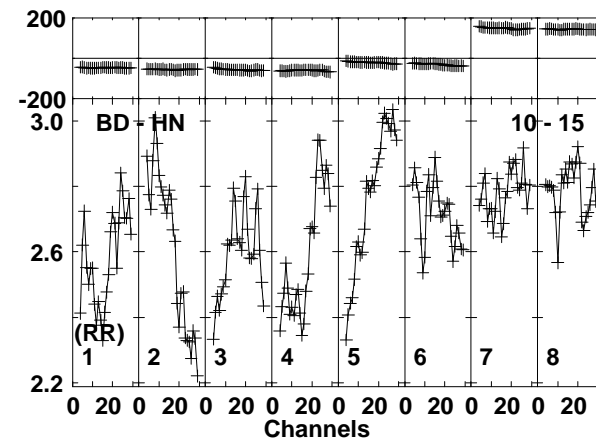
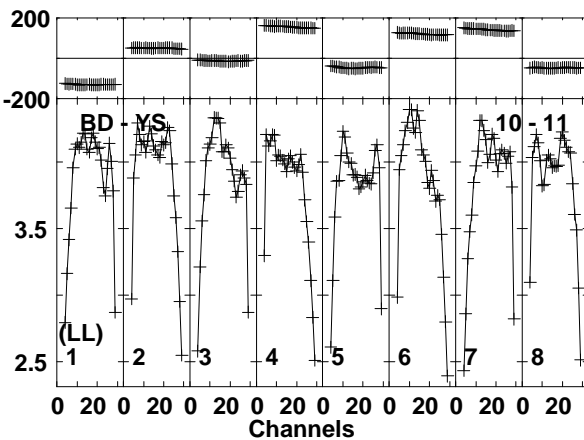
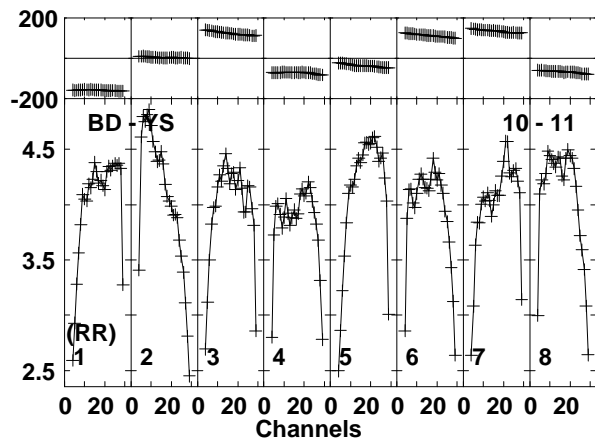
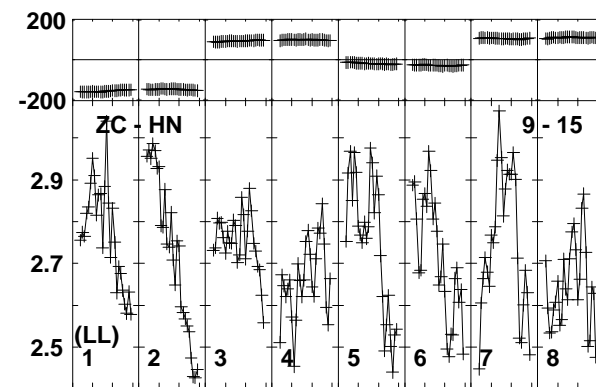
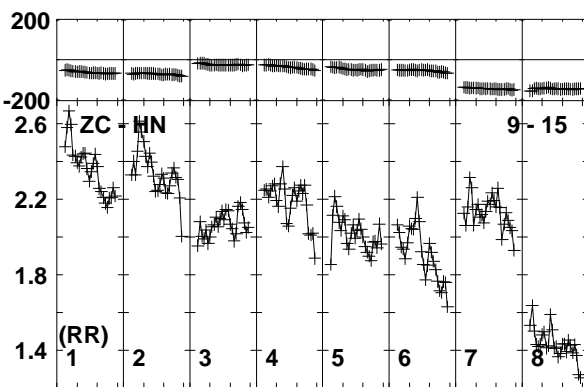
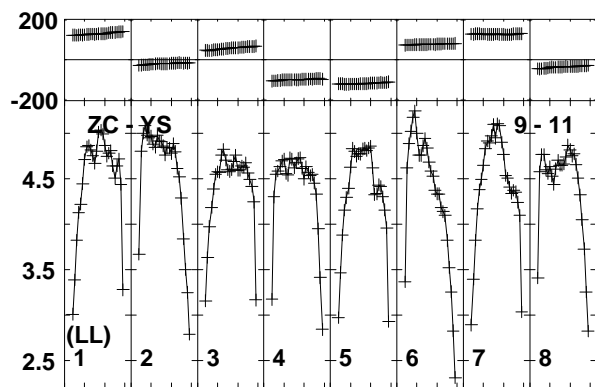
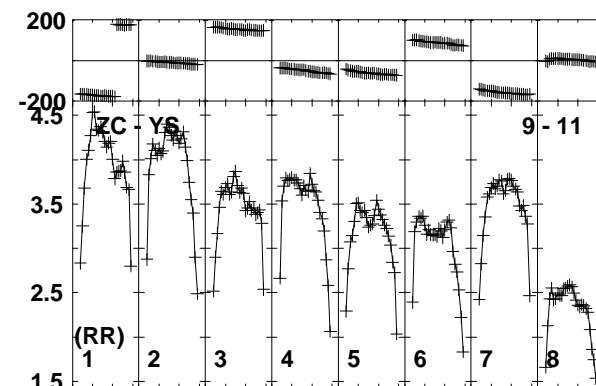
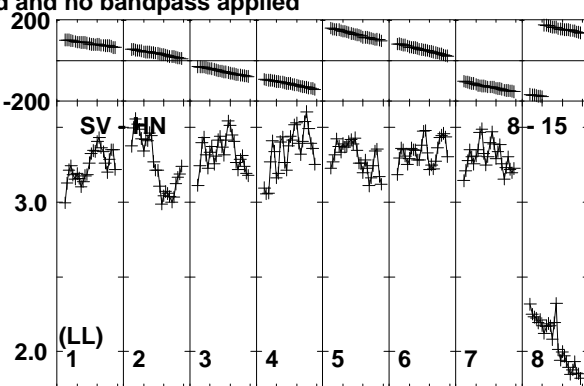
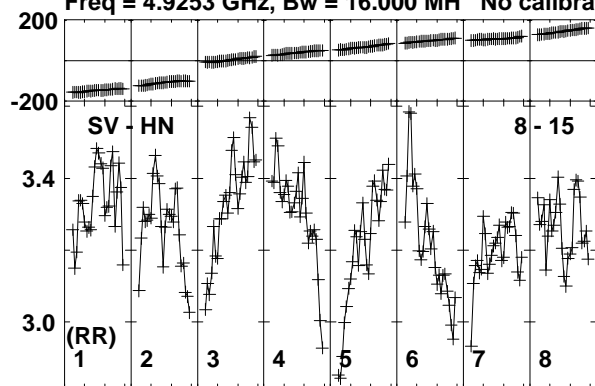

Lower frame: Milli Ampl Jy Top frame: Phas deg
Vector averaged cross-power spectrum Baseline: SV (08) - HN (15)
Timerange: 01/00:35:16 to 01/00:37:08

Plot file version 403 created 11-APR-2016 17:09:22

J1128+5925 GP053G 3.UVDATA.1

Freq = 4.9253 GHz, Bw = 16.000 MH No calibration applied and no bandpass applied

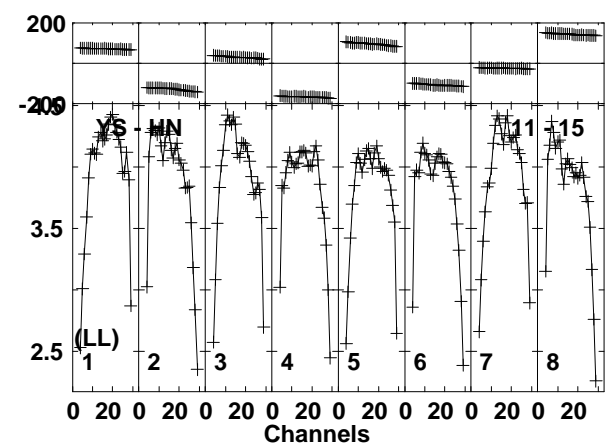
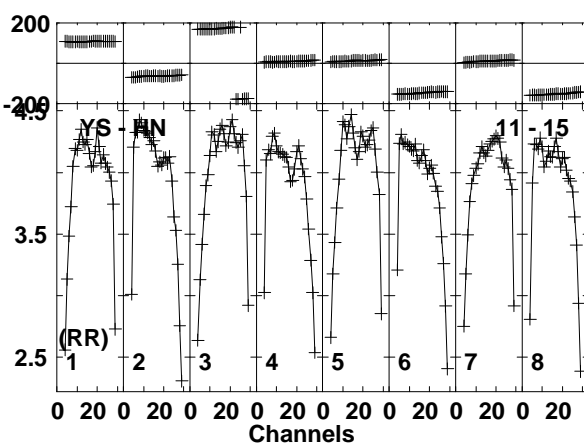
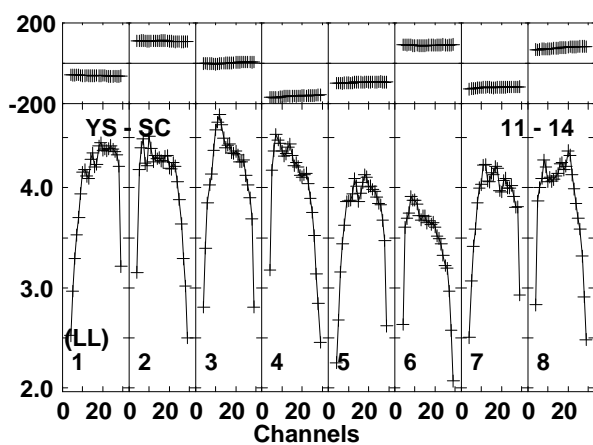
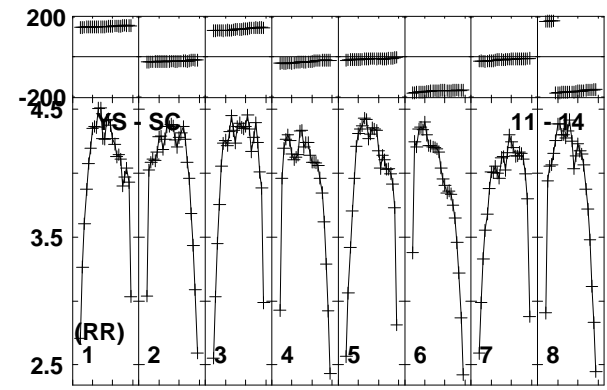
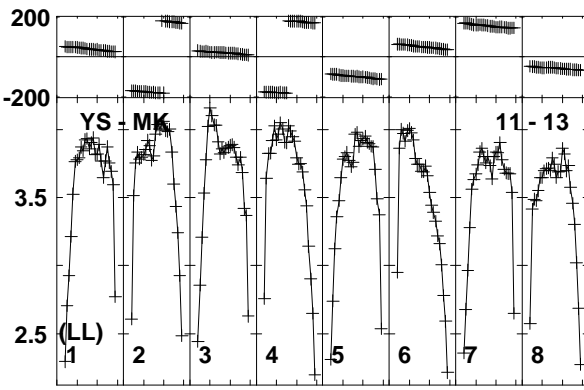
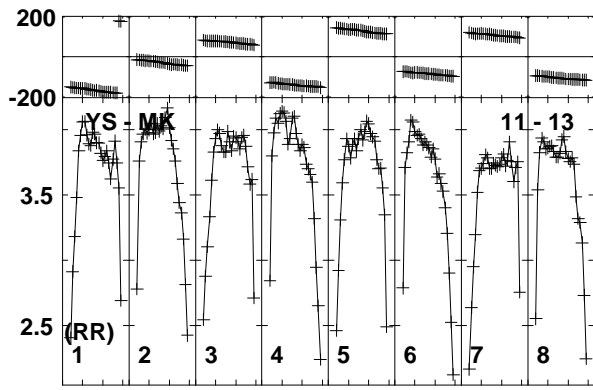
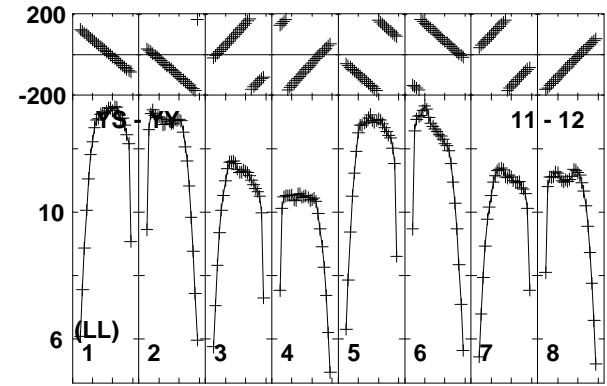
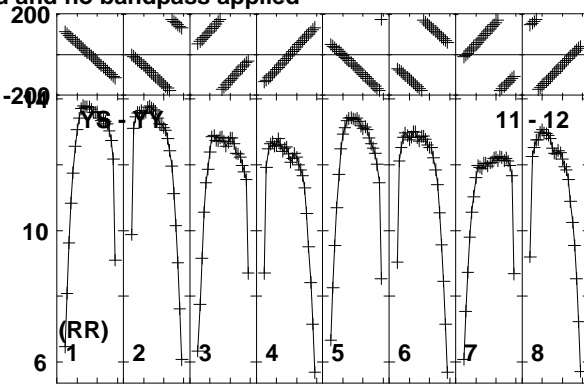
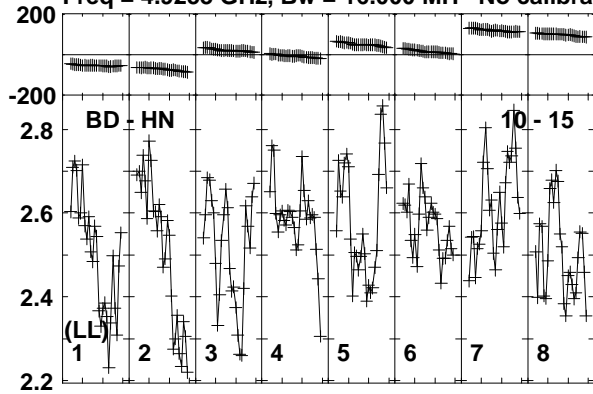

Lower frame: Milli Ampl Jy Top frame: Phas deg
Vector averaged cross-power spectrum Baseline: BD (10) - HN (15)
Timerange: 01/00:35:16 to 01/00:37:08

Plot file version 404 created 11-APR-2016 17:09:22

J1128+5925 GP053G 3.UVDATA.1

Freq = 4.9253 GHz, Bw = 16.000 MH No calibration applied and no bandpass applied

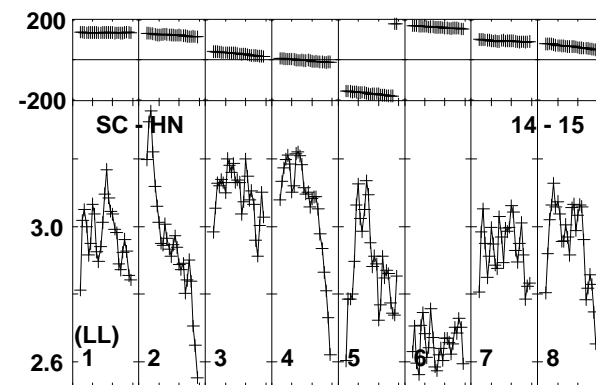
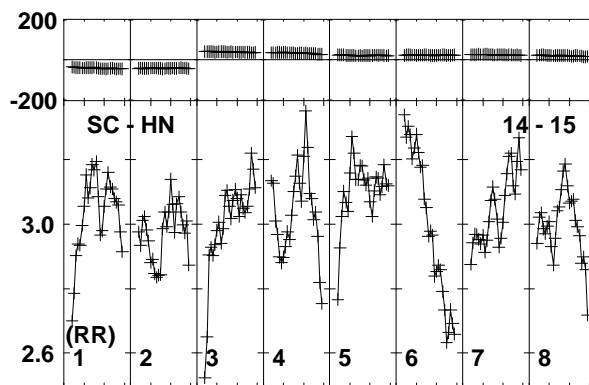
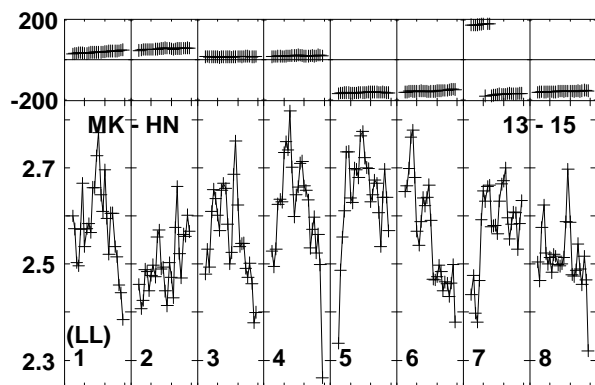
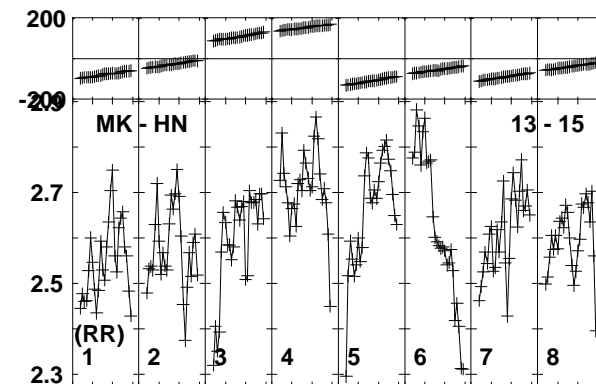
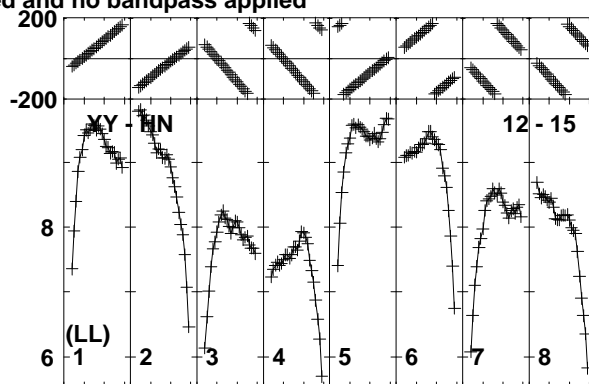
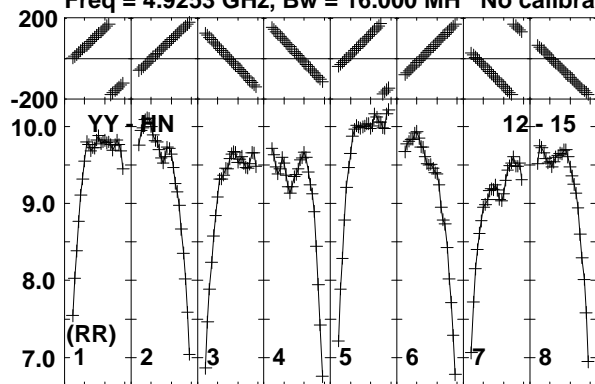

Lower frame: Milli Ampl Jy Top frame: Phas deg
Vector averaged cross-power spectrum Baseline: YY (12) - HN (15)
Timerange: 01/00:35:16 to 01/00:37:08

Plot file version 405 created 11-APR-2016 17:09:22

ARP299C GP053G 3.UVDATA.1

Freq = 4.9253 GHz, Bw = 16.000 MH No calibration applied and no bandpass applied

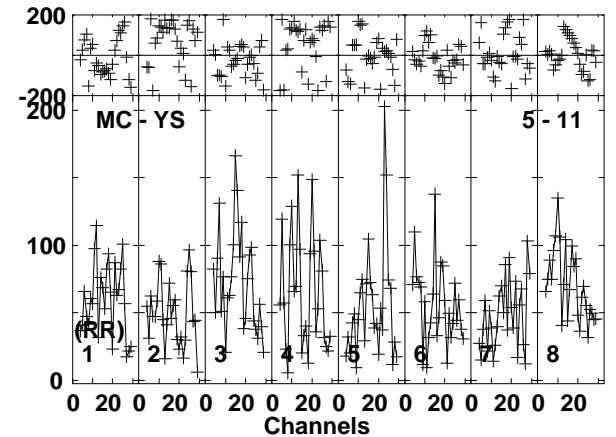
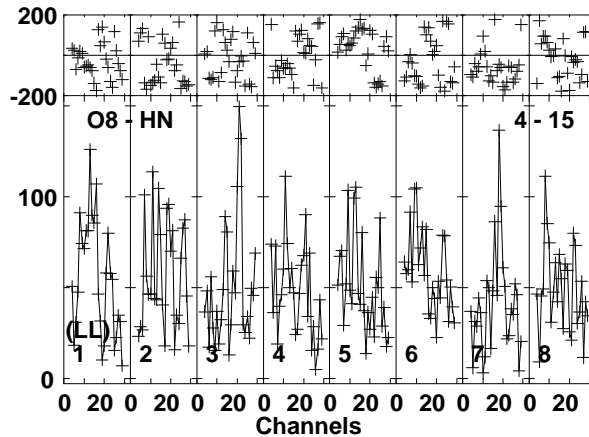
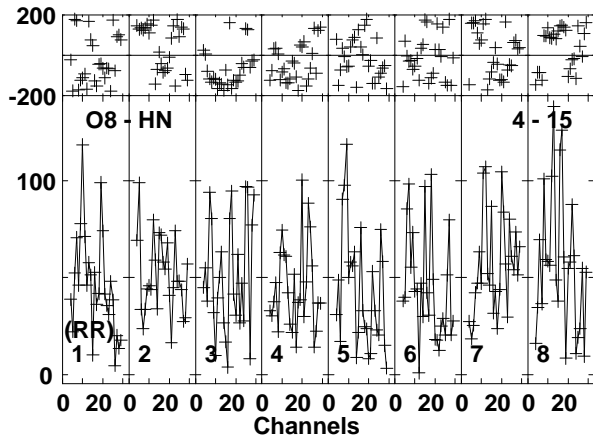
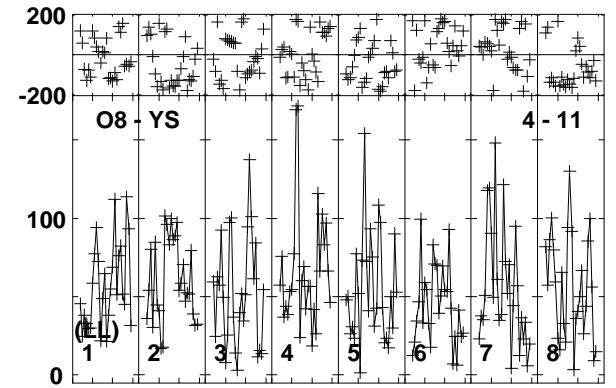
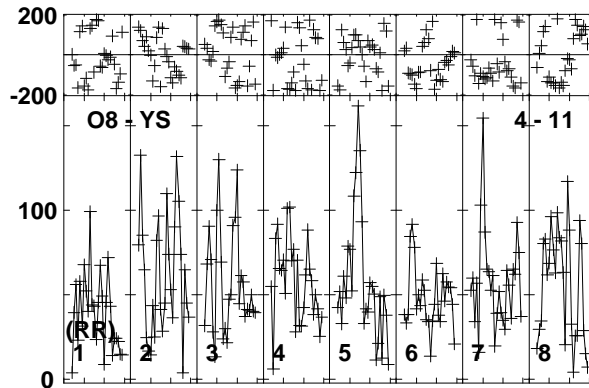
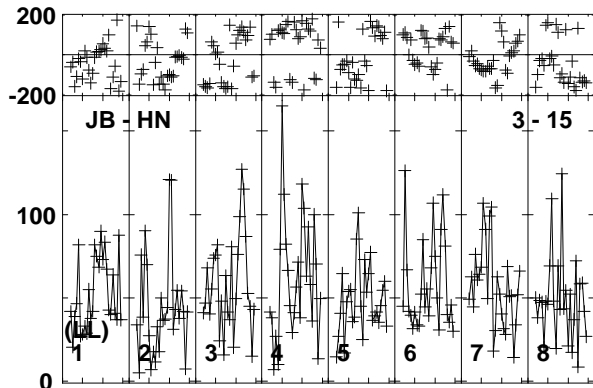
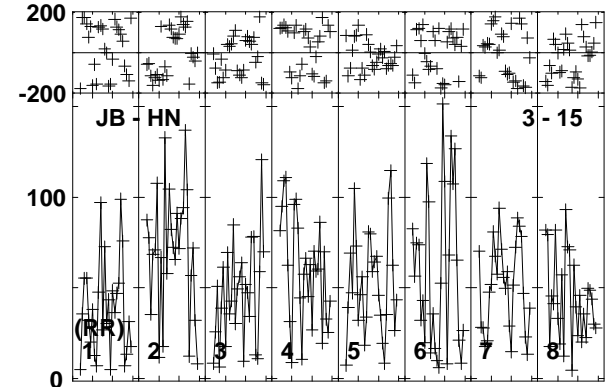
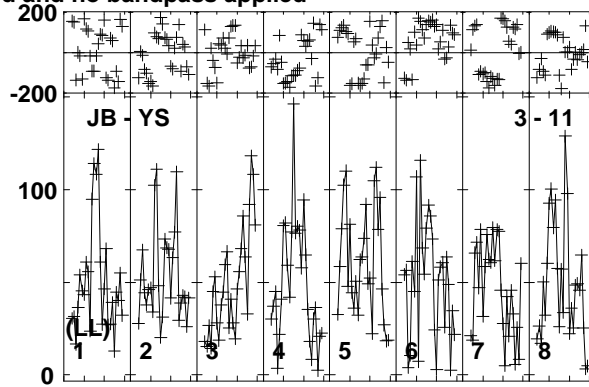
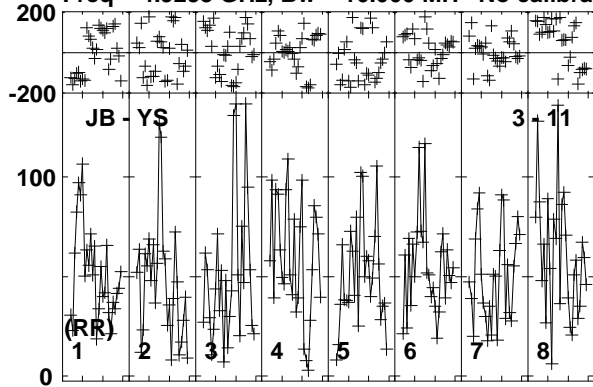

Lower frame: Micro Ampl Jy Top frame: Phas deg
Vector averaged cross-power spectrum Baseline: JB (03) - YS (11)
Timerange: 01/00:37:13 to 01/00:42:27

Plot file version 406 created 11-APR-2016 17:09:23

ARP299C GP053G 3.UVDATA.1

Freq = 4.9253 GHz, Bw = 16.000 MH No calibration applied and no bandpass applied

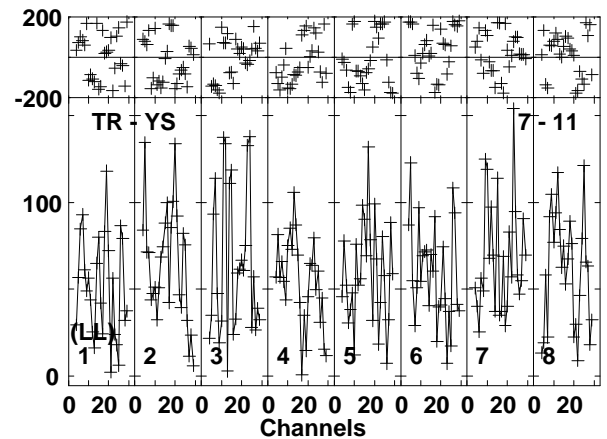
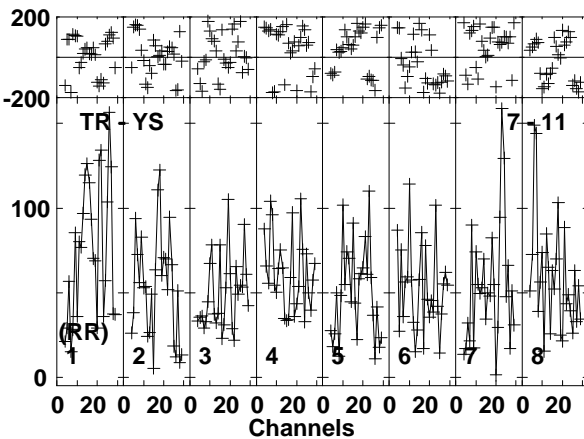
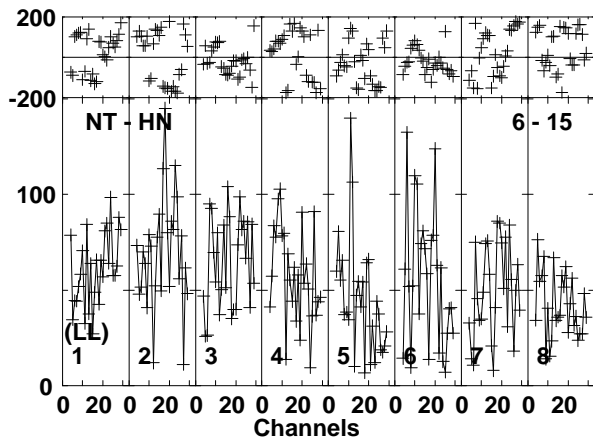
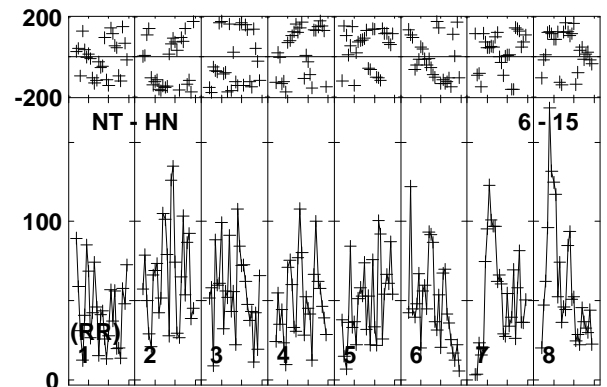
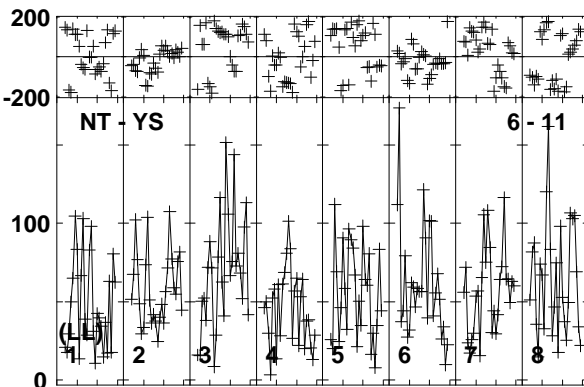
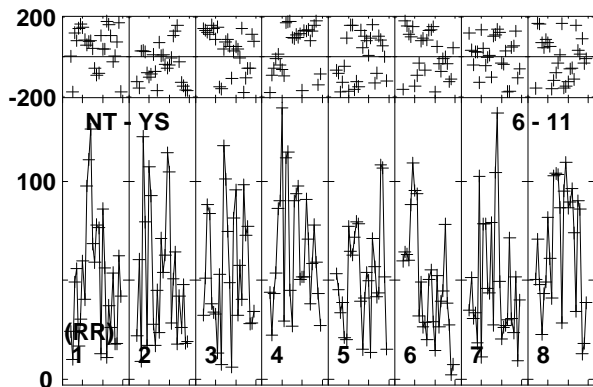
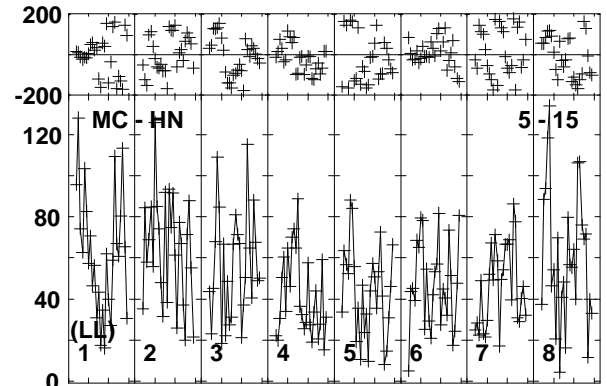
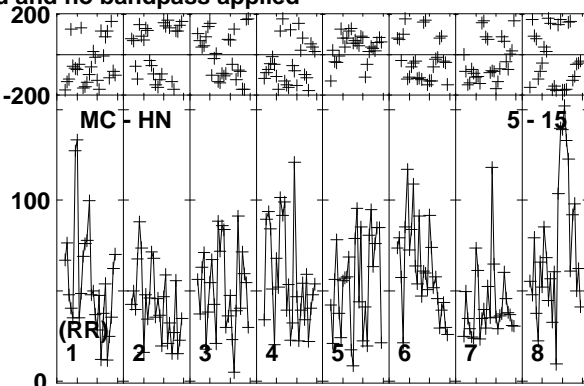
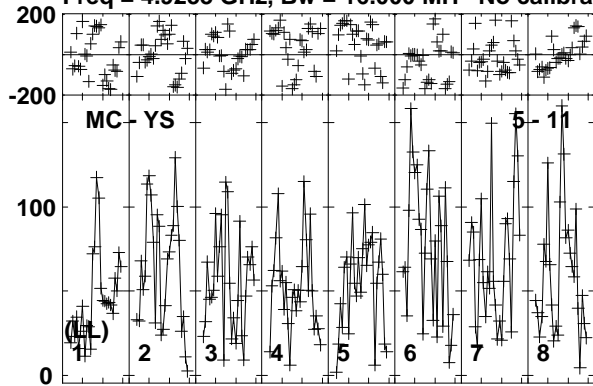

Lower frame: Micro Ampl Jy Top frame: Phas deg
Vector averaged cross-power spectrum Baseline: MC (05) - YS (11)
Timerange: 01/00:37:13 to 01/00:42:27

Plot file version 407 created 11-APR-2016 17:09:23

ARP299C GP053G 3.UVDATA.1

Freq = 4.9253 GHz, Bw = 16.000 MH No calibration applied and no bandpass applied

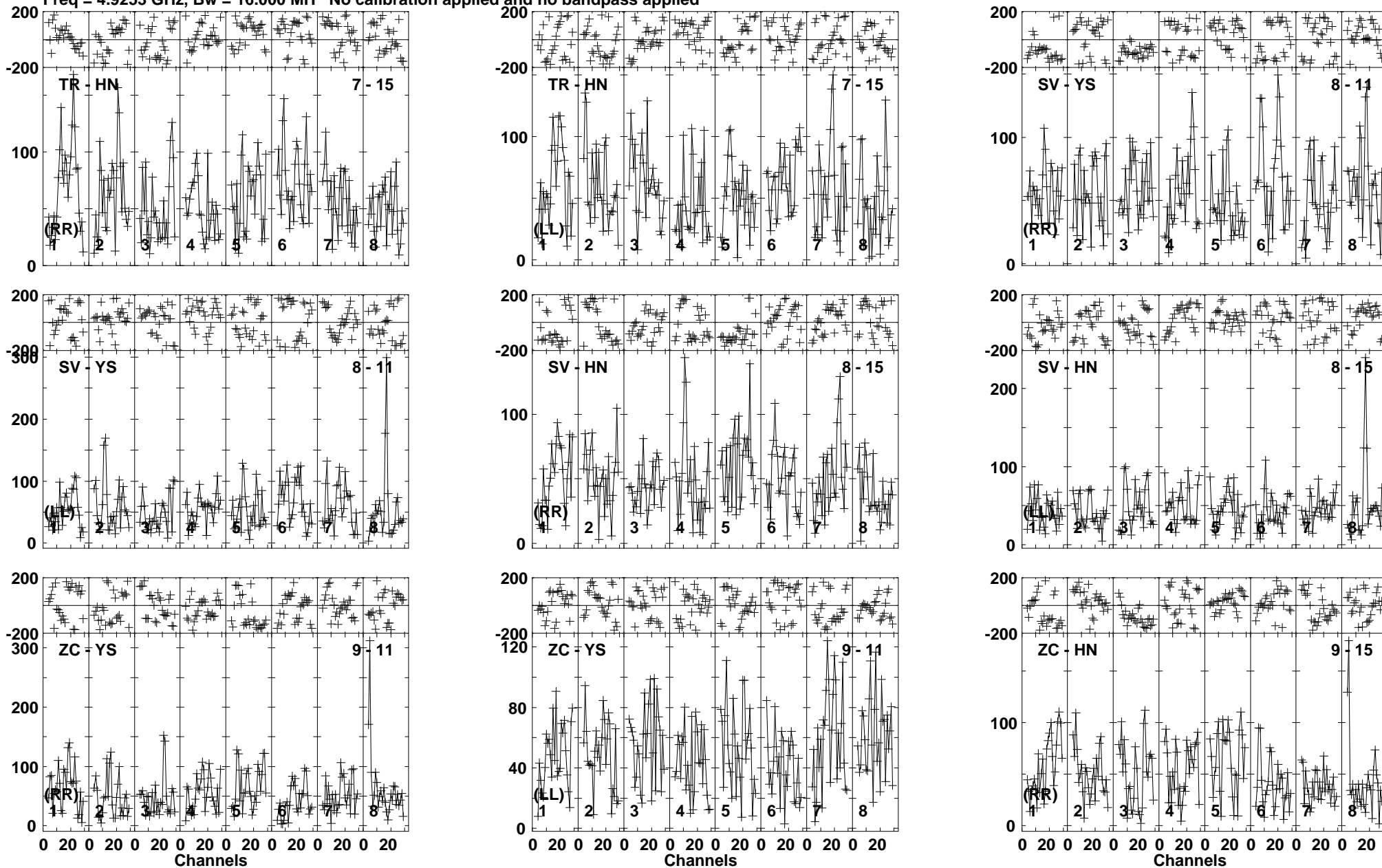

Lower frame: Micro Ampl Jy Top frame: Phas deg
Vector averaged cross-power spectrum Baseline: TR (07) - HN (15)
Timerange: 01/00:37:13 to 01/00:42:27

Plot file version 408 created 11-APR-2016 17:09:23

ARP299C GP053G 3.UVDATA.1

Freq = 4.9253 GHz, Bw = 16.000 MH No calibration applied and no bandpass applied

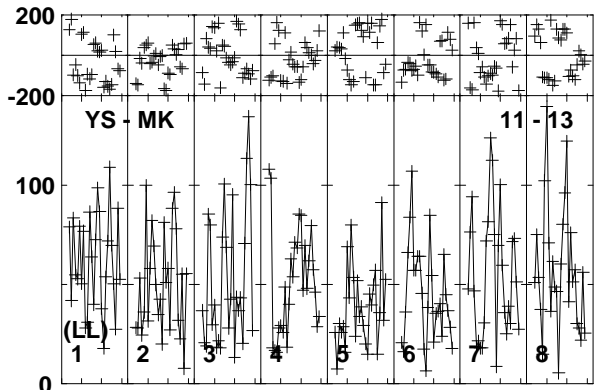
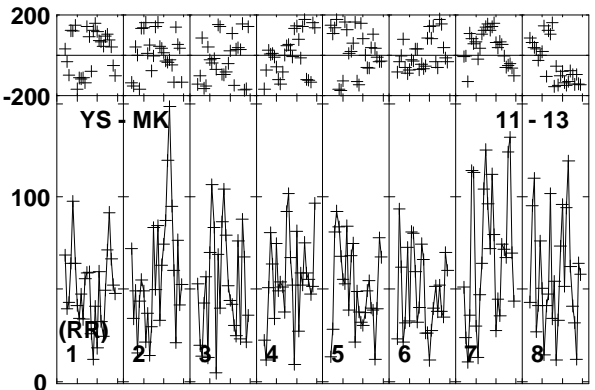
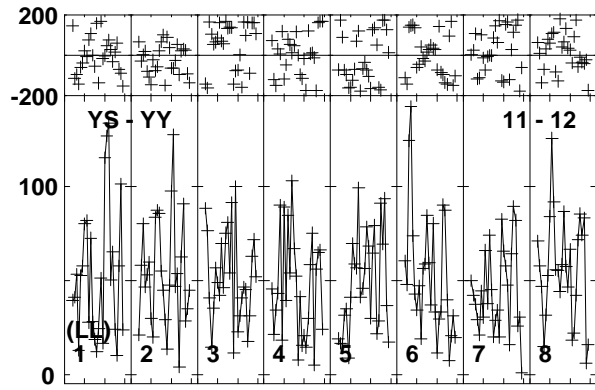
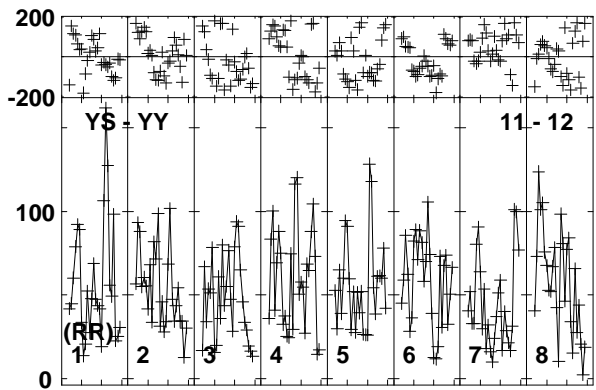
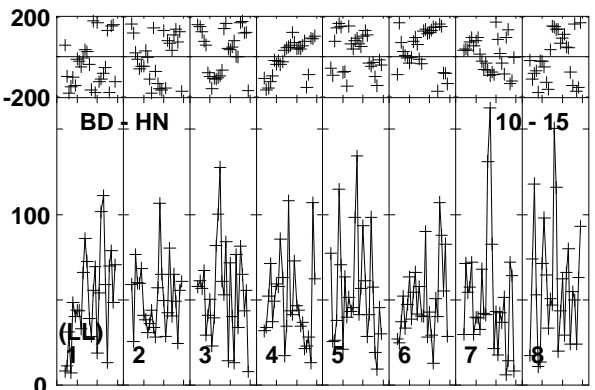
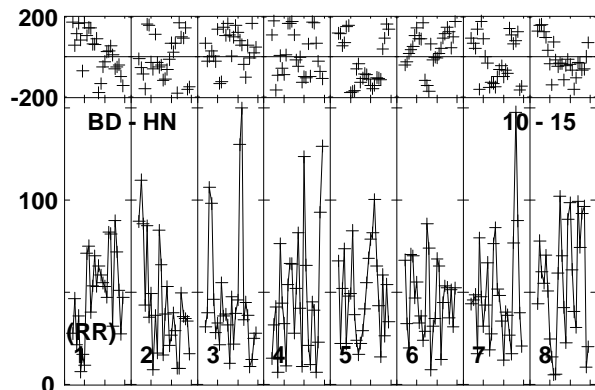
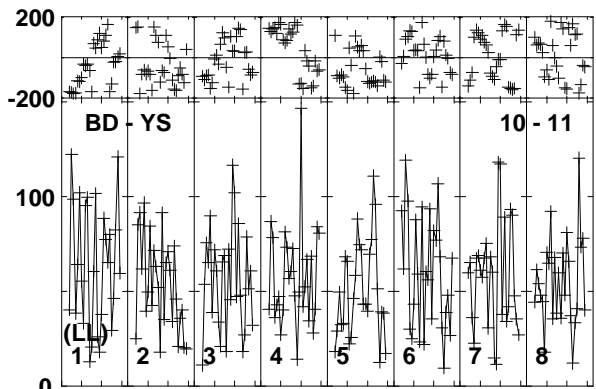
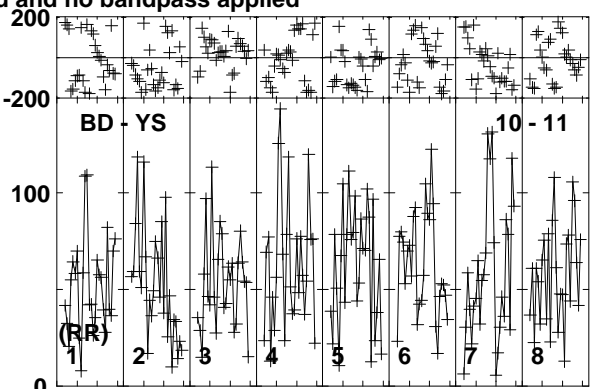
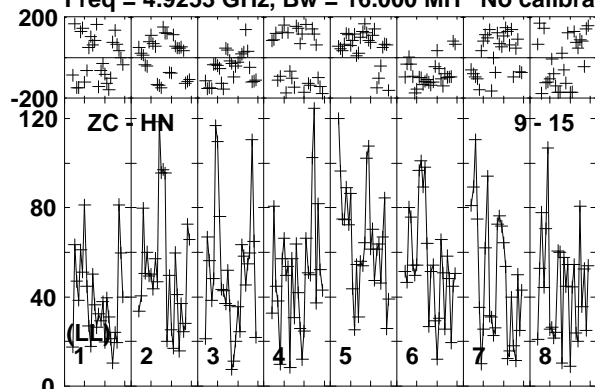

Lower frame: Micro Ampl Jy Top frame: Phas deg
Vector averaged cross-power spectrum Baseline: ZC (09) - HN (15)
Timerange: 01/00:37:13 to 01/00:42:27

Plot file version 409 created 11-APR-2016 17:09:23

ARP299C GP053G 3.UVDATA.1

Freq = 4.9253 GHz, Bw = 16.000 MH No calibration applied and no bandpass applied

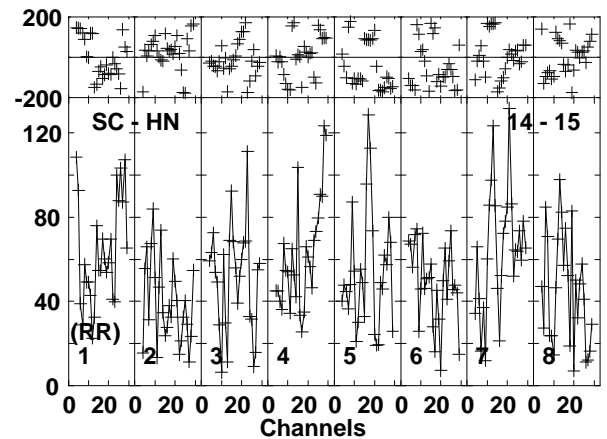
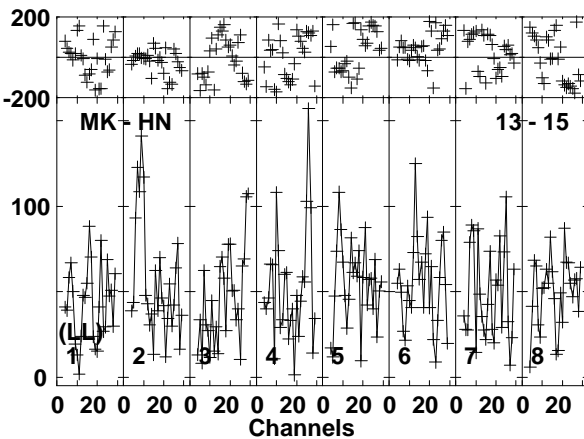
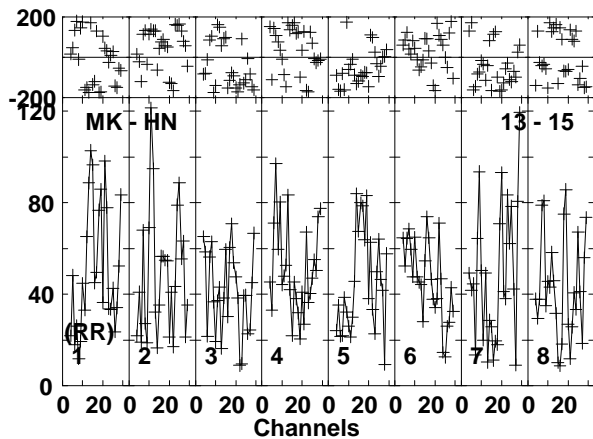
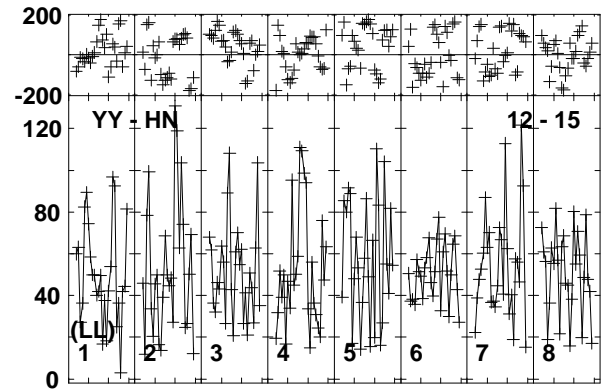
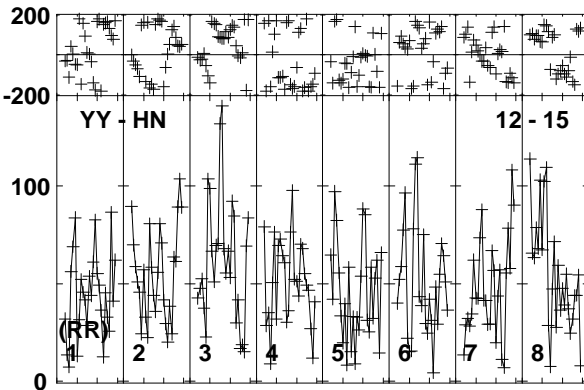
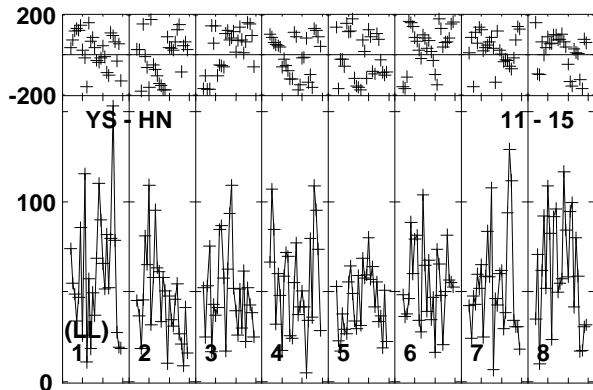
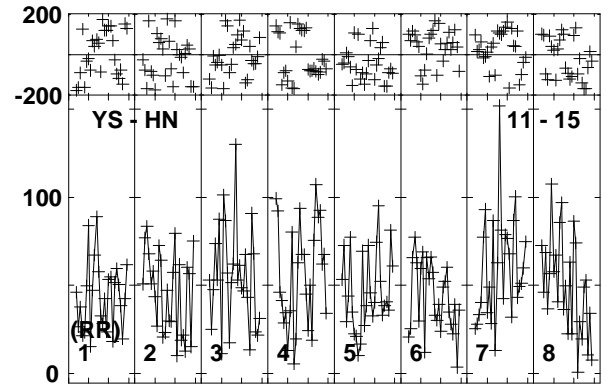
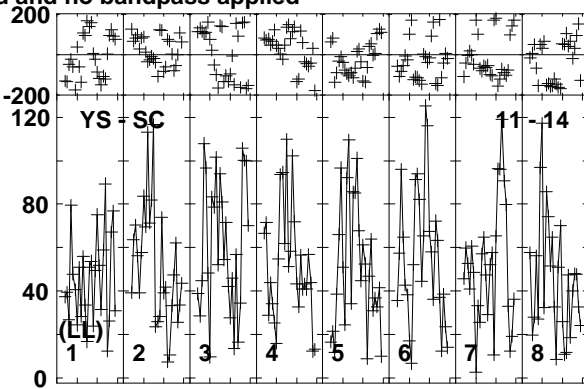
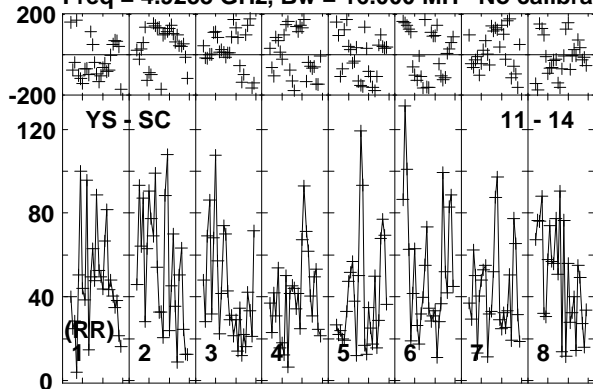

Lower frame: Micro Ampl Jy Top frame: Phas deg
Vector averaged cross-power spectrum Baseline: YS (11) - SC (14)
Timerange: 01/00:37:13 to 01/00:42:27

Plot file version 410 created 11-APR-2016 17:09:23

ARP299C GP053G 3.UVDATA.1

Freq = 4.9253 GHz, Bw = 16.000 MH No calibration applied and no bandpass applied

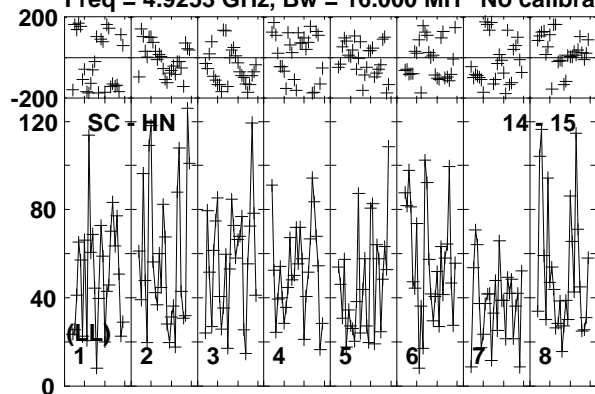

Lower frame: Micro Ampl Jy Top frame: Phas deg
Vector averaged cross-power spectrum Baseline: SC (14) - HN (15)
Timerange: 01/00:37:13 to 01/00:42:27

Plot file version 411 created 11-APR-2016 17:09:23

J1128+5925 GP053G 3.UVDATA.1

Freq = 4.9253 GHz, Bw = 16.000 MH No calibration applied and no bandpass applied

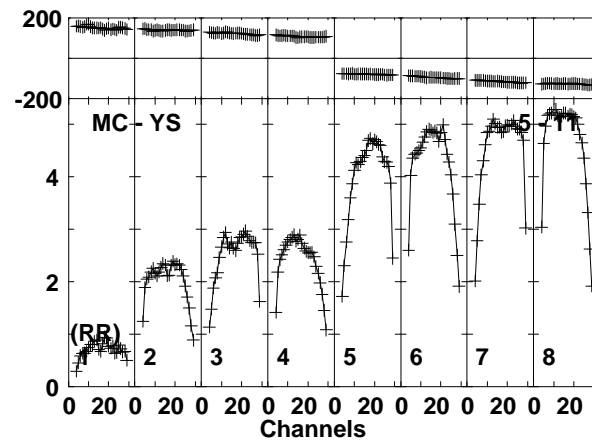
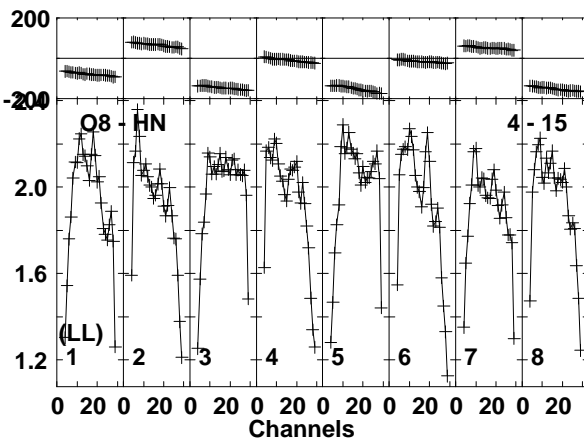
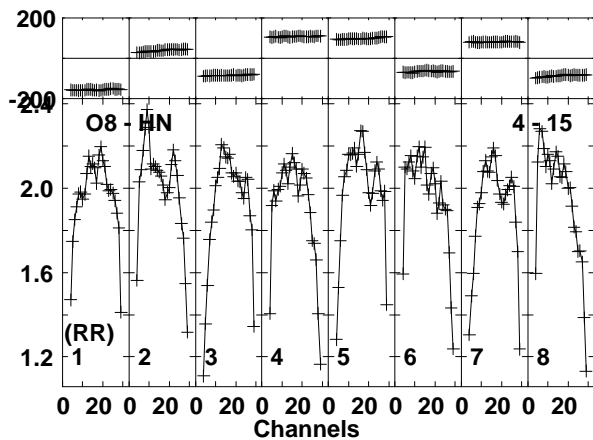
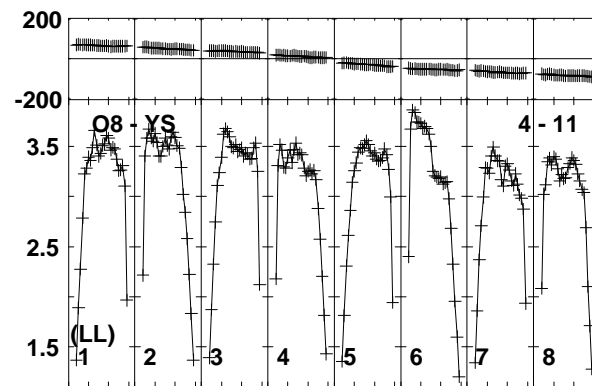
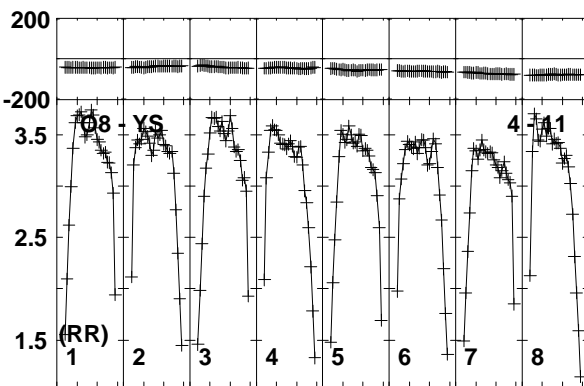
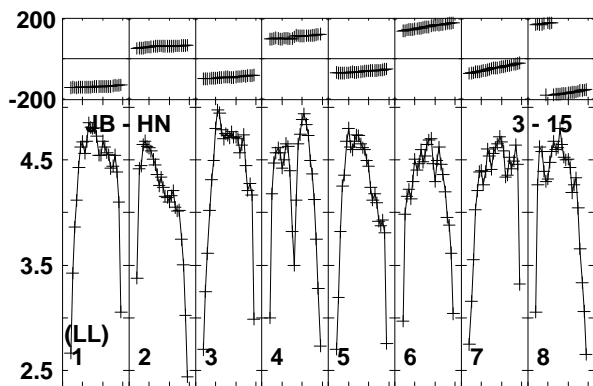
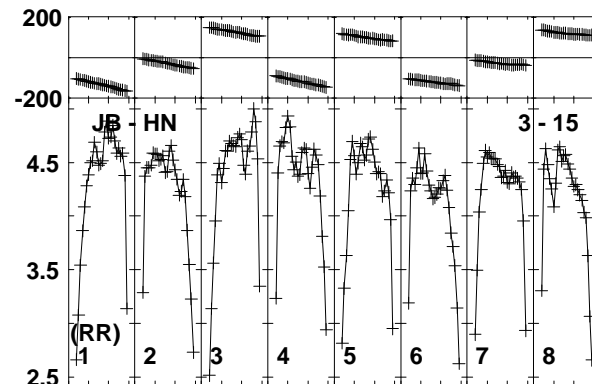
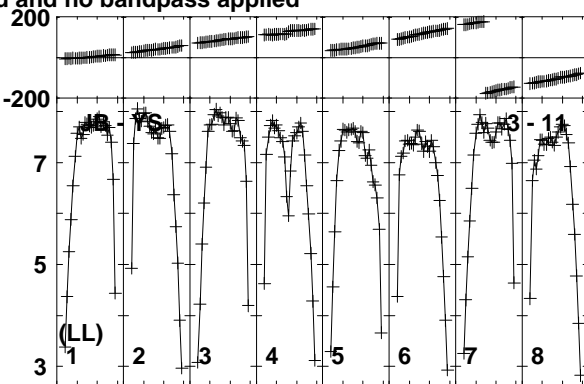
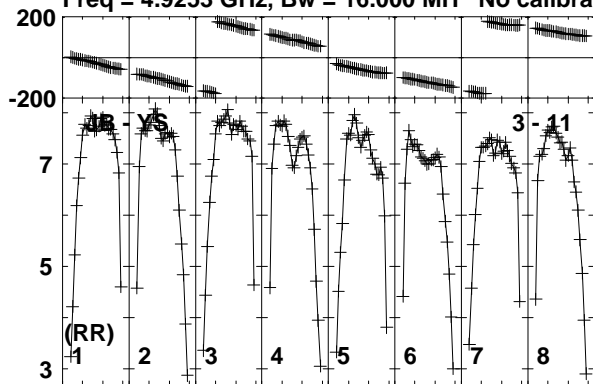

Lower frame: Milli Ampl Jy Top frame: Phas deg
Vector averaged cross-power spectrum Baseline: JB (03) - YS (11)
Timerange: 01/00:42:33 to 01/00:44:17

Plot file version 412 created 11-APR-2016 17:09:24

J1128+5925 GP053G 3.UVDATA.1

Freq = 4.9253 GHz, Bw = 16.000 MH No calibration applied and no bandpass applied

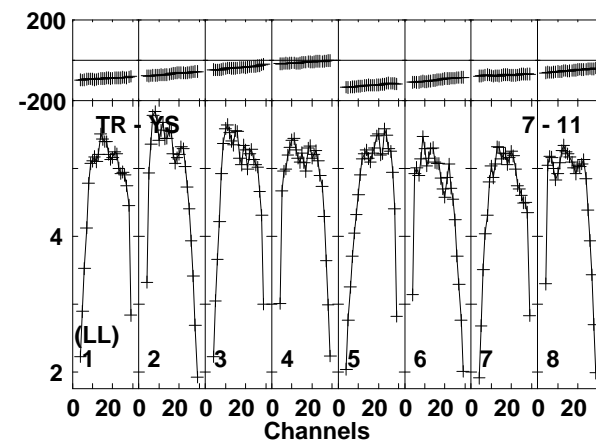
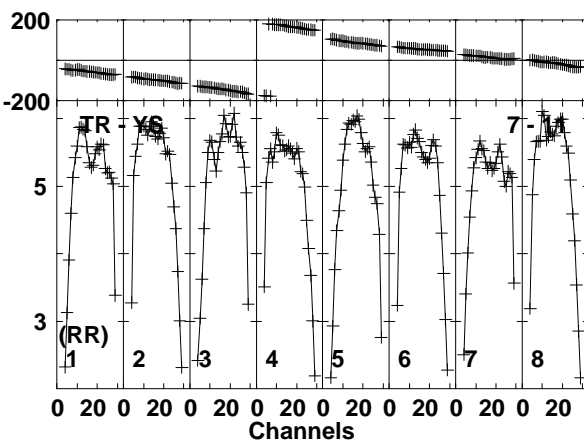
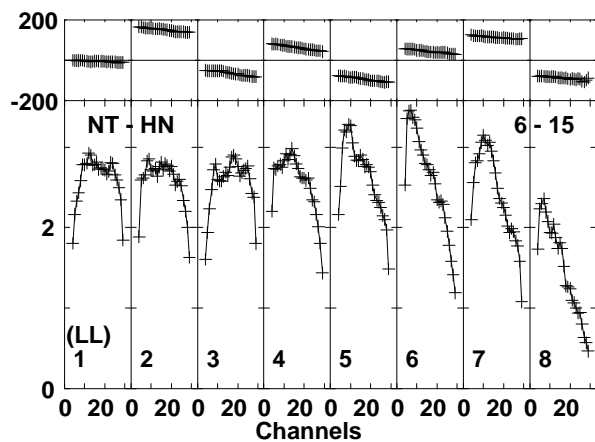
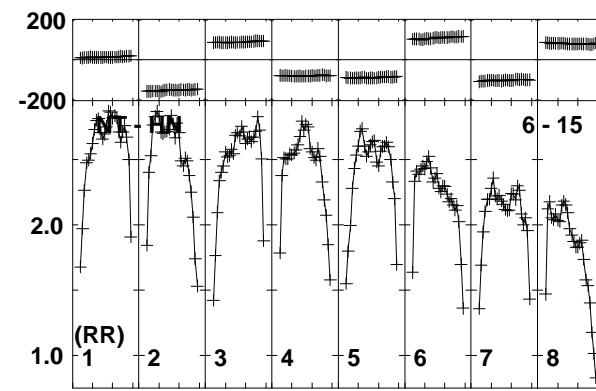
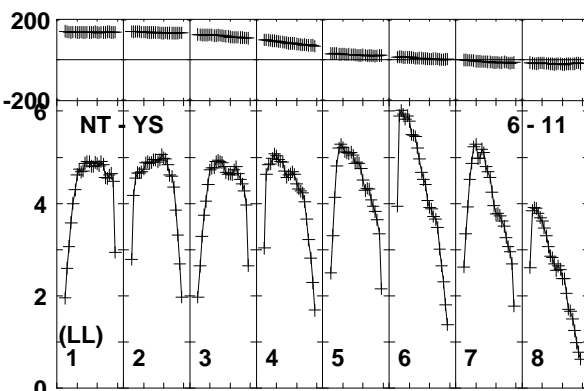
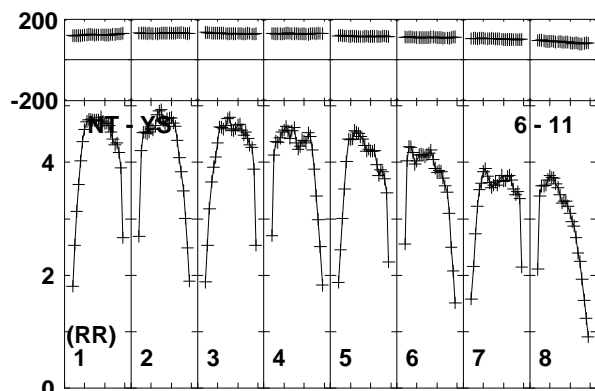
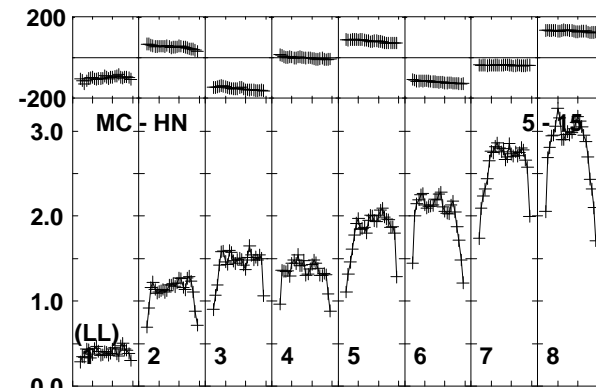
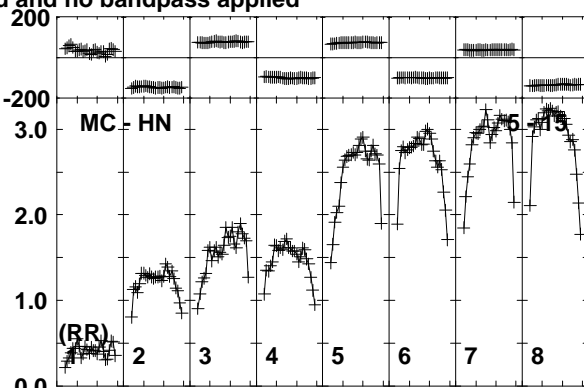
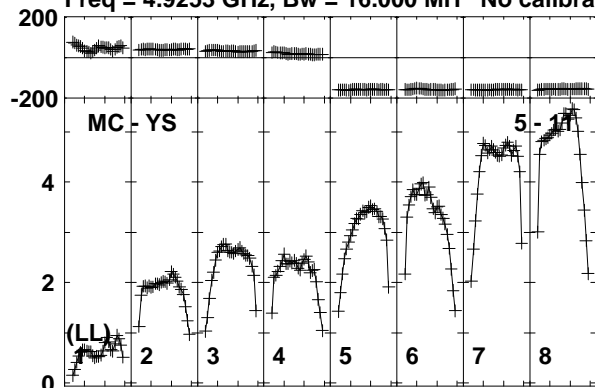

Lower frame: Milli Ampl Jy Top frame: Phas deg
Vector averaged cross-power spectrum Baseline: MC (05) - YS (11)
Timerange: 01/00:42:33 to 01/00:44:17

Plot file version 413 created 11-APR-2016 17:09:24

J1128+5925 GP053G 3.UVDATA.1

Freq = 4.9253 GHz, Bw = 16.000 MH No calibration applied and no bandpass applied

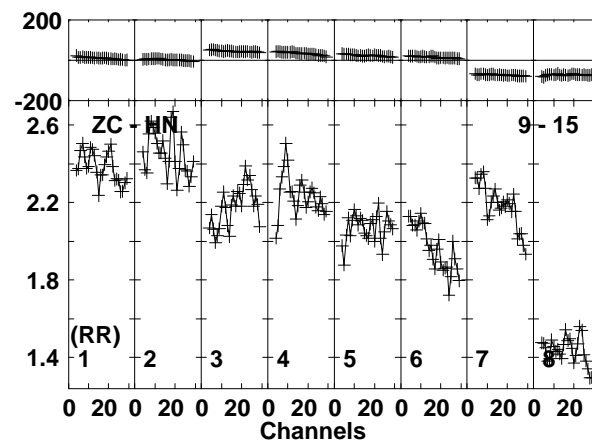
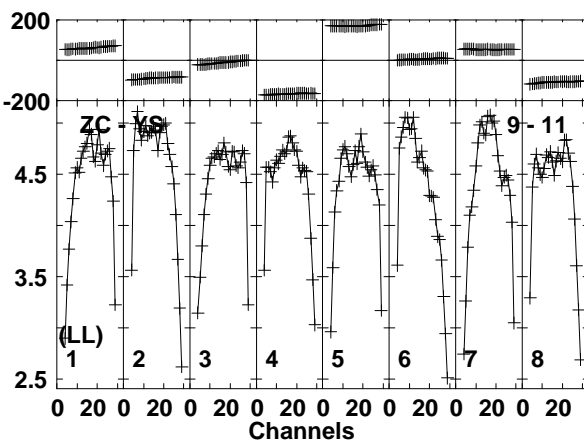
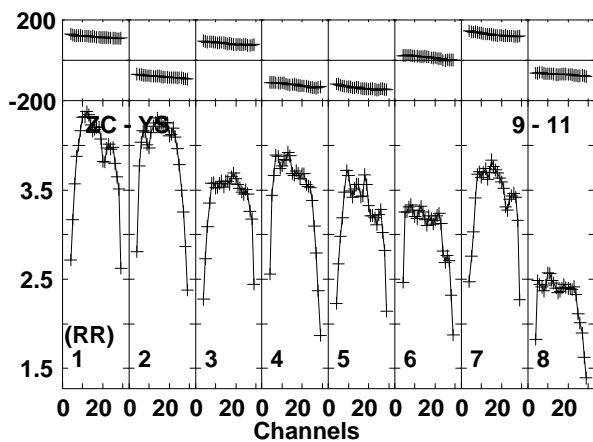
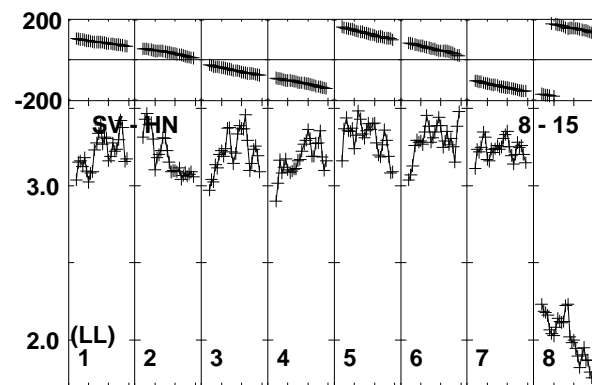
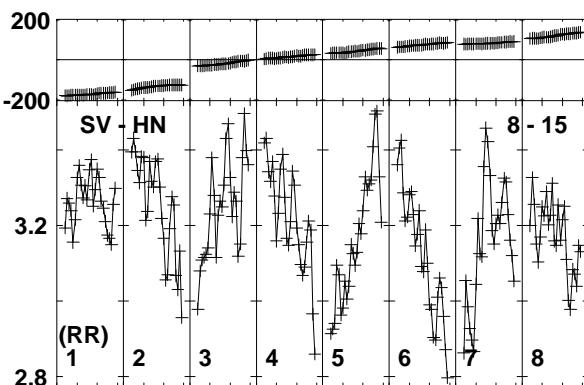
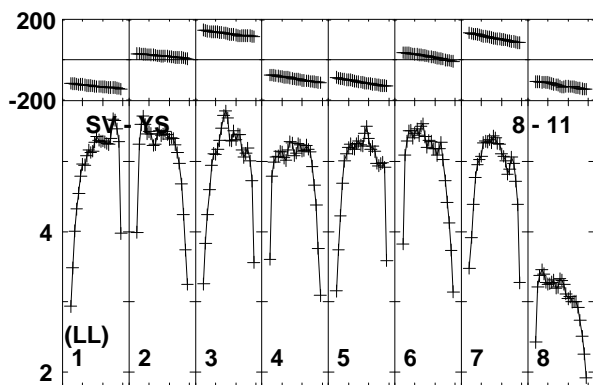
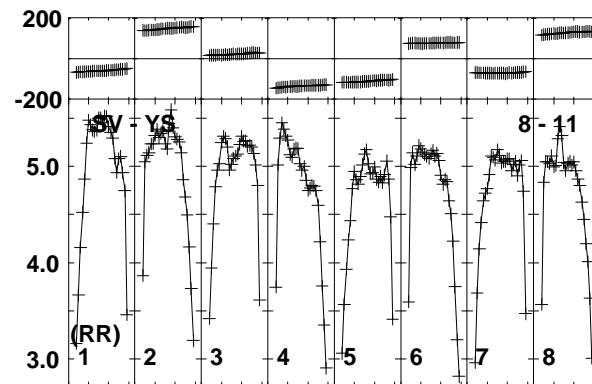
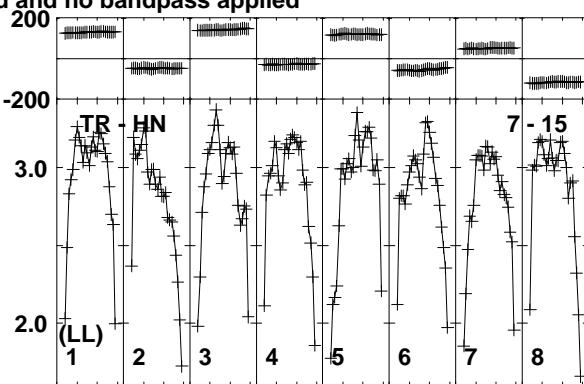
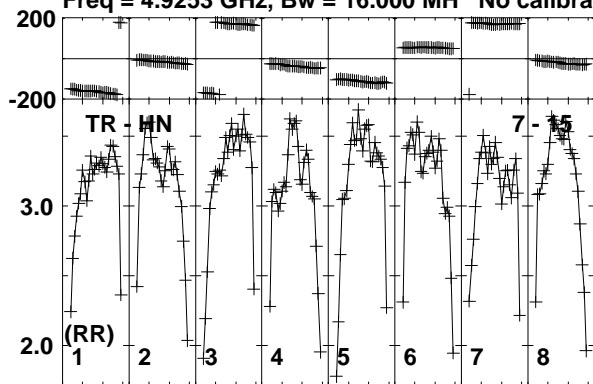

Lower frame: Milli Ampl Jy Top frame: Phas deg
Vector averaged cross-power spectrum Baseline: TR (07) - HN (15)
Timerange: 01/00:42:33 to 01/00:44:17

Plot file version 414 created 11-APR-2016 17:09:24

J1128+5925 GP053G 3.UVDATA.1

Freq = 4.9253 GHz, Bw = 16.000 MH No calibration applied and no bandpass applied

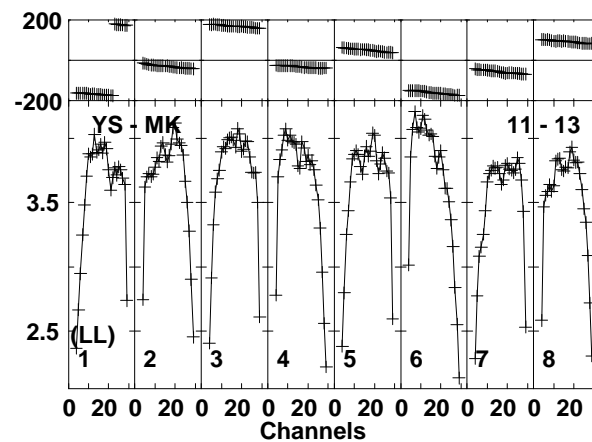
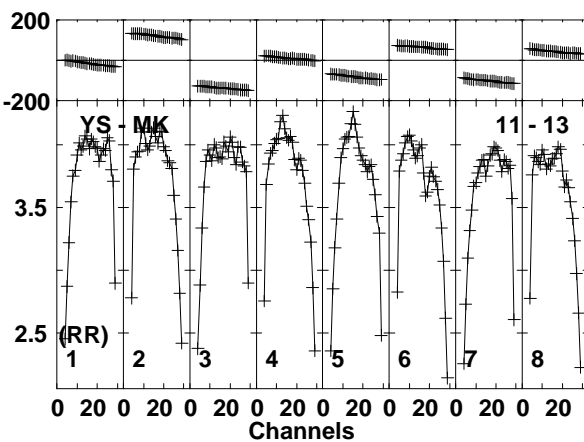
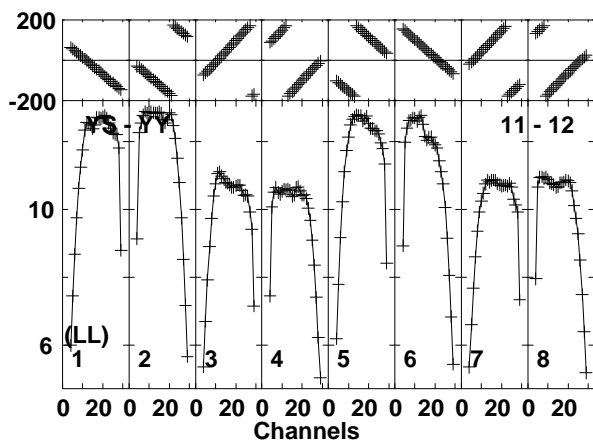
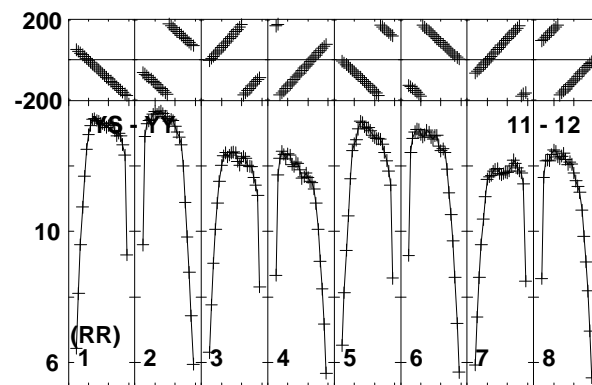
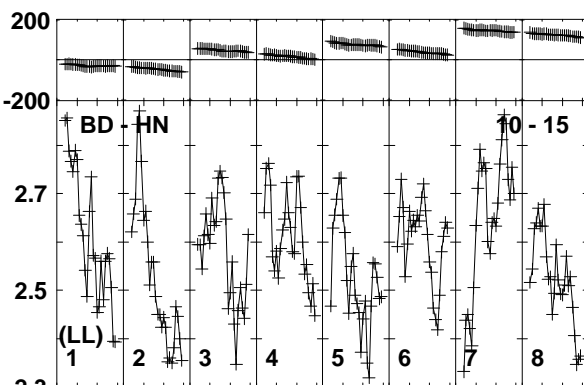
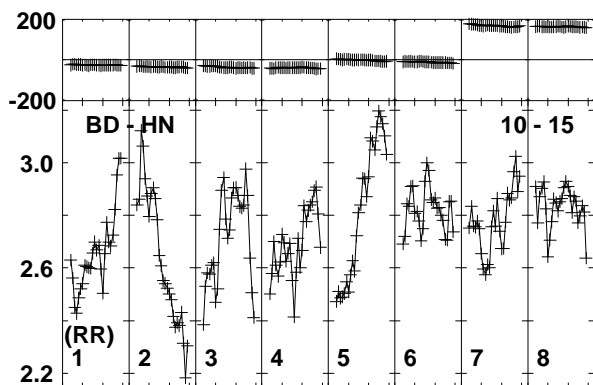
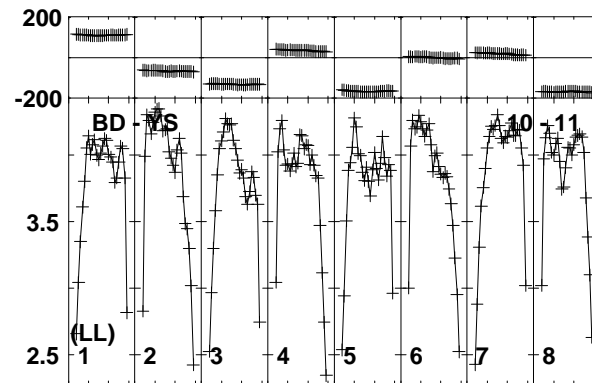
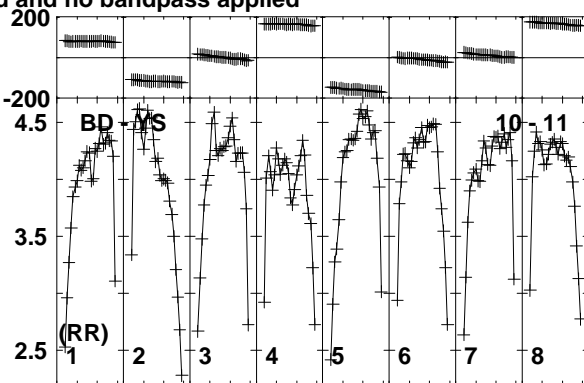
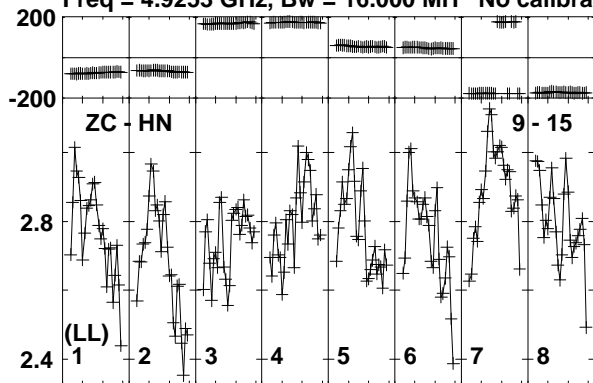

Lower frame: Milli Ampl Jy Top frame: Phas deg
Vector averaged cross-power spectrum Baseline: ZC (09) - HN (15)
Timerange: 01/00:42:33 to 01/00:44:17

Plot file version 415 created 11-APR-2016 17:09:24

J1128+5925 GP053G 3.UVDATA.1

Freq = 4.9253 GHz, Bw = 16.000 MH No calibration applied and no bandpass applied

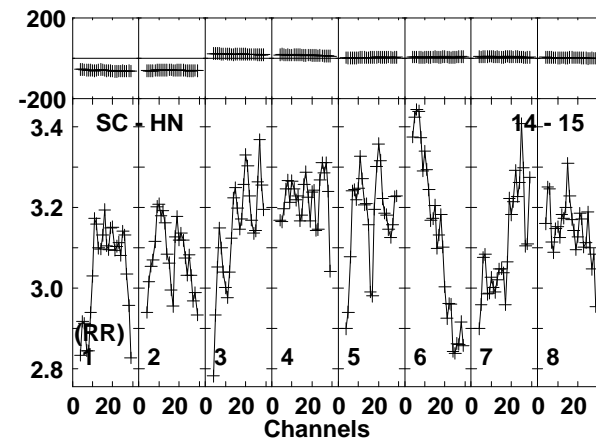
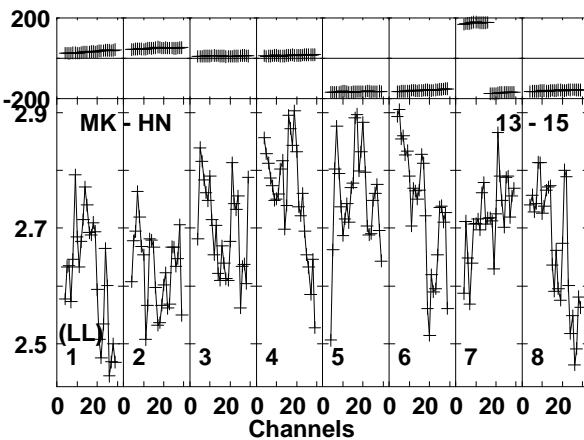
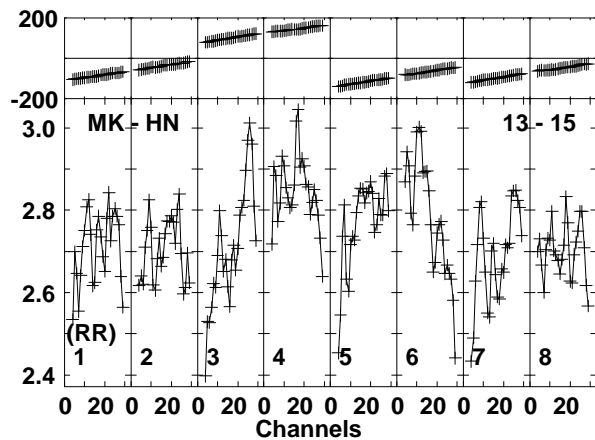
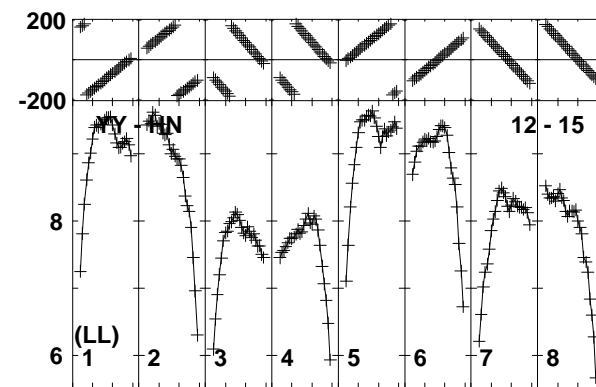
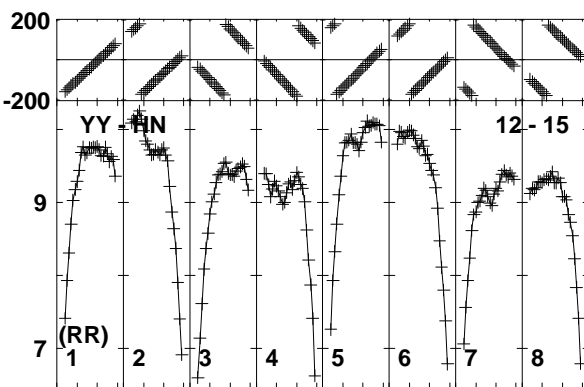
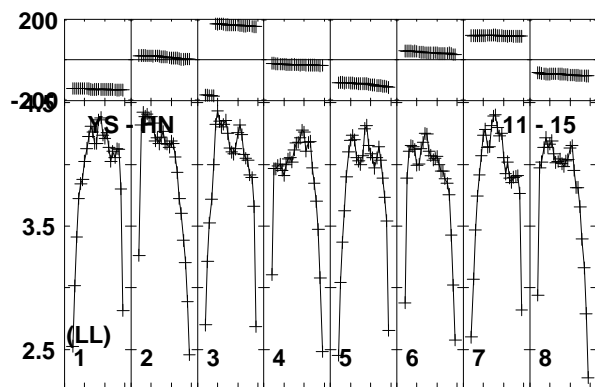
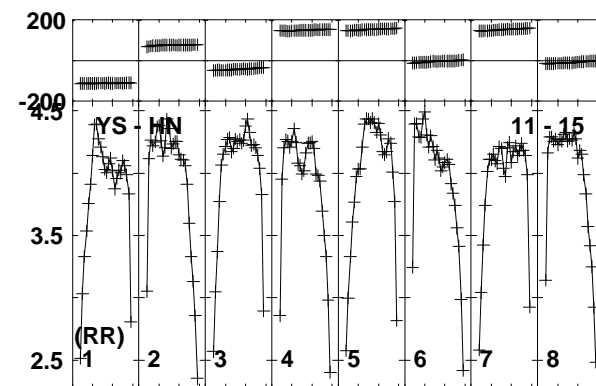
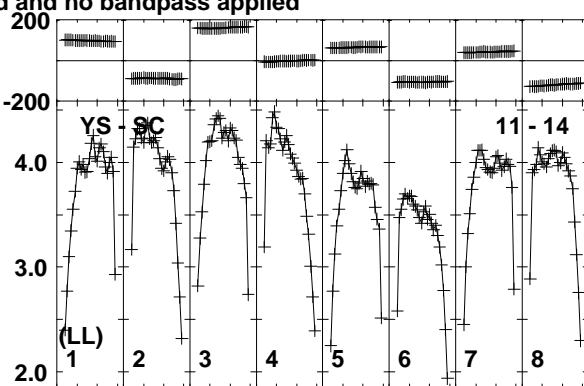
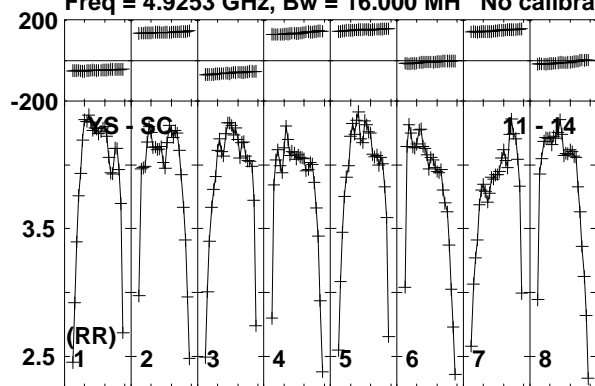

Lower frame: Milli Ampl Jy Top frame: Phas deg
Vector averaged cross-power spectrum Baseline: YS (11) - SC (14)
Timerange: 01/00:42:33 to 01/00:44:17

Plot file version 416 created 11-APR-2016 17:09:24

J1128+5925 GP053G 3.UVDATA.1

Freq = 4.9253 GHz, Bw = 16.000 MH No calibration applied and no bandpass applied

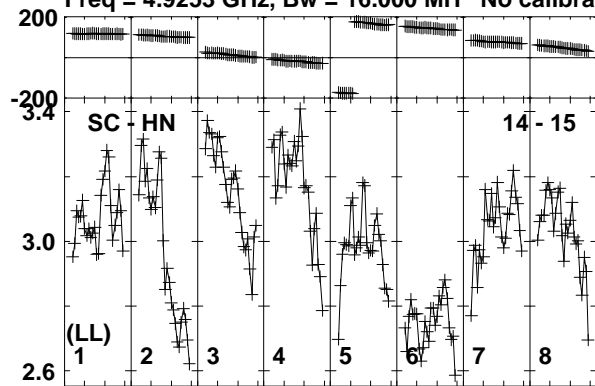

Lower frame: Milli Ampl Jy Top frame: Phas deg
Vector averaged cross-power spectrum Baseline: SC (14) - HN (15)
Timerange: 01/00:42:33 to 01/00:44:17

Plot file version 417 created 11-APR-2016 17:09:24

ARP299C GP053G 3.UVDATA.1

Freq = 4.9253 GHz, Bw = 16.000 MH No calibration applied and no bandpass applied

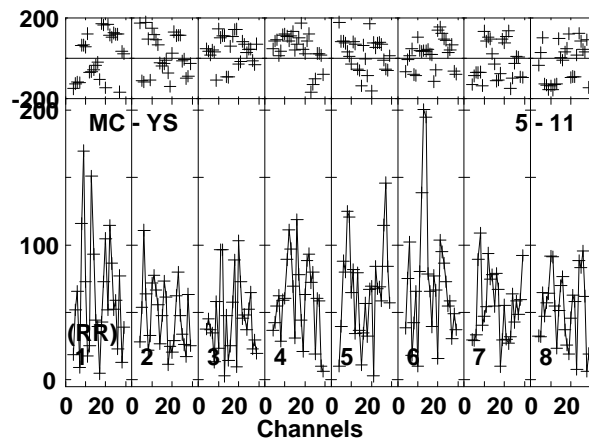
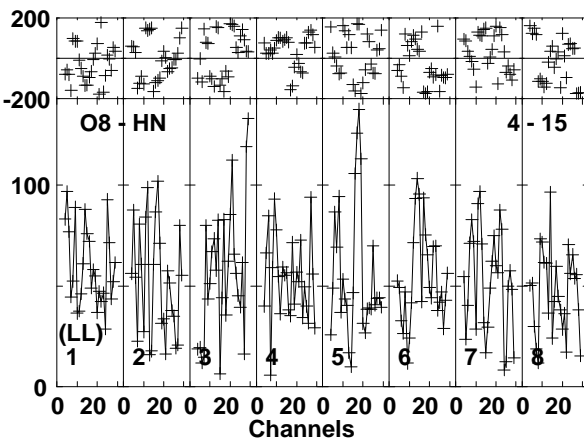
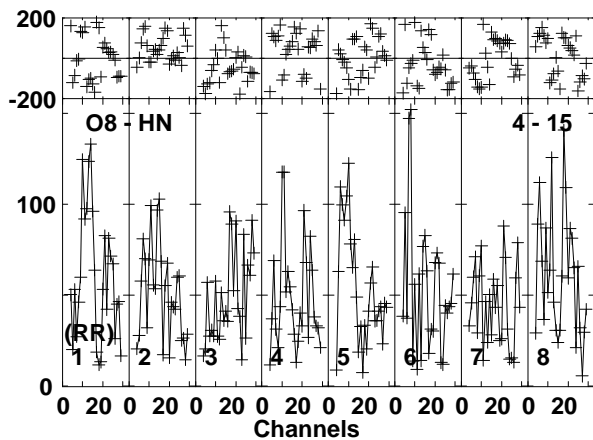
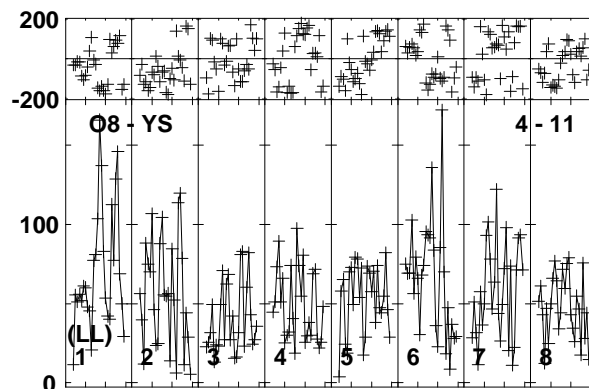
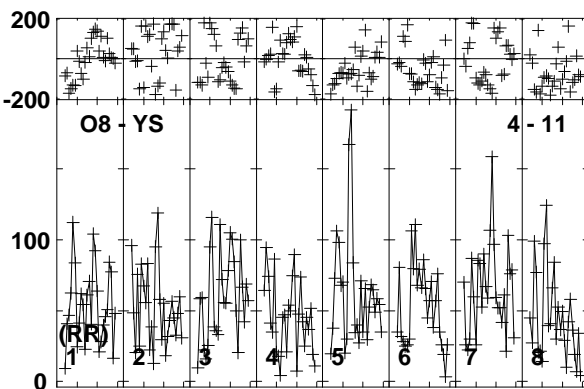
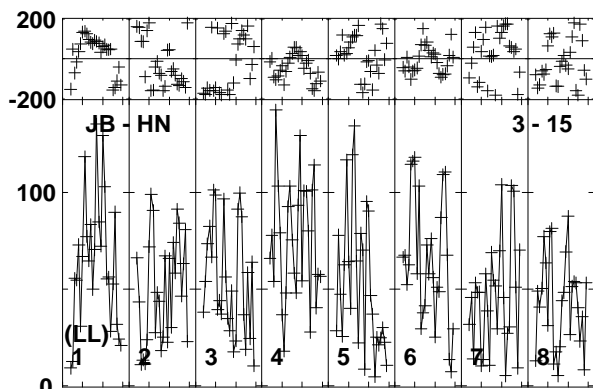
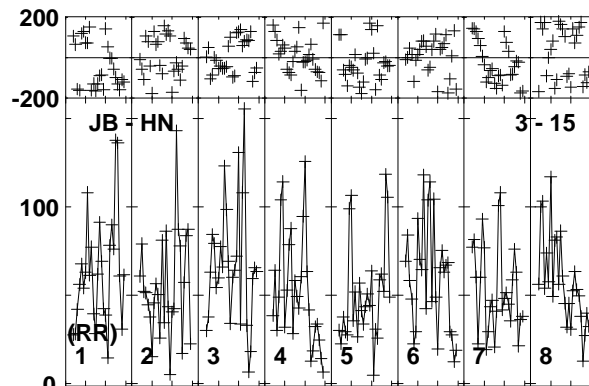
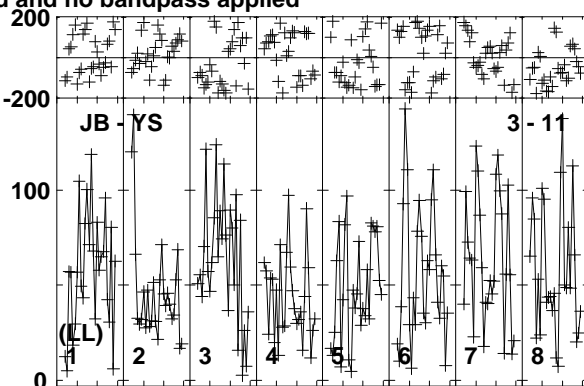
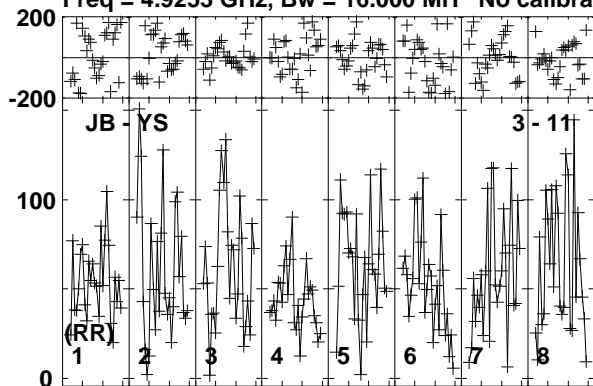

Lower frame: Micro Ampl Jy Top frame: Phas deg
Vector averaged cross-power spectrum Baseline: JB (03) - YS (11)
Timerange: 01/00:44:23 to 01/00:49:35

Plot file version 418 created 11-APR-2016 17:09:25

ARP299C GP053G 3.UVDATA.1

Freq = 4.9253 GHz, Bw = 16.000 MH No calibration applied and no bandpass applied

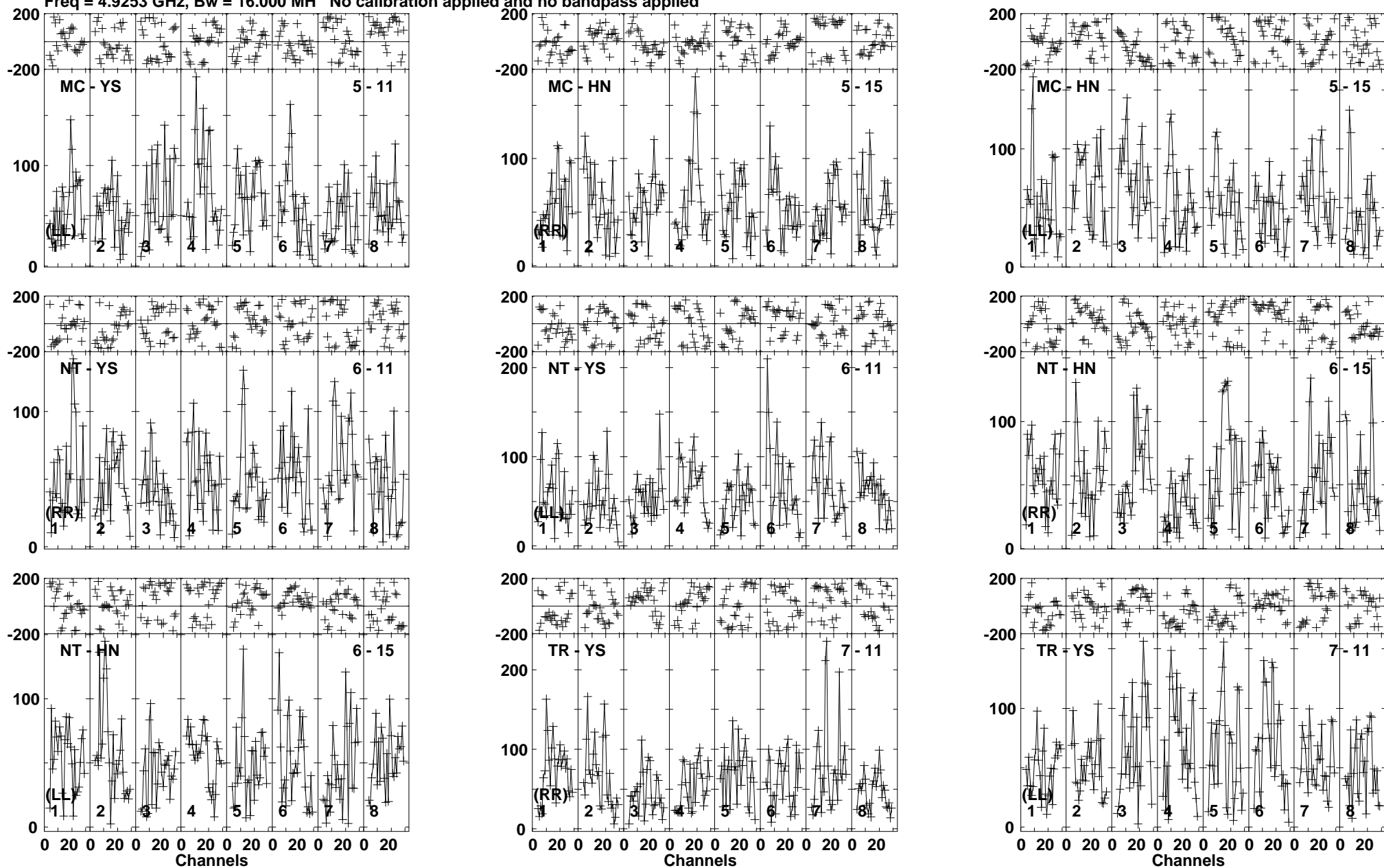

Lower frame: Micro Ampl Jy Top frame: Phas deg
Vector averaged cross-power spectrum Baseline: MC (05) - YS (11)
Timerange: 01/00:44:23 to 01/00:49:35

Plot file version 419 created 11-APR-2016 17:09:25

ARP299C GP053G 3.UVDATA.1

Freq = 4.9253 GHz, Bw = 16.000 MH No calibration applied and no bandpass applied

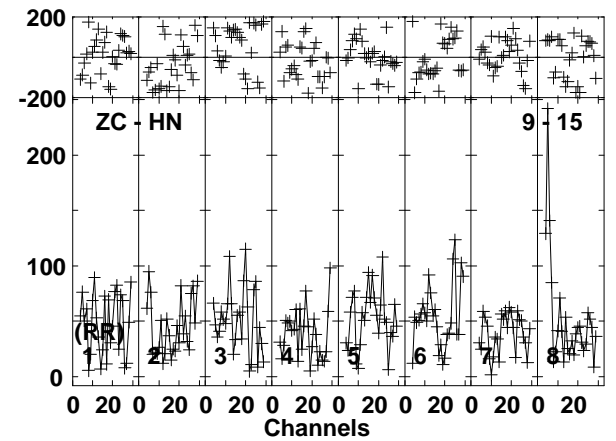
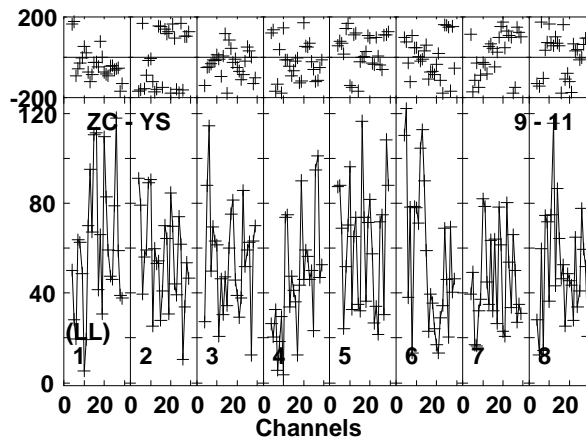
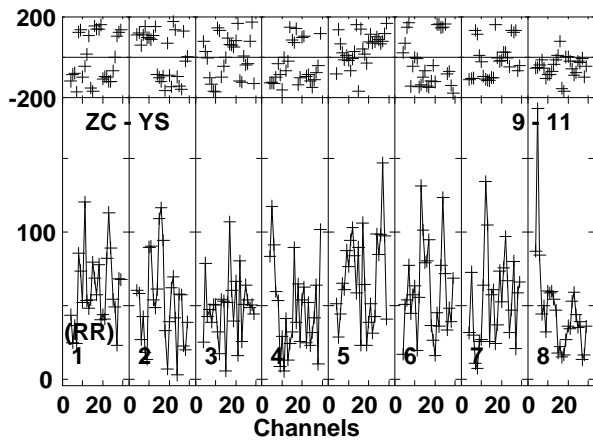
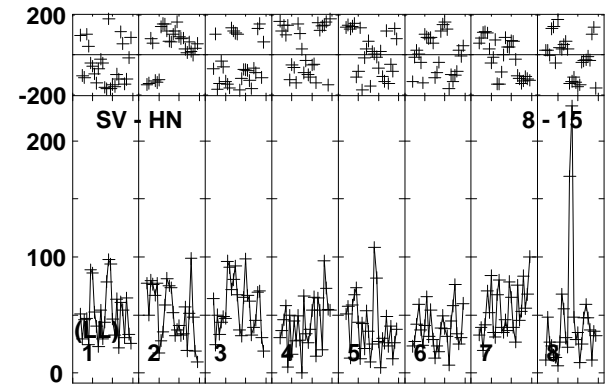
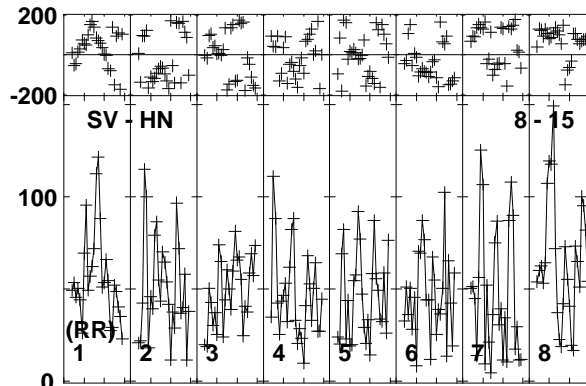
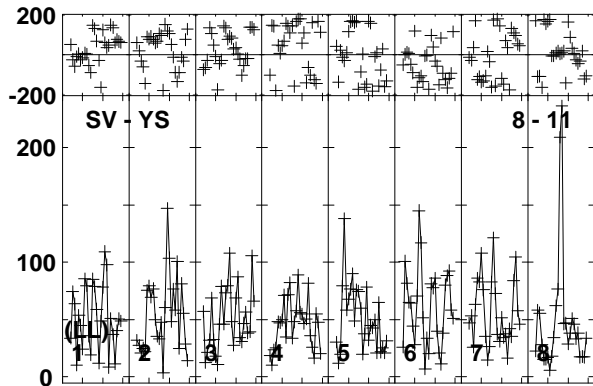
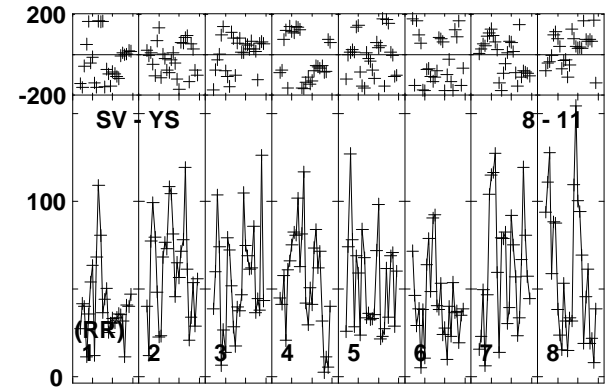
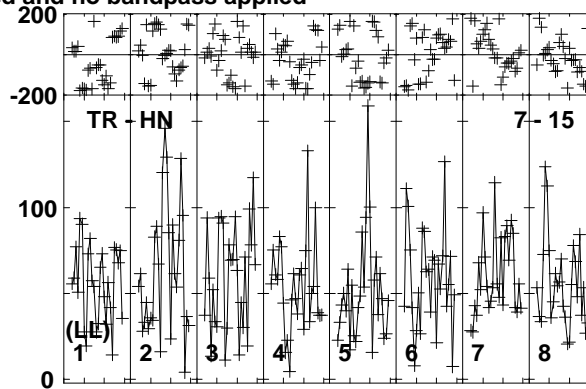
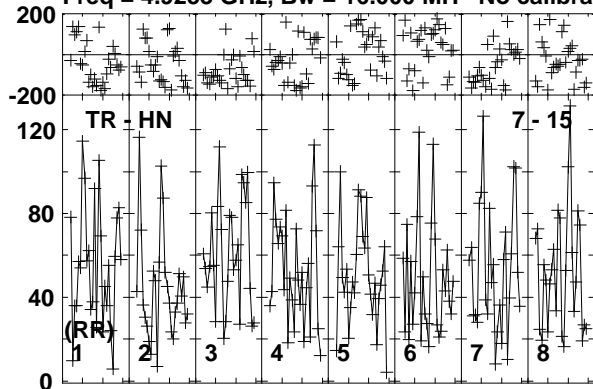

Lower frame: Micro Ampl Jy Top frame: Phas deg
Vector averaged cross-power spectrum Baseline: TR (07) - HN (15)
Timerange: 01/00:44:23 to 01/00:49:35

Plot file version 420 created 11-APR-2016 17:09:25

ARP299C GP053G 3.UVDATA.1

Freq = 4.9253 GHz, Bw = 16.000 MH No calibration applied and no bandpass applied

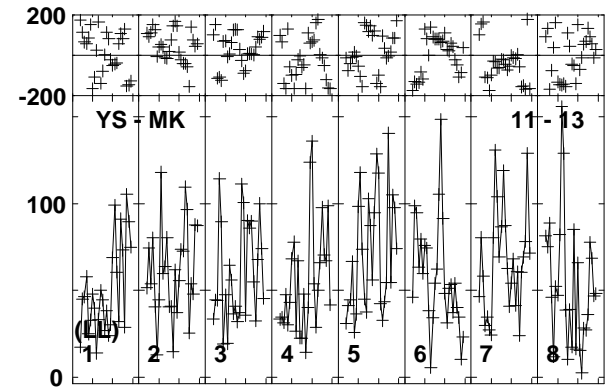
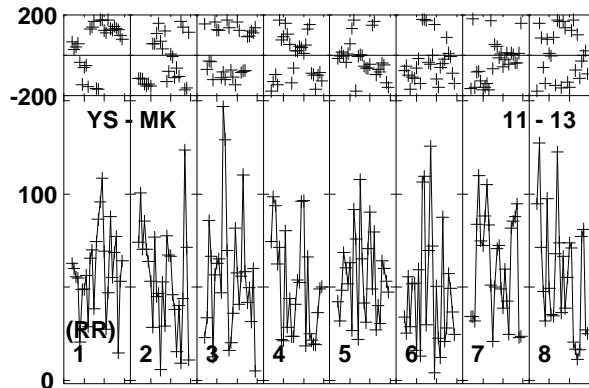
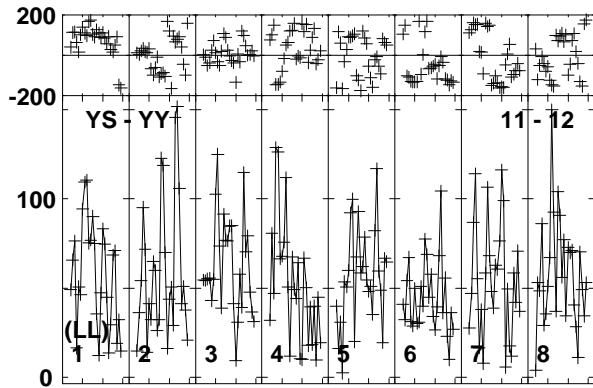
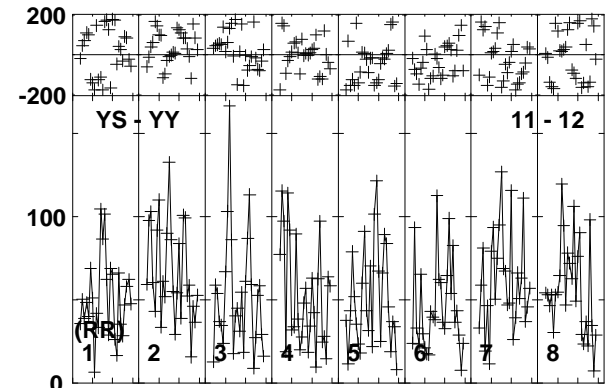
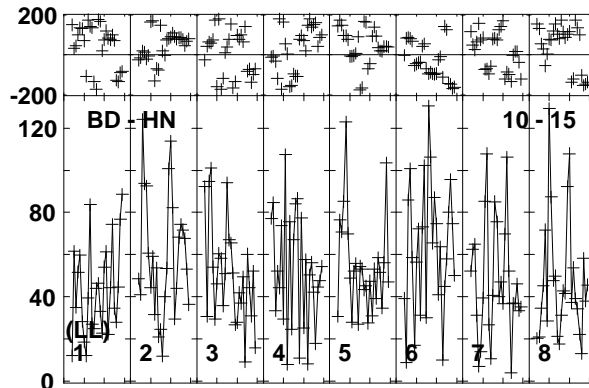
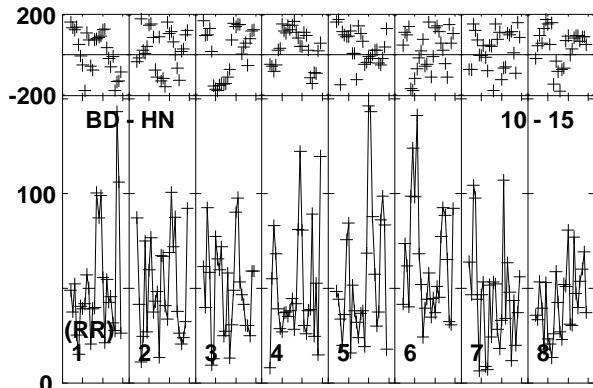
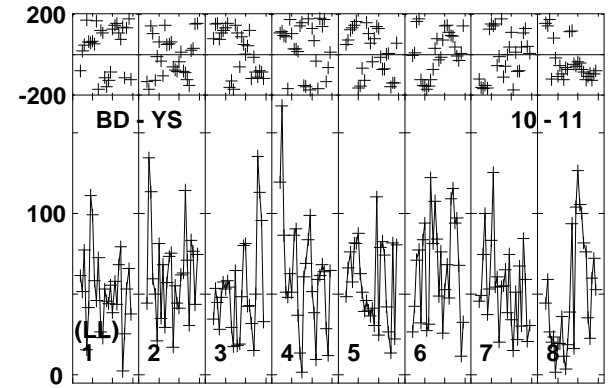
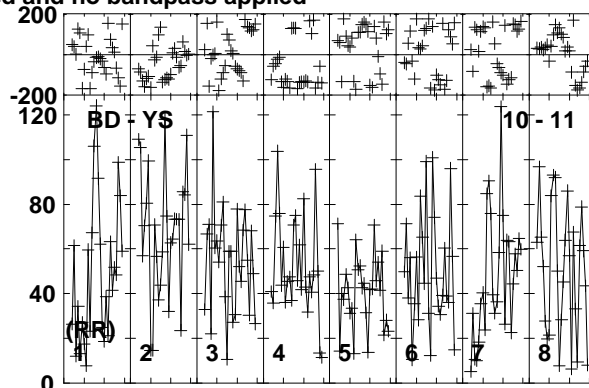
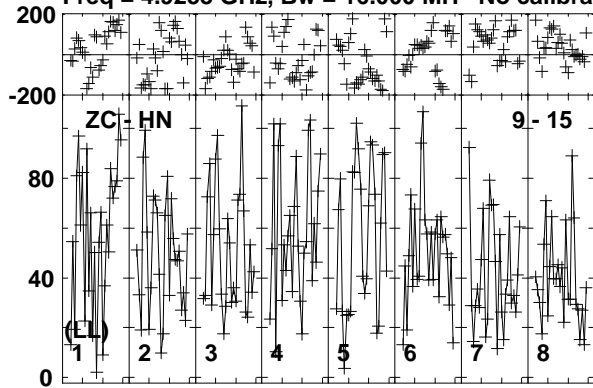

Lower frame: Micro Ampl Jy Top frame: Phas deg
Vector averaged cross-power spectrum Baseline: ZC (09) - HN (15)
Timerange: 01/00:44:23 to 01/00:49:35

Plot file version 421 created 11-APR-2016 17:09:25

ARP299C GP053G 3.UVDATA.1

Freq = 4.9253 GHz, Bw = 16.000 MH No calibration applied and no bandpass applied

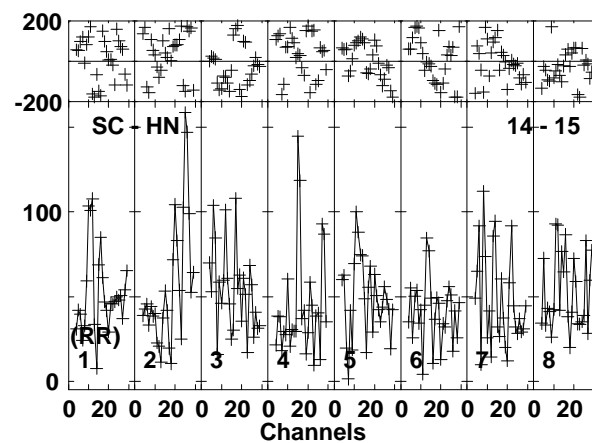
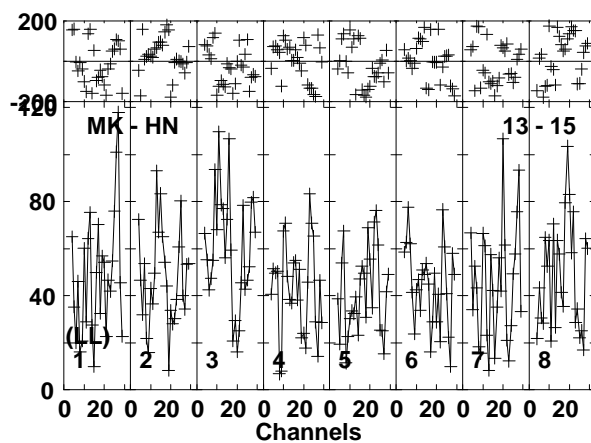
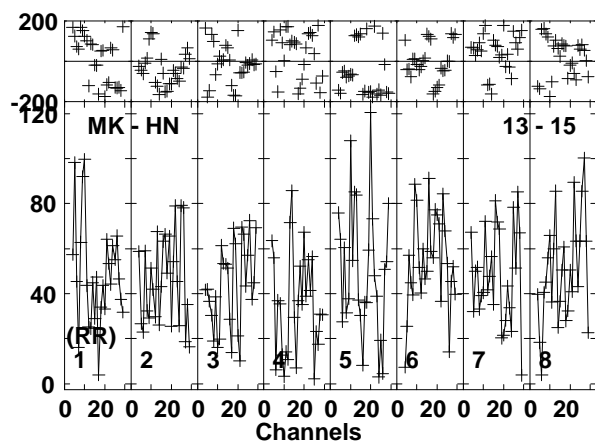
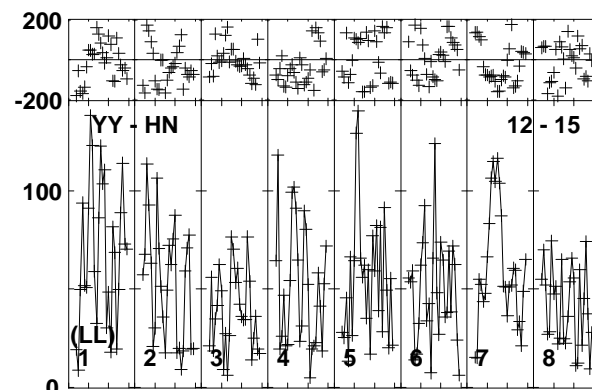
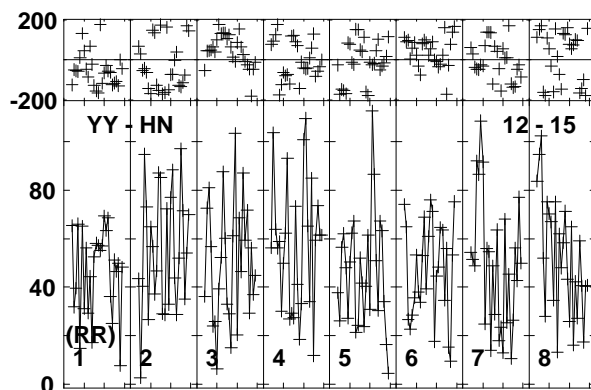
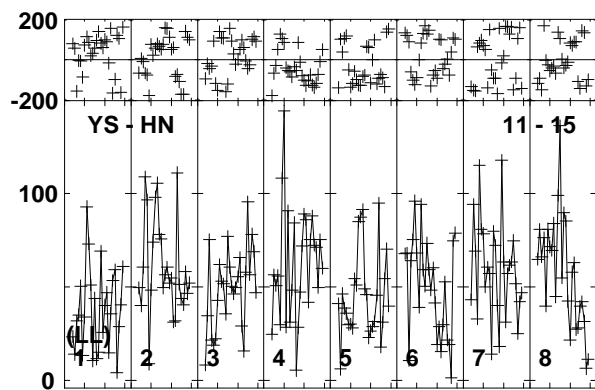
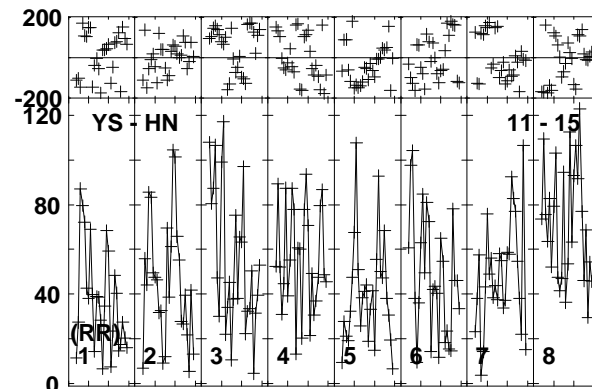
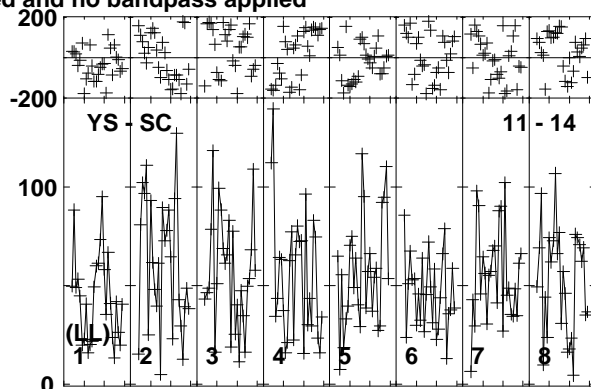
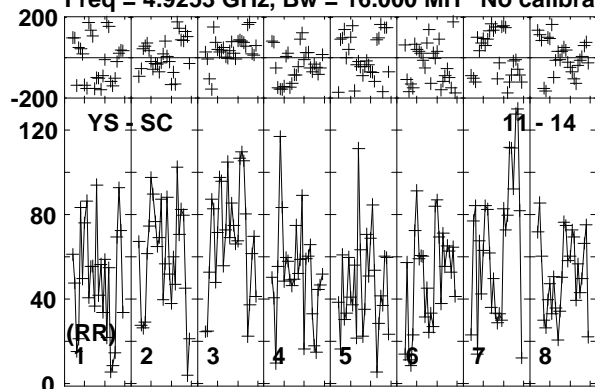

Lower frame: Micro Ampl Jy Top frame: Phas deg
Vector averaged cross-power spectrum Baseline: YS (11) - SC (14)
Timerange: 01/00:44:23 to 01/00:49:35

Plot file version 422 created 11-APR-2016 17:09:25

ARP299C GP053G 3.UVDATA.1

Freq = 4.9253 GHz, Bw = 16.000 MH No calibration applied and no bandpass applied

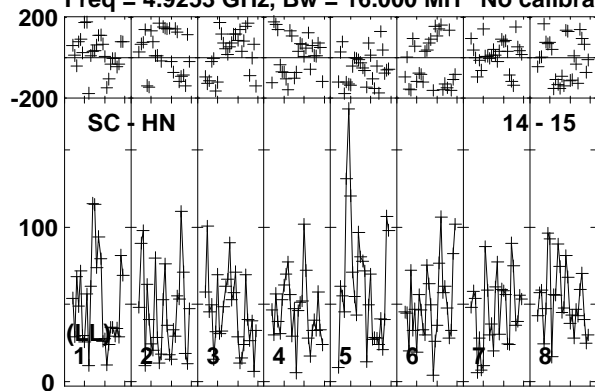

Lower frame: Micro Ampl Jy Top frame: Phas deg
Vector averaged cross-power spectrum Baseline: SC (14) - HN (15)
Timerange: 01/00:44:23 to 01/00:49:35

Plot file version 423 created 11-APR-2016 17:09:25

J1128+5925 GP053G 3.UVDATA.1

Freq = 4.9253 GHz, Bw = 16.000 MH No calibration applied and no bandpass applied

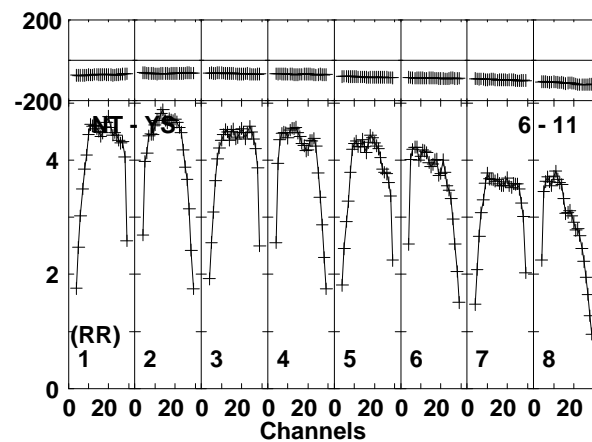
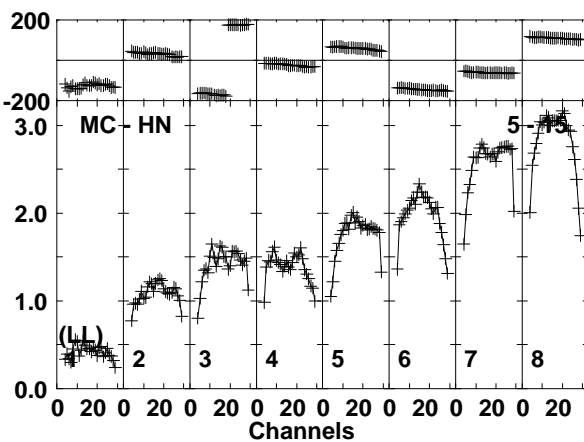
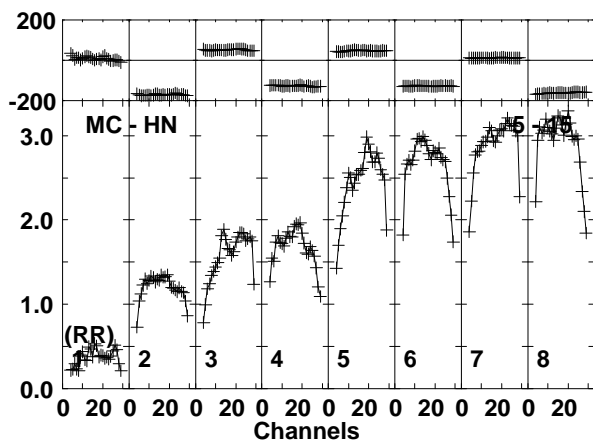
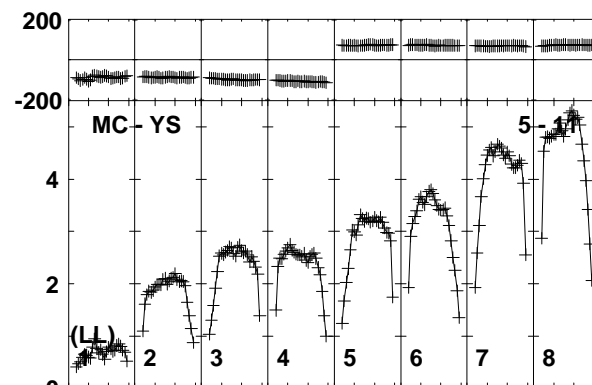
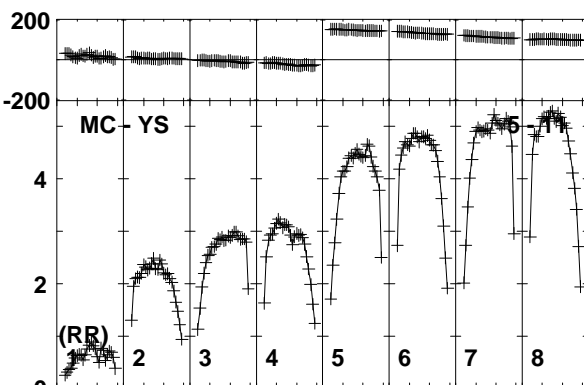
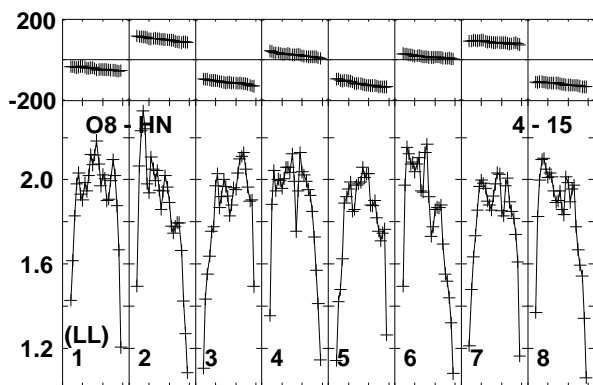
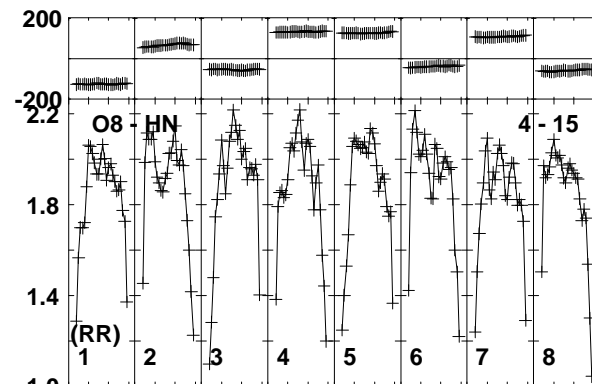
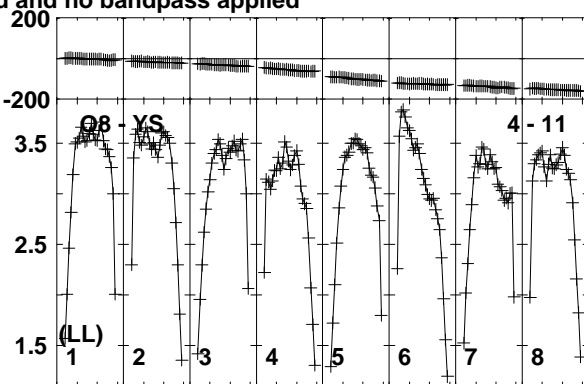
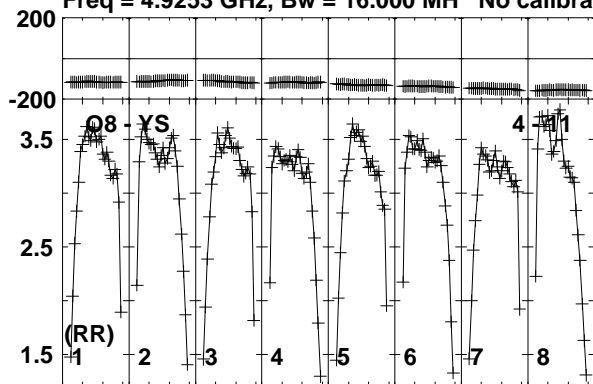

Lower frame: Milli Ampl Jy Top frame: Phas deg
Vector averaged cross-power spectrum Baseline: O8 (04) - YS (11)
Timerange: 01/00:49:41 to 01/00:51:33

Plot file version 424 created 11-APR-2016 17:09:26

J1128+5925 GP053G 3.UVDATA.1

Freq = 4.9253 GHz, Bw = 16.000 MH No calibration applied and no bandpass applied

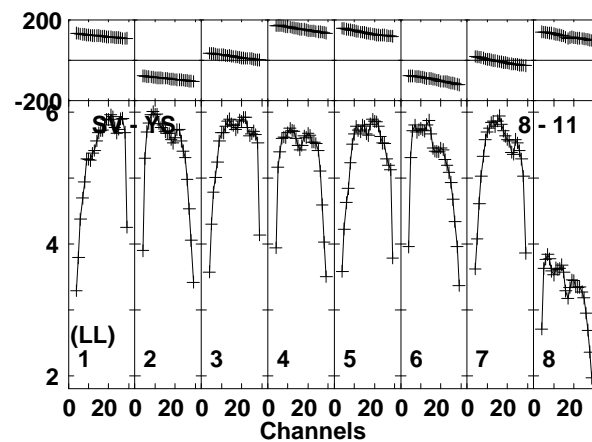
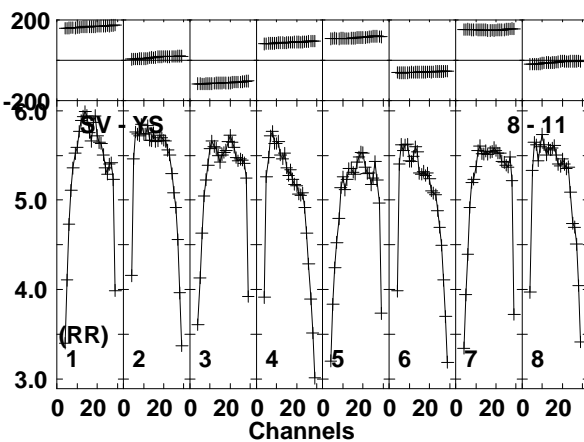
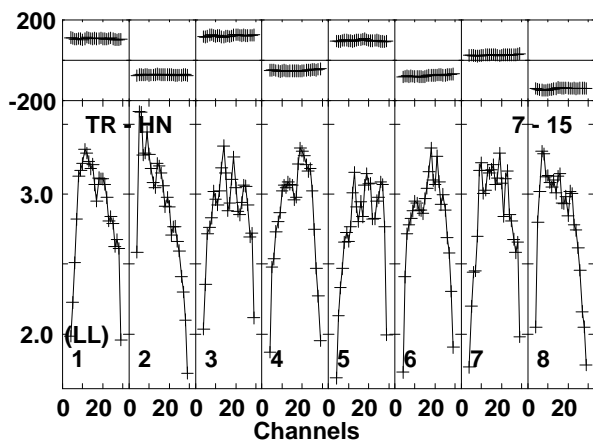
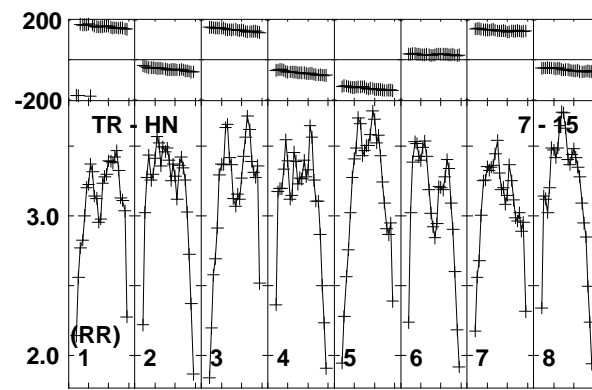
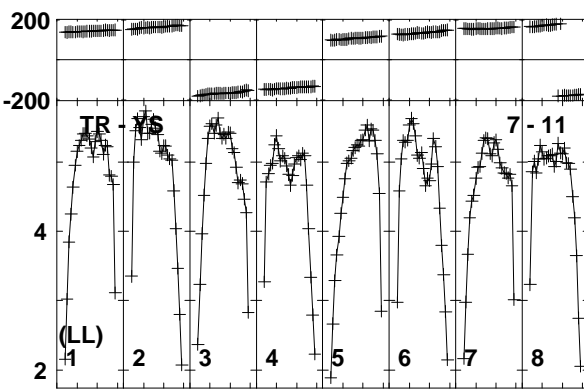
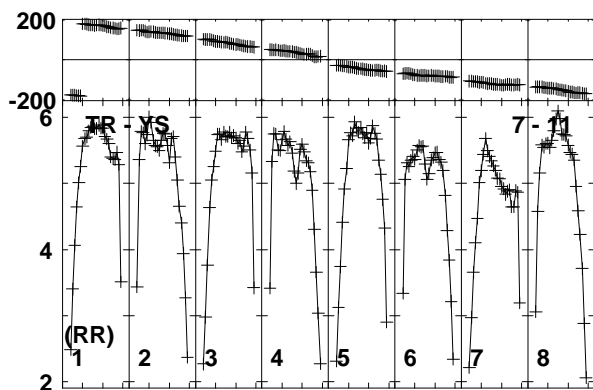
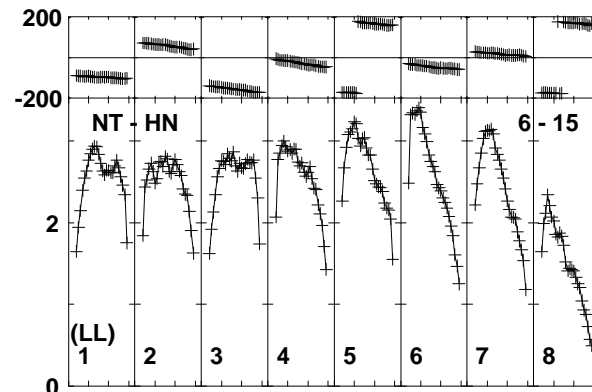
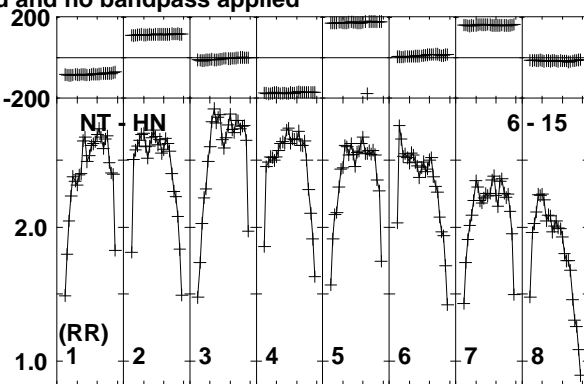
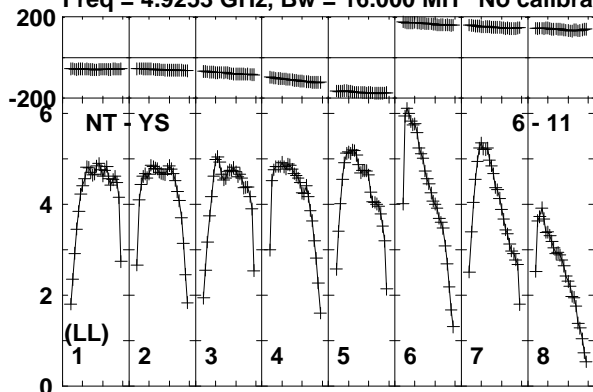

Lower frame: Milli Ampl Jy Top frame: Phas deg
Vector averaged cross-power spectrum Baseline: NT (06) - YS (11)
Timerange: 01/00:49:41 to 01/00:51:33

Plot file version 425 created 11-APR-2016 17:09:26

J1128+5925 GP053G 3.UVDATA.1

Freq = 4.9253 GHz, Bw = 16.000 MH No calibration applied and no bandpass applied

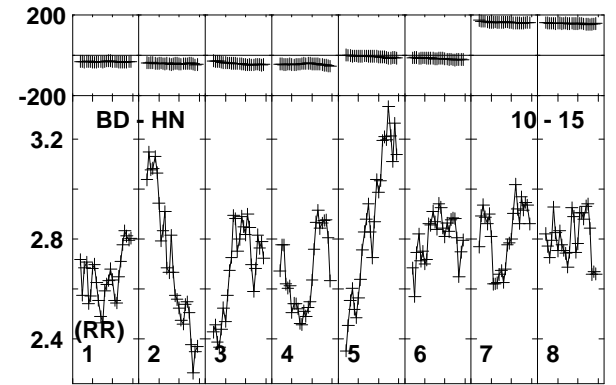
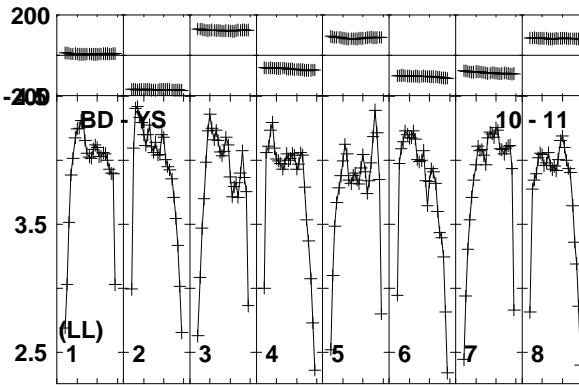
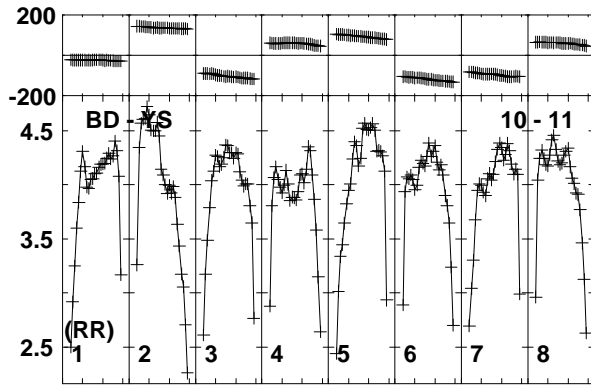
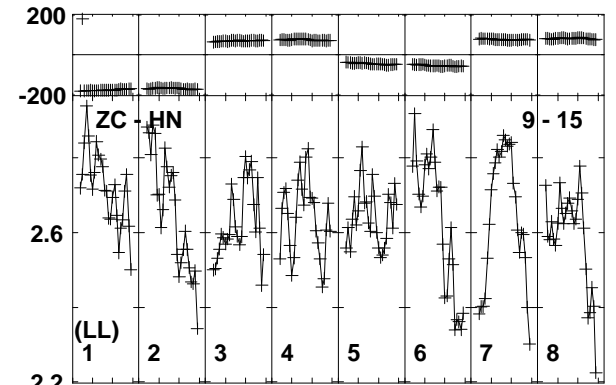
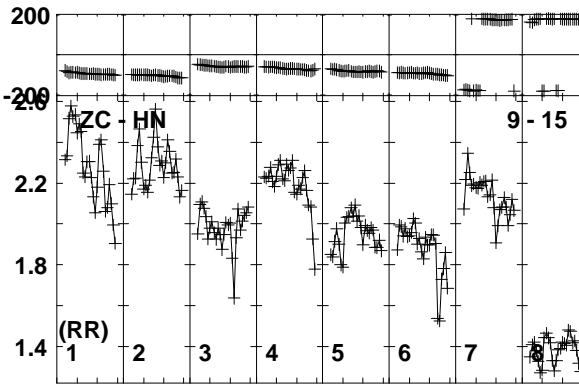
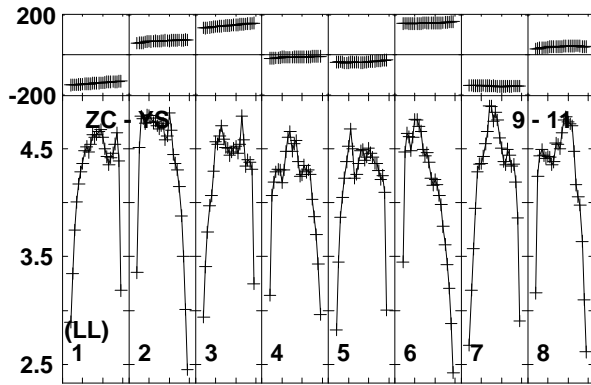
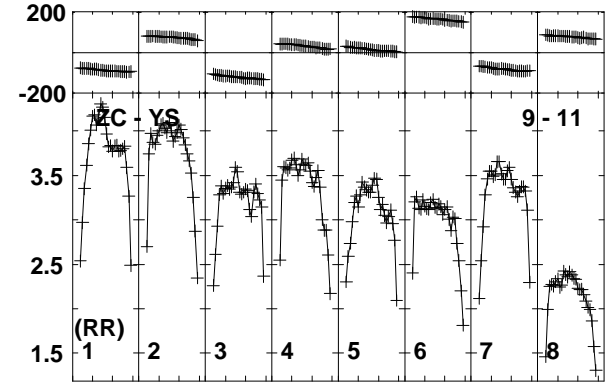
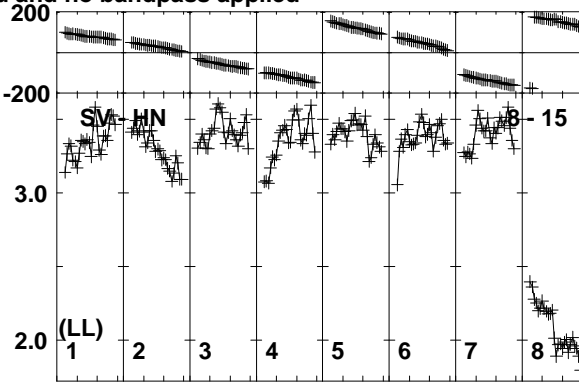
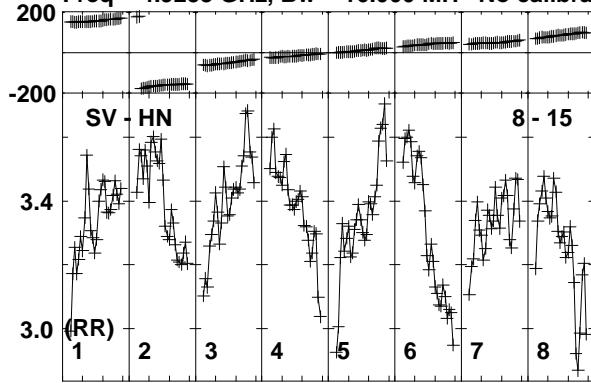

Lower frame: Milli Ampl Jy Top frame: Phas deg

Vector averaged cross-power spectrum Baseline: SV (08) - HN (15)

Timerange: 01/00:49:41 to 01/00:51:33

Plot file version 426 created 11-APR-2016 17:09:26

J1128+5925 GP053G 3.UVDATA.1

Freq = 4.9253 GHz, Bw = 16.000 MH No calibration applied and no bandpass applied

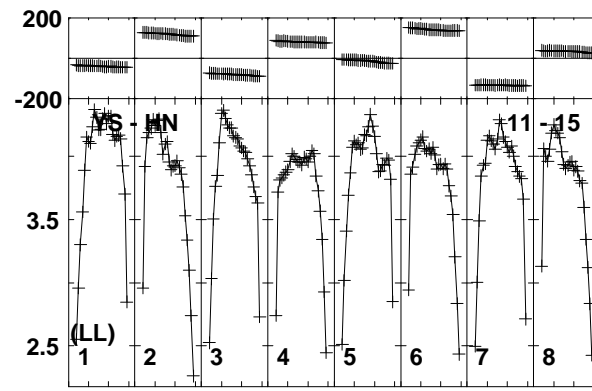
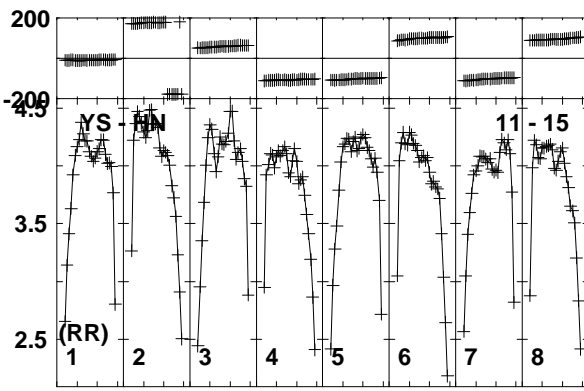
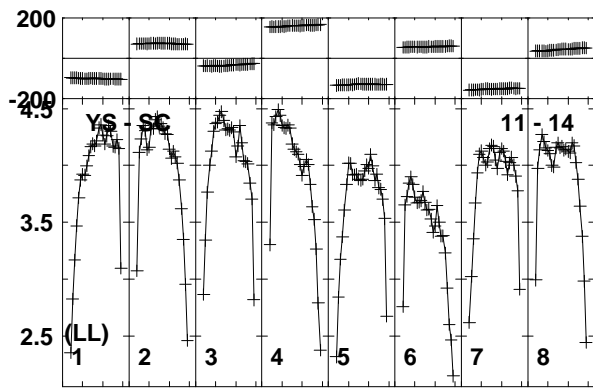
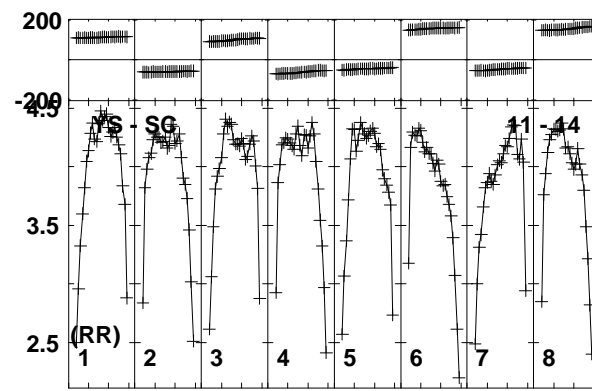
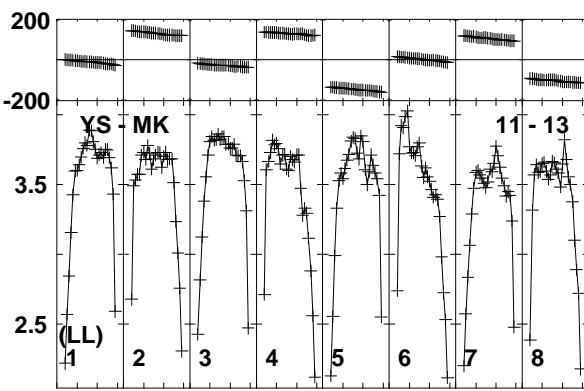
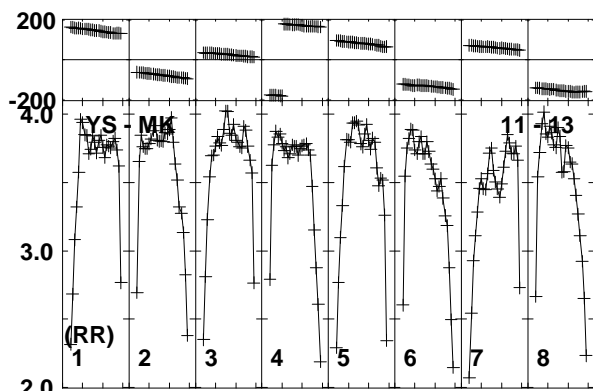
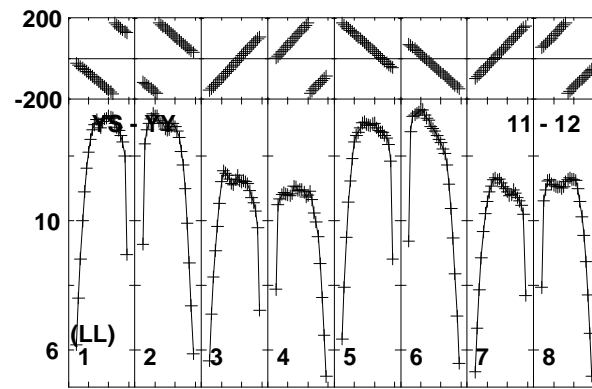
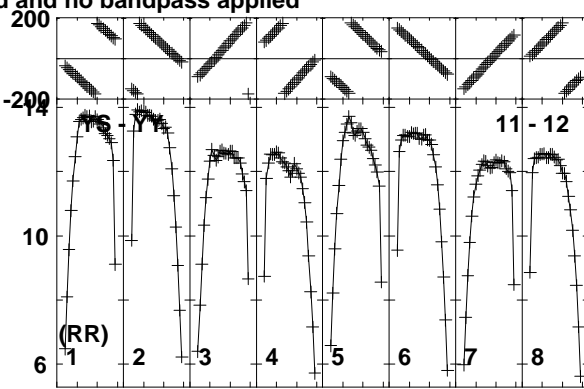
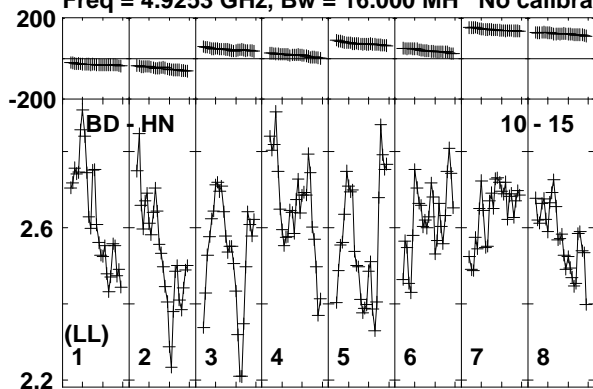

Lower frame: Milli Ampl Jy Top frame: Phas deg
Vector averaged cross-power spectrum Baseline: BD (10) - HN (15)
Timerange: 01/00:49:41 to 01/00:51:33

Plot file version 427 created 11-APR-2016 17:09:26

J1128+5925 GP053G 3.UVDATA.1

Freq = 4.9253 GHz, Bw = 16.000 MH No calibration applied and no bandpass applied

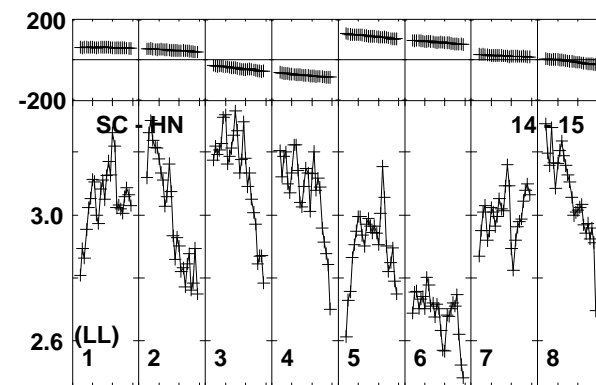
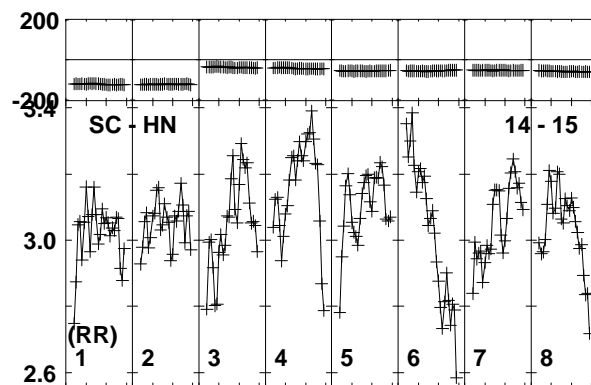
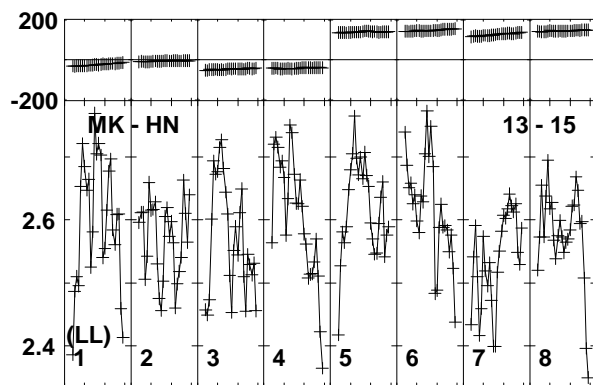
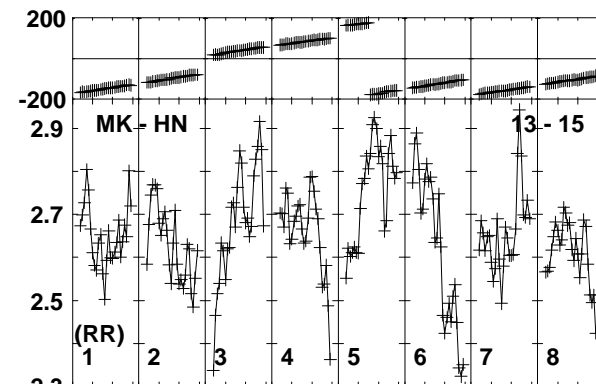
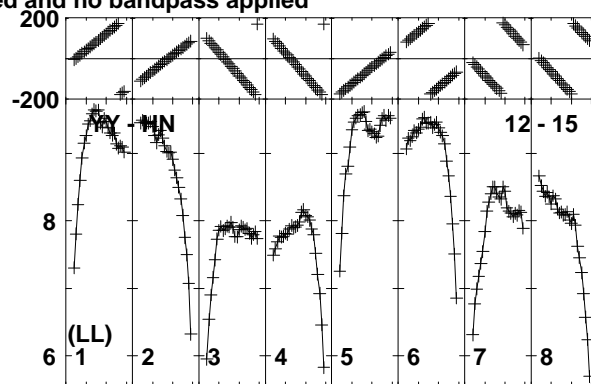
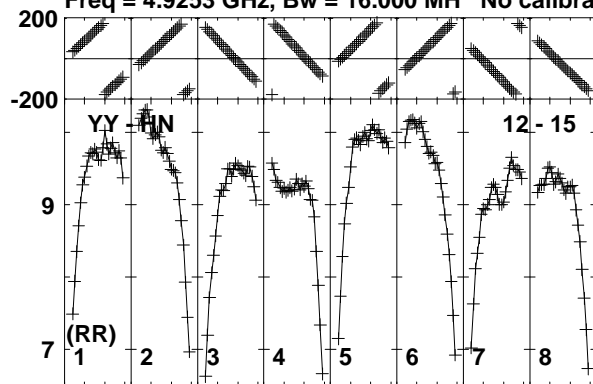

Lower frame: Milli Ampl Jy Top frame: Phas deg
Vector averaged cross-power spectrum Baseline: YY (12) - HN (15)
Timerange: 01/00:49:41 to 01/00:51:33

Plot file version 428 created 11-APR-2016 17:09:26

ARP299C GP053G 3.UVDATA.1

Freq = 4.9253 GHz, Bw = 16.000 MH No calibration applied and no bandpass applied

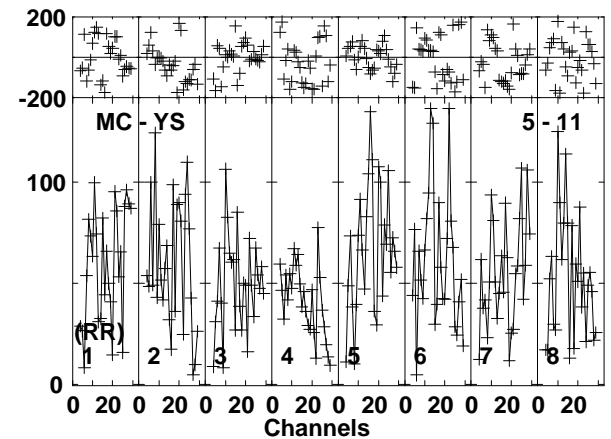
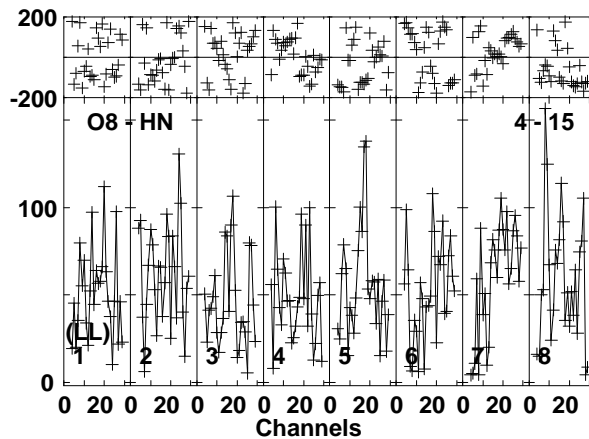
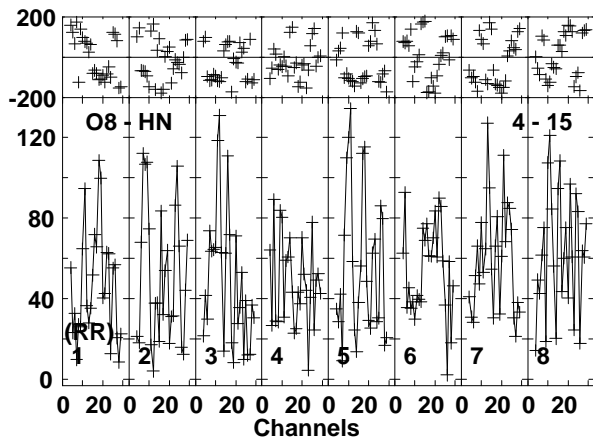
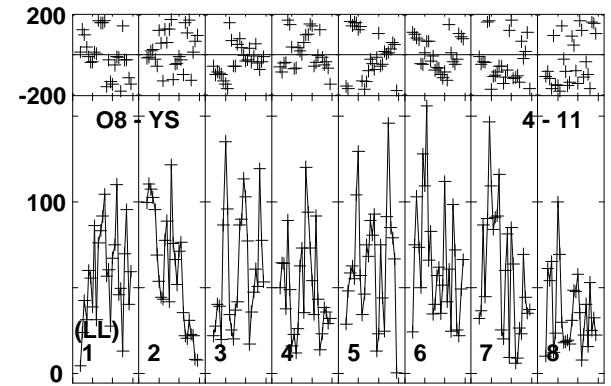
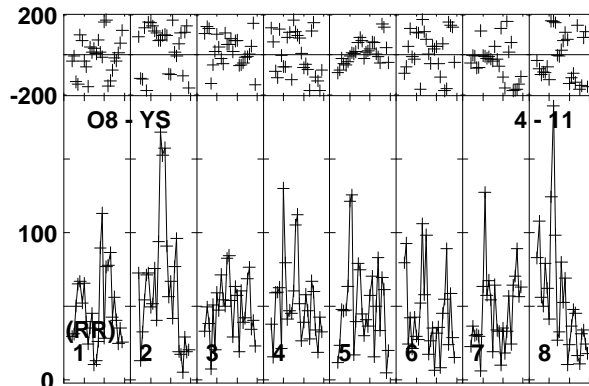
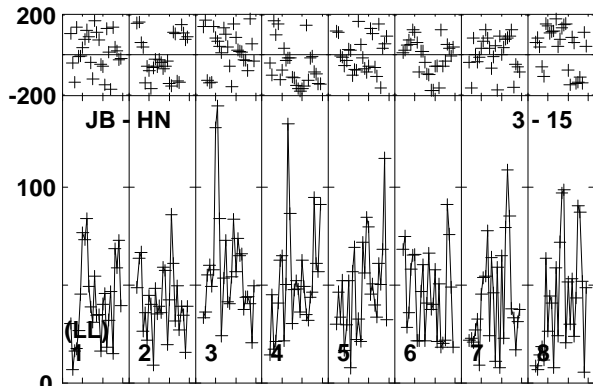
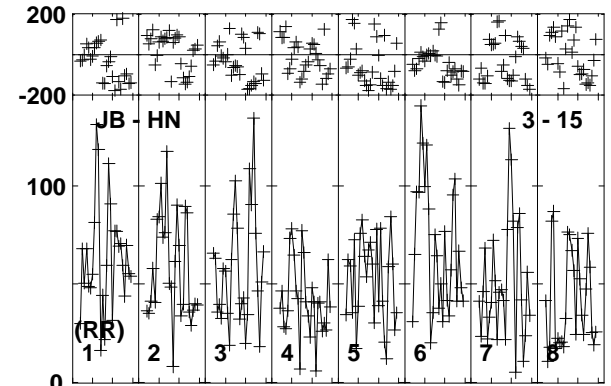
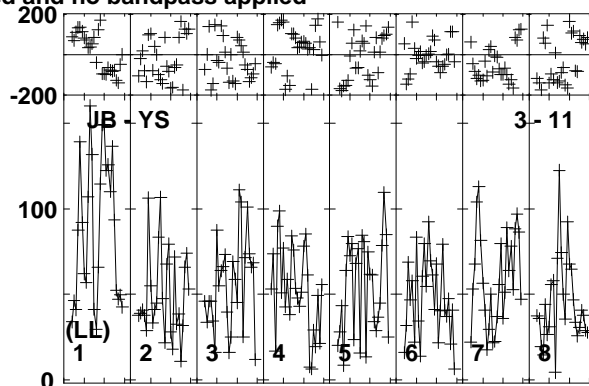
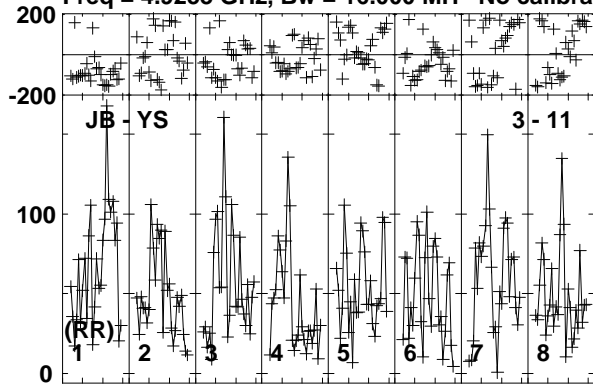

Lower frame: Micro Ampl Jy Top frame: Phas deg
Vector averaged cross-power spectrum Baseline: JB (03) - YS (11)
Timerange: 01/00:51:38 to 01/00:56:52

Plot file version 429 created 11-APR-2016 17:09:26

ARP299C GP053G 3.UVDATA.1

Freq = 4.9253 GHz, Bw = 16.000 MH No calibration applied and no bandpass applied

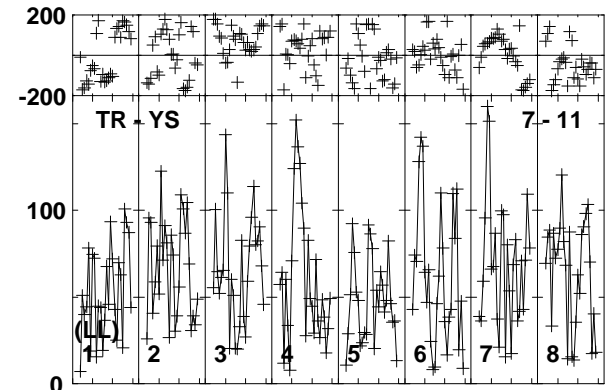
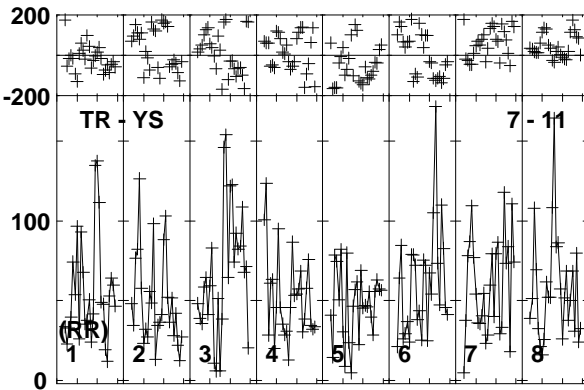
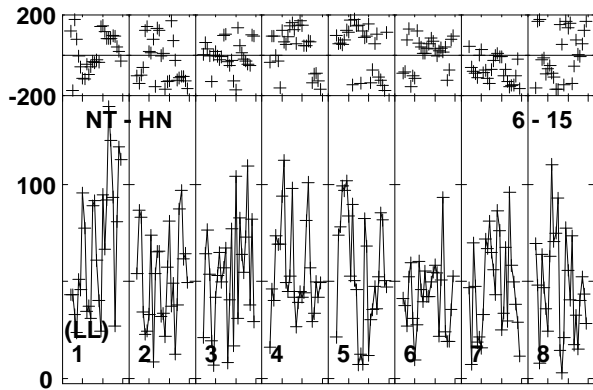
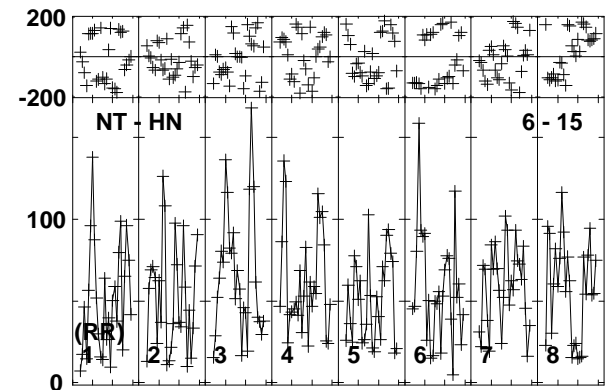
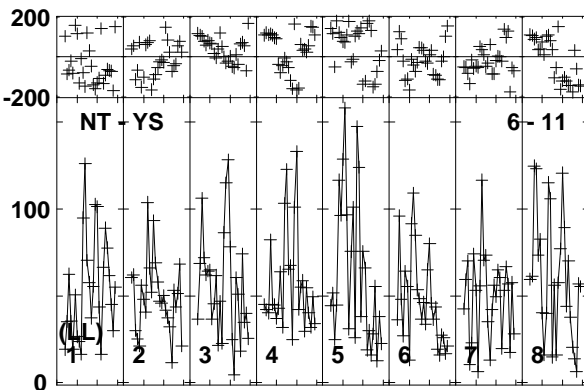
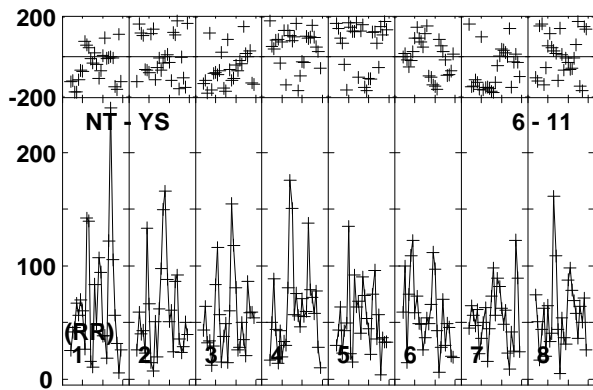
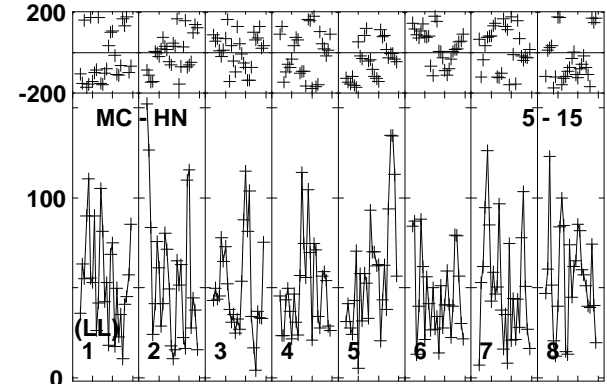
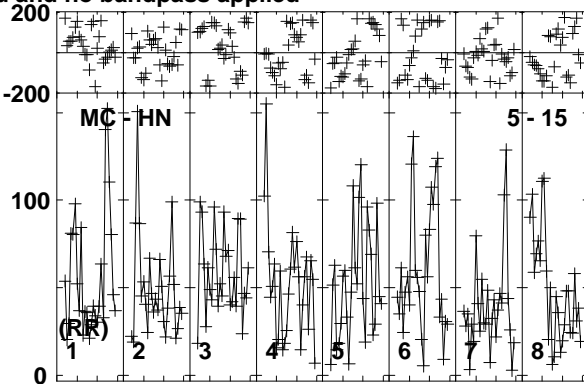
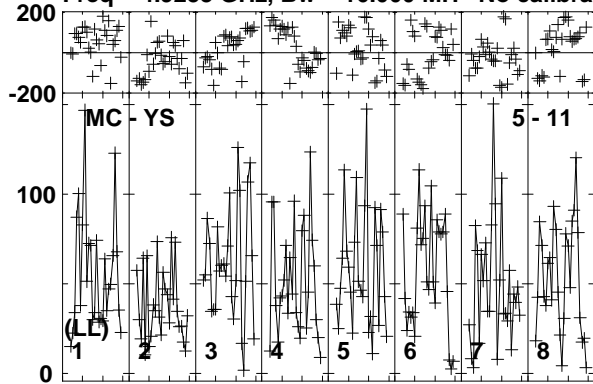

Lower frame: Micro Ampl Jy Top frame: Phas deg
Vector averaged cross-power spectrum Baseline: MC (05) - YS (11)
Timerange: 01/00:51:38 to 01/00:56:52

Plot file version 430 created 11-APR-2016 17:09:27

ARP299C GP053G 3.UVDATA.1

Freq = 4.9253 GHz, Bw = 16.000 MH No calibration applied and no bandpass applied

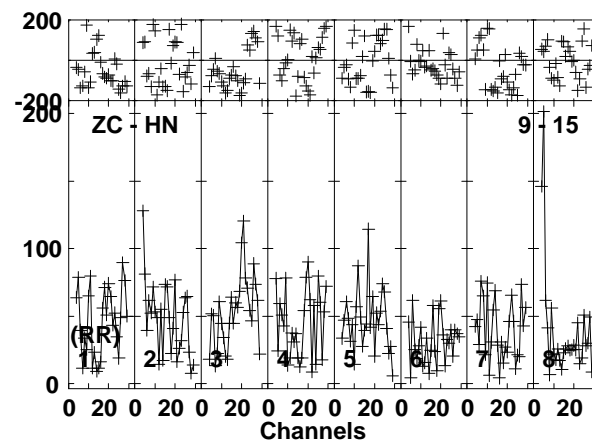
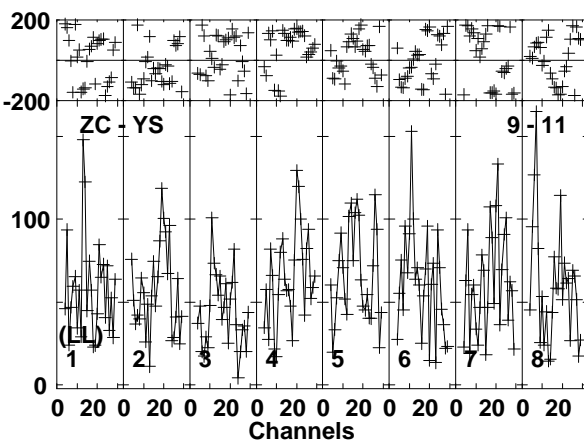
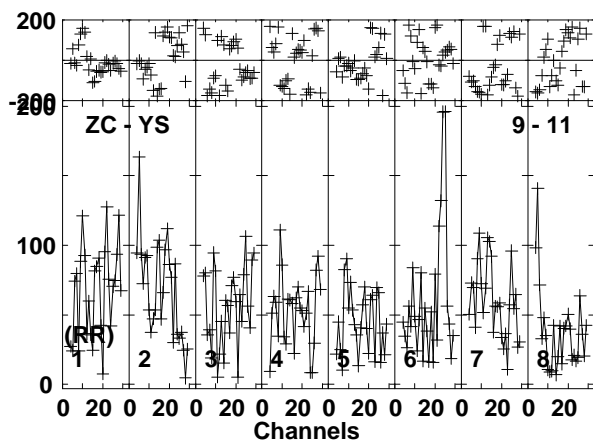
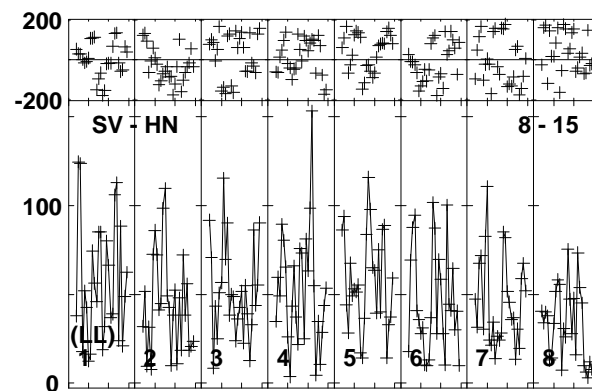
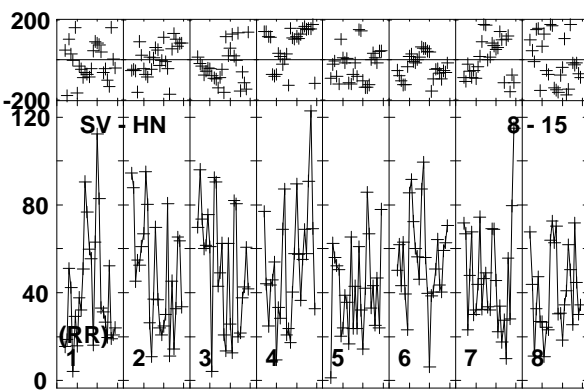
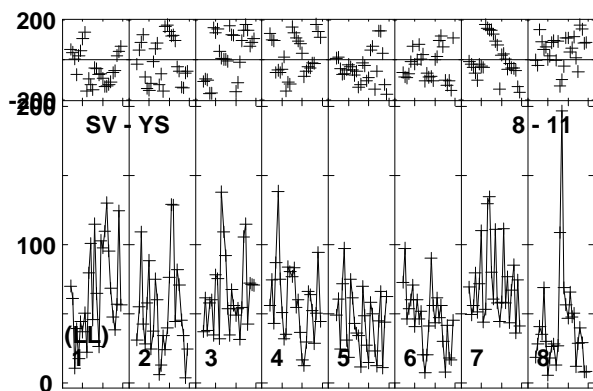
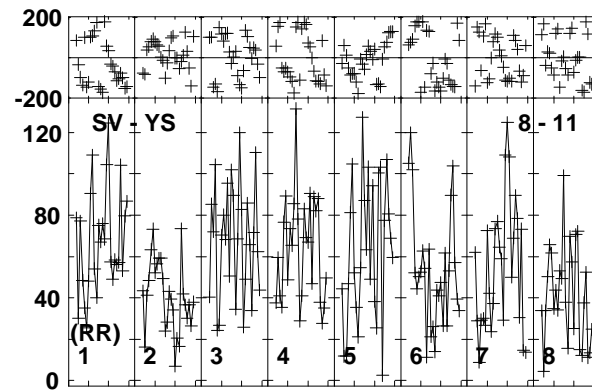
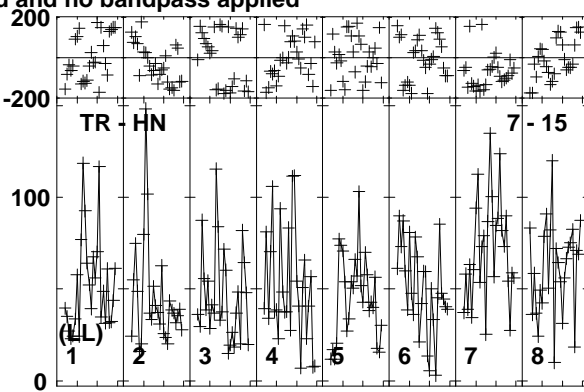
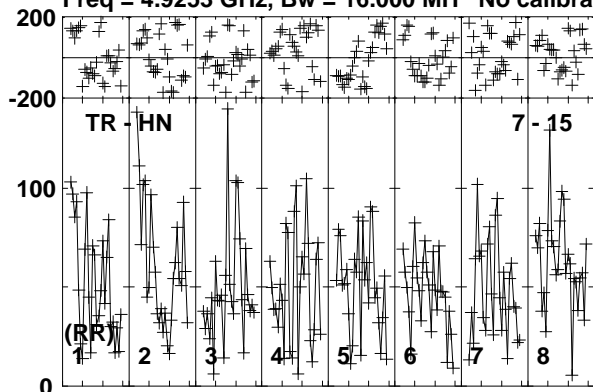

Lower frame: Micro Ampl Jy Top frame: Phas deg
Vector averaged cross-power spectrum Baseline: TR (07) - HN (15)
Timerange: 01/00:51:38 to 01/00:56:52

Plot file version 431 created 11-APR-2016 17:09:27

ARP299C GP053G 3.UVDATA.1

Freq = 4.9253 GHz, Bw = 16.000 MH No calibration applied and no bandpass applied

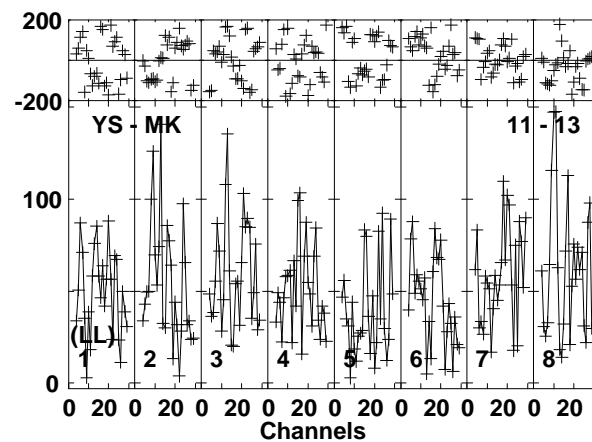
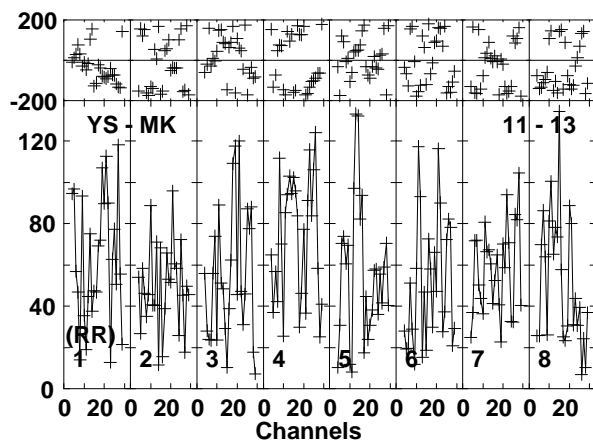
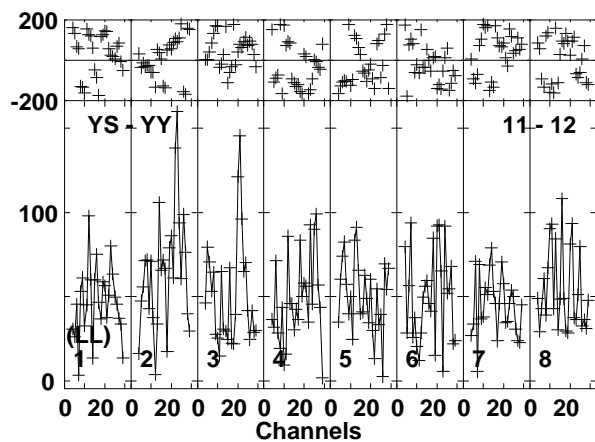
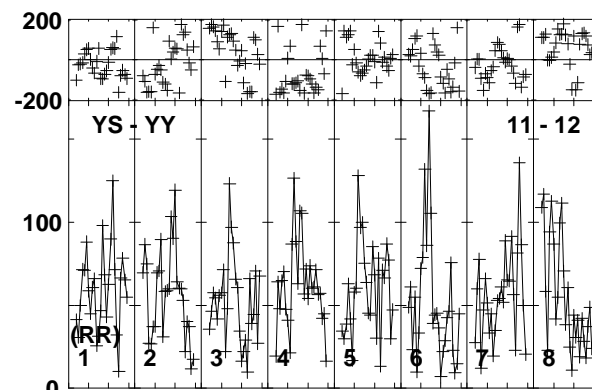
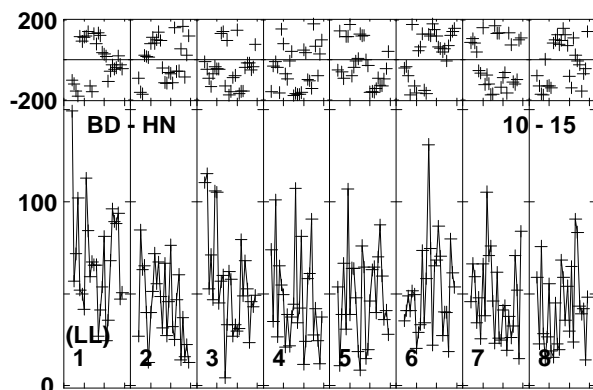
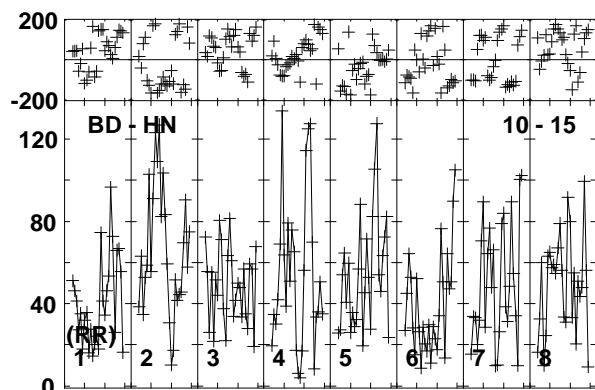
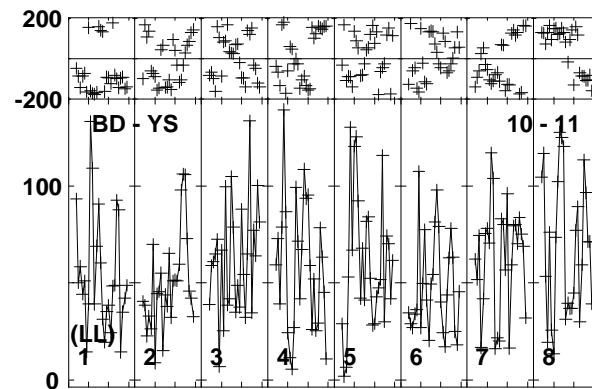
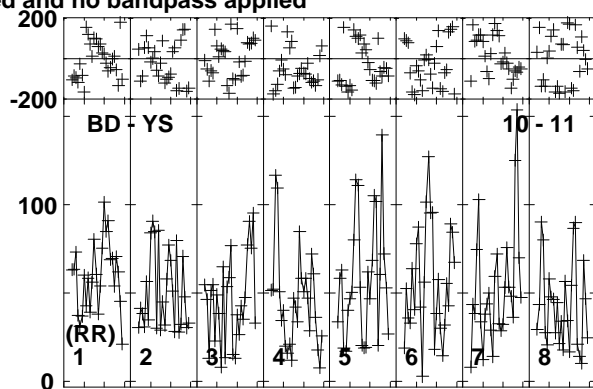
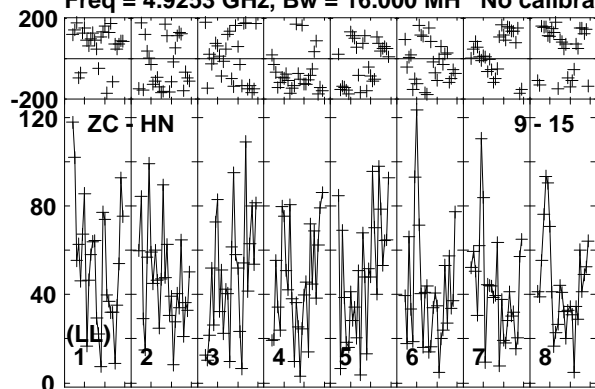

Lower frame: Micro Ampl Jy Top frame: Phas deg
Vector averaged cross-power spectrum Baseline: ZC (09) - HN (15)
Timerange: 01/00:51:38 to 01/00:56:52

Plot file version 432 created 11-APR-2016 17:09:27

ARP299C GP053G 3.UVDATA.1

Freq = 4.9253 GHz, Bw = 16.000 MH No calibration applied and no bandpass applied

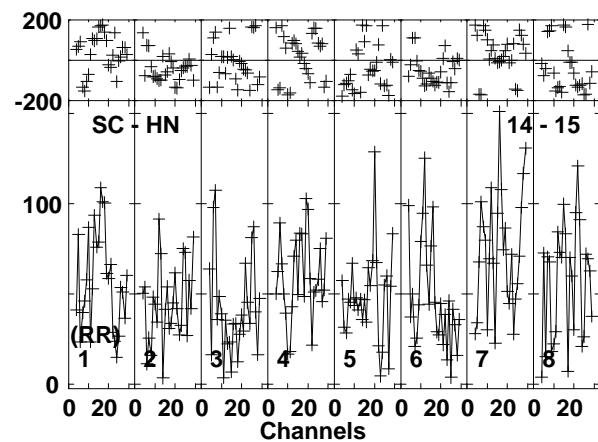
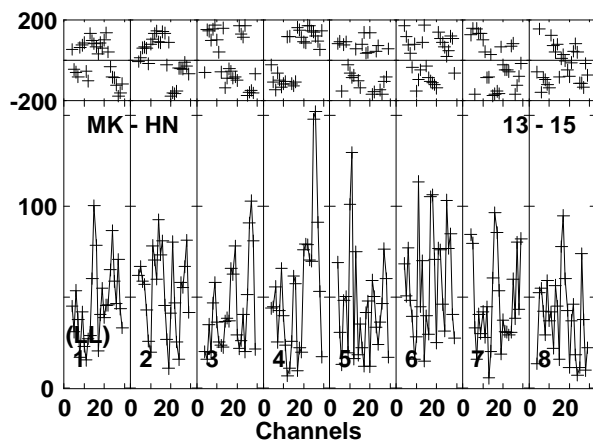
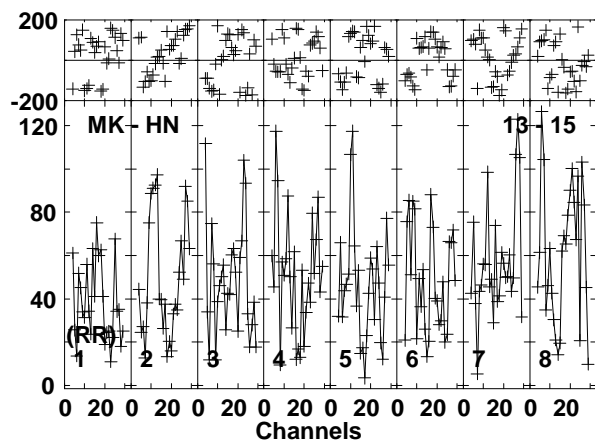
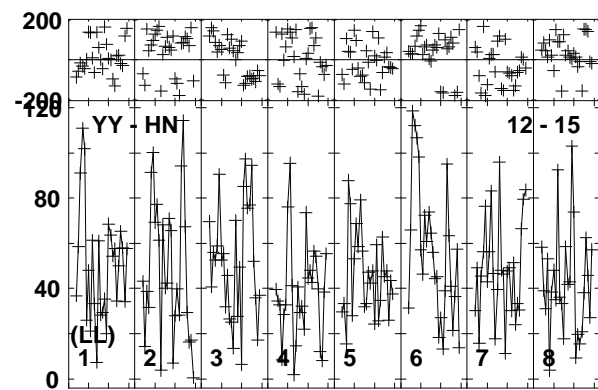
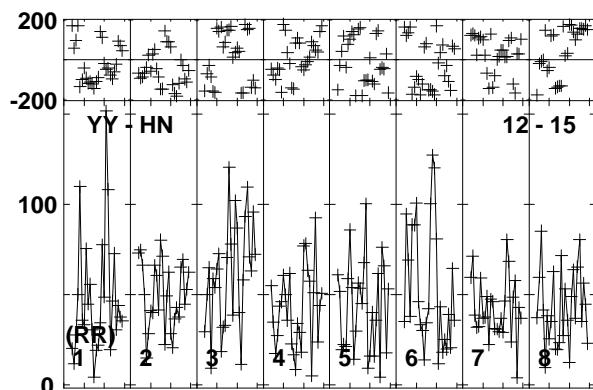
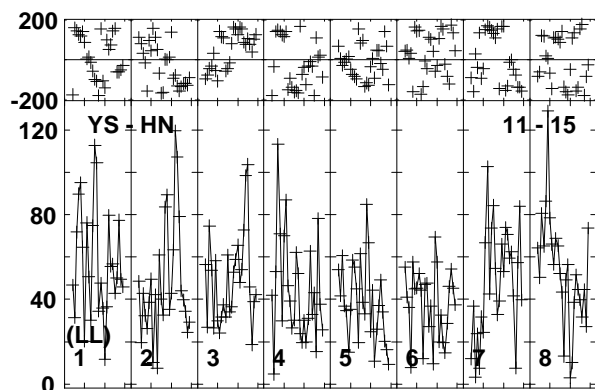
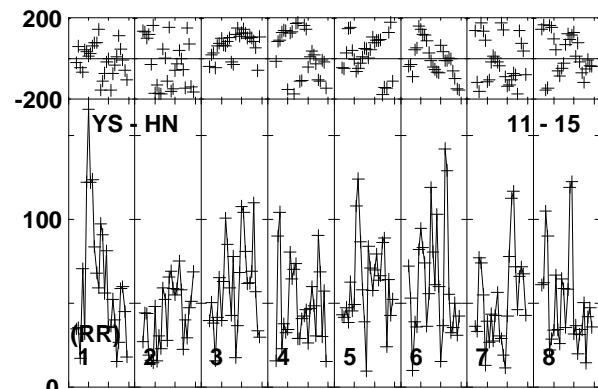
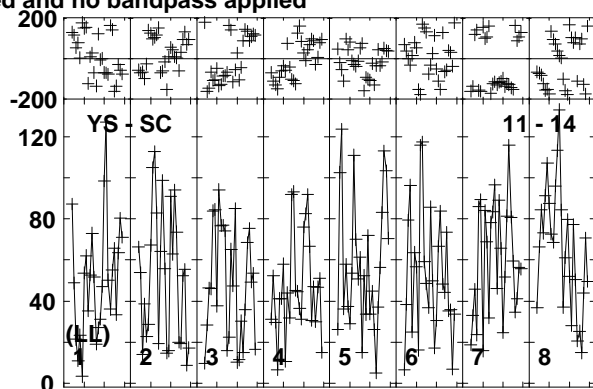
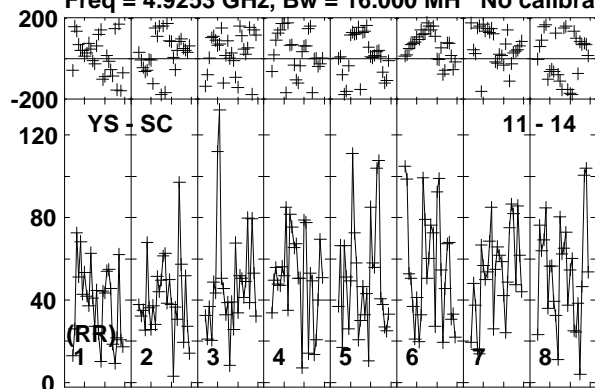

Lower frame: Micro Ampl Jy Top frame: Phas deg
Vector averaged cross-power spectrum Baseline: YS (11) - SC (14)
Timerange: 01/00:51:38 to 01/00:56:52

Plot file version 433 created 11-APR-2016 17:09:27

ARP299C GP053G 3.UVDATA.1

Freq = 4.9253 GHz, Bw = 16.000 MH No calibration applied and no bandpass applied

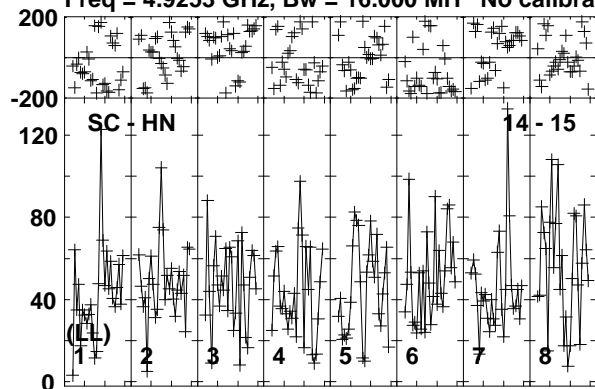

Lower frame: Micro Ampl Jy Top frame: Phas deg
Vector averaged cross-power spectrum Baseline: SC (14) - HN (15)
Timerange: 01/00:51:38 to 01/00:56:52

Plot file version 434 created 11-APR-2016 17:09:27

J1128+5925 GP053G 3.UVDATA.1

Freq = 4.9253 GHz, Bw = 16.000 MH No calibration applied and no bandpass applied

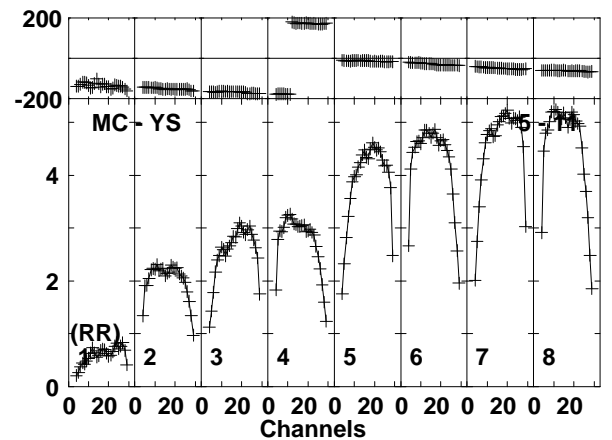
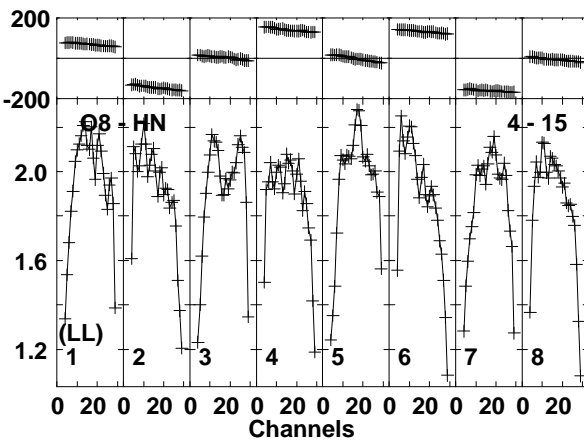
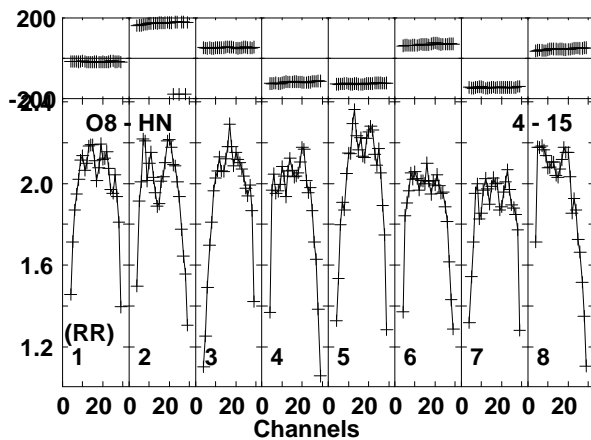
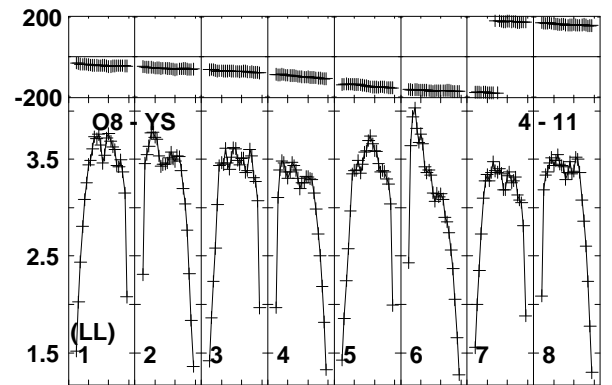
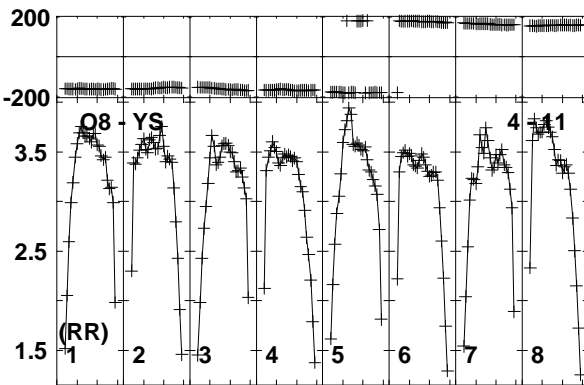
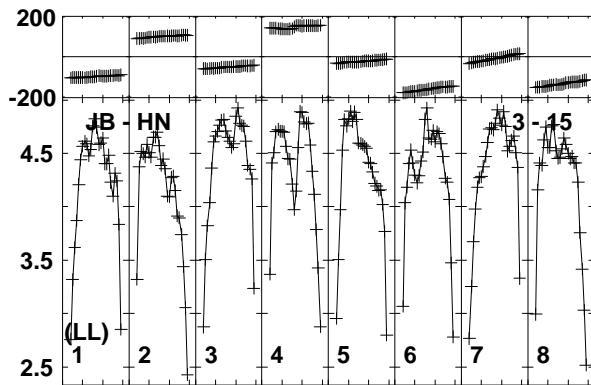
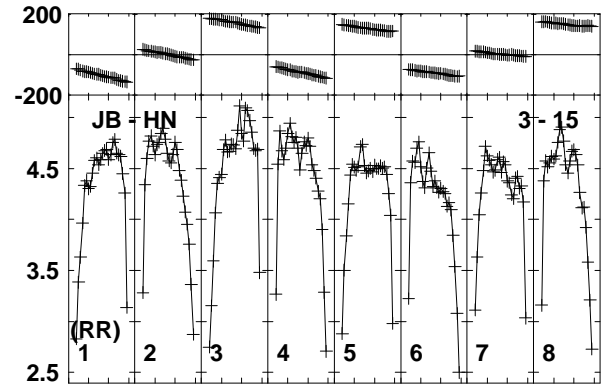
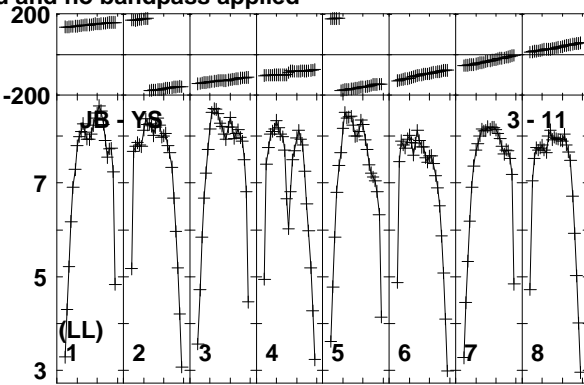
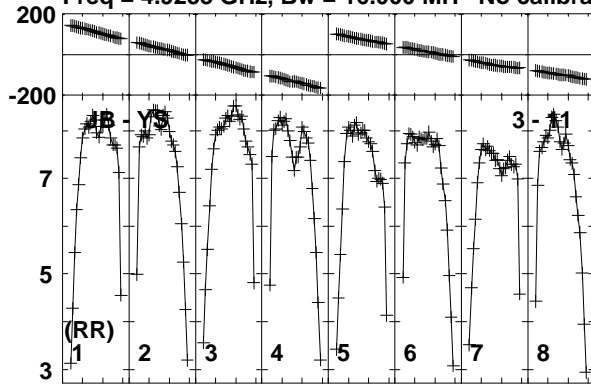

Lower frame: Milli Ampl Jy Top frame: Phas deg
Vector averaged cross-power spectrum Baseline: JB (03) - YS (11)
Timerange: 01/00:56:58 to 01/00:58:42

Plot file version 435 created 11-APR-2016 17:09:27

J1128+5925 GP053G 3.UVDATA.1

Freq = 4.9253 GHz, Bw = 16.000 MH No calibration applied and no bandpass applied

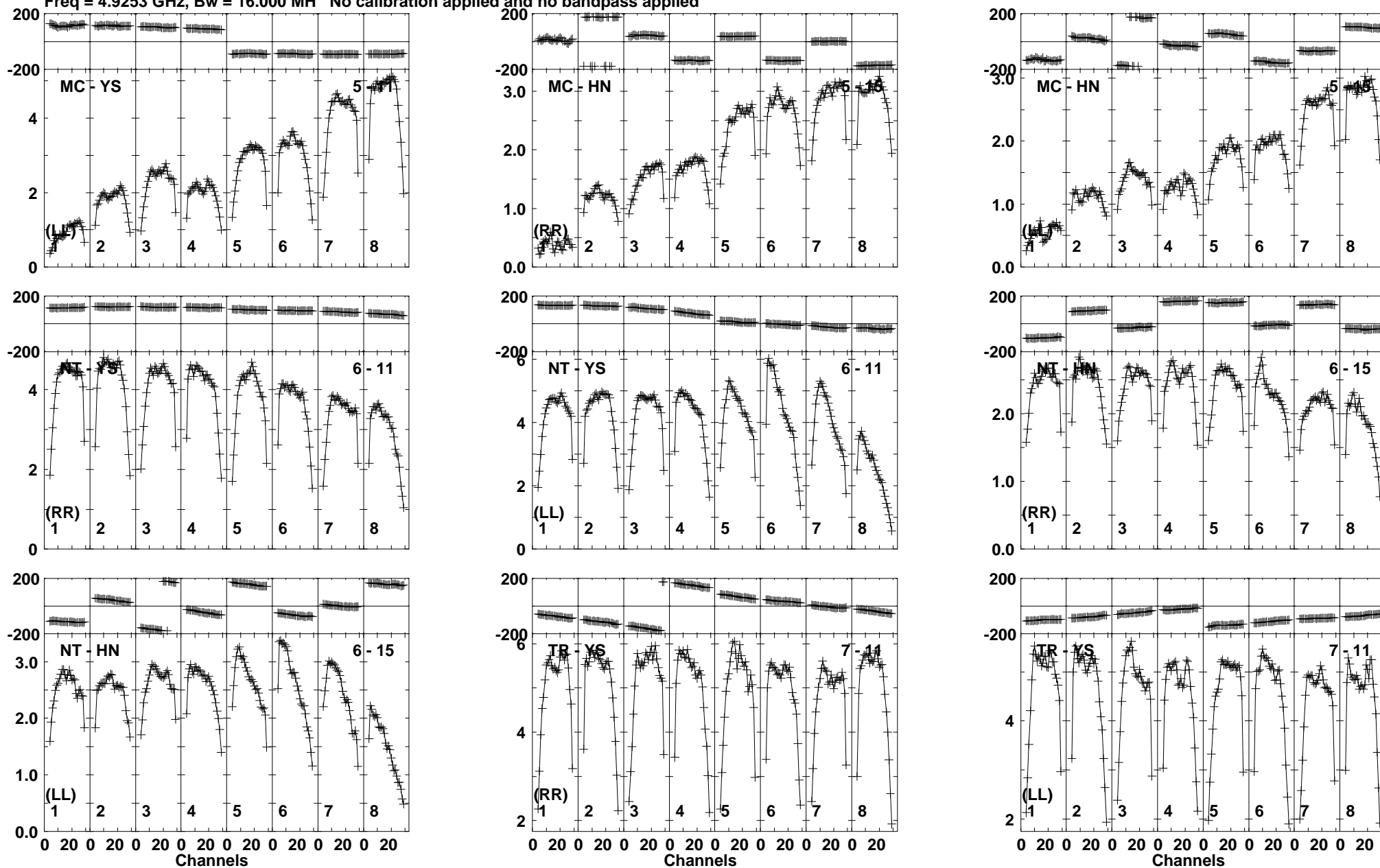

Lower frame: Milli Ampl Jy Top frame: Phas deg
Vector averaged cross-power spectrum Baseline: MC (05) - YS (11)
Timerange: 01/00:56:58 to 01/00:58:42

Plot file version 436 created 11-APR-2016 17:09:28

J1128+5925 GP053G 3.UVDATA.1

Freq = 4.9253 GHz, Bw = 16.000 MH No calibration applied and no bandpass applied

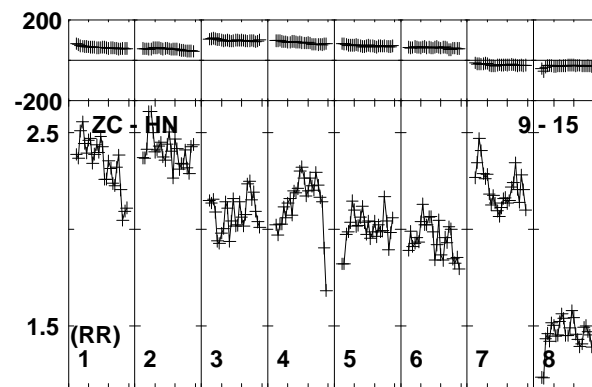
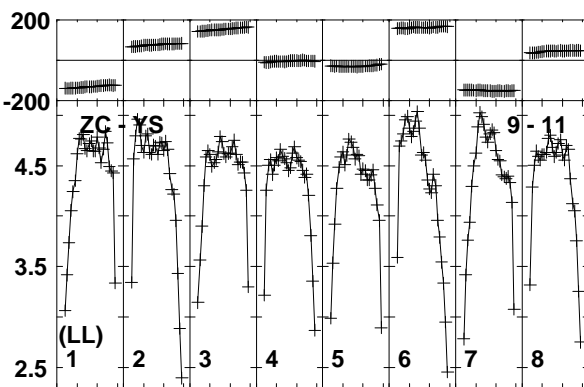
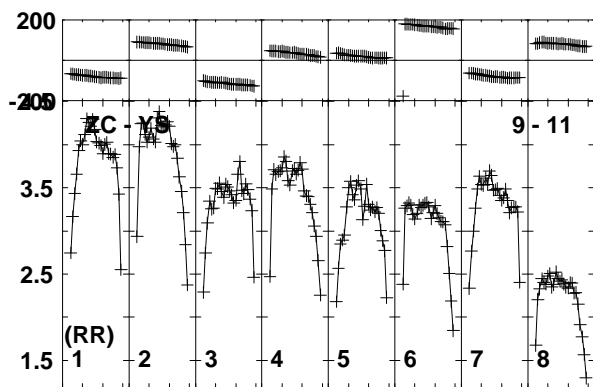
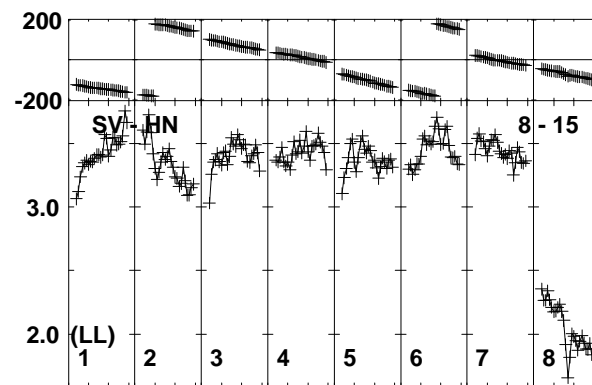
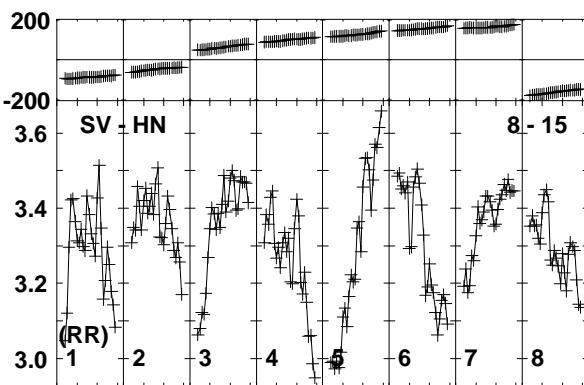
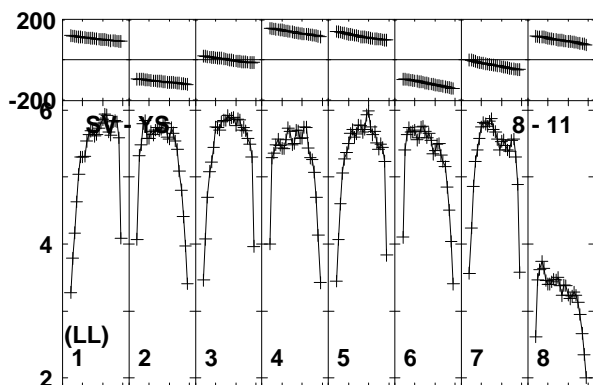
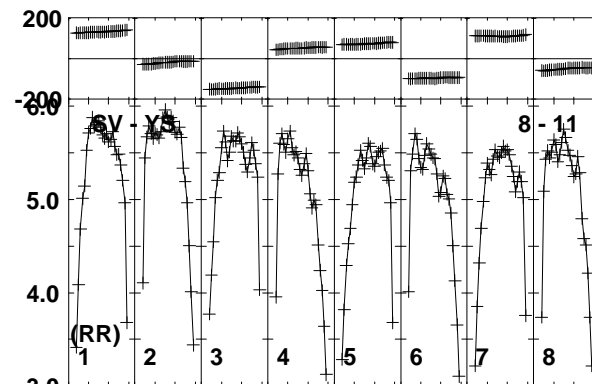
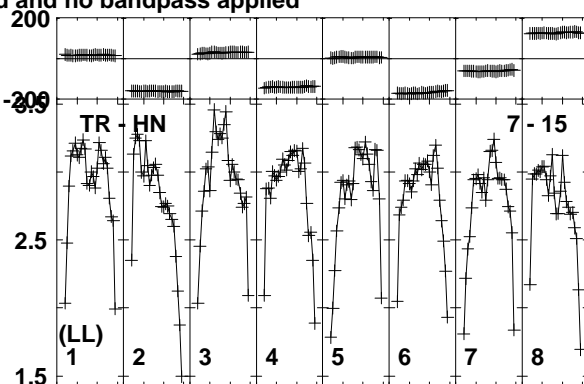
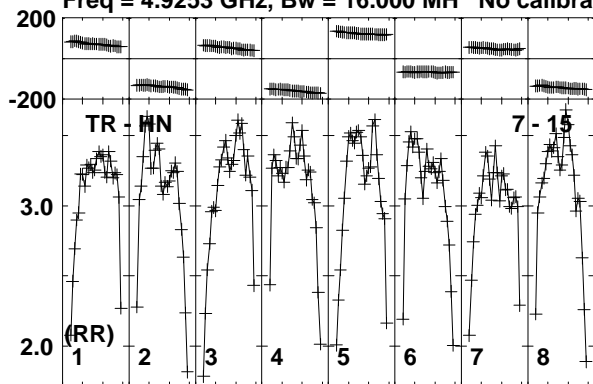

Lower frame: Milli Ampl Jy Top frame: Phas deg

Vector averaged cross-power spectrum Baseline: TR (07) - HN (15)

Timerange: 01/00:56:58 to 01/00:58:42

Plot file version 437 created 11-APR-2016 17:09:28

J1128+5925 GP053G 3.UVDATA.1

Freq = 4.9253 GHz, Bw = 16.000 MH No calibration applied and no bandpass applied

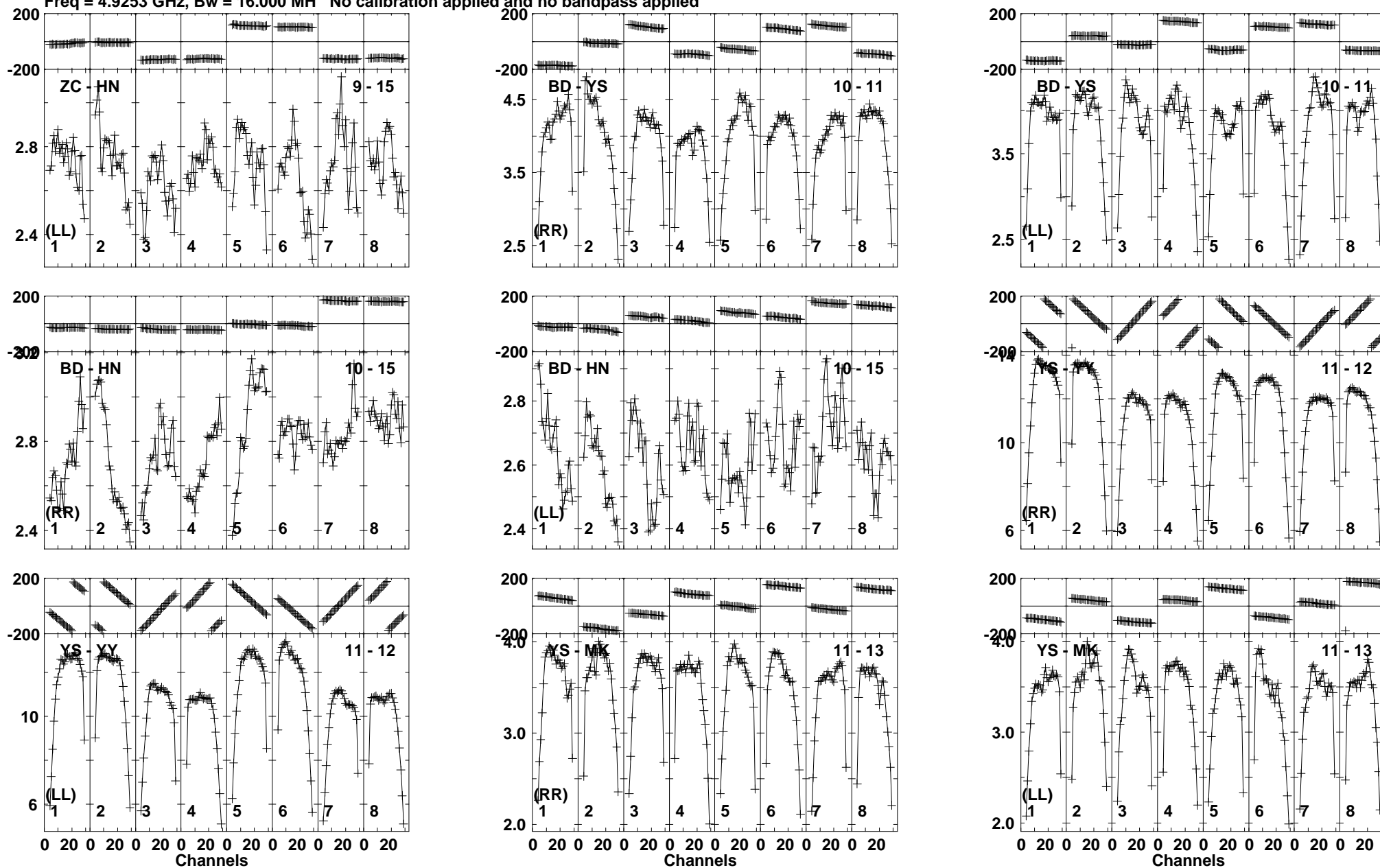

Lower frame: Milli Ampl Jy Top frame: Phas deg
Vector averaged cross-power spectrum Baseline: ZC (09) - HN (15)
Timerange: 01/00:56:58 to 01/00:58:42

Plot file version 438 created 11-APR-2016 17:09:28

J1128+5925 GP053G 3.UVDATA.1

Freq = 4.9253 GHz, Bw = 16.000 MH No calibration applied and no bandpass applied

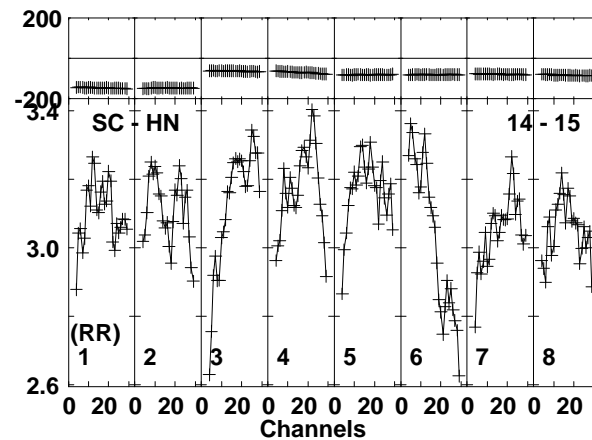
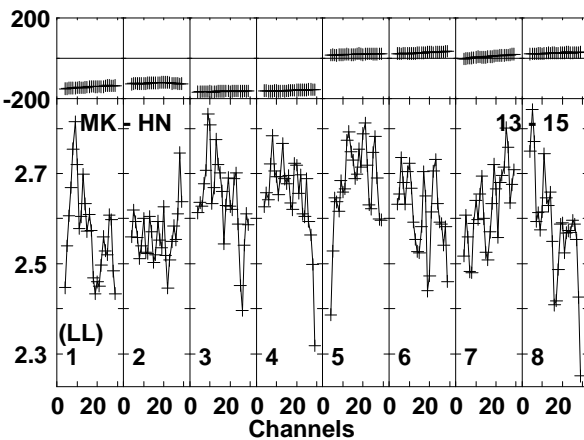
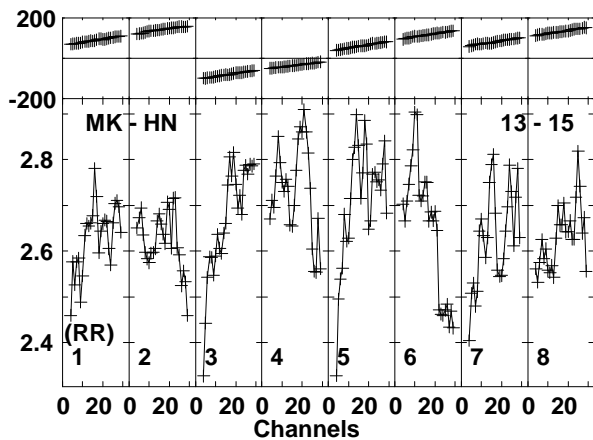
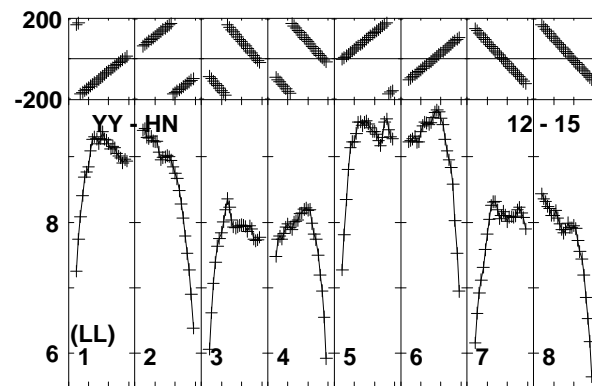
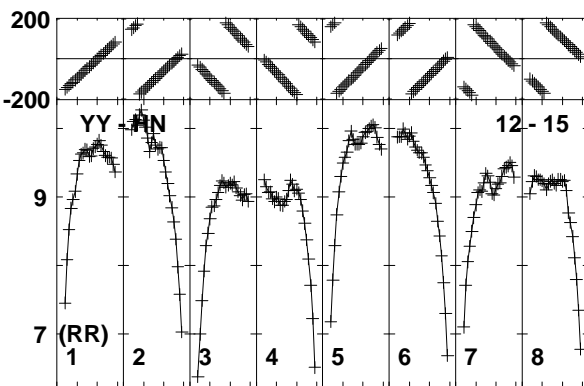
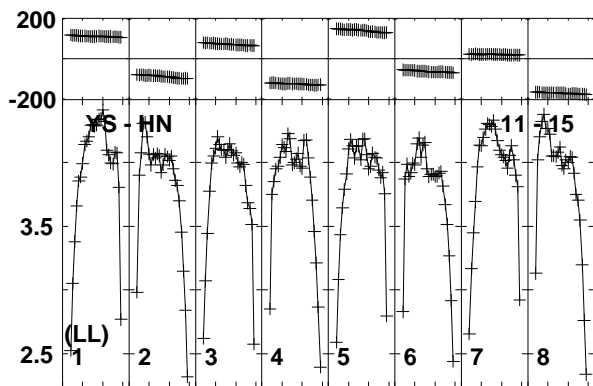
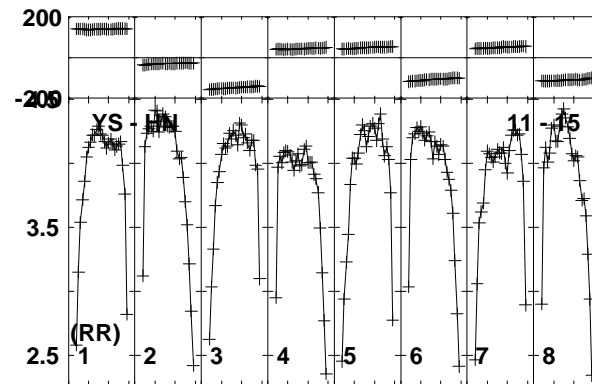
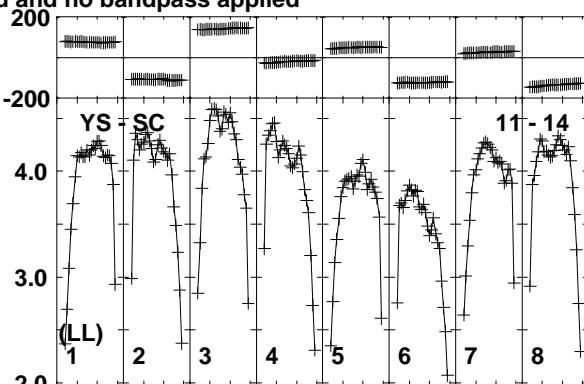
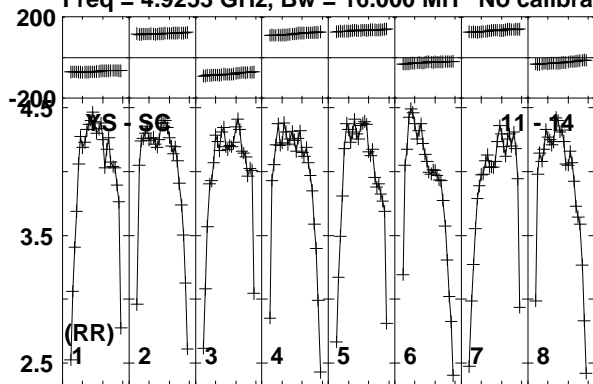

Lower frame: Milli Ampl Jy Top frame: Phas deg
Vector averaged cross-power spectrum Baseline: YS (11) - SC (14)
Timerange: 01/00:56:58 to 01/00:58:42

Plot file version 439 created 11-APR-2016 17:09:28
J1128+5925 GP053G 3.UVDATA.1
Freq = 4.9253 GHz, Bw = 16.000 MH No calibration applied and no bandpass applied

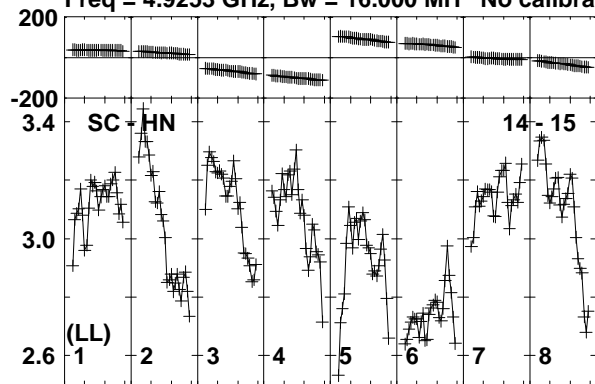

Lower frame: Milli Ampl Jy Top frame: Phas deg
Vector averaged cross-power spectrum Baseline: SC (14) - HN (15)
Timerange: 01/00:56:58 to 01/00:58:42

Plot file version 440 created 11-APR-2016 17:09:28

ARP299C GP053G 3.UVDATA.1

Freq = 4.9253 GHz, Bw = 16.000 MH No calibration applied and no bandpass applied

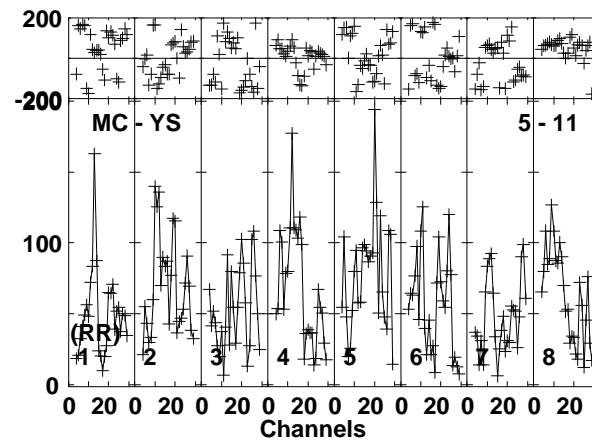
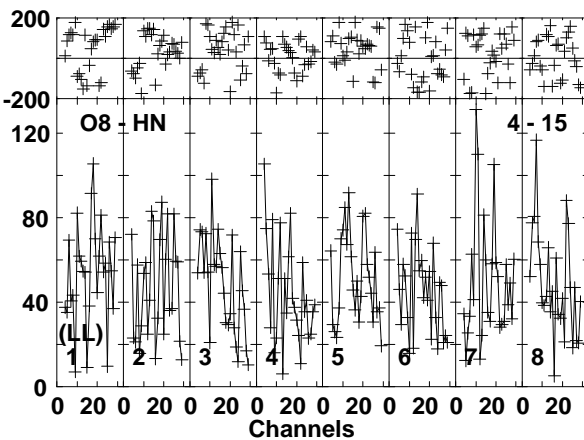
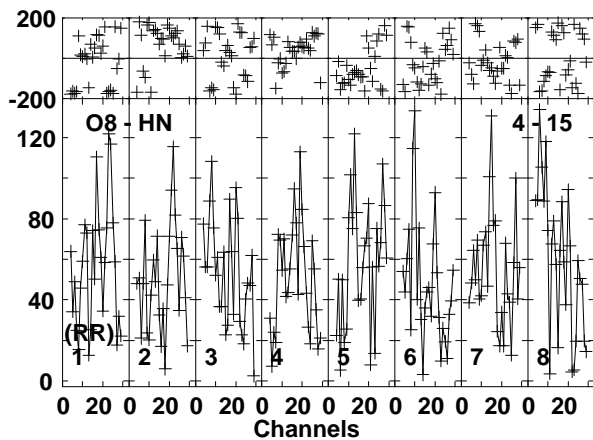
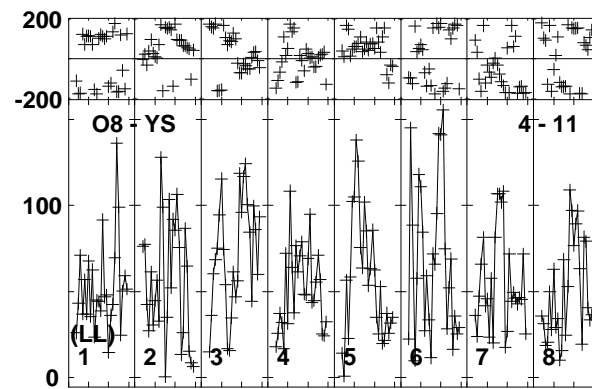
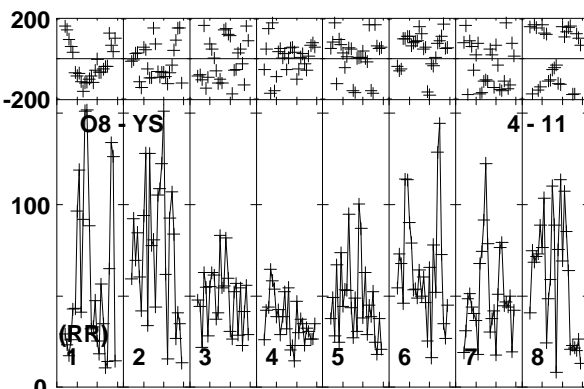
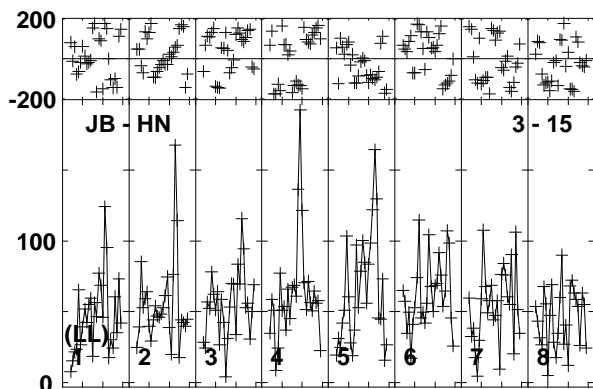
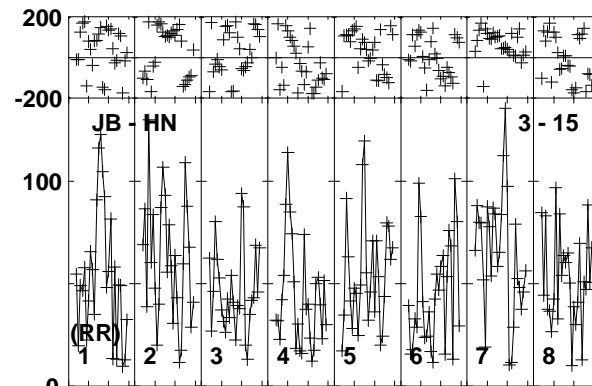
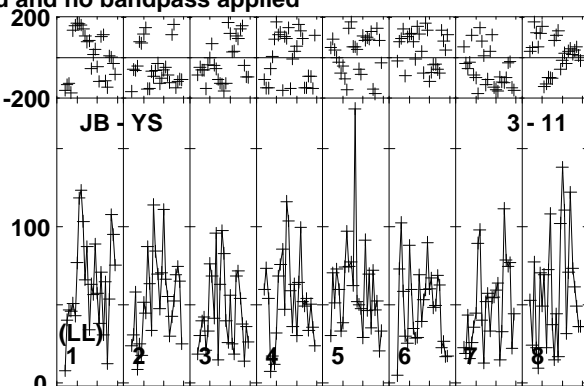
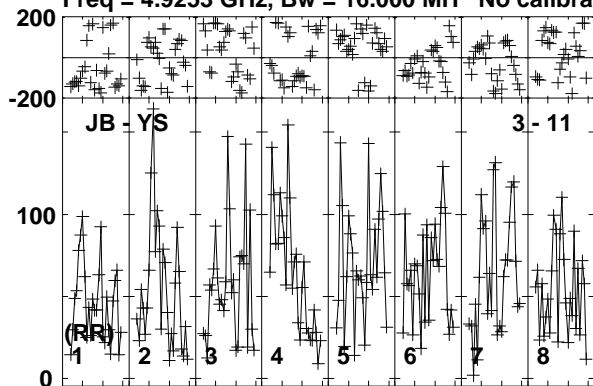

Lower frame: Micro Ampl Jy Top frame: Phas deg
Vector averaged cross-power spectrum Baseline: JB (03) - YS (11)
Timerange: 01/00:58:48 to 01/01:04:00

Plot file version 441 created 11-APR-2016 17:09:28

ARP299C GP053G 3.UVDATA.1

Freq = 4.9253 GHz, Bw = 16.000 MH No calibration applied and no bandpass applied

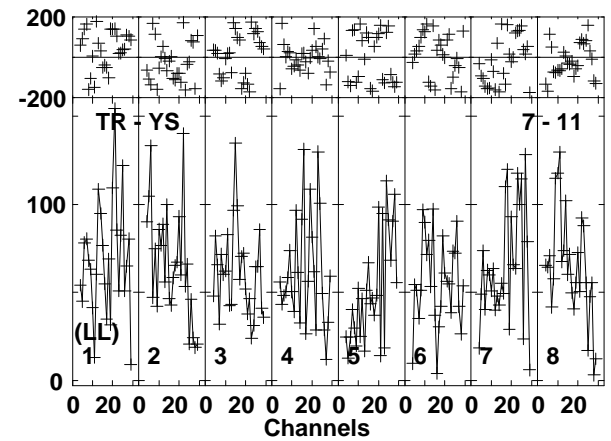
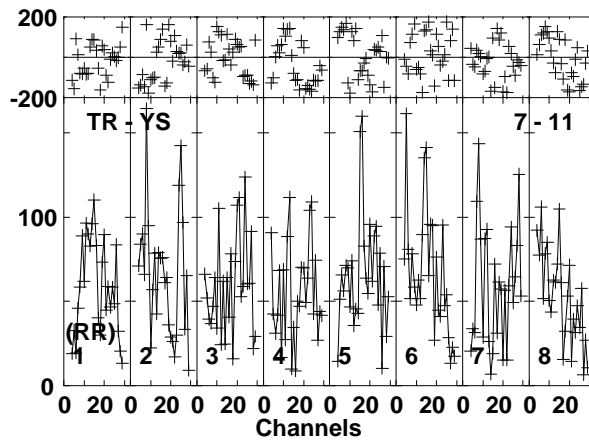
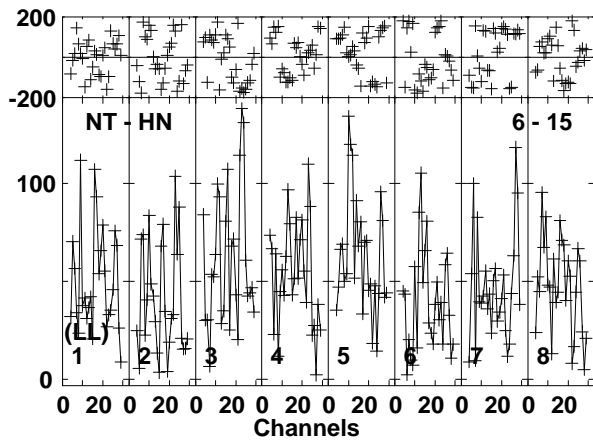
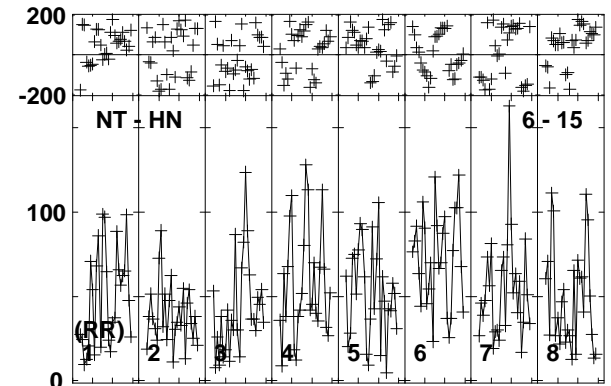
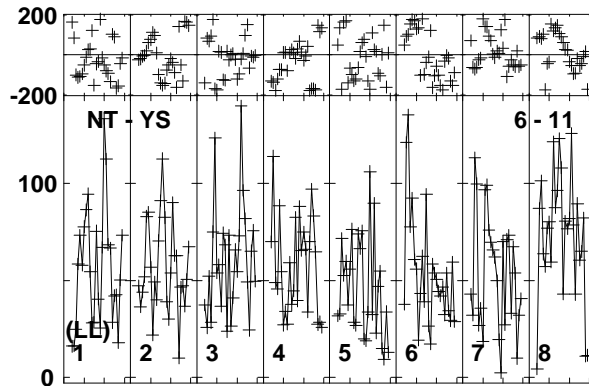
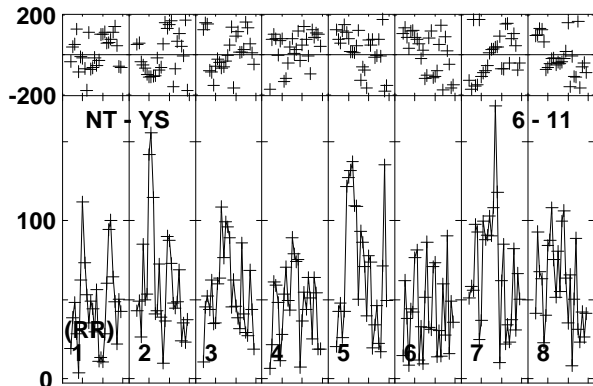
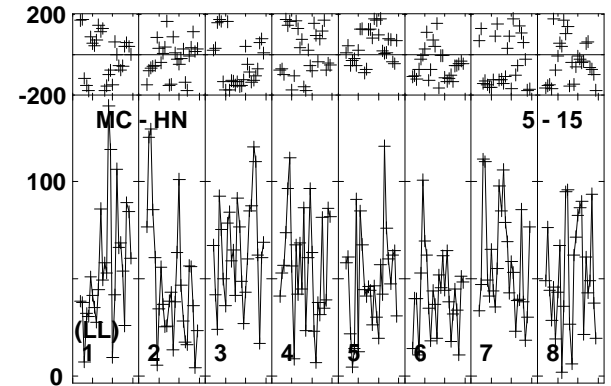
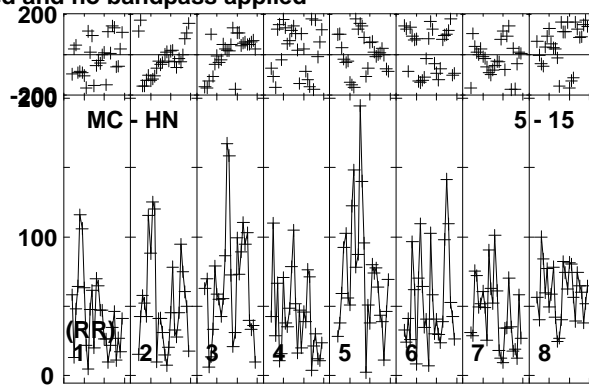
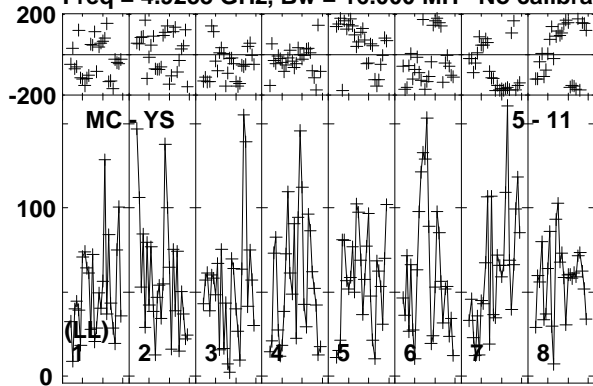

Lower frame: Micro Ampl Jy Top frame: Phas deg
Vector averaged cross-power spectrum Baseline: MC (05) - YS (11)
Timerange: 01/00:58:48 to 01/01:04:00

Plot file version 442 created 11-APR-2016 17:09:28

ARP299C GP053G 3.UVDATA.1

Freq = 4.9253 GHz, Bw = 16.000 MH No calibration applied and no bandpass applied

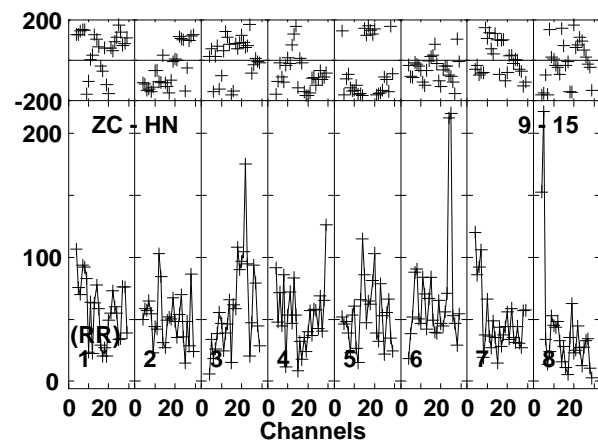
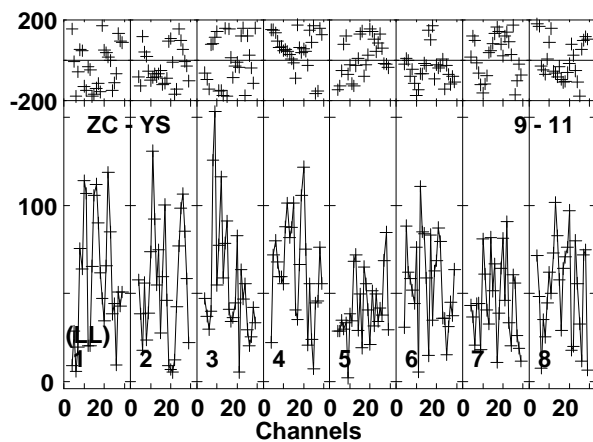
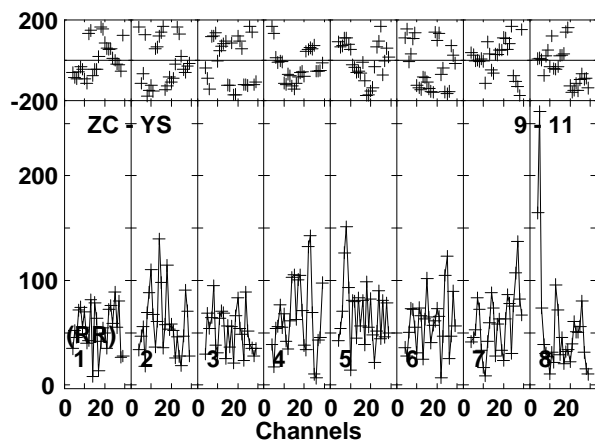
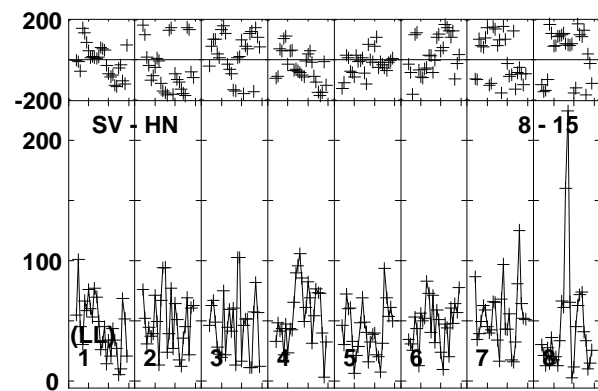
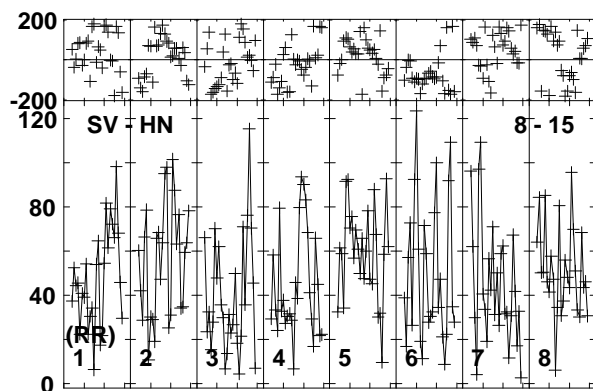
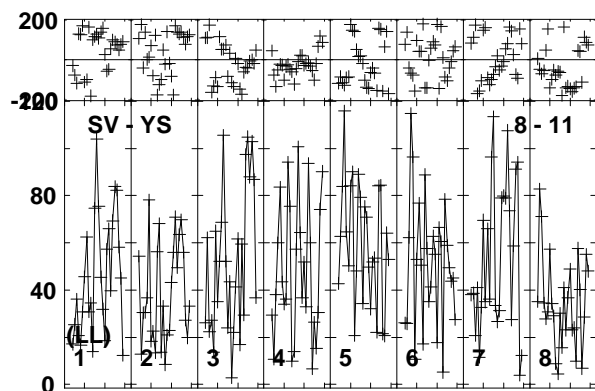
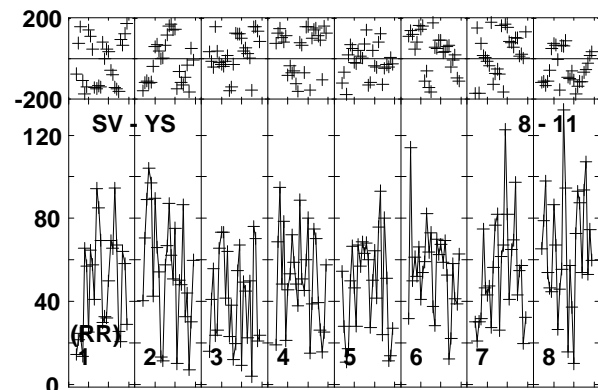
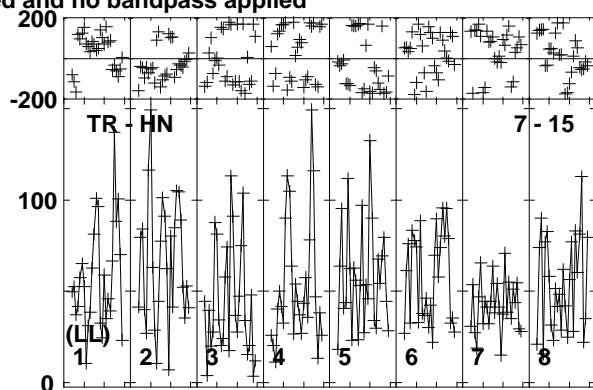
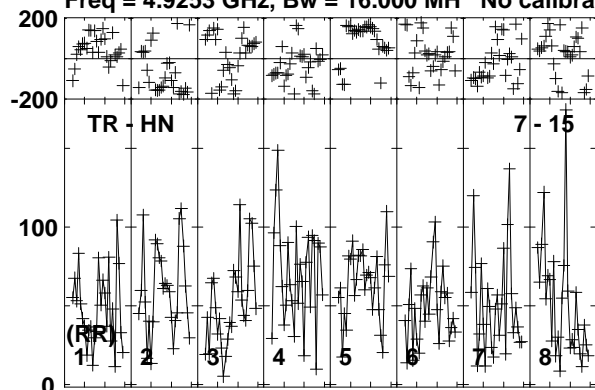

Lower frame: Micro Ampl Jy Top frame: Phas deg
Vector averaged cross-power spectrum Baseline: TR (07) - HN (15)
Timerange: 01/00:58:48 to 01/01:04:00

Plot file version 443 created 11-APR-2016 17:09:29

ARP299C GP053G 3.UVDATA.1

Freq = 4.9253 GHz, Bw = 16.000 MH No calibration applied and no bandpass applied

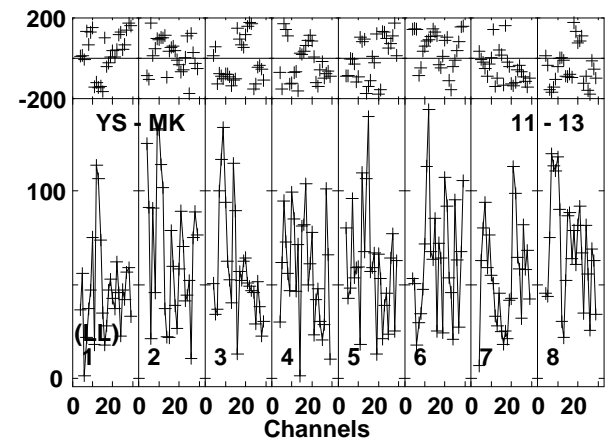
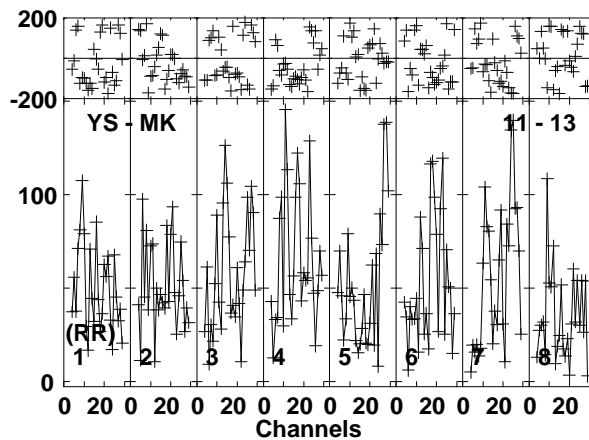
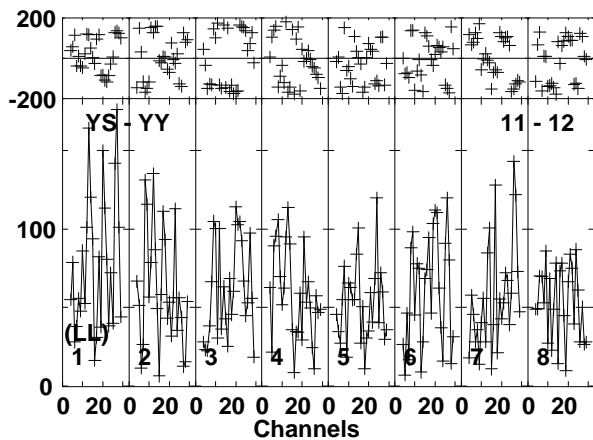
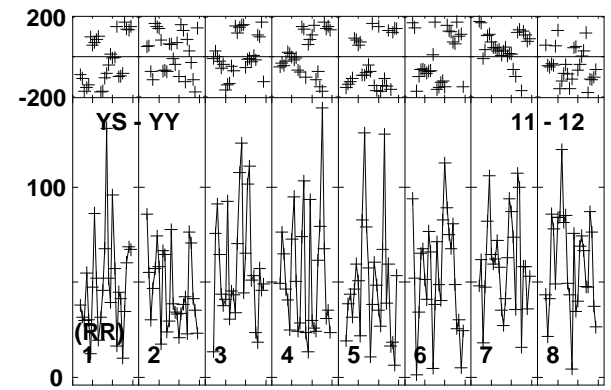
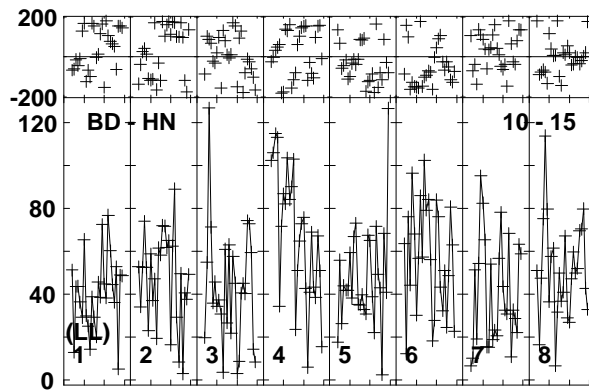
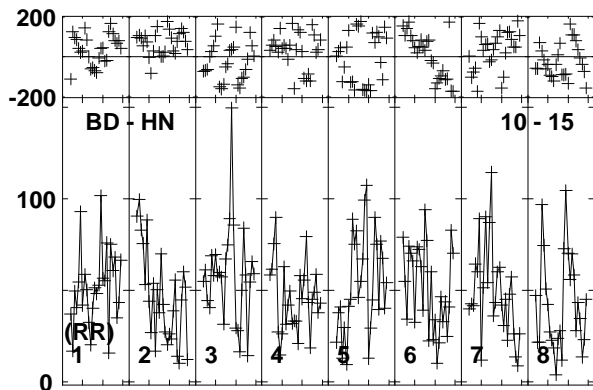
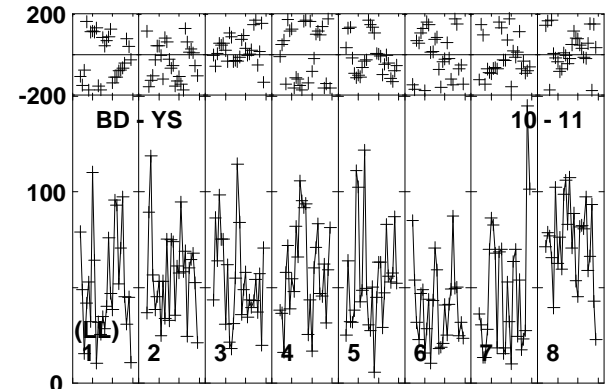
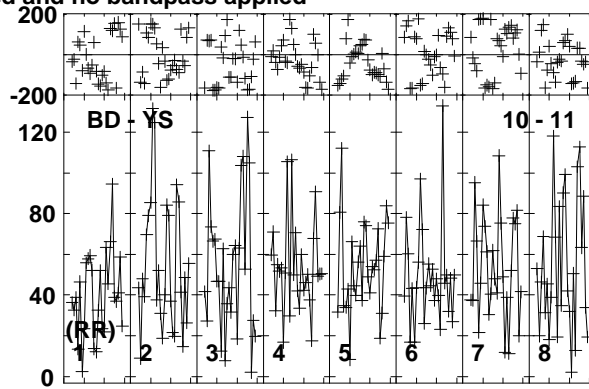
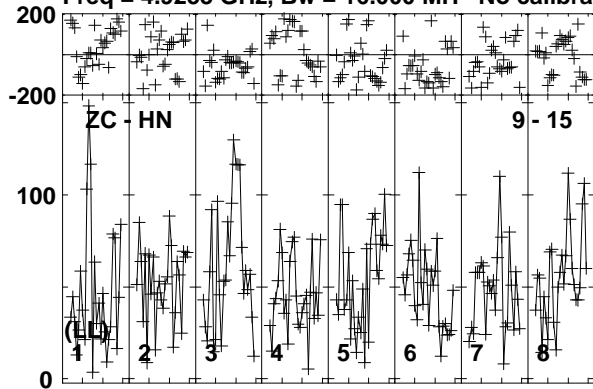

Lower frame: Micro Ampl Jy Top frame: Phas deg
Vector averaged cross-power spectrum Baseline: ZC (09) - HN (15)
Timerange: 01/00:58:48 to 01/01:04:00

Plot file version 444 created 11-APR-2016 17:09:29

ARP299C GP053G 3.UVDATA.1

Freq = 4.9253 GHz, Bw = 16.000 MH No calibration applied and no bandpass applied

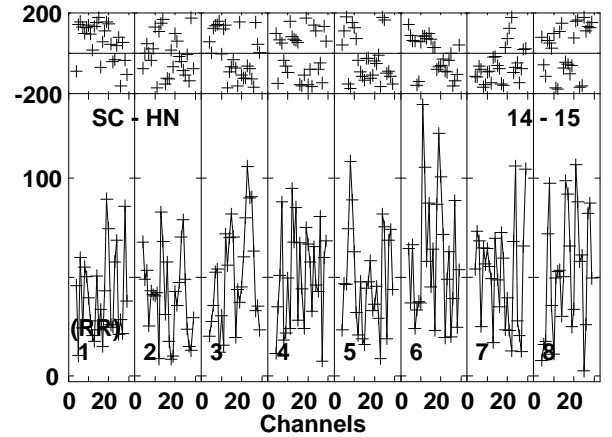
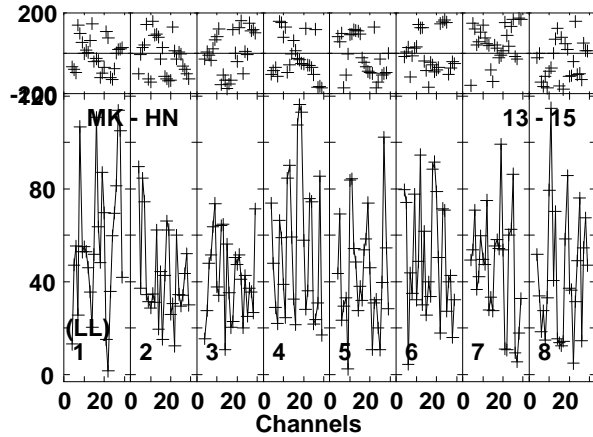
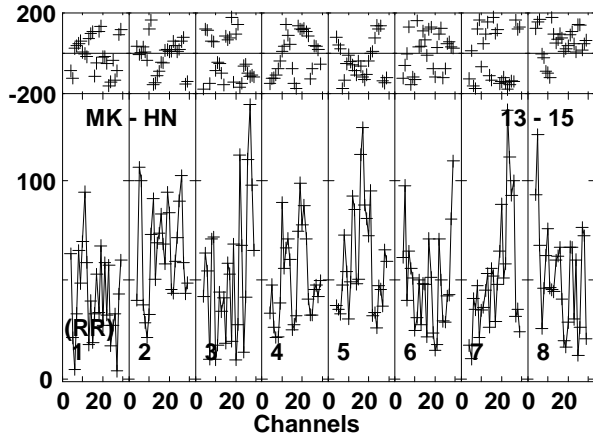
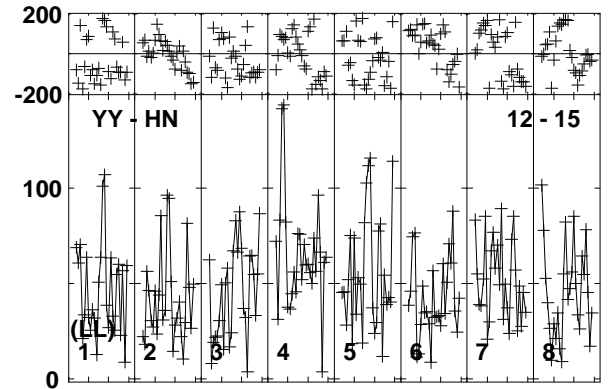
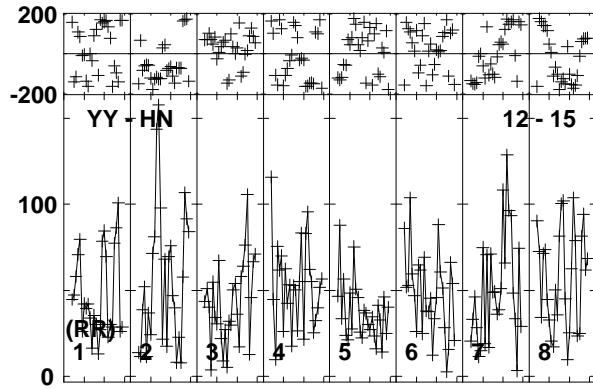
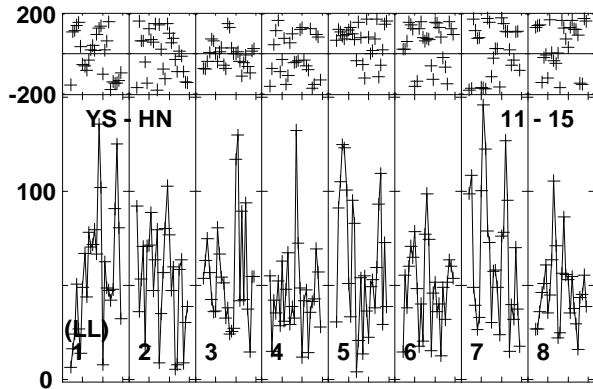
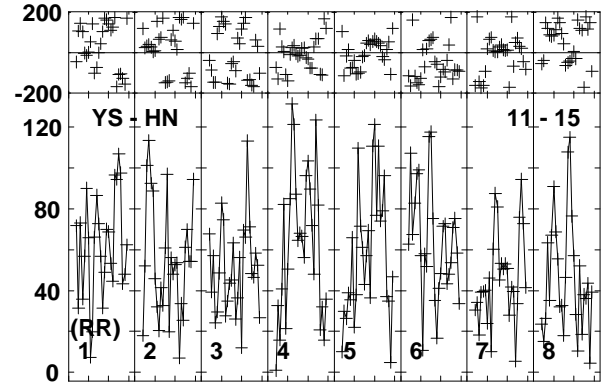
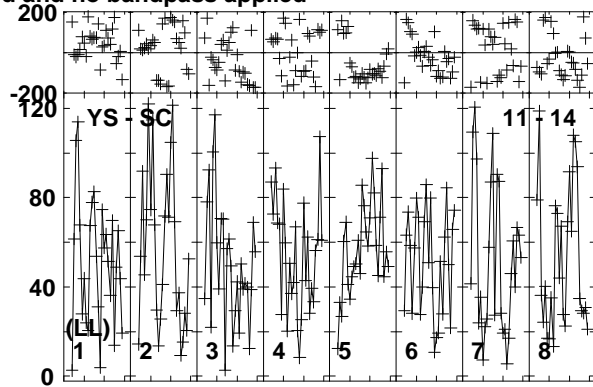
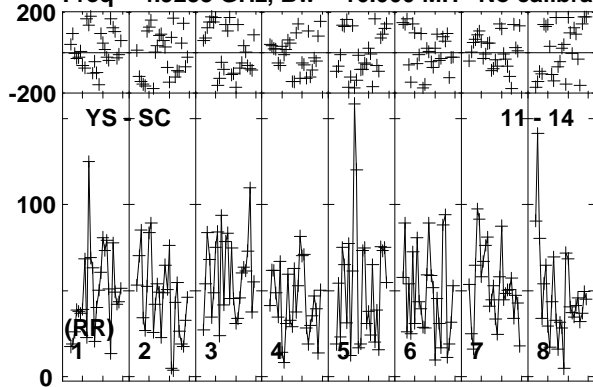

Lower frame: Micro Ampl Jy Top frame: Phas deg
Vector averaged cross-power spectrum Baseline: YS (11) - SC (14)
Timerange: 01/00:58:48 to 01/01:04:00

Plot file version 445 created 11-APR-2016 17:09:29

ARP299C GP053G 3.UVDATA.1

Freq = 4.9253 GHz, Bw = 16.000 MH No calibration applied and no bandpass applied

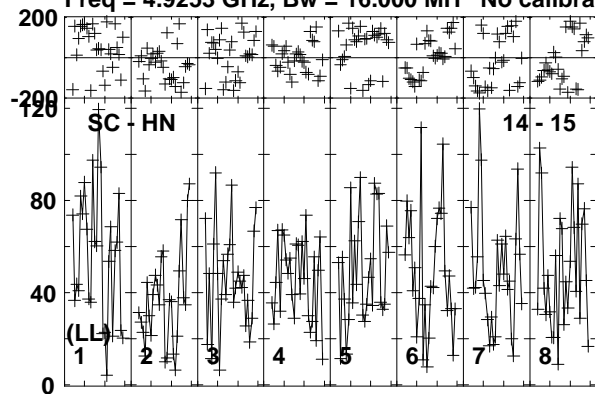

Lower frame: Micro Ampl Jy Top frame: Phas deg
Vector averaged cross-power spectrum Baseline: SC (14) - HN (15)
Timerange: 01/00:58:48 to 01/01:04:00

Plot file version 446 created 11-APR-2016 17:09:29

J1128+5925 GP053G 3.UVDATA.1

Freq = 4.9253 GHz, Bw = 16.000 MH No calibration applied and no bandpass applied

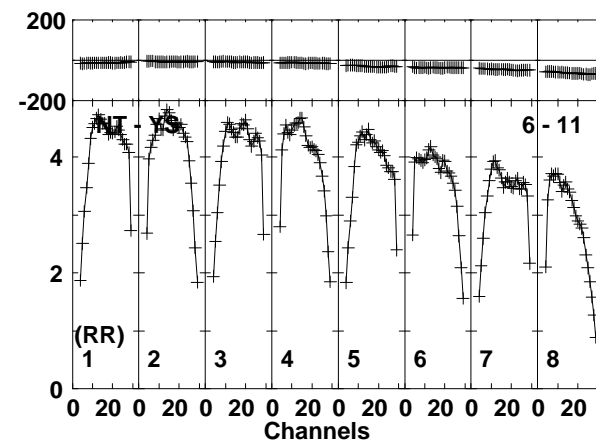
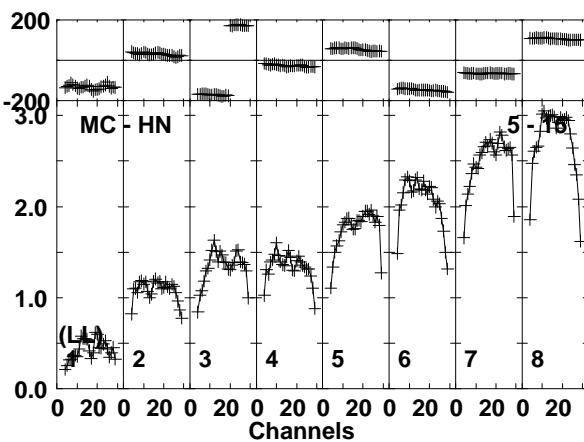
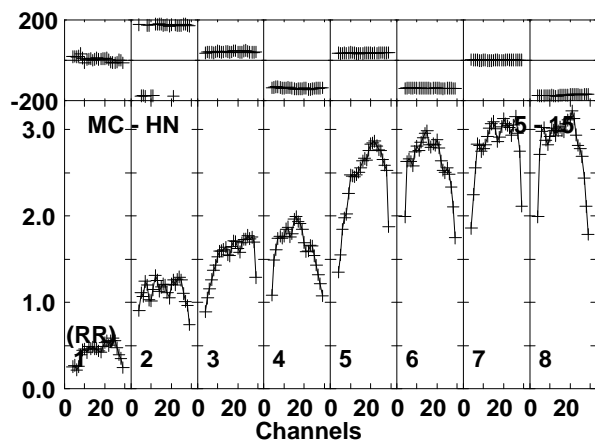
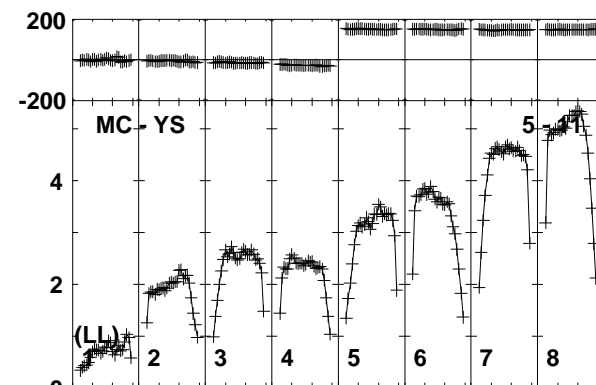
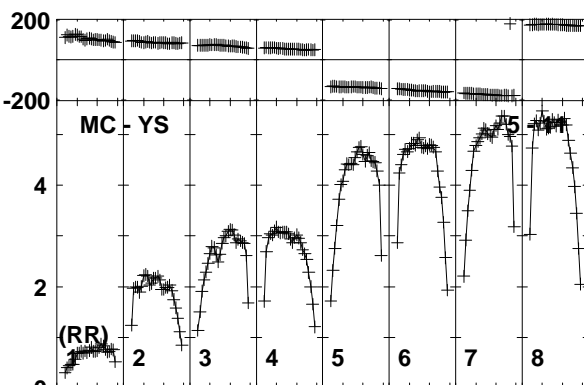
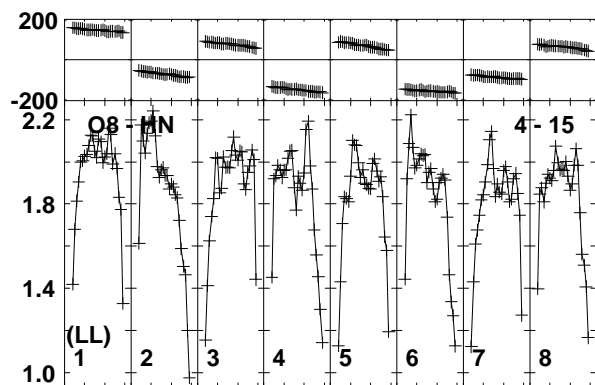
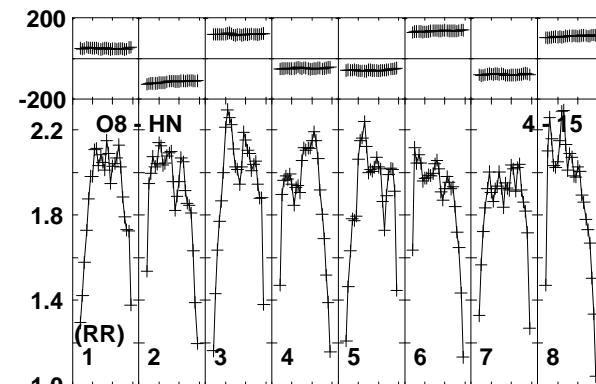
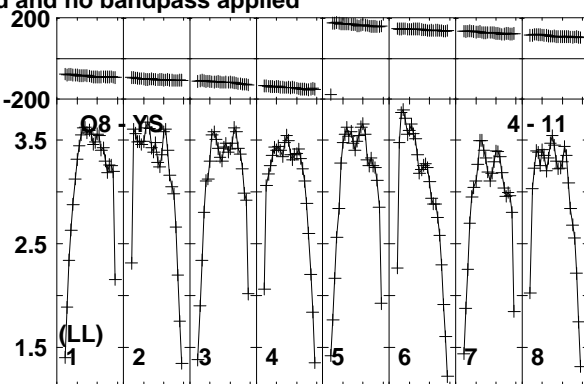
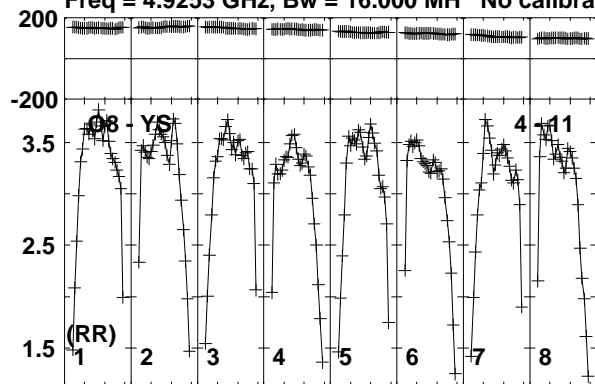

Lower frame: Milli Ampl Jy Top frame: Phas deg
Vector averaged cross-power spectrum Baseline: O8 (04) - YS (11)
Timerange: 01/01:04:06 to 01/01:05:58

Plot file version 447 created 11-APR-2016 17:09:29

J1128+5925 GP053G 3.UVDATA.1

Freq = 4.9253 GHz, Bw = 16.000 MH No calibration applied and no bandpass applied

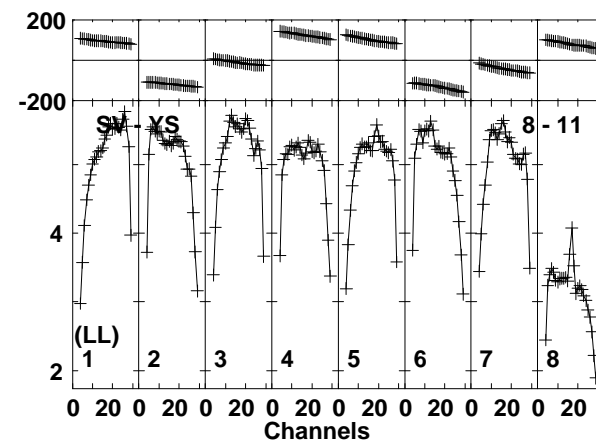
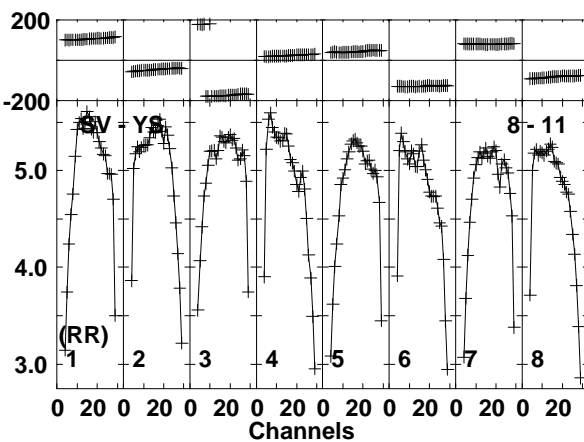
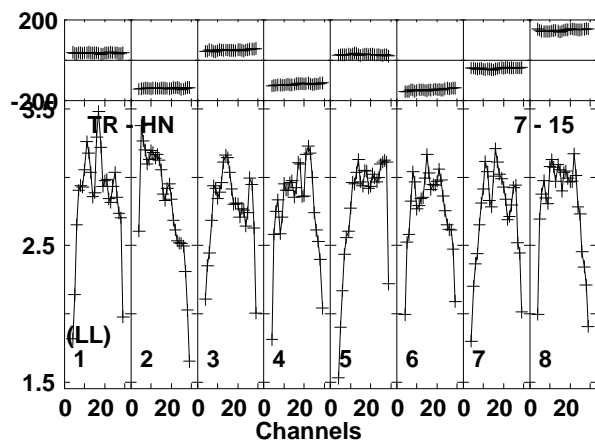
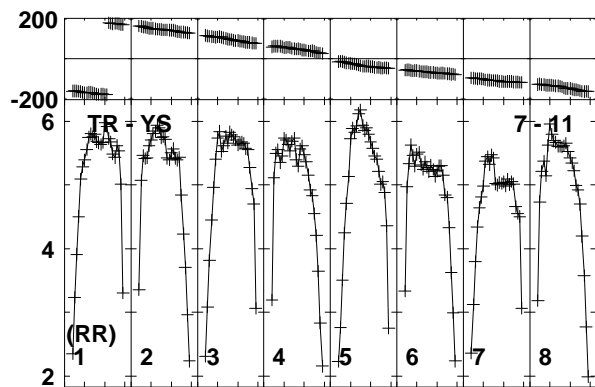
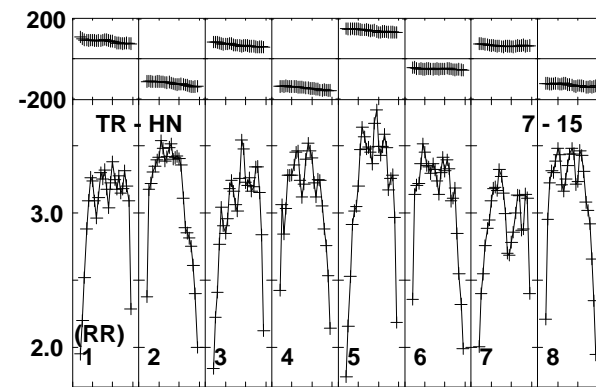
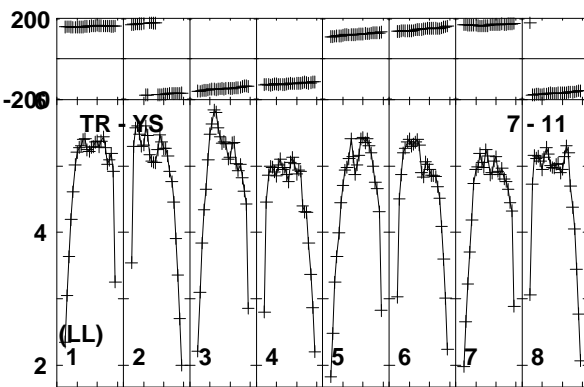
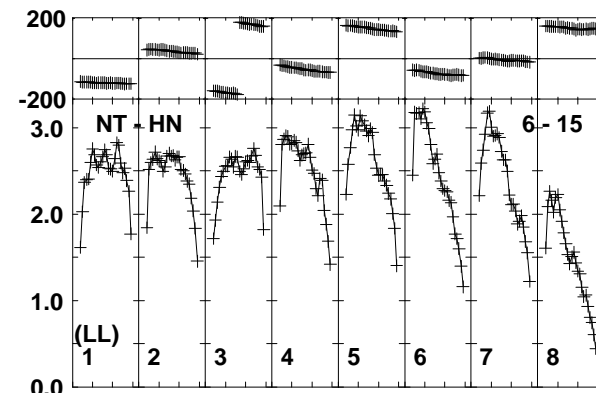
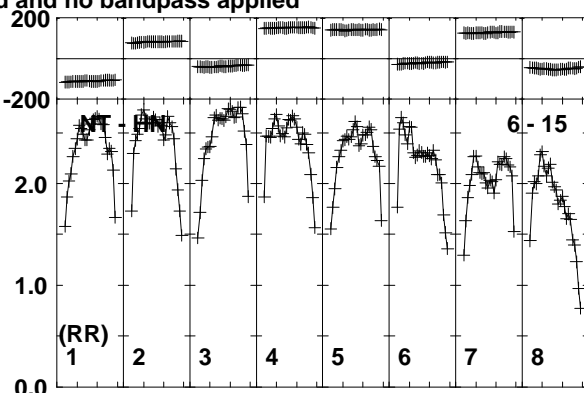
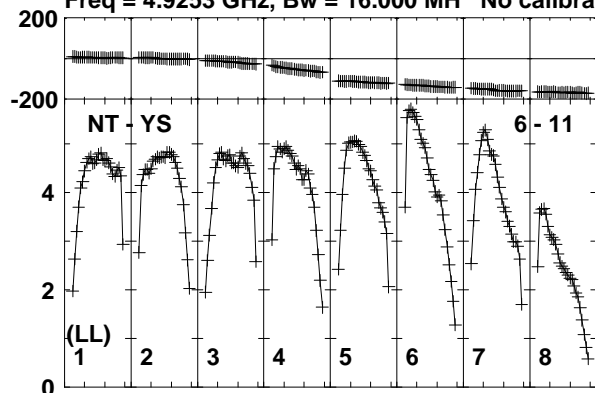

Lower frame: Milli Ampl Jy Top frame: Phas deg
Vector averaged cross-power spectrum Baseline: NT (06) - YS (11)
Timerange: 01/01:04:06 to 01/01:05:58

Plot file version 448 created 11-APR-2016 17:09:29

J1128+5925 GP053G 3.UVDATA.1

Freq = 4.9253 GHz, Bw = 16.000 MH No calibration applied and no bandpass applied

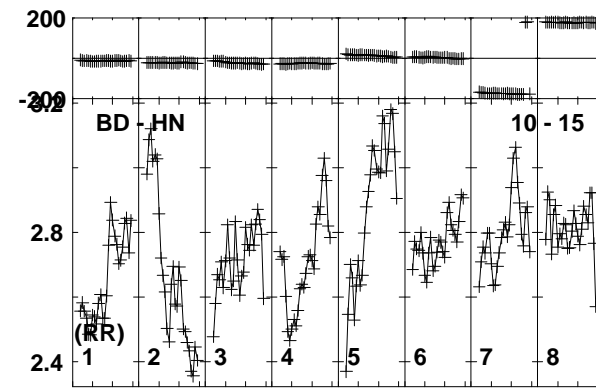
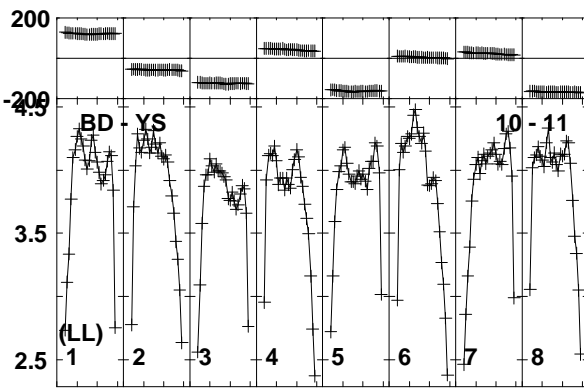
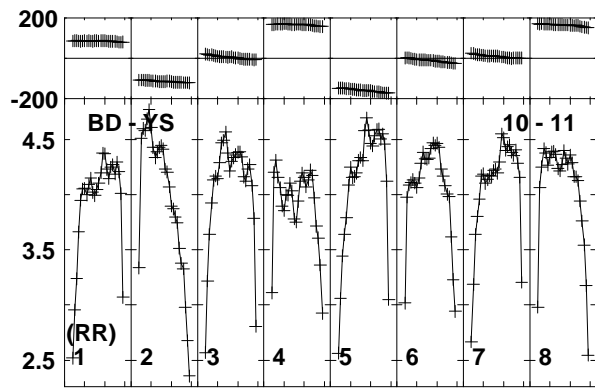
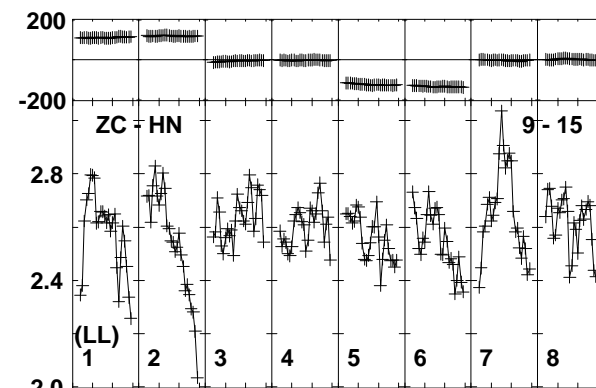
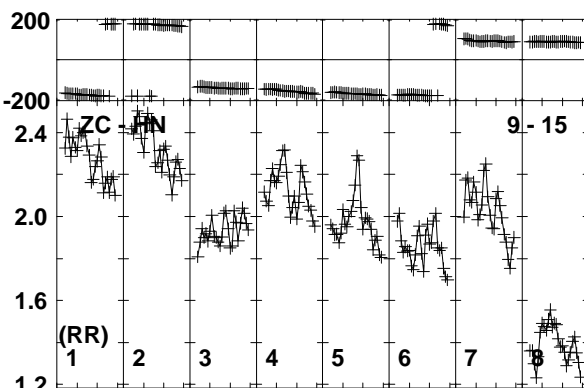
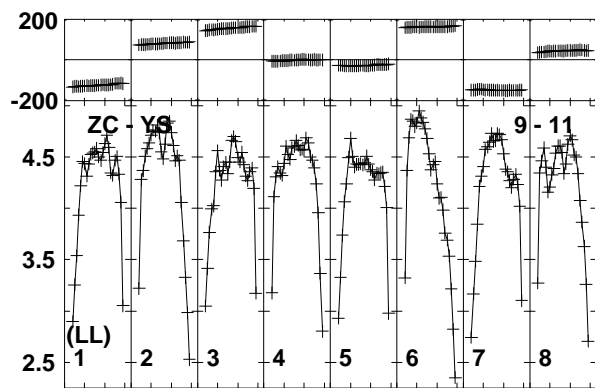
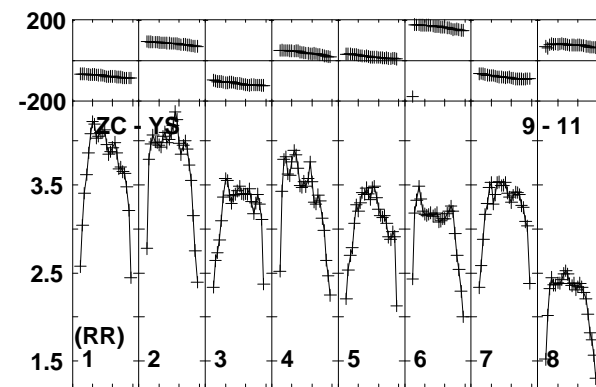
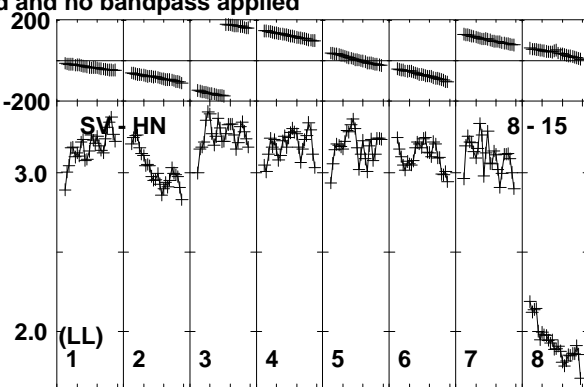
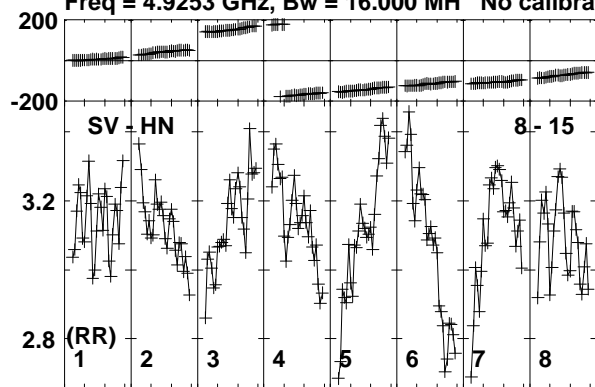

Lower frame: Milli Ampl Jy Top frame: Phas deg
Vector averaged cross-power spectrum Baseline: SV (08) - HN (15)
Timerange: 01/01:04:06 to 01/01:05:58

Plot file version 449 created 11-APR-2016 17:09:30

J1128+5925 GP053G 3.UVDATA.1

Freq = 4.9253 GHz, Bw = 16.000 MH No calibration applied and no bandpass applied

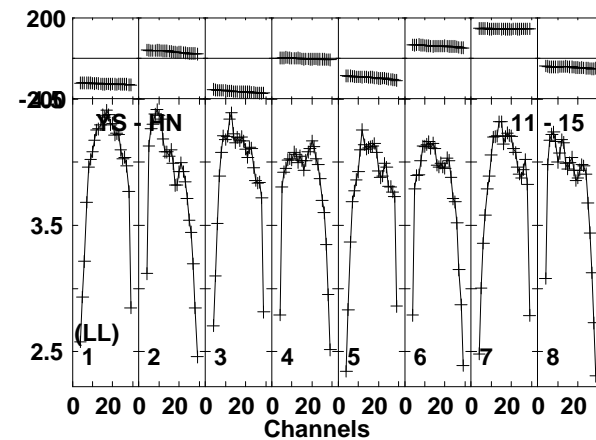
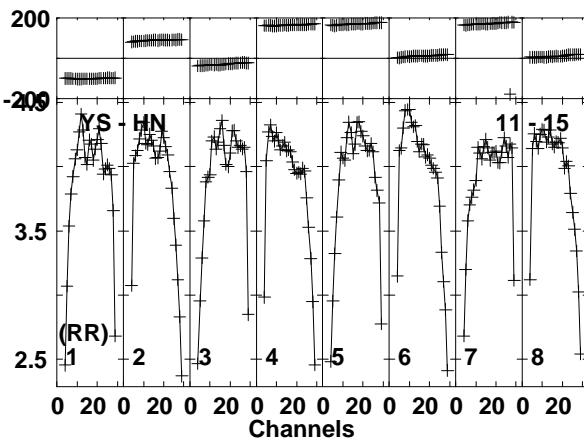
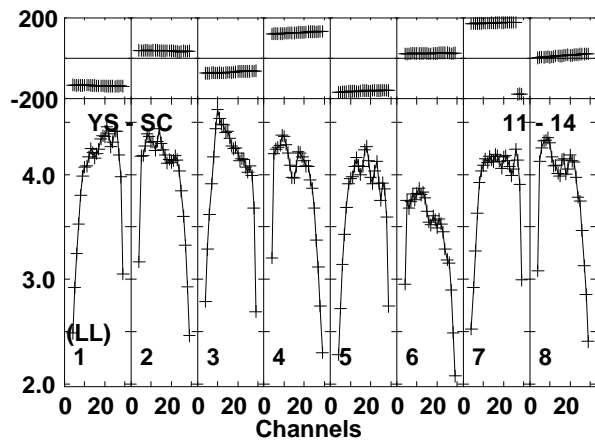
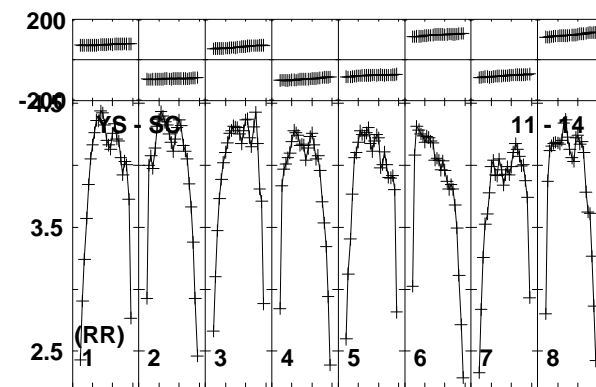
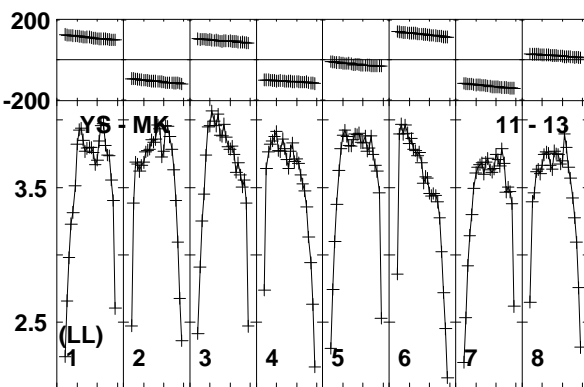
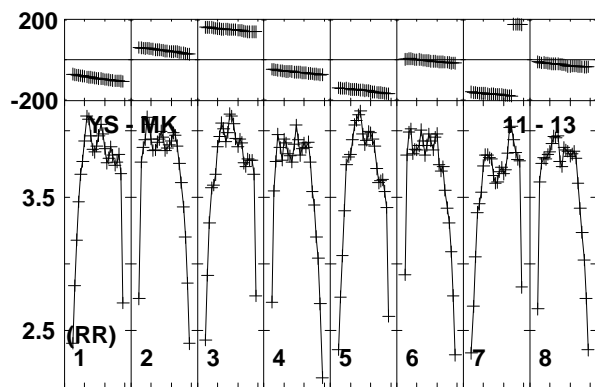
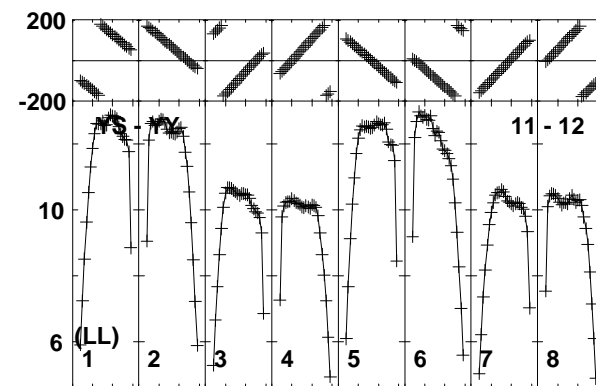
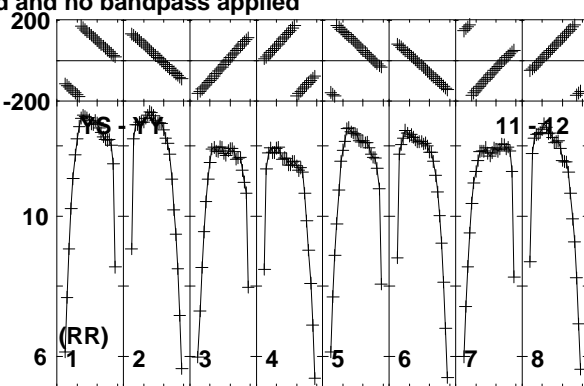
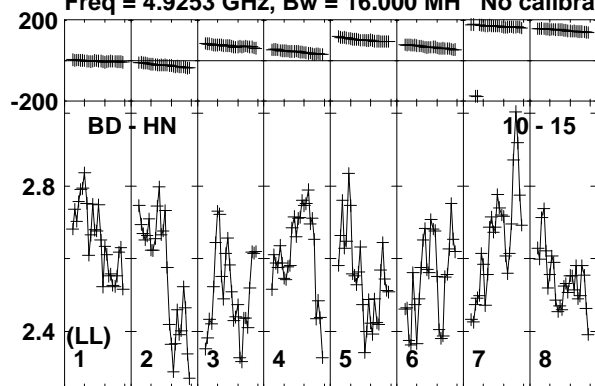

Lower frame: Milli Ampl Jy Top frame: Phas deg
Vector averaged cross-power spectrum Baseline: BD (10) - HN (15)
Timerange: 01/01:04:06 to 01/01:05:58

Plot file version 450 created 11-APR-2016 17:09:30

J1128+5925 GP053G 3.UVDATA.1

Freq = 4.9253 GHz, Bw = 16.000 MH No calibration applied and no bandpass applied

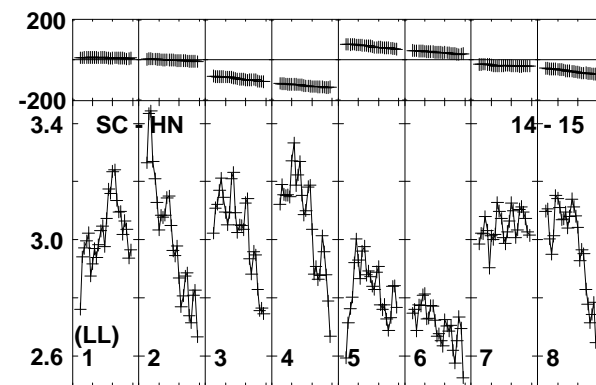
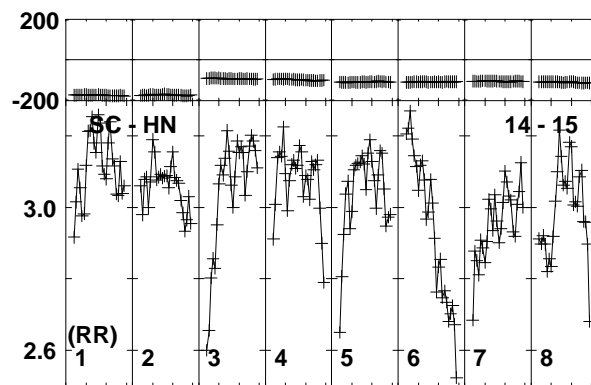
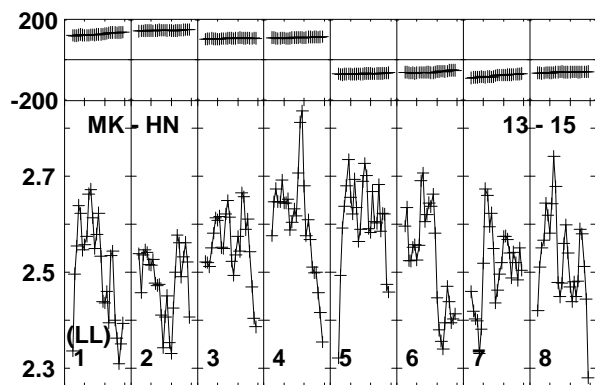
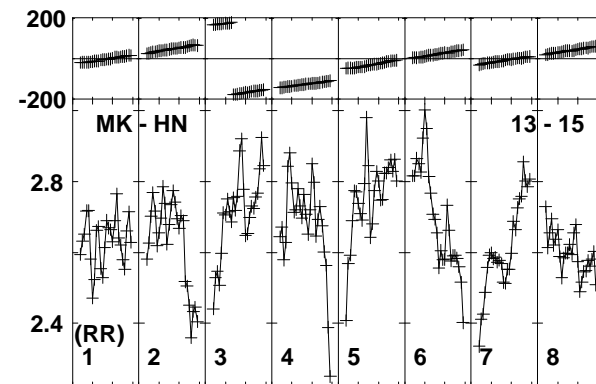
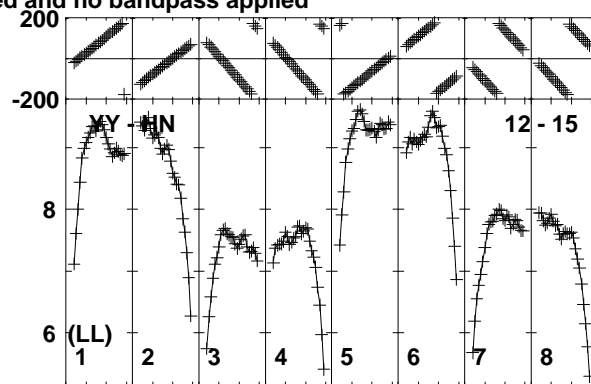
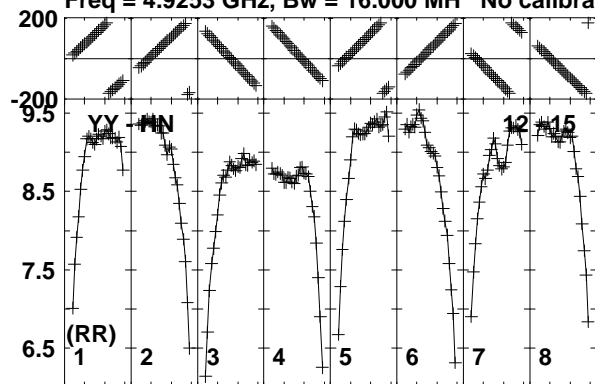

Lower frame: Milli Ampl Jy Top frame: Phas deg
Vector averaged cross-power spectrum Baseline: YY (12) - HN (15)
Timerange: 01/01:04:06 to 01/01:05:58

Plot file version 451 created 11-APR-2016 17:09:30

ARP299C GP053G 3.UVDATA.1

Freq = 4.9253 GHz, Bw = 16.000 MH No calibration applied and no bandpass applied

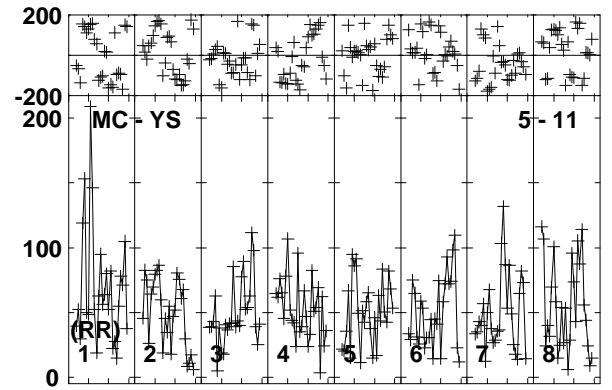
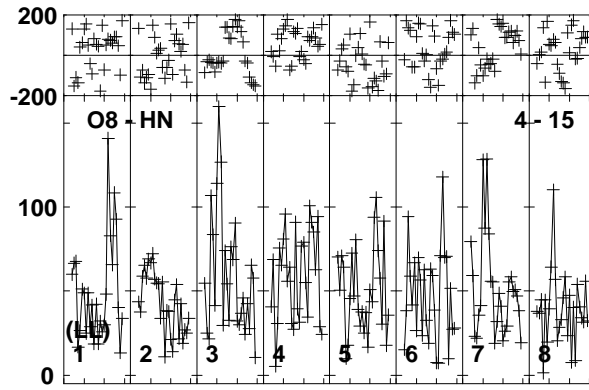
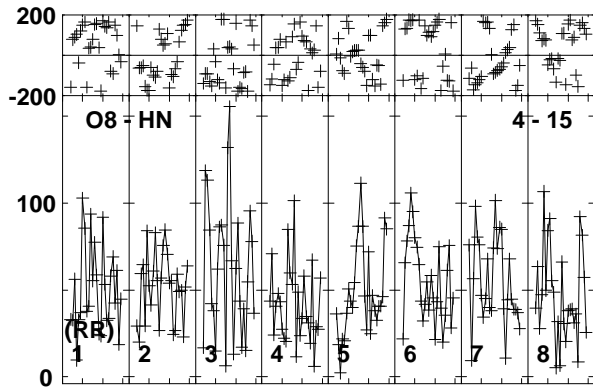
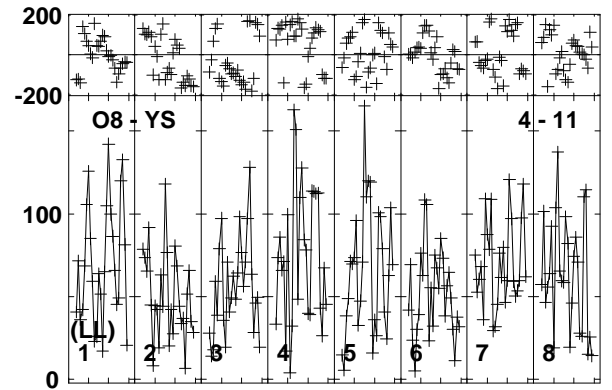
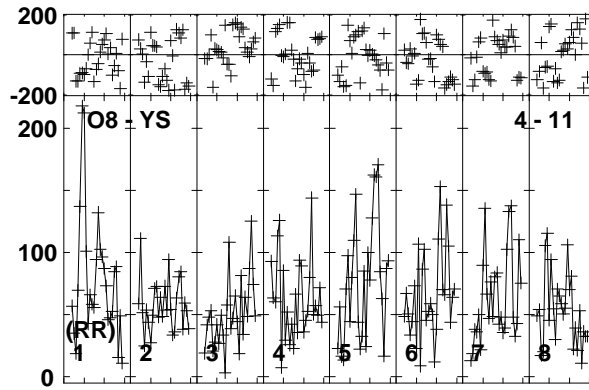
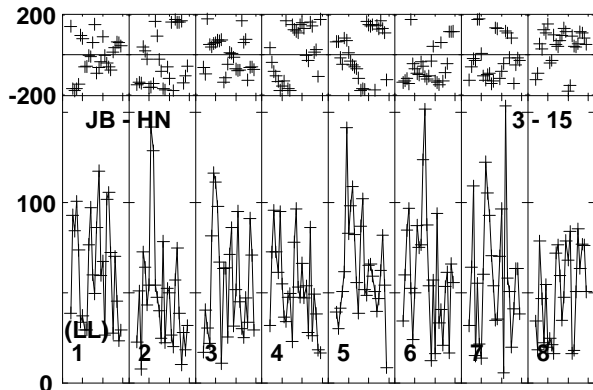
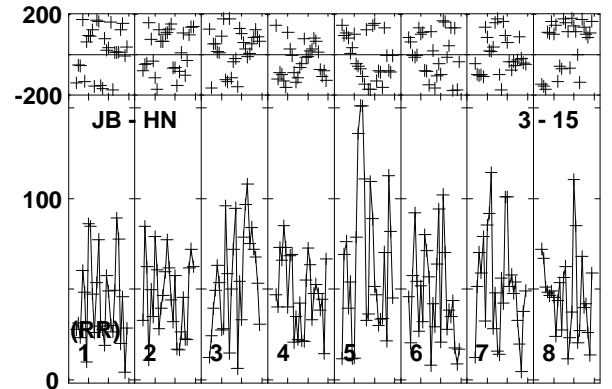
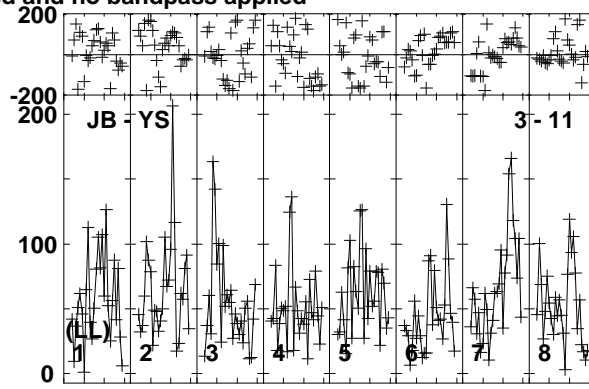
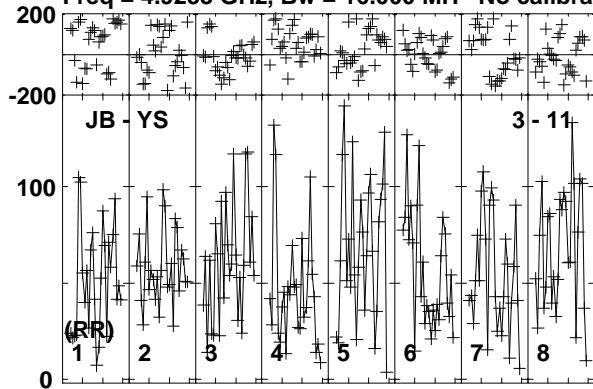

Lower frame: Micro Ampl Jy Top frame: Phas deg
Vector averaged cross-power spectrum Baseline: JB (03) - YS (11)
Timerange: 01/01:06:03 to 01/01:11:17

Plot file version 452 created 11-APR-2016 17:09:30

ARP299C GP053G 3.UVDATA.1

Freq = 4.9253 GHz, Bw = 16.000 MH No calibration applied and no bandpass applied

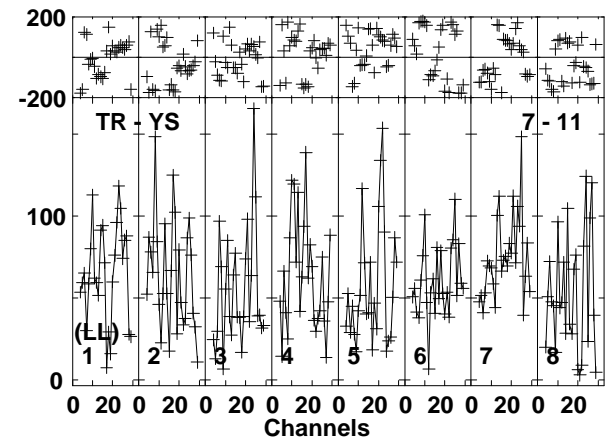
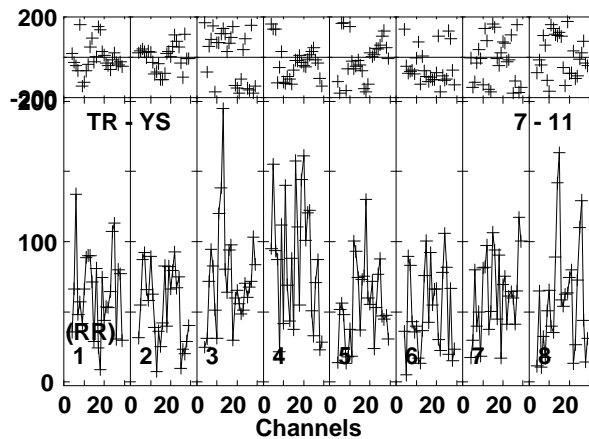
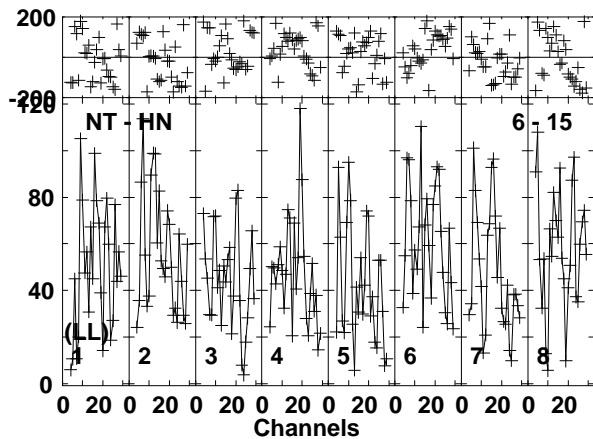
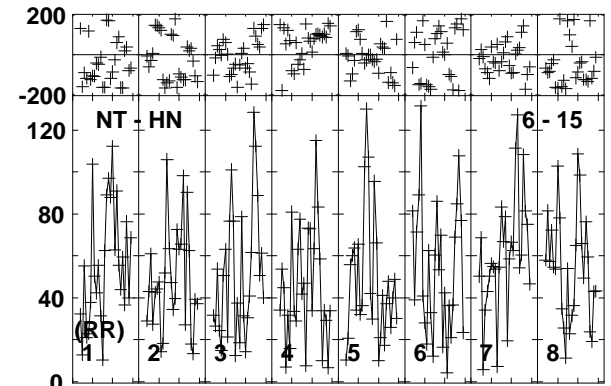
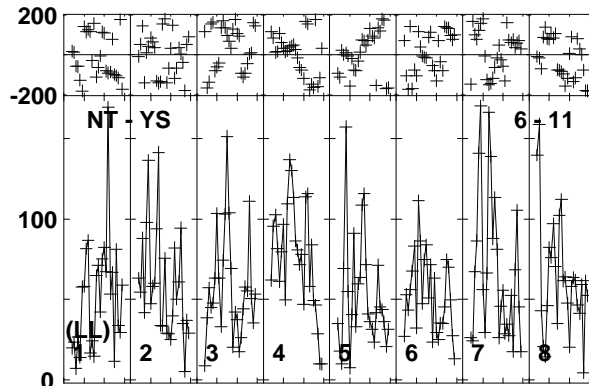
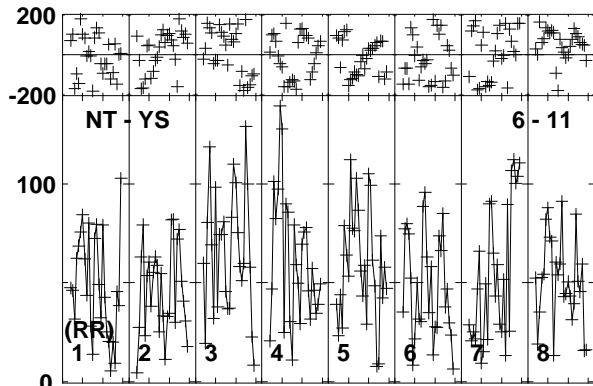
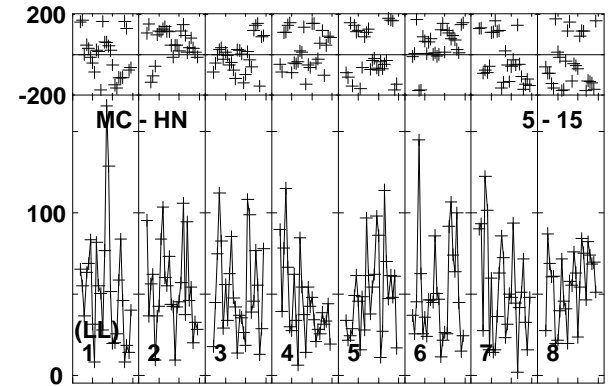
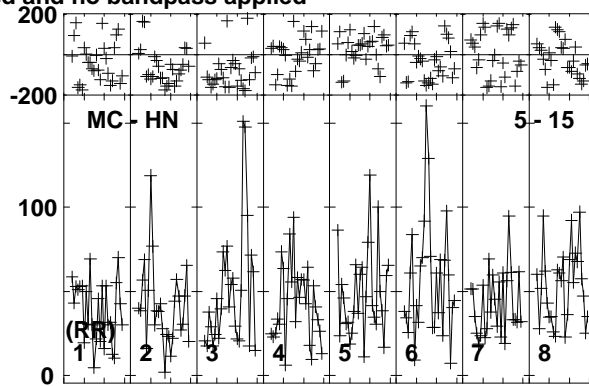
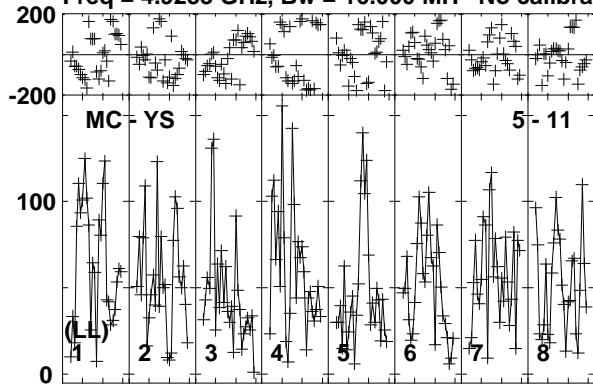

Lower frame: Micro Ampl Jy Top frame: Phas deg
Vector averaged cross-power spectrum Baseline: MC (05) - YS (11)
Timerange: 01/01:06:03 to 01/01:11:17

Plot file version 453 created 11-APR-2016 17:09:30

ARP299C GP053G 3.UVDATA.1

Freq = 4.9253 GHz, Bw = 16.000 MH No calibration applied and no bandpass applied

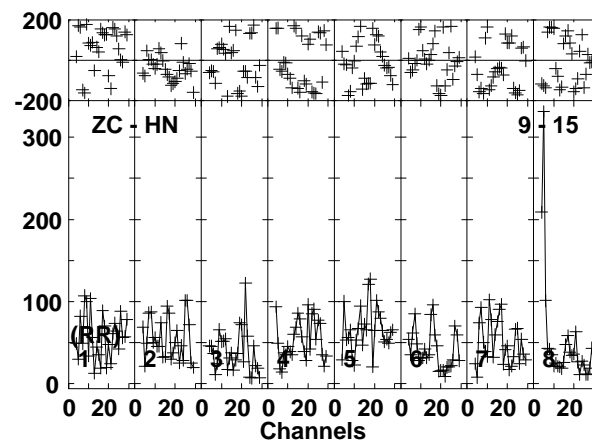
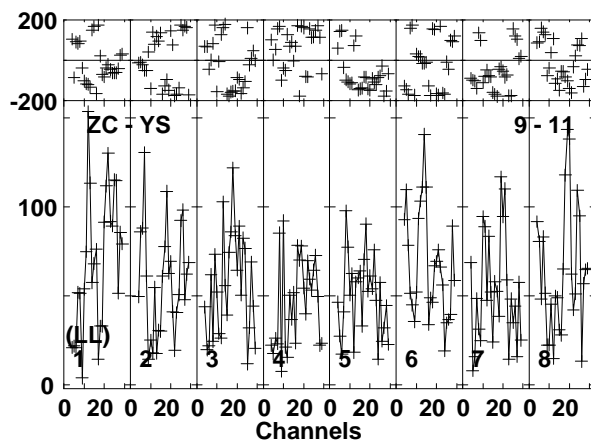
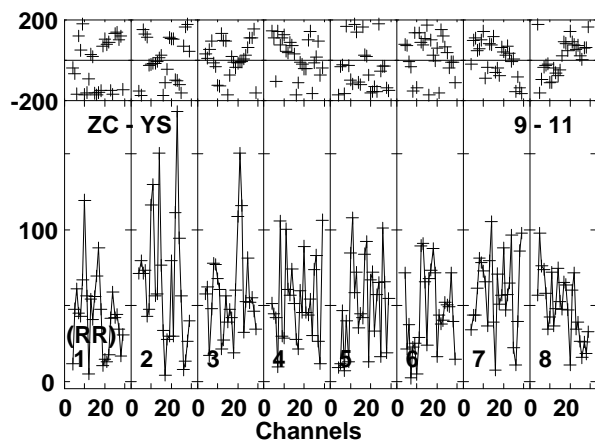
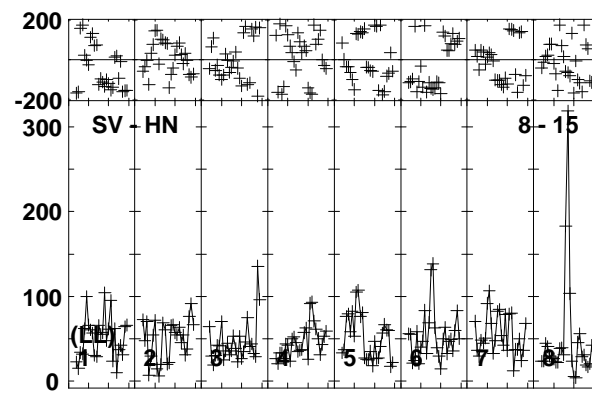
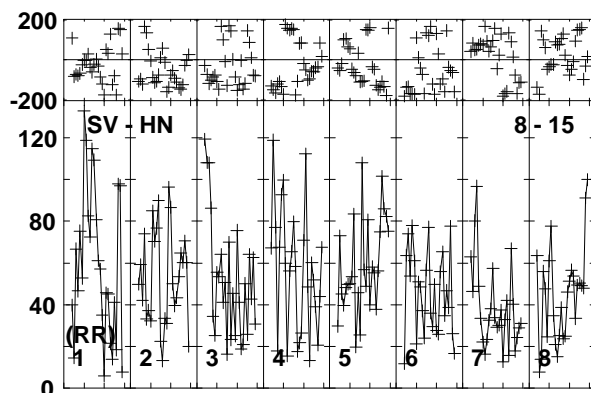
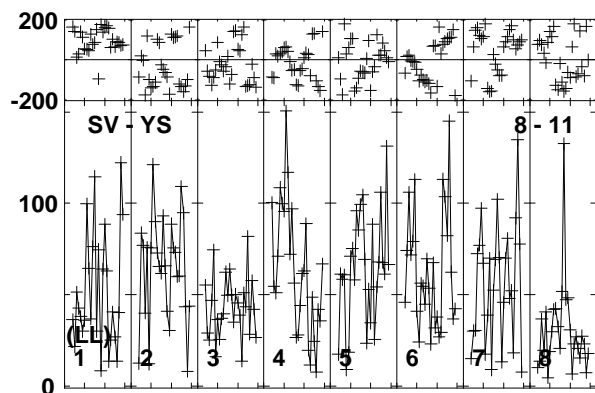
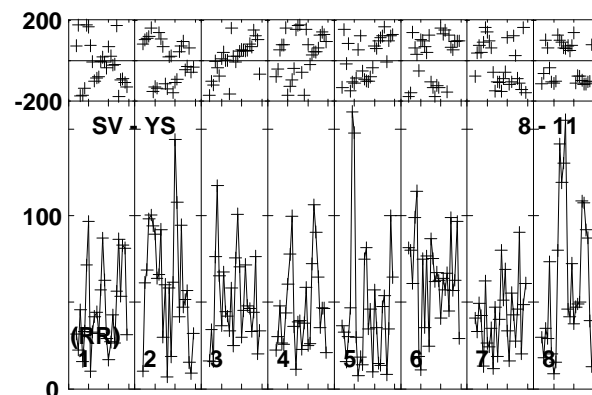
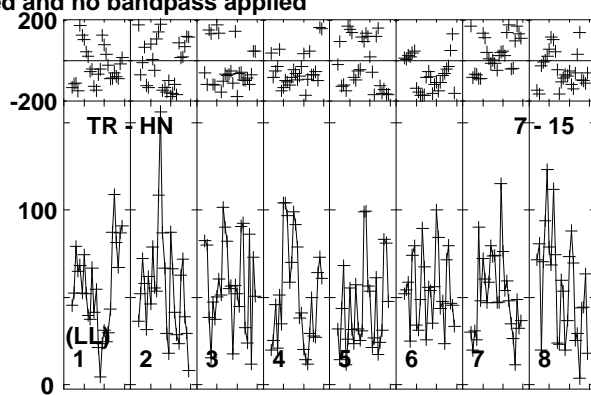
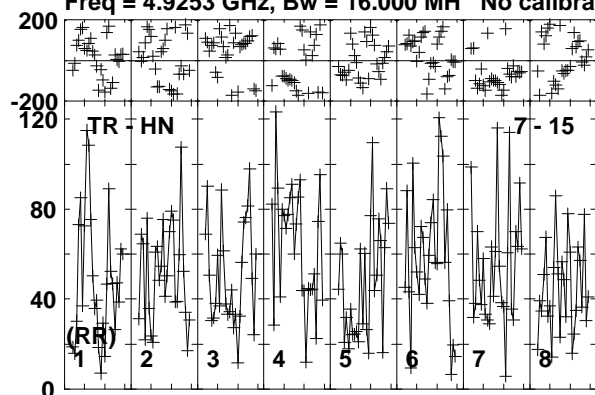

Lower frame: Micro Ampl Jy Top frame: Phas deg
Vector averaged cross-power spectrum Baseline: TR (07) - HN (15)
Timerange: 01/01:06:03 to 01/01:11:17

Plot file version 454 created 11-APR-2016 17:09:31

ARP299C GP053G 3.UVDATA.1

Freq = 4.9253 GHz, Bw = 16.000 MH No calibration applied and no bandpass applied

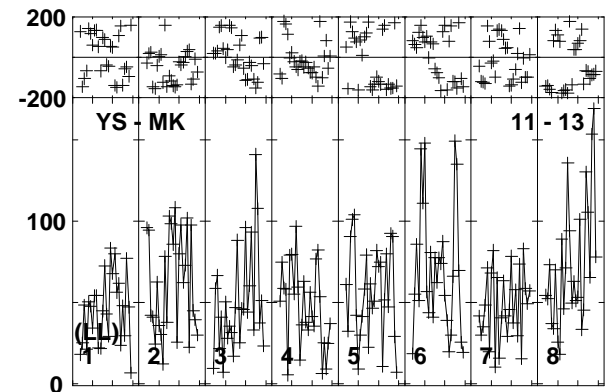
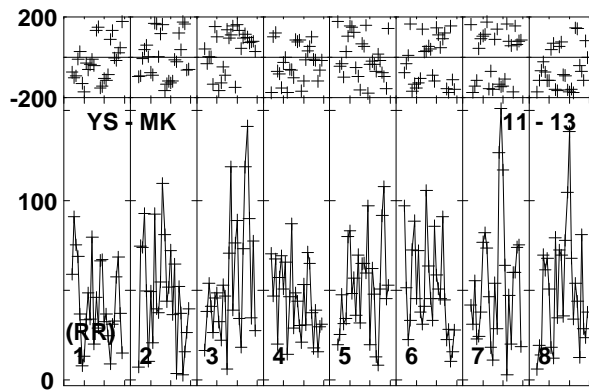
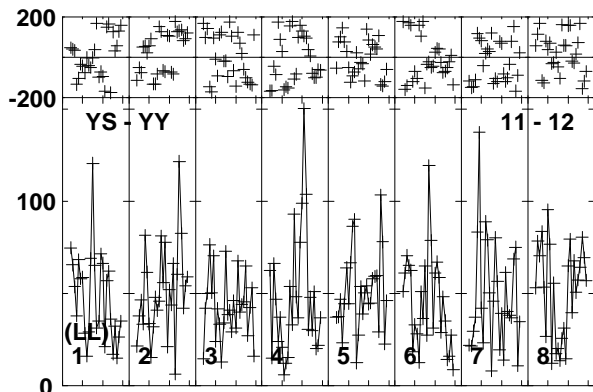
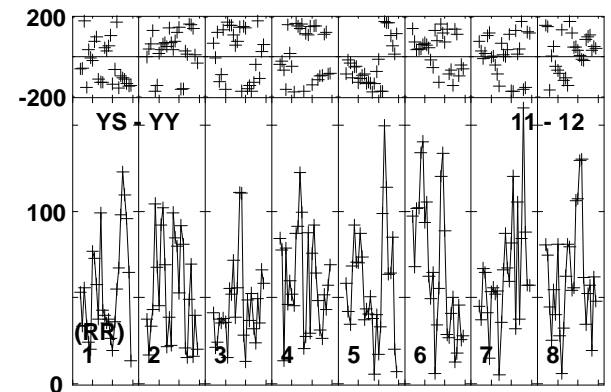
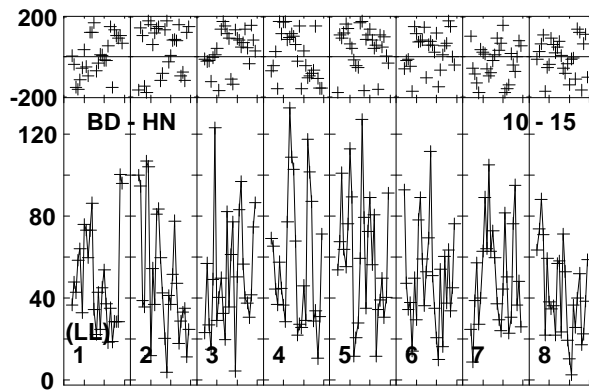
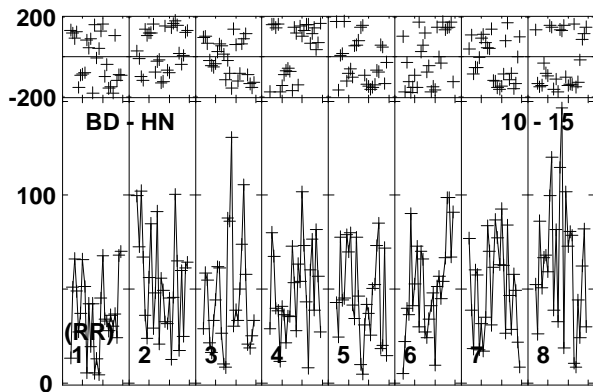
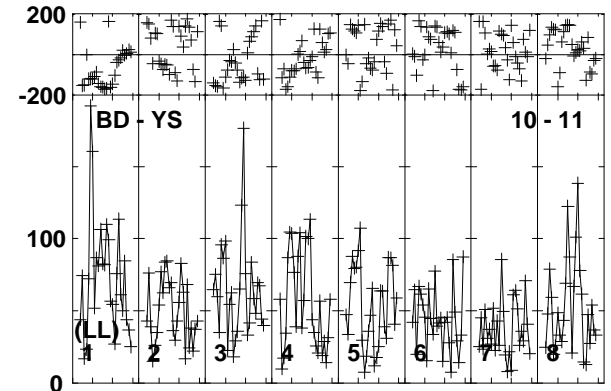
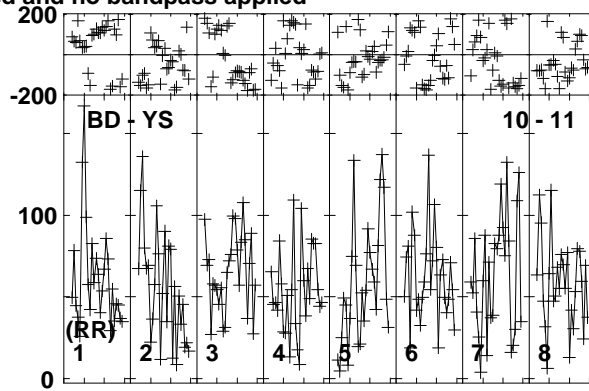
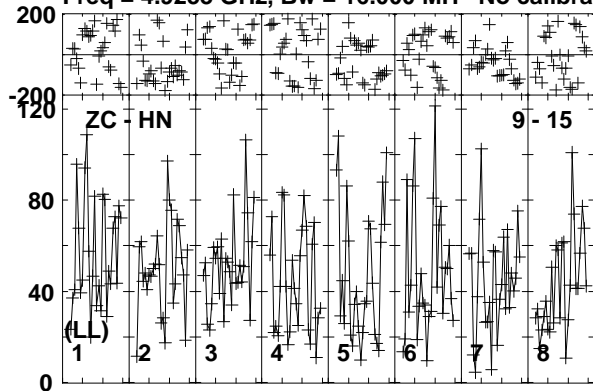

Lower frame: Micro Ampl Jy Top frame: Phas deg
Vector averaged cross-power spectrum Baseline: ZC (09) - HN (15)
Timerange: 01/01:06:03 to 01/01:11:17

Plot file version 455 created 11-APR-2016 17:09:31

ARP299C GP053G 3.UVDATA.1

Freq = 4.9253 GHz, Bw = 16.000 MH No calibration applied and no bandpass applied

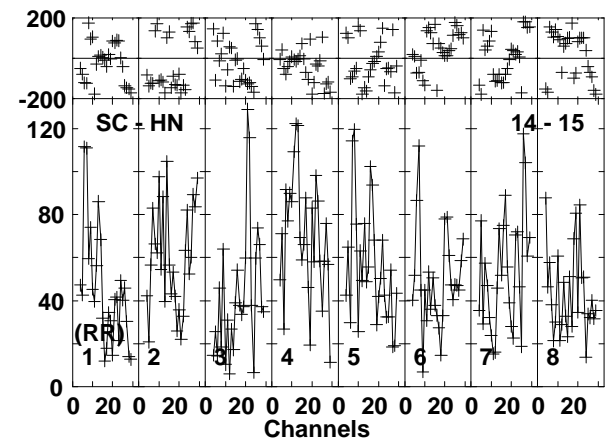
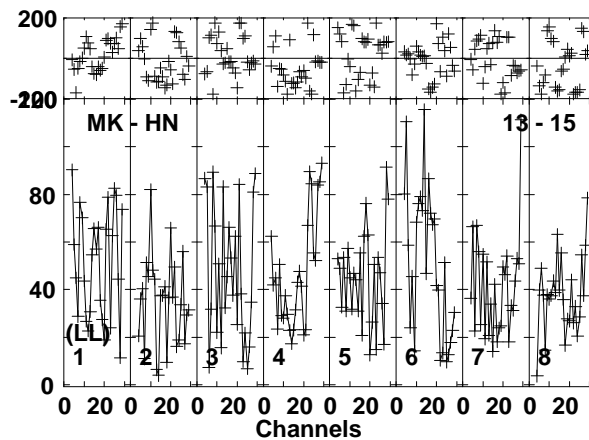
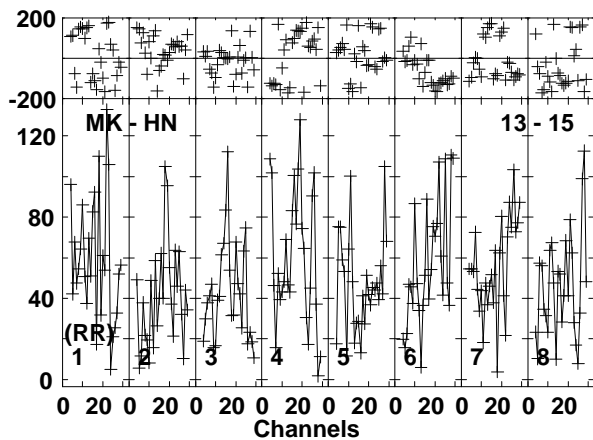
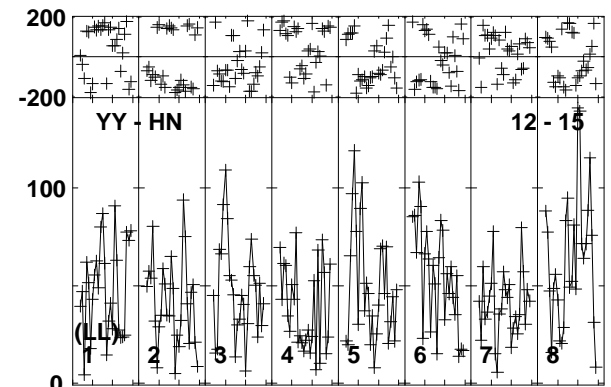
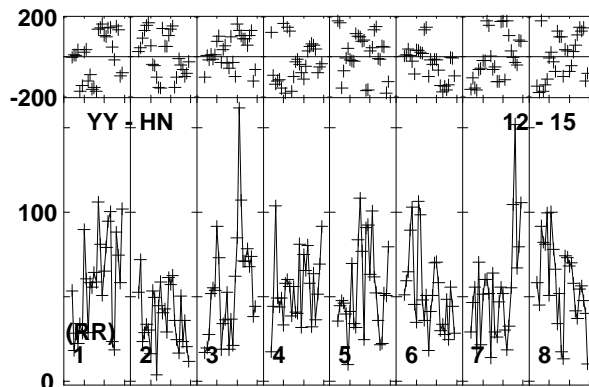
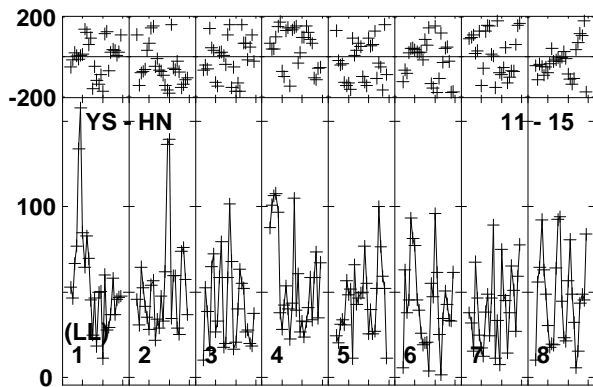
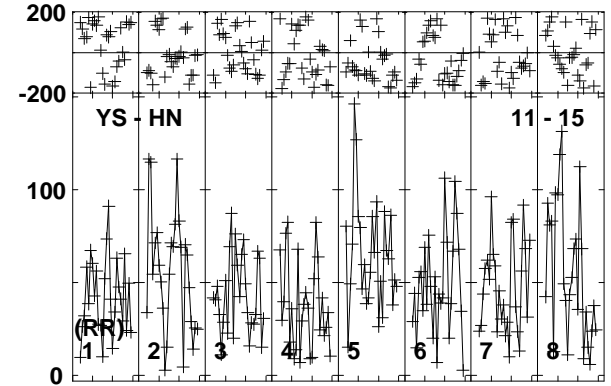
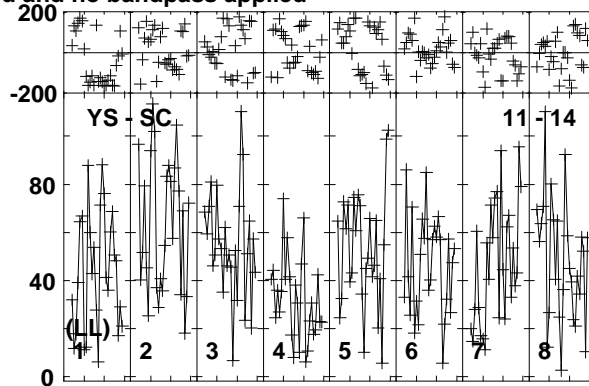
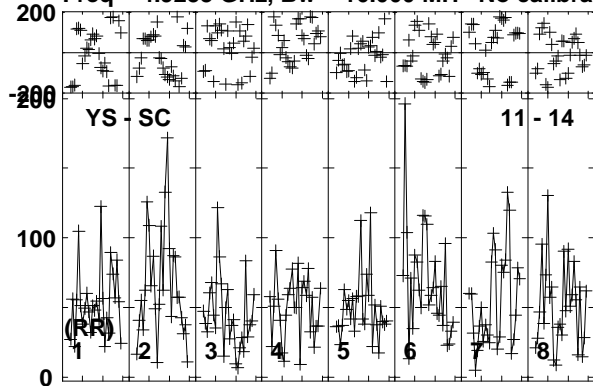

Lower frame: Micro Ampl Jy Top frame: Phas deg
Vector averaged cross-power spectrum Baseline: YS (11) - SC (14)
Timerange: 01/01:06:03 to 01/01:11:17

Plot file version 456 created 11-APR-2016 17:09:31

ARP299C GP053G 3.UVDATA.1

Freq = 4.9253 GHz, Bw = 16.000 MH No calibration applied and no bandpass applied

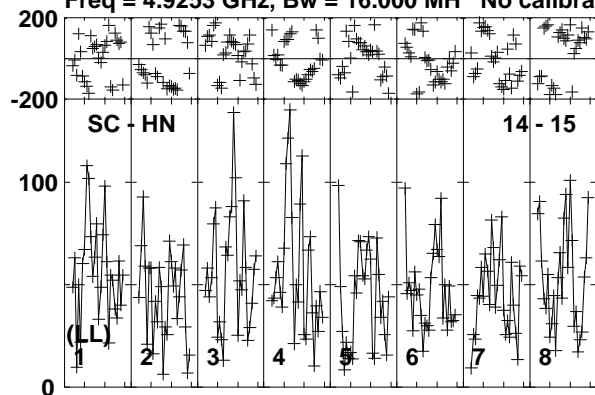

Lower frame: Micro Ampl Jy Top frame: Phas deg
Vector averaged cross-power spectrum Baseline: SC (14) - HN (15)
Timerange: 01/01:06:03 to 01/01:11:17

Plot file version 457 created 11-APR-2016 17:09:31

J1128+5925 GP053G 3.UVDATA.1

Freq = 4.9253 GHz, Bw = 16.000 MH No calibration applied and no bandpass applied

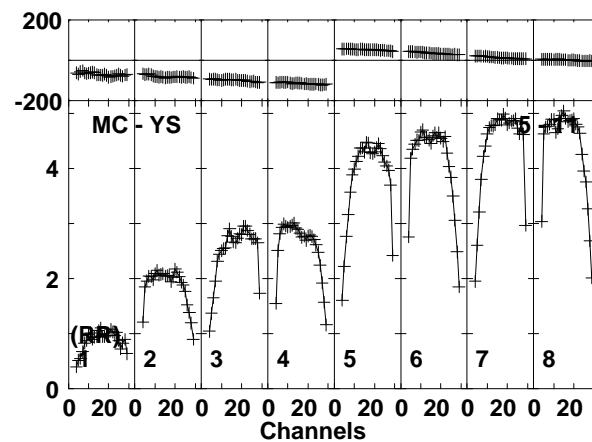
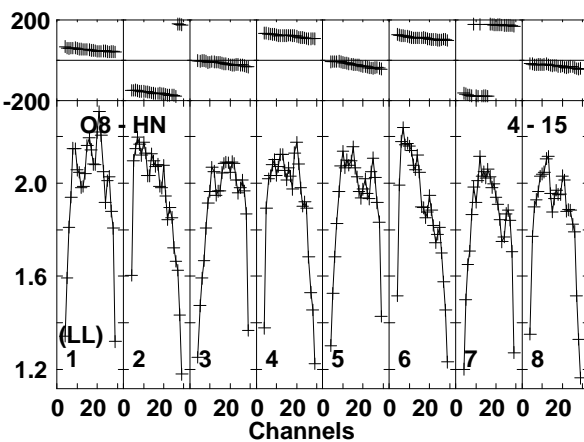
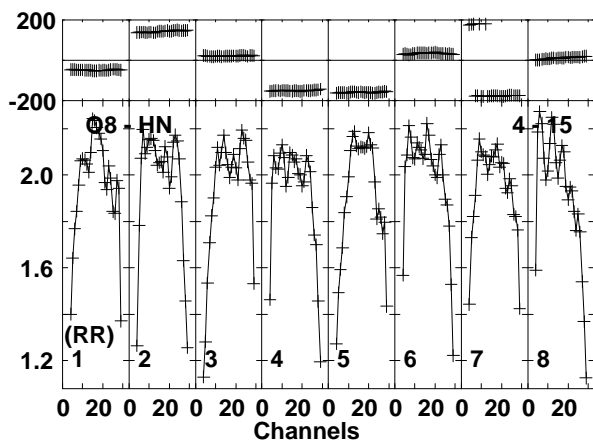
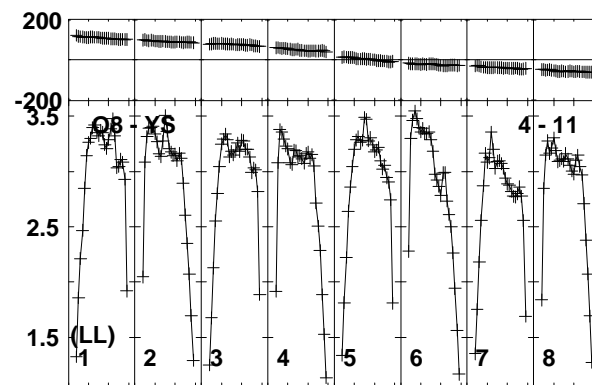
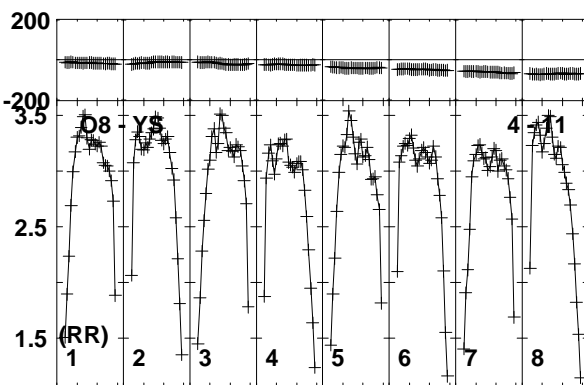
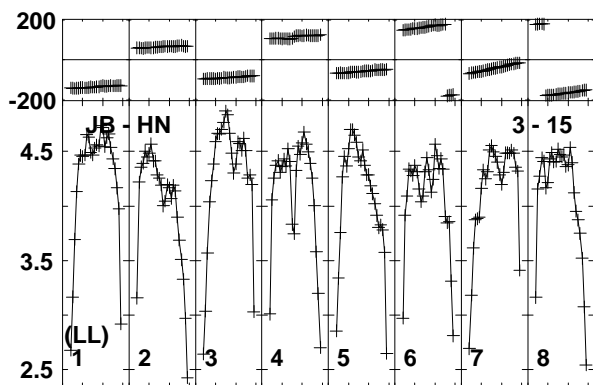
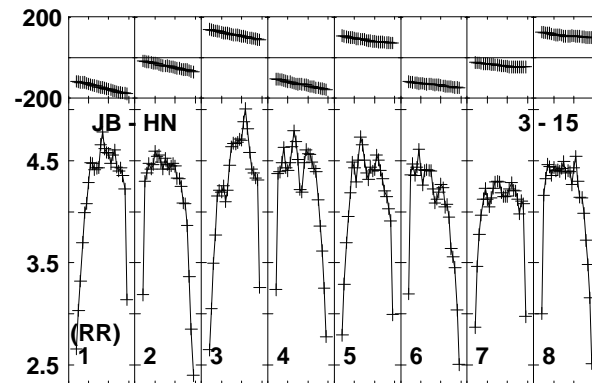
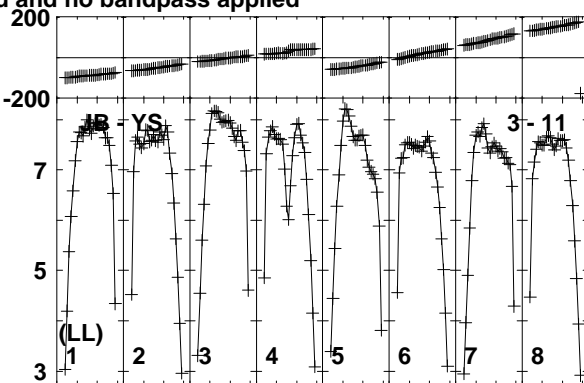
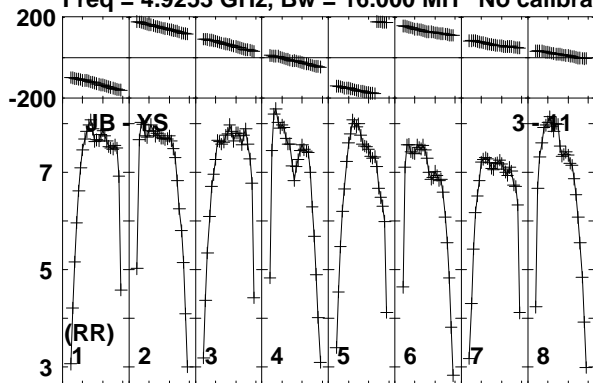

Lower frame: Milli Ampl Jy Top frame: Phas deg
Vector averaged cross-power spectrum Baseline: JB (03) - YS (11)
Timerange: 01/01:11:23 to 01/01:13:07

Plot file version 458 created 11-APR-2016 17:09:31

J1128+5925 GP053G 3.UVDATA.1

Freq = 4.9253 GHz, Bw = 16.000 MH No calibration applied and no bandpass applied

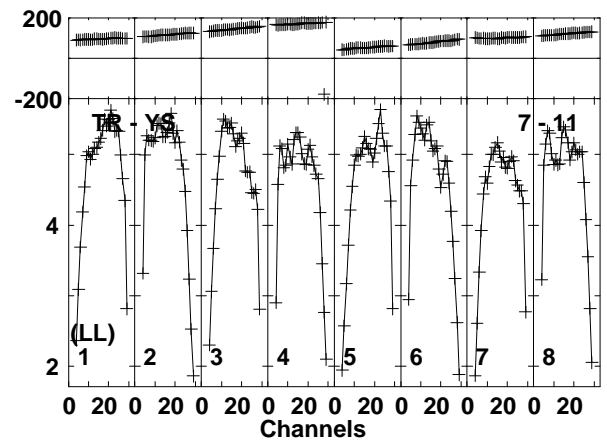
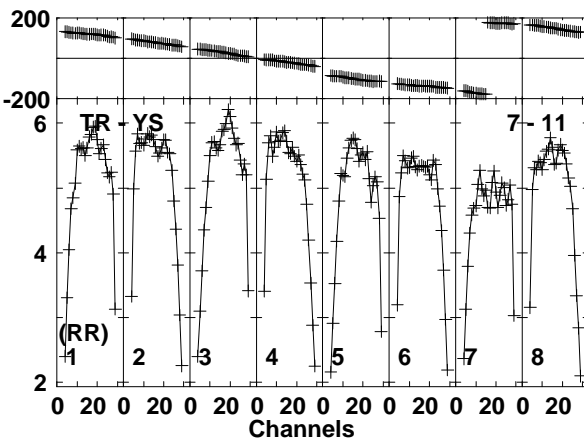
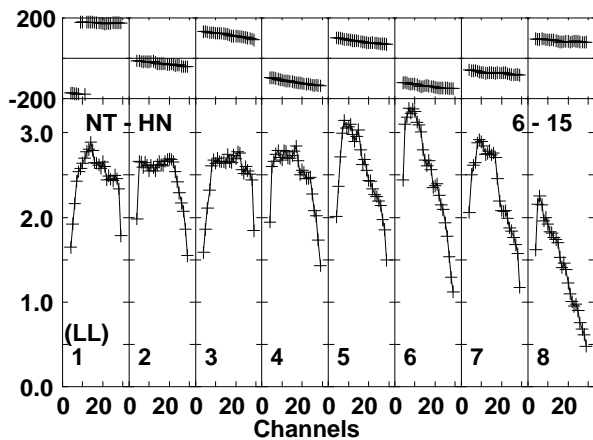
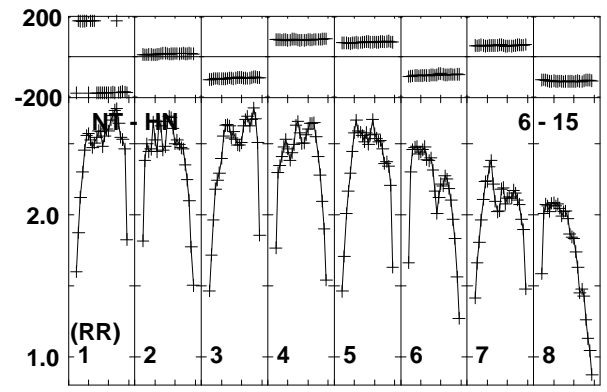
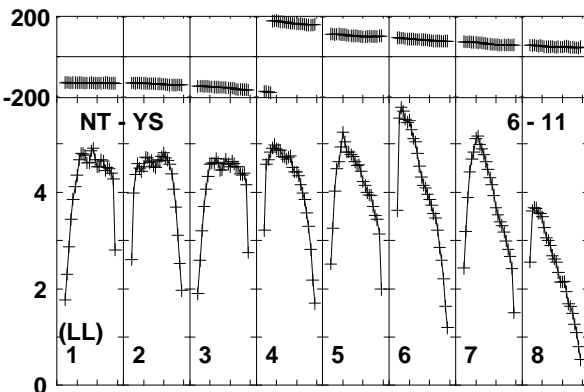
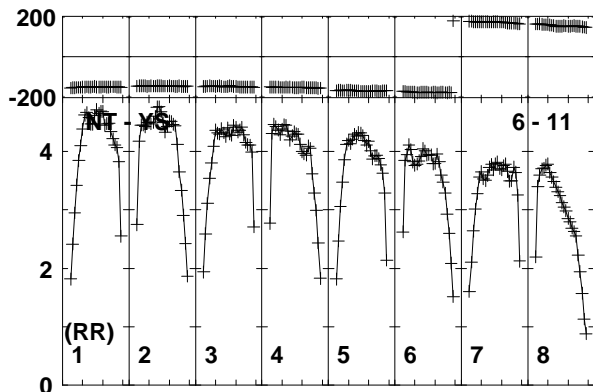
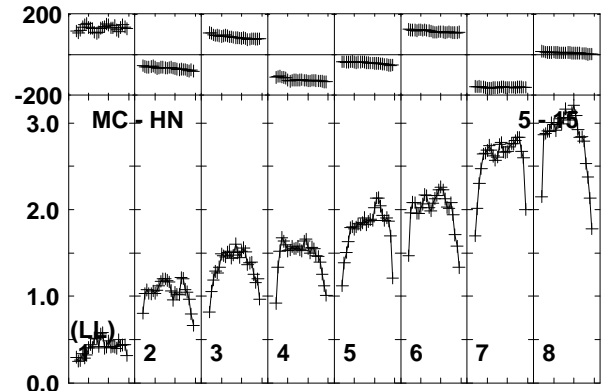
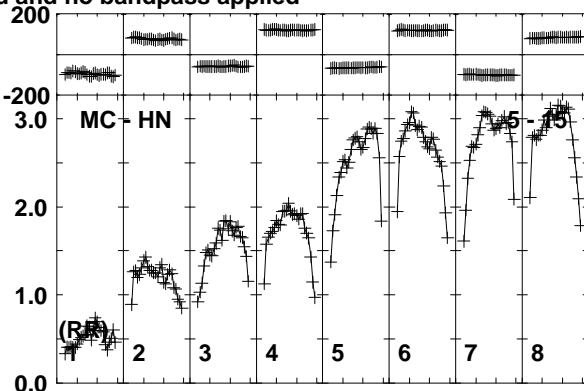
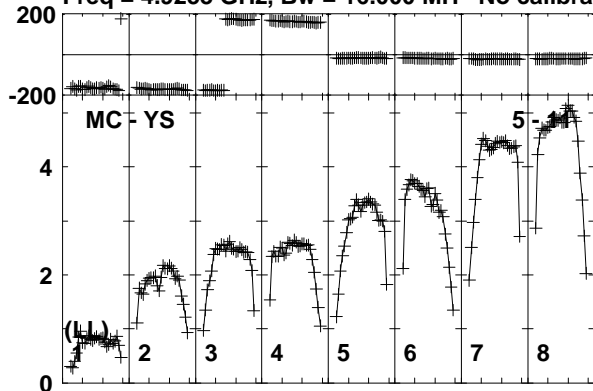

Lower frame: Milli Ampl Jy Top frame: Phas deg

Vector averaged cross-power spectrum Baseline: MC (05) - YS (11)

Timerange: 01/01:11:23 to 01/01:13:07

Plot file version 459 created 11-APR-2016 17:09:31

J1128+5925 GP053G 3.UVDATA.1

Freq = 4.9253 GHz, Bw = 16.000 MH No calibration applied and no bandpass applied

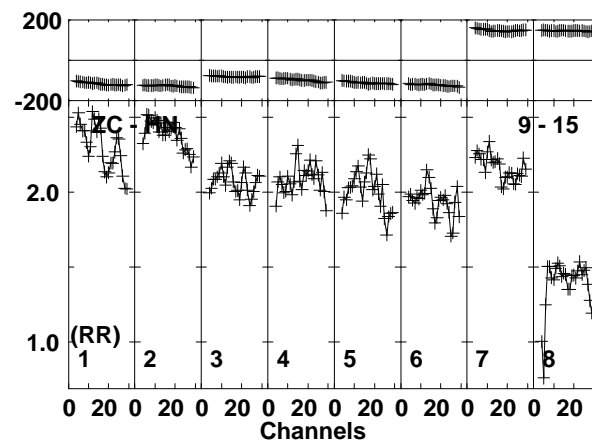
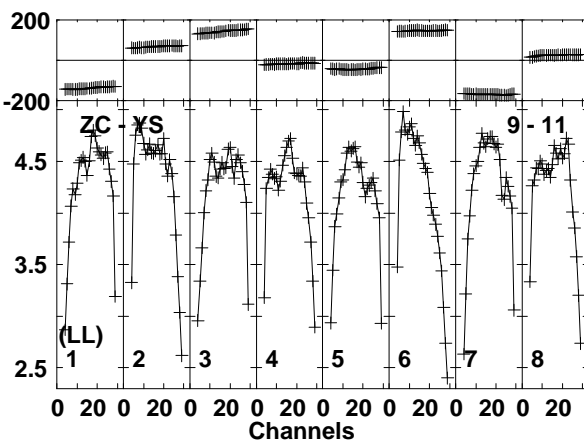
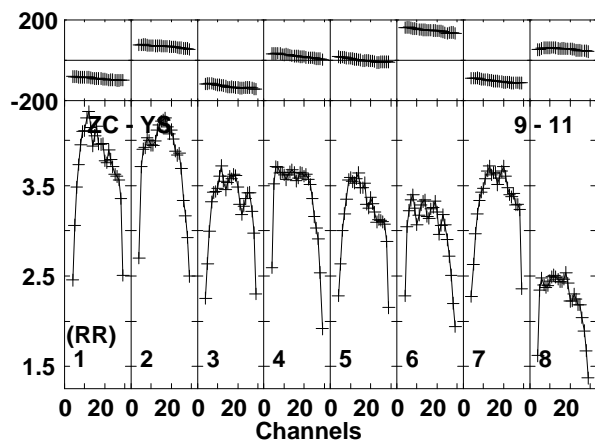
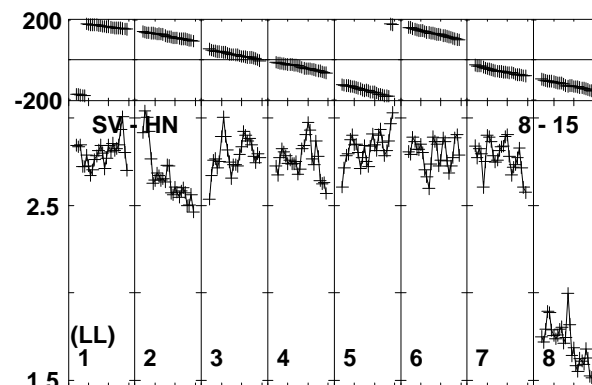
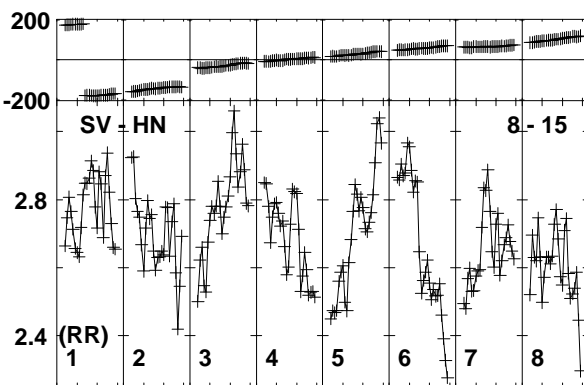
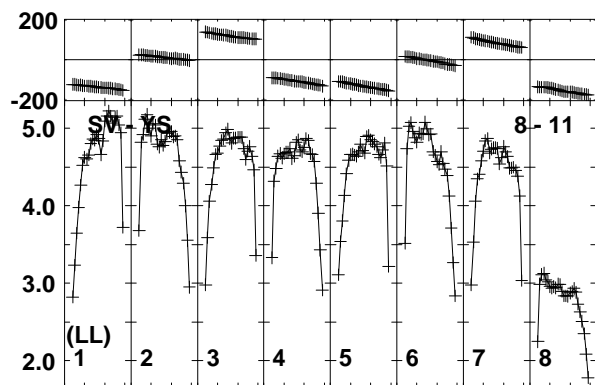
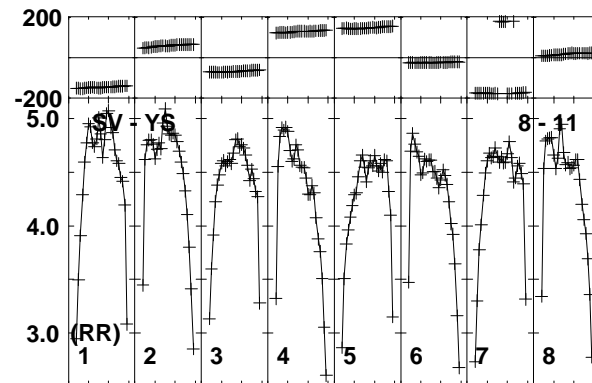
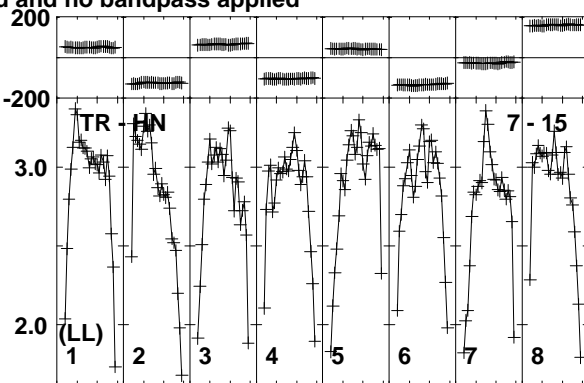
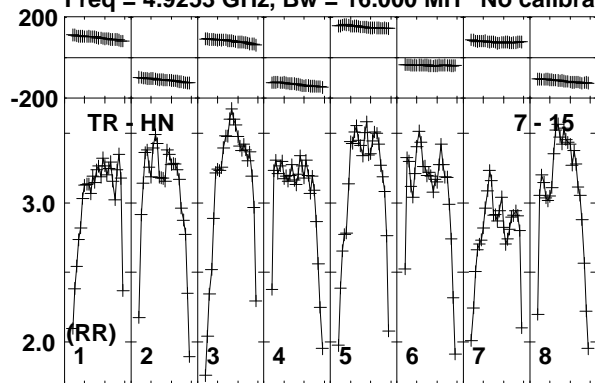

Lower frame: Milli Ampl Jy Top frame: Phas deg
Vector averaged cross-power spectrum Baseline: TR (07) - HN (15)
Timerange: 01/01:11:23 to 01/01:13:07

Plot file version 460 created 11-APR-2016 17:09:31

J1128+5925 GP053G 3.UVDATA.1

Freq = 4.9253 GHz, Bw = 16.000 MH No calibration applied and no bandpass applied

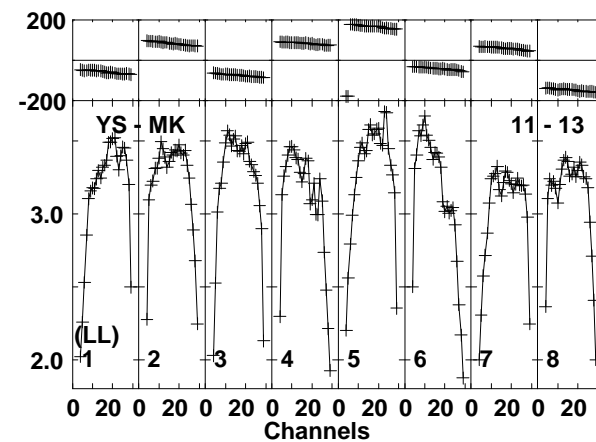
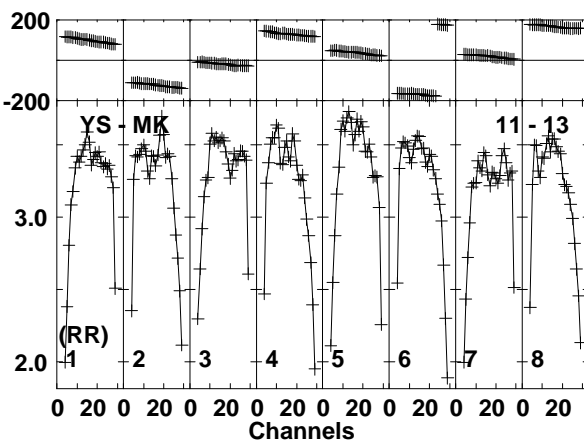
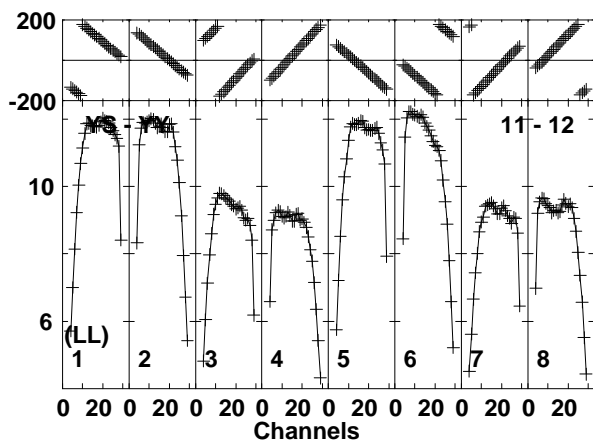
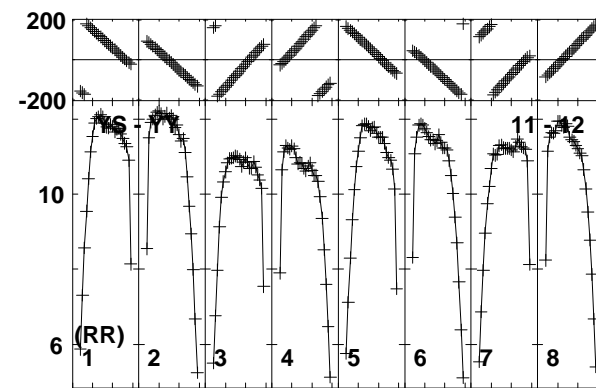
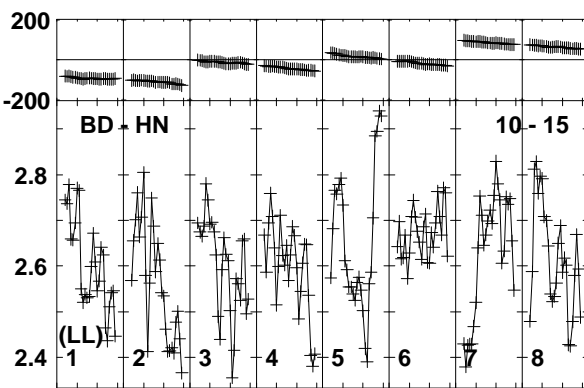
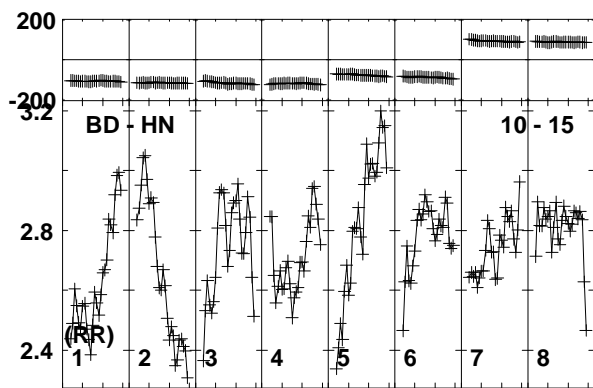
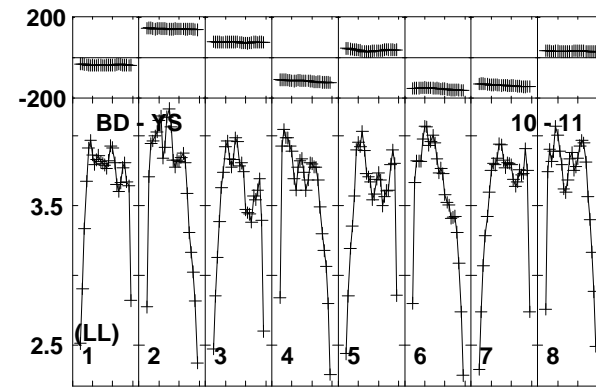
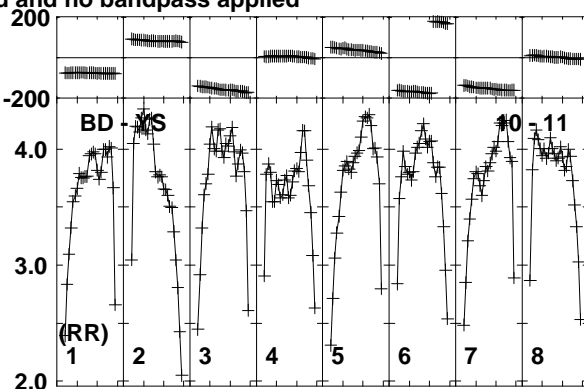
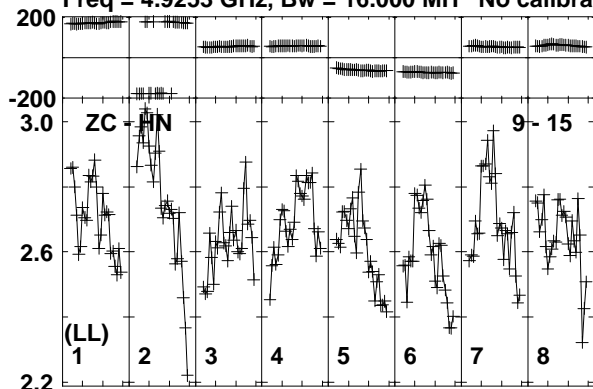

Lower frame: Milli Ampl Jy Top frame: Phas deg
Vector averaged cross-power spectrum Baseline: ZC (09) - HN (15)
Timerange: 01/01:11:23 to 01/01:13:07

Plot file version 461 created 11-APR-2016 17:09:32

J1128+5925 GP053G 3.UVDATA.1

Freq = 4.9253 GHz, Bw = 16.000 MH No calibration applied and no bandpass applied

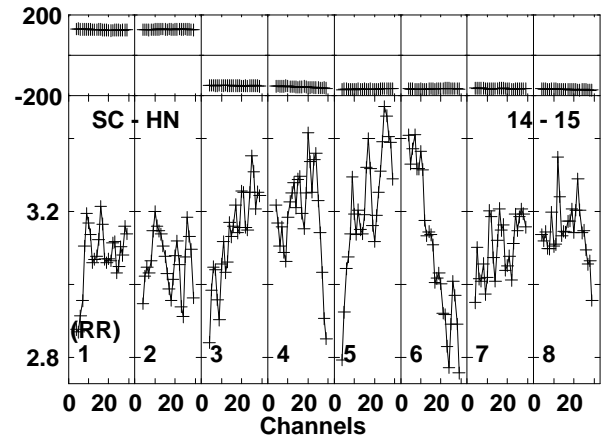
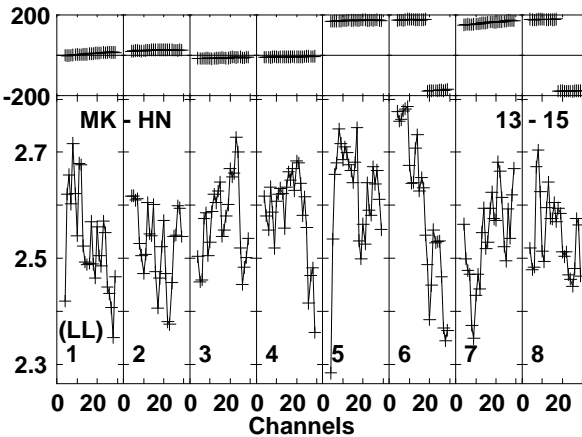
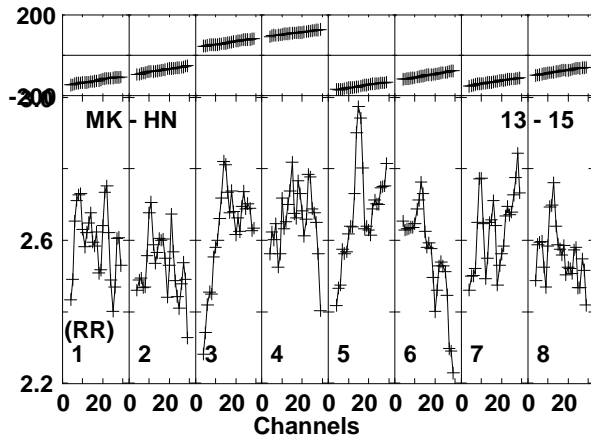
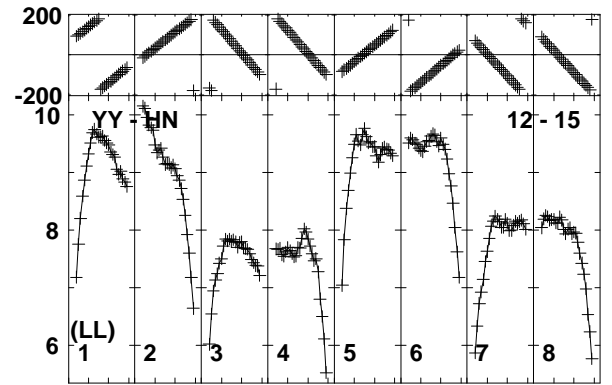
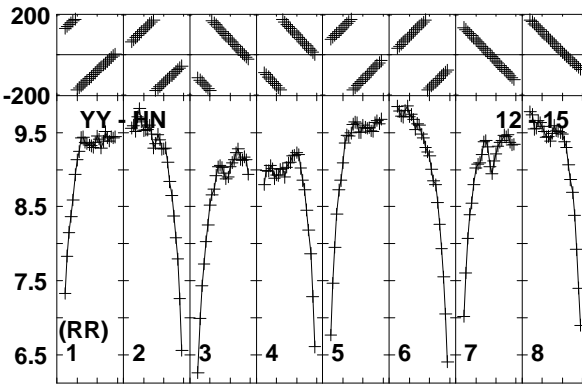
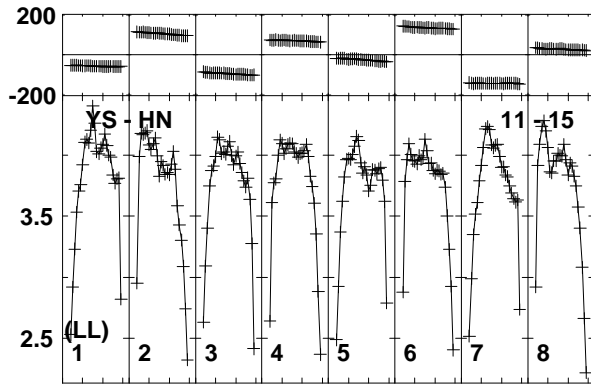
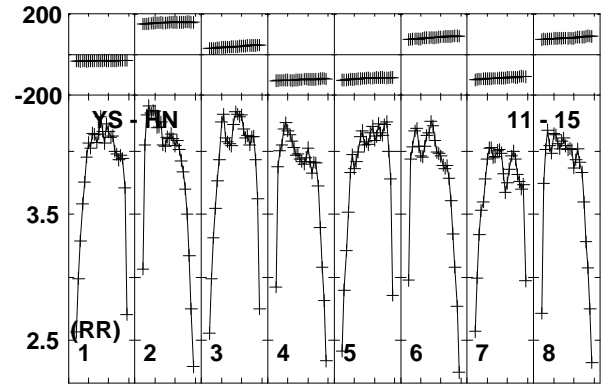
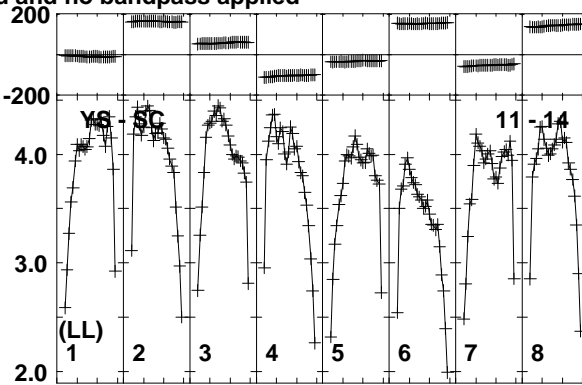
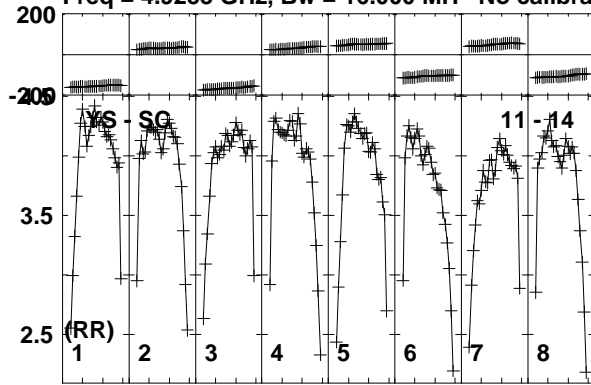

Lower frame: Milli Ampl Jy Top frame: Phas deg
Vector averaged cross-power spectrum Baseline: YS (11) - SC (14)
Timerange: 01/01:11:23 to 01/01:13:07

Plot file version 462 created 11-APR-2016 17:09:32
J1128+5925 GP053G 3.UVDATA.1
Freq = 4.9253 GHz, Bw = 16.000 MH No calibration applied and no bandpass applied

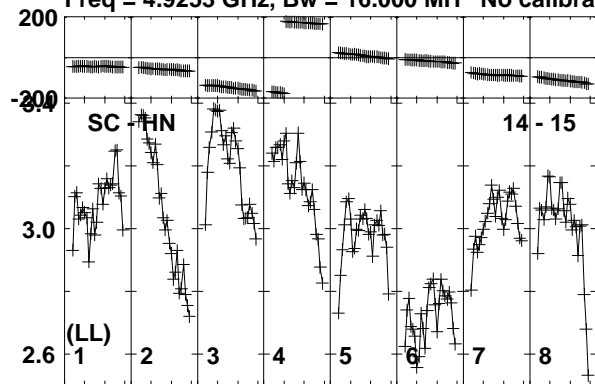

Lower frame: Milli Ampl Jy Top frame: Phas deg
Vector averaged cross-power spectrum Baseline: SC (14) - HN (15)
Timerange: 01/01:11:23 to 01/01:13:07

Plot file version 463 created 11-APR-2016 17:09:32

ARP299C GP053G 3.UVDATA.1

Freq = 4.9253 GHz, Bw = 16.000 MH No calibration applied and no bandpass applied

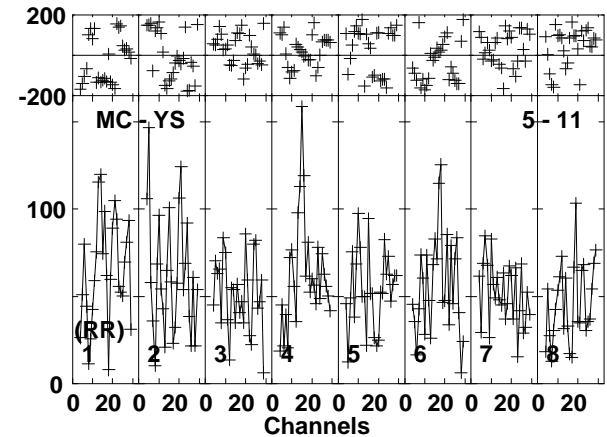
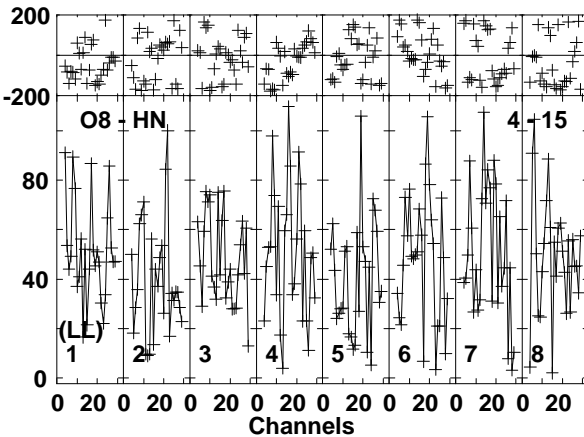
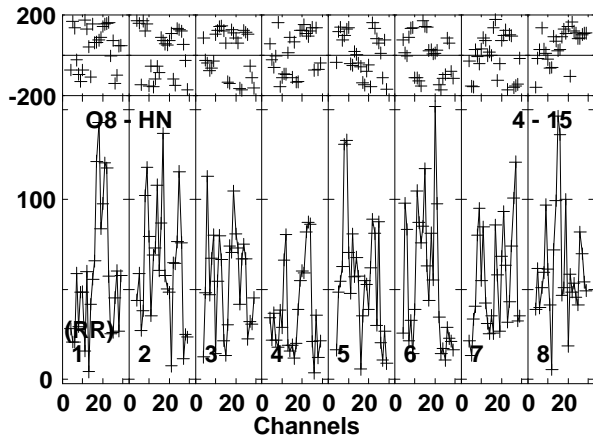
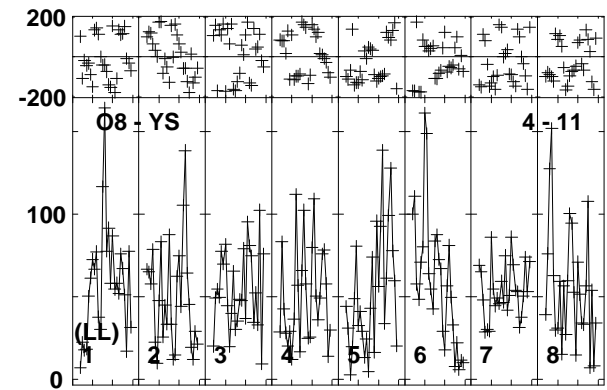
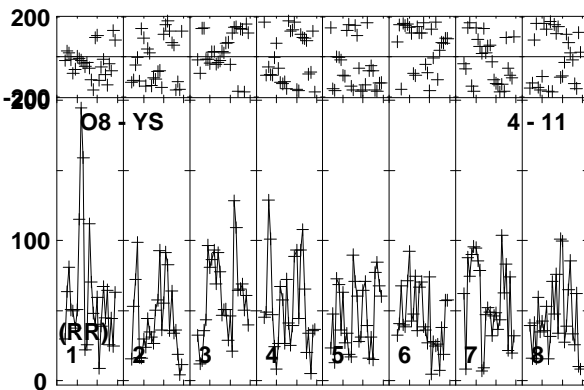
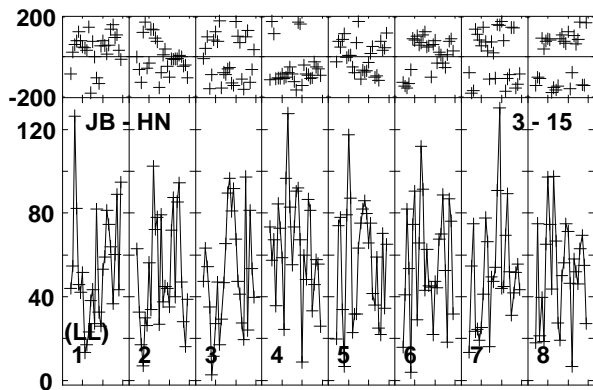
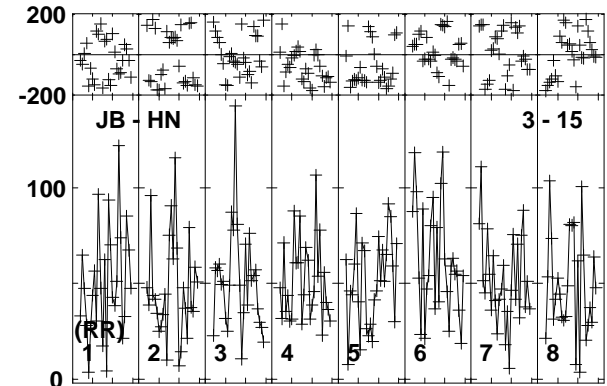
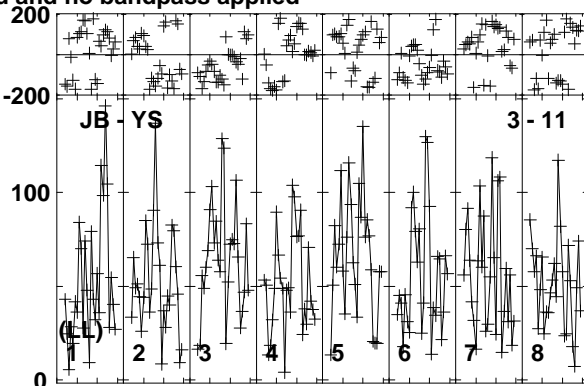
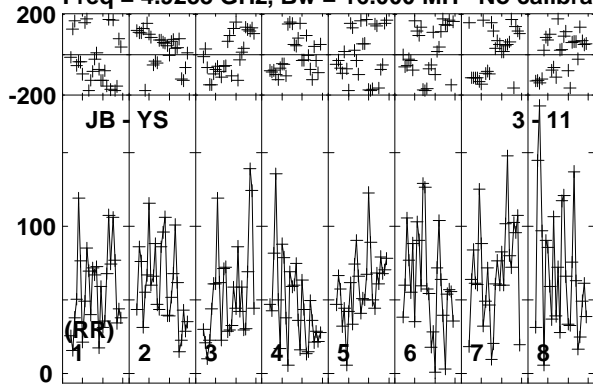

Lower frame: Micro Ampl Jy Top frame: Phas deg
Vector averaged cross-power spectrum Baseline: JB (03) - YS (11)
Timerange: 01/01:13:13 to 01/01:18:25

Plot file version 464 created 11-APR-2016 17:09:32

ARP299C GP053G 3.UVDATA.1

Freq = 4.9253 GHz, Bw = 16.000 MH No calibration applied and no bandpass applied

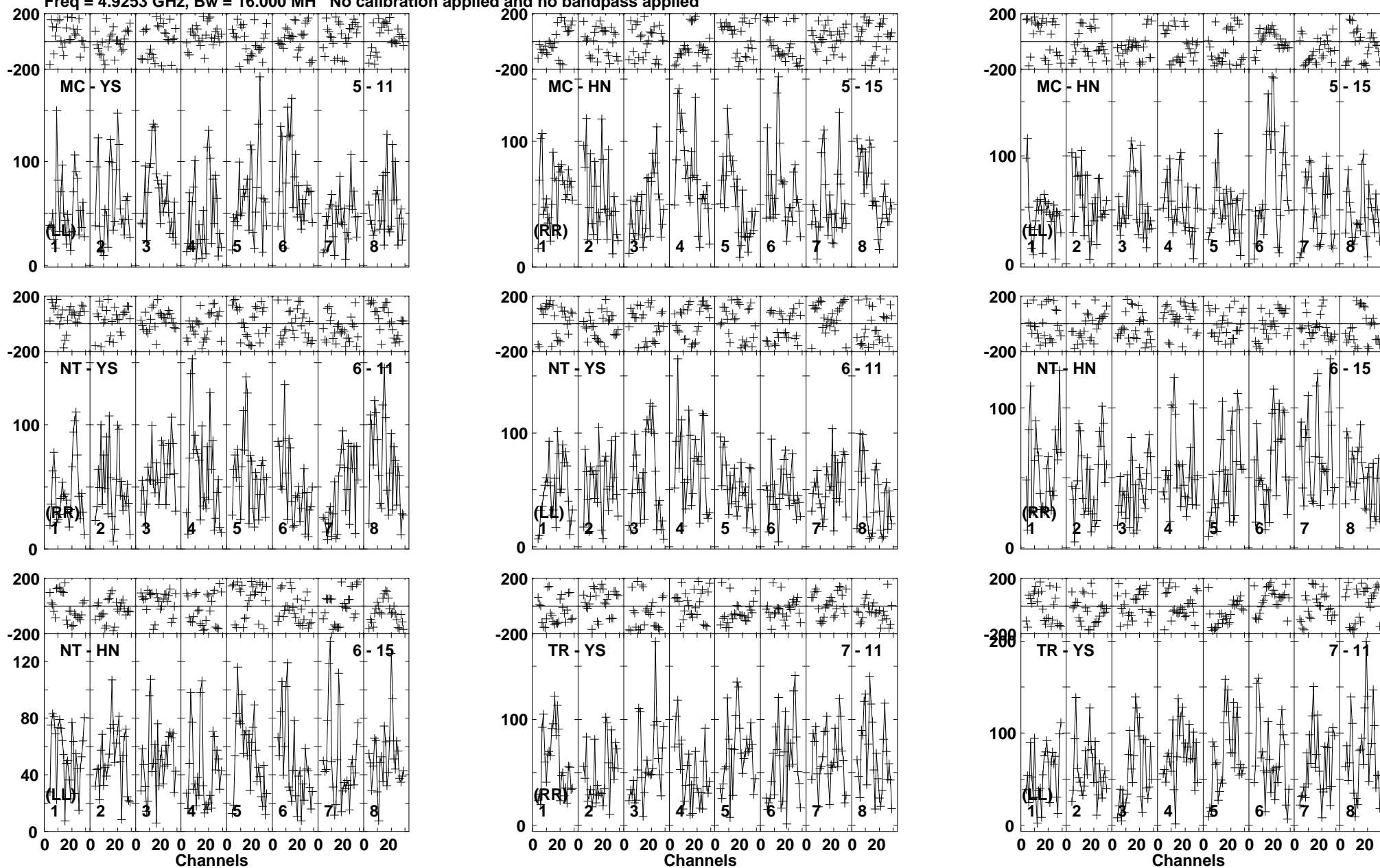

Lower frame: Micro Ampl Jy Top frame: Phas deg
Vector averaged cross-power spectrum Baseline: MC (05) - YS (11)
Timerange: 01/01:13:13 to 01/01:18:25

Plot file version 465 created 11-APR-2016 17:09:32

ARP299C GP053G 3.UVDATA.1

Freq = 4.9253 GHz, Bw = 16.000 MH No calibration applied and no bandpass applied

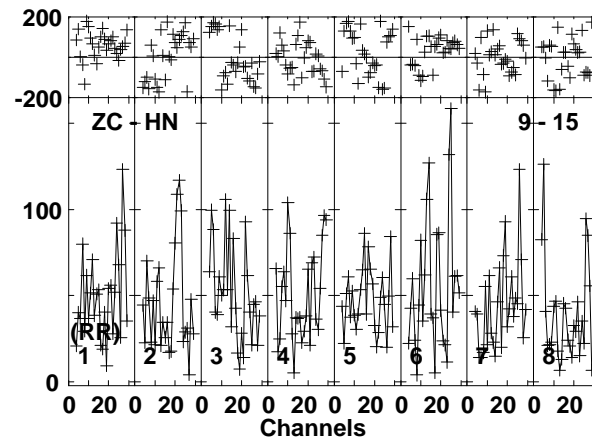
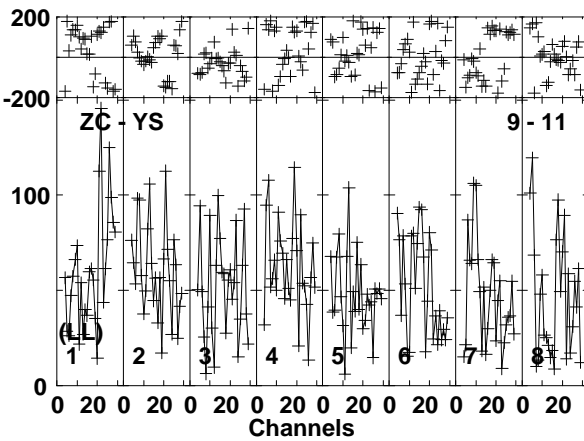
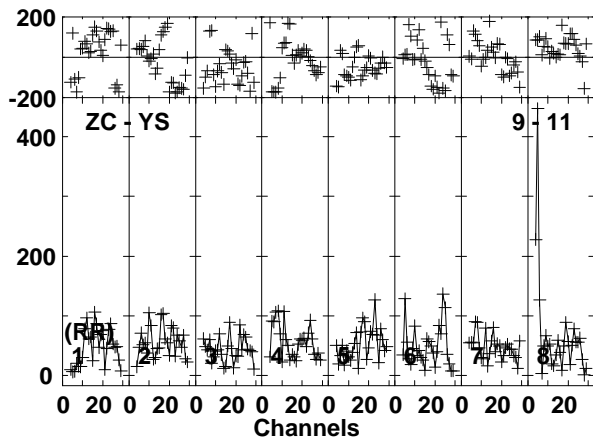
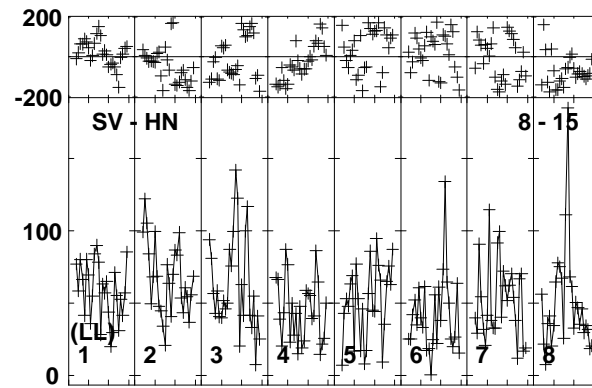
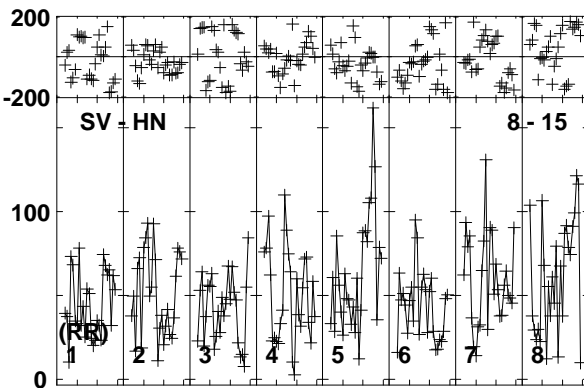
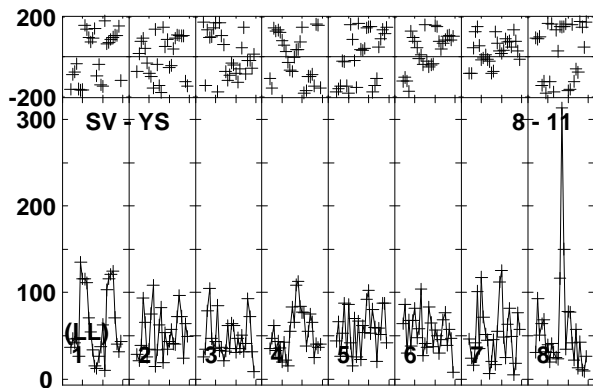
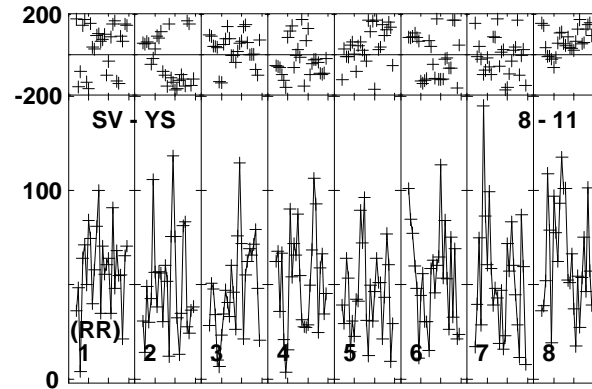
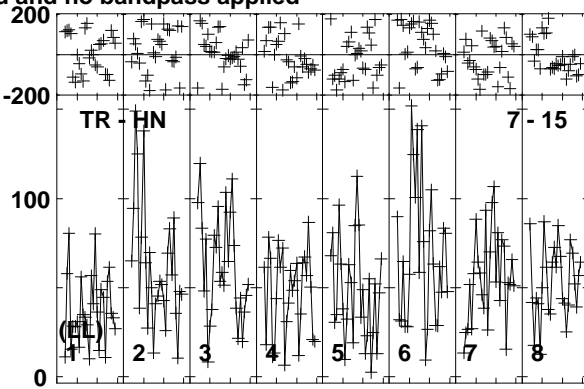
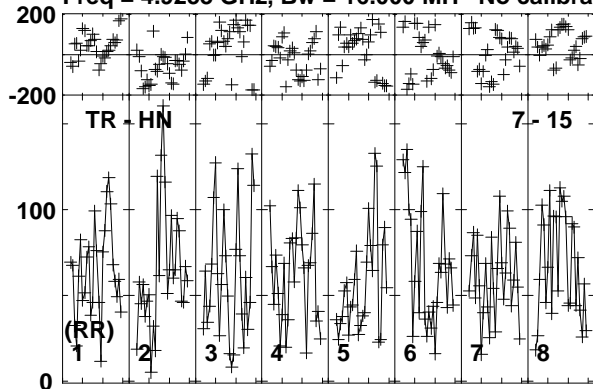

Lower frame: Micro Ampl Jy Top frame: Phas deg
Vector averaged cross-power spectrum Baseline: TR (07) - HN (15)
Timerange: 01/01:13:13 to 01/01:18:25

Plot file version 466 created 11-APR-2016 17:09:32

ARP299C GP053G 3.UVDATA.1

Freq = 4.9253 GHz, Bw = 16.000 MH No calibration applied and no bandpass applied

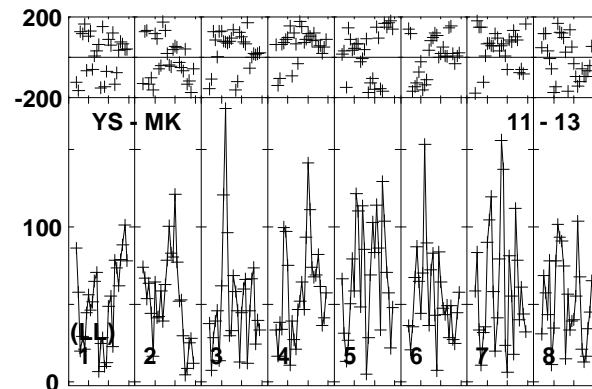
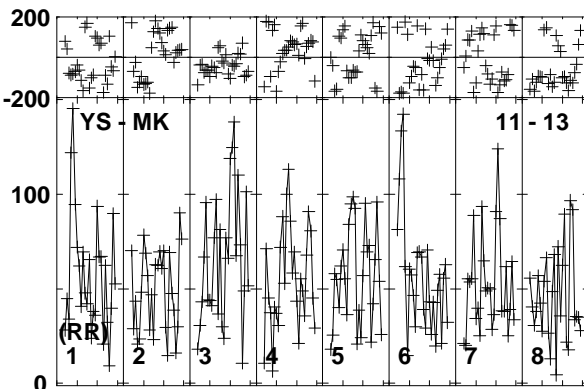
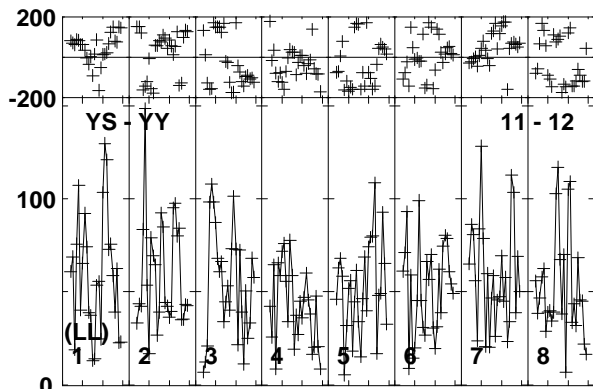
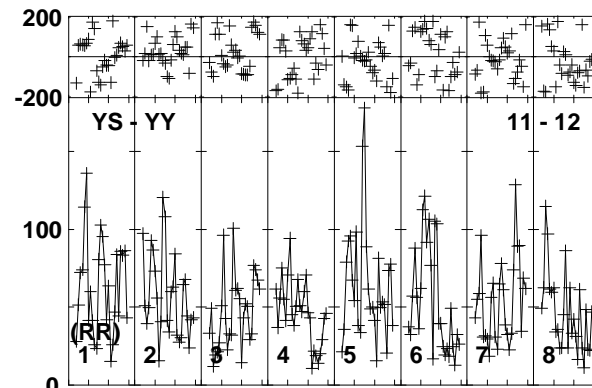
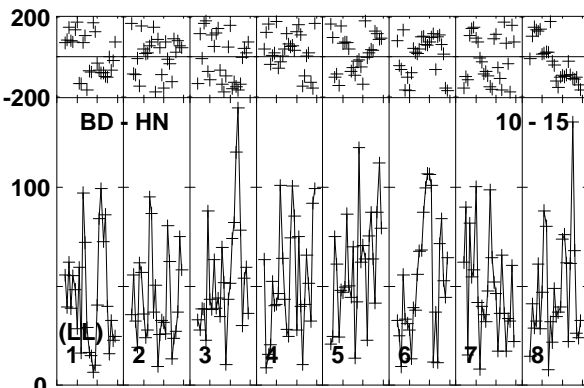
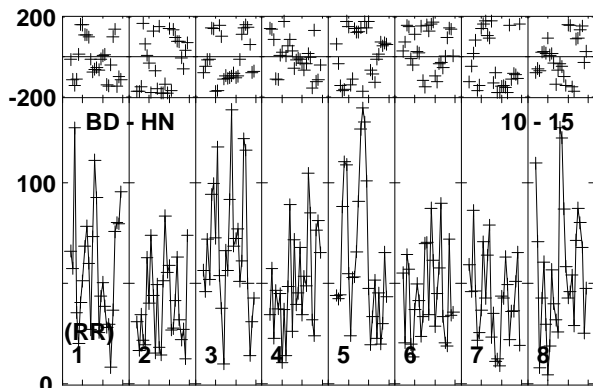
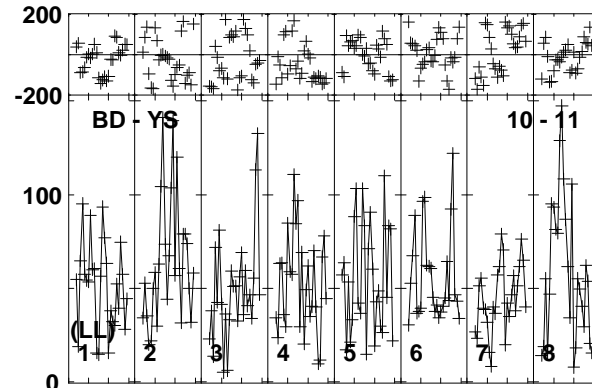
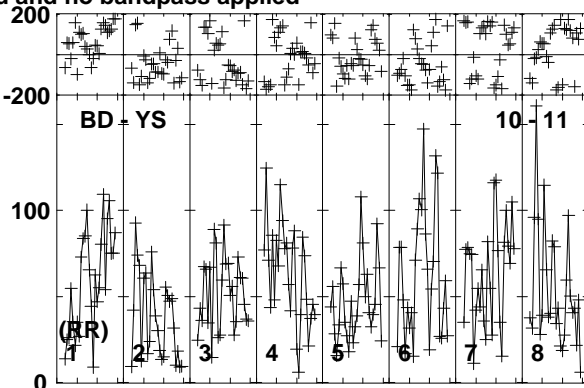
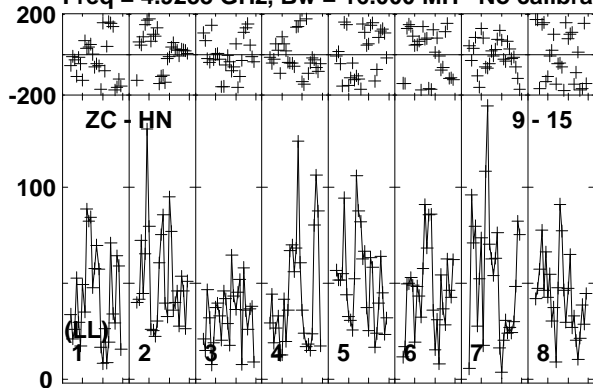

Lower frame: Micro Ampl Jy Top frame: Phas deg
Vector averaged cross-power spectrum Baseline: ZC (09) - HN (15)
Timerange: 01/01:13:13 to 01/01:18:25

Plot file version 467 created 11-APR-2016 17:09:32

ARP299C GP053G 3.UVDATA.1

Freq = 4.9253 GHz, Bw = 16.000 MH No calibration applied and no bandpass applied

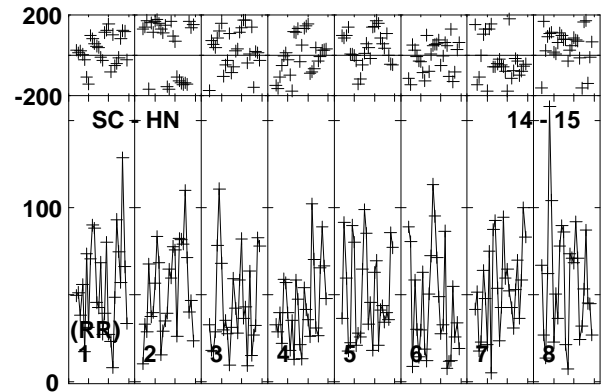
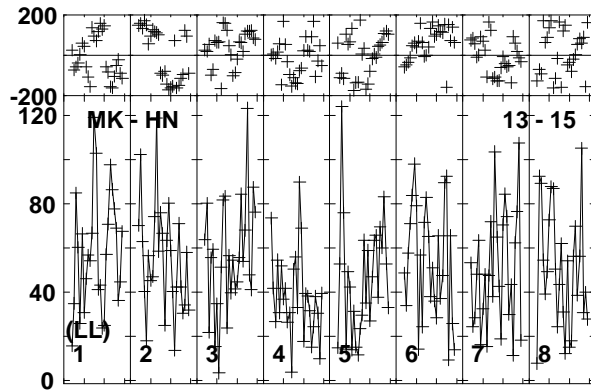
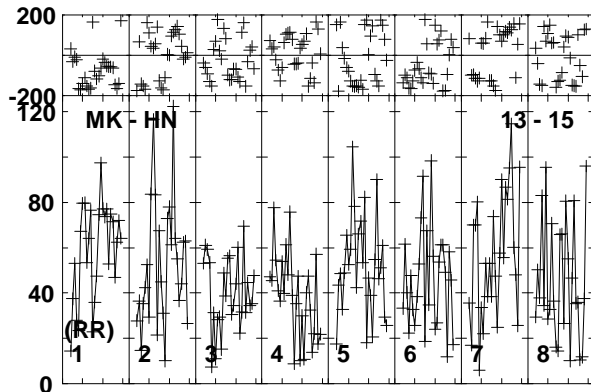
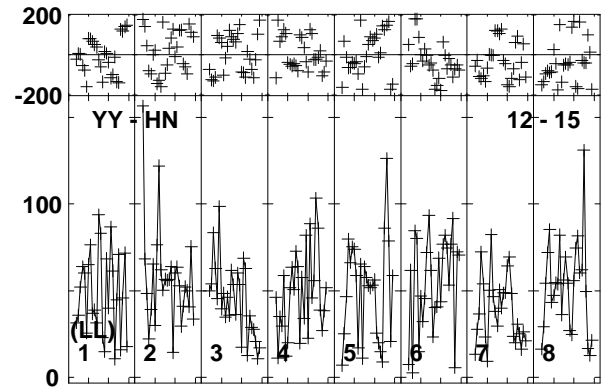
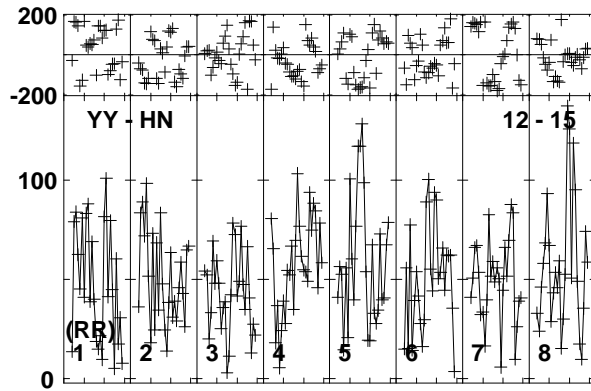
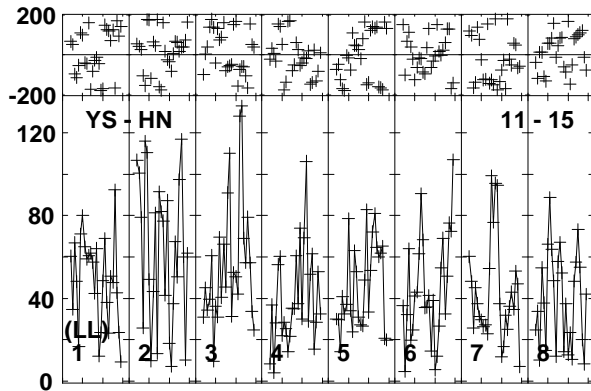
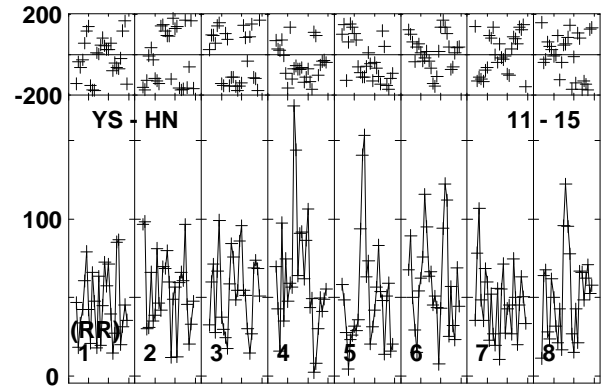
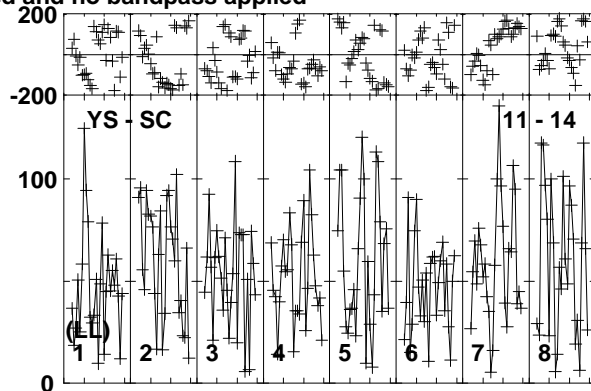
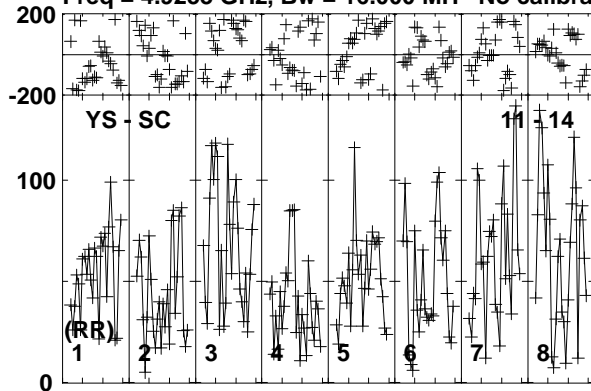

Lower frame: Micro Ampl Jy Top frame: Phas deg
Vector averaged cross-power spectrum Baseline: YS (11) - SC (14)
Timerange: 01/01:13:13 to 01/01:18:25

Plot file version 468 created 11-APR-2016 17:09:33

ARP299C GP053G 3.UVDATA.1

Freq = 4.9253 GHz, Bw = 16.000 MH No calibration applied and no bandpass applied

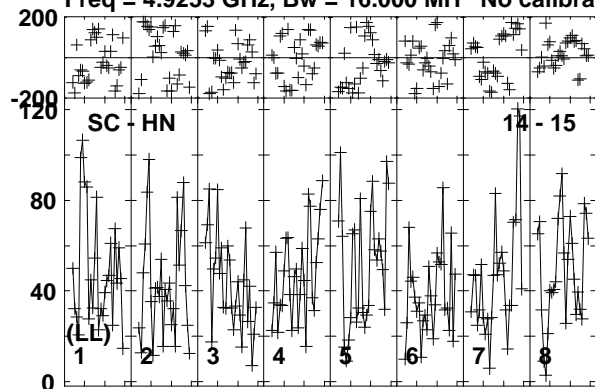

Lower frame: Micro Ampl Jy Top frame: Phas deg
Vector averaged cross-power spectrum Baseline: SC (14) - HN (15)
Timerange: 01/01:13:13 to 01/01:18:25

Plot file version 469 created 11-APR-2016 17:09:33

J1128+5925 GP053G 3.UVDATA.1

Freq = 4.9253 GHz, Bw = 16.000 MH No calibration applied and no bandpass applied

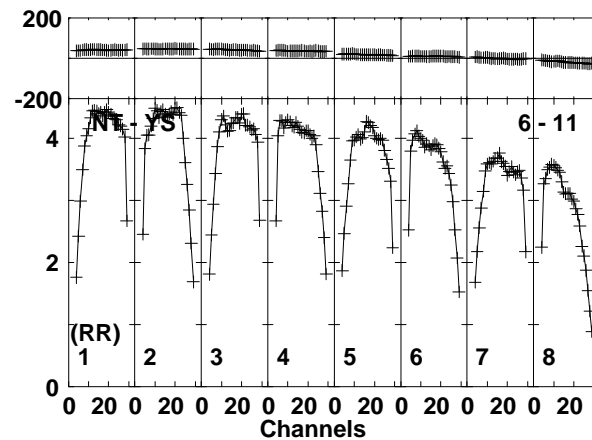
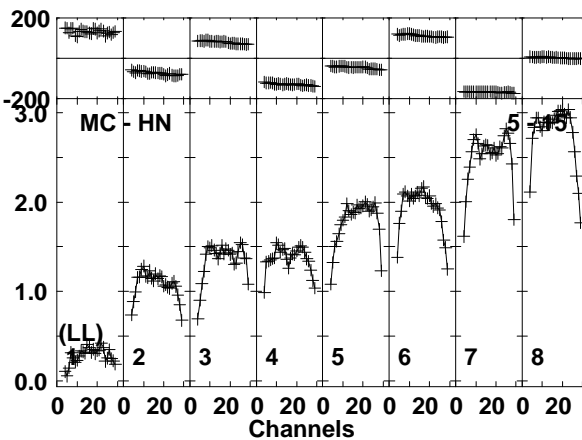
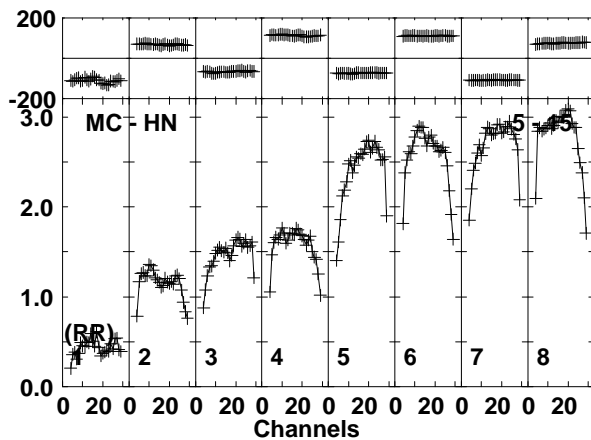
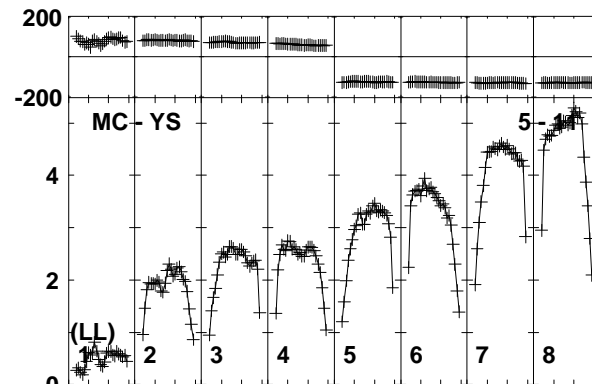
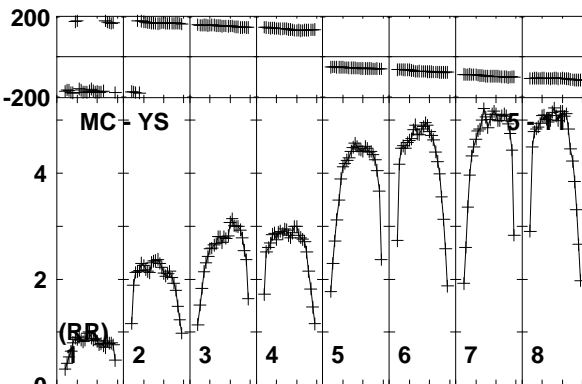
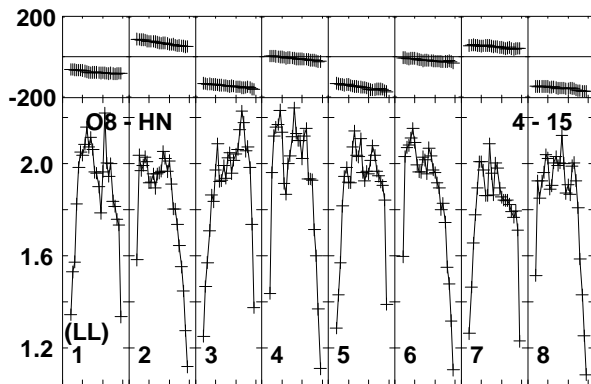
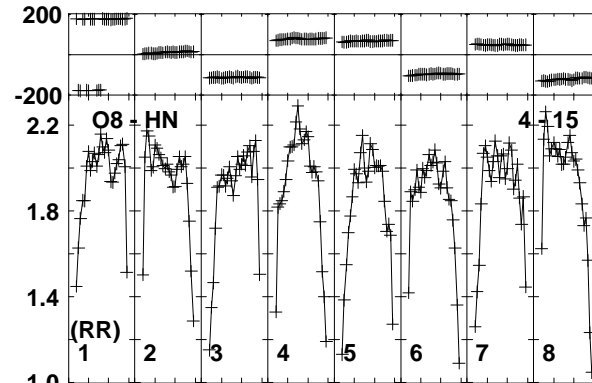
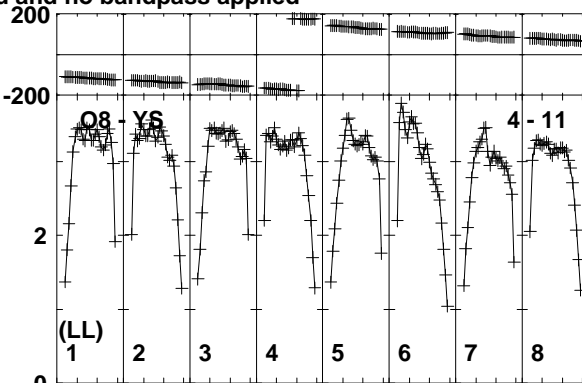
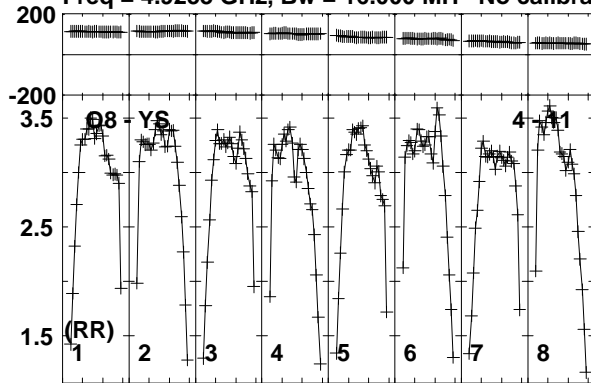

Lower frame: Milli Ampl Jy Top frame: Phas deg
Vector averaged cross-power spectrum Baseline: O8 (04) - YS (11)
Timerange: 01/01:18:31 to 01/01:20:23

Plot file version 470 created 11-APR-2016 17:09:33

J1128+5925 GP053G 3.UVDATA.1

Freq = 4.9253 GHz, Bw = 16.000 MH No calibration applied and no bandpass applied

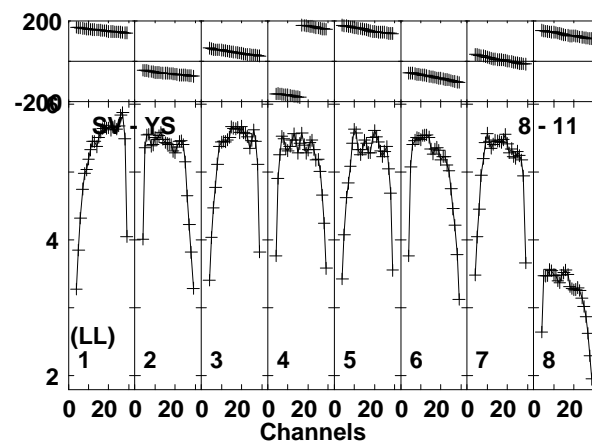
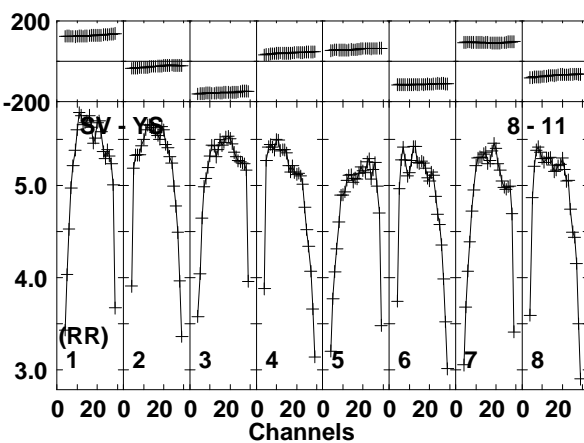
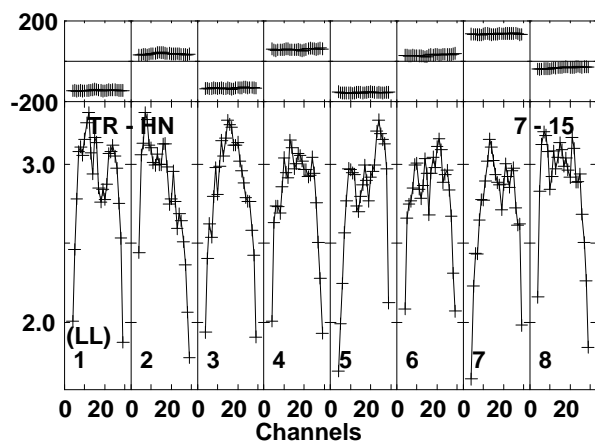
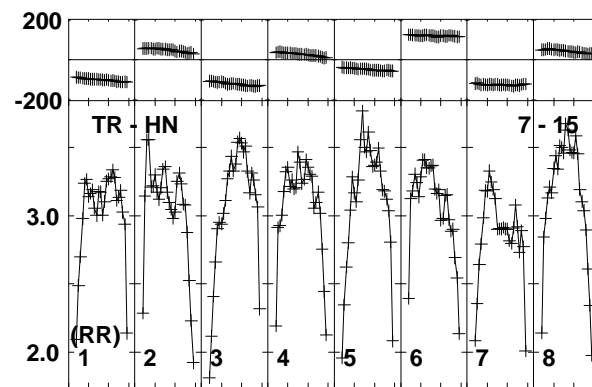
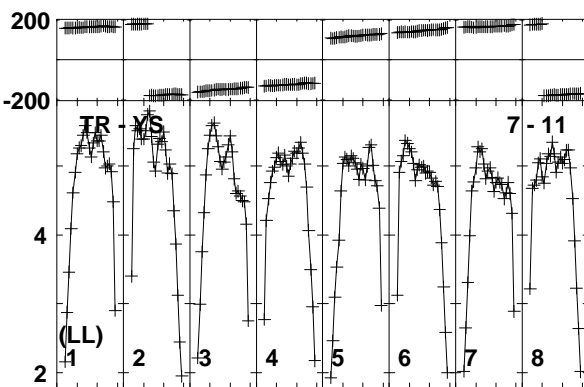
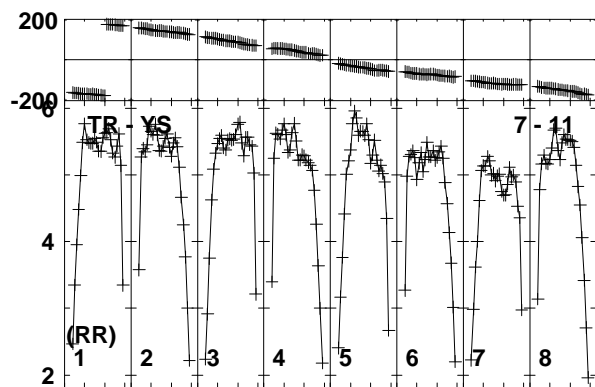
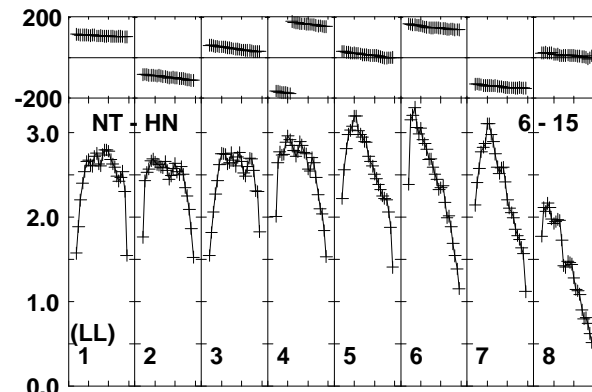
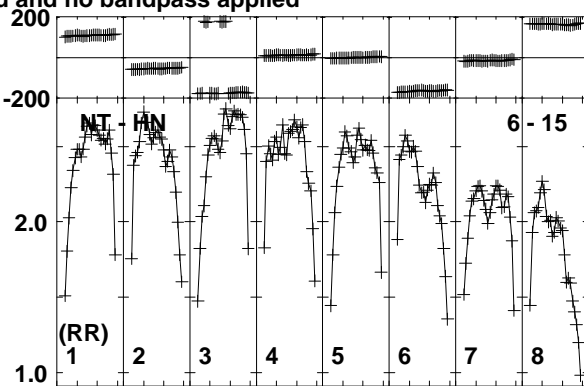
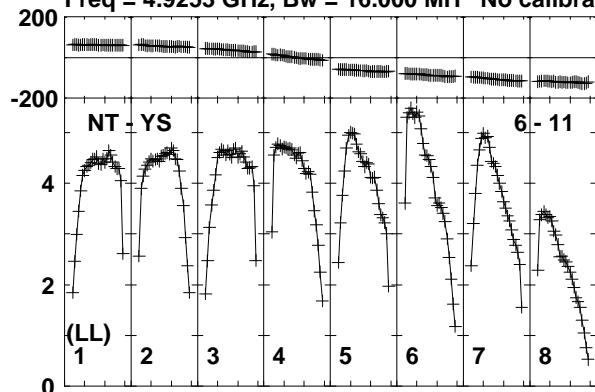

Lower frame: Milli Ampl Jy Top frame: Phas deg
Vector averaged cross-power spectrum Baseline: NT (06) - YS (11)
Timerange: 01/01:18:31 to 01/01:20:23

Plot file version 471 created 11-APR-2016 17:09:33

J1128+5925 GP053G 3.UVDATA.1

Freq = 4.9253 GHz, Bw = 16.000 MH No calibration applied and no bandpass applied

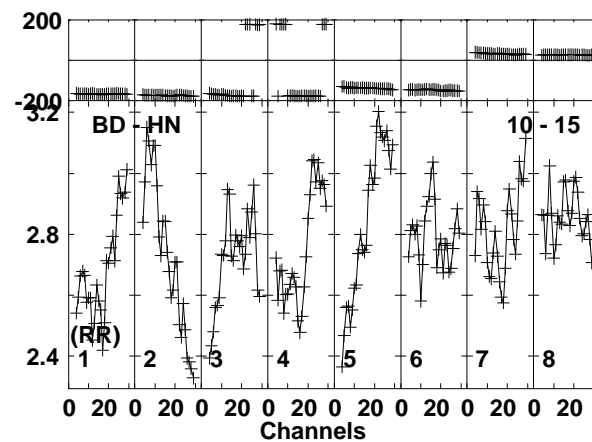
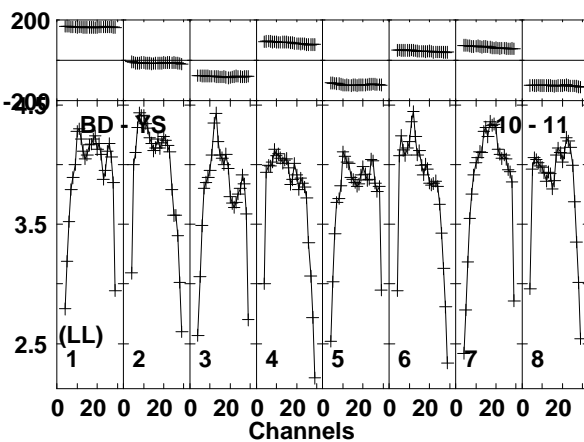
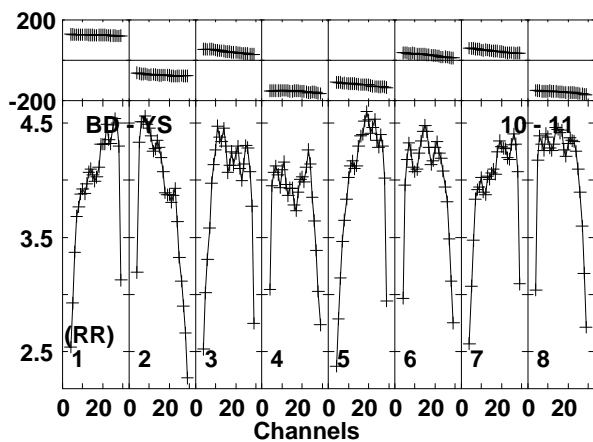
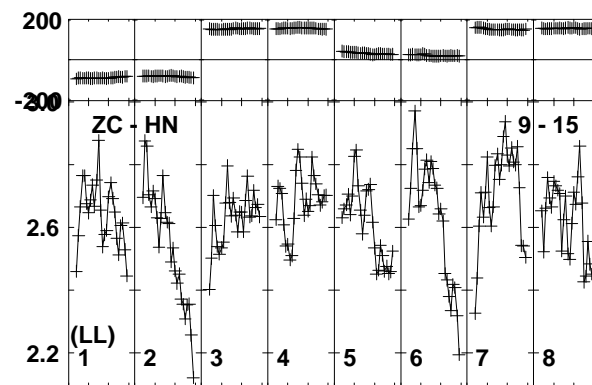
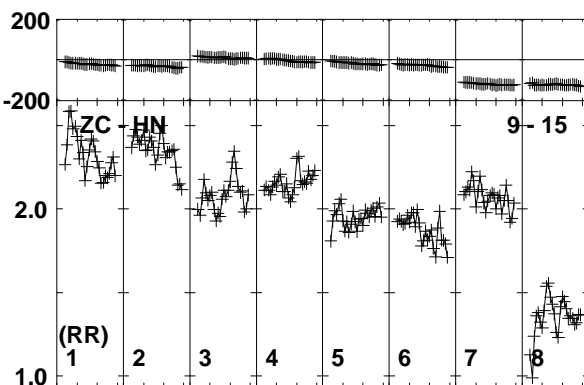
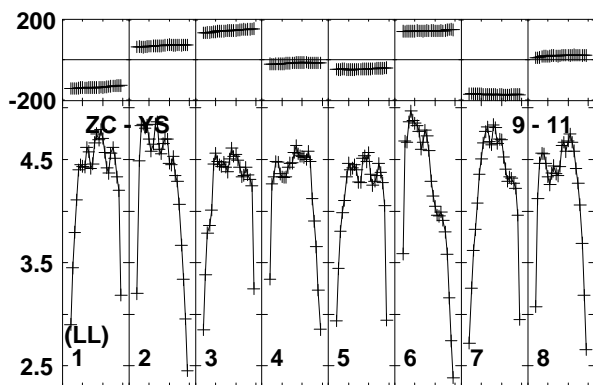
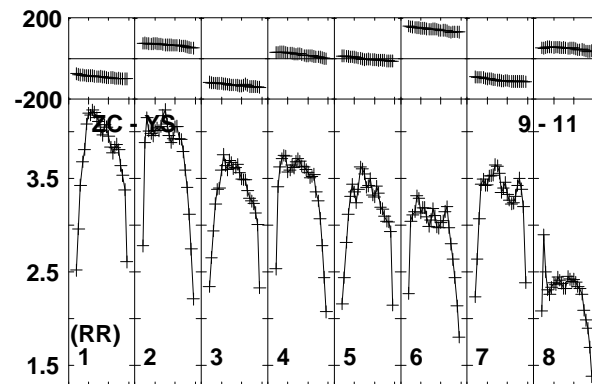
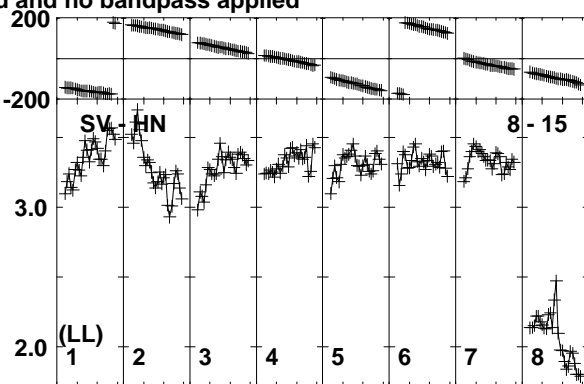
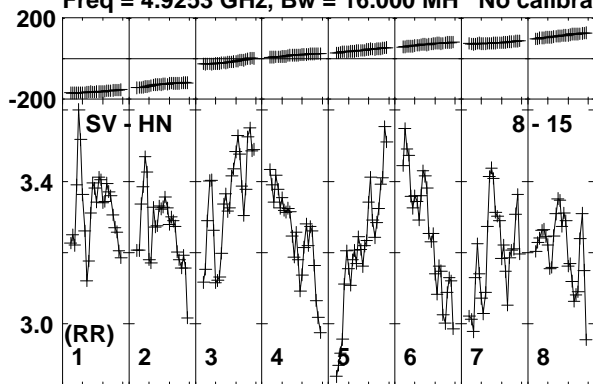

Lower frame: Milli Ampl Jy Top frame: Phas deg
Vector averaged cross-power spectrum Baseline: SV (08) - HN (15)
Timerange: 01/01:18:31 to 01/01:20:23

Plot file version 472 created 11-APR-2016 17:09:33

J1128+5925 GP053G 3.UVDATA.1

Freq = 4.9253 GHz, Bw = 16.000 MH No calibration applied and no bandpass applied

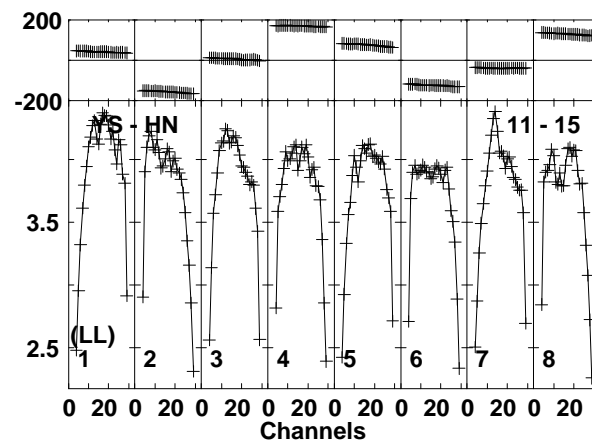
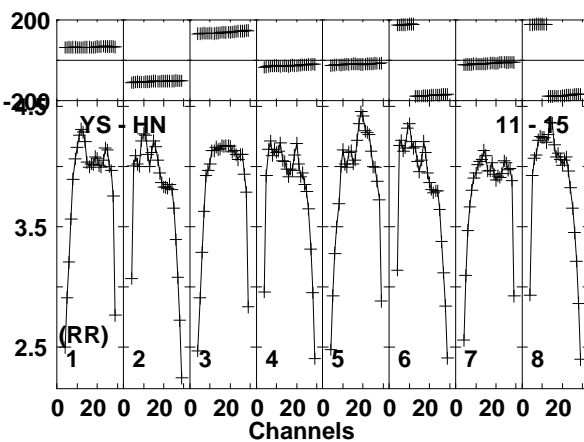
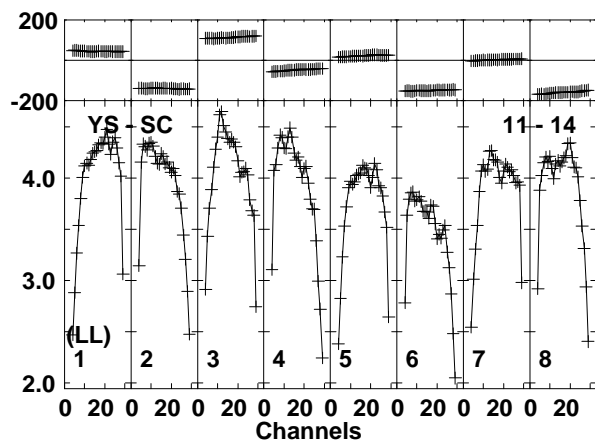
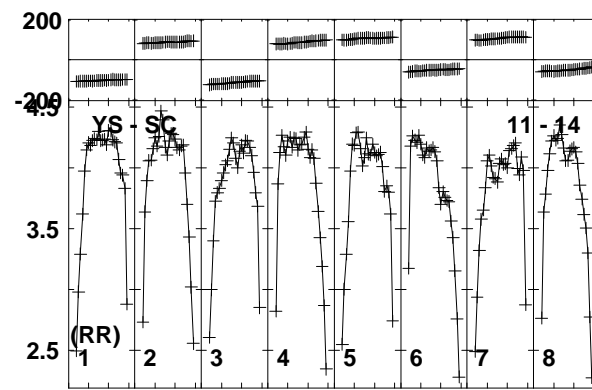
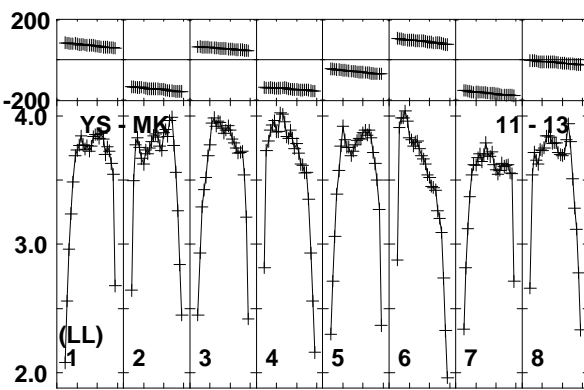
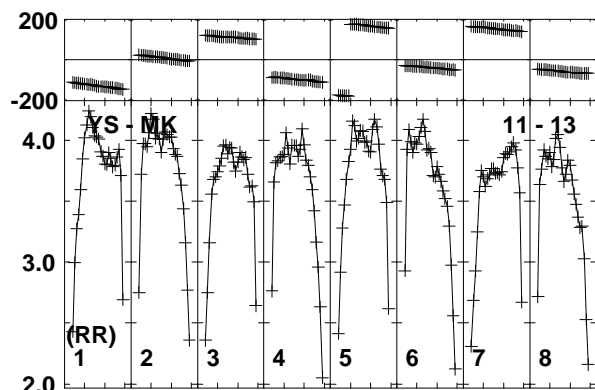
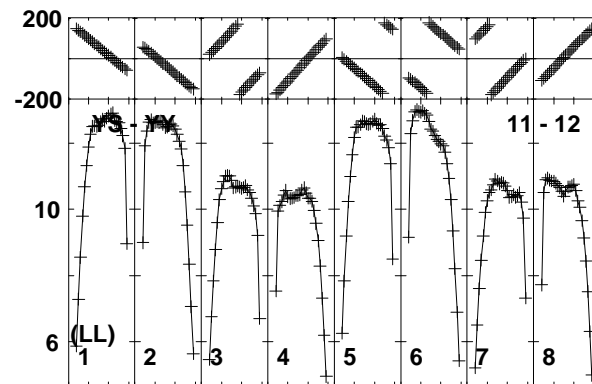
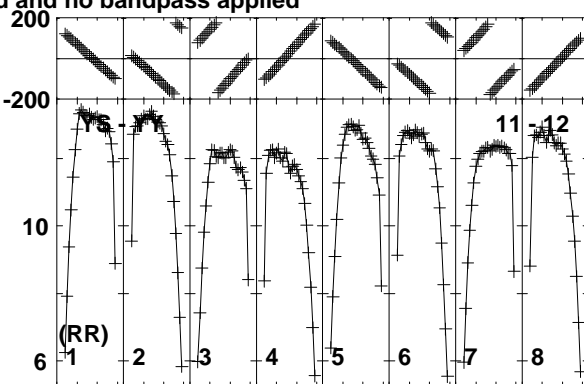
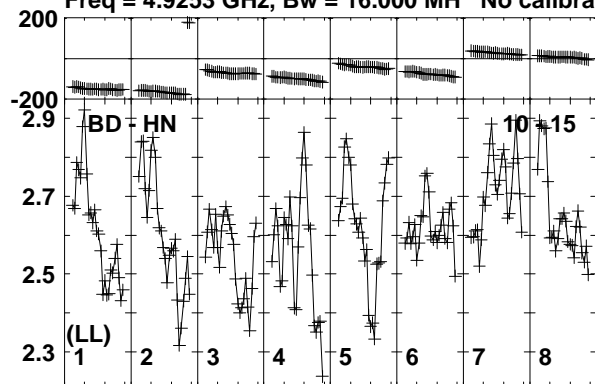

Lower frame: Milli Ampl Jy Top frame: Phas deg
Vector averaged cross-power spectrum Baseline: BD (10) - HN (15)
Timerange: 01/01:18:31 to 01/01:20:23

Plot file version 473 created 11-APR-2016 17:09:33

J1128+5925 GP053G 3.UVDATA.1

Freq = 4.9253 GHz, Bw = 16.000 MH No calibration applied and no bandpass applied

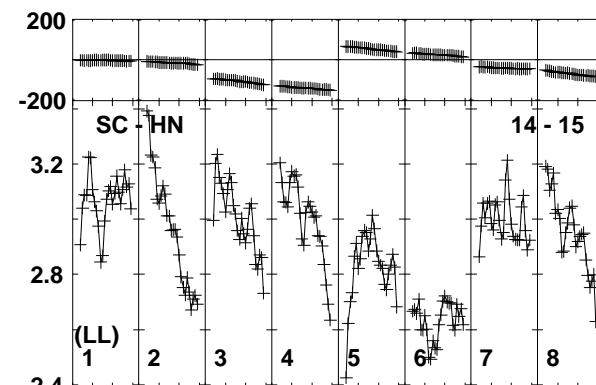
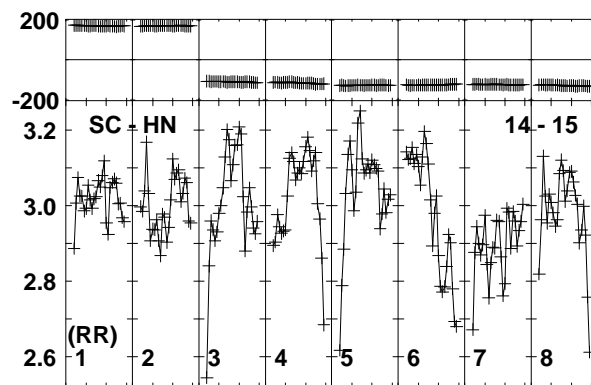
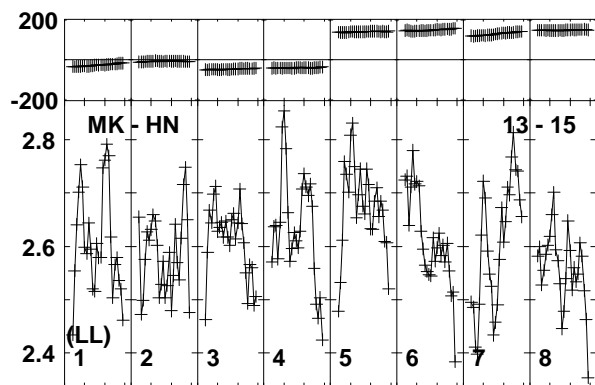
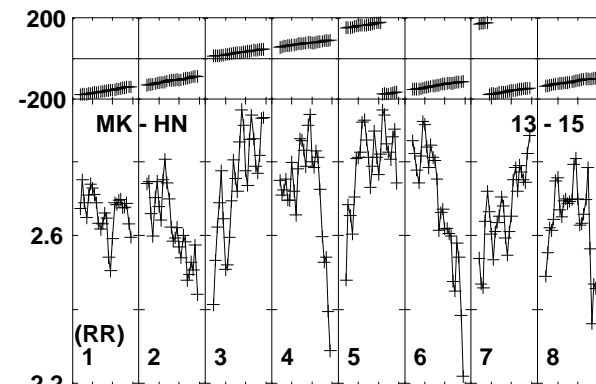
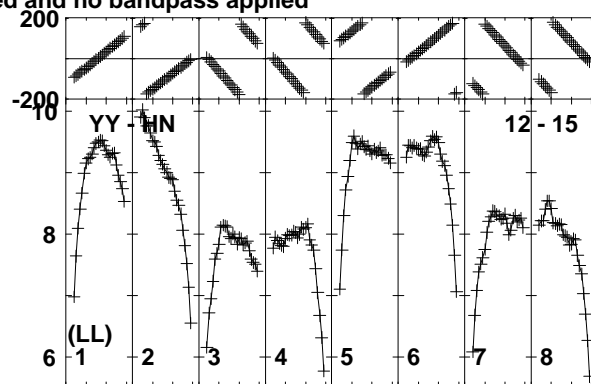
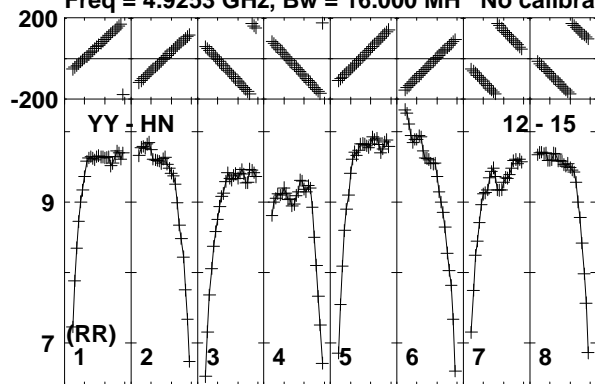

Lower frame: Milli Ampl Jy Top frame: Phas deg
Vector averaged cross-power spectrum Baseline: YY (12) - HN (15)
Timerange: 01/01:18:31 to 01/01:20:23

Plot file version 474 created 11-APR-2016 17:09:34

ARP299C GP053G 3.UVDATA.1

Freq = 4.9253 GHz, Bw = 16.000 MH No calibration applied and no bandpass applied

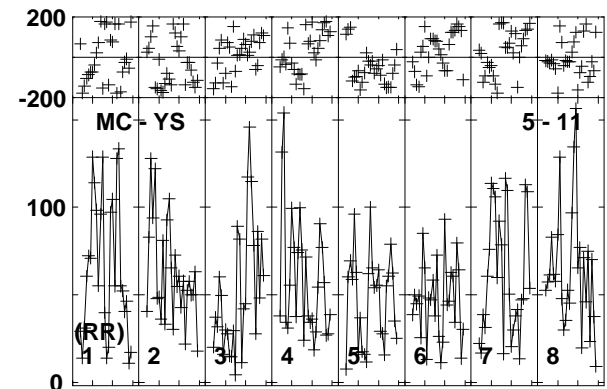
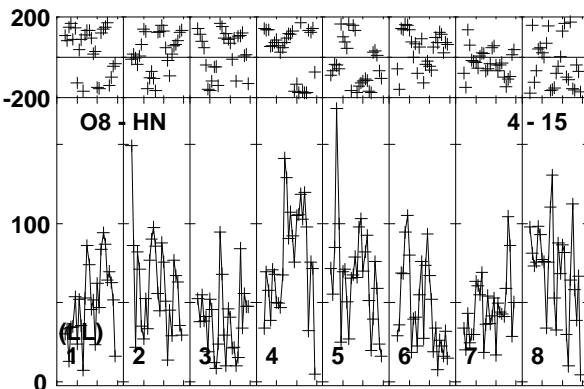
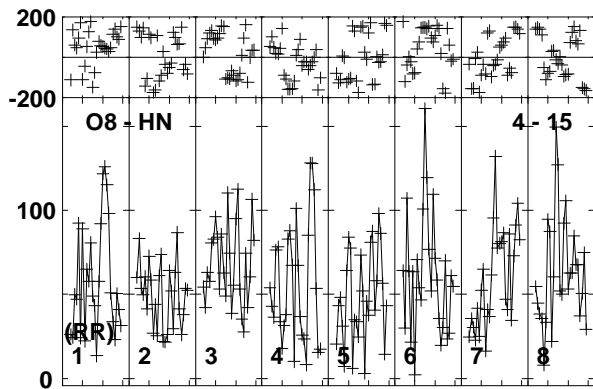
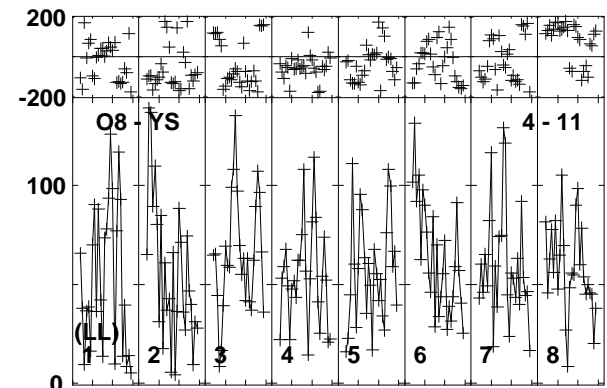
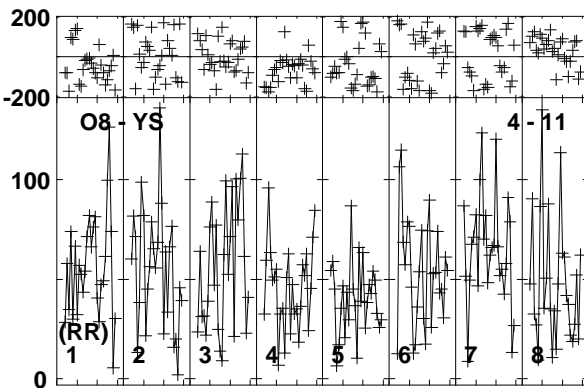
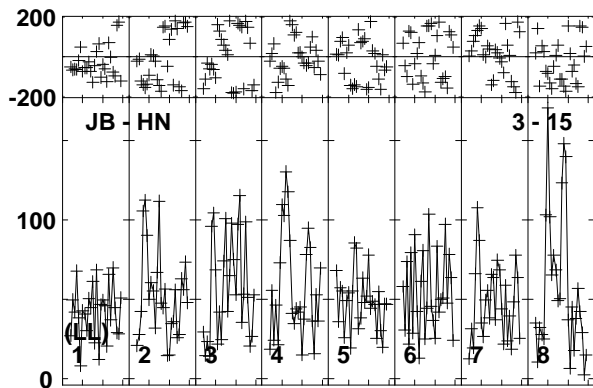
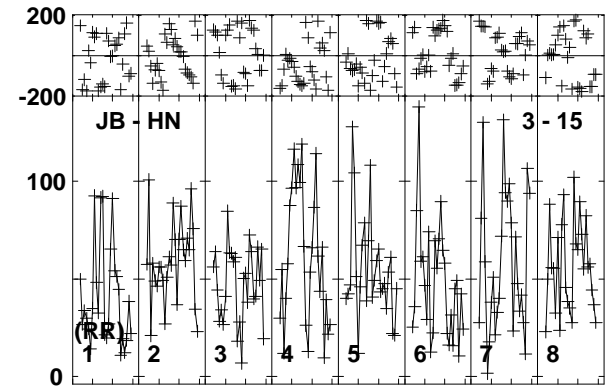
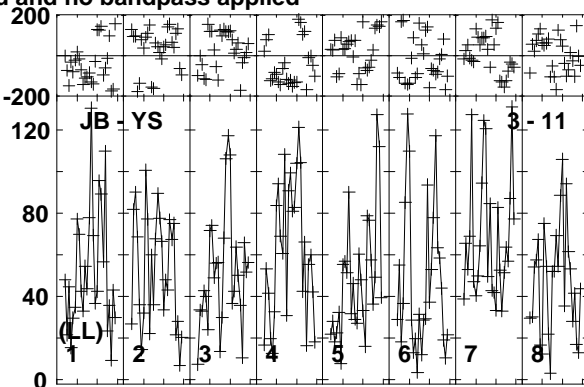
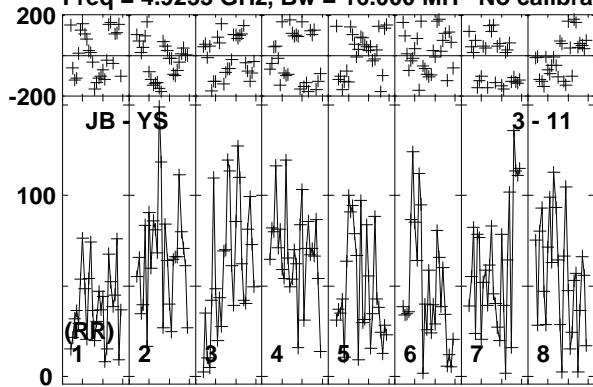

Lower frame: Micro Ampl Jy Top frame: Phas deg
Vector averaged cross-power spectrum Baseline: JB (03) - YS (11)
Timerange: 01/01:20:28 to 01/01:25:42

Plot file version 475 created 11-APR-2016 17:09:34

ARP299C GP053G 3.UVDATA.1

Freq = 4.9253 GHz, Bw = 16.000 MH No calibration applied and no bandpass applied

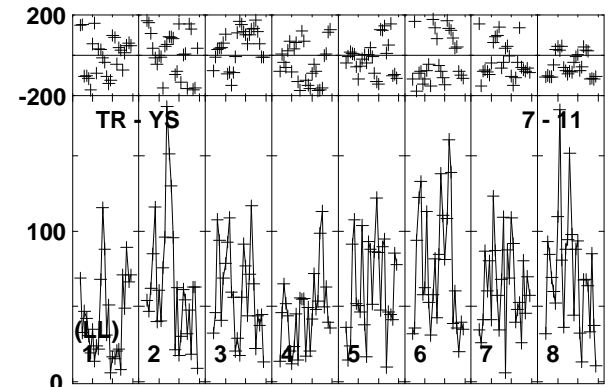
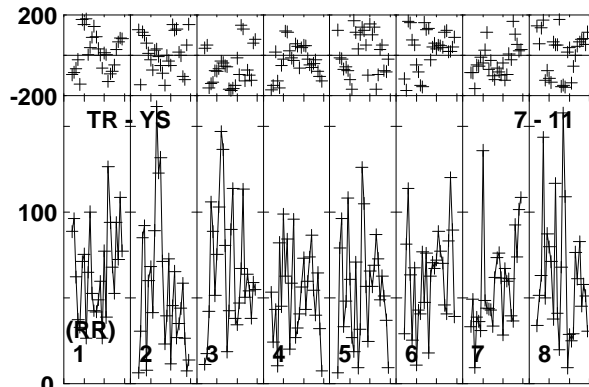
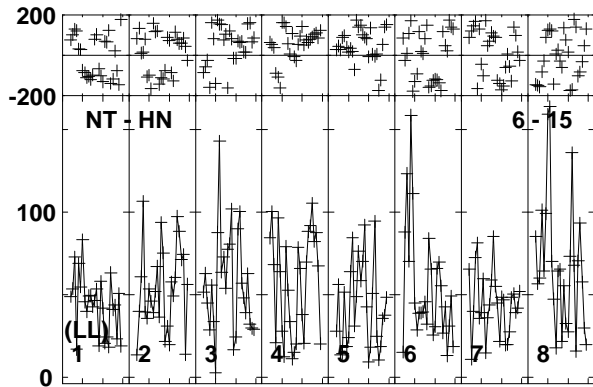
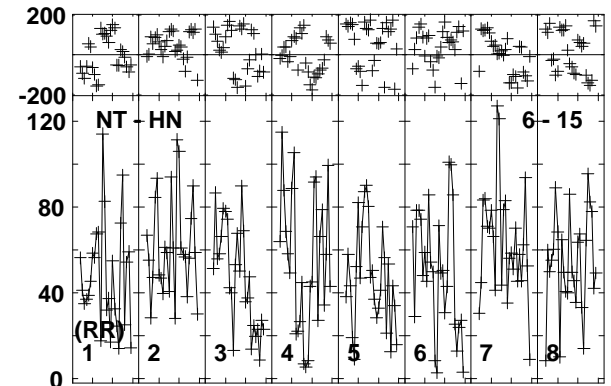
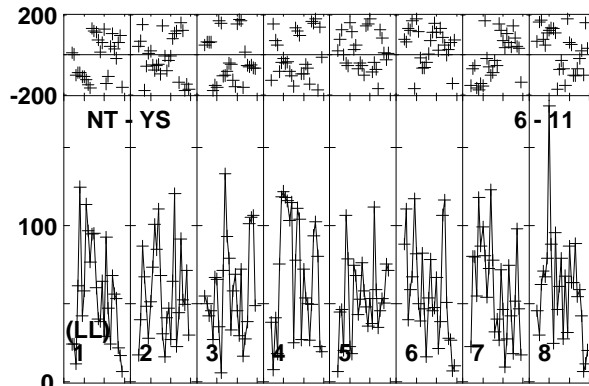
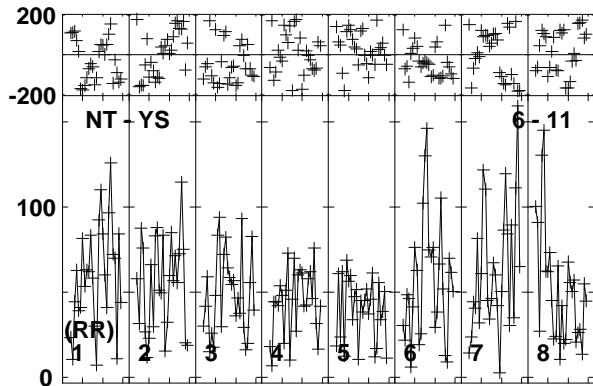
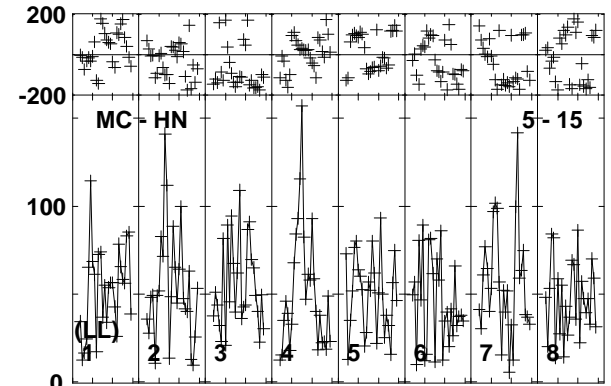
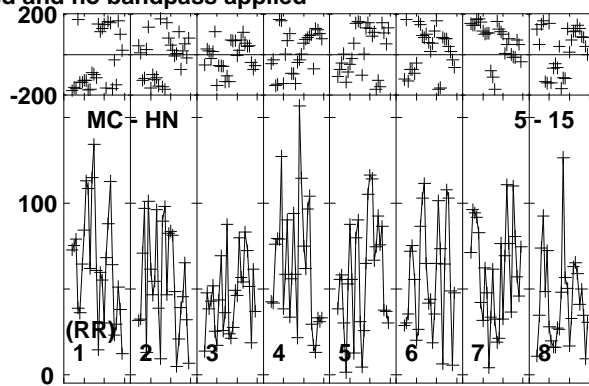
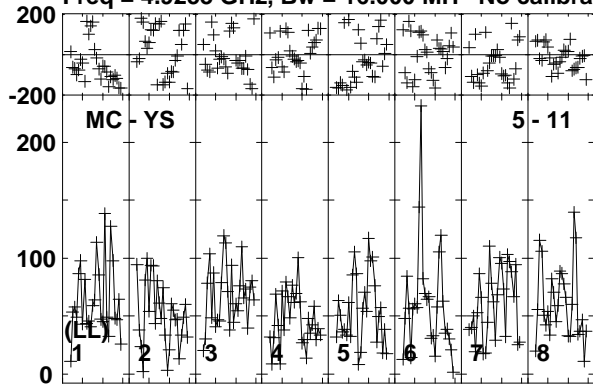

Lower frame: Micro Ampl Jy Top frame: Phas deg
Vector averaged cross-power spectrum Baseline: MC (05) - YS (11)
Timerange: 01/01:20:28 to 01/01:25:42

Plot file version 476 created 11-APR-2016 17:09:34

ARP299C GP053G 3.UVDATA.1

Freq = 4.9253 GHz, Bw = 16.000 MH No calibration applied and no bandpass applied

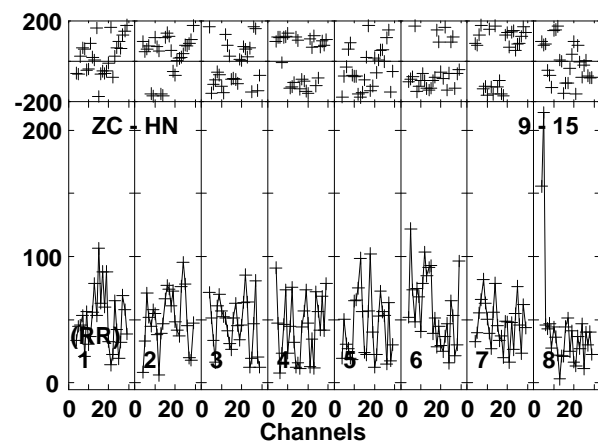
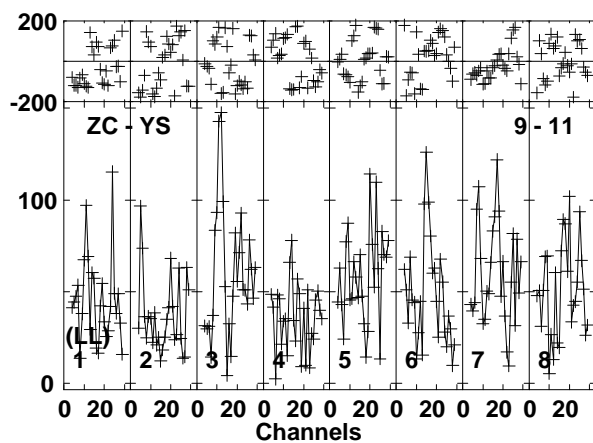
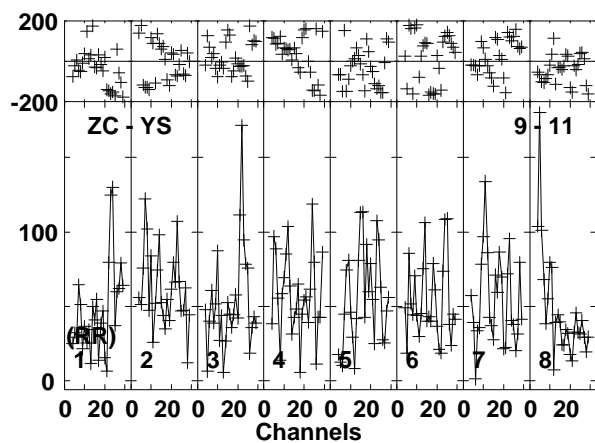
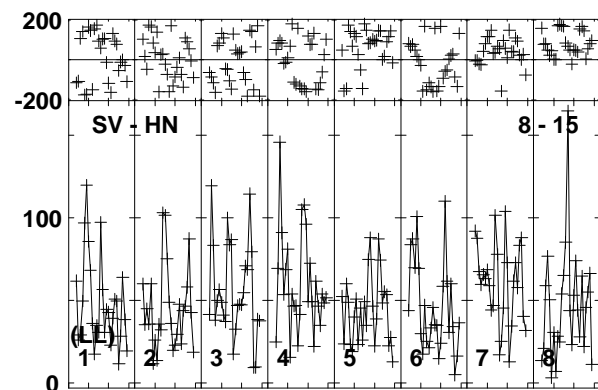
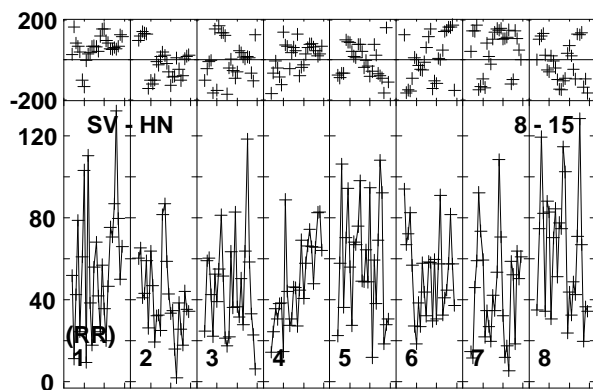
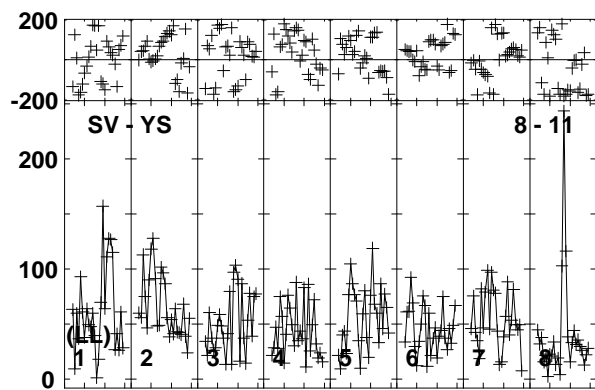
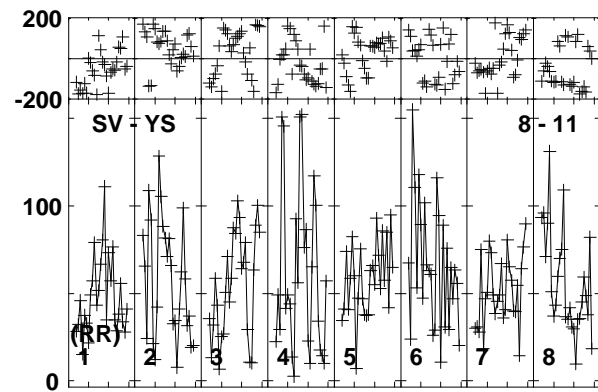
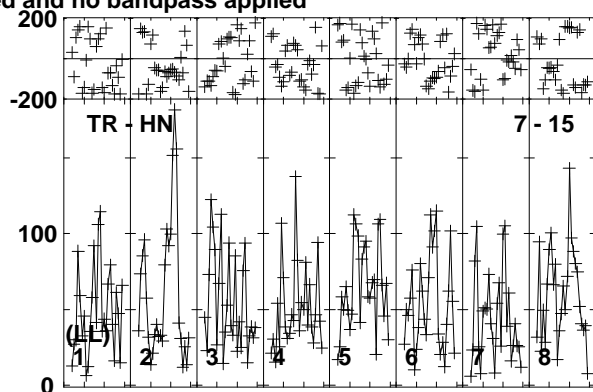
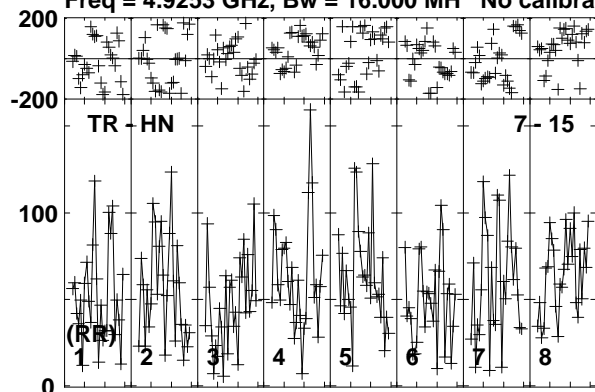

Lower frame: Micro Ampl Jy Top frame: Phas deg
Vector averaged cross-power spectrum Baseline: TR (07) - HN (15)
Timerange: 01/01:20:28 to 01/01:25:42

Plot file version 477 created 11-APR-2016 17:09:34

ARP299C GP053G 3.UVDATA.1

Freq = 4.9253 GHz, Bw = 16.000 MH No calibration applied and no bandpass applied

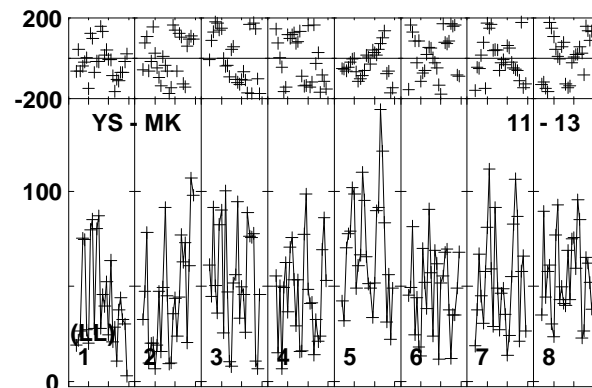
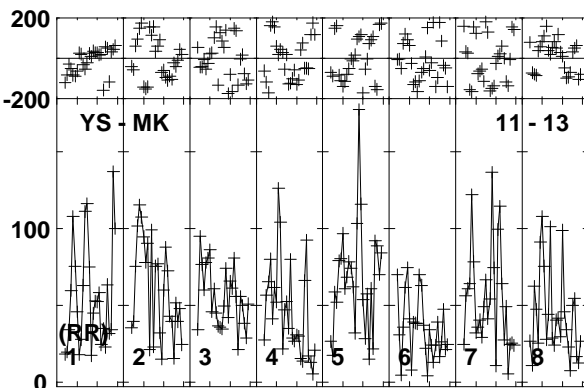
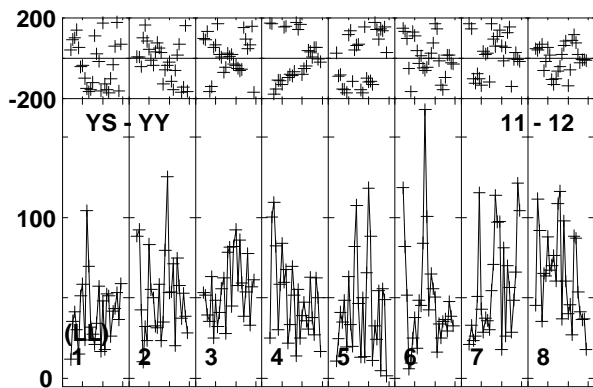
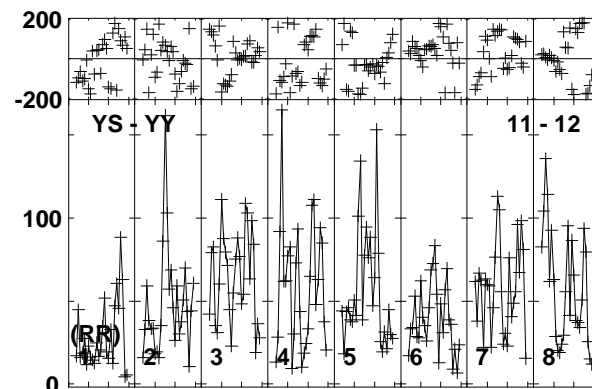
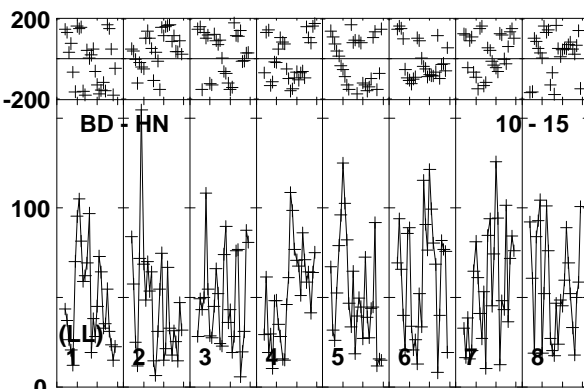
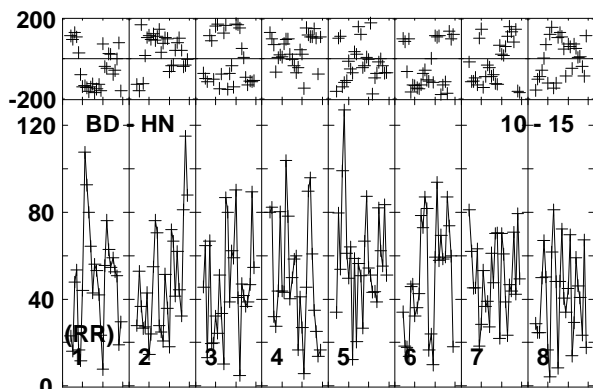
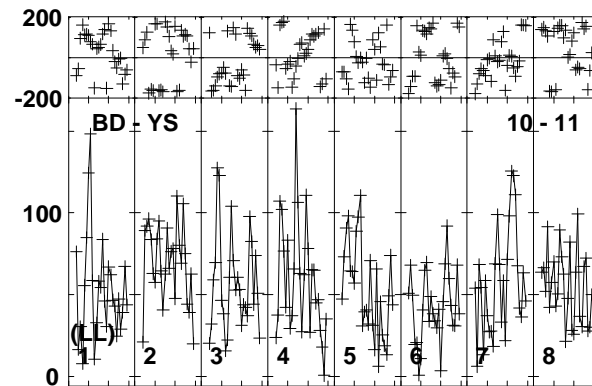
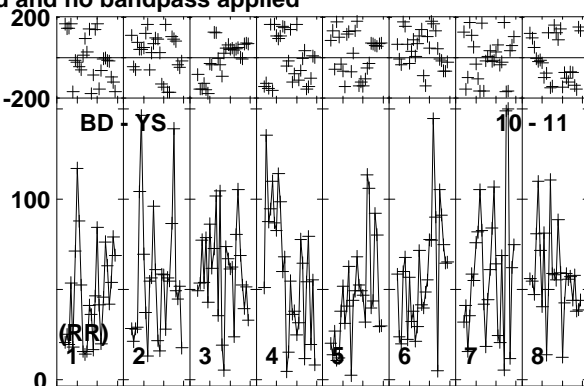
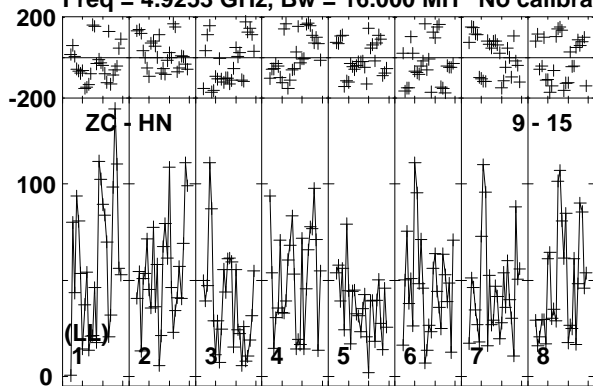

Lower frame: Micro Ampl Jy Top frame: Phas deg
Vector averaged cross-power spectrum Baseline: ZC (09) - HN (15)
Timerange: 01/01:20:28 to 01/01:25:42

Plot file version 478 created 11-APR-2016 17:09:34

ARP299C GP053G 3.UVDATA.1

Freq = 4.9253 GHz, Bw = 16.000 MH No calibration applied and no bandpass applied

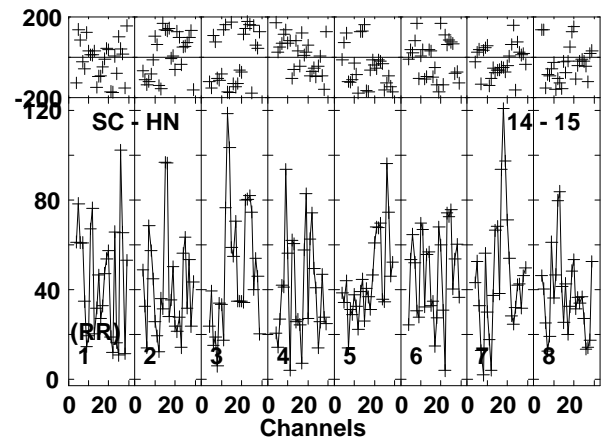
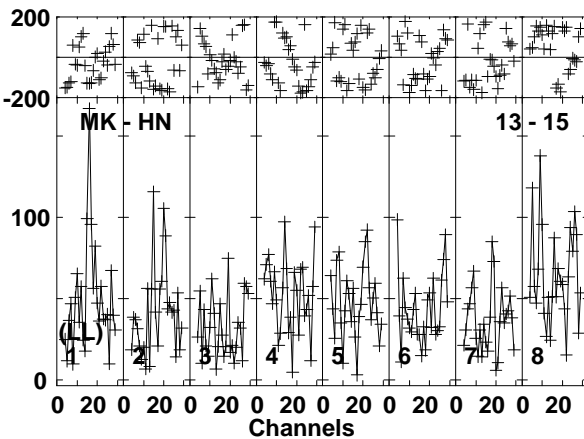
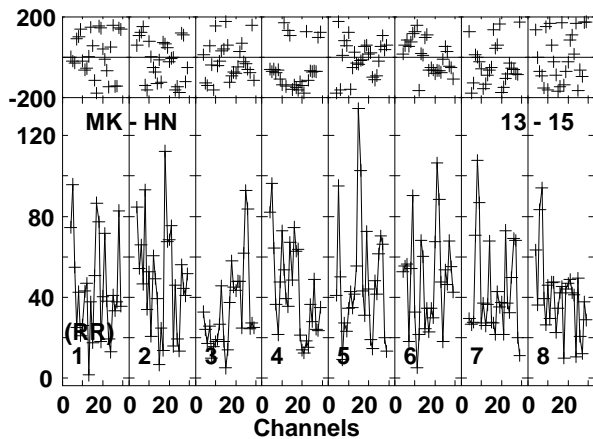
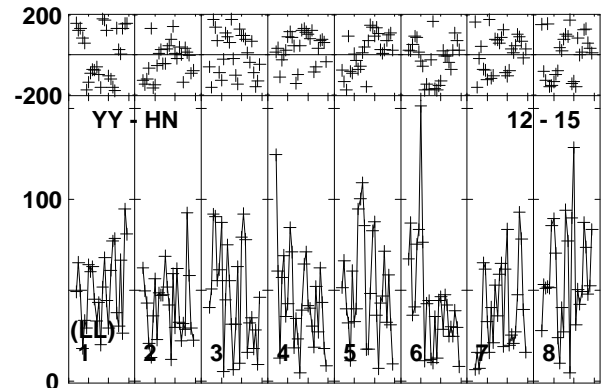
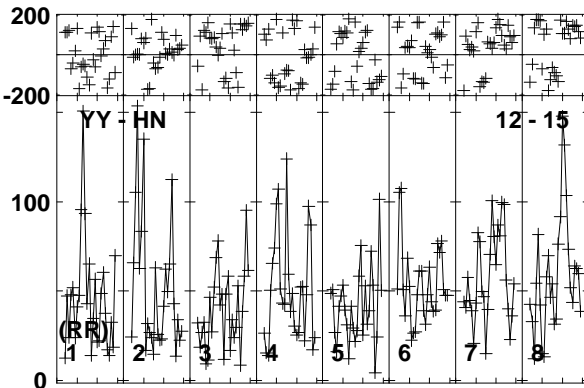
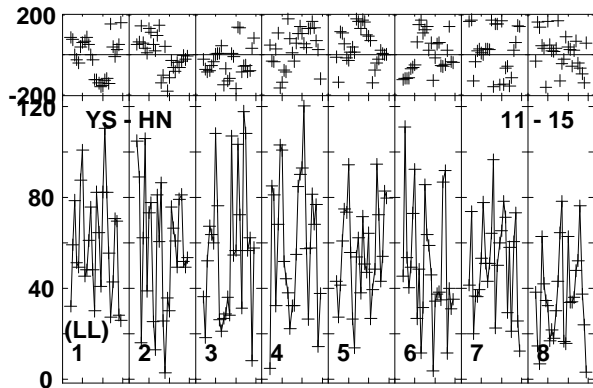
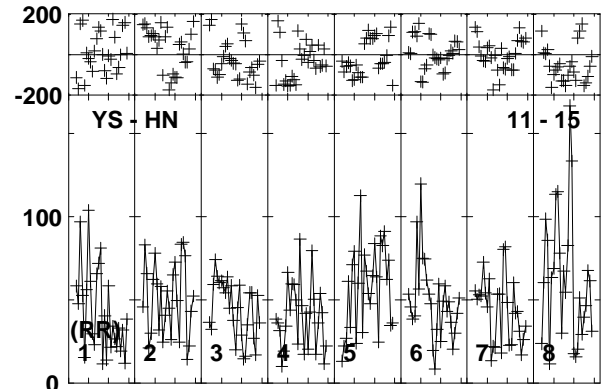
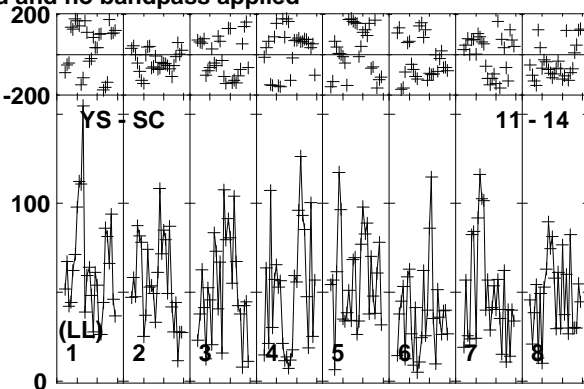
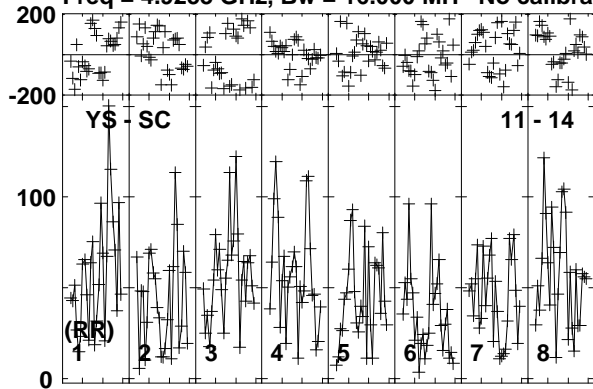

Lower frame: Micro Ampl Jy Top frame: Phas deg
Vector averaged cross-power spectrum Baseline: YS (11) - SC (14)
Timerange: 01/01:20:28 to 01/01:25:42

Plot file version 479 created 11-APR-2016 17:09:34

ARP299C GP053G 3.UVDATA.1

Freq = 4.9253 GHz, Bw = 16.000 MH No calibration applied and no bandpass applied

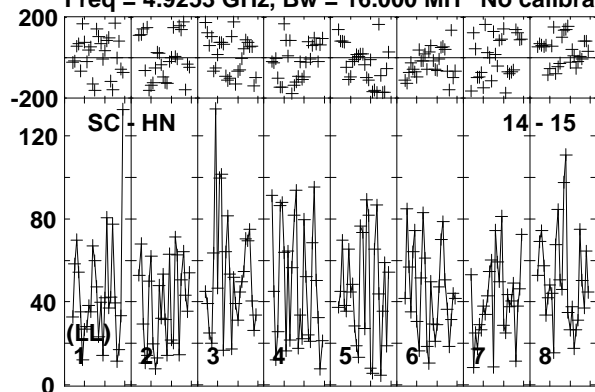

Lower frame: Micro Ampl Jy Top frame: Phas deg
Vector averaged cross-power spectrum Baseline: SC (14) - HN (15)
Timerange: 01/01:20:28 to 01/01:25:42

Plot file version 480 created 11-APR-2016 17:09:35

J1128+5925 GP053G 3.UVDATA.1

Freq = 4.9253 GHz, Bw = 16.000 MH No calibration applied and no bandpass applied

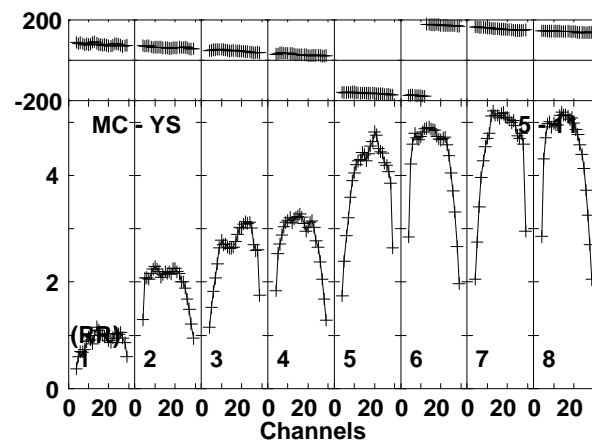
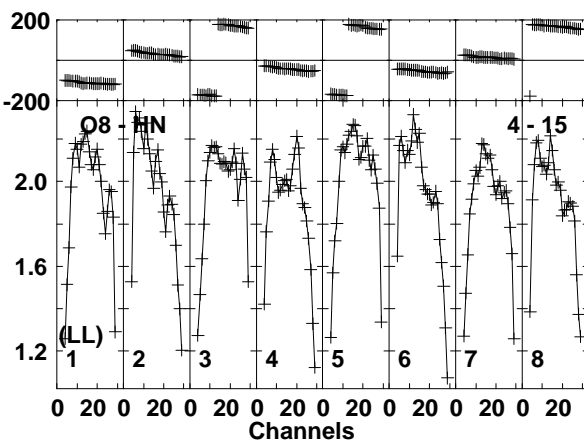
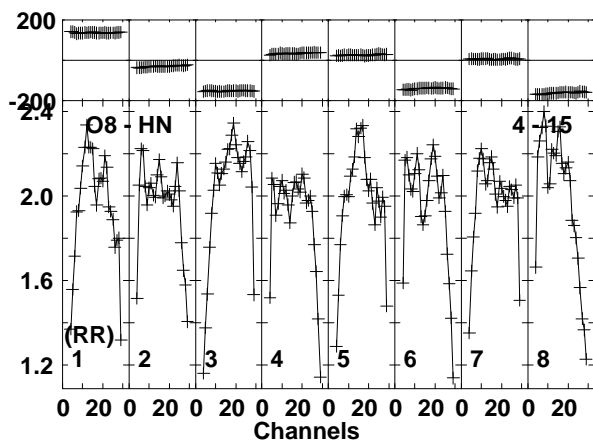
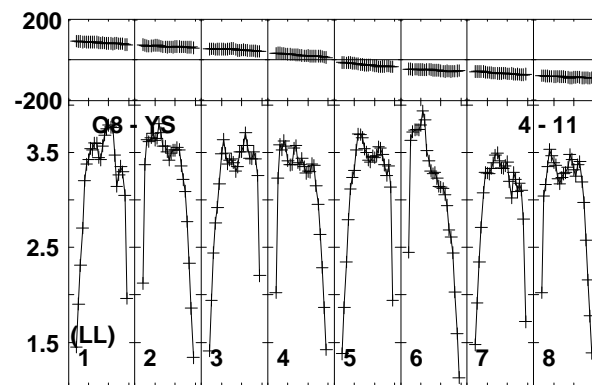
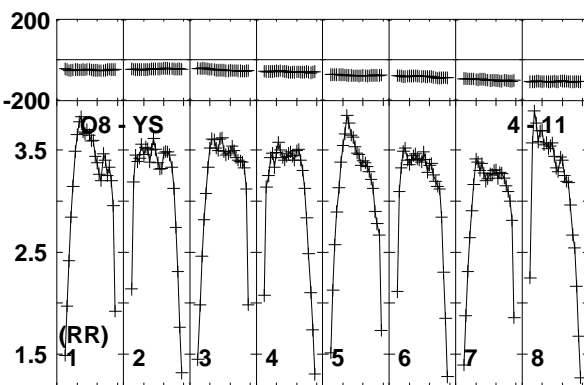
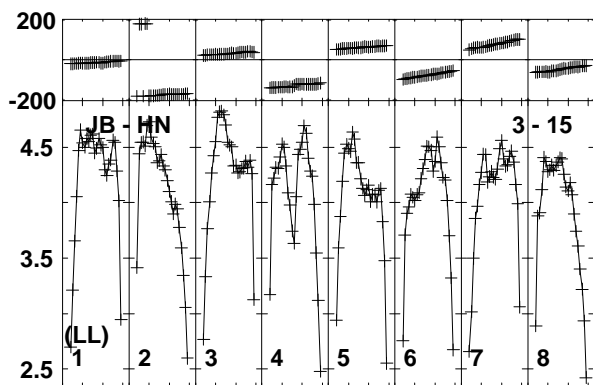
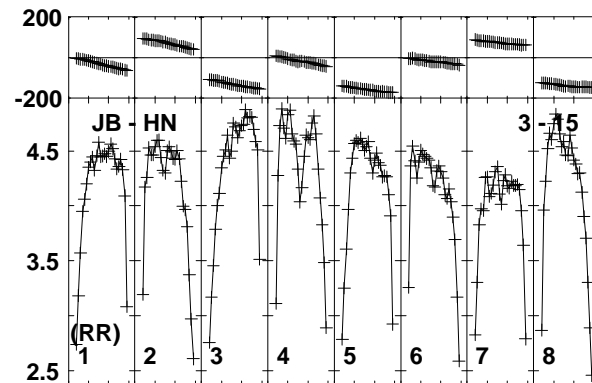
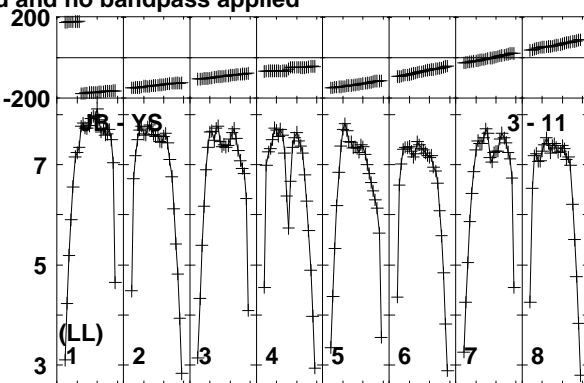
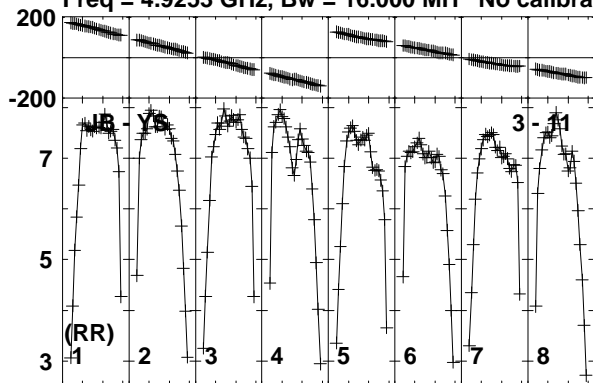

Lower frame: Milli Ampl Jy Top frame: Phas deg
Vector averaged cross-power spectrum Baseline: JB (03) - YS (11)
Timerange: 01/01:25:48 to 01/01:27:32

Plot file version 481 created 11-APR-2016 17:09:35

J1128+5925 GP053G 3.UVDATA.1

Freq = 4.9253 GHz, Bw = 16.000 MH No calibration applied and no bandpass applied

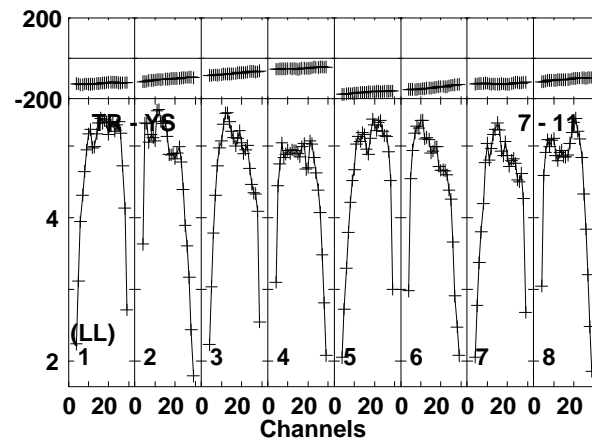
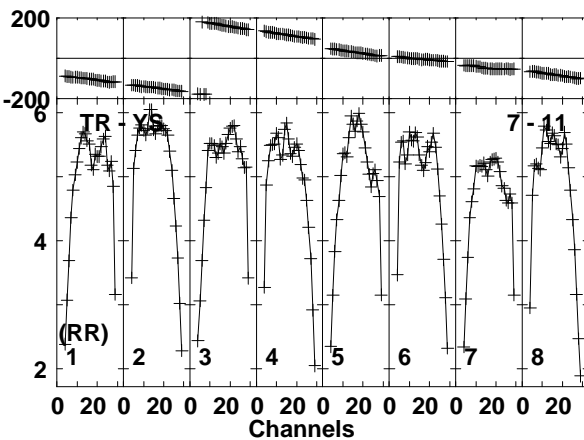
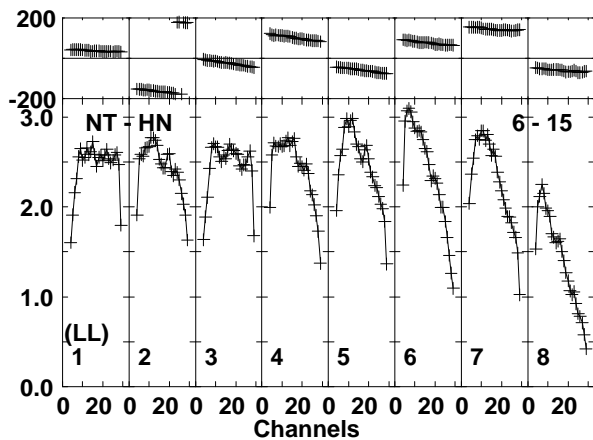
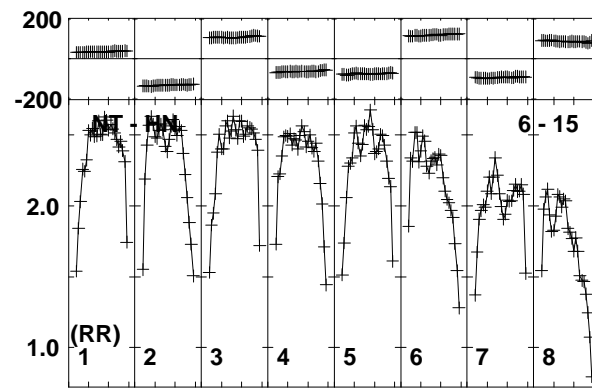
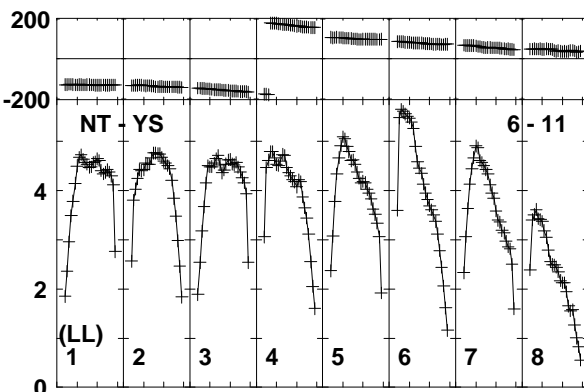
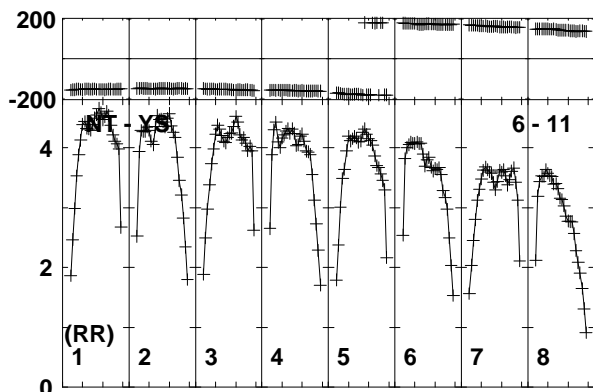
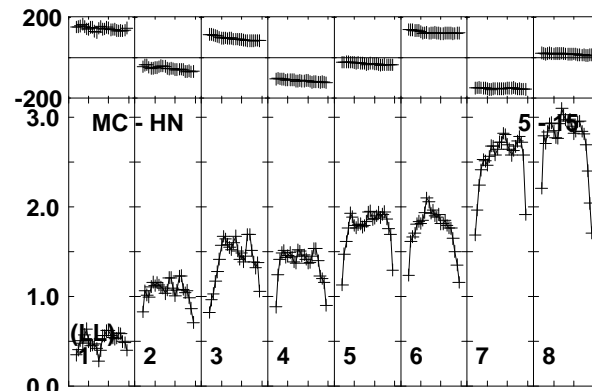
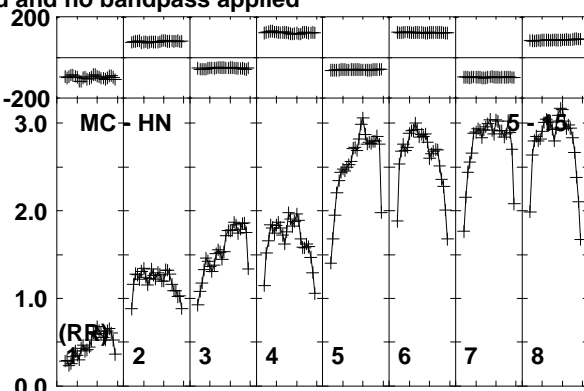
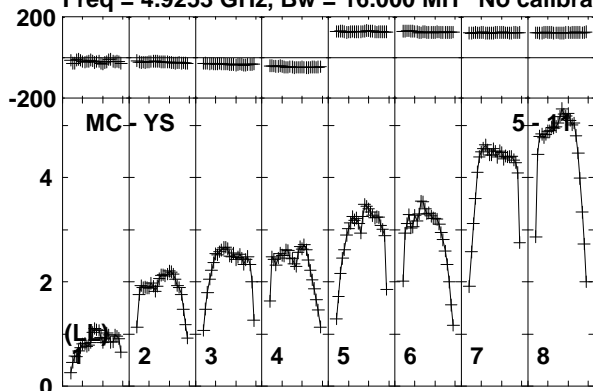

Lower frame: Milli Ampl Jy Top frame: Phas deg
Vector averaged cross-power spectrum Baseline: MC (05) - YS (11)
Timerange: 01/01:25:48 to 01/01:27:32

Plot file version 482 created 11-APR-2016 17:09:35

J1128+5925 GP053G 3.UVDATA.1

Freq = 4.9253 GHz, Bw = 16.000 MH No calibration applied and no bandpass applied

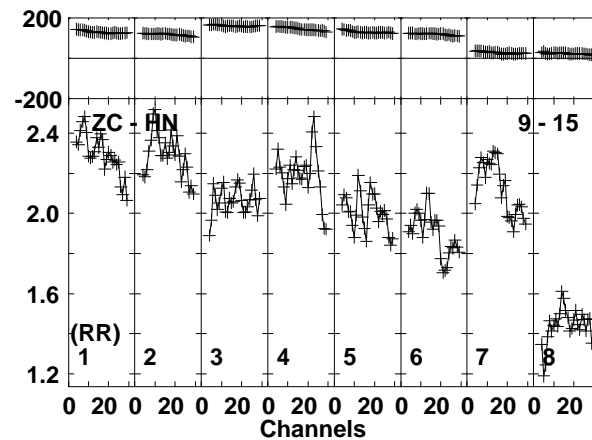
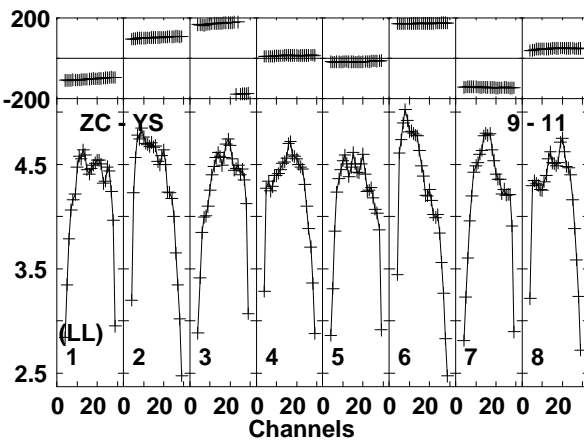
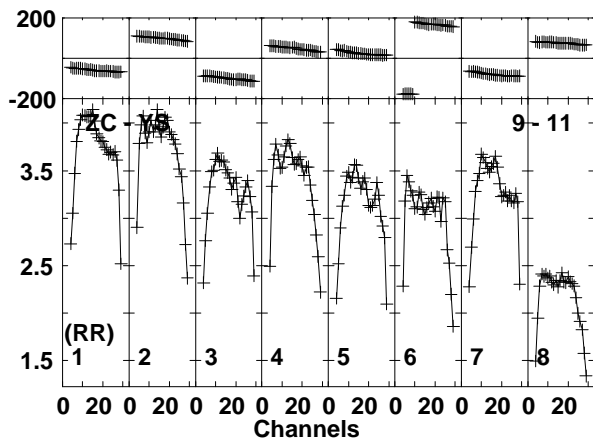
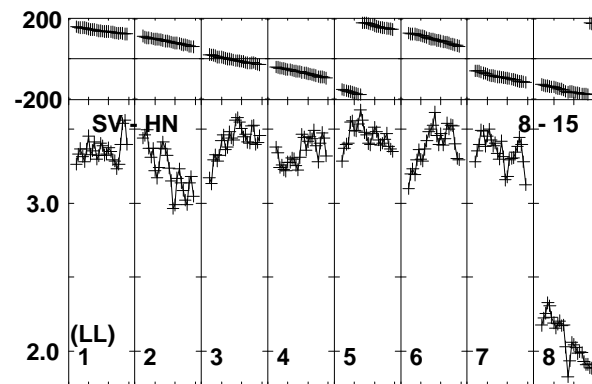
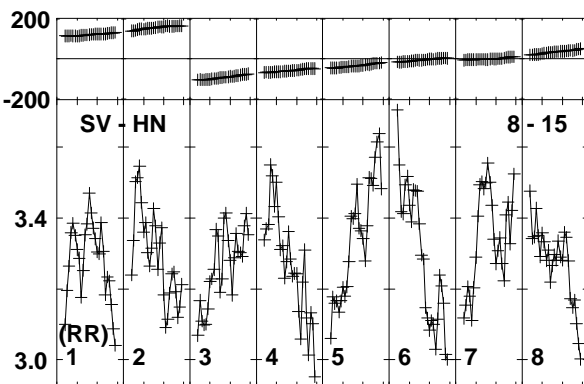
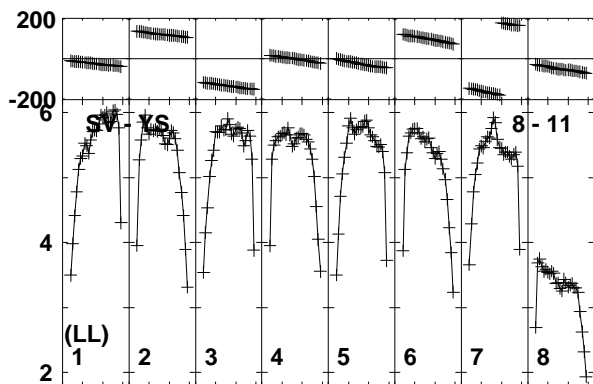
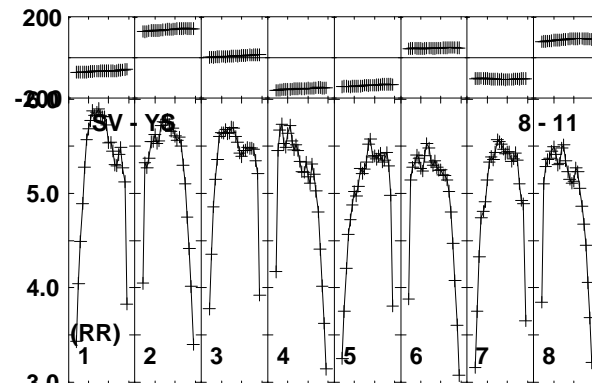
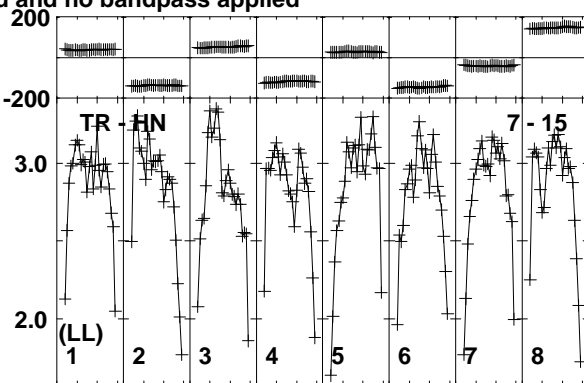
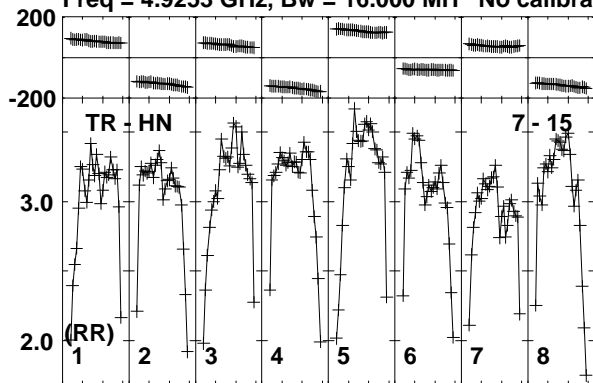

Lower frame: Milli Ampl Jy Top frame: Phas deg
Vector averaged cross-power spectrum Baseline: TR (07) - HN (15)
Timerange: 01/01:25:48 to 01/01:27:32

Plot file version 483 created 11-APR-2016 17:09:35

J1128+5925 GP053G 3.UVDATA.1

Freq = 4.9253 GHz, Bw = 16.000 MH No calibration applied and no bandpass applied

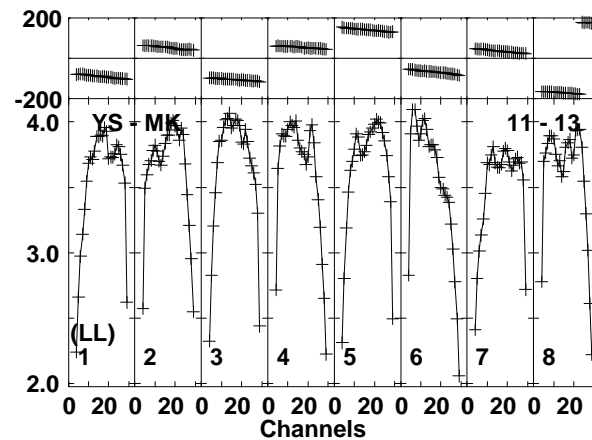
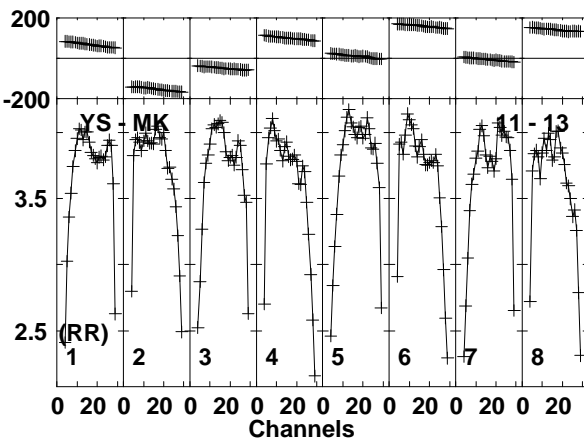
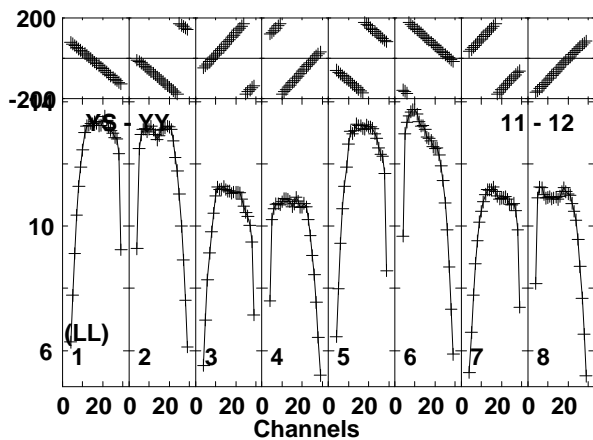
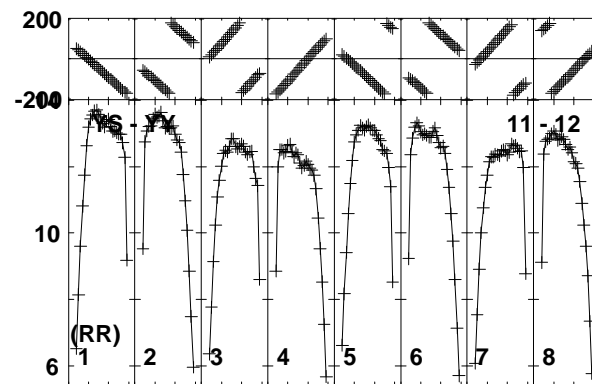
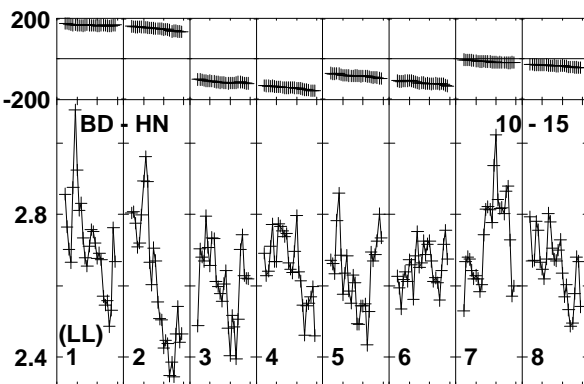
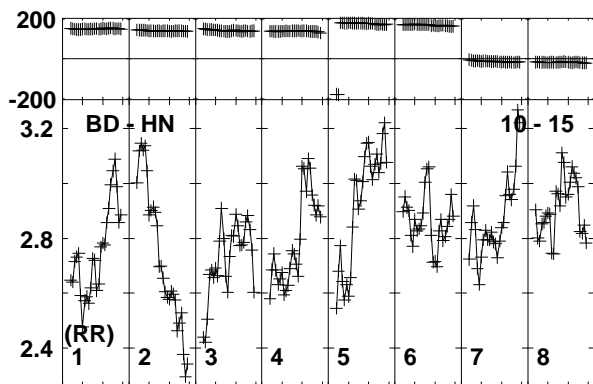
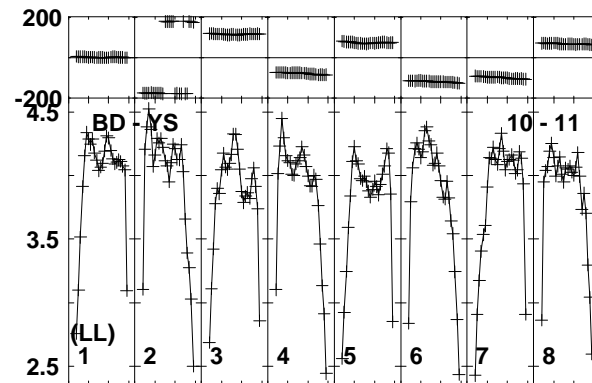
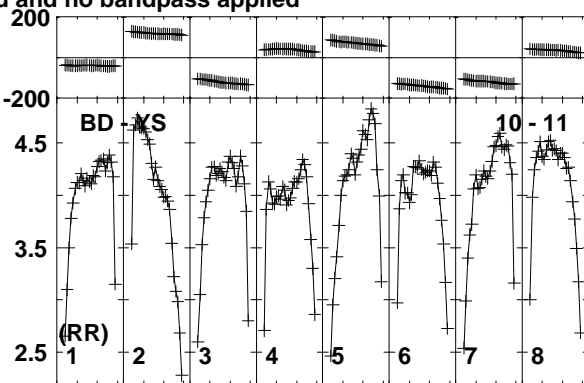
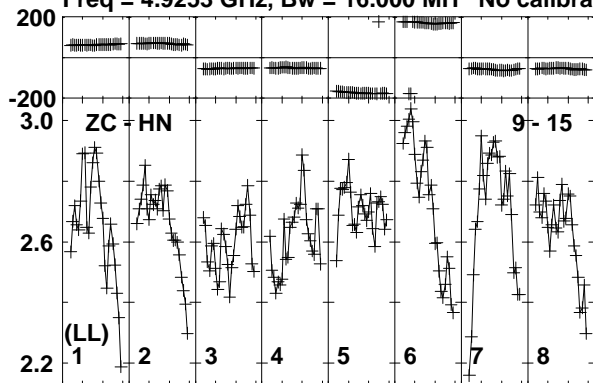

Lower frame: Milli Ampl Jy Top frame: Phas deg
Vector averaged cross-power spectrum Baseline: ZC (09) - HN (15)
Timerange: 01/01:25:48 to 01/01:27:32

Plot file version 484 created 11-APR-2016 17:09:35

J1128+5925 GP053G 3.UVDATA.1

Freq = 4.9253 GHz, Bw = 16.000 MH No calibration applied and no bandpass applied

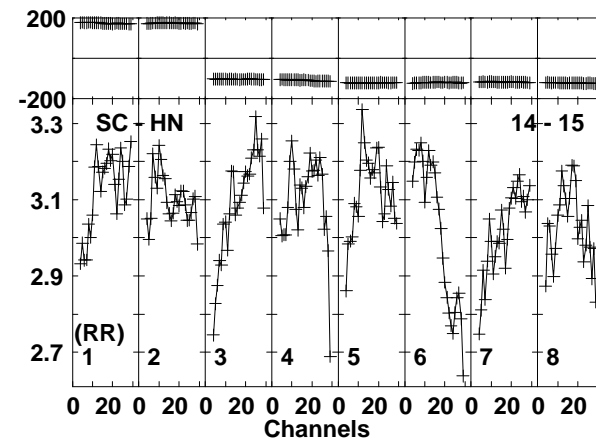
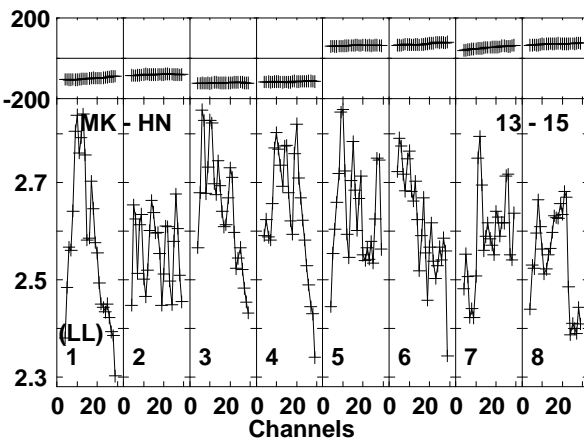
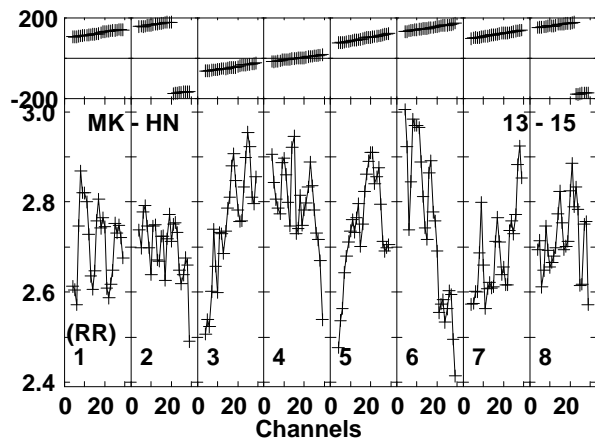
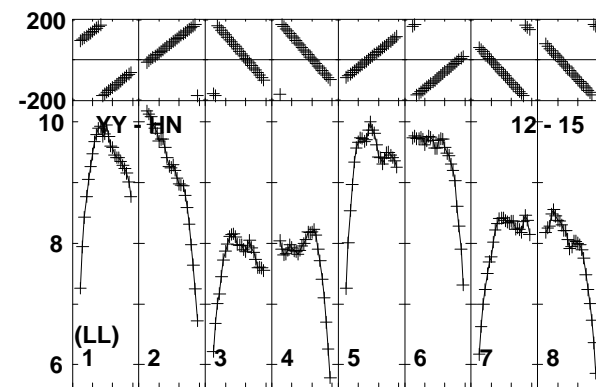
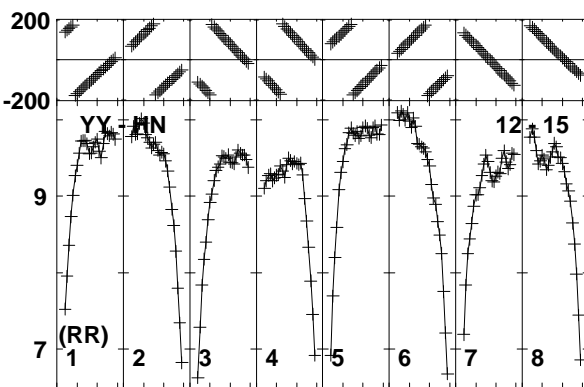
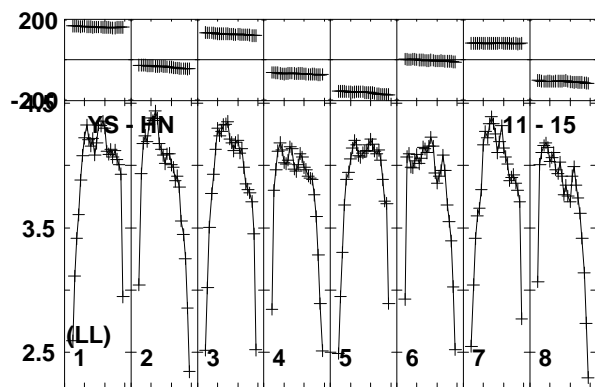
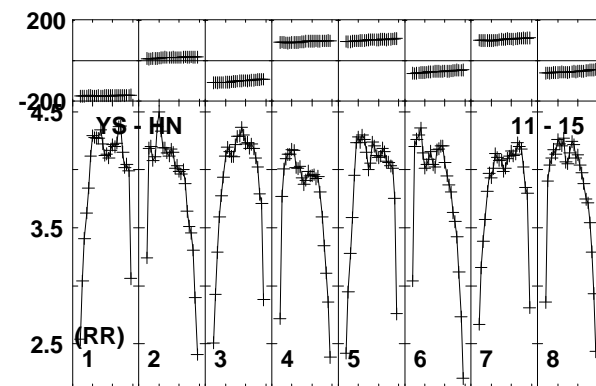
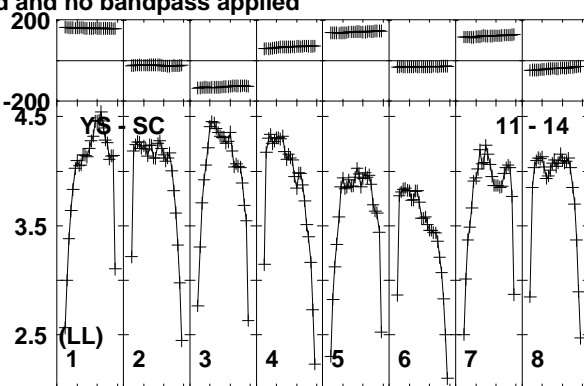
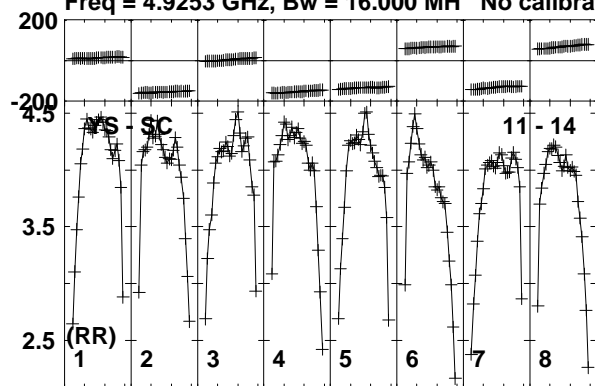

Lower frame: Milli Ampl Jy Top frame: Phas deg
Vector averaged cross-power spectrum Baseline: YS (11) - SC (14)
Timerange: 01/01:25:48 to 01/01:27:32

Plot file version 485 created 11-APR-2016 17:09:35
J1128+5925 GP053G 3.UVDATA.1
Freq = 4.9253 GHz, Bw = 16.000 MH No calibration applied and no bandpass applied

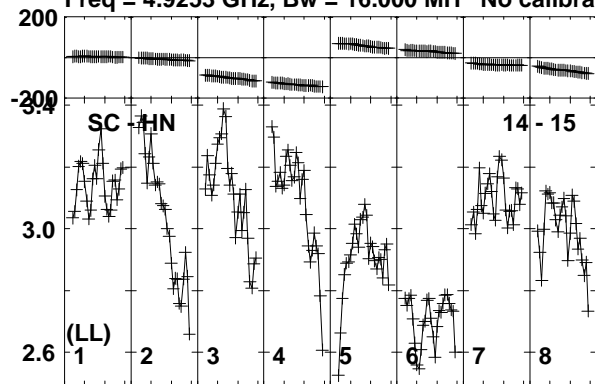

Lower frame: Milli Ampl Jy Top frame: Phas deg
Vector averaged cross-power spectrum Baseline: SC (14) - HN (15)
Timerange: 01/01:25:48 to 01/01:27:32

Plot file version 486 created 11-APR-2016 17:09:35

ARP299C GP053G 3.UVDATA.1

Freq = 4.9253 GHz, Bw = 16.000 MH No calibration applied and no bandpass applied

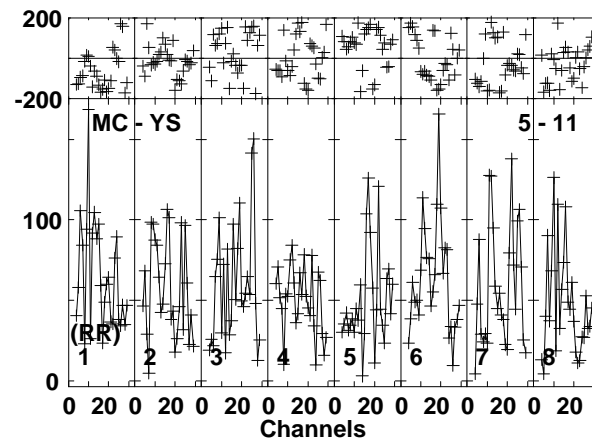
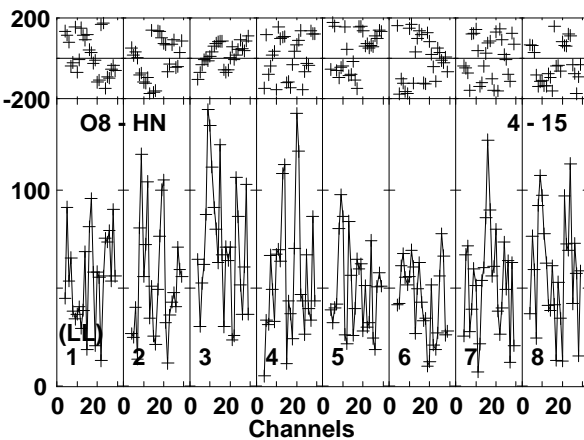
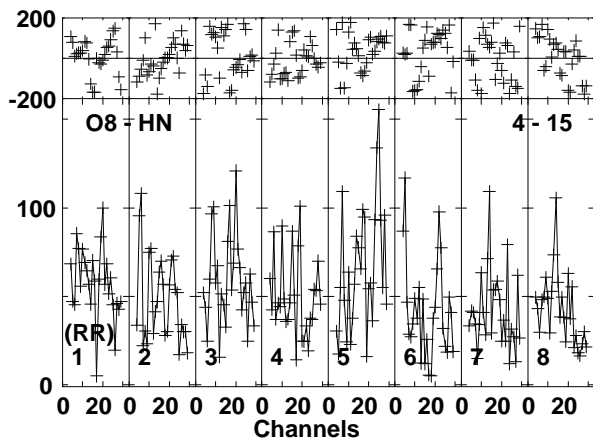
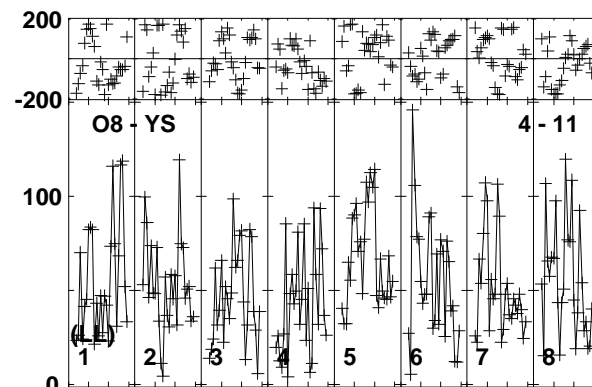
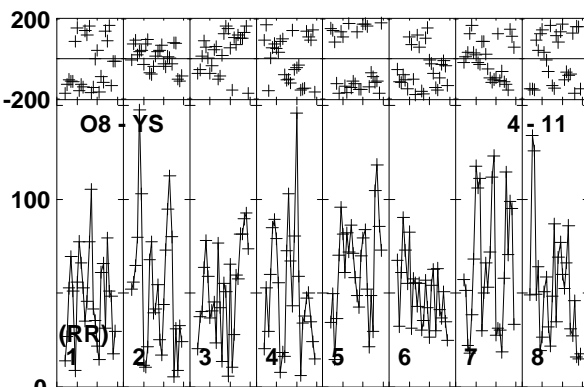
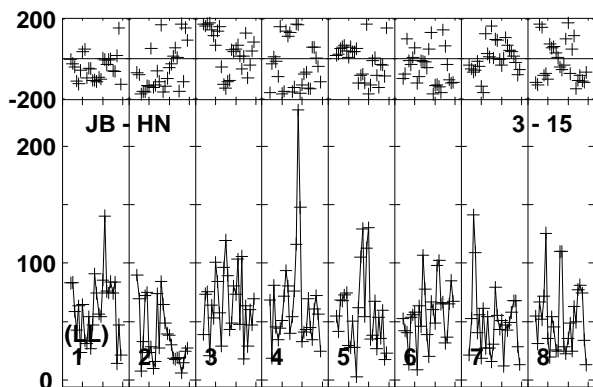
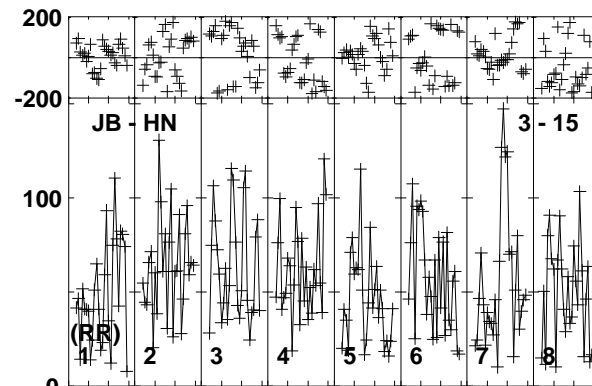
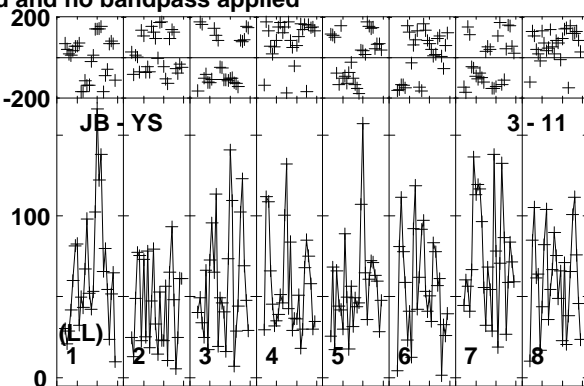
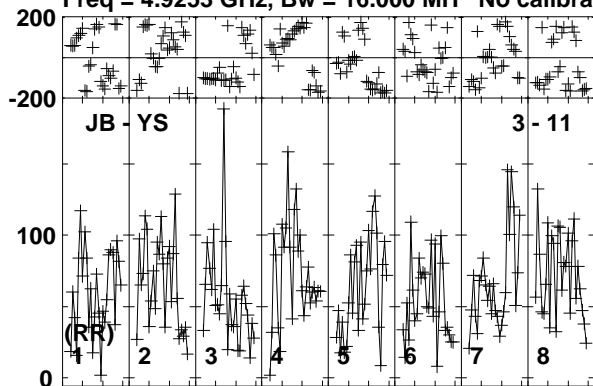

Lower frame: Micro Ampl Jy Top frame: Phas deg
Vector averaged cross-power spectrum Baseline: JB (03) - YS (11)
Timerange: 01/01:27:38 to 01/01:32:50

Plot file version 487 created 11-APR-2016 17:09:36

ARP299C GP053G 3.UVDATA.1

Freq = 4.9253 GHz, Bw = 16.000 MH No calibration applied and no bandpass applied

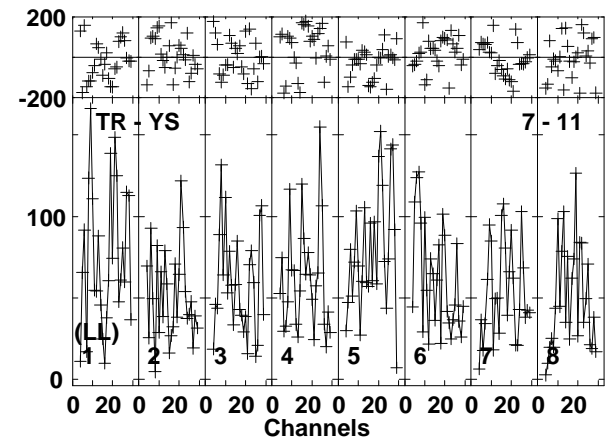
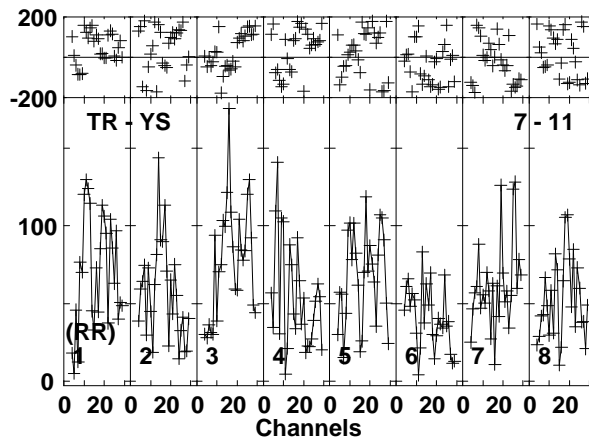
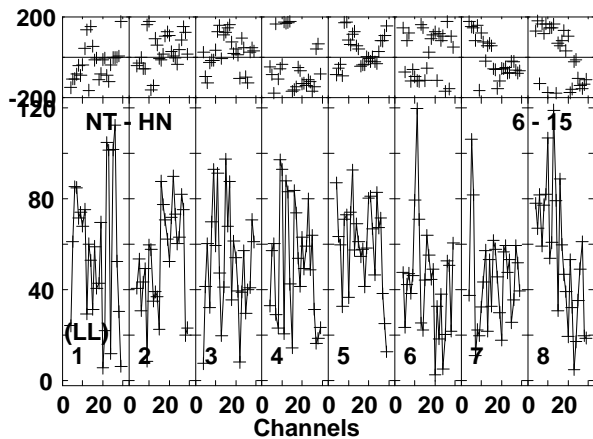
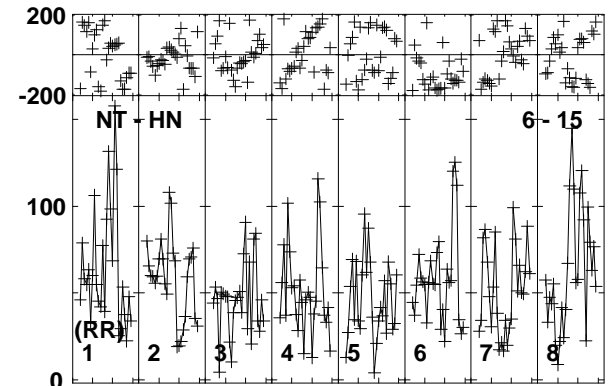
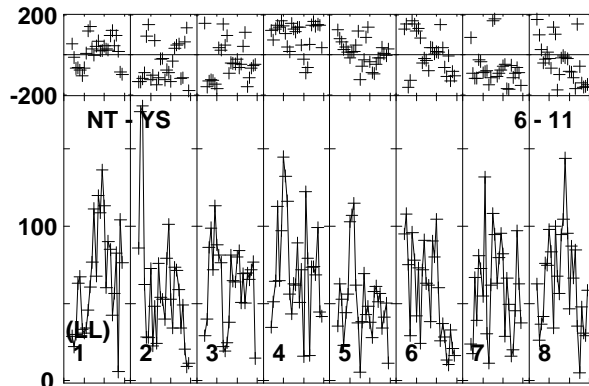
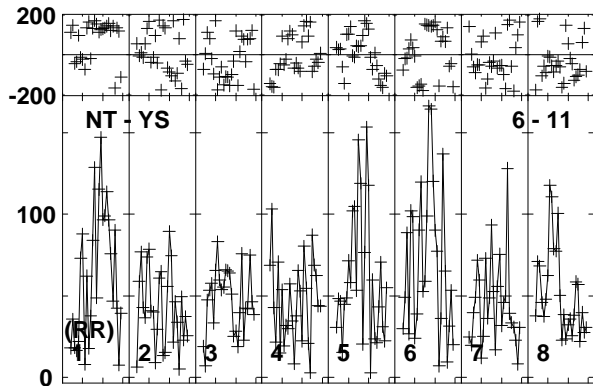
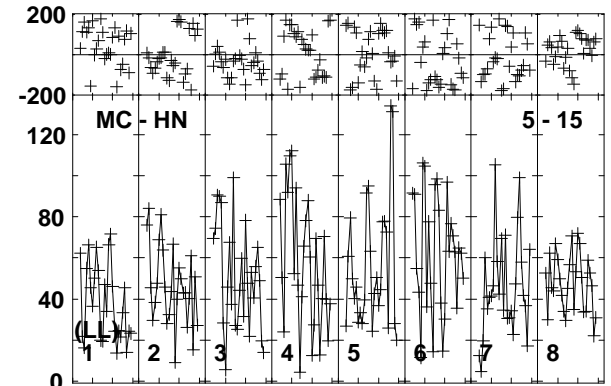
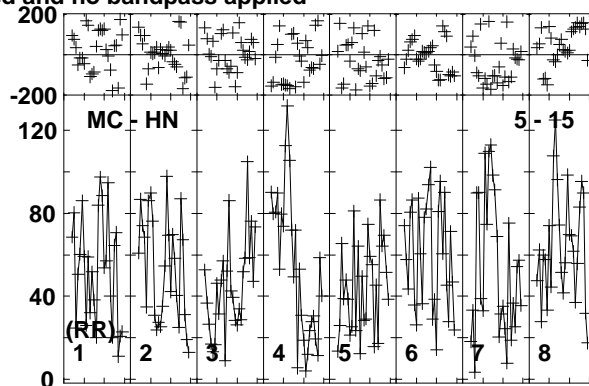
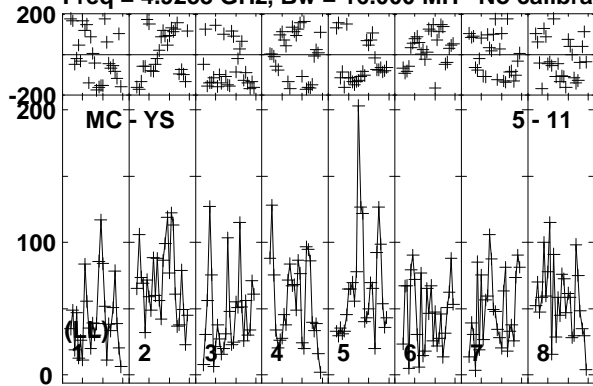

Lower frame: Micro Ampl Jy Top frame: Phas deg
Vector averaged cross-power spectrum Baseline: MC (05) - YS (11)
Timerange: 01/01:27:38 to 01/01:32:50

Plot file version 488 created 11-APR-2016 17:09:36

ARP299C GP053G 3.UVDATA.1

Freq = 4.9253 GHz, Bw = 16.000 MH No calibration applied and no bandpass applied

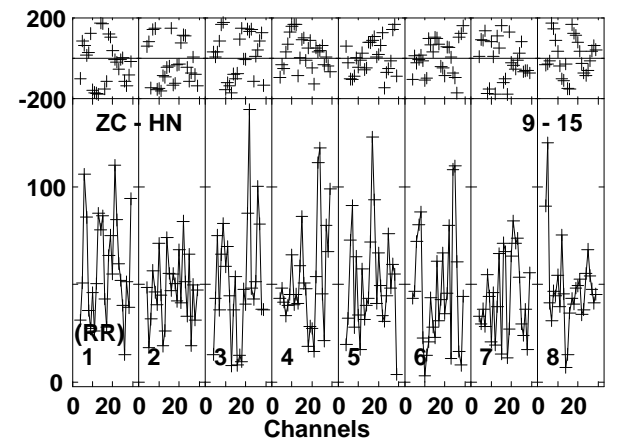
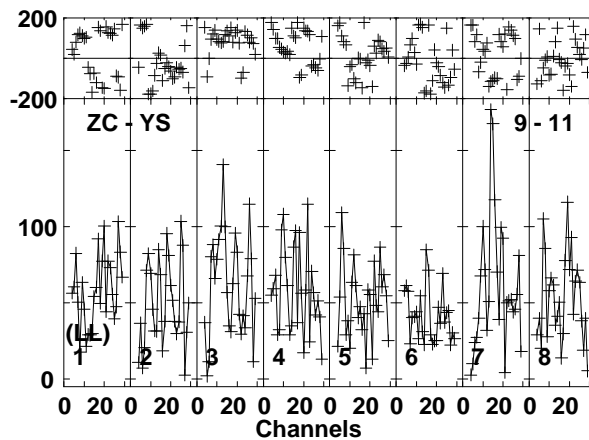
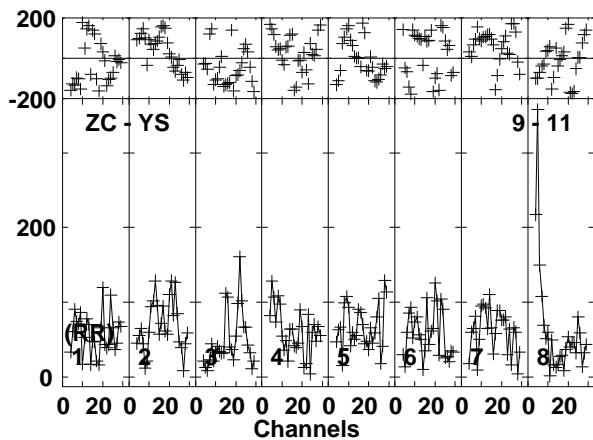
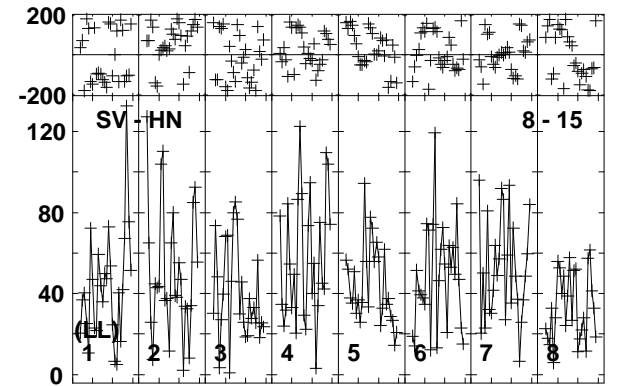
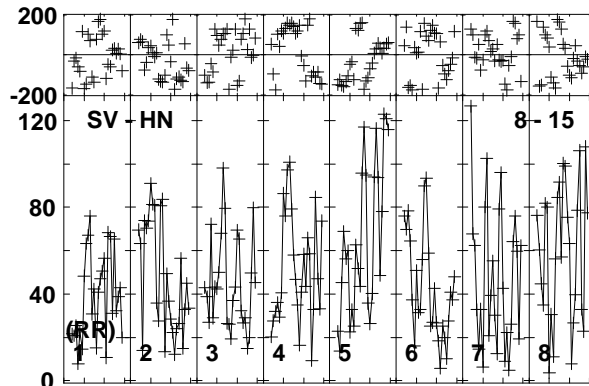
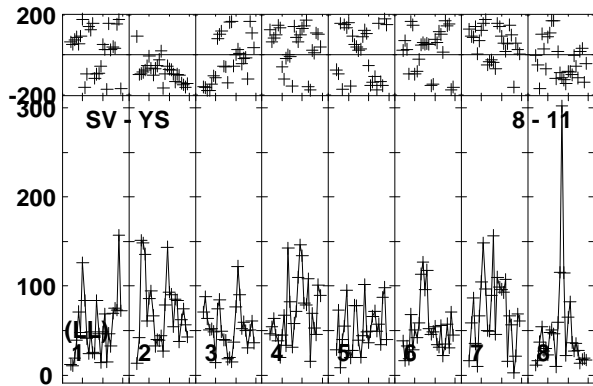
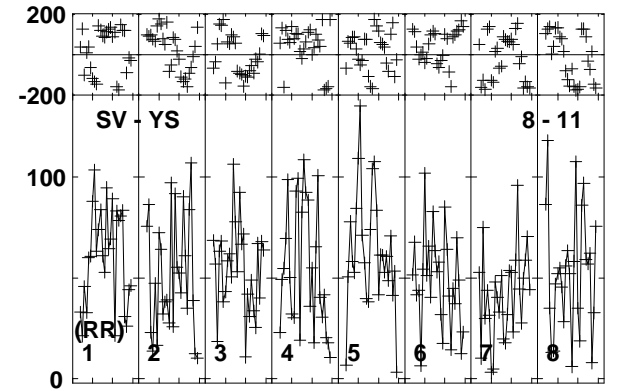
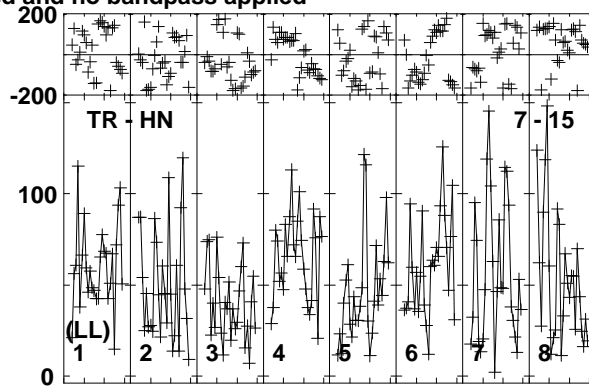
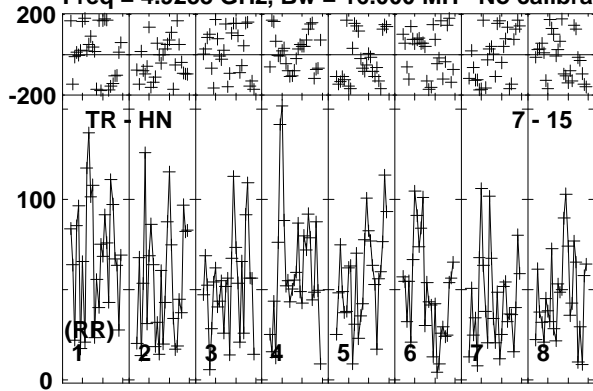

Lower frame: Micro Ampl Jy Top frame: Phas deg
Vector averaged cross-power spectrum Baseline: TR (07) - HN (15)
Timerange: 01/01:27:38 to 01/01:32:50

Plot file version 489 created 11-APR-2016 17:09:36

ARP299C GP053G 3.UVDATA.1

Freq = 4.9253 GHz, Bw = 16.000 MH No calibration applied and no bandpass applied

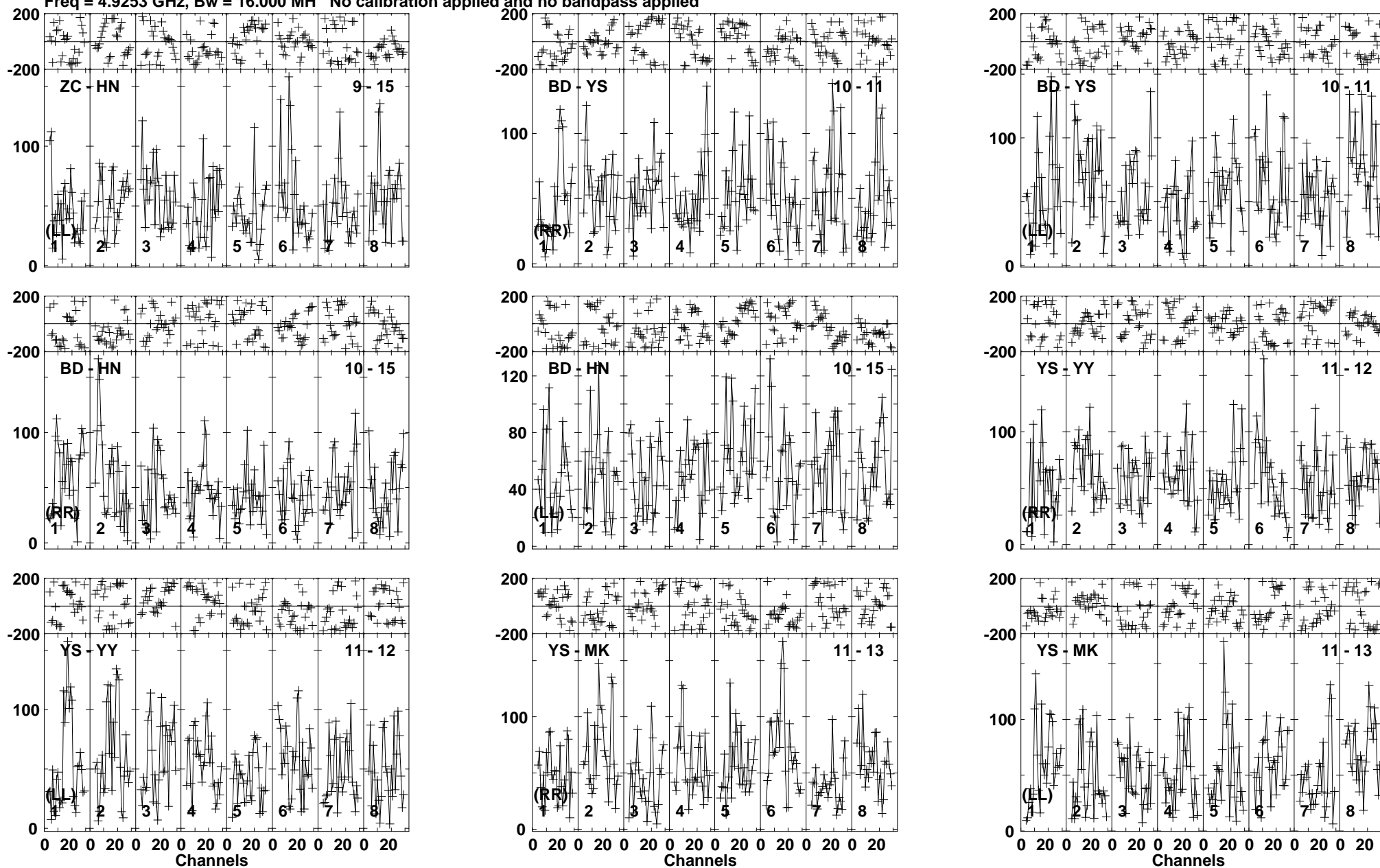

Lower frame: Micro Ampl Jy Top frame: Phas deg
Vector averaged cross-power spectrum Baseline: ZC (09) - HN (15)
Timerange: 01/01:27:38 to 01/01:32:50

Plot file version 490 created 11-APR-2016 17:09:36

ARP299C GP053G 3.UVDATA.1

Freq = 4.9253 GHz, Bw = 16.000 MH No calibration applied and no bandpass applied

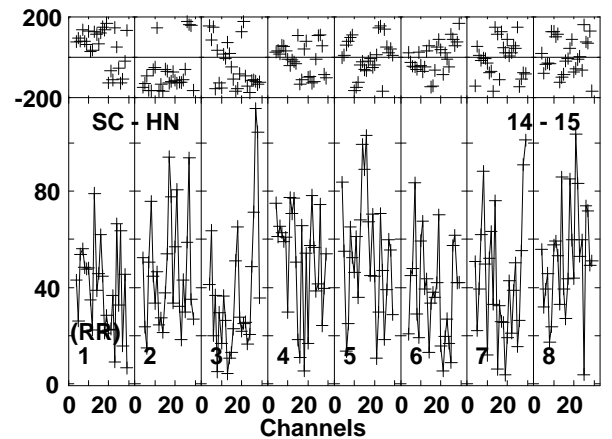
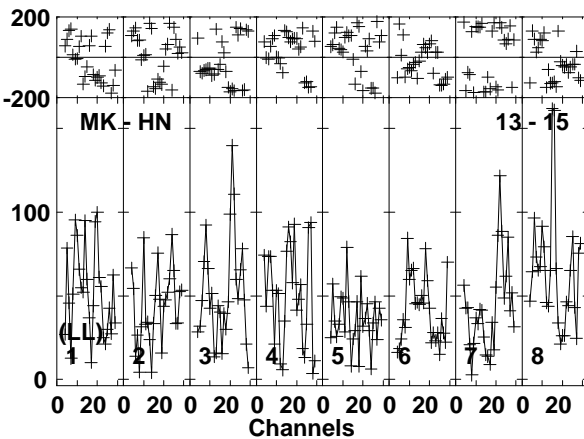
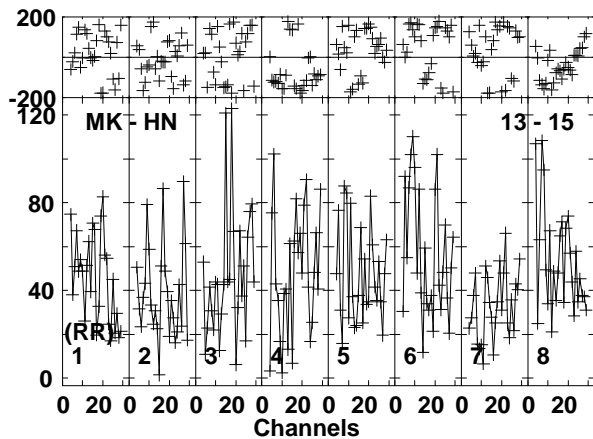
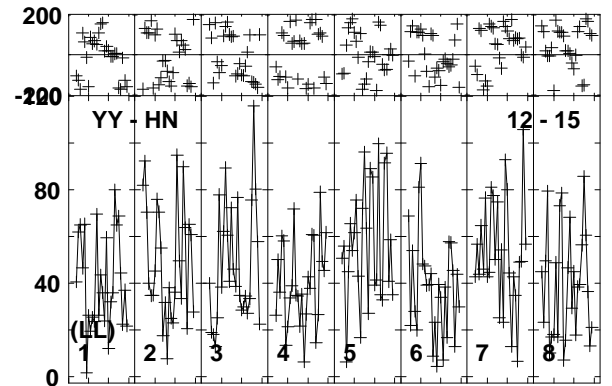
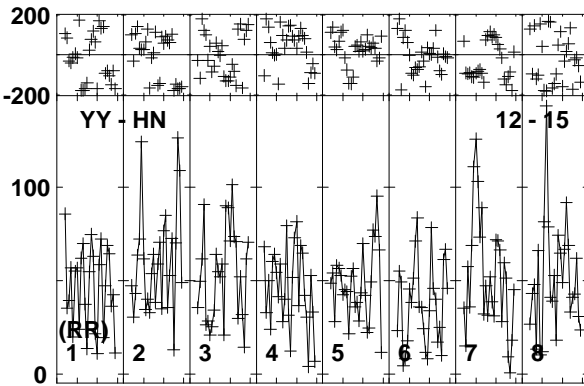
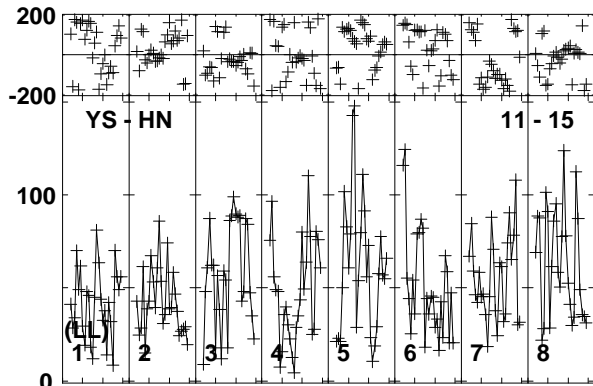
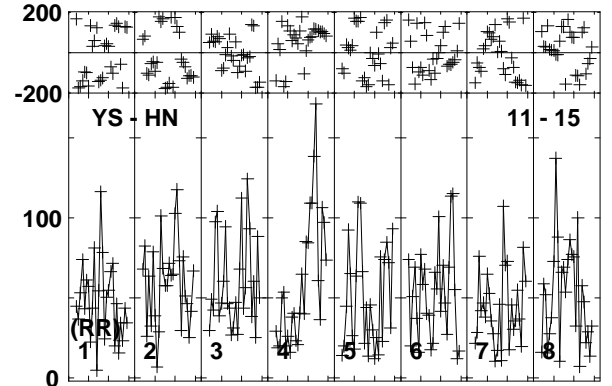
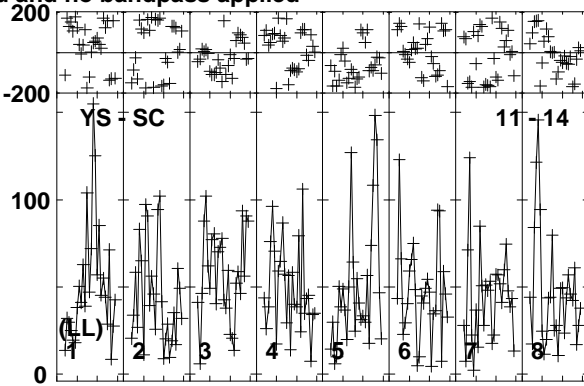
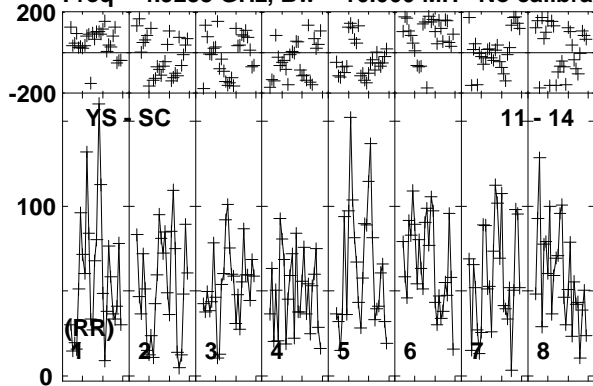

Lower frame: Micro Ampl Jy Top frame: Phas deg
Vector averaged cross-power spectrum Baseline: YS (11) - SC (14)
Timerange: 01/01:27:38 to 01/01:32:50

Plot file version 491 created 11-APR-2016 17:09:36

ARP299C GP053G 3.UVDATA.1

Freq = 4.9253 GHz, Bw = 16.000 MH No calibration applied and no bandpass applied

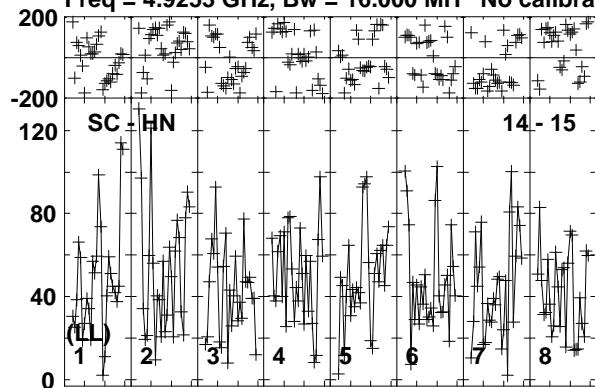

Lower frame: Micro Ampl Jy Top frame: Phas deg
Vector averaged cross-power spectrum Baseline: SC (14) - HN (15)
Timerange: 01/01:27:38 to 01/01:32:50

Plot file version 492 created 11-APR-2016 17:09:36

J1128+5925 GP053G 3.UVDATA.1

Freq = 4.9253 GHz, Bw = 16.000 MH No calibration applied and no bandpass applied

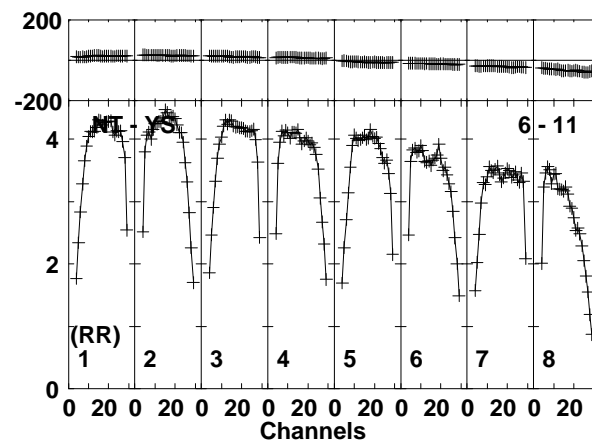
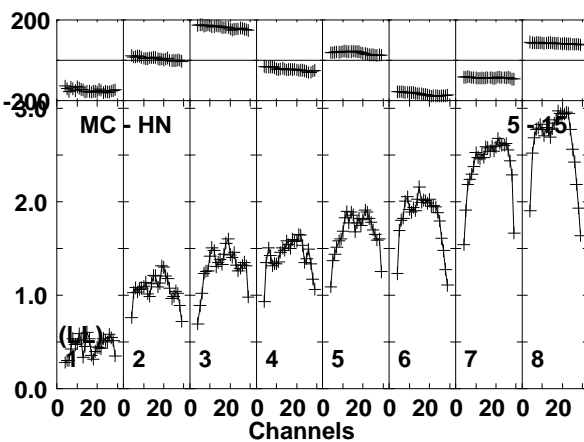
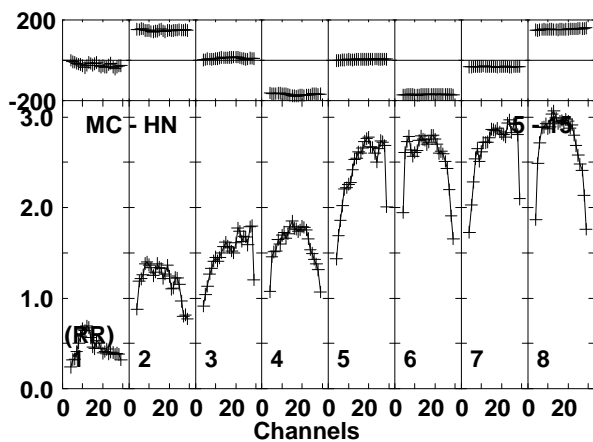
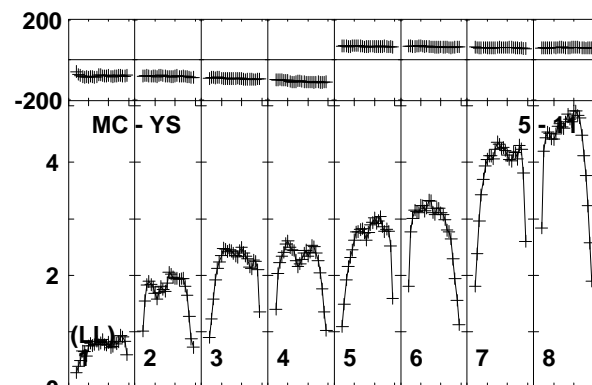
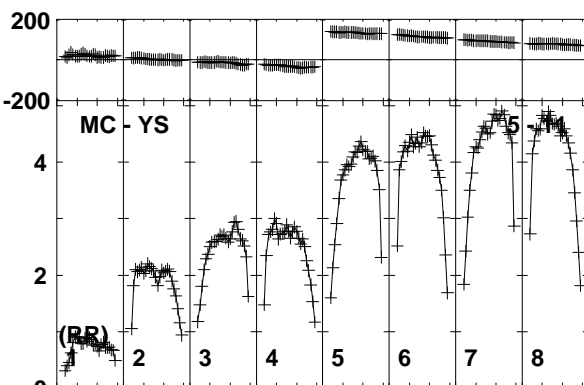
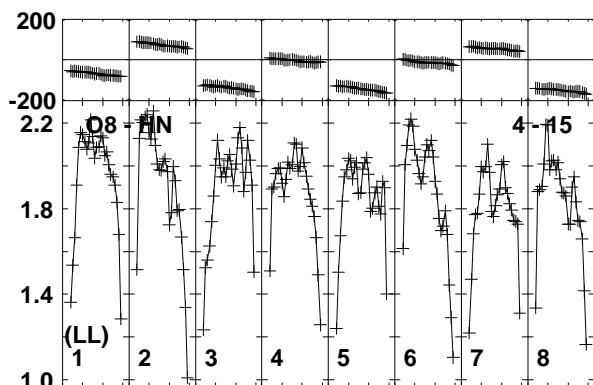
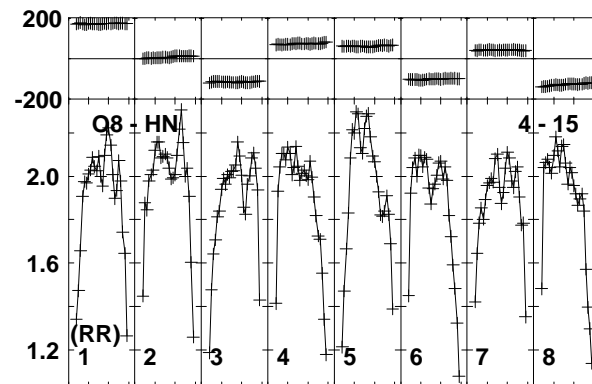
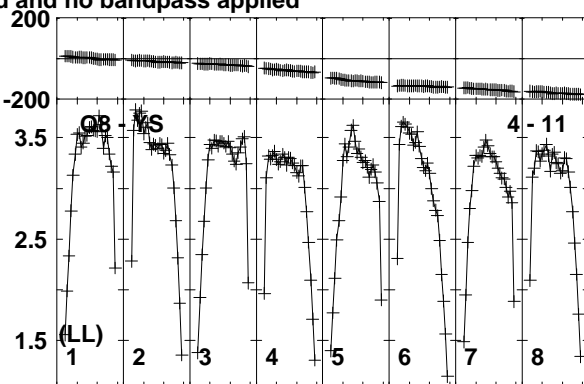
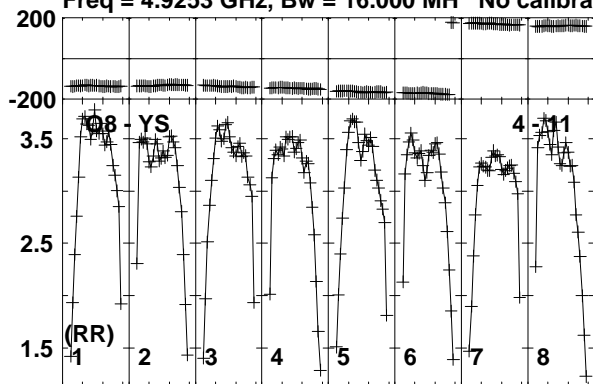

Lower frame: Milli Ampl Jy Top frame: Phas deg
Vector averaged cross-power spectrum Baseline: O8 (04) - YS (11)
Timerange: 01/01:32:56 to 01/01:34:48

Plot file version 493 created 11-APR-2016 17:09:37

J1128+5925 GP053G 3.UVDATA.1

Freq = 4.9253 GHz, Bw = 16.000 MH No calibration applied and no bandpass applied

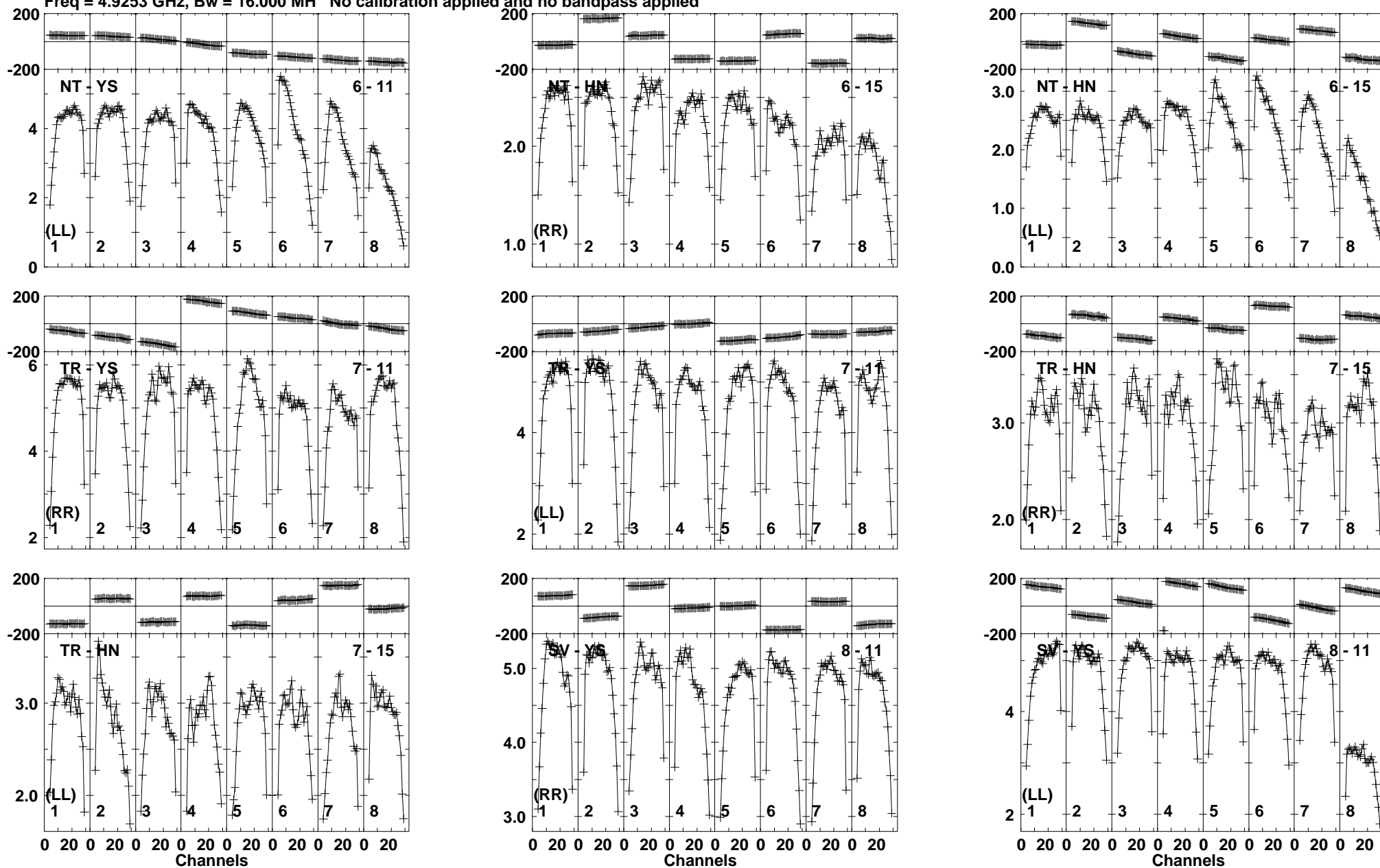

Lower frame: Milli Ampl Jy Top frame: Phas deg
Vector averaged cross-power spectrum Baseline: NT (06) - YS (11)
Timerange: 01/01:32:56 to 01/01:34:48

Plot file version 494 created 11-APR-2016 17:09:37

J1128+5925 GP053G 3.UVDATA.1

Freq = 4.9253 GHz, Bw = 16.000 MH No calibration applied and no bandpass applied

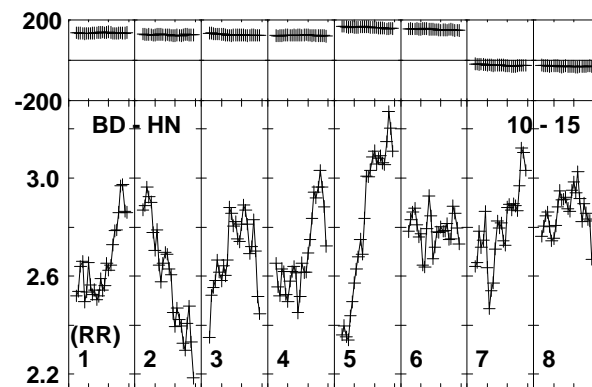
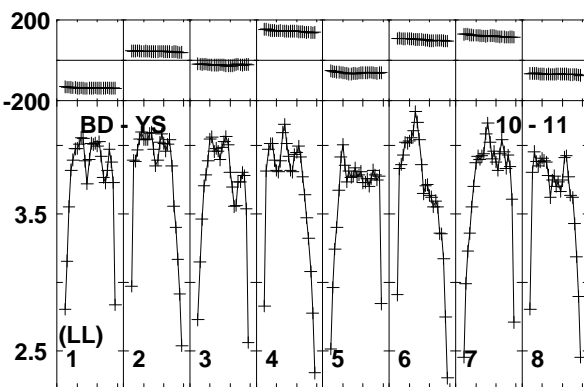
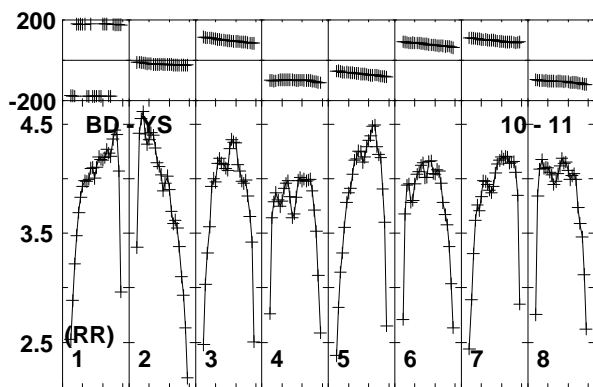
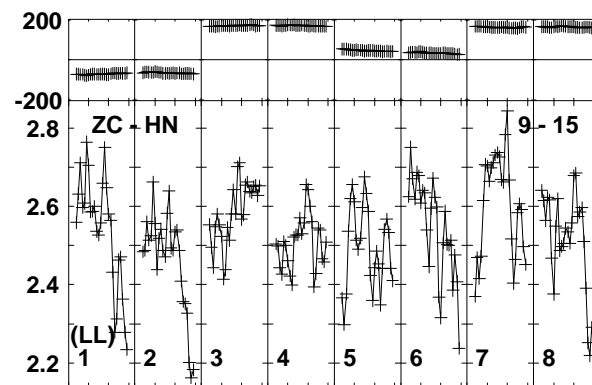
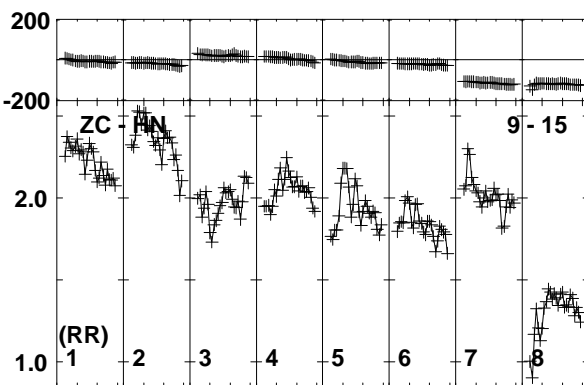
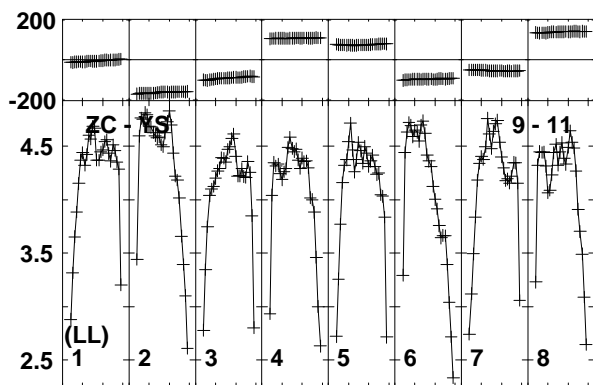
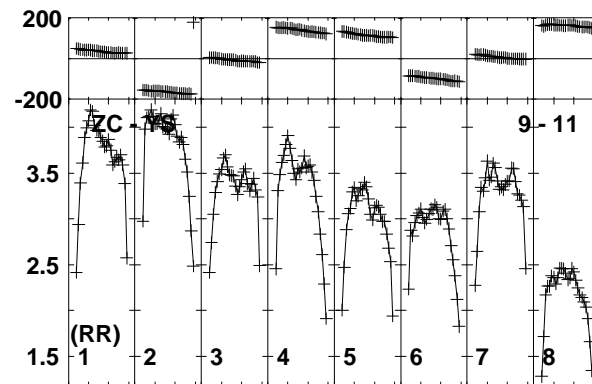
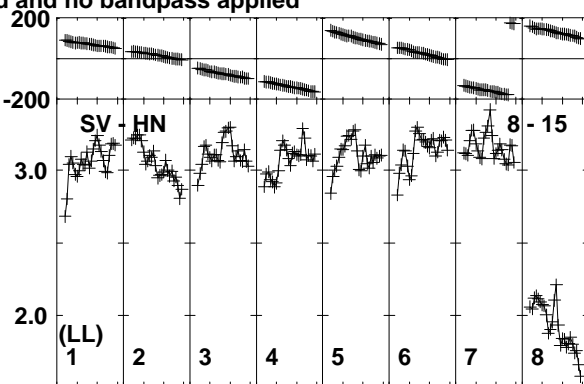
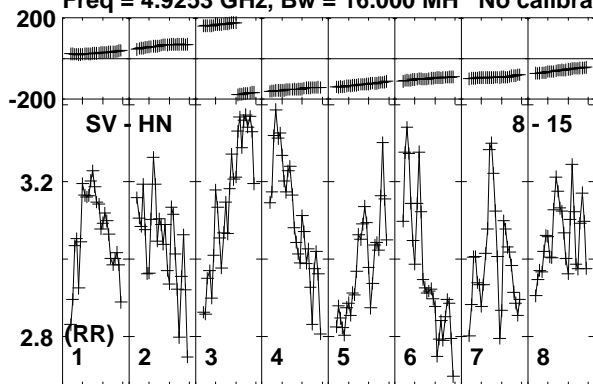

Lower frame: Milli Ampl Jy Top frame: Phas deg

Vector averaged cross-power spectrum Baseline: SV (08) - HN (15)

Timerange: 01/01:32:56 to 01/01:34:48

Plot file version 495 created 11-APR-2016 17:09:37

J1128+5925 GP053G 3.UVDATA.1

Freq = 4.9253 GHz, Bw = 16.000 MH No calibration applied and no bandpass applied

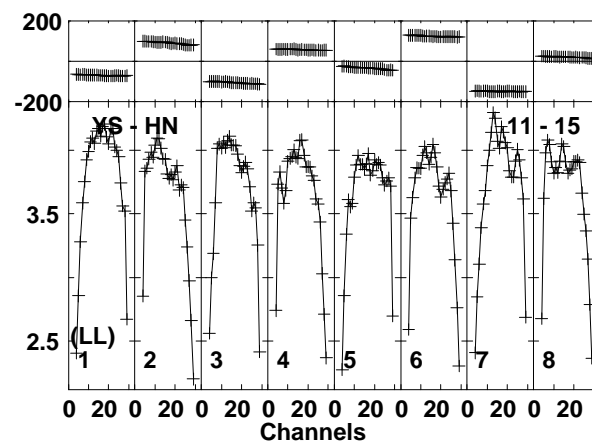
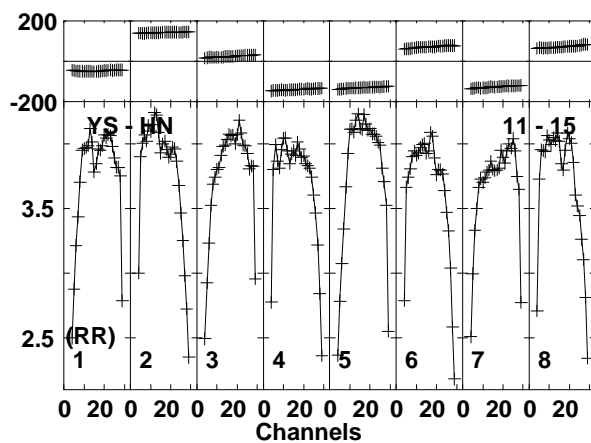
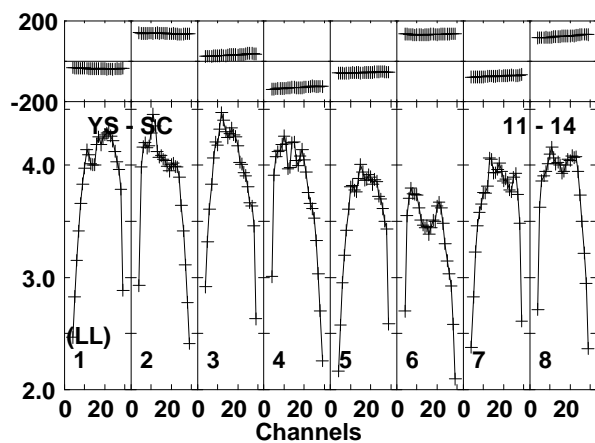
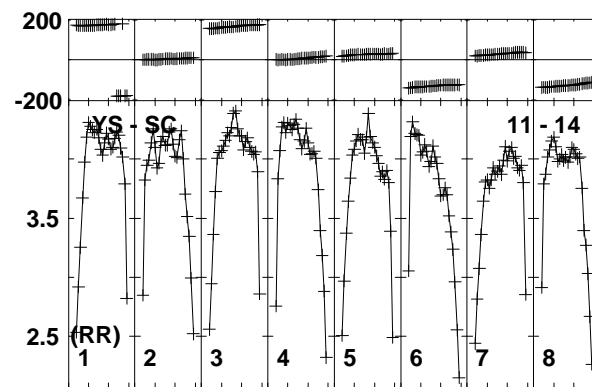
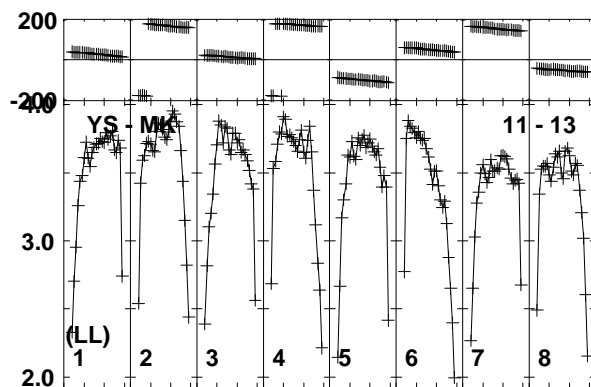
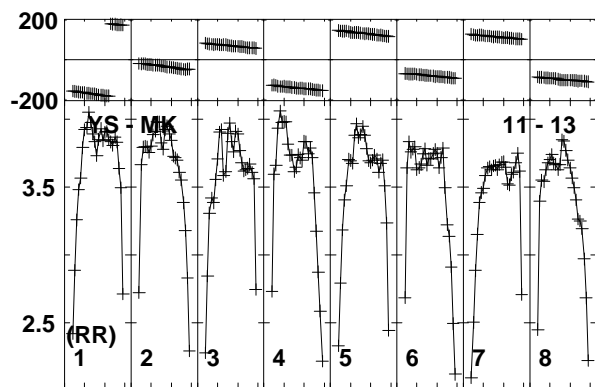
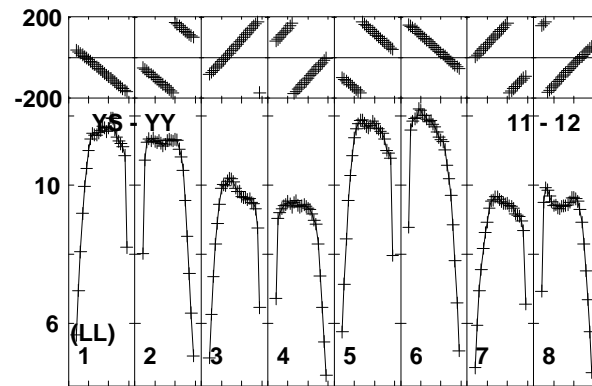
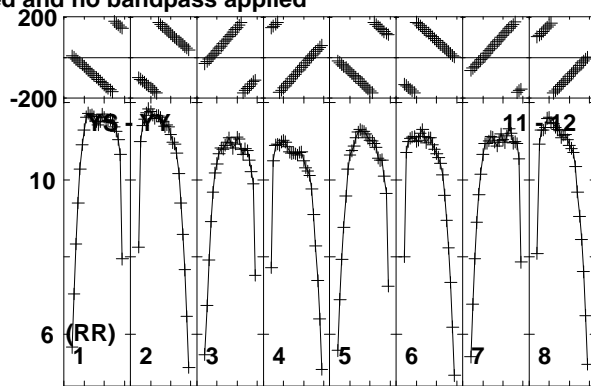
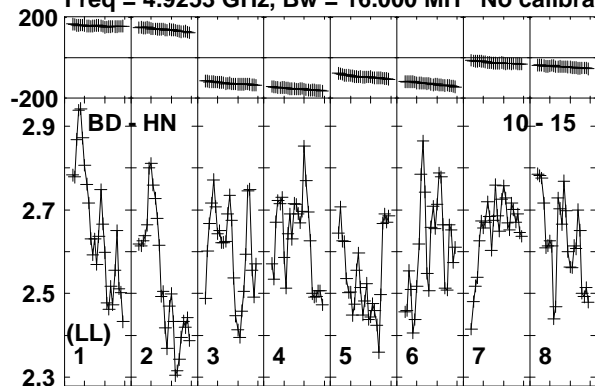

Lower frame: Milli Ampl Jy Top frame: Phas deg
Vector averaged cross-power spectrum Baseline: BD (10) - HN (15)
Timerange: 01/01:32:56 to 01/01:34:48

Plot file version 496 created 11-APR-2016 17:09:37

J1128+5925 GP053G 3.UVDATA.1

Freq = 4.9253 GHz, Bw = 16.000 MH No calibration applied and no bandpass applied

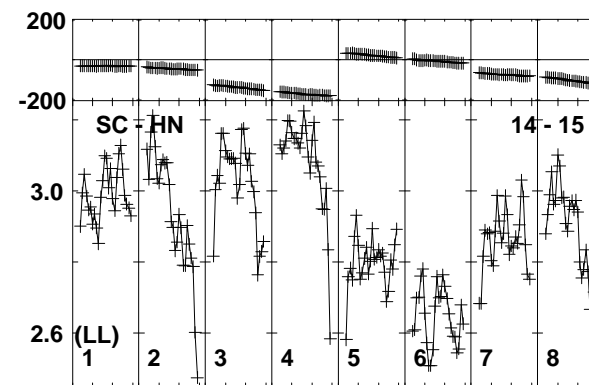
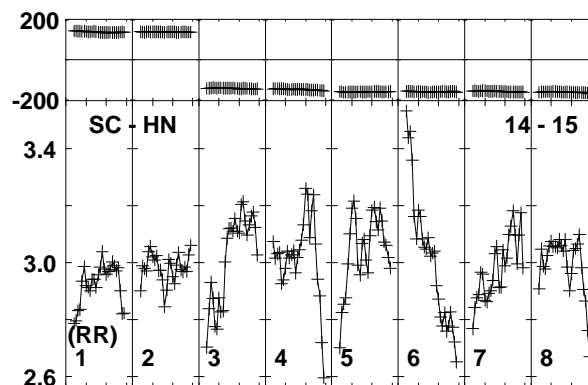
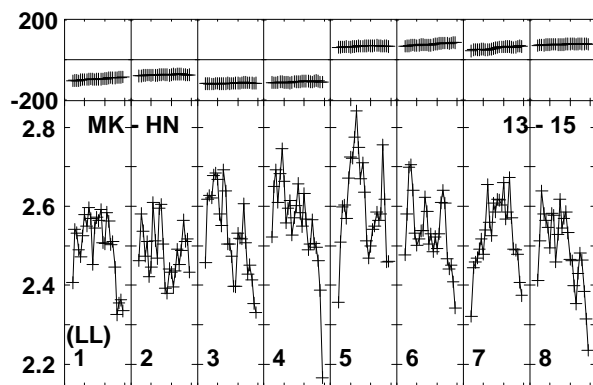
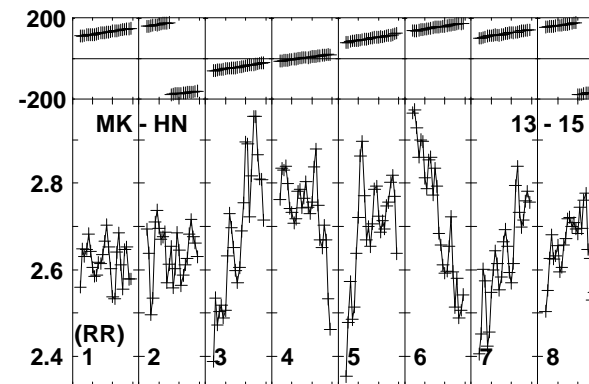
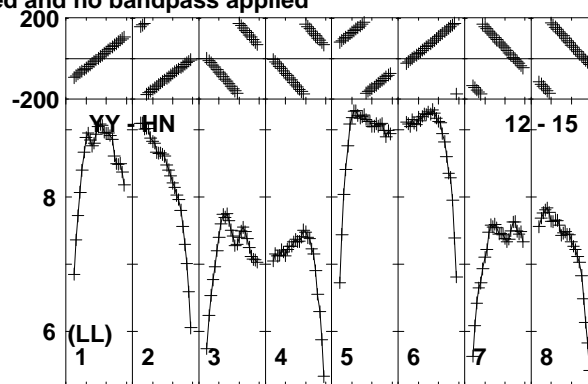
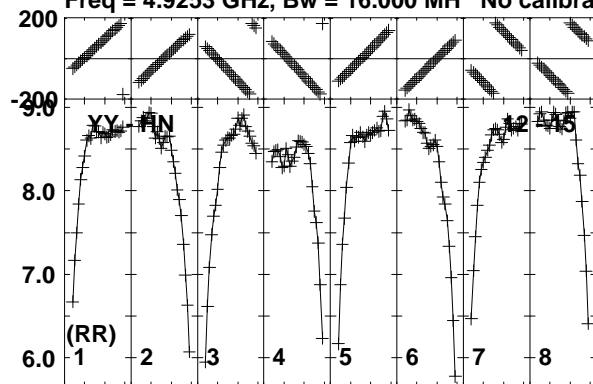

Lower frame: Milli Ampl Jy Top frame: Phas deg
Vector averaged cross-power spectrum Baseline: YY (12) - HN (15)
Timerange: 01/01:32:56 to 01/01:34:48

Plot file version 497 created 11-APR-2016 17:09:37

ARP299C GP053G 3.UVDATA.1

Freq = 4.9253 GHz, Bw = 16.000 MH No calibration applied and no bandpass applied

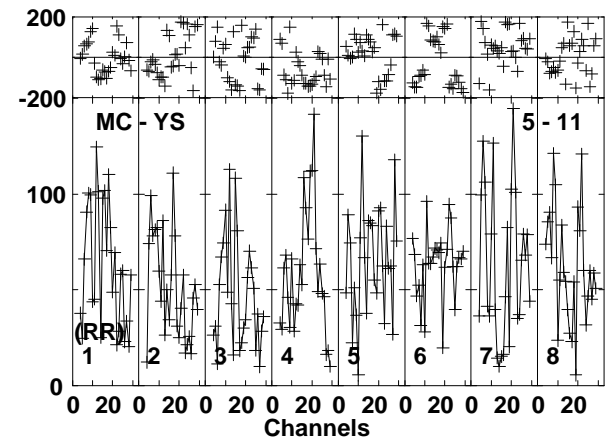
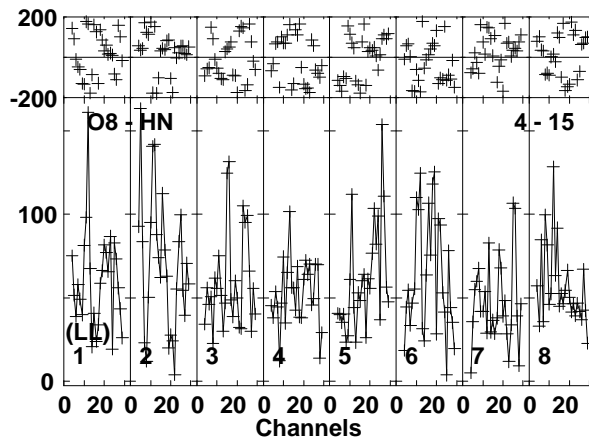
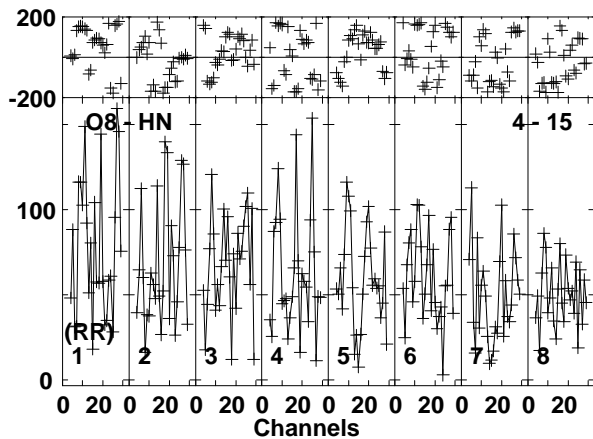
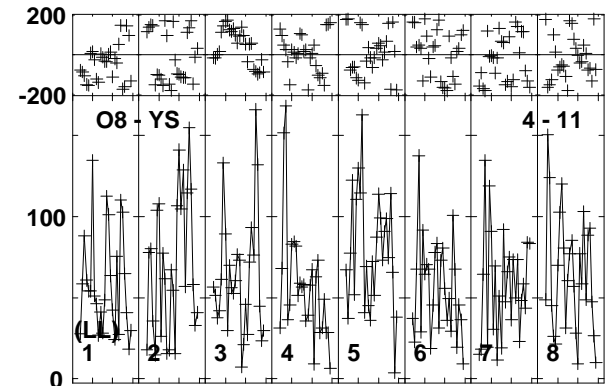
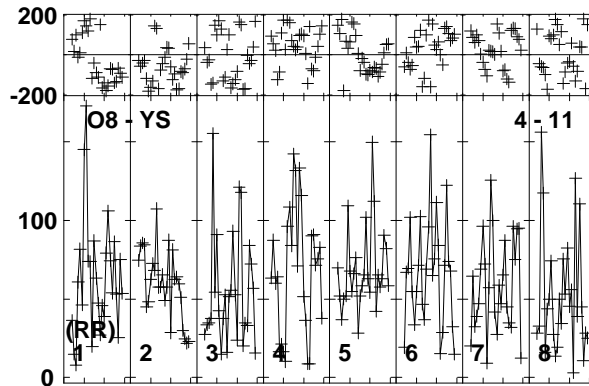
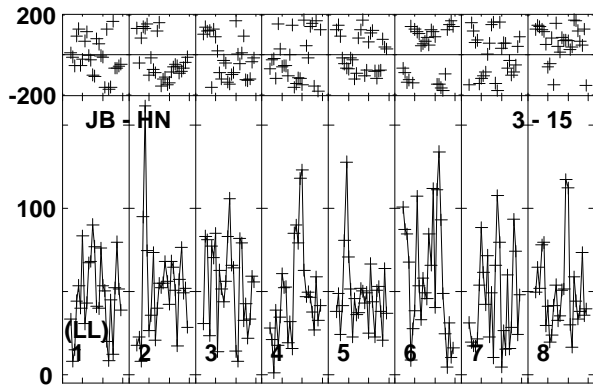
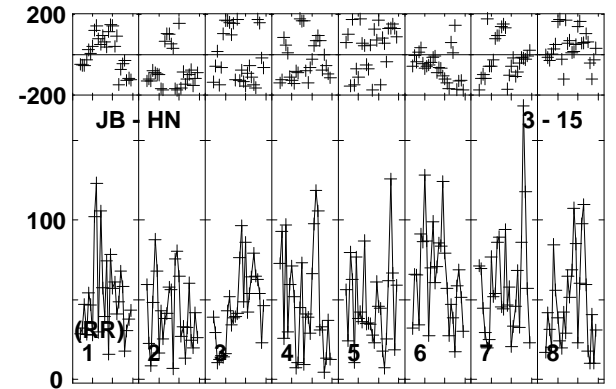
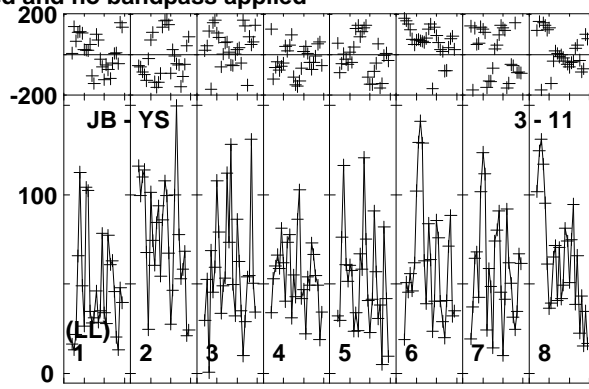
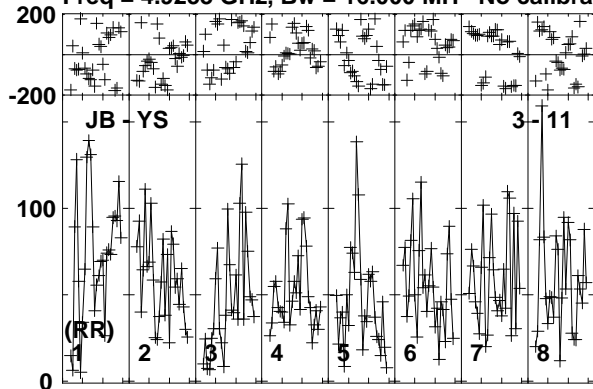

Lower frame: Micro Ampl Jy Top frame: Phas deg
Vector averaged cross-power spectrum Baseline: JB (03) - YS (11)
Timerange: 01/01:34:53 to 01/01:40:07

Plot file version 498 created 11-APR-2016 17:09:38

ARP299C GP053G 3.UVDATA.1

Freq = 4.9253 GHz, Bw = 16.000 MH No calibration applied and no bandpass applied

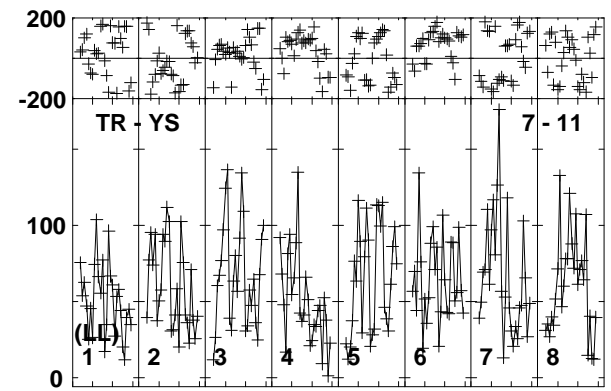
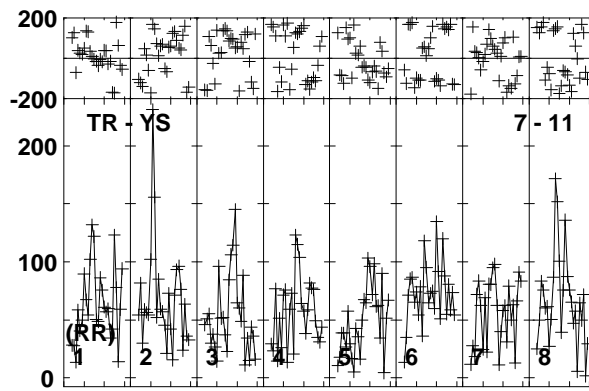
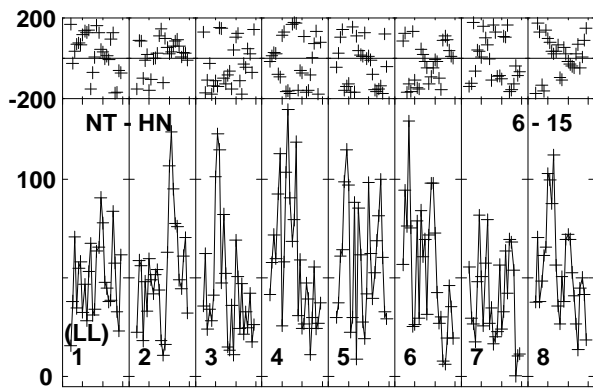
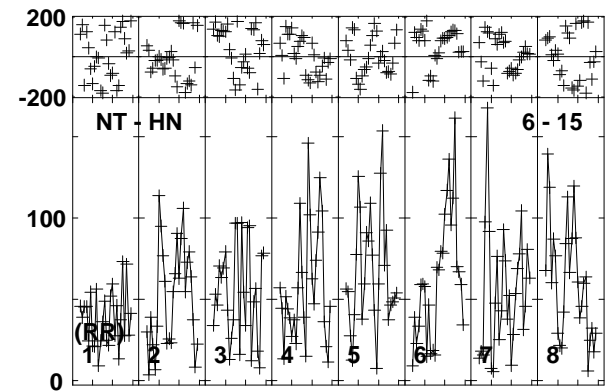
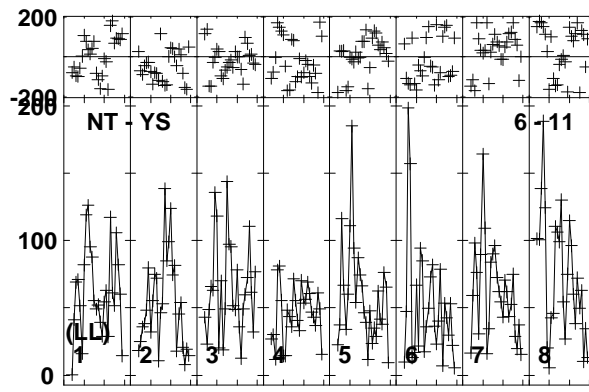
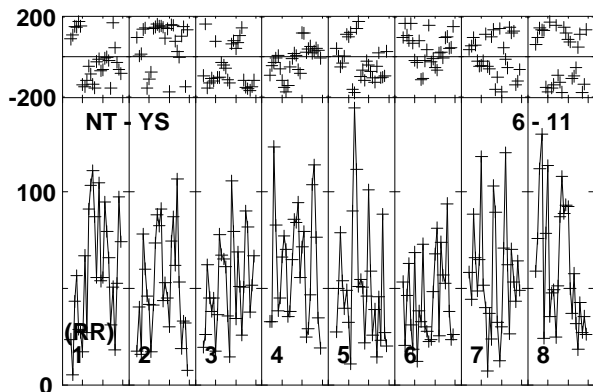
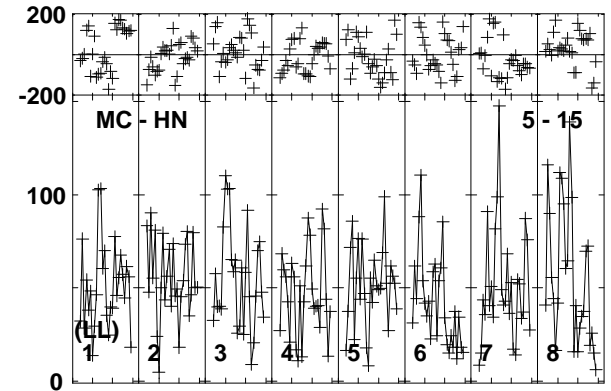
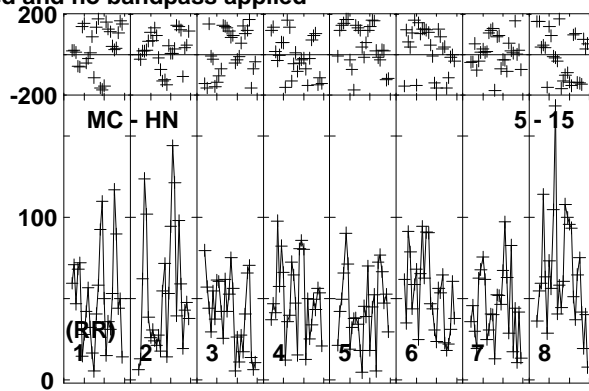
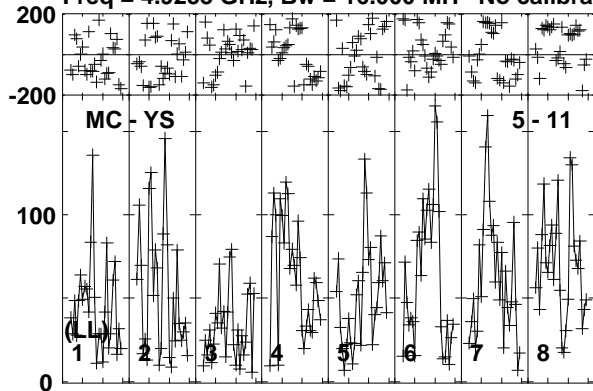

Lower frame: Micro Ampl Jy Top frame: Phas deg
Vector averaged cross-power spectrum Baseline: MC (05) - YS (11)
Timerange: 01/01:34:53 to 01/01:40:07

Plot file version 499 created 11-APR-2016 17:09:38

ARP299C GP053G 3.UVDATA.1

Freq = 4.9253 GHz, Bw = 16.000 MH No calibration applied and no bandpass applied

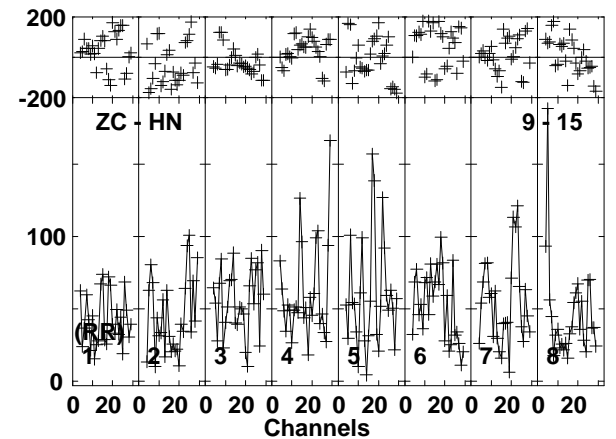
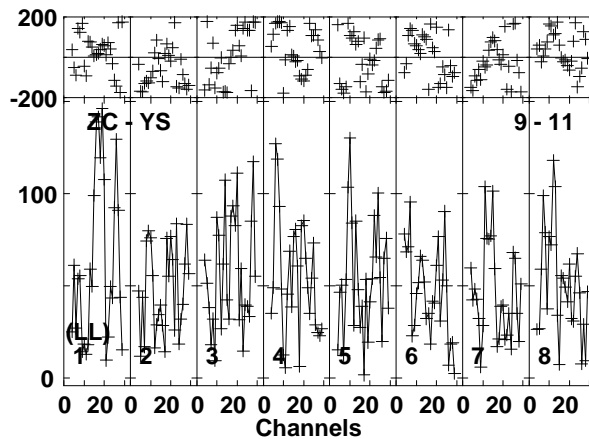
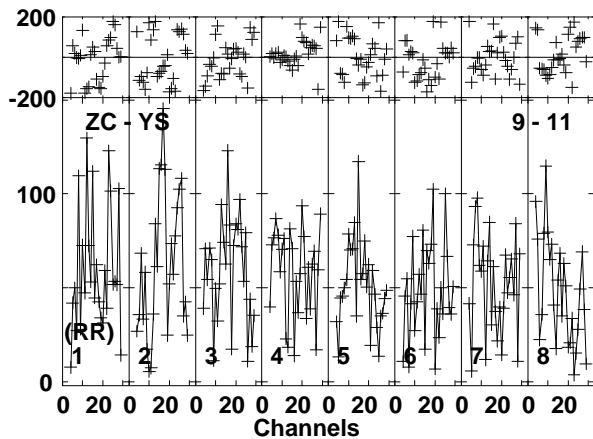
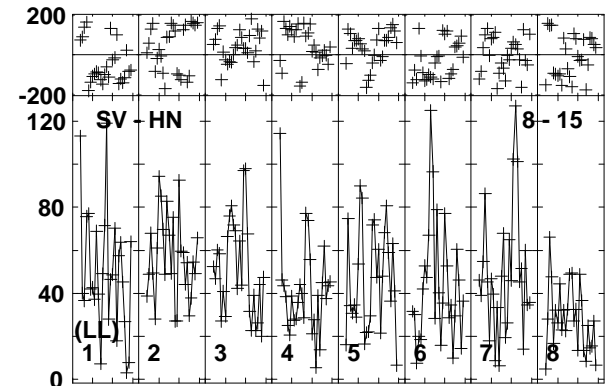
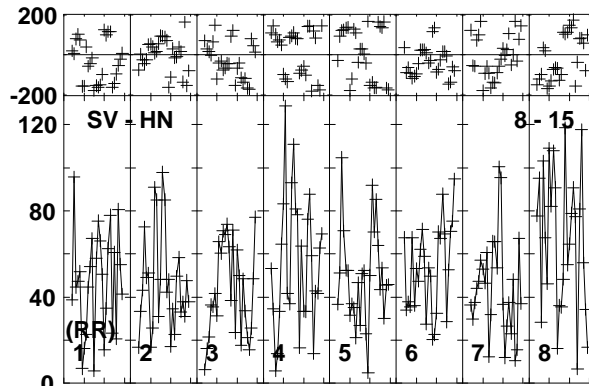
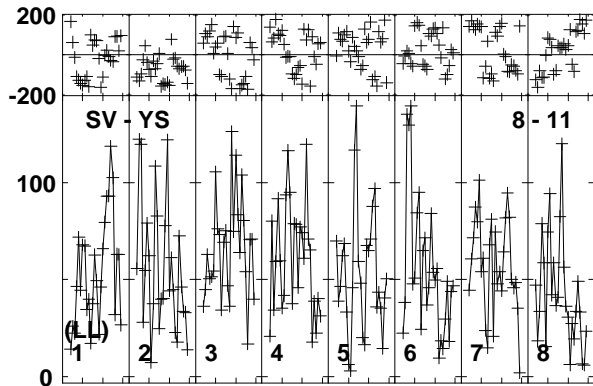
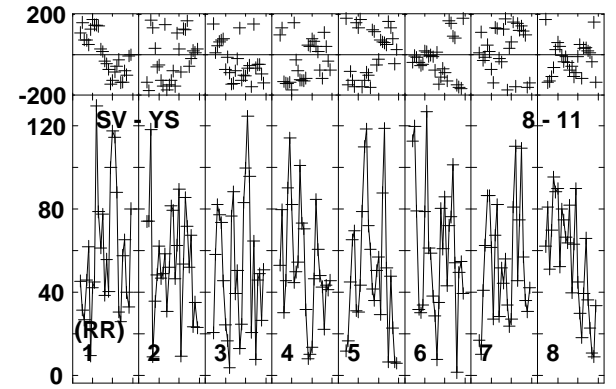
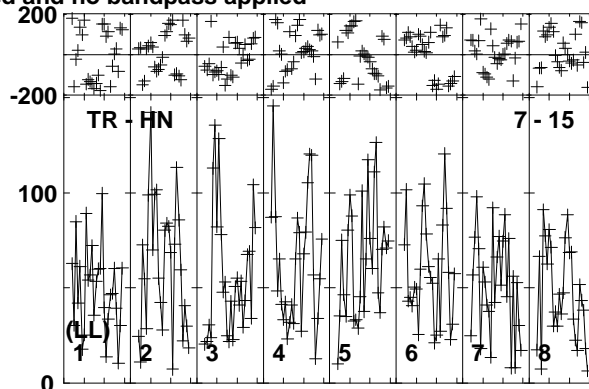
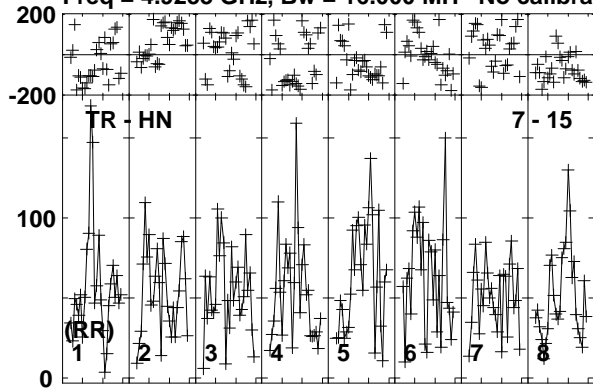

Lower frame: Micro Ampl Jy Top frame: Phas deg
Vector averaged cross-power spectrum Baseline: TR (07) - HN (15)
Timerange: 01/01:34:53 to 01/01:40:07

Plot file version 500 created 11-APR-2016 17:09:38

ARP299C GP053G 3.UVDATA.1

Freq = 4.9253 GHz, Bw = 16.000 MH No calibration applied and no bandpass applied

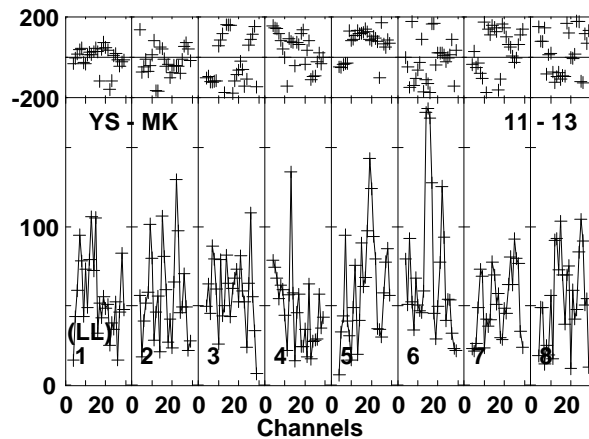
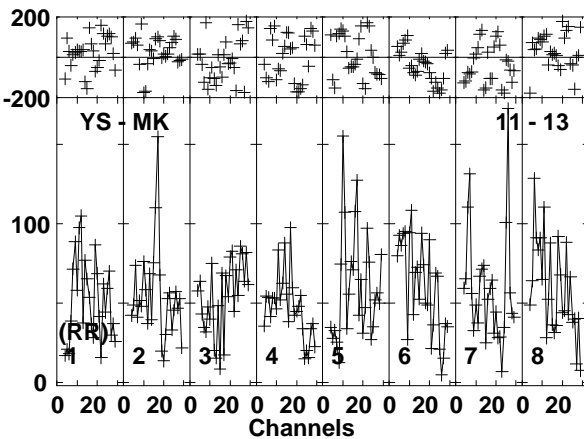
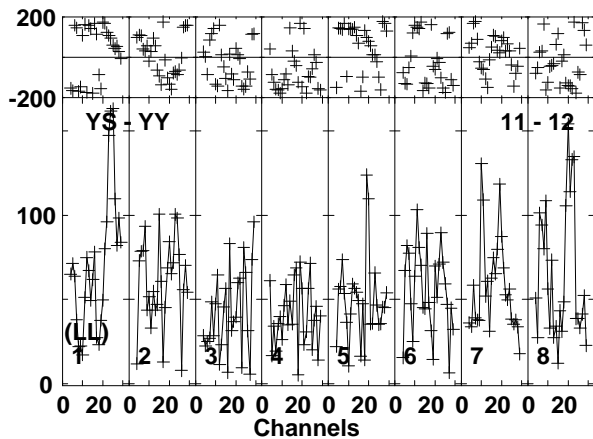
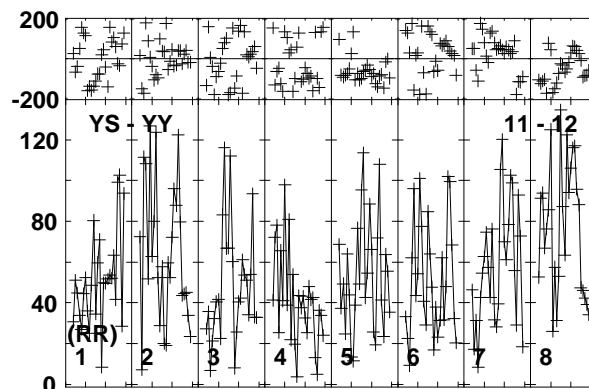
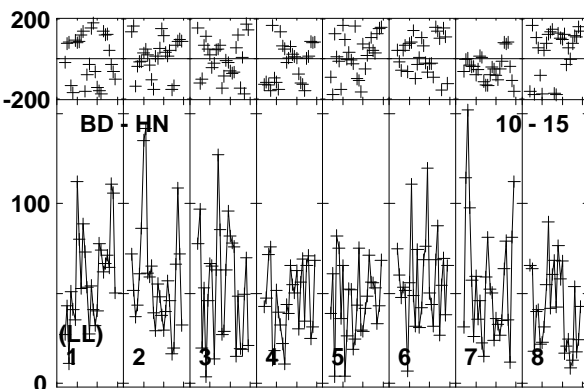
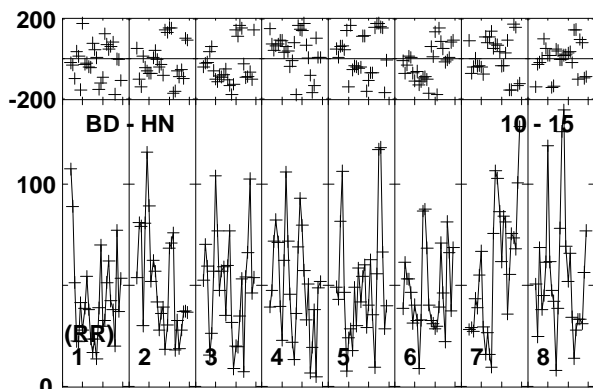
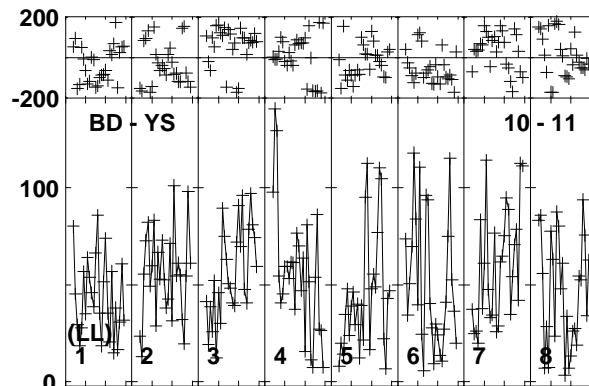
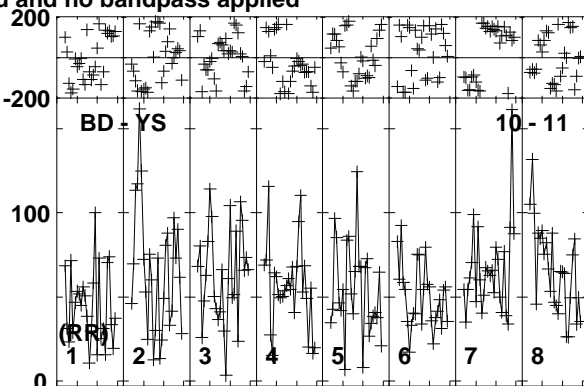
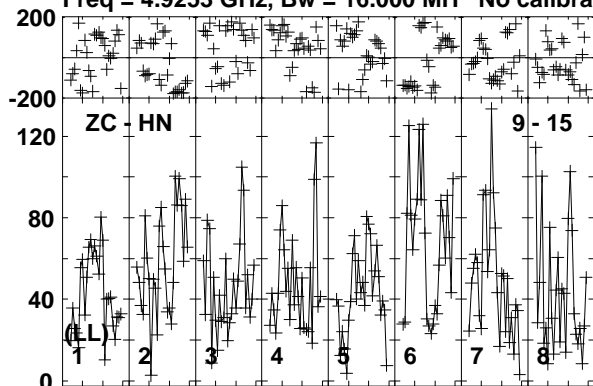

Lower frame: Micro Ampl Jy Top frame: Phas deg
Vector averaged cross-power spectrum Baseline: ZC (09) - HN (15)
Timerange: 01/01:34:53 to 01/01:40:07

Plot file version 501 created 11-APR-2016 17:09:38

ARP299C GP053G 3.UVDATA.1

Freq = 4.9253 GHz, Bw = 16.000 MH No calibration applied and no bandpass applied

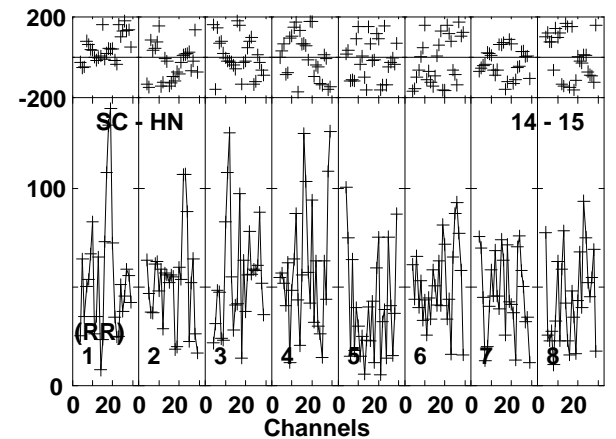
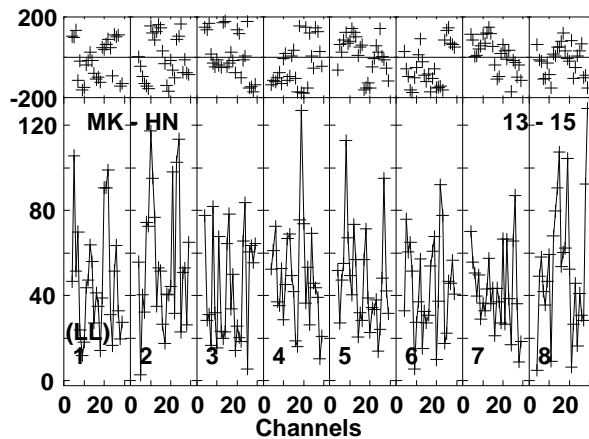
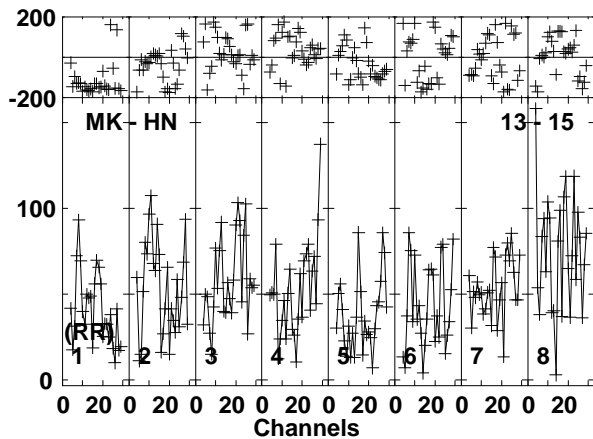
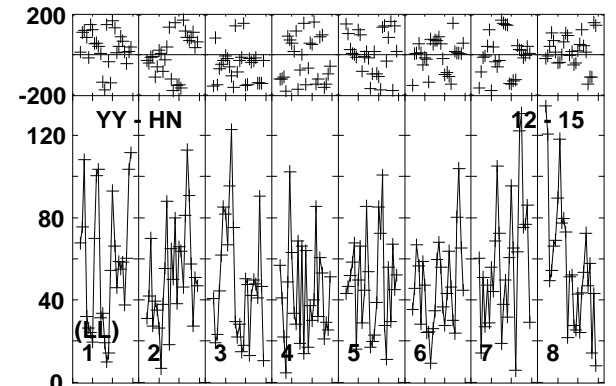
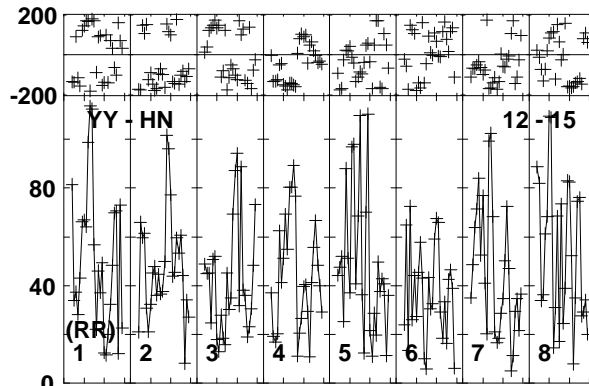
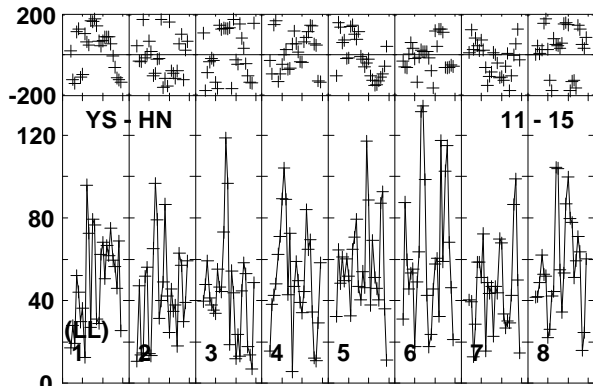
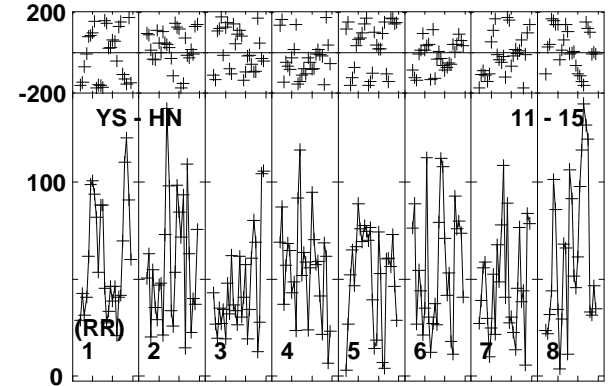
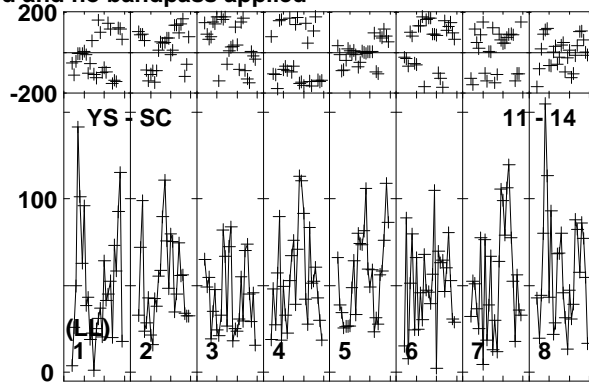
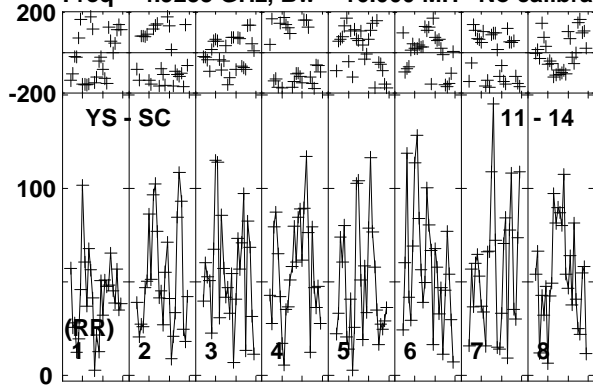

Lower frame: Micro Ampl Jy Top frame: Phas deg
Vector averaged cross-power spectrum Baseline: YS (11) - SC (14)
Timerange: 01/01:34:53 to 01/01:40:07

Plot file version 502 created 11-APR-2016 17:09:38

ARP299C GP053G 3.UVDATA.1

Freq = 4.9253 GHz, Bw = 16.000 MH No calibration applied and no bandpass applied

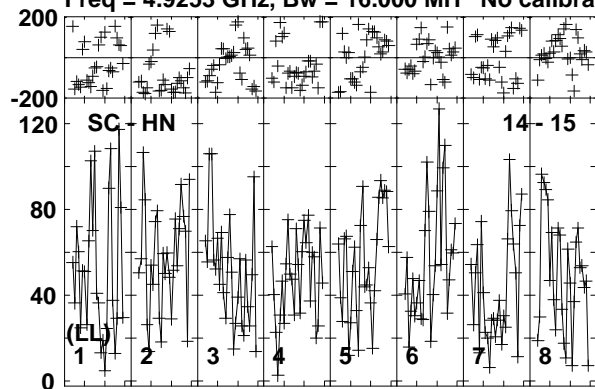

Lower frame: Micro Ampl Jy Top frame: Phas deg
Vector averaged cross-power spectrum Baseline: SC (14) - HN (15)
Timerange: 01/01:34:53 to 01/01:40:07

Plot file version 503 created 11-APR-2016 17:09:38

J1128+5925 GP053G 3.UVDATA.1

Freq = 4.9253 GHz, Bw = 16.000 MH No calibration applied and no bandpass applied

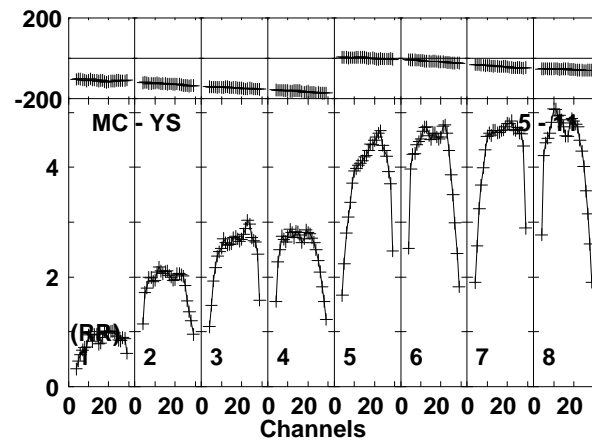
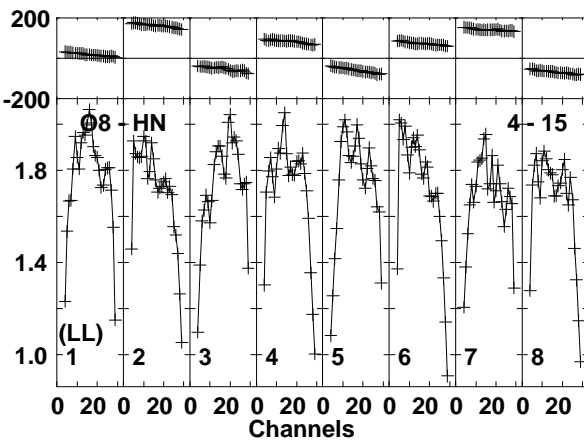
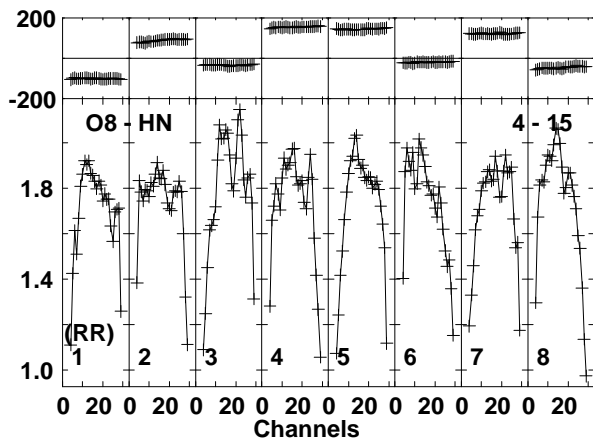
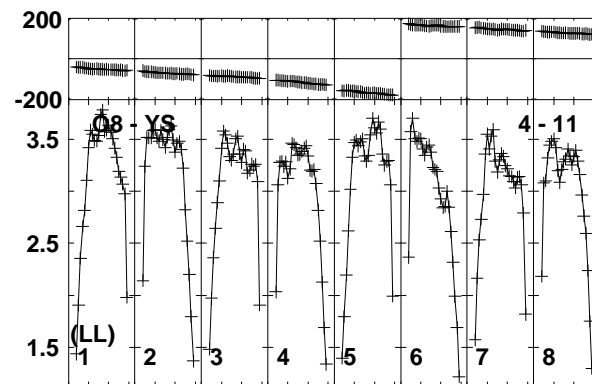
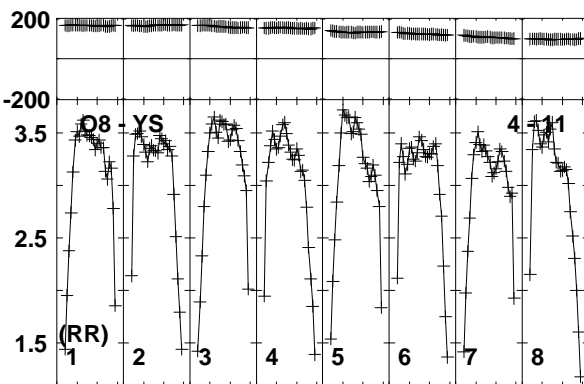
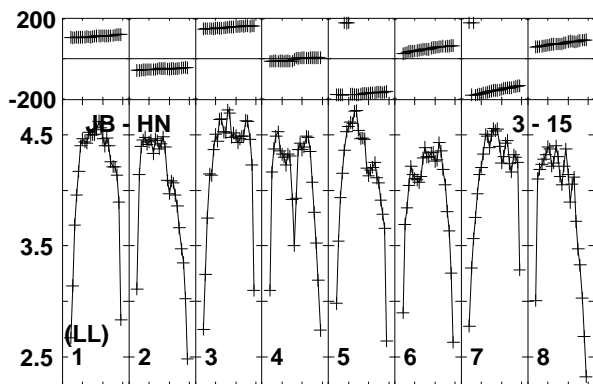
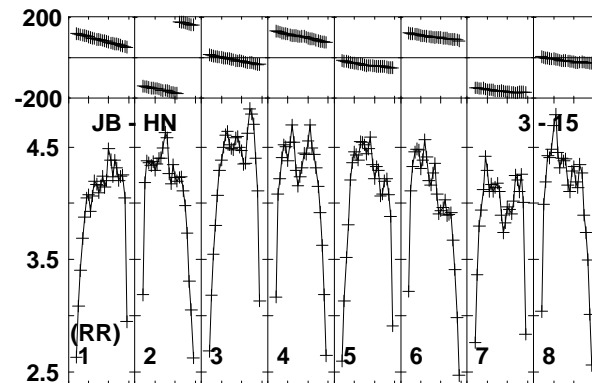
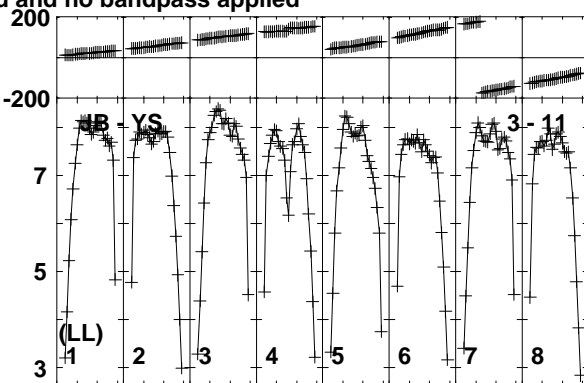
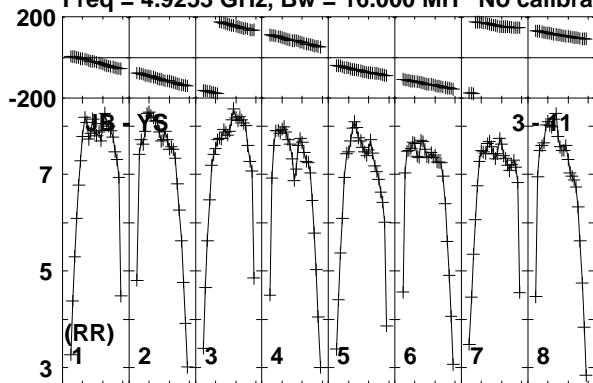

Lower frame: Milli Ampl Jy Top frame: Phas deg
Vector averaged cross-power spectrum Baseline: JB (03) - YS (11)
Timerange: 01/01:40:13 to 01/01:41:57

Plot file version 504 created 11-APR-2016 17:09:39

J1128+5925 GP053G 3.UVDATA.1

Freq = 4.9253 GHz, Bw = 16.000 MH No calibration applied and no bandpass applied

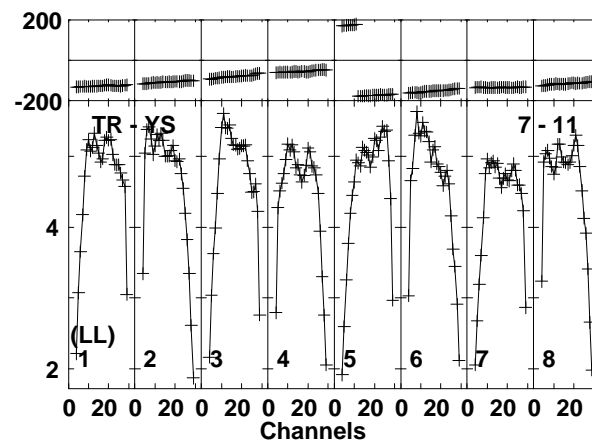
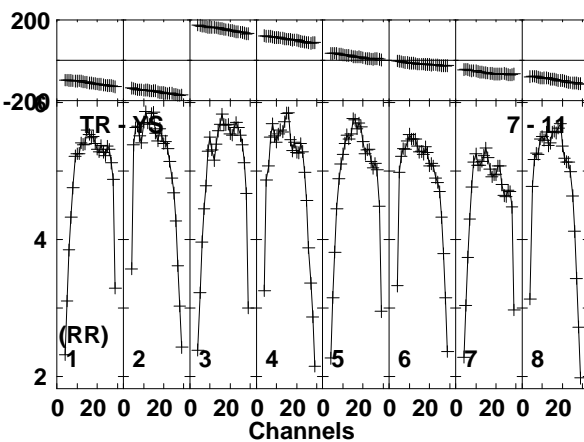
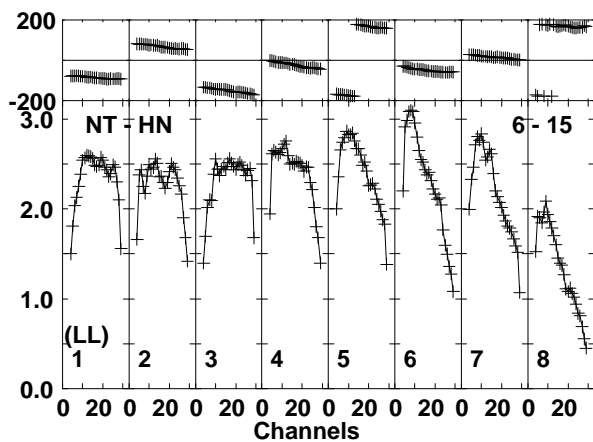
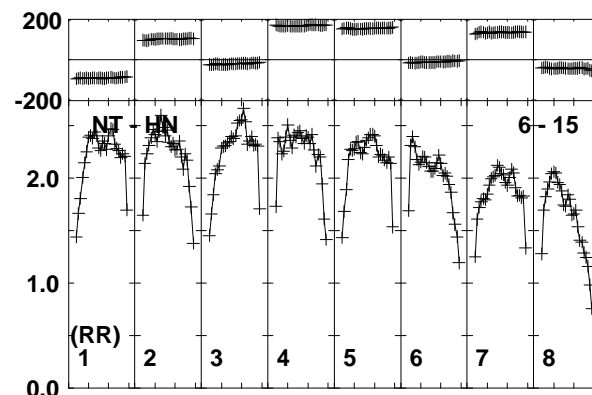
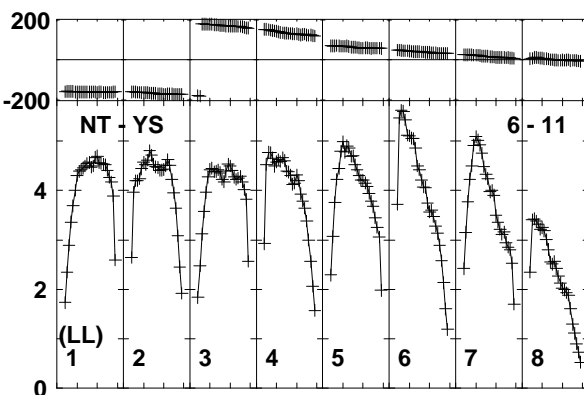
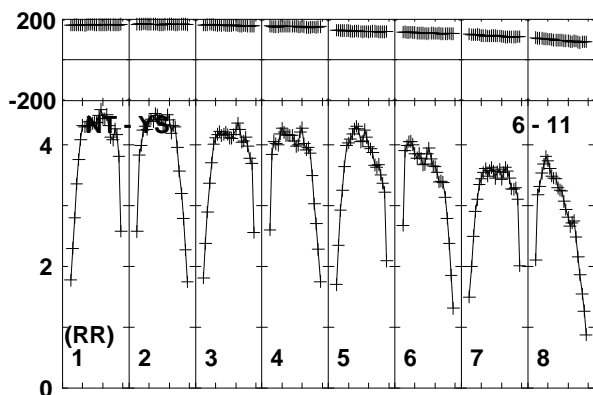
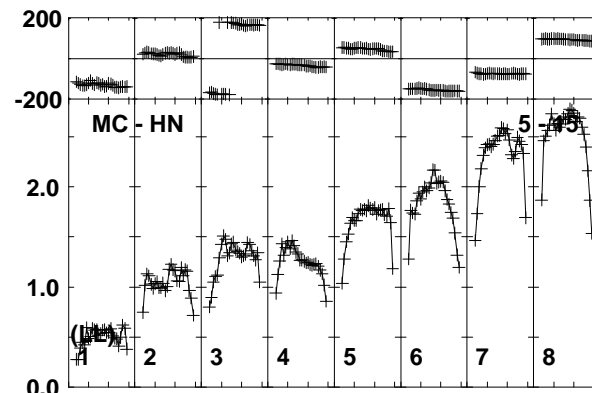
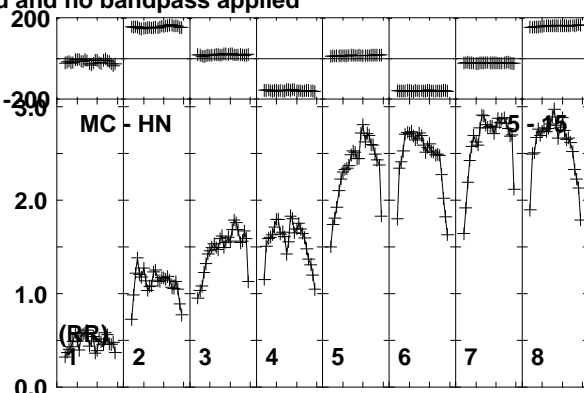
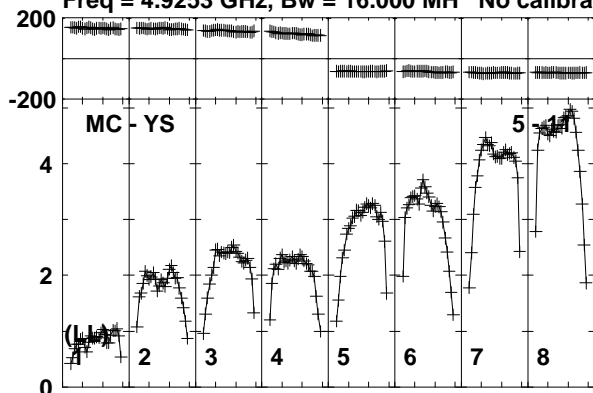

Lower frame: Milli Ampl Jy Top frame: Phas deg

Vector averaged cross-power spectrum Baseline: MC (05) - YS (11)

Timerange: 01/01:40:13 to 01/01:41:57

Plot file version 505 created 11-APR-2016 17:09:39

J1128+5925 GP053G 3.UVDATA.1

Freq = 4.9253 GHz, Bw = 16.000 MH No calibration applied and no bandpass applied

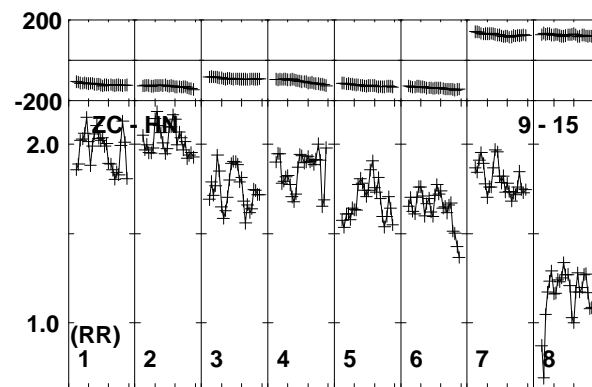
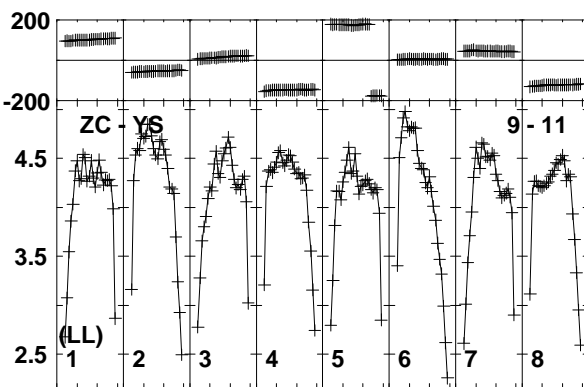
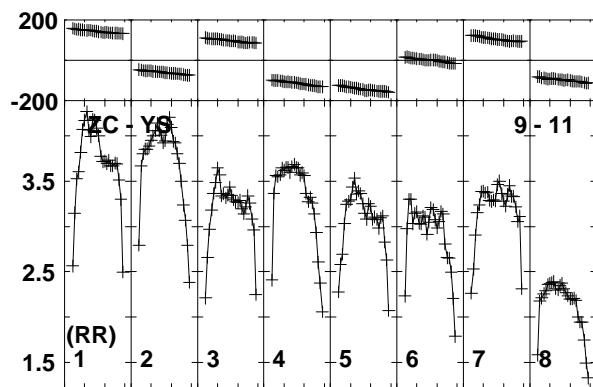
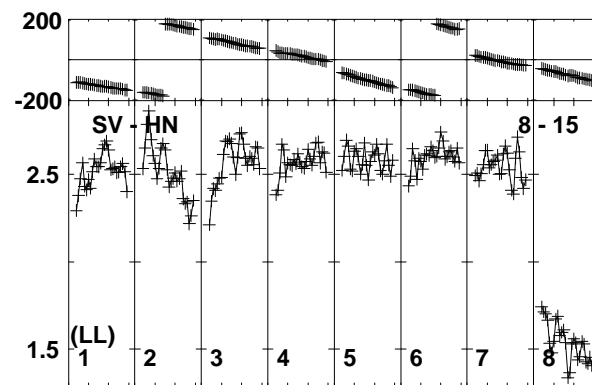
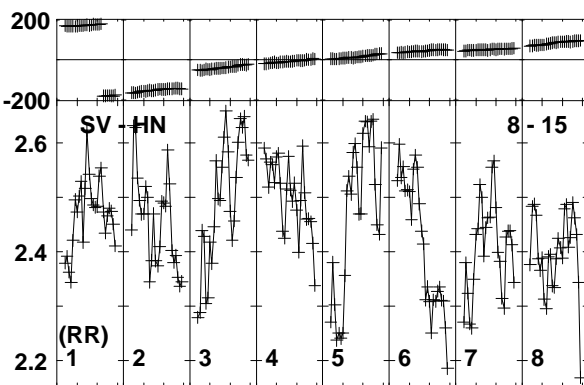
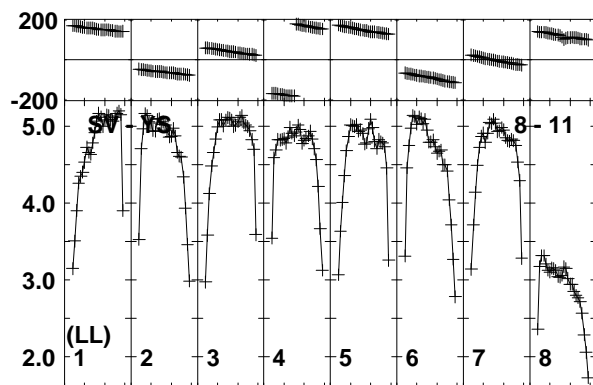
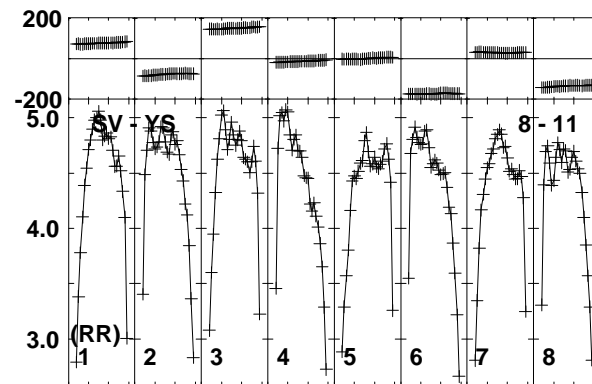
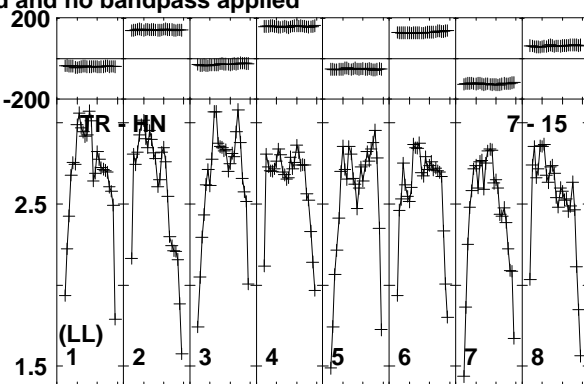
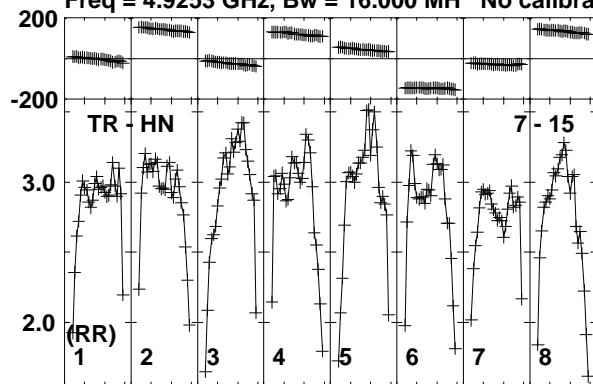

Lower frame: Milli Ampl Jy Top frame: Phas deg
Vector averaged cross-power spectrum Baseline: TR (07) - HN (15)
Timerange: 01/01:40:13 to 01/01:41:57

Plot file version 506 created 11-APR-2016 17:09:39

J1128+5925 GP053G 3.UVDATA.1

Freq = 4.9253 GHz, Bw = 16.000 MH No calibration applied and no bandpass applied

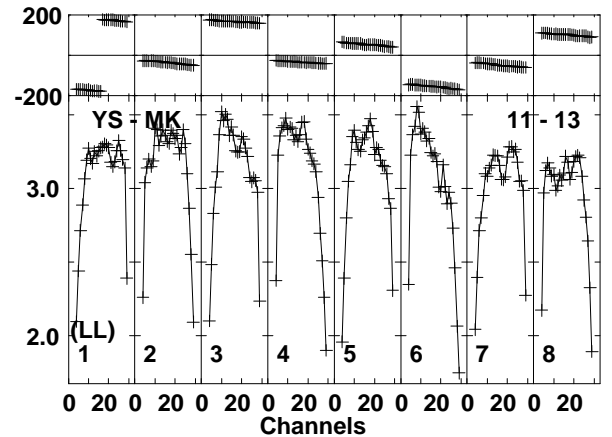
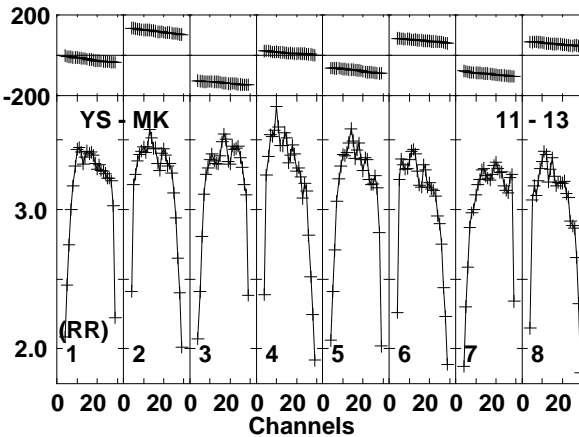
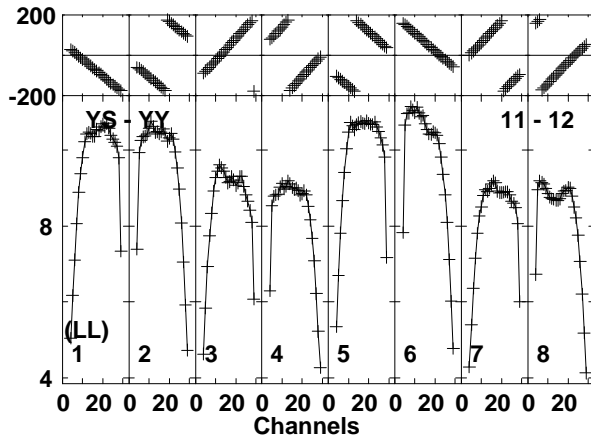
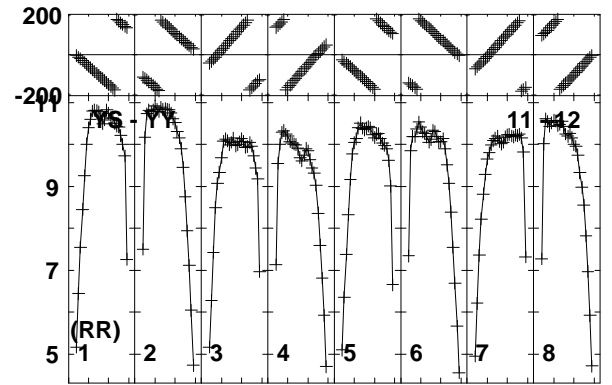
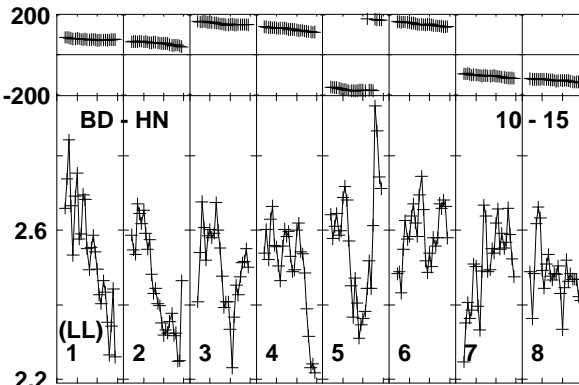
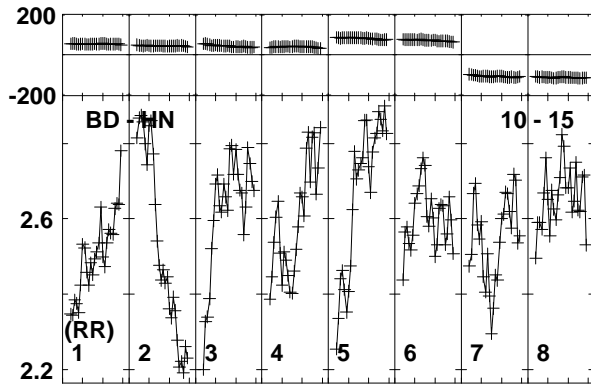
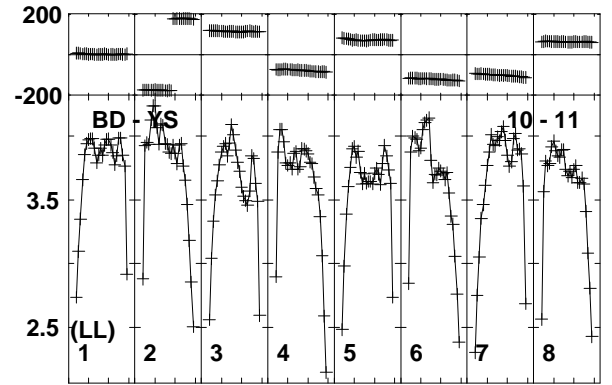
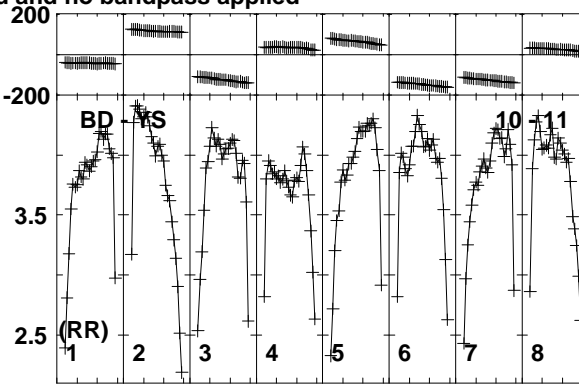
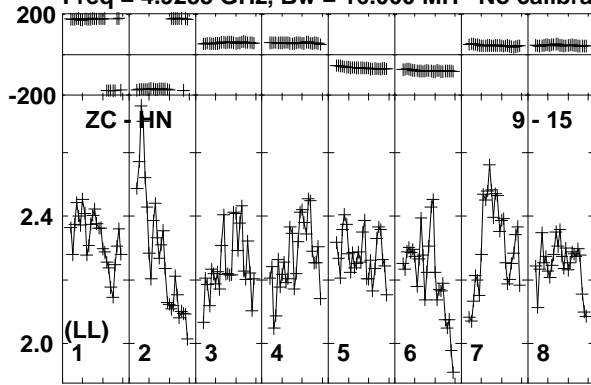

Lower frame: Milli Ampl Jy Top frame: Phas deg
Vector averaged cross-power spectrum Baseline: ZC (09) - HN (15)
Timerange: 01/01:40:13 to 01/01:41:57

Plot file version 507 created 11-APR-2016 17:09:39

J1128+5925 GP053G 3.UVDATA.1

Freq = 4.9253 GHz, Bw = 16.000 MH No calibration applied and no bandpass applied

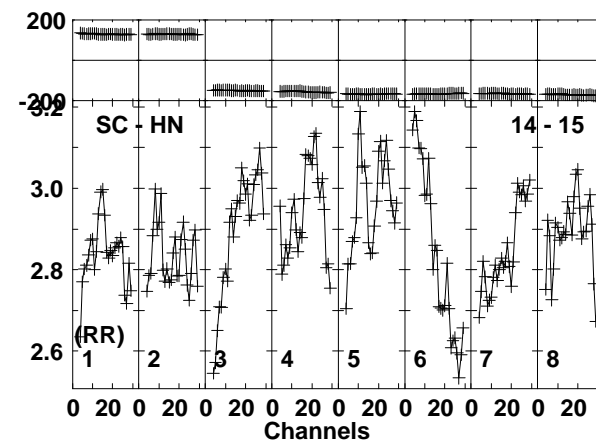
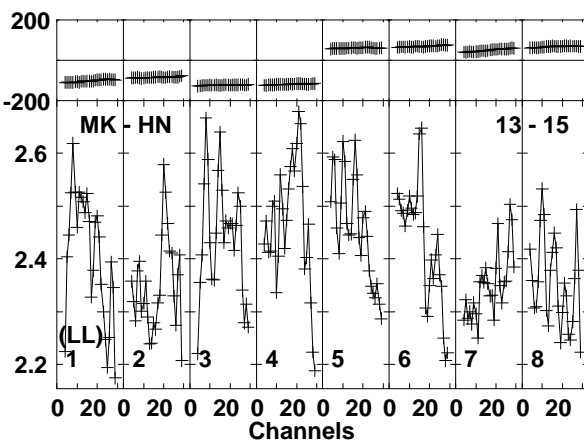
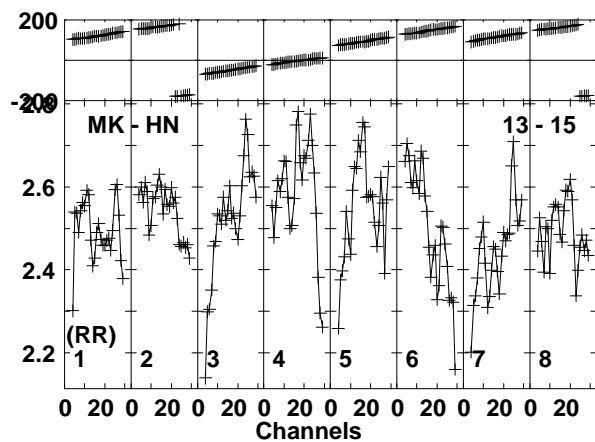
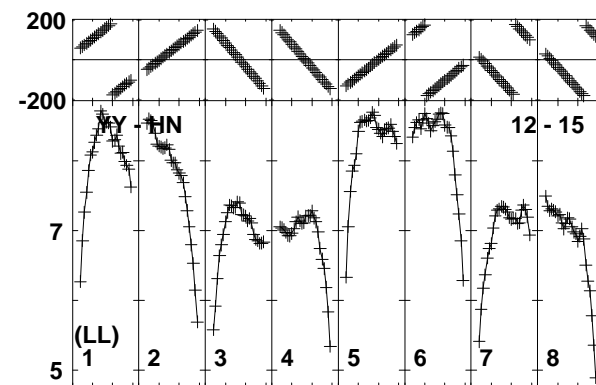
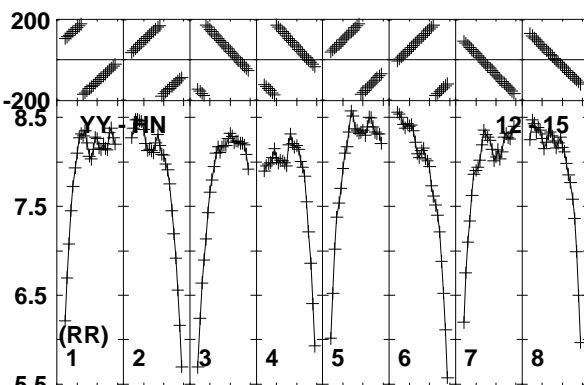
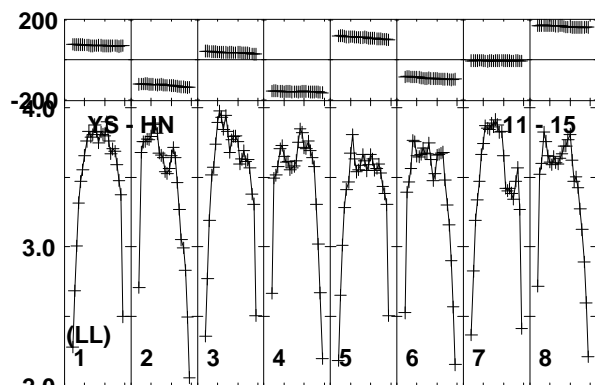
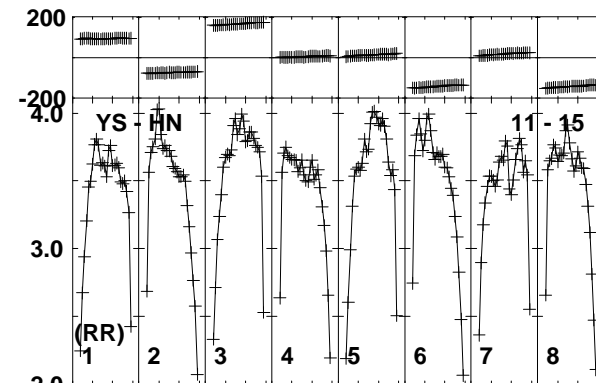
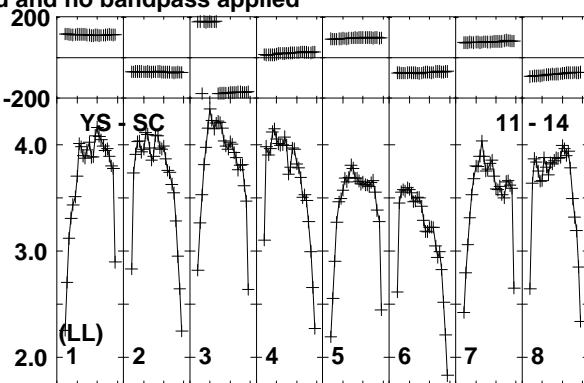
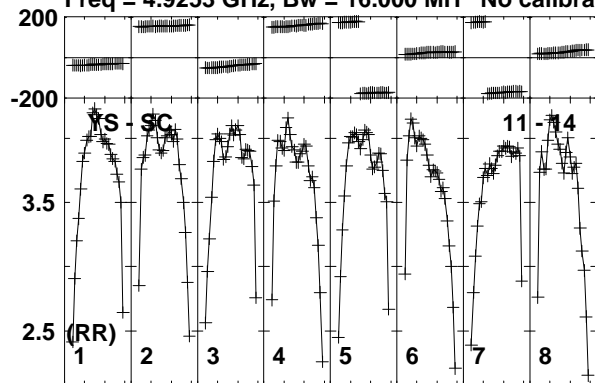

Lower frame: Milli Ampl Jy Top frame: Phas deg
Vector averaged cross-power spectrum Baseline: YS (11) - SC (14)
Timerange: 01/01:40:13 to 01/01:41:57

Plot file version 508 created 11-APR-2016 17:09:39
J1128+5925 GP053G 3.UVDATA.1
Freq = 4.9253 GHz, Bw = 16.000 MH No calibration applied and no bandpass applied

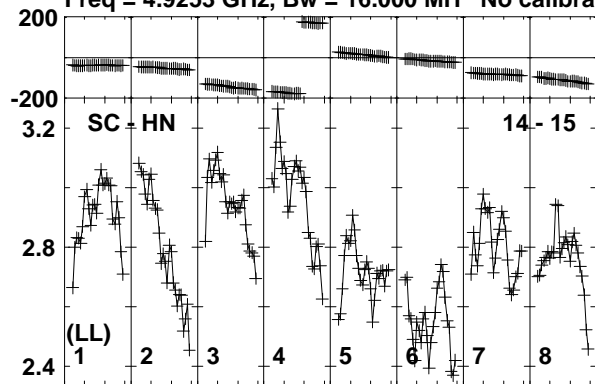

Lower frame: Milli Ampl Jy Top frame: Phas deg
Vector averaged cross-power spectrum Baseline: SC (14) - HN (15)
Timerange: 01/01:40:13 to 01/01:41:57

Plot file version 509 created 11-APR-2016 17:09:39

ARP299C GP053G 3.UVDATA.1

Freq = 4.9253 GHz, Bw = 16.000 MH No calibration applied and no bandpass applied

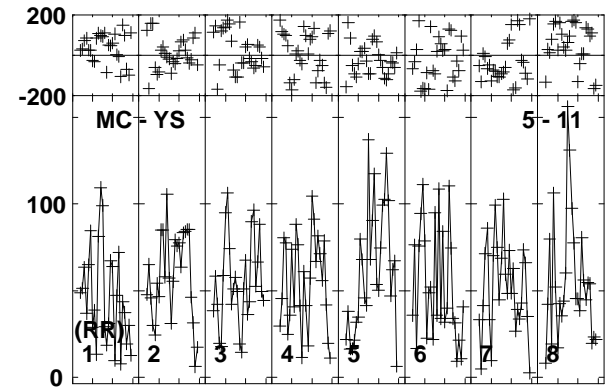
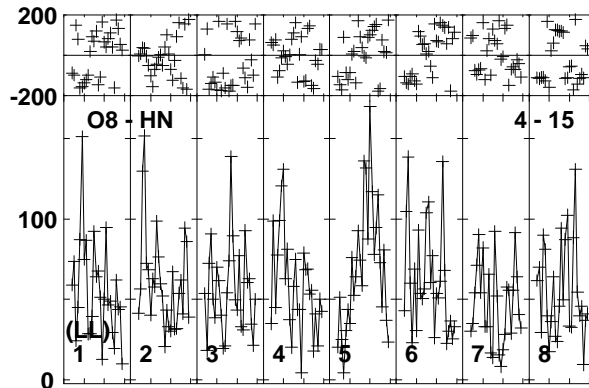
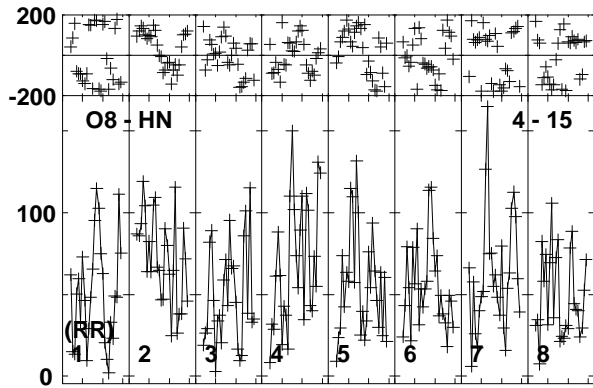
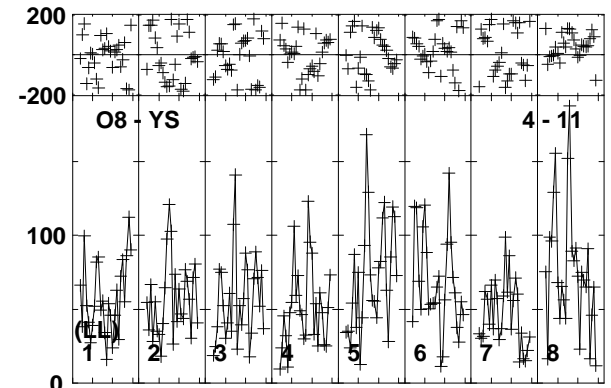
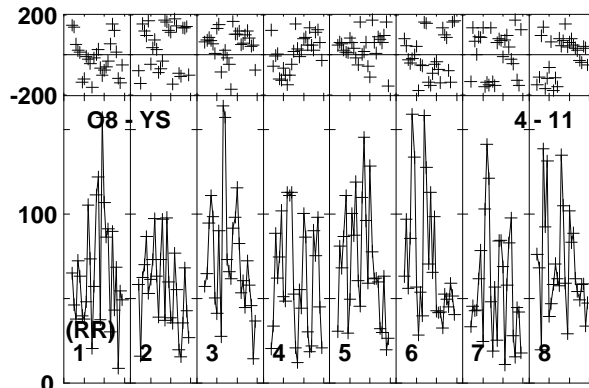
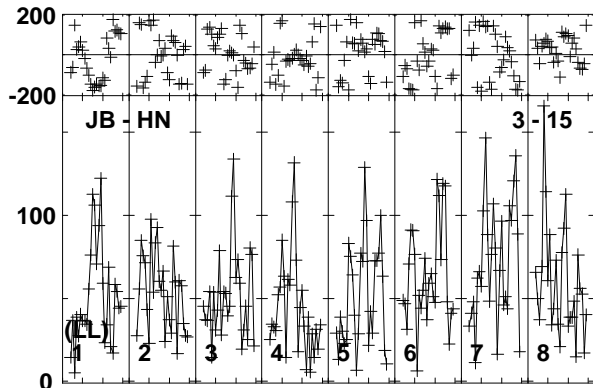
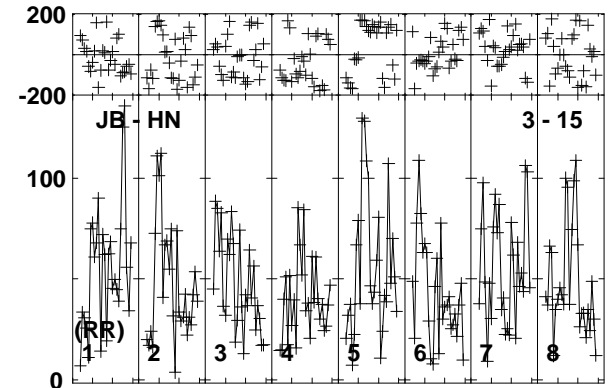
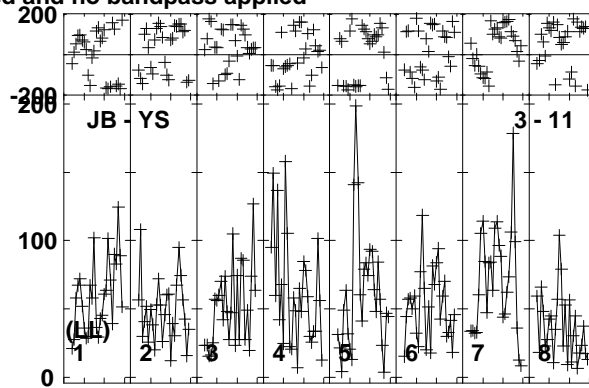
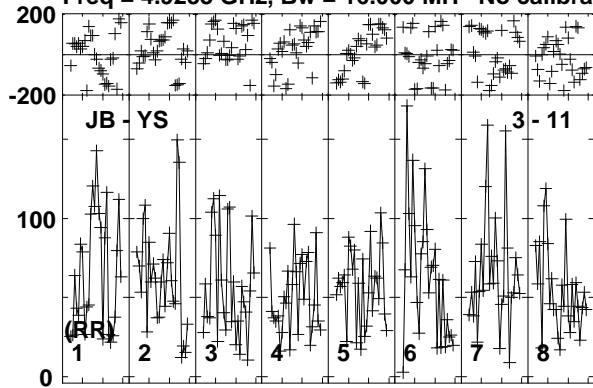

Lower frame: Micro Ampl Jy Top frame: Phas deg
Vector averaged cross-power spectrum Baseline: JB (03) - YS (11)
Timerange: 01/01:42:03 to 01/01:47:15

Plot file version 510 created 11-APR-2016 17:09:39

ARP299C GP053G 3.UVDATA.1

Freq = 4.9253 GHz, Bw = 16.000 MH No calibration applied and no bandpass applied

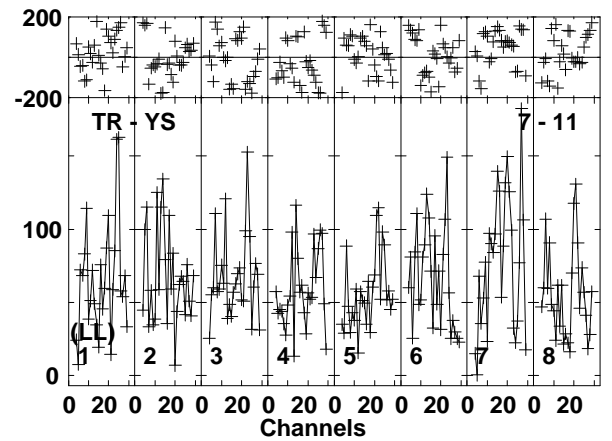
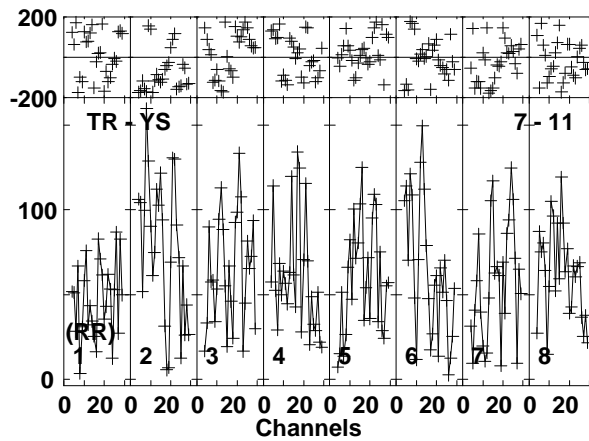
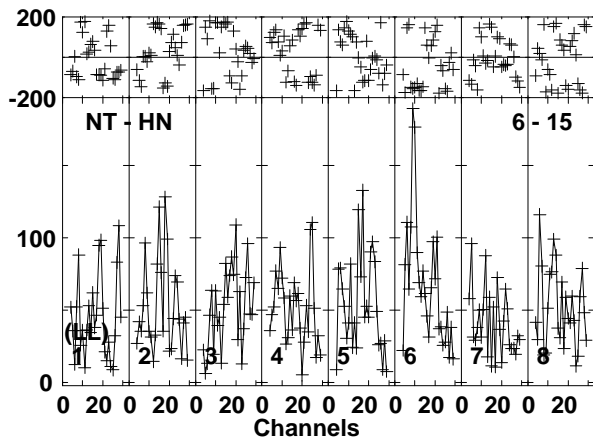
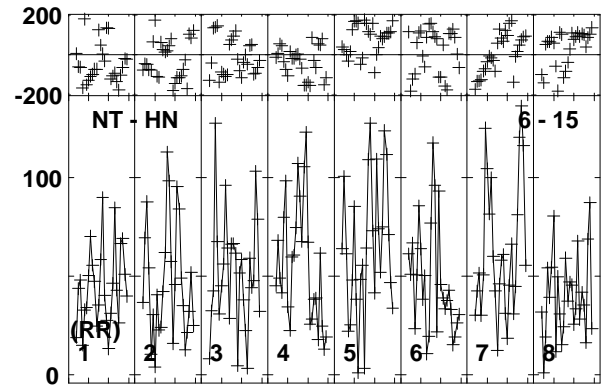
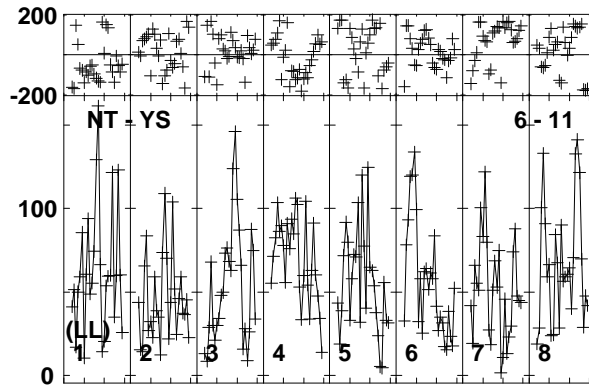
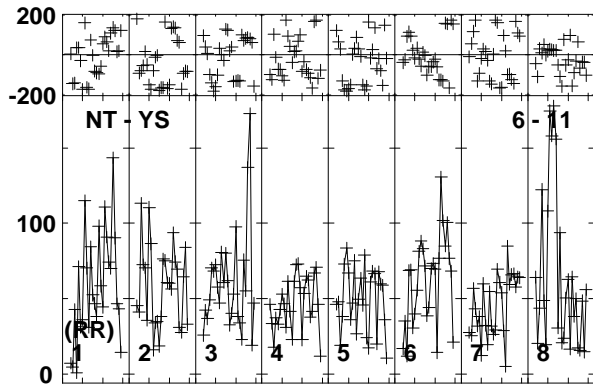
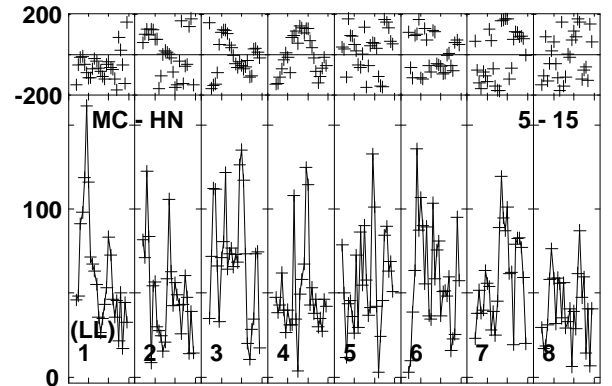
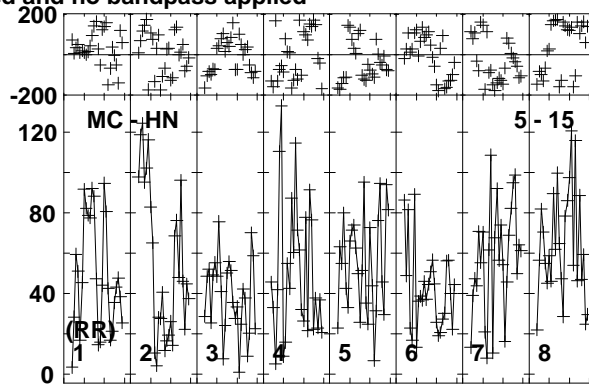
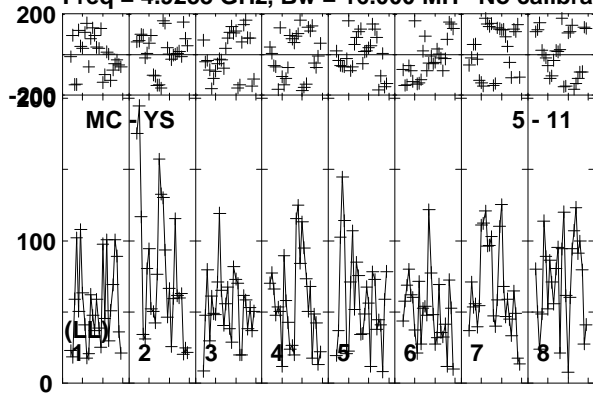

Lower frame: Micro Ampl Jy Top frame: Phas deg
Vector averaged cross-power spectrum Baseline: MC (05) - YS (11)
Timerange: 01/01:42:03 to 01/01:47:15

Plot file version 511 created 11-APR-2016 17:09:40

ARP299C GP053G 3.UVDATA.1

Freq = 4.9253 GHz, Bw = 16.000 MH No calibration applied and no bandpass applied

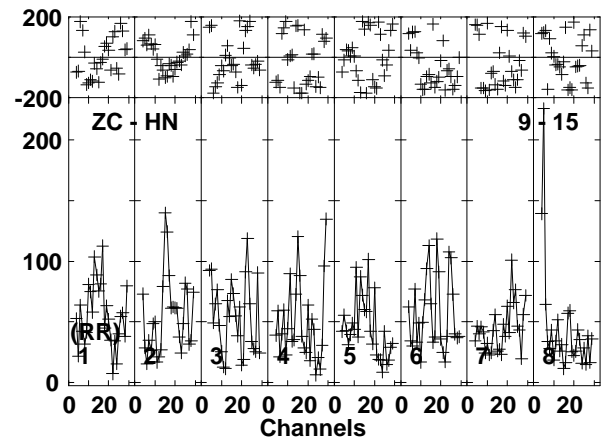
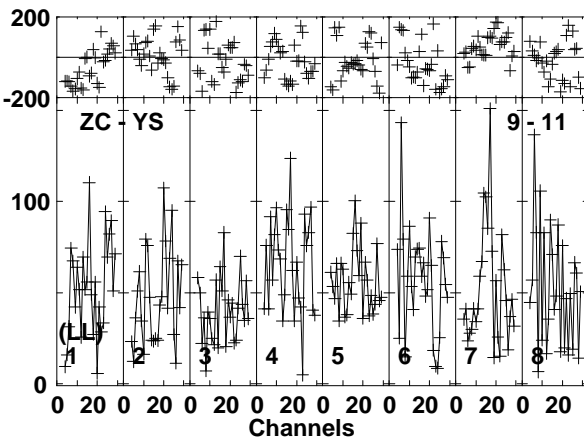
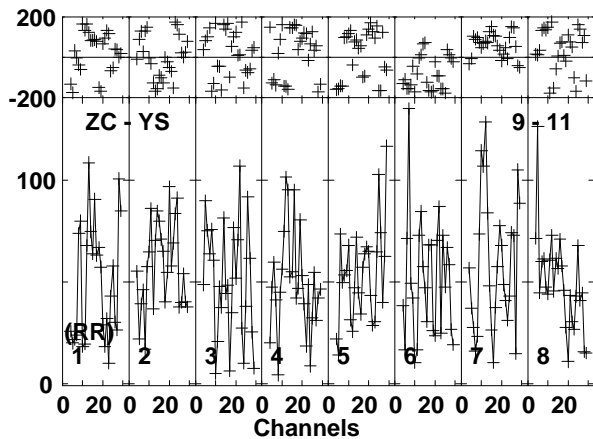
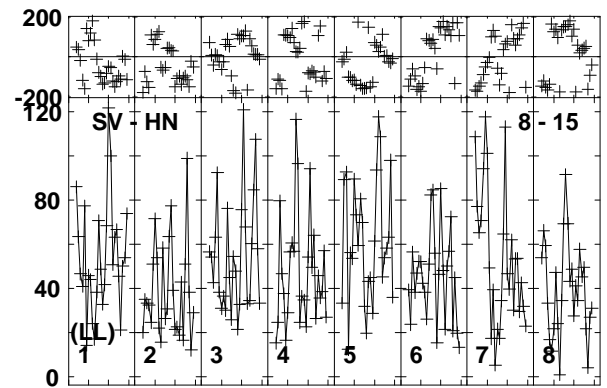
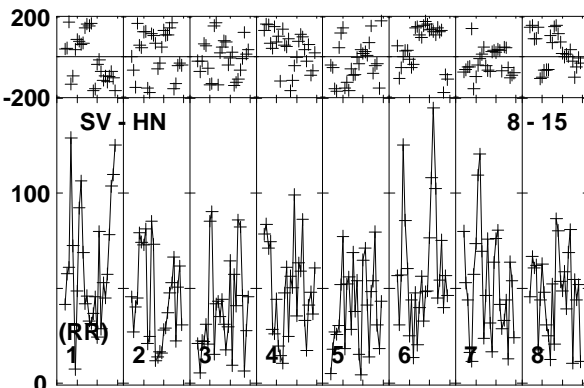
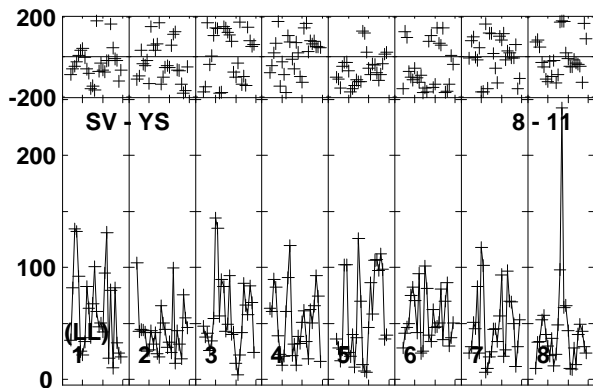
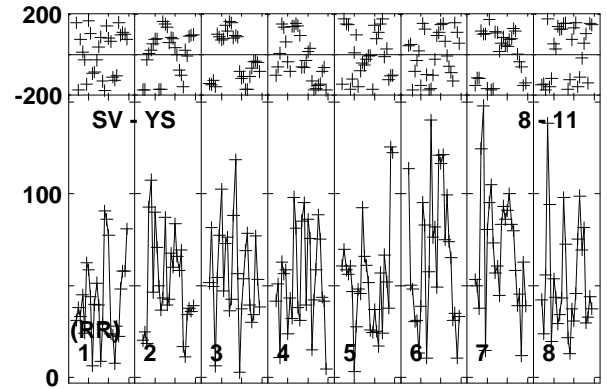
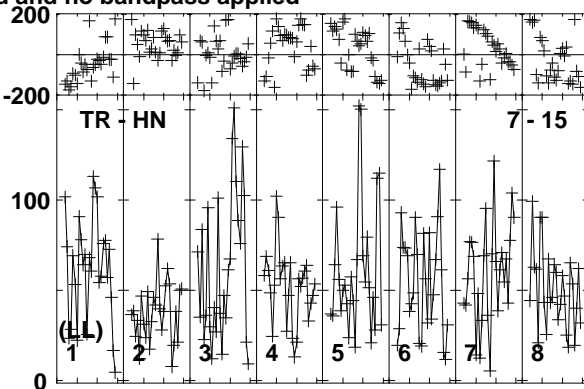
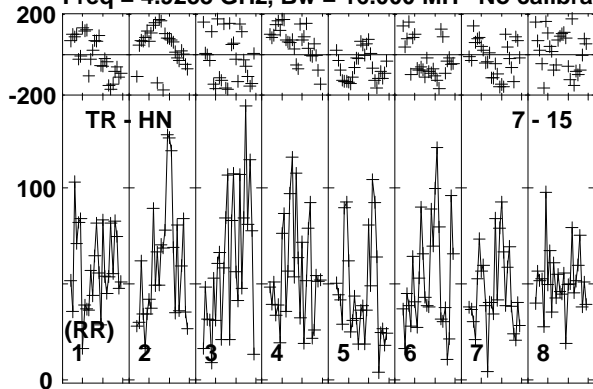

Lower frame: Micro Ampl Jy Top frame: Phas deg
Vector averaged cross-power spectrum Baseline: TR (07) - HN (15)
Timerange: 01/01:42:03 to 01/01:47:15

Plot file version 512 created 11-APR-2016 17:09:40

ARP299C GP053G 3.UVDATA.1

Freq = 4.9253 GHz, Bw = 16.000 MH No calibration applied and no bandpass applied

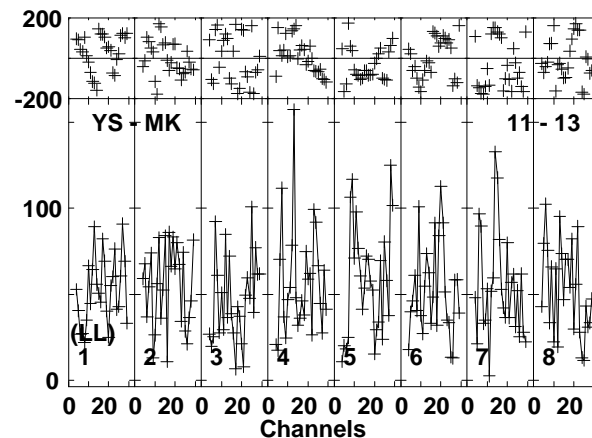
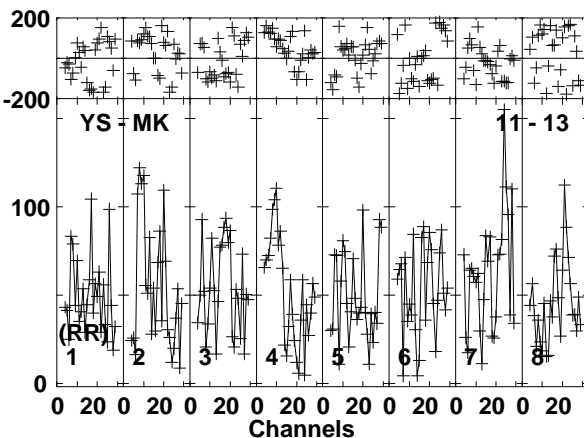
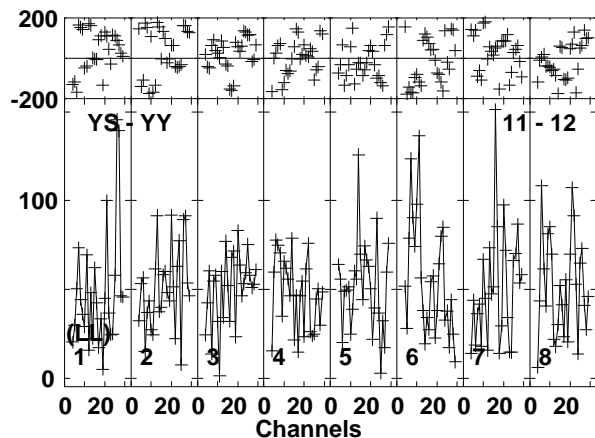
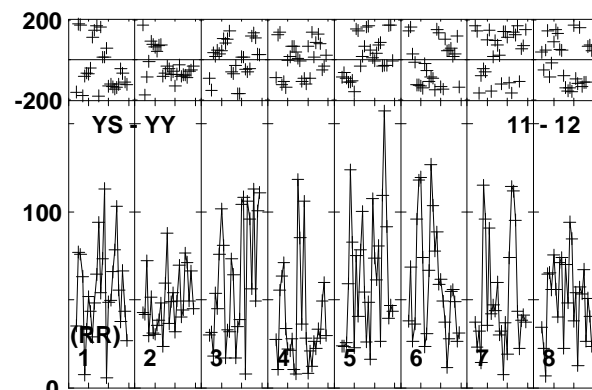
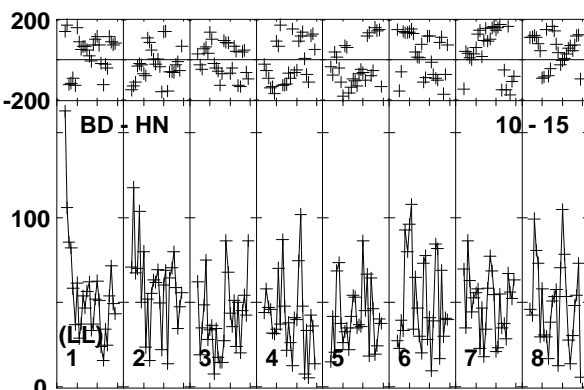
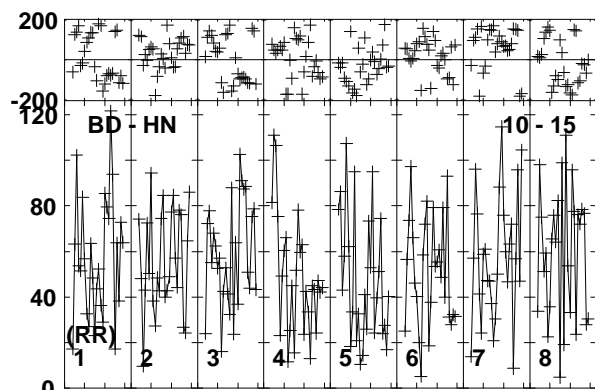
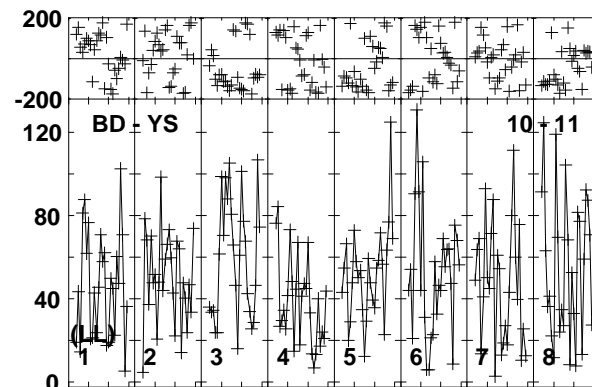
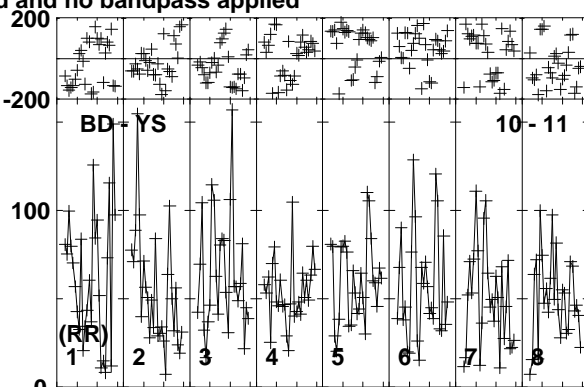
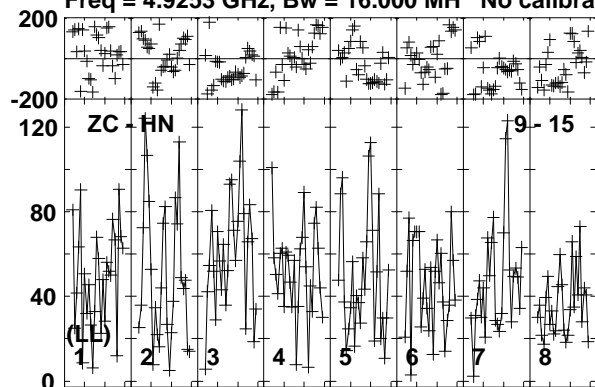

Lower frame: Micro Ampl Jy Top frame: Phas deg
Vector averaged cross-power spectrum Baseline: ZC (09) - HN (15)
Timerange: 01/01:42:03 to 01/01:47:15

Plot file version 513 created 11-APR-2016 17:09:40

ARP299C GP053G 3.UVDATA.1

Freq = 4.9253 GHz, Bw = 16.000 MH No calibration applied and no bandpass applied

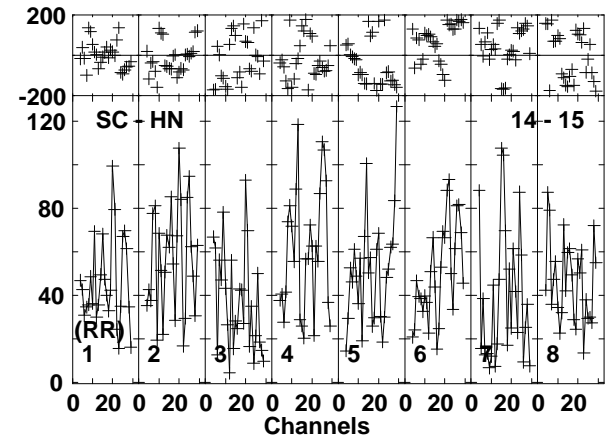
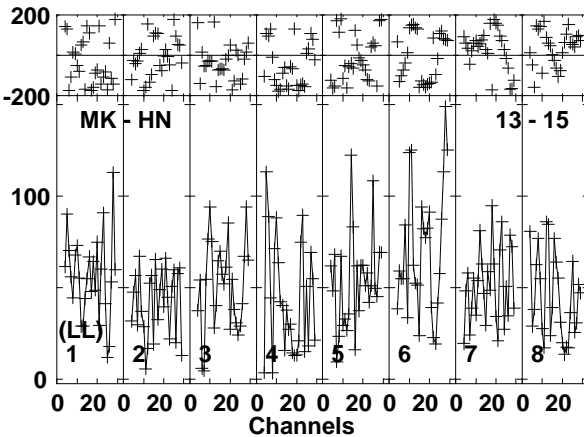
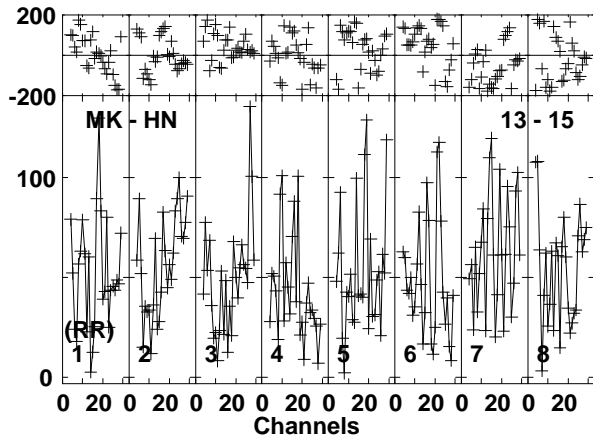
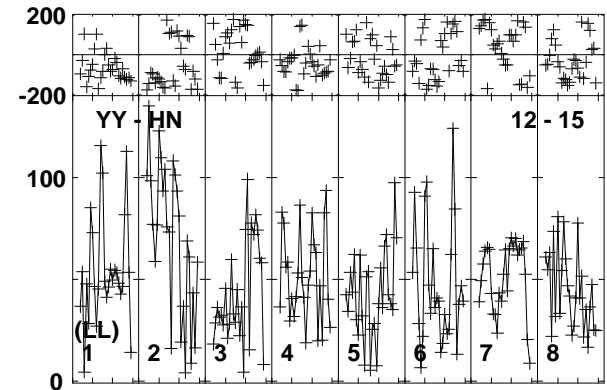
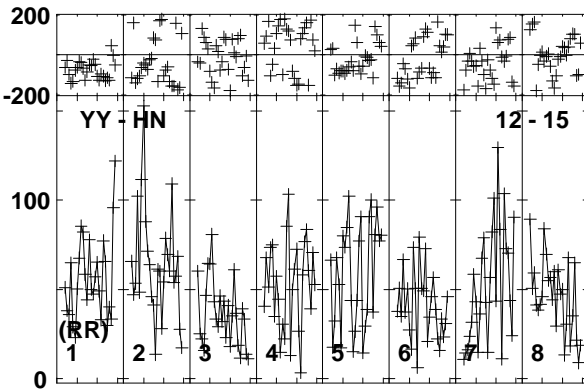
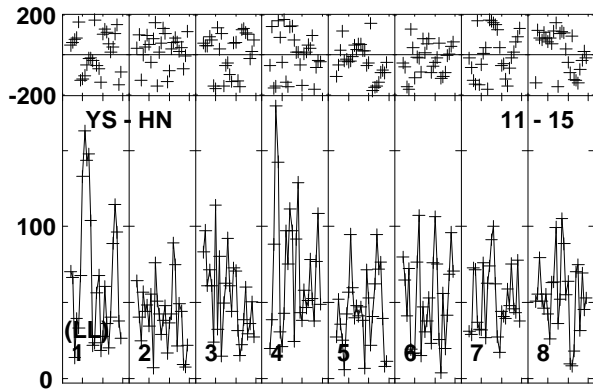
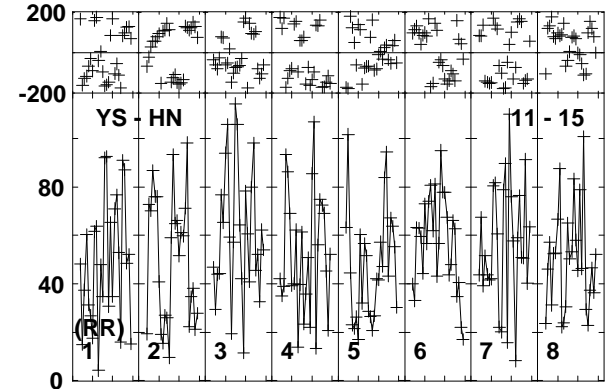
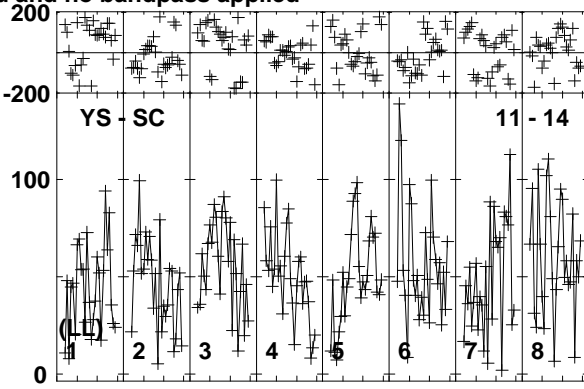
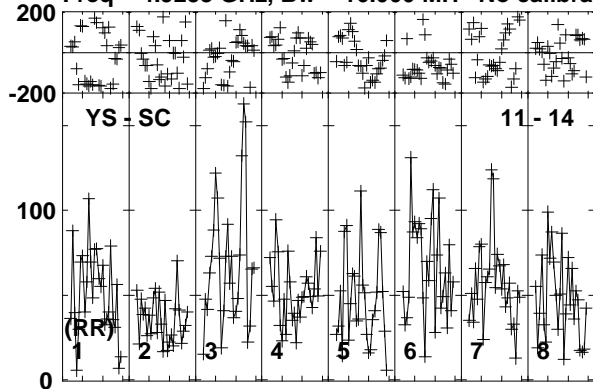

Lower frame: Micro Ampl Jy Top frame: Phas deg
Vector averaged cross-power spectrum Baseline: YS (11) - SC (14)
Timerange: 01/01:42:03 to 01/01:47:15

Plot file version 514 created 11-APR-2016 17:09:40

ARP299C GP053G 3.UVDATA.1

Freq = 4.9253 GHz, Bw = 16.000 MH No calibration applied and no bandpass applied

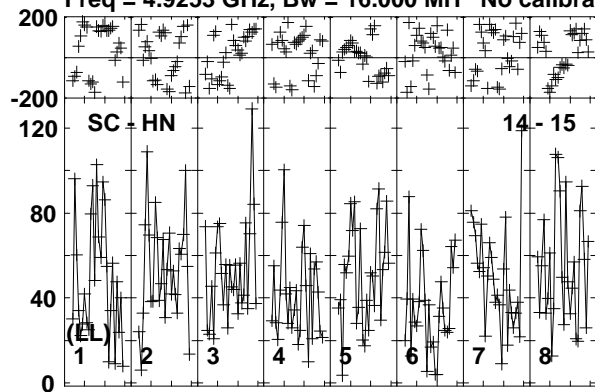

Lower frame: Micro Ampl Jy Top frame: Phas deg
Vector averaged cross-power spectrum Baseline: SC (14) - HN (15)
Timerange: 01/01:42:03 to 01/01:47:15

Plot file version 515 created 11-APR-2016 17:09:40

J1128+5925 GP053G 3.UVDATA.1

Freq = 4.9253 GHz, Bw = 16.000 MH No calibration applied and no bandpass applied

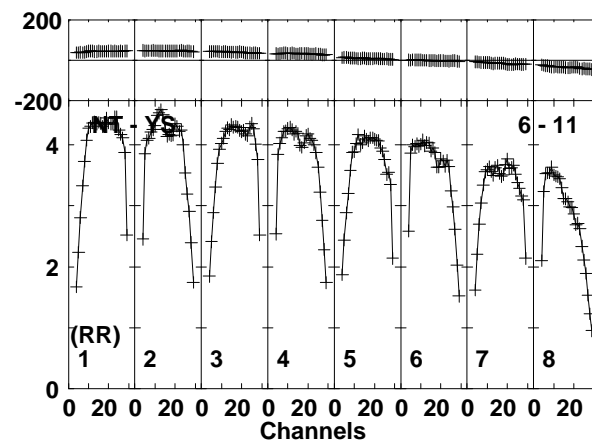
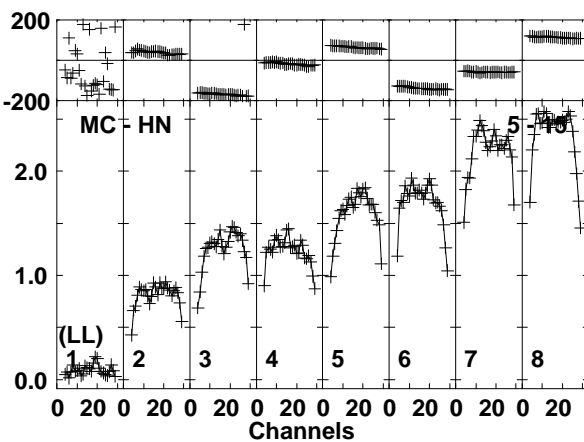
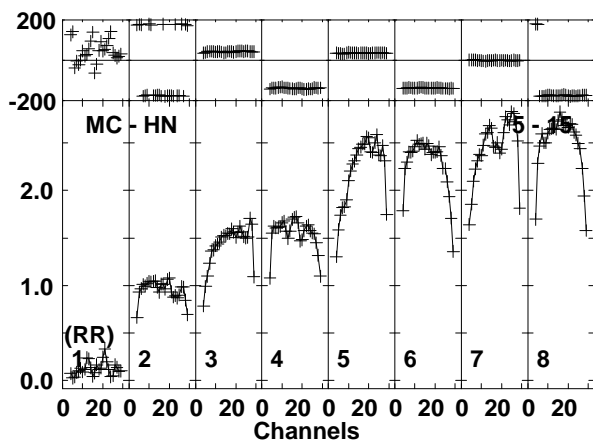
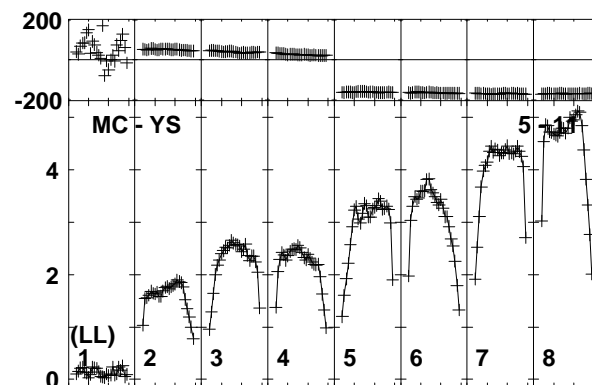
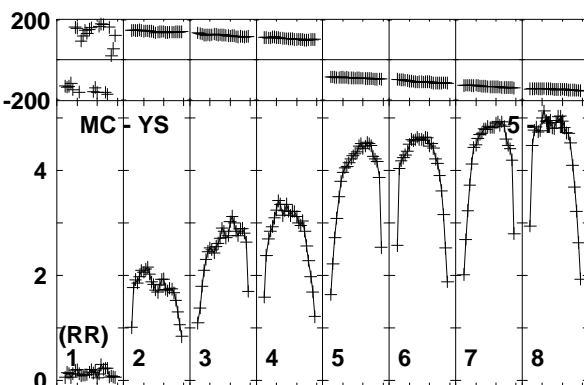
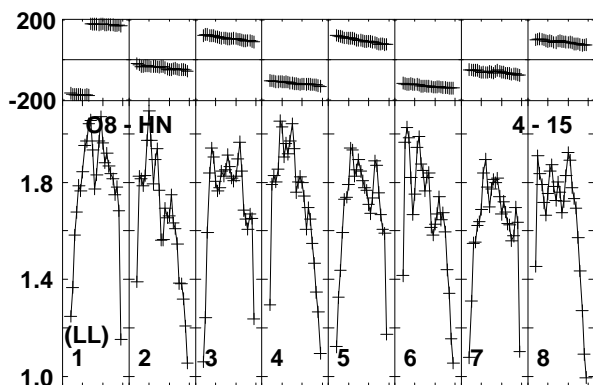
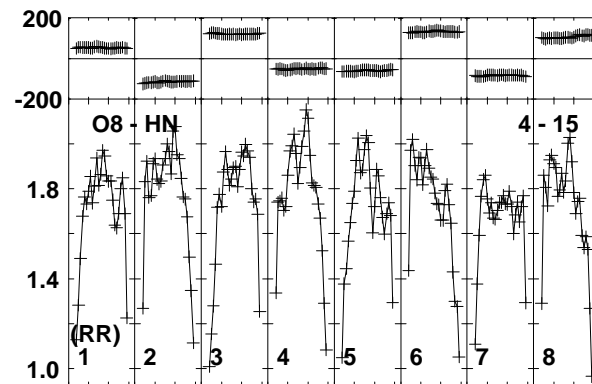
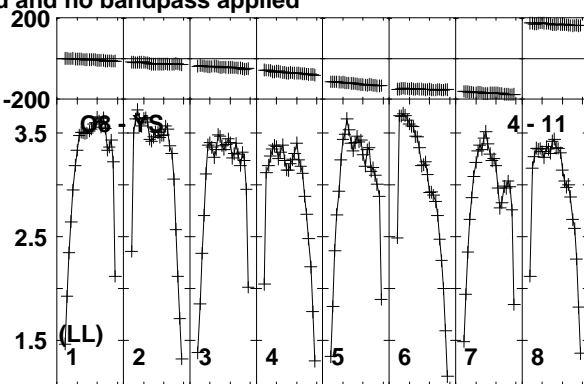
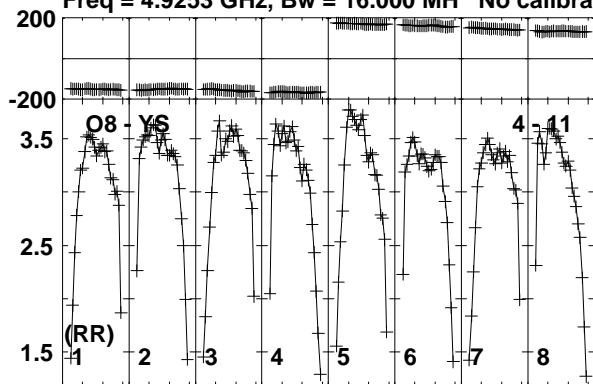

Lower frame: Milli Ampl Jy Top frame: Phas deg
Vector averaged cross-power spectrum Baseline: O8 (04) - YS (11)
Timerange: 01/01:47:21 to 01/01:49:13

Plot file version 516 created 11-APR-2016 17:09:41

J1128+5925 GP053G 3.UVDATA.1

Freq = 4.9253 GHz, Bw = 16.000 MH No calibration applied and no bandpass applied

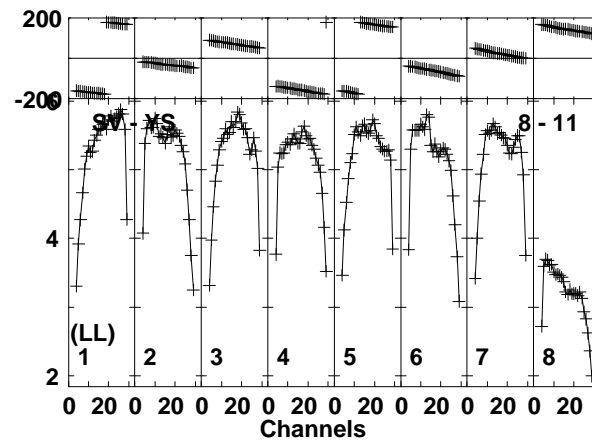
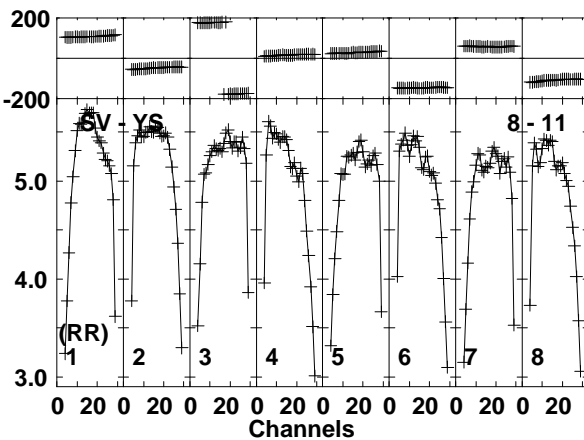
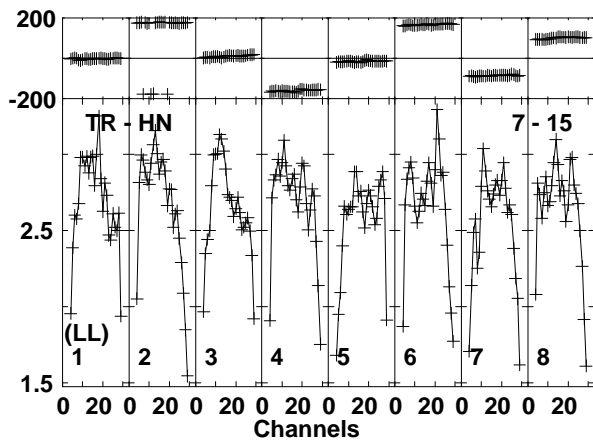
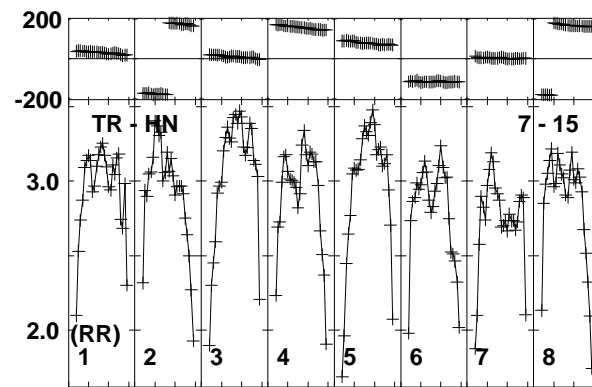
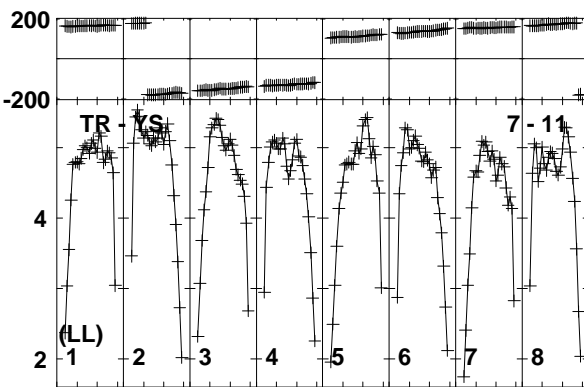
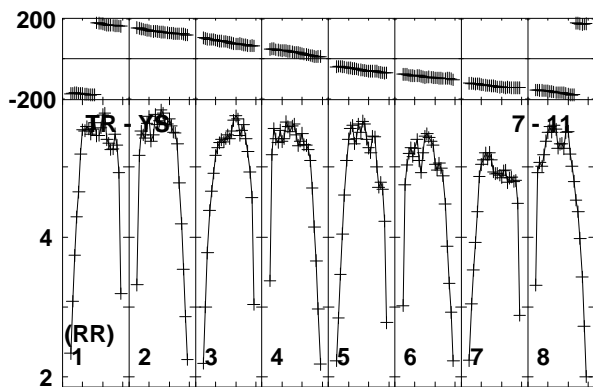
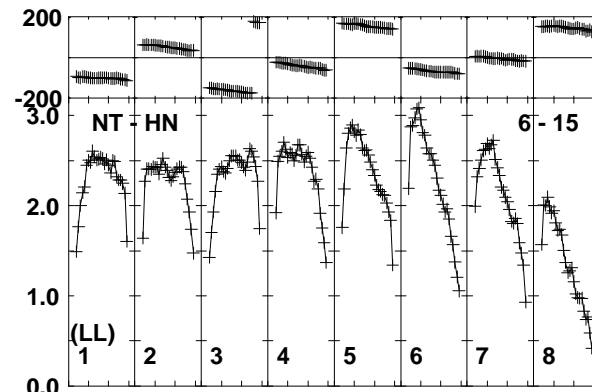
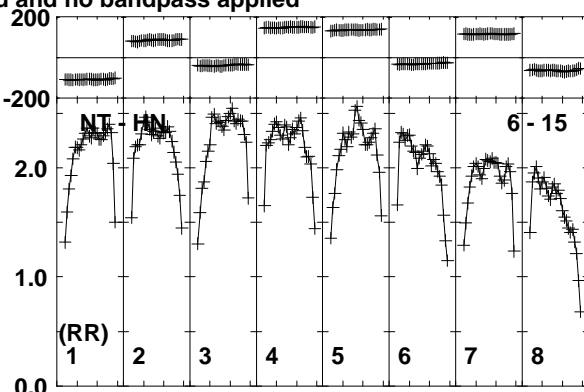
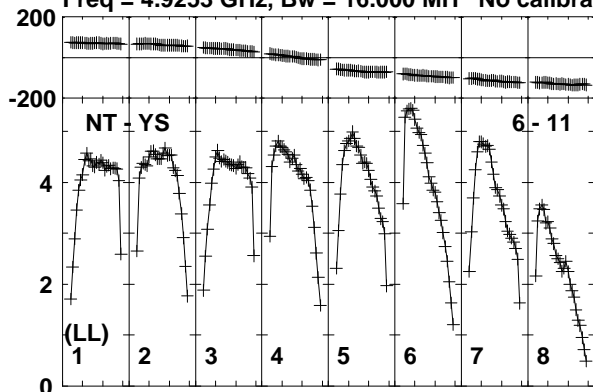

Lower frame: Milli Ampl Jy Top frame: Phas deg
Vector averaged cross-power spectrum Baseline: NT (06) - YS (11)
Timerange: 01/01:47:21 to 01/01:49:13

Plot file version 517 created 11-APR-2016 17:09:41

J1128+5925 GP053G 3.UVDATA.1

Freq = 4.9253 GHz, Bw = 16.000 MH No calibration applied and no bandpass applied

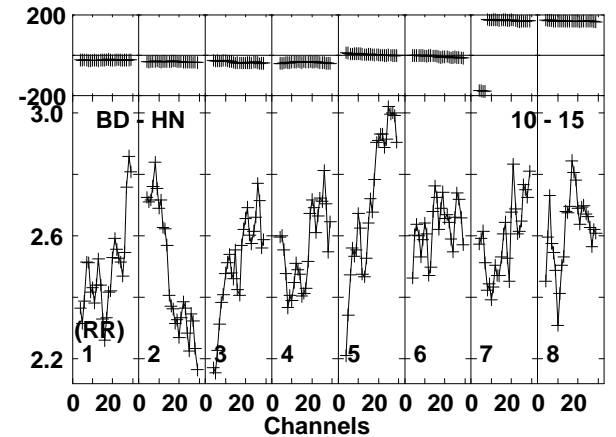
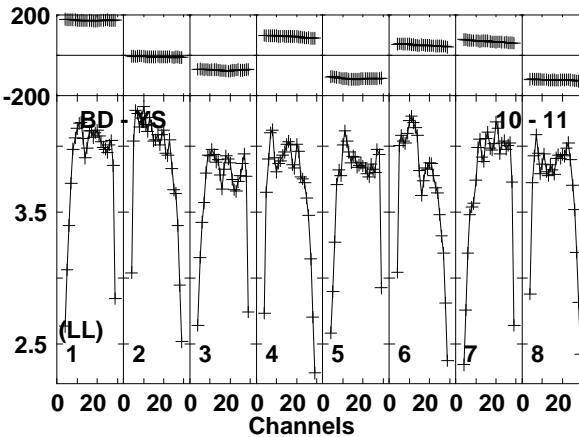
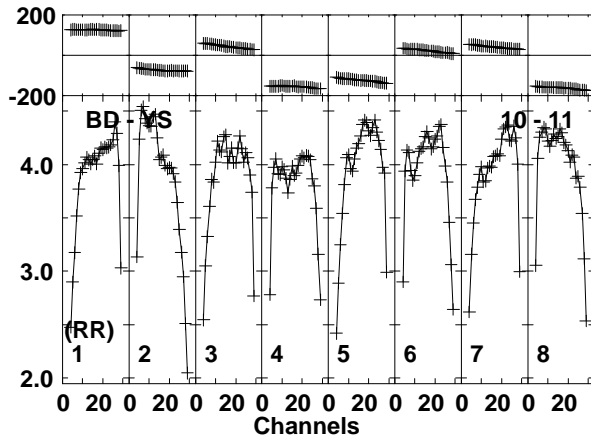
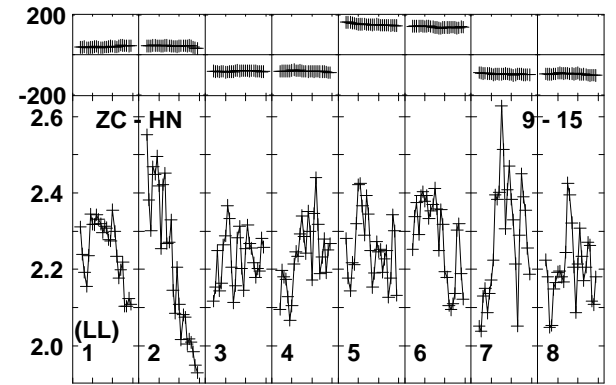
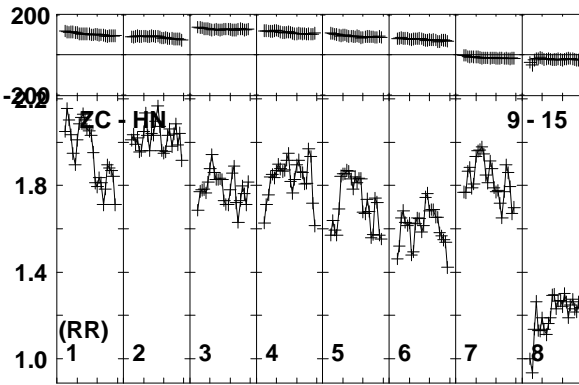
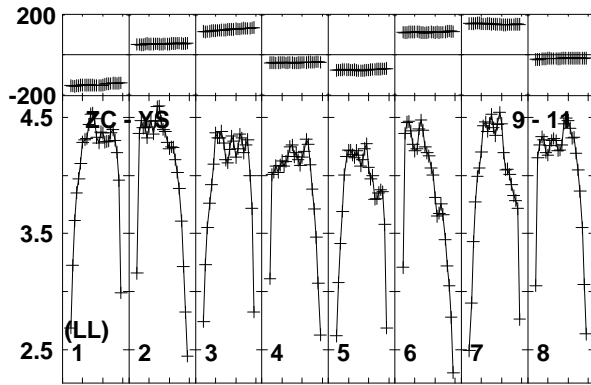
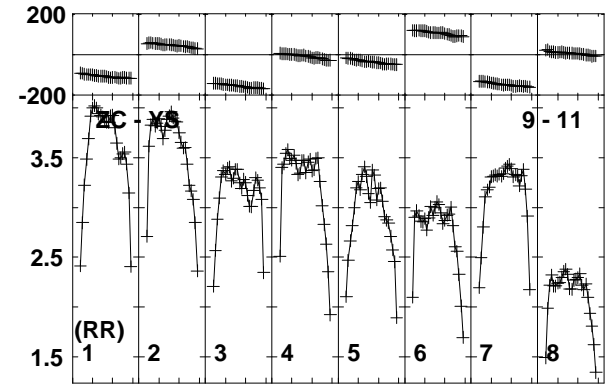
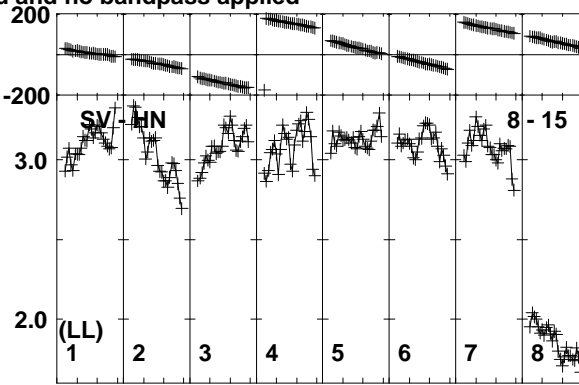
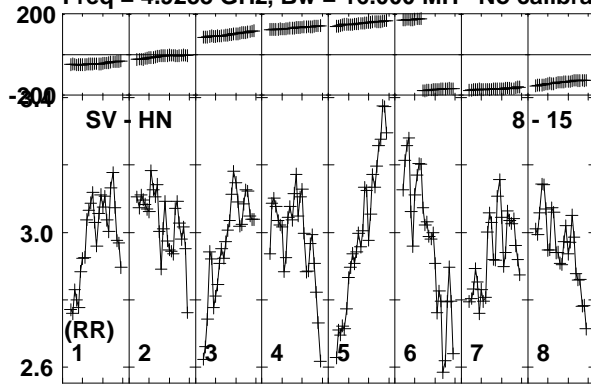

Lower frame: Milli Ampl Jy Top frame: Phas deg
Vector averaged cross-power spectrum Baseline: SV (08) - HN (15)
Timerange: 01/01:47:21 to 01/01:49:13

Plot file version 518 created 11-APR-2016 17:09:41

J1128+5925 GP053G 3.UVDATA.1

Freq = 4.9253 GHz, Bw = 16.000 MH No calibration applied and no bandpass applied

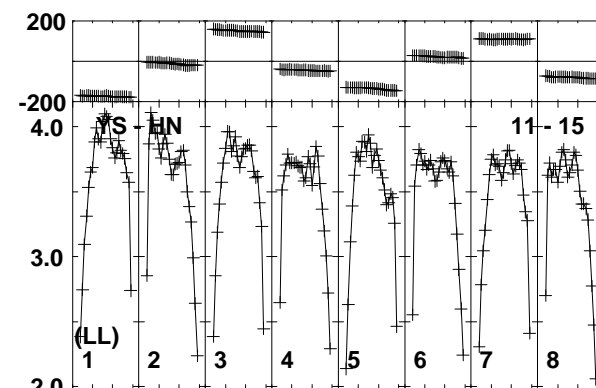
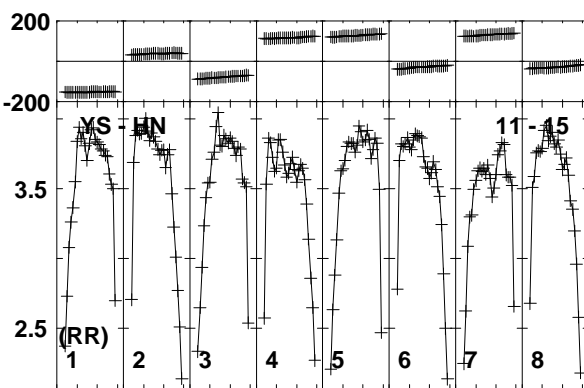
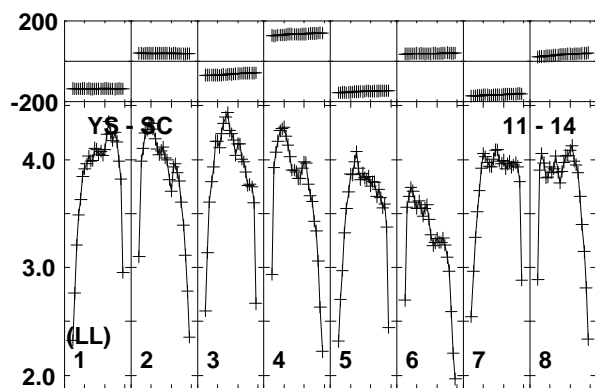
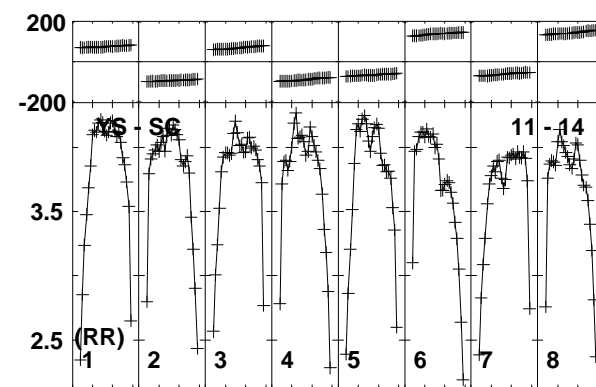
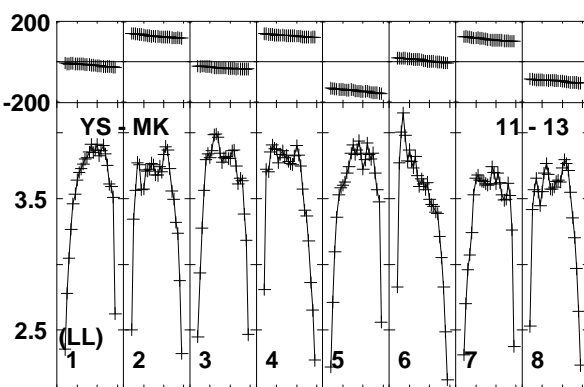
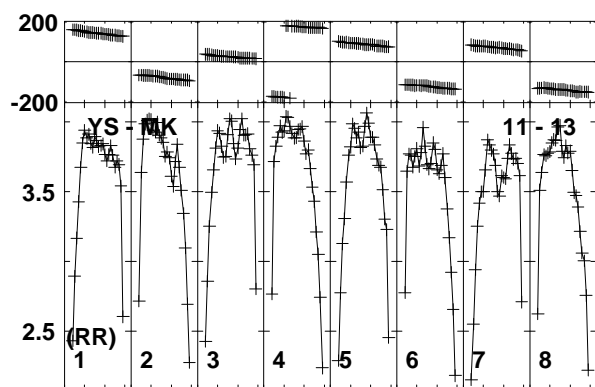
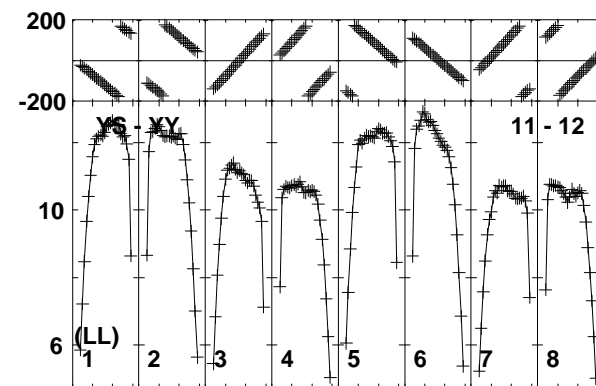
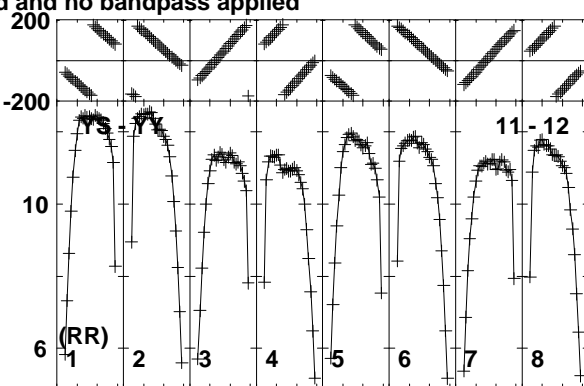
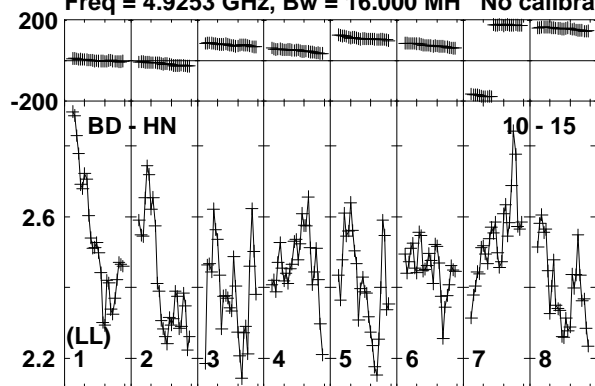

Lower frame: Milli Ampl Jy Top frame: Phas deg
Vector averaged cross-power spectrum Baseline: BD (10) - HN (15)
Timerange: 01/01:47:21 to 01/01:49:13

Plot file version 519 created 11-APR-2016 17:09:41

J1128+5925 GP053G 3.UVDATA.1

Freq = 4.9253 GHz, Bw = 16.000 MH No calibration applied and no bandpass applied

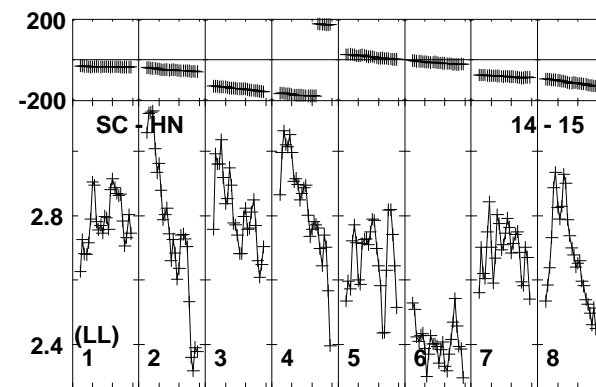
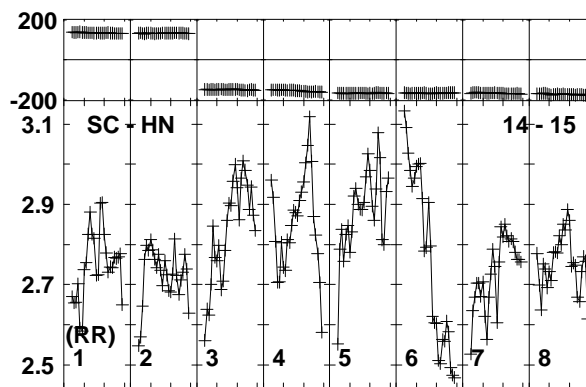
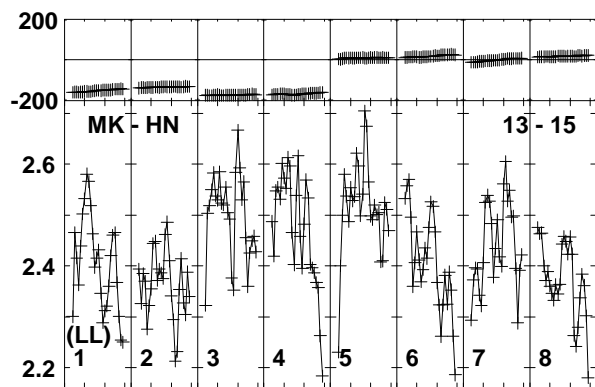
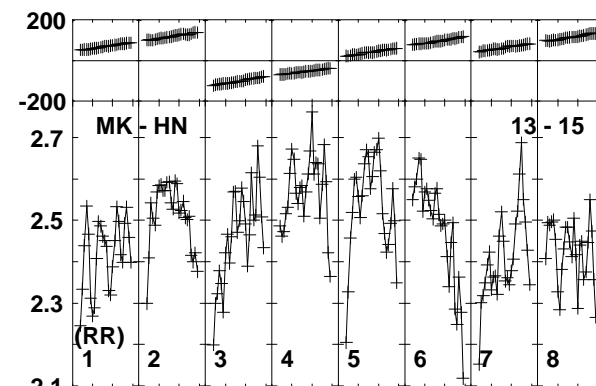
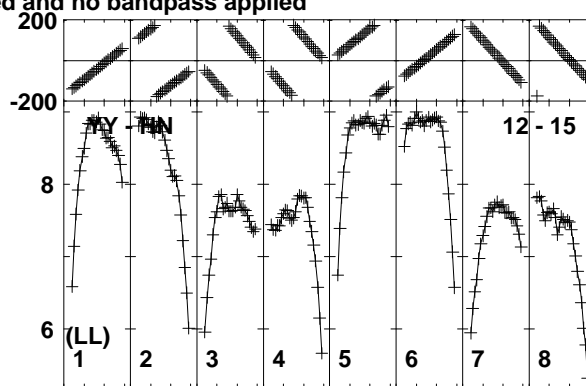
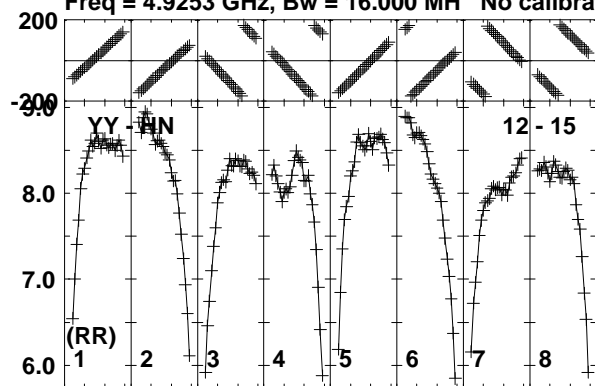

Lower frame: Milli Ampl Jy Top frame: Phas deg
Vector averaged cross-power spectrum Baseline: YY (12) - HN (15)
Timerange: 01/01:47:21 to 01/01:49:13

Plot file version 520 created 11-APR-2016 17:09:41

ARP299C GP053G 3.UVDATA.1

Freq = 4.9253 GHz, Bw = 16.000 MH No calibration applied and no bandpass applied

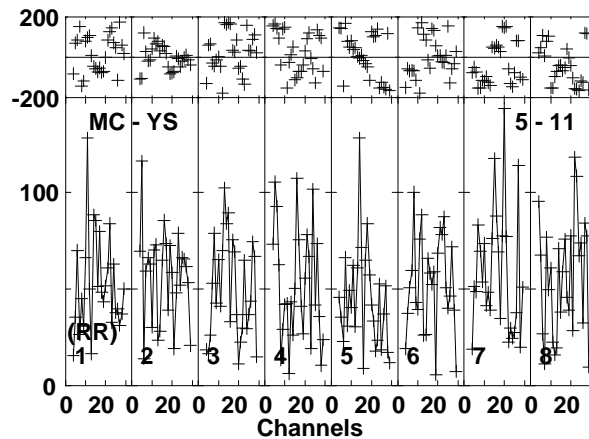
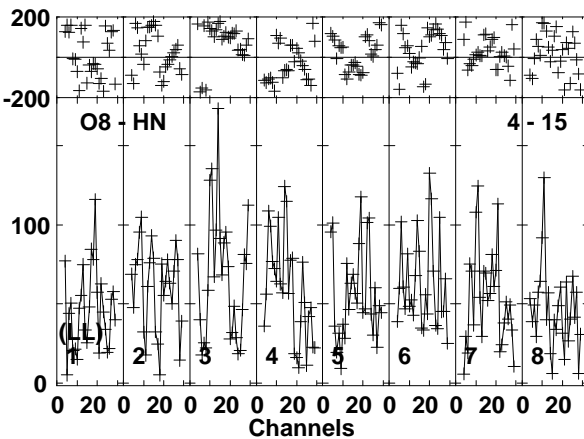
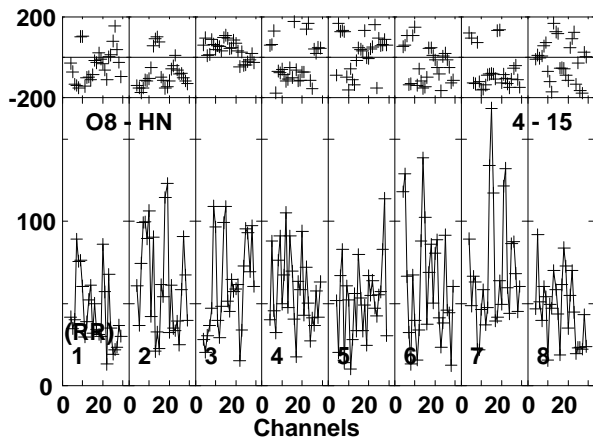
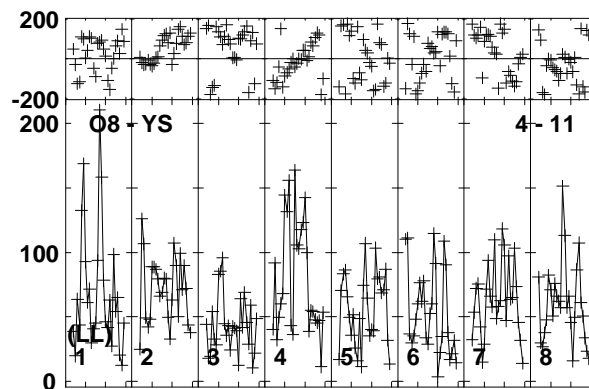
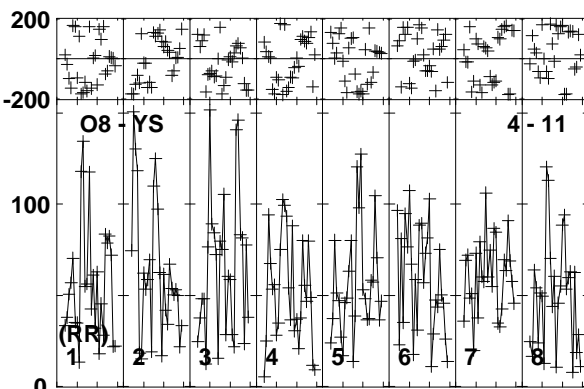
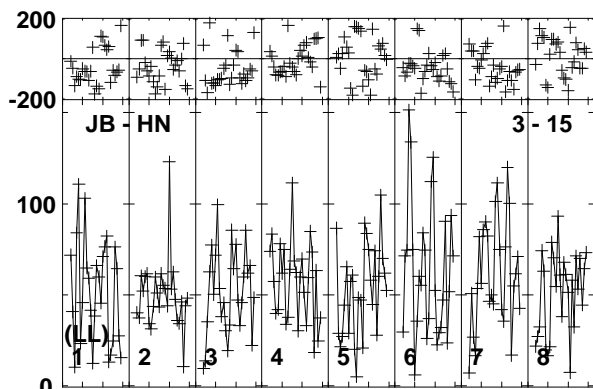
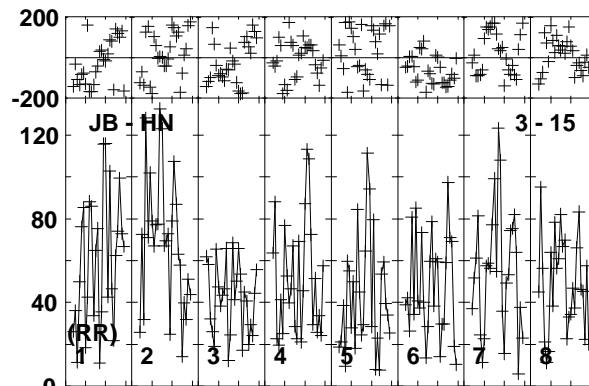
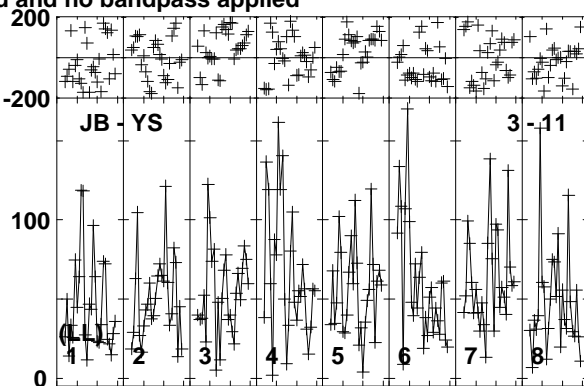
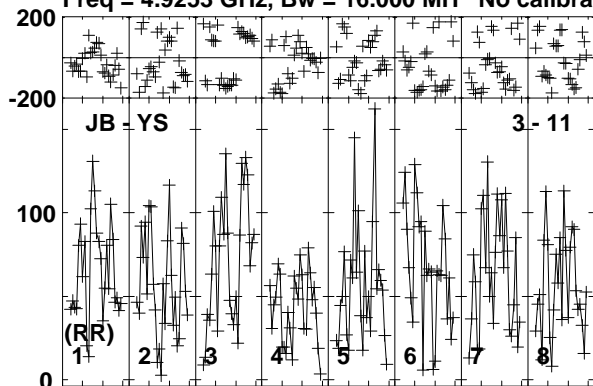

Lower frame: Micro Ampl Jy Top frame: Phas deg
Vector averaged cross-power spectrum Baseline: JB (03) - YS (11)
Timerange: 01/01:49:18 to 01/01:54:32

Plot file version 521 created 11-APR-2016 17:09:41

ARP299C GP053G 3.UVDATA.1

Freq = 4.9253 GHz, Bw = 16.000 MH No calibration applied and no bandpass applied

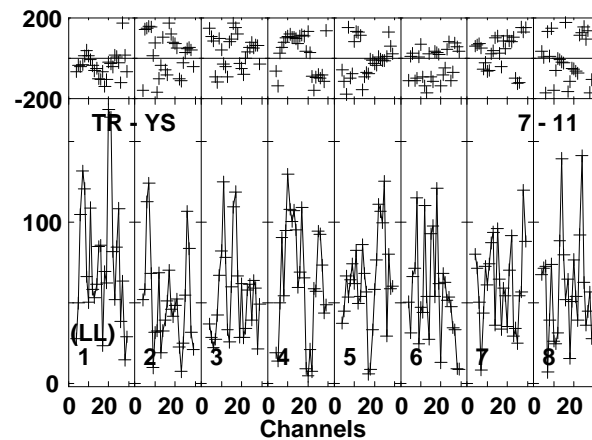
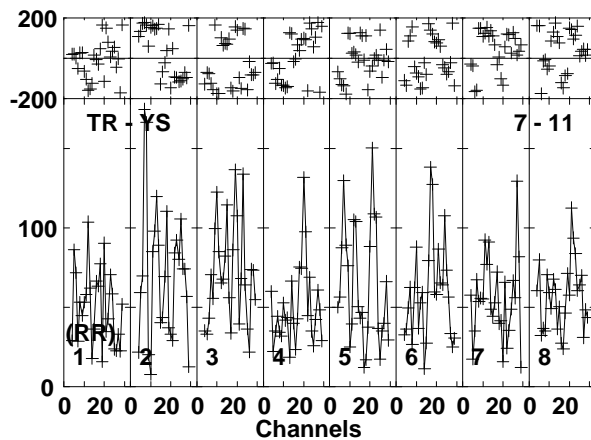
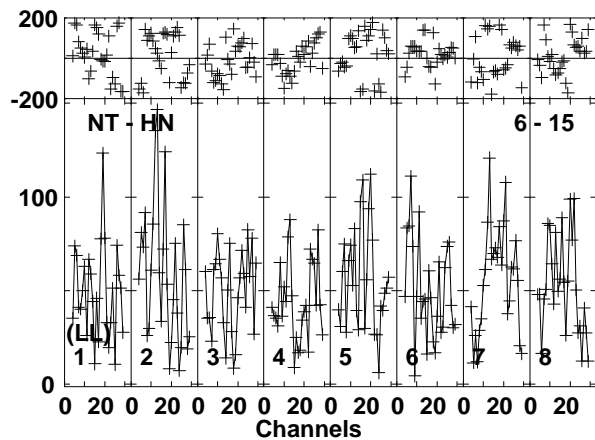
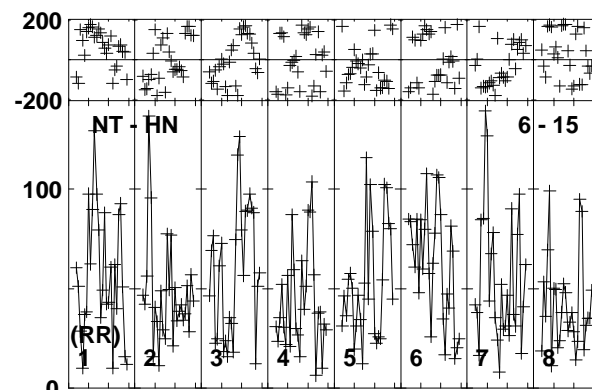
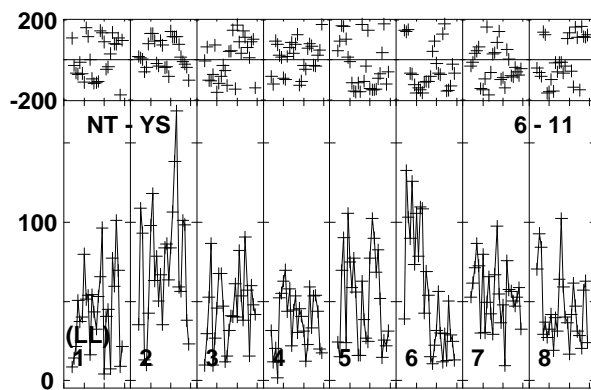
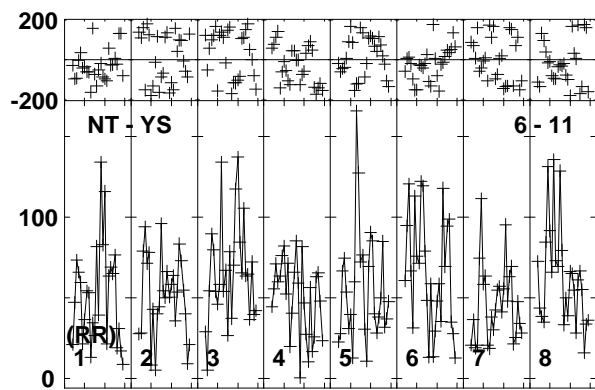
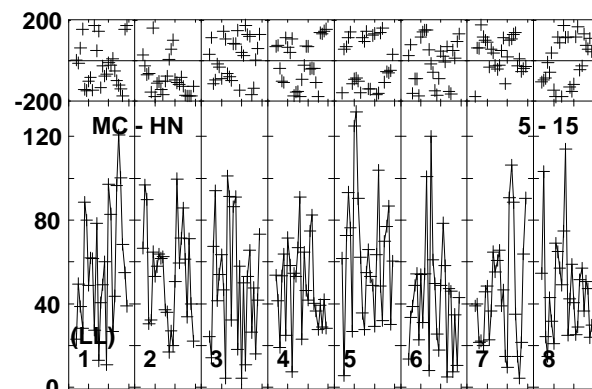
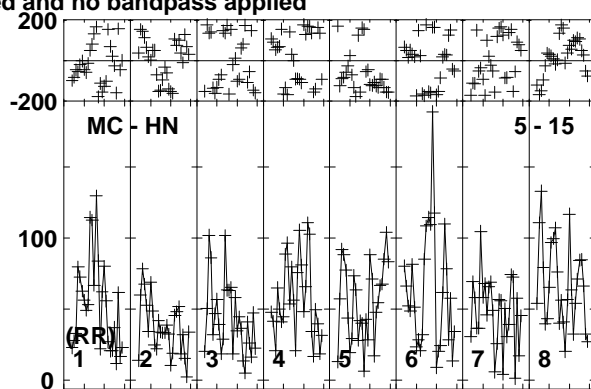
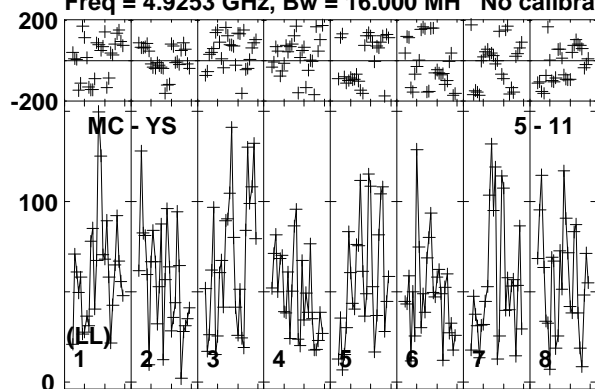

Lower frame: Micro Ampl Jy Top frame: Phas deg
Vector averaged cross-power spectrum Baseline: MC (05) - YS (11)
Timerange: 01/01:49:18 to 01/01:54:32

Plot file version 522 created 11-APR-2016 17:09:42

ARP299C GP053G 3.UVDATA.1

Freq = 4.9253 GHz, Bw = 16.000 MH No calibration applied and no bandpass applied

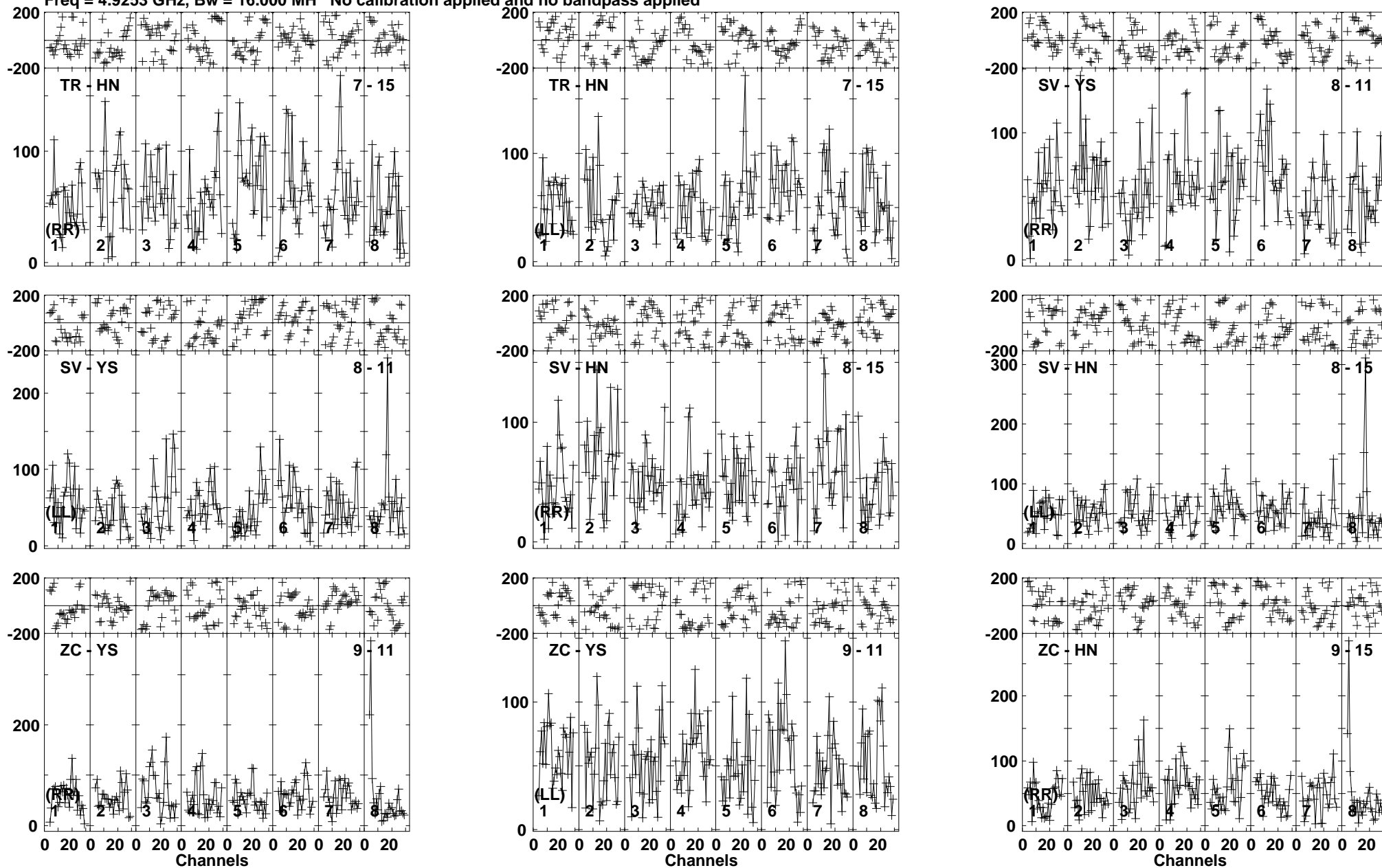

Lower frame: Micro Ampl Jy Top frame: Phas deg
Vector averaged cross-power spectrum Baseline: TR (07) - HN (15)
Timerange: 01/01:49:18 to 01/01:54:32

Plot file version 523 created 11-APR-2016 17:09:42

ARP299C GP053G 3.UVDATA.1

Freq = 4.9253 GHz, Bw = 16.000 MH No calibration applied and no bandpass applied

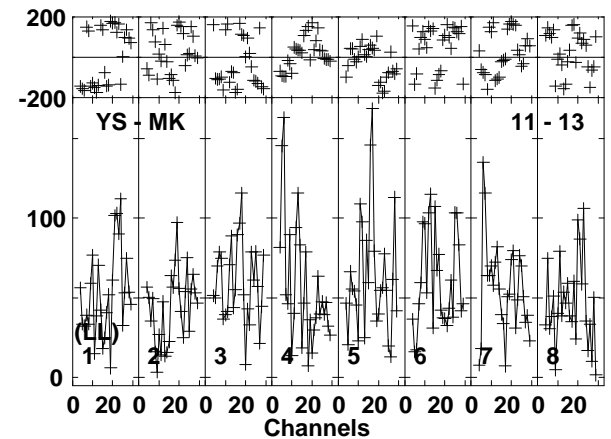
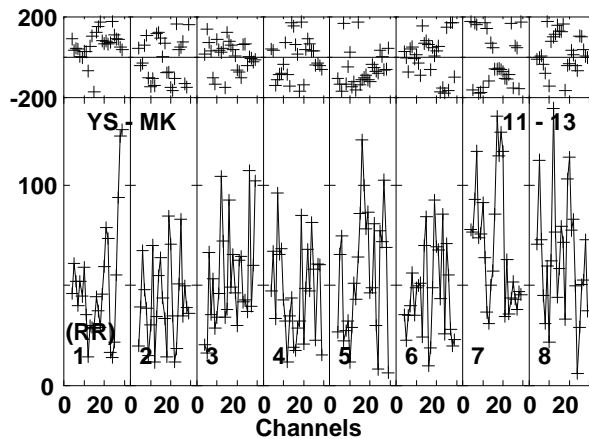
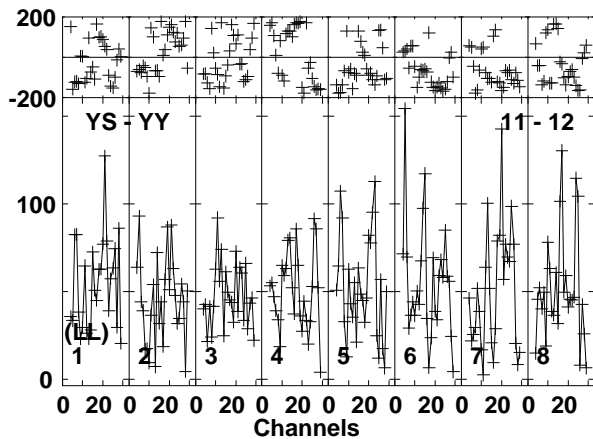
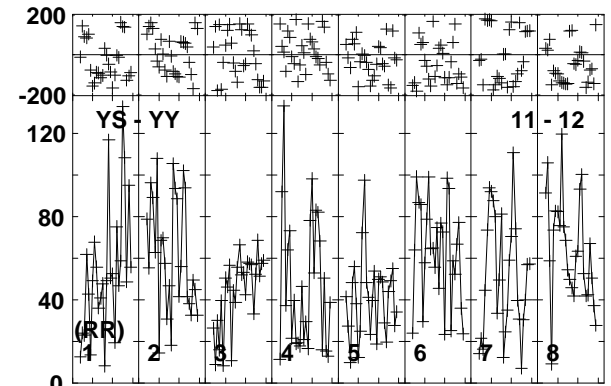
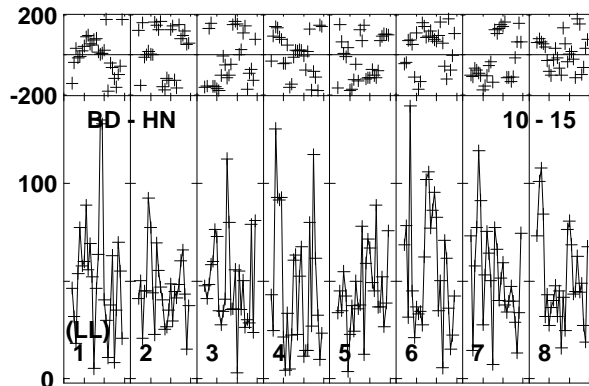
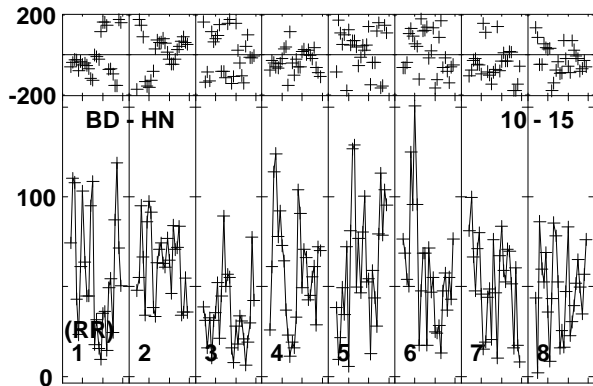
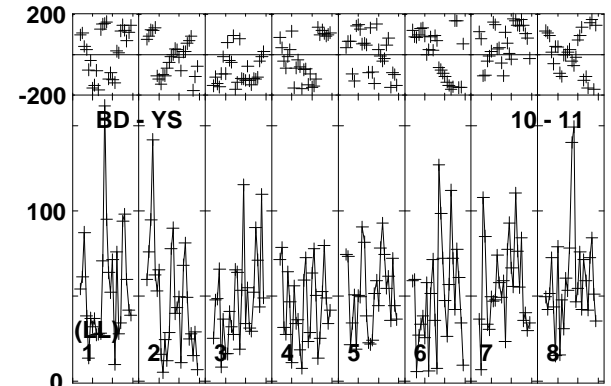
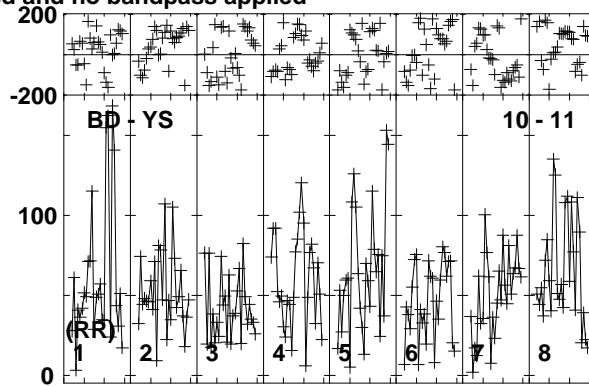
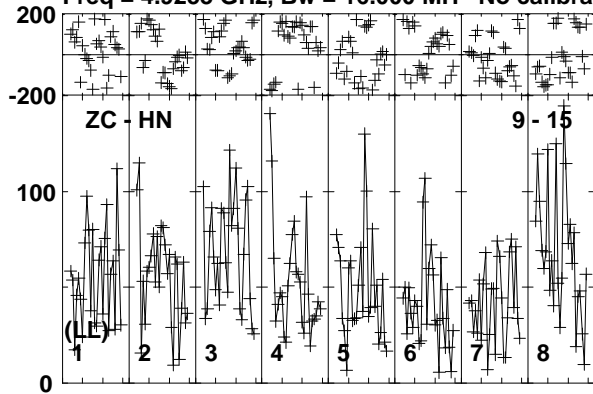

Lower frame: Micro Ampl Jy Top frame: Phas deg
Vector averaged cross-power spectrum Baseline: ZC (09) - HN (15)
Timerange: 01/01:49:18 to 01/01:54:32

Plot file version 524 created 11-APR-2016 17:09:42

ARP299C GP053G 3.UVDATA.1

Freq = 4.9253 GHz, Bw = 16.000 MH No calibration applied and no bandpass applied

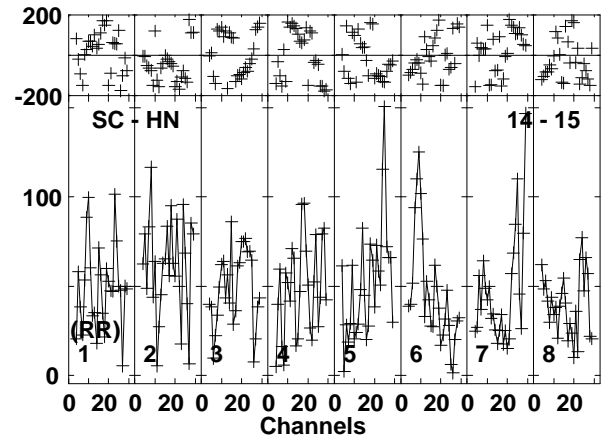
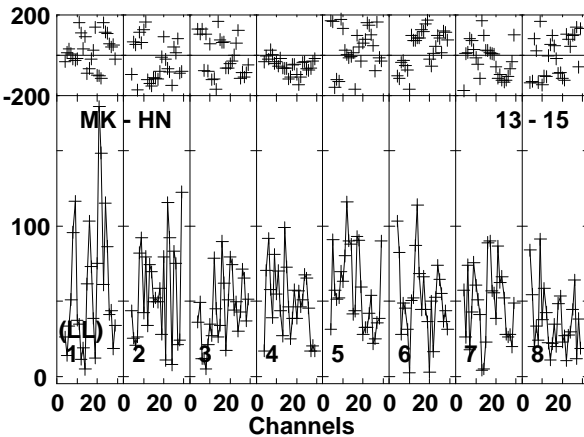
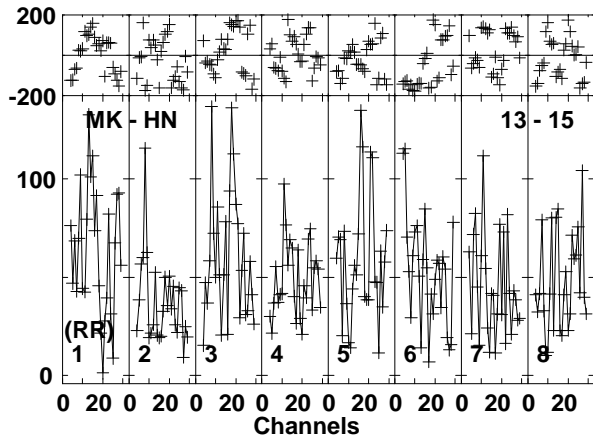
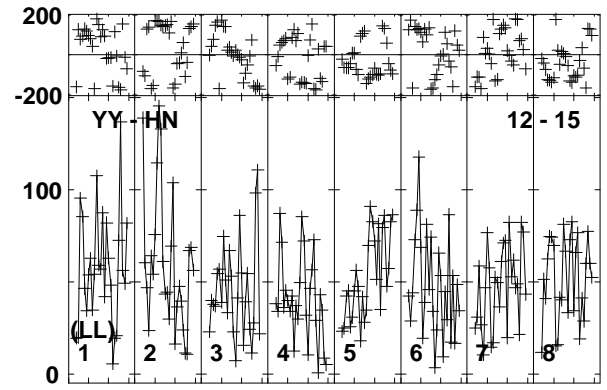
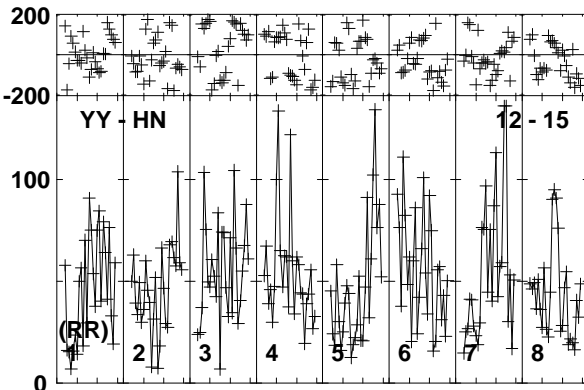
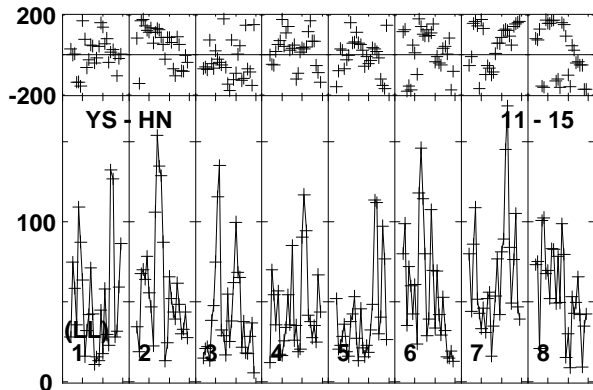
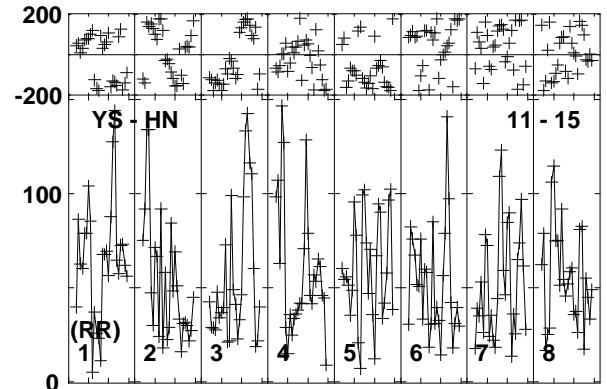
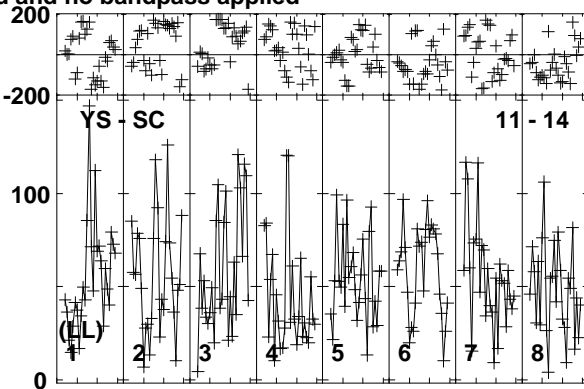
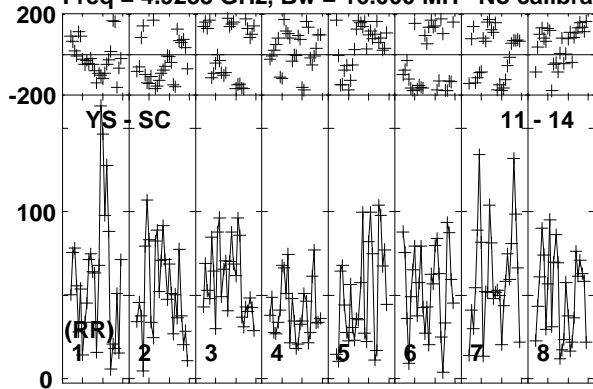

Lower frame: Micro Ampl Jy Top frame: Phas deg
Vector averaged cross-power spectrum Baseline: YS (11) - SC (14)
Timerange: 01/01:49:18 to 01/01:54:32

Plot file version 525 created 11-APR-2016 17:09:42

ARP299C GP053G 3.UVDATA.1

Freq = 4.9253 GHz, Bw = 16.000 MH No calibration applied and no bandpass applied

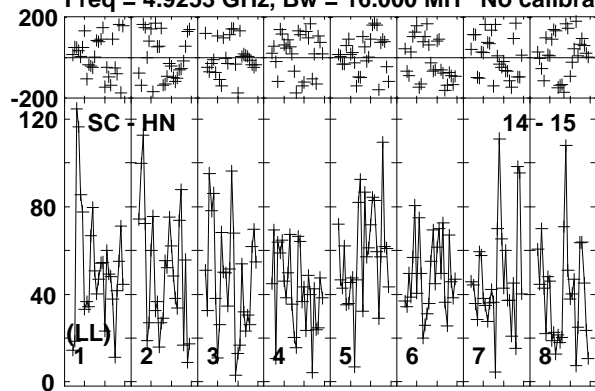

Lower frame: Micro Ampl Jy Top frame: Phas deg
Vector averaged cross-power spectrum Baseline: SC (14) - HN (15)
Timerange: 01/01:49:18 to 01/01:54:32

Plot file version 526 created 11-APR-2016 17:09:42

J1128+5925 GP053G 3.UVDATA.1

Freq = 4.9253 GHz, Bw = 16.000 MH No calibration applied and no bandpass applied

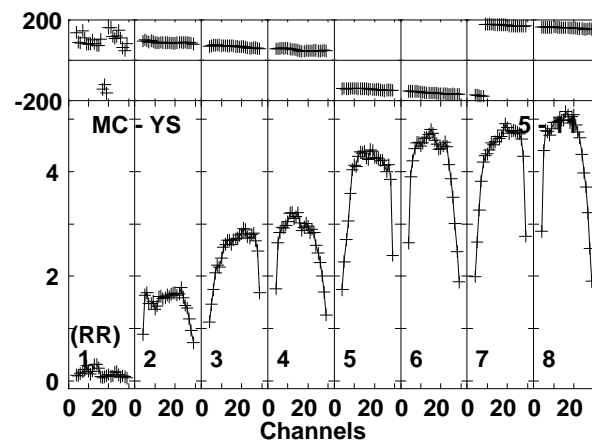
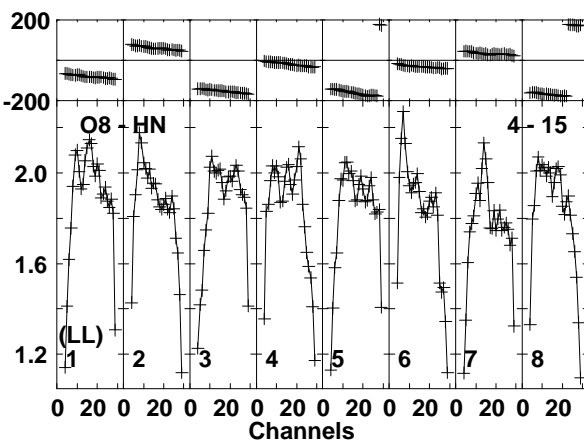
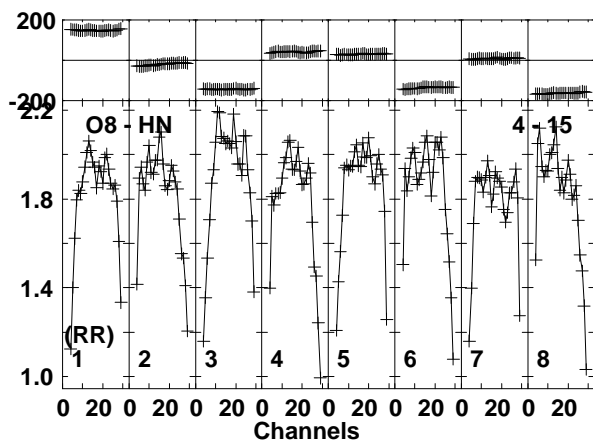
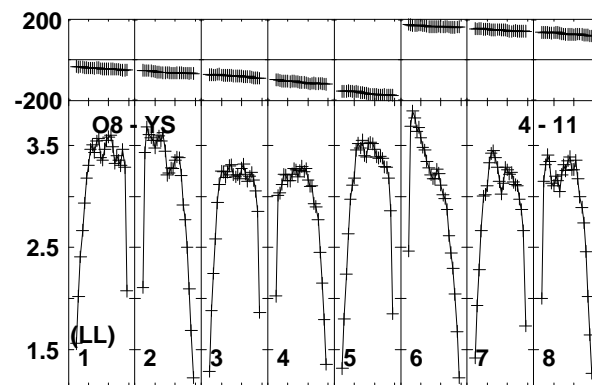
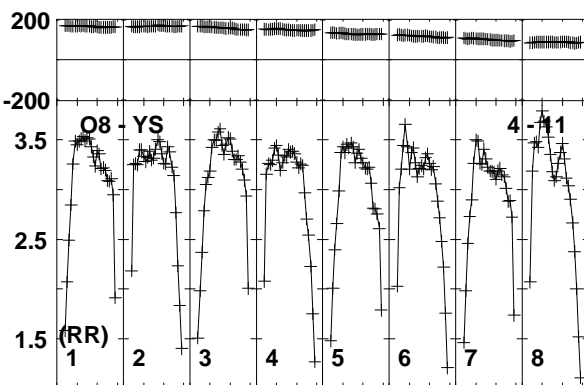
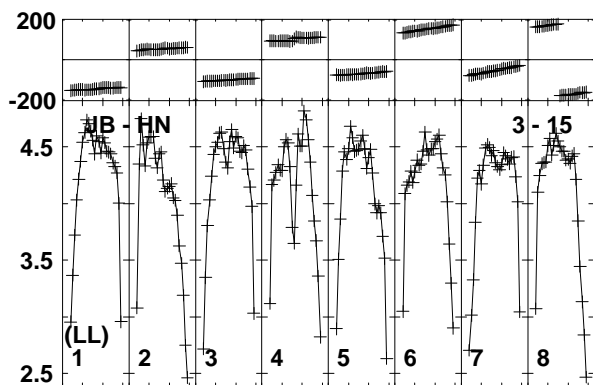
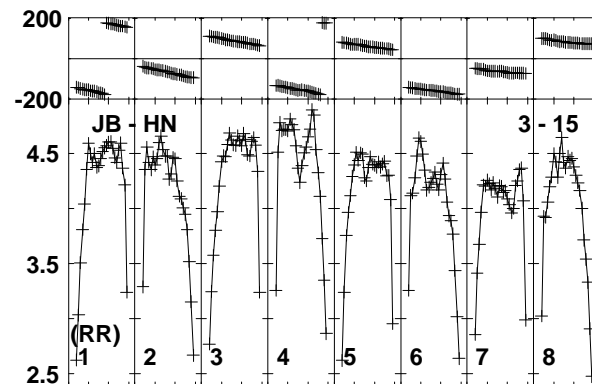
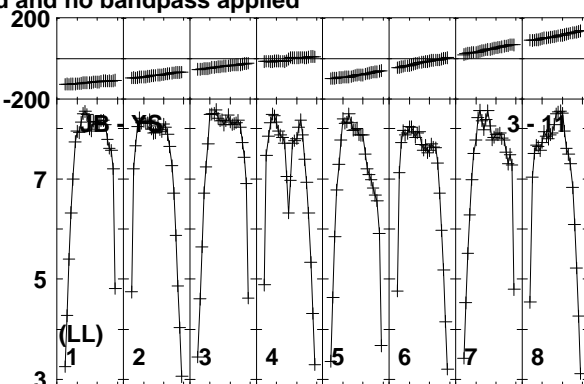
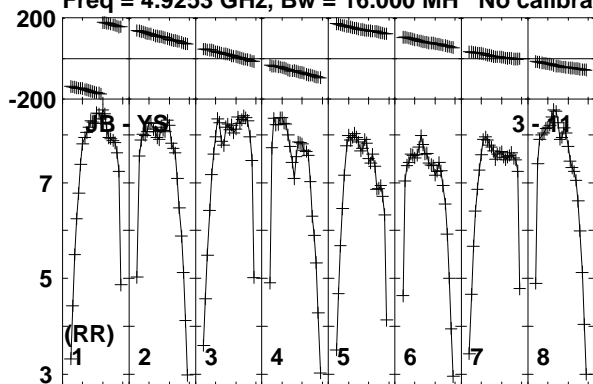

Lower frame: Milli Ampl Jy Top frame: Phas deg
Vector averaged cross-power spectrum Baseline: JB (03) - YS (11)
Timerange: 01/01:54:38 to 01/01:56:22

Plot file version 527 created 11-APR-2016 17:09:42

J1128+5925 GP053G 3.UVDATA.1

Freq = 4.9253 GHz, Bw = 16.000 MH No calibration applied and no bandpass applied

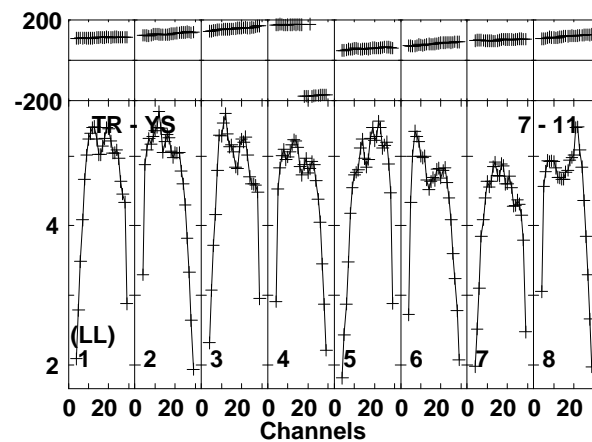
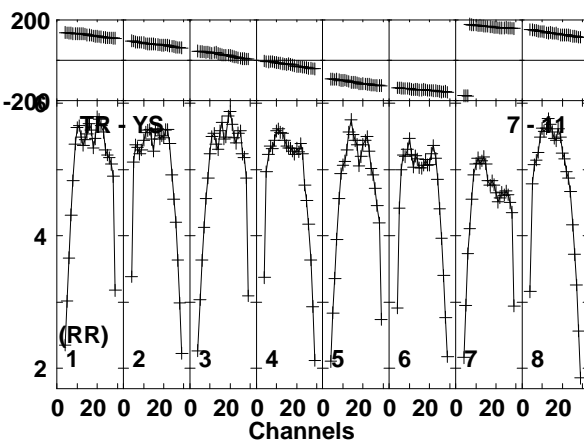
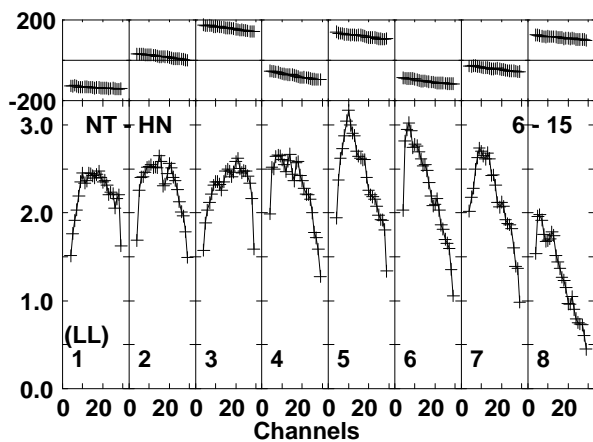
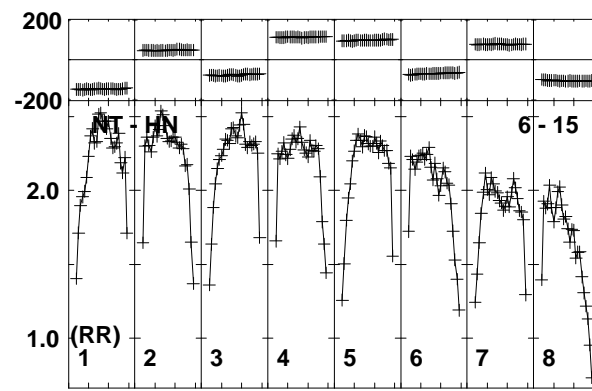
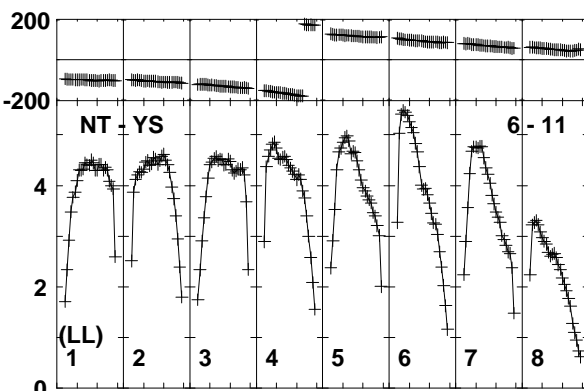
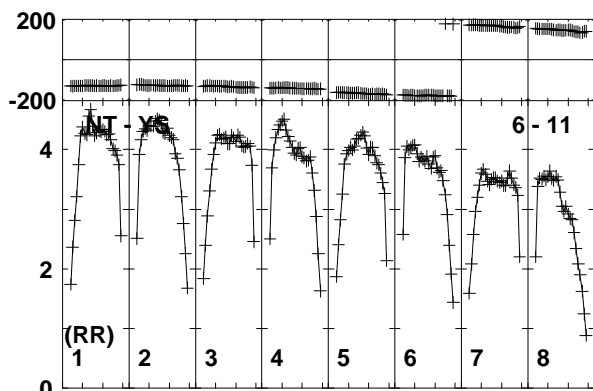
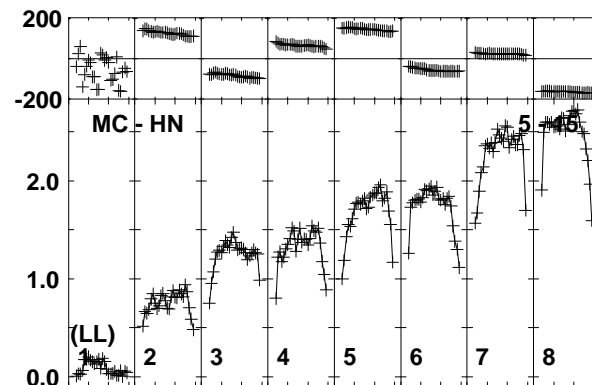
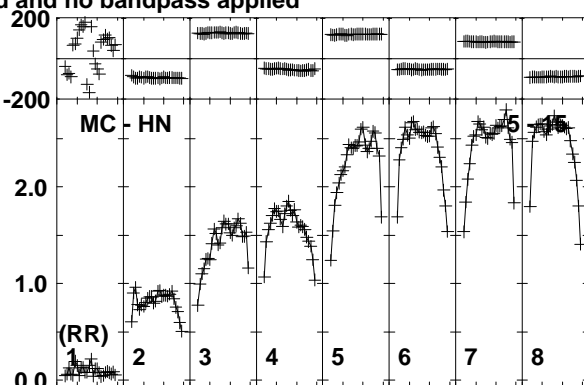
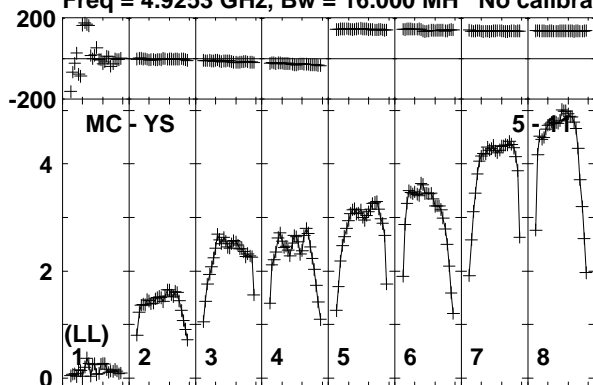

Lower frame: Milli Ampl Jy Top frame: Phas deg

Vector averaged cross-power spectrum Baseline: MC (05) - YS (11)

Timerange: 01/01:54:38 to 01/01:56:22

Plot file version 528 created 11-APR-2016 17:09:42

J1128+5925 GP053G 3.UVDATA.1

Freq = 4.9253 GHz, Bw = 16.000 MH No calibration applied and no bandpass applied

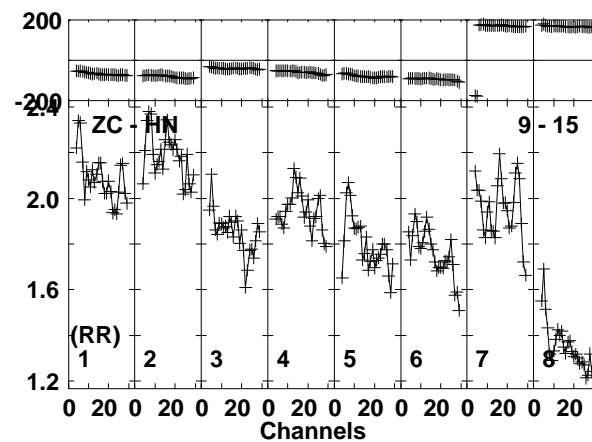
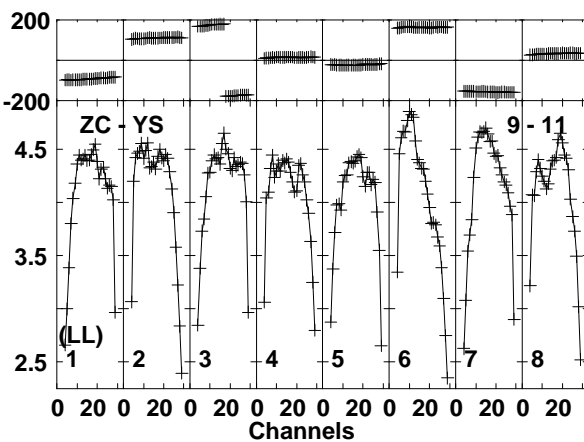
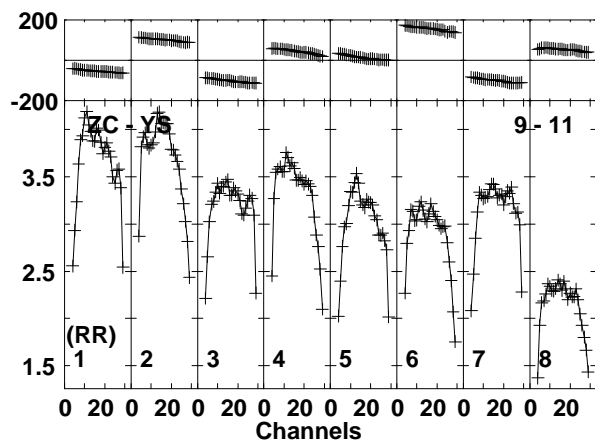
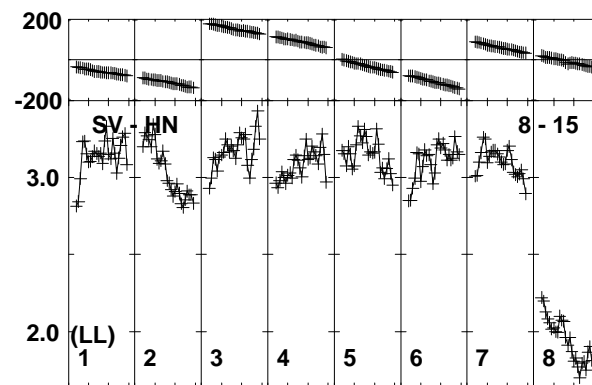
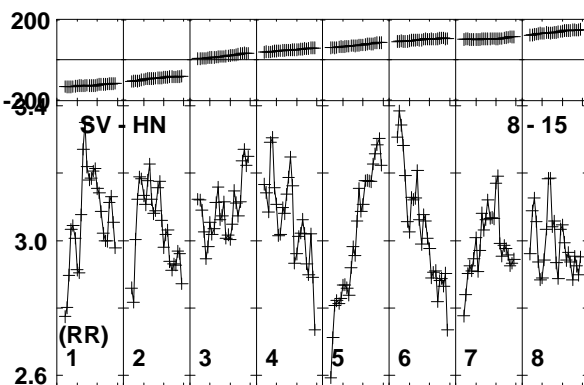
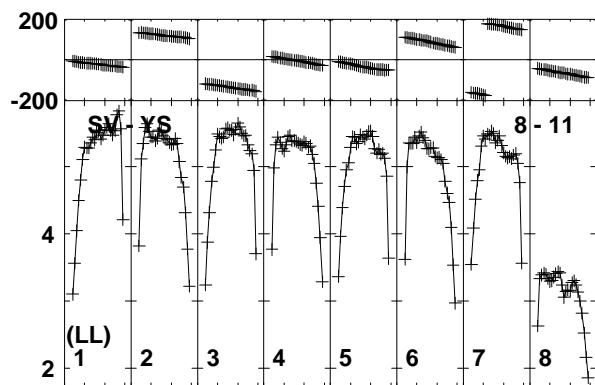
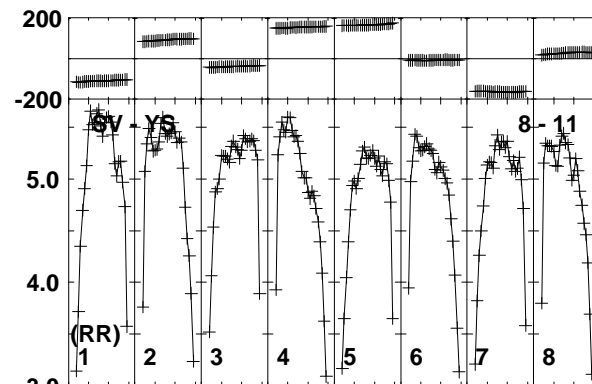
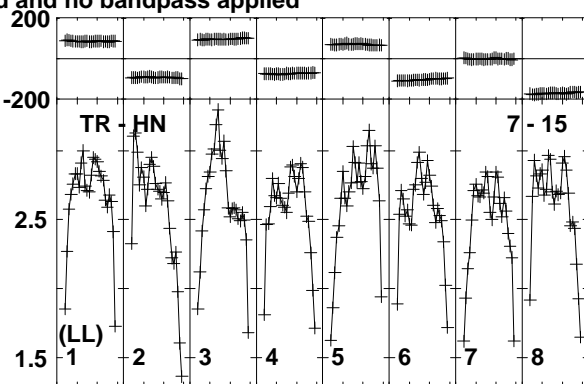
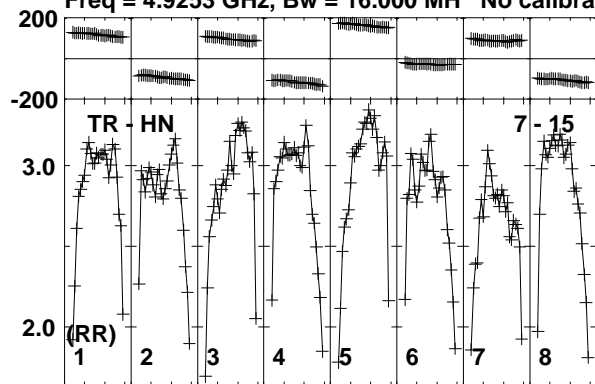

Lower frame: Milli Ampl Jy Top frame: Phas deg
Vector averaged cross-power spectrum Baseline: TR (07) - HN (15)
Timerange: 01/01:54:38 to 01/01:56:22

Plot file version 529 created 11-APR-2016 17:09:43

J1128+5925 GP053G 3.UVDATA.1

Freq = 4.9253 GHz, Bw = 16.000 MH No calibration applied and no bandpass applied

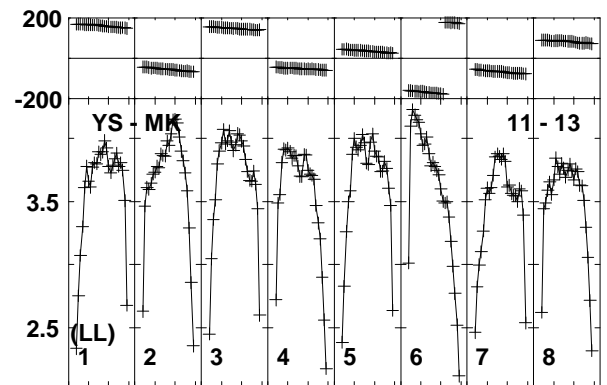
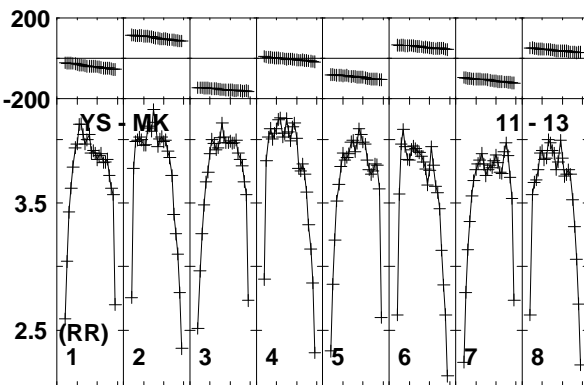
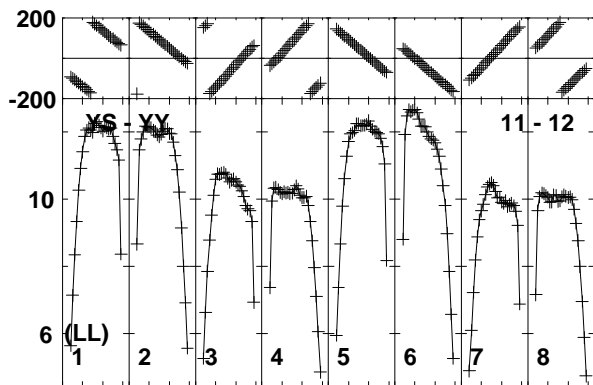
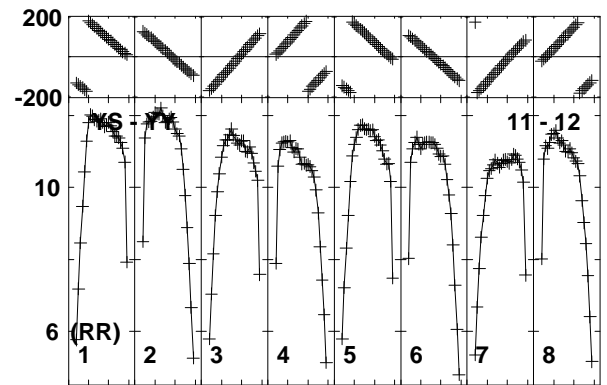
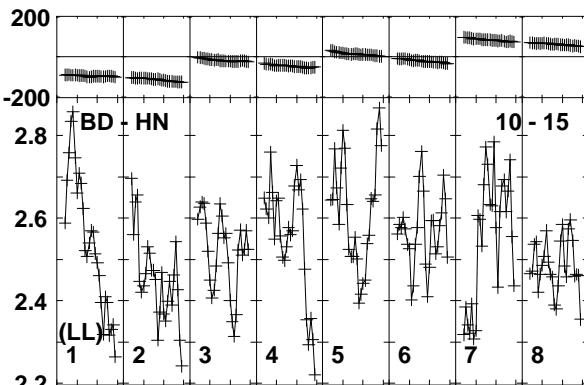
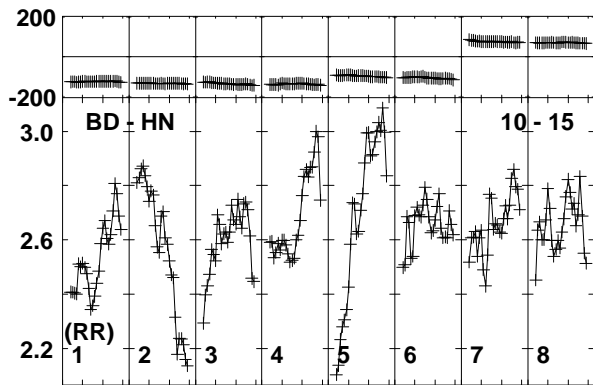
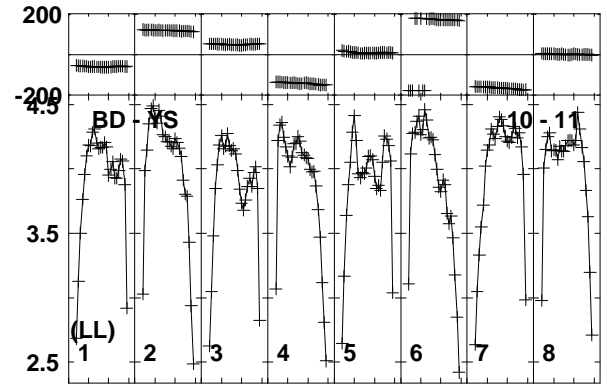
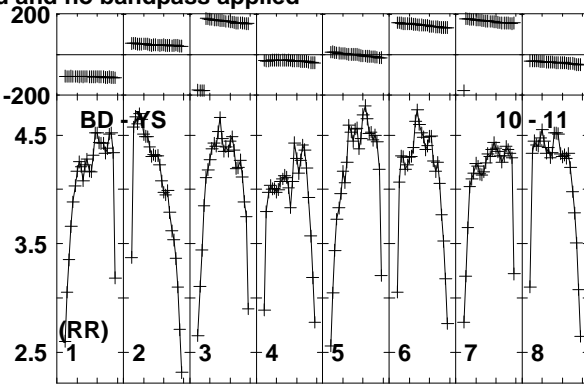
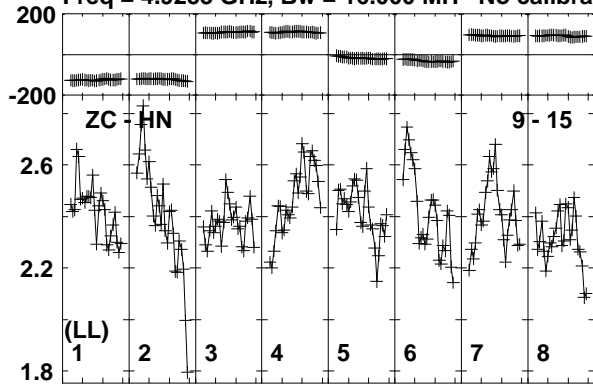

Lower frame: Milli Ampl Jy Top frame: Phas deg
Vector averaged cross-power spectrum Baseline: ZC (09) - HN (15)
Timerange: 01/01:54:38 to 01/01:56:22

Plot file version 530 created 11-APR-2016 17:09:43

J1128+5925 GP053G 3.UVDATA.1

Freq = 4.9253 GHz, Bw = 16.000 MH No calibration applied and no bandpass applied

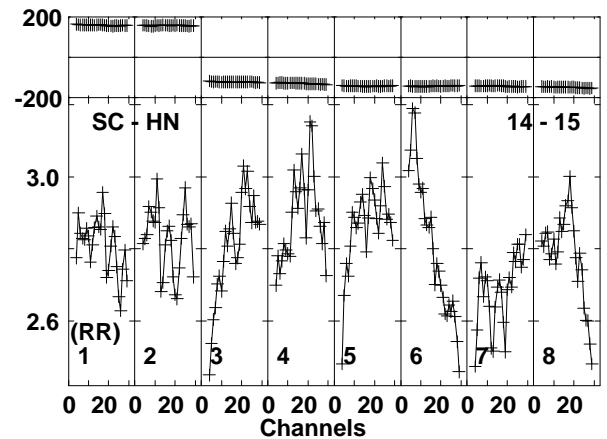
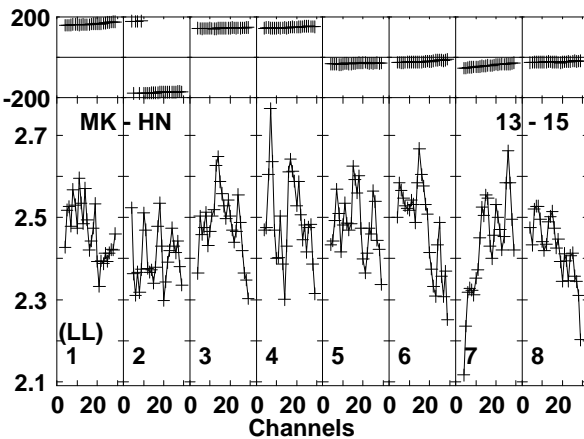
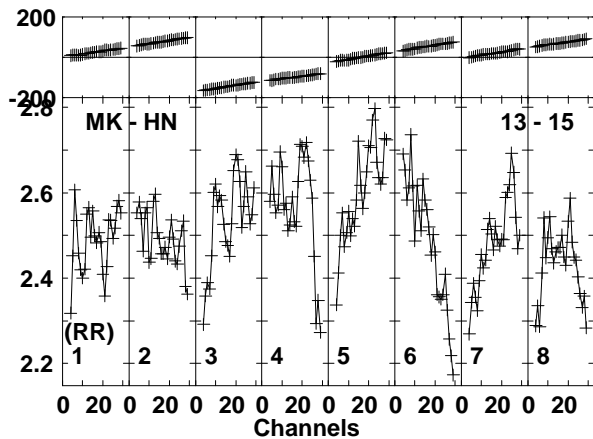
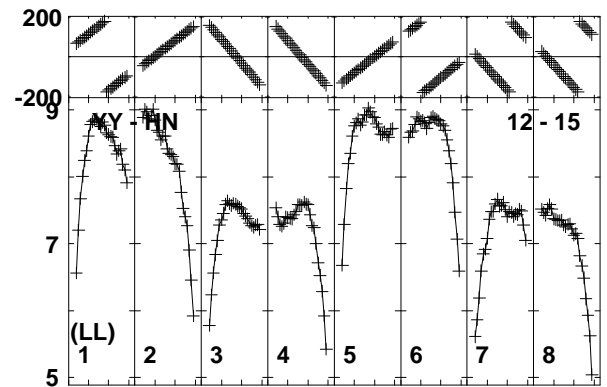
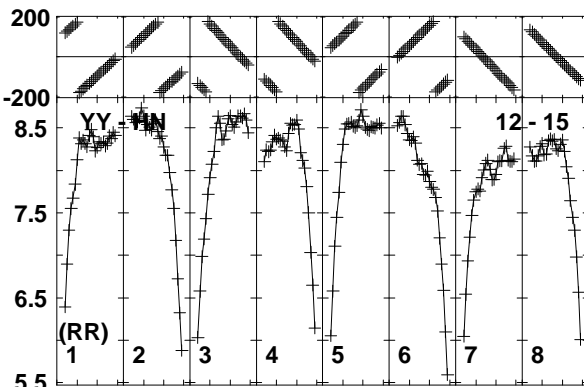
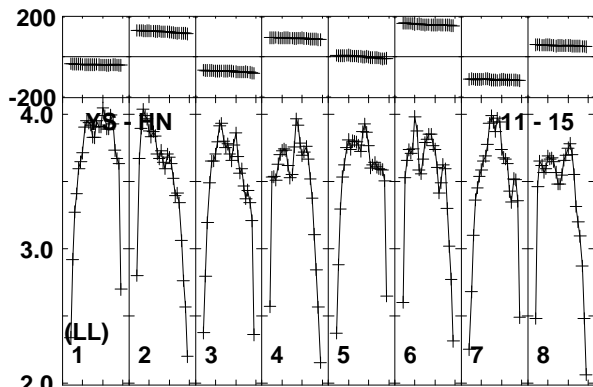
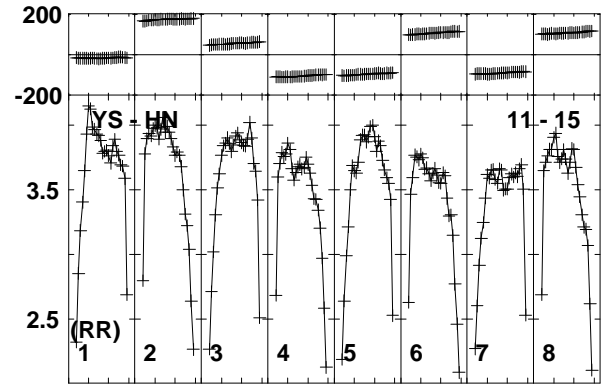
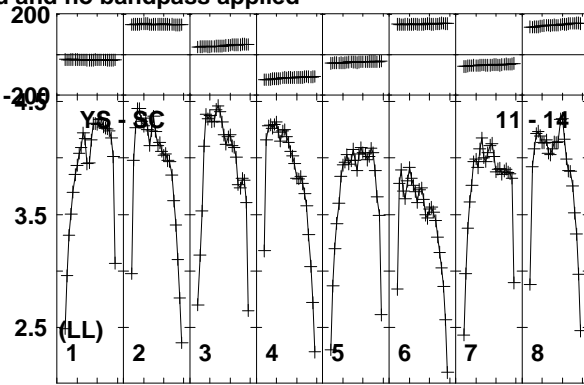
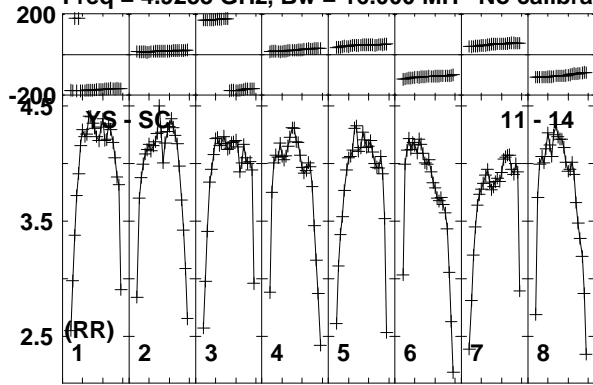

Lower frame: Milli Ampl Jy Top frame: Phas deg
Vector averaged cross-power spectrum Baseline: YS (11) - SC (14)
Timerange: 01/01:54:38 to 01/01:56:22

Plot file version 531 created 11-APR-2016 17:09:43
J1128+5925 GP053G 3.UVDATA.1
Freq = 4.9253 GHz, Bw = 16.000 MH No calibration applied and no bandpass applied

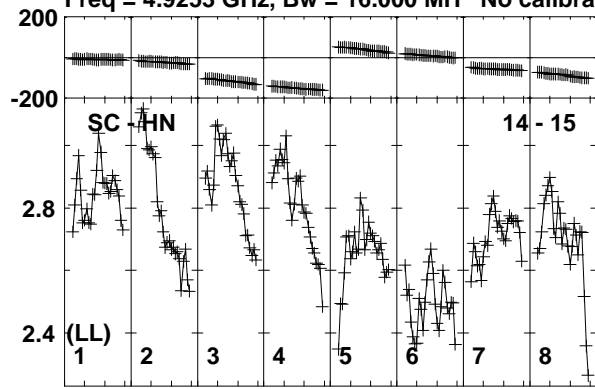

Lower frame: Milli Ampl Jy Top frame: Phas deg
Vector averaged cross-power spectrum Baseline: SC (14) - HN (15)
Timerange: 01/01:54:38 to 01/01:56:22

Plot file version 532 created 11-APR-2016 17:09:43

ARP299C GP053G 3.UVDATA.1

Freq = 4.9253 GHz, Bw = 16.000 MH No calibration applied and no bandpass applied

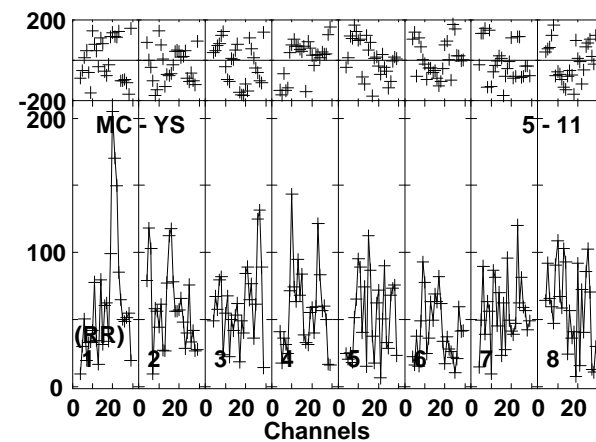
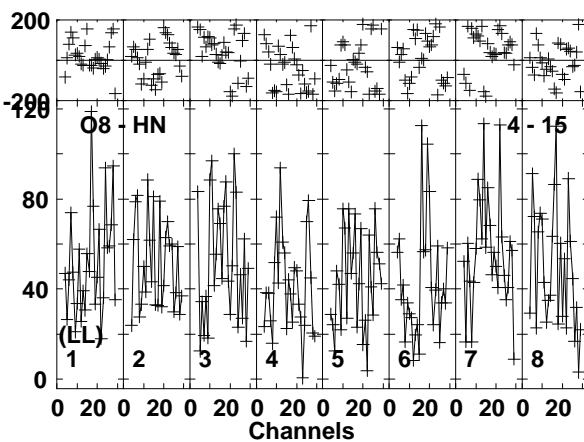
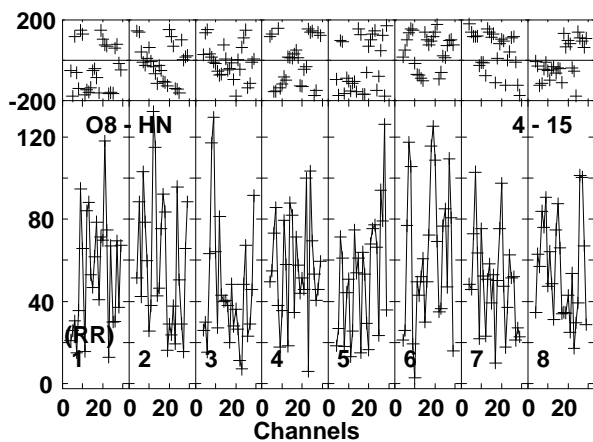
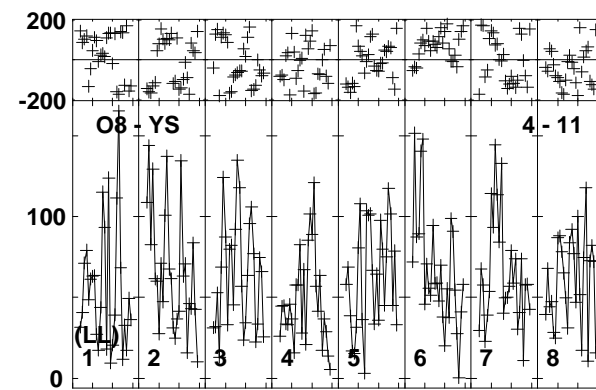
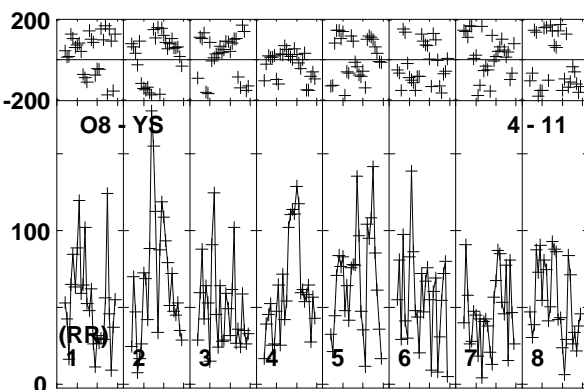
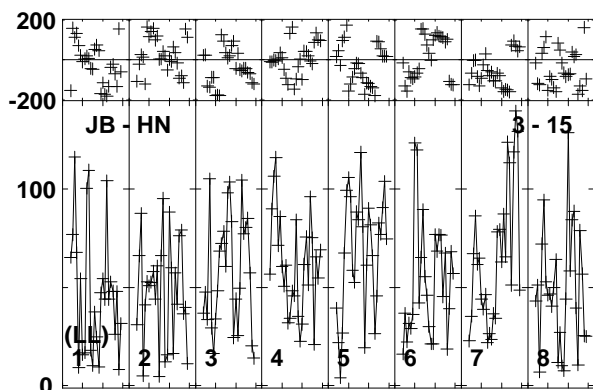
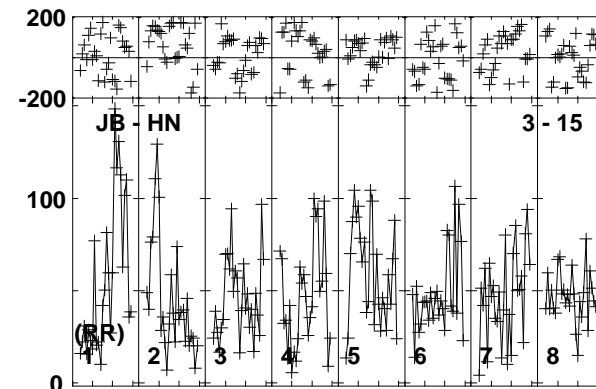
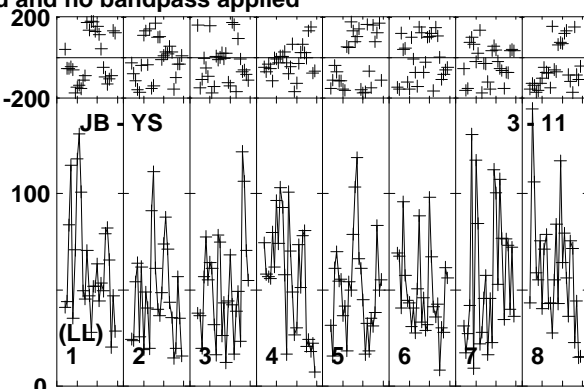
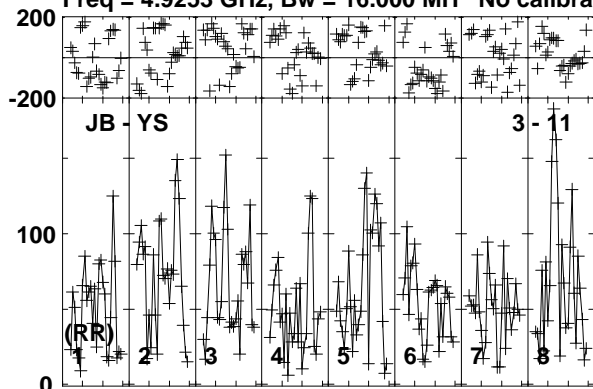

Lower frame: Micro Ampl Jy Top frame: Phas deg
Vector averaged cross-power spectrum Baseline: JB (03) - YS (11)
Timerange: 01/01:56:28 to 01/02:01:40

Plot file version 533 created 11-APR-2016 17:09:43

ARP299C GP053G 3.UVDATA.1

Freq = 4.9253 GHz, Bw = 16.000 MH No calibration applied and no bandpass applied

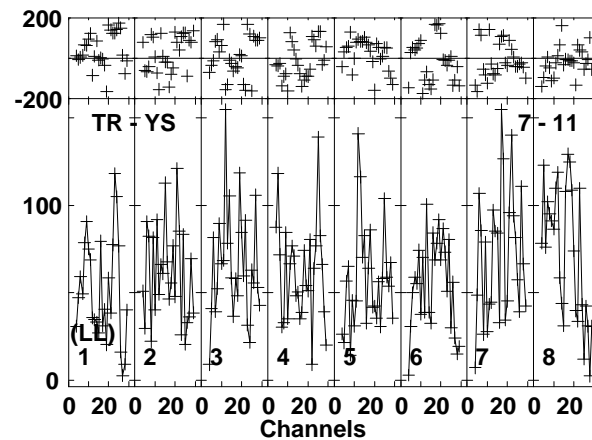
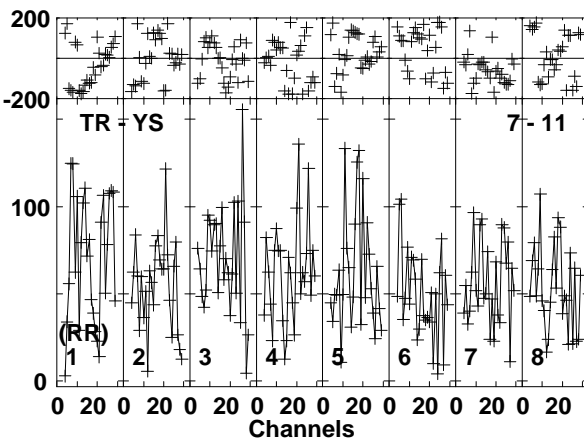
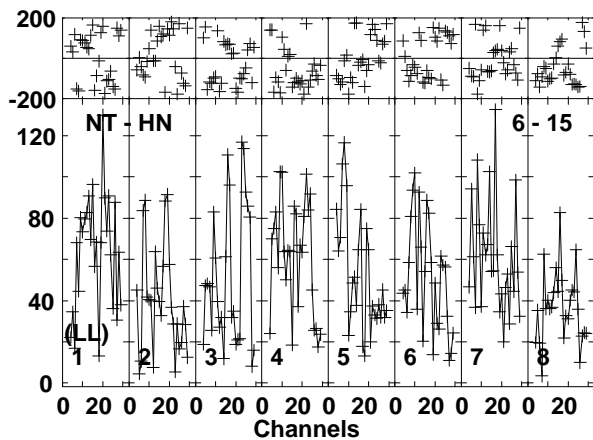
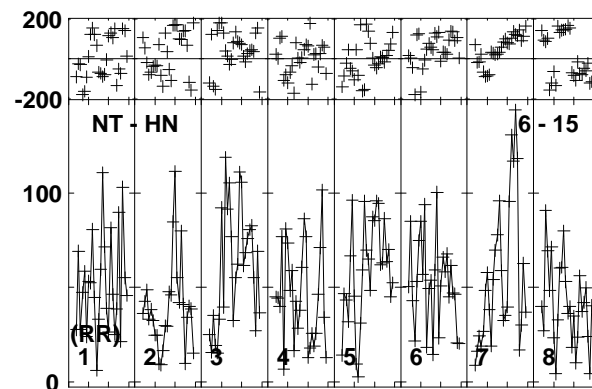
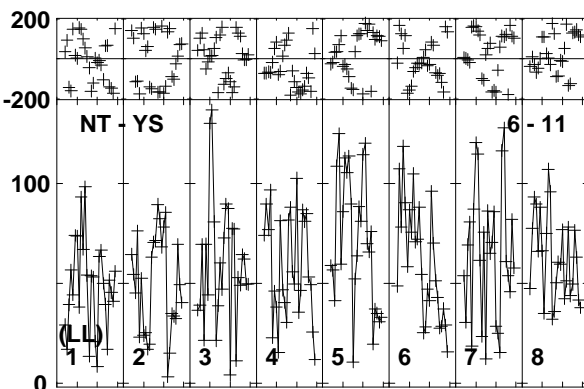
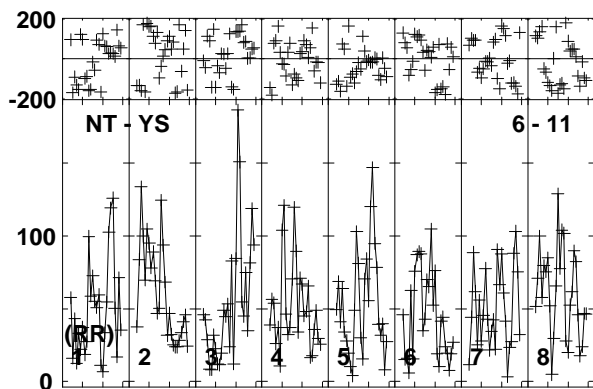
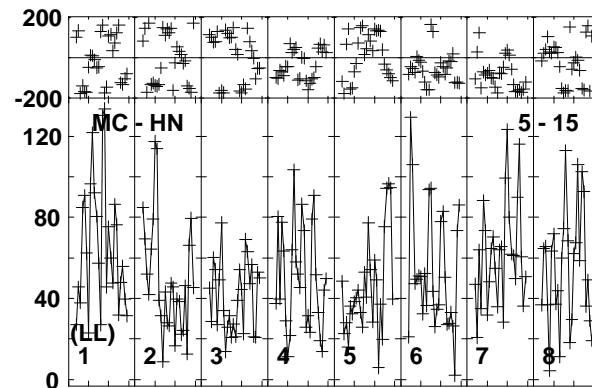
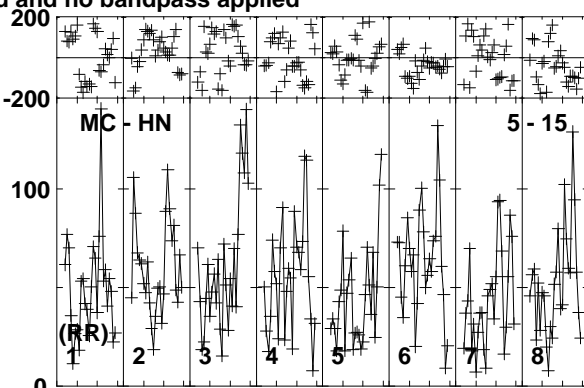
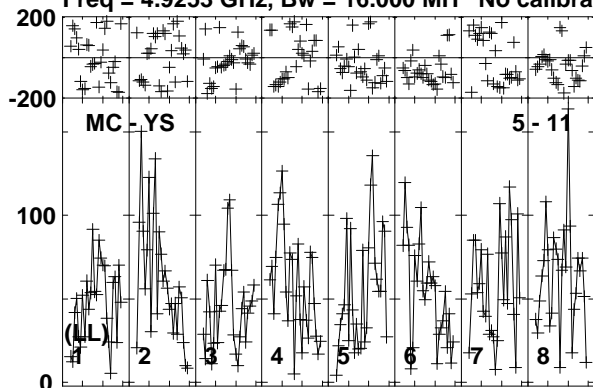

Lower frame: Micro Ampl Jy Top frame: Phas deg
Vector averaged cross-power spectrum Baseline: MC (05) - YS (11)
Timerange: 01/01:56:28 to 01/02:01:40

Plot file version 534 created 11-APR-2016 17:09:43

ARP299C GP053G 3.UVDATA.1

Freq = 4.9253 GHz, Bw = 16.000 MH No calibration applied and no bandpass applied

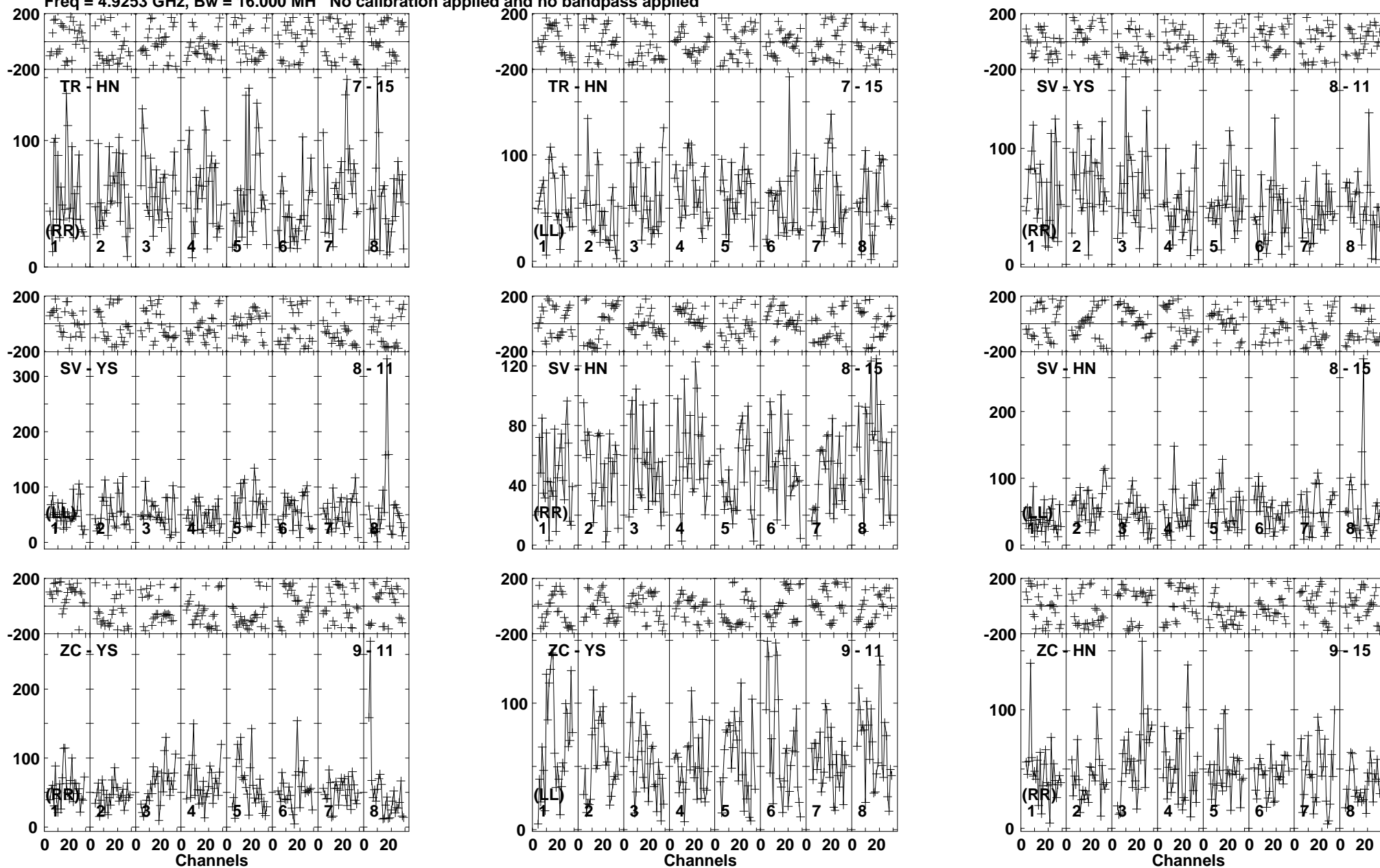

Lower frame: Micro Ampl Jy Top frame: Phas deg
Vector averaged cross-power spectrum Baseline: TR (07) - HN (15)
Timerange: 01/01:56:28 to 01/02:01:40

Plot file version 535 created 11-APR-2016 17:09:43

ARP299C GP053G 3.UVDATA.1

Freq = 4.9253 GHz, Bw = 16.000 MH No calibration applied and no bandpass applied

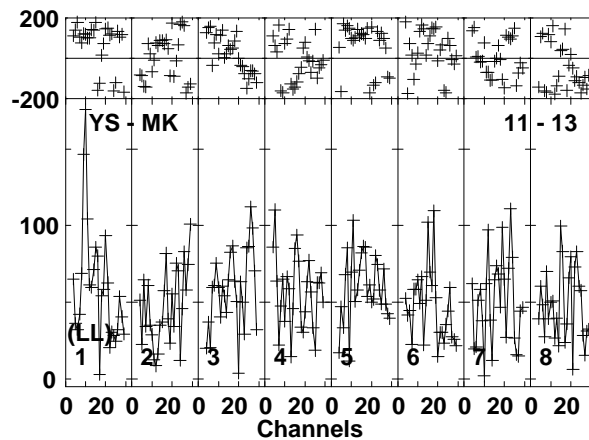
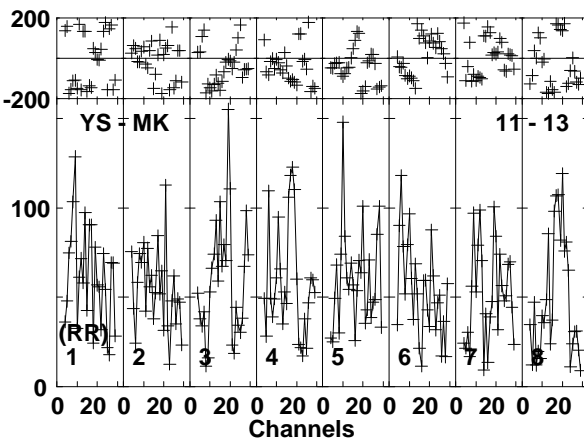
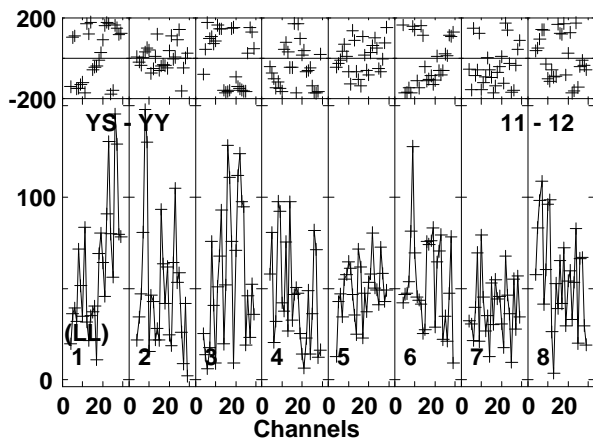
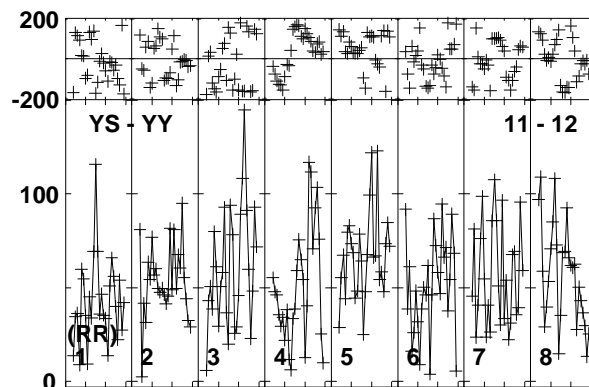
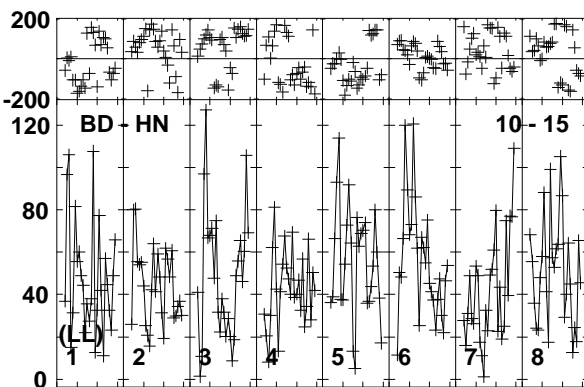
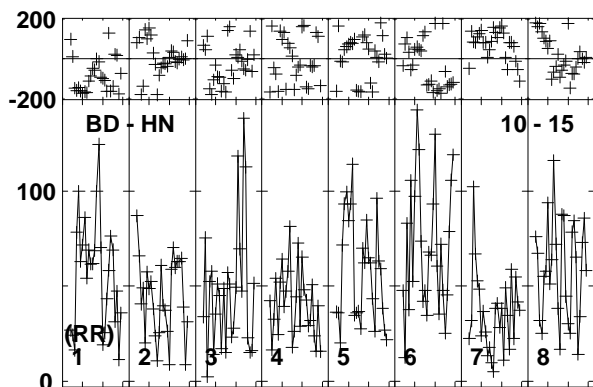
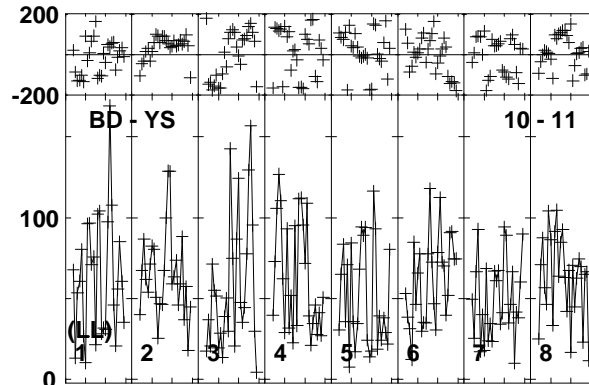
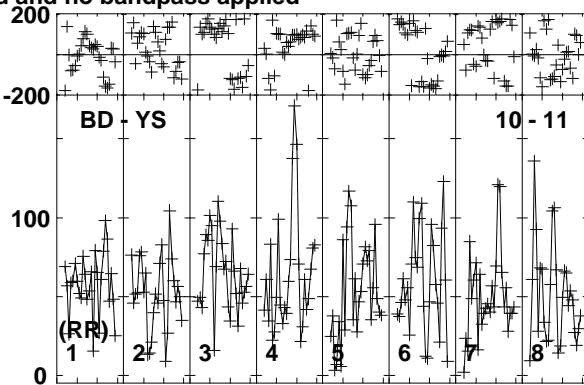
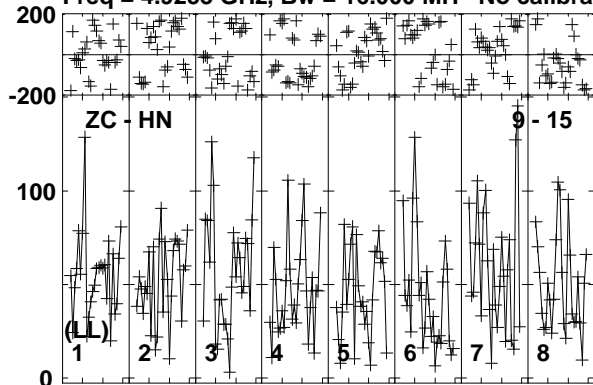

Lower frame: Micro Ampl Jy Top frame: Phas deg
Vector averaged cross-power spectrum Baseline: ZC (09) - HN (15)
Timerange: 01/01:56:28 to 01/02:01:40

Plot file version 536 created 11-APR-2016 17:09:44

ARP299C GP053G 3.UVDATA.1

Freq = 4.9253 GHz, Bw = 16.000 MH No calibration applied and no bandpass applied

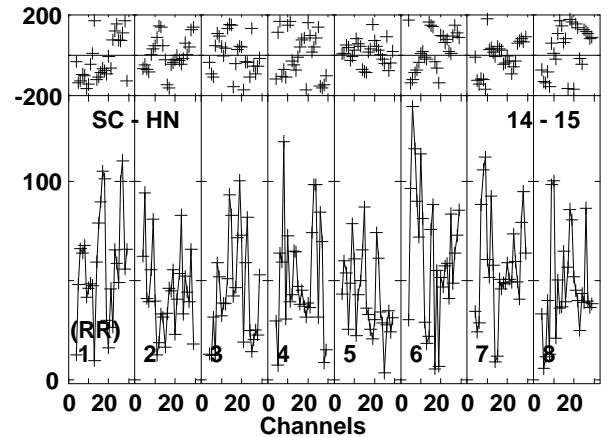
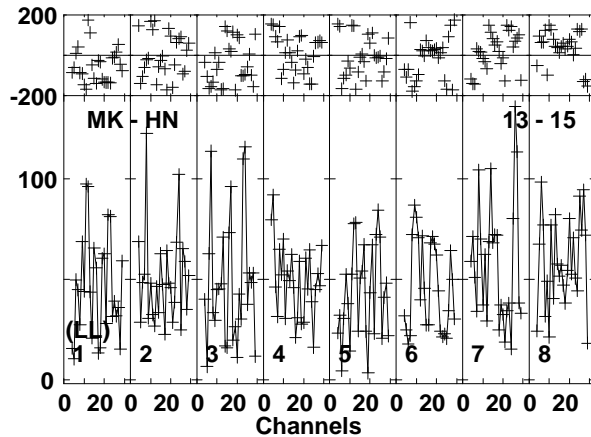
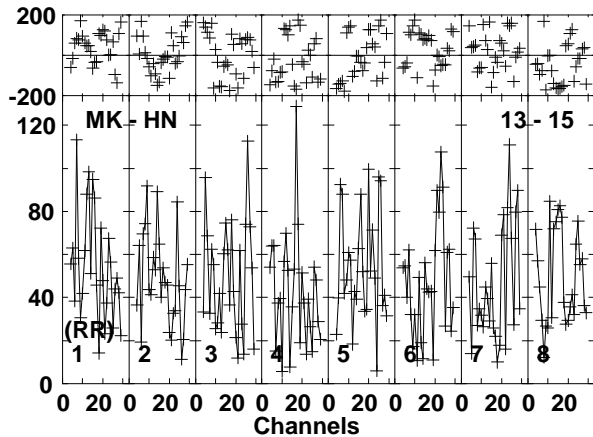
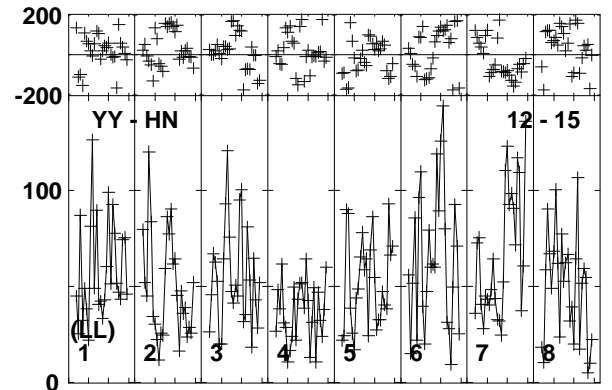
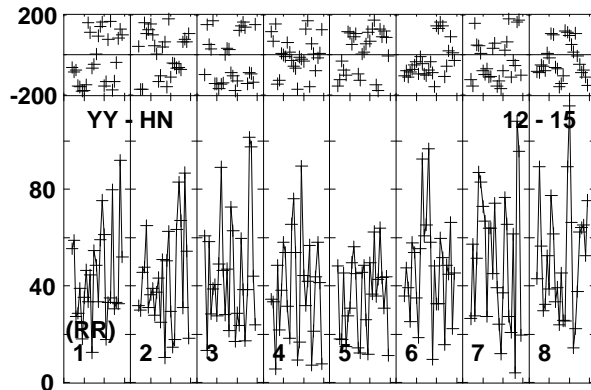
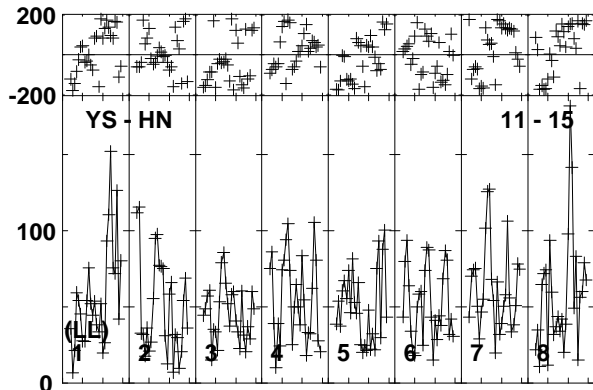
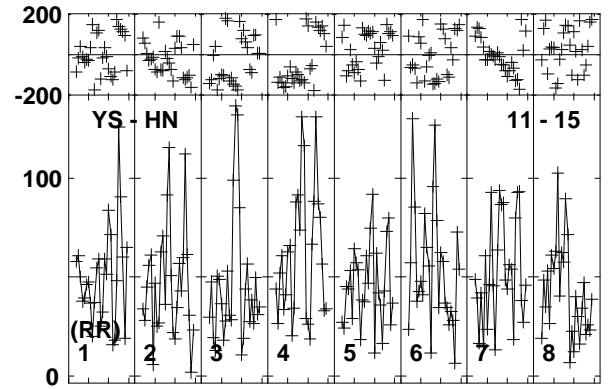
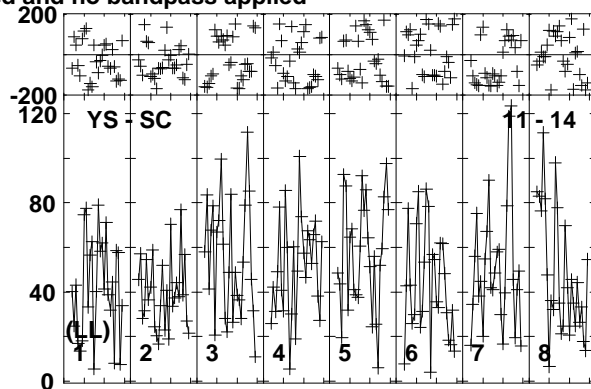
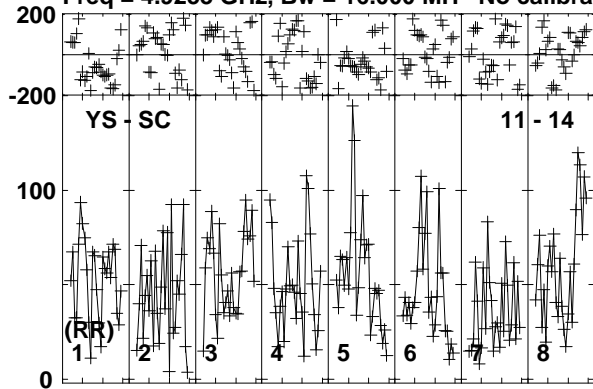

Lower frame: Micro Ampl Jy Top frame: Phas deg
Vector averaged cross-power spectrum Baseline: YS (11) - SC (14)
Timerange: 01/01:56:28 to 01/02:01:40

Plot file version 537 created 11-APR-2016 17:09:44

ARP299C GP053G 3.UVDATA.1

Freq = 4.9253 GHz, Bw = 16.000 MH No calibration applied and no bandpass applied

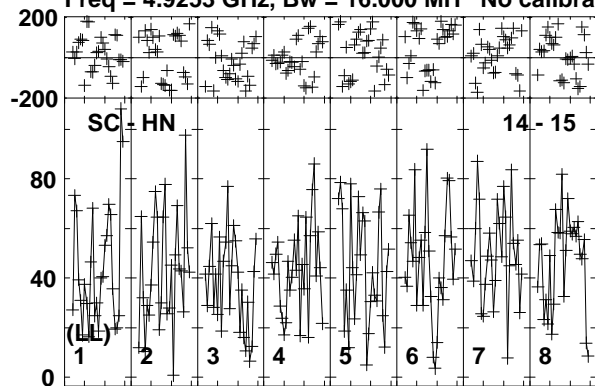

Lower frame: Micro Ampl Jy Top frame: Phas deg
Vector averaged cross-power spectrum Baseline: SC (14) - HN (15)
Timerange: 01/01:56:28 to 01/02:01:40

Plot file version 538 created 11-APR-2016 17:09:44

J1128+5925 GP053G 3.UVDATA.1

Freq = 4.9253 GHz, Bw = 16.000 MH No calibration applied and no bandpass applied

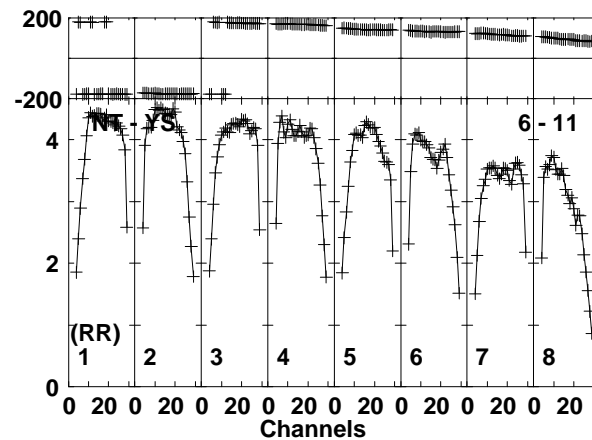
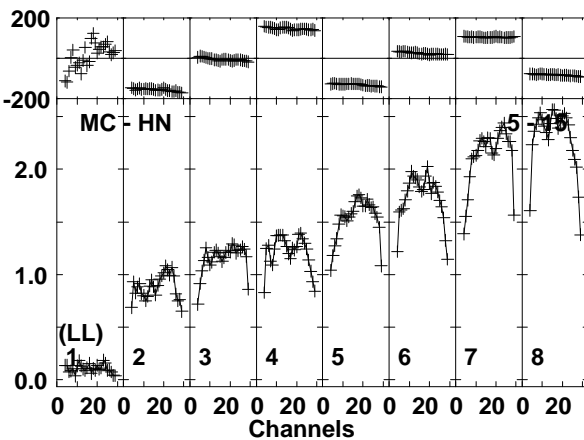
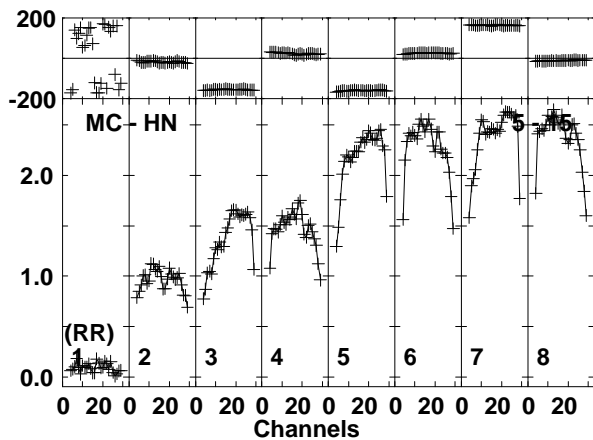
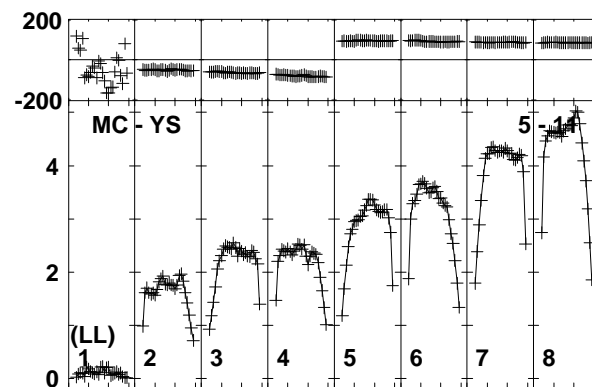
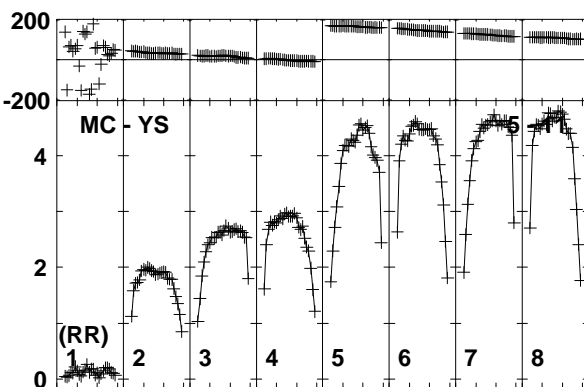
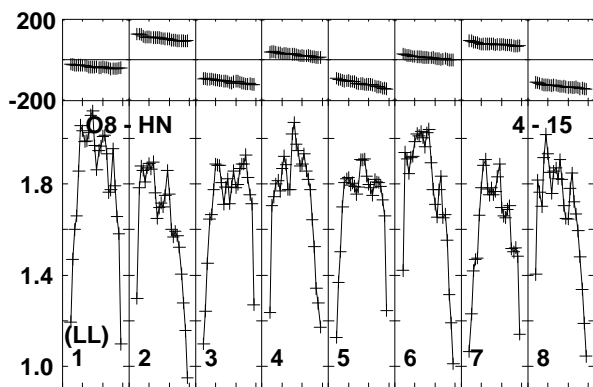
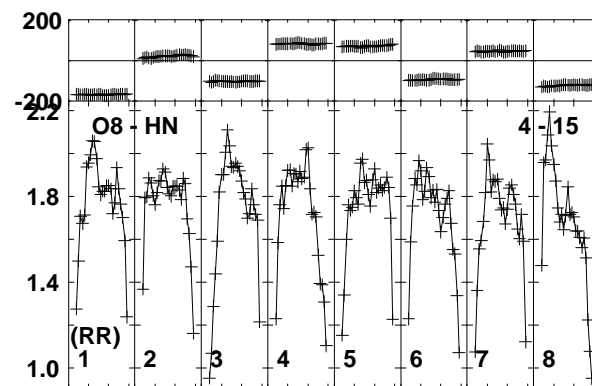
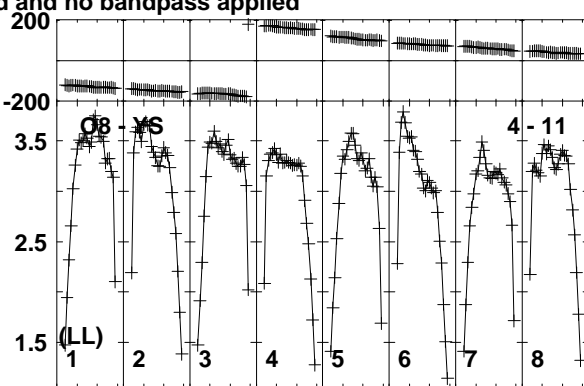
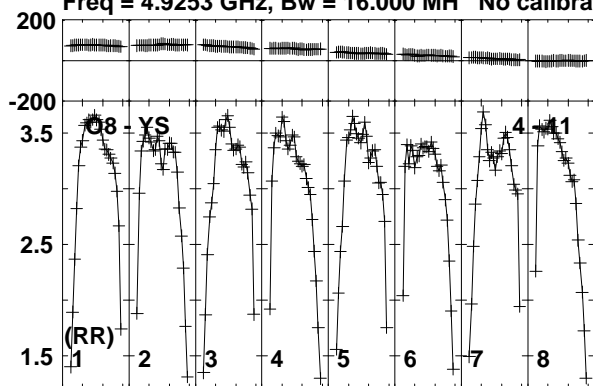

Lower frame: Milli Ampl Jy Top frame: Phas deg
Vector averaged cross-power spectrum Baseline: O8 (04) - YS (11)
Timerange: 01/02:01:46 to 01/02:03:38

Plot file version 539 created 11-APR-2016 17:09:44

J1128+5925 GP053G 3.UVDATA.1

Freq = 4.9253 GHz, Bw = 16.000 MH No calibration applied and no bandpass applied

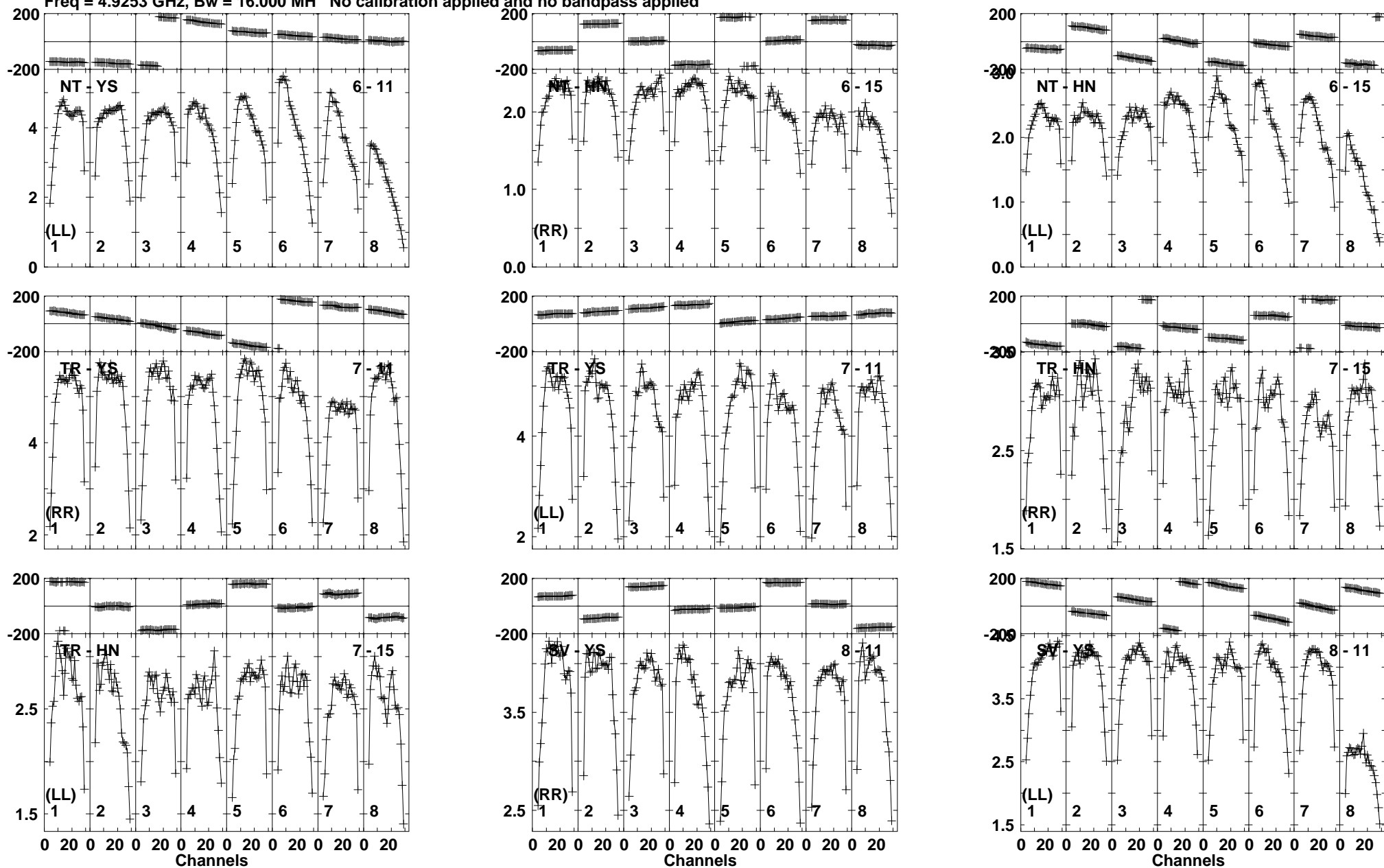

Lower frame: Milli Ampl Jy Top frame: Phas deg
Vector averaged cross-power spectrum Baseline: NT (06) - YS (11)
Timerange: 01/02:01:46 to 01/02:03:38

Plot file version 540 created 11-APR-2016 17:09:44

J1128+5925 GP053G 3.UVDATA.1

Freq = 4.9253 GHz, Bw = 16.000 MH No calibration applied and no bandpass applied

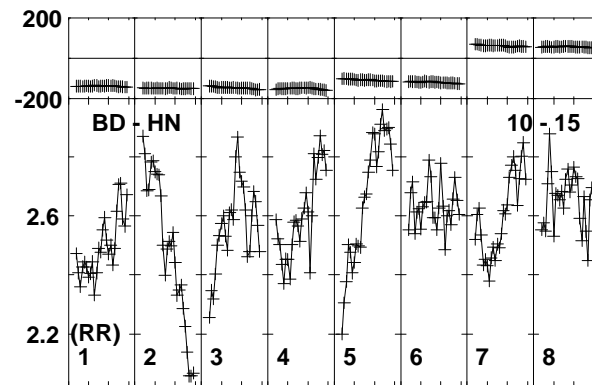
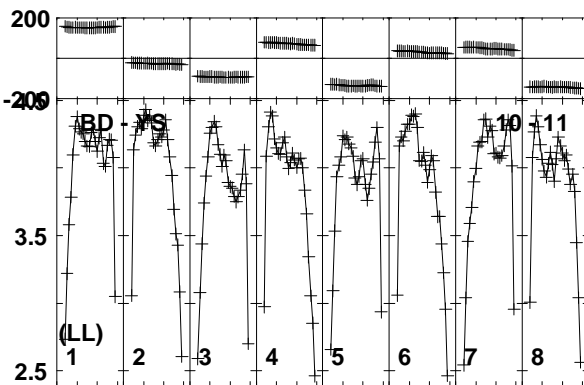
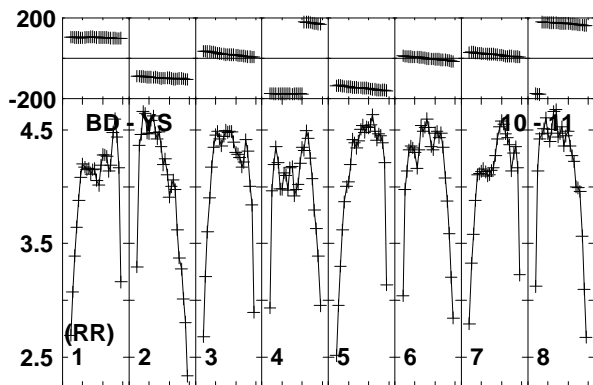
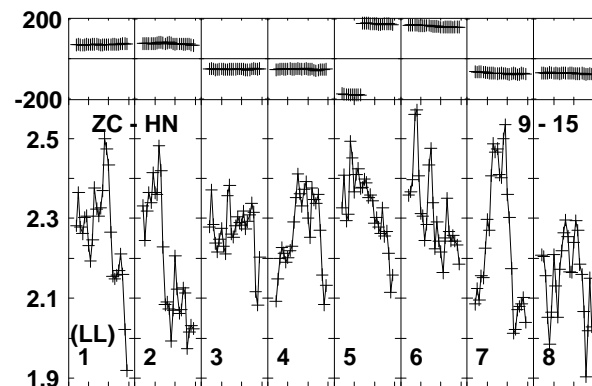
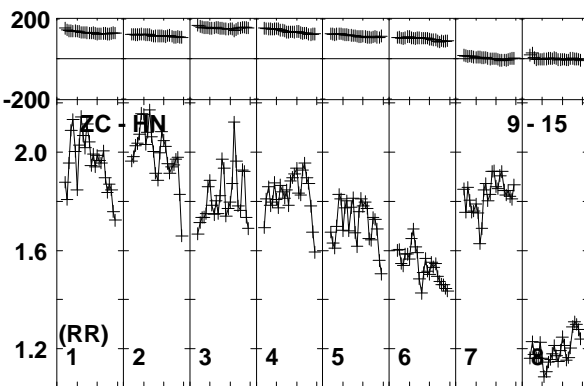
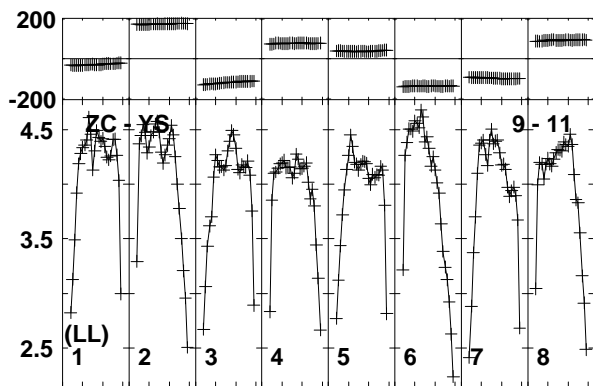
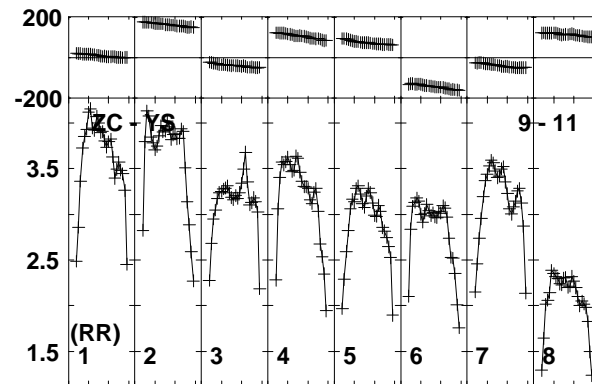
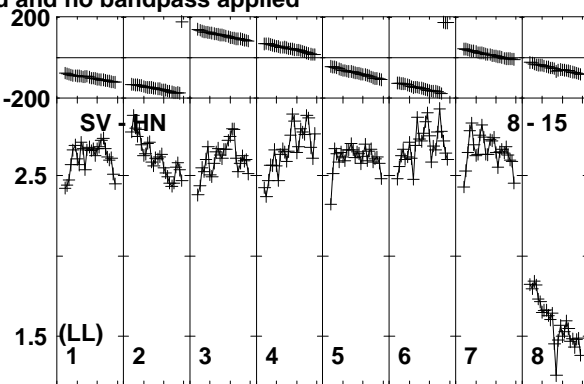
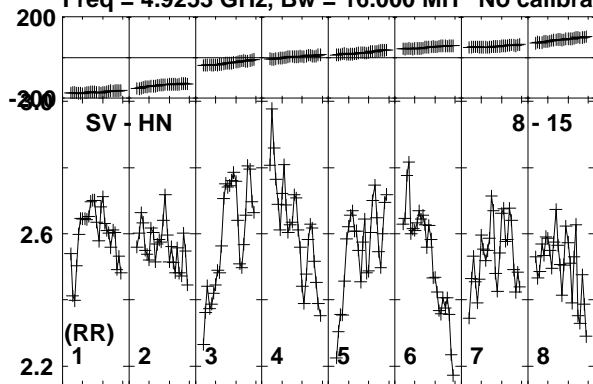

0 20 0 20 0 20 0 20 0 20 0 20 0 20 0 20 0 20
Channels

0 20 0 20 0 20 0 20 0 20 0 20 0 20 0 20 0 20
Channels

0 20 0 20 0 20 0 20 0 20 0 20 0 20 0 20 0 20
Channels

Lower frame: Milli Ampl Jy Top frame: Phas deg
Vector averaged cross-power spectrum Baseline: SV (08) - HN (15)
Timerange: 01/02:01:46 to 01/02:03:38

Plot file version 541 created 11-APR-2016 17:09:44

J1128+5925 GP053G 3.UVDATA.1

Freq = 4.9253 GHz, Bw = 16.000 MH No calibration applied and no bandpass applied

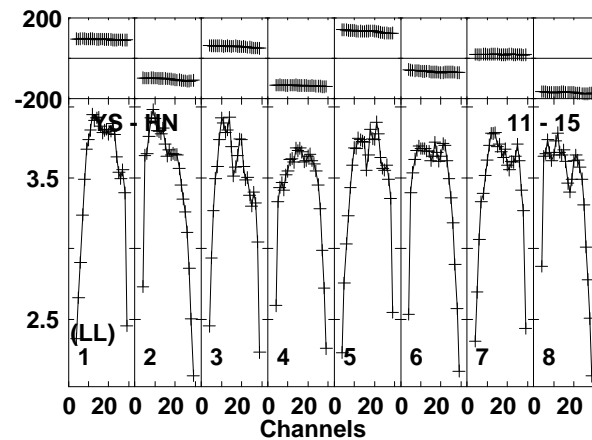
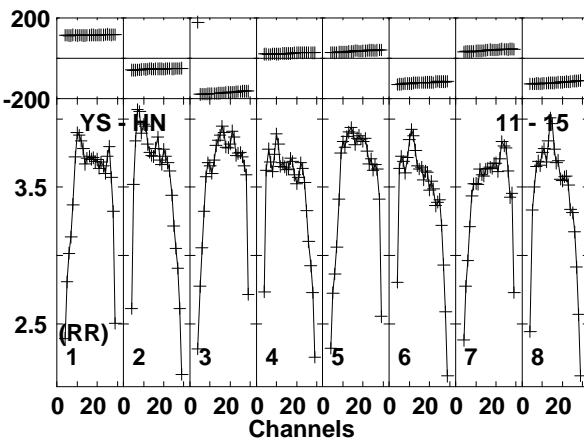
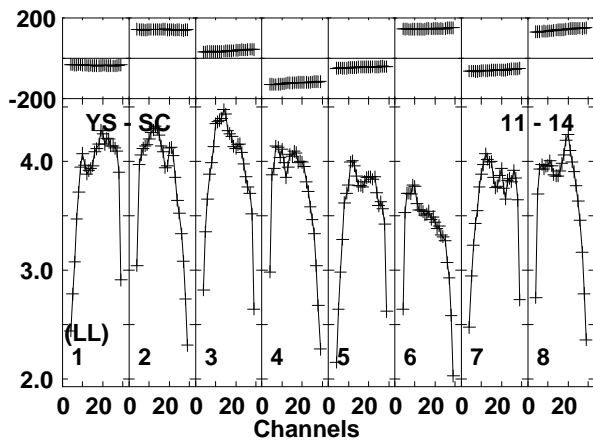
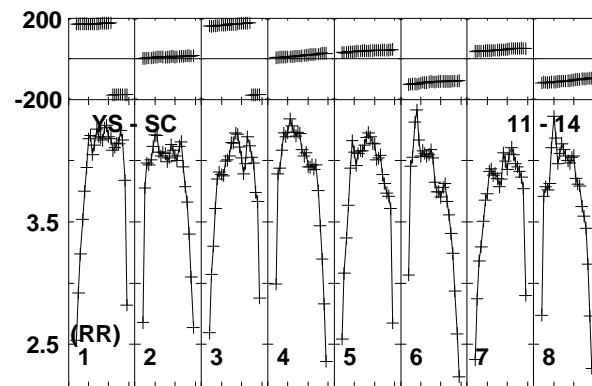
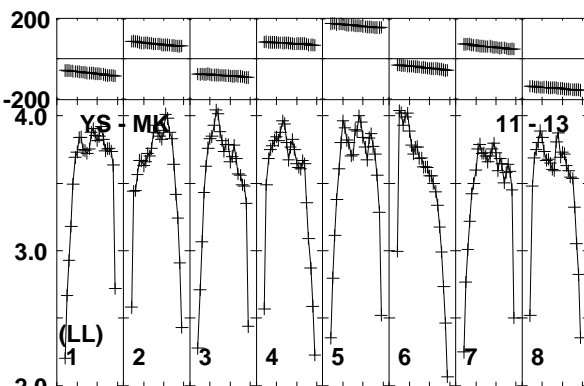
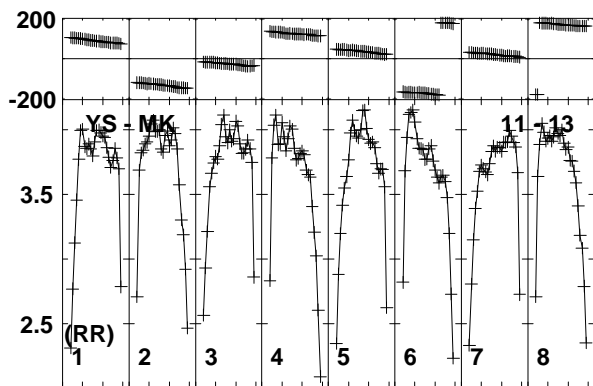
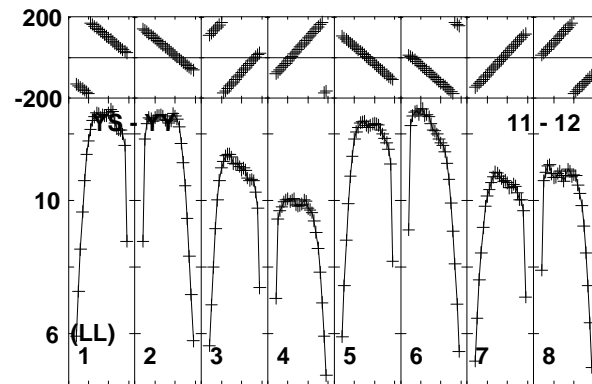
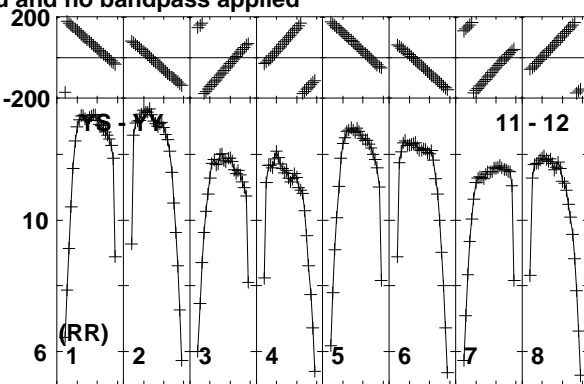
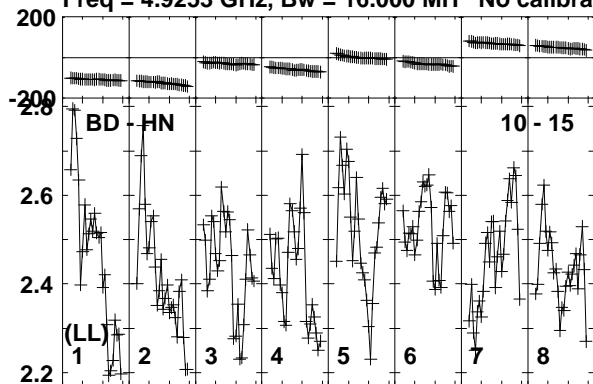

Lower frame: Milli Ampl Jy Top frame: Phas deg
Vector averaged cross-power spectrum Baseline: BD (10) - HN (15)
Timerange: 01/02:01:46 to 01/02:03:38

Plot file version 542 created 11-APR-2016 17:09:45

J1128+5925 GP053G 3.UVDATA.1

Freq = 4.9253 GHz, Bw = 16.000 MH No calibration applied and no bandpass applied

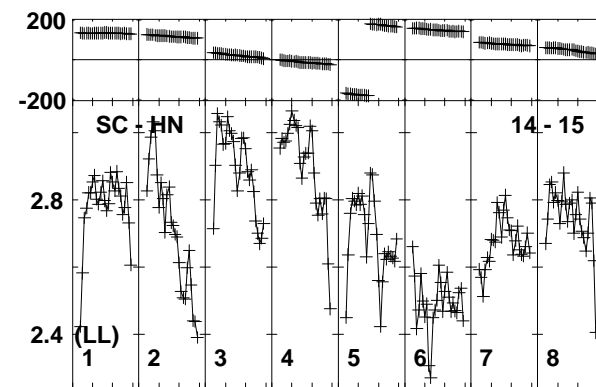
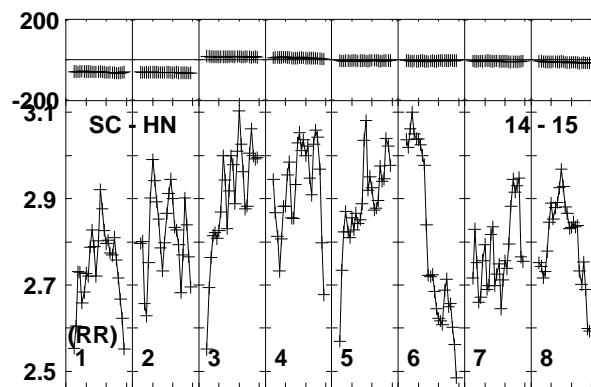
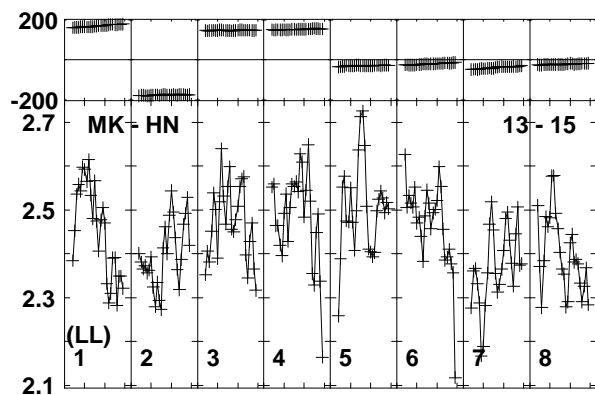
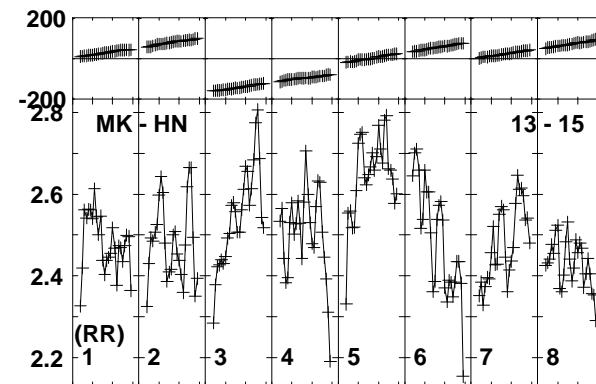
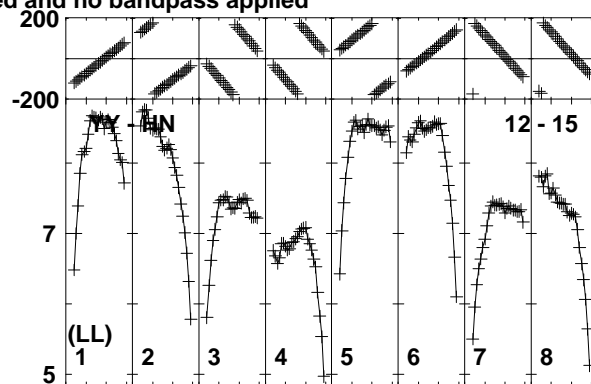
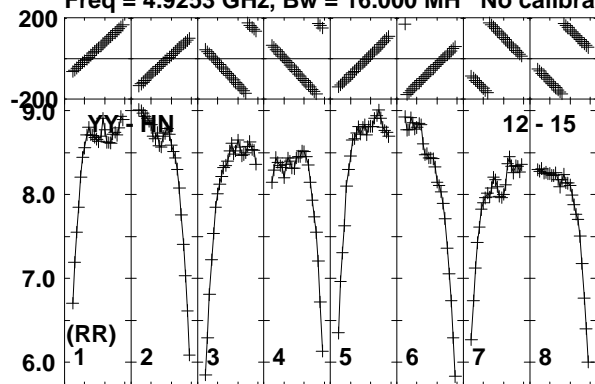

Lower frame: Milli Ampl Jy Top frame: Phas deg
Vector averaged cross-power spectrum Baseline: YY (12) - HN (15)
Timerange: 01/02:01:46 to 01/02:03:38

Plot file version 543 created 11-APR-2016 17:09:45

ARP299C GP053G 3.UVDATA.1

Freq = 4.9253 GHz, Bw = 16.000 MH No calibration applied and no bandpass applied

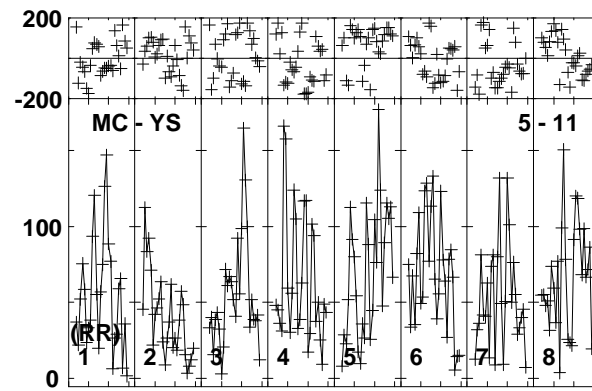
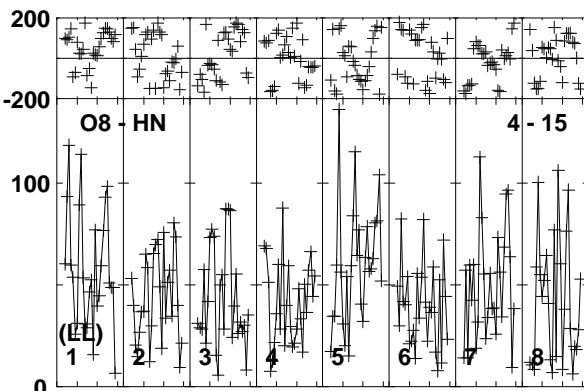
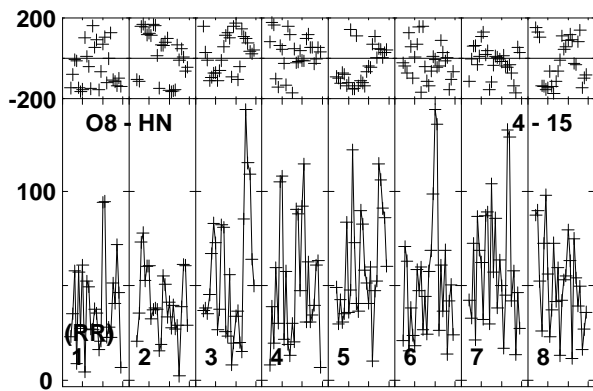
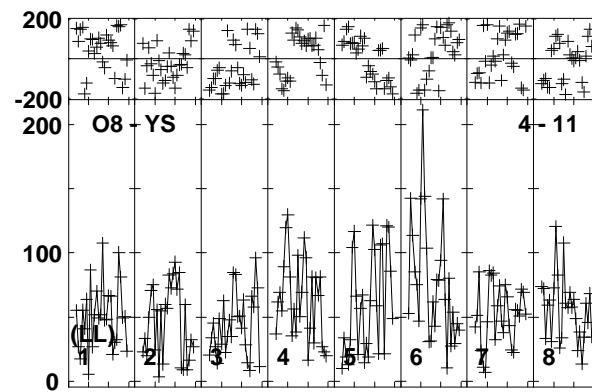
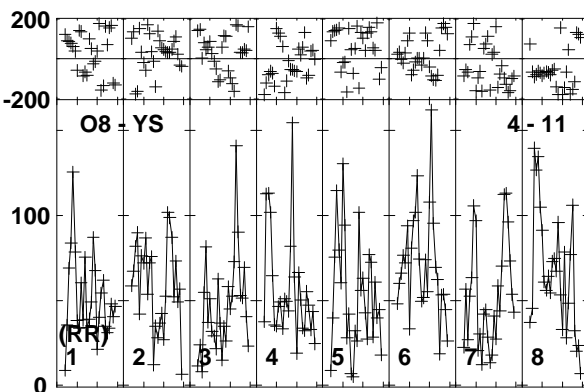
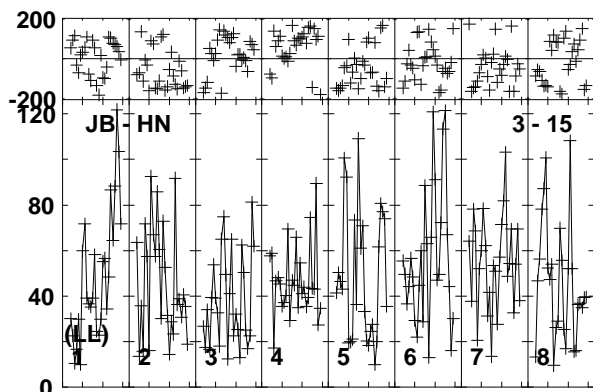
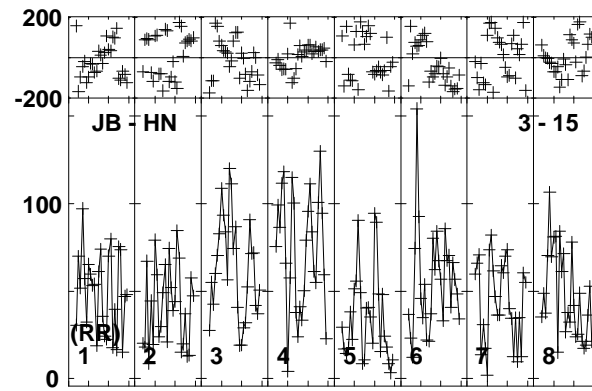
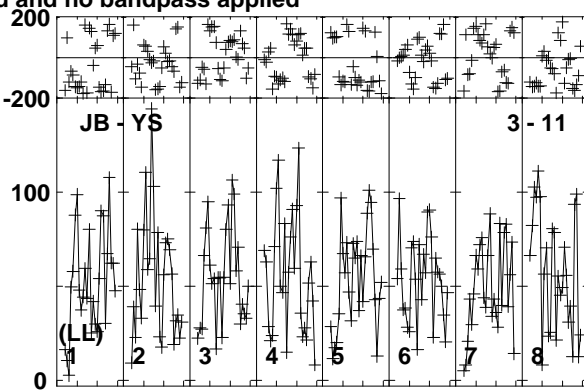
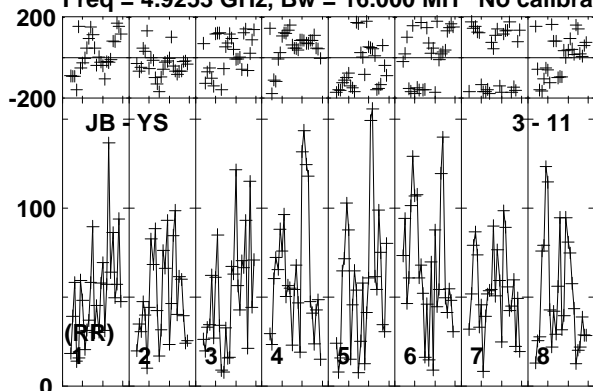

Lower frame: Micro Ampl Jy Top frame: Phas deg
Vector averaged cross-power spectrum Baseline: JB (03) - YS (11)
Timerange: 01/02:03:43 to 01/02:08:57

Plot file version 544 created 11-APR-2016 17:09:45

ARP299C GP053G 3.UVDATA.1

Freq = 4.9253 GHz, Bw = 16.000 MH No calibration applied and no bandpass applied

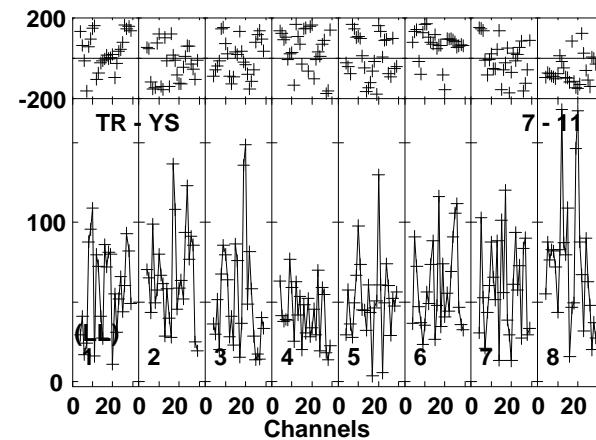
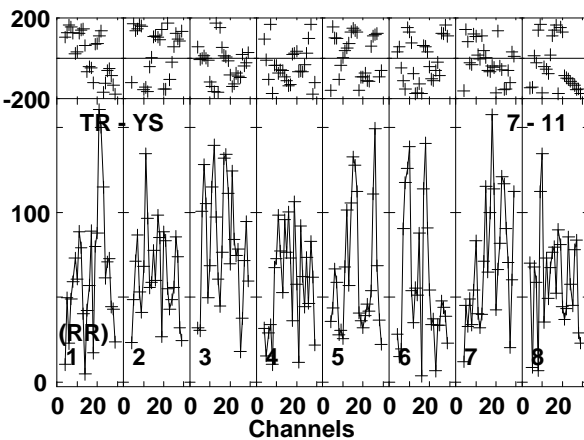
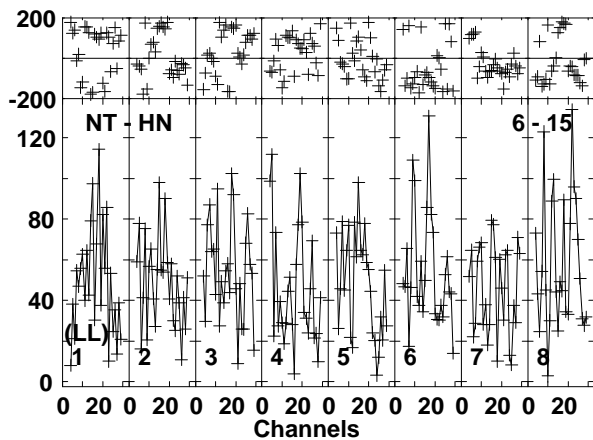
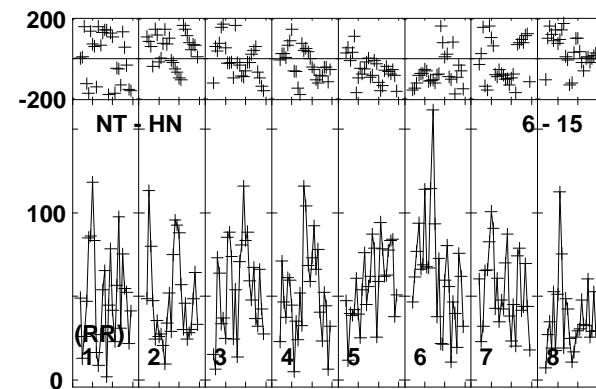
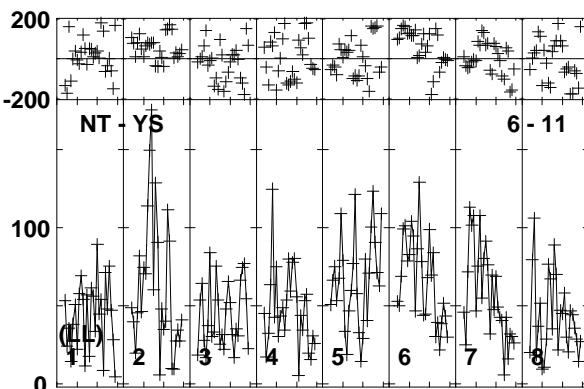
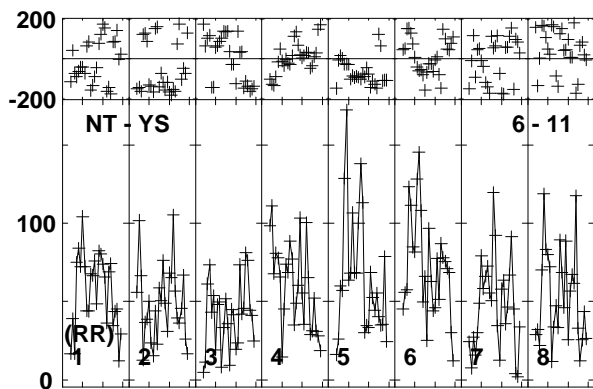
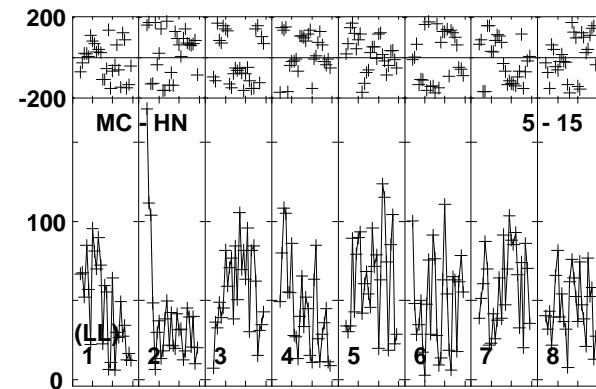
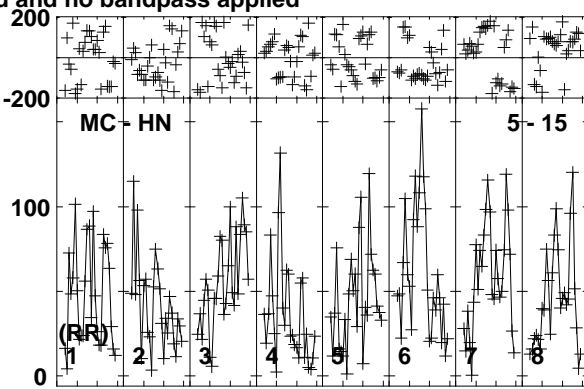
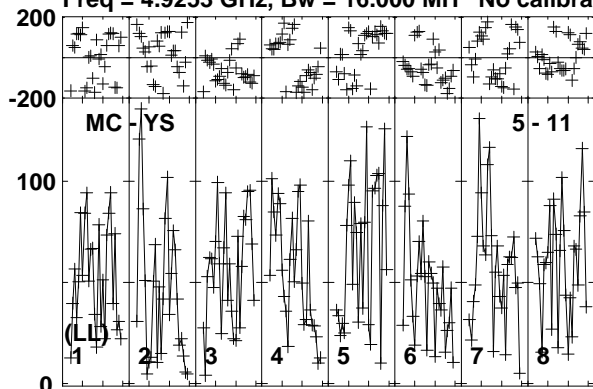

Lower frame: Micro Ampl Jy Top frame: Phas deg
Vector averaged cross-power spectrum Baseline: MC (05) - YS (11)
Timerange: 01/02:03:43 to 01/02:08:57

Plot file version 545 created 11-APR-2016 17:09:45

ARP299C GP053G 3.UVDATA.1

Freq = 4.9253 GHz, Bw = 16.000 MH No calibration applied and no bandpass applied

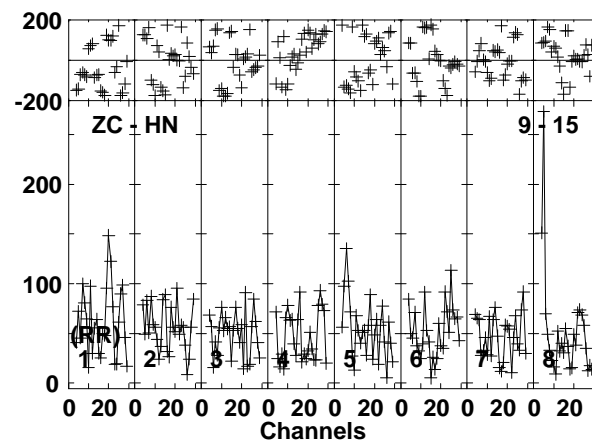
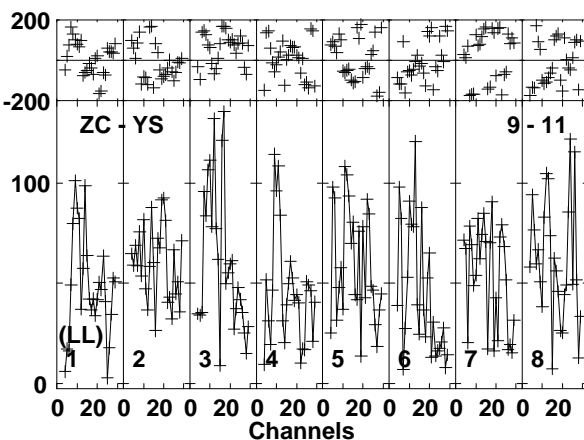
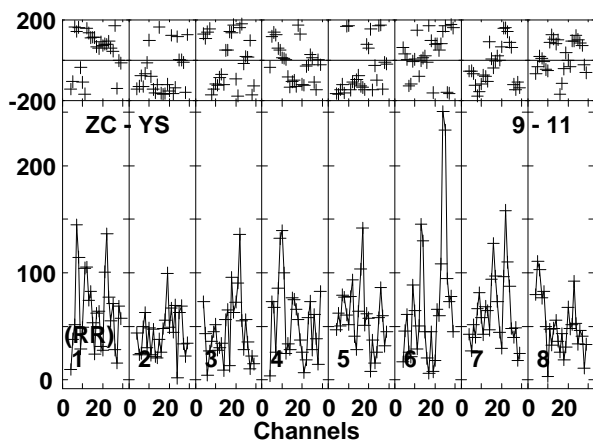
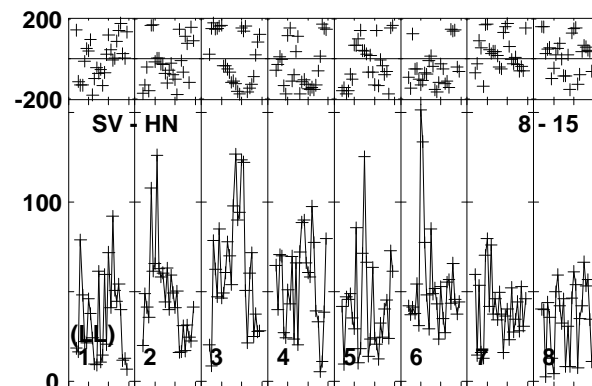
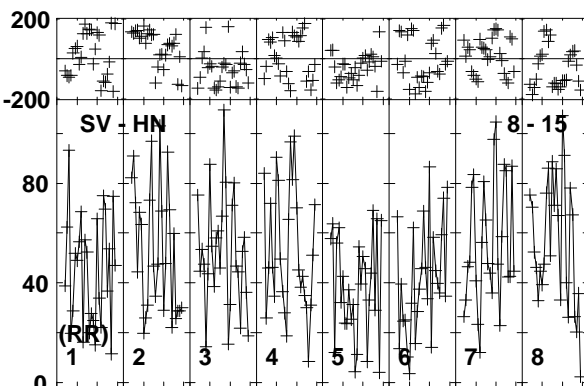
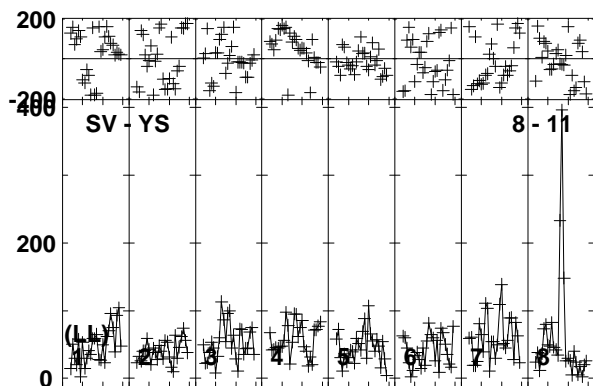
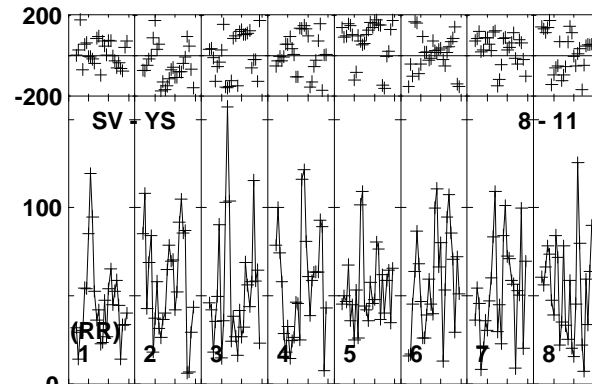
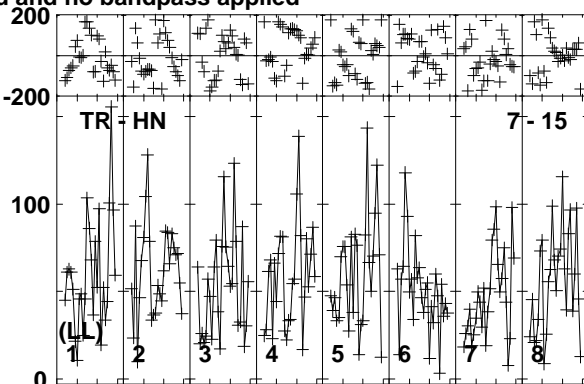
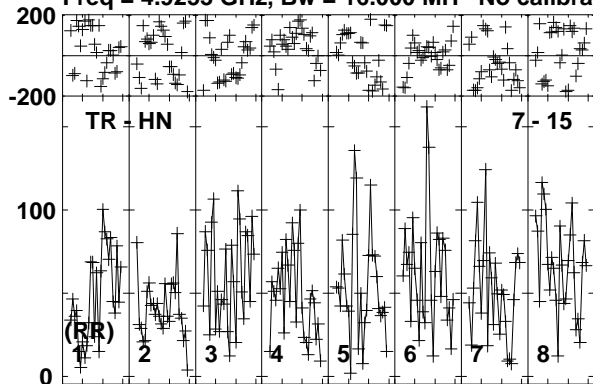

Lower frame: Micro Ampl Jy Top frame: Phas deg
Vector averaged cross-power spectrum Baseline: TR (07) - HN (15)
Timerange: 01/02:03:43 to 01/02:08:57

Plot file version 546 created 11-APR-2016 17:09:45

ARP299C GP053G 3.UVDATA.1

Freq = 4.9253 GHz, Bw = 16.000 MH No calibration applied and no bandpass applied

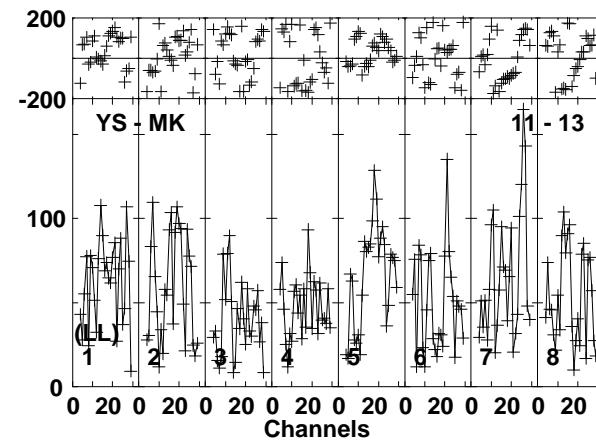
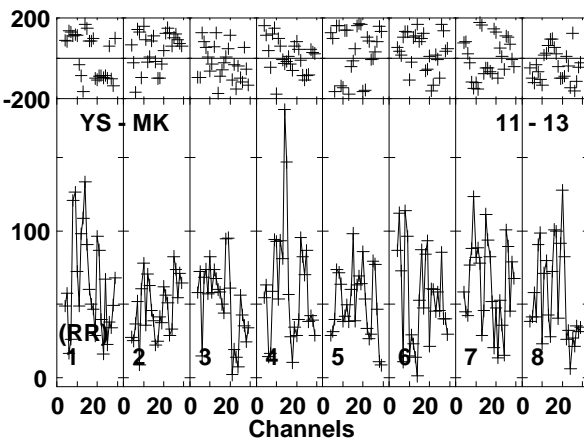
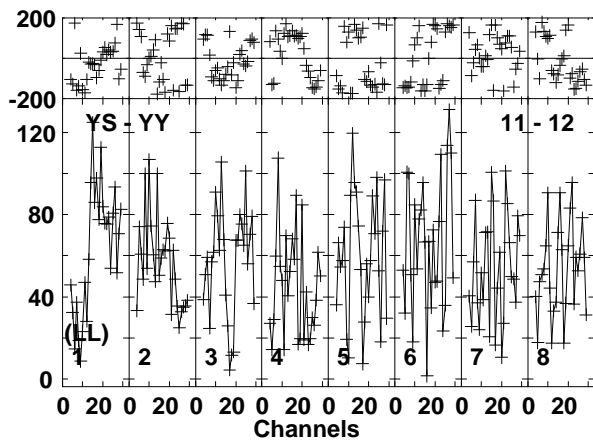
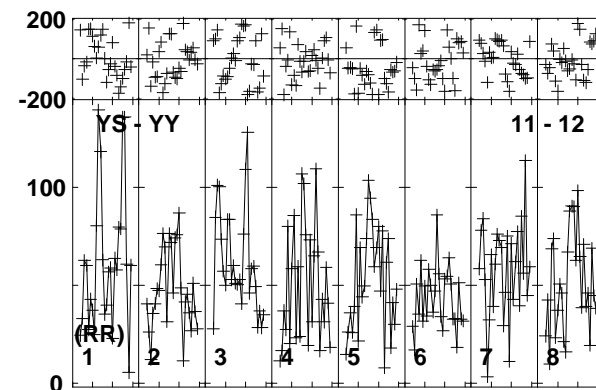
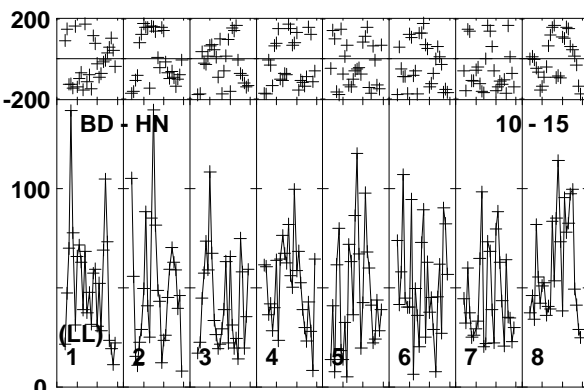
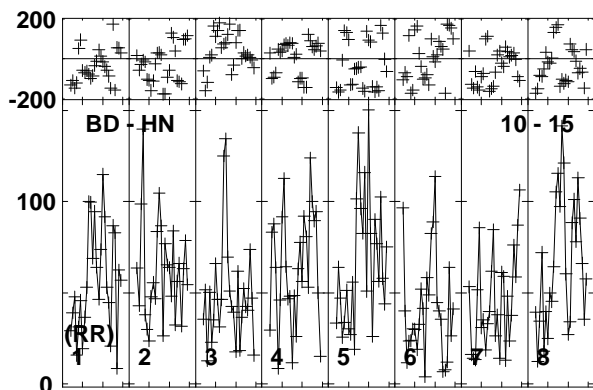
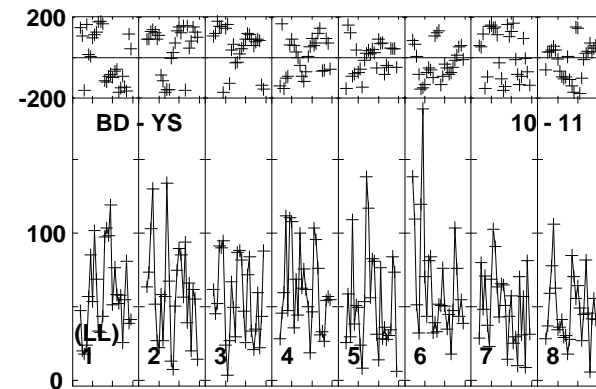
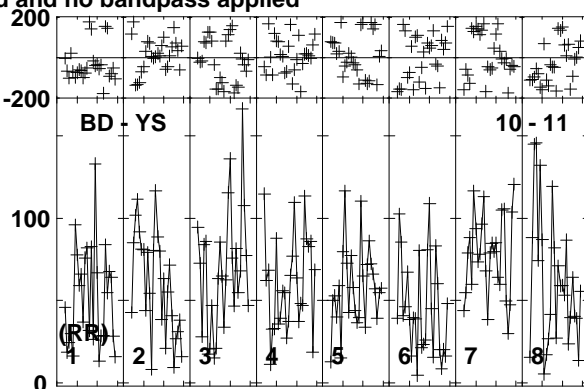
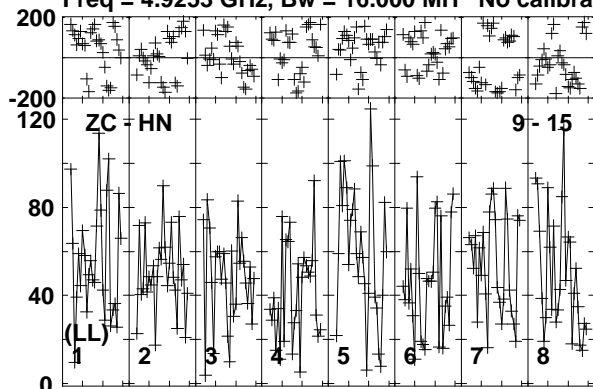

Lower frame: Micro Ampl Jy Top frame: Phas deg
Vector averaged cross-power spectrum Baseline: ZC (09) - HN (15)
Timerange: 01/02:03:43 to 01/02:08:57

Plot file version 547 created 11-APR-2016 17:09:46

ARP299C GP053G 3.UVDATA.1

Freq = 4.9253 GHz, Bw = 16.000 MH No calibration applied and no bandpass applied

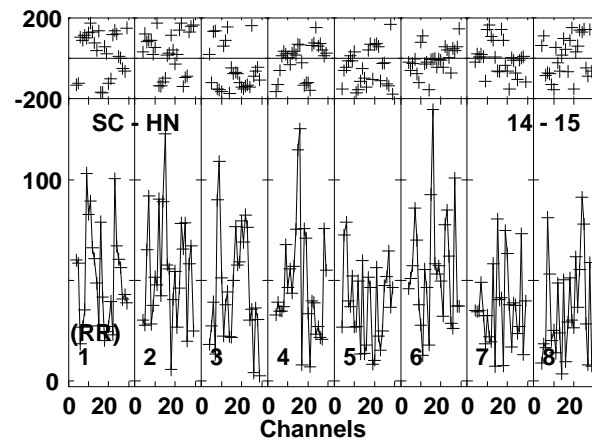
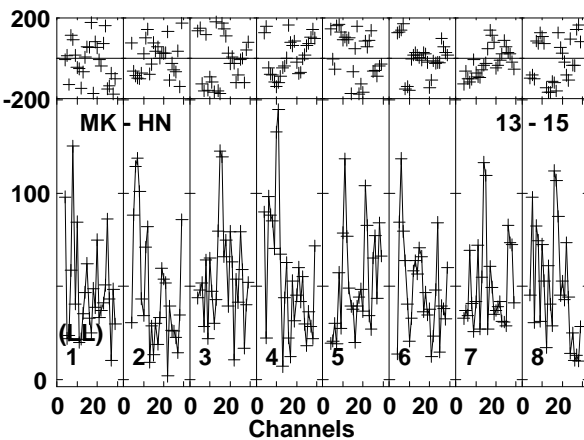
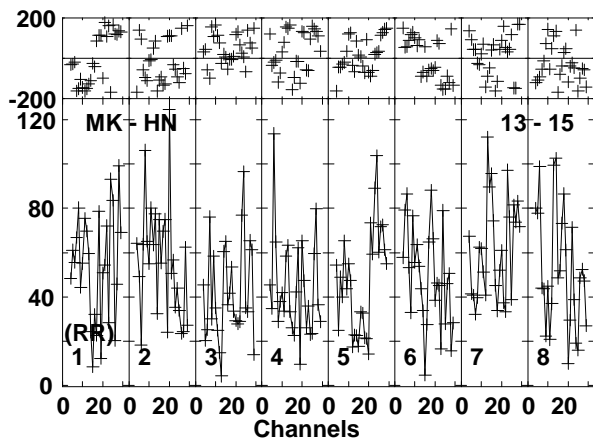
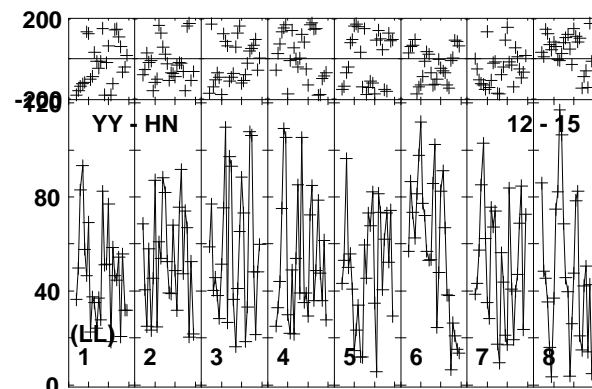
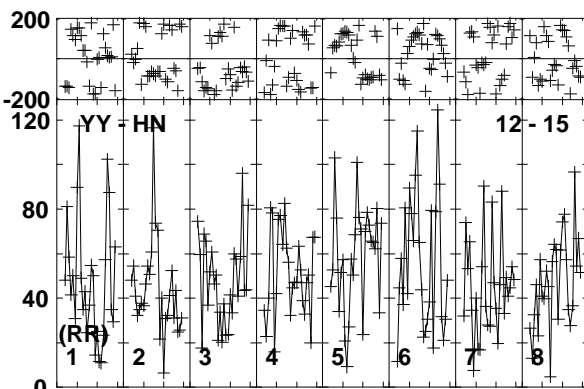
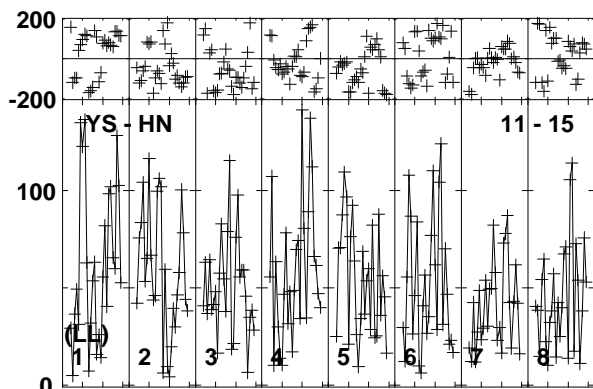
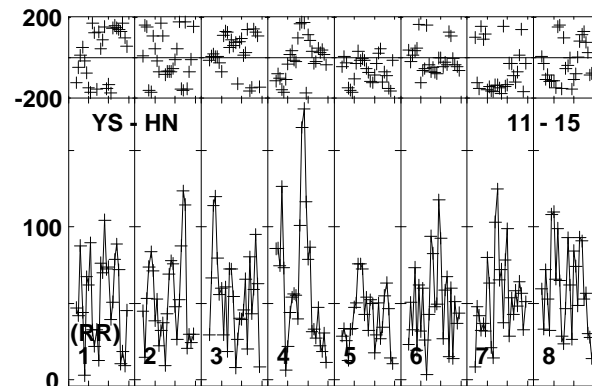
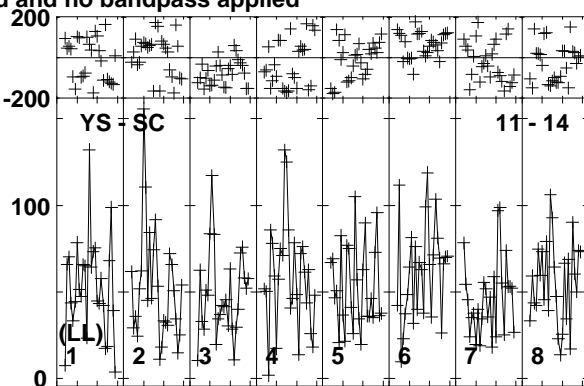
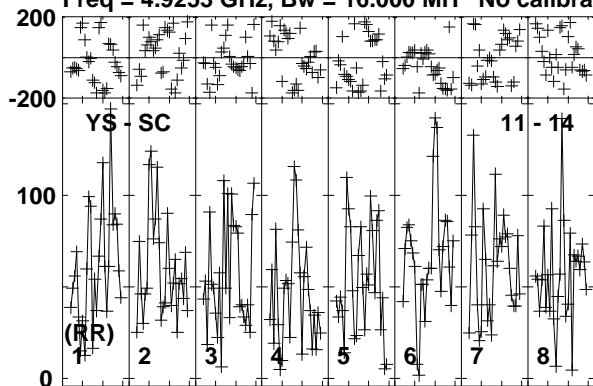

Lower frame: Micro Ampl Jy Top frame: Phas deg
Vector averaged cross-power spectrum Baseline: YS (11) - SC (14)
Timerange: 01/02:03:43 to 01/02:08:57

Plot file version 548 created 11-APR-2016 17:09:46

ARP299C GP053G 3.UVDATA.1

Freq = 4.9253 GHz, Bw = 16.000 MH No calibration applied and no bandpass applied

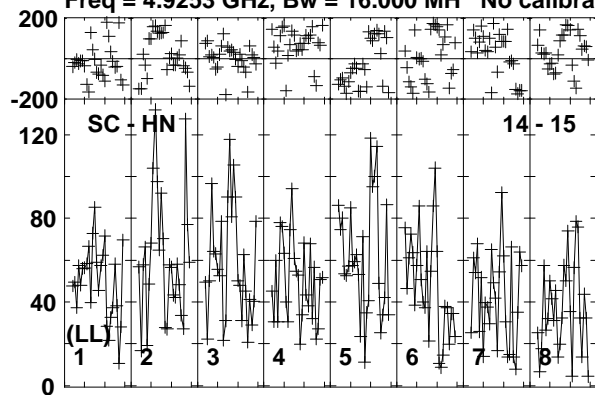

Lower frame: Micro Ampl Jy Top frame: Phas deg
Vector averaged cross-power spectrum Baseline: SC (14) - HN (15)
Timerange: 01/02:03:43 to 01/02:08:57

Plot file version 549 created 11-APR-2016 17:09:46

J1128+5925 GP053G 3.UVDATA.1

Freq = 4.9253 GHz, Bw = 16.000 MH No calibration applied and no bandpass applied

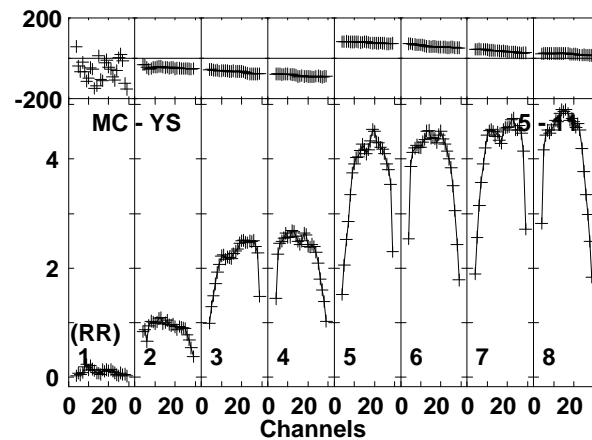
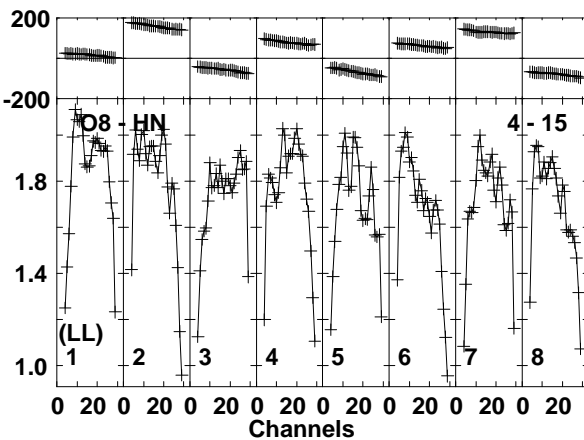
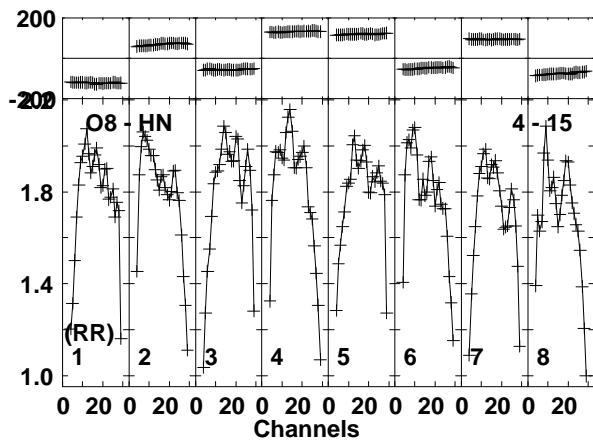
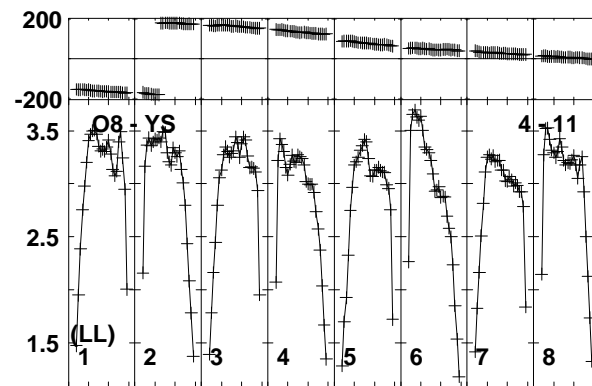
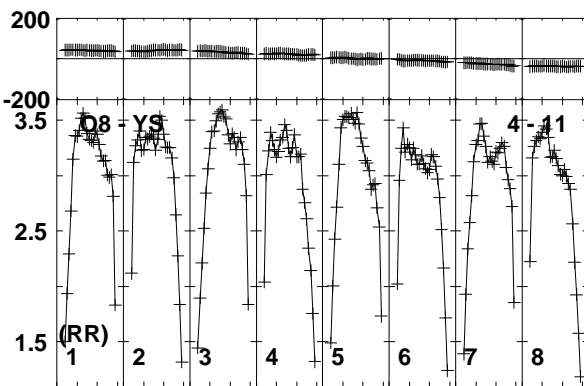
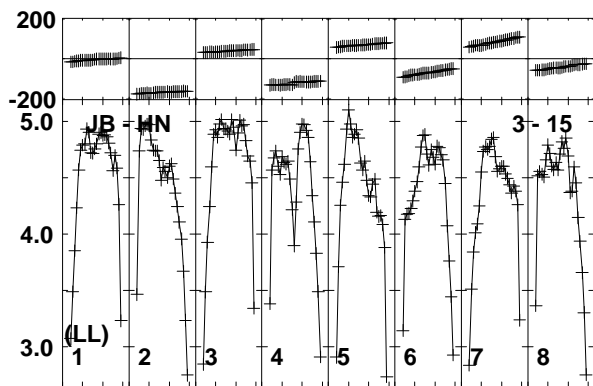
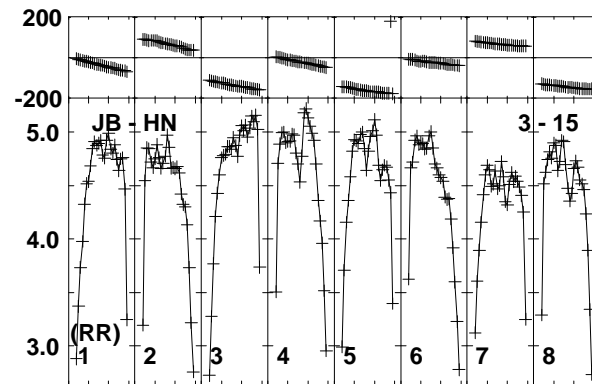
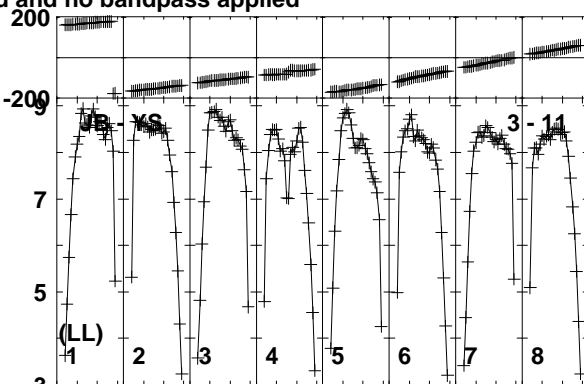
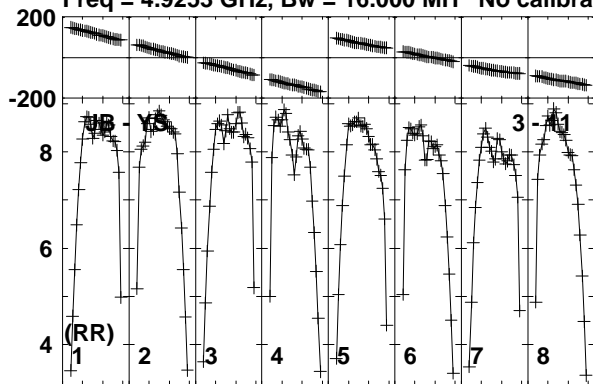

Lower frame: Milli Ampl Jy Top frame: Phas deg
Vector averaged cross-power spectrum Baseline: JB (03) - YS (11)
Timerange: 01/02:09:03 to 01/02:10:47

Plot file version 550 created 11-APR-2016 17:09:46

J1128+5925 GP053G 3.UVDATA.1

Freq = 4.9253 GHz, Bw = 16.000 MH No calibration applied and no bandpass applied

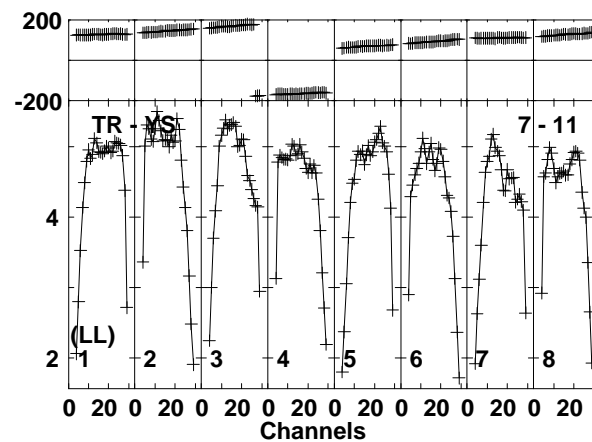
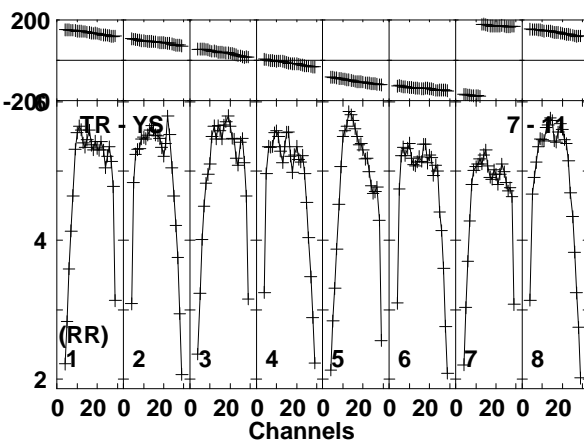
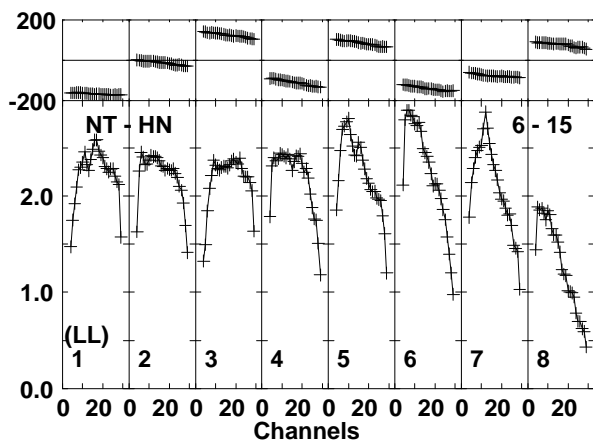
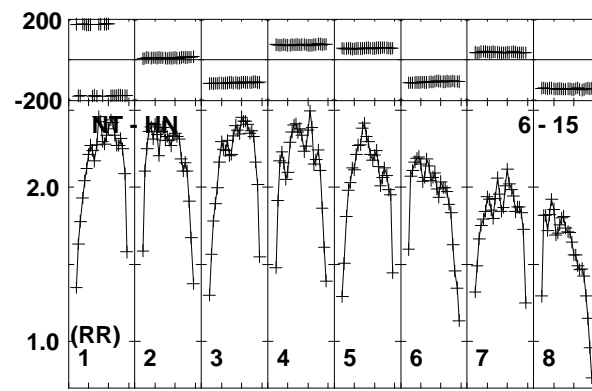
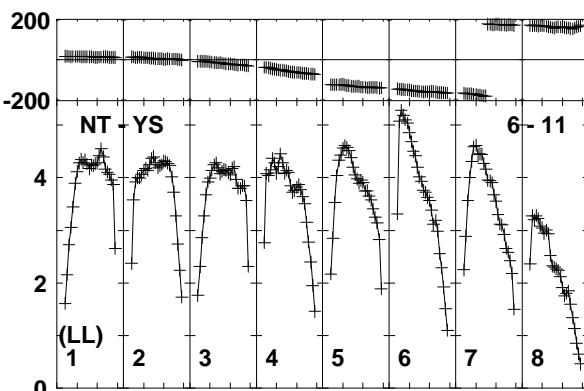
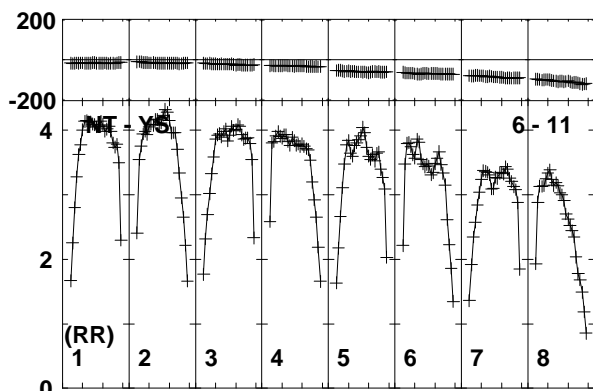
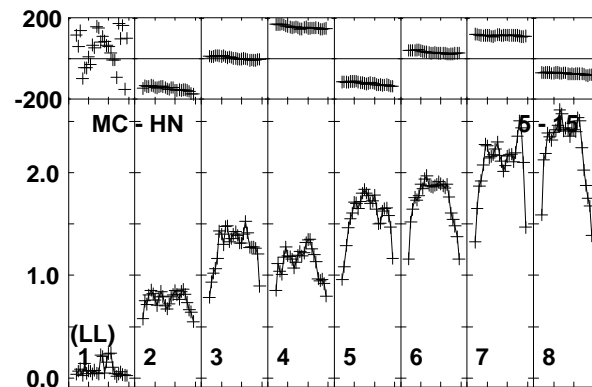
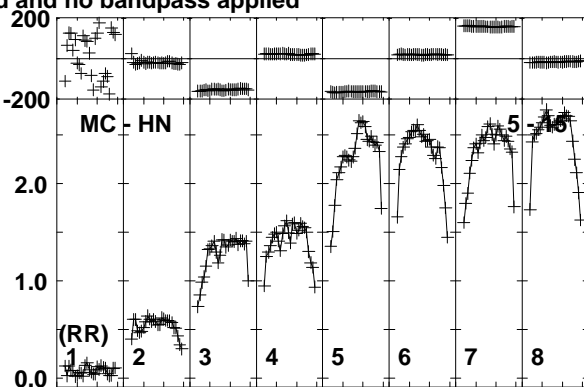
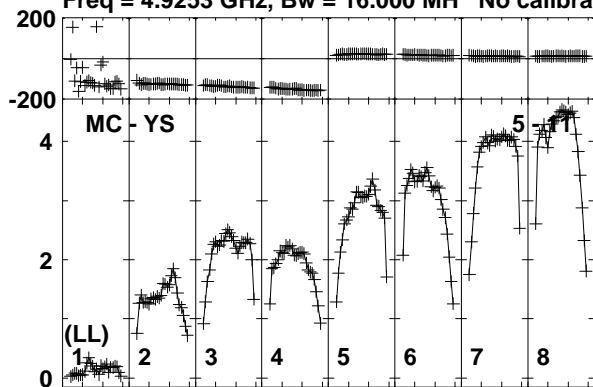

Lower frame: Milli Ampl Jy Top frame: Phas deg

Vector averaged cross-power spectrum Baseline: MC (05) - YS (11)

Timerange: 01/02:09:03 to 01/02:10:47

Plot file version 551 created 11-APR-2016 17:09:46

J1128+5925 GP053G 3.UVDATA.1

Freq = 4.9253 GHz, Bw = 16.000 MH No calibration applied and no bandpass applied

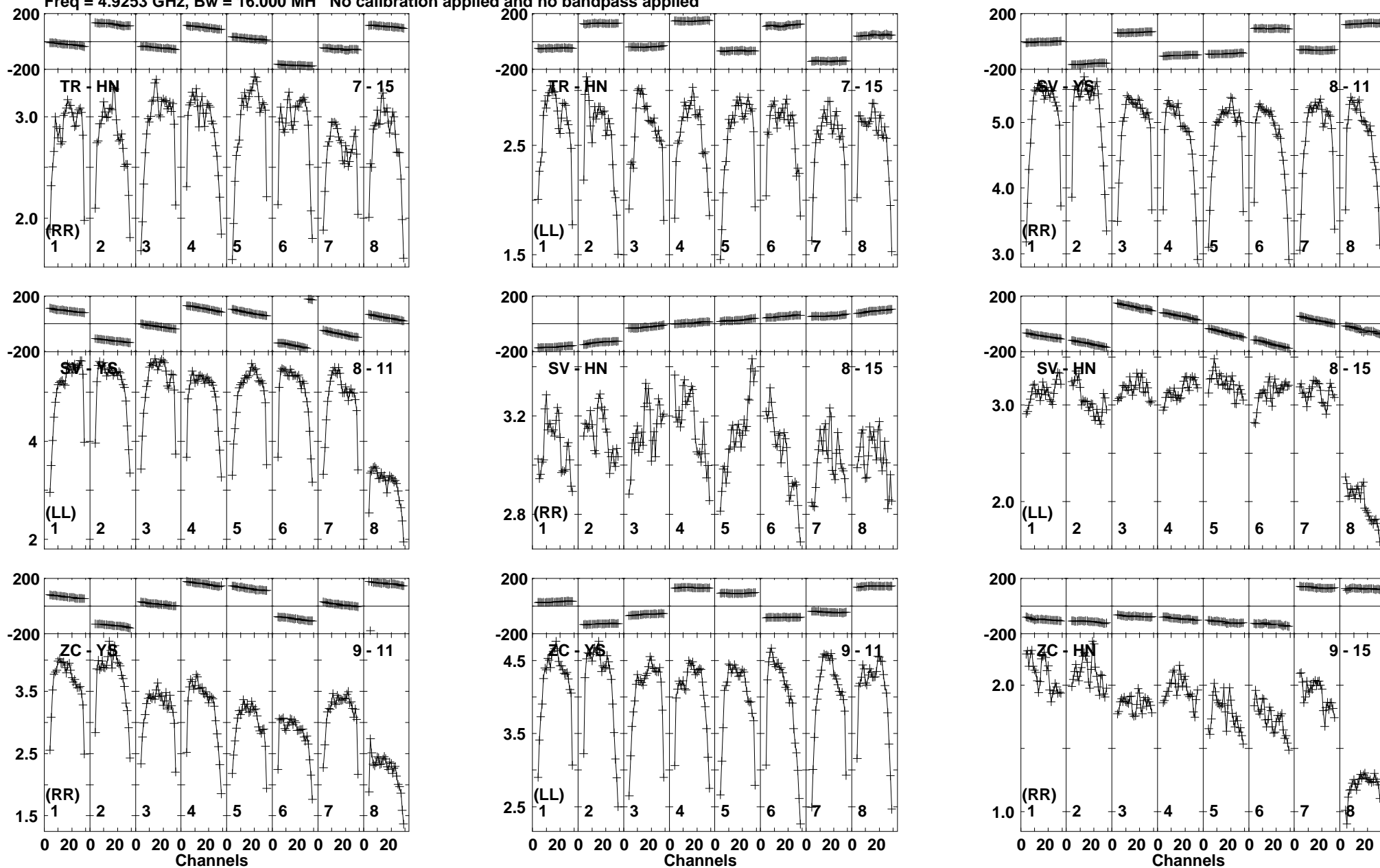

Lower frame: Milli Ampl Jy Top frame: Phas deg
Vector averaged cross-power spectrum Baseline: TR (07) - HN (15)
Timerange: 01/02:09:03 to 01/02:10:47

Plot file version 552 created 11-APR-2016 17:09:46

J1128+5925 GP053G 3.UVDATA.1

Freq = 4.9253 GHz, Bw = 16.000 MH No calibration applied and no bandpass applied

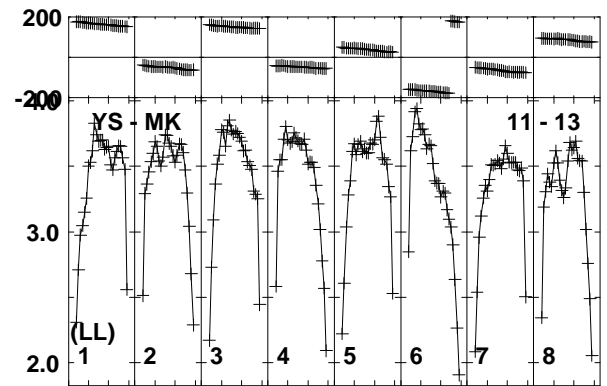
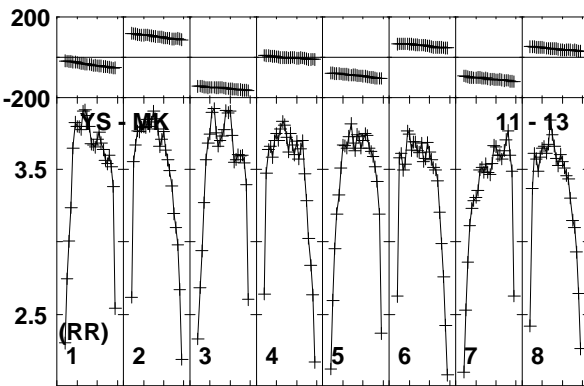
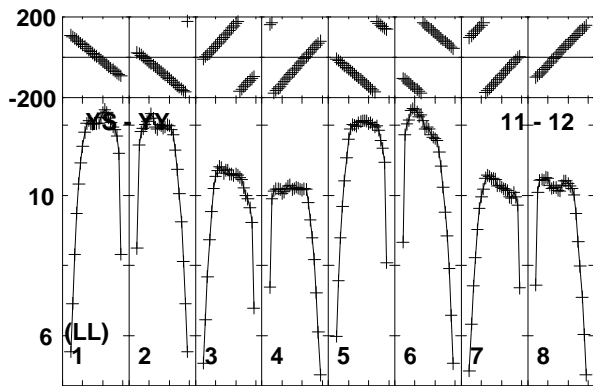
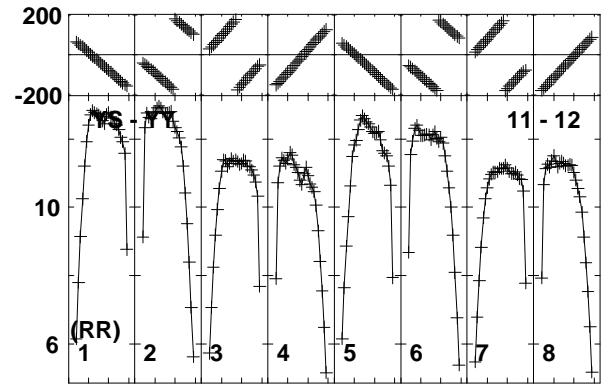
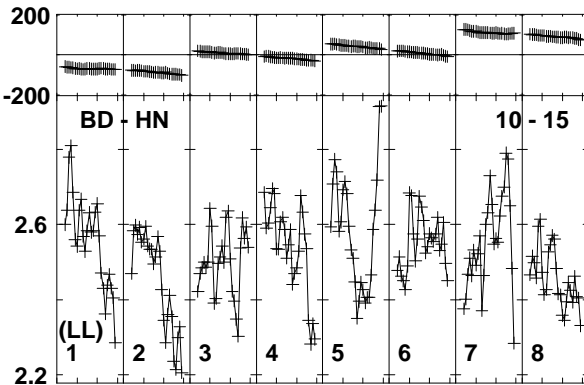
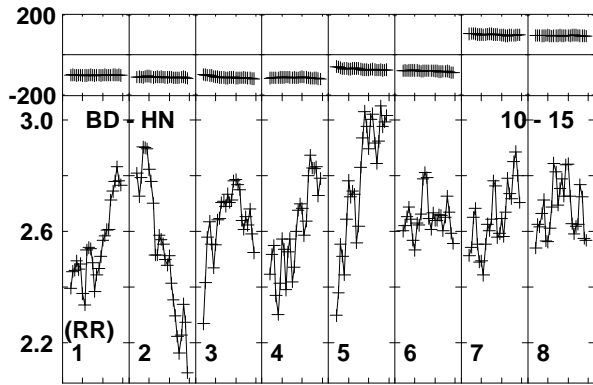
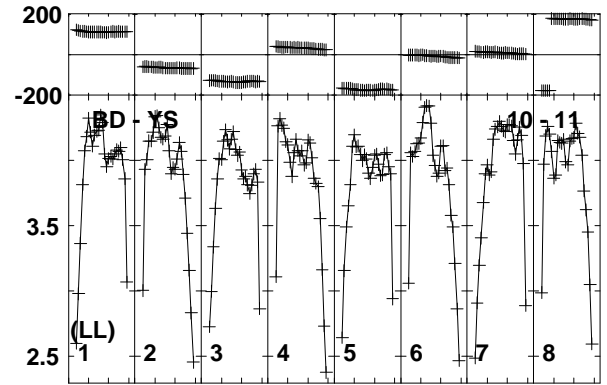
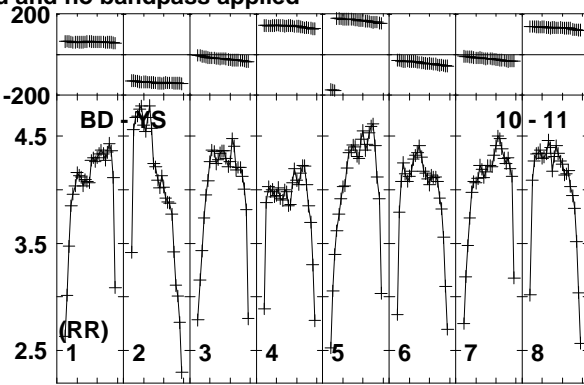
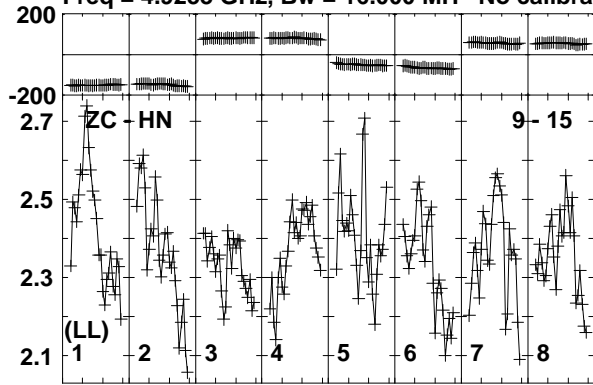

Lower frame: Milli Ampl Jy Top frame: Phas deg
Vector averaged cross-power spectrum Baseline: ZC (09) - HN (15)
Timerange: 01/02:09:03 to 01/02:10:47

Plot file version 553 created 11-APR-2016 17:09:46

J1128+5925 GP053G 3.UVDATA.1

Freq = 4.9253 GHz, Bw = 16.000 MH No calibration applied and no bandpass applied

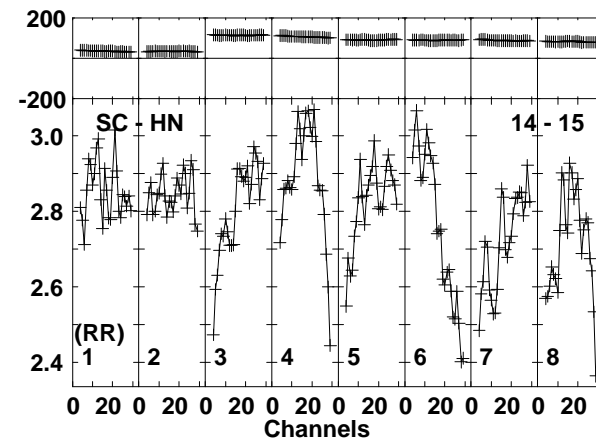
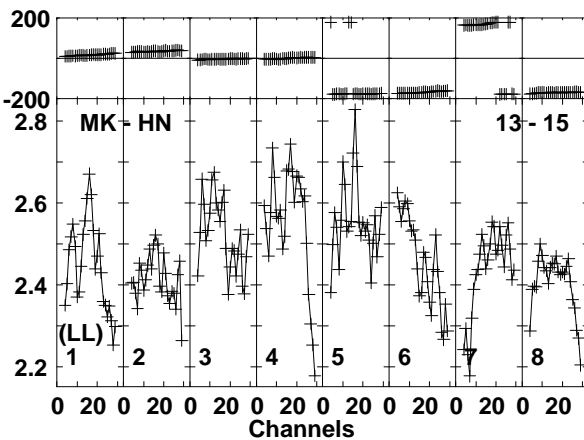
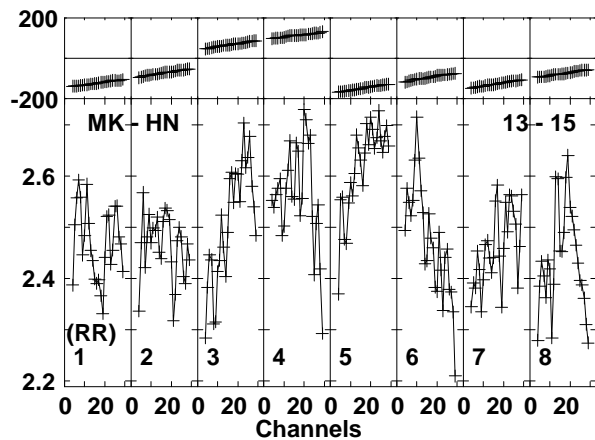
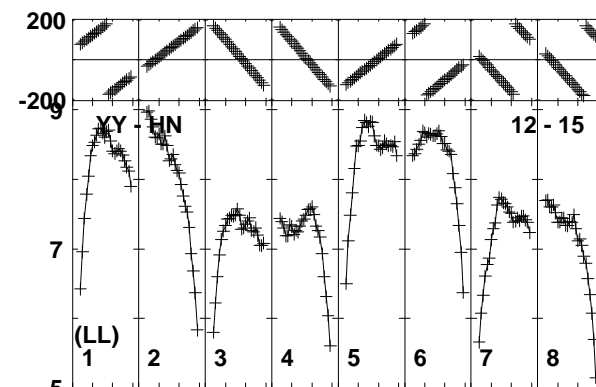
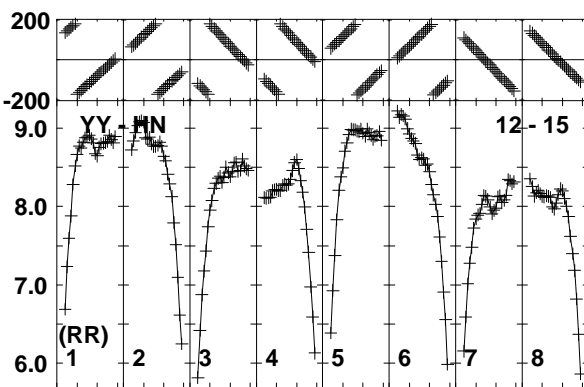
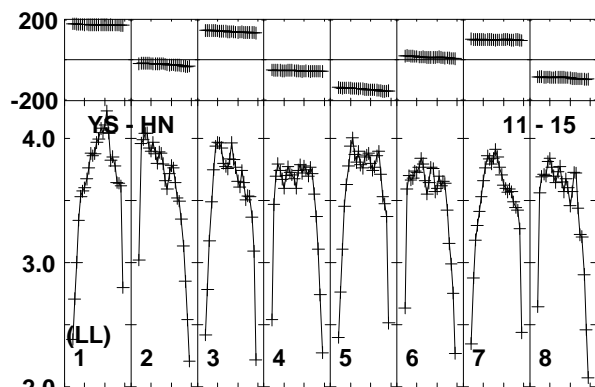
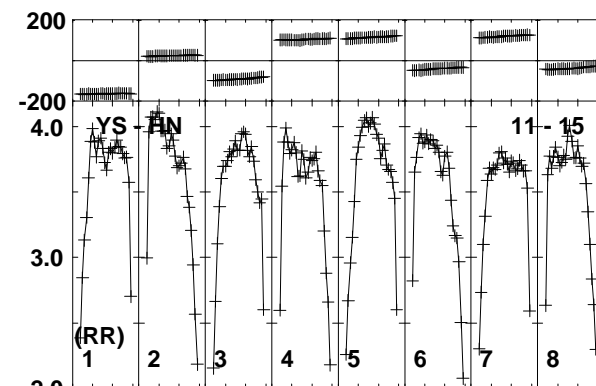
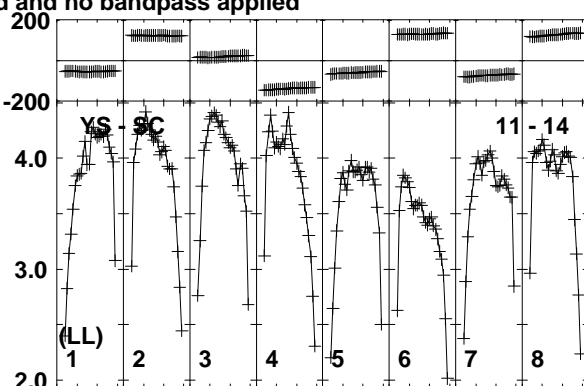
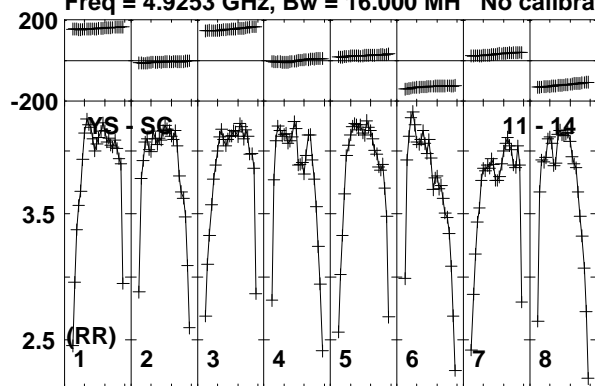

Lower frame: Milli Ampl Jy Top frame: Phas deg
Vector averaged cross-power spectrum Baseline: YS (11) - SC (14)
Timerange: 01/02:09:03 to 01/02:10:47

Plot file version 554 created 11-APR-2016 17:09:46

J1128+5925 GP053G 3.UVDATA.1

Freq = 4.9253 GHz, Bw = 16.000 MH No calibration applied and no bandpass applied

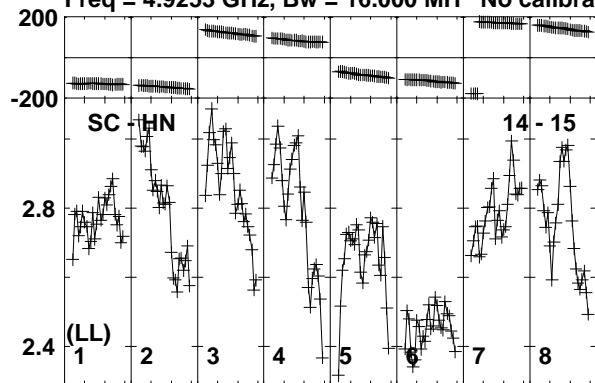

Lower frame: Milli Ampl Jy Top frame: Phas deg
Vector averaged cross-power spectrum Baseline: SC (14) - HN (15)
Timerange: 01/02:09:03 to 01/02:10:47

Plot file version 555 created 11-APR-2016 17:09:47

ARP299C GP053G 3.UVDATA.1

Freq = 4.9253 GHz, Bw = 16.000 MH No calibration applied and no bandpass applied

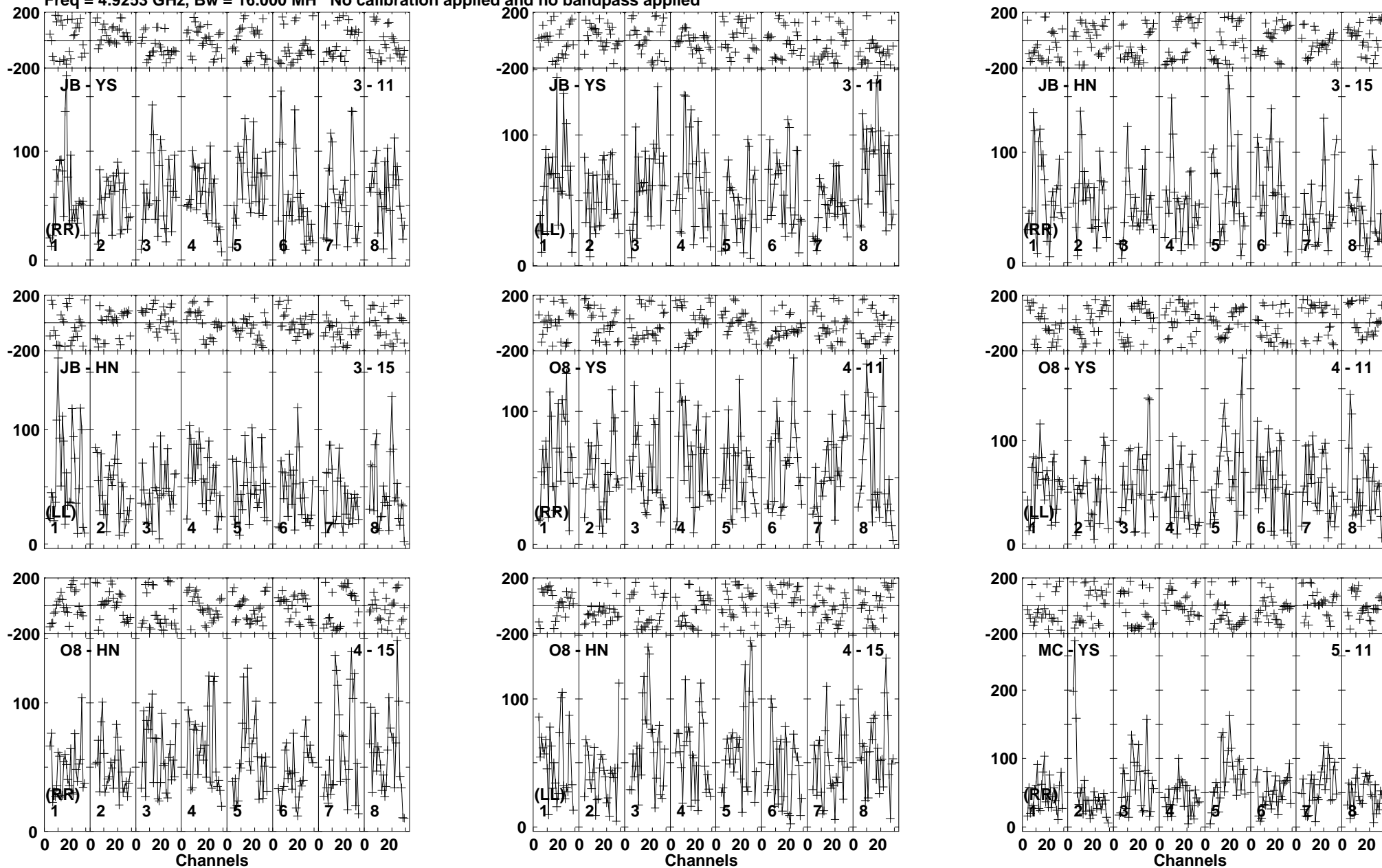

Lower frame: Micro Ampl Jy Top frame: Phas deg
Vector averaged cross-power spectrum Baseline: JB (03) - YS (11)
Timerange: 01/02:10:53 to 01/02:16:05

Plot file version 556 created 11-APR-2016 17:09:47

ARP299C GP053G 3.UVDATA.1

Freq = 4.9253 GHz, Bw = 16.000 MH No calibration applied and no bandpass applied

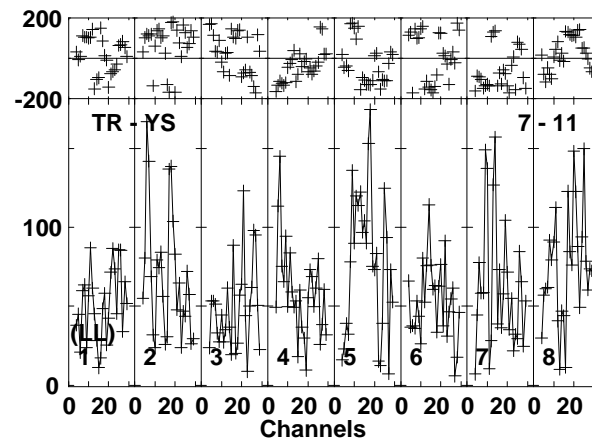
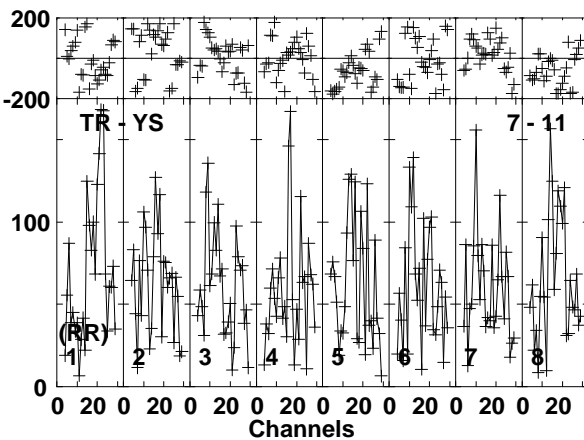
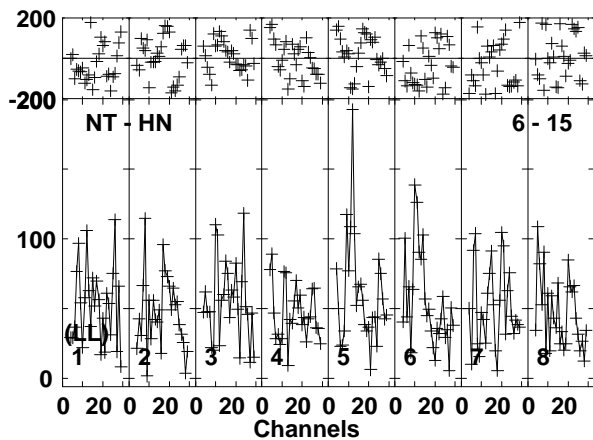
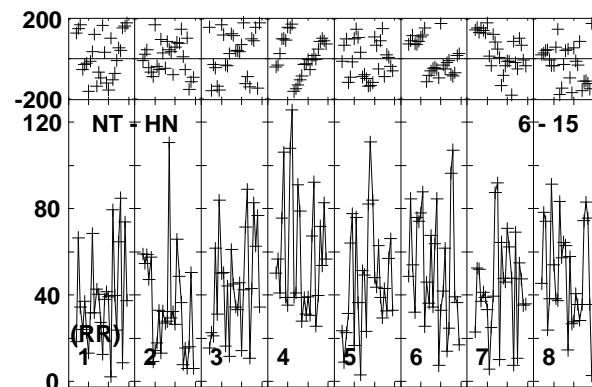
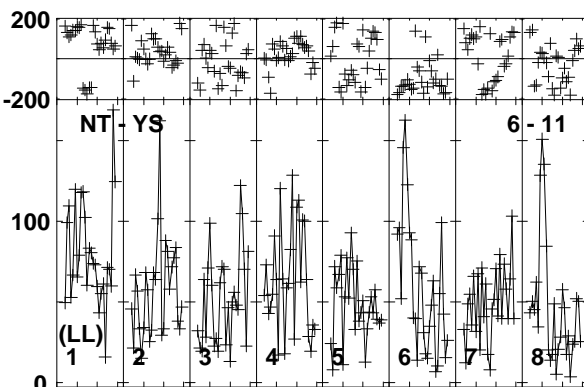
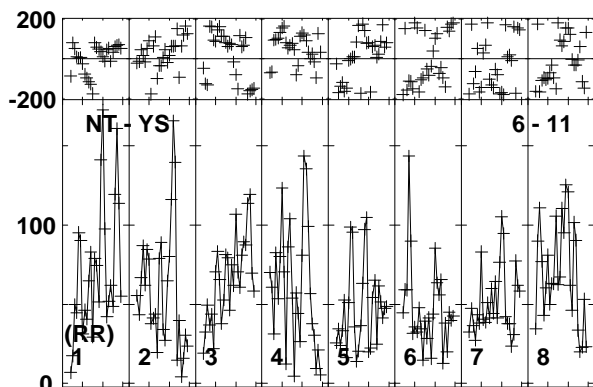
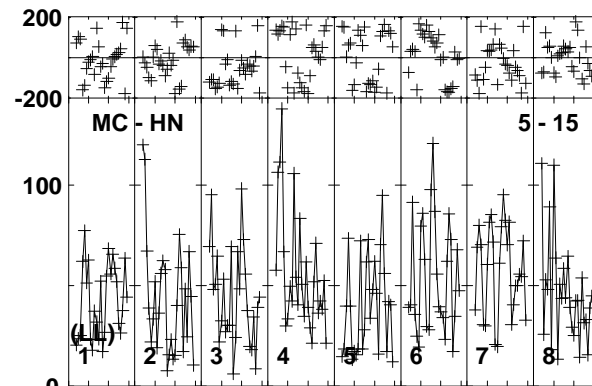
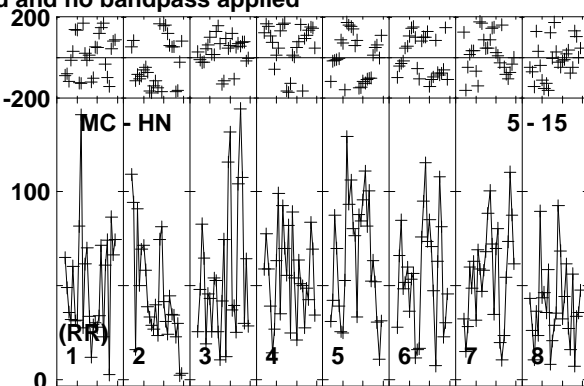
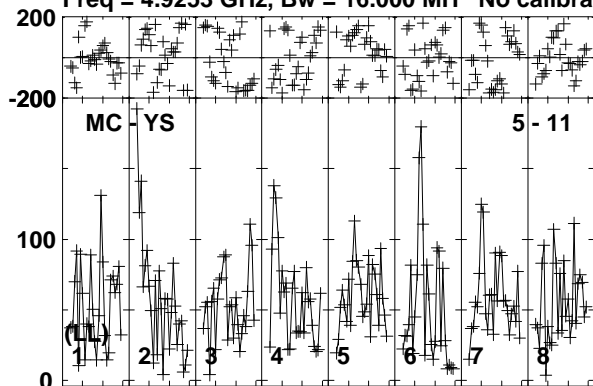

Lower frame: Micro Ampl Jy Top frame: Phas deg
Vector averaged cross-power spectrum Baseline: MC (05) - YS (11)
Timerange: 01/02:10:53 to 01/02:16:05

Plot file version 557 created 11-APR-2016 17:09:47

ARP299C GP053G 3.UVDATA.1

Freq = 4.9253 GHz, Bw = 16.000 MH No calibration applied and no bandpass applied

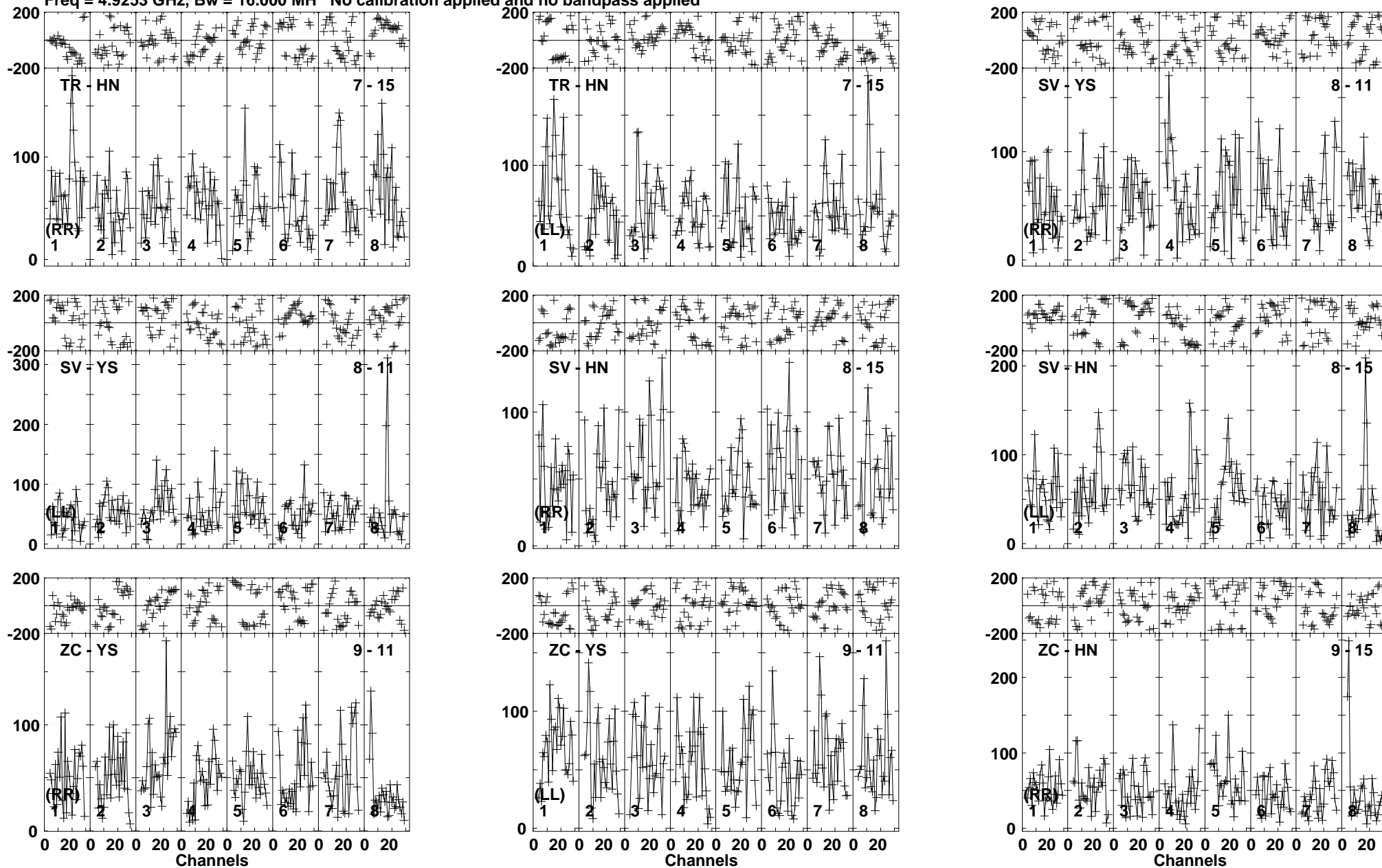

Lower frame: Micro Ampl Jy Top frame: Phas deg
Vector averaged cross-power spectrum Baseline: TR (07) - HN (15)
Timerange: 01/02:10:53 to 01/02:16:05

Plot file version 558 created 11-APR-2016 17:09:47

ARP299C GP053G 3.UVDATA.1

Freq = 4.9253 GHz, Bw = 16.000 MH No calibration applied and no bandpass applied

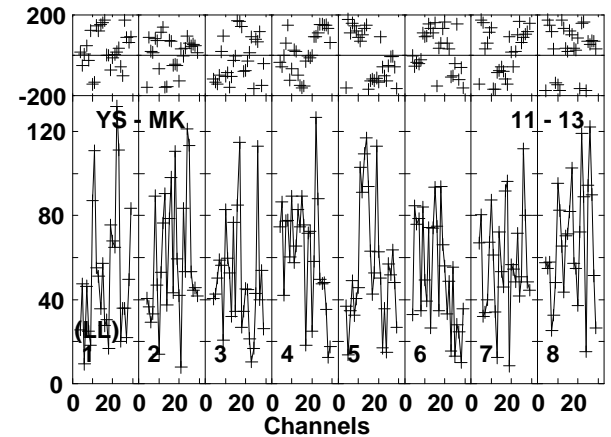
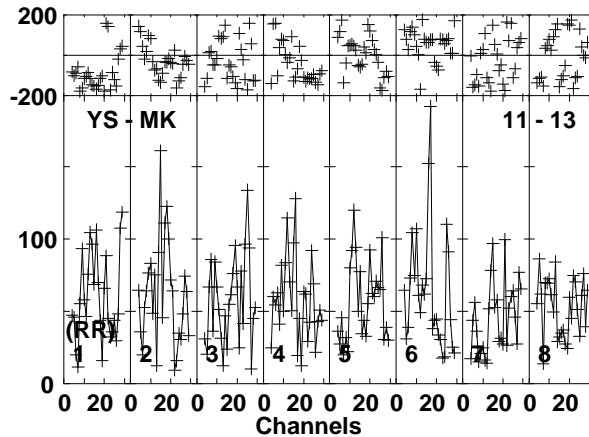
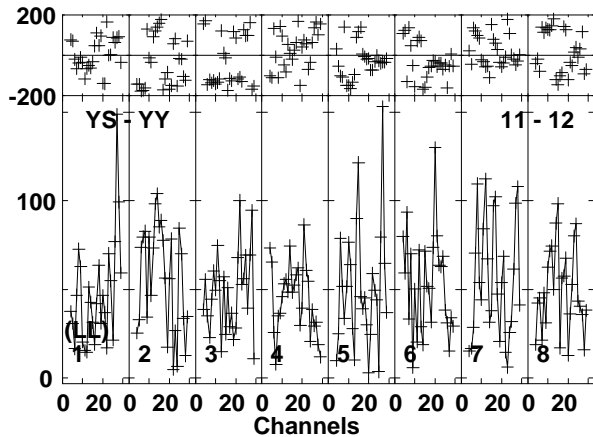
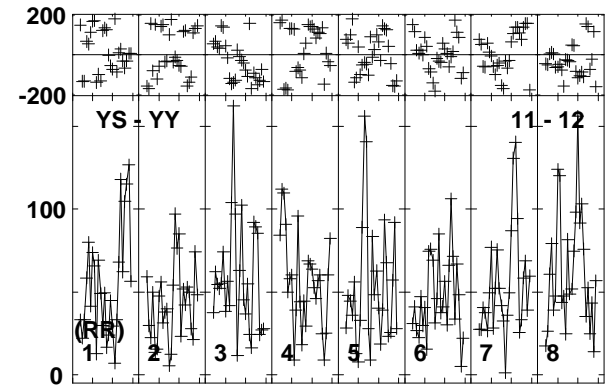
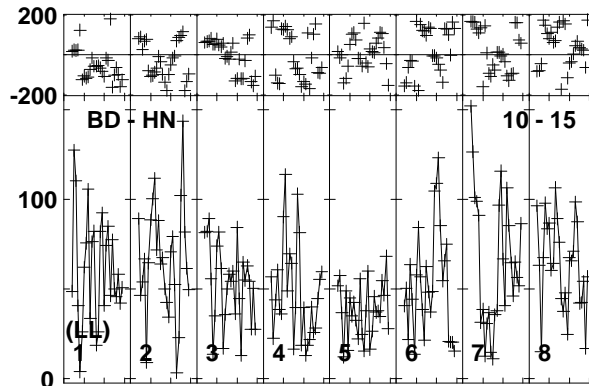
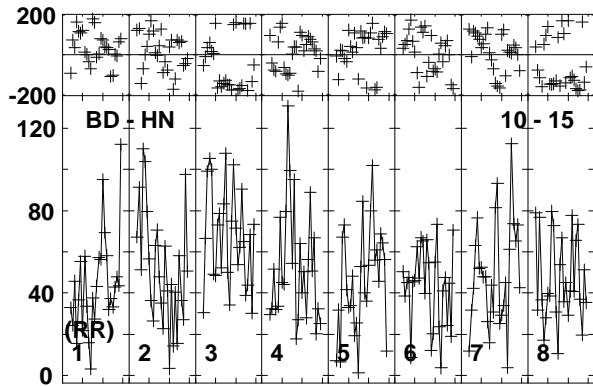
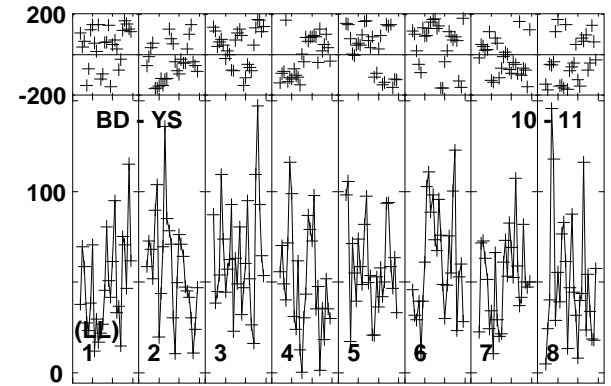
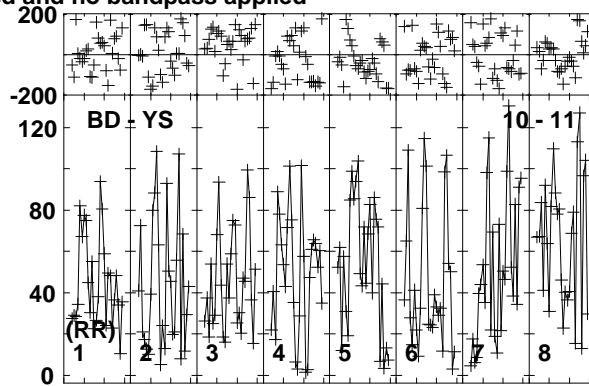
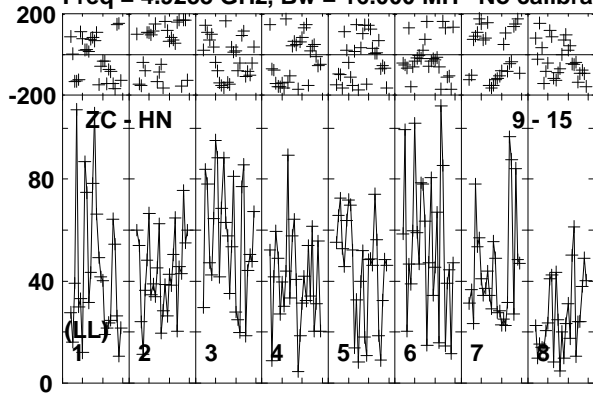

Lower frame: Micro Ampl Jy Top frame: Phas deg
Vector averaged cross-power spectrum Baseline: ZC (09) - HN (15)
Timerange: 01/02:10:53 to 01/02:16:05

Plot file version 559 created 11-APR-2016 17:09:47

ARP299C GP053G 3.UVDATA.1

Freq = 4.9253 GHz, Bw = 16.000 MH No calibration applied and no bandpass applied

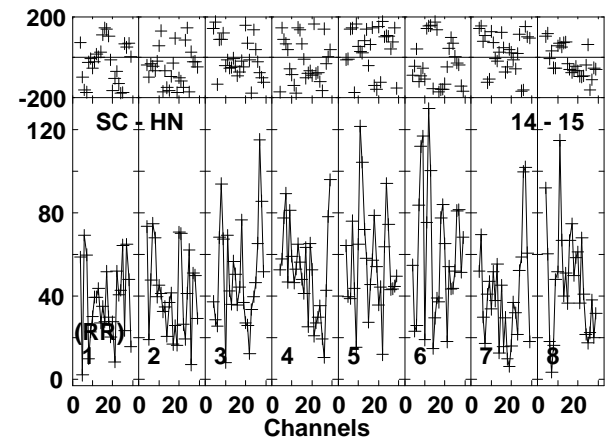
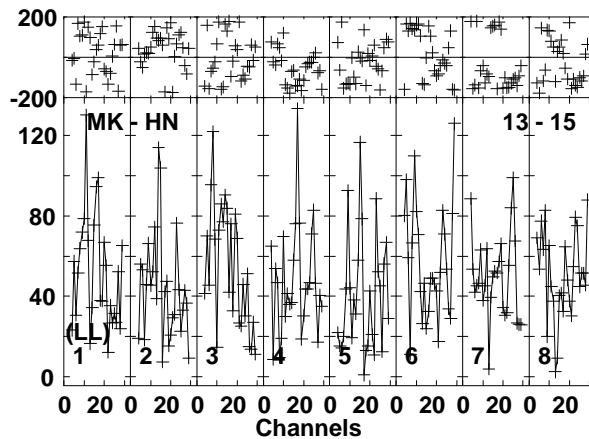
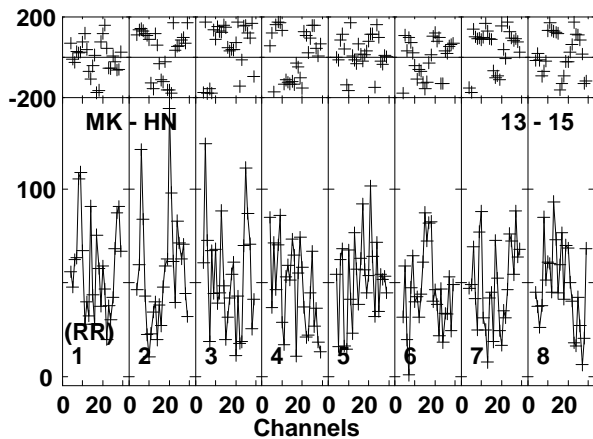
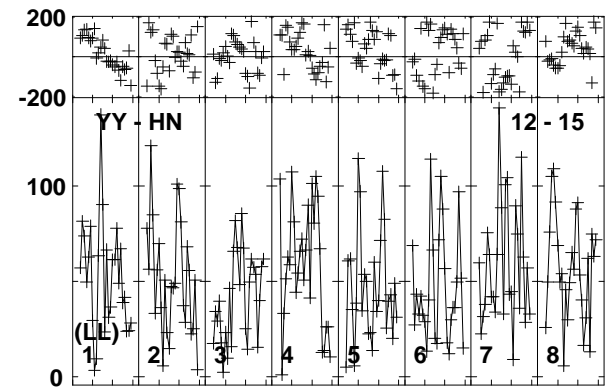
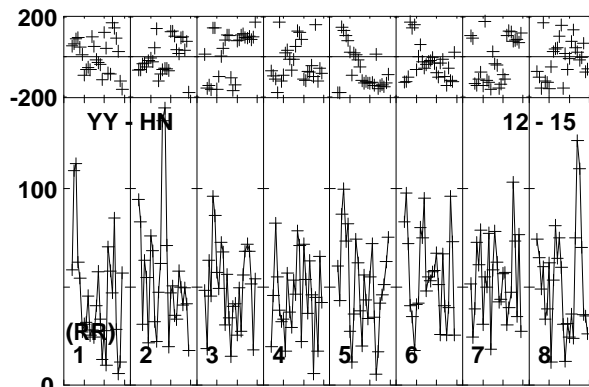
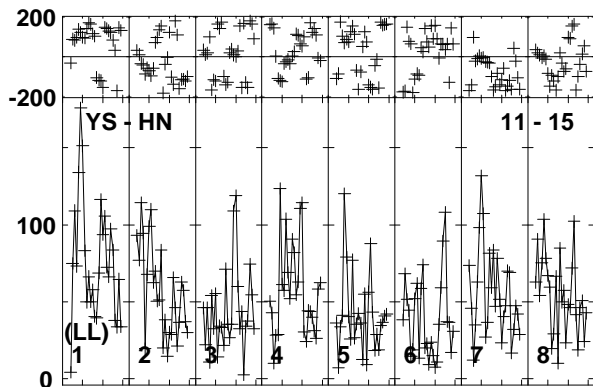
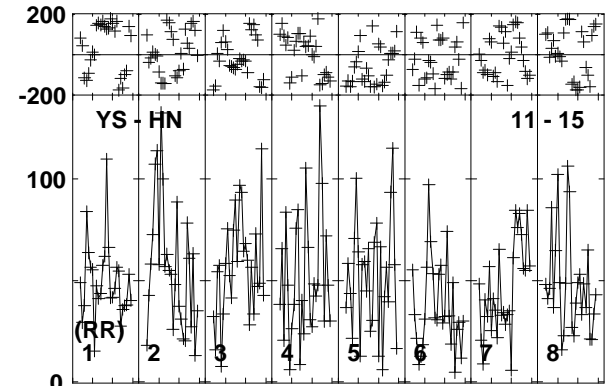
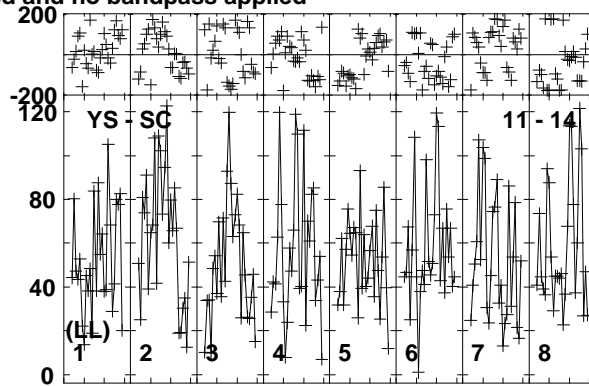
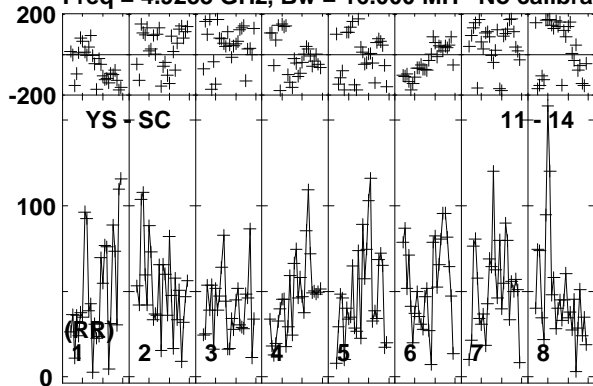

Lower frame: Micro Ampl Jy Top frame: Phas deg

Vector averaged cross-power spectrum Baseline: YS (11) - SC (14)

Timerange: 01/02:10:53 to 01/02:16:05

Plot file version 560 created 11-APR-2016 17:09:48

ARP299C GP053G 3.UVDATA.1

Freq = 4.9253 GHz, Bw = 16.000 MH No calibration applied and no bandpass applied

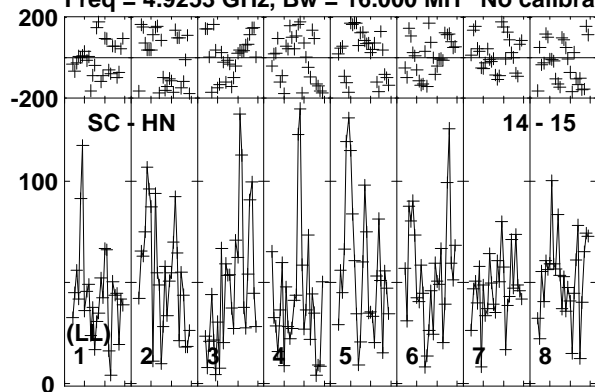

Lower frame: Micro Ampl Jy Top frame: Phas deg
Vector averaged cross-power spectrum Baseline: SC (14) - HN (15)
Timerange: 01/02:10:53 to 01/02:16:05

Plot file version 561 created 11-APR-2016 17:09:48
 J1128+5925 GP053G 3.UVDATA.1

Freq = 4.9253 GHz, Bw = 16.000 MH No calibration applied and no bandpass applied

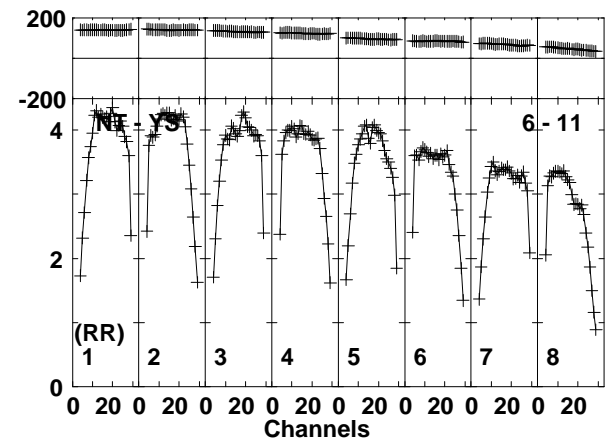
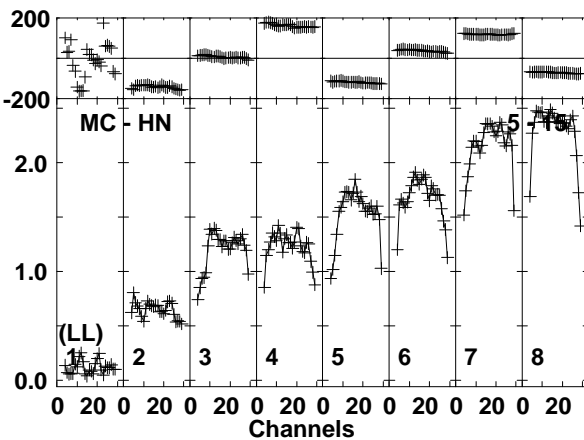
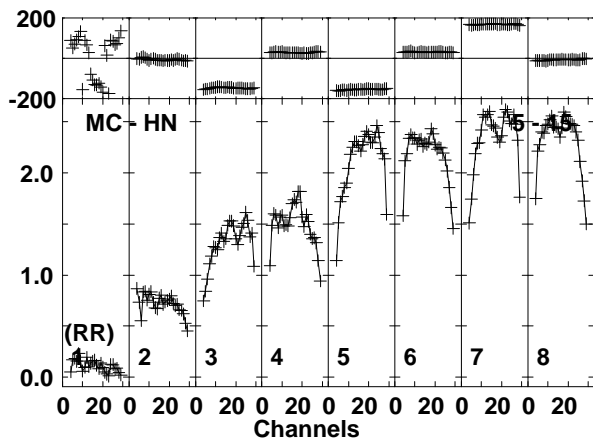
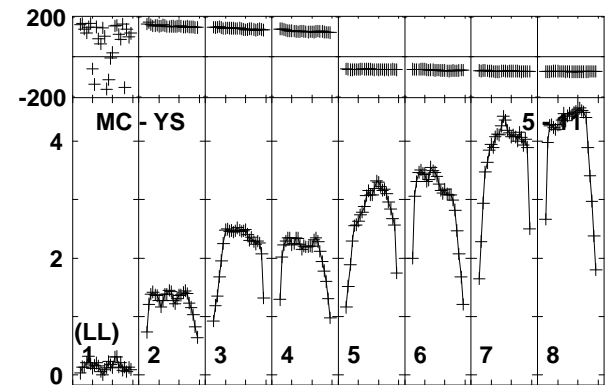
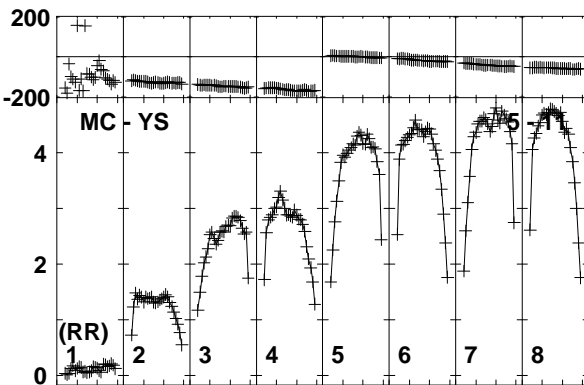
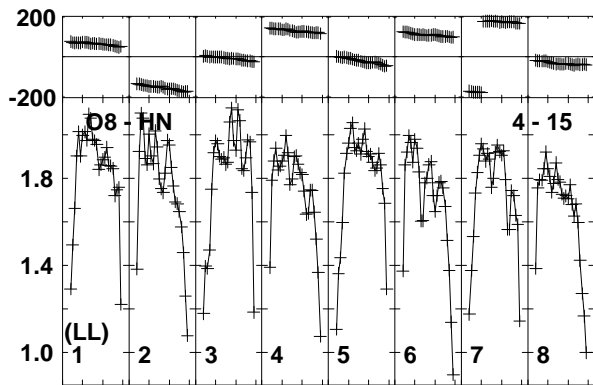
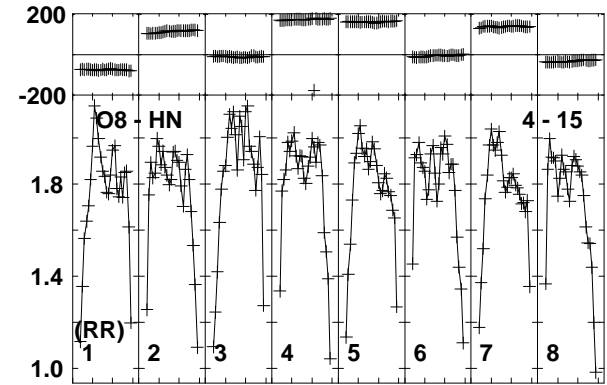
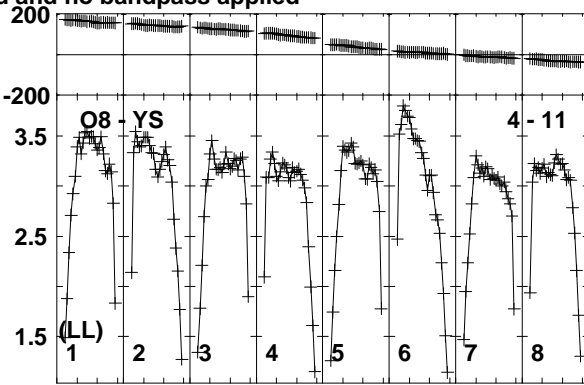
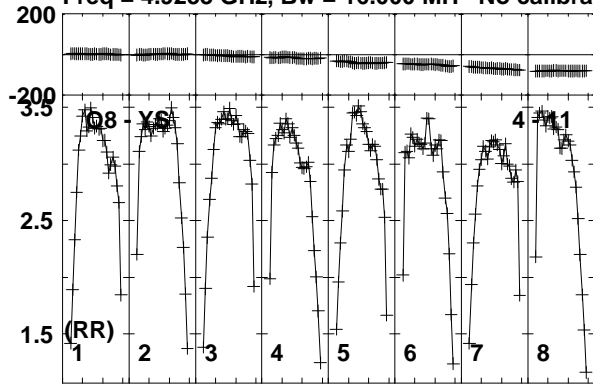

Lower frame: Milli Ampl Jy Top frame: Phas deg
 Vector averaged cross-power spectrum Baseline: O8 (04) - YS (11)
 Timerange: 01/02:16:11 to 01/02:18:03

Plot file version 562 created 11-APR-2016 17:09:48

J1128+5925 GP053G 3.UVDATA.1

Freq = 4.9253 GHz, Bw = 16.000 MH No calibration applied and no bandpass applied

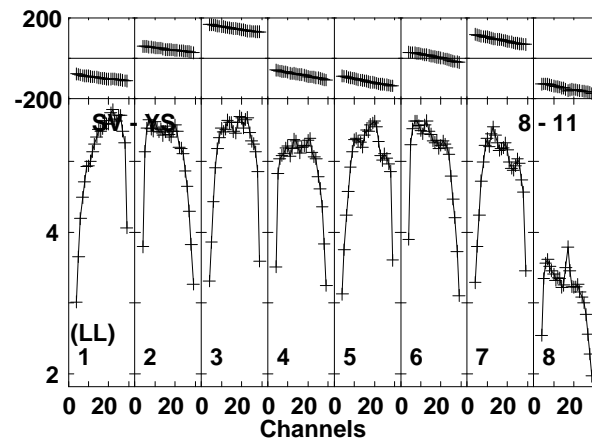
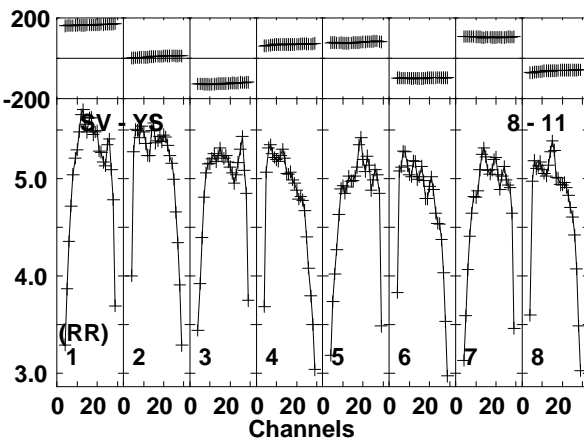
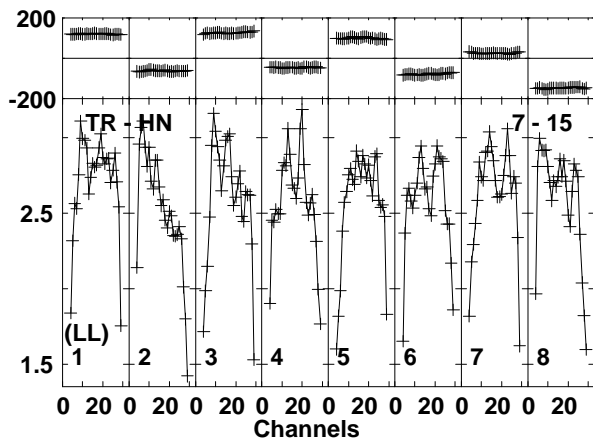
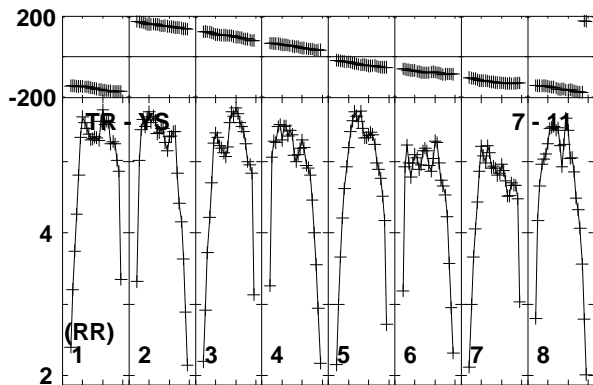
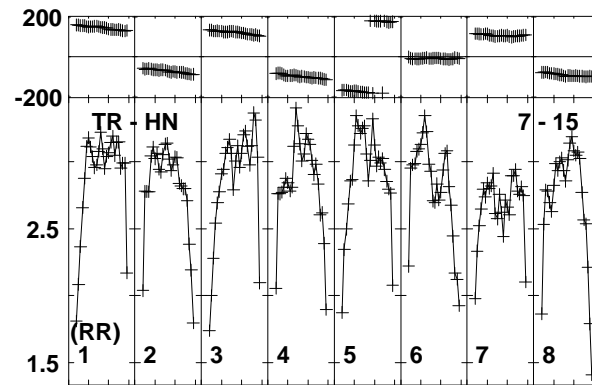
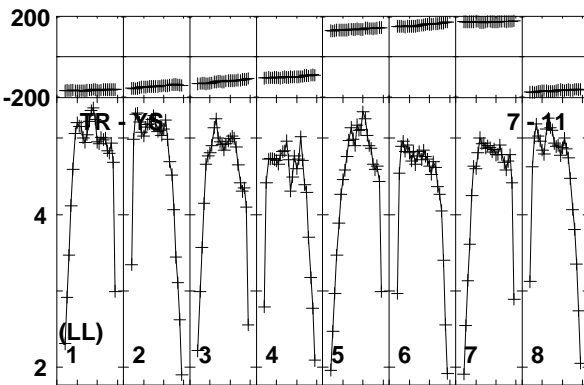
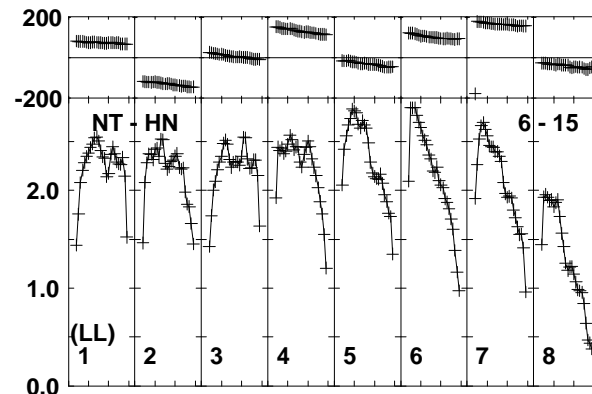
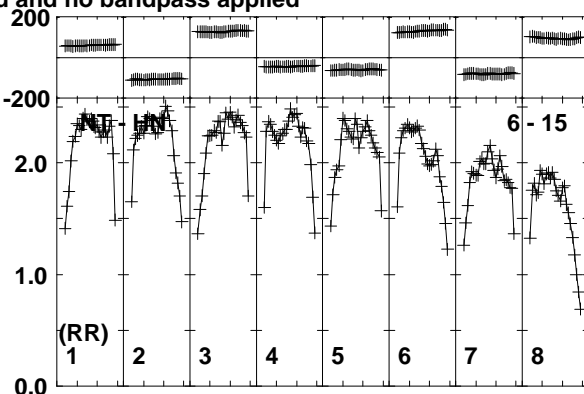
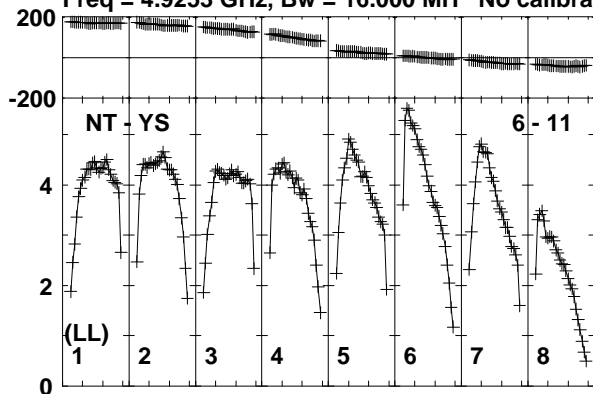

Lower frame: Milli Ampl Jy Top frame: Phas deg
Vector averaged cross-power spectrum Baseline: NT (06) - YS (11)
Timerange: 01/02:16:11 to 01/02:18:03

Plot file version 563 created 11-APR-2016 17:09:48

J1128+5925 GP053G 3.UVDATA.1

Freq = 4.9253 GHz, Bw = 16.000 MH No calibration applied and no bandpass applied

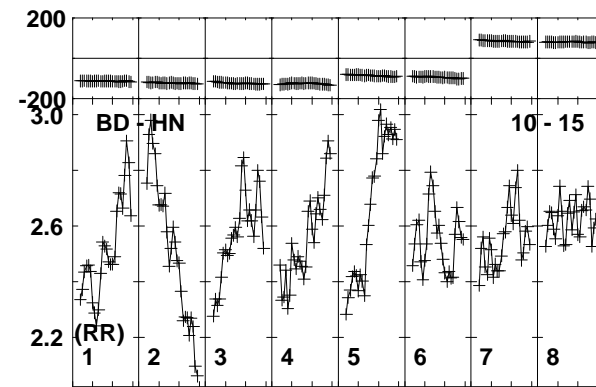
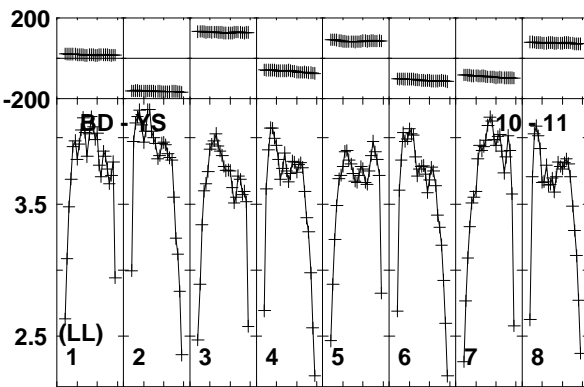
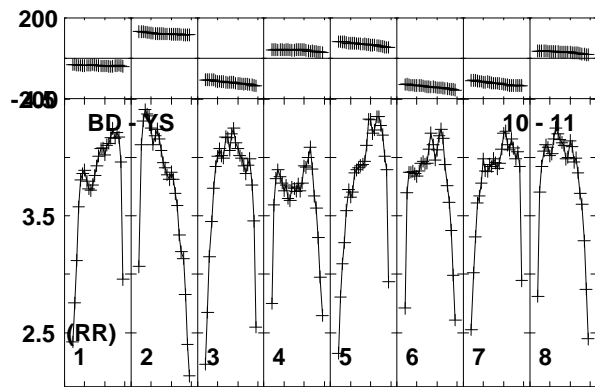
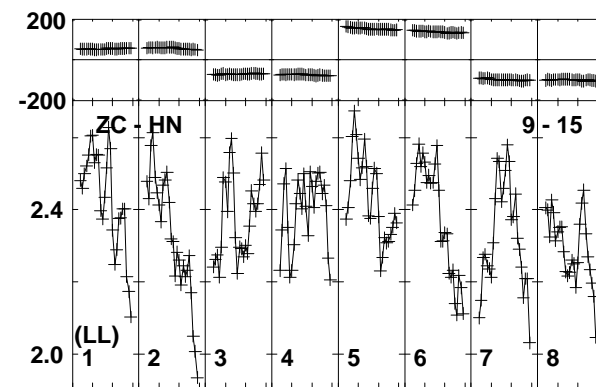
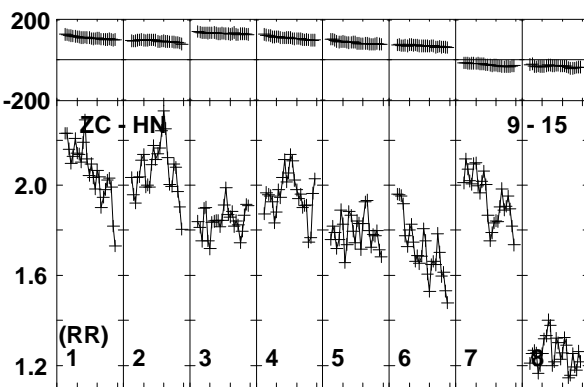
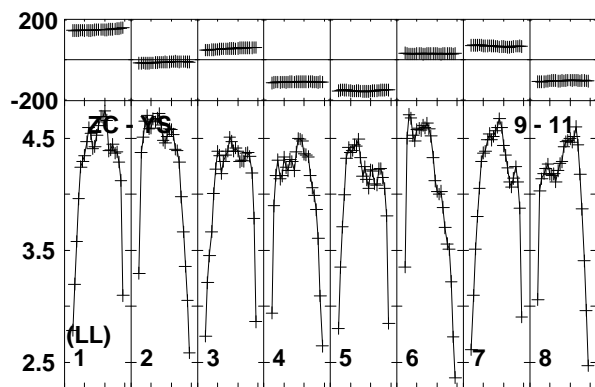
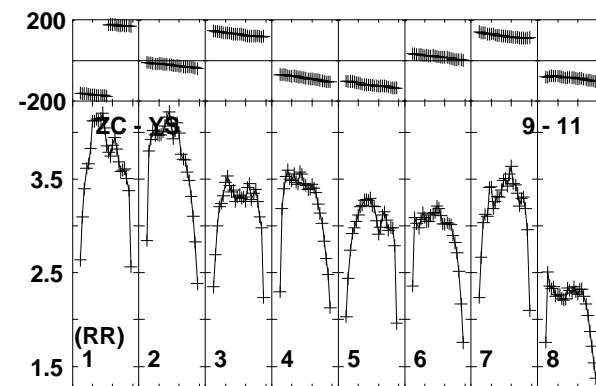
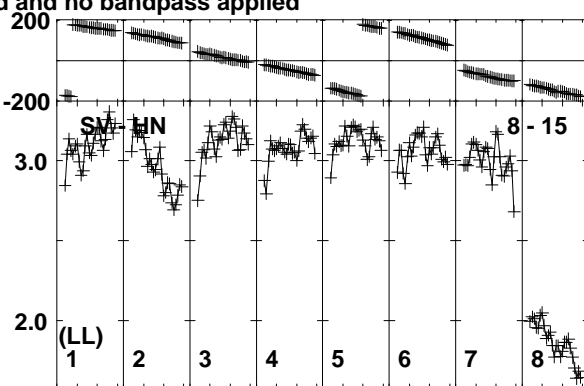
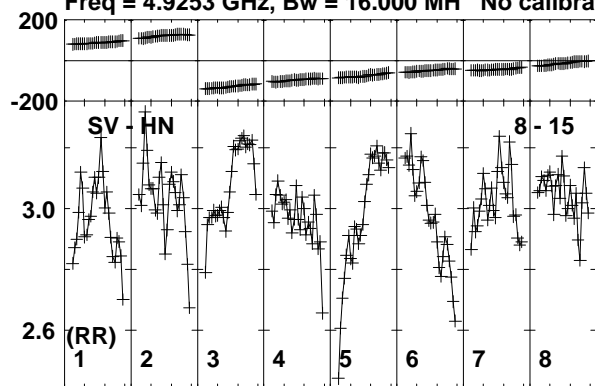

Lower frame: Milli Ampl Jy Top frame: Phas deg
Vector averaged cross-power spectrum Baseline: SV (08) - HN (15)
Timerange: 01/02:16:11 to 01/02:18:03

Plot file version 564 created 11-APR-2016 17:09:48

J1128+5925 GP053G 3.UVDATA.1

Freq = 4.9253 GHz, Bw = 16.000 MH No calibration applied and no bandpass applied

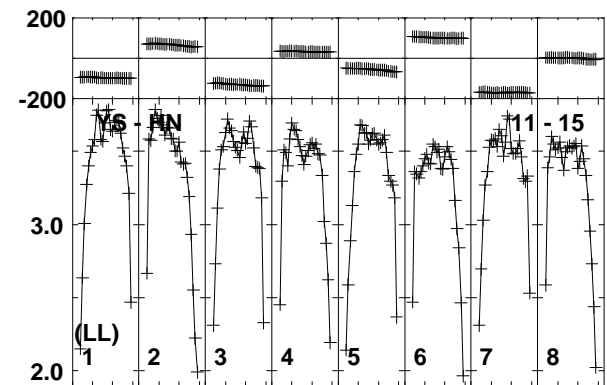
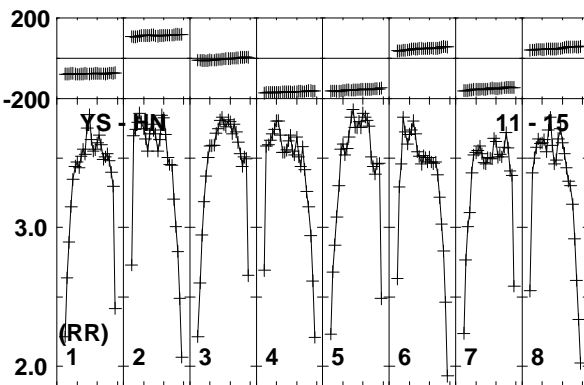
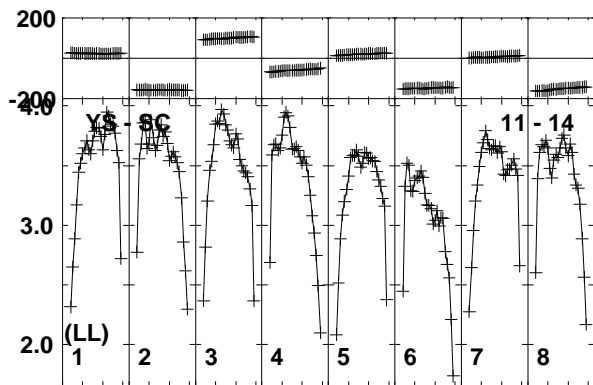
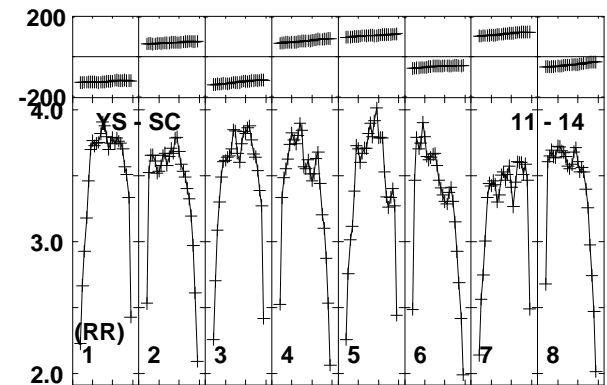
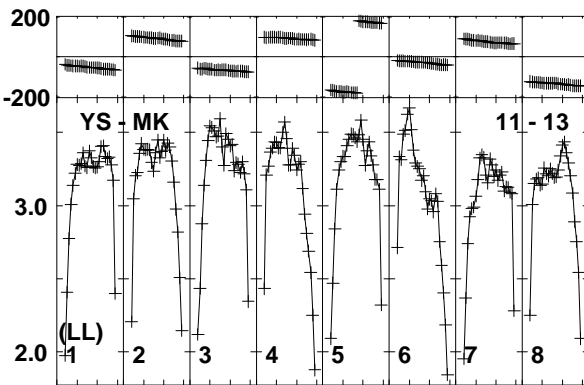
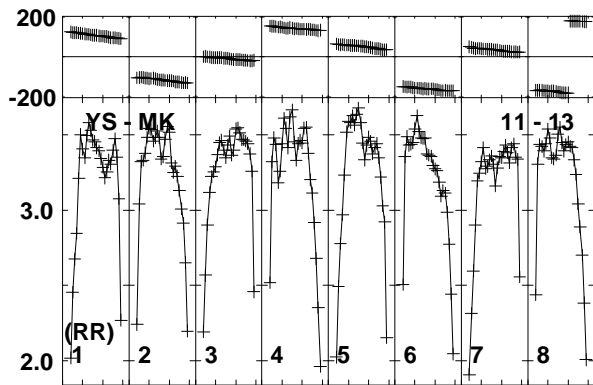
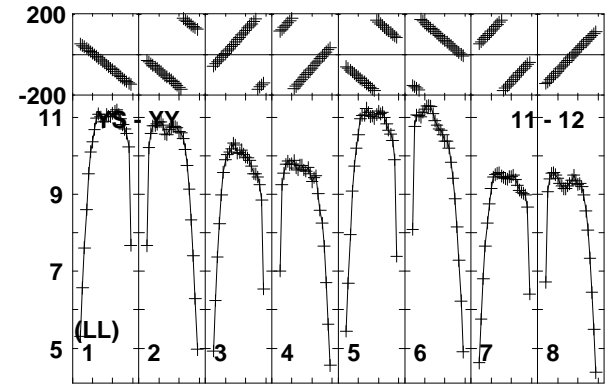
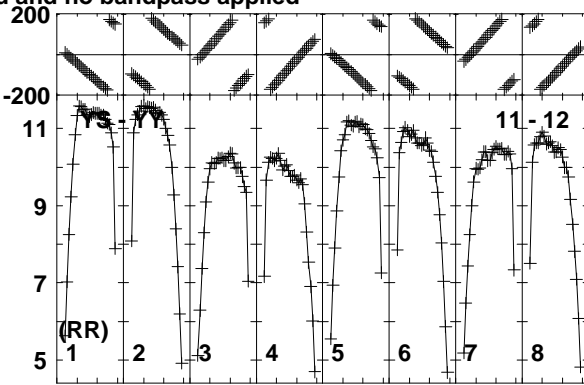
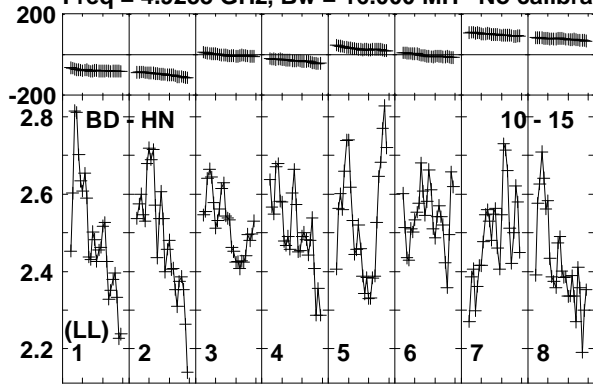

Lower frame: Milli Ampl Jy Top frame: Phas deg
Vector averaged cross-power spectrum Baseline: BD (10) - HN (15)
Timerange: 01/02:16:11 to 01/02:18:03

Plot file version 565 created 11-APR-2016 17:09:48

J1128+5925 GP053G 3.UVDATA.1

Freq = 4.9253 GHz, Bw = 16.000 MH No calibration applied and no bandpass applied

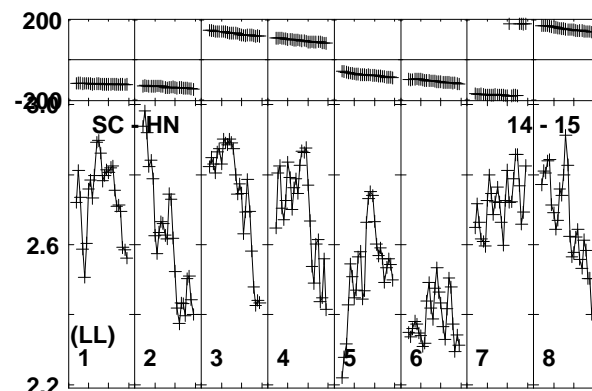
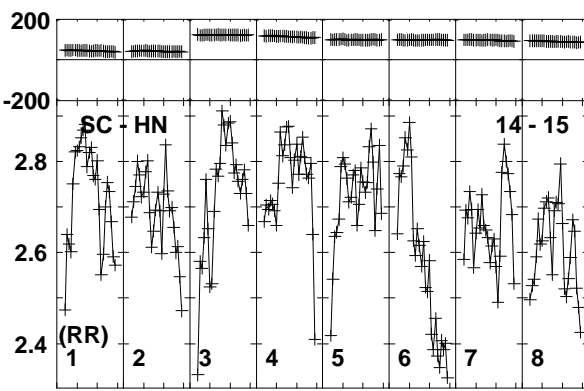
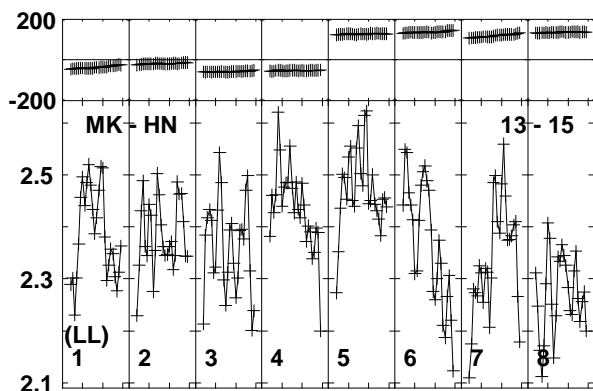
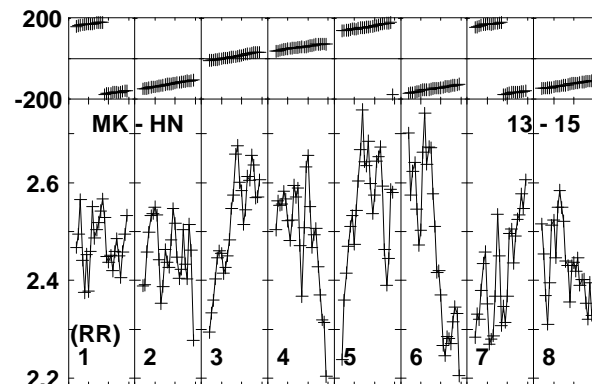
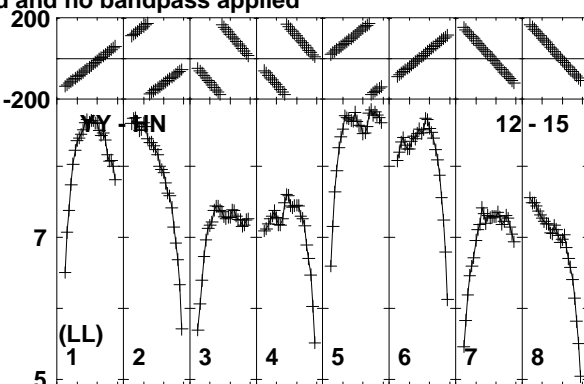
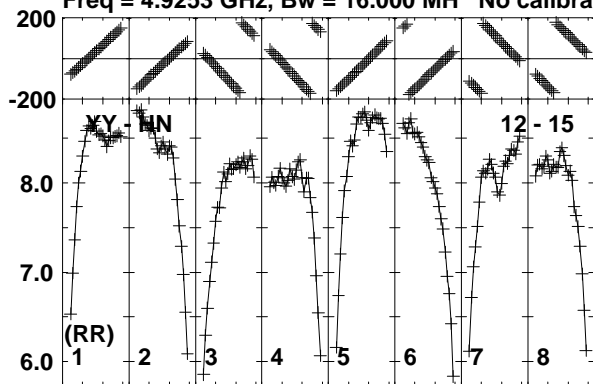

Lower frame: Milli Ampl Jy Top frame: Phas deg
Vector averaged cross-power spectrum Baseline: YY (12) - HN (15)
Timerange: 01/02:16:11 to 01/02:18:03

Plot file version 566 created 11-APR-2016 17:09:48

ARP299C GP053G 3.UVDATA.1

Freq = 4.9253 GHz, Bw = 16.000 MH No calibration applied and no bandpass applied

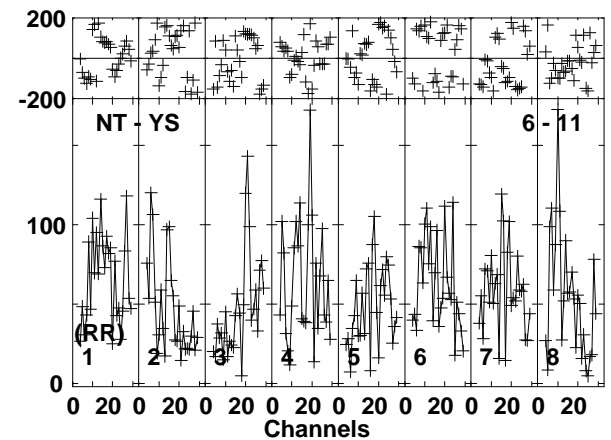
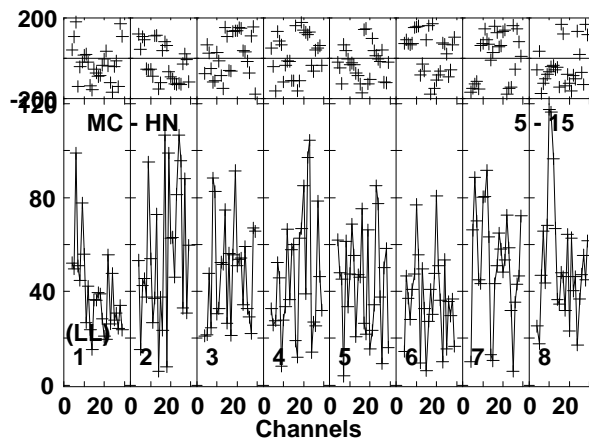
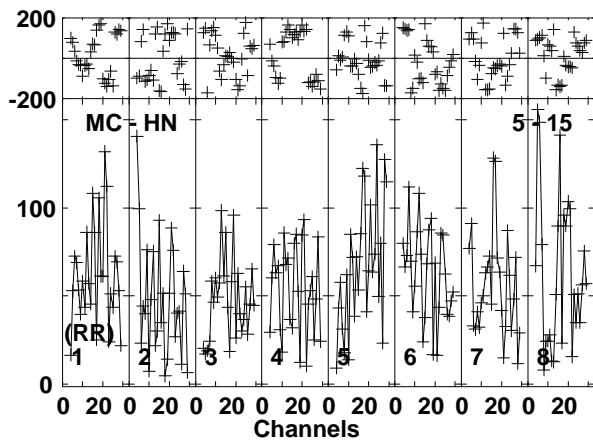
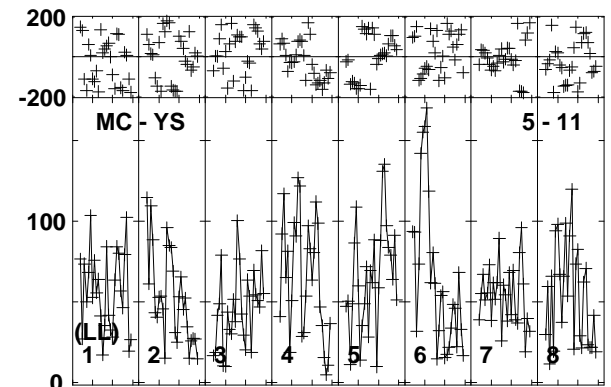
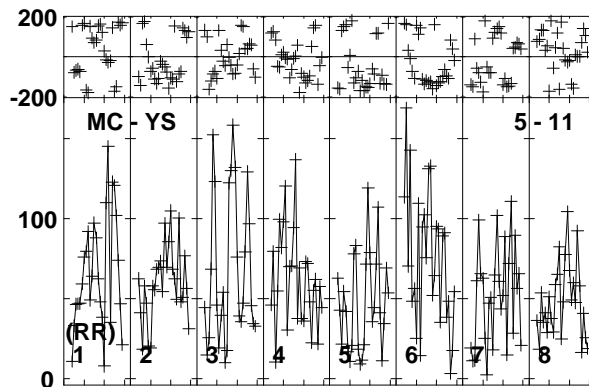
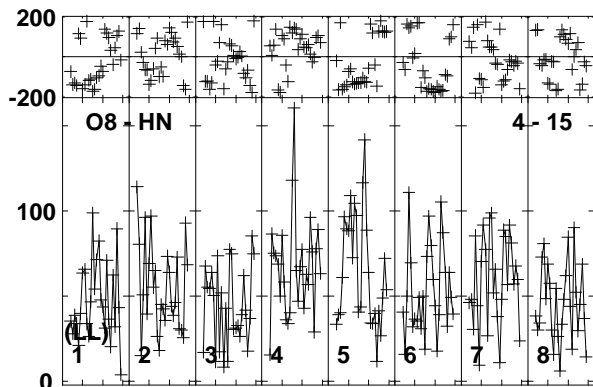
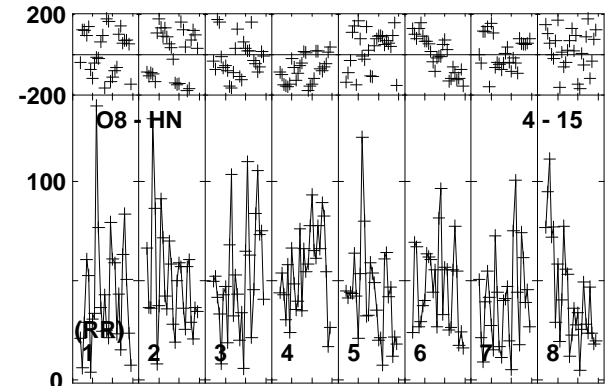
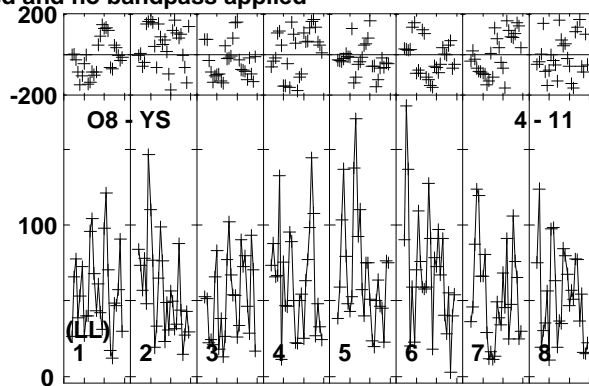
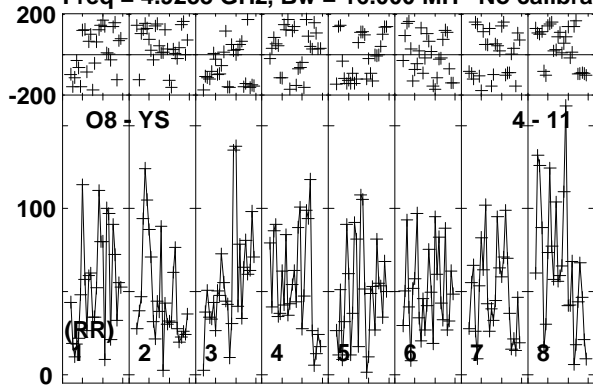

Lower frame: Micro Ampl Jy Top frame: Phas deg
Vector averaged cross-power spectrum Baseline: O8 (04) - YS (11)
Timerange: 01/02:18:08 to 01/02:23:22

Plot file version 567 created 11-APR-2016 17:09:49

ARP299C GP053G 3.UVDATA.1

Freq = 4.9253 GHz, Bw = 16.000 MH No calibration applied and no bandpass applied

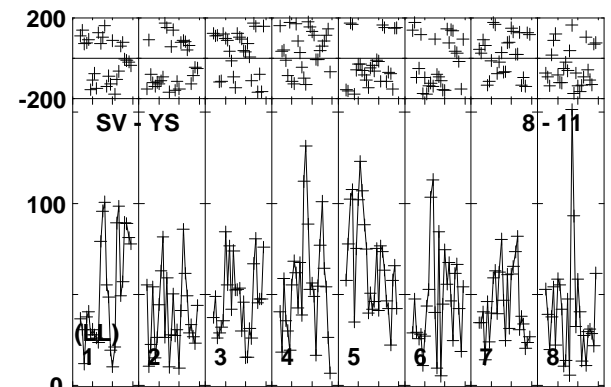
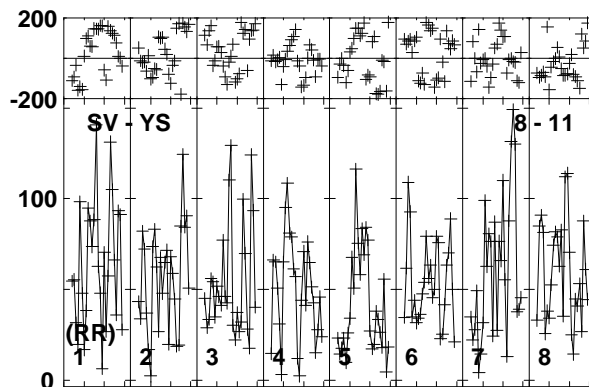
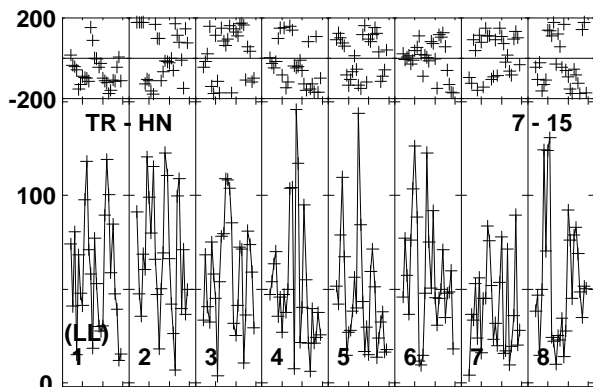
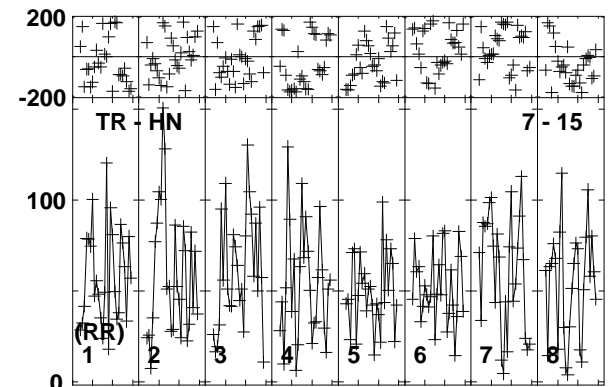
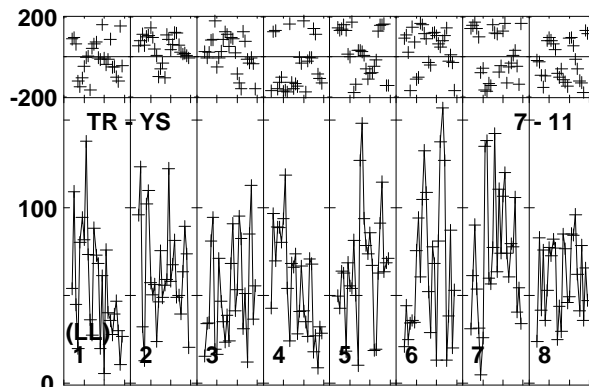
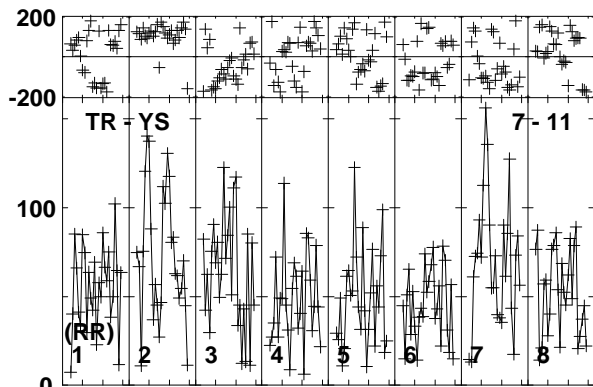
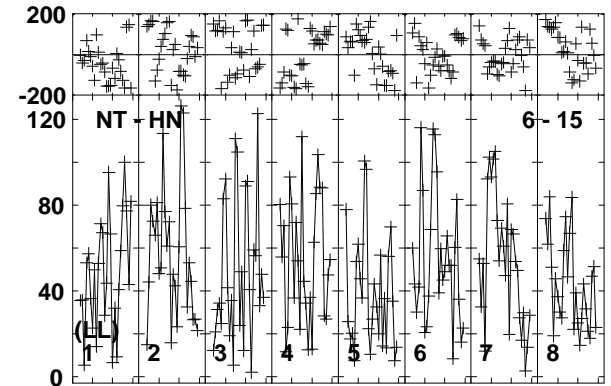
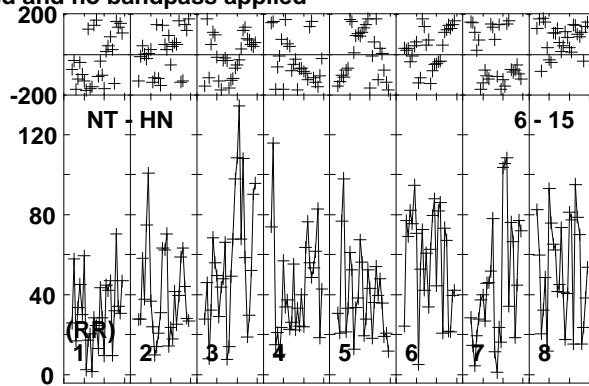
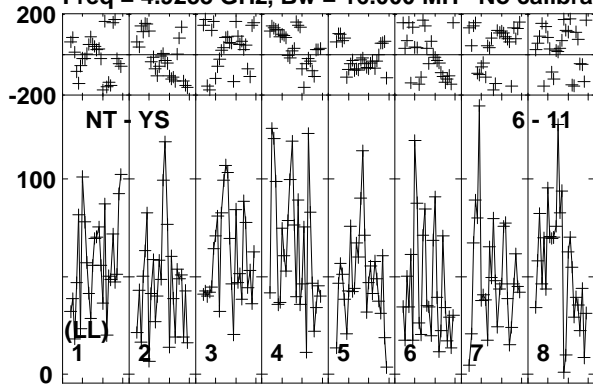

Lower frame: Micro Ampl Jy Top frame: Phas deg
Vector averaged cross-power spectrum Baseline: NT (06) - YS (11)
Timerange: 01/02:18:08 to 01/02:23:22

Plot file version 568 created 11-APR-2016 17:09:49

ARP299C GP053G 3.UVDATA.1

Freq = 4.9253 GHz, Bw = 16.000 MH No calibration applied and no bandpass applied

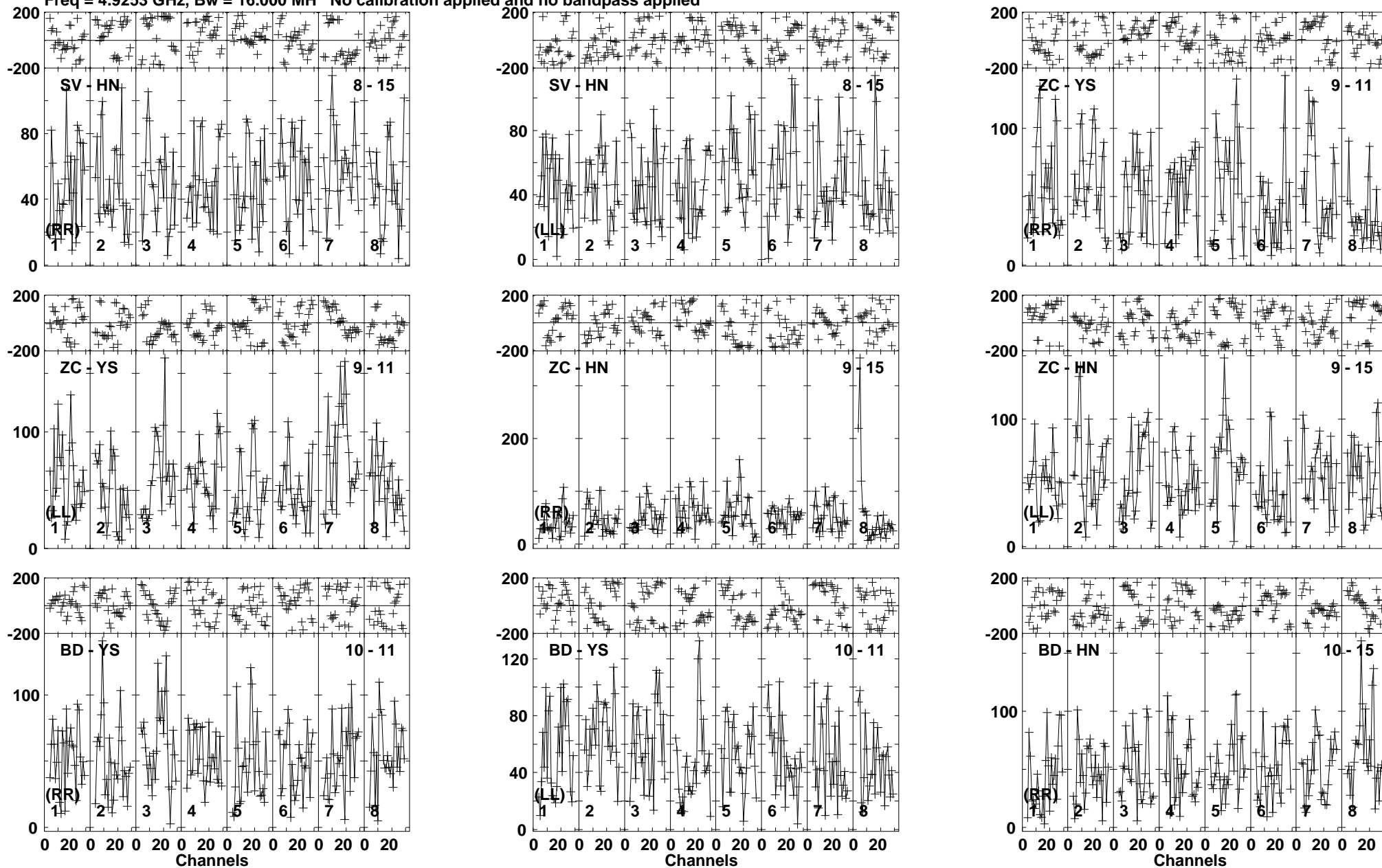

Lower frame: Micro Ampl Jy Top frame: Phas deg
Vector averaged cross-power spectrum Baseline: SV (08) - HN (15)
Timerange: 01/02:18:08 to 01/02:23:22

Plot file version 569 created 11-APR-2016 17:09:49

ARP299C GP053G 3.UVDATA.1

Freq = 4.9253 GHz, Bw = 16.000 MH No calibration applied and no bandpass applied

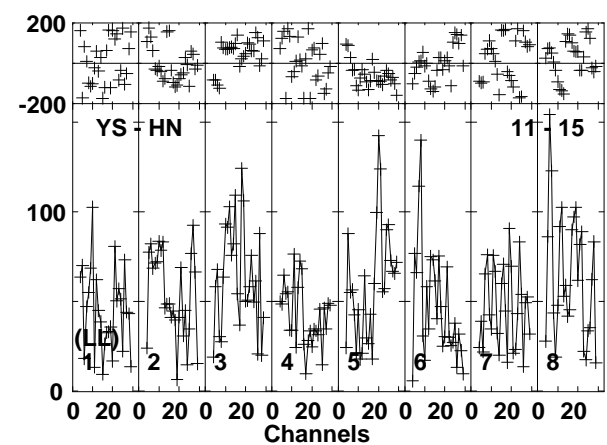
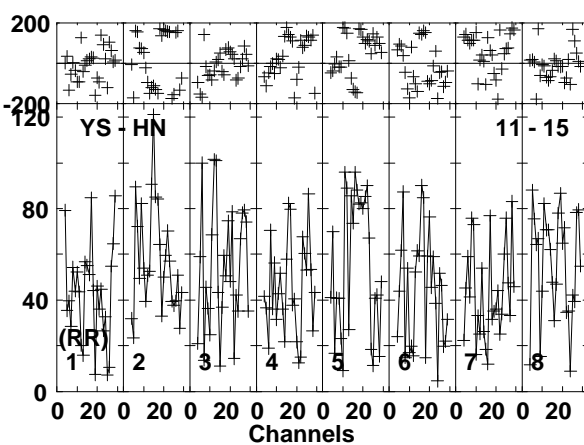
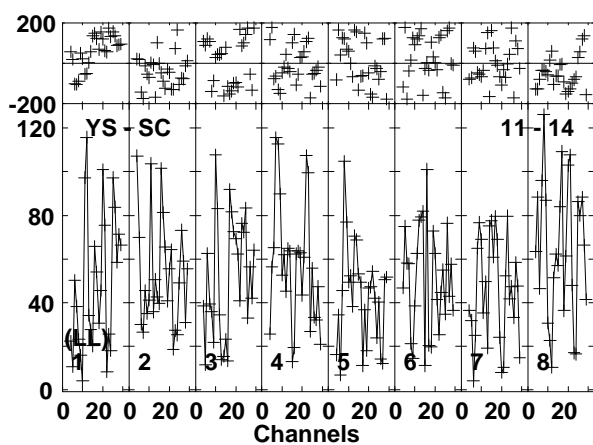
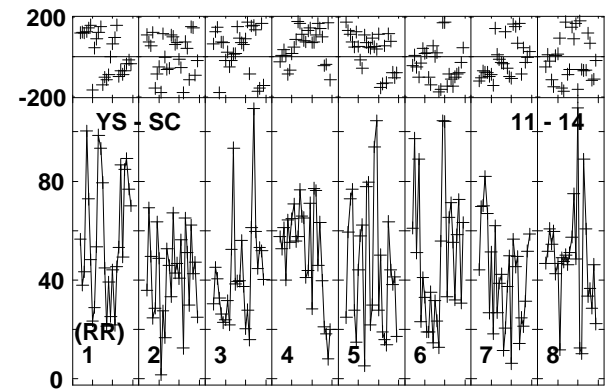
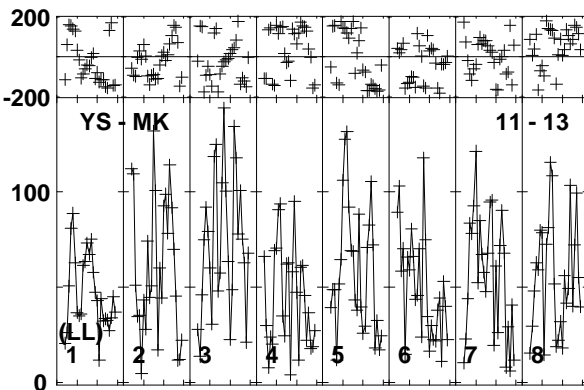
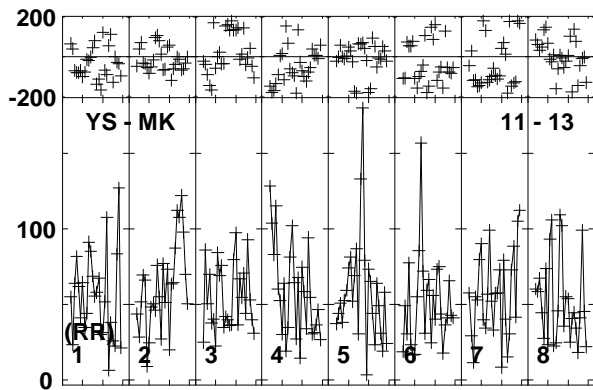
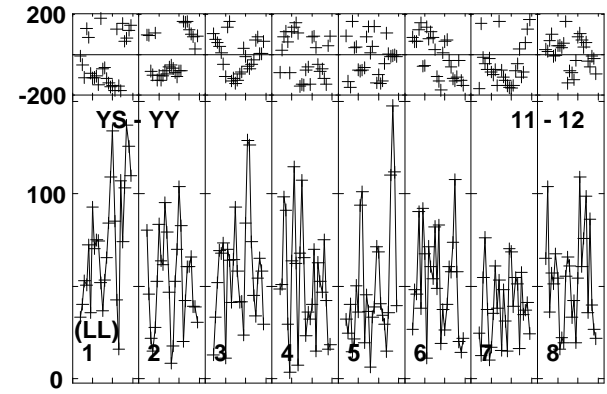
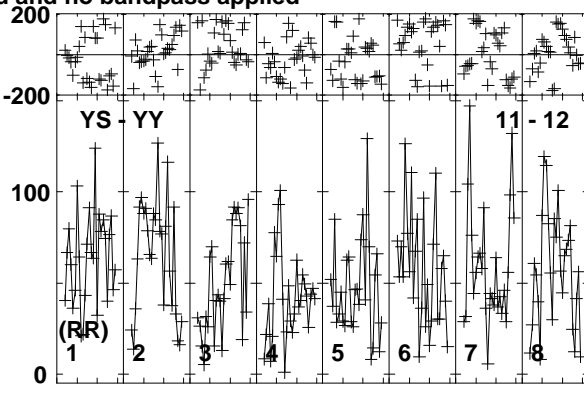
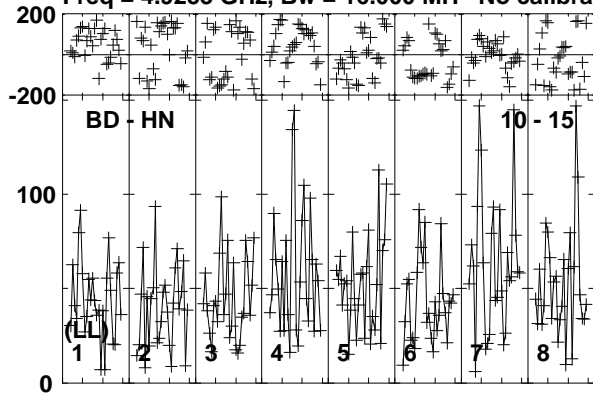

Lower frame: Micro Ampl Jy Top frame: Phas deg
Vector averaged cross-power spectrum Baseline: BD (10) - HN (15)
Timerange: 01/02:18:08 to 01/02:23:22

Plot file version 570 created 11-APR-2016 17:09:49

ARP299C GP053G 3.UVDATA.1

Freq = 4.9253 GHz, Bw = 16.000 MH No calibration applied and no bandpass applied

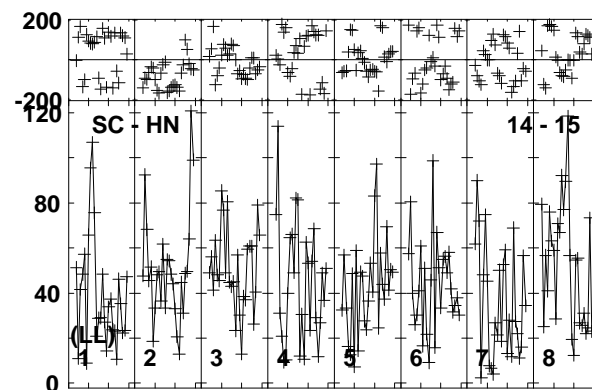
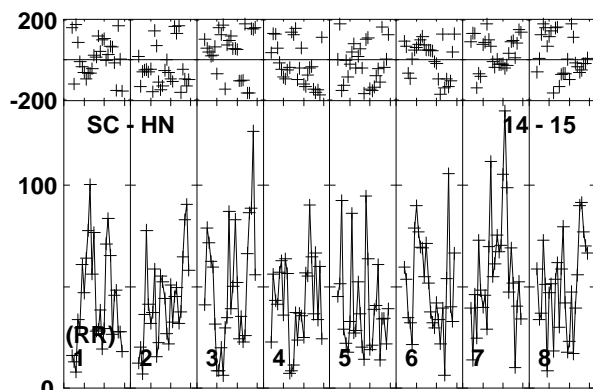
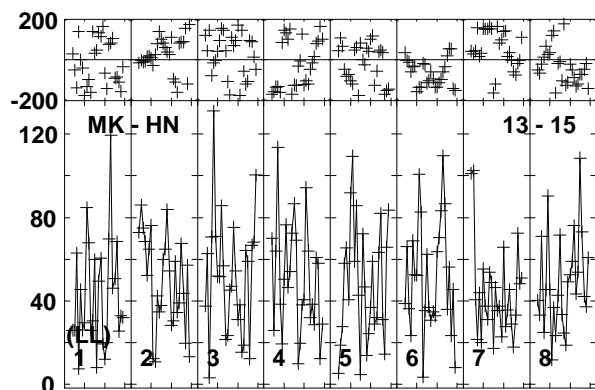
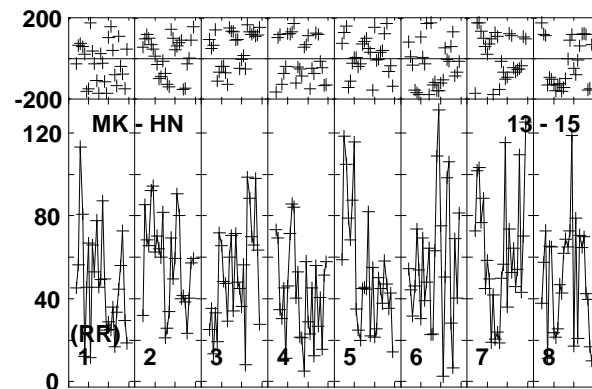
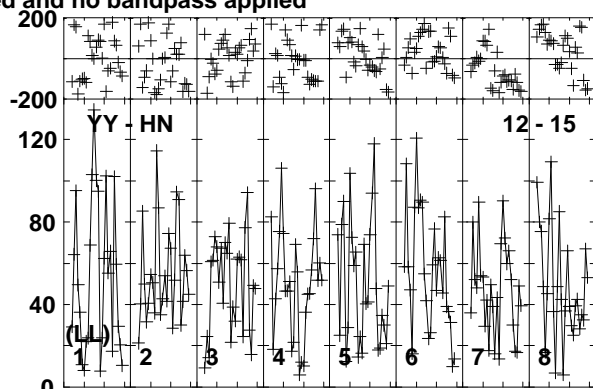
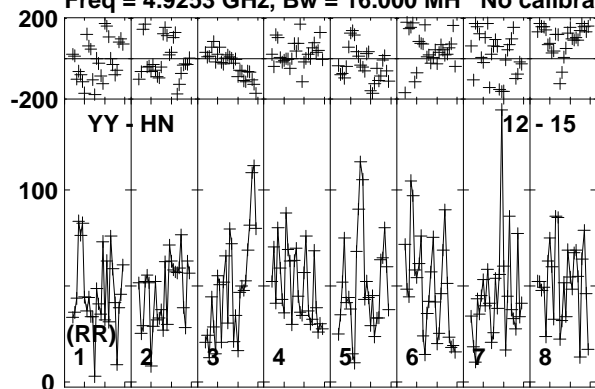

Lower frame: Micro Ampl Jy Top frame: Phas deg
Vector averaged cross-power spectrum Baseline: YY (12) - HN (15)
Timerange: 01/02:18:08 to 01/02:23:22

Plot file version 571 created 11-APR-2016 17:09:49

J1128+5925 GP053G 3.UVDATA.1

Freq = 4.9253 GHz, Bw = 16.000 MH No calibration applied and no bandpass applied

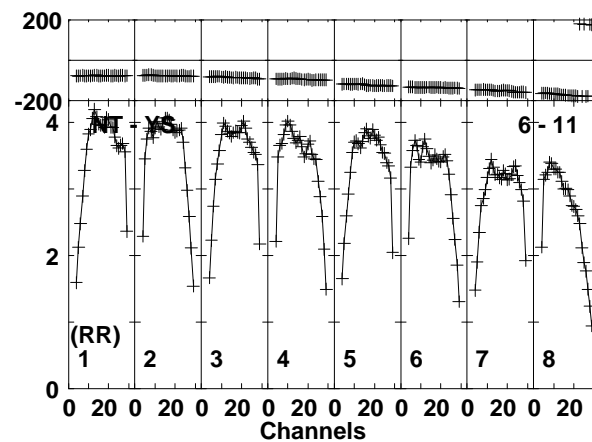
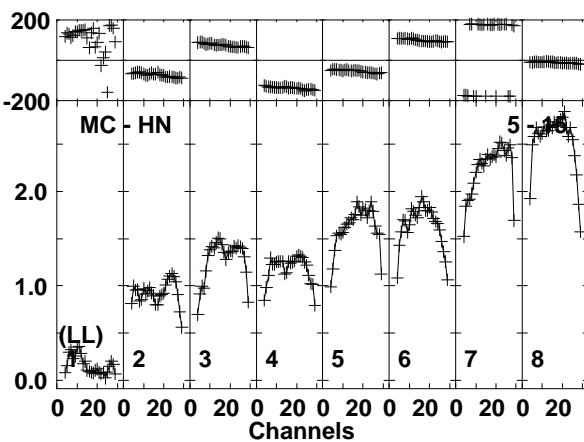
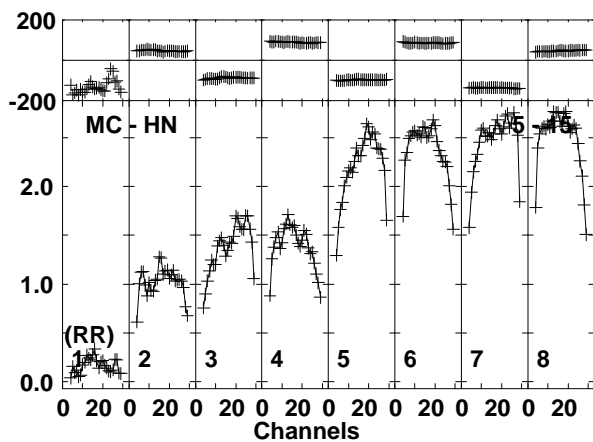
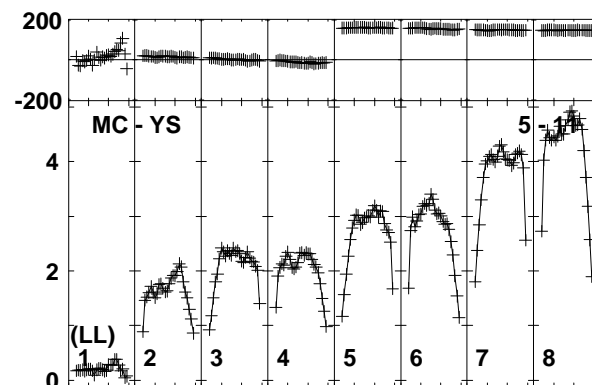
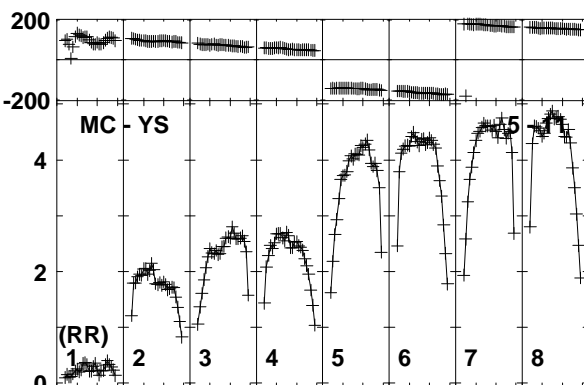
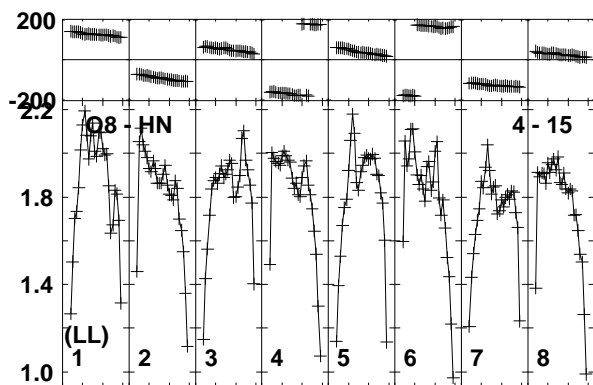
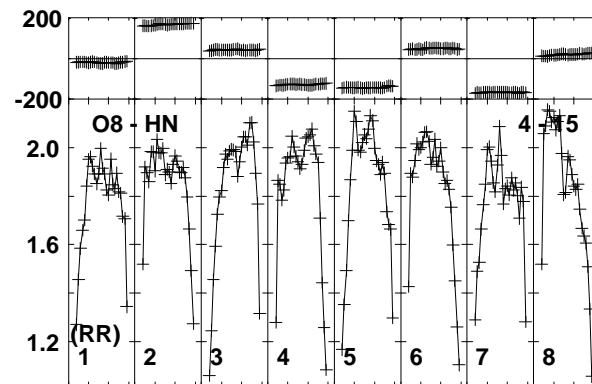
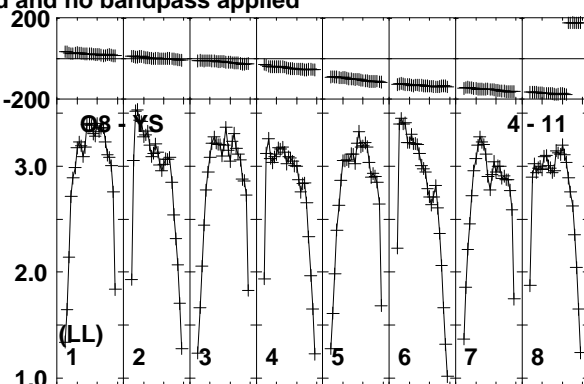
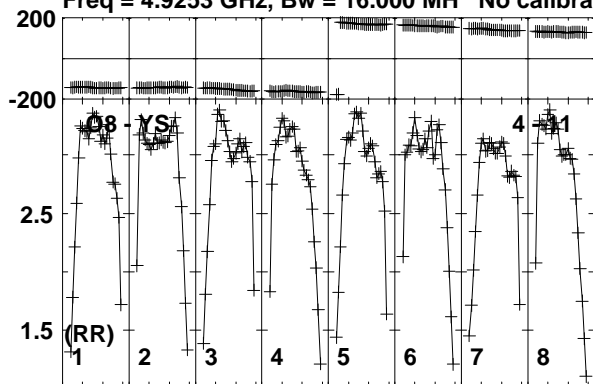

Lower frame: Milli Ampl Jy Top frame: Phas deg
Vector averaged cross-power spectrum Baseline: O8 (04) - YS (11)
Timerange: 01/02:23:28 to 01/02:25:12

Plot file version 572 created 11-APR-2016 17:09:49

J1128+5925 GP053G 3.UVDATA.1

Freq = 4.9253 GHz, Bw = 16.000 MH No calibration applied and no bandpass applied

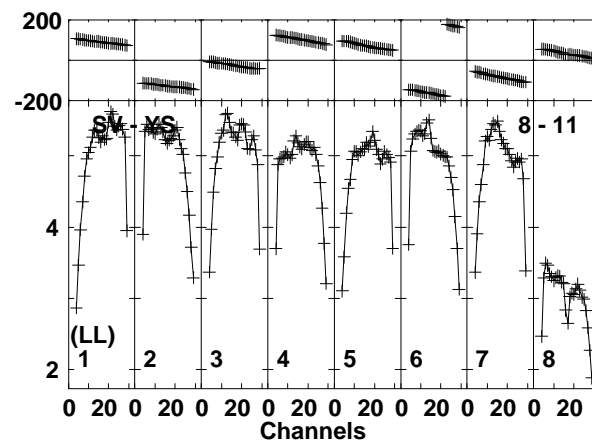
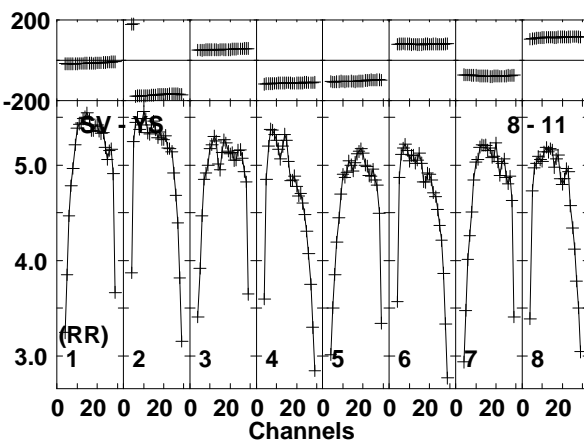
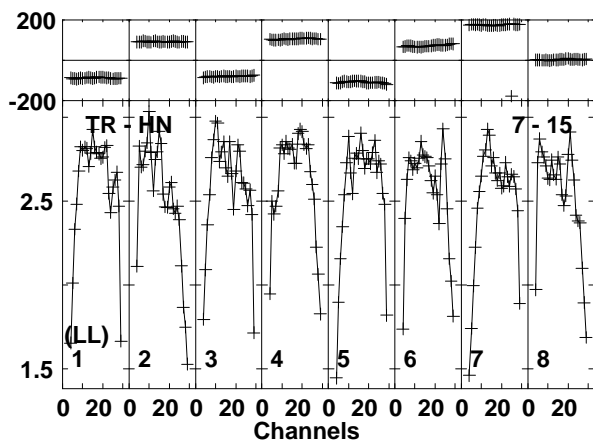
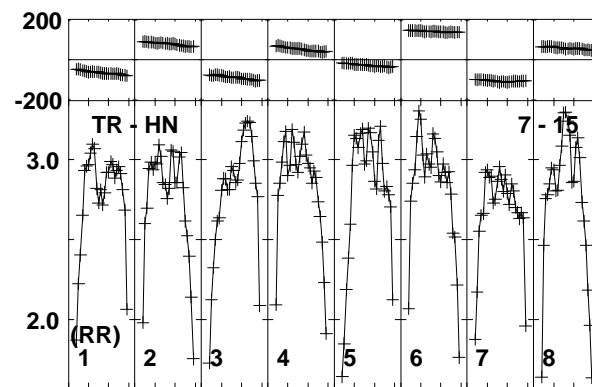
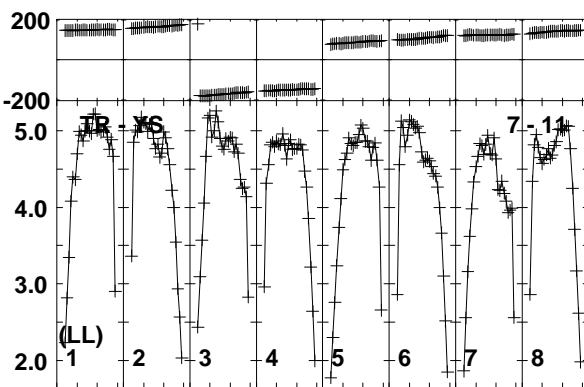
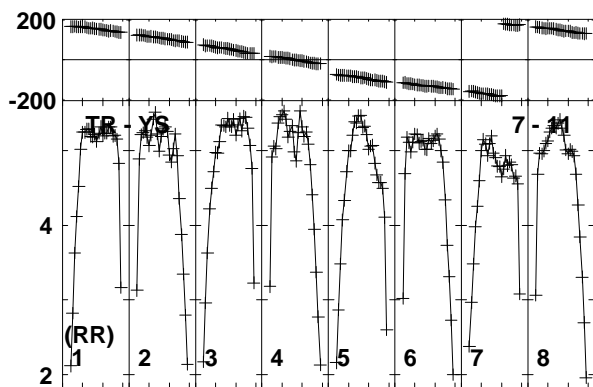
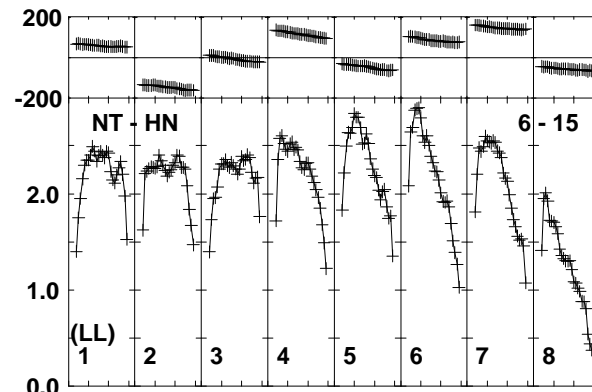
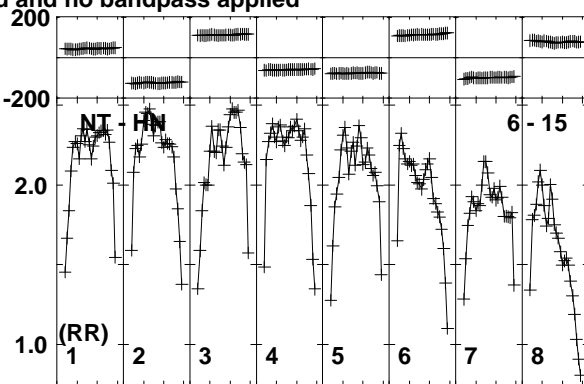
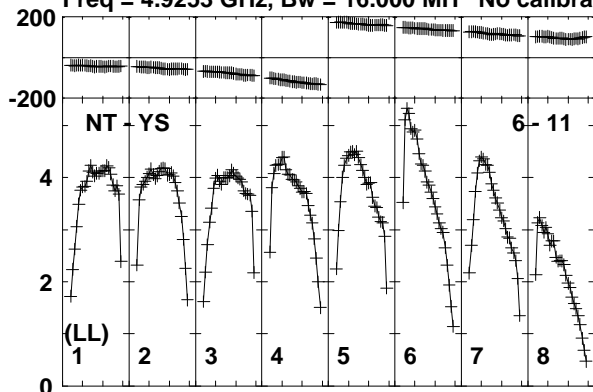

Lower frame: Milli Ampl Jy Top frame: Phas deg
Vector averaged cross-power spectrum Baseline: NT (06) - YS (11)
Timerange: 01/02:23:28 to 01/02:25:12

Plot file version 573 created 11-APR-2016 17:09:49
 J1128+5925 GP053G 3.UVDATA.1

Freq = 4.9253 GHz, Bw = 16.000 MH No calibration applied and no bandpass applied

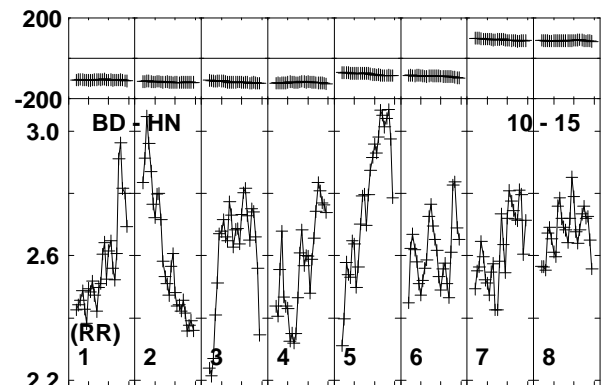
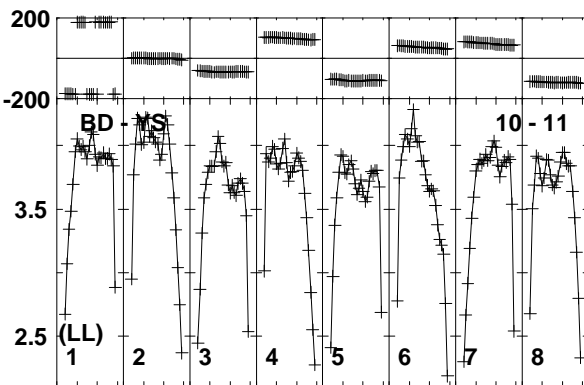
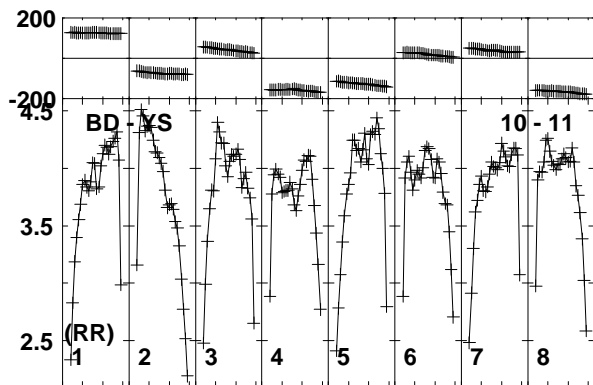
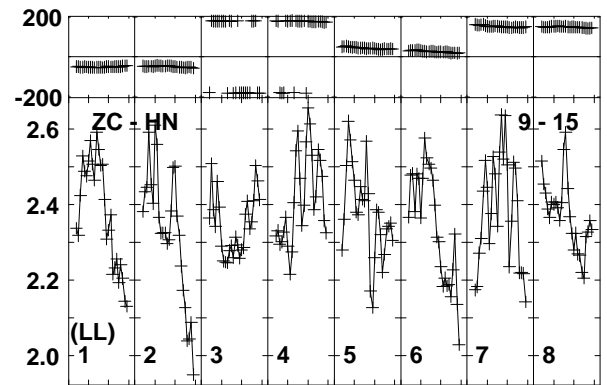
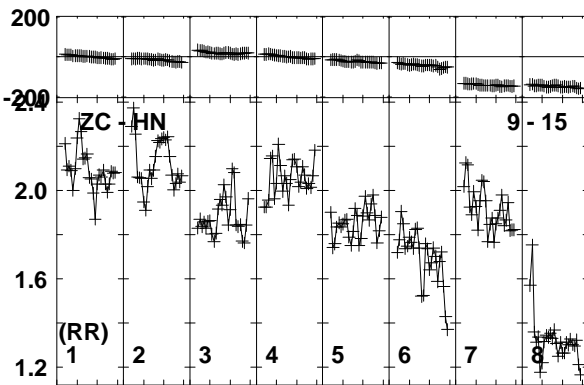
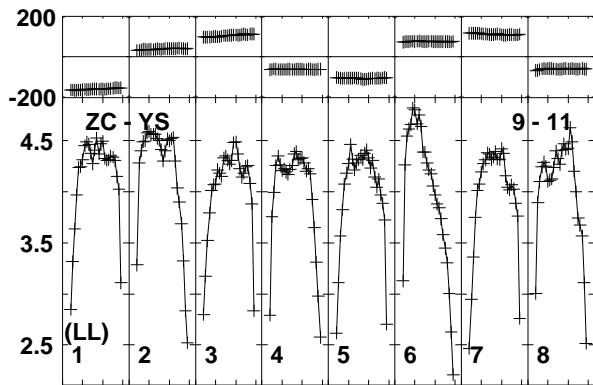
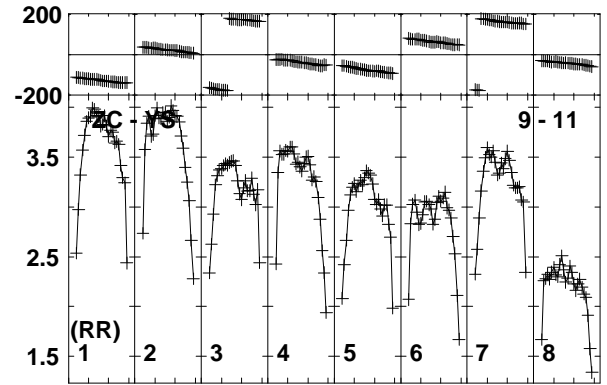
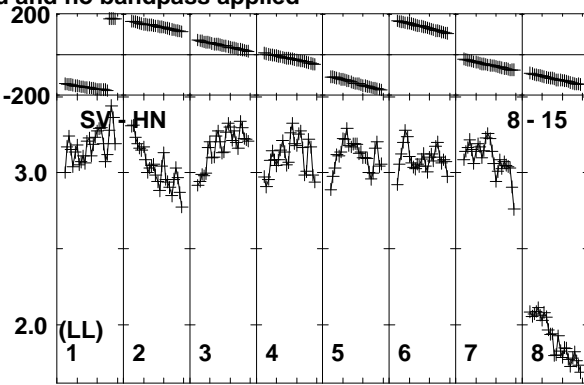
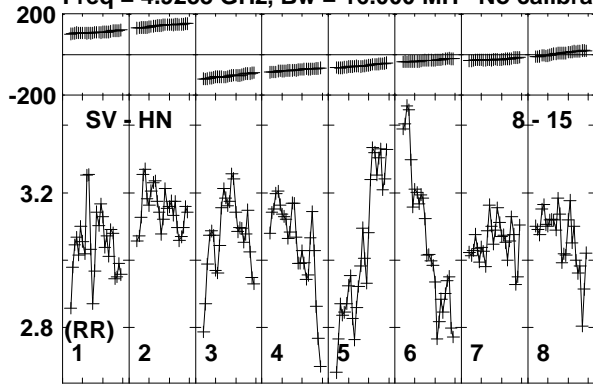

Lower frame: Milli Ampl Jy Top frame: Phas deg
 Vector averaged cross-power spectrum Baseline: SV (08) - HN (15)
 Timerange: 01/02:23:28 to 01/02:25:12

Plot file version 574 created 11-APR-2016 17:09:49

J1128+5925 GP053G 3.UVDATA.1

Freq = 4.9253 GHz, Bw = 16.000 MH No calibration applied and no bandpass applied

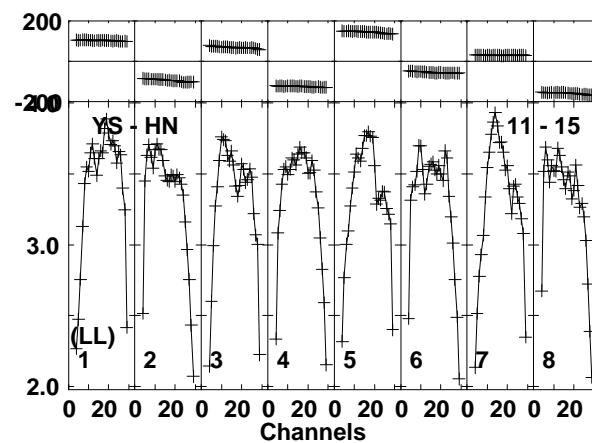
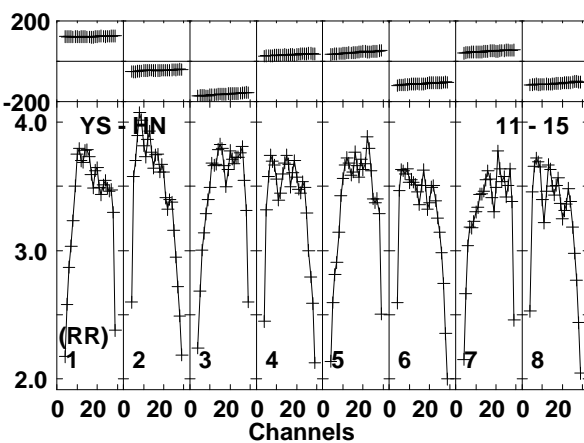
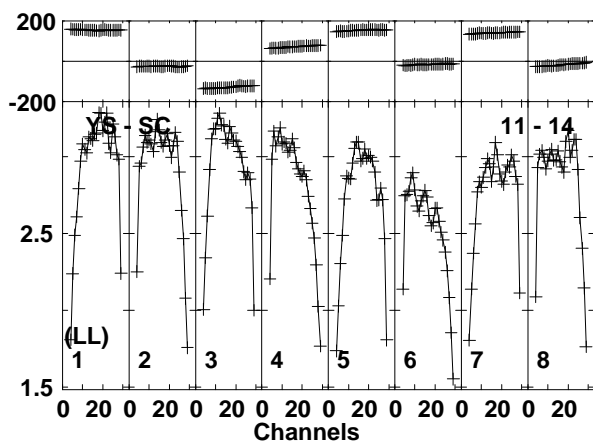
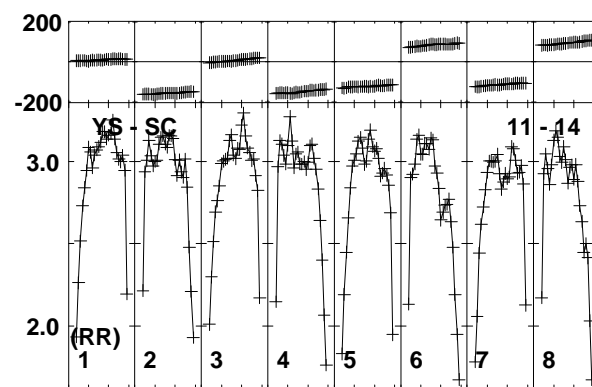
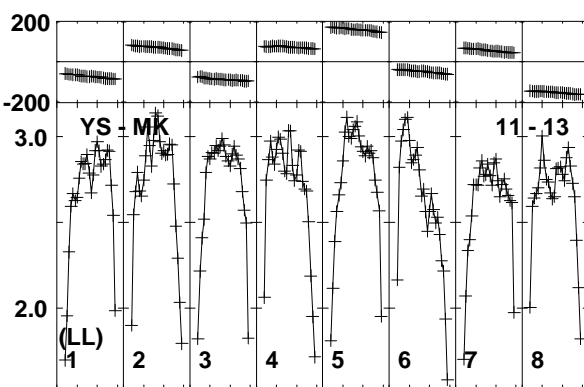
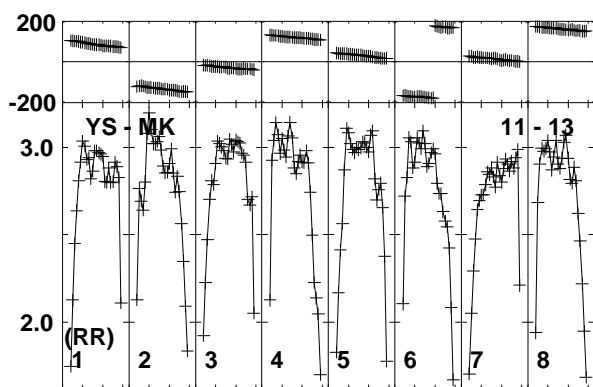
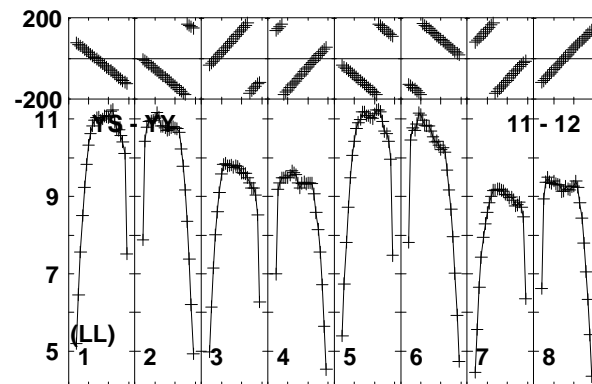
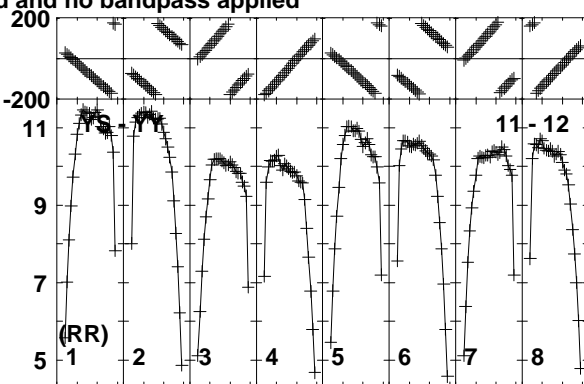
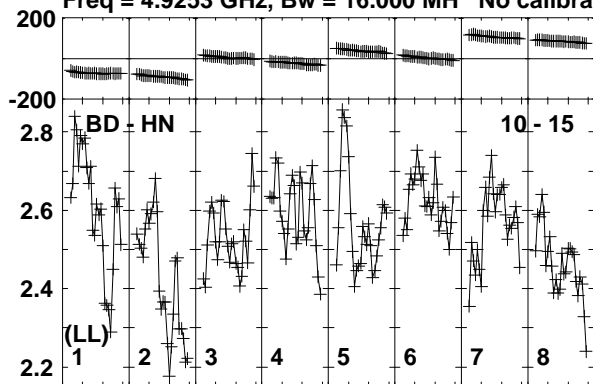

Lower frame: Milli Ampl Jy Top frame: Phas deg
Vector averaged cross-power spectrum Baseline: BD (10) - HN (15)
Timerange: 01/02:23:28 to 01/02:25:12

Plot file version 575 created 11-APR-2016 17:09:50

J1128+5925 GP053G 3.UVDATA.1

Freq = 4.9253 GHz, Bw = 16.000 MH No calibration applied and no bandpass applied

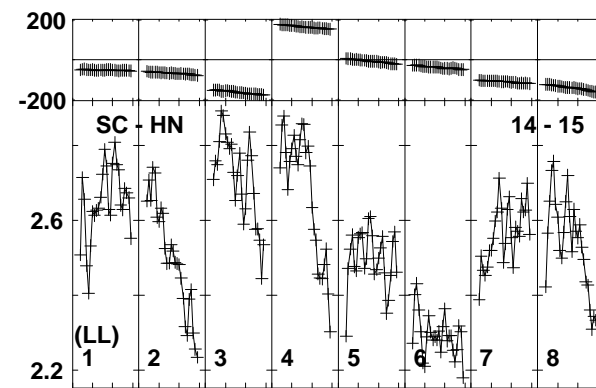
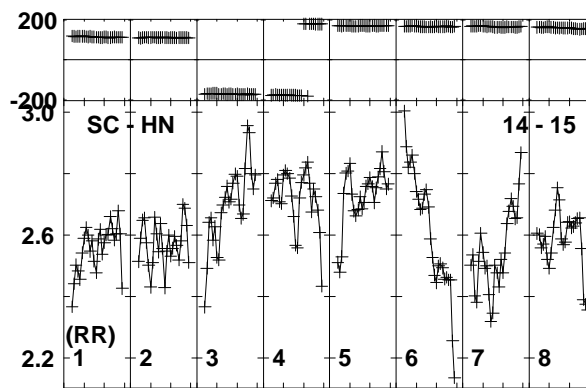
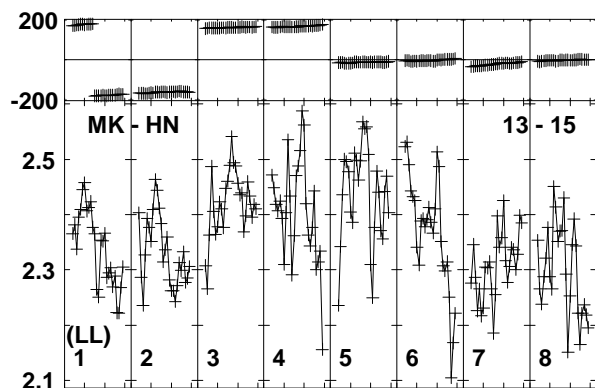
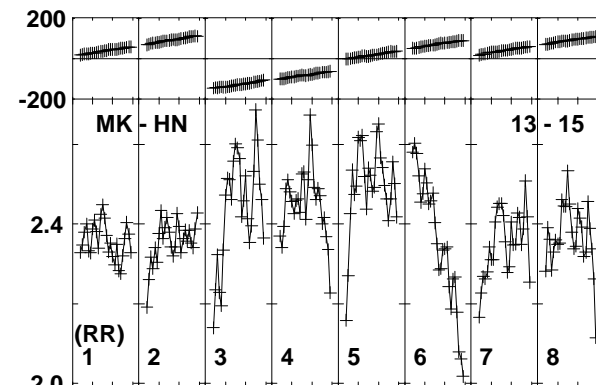
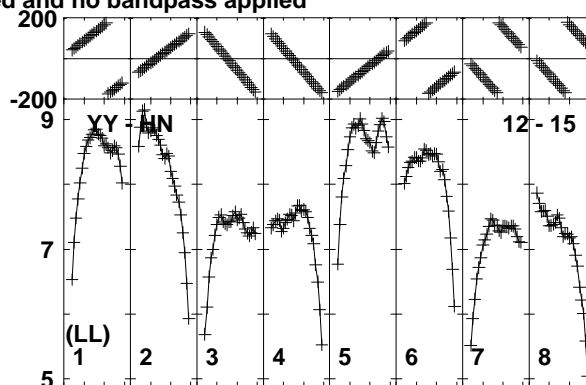
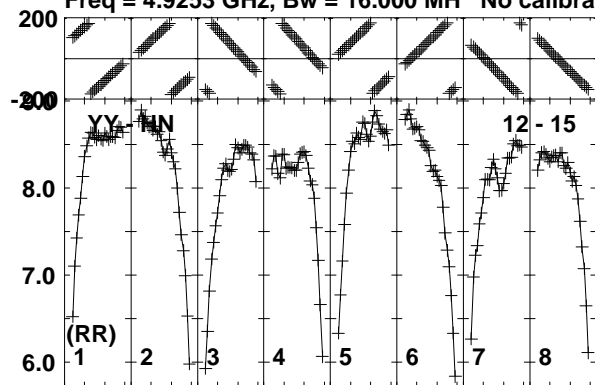

Lower frame: Milli Ampl Jy Top frame: Phas deg
Vector averaged cross-power spectrum Baseline: YY (12) - HN (15)
Timerange: 01/02:23:28 to 01/02:25:12

Plot file version 576 created 11-APR-2016 17:09:50

3C286 GP053G 3.UVDATA.1

Freq = 4.9253 GHz, Bw = 16.000 MH No calibration applied and no bandpass applied

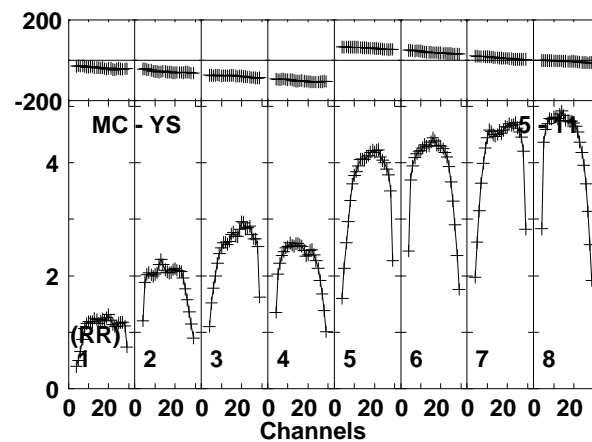
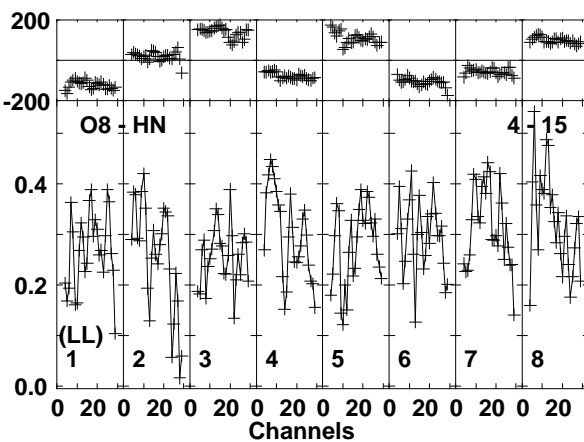
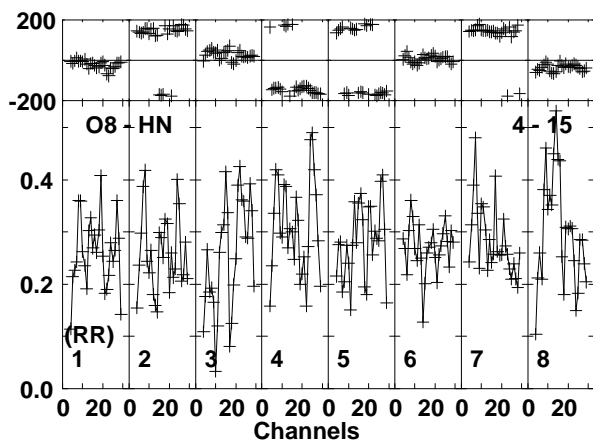
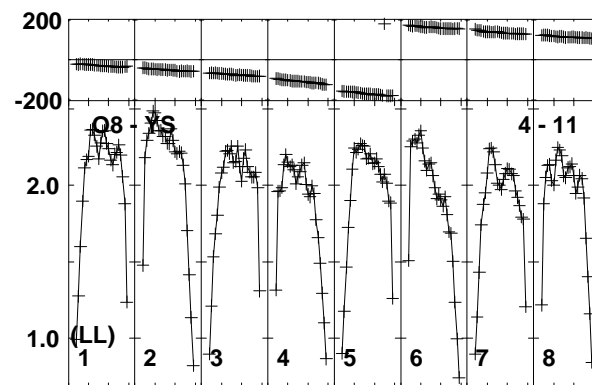
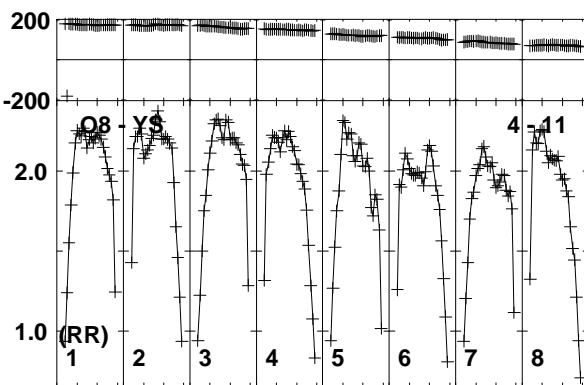
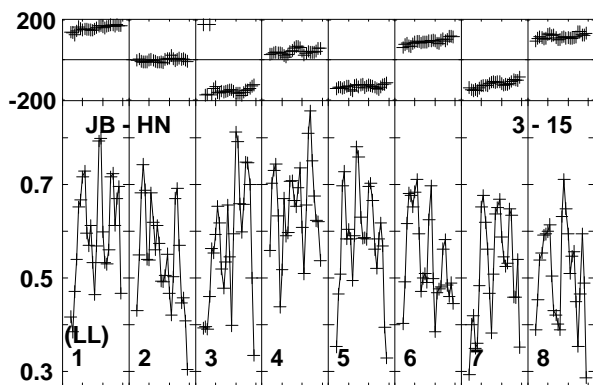
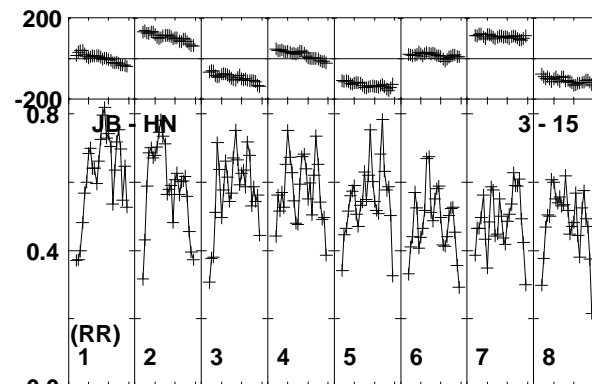
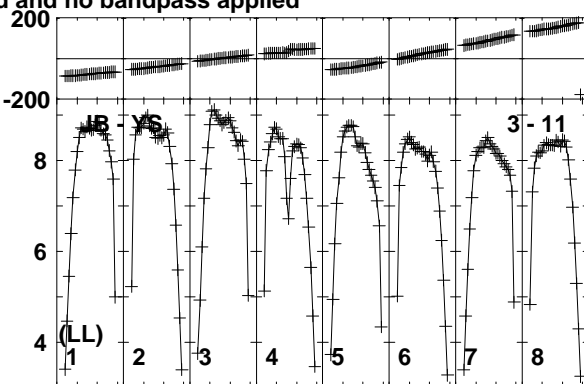
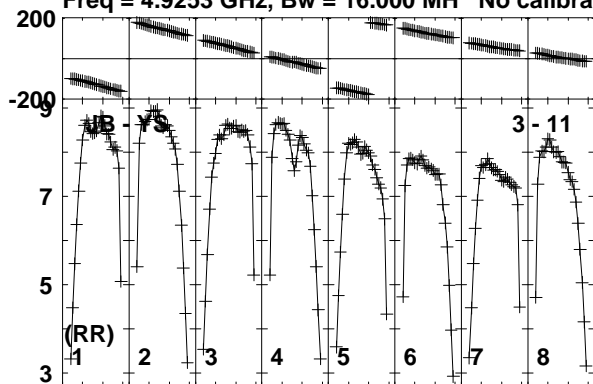

Lower frame: Milli Ampl Jy Top frame: Phas deg
Vector averaged cross-power spectrum Baseline: JB (03) - YS (11)
Timerange: 01/02:25:52 to 01/02:29:58

Plot file version 577 created 11-APR-2016 17:09:50

3C286 GP053G 3.UVDATA.1

Freq = 4.9253 GHz, Bw = 16.000 MH No calibration applied and no bandpass applied

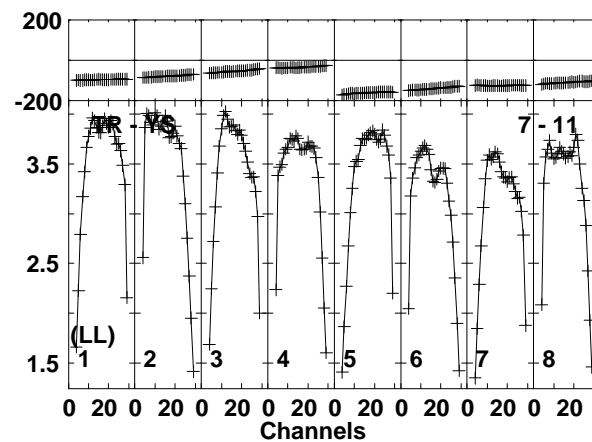
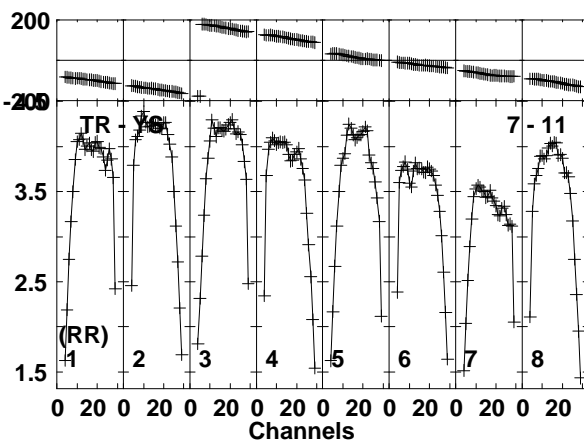
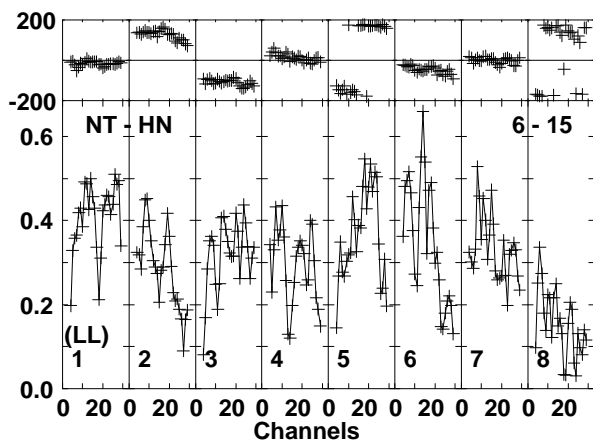
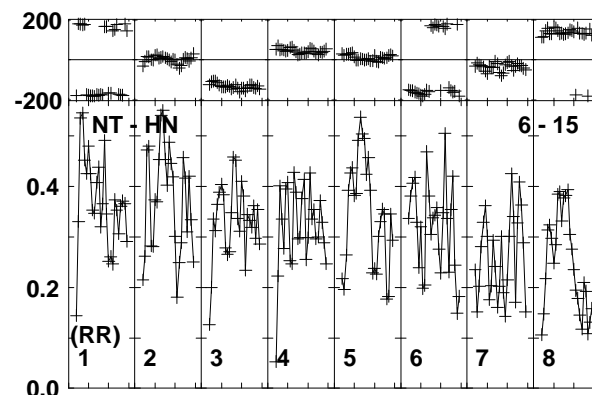
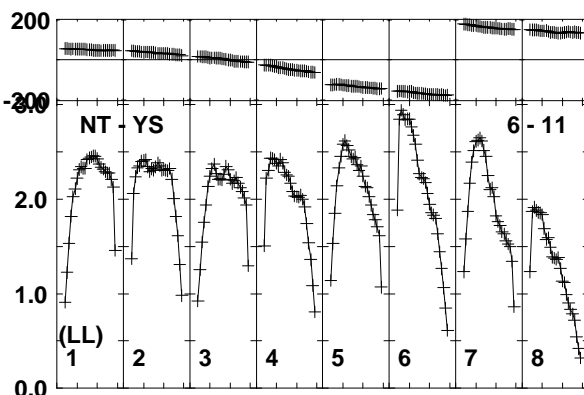
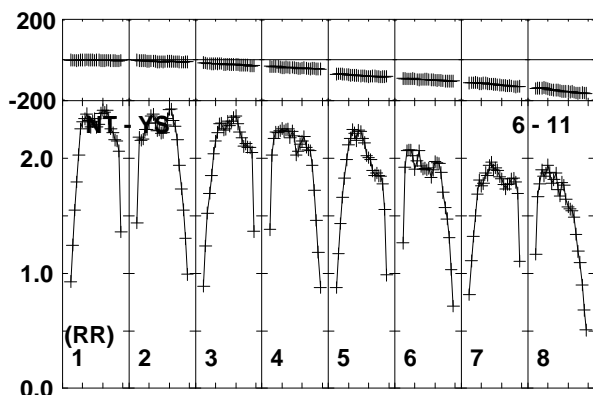
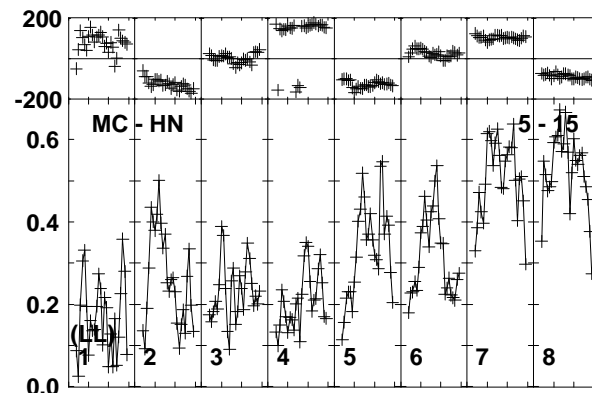
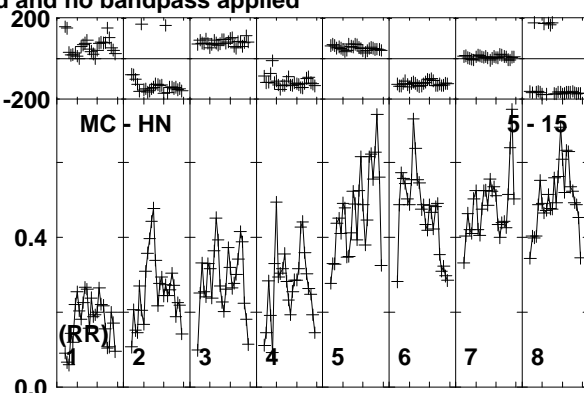
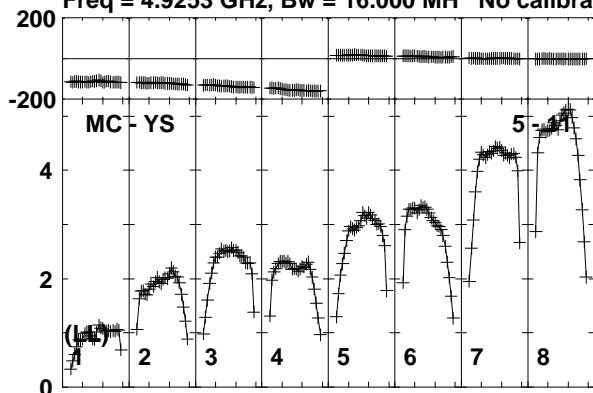

Lower frame: Milli Ampl Jy Top frame: Phas deg
Vector averaged cross-power spectrum Baseline: MC (05) - YS (11)
Timerange: 01/02:25:52 to 01/02:29:58

Plot file version 578 created 11-APR-2016 17:09:50

3C286 GP053G 3.UVDATA.1

Freq = 4.9253 GHz, Bw = 16.000 MH No calibration applied and no bandpass applied

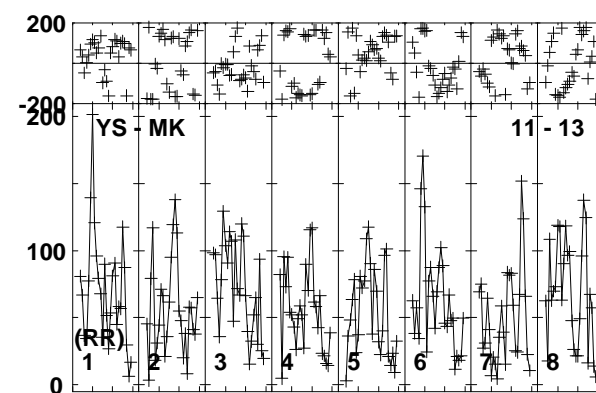
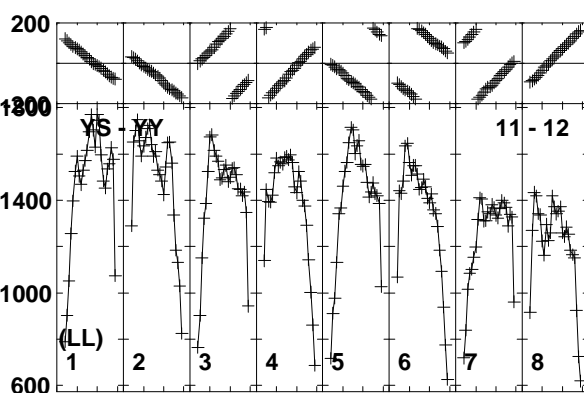
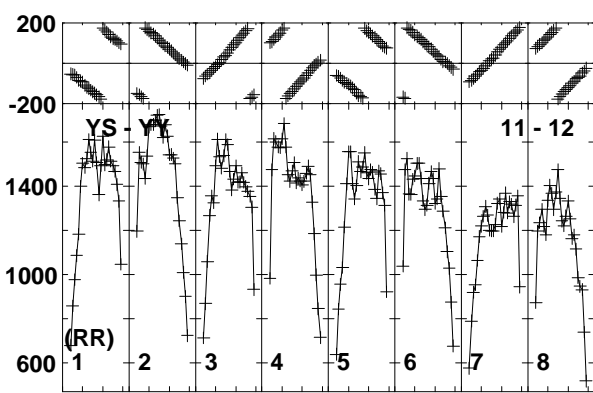
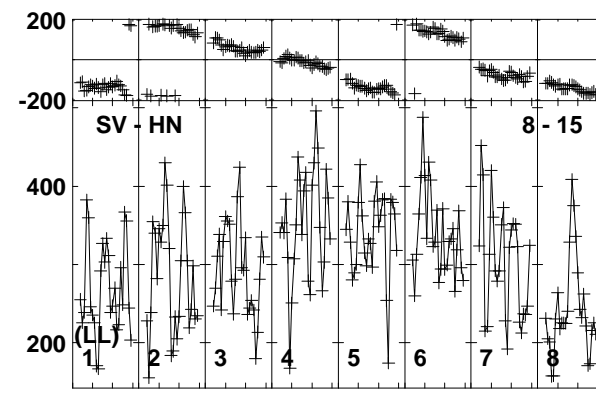
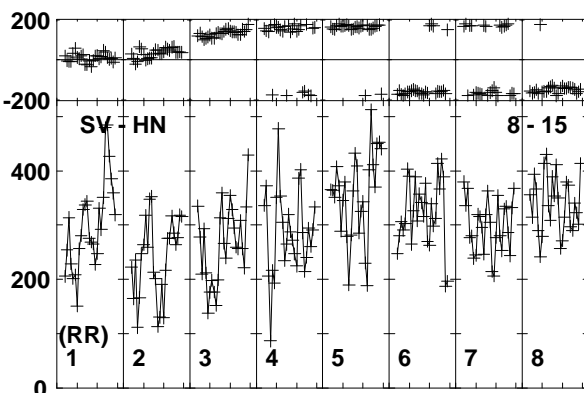
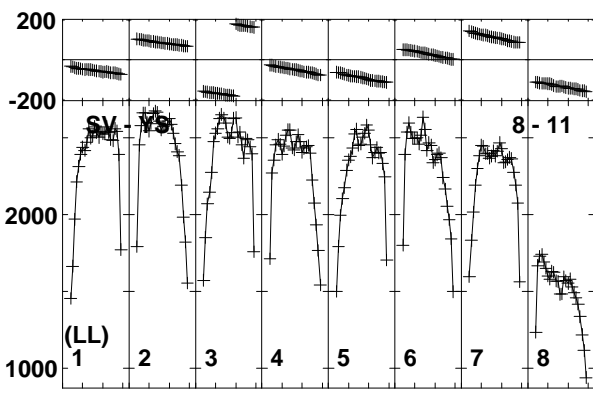
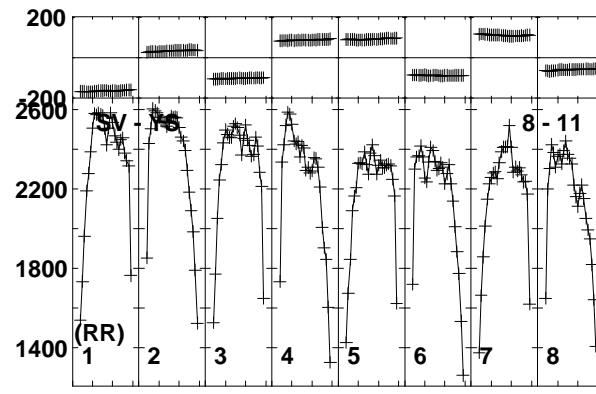
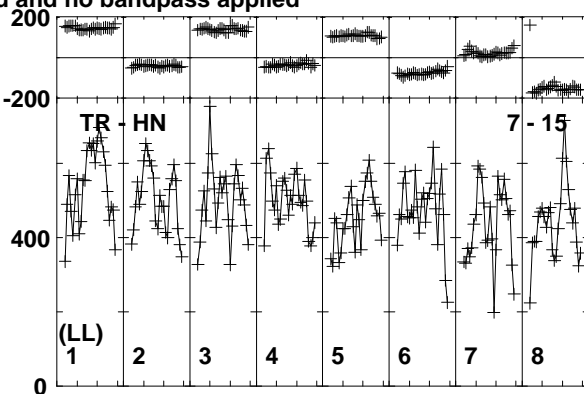
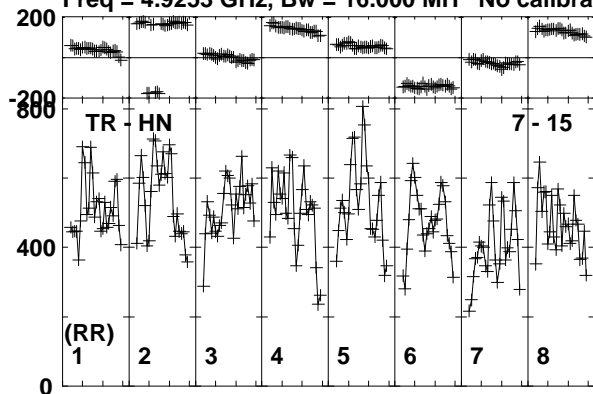

Lower frame: Micro Ampl Jy Top frame: Phas deg
Vector averaged cross-power spectrum Baseline: TR (07) - HN (15)
Timerange: 01/02:25:52 to 01/02:29:58

Plot file version 579 created 11-APR-2016 17:09:50

3C286 GP053G 3.UVDATA.1

Freq = 4.9253 GHz, Bw = 16.000 MH No calibration applied and no bandpass applied

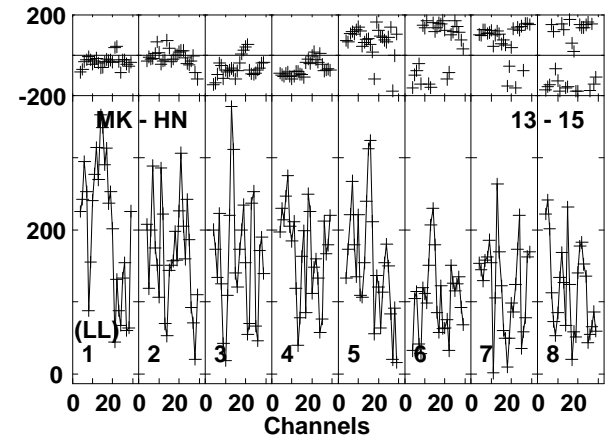
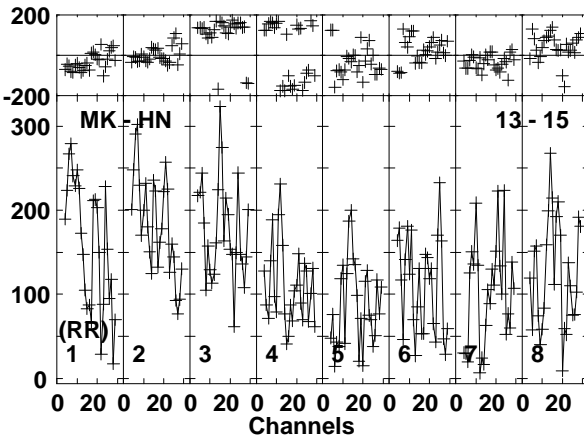
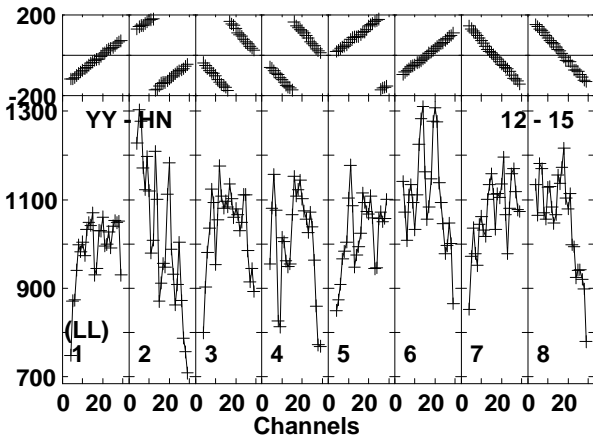
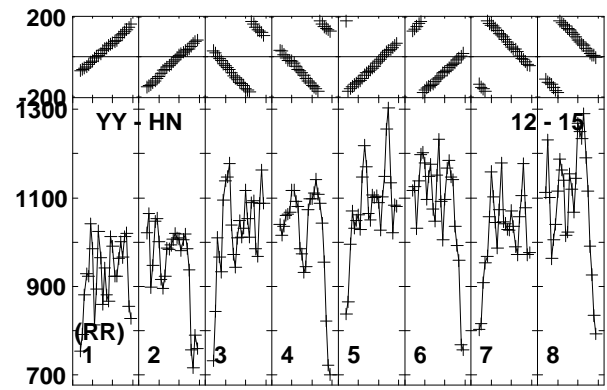
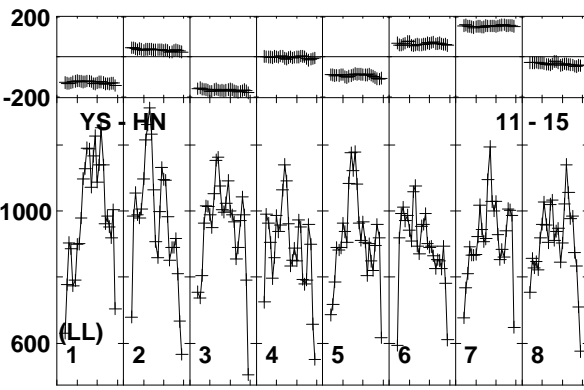
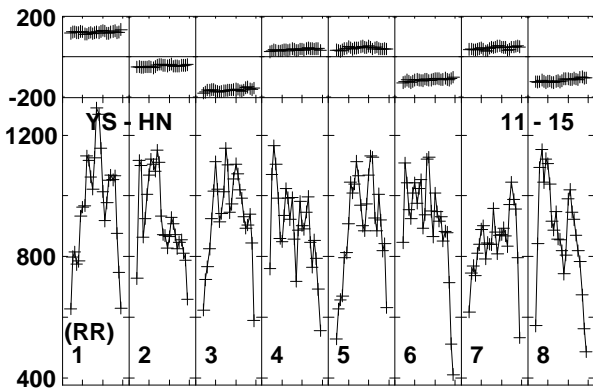
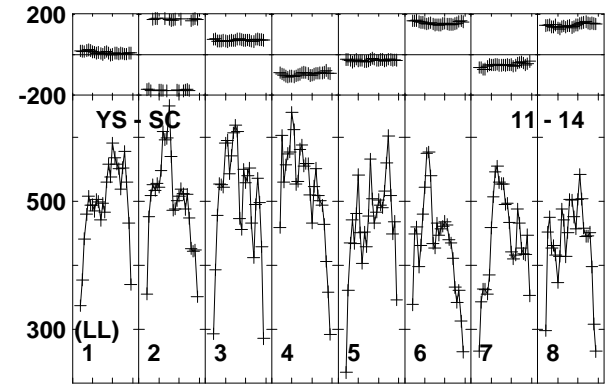
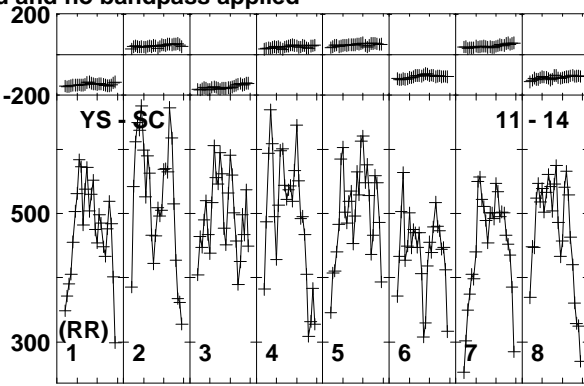
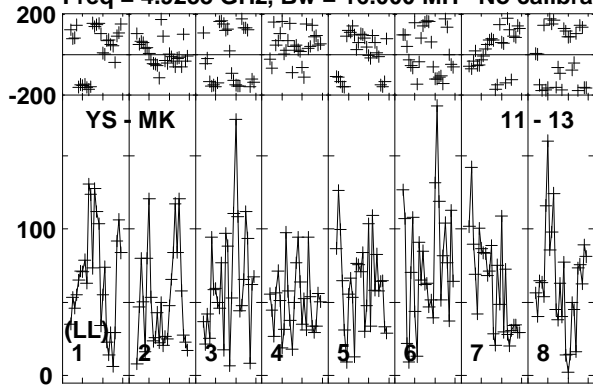

Lower frame: Micro Ampl Jy Top frame: Phas deg
Vector averaged cross-power spectrum Baseline: YS (11) - MK (13)
Timerange: 01/02:25:52 to 01/02:29:58

Plot file version 580 created 11-APR-2016 17:09:50

3C286 GP053G 3.UVDATA.1

Freq = 4.9253 GHz, Bw = 16.000 MH No calibration applied and no bandpass applied

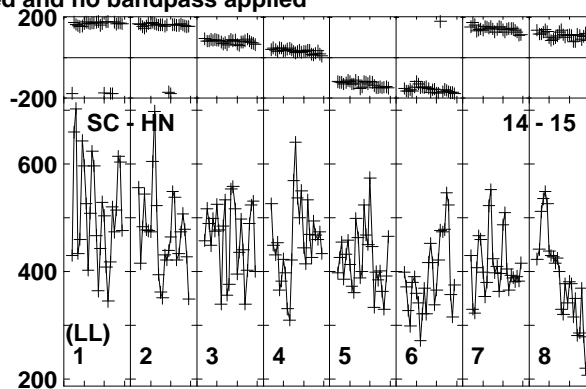
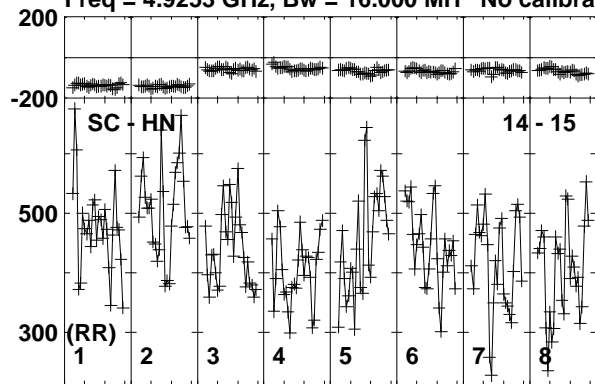

Lower frame: Micro Ampl Jy Top frame: Phas deg
Vector averaged cross-power spectrum Baseline: SC (14) - HN (15)
Timerange: 01/02:25:52 to 01/02:29:58