

Plot file version 1 created 07-JUN-2013 14:03:11

0528+134 N13M1.UVDATA.1

Freq = 6.6606 GHz, Bw = 2.000 MH No calibration applied and no bandpass applied

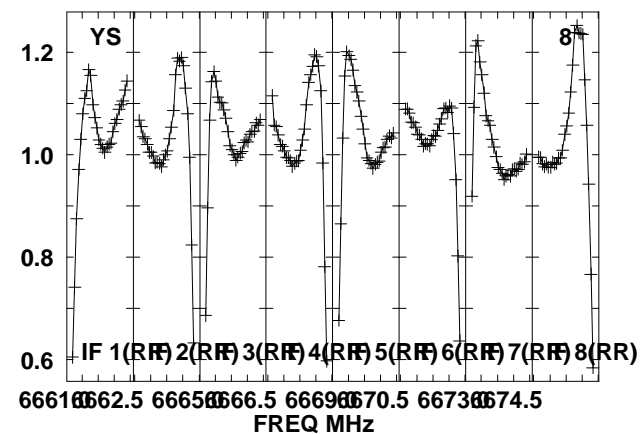
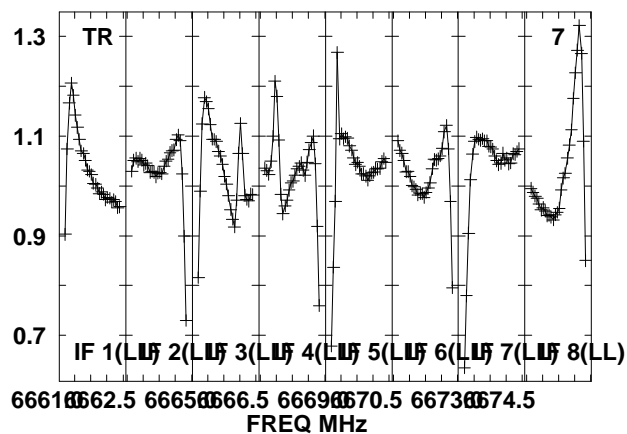
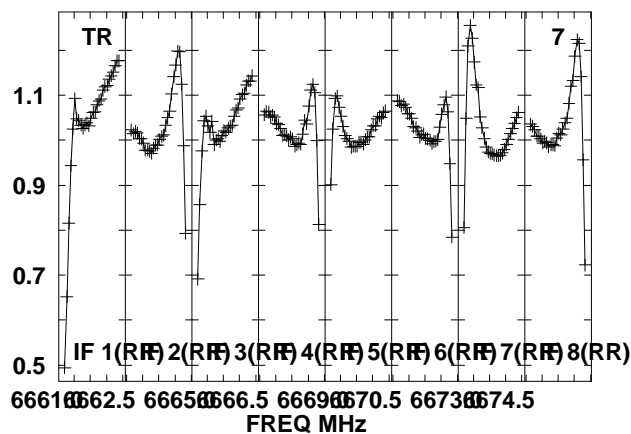
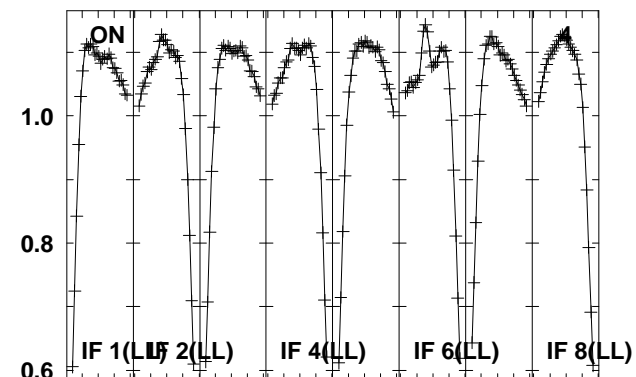
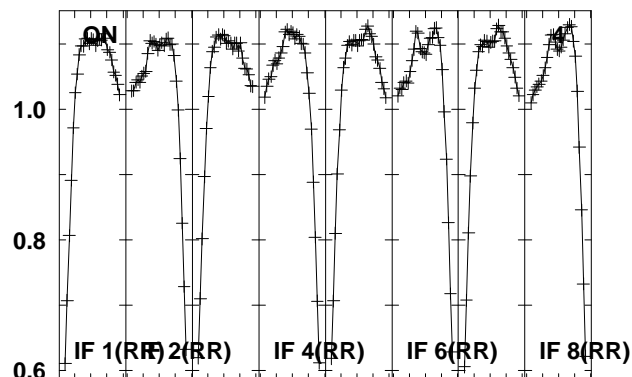
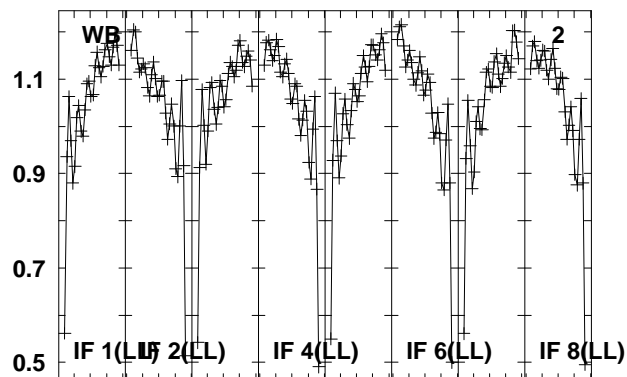
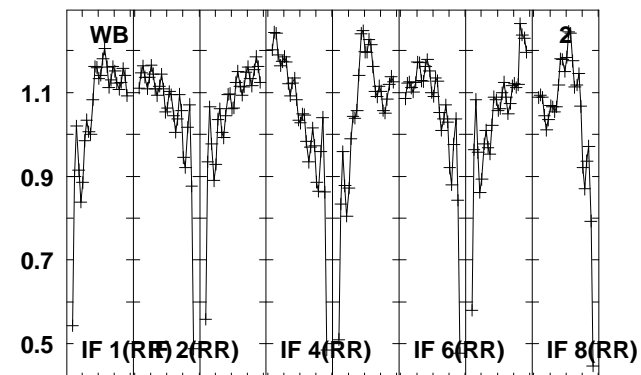
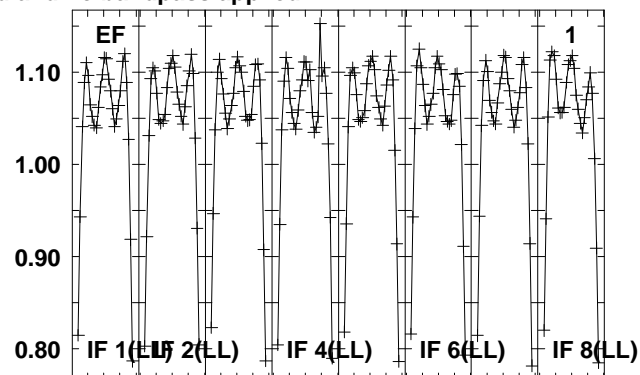
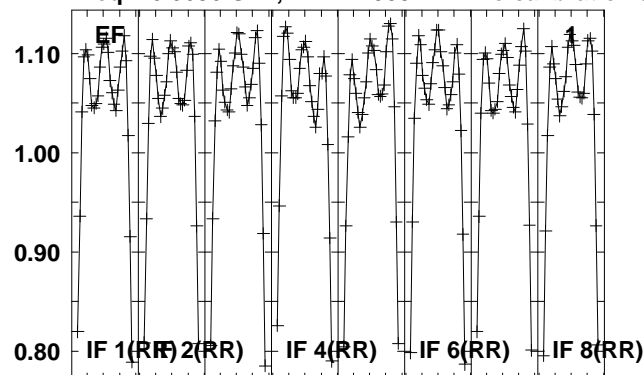

Lower frame: Real Jy
Total-power spectrum Antenna: *
Timerange: 00/15:00:03 to 00/15:04:59

Plot file version 2 created 07-JUN-2013 14:03:12

0528+134 N13M1.UVDATA.1

Freq = 6.6606 GHz, Bw = 2.000 MH No calibration applied and no bandpass applied

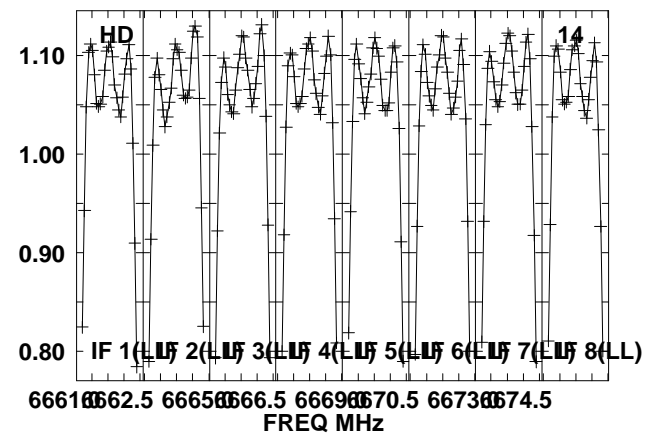
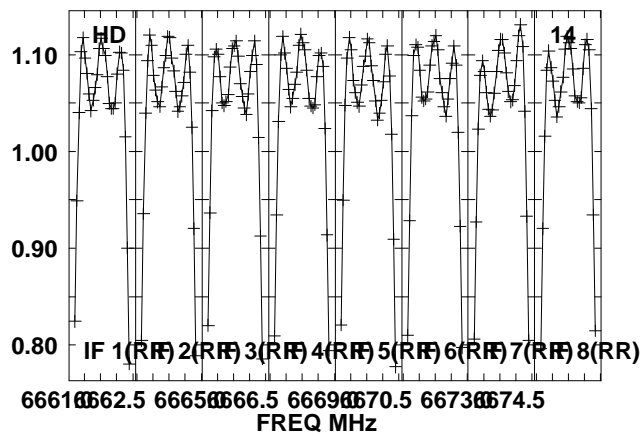
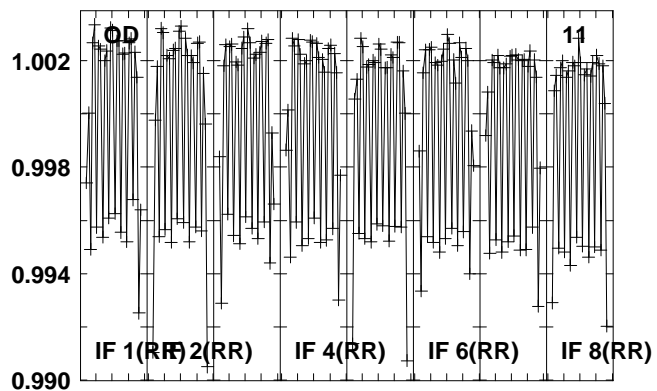
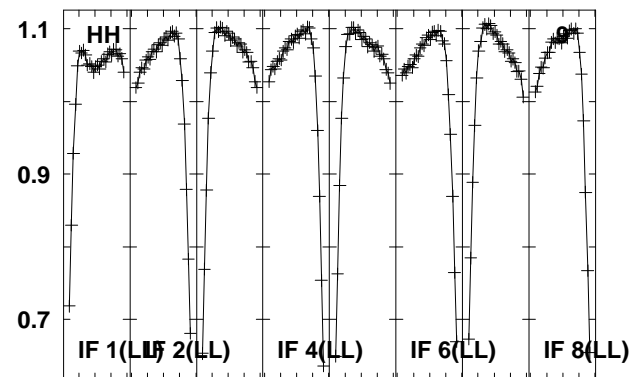
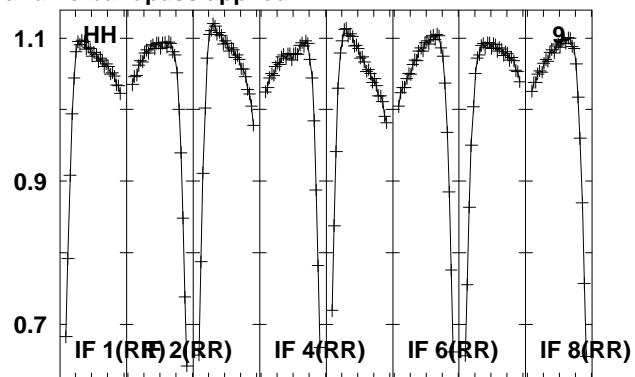
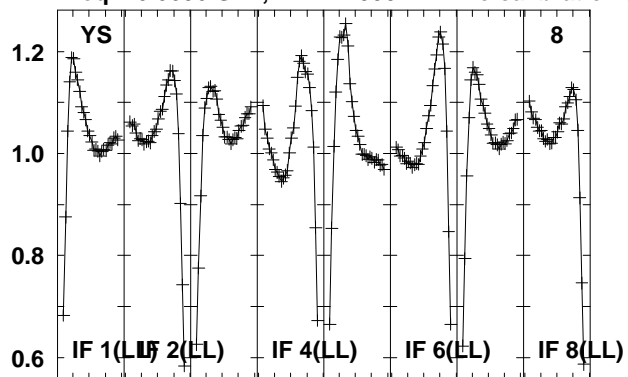

Lower frame: Real Jy
Total-power spectrum Antenna: *
Timerange: 00/15:00:03 to 00/15:04:59

Plot file version 3 created 07-JUN-2013 14:03:13

0528+134 N13M1.UVDATA.1

Freq = 6.6606 GHz, Bw = 2.000 MH No calibration applied and no bandpass applied

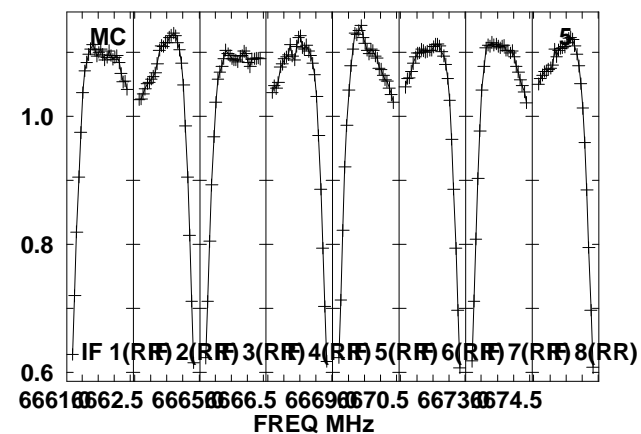
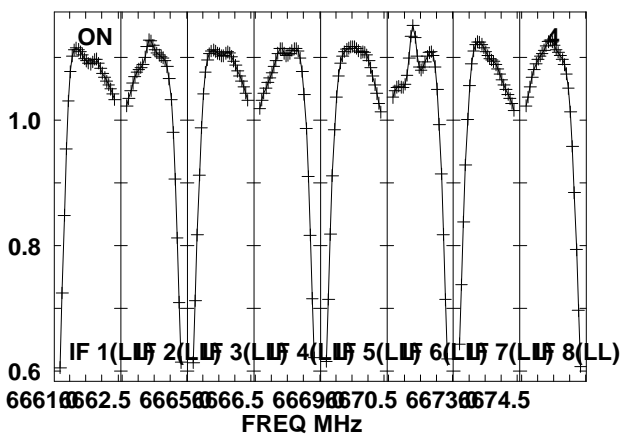
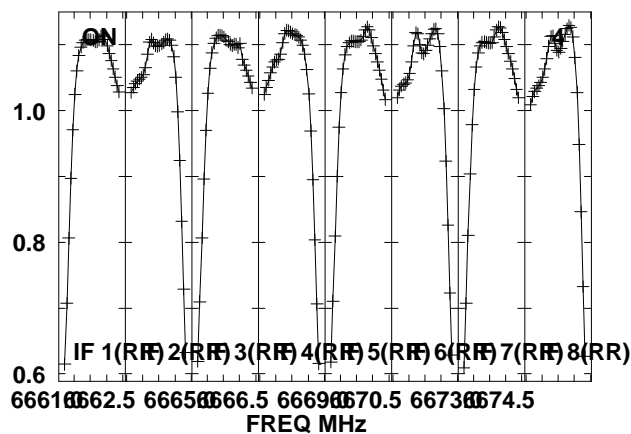
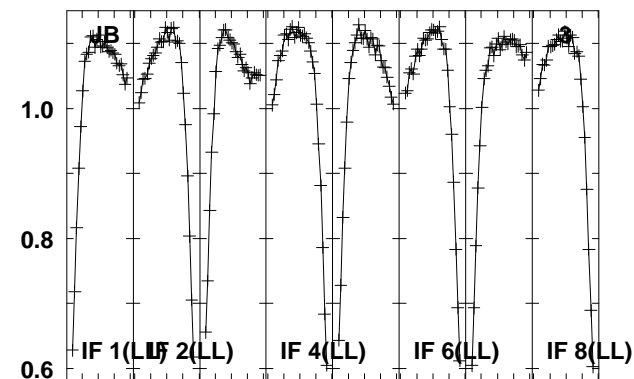
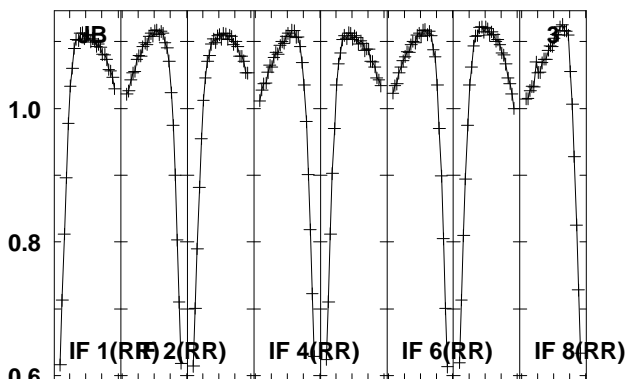
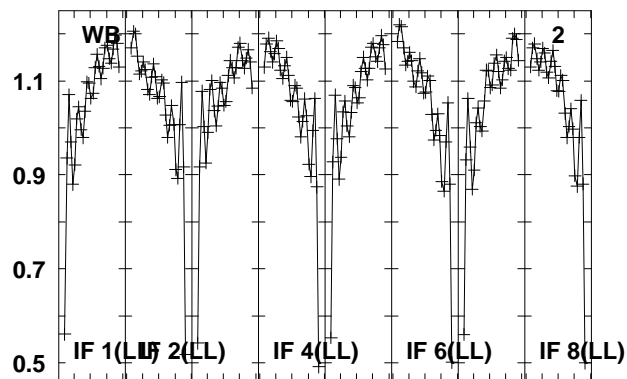
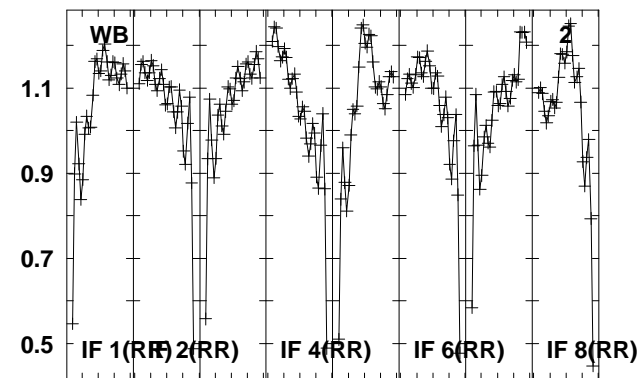
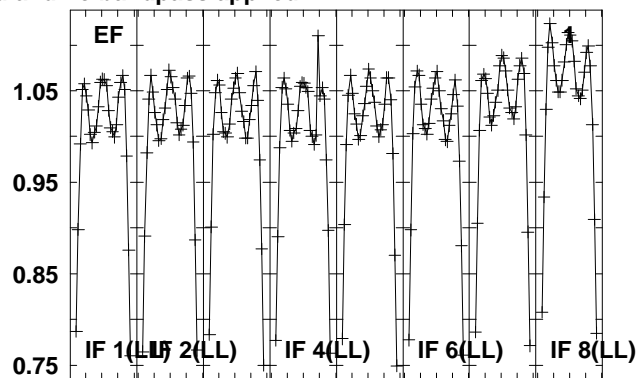
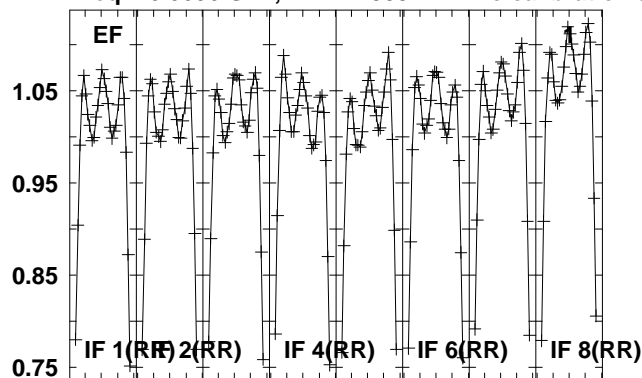

Lower frame: Real Jy
Total-power spectrum Antenna: *
Timerange: 00/15:06:03 to 00/15:10:59

Plot file version 4 created 07-JUN-2013 14:03:13

0528+134 N13M1.UVDATA.1

Freq = 6.6606 GHz, Bw = 2.000 MH No calibration applied and no bandpass applied

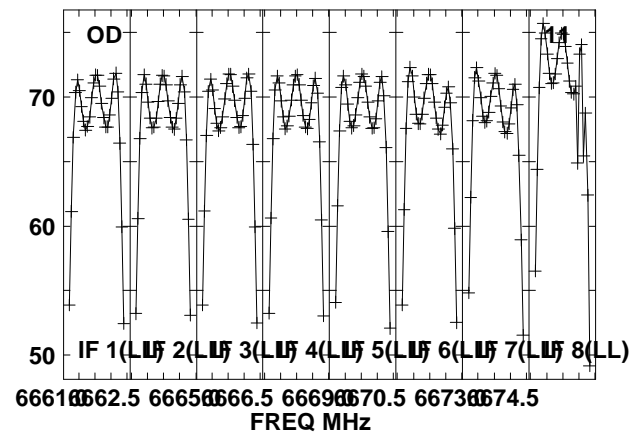
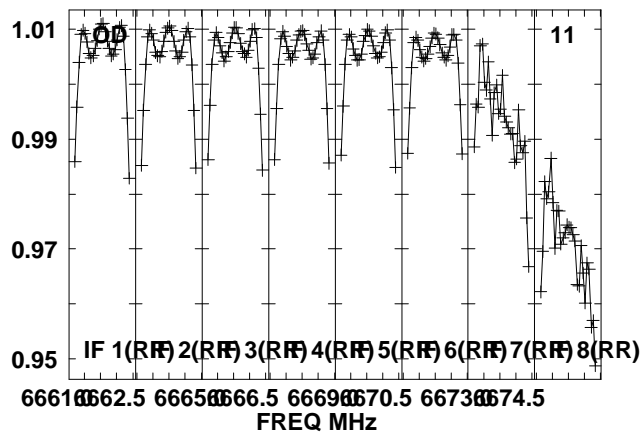
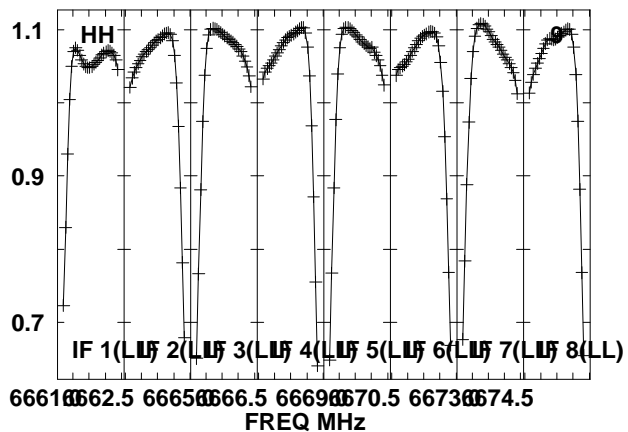
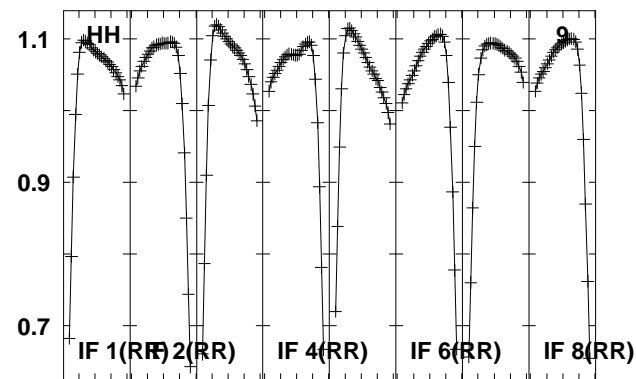
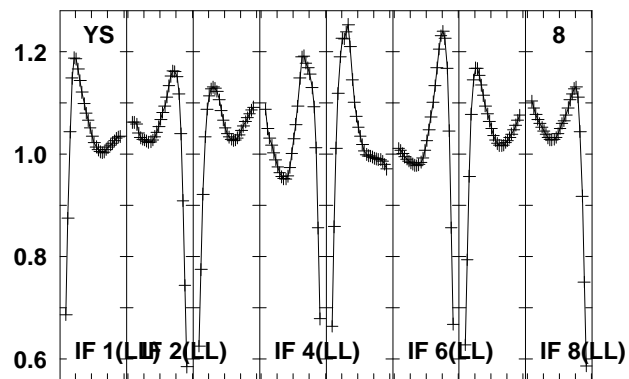
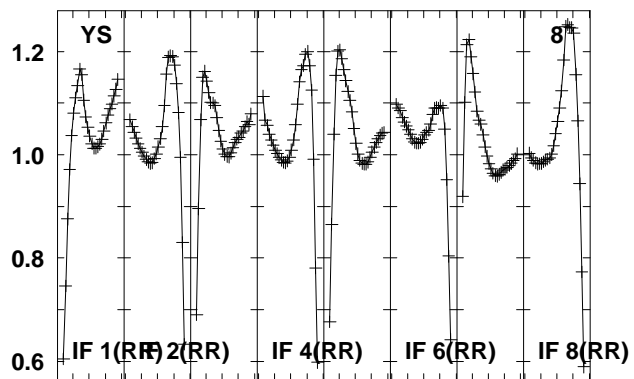
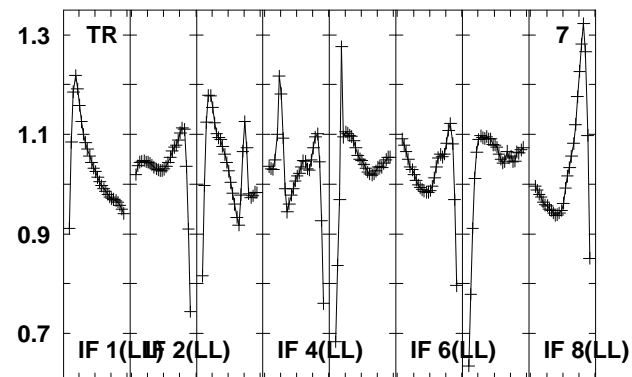
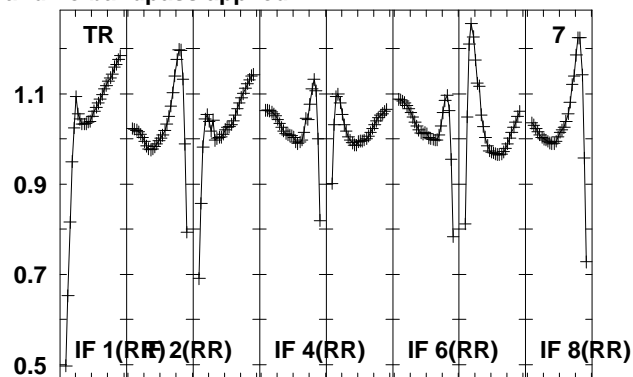
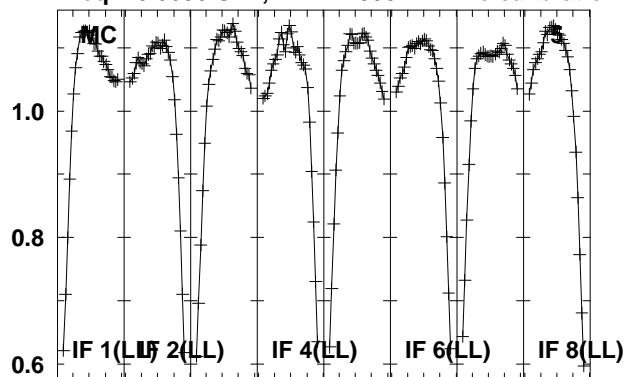

Lower frame: Real Jy
Total-power spectrum Antenna: *
Timerange: 00/15:06:03 to 00/15:10:59

Plot file version 5 created 07-JUN-2013 14:03:14

0528+134 N13M1.UVDATA.1

Freq = 6.6606 GHz, Bw = 2.000 MH No calibration applied and no bandpass applied

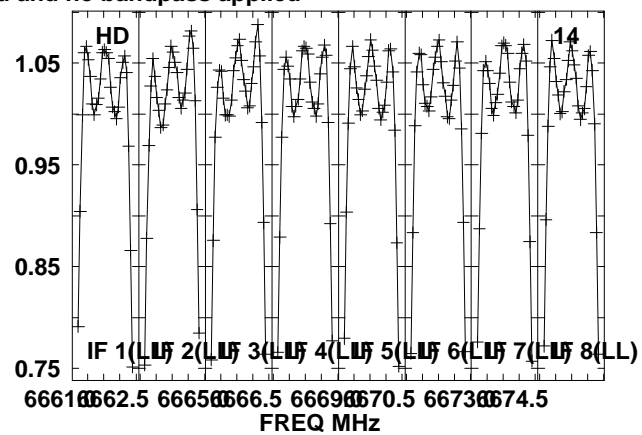
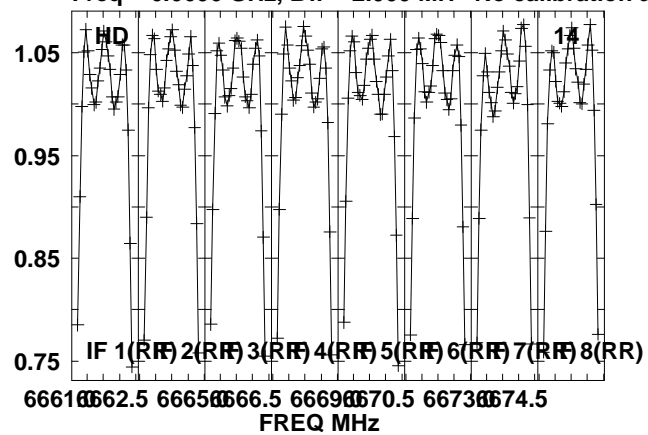

Lower frame: Real Jy
Total-power spectrum Antenna: *
Timerange: 00/15:06:03 to 00/15:10:59

Plot file version 6 created 07-JUN-2013 14:03:15

0528+134 N13M1.UVDATA.1

Freq = 6.6606 GHz, Bw = 2.000 MH No calibration applied and no bandpass applied

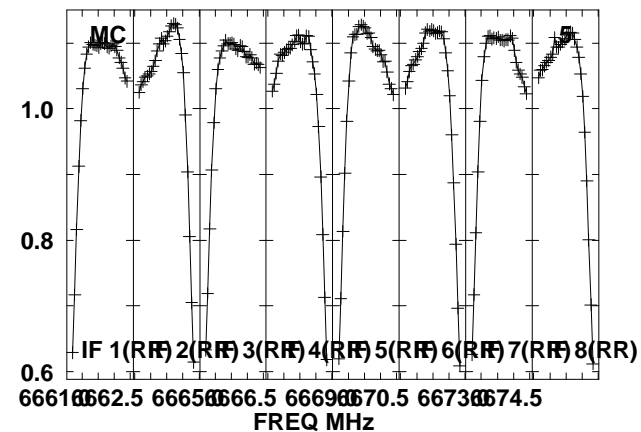
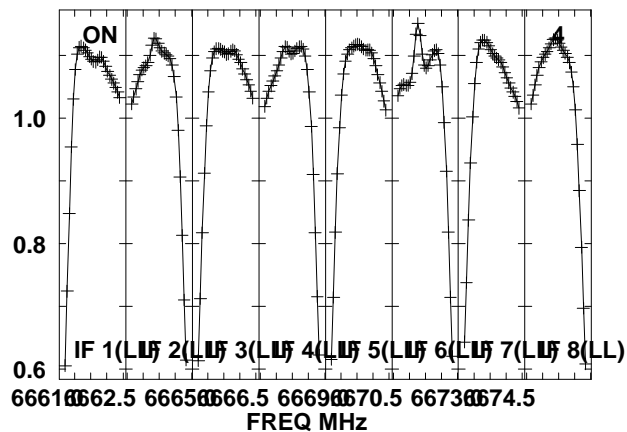
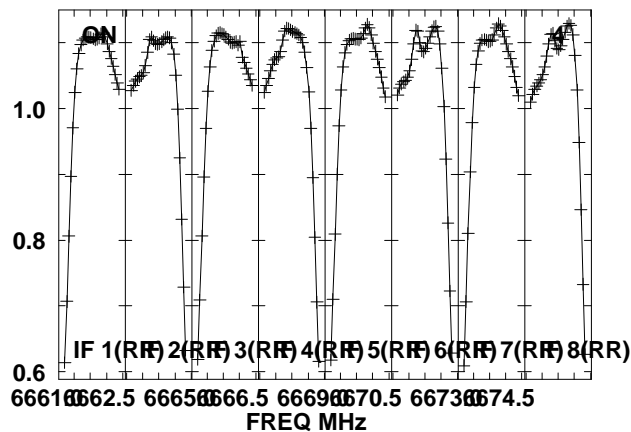
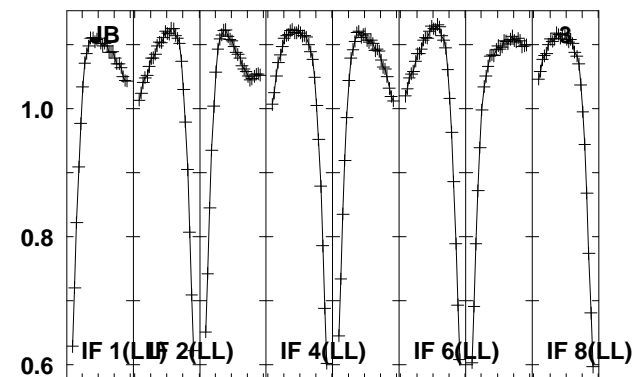
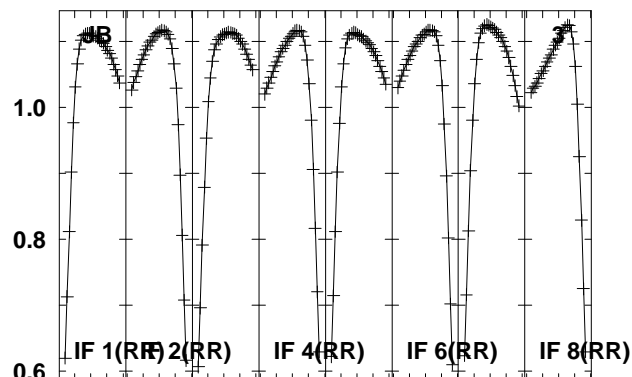
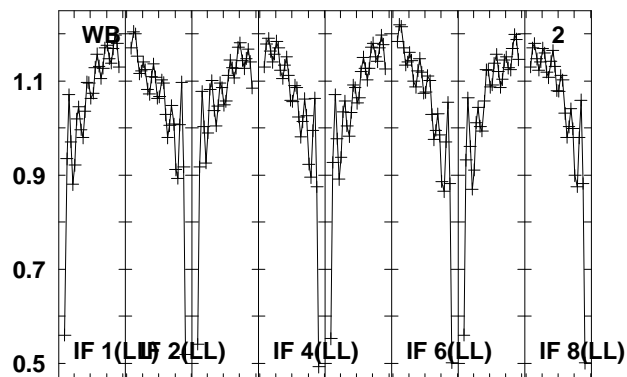
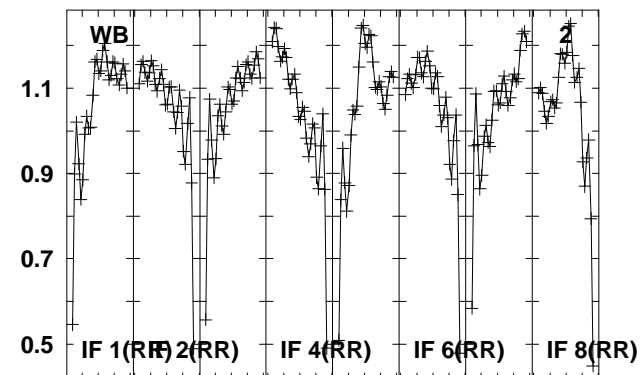
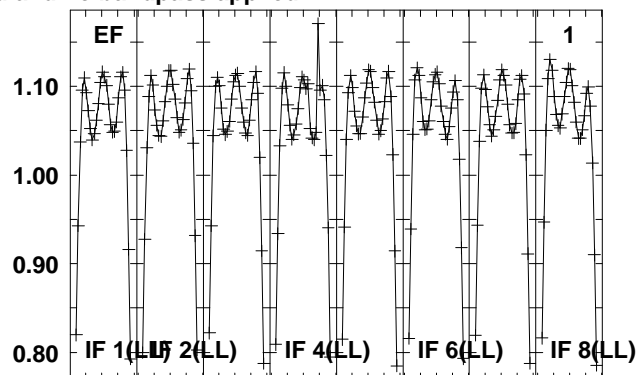
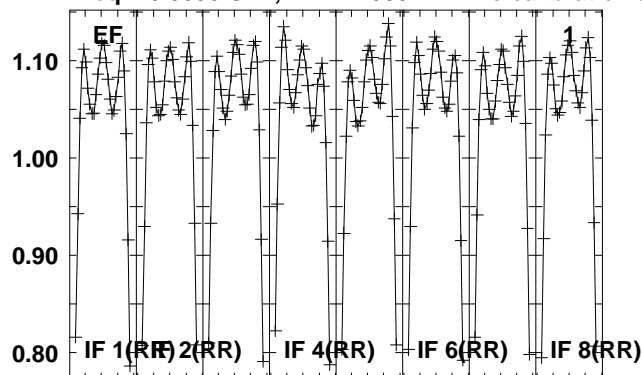

Lower frame: Real Jy
Total-power spectrum Antenna: *
Timerange: 00/15:13:03 to 00/15:22:59

Plot file version 7 created 07-JUN-2013 14:03:16

0528+134 N13M1.UVDATA.1

Freq = 6.6606 GHz, Bw = 2.000 MH No calibration applied and no bandpass applied

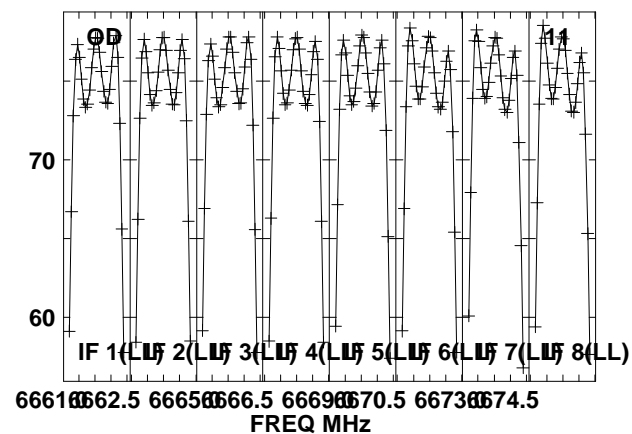
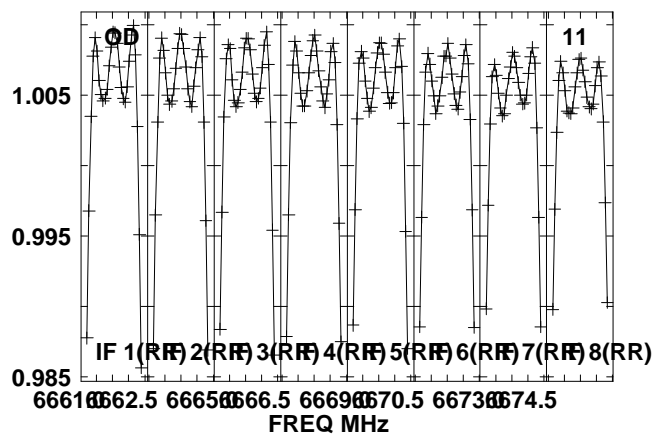
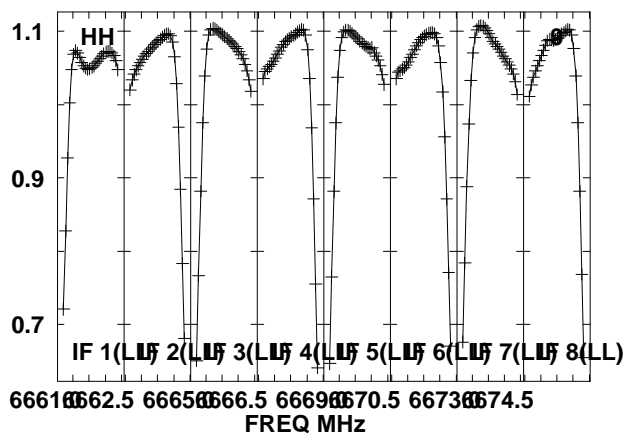
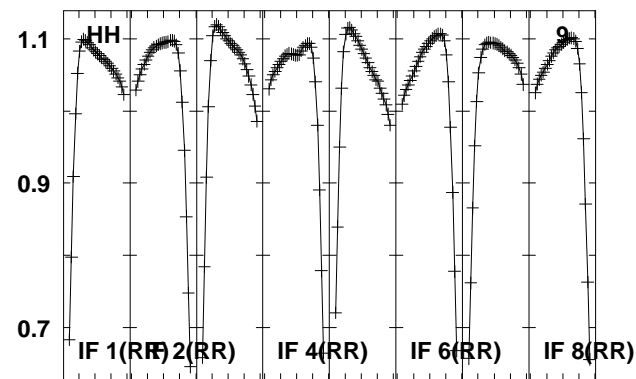
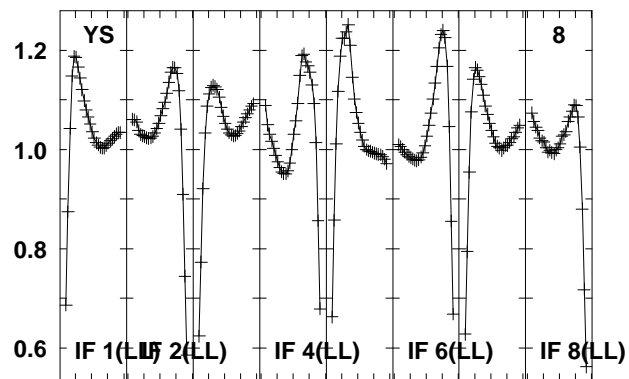
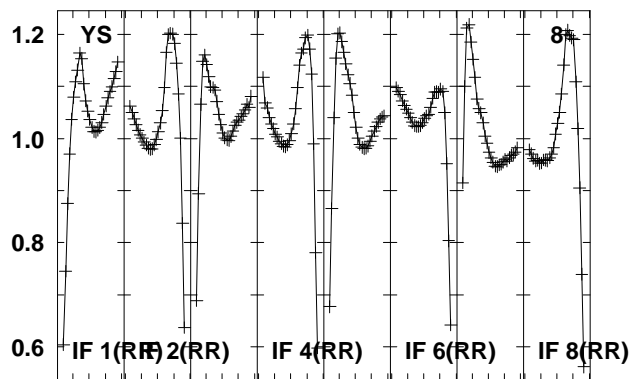
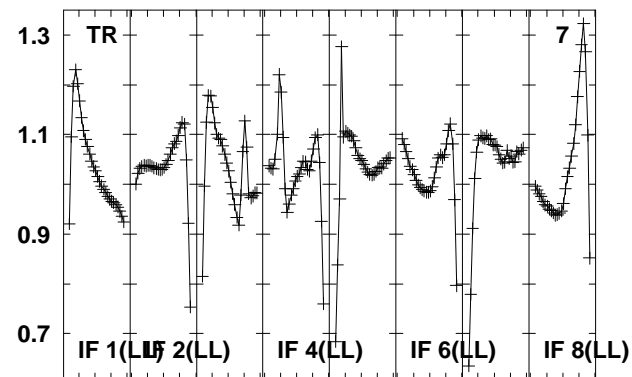
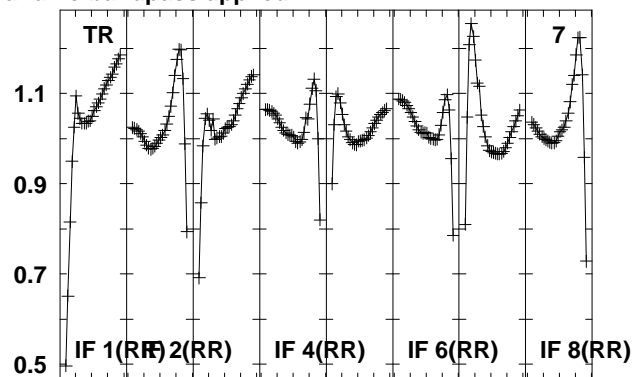
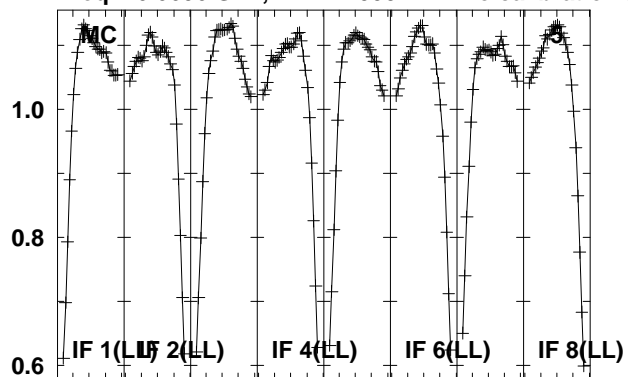

Lower frame: Real Jy
Total-power spectrum Antenna: *
Timerange: 00/15:13:03 to 00/15:22:59

Plot file version 8 created 07-JUN-2013 14:03:18

0528+134 N13M1.UVDATA.1

Freq = 6.6606 GHz, Bw = 2.000 MH No calibration applied and no bandpass applied

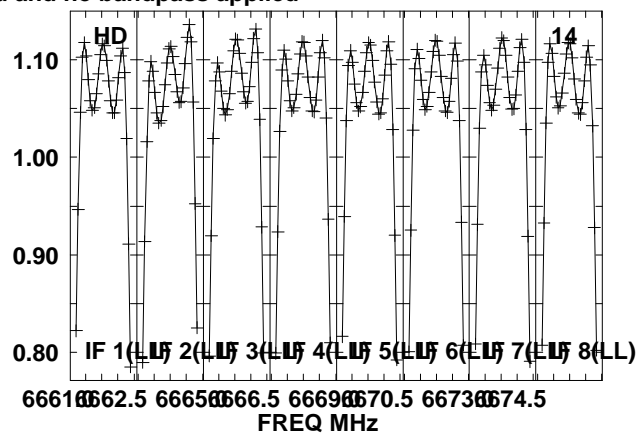
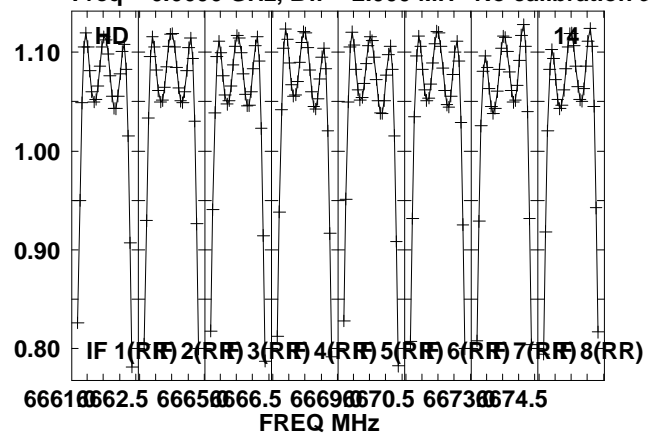

Lower frame: Real Jy

Total-power spectrum Antenna: *

Timerange: 00/15:13:03 to 00/15:22:59

Plot file version 9 created 07-JUN-2013 14:03:18

J0522+1415 N13M1.UVDATA.1

Freq = 6.6606 GHz, Bw = 2.000 MH No calibration applied and no bandpass applied

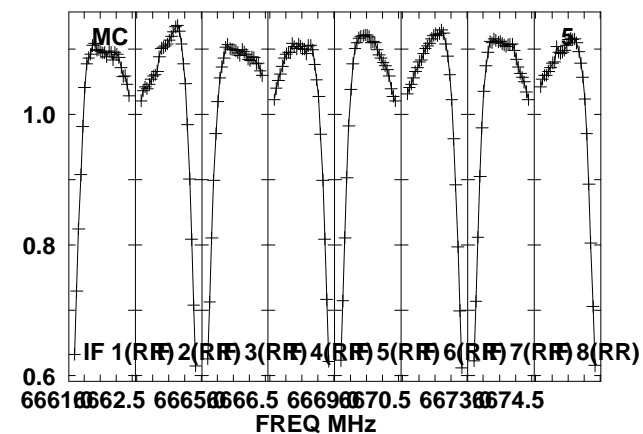
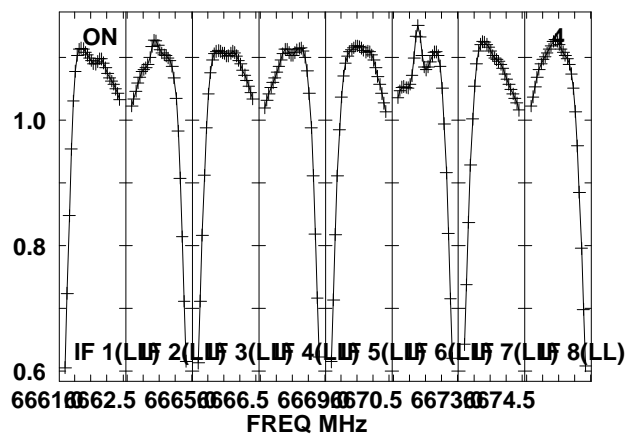
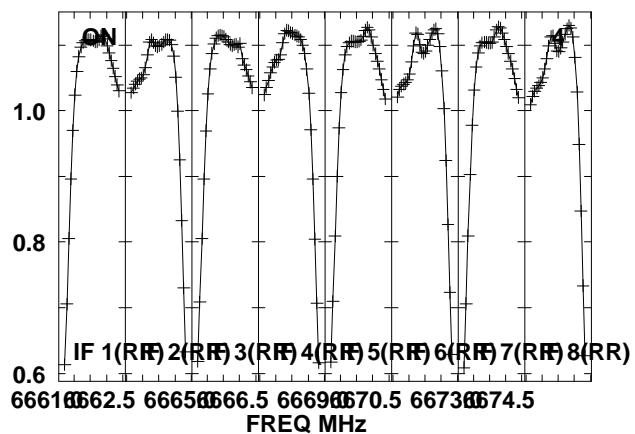
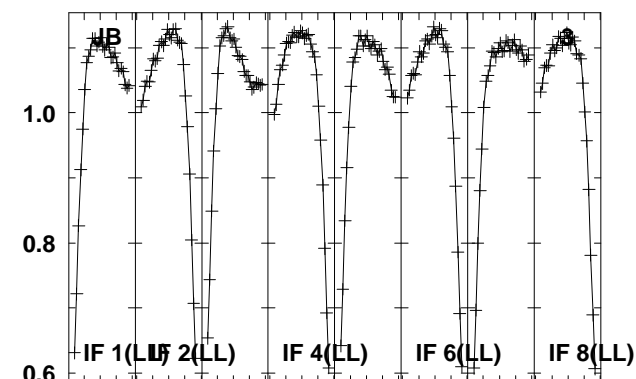
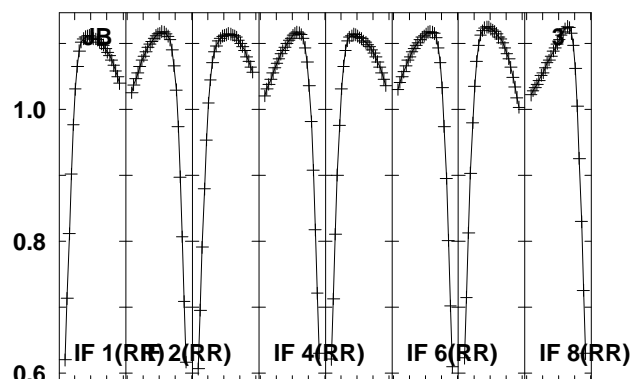
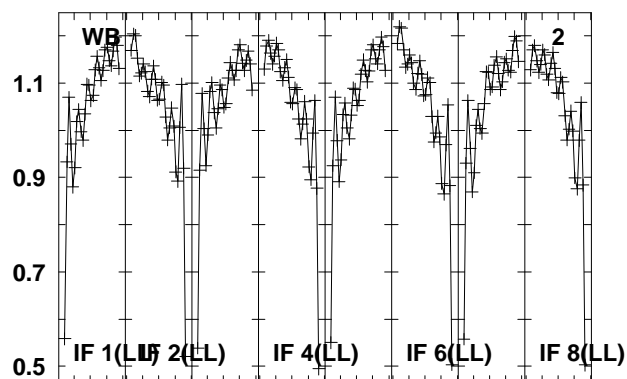
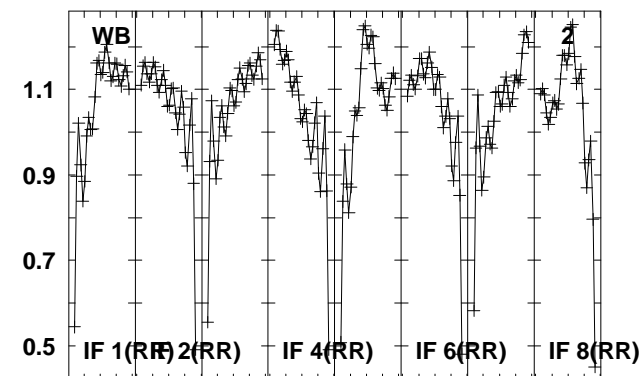
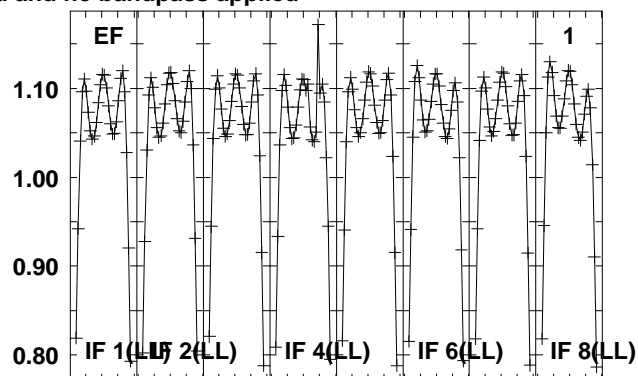
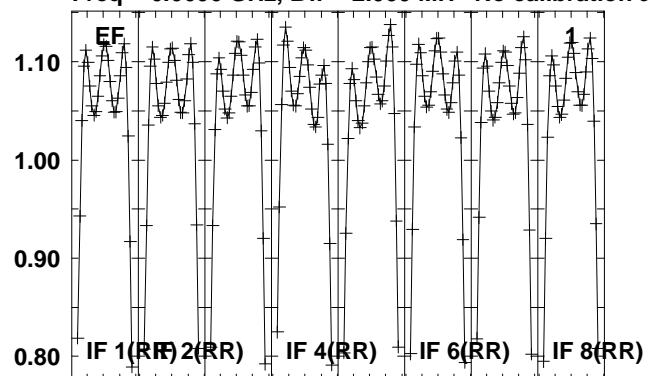

Lower frame: Real Jy
Total-power spectrum Antenna: *
Timerange: 00/15:24:03 to 00/15:25:59

Plot file version 10 created 07-JUN-2013 14:03:18
 J0522+1415 N13M1.UVDATA.1
 Freq = 6.6606 GHz, Bw = 2.000 MH No calibration applied and no bandpass applied

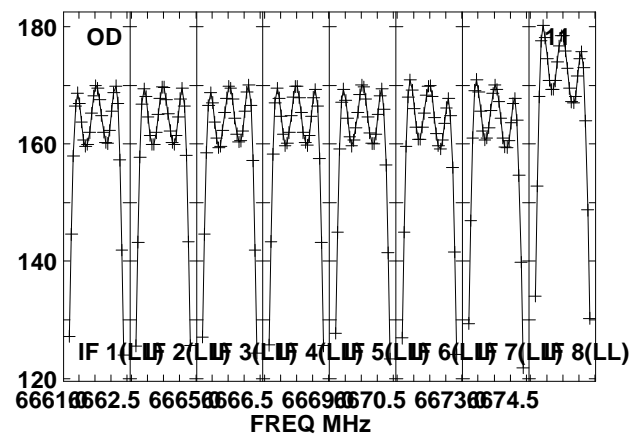
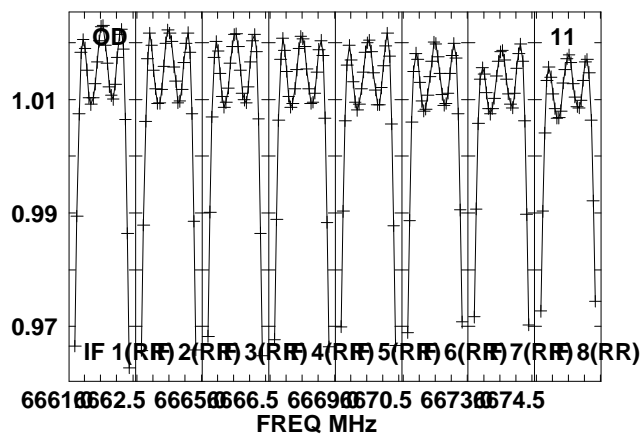
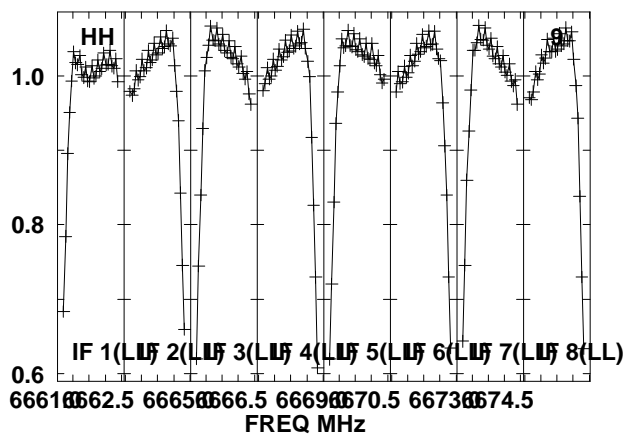
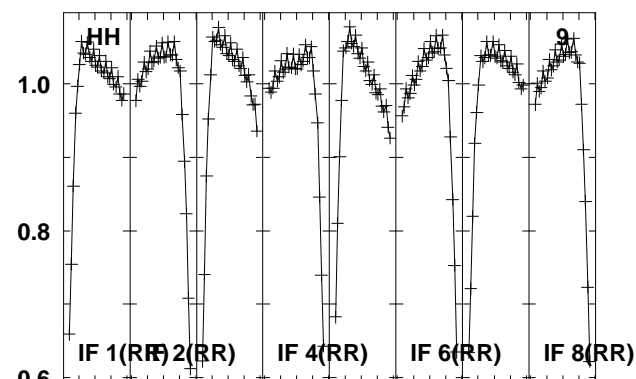
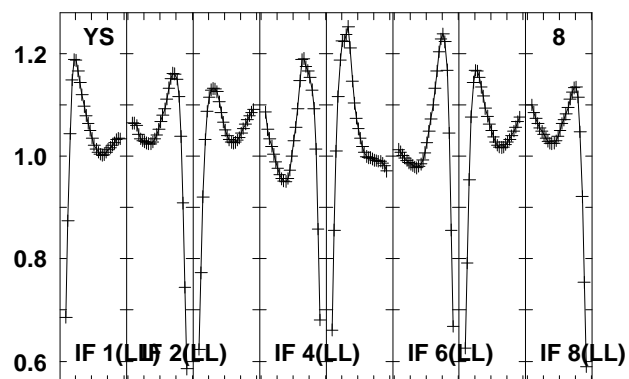
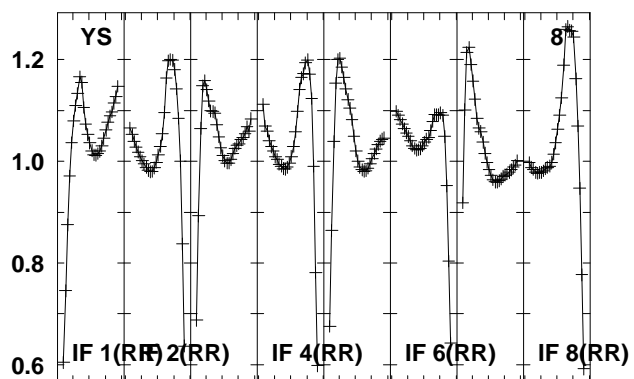
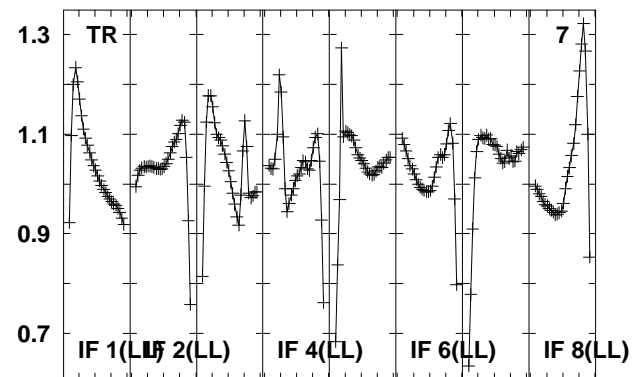
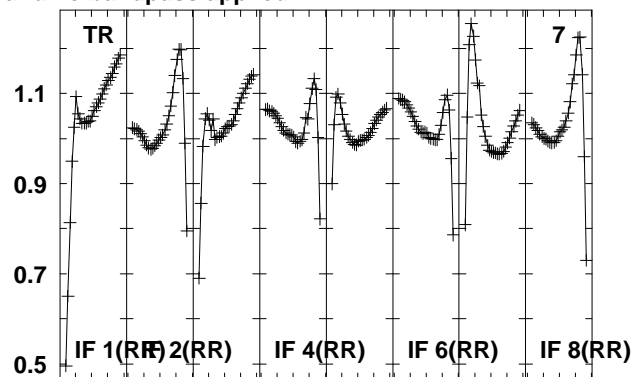
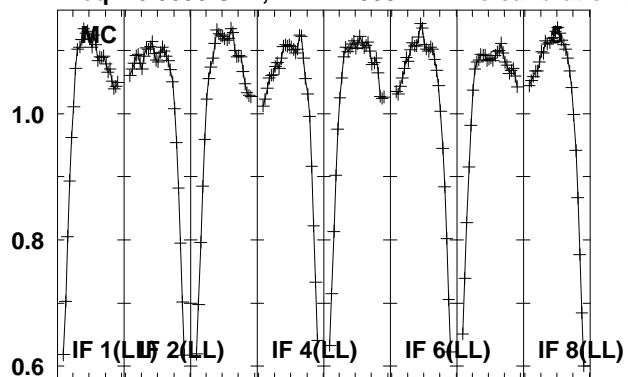

Lower frame: Real Jy
 Total-power spectrum Antenna: *
 Timerange: 00/15:24:03 to 00/15:25:59

Plot file version 11 created 07-JUN-2013 14:03:19

J0522+1415 N13M1.UVDATA.1

Freq = 6.6606 GHz, Bw = 2.000 MH No calibration applied and no bandpass applied

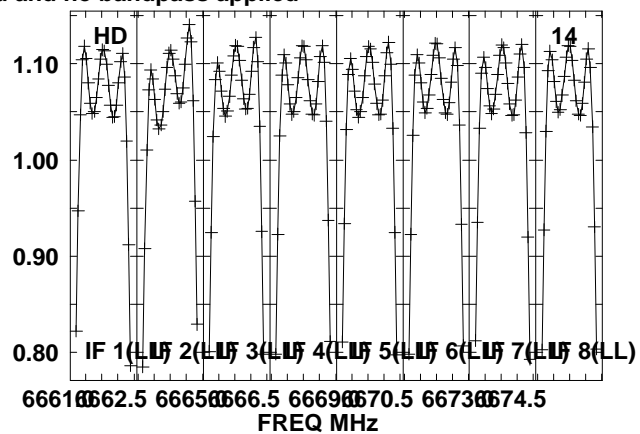
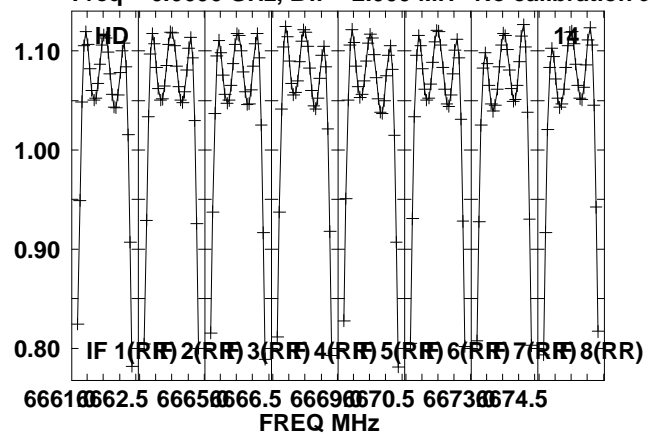

Lower frame: Real Jy

Total-power spectrum Antenna: *

Timerange: 00/15:24:03 to 00/15:25:59

Plot file version 12 created 07-JUN-2013 14:03:19

0528+134 N13M1.UVDATA.1

Freq = 6.6606 GHz, Bw = 2.000 MH No calibration applied and no bandpass applied

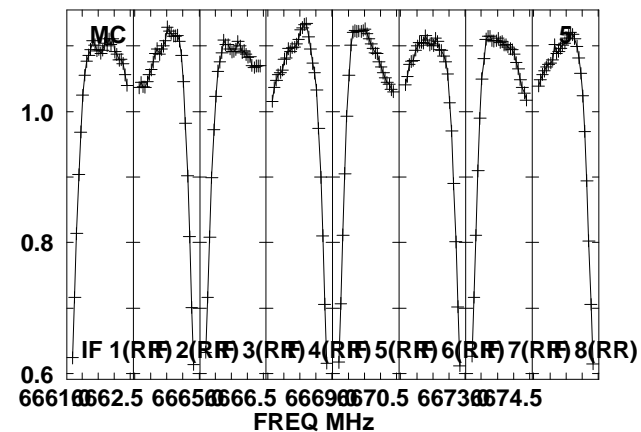
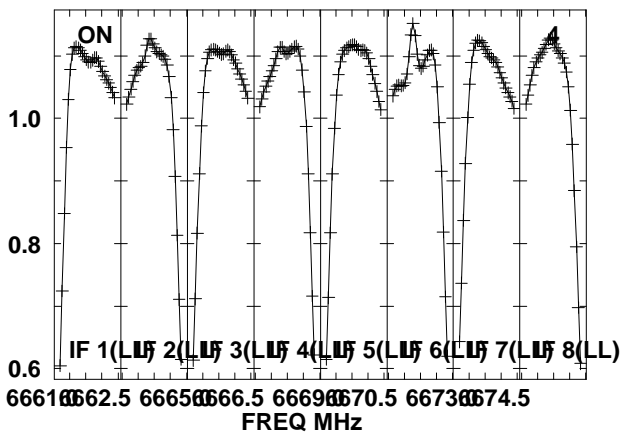
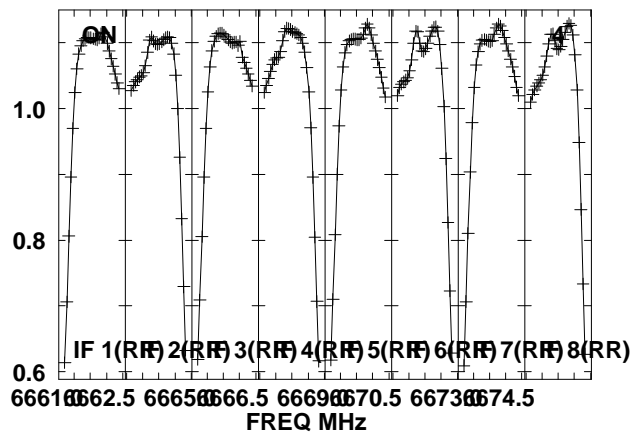
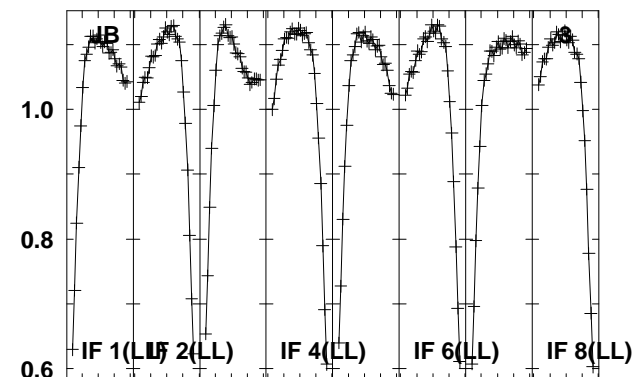
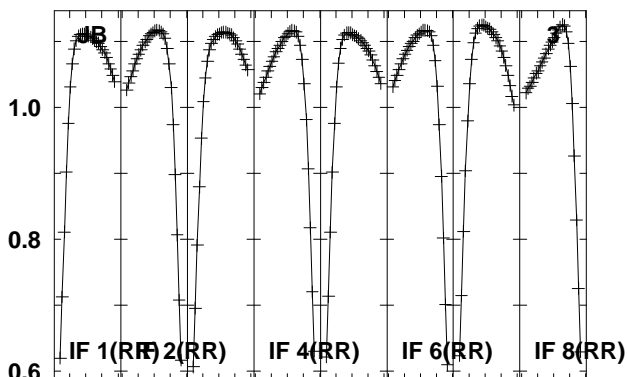
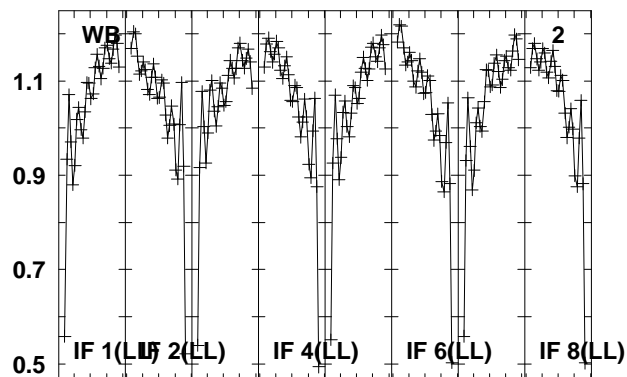
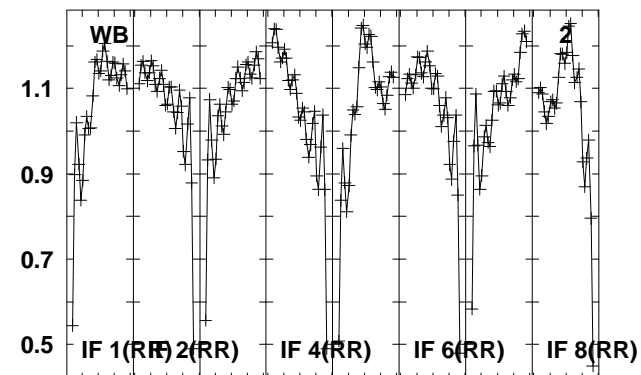
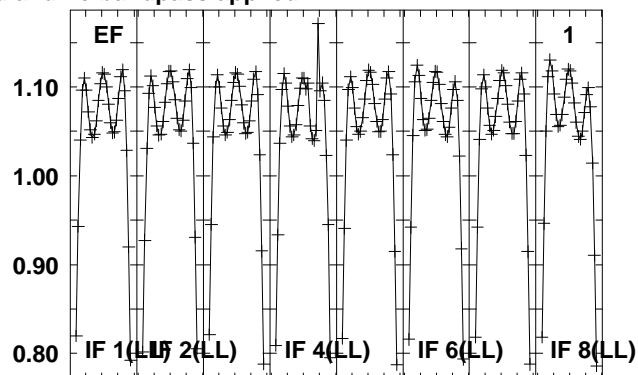
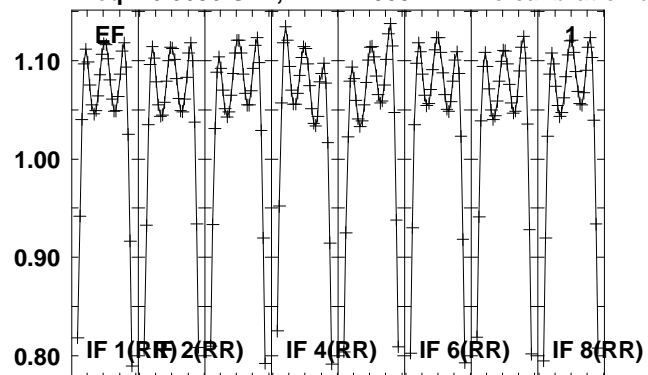

Lower frame: Real Jy
Total-power spectrum Antenna: *
Timerange: 00/15:26:09 to 00/15:28:59

Plot file version 13 created 07-JUN-2013 14:03:19

0528+134 N13M1.UVDATA.1

Freq = 6.6606 GHz, Bw = 2.000 MH No calibration applied and no bandpass applied

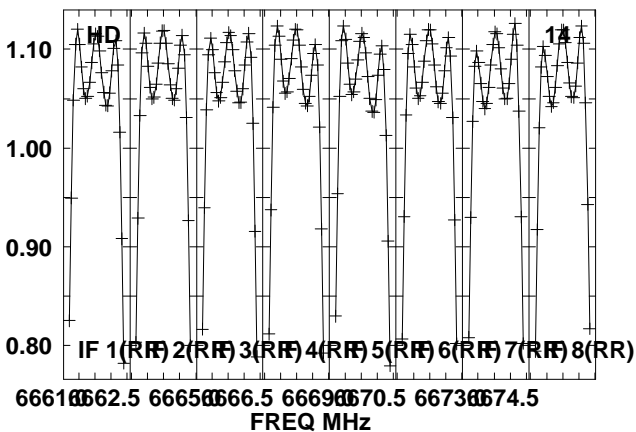
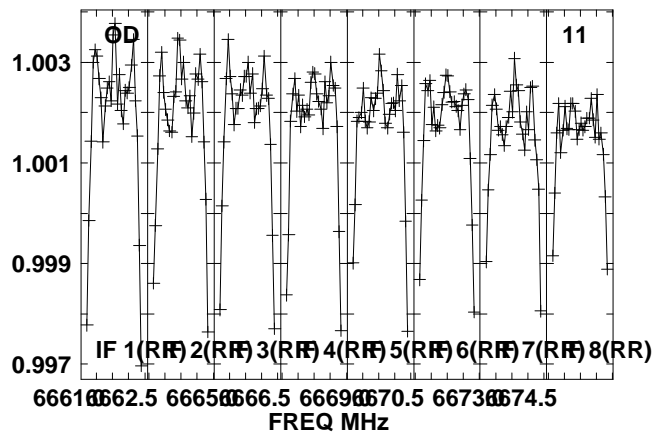
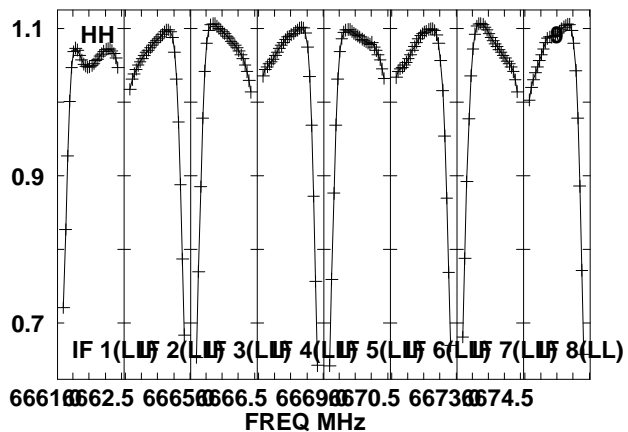
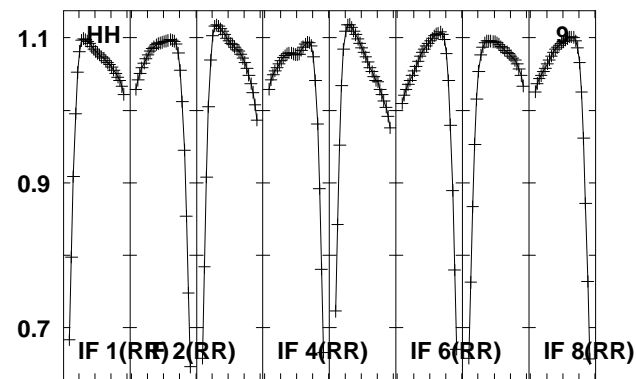
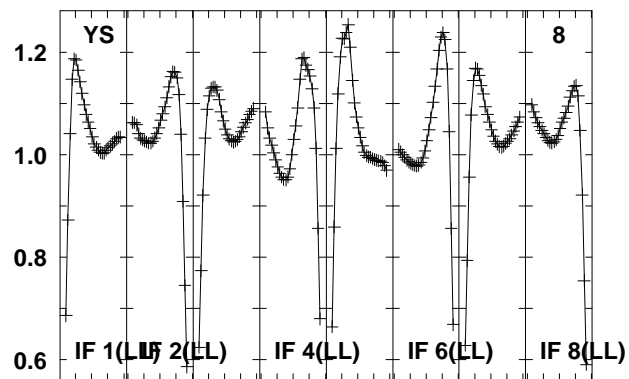
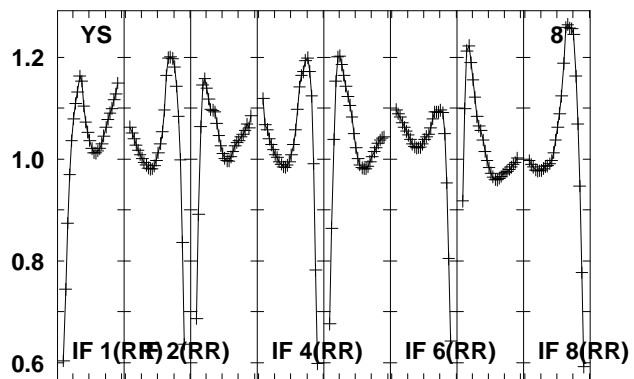
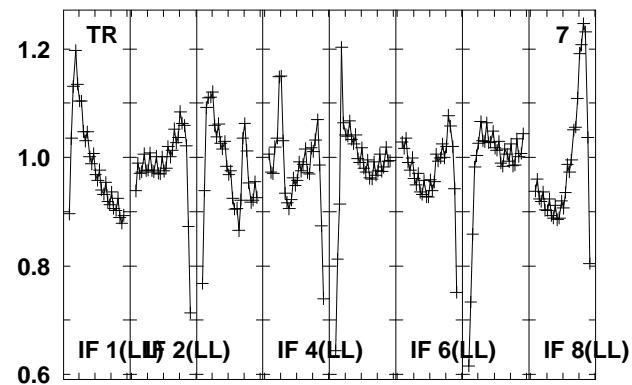
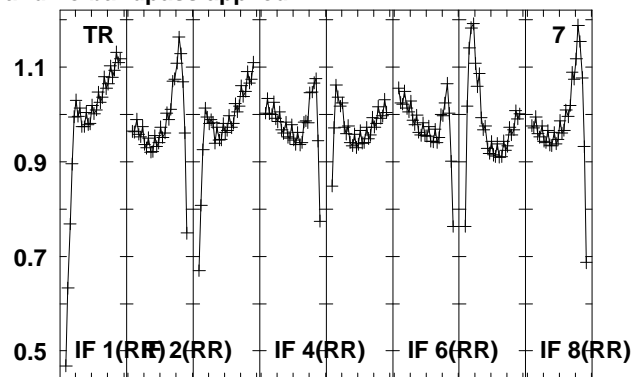
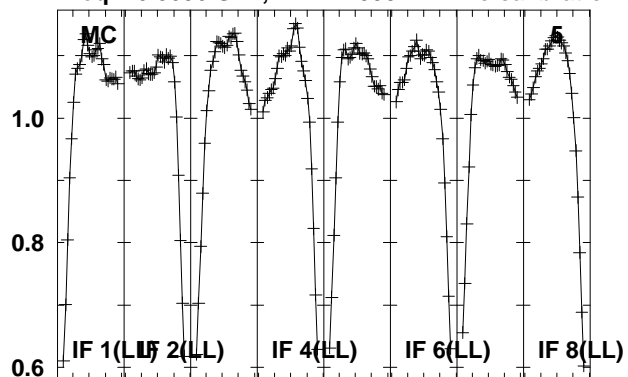

6661 6662.5 6665 6666.5 6669 6670.5 6673 6674.5
FREQ MHz

Lower frame: Real Jy
Total-power spectrum Antenna: *
Timerange: 00/15:26:09 to 00/15:28:59

Plot file version 14 created 07-JUN-2013 14:03:20

0528+134 N13M1.UVDATA.1

Freq = 6.6606 GHz, Bw = 2.000 MH No calibration applied and no bandpass applied

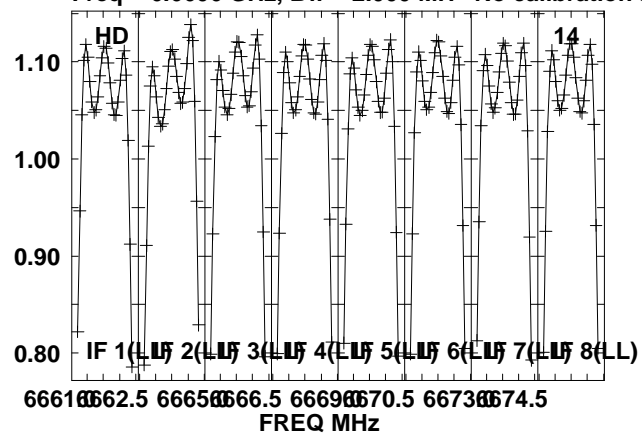

Lower frame: Real Jy

Total-power spectrum Antenna: *

Timerange: 00/15:26:09 to 00/15:28:59

Plot file version 15 created 07-JUN-2013 14:03:20

J0522+1415 N13M1.UVDATA.1

Freq = 6.6606 GHz, Bw = 2.000 MH No calibration applied and no bandpass applied

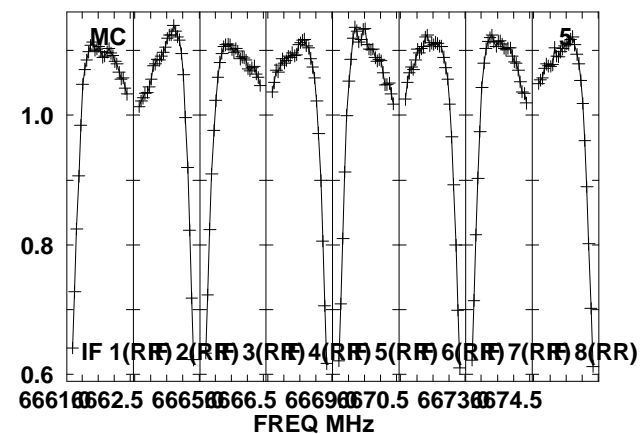
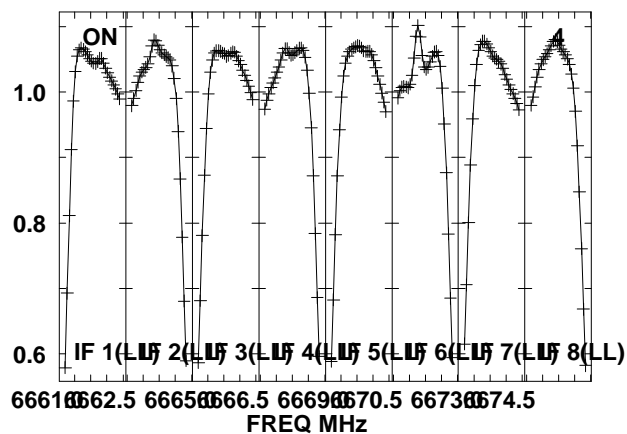
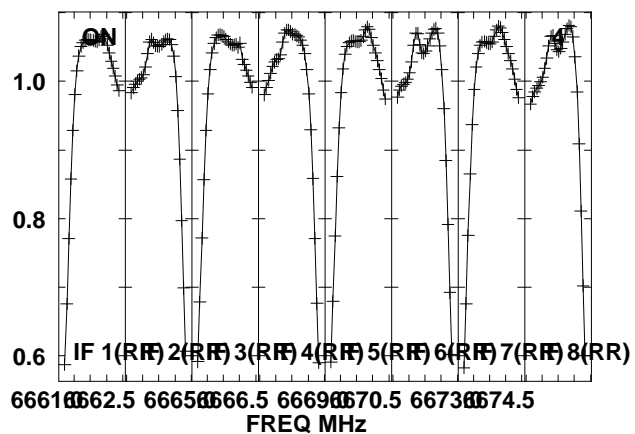
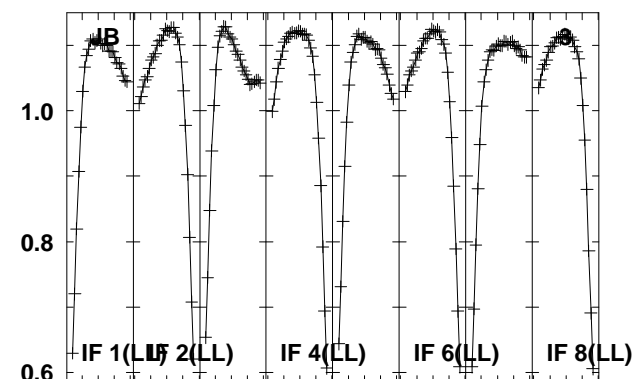
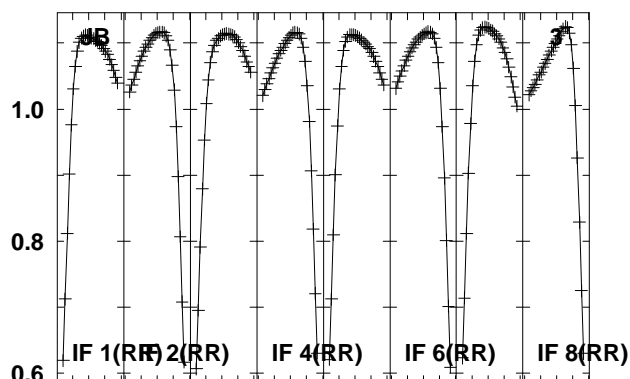
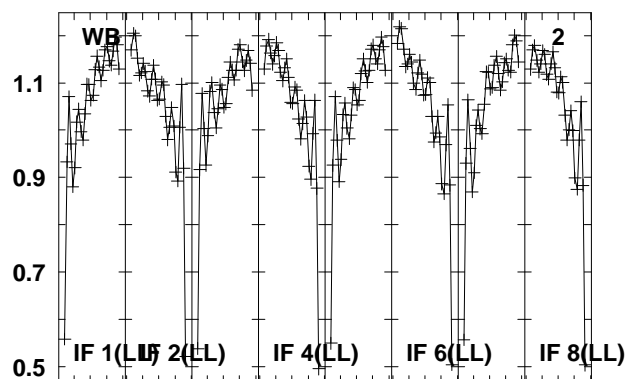
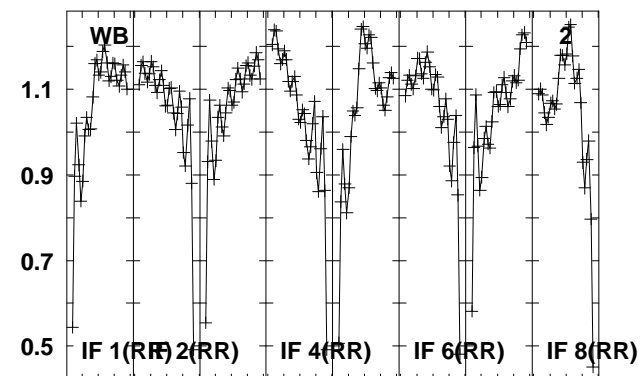
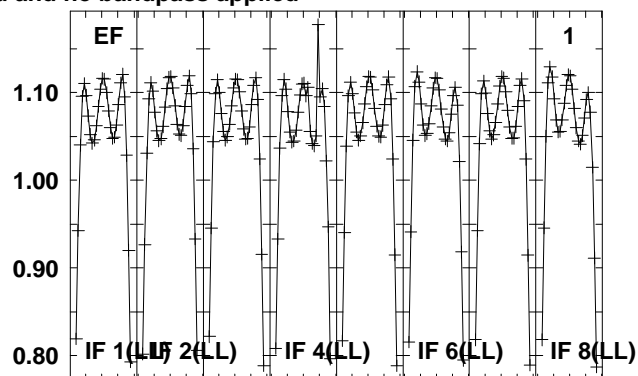
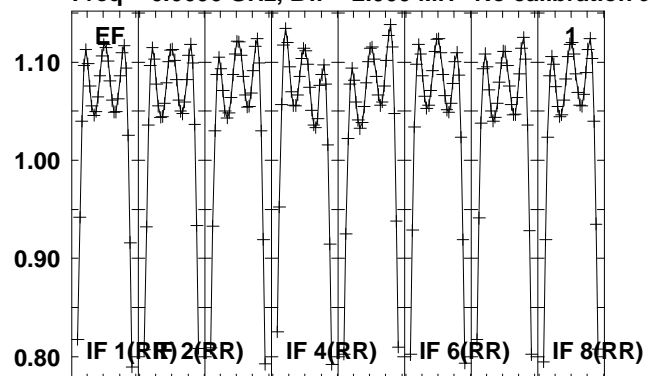

Lower frame: Real Jy

Total-power spectrum Antenna: *

Timerange: 00/15:29:09 to 00/15:30:59

Plot file version 16 created 07-JUN-2013 14:03:20

J0522+1415 N13M1.UVDATA.1

Freq = 6.6606 GHz, Bw = 2.000 MH No calibration applied and no bandpass applied

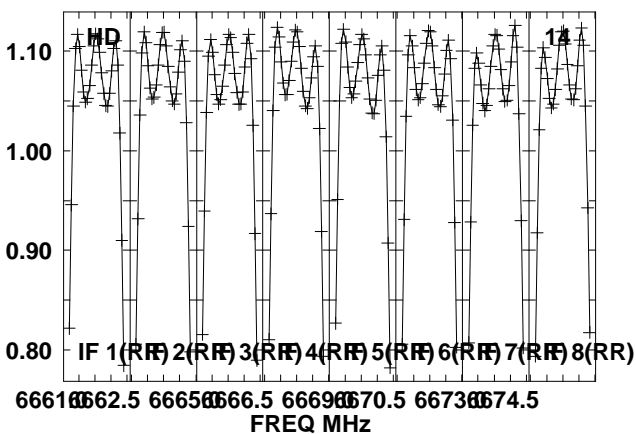
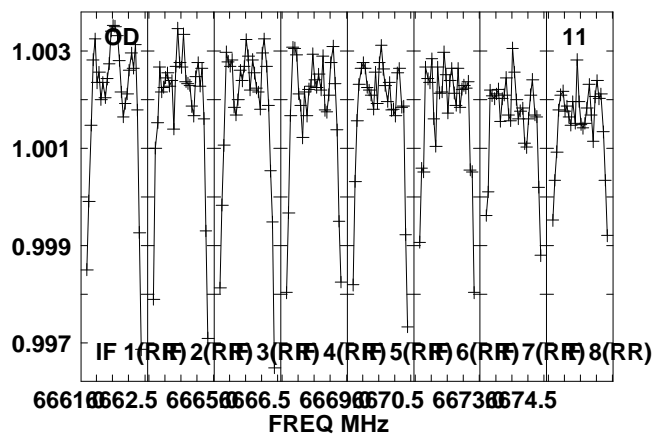
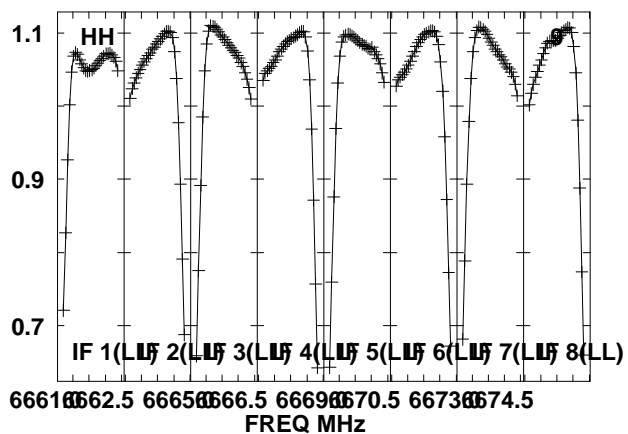
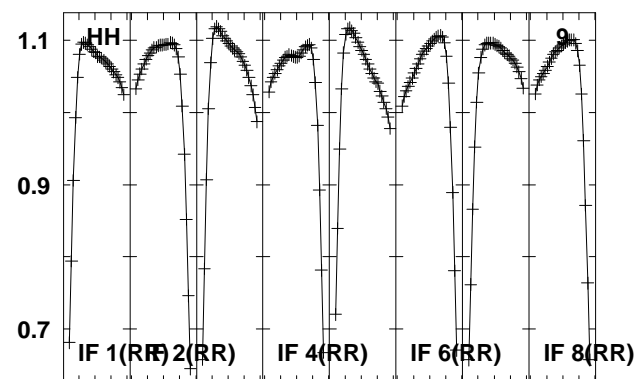
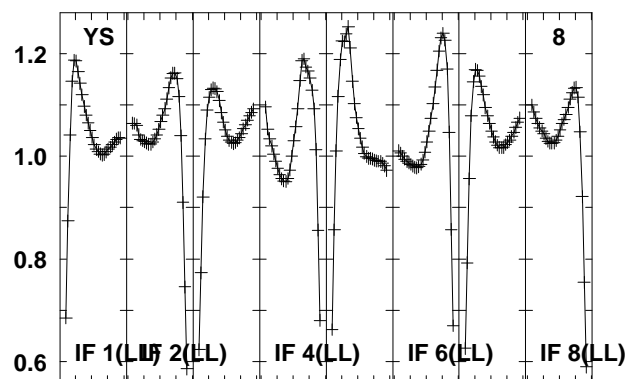
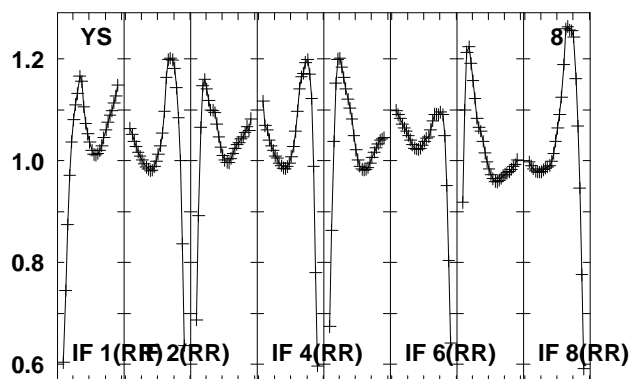
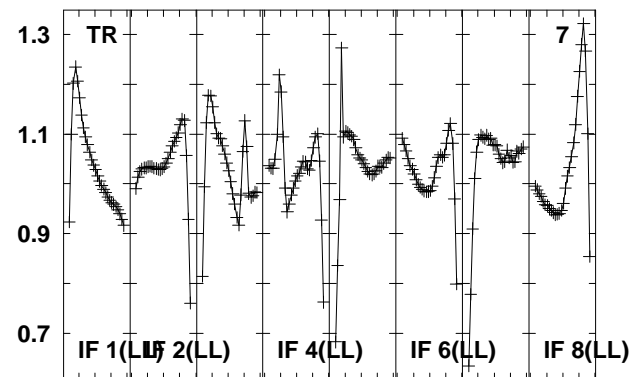
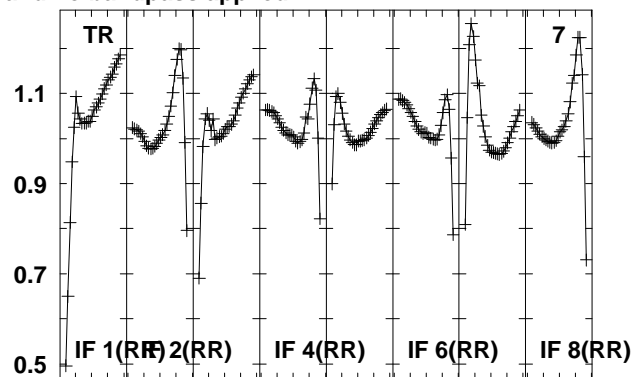
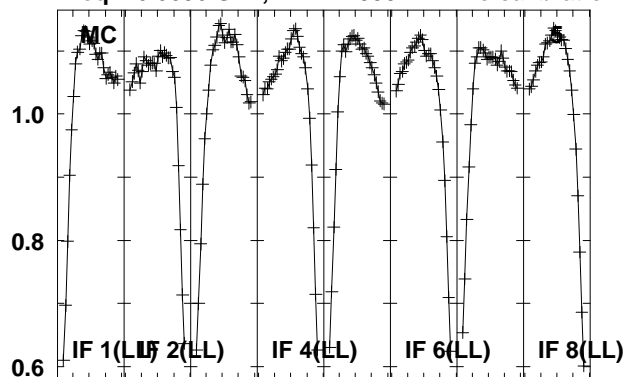

Lower frame: Real Jy
Total-power spectrum Antenna: *
Timerange: 00/15:29:09 to 00/15:30:59

Plot file version 17 created 07-JUN-2013 14:03:20

J0522+1415 N13M1.UVDATA.1

Freq = 6.6606 GHz, Bw = 2.000 MH No calibration applied and no bandpass applied

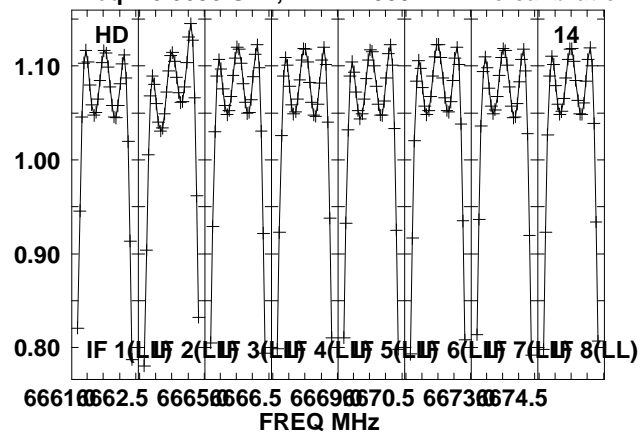

Lower frame: Real Jy

Total-power spectrum Antenna: *

Timerange: 00/15:29:09 to 00/15:30:59

Plot file version 18 created 07-JUN-2013 14:03:20

0528+134 N13M1.UVDATA.1

Freq = 6.6606 GHz, Bw = 2.000 MH No calibration applied and no bandpass applied

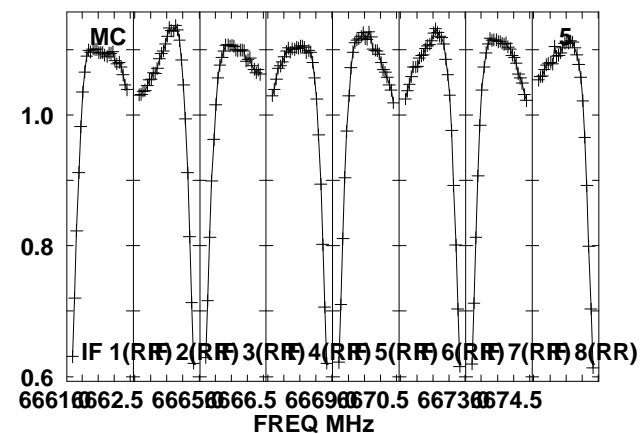
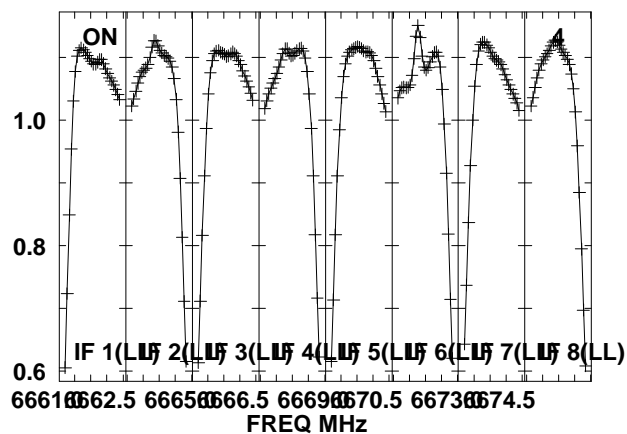
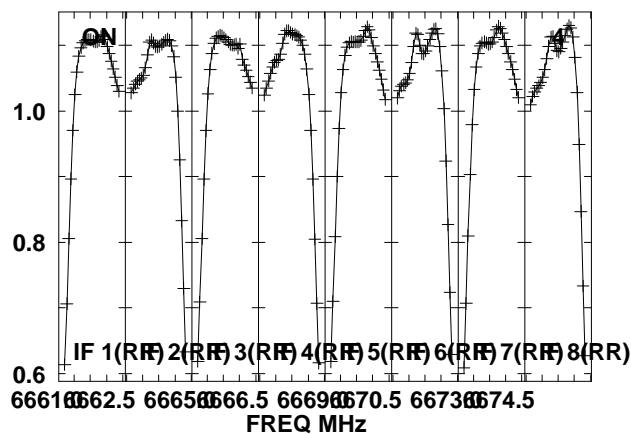
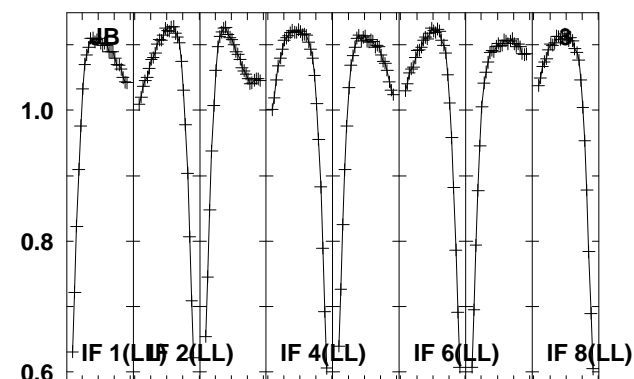
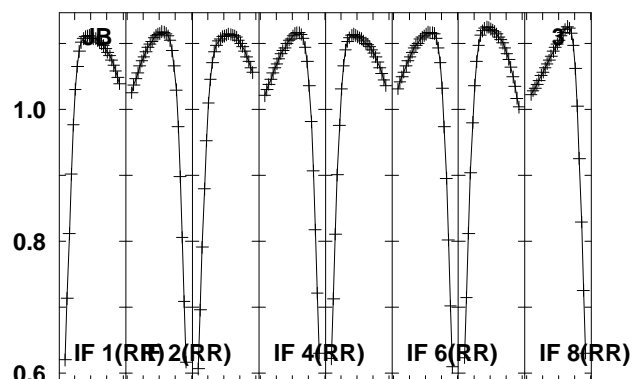
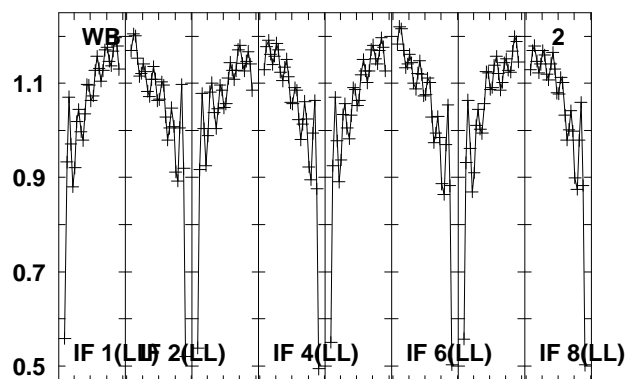
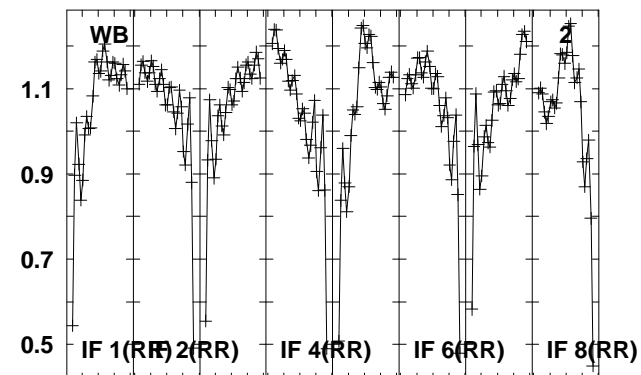
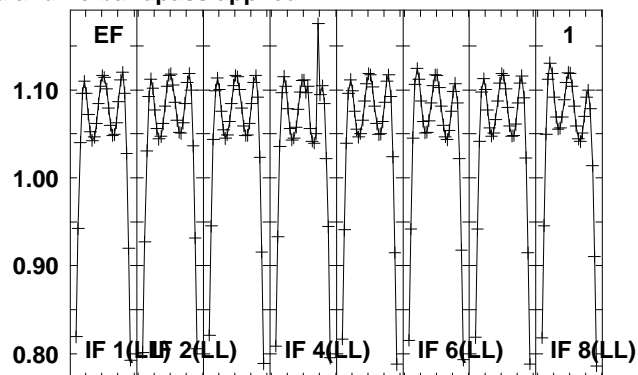
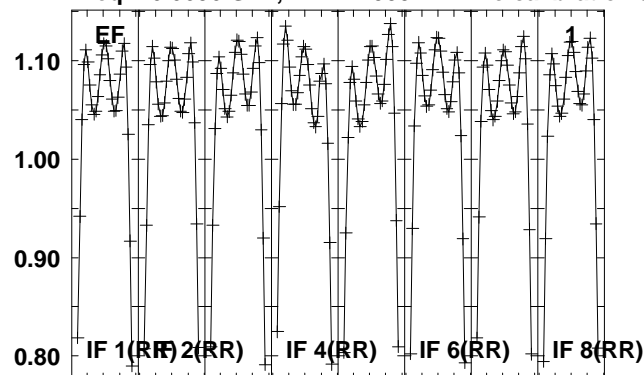

Lower frame: Real Jy
Total-power spectrum Antenna: *
Timerange: 00/15:31:09 to 00/15:33:59

Plot file version 19 created 07-JUN-2013 14:03:21

0528+134 N13M1.UVDATA.1

Freq = 6.6606 GHz, Bw = 2.000 MH No calibration applied and no bandpass applied

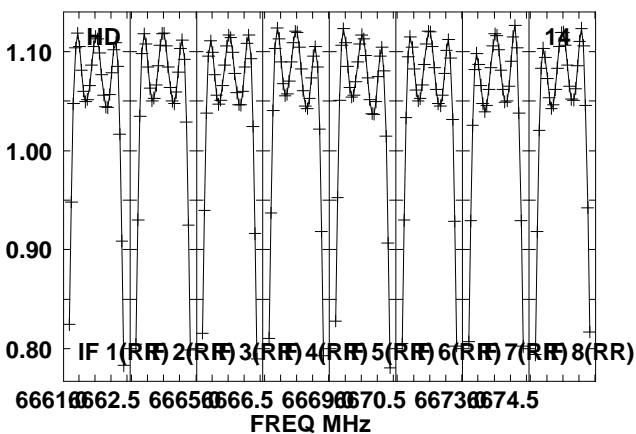
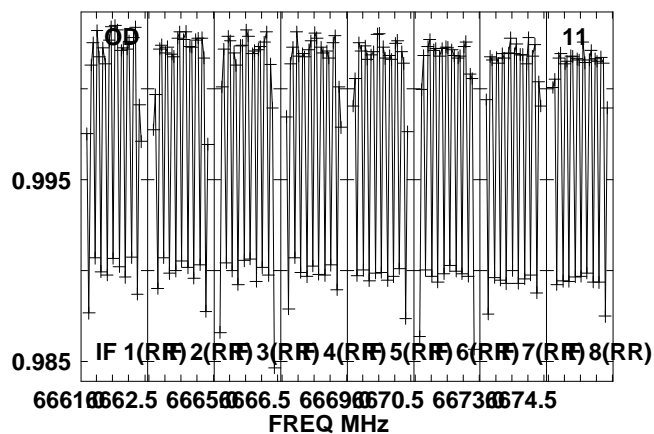
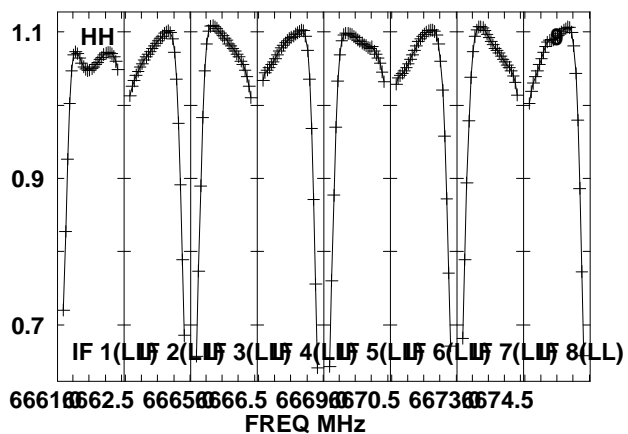
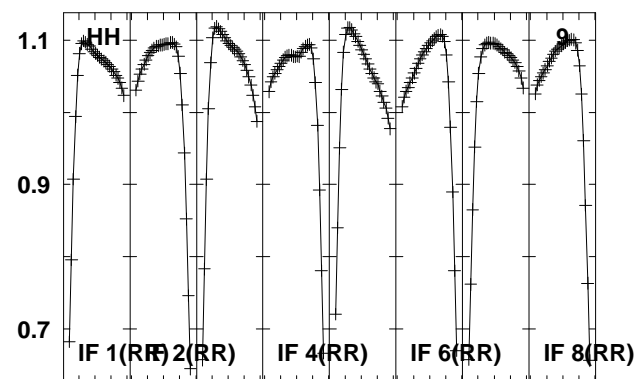
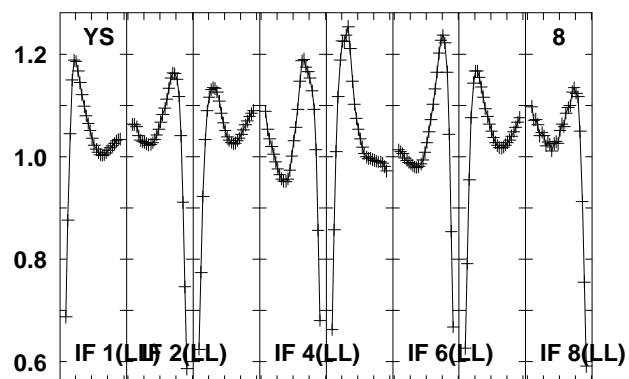
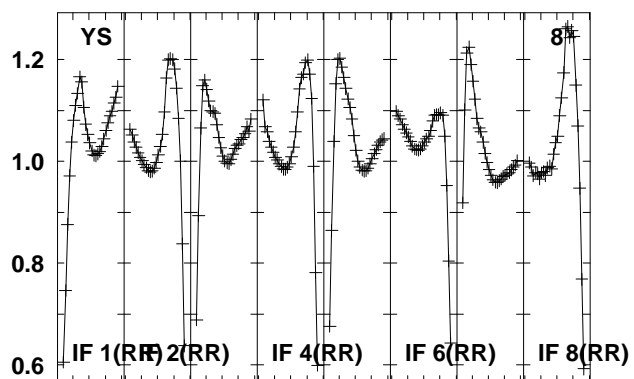
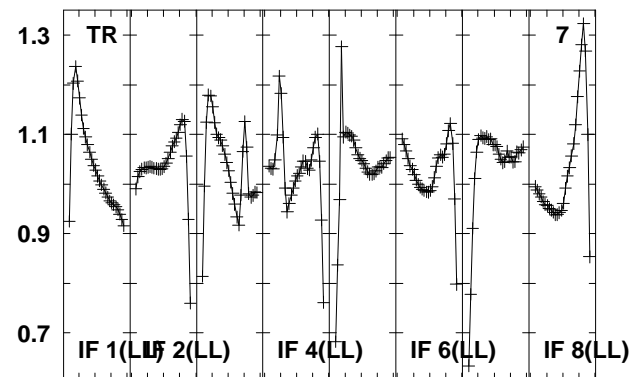
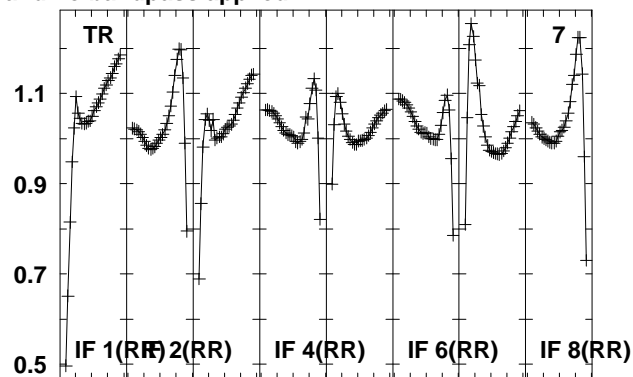
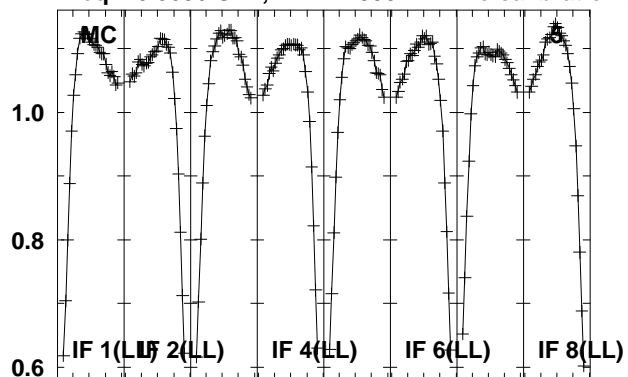

6661 6662.5 6665 6666.5 6669 6670.5 6673 6674.5
FREQ MHz

6661 6662.5 6665 6666.5 6669 6670.5 6673 6674.5
FREQ MHz

6661 6662.5 6665 6666.5 6669 6670.5 6673 6674.5
FREQ MHz

Lower frame: Real Jy
Total-power spectrum Antenna: *
Timerange: 00/15:31:09 to 00/15:33:59

Plot file version 20 created 07-JUN-2013 14:03:21

0528+134 N13M1.UVDATA.1

Freq = 6.6606 GHz, Bw = 2.000 MH No calibration applied and no bandpass applied

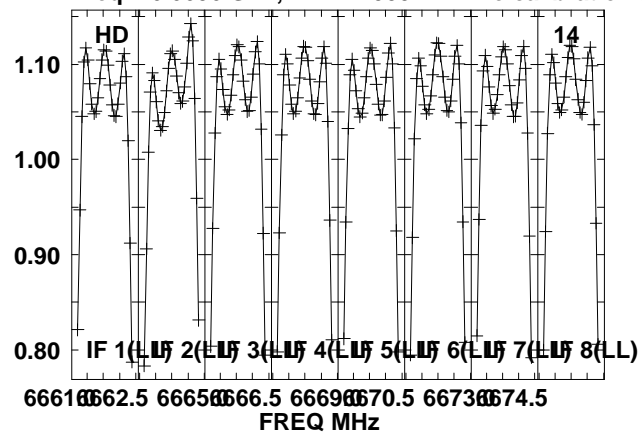

Lower frame: Real Jy

Total-power spectrum Antenna: *

Timerange: 00/15:31:09 to 00/15:33:59

Plot file version 21 created 07-JUN-2013 14:03:21

J0522+1415 N13M1.UVDATA.1

Freq = 6.6606 GHz, Bw = 2.000 MH No calibration applied and no bandpass applied

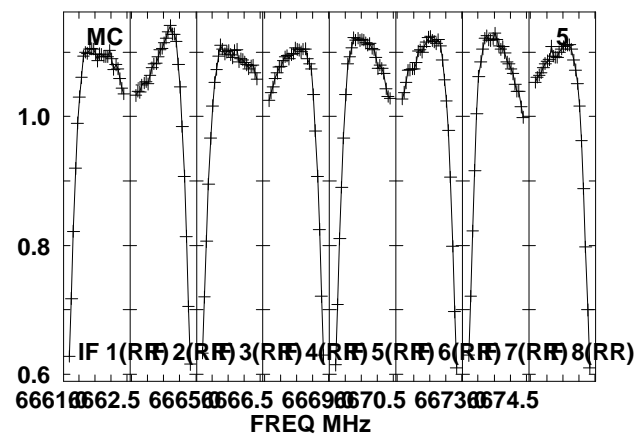
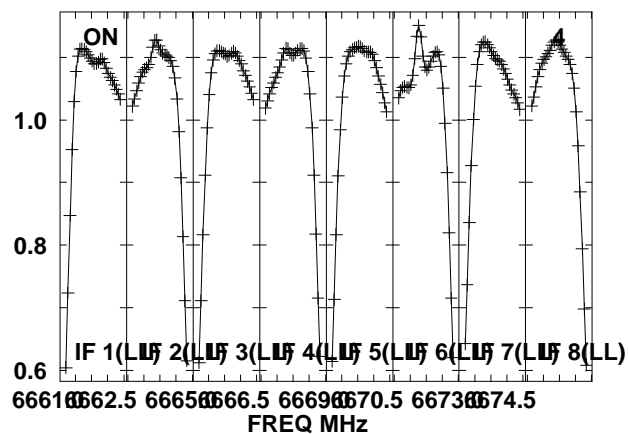
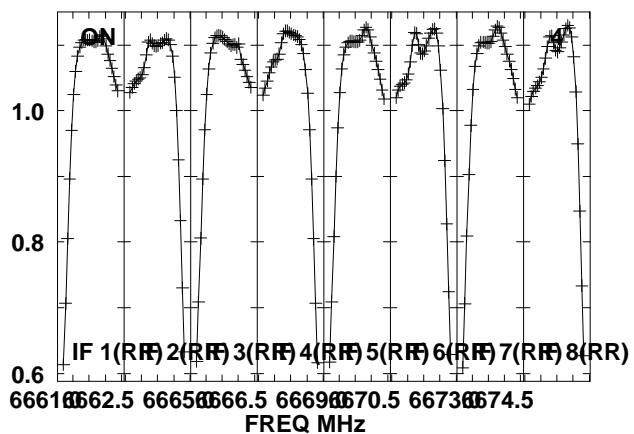
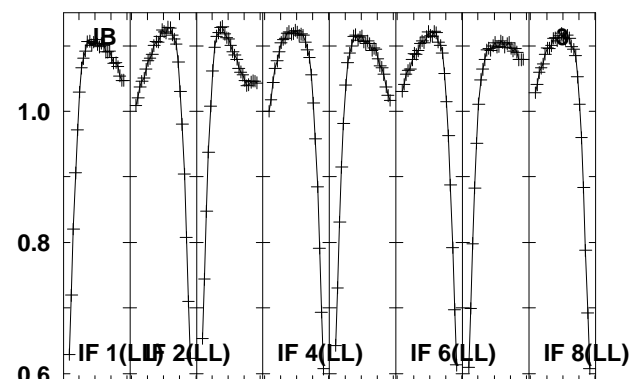
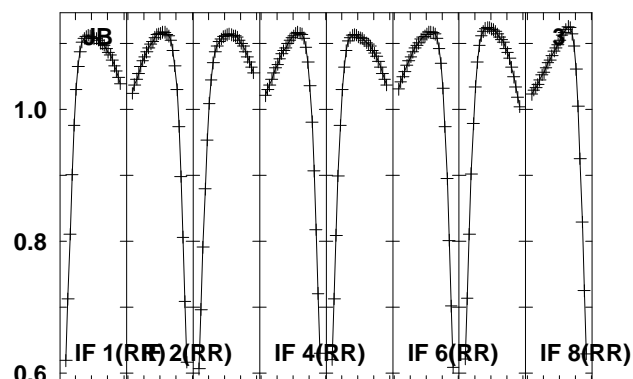
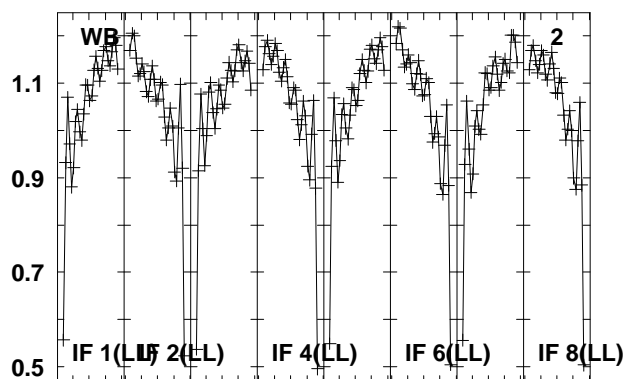
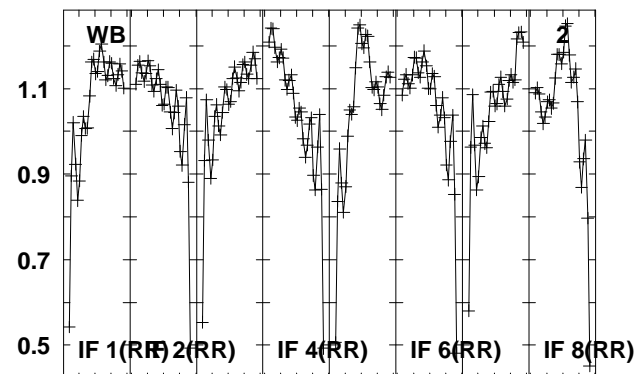
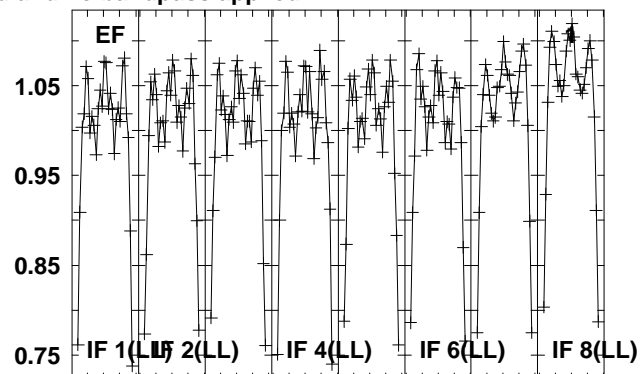
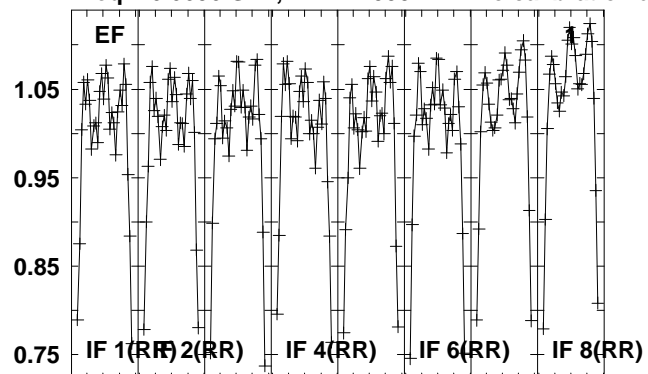

Lower frame: Real Jy
Total-power spectrum Antenna: *
Timerange: 00/15:35:03 to 00/15:36:59

Plot file version 22 created 07-JUN-2013 14:03:22

J0522+1415 N13M1.UVDATA.1

Freq = 6.6606 GHz, Bw = 2.000 MH No calibration applied and no bandpass applied

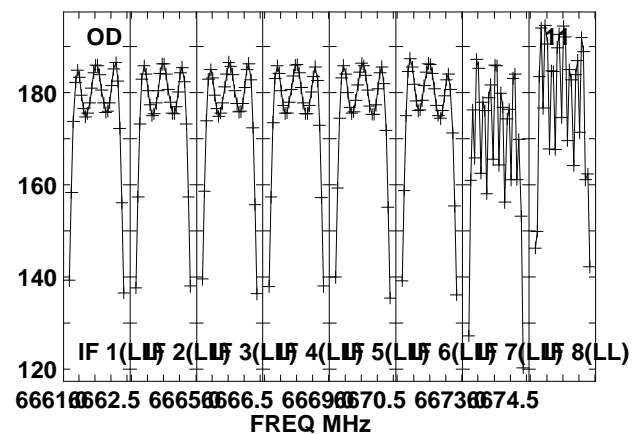
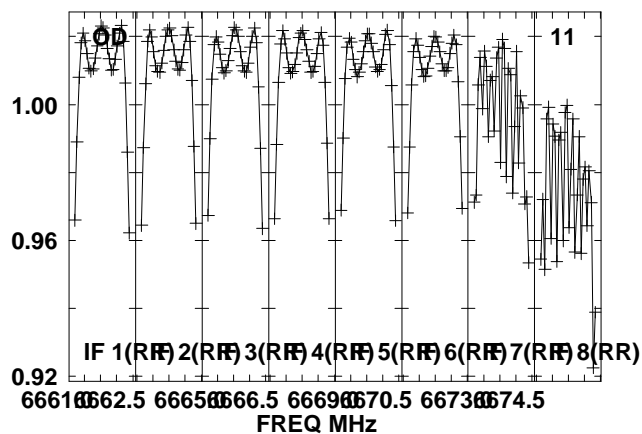
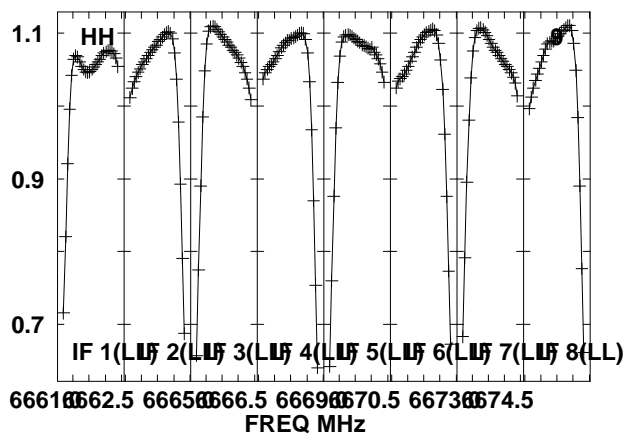
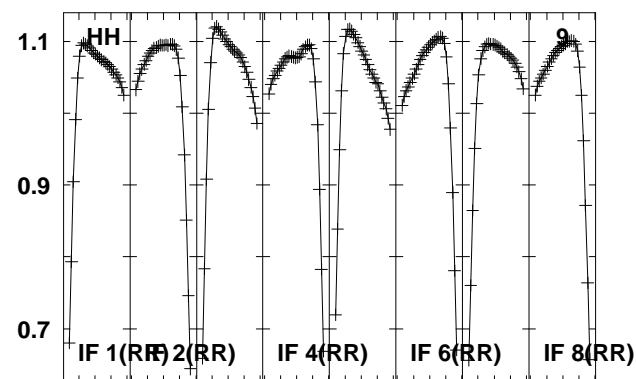
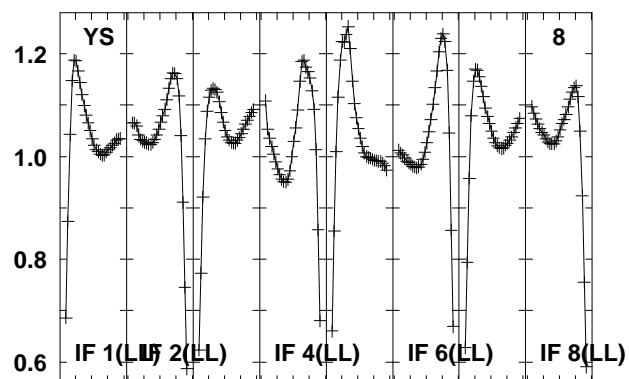
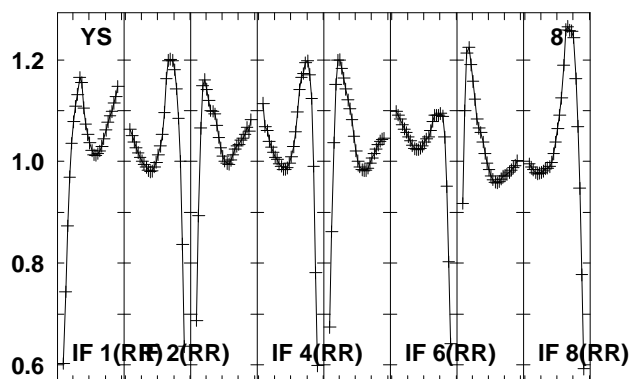
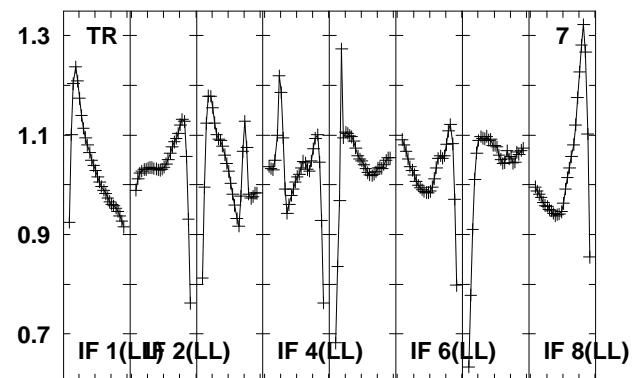
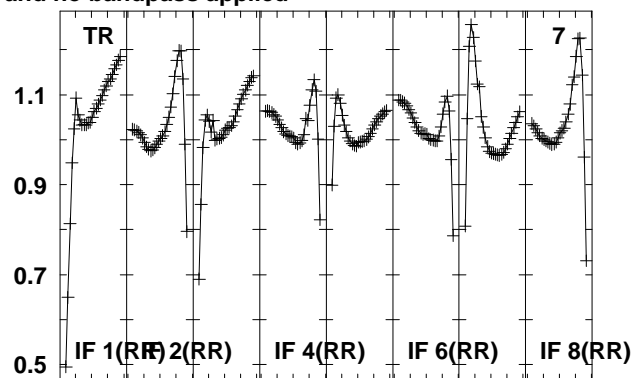
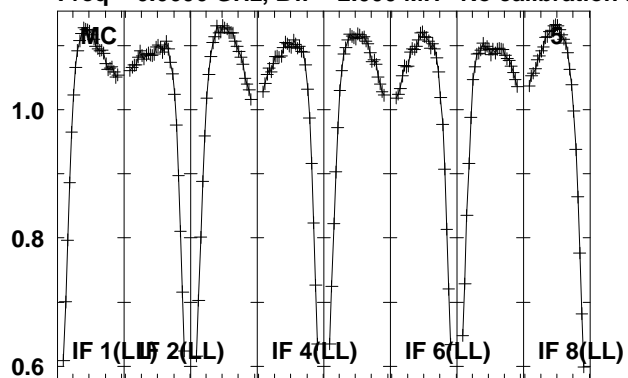

Lower frame: Real Jy
Total-power spectrum Antenna: *
Timerange: 00/15:35:03 to 00/15:36:59

Plot file version 23 created 07-JUN-2013 14:03:22

J0522+1415 N13M1.UVDATA.1

Freq = 6.6606 GHz, Bw = 2.000 MH No calibration applied and no bandpass applied

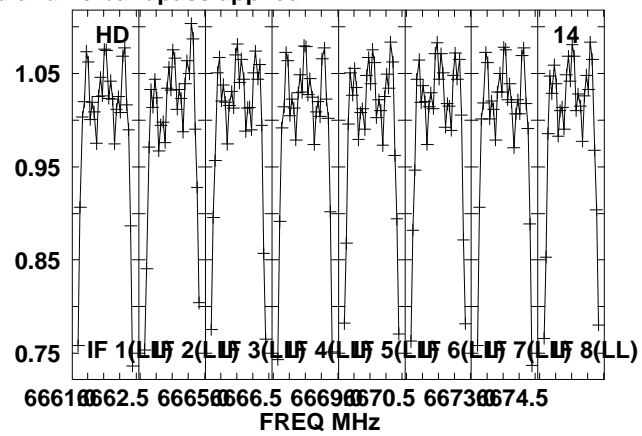
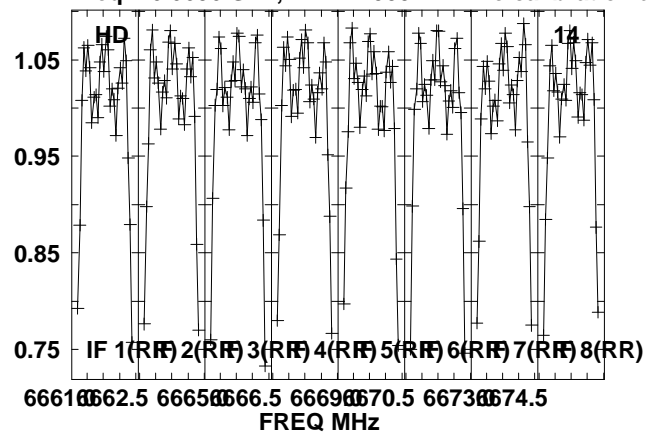

Lower frame: Real Jy
Total-power spectrum Antenna: *
Timerange: 00/15:35:03 to 00/15:36:59

Plot file version 24 created 07-JUN-2013 14:03:22

0528+134 N13M1.UVDATA.1

Freq = 6.6606 GHz, Bw = 2.000 MH No calibration applied and no bandpass applied

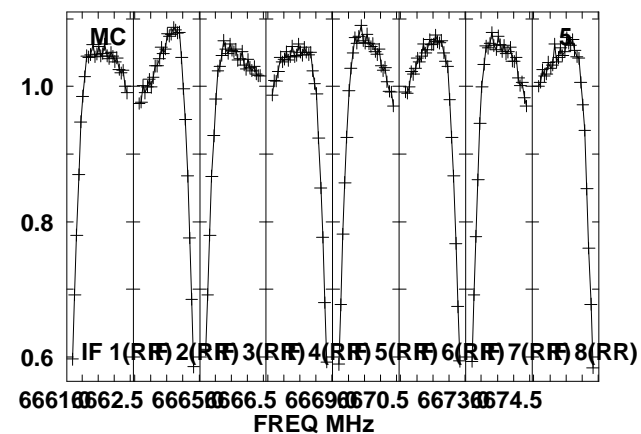
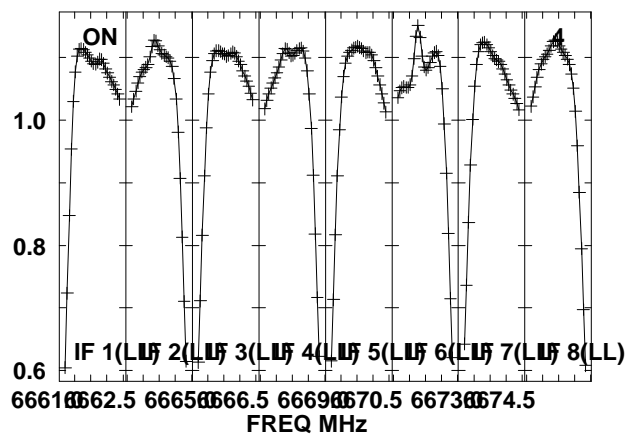
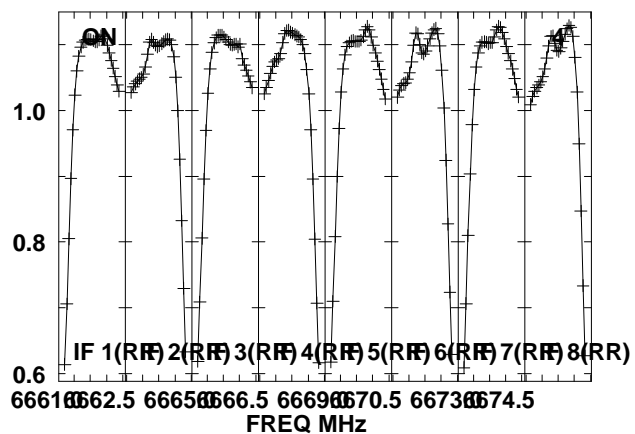
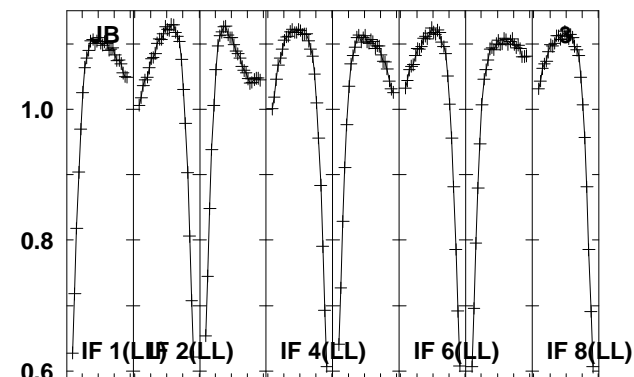
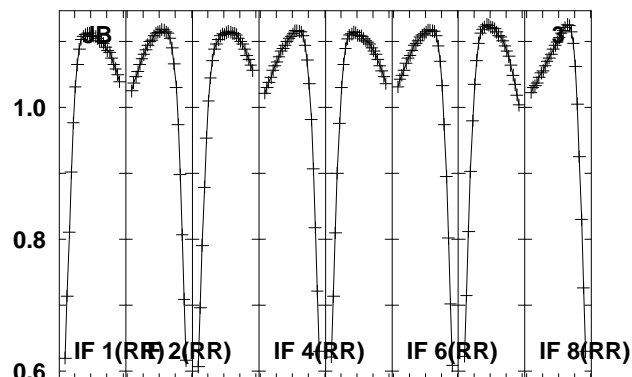
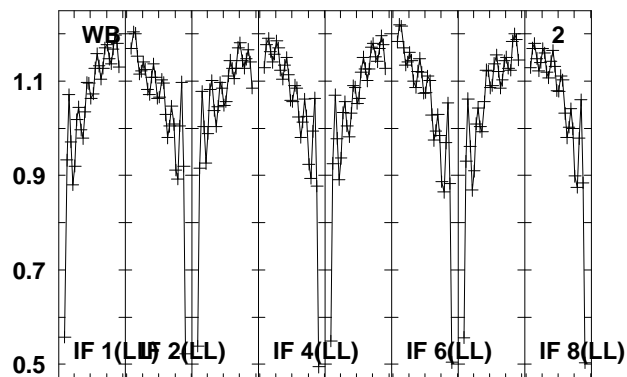
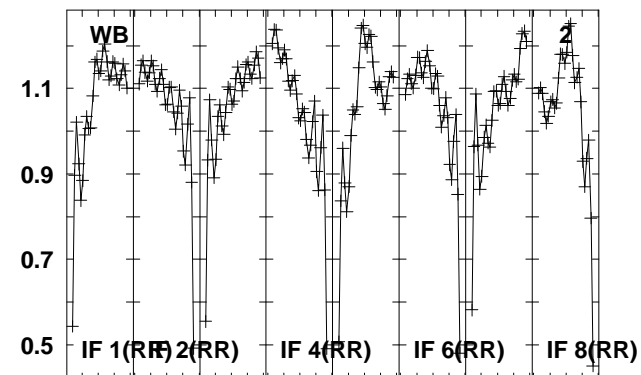
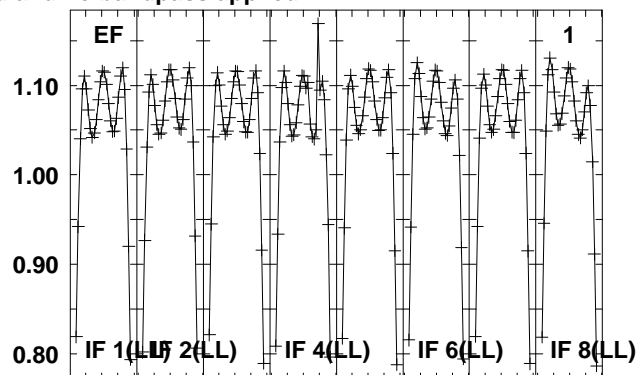
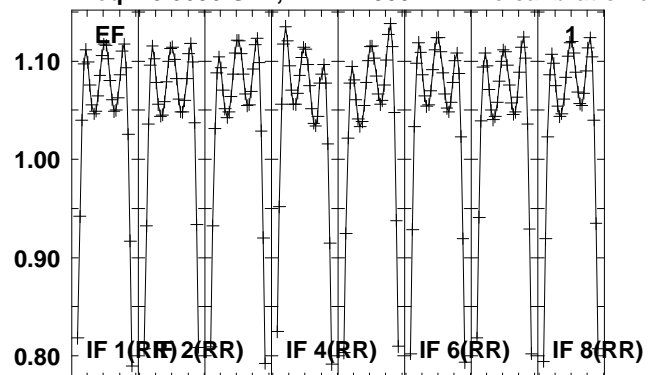

Lower frame: Real Jy

Total-power spectrum Antenna: *

Timerange: 00/15:37:09 to 00/15:39:59

Plot file version 25 created 07-JUN-2013 14:03:23

0528+134 N13M1.UVDATA.1

Freq = 6.6606 GHz, Bw = 2.000 MH No calibration applied and no bandpass applied

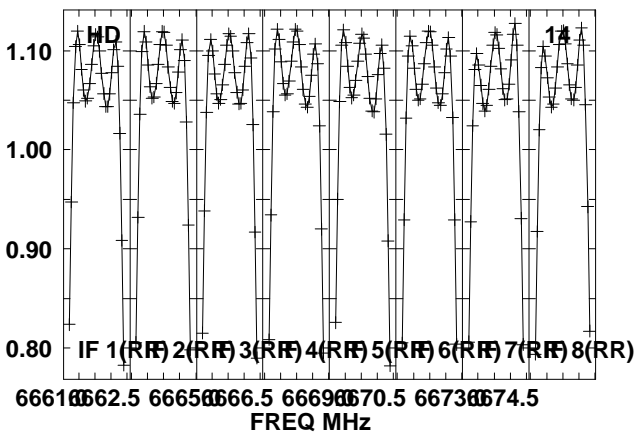
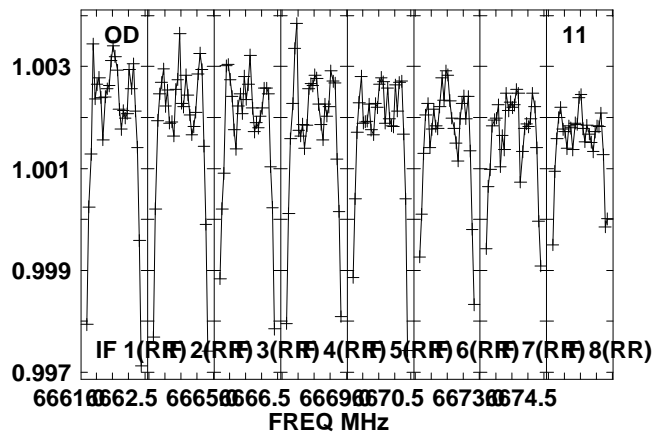
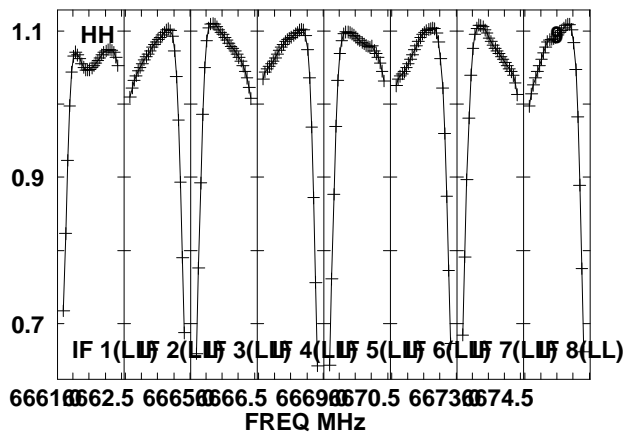
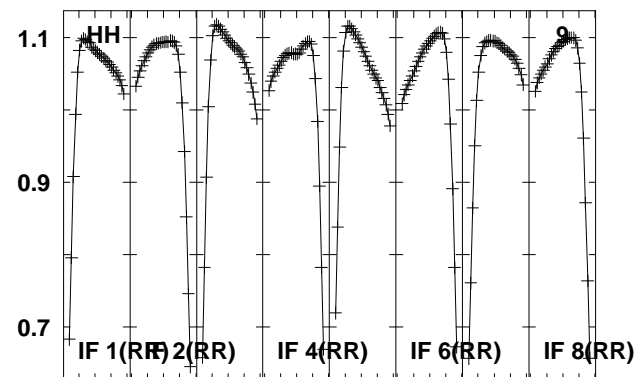
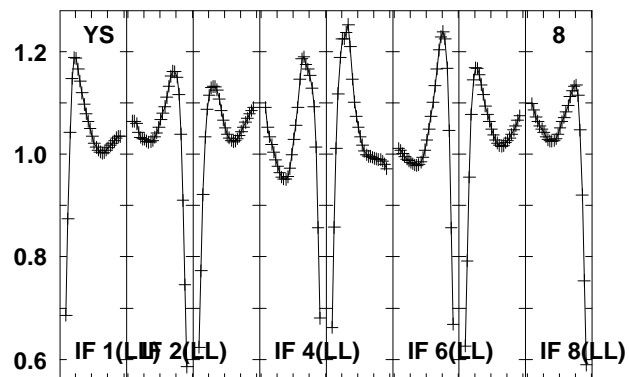
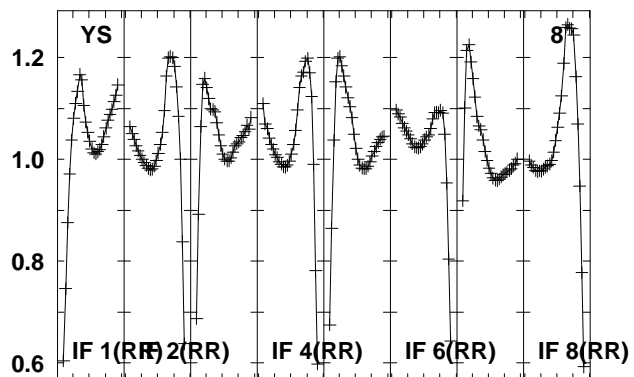
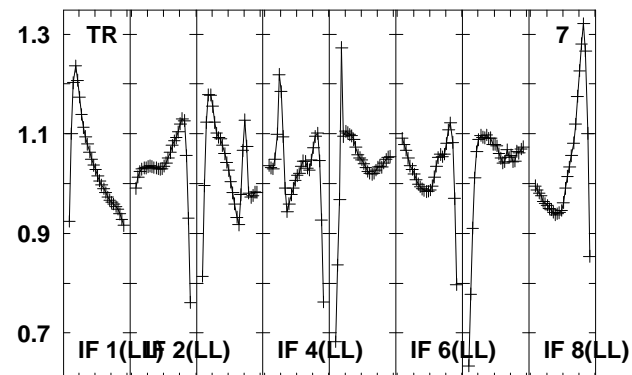
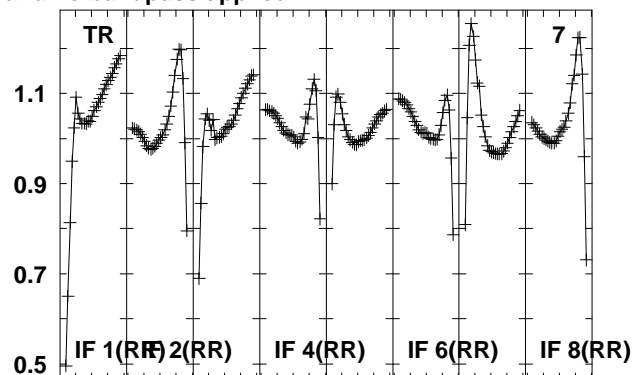
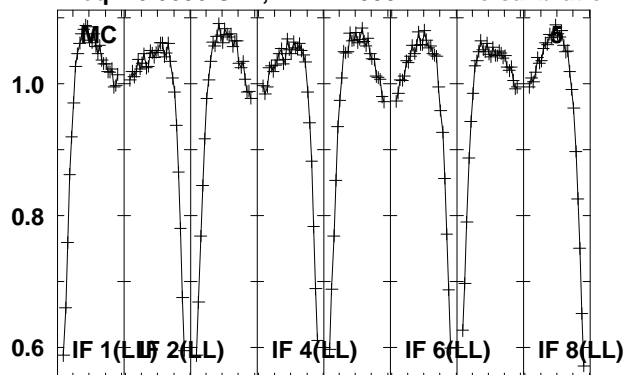

Lower frame: Real Jy
Total-power spectrum Antenna: *
Timerange: 00/15:37:09 to 00/15:39:59

Plot file version 26 created 07-JUN-2013 14:03:23

0528+134 N13M1.UVDATA.1

Freq = 6.6606 GHz, Bw = 2.000 MH No calibration applied and no bandpass applied

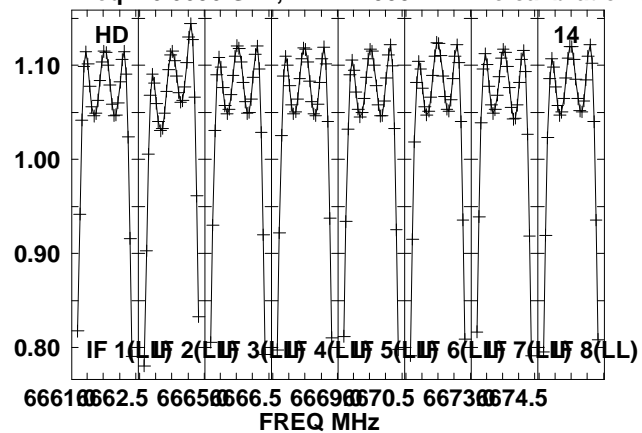

Lower frame: Real Jy

Total-power spectrum Antenna: *

Timerange: 00/15:37:09 to 00/15:39:59

Plot file version 27 created 07-JUN-2013 14:03:23

J0522+1415 N13M1.UVDATA.1

Freq = 6.6606 GHz, Bw = 2.000 MH No calibration applied and no bandpass applied

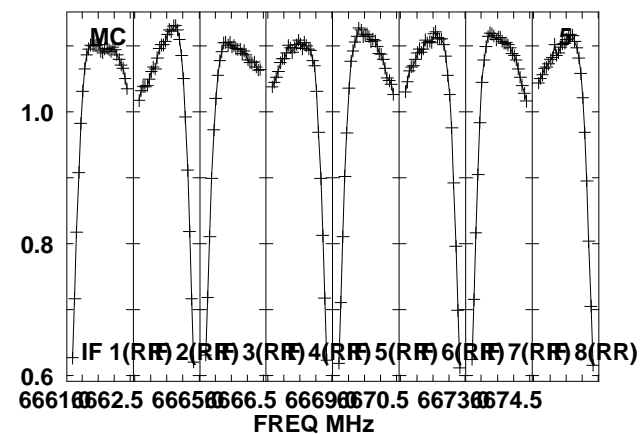
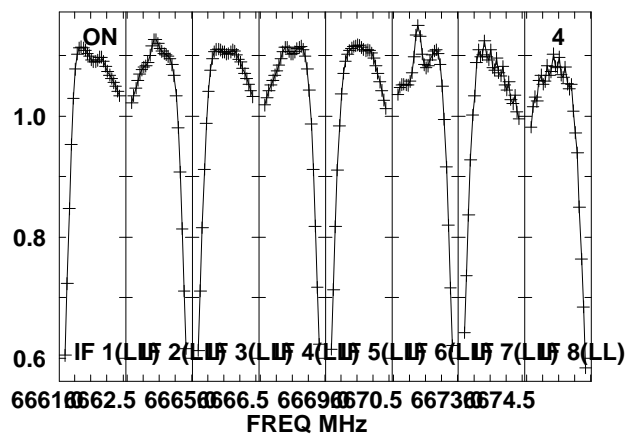
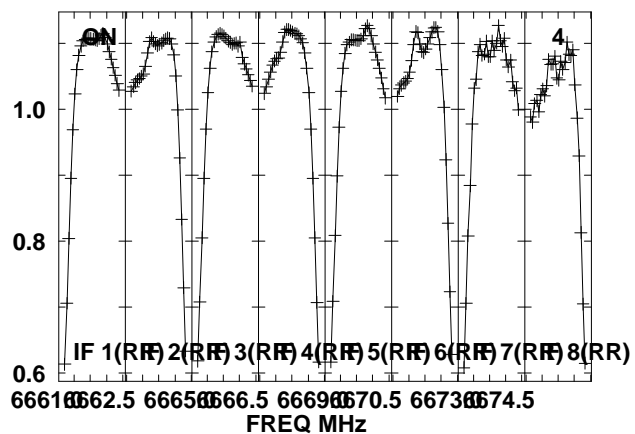
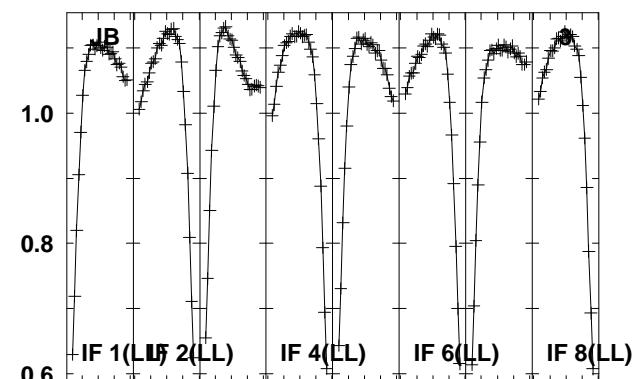
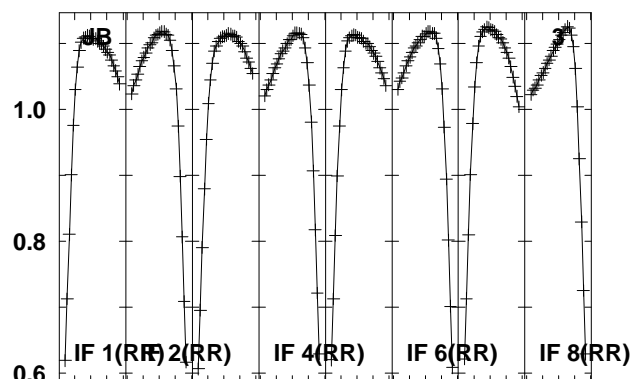
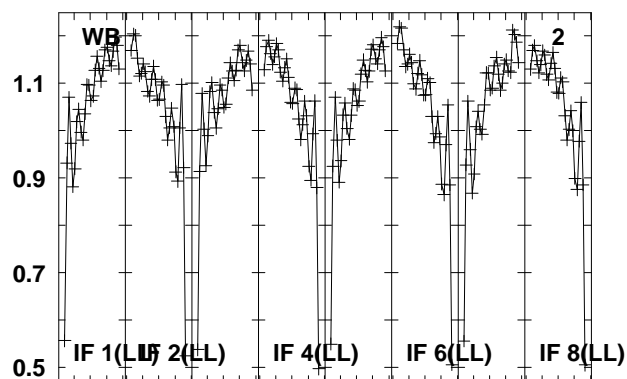
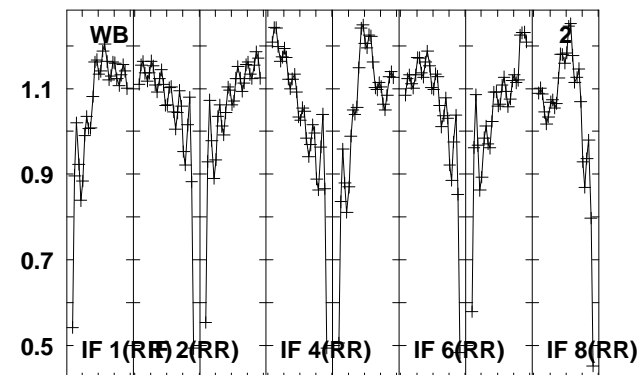
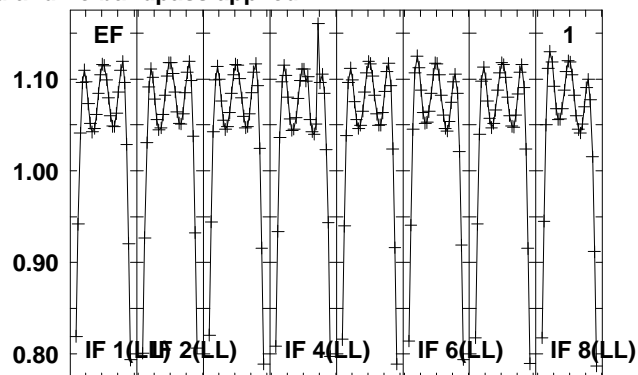
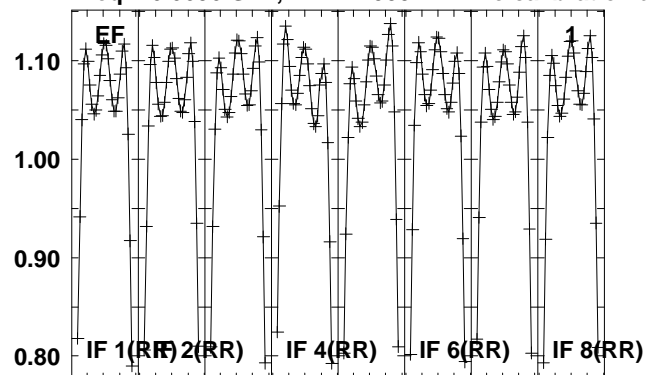

Lower frame: Real Jy

Total-power spectrum Antenna: *

Timerange: 00/15:40:09 to 00/15:41:59

Plot file version 28 created 07-JUN-2013 14:03:24

J0522+1415 N13M1.UVDATA.1

Freq = 6.6606 GHz, Bw = 2.000 MH No calibration applied and no bandpass applied

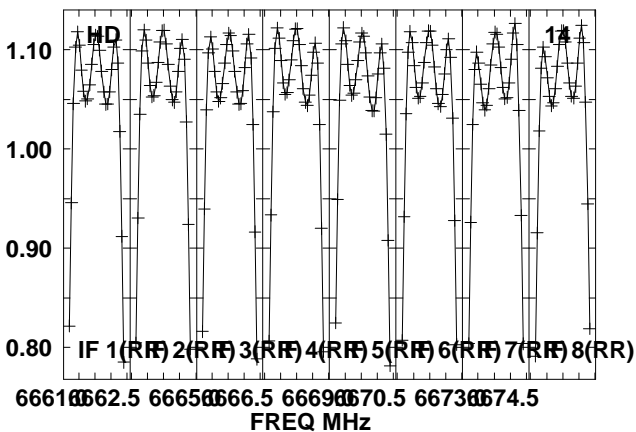
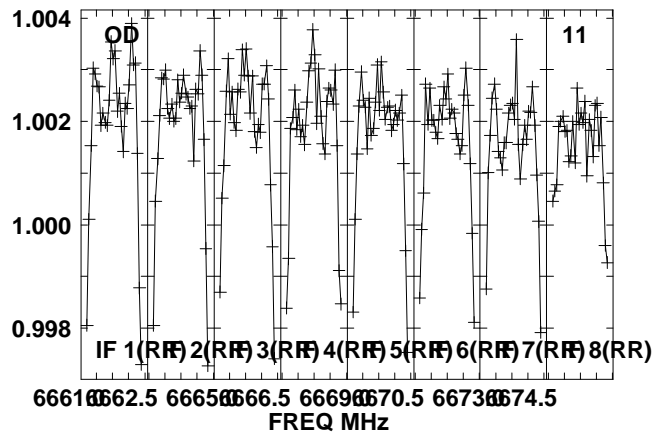
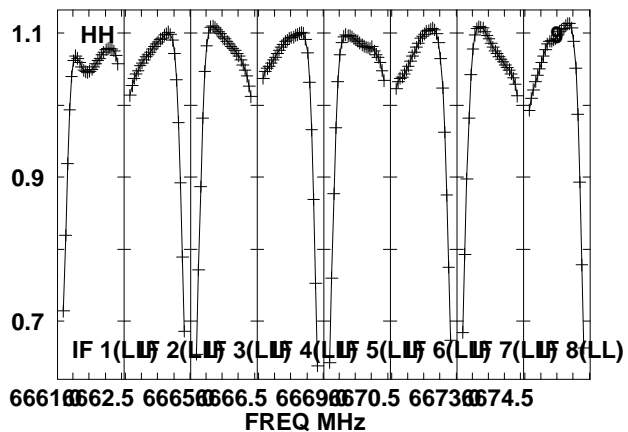
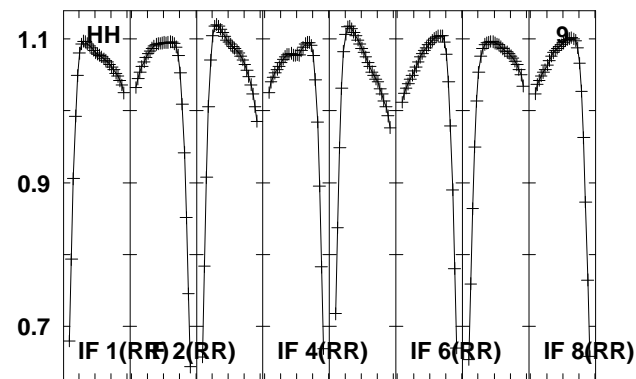
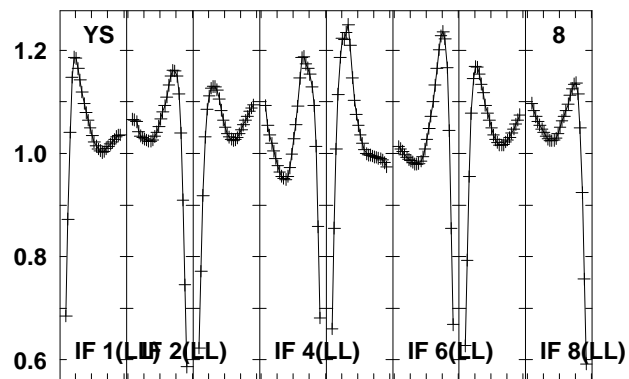
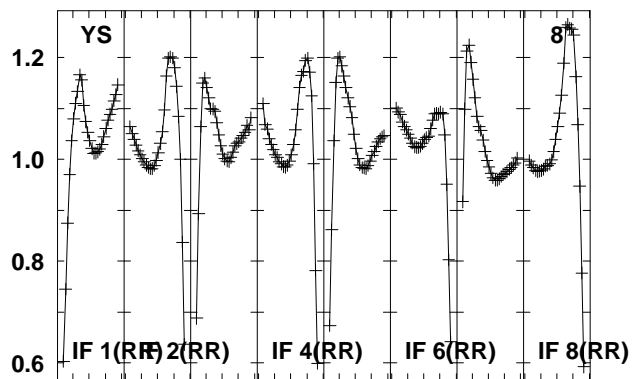
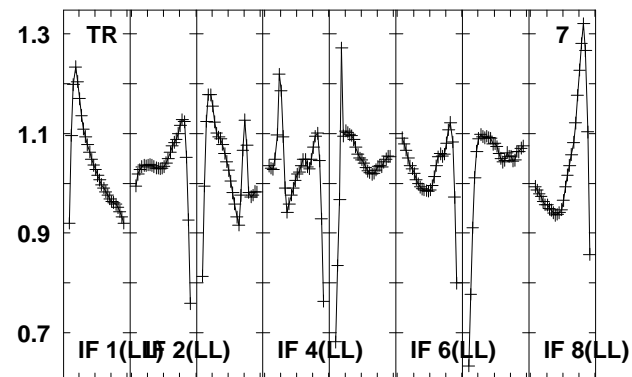
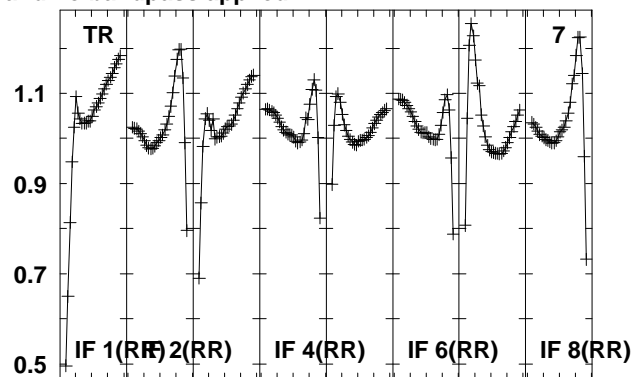
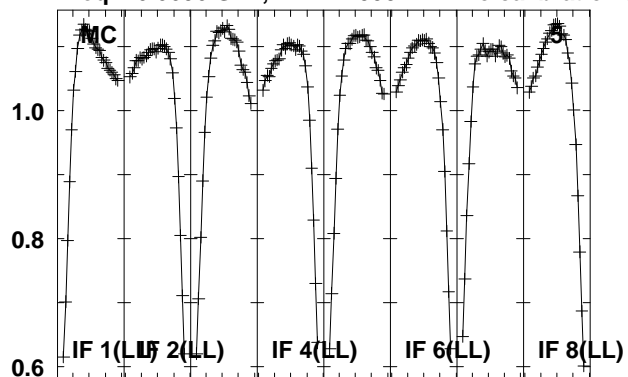

6661 6662.5 6665 6666.5 6669 6670.5 6673 6674.5
FREQ MHz

Lower frame: Real Jy
Total-power spectrum Antenna: *
Timerange: 00/15:40:09 to 00/15:41:59

Plot file version 29 created 07-JUN-2013 14:03:24

J0522+1415 N13M1.UVDATA.1

Freq = 6.6606 GHz, Bw = 2.000 MH No calibration applied and no bandpass applied

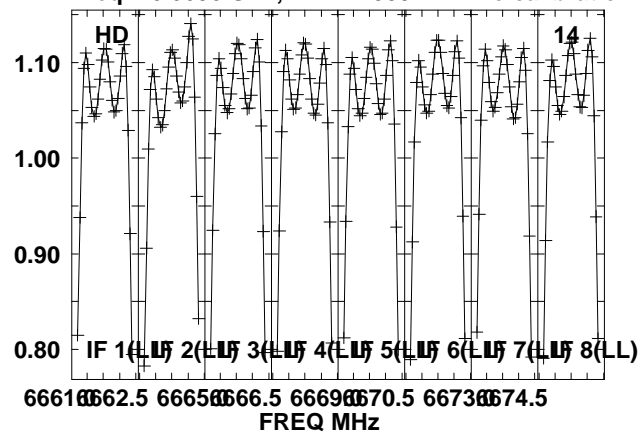

Lower frame: Real Jy

Total-power spectrum Antenna: *

Timerange: 00/15:40:09 to 00/15:41:59

Plot file version 30 created 07-JUN-2013 14:03:24

0528+134 N13M1.UVDATA.1

Freq = 6.6606 GHz, Bw = 2.000 MH No calibration applied and no bandpass applied

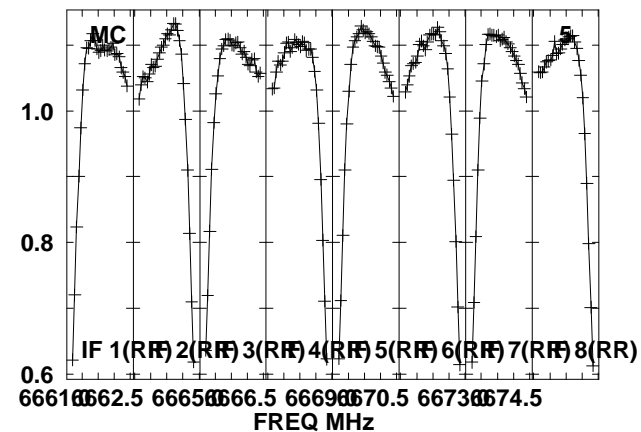
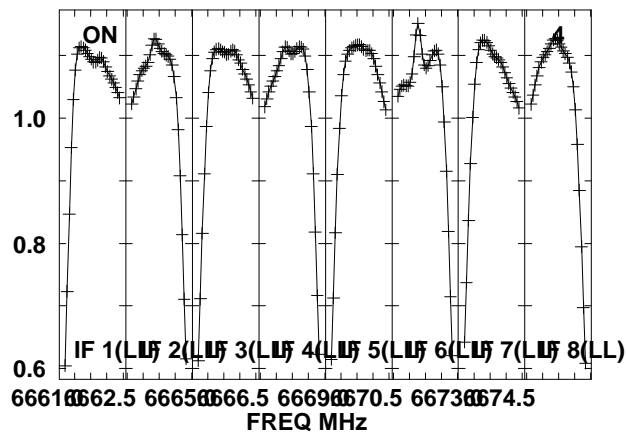
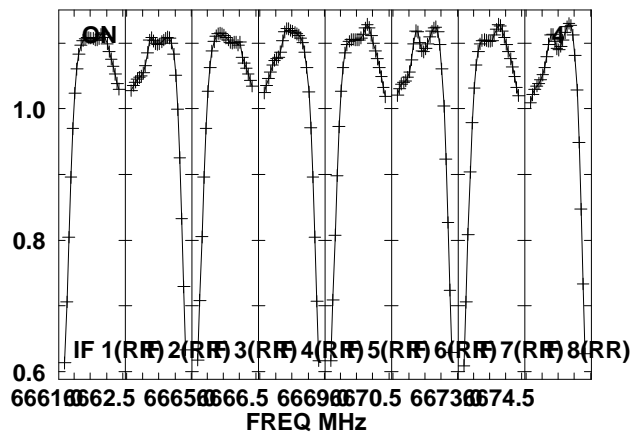
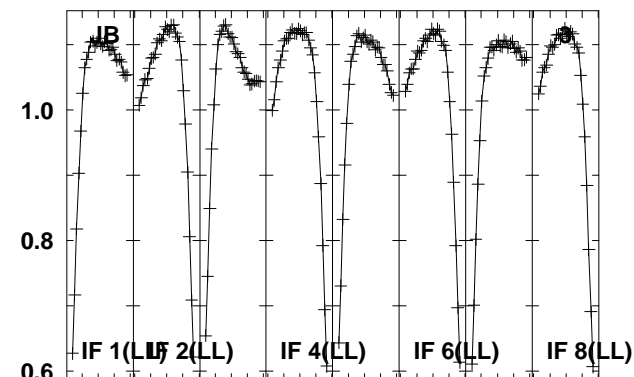
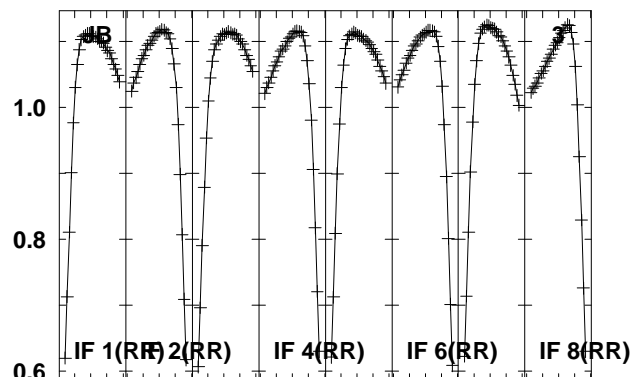
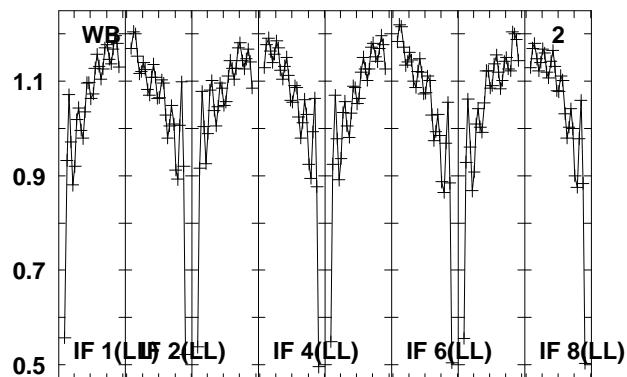
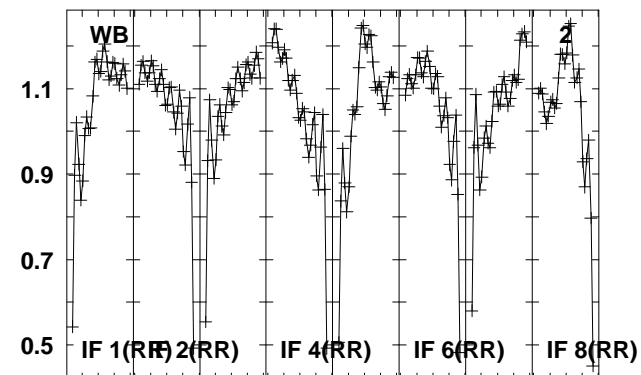
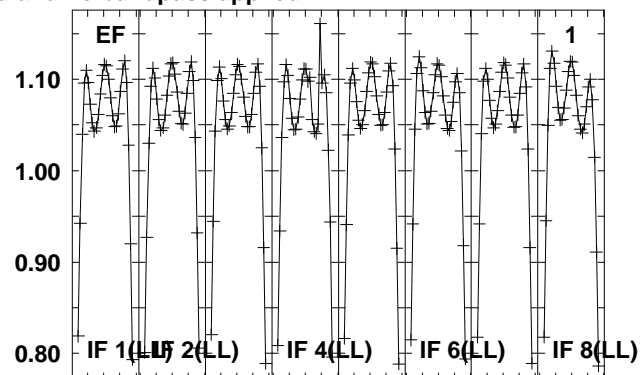
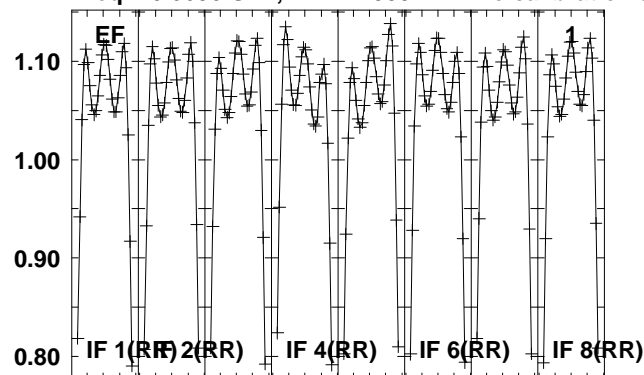

Lower frame: Real Jy
Total-power spectrum Antenna: *
Timerange: 00/15:42:09 to 00/15:44:59

Plot file version 31 created 07-JUN-2013 14:03:24

0528+134 N13M1.UVDATA.1

Freq = 6.6606 GHz, Bw = 2.000 MH No calibration applied and no bandpass applied

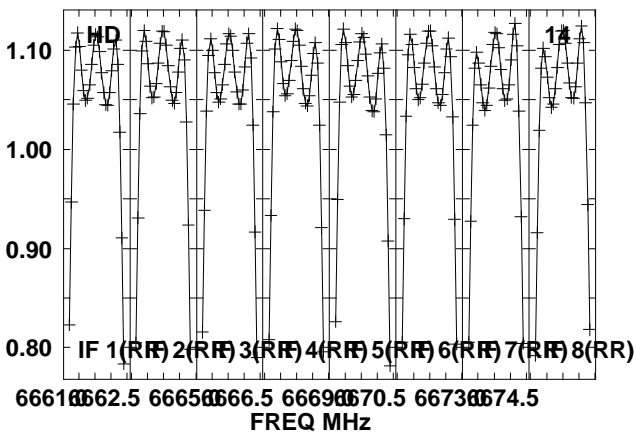
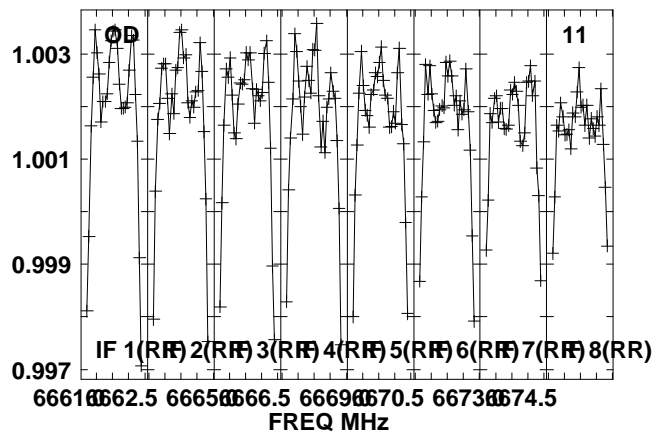
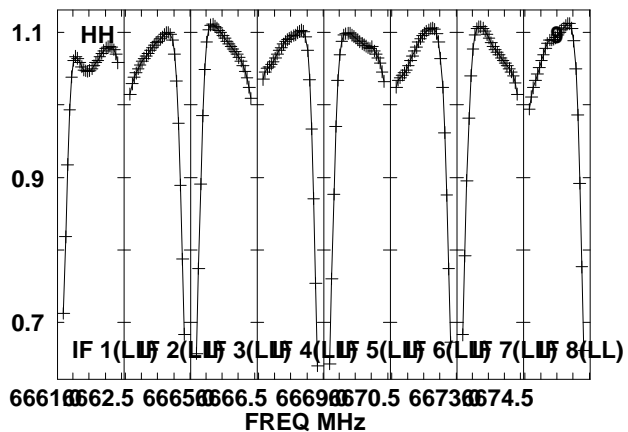
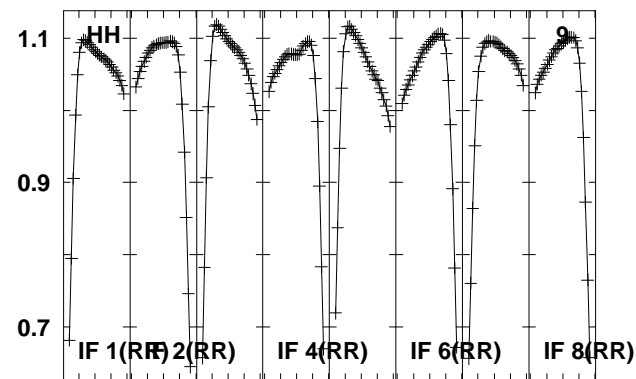
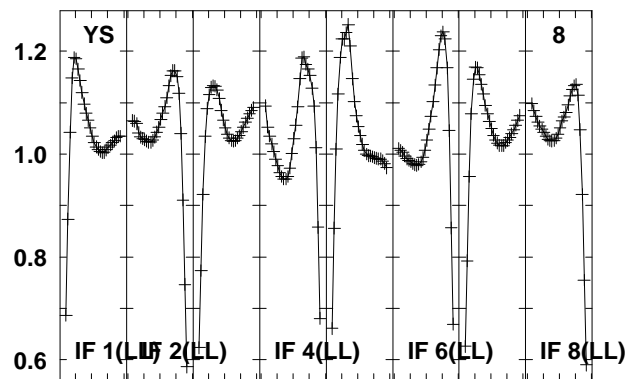
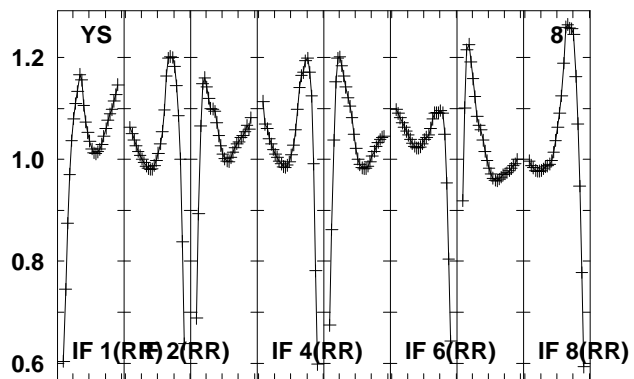
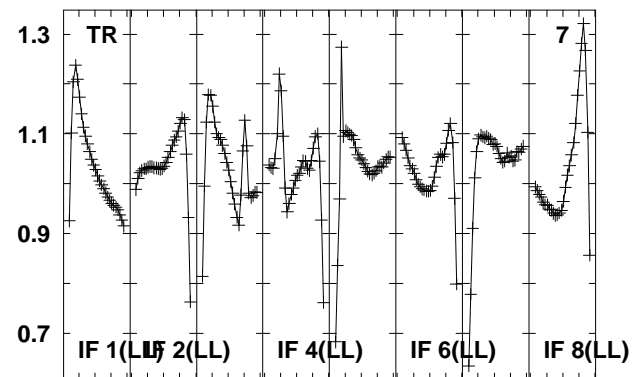
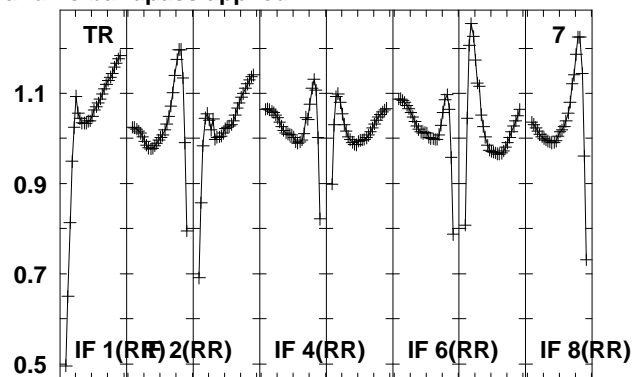
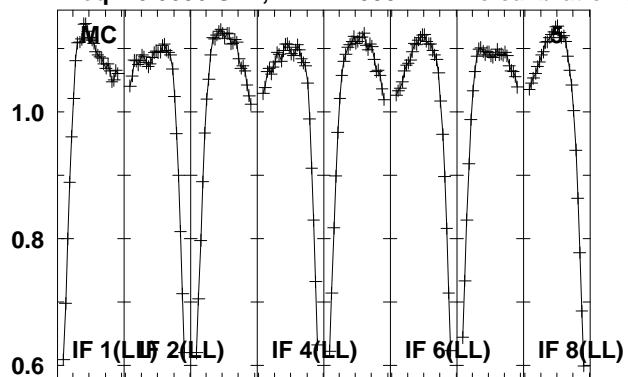

Lower frame: Real Jy
Total-power spectrum Antenna: *
Timerange: 00/15:42:09 to 00/15:44:59

Plot file version 32 created 07-JUN-2013 14:03:25
0528+134 N13M1.UVDATA.1
Freq = 6.6606 GHz, Bw = 2.000 MH No calibration applied and no bandpass applied

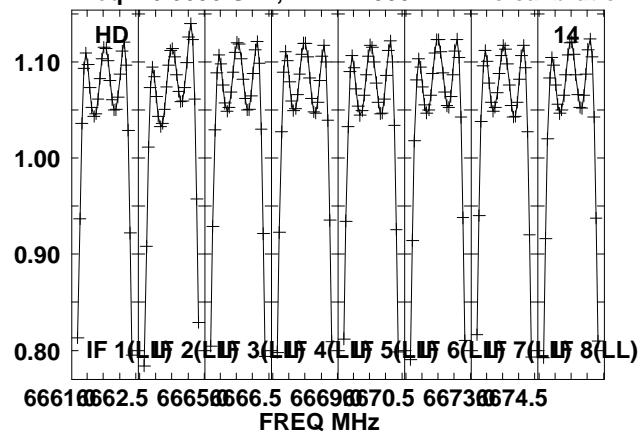

Lower frame: Real Jy
Total-power spectrum Antenna: *
Timerange: 00/15:42:09 to 00/15:44:59

Plot file version 33 created 07-JUN-2013 14:03:25

J0522+1415 N13M1.UVDATA.1

Freq = 6.6606 GHz, Bw = 2.000 MH No calibration applied and no bandpass applied

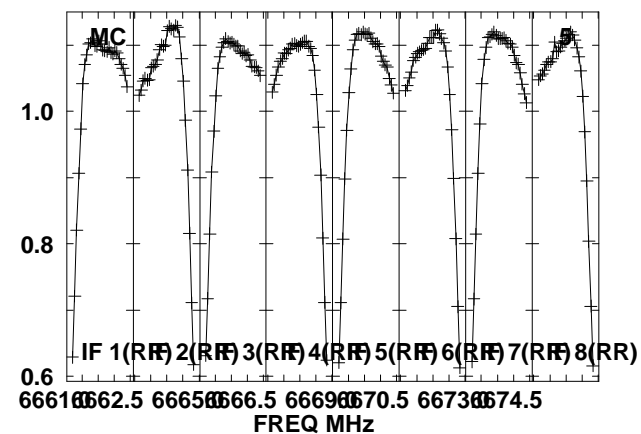
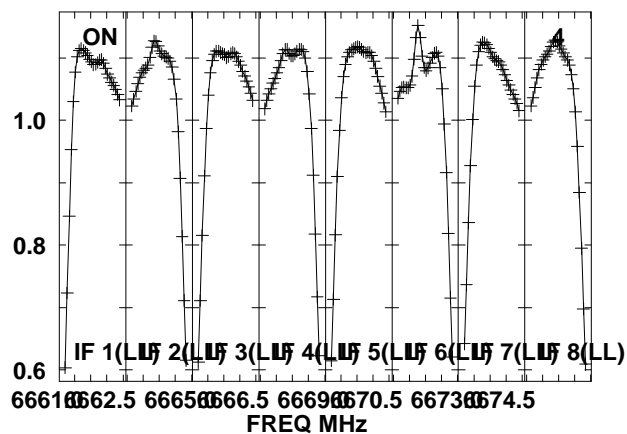
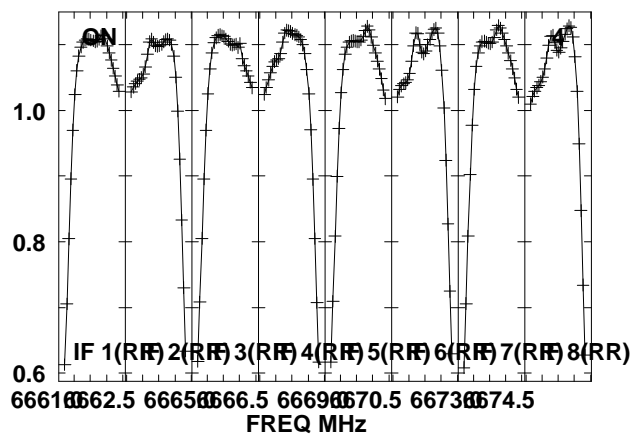
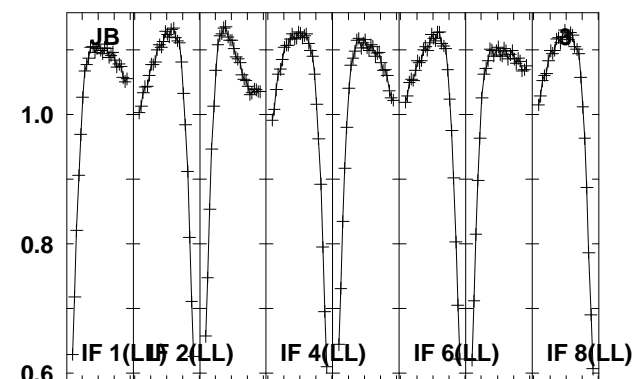
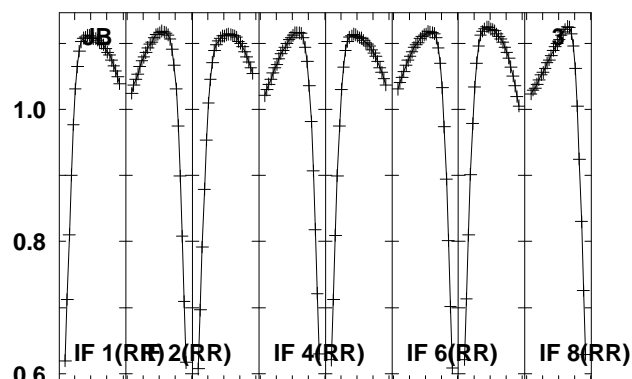
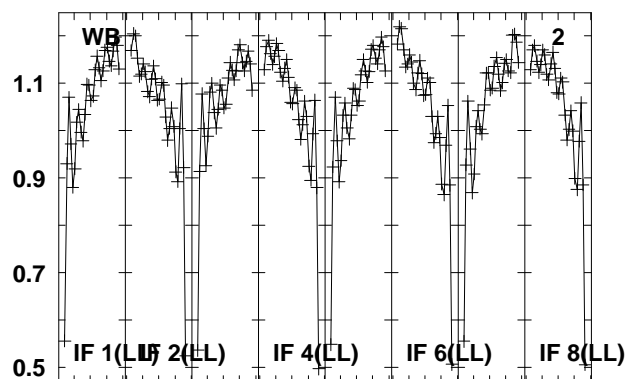
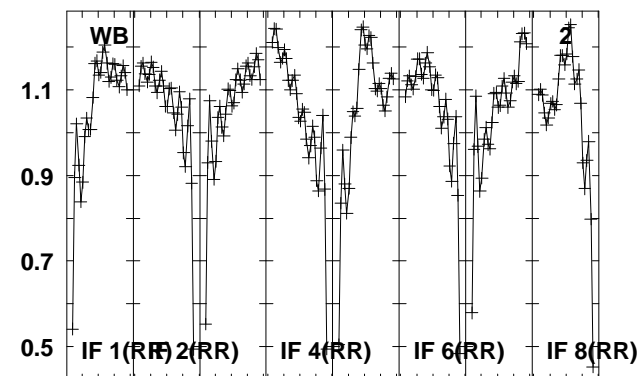
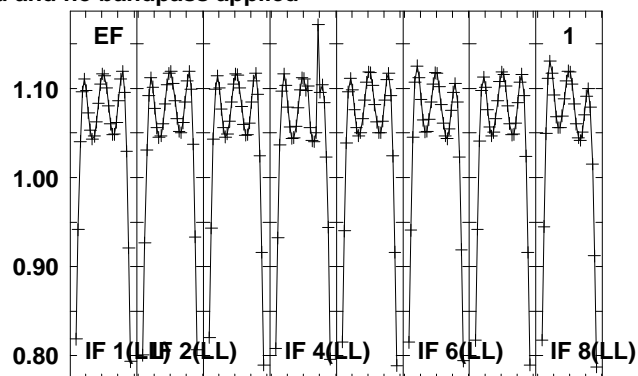
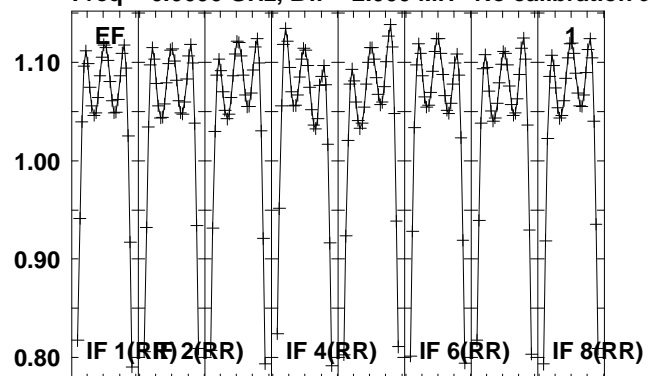

Lower frame: Real Jy

Total-power spectrum Antenna: *

Timerange: 00/15:46:03 to 00/15:47:59

Plot file version 34 created 07-JUN-2013 14:03:26

J0522+1415 N13M1.UVDATA.1

Freq = 6.6606 GHz, Bw = 2.000 MH No calibration applied and no bandpass applied

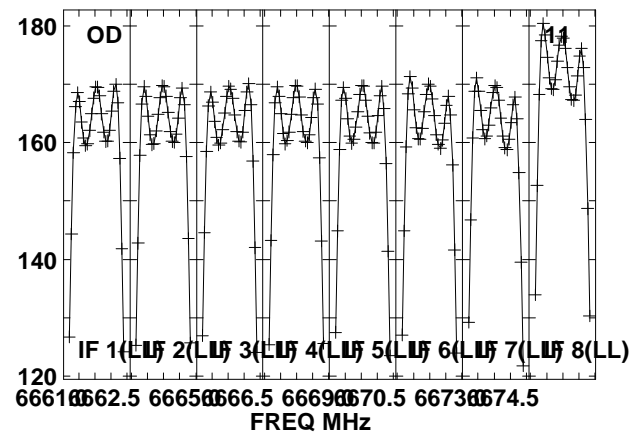
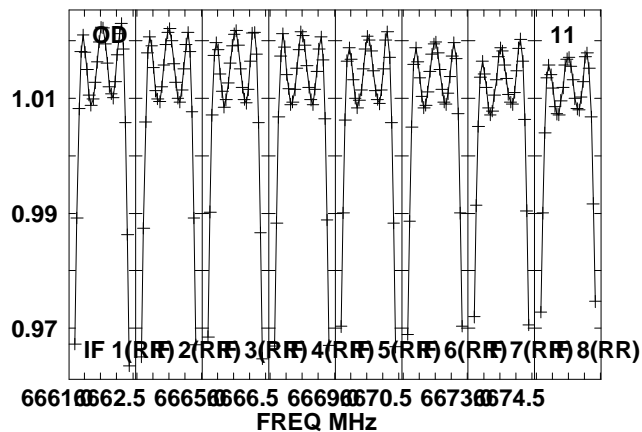
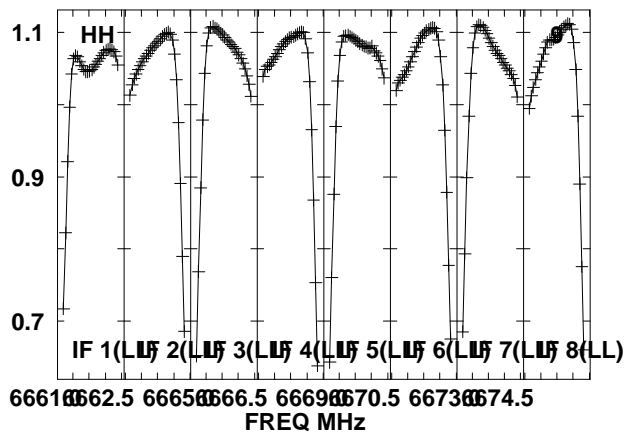
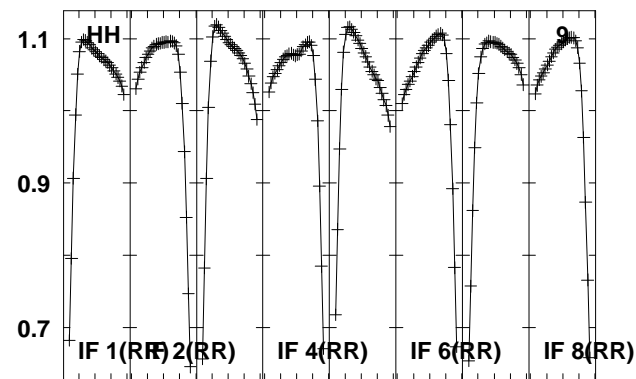
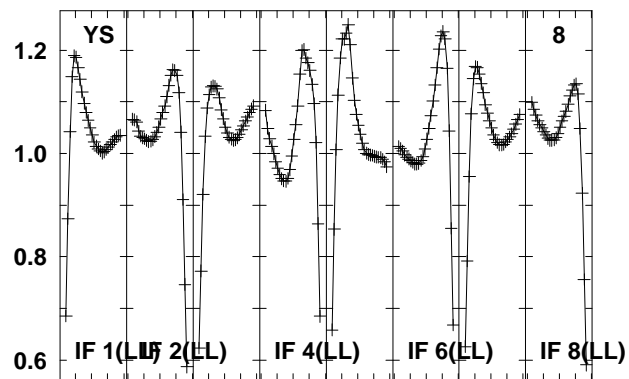
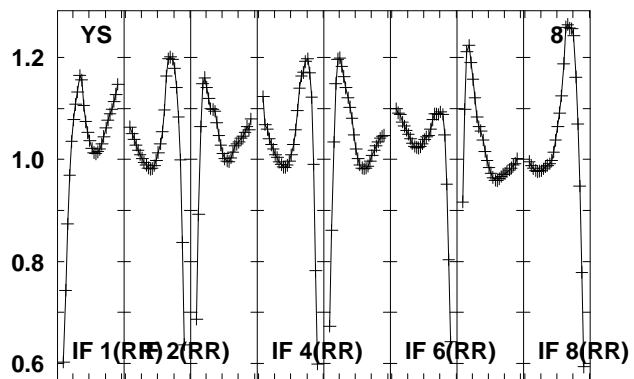
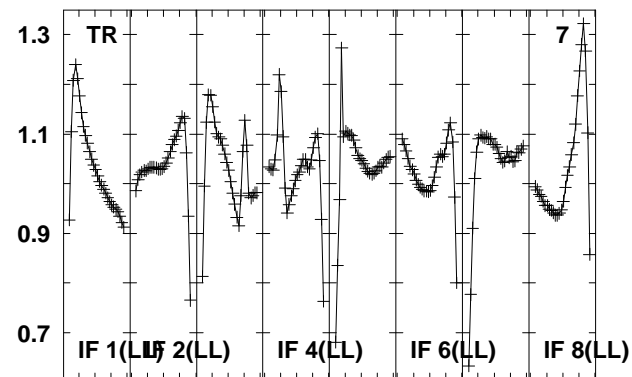
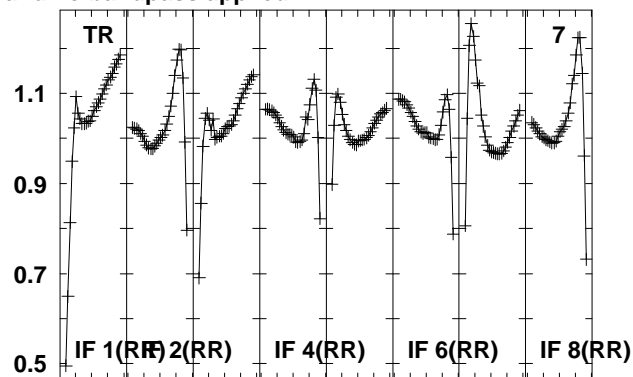
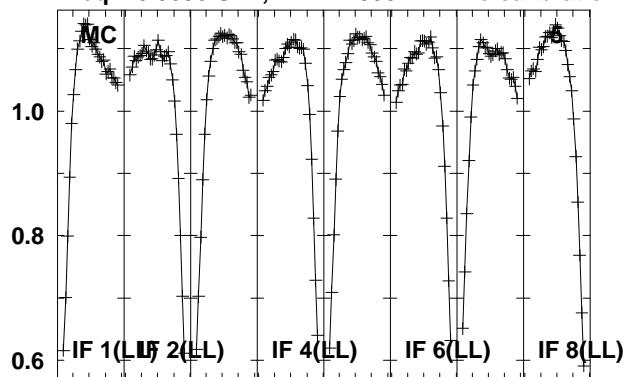

Lower frame: Real Jy
Total-power spectrum Antenna: *
Timerange: 00/15:46:03 to 00/15:47:59

Plot file version 35 created 07-JUN-2013 14:03:26

J0522+1415 N13M1.UVDATA.1

Freq = 6.6606 GHz, Bw = 2.000 MH No calibration applied and no bandpass applied

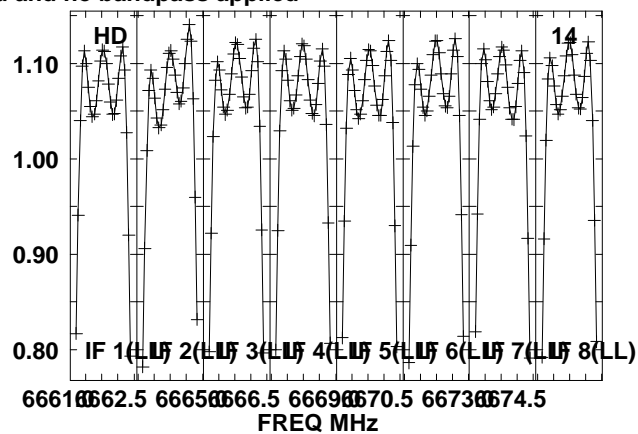
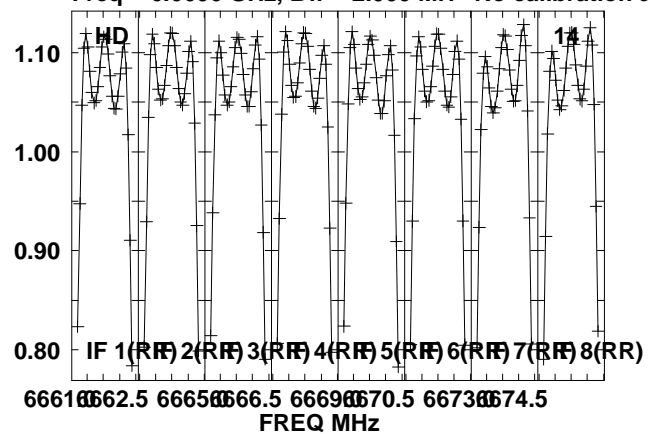

Lower frame: Real Jy
Total-power spectrum Antenna: *
Timerange: 00/15:46:03 to 00/15:47:59

Plot file version 36 created 07-JUN-2013 14:03:26

0528+134 N13M1.UVDATA.1

Freq = 6.6606 GHz, Bw = 2.000 MH No calibration applied and no bandpass applied

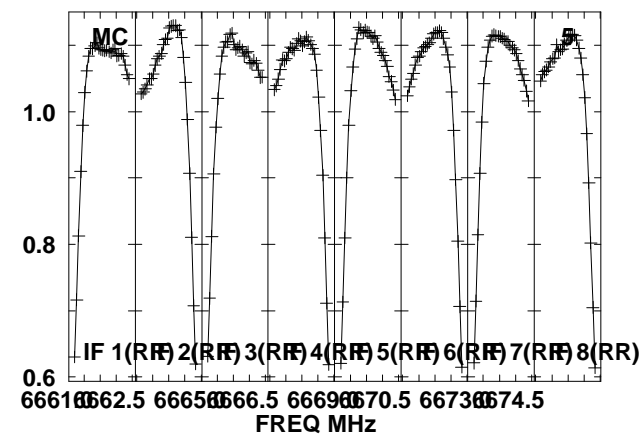
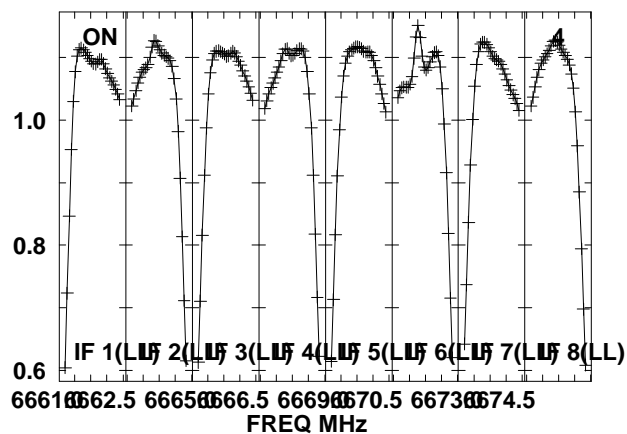
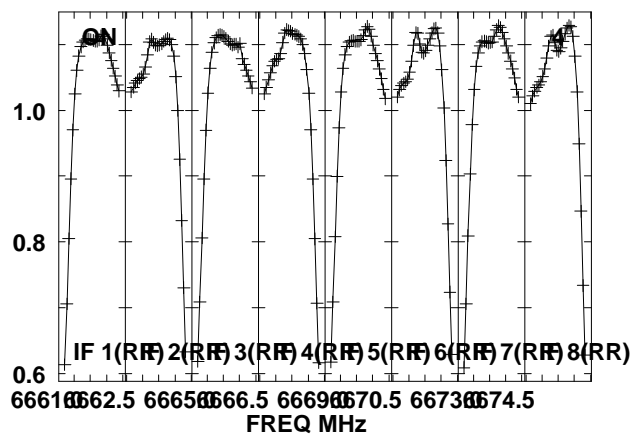
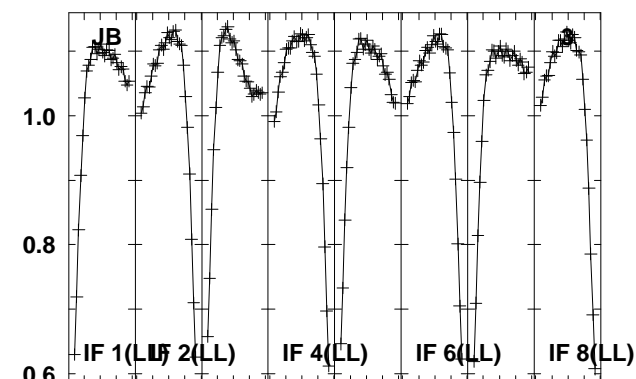
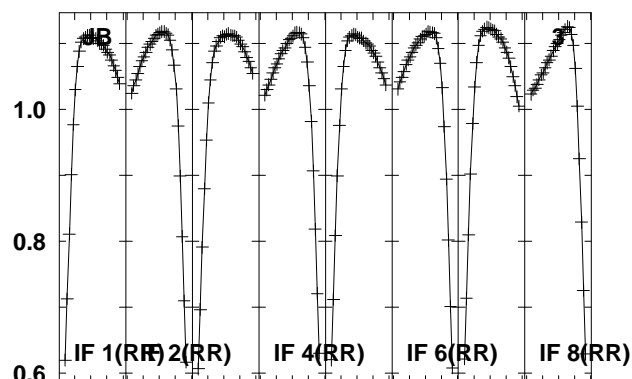
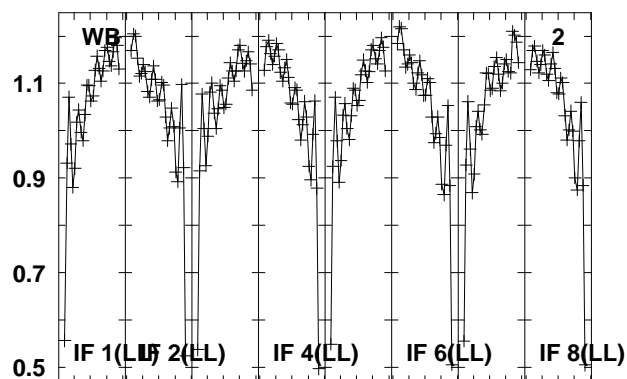
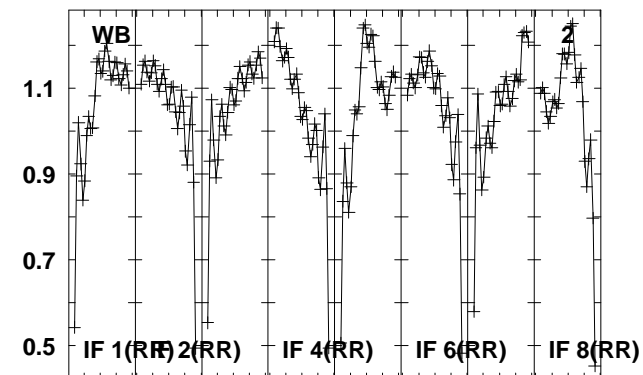
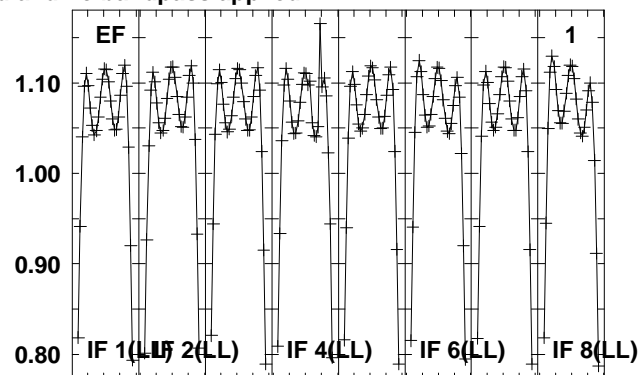
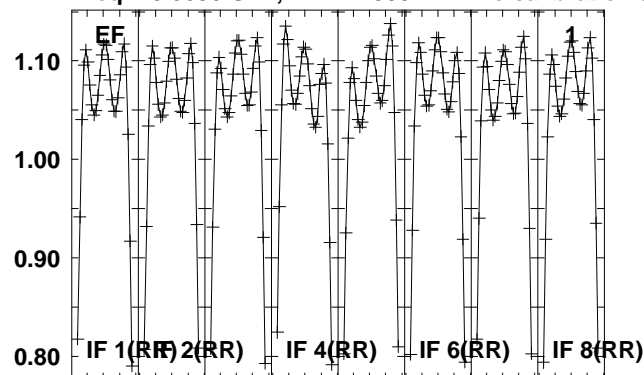

Lower frame: Real Jy

Total-power spectrum Antenna: *

Timerange: 00/15:48:09 to 00/15:50:59

Plot file version 37 created 07-JUN-2013 14:03:26

0528+134 N13M1.UVDATA.1

Freq = 6.6606 GHz, Bw = 2.000 MH No calibration applied and no bandpass applied

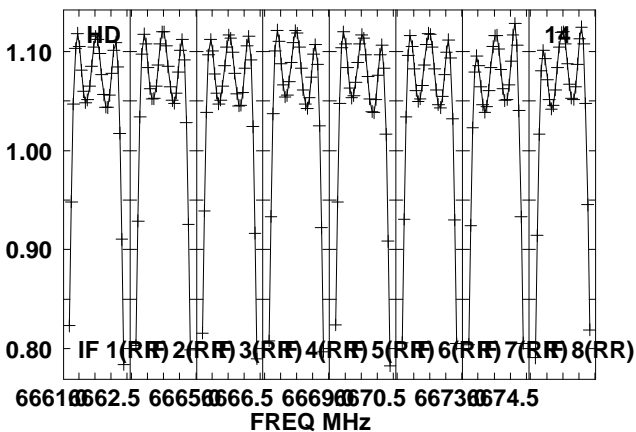
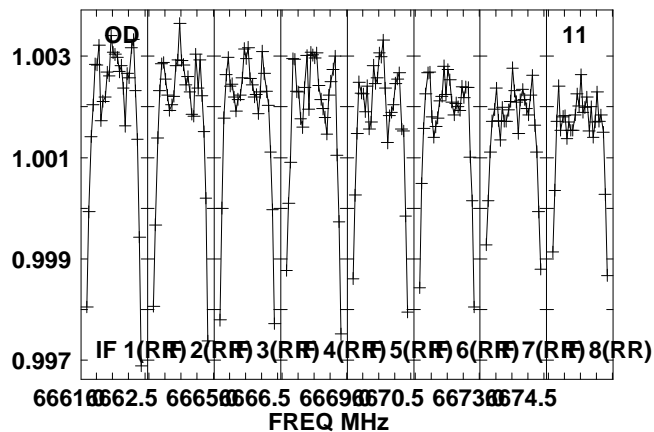
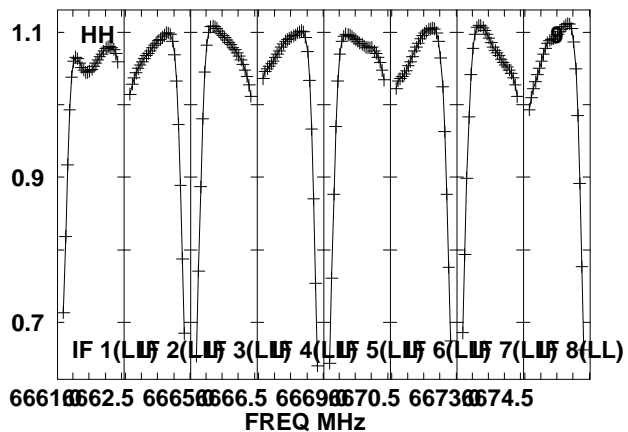
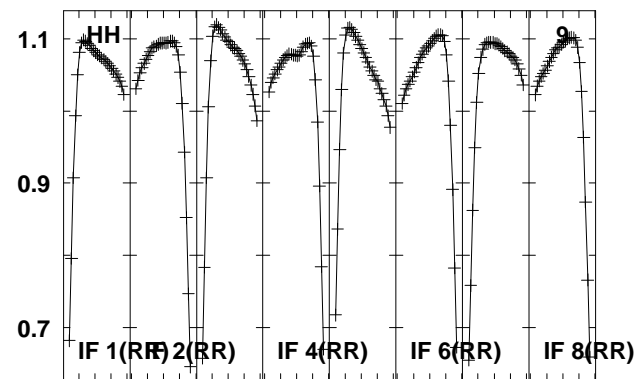
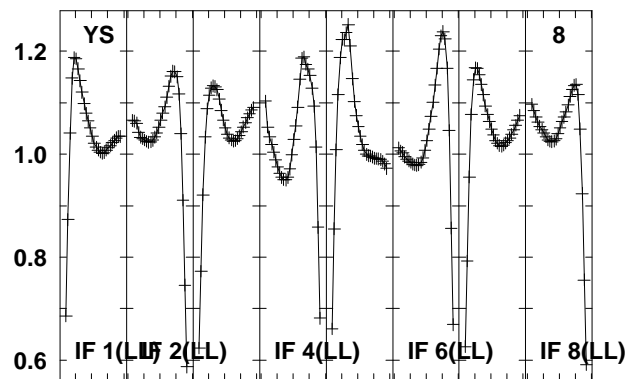
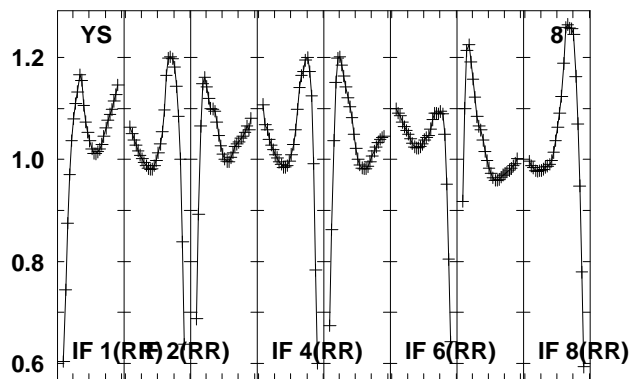
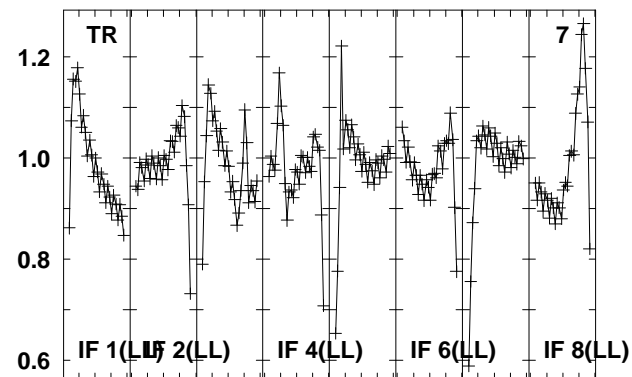
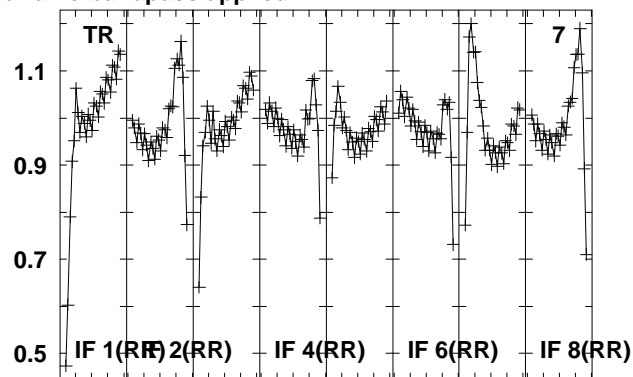
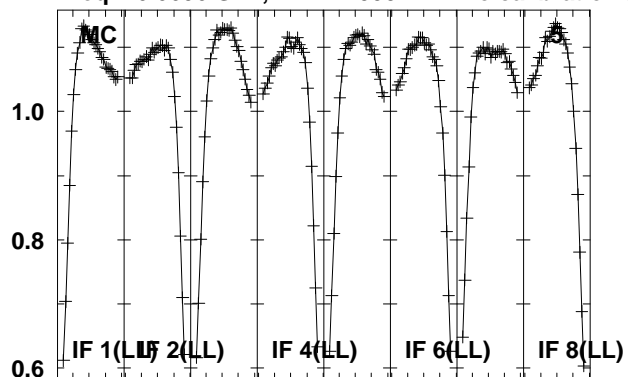

Lower frame: Real Jy
Total-power spectrum Antenna: *
Timerange: 00/15:48:09 to 00/15:50:59

Plot file version 38 created 07-JUN-2013 14:03:27

0528+134 N13M1.UVDATA.1

Freq = 6.6606 GHz, Bw = 2.000 MH No calibration applied and no bandpass applied

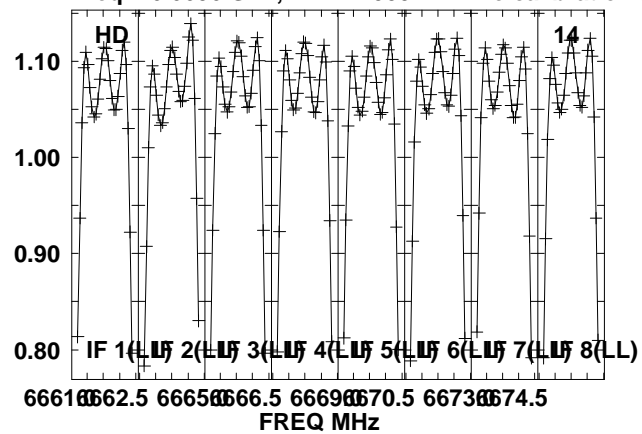

Lower frame: Real Jy

Total-power spectrum Antenna: *

Timerange: 00/15:48:09 to 00/15:50:59

Plot file version 39 created 07-JUN-2013 14:03:27

J0522+1415 N13M1.UVDATA.1

Freq = 6.6606 GHz, Bw = 2.000 MH No calibration applied and no bandpass applied

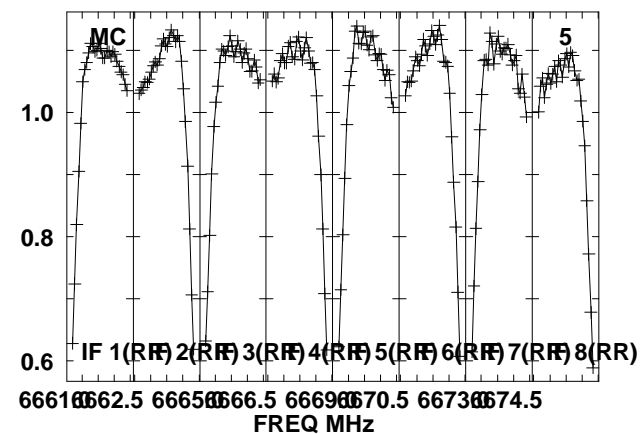
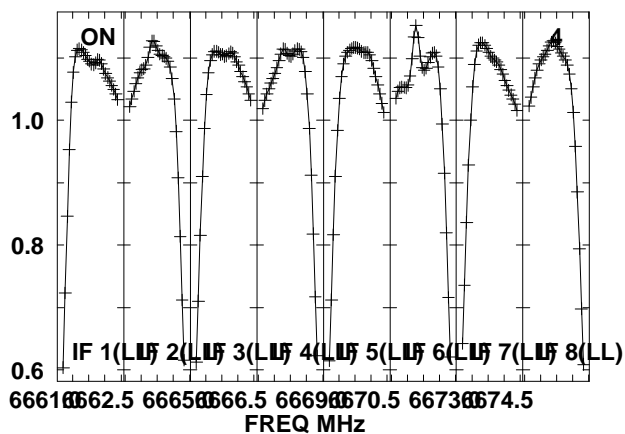
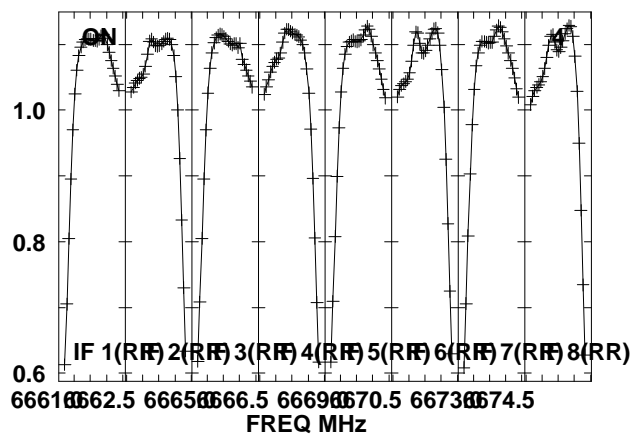
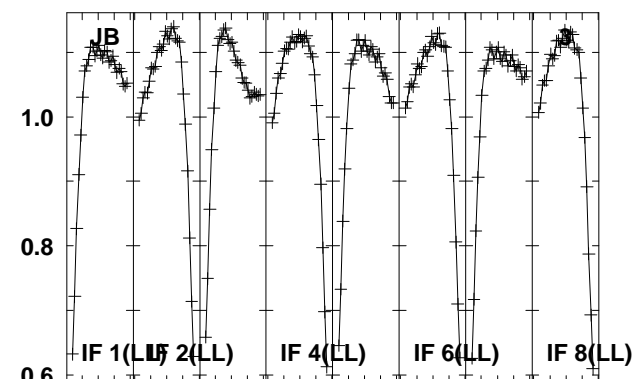
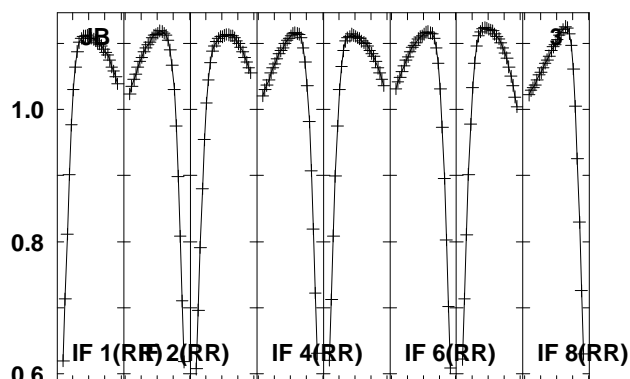
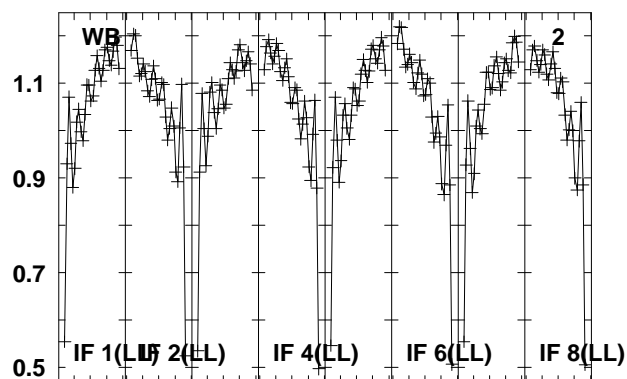
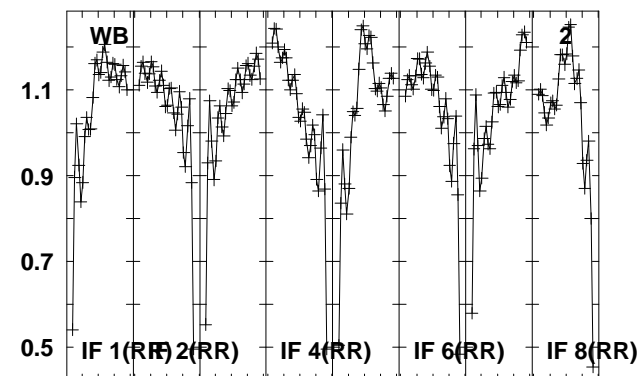
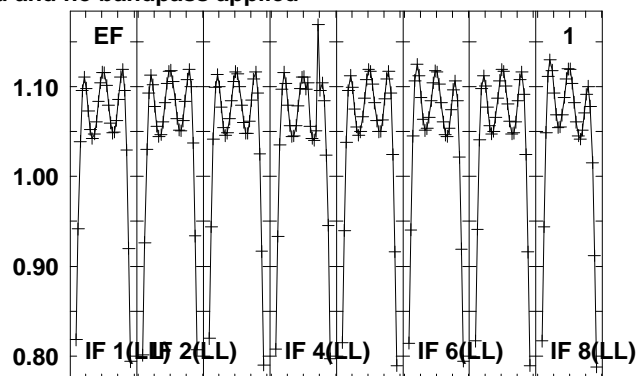
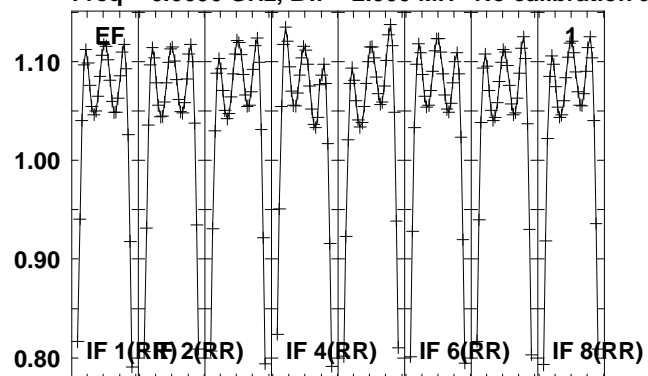

Lower frame: Real Jy
Total-power spectrum Antenna: *
Timerange: 00/15:51:09 to 00/15:52:59

Plot file version 40 created 07-JUN-2013 14:03:27

J0522+1415 N13M1.UVDATA.1

Freq = 6.6606 GHz, Bw = 2.000 MH No calibration applied and no bandpass applied

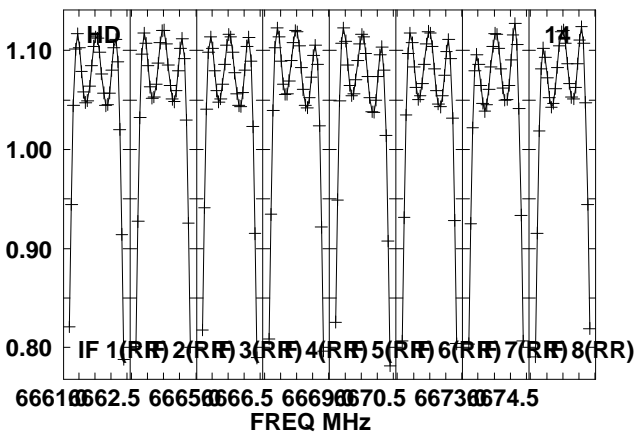
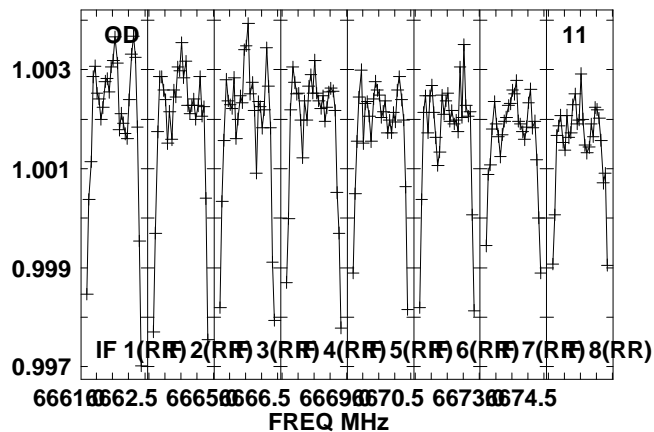
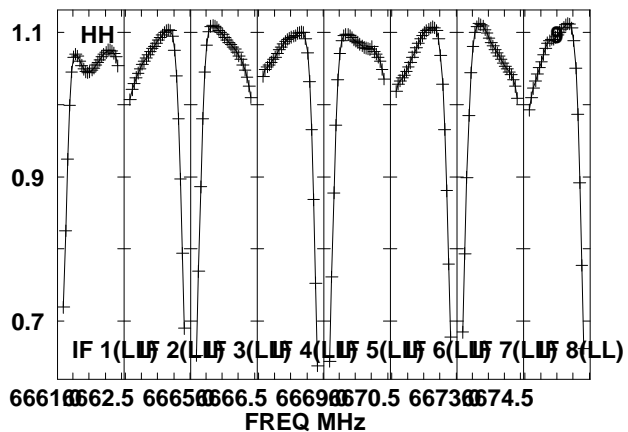
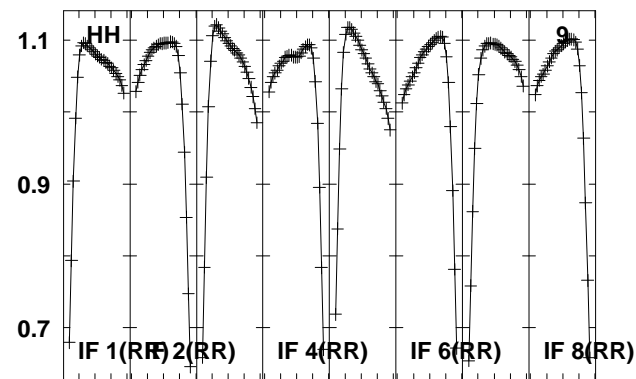
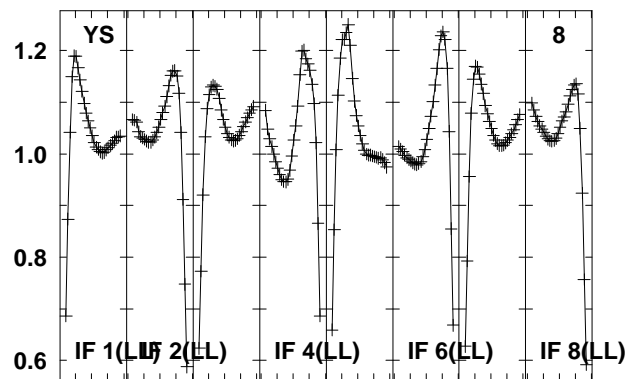
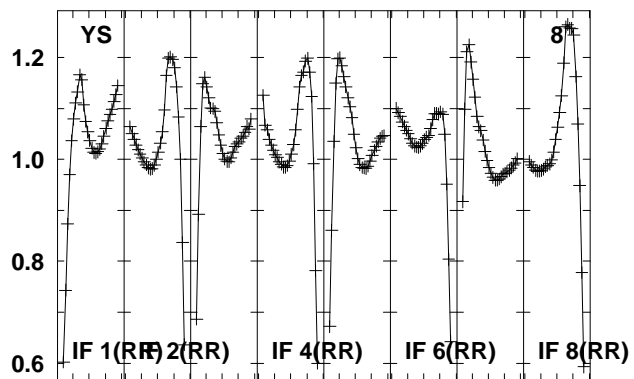
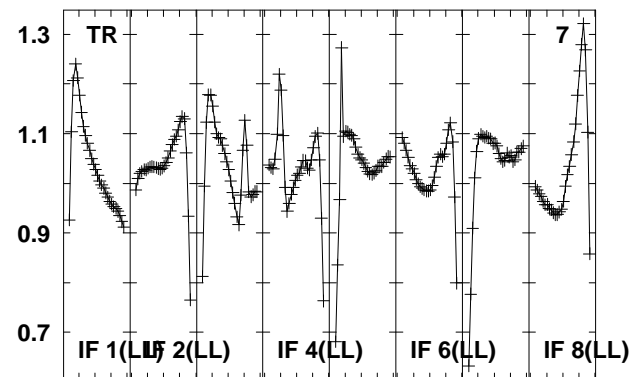
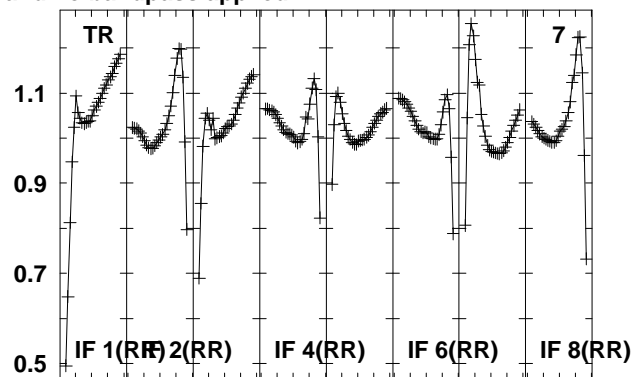
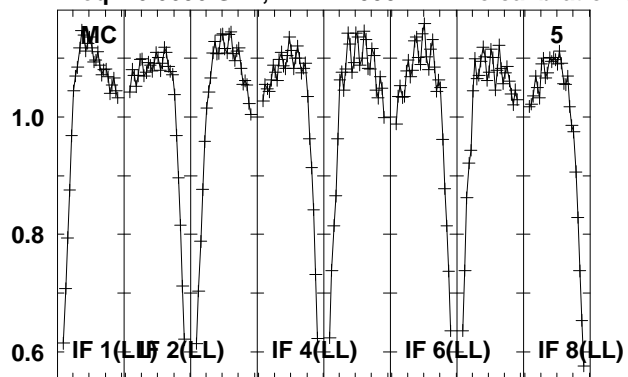

Lower frame: Real Jy
Total-power spectrum Antenna: *
Timerange: 00/15:51:09 to 00/15:52:59

Plot file version 41 created 07-JUN-2013 14:03:28

J0522+1415 N13M1.UVDATA.1

Freq = 6.6606 GHz, Bw = 2.000 MH No calibration applied and no bandpass applied

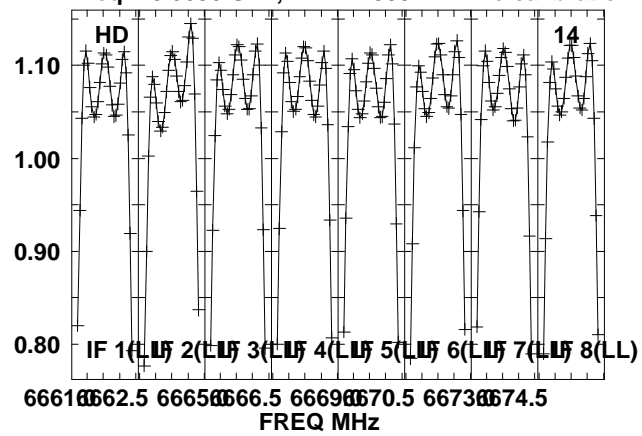

Lower frame: Real Jy

Total-power spectrum Antenna: *

Timerange: 00/15:51:09 to 00/15:52:59

Plot file version 42 created 07-JUN-2013 14:03:28

0528+134 N13M1.UVDATA.1

Freq = 6.6606 GHz, Bw = 2.000 MH No calibration applied and no bandpass applied

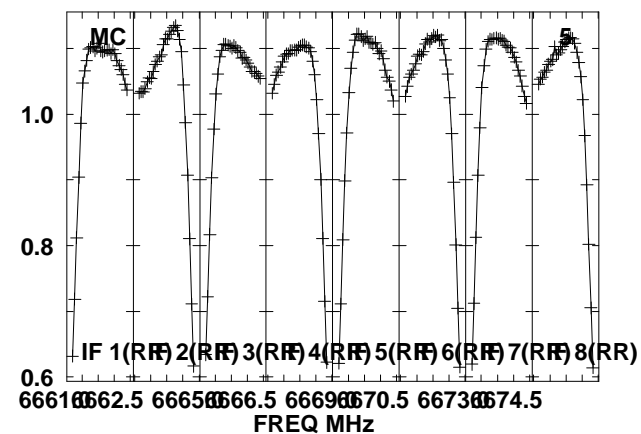
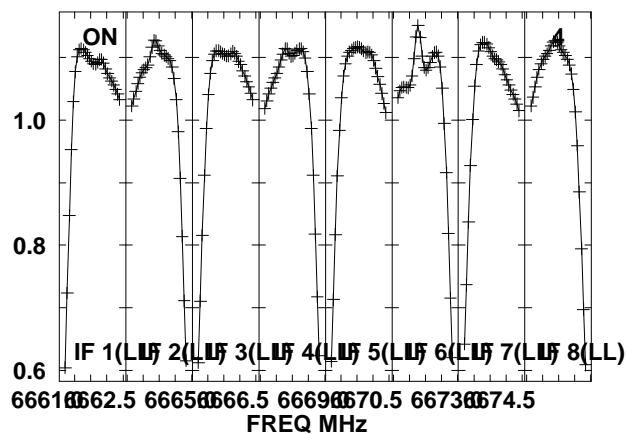
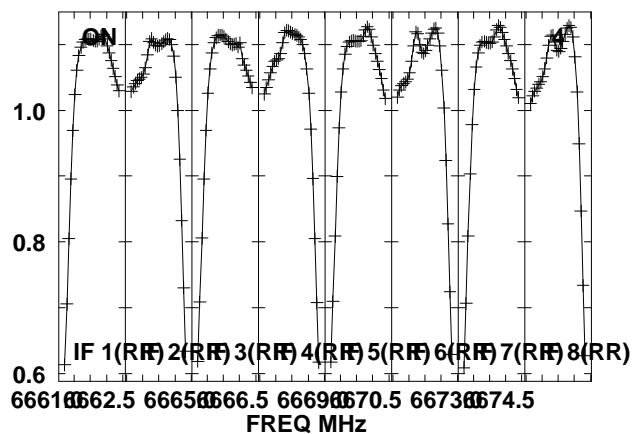
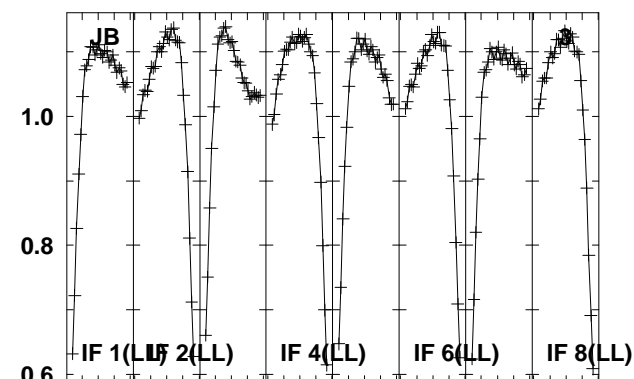
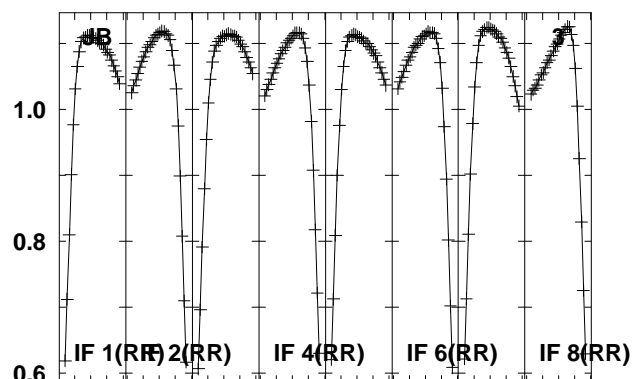
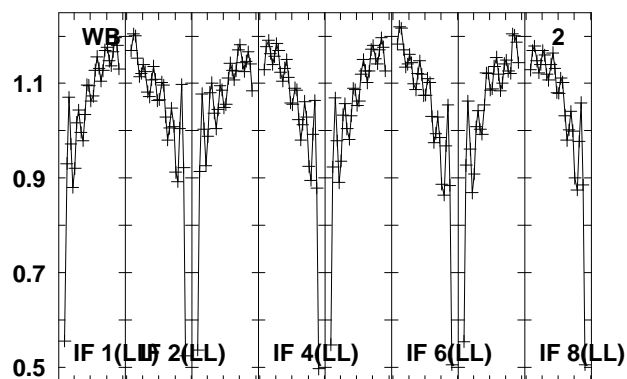
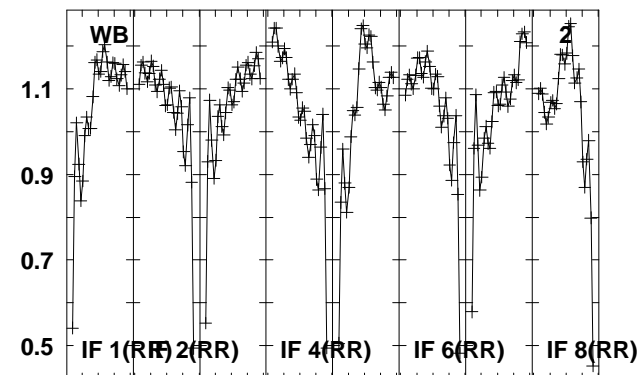
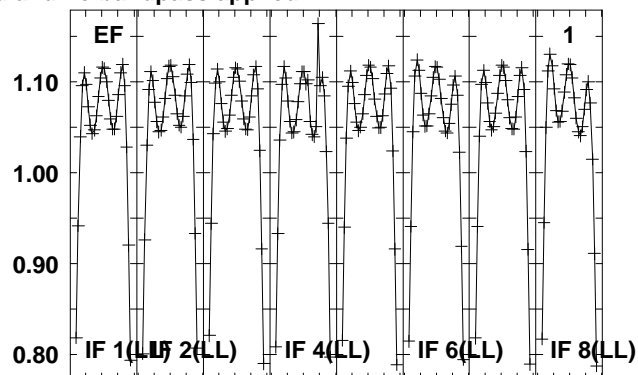
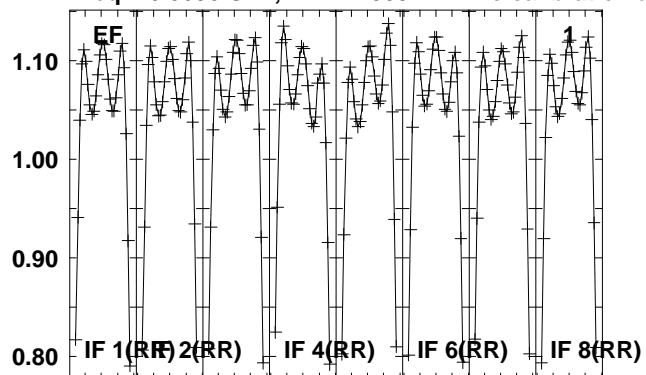

Lower frame: Real Jy

Total-power spectrum Antenna: *

Timerange: 00/15:53:09 to 00/15:55:59

Plot file version 43 created 07-JUN-2013 14:03:28

0528+134 N13M1.UVDATA.1

Freq = 6.6606 GHz, Bw = 2.000 MH No calibration applied and no bandpass applied

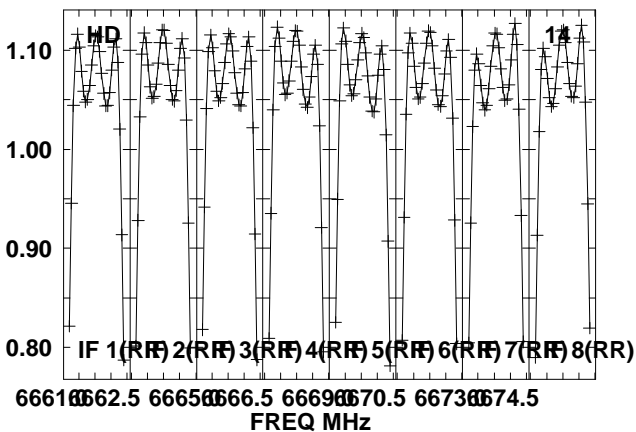
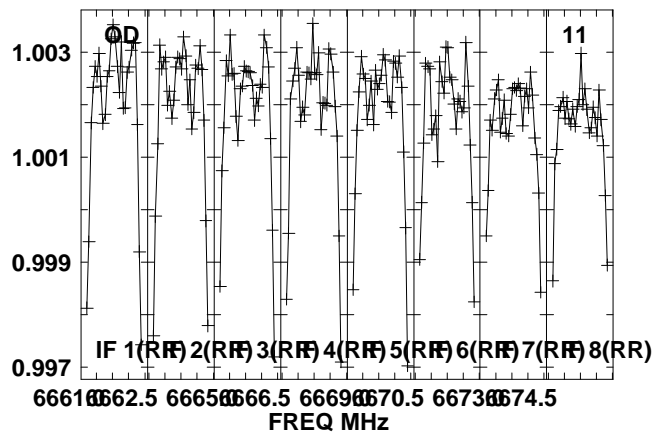
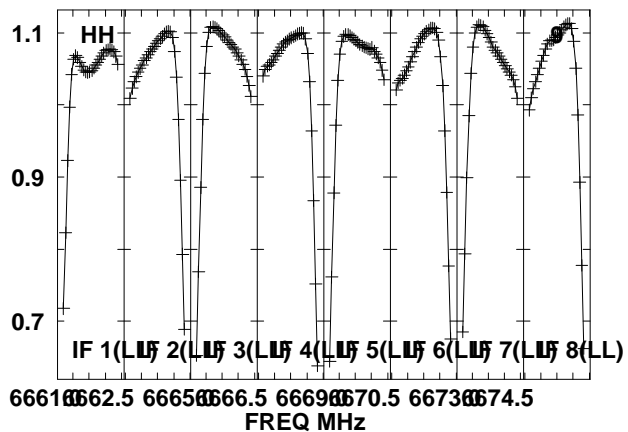
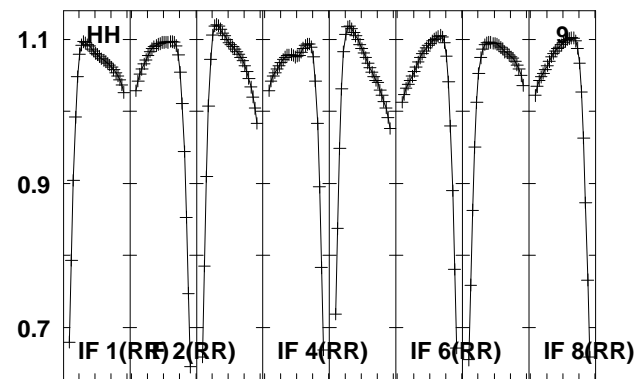
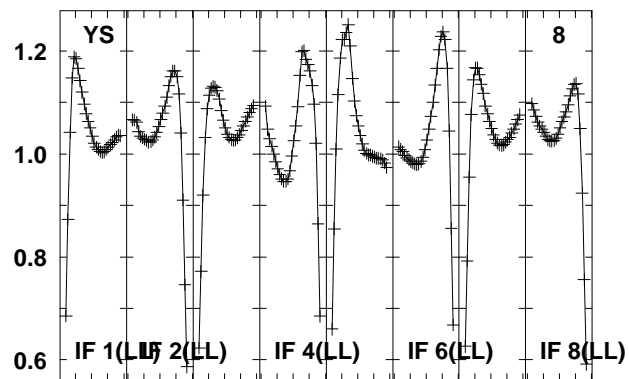
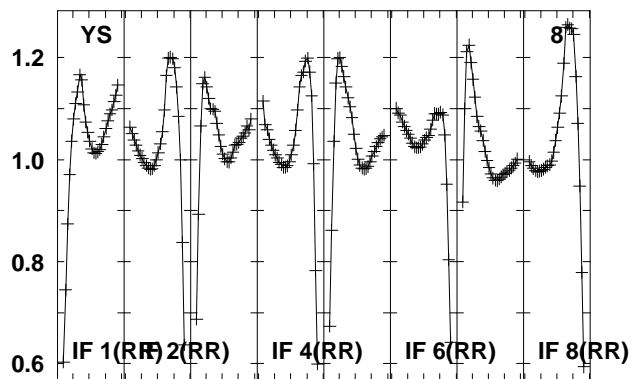
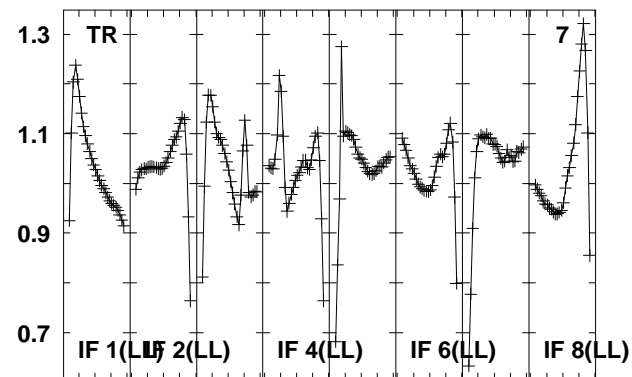
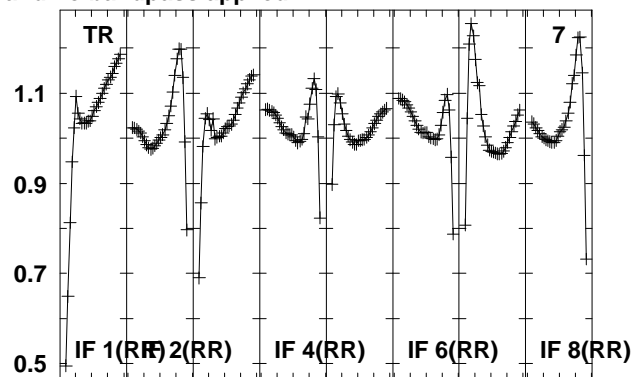
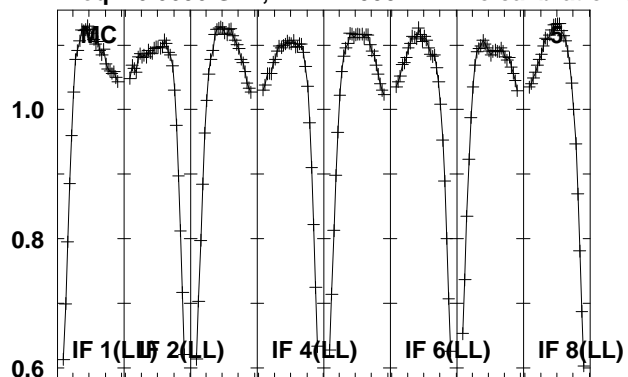

6661 6662.5 6665 6666.5 6669 6670.5 6673 6674.5
FREQ MHz

6661 6662.5 6665 6666.5 6669 6670.5 6673 6674.5
FREQ MHz

6661 6662.5 6665 6666.5 6669 6670.5 6673 6674.5
FREQ MHz

Lower frame: Real Jy
Total-power spectrum Antenna: *
Timerange: 00/15:53:09 to 00/15:55:59

Plot file version 44 created 07-JUN-2013 14:03:29
0528+134 N13M1.UVDATA.1
Freq = 6.6606 GHz, Bw = 2.000 MH No calibration applied and no bandpass applied

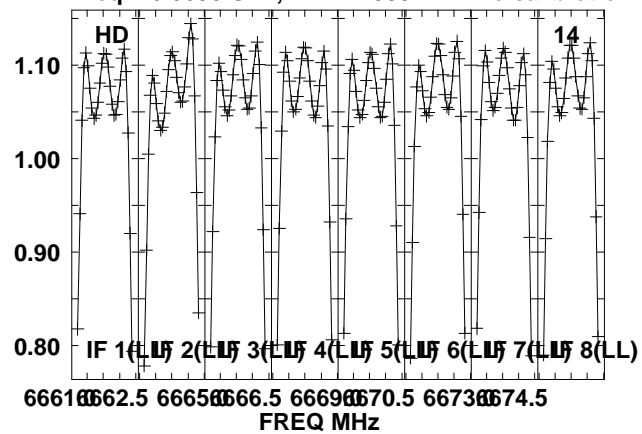

Lower frame: Real Jy
Total-power spectrum Antenna: *
Timerange: 00/15:53:09 to 00/15:55:59

Plot file version 45 created 07-JUN-2013 14:03:29

J0522+1415 N13M1.UVDATA.1

Freq = 6.6606 GHz, Bw = 2.000 MH No calibration applied and no bandpass applied

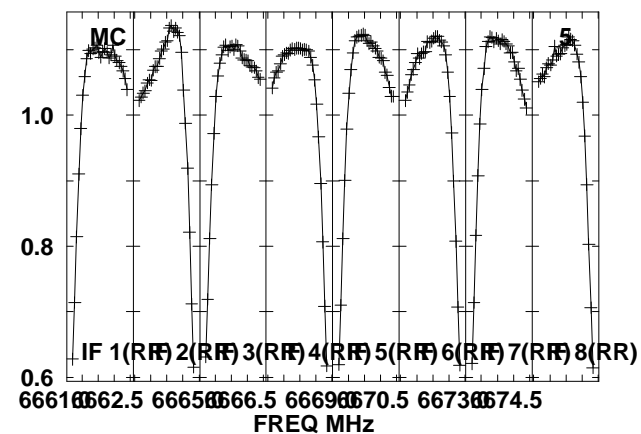
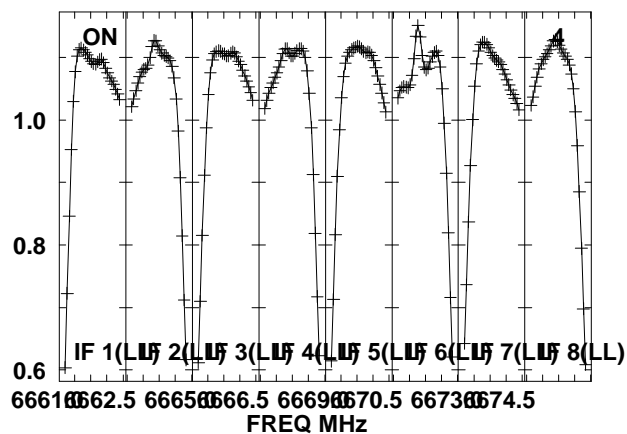
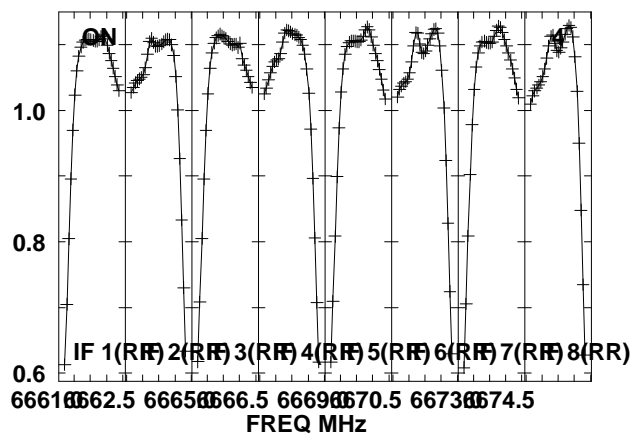
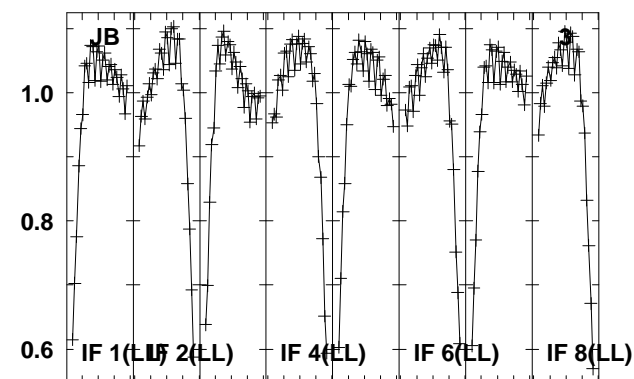
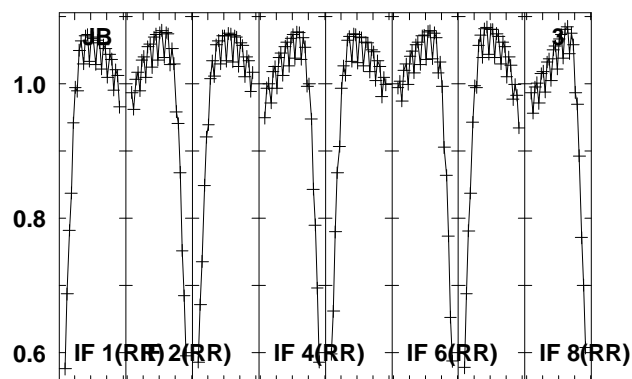
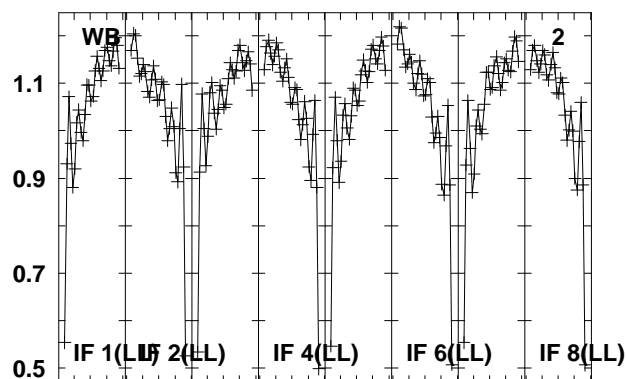
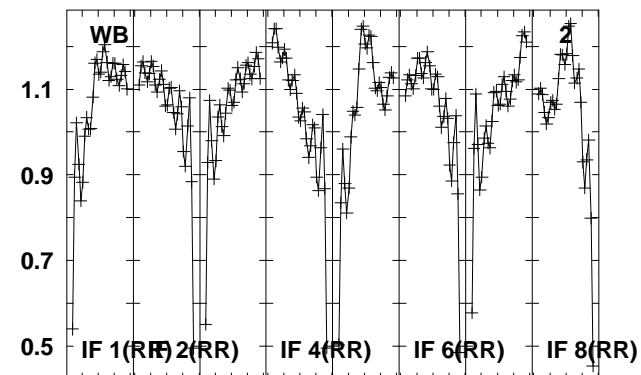
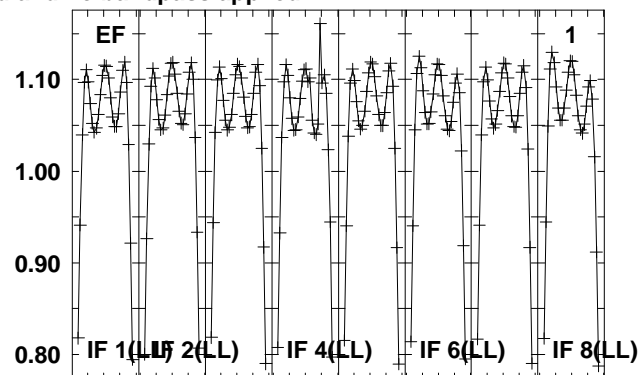
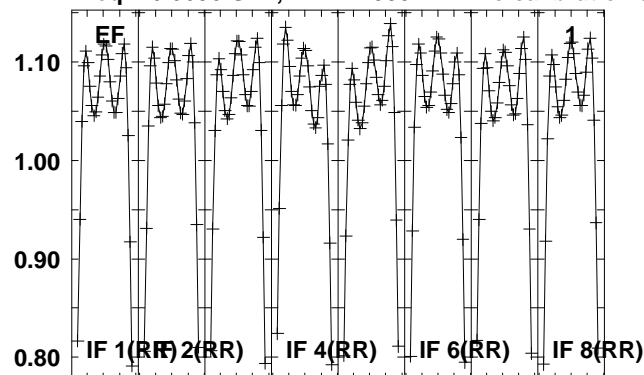

Lower frame: Real Jy
Total-power spectrum Antenna: *
Timerange: 00/15:57:03 to 00/15:58:59

Plot file version 46 created 07-JUN-2013 14:03:29

J0522+1415 N13M1.UVDATA.1

Freq = 6.6606 GHz, Bw = 2.000 MH No calibration applied and no bandpass applied

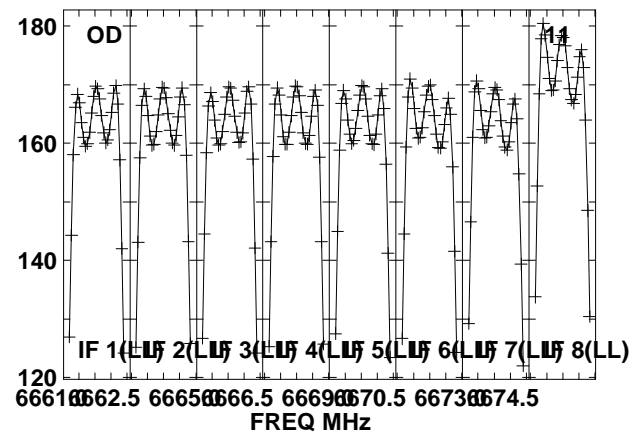
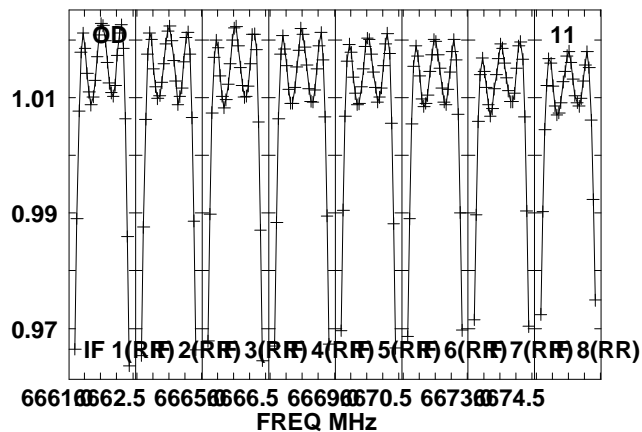
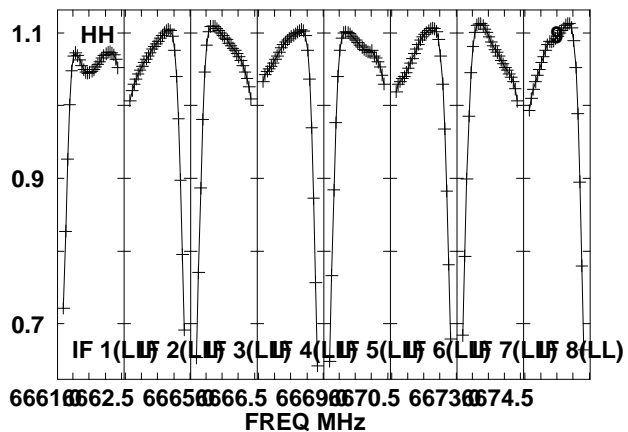
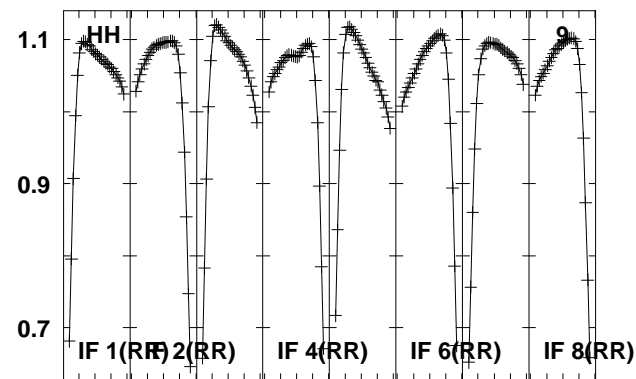
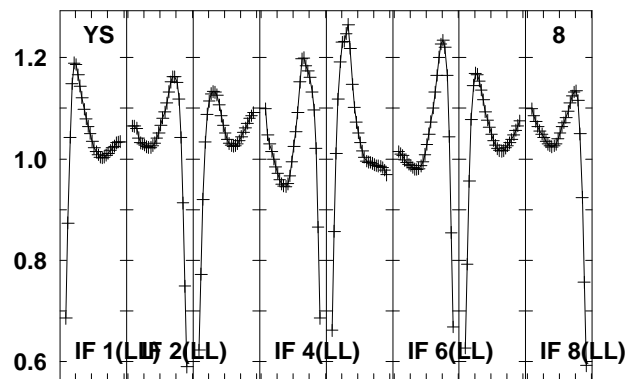
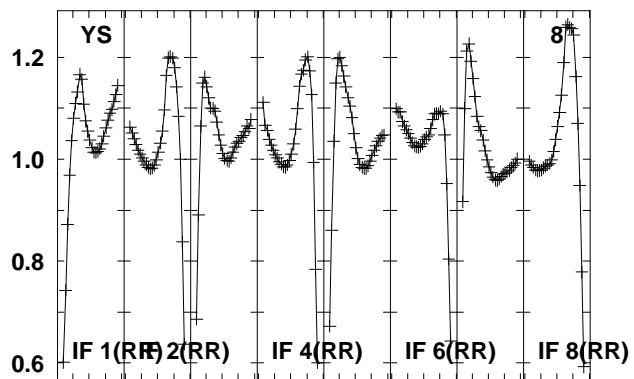
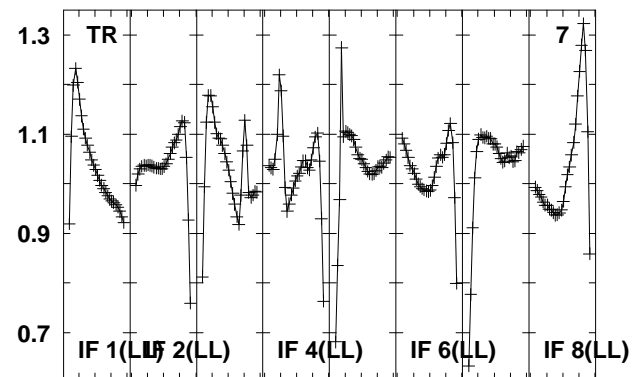
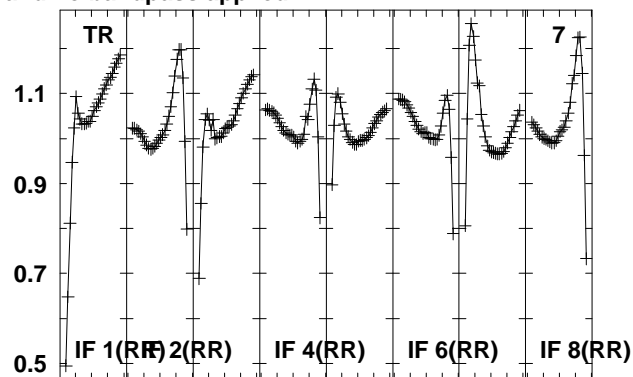
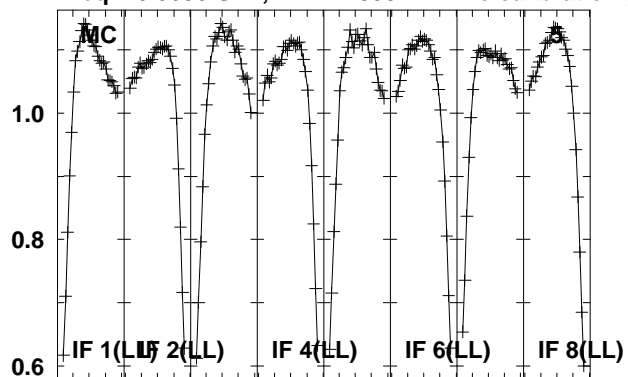

Lower frame: Real Jy
Total-power spectrum Antenna: *
Timerange: 00/15:57:03 to 00/15:58:59

Plot file version 47 created 07-JUN-2013 14:03:30

J0522+1415 N13M1.UVDATA.1

Freq = 6.6606 GHz, Bw = 2.000 MH No calibration applied and no bandpass applied

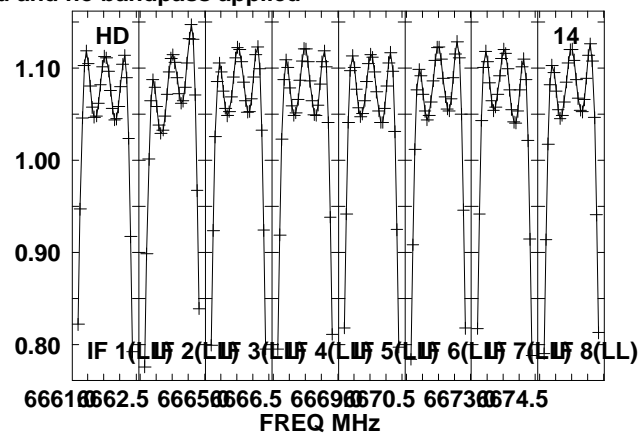
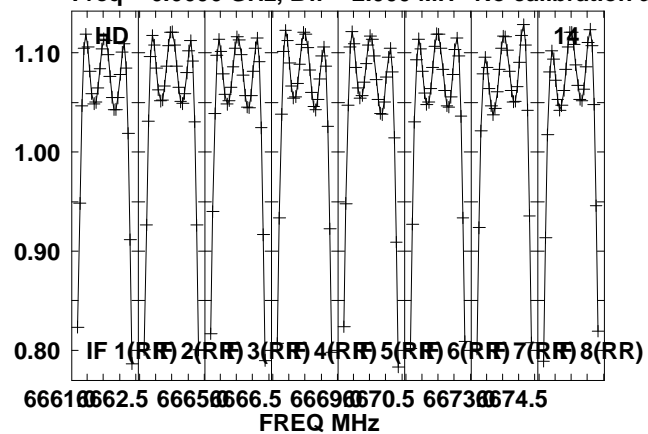

Lower frame: Real Jy
Total-power spectrum Antenna: *
Timerange: 00/15:57:03 to 00/15:58:59

Plot file version 48 created 07-JUN-2013 14:03:30

0528+134 N13M1.UVDATA.1

Freq = 6.6606 GHz, Bw = 2.000 MH No calibration applied and no bandpass applied

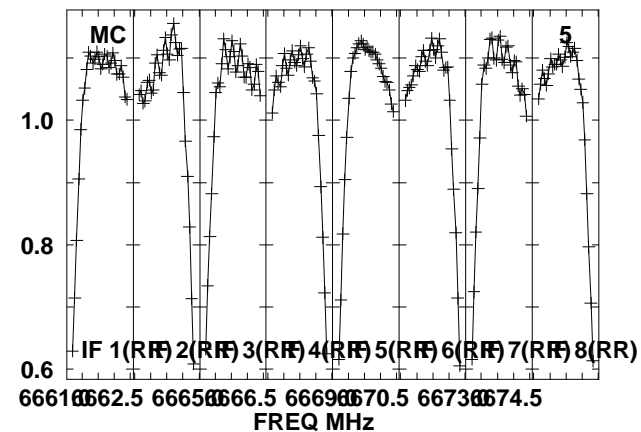
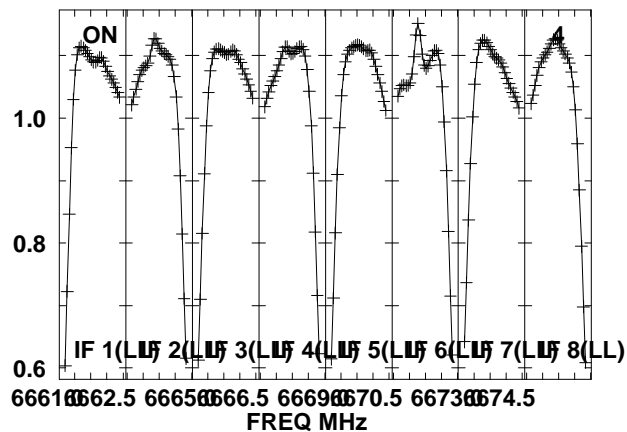
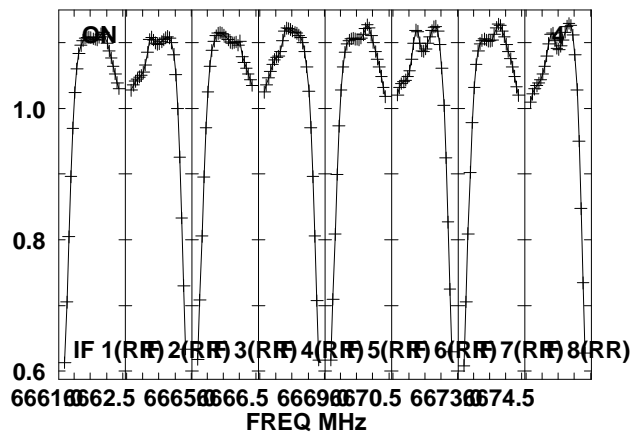
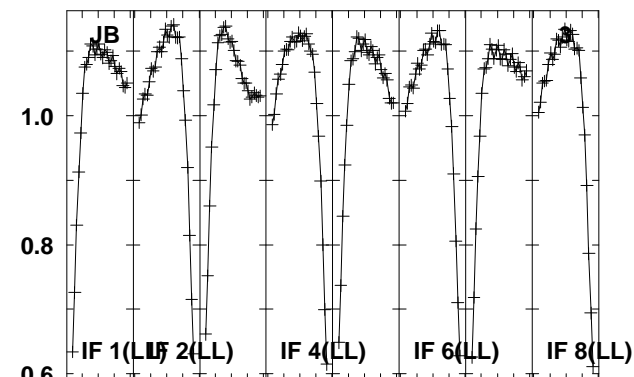
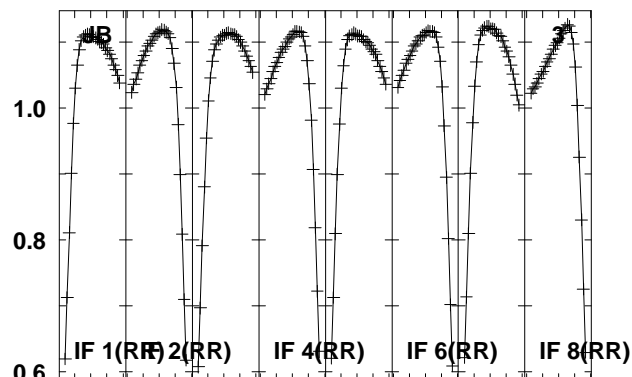
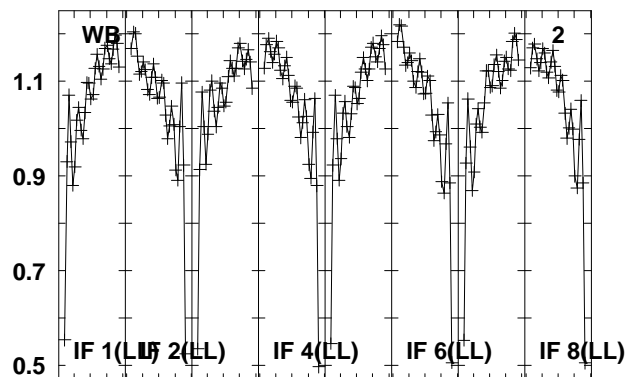
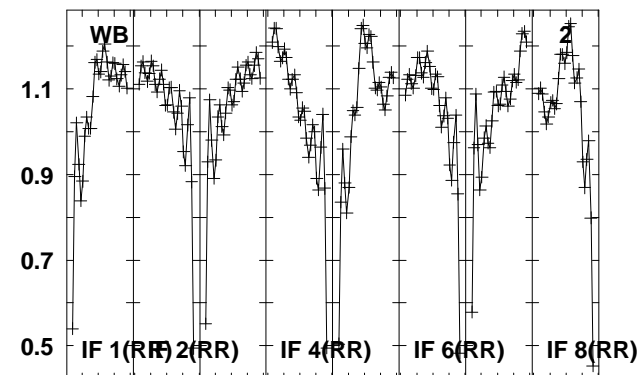
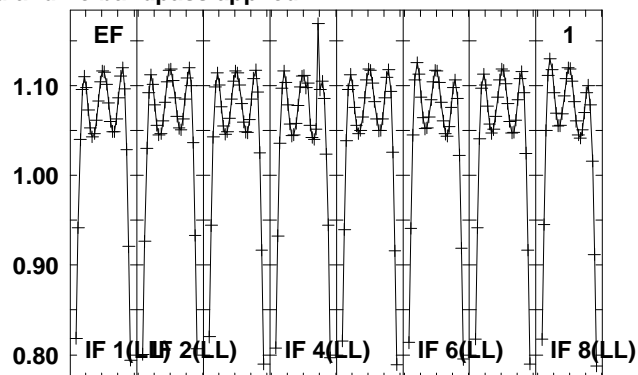
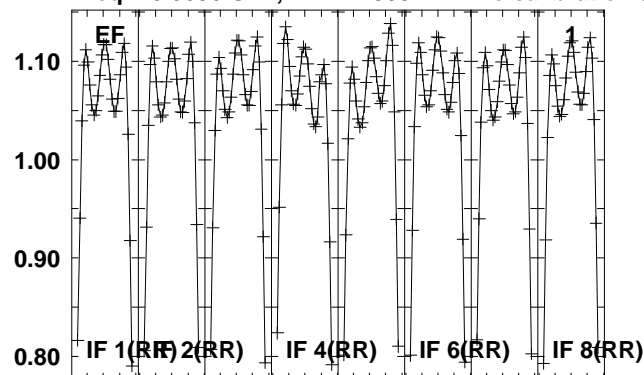

Lower frame: Real Jy
Total-power spectrum Antenna: *
Timerange: 00/15:59:09 to 00/16:01:59

Plot file version 49 created 07-JUN-2013 14:03:30

0528+134 N13M1.UVDATA.1

Freq = 6.6606 GHz, Bw = 2.000 MH No calibration applied and no bandpass applied

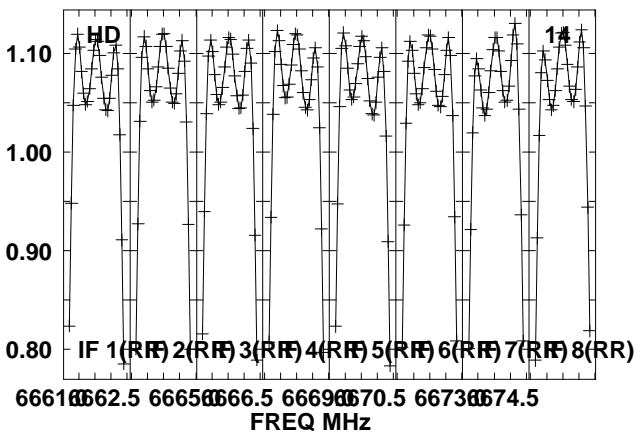
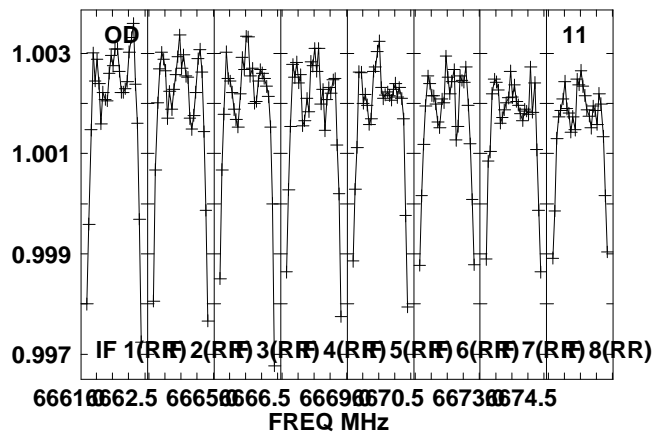
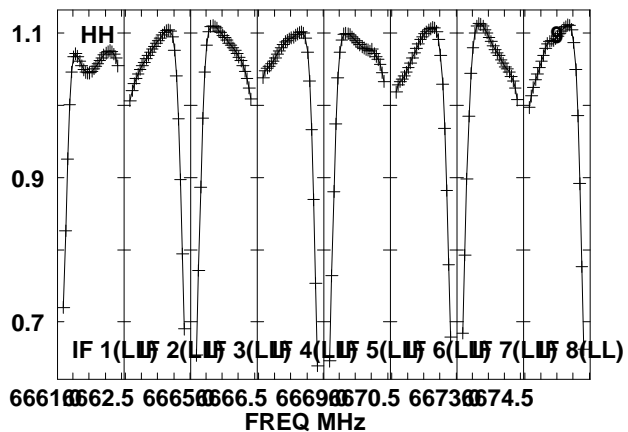
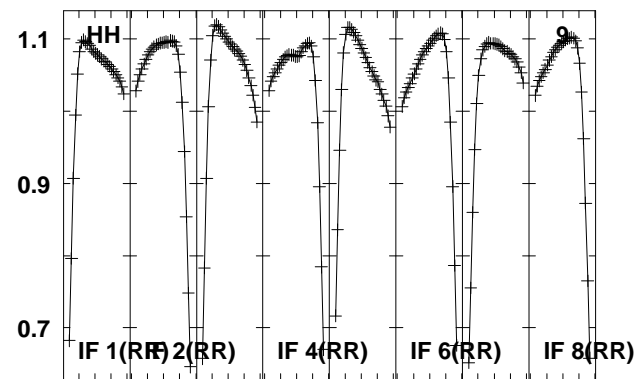
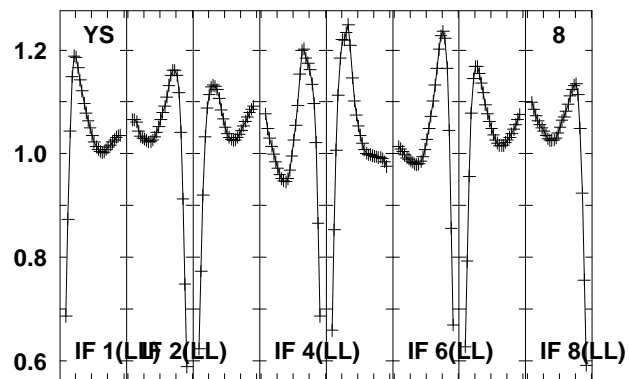
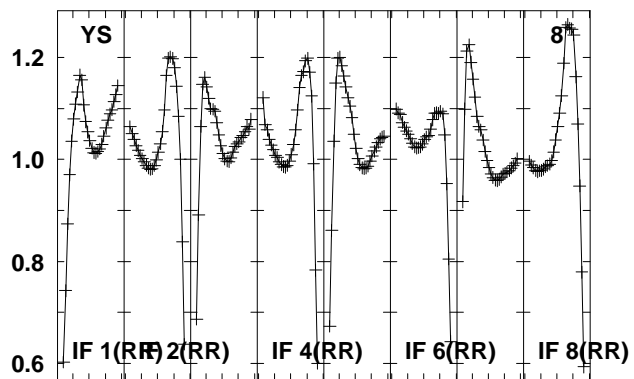
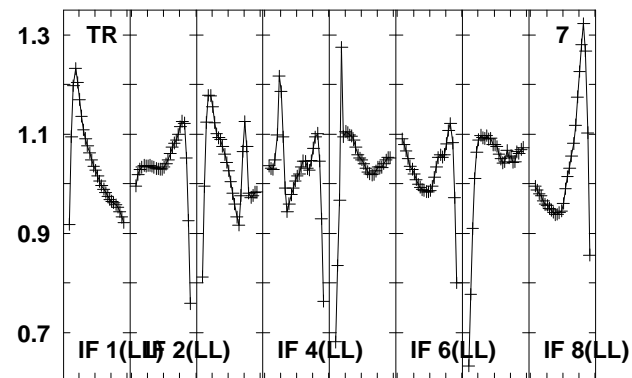
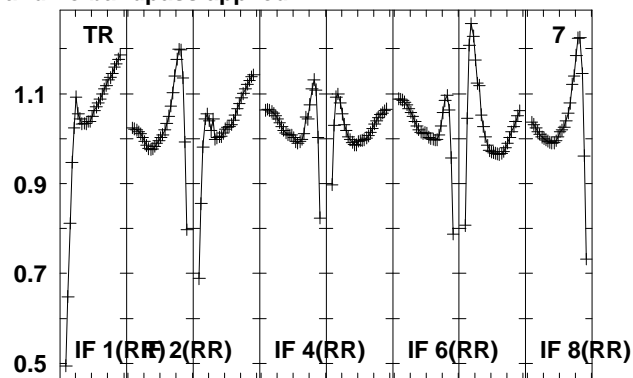
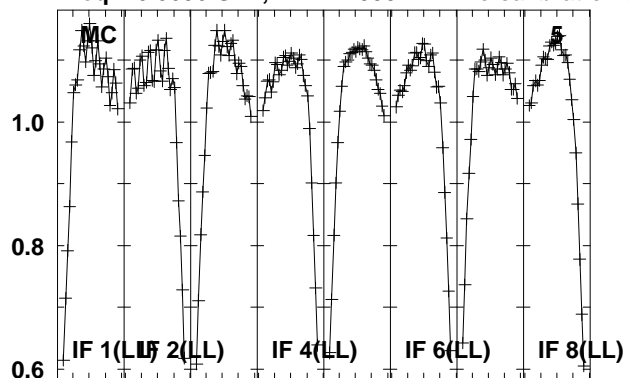

Lower frame: Real Jy
Total-power spectrum Antenna: *
Timerange: 00/15:59:09 to 00/16:01:59

Plot file version 50 created 07-JUN-2013 14:03:31
0528+134 N13M1.UVDATA.1
Freq = 6.6606 GHz, Bw = 2.000 MH No calibration applied and no bandpass applied

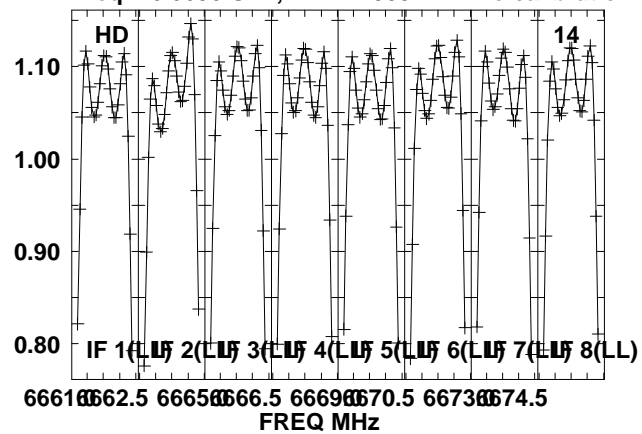

Lower frame: Real Jy
Total-power spectrum Antenna: *
Timerange: 00/15:59:09 to 00/16:01:59

Plot file version 51 created 07-JUN-2013 14:03:31

0528+134 N13M1.UVDATA.1

Freq = 6.6606 GHz, Bw = 2.000 MH No calibration applied and no bandpass applied

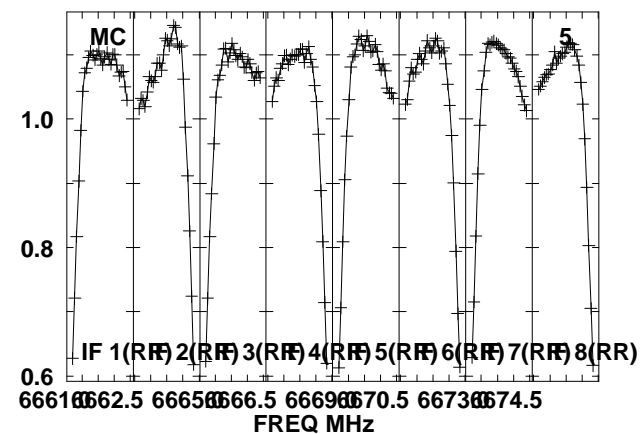
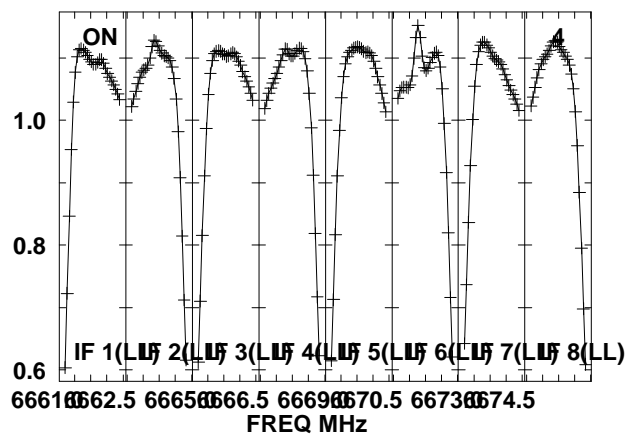
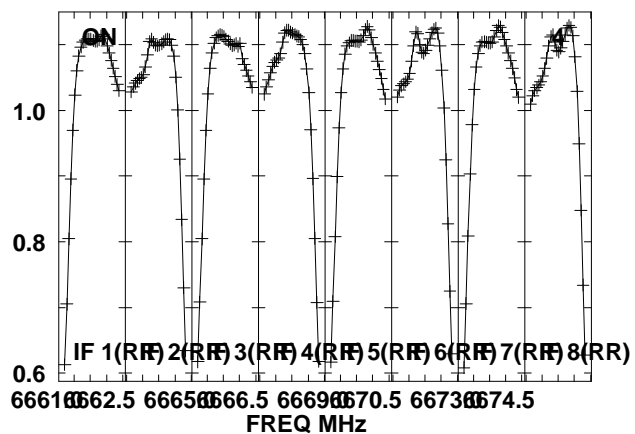
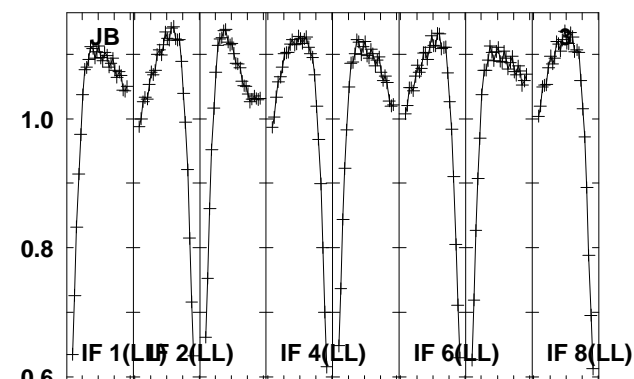
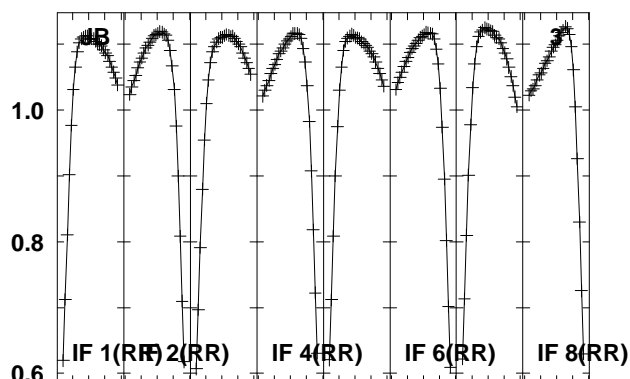
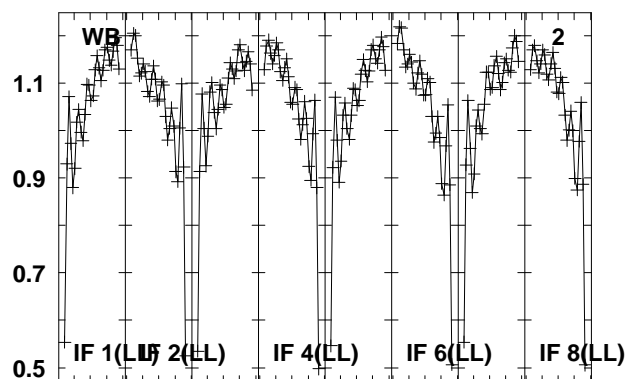
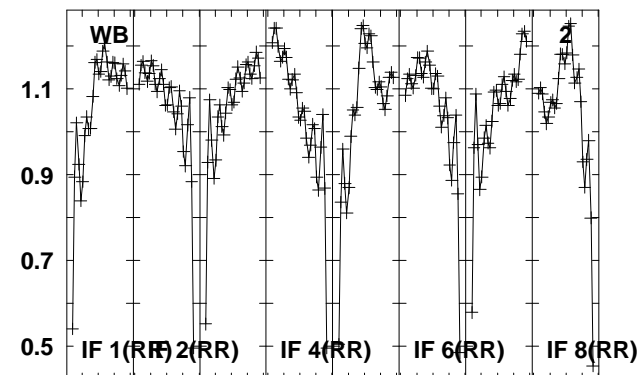
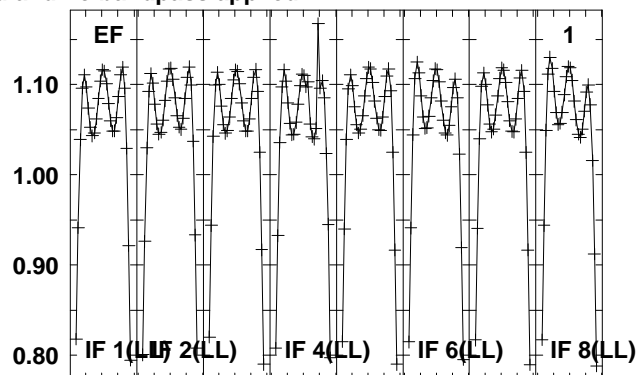
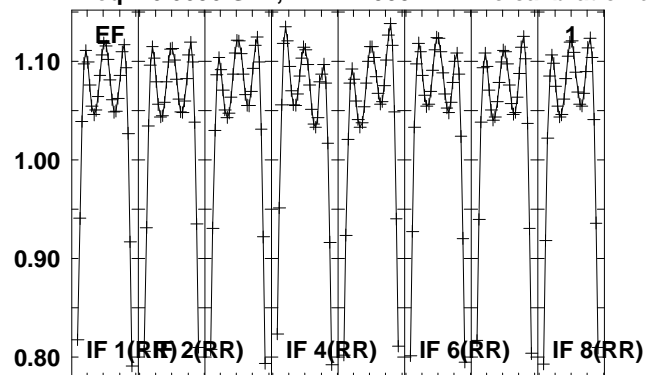

Lower frame: Real Jy

Total-power spectrum Antenna: *

Timerange: 00/16:03:03 to 00/16:04:59

Plot file version 52 created 07-JUN-2013 14:03:31

0528+134 N13M1.UVDATA.1

Freq = 6.6606 GHz, Bw = 2.000 MH No calibration applied and no bandpass applied

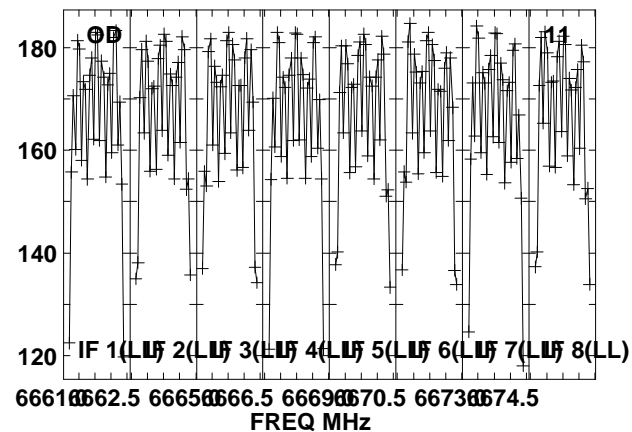
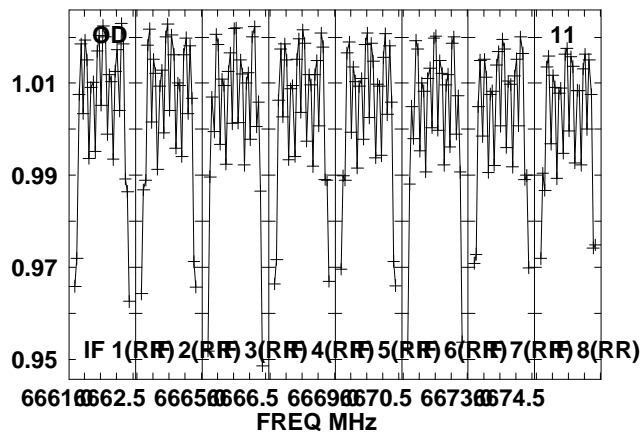
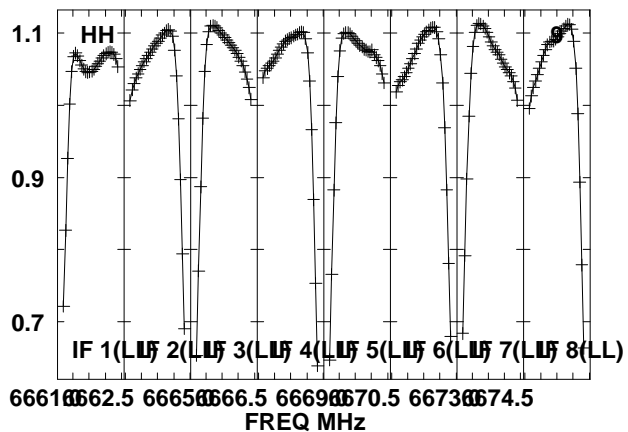
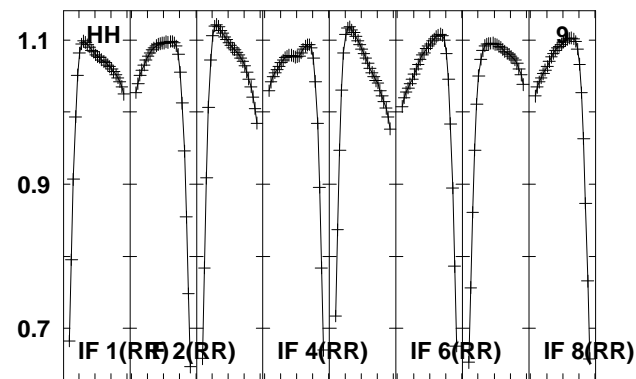
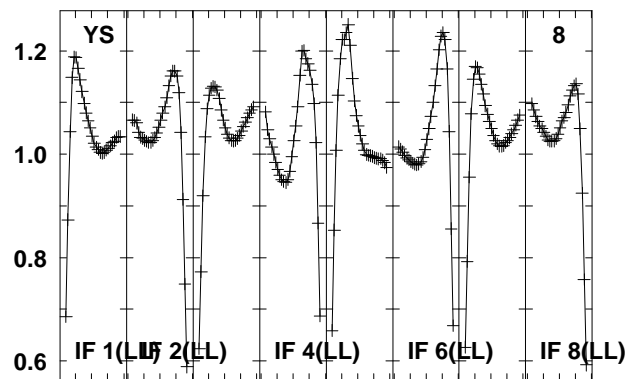
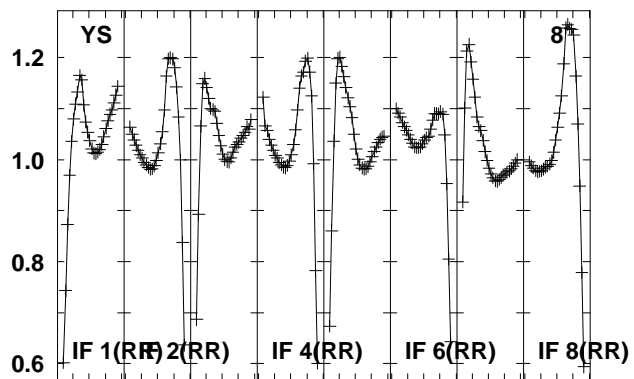
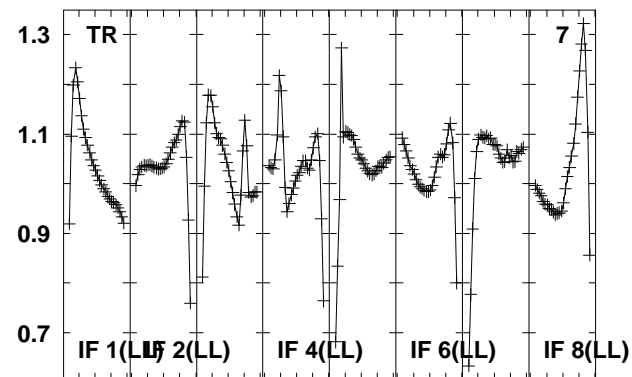
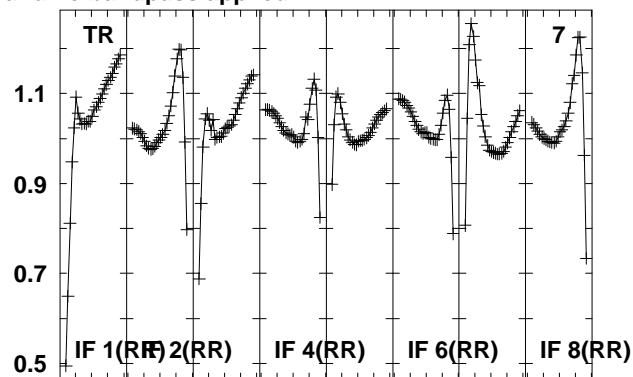
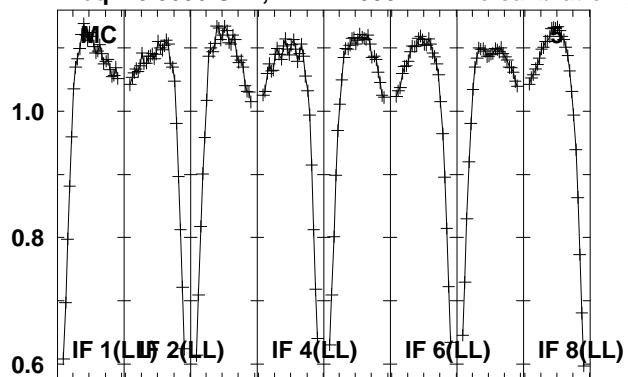

Lower frame: Real Jy
Total-power spectrum Antenna: *
Timerange: 00/16:03:03 to 00/16:04:59

Plot file version 53 created 07-JUN-2013 14:03:32

0528+134 N13M1.UVDATA.1

Freq = 6.6606 GHz, Bw = 2.000 MH No calibration applied and no bandpass applied

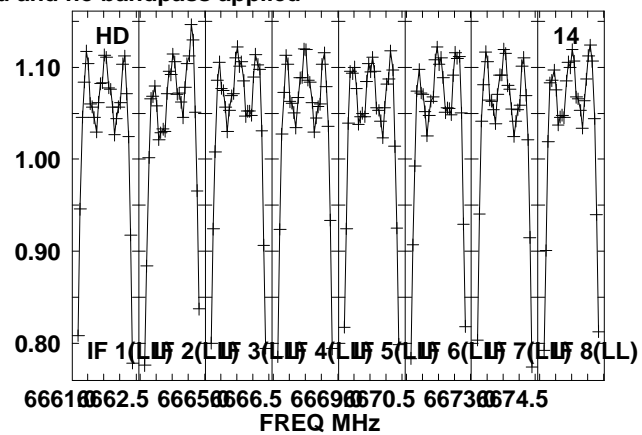
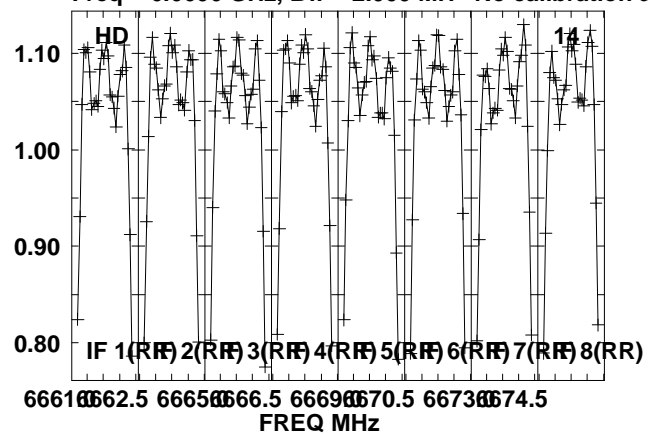

Lower frame: Real Jy
Total-power spectrum Antenna: *
Timerange: 00/16:03:03 to 00/16:04:59

Plot file version 54 created 07-JUN-2013 14:03:32

0528+134 N13M1.UVDATA.1

Freq = 6.6606 GHz, Bw = 2.000 MH No calibration applied and no bandpass applied

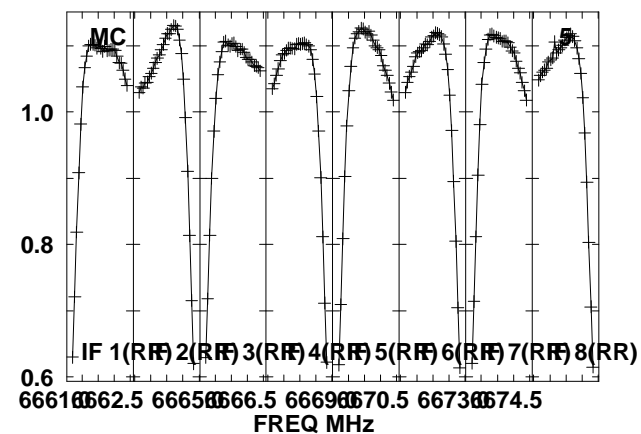
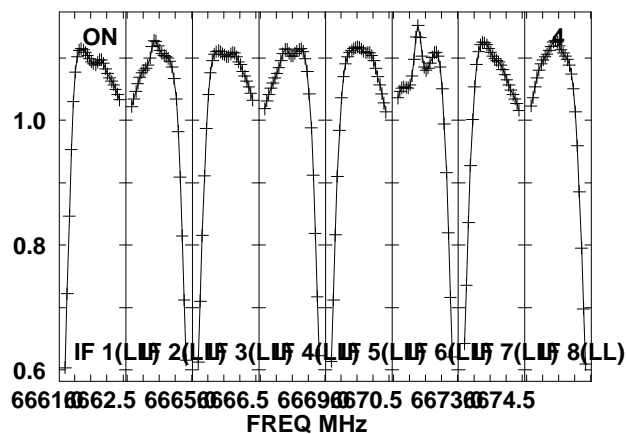
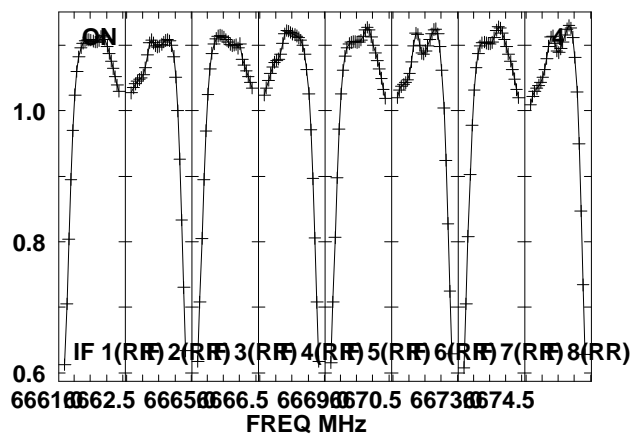
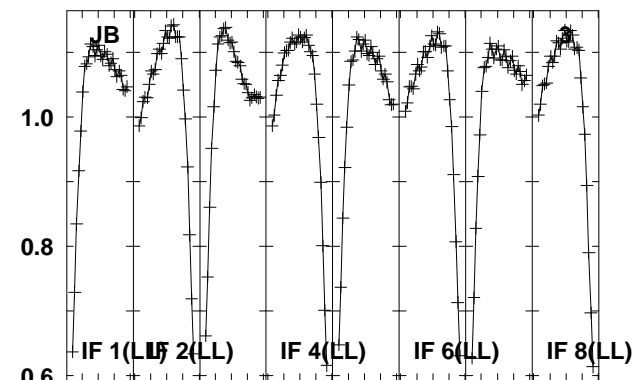
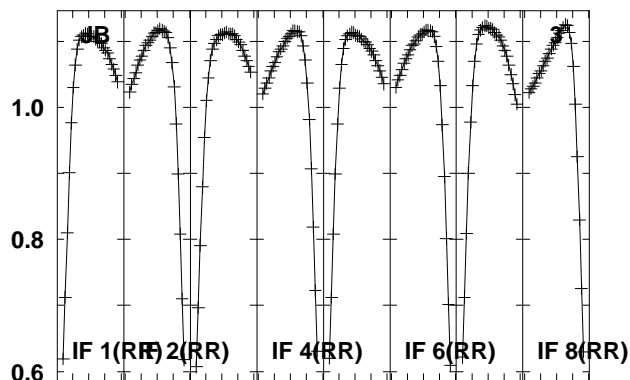
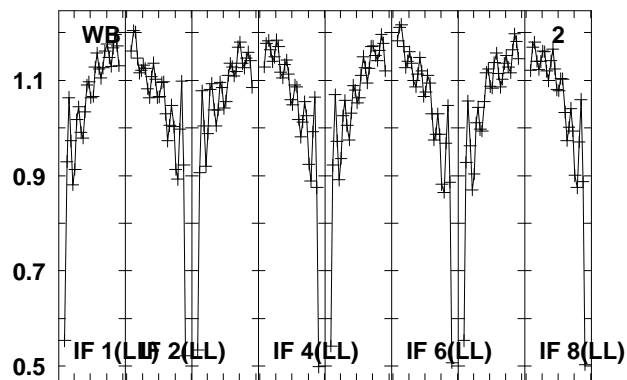
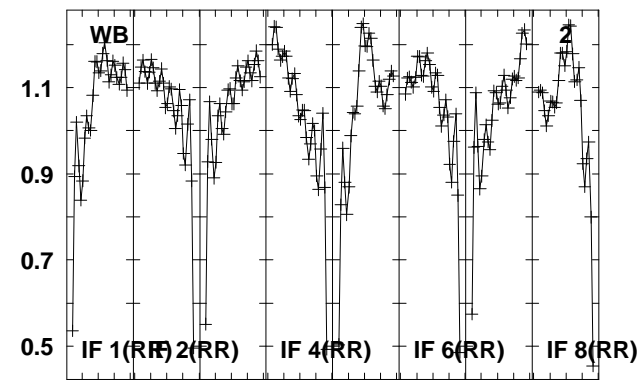
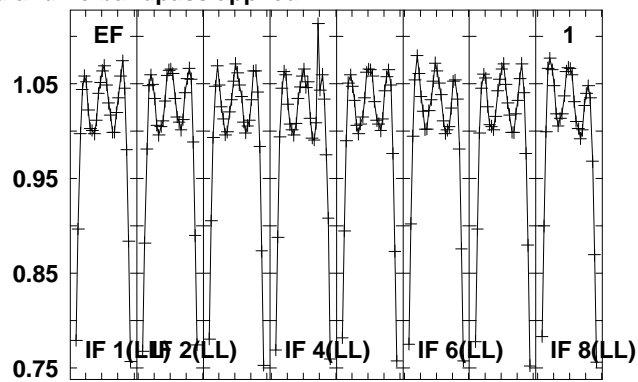
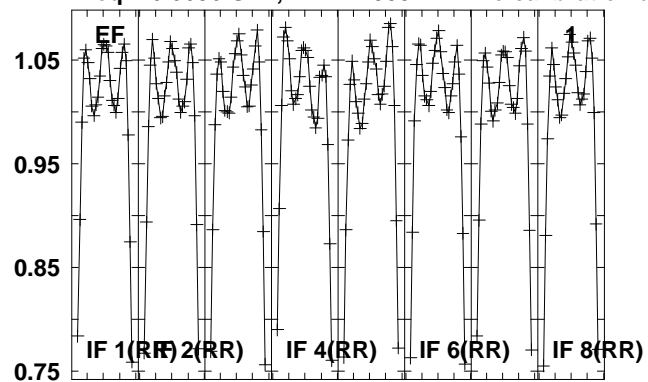

Lower frame: Real Jy
Total-power spectrum Antenna: *
Timerange: 00/16:06:03 to 00/16:10:59

Plot file version 55 created 07-JUN-2013 14:03:32

0528+134 N13M1.UVDATA.1

Freq = 6.6606 GHz, Bw = 2.000 MH No calibration applied and no bandpass applied

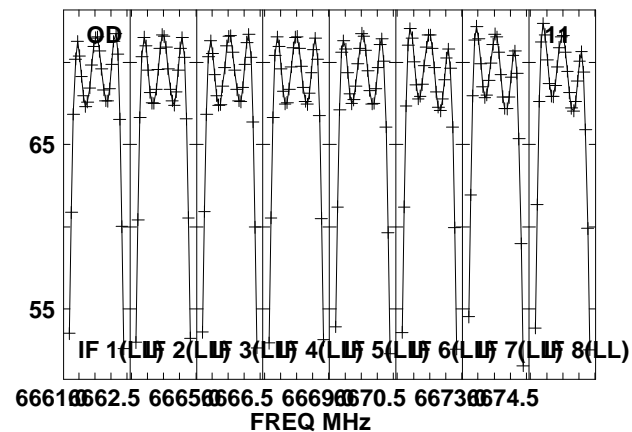
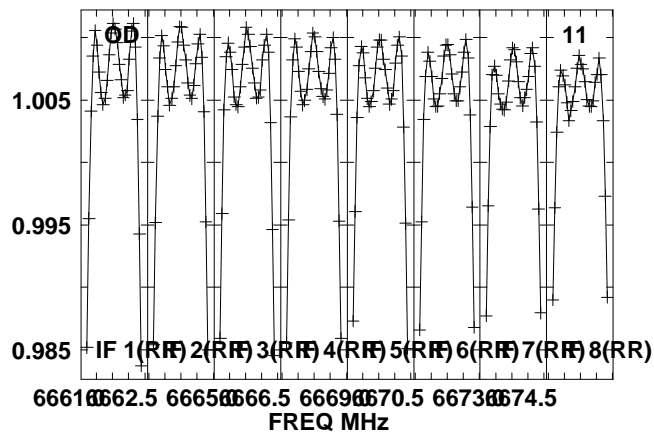
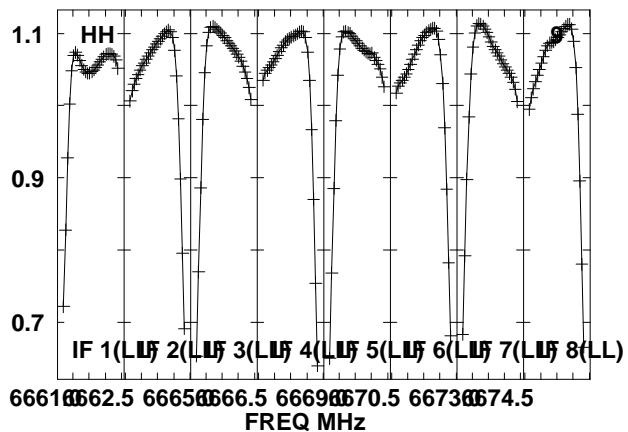
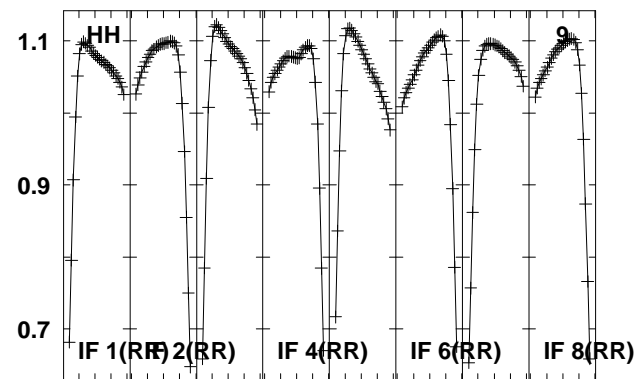
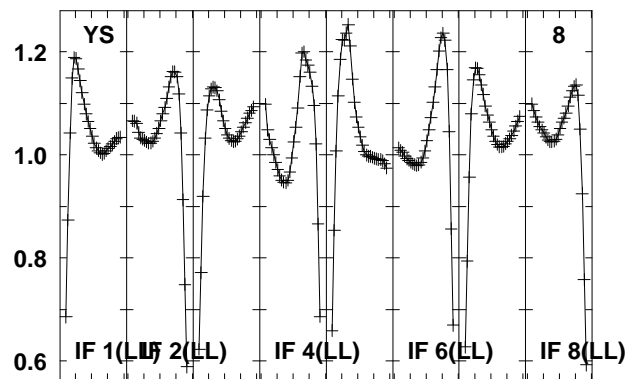
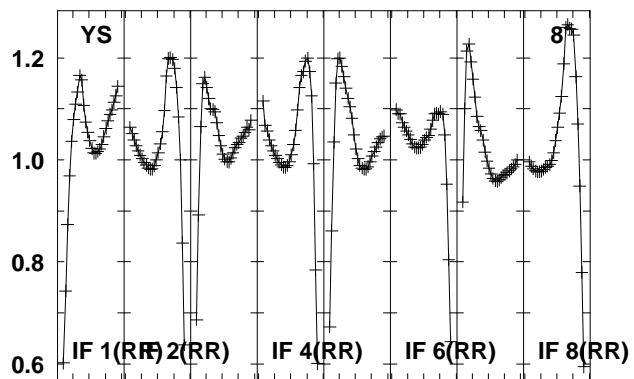
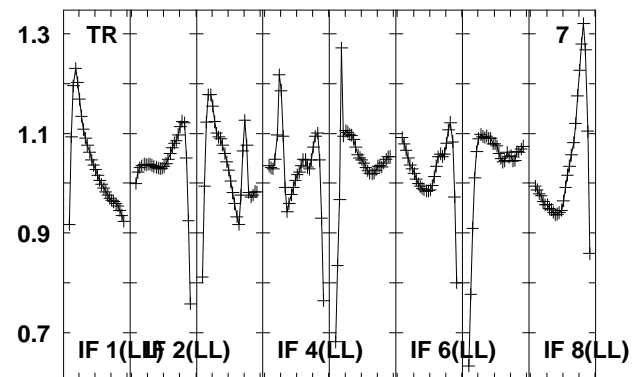
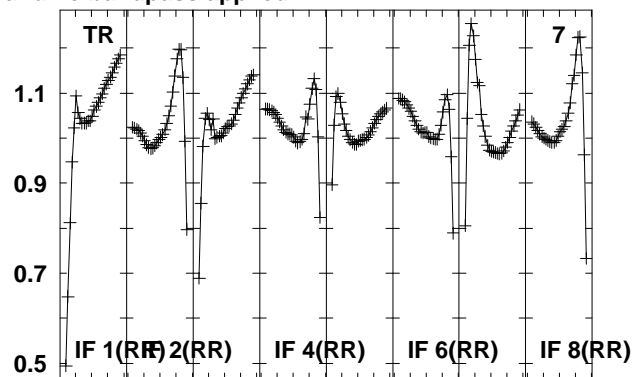
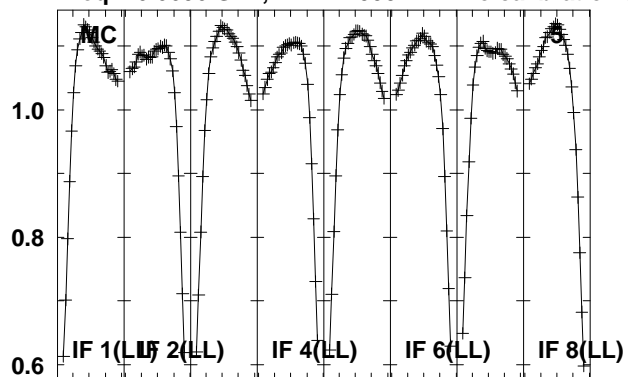

Lower frame: Real Jy
Total-power spectrum Antenna: *
Timerange: 00/16:06:03 to 00/16:10:59

Plot file version 56 created 07-JUN-2013 14:03:34

0528+134 N13M1.UVDATA.1

Freq = 6.6606 GHz, Bw = 2.000 MH No calibration applied and no bandpass applied

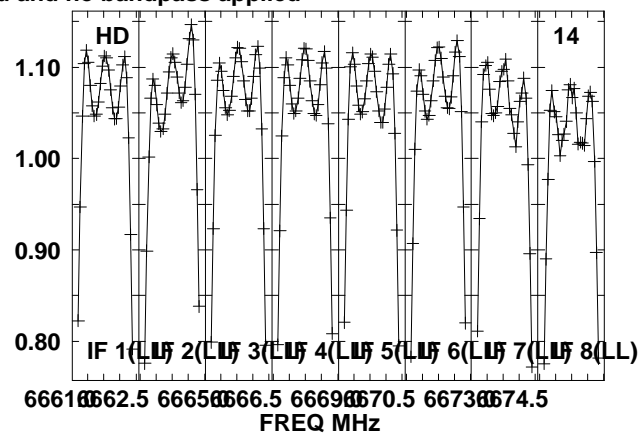
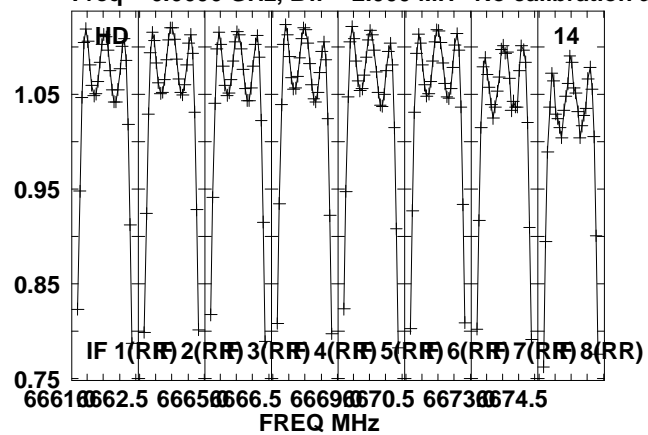

Lower frame: Real Jy
Total-power spectrum Antenna: *
Timerange: 00/16:06:03 to 00/16:10:59

Plot file version 57 created 07-JUN-2013 14:03:34

0528+134 N13M1.UVDATA.1

Freq = 6.6606 GHz, Bw = 2.000 MH No calibration applied and no bandpass applied

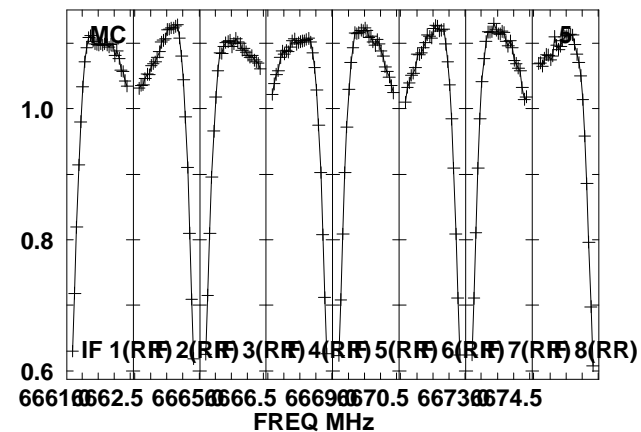
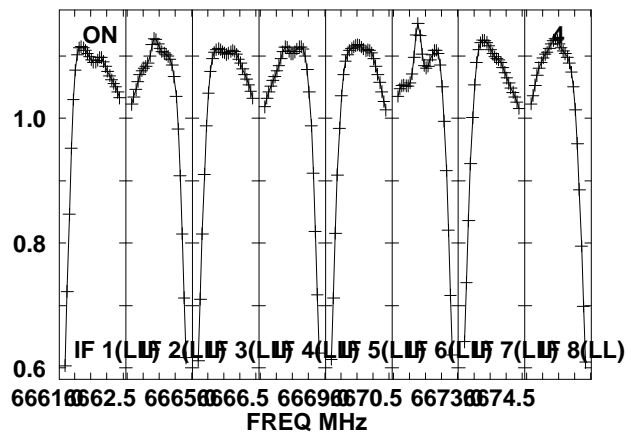
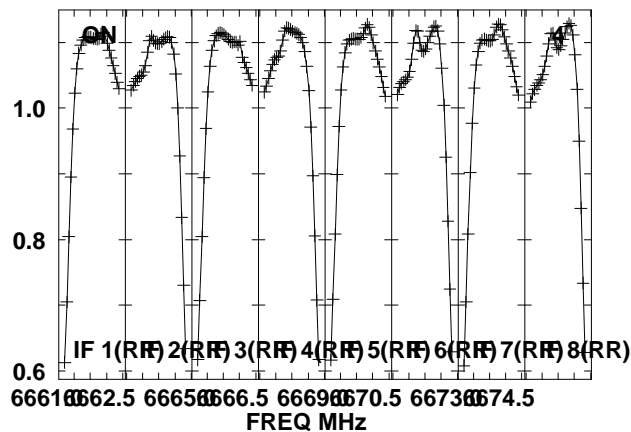
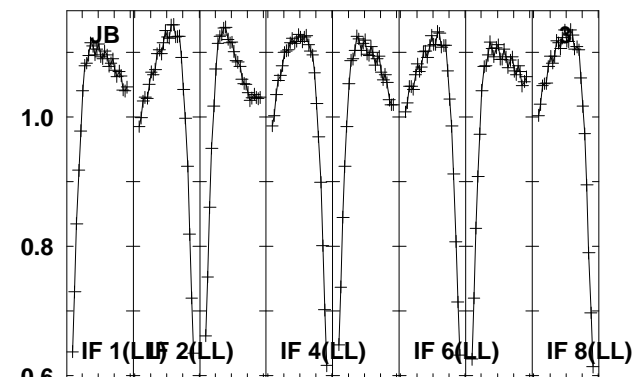
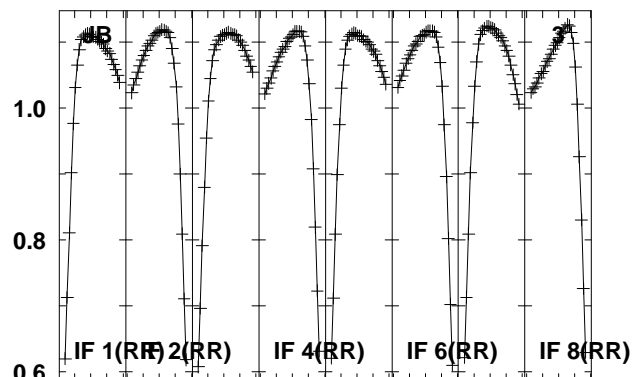
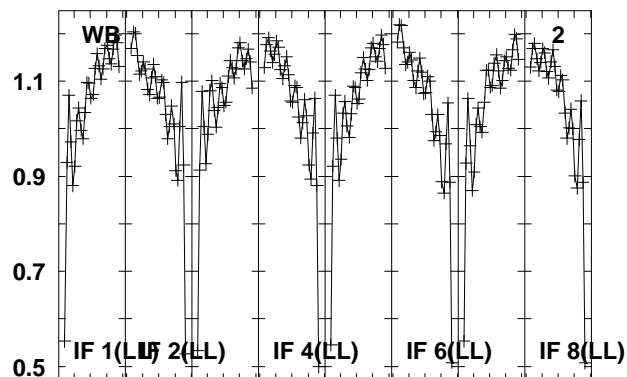
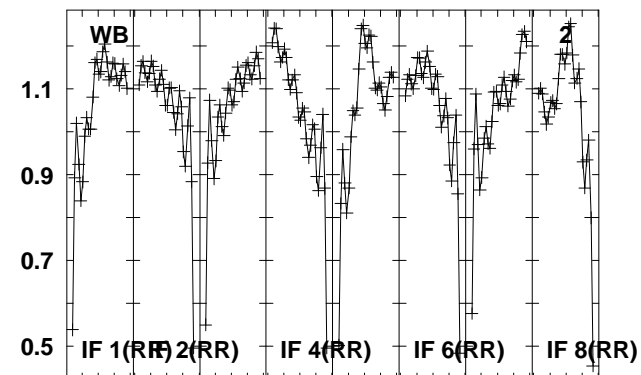
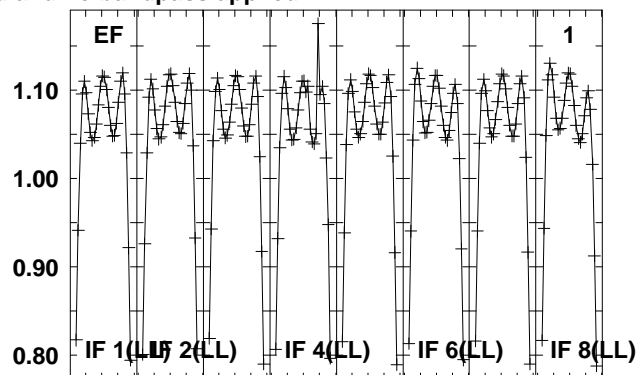
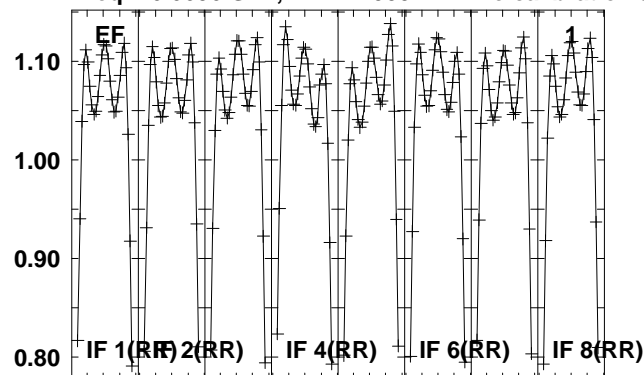

Lower frame: Real Jy

Total-power spectrum Antenna: *

Timerange: 00/16:12:03 to 00/16:13:59

Plot file version 58 created 07-JUN-2013 14:03:34

0528+134 N13M1.UVDATA.1

Freq = 6.6606 GHz, Bw = 2.000 MH No calibration applied and no bandpass applied

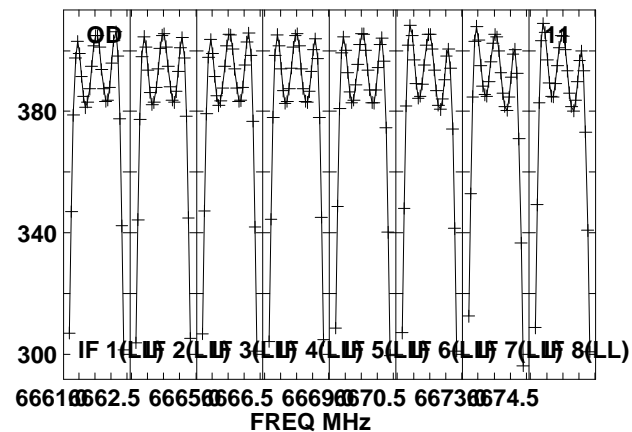
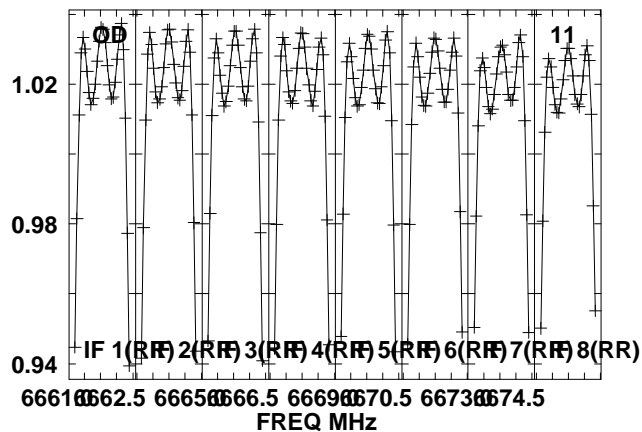
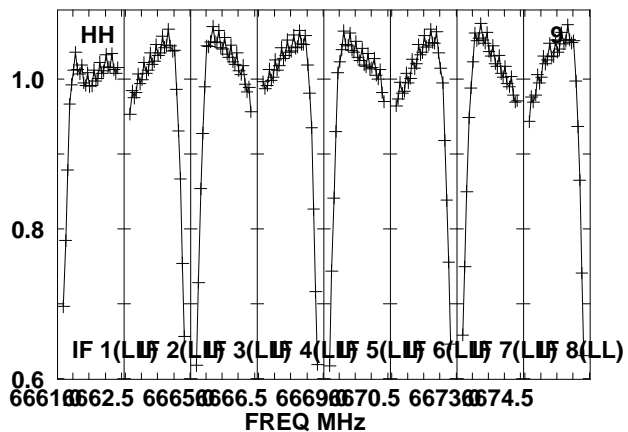
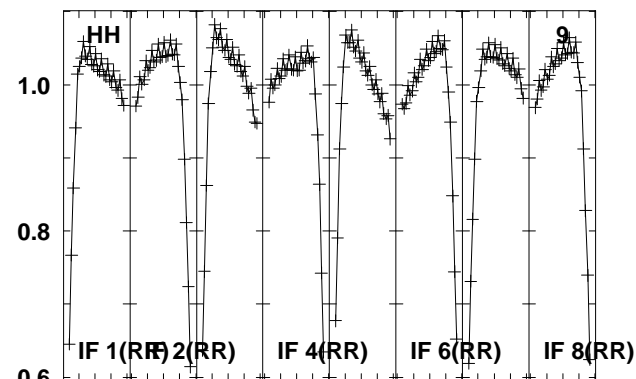
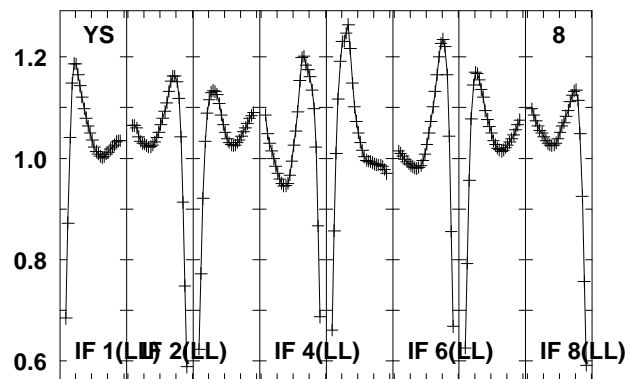
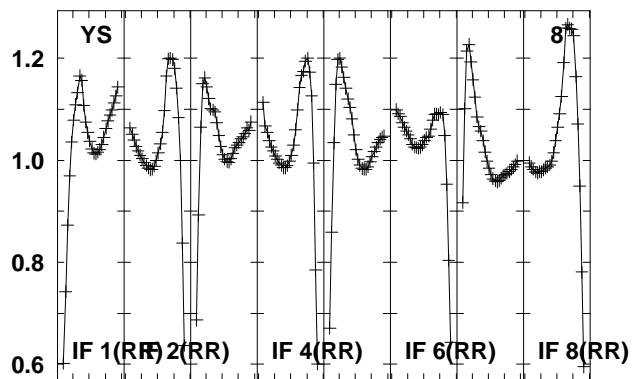
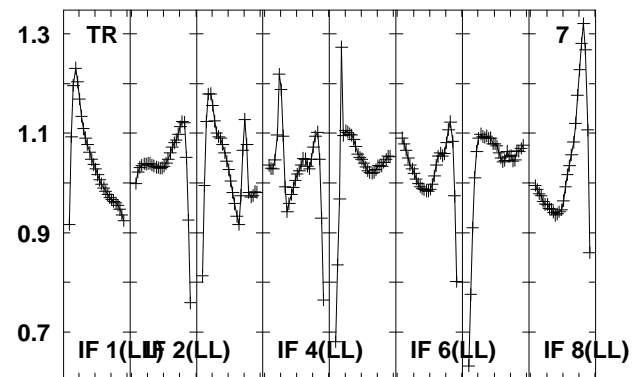
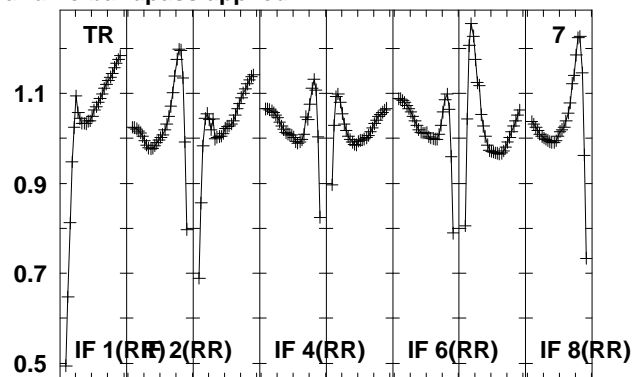
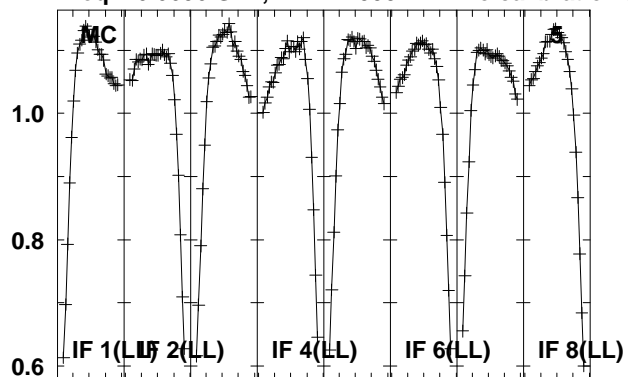

Lower frame: Real Jy
Total-power spectrum Antenna: *
Timerange: 00/16:12:03 to 00/16:13:59

Plot file version 59 created 07-JUN-2013 14:03:34

0528+134 N13M1.UVDATA.1

Freq = 6.6606 GHz, Bw = 2.000 MH No calibration applied and no bandpass applied

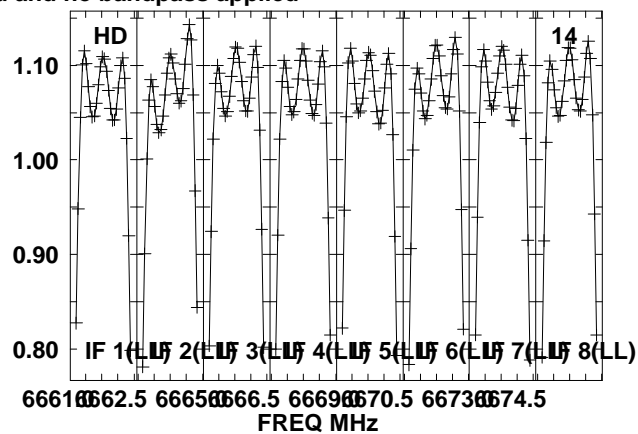
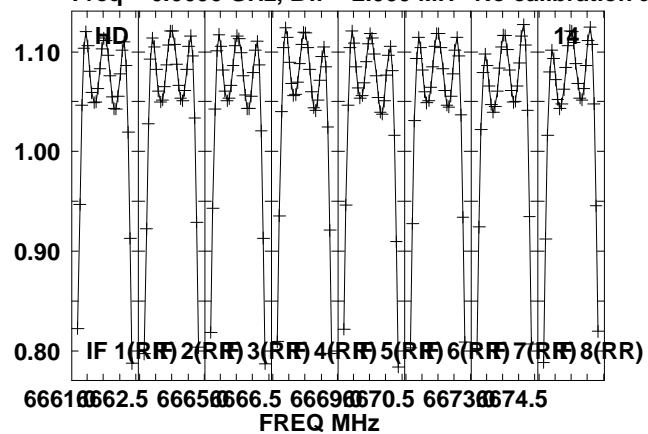

Lower frame: Real Jy

Total-power spectrum Antenna: *

Timerange: 00/16:12:03 to 00/16:13:59

Plot file version 60 created 07-JUN-2013 14:03:34

J0522+1415 N13M1.UVDATA.1

Freq = 6.6606 GHz, Bw = 2.000 MH No calibration applied and no bandpass applied

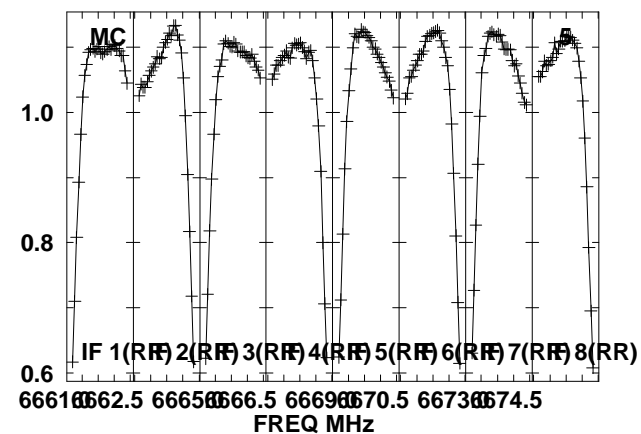
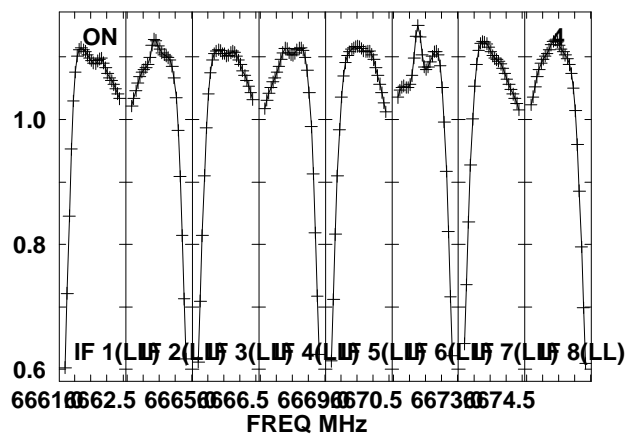
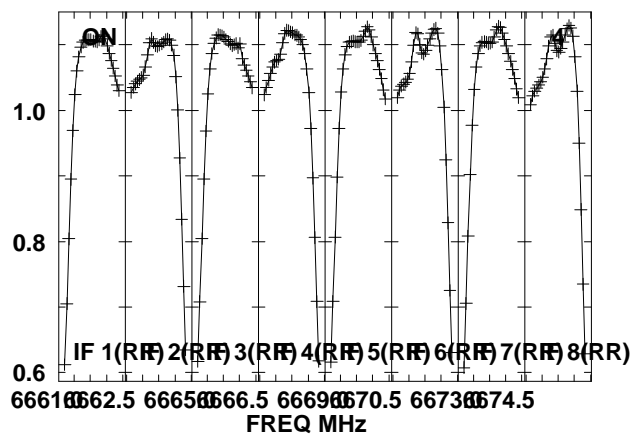
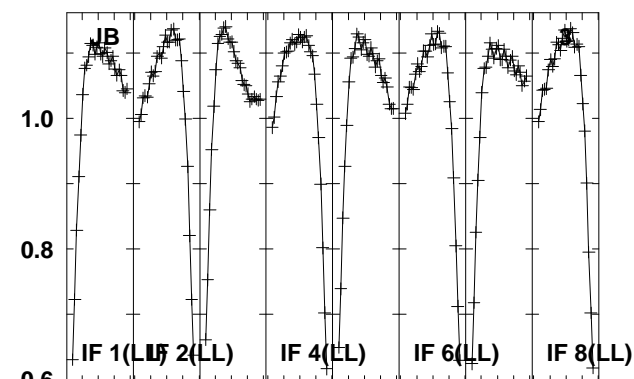
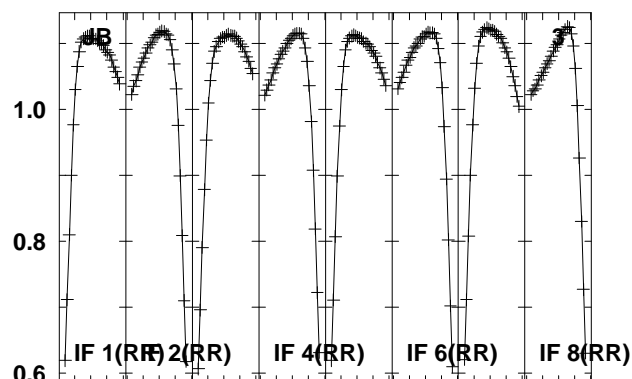
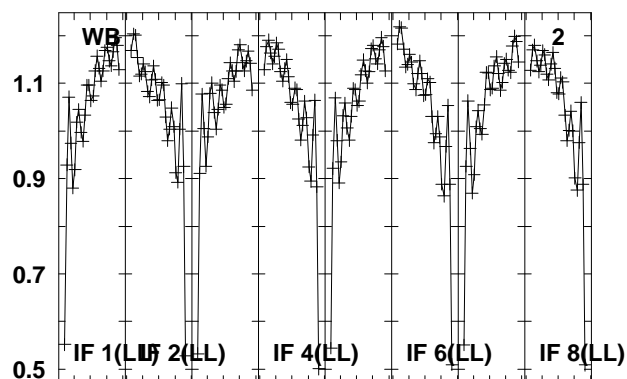
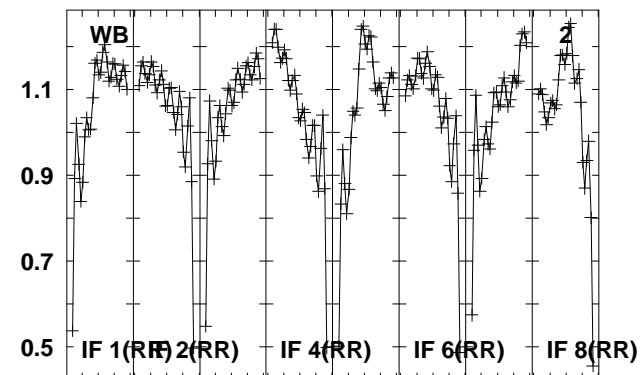
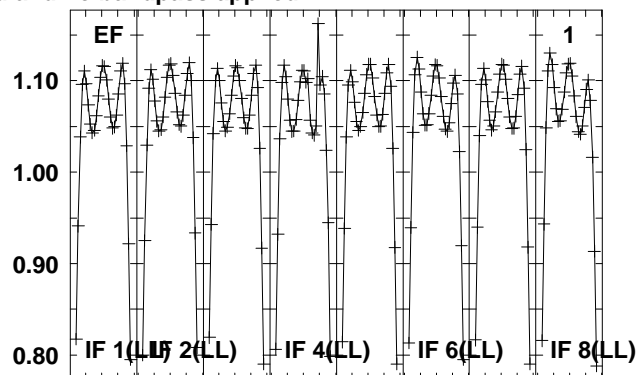
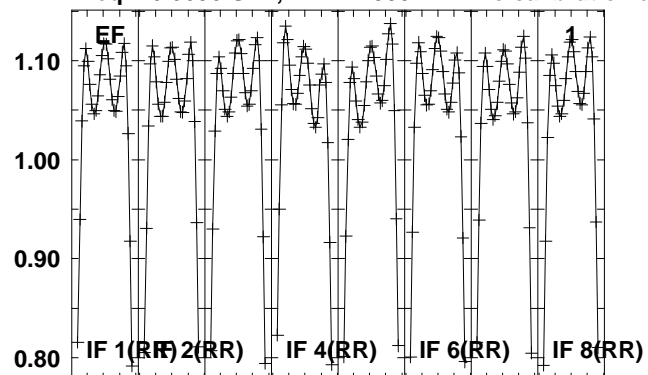

Lower frame: Real Jy
Total-power spectrum Antenna: *
Timerange: 00/16:14:09 to 00/16:15:59

Plot file version 61 created 07-JUN-2013 14:03:35

J0522+1415 N13M1.UVDATA.1

Freq = 6.6606 GHz, Bw = 2.000 MH No calibration applied and no bandpass applied

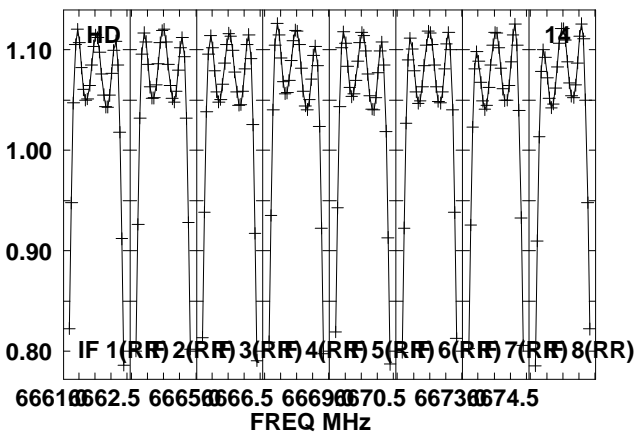
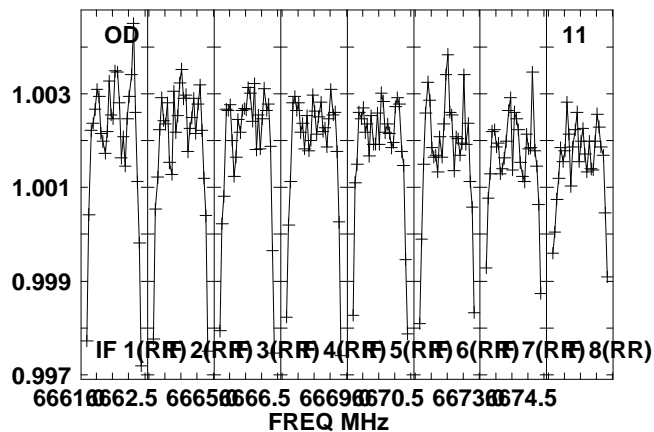
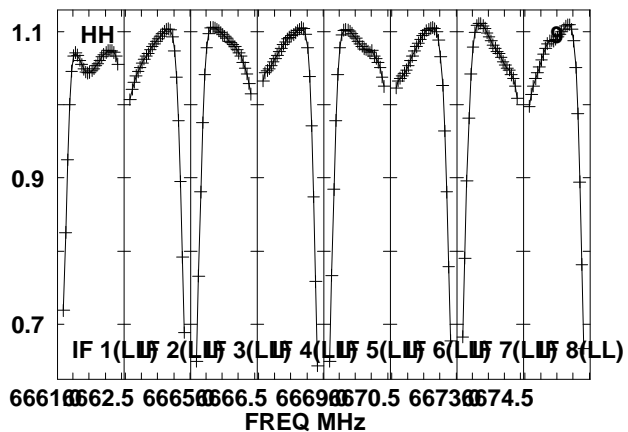
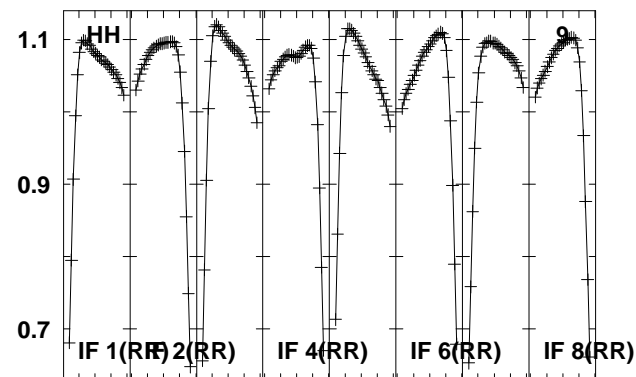
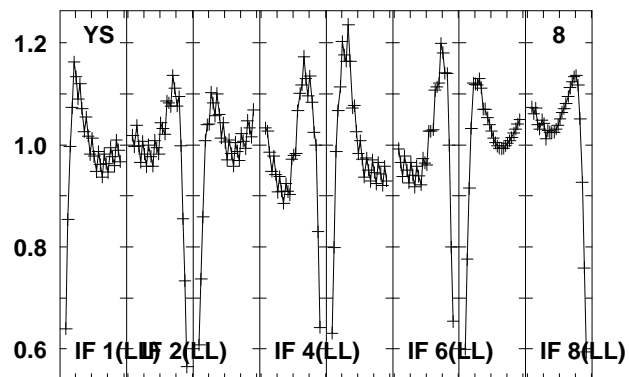
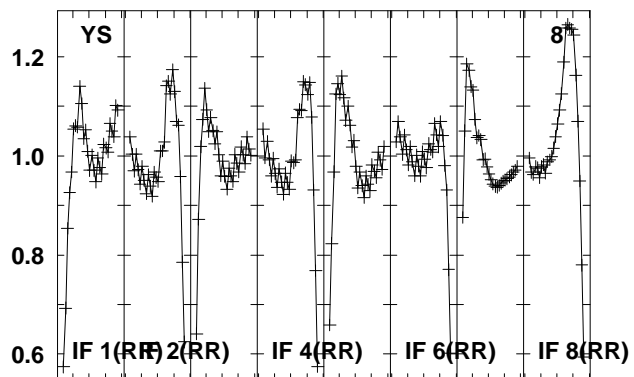
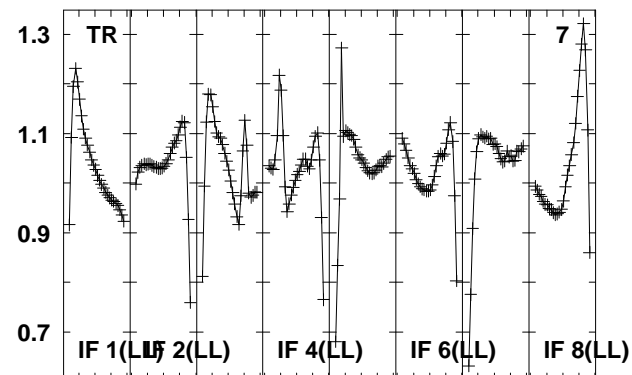
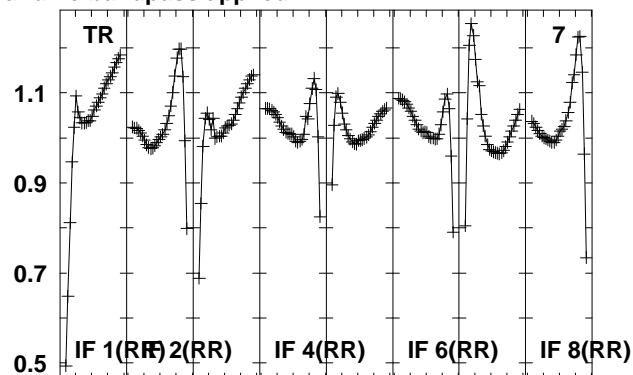
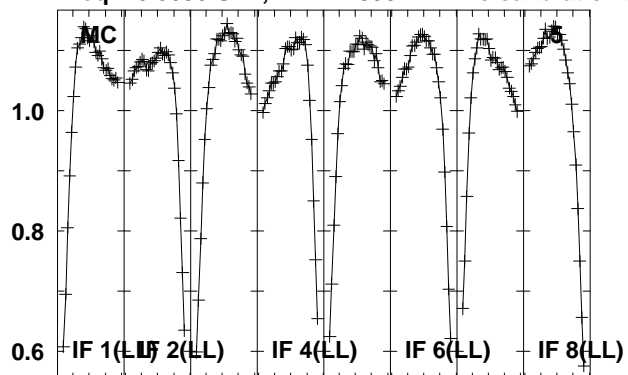

Lower frame: Real Jy
Total-power spectrum Antenna: *
Timerange: 00/16:14:09 to 00/16:15:59

Plot file version 62 created 07-JUN-2013 14:03:35
J0522+1415 N13M1.UVDATA.1
Freq = 6.6606 GHz, Bw = 2.000 MH No calibration applied and no bandpass applied

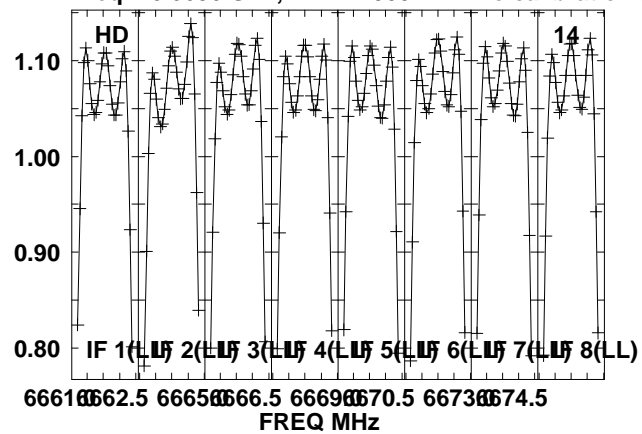

Lower frame: Real Jy
Total-power spectrum Antenna: *
Timerange: 00/16:14:09 to 00/16:15:59

Plot file version 63 created 07-JUN-2013 14:03:35

0528+134 N13M1.UVDATA.1

Freq = 6.6606 GHz, Bw = 2.000 MH No calibration applied and no bandpass applied

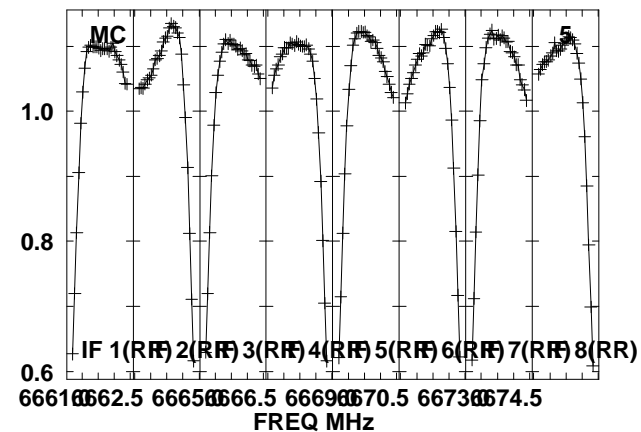
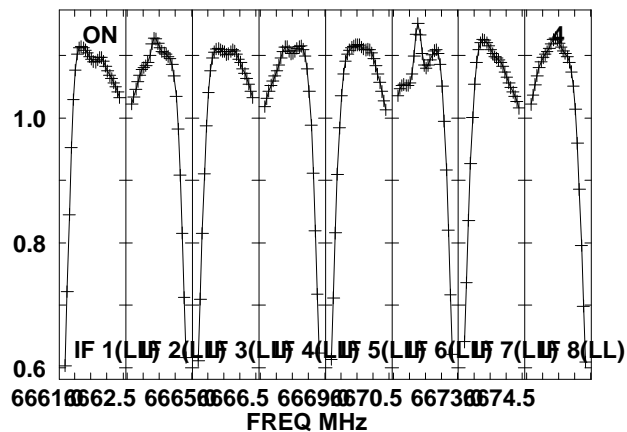
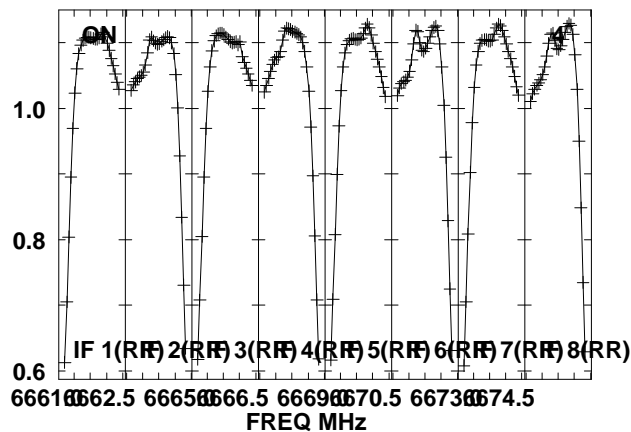
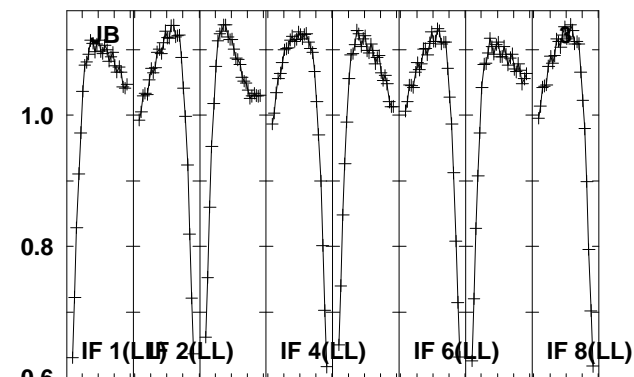
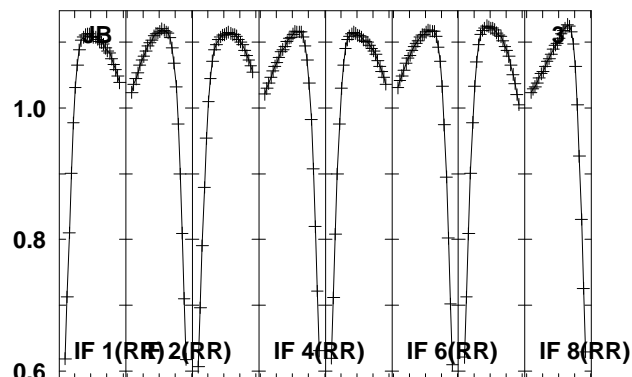
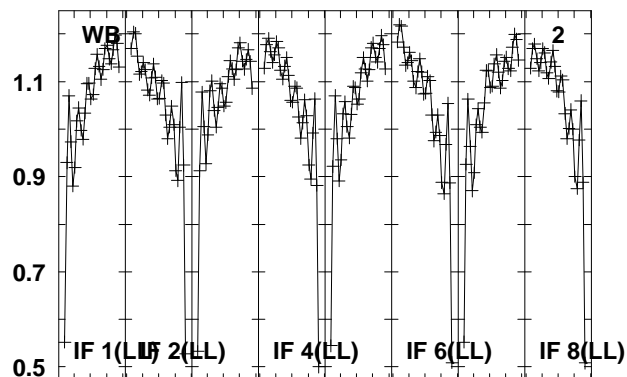
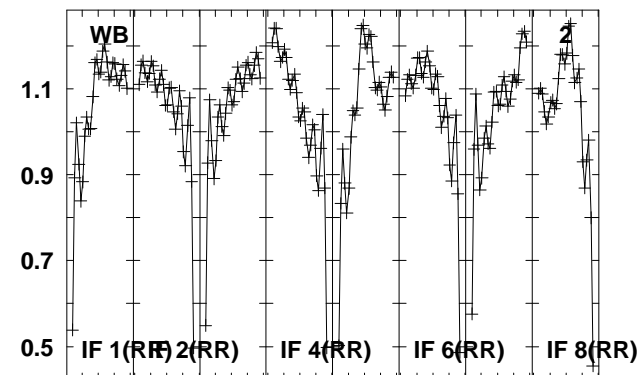
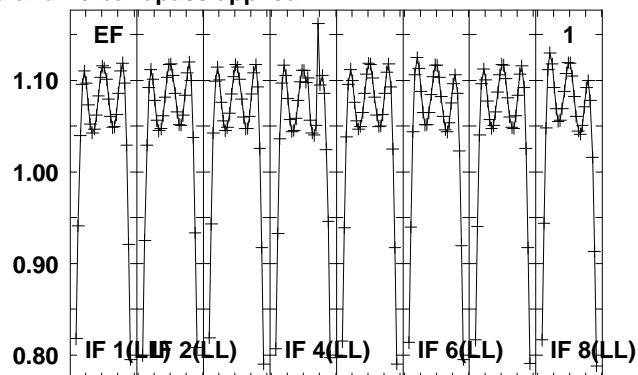
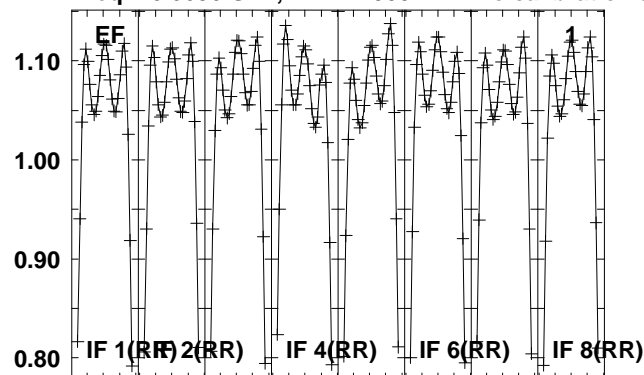

Lower frame: Real Jy

Total-power spectrum Antenna: *

Timerange: 00/16:16:09 to 00/16:18:59

Plot file version 64 created 07-JUN-2013 14:03:35

0528+134 N13M1.UVDATA.1

Freq = 6.6606 GHz, Bw = 2.000 MH No calibration applied and no bandpass applied

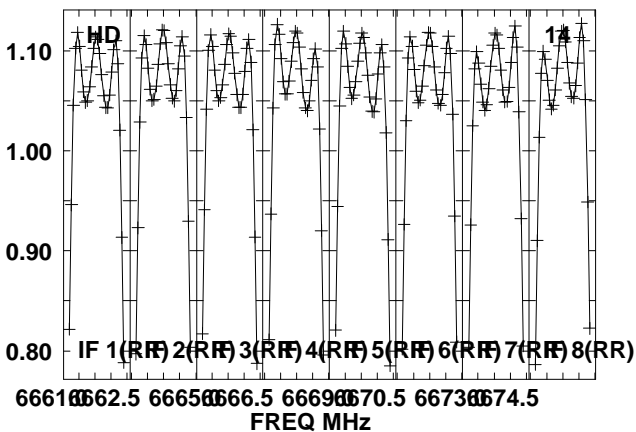
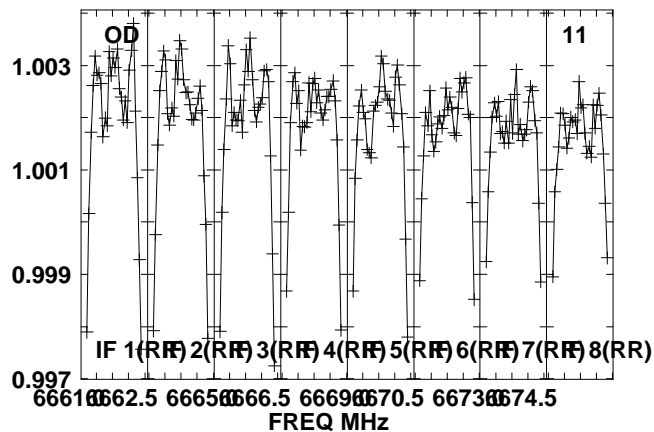
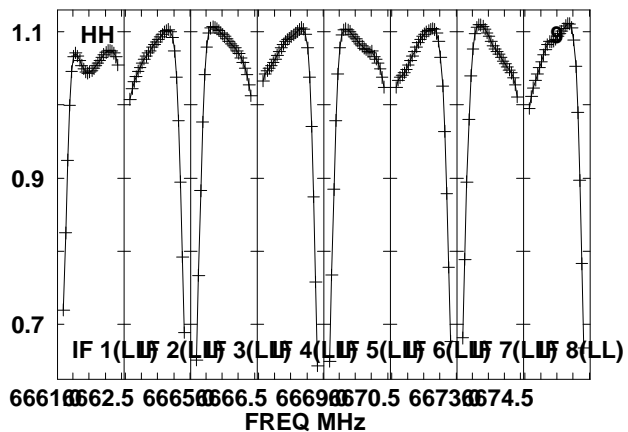
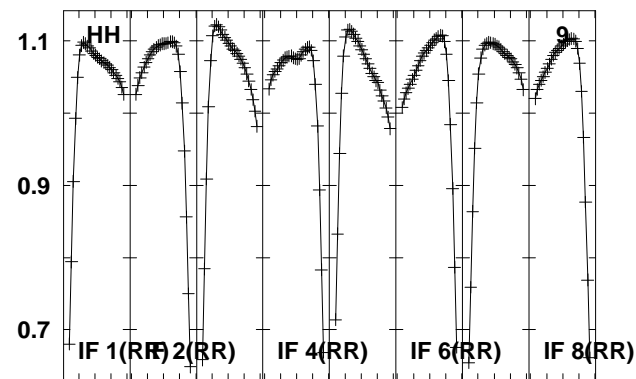
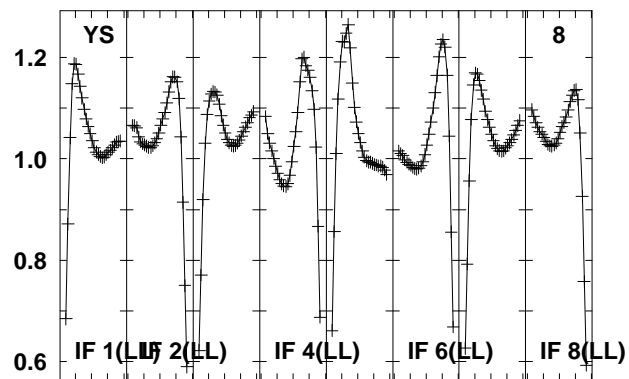
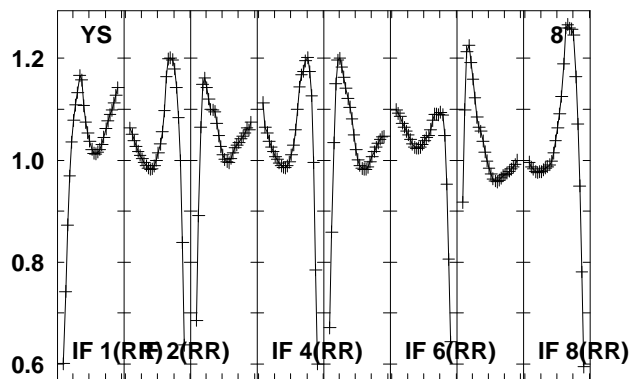
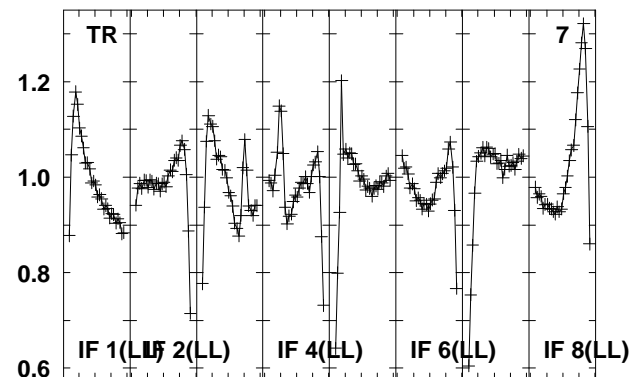
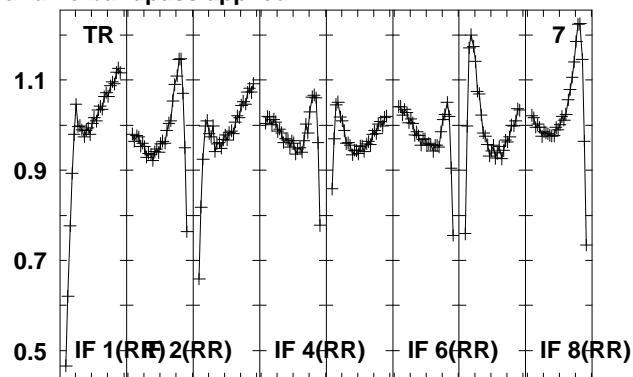
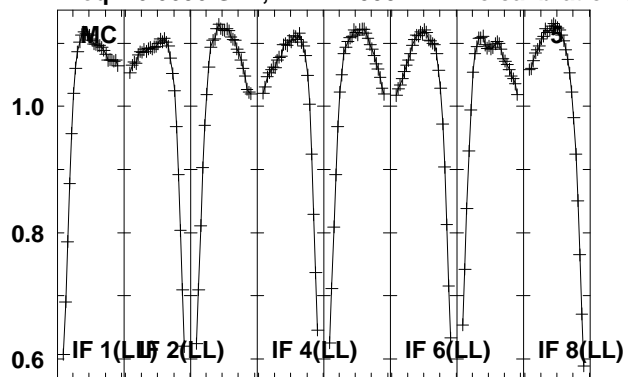

Lower frame: Real Jy
Total-power spectrum Antenna: *
Timerange: 00/16:16:09 to 00/16:18:59

Plot file version 65 created 07-JUN-2013 14:03:36
0528+134 N13M1.UVDATA.1
Freq = 6.6606 GHz, Bw = 2.000 MH No calibration applied and no bandpass applied

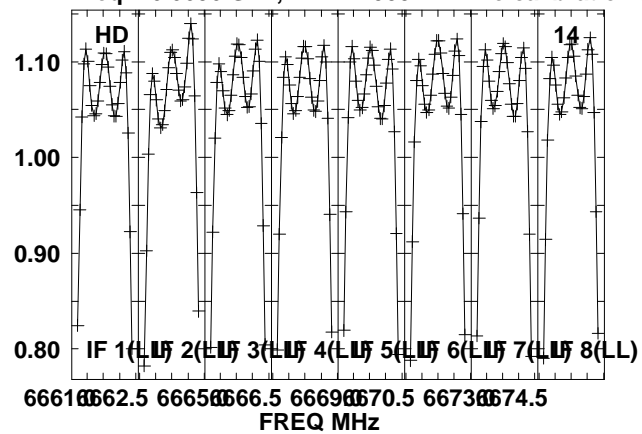

Lower frame: Real Jy
Total-power spectrum Antenna: *
Timerange: 00/16:16:09 to 00/16:18:59

Plot file version 66 created 07-JUN-2013 14:03:36

J0522+1415 N13M1.UVDATA.1

Freq = 6.6606 GHz, Bw = 2.000 MH No calibration applied and no bandpass applied

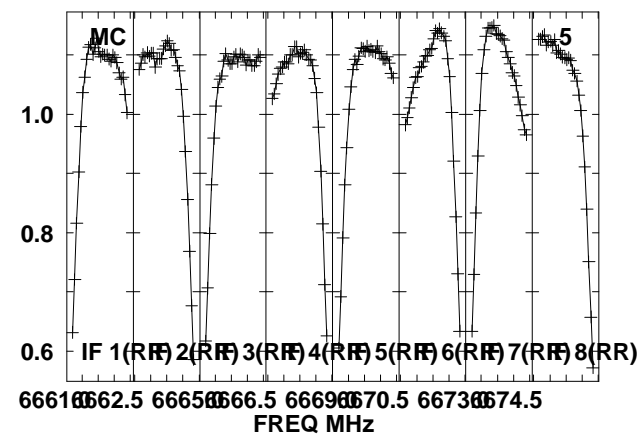
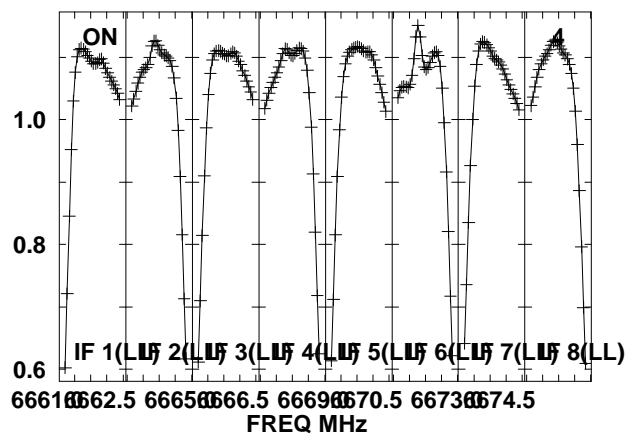
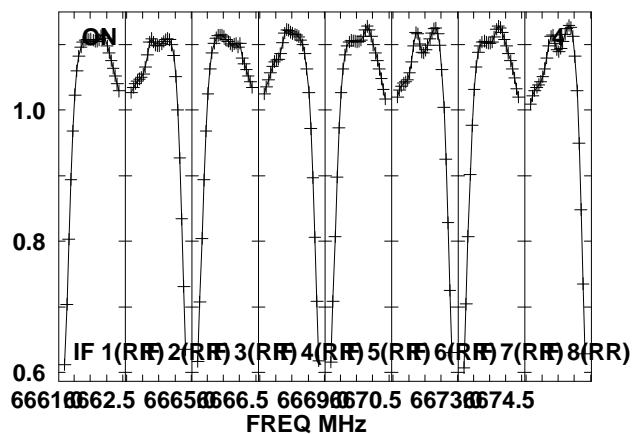
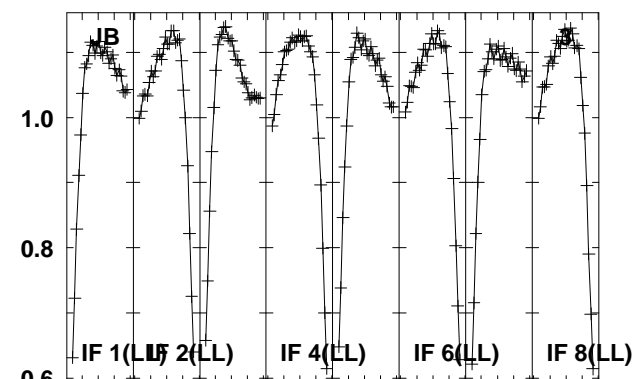
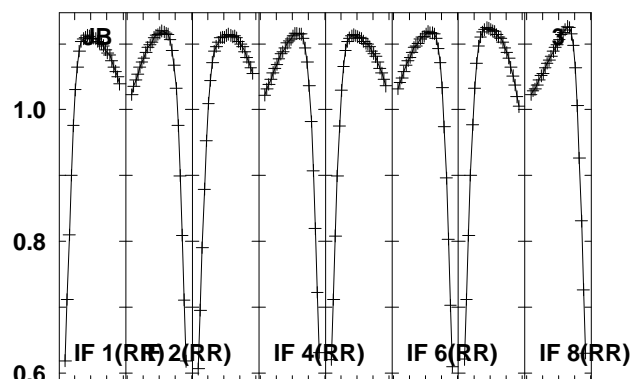
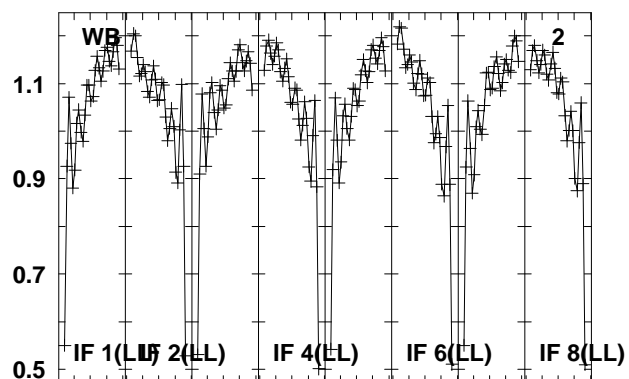
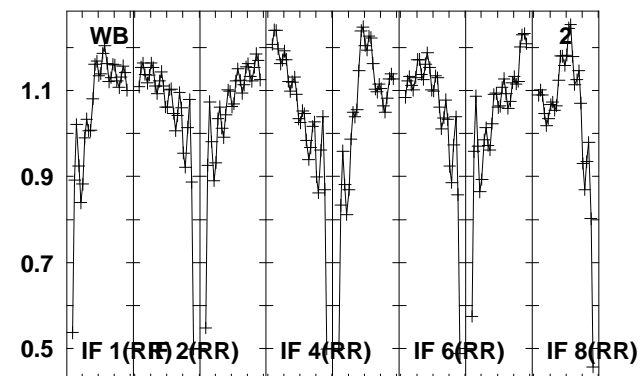
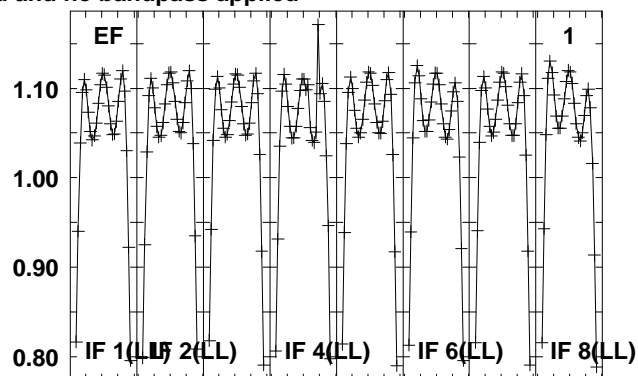
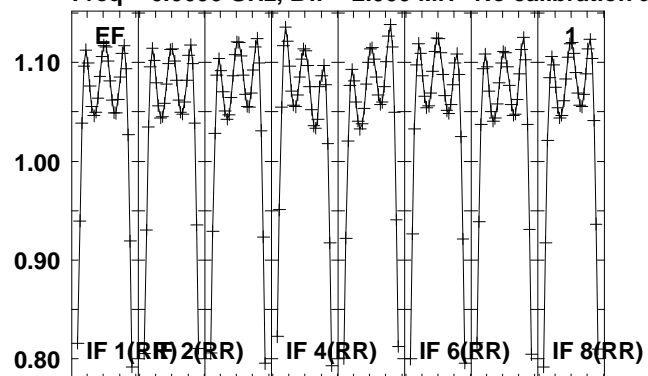

Lower frame: Real Jy
Total-power spectrum Antenna: *
Timerange: 00/16:20:03 to 00/16:21:59

Plot file version 67 created 07-JUN-2013 14:03:36

J0522+1415 N13M1.UVDATA.1

Freq = 6.6606 GHz, Bw = 2.000 MH No calibration applied and no bandpass applied

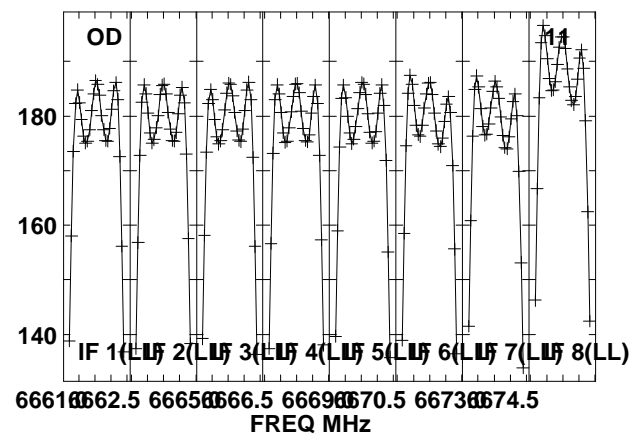
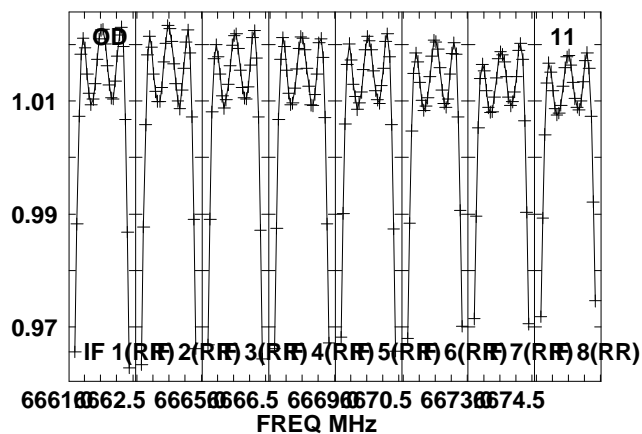
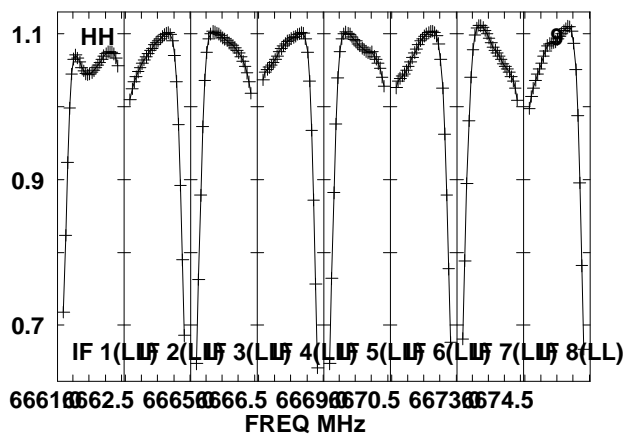
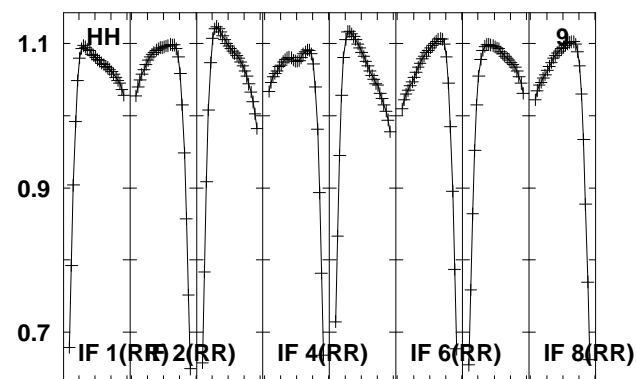
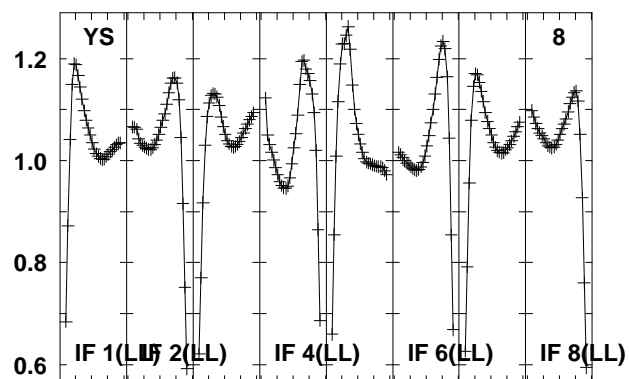
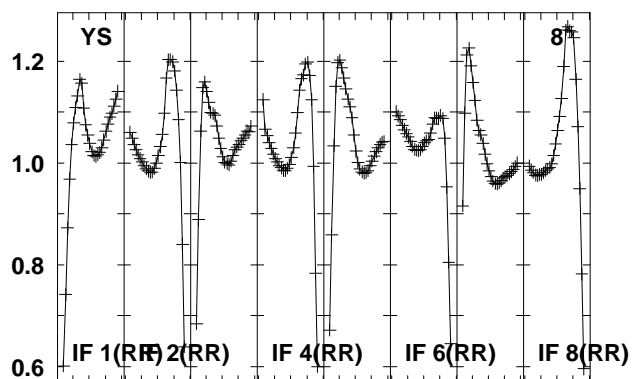
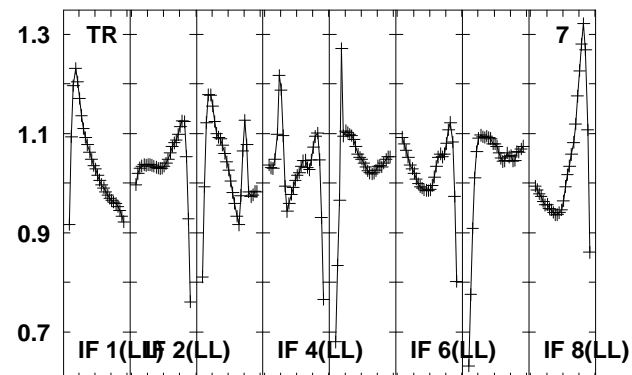
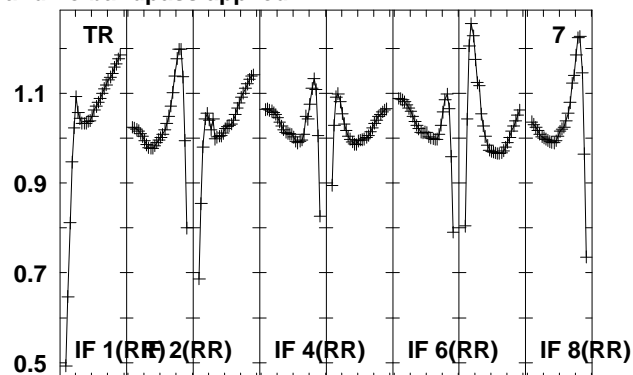
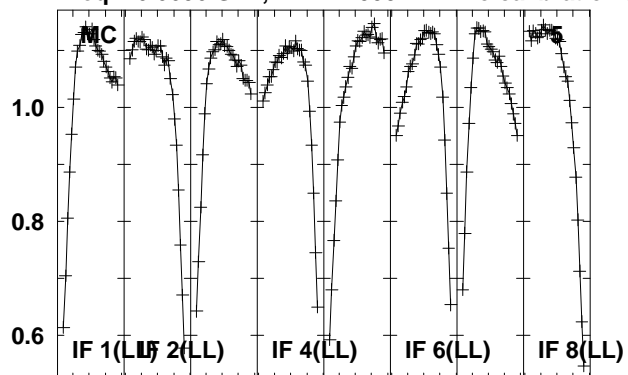

Lower frame: Real Jy
Total-power spectrum Antenna: *
Timerange: 00/16:20:03 to 00/16:21:59

Plot file version 68 created 07-JUN-2013 14:03:37

J0522+1415 N13M1.UVDATA.1

Freq = 6.6606 GHz, Bw = 2.000 MH No calibration applied and no bandpass applied

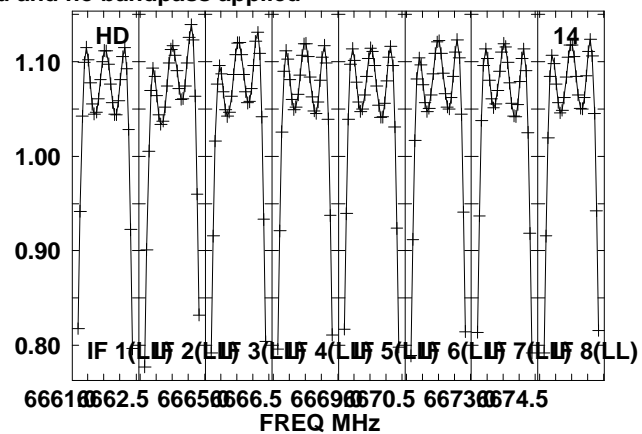
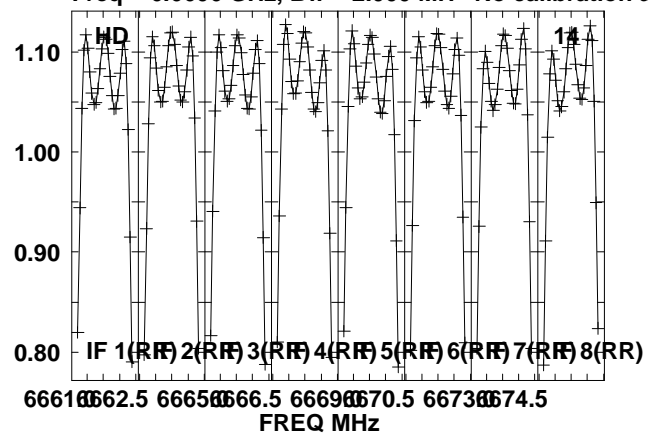

Lower frame: Real Jy

Total-power spectrum Antenna: *

Timerange: 00/16:20:03 to 00/16:21:59

Plot file version 69 created 07-JUN-2013 14:03:37

0528+134 N13M1.UVDATA.1

Freq = 6.6606 GHz, Bw = 2.000 MH No calibration applied and no bandpass applied

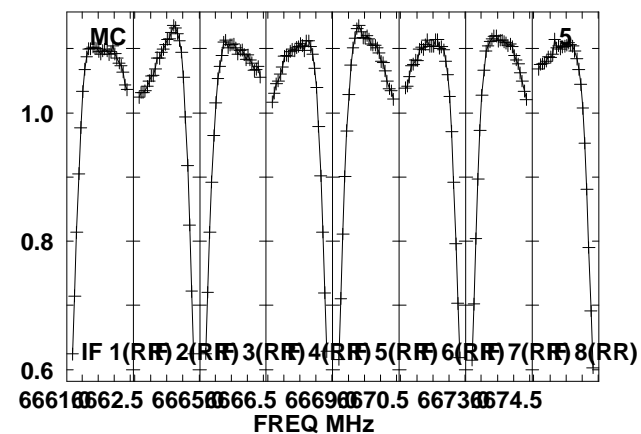
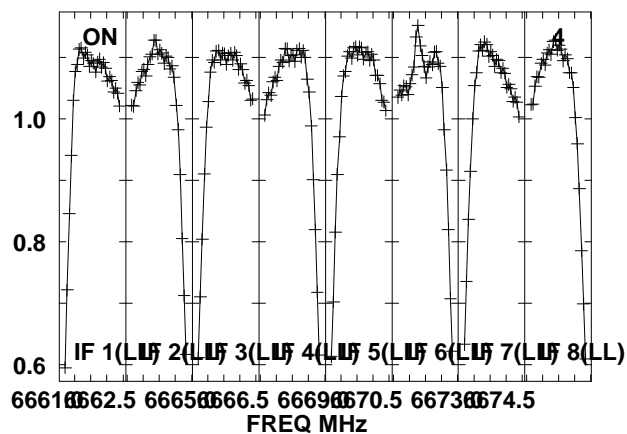
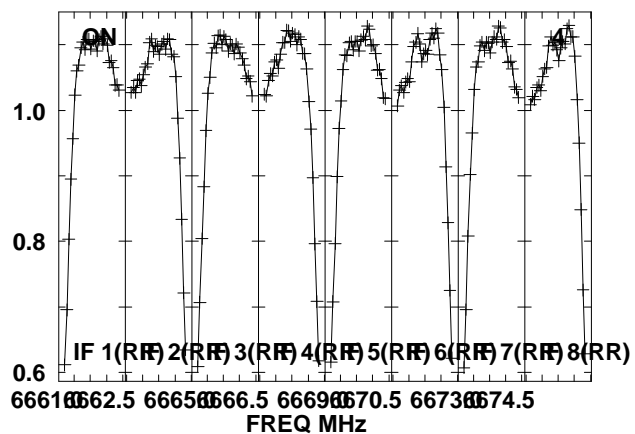
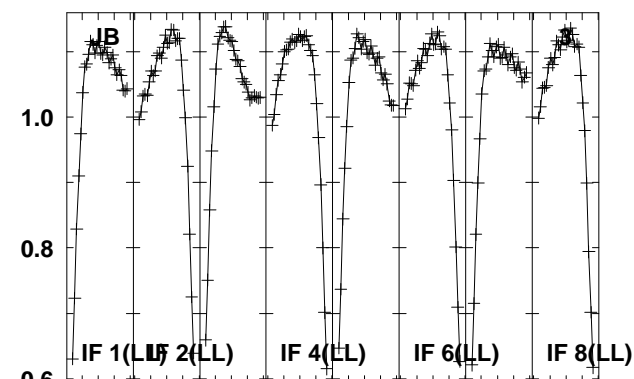
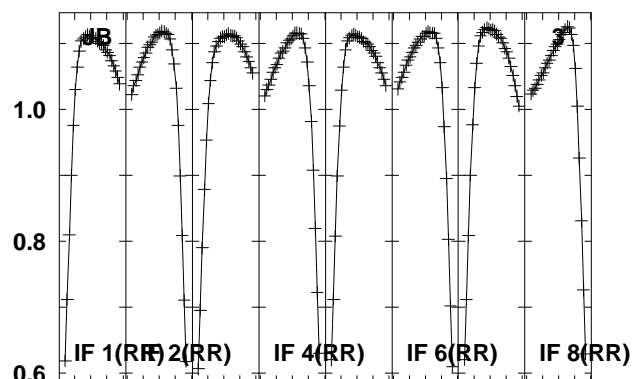
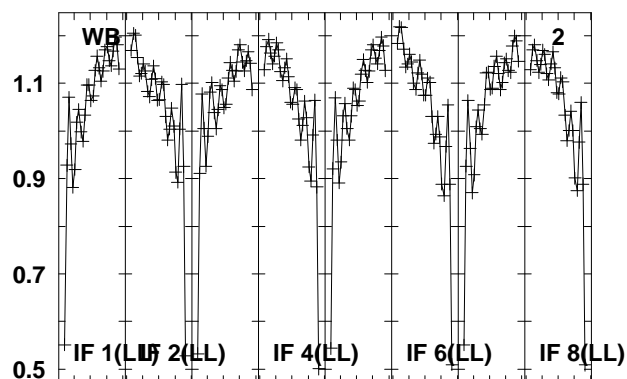
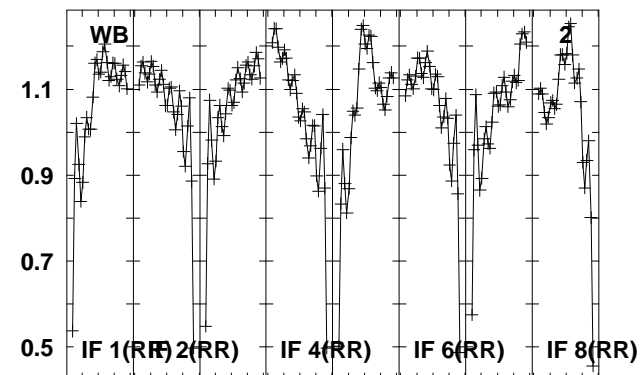
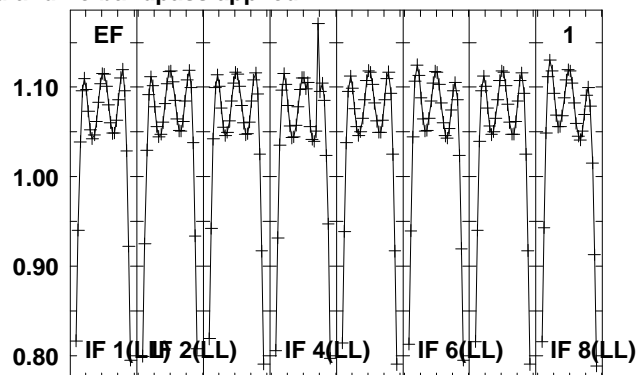
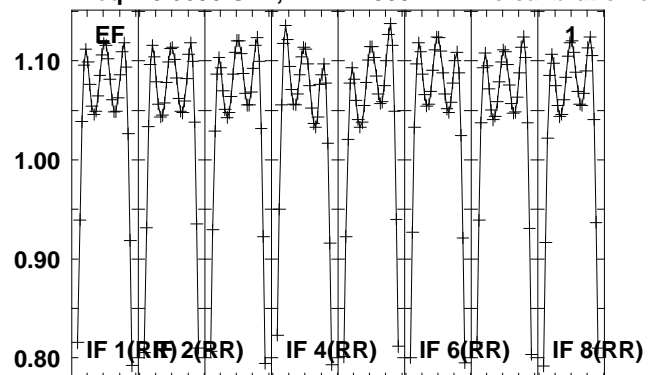

Lower frame: Real Jy

Total-power spectrum Antenna: *

Timerange: 00/16:22:09 to 00/16:24:59

Plot file version 70 created 07-JUN-2013 14:03:37

0528+134 N13M1.UVDATA.1

Freq = 6.6606 GHz, Bw = 2.000 MH No calibration applied and no bandpass applied

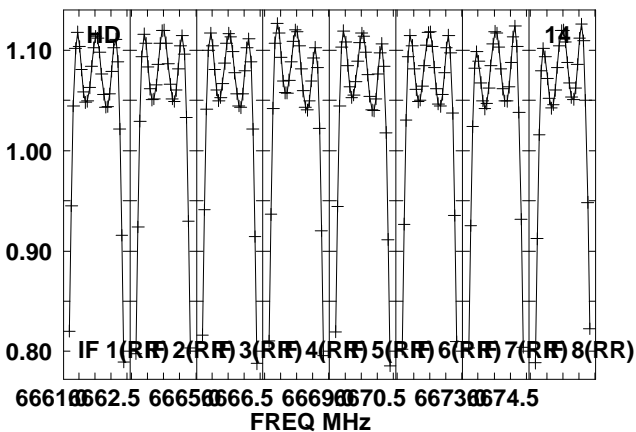
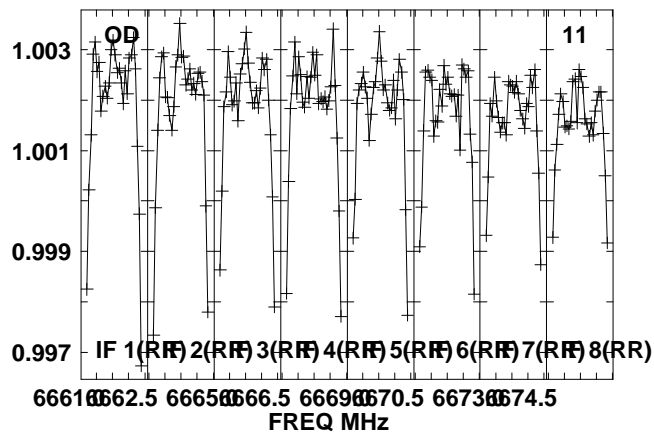
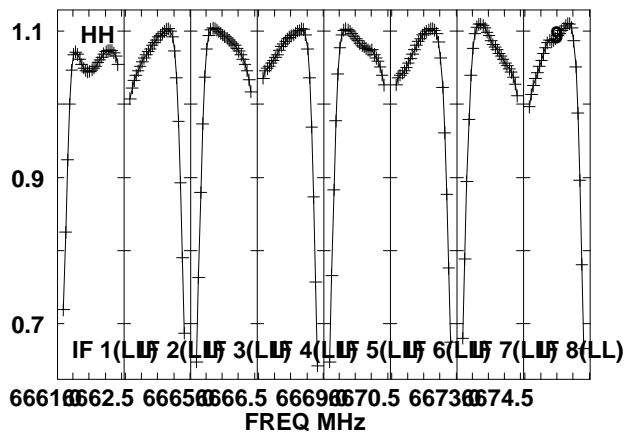
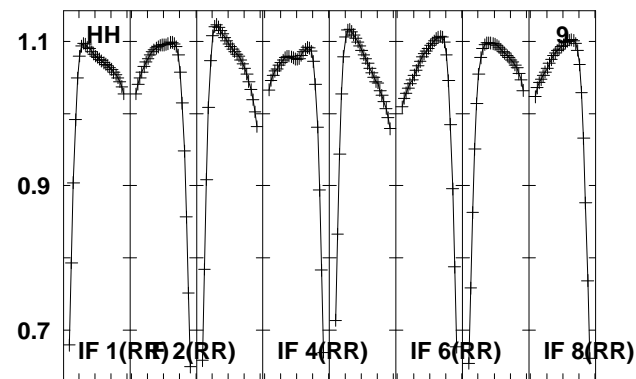
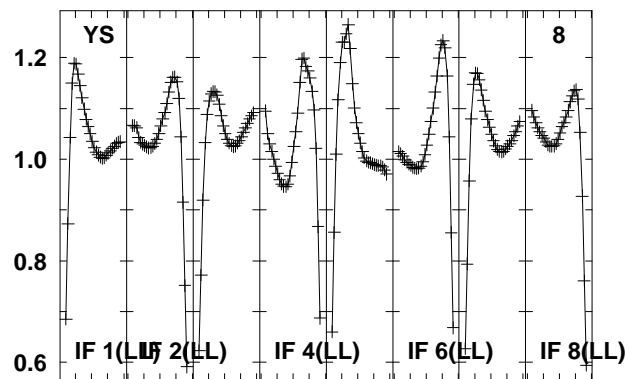
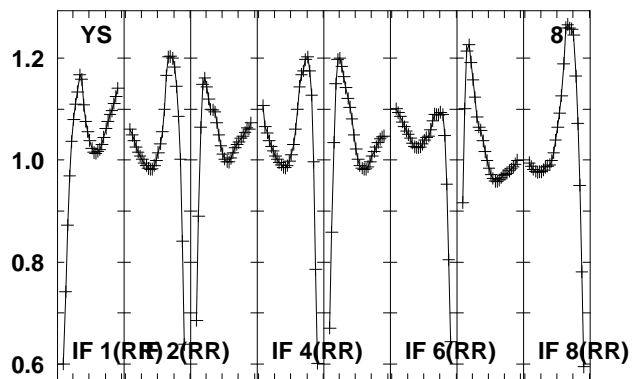
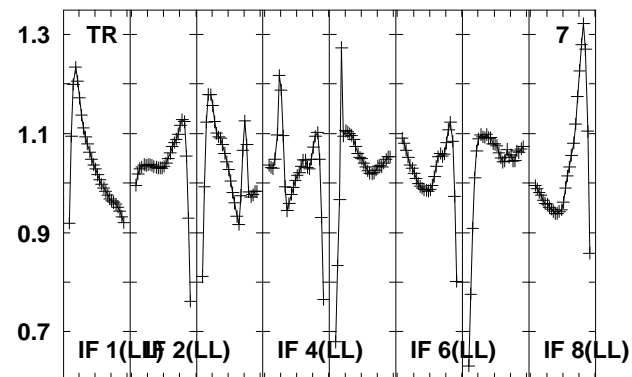
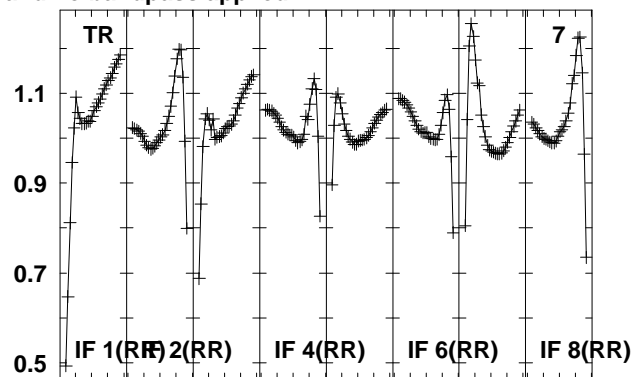
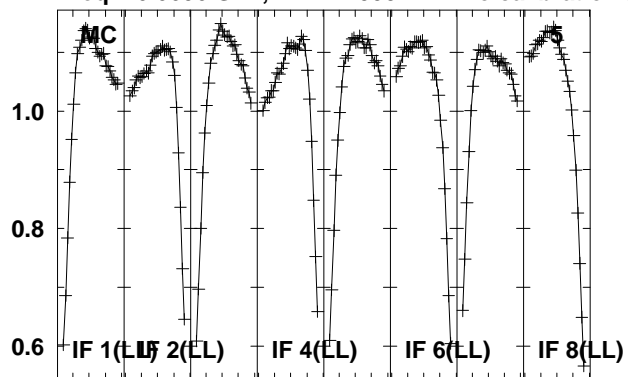

6661 6662.5 6665 6666.5 6669 6670.5 6673 6674.5
FREQ MHz

6661 6662.5 6665 6666.5 6669 6670.5 6673 6674.5
FREQ MHz

6661 6662.5 6665 6666.5 6669 6670.5 6673 6674.5
FREQ MHz

Lower frame: Real Jy
Total-power spectrum Antenna: *
Timerange: 00/16:22:09 to 00/16:24:59

Plot file version 71 created 07-JUN-2013 14:03:38

0528+134 N13M1.UVDATA.1

Freq = 6.6606 GHz, Bw = 2.000 MH No calibration applied and no bandpass applied

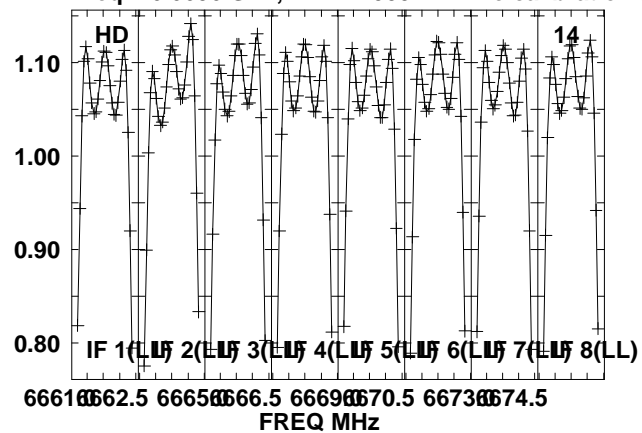

Lower frame: Real Jy

Total-power spectrum Antenna: *

Timerange: 00/16:22:09 to 00/16:24:59

Plot file version 72 created 07-JUN-2013 14:03:38

J0522+1415 N13M1.UVDATA.1

Freq = 6.6606 GHz, Bw = 2.000 MH No calibration applied and no bandpass applied

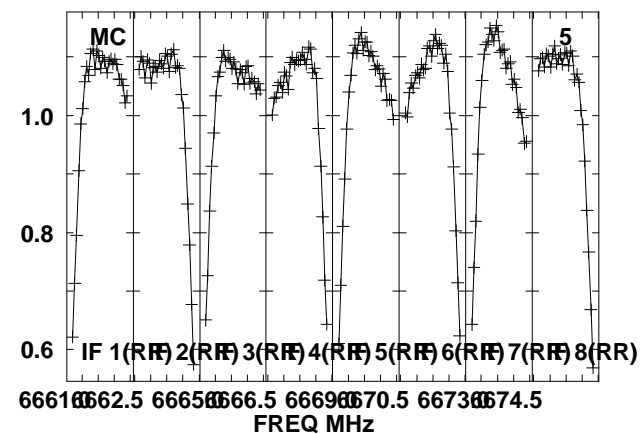
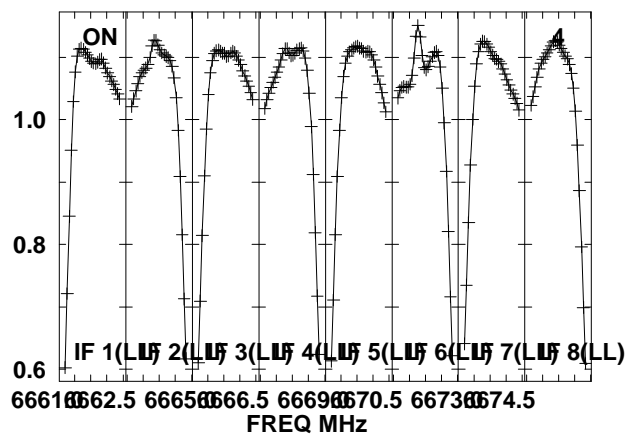
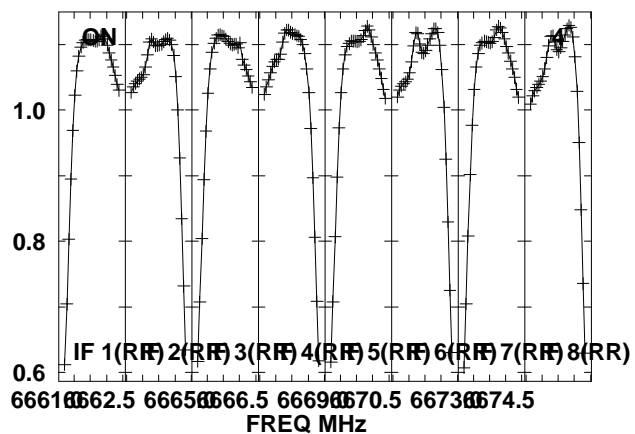
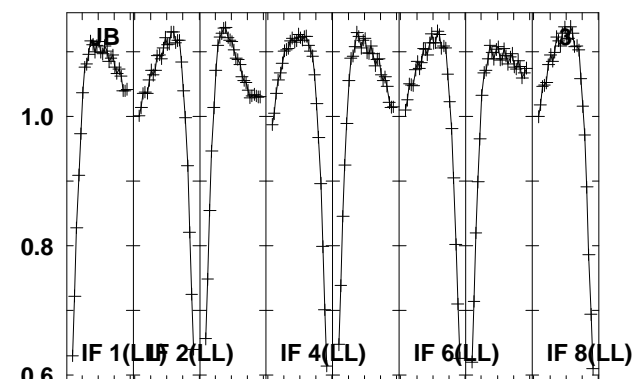
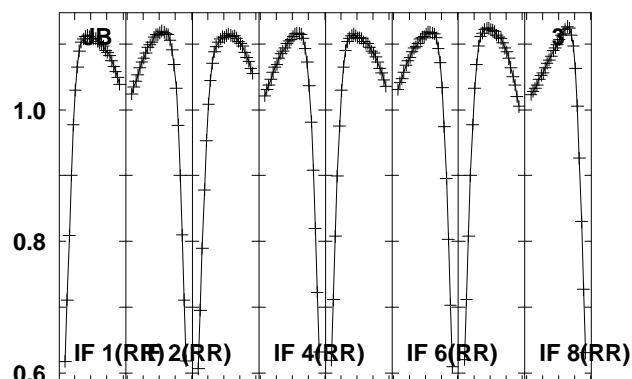
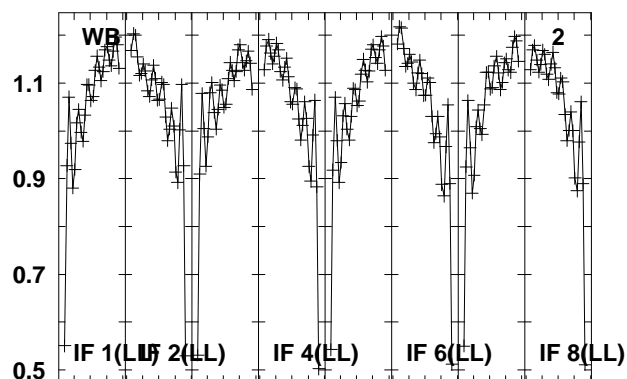
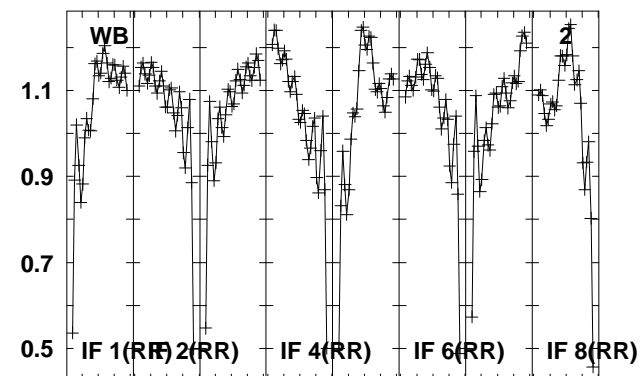
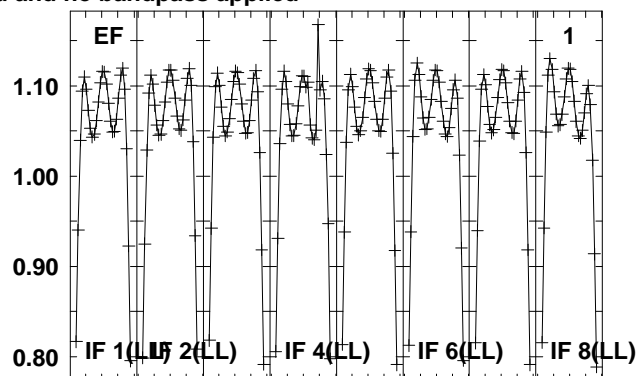
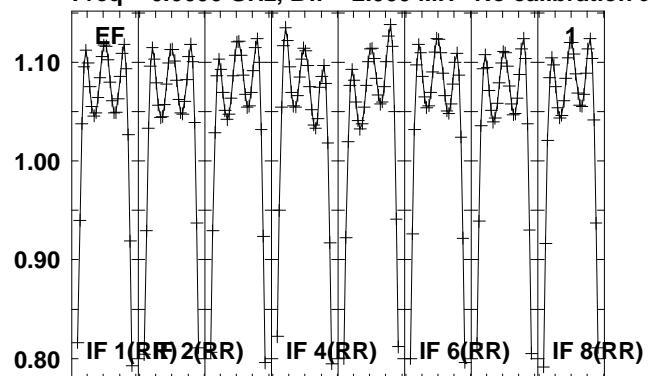

Lower frame: Real Jy
Total-power spectrum Antenna: *
Timerange: 00/16:25:09 to 00/16:26:59

Plot file version 73 created 07-JUN-2013 14:03:38

J0522+1415 N13M1.UVDATA.1

Freq = 6.6606 GHz, Bw = 2.000 MH No calibration applied and no bandpass applied

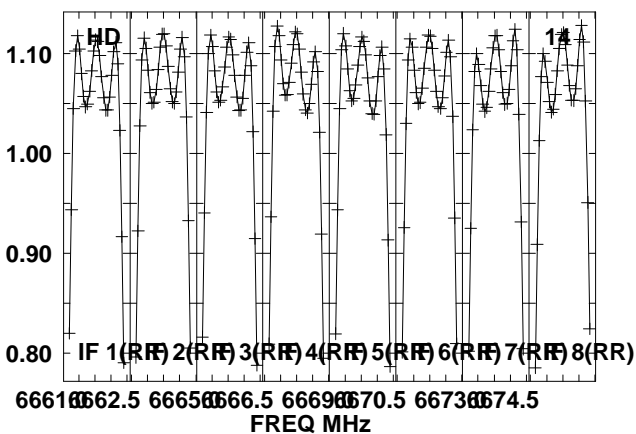
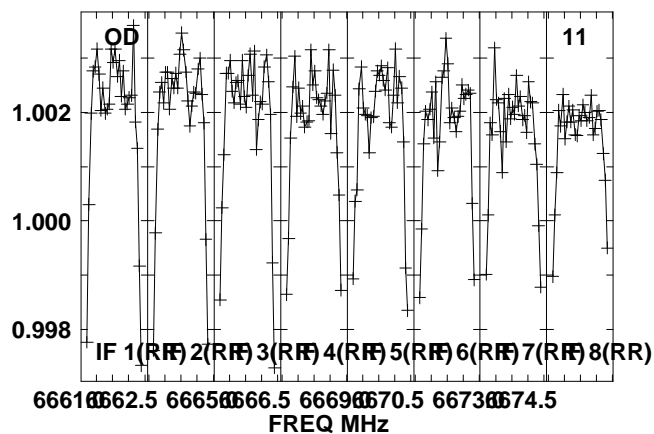
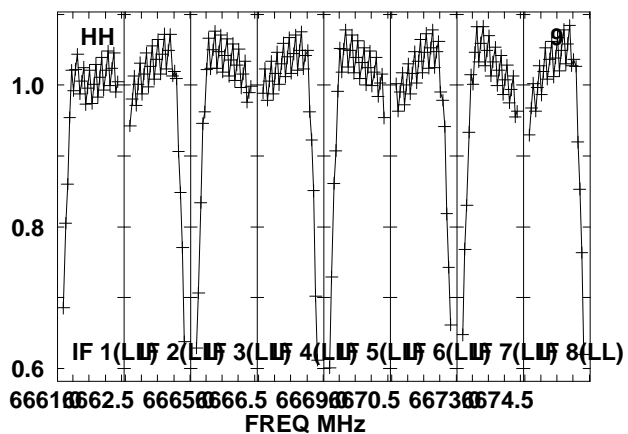
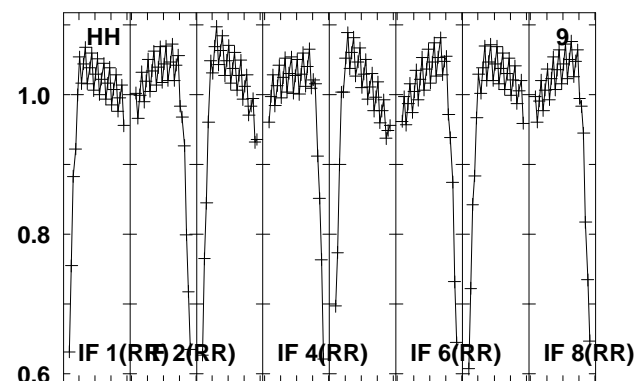
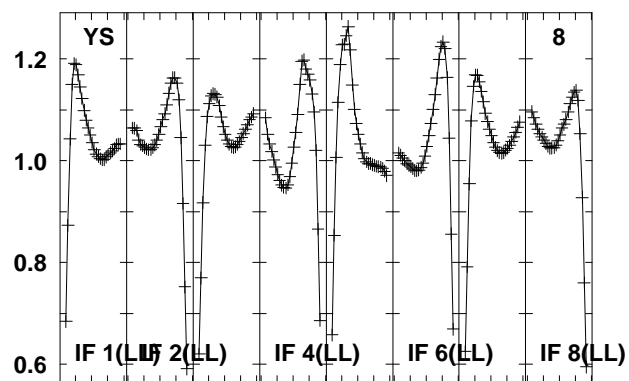
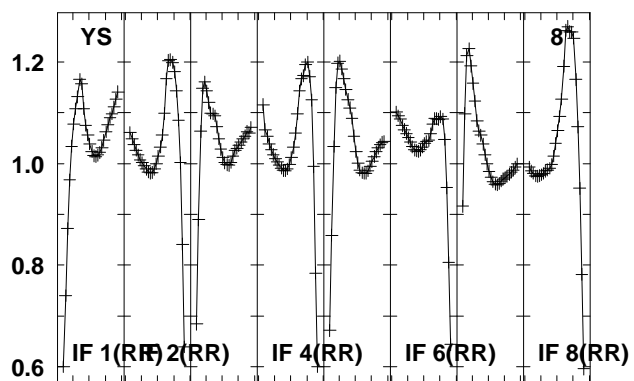
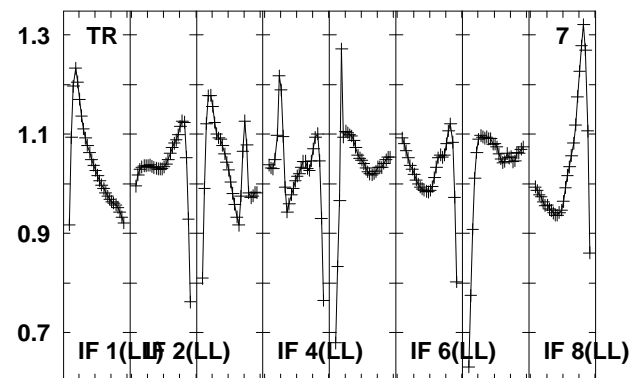
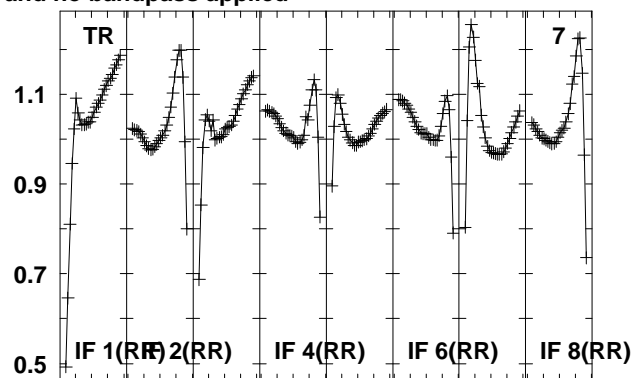
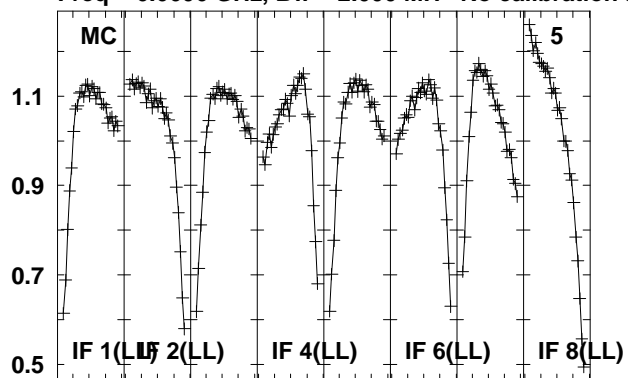

Lower frame: Real Jy
Total-power spectrum Antenna: *
Timerange: 00/16:25:09 to 00/16:26:59

Plot file version 74 created 07-JUN-2013 14:03:39
J0522+1415 N13M1.UVDATA.1
Freq = 6.6606 GHz, Bw = 2.000 MH No calibration applied and no bandpass applied

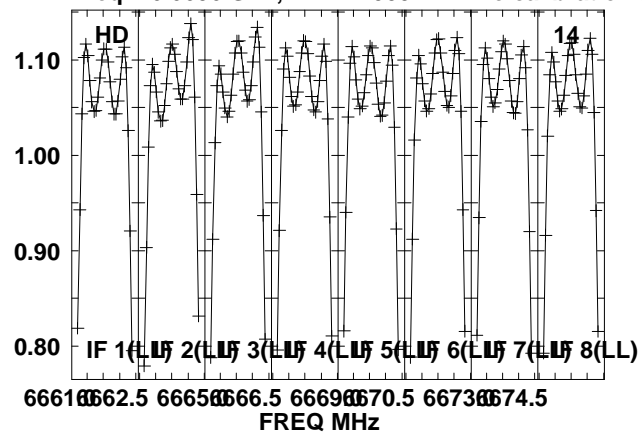

Lower frame: Real Jy
Total-power spectrum Antenna: *
Timerange: 00/16:25:09 to 00/16:26:59

Plot file version 75 created 07-JUN-2013 14:03:39

0528+134 N13M1.UVDATA.1

Freq = 6.6606 GHz, Bw = 2.000 MH No calibration applied and no bandpass applied

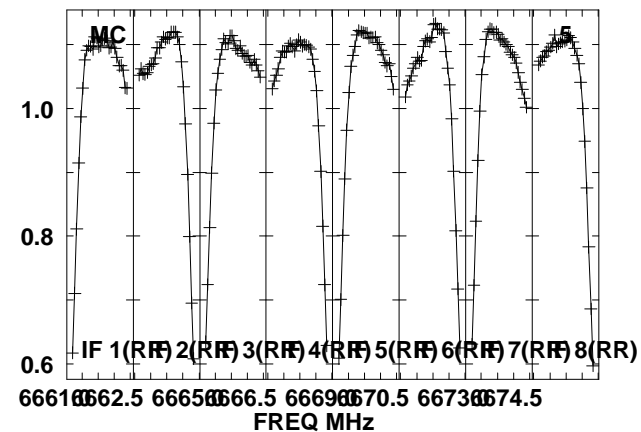
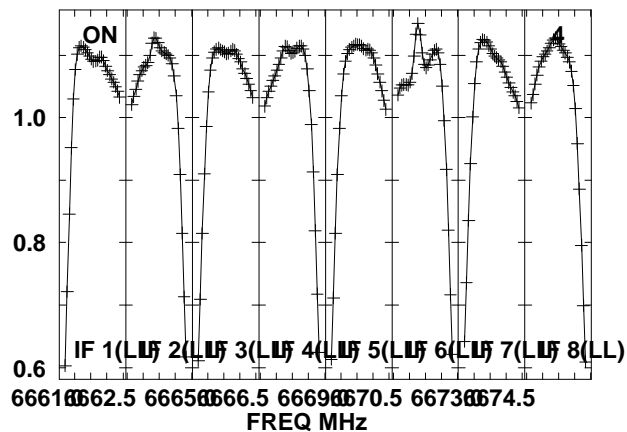
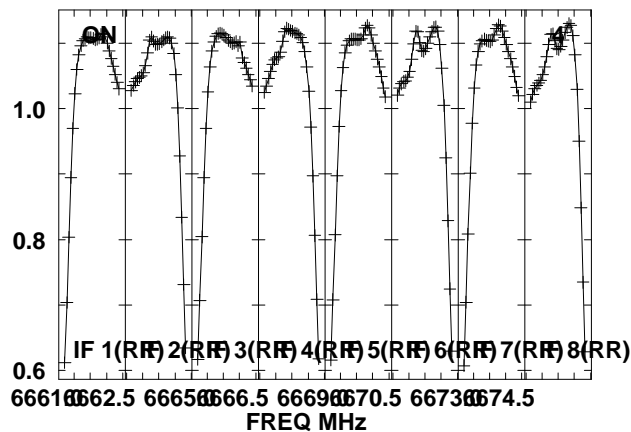
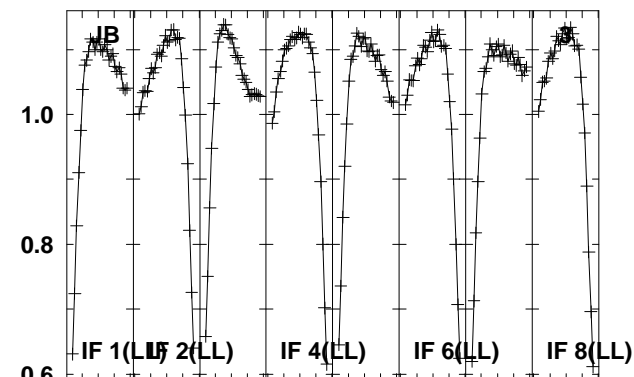
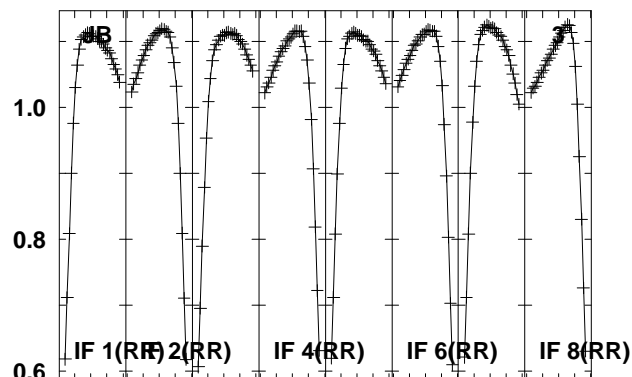
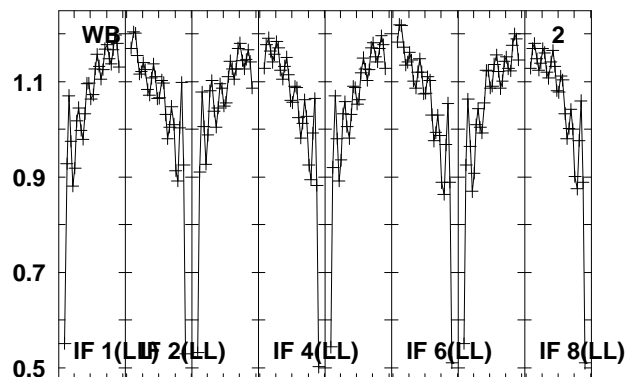
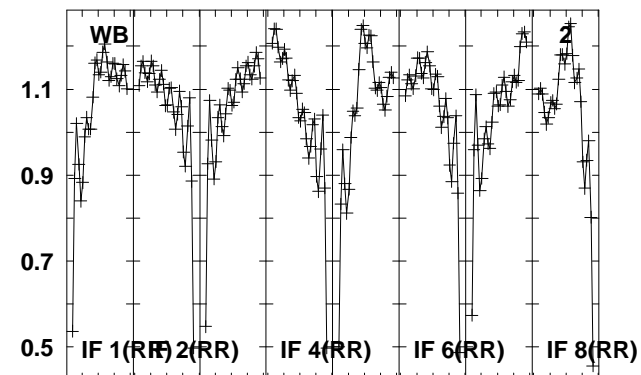
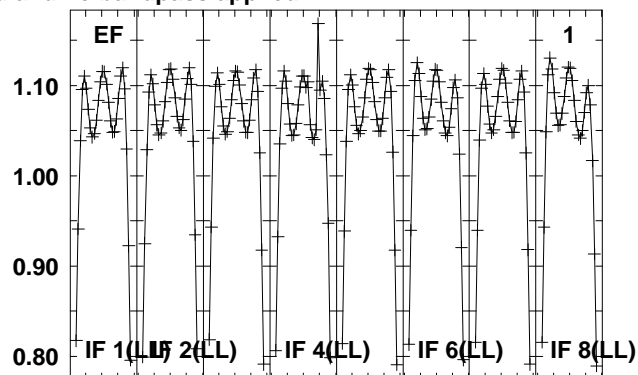
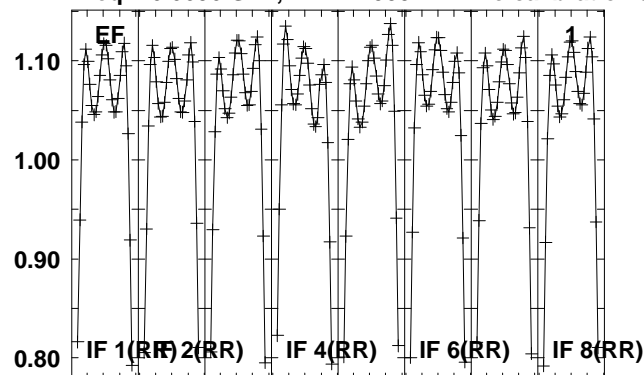

Lower frame: Real Jy

Total-power spectrum Antenna: *

Timerange: 00/16:27:09 to 00/16:29:59

Plot file version 76 created 07-JUN-2013 14:03:39

0528+134 N13M1.UVDATA.1

Freq = 6.6606 GHz, Bw = 2.000 MH No calibration applied and no bandpass applied

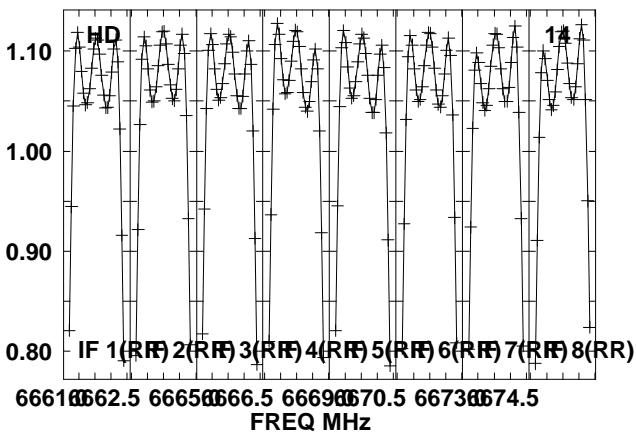
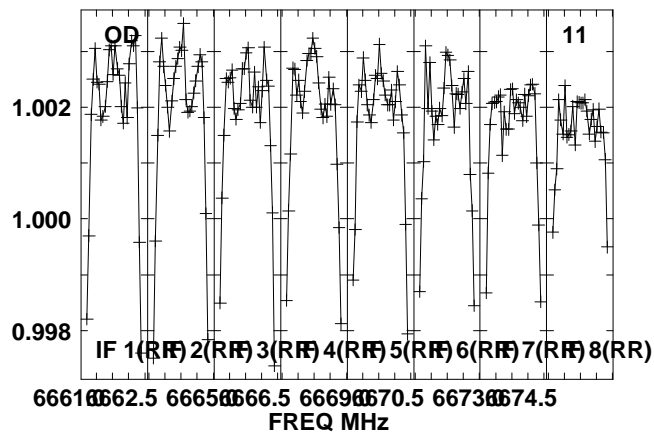
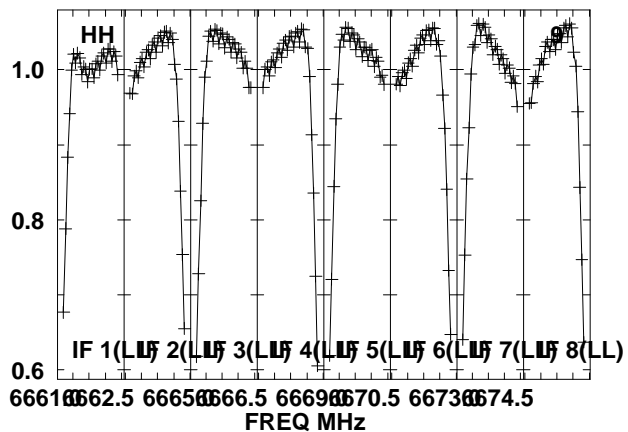
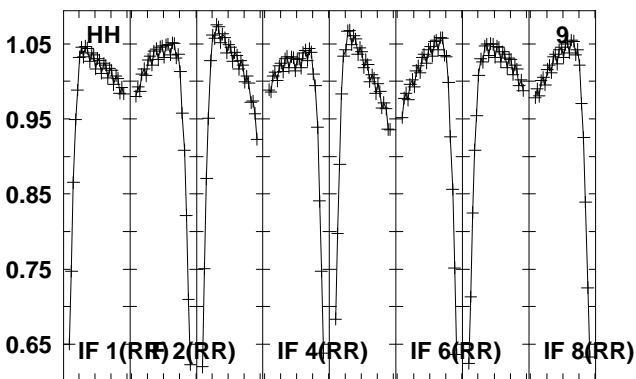
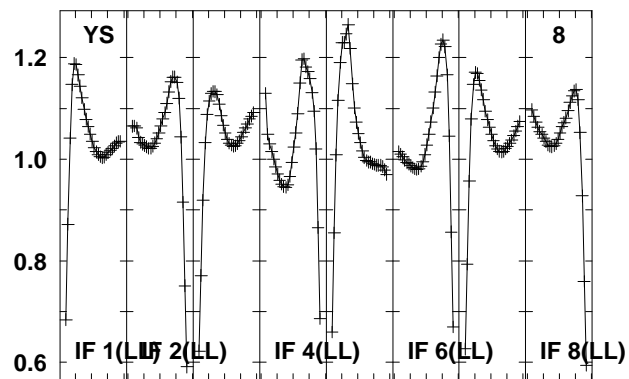
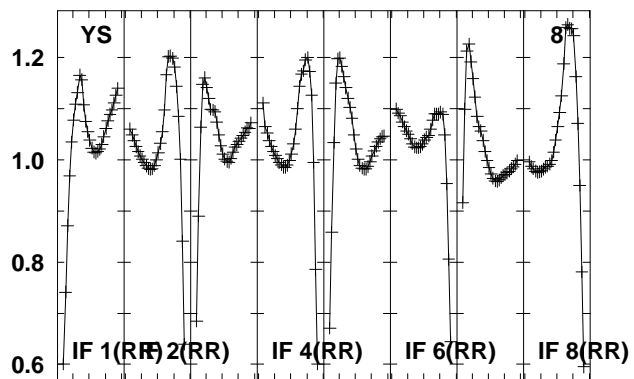
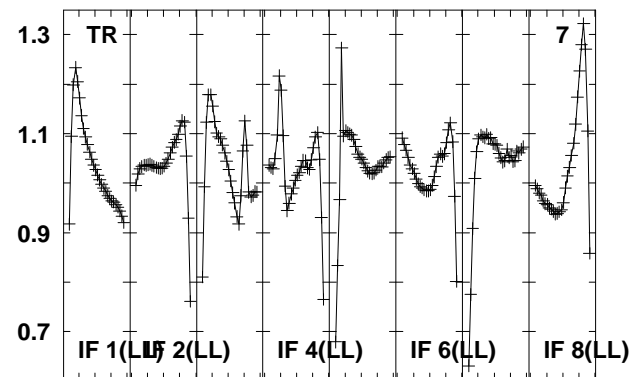
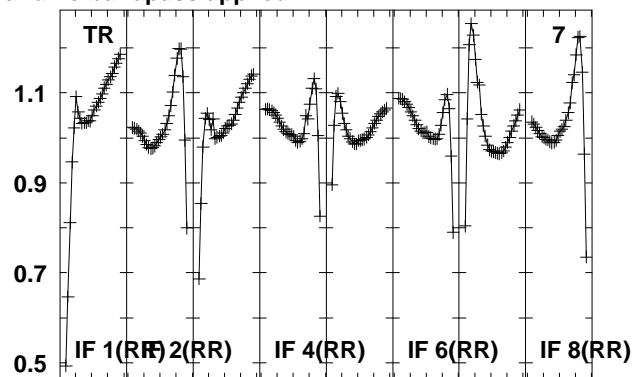
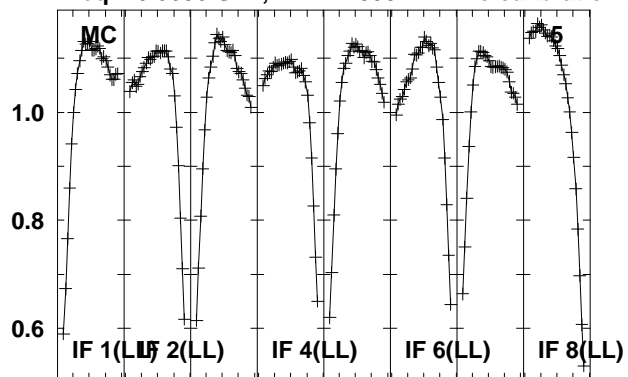

Lower frame: Real Jy
Total-power spectrum Antenna: *
Timerange: 00/16:27:09 to 00/16:29:59

Plot file version 77 created 07-JUN-2013 14:03:40
0528+134 N13M1.UVDATA.1
Freq = 6.6606 GHz, Bw = 2.000 MH No calibration applied and no bandpass applied

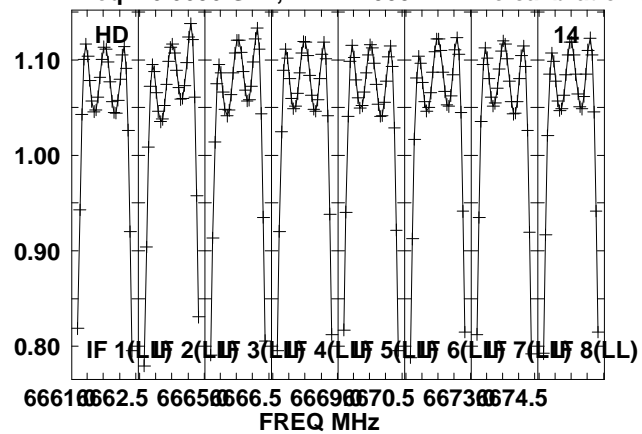

Lower frame: Real Jy
Total-power spectrum Antenna: *
Timerange: 00/16:27:09 to 00/16:29:59

Plot file version 78 created 07-JUN-2013 14:03:40

J0522+1415 N13M1.UVDATA.1

Freq = 6.6606 GHz, Bw = 2.000 MH No calibration applied and no bandpass applied

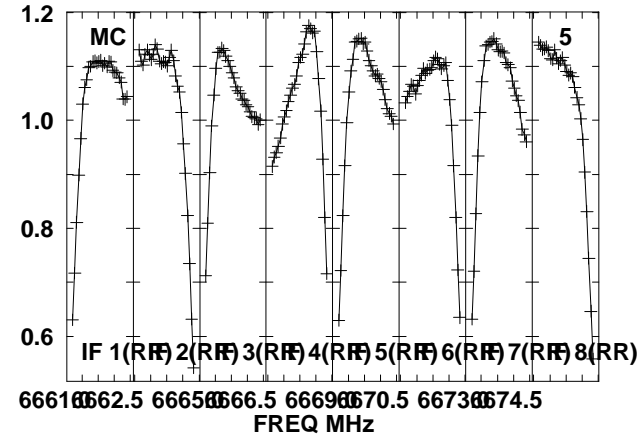
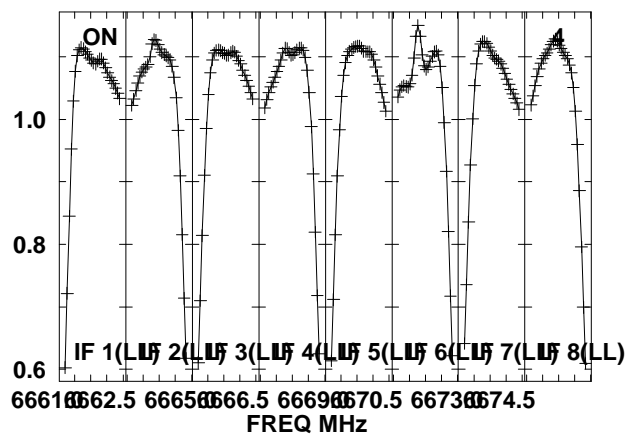
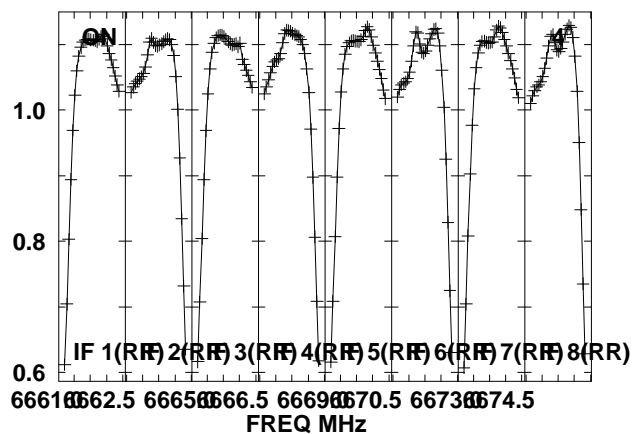
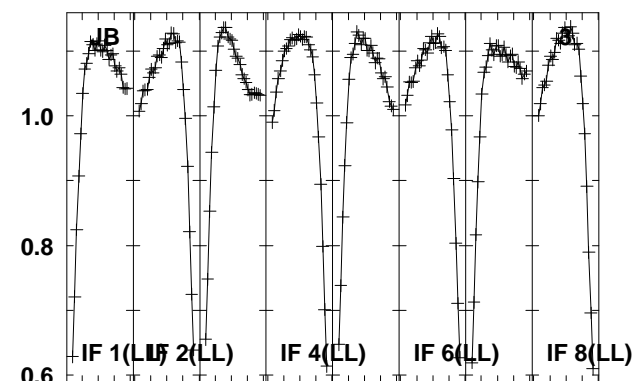
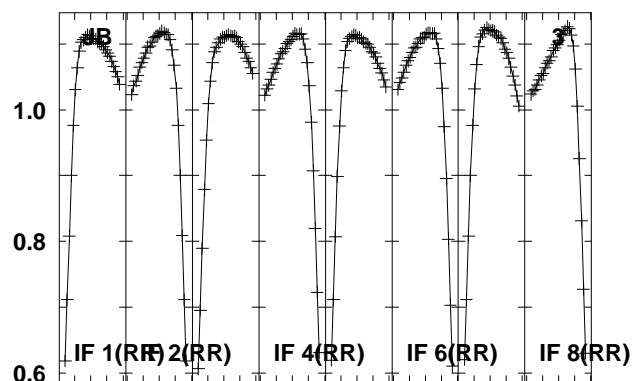
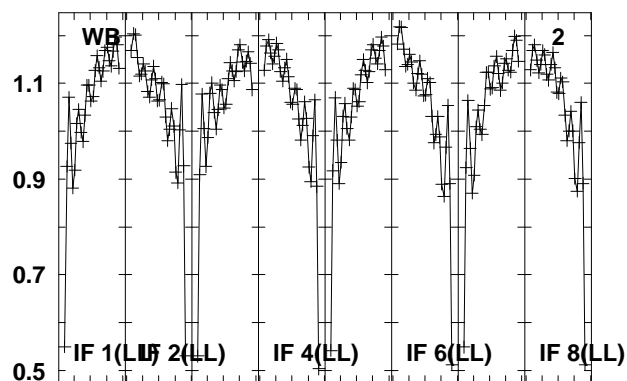
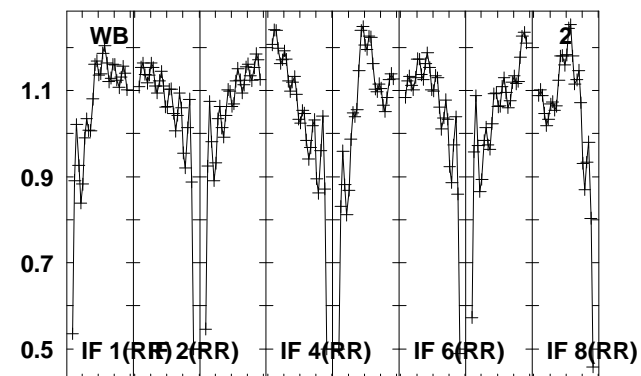
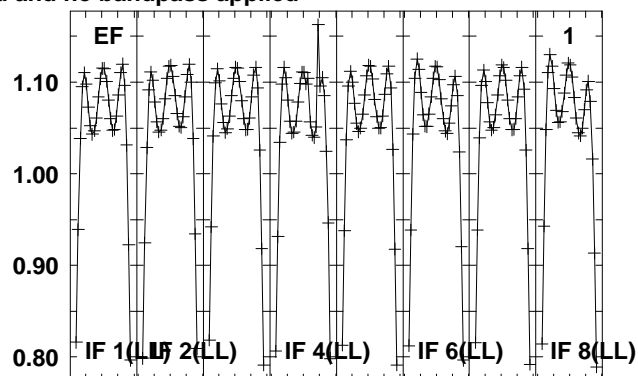
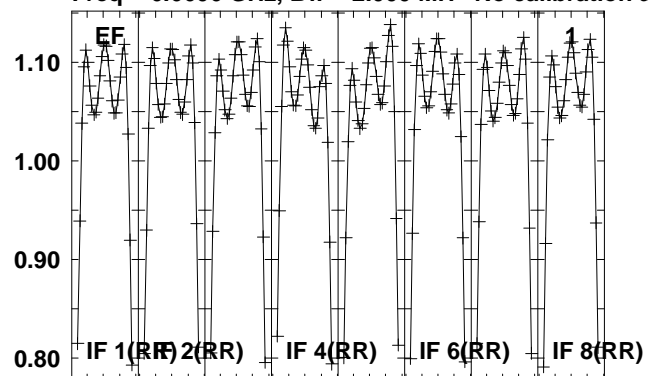

Lower frame: Real Jy
Total-power spectrum Antenna: *
Timerange: 00/16:31:03 to 00/16:32:59

Plot file version 79 created 07-JUN-2013 14:03:40

J0522+1415 N13M1.UVDATA.1

Freq = 6.6606 GHz, Bw = 2.000 MH No calibration applied and no bandpass applied

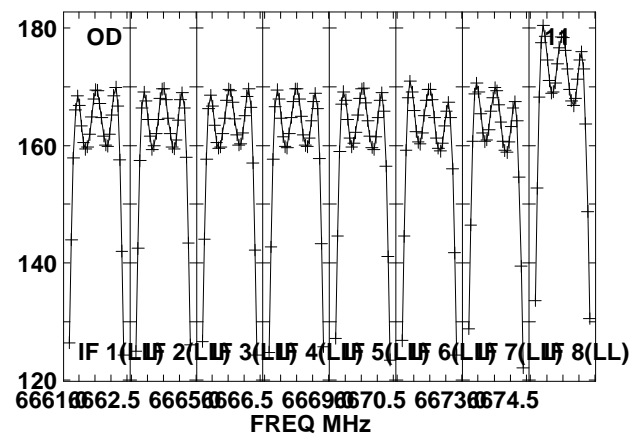
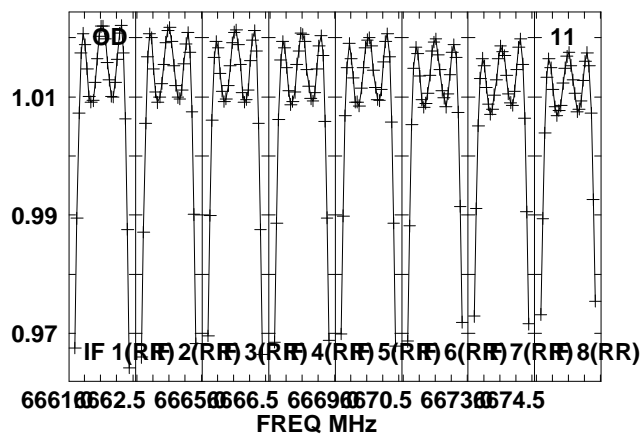
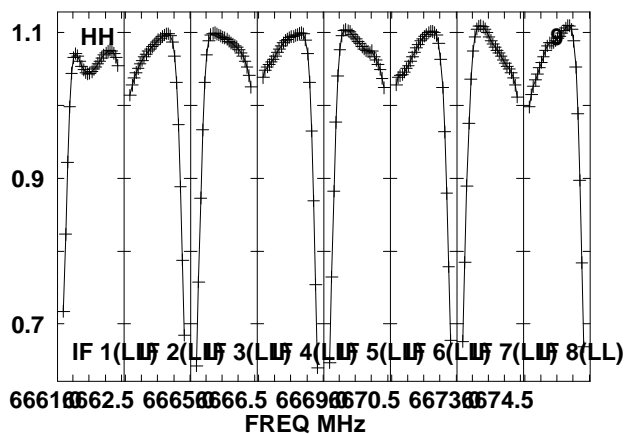
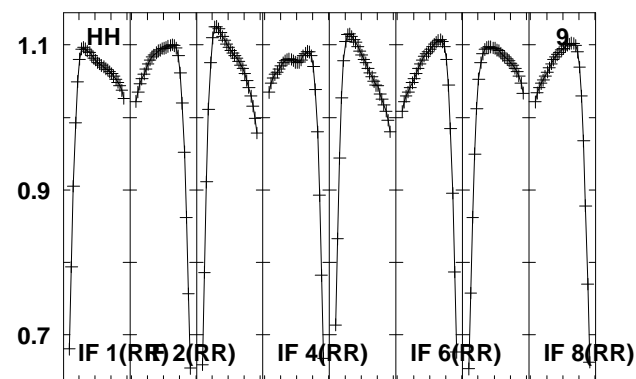
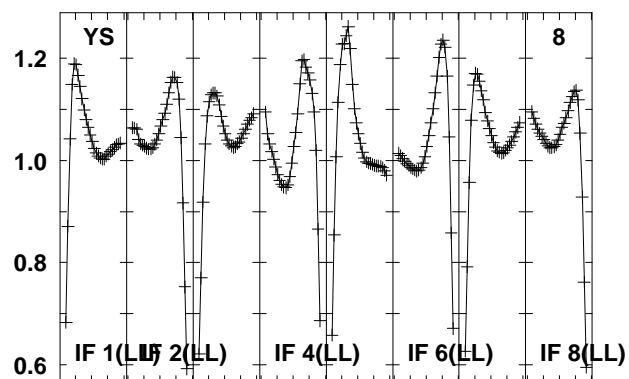
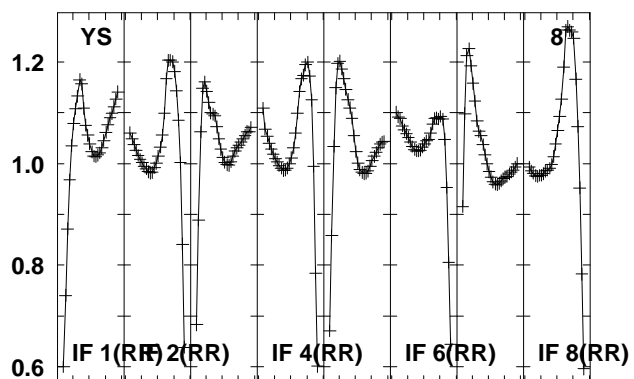
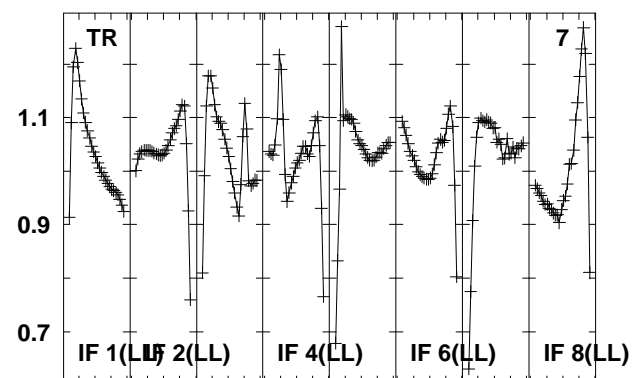
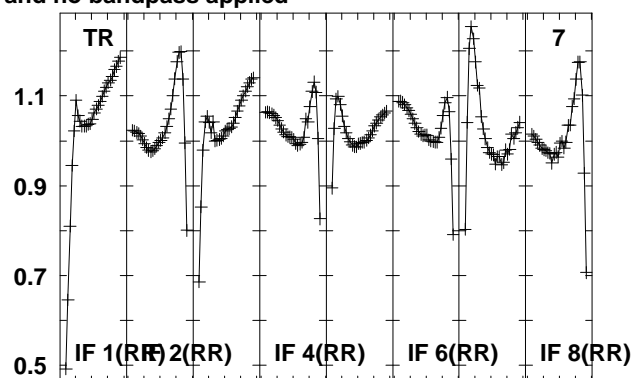
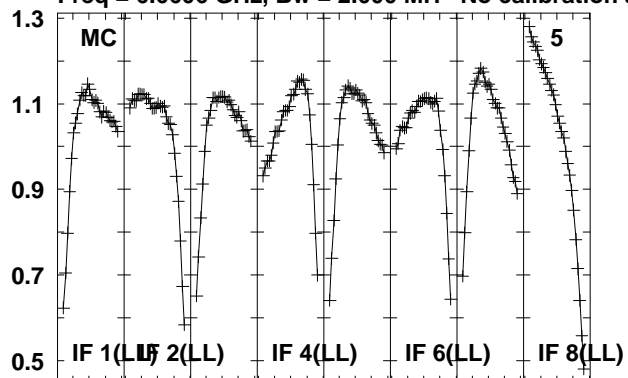

Lower frame: Real Jy
Total-power spectrum Antenna: *
Timerange: 00/16:31:03 to 00/16:32:59

Plot file version 80 created 07-JUN-2013 14:03:40

J0522+1415 N13M1.UVDATA.1

Freq = 6.6606 GHz, Bw = 2.000 MH No calibration applied and no bandpass applied

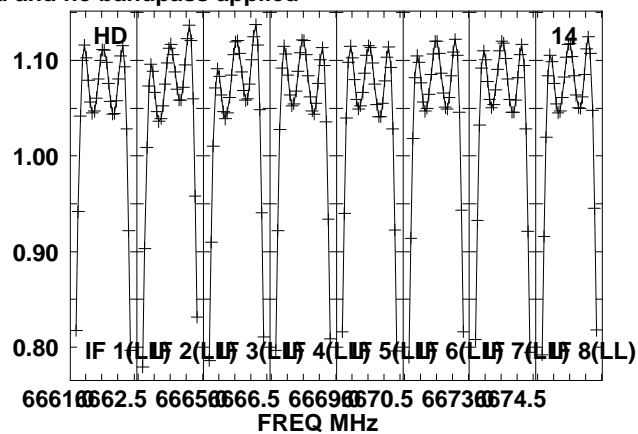
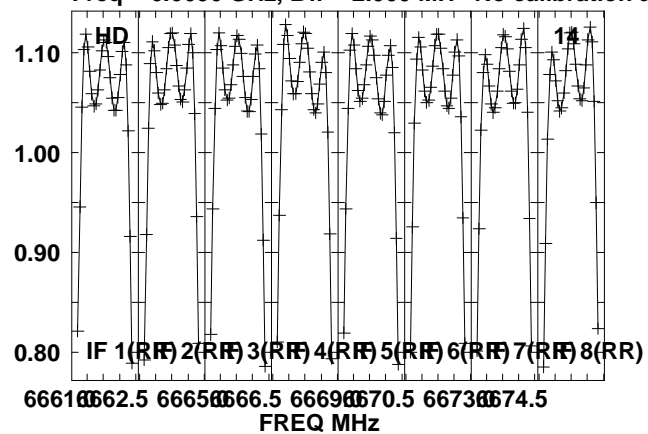

Lower frame: Real Jy

Total-power spectrum Antenna: *

Timerange: 00/16:31:03 to 00/16:32:59

Plot file version 81 created 07-JUN-2013 14:03:40

0528+134 N13M1.UVDATA.1

Freq = 6.6606 GHz, Bw = 2.000 MH No calibration applied and no bandpass applied

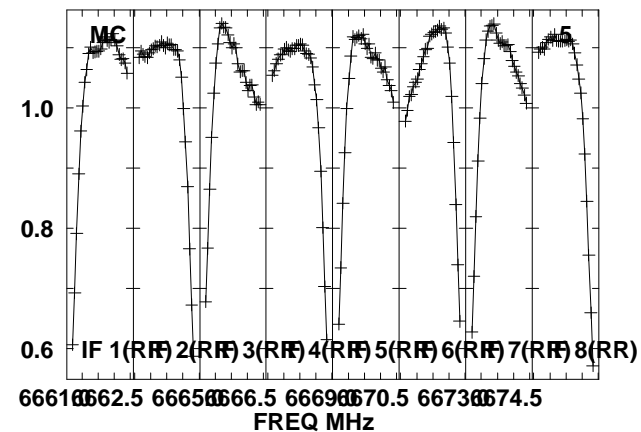
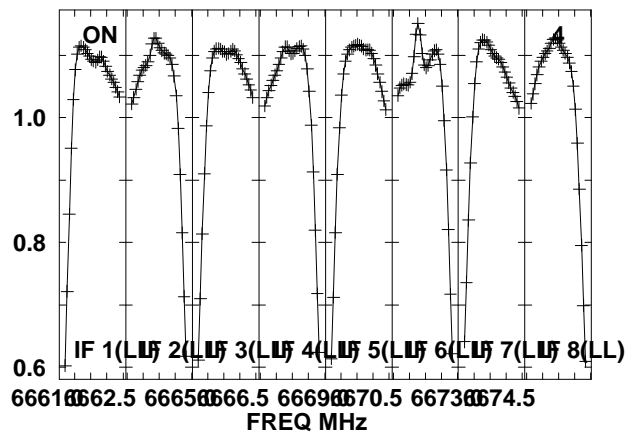
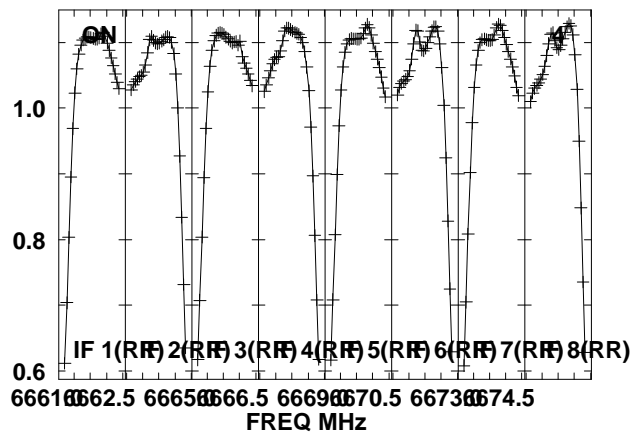
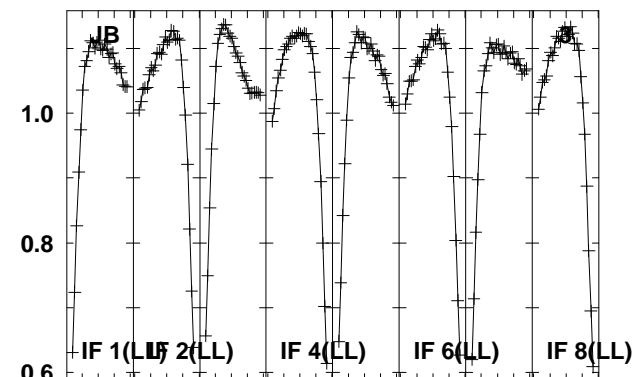
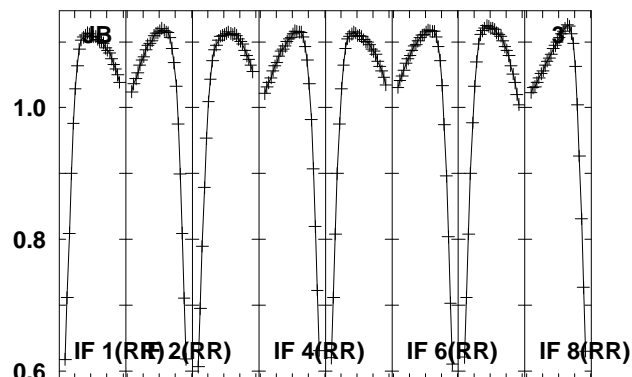
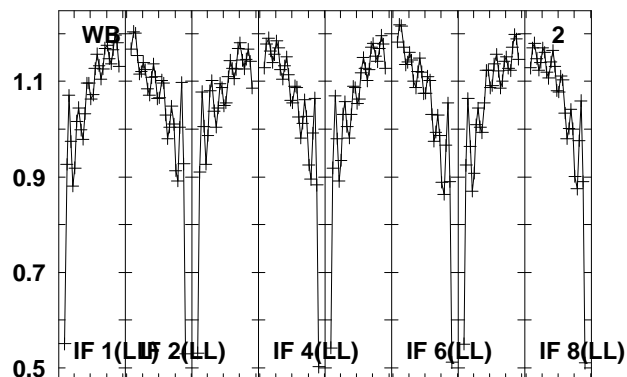
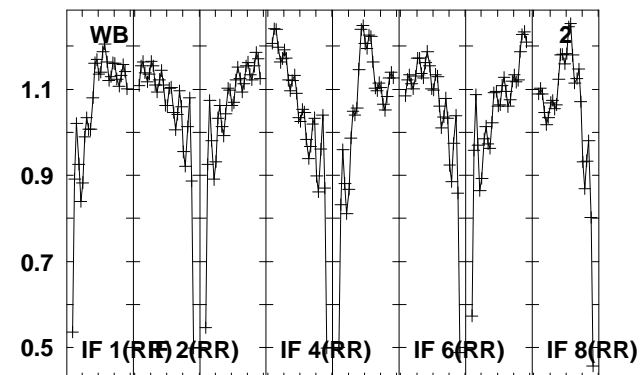
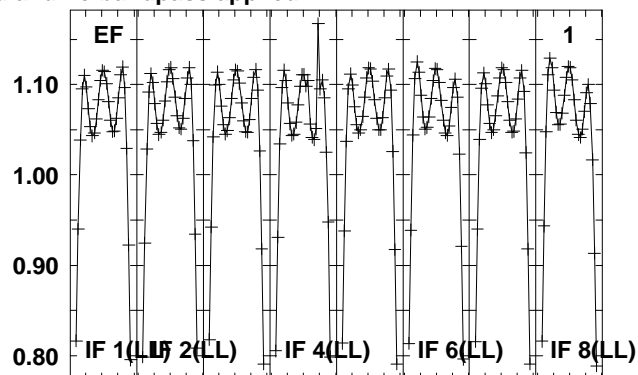
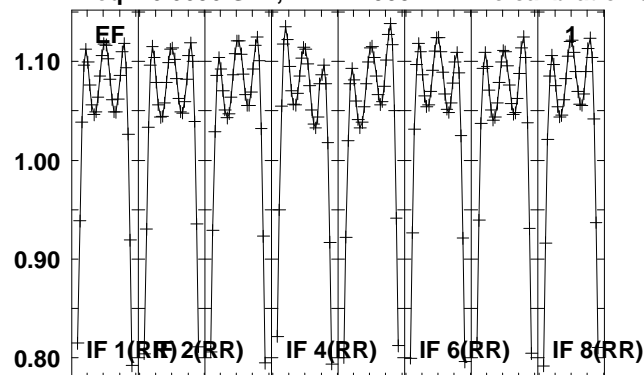

Lower frame: Real Jy
Total-power spectrum Antenna: *
Timerange: 00/16:33:09 to 00/16:35:59

Plot file version 82 created 07-JUN-2013 14:03:41

0528+134 N13M1.UVDATA.1

Freq = 6.6606 GHz, Bw = 2.000 MH No calibration applied and no bandpass applied

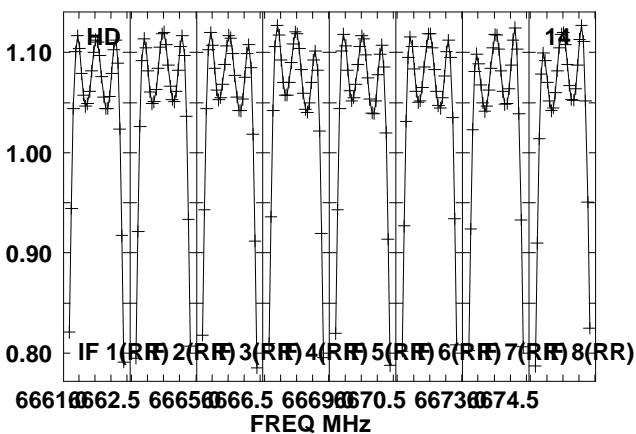
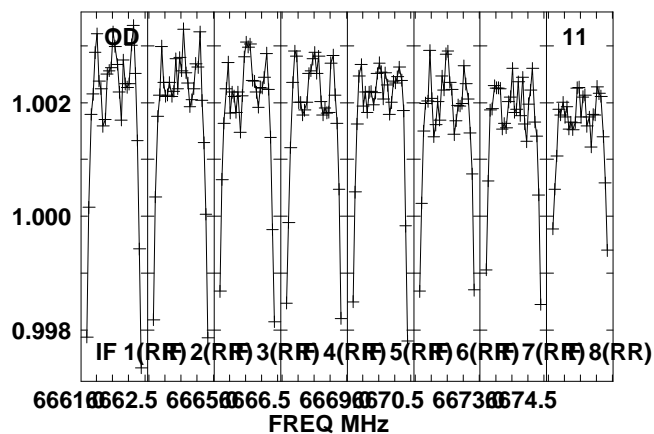
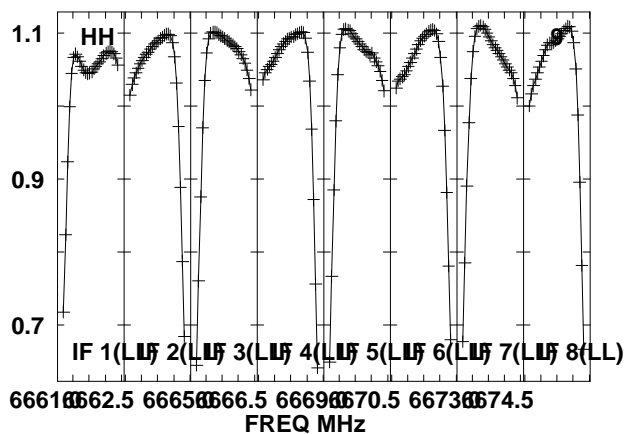
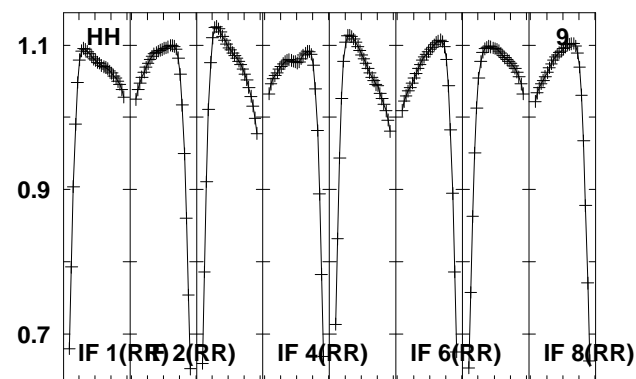
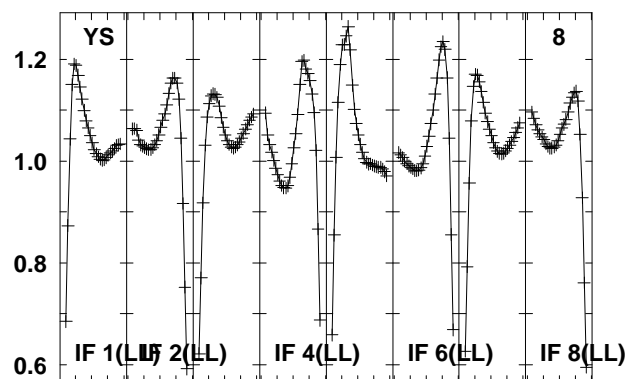
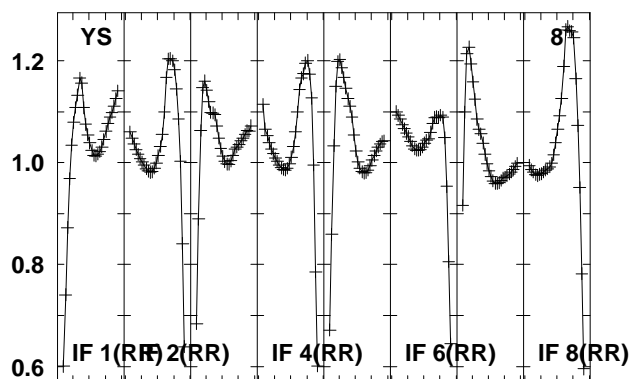
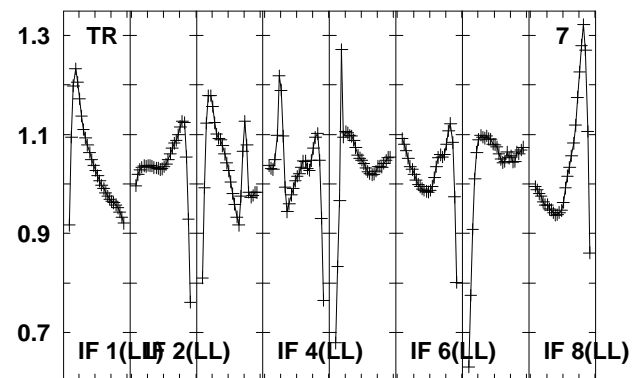
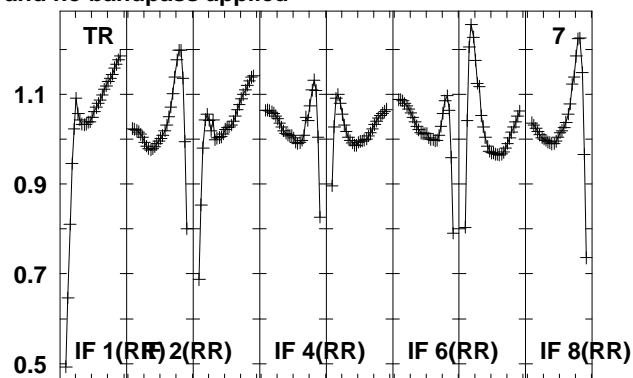
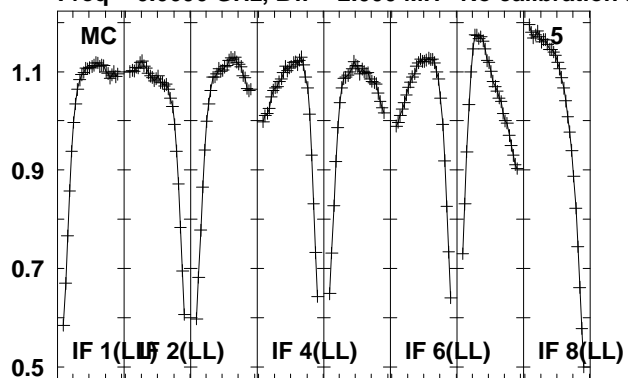

Lower frame: Real Jy

Total-power spectrum Antenna: *

Timerange: 00/16:33:09 to 00/16:35:59

Plot file version 83 created 07-JUN-2013 14:03:41
0528+134 N13M1.UVDATA.1
Freq = 6.6606 GHz, Bw = 2.000 MH No calibration applied and no bandpass applied

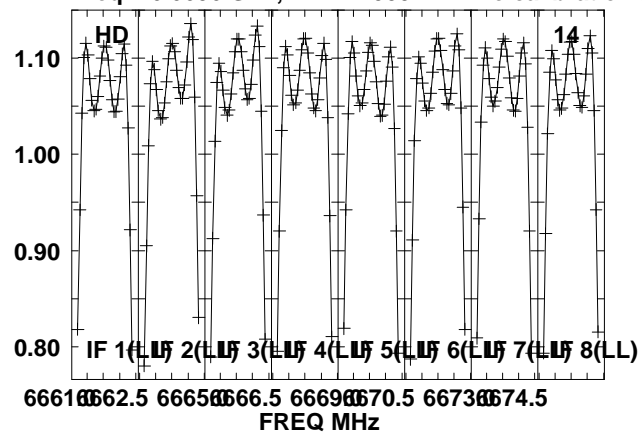

Lower frame: Real Jy
Total-power spectrum Antenna: *
Timerange: 00/16:33:09 to 00/16:35:59

Plot file version 84 created 07-JUN-2013 14:03:41

J0522+1415 N13M1.UVDATA.1

Freq = 6.6606 GHz, Bw = 2.000 MH No calibration applied and no bandpass applied

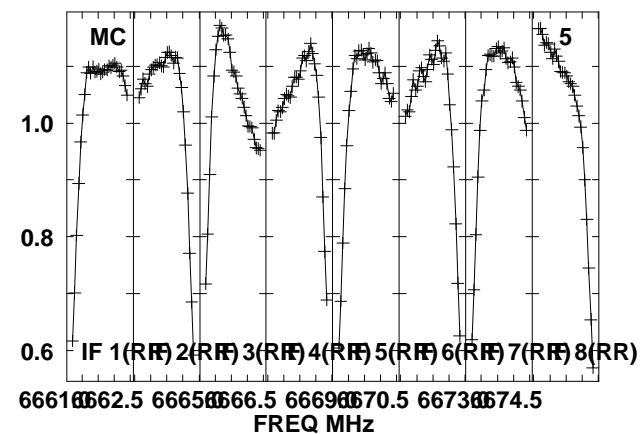
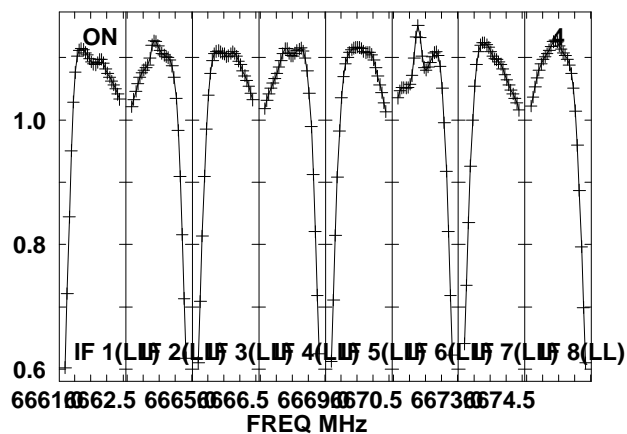
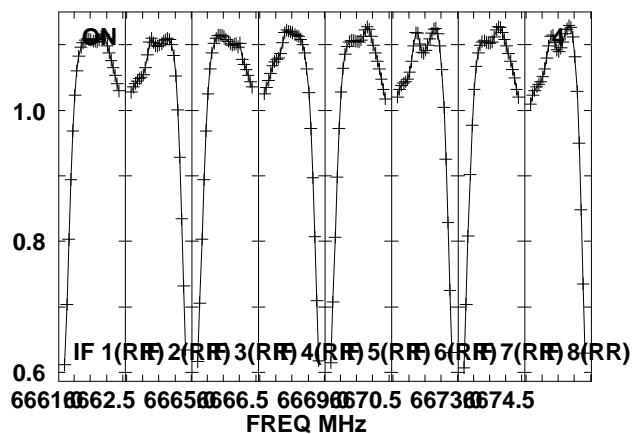
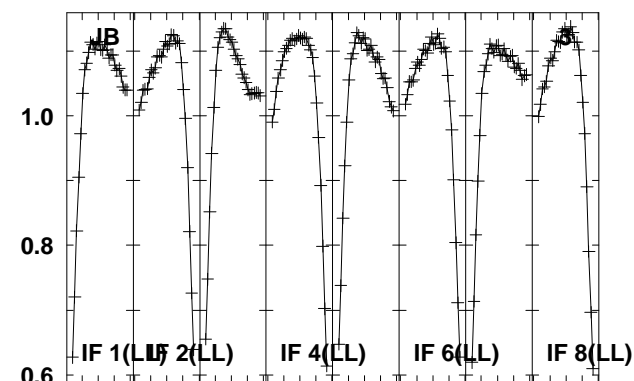
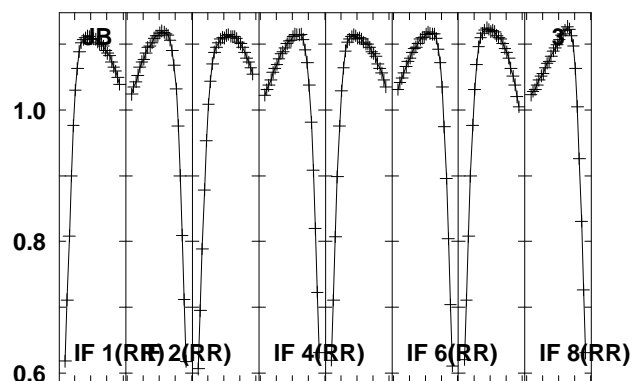
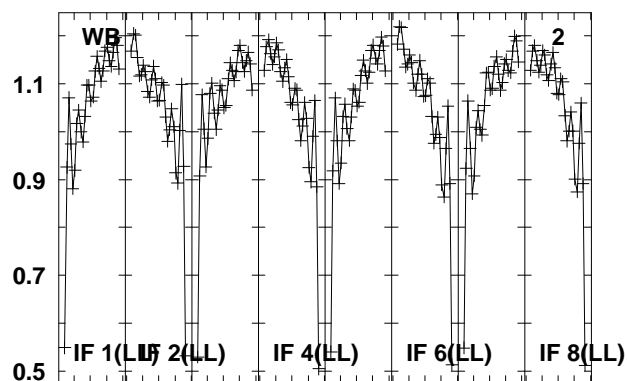
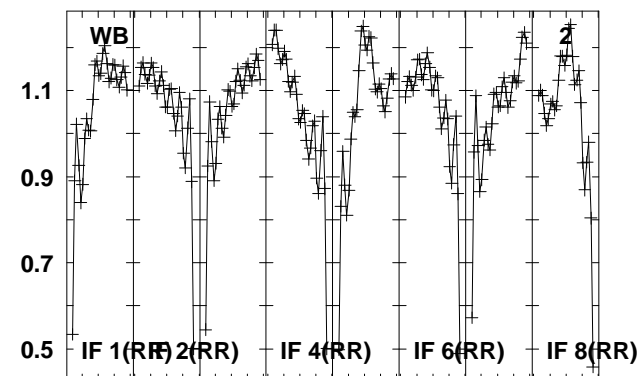
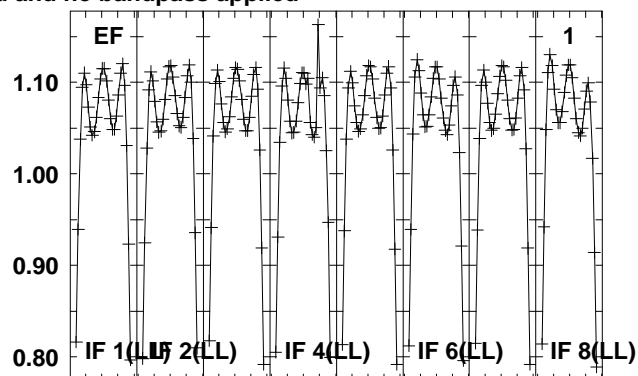
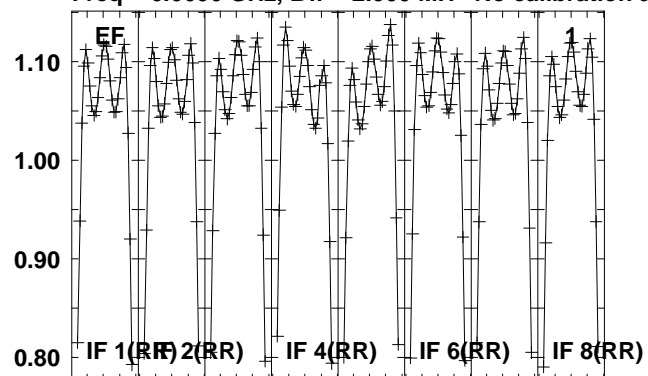

Lower frame: Real Jy

Total-power spectrum Antenna: *

Timerange: 00/16:36:09 to 00/16:37:59

Plot file version 85 created 07-JUN-2013 14:03:41

J0522+1415 N13M1.UVDATA.1

Freq = 6.6606 GHz, Bw = 2.000 MH No calibration applied and no bandpass applied

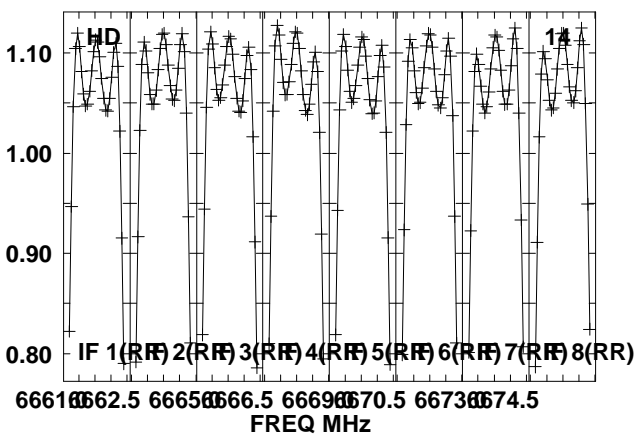
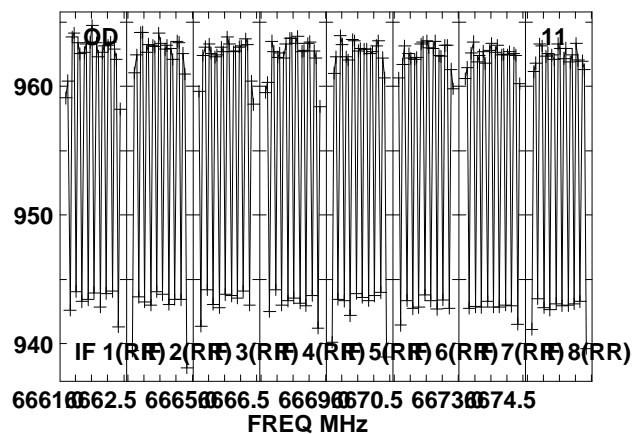
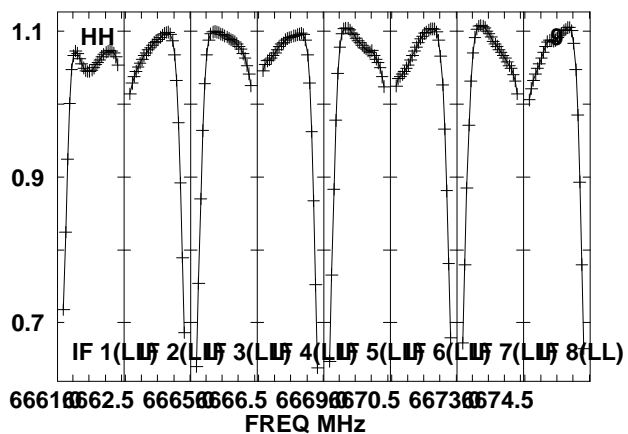
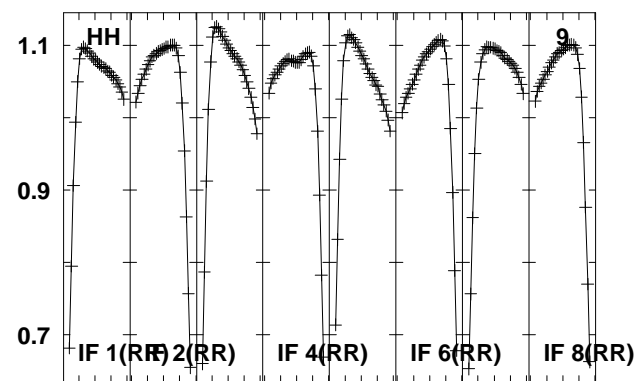
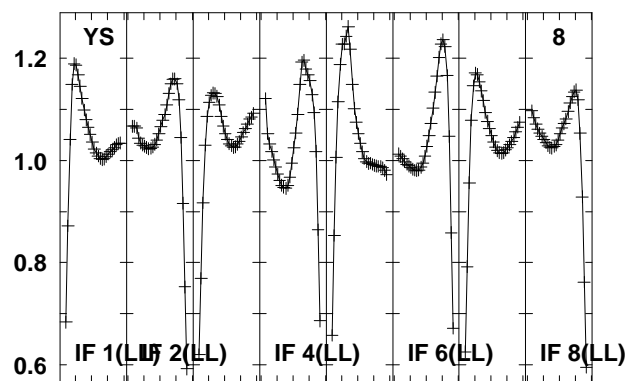
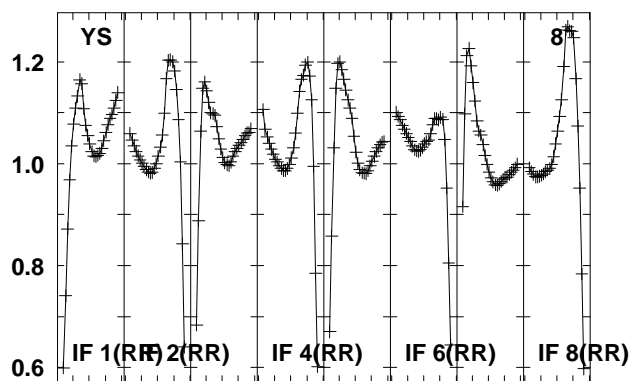
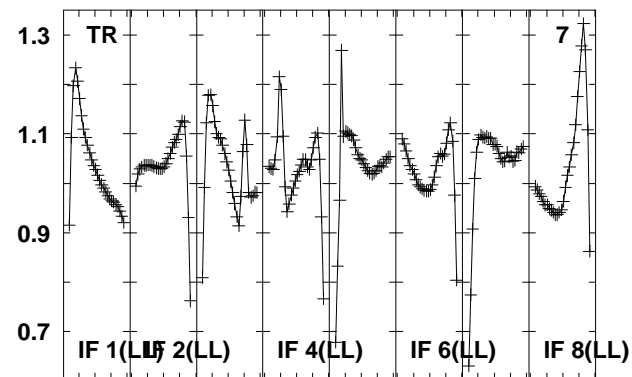
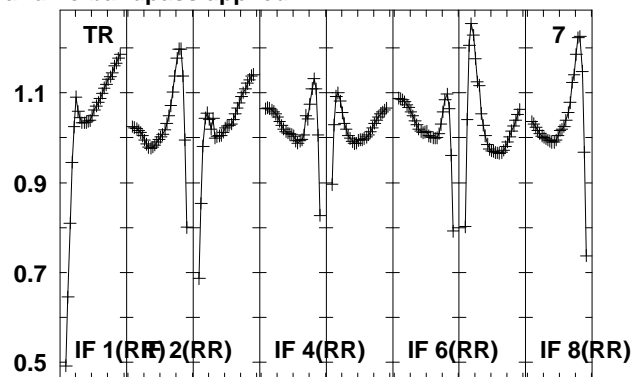
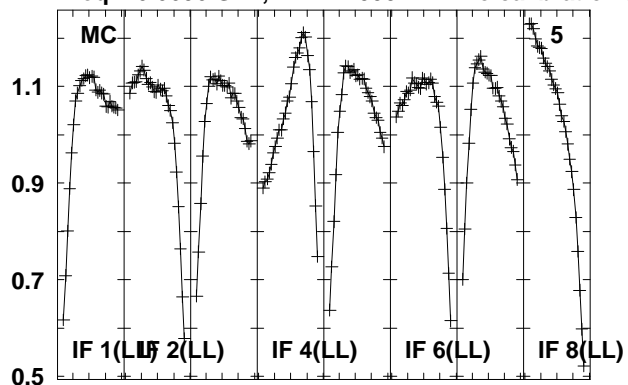

Lower frame: Real Jy
Total-power spectrum Antenna: *
Timerange: 00/16:36:09 to 00/16:37:59

Plot file version 86 created 07-JUN-2013 14:03:42

J0522+1415 N13M1.UVDATA.1

Freq = 6.6606 GHz, Bw = 2.000 MH No calibration applied and no bandpass applied

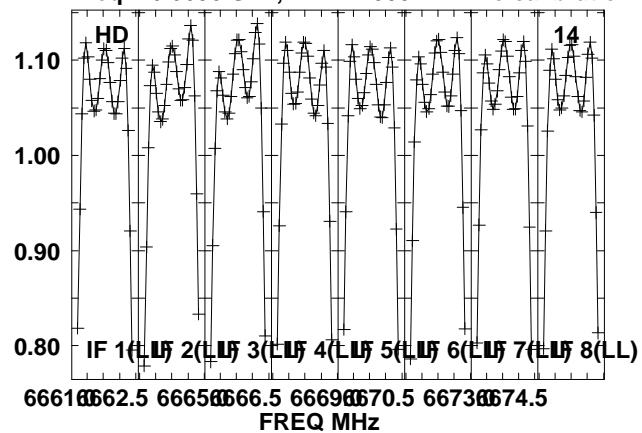

Lower frame: Real Jy

Total-power spectrum Antenna: *

Timerange: 00/16:36:09 to 00/16:37:59

Plot file version 87 created 07-JUN-2013 14:03:42

0528+134 N13M1.UVDATA.1

Freq = 6.6606 GHz, Bw = 2.000 MH No calibration applied and no bandpass applied

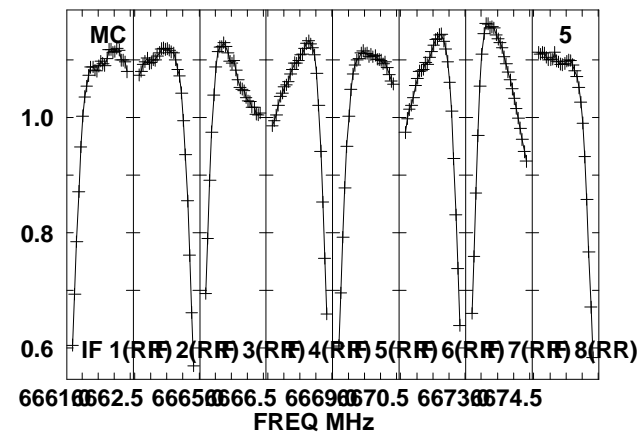
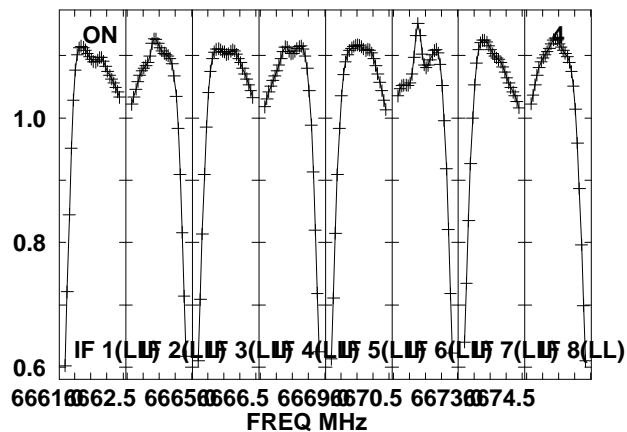
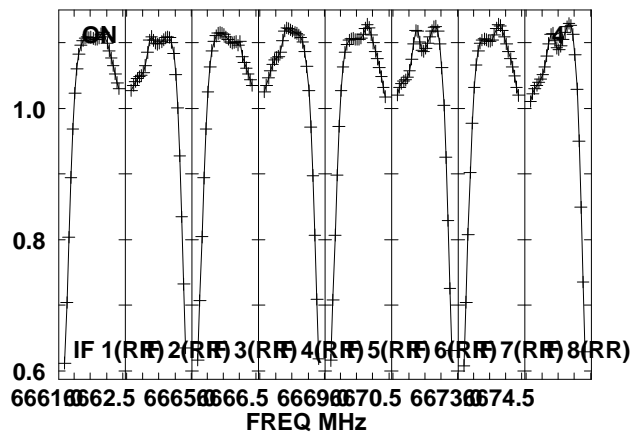
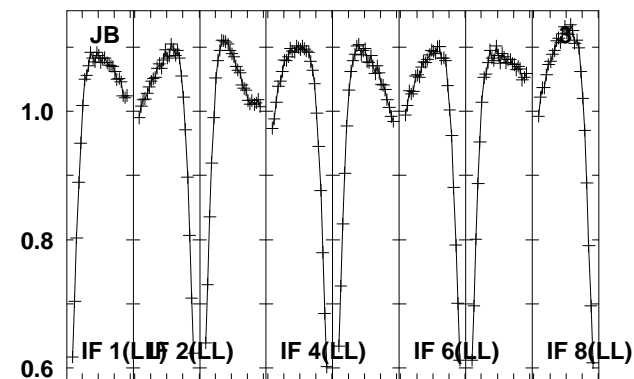
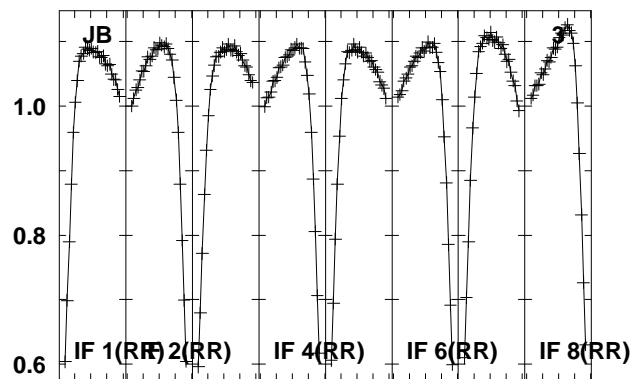
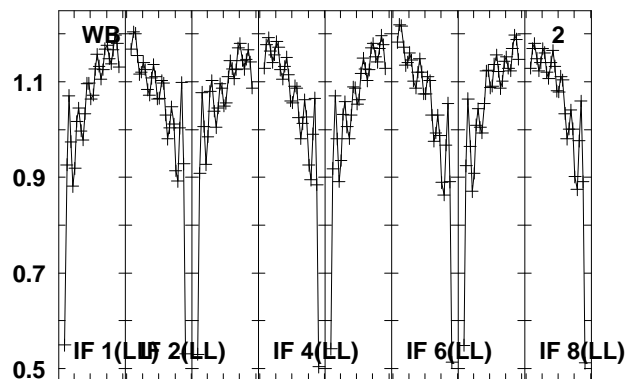
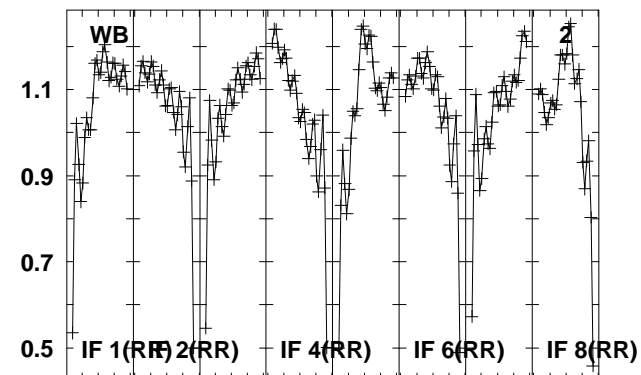
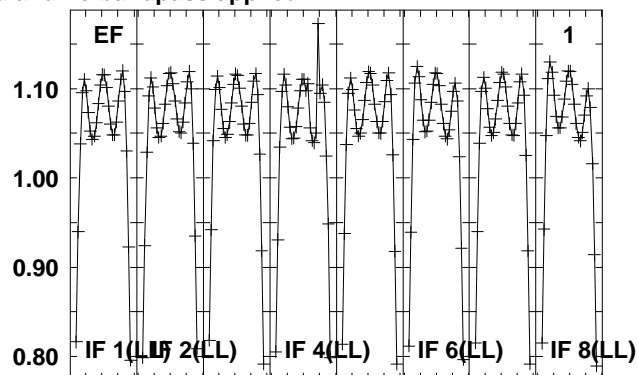
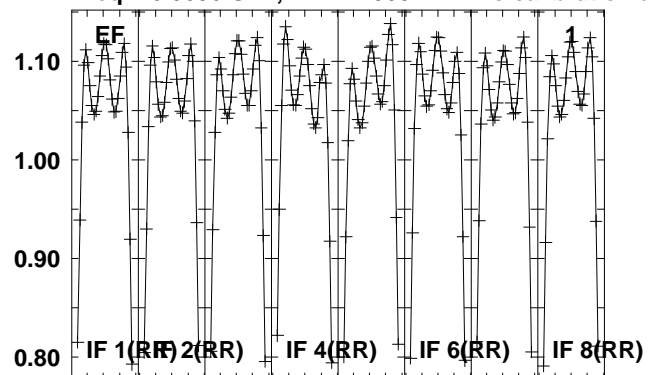

Lower frame: Real Jy
Total-power spectrum Antenna: *
Timerange: 00/16:39:03 to 00/16:44:59

Plot file version 88 created 07-JUN-2013 14:03:43

0528+134 N13M1.UVDATA.1

Freq = 6.6606 GHz, Bw = 2.000 MH No calibration applied and no bandpass applied

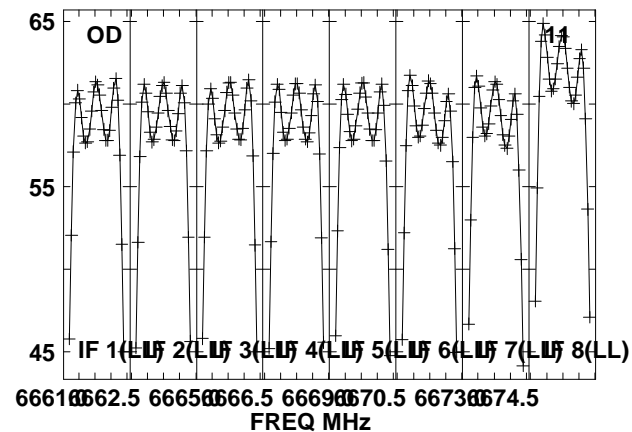
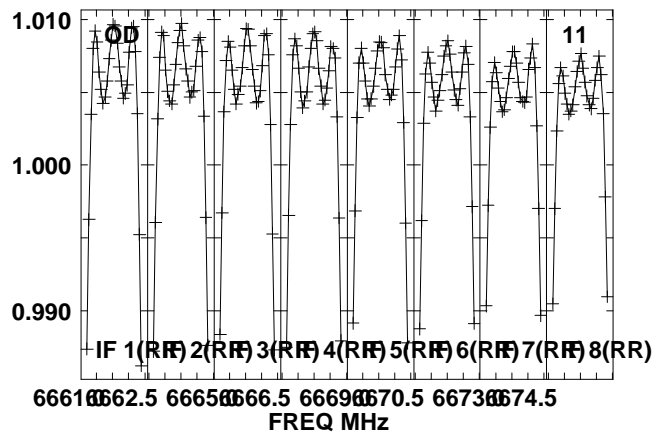
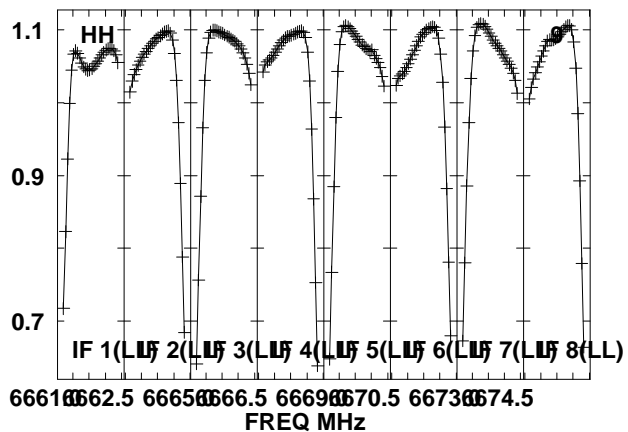
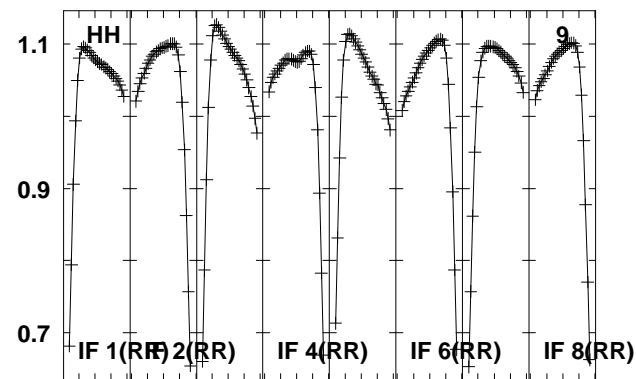
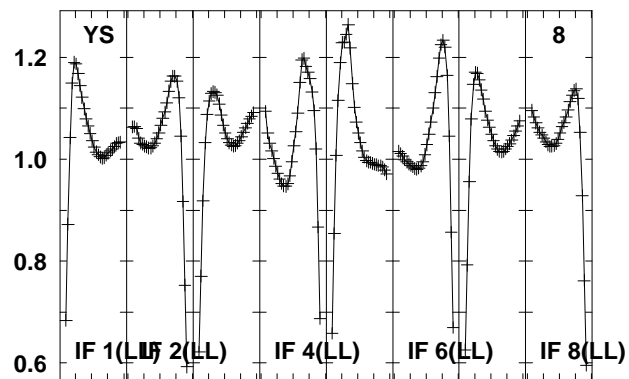
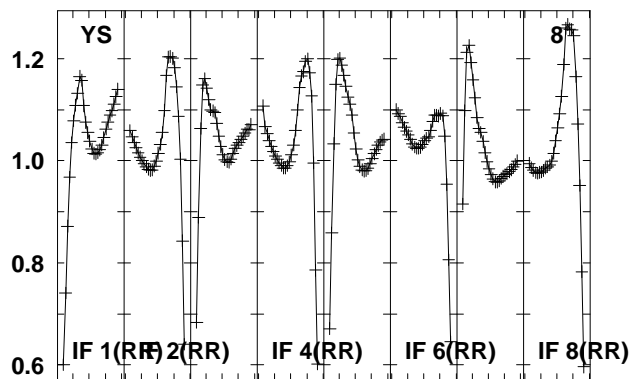
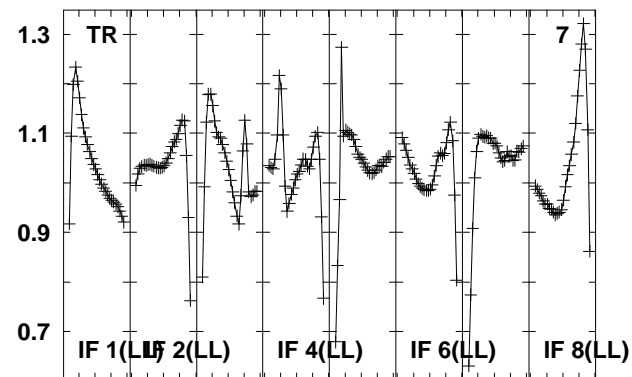
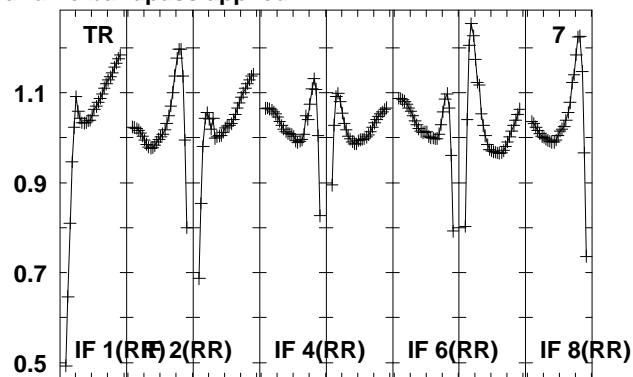
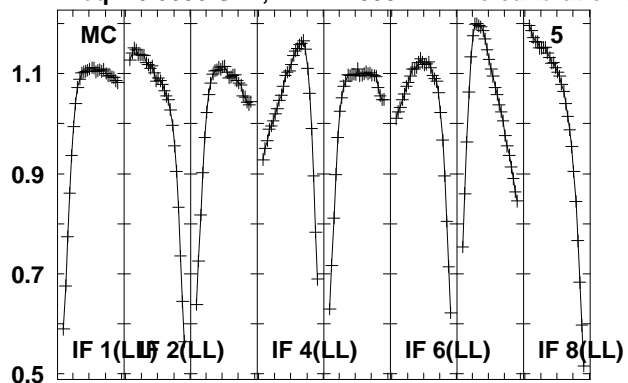

66610 6662.5 66650 6666.5 66690 6670.5 66730 6674.5
FREQ MHz
Lower frame: Real Jy
Total-power spectrum Antenna: *
Timerange: 00/16:39:03 to 00/16:44:59

Plot file version 89 created 07-JUN-2013 14:03:44

0528+134 N13M1.UVDATA.1

Freq = 6.6606 GHz, Bw = 2.000 MH No calibration applied and no bandpass applied

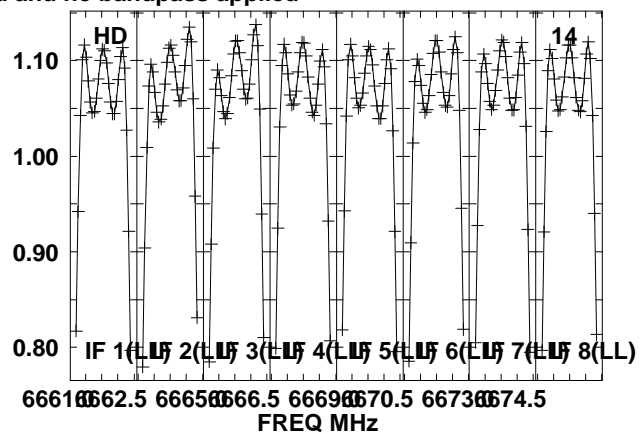
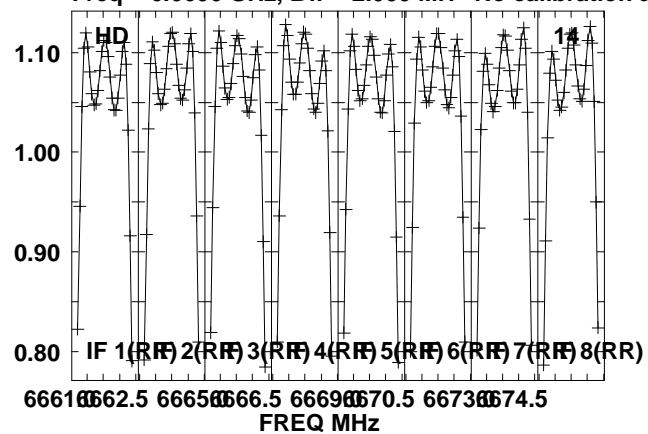

Lower frame: Real Jy

Total-power spectrum Antenna: *

Timerange: 00/16:39:03 to 00/16:44:59

Plot file version 90 created 07-JUN-2013 14:03:44

J0522+1415 N13M1.UVDATA.1

Freq = 6.6606 GHz, Bw = 2.000 MH No calibration applied and no bandpass applied

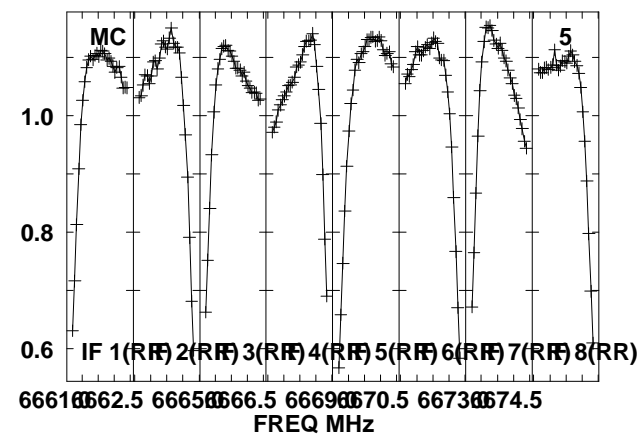
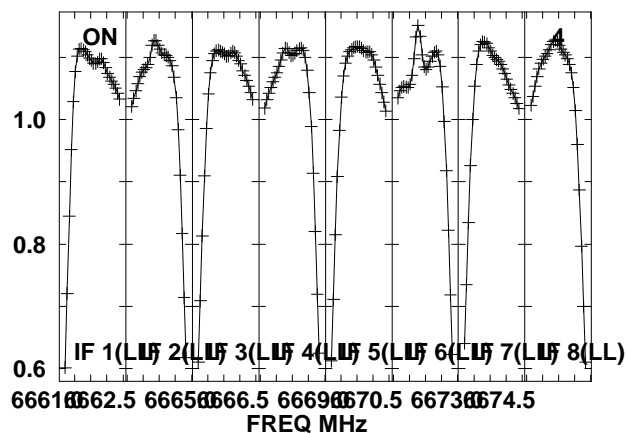
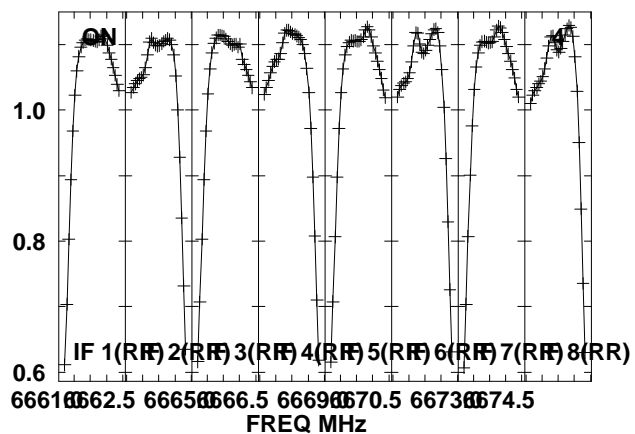
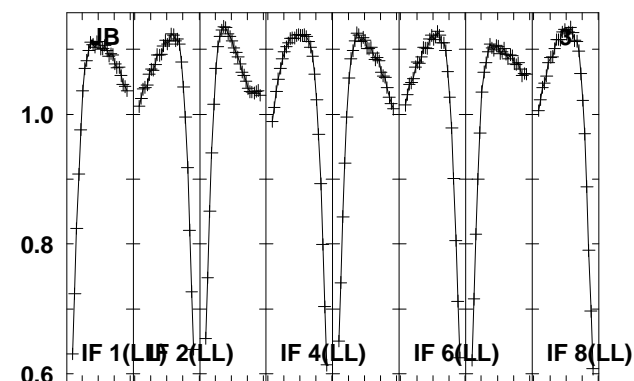
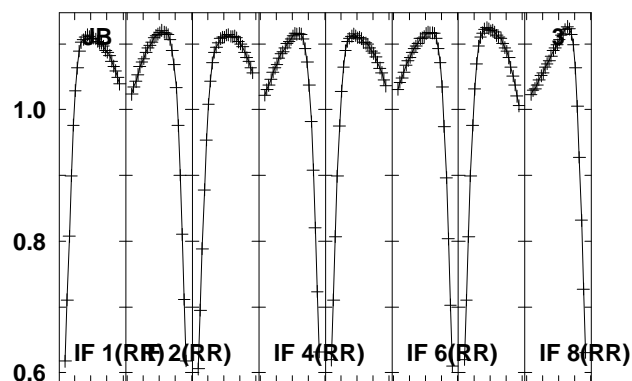
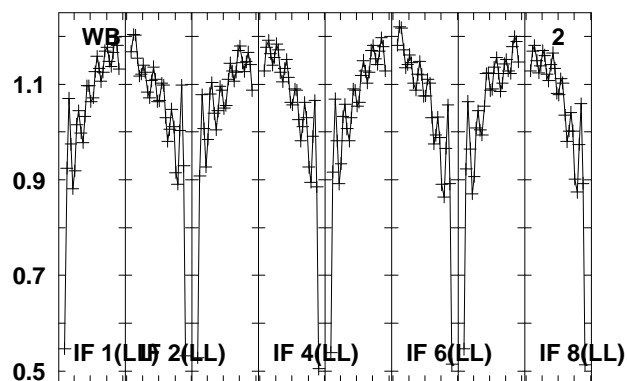
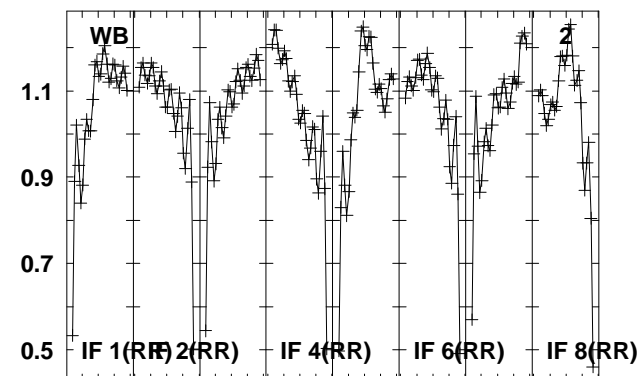
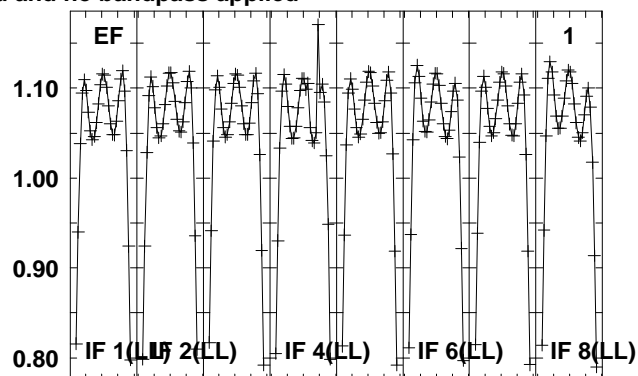
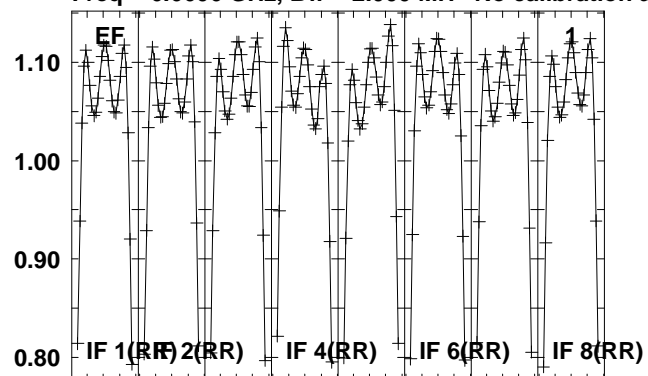

Lower frame: Real Jy
Total-power spectrum Antenna: *
Timerange: 00/16:45:09 to 00/16:46:59

Plot file version 91 created 07-JUN-2013 14:03:44

J0522+1415 N13M1.UVDATA.1

Freq = 6.6606 GHz, Bw = 2.000 MH No calibration applied and no bandpass applied

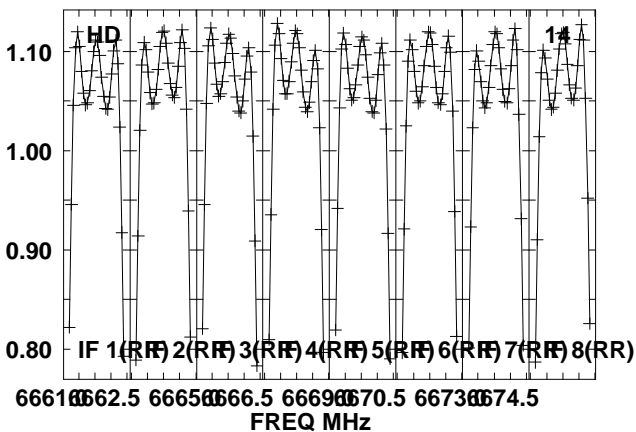
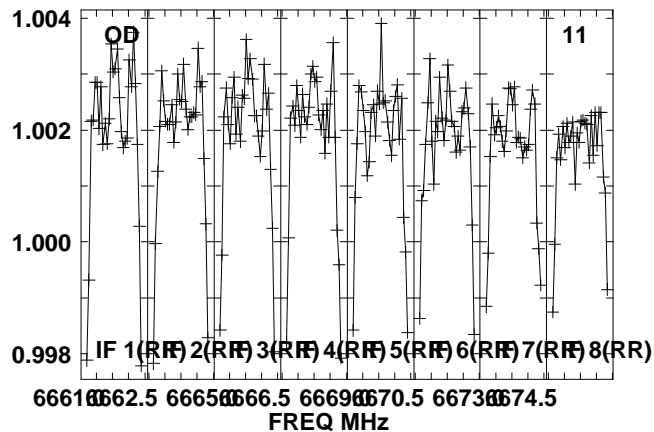
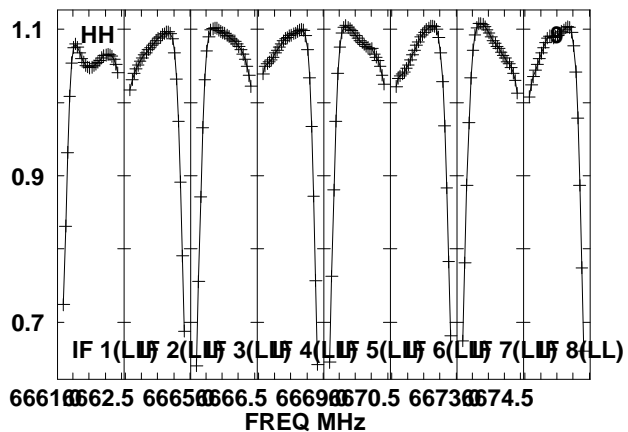
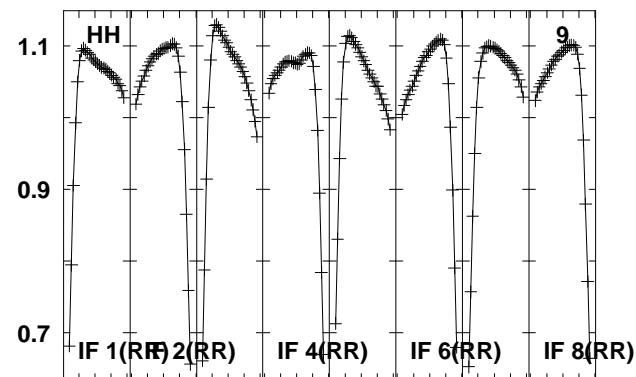
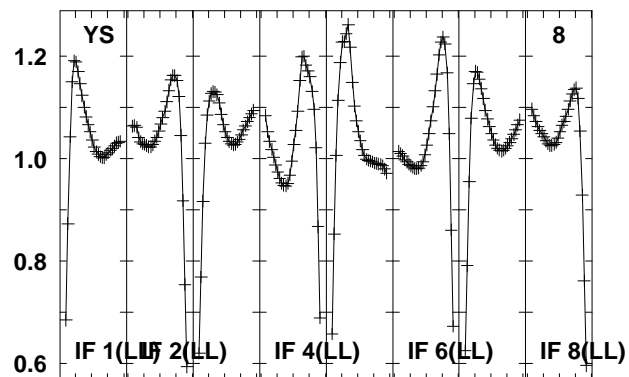
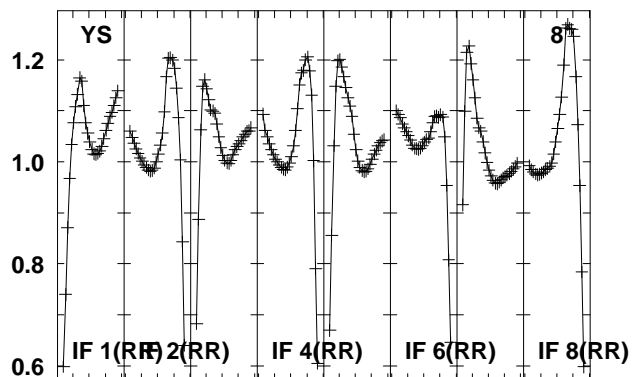
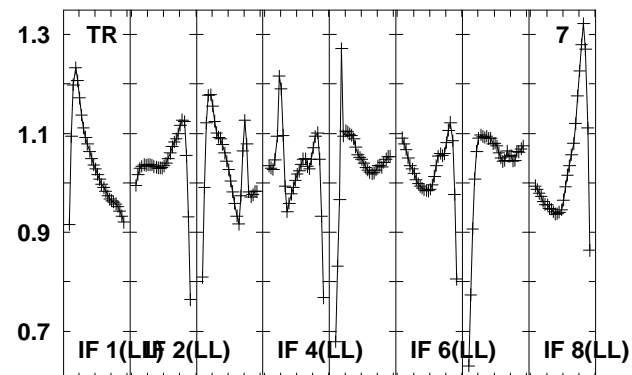
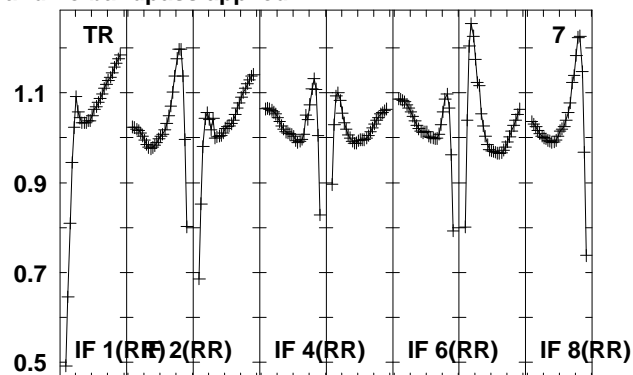
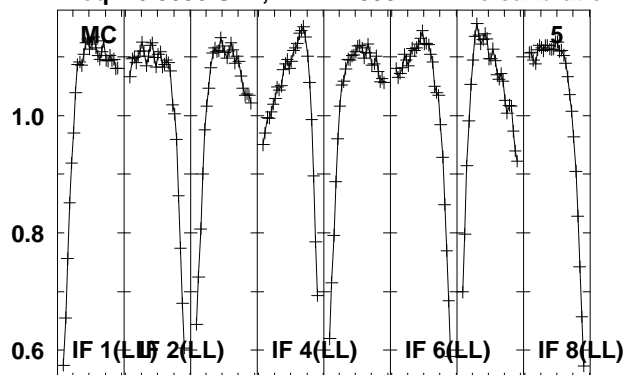

Lower frame: Real Jy
Total-power spectrum Antenna: *
Timerange: 00/16:45:09 to 00/16:46:59

Plot file version 92 created 07-JUN-2013 14:03:45
J0522+1415 N13M1.UVDATA.1
Freq = 6.6606 GHz, Bw = 2.000 MH No calibration applied and no bandpass applied

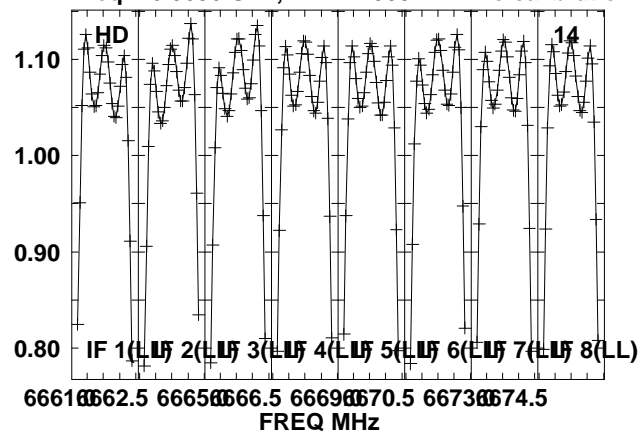

Lower frame: Real Jy
Total-power spectrum Antenna: *
Timerange: 00/16:45:09 to 00/16:46:59

Plot file version 93 created 07-JUN-2013 14:03:45

0528+134 N13M1.UVDATA.1

Freq = 6.6606 GHz, Bw = 2.000 MH No calibration applied and no bandpass applied

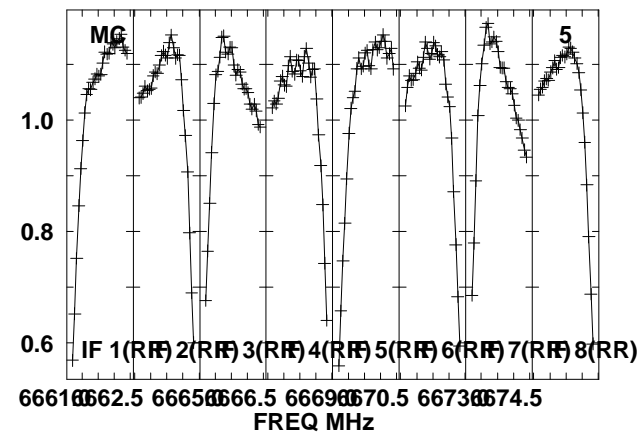
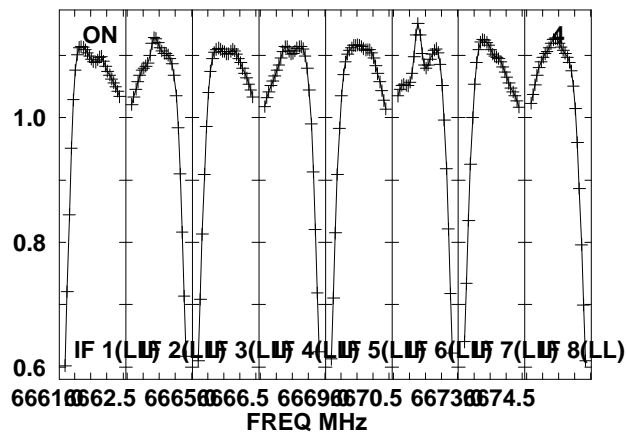
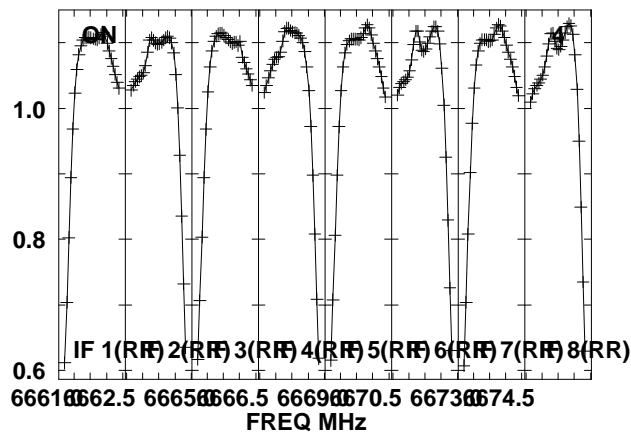
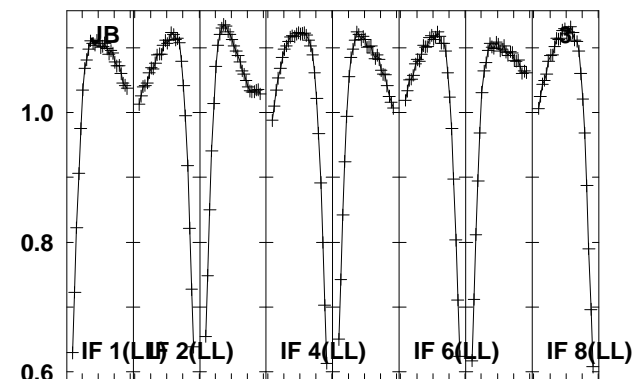
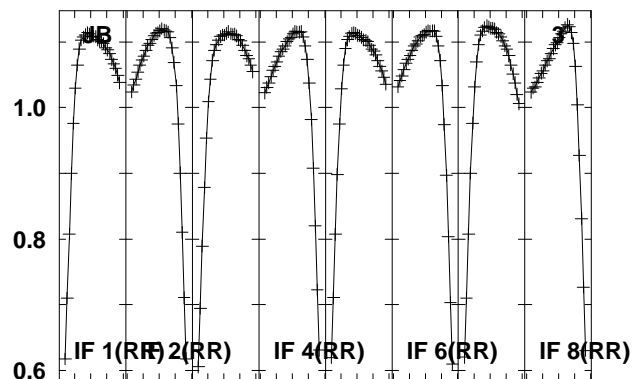
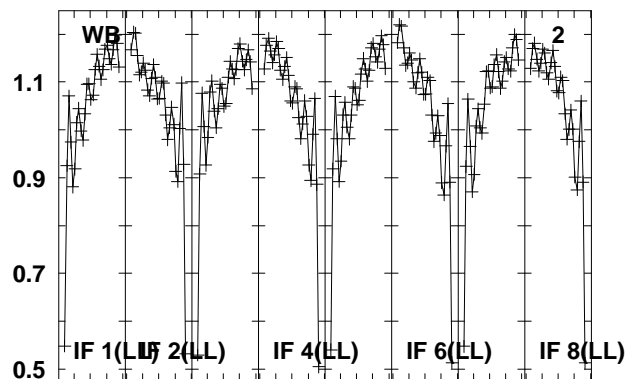
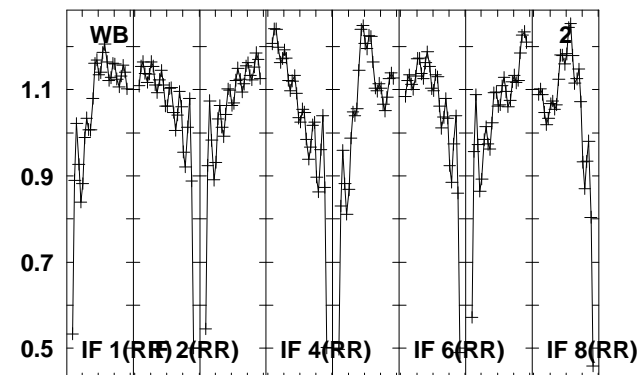
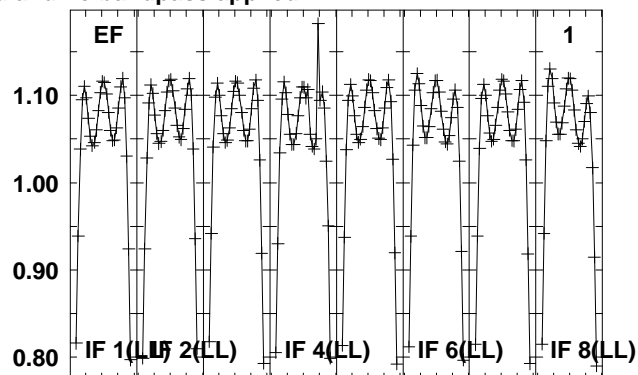
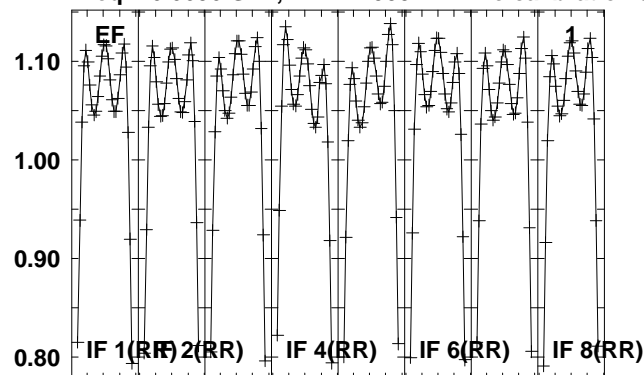

Lower frame: Real Jy
Total-power spectrum Antenna: *
Timerange: 00/16:48:03 to 00/16:49:59

Plot file version 94 created 07-JUN-2013 14:03:45

0528+134 N13M1.UVDATA.1

Freq = 6.6606 GHz, Bw = 2.000 MH No calibration applied and no bandpass applied

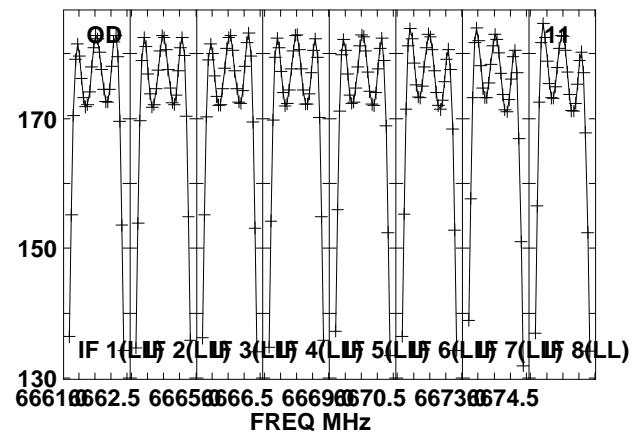
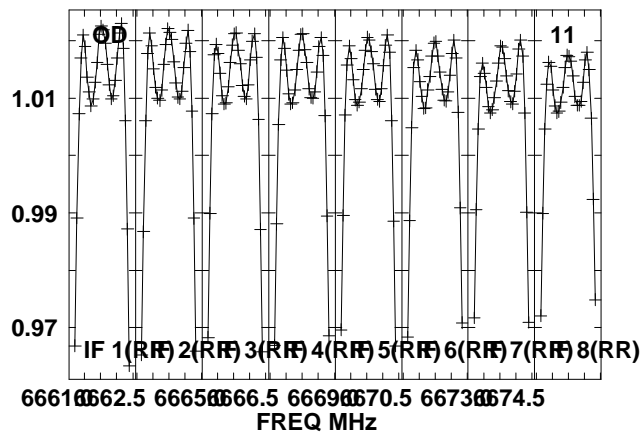
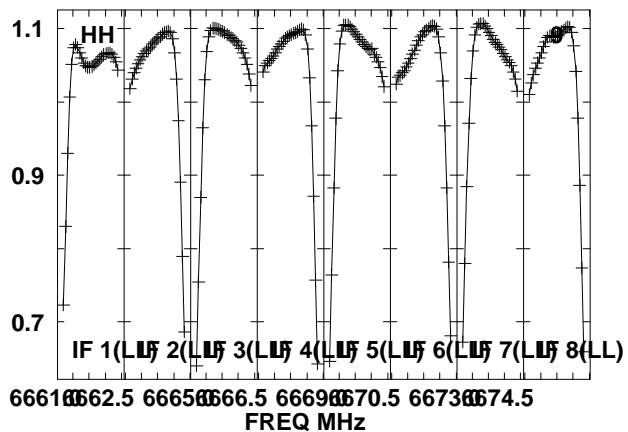
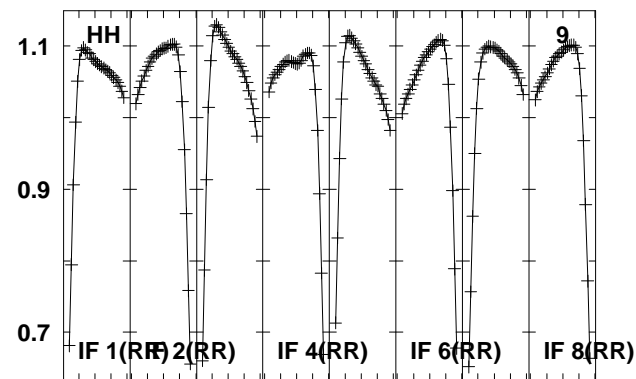
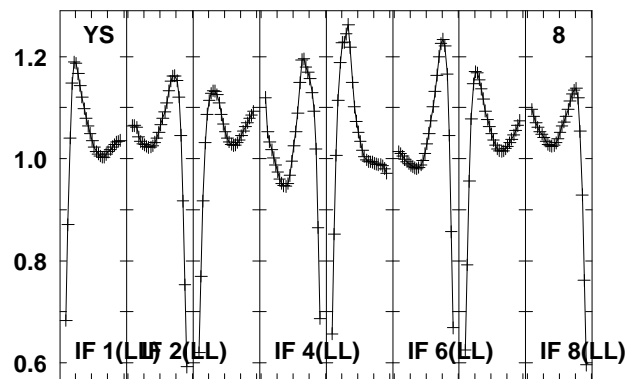
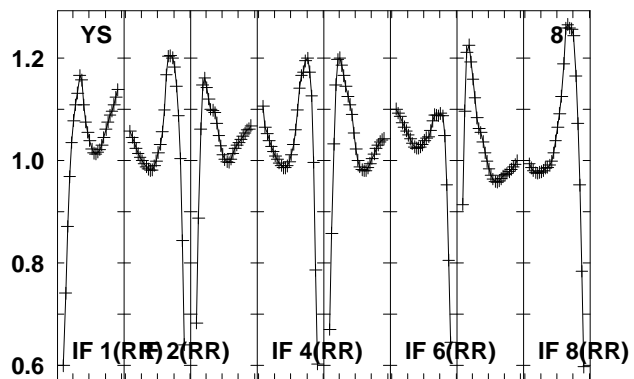
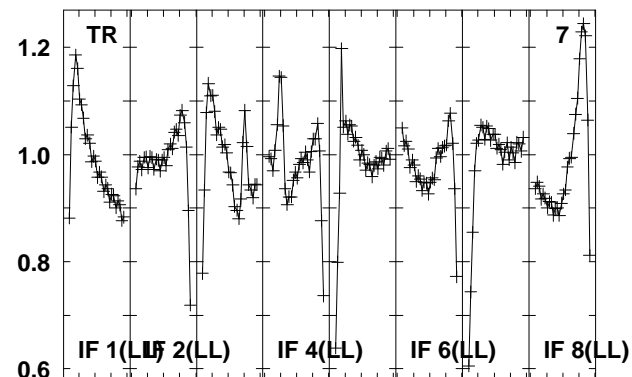
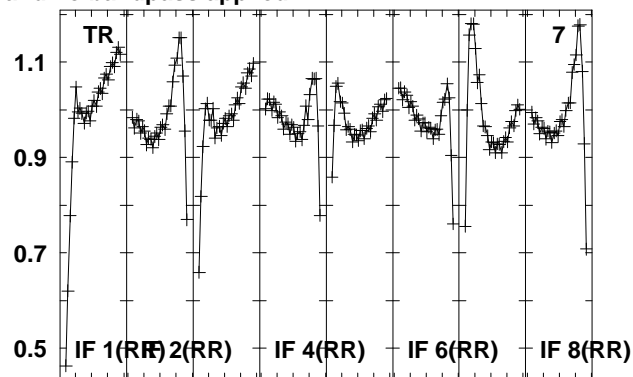
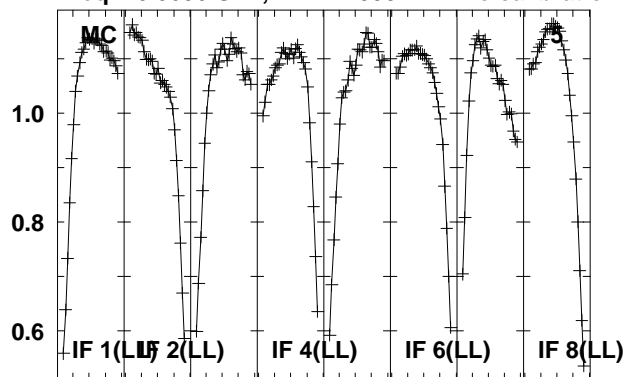

Lower frame: Real Jy
Total-power spectrum Antenna: *
Timerange: 00/16:48:03 to 00/16:49:59

Plot file version 95 created 07-JUN-2013 14:03:45

0528+134 N13M1.UVDATA.1

Freq = 6.6606 GHz, Bw = 2.000 MH No calibration applied and no bandpass applied

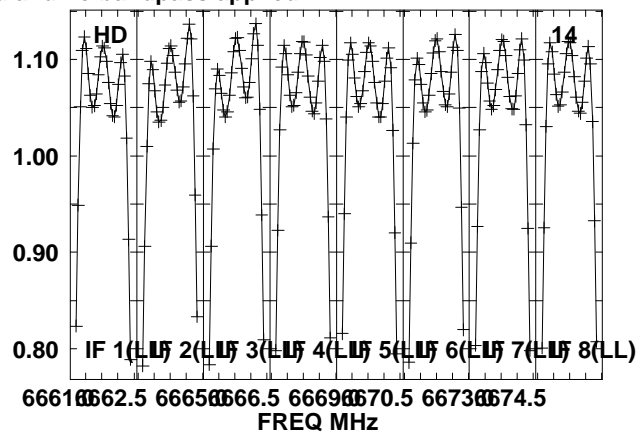
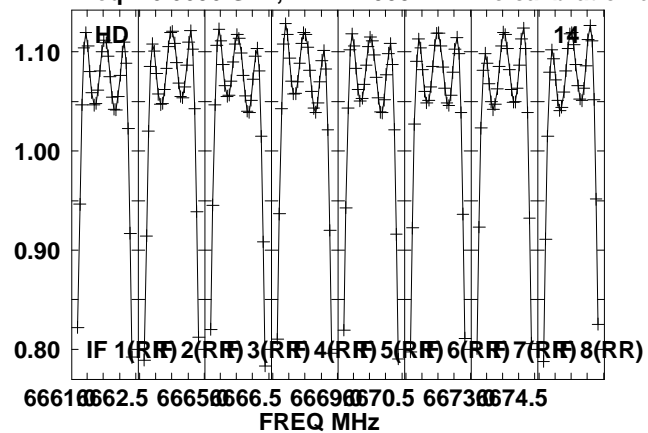

Lower frame: Real Jy
Total-power spectrum Antenna: *
Timerange: 00/16:48:03 to 00/16:49:59

Plot file version 96 created 07-JUN-2013 14:03:46
 0528+134 N13M1.UVDATA.1
 Freq = 6.6606 GHz, Bw = 2.000 MH No calibration applied and no bandpass applied

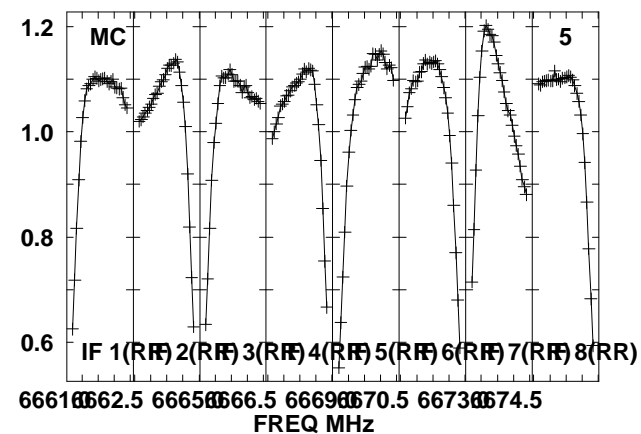
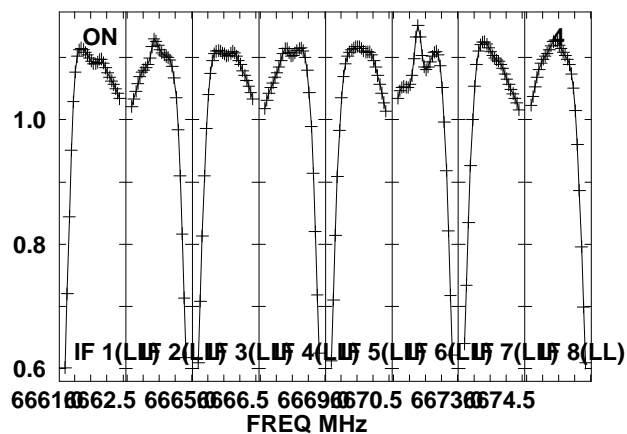
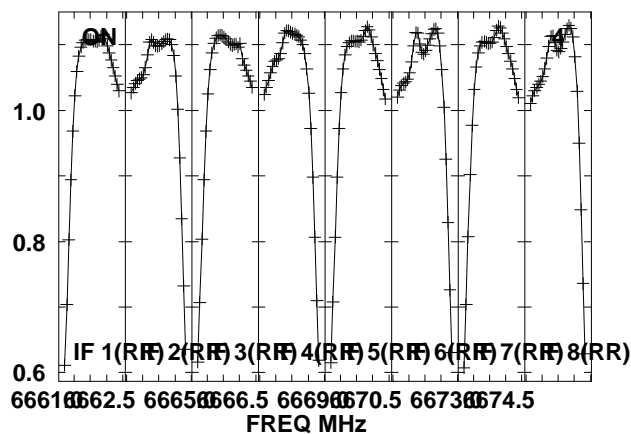
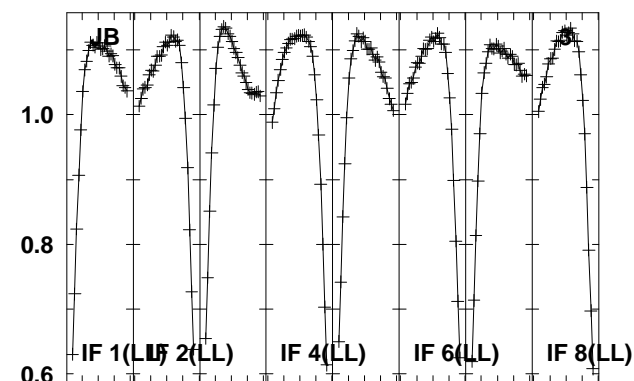
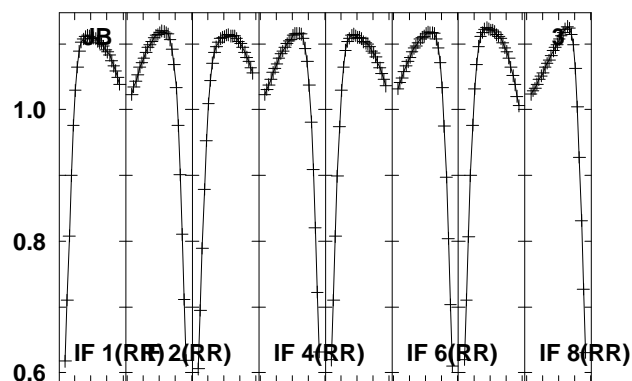
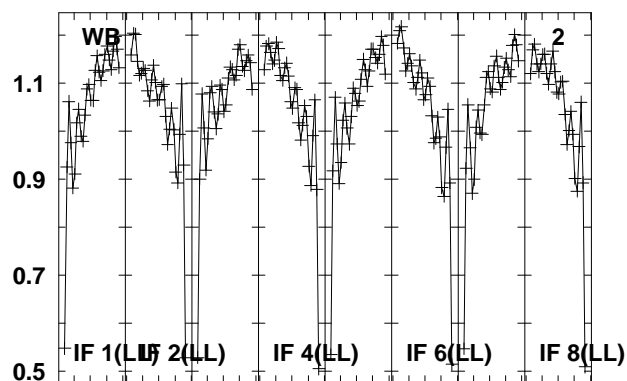
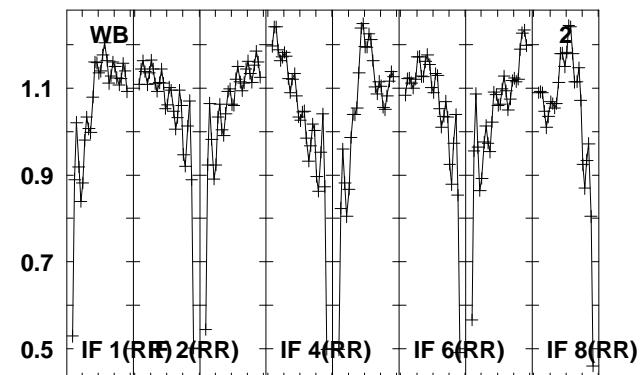
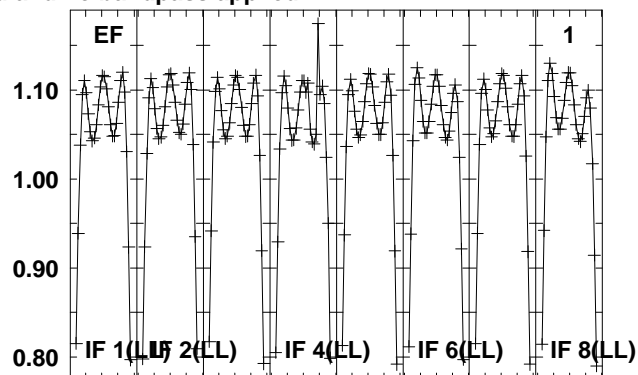
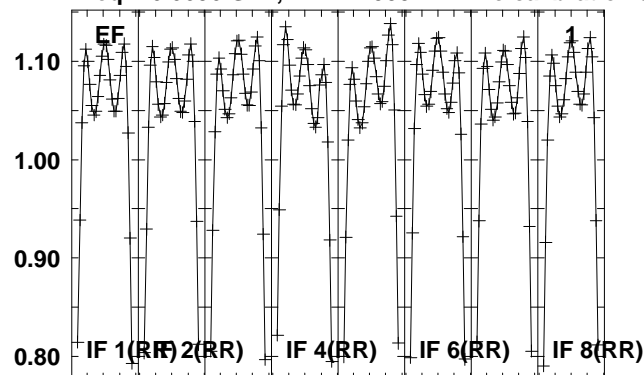

Lower frame: Real Jy
 Total-power spectrum Antenna: *
 Timerange: 00/16:51:03 to 00/16:54:59

Plot file version 97 created 07-JUN-2013 14:03:46

0528+134 N13M1.UVDATA.1

Freq = 6.6606 GHz, Bw = 2.000 MH No calibration applied and no bandpass applied

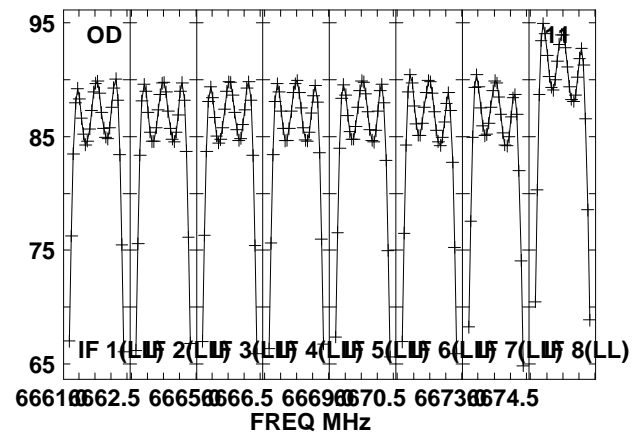
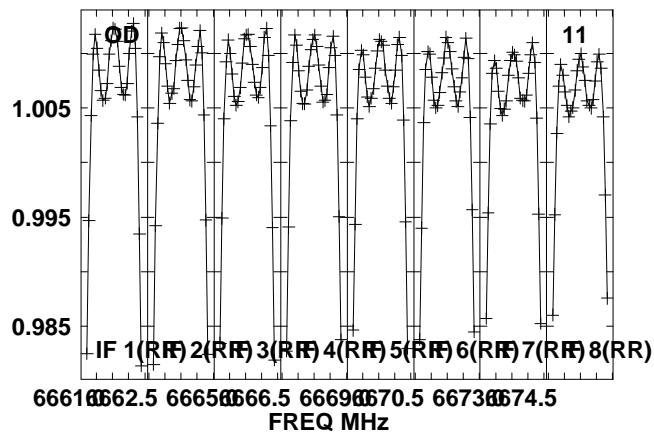
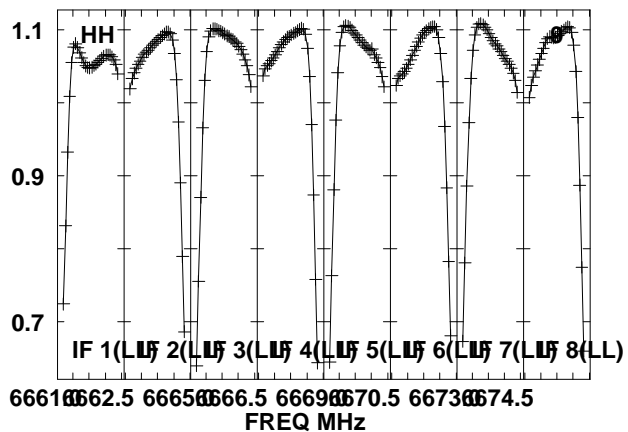
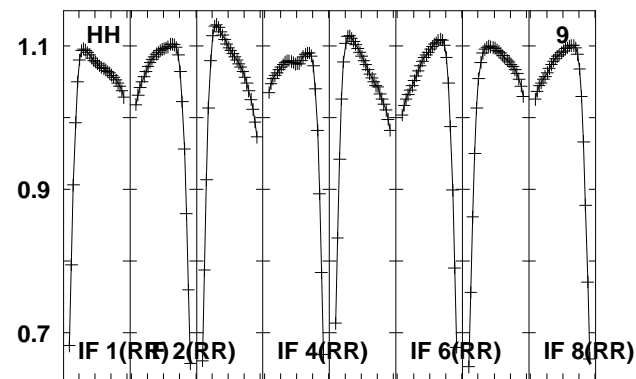
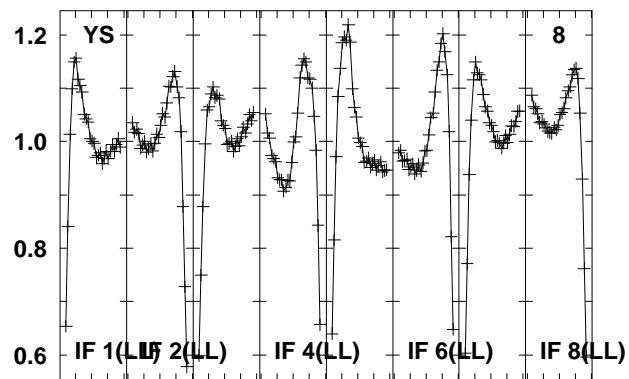
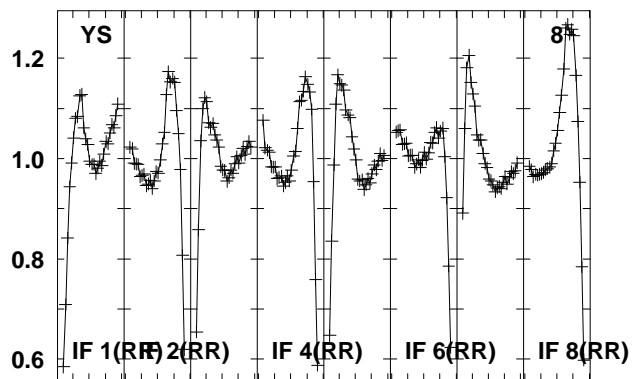
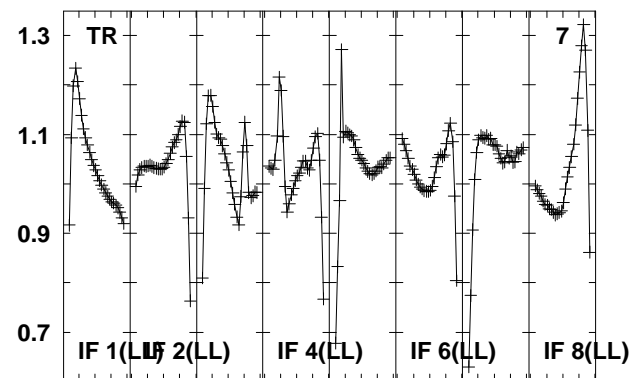
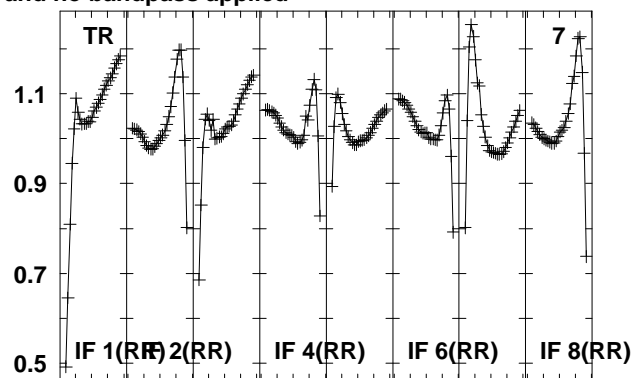
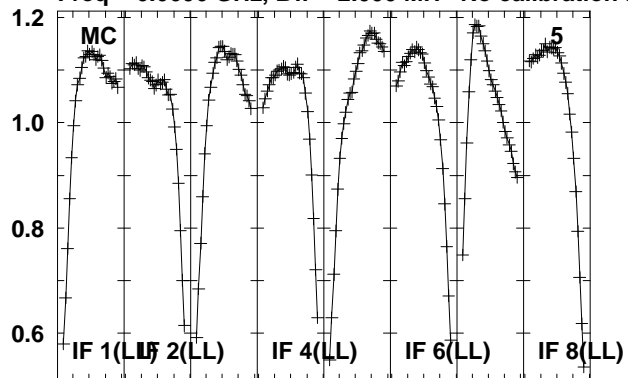

Lower frame: Real Jy
Total-power spectrum Antenna: *
Timerange: 00/16:51:03 to 00/16:54:59

Plot file version 98 created 07-JUN-2013 14:03:47

0528+134 N13M1.UVDATA.1

Freq = 6.6606 GHz, Bw = 2.000 MH No calibration applied and no bandpass applied

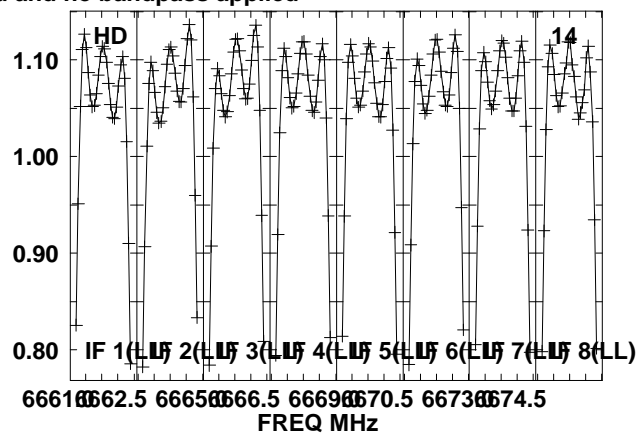
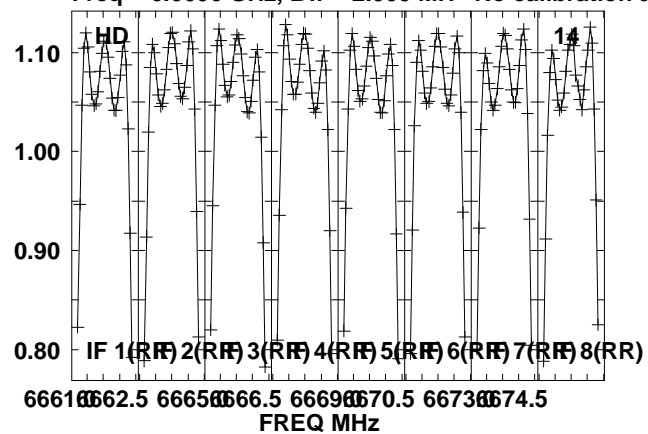

Lower frame: Real Jy
Total-power spectrum Antenna: *
Timerange: 00/16:51:03 to 00/16:54:59

Plot file version 99 created 07-JUN-2013 14:03:47

0528+134 N13M1.UVDATA.1

Freq = 6.6606 GHz, Bw = 2.000 MH No calibration applied and no bandpass applied

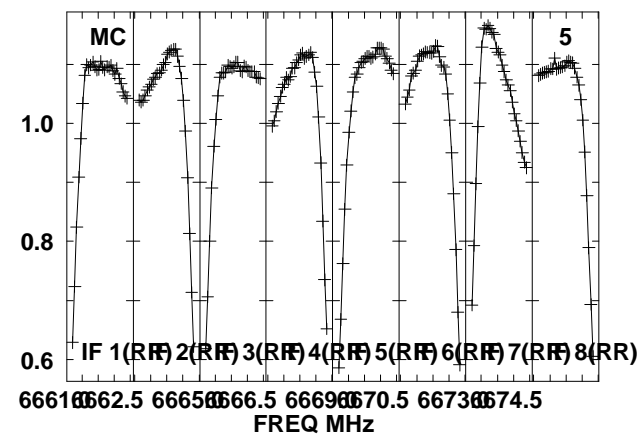
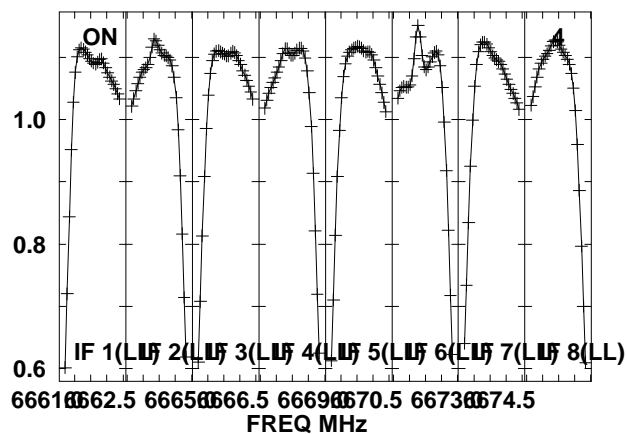
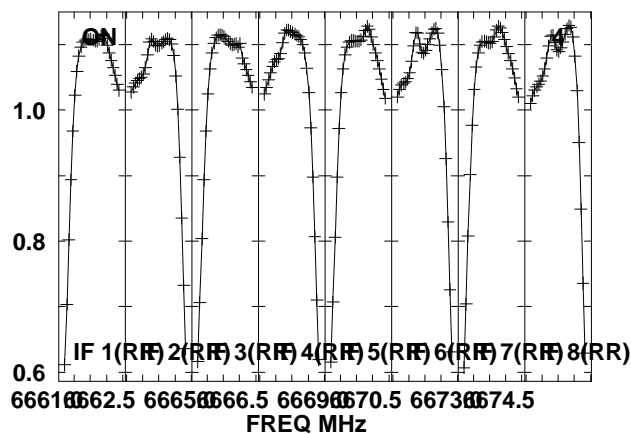
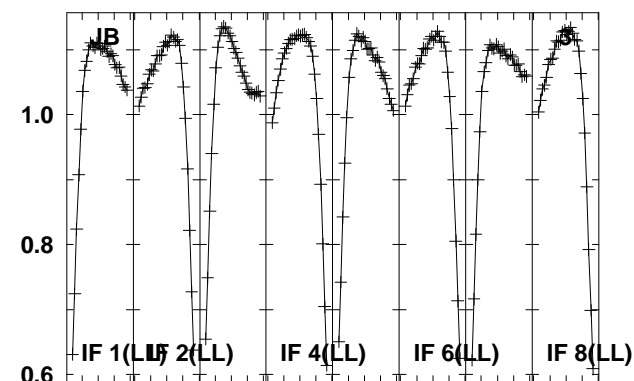
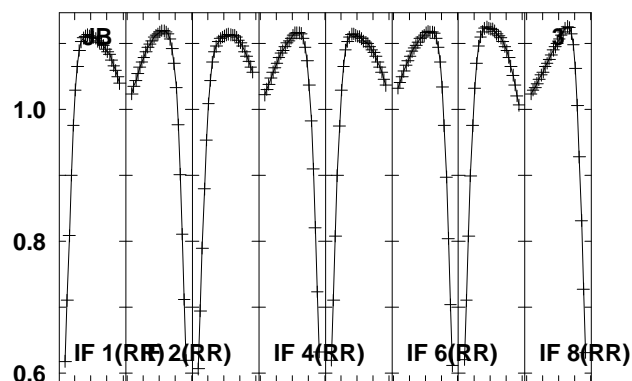
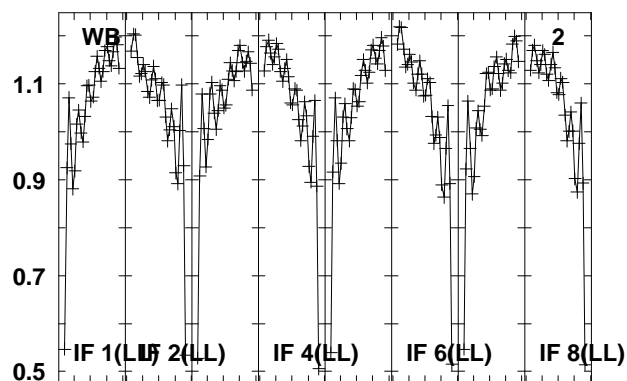
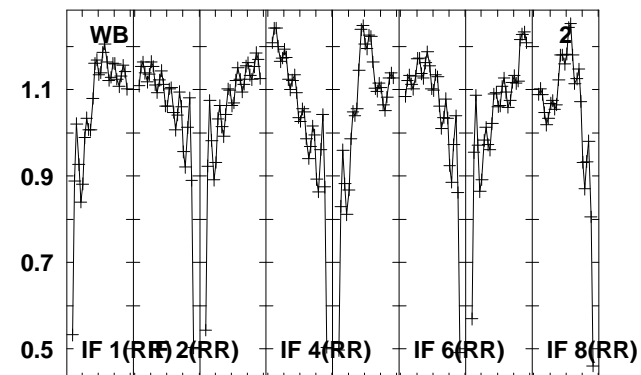
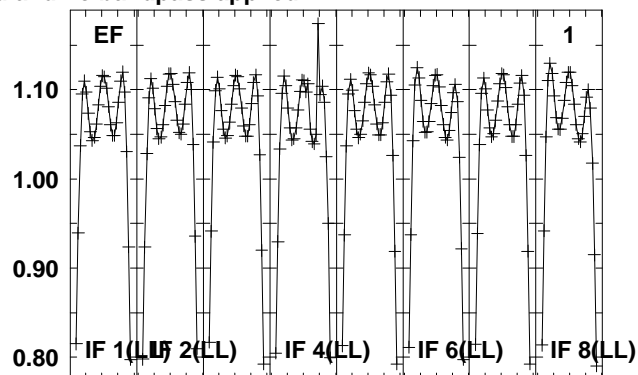
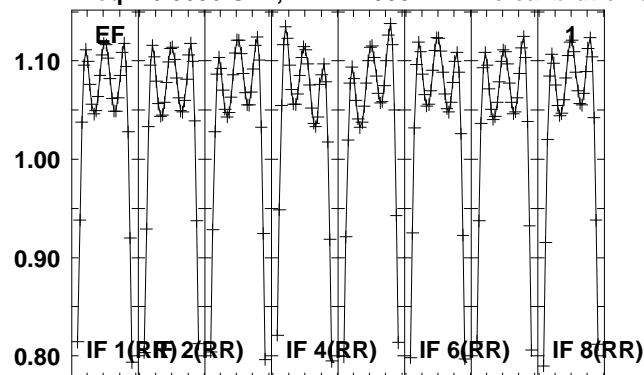

Lower frame: Real Jy
Total-power spectrum Antenna: *
Timerange: 00/16:56:03 to 00/16:59:59

Plot file version 100 created 07-JUN-2013 14:03:48

0528+134 N13M1.UVDATA.1

Freq = 6.6606 GHz, Bw = 2.000 MH No calibration applied and no bandpass applied

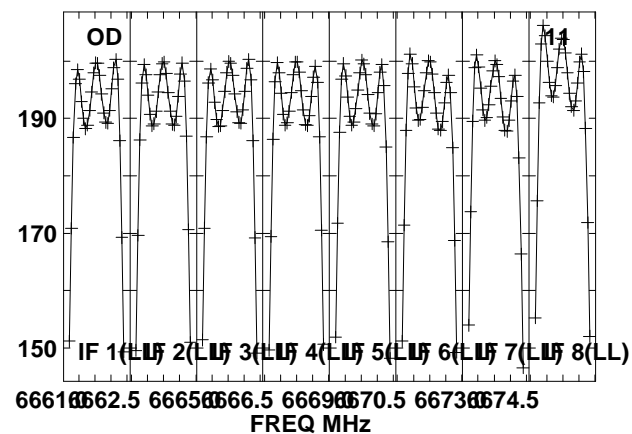
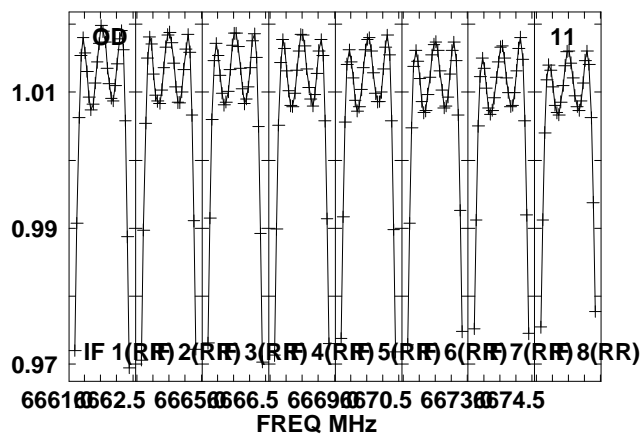
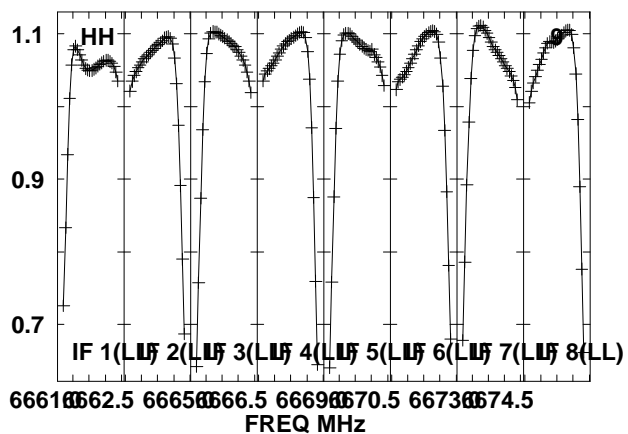
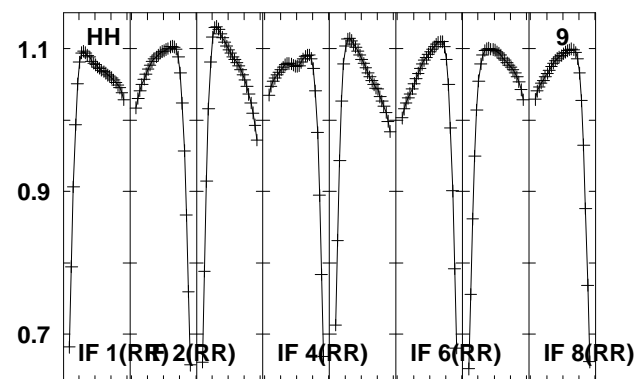
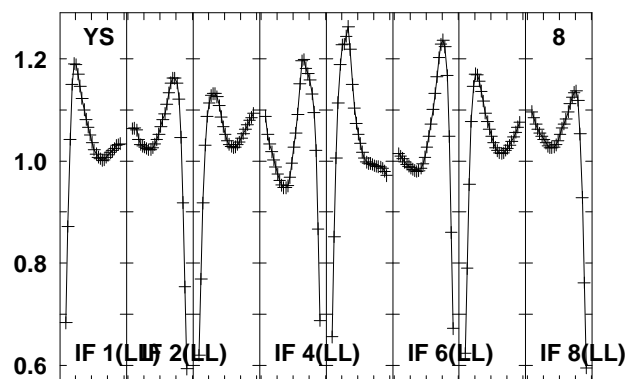
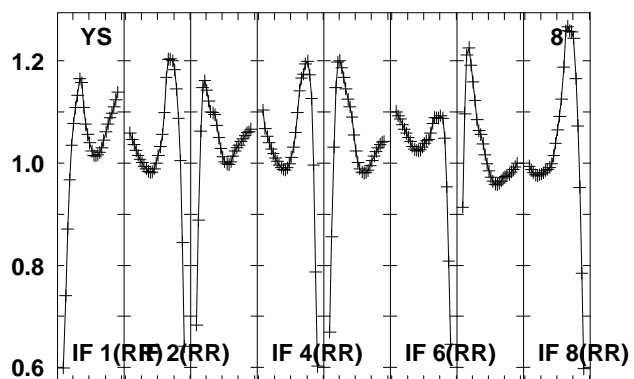
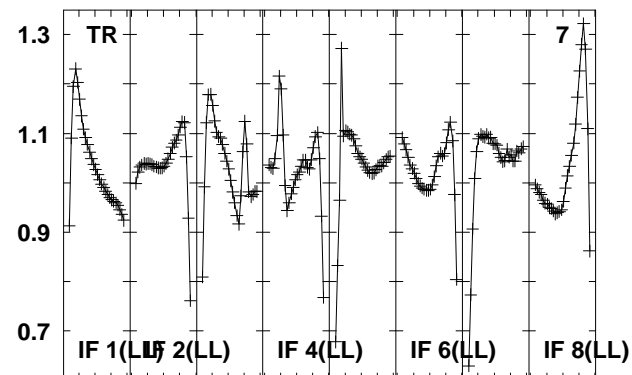
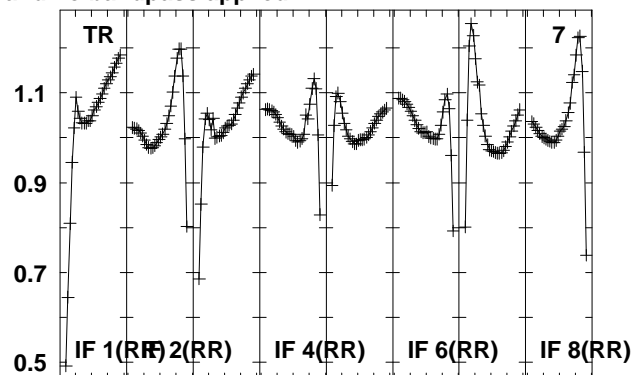
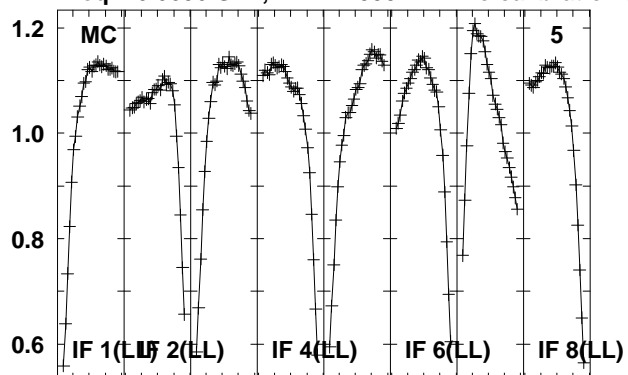

Lower frame: Real Jy
Total-power spectrum Antenna: *
Timerange: 00/16:56:03 to 00/16:59:59

Plot file version 101 created 07-JUN-2013 14:03:49

0528+134 N13M1.UVDATA.1

Freq = 6.6606 GHz, Bw = 2.000 MH No calibration applied and no bandpass applied

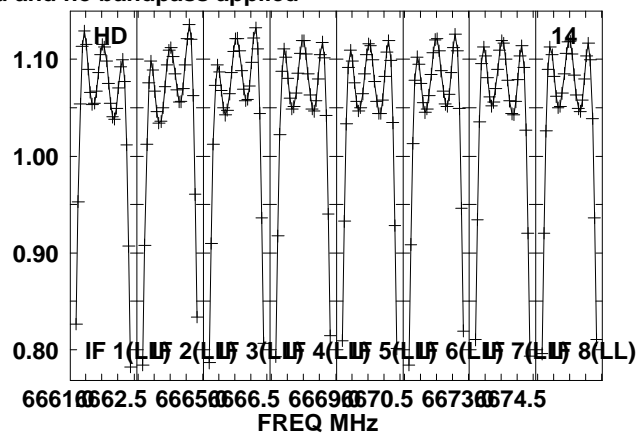
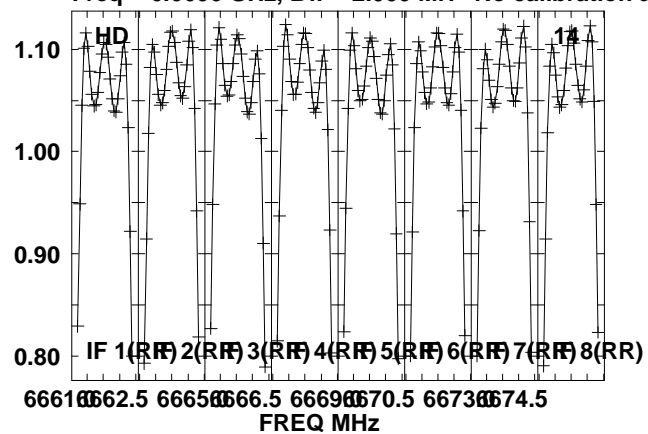

Lower frame: Real Jy
Total-power spectrum Antenna: *
Timerange: 00/16:56:03 to 00/16:59:59