

Plot file version 1 created 28-JAN-2015 14:38:03

3C345 N14C3.UVDATA.1

Freq = 4.9270 GHz, Bw = 16.000 MH No calibration applied and no bandpass applied

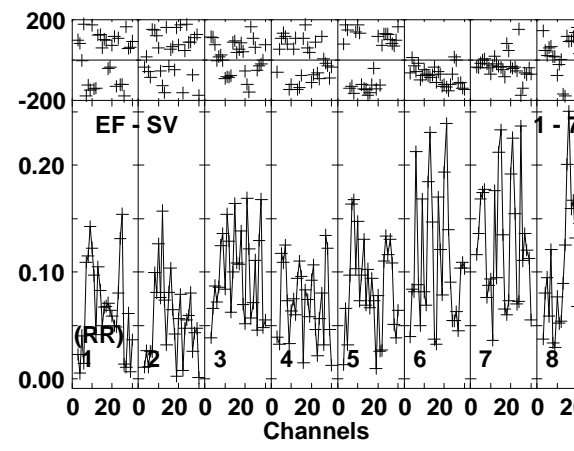
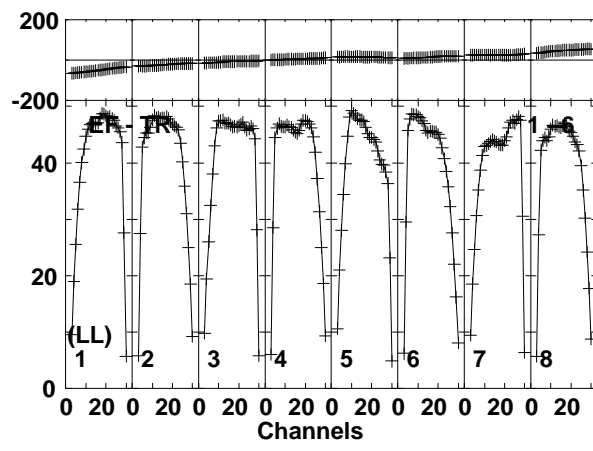
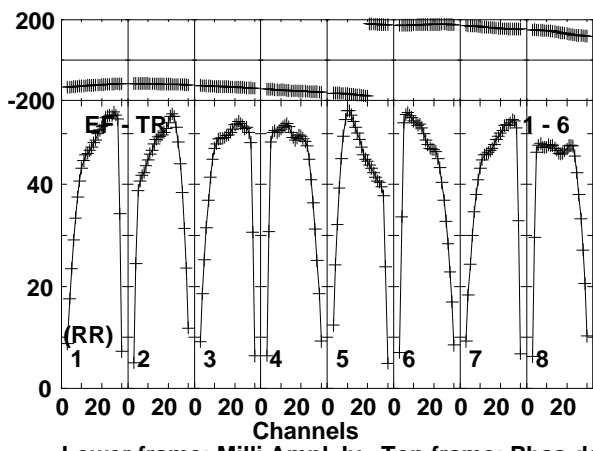
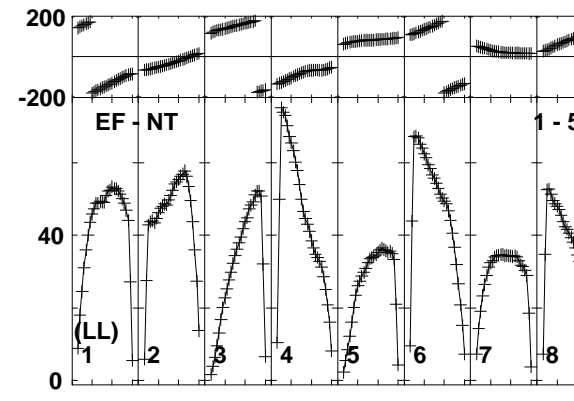
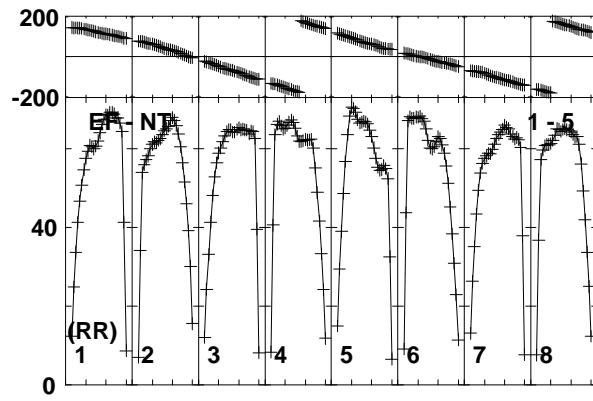
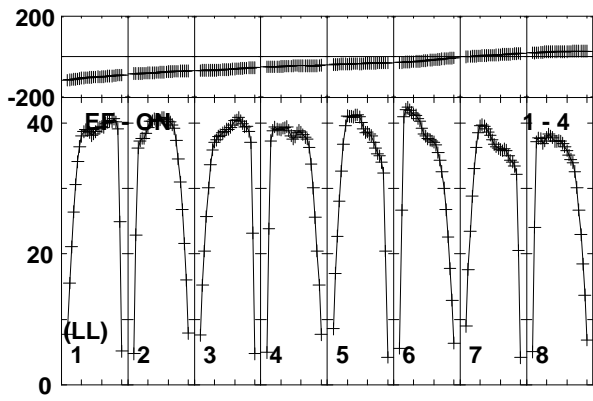
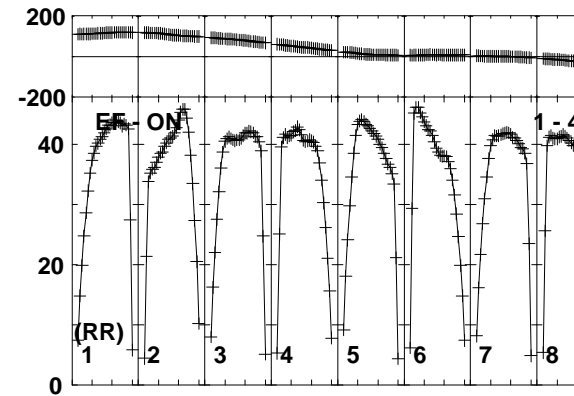
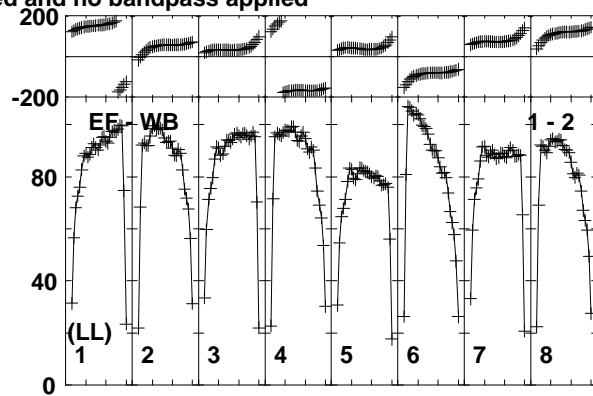
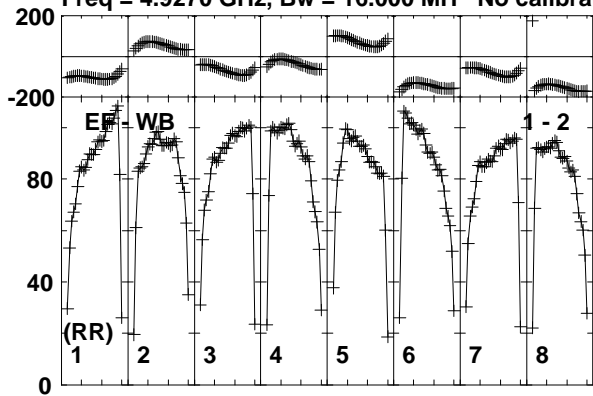

Lower frame: Milli Ampl Jy Top frame: Phas deg
Vector averaged cross-power spectrum Baseline: EF (01) - WB (02)
Timerange: 00/12:00:03 to 00/12:03:59

Plot file version 2 created 28-JAN-2015 14:38:03

3C345 N14C3.UVDATA.1

Freq = 4.9270 GHz, Bw = 16.000 MH No calibration applied and no bandpass applied

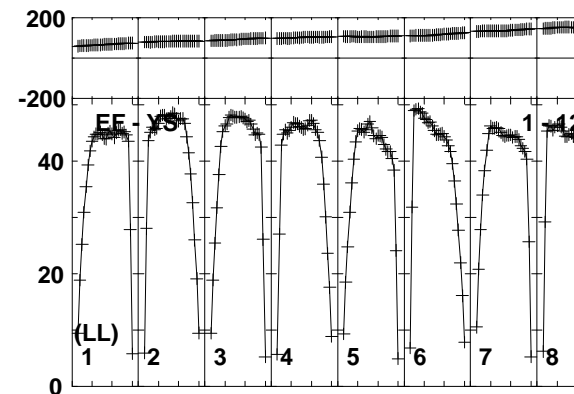
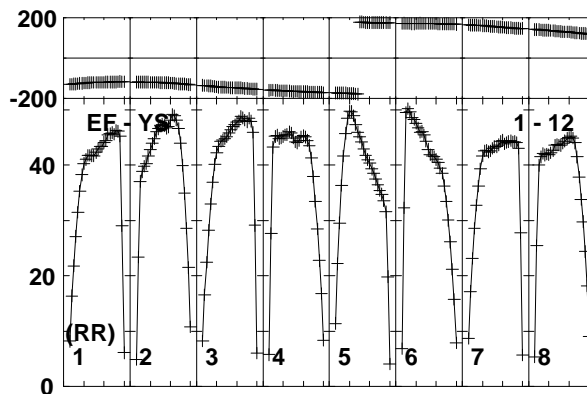
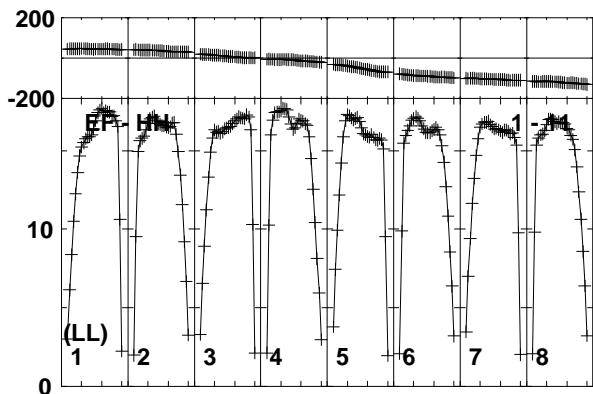
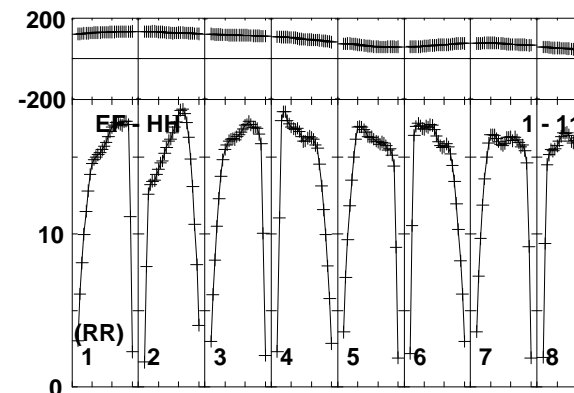
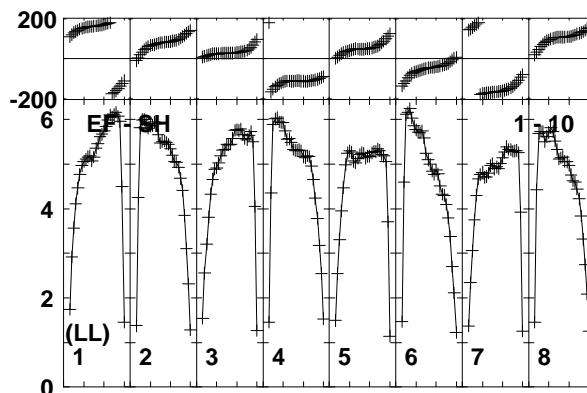
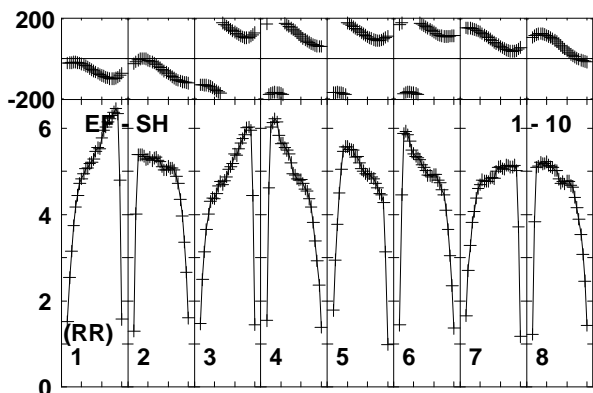
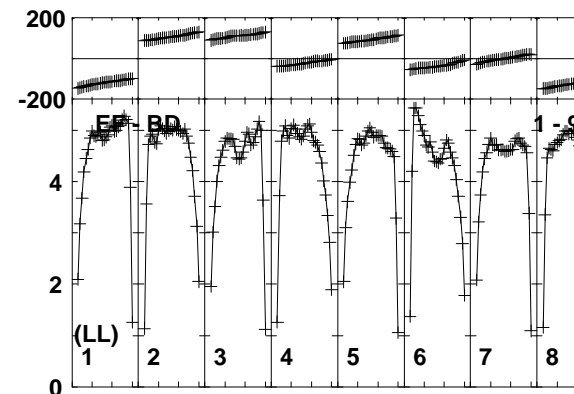
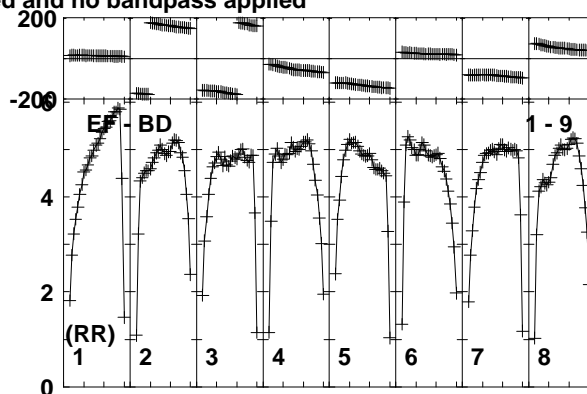
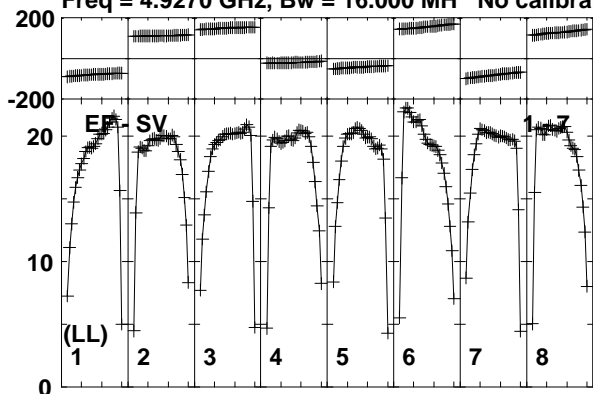

Lower frame: Milli Ampl Jy Top frame: Phas deg
Vector averaged cross-power spectrum Baseline: EF (01) - SV (07)
Timerange: 00:12:00:03 to 00:12:03:59

Plot file version 3 created 28-JAN-2015 14:38:04

3C345 N14C3.UVDATA.1

Freq = 4.9270 GHz, Bw = 16.000 MH No calibration applied and no bandpass applied

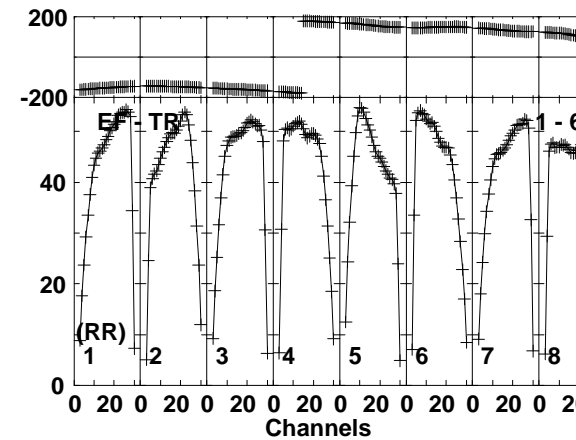
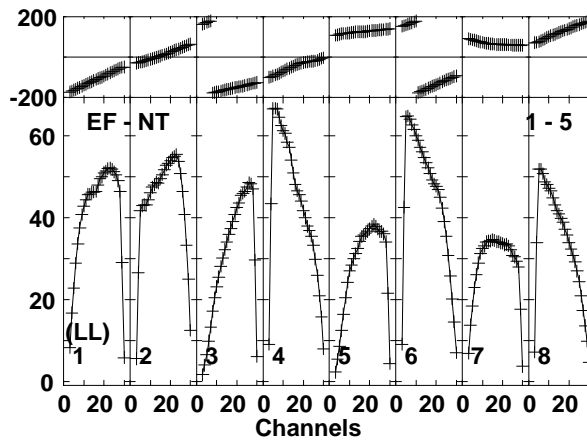
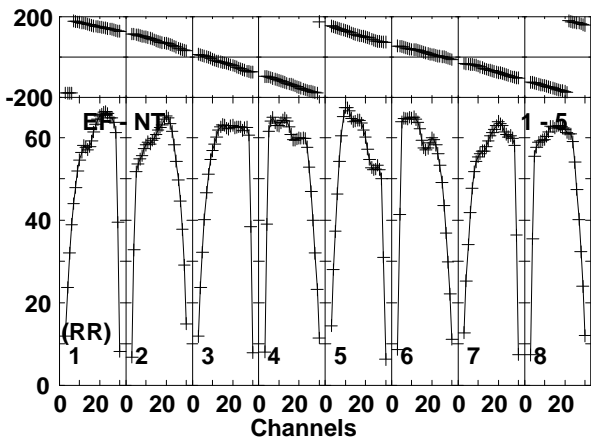
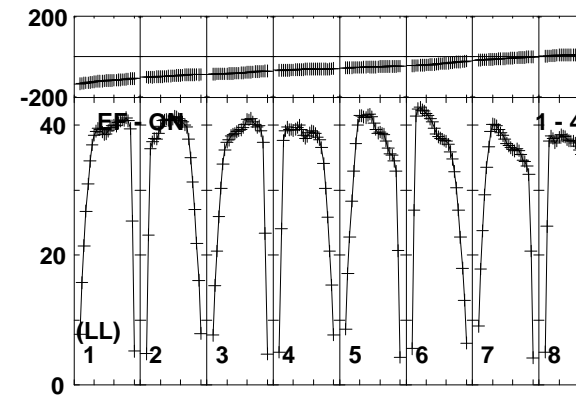
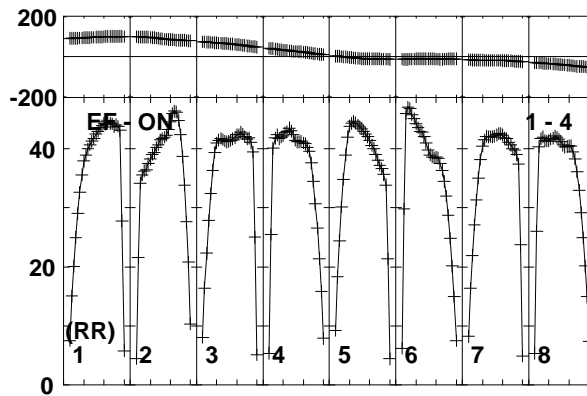
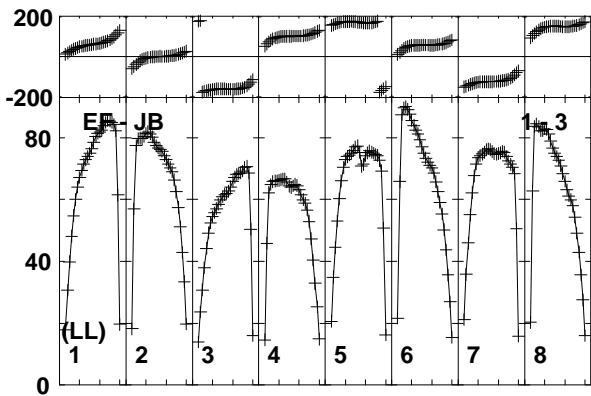
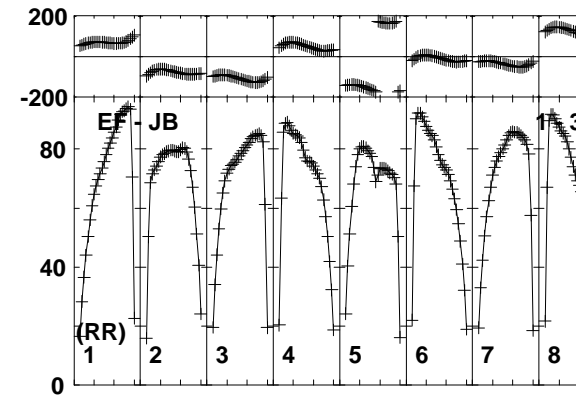
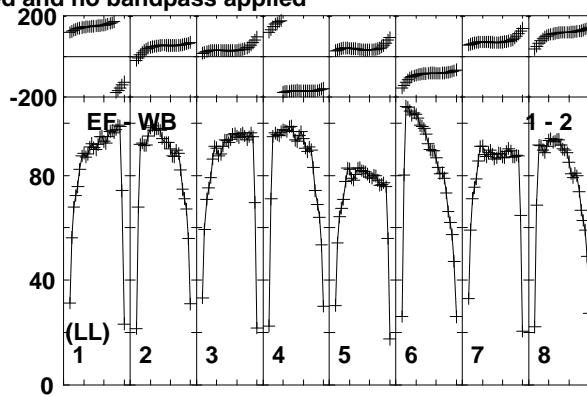
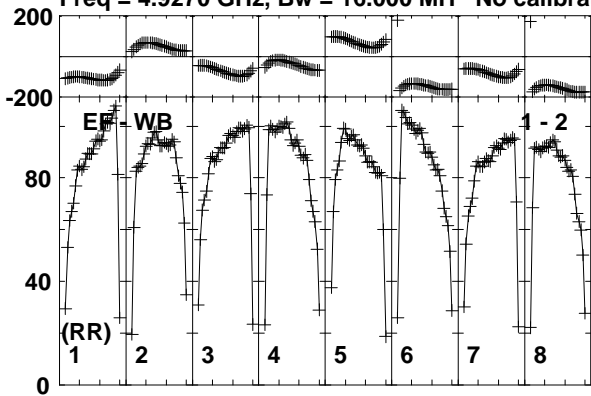

Lower frame: Milli Ampl Jy Top frame: Phas deg
Vector averaged cross-power spectrum Baseline: EF (01) - WB (02)
Timerange: 00:12:06:03 to 00:12:09:59

Plot file version 4 created 28-JAN-2015 14:38:04

3C345 N14C3.UVDATA.1

Freq = 4.9270 GHz, Bw = 16.000 MH No calibration applied and no bandpass applied

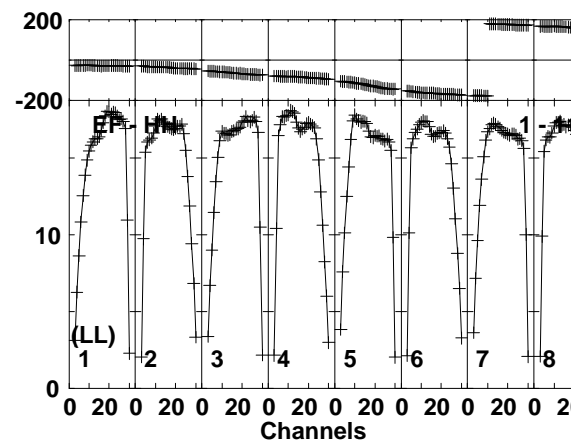
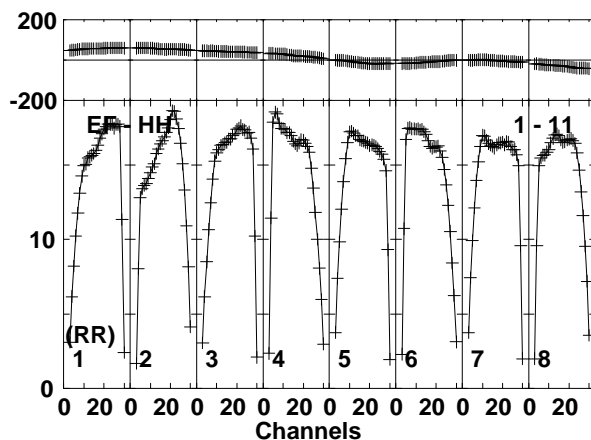
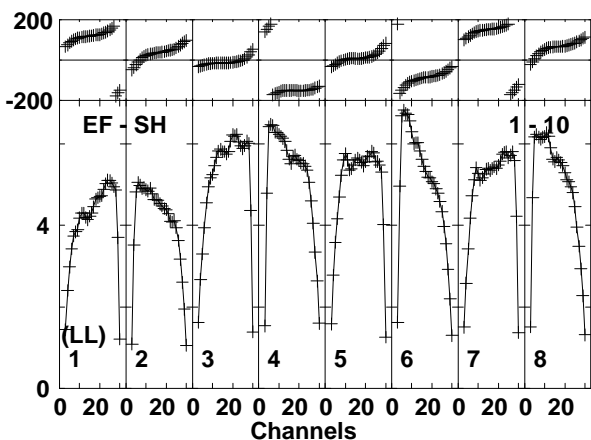
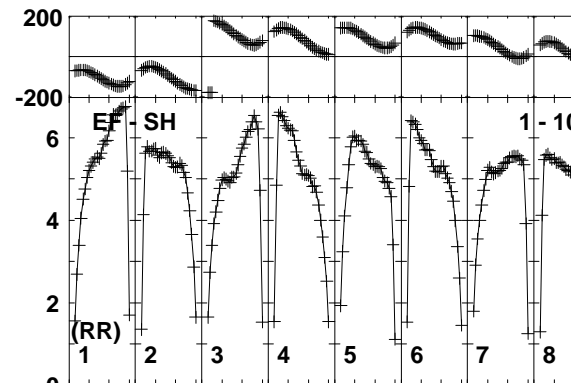
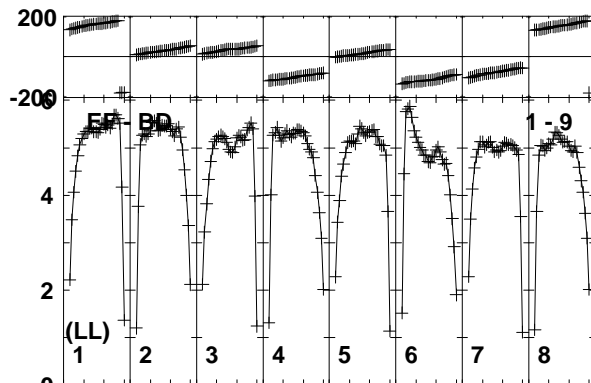
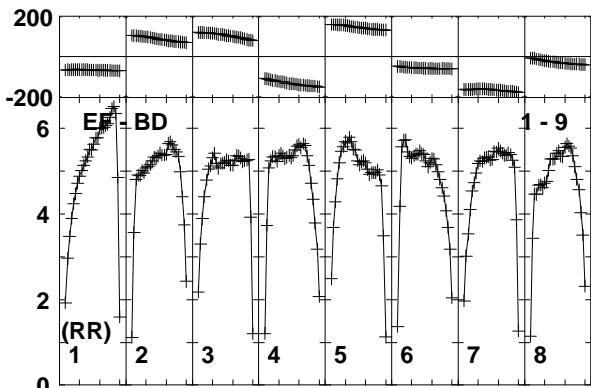
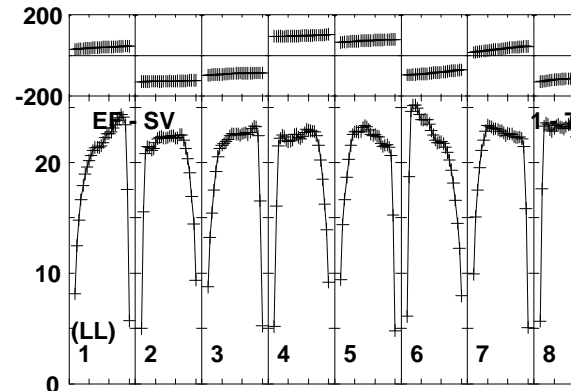
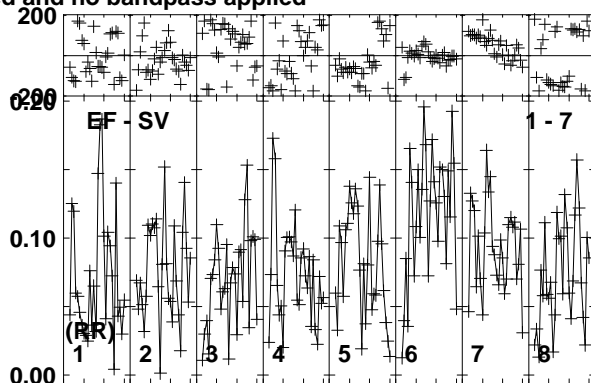
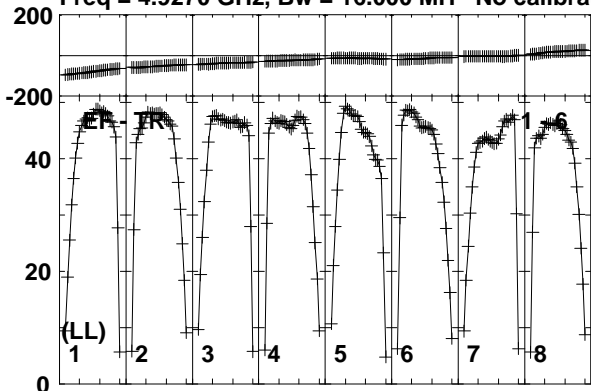

Lower frame: Milli Ampl Jy Top frame: Phas deg
Vector averaged cross-power spectrum Baseline: EF (01) - TR (06)
Timerange: 00:12:06:03 to 00:12:09:59

Plot file version 5 created 28-JAN-2015 14:38:04

3C345 N14C3.UVDATA.1

Freq = 4.9270 GHz, Bw = 16.000 MH No calibration applied and no bandpass applied

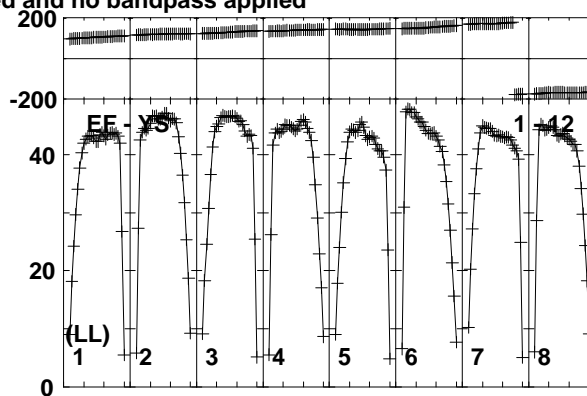
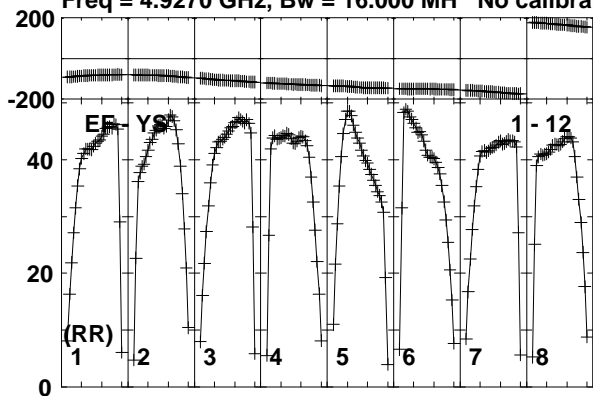

Lower frame: Milli Ampl Jy Top frame: Phas deg
Vector averaged cross-power spectrum Baseline: EF (01) - YS (12)
Timerange: 00/12:06:03 to 00/12:09:59

Plot file version 6 created 28-JAN-2015 14:38:04

3C345 N14C3.UVDATA.1

Freq = 4.9270 GHz, Bw = 16.000 MH No calibration applied and no bandpass applied

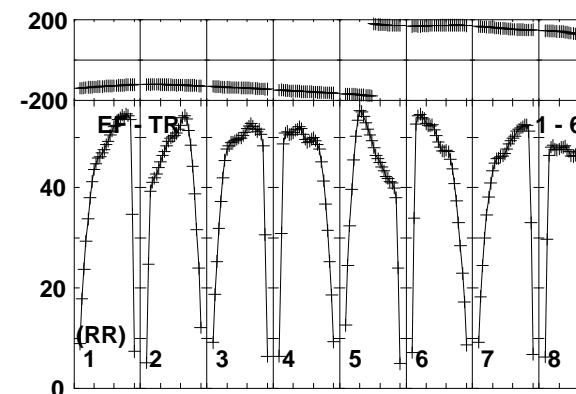
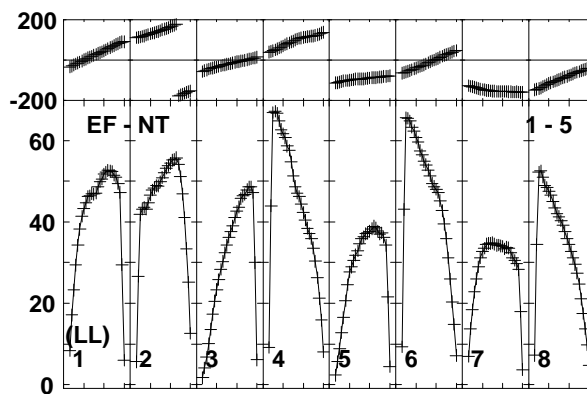
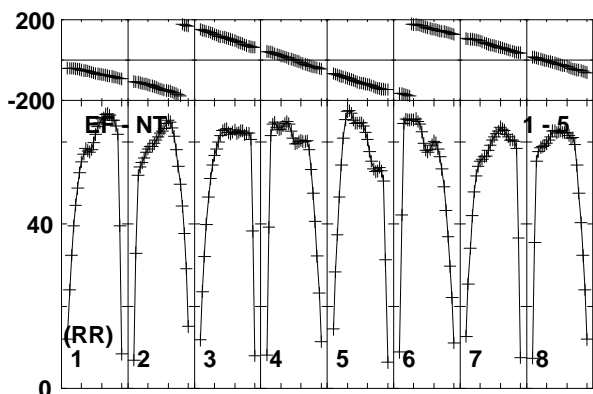
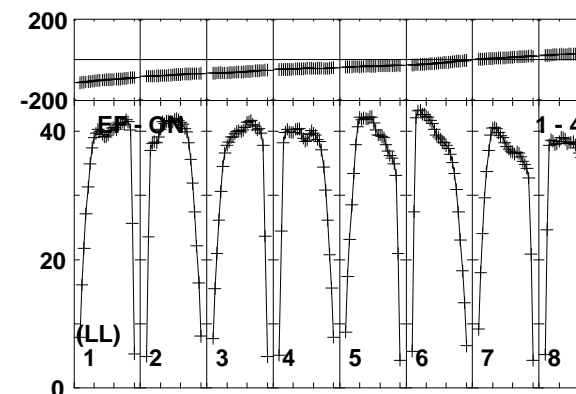
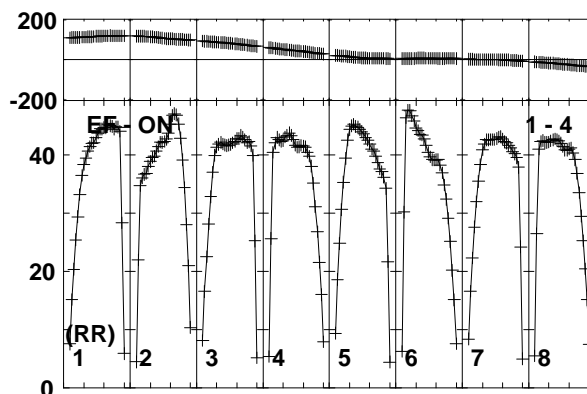
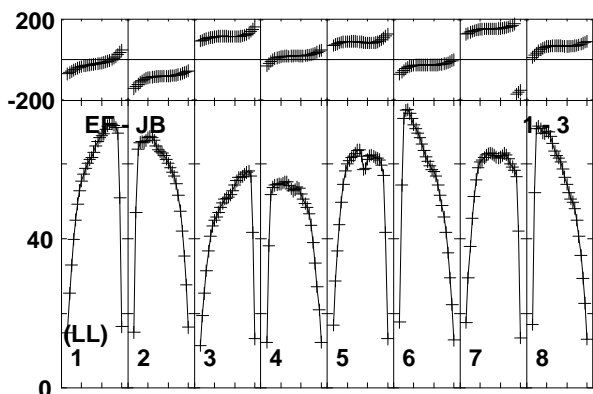
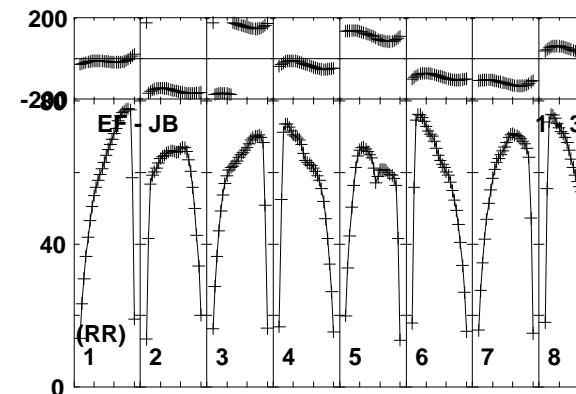
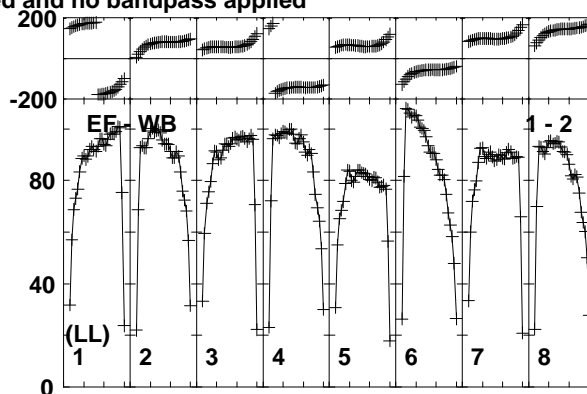
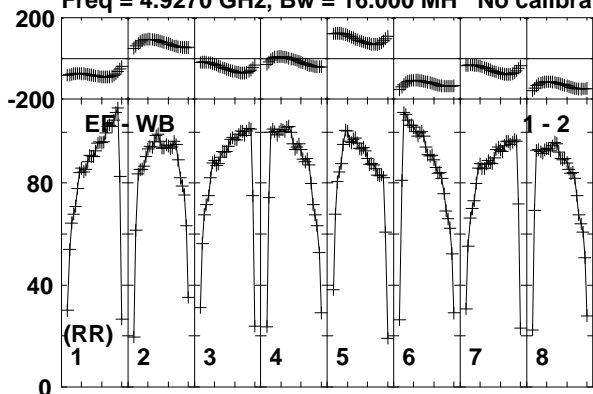

Lower frame: Milli Ampl Jy Top frame: Phas deg
Vector averaged cross-power spectrum Baseline: EF (01) - WB (02)
Timerange: 00:12:12:03 to 00:12:12:59

Plot file version 7 created 28-JAN-2015 14:38:04

3C345 N14C3.UVDATA.1

Freq = 4.9270 GHz, Bw = 16.000 MH No calibration applied and no bandpass applied

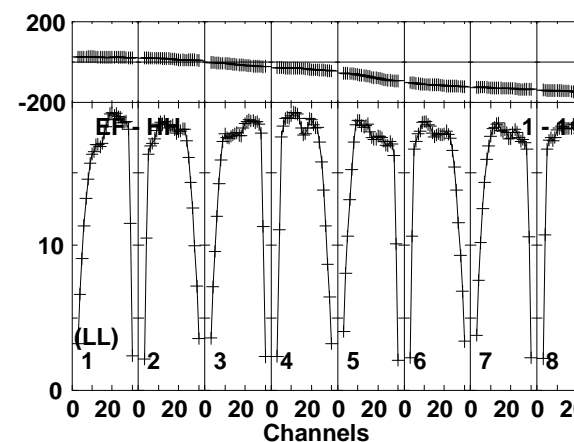
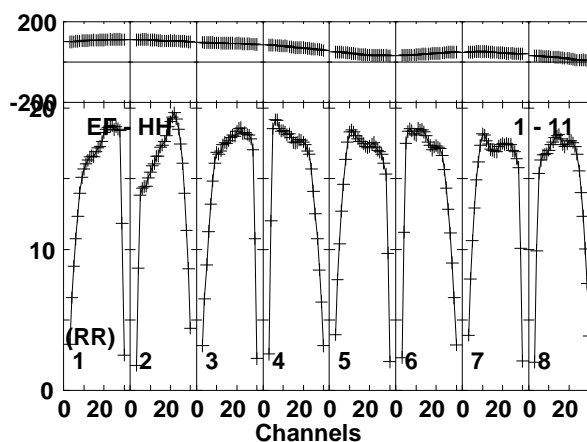
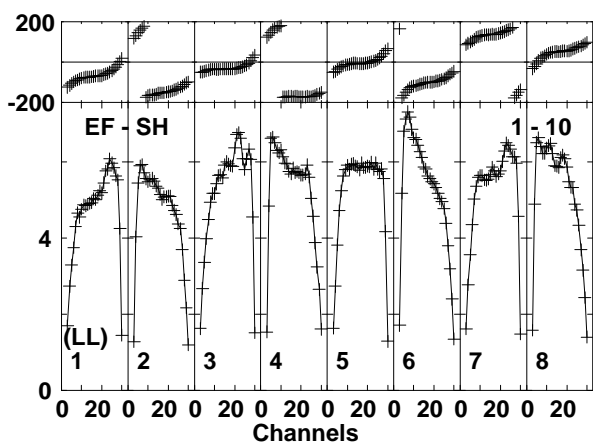
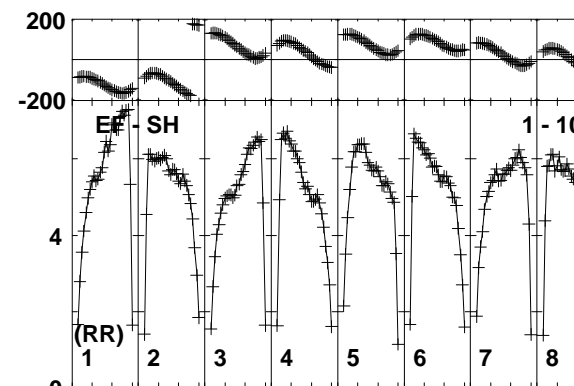
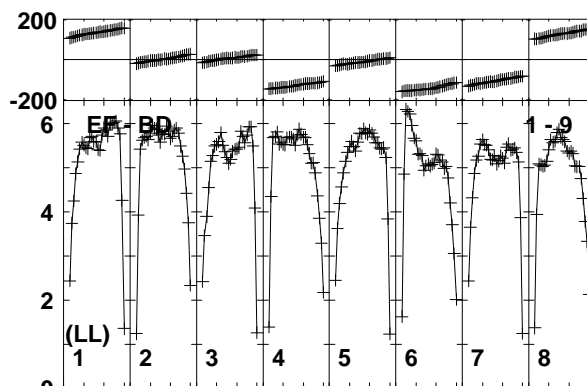
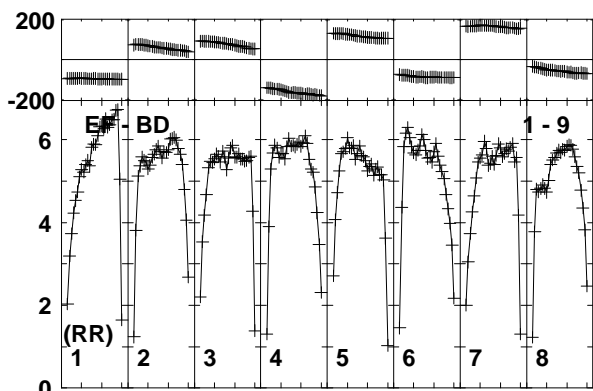
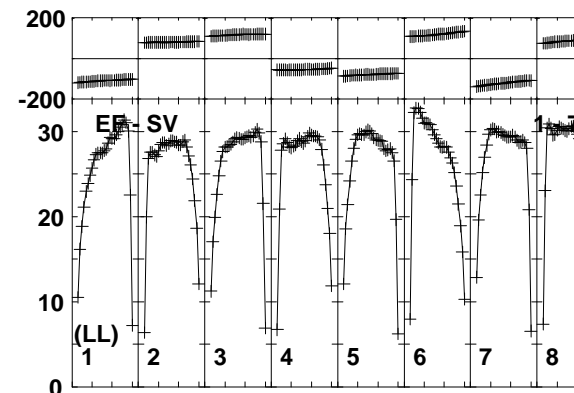
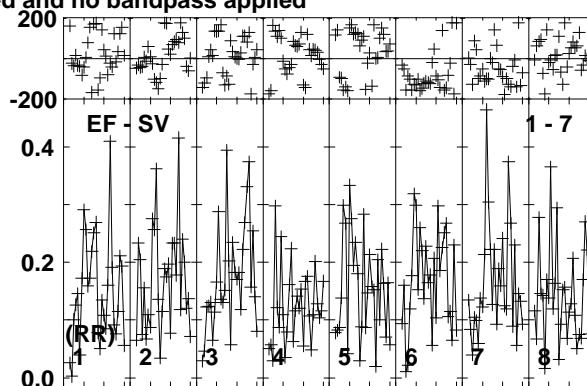
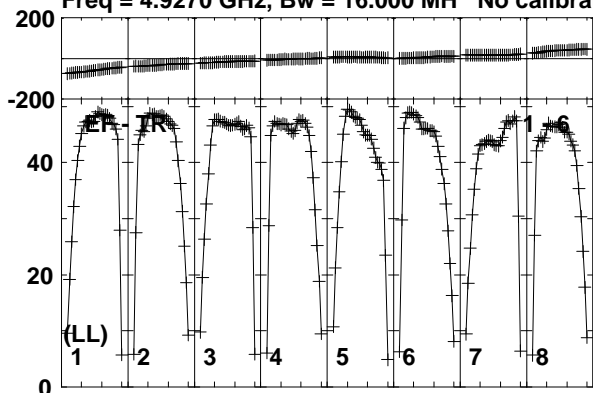

Lower frame: Milli Ampl Jy Top frame: Phas deg
Vector averaged cross-power spectrum Baseline: EF (01) - TR (06)
Timerange: 00:12:12:03 to 00:12:12:59

Plot file version 8 created 28-JAN-2015 14:38:04

3C345 N14C3.UVDATA.1

Freq = 4.9270 GHz, Bw = 16.000 MH No calibration applied and no bandpass applied

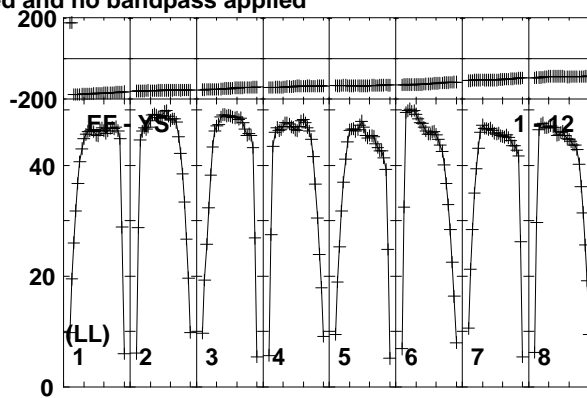
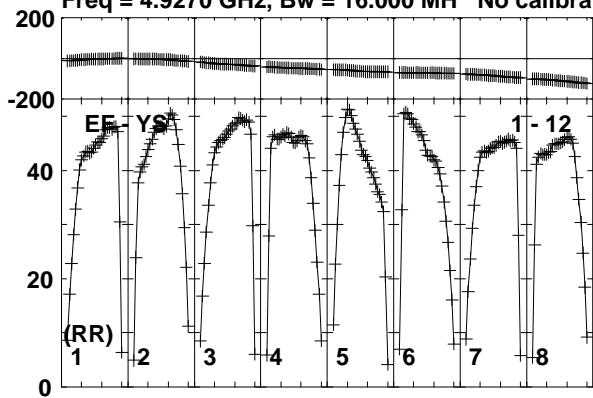

Lower frame: Milli Ampl Jy Top frame: Phas deg
Vector averaged cross-power spectrum Baseline: EF (01) - YS (12)
Timerange: 00/12:12:03 to 00/12:12:59

Plot file version 9 created 28-JAN-2015 14:38:04

3C345 N14C3.UVDATA.1

Freq = 4.9270 GHz, Bw = 16.000 MH No calibration applied and no bandpass applied

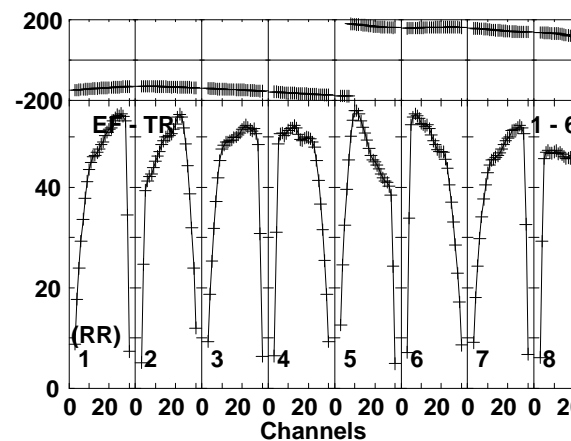
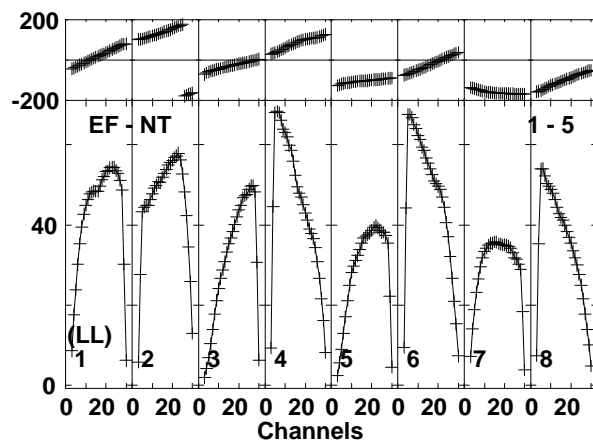
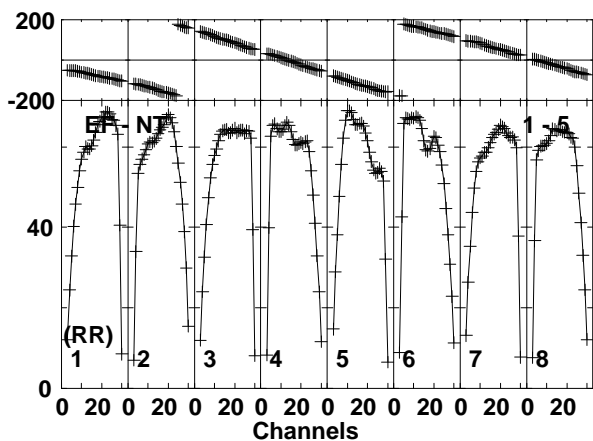
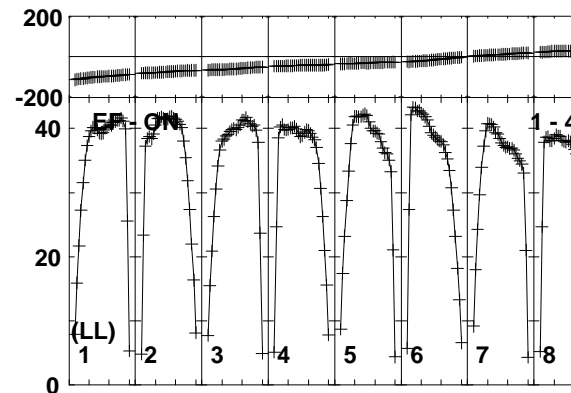
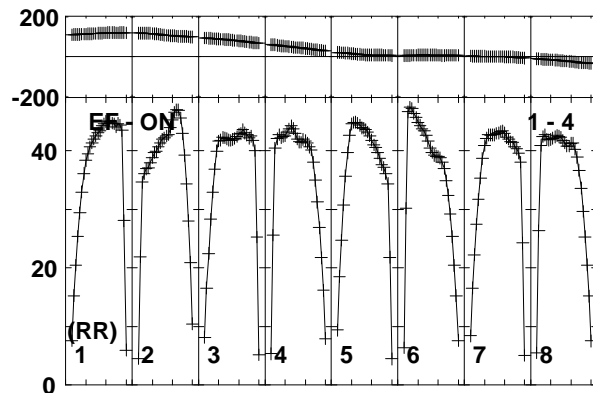
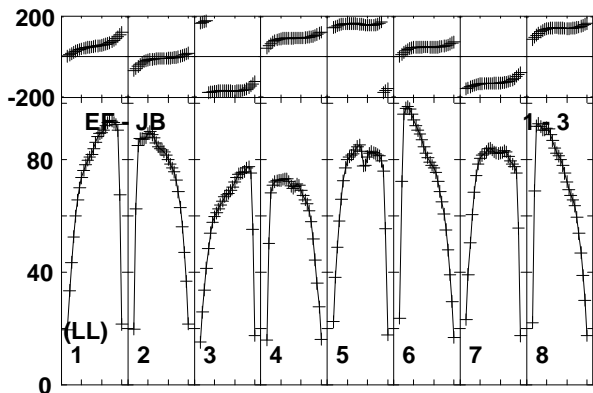
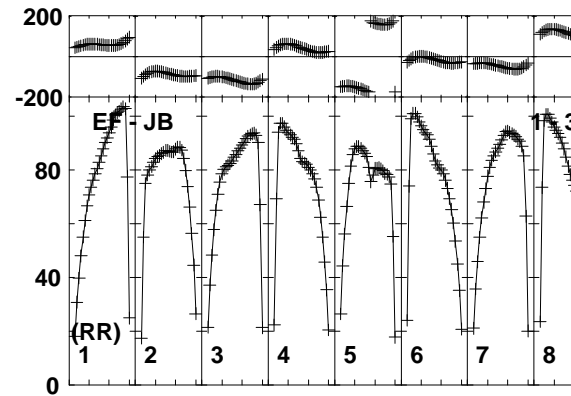
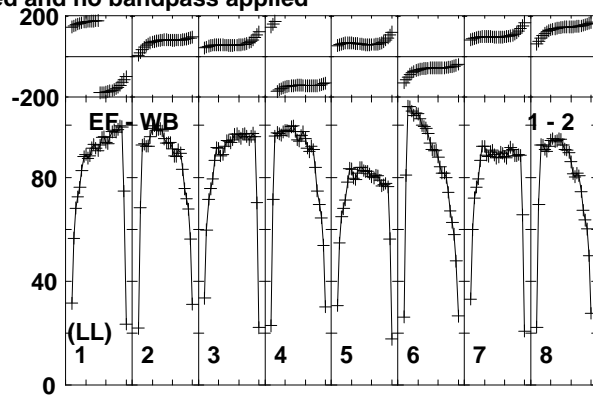
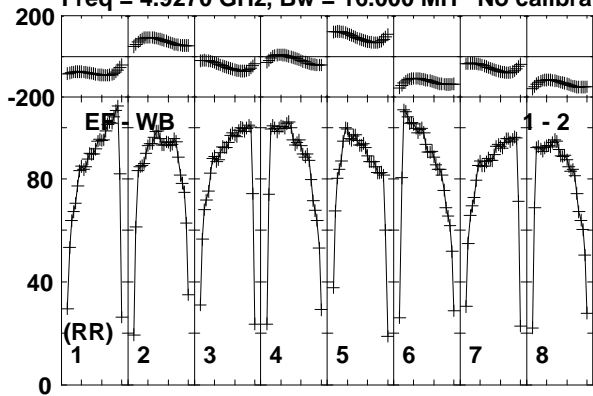

Lower frame: Milli Ampl Jy Top frame: Phas deg
Vector averaged cross-power spectrum Baseline: EF (01) - WB (02)
Timerange: 00:12:13:43 to 00:12:14:39

Plot file version 10 created 28-JAN-2015 14:38:04

3C345 N14C3.UVDATA.1

Freq = 4.9270 GHz, Bw = 16.000 MH No calibration applied and no bandpass applied

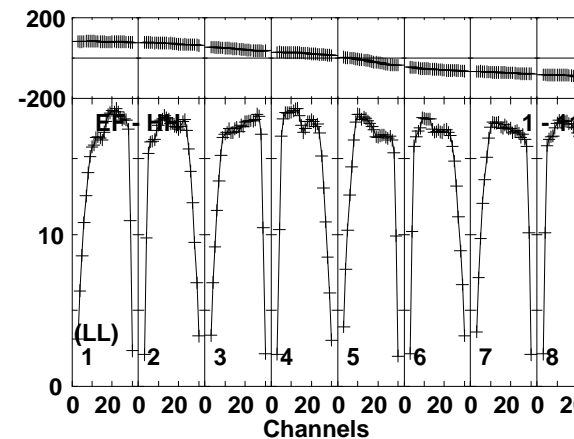
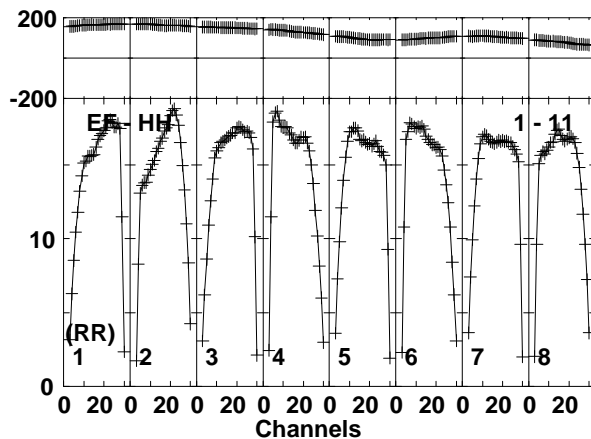
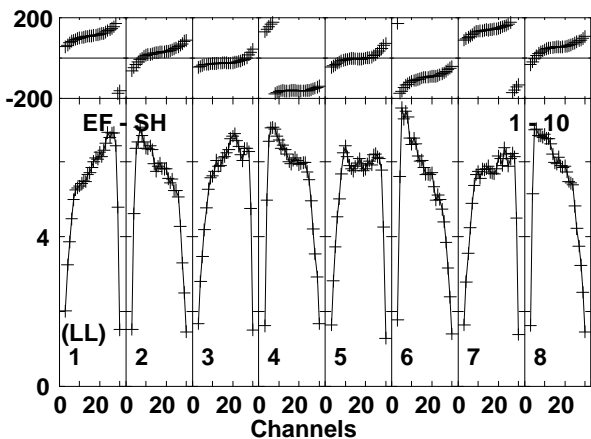
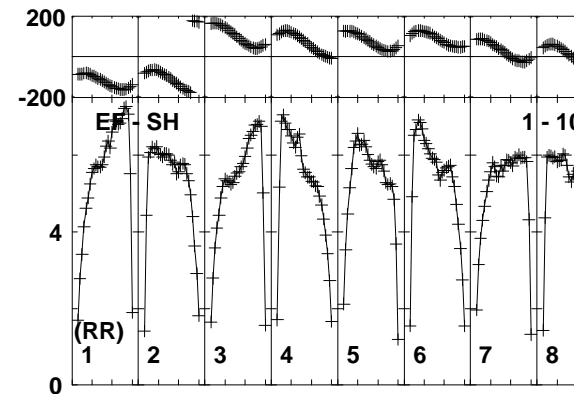
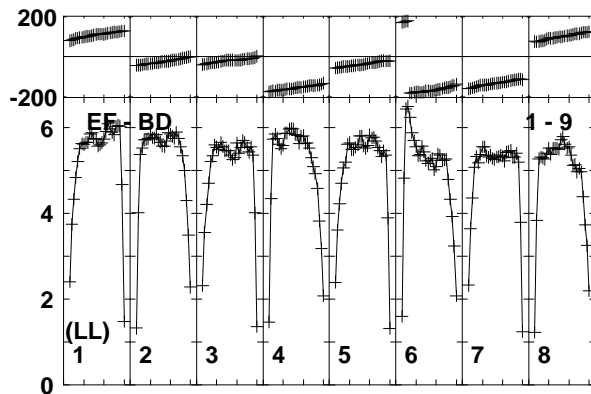
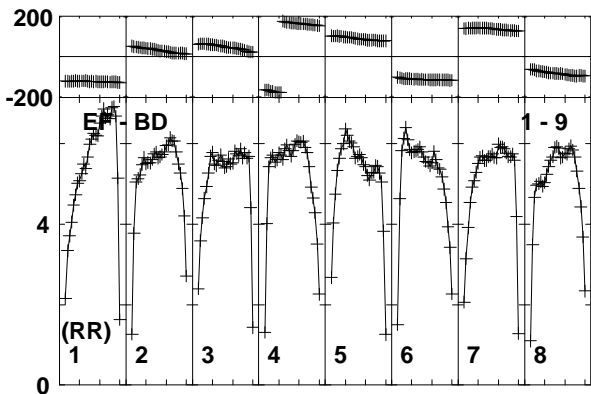
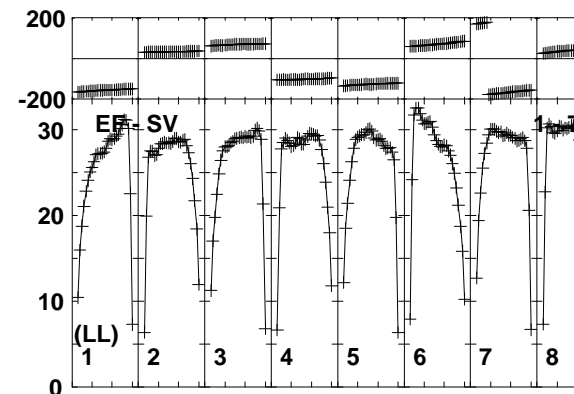
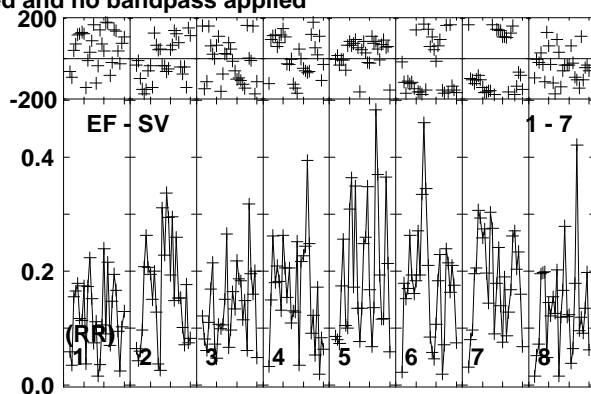
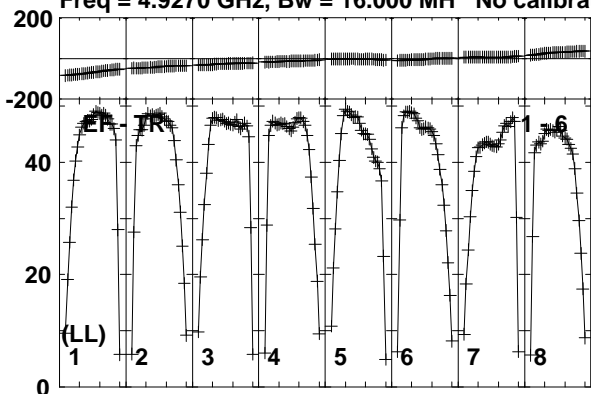

Lower frame: Milli Ampl Jy Top frame: Phas deg
Vector averaged cross-power spectrum Baseline: EF (01) - TR (06)
Timerange: 00:12:13:43 to 00:12:14:39

Plot file version 11 created 28-JAN-2015 14:38:04

3C345 N14C3.UVDATA.1

Freq = 4.9270 GHz, Bw = 16.000 MH No calibration applied and no bandpass applied

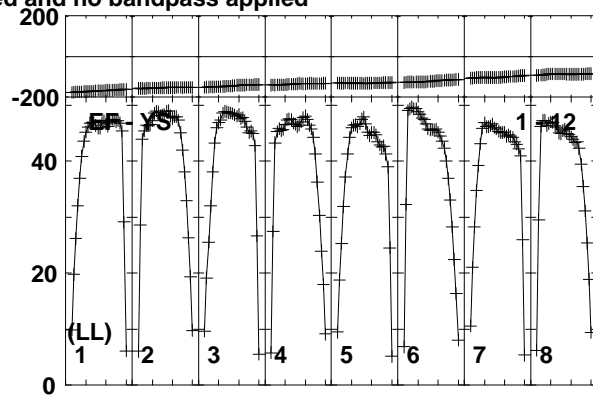
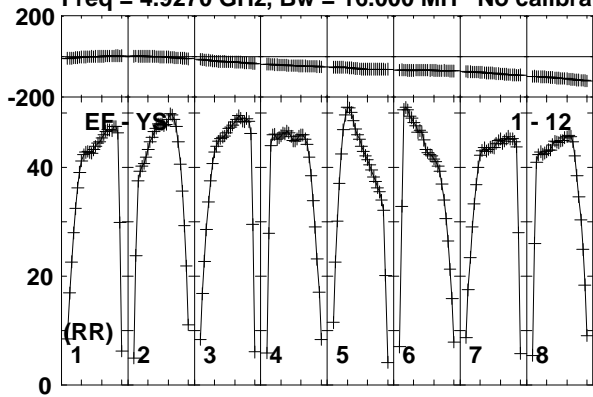

Lower frame: Milli Ampl Jy Top frame: Phas deg
Vector averaged cross-power spectrum Baseline: EF (01) - YS (12)
Timerange: 00/12:13:43 to 00/12:14:39

Plot file version 12 created 28-JAN-2015 14:38:04

J1640+3946 N14C3.UVDATA.1

Freq = 4.9270 GHz, Bw = 16.000 MH No calibration applied and no bandpass applied

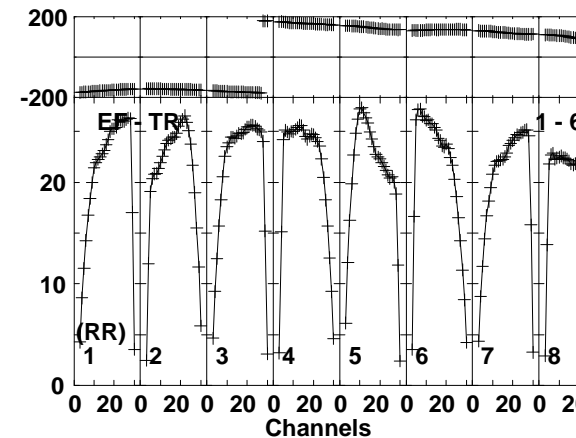
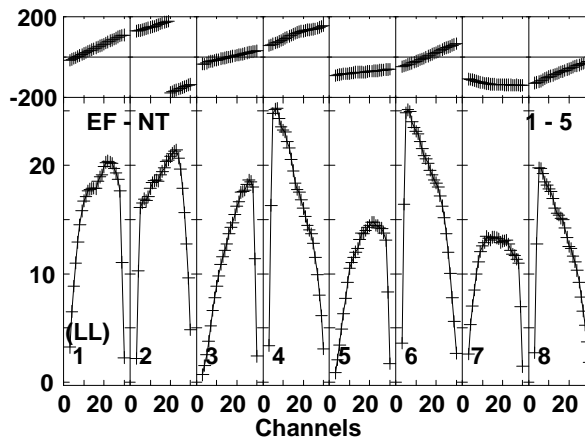
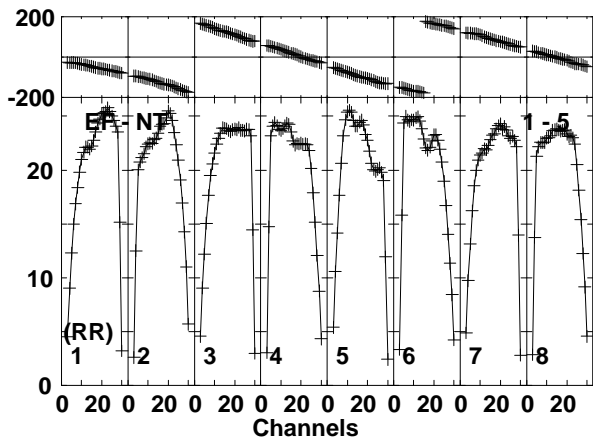
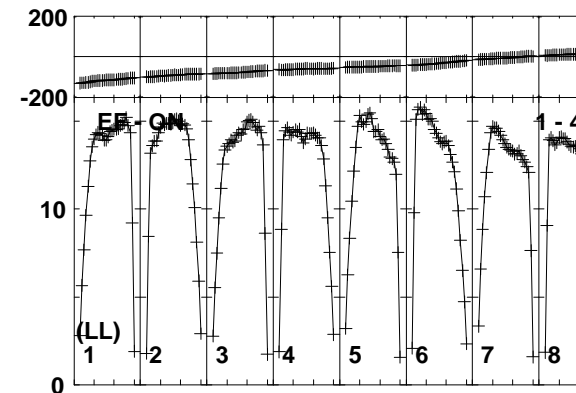
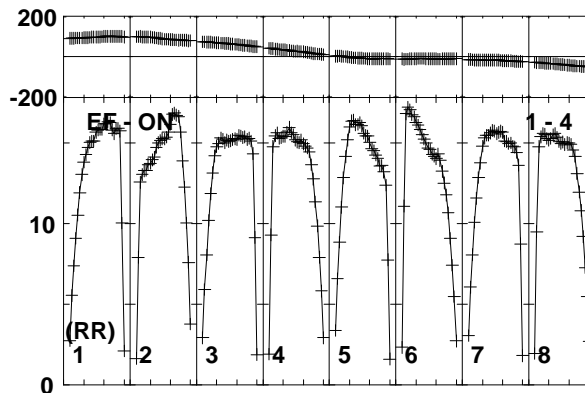
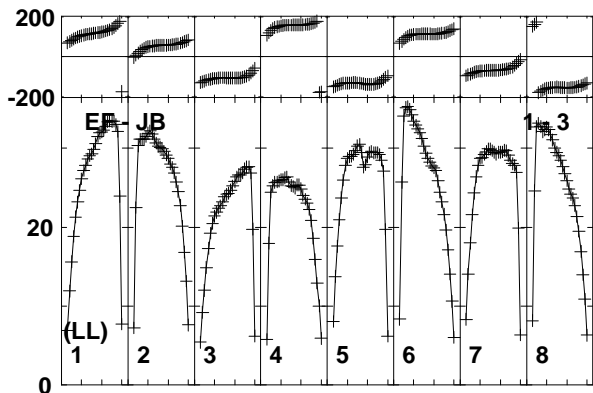
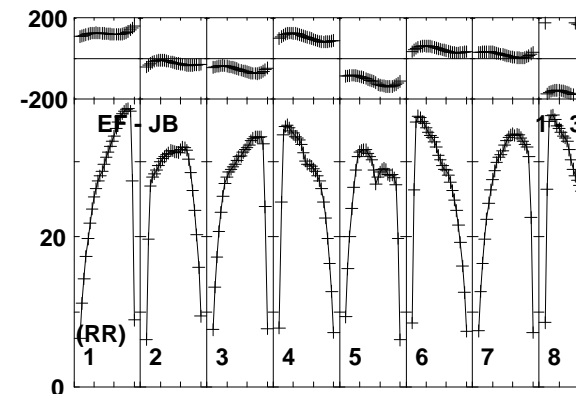
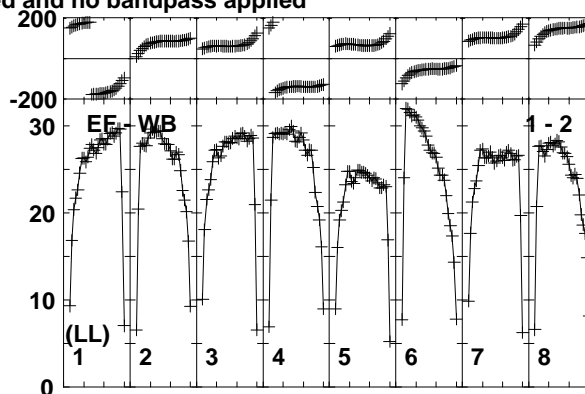
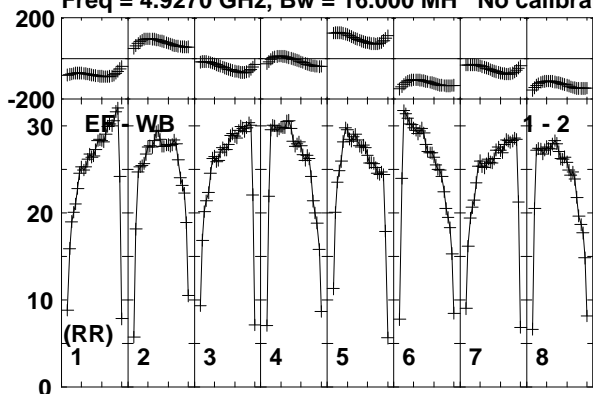

Lower frame: Milli Ampl Jy Top frame: Phas deg
Vector averaged cross-power spectrum Baseline: EF (01) - WB (02)
Timerange: 00:12:15:23 to 00:12:16:19

Plot file version 13 created 28-JAN-2015 14:38:04

J1640+3946 N14C3.UVDATA.1

Freq = 4.9270 GHz, Bw = 16.000 MH No calibration applied and no bandpass applied

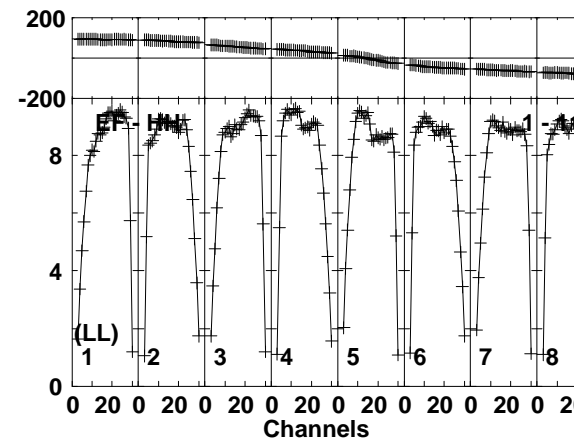
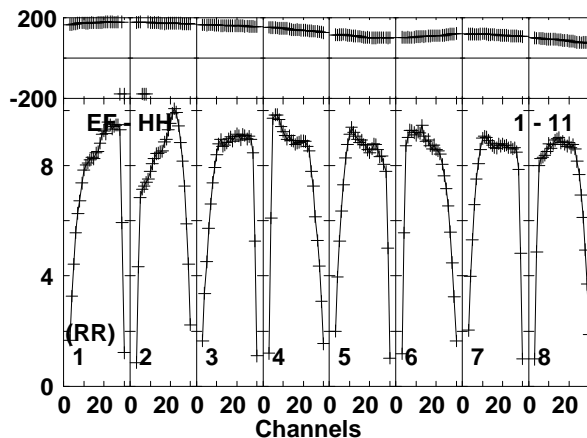
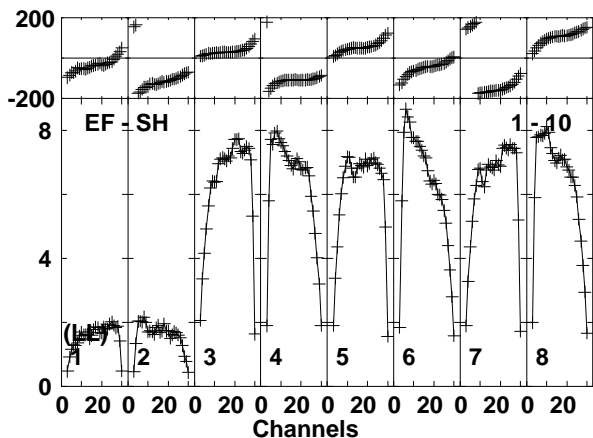
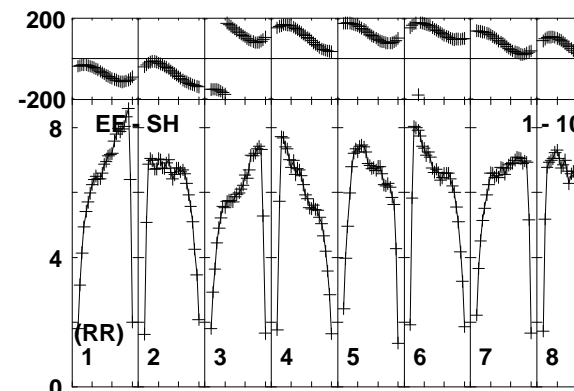
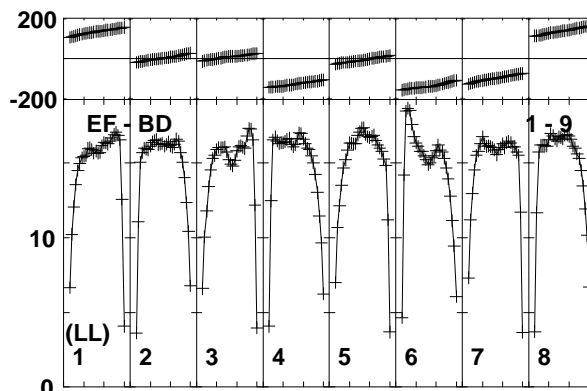
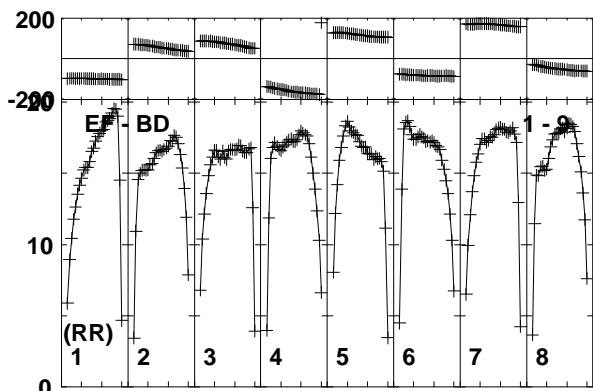
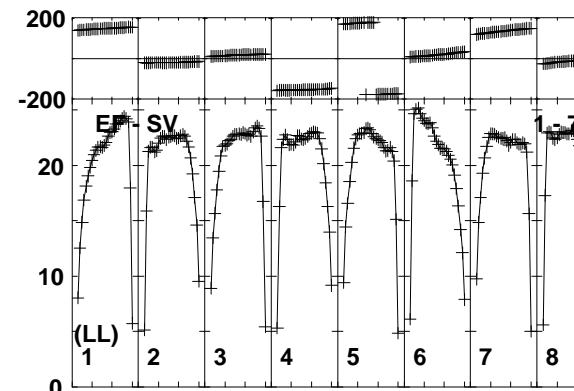
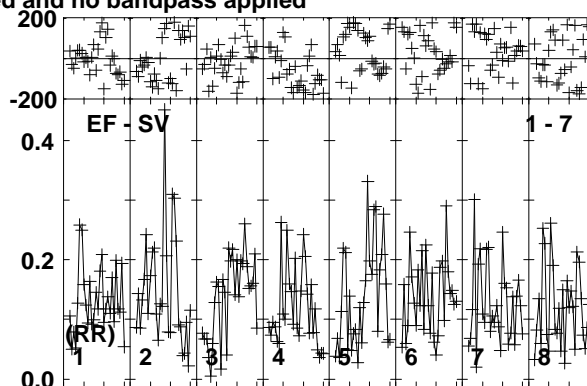
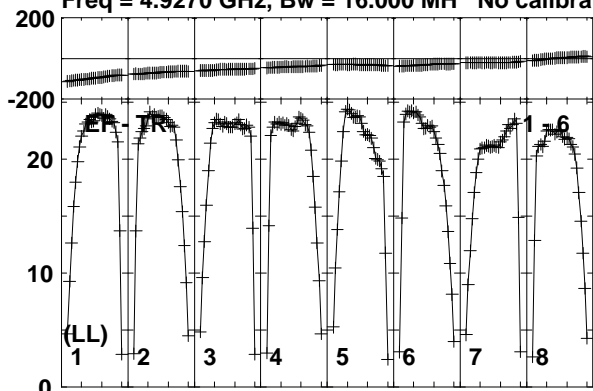

Lower frame: Milli Ampl Jy Top frame: Phas deg
Vector averaged cross-power spectrum Baseline: EF (01) - TR (06)
Timerange: 00:12:15:23 to 00:12:16:19

Plot file version 14 created 28-JAN-2015 14:38:04

J1640+3946 N14C3.UVDATA.1

Freq = 4.9270 GHz, Bw = 16.000 MH No calibration applied and no bandpass applied

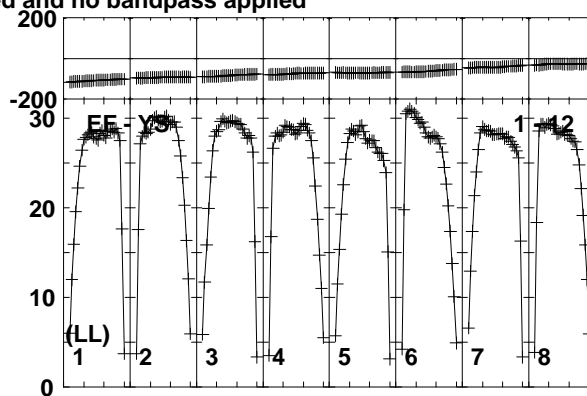
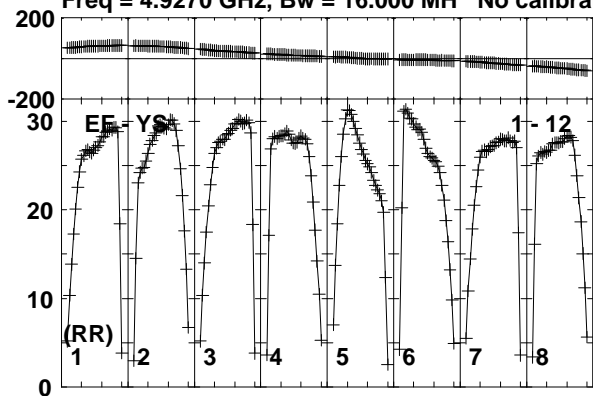

Lower frame: Milli Ampl Jy Top frame: Phas deg
Vector averaged cross-power spectrum Baseline: EF (01) - YS (12)
Timerange: 00/12:15:23 to 00/12:16:19

Plot file version 15 created 28-JAN-2015 14:38:04

3C345 N14C3.UVDATA.1

Freq = 4.9270 GHz, Bw = 16.000 MH No calibration applied and no bandpass applied

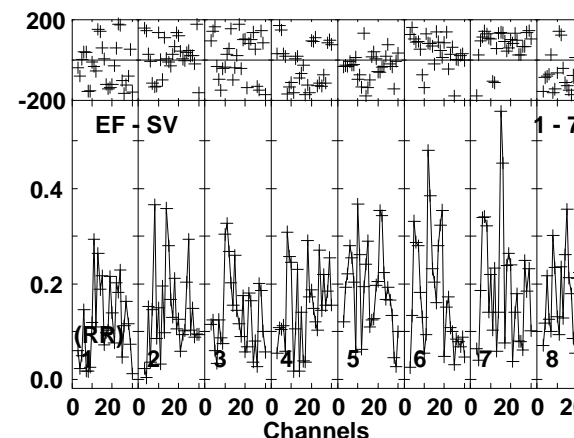
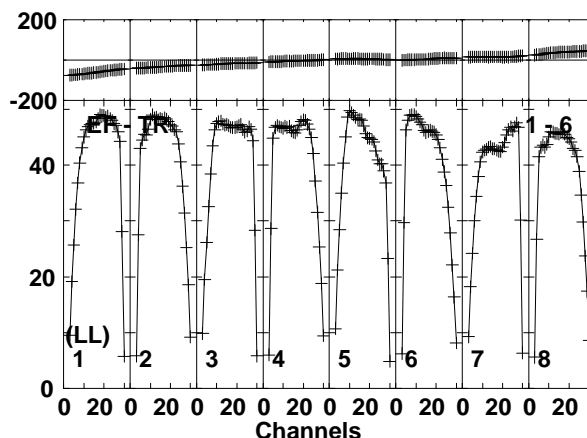
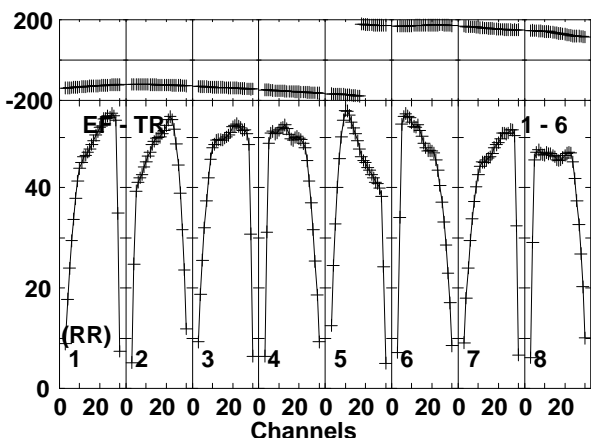
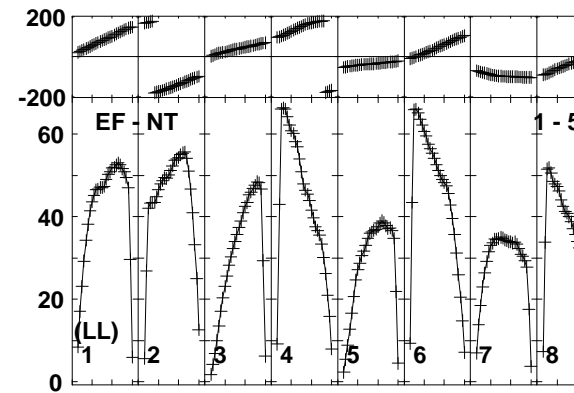
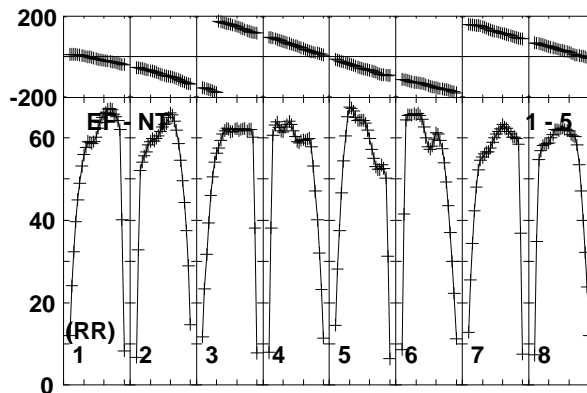
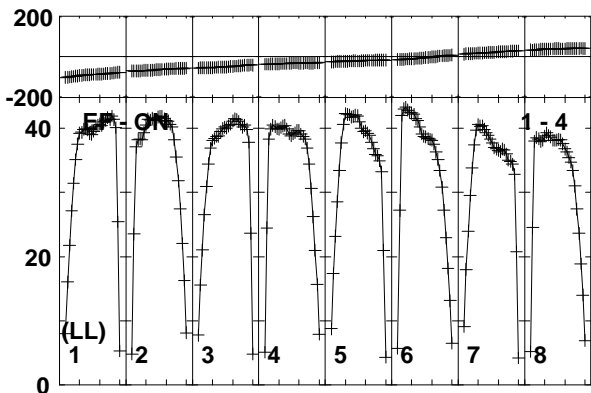
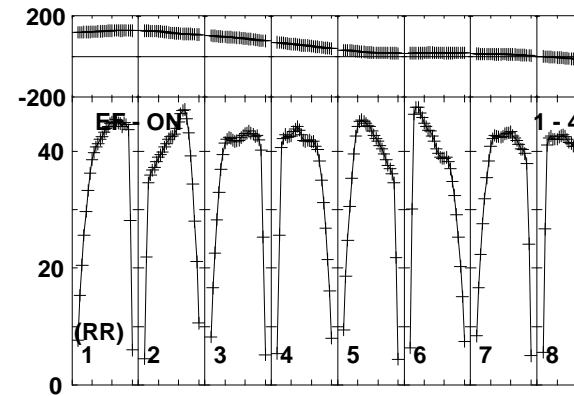
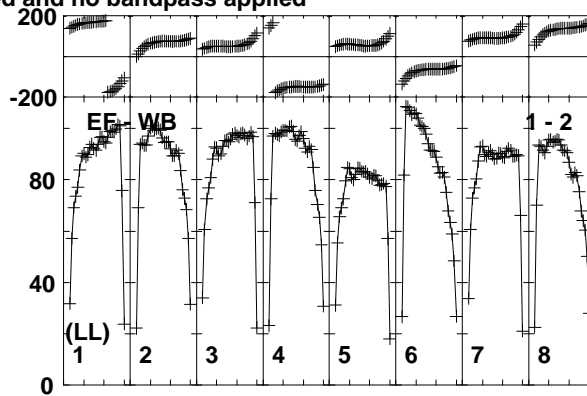
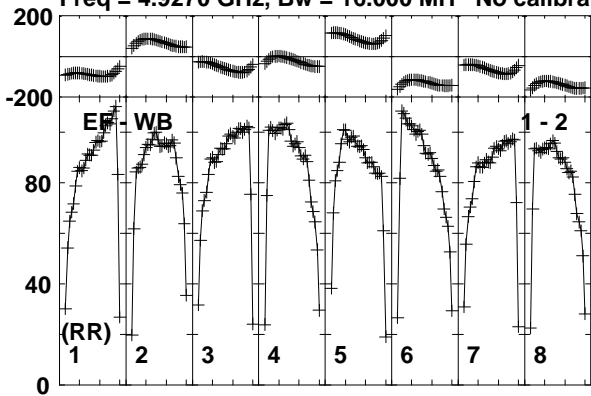

Lower frame: Milli Ampl Jy Top frame: Phas deg
Vector averaged cross-power spectrum Baseline: EF (01) - WB (02)
Timerange: 00/12:17:03 to 00/12:17:59

Plot file version 16 created 28-JAN-2015 14:38:04

3C345 N14C3.UVDATA.1

Freq = 4.9270 GHz, Bw = 16.000 MH No calibration applied and no bandpass applied

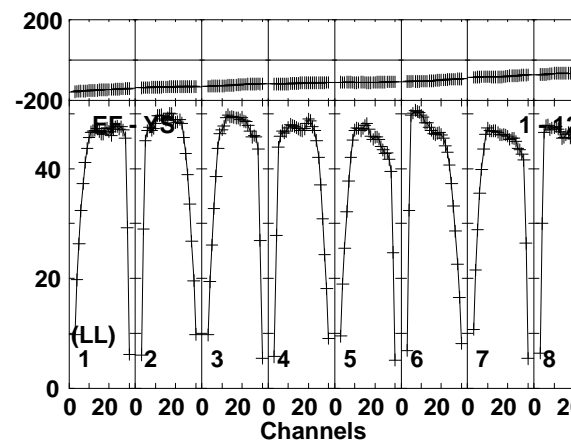
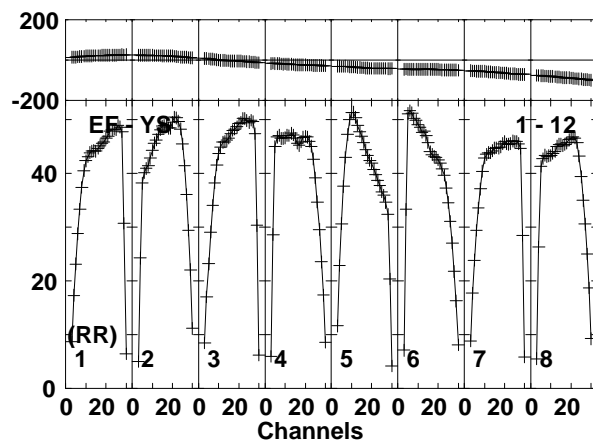
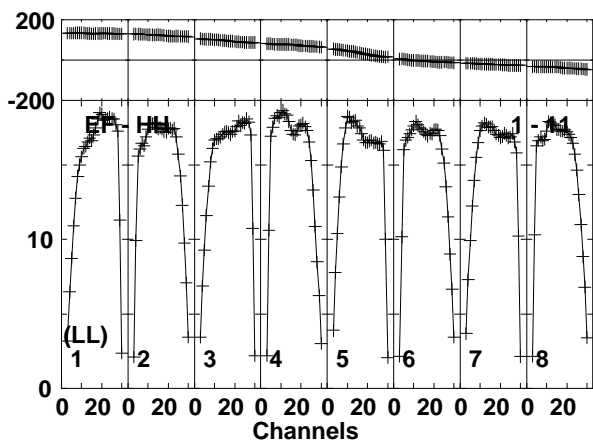
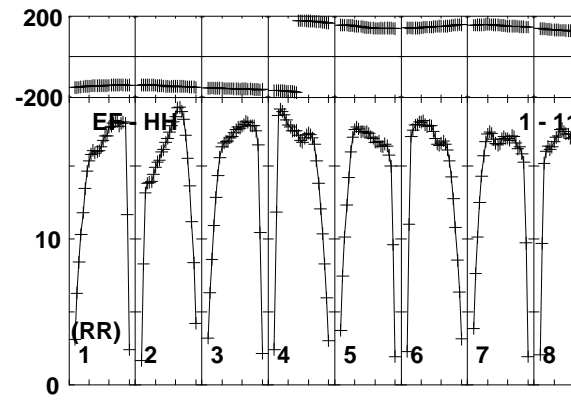
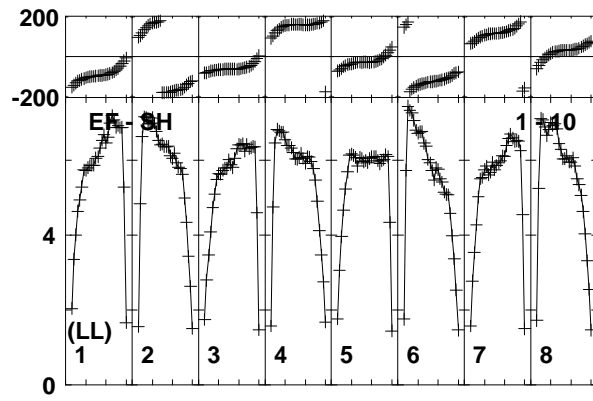
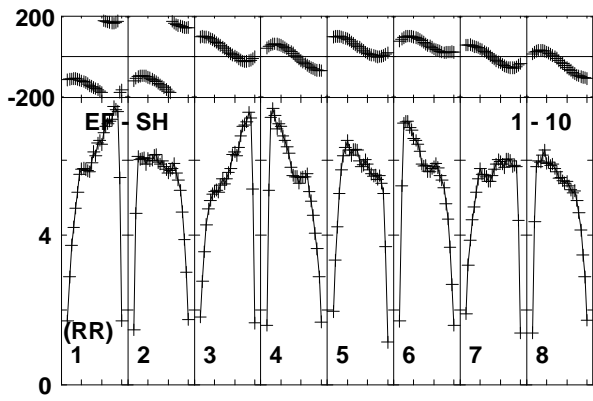
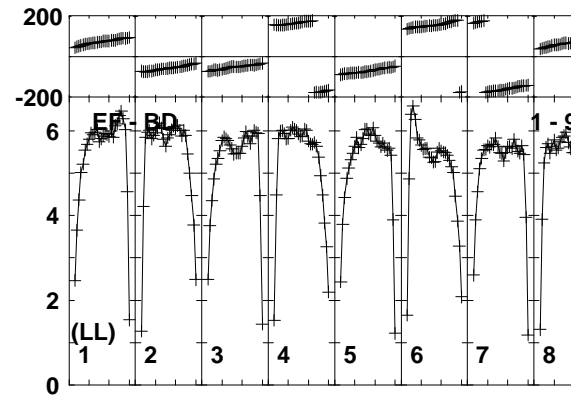
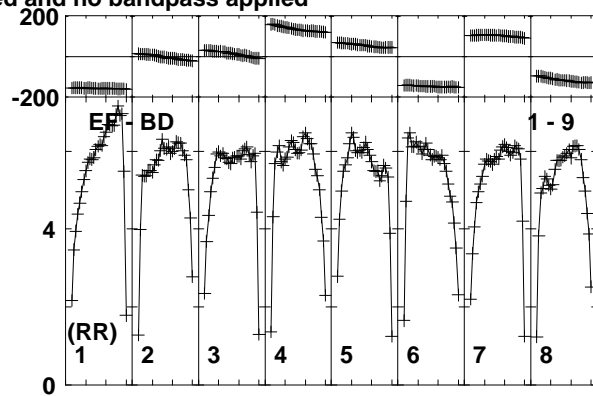
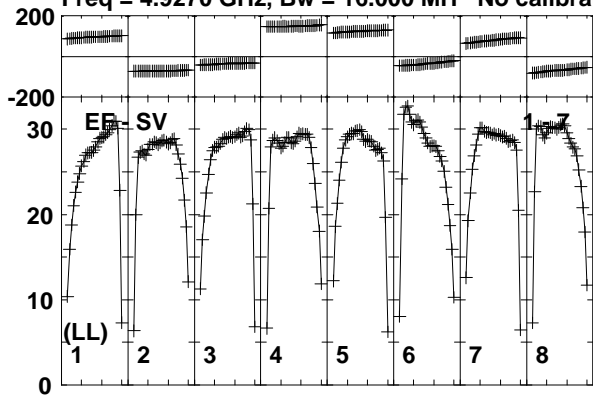

Lower frame: Milli Ampl Jy Top frame: Phas deg
Vector averaged cross-power spectrum Baseline: EF (01) - SV (07)
Timerange: 00:12:17:03 to 00:12:17:59

Plot file version 17 created 28-JAN-2015 14:38:04

J1640+3946 N14C3.UVDATA.1

Freq = 4.9270 GHz, Bw = 16.000 MH No calibration applied and no bandpass applied

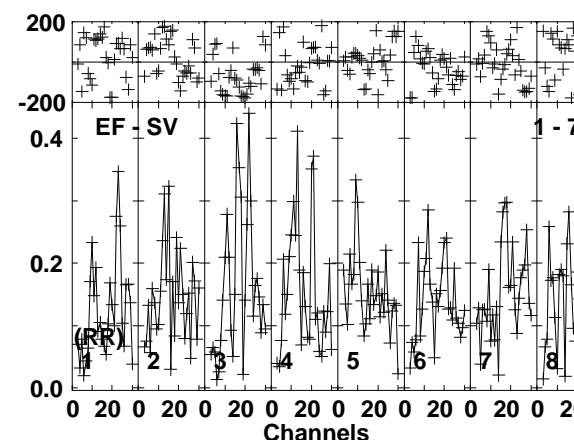
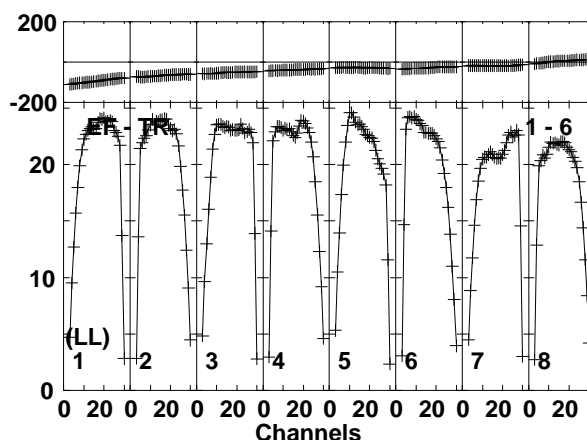
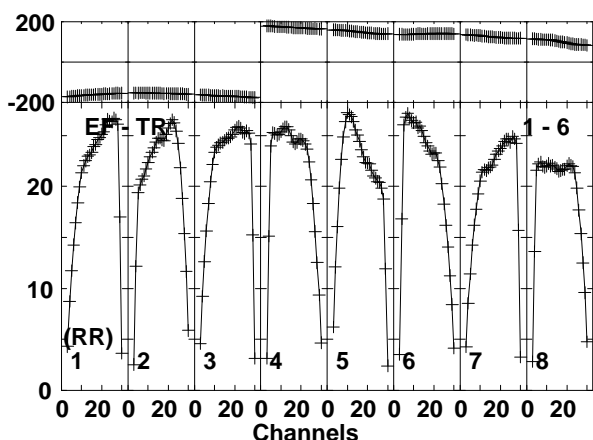
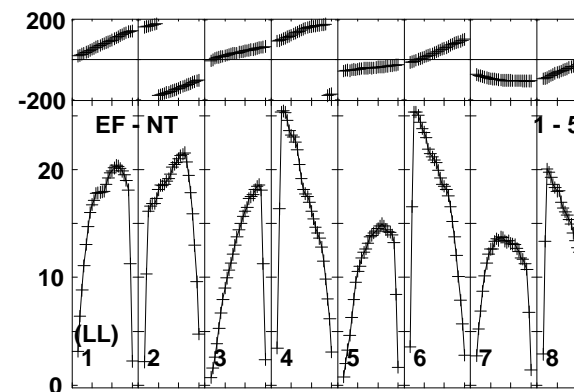
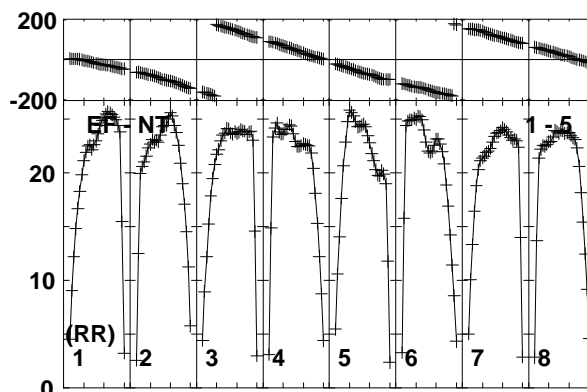
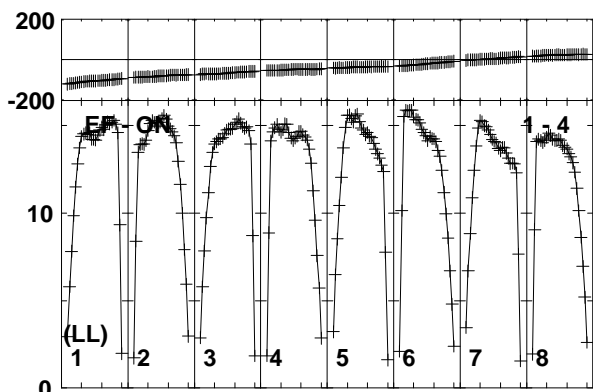
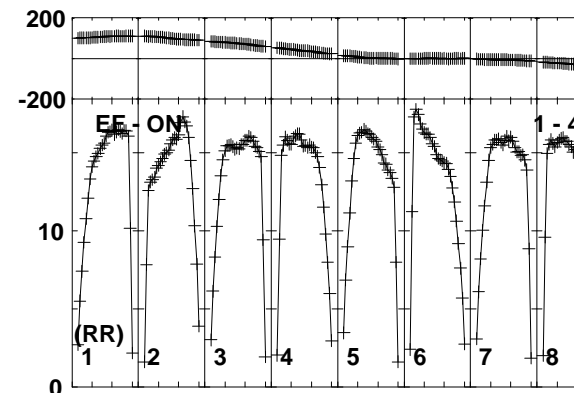
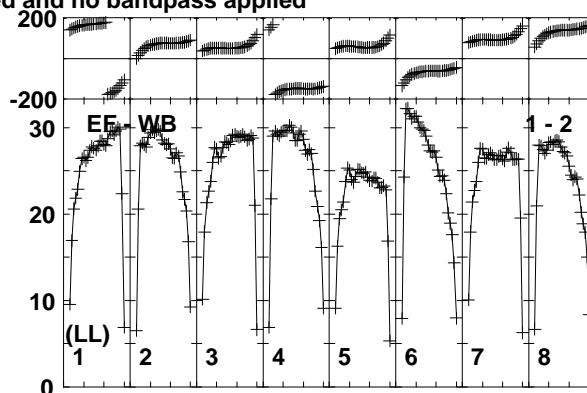
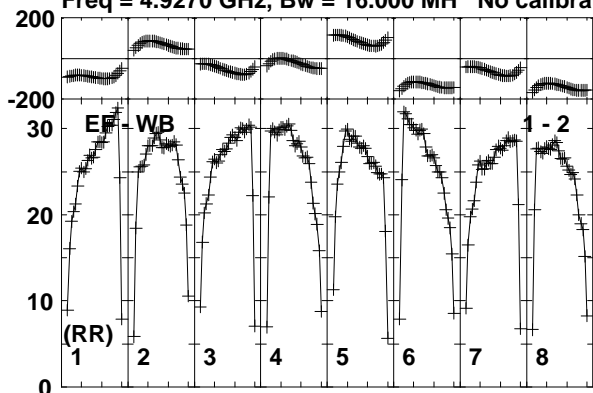

Lower frame: Milli Ampl Jy Top frame: Phas deg
Vector averaged cross-power spectrum Baseline: EF (01) - WB (02)
Timerange: 00:12:18:43 to 00:12:19:39

Plot file version 18 created 28-JAN-2015 14:38:04

J1640+3946 N14C3.UVDATA.1

Freq = 4.9270 GHz, Bw = 16.000 MH No calibration applied and no bandpass applied

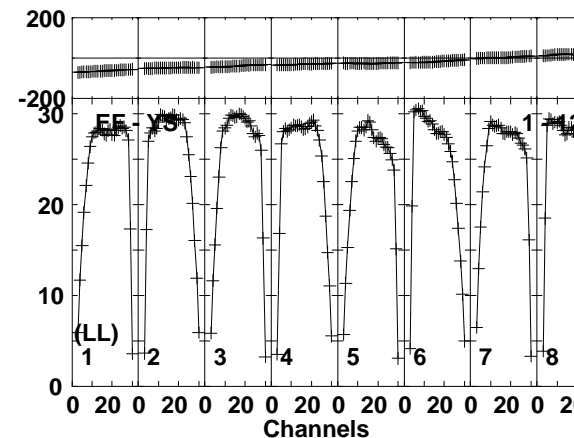
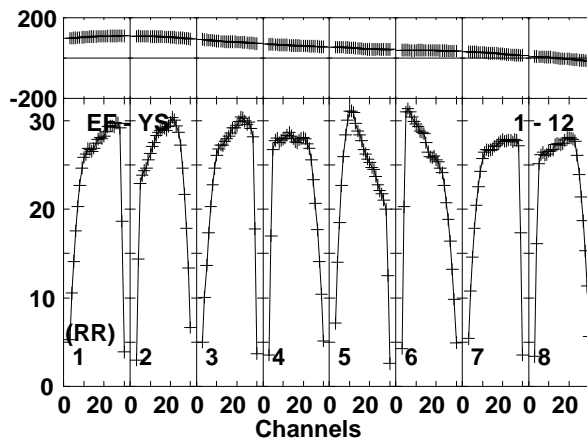
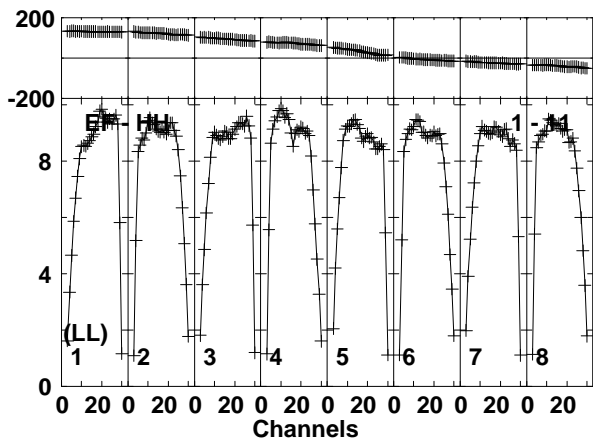
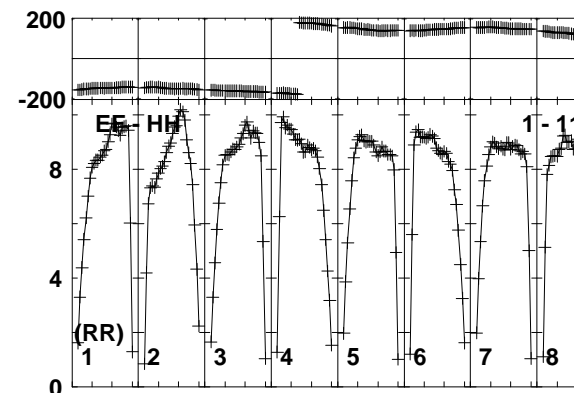
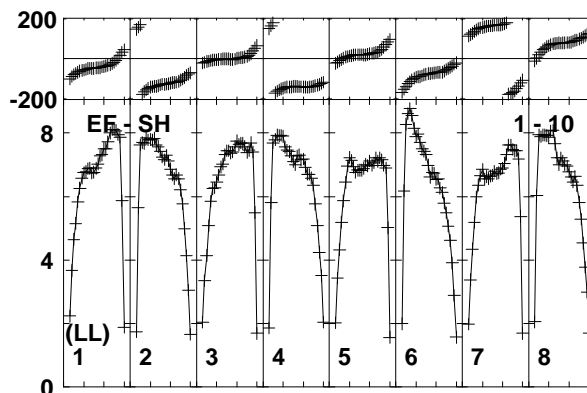
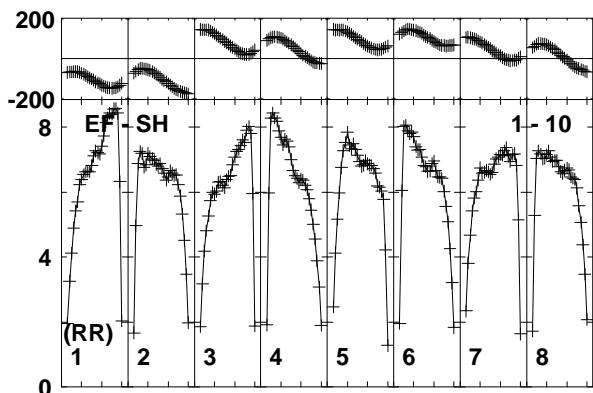
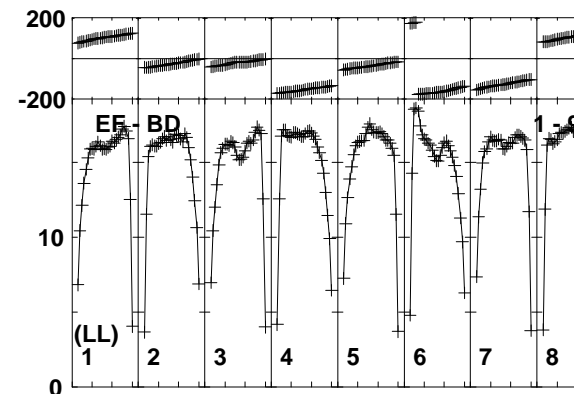
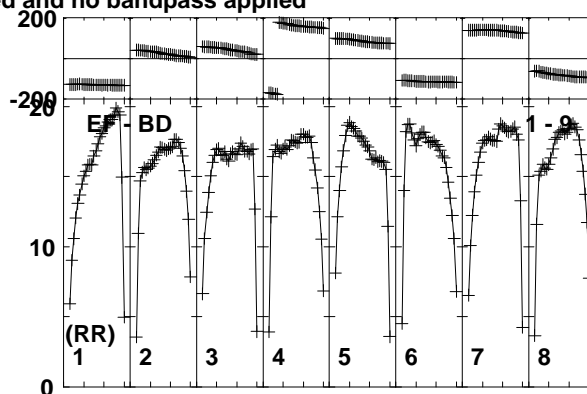
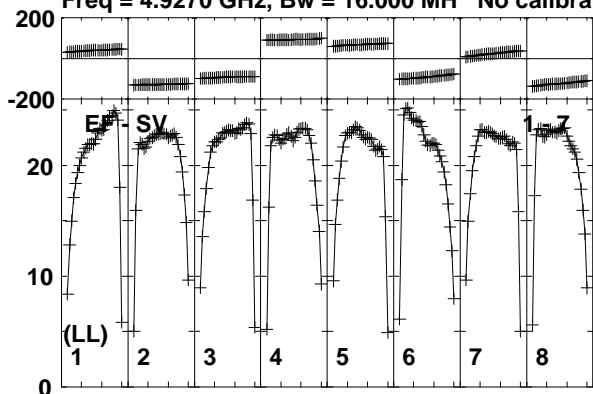

Lower frame: Milli Ampl Jy Top frame: Phas deg
Vector averaged cross-power spectrum Baseline: EF (01) - SV (07)
Timerange: 00:12:18:43 to 00:12:19:39

Plot file version 19 created 28-JAN-2015 14:38:04

3C345 N14C3.UVDATA.1

Freq = 4.9270 GHz, Bw = 16.000 MH No calibration applied and no bandpass applied

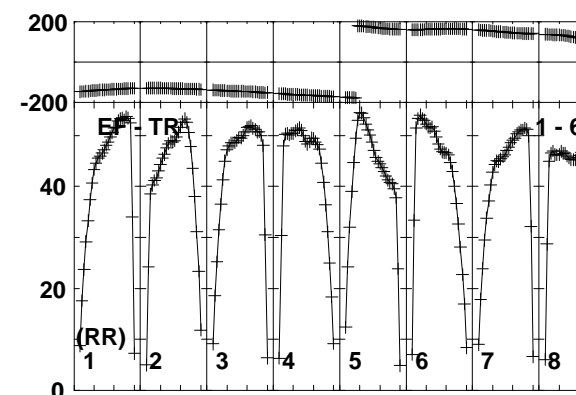
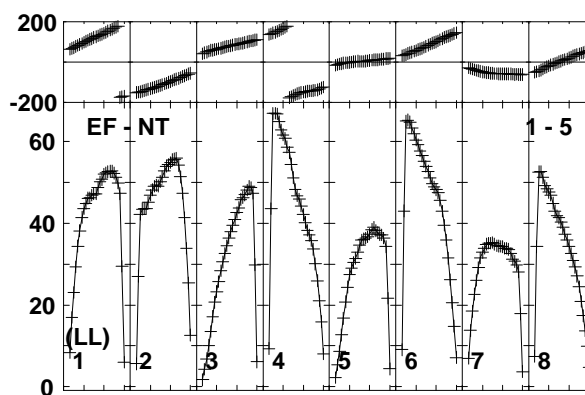
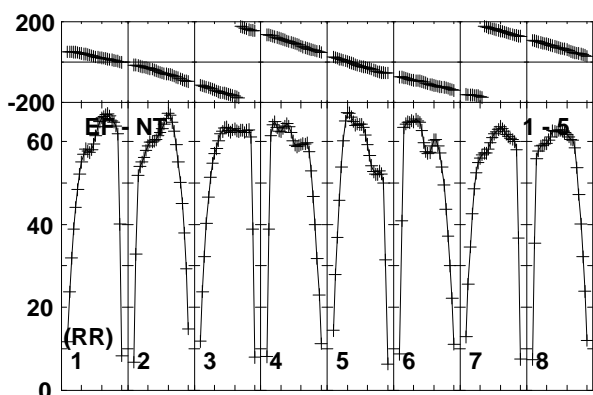
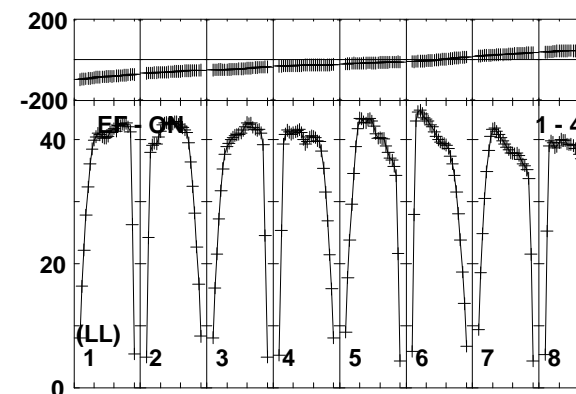
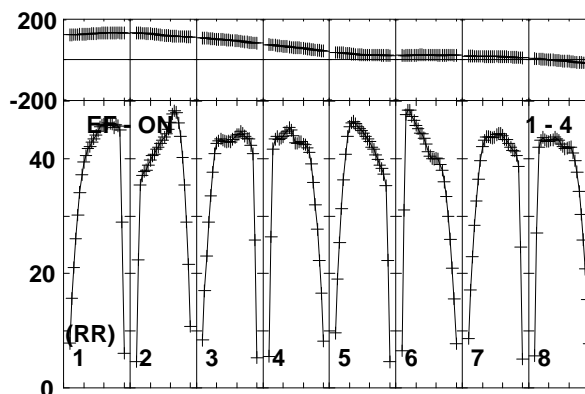
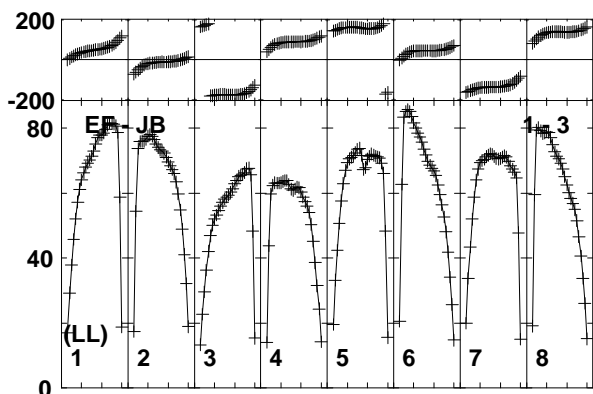
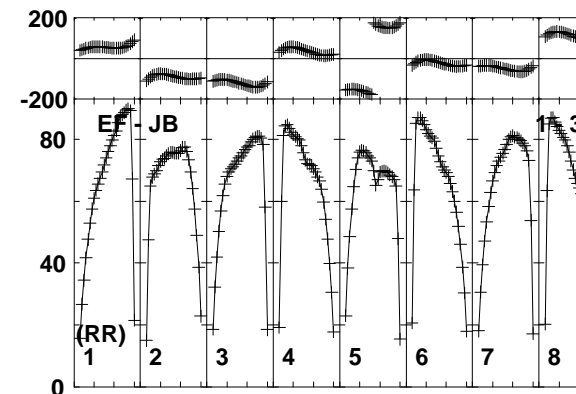
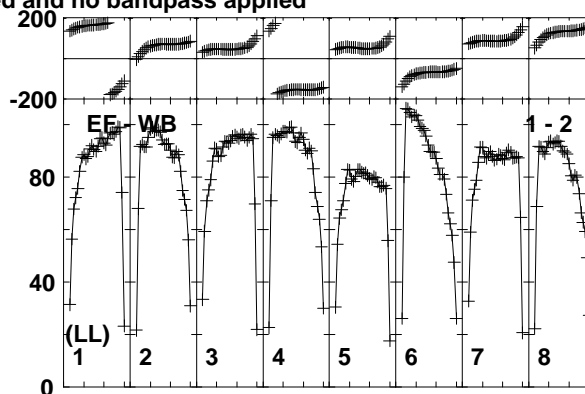
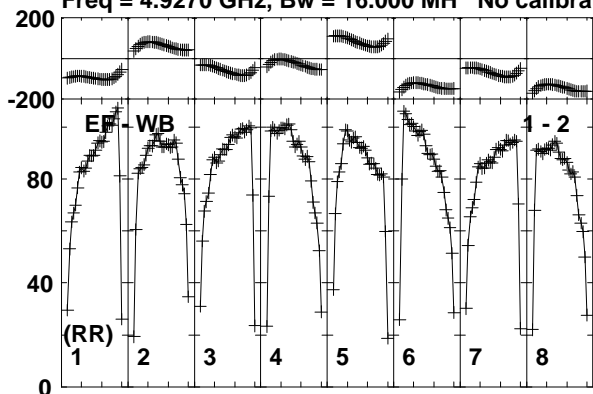

Lower frame: Milli Ampl Jy Top frame: Phas deg
Vector averaged cross-power spectrum Baseline: EF (01) - WB (02)
Timerange: 00:12:20:23 to 00:12:21:19

Plot file version 20 created 28-JAN-2015 14:38:04

3C345 N14C3.UVDATA.1

Freq = 4.9270 GHz, Bw = 16.000 MH No calibration applied and no bandpass applied

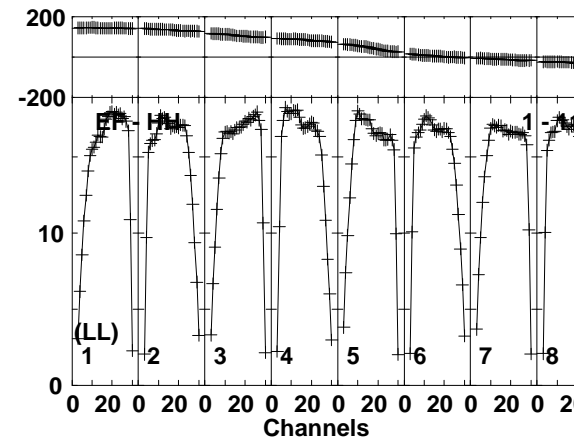
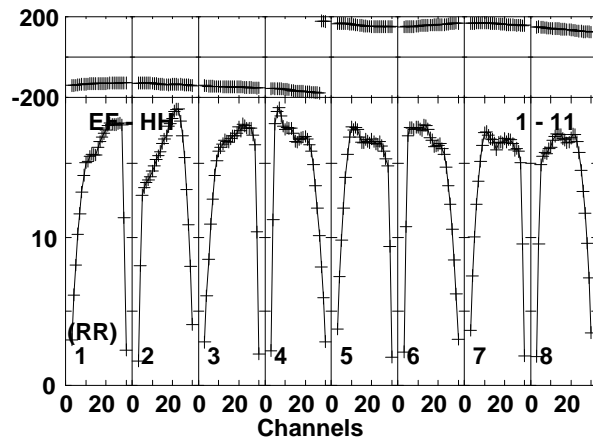
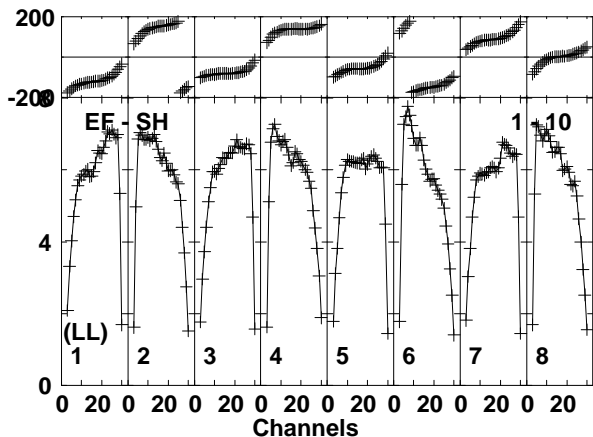
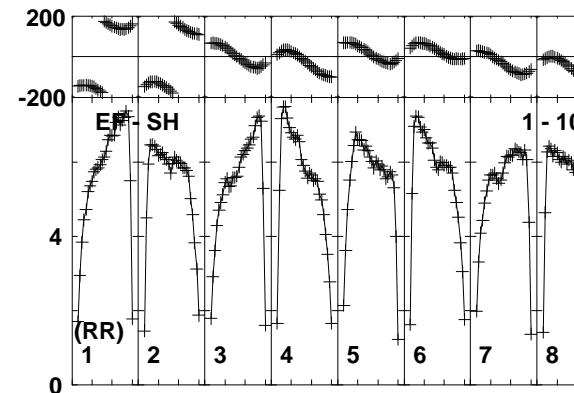
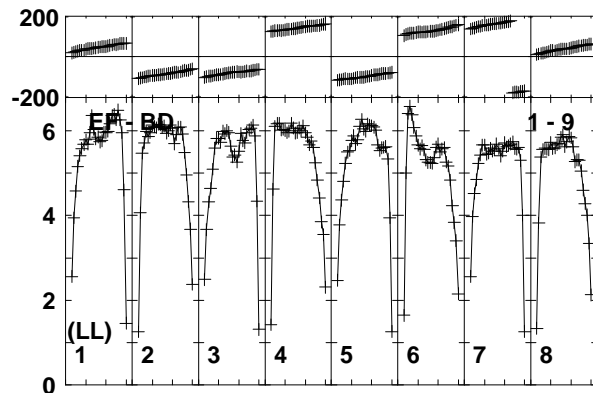
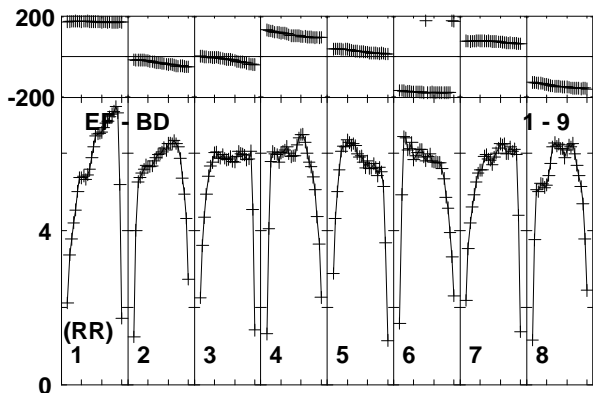
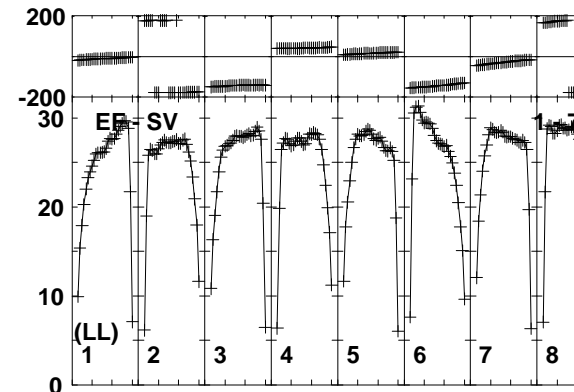
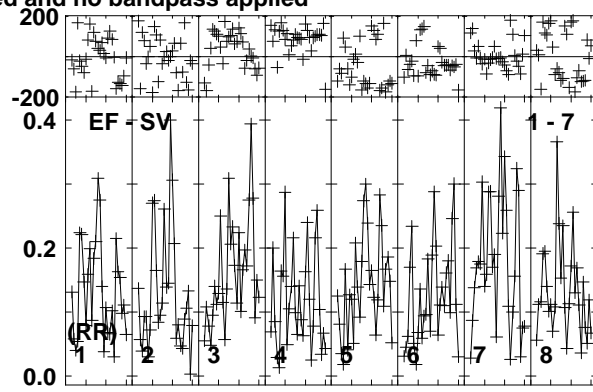
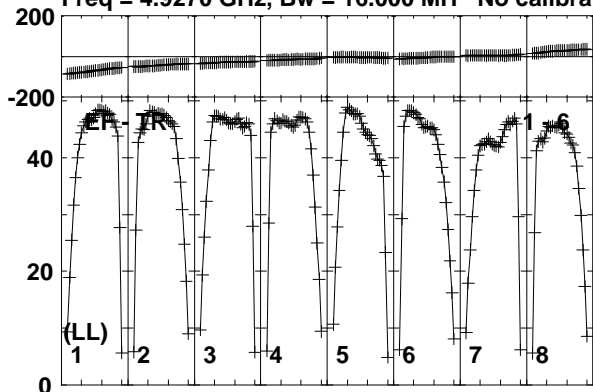

Lower frame: Milli Ampl Jy Top frame: Phas deg
Vector averaged cross-power spectrum Baseline: EF (01) - TR (06)
Timerange: 00/12:20:23 to 00/12:21:19

Plot file version 21 created 28-JAN-2015 14:38:04

3C345 N14C3.UVDATA.1

Freq = 4.9270 GHz, Bw = 16.000 MH No calibration applied and no bandpass applied

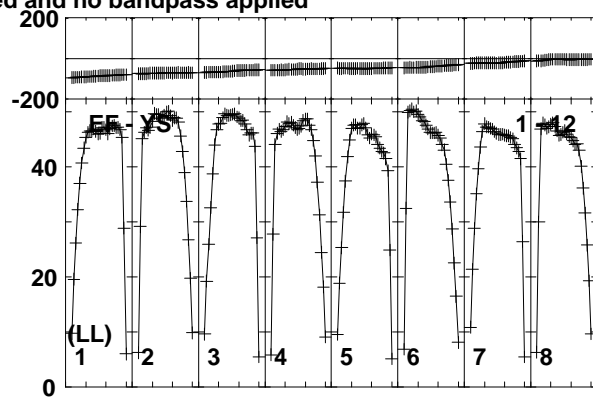
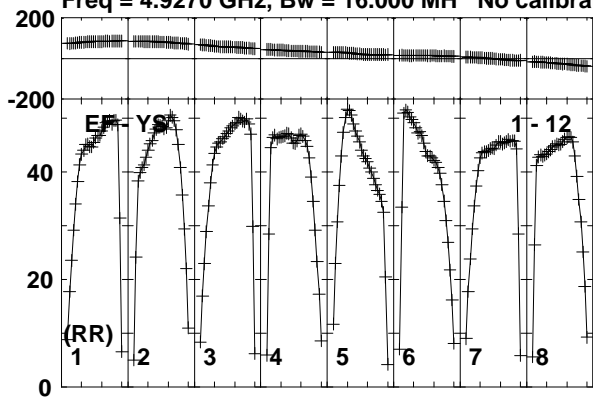

Lower frame: Milli Ampl Jy Top frame: Phas deg
Vector averaged cross-power spectrum Baseline: EF (01) - YS (12)
Timerange: 00/12:20:23 to 00/12:21:19

Plot file version 22 created 28-JAN-2015 14:38:04

J1640+3946 N14C3.UVDATA.1

Freq = 4.9270 GHz, Bw = 16.000 MH No calibration applied and no bandpass applied

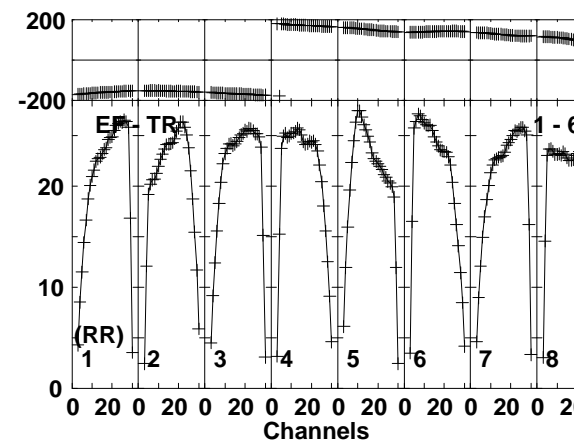
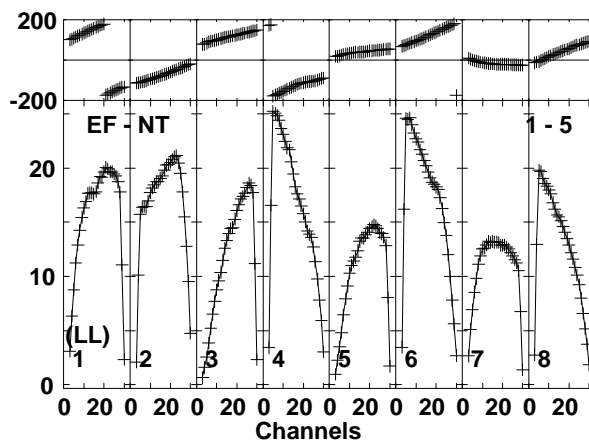
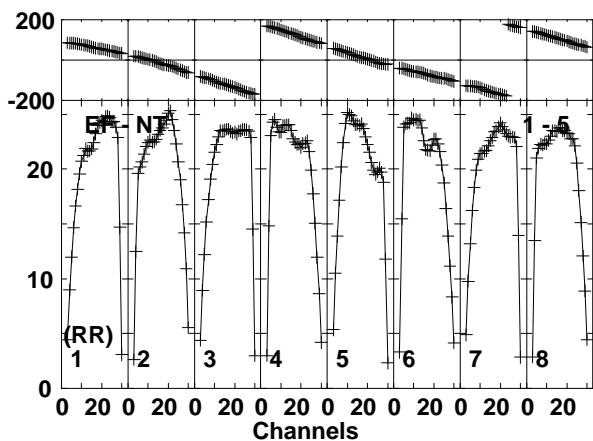
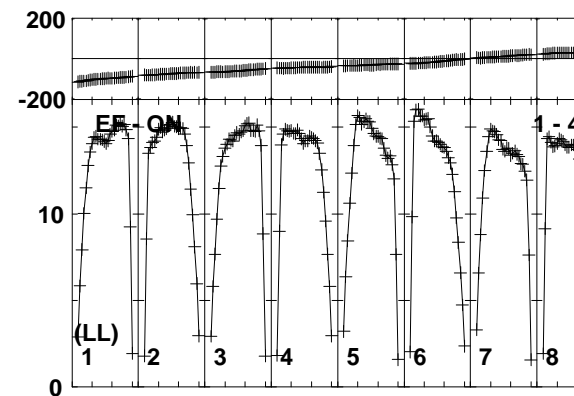
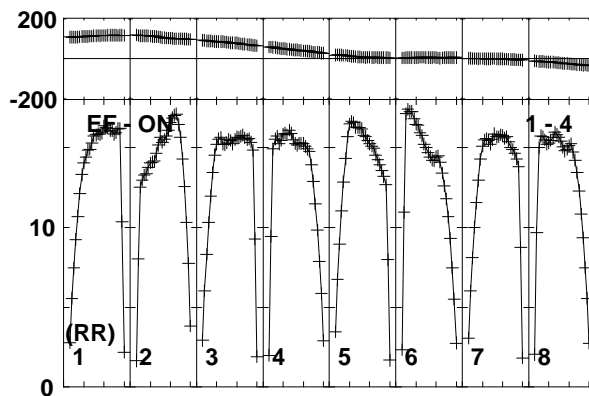
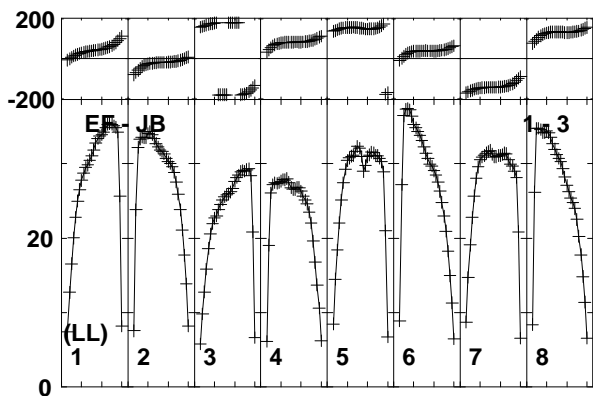
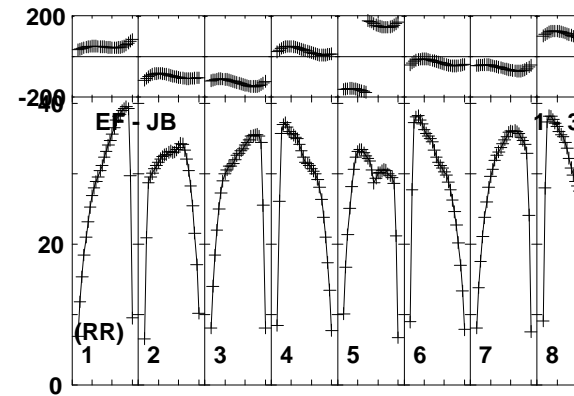
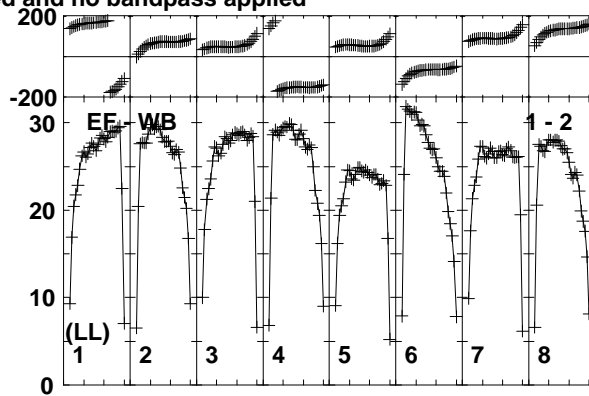
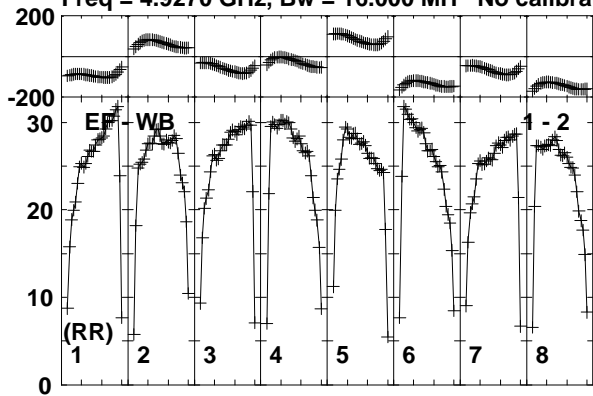

Lower frame: Milli Ampl Jy Top frame: Phas deg
Vector averaged cross-power spectrum Baseline: EF (01) - WB (02)
Timerange: 00:12:22:03 to 00:12:22:59

Plot file version 23 created 28-JAN-2015 14:38:04

J1640+3946 N14C3.UVDATA.1

Freq = 4.9270 GHz, Bw = 16.000 MH No calibration applied and no bandpass applied

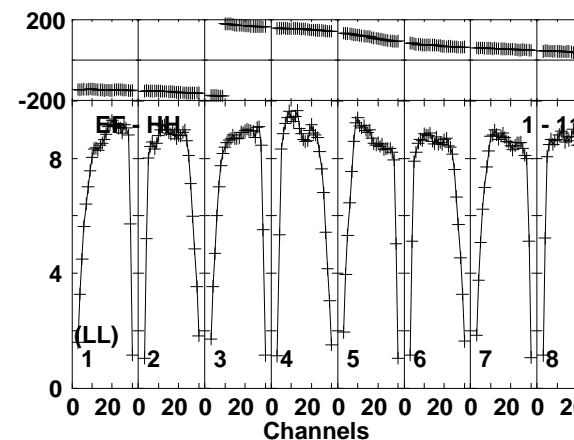
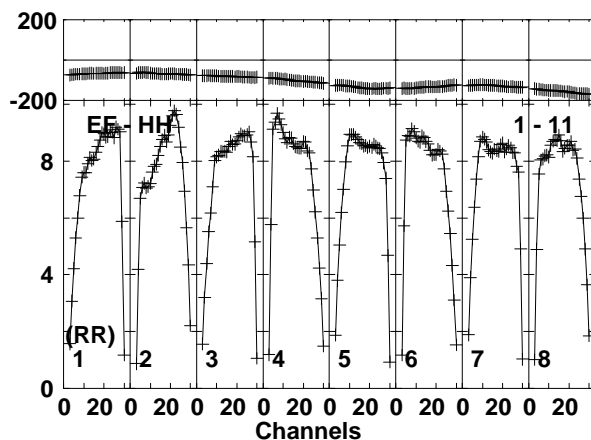
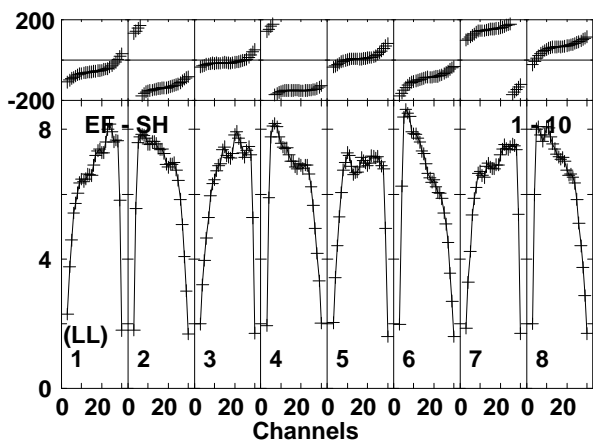
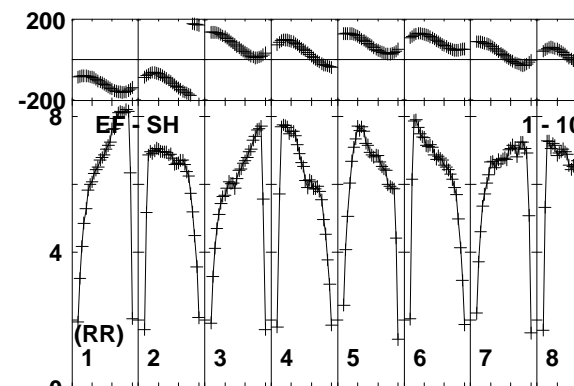
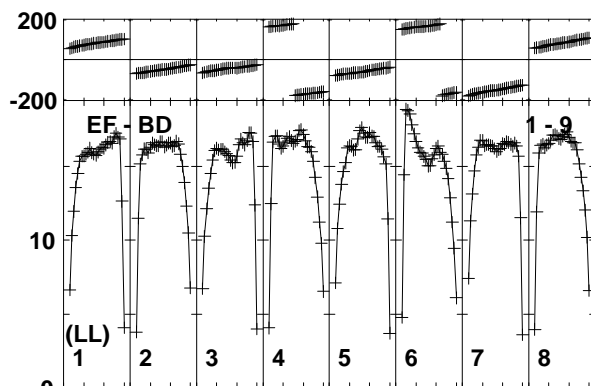
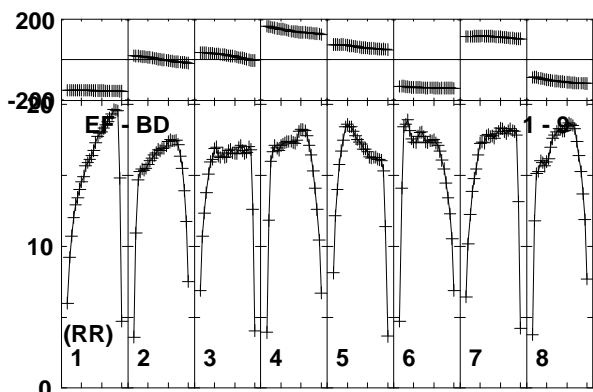
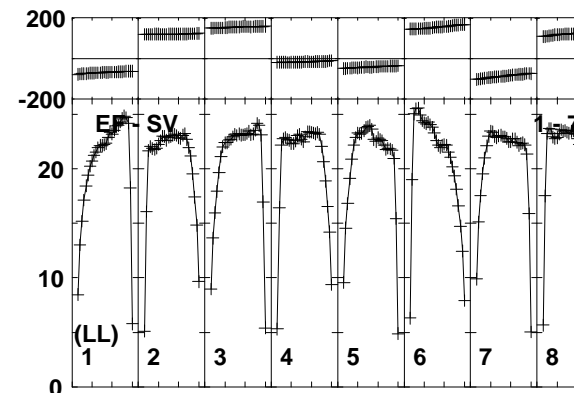
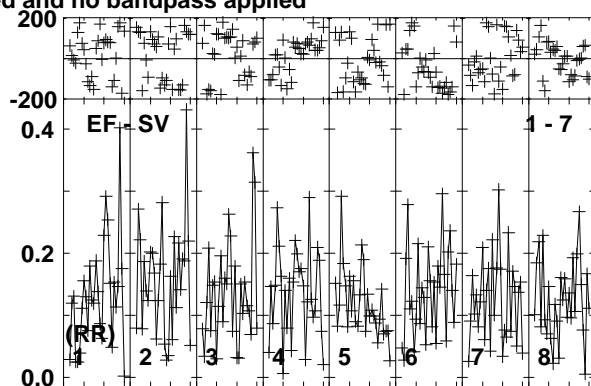
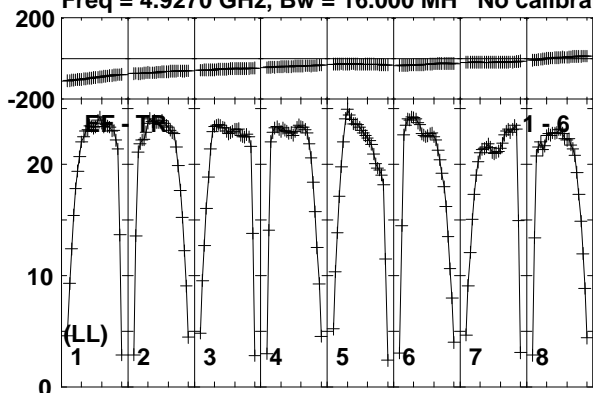

Lower frame: Milli Ampl Jy Top frame: Phas deg
Vector averaged cross-power spectrum Baseline: EF (01) - TR (06)
Timerange: 00:12:22:03 to 00:12:22:59

Plot file version 24 created 28-JAN-2015 14:38:05

J1640+3946 N14C3.UVDATA.1

Freq = 4.9270 GHz, Bw = 16.000 MH No calibration applied and no bandpass applied

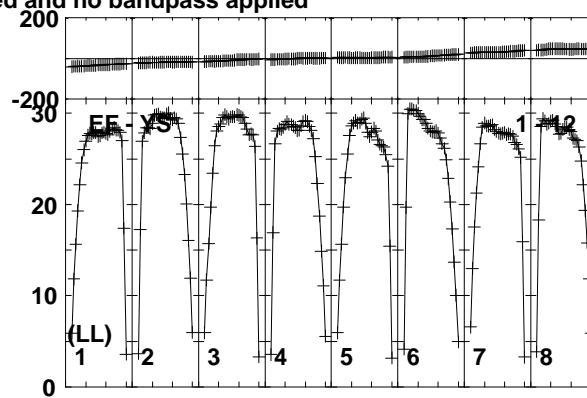
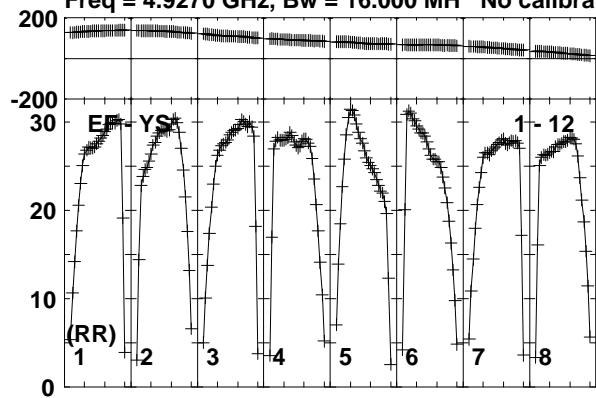

Lower frame: Milli Ampl Jy Top frame: Phas deg
Vector averaged cross-power spectrum Baseline: EF (01) - YS (12)
Timerange: 00/12:22:03 to 00/12:22:59

Plot file version 25 created 28-JAN-2015 14:38:05

3C345 N14C3.UVDATA.1

Freq = 4.9270 GHz, Bw = 16.000 MH No calibration applied and no bandpass applied

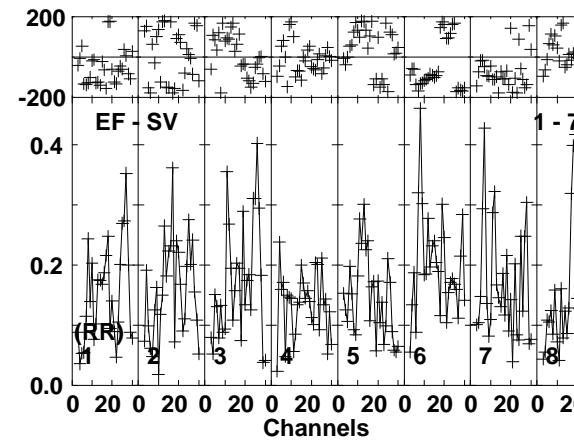
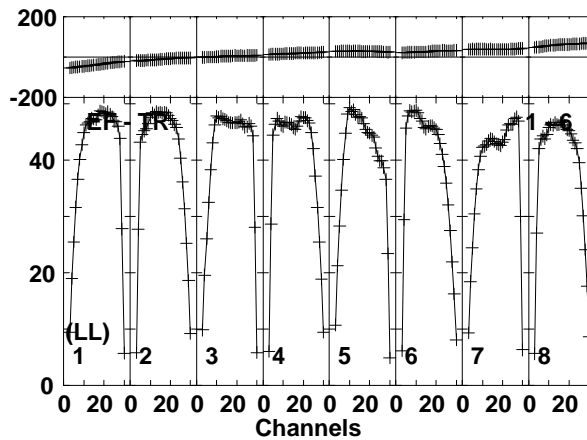
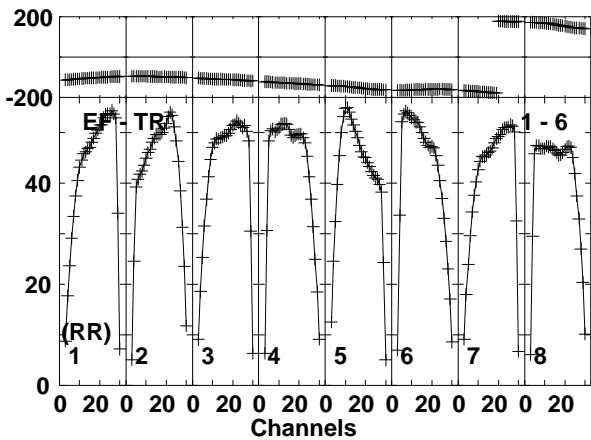
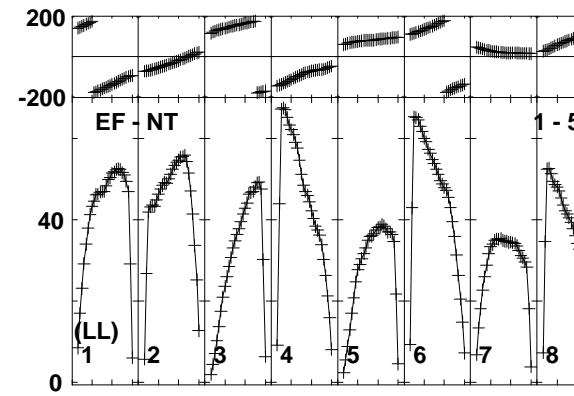
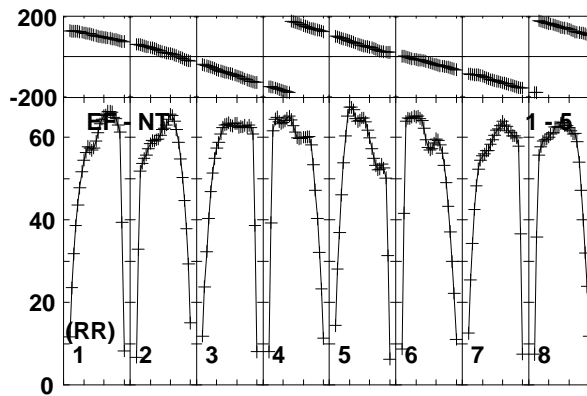
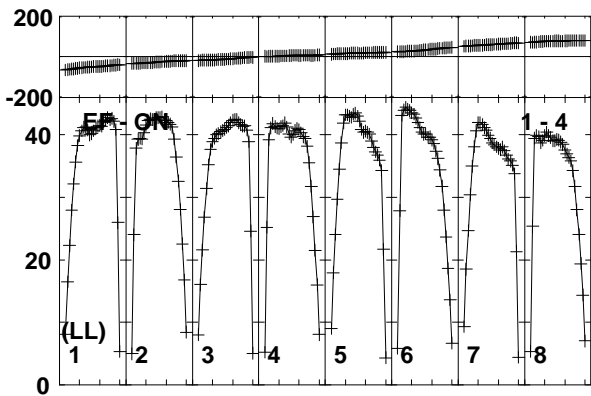
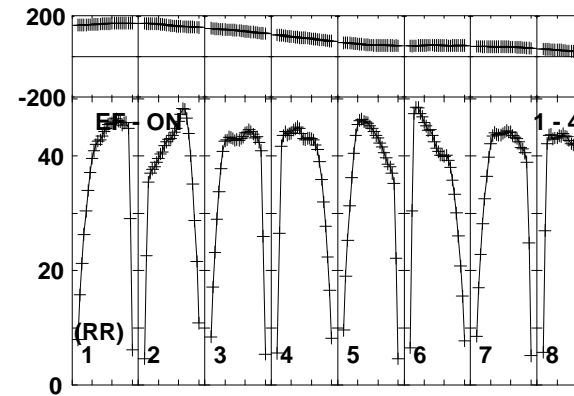
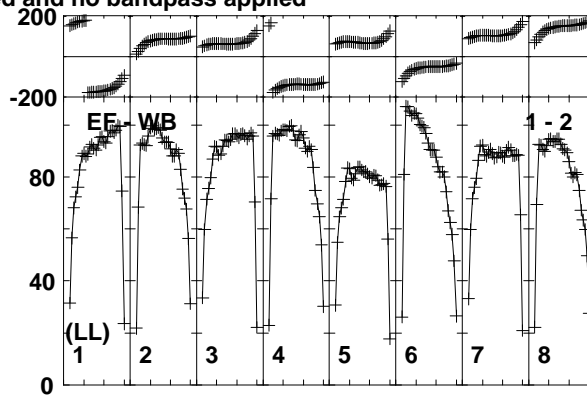
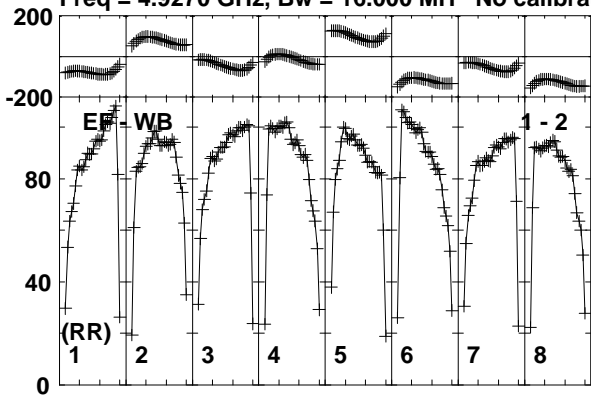

Lower frame: Milli Ampl Jy Top frame: Phas deg
Vector averaged cross-power spectrum Baseline: EF (01) - WB (02)
Timerange: 00/12:23:43 to 00/12:24:39

Plot file version 26 created 28-JAN-2015 14:38:05

3C345 N14C3.UVDATA.1

Freq = 4.9270 GHz, Bw = 16.000 MH No calibration applied and no bandpass applied

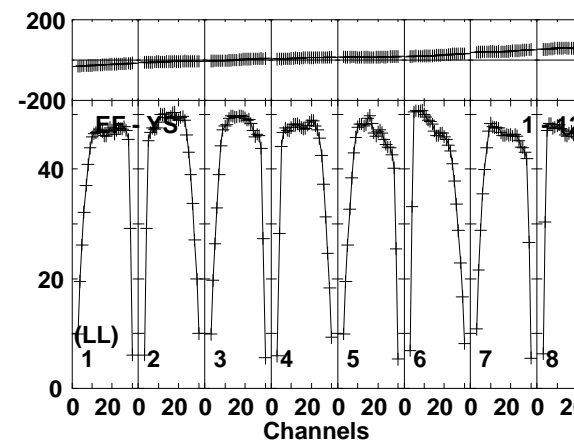
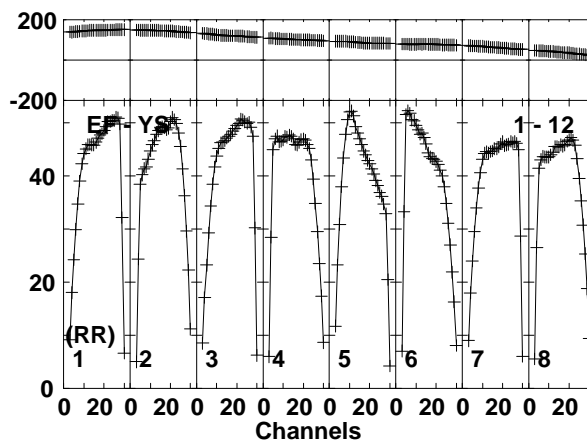
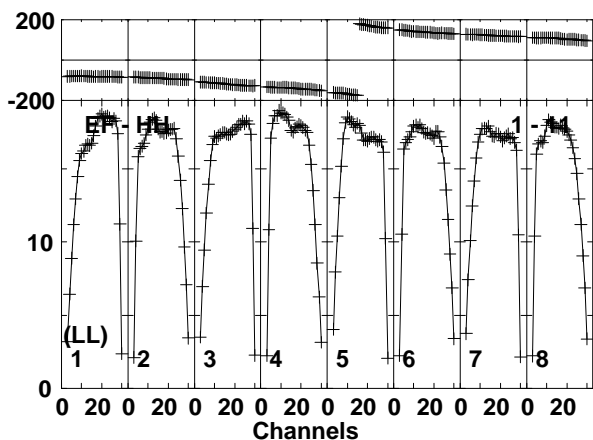
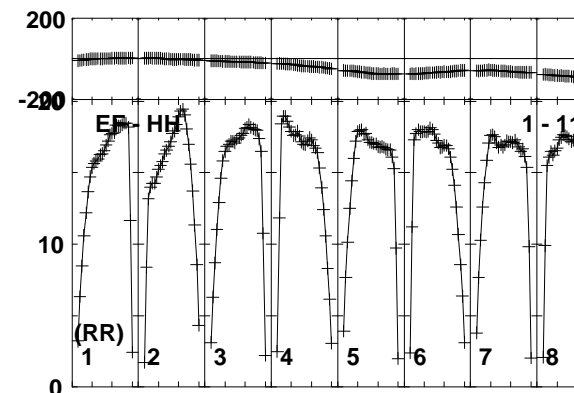
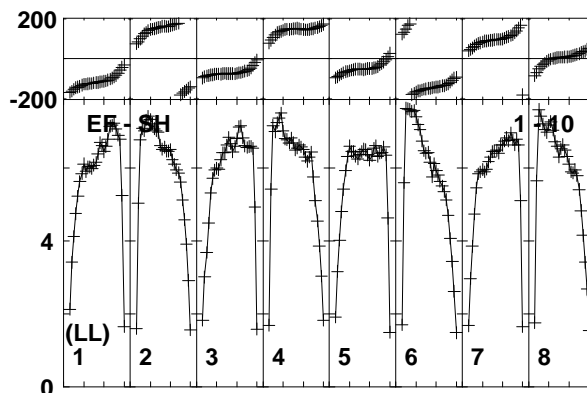
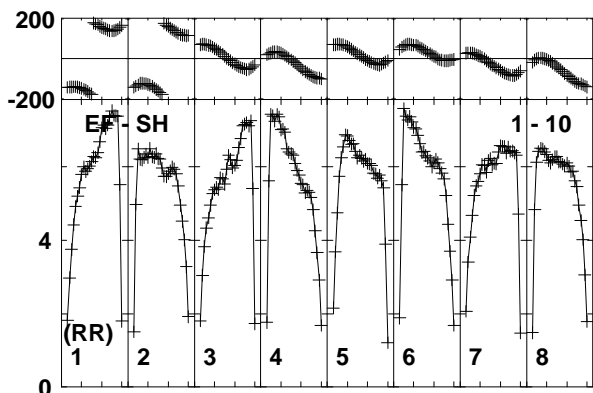
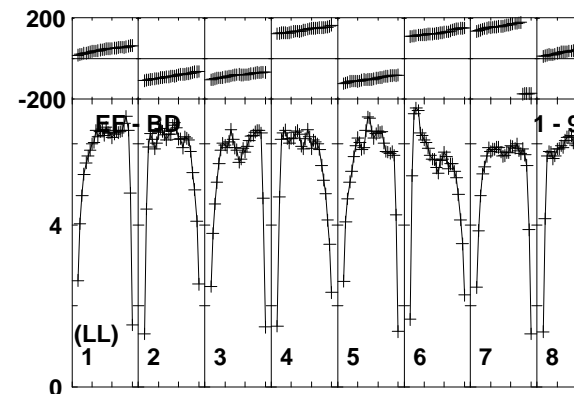
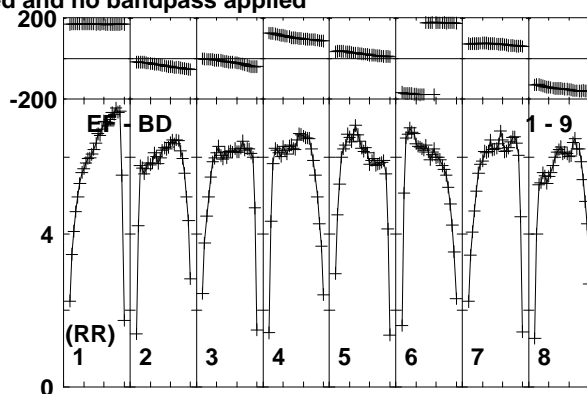
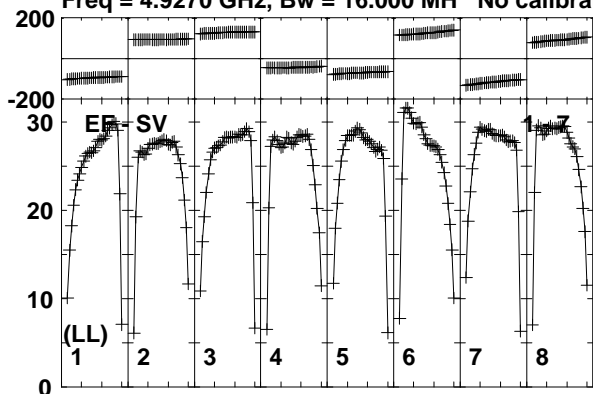

Lower frame: Milli Ampl Jy Top frame: Phas deg
Vector averaged cross-power spectrum Baseline: EF (01) - SV (07)
Timerange: 00/12:23:43 to 00/12:24:39

Plot file version 27 created 28-JAN-2015 14:38:05

J1640+3946 N14C3.UVDATA.1

Freq = 4.9270 GHz, Bw = 16.000 MH No calibration applied and no bandpass applied

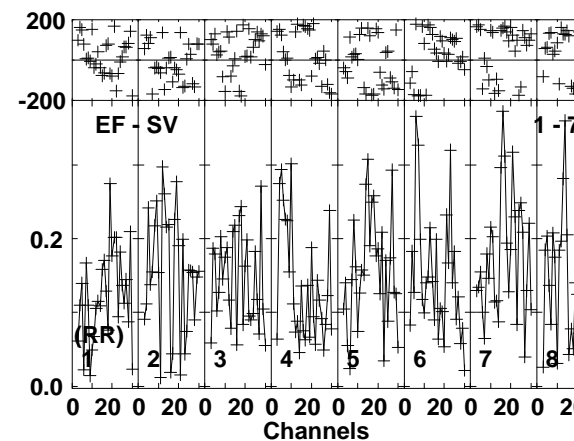
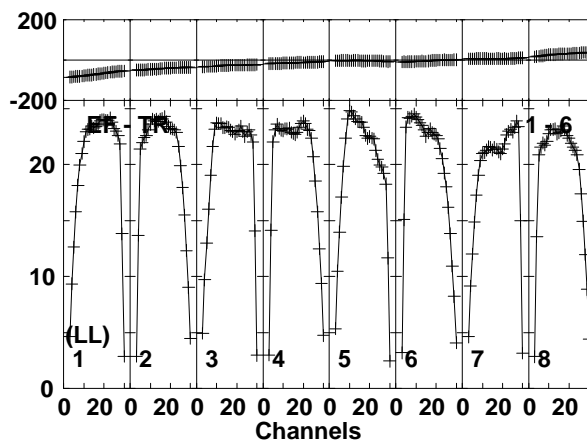
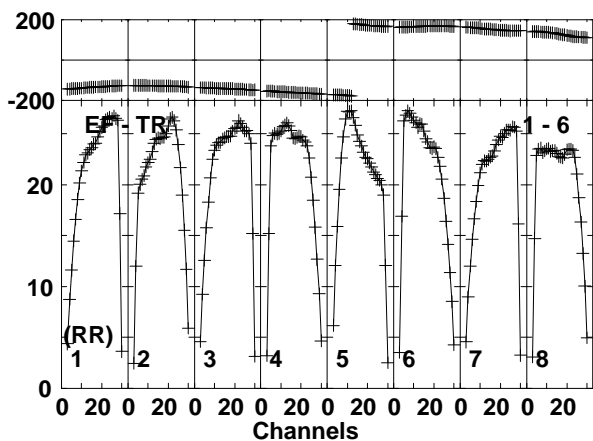
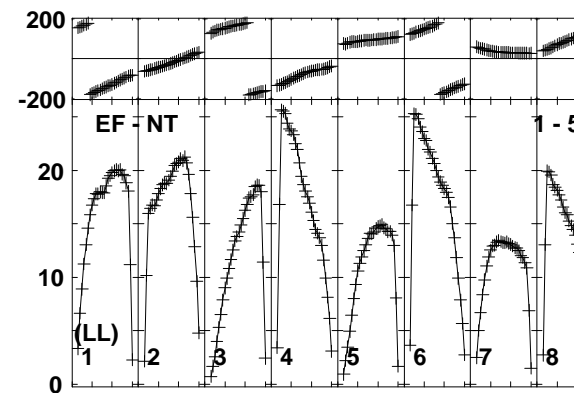
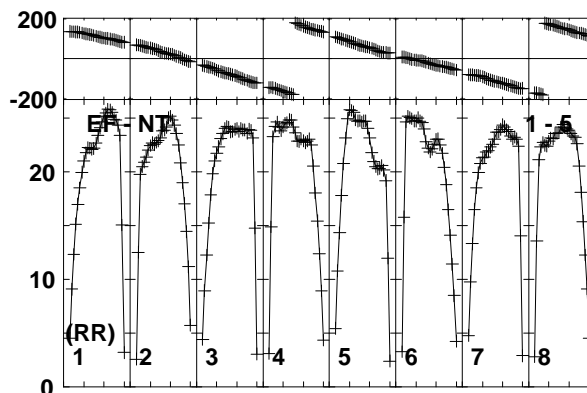
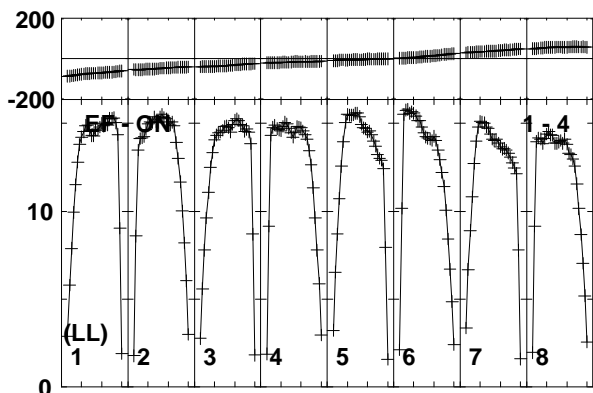
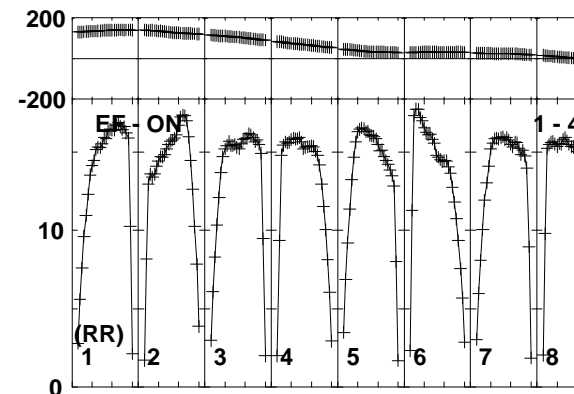
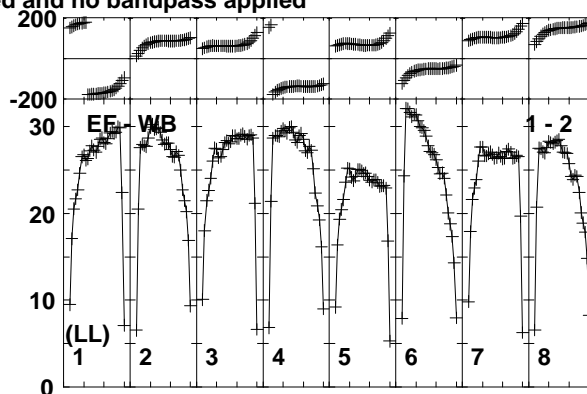
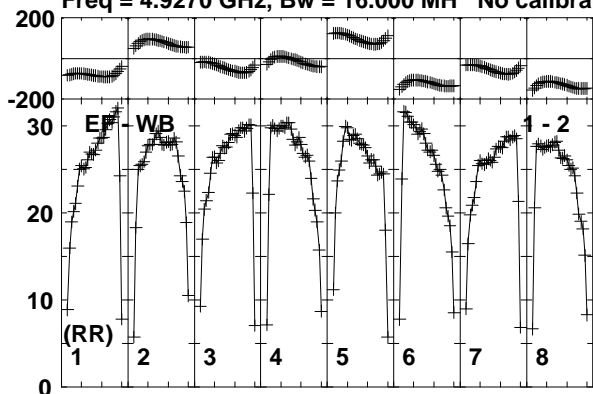

Lower frame: Milli Ampl Jy Top frame: Phas deg
Vector averaged cross-power spectrum Baseline: EF (01) - WB (02)
Timerange: 00/12:25:23 to 00/12:26:19

Plot file version 28 created 28-JAN-2015 14:38:05

J1640+3946 N14C3.UVDATA.1

Freq = 4.9270 GHz, Bw = 16.000 MH No calibration applied and no bandpass applied

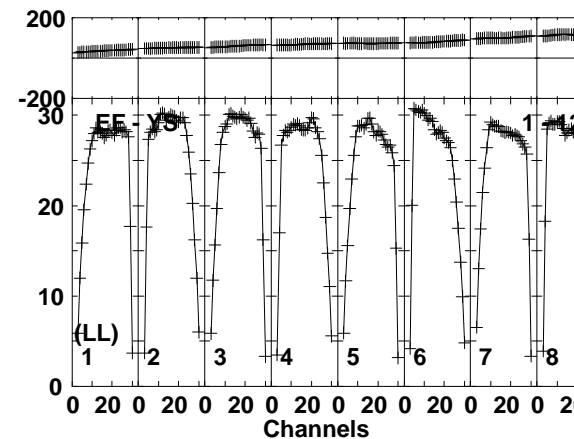
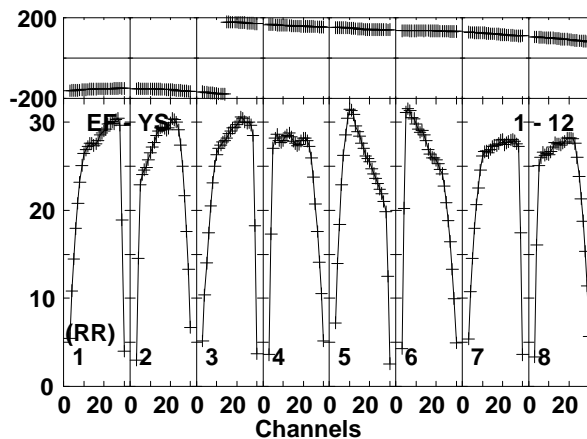
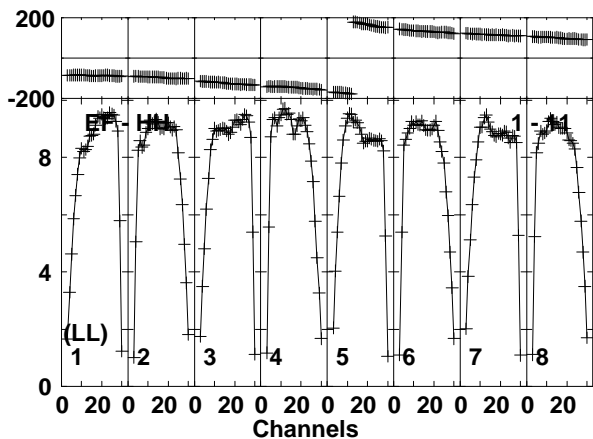
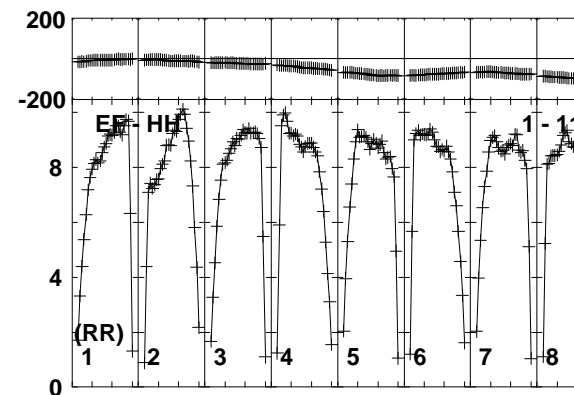
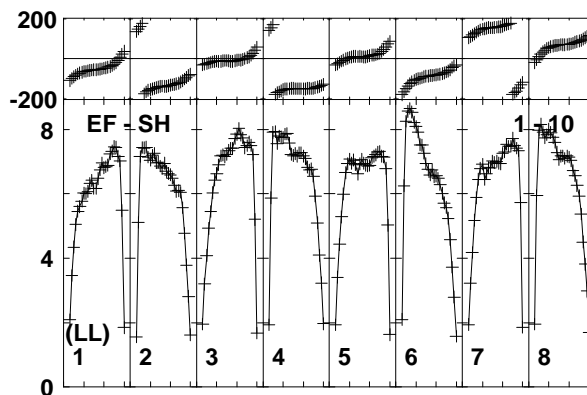
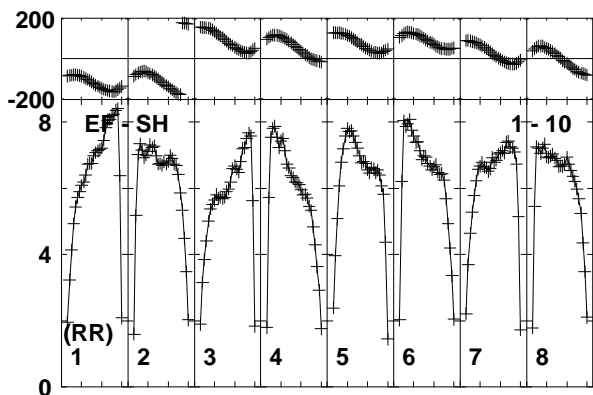
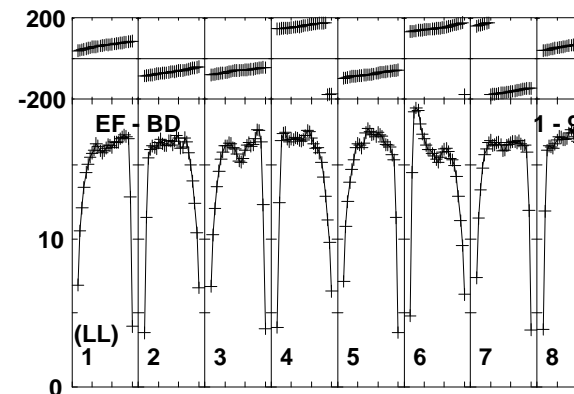
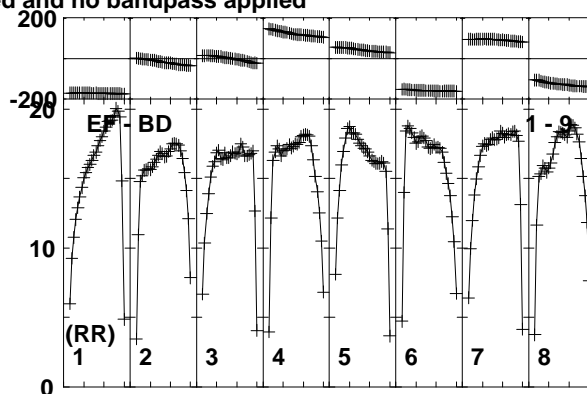
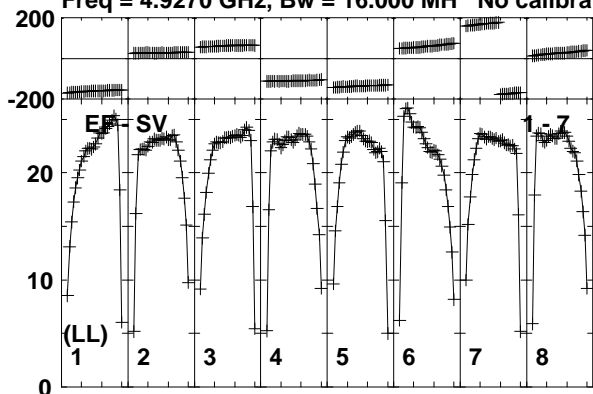

Lower frame: Milli Ampl Jy Top frame: Phas deg
Vector averaged cross-power spectrum Baseline: EF (01) - SV (07)
Timerange: 00:12:25:23 to 00:12:26:19

Plot file version 29 created 28-JAN-2015 14:38:05

3C345 N14C3.UVDATA.1

Freq = 4.9270 GHz, Bw = 16.000 MH No calibration applied and no bandpass applied

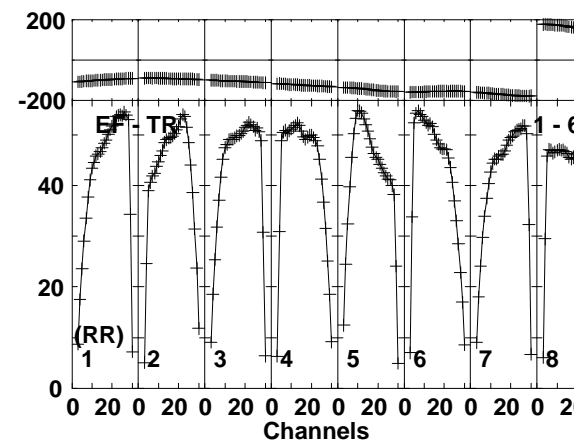
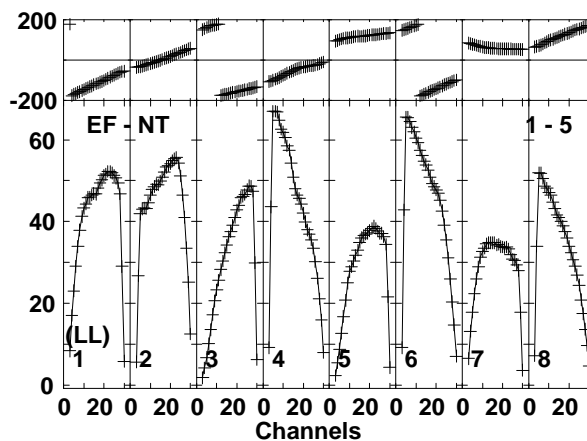
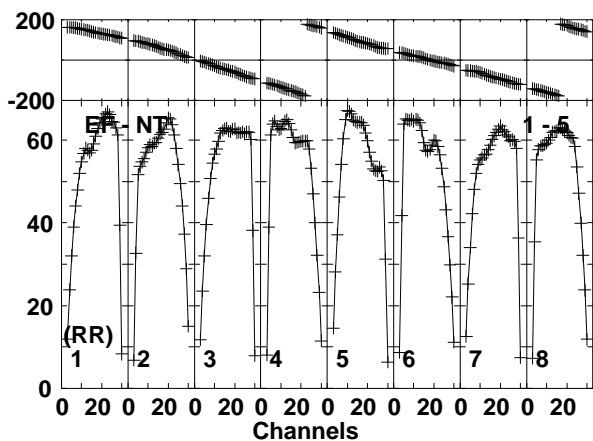
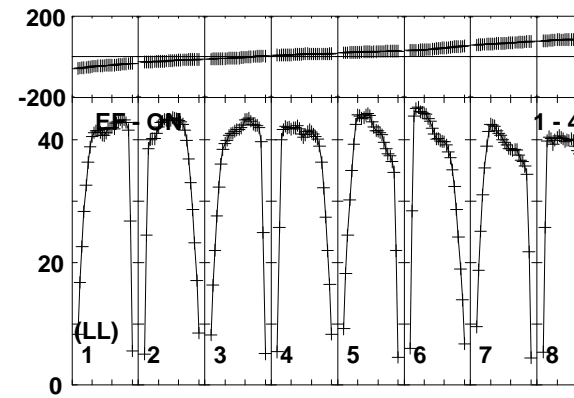
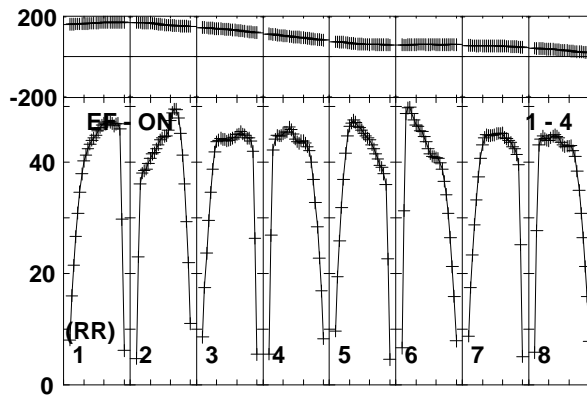
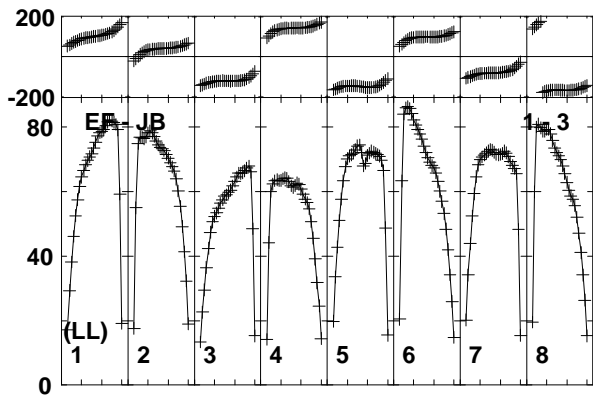
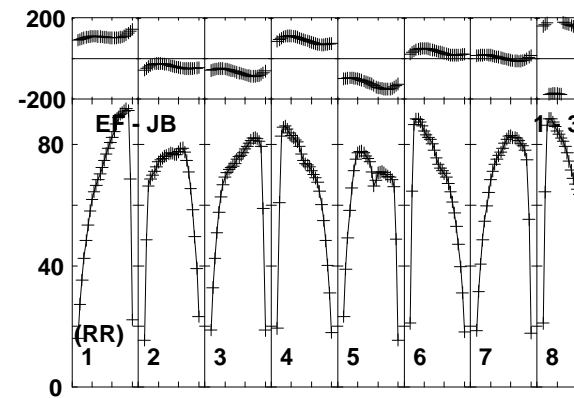
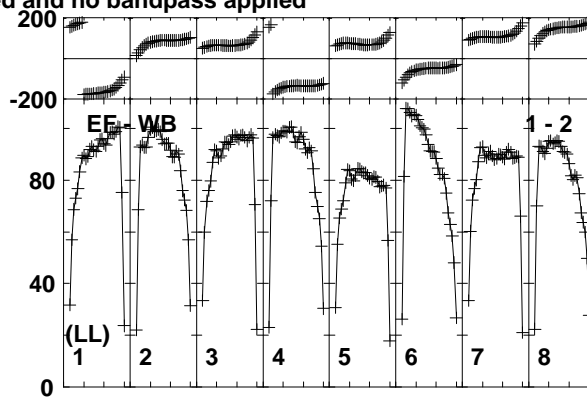
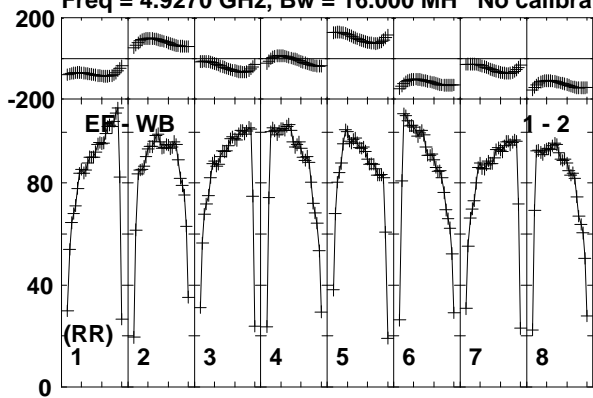

Lower frame: Milli Ampl Jy Top frame: Phas deg
Vector averaged cross-power spectrum Baseline: EF (01) - WB (02)
Timerange: 00:12:27:03 to 00:12:27:59

Plot file version 30 created 28-JAN-2015 14:38:05

3C345 N14C3.UVDATA.1

Freq = 4.9270 GHz, Bw = 16.000 MH No calibration applied and no bandpass applied

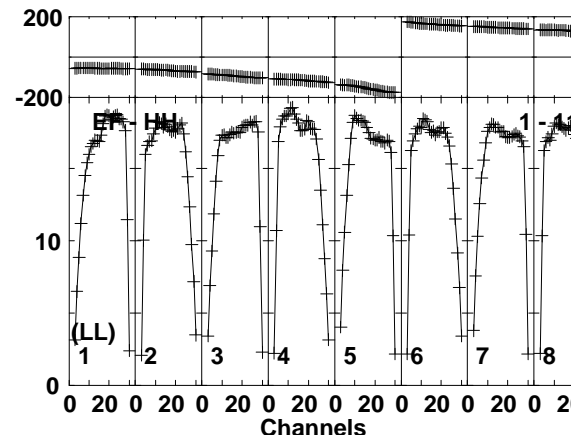
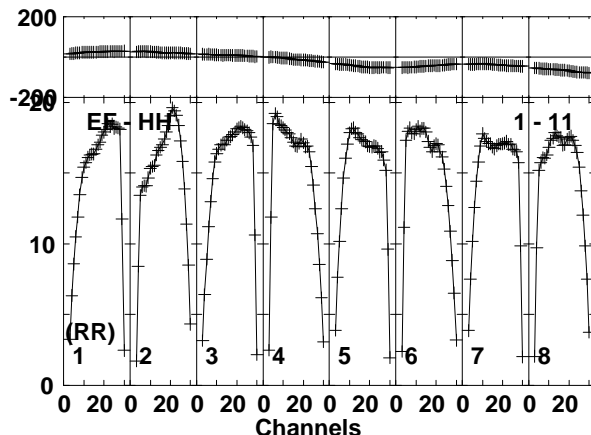
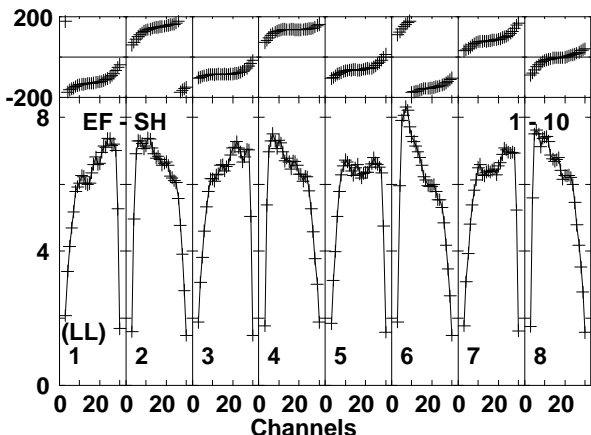
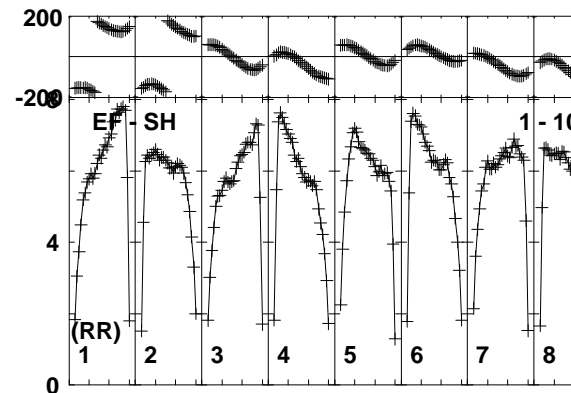
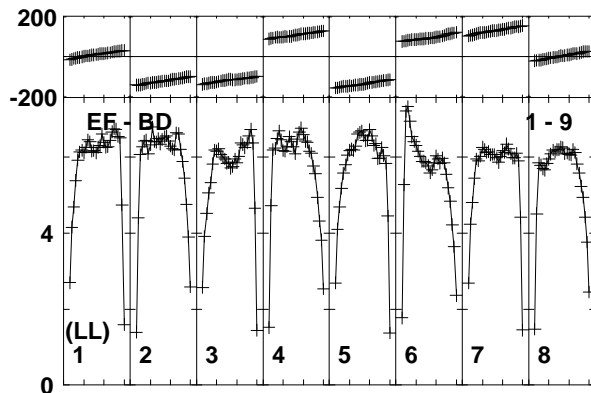
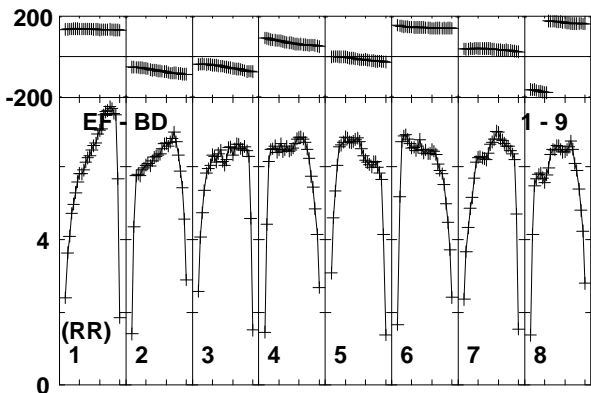
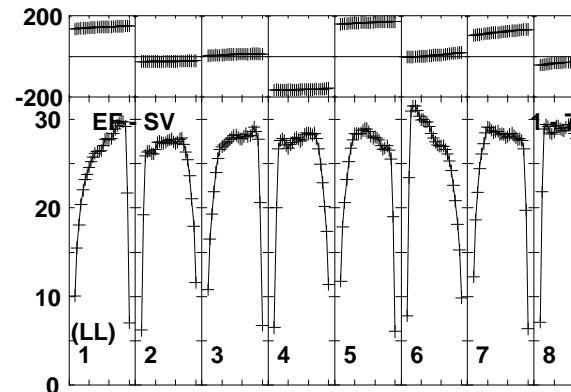
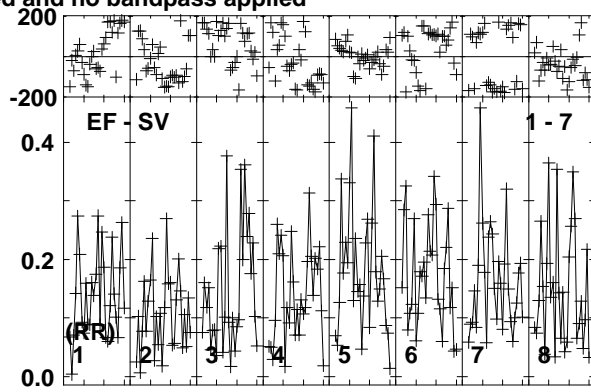
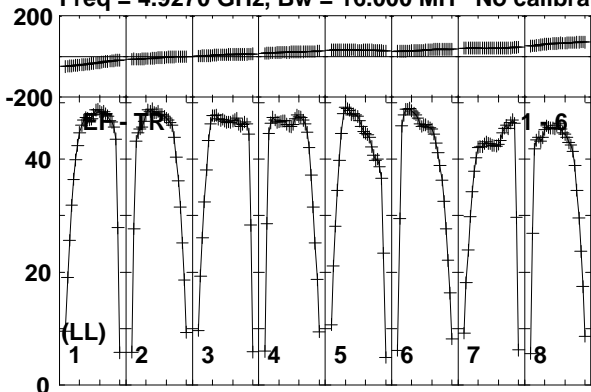

Lower frame: Milli Ampl Jy Top frame: Phas deg
Vector averaged cross-power spectrum Baseline: EF (01) - TR (06)
Timerange: 00:12:27:03 to 00:12:27:59

Plot file version 31 created 28-JAN-2015 14:38:05

3C345 N14C3.UVDATA.1

Freq = 4.9270 GHz, Bw = 16.000 MH No calibration applied and no bandpass applied

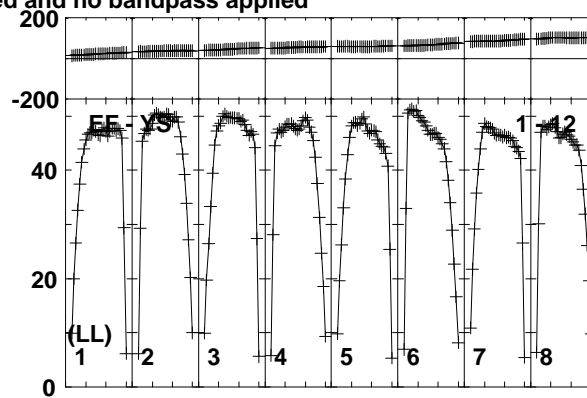
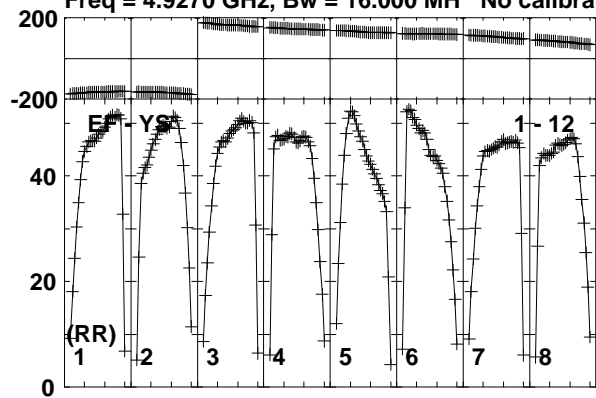

Lower frame: Milli Ampl Jy Top frame: Phas deg
Vector averaged cross-power spectrum Baseline: EF (01) - YS (12)
Timerange: 00/12:27:03 to 00/12:27:59

Plot file version 32 created 28-JAN-2015 14:38:05

J1640+3946 N14C3.UVDATA.1

Freq = 4.9270 GHz, Bw = 16.000 MH No calibration applied and no bandpass applied

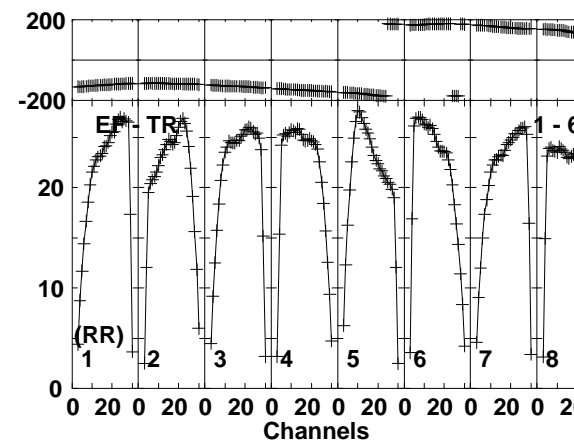
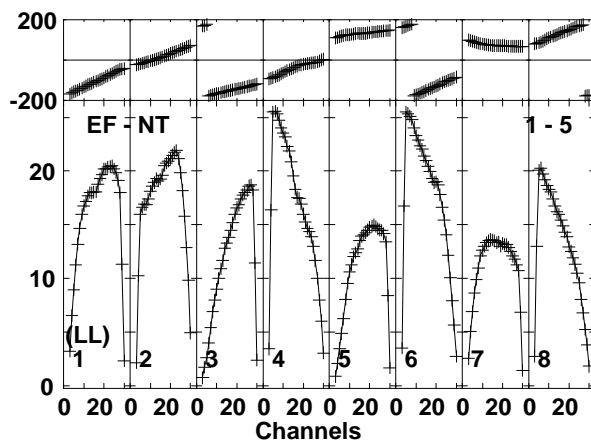
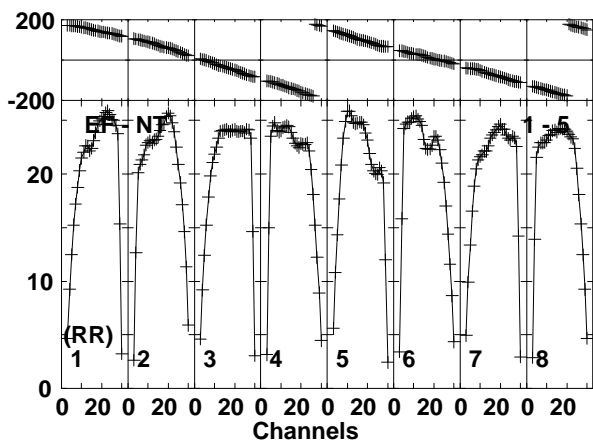
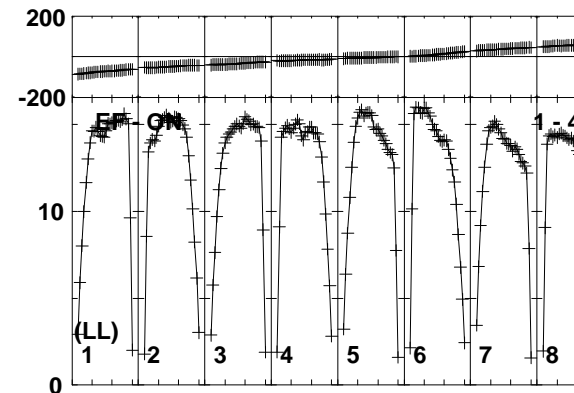
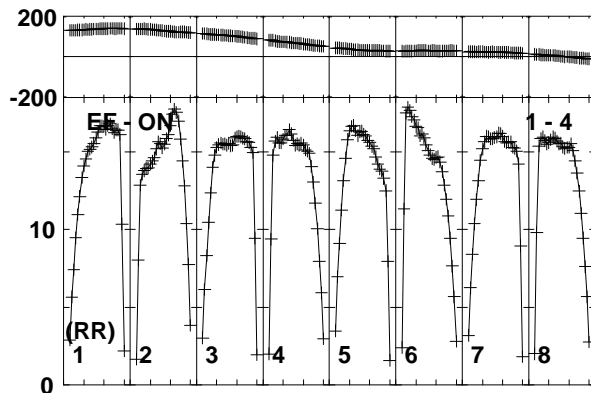
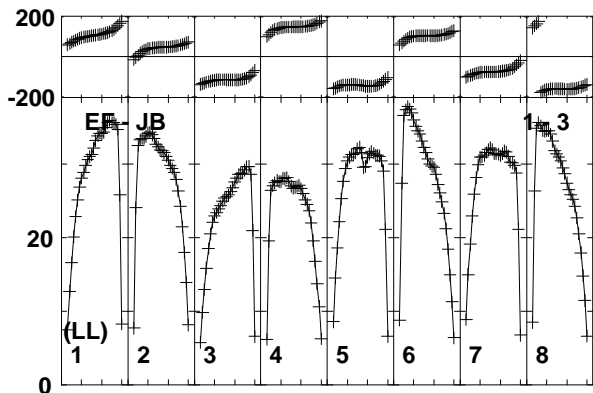
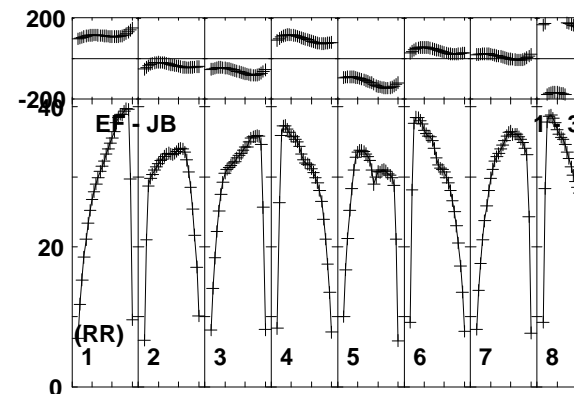
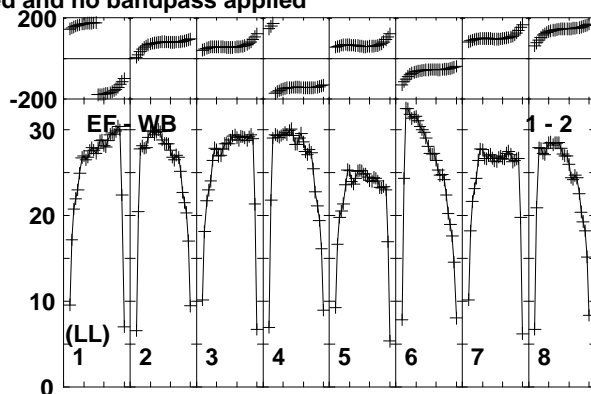
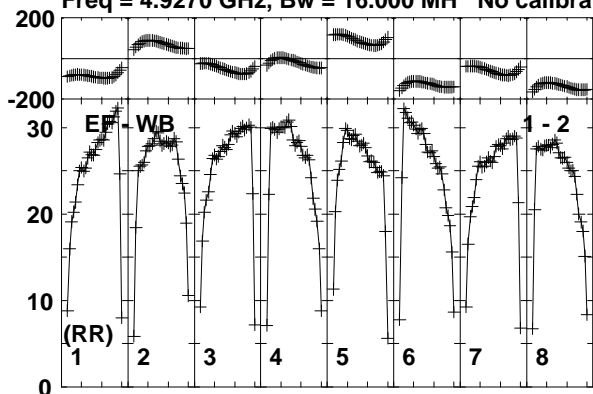

Lower frame: Milli Ampl Jy Top frame: Phas deg
Vector averaged cross-power spectrum Baseline: EF (01) - WB (02)
Timerange: 00/12:28:43 to 00/12:29:39

Plot file version 33 created 28-JAN-2015 14:38:05

J1640+3946 N14C3.UVDATA.1

Freq = 4.9270 GHz, Bw = 16.000 MH No calibration applied and no bandpass applied

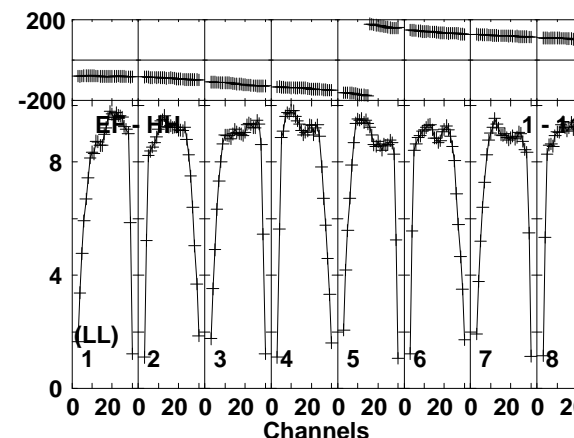
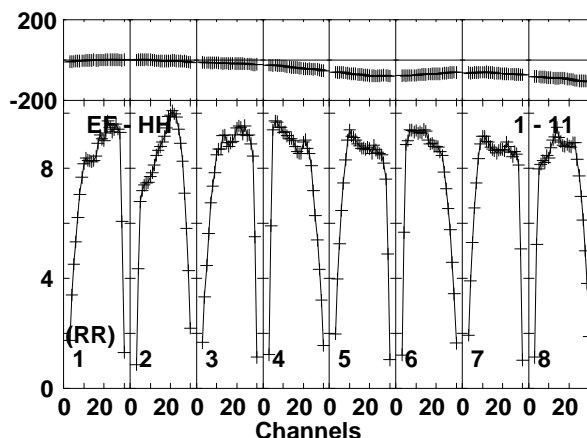
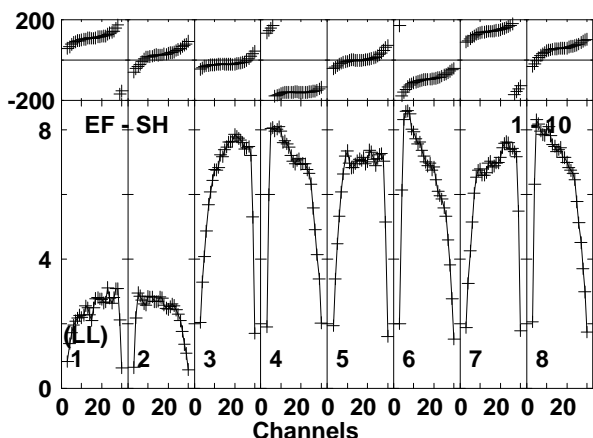
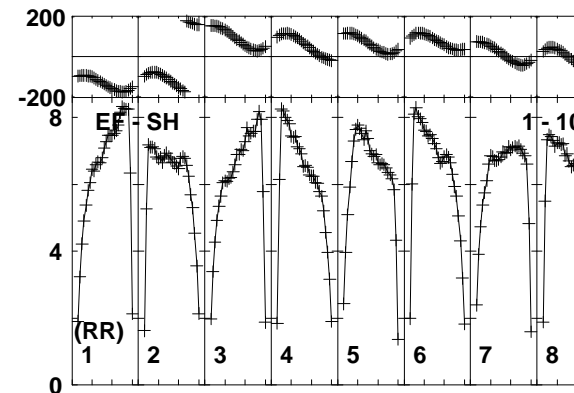
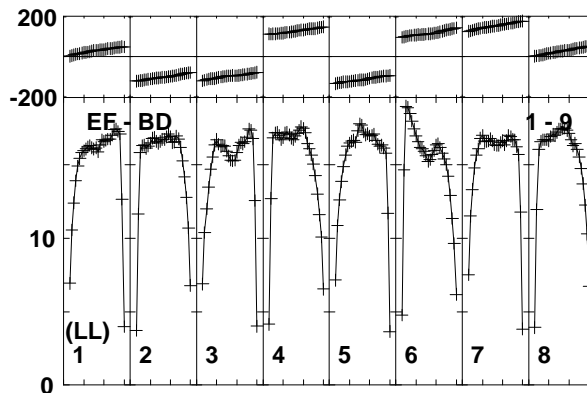
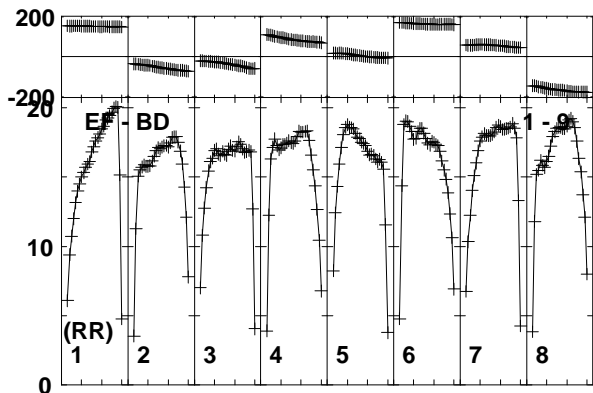
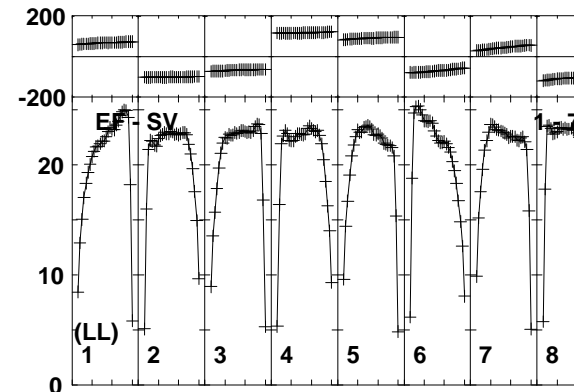
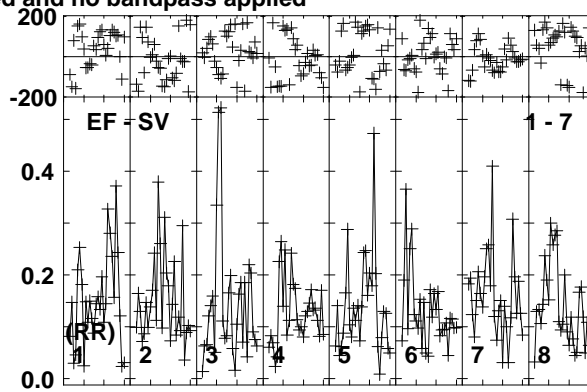
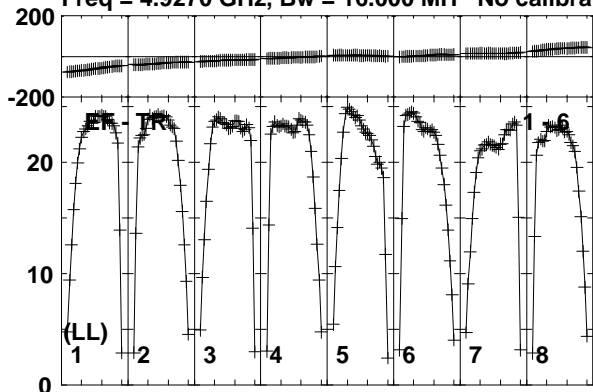

Lower frame: Milli Ampl Jy Top frame: Phas deg
Vector averaged cross-power spectrum Baseline: EF (01) - TR (06)
Timerange: 00:12:28:43 to 00:12:29:39

Plot file version 34 created 28-JAN-2015 14:38:05

J1640+3946 N14C3.UVDATA.1

Freq = 4.9270 GHz, Bw = 16.000 MH No calibration applied and no bandpass applied

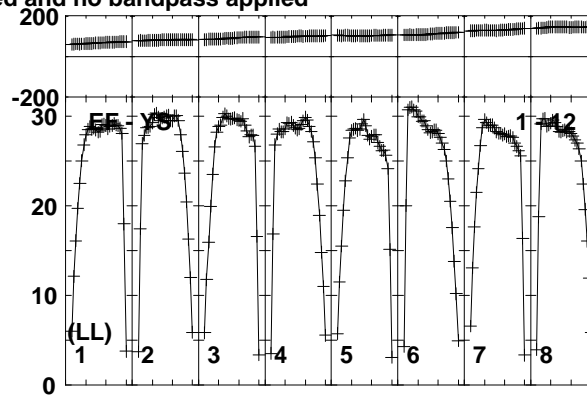
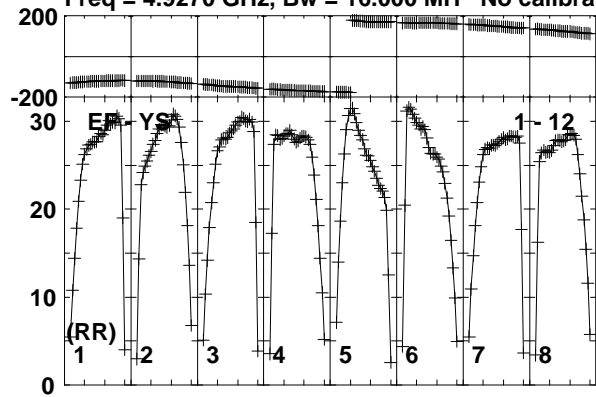

Lower frame: Milli Ampl Jy Top frame: Phas deg
Vector averaged cross-power spectrum Baseline: EF (01) - YS (12)
Timerange: 00/12:28:43 to 00/12:29:39

Plot file version 35 created 28-JAN-2015 14:38:05

3C345 N14C3.UVDATA.1

Freq = 4.9270 GHz, Bw = 16.000 MH No calibration applied and no bandpass applied

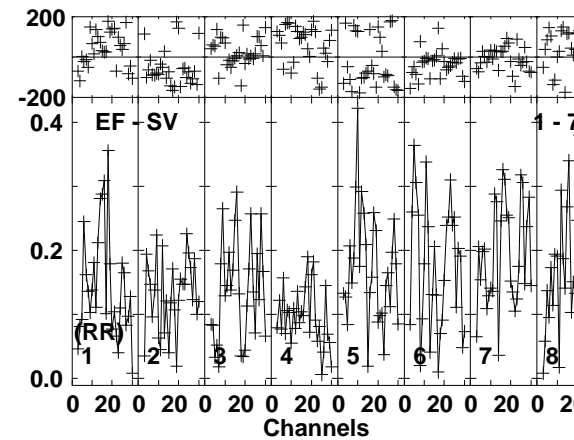
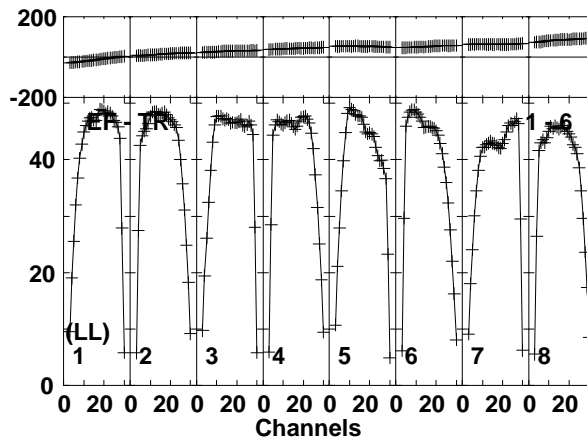
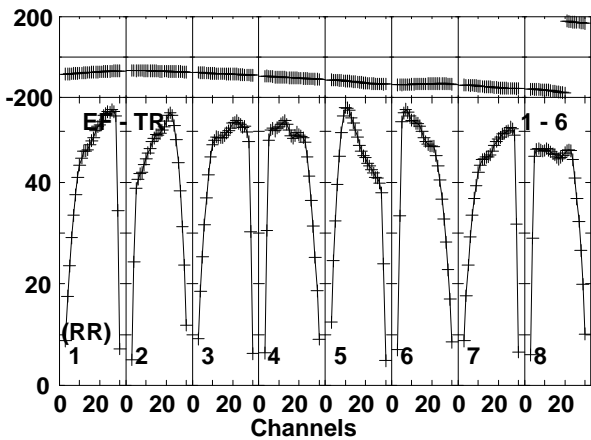
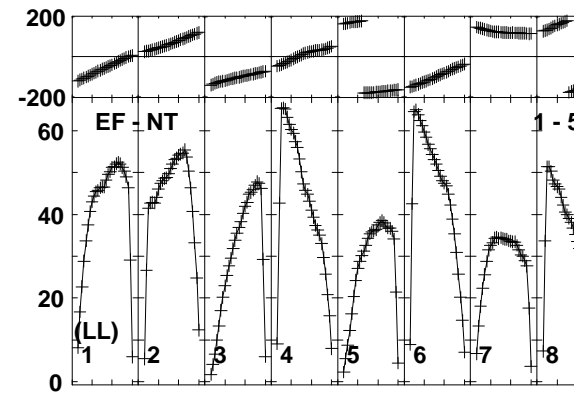
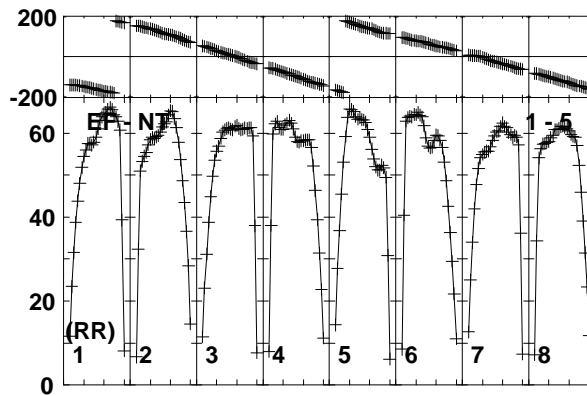
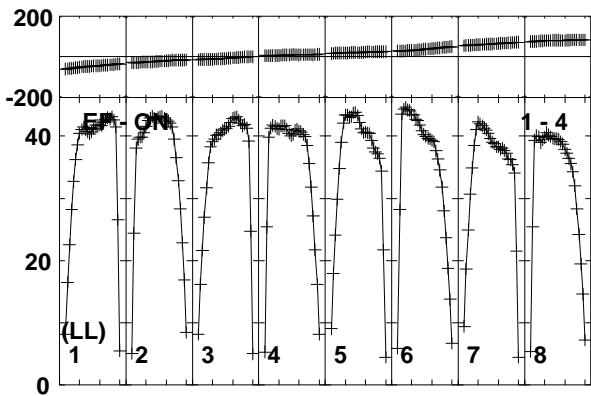
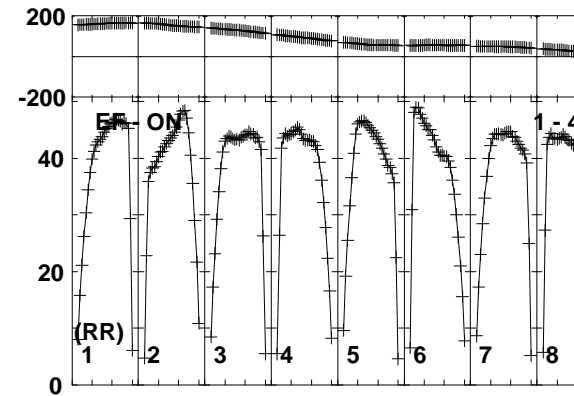
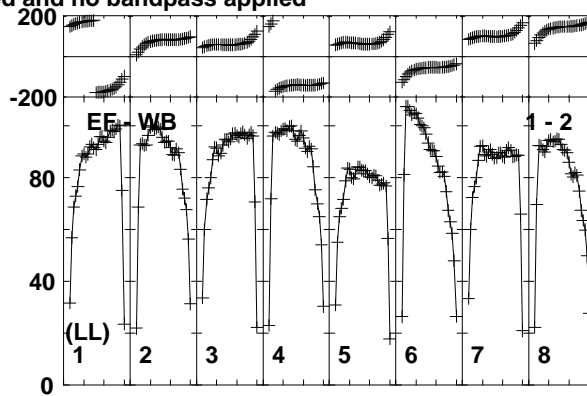
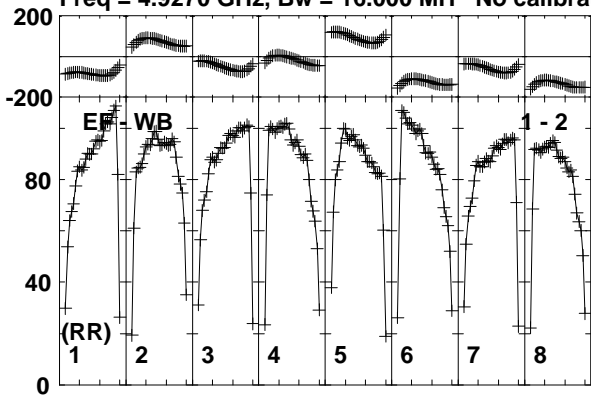

Lower frame: Milli Ampl Jy Top frame: Phas deg
Vector averaged cross-power spectrum Baseline: EF (01) - WB (02)
Timerange: 00/12:30:23 to 00/12:31:19

Plot file version 36 created 28-JAN-2015 14:38:05

3C345 N14C3.UVDATA.1

Freq = 4.9270 GHz, Bw = 16.000 MH No calibration applied and no bandpass applied

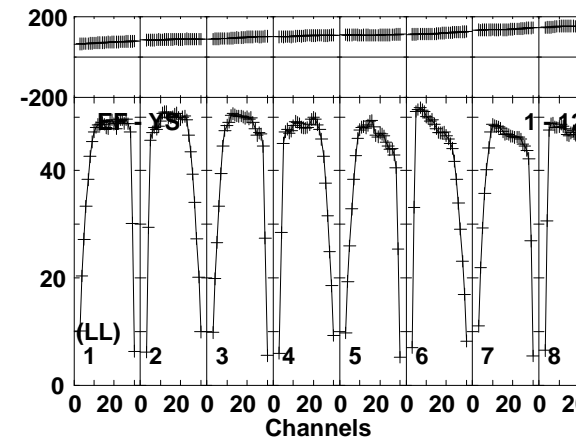
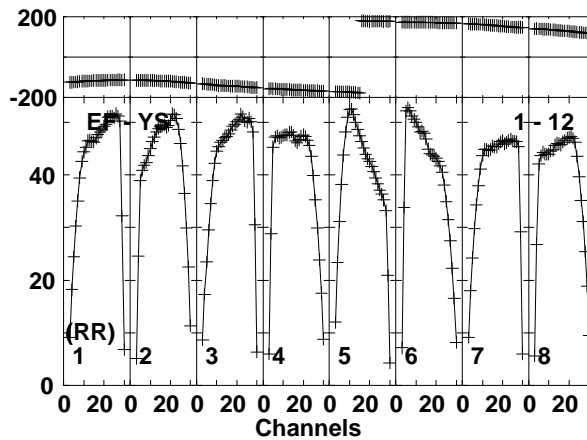
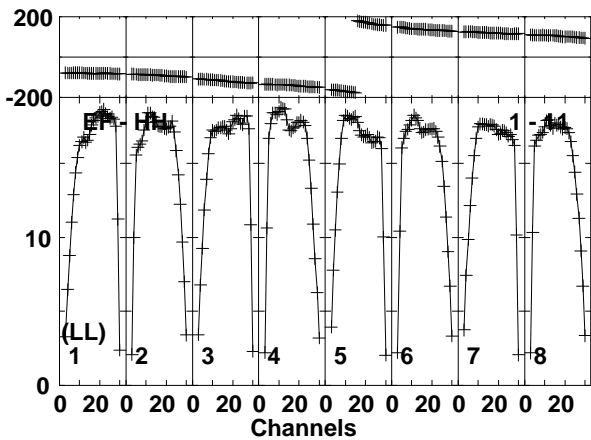
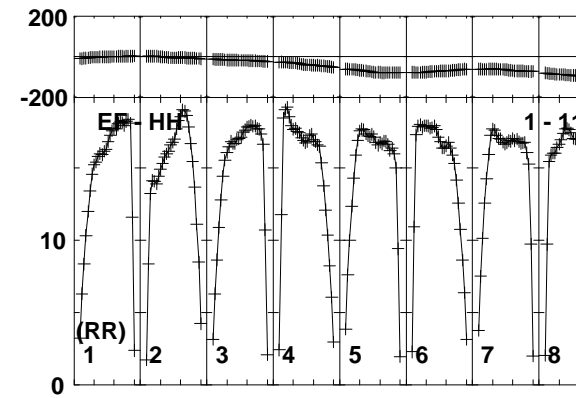
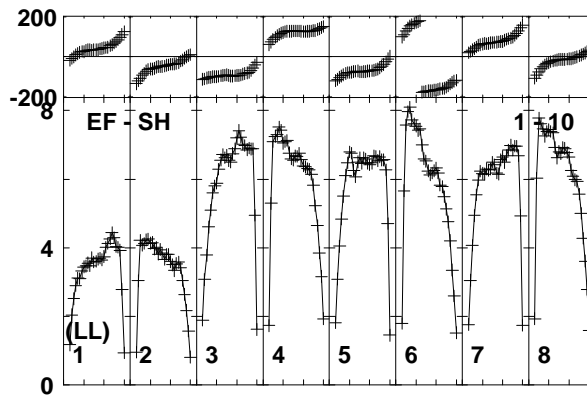
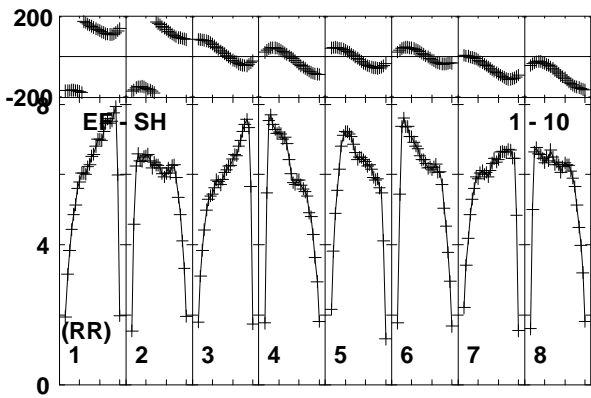
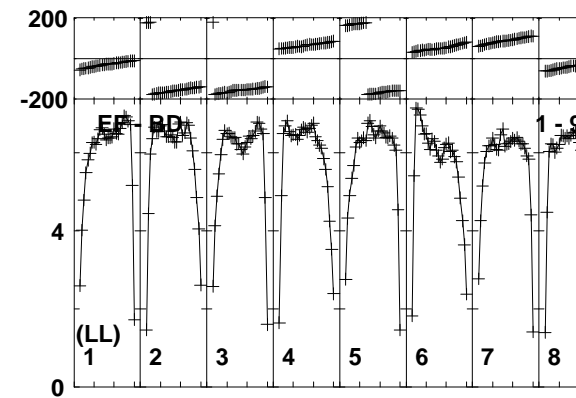
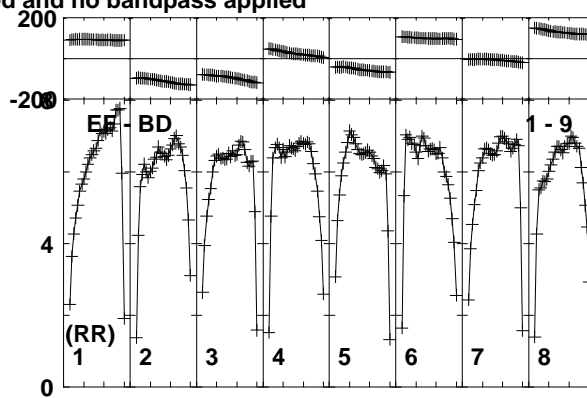
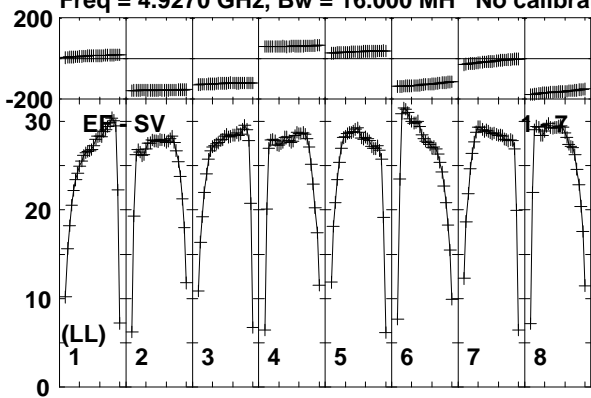

Lower frame: Milli Ampl Jy Top frame: Phas deg
Vector averaged cross-power spectrum Baseline: EF (01) - SV (07)
Timerange: 00:12:30:23 to 00:12:31:19

Plot file version 37 created 28-JAN-2015 14:38:05

J1640+3946 N14C3.UVDATA.1

Freq = 4.9270 GHz, Bw = 16.000 MH No calibration applied and no bandpass applied

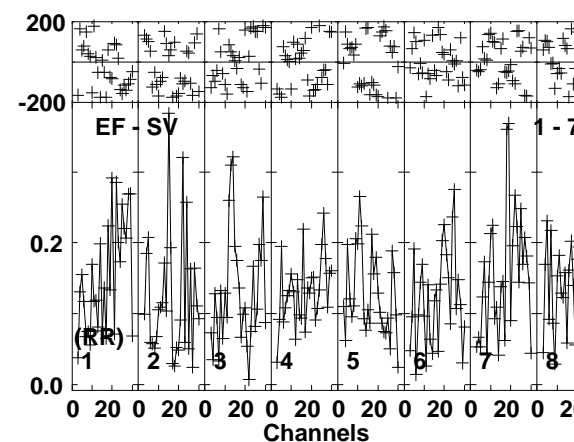
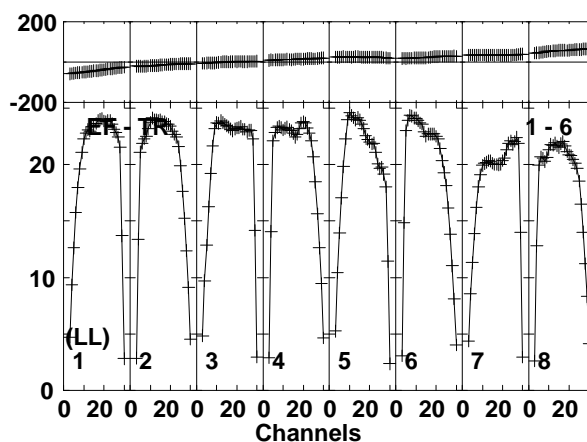
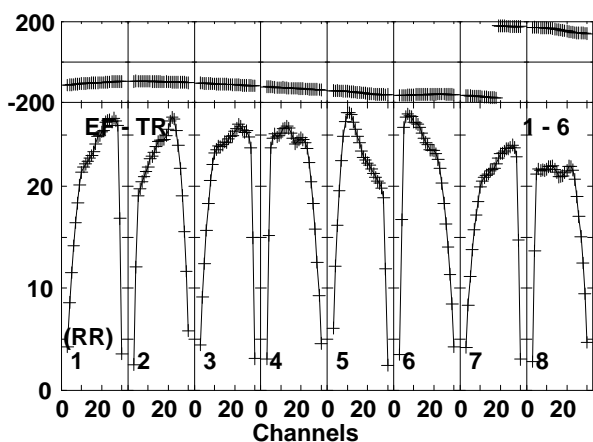
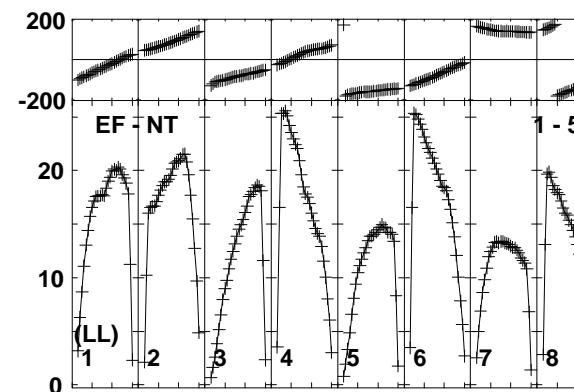
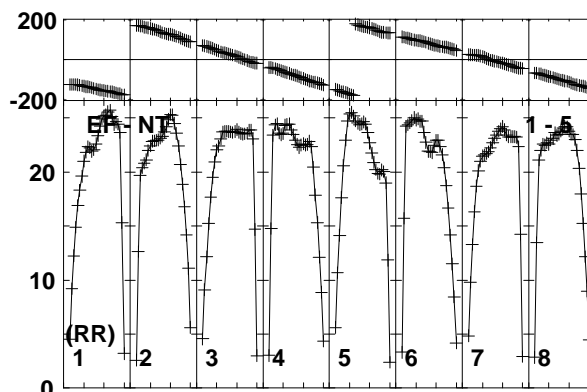
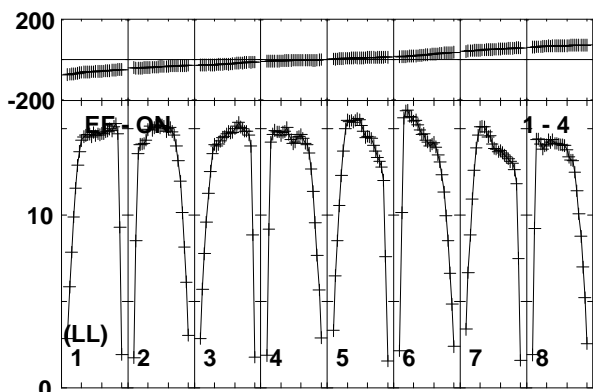
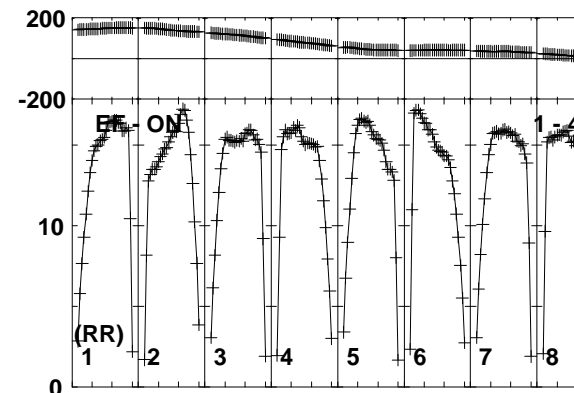
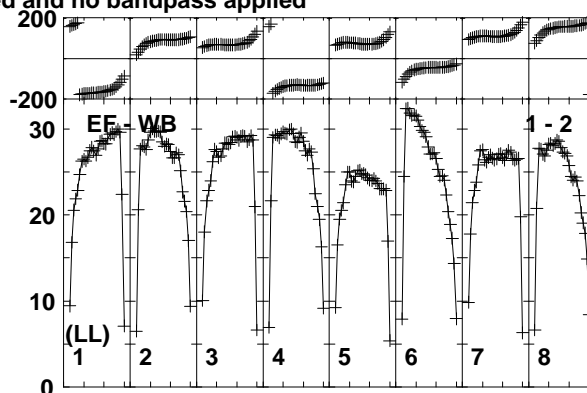
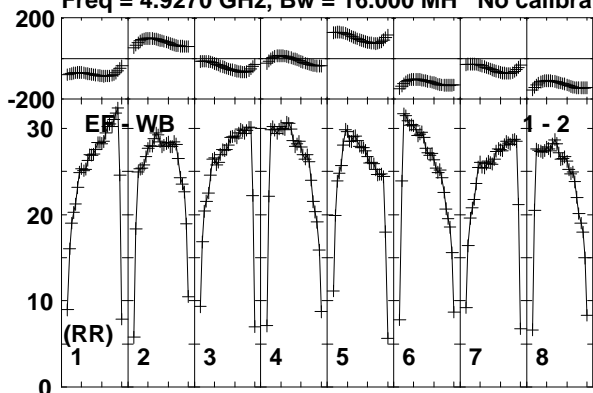

Lower frame: Milli Ampl Jy Top frame: Phas deg
Vector averaged cross-power spectrum Baseline: EF (01) - WB (02)
Timerange: 00/12:32:03 to 00/12:32:59

Plot file version 38 created 28-JAN-2015 14:38:05

J1640+3946 N14C3.UVDATA.1

Freq = 4.9270 GHz, Bw = 16.000 MH No calibration applied and no bandpass applied

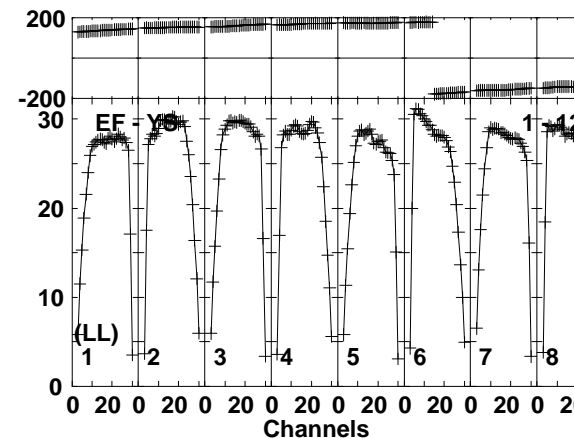
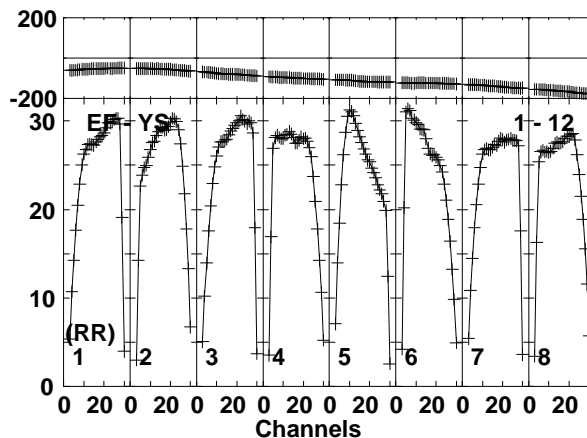
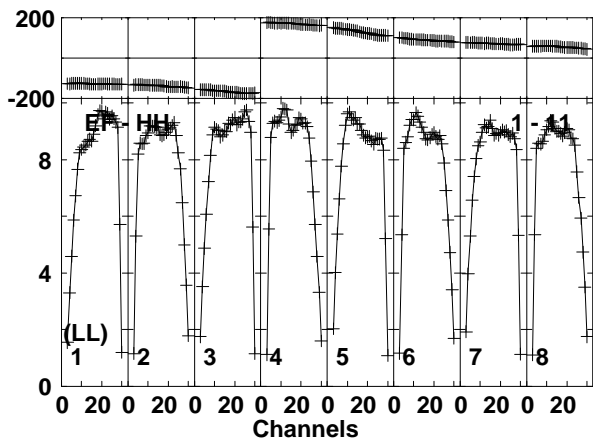
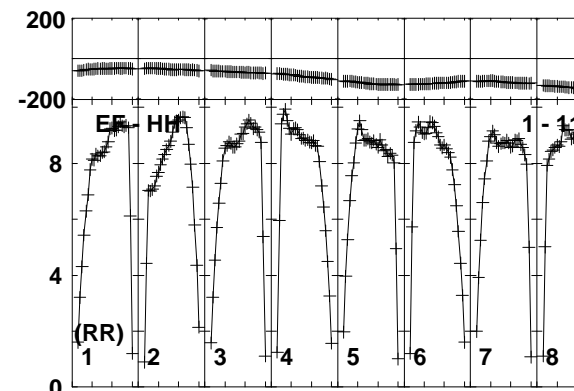
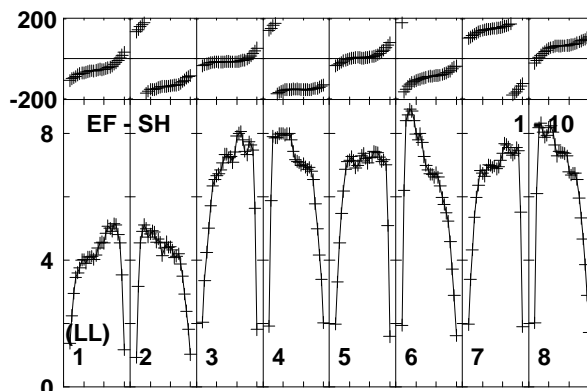
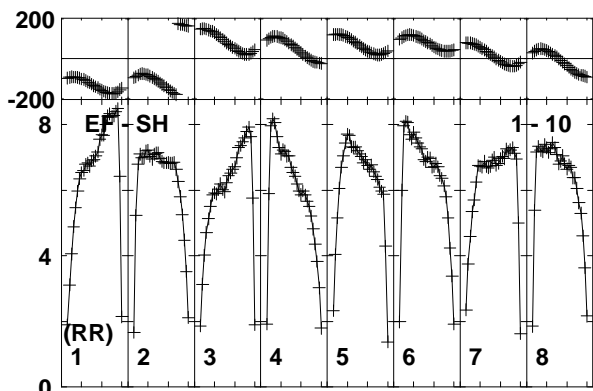
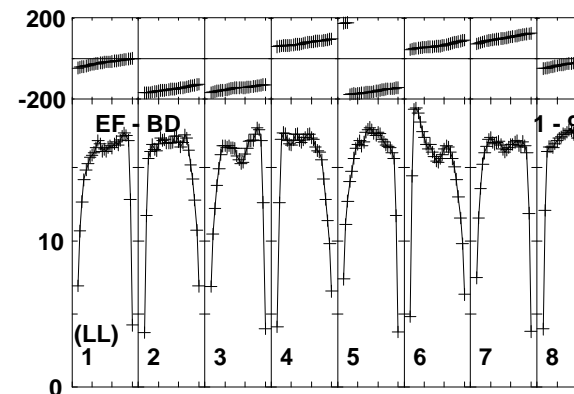
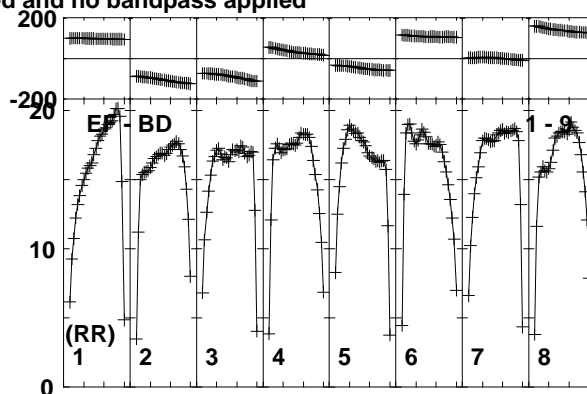
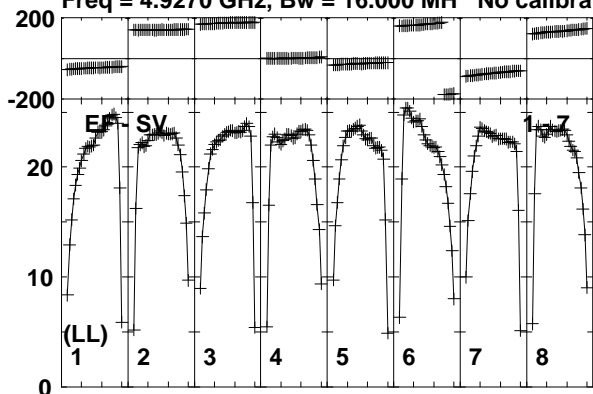

Lower frame: Milli Ampl Jy Top frame: Phas deg
Vector averaged cross-power spectrum Baseline: EF (01) - SV (07)
Timerange: 00:12:32:03 to 00:12:32:59

Plot file version 39 created 28-JAN-2015 14:38:05

3C345 N14C3.UVDATA.1

Freq = 4.9270 GHz, Bw = 16.000 MH No calibration applied and no bandpass applied

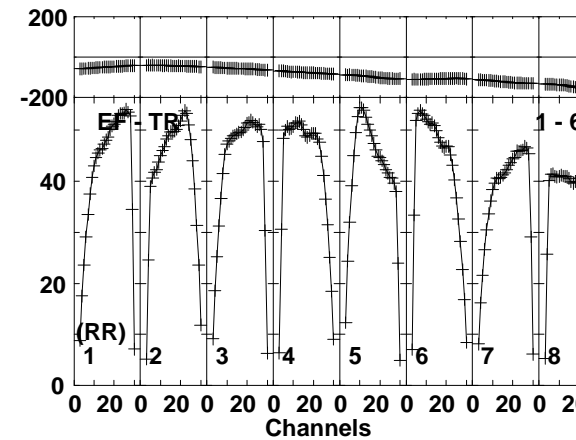
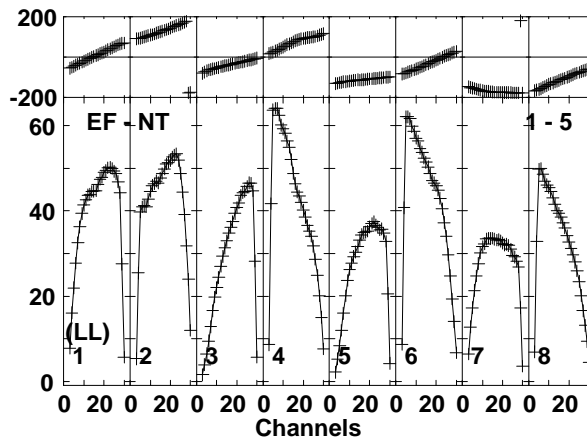
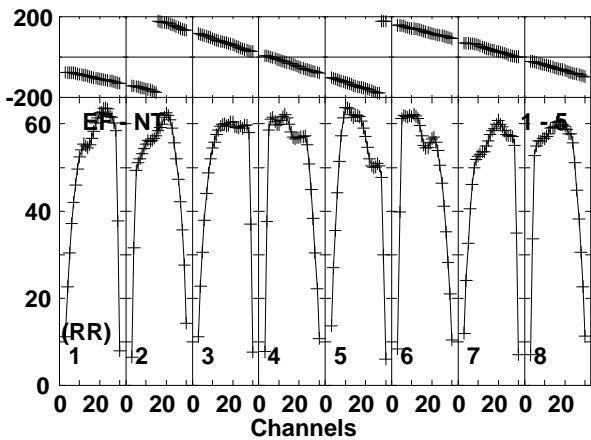
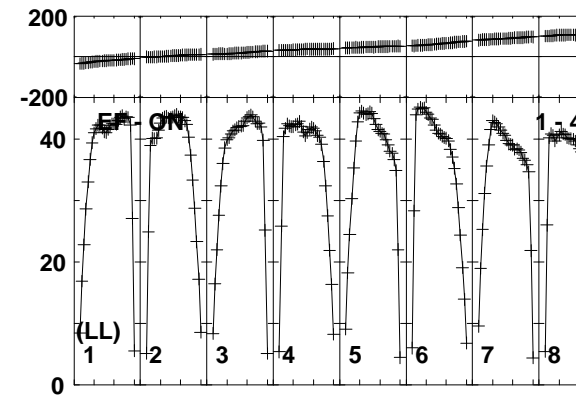
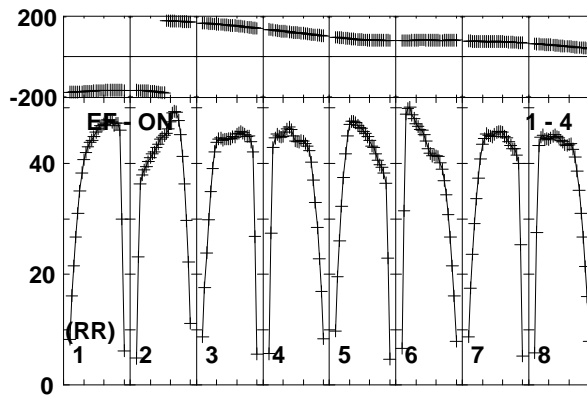
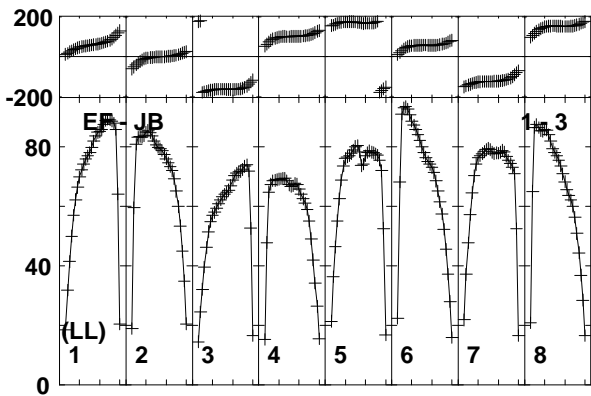
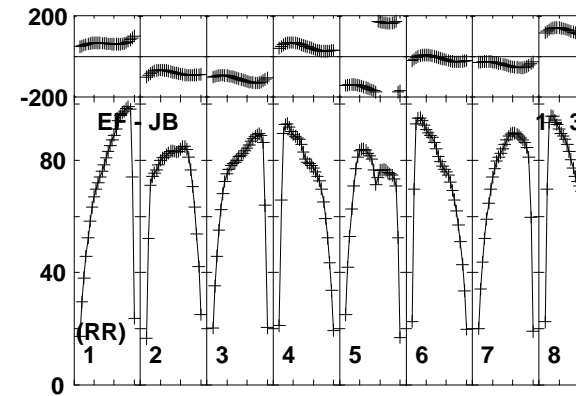
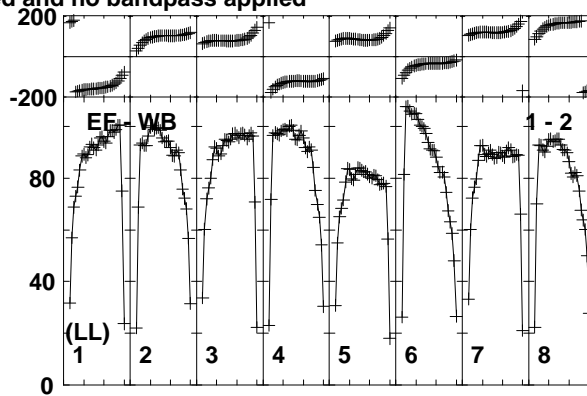
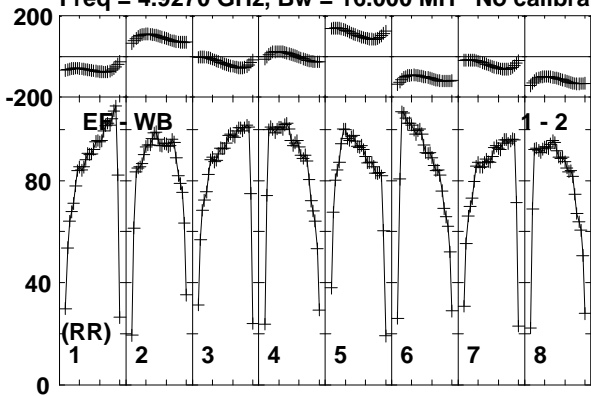

Lower frame: Milli Ampl Jy Top frame: Phas deg
Vector averaged cross-power spectrum Baseline: EF (01) - WB (02)
Timerange: 00:12:33:43 to 00:12:34:39

Plot file version 40 created 28-JAN-2015 14:38:05

3C345 N14C3.UVDATA.1

Freq = 4.9270 GHz, Bw = 16.000 MH No calibration applied and no bandpass applied

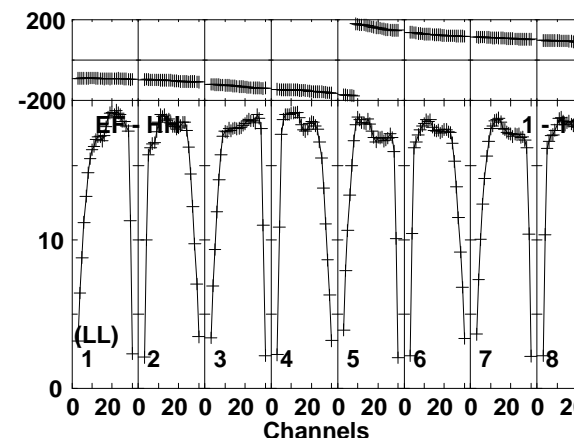
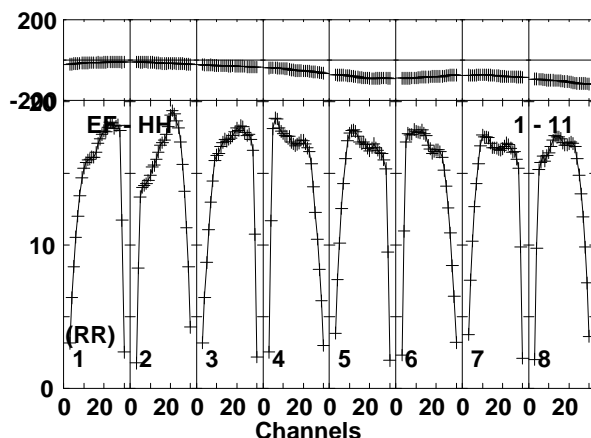
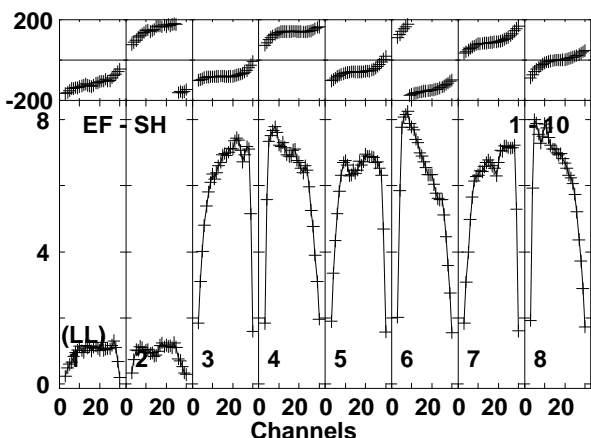
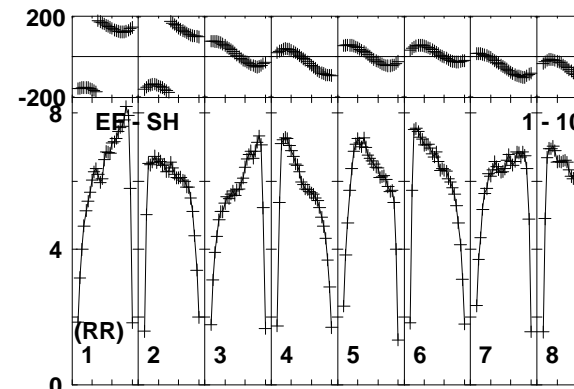
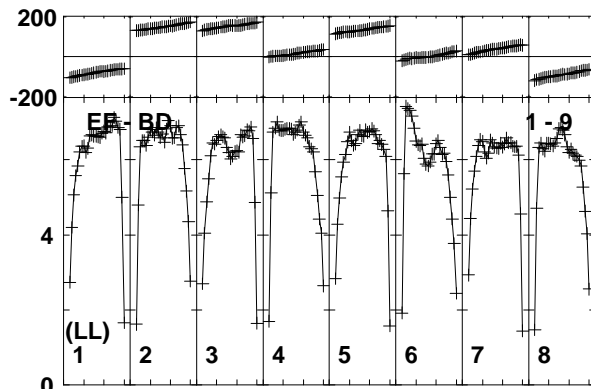
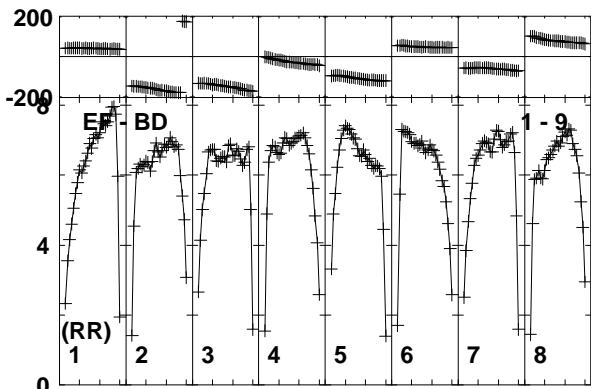
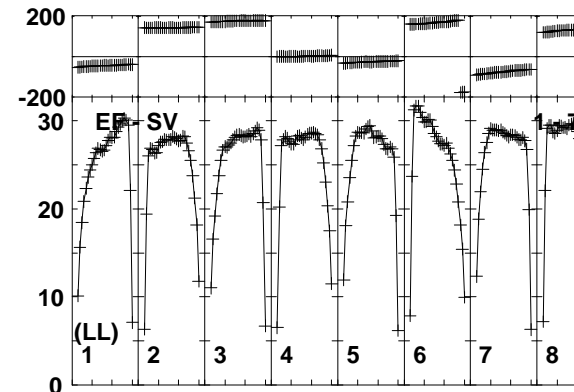
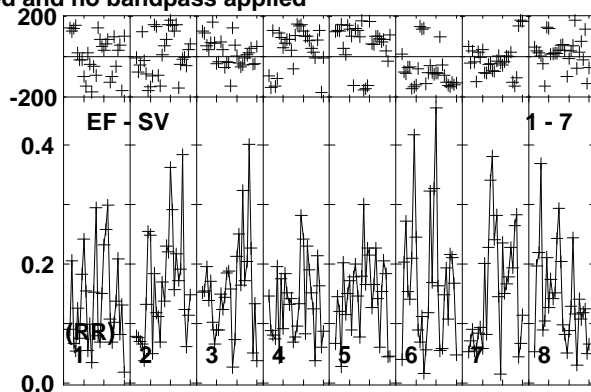
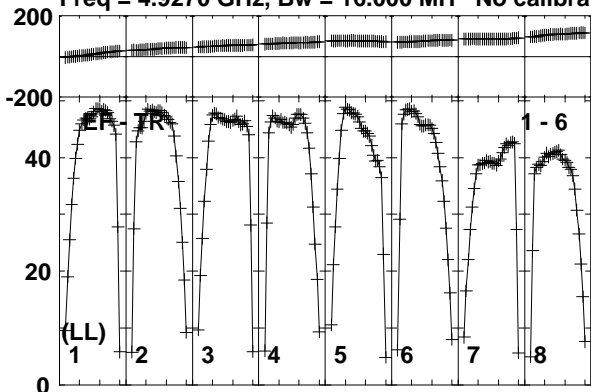

Lower frame: Milli Ampl Jy Top frame: Phas deg
Vector averaged cross-power spectrum Baseline: EF (01) - TR (06)
Timerange: 00:12:33:43 to 00:12:34:39

Plot file version 41 created 28-JAN-2015 14:38:05

3C345 N14C3.UVDATA.1

Freq = 4.9270 GHz, Bw = 16.000 MH No calibration applied and no bandpass applied

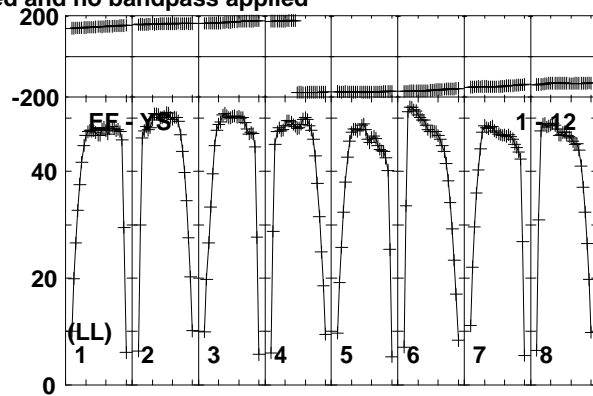
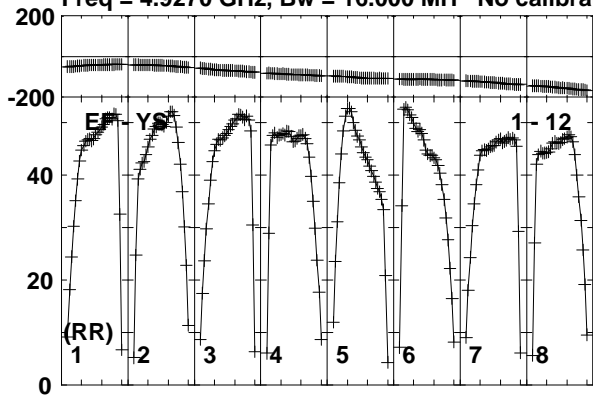

Lower frame: Milli Ampl Jy Top frame: Phas deg
Vector averaged cross-power spectrum Baseline: EF (01) - YS (12)
Timerange: 00/12:33:43 to 00/12:34:39

Plot file version 42 created 28-JAN-2015 14:38:05

J1640+3946 N14C3.UVDATA.1

Freq = 4.9270 GHz, Bw = 16.000 MH No calibration applied and no bandpass applied

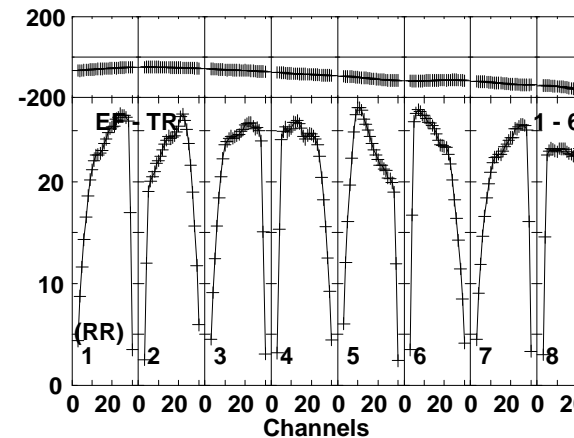
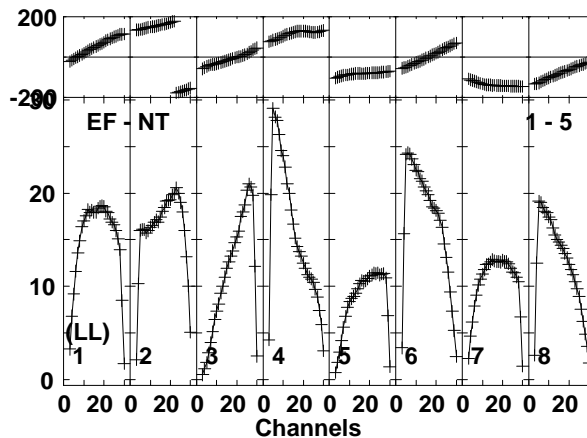
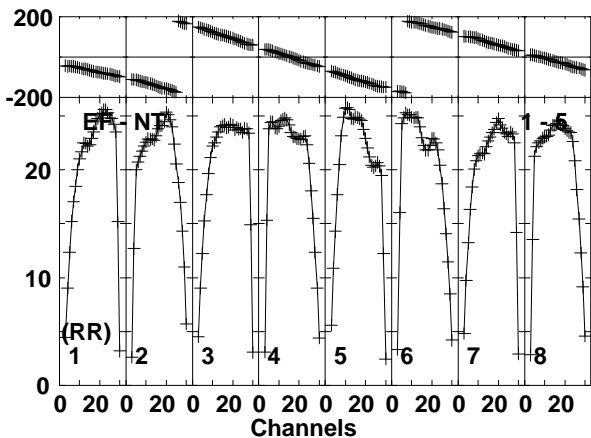
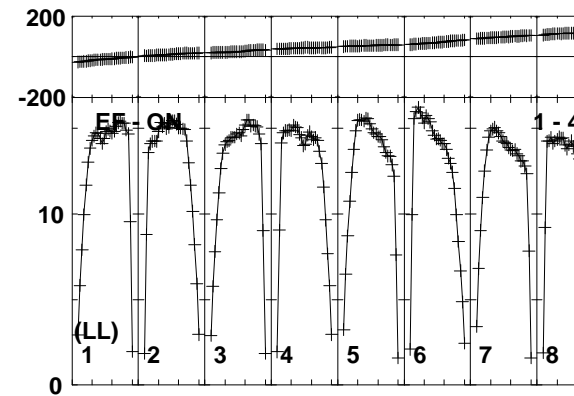
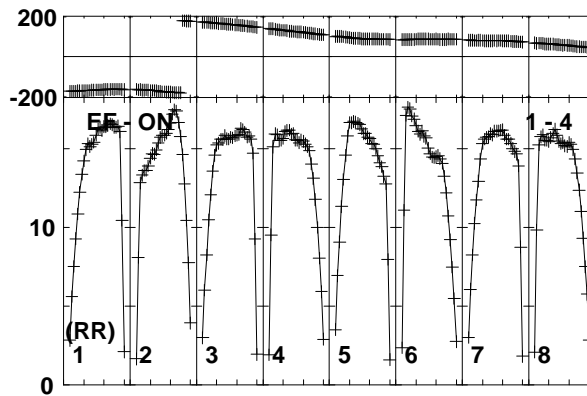
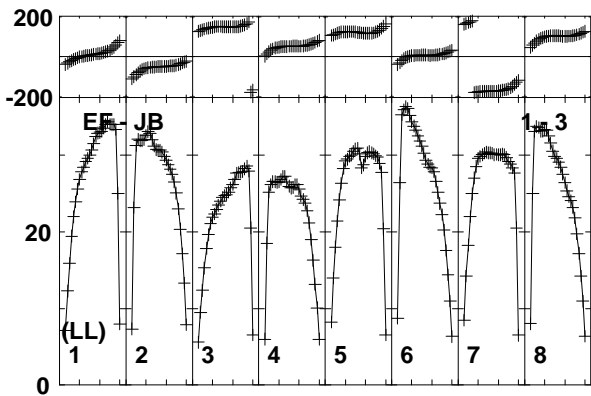
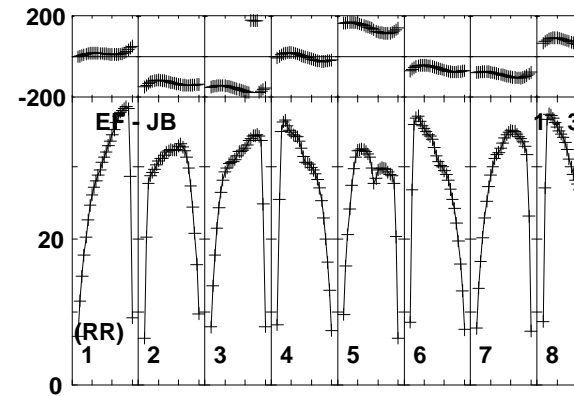
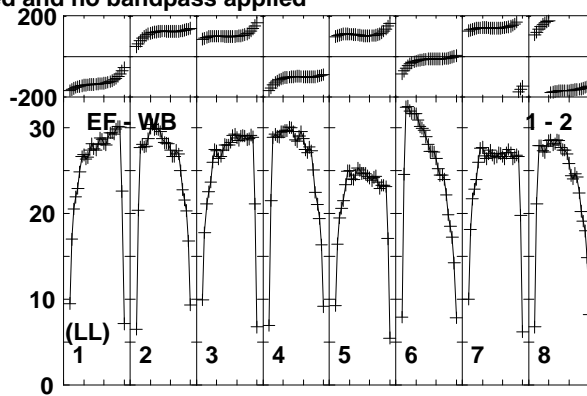
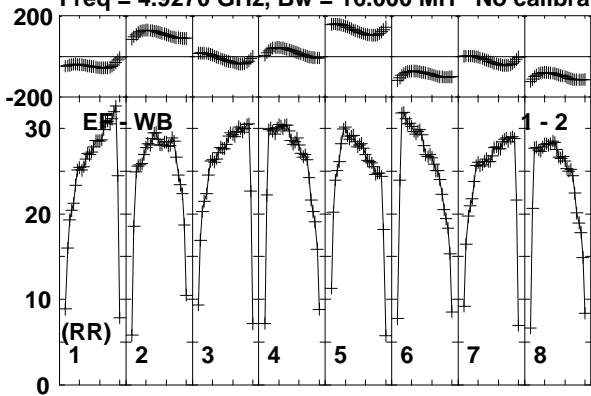

Lower frame: Milli Ampl Jy Top frame: Phas deg
Vector averaged cross-power spectrum Baseline: EF (01) - WB (02)
Timerange: 00:12:35:23 to 00:12:36:19

Plot file version 43 created 28-JAN-2015 14:38:05

J1640+3946 N14C3.UVDATA.1

Freq = 4.9270 GHz, Bw = 16.000 MH No calibration applied and no bandpass applied

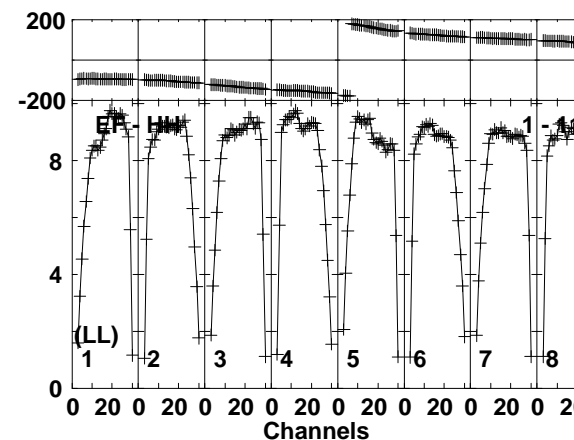
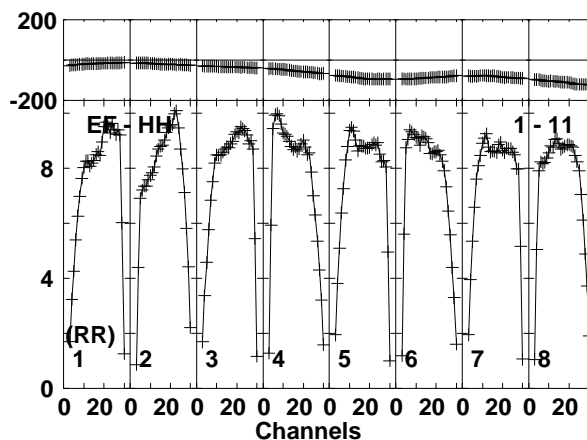
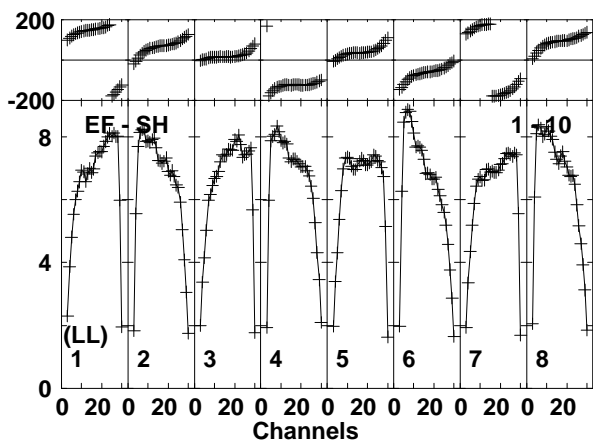
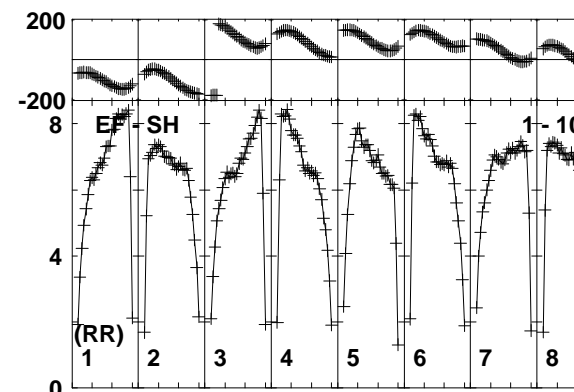
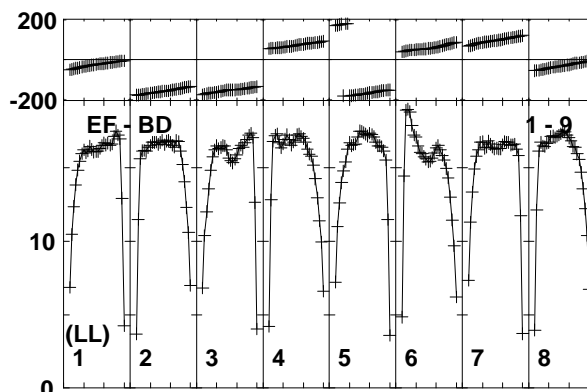
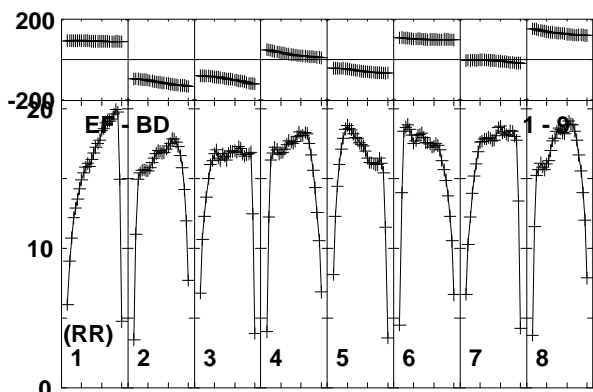
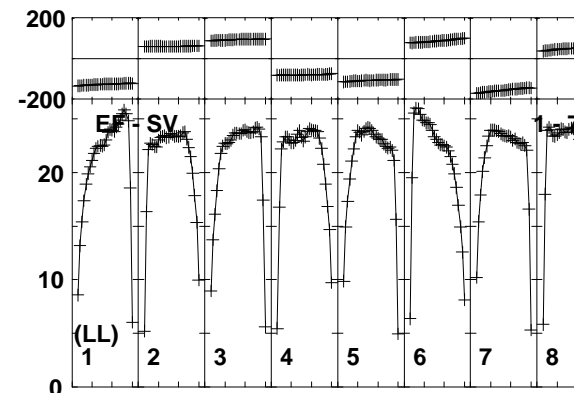
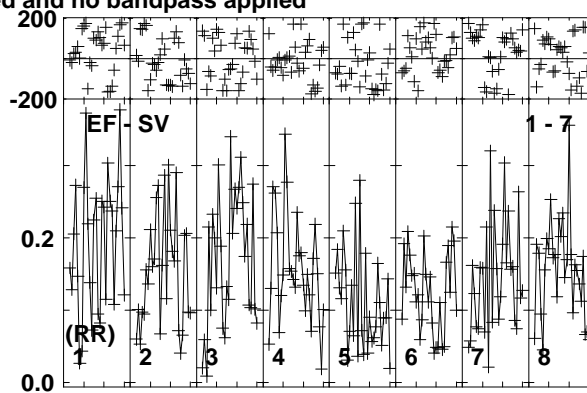
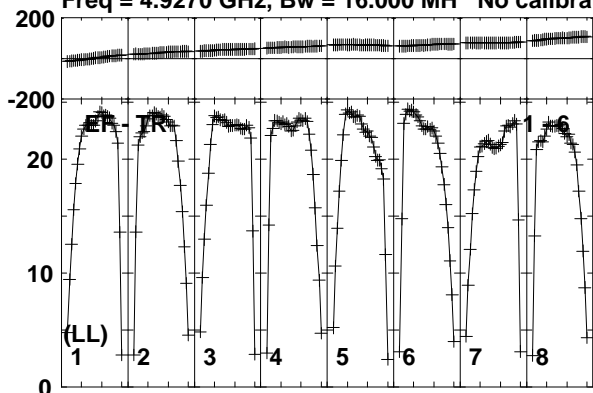

Lower frame: Milli Ampl Jy Top frame: Phas deg
Vector averaged cross-power spectrum Baseline: EF (01) - TR (06)
Timerange: 00:12:35:23 to 00:12:36:19

Plot file version 44 created 28-JAN-2015 14:38:05

J1640+3946 N14C3.UVDATA.1

Freq = 4.9270 GHz, Bw = 16.000 MH No calibration applied and no bandpass applied

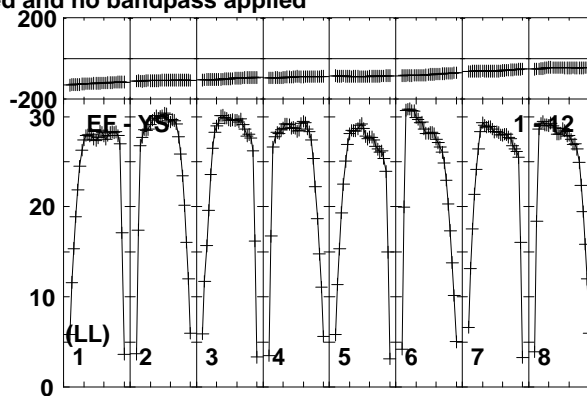
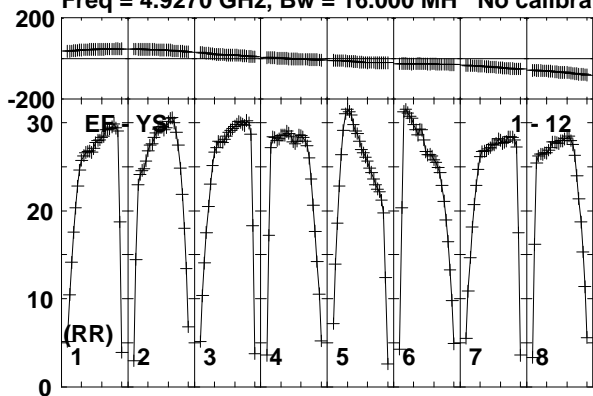

Lower frame: Milli Ampl Jy Top frame: Phas deg
Vector averaged cross-power spectrum Baseline: EF (01) - YS (12)
Timerange: 00/12:35:23 to 00/12:36:19

Plot file version 45 created 28-JAN-2015 14:38:05

3C345 N14C3.UVDATA.1

Freq = 4.9270 GHz, Bw = 16.000 MH No calibration applied and no bandpass applied

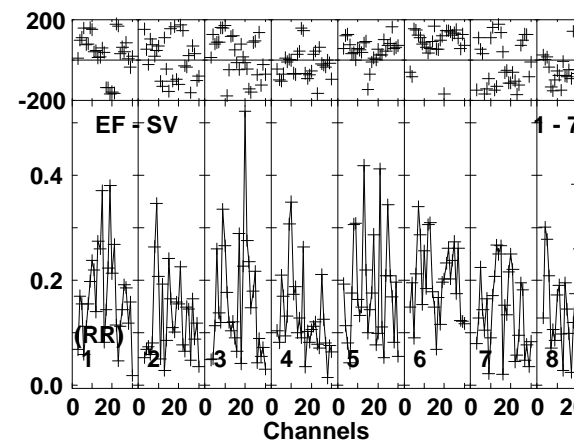
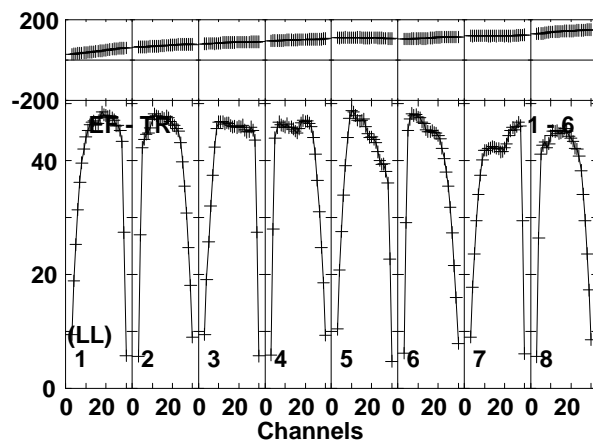
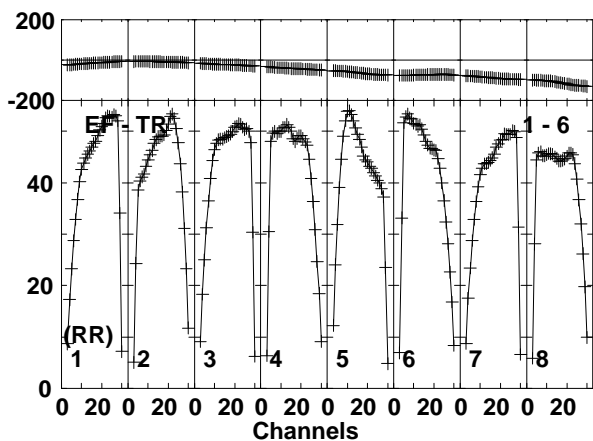
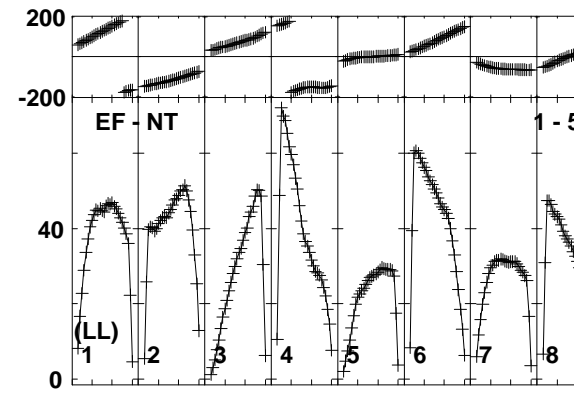
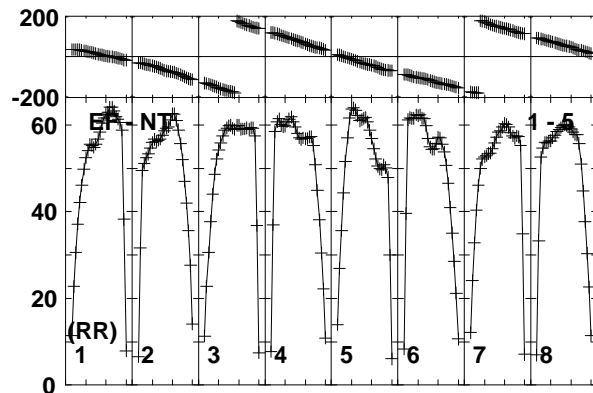
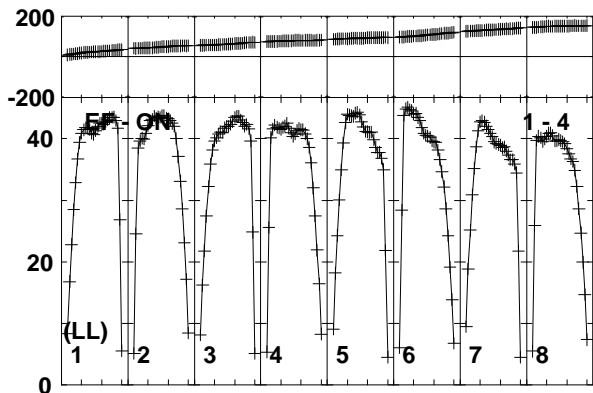
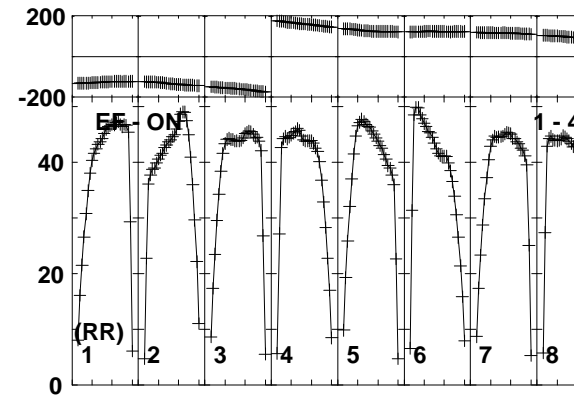
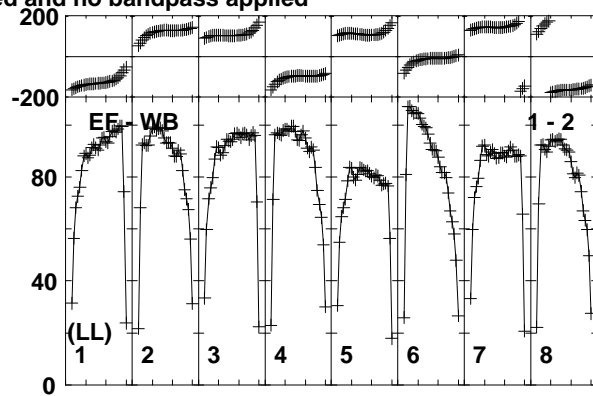
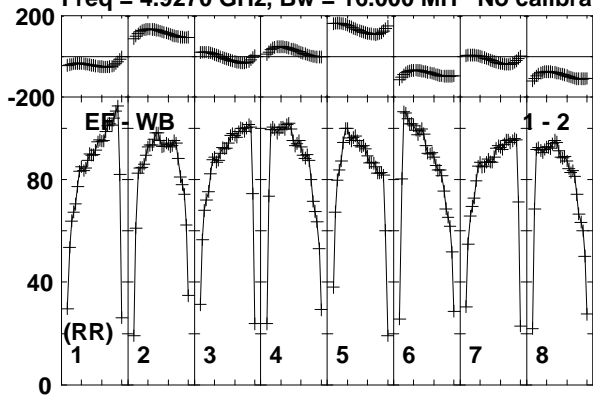

Lower frame: Milli Ampl Jy Top frame: Phas deg
Vector averaged cross-power spectrum Baseline: EF (01) - WB (02)
Timerange: 00:12:37:03 to 00:12:37:59

Plot file version 46 created 28-JAN-2015 14:38:06

3C345 N14C3.UVDATA.1

Freq = 4.9270 GHz, Bw = 16.000 MH No calibration applied and no bandpass applied

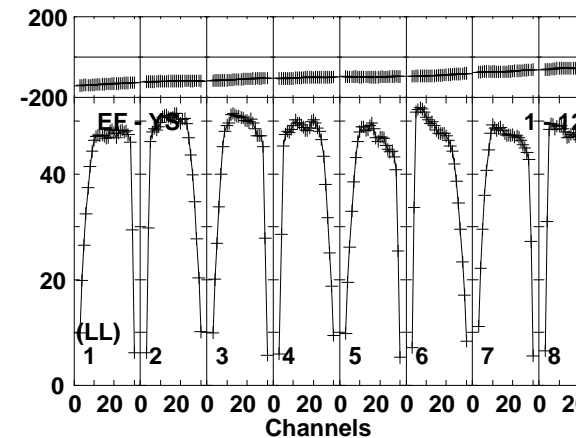
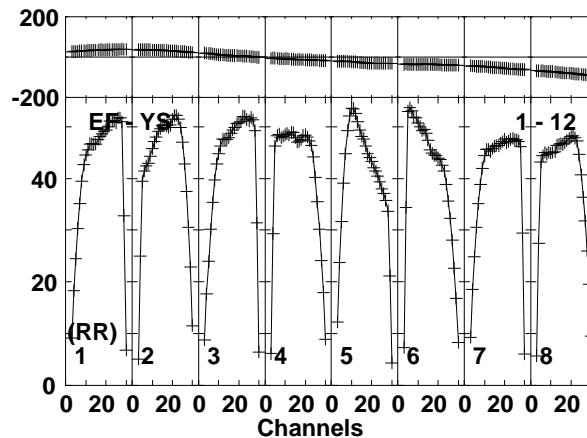
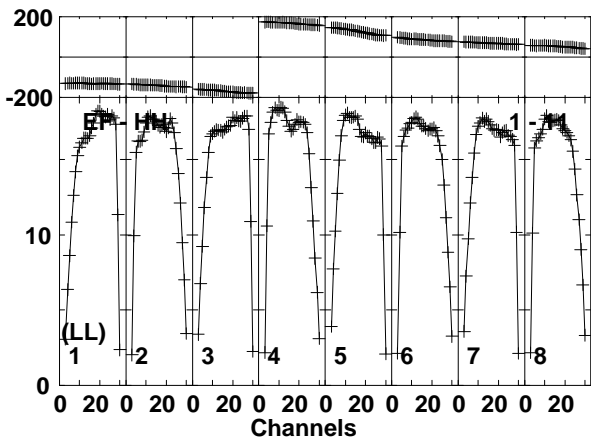
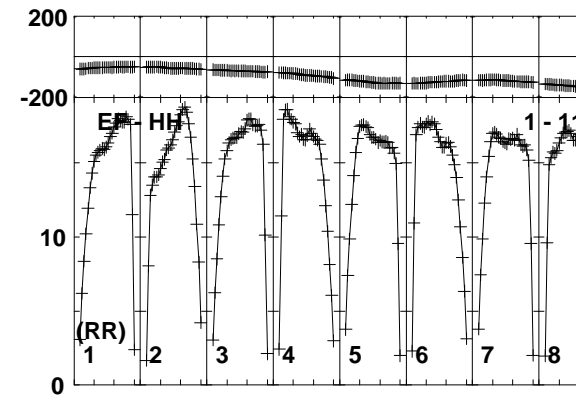
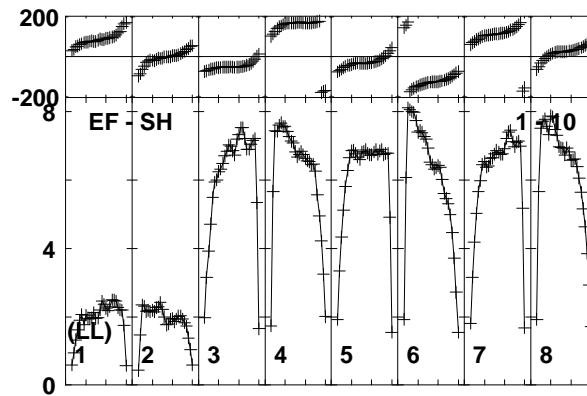
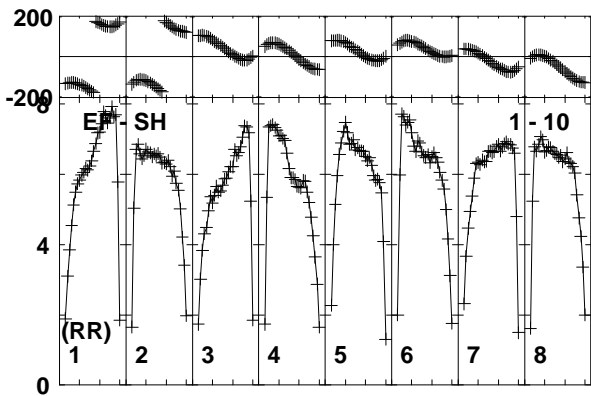
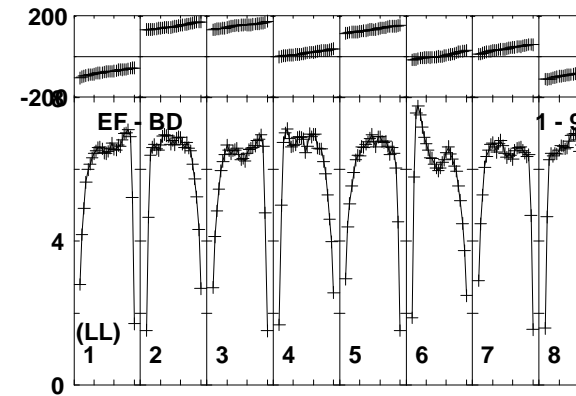
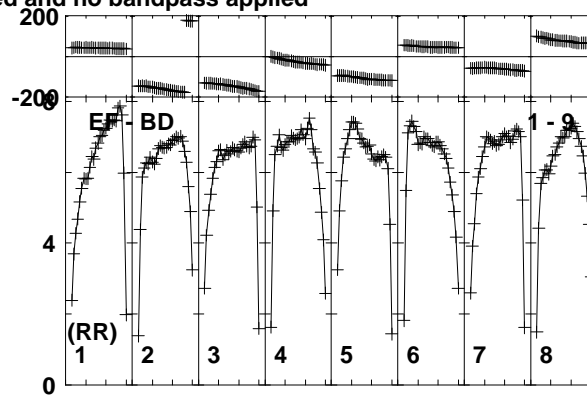
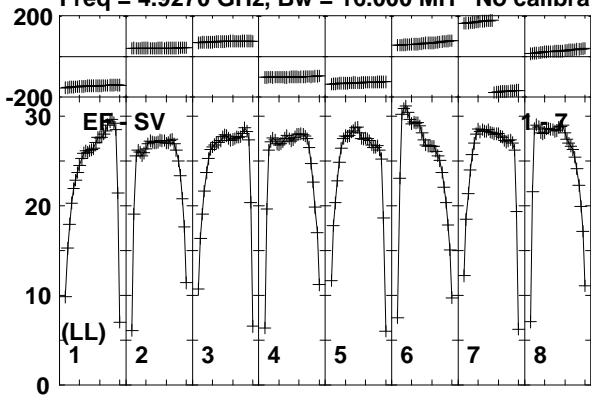

Lower frame: Milli Ampl Jy Top frame: Phas deg
Vector averaged cross-power spectrum Baseline: EF (01) - SV (07)
Timerange: 00:12:37:03 to 00:12:37:59

Plot file version 47 created 28-JAN-2015 14:38:06

J1640+3946 N14C3.UVDATA.1

Freq = 4.9270 GHz, Bw = 16.000 MH No calibration applied and no bandpass applied

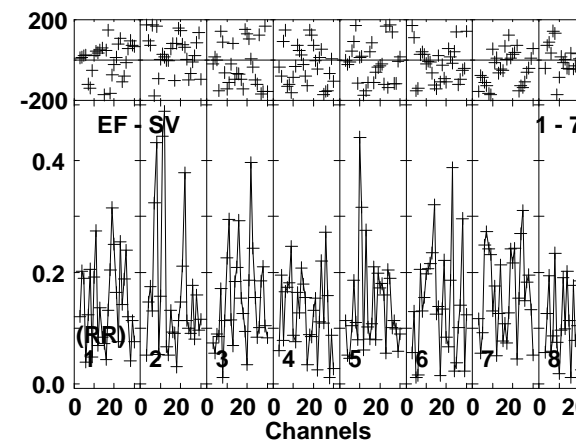
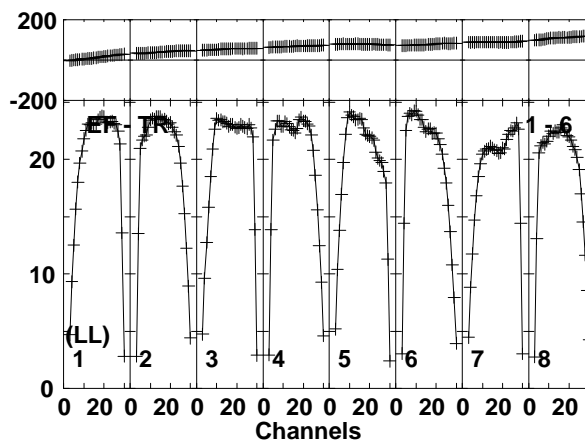
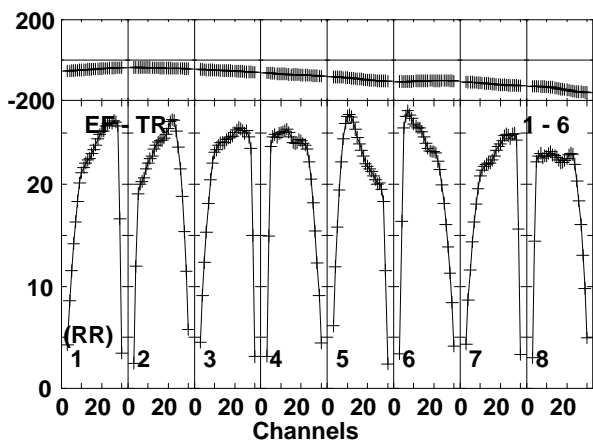
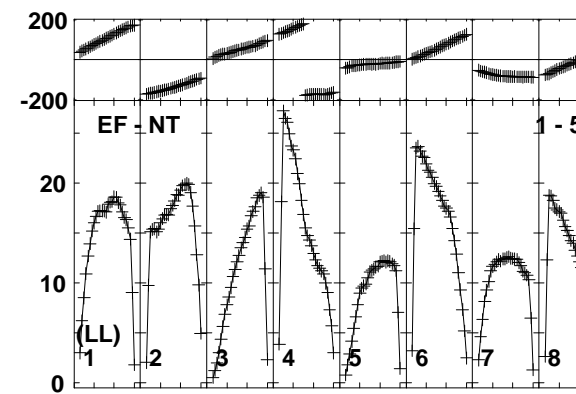
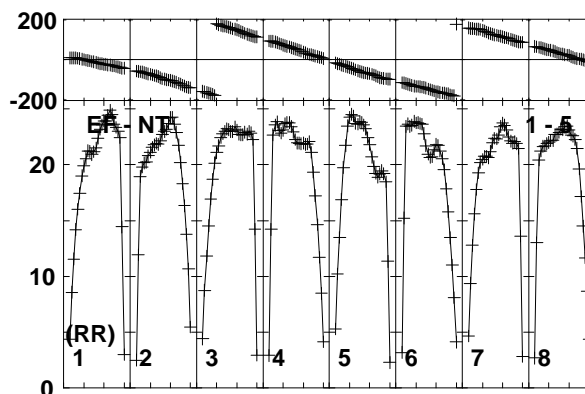
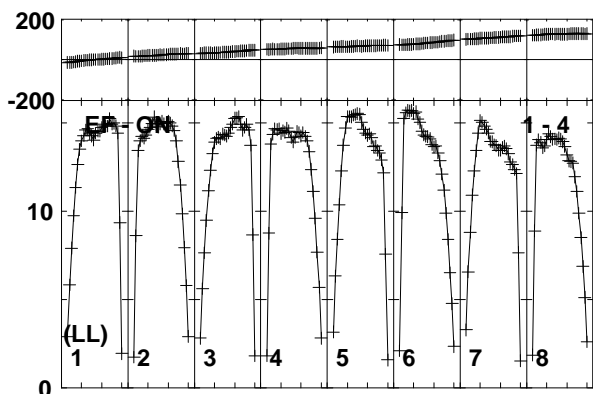
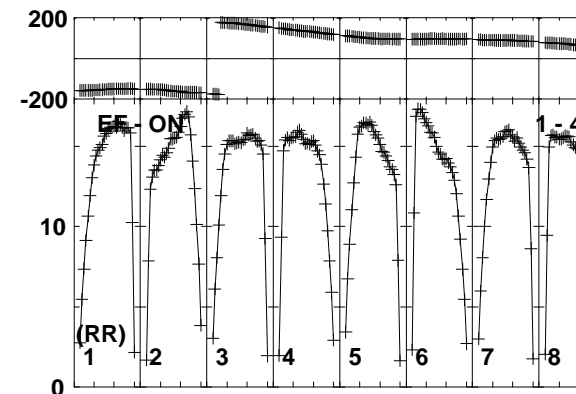
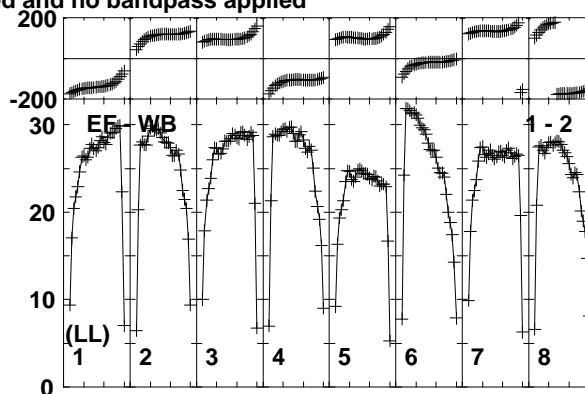
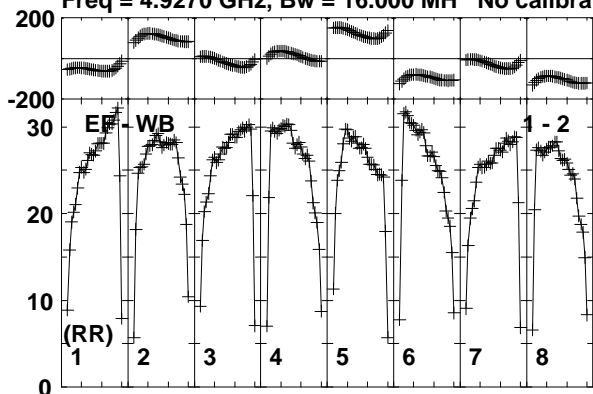

Lower frame: Milli Ampl Jy Top frame: Phas deg
Vector averaged cross-power spectrum Baseline: EF (01) - WB (02)
Timerange: 00/12:38:43 to 00/12:39:39

Plot file version 48 created 28-JAN-2015 14:38:06

J1640+3946 N14C3.UVDATA.1

Freq = 4.9270 GHz, Bw = 16.000 MH No calibration applied and no bandpass applied

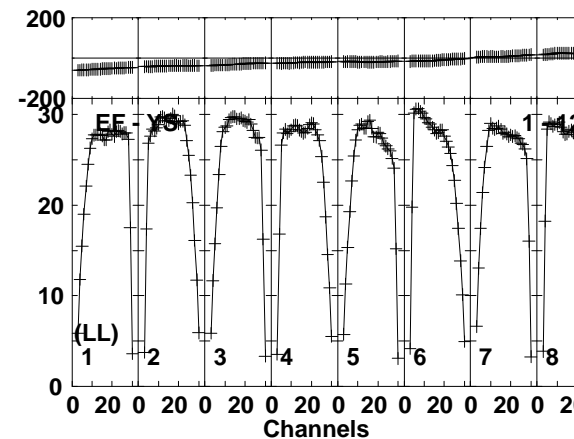
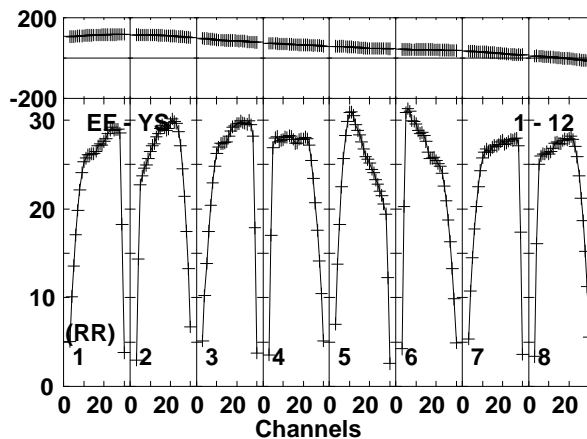
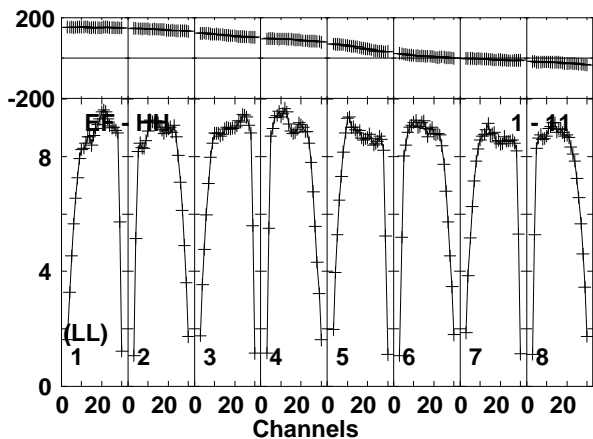
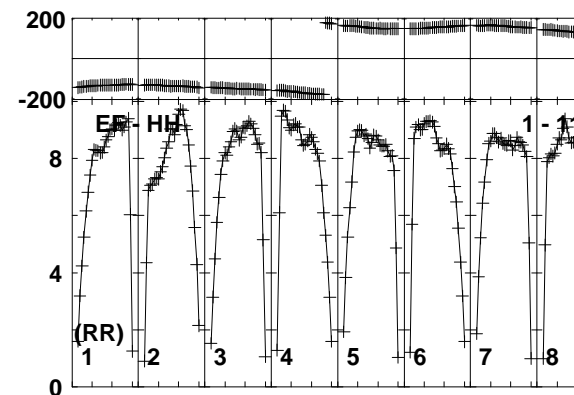
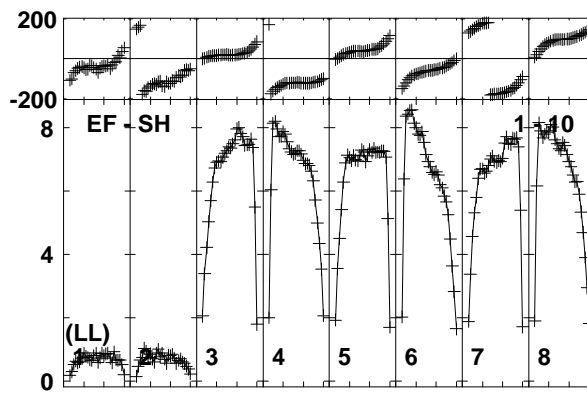
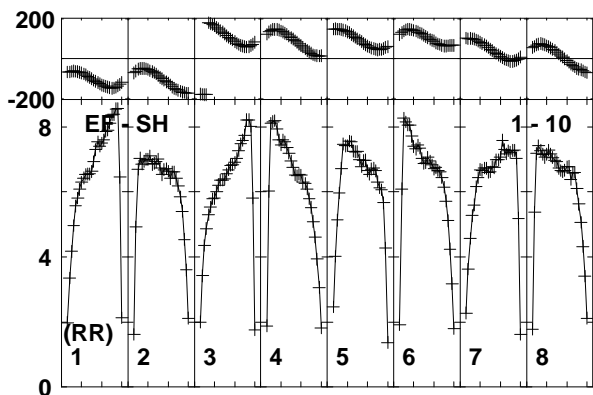
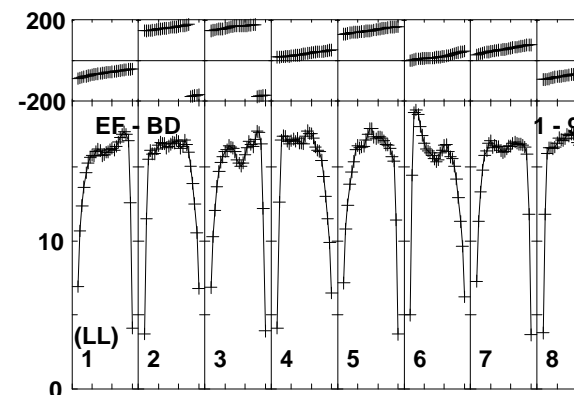
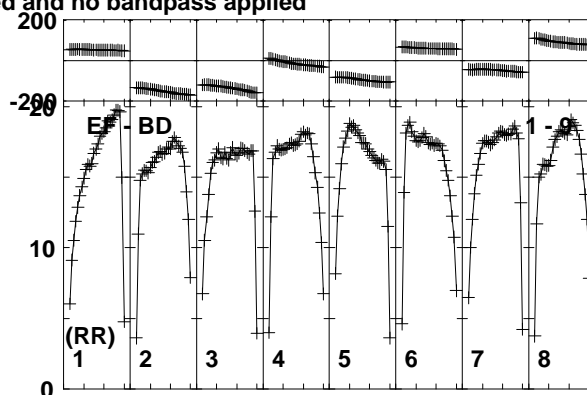
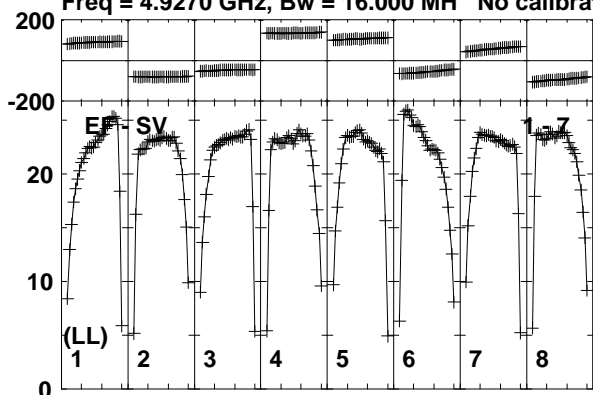

Lower frame: Milli Ampl Jy Top frame: Phas deg
Vector averaged cross-power spectrum Baseline: EF (01) - SV (07)
Timerange: 00:12:38:43 to 00:12:39:39

Plot file version 49 created 28-JAN-2015 14:38:06

3C345 N14C3.UVDATA.1

Freq = 4.9270 GHz, Bw = 16.000 MH No calibration applied and no bandpass applied

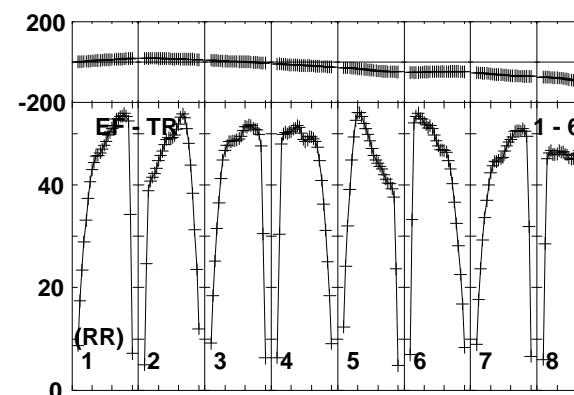
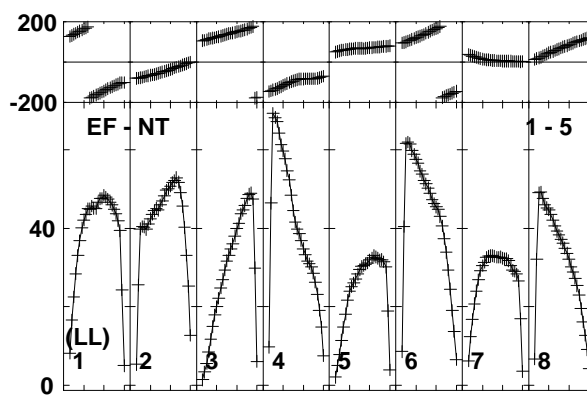
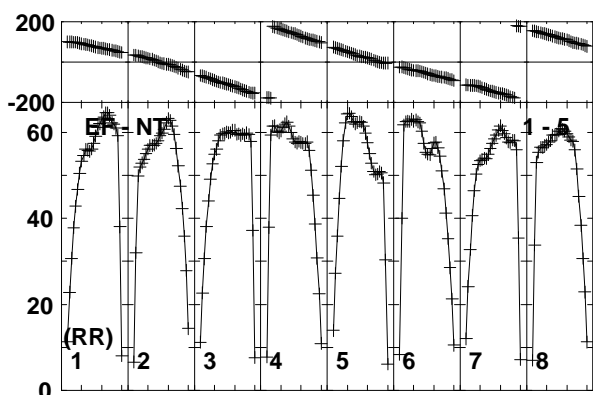
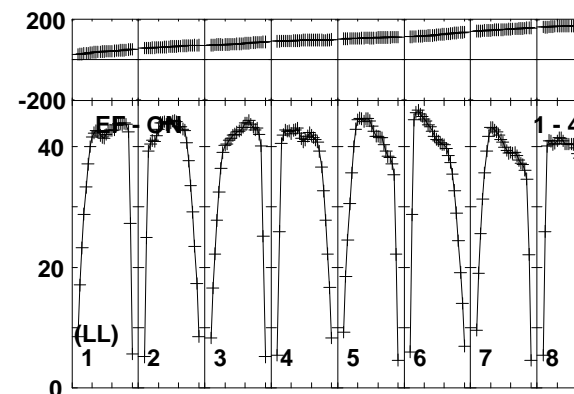
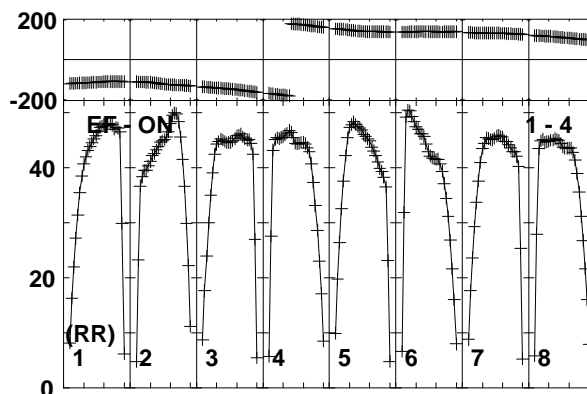
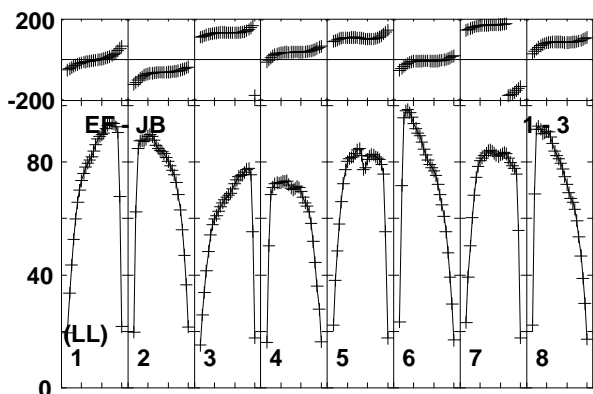
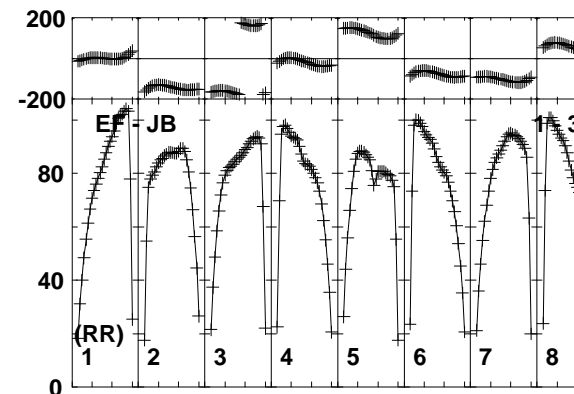
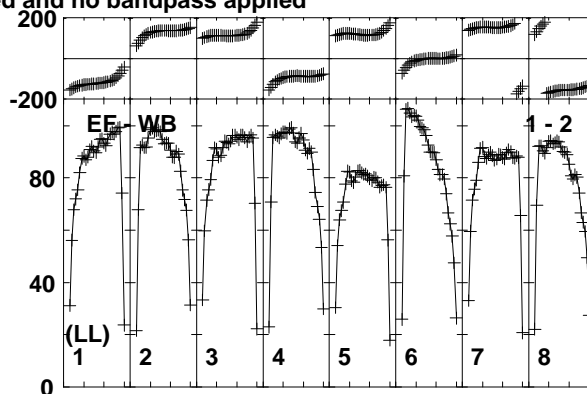
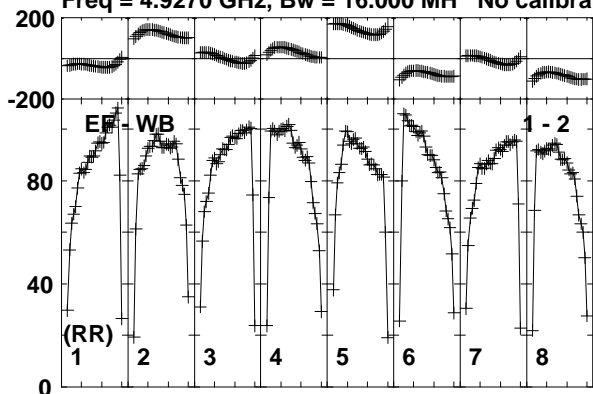

Lower frame: Milli Ampl Jy Top frame: Phas deg
Vector averaged cross-power spectrum Baseline: EF (01) - WB (02)
Timerange: 00:12:40:23 to 00:12:41:19

Plot file version 50 created 28-JAN-2015 14:38:06

3C345 N14C3.UVDATA.1

Freq = 4.9270 GHz, Bw = 16.000 MH No calibration applied and no bandpass applied

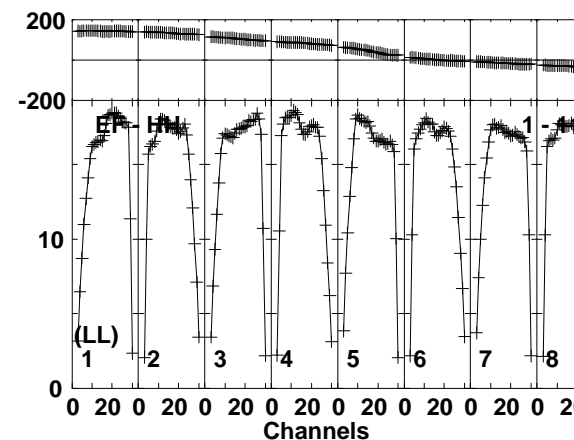
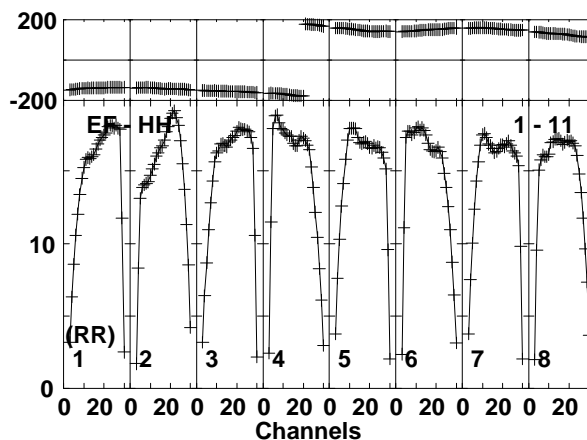
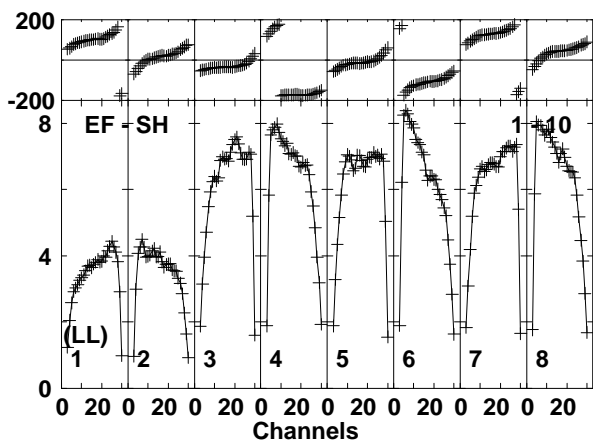
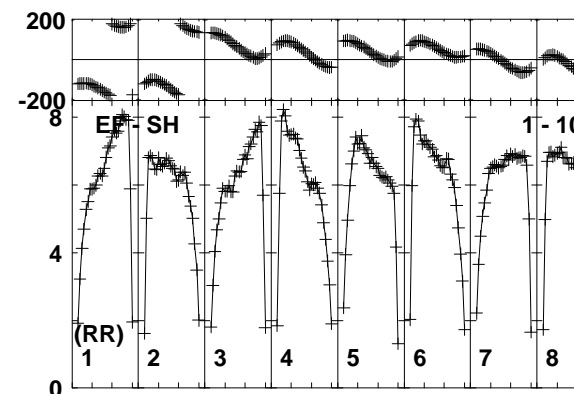
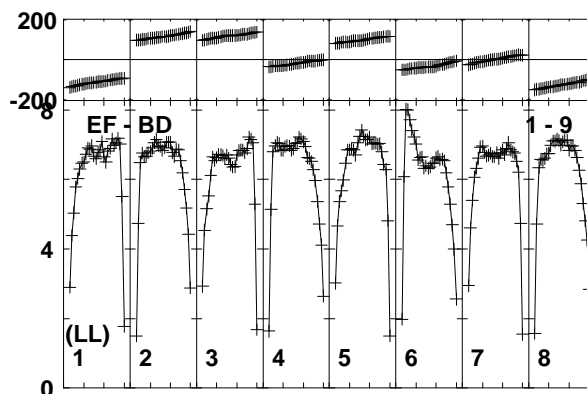
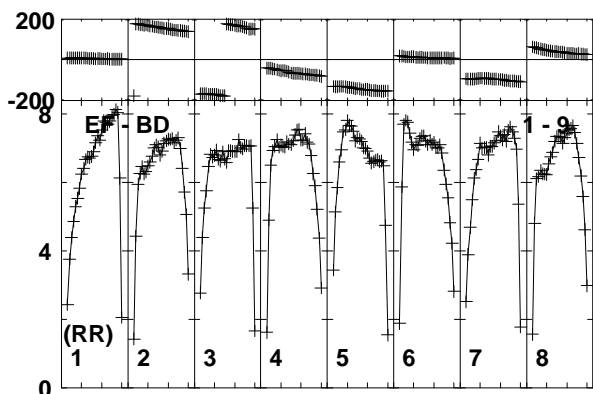
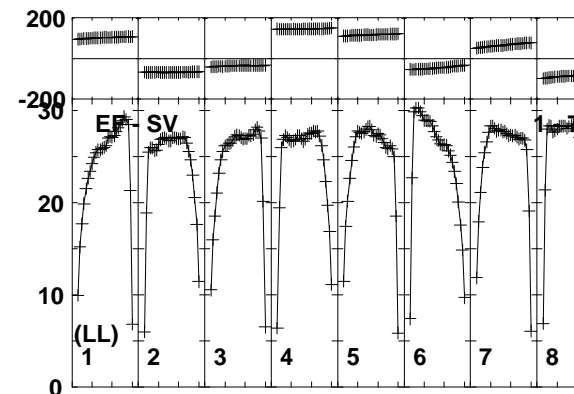
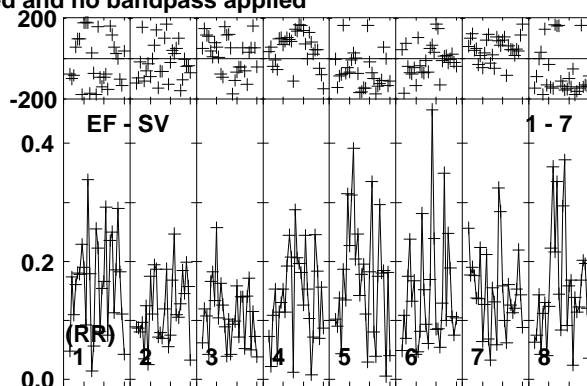
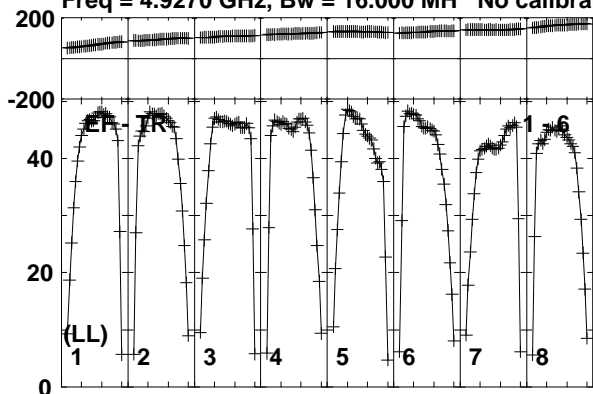

Lower frame: Milli Ampl Jy Top frame: Phas deg
Vector averaged cross-power spectrum Baseline: EF (01) - TR (06)
Timerange: 00:12:40:23 to 00:12:41:19

Plot file version 51 created 28-JAN-2015 14:38:06

3C345 N14C3.UVDATA.1

Freq = 4.9270 GHz, Bw = 16.000 MH No calibration applied and no bandpass applied

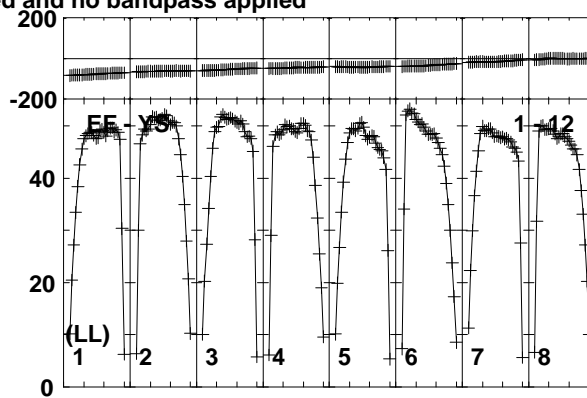
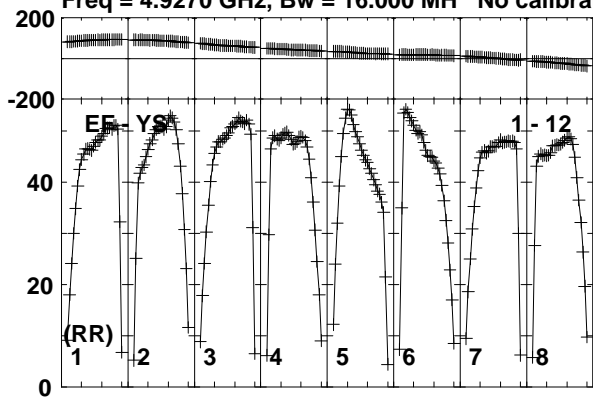

Lower frame: Milli Ampl Jy Top frame: Phas deg
Vector averaged cross-power spectrum Baseline: EF (01) - YS (12)
Timerange: 00/12:40:23 to 00/12:41:19

Plot file version 52 created 28-JAN-2015 14:38:06

J1640+3946 N14C3.UVDATA.1

Freq = 4.9270 GHz, Bw = 16.000 MH No calibration applied and no bandpass applied

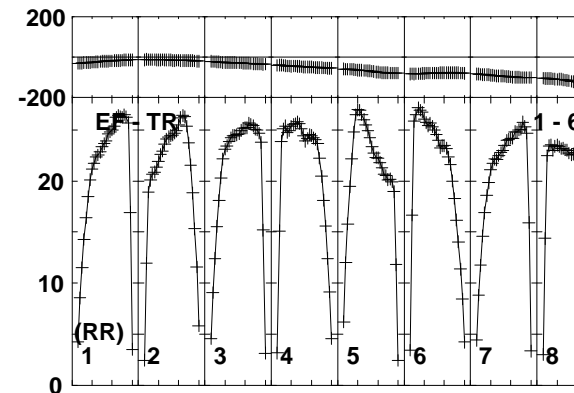
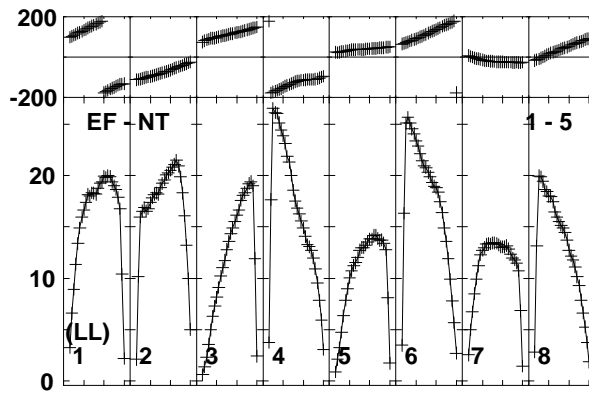
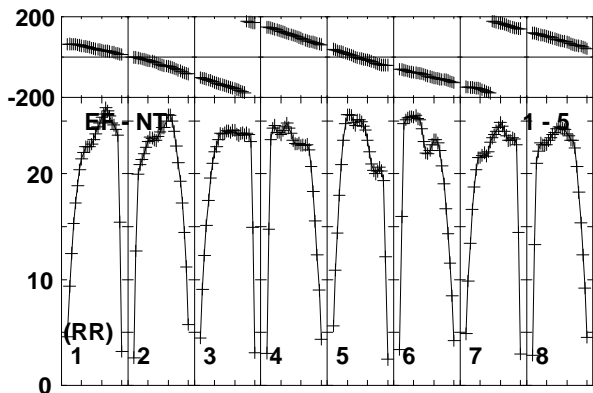
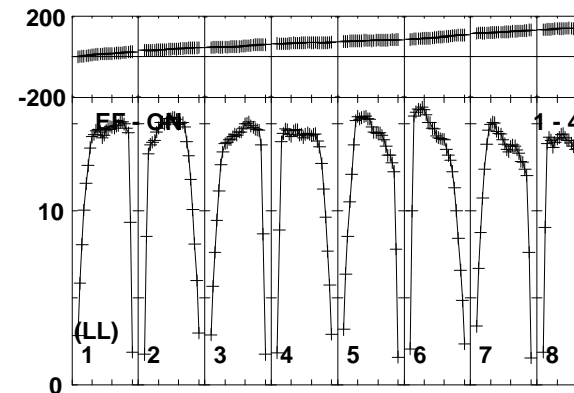
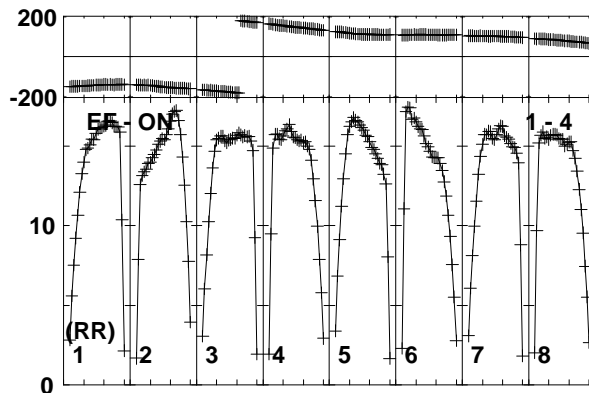
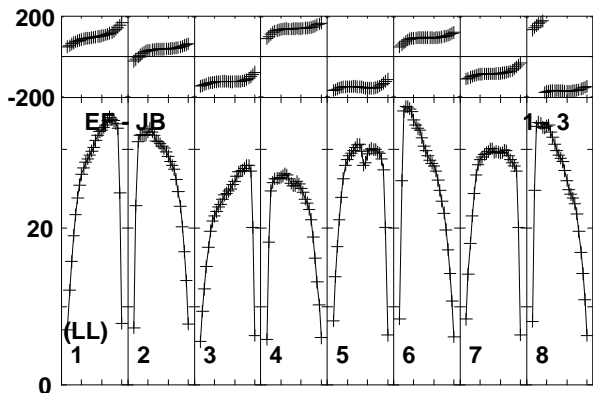
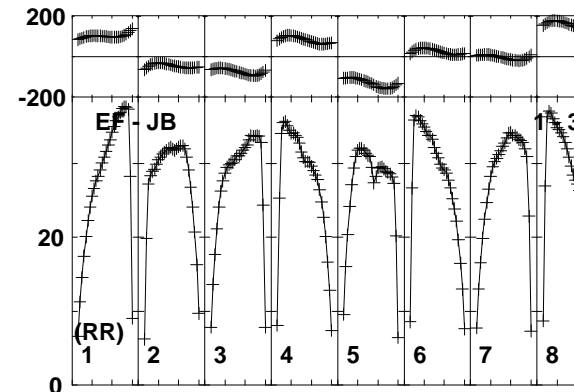
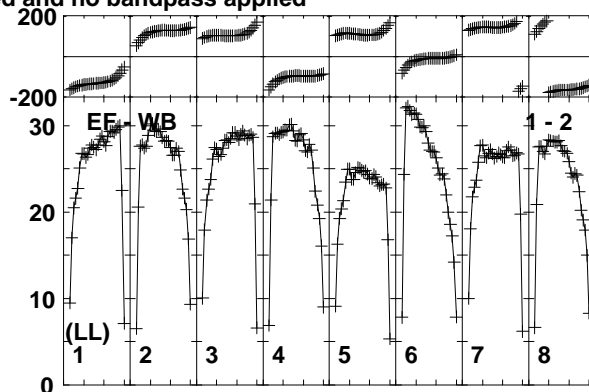
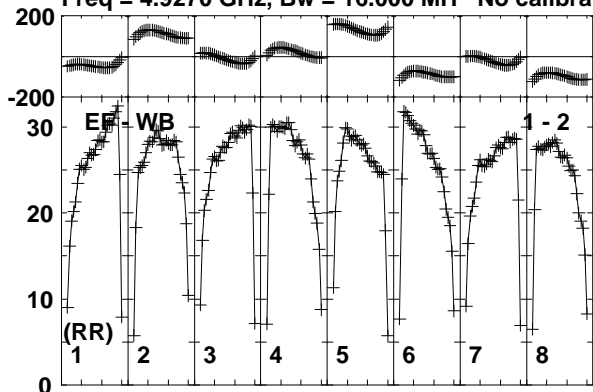

Lower frame: Milli Ampl Jy Top frame: Phas deg
Vector averaged cross-power spectrum Baseline: EF (01) - WB (02)
Timerange: 00/12:42:03 to 00/12:42:59

Plot file version 53 created 28-JAN-2015 14:38:06

J1640+3946 N14C3.UVDATA.1

Freq = 4.9270 GHz, Bw = 16.000 MH No calibration applied and no bandpass applied

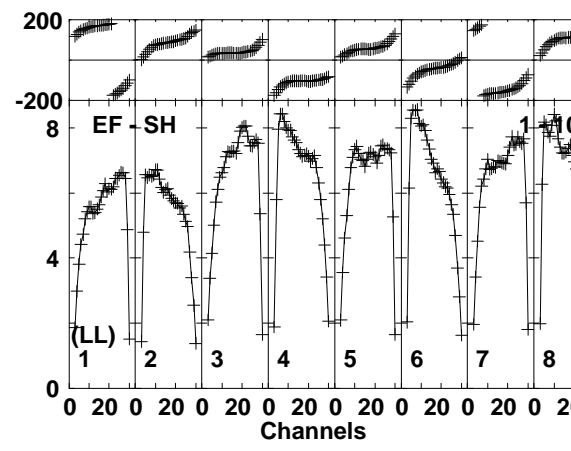
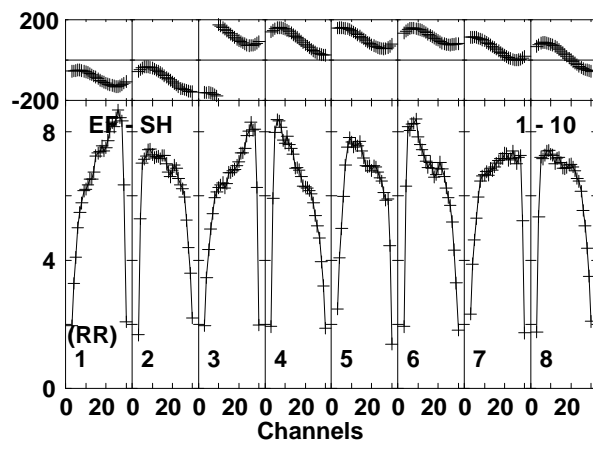
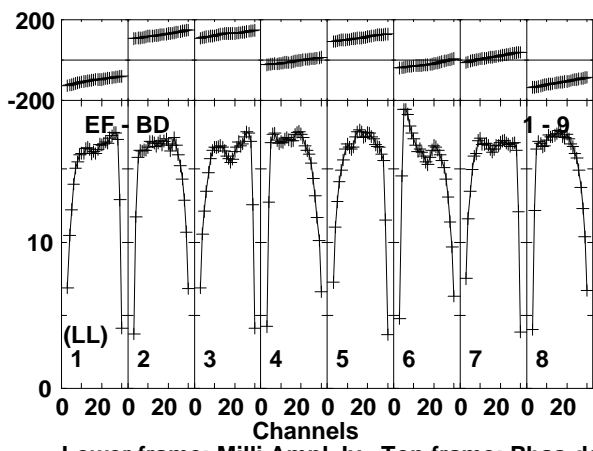
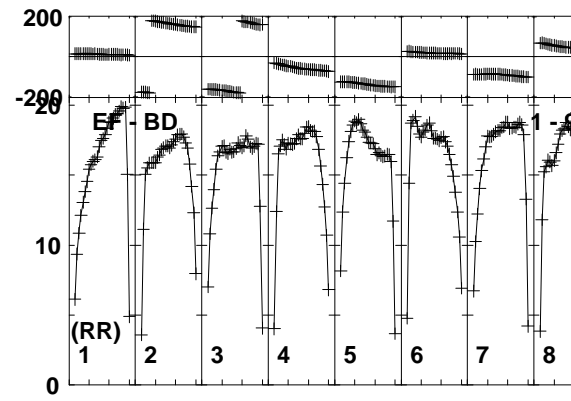
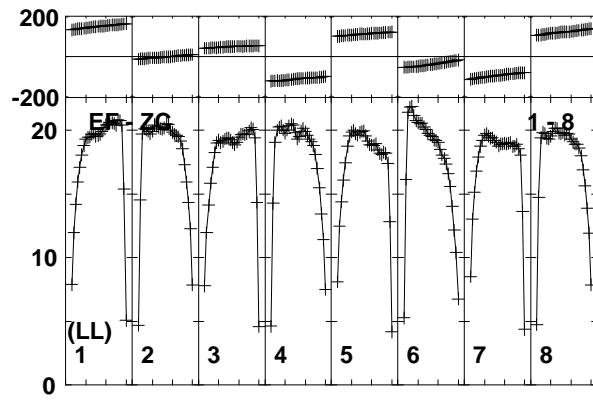
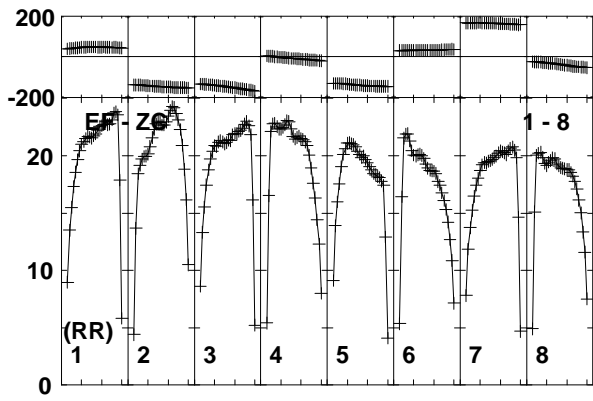
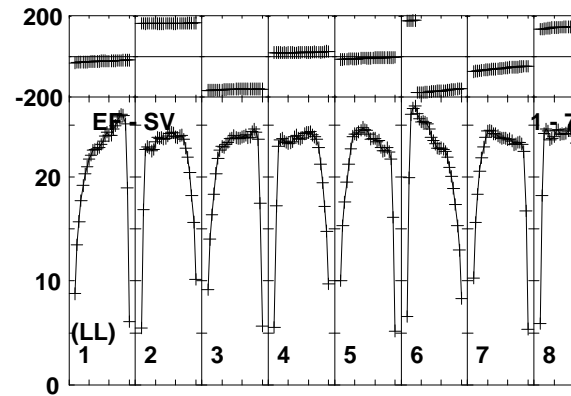
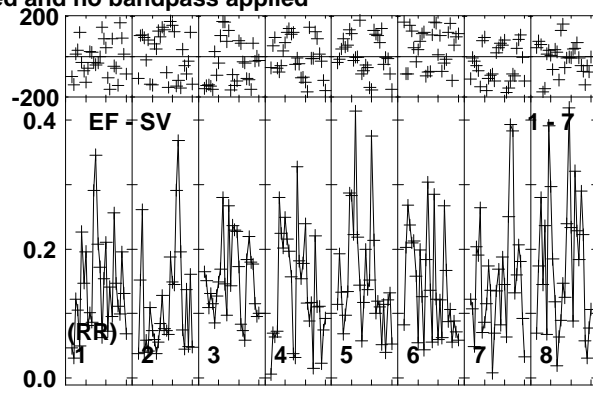
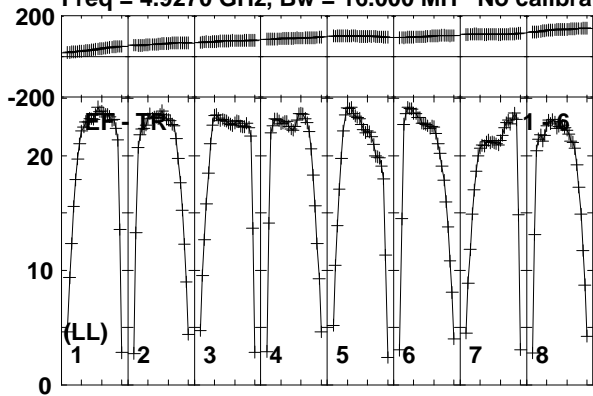

Lower frame: Milli Ampl Jy Top frame: Phas deg
Vector averaged cross-power spectrum Baseline: EF (01) - TR (06)
Timerange: 00:12:42:03 to 00:12:42:59

Plot file version 54 created 28-JAN-2015 14:38:06

J1640+3946 N14C3.UVDATA.1

Freq = 4.9270 GHz, Bw = 16.000 MH No calibration applied and no bandpass applied

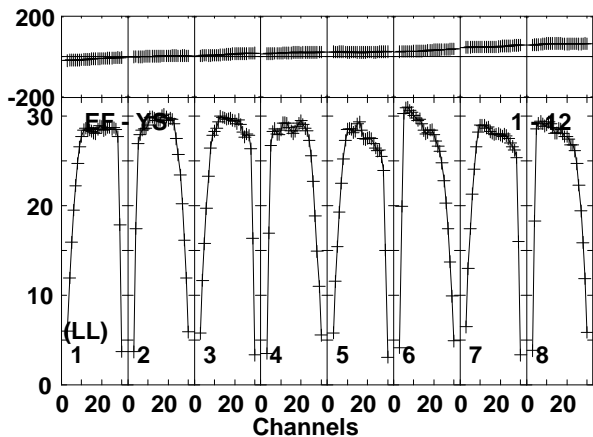
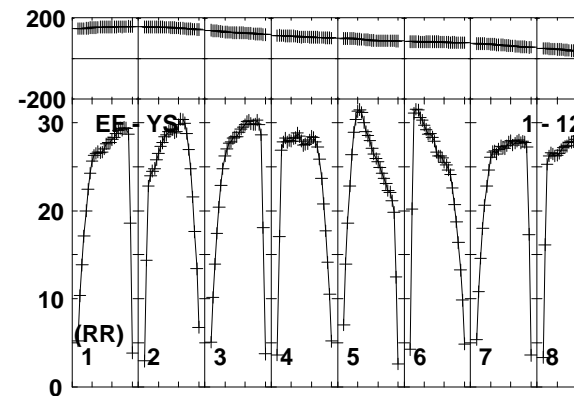
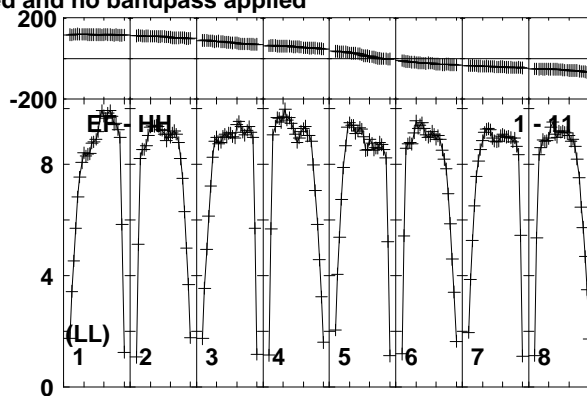
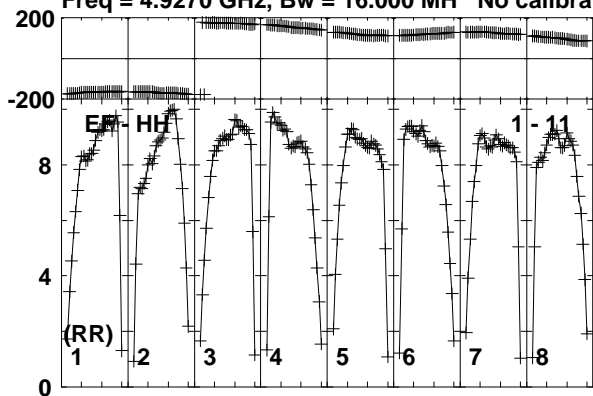

Lower frame: Milli Ampl Jy Top frame: Phas deg
Vector averaged cross-power spectrum Baseline: EF (01) - HH (11)
Timerange: 00/12:42:03 to 00/12:42:59

Plot file version 55 created 28-JAN-2015 14:38:06

3C345 N14C3.UVDATA.1

Freq = 4.9270 GHz, Bw = 16.000 MH No calibration applied and no bandpass applied

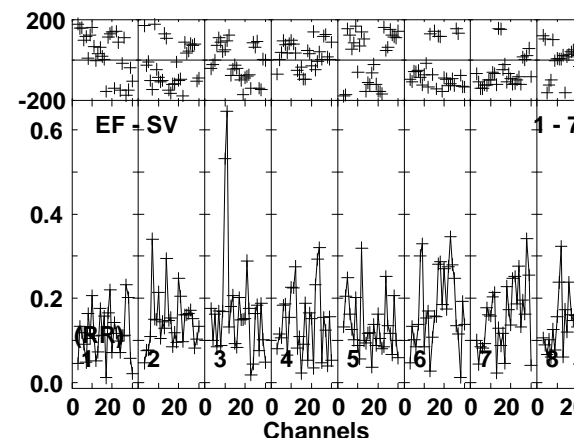
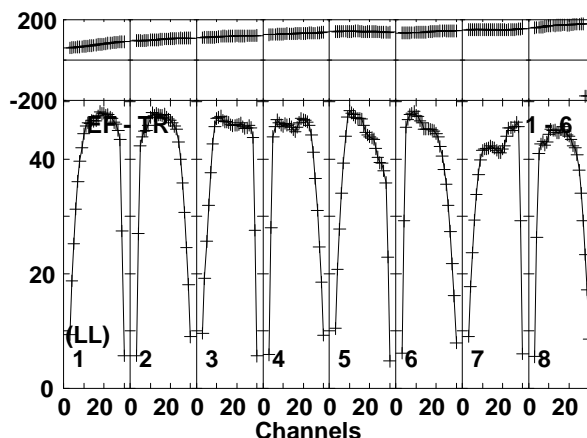
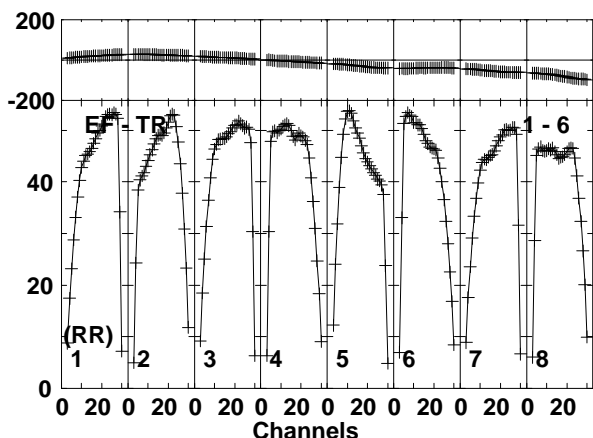
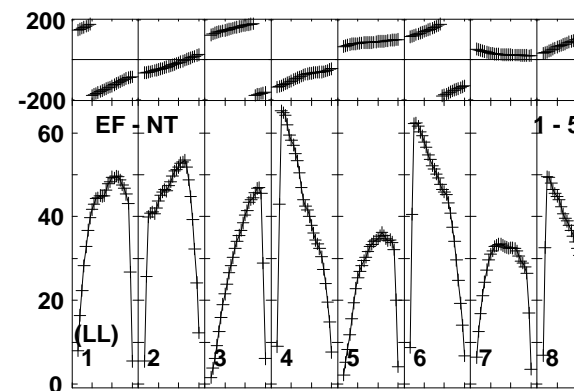
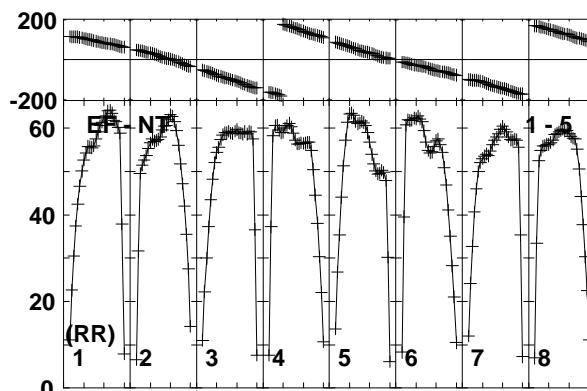
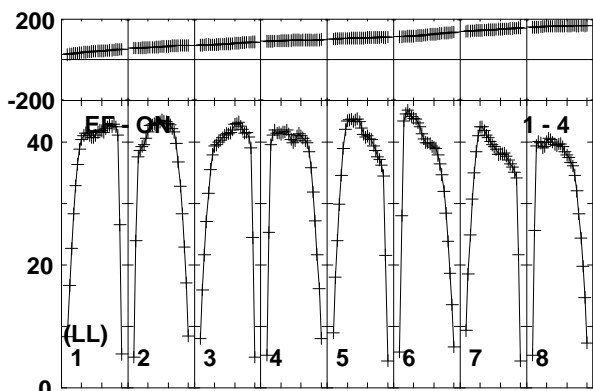
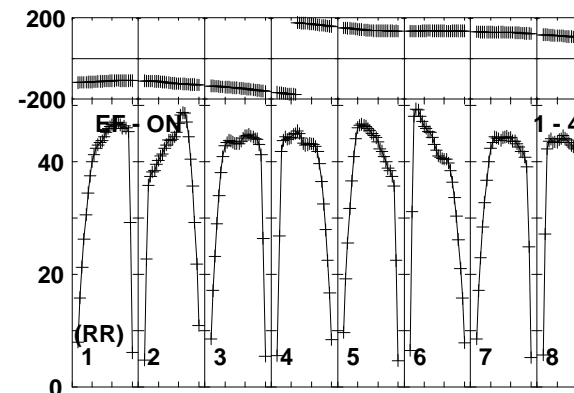
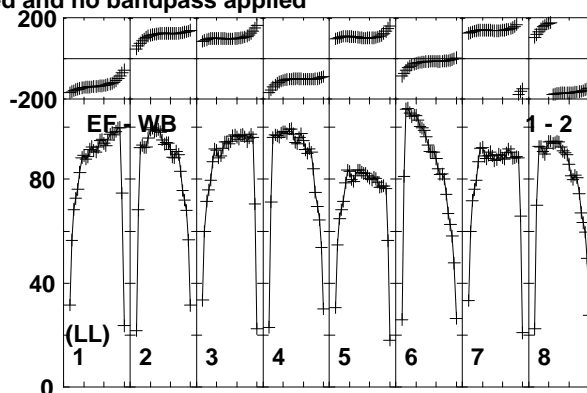
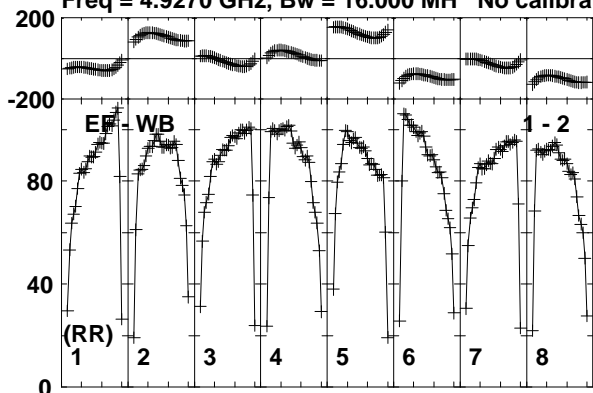

Lower frame: Milli Ampl Jy Top frame: Phas deg
Vector averaged cross-power spectrum Baseline: EF (01) - WB (02)
Timerange: 00/12:43:43 to 00/12:44:39

Plot file version 56 created 28-JAN-2015 14:38:06

3C345 N14C3.UVDATA.1

Freq = 4.9270 GHz, Bw = 16.000 MH No calibration applied and no bandpass applied

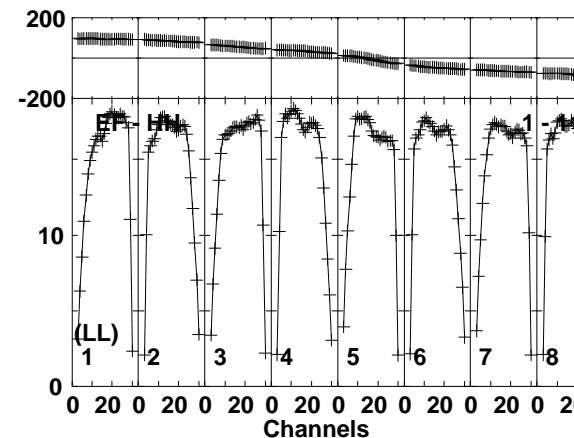
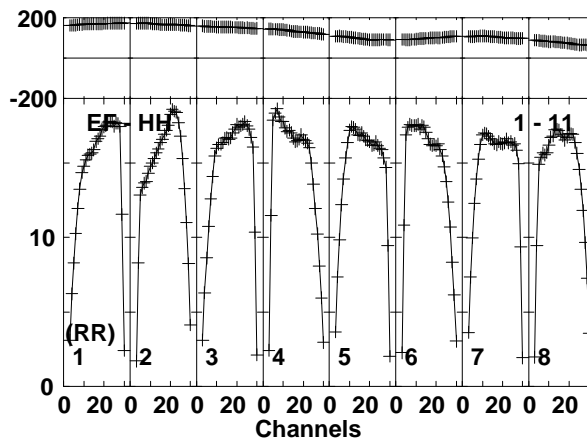
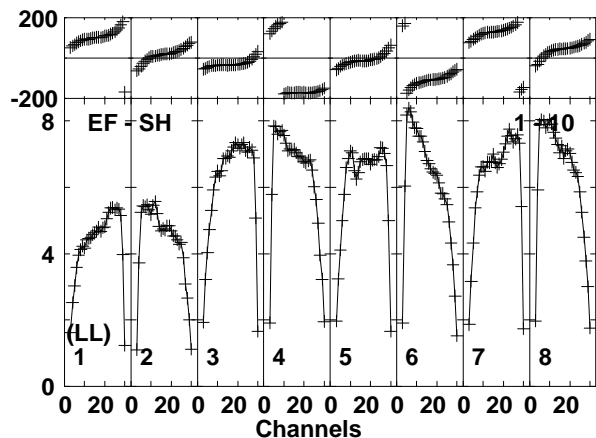
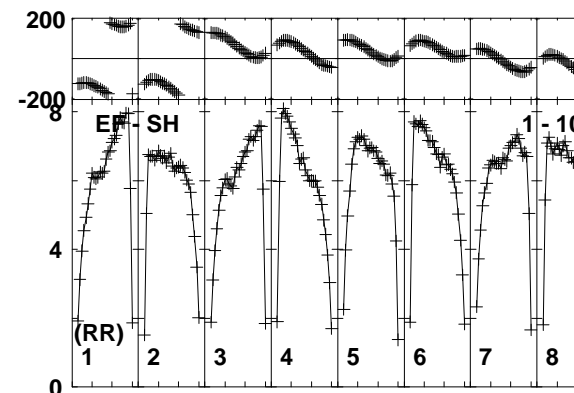
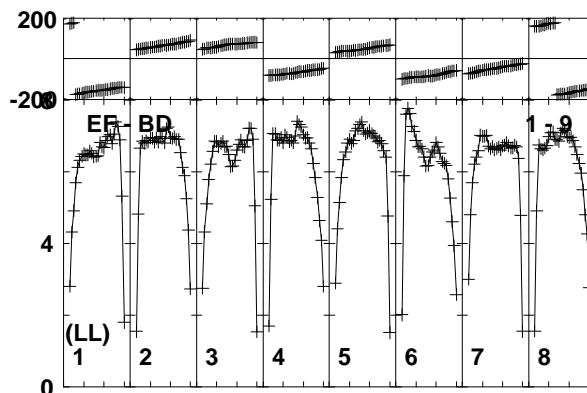
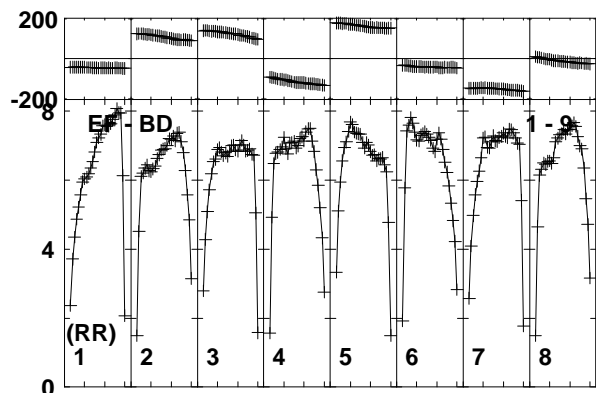
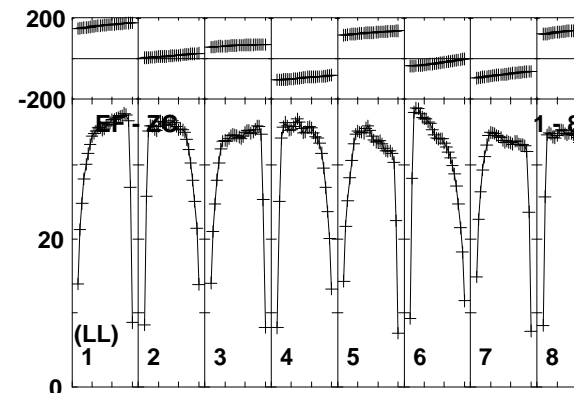
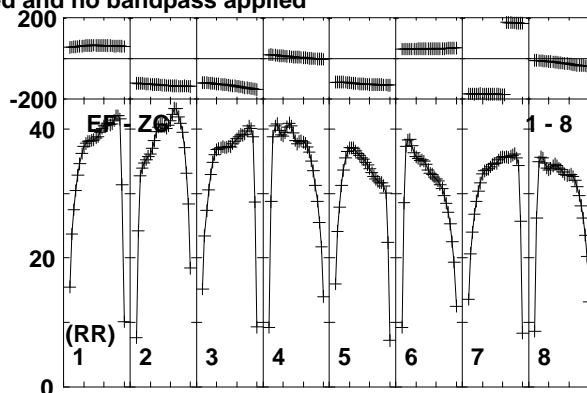
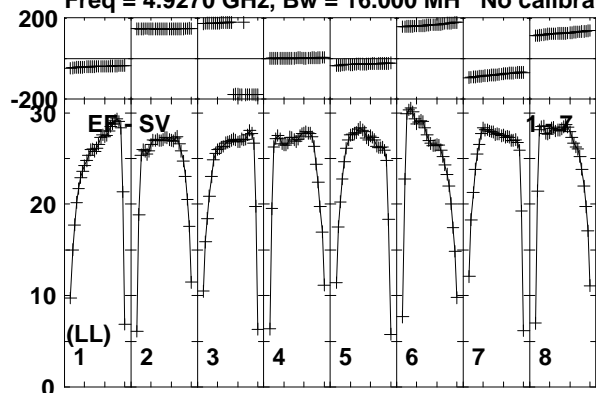

Lower frame: Milli Ampl Jy Top frame: Phas deg
Vector averaged cross-power spectrum Baseline: EF (01) - SV (07)
Timerange: 00/12:43:43 to 00/12:44:39

Plot file version 57 created 28-JAN-2015 14:38:06

3C345 N14C3.UVDATA.1

Freq = 4.9270 GHz, Bw = 16.000 MH No calibration applied and no bandpass applied

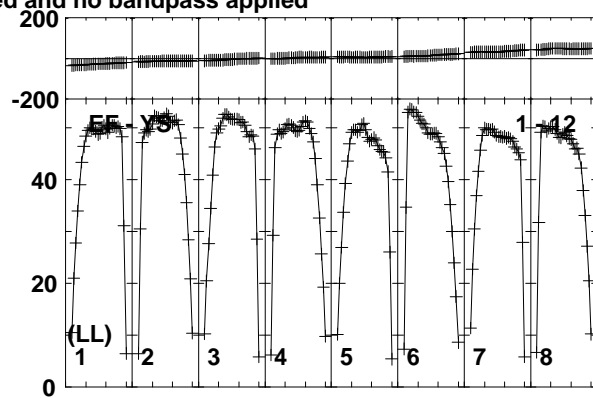
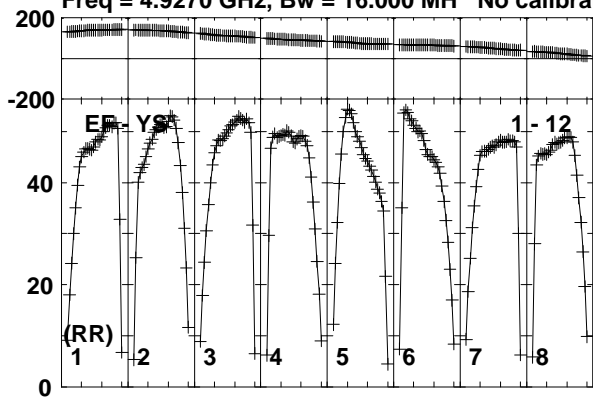

Lower frame: Milli Ampl Jy Top frame: Phas deg
Vector averaged cross-power spectrum Baseline: EF (01) - YS (12)
Timerange: 00/12:43:43 to 00/12:44:39

Plot file version 58 created 28-JAN-2015 14:38:06

J1640+3946 N14C3.UVDATA.1

Freq = 4.9270 GHz, Bw = 16.000 MH No calibration applied and no bandpass applied

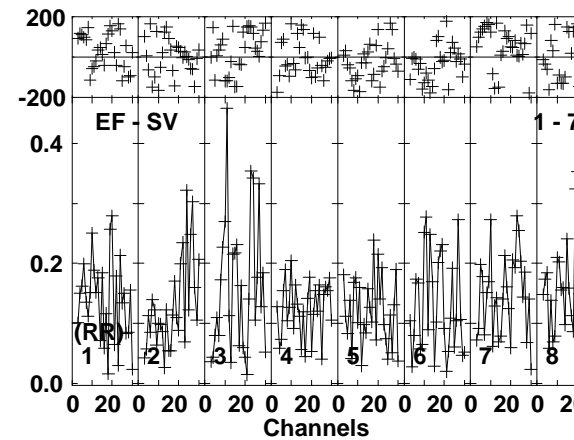
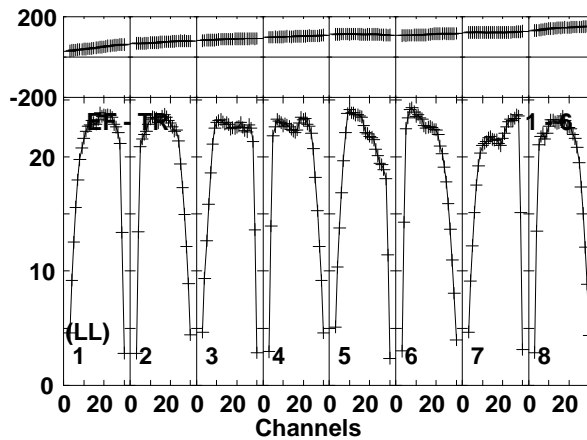
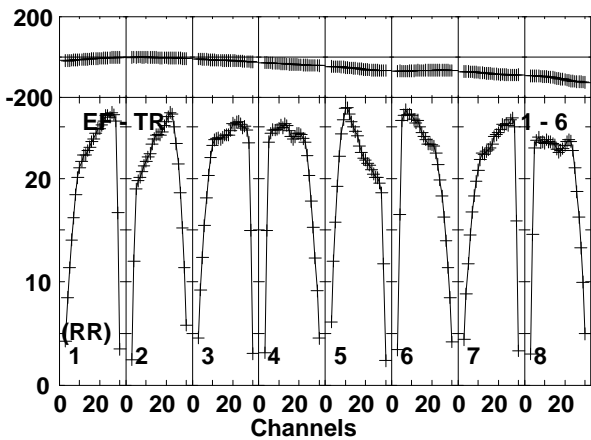
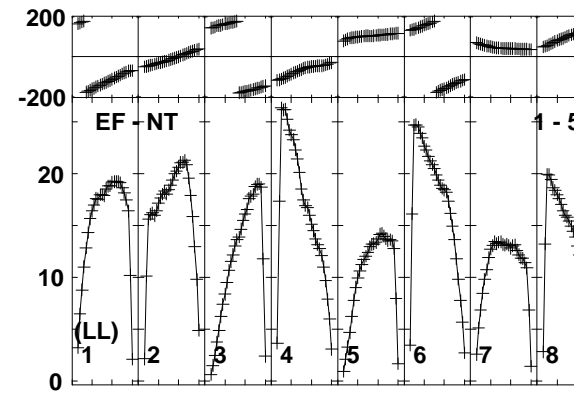
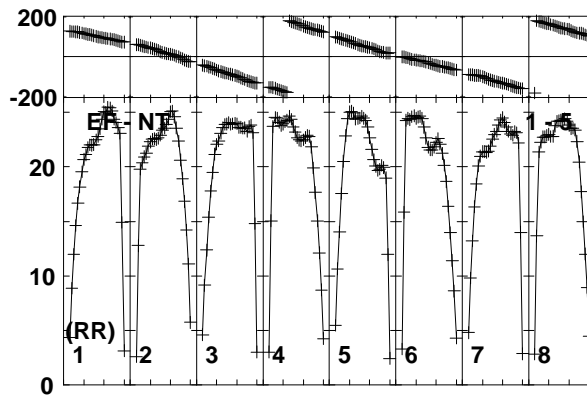
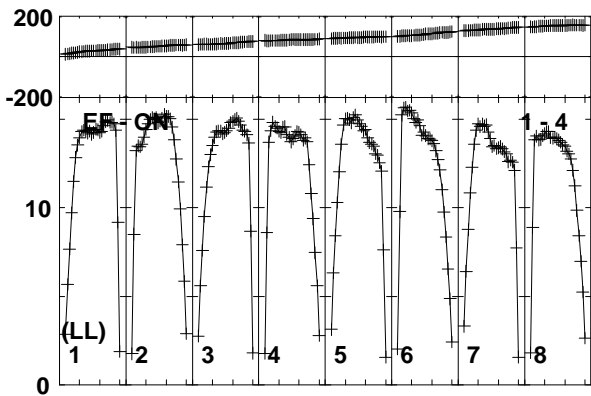
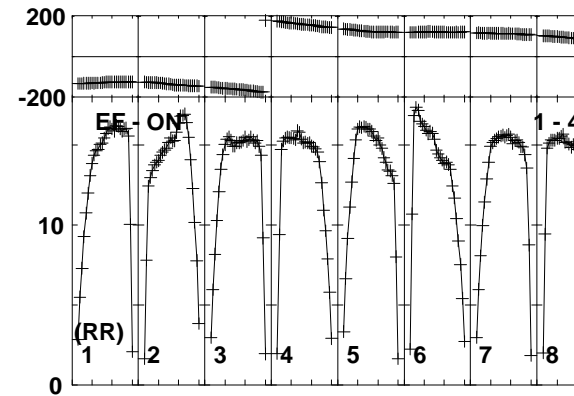
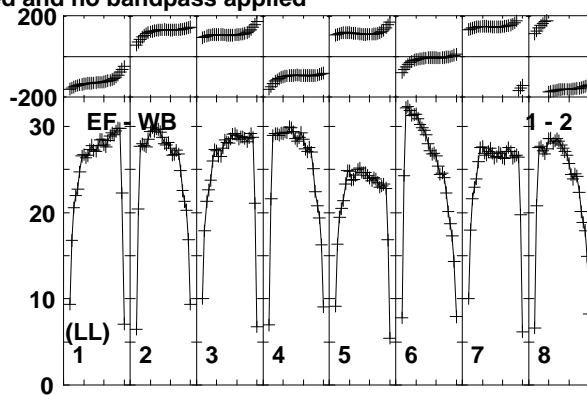
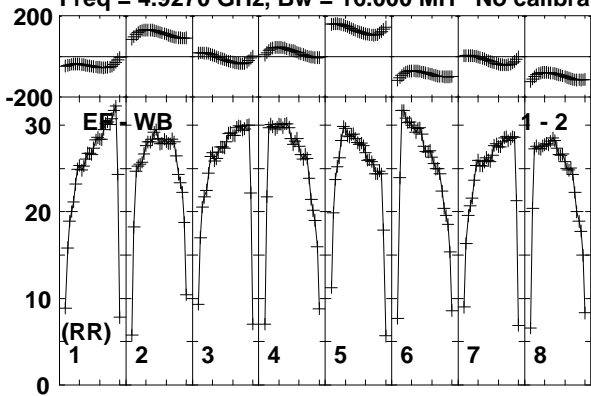

Lower frame: Milli Ampl Jy Top frame: Phas deg
Vector averaged cross-power spectrum Baseline: EF (01) - WB (02)
Timerange: 00/12:45:23 to 00/12:46:19

Plot file version 59 created 28-JAN-2015 14:38:06

J1640+3946 N14C3.UVDATA.1

Freq = 4.9270 GHz, Bw = 16.000 MH No calibration applied and no bandpass applied

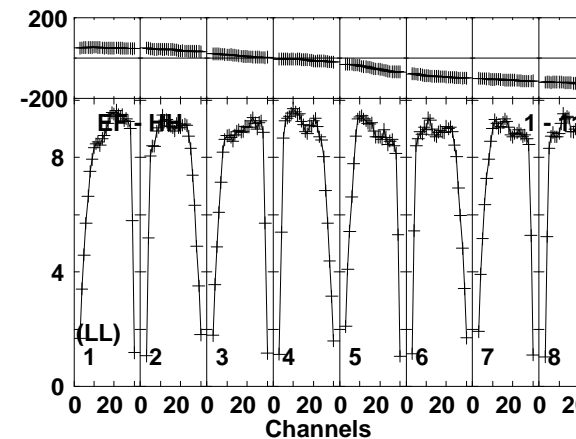
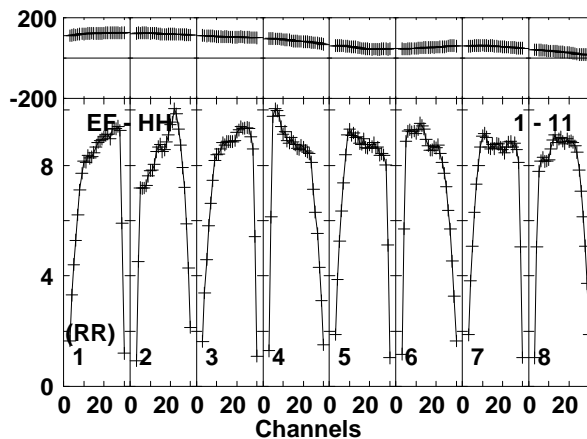
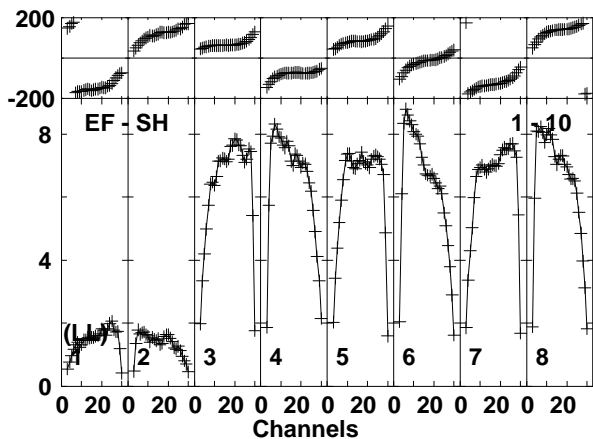
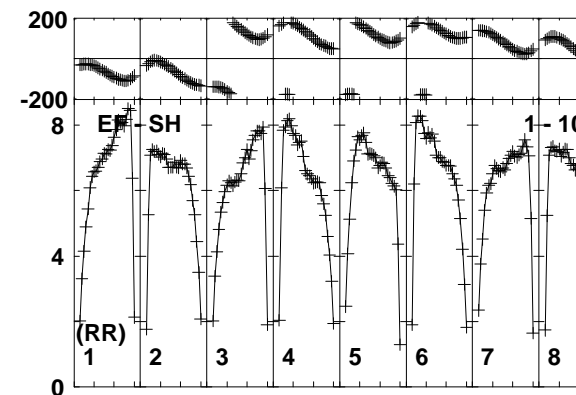
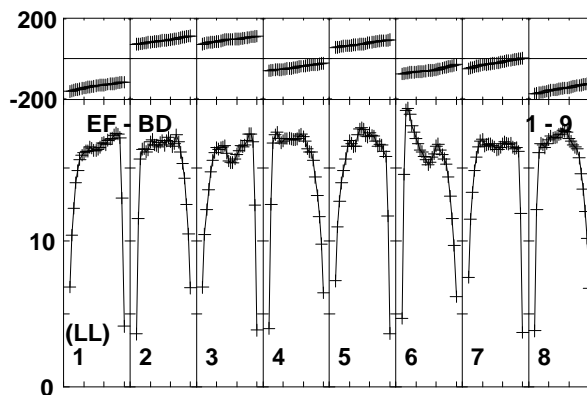
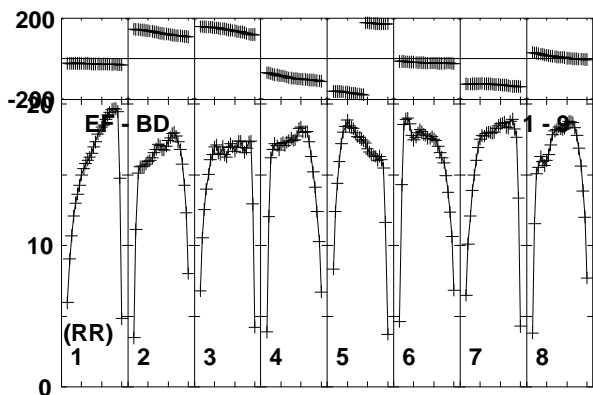
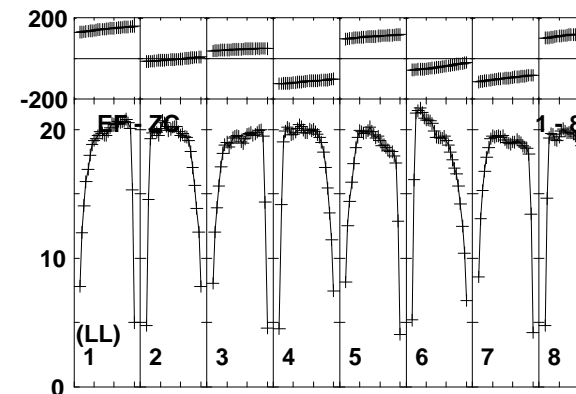
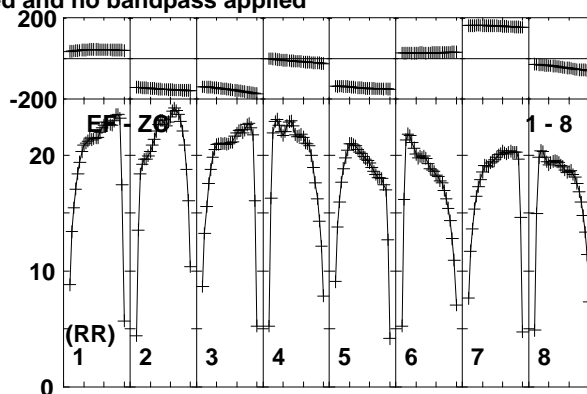
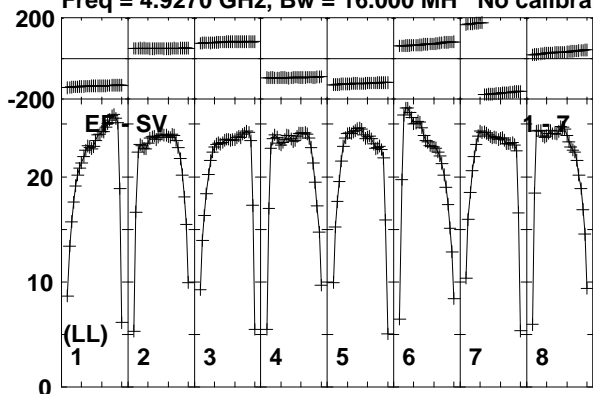

Lower frame: Milli Ampl Jy Top frame: Phas deg
Vector averaged cross-power spectrum Baseline: EF (01) - SV (07)
Timerange: 00:12:45:23 to 00:12:46:19

Plot file version 60 created 28-JAN-2015 14:38:06

J1640+3946 N14C3.UVDATA.1

Freq = 4.9270 GHz, Bw = 16.000 MH No calibration applied and no bandpass applied

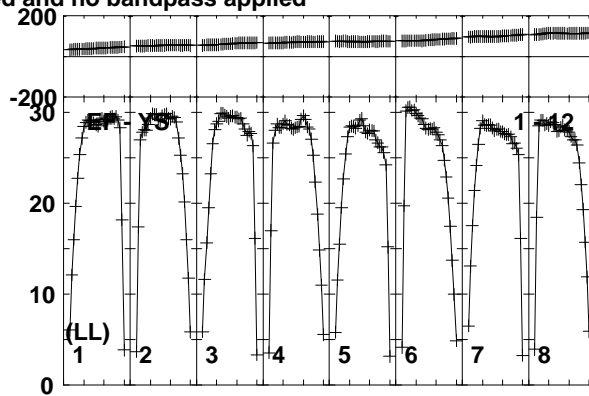
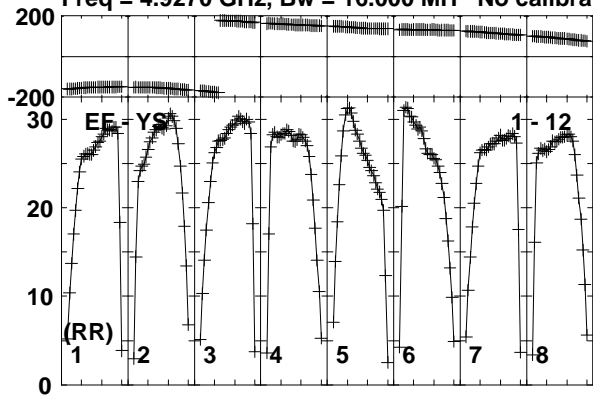

Lower frame: Milli Ampl Jy Top frame: Phas deg
Vector averaged cross-power spectrum Baseline: EF (01) - YS (12)
Timerange: 00/12:45:23 to 00/12:46:19

Plot file version 61 created 28-JAN-2015 14:38:06

3C345 N14C3.UVDATA.1

Freq = 4.9270 GHz, Bw = 16.000 MH No calibration applied and no bandpass applied

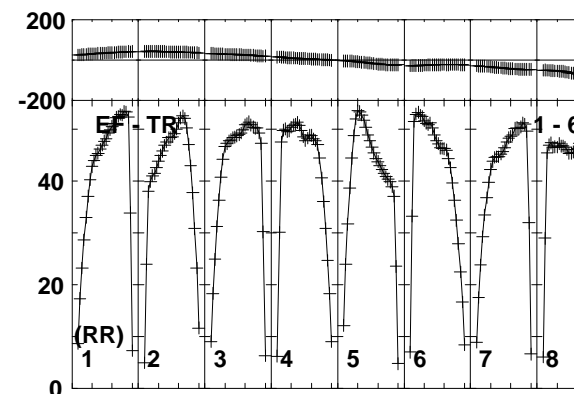
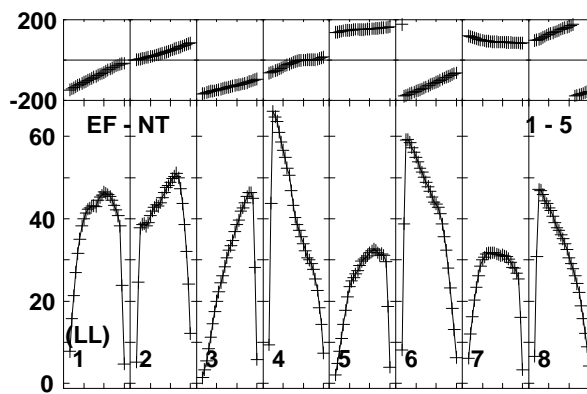
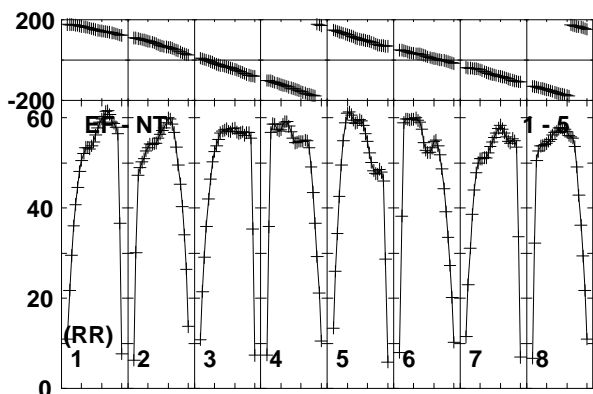
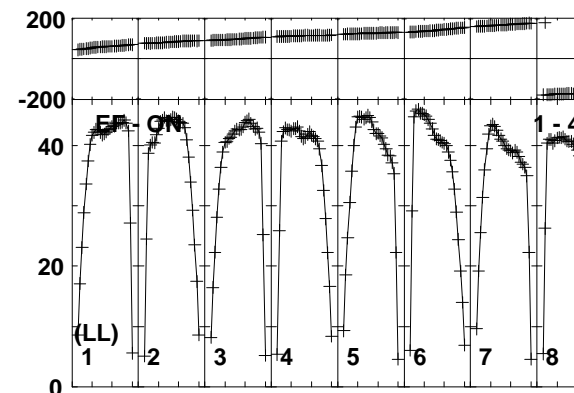
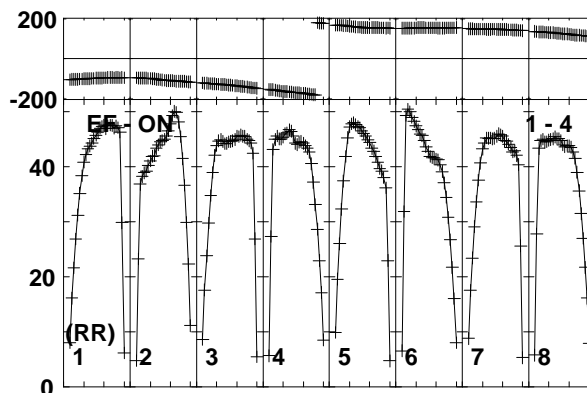
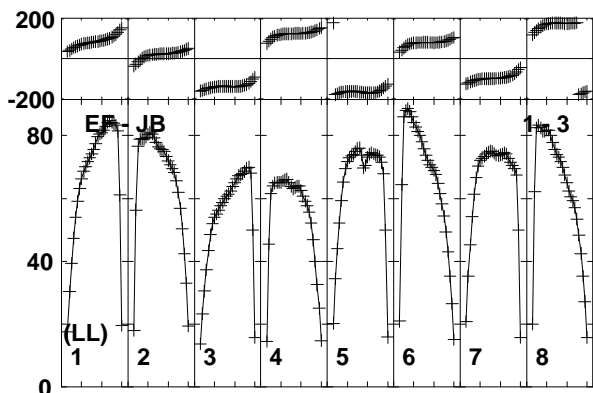
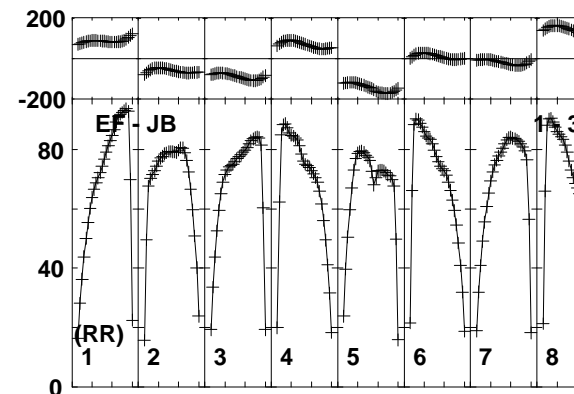
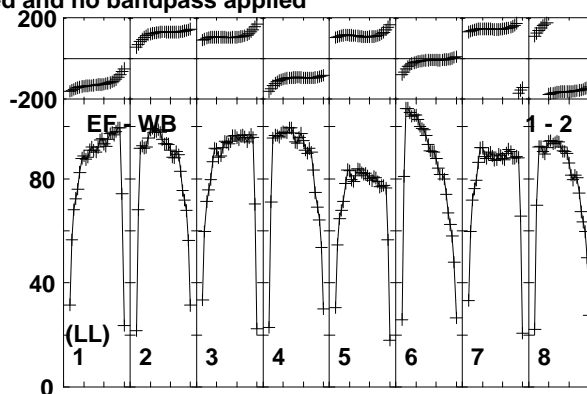
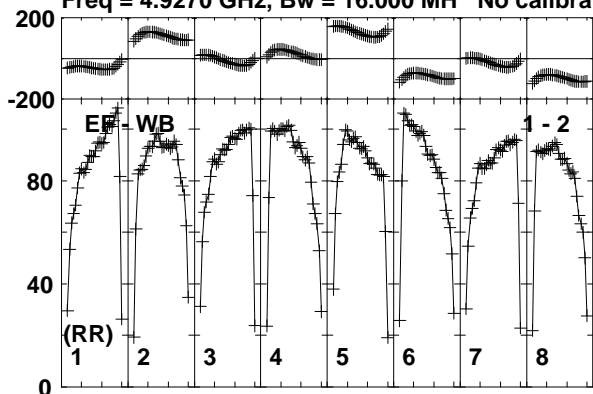

Lower frame: Milli Ampl Jy Top frame: Phas deg
Vector averaged cross-power spectrum Baseline: EF (01) - WB (02)
Timerange: 00:12:47:03 to 00:12:47:59

Plot file version 62 created 28-JAN-2015 14:38:06

3C345 N14C3.UVDATA.1

Freq = 4.9270 GHz, Bw = 16.000 MH No calibration applied and no bandpass applied

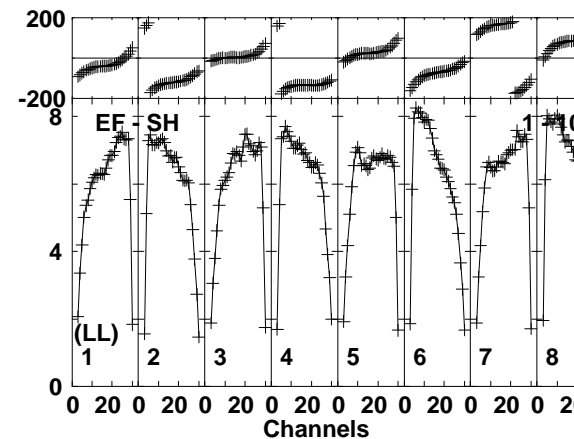
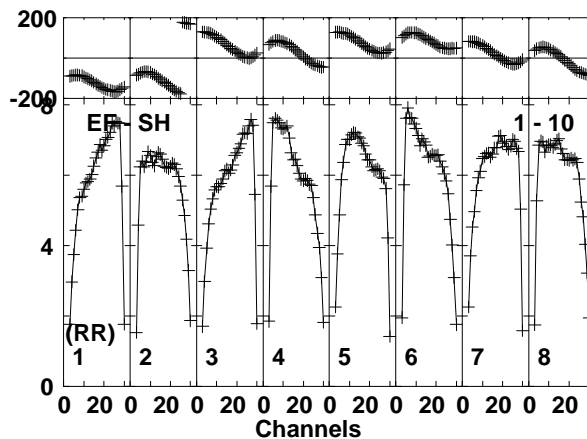
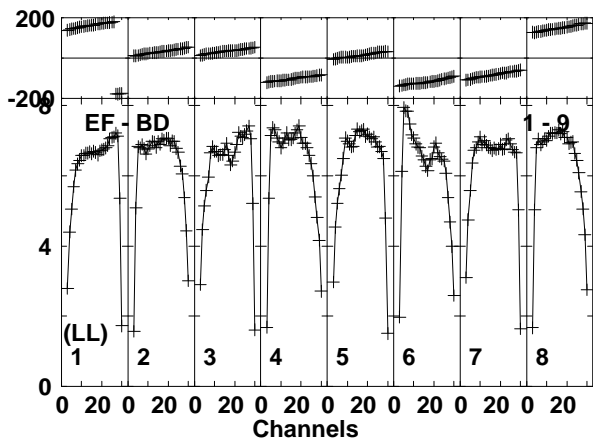
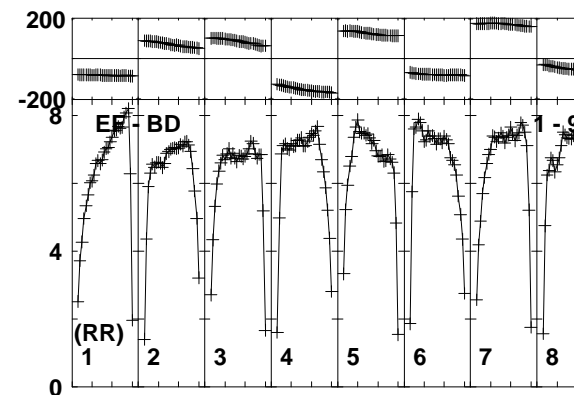
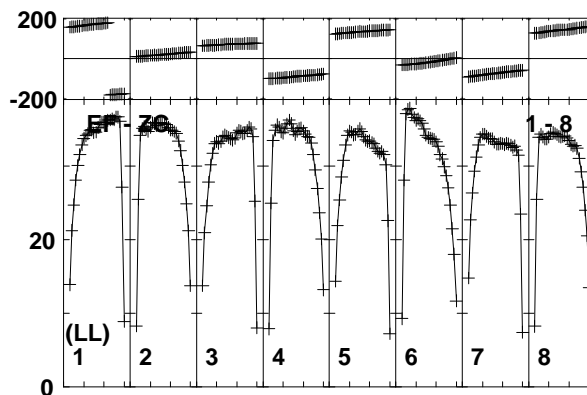
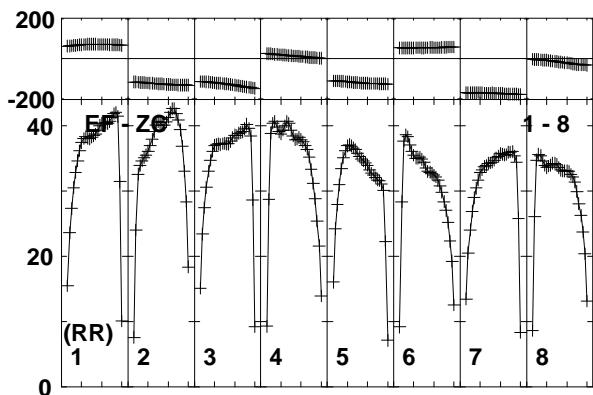
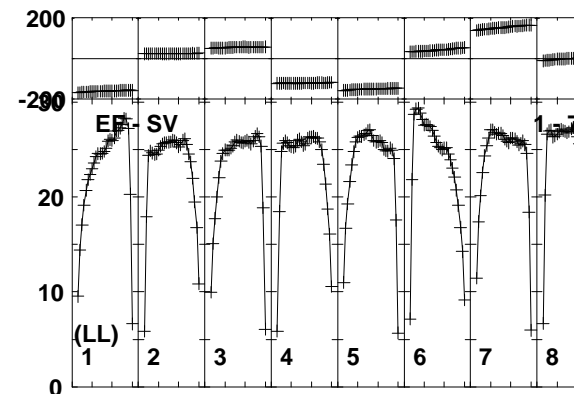
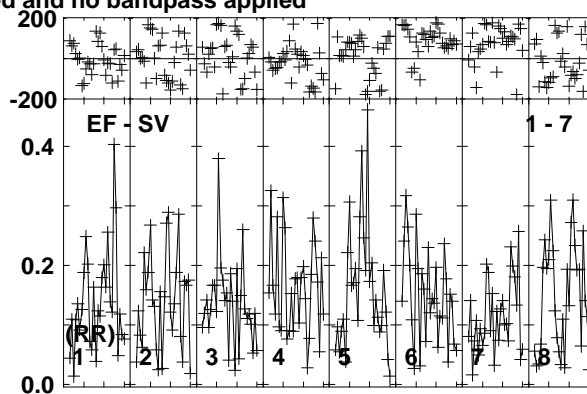
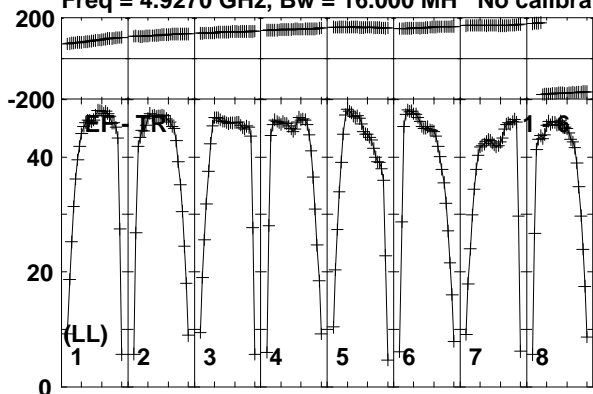

Lower frame: Milli Ampl Jy Top frame: Phas deg
Vector averaged cross-power spectrum Baseline: EF (01) - TR (06)
Timerange: 00:12:47:03 to 00:12:47:59

Plot file version 63 created 28-JAN-2015 14:38:06

3C345 N14C3.UVDATA.1

Freq = 4.9270 GHz, Bw = 16.000 MH No calibration applied and no bandpass applied

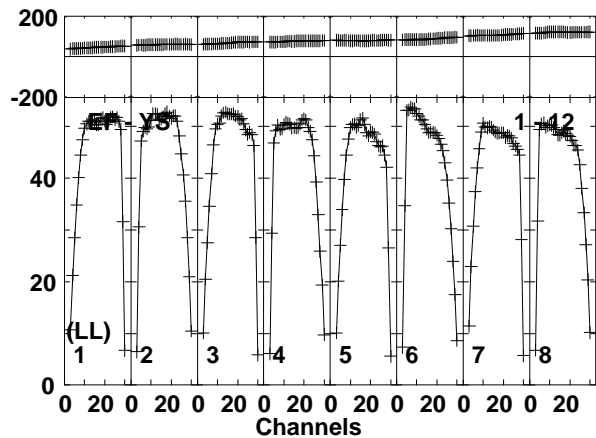
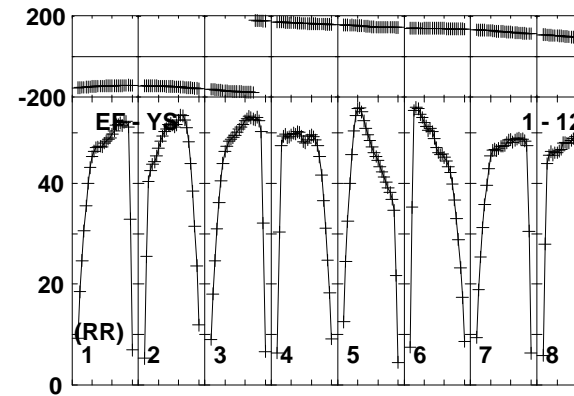
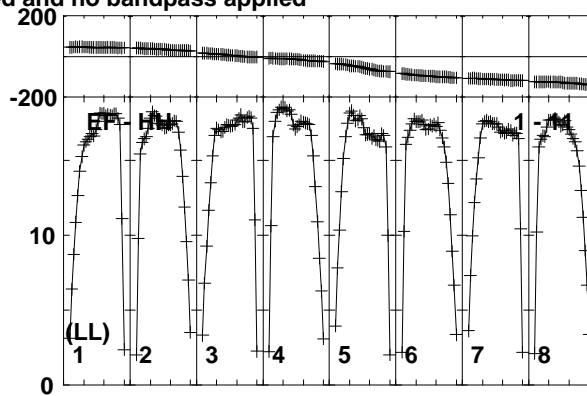
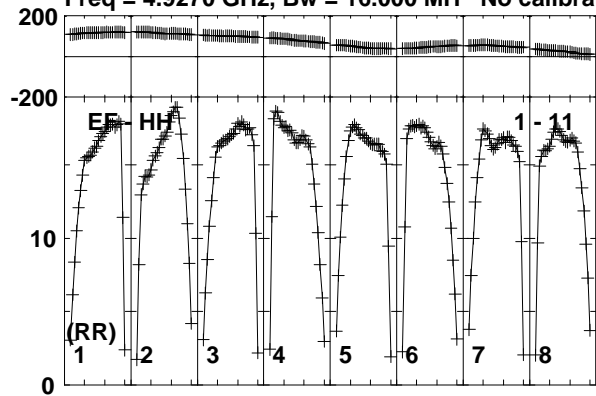

Lower frame: Milli Ampl Jy Top frame: Phas deg
Vector averaged cross-power spectrum Baseline: EF (01) - HH (11)
Timerange: 00/12:47:03 to 00/12:47:59

Plot file version 64 created 28-JAN-2015 14:38:06

J1640+3946 N14C3.UVDATA.1

Freq = 4.9270 GHz, Bw = 16.000 MH No calibration applied and no bandpass applied

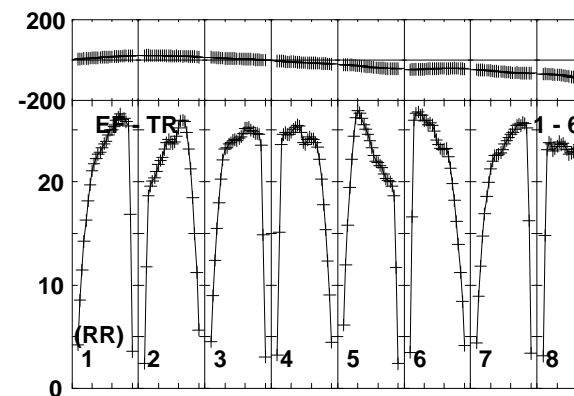
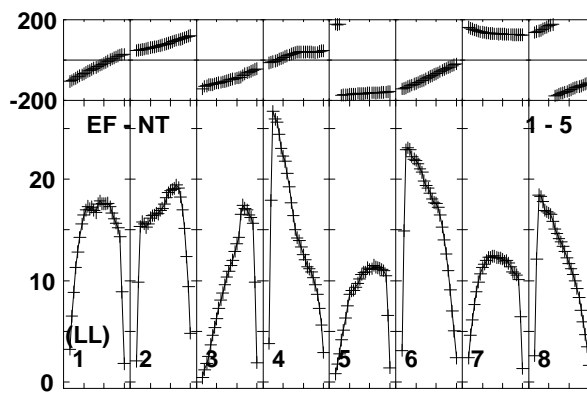
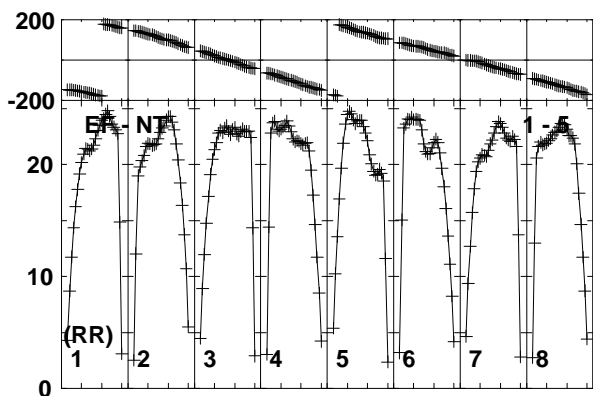
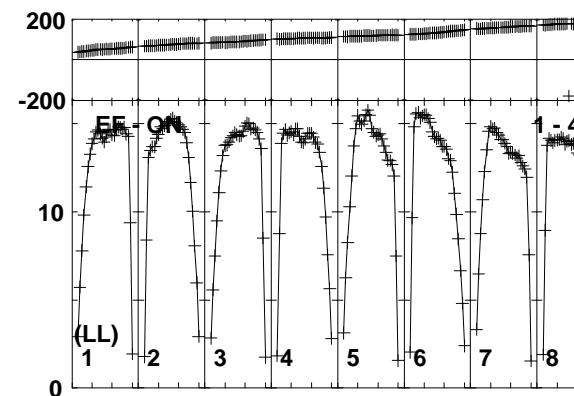
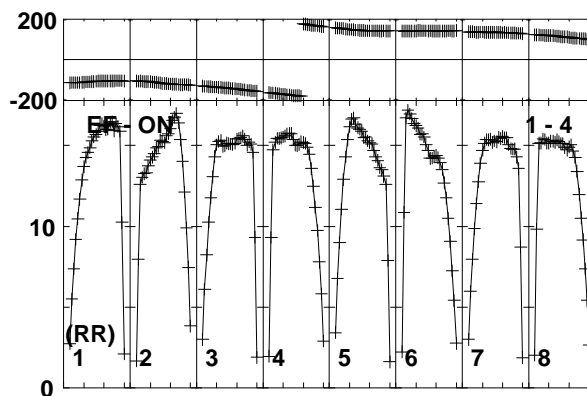
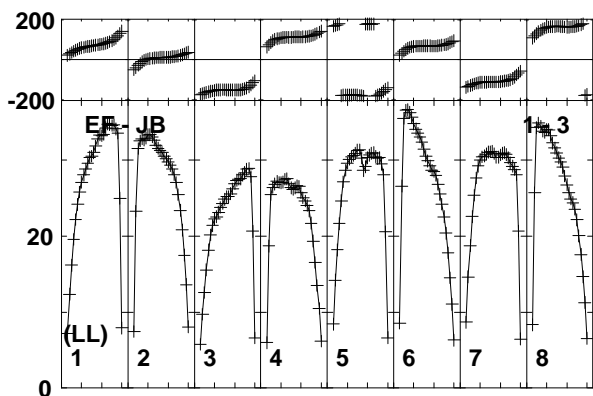
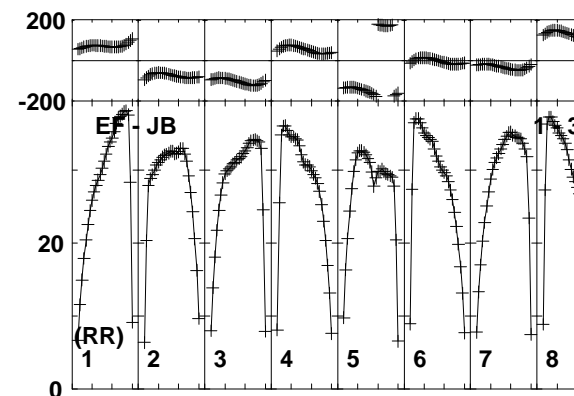
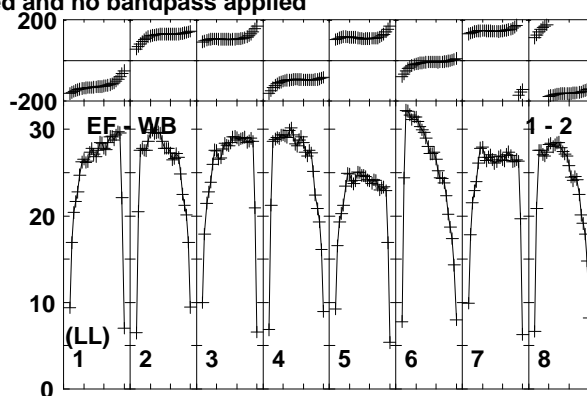
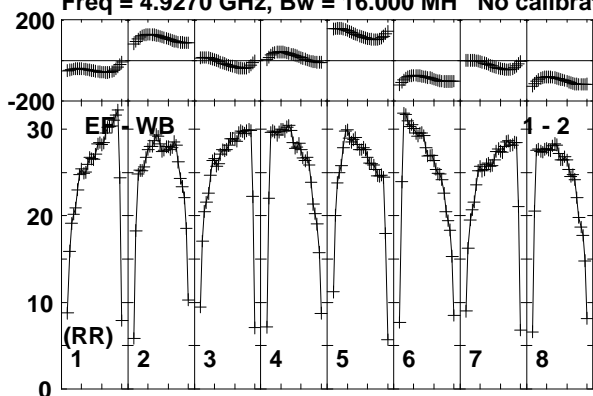

Lower frame: Milli Ampl Jy Top frame: Phas deg
Vector averaged cross-power spectrum Baseline: EF (01) - WB (02)
Timerange: 00:12:48:43 to 00:12:49:39

Plot file version 65 created 28-JAN-2015 14:38:06

J1640+3946 N14C3.UVDATA.1

Freq = 4.9270 GHz, Bw = 16.000 MH No calibration applied and no bandpass applied

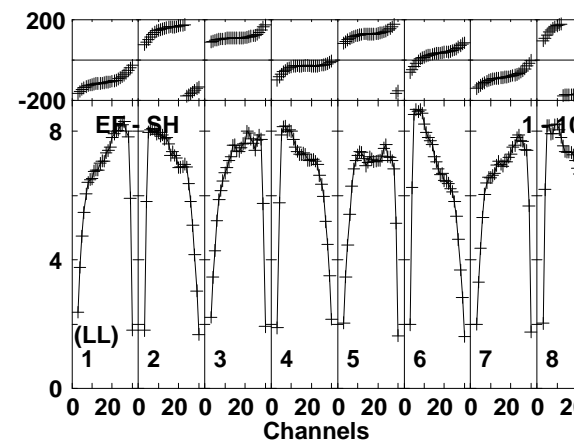
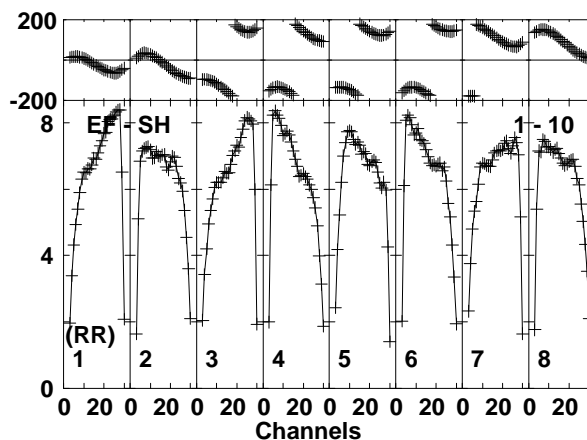
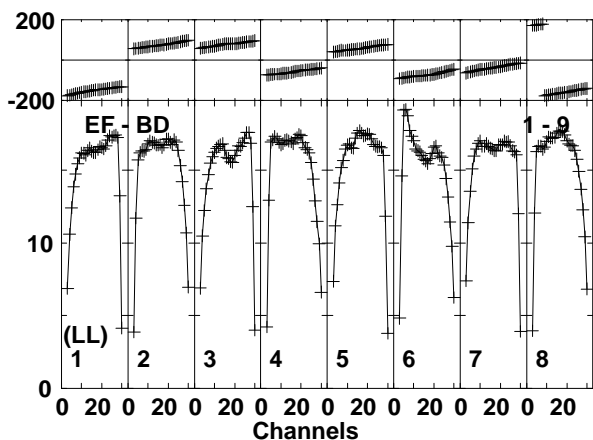
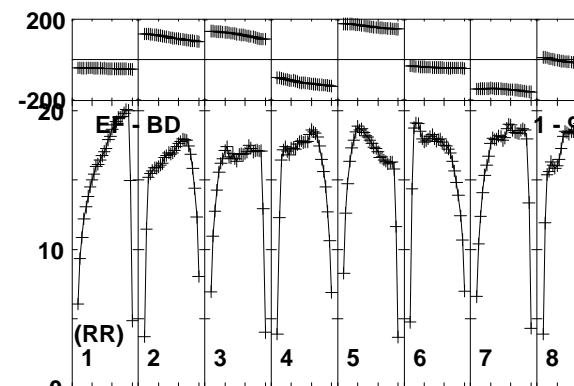
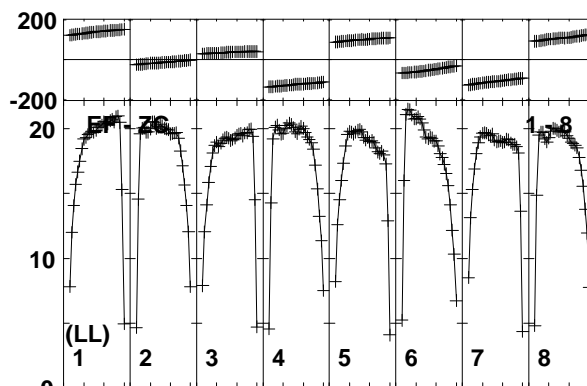
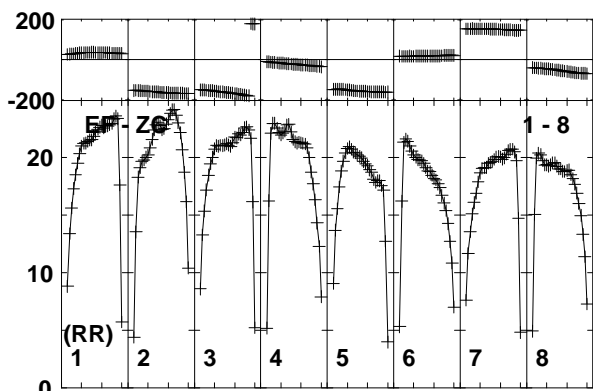
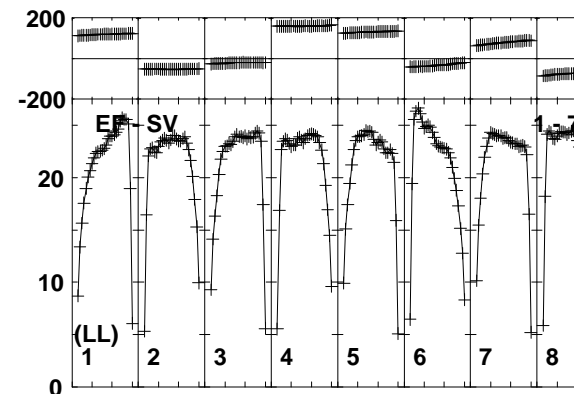
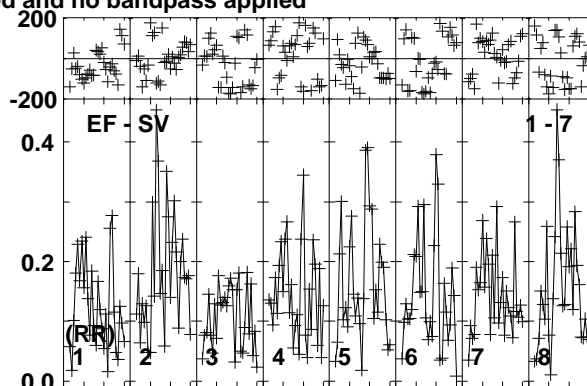
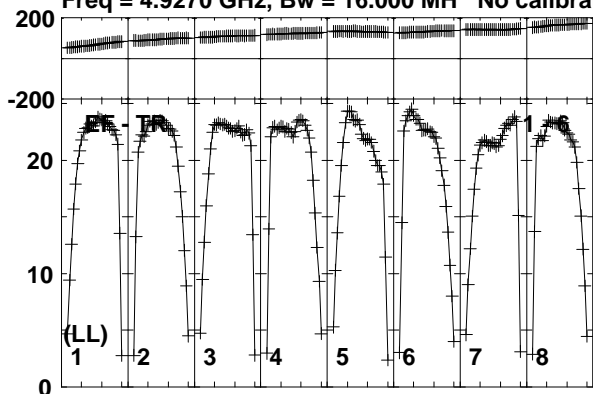

Lower frame: Milli Ampl Jy Top frame: Phas deg
Vector averaged cross-power spectrum Baseline: EF (01) - TR (06)
Timerange: 00:12:48:43 to 00:12:49:39

Plot file version 66 created 28-JAN-2015 14:38:06

J1640+3946 N14C3.UVDATA.1

Freq = 4.9270 GHz, Bw = 16.000 MH No calibration applied and no bandpass applied

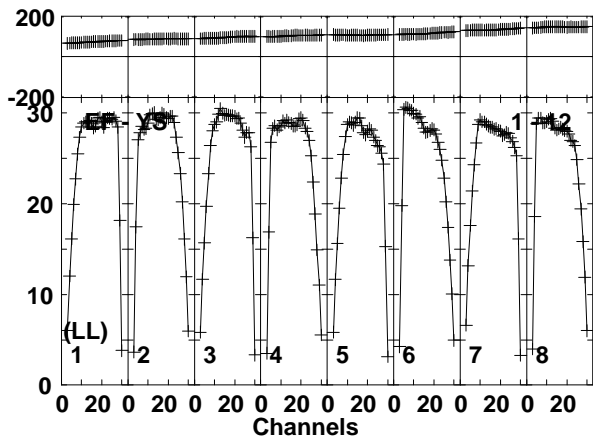
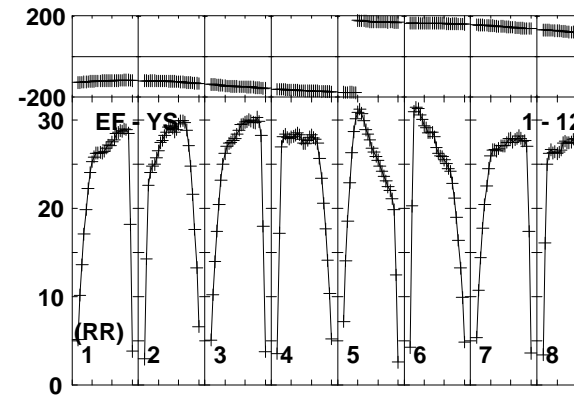
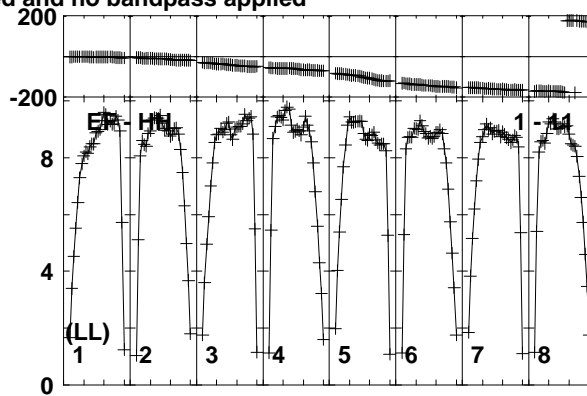
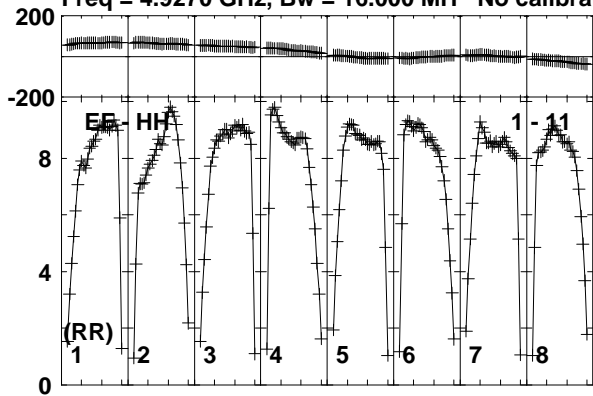

Lower frame: Milli Ampl Jy Top frame: Phas deg
Vector averaged cross-power spectrum Baseline: EF (01) - HH (11)
Timerange: 00/12:48:43 to 00/12:49:39

Plot file version 67 created 28-JAN-2015 14:38:06

3C345 N14C3.UVDATA.1

Freq = 4.9270 GHz, Bw = 16.000 MH No calibration applied and no bandpass applied

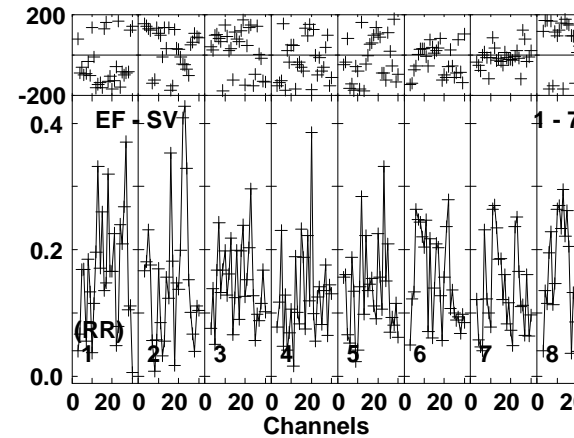
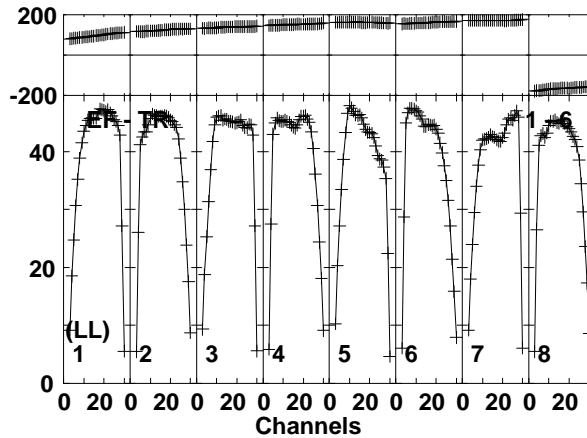
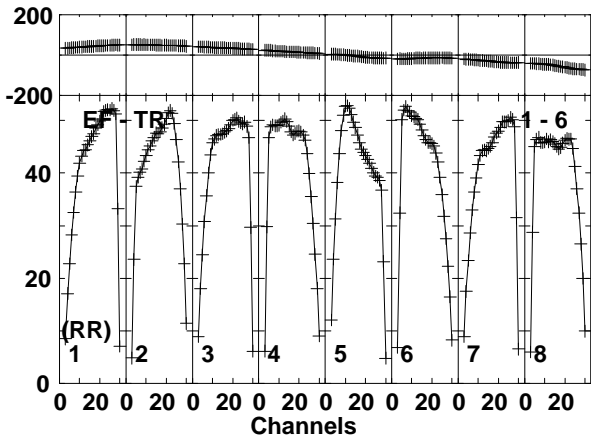
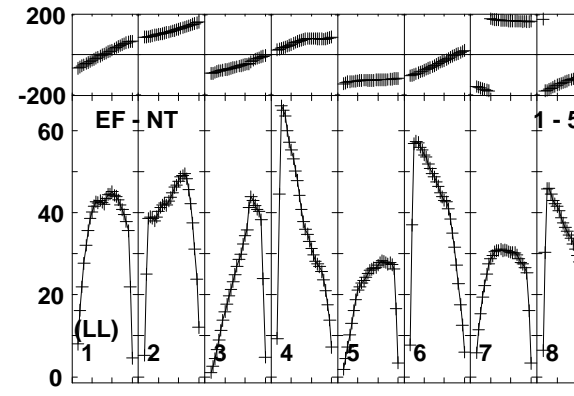
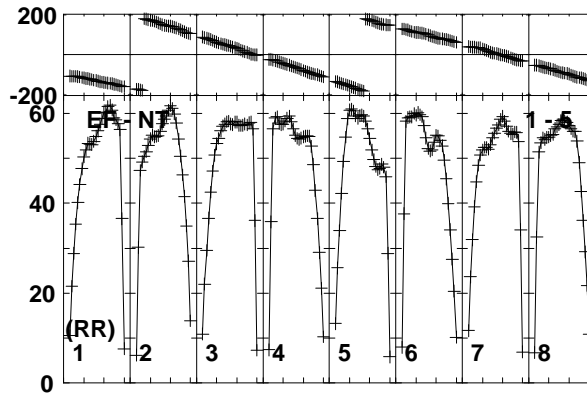
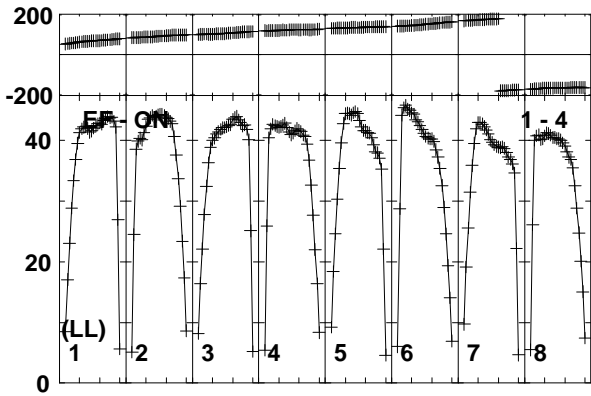
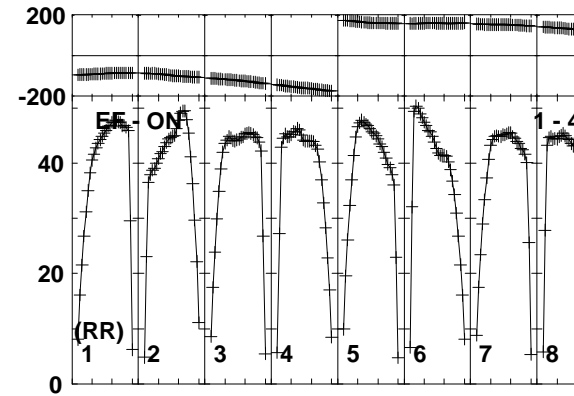
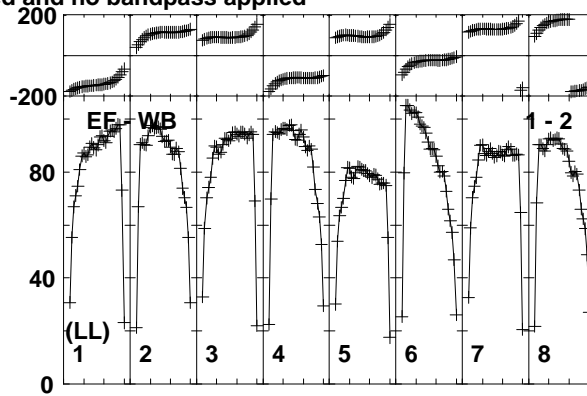
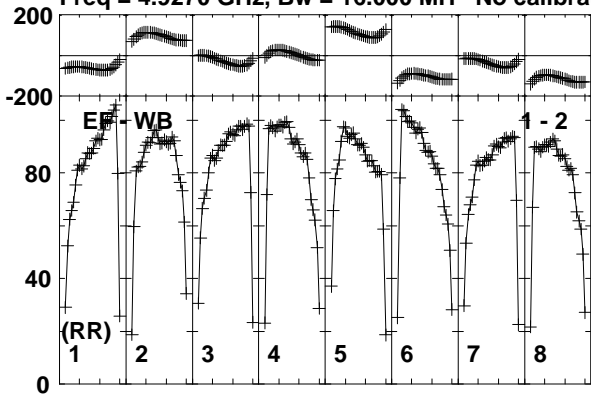

Lower frame: Milli Ampl Jy Top frame: Phas deg
Vector averaged cross-power spectrum Baseline: EF (01) - WB (02)
Timerange: 00/12:50:23 to 00/12:51:19

Plot file version 68 created 28-JAN-2015 14:38:07

3C345 N14C3.UVDATA.1

Freq = 4.9270 GHz, Bw = 16.000 MH No calibration applied and no bandpass applied

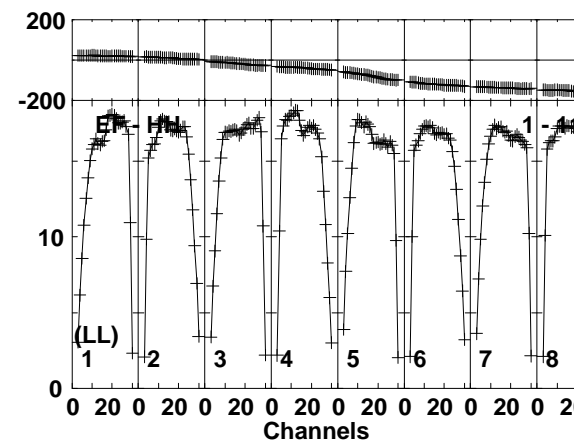
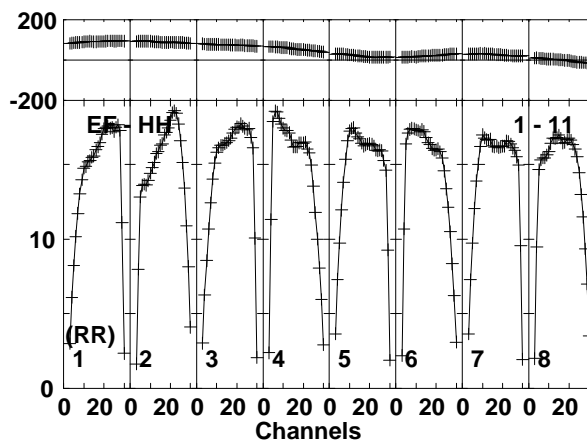
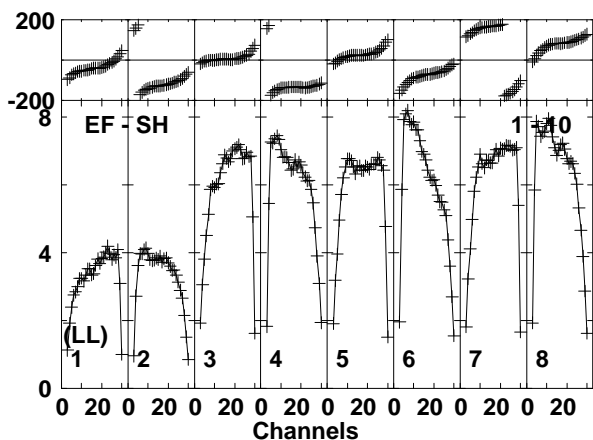
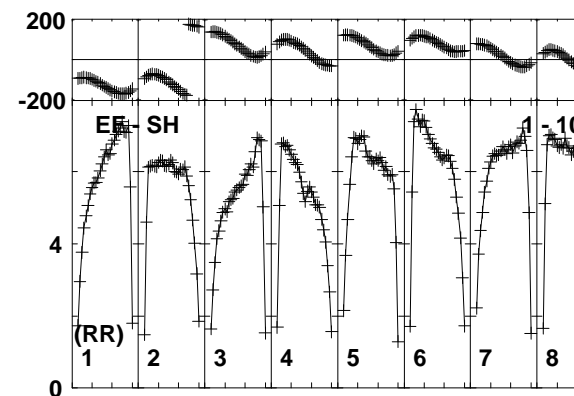
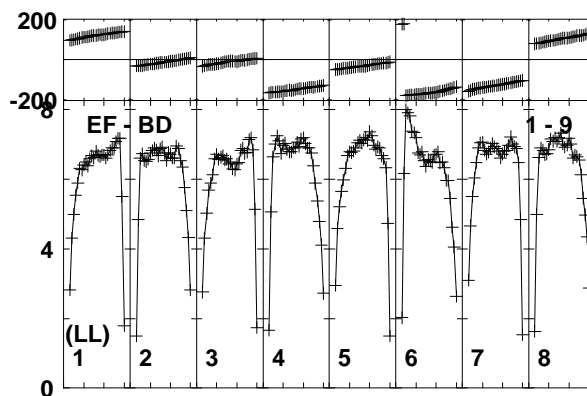
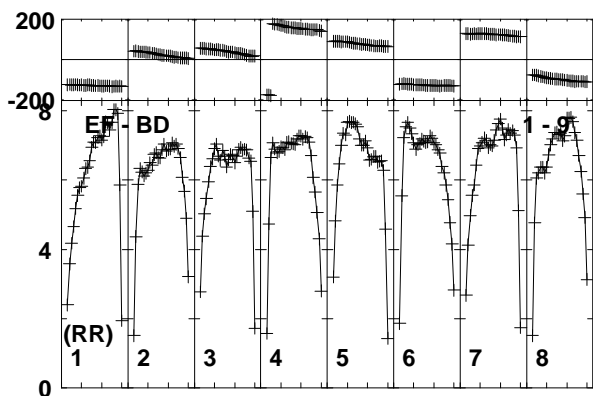
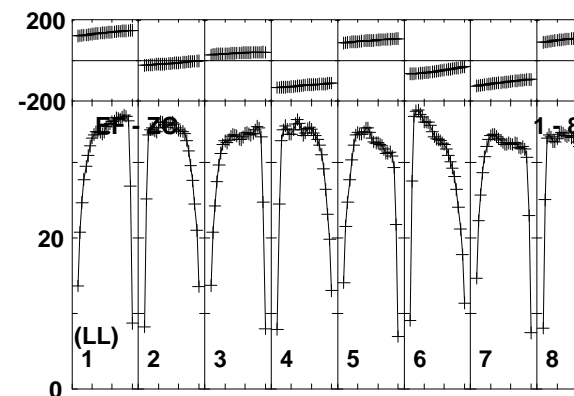
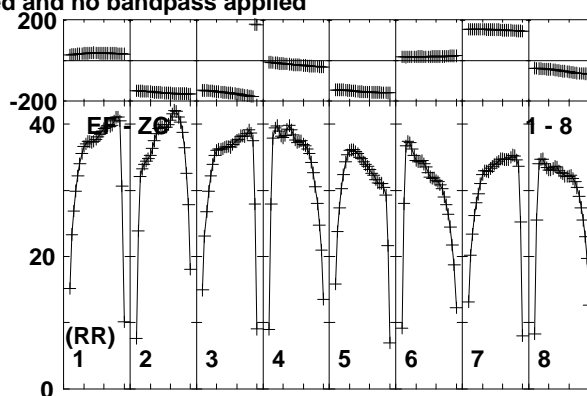
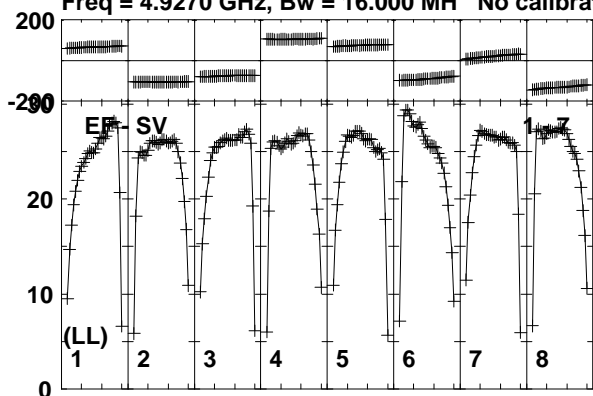

Lower frame: Milli Ampl Jy Top frame: Phas deg
Vector averaged cross-power spectrum Baseline: EF (01) - SV (07)
Timerange: 00:12:50:23 to 00:12:51:19

Plot file version 69 created 28-JAN-2015 14:38:07

3C345 N14C3.UVDATA.1

Freq = 4.9270 GHz, Bw = 16.000 MH No calibration applied and no bandpass applied

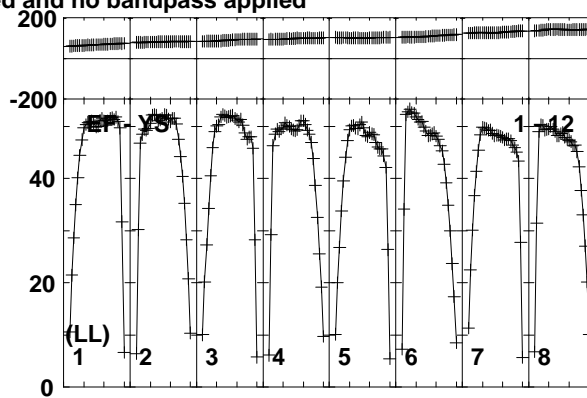
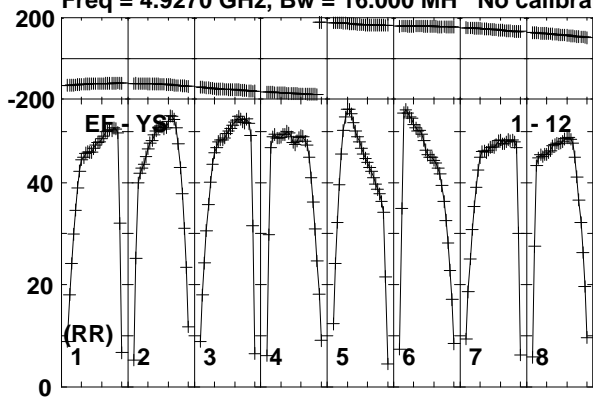

Lower frame: Milli Ampl Jy Top frame: Phas deg
Vector averaged cross-power spectrum Baseline: EF (01) - YS (12)
Timerange: 00/12:50:23 to 00/12:51:19

Plot file version 70 created 28-JAN-2015 14:38:07

J1640+3946 N14C3.UVDATA.1

Freq = 4.9270 GHz, Bw = 16.000 MH No calibration applied and no bandpass applied

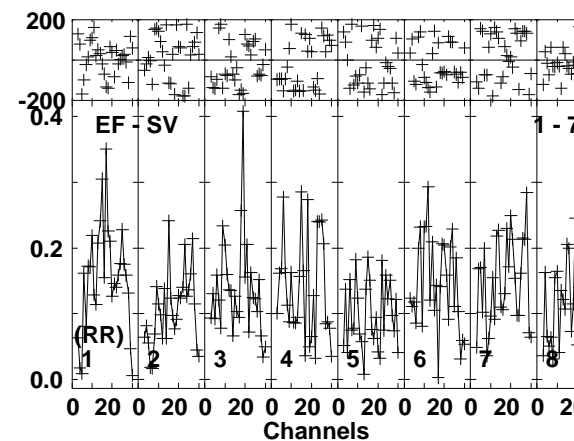
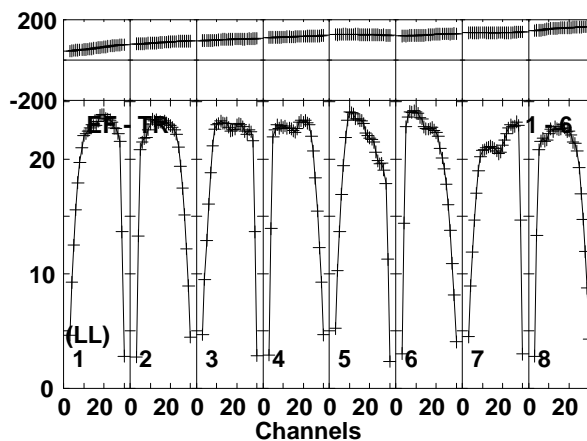
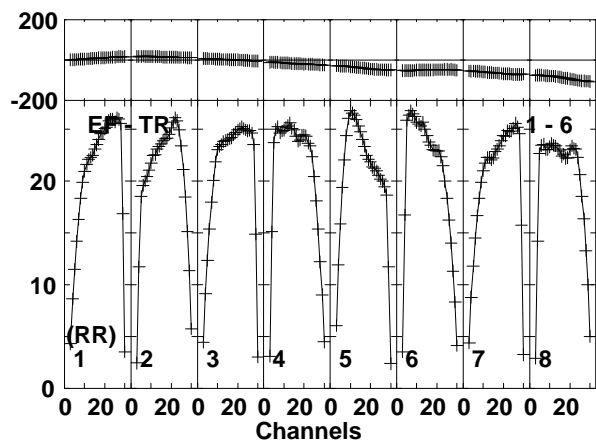
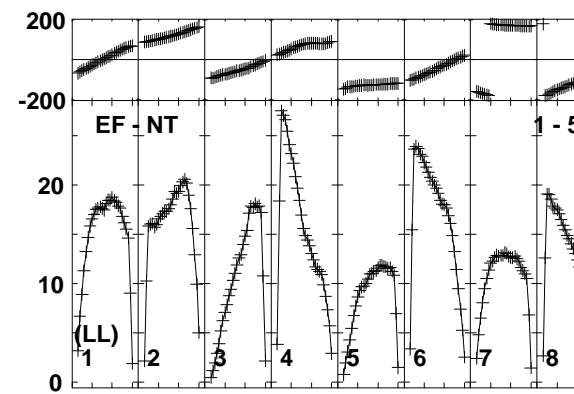
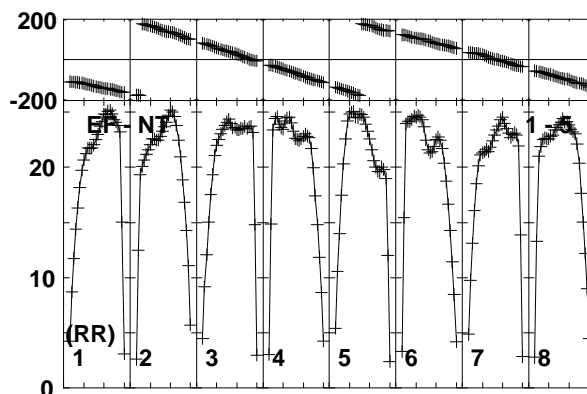
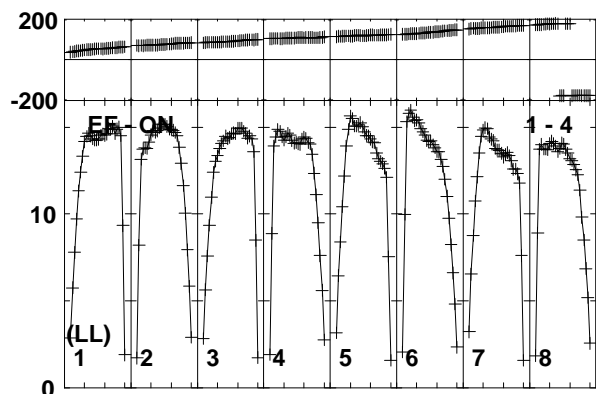
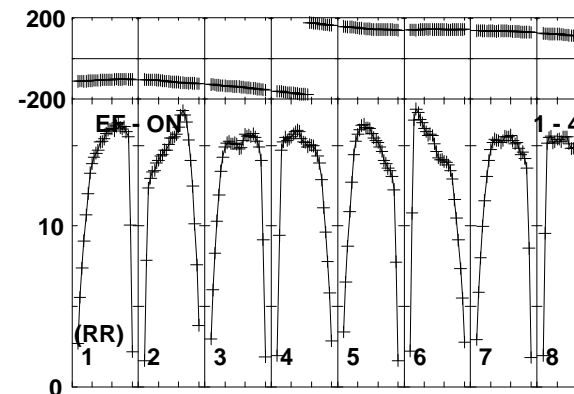
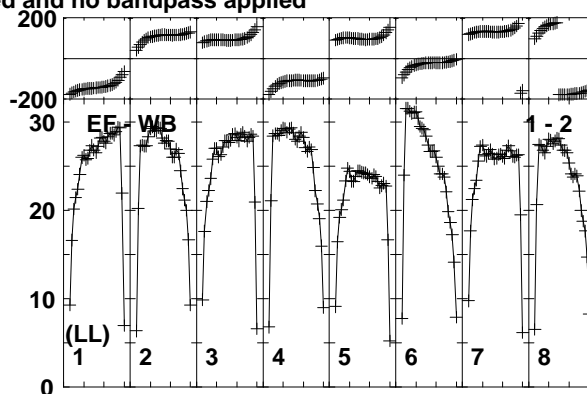
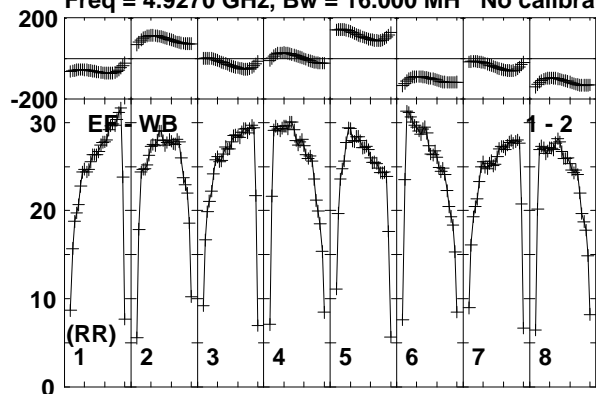

Lower frame: Milli Ampl Jy Top frame: Phas deg
Vector averaged cross-power spectrum Baseline: EF (01) - WB (02)
Timerange: 00/12:52:03 to 00/12:52:59

Plot file version 71 created 28-JAN-2015 14:38:07

J1640+3946 N14C3.UVDATA.1

Freq = 4.9270 GHz, Bw = 16.000 MH No calibration applied and no bandpass applied

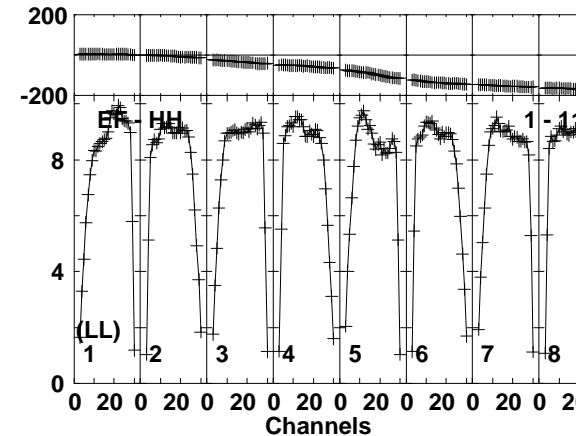
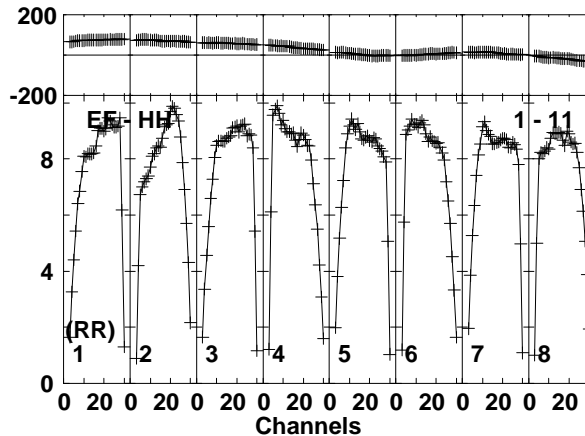
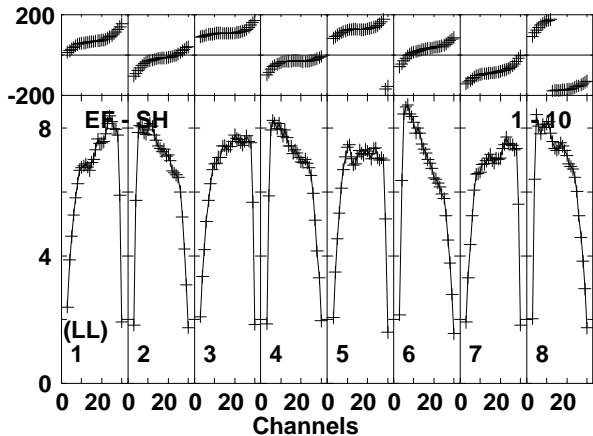
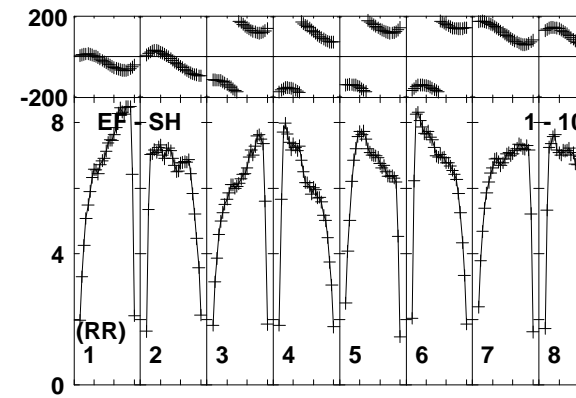
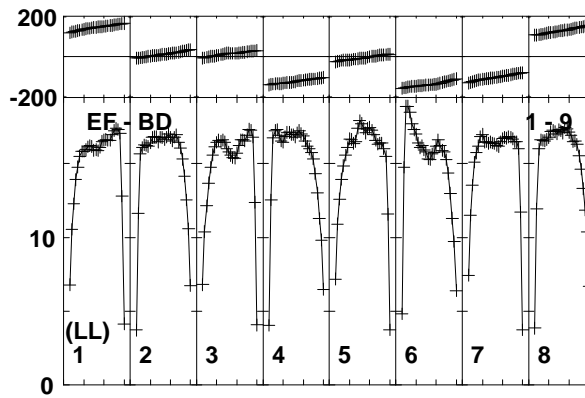
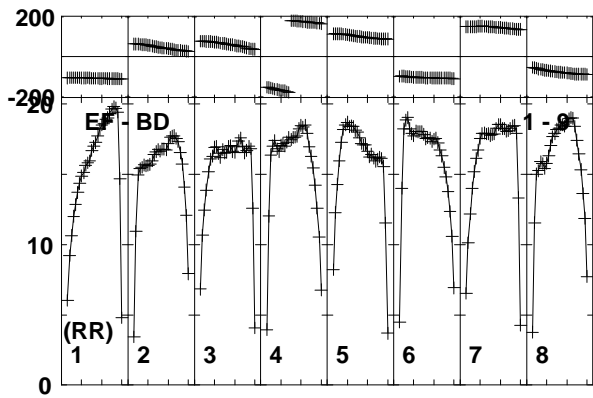
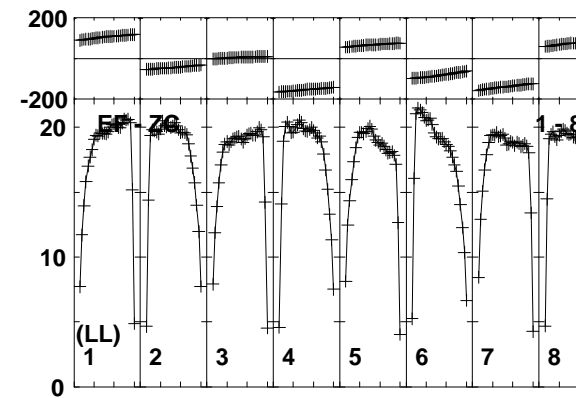
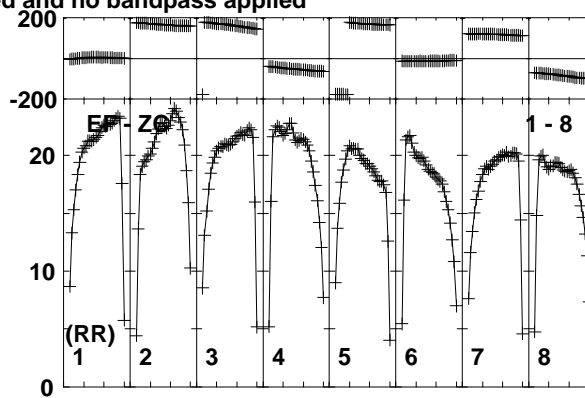
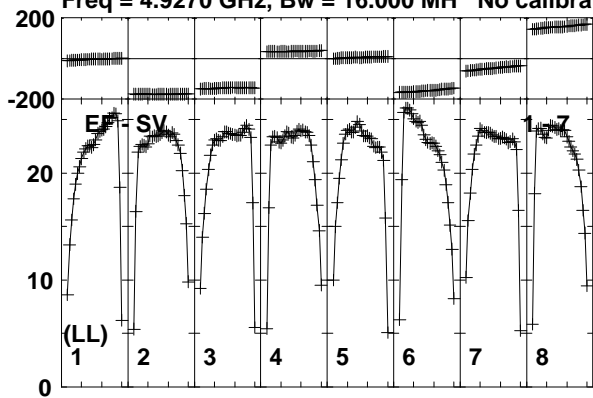

Lower frame: Milli Ampl Jy Top frame: Phas deg
Vector averaged cross-power spectrum Baseline: EF (01) - SV (07)
Timerange: 00/12:52:03 to 00/12:52:59

Plot file version 72 created 28-JAN-2015 14:38:07

J1640+3946 N14C3.UVDATA.1

Freq = 4.9270 GHz, Bw = 16.000 MH No calibration applied and no bandpass applied

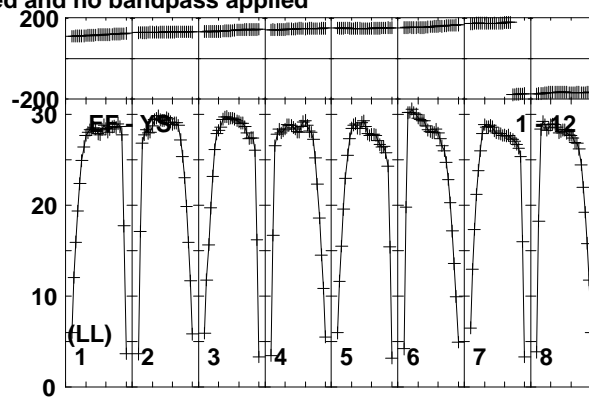
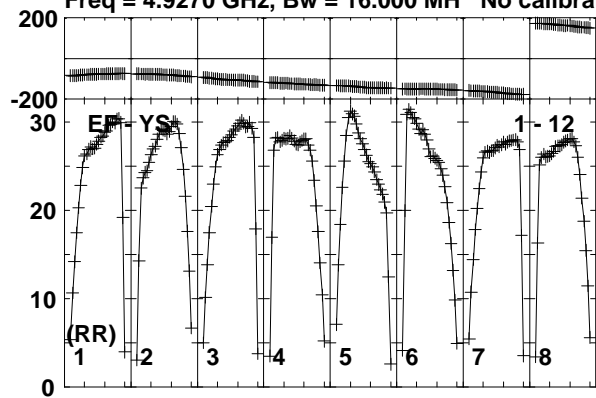

Lower frame: Milli Ampl Jy Top frame: Phas deg
Vector averaged cross-power spectrum Baseline: EF (01) - YS (12)
Timerange: 00/12:52:03 to 00/12:52:59

Plot file version 73 created 28-JAN-2015 14:38:07

3C345 N14C3.UVDATA.1

Freq = 4.9270 GHz, Bw = 16.000 MH No calibration applied and no bandpass applied

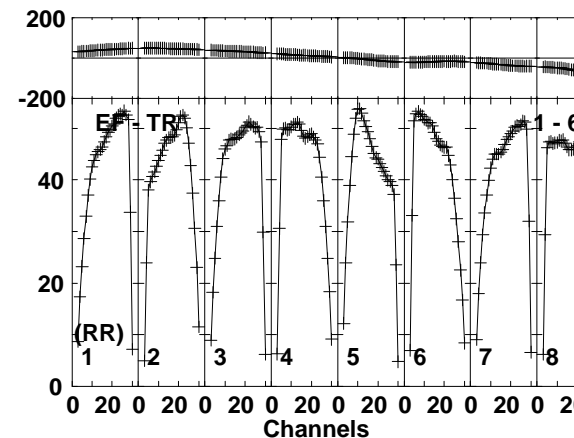
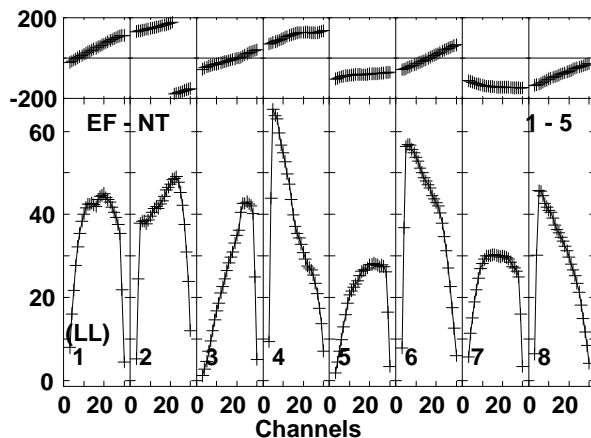
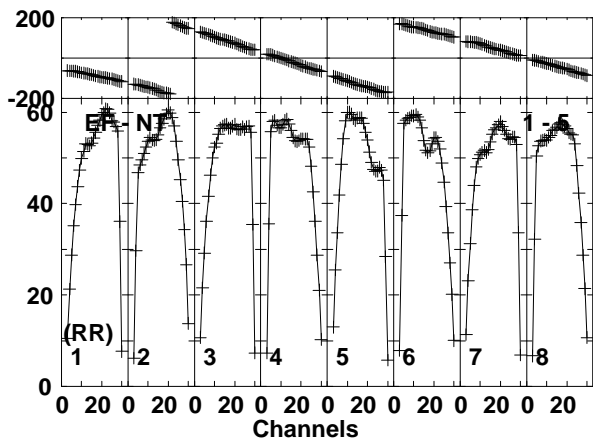
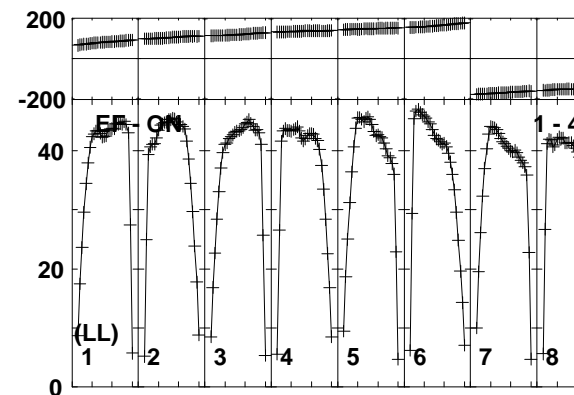
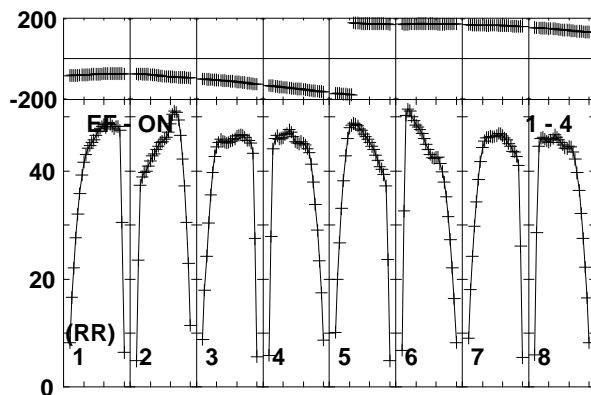
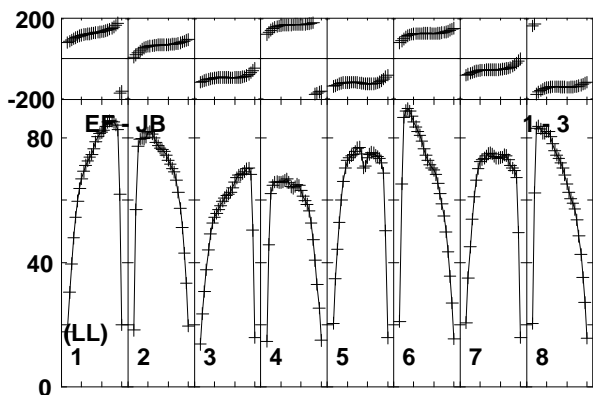
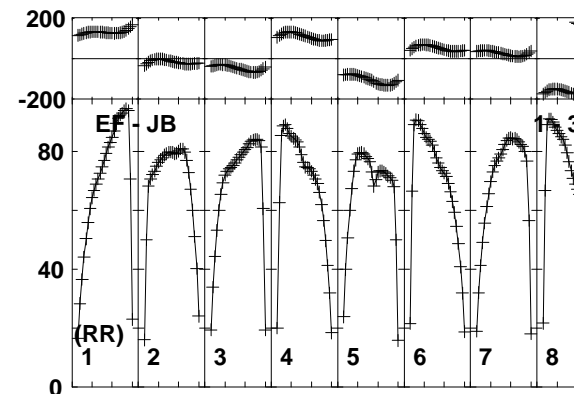
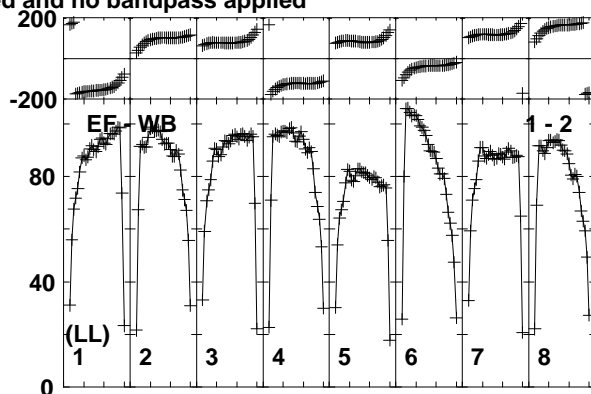
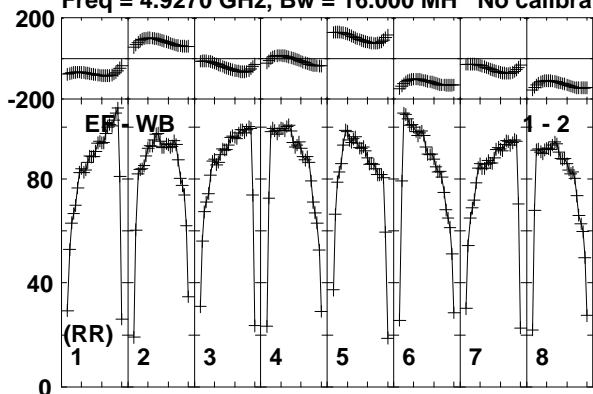

Lower frame: Milli Ampl Jy Top frame: Phas deg
Vector averaged cross-power spectrum Baseline: EF (01) - WB (02)
Timerange: 00:12:53:43 to 00:12:54:39

Plot file version 74 created 28-JAN-2015 14:38:07

3C345 N14C3.UVDATA.1

Freq = 4.9270 GHz, Bw = 16.000 MH No calibration applied and no bandpass applied

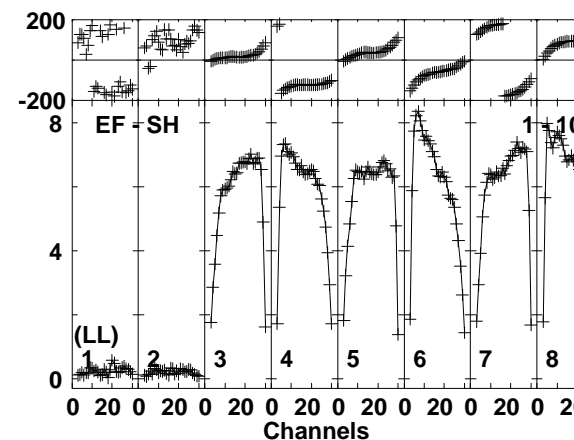
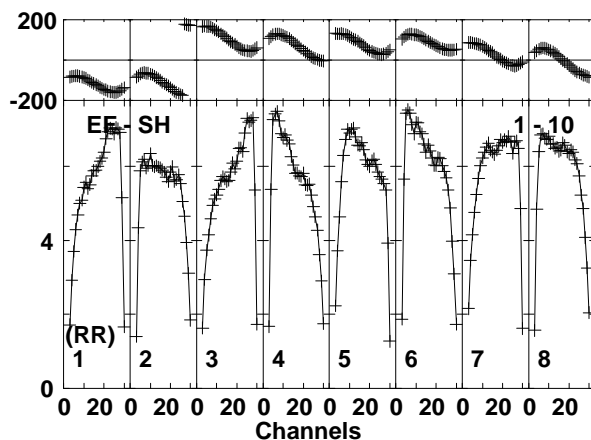
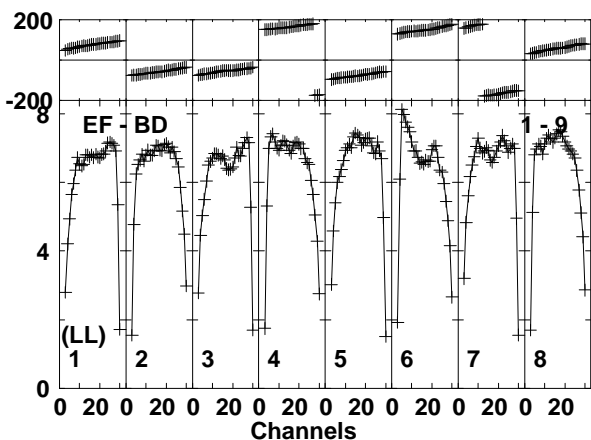
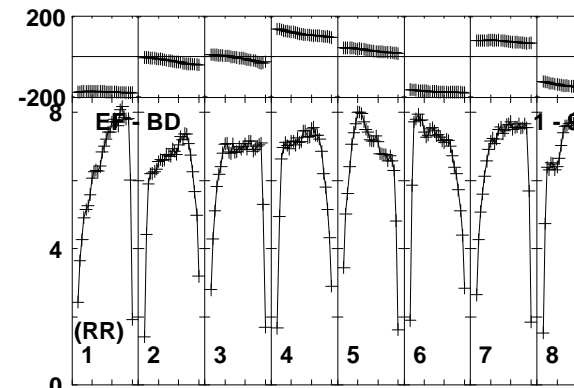
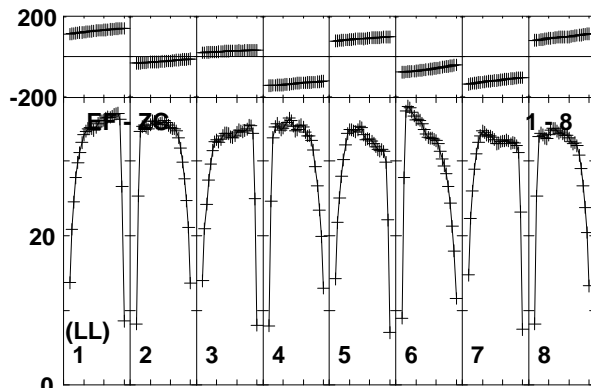
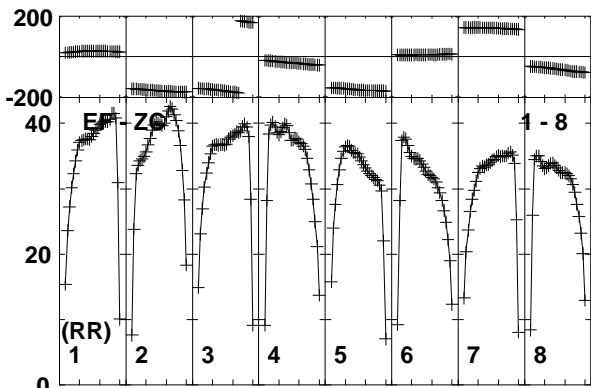
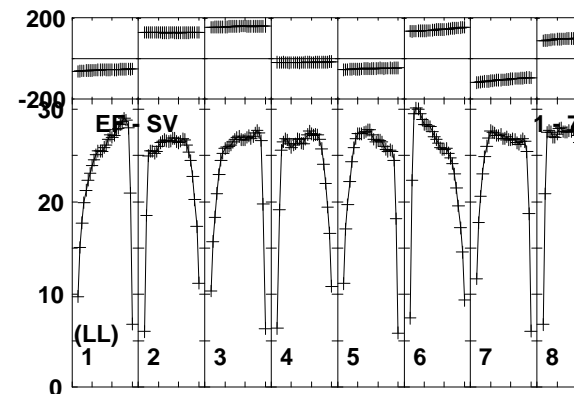
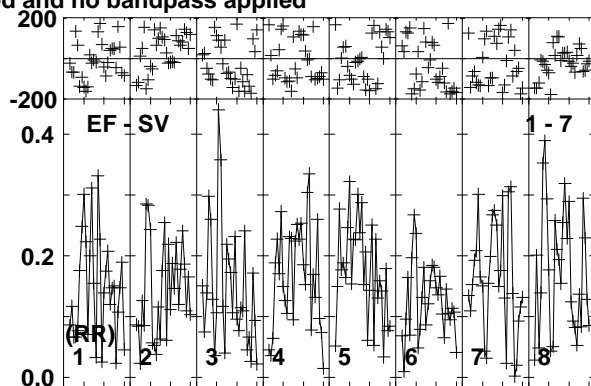
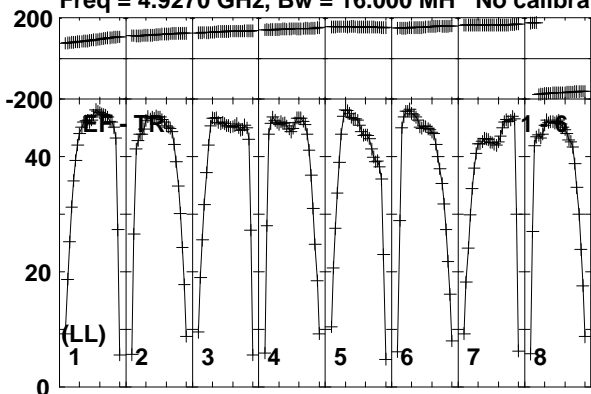

Lower frame: Milli Ampl Jy Top frame: Phas deg
Vector averaged cross-power spectrum Baseline: EF (01) - TR (06)
Timerange: 00:12:53:43 to 00:12:54:39

Plot file version 75 created 28-JAN-2015 14:38:07

3C345 N14C3.UVDATA.1

Freq = 4.9270 GHz, Bw = 16.000 MH No calibration applied and no bandpass applied

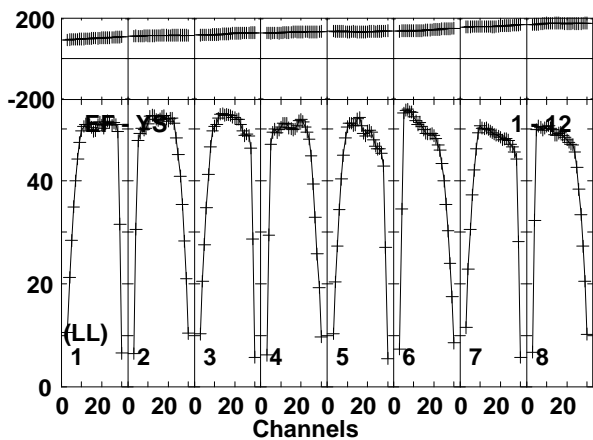
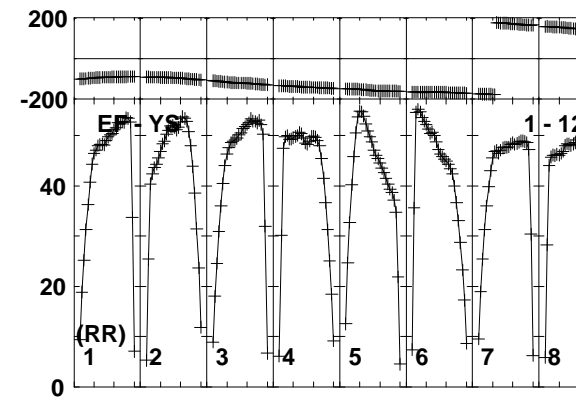
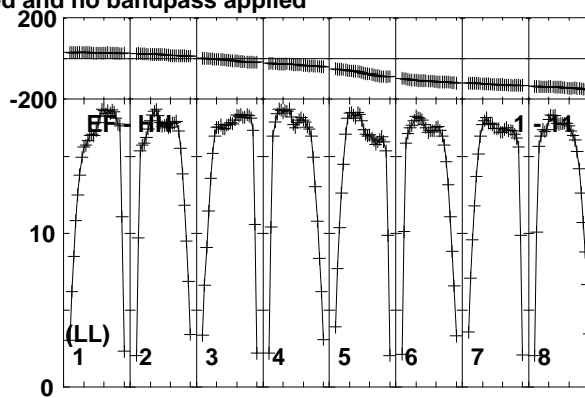
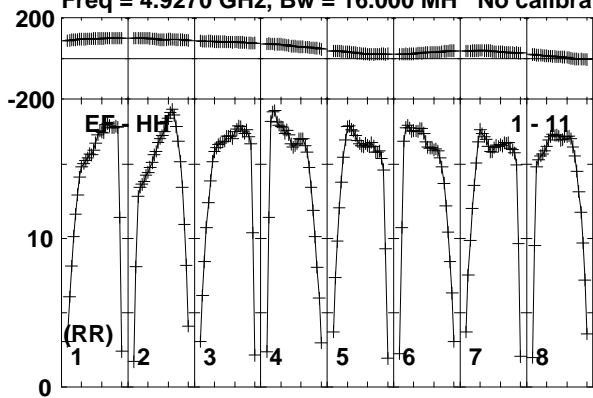

Lower frame: Milli Ampl Jy Top frame: Phas deg
Vector averaged cross-power spectrum Baseline: EF (01) - HH (11)
Timerange: 00/12:53:43 to 00/12:54:39

Plot file version 76 created 28-JAN-2015 14:38:07

J1640+3946 N14C3.UVDATA.1

Freq = 4.9270 GHz, Bw = 16.000 MH No calibration applied and no bandpass applied

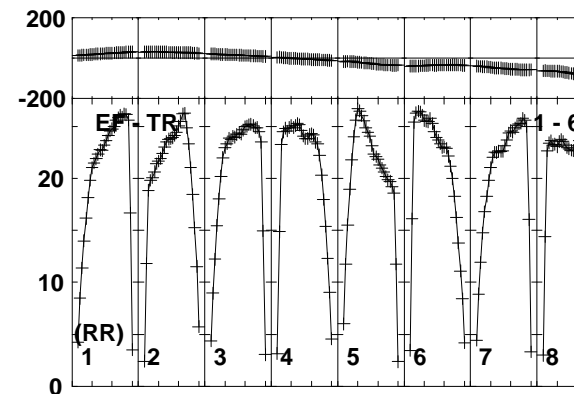
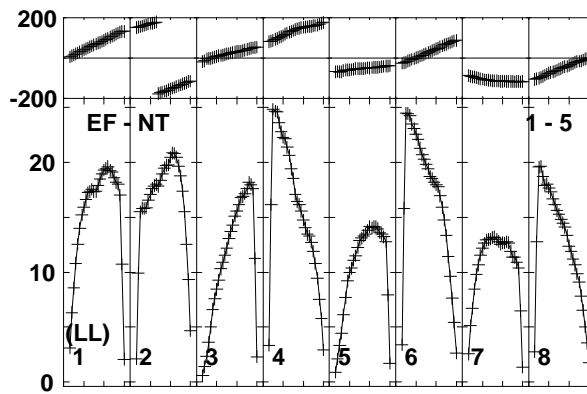
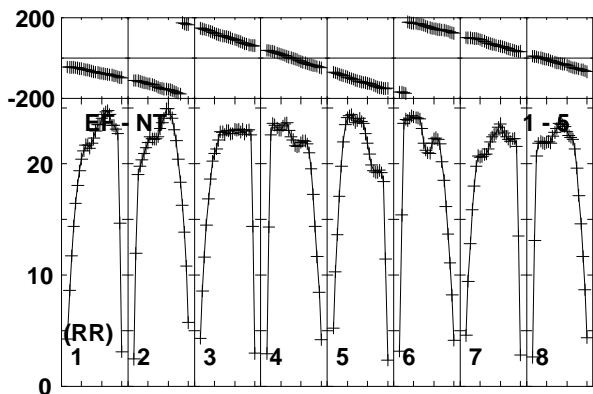
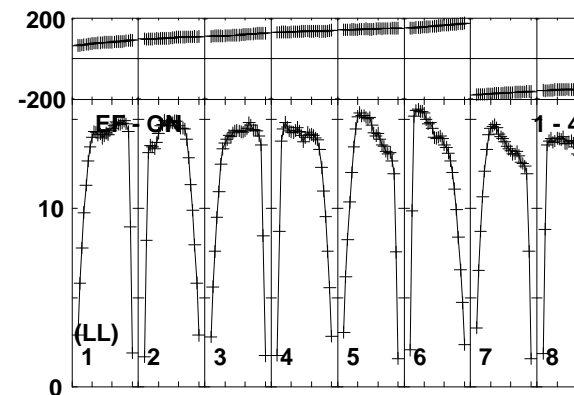
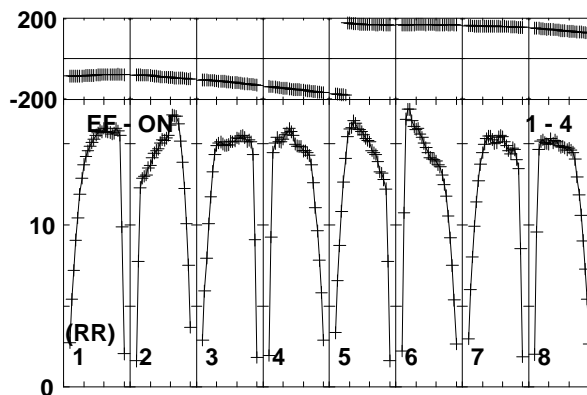
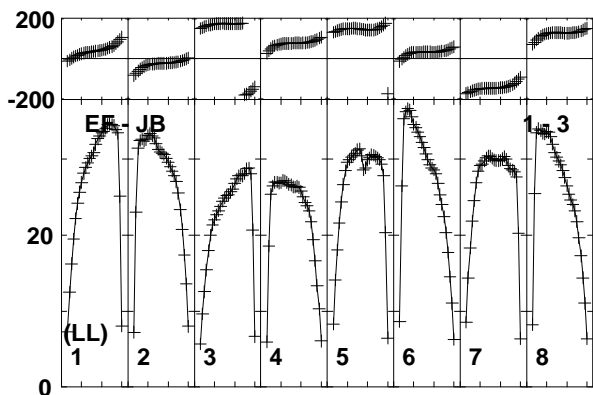
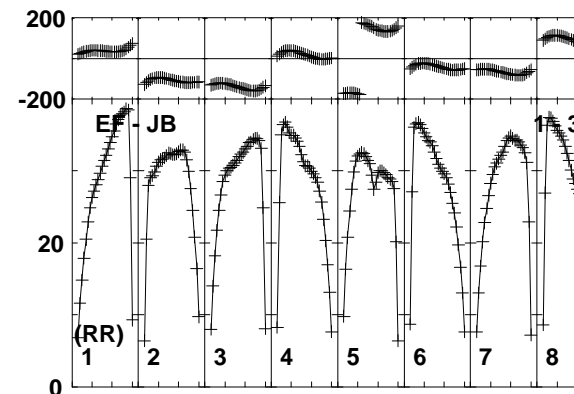
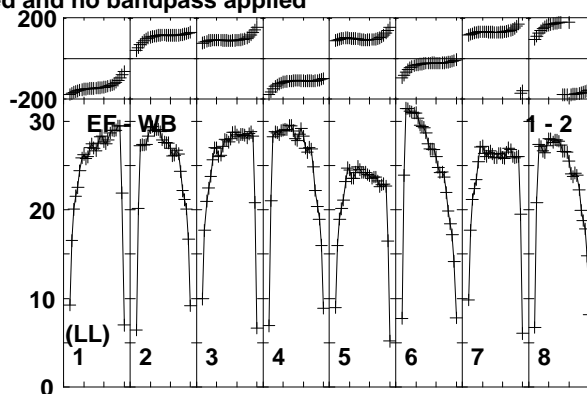
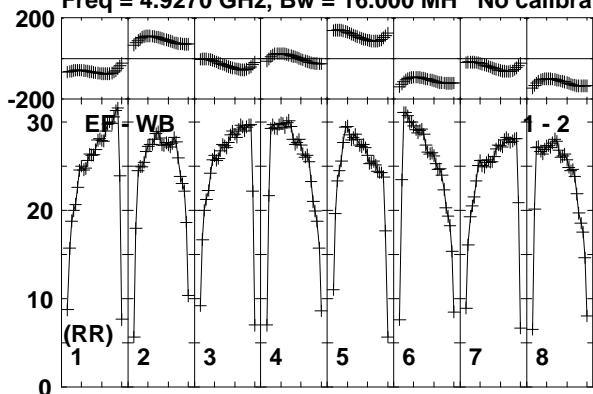

Lower frame: Milli Ampl Jy Top frame: Phas deg
Vector averaged cross-power spectrum Baseline: EF (01) - WB (02)
Timerange: 00/12:55:23 to 00/12:56:19

Plot file version 77 created 28-JAN-2015 14:38:07

J1640+3946 N14C3.UVDATA.1

Freq = 4.9270 GHz, Bw = 16.000 MH No calibration applied and no bandpass applied

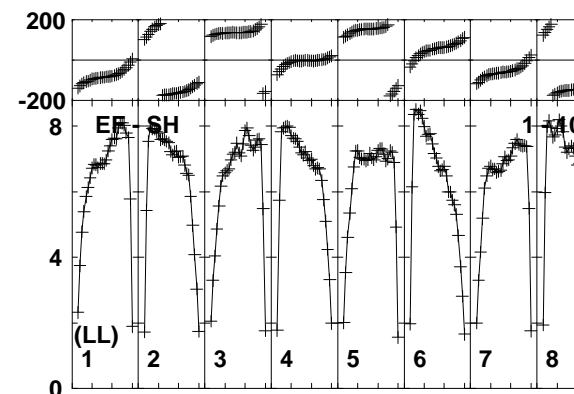
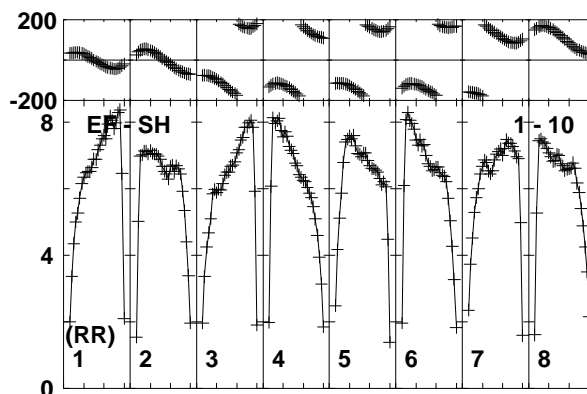
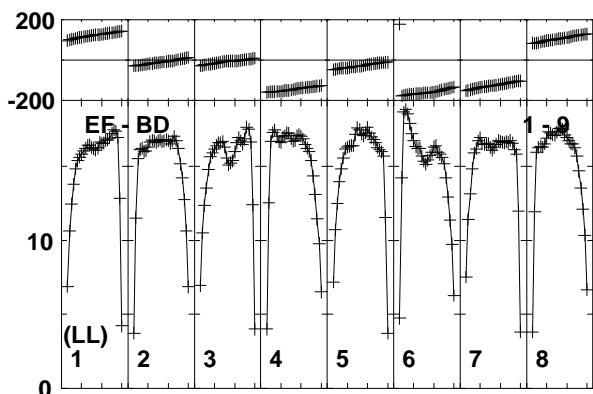
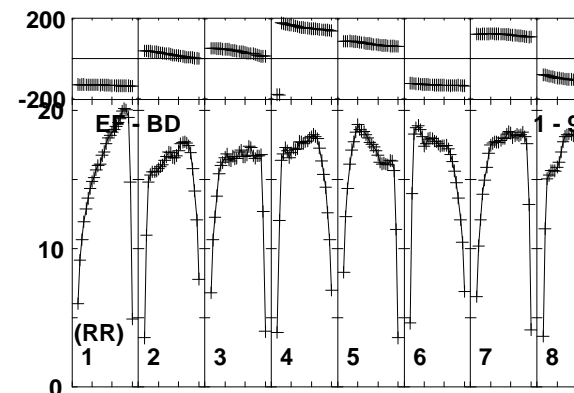
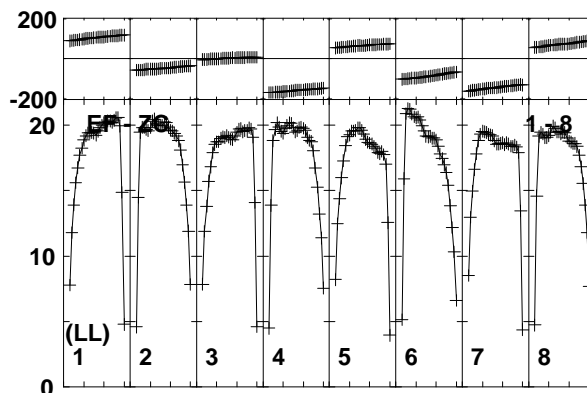
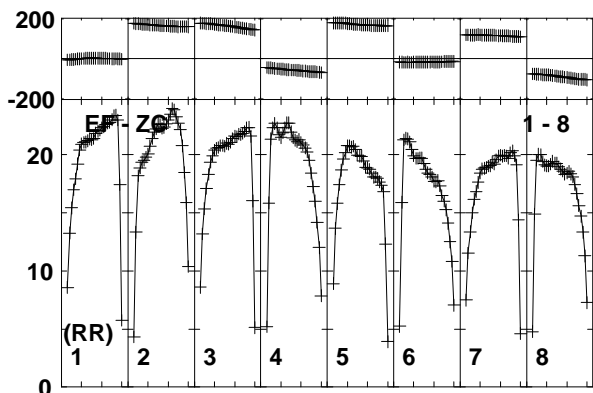
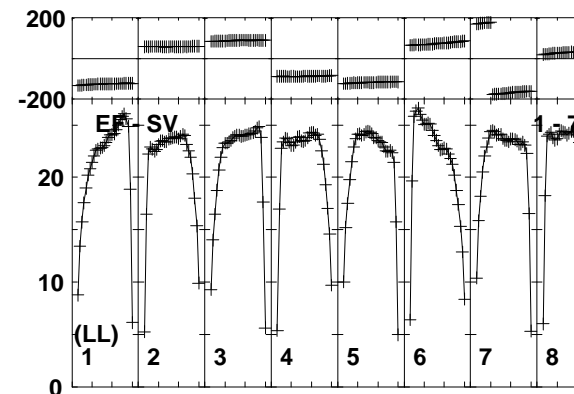
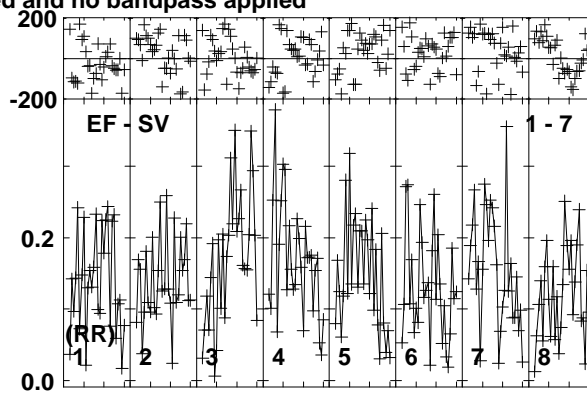
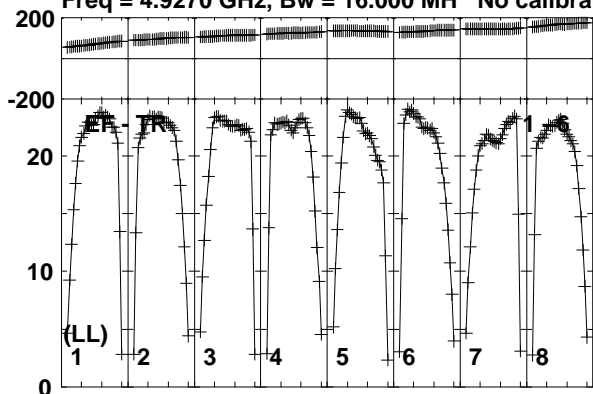

Lower frame: Milli Ampl Jy Top frame: Phas deg
Vector averaged cross-power spectrum Baseline: EF (01) - TR (06)
Timerange: 00:12:55:23 to 00:12:56:19

Plot file version 78 created 28-JAN-2015 14:38:07

J1640+3946 N14C3.UVDATA.1

Freq = 4.9270 GHz, Bw = 16.000 MH No calibration applied and no bandpass applied

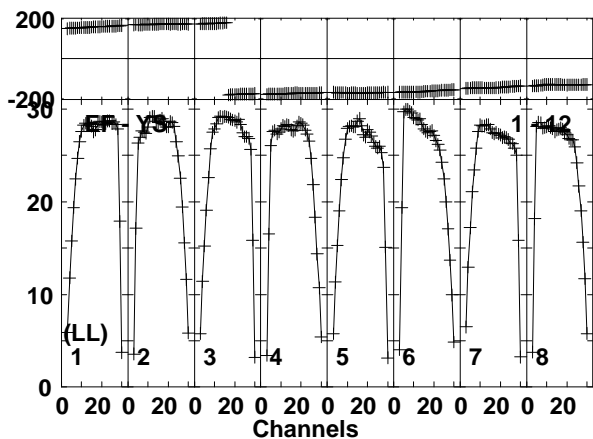
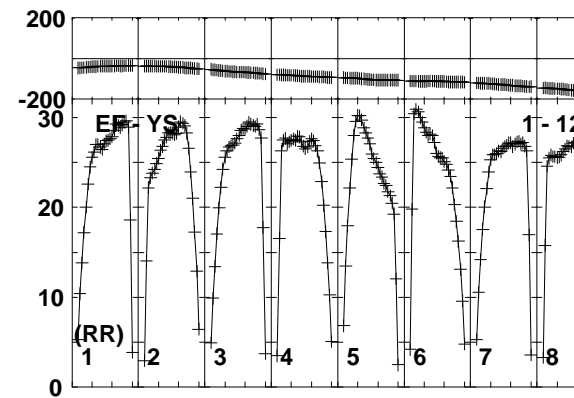
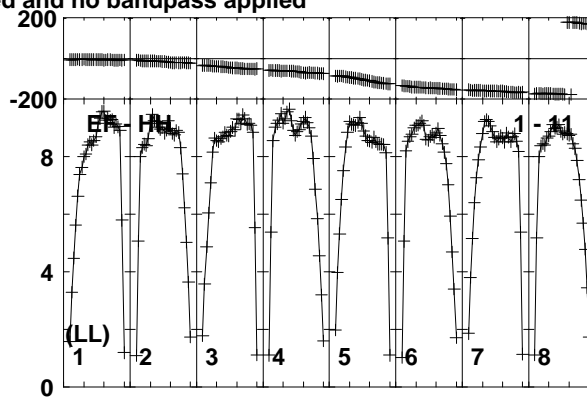
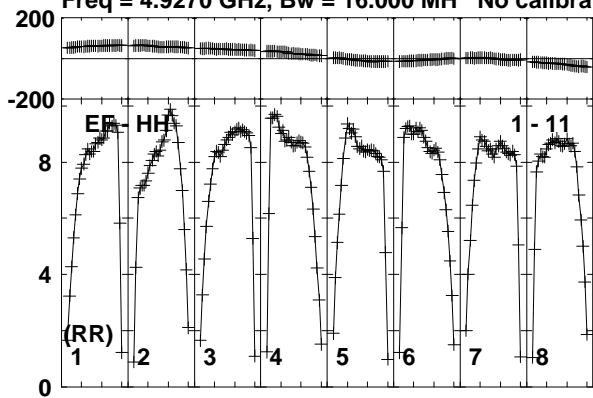

Lower frame: Milli Ampl Jy Top frame: Phas deg
Vector averaged cross-power spectrum Baseline: EF (01) - HH (11)
Timerange: 00/12:55:23 to 00/12:56:19

Plot file version 79 created 28-JAN-2015 14:38:07

3C345 N14C3.UVDATA.1

Freq = 4.9270 GHz, Bw = 16.000 MH No calibration applied and no bandpass applied

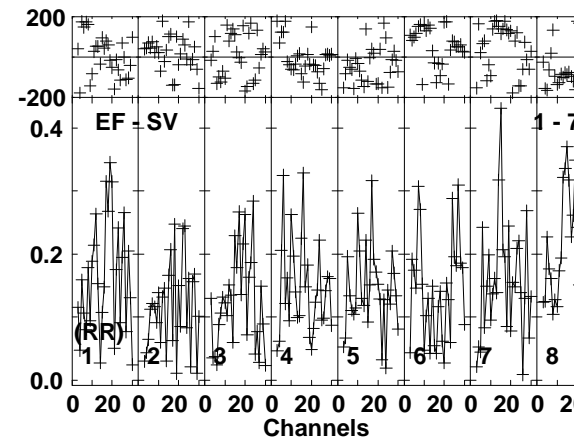
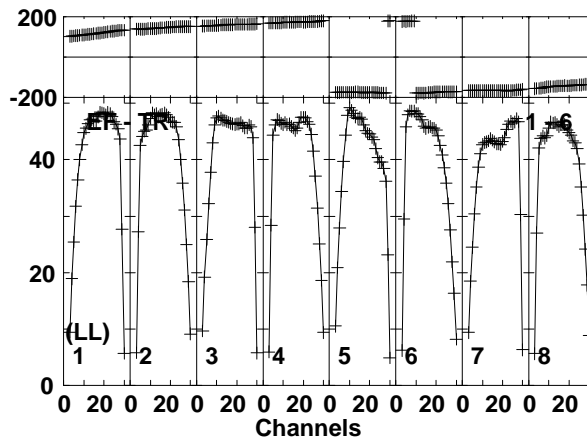
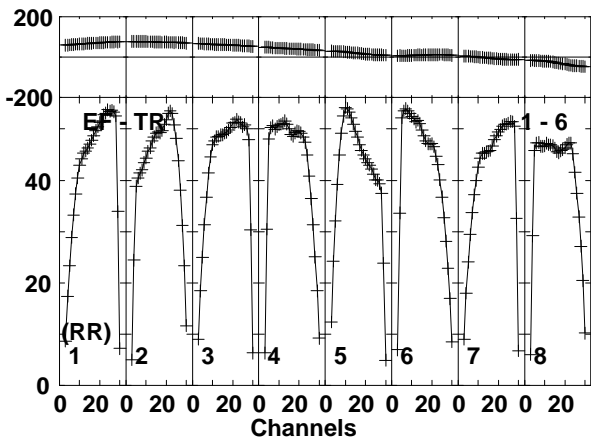
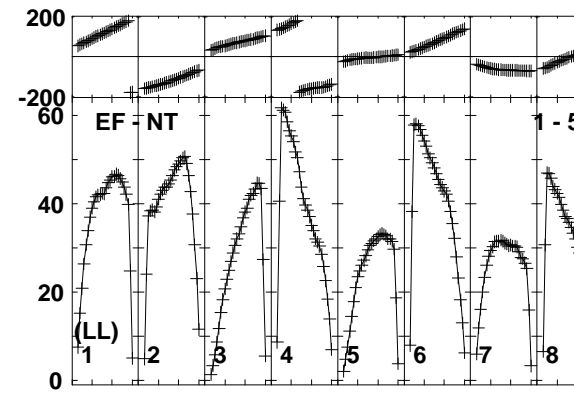
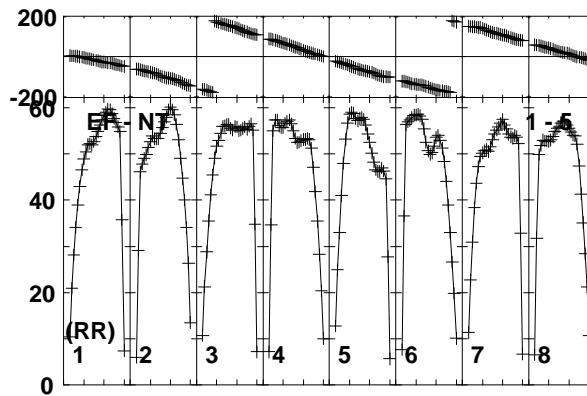
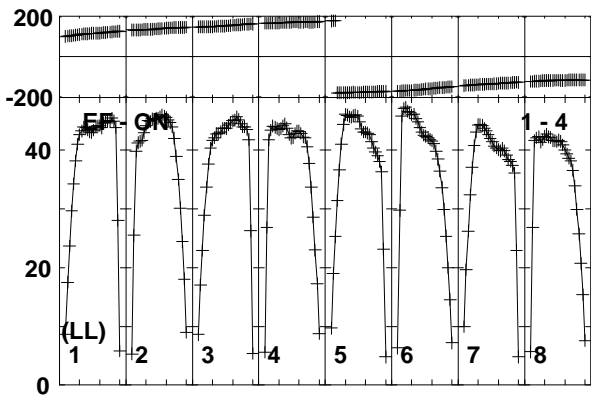
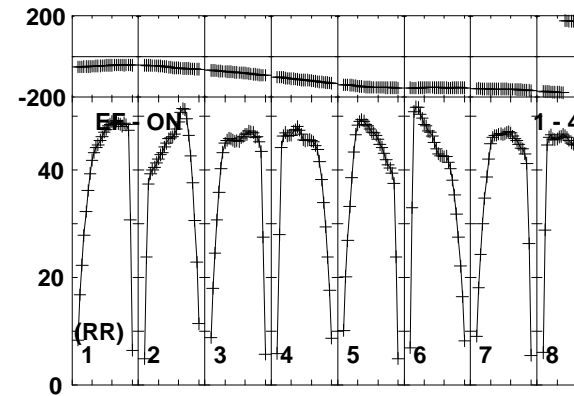
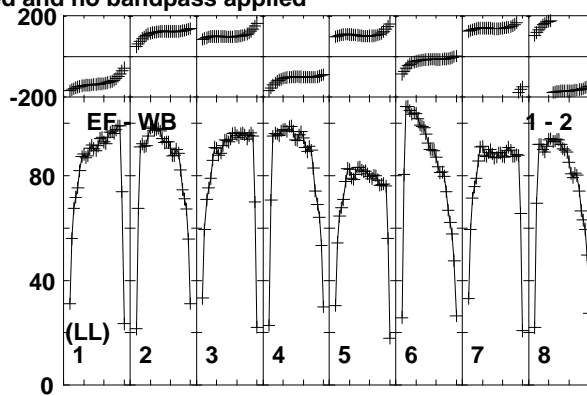
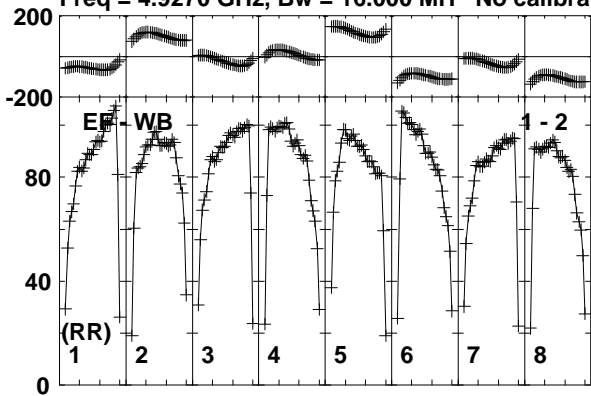

Lower frame: Milli Ampl Jy Top frame: Phas deg
Vector averaged cross-power spectrum Baseline: EF (01) - WB (02)
Timerange: 00:12:57:03 to 00:12:57:59

Plot file version 80 created 28-JAN-2015 14:38:07

3C345 N14C3.UVDATA.1

Freq = 4.9270 GHz, Bw = 16.000 MH No calibration applied and no bandpass applied

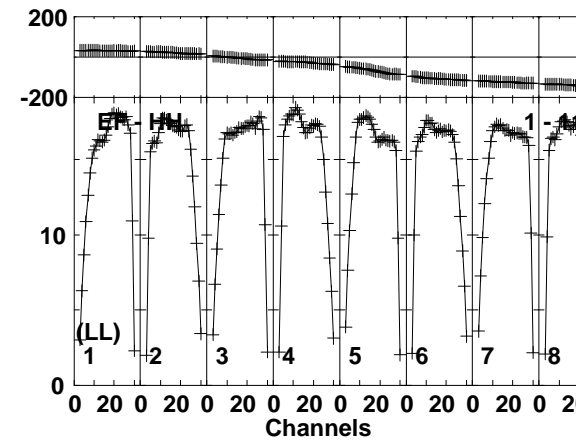
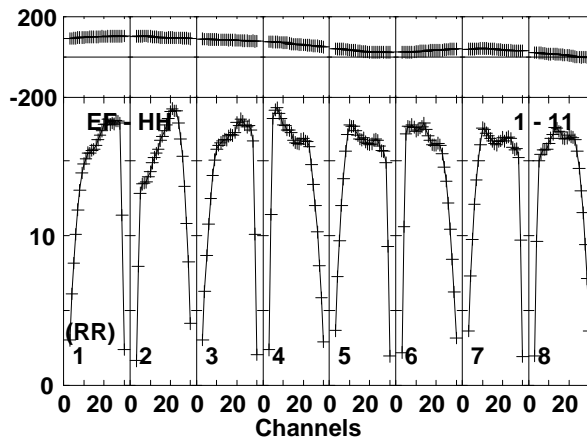
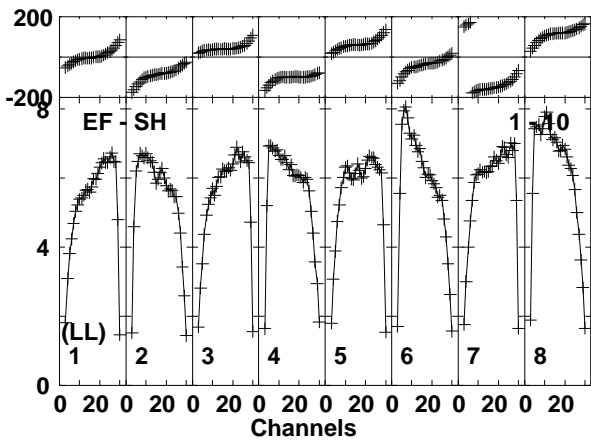
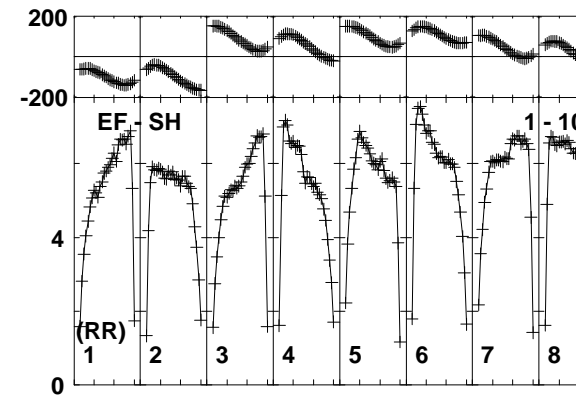
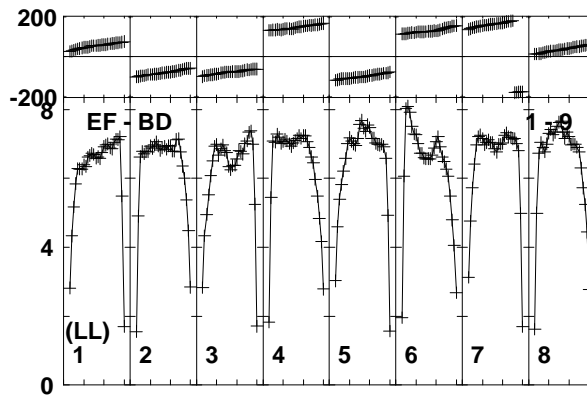
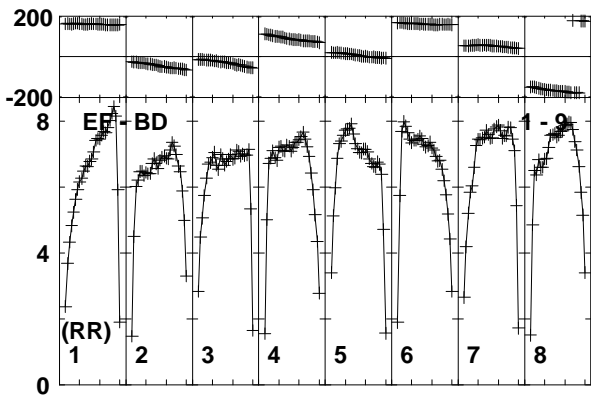
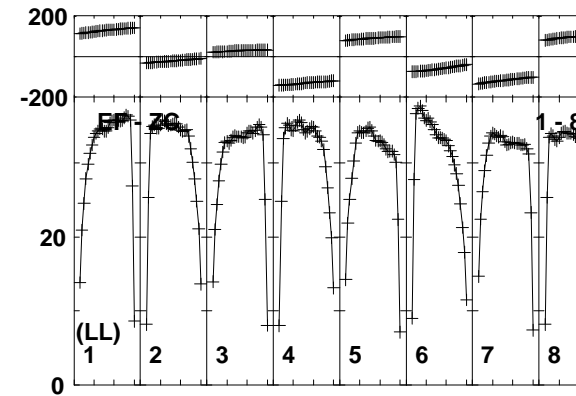
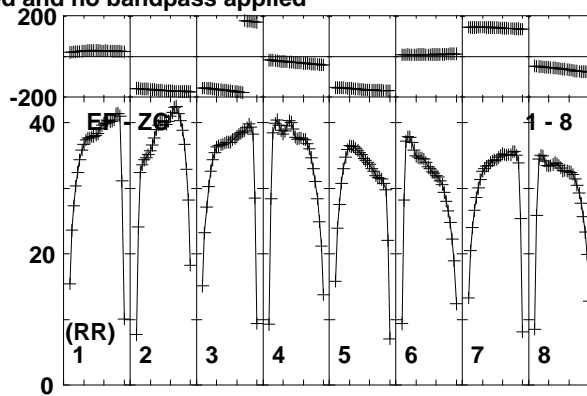
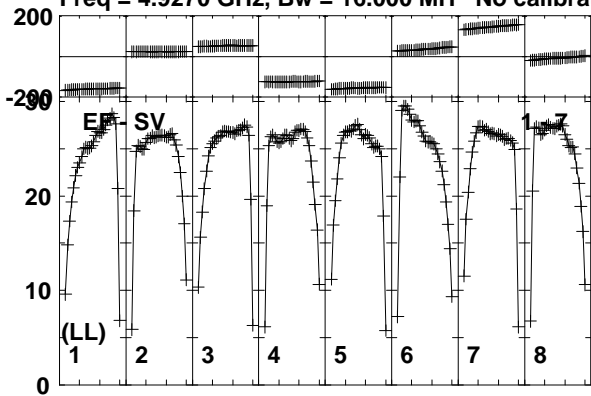

Lower frame: Milli Ampl Jy Top frame: Phas deg
Vector averaged cross-power spectrum Baseline: EF (01) - SV (07)
Timerange: 00:12:57:03 to 00:12:57:59

Plot file version 81 created 28-JAN-2015 14:38:07

3C345 N14C3.UVDATA.1

Freq = 4.9270 GHz, Bw = 16.000 MH No calibration applied and no bandpass applied

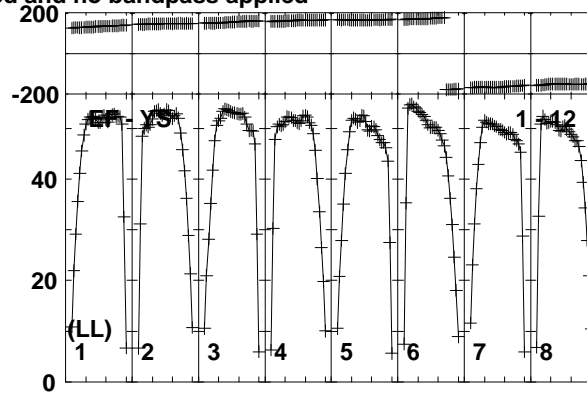
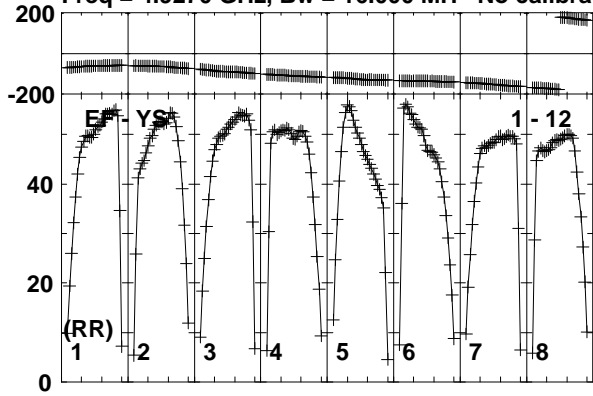

Lower frame: Milli Ampl Jy Top frame: Phas deg
Vector averaged cross-power spectrum Baseline: EF (01) - YS (12)
Timerange: 00/12:57:03 to 00/12:57:59

Plot file version 82 created 28-JAN-2015 14:38:07

J1640+3946 N14C3.UVDATA.1

Freq = 4.9270 GHz, Bw = 16.000 MH No calibration applied and no bandpass applied

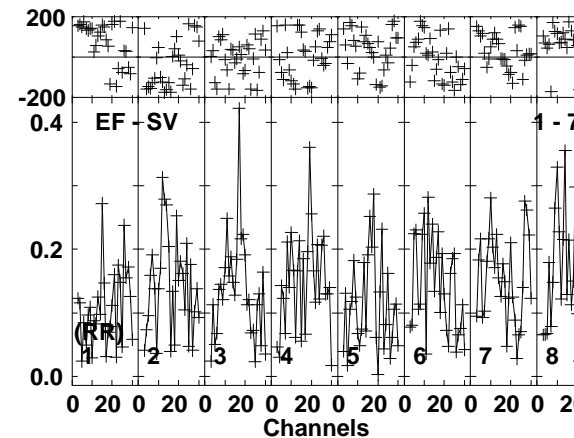
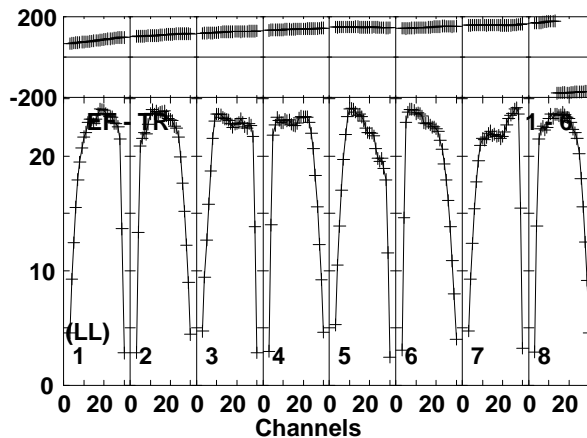
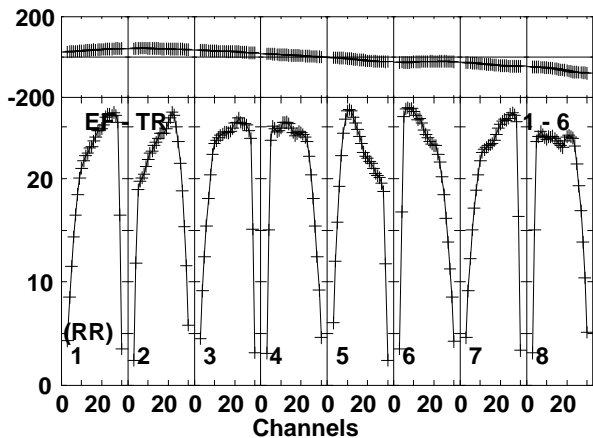
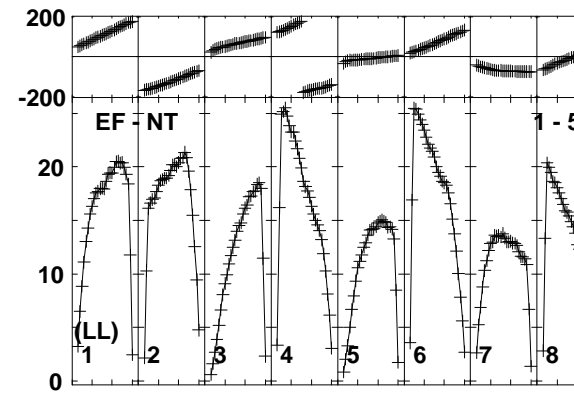
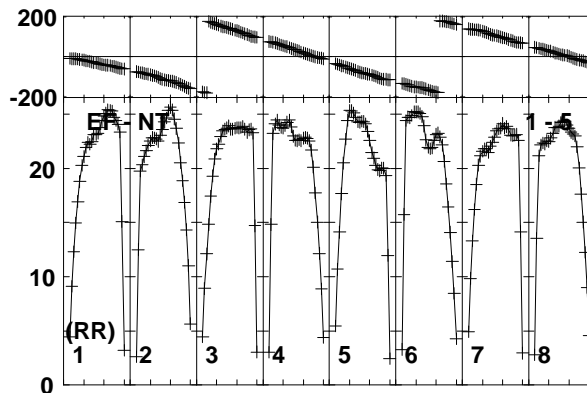
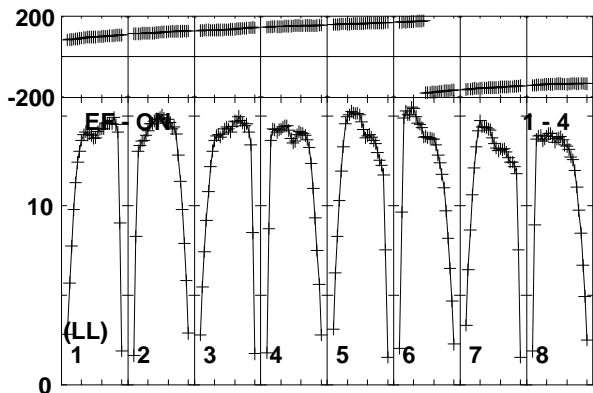
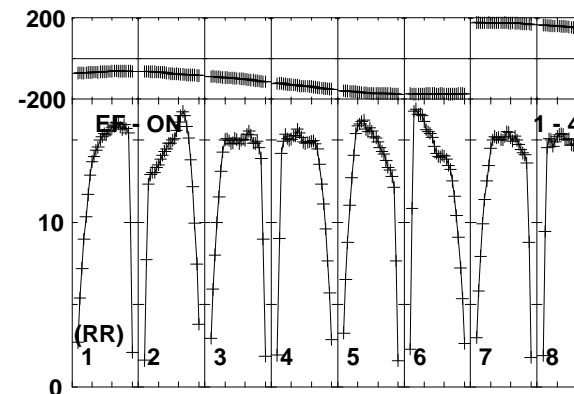
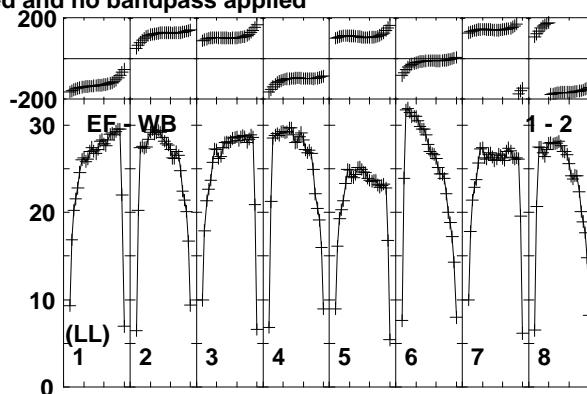
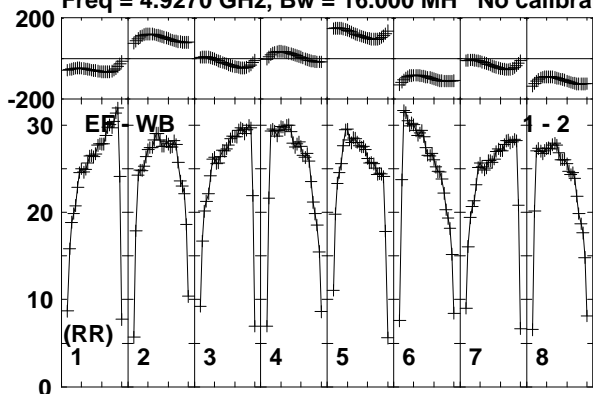

Lower frame: Milli Ampl Jy Top frame: Phas deg
Vector averaged cross-power spectrum Baseline: EF (01) - WB (02)
Timerange: 00/12:58:43 to 00/12:59:39

Plot file version 83 created 28-JAN-2015 14:38:07

J1640+3946 N14C3.UVDATA.1

Freq = 4.9270 GHz, Bw = 16.000 MH No calibration applied and no bandpass applied

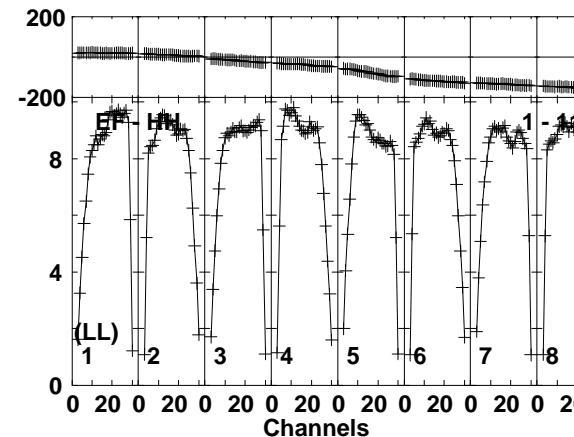
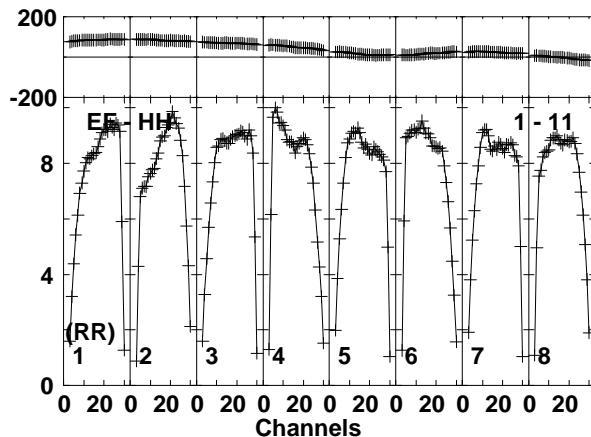
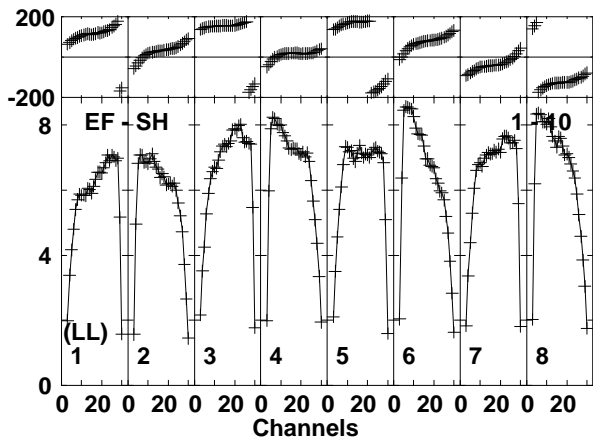
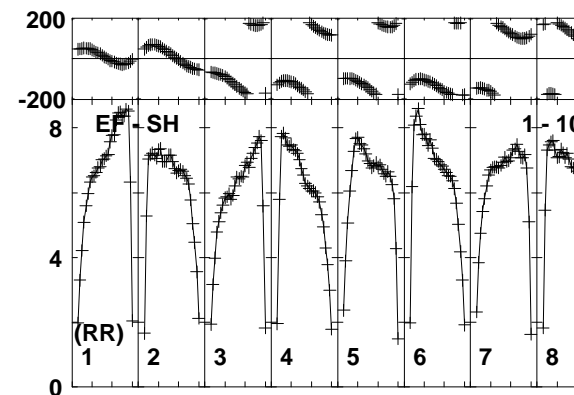
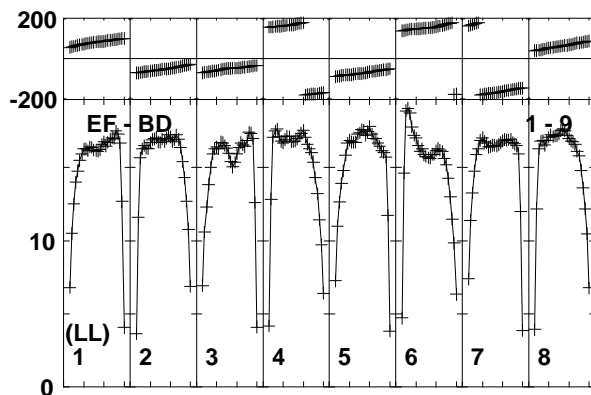
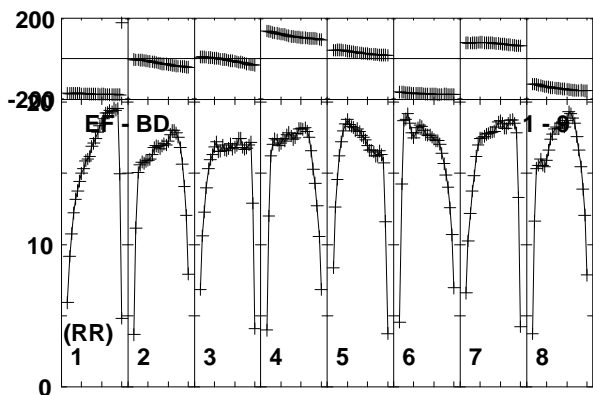
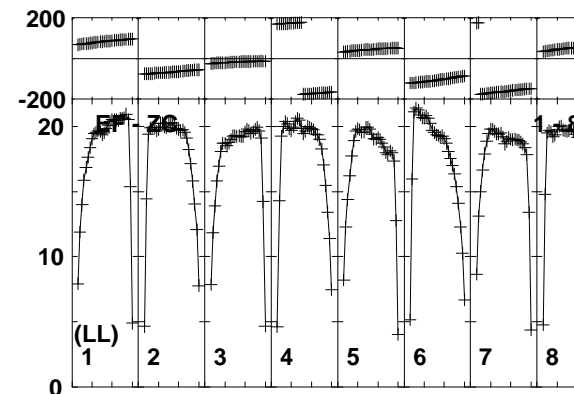
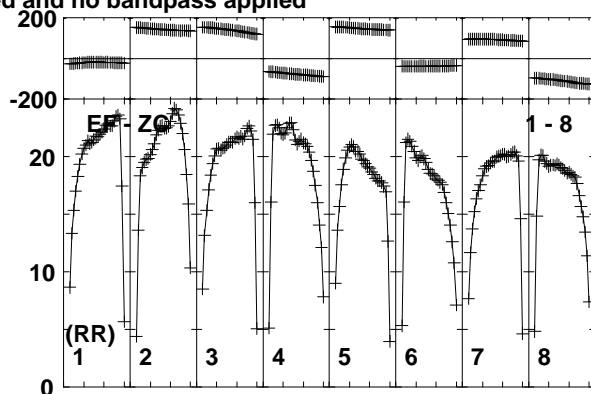
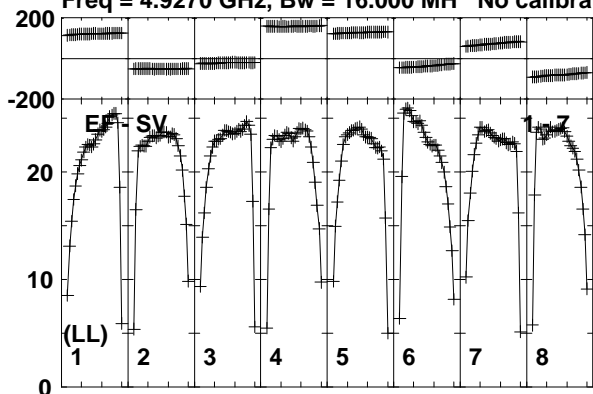

Lower frame: Milli Ampl Jy Top frame: Phas deg
Vector averaged cross-power spectrum Baseline: EF (01) - SV (07)
Timerange: 00:12:58:43 to 00:12:59:39

Plot file version 84 created 28-JAN-2015 14:38:07

J1640+3946 N14C3.UVDATA.1

Freq = 4.9270 GHz, Bw = 16.000 MH No calibration applied and no bandpass applied

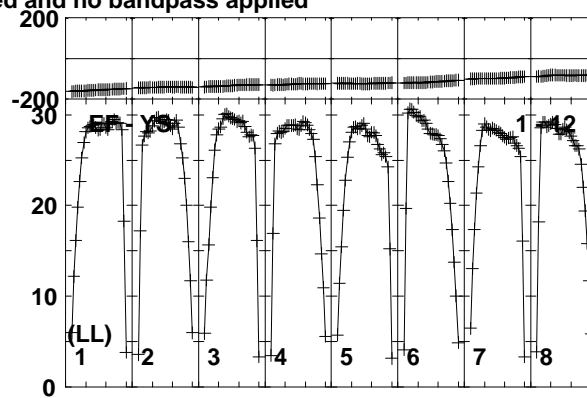
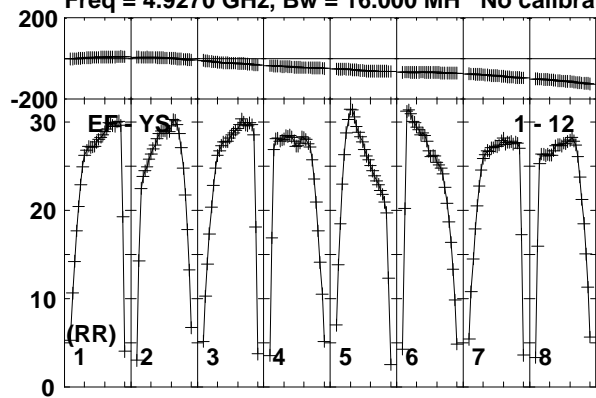

Lower frame: Milli Ampl Jy Top frame: Phas deg
Vector averaged cross-power spectrum Baseline: EF (01) - YS (12)
Timerange: 00/12:58:43 to 00/12:59:39

Plot file version 85 created 28-JAN-2015 14:38:07

3C345 N14C3.UVDATA.1

Freq = 4.9270 GHz, Bw = 16.000 MH No calibration applied and no bandpass applied

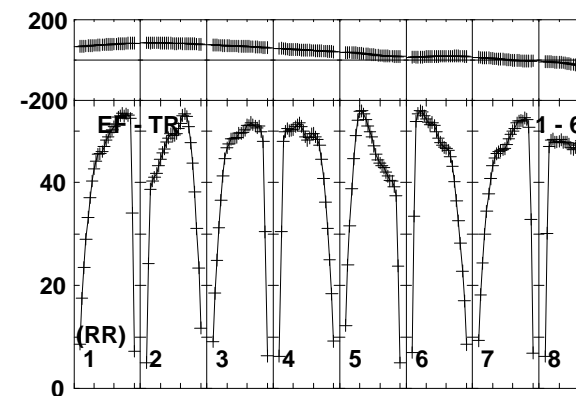
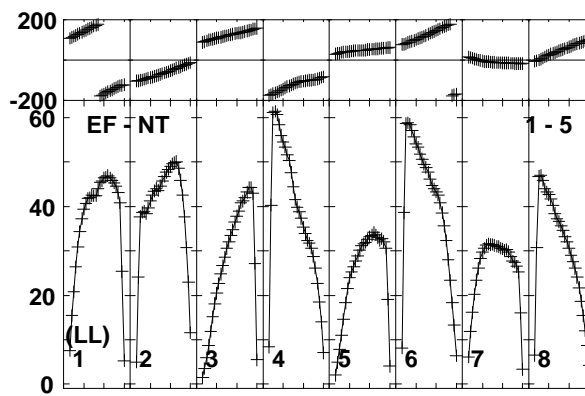
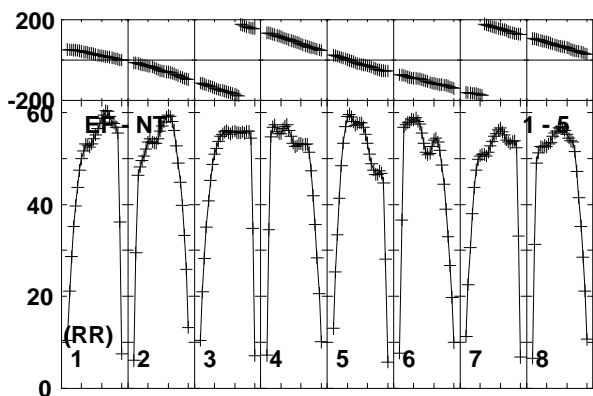
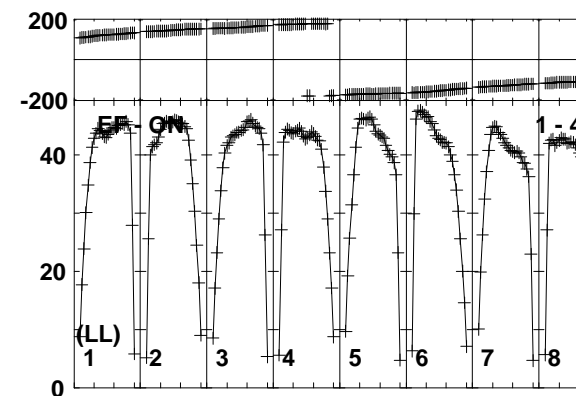
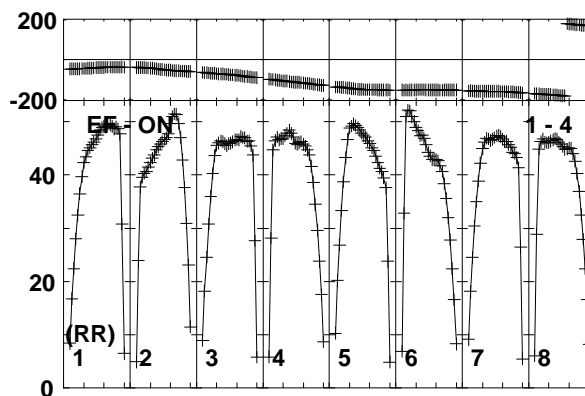
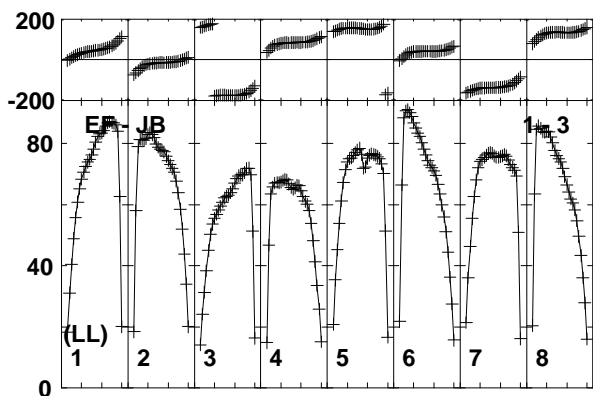
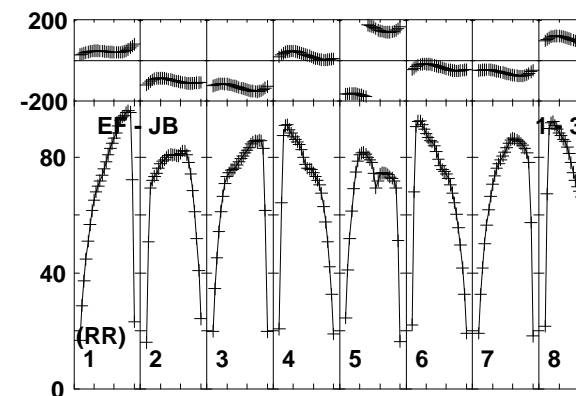
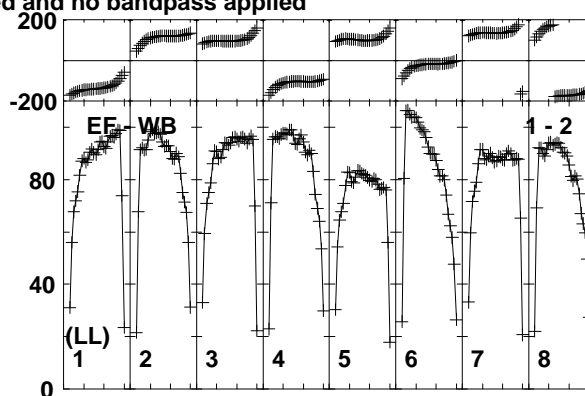
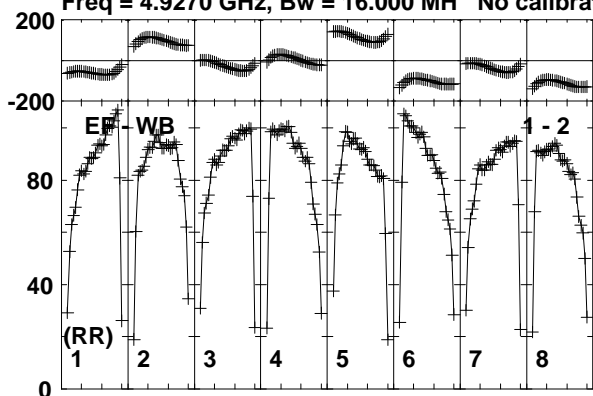

Lower frame: Milli Ampl Jy Top frame: Phas deg
Vector averaged cross-power spectrum Baseline: EF (01) - WB (02)
Timerange: 00/13:00:23 to 00/13:01:19

Plot file version 86 created 28-JAN-2015 14:38:07

3C345 N14C3.UVDATA.1

Freq = 4.9270 GHz, Bw = 16.000 MH No calibration applied and no bandpass applied

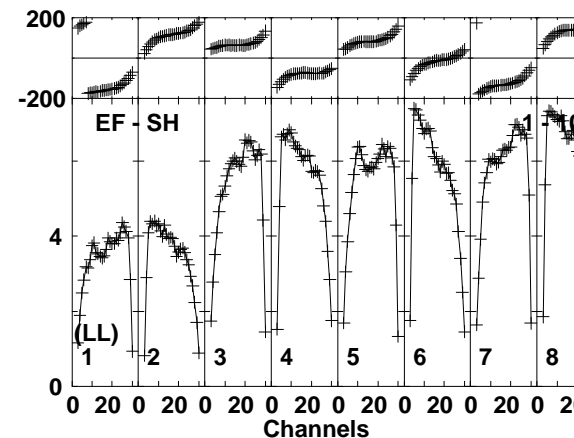
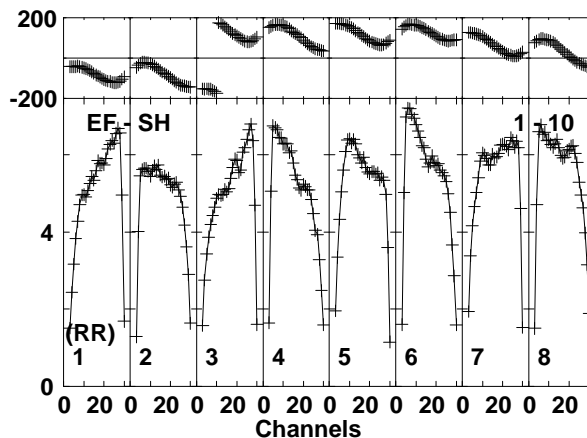
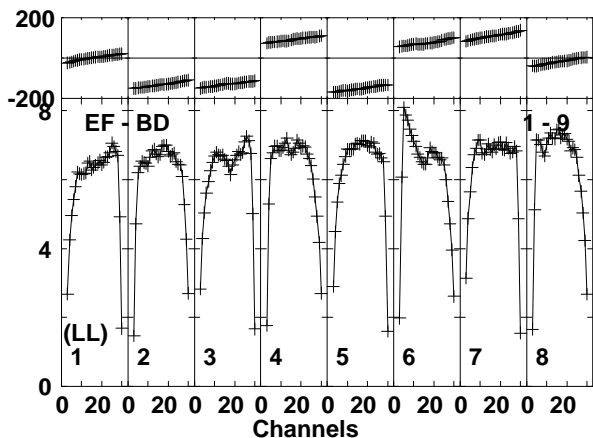
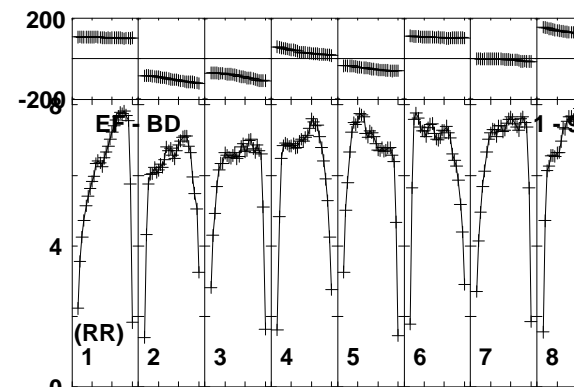
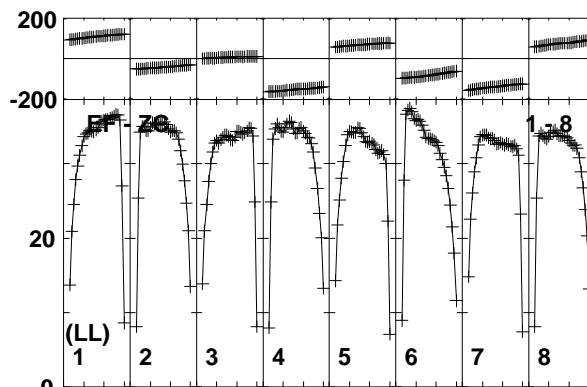
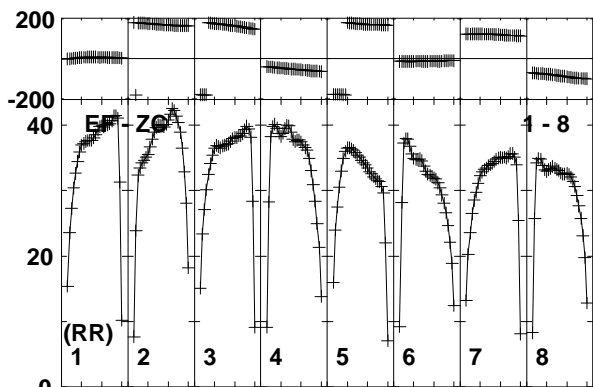
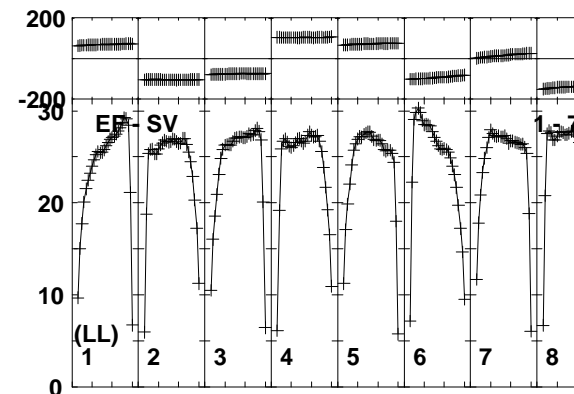
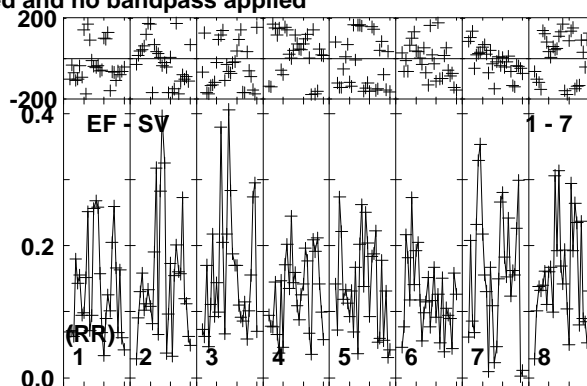
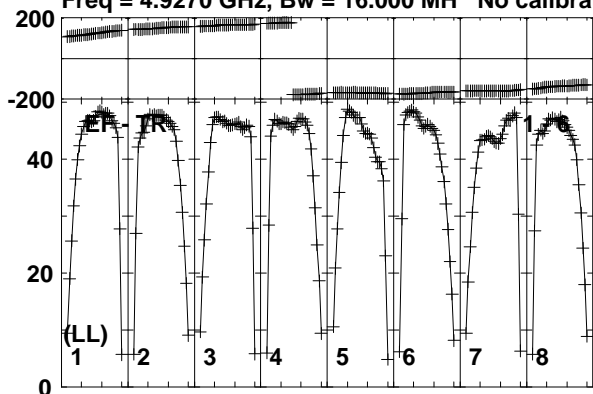

Lower frame: Milli Ampl Jy Top frame: Phas deg
Vector averaged cross-power spectrum Baseline: EF (01) - TR (06)
Timerange: 00/13:00:23 to 00/13:01:19

Plot file version 87 created 28-JAN-2015 14:38:07

3C345 N14C3.UVDATA.1

Freq = 4.9270 GHz, Bw = 16.000 MH No calibration applied and no bandpass applied

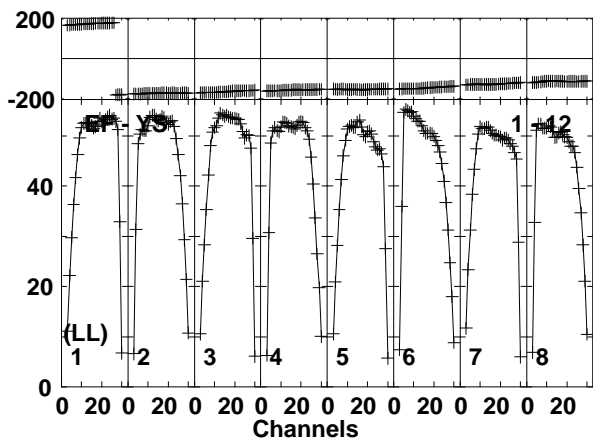
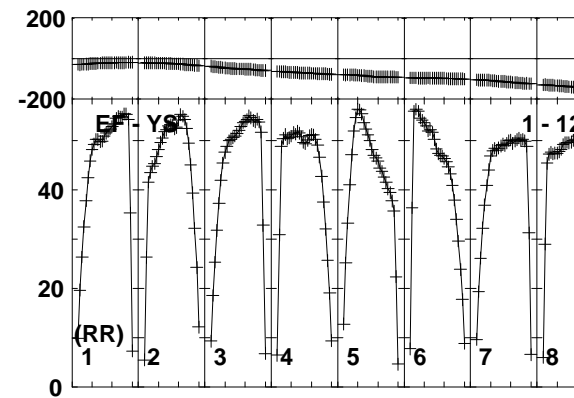
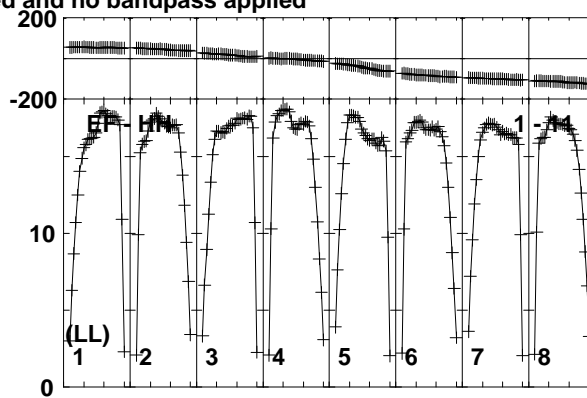
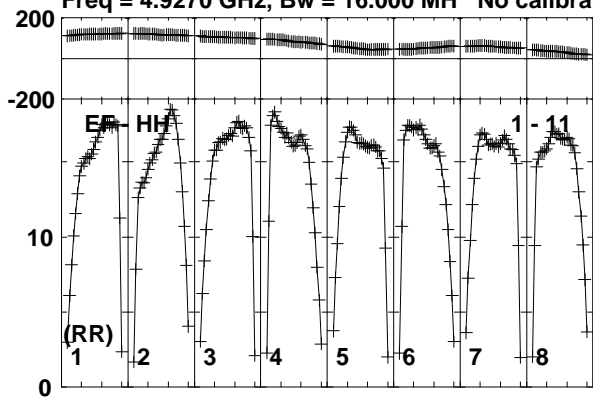

Lower frame: Milli Ampl Jy Top frame: Phas deg
Vector averaged cross-power spectrum Baseline: EF (01) - HH (11)
Timerange: 00/13:00:23 to 00/13:01:19

Plot file version 88 created 28-JAN-2015 14:38:07

J1640+3946 N14C3.UVDATA.1

Freq = 4.9270 GHz, Bw = 16.000 MH No calibration applied and no bandpass applied

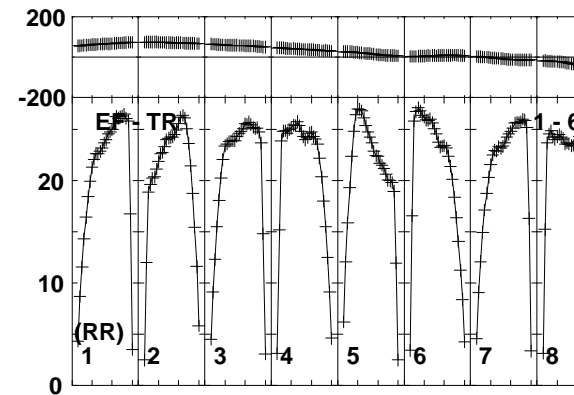
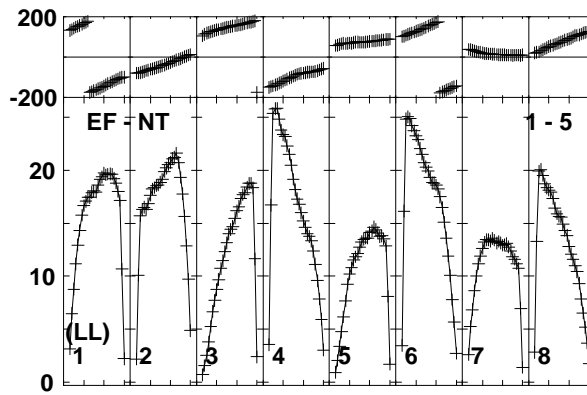
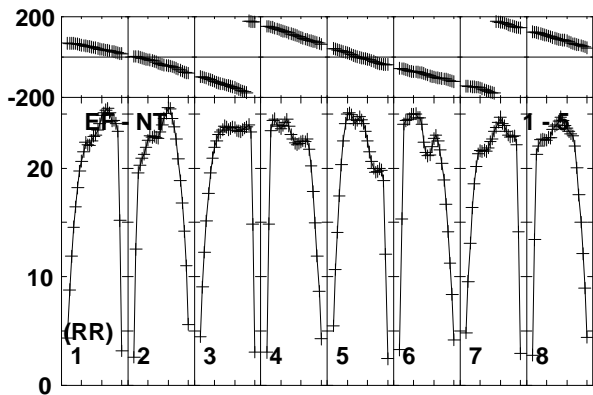
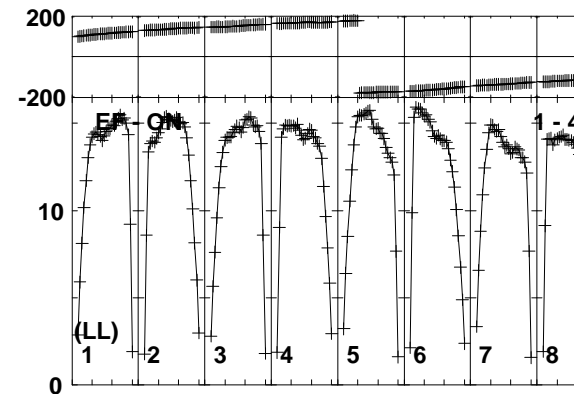
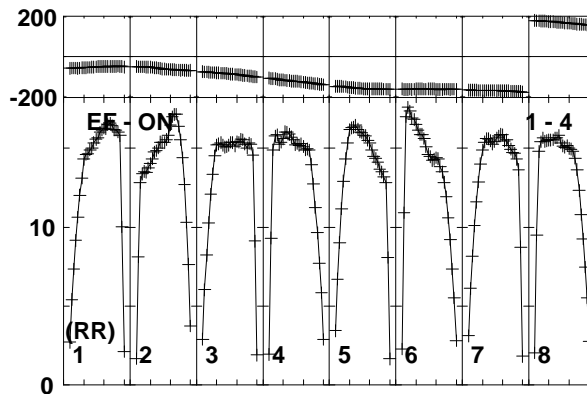
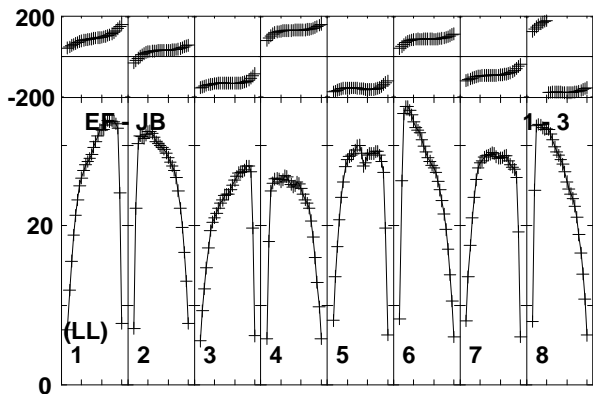
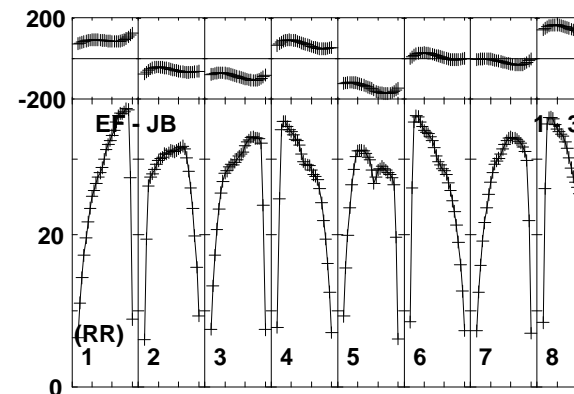
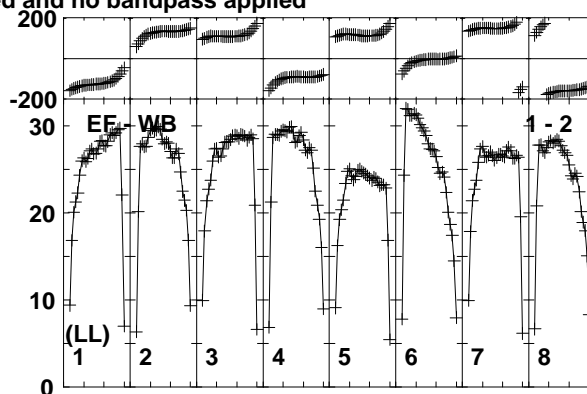
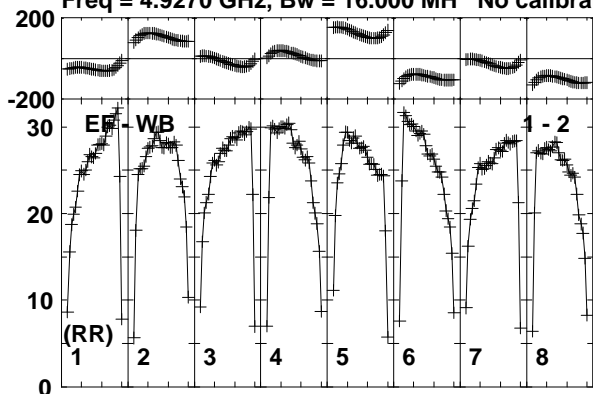

Lower frame: Milli Ampl Jy Top frame: Phas deg
Vector averaged cross-power spectrum Baseline: EF (01) - WB (02)
Timerange: 00/13:02:03 to 00/13:02:59

Plot file version 89 created 28-JAN-2015 14:38:07

J1640+3946 N14C3.UVDATA.1

Freq = 4.9270 GHz, Bw = 16.000 MH No calibration applied and no bandpass applied

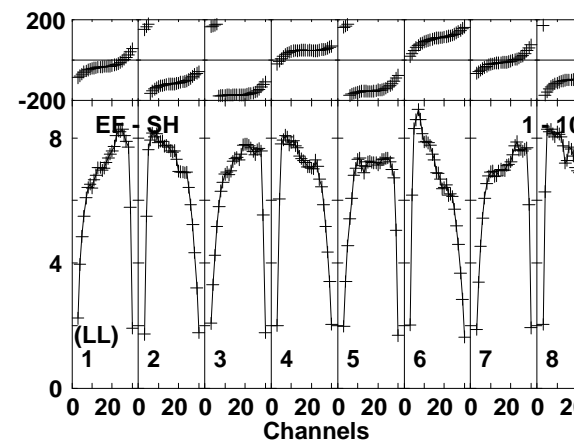
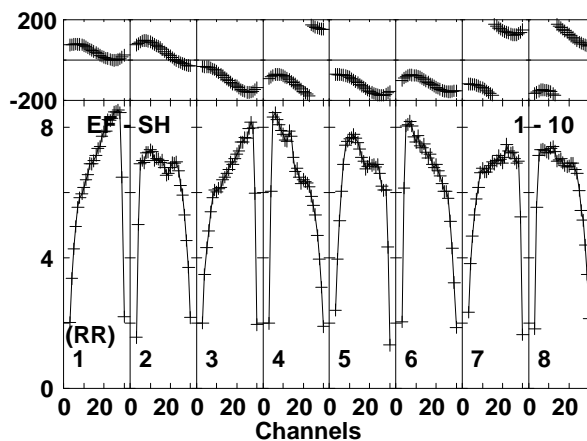
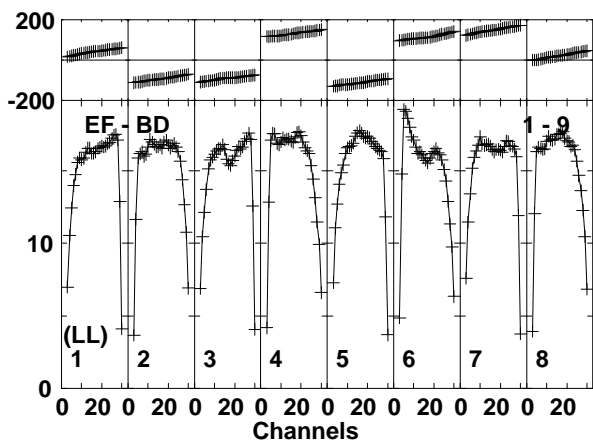
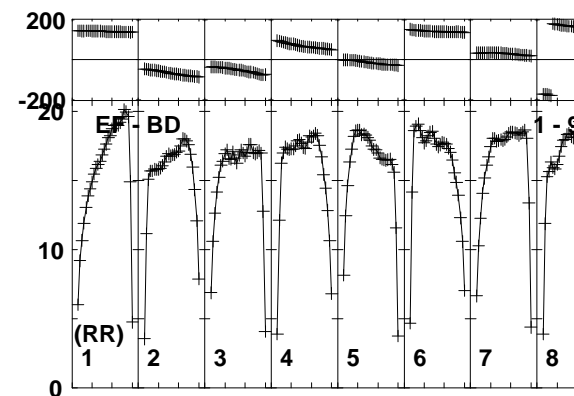
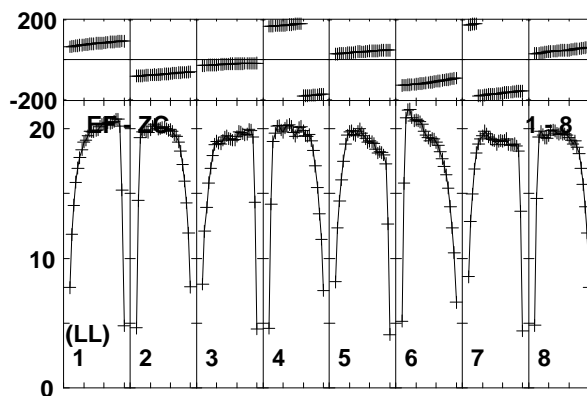
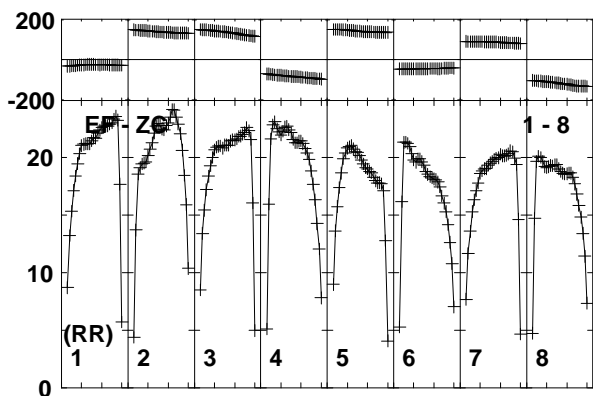
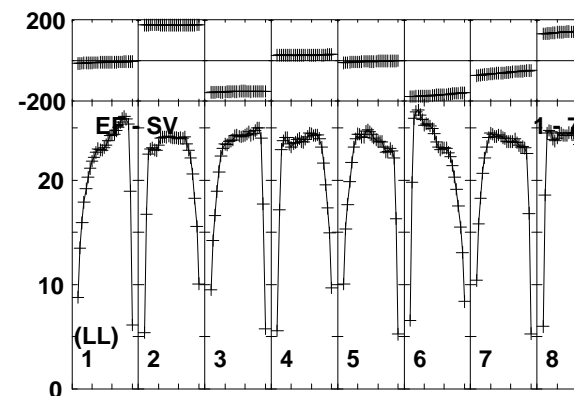
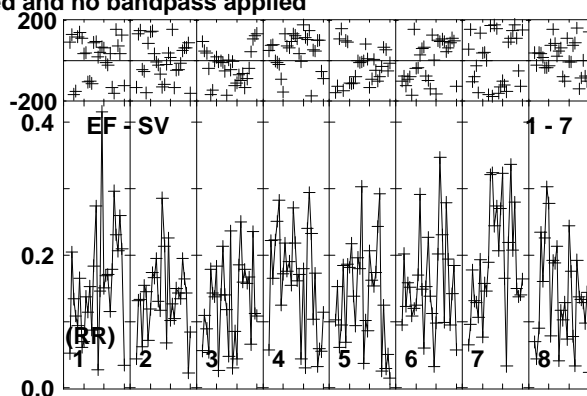
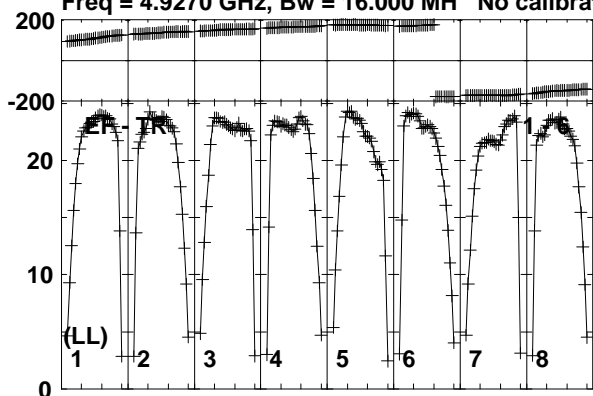

Lower frame: Milli Ampl Jy Top frame: Phas deg
Vector averaged cross-power spectrum Baseline: EF (01) - TR (06)
Timerange: 00/13:02:03 to 00/13:02:59

Plot file version 90 created 28-JAN-2015 14:38:07

J1640+3946 N14C3.UVDATA.1

Freq = 4.9270 GHz, Bw = 16.000 MH No calibration applied and no bandpass applied

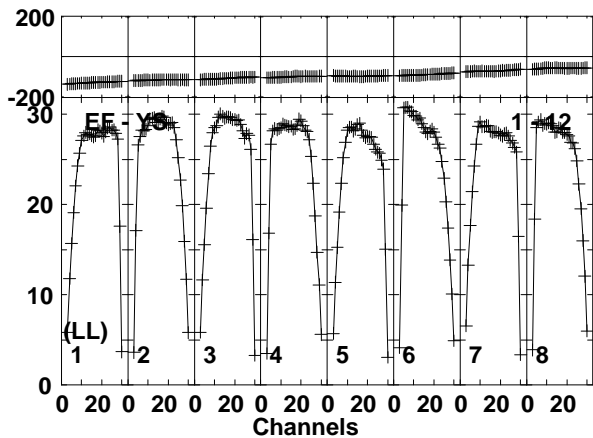
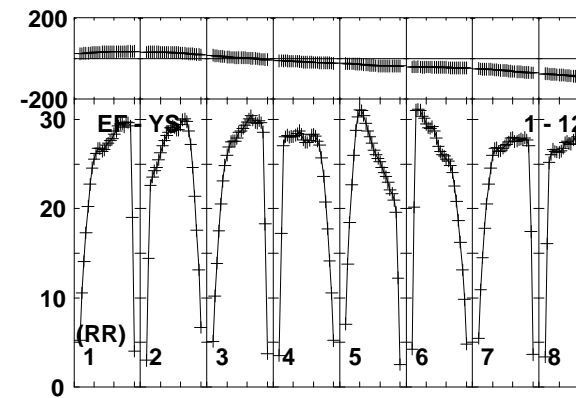
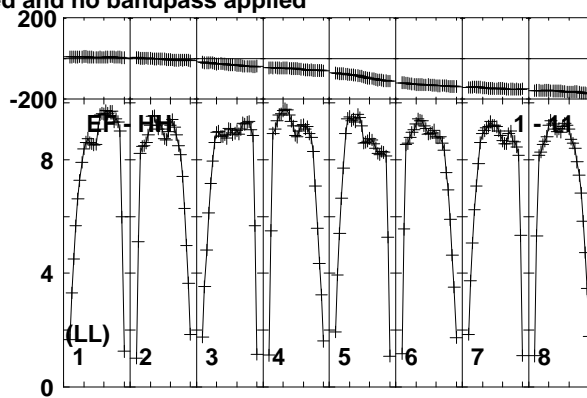
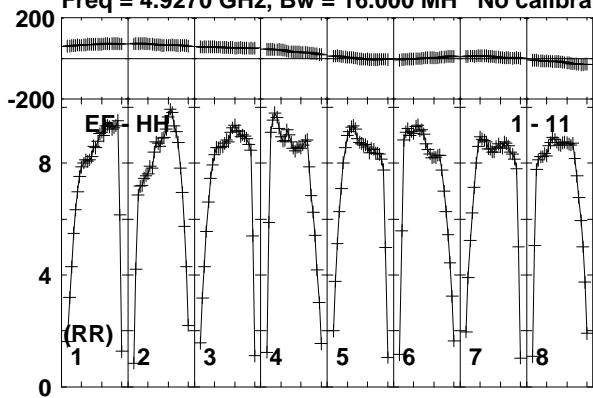

Lower frame: Milli Ampl Jy Top frame: Phas deg
Vector averaged cross-power spectrum Baseline: EF (01) - HH (11)
Timerange: 00/13:02:03 to 00/13:02:59

Plot file version 91 created 28-JAN-2015 14:38:08

3C345 N14C3.UVDATA.1

Freq = 4.9270 GHz, Bw = 16.000 MH No calibration applied and no bandpass applied

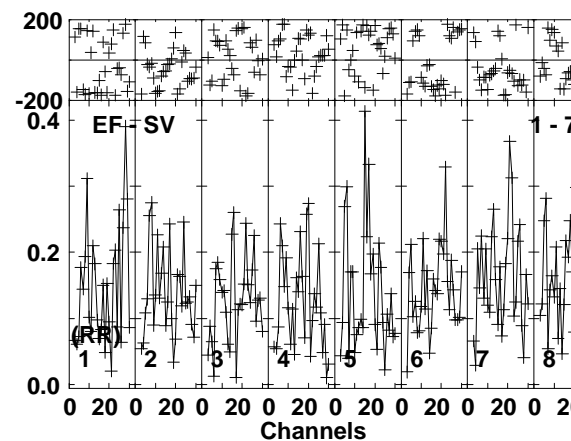
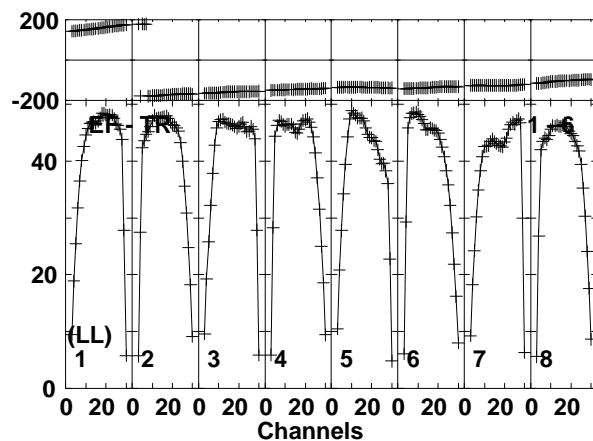
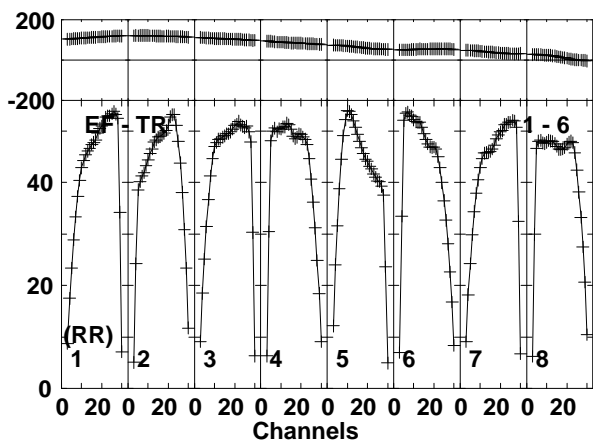
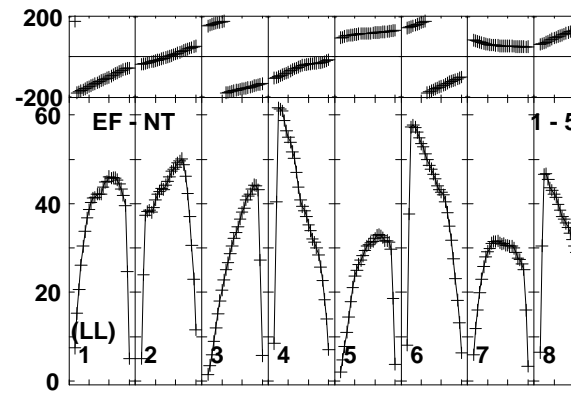
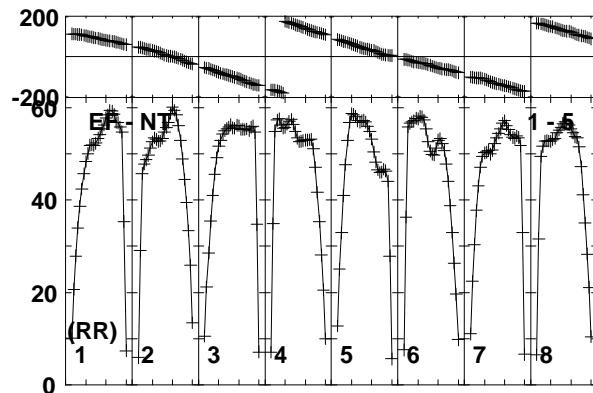
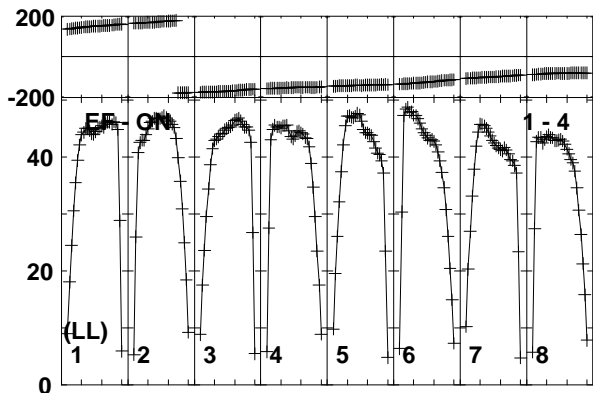
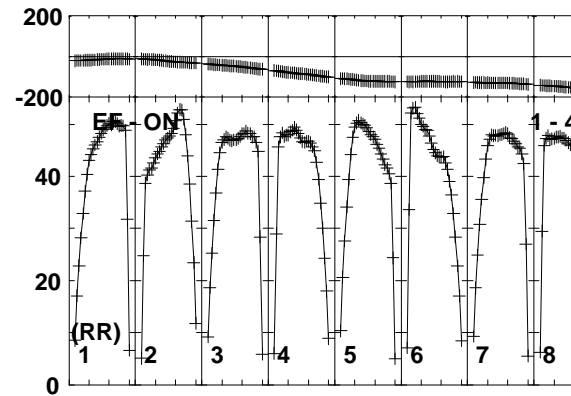
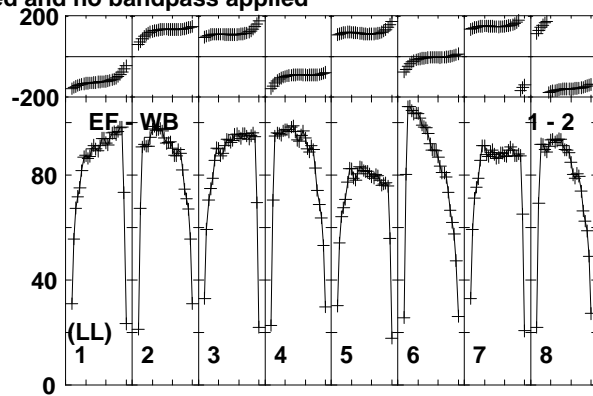
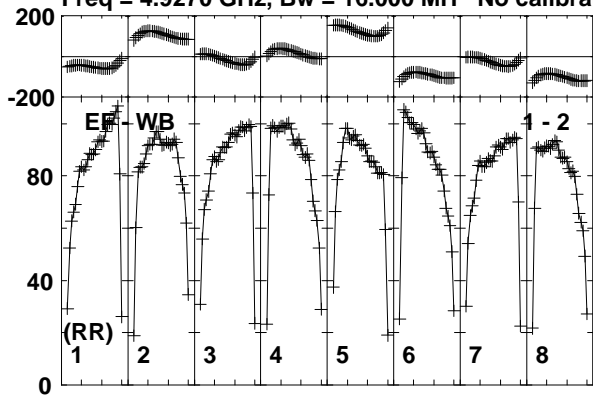

Lower frame: Milli Ampl Jy Top frame: Phas deg
Vector averaged cross-power spectrum Baseline: EF (01) - WB (02)
Timerange: 00/13:03:43 to 00/13:04:39

Plot file version 92 created 28-JAN-2015 14:38:08

3C345 N14C3.UVDATA.1

Freq = 4.9270 GHz, Bw = 16.000 MH No calibration applied and no bandpass applied

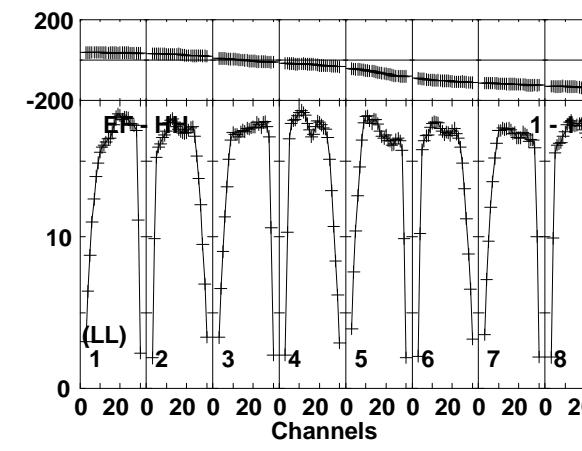
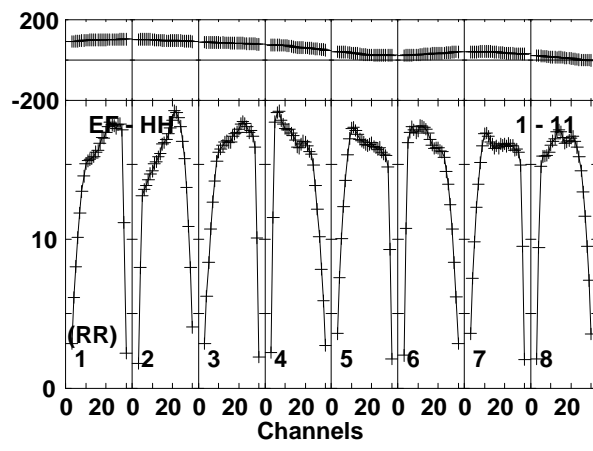
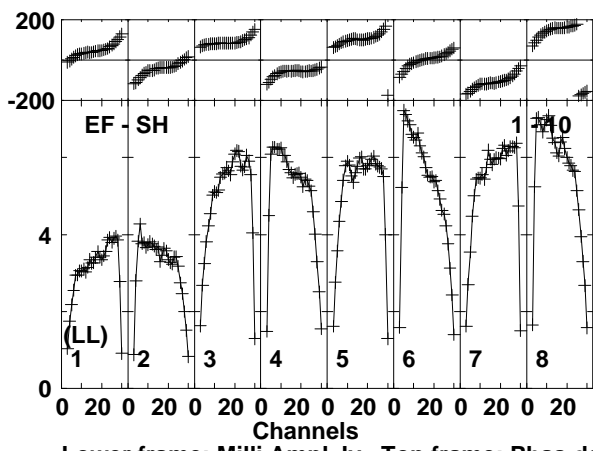
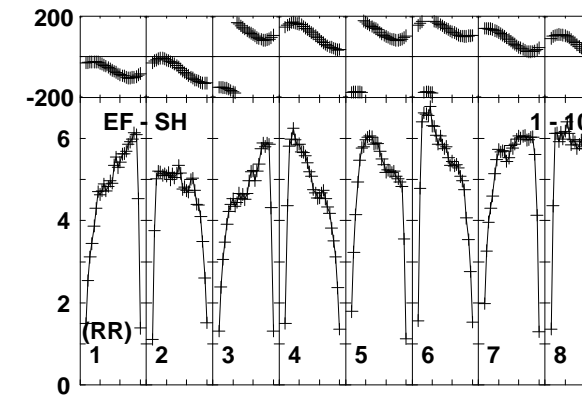
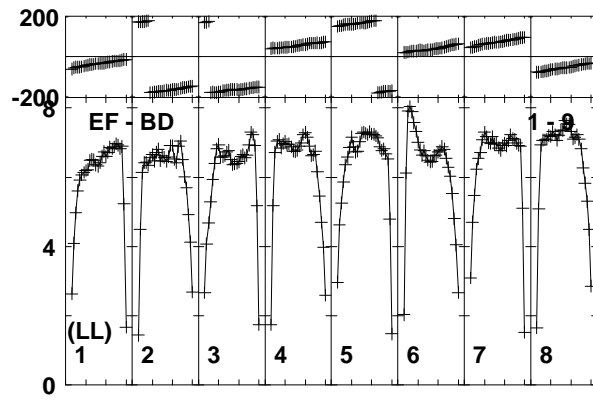
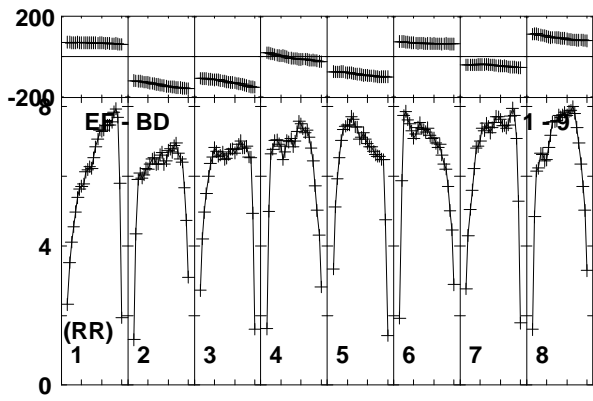
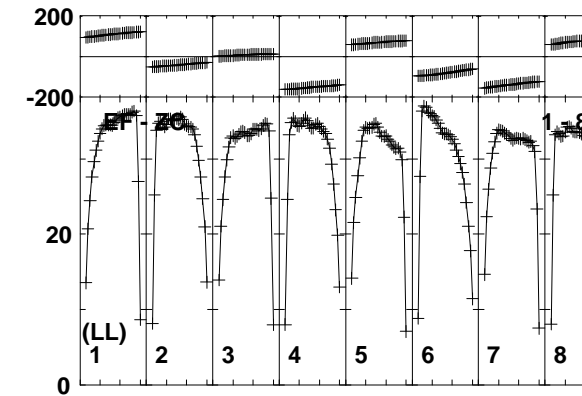
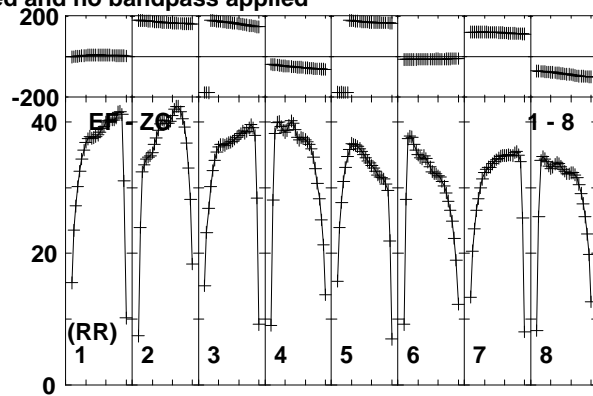
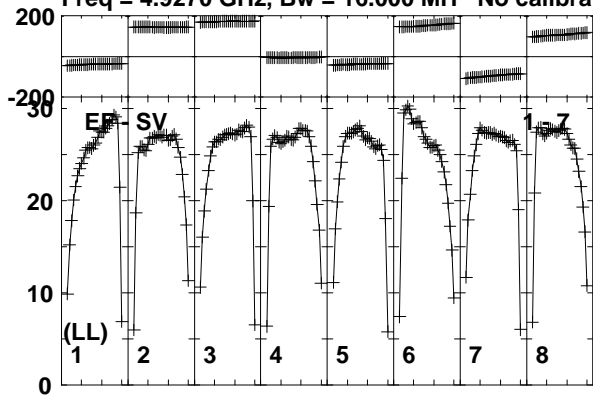

Lower frame: Milli Ampl Jy Top frame: Phas deg
Vector averaged cross-power spectrum Baseline: EF (01) - SV (07)
Timerange: 00/13:03:43 to 00/13:04:39

Plot file version 93 created 28-JAN-2015 14:38:08

3C345 N14C3.UVDATA.1

Freq = 4.9270 GHz, Bw = 16.000 MH No calibration applied and no bandpass applied

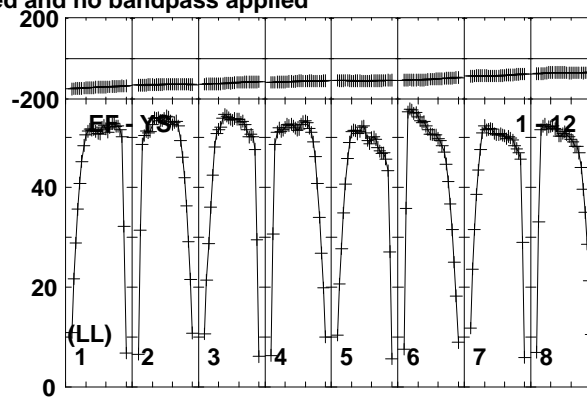
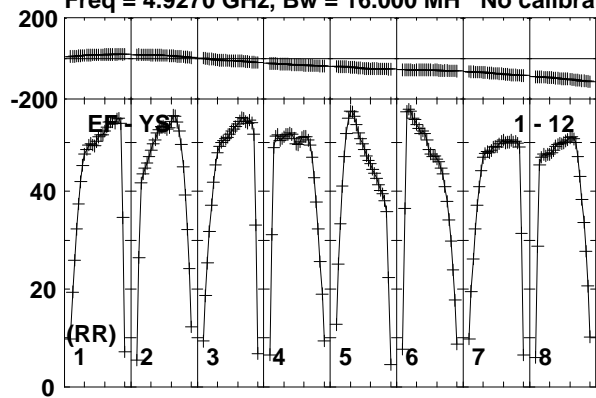

Lower frame: Milli Ampl Jy Top frame: Phas deg
Vector averaged cross-power spectrum Baseline: EF (01) - YS (12)
Timerange: 00/13:03:43 to 00/13:04:39

Plot file version 94 created 28-JAN-2015 14:38:08

J1640+3946 N14C3.UVDATA.1

Freq = 4.9270 GHz, Bw = 16.000 MH No calibration applied and no bandpass applied

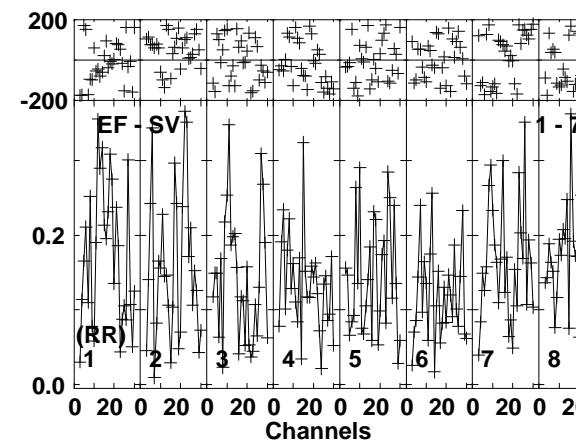
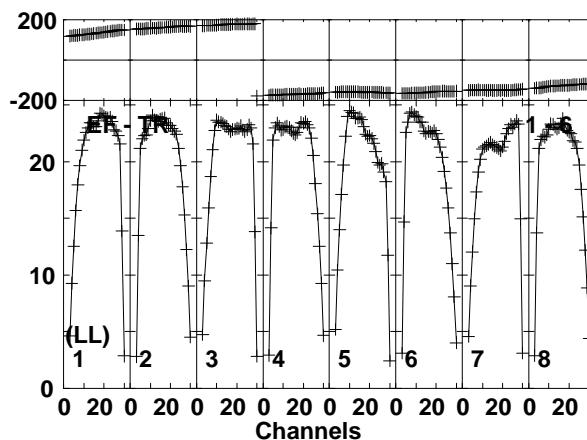
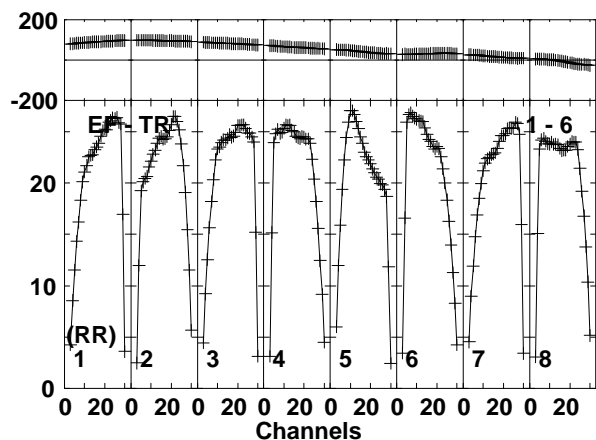
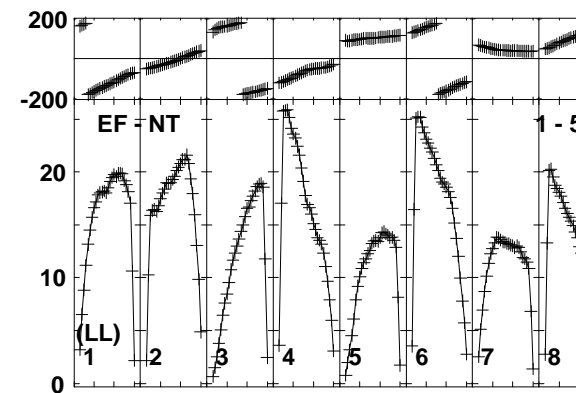
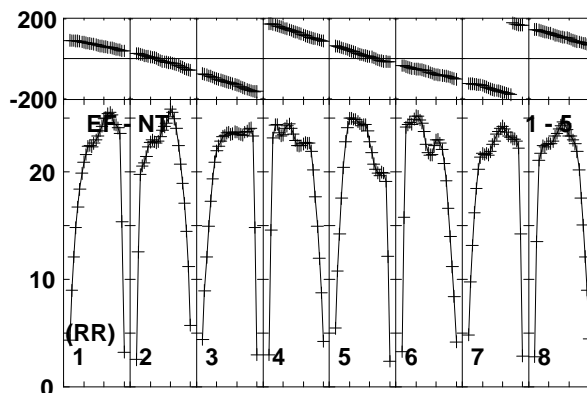
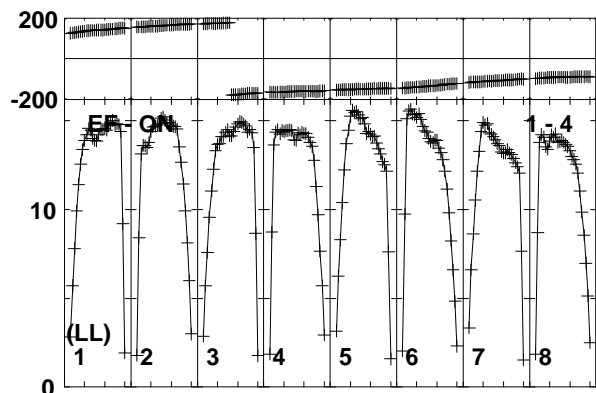
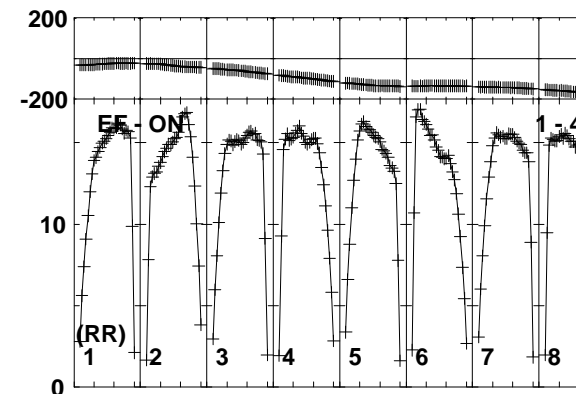
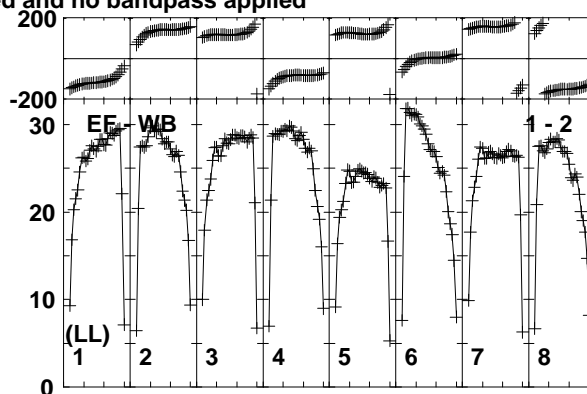
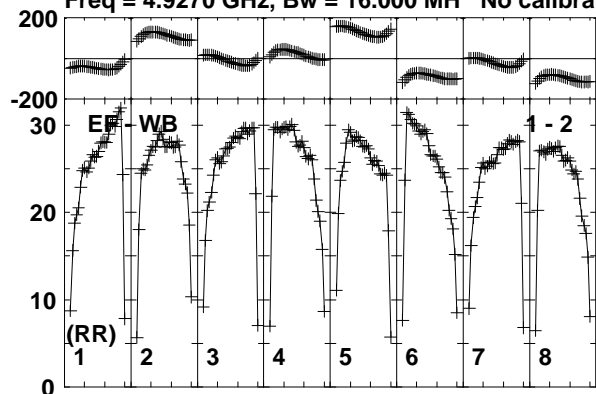

Lower frame: Milli Ampl Jy Top frame: Phas deg
Vector averaged cross-power spectrum Baseline: EF (01) - WB (02)
Timerange: 00/13:05:23 to 00/13:06:19

Plot file version 95 created 28-JAN-2015 14:38:08

J1640+3946 N14C3.UVDATA.1

Freq = 4.9270 GHz, Bw = 16.000 MH No calibration applied and no bandpass applied

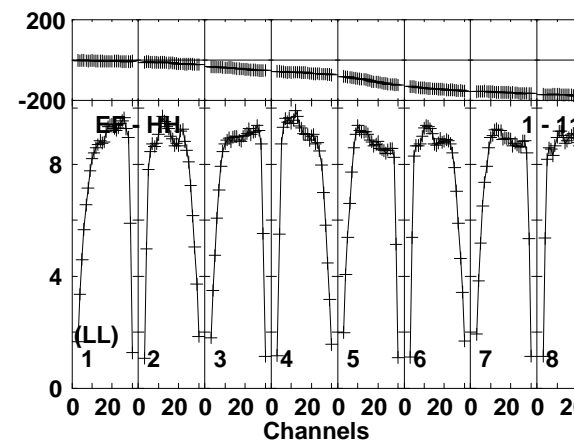
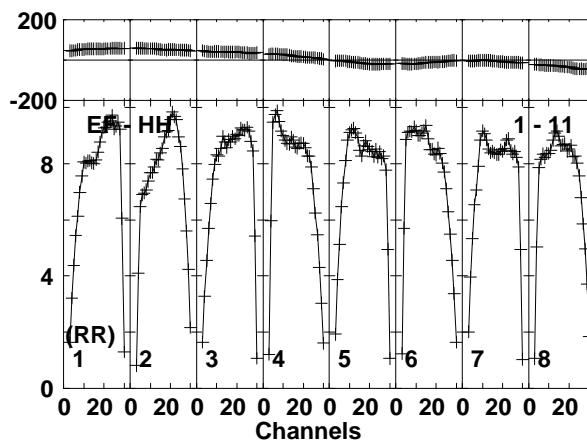
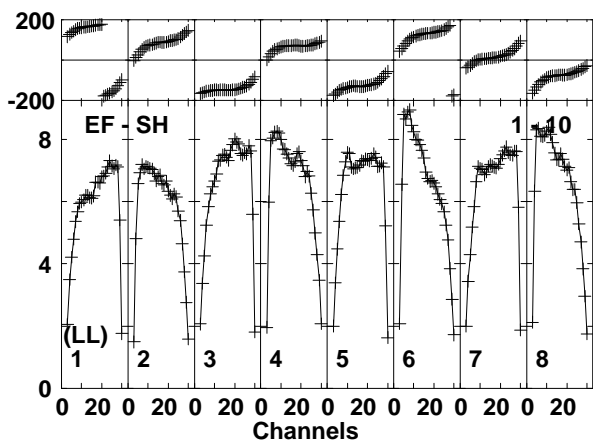
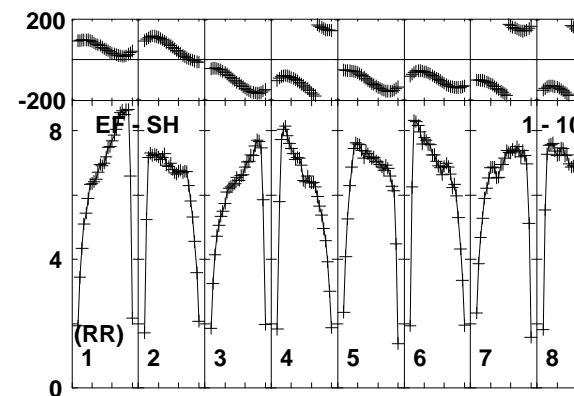
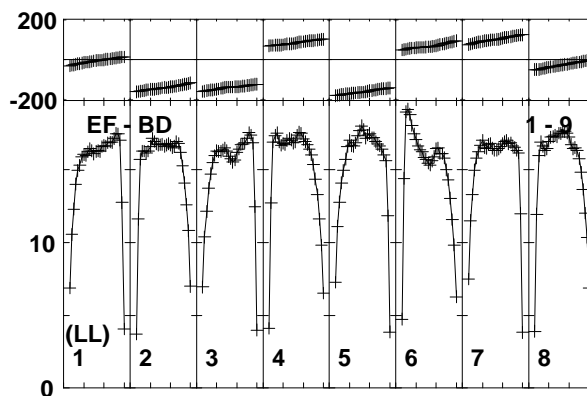
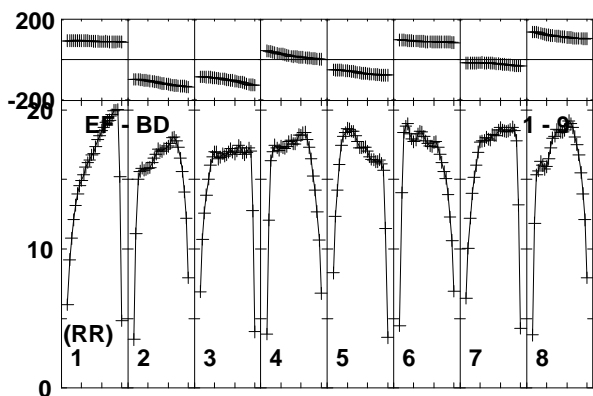
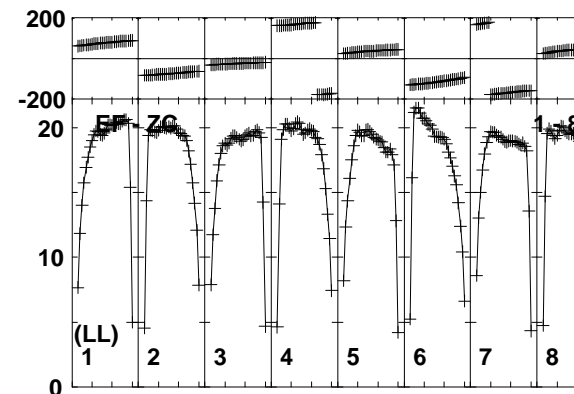
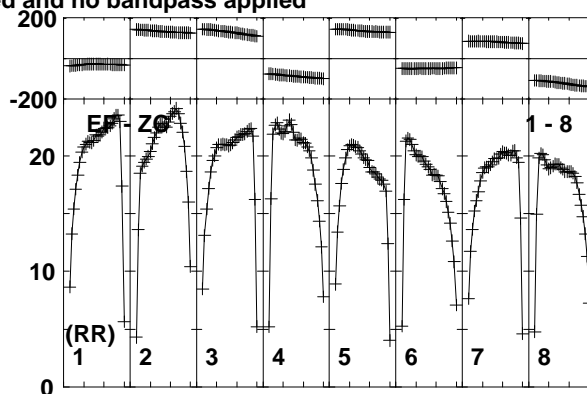
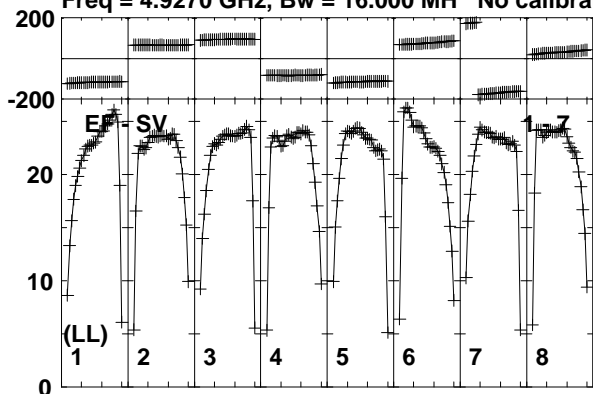

Lower frame: Milli Ampl Jy Top frame: Phas deg
Vector averaged cross-power spectrum Baseline: EF (01) - SV (07)
Timerange: 00/13:05:23 to 00/13:06:19

Plot file version 96 created 28-JAN-2015 14:38:08

J1640+3946 N14C3.UVDATA.1

Freq = 4.9270 GHz, Bw = 16.000 MH No calibration applied and no bandpass applied

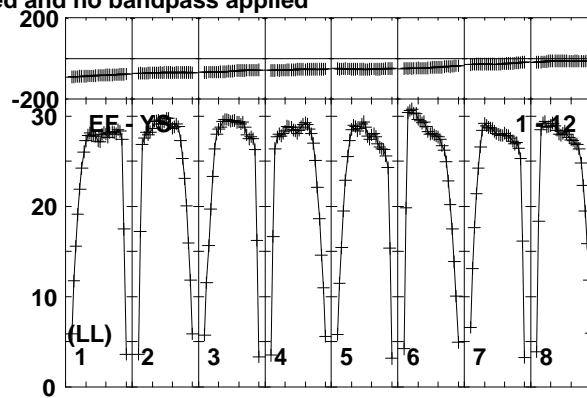
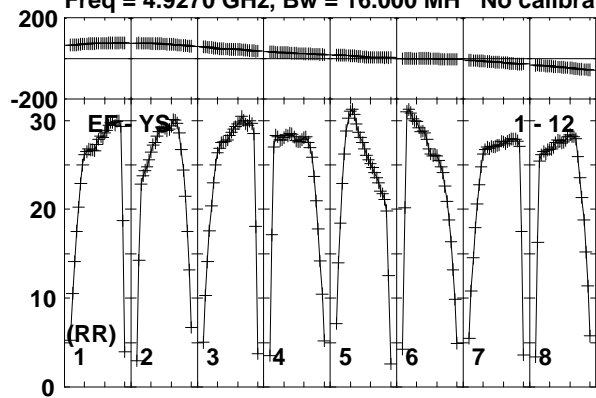

Lower frame: Milli Ampl Jy Top frame: Phas deg
Vector averaged cross-power spectrum Baseline: EF (01) - YS (12)
Timerange: 00/13:05:23 to 00/13:06:19

Plot file version 97 created 28-JAN-2015 14:38:08

1848+283 N14C3.UVDATA.1

Freq = 4.9270 GHz, Bw = 16.000 MH No calibration applied and no bandpass applied

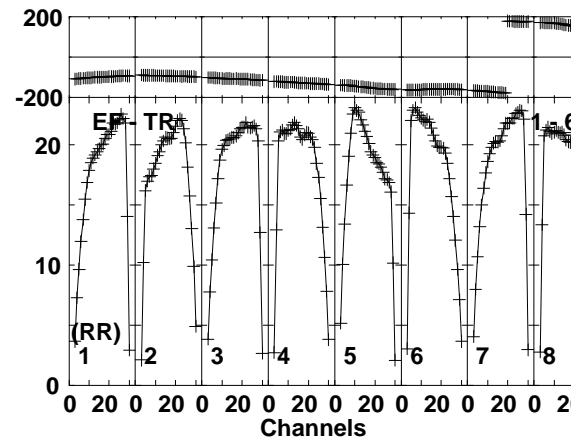
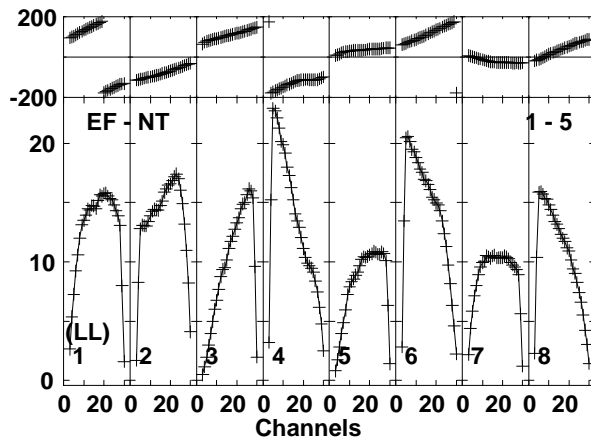
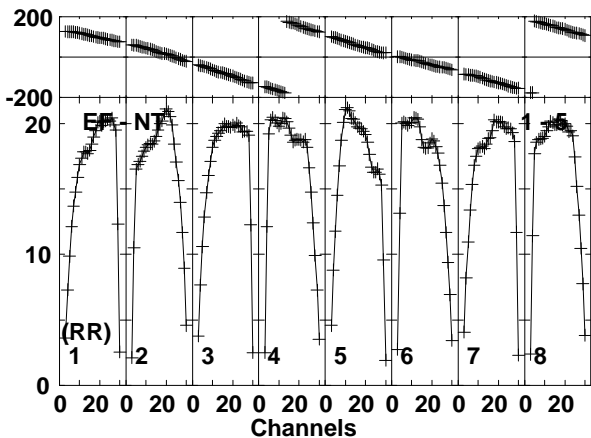
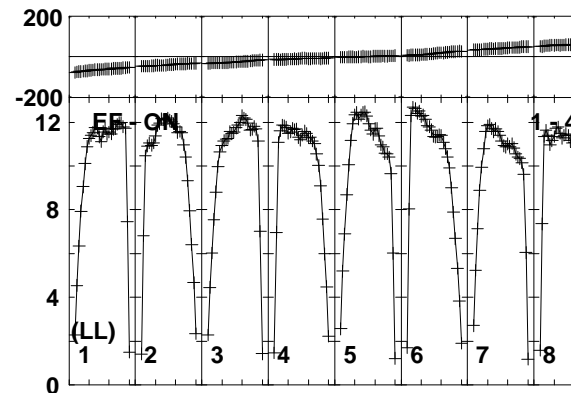
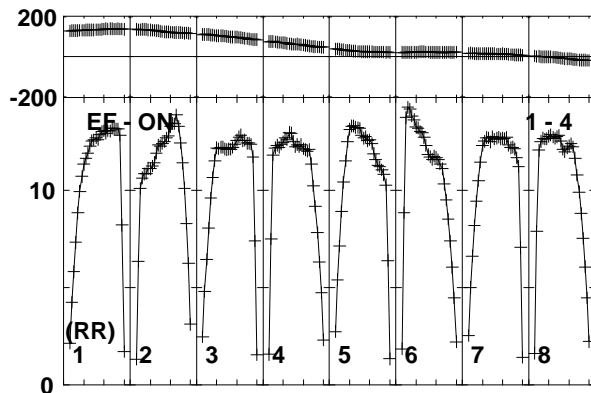
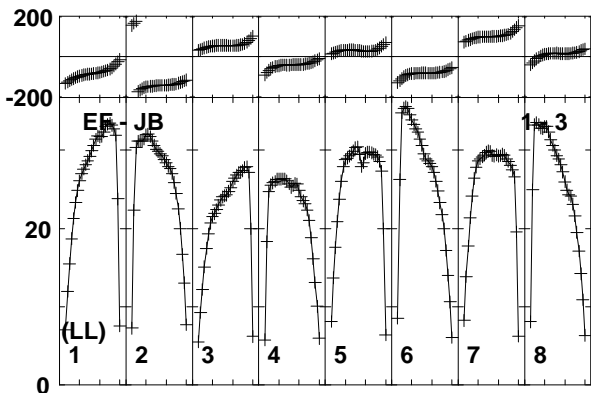
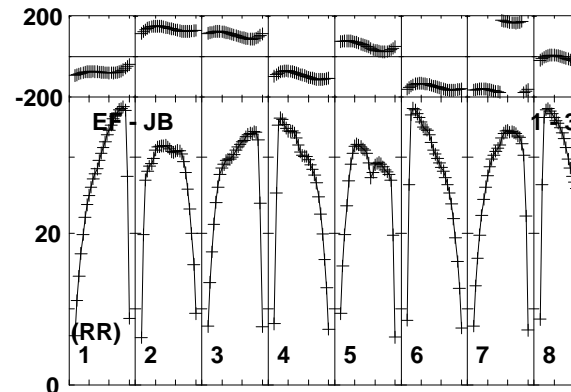
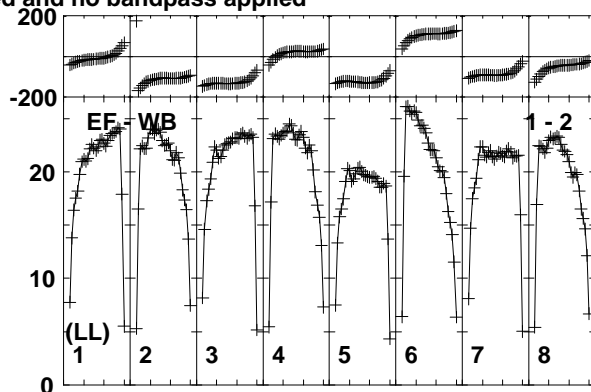
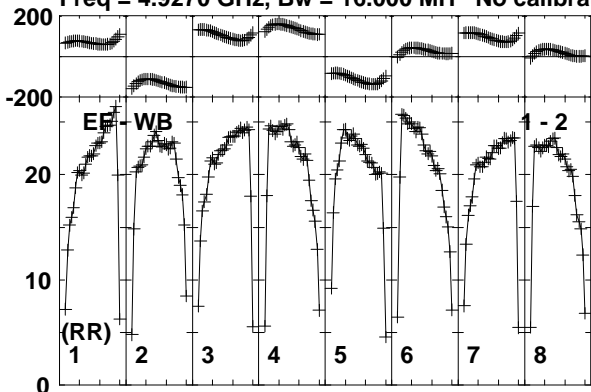

Lower frame: Milli Ampl Jy Top frame: Phas deg
Vector averaged cross-power spectrum Baseline: EF (01) - WB (02)
Timerange: 00/13:14:23 to 00/13:15:19

Plot file version 98 created 28-JAN-2015 14:38:08

1848+283 N14C3.UVDATA.1

Freq = 4.9270 GHz, Bw = 16.000 MH No calibration applied and no bandpass applied

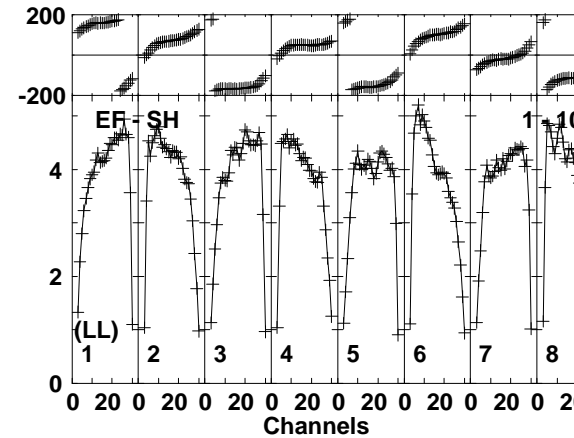
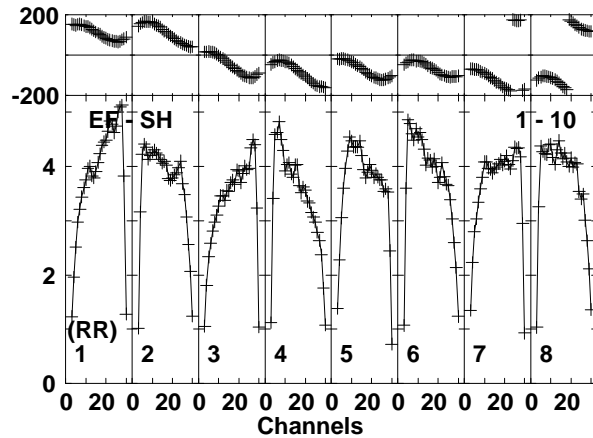
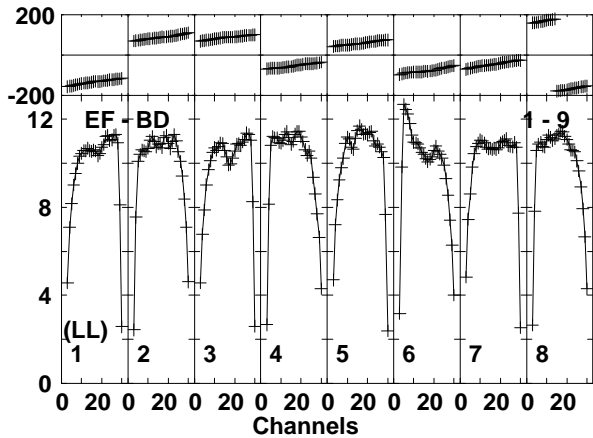
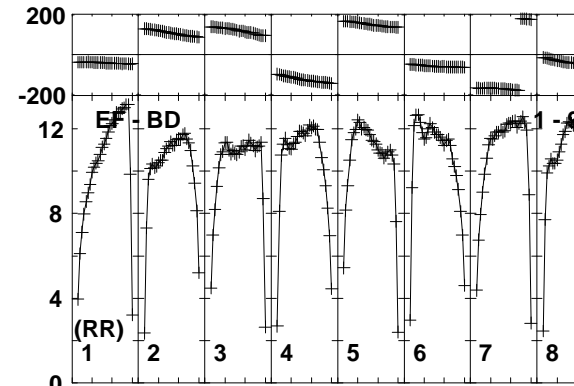
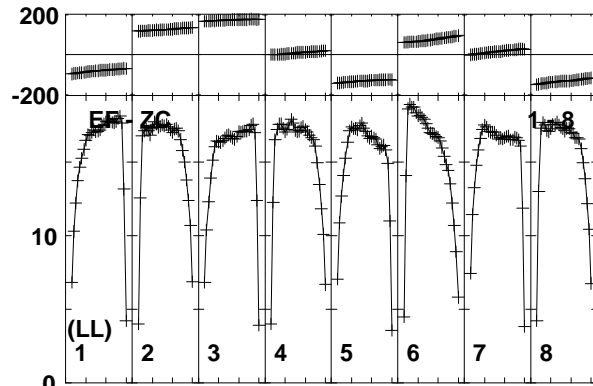
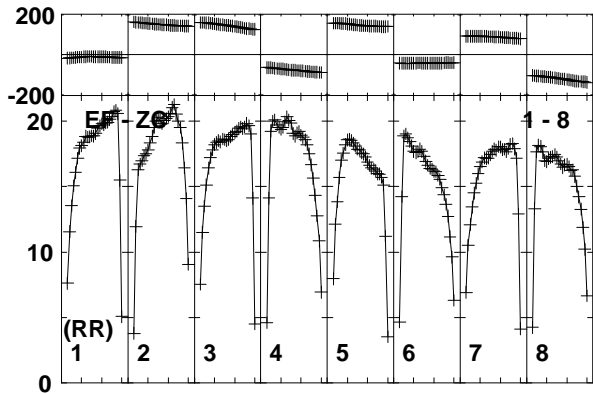
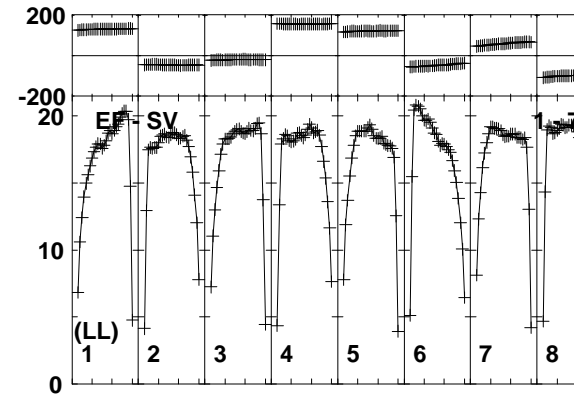
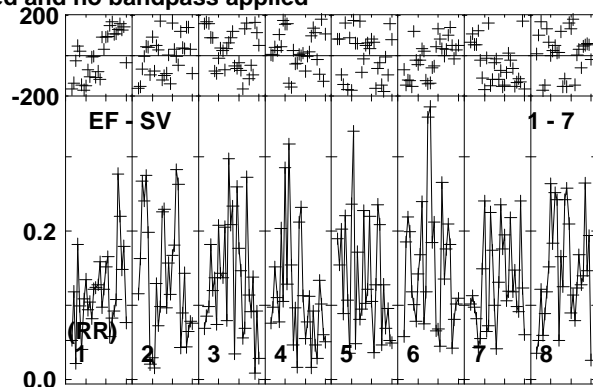
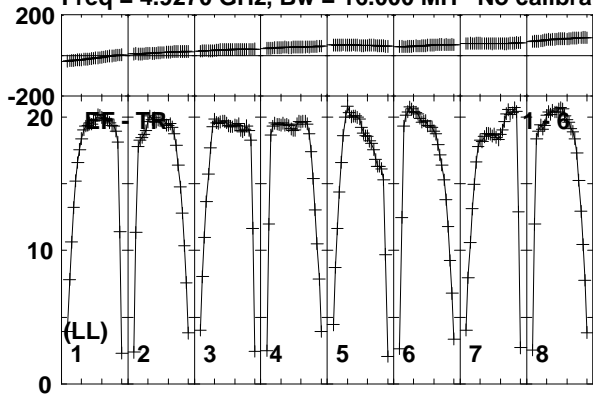

Lower frame: Milli Ampl Jy Top frame: Phas deg
Vector averaged cross-power spectrum Baseline: EF (01) - TR (06)
Timerange: 00/13:14:23 to 00/13:15:19

Plot file version 99 created 28-JAN-2015 14:38:08

1848+283 N14C3.UVDATA.1

Freq = 4.9270 GHz, Bw = 16.000 MH No calibration applied and no bandpass applied

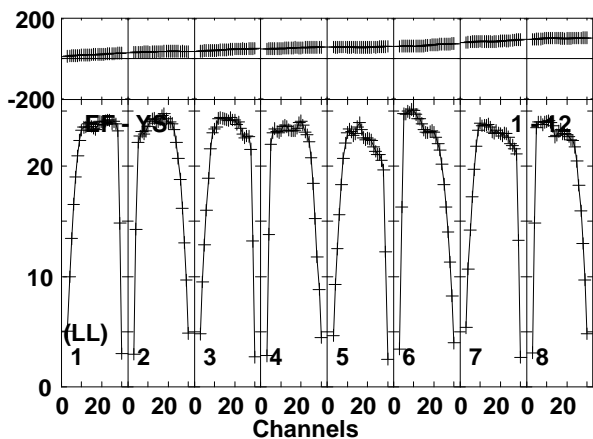
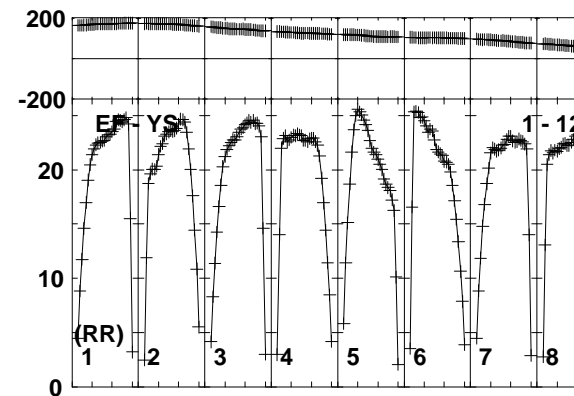
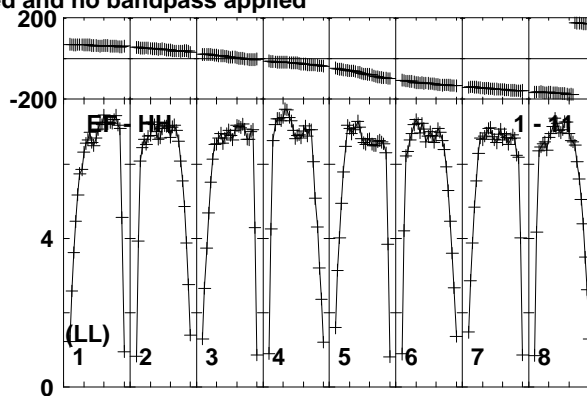
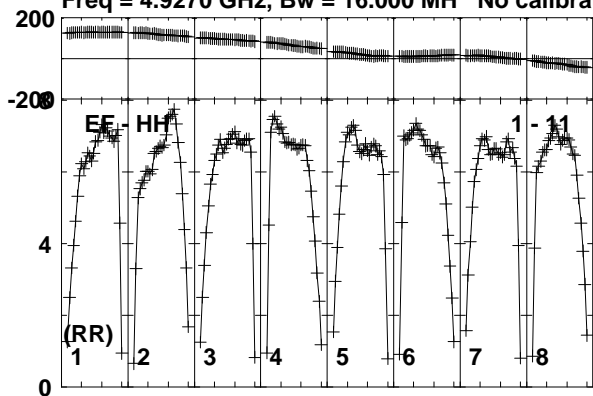

Lower frame: Milli Ampl Jy Top frame: Phas deg
Vector averaged cross-power spectrum Baseline: EF (01) - HH (11)
Timerange: 00/13:14:23 to 00/13:15:19

Plot file version 100 created 28-JAN-2015 14:38:08

1848+283 N14C3.UVDATA.1

Freq = 4.9270 GHz, Bw = 16.000 MH No calibration applied and no bandpass applied

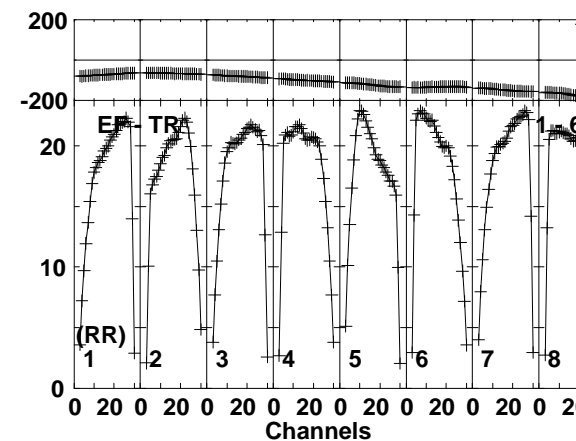
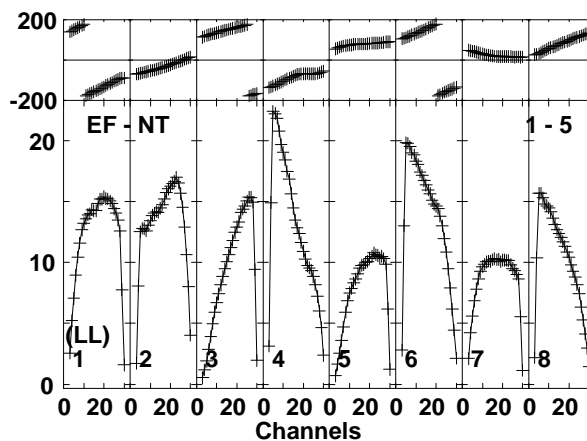
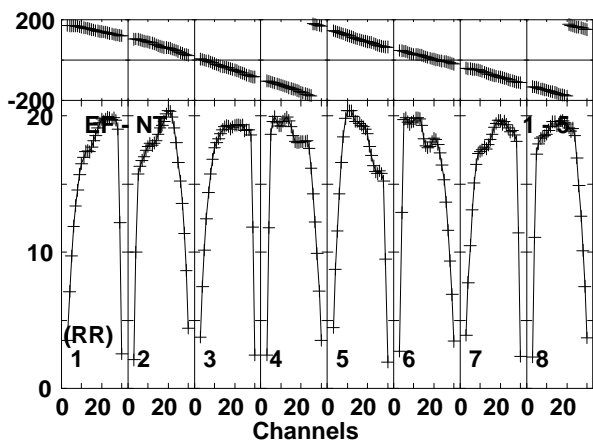
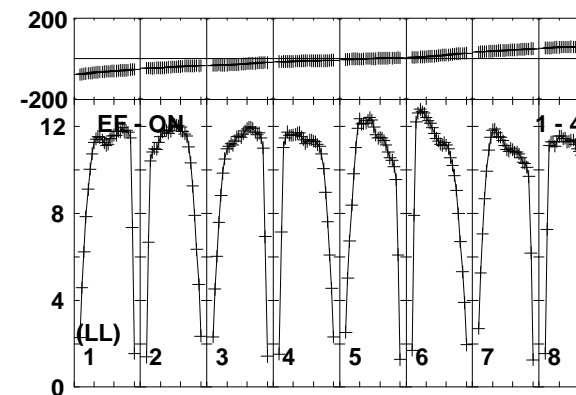
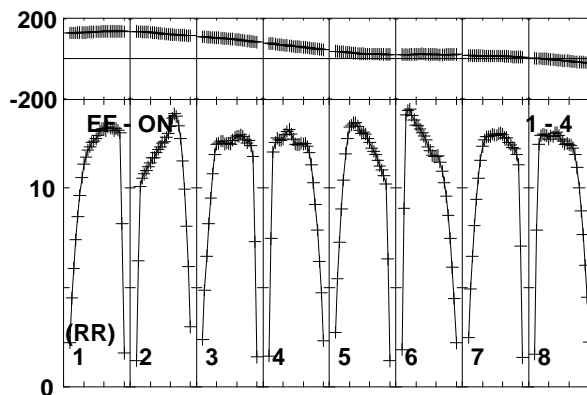
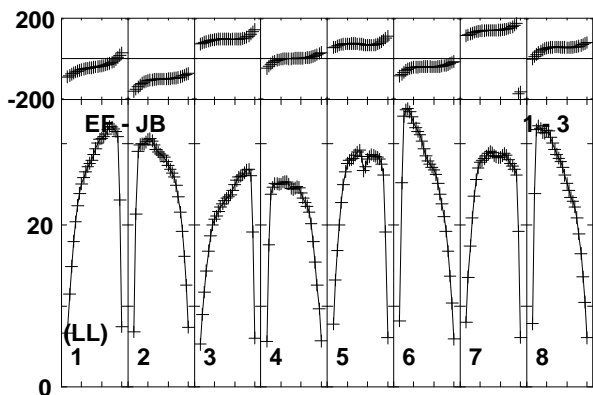
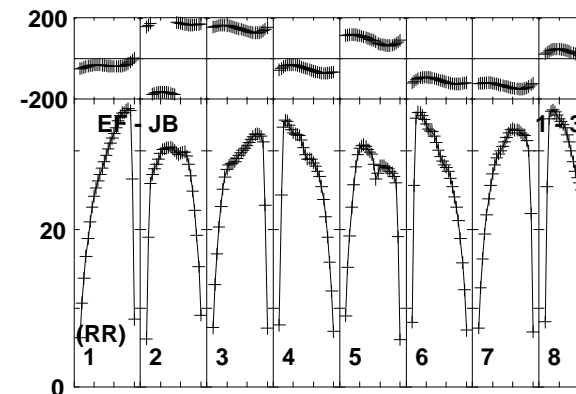
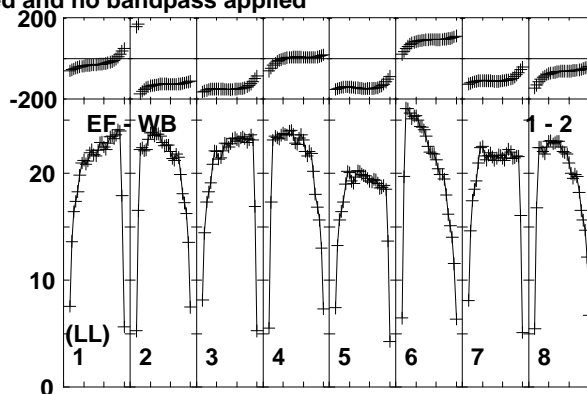
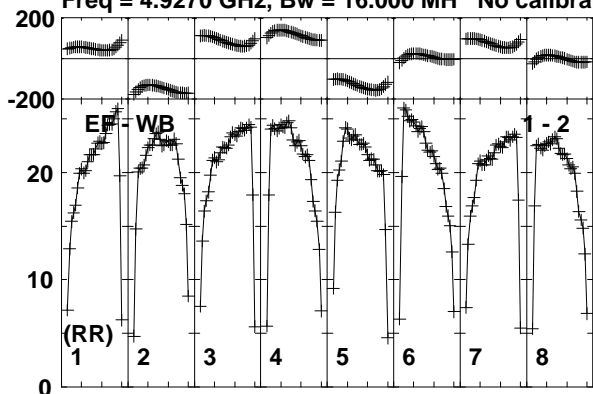

Lower frame: Milli Ampl Jy Top frame: Phas deg
Vector averaged cross-power spectrum Baseline: EF (01) - WB (02)
Timerange: 00/13:17:23 to 00/13:21:19

Plot file version 101 created 28-JAN-2015 14:38:08

1848+283 N14C3.UVDATA.1

Freq = 4.9270 GHz, Bw = 16.000 MH No calibration applied and no bandpass applied

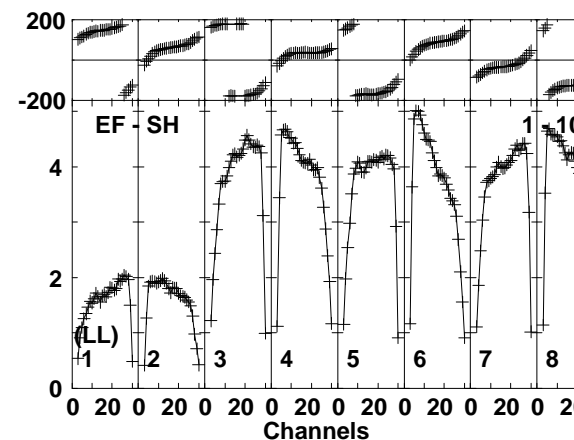
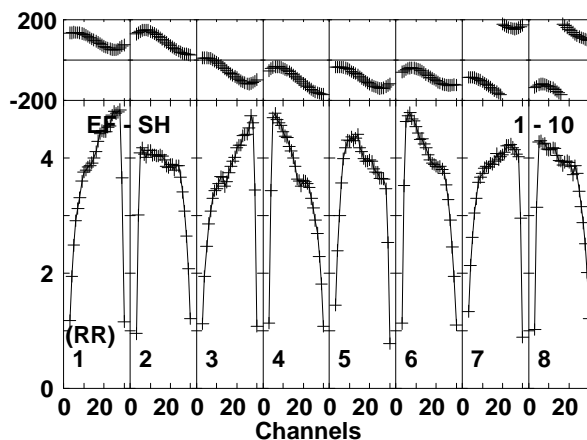
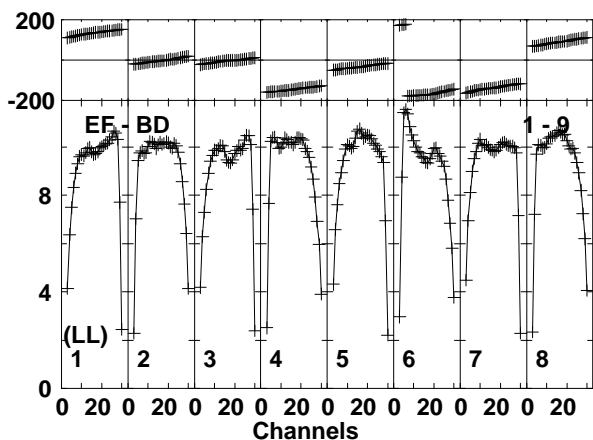
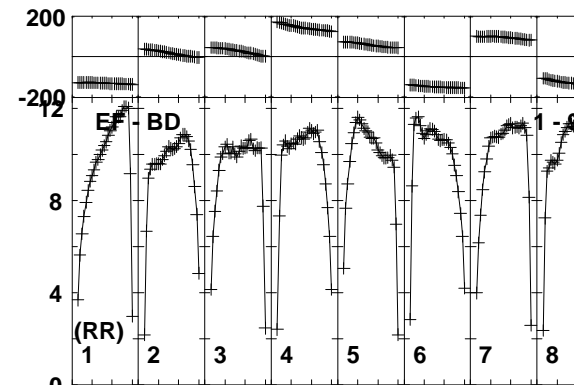
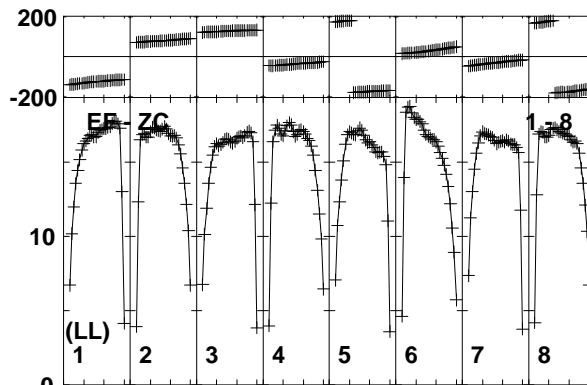
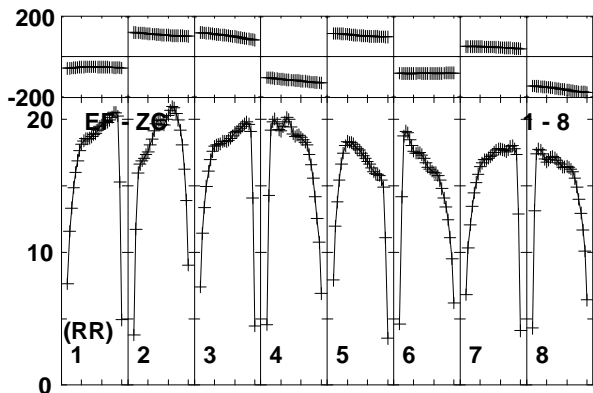
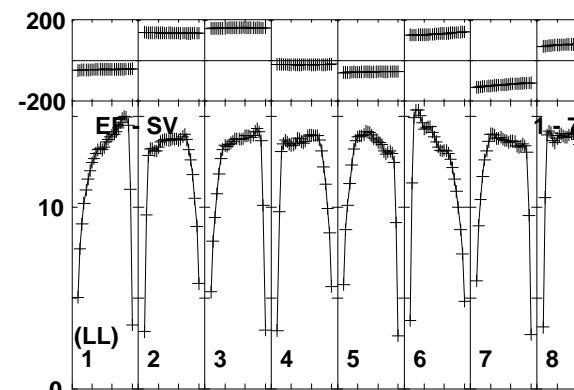
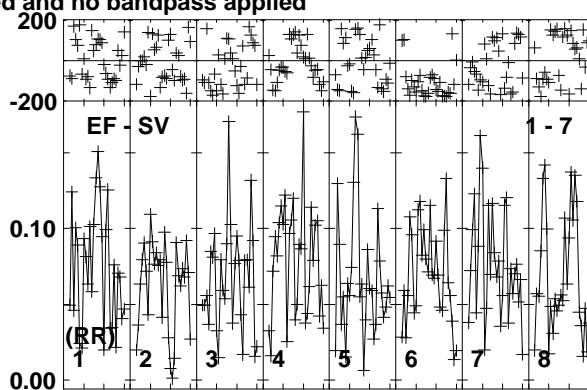
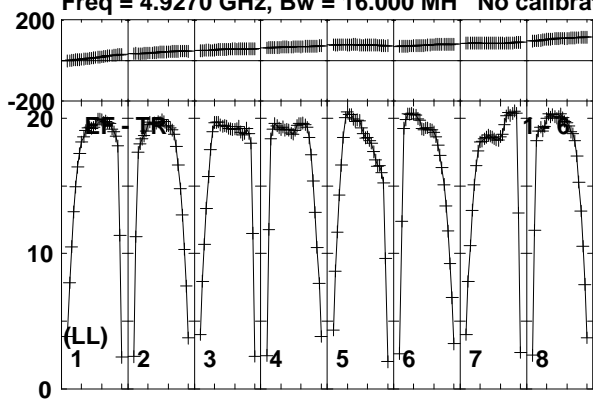

Lower frame: Milli Ampl Jy Top frame: Phas deg
Vector averaged cross-power spectrum Baseline: EF (01) - TR (06)
Timerange: 00/13:17:23 to 00/13:21:19

Plot file version 102 created 28-JAN-2015 14:38:08

1848+283 N14C3.UVDATA.1

Freq = 4.9270 GHz, Bw = 16.000 MH No calibration applied and no bandpass applied

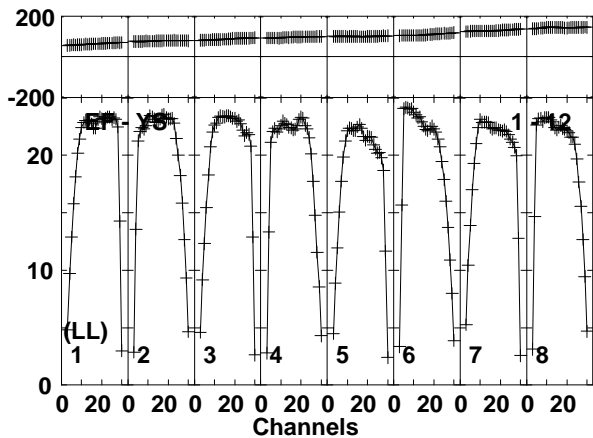
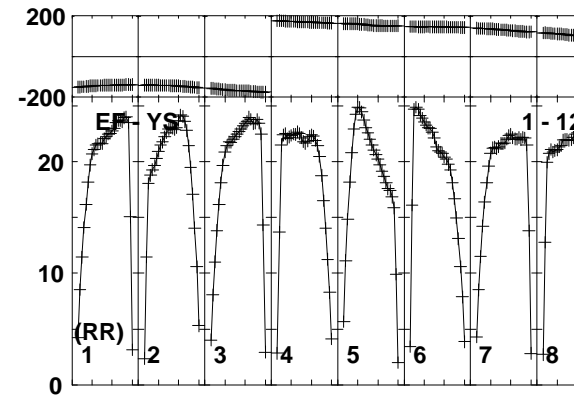
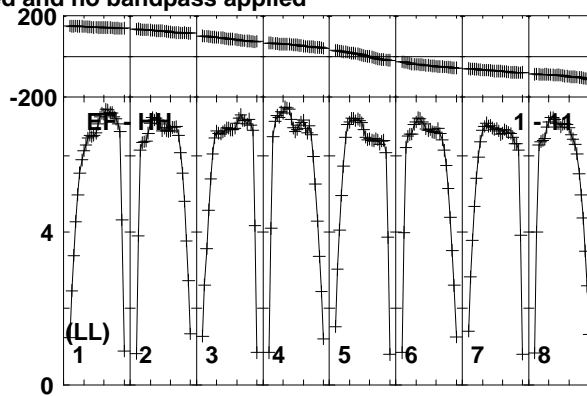
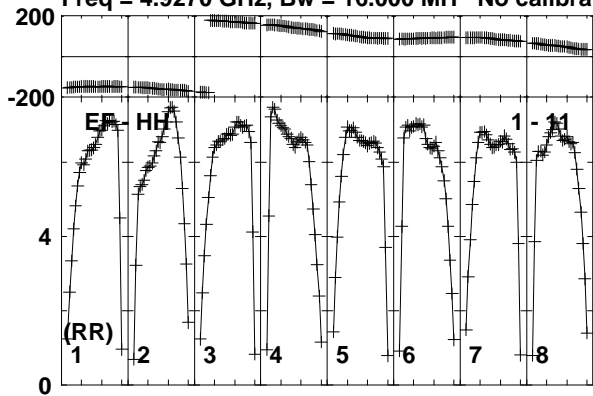

Lower frame: Milli Ampl Jy Top frame: Phas deg
Vector averaged cross-power spectrum Baseline: EF (01) - HH (11)
Timerange: 00/13:17:23 to 00/13:21:19

Plot file version 103 created 28-JAN-2015 14:38:08

1848+283 N14C3.UVDATA.1

Freq = 4.9270 GHz, Bw = 16.000 MH No calibration applied and no bandpass applied

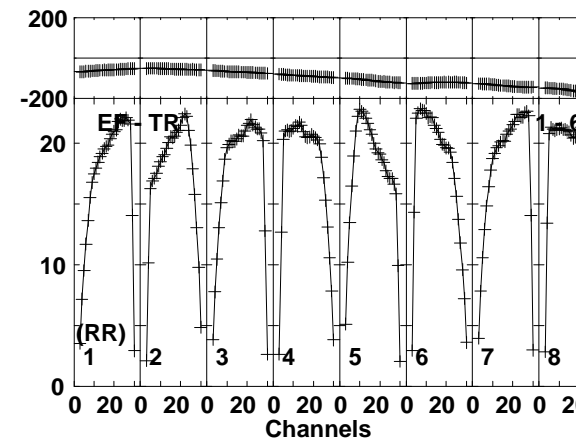
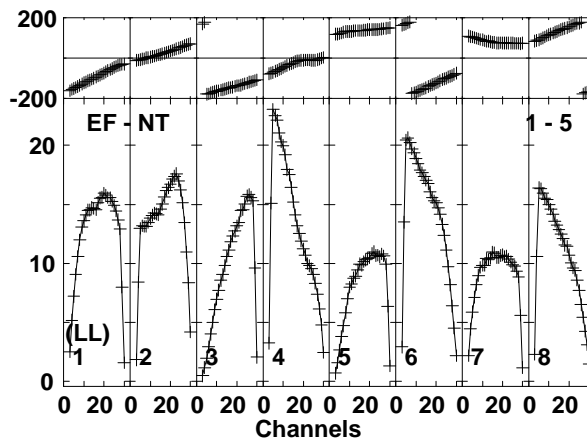
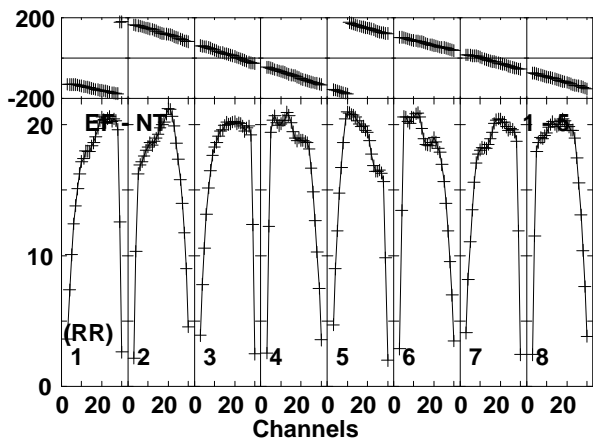
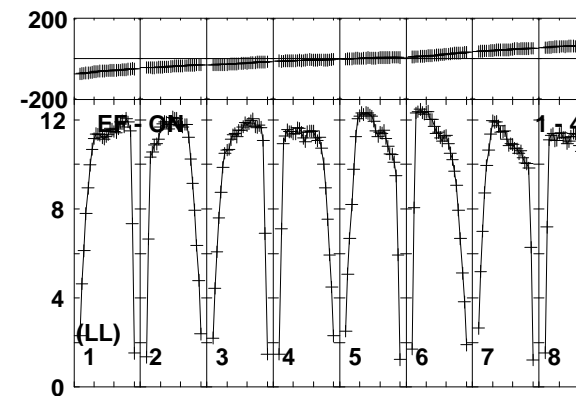
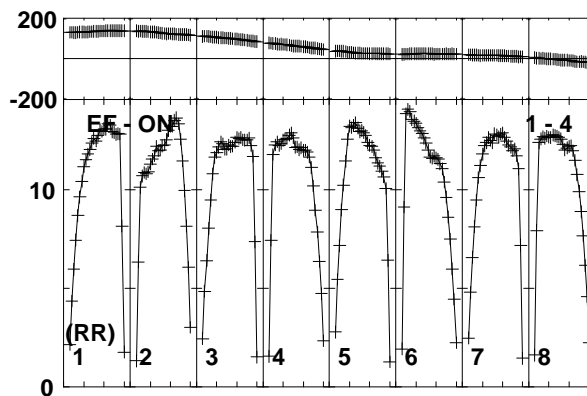
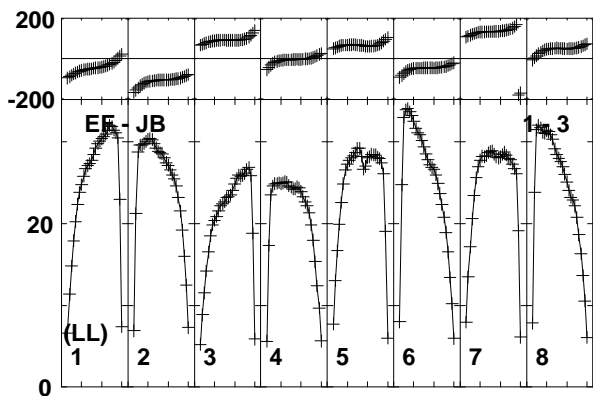
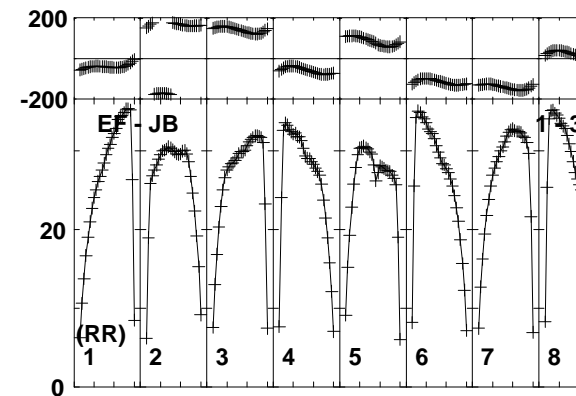
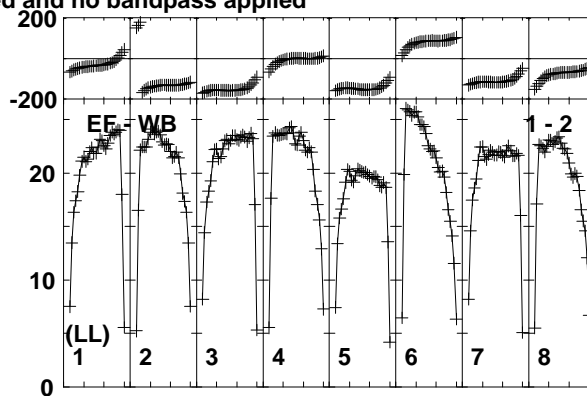
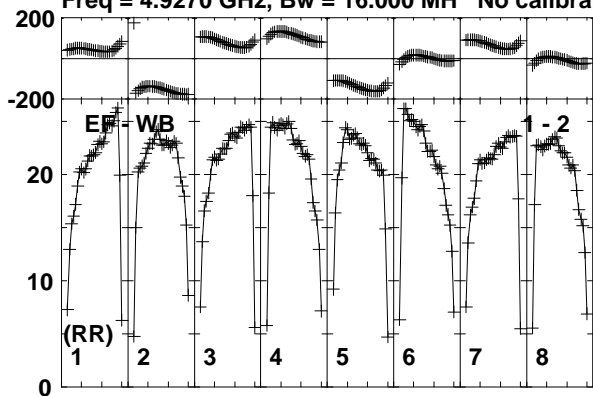

Lower frame: Milli Ampl Jy Top frame: Phas deg
Vector averaged cross-power spectrum Baseline: EF (01) - WB (02)
Timerange: 00/13:23:23 to 00/13:24:19

Plot file version 104 created 28-JAN-2015 14:38:08

1848+283 N14C3.UVDATA.1

Freq = 4.9270 GHz, Bw = 16.000 MH No calibration applied and no bandpass applied

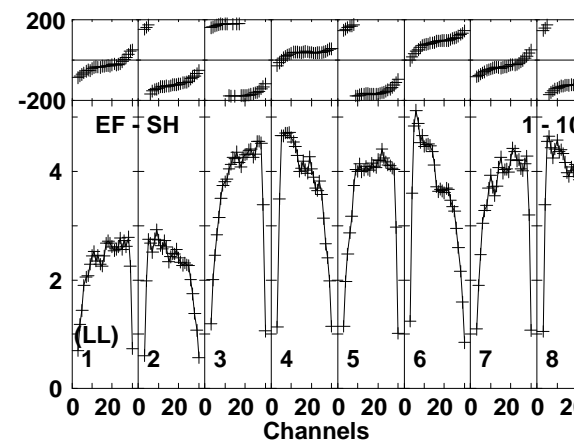
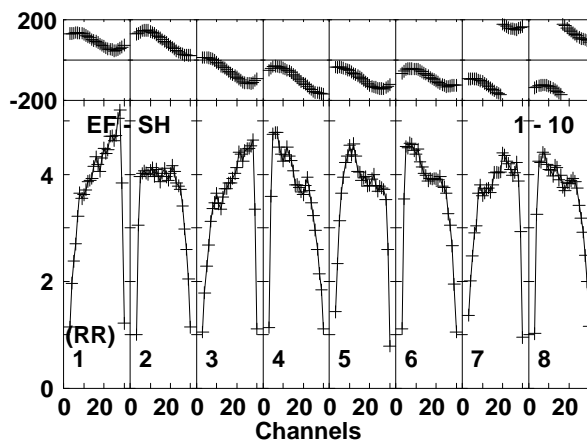
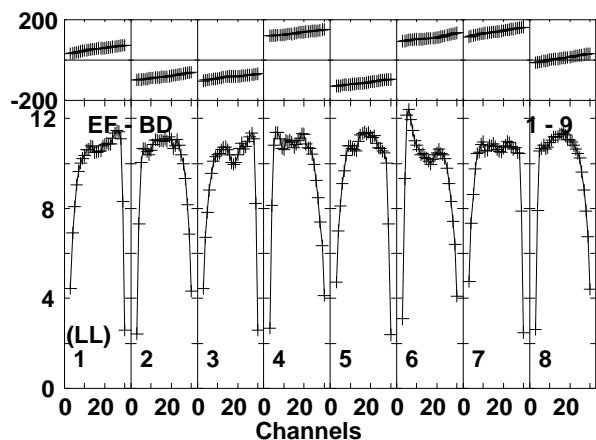
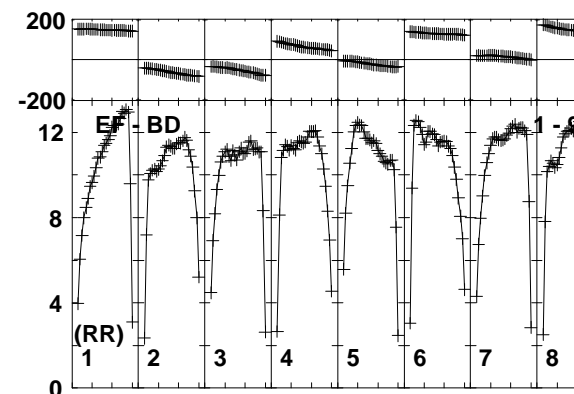
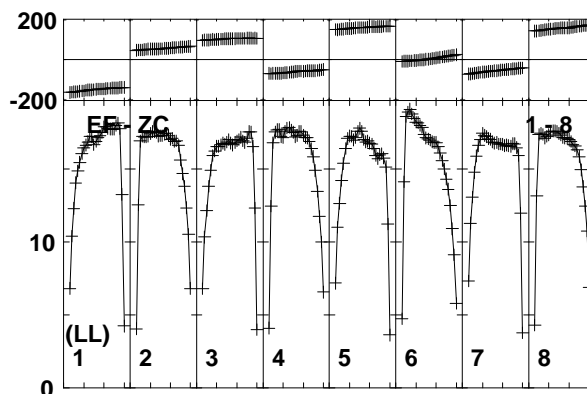
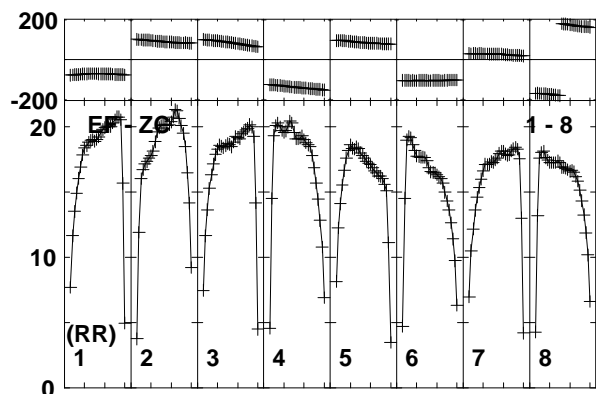
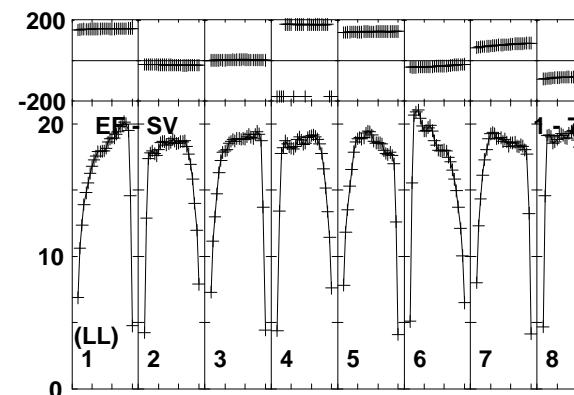
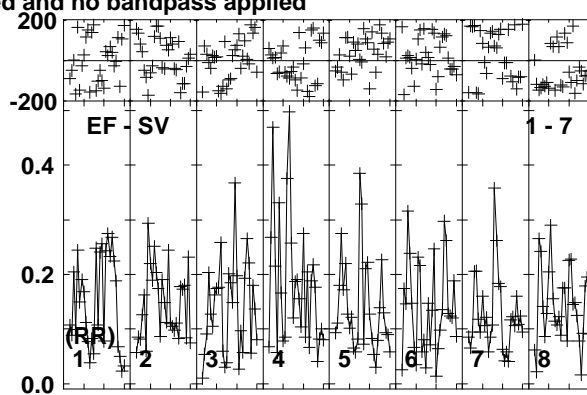
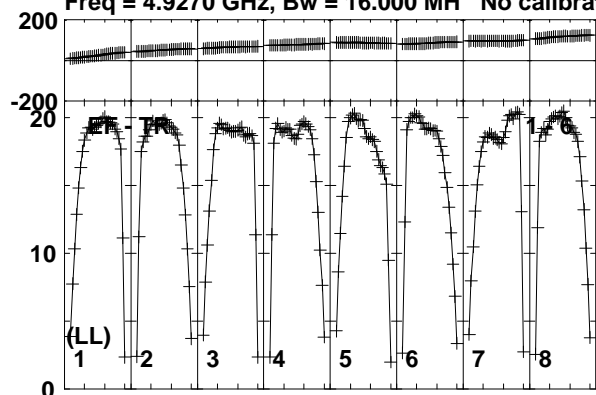

Lower frame: Milli Ampl Jy Top frame: Phas deg
Vector averaged cross-power spectrum Baseline: EF (01) - TR (06)
Timerange: 00/13:23:23 to 00/13:24:19

Plot file version 105 created 28-JAN-2015 14:38:08

1848+283 N14C3.UVDATA.1

Freq = 4.9270 GHz, Bw = 16.000 MH No calibration applied and no bandpass applied

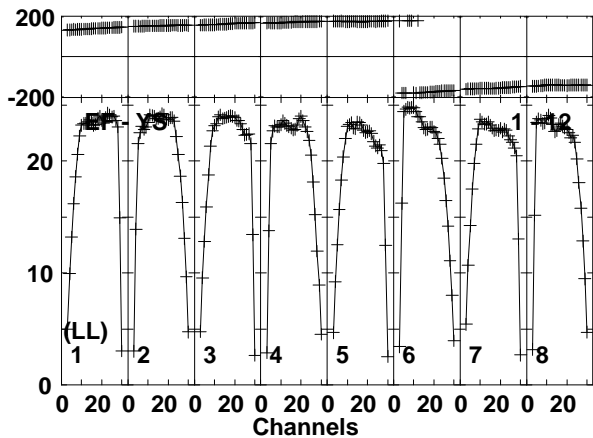
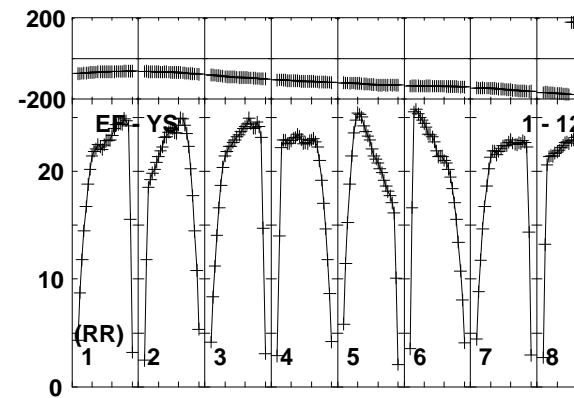
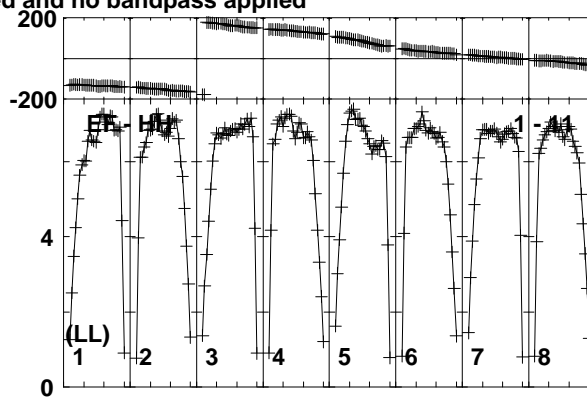
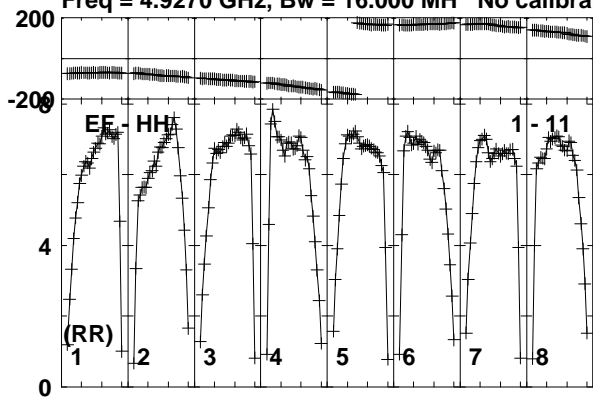

Lower frame: Milli Ampl Jy Top frame: Phas deg
Vector averaged cross-power spectrum Baseline: EF (01) - HH (11)
Timerange: 00/13:23:23 to 00/13:24:19

Plot file version 106 created 28-JAN-2015 14:38:08

J1849+3024 N14C3.UVDATA.1

Freq = 4.9270 GHz, Bw = 16.000 MH No calibration applied and no bandpass applied

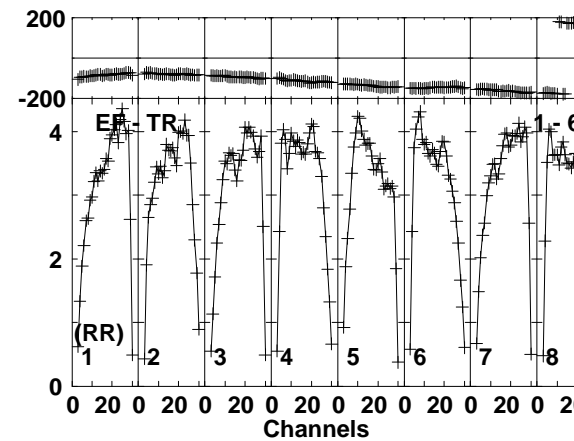
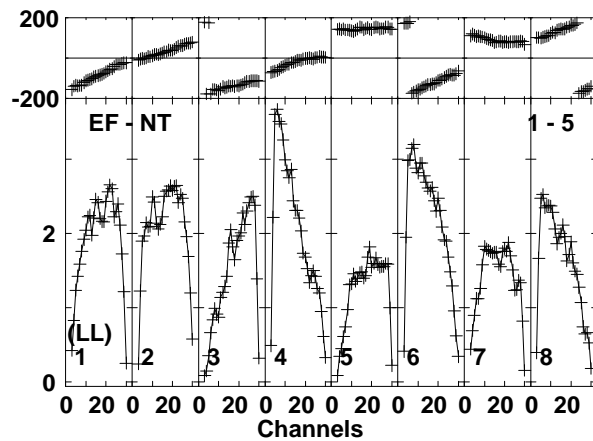
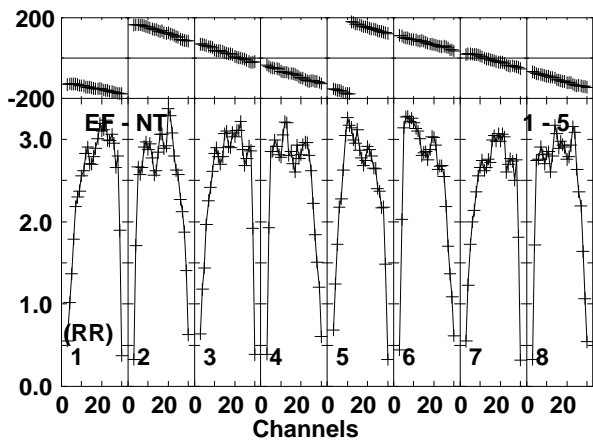
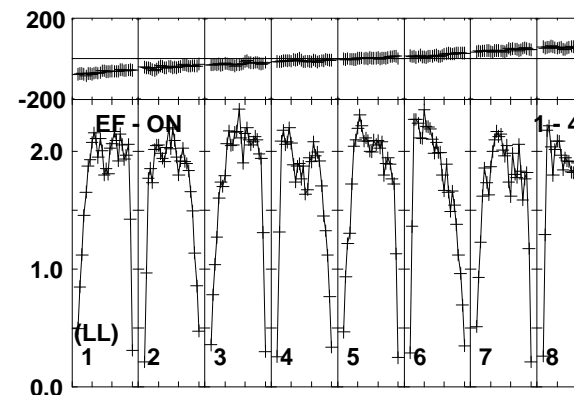
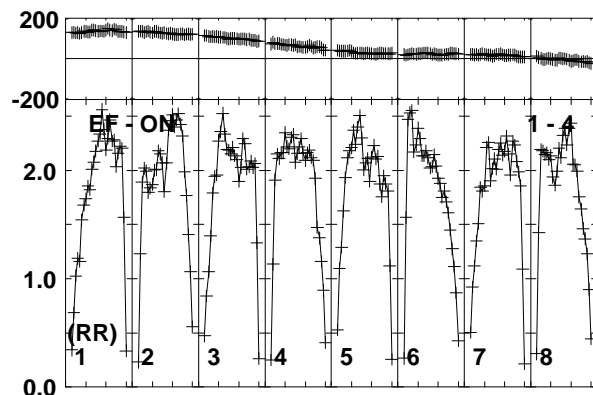
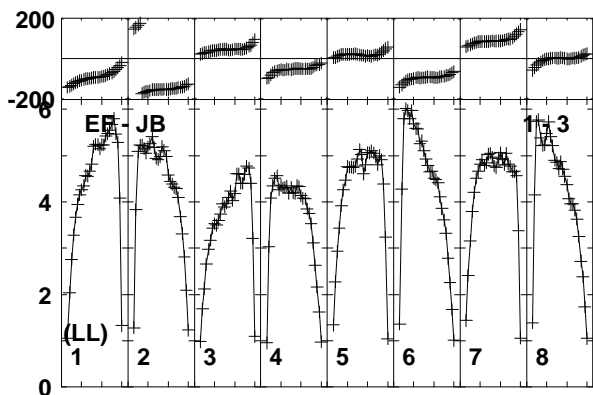
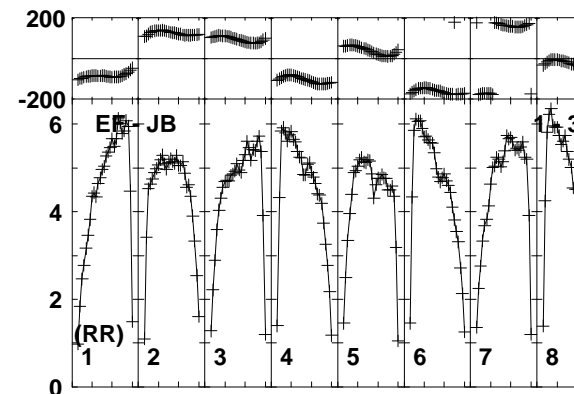
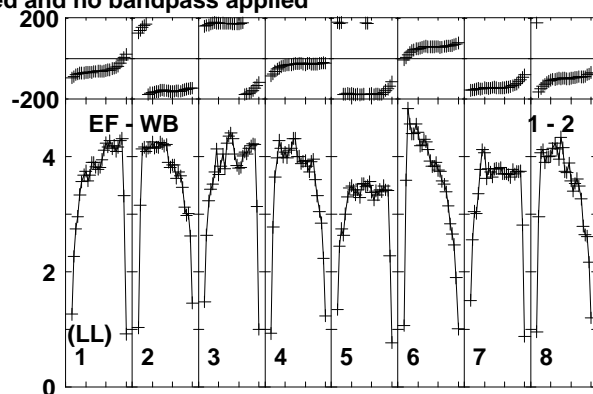
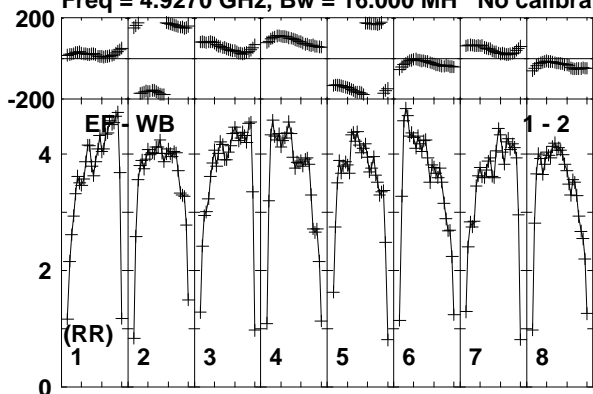

Lower frame: Milli Ampl Jy Top frame: Phas deg
Vector averaged cross-power spectrum Baseline: EF (01) - WB (02)
Timerange: 00:13:25:03 to 00:13:25:59

Plot file version 107 created 28-JAN-2015 14:38:08

J1849+3024 N14C3.UVDATA.1

Freq = 4.9270 GHz, Bw = 16.000 MH No calibration applied and no bandpass applied

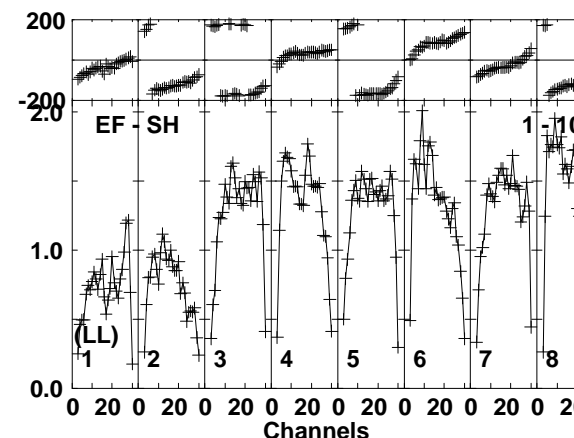
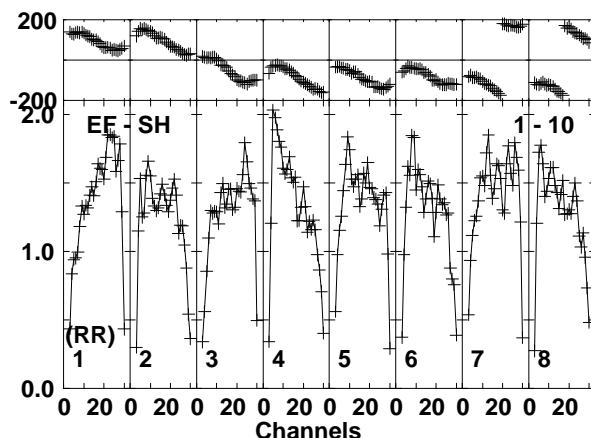
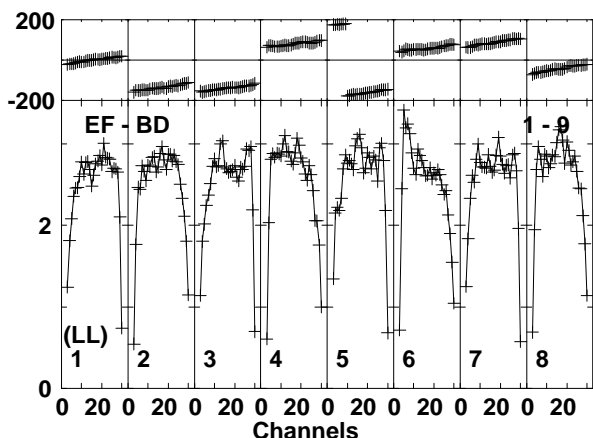
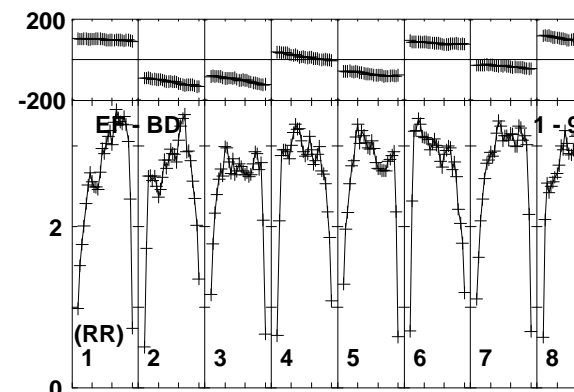
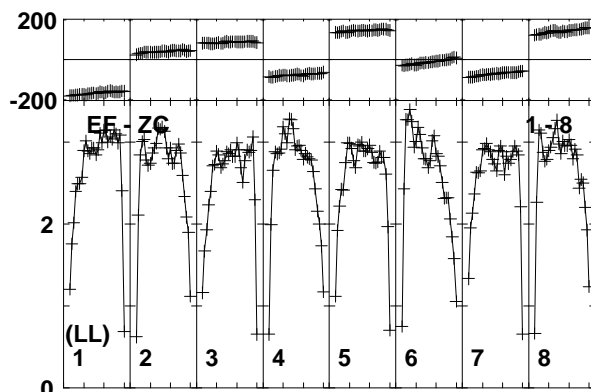
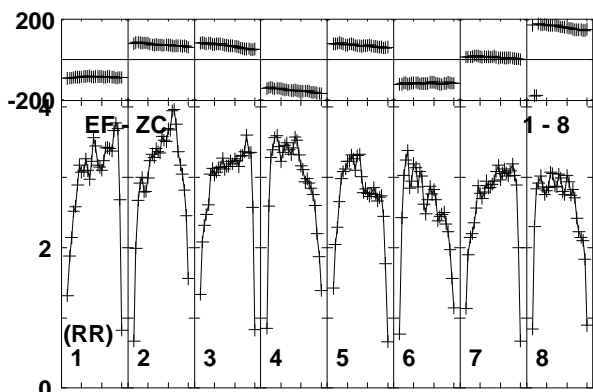
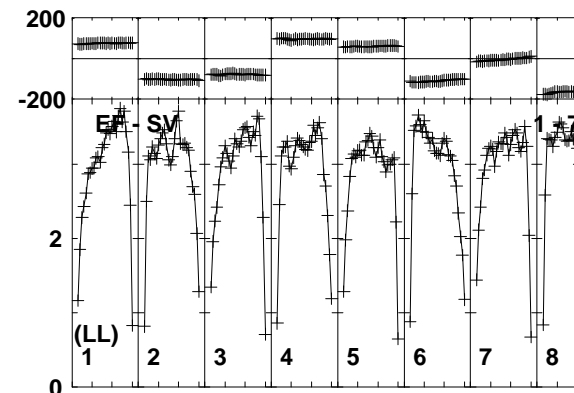
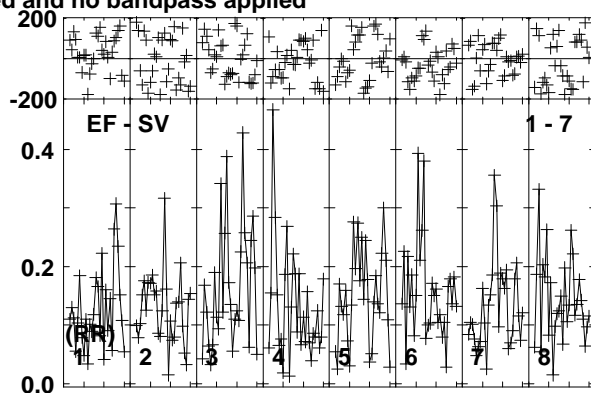
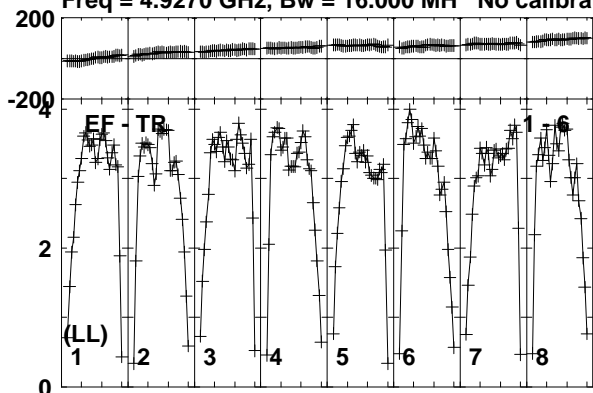

Lower frame: Milli Ampl Jy Top frame: Phas deg
Vector averaged cross-power spectrum Baseline: EF (01) - TR (06)
Timerange: 00:13:25:03 to 00:13:25:59

Plot file version 108 created 28-JAN-2015 14:38:09

J1849+3024 N14C3.UVDATA.1

Freq = 4.9270 GHz, Bw = 16.000 MH No calibration applied and no bandpass applied

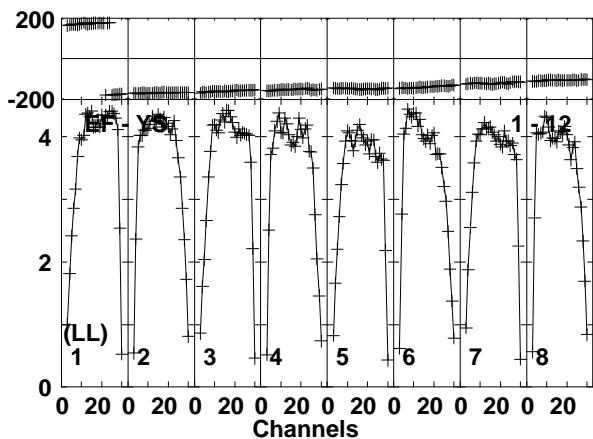
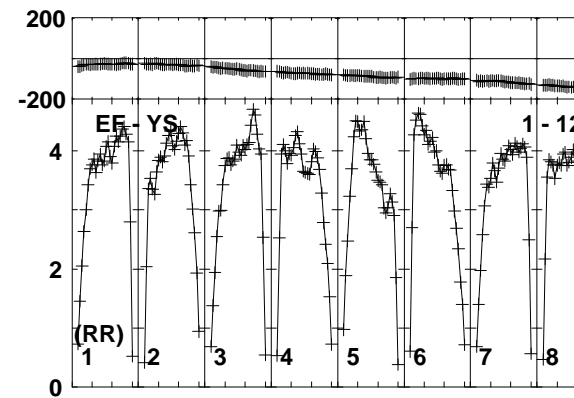
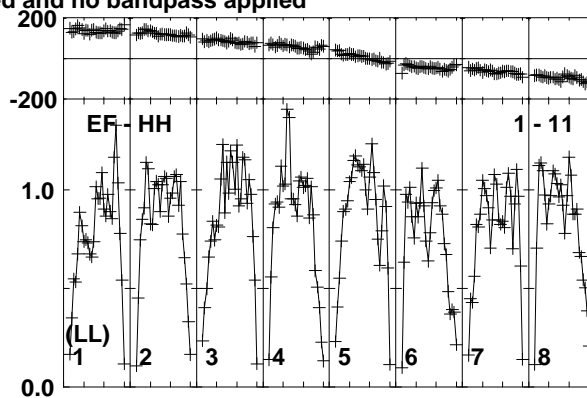
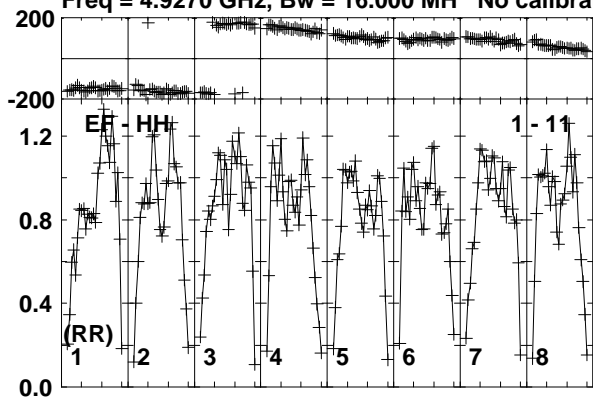

Lower frame: Milli Ampl Jy Top frame: Phas deg
Vector averaged cross-power spectrum Baseline: EF (01) - HH (11)
Timerange: 00/13:25:03 to 00/13:25:59

Plot file version 109 created 28-JAN-2015 14:38:09

1848+283 N14C3.UVDATA.1

Freq = 4.9270 GHz, Bw = 16.000 MH No calibration applied and no bandpass applied

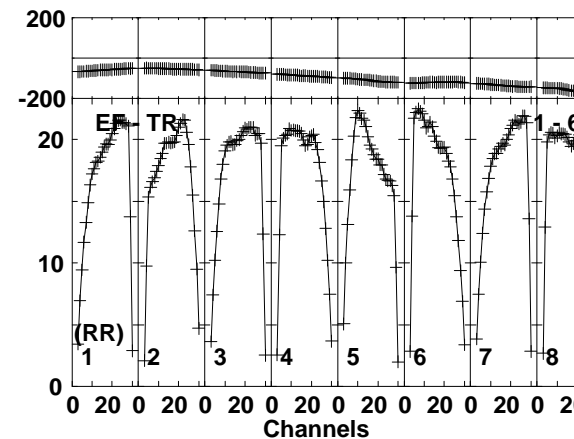
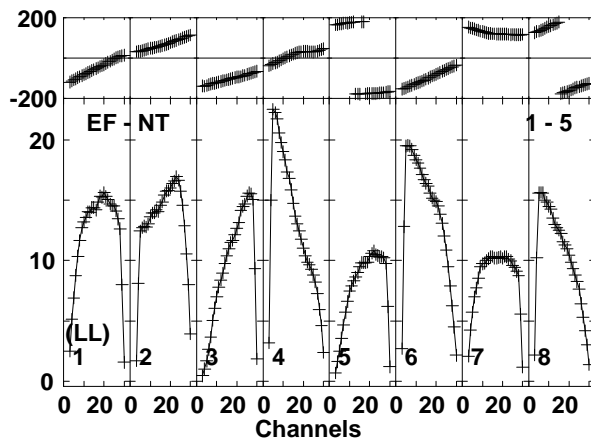
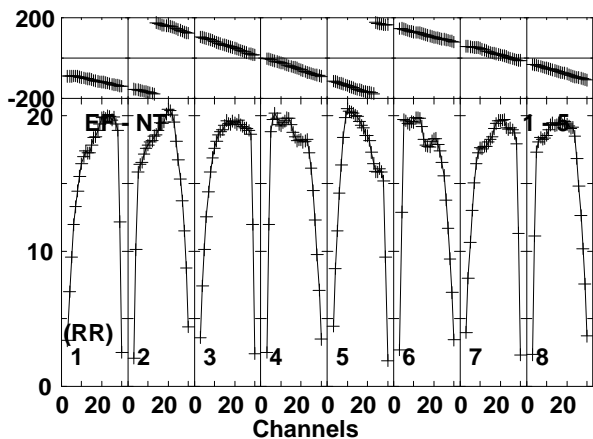
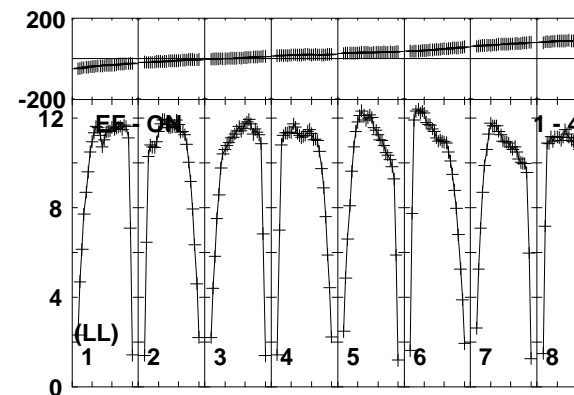
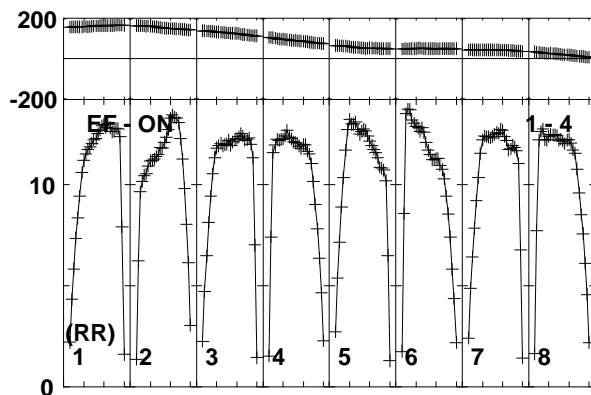
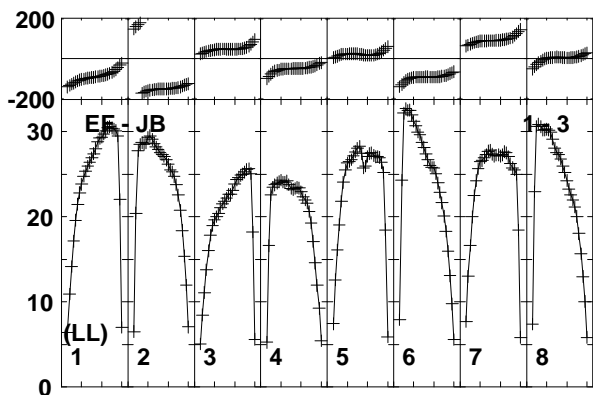
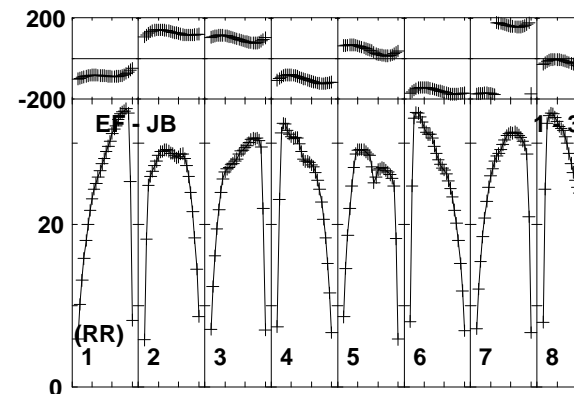
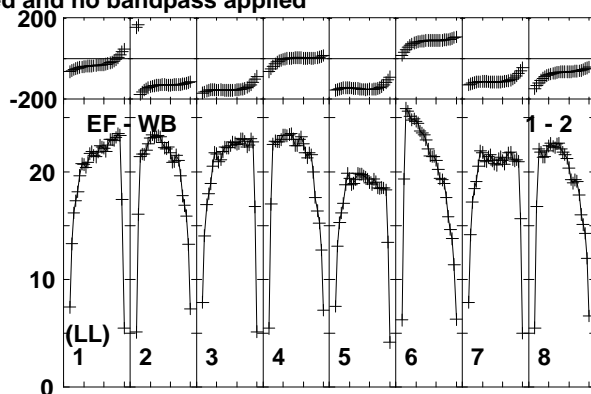
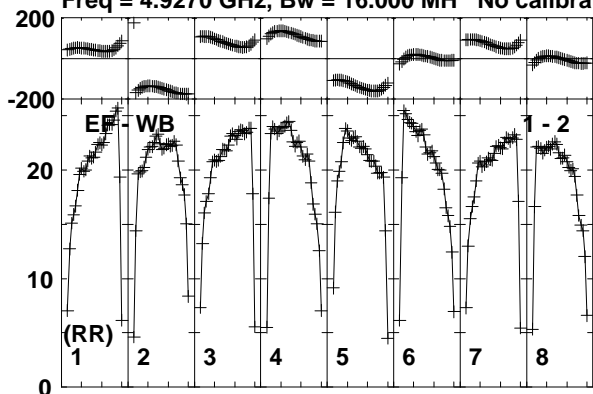

Lower frame: Milli Ampl Jy Top frame: Phas deg
Vector averaged cross-power spectrum Baseline: EF (01) - WB (02)
Timerange: 00/13:26:43 to 00/13:27:39

Plot file version 110 created 28-JAN-2015 14:38:09

1848+283 N14C3.UVDATA.1

Freq = 4.9270 GHz, Bw = 16.000 MH No calibration applied and no bandpass applied

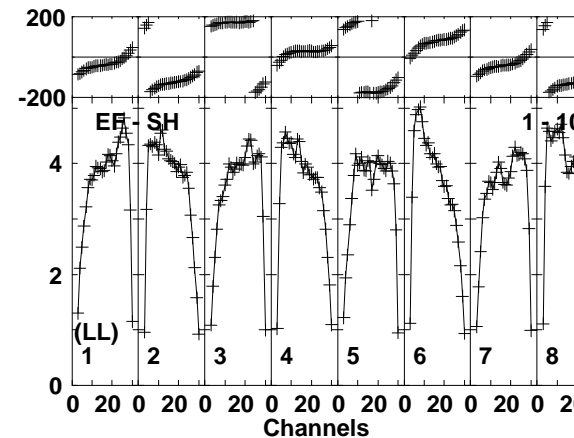
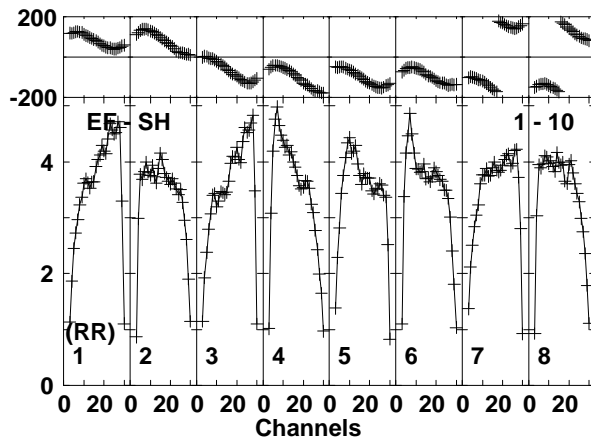
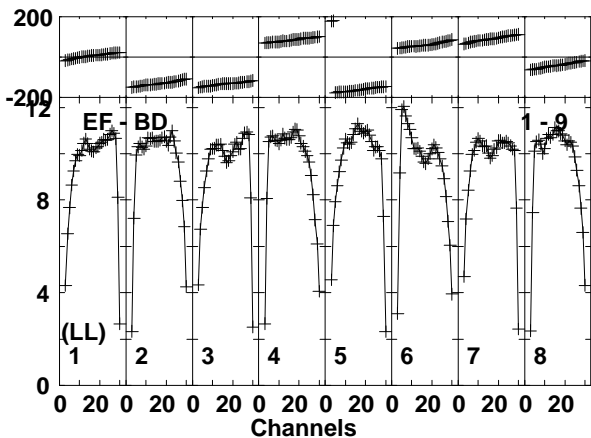
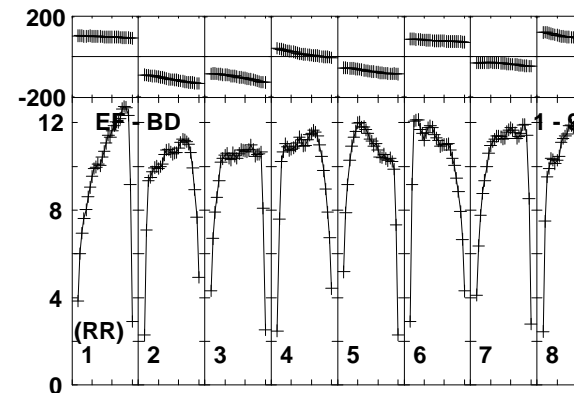
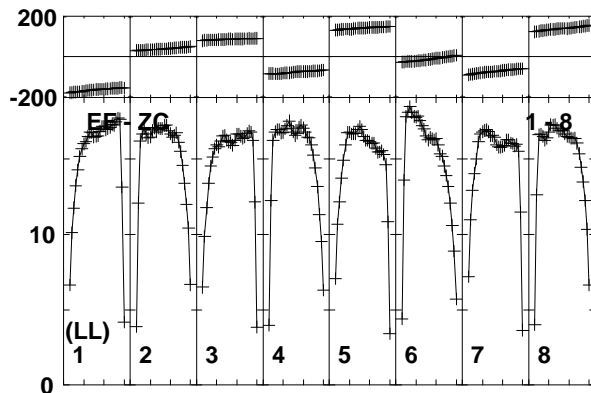
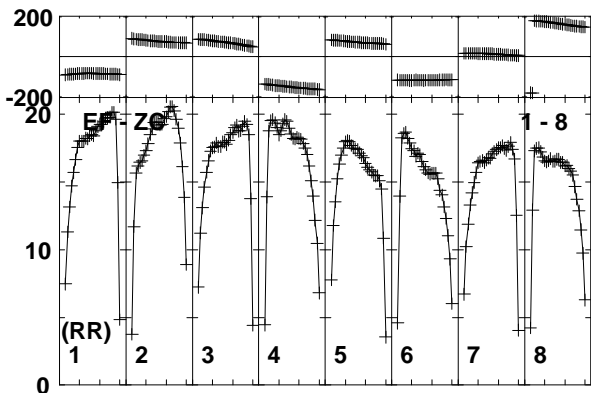
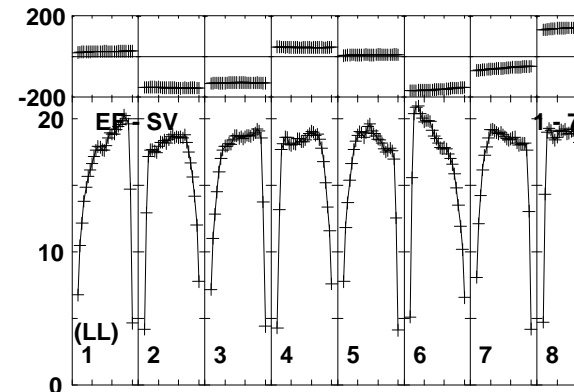
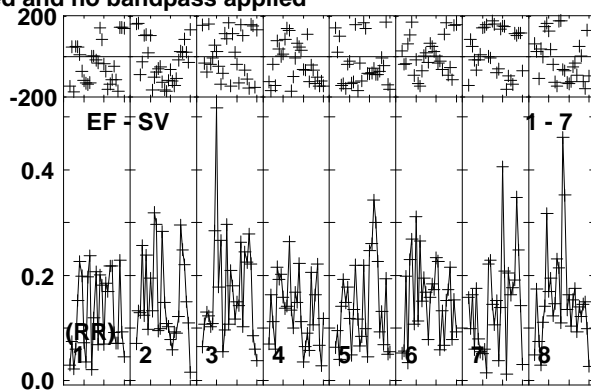
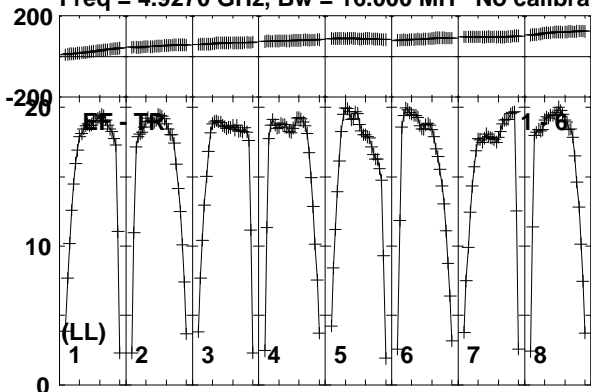

Lower frame: Milli Ampl Jy Top frame: Phas deg
Vector averaged cross-power spectrum Baseline: EF (01) - TR (06)
Timerange: 00/13:26:43 to 00/13:27:39

Plot file version 111 created 28-JAN-2015 14:38:09

1848+283 N14C3.UVDATA.1

Freq = 4.9270 GHz, Bw = 16.000 MH No calibration applied and no bandpass applied

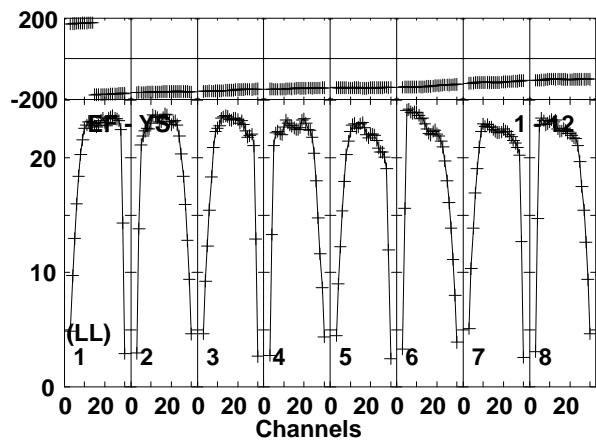
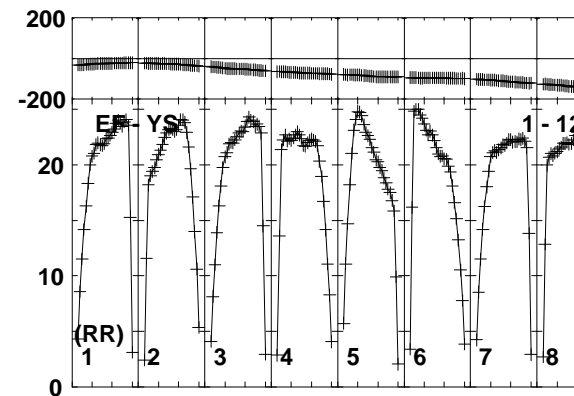
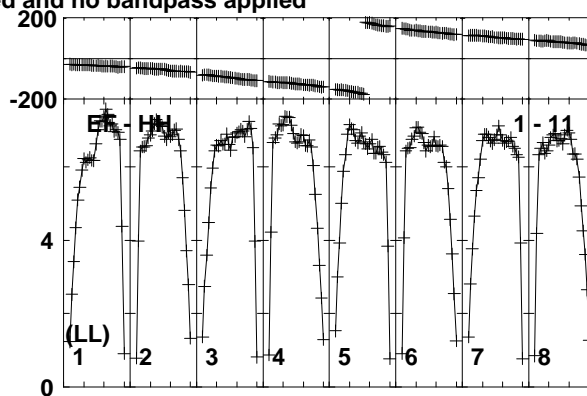
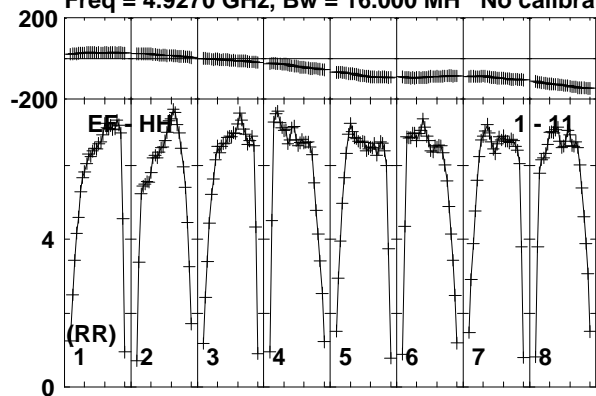

Lower frame: Milli Ampl Jy Top frame: Phas deg
Vector averaged cross-power spectrum Baseline: EF (01) - HH (11)
Timerange: 00/13:26:43 to 00/13:27:39

Plot file version 112 created 28-JAN-2015 14:38:09

J1849+3024 N14C3.UVDATA.1

Freq = 4.9270 GHz, Bw = 16.000 MH No calibration applied and no bandpass applied

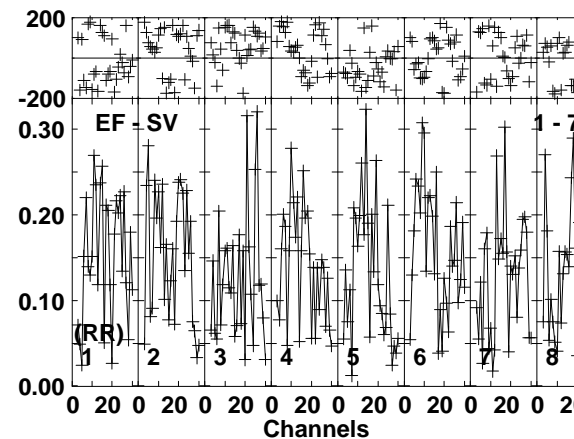
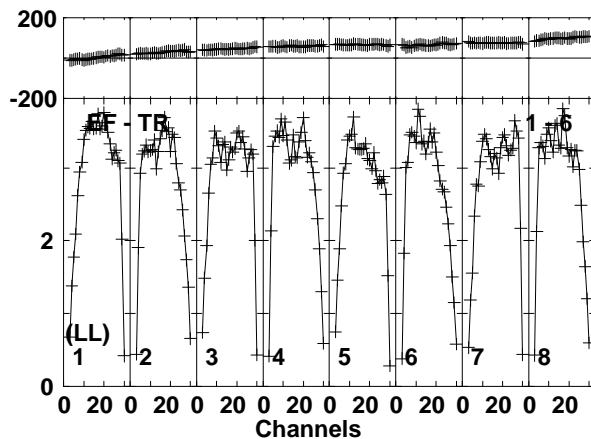
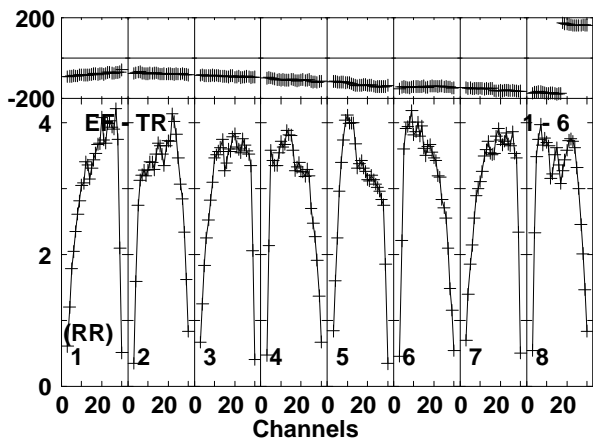
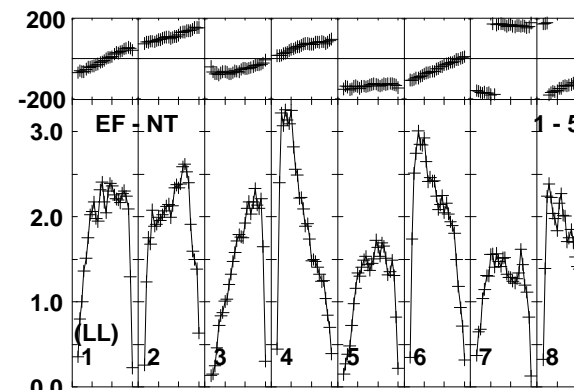
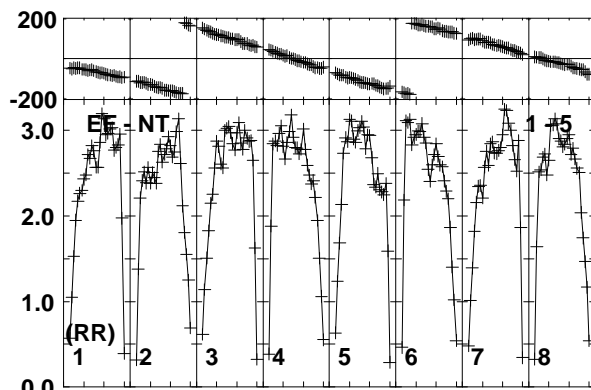
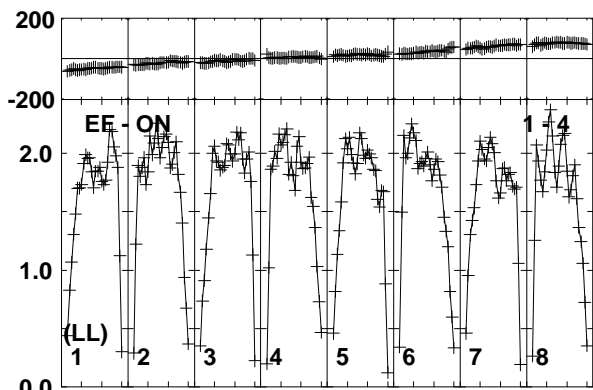
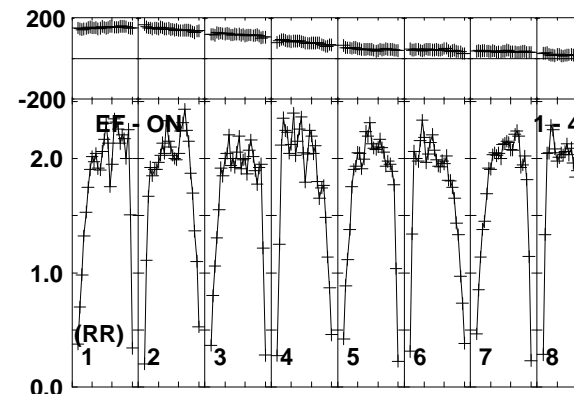
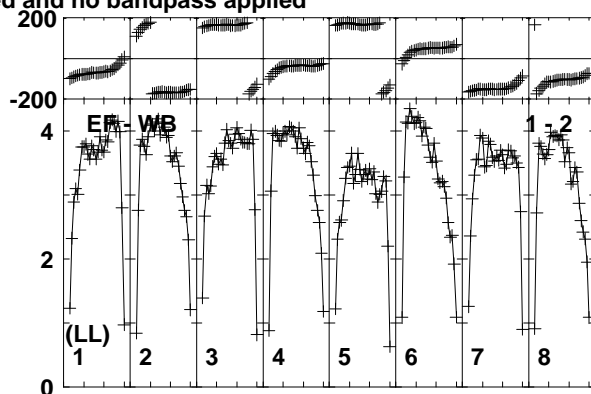
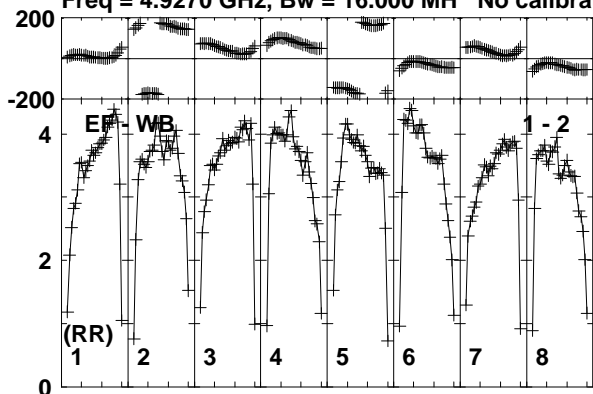

Lower frame: Milli Ampl Jy Top frame: Phas deg
Vector averaged cross-power spectrum Baseline: EF (01) - WB (02)
Timerange: 00/13:28:23 to 00/13:29:19

Plot file version 113 created 28-JAN-2015 14:38:09

J1849+3024 N14C3.UVDATA.1

Freq = 4.9270 GHz, Bw = 16.000 MH No calibration applied and no bandpass applied

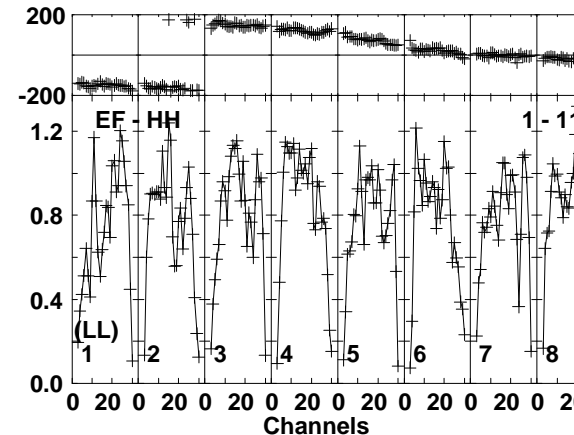
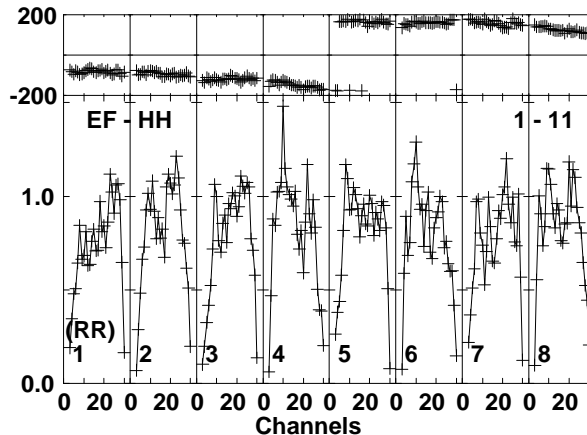
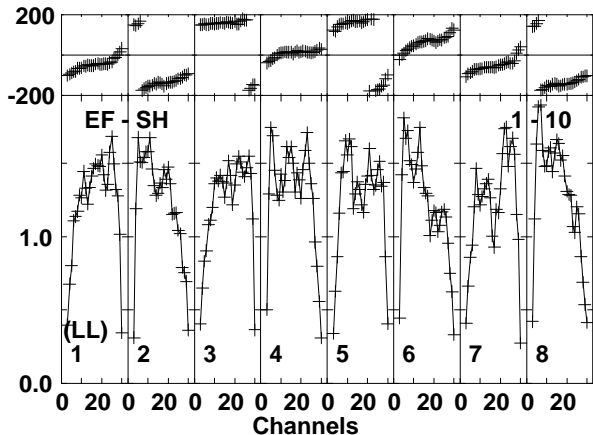
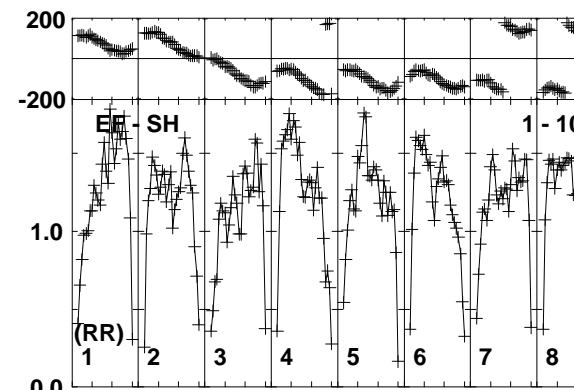
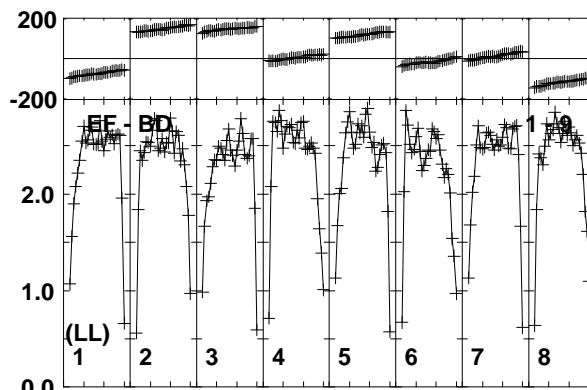
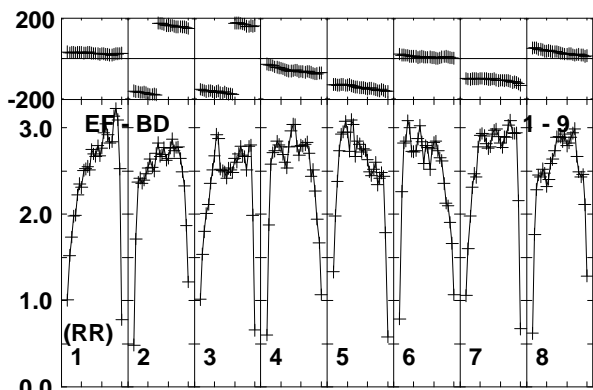
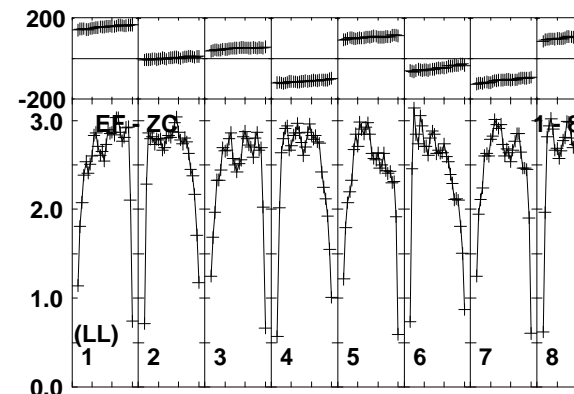
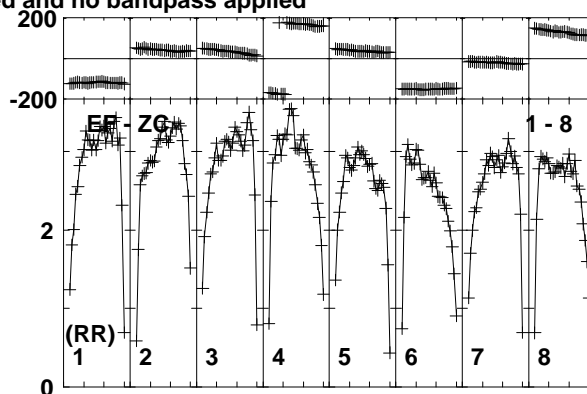
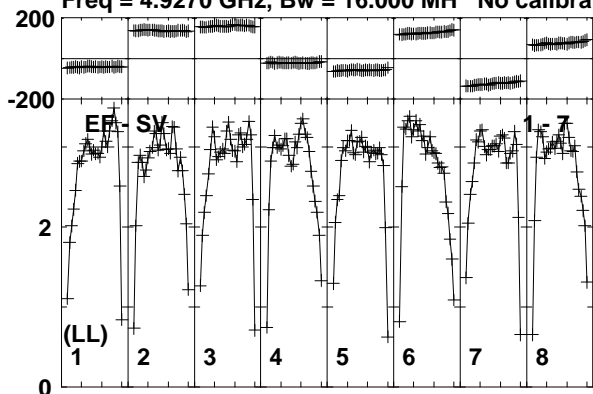

Lower frame: Milli Ampl Jy Top frame: Phas deg
Vector averaged cross-power spectrum Baseline: EF (01) - SV (07)
Timerange: 00/13:28:23 to 00/13:29:19

Plot file version 114 created 28-JAN-2015 14:38:09

J1849+3024 N14C3.UVDATA.1

Freq = 4.9270 GHz, Bw = 16.000 MH No calibration applied and no bandpass applied

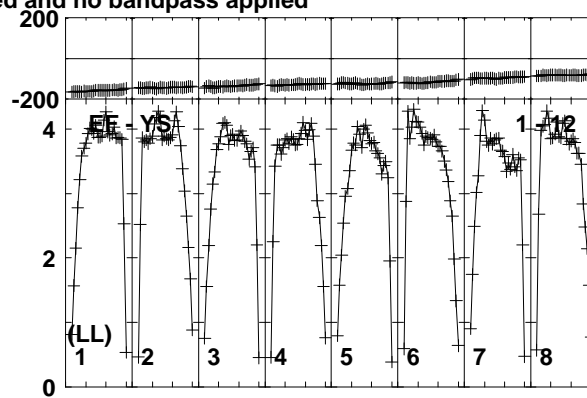
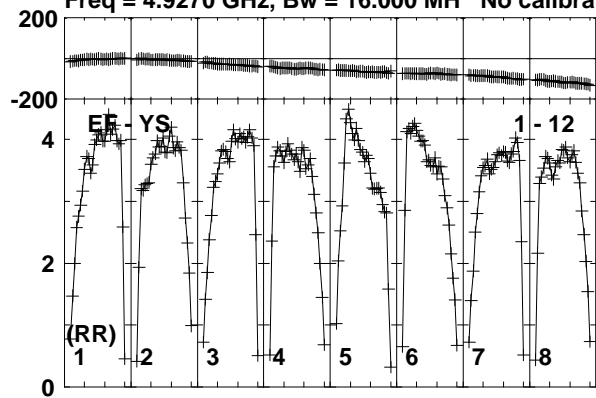

Lower frame: Milli Ampl Jy Top frame: Phas deg
Vector averaged cross-power spectrum Baseline: EF (01) - YS (12)
Timerange: 00/13:28:23 to 00/13:29:19

Plot file version 115 created 28-JAN-2015 14:38:09

1848+283 N14C3.UVDATA.1

Freq = 4.9270 GHz, Bw = 16.000 MH No calibration applied and no bandpass applied

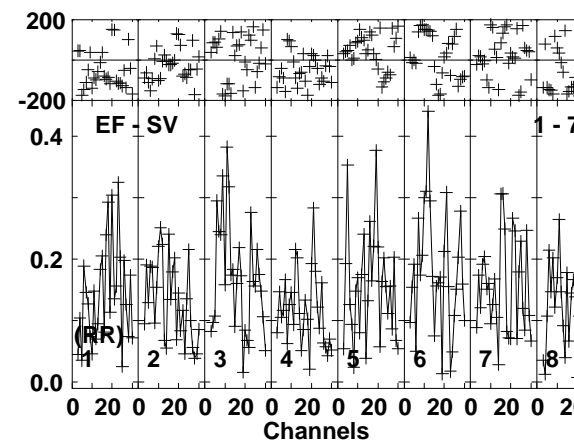
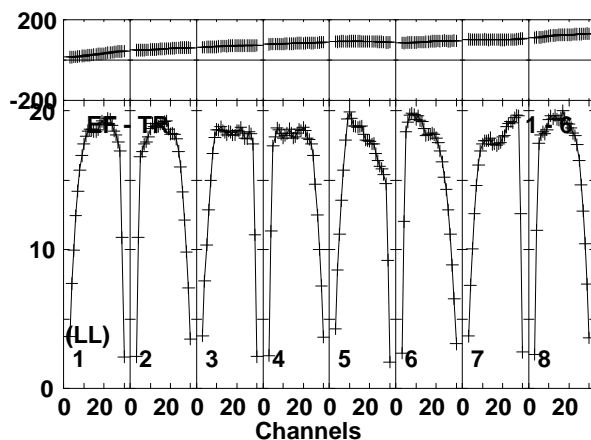
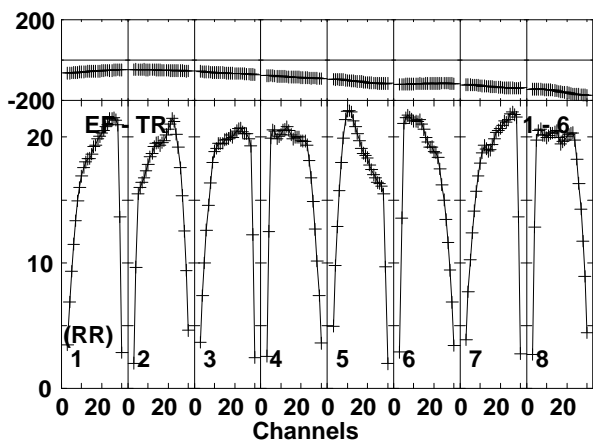
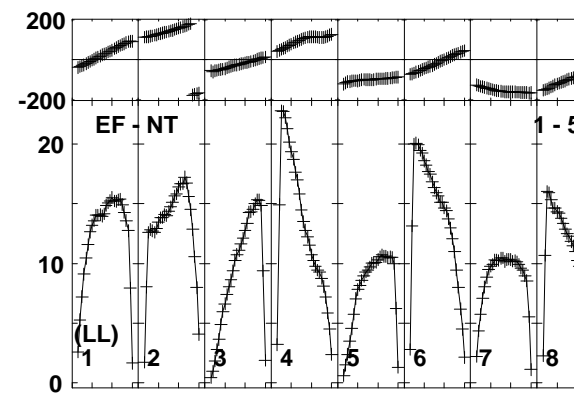
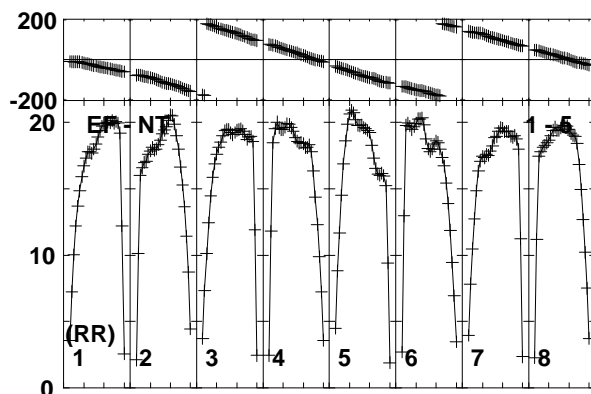
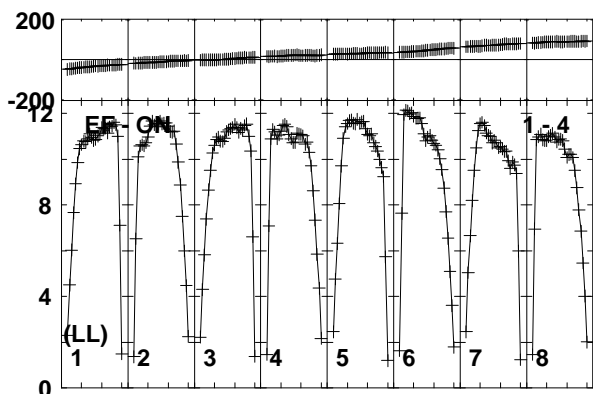
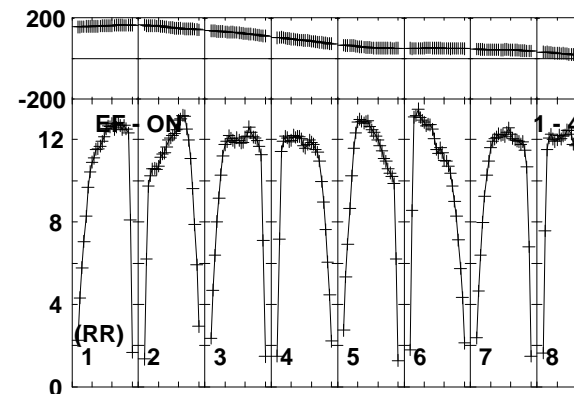
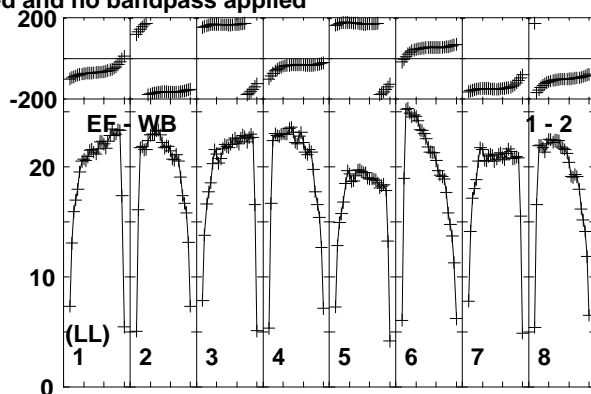
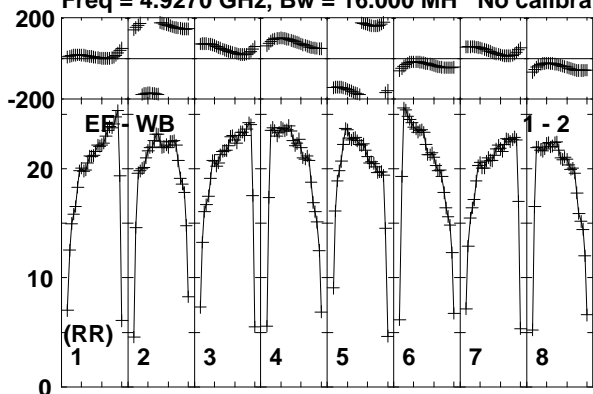

Lower frame: Milli Ampl Jy Top frame: Phas deg
Vector averaged cross-power spectrum Baseline: EF (01) - WB (02)
Timerange: 00/13:30:03 to 00/13:30:59

Plot file version 116 created 28-JAN-2015 14:38:09

1848+283 N14C3.UVDATA.1

Freq = 4.9270 GHz, Bw = 16.000 MH No calibration applied and no bandpass applied

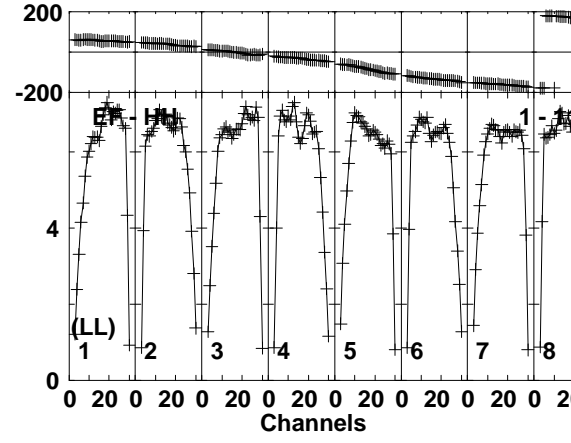
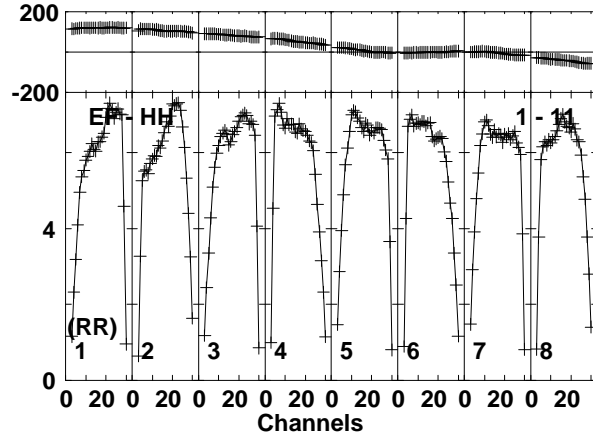
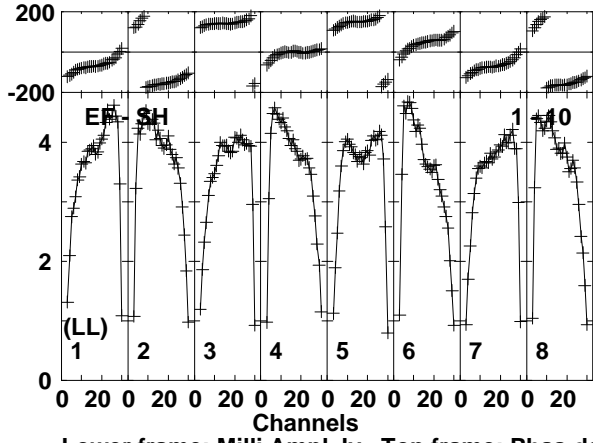
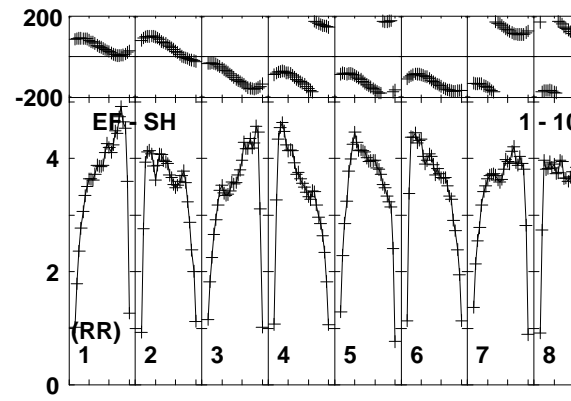
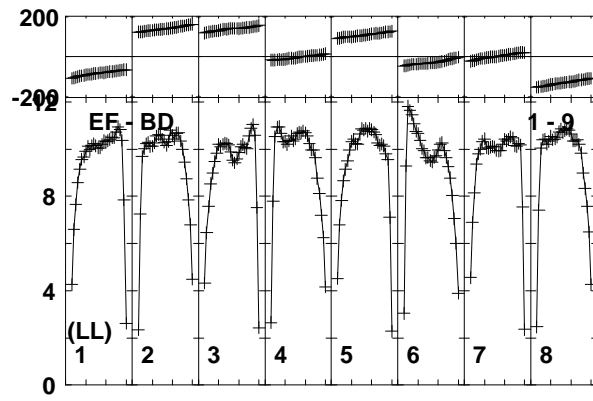
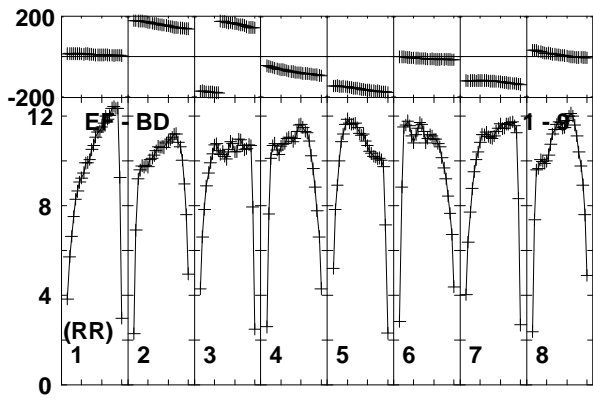
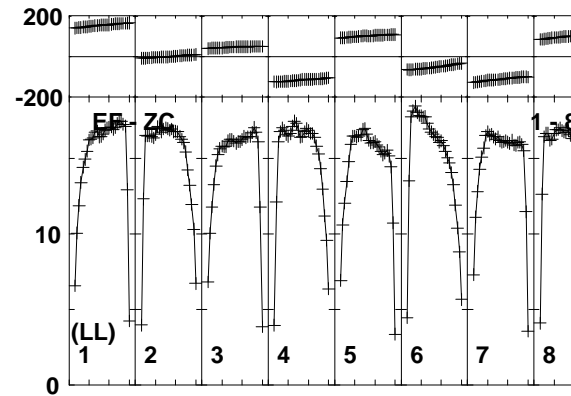
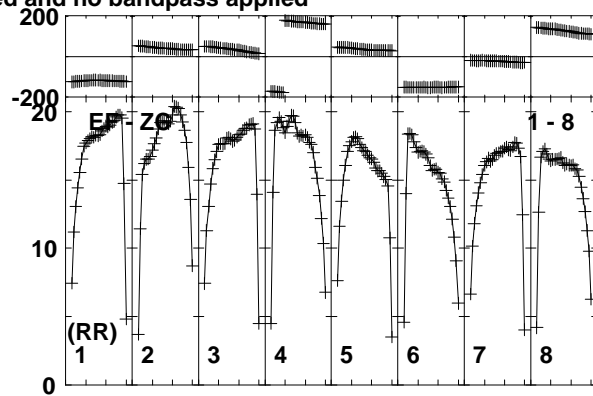
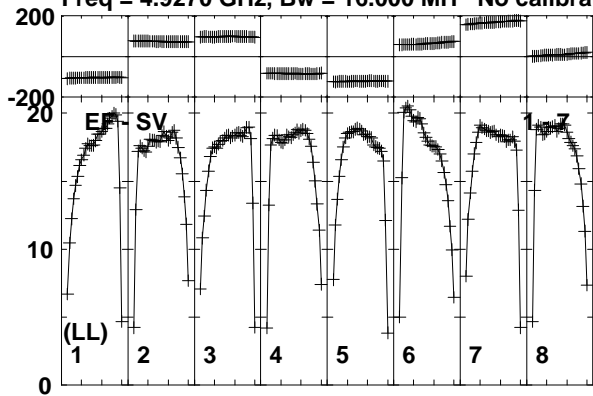

Lower frame: Milli Ampl Jy Top frame: Phas deg
Vector averaged cross-power spectrum Baseline: EF (01) - SV (07)
Timerange: 00/13:30:03 to 00/13:30:59

Plot file version 117 created 28-JAN-2015 14:38:09
1848+283 N14C3.UVDATA.1

Freq = 4.9270 GHz, Bw = 16.000 MH No calibration applied and no bandpass applied

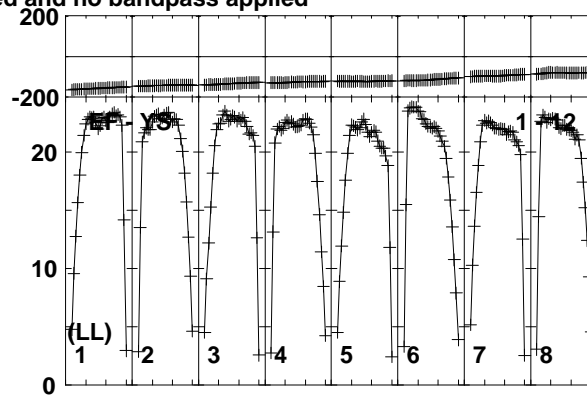

Lower frame: Milli Ampl Jy Top frame: Phas deg
Vector averaged cross-power spectrum Baseline: EF (01) - YS (12)
Timerange: 00/13:30:03 to 00/13:30:59

Plot file version 118 created 28-JAN-2015 14:38:09

J1849+3024 N14C3.UVDATA.1

Freq = 4.9270 GHz, Bw = 16.000 MH No calibration applied and no bandpass applied

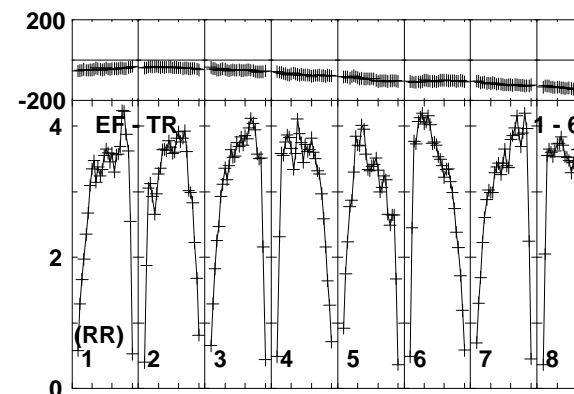
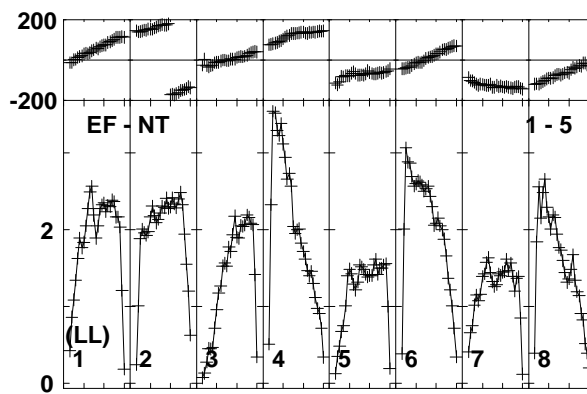
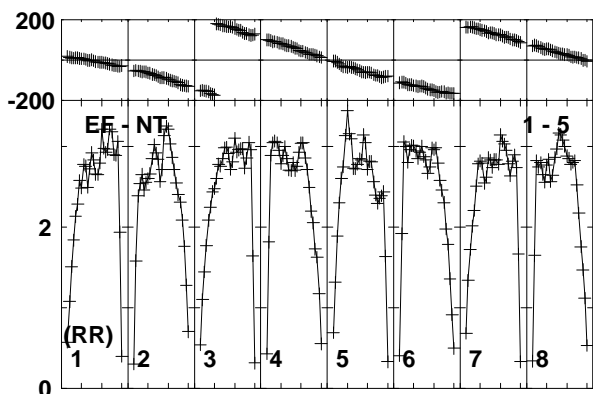
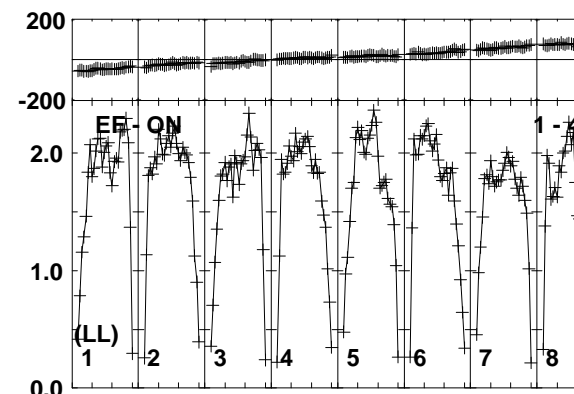
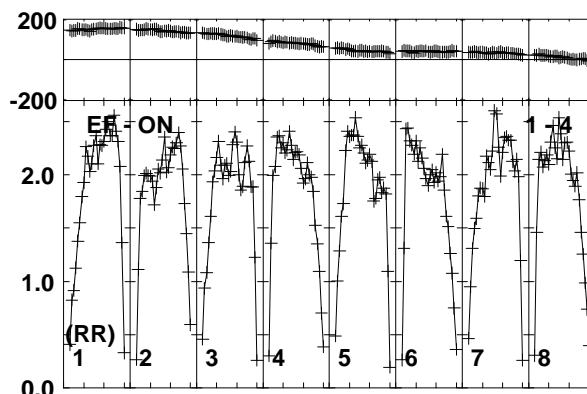
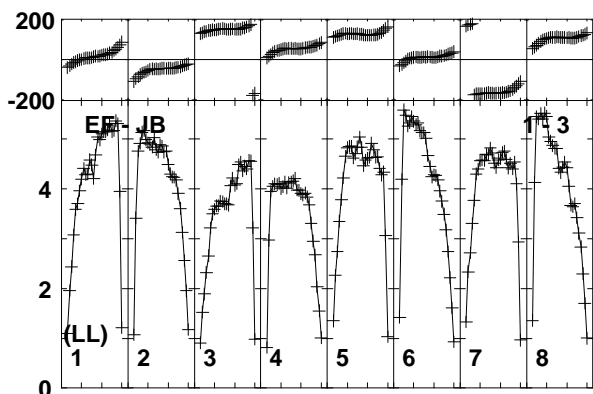
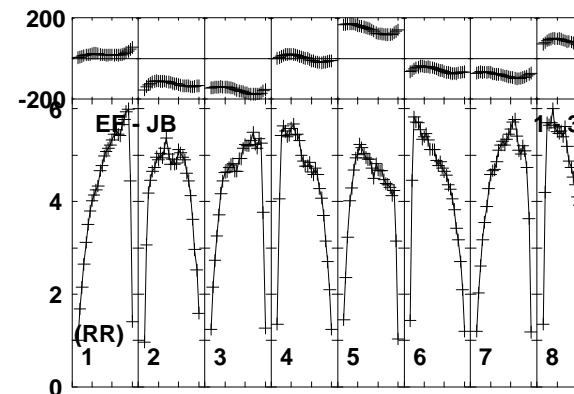
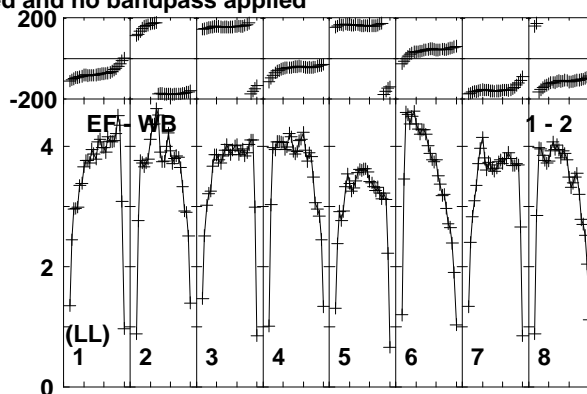
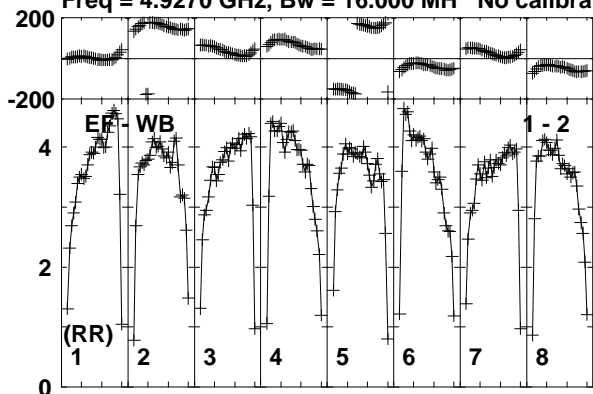

Lower frame: Milli Ampl Jy Top frame: Phas deg
Vector averaged cross-power spectrum Baseline: EF (01) - WB (02)
Timerange: 00:13:31:43 to 00:13:32:39

Plot file version 119 created 28-JAN-2015 14:38:09

J1849+3024 N14C3.UVDATA.1

Freq = 4.9270 GHz, Bw = 16.000 MH No calibration applied and no bandpass applied

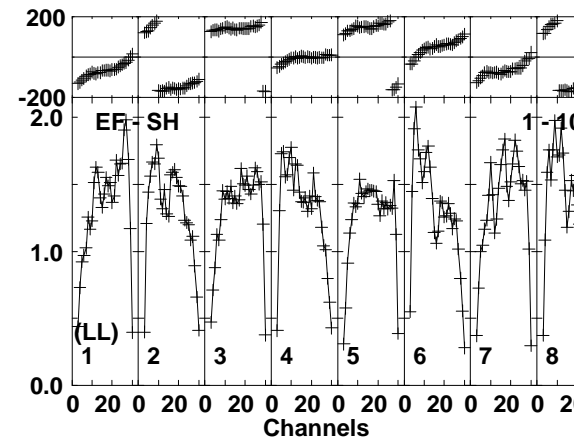
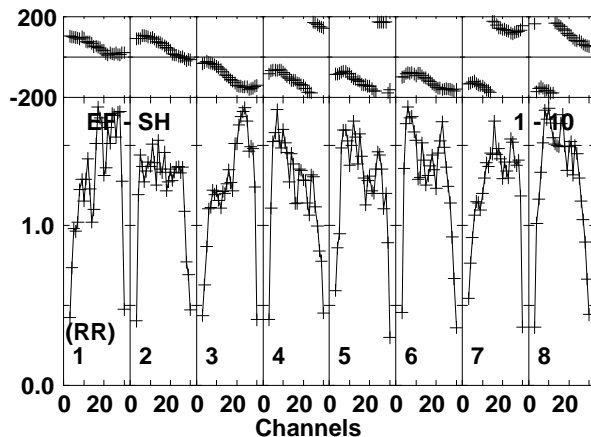
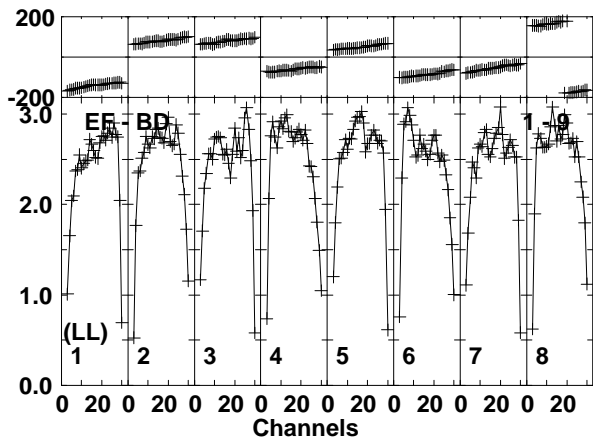
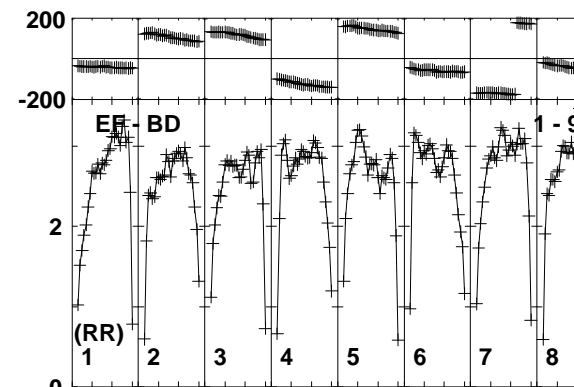
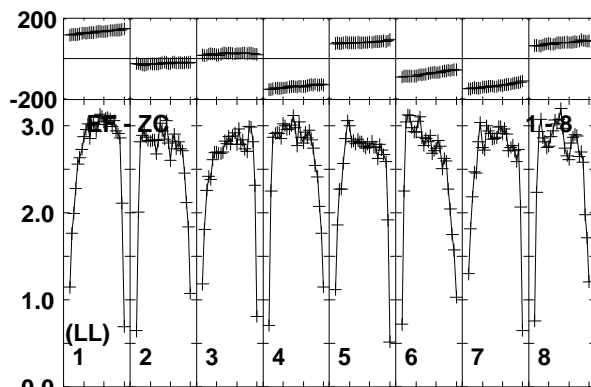
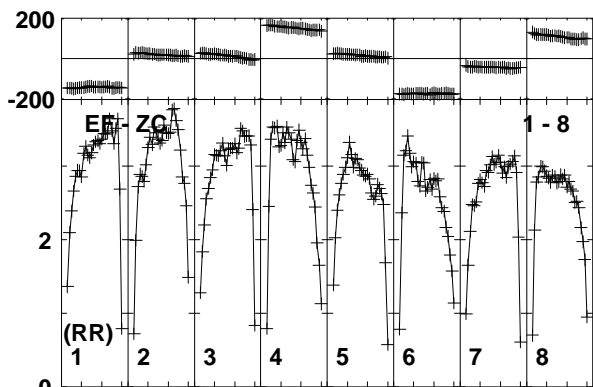
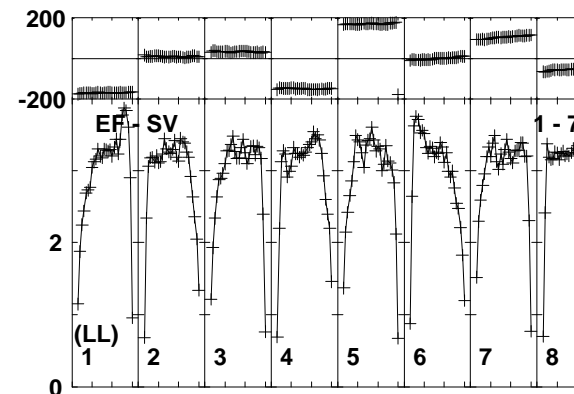
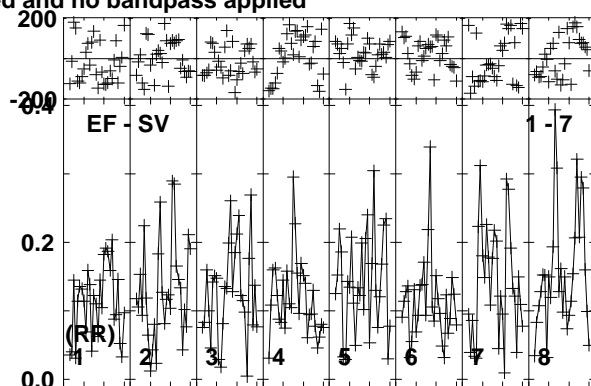
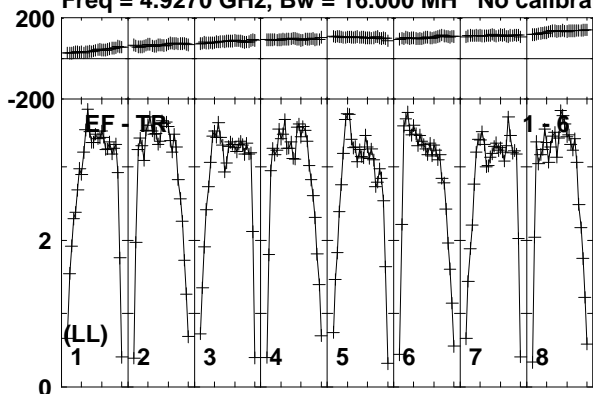

Lower frame: Milli Ampl Jy Top frame: Phas deg
Vector averaged cross-power spectrum Baseline: EF (01) - TR (06)
Timerange: 00:13:31:43 to 00:13:32:39

Plot file version 120 created 28-JAN-2015 14:38:09

J1849+3024 N14C3.UVDATA.1

Freq = 4.9270 GHz, Bw = 16.000 MH No calibration applied and no bandpass applied

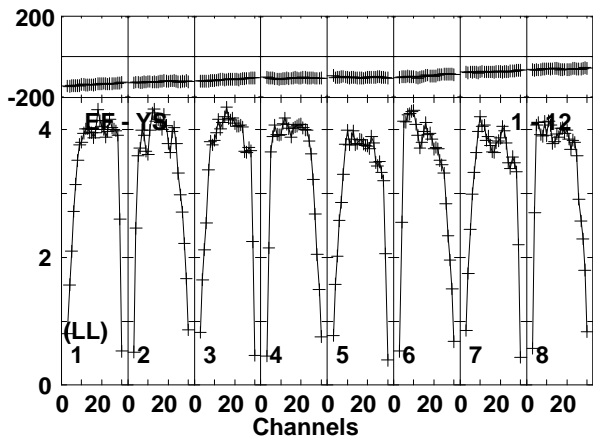
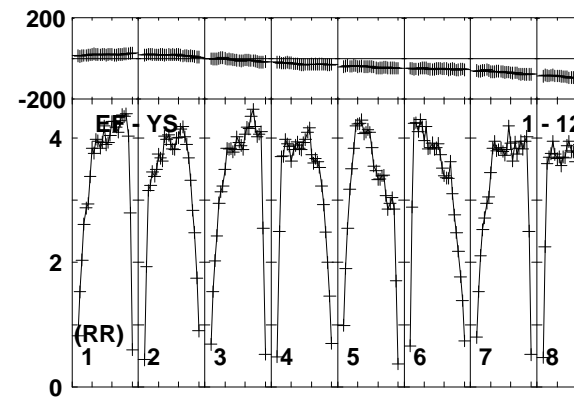
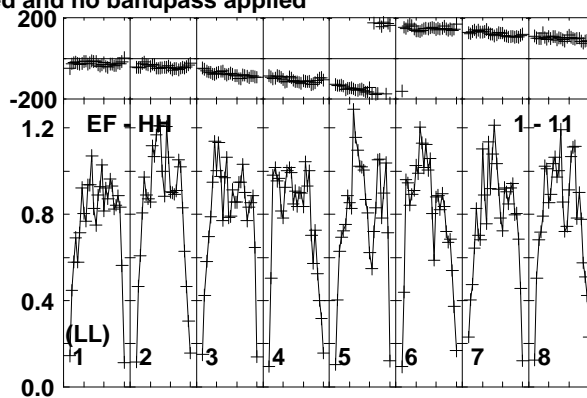
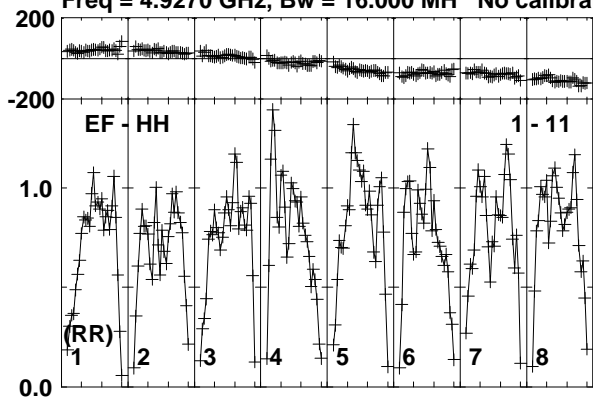

Lower frame: Milli Ampl Jy Top frame: Phas deg
Vector averaged cross-power spectrum Baseline: EF (01) - HH (11)
Timerange: 00/13:31:43 to 00/13:32:39

Plot file version 121 created 28-JAN-2015 14:38:09

1848+283 N14C3.UVDATA.1

Freq = 4.9270 GHz, Bw = 16.000 MH No calibration applied and no bandpass applied

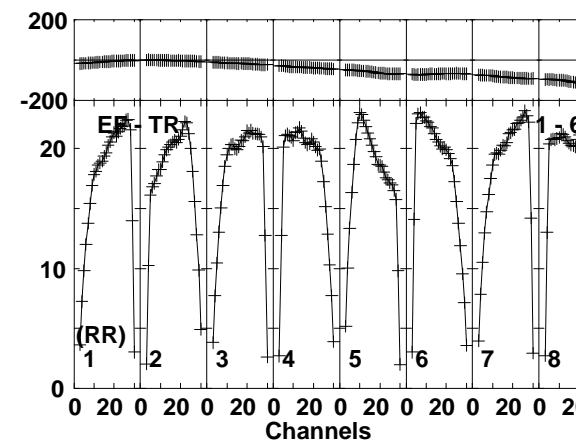
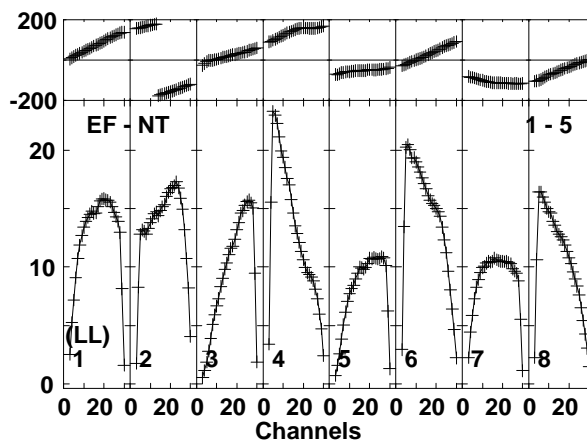
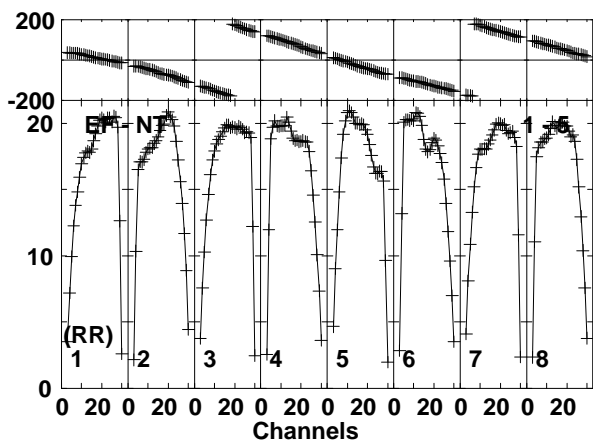
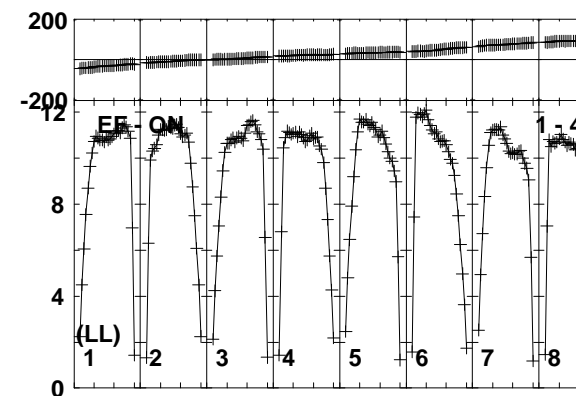
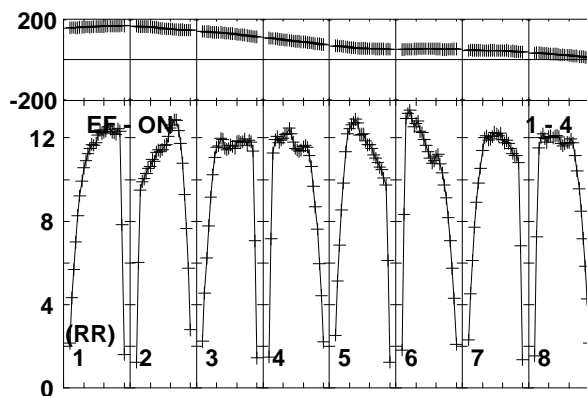
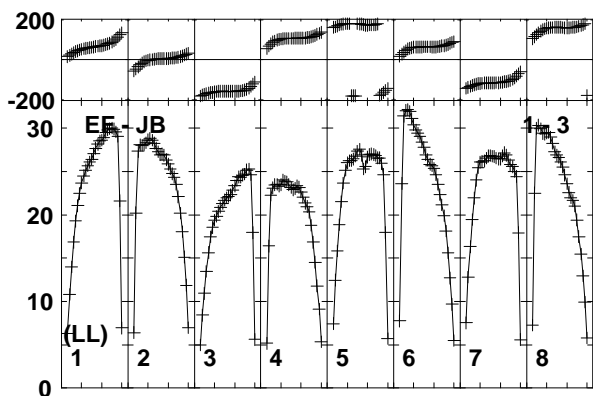
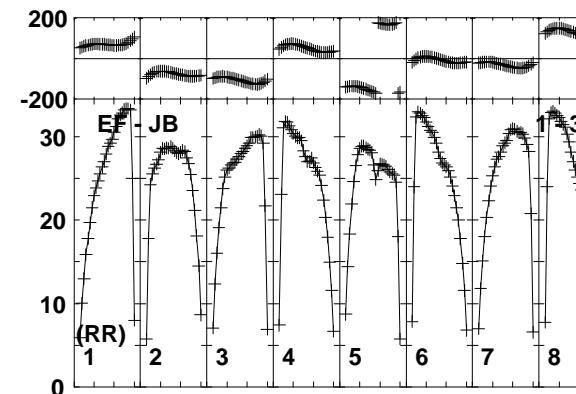
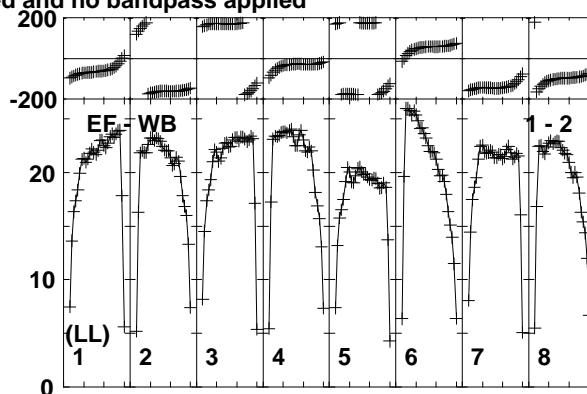
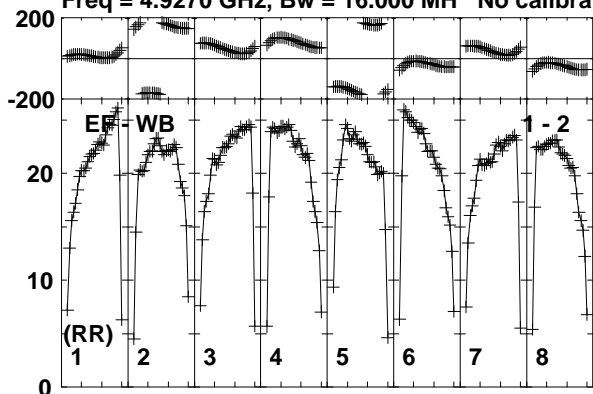

Lower frame: Milli Ampl Jy Top frame: Phas deg
Vector averaged cross-power spectrum Baseline: EF (01) - WB (02)
Timerange: 00/13:33:23 to 00/13:34:19

Plot file version 122 created 28-JAN-2015 14:38:09

1848+283 N14C3.UVDATA.1

Freq = 4.9270 GHz, Bw = 16.000 MH No calibration applied and no bandpass applied

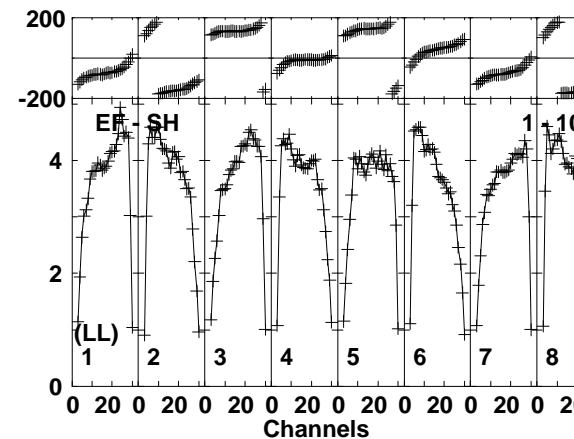
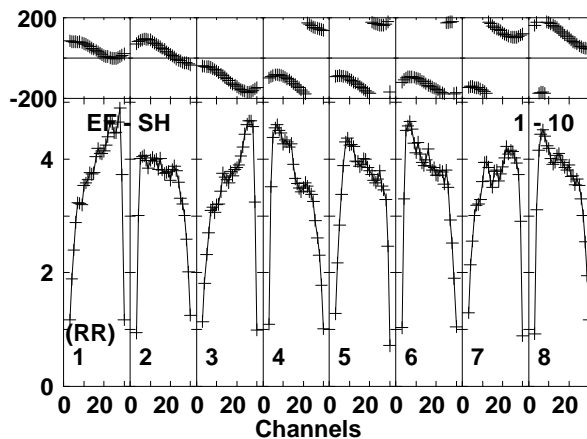
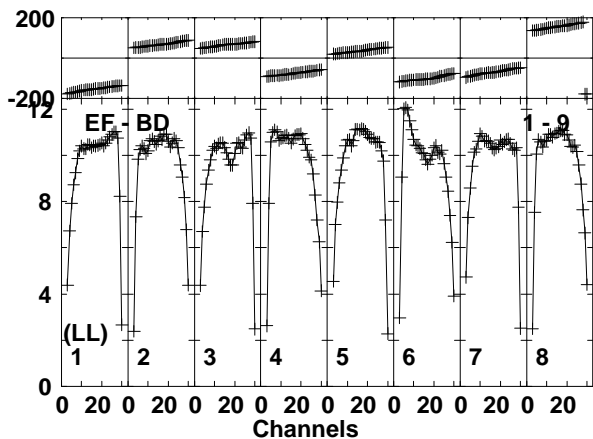
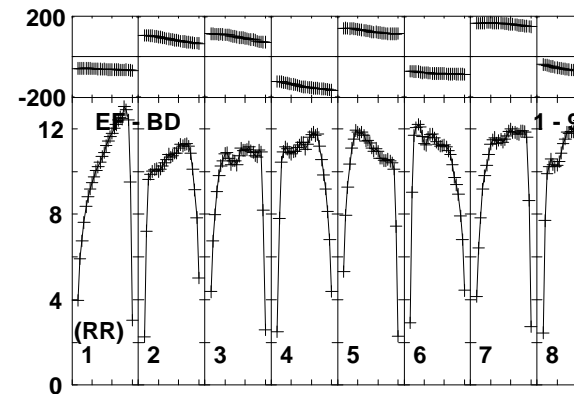
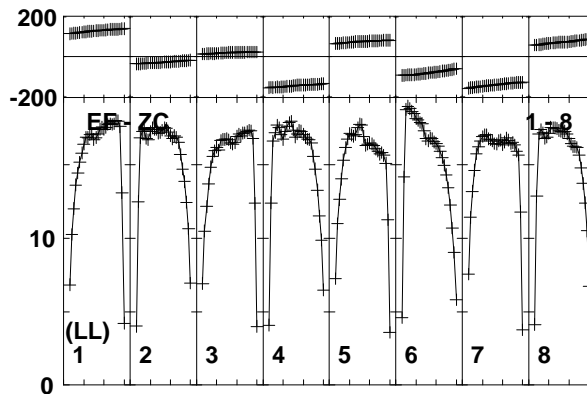
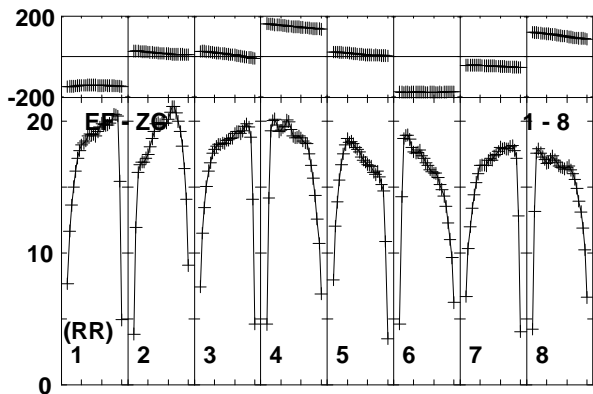
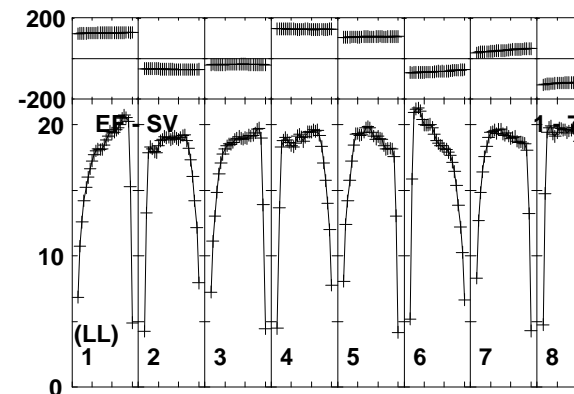
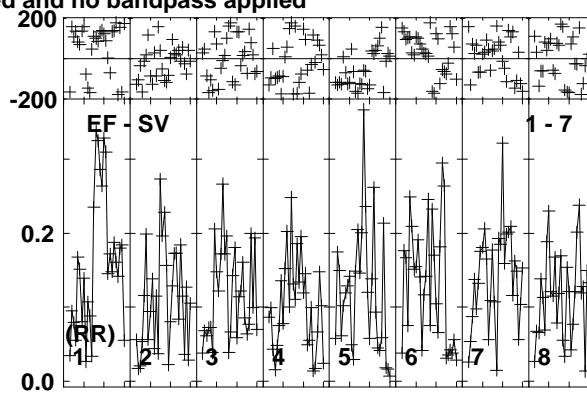
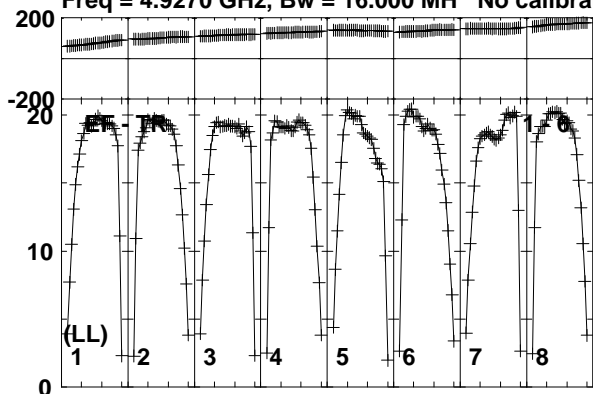

Lower frame: Milli Ampl Jy Top frame: Phas deg
Vector averaged cross-power spectrum Baseline: EF (01) - TR (06)
Timerange: 00/13:33:23 to 00/13:34:19

Plot file version 123 created 28-JAN-2015 14:38:09

1848+283 N14C3.UVDATA.1

Freq = 4.9270 GHz, Bw = 16.000 MH No calibration applied and no bandpass applied

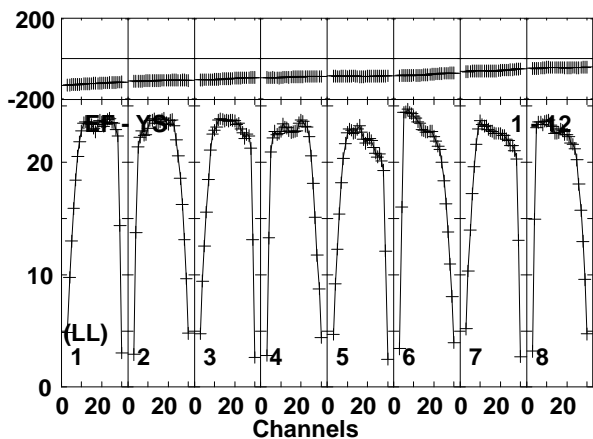
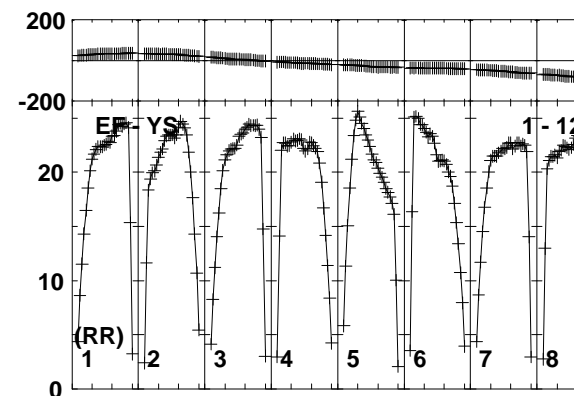
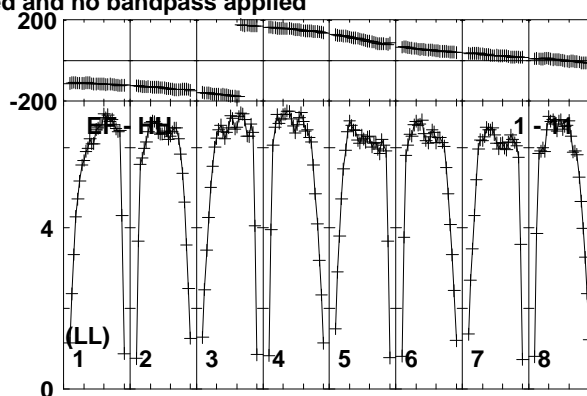
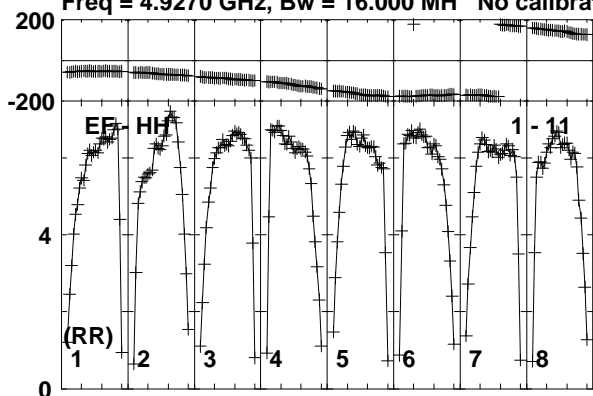

Lower frame: Milli Ampl Jy Top frame: Phas deg
Vector averaged cross-power spectrum Baseline: EF (01) - HH (11)
Timerange: 00/13:33:23 to 00/13:34:19

Plot file version 124 created 28-JAN-2015 14:38:09

J1849+3024 N14C3.UVDATA.1

Freq = 4.9270 GHz, Bw = 16.000 MH No calibration applied and no bandpass applied

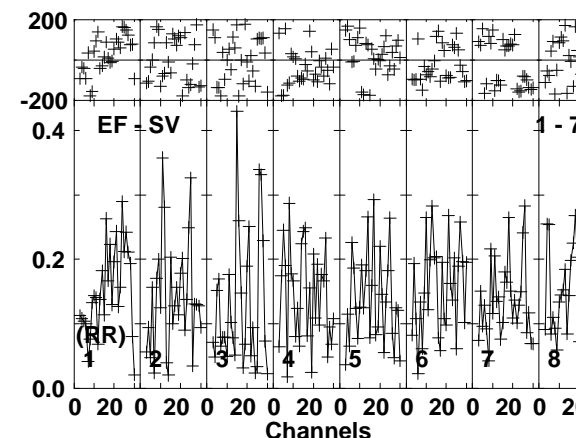
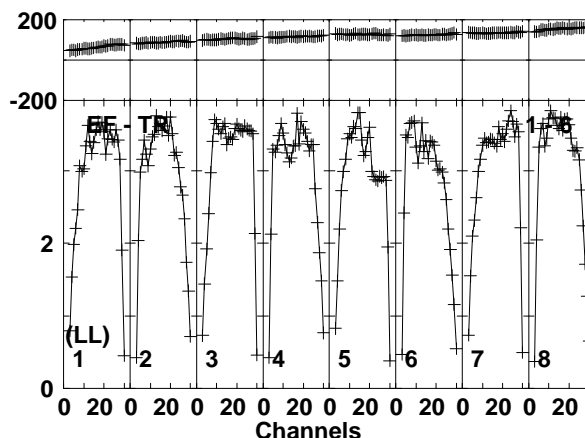
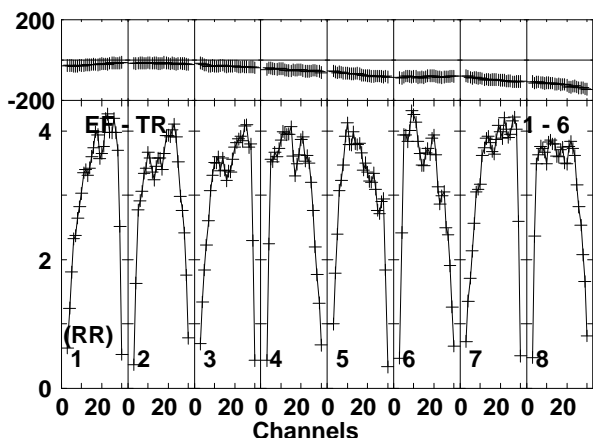
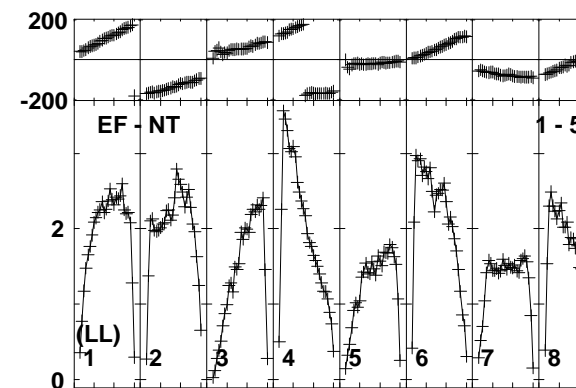
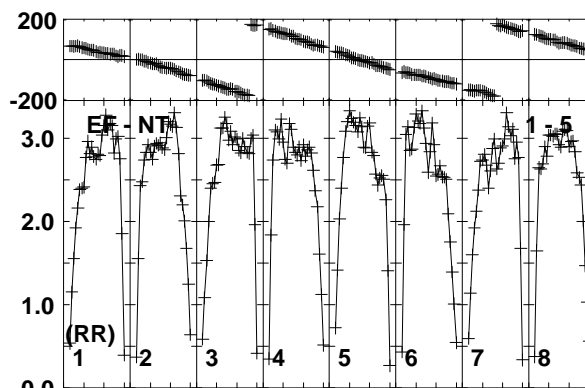
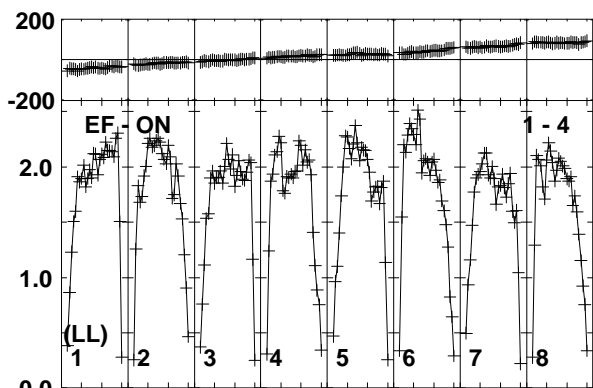
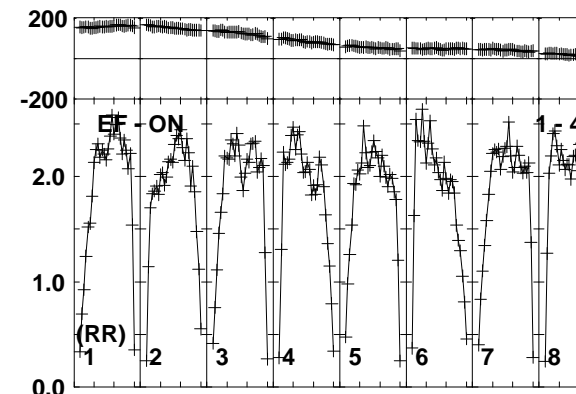
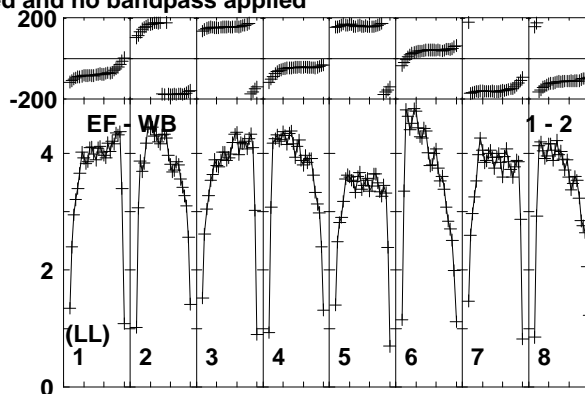
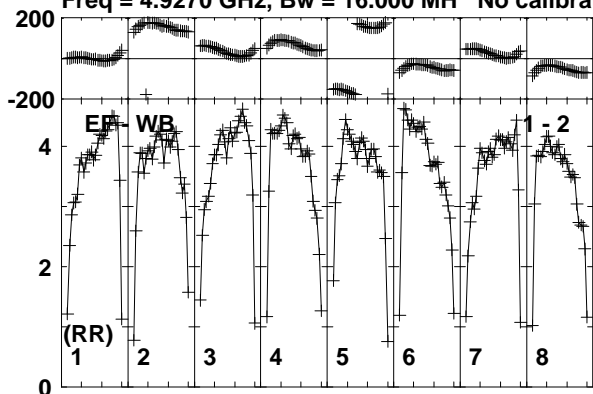

Lower frame: Milli Ampl Jy Top frame: Phas deg
Vector averaged cross-power spectrum Baseline: EF (01) - WB (02)
Timerange: 00/13:35:03 to 00/13:35:59

Plot file version 125 created 28-JAN-2015 14:38:09

J1849+3024 N14C3.UVDATA.1

Freq = 4.9270 GHz, Bw = 16.000 MH No calibration applied and no bandpass applied

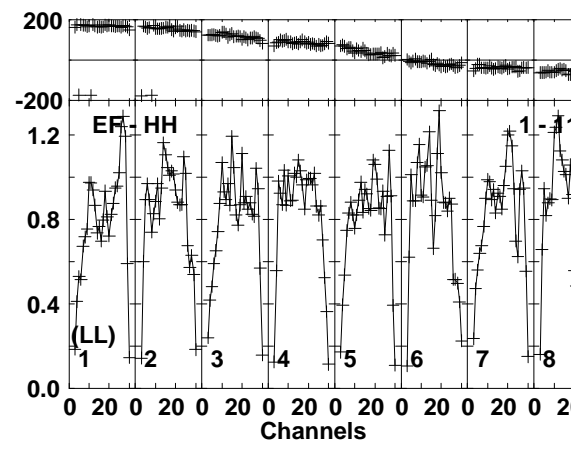
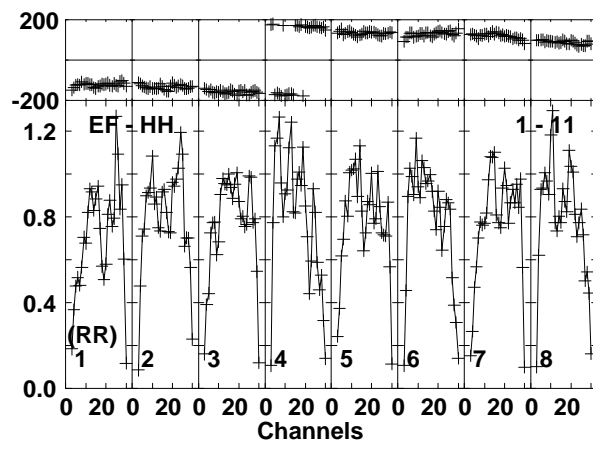
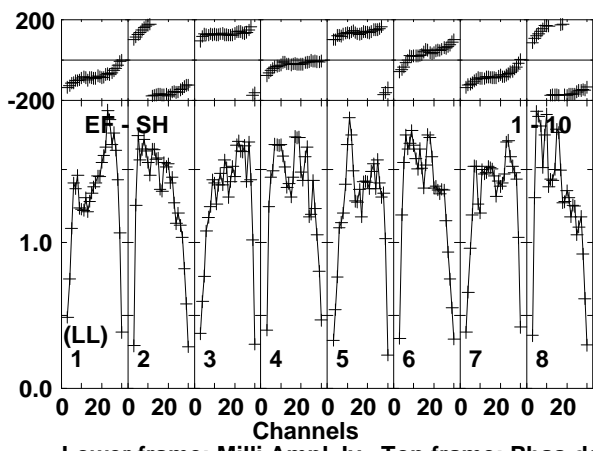
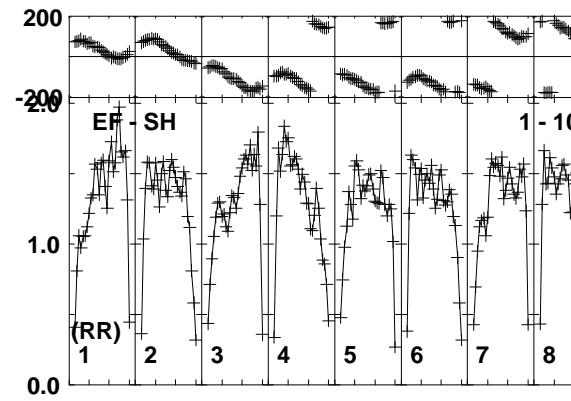
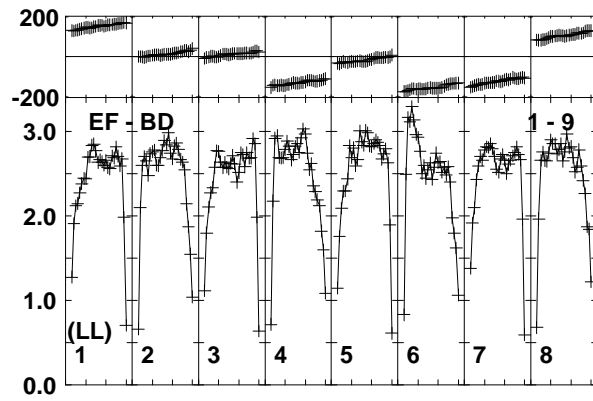
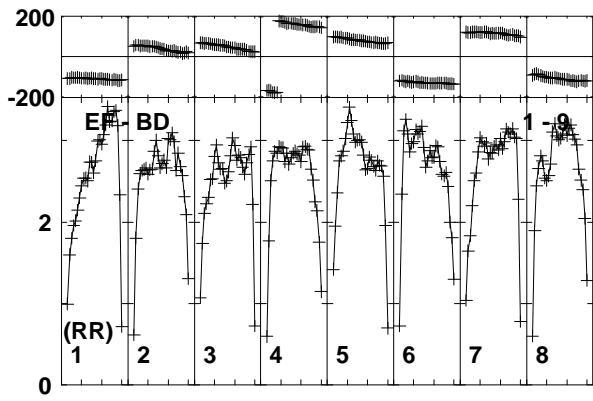
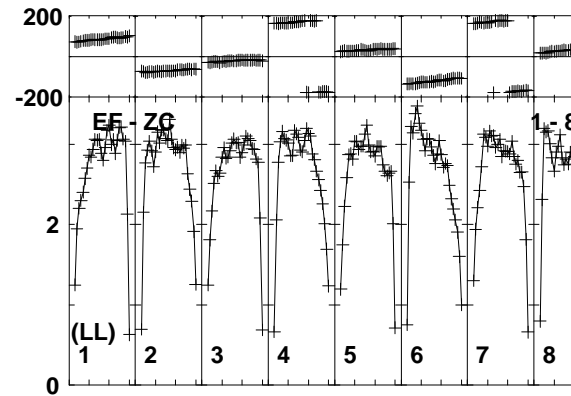
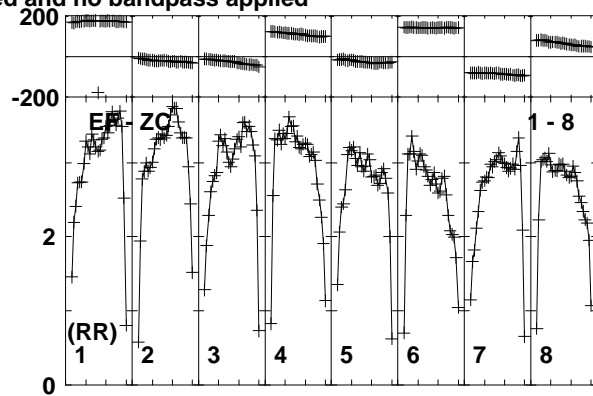
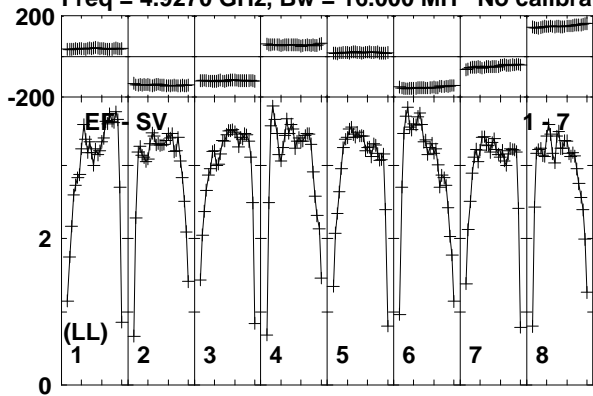

Lower frame: Milli Ampl Jy Top frame: Phas deg
Vector averaged cross-power spectrum Baseline: EF (01) - SV (07)
Timerange: 00:13:35:03 to 00:13:35:59

Plot file version 126 created 28-JAN-2015 14:38:09

J1849+3024 N14C3.UVDATA.1

Freq = 4.9270 GHz, Bw = 16.000 MH No calibration applied and no bandpass applied

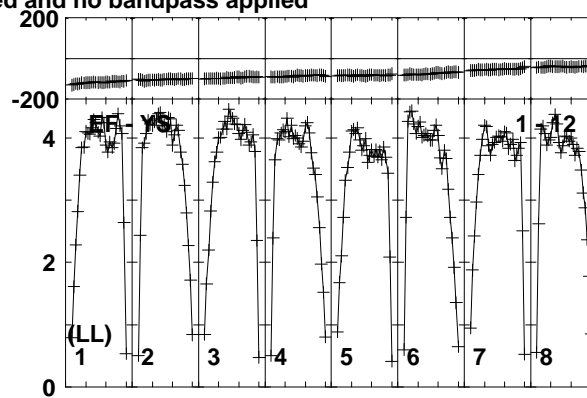
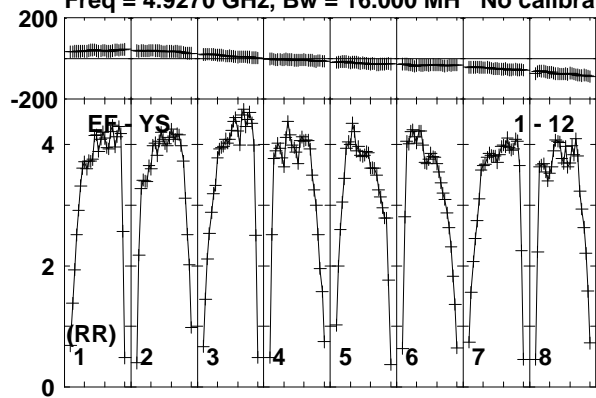

Lower frame: Milli Ampl Jy Top frame: Phas deg
Vector averaged cross-power spectrum Baseline: EF (01) - YS (12)
Timerange: 00/13:35:03 to 00/13:35:59

Plot file version 127 created 28-JAN-2015 14:38:09

1848+283 N14C3.UVDATA.1

Freq = 4.9270 GHz, Bw = 16.000 MH No calibration applied and no bandpass applied

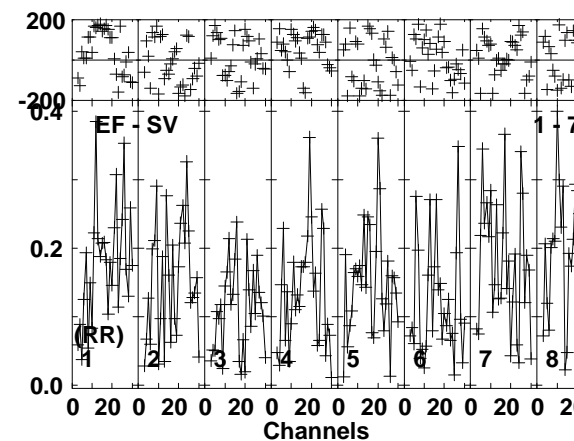
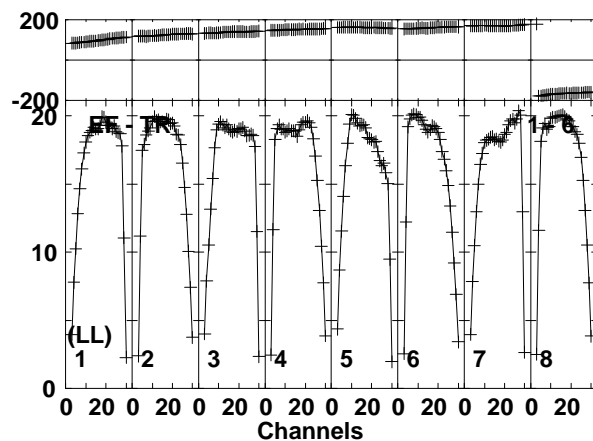
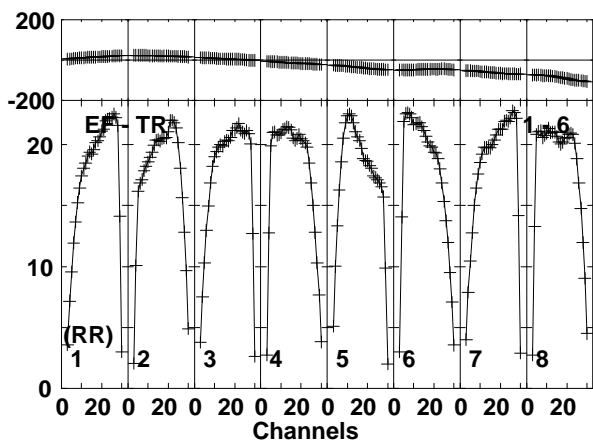
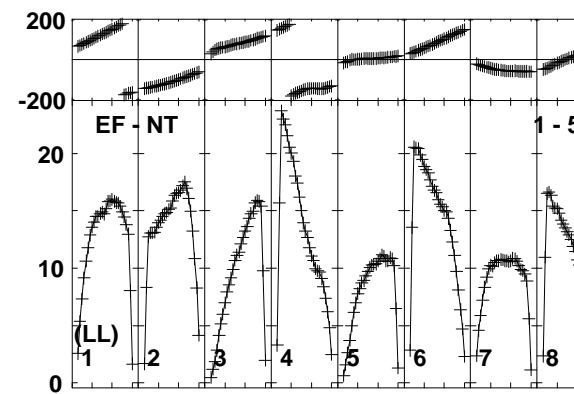
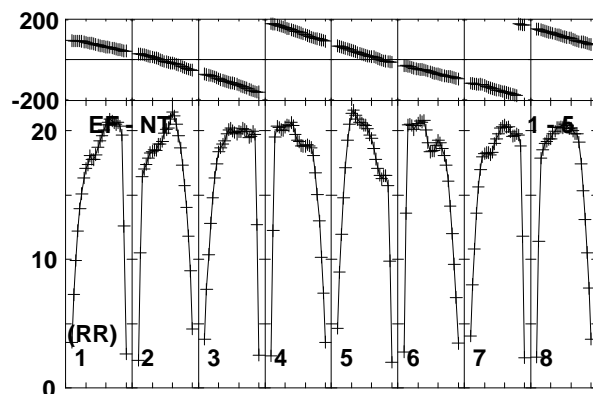
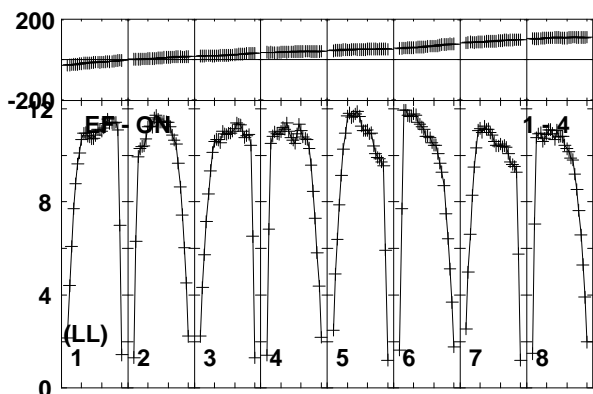
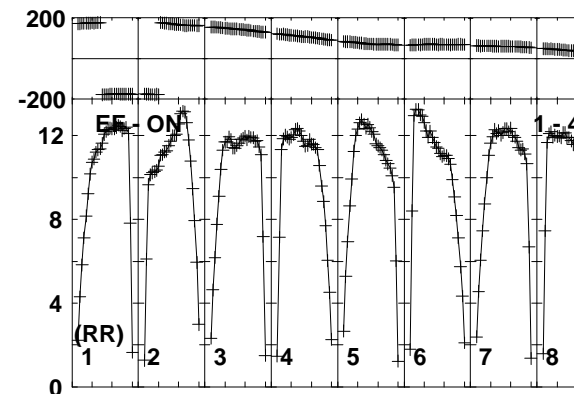
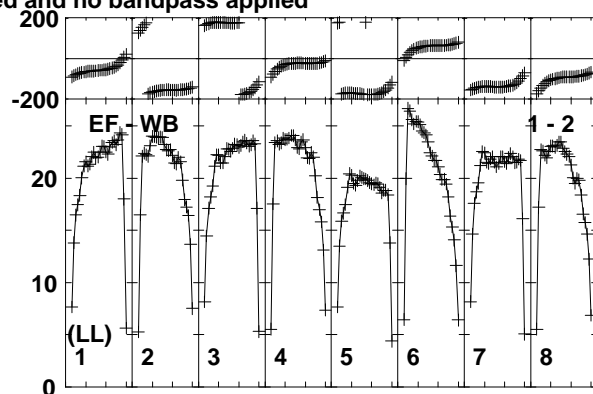
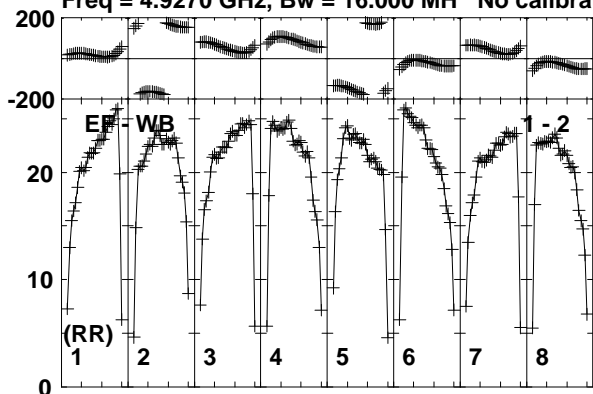

Lower frame: Milli Ampl Jy Top frame: Phas deg
Vector averaged cross-power spectrum Baseline: EF (01) - WB (02)
Timerange: 00/13:36:43 to 00/13:37:39

Plot file version 128 created 28-JAN-2015 14:38:09

1848+283 N14C3.UVDATA.1

Freq = 4.9270 GHz, Bw = 16.000 MH No calibration applied and no bandpass applied

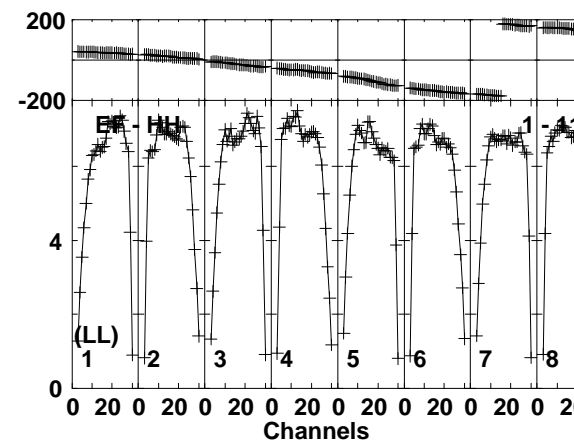
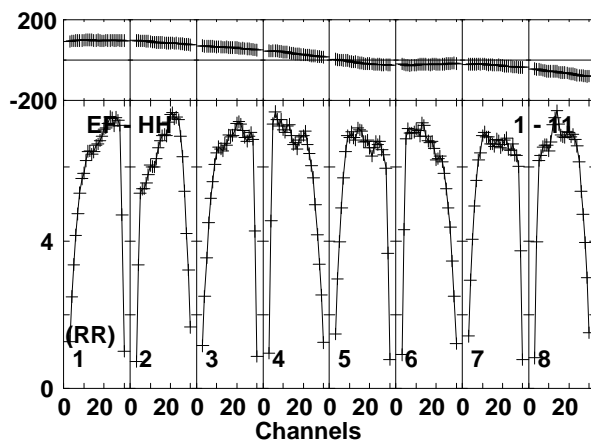
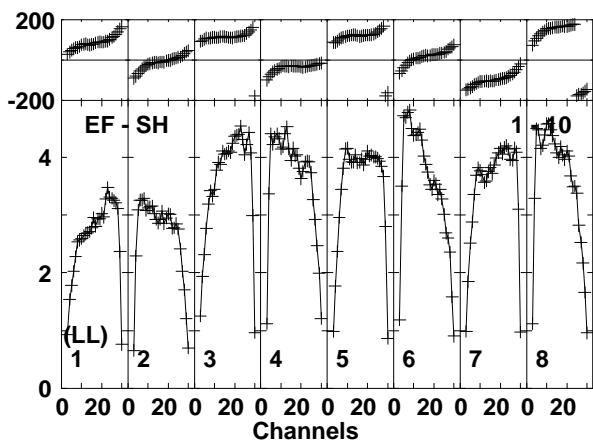
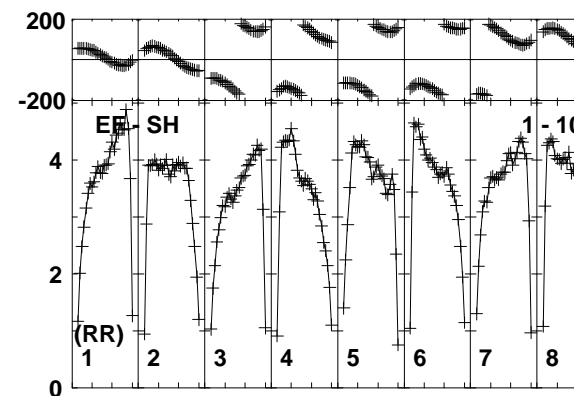
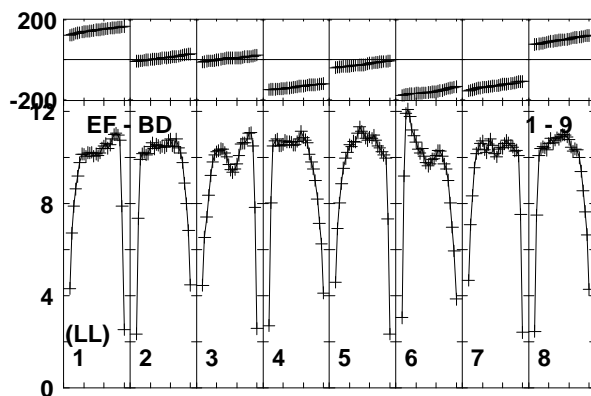
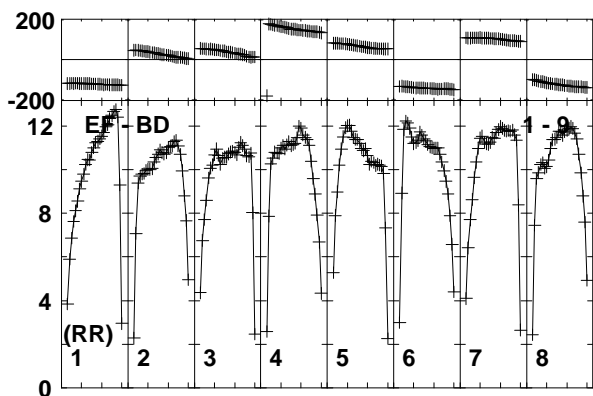
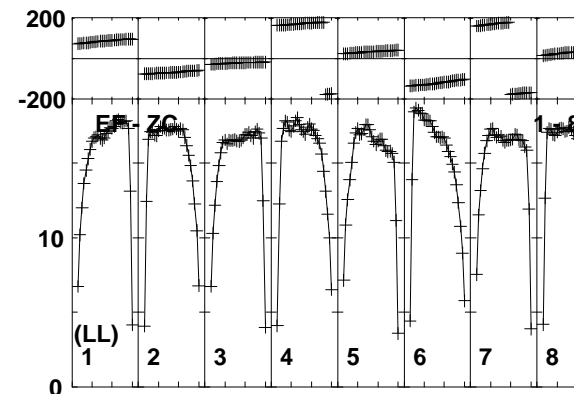
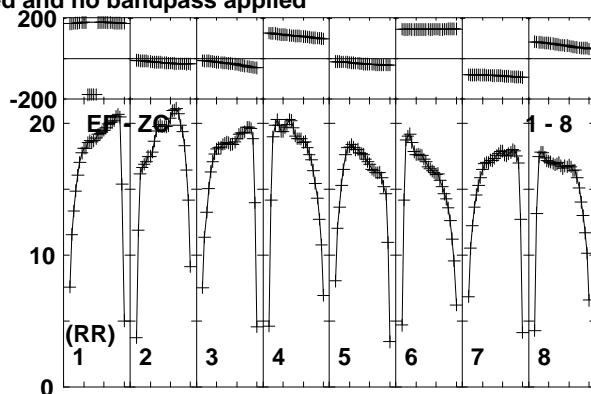
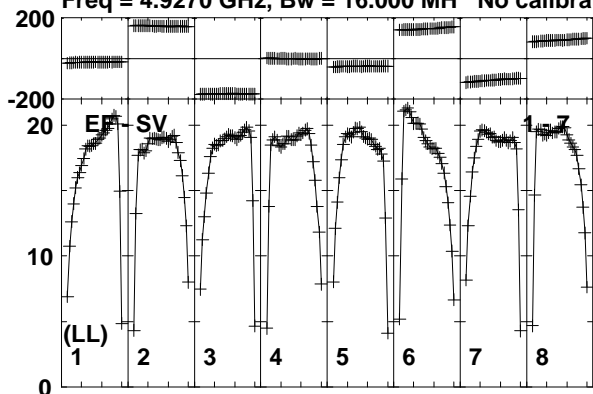

Lower frame: Milli Ampl Jy Top frame: Phas deg
Vector averaged cross-power spectrum Baseline: EF (01) - SV (07)
Timerange: 00/13:36:43 to 00/13:37:39

Plot file version 129 created 28-JAN-2015 14:38:09

1848+283 N14C3.UVDATA.1

Freq = 4.9270 GHz, Bw = 16.000 MH No calibration applied and no bandpass applied

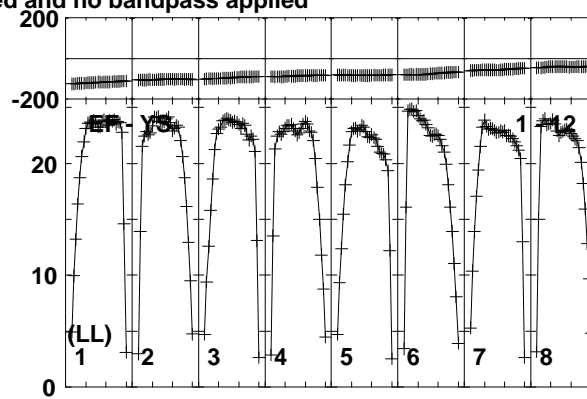
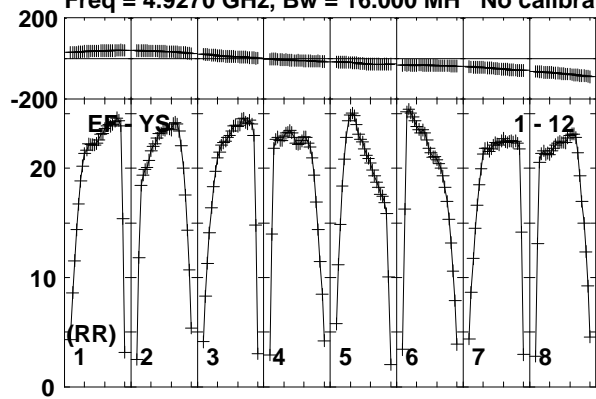

Lower frame: Milli Ampl Jy Top frame: Phas deg
Vector averaged cross-power spectrum Baseline: EF (01) - YS (12)
Timerange: 00/13:36:43 to 00/13:37:39

Plot file version 130 created 28-JAN-2015 14:38:09

J1849+3024 N14C3.UVDATA.1

Freq = 4.9270 GHz, Bw = 16.000 MH No calibration applied and no bandpass applied

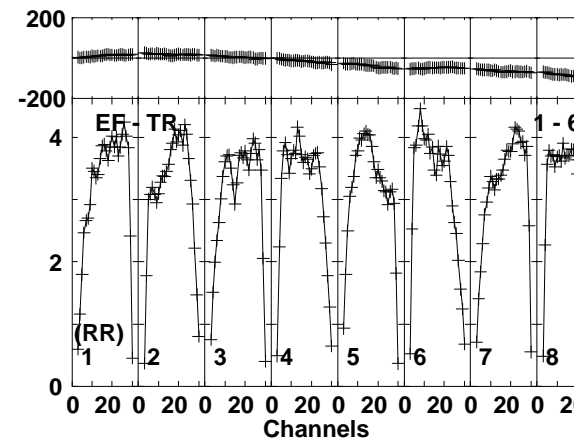
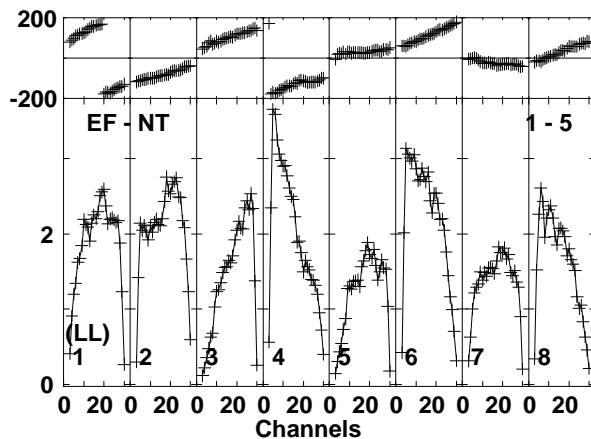
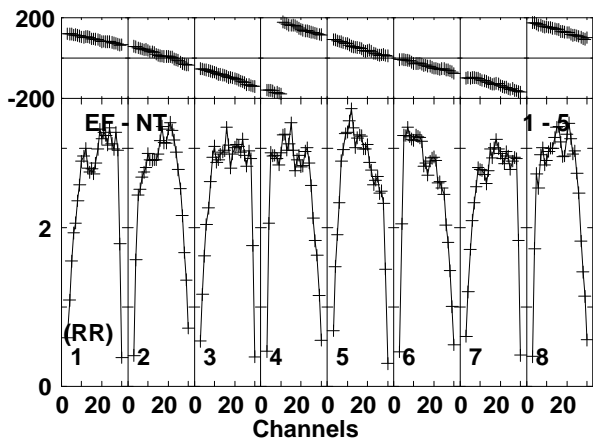
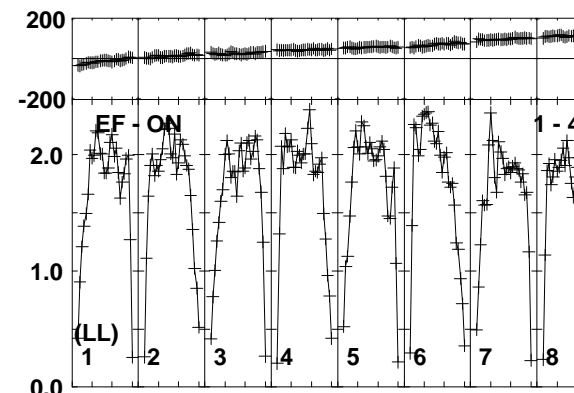
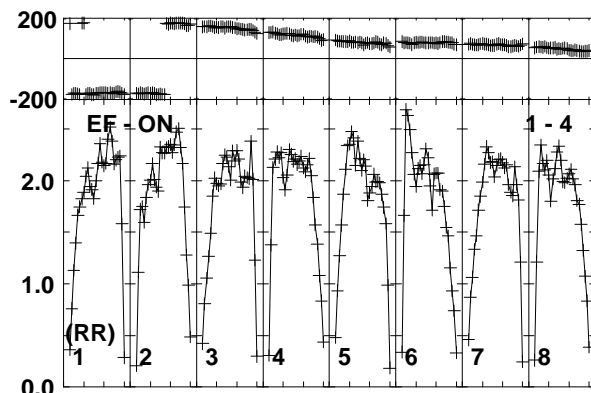
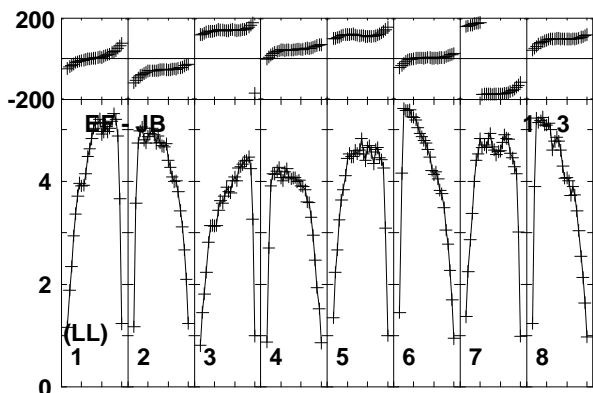
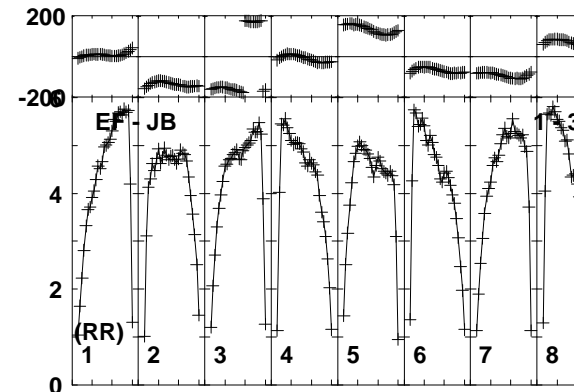
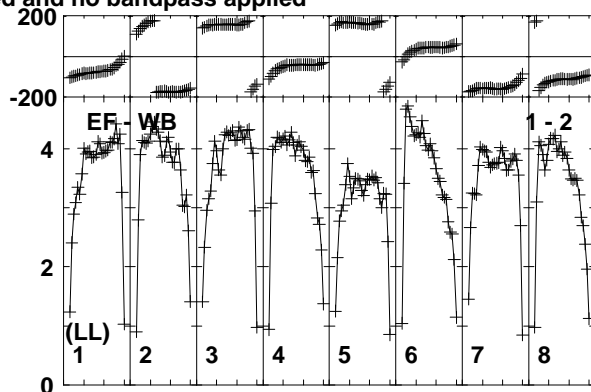
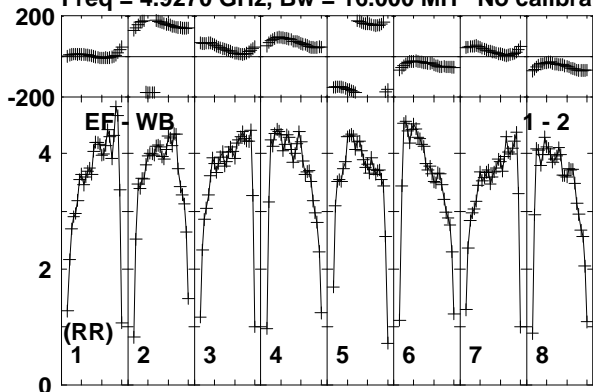

Lower frame: Milli Ampl Jy Top frame: Phas deg
Vector averaged cross-power spectrum Baseline: EF (01) - WB (02)
Timerange: 00/13:38:23 to 00/13:39:19

Plot file version 131 created 28-JAN-2015 14:38:09

J1849+3024 N14C3.UVDATA.1

Freq = 4.9270 GHz, Bw = 16.000 MH No calibration applied and no bandpass applied

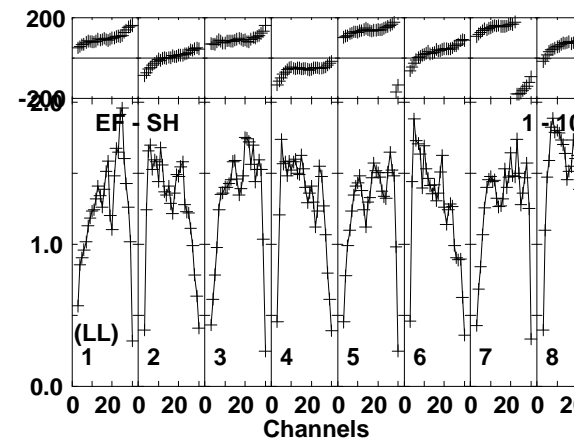
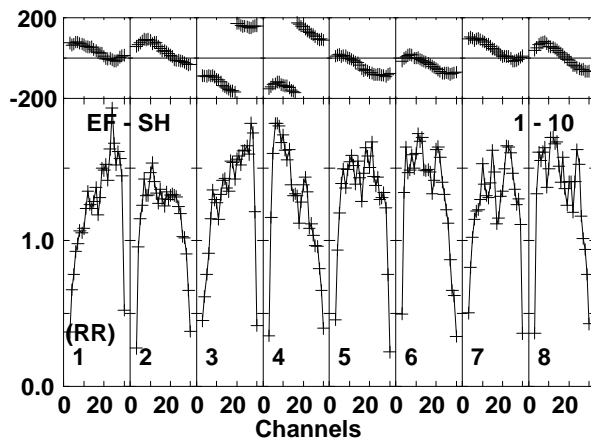
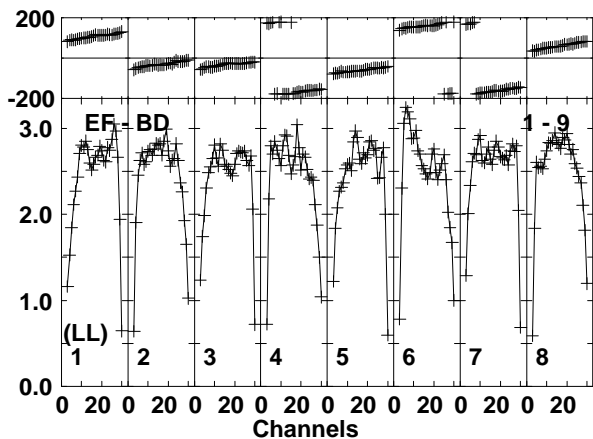
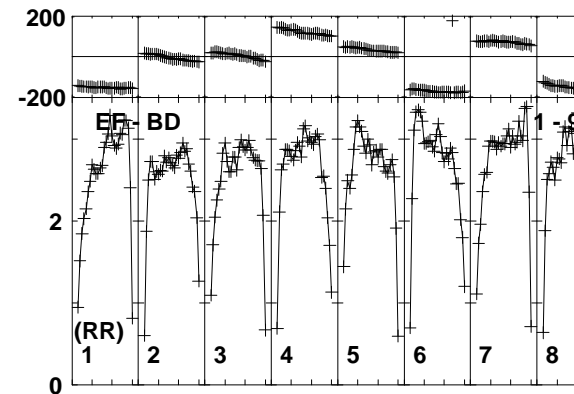
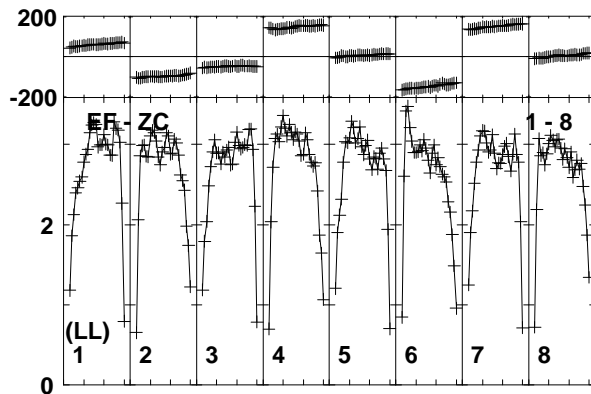
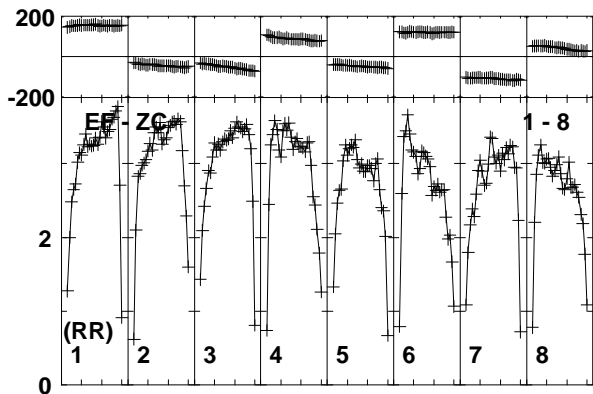
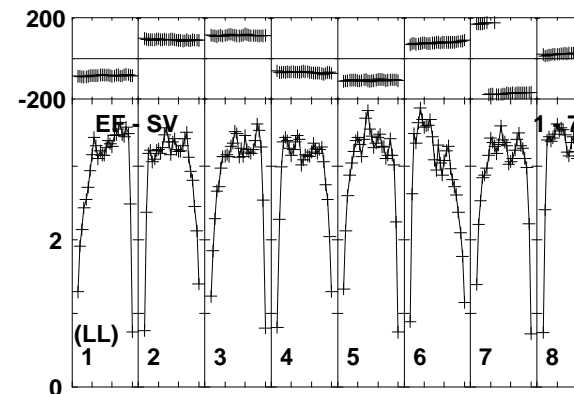
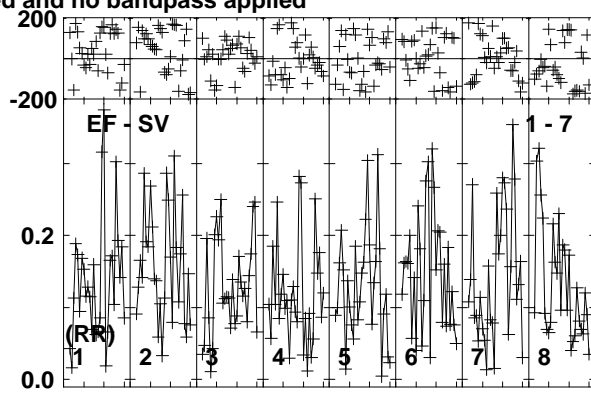
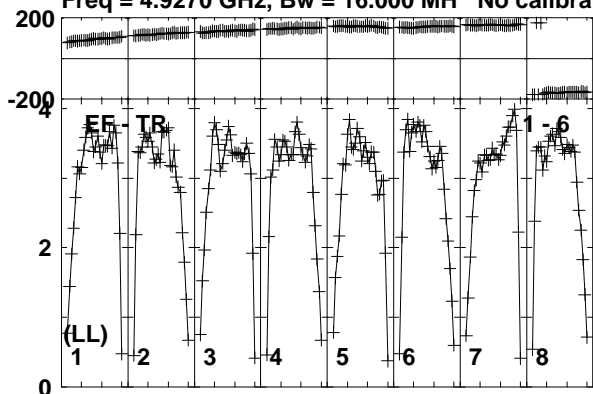

Lower frame: Milli Ampl Jy Top frame: Phas deg
Vector averaged cross-power spectrum Baseline: EF (01) - TR (06)
Timerange: 00/13:38:23 to 00/13:39:19

Plot file version 132 created 28-JAN-2015 14:38:10

J1849+3024 N14C3.UVDATA.1

Freq = 4.9270 GHz, Bw = 16.000 MH No calibration applied and no bandpass applied

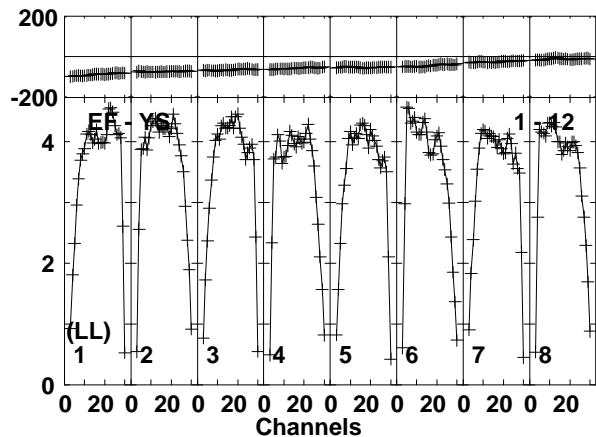
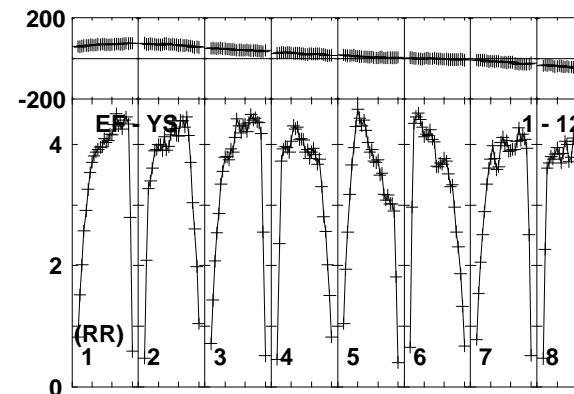
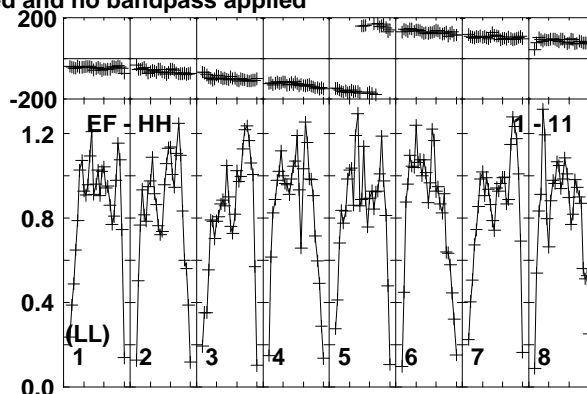
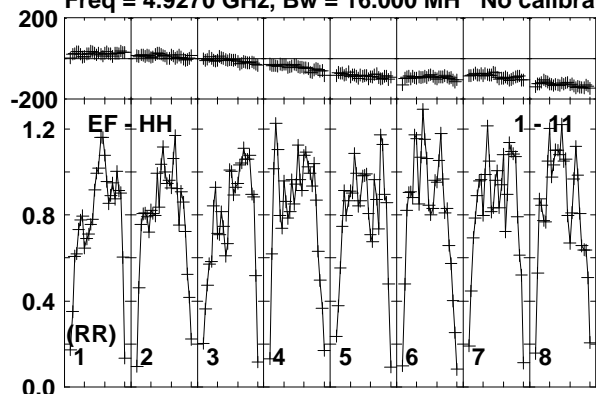

Lower frame: Milli Ampl Jy Top frame: Phas deg
Vector averaged cross-power spectrum Baseline: EF (01) - HH (11)
Timerange: 00/13:38:23 to 00/13:39:19

Plot file version 133 created 28-JAN-2015 14:38:10

1848+283 N14C3.UVDATA.1

Freq = 4.9270 GHz, Bw = 16.000 MH No calibration applied and no bandpass applied

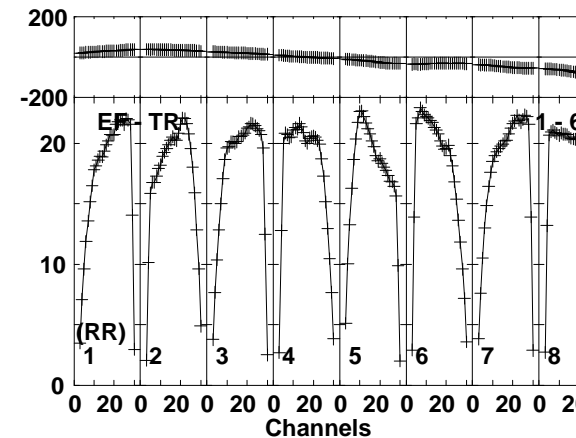
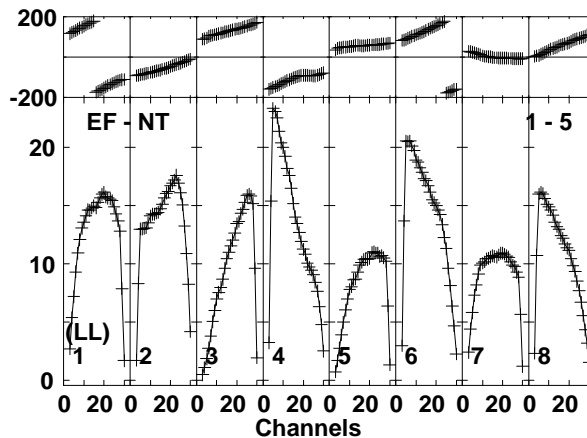
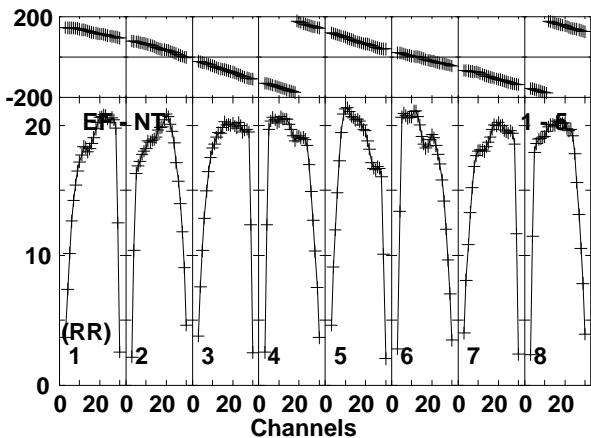
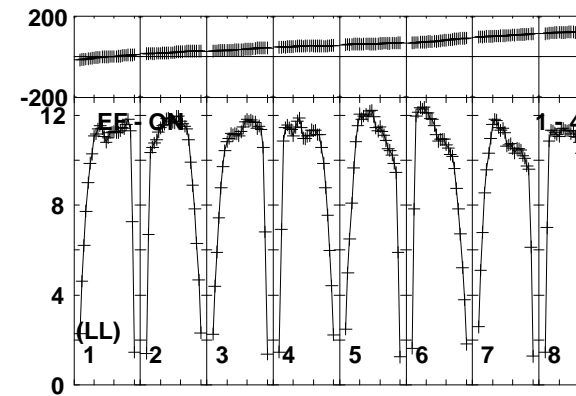
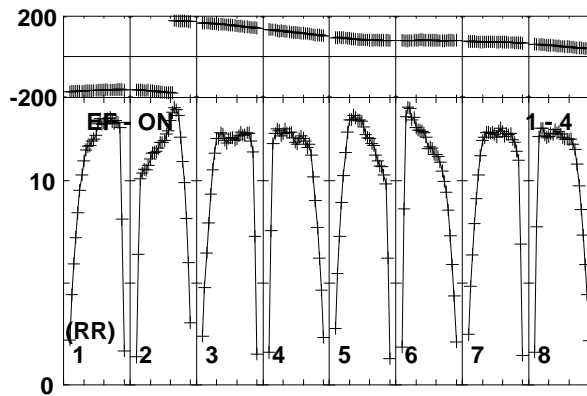
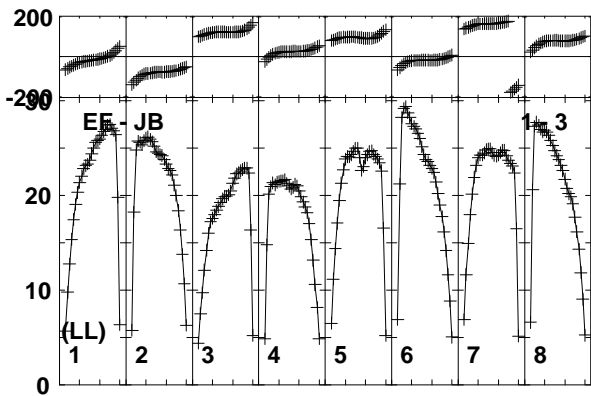
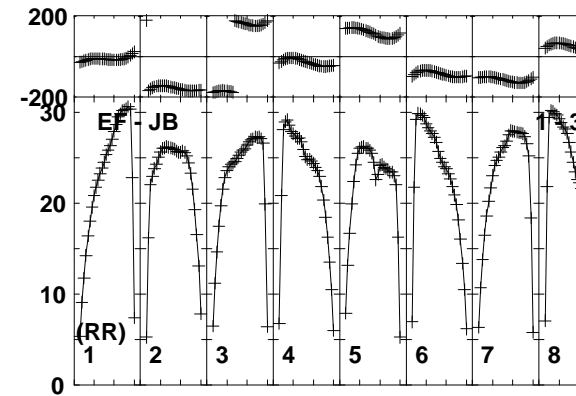
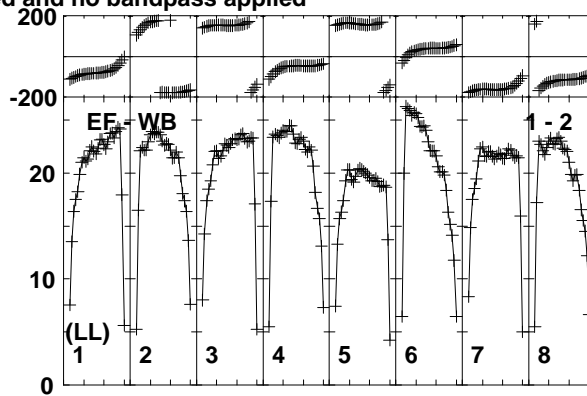
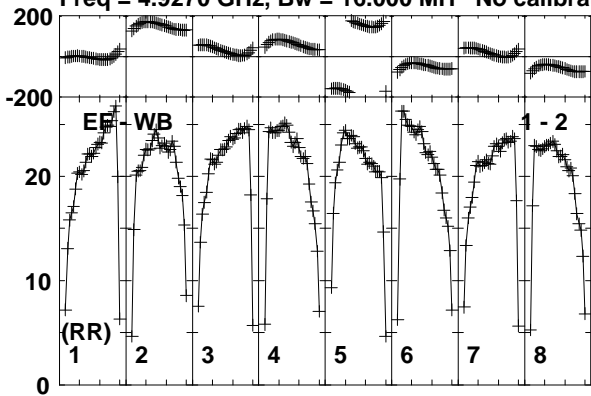

Lower frame: Milli Ampl Jy Top frame: Phas deg
Vector averaged cross-power spectrum Baseline: EF (01) - WB (02)
Timerange: 00:13:40:03 to 00:13:40:59

Plot file version 134 created 28-JAN-2015 14:38:10

1848+283 N14C3.UVDATA.1

Freq = 4.9270 GHz, Bw = 16.000 MH No calibration applied and no bandpass applied

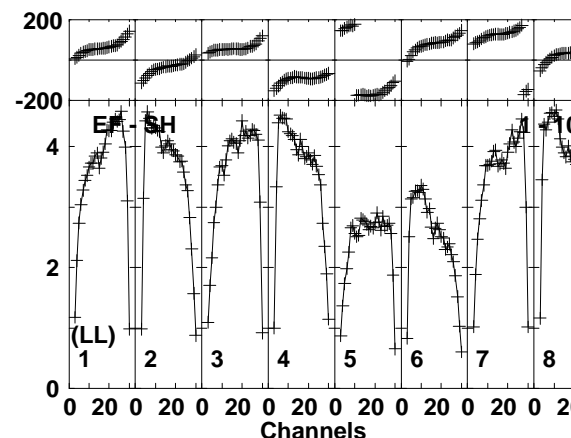
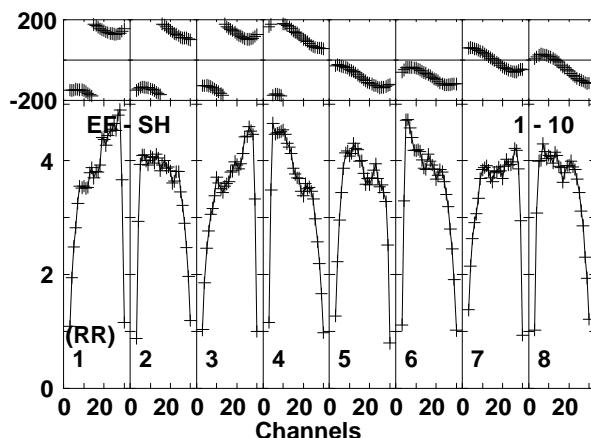
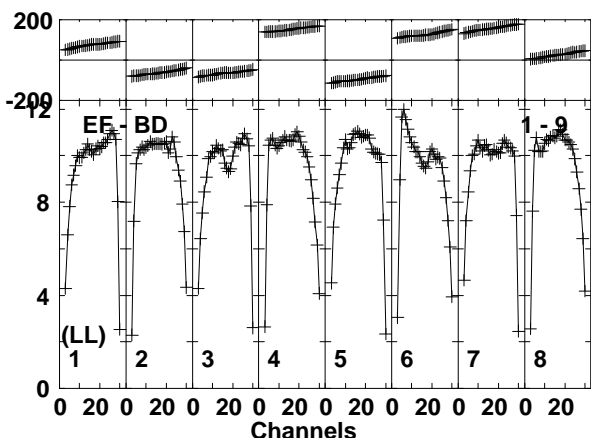
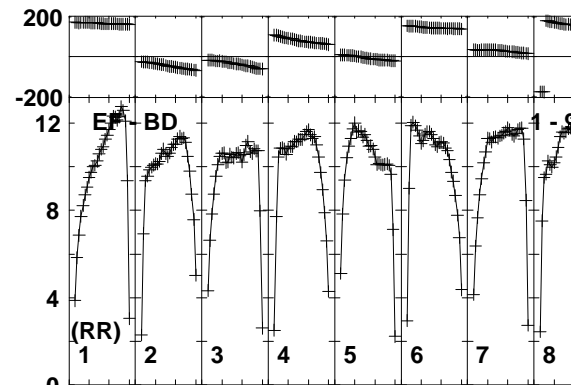
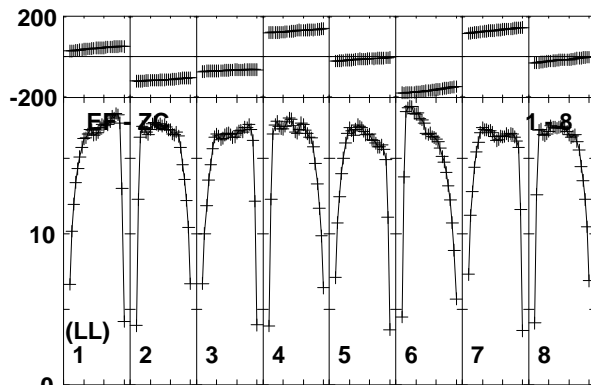
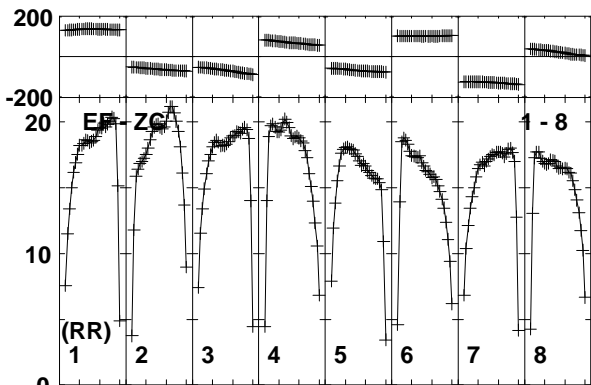
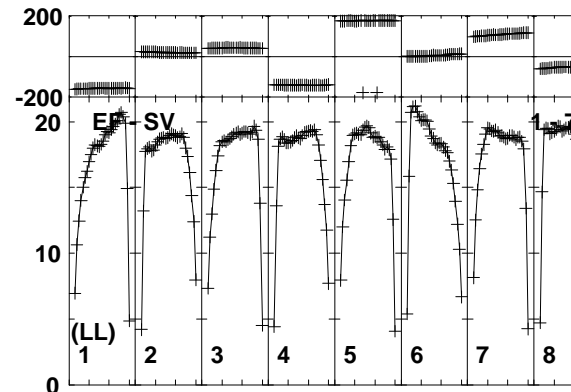
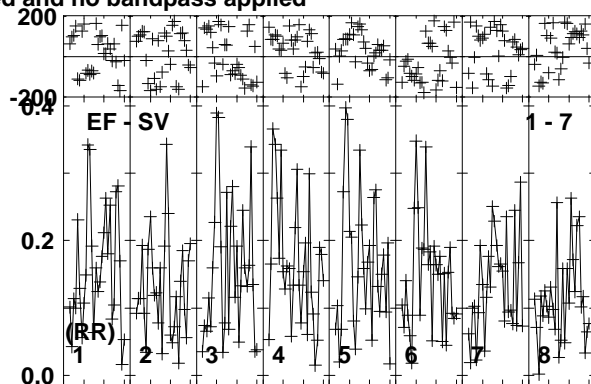
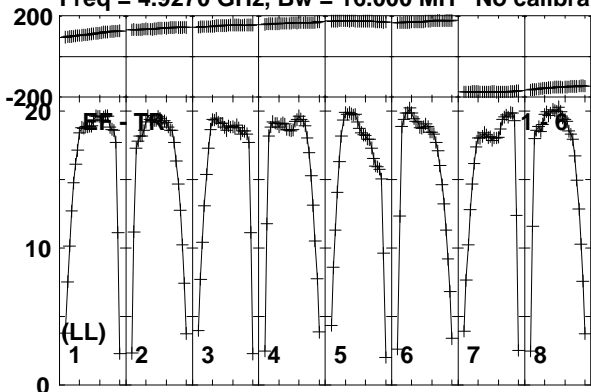

Lower frame: Milli Ampl Jy Top frame: Phas deg
Vector averaged cross-power spectrum Baseline: EF (01) - TR (06)
Timerange: 00:13:40:03 to 00:13:40:59

Plot file version 135 created 28-JAN-2015 14:38:10

1848+283 N14C3.UVDATA.1

Freq = 4.9270 GHz, Bw = 16.000 MH No calibration applied and no bandpass applied

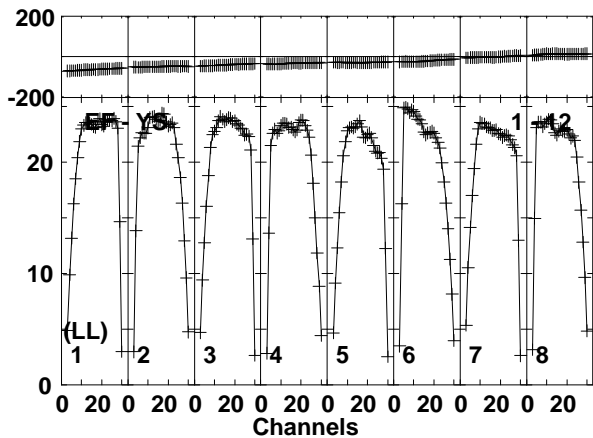
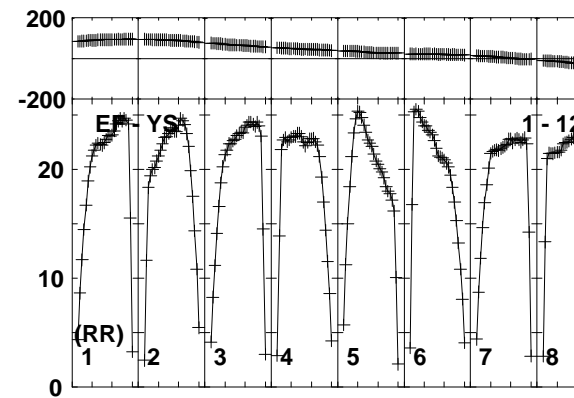
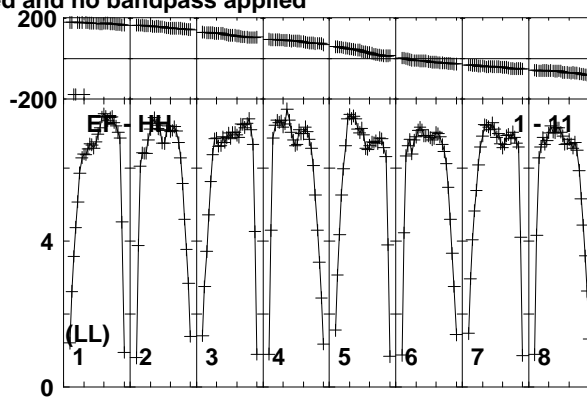
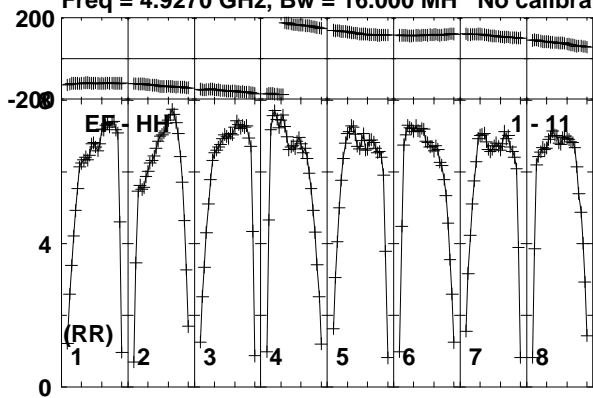

Lower frame: Milli Ampl Jy Top frame: Phas deg
Vector averaged cross-power spectrum Baseline: EF (01) - HH (11)
Timerange: 00/13:40:03 to 00/13:40:59

Plot file version 136 created 28-JAN-2015 14:38:10

J1849+3024 N14C3.UVDATA.1

Freq = 4.9270 GHz, Bw = 16.000 MH No calibration applied and no bandpass applied

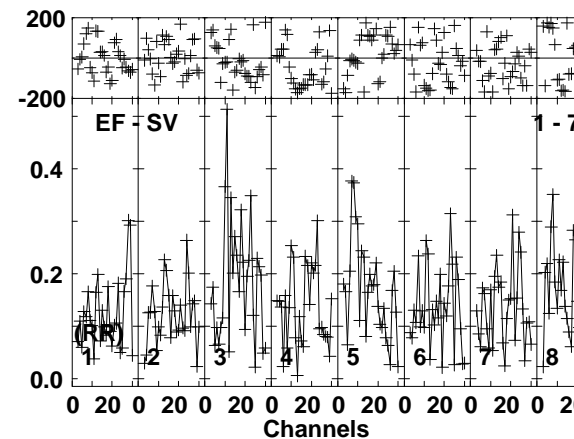
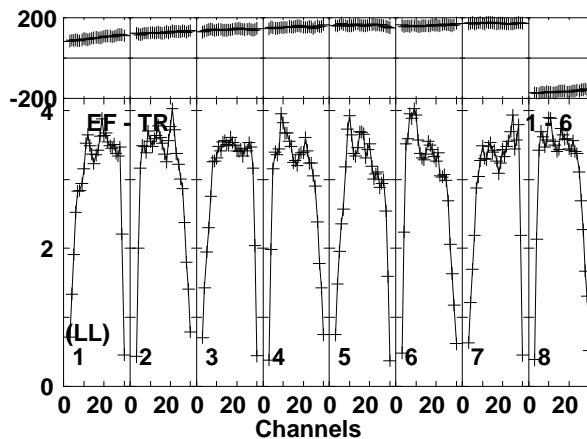
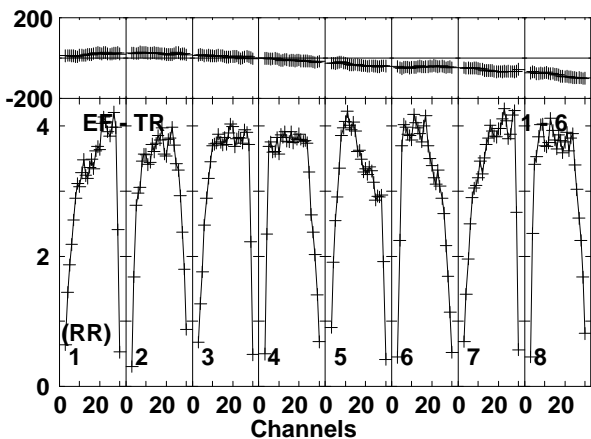
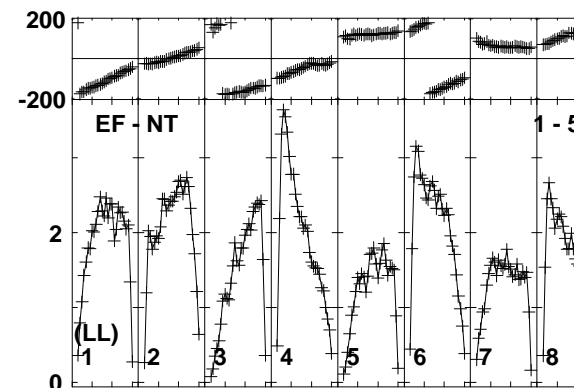
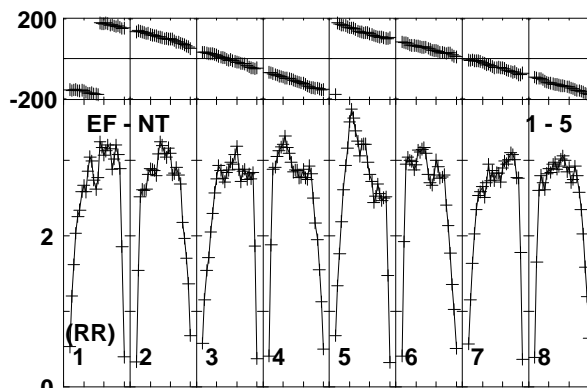
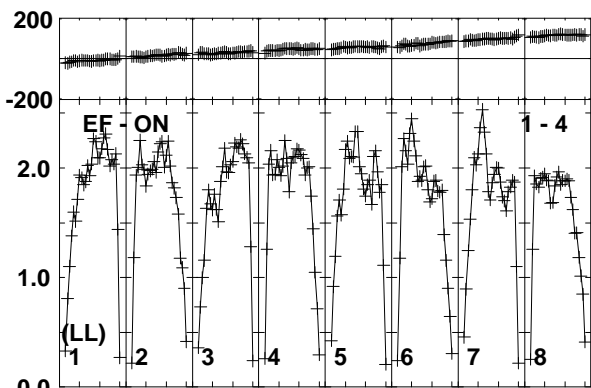
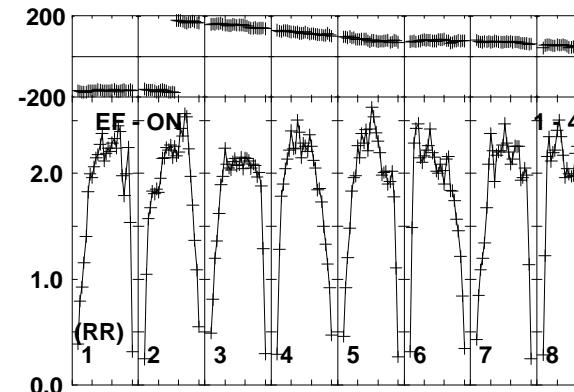
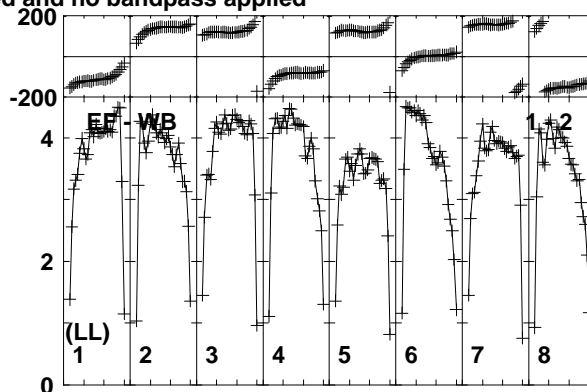
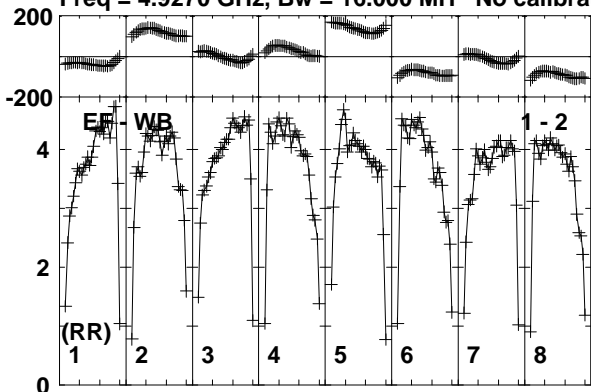

Lower frame: Milli Ampl Jy Top frame: Phas deg
Vector averaged cross-power spectrum Baseline: EF (01) - WB (02)
Timerange: 00/13:41:43 to 00/13:42:39

Plot file version 137 created 28-JAN-2015 14:38:10

J1849+3024 N14C3.UVDATA.1

Freq = 4.9270 GHz, Bw = 16.000 MH No calibration applied and no bandpass applied

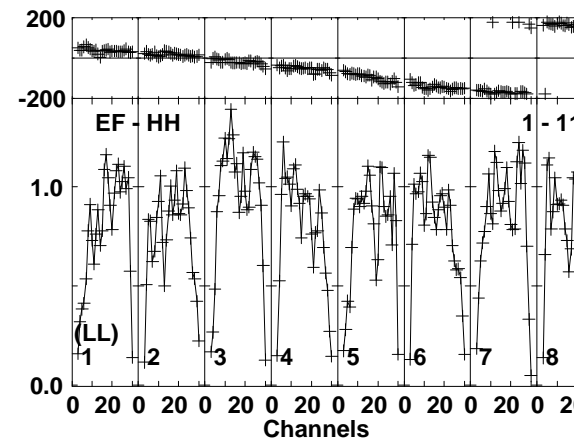
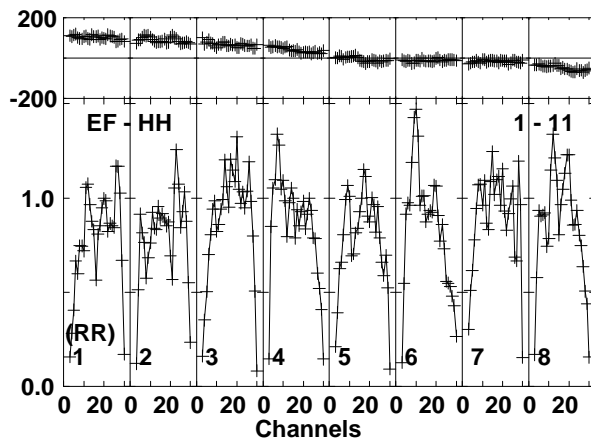
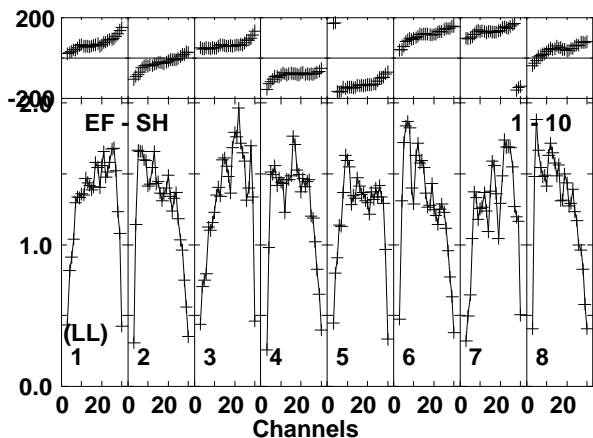
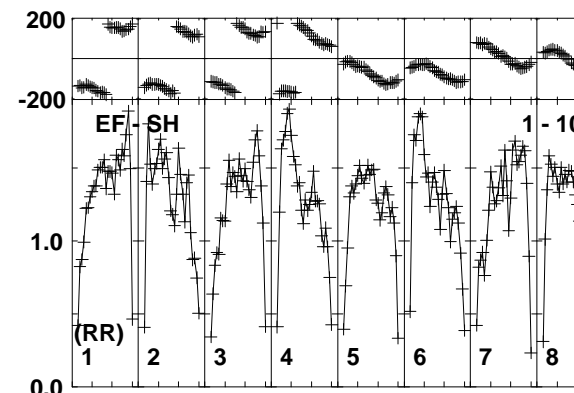
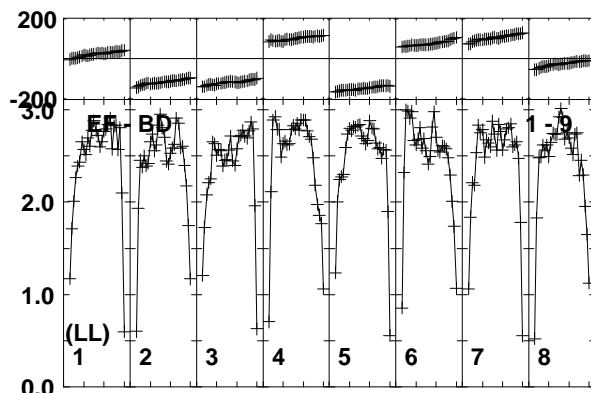
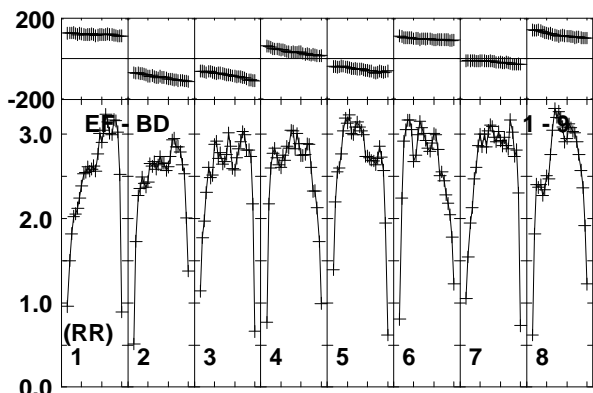
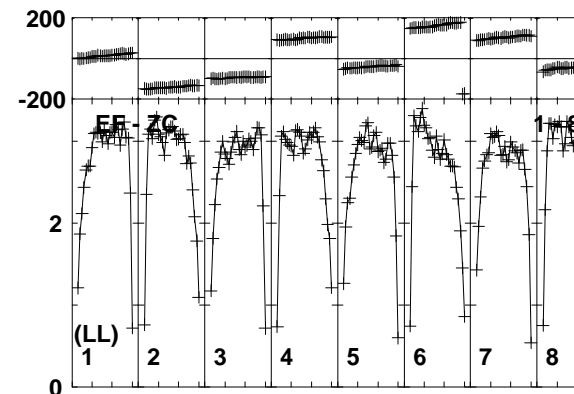
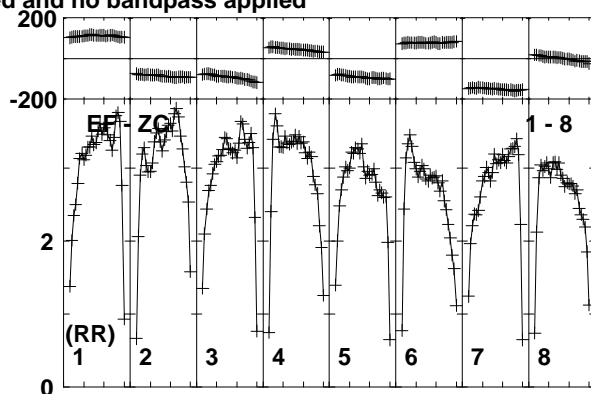
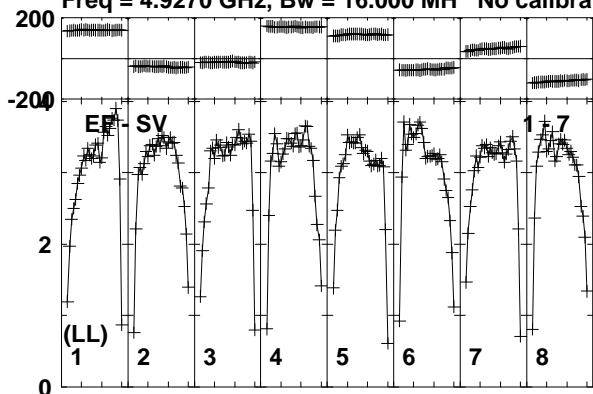

Lower frame: Milli Ampl Jy Top frame: Phas deg
Vector averaged cross-power spectrum Baseline: EF (01) - SV (07)
Timerange: 00/13:41:43 to 00/13:42:39

Plot file version 138 created 28-JAN-2015 14:38:10
J1849+3024 N14C3.UVDATA.1

Freq = 4.9270 GHz, Bw = 16.000 MH No calibration applied and no bandpass applied

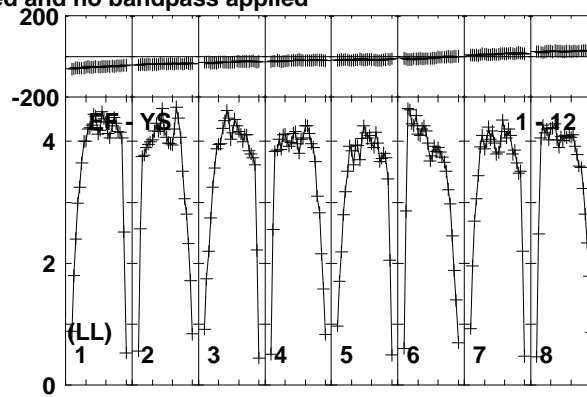
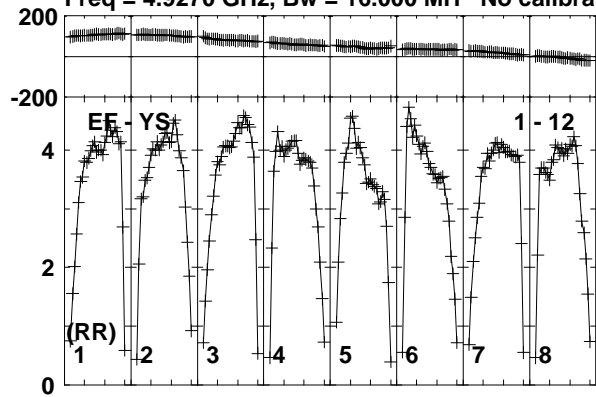

Lower frame: Milli Ampl Jy Top frame: Phas deg
Vector averaged cross-power spectrum Baseline: EF (01) - YS (12)
Timerange: 00/13:41:43 to 00/13:42:39

Plot file version 139 created 28-JAN-2015 14:38:10

1848+283 N14C3.UVDATA.1

Freq = 4.9270 GHz, Bw = 16.000 MH No calibration applied and no bandpass applied

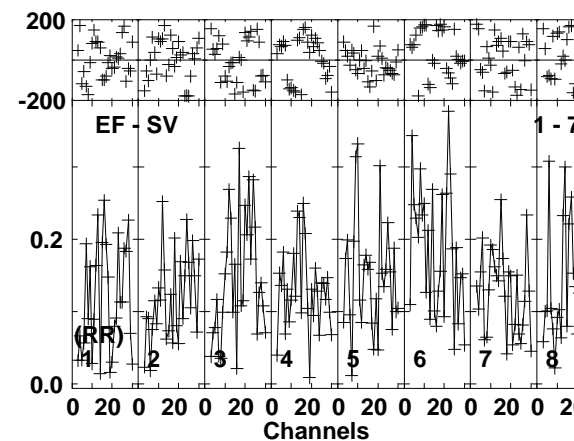
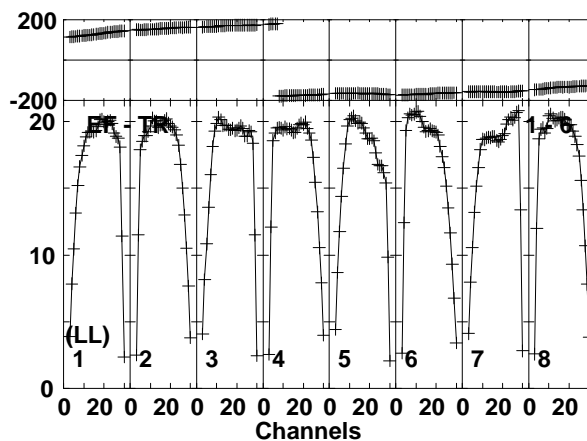
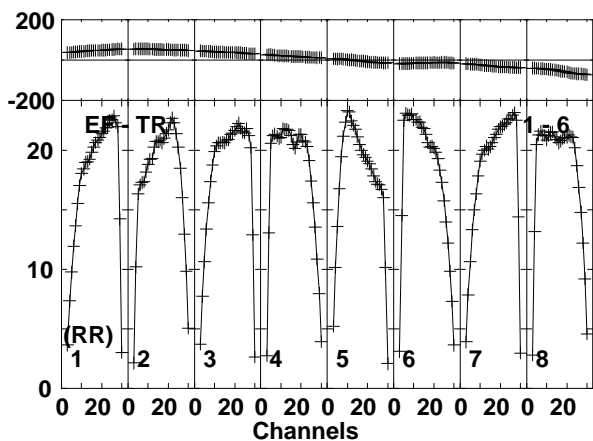
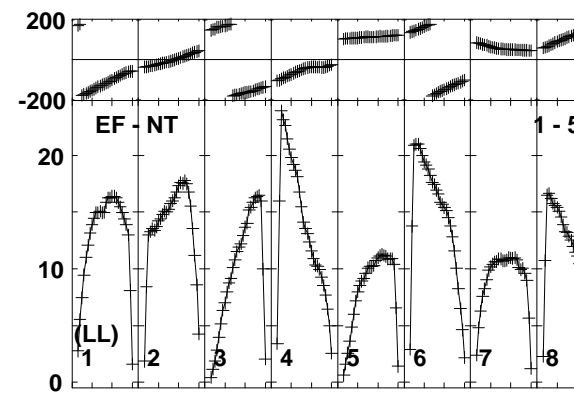
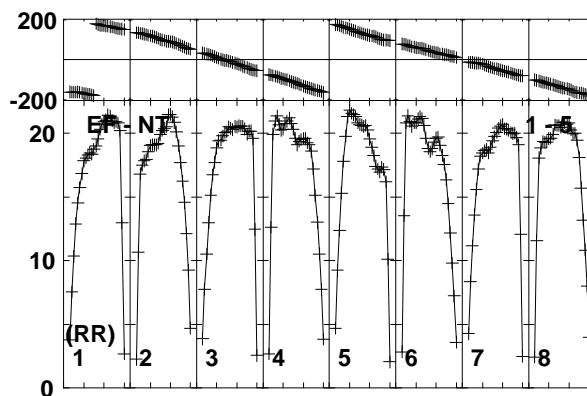
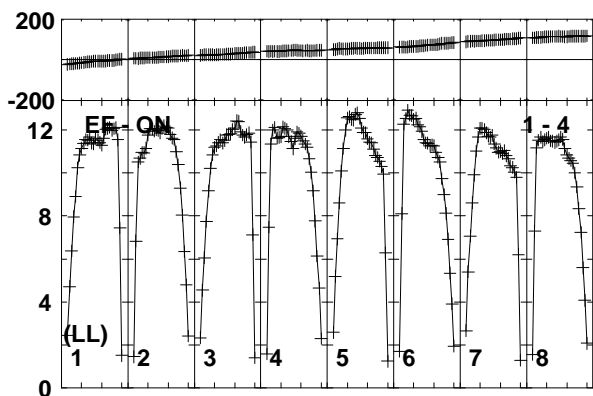
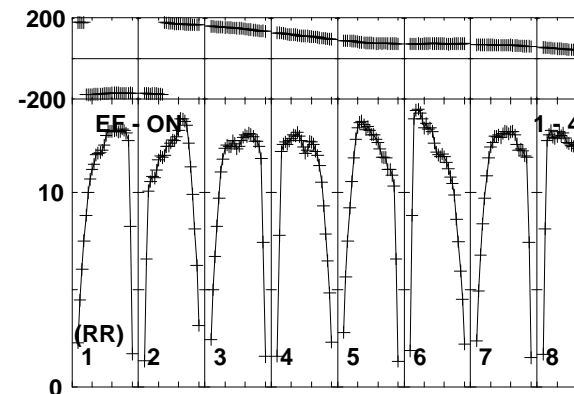
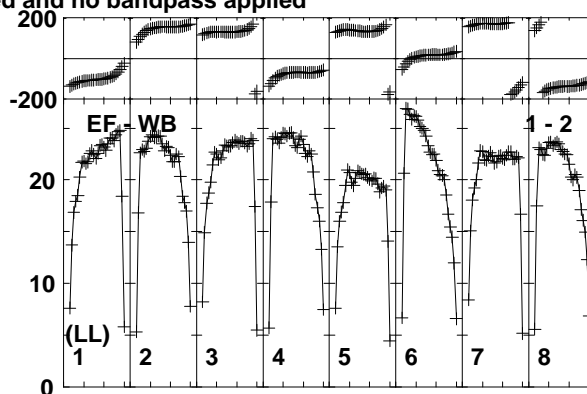
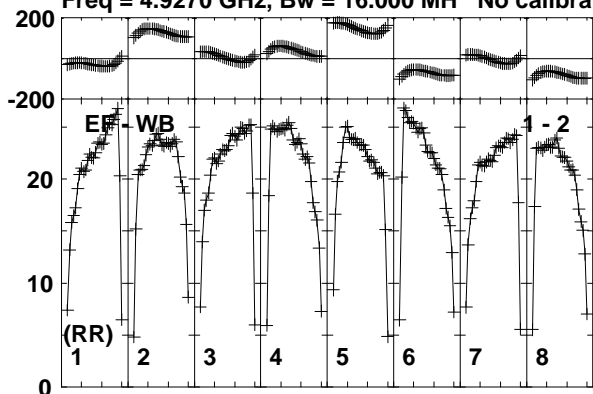

Lower frame: Milli Ampl Jy Top frame: Phas deg
Vector averaged cross-power spectrum Baseline: EF (01) - WB (02)
Timerange: 00/13:43:23 to 00/13:44:19

Plot file version 140 created 28-JAN-2015 14:38:10

1848+283 N14C3.UVDATA.1

Freq = 4.9270 GHz, Bw = 16.000 MH No calibration applied and no bandpass applied

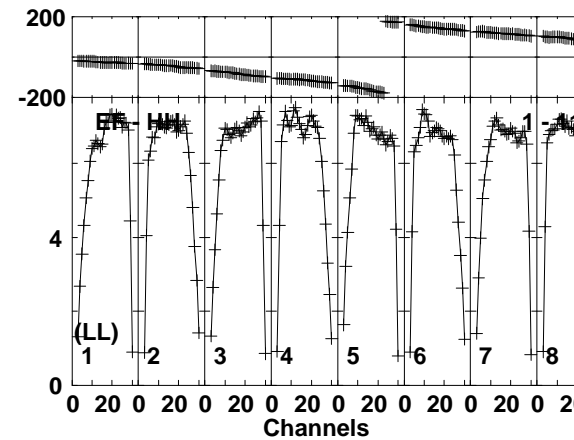
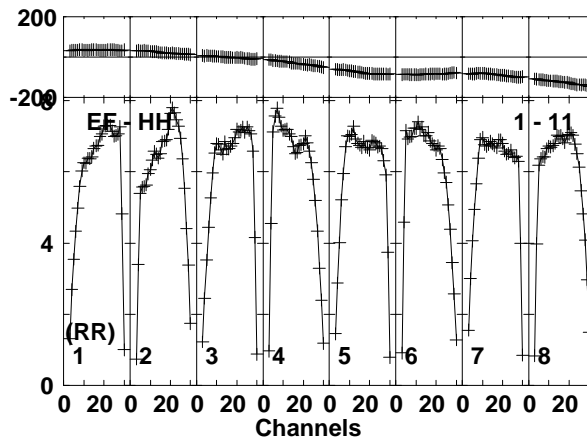
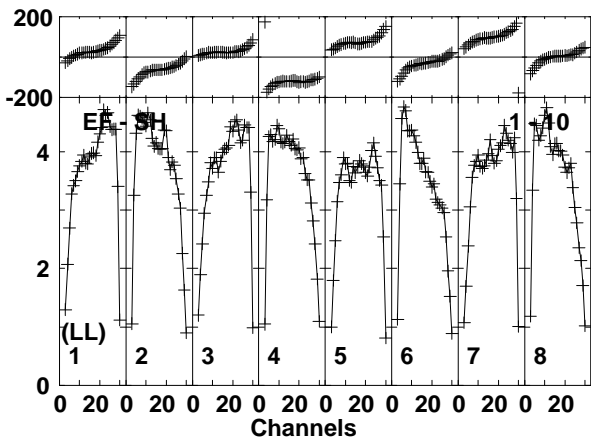
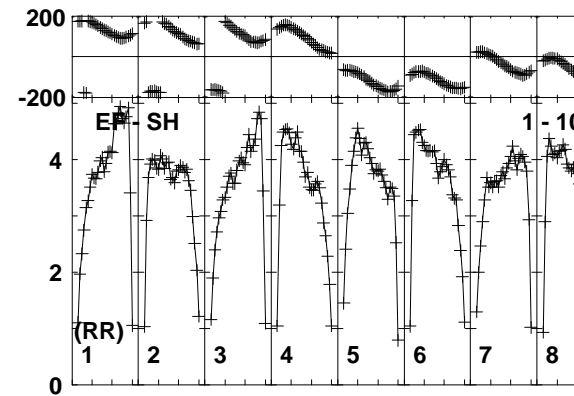
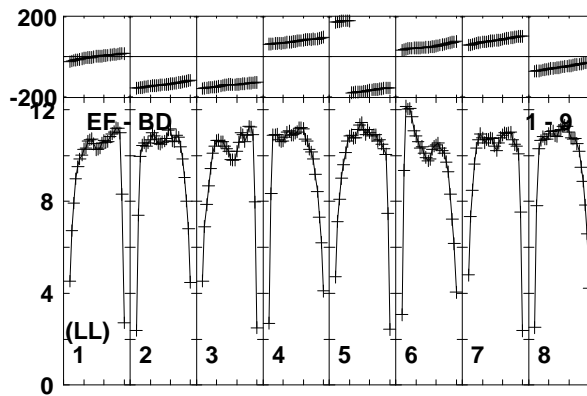
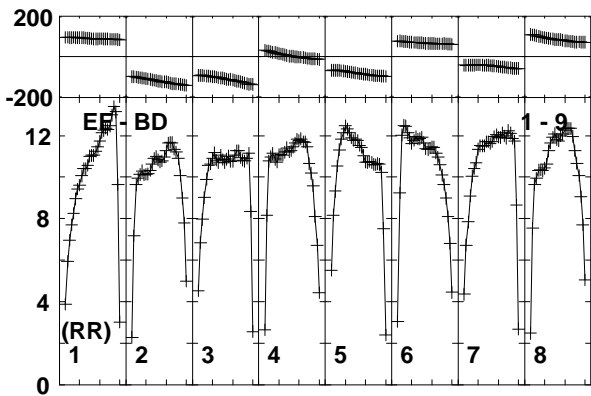
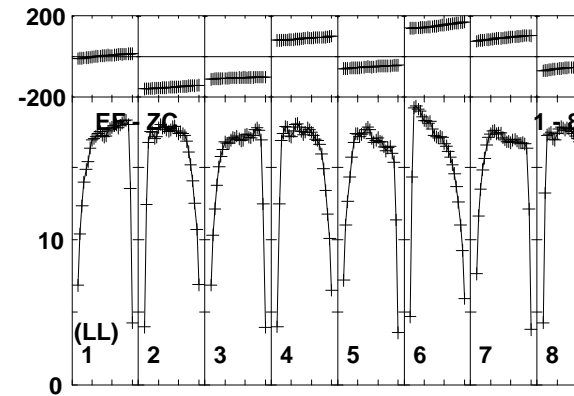
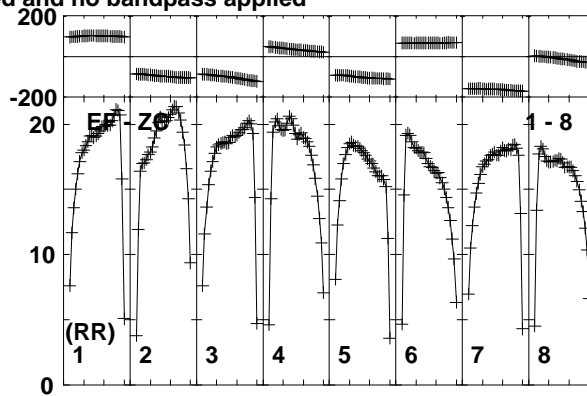
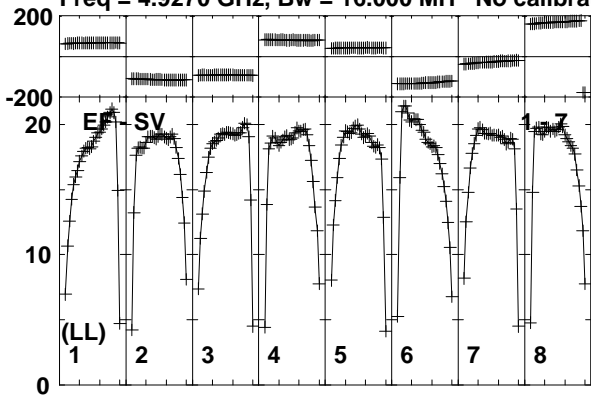

Lower frame: Milli Ampl Jy Top frame: Phas deg
Vector averaged cross-power spectrum Baseline: EF (01) - SV (07)
Timerange: 00/13:43:23 to 00/13:44:19

Plot file version 141 created 28-JAN-2015 14:38:10

1848+283 N14C3.UVDATA.1

Freq = 4.9270 GHz, Bw = 16.000 MH No calibration applied and no bandpass applied

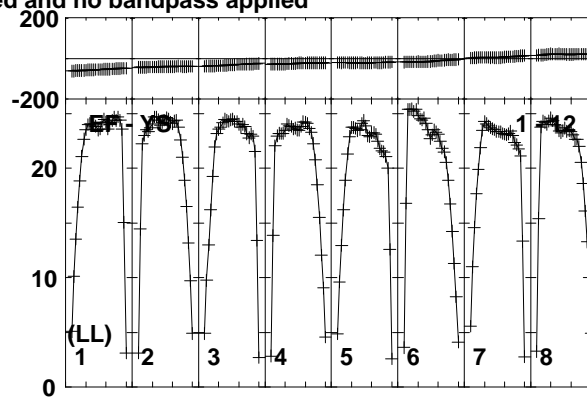
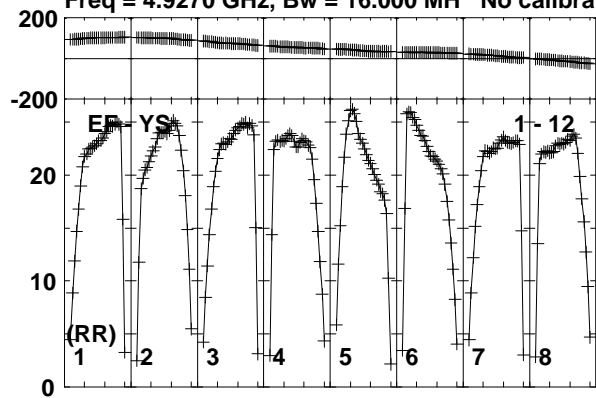

Lower frame: Milli Ampl Jy Top frame: Phas deg
Vector averaged cross-power spectrum Baseline: EF (01) - YS (12)
Timerange: 00/13:43:23 to 00/13:44:19

Plot file version 142 created 28-JAN-2015 14:38:10

J1849+3024 N14C3.UVDATA.1

Freq = 4.9270 GHz, Bw = 16.000 MH No calibration applied and no bandpass applied

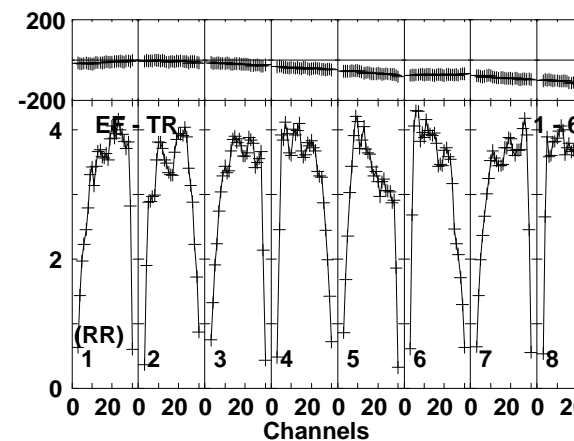
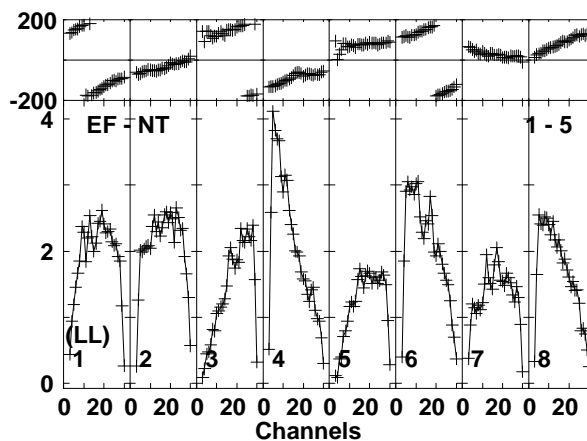
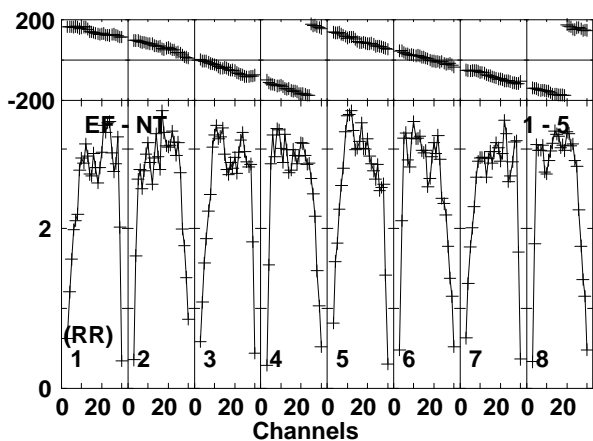
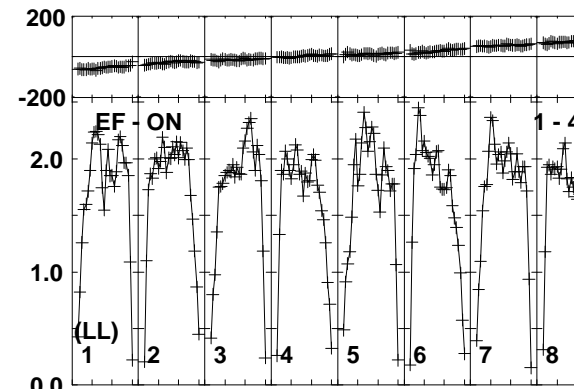
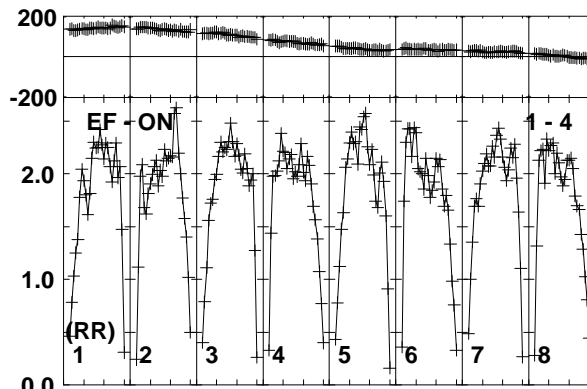
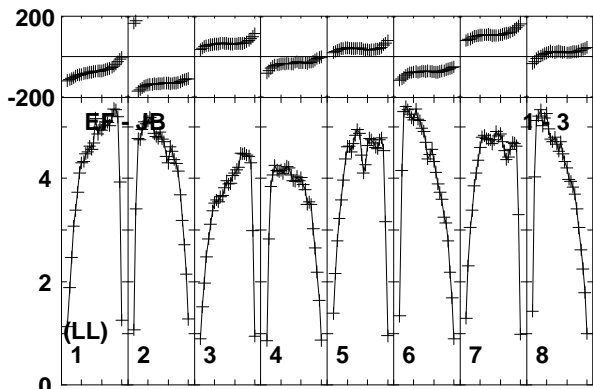
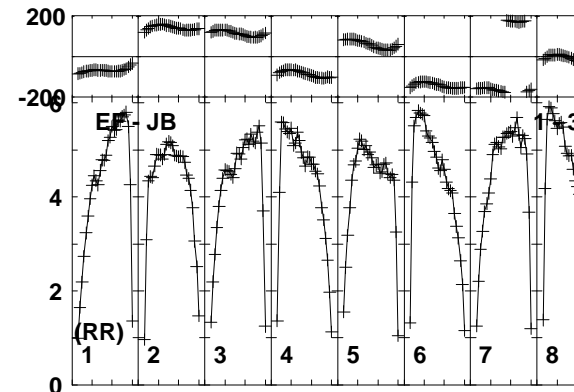
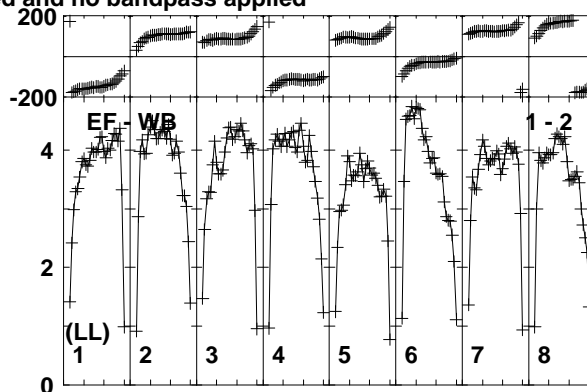
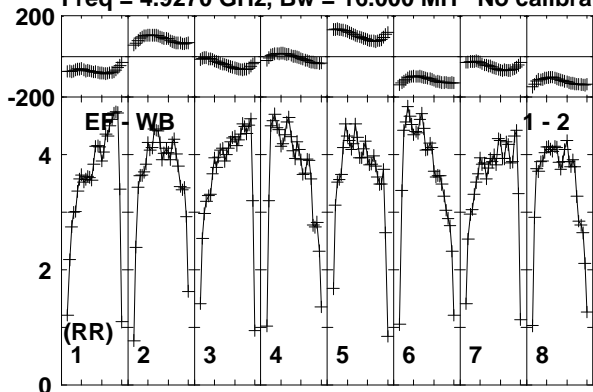

Lower frame: Milli Ampl Jy Top frame: Phas deg
Vector averaged cross-power spectrum Baseline: EF (01) - WB (02)
Timerange: 00:13:45:03 to 00:13:45:59

Plot file version 143 created 28-JAN-2015 14:38:10

J1849+3024 N14C3.UVDATA.1

Freq = 4.9270 GHz, Bw = 16.000 MH No calibration applied and no bandpass applied

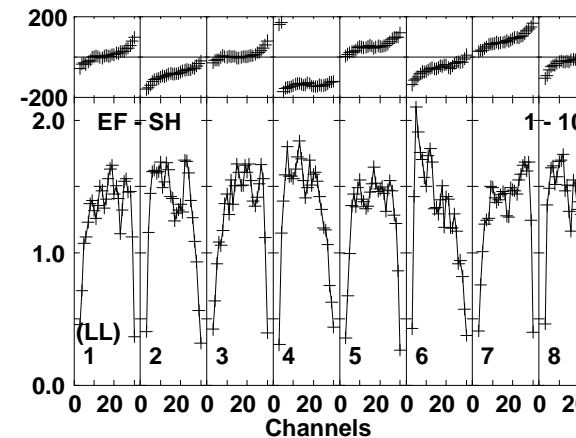
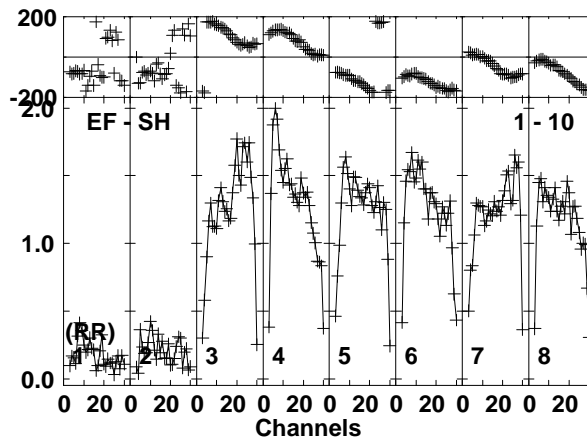
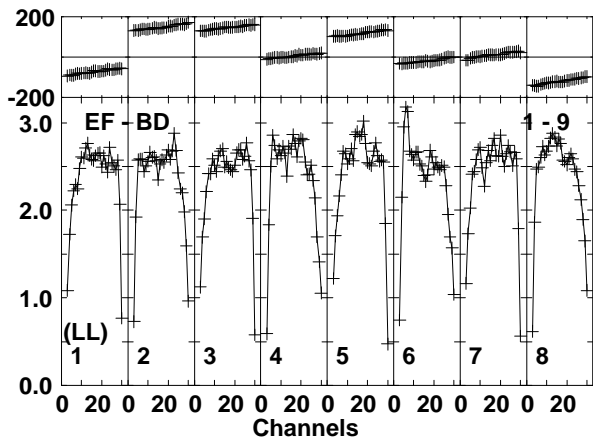
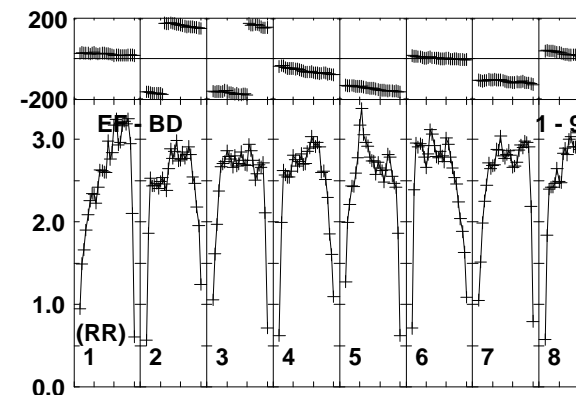
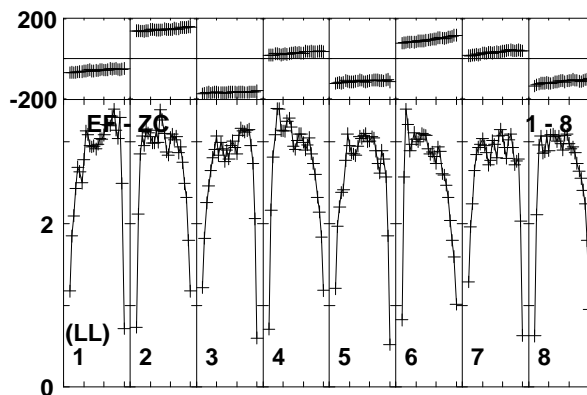
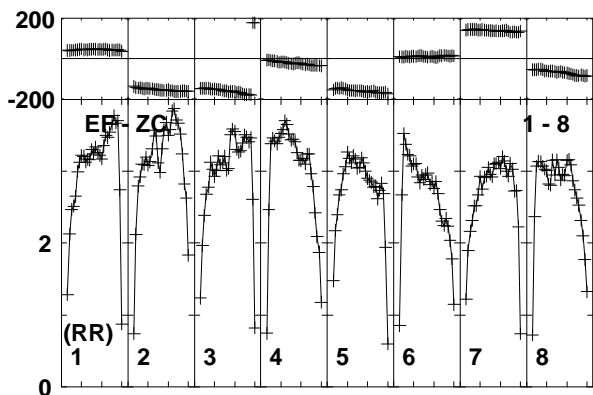
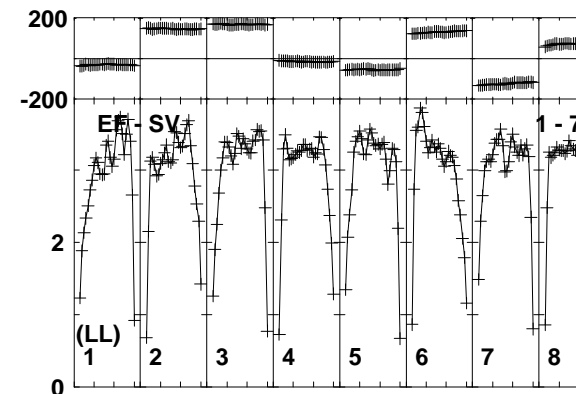
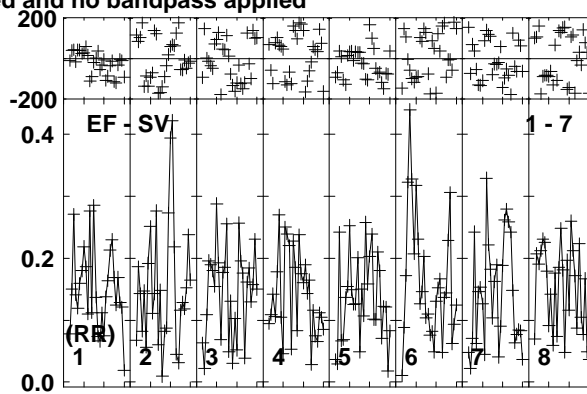
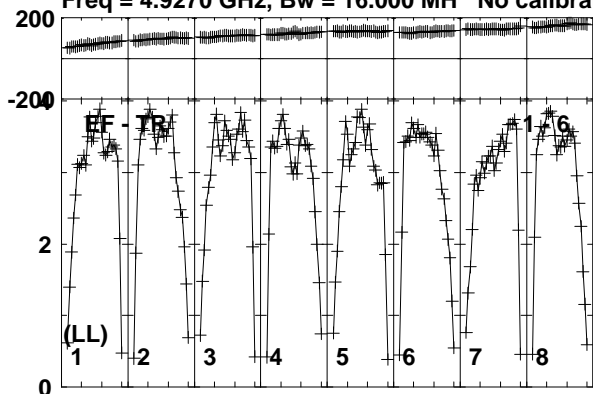

Lower frame: Milli Ampl Jy Top frame: Phas deg
Vector averaged cross-power spectrum Baseline: EF (01) - TR (06)
Timerange: 00:13:45:03 to 00:13:45:59

Plot file version 144 created 28-JAN-2015 14:38:10

J1849+3024 N14C3.UVDATA.1

Freq = 4.9270 GHz, Bw = 16.000 MH No calibration applied and no bandpass applied

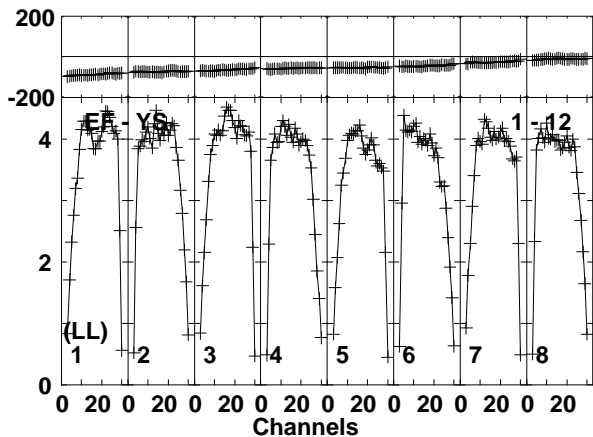
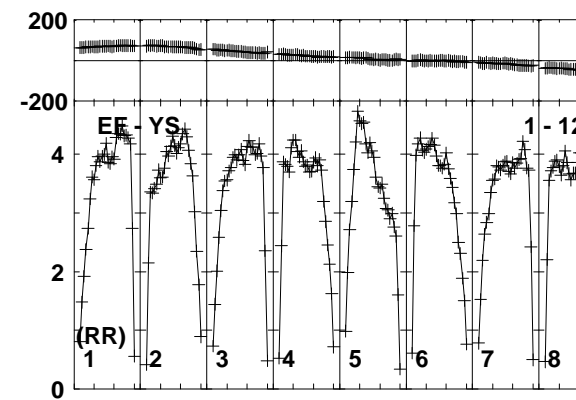
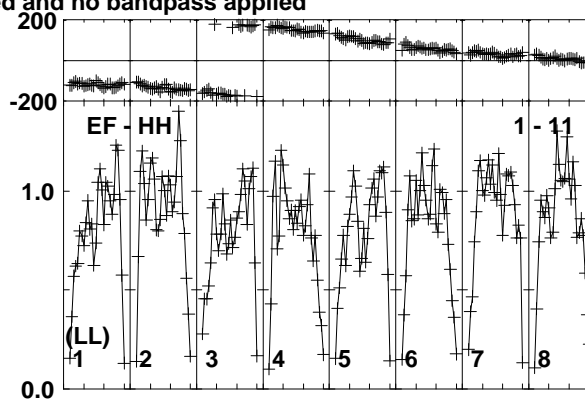
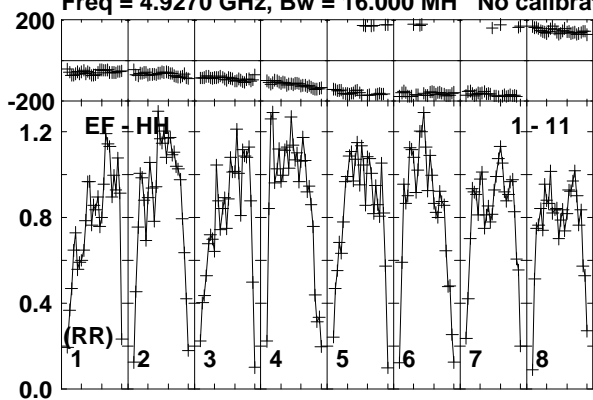

Lower frame: Milli Ampl Jy Top frame: Phas deg
Vector averaged cross-power spectrum Baseline: EF (01) - HH (11)
Timerange: 00/13:45:03 to 00/13:45:59

Plot file version 145 created 28-JAN-2015 14:38:10

1848+283 N14C3.UVDATA.1

Freq = 4.9270 GHz, Bw = 16.000 MH No calibration applied and no bandpass applied

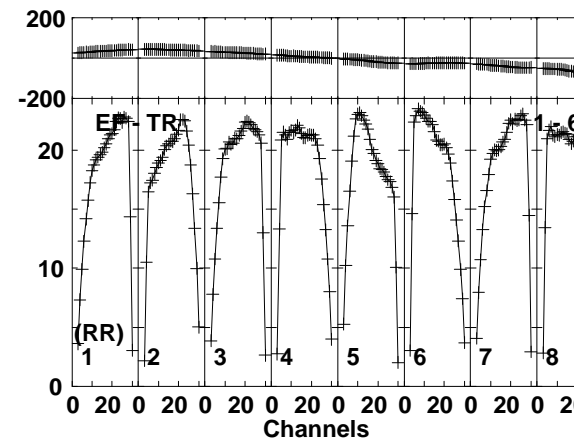
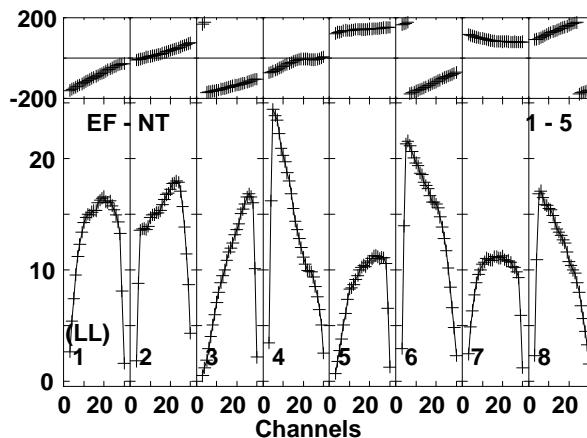
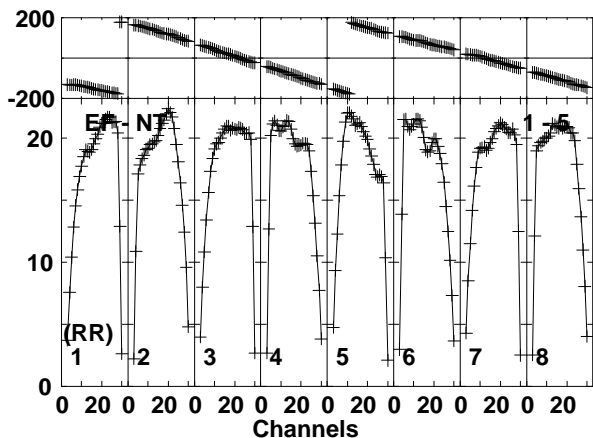
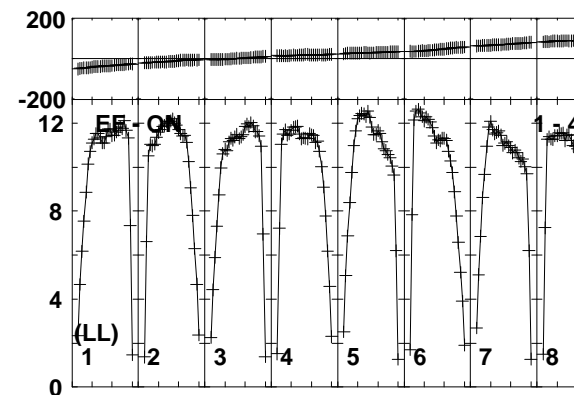
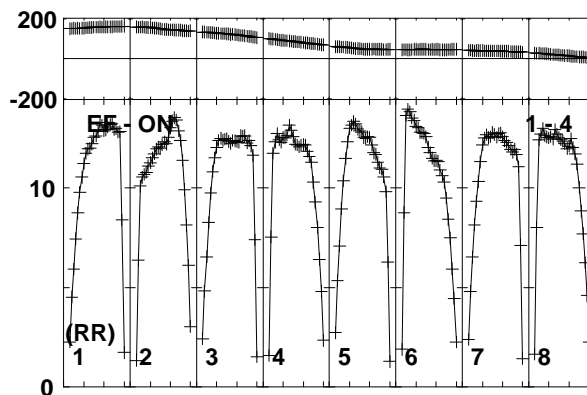
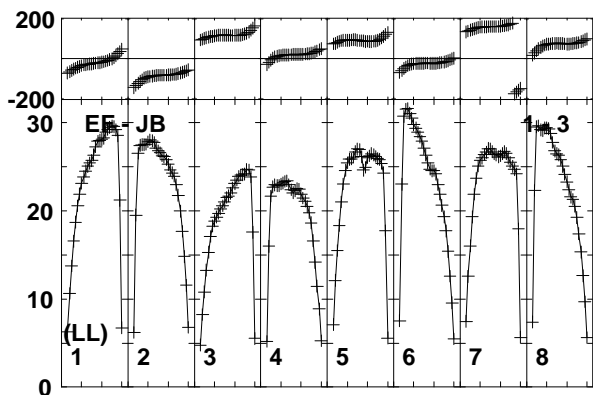
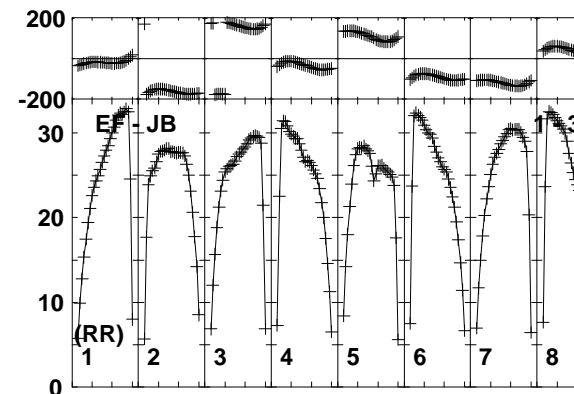
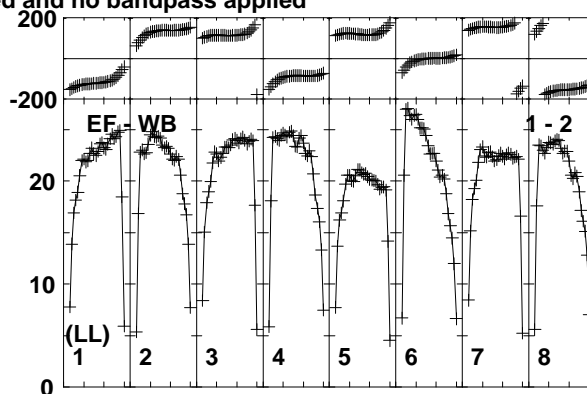
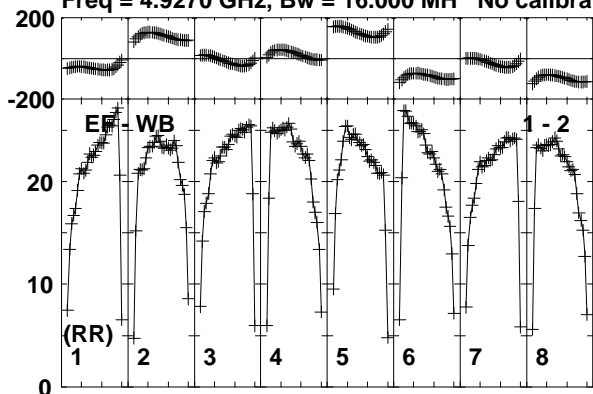

Lower frame: Milli Ampl Jy Top frame: Phas deg
Vector averaged cross-power spectrum Baseline: EF (01) - WB (02)
Timerange: 00/13:46:43 to 00/13:47:39

Plot file version 146 created 28-JAN-2015 14:38:10

1848+283 N14C3.UVDATA.1

Freq = 4.9270 GHz, Bw = 16.000 MH No calibration applied and no bandpass applied

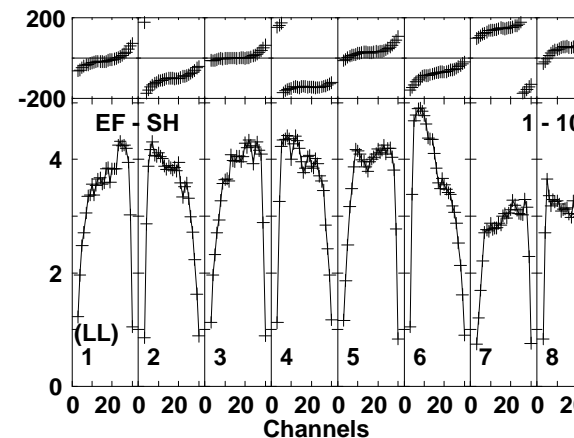
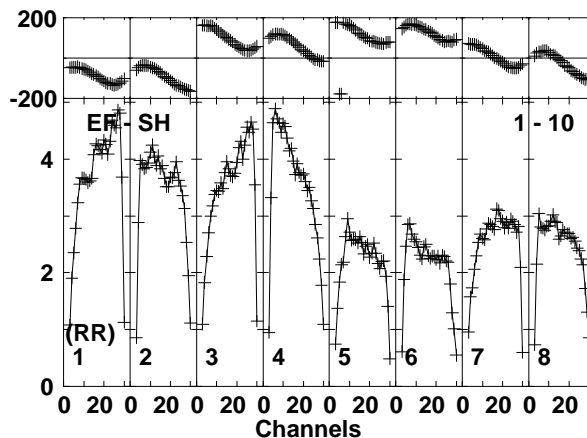
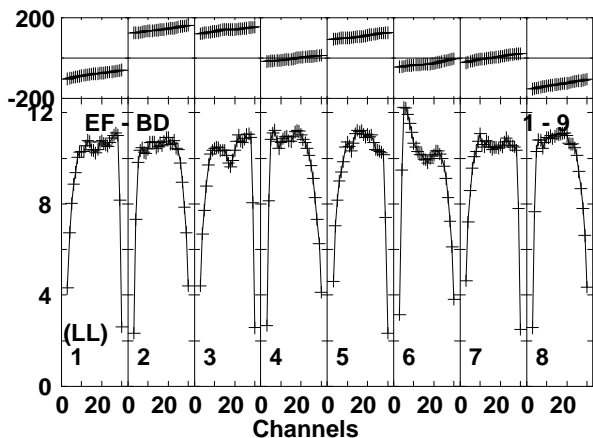
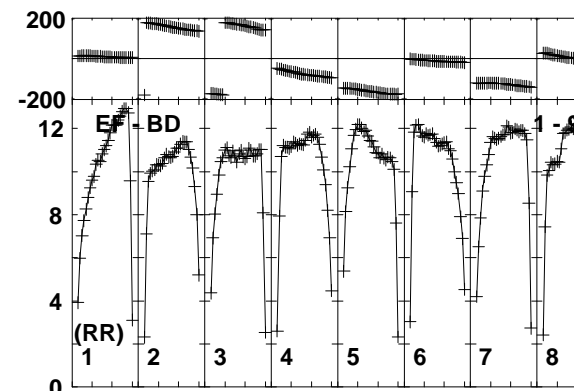
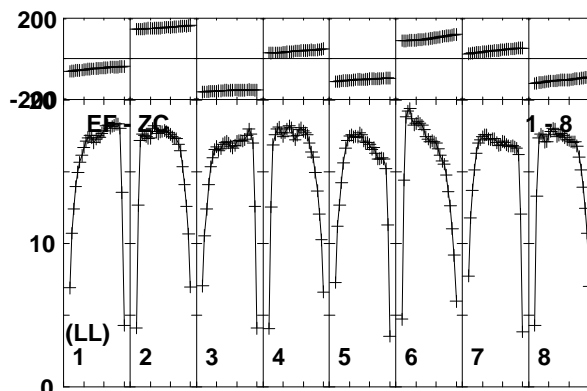
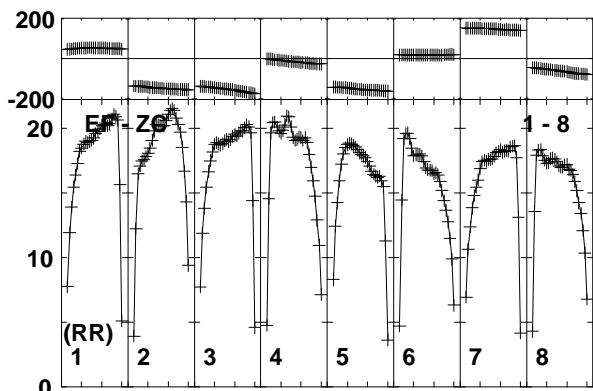
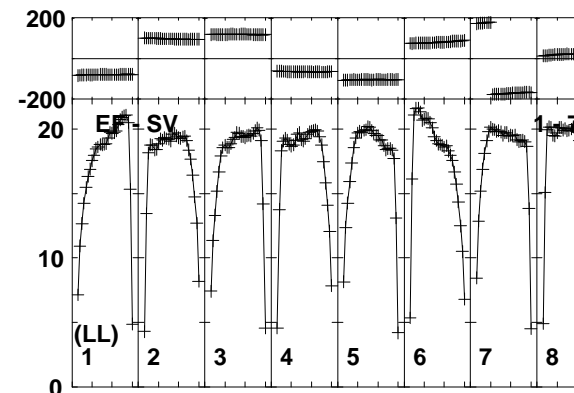
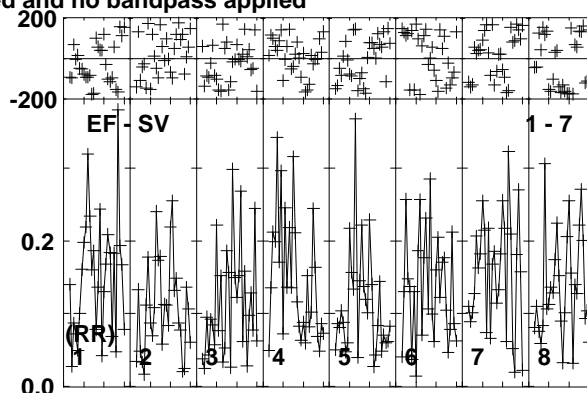
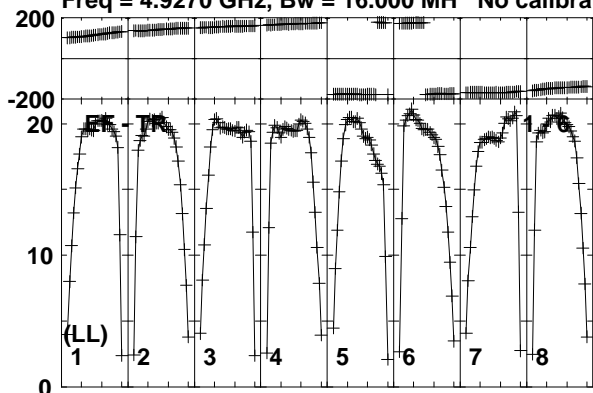

Lower frame: Milli Ampl Jy Top frame: Phas deg
Vector averaged cross-power spectrum Baseline: EF (01) - TR (06)
Timerange: 00:13:46:43 to 00:13:47:39

Plot file version 147 created 28-JAN-2015 14:38:10

1848+283 N14C3.UVDATA.1

Freq = 4.9270 GHz, Bw = 16.000 MH No calibration applied and no bandpass applied

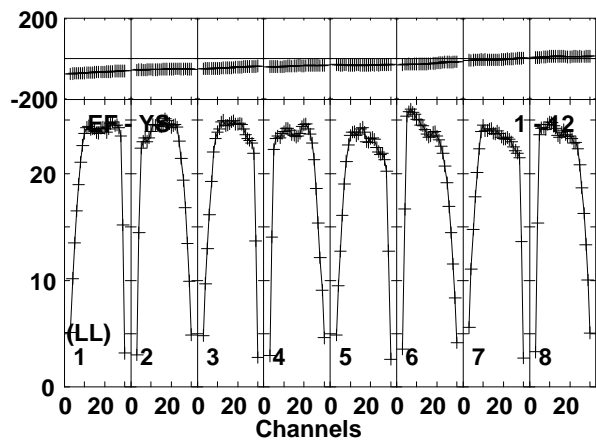
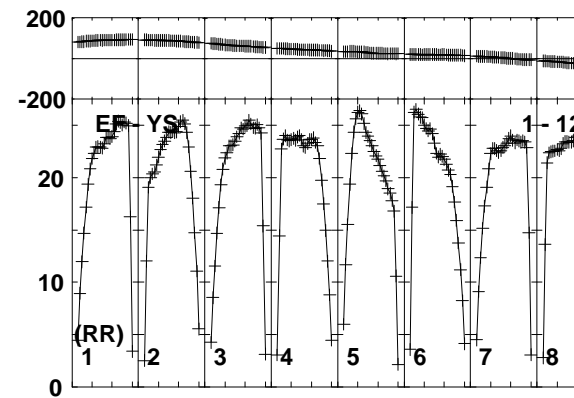
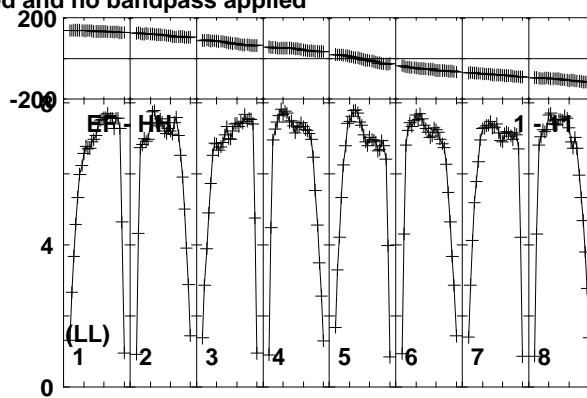
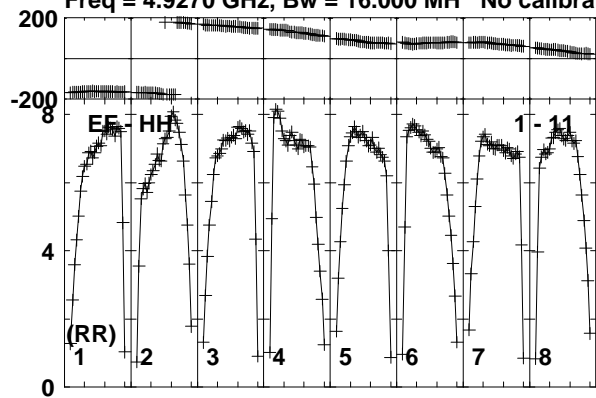

Lower frame: Milli Ampl Jy Top frame: Phas deg
Vector averaged cross-power spectrum Baseline: EF (01) - HH (11)
Timerange: 00/13:46:43 to 00/13:47:39

Plot file version 148 created 28-JAN-2015 14:38:10

J1849+3024 N14C3.UVDATA.1

Freq = 4.9270 GHz, Bw = 16.000 MH No calibration applied and no bandpass applied

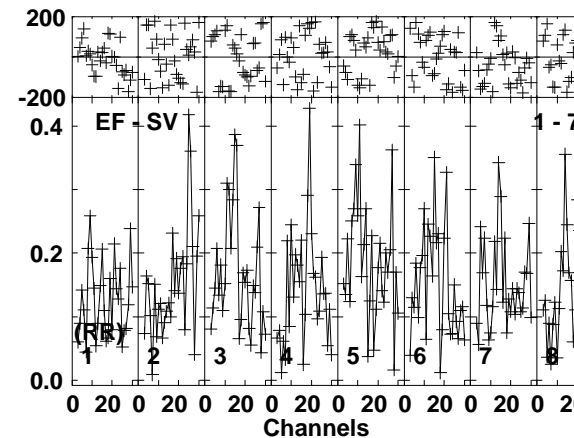
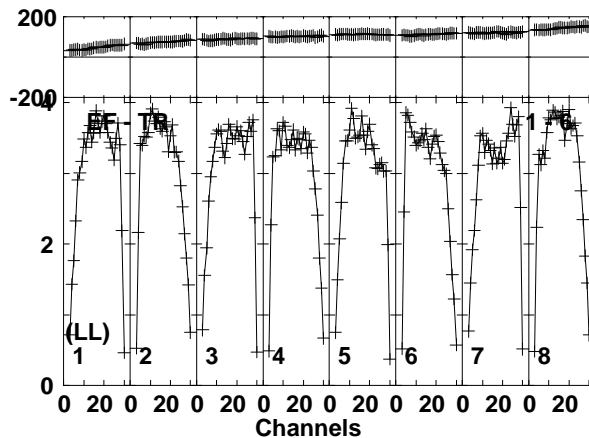
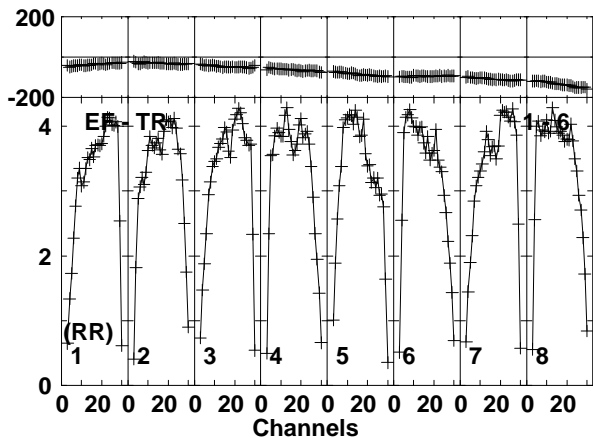
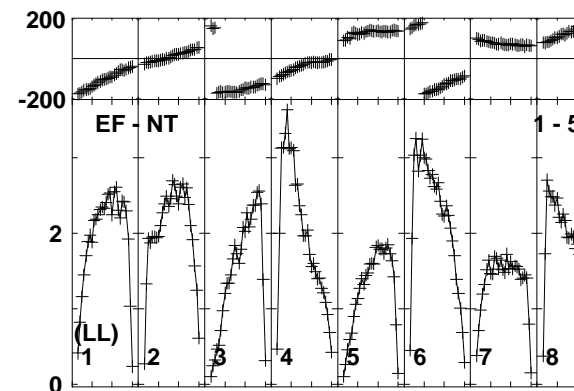
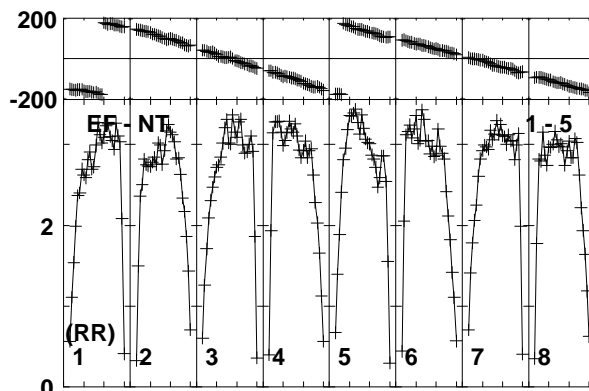
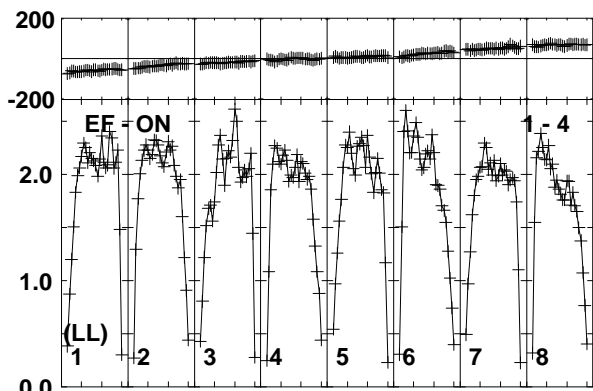
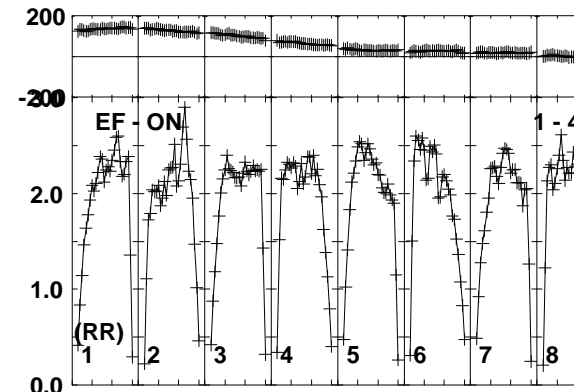
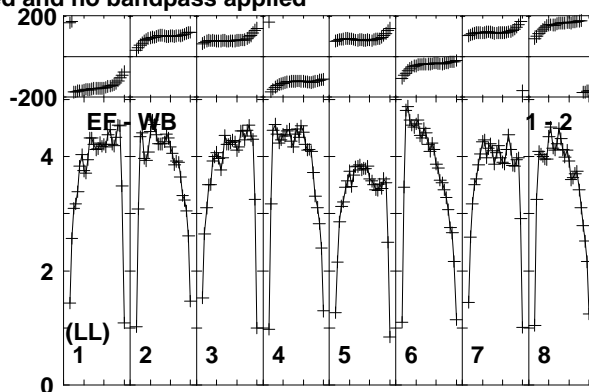
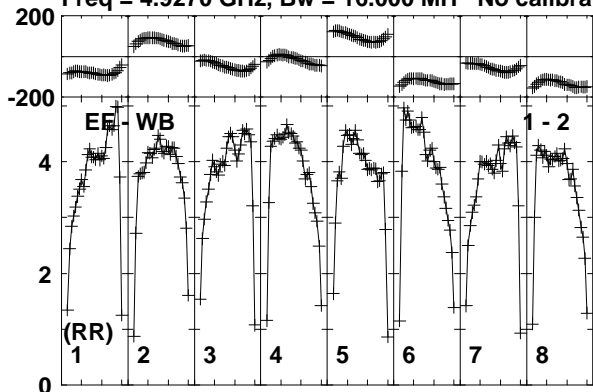

Lower frame: Milli Ampl Jy Top frame: Phas deg
Vector averaged cross-power spectrum Baseline: EF (01) - WB (02)
Timerange: 00/13:48:23 to 00/13:49:19

Plot file version 149 created 28-JAN-2015 14:38:10

J1849+3024 N14C3.UVDATA.1

Freq = 4.9270 GHz, Bw = 16.000 MH No calibration applied and no bandpass applied

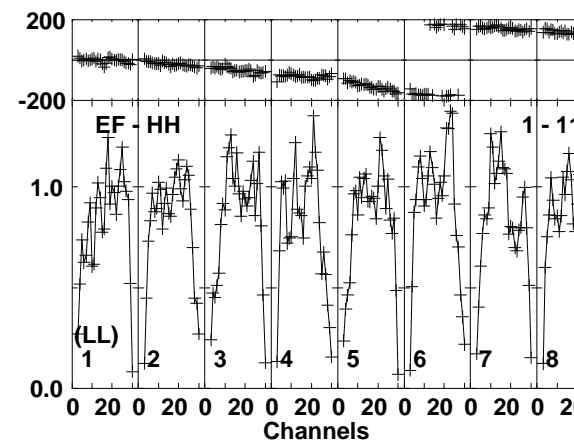
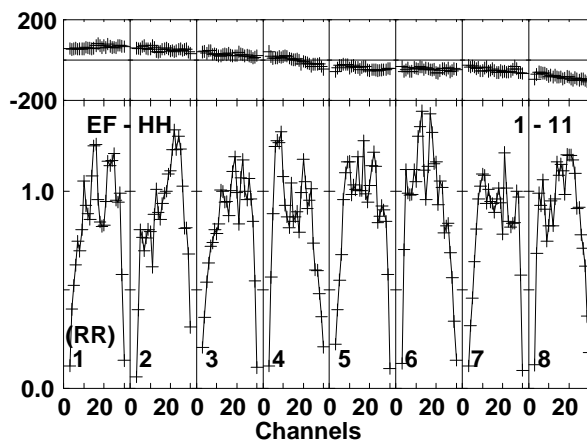
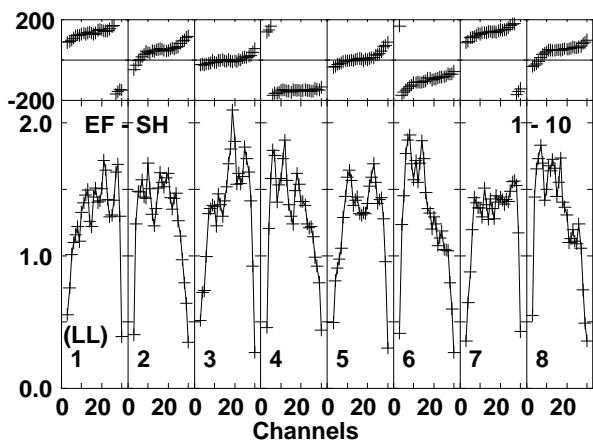
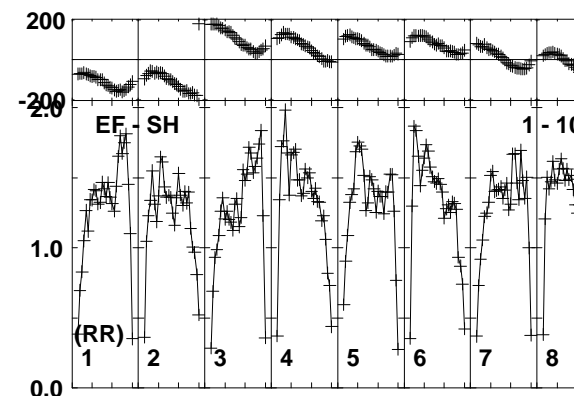
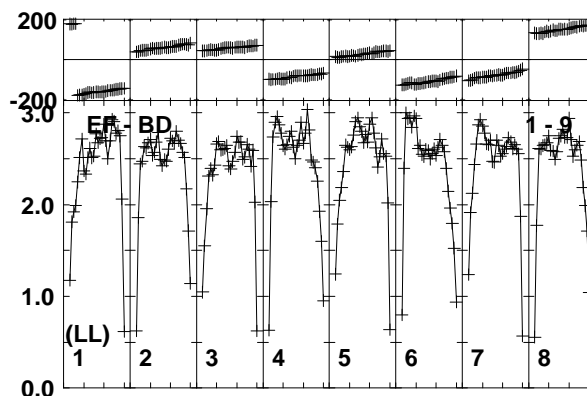
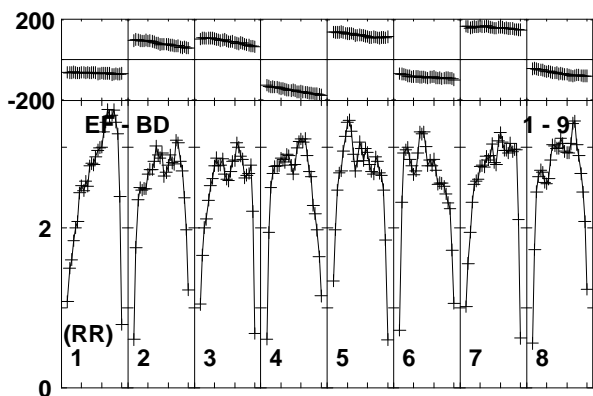
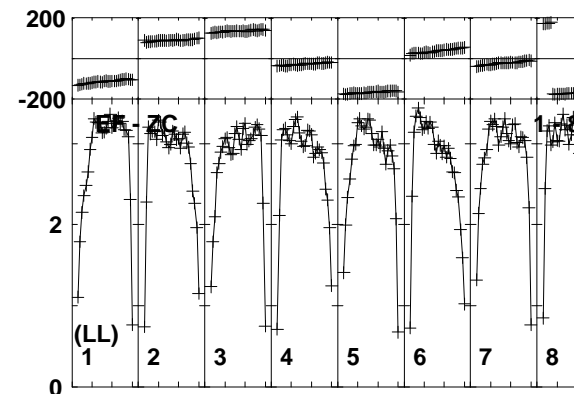
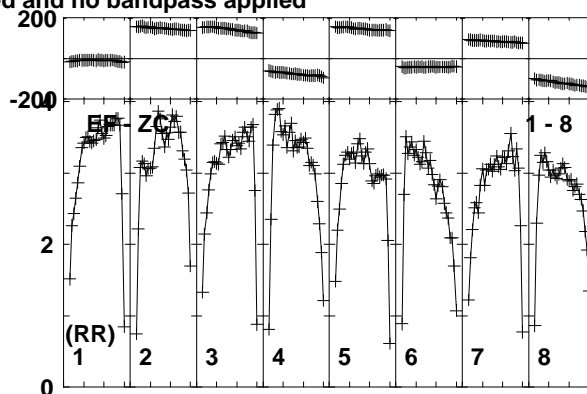
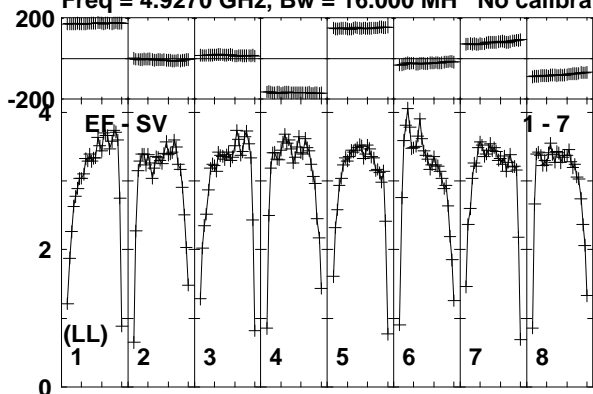

Lower frame: Milli Ampl Jy Top frame: Phas deg
Vector averaged cross-power spectrum Baseline: EF (01) - SV (07)
Timerange: 00/13:48:23 to 00/13:49:19

Plot file version 150 created 28-JAN-2015 14:38:10

J1849+3024 N14C3.UVDATA.1

Freq = 4.9270 GHz, Bw = 16.000 MH No calibration applied and no bandpass applied

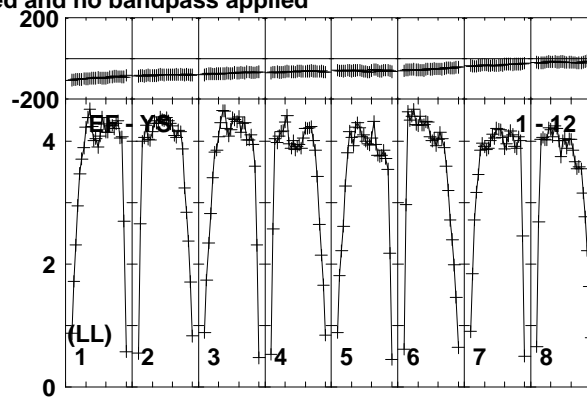
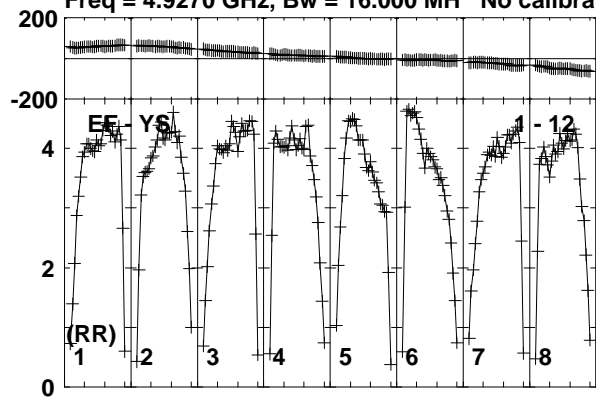

Lower frame: Milli Ampl Jy Top frame: Phas deg
Vector averaged cross-power spectrum Baseline: EF (01) - YS (12)
Timerange: 00/13:48:23 to 00/13:49:19

Plot file version 151 created 28-JAN-2015 14:38:10

1848+283 N14C3.UVDATA.1

Freq = 4.9270 GHz, Bw = 16.000 MH No calibration applied and no bandpass applied

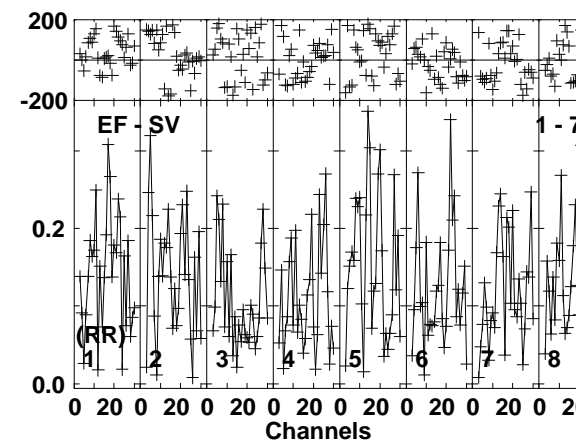
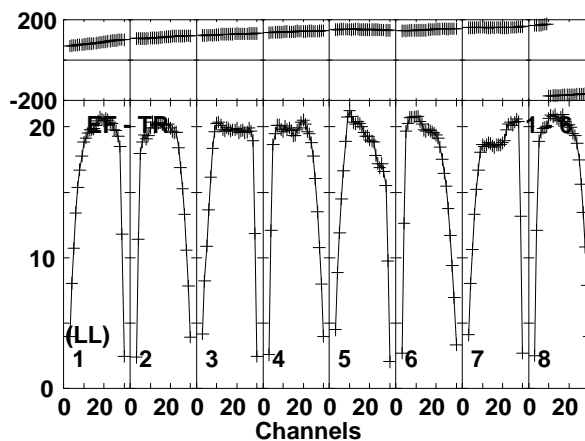
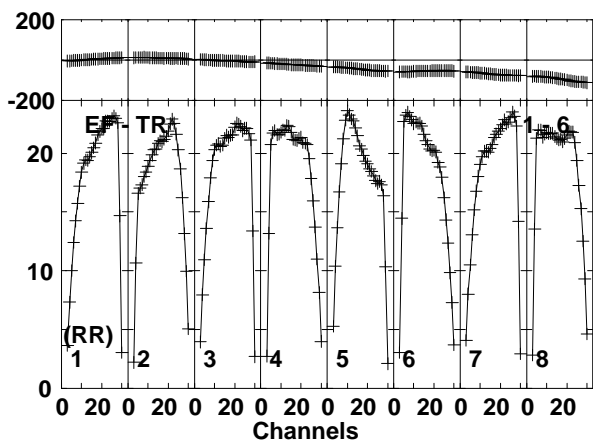
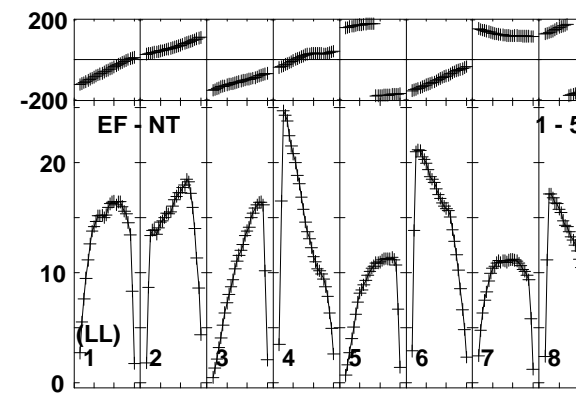
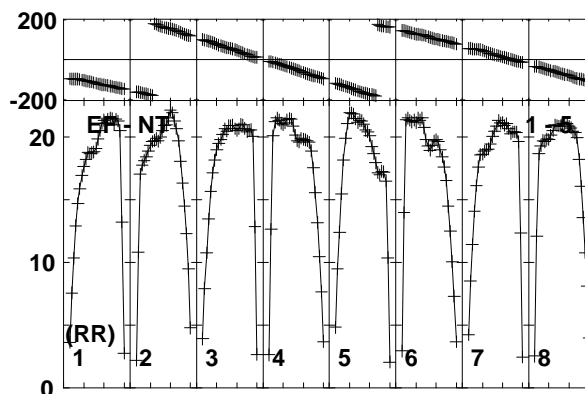
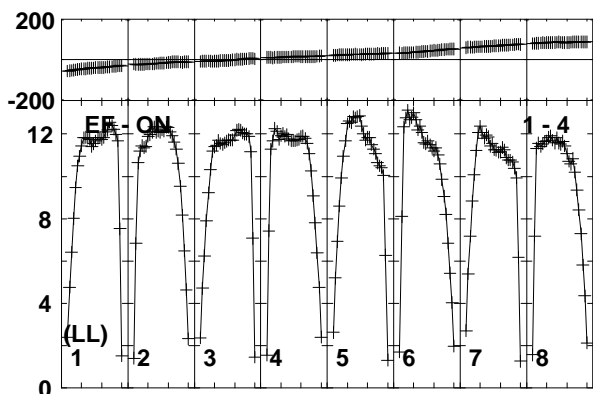
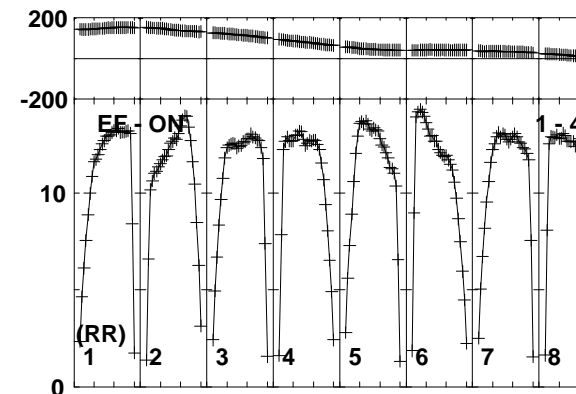
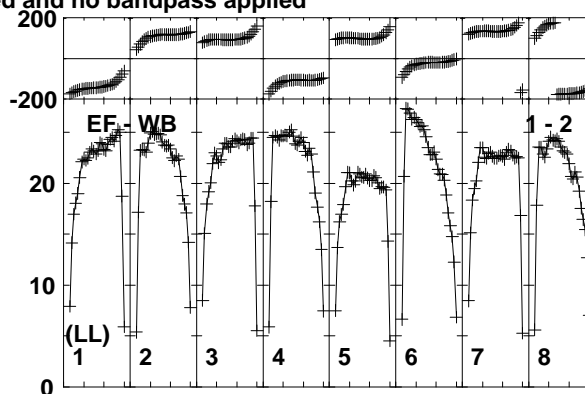
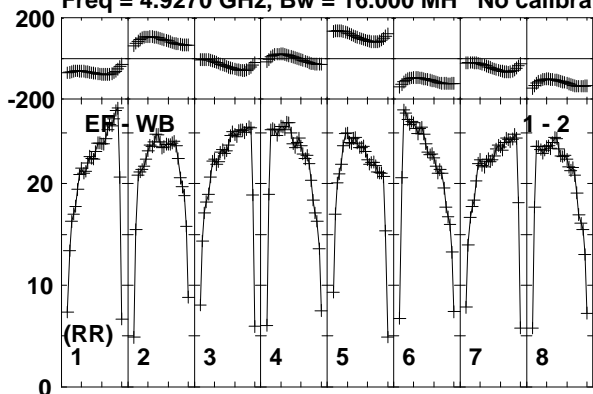

Lower frame: Milli Ampl Jy Top frame: Phas deg
Vector averaged cross-power spectrum Baseline: EF (01) - WB (02)
Timerange: 00/13:50:03 to 00/13:50:59

Plot file version 152 created 28-JAN-2015 14:38:10

1848+283 N14C3.UVDATA.1

Freq = 4.9270 GHz, Bw = 16.000 MH No calibration applied and no bandpass applied

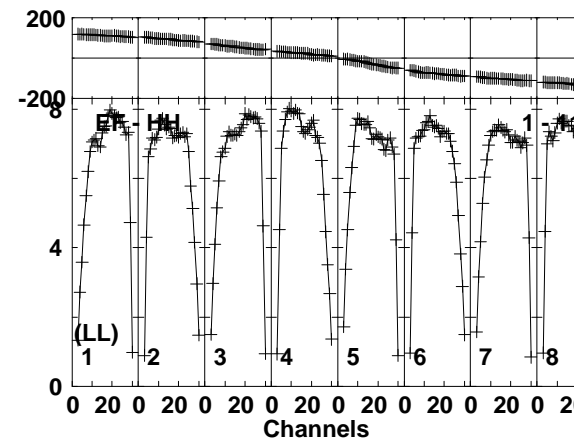
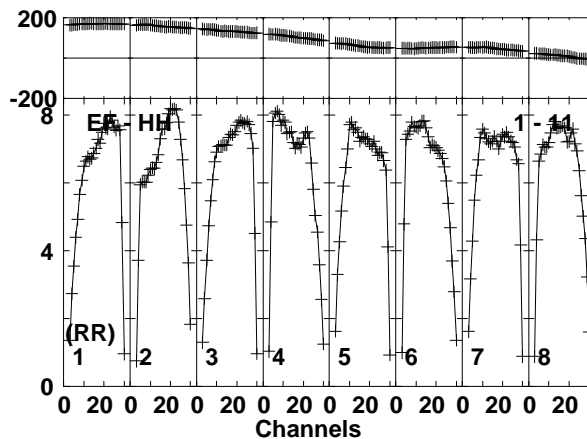
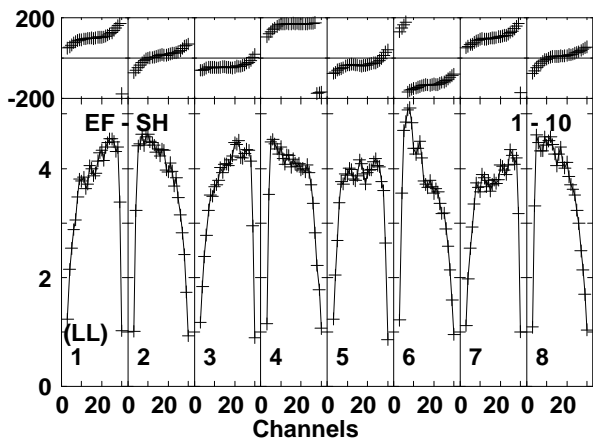
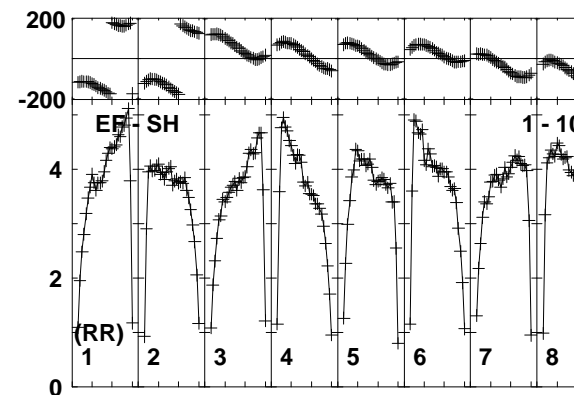
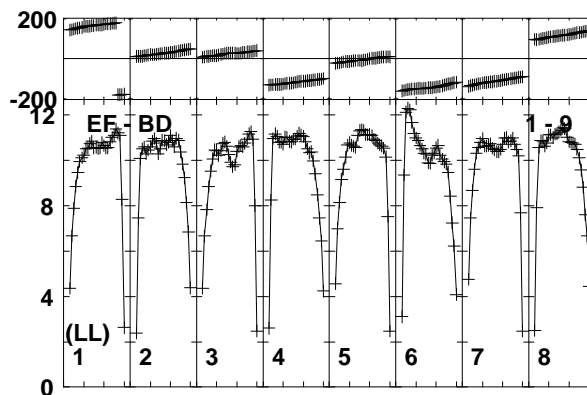
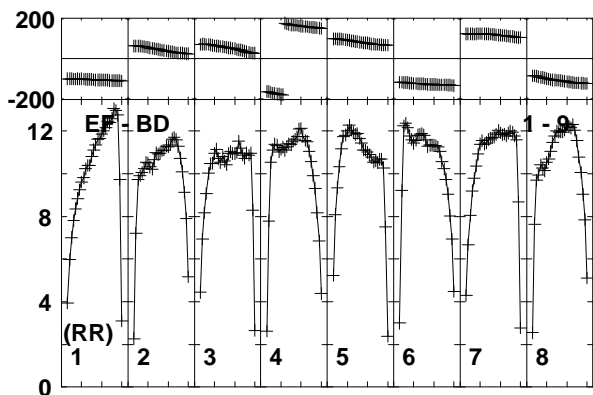
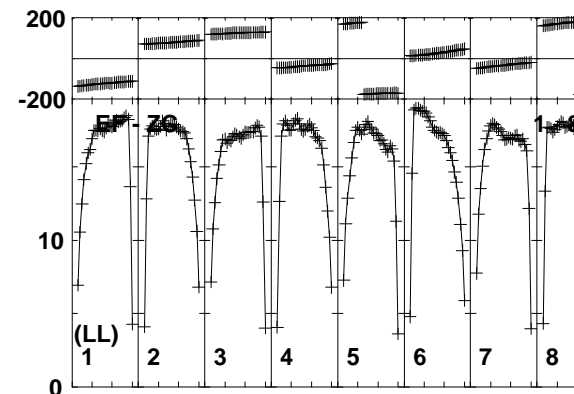
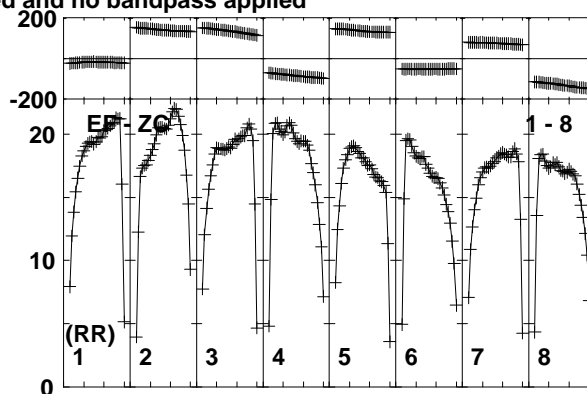
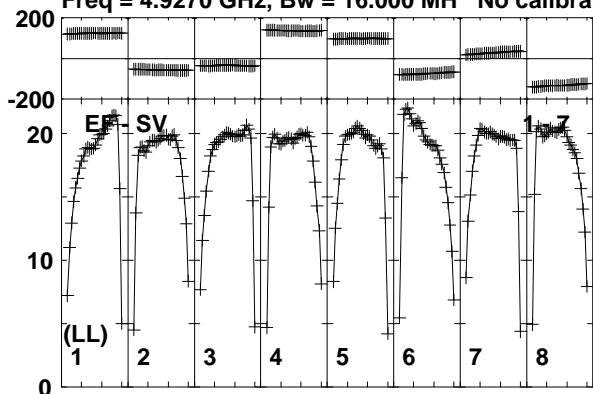

Lower frame: Milli Ampl Jy Top frame: Phas deg
Vector averaged cross-power spectrum Baseline: EF (01) - SV (07)
Timerange: 00/13:50:03 to 00/13:50:59

Plot file version 153 created 28-JAN-2015 14:38:10

1848+283 N14C3.UVDATA.1

Freq = 4.9270 GHz, Bw = 16.000 MH No calibration applied and no bandpass applied

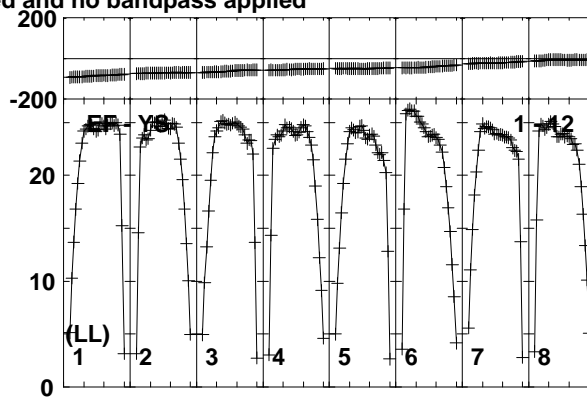
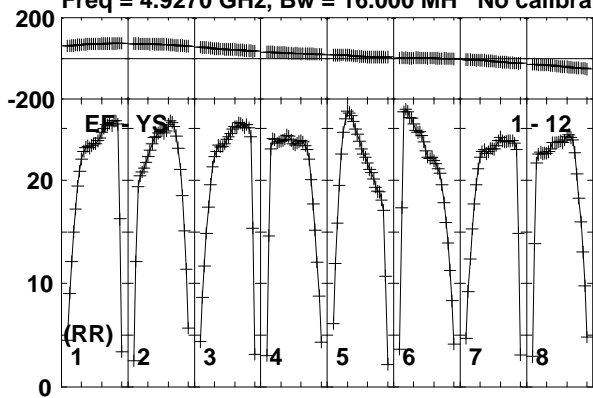

Lower frame: Milli Ampl Jy Top frame: Phas deg
Vector averaged cross-power spectrum Baseline: EF (01) - YS (12)
Timerange: 00/13:50:03 to 00/13:50:59

Plot file version 154 created 28-JAN-2015 14:38:10

J1849+3024 N14C3.UVDATA.1

Freq = 4.9270 GHz, Bw = 16.000 MH No calibration applied and no bandpass applied

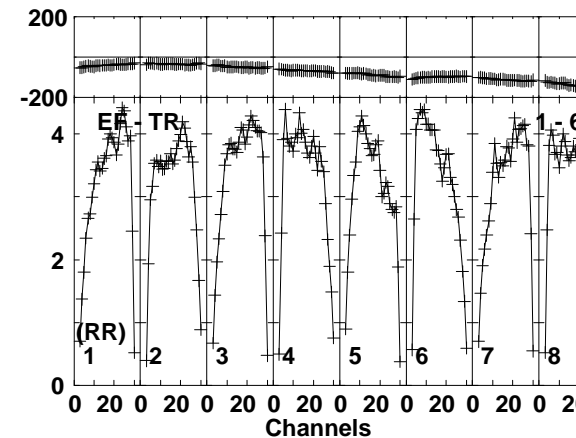
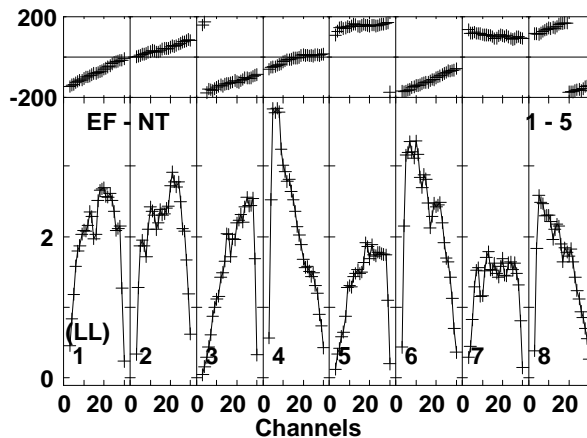
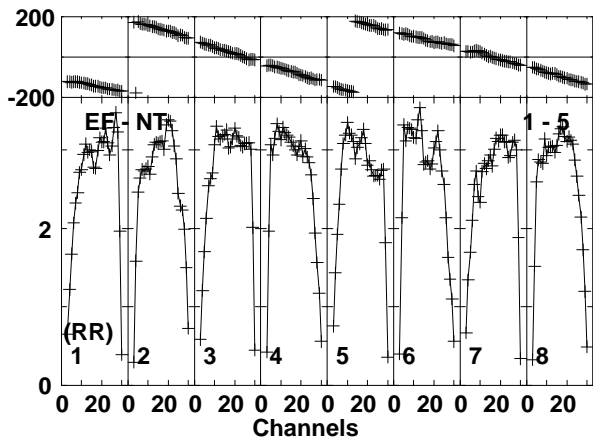
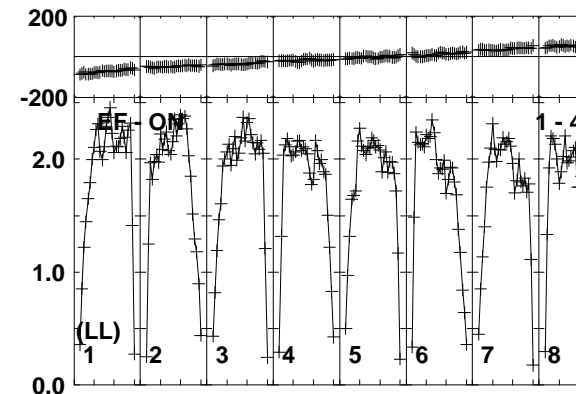
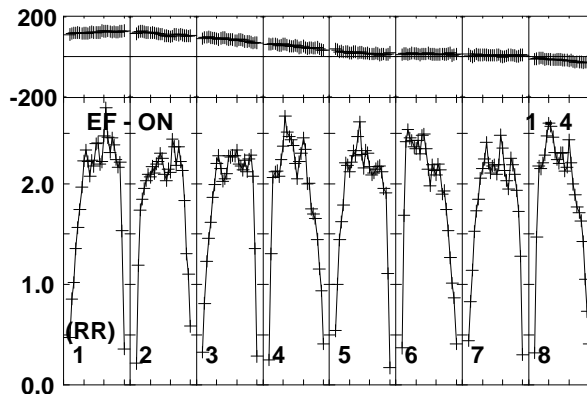
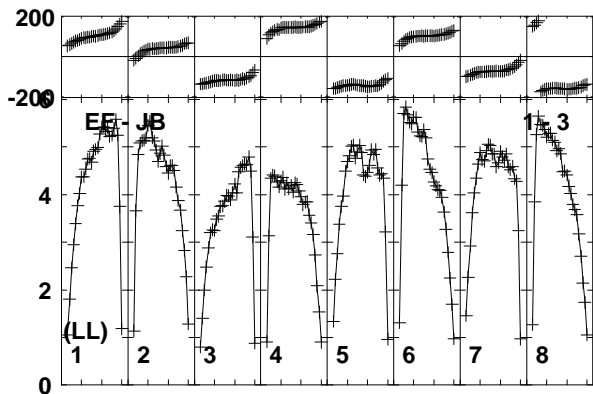
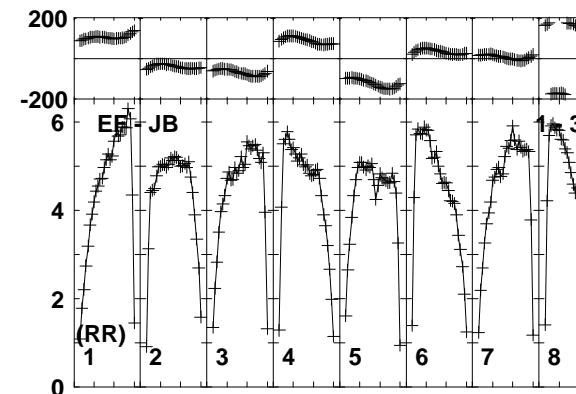
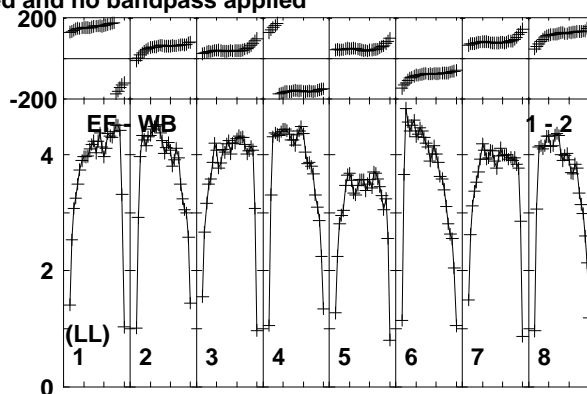
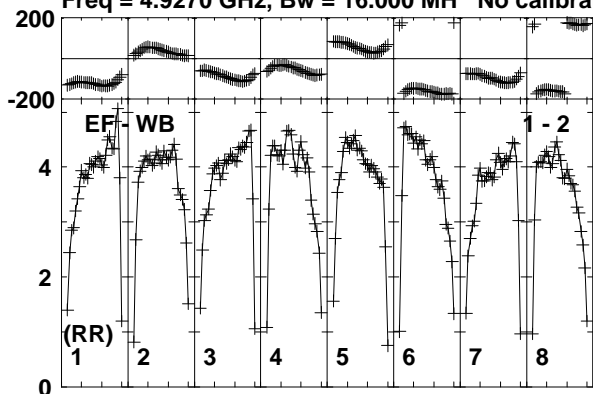

Lower frame: Milli Ampl Jy Top frame: Phas deg
Vector averaged cross-power spectrum Baseline: EF (01) - WB (02)
Timerange: 00:13:51:43 to 00:13:52:39

Plot file version 155 created 28-JAN-2015 14:38:10

J1849+3024 N14C3.UVDATA.1

Freq = 4.9270 GHz, Bw = 16.000 MH No calibration applied and no bandpass applied

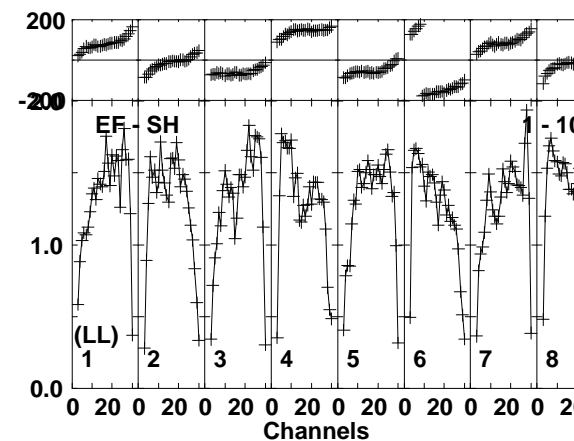
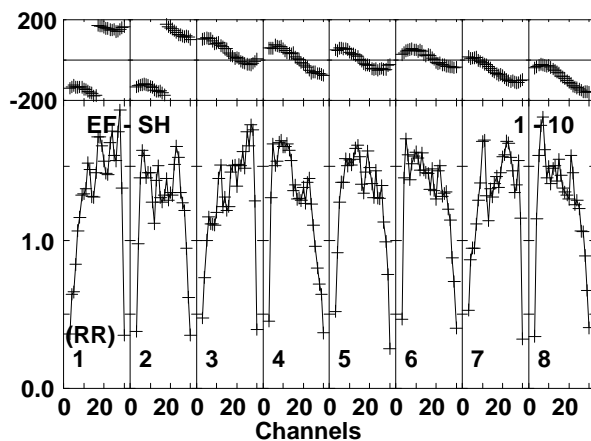
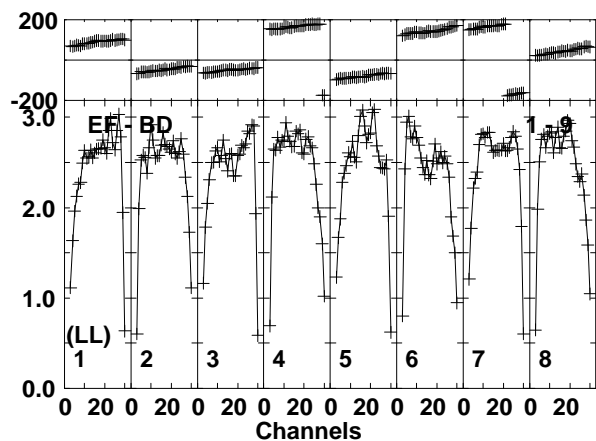
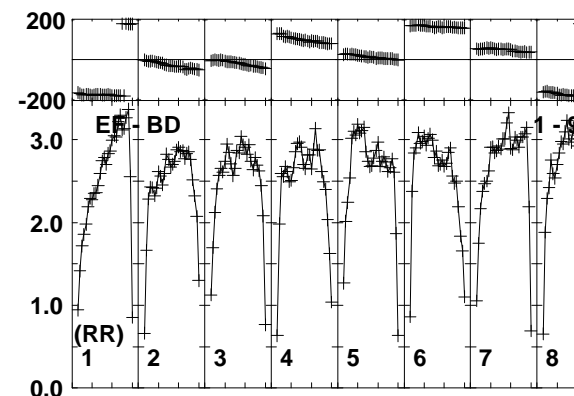
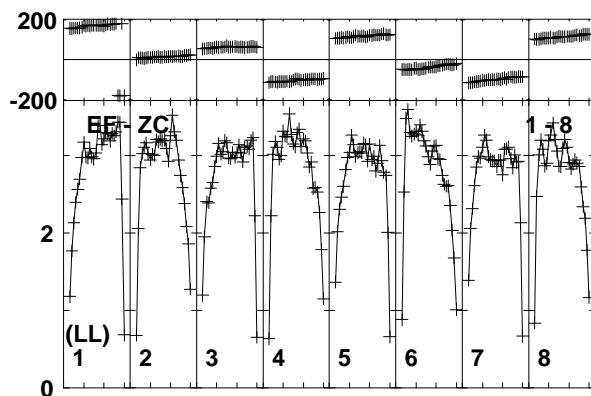
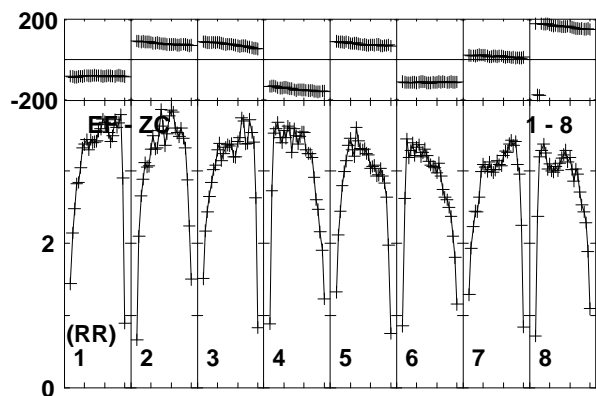
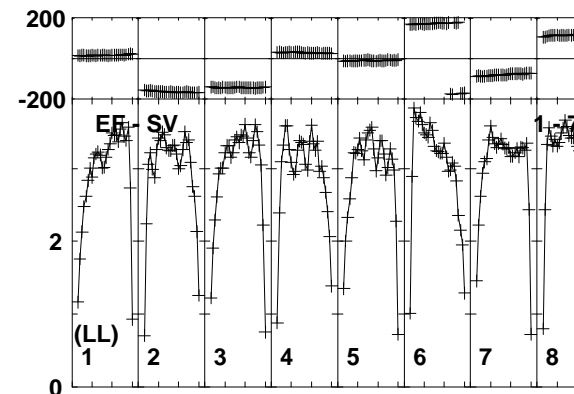
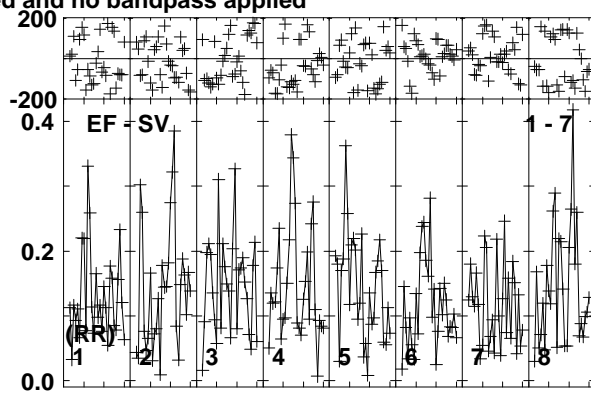
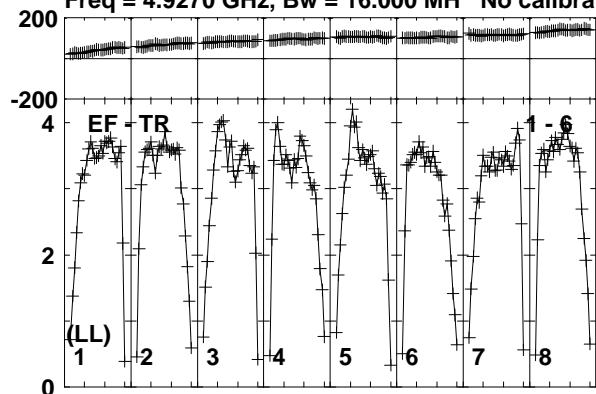

Lower frame: Milli Ampl Jy Top frame: Phas deg
Vector averaged cross-power spectrum Baseline: EF (01) - TR (06)
Timerange: 00:13:51:43 to 00:13:52:39

Plot file version 156 created 28-JAN-2015 14:38:11

J1849+3024 N14C3.UVDATA.1

Freq = 4.9270 GHz, Bw = 16.000 MH No calibration applied and no bandpass applied

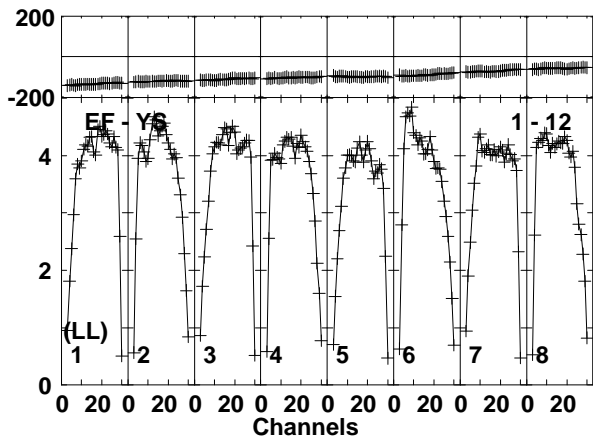
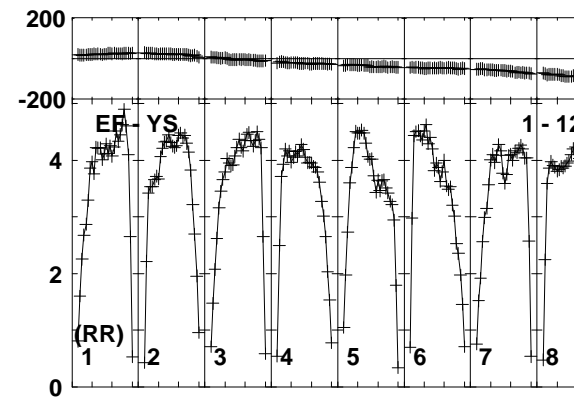
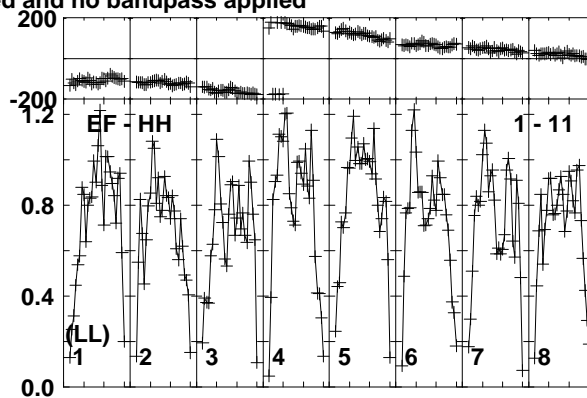
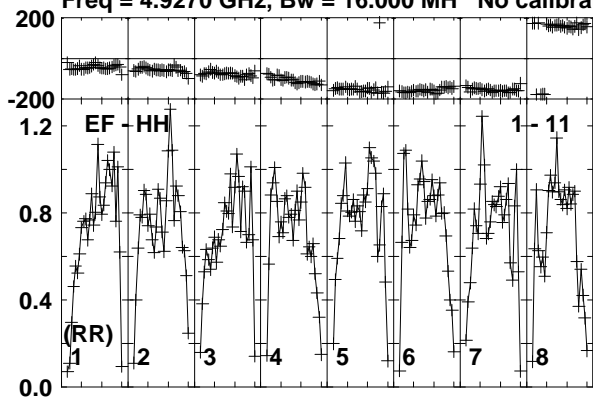

Lower frame: Milli Ampl Jy Top frame: Phas deg
Vector averaged cross-power spectrum Baseline: EF (01) - HH (11)
Timerange: 00/13:51:43 to 00/13:52:39

Plot file version 157 created 28-JAN-2015 14:38:11

1848+283 N14C3.UVDATA.1

Freq = 4.9270 GHz, Bw = 16.000 MH No calibration applied and no bandpass applied

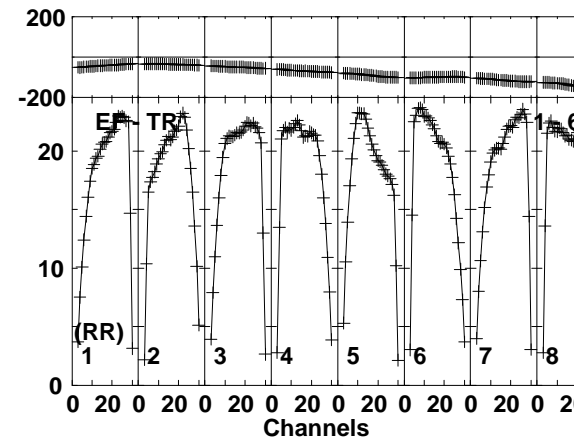
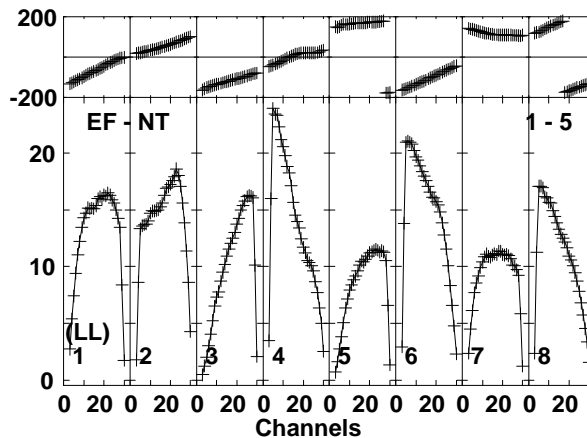
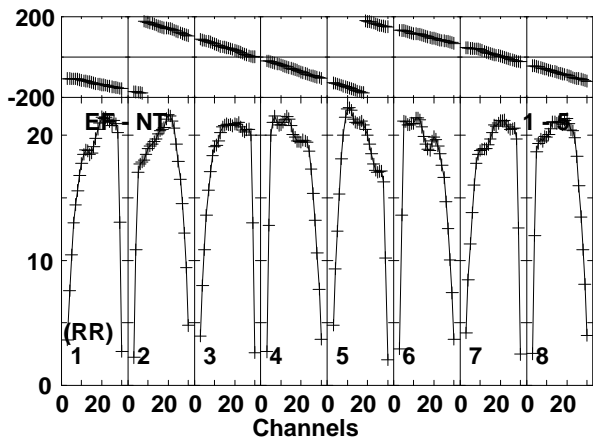
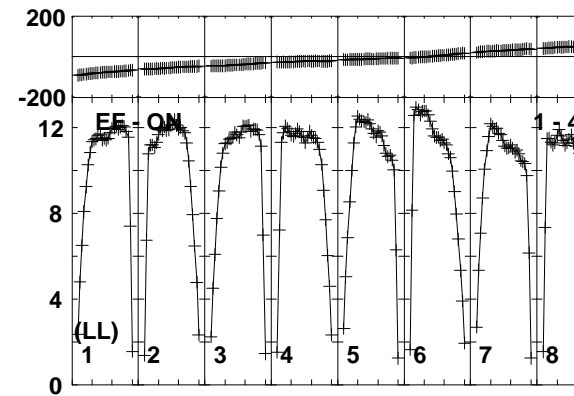
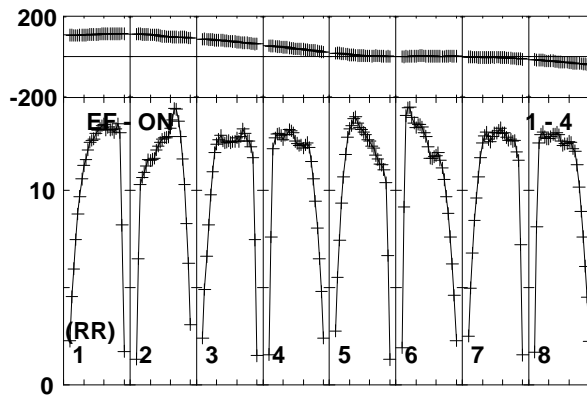
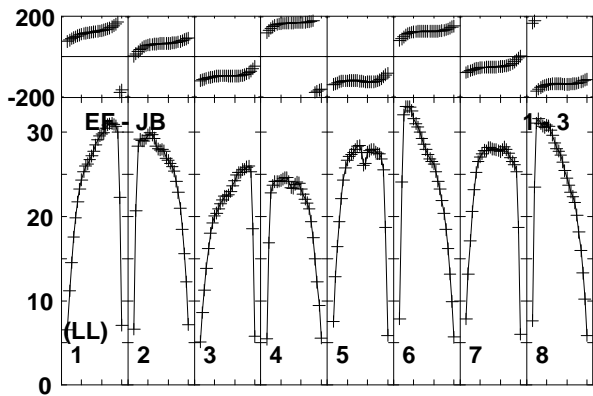
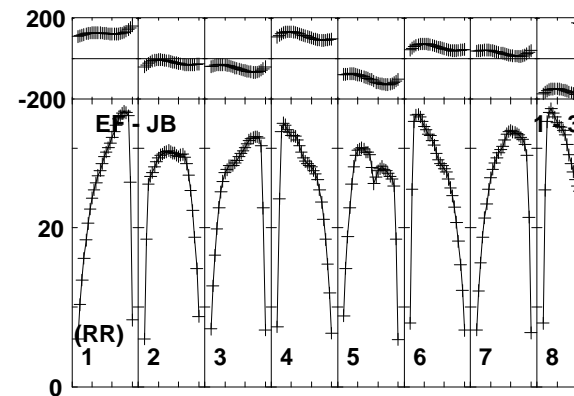
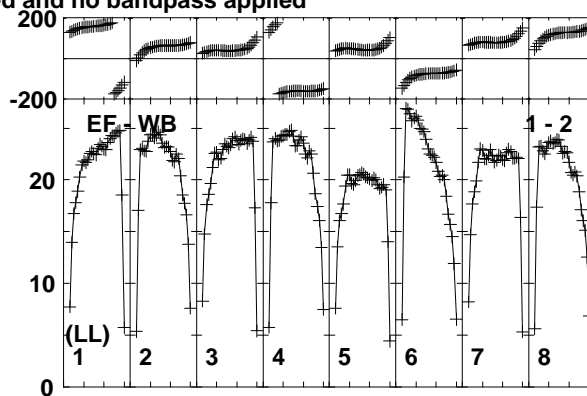
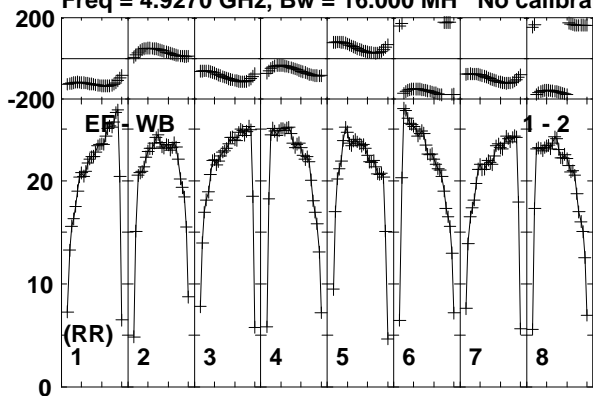

Lower frame: Milli Ampl Jy Top frame: Phas deg
Vector averaged cross-power spectrum Baseline: EF (01) - WB (02)
Timerange: 00/13:53:23 to 00/13:54:19

Plot file version 158 created 28-JAN-2015 14:38:11

1848+283 N14C3.UVDATA.1

Freq = 4.9270 GHz, Bw = 16.000 MH No calibration applied and no bandpass applied

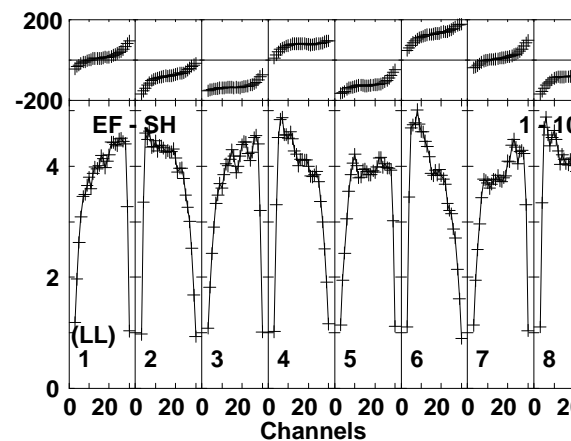
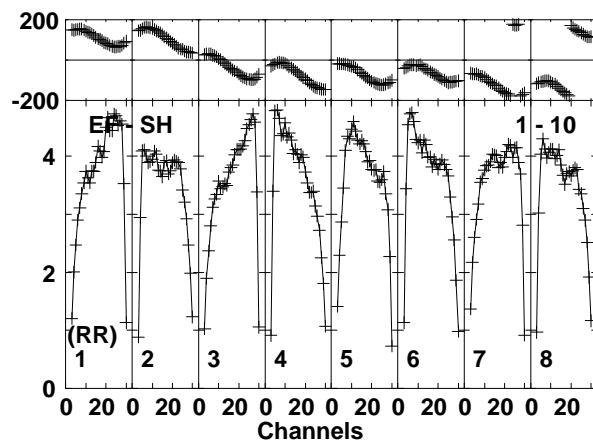
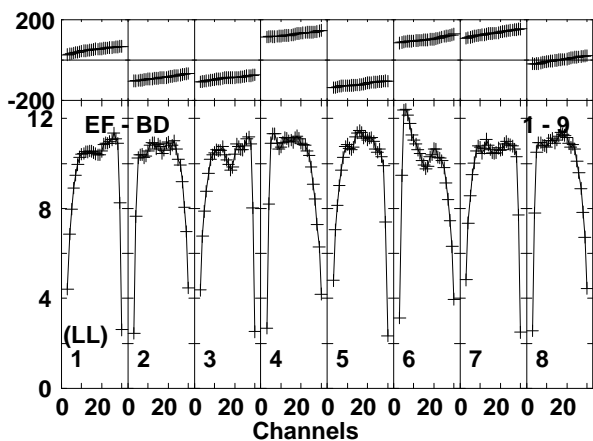
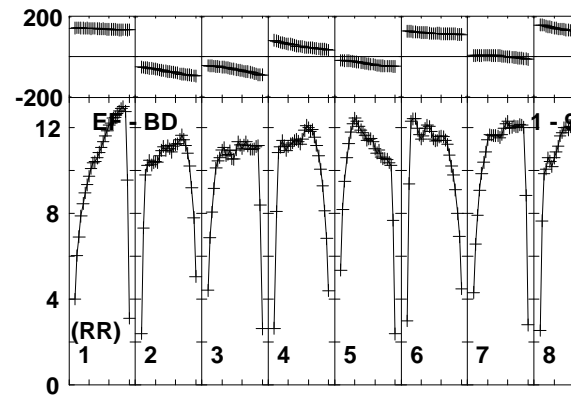
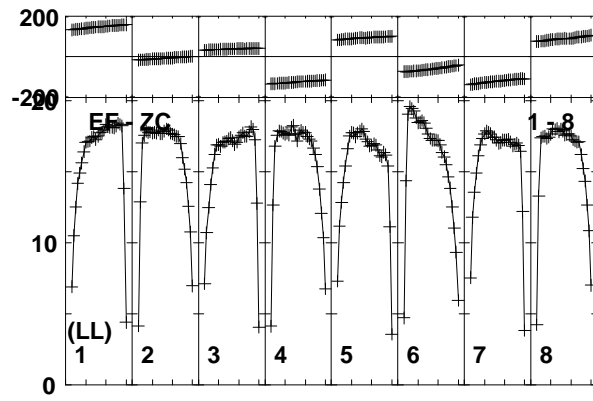
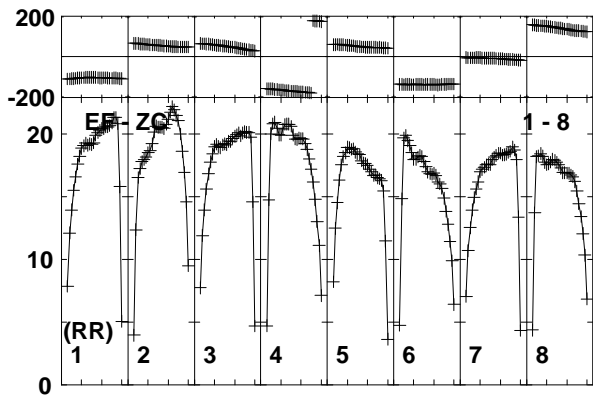
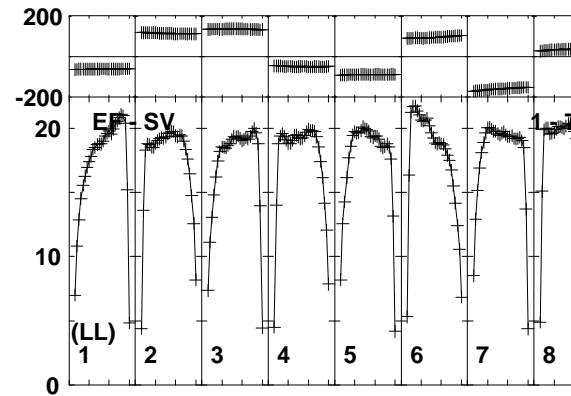
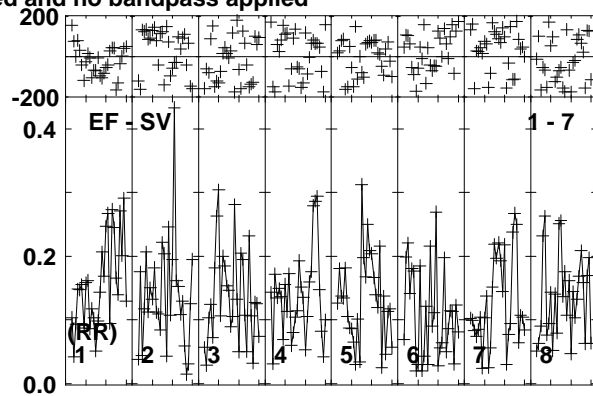
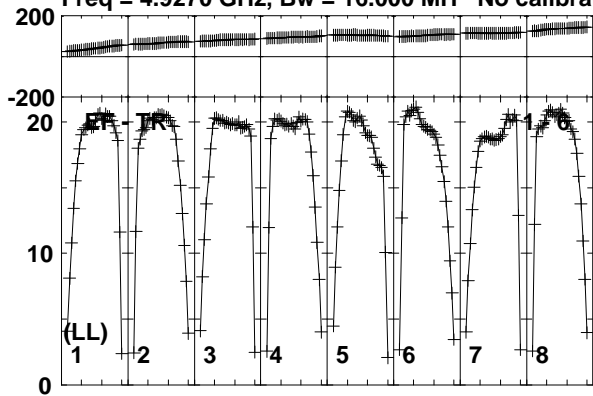

Lower frame: Milli Ampl Jy Top frame: Phas deg
Vector averaged cross-power spectrum Baseline: EF (01) - TR (06)
Timerange: 00/13:53:23 to 00/13:54:19

Plot file version 159 created 28-JAN-2015 14:38:11

1848+283 N14C3.UVDATA.1

Freq = 4.9270 GHz, Bw = 16.000 MH No calibration applied and no bandpass applied

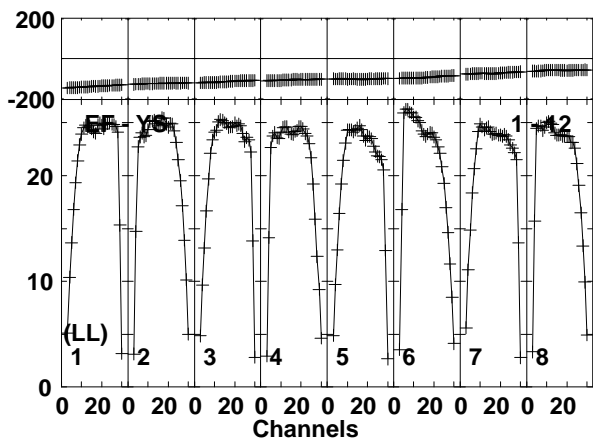
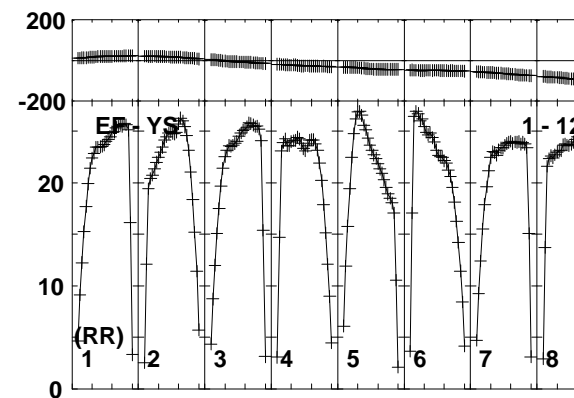
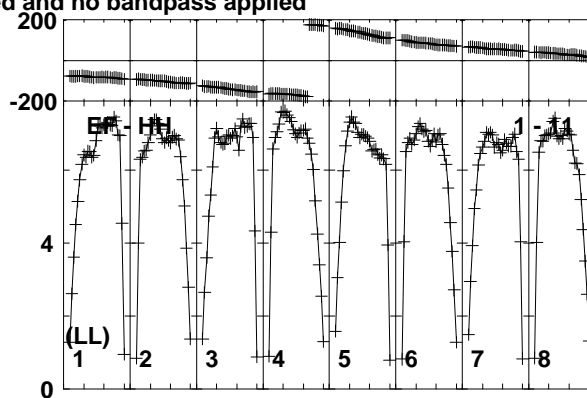
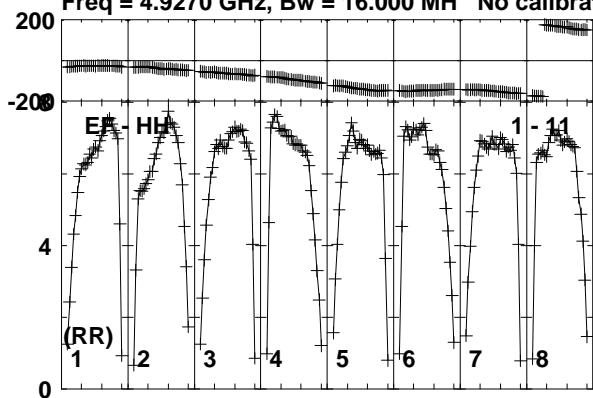

Lower frame: Milli Ampl Jy Top frame: Phas deg
Vector averaged cross-power spectrum Baseline: EF (01) - HH (11)
Timerange: 00/13:53:23 to 00/13:54:19

Plot file version 160 created 28-JAN-2015 14:38:11

J1849+3024 N14C3.UVDATA.1

Freq = 4.9270 GHz, Bw = 16.000 MH No calibration applied and no bandpass applied

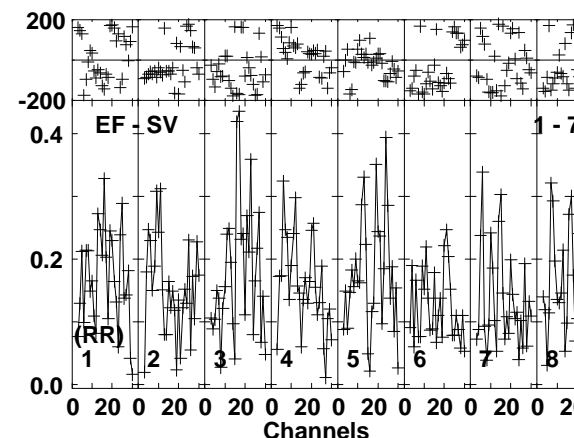
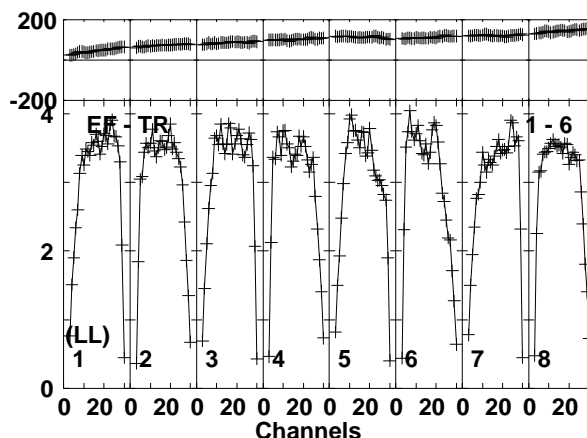
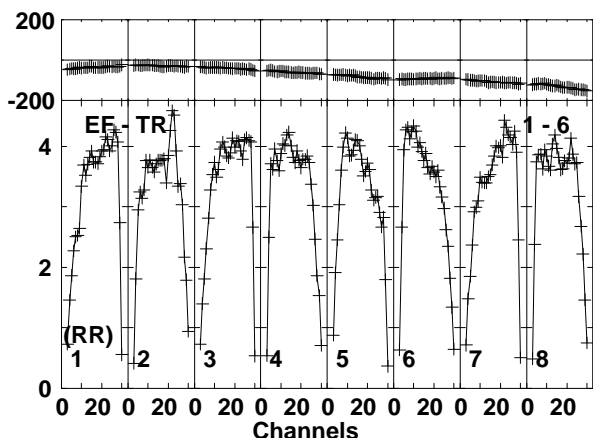
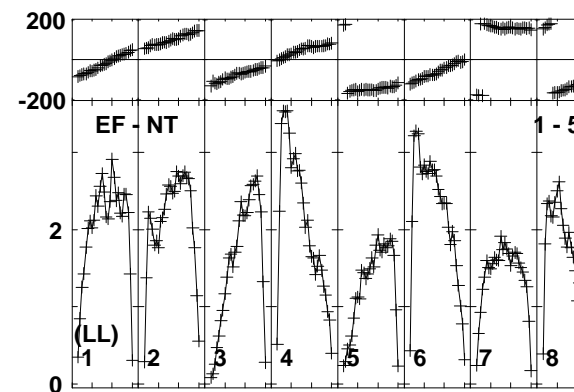
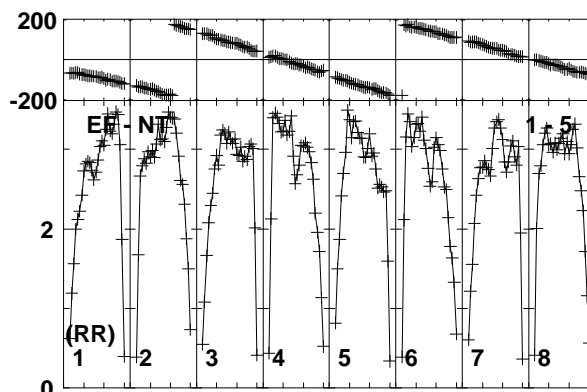
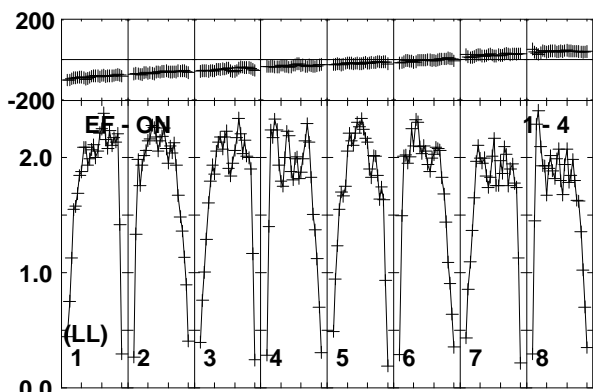
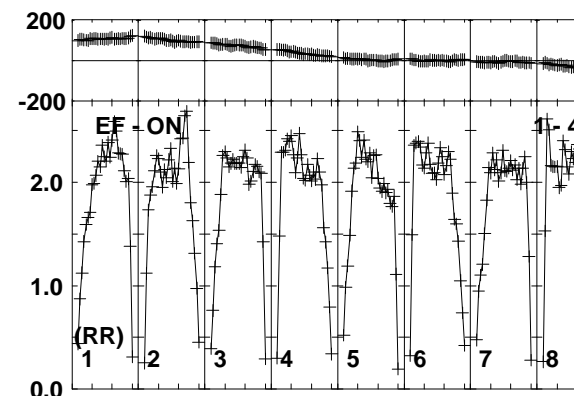
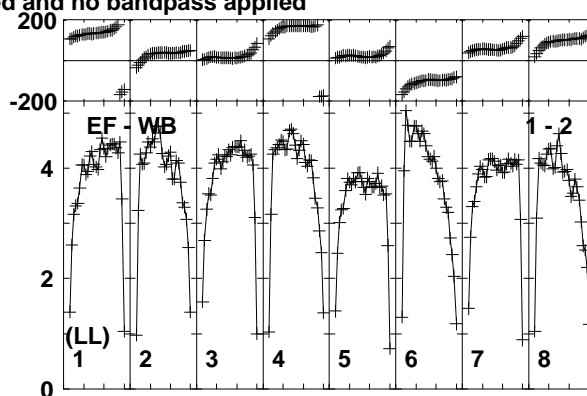
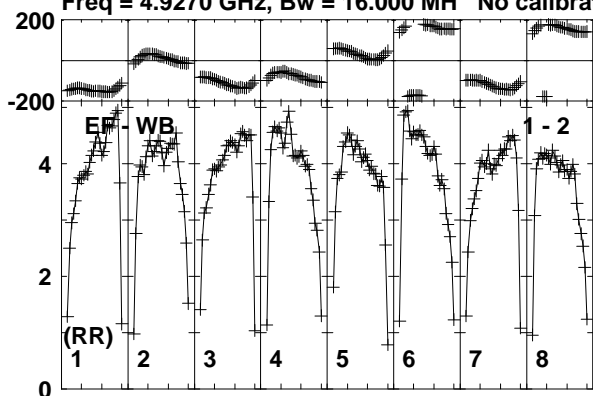

Lower frame: Milli Ampl Jy Top frame: Phas deg
Vector averaged cross-power spectrum Baseline: EF (01) - WB (02)
Timerange: 00/13:55:03 to 00/13:55:59

Plot file version 161 created 28-JAN-2015 14:38:11

J1849+3024 N14C3.UVDATA.1

Freq = 4.9270 GHz, Bw = 16.000 MH No calibration applied and no bandpass applied

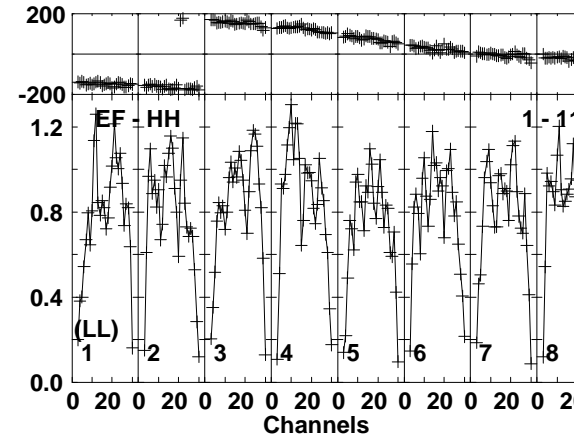
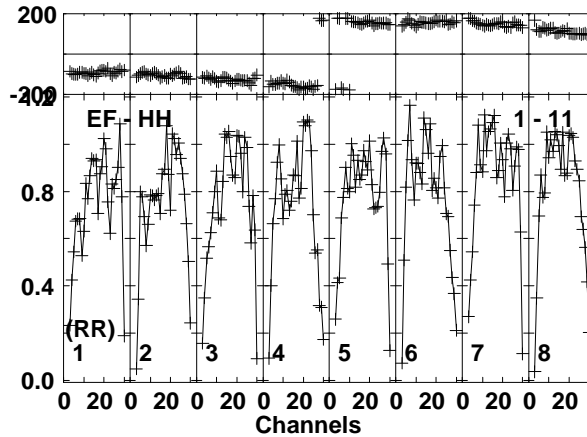
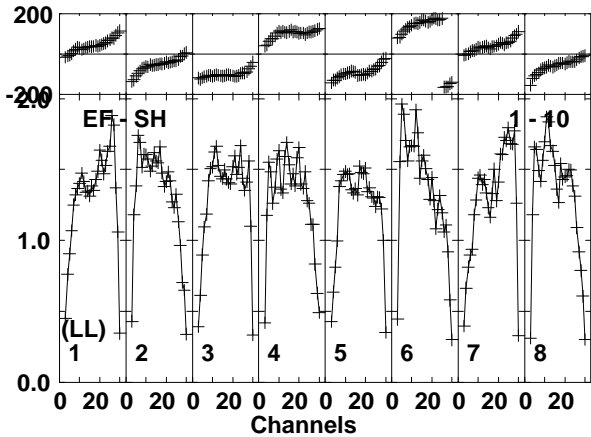
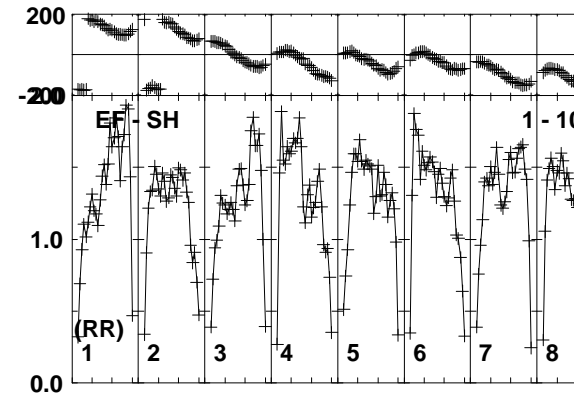
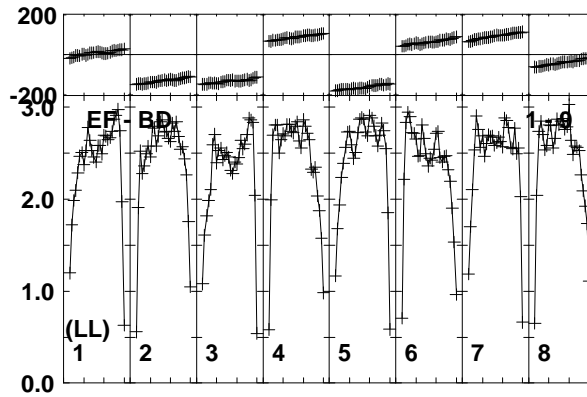
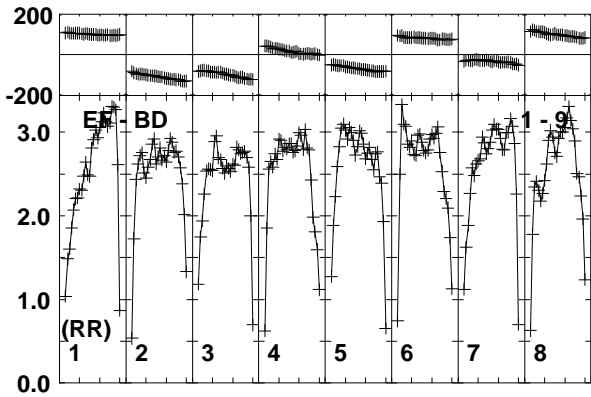
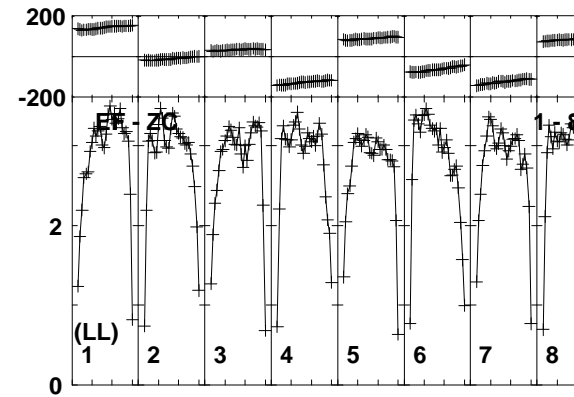
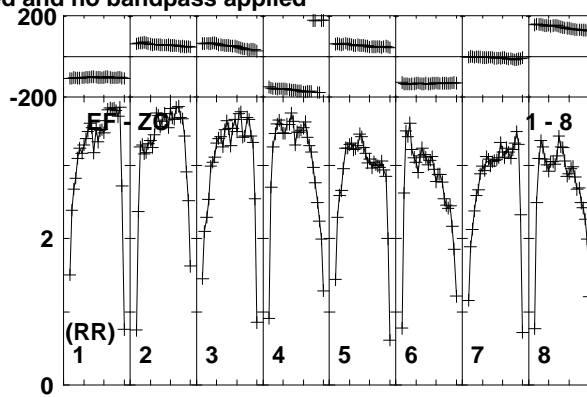
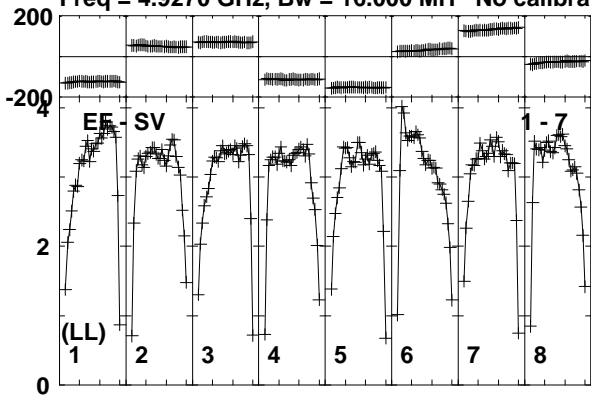

Lower frame: Milli Ampl Jy Top frame: Phas deg
Vector averaged cross-power spectrum Baseline: EF (01) - SV (07)
Timerange: 00/13:55:03 to 00/13:55:59

Plot file version 162 created 28-JAN-2015 14:38:11

J1849+3024 N14C3.UVDATA.1

Freq = 4.9270 GHz, Bw = 16.000 MH No calibration applied and no bandpass applied

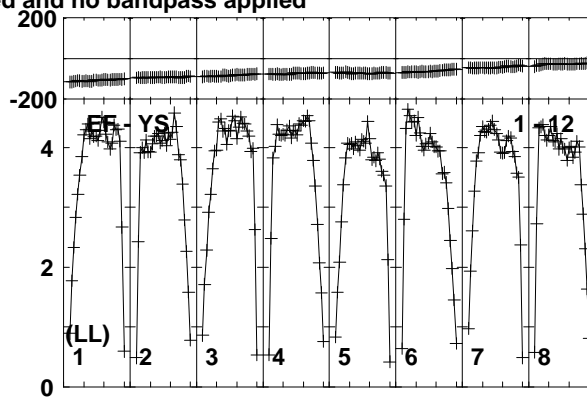
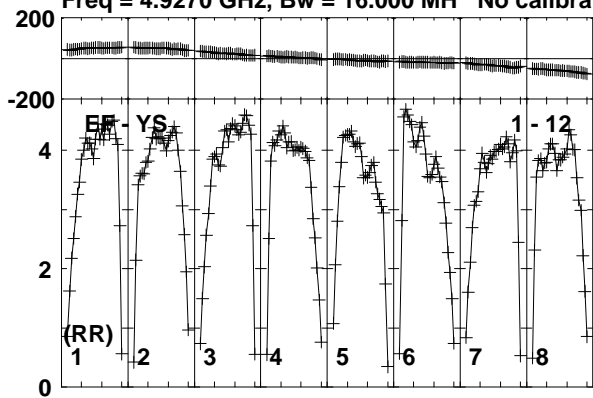

Lower frame: Milli Ampl Jy Top frame: Phas deg
Vector averaged cross-power spectrum Baseline: EF (01) - YS (12)
Timerange: 00/13:55:03 to 00/13:55:59

Plot file version 163 created 28-JAN-2015 14:38:11

1848+283 N14C3.UVDATA.1

Freq = 4.9270 GHz, Bw = 16.000 MH No calibration applied and no bandpass applied

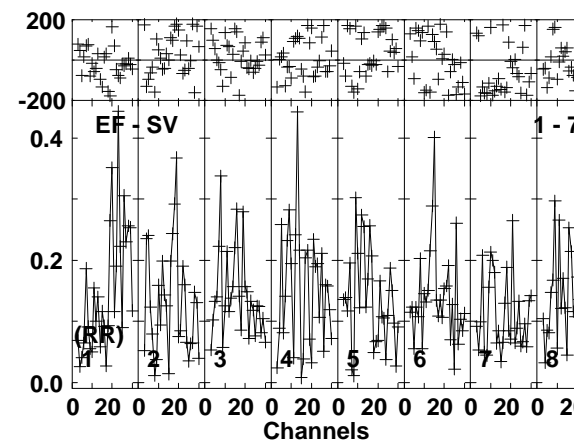
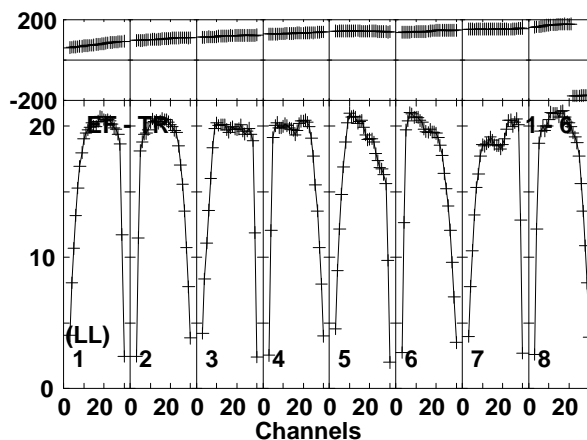
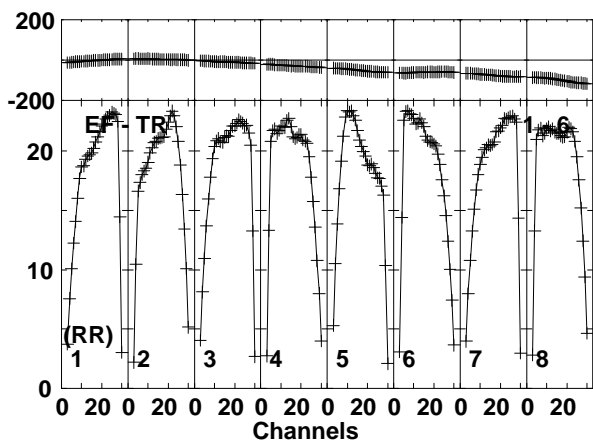
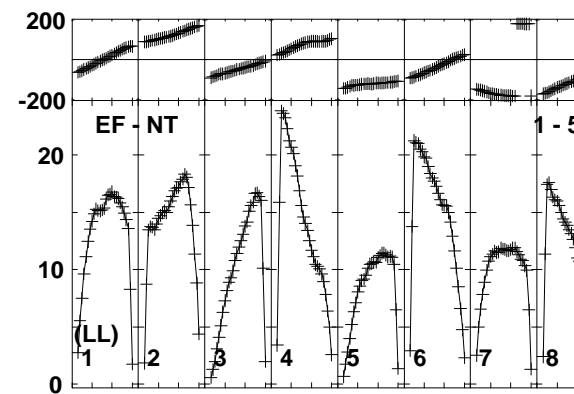
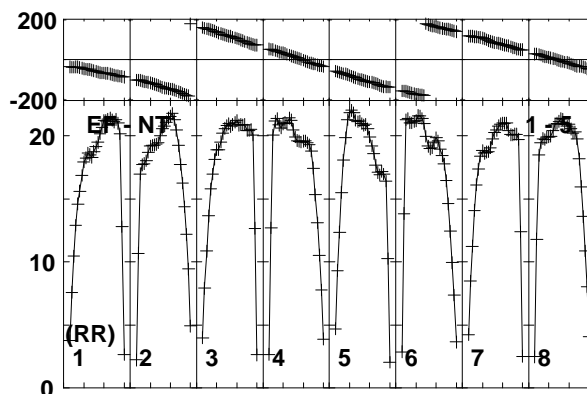
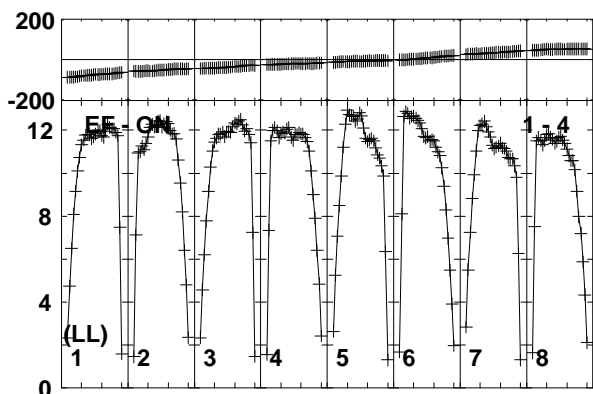
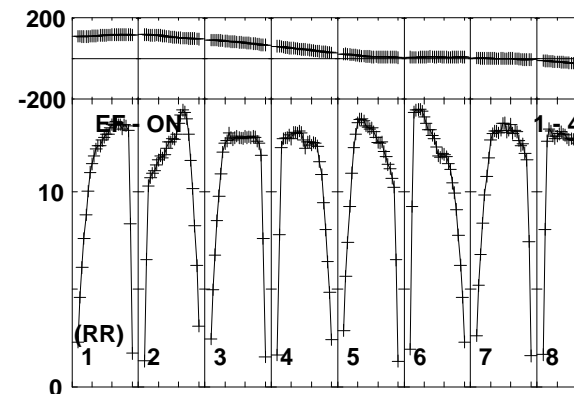
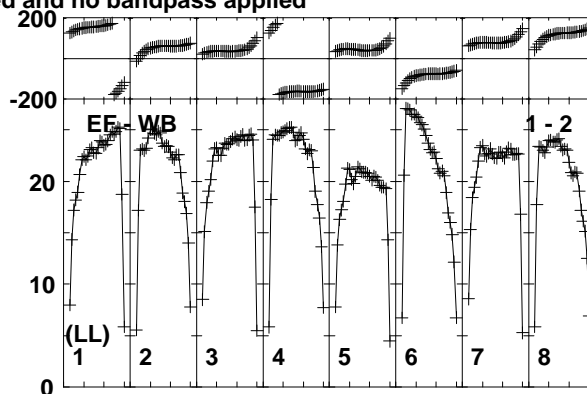
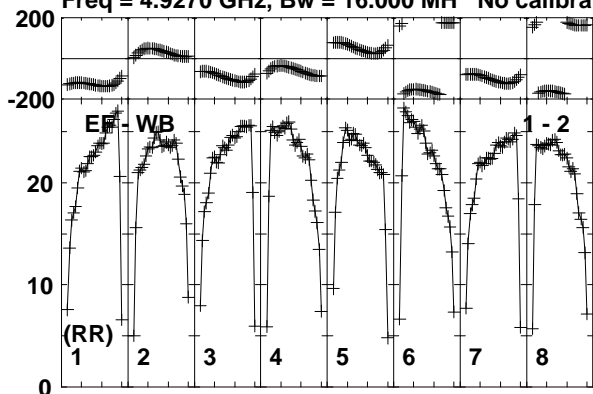

Lower frame: Milli Ampl Jy Top frame: Phas deg
Vector averaged cross-power spectrum Baseline: EF (01) - WB (02)
Timerange: 00/13:56:43 to 00/13:57:39

Plot file version 164 created 28-JAN-2015 14:38:11

1848+283 N14C3.UVDATA.1

Freq = 4.9270 GHz, Bw = 16.000 MH No calibration applied and no bandpass applied

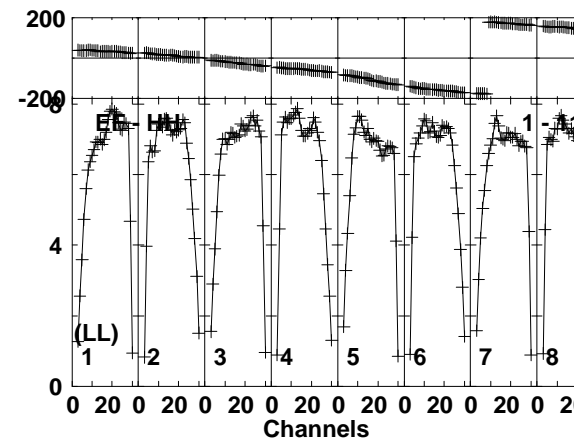
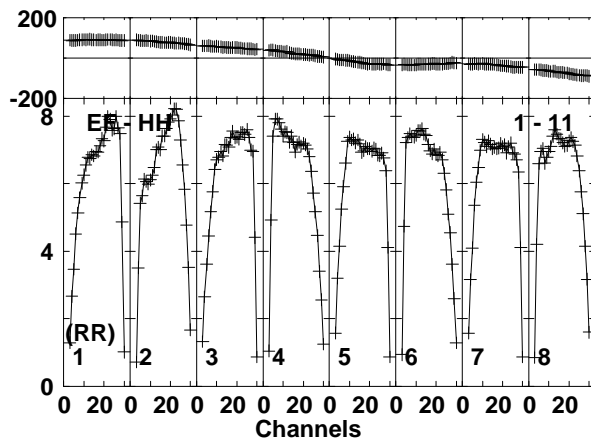
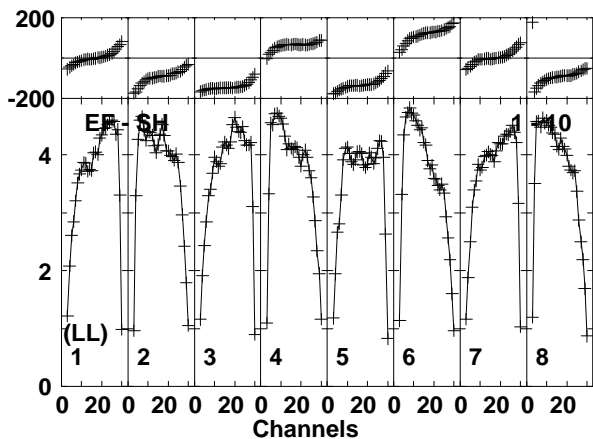
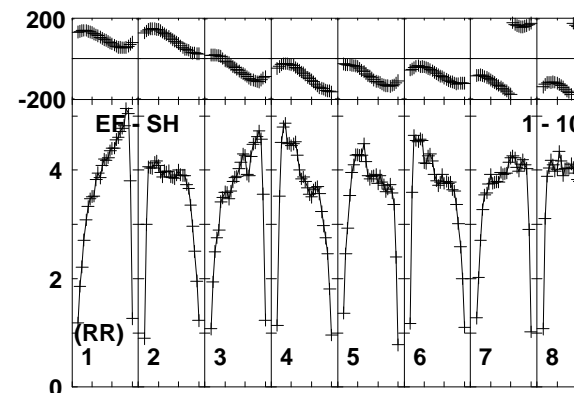
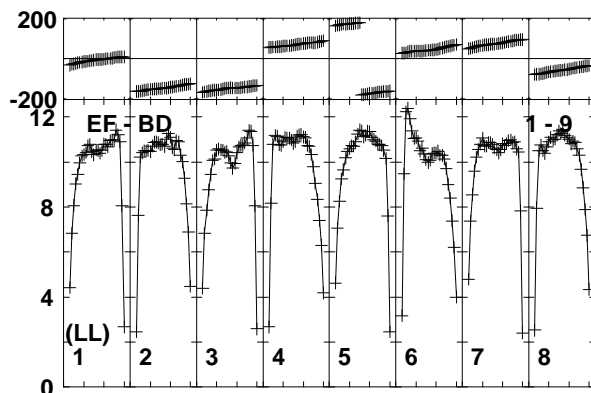
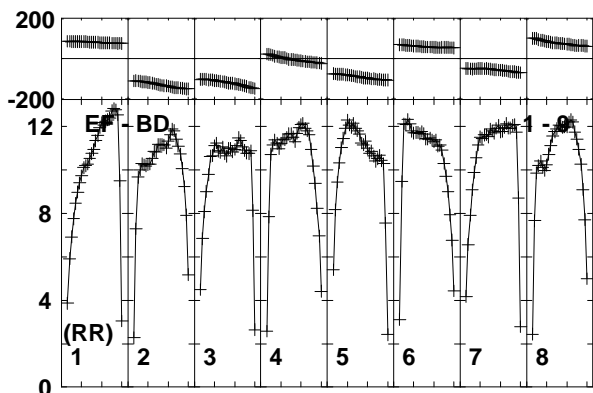
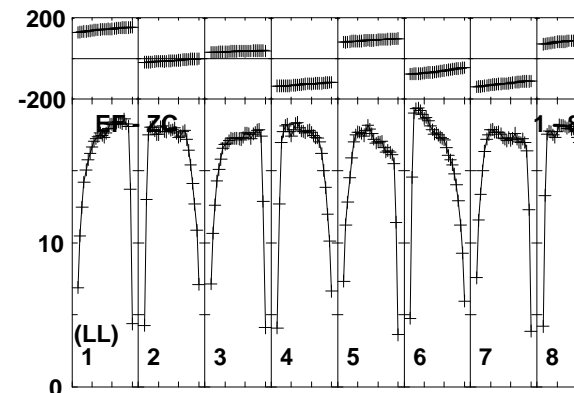
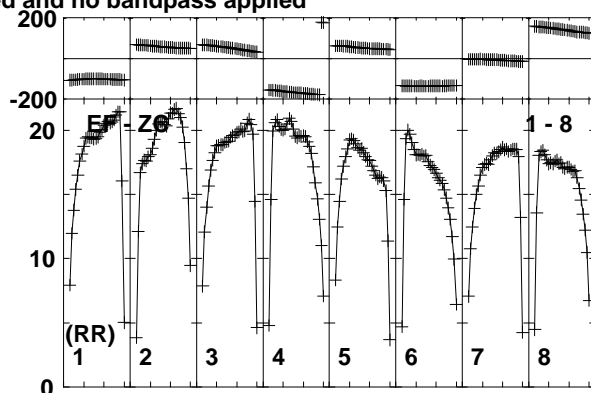
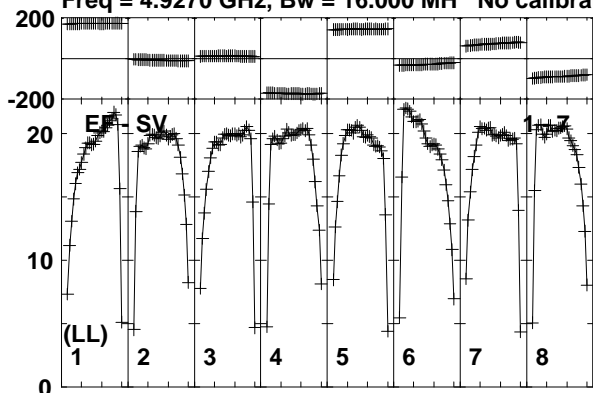

Lower frame: Milli Ampl Jy Top frame: Phas deg
Vector averaged cross-power spectrum Baseline: EF (01) - SV (07)
Timerange: 00/13:56:43 to 00/13:57:39

Plot file version 165 created 28-JAN-2015 14:38:11

1848+283 N14C3.UVDATA.1

Freq = 4.9270 GHz, Bw = 16.000 MH No calibration applied and no bandpass applied

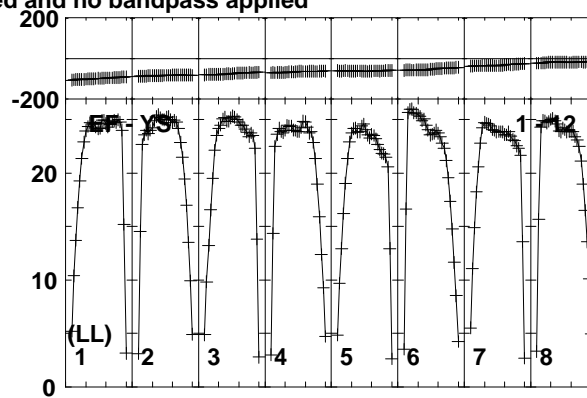
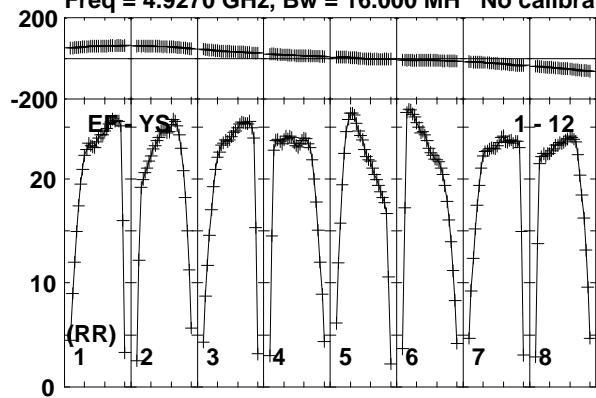

Lower frame: Milli Ampl Jy Top frame: Phas deg
Vector averaged cross-power spectrum Baseline: EF (01) - YS (12)
Timerange: 00/13:56:43 to 00/13:57:39

Plot file version 166 created 28-JAN-2015 14:38:11

J1849+3024 N14C3.UVDATA.1

Freq = 4.9270 GHz, Bw = 16.000 MH No calibration applied and no bandpass applied

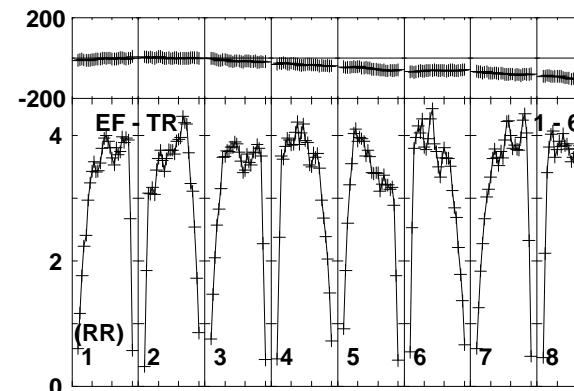
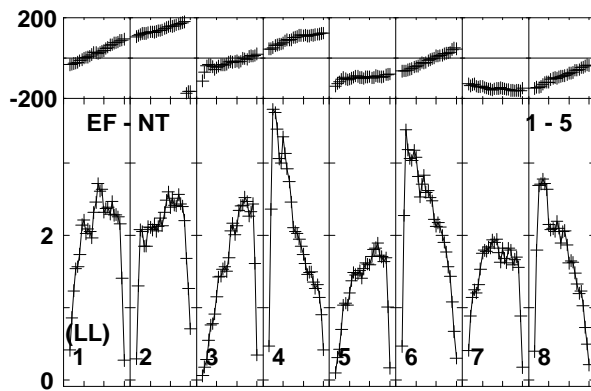
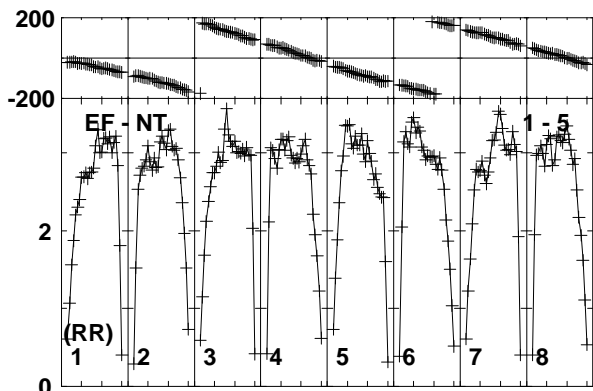
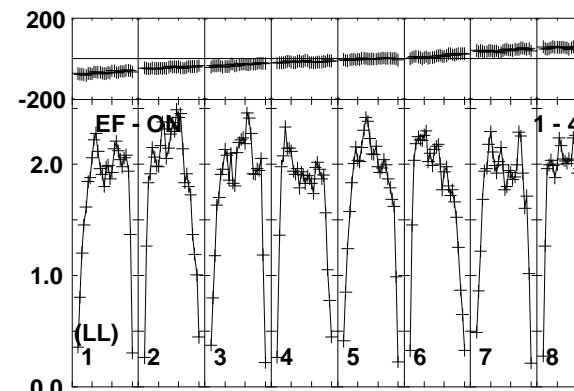
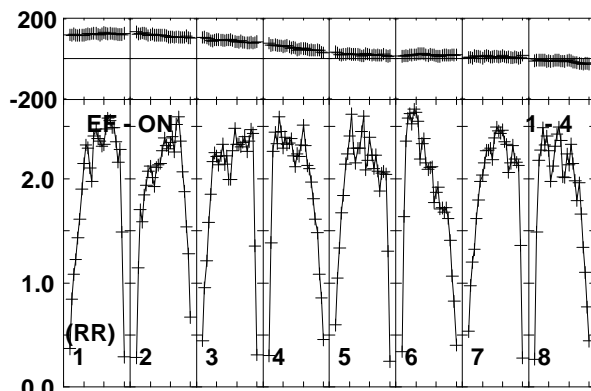
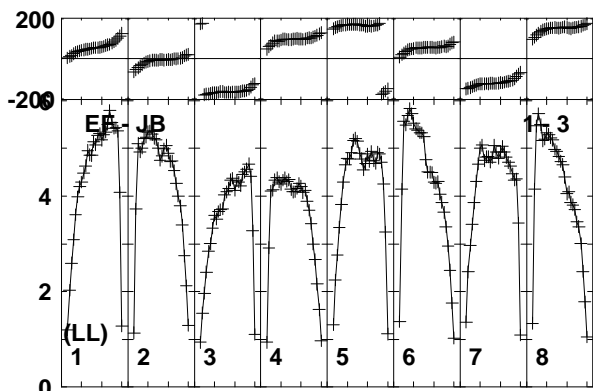
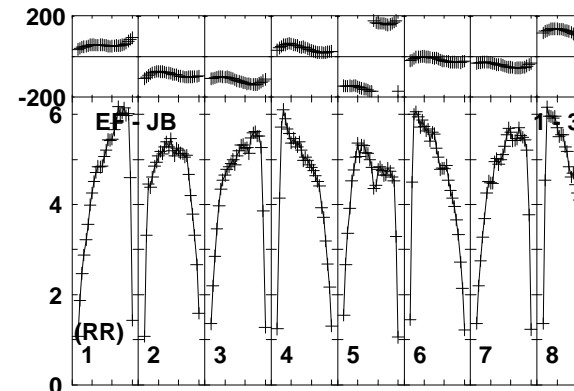
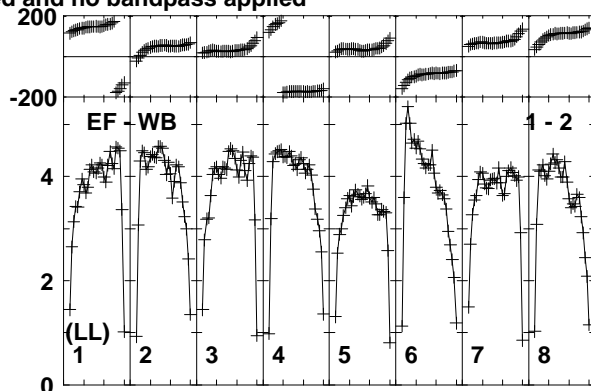
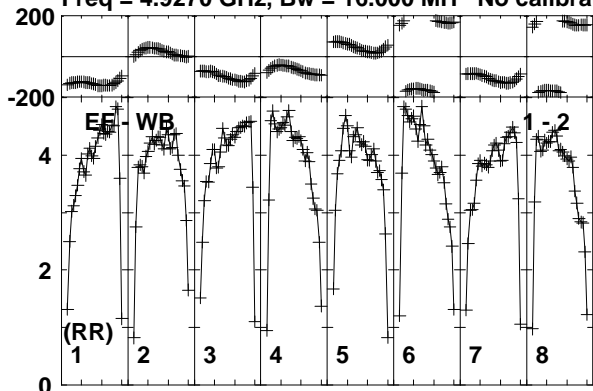

Lower frame: Milli Ampl Jy Top frame: Phas deg
Vector averaged cross-power spectrum Baseline: EF (01) - WB (02)
Timerange: 00:13:58:23 to 00:13:59:19

Plot file version 167 created 28-JAN-2015 14:38:11

J1849+3024 N14C3.UVDATA.1

Freq = 4.9270 GHz, Bw = 16.000 MH No calibration applied and no bandpass applied

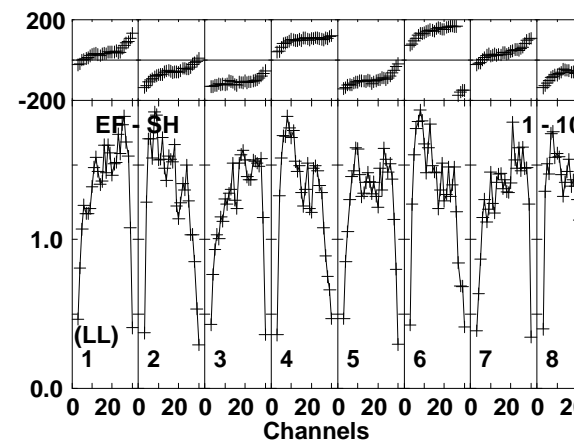
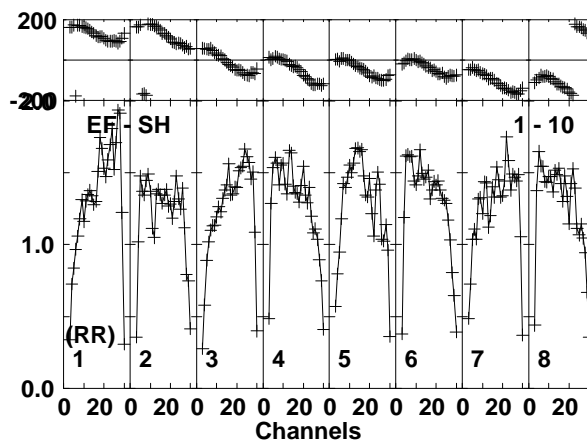
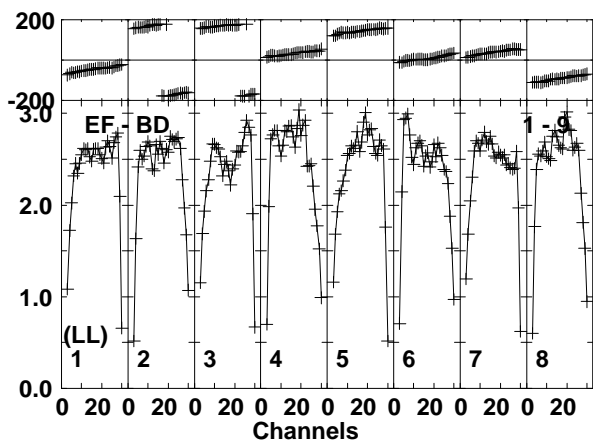
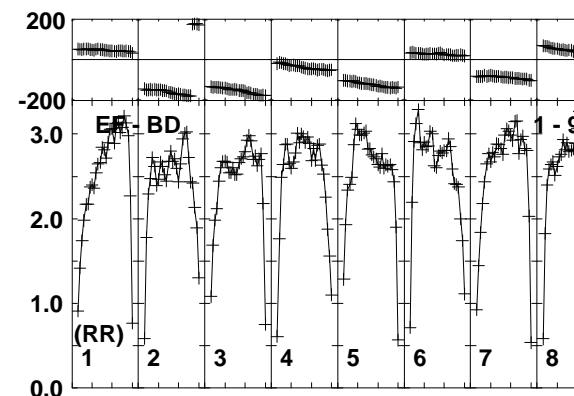
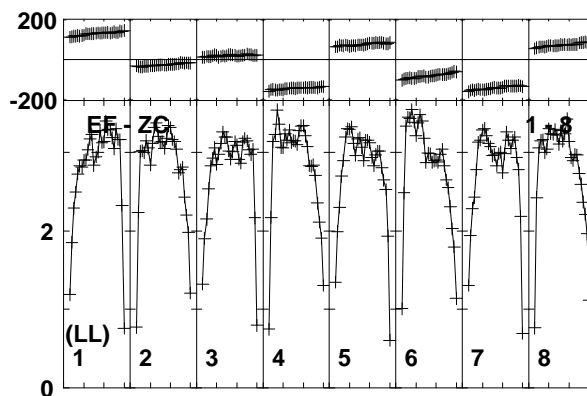
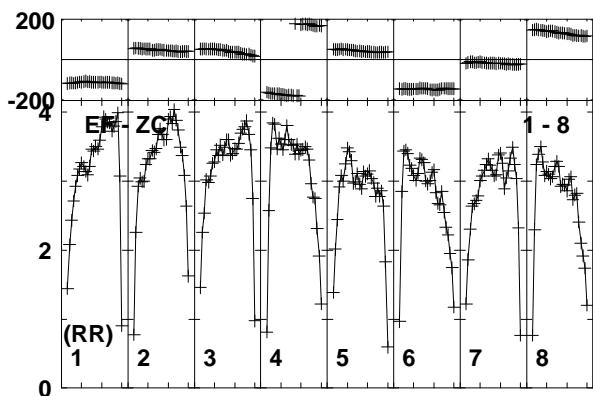
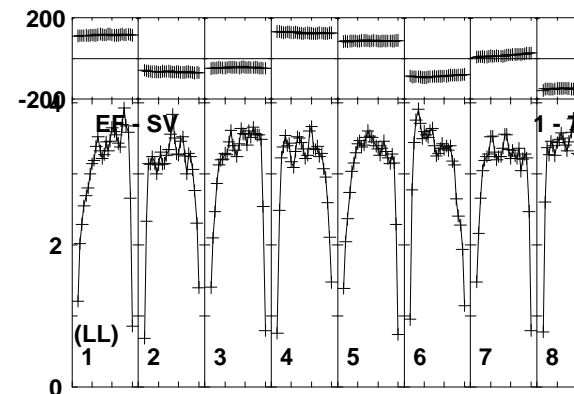
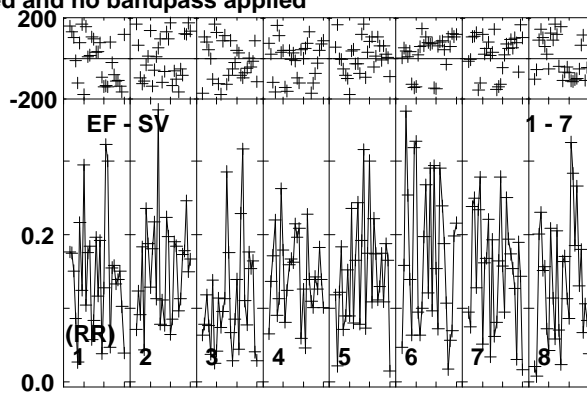
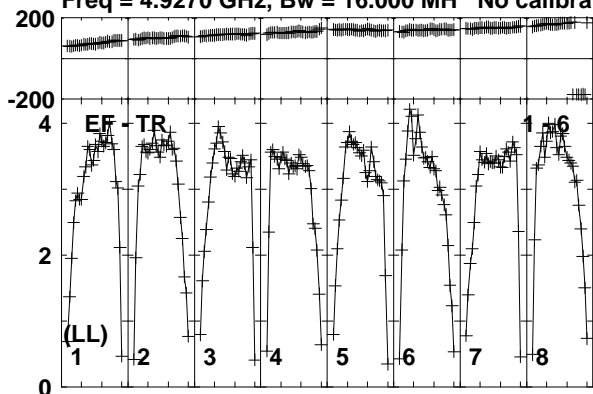

Lower frame: Milli Ampl Jy Top frame: Phas deg
Vector averaged cross-power spectrum Baseline: EF (01) - TR (06)
Timerange: 00:13:58:23 to 00:13:59:19

Plot file version 168 created 28-JAN-2015 14:38:11

J1849+3024 N14C3.UVDATA.1

Freq = 4.9270 GHz, Bw = 16.000 MH No calibration applied and no bandpass applied

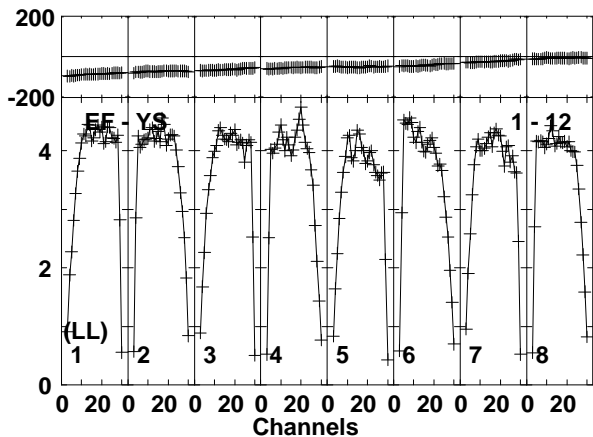
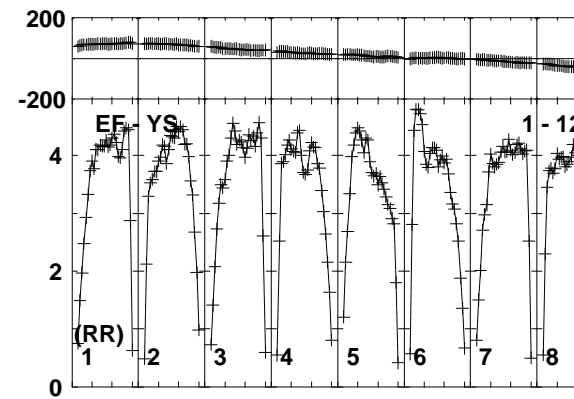
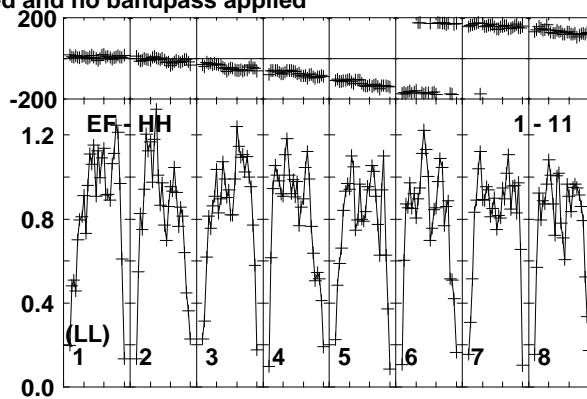
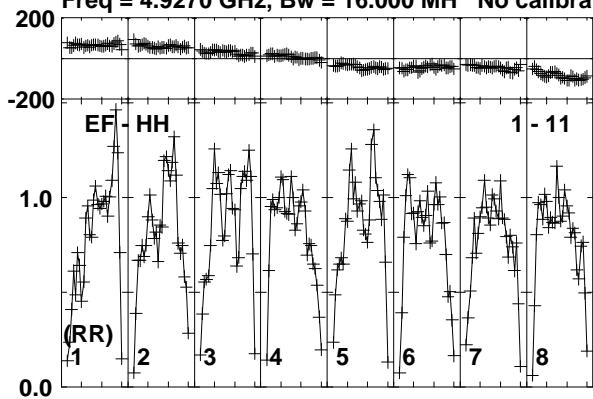

Lower frame: Milli Ampl Jy Top frame: Phas deg
Vector averaged cross-power spectrum Baseline: EF (01) - HH (11)
Timerange: 00/13:58:23 to 00/13:59:19

Plot file version 169 created 28-JAN-2015 14:38:11

1848+283 N14C3.UVDATA.1

Freq = 4.9270 GHz, Bw = 16.000 MH No calibration applied and no bandpass applied

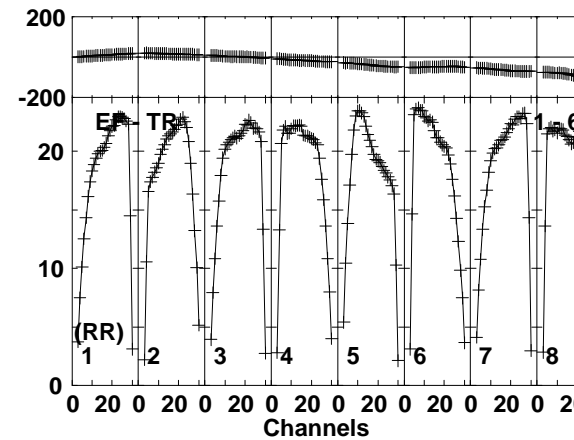
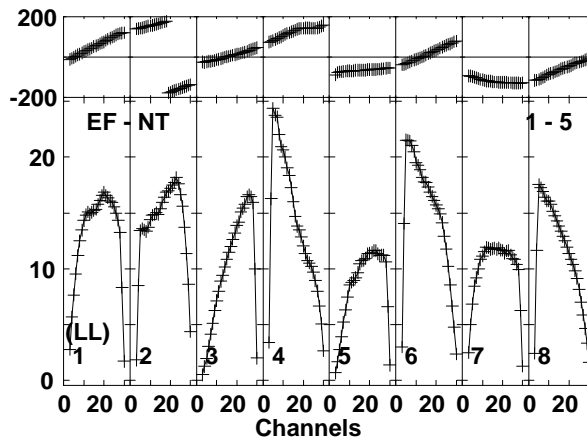
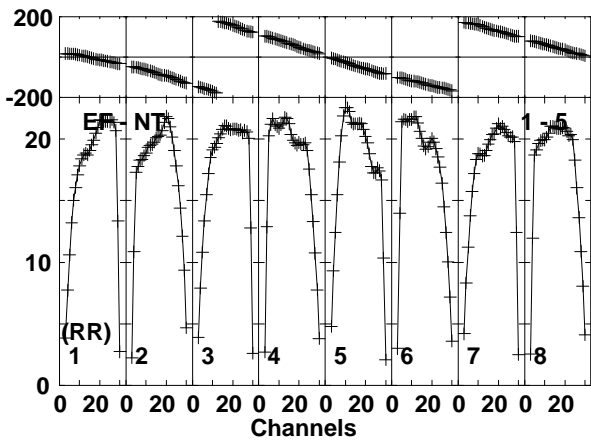
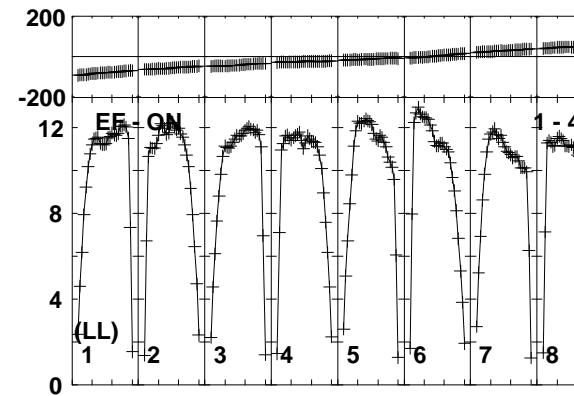
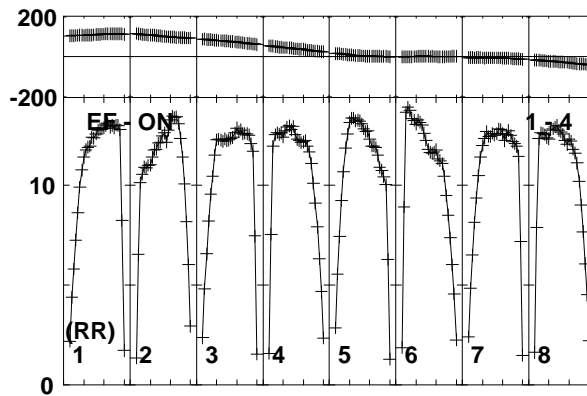
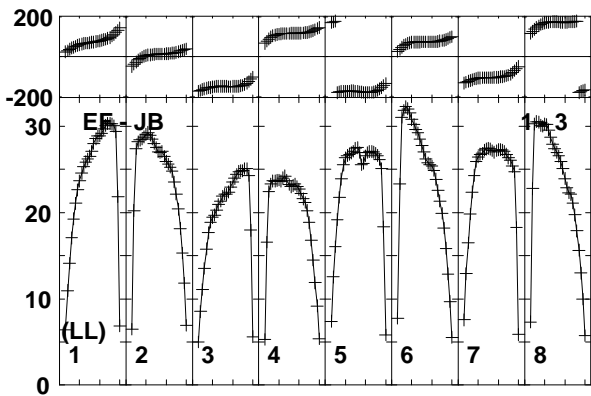
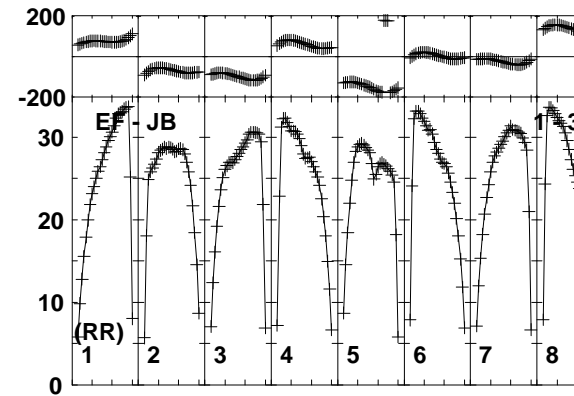
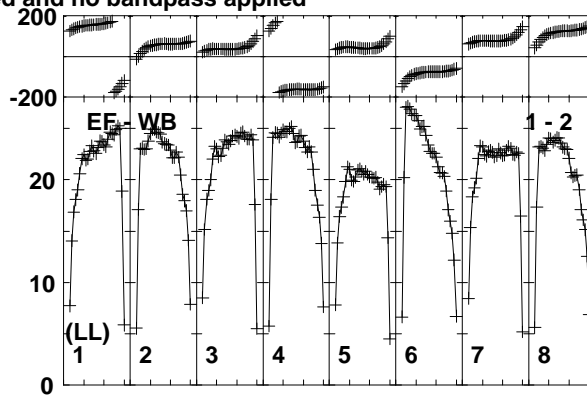
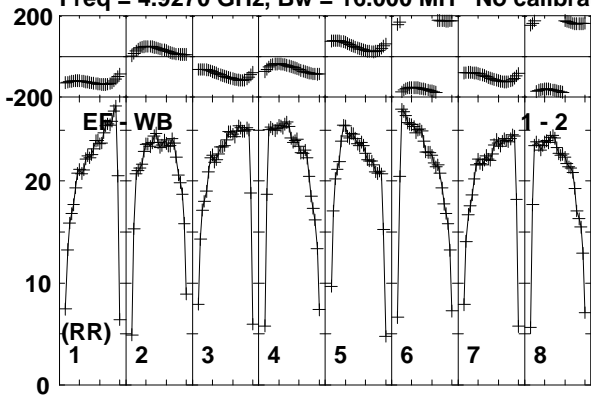

Lower frame: Milli Ampl Jy Top frame: Phas deg
Vector averaged cross-power spectrum Baseline: EF (01) - WB (02)
Timerange: 00/14:00:03 to 00/14:00:59

Plot file version 170 created 28-JAN-2015 14:38:11

1848+283 N14C3.UVDATA.1

Freq = 4.9270 GHz, Bw = 16.000 MH No calibration applied and no bandpass applied

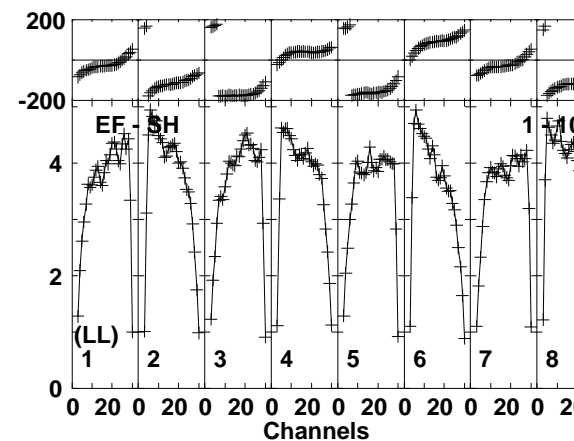
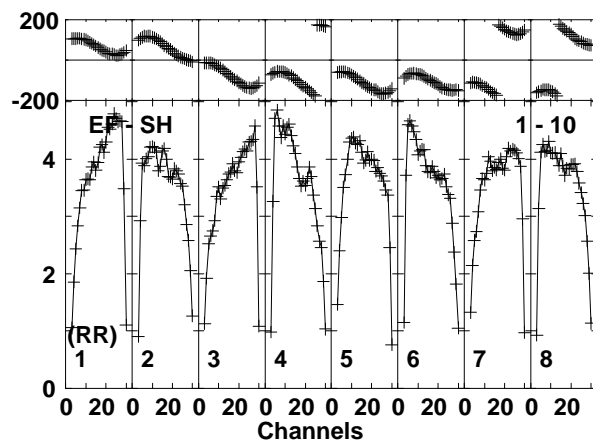
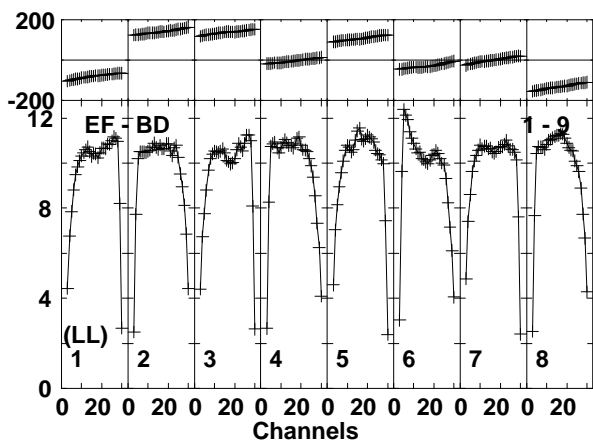
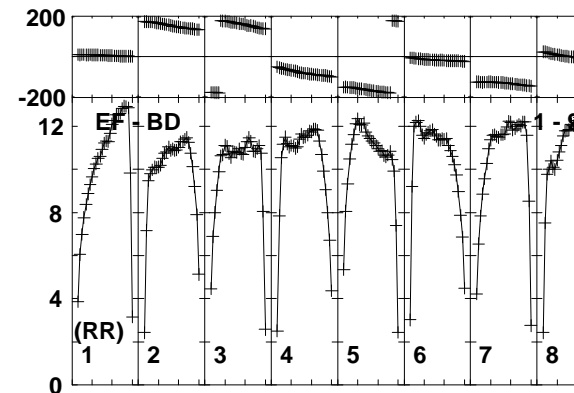
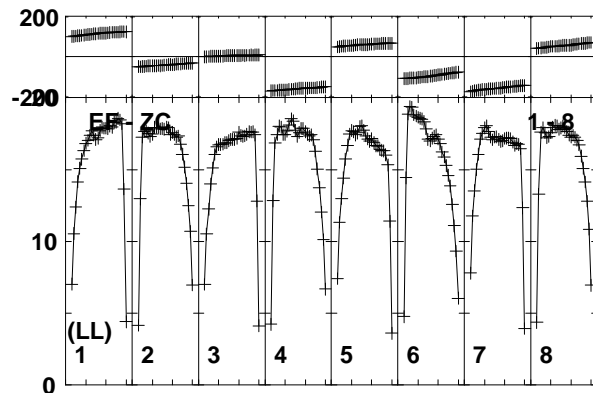
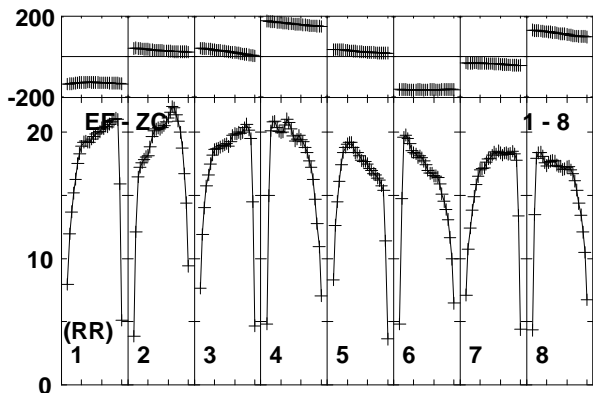
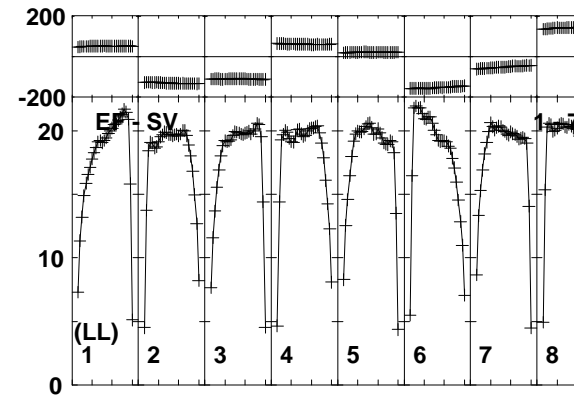
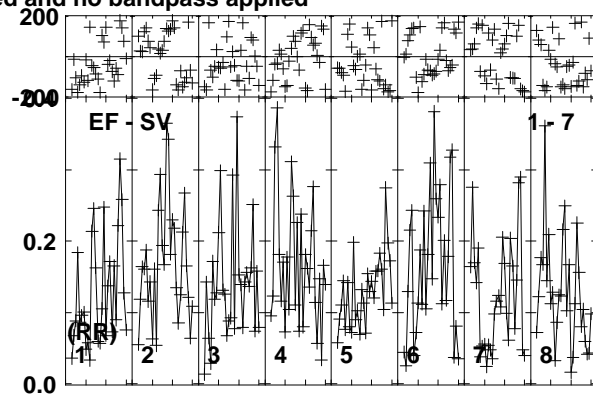
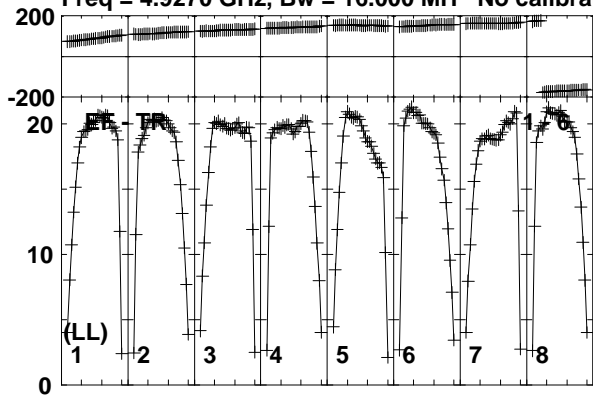

Lower frame: Milli Ampl Jy Top frame: Phas deg
Vector averaged cross-power spectrum Baseline: EF (01) - TR (06)
Timerange: 00/14:00:03 to 00/14:00:59

Plot file version 171 created 28-JAN-2015 14:38:11

1848+283 N14C3.UVDATA.1

Freq = 4.9270 GHz, Bw = 16.000 MH No calibration applied and no bandpass applied

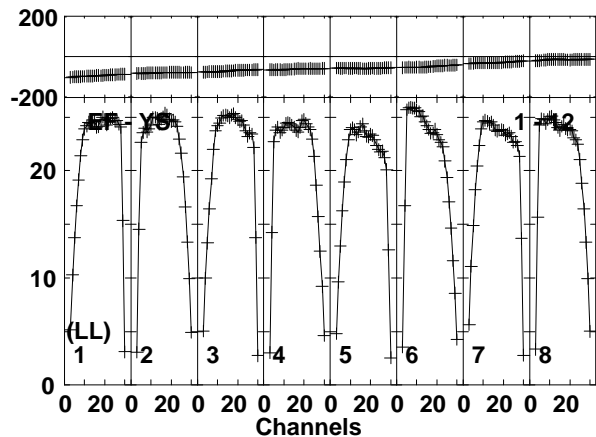
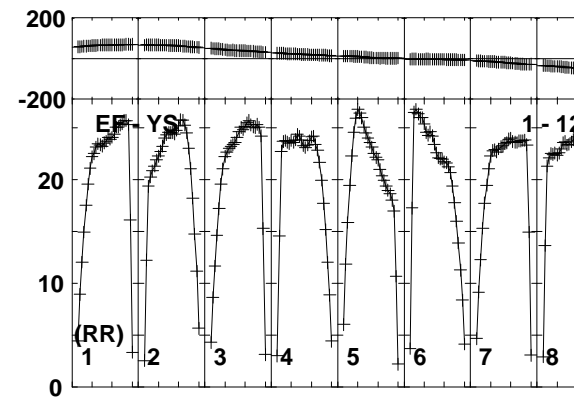
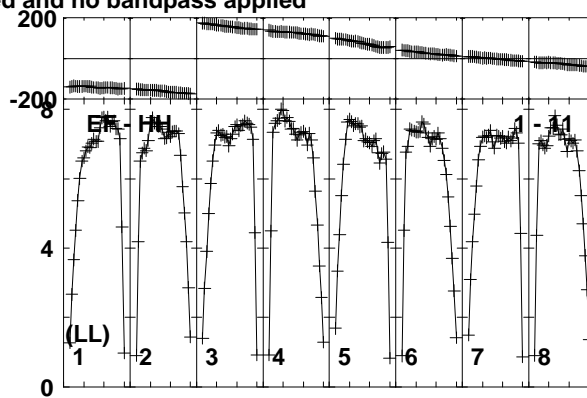
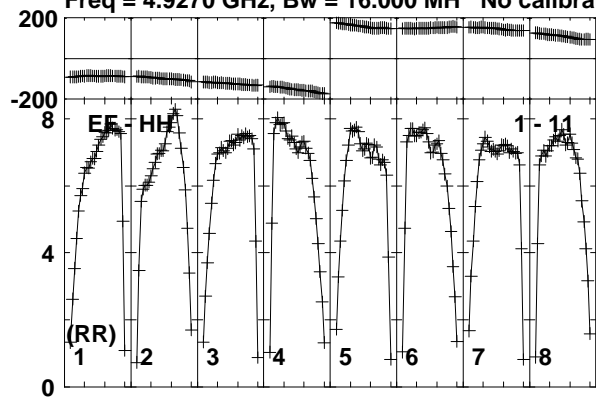

Lower frame: Milli Ampl Jy Top frame: Phas deg
Vector averaged cross-power spectrum Baseline: EF (01) - HH (11)
Timerange: 00/14:00:03 to 00/14:00:59

Plot file version 172 created 28-JAN-2015 14:38:11

J1849+3024 N14C3.UVDATA.1

Freq = 4.9270 GHz, Bw = 16.000 MH No calibration applied and no bandpass applied

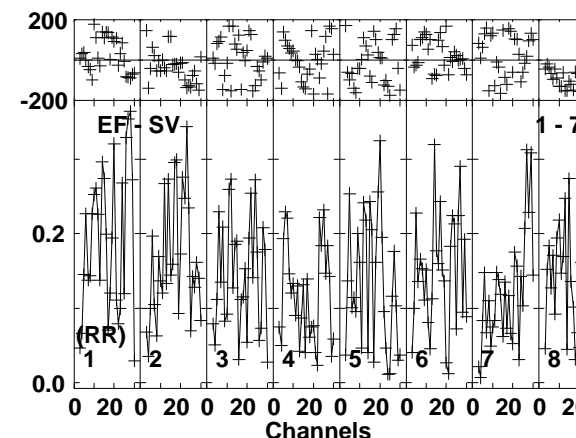
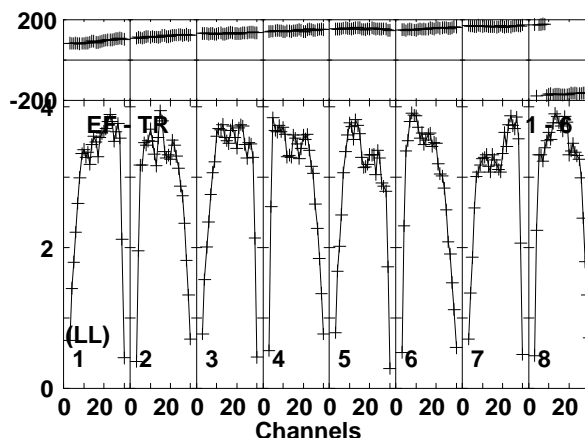
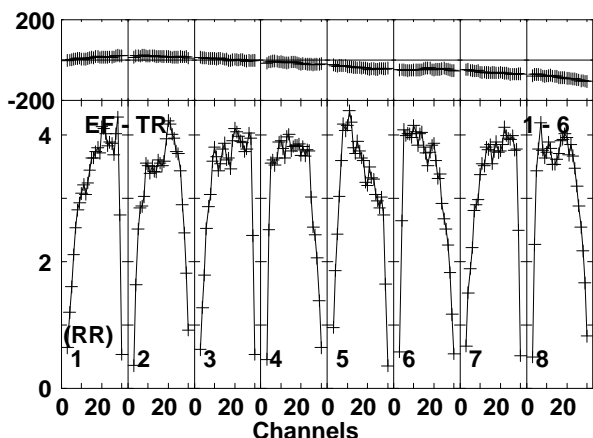
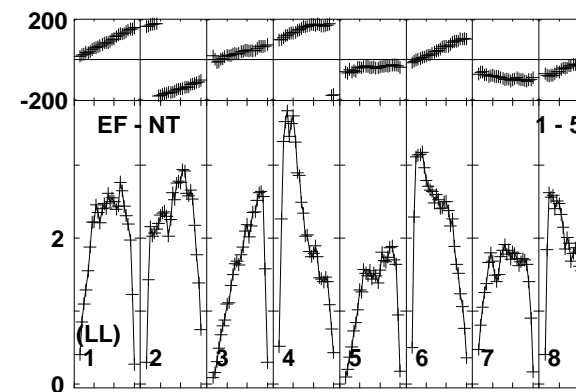
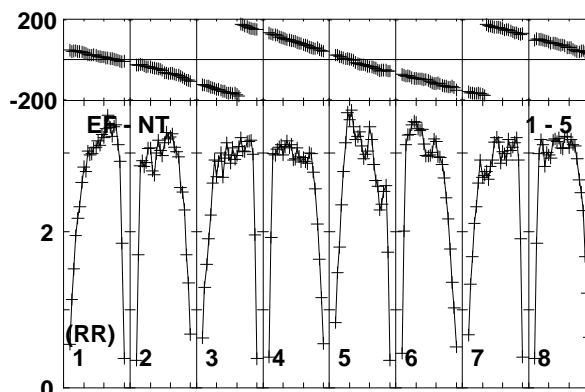
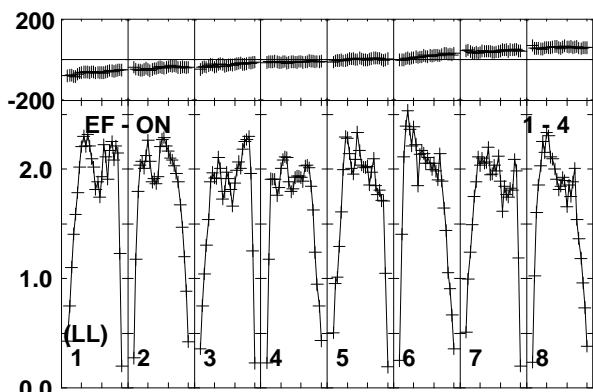
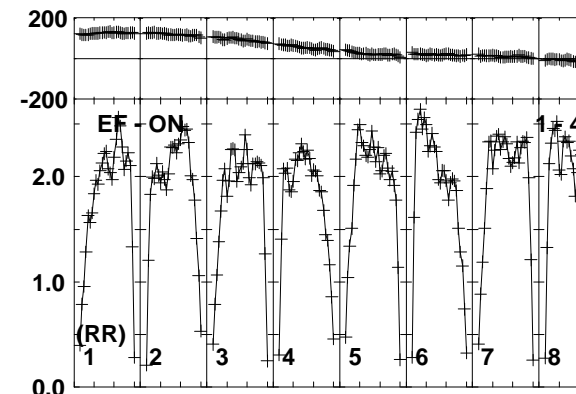
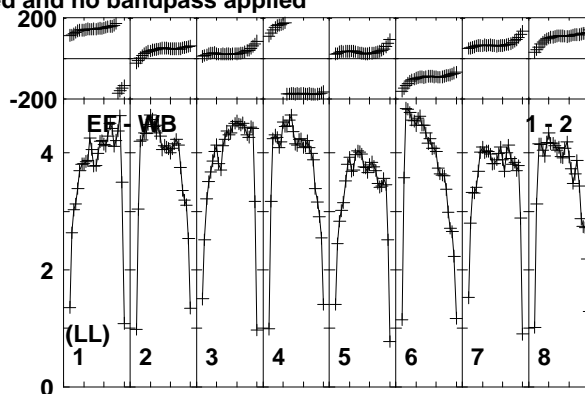
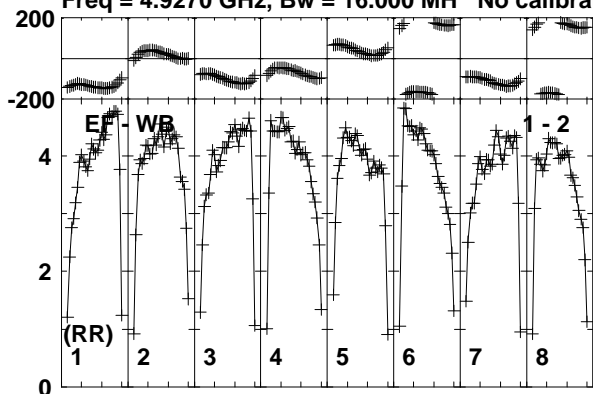

Lower frame: Milli Ampl Jy Top frame: Phas deg
Vector averaged cross-power spectrum Baseline: EF (01) - WB (02)
Timerange: 00/14:01:43 to 00/14:02:39

Plot file version 173 created 28-JAN-2015 14:38:11

J1849+3024 N14C3.UVDATA.1

Freq = 4.9270 GHz, Bw = 16.000 MH No calibration applied and no bandpass applied

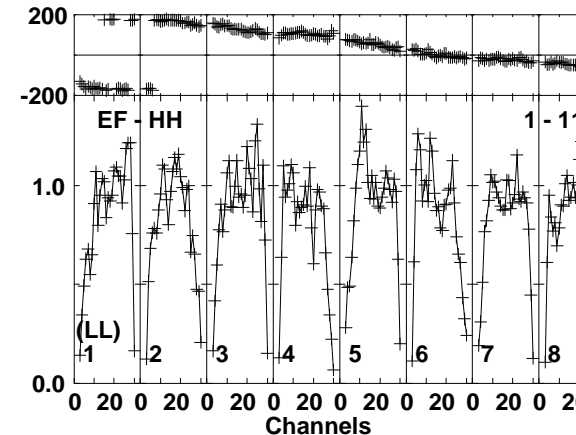
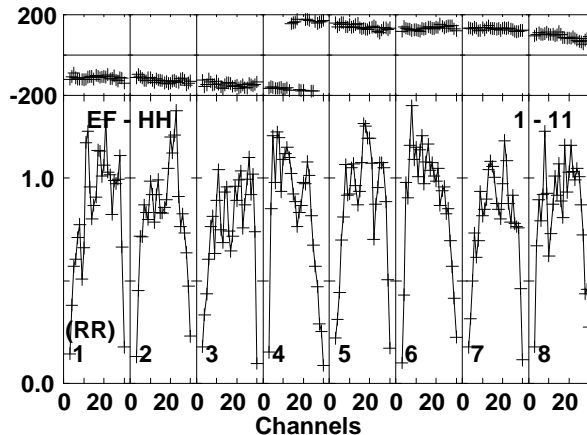
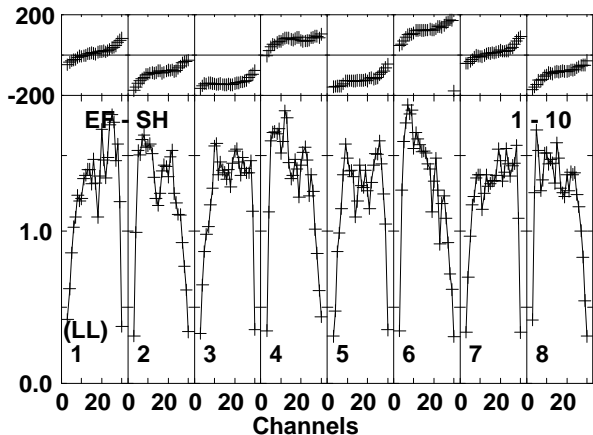
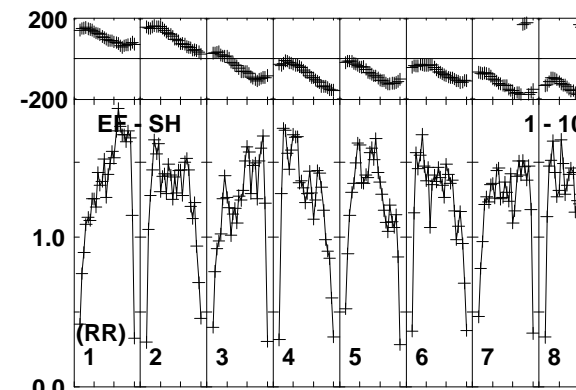
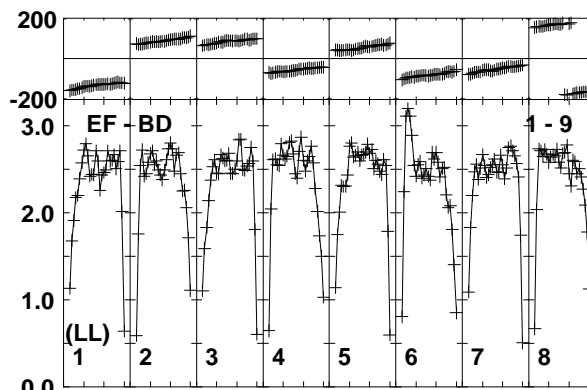
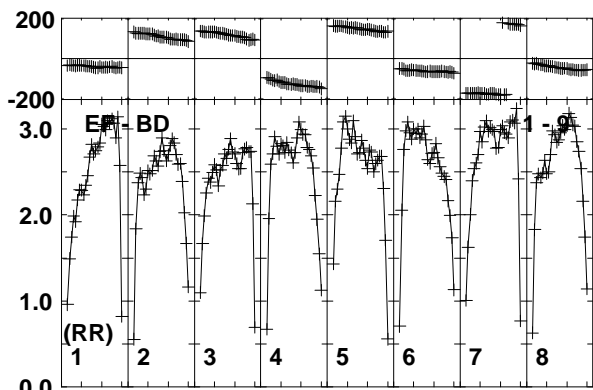
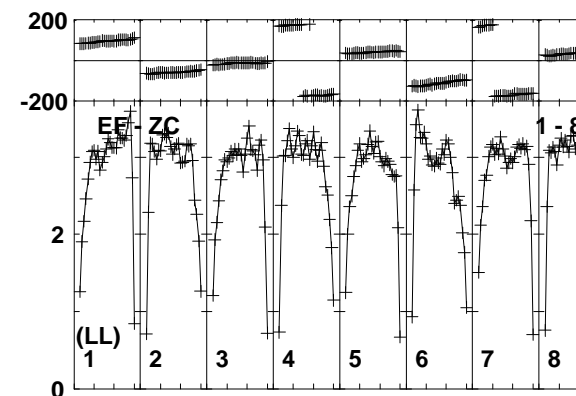
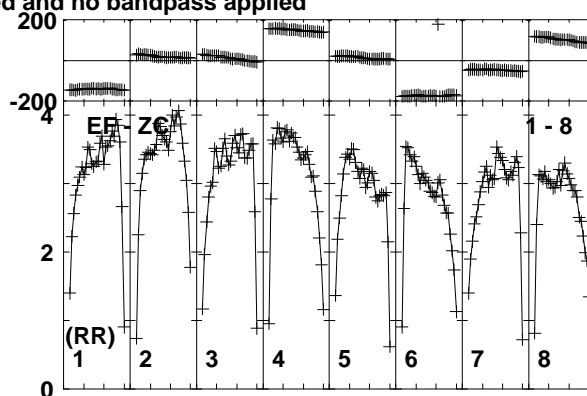
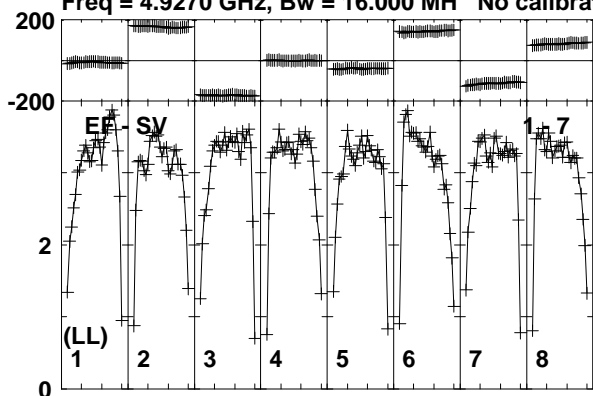

Lower frame: Milli Ampl Jy Top frame: Phas deg
Vector averaged cross-power spectrum Baseline: EF (01) - SV (07)
Timerange: 00/14:01:43 to 00/14:02:39

Plot file version 174 created 28-JAN-2015 14:38:11

J1849+3024 N14C3.UVDATA.1

Freq = 4.9270 GHz, Bw = 16.000 MH No calibration applied and no bandpass applied

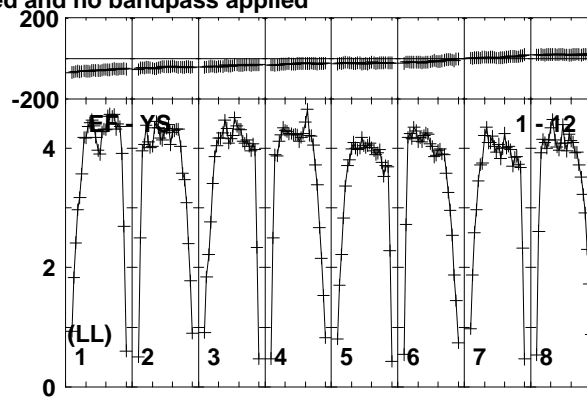
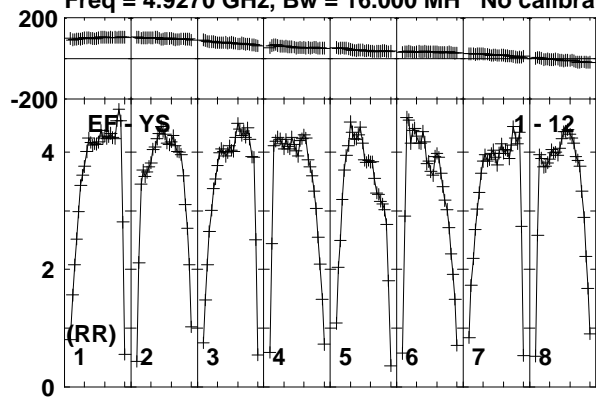

Lower frame: Milli Ampl Jy Top frame: Phas deg
Vector averaged cross-power spectrum Baseline: EF (01) - YS (12)
Timerange: 00/14:01:43 to 00/14:02:39

Plot file version 175 created 28-JAN-2015 14:38:11

1848+283 N14C3.UVDATA.1

Freq = 4.9270 GHz, Bw = 16.000 MH No calibration applied and no bandpass applied

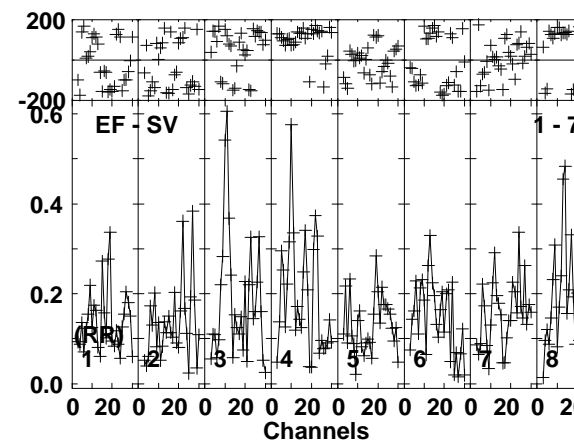
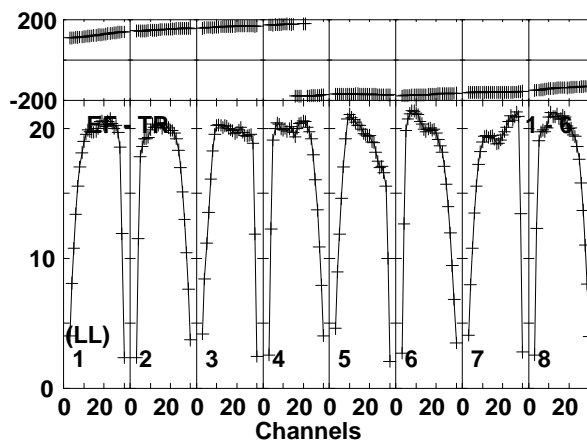
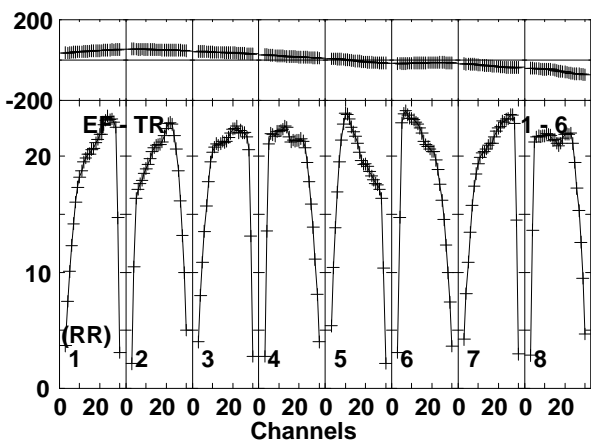
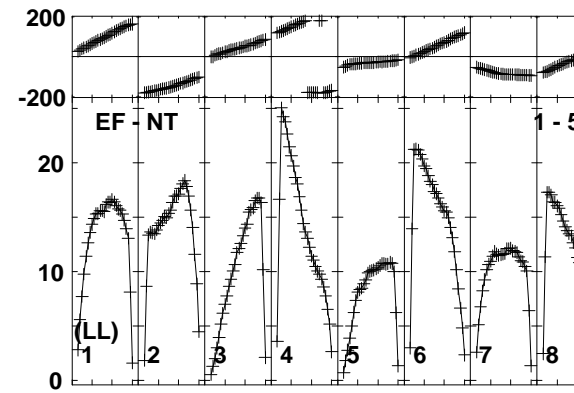
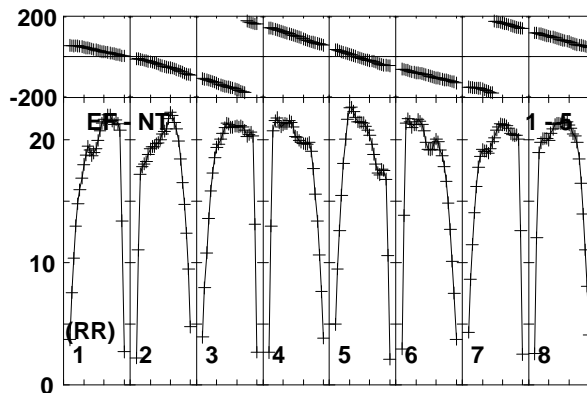
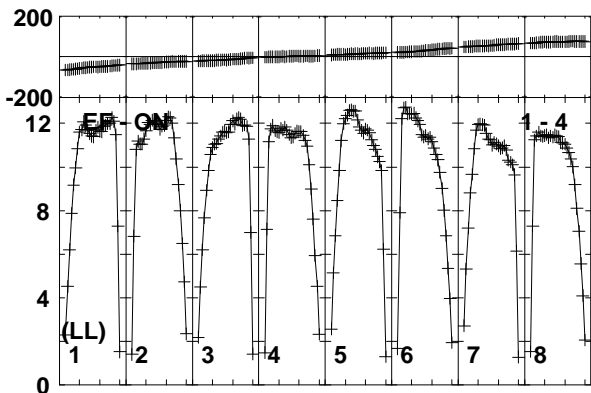
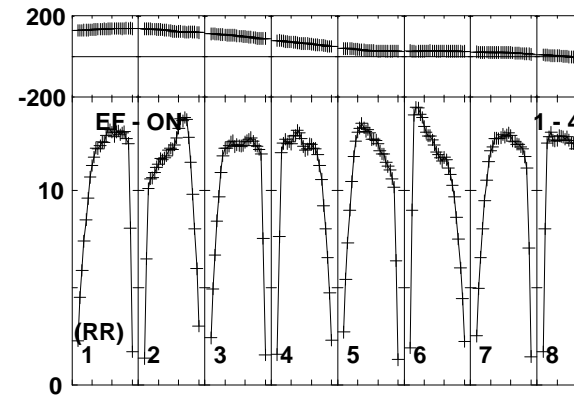
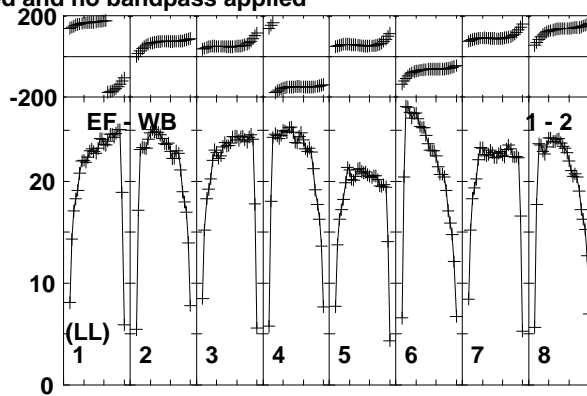
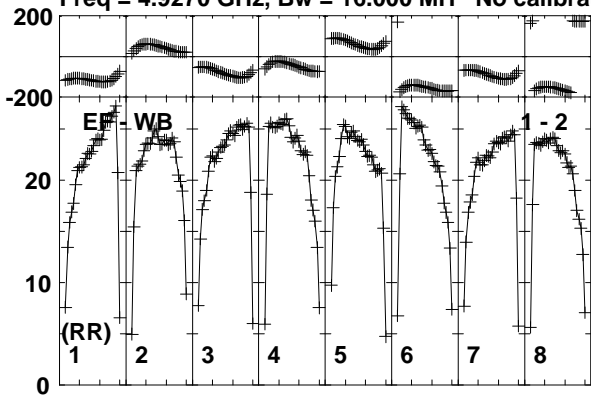

Lower frame: Milli Ampl Jy Top frame: Phas deg
Vector averaged cross-power spectrum Baseline: EF (01) - WB (02)
Timerange: 00/14:03:23 to 00/14:04:19

Plot file version 176 created 28-JAN-2015 14:38:11

1848+283 N14C3.UVDATA.1

Freq = 4.9270 GHz, Bw = 16.000 MH No calibration applied and no bandpass applied

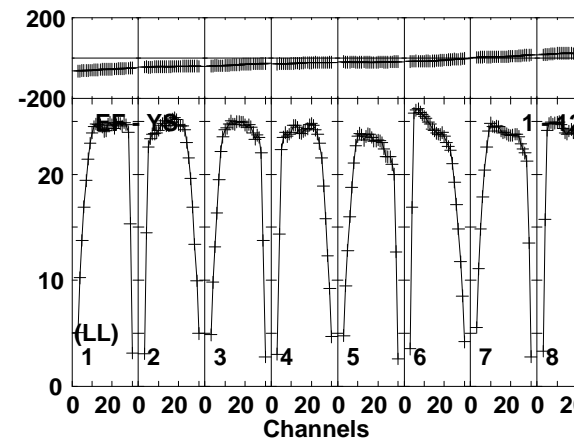
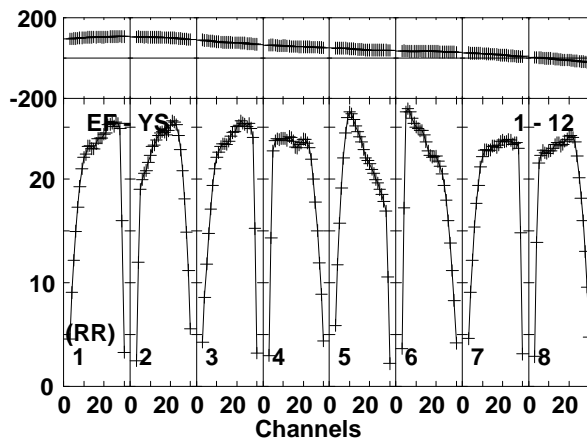
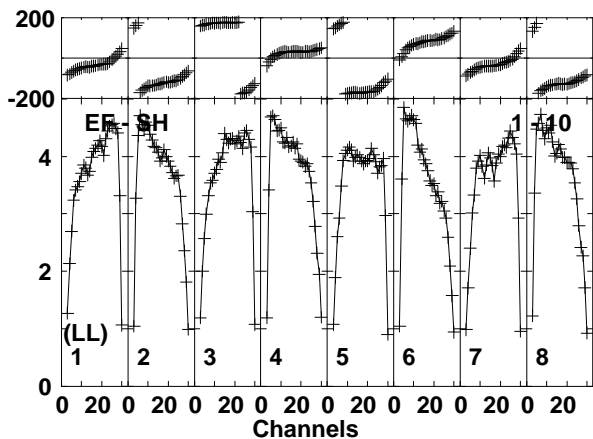
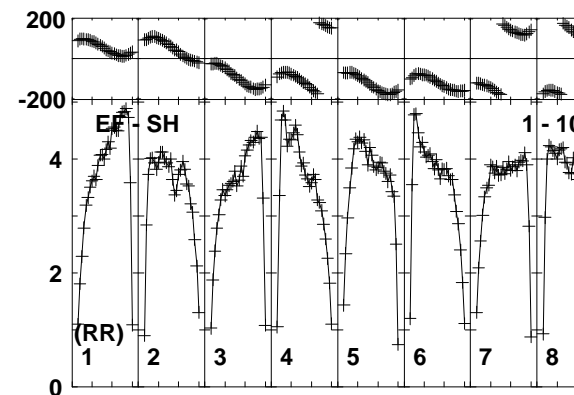
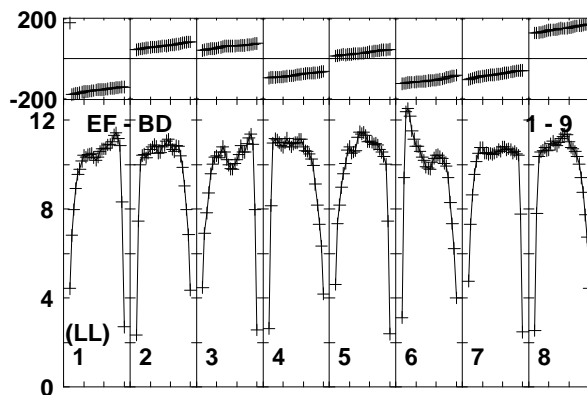
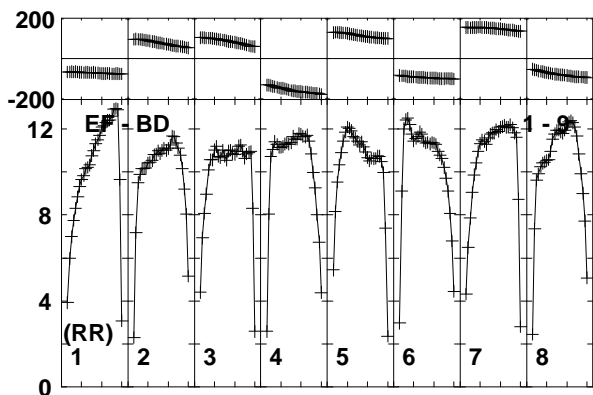
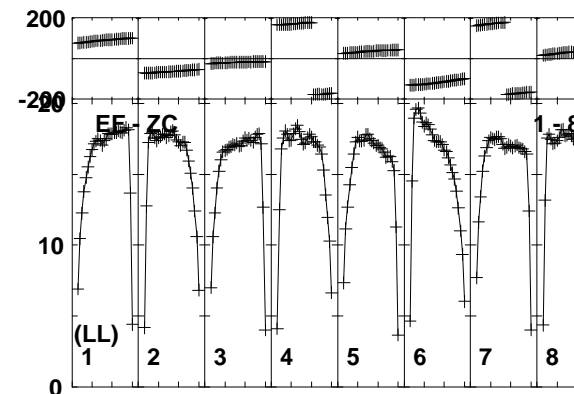
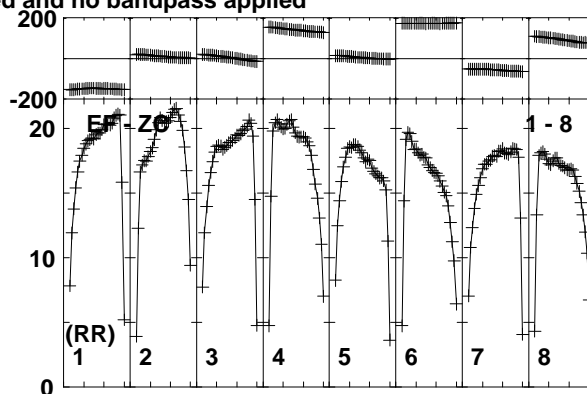
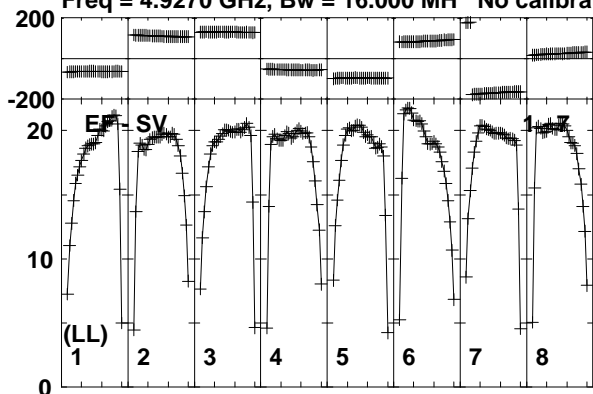

Lower frame: Milli Ampl Jy Top frame: Phas deg
Vector averaged cross-power spectrum Baseline: EF (01) - SV (07)
Timerange: 00/14:03:23 to 00/14:04:19

Plot file version 177 created 28-JAN-2015 14:38:11

J1849+3024 N14C3.UVDATA.1

Freq = 4.9270 GHz, Bw = 16.000 MH No calibration applied and no bandpass applied

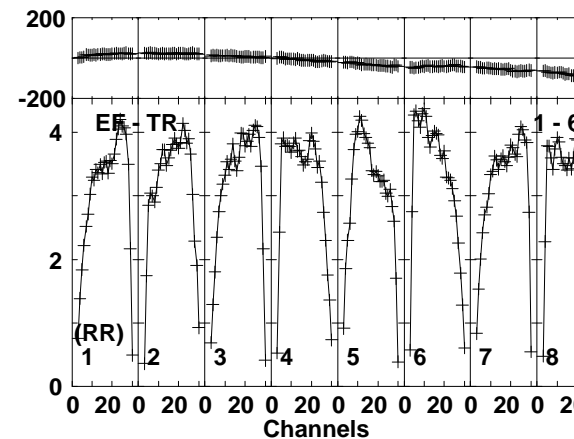
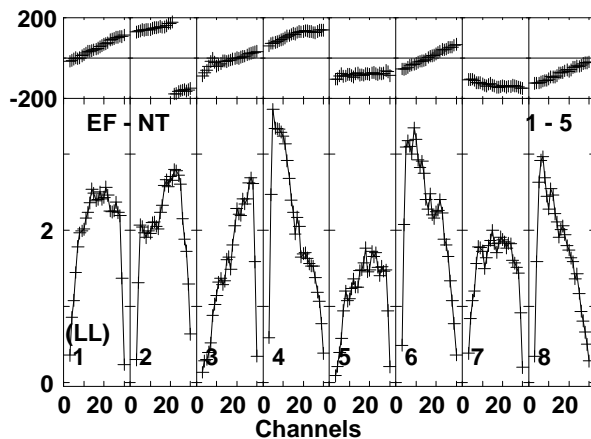
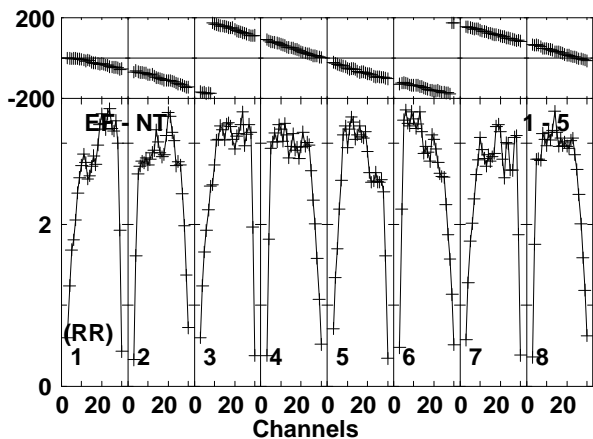
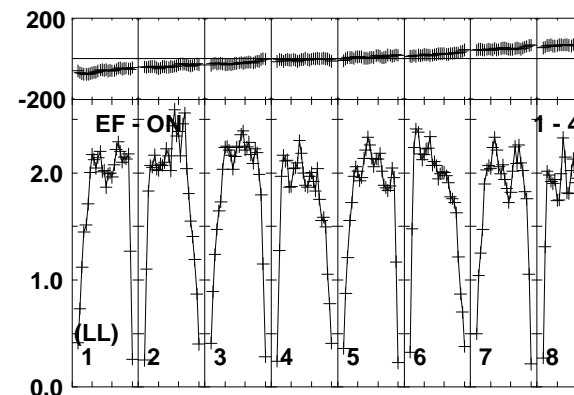
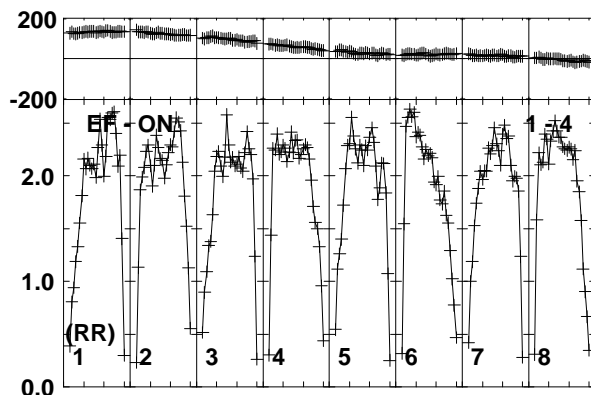
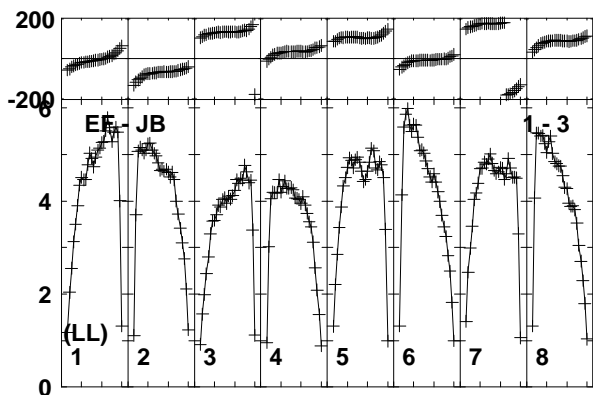
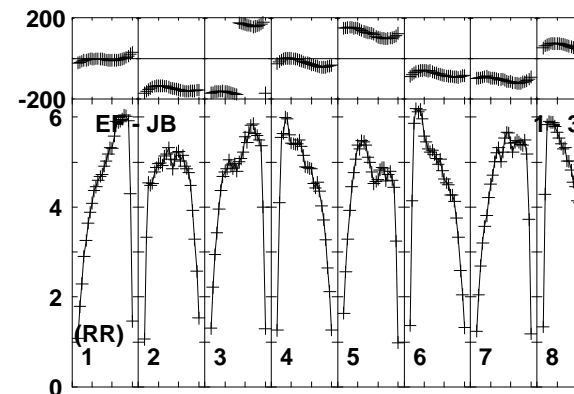
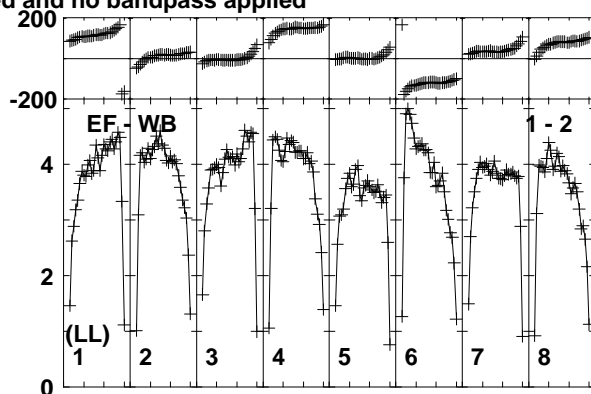
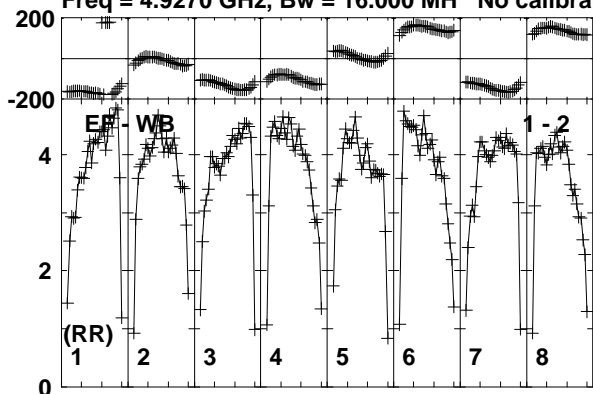

Lower frame: Milli Ampl Jy Top frame: Phas deg
Vector averaged cross-power spectrum Baseline: EF (01) - WB (02)
Timerange: 00/14:05:03 to 00/14:05:59

Plot file version 178 created 28-JAN-2015 14:38:11

J1849+3024 N14C3.UVDATA.1

Freq = 4.9270 GHz, Bw = 16.000 MH No calibration applied and no bandpass applied

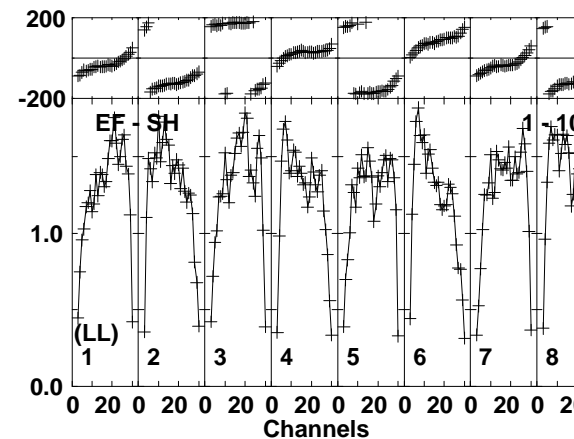
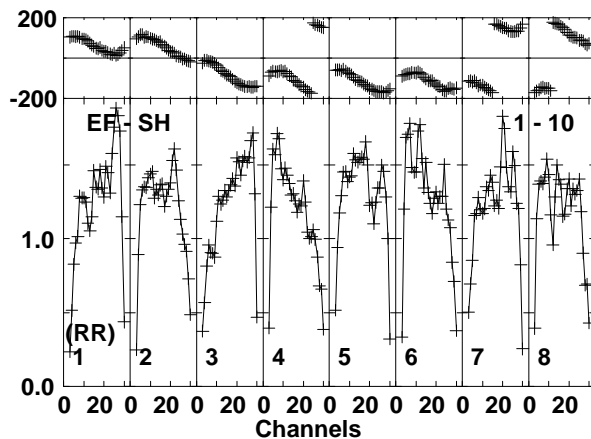
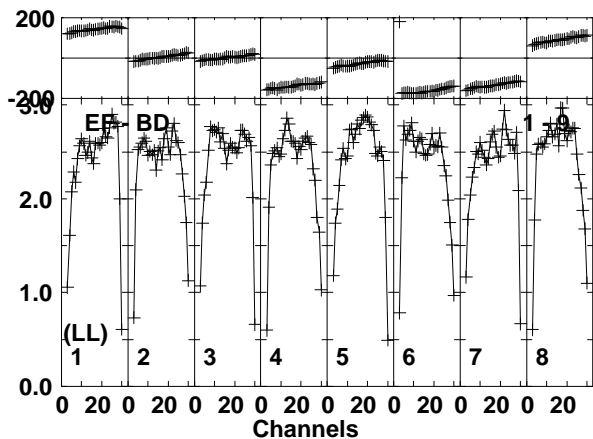
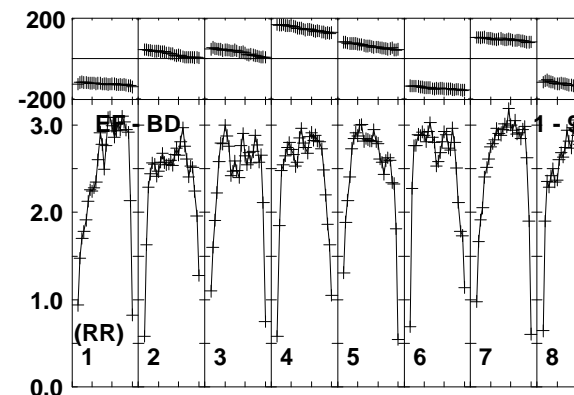
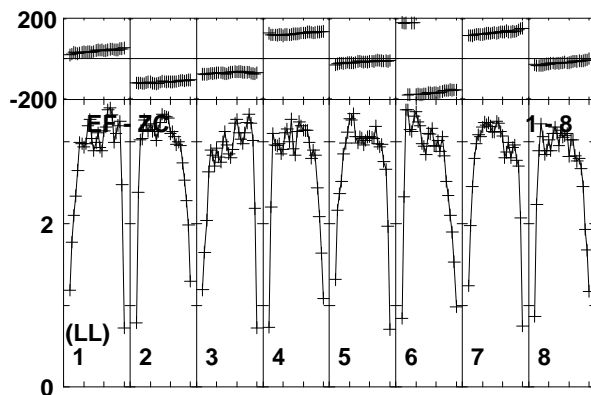
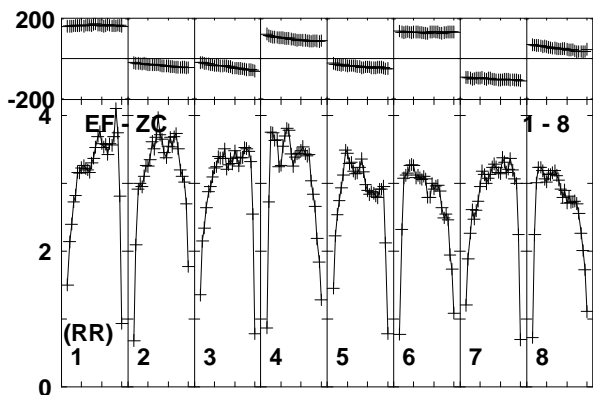
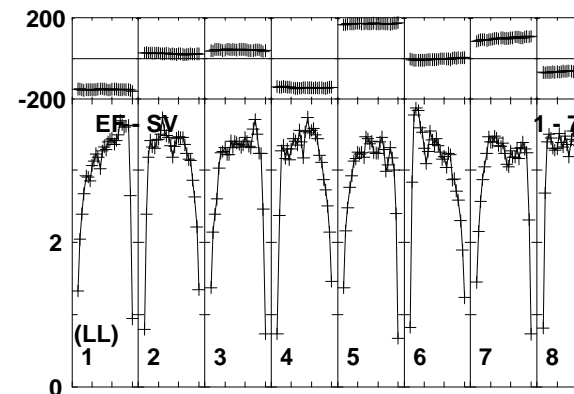
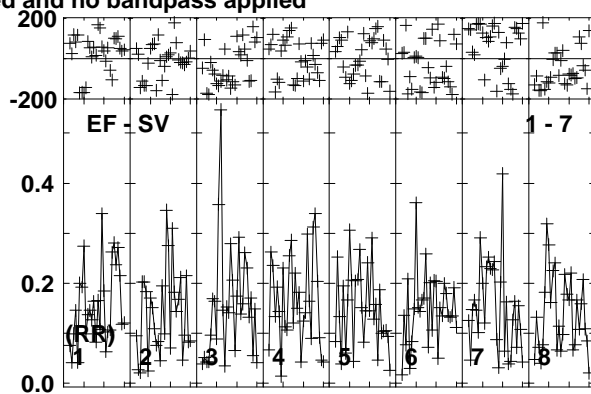
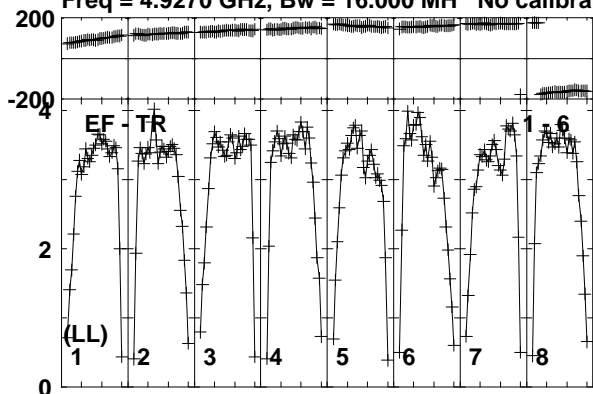

Lower frame: Milli Ampl Jy Top frame: Phas deg
Vector averaged cross-power spectrum Baseline: EF (01) - TR (06)
Timerange: 00/14:05:03 to 00/14:05:59

Plot file version 179 created 28-JAN-2015 14:38:12

J1849+3024 N14C3.UVDATA.1

Freq = 4.9270 GHz, Bw = 16.000 MH No calibration applied and no bandpass applied

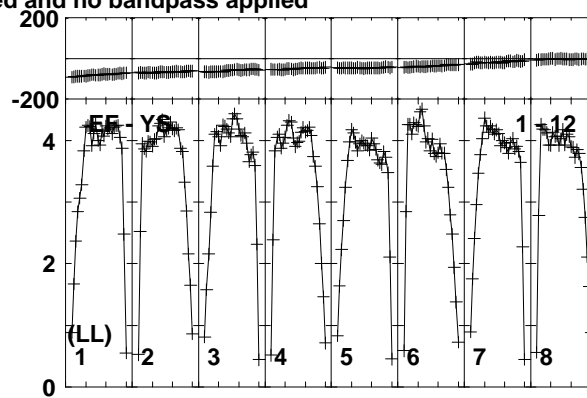
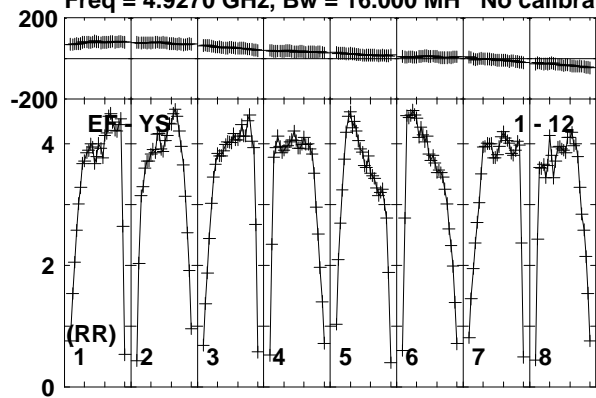

Lower frame: Milli Ampl Jy Top frame: Phas deg
Vector averaged cross-power spectrum Baseline: EF (01) - YS (12)
Timerange: 00/14:05:03 to 00/14:05:59

Plot file version 180 created 28-JAN-2015 14:38:12

1848+283 N14C3.UVDATA.1

Freq = 4.9270 GHz, Bw = 16.000 MH No calibration applied and no bandpass applied

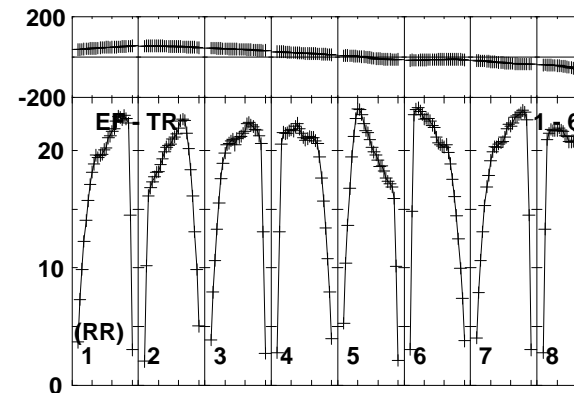
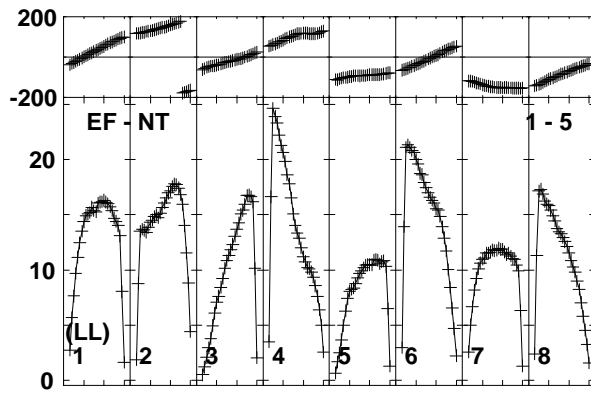
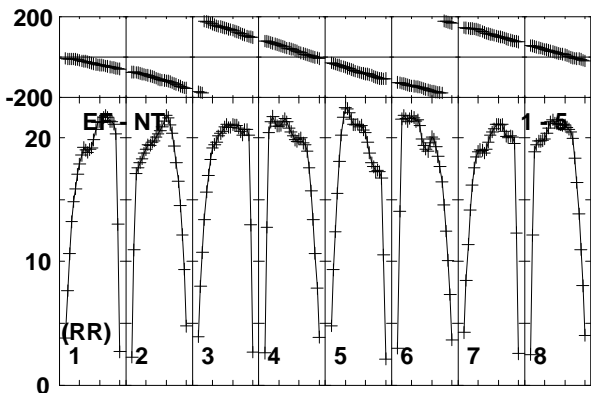
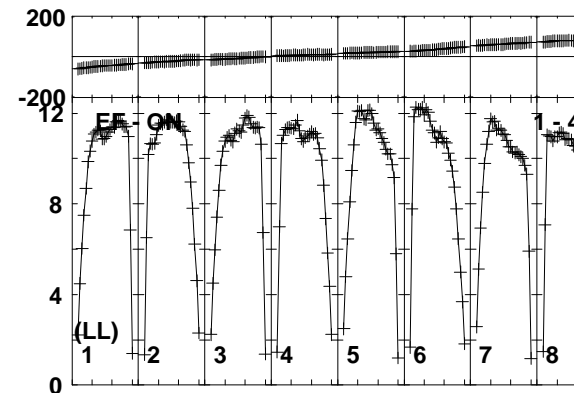
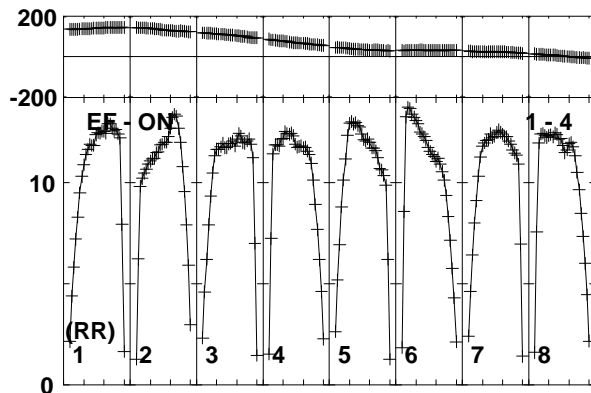
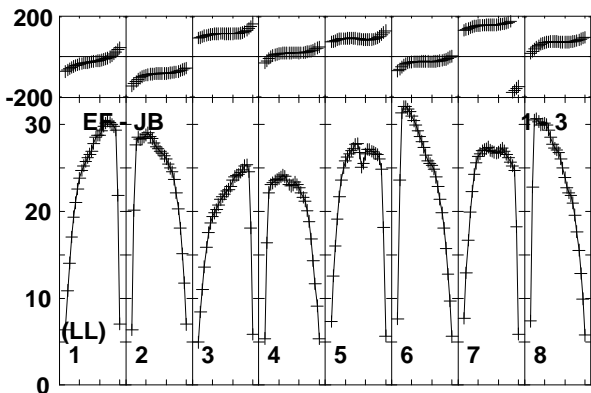
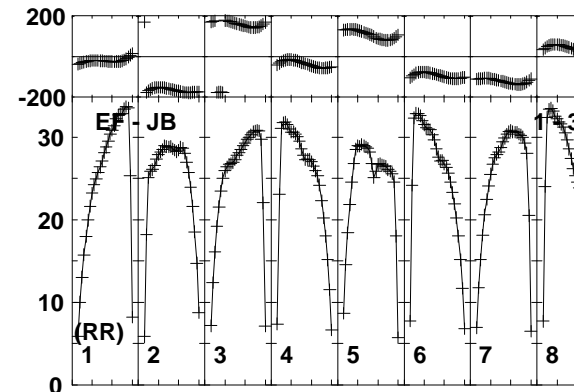
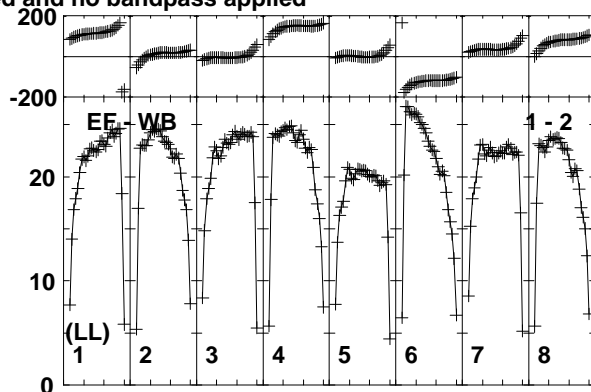
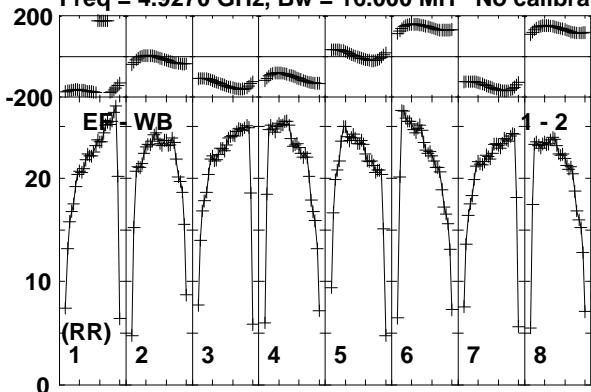

Lower frame: Milli Ampl Jy Top frame: Phas deg
Vector averaged cross-power spectrum Baseline: EF (01) - WB (02)
Timerange: 00/14:06:43 to 00/14:07:39

Plot file version 181 created 28-JAN-2015 14:38:12

1848+283 N14C3.UVDATA.1

Freq = 4.9270 GHz, Bw = 16.000 MH No calibration applied and no bandpass applied

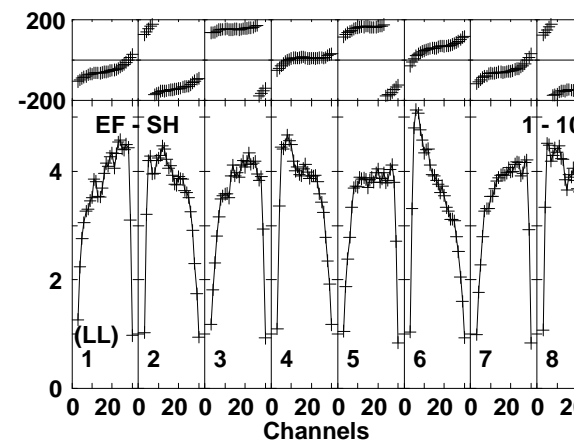
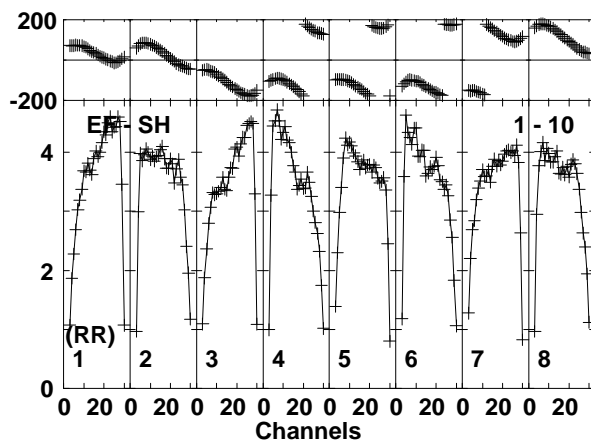
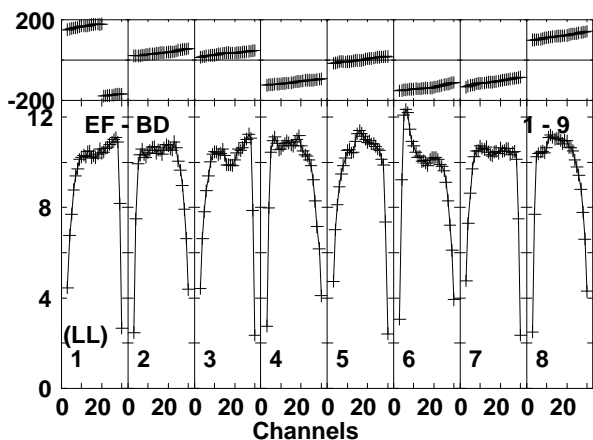
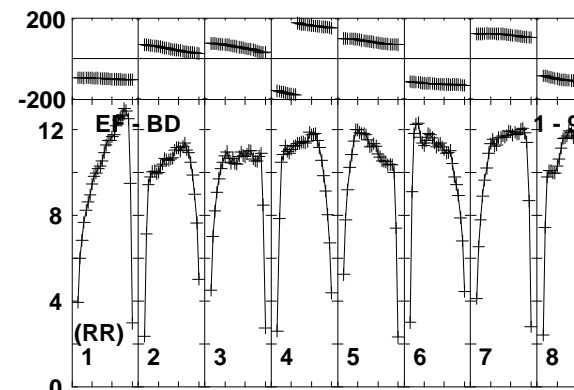
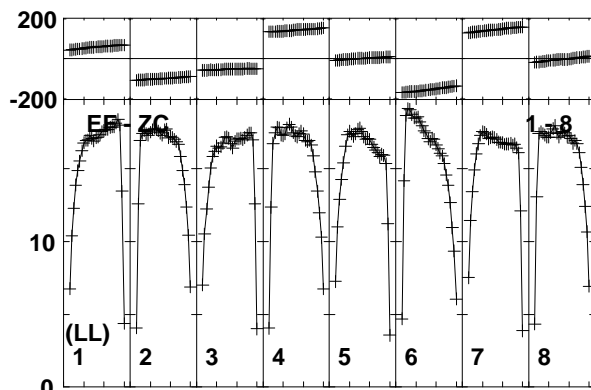
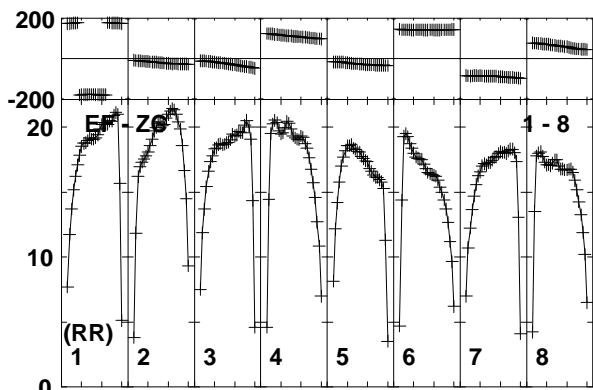
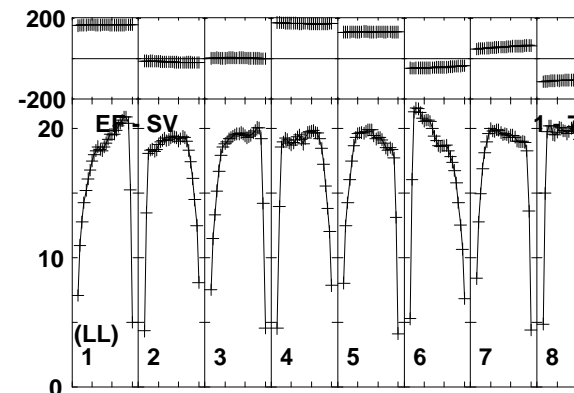
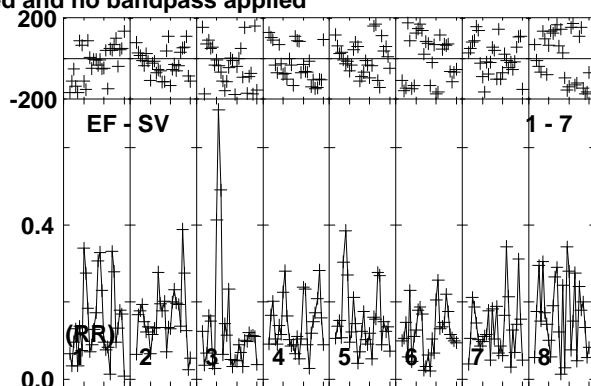
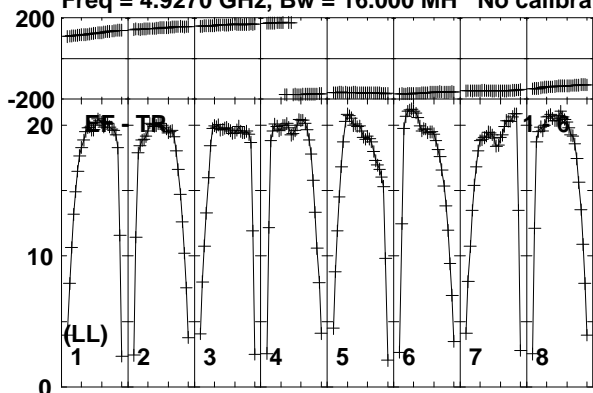

Lower frame: Milli Ampl Jy Top frame: Phas deg
Vector averaged cross-power spectrum Baseline: EF (01) - TR (06)
Timerange: 00/14:06:43 to 00/14:07:39

Plot file version 182 created 28-JAN-2015 14:38:12

1848+283 N14C3.UVDATA.1

Freq = 4.9270 GHz, Bw = 16.000 MH No calibration applied and no bandpass applied

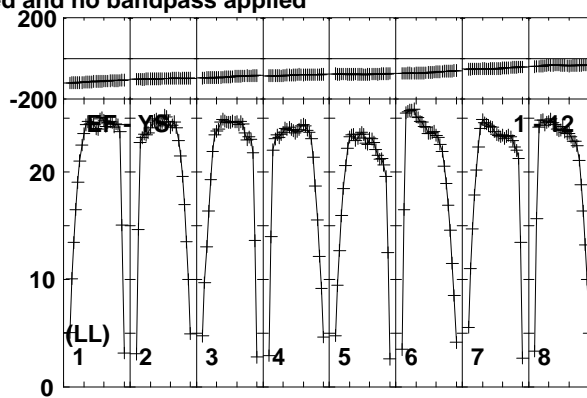
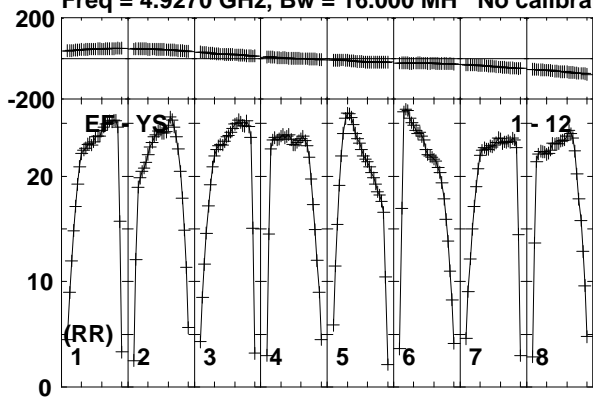

Lower frame: Milli Ampl Jy Top frame: Phas deg
Vector averaged cross-power spectrum Baseline: EF (01) - YS (12)
Timerange: 00/14:06:43 to 00/14:07:39

Plot file version 183 created 28-JAN-2015 14:38:12

J1849+3024 N14C3.UVDATA.1

Freq = 4.9270 GHz, Bw = 16.000 MH No calibration applied and no bandpass applied

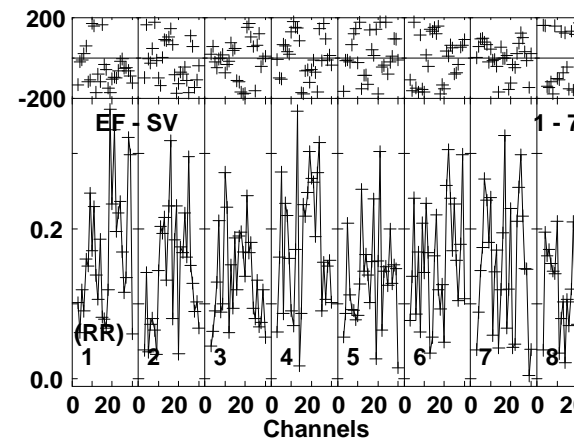
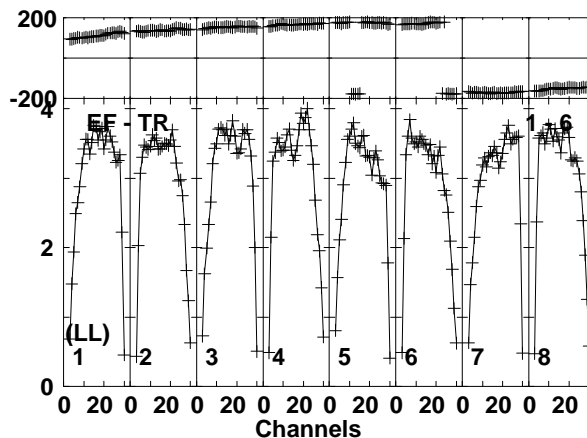
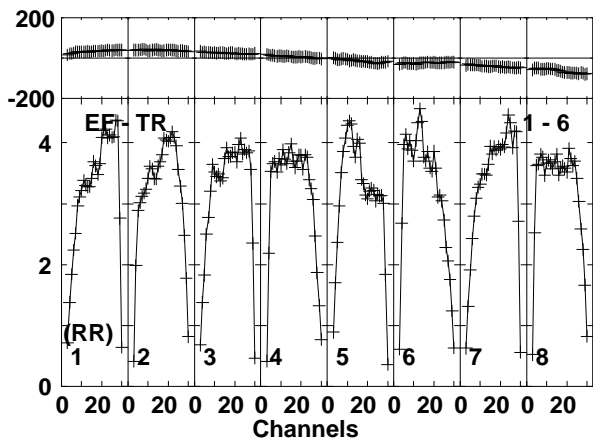
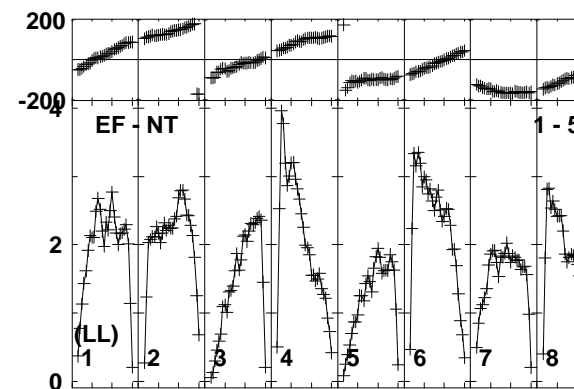
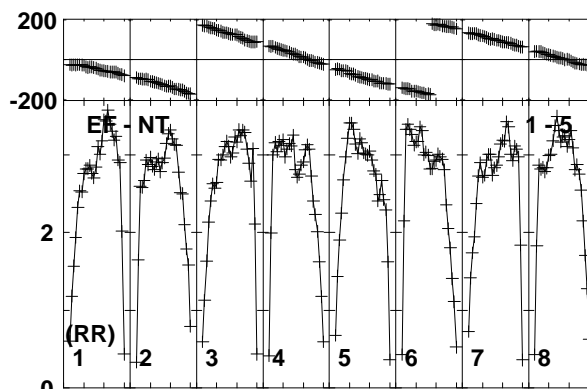
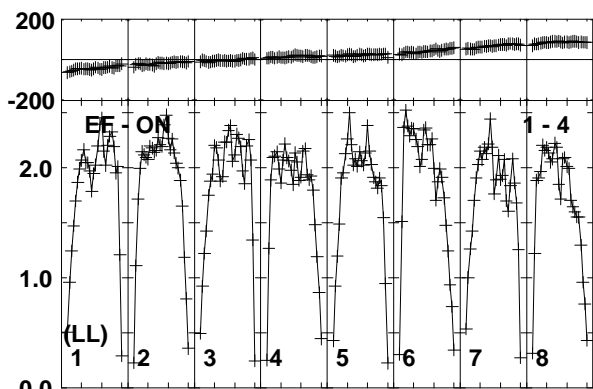
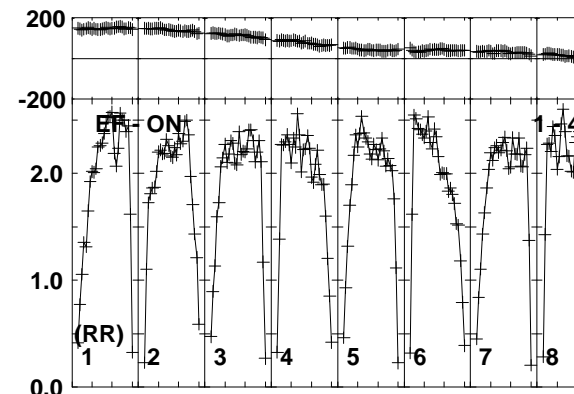
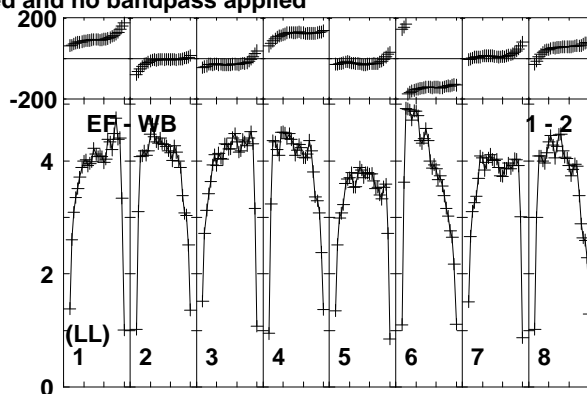
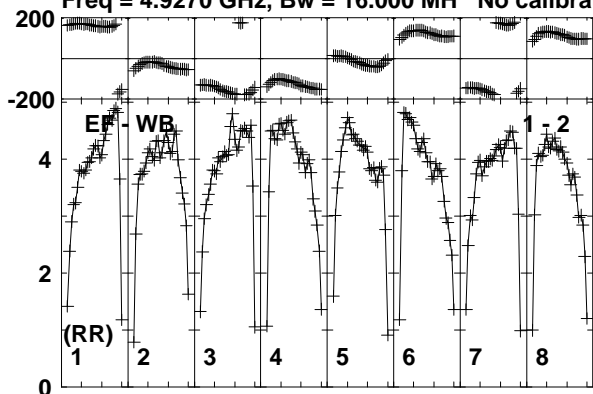

Lower frame: Milli Ampl Jy Top frame: Phas deg
Vector averaged cross-power spectrum Baseline: EF (01) - WB (02)
Timerange: 00/14:08:23 to 00/14:09:19

Plot file version 184 created 28-JAN-2015 14:38:12

J1849+3024 N14C3.UVDATA.1

Freq = 4.9270 GHz, Bw = 16.000 MH No calibration applied and no bandpass applied

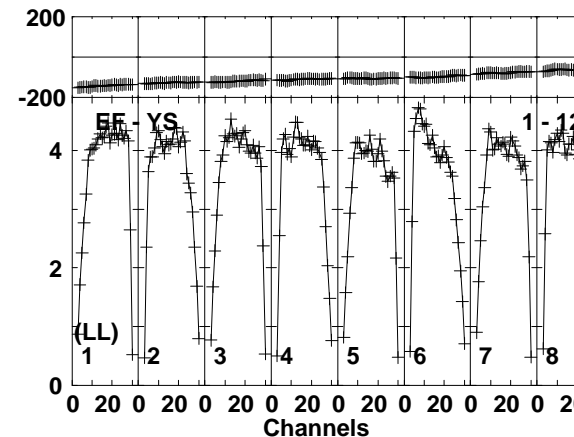
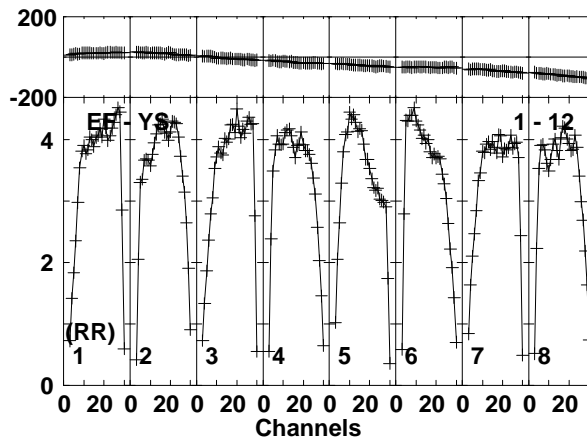
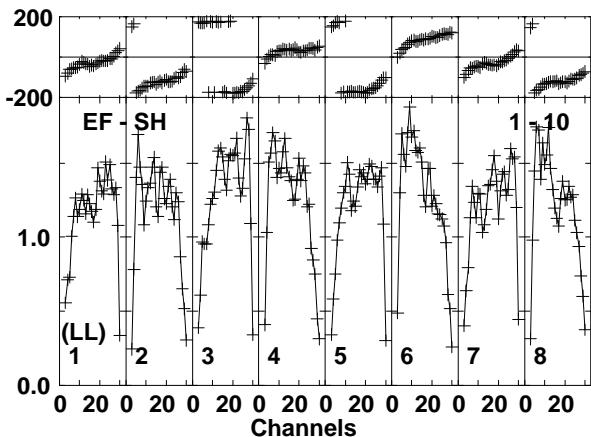
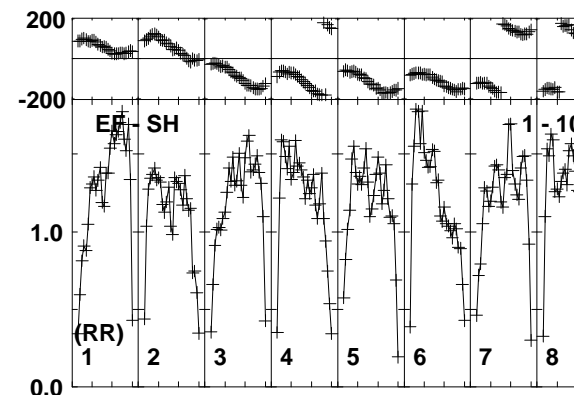
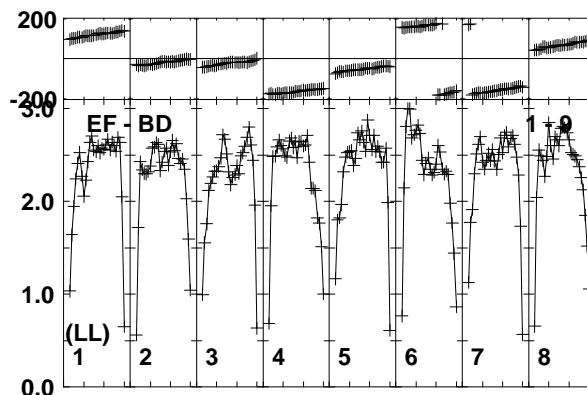
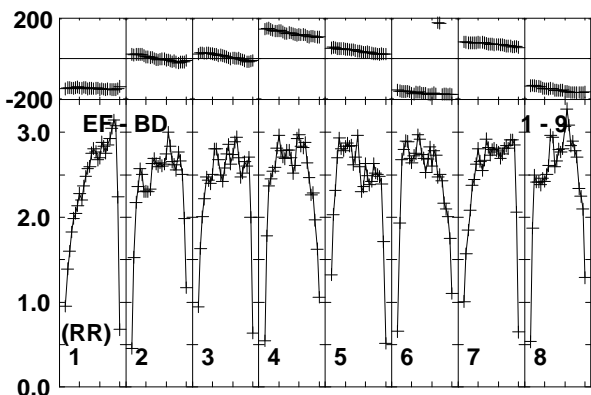
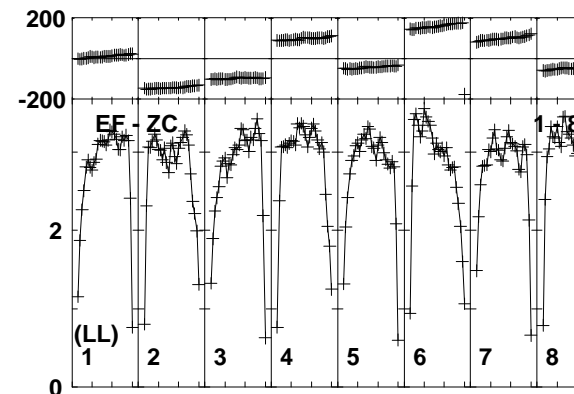
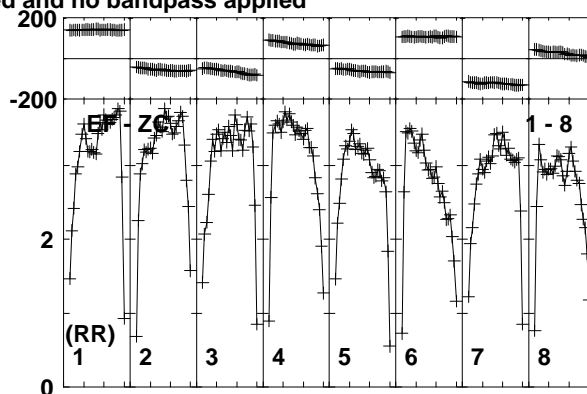
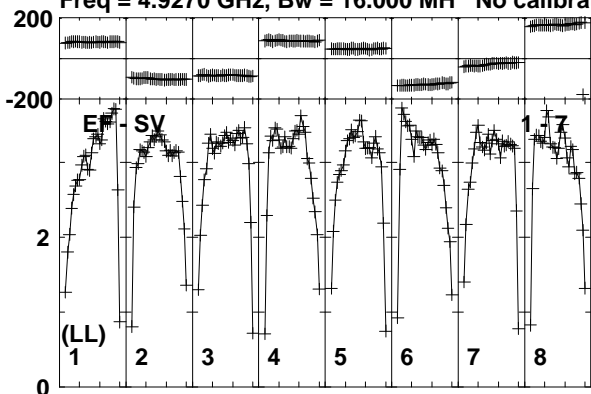

Lower frame: Milli Ampl Jy Top frame: Phas deg
Vector averaged cross-power spectrum Baseline: EF (01) - SV (07)
Timerange: 00/14:08:23 to 00/14:09:19

Plot file version 185 created 28-JAN-2015 14:38:12

1848+283 N14C3.UVDATA.1

Freq = 4.9270 GHz, Bw = 16.000 MH No calibration applied and no bandpass applied

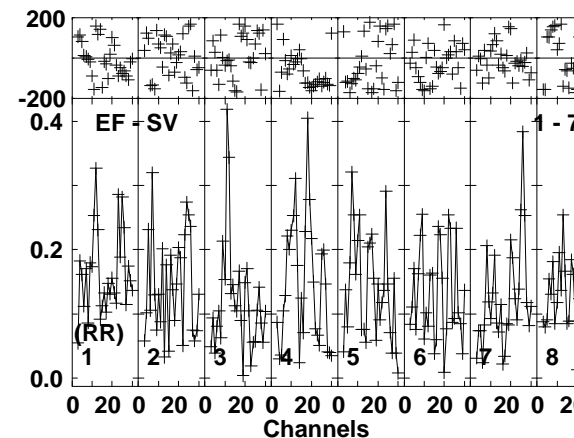
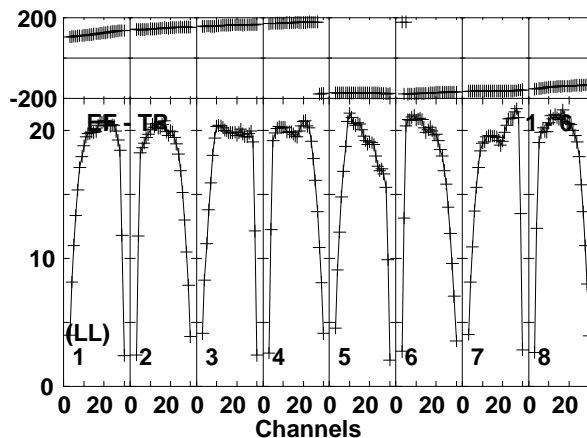
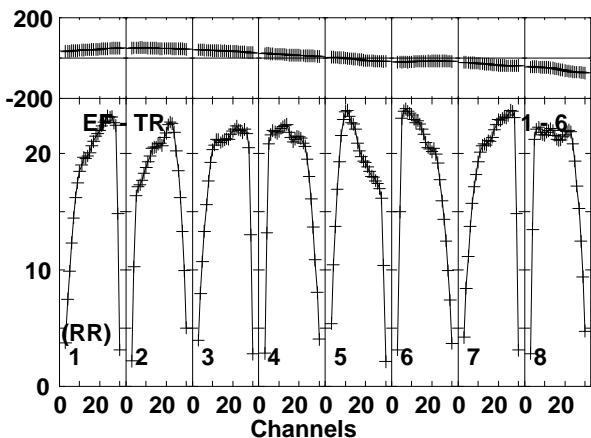
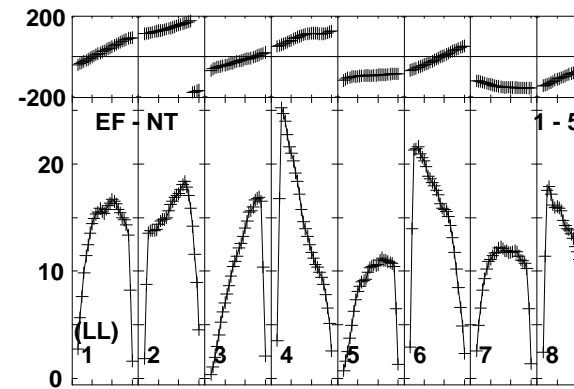
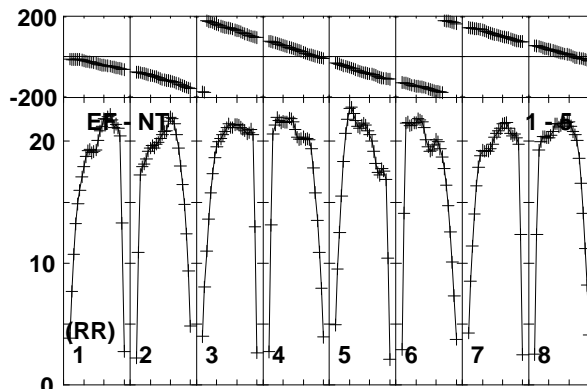
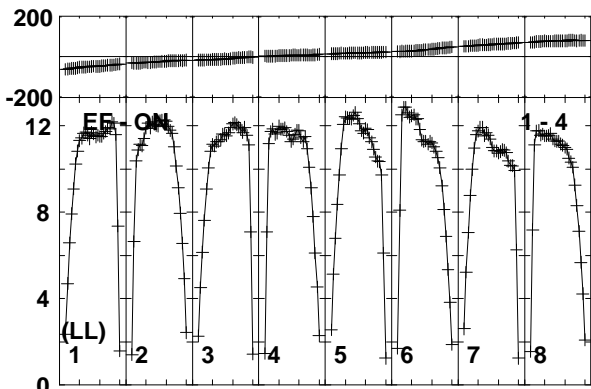
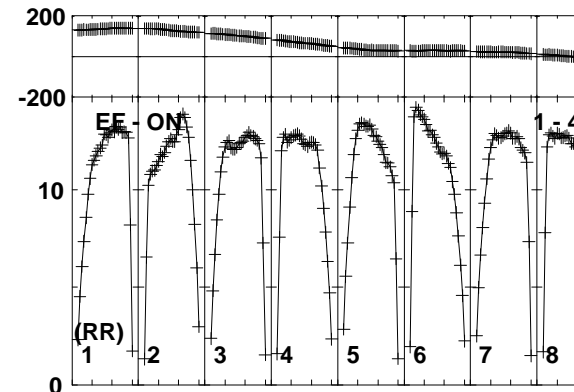
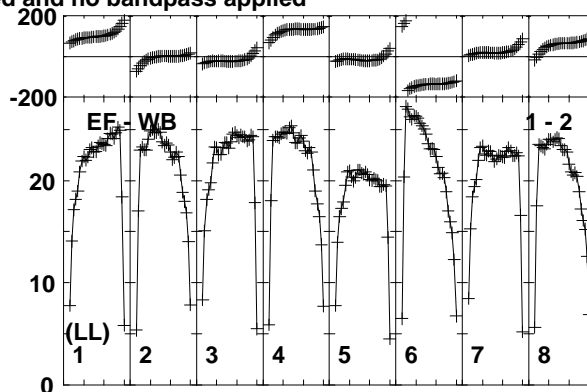
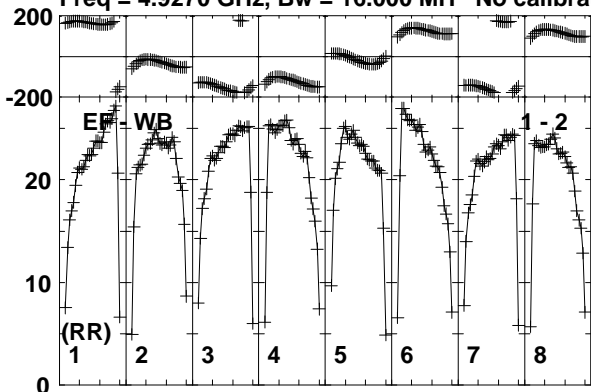

Lower frame: Milli Ampl Jy Top frame: Phas deg
Vector averaged cross-power spectrum Baseline: EF (01) - WB (02)
Timerange: 00/14:10:03 to 00/14:10:59

Plot file version 186 created 28-JAN-2015 14:38:12

1848+283 N14C3.UVDATA.1

Freq = 4.9270 GHz, Bw = 16.000 MH No calibration applied and no bandpass applied

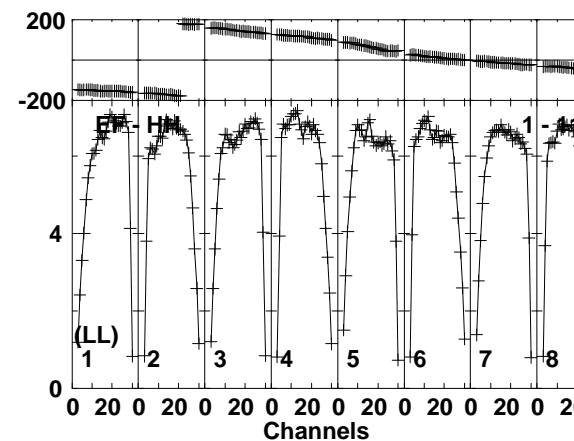
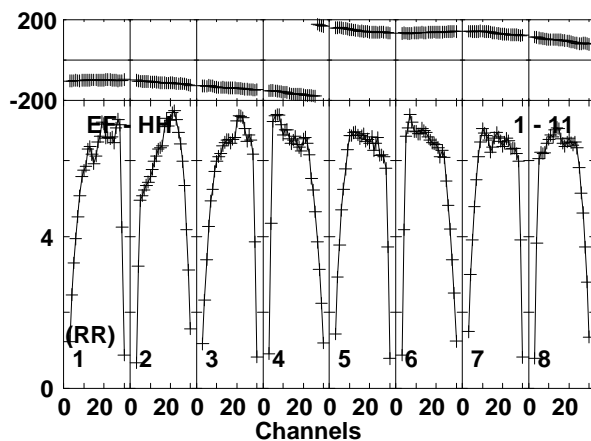
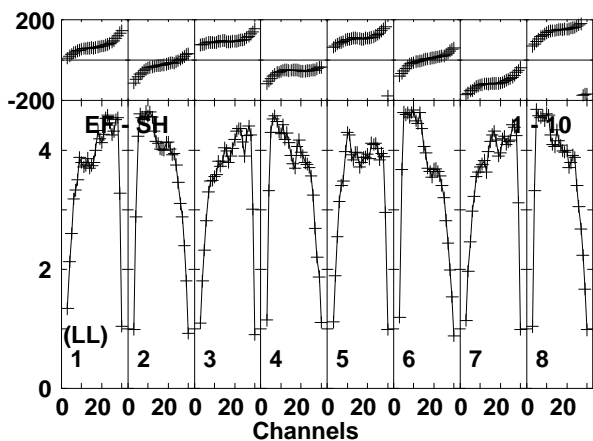
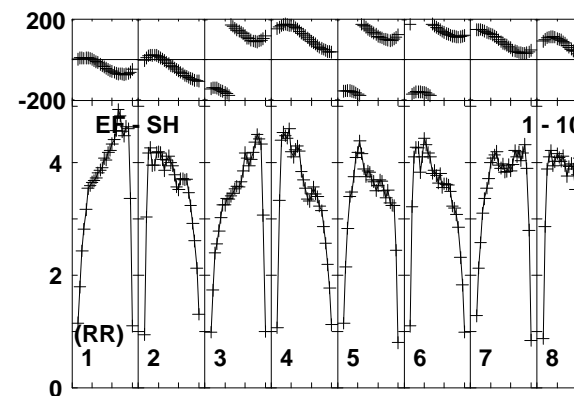
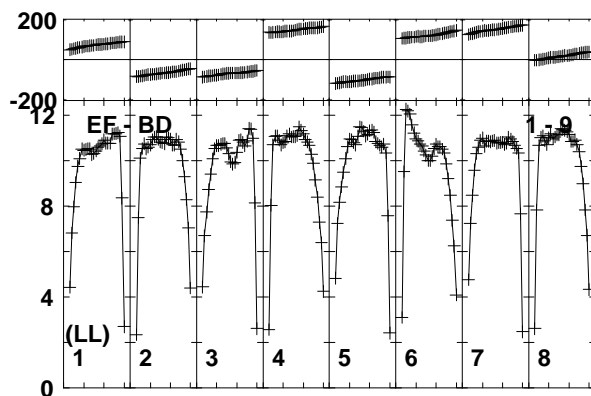
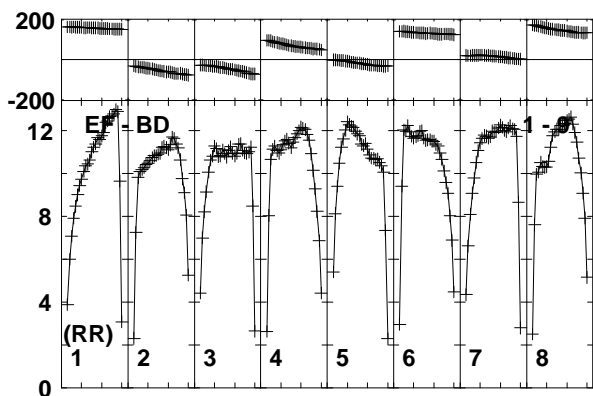
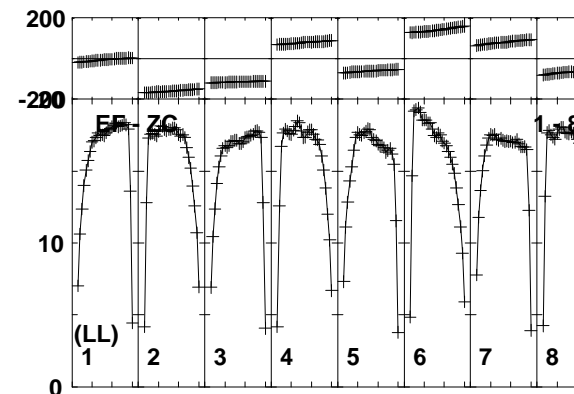
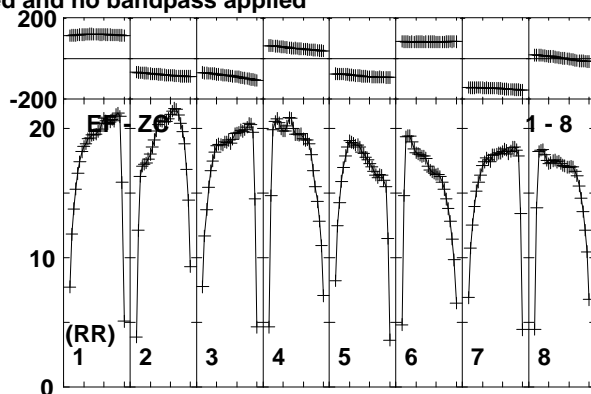
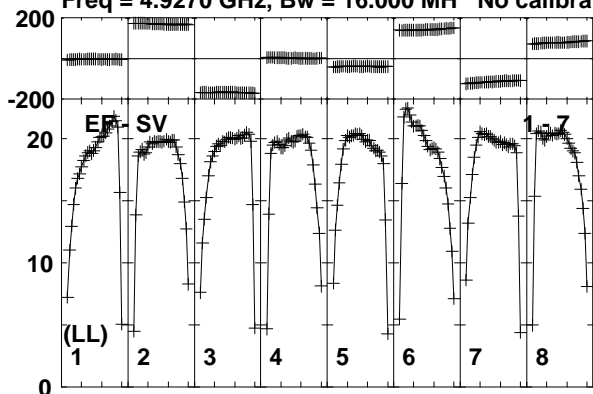

Lower frame: Milli Ampl Jy Top frame: Phas deg
Vector averaged cross-power spectrum Baseline: EF (01) - SV (07)
Timerange: 00/14:10:03 to 00/14:10:59

Plot file version 187 created 28-JAN-2015 14:38:12

1848+283 N14C3.UVDATA.1

Freq = 4.9270 GHz, Bw = 16.000 MH No calibration applied and no bandpass applied

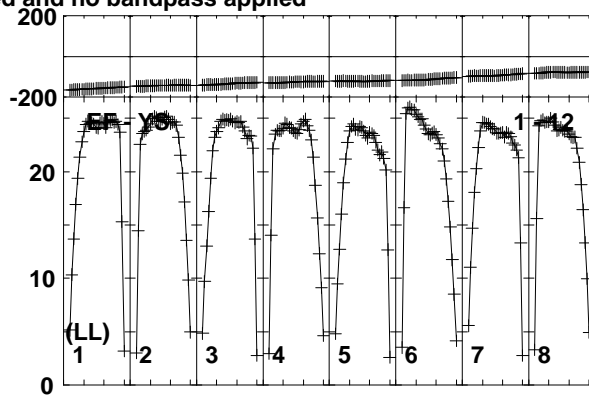
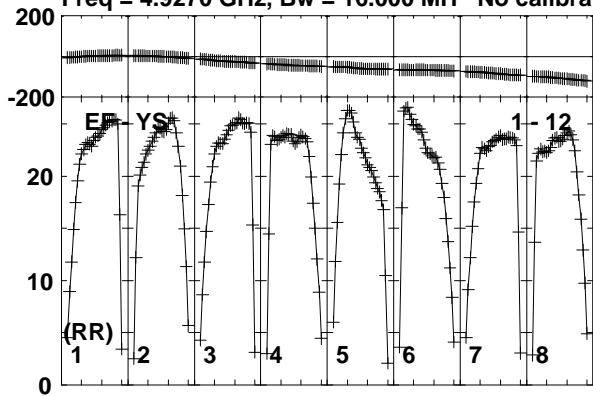

Lower frame: Milli Ampl Jy Top frame: Phas deg
Vector averaged cross-power spectrum Baseline: EF (01) - YS (12)
Timerange: 00/14:10:03 to 00/14:10:59

Plot file version 188 created 28-JAN-2015 14:38:12

J1849+3024 N14C3.UVDATA.1

Freq = 4.9270 GHz, Bw = 16.000 MH No calibration applied and no bandpass applied

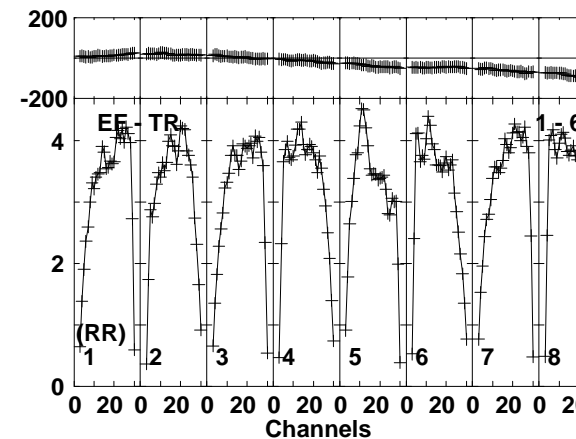
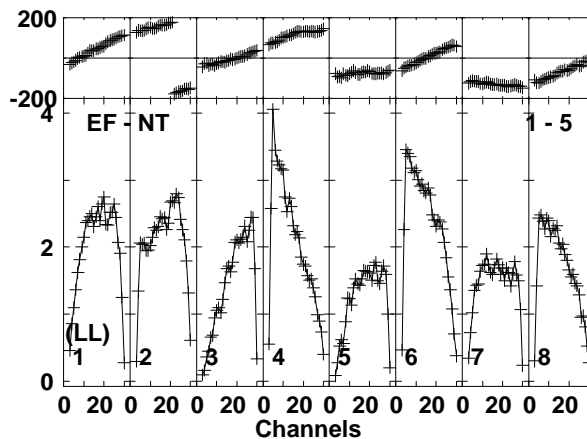
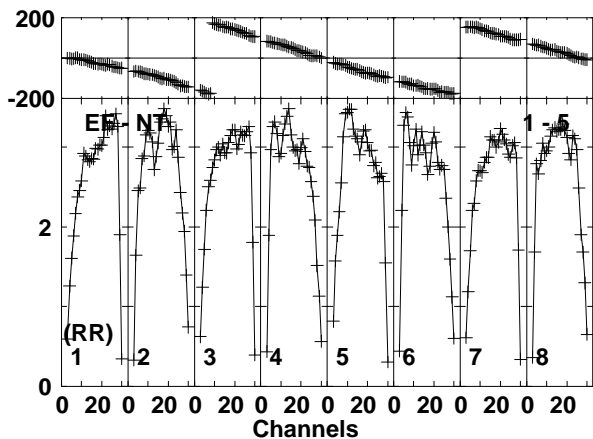
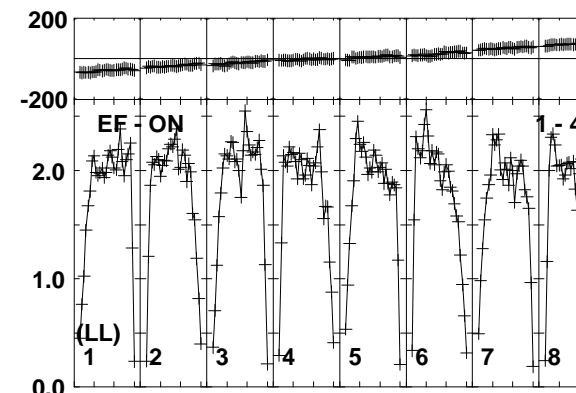
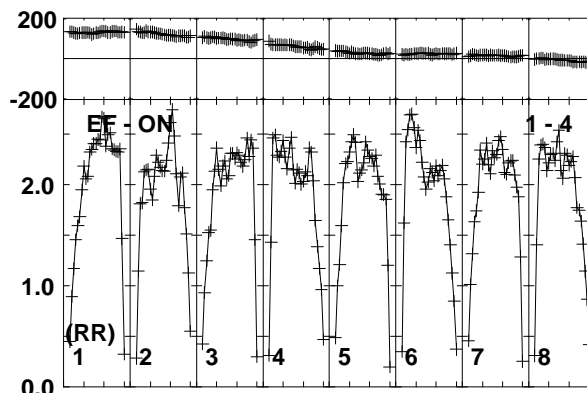
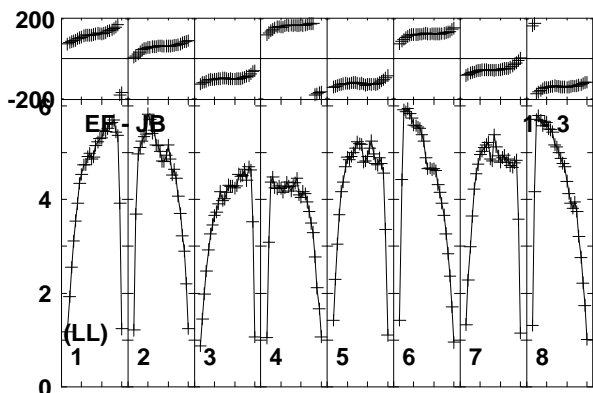
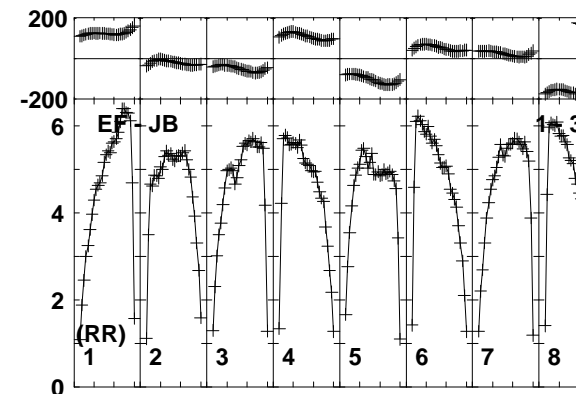
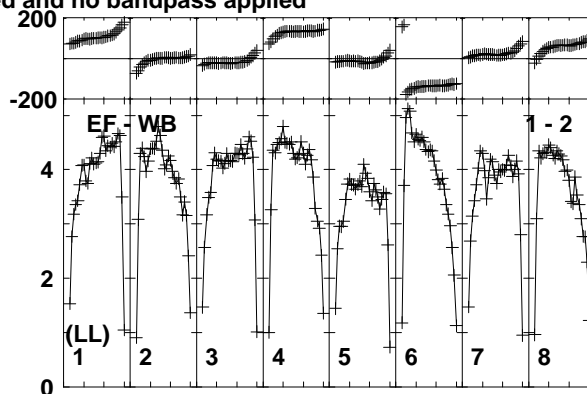
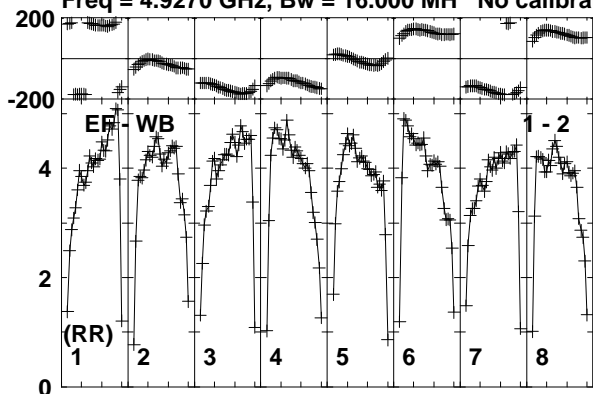

Lower frame: Milli Ampl Jy Top frame: Phas deg
Vector averaged cross-power spectrum Baseline: EF (01) - WB (02)
Timerange: 00/14:11:43 to 00/14:12:39

Plot file version 189 created 28-JAN-2015 14:38:12

J1849+3024 N14C3.UVDATA.1

Freq = 4.9270 GHz, Bw = 16.000 MH No calibration applied and no bandpass applied

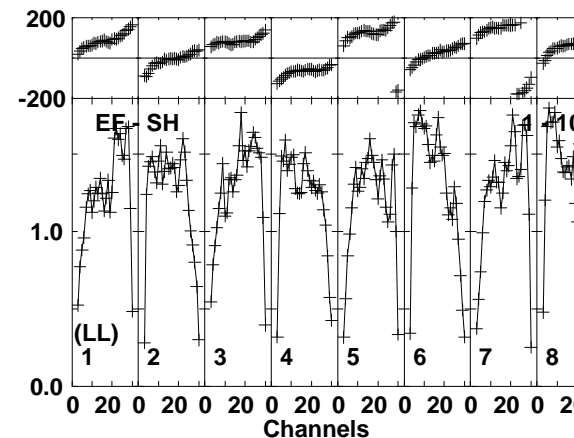
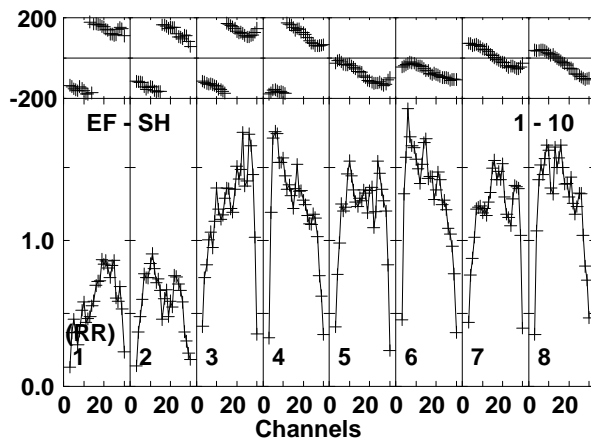
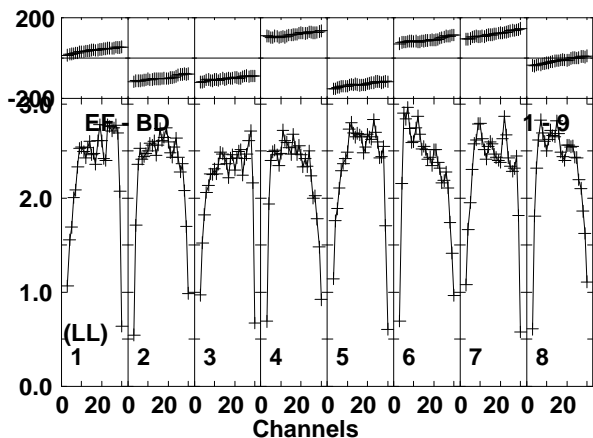
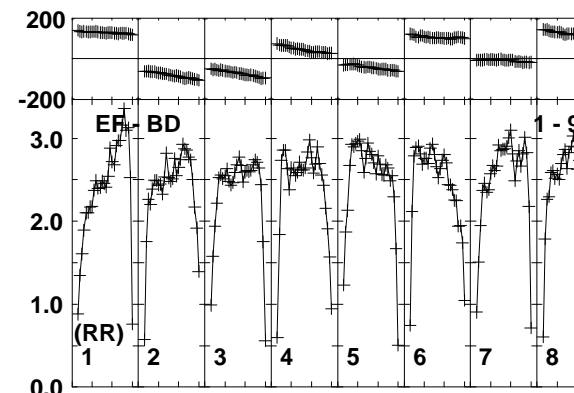
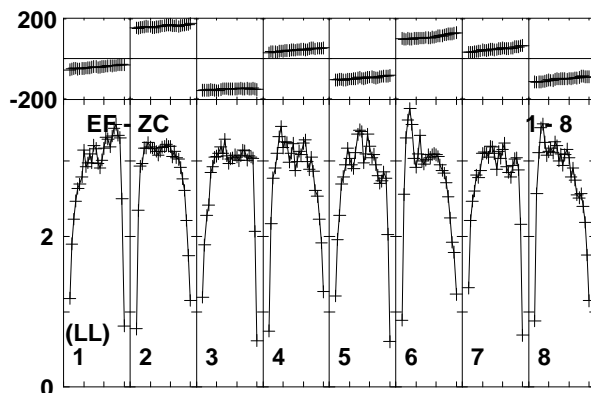
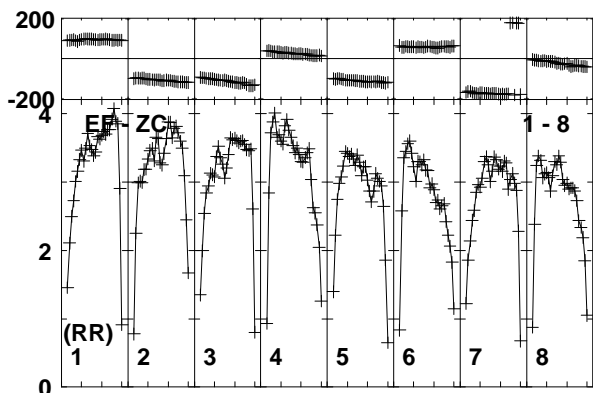
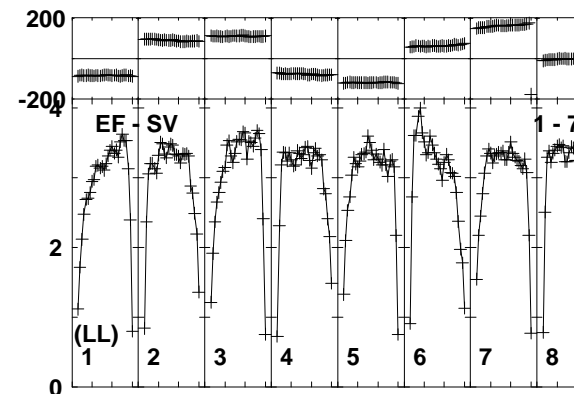
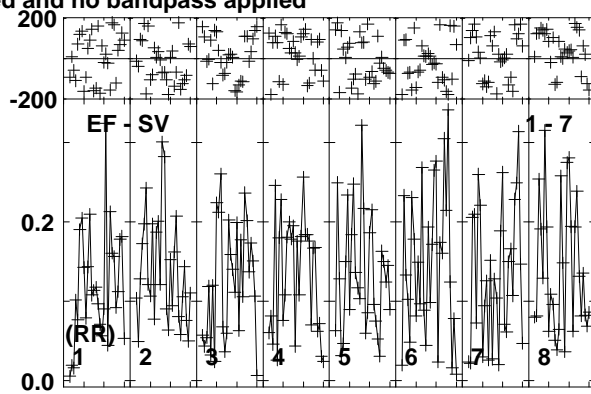
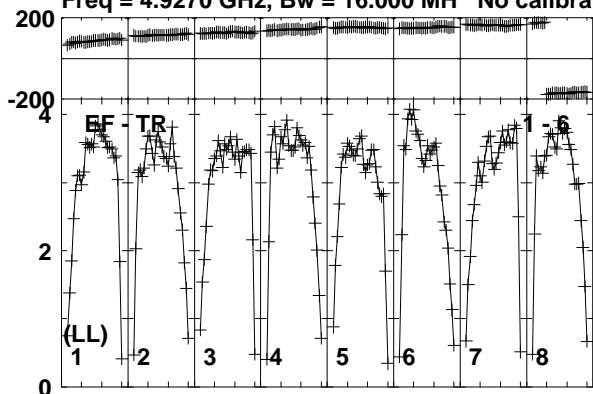

Lower frame: Milli Ampl Jy Top frame: Phas deg
Vector averaged cross-power spectrum Baseline: EF (01) - TR (06)
Timerange: 00/14:11:43 to 00/14:12:39

Plot file version 190 created 28-JAN-2015 14:38:12

J1849+3024 N14C3.UVDATA.1

Freq = 4.9270 GHz, Bw = 16.000 MH No calibration applied and no bandpass applied

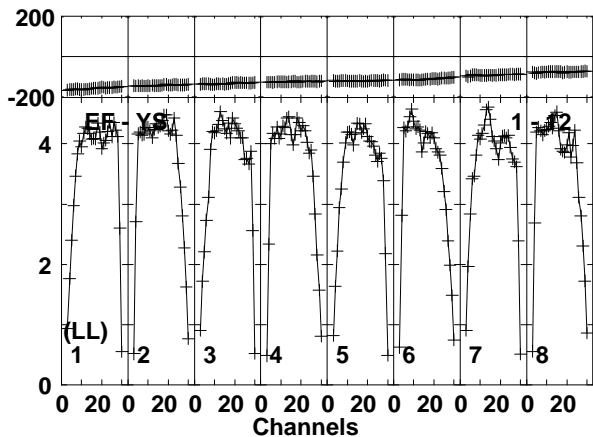
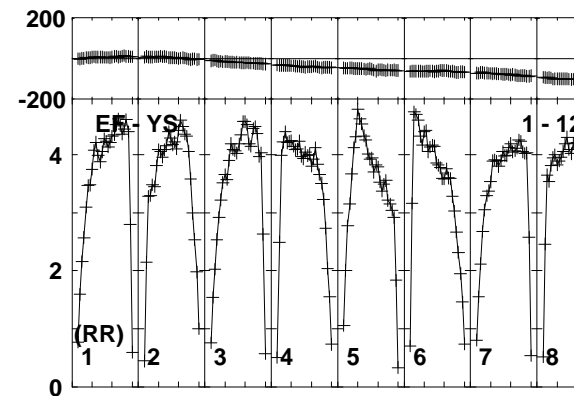
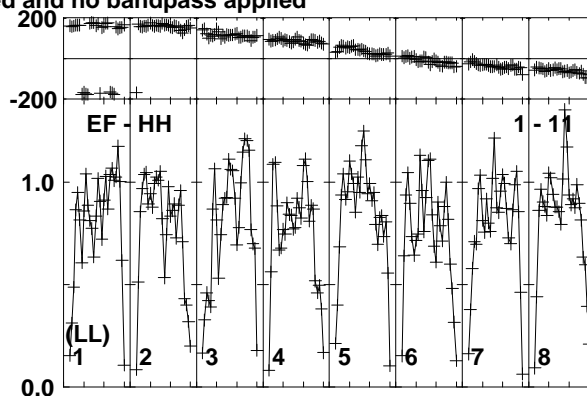
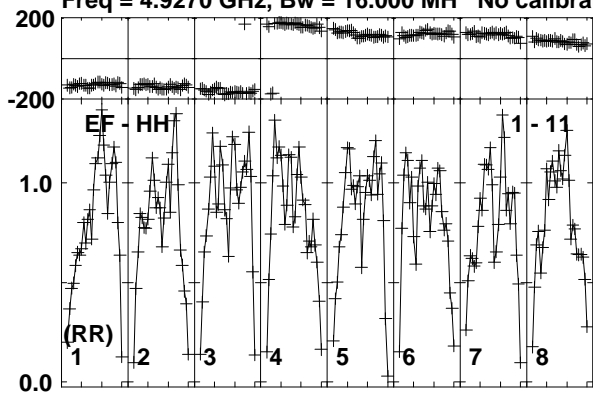

Lower frame: Milli Ampl Jy Top frame: Phas deg
Vector averaged cross-power spectrum Baseline: EF (01) - HH (11)
Timerange: 00/14:11:43 to 00/14:12:39

Plot file version 191 created 28-JAN-2015 14:38:12

1848+283 N14C3.UVDATA.1

Freq = 4.9270 GHz, Bw = 16.000 MH No calibration applied and no bandpass applied

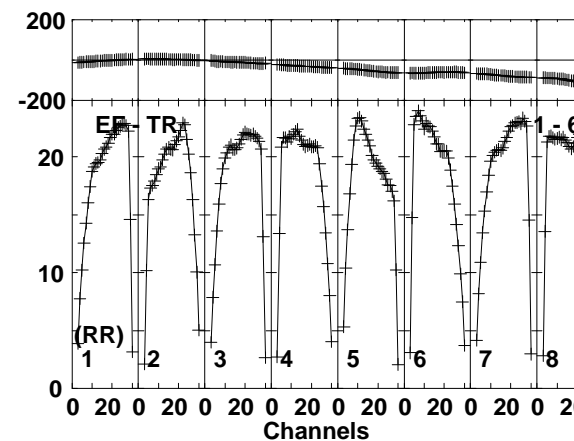
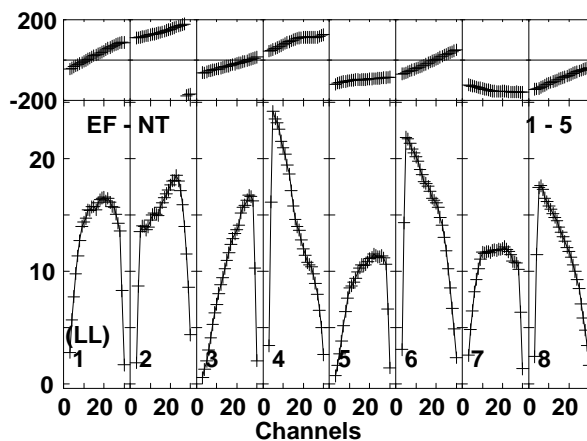
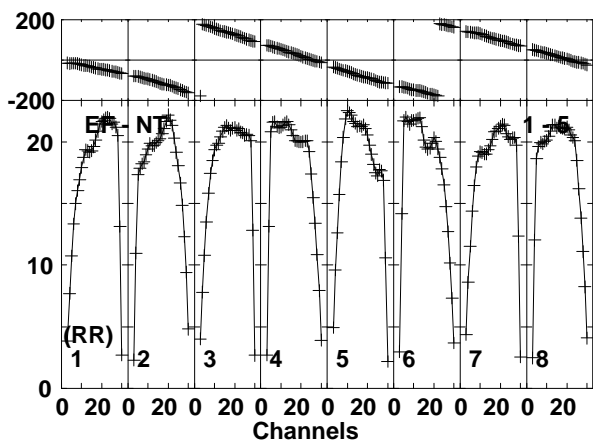
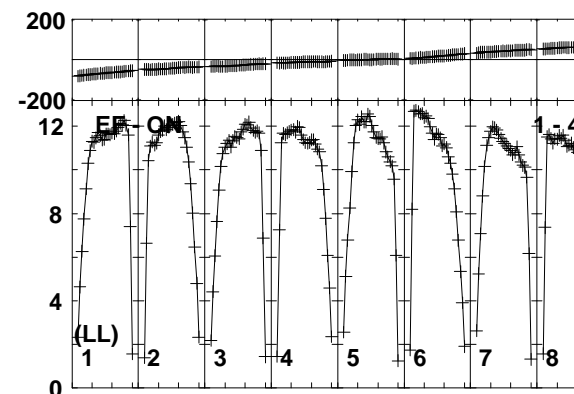
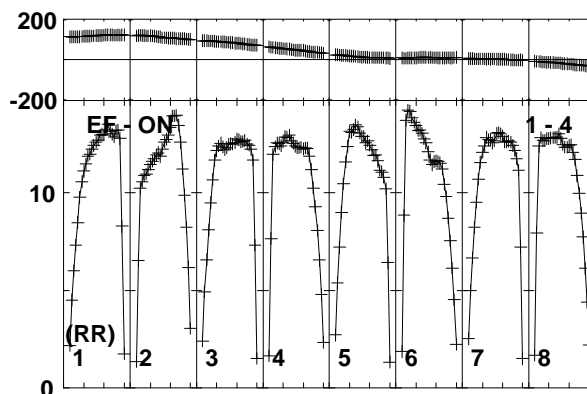
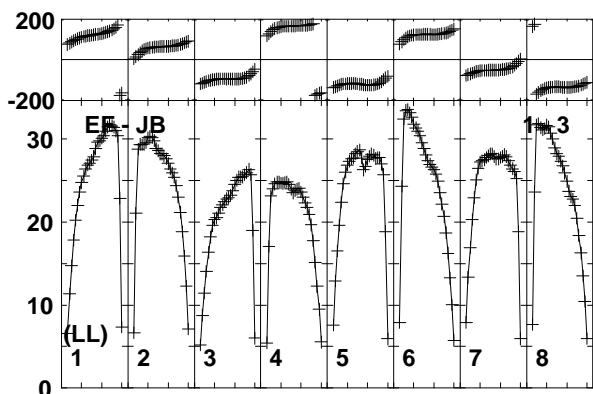
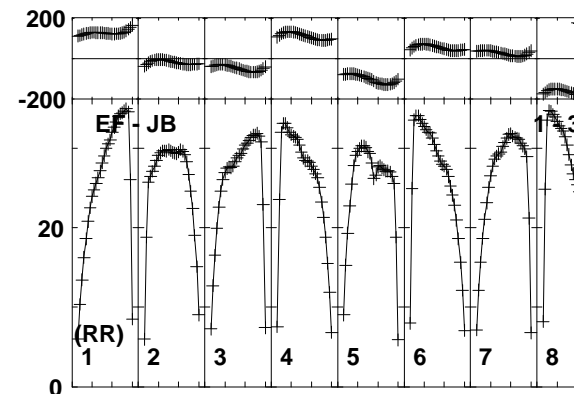
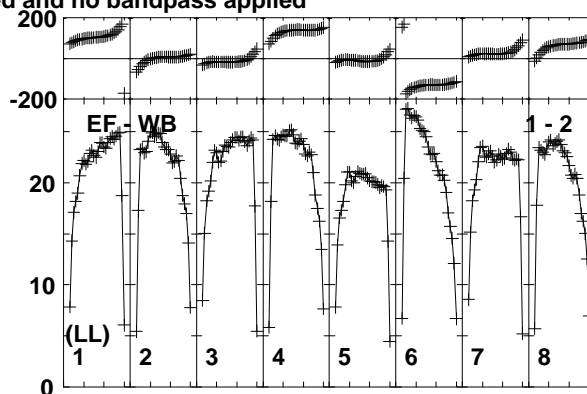
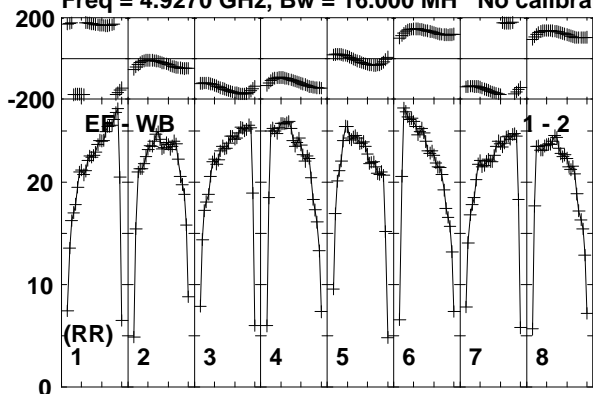

Lower frame: Milli Ampl Jy Top frame: Phas deg
Vector averaged cross-power spectrum Baseline: EF (01) - WB (02)
Timerange: 00/14:13:23 to 00/14:14:19

Plot file version 192 created 28-JAN-2015 14:38:12

1848+283 N14C3.UVDATA.1

Freq = 4.9270 GHz, Bw = 16.000 MH No calibration applied and no bandpass applied

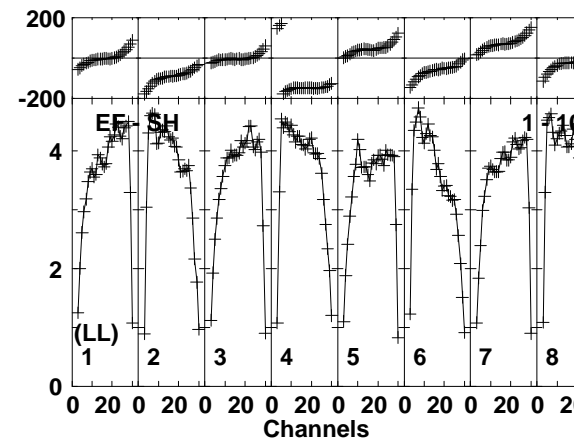
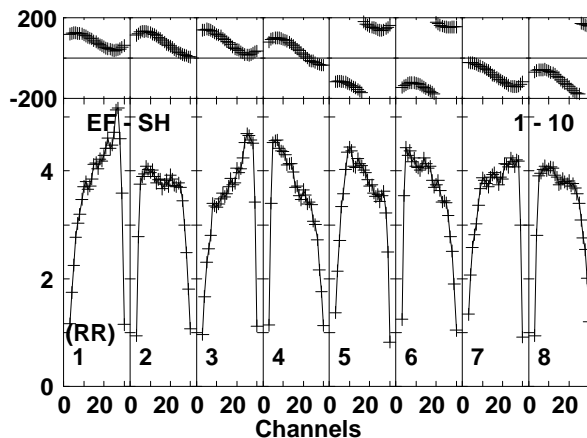
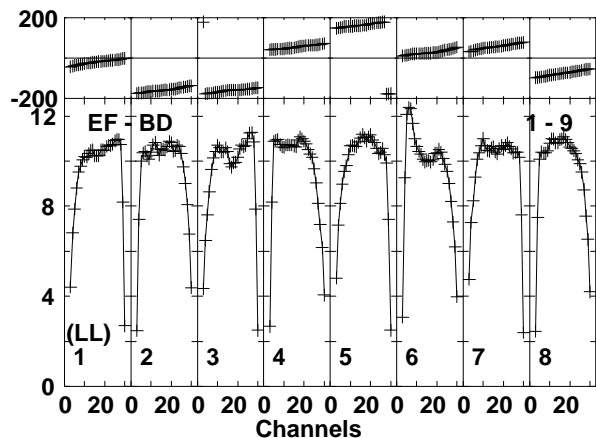
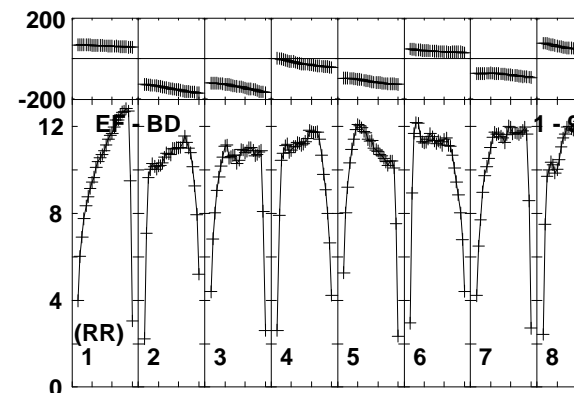
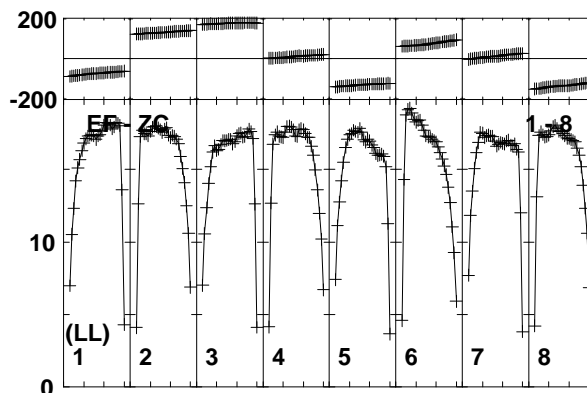
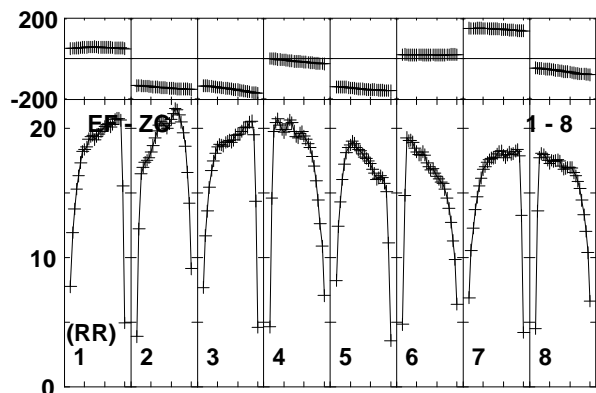
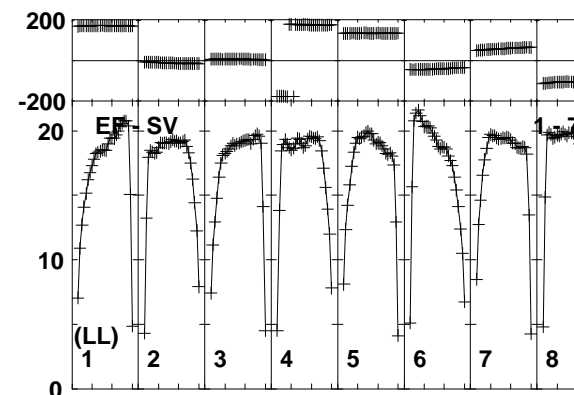
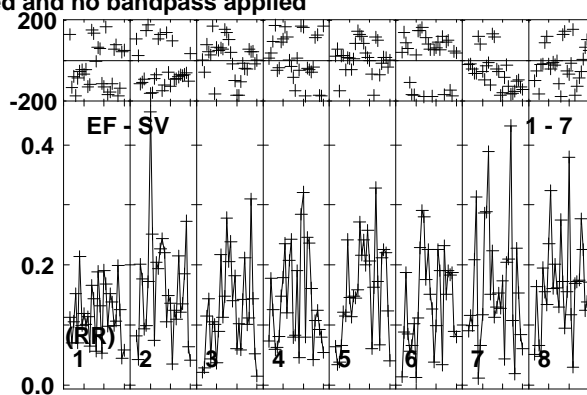
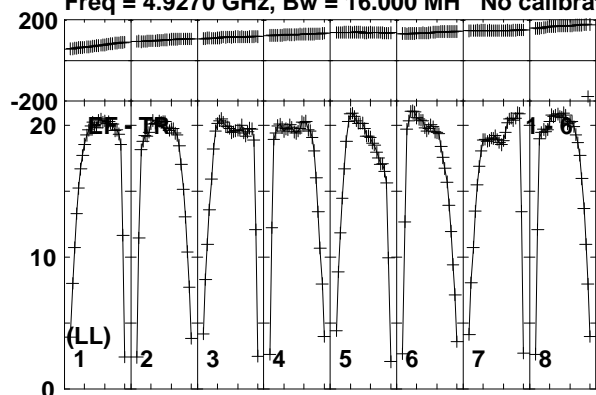

Lower frame: Milli Ampl Jy Top frame: Phas deg
Vector averaged cross-power spectrum Baseline: EF (01) - TR (06)
Timerange: 00/14:13:23 to 00/14:14:19

Plot file version 193 created 28-JAN-2015 14:38:12

1848+283 N14C3.UVDATA.1

Freq = 4.9270 GHz, Bw = 16.000 MH No calibration applied and no bandpass applied

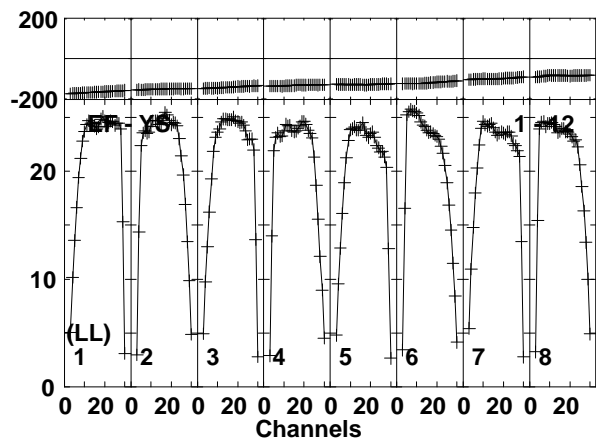
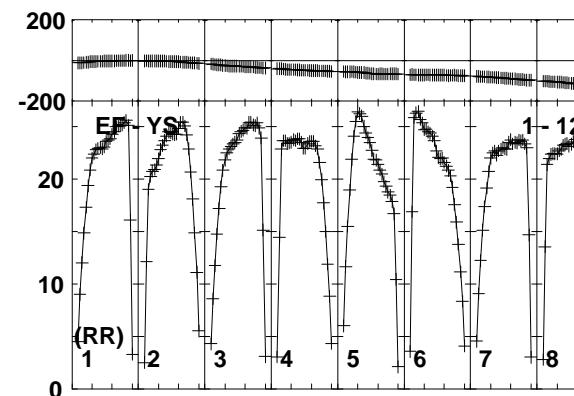
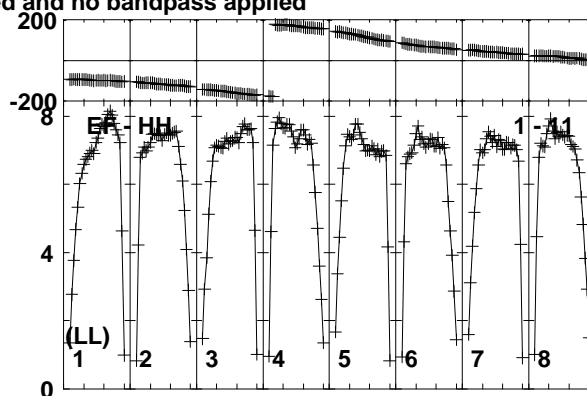
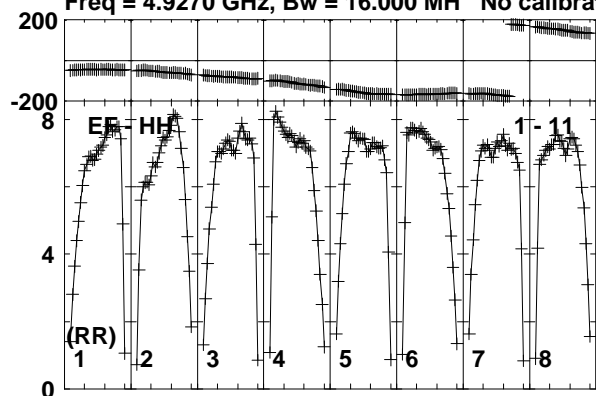

Lower frame: Milli Ampl Jy Top frame: Phas deg
Vector averaged cross-power spectrum Baseline: EF (01) - HH (11)
Timerange: 00/14:13:23 to 00/14:14:19

Plot file version 194 created 28-JAN-2015 14:38:12

J1849+3024 N14C3.UVDATA.1

Freq = 4.9270 GHz, Bw = 16.000 MH No calibration applied and no bandpass applied

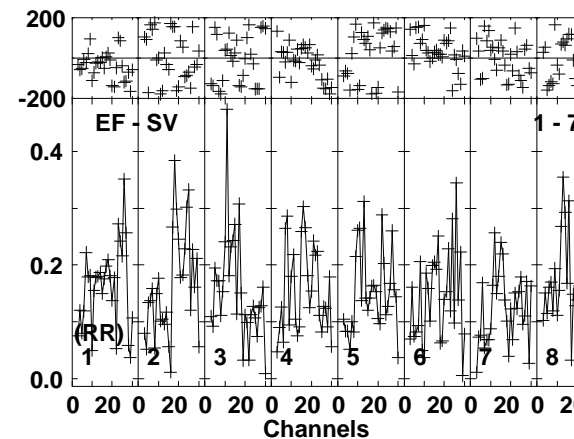
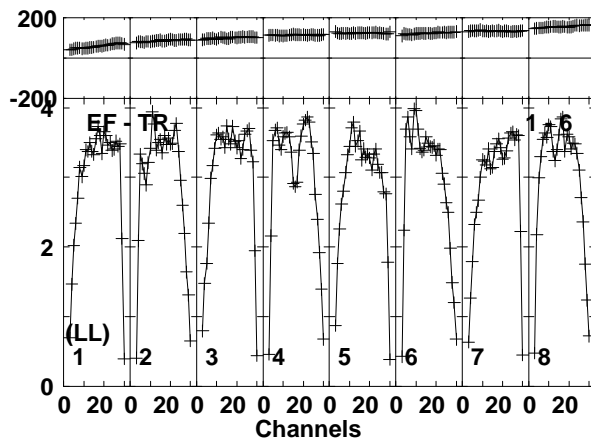
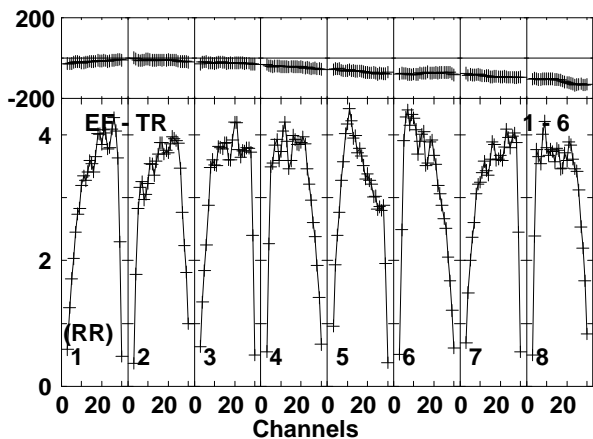
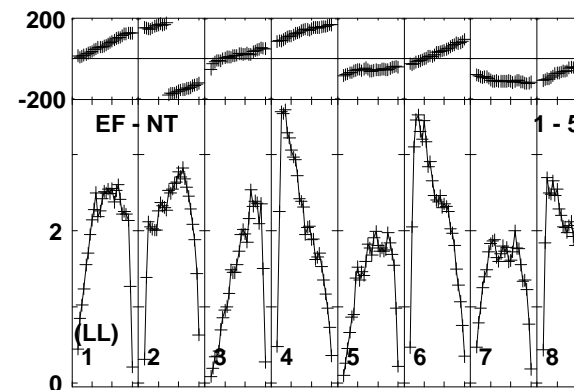
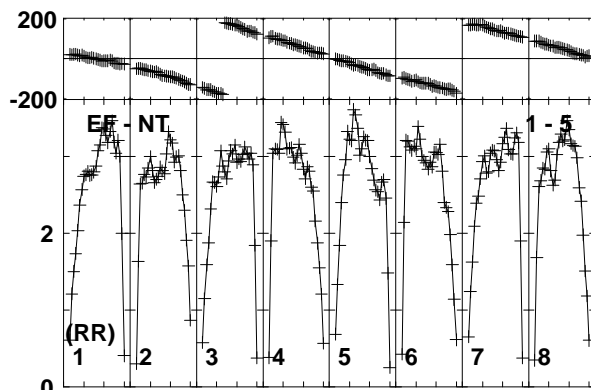
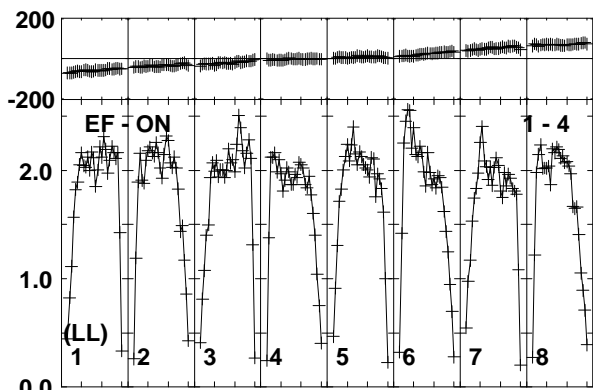
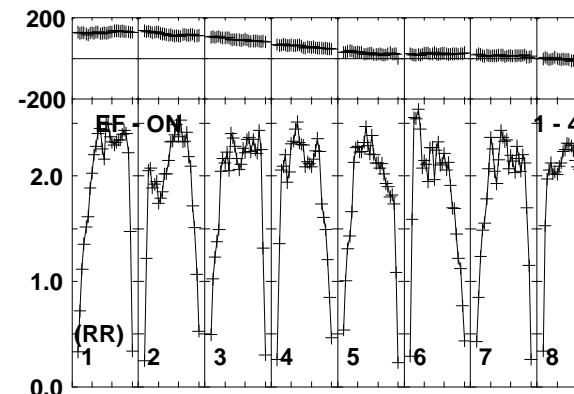
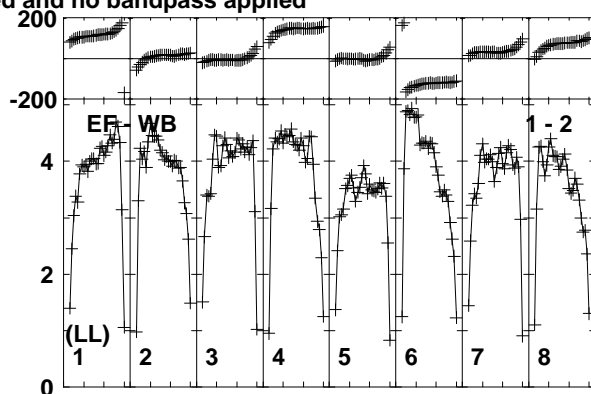
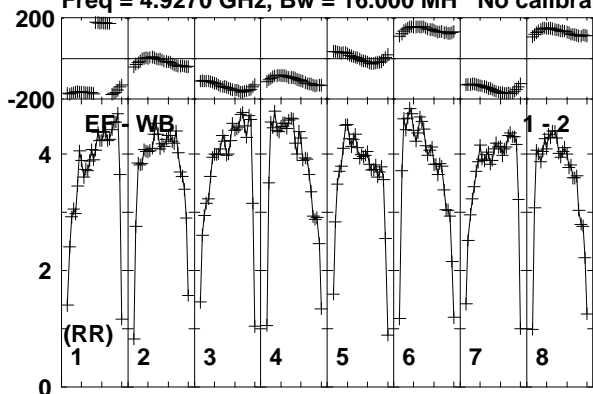

Lower frame: Milli Ampl Jy Top frame: Phas deg
Vector averaged cross-power spectrum Baseline: EF (01) - WB (02)
Timerange: 00/14:15:03 to 00/14:15:59

Plot file version 195 created 28-JAN-2015 14:38:12

J1849+3024 N14C3.UVDATA.1

Freq = 4.9270 GHz, Bw = 16.000 MH No calibration applied and no bandpass applied

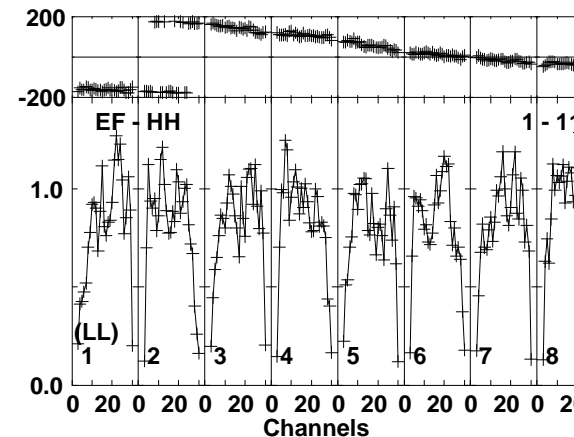
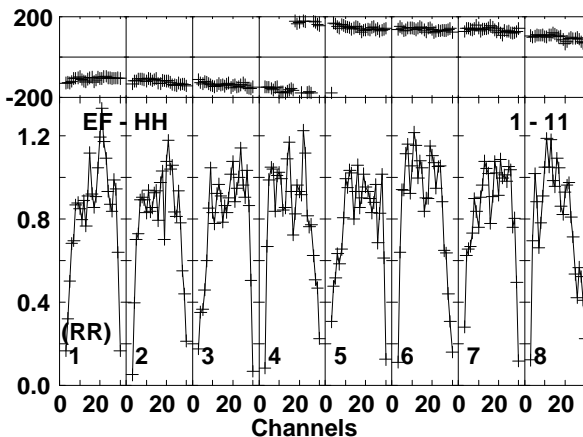
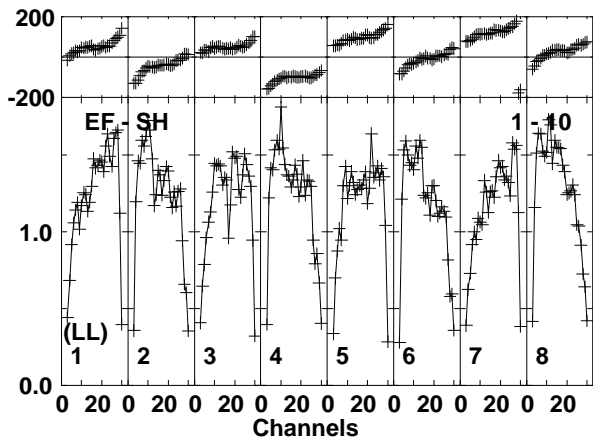
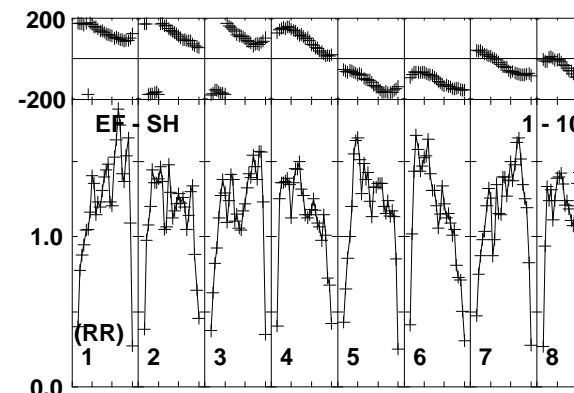
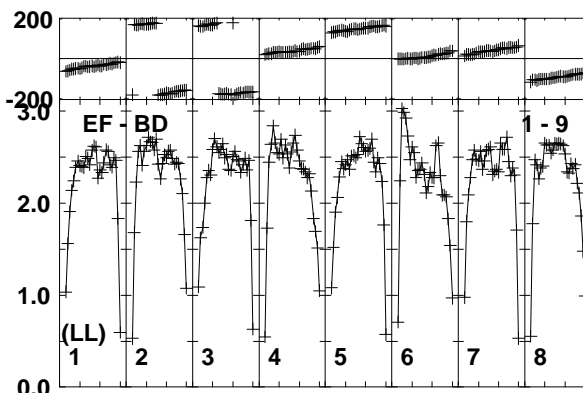
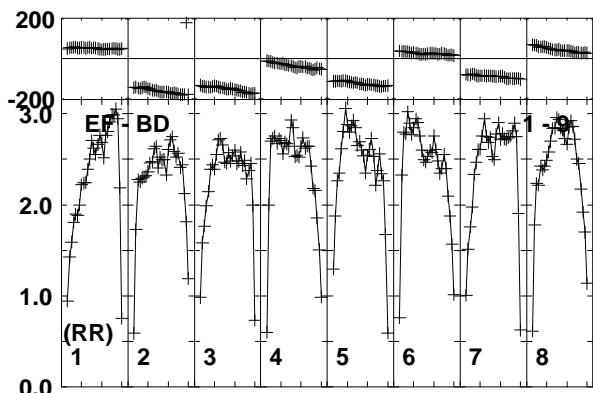
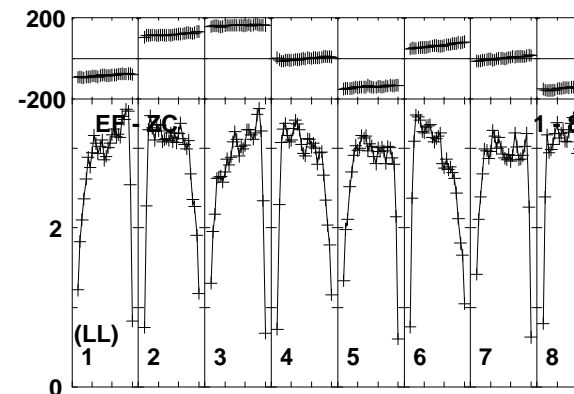
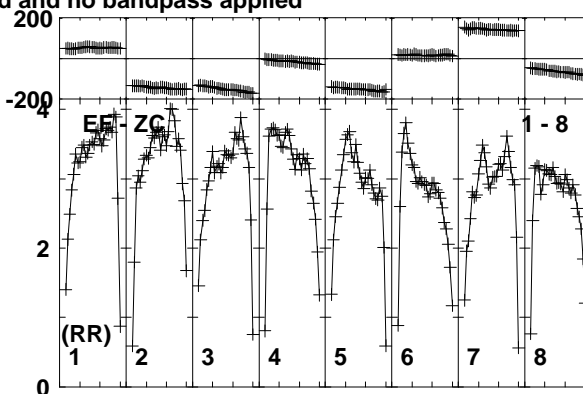
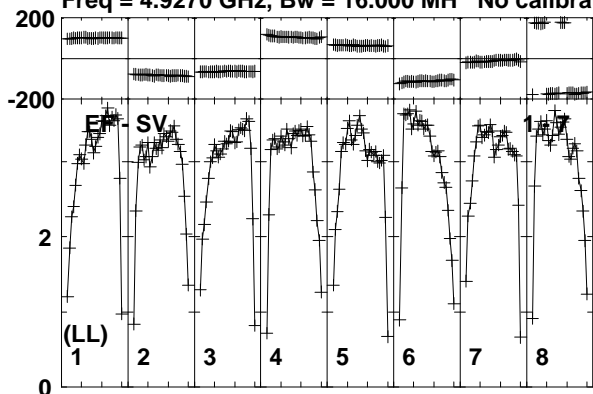

Lower frame: Milli Ampl Jy Top frame: Phas deg
Vector averaged cross-power spectrum Baseline: EF (01) - SV (07)
Timerange: 00/14:15:03 to 00/14:15:59

Plot file version 196 created 28-JAN-2015 14:38:12

J1849+3024 N14C3.UVDATA.1

Freq = 4.9270 GHz, Bw = 16.000 MH No calibration applied and no bandpass applied

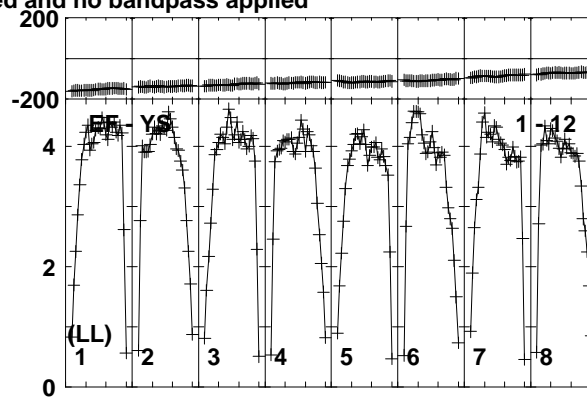
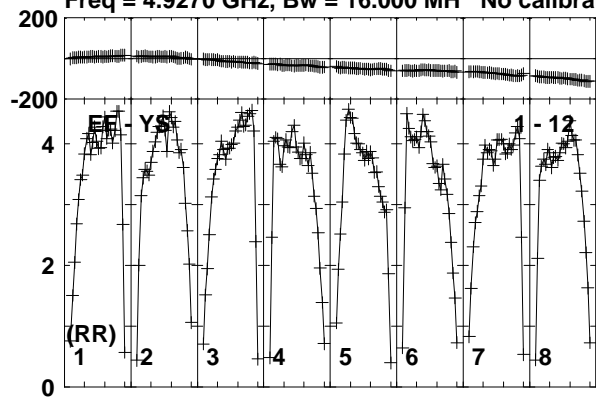

Lower frame: Milli Ampl Jy Top frame: Phas deg
Vector averaged cross-power spectrum Baseline: EF (01) - YS (12)
Timerange: 00/14:15:03 to 00/14:15:59

Plot file version 197 created 28-JAN-2015 14:38:12

1848+283 N14C3.UVDATA.1

Freq = 4.9270 GHz, Bw = 16.000 MH No calibration applied and no bandpass applied

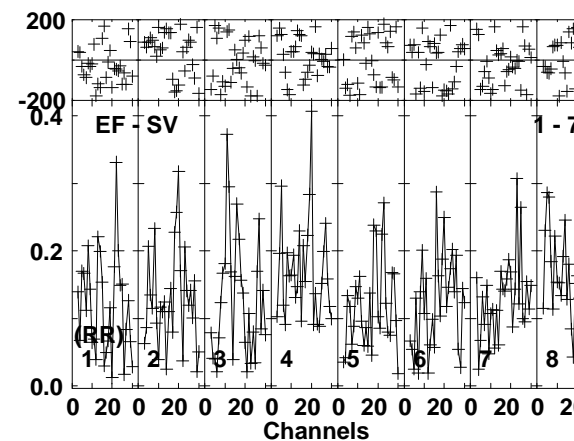
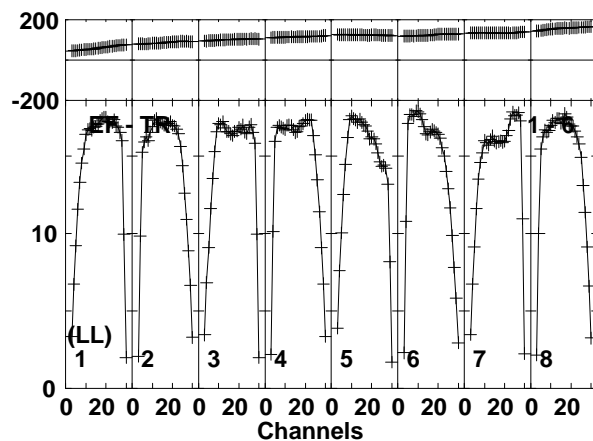
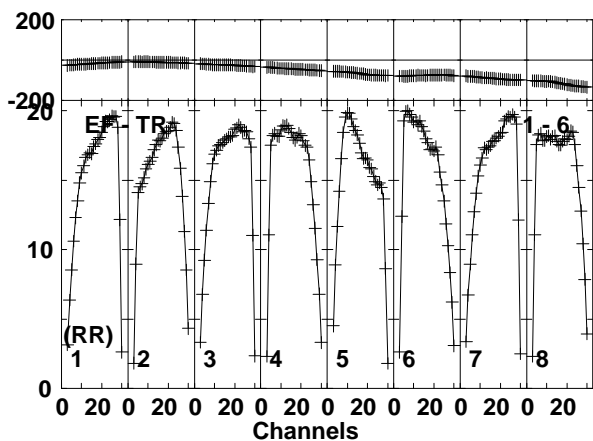
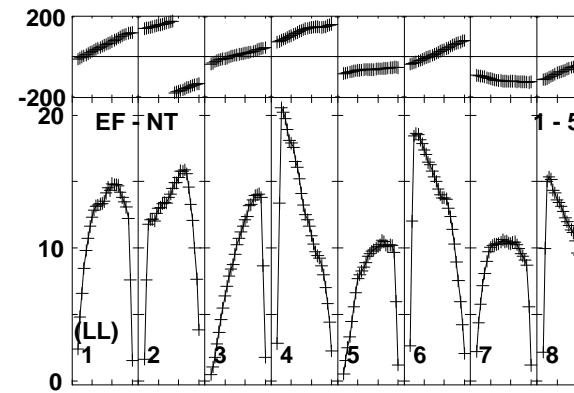
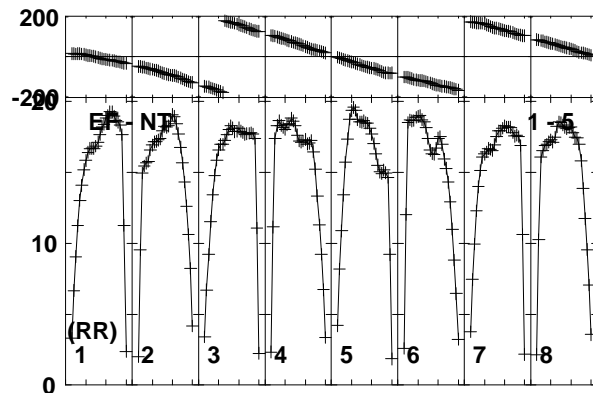
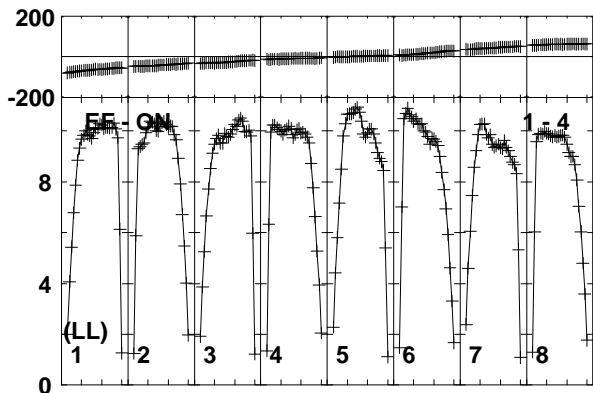
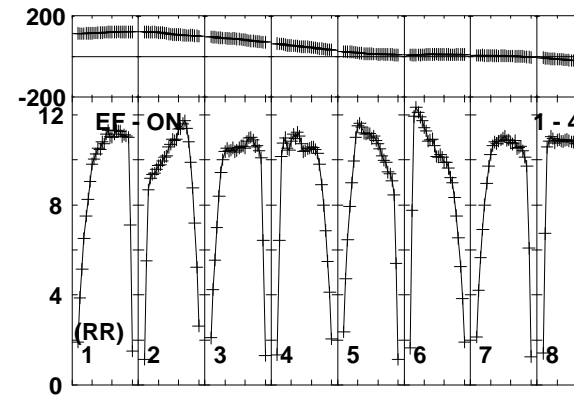
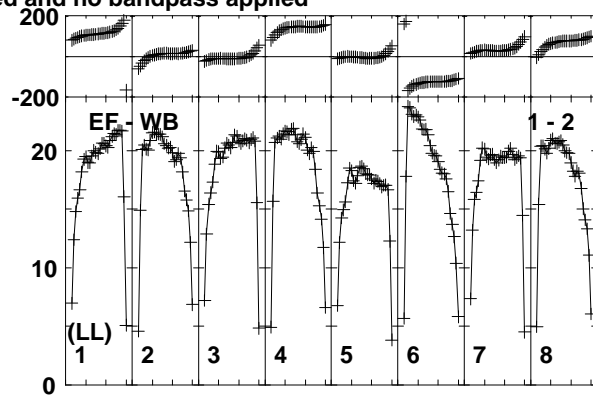
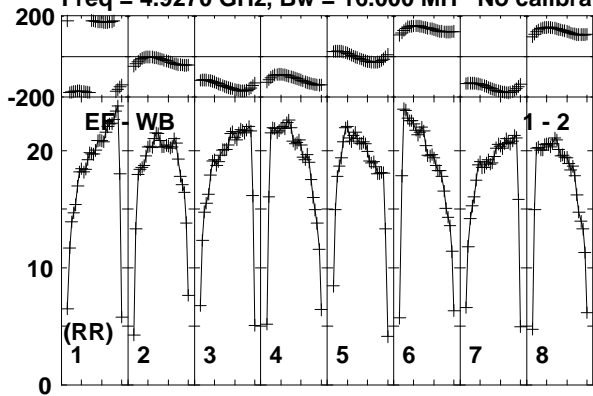

Lower frame: Milli Ampl Jy Top frame: Phas deg
Vector averaged cross-power spectrum Baseline: EF (01) - WB (02)
Timerange: 00/14:16:43 to 00/14:17:39

Plot file version 198 created 28-JAN-2015 14:38:12

1848+283 N14C3.UVDATA.1

Freq = 4.9270 GHz, Bw = 16.000 MH No calibration applied and no bandpass applied

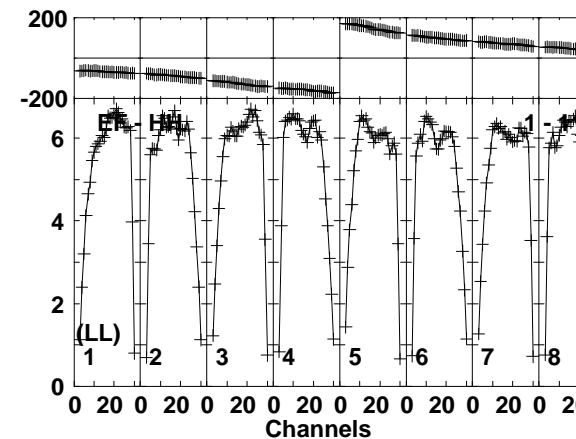
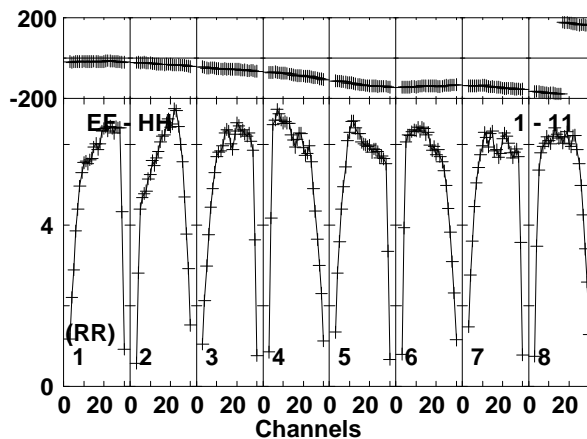
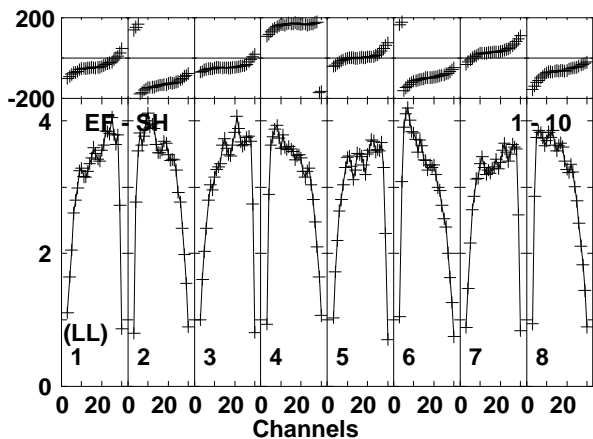
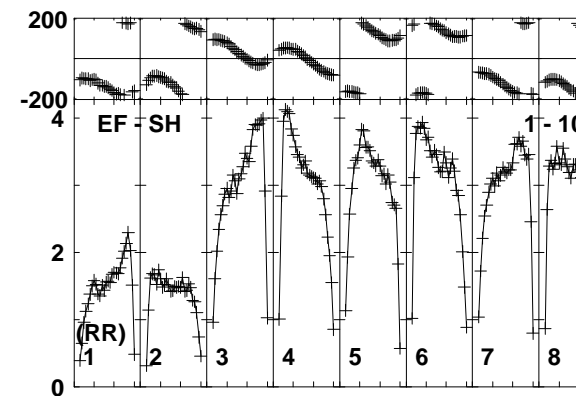
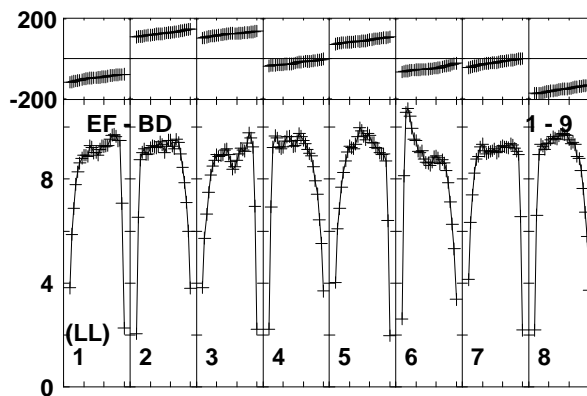
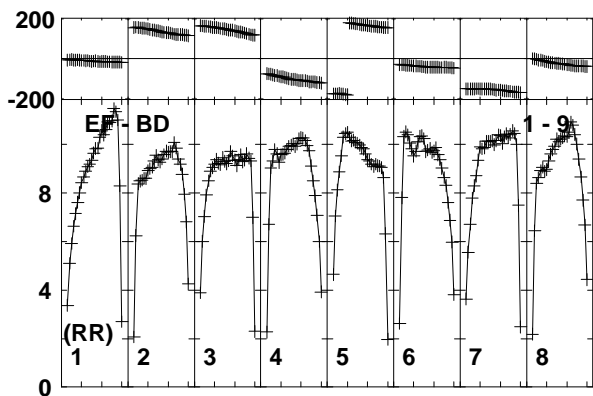
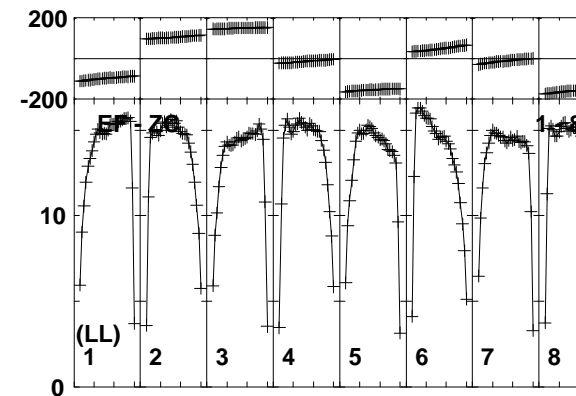
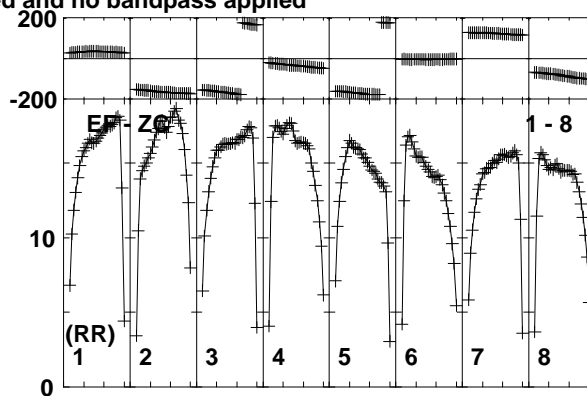
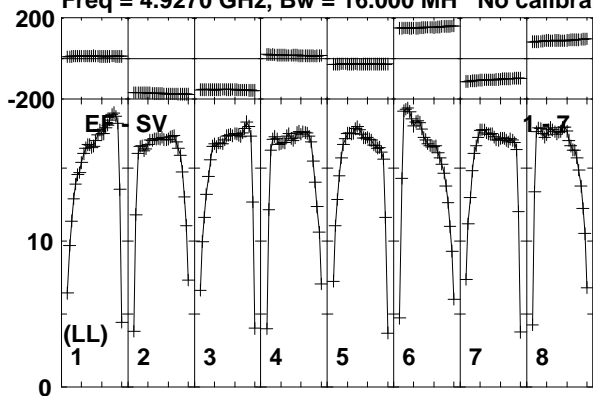

Lower frame: Milli Ampl Jy Top frame: Phas deg
Vector averaged cross-power spectrum Baseline: EF (01) - SV (07)
Timerange: 00/14:16:43 to 00/14:17:39

Plot file version 199 created 28-JAN-2015 14:38:12

1848+283 N14C3.UVDATA.1

Freq = 4.9270 GHz, Bw = 16.000 MH No calibration applied and no bandpass applied

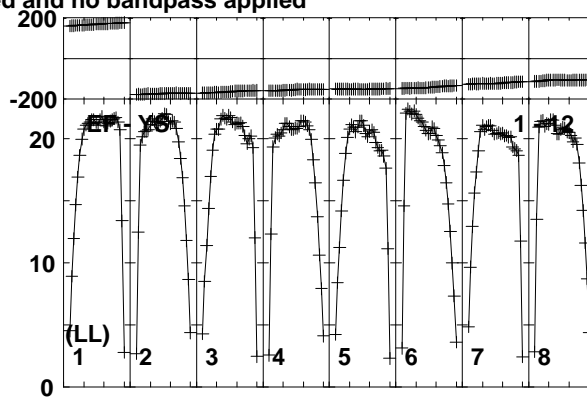
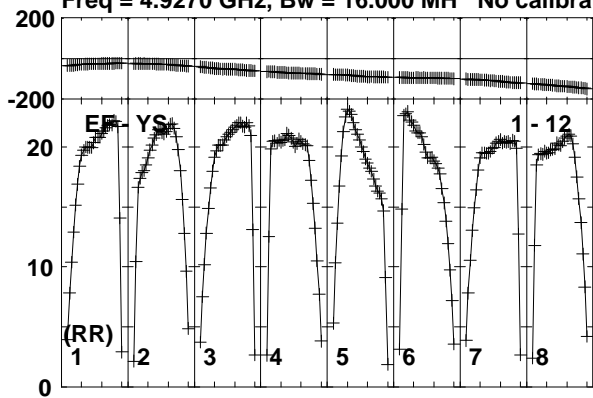

Lower frame: Milli Ampl Jy Top frame: Phas deg
Vector averaged cross-power spectrum Baseline: EF (01) - YS (12)
Timerange: 00/14:16:43 to 00/14:17:39

Plot file version 200 created 28-JAN-2015 14:38:12

2023+336 N14C3.UVDATA.1

Freq = 4.9270 GHz, Bw = 16.000 MH No calibration applied and no bandpass applied

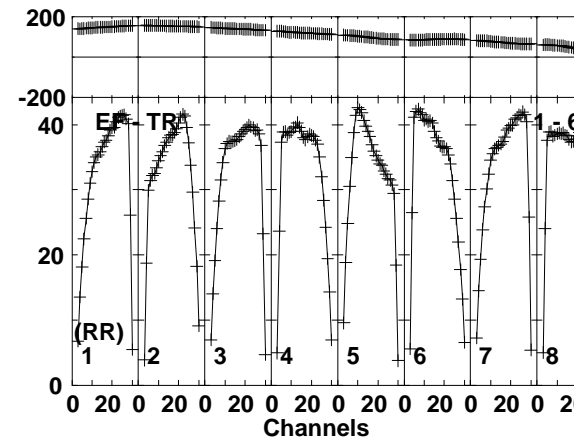
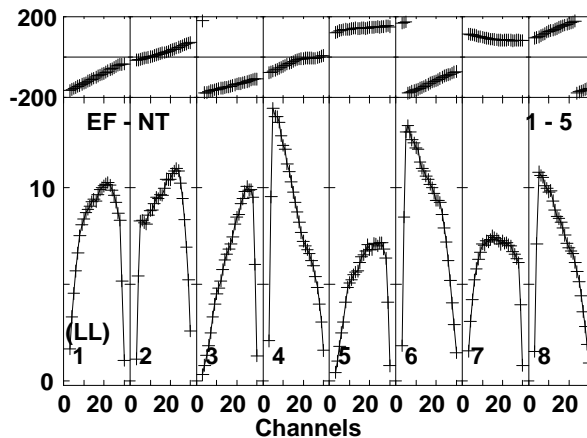
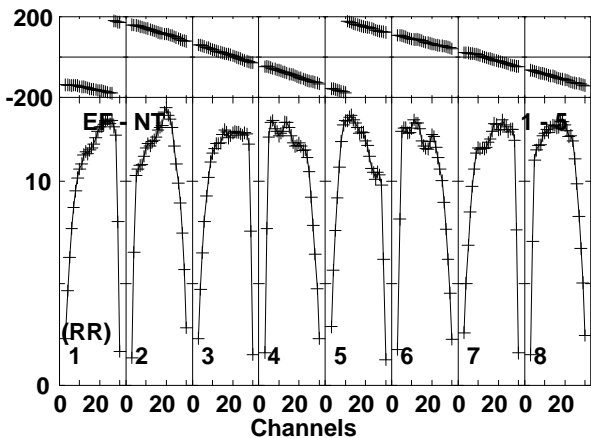
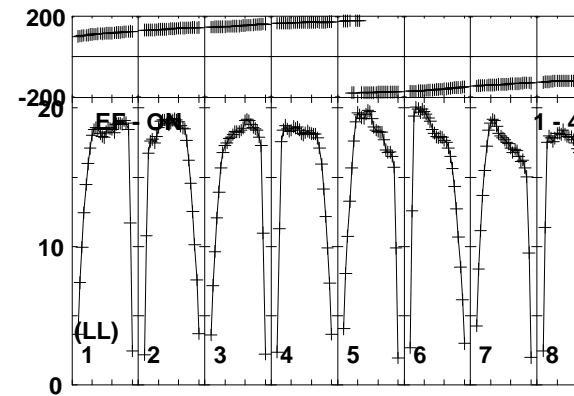
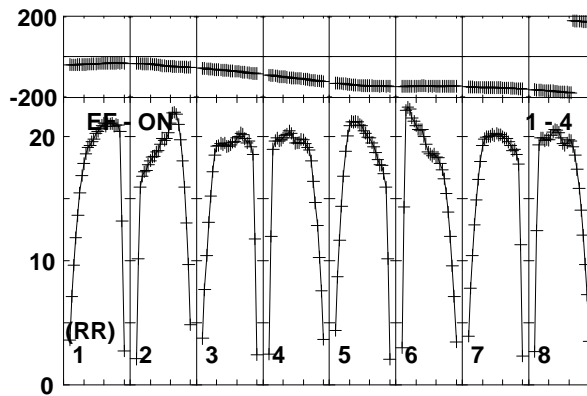
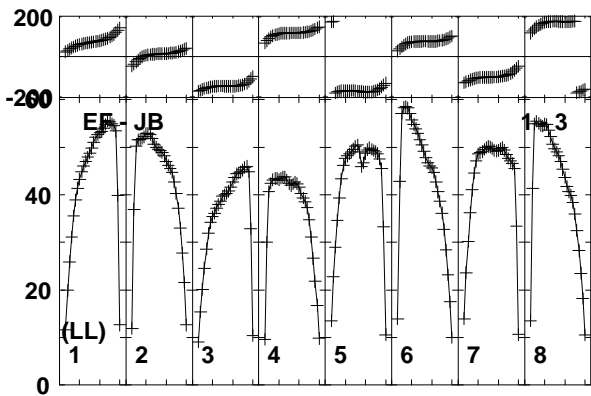
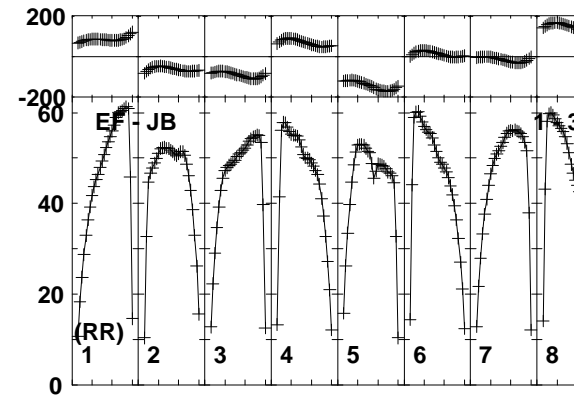
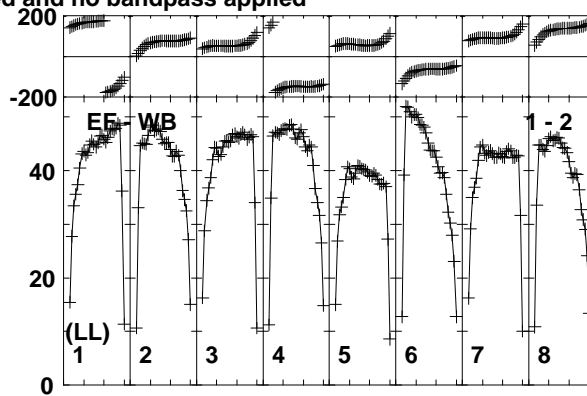
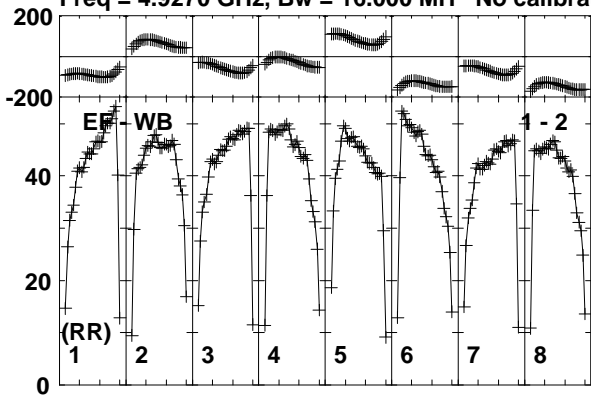

Lower frame: Milli Ampl Jy Top frame: Phas deg
Vector averaged cross-power spectrum Baseline: EF (01) - WB (02)
Timerange: 00/14:23:43 to 00/14:24:39

Plot file version 201 created 28-JAN-2015 14:38:13

2023+336 N14C3.UVDATA.1

Freq = 4.9270 GHz, Bw = 16.000 MH No calibration applied and no bandpass applied

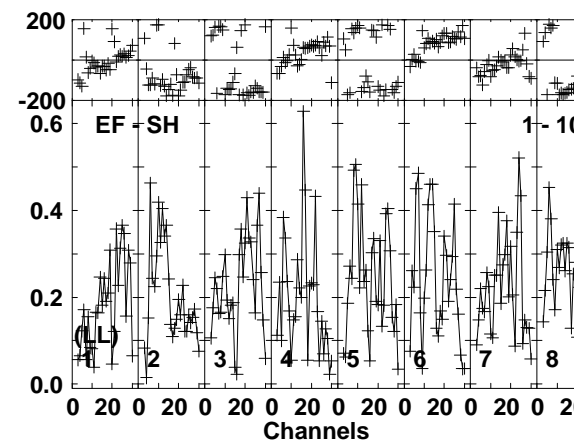
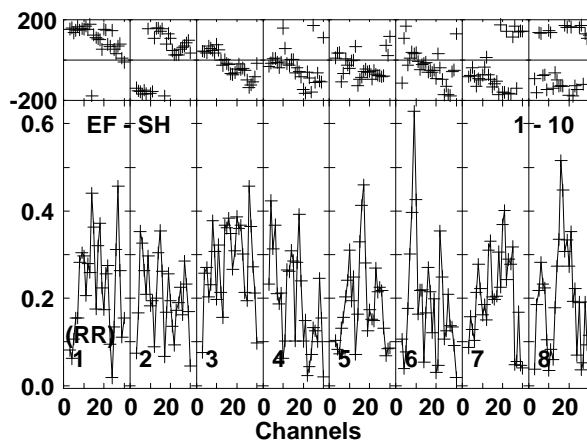
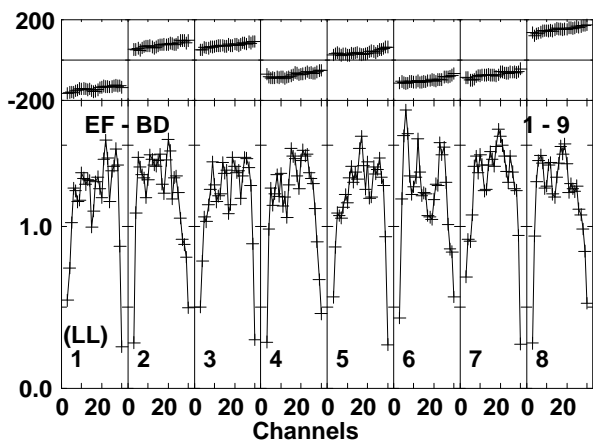
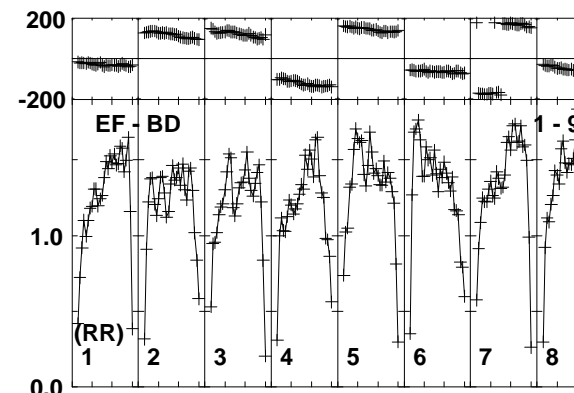
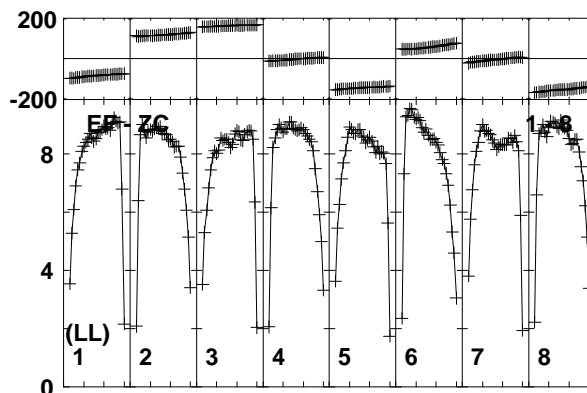
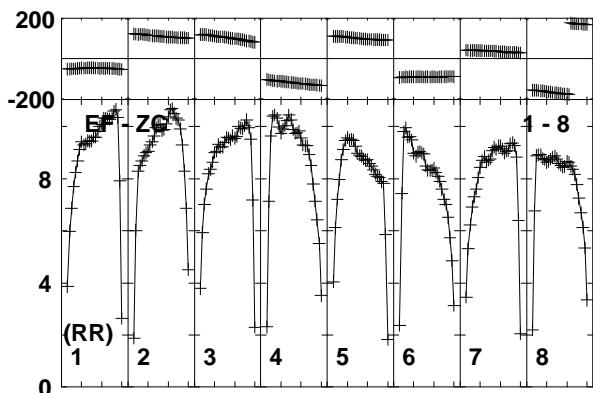
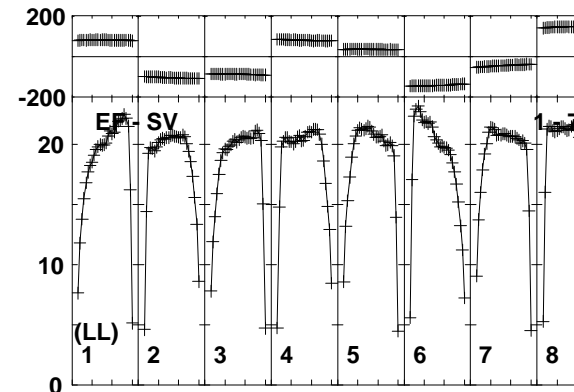
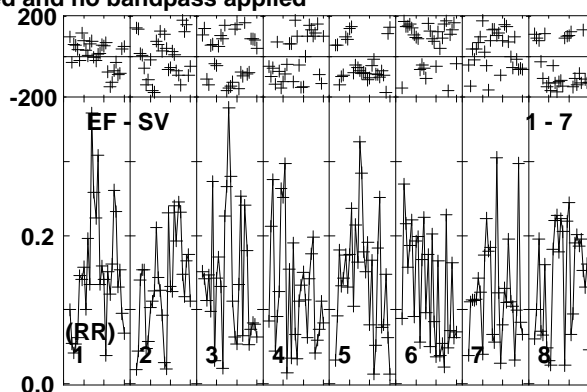
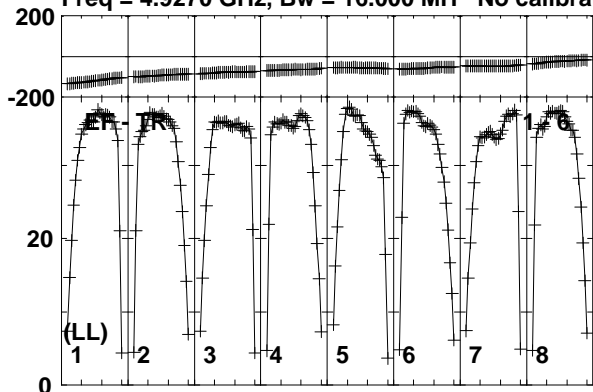

Lower frame: Milli Ampl Jy Top frame: Phas deg
Vector averaged cross-power spectrum Baseline: EF (01) - TR (06)
Timerange: 00/14:23:43 to 00/14:24:39

Plot file version 202 created 28-JAN-2015 14:38:13

2023+336 N14C3.UVDATA.1

Freq = 4.9270 GHz, Bw = 16.000 MH No calibration applied and no bandpass applied

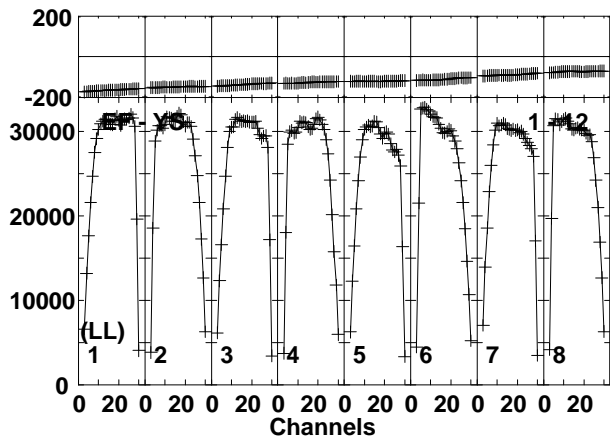
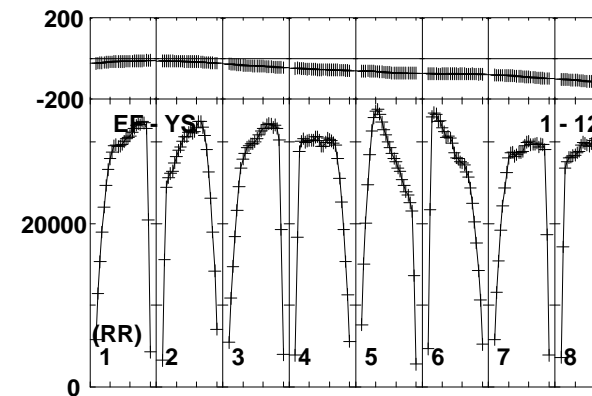
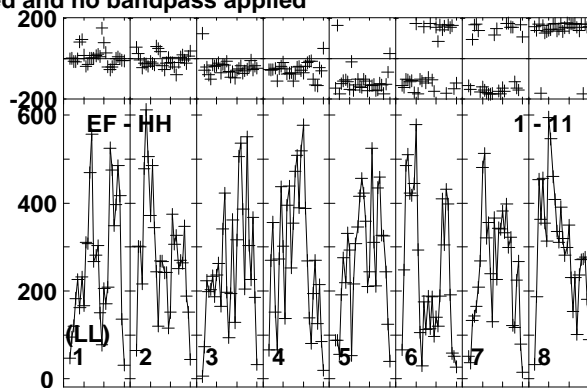
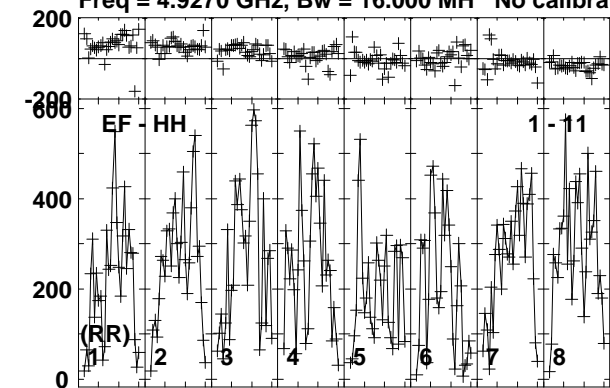

Lower frame: Micro Ampl Jy Top frame: Phas deg
Vector averaged cross-power spectrum Baseline: EF (01) - HH (11)
Timerange: 00/14:23:43 to 00/14:24:39

Plot file version 203 created 28-JAN-2015 14:38:13

2023+336 N14C3.UVDATA.1

Freq = 4.9270 GHz, Bw = 16.000 MH No calibration applied and no bandpass applied

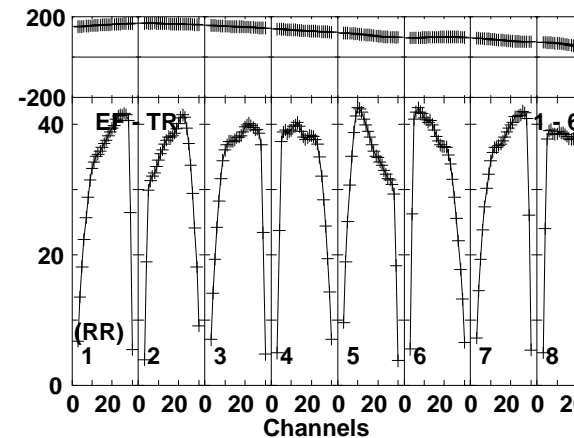
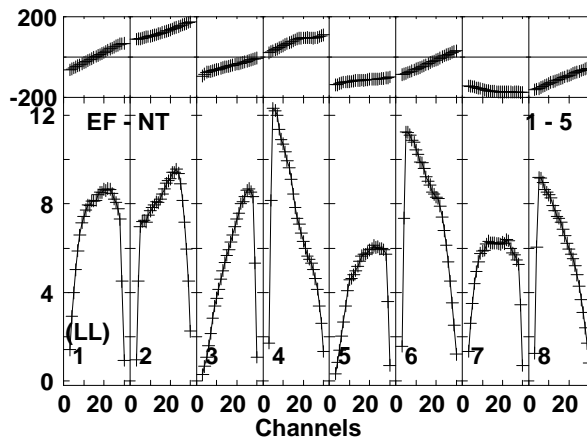
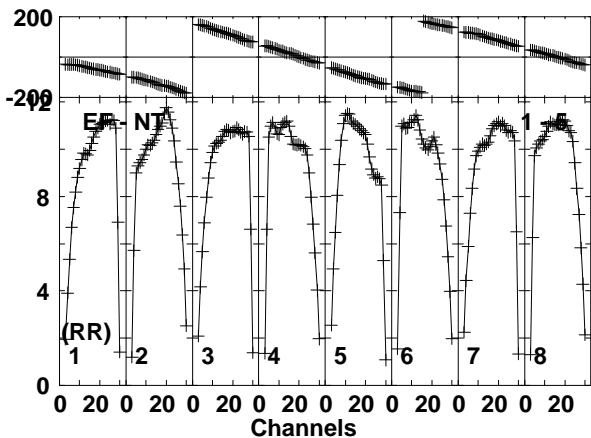
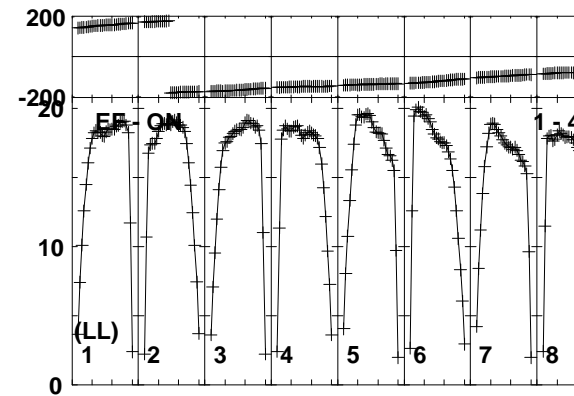
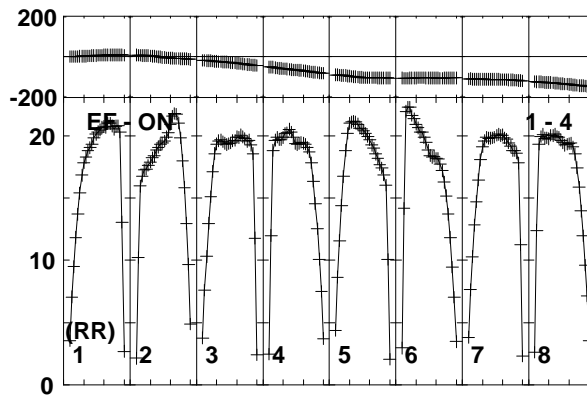
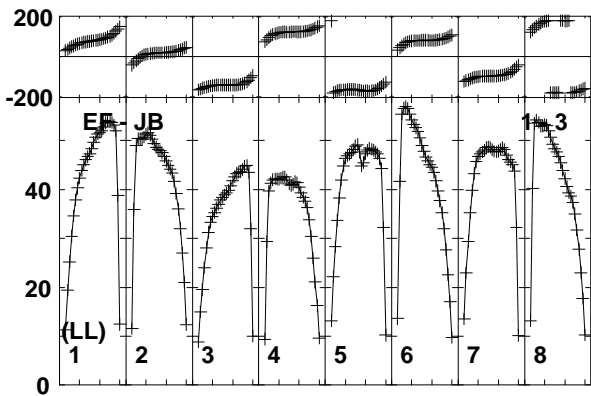
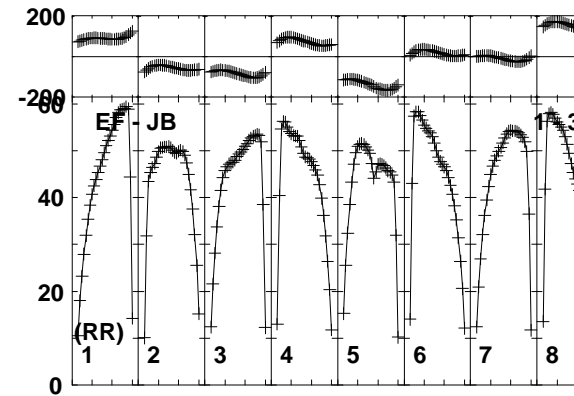
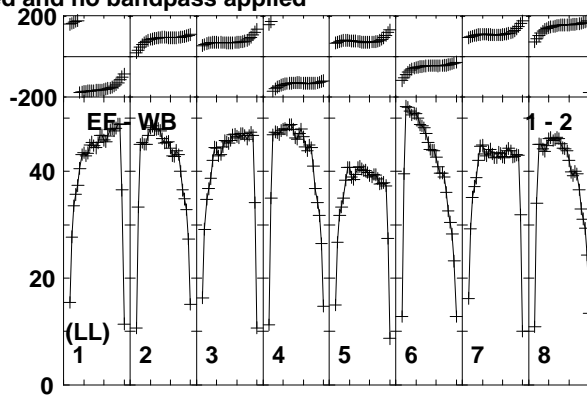
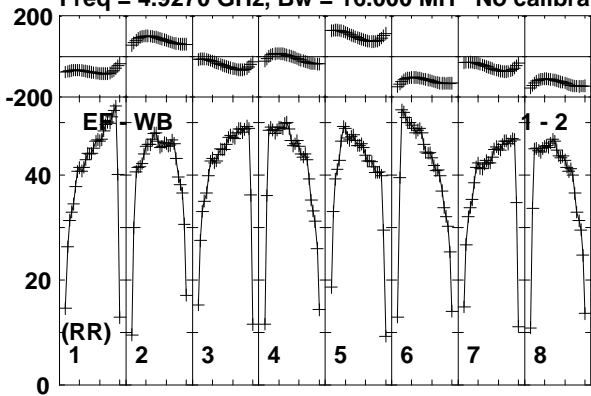

Lower frame: Milli Ampl Jy Top frame: Phas deg
Vector averaged cross-power spectrum Baseline: EF (01) - WB (02)
Timerange: 00/14:26:03 to 00/14:29:59

Plot file version 204 created 28-JAN-2015 14:38:13

2023+336 N14C3.UVDATA.1

Freq = 4.9270 GHz, Bw = 16.000 MH No calibration applied and no bandpass applied

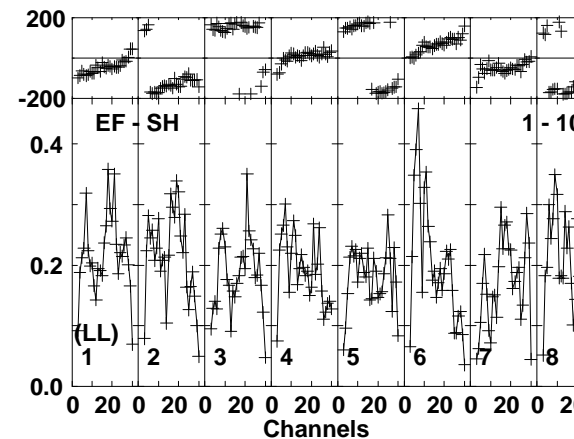
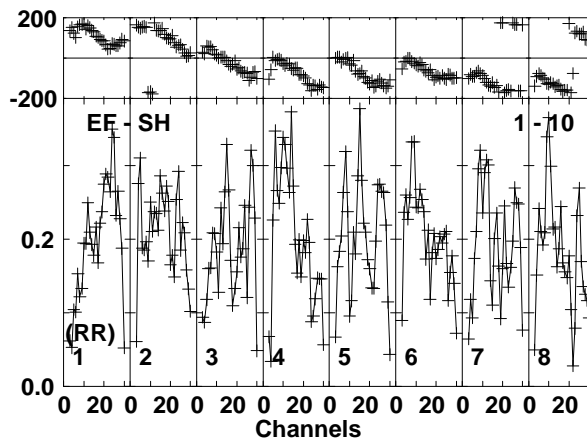
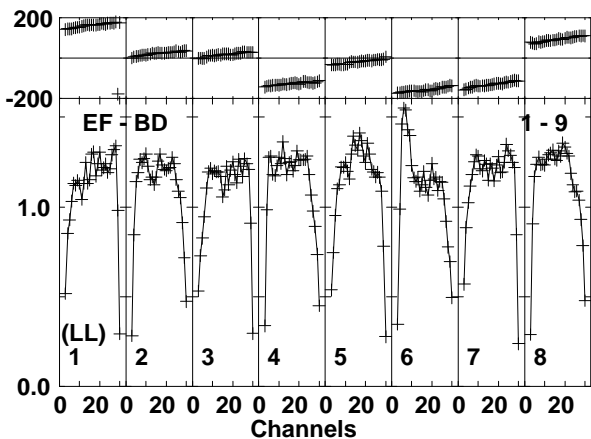
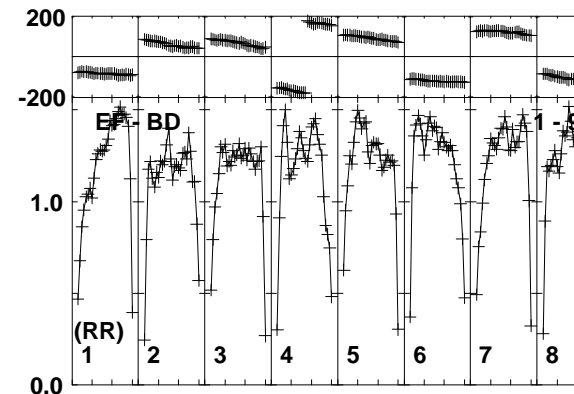
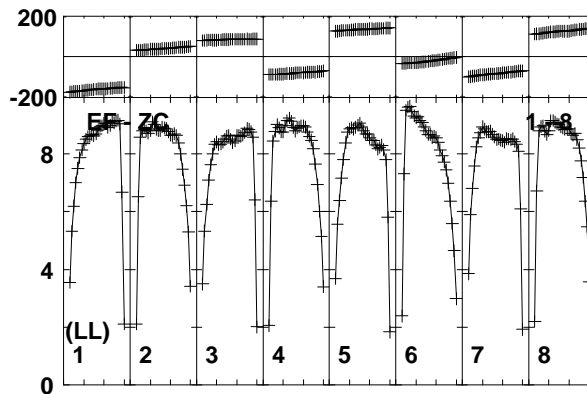
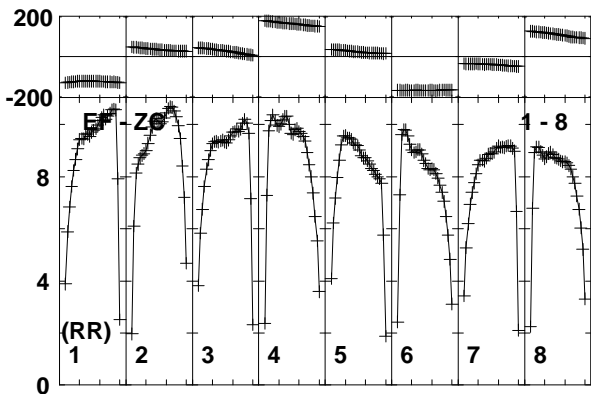
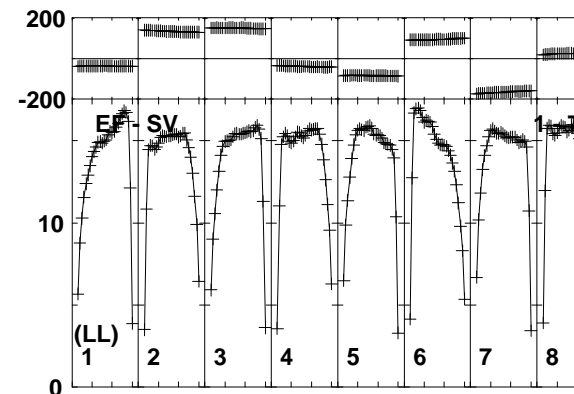
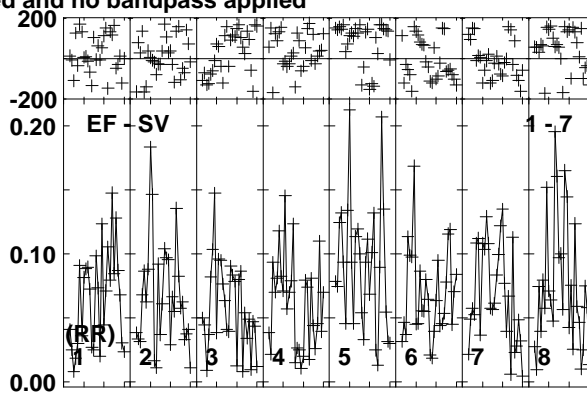
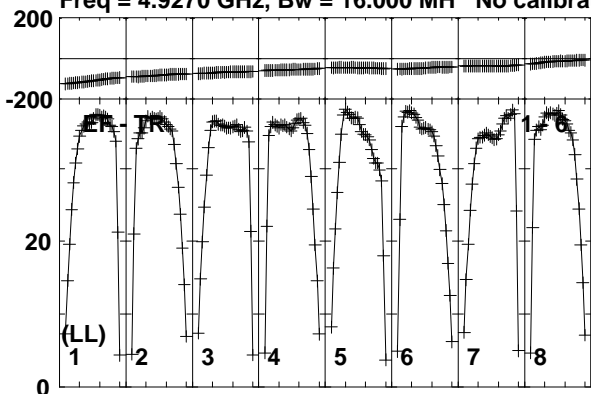

Lower frame: Milli Ampl Jy Top frame: Phas deg
Vector averaged cross-power spectrum Baseline: EF (01) - TR (06)
Timerange: 00/14:26:03 to 00/14:29:59

Plot file version 205 created 28-JAN-2015 14:38:13

2023+336 N14C3.UVDATA.1

Freq = 4.9270 GHz, Bw = 16.000 MH No calibration applied and no bandpass applied

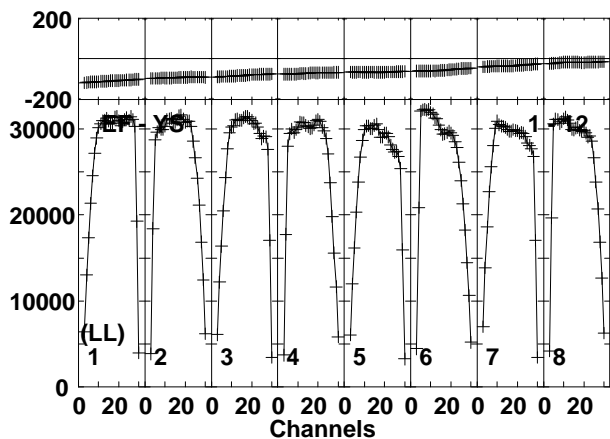
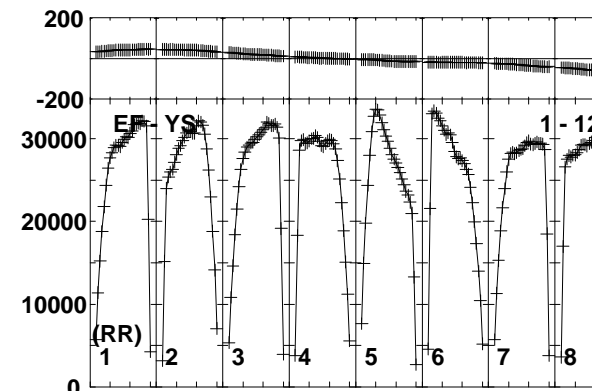
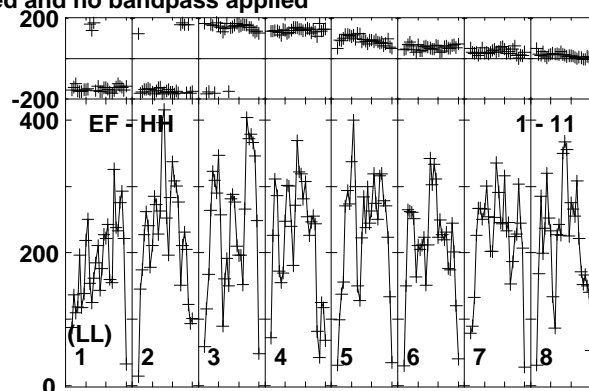
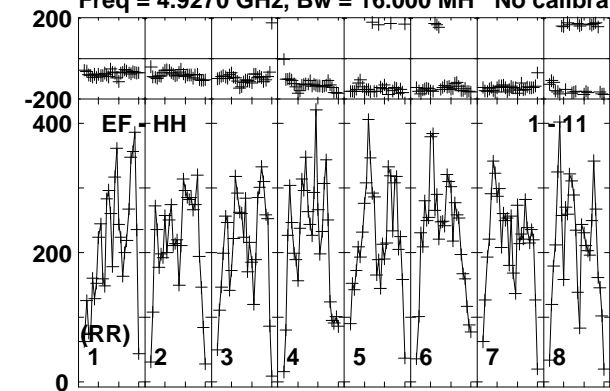

Lower frame: Micro Ampl Jy Top frame: Phas deg
Vector averaged cross-power spectrum Baseline: EF (01) - HH (11)
Timerange: 00/14:26:03 to 00/14:29:59

Plot file version 206 created 28-JAN-2015 14:38:13

2023+336 N14C3.UVDATA.1

Freq = 4.9270 GHz, Bw = 16.000 MH No calibration applied and no bandpass applied

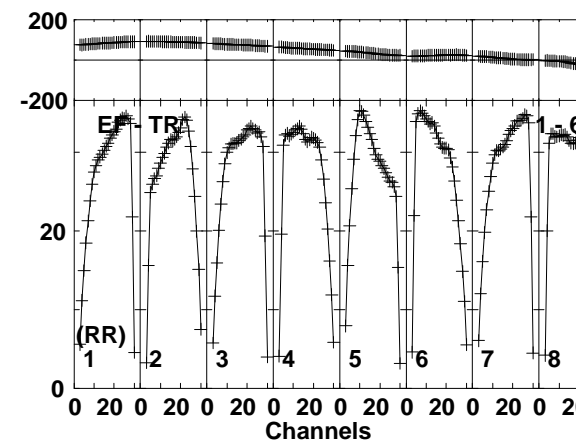
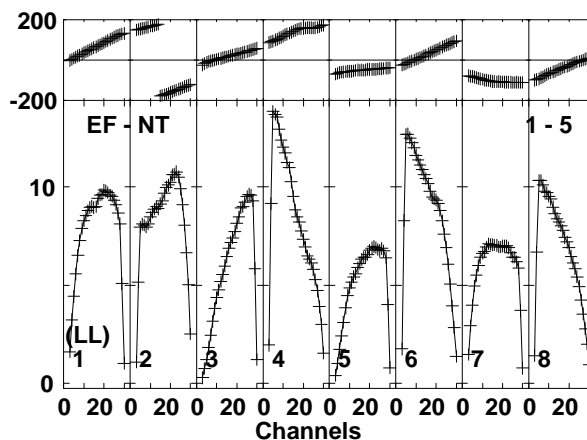
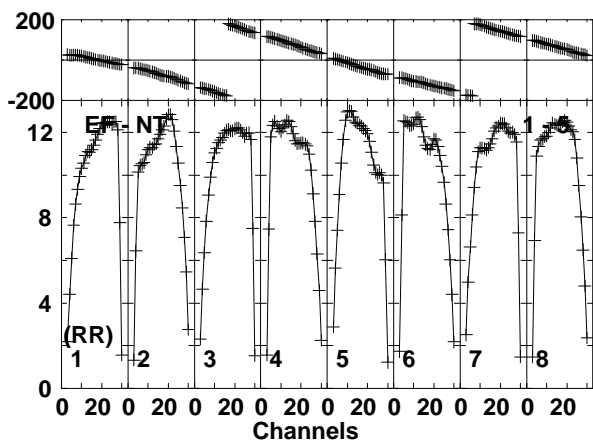
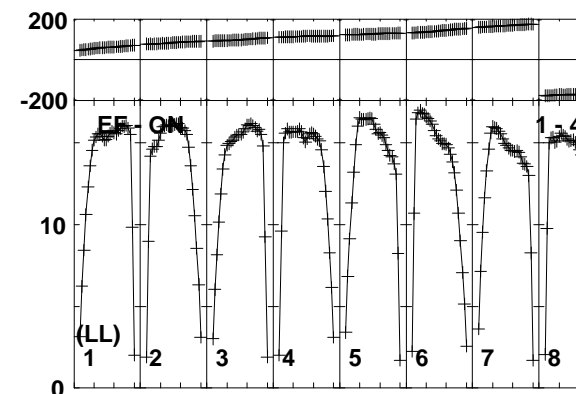
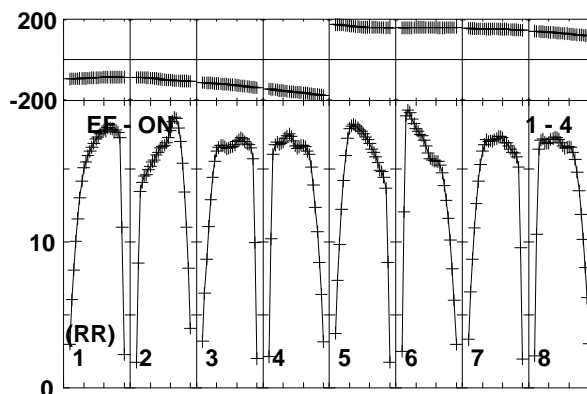
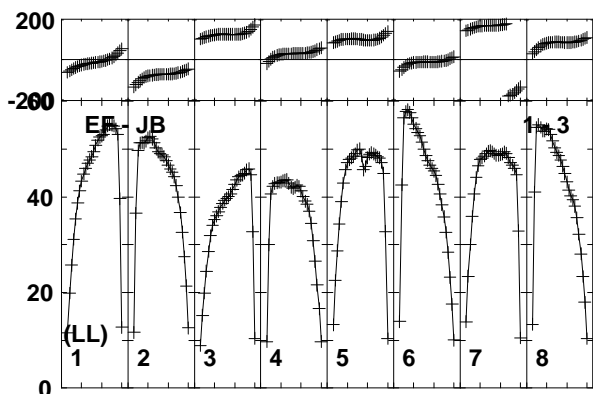
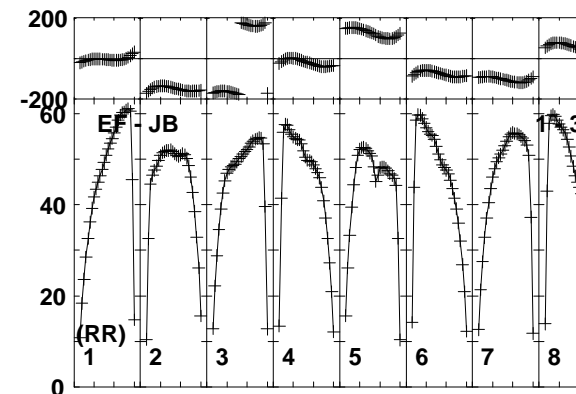
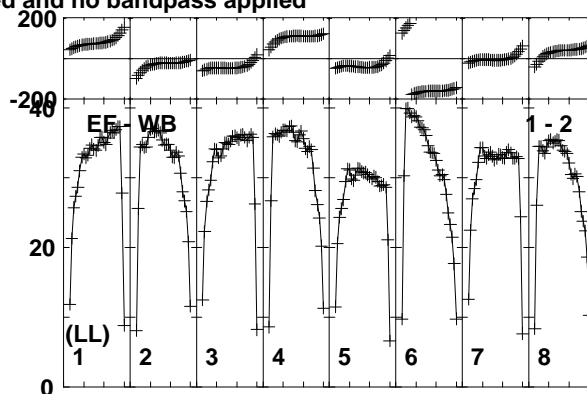
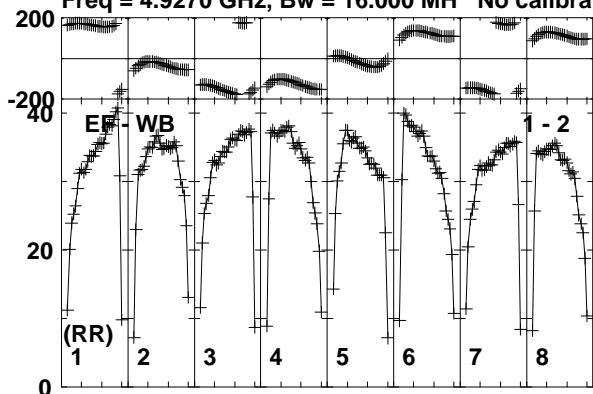

Lower frame: Milli Ampl Jy Top frame: Phas deg
Vector averaged cross-power spectrum Baseline: EF (01) - WB (02)
Timerange: 00/14:32:03 to 00/14:39:59

Plot file version 207 created 28-JAN-2015 14:38:14

2023+336 N14C3.UVDATA.1

Freq = 4.9270 GHz, Bw = 16.000 MH No calibration applied and no bandpass applied

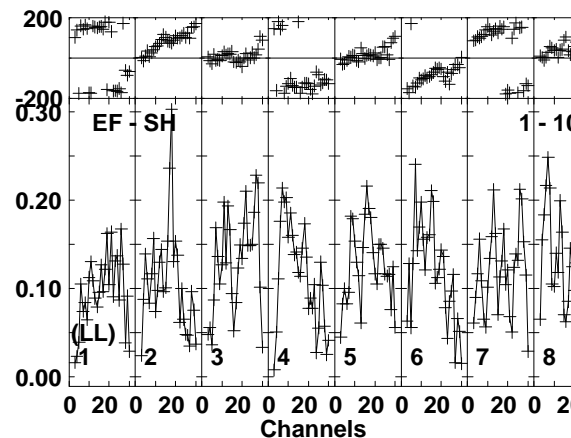
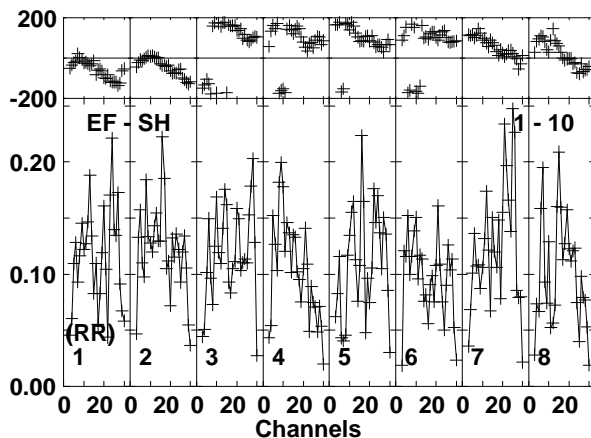
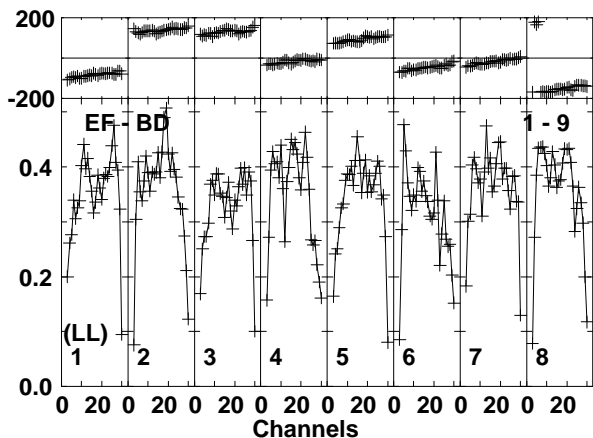
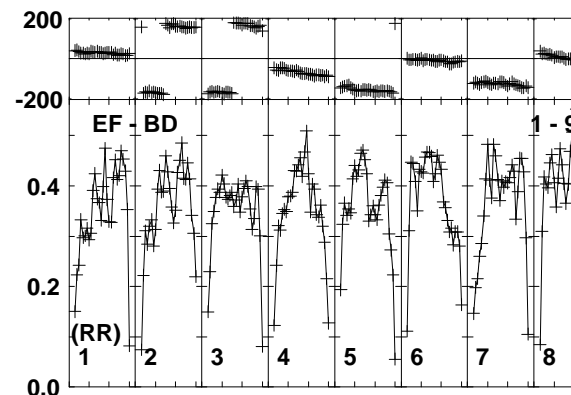
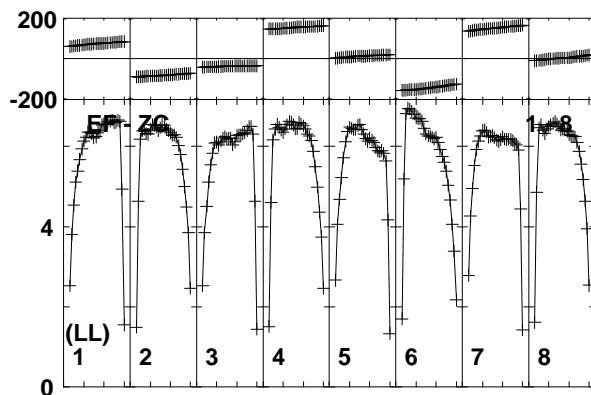
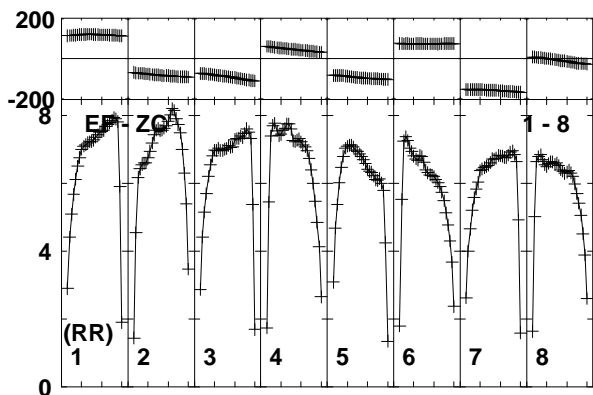
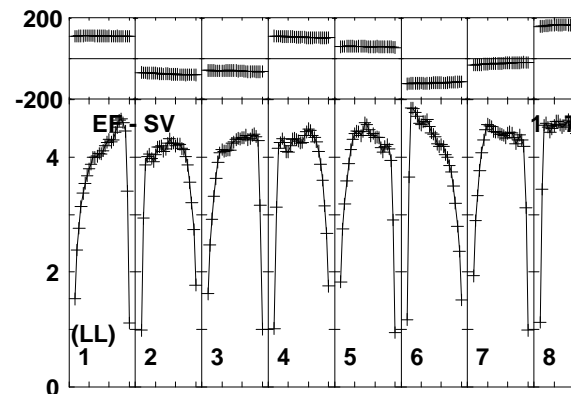
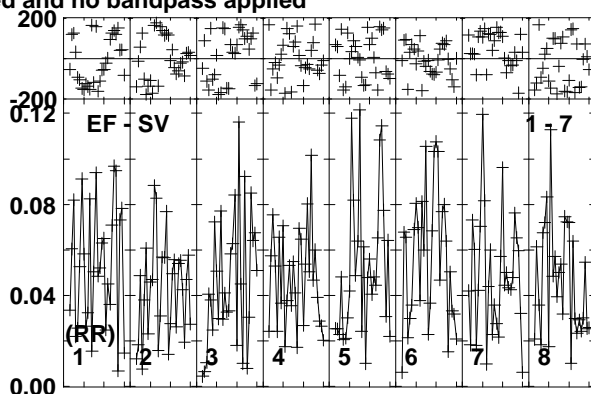
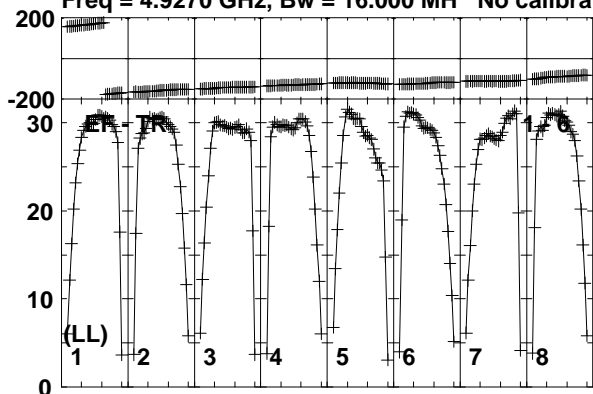

Lower frame: Milli Ampl Jy Top frame: Phas deg
Vector averaged cross-power spectrum Baseline: EF (01) - TR (06)
Timerange: 00/14:32:03 to 00/14:39:59

Plot file version 208 created 28-JAN-2015 14:38:14

2023+336 N14C3.UVDATA.1

Freq = 4.9270 GHz, Bw = 16.000 MH No calibration applied and no bandpass applied

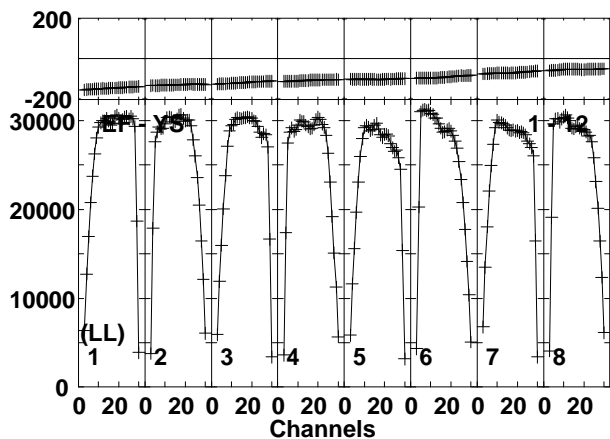
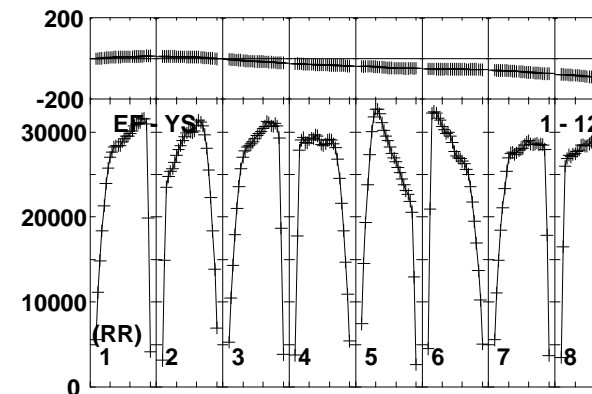
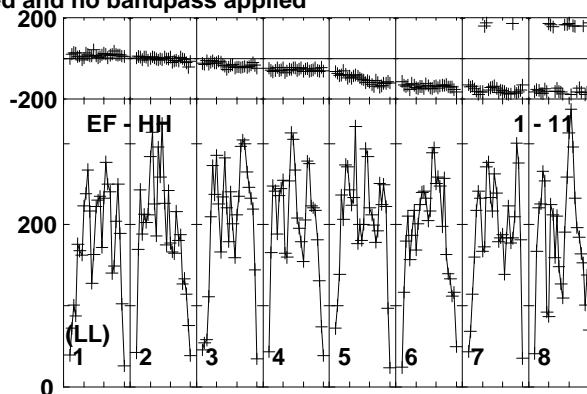
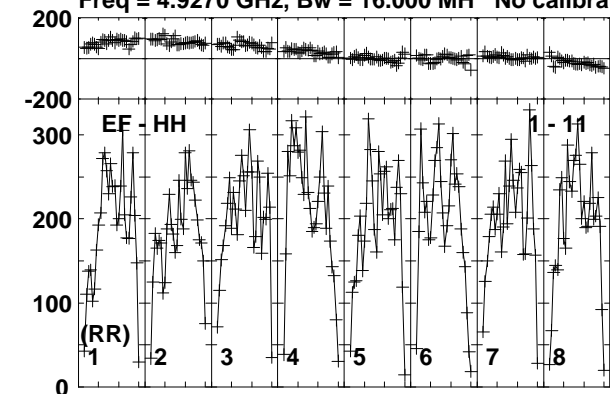

Lower frame: Micro Ampl Jy Top frame: Phas deg
Vector averaged cross-power spectrum Baseline: EF (01) - HH (11)
Timerange: 00/14:32:03 to 00/14:39:59

Plot file version 209 created 28-JAN-2015 14:38:14

2023+336 N14C3.UVDATA.1

Freq = 4.9270 GHz, Bw = 16.000 MH No calibration applied and no bandpass applied

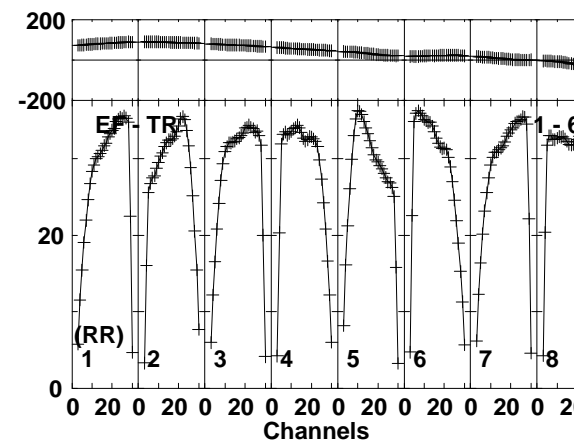
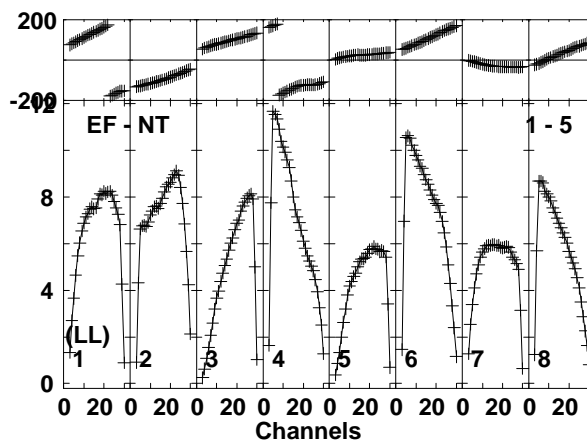
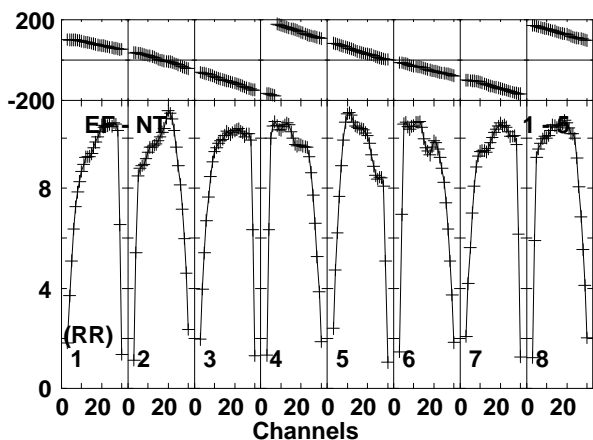
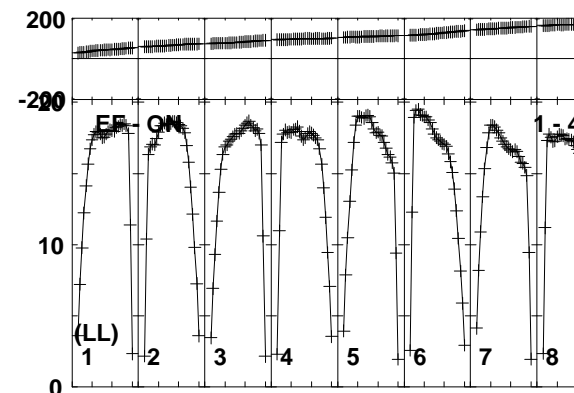
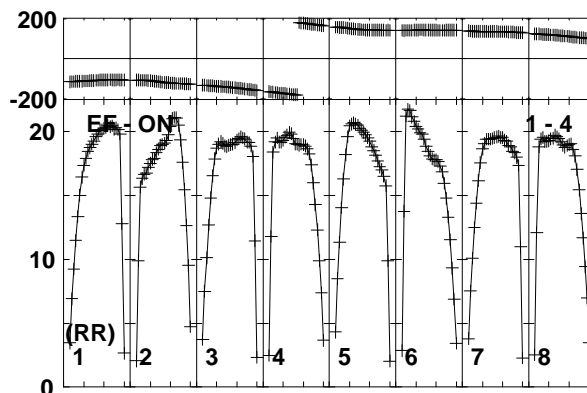
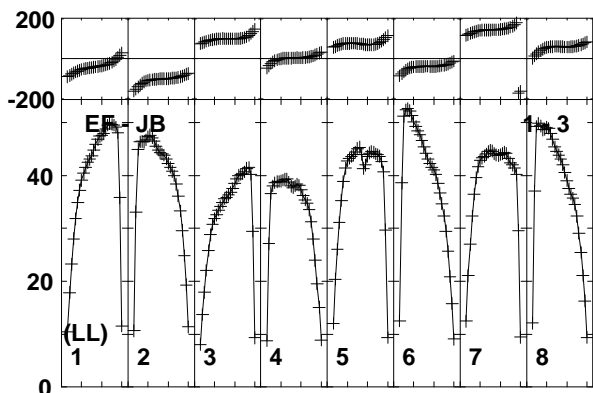
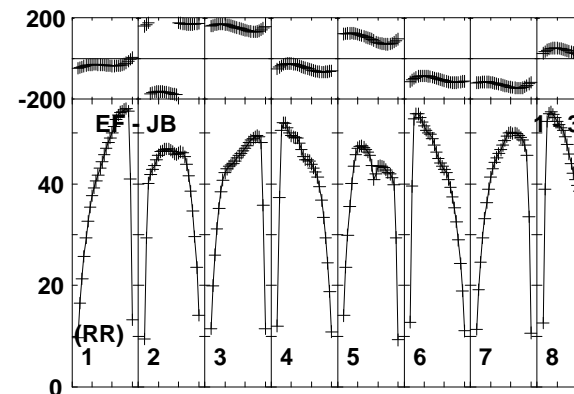
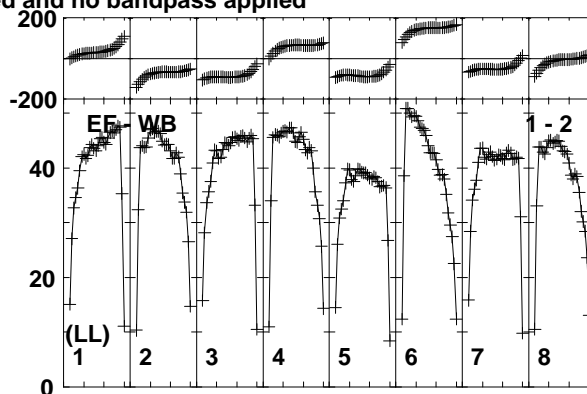
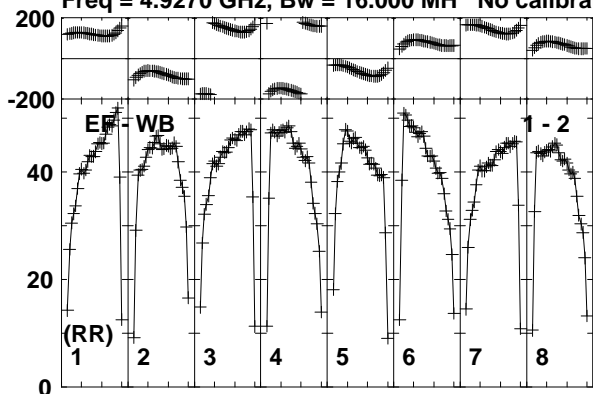

Lower frame: Milli Ampl Jy Top frame: Phas deg
Vector averaged cross-power spectrum Baseline: EF (01) - WB (02)
Timerange: 00/14:42:03 to 00/14:49:59

Plot file version 210 created 28-JAN-2015 14:38:14

2023+336 N14C3.UVDATA.1

Freq = 4.9270 GHz, Bw = 16.000 MH No calibration applied and no bandpass applied

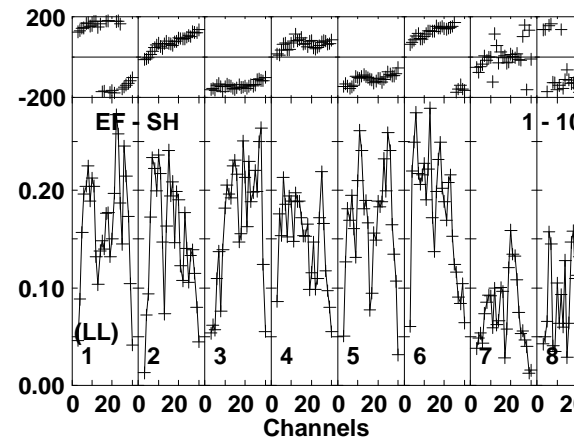
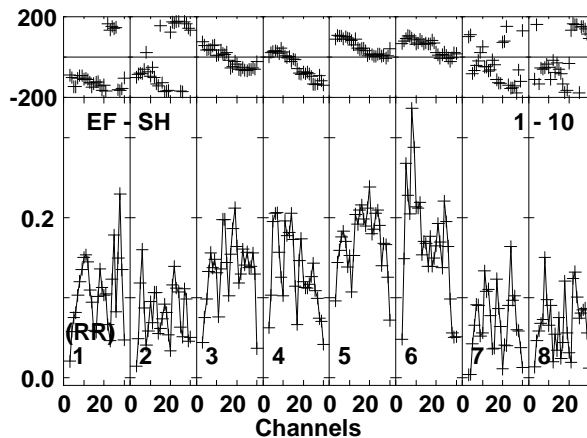
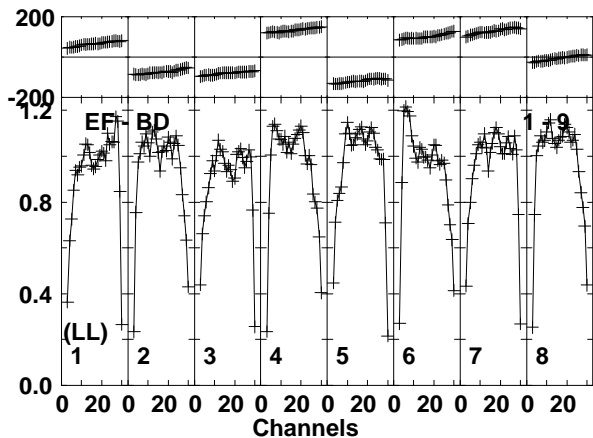
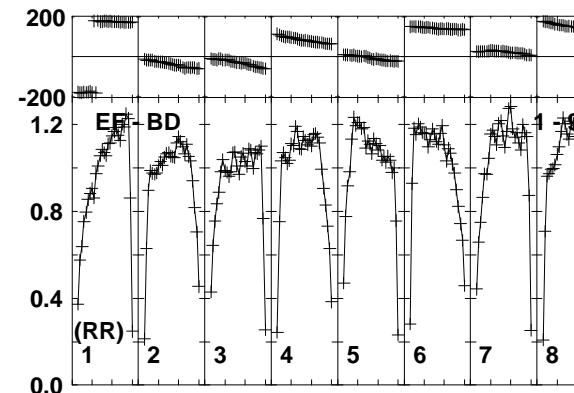
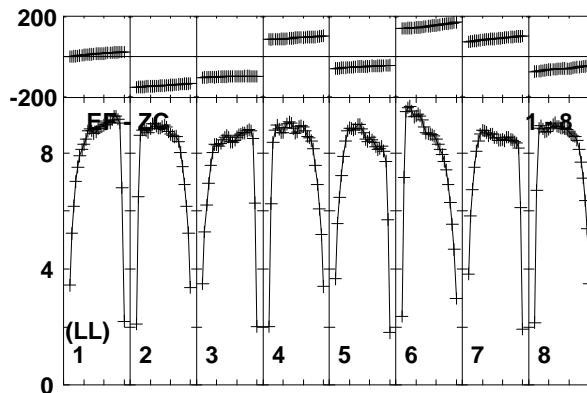
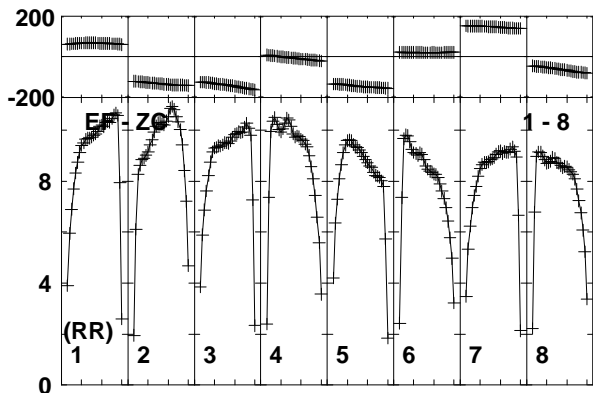
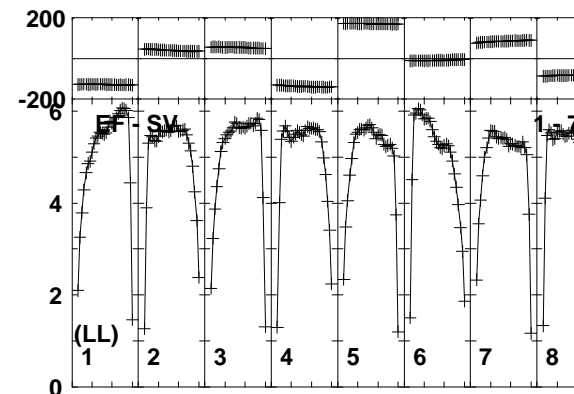
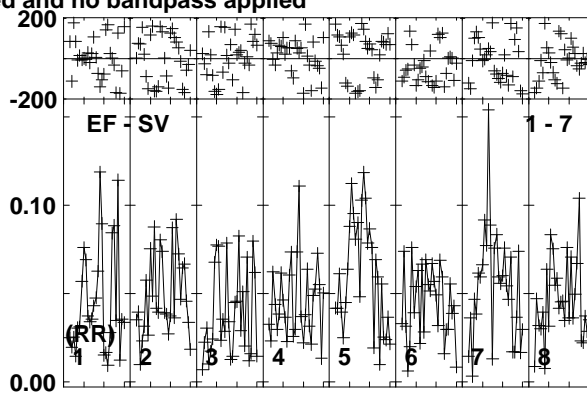
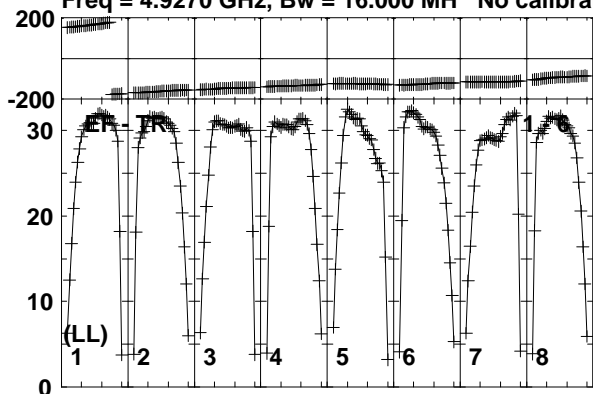

Lower frame: Milli Ampl Jy Top frame: Phas deg
Vector averaged cross-power spectrum Baseline: EF (01) - TR (06)
Timerange: 00/14:42:03 to 00/14:49:59

Plot file version 211 created 28-JAN-2015 14:38:15
2023+336 N14C3.UVDATA.1

Freq = 4.9270 GHz, Bw = 16.000 MH No calibration applied and no bandpass applied

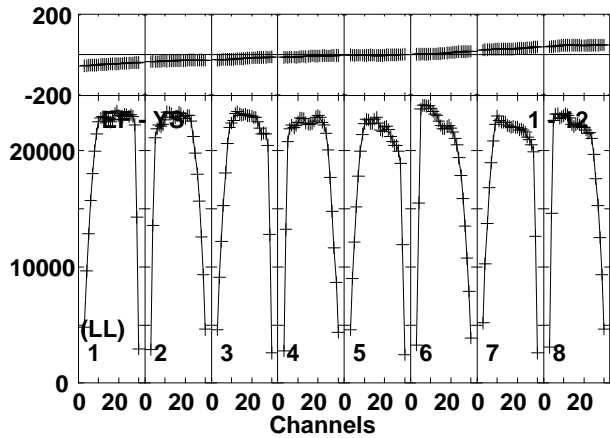
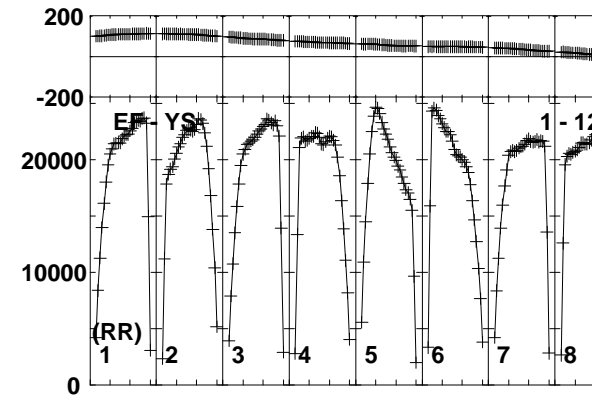
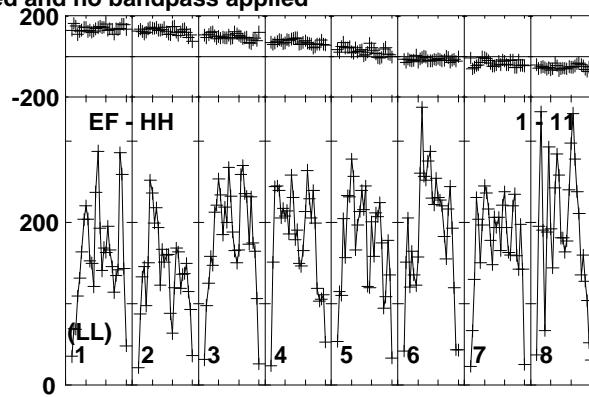
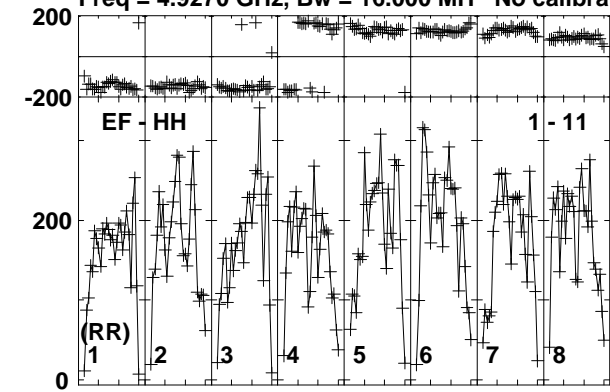

Lower frame: Micro Ampl Jy Top frame: Phas deg
Vector averaged cross-power spectrum Baseline: EF (01) - HH (11)
Timerange: 00/14:42:03 to 00/14:49:59

Plot file version 212 created 28-JAN-2015 14:38:15

2023+336 N14C3.UVDATA.1

Freq = 4.9270 GHz, Bw = 16.000 MH No calibration applied and no bandpass applied

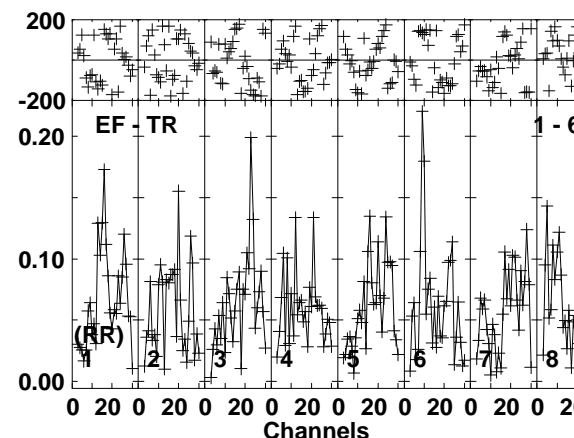
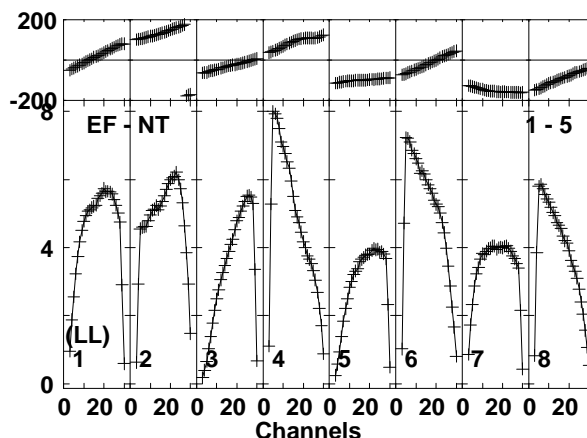
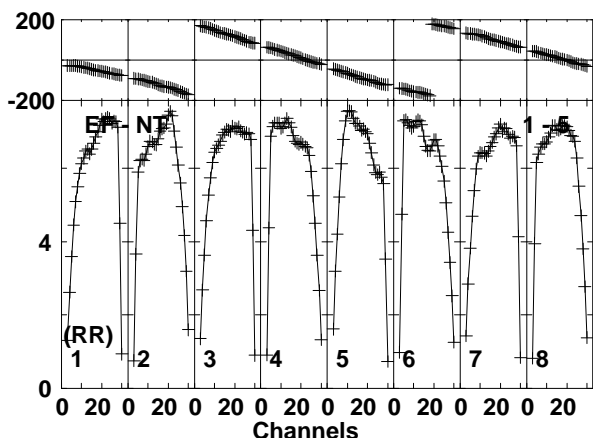
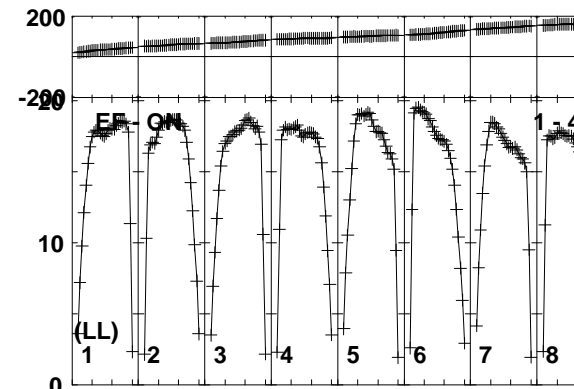
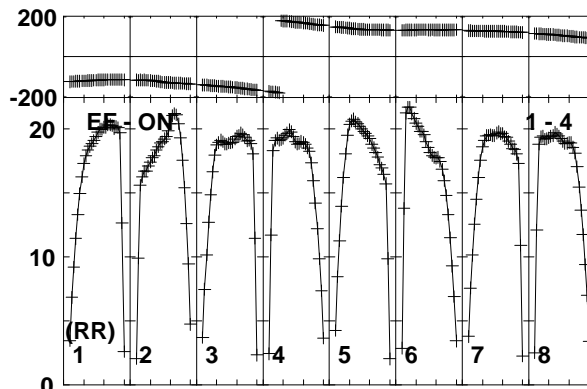
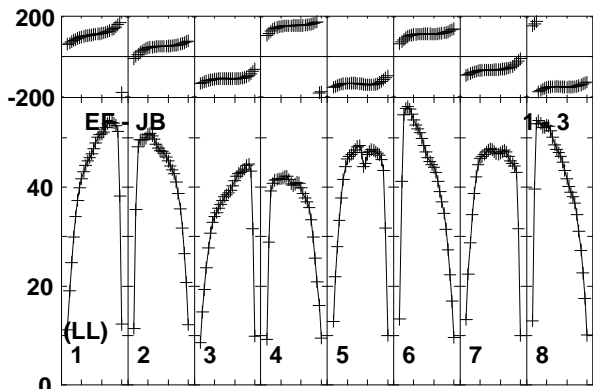
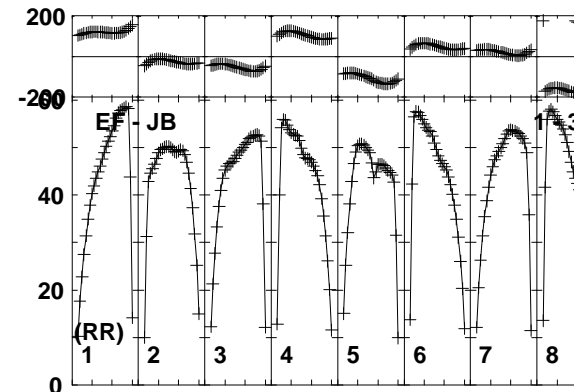
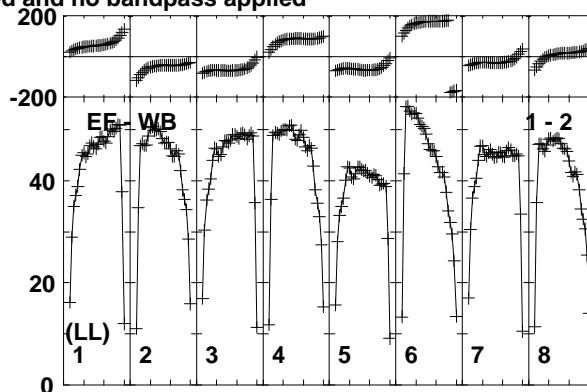
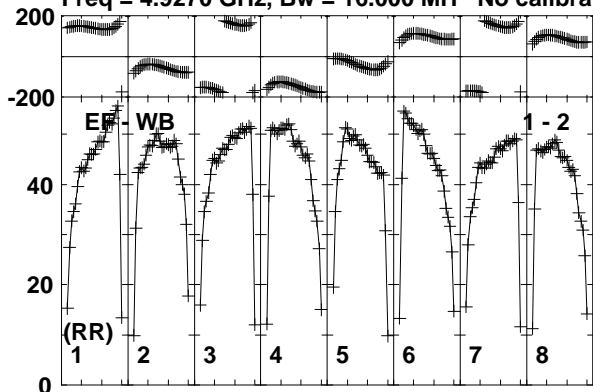

Lower frame: Milli Ampl Jy Top frame: Phas deg
Vector averaged cross-power spectrum Baseline: EF (01) - WB (02)
Timerange: 00/14:52:03 to 00/14:59:59

Plot file version 213 created 28-JAN-2015 14:38:15

2023+336 N14C3.UVDATA.1

Freq = 4.9270 GHz, Bw = 16.000 MH No calibration applied and no bandpass applied

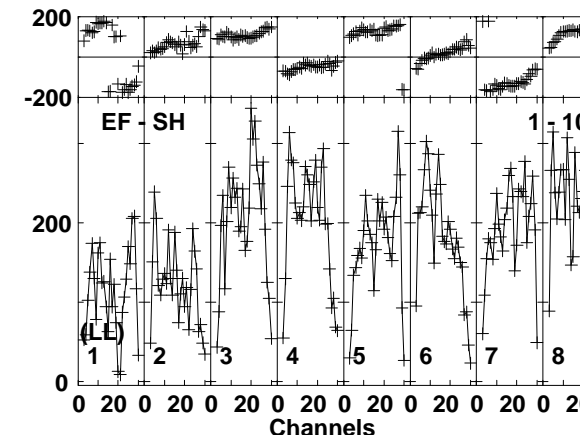
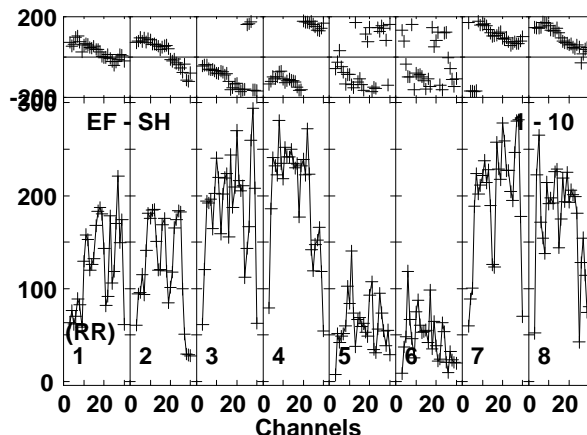
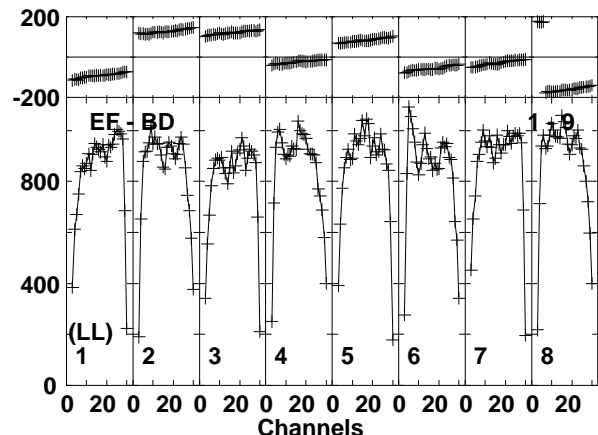
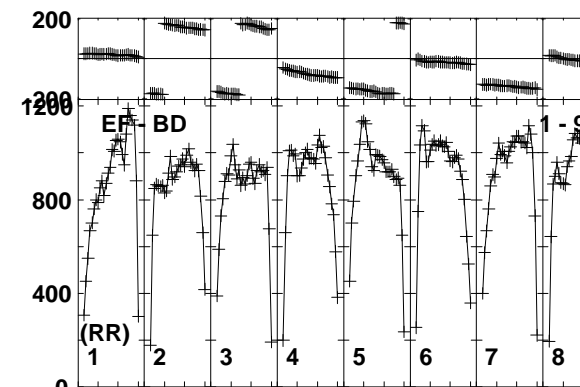
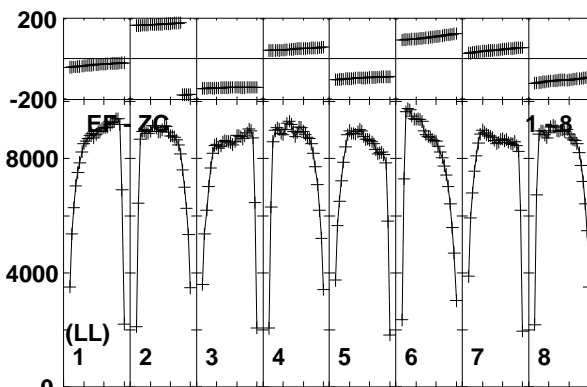
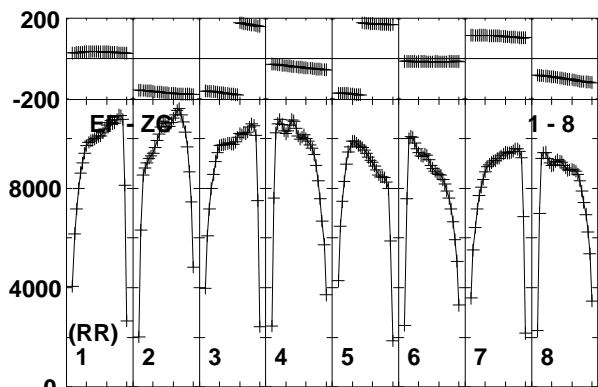
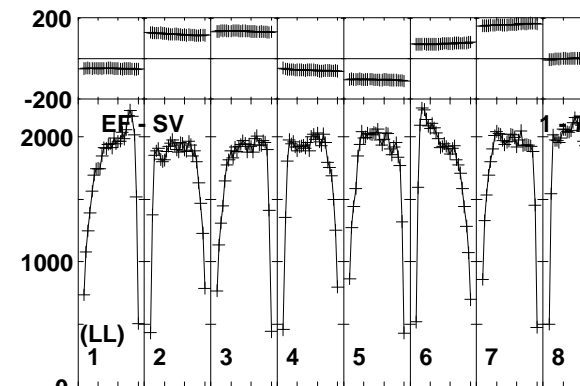
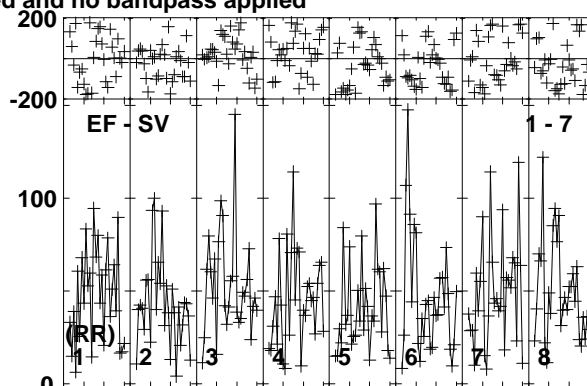
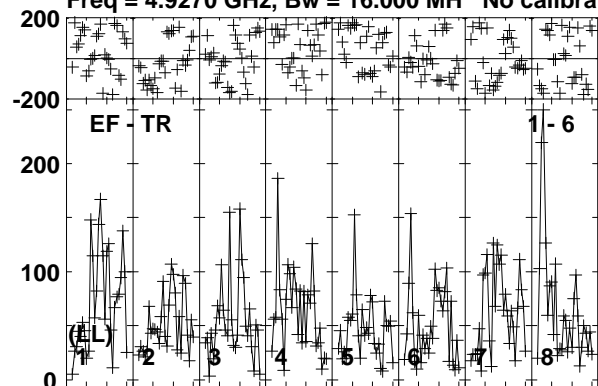

Lower frame: Micro Ampl Jy Top frame: Phas deg
Vector averaged cross-power spectrum Baseline: EF (01) - TR (06)
Timerange: 00/14:52:03 to 00/14:59:59

Plot file version 214 created 28-JAN-2015 14:38:15

2023+336 N14C3.UVDATA.1

Freq = 4.9270 GHz, Bw = 16.000 MH No calibration applied and no bandpass applied

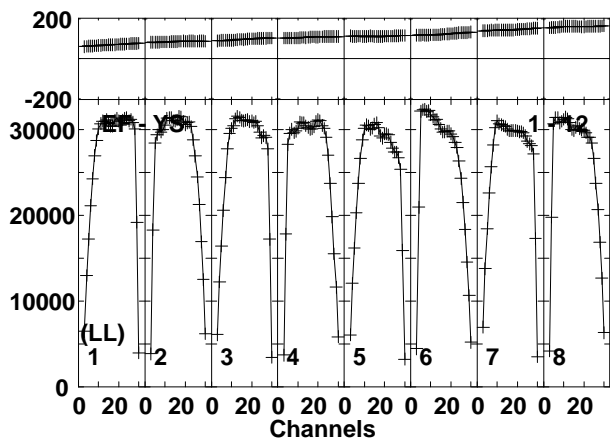
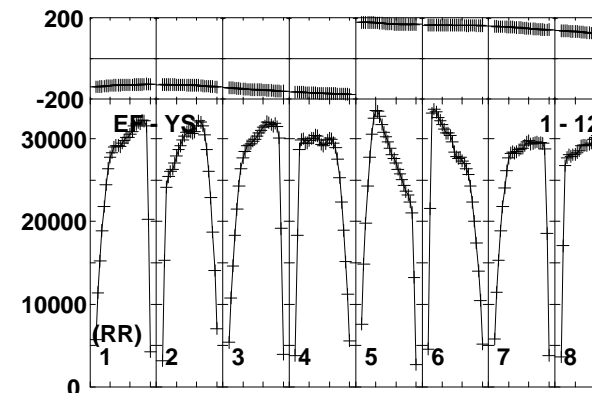
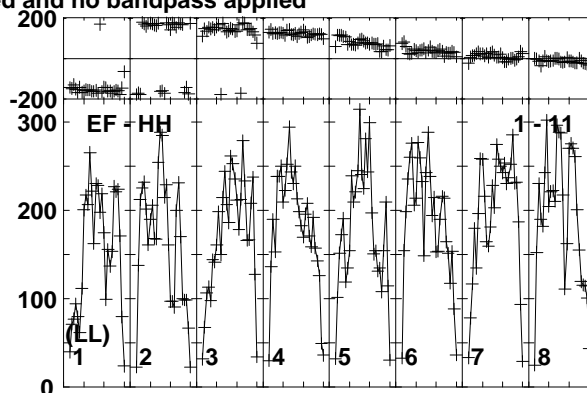
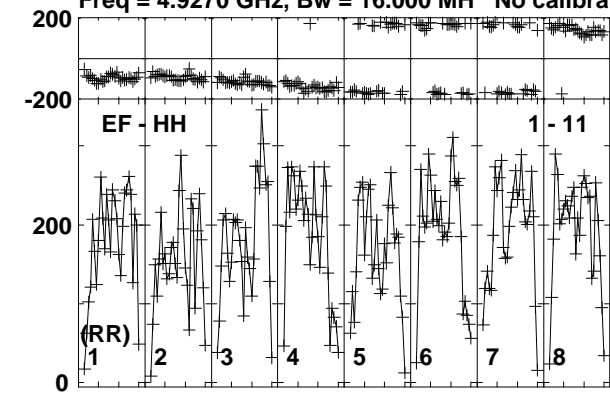

Lower frame: Micro Ampl Jy Top frame: Phas deg
Vector averaged cross-power spectrum Baseline: EF (01) - HH (11)
Timerange: 00/14:52:03 to 00/14:59:59