

Plot file version 1 created 01-AUG-2018 16:38:02
 J0530+1331 N18L1 2.UVDATA.1
 Freq = 1.6266 GHz, Bw = 8.000 MH No calibration applied and no bandpass applied

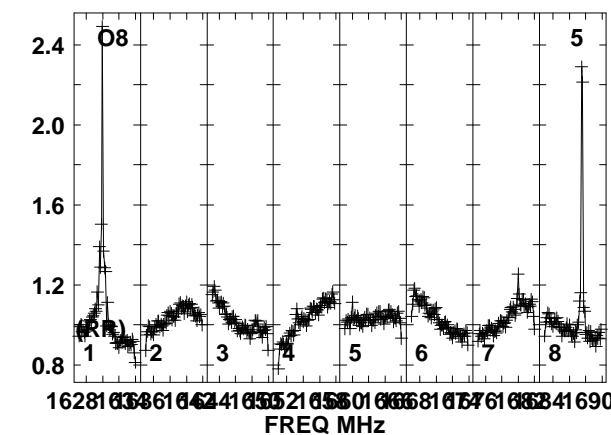
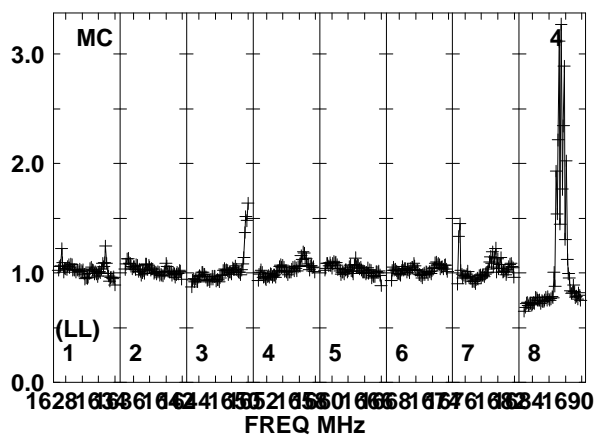
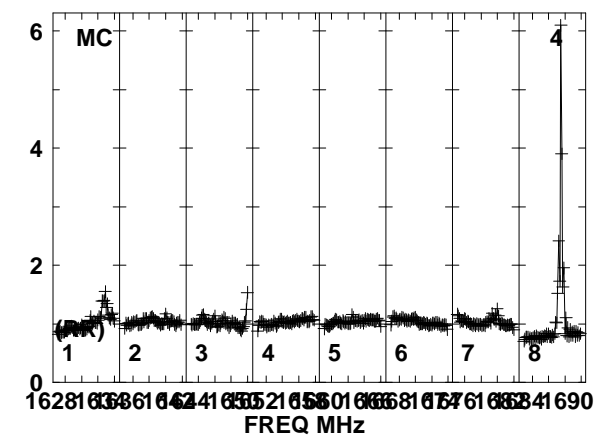
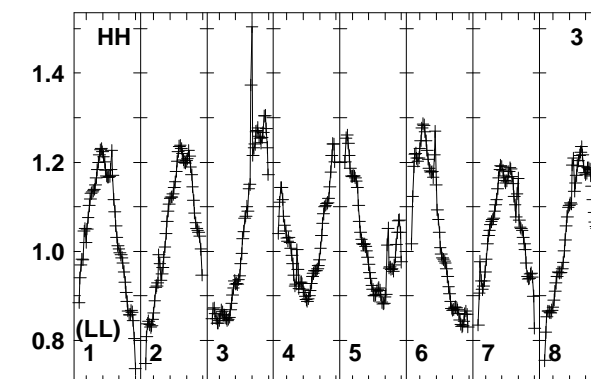
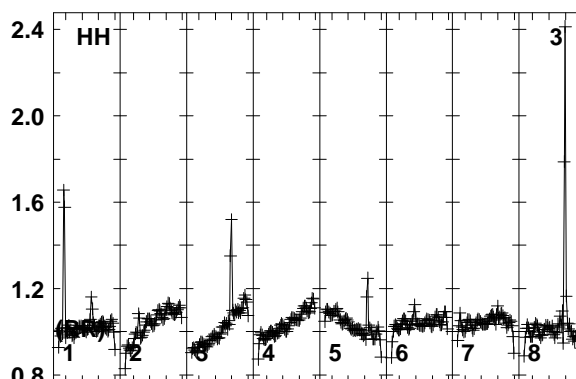
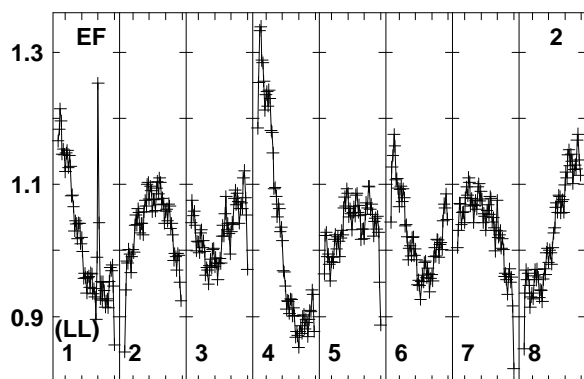
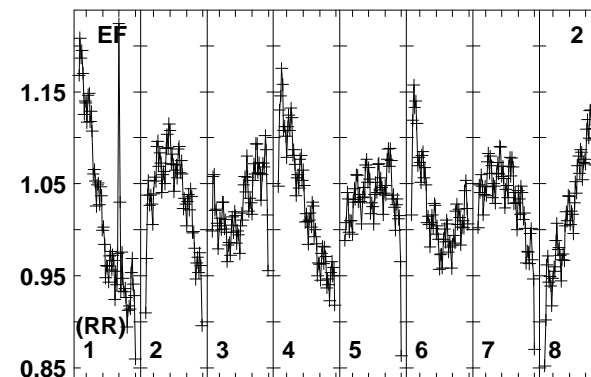
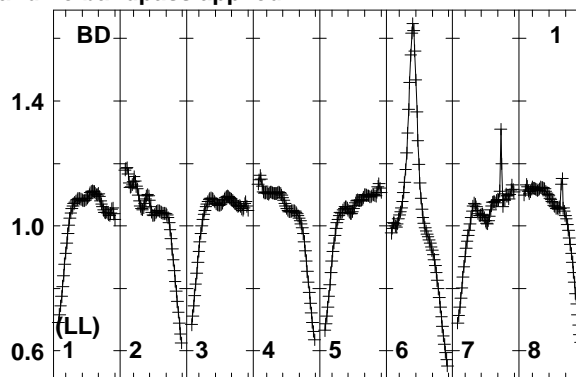
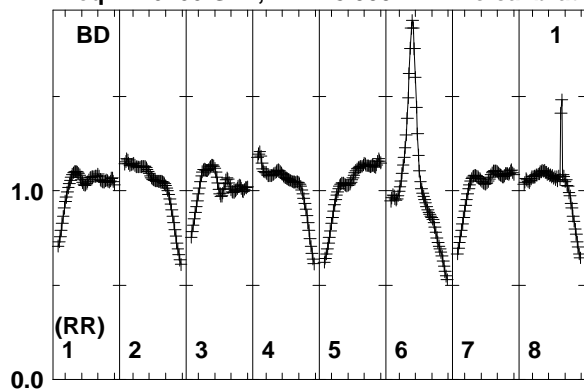

Lower frame: Real Jy
 Total-power spectrum Antenna: BD (01)
 Timerange: 00/15:55:31 to 00/15:56:59

Plot file version 2 created 01-AUG-2018 16:38:02

J0530+1331 N18L1 2.UVDATA.1

Freq = 1.6266 GHz, Bw = 8.000 MH No calibration applied and no bandpass applied

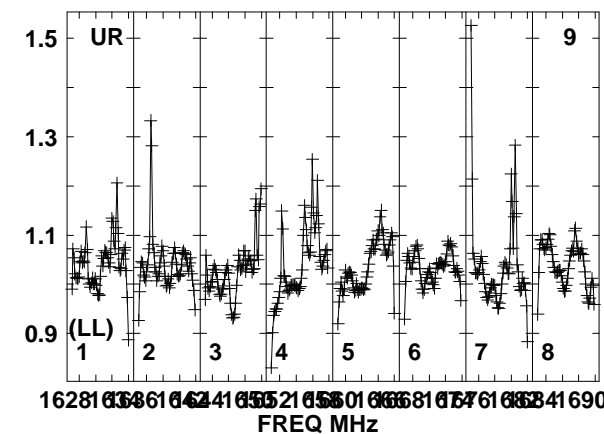
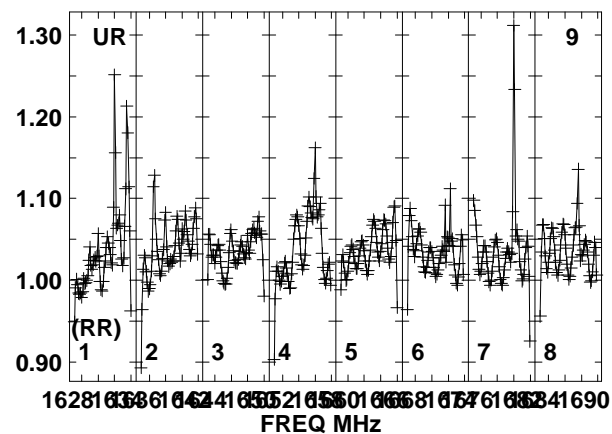
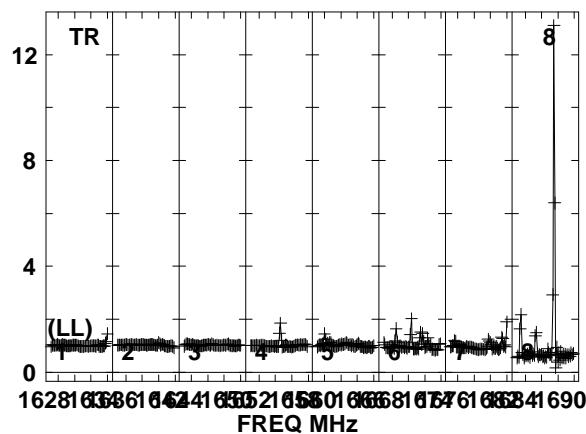
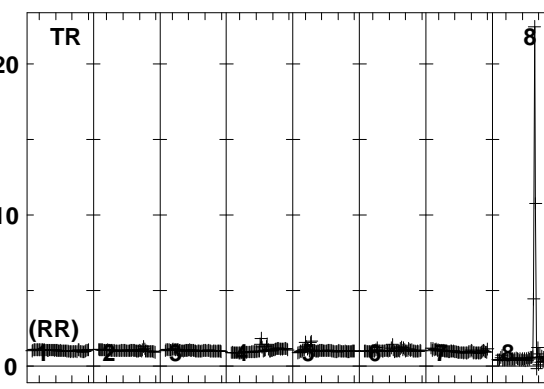
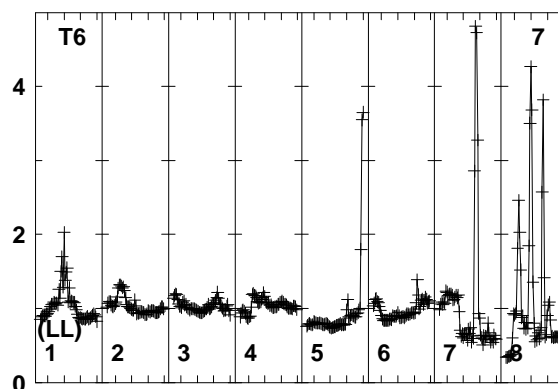
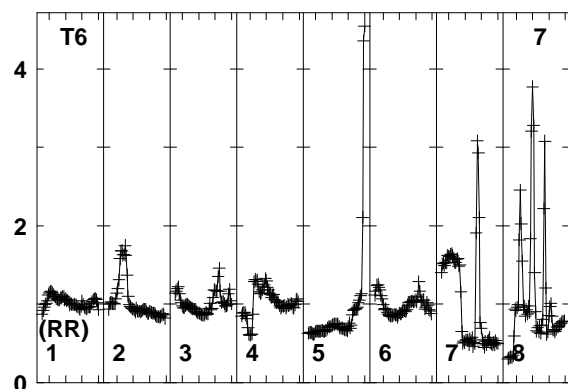
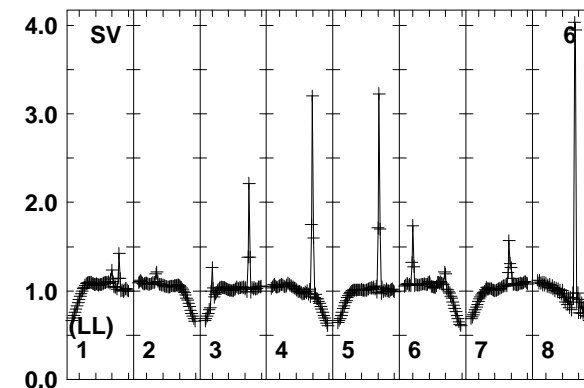
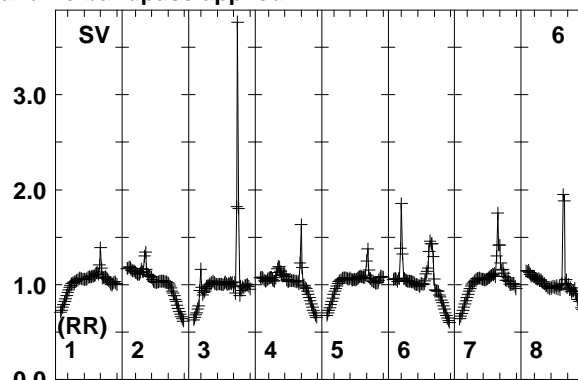
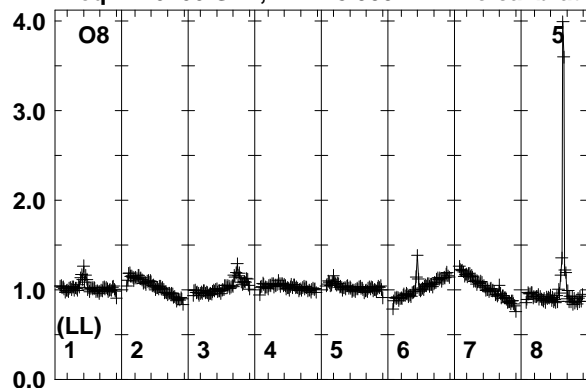

Lower frame: Real Jy
Total-power spectrum Antenna: O8 (05)
Timerange: 00/15:55:31 to 00/15:56:59

Plot file version 3 created 01-AUG-2018 16:38:02

J0530+1331 N18L1 2.UVDATA.1

Freq = 1.6266 GHz, Bw = 8.000 MH No calibration applied and no bandpass applied

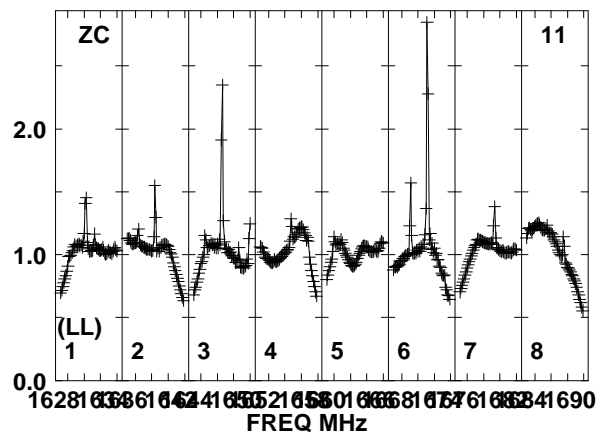
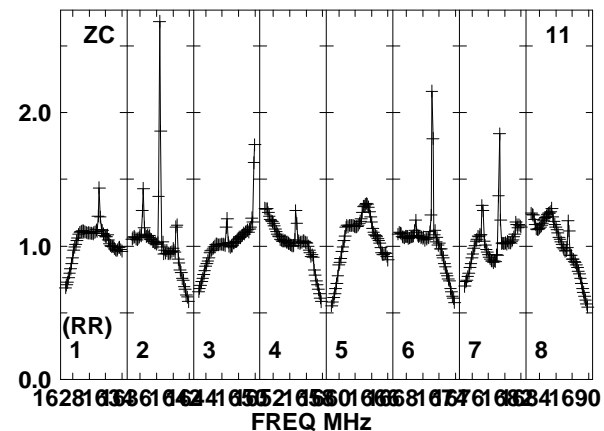
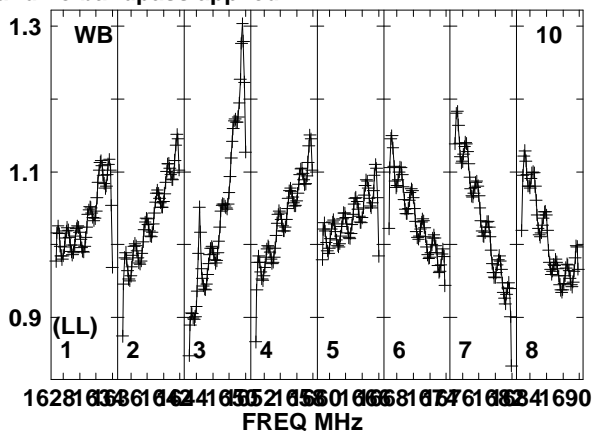
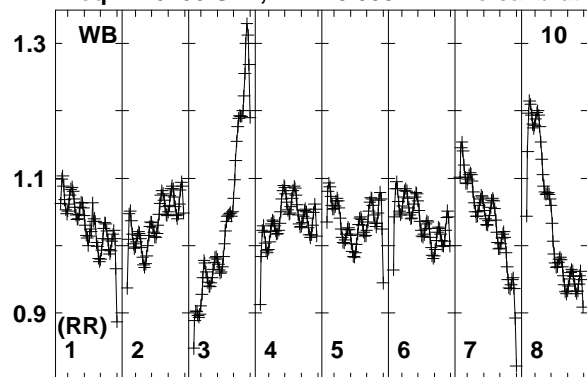

Lower frame: Real Jy
Total-power spectrum Antenna: WB (10)
Timerange: 00/15:55:31 to 00/15:56:59

Plot file version 4 created 01-AUG-2018 16:38:02

PB+4-4 N18L1 2.UVDATA.1

Freq = 1.6266 GHz, Bw = 8.000 MH No calibration applied and no bandpass applied

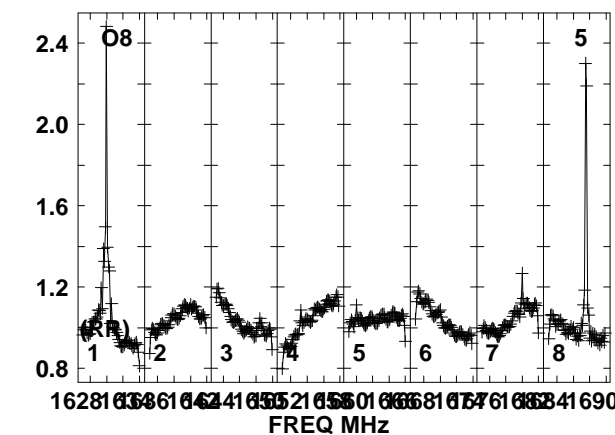
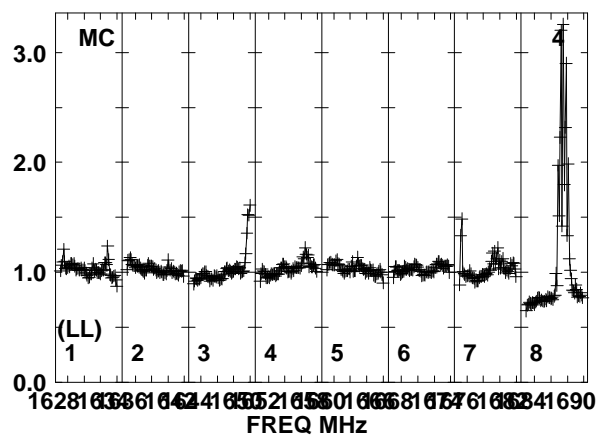
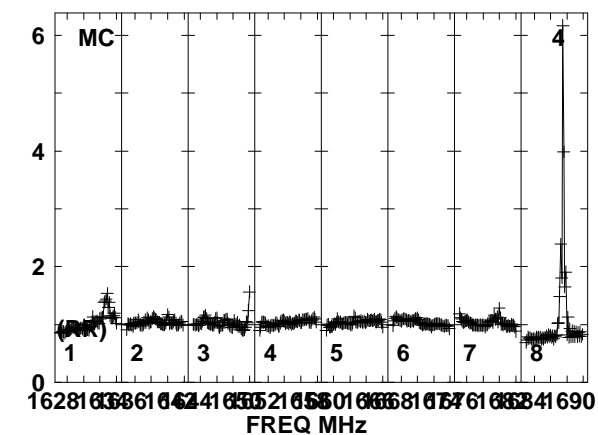
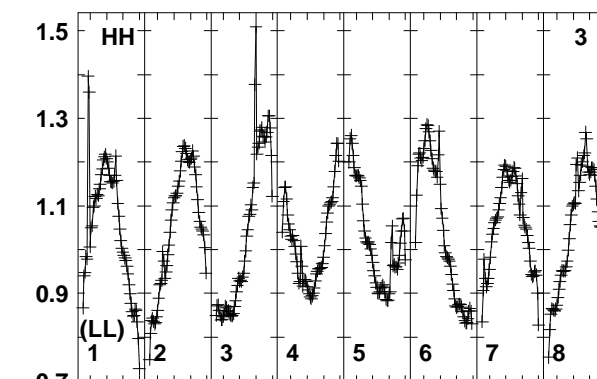
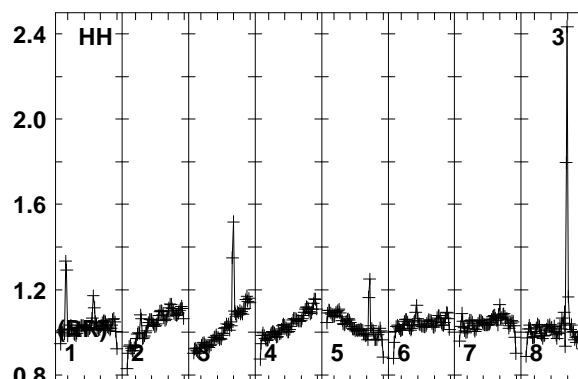
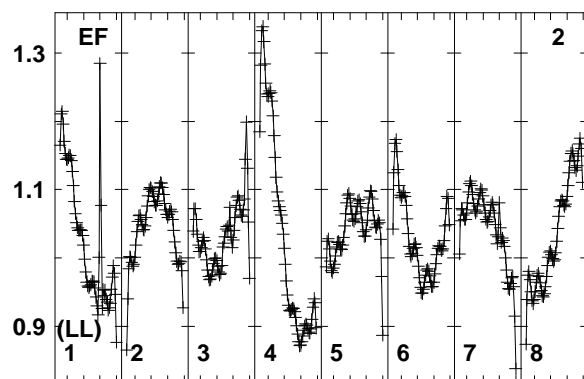
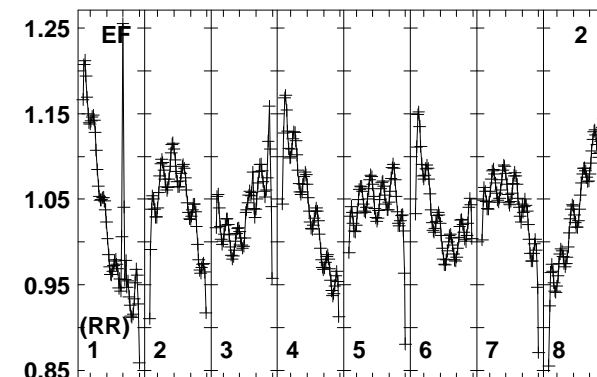
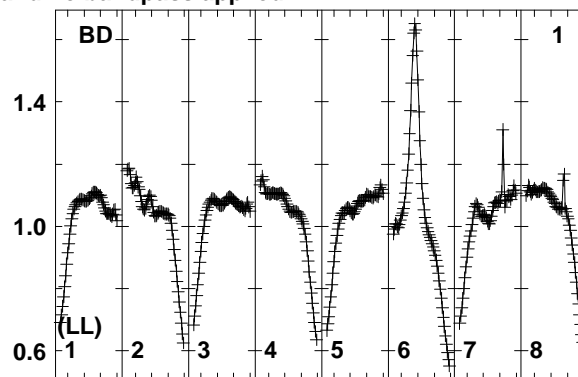
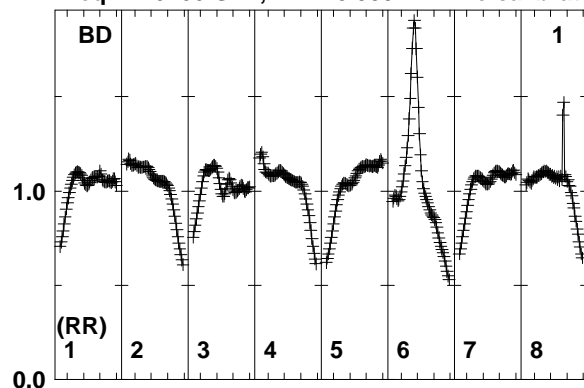

Lower frame: Real Jy
Total-power spectrum Antenna: BD (01)
Timerange: 00/15:57:05 to 00/15:59:29

Plot file version 5 created 01-AUG-2018 16:38:02

PB+4-4 N18L1 2.UVDATA.1

Freq = 1.6266 GHz, Bw = 8.000 MH No calibration applied and no bandpass applied

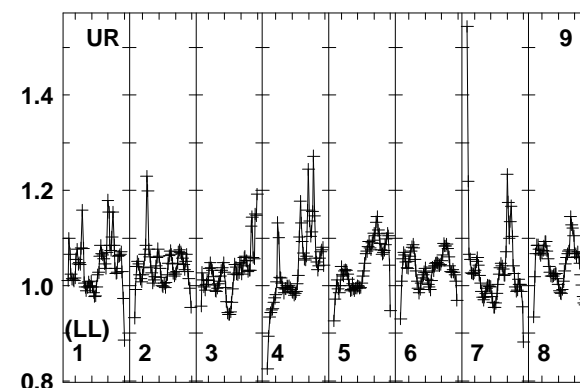
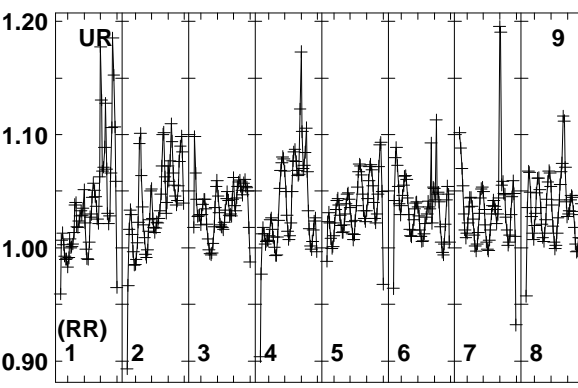
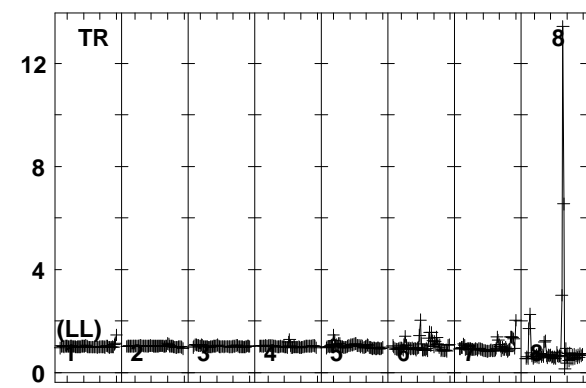
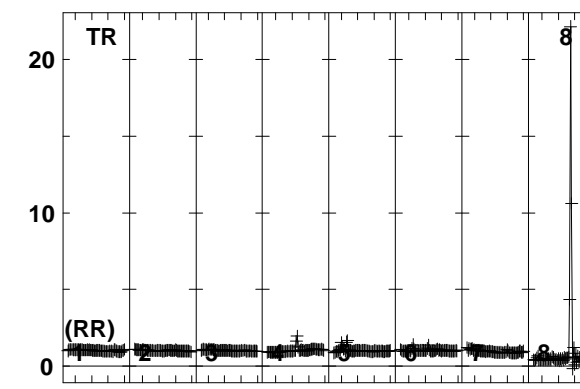
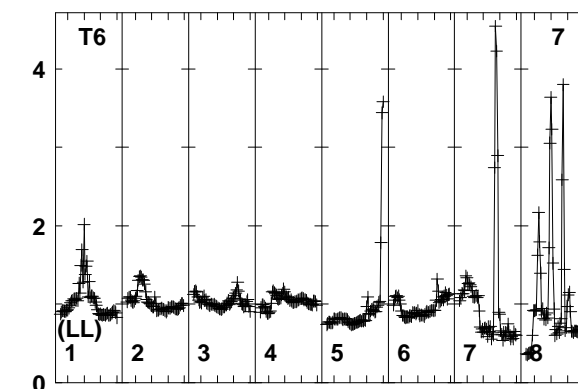
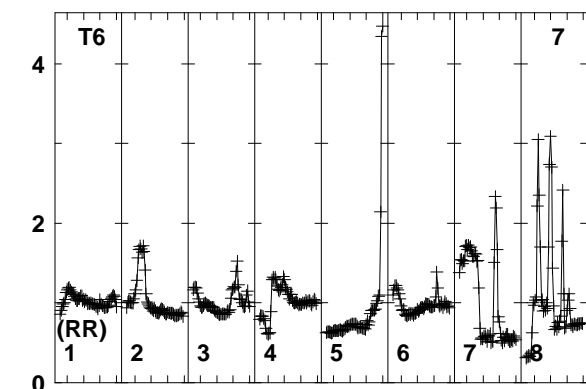
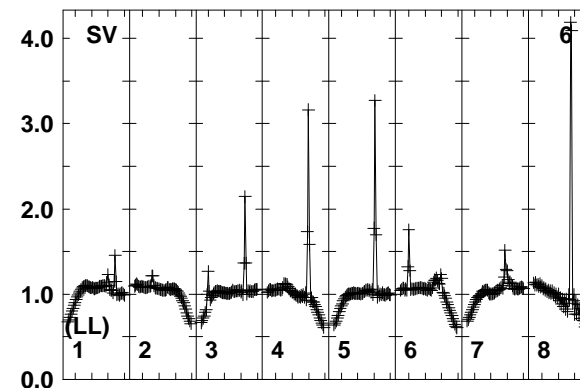
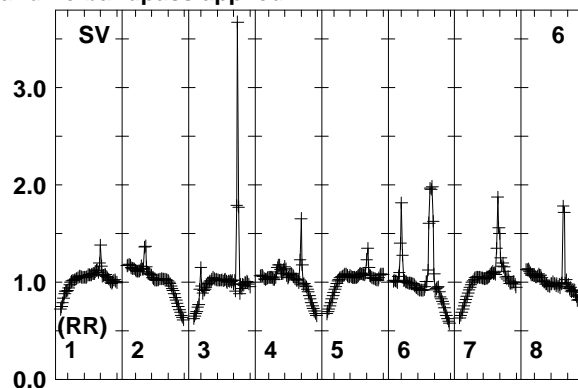
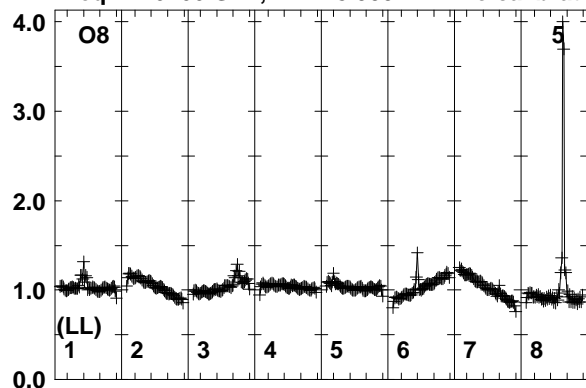

1628103961642416552165801666816746168241690
FREQ MHz

1628103961642416552165801666816746168241690
FREQ MHz

1628103961642416552165801666816746168241690
FREQ MHz

Lower frame: Real Jy
Total-power spectrum Antenna: O8 (05)
Timerange: 00/15:57:05 to 00/15:59:29

Plot file version 6 created 01-AUG-2018 16:38:02

PB+4-4 N18L1 2.UVDATA.1

Freq = 1.6266 GHz, Bw = 8.000 MH No calibration applied and no bandpass applied

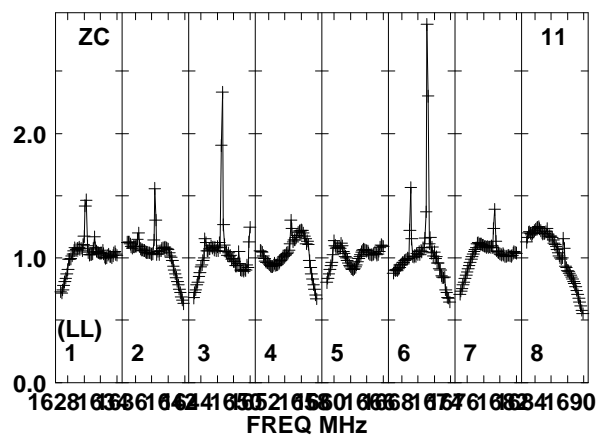
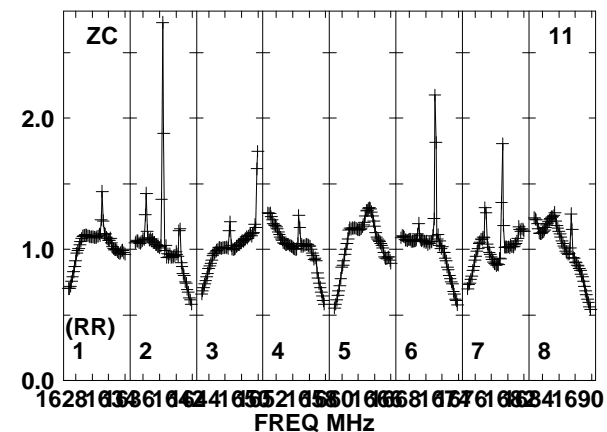
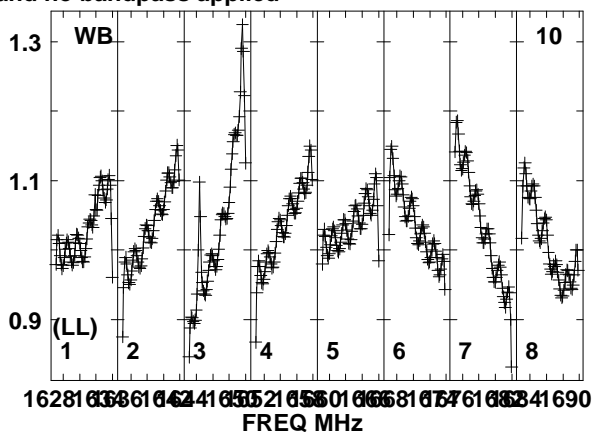
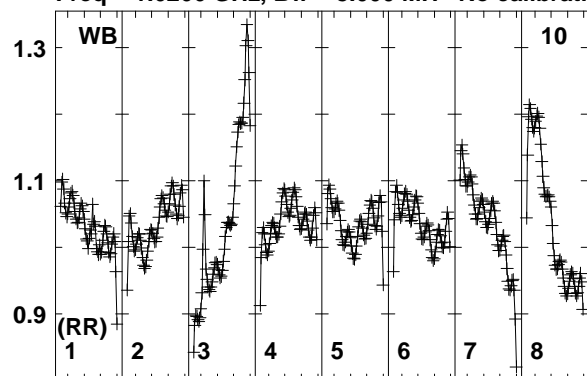

Lower frame: Real Jy
Total-power spectrum Antenna: WB (10)
Timerange: 00/15:57:05 to 00/15:59:29

Plot file version 7 created 01-AUG-2018 16:38:03
 PB+3-4 N18L1 2.UVDATA.1
 Freq = 1.6266 GHz, Bw = 8.000 MH No calibration applied and no bandpass applied

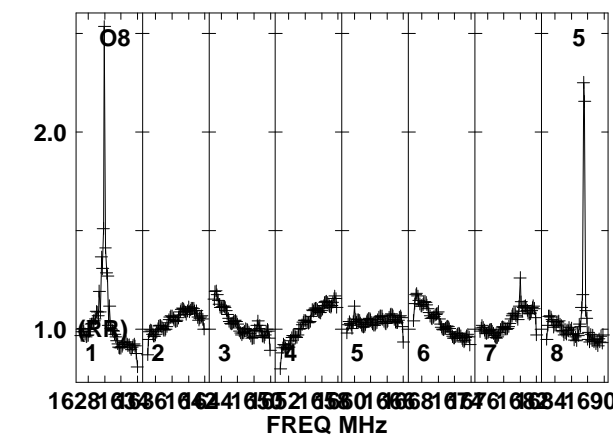
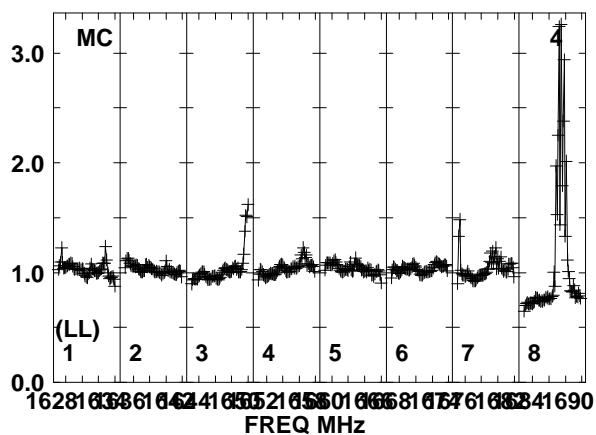
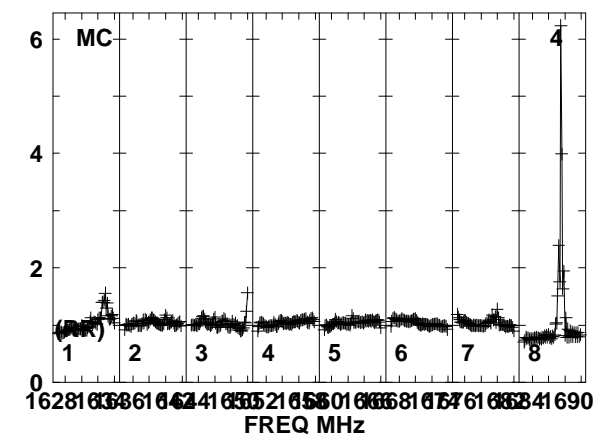
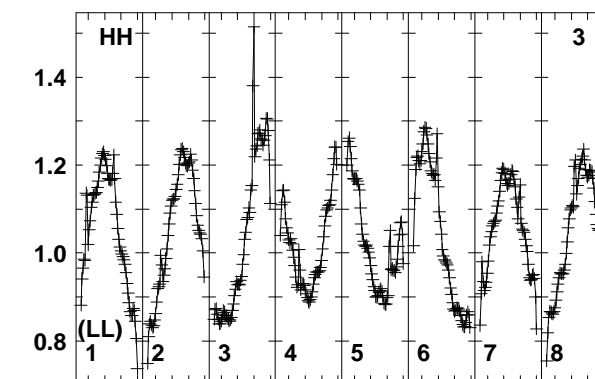
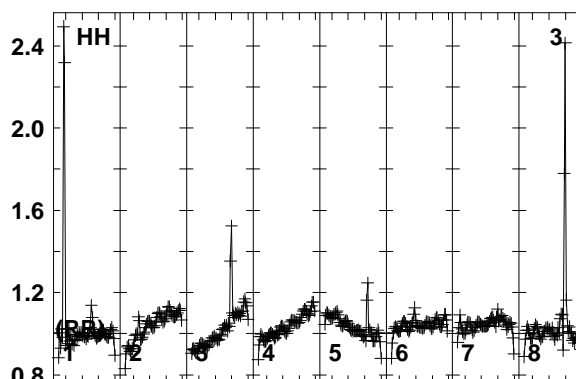
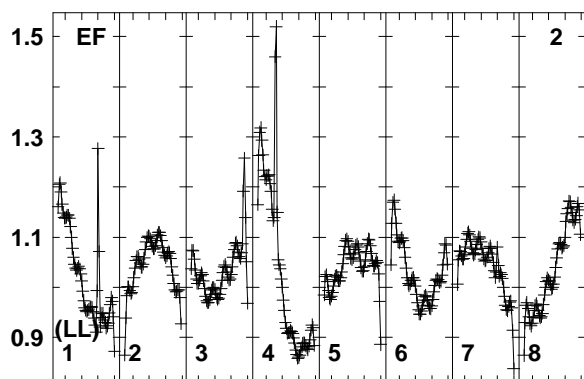
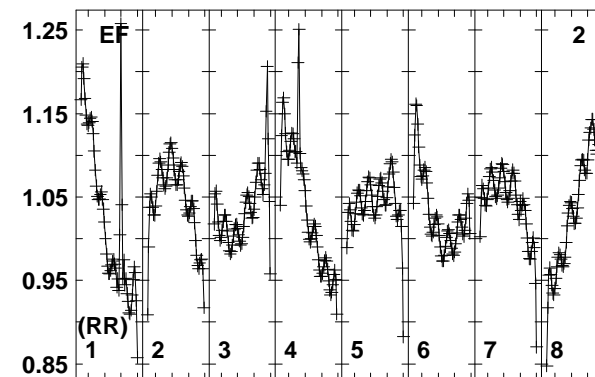
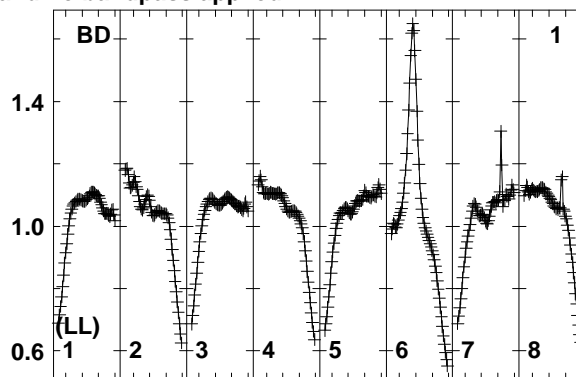
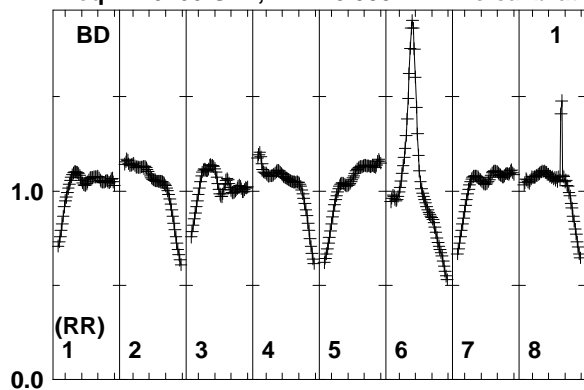

Lower frame: Real Jy
 Total-power spectrum Antenna: BD (01)
 Timerange: 00/15:59:33 to 00/16:01:59

Plot file version 8 created 01-AUG-2018 16:38:03

PB+3-4 N18L1 2.UVDATA.1

Freq = 1.6266 GHz, Bw = 8.000 MH No calibration applied and no bandpass applied

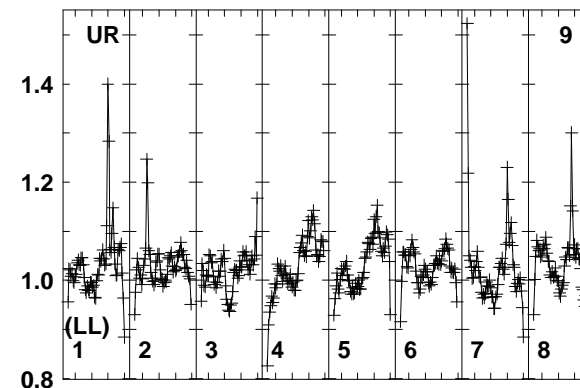
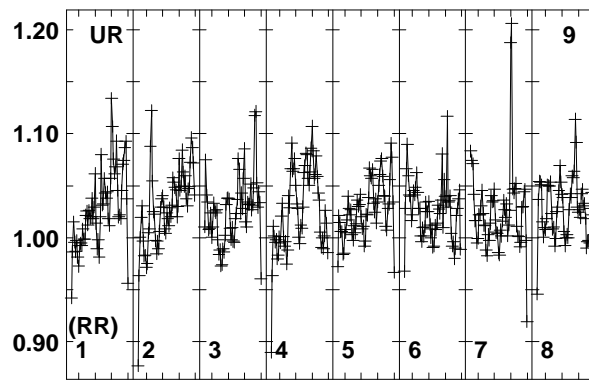
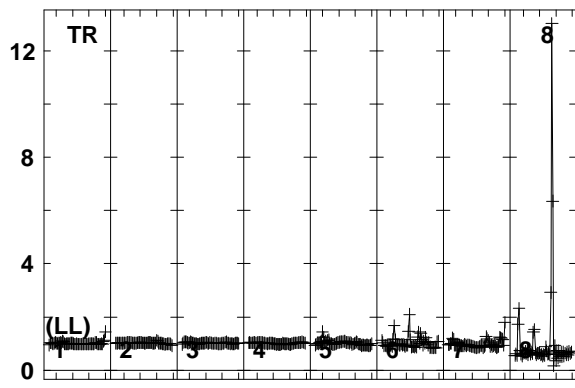
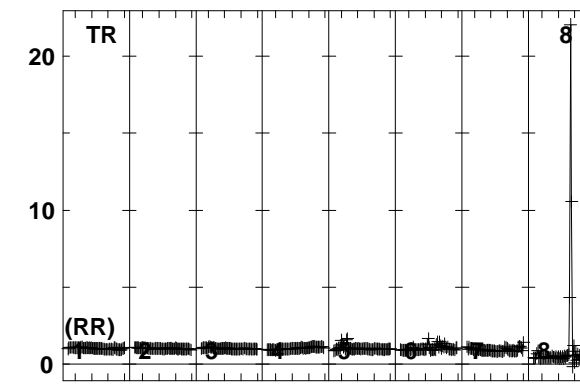
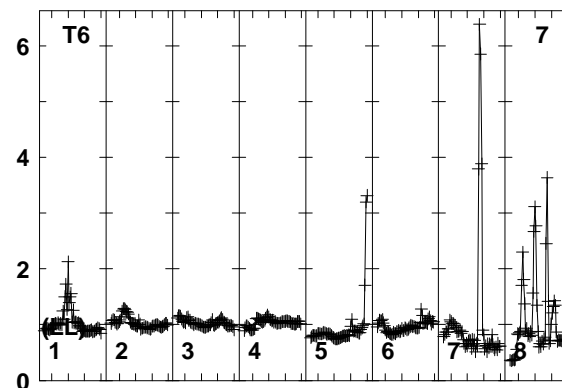
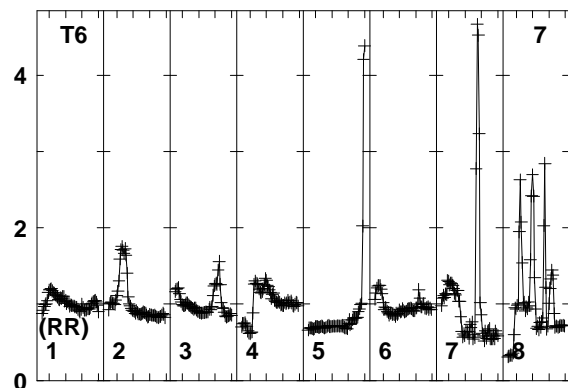
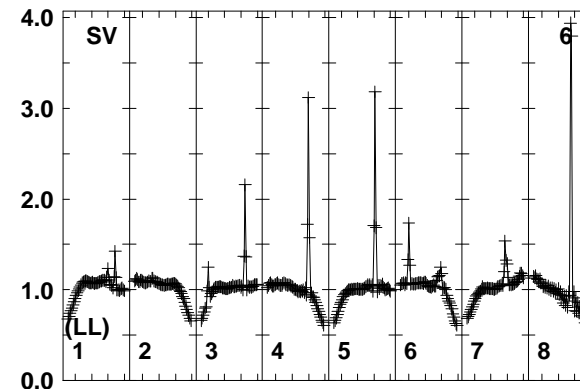
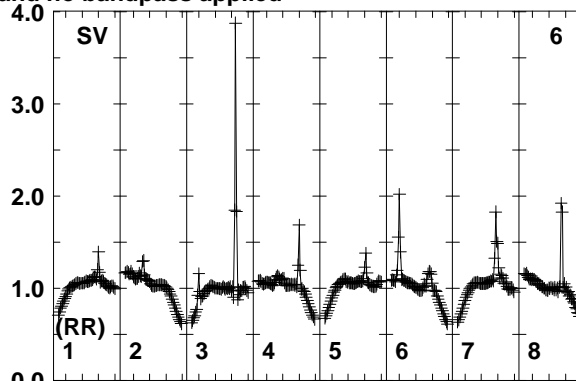
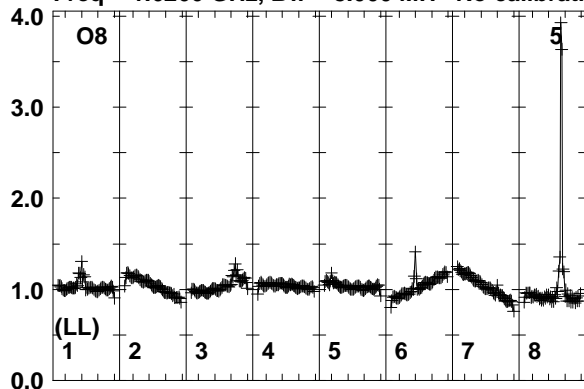

1628163861642416552165801666816746168241690
FREQ MHz

1628163861642416552165801666816746168241690
FREQ MHz

1628163861642416552165801666816746168241690
FREQ MHz

Lower frame: Real Jy
Total-power spectrum Antenna: O8 (05)
Timerange: 00/15:59:33 to 00/16:01:59

Plot file version 9 created 01-AUG-2018 16:38:03

PB+3-4 N18L1 2.UVDATA.1

Freq = 1.6266 GHz, Bw = 8.000 MH No calibration applied and no bandpass applied

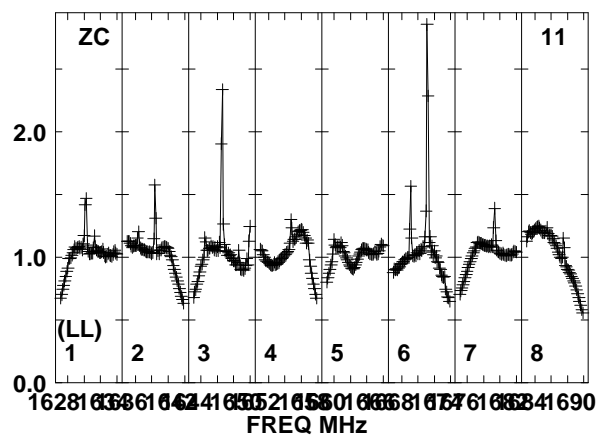
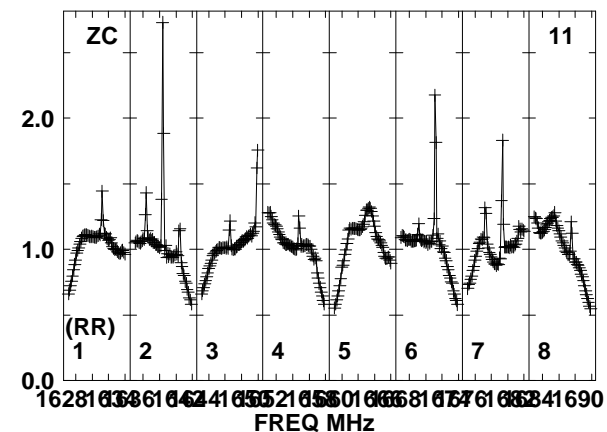
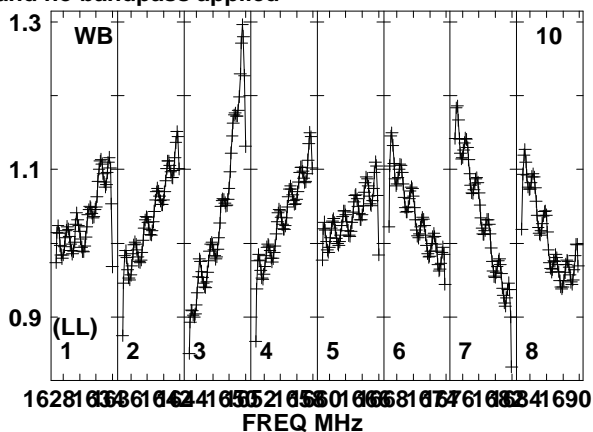
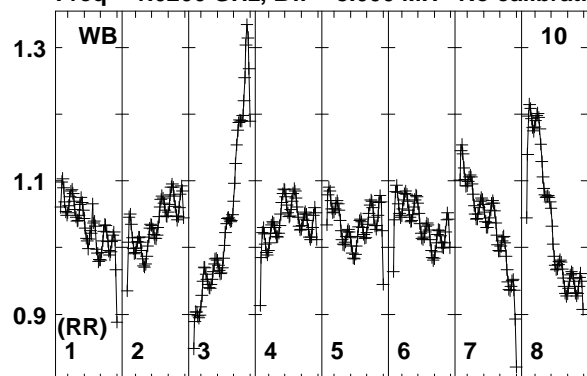

Lower frame: Real Jy
Total-power spectrum Antenna: WB (10)
Timerange: 00/15:59:33 to 00/16:01:59

Plot file version 10 created 01-AUG-2018 16:38:03

PB+2-4 N18L1 2.UVDATA.1

Freq = 1.6266 GHz, Bw = 8.000 MH No calibration applied and no bandpass applied

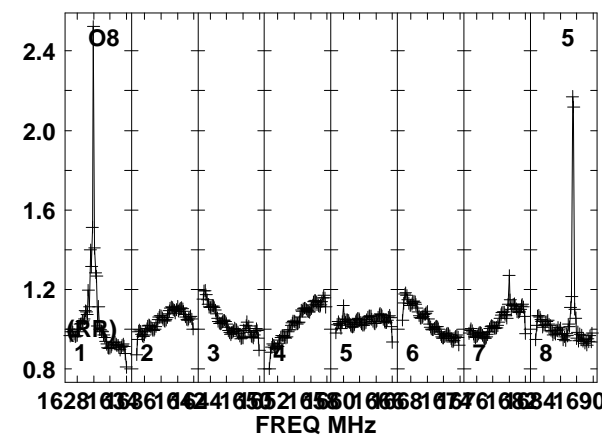
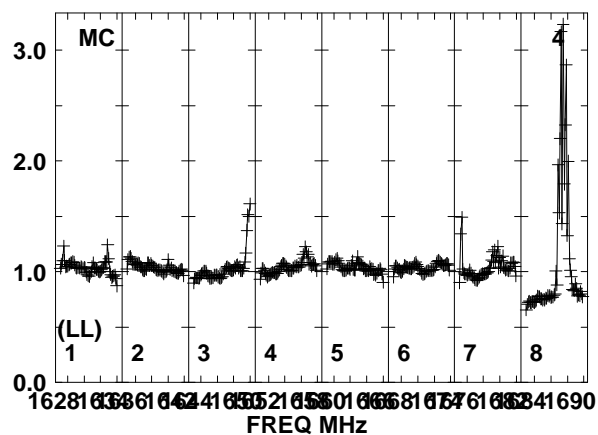
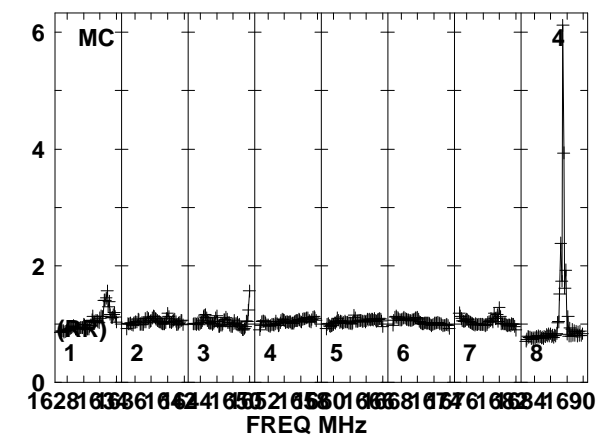
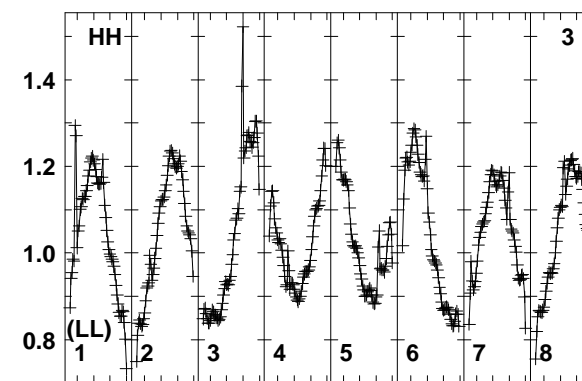
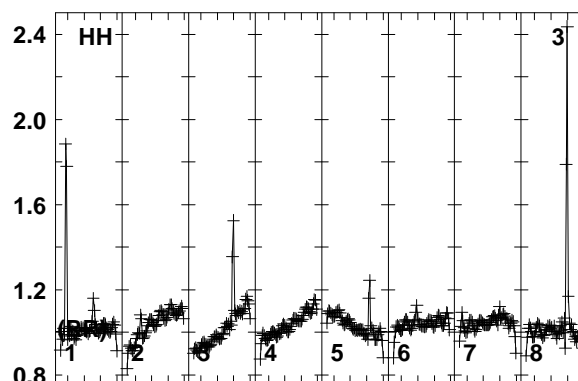
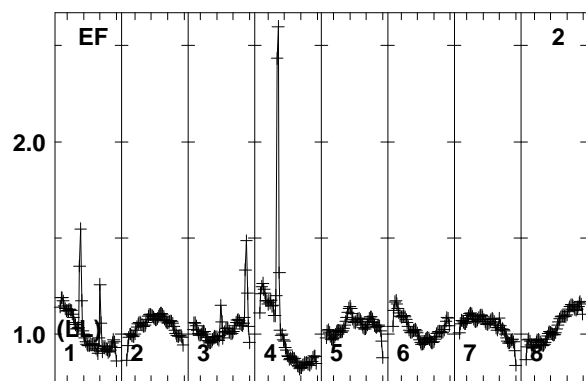
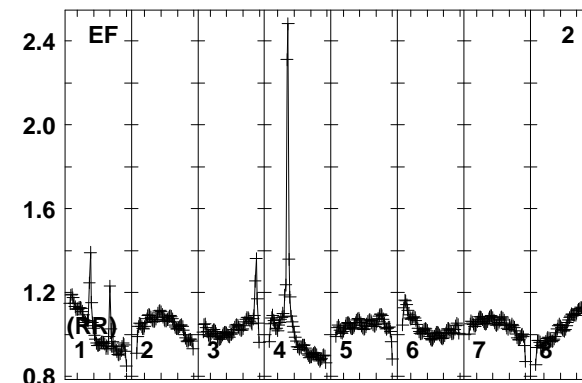
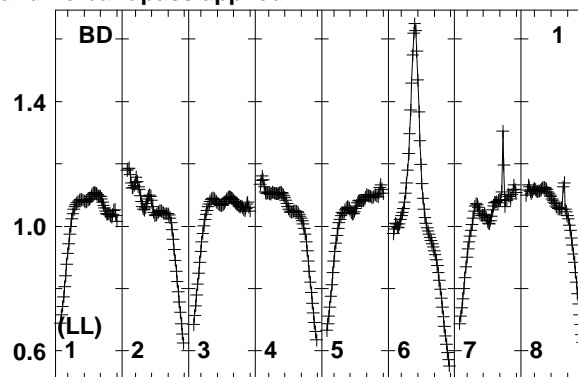
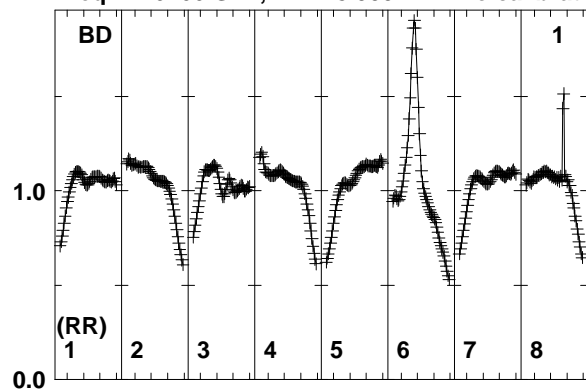

Lower frame: Real Jy
Total-power spectrum Antenna: BD (01)
Timerange: 00/16:02:03 to 00/16:04:29

Plot file version 11 created 01-AUG-2018 16:38:03

PB+2-4 N18L1 2.UVDATA.1

Freq = 1.6266 GHz, Bw = 8.000 MH No calibration applied and no bandpass applied

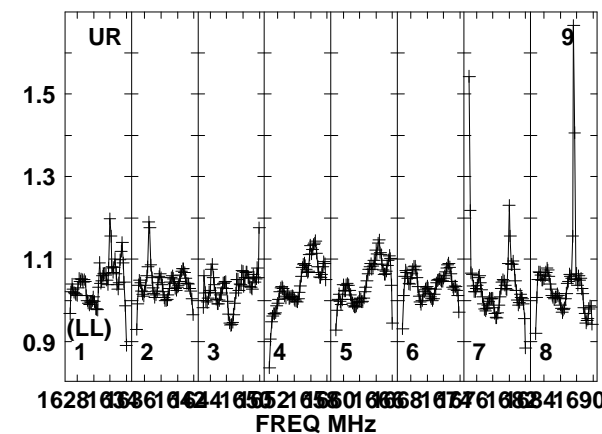
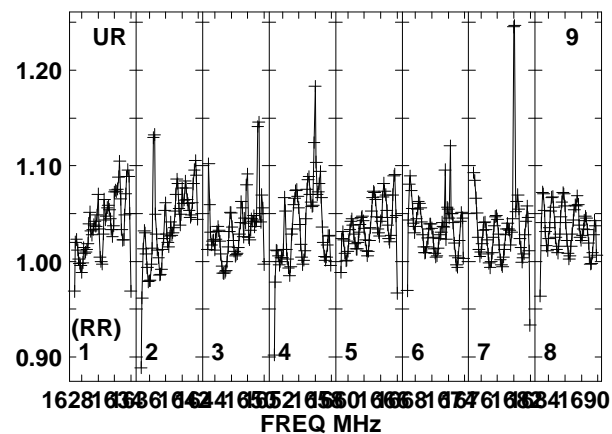
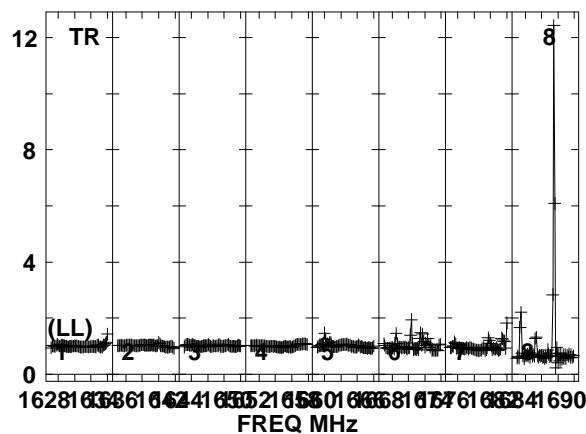
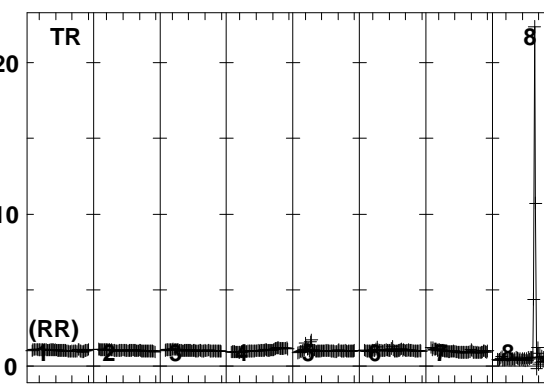
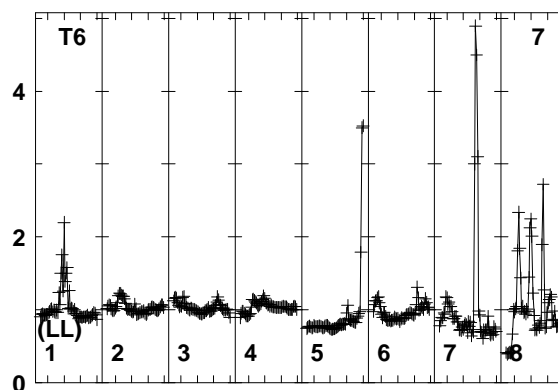
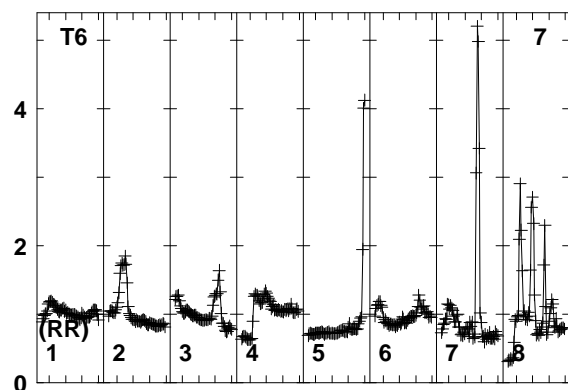
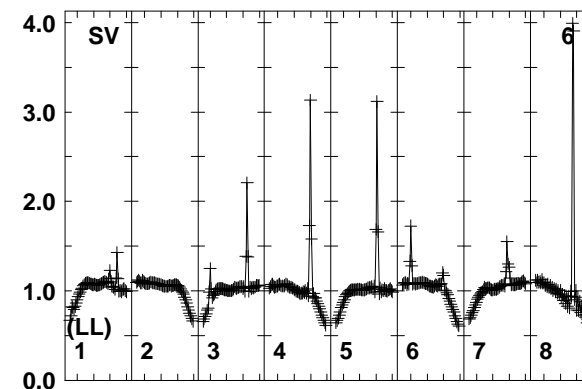
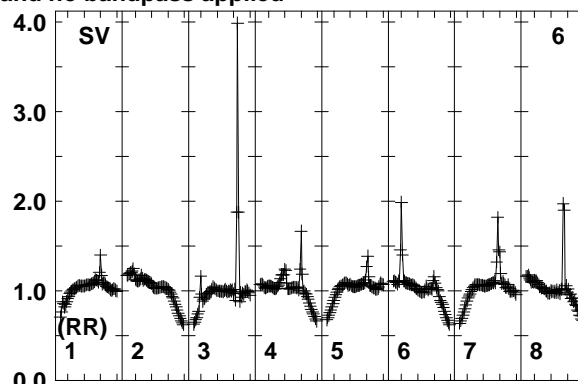
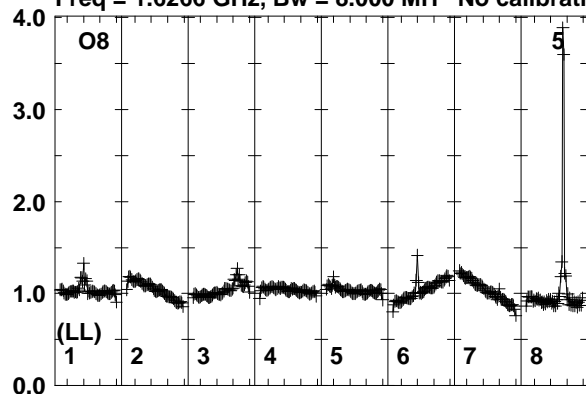

Lower frame: Real Jy
Total-power spectrum Antenna: O8 (05)
Timerange: 00/16:02:03 to 00/16:04:29

Plot file version 12 created 01-AUG-2018 16:38:03

PB+2-4 N18L1 2.UVDATA.1

Freq = 1.6266 GHz, Bw = 8.000 MH No calibration applied and no bandpass applied

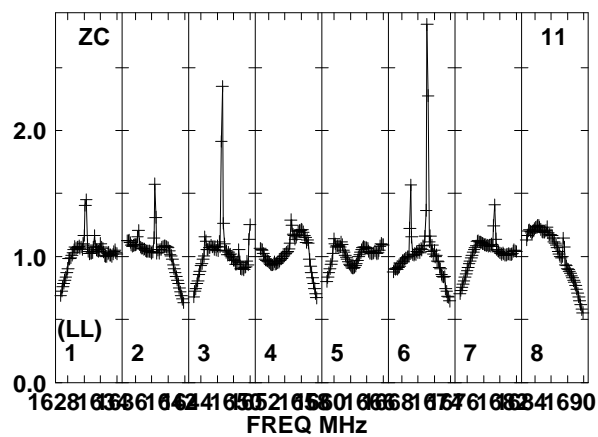
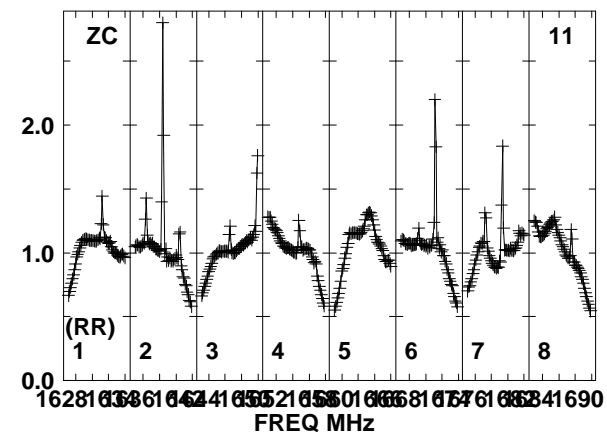
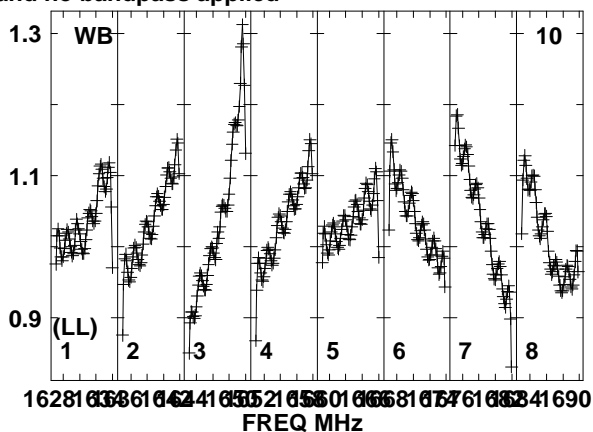
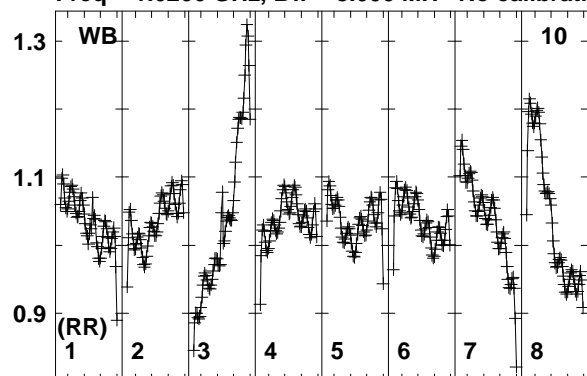

Lower frame: Real Jy
Total-power spectrum Antenna: WB (10)
Timerange: 00/16:02:03 to 00/16:04:29

Plot file version 13 created 01-AUG-2018 16:38:03

PB+1-4 N18L1 2.UVDATA.1

Freq = 1.6266 GHz, Bw = 8.000 MH No calibration applied and no bandpass applied

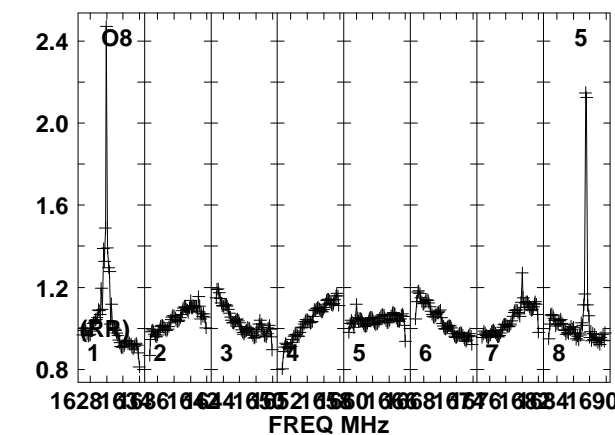
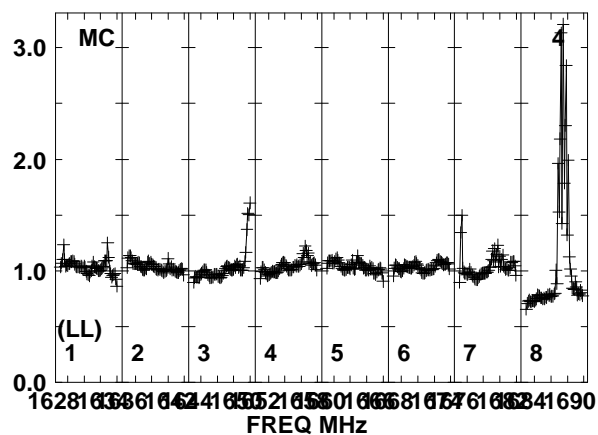
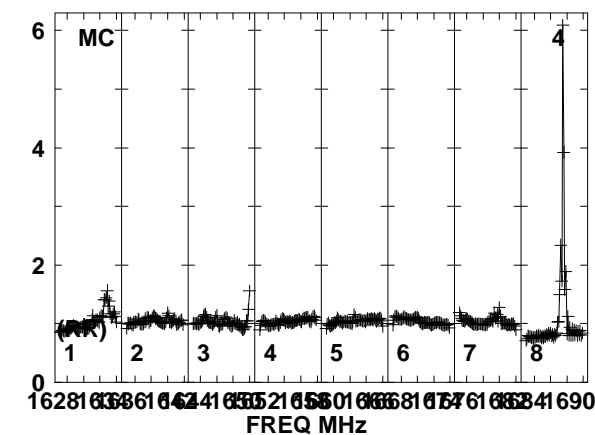
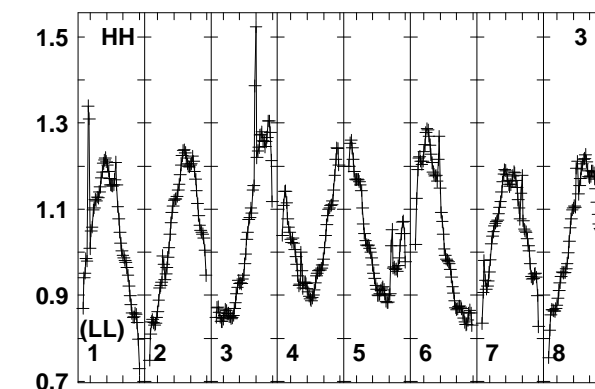
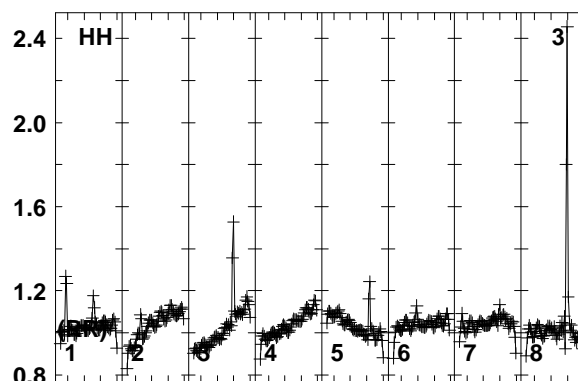
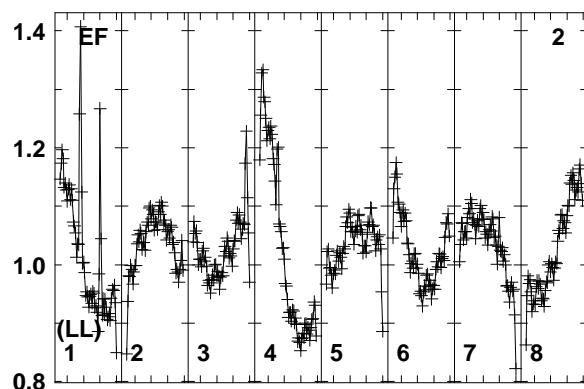
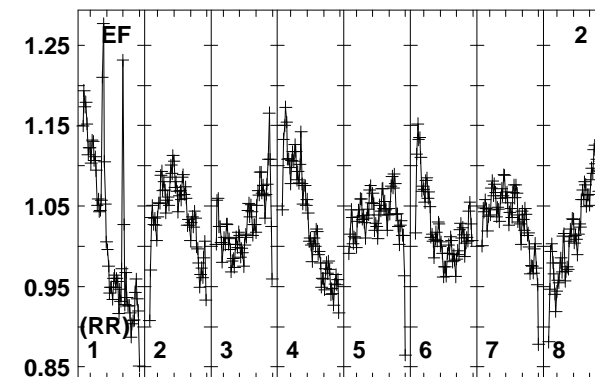
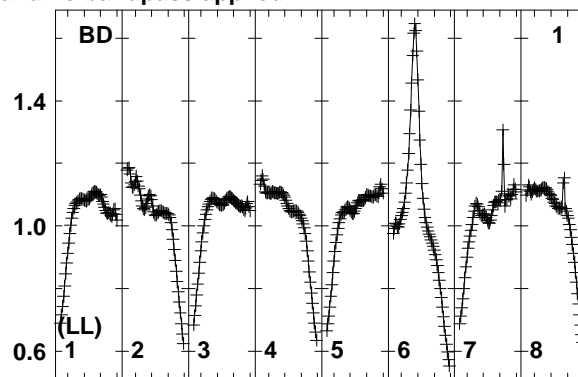
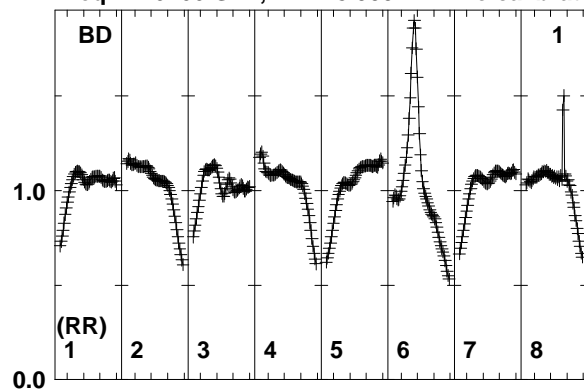

Lower frame: Real Jy
Total-power spectrum Antenna: BD (01)
Timerange: 00/16:04:33 to 00/16:06:59

Plot file version 14 created 01-AUG-2018 16:38:04

PB+1-4 N18L1 2.UVDATA.1

Freq = 1.6266 GHz, Bw = 8.000 MH No calibration applied and no bandpass applied

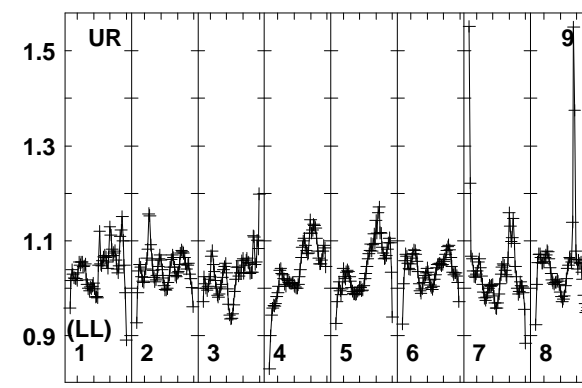
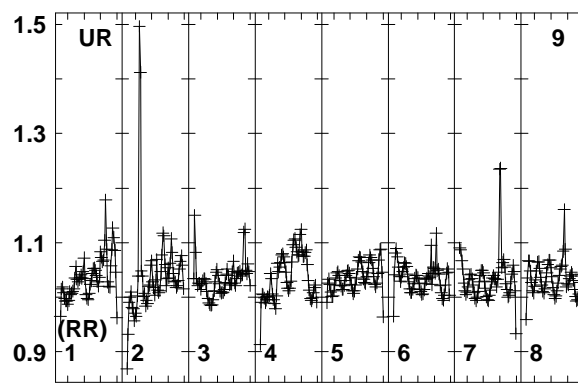
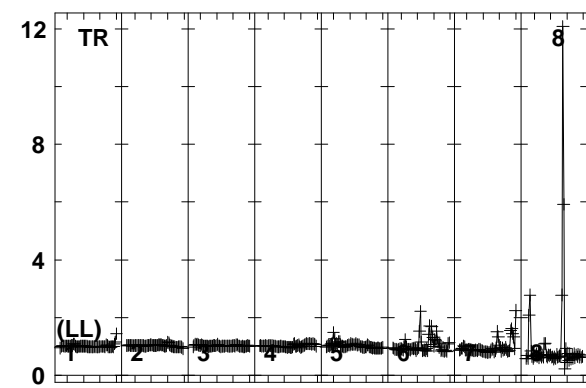
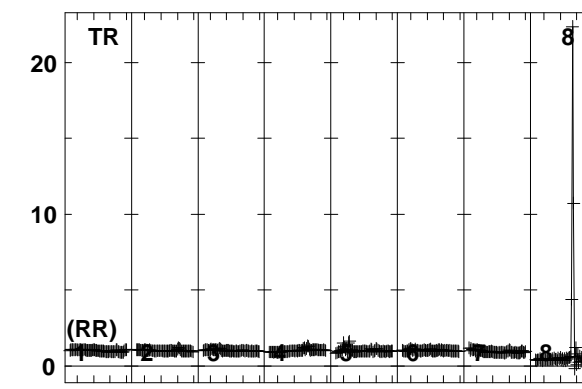
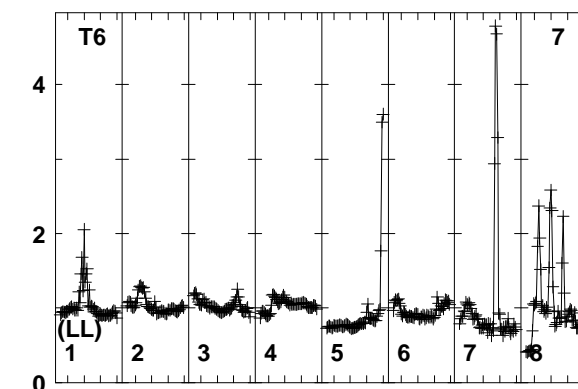
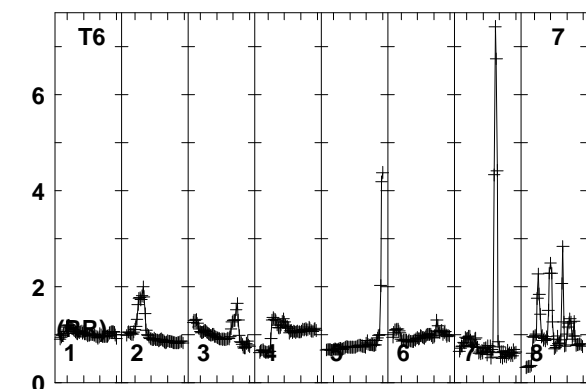
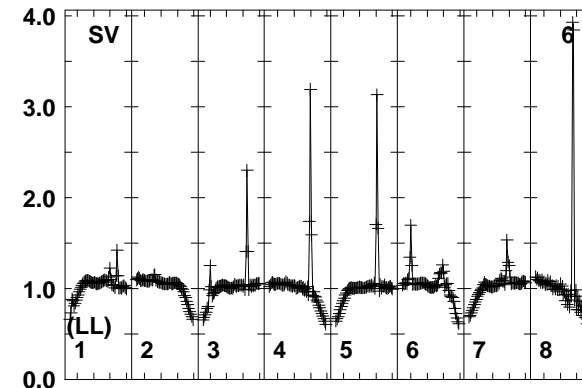
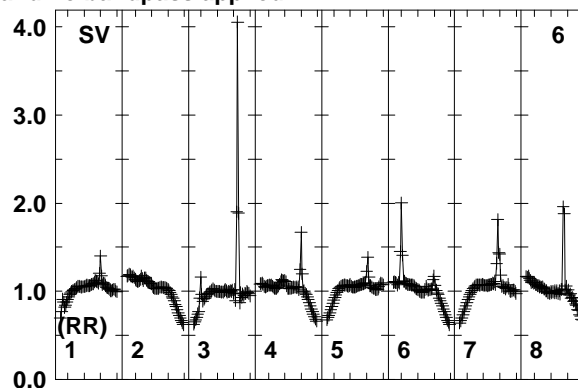
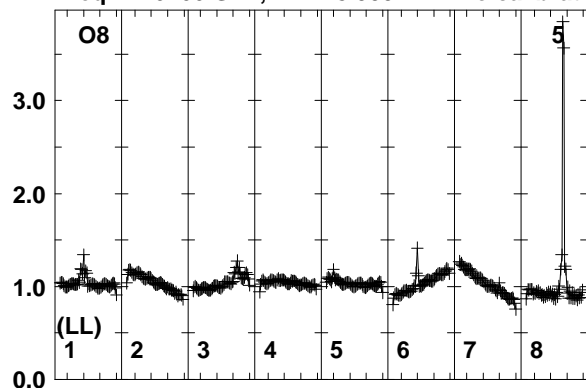

1628103961642416552165801666816746168241690
FREQ MHz

1628103961642416552165801666816746168241690
FREQ MHz

1628103961642416552165801666816746168241690
FREQ MHz

Lower frame: Real Jy
Total-power spectrum Antenna: O8 (05)
Timerange: 00/16:04:33 to 00/16:06:59

Plot file version 15 created 01-AUG-2018 16:38:04

PB+1-4 N18L1 2.UVDATA.1

Freq = 1.6266 GHz, Bw = 8.000 MH No calibration applied and no bandpass applied

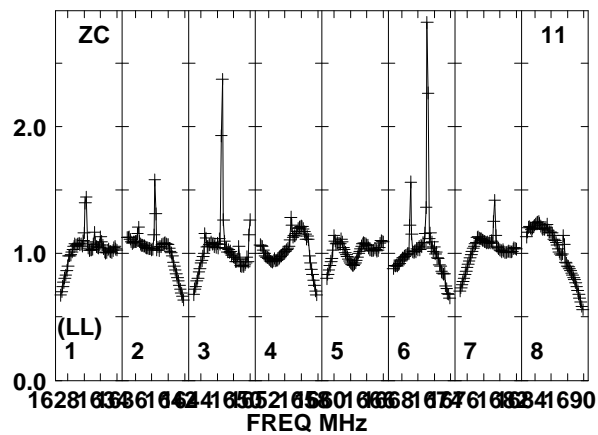
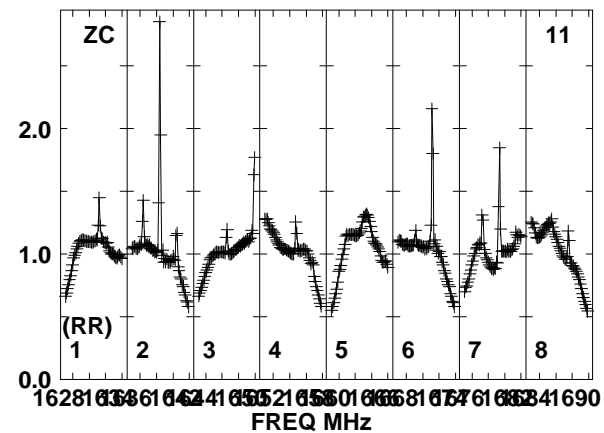
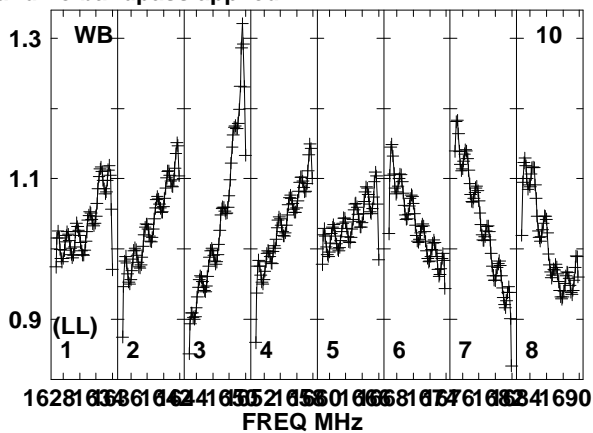
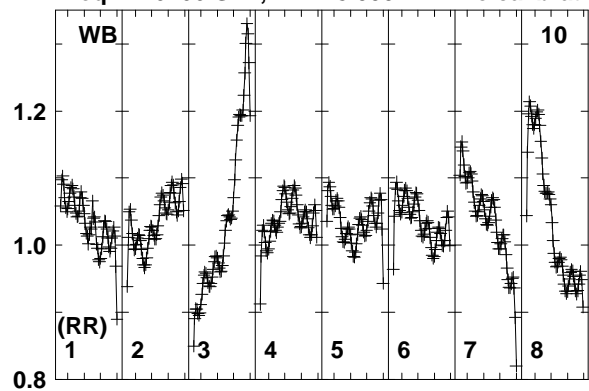

Lower frame: Real Jy
Total-power spectrum Antenna: WB (10)
Timerange: 00/16:04:33 to 00/16:06:59

Plot file version 16 created 01-AUG-2018 16:38:04

J0530+1331 N18L1 2.UVDATA.1

Freq = 1.6266 GHz, Bw = 8.000 MH No calibration applied and no bandpass applied

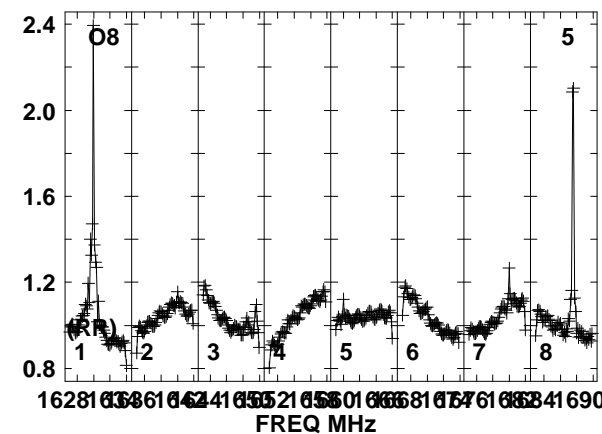
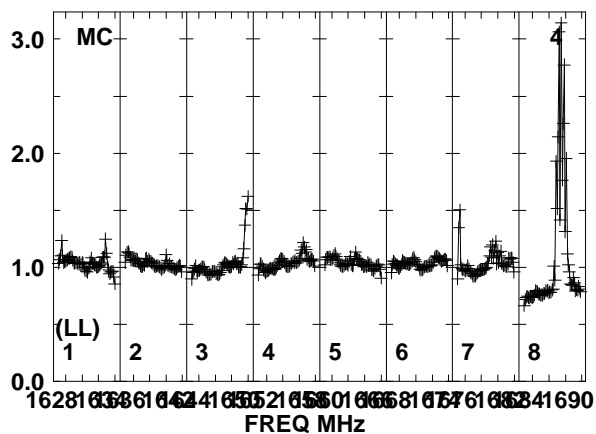
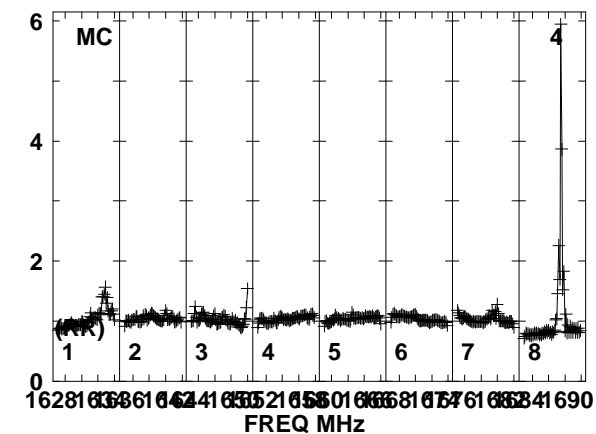
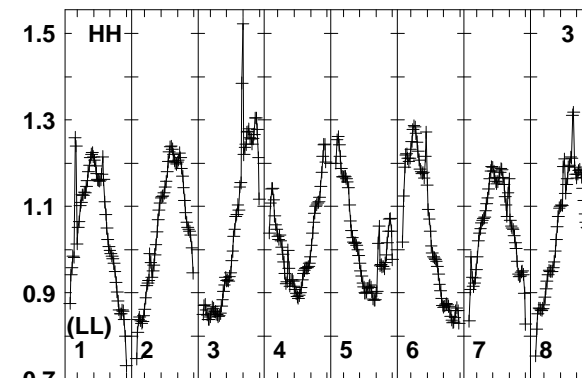
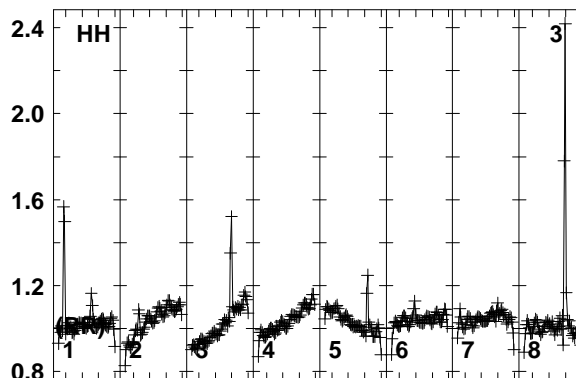
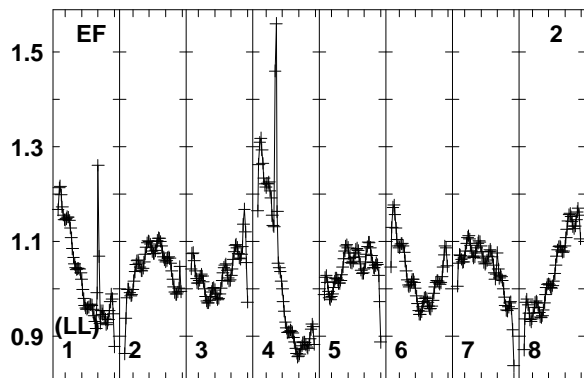
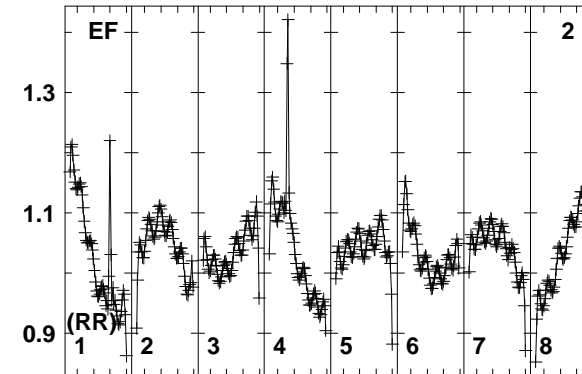
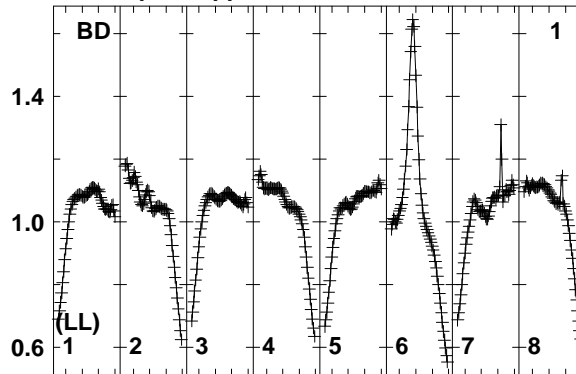
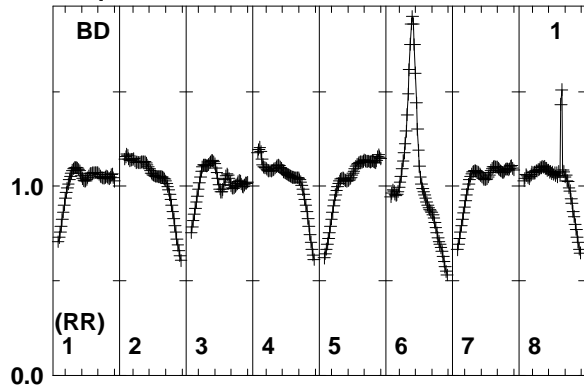

Lower frame: Real Jy
Total-power spectrum Antenna: BD (01)
Timerange: 00/16:07:41 to 00/16:08:59

Plot file version 17 created 01-AUG-2018 16:38:04

J0530+1331 N18L1 2.UVDATA.1

Freq = 1.6266 GHz, Bw = 8.000 MH No calibration applied and no bandpass applied

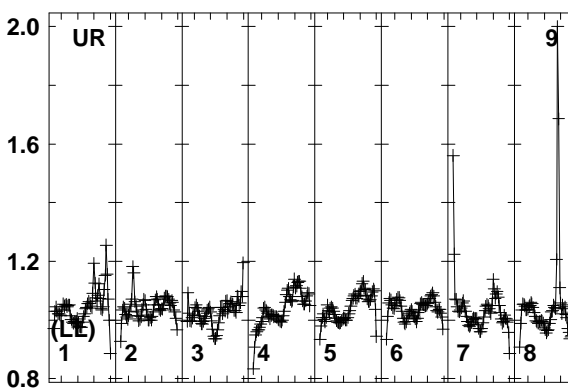
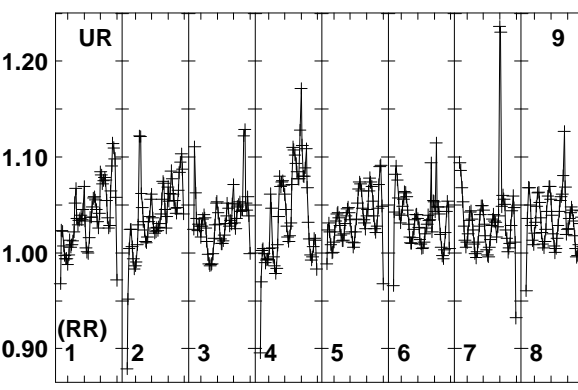
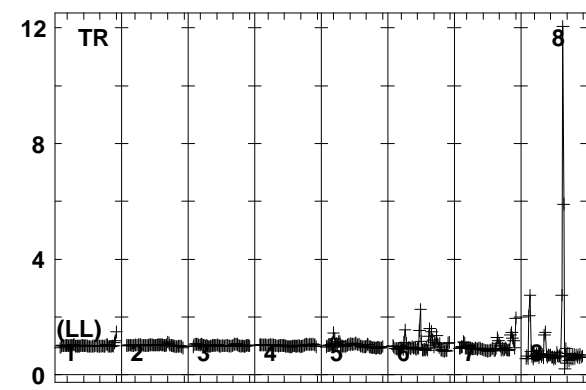
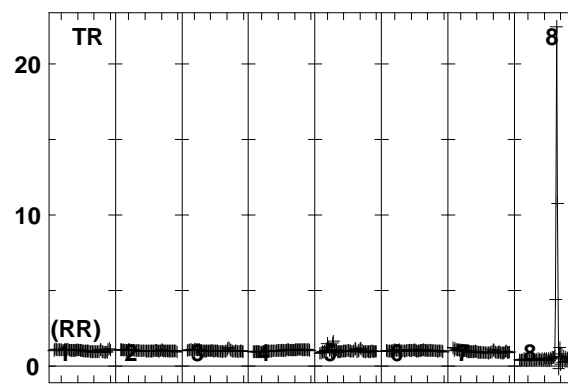
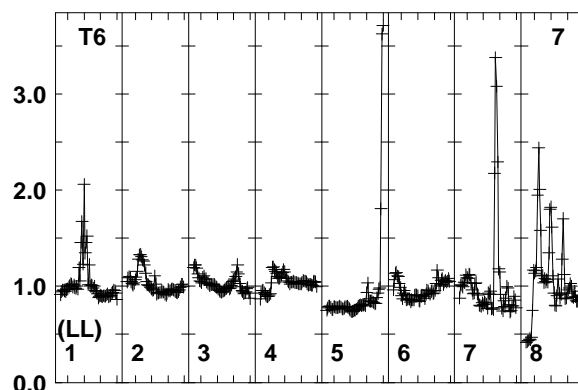
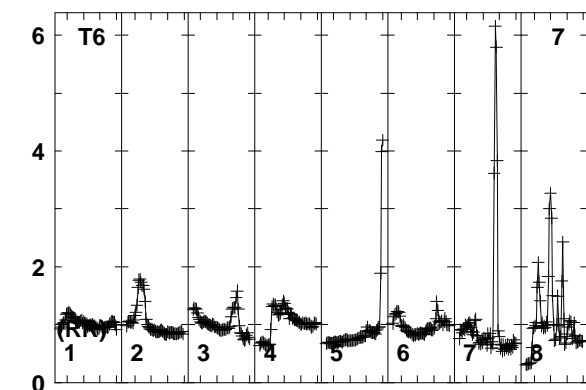
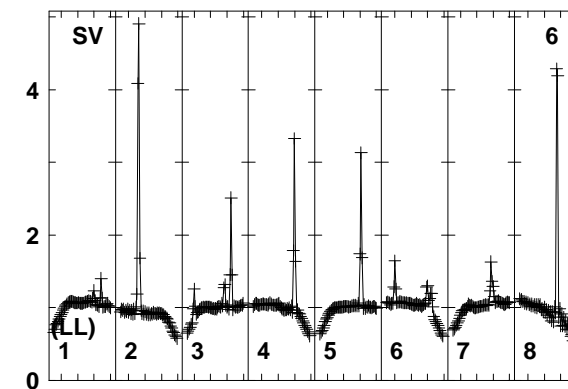
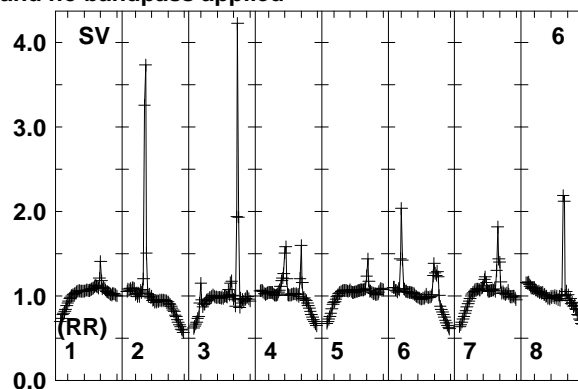
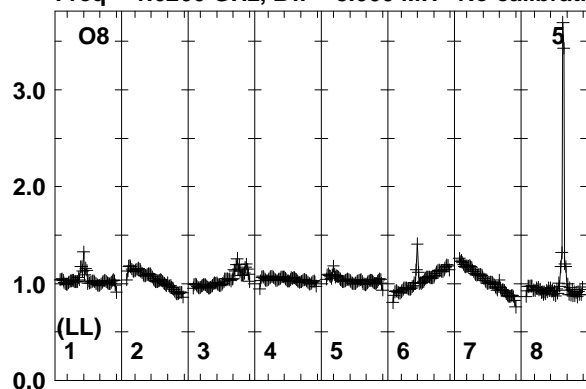

1628163861642416552165801666816746168241690
FREQ MHz

1628163861642416552165801666816746168241690
FREQ MHz

1628163861642416552165801666816746168241690
FREQ MHz

Lower frame: Real Jy
Total-power spectrum Antenna: O8 (05)
Timerange: 00/16:07:41 to 00/16:08:59

Plot file version 18 created 01-AUG-2018 16:38:04

J0530+1331 N18L1 2.UVDATA.1

Freq = 1.6266 GHz, Bw = 8.000 MH No calibration applied and no bandpass applied

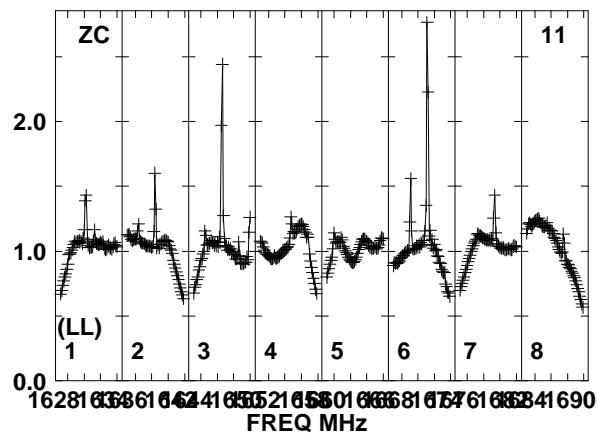
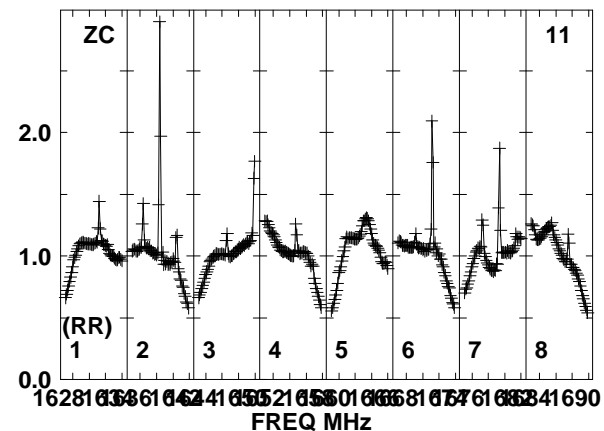
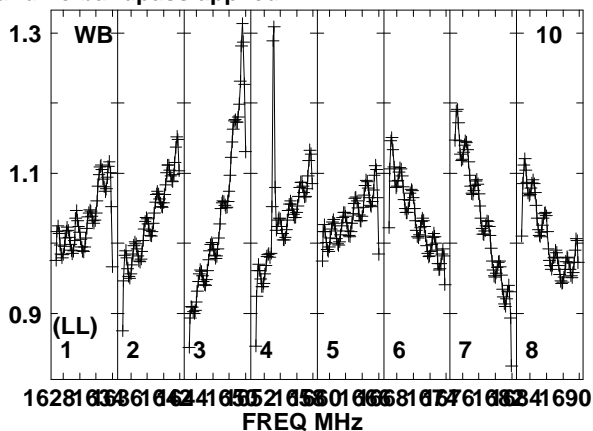
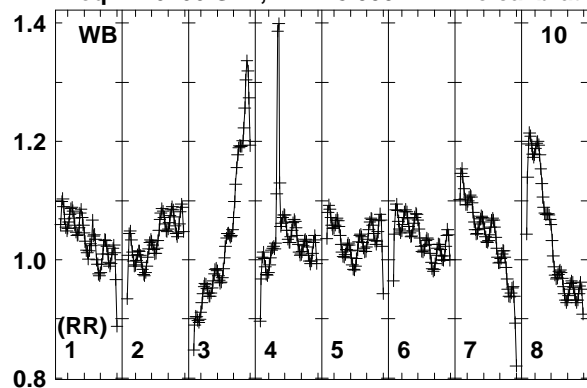

Lower frame: Real Jy
Total-power spectrum Antenna: WB (10)
Timerange: 00/16:07:41 to 00/16:08:59

Plot file version 19 created 01-AUG-2018 16:38:04
 PB+0-4 N18L1 2.UVDATA.1
 Freq = 1.6266 GHz, Bw = 8.000 MH No calibration applied and no bandpass applied

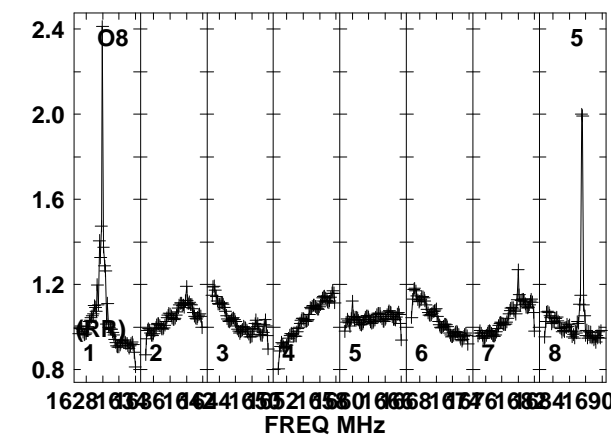
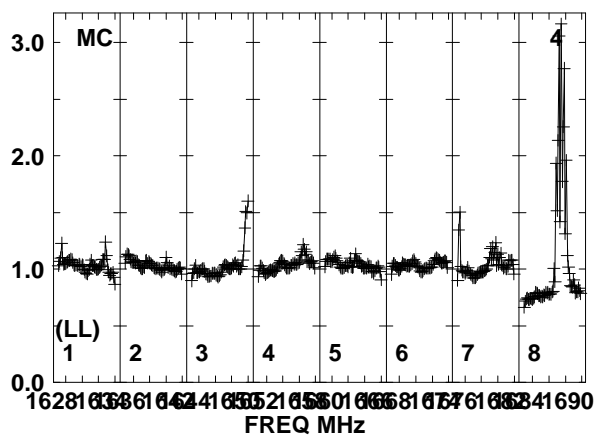
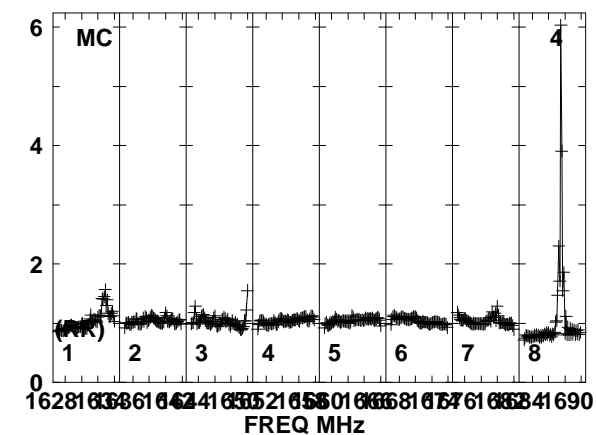
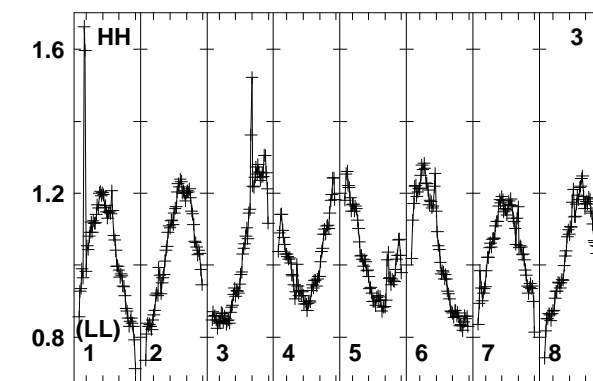
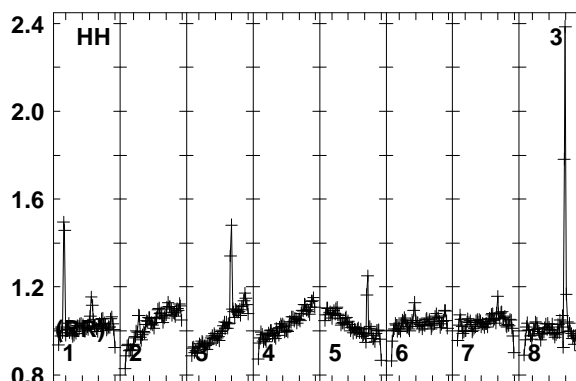
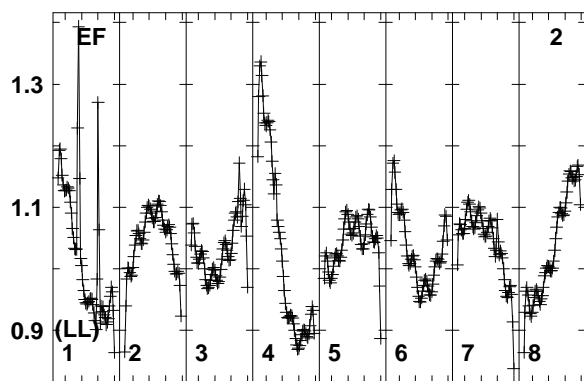
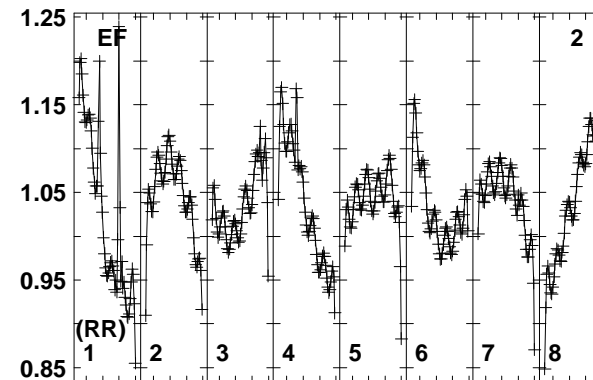
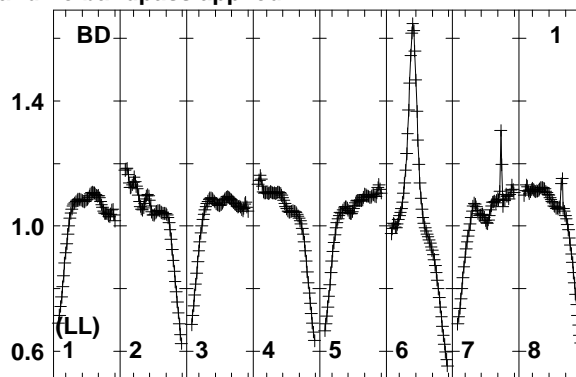
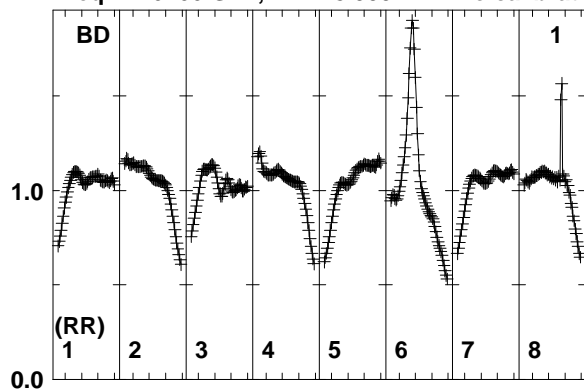

Lower frame: Real Jy
 Total-power spectrum Antenna: BD (01)
 Timerange: 00/16:09:05 to 00/16:11:29

Plot file version 20 created 01-AUG-2018 16:38:04
 PB+0-4 N18L1 2.UVDATA.1
 Freq = 1.6266 GHz, Bw = 8.000 MH No calibration applied and no bandpass applied

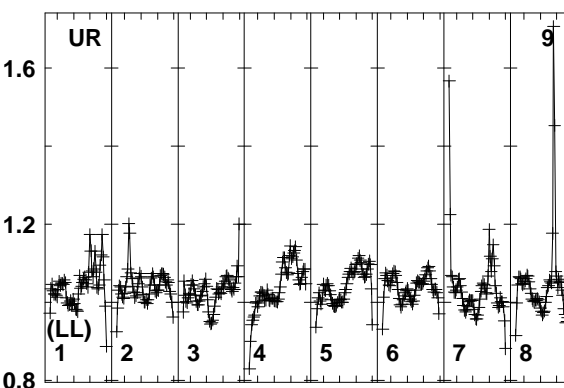
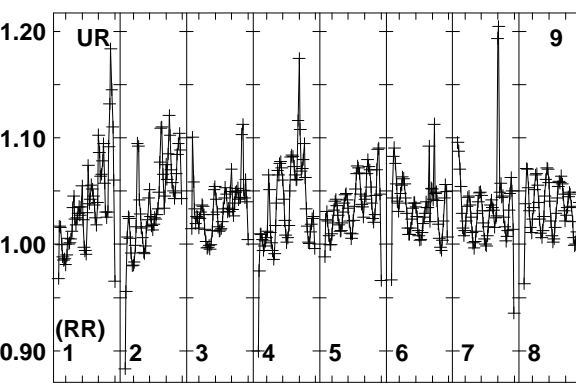
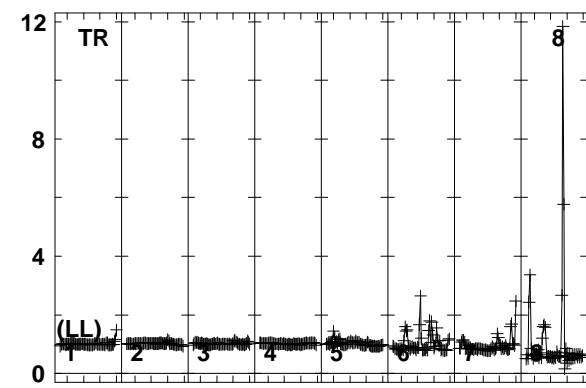
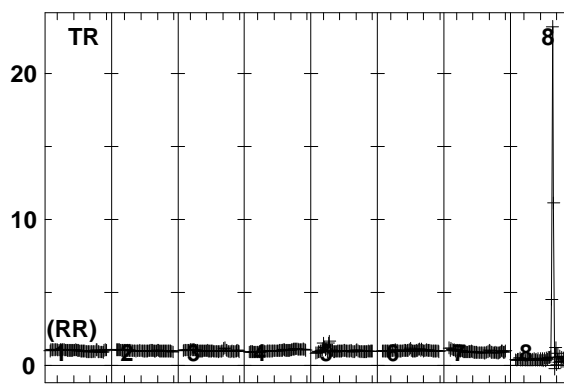
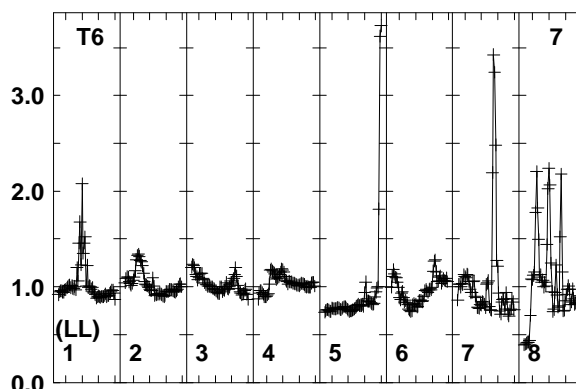
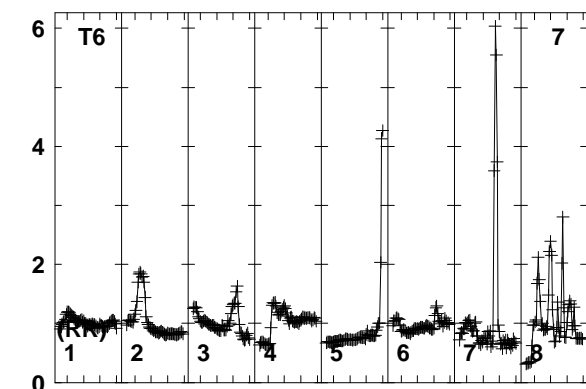
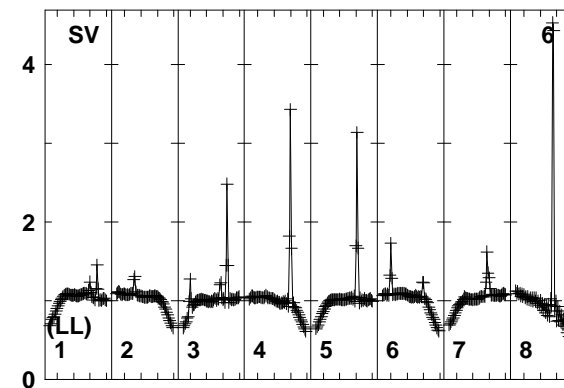
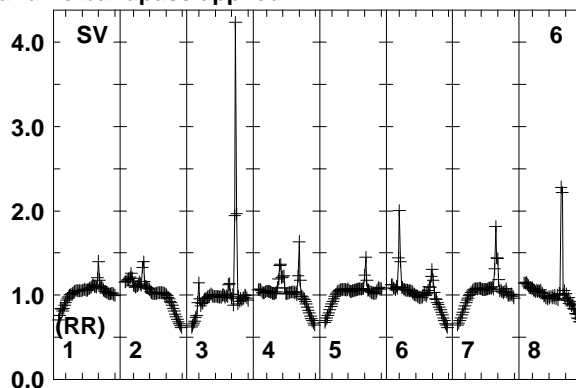
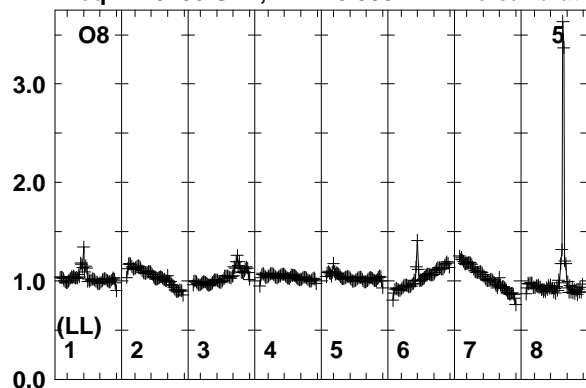

1628163861642416552165801666816746168241690
 FREQ MHz

1628163861642416552165801666816746168241690
 FREQ MHz

1628163861642416552165801666816746168241690
 FREQ MHz

Lower frame: Real Jy
 Total-power spectrum Antenna: O8 (05)
 Timerange: 00/16:09:05 to 00/16:11:29

Plot file version 21 created 01-AUG-2018 16:38:04

PB+0-4 N18L1 2.UVDATA.1

Freq = 1.6266 GHz, Bw = 8.000 MH No calibration applied and no bandpass applied

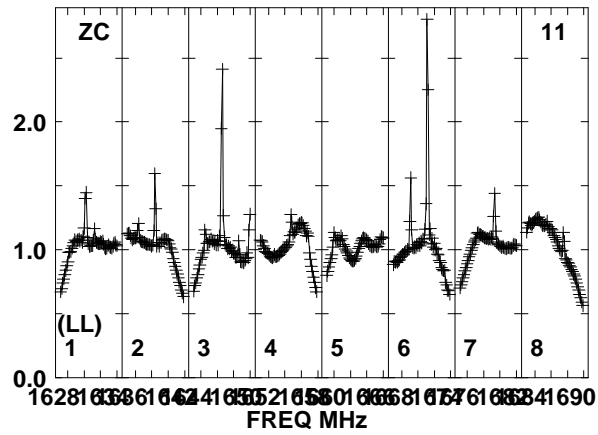
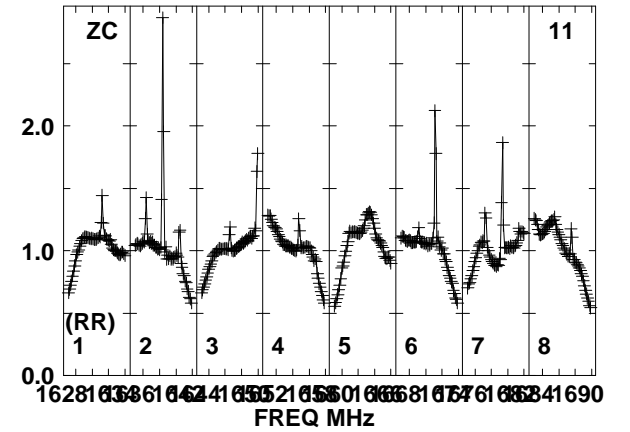
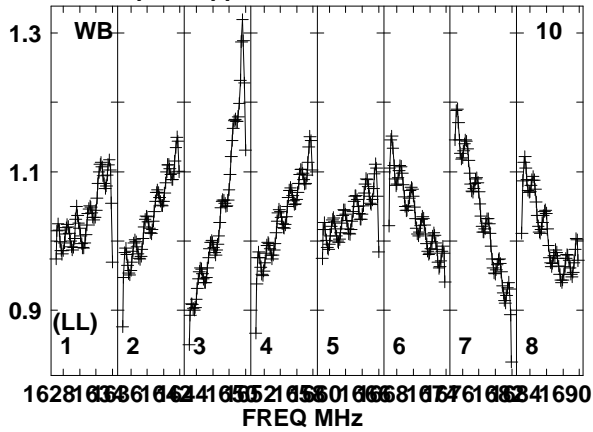
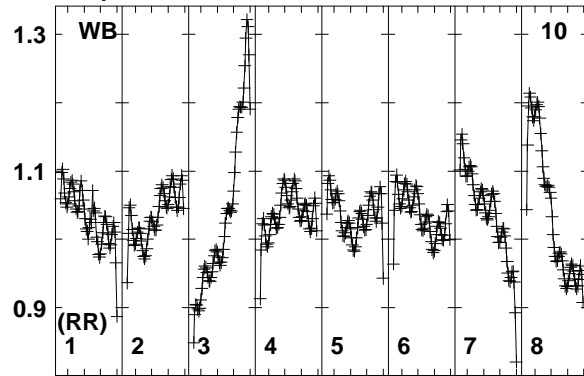

Lower frame: Real Jy
Total-power spectrum Antenna: WB (10)
Timerange: 00/16:09:05 to 00/16:11:29

Plot file version 22 created 01-AUG-2018 16:38:05
 PB-1-4 N18L1 2.UVDATA.1
 Freq = 1.6266 GHz, Bw = 8.000 MH No calibration applied and no bandpass applied

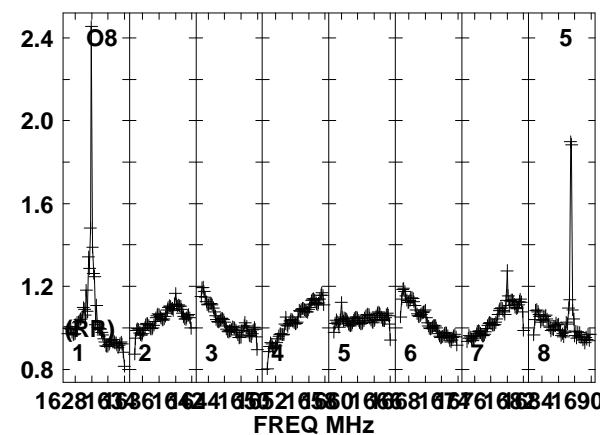
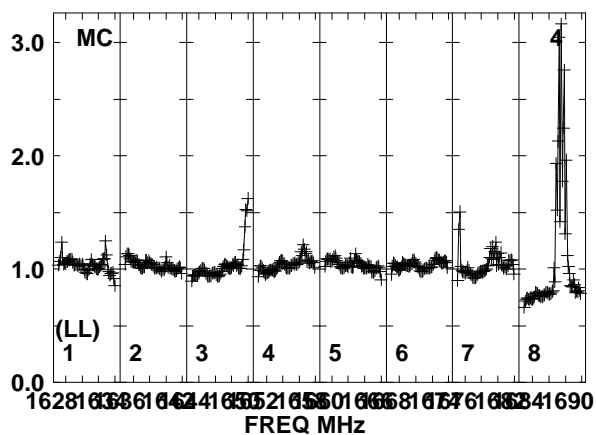
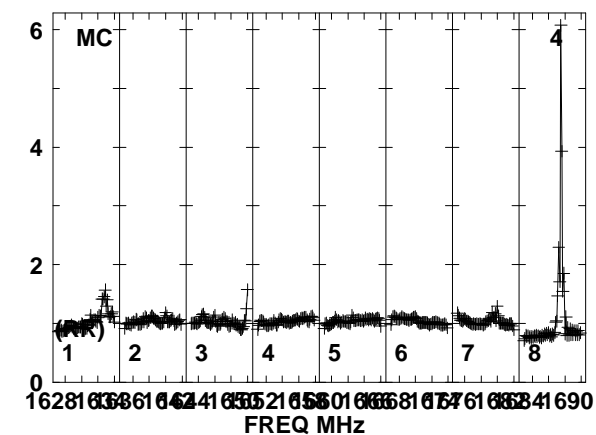
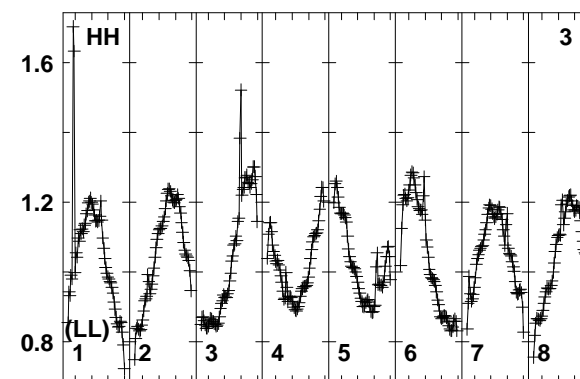
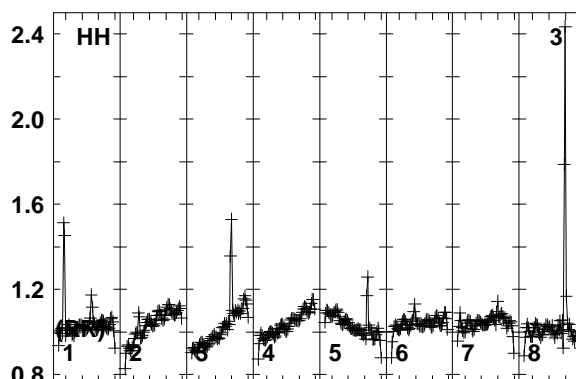
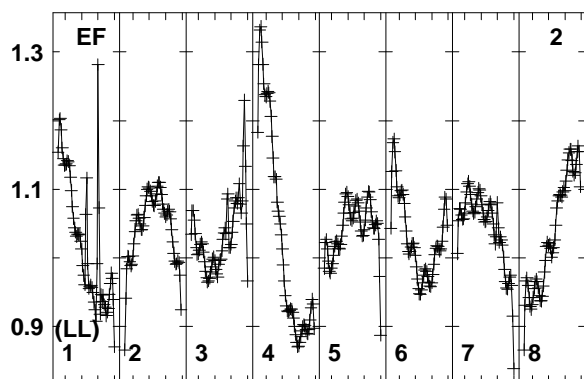
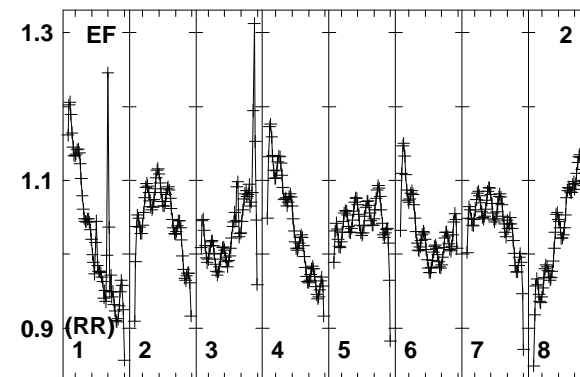
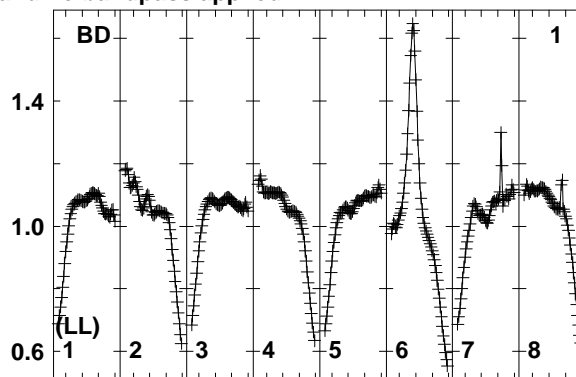
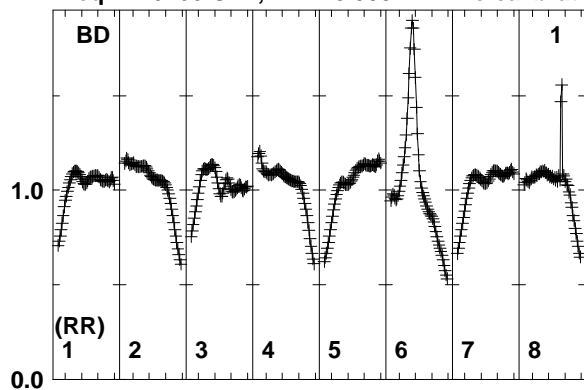

Lower frame: Real Jy
 Total-power spectrum Antenna: BD (01)
 Timerange: 00/16:11:33 to 00/16:13:59

Plot file version 23 created 01-AUG-2018 16:38:05
 PB-1-4 N18L1 2.UVDATA.1
 Freq = 1.6266 GHz, Bw = 8.000 MH No calibration applied and no bandpass applied

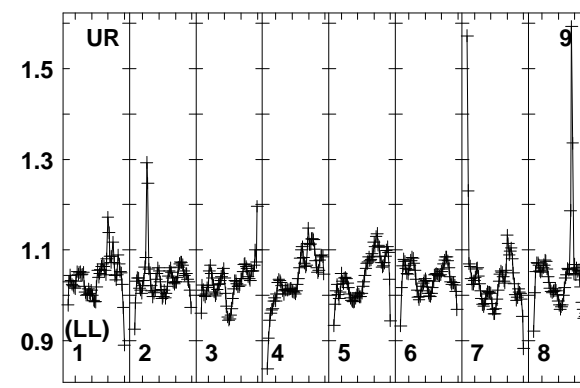
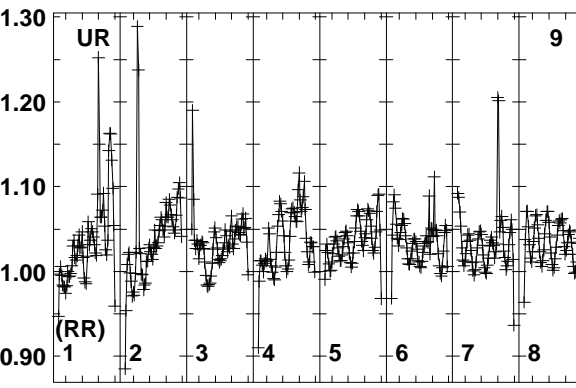
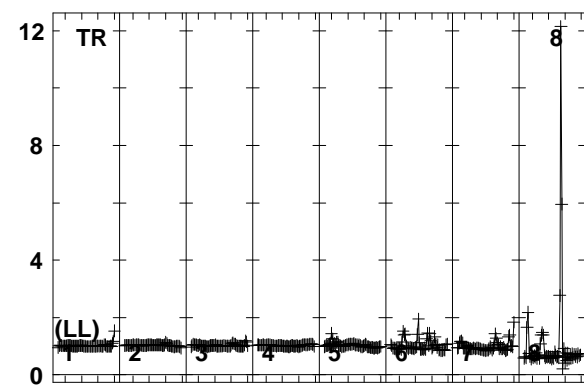
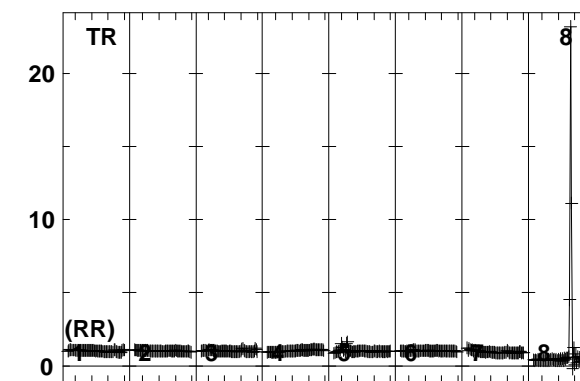
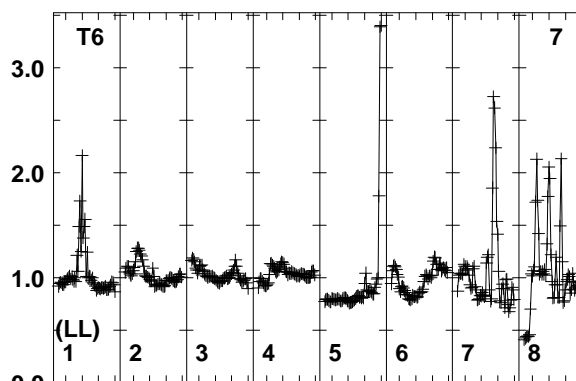
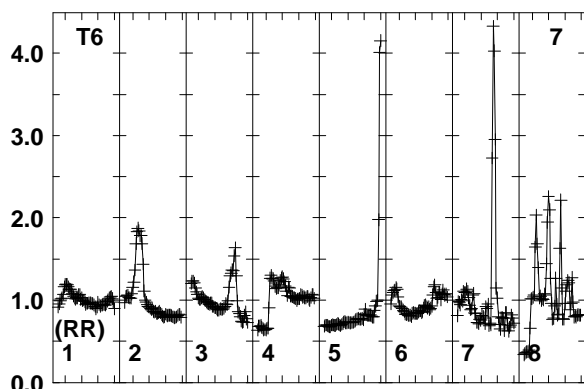
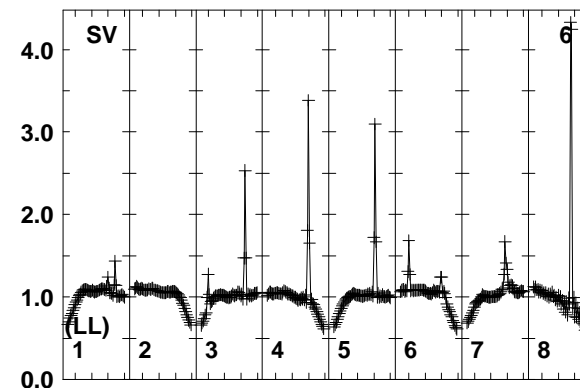
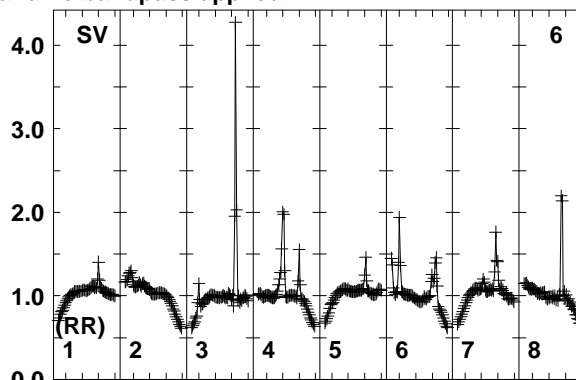
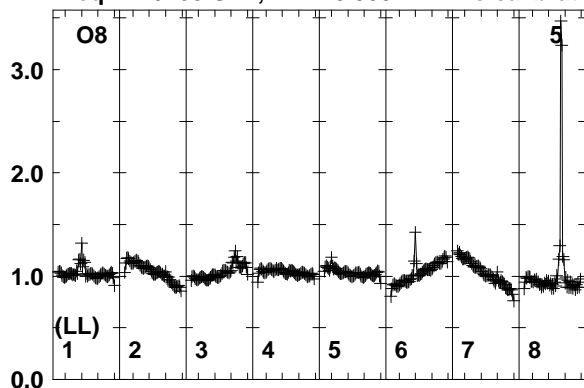

1628163861642416552165801666816746168241690
 FREQ MHz

1628163861642416552165801666816746168241690
 FREQ MHz

1628163861642416552165801666816746168241690
 FREQ MHz

Lower frame: Real Jy
 Total-power spectrum Antenna: O8 (05)
 Timerange: 00/16:11:33 to 00/16:13:59

Plot file version 24 created 01-AUG-2018 16:38:05

PB-1-4 N18L1 2.UVDATA.1

Freq = 1.6266 GHz, Bw = 8.000 MH No calibration applied and no bandpass applied

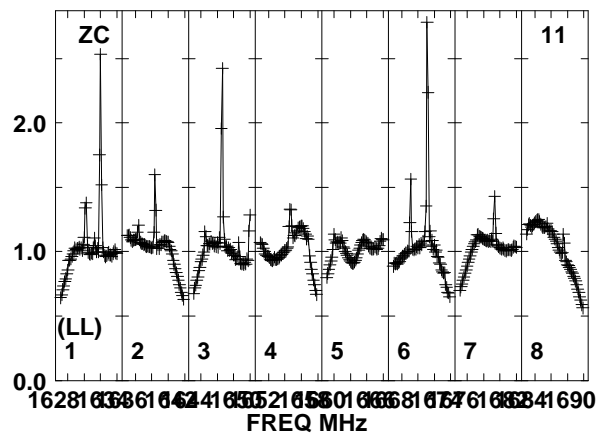
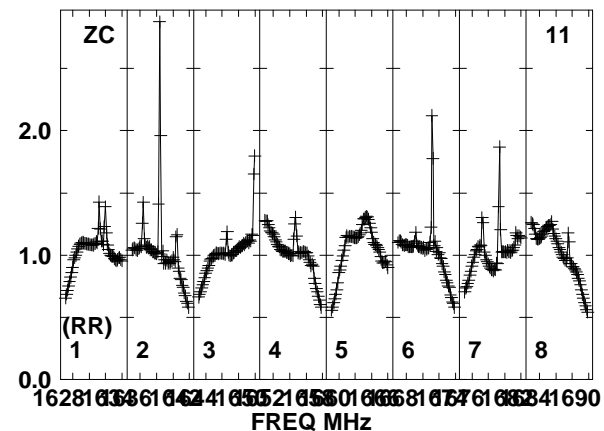
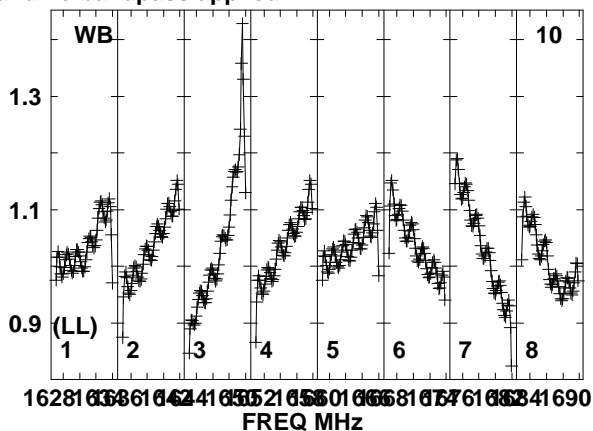
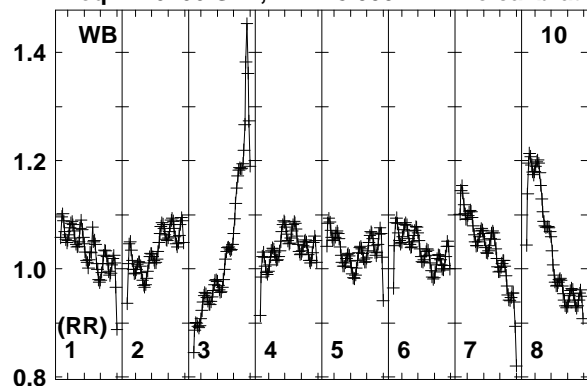

Lower frame: Real Jy
Total-power spectrum Antenna: WB (10)
Timerange: 00/16:11:33 to 00/16:13:59

Plot file version 25 created 01-AUG-2018 16:38:05
 PB-2-4 N18L1 2.UVDATA.1
 Freq = 1.6266 GHz, Bw = 8.000 MH No calibration applied and no bandpass applied

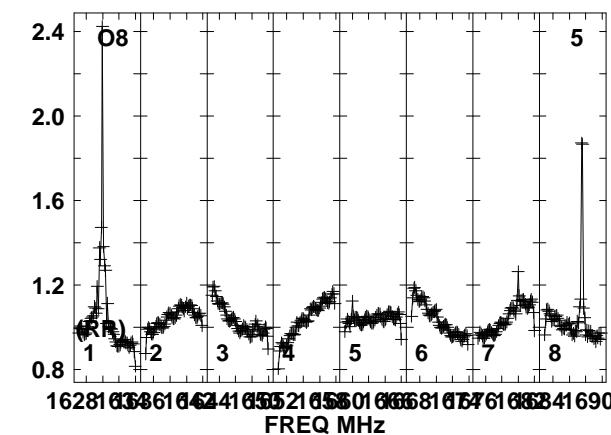
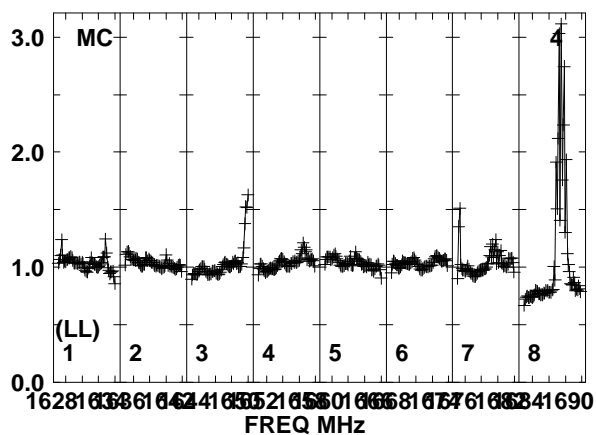
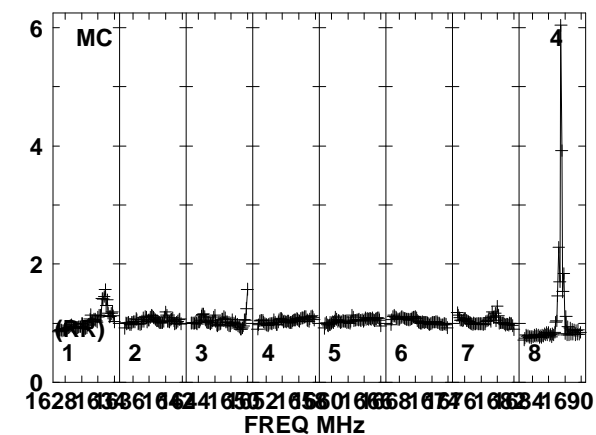
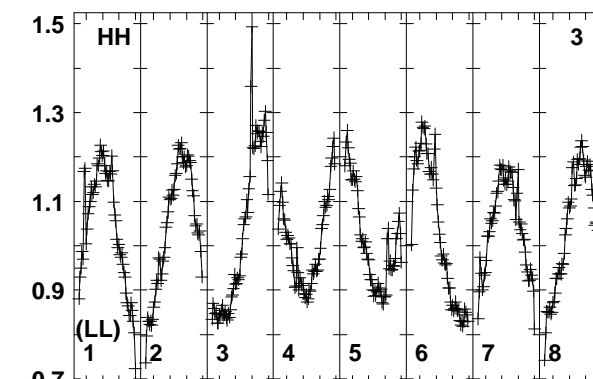
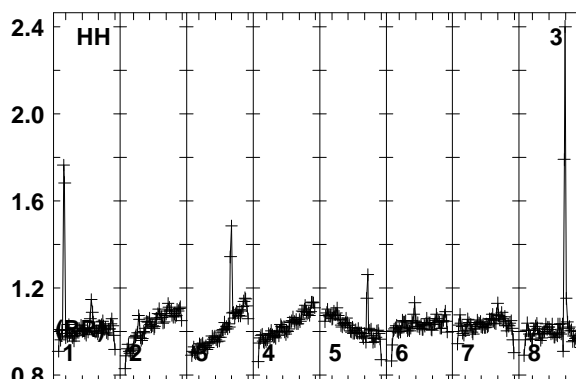
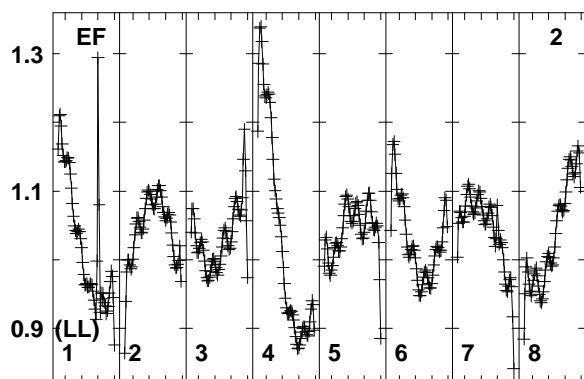
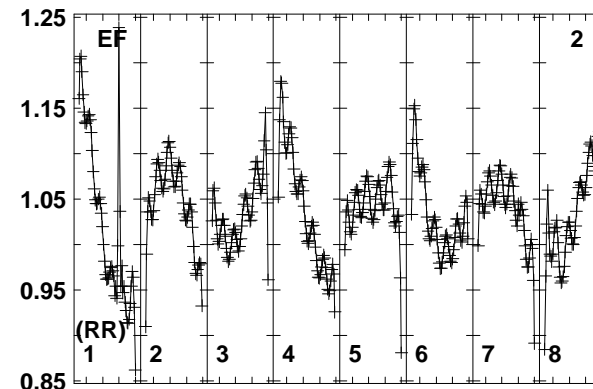
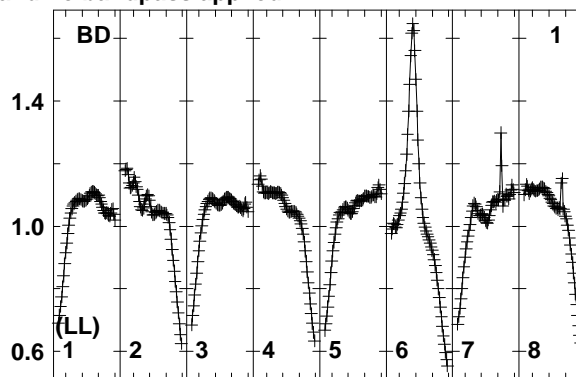
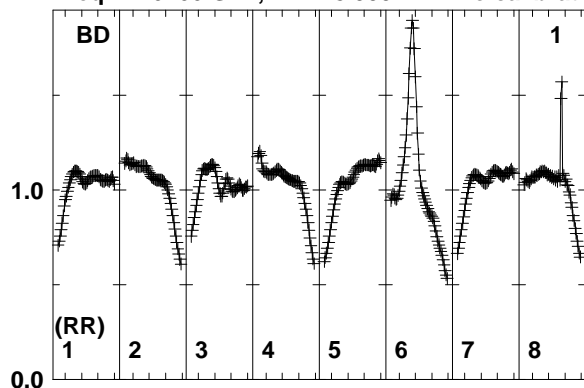

Lower frame: Real Jy
 Total-power spectrum Antenna: BD (01)
 Timerange: 00/16:14:03 to 00/16:16:29

Plot file version 26 created 01-AUG-2018 16:38:05
 PB-2-4 N18L1 2.UVDATA.1
 Freq = 1.6266 GHz, Bw = 8.000 MH No calibration applied and no bandpass applied

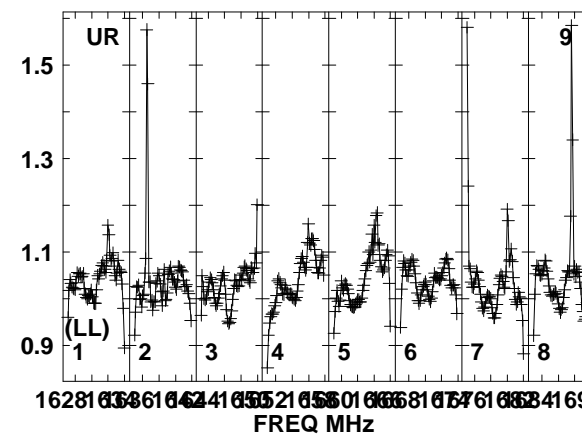
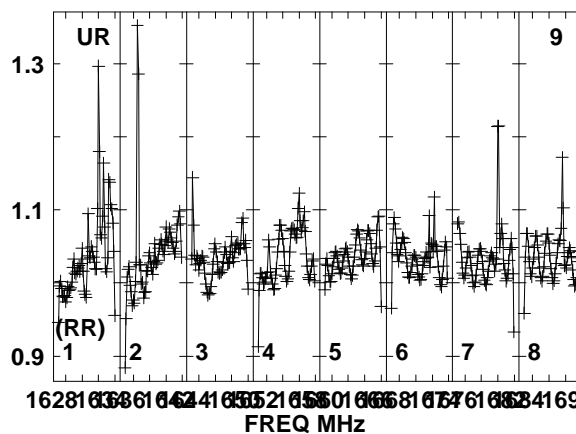
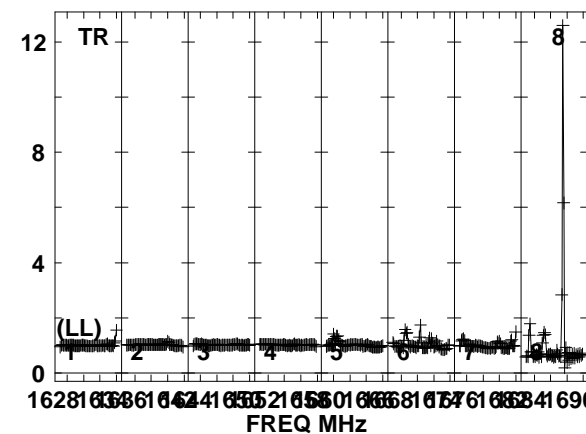
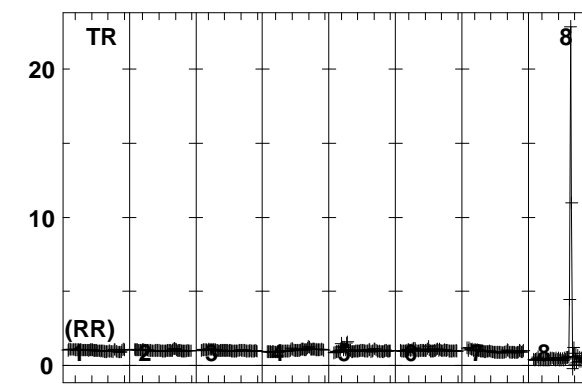
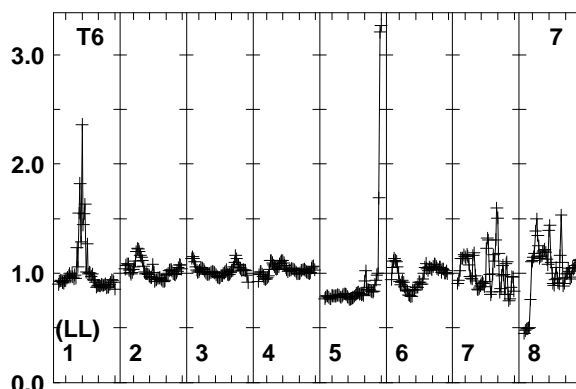
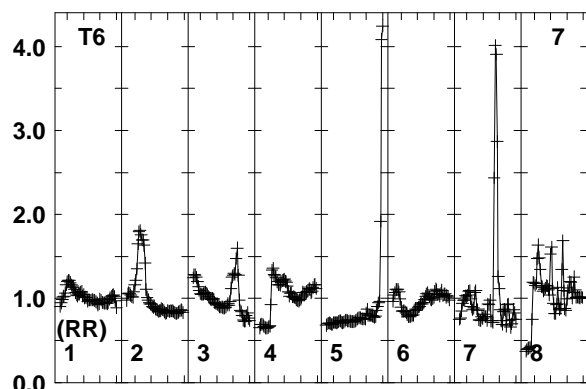
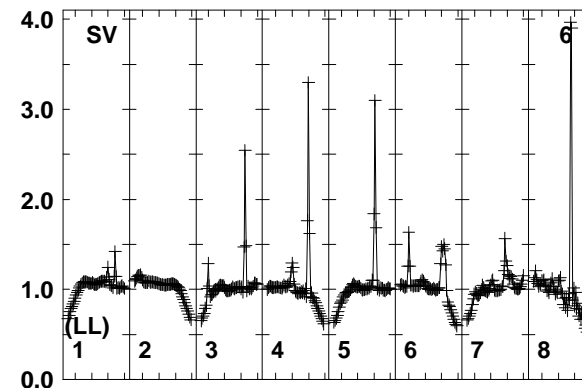
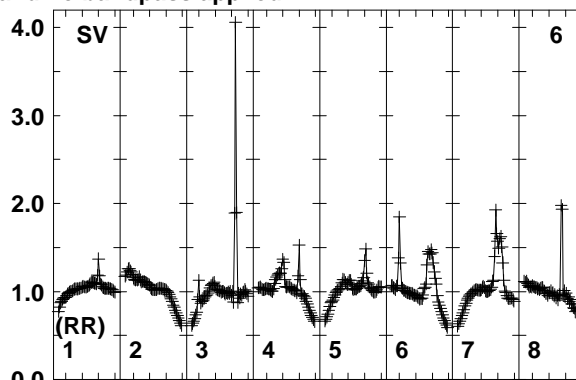
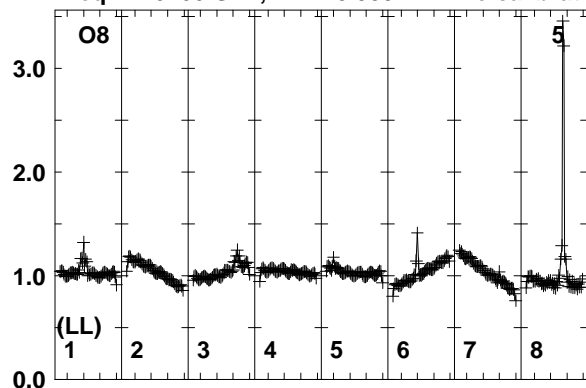

Lower frame: Real Jy
 Total-power spectrum Antenna: O8 (05)
 Timerange: 00/16:14:03 to 00/16:16:29

Plot file version 27 created 01-AUG-2018 16:38:05

PB-2-4 N18L1 2.UVDATA.1

Freq = 1.6266 GHz, Bw = 8.000 MH No calibration applied and no bandpass applied

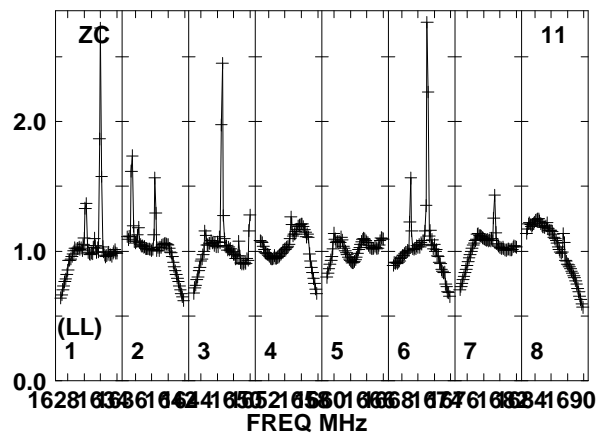
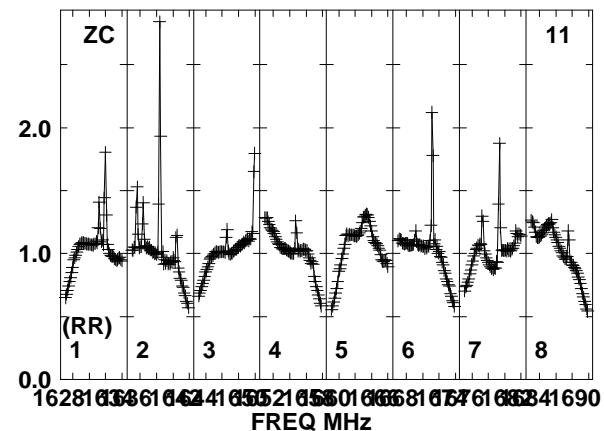
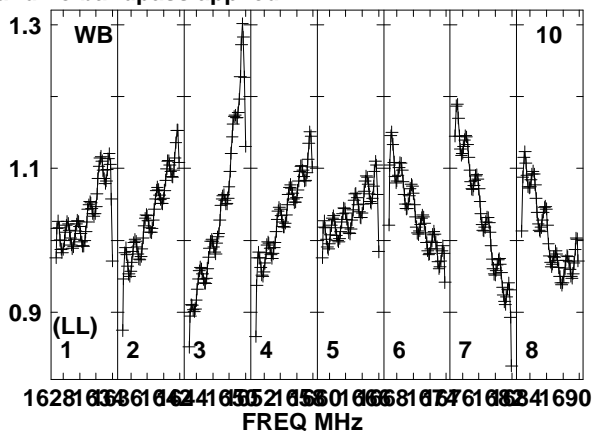
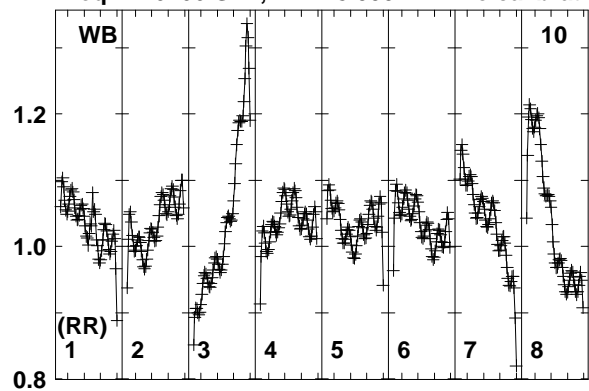

Lower frame: Real Jy
Total-power spectrum Antenna: WB (10)
Timerange: 00/16:14:03 to 00/16:16:29

Plot file version 28 created 01-AUG-2018 16:38:05
 PB-3-4 N18L1 2.UVDATA.1
 Freq = 1.6266 GHz, Bw = 8.000 MH No calibration applied and no bandpass applied

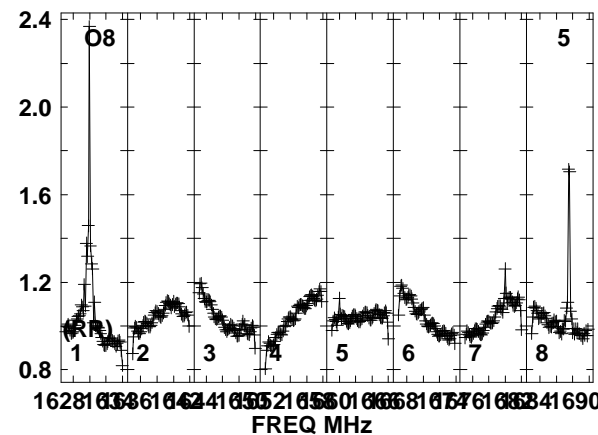
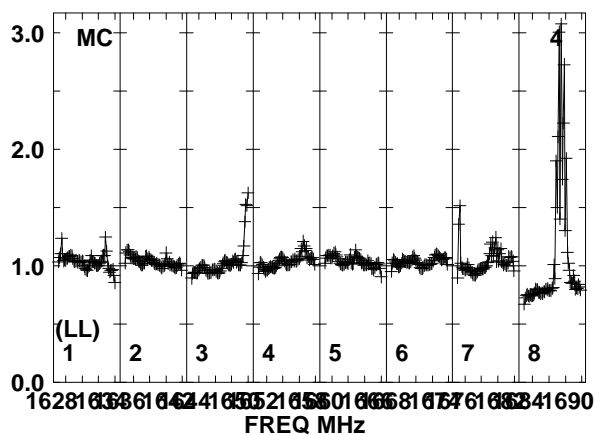
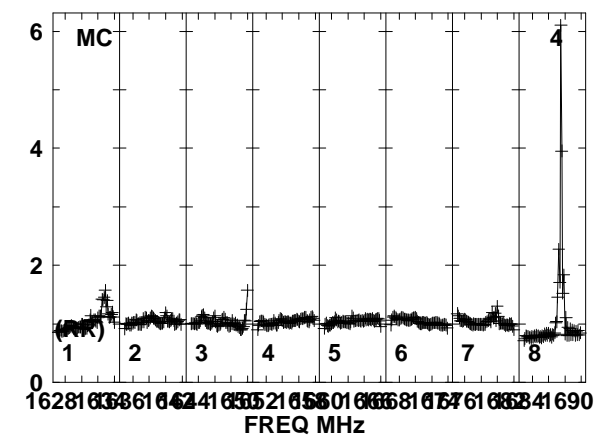
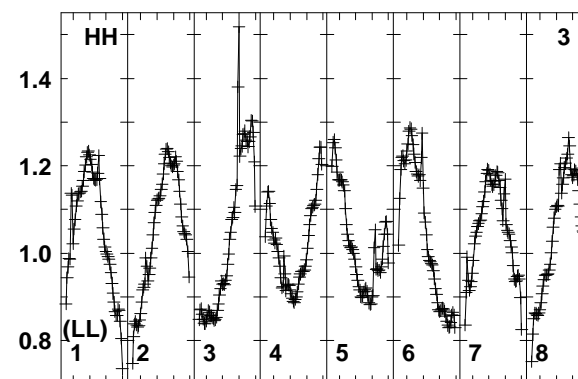
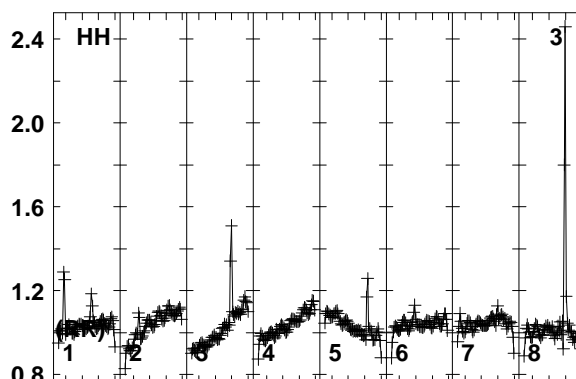
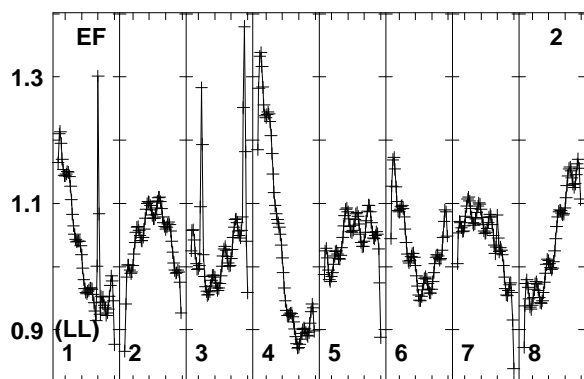
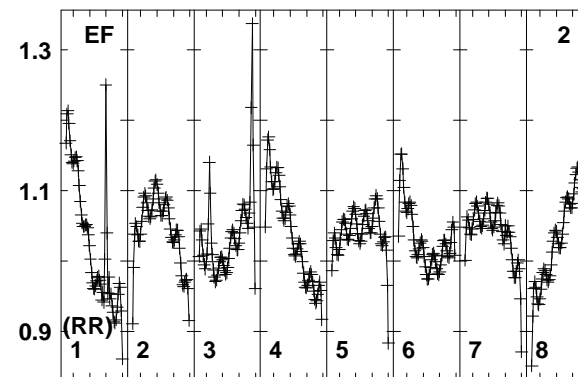
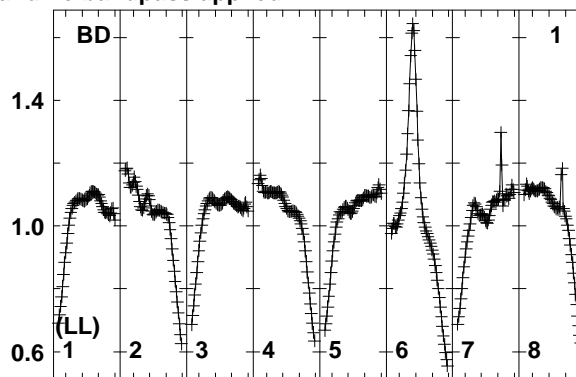
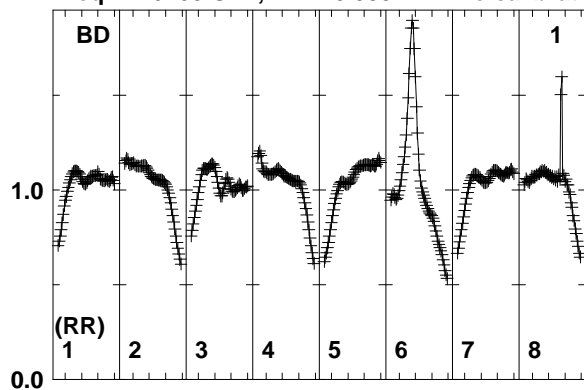

Lower frame: Real Jy
 Total-power spectrum Antenna: BD (01)
 Timerange: 00/16:16:33 to 00/16:18:59

Plot file version 29 created 01-AUG-2018 16:38:06
 PB-3-4 N18L1 2.UVDATA.1
 Freq = 1.6266 GHz, Bw = 8.000 MH No calibration applied and no bandpass applied

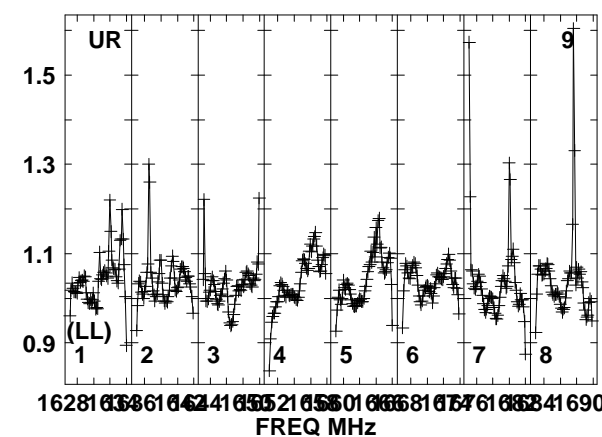
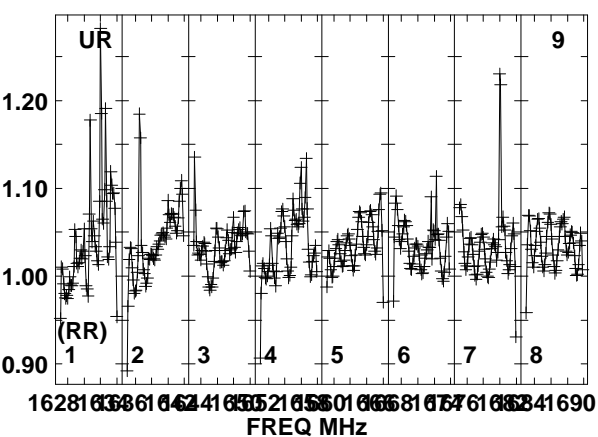
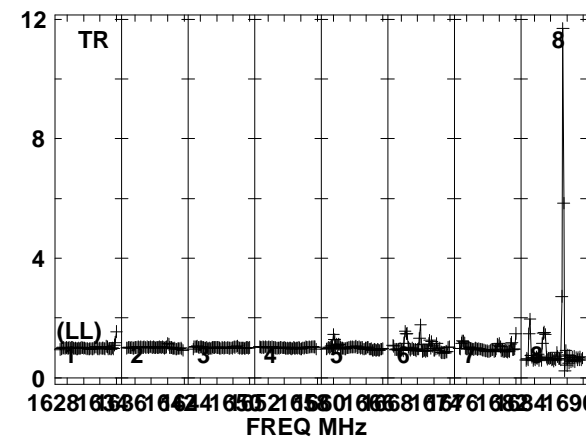
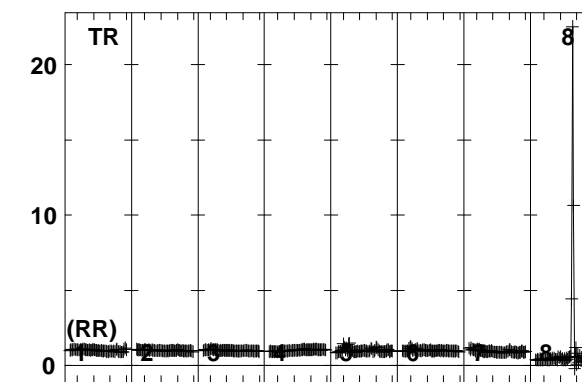
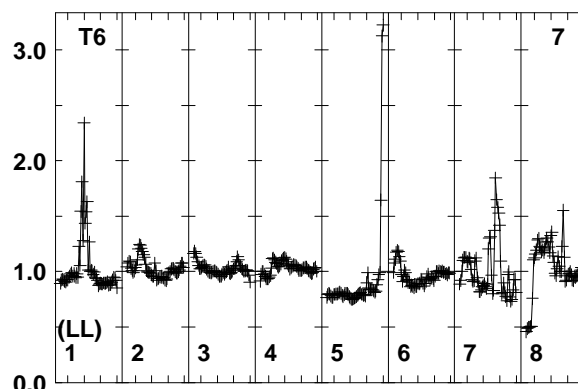
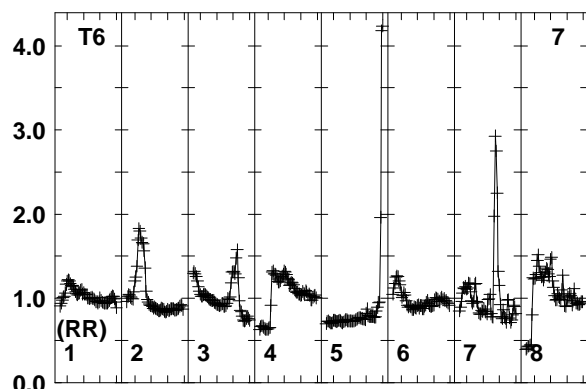
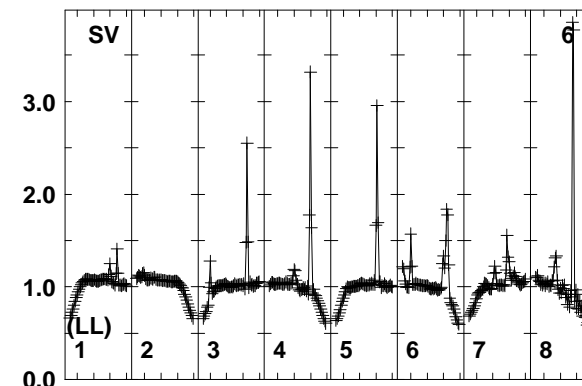
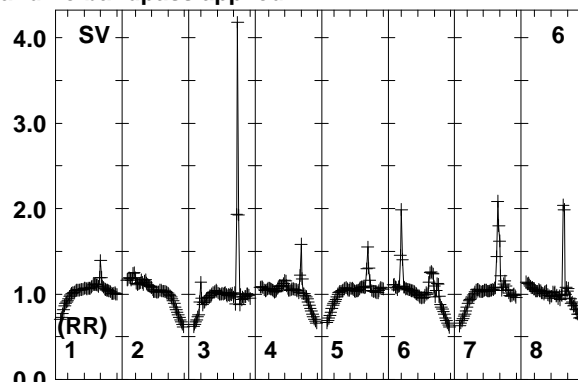
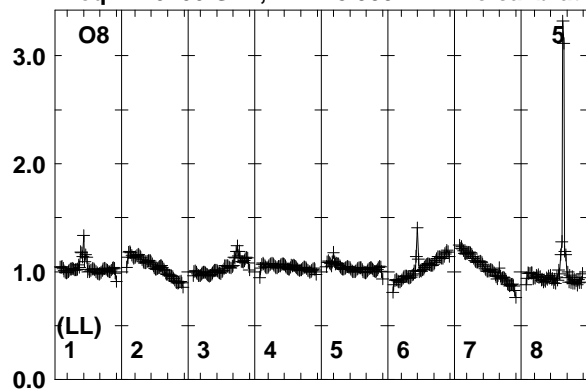

Lower frame: Real Jy
 Total-power spectrum Antenna: O8 (05)
 Timerange: 00/16:16:33 to 00/16:18:59

Plot file version 30 created 01-AUG-2018 16:38:06

PB-3-4 N18L1 2.UVDATA.1

Freq = 1.6266 GHz, Bw = 8.000 MH No calibration applied and no bandpass applied

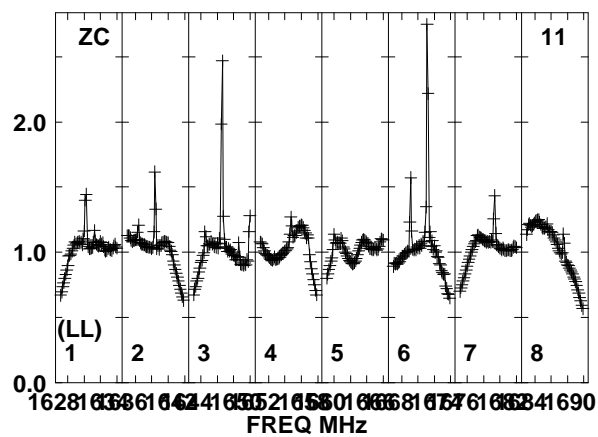
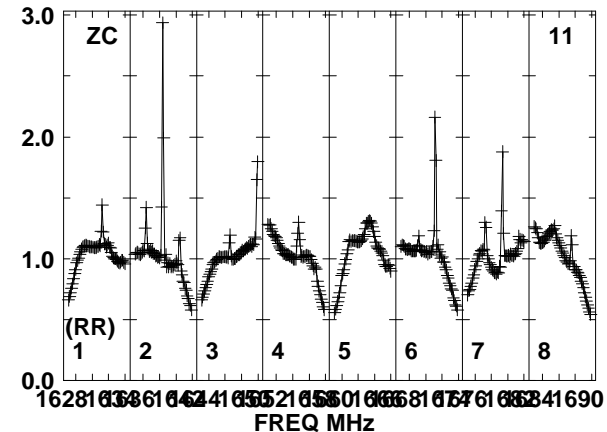
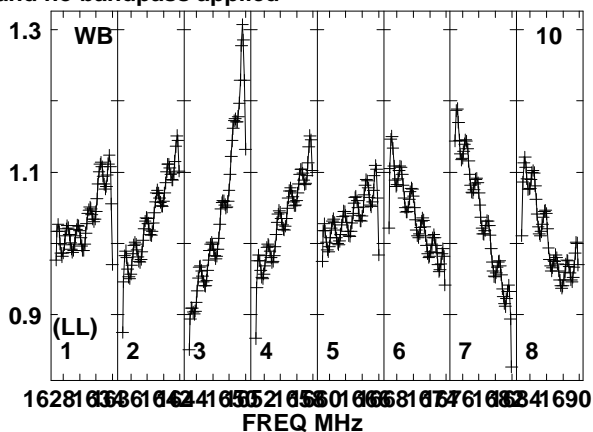
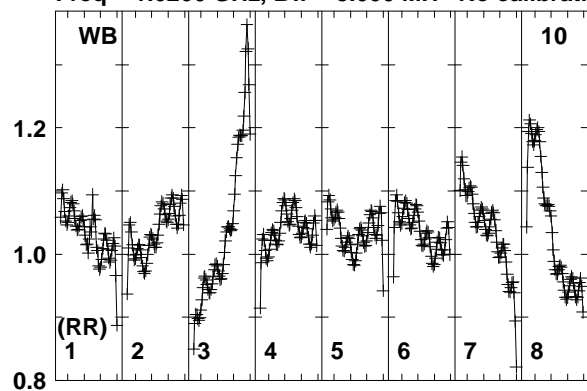

Lower frame: Real Jy
Total-power spectrum Antenna: WB (10)
Timerange: 00/16:16:33 to 00/16:18:59

Plot file version 31 created 01-AUG-2018 16:38:06
 J0530+1331 N18L1 2.UVDATA.1
 Freq = 1.6266 GHz, Bw = 8.000 MH No calibration applied and no bandpass applied

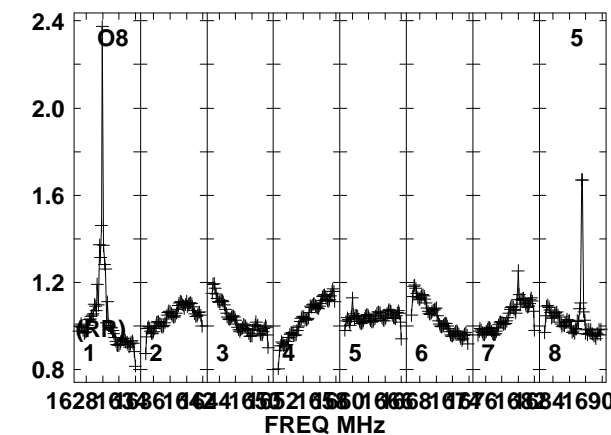
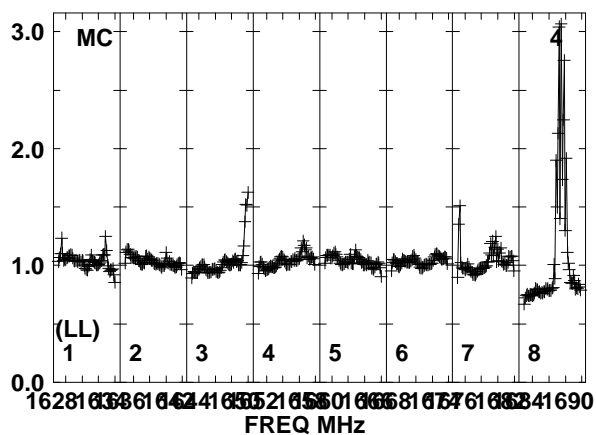
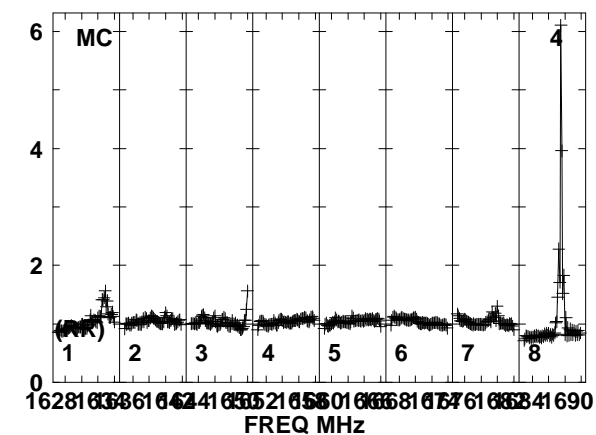
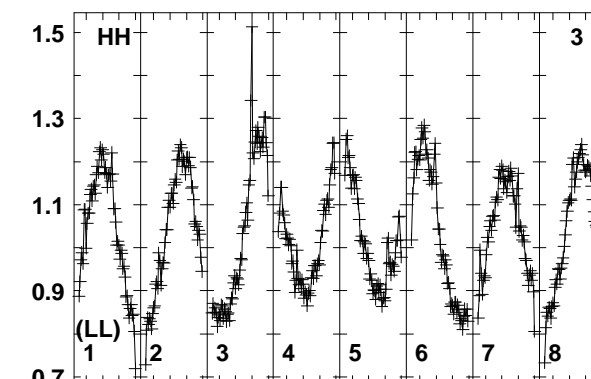
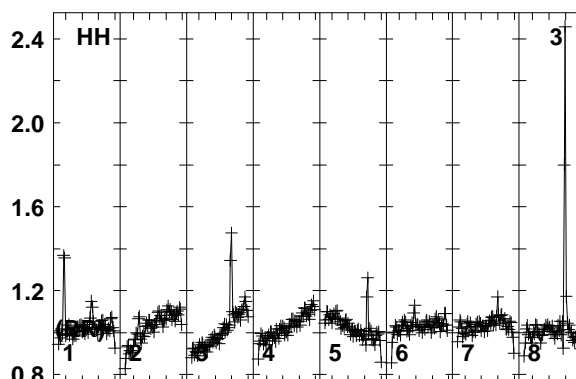
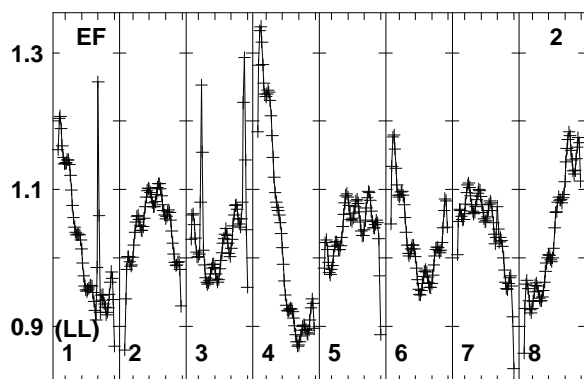
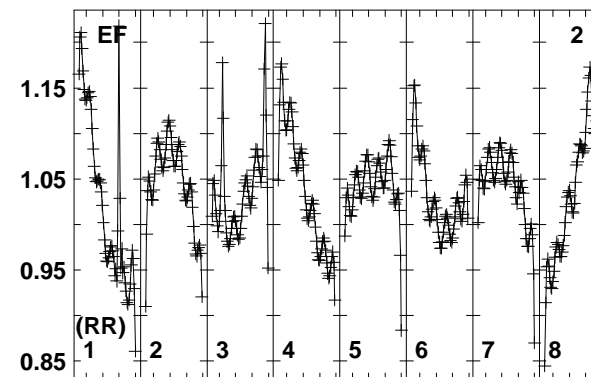
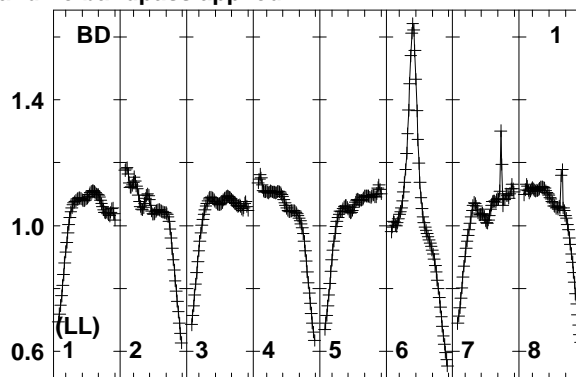
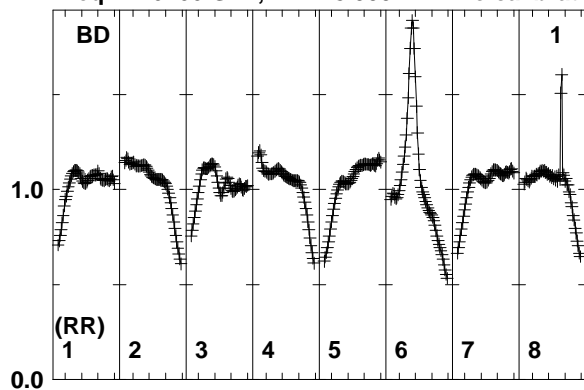

Lower frame: Real Jy
 Total-power spectrum Antenna: BD (01)
 Timerange: 00/16:19:41 to 00/16:20:59

Plot file version 32 created 01-AUG-2018 16:38:06

J0530+1331 N18L1 2.UVDATA.1

Freq = 1.6266 GHz, Bw = 8.000 MH No calibration applied and no bandpass applied

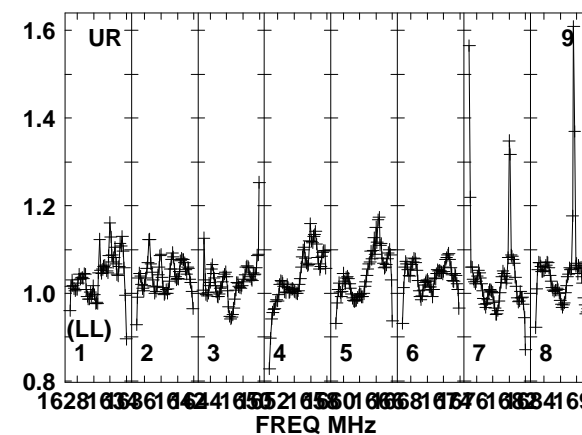
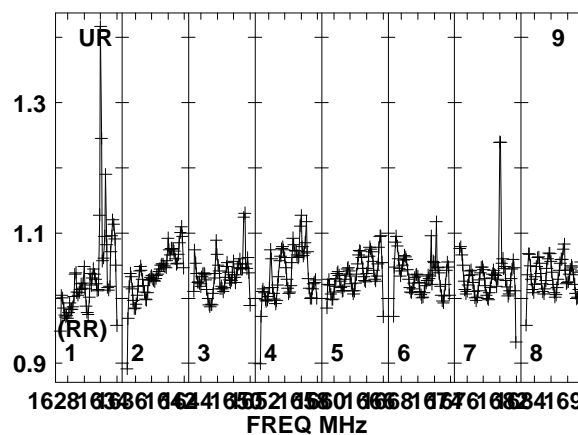
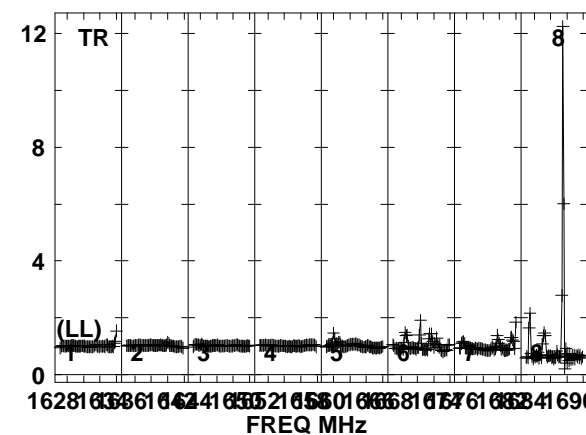
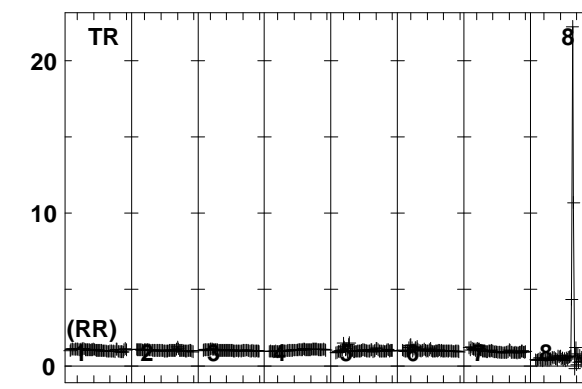
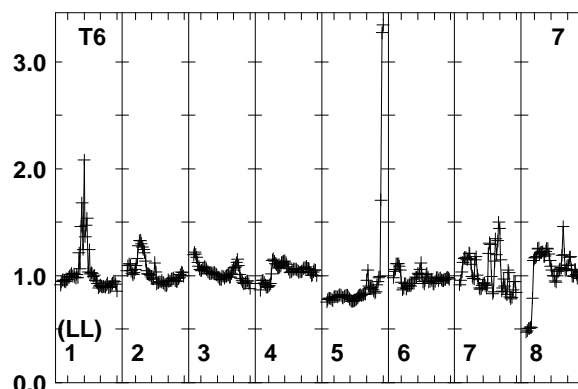
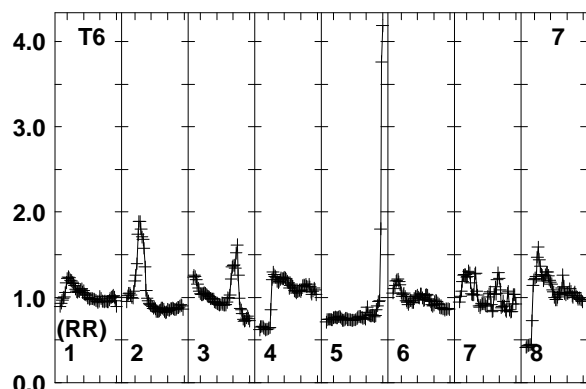
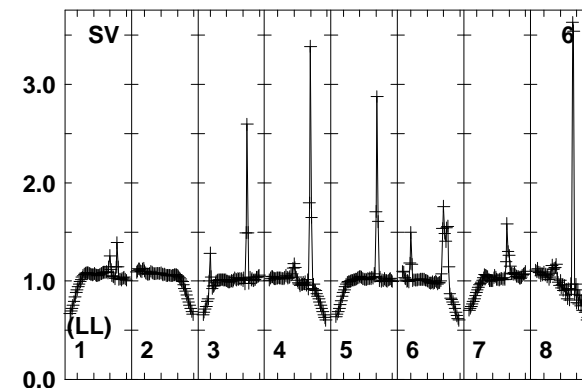
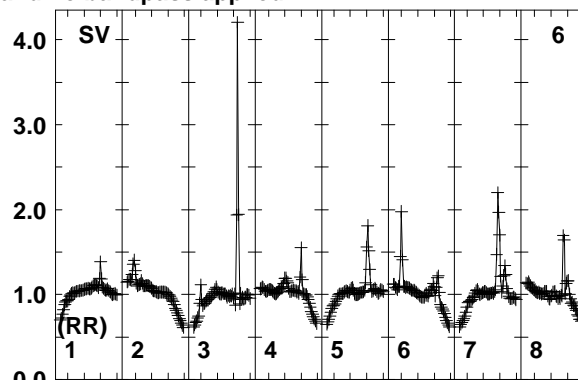
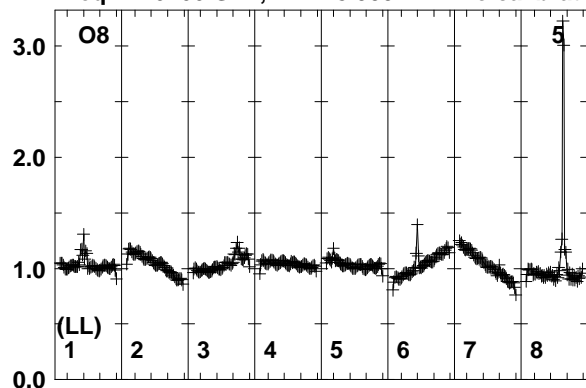

Lower frame: Real Jy
Total-power spectrum Antenna: O8 (05)
Timerange: 00/16:19:41 to 00/16:20:59

Plot file version 33 created 01-AUG-2018 16:38:06

J0530+1331 N18L1 2.UVDATA.1

Freq = 1.6266 GHz, Bw = 8.000 MH No calibration applied and no bandpass applied

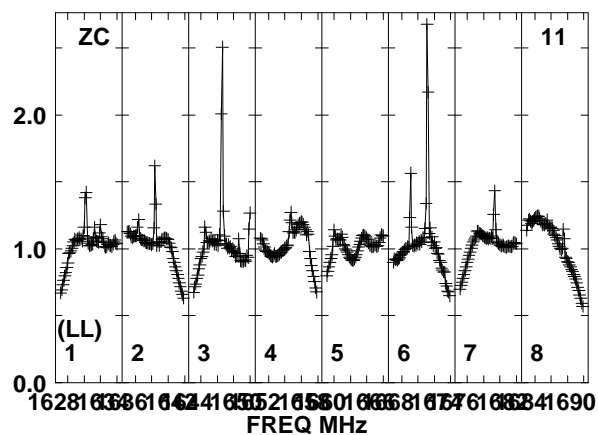
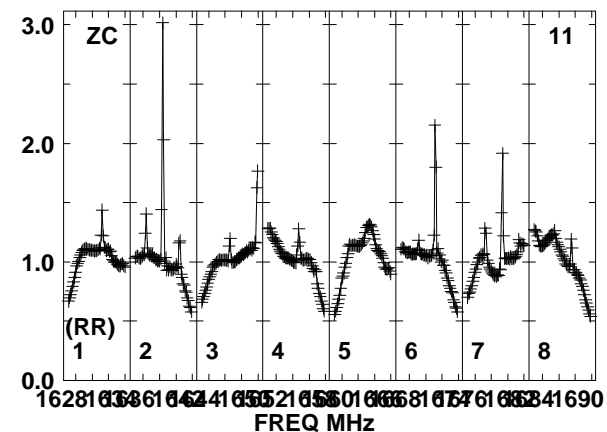
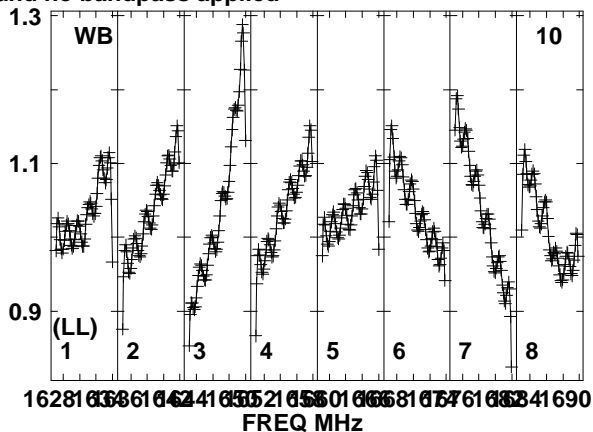
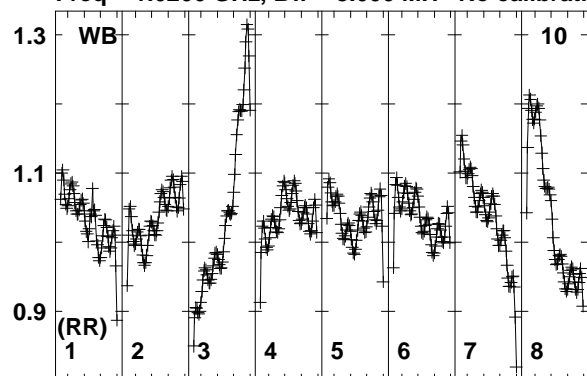

Lower frame: Real Jy
Total-power spectrum Antenna: WB (10)
Timerange: 00/16:19:41 to 00/16:20:59

Plot file version 34 created 01-AUG-2018 16:38:06
 PB-4-4 N18L1 2.UVDATA.1
 Freq = 1.6266 GHz, Bw = 8.000 MH No calibration applied and no bandpass applied

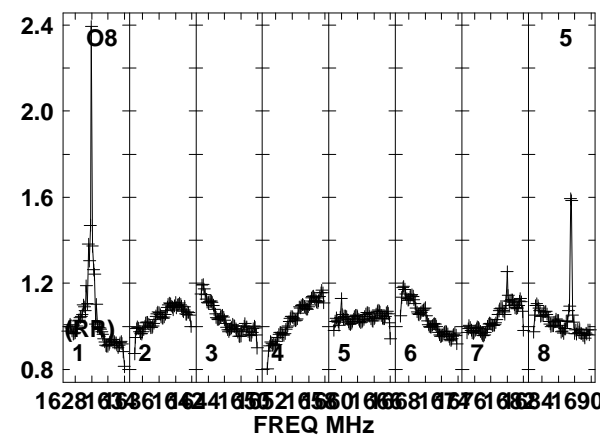
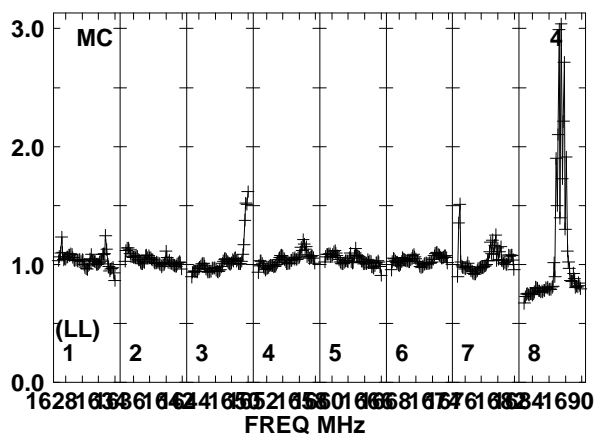
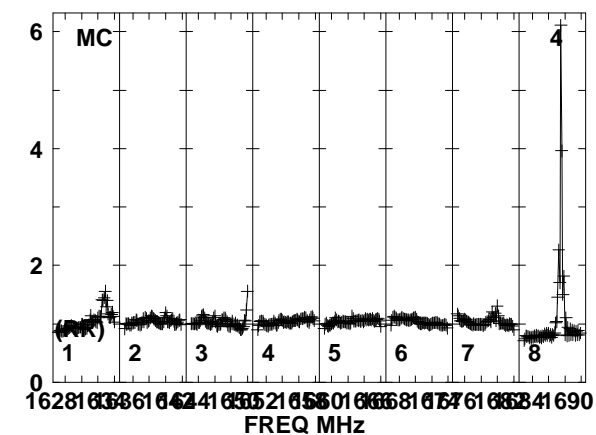
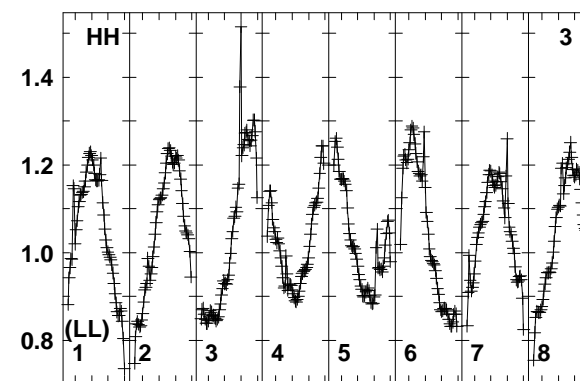
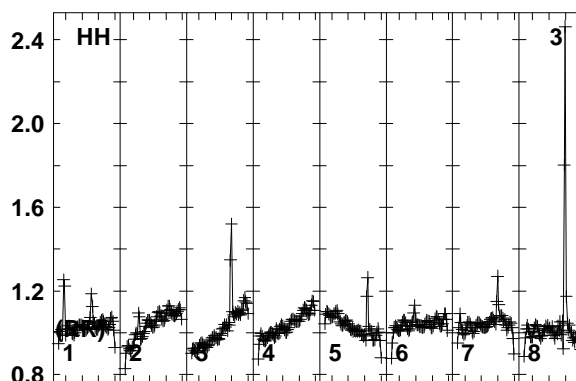
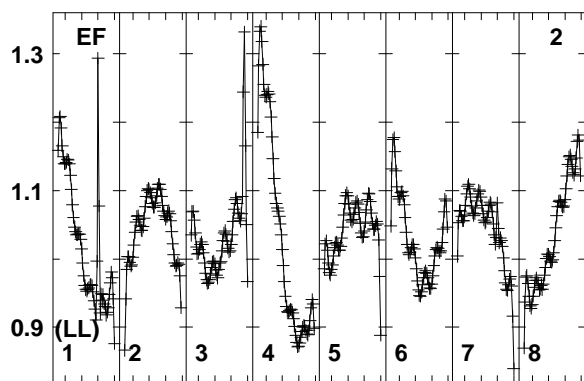
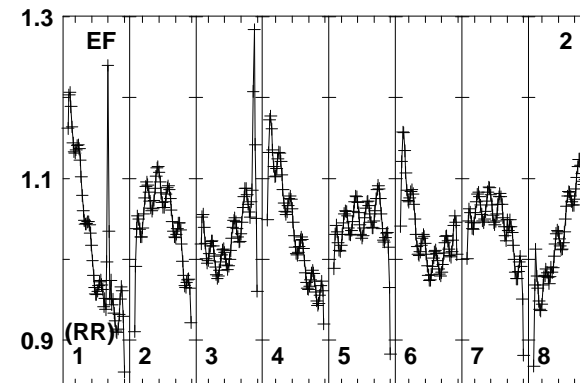
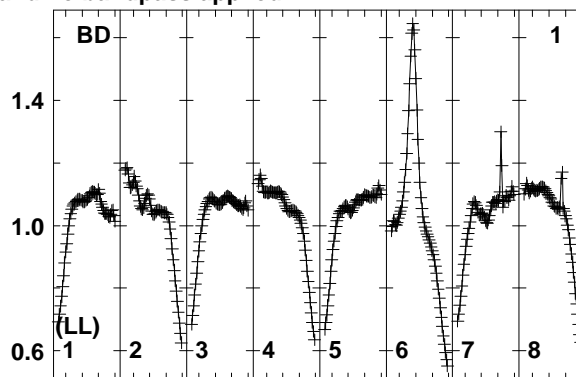
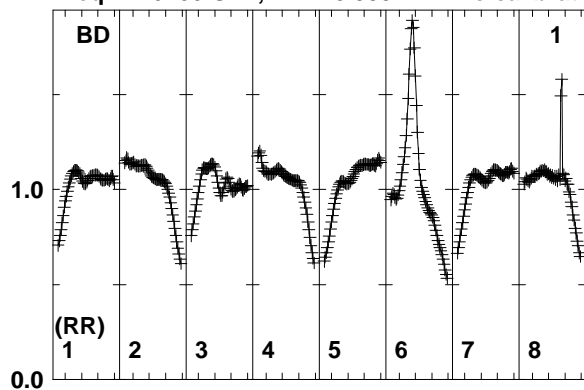

Lower frame: Real Jy
 Total-power spectrum Antenna: BD (01)
 Timerange: 00/16:21:05 to 00/16:23:29

Plot file version 35 created 01-AUG-2018 16:38:06
 PB-4-4 N18L1 2.UVDATA.1
 Freq = 1.6266 GHz, Bw = 8.000 MH No calibration applied and no bandpass applied

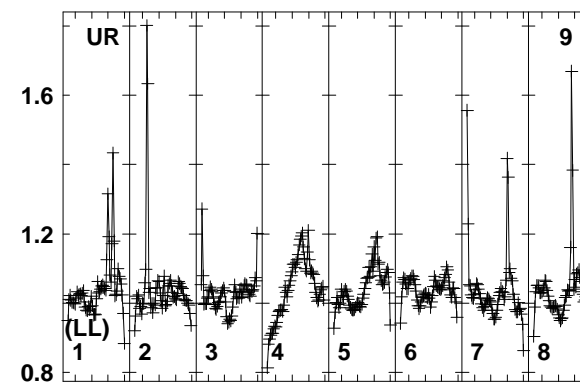
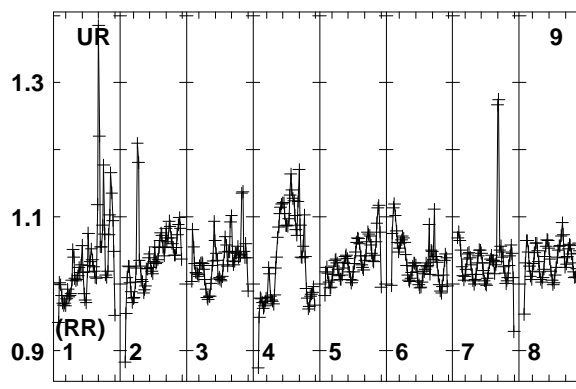
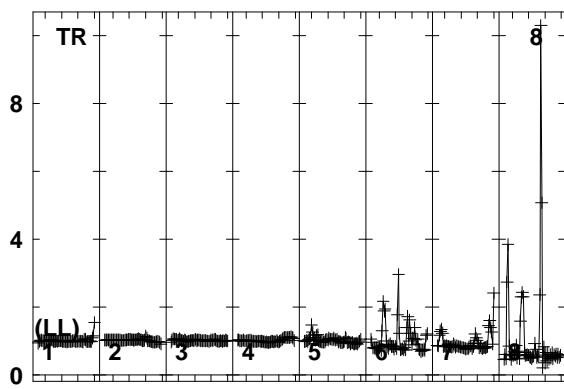
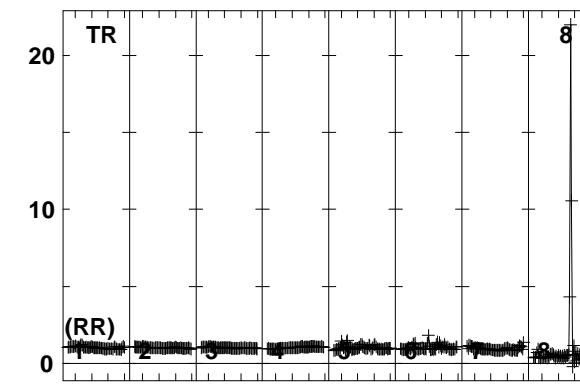
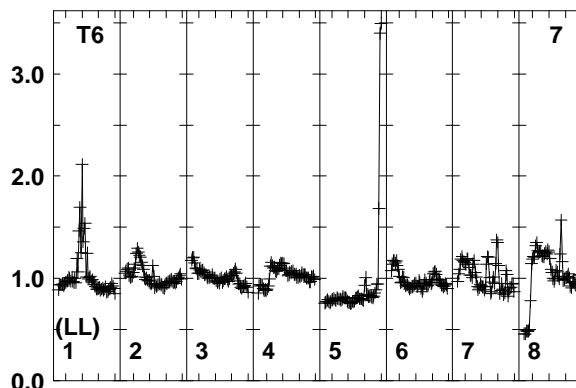
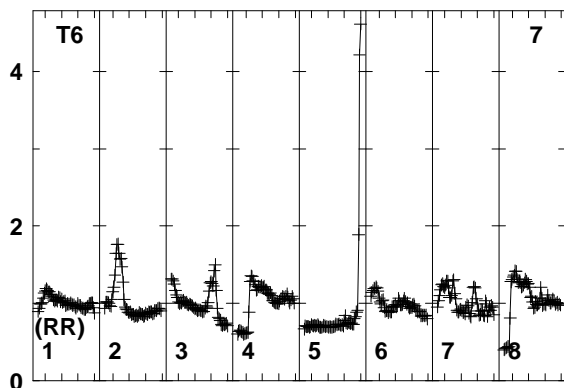
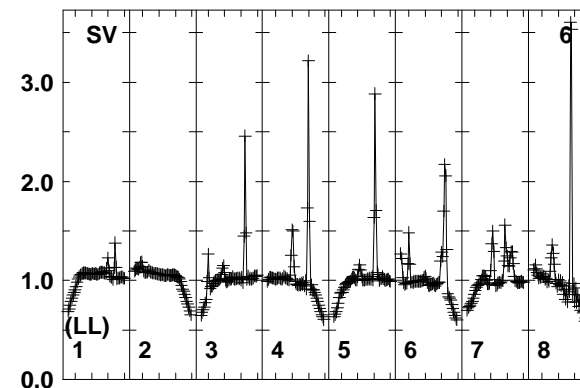
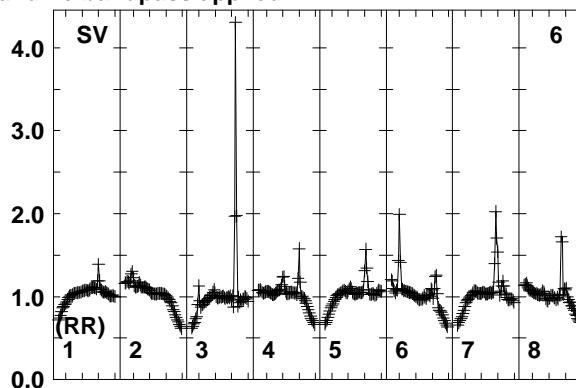
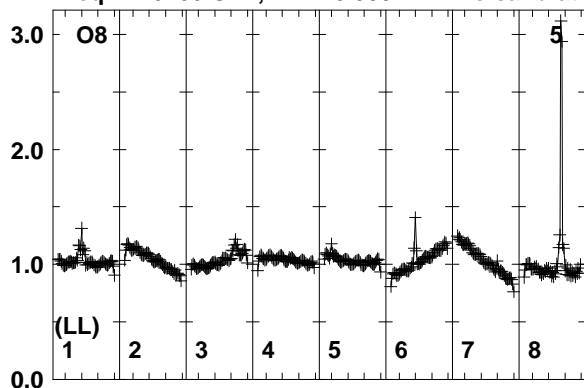

1628163861642416552165801666816746168241690
 FREQ MHz

1628163861642416552165801666816746168241690
 FREQ MHz

1628163861642416552165801666816746168241690
 FREQ MHz

Lower frame: Real Jy
 Total-power spectrum Antenna: O8 (05)
 Timerange: 00/16:21:05 to 00/16:23:29

Plot file version 36 created 01-AUG-2018 16:38:06

PB-4-4 N18L1 2.UVDATA.1

Freq = 1.6266 GHz, Bw = 8.000 MH No calibration applied and no bandpass applied

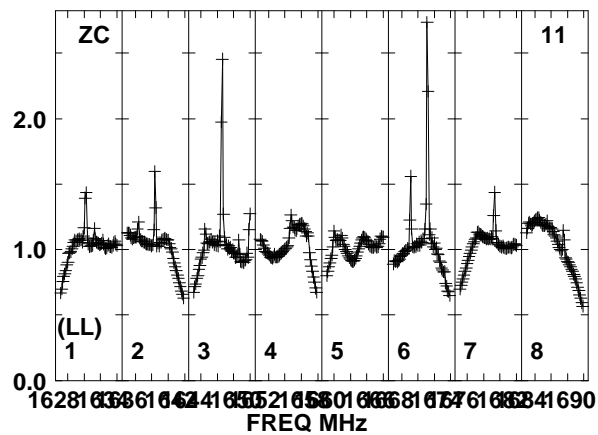
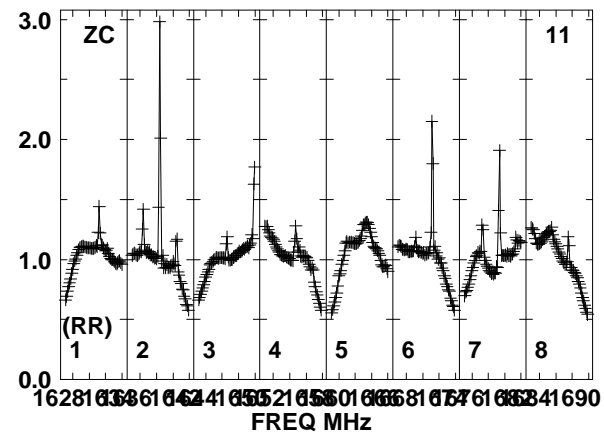
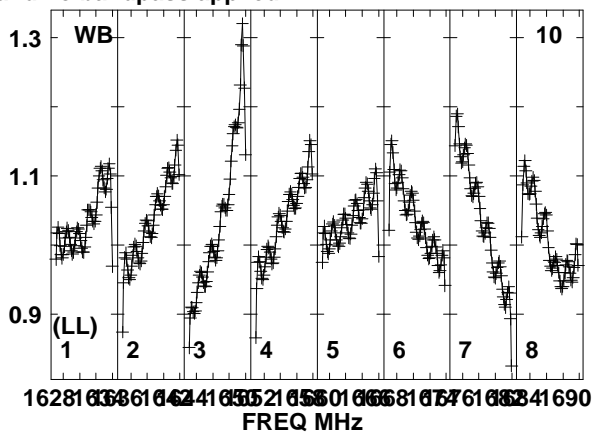
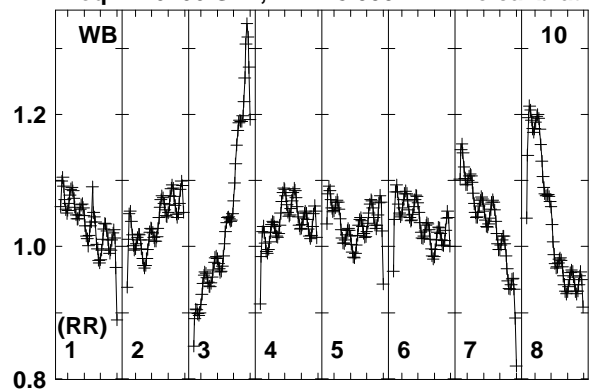

Lower frame: Real Jy
Total-power spectrum Antenna: WB (10)
Timerange: 00/16:21:05 to 00/16:23:29

Plot file version 37 created 01-AUG-2018 16:38:07
 PB-4-3 N18L1 2.UVDATA.1
 Freq = 1.6266 GHz, Bw = 8.000 MH No calibration applied and no bandpass applied

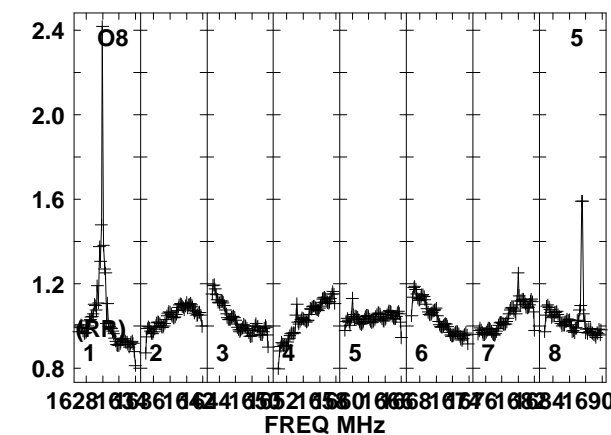
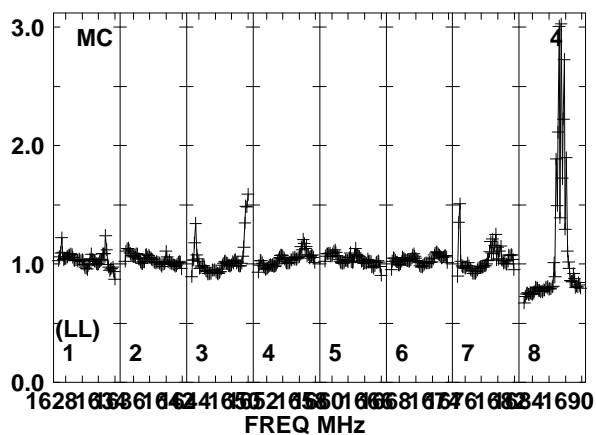
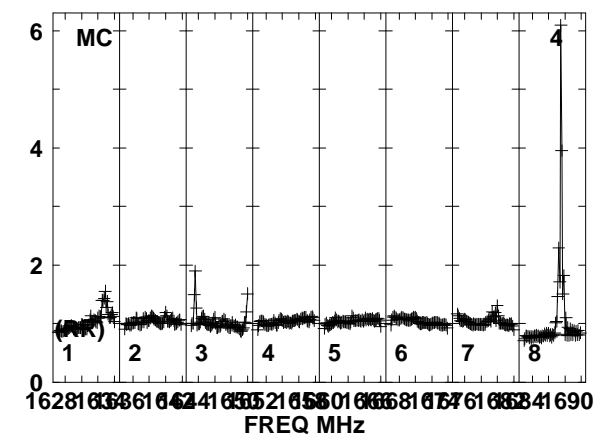
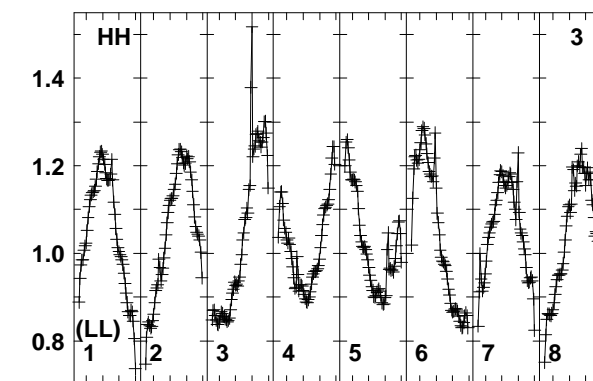
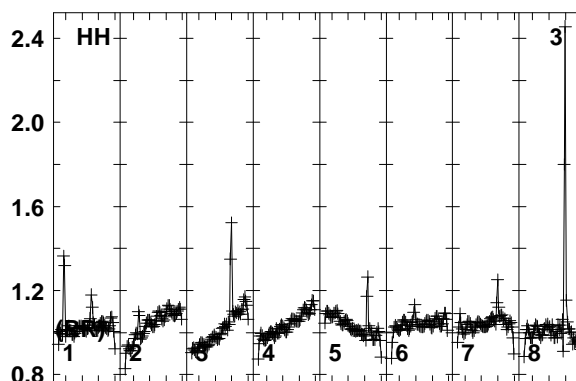
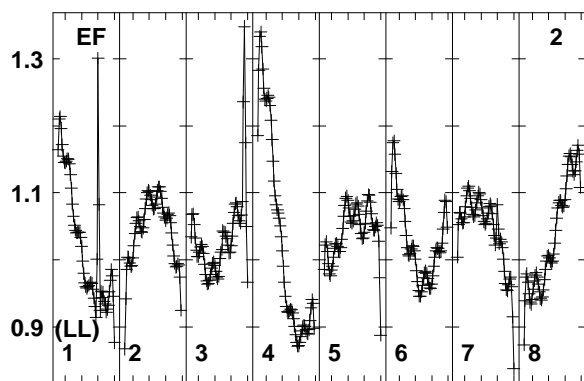
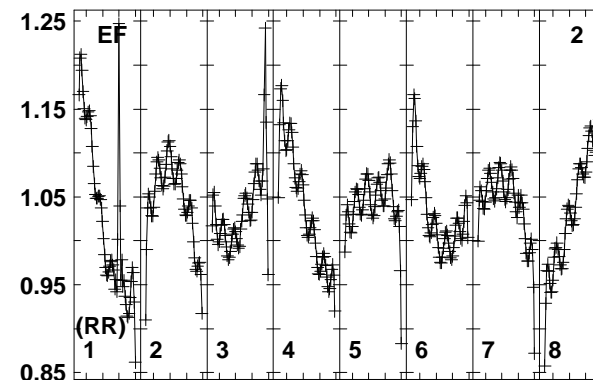
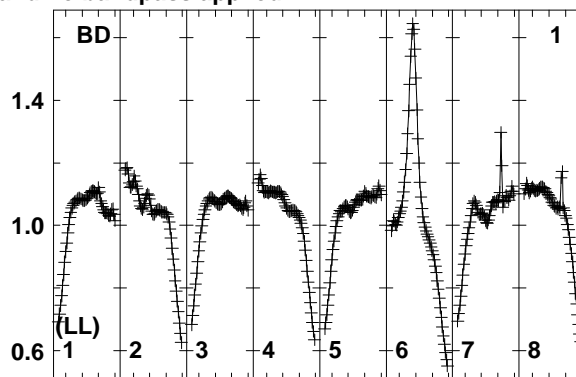
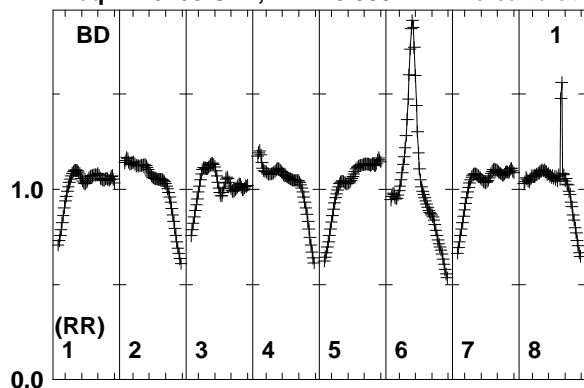

Lower frame: Real Jy
 Total-power spectrum Antenna: BD (01)
 Timerange: 00/16:23:33 to 00/16:25:59

Plot file version 38 created 01-AUG-2018 16:38:07

PB-4-3 N18L1 2.UVDATA.1

Freq = 1.6266 GHz, Bw = 8.000 MH No calibration applied and no bandpass applied

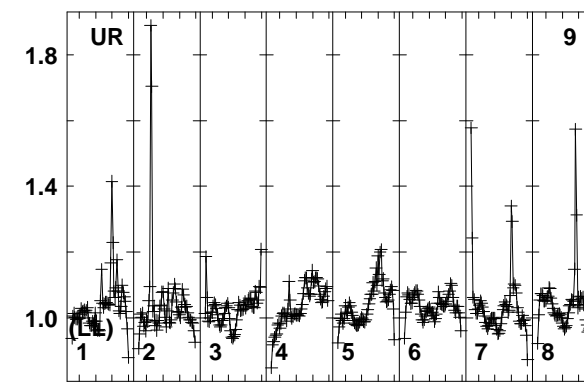
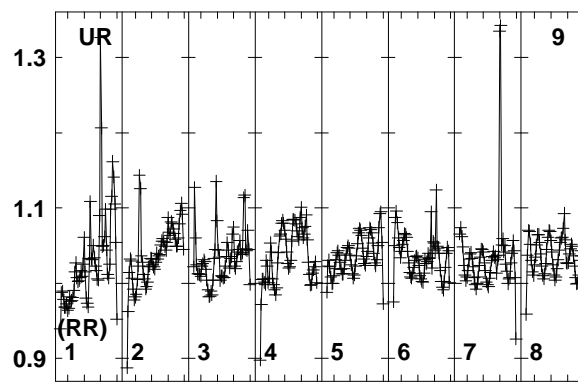
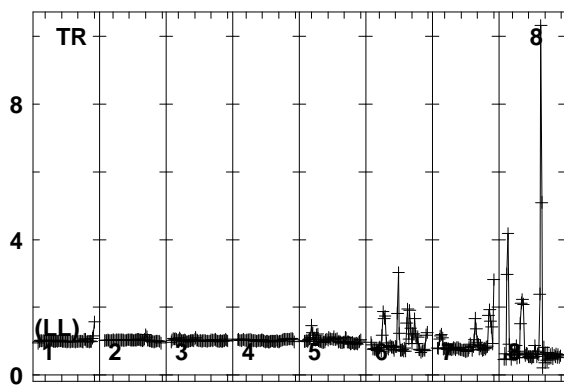
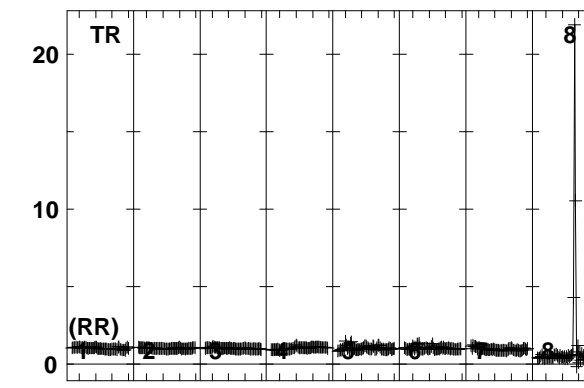
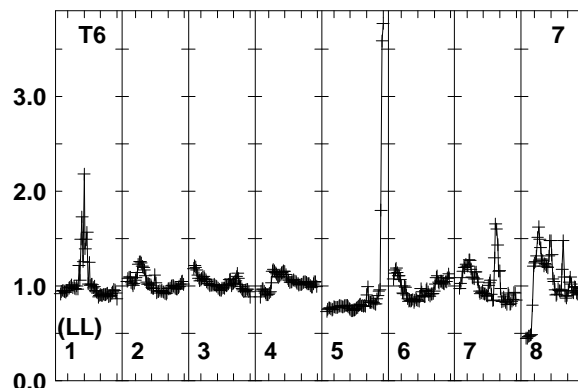
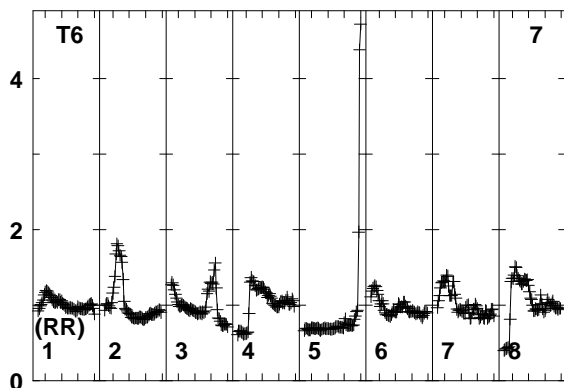
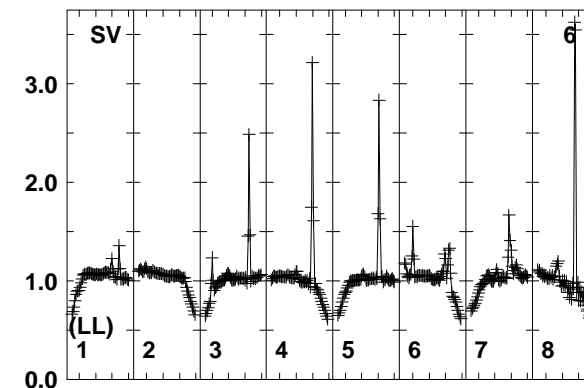
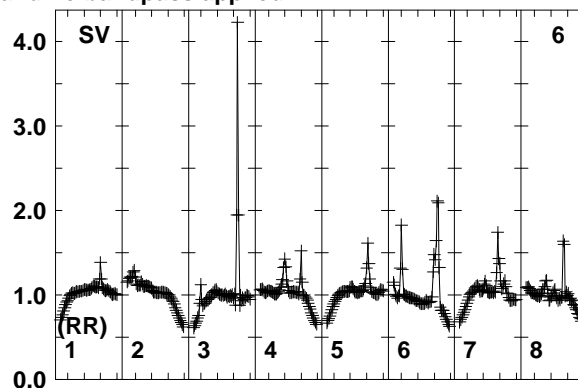
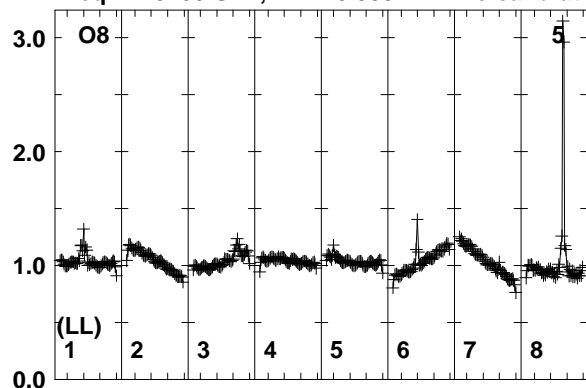

1628163861642416521658016681676168241690
FREQ MHz

1628163861642416521658016681676168241690
FREQ MHz

1628163861642416521658016681676168241690
FREQ MHz

Lower frame: Real Jy
Total-power spectrum Antenna: O8 (05)
Timerange: 00/16:23:33 to 00/16:25:59

Plot file version 39 created 01-AUG-2018 16:38:07

PB-4-3 N18L1 2.UVDATA.1

Freq = 1.6266 GHz, Bw = 8.000 MH No calibration applied and no bandpass applied

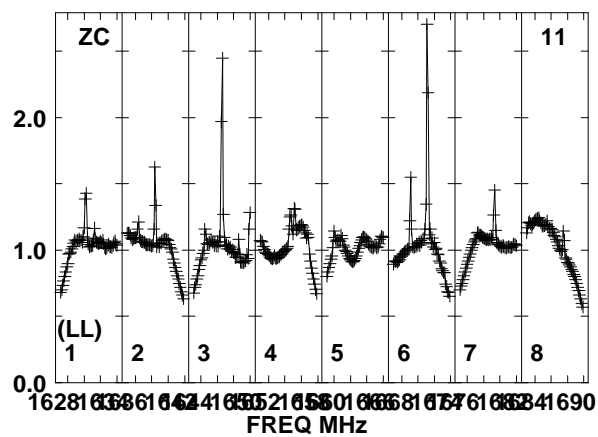
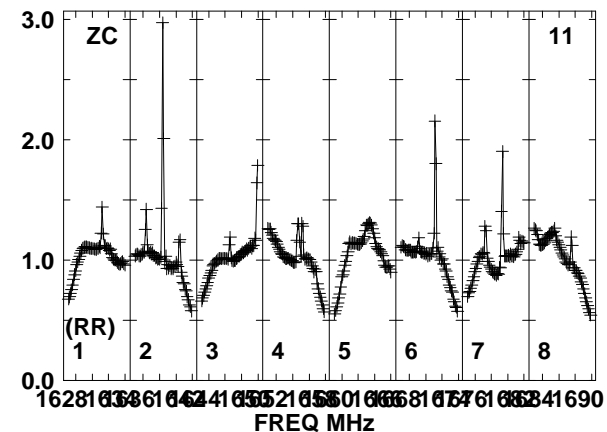
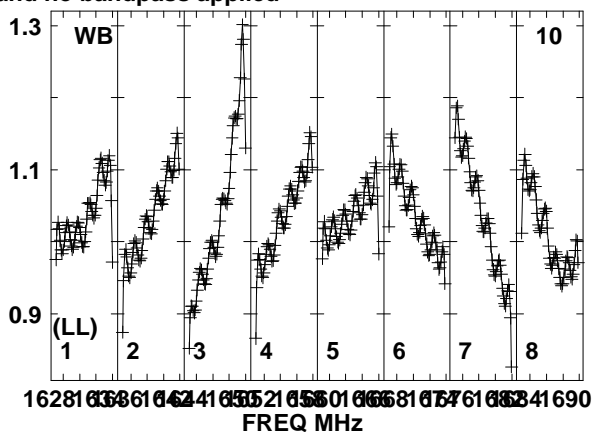
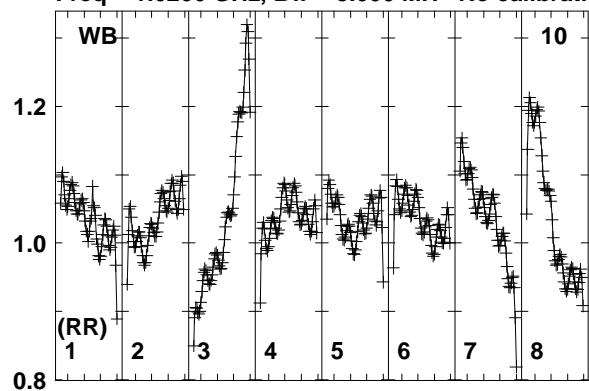

Lower frame: Real Jy
Total-power spectrum Antenna: WB (10)
Timerange: 00/16:23:33 to 00/16:25:59

Plot file version 40 created 01-AUG-2018 16:38:07
 PB-3-3 N18L1 2.UVDATA.1
 Freq = 1.6266 GHz, Bw = 8.000 MH No calibration applied and no bandpass applied

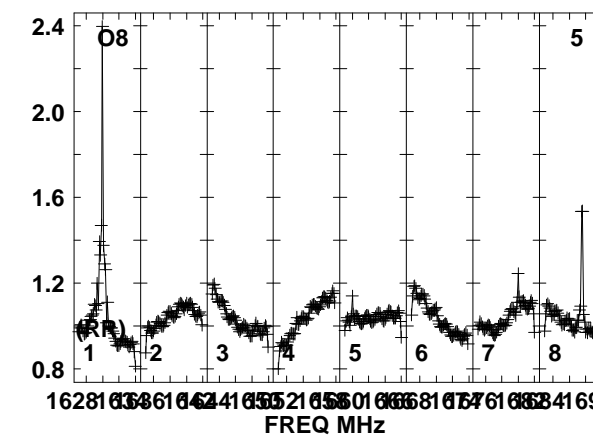
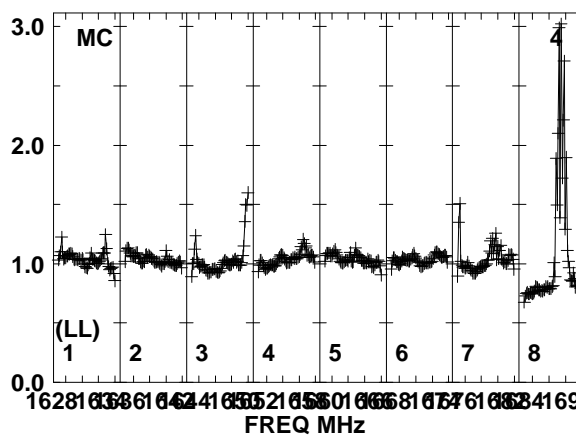
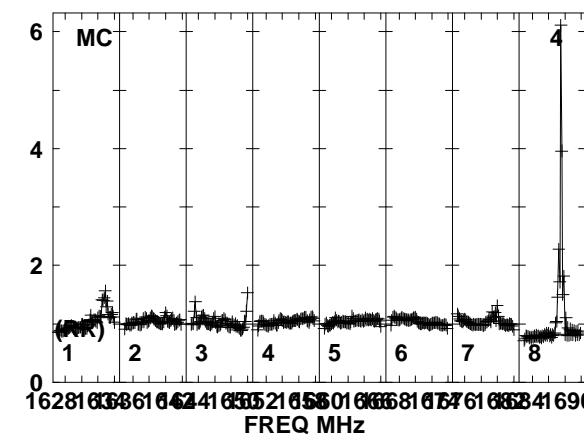
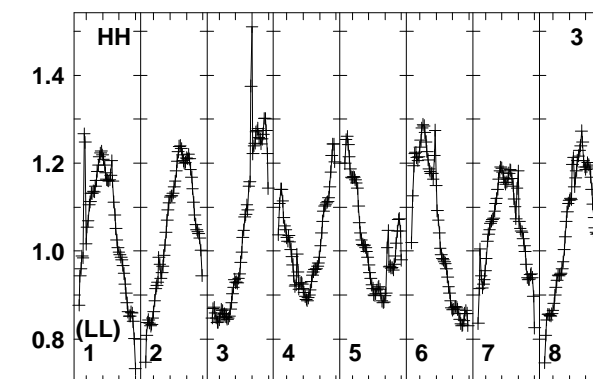
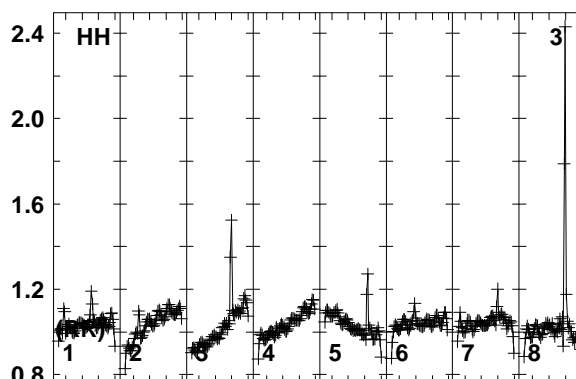
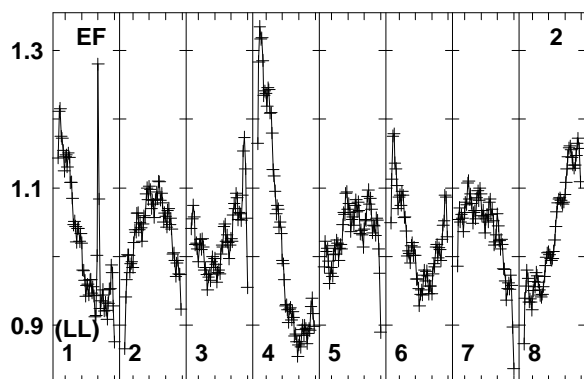
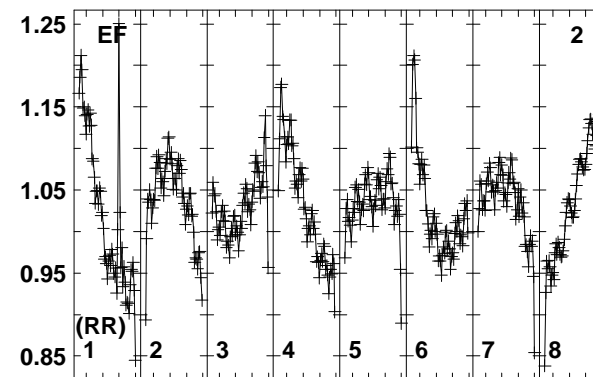
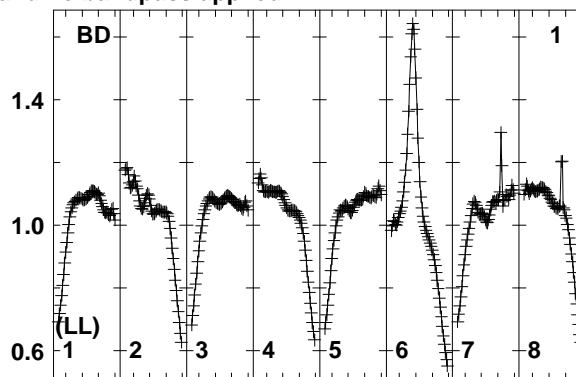
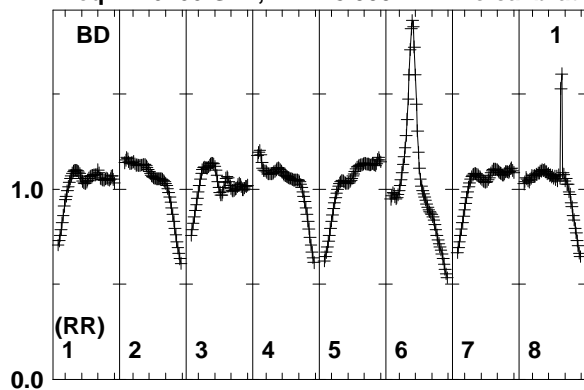

Lower frame: Real Jy
 Total-power spectrum Antenna: BD (01)
 Timerange: 00/16:26:03 to 00/16:28:29

Plot file version 41 created 01-AUG-2018 16:38:07
 PB-3-3 N18L1 2.UVDATA.1
 Freq = 1.6266 GHz, Bw = 8.000 MH No calibration applied and no bandpass applied

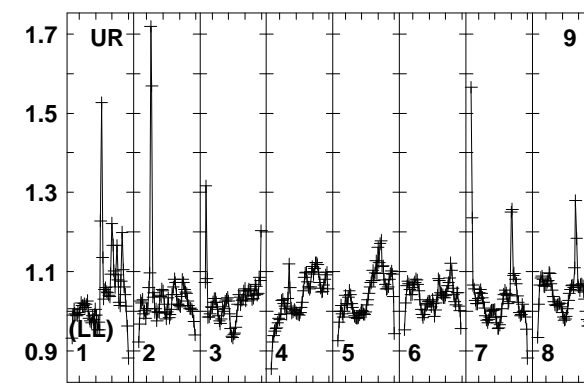
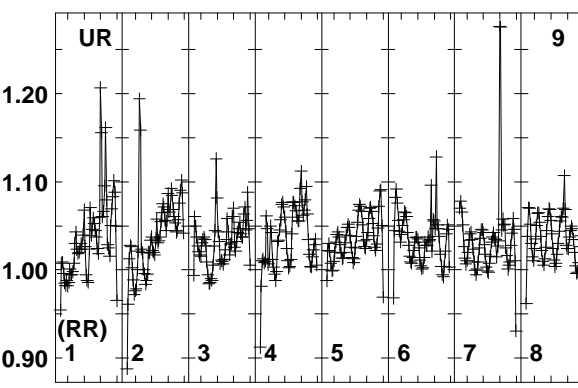
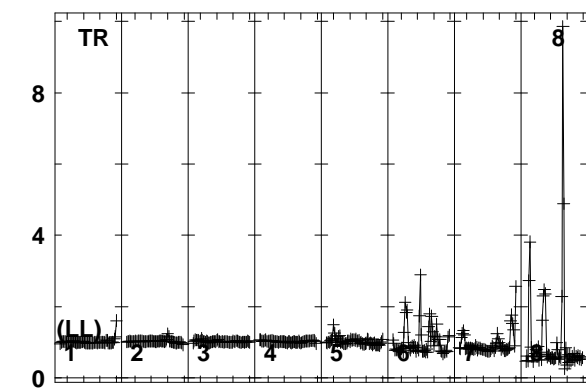
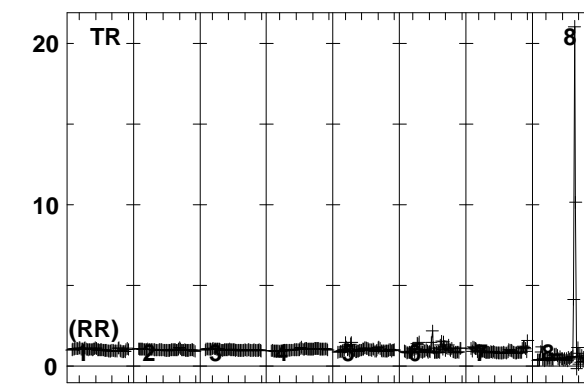
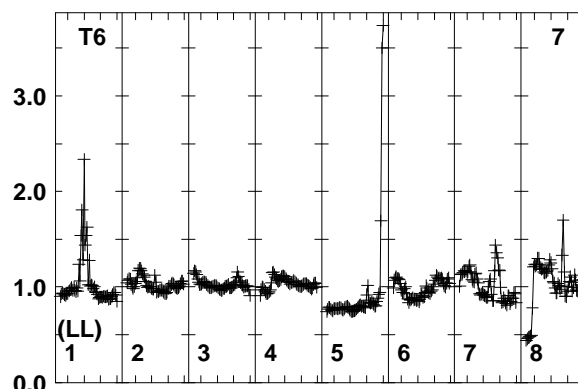
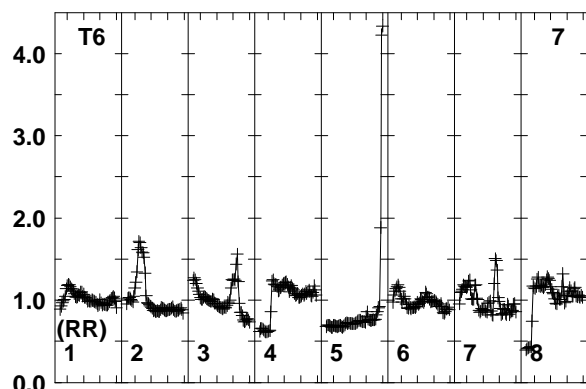
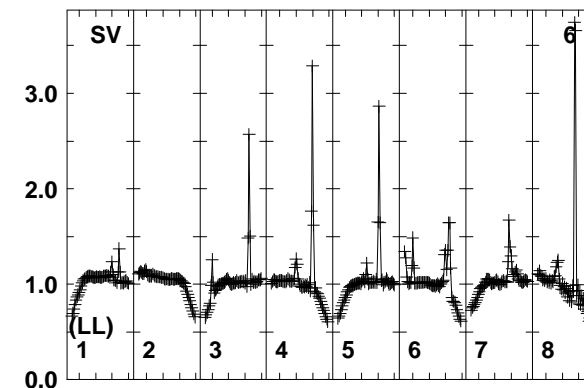
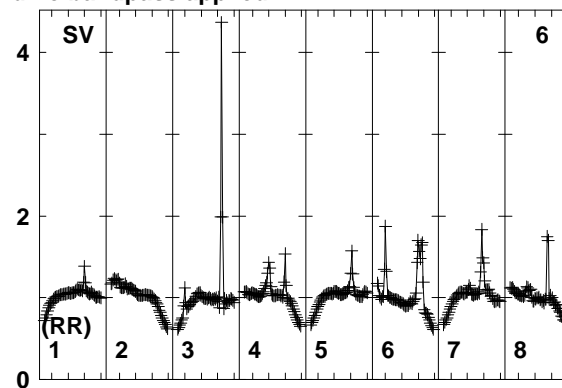
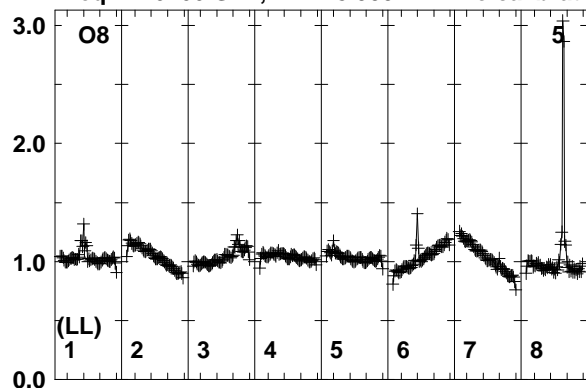

1628163861642416552165801666816746168241690
 FREQ MHz

1628163861642416552165801666816746168241690
 FREQ MHz

1628163861642416552165801666816746168241690
 FREQ MHz

Lower frame: Real Jy
 Total-power spectrum Antenna: O8 (05)
 Timerange: 00/16:26:03 to 00/16:28:29

Plot file version 42 created 01-AUG-2018 16:38:07

PB-3-3 N18L1 2.UVDATA.1

Freq = 1.6266 GHz, Bw = 8.000 MH No calibration applied and no bandpass applied

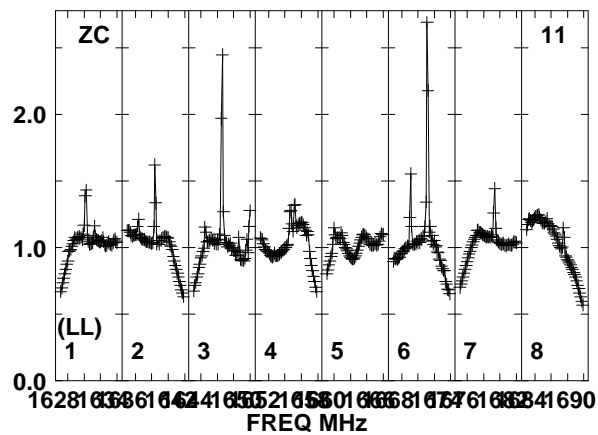
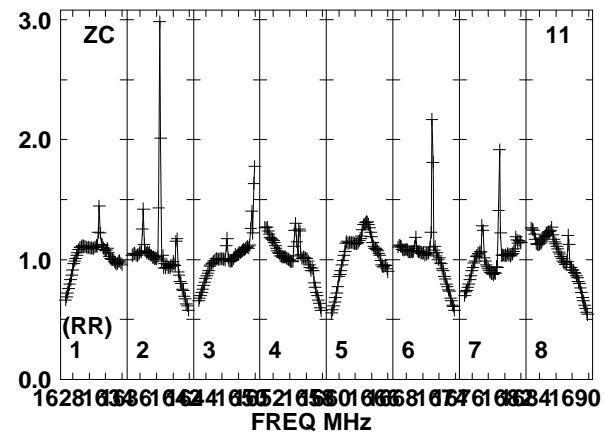
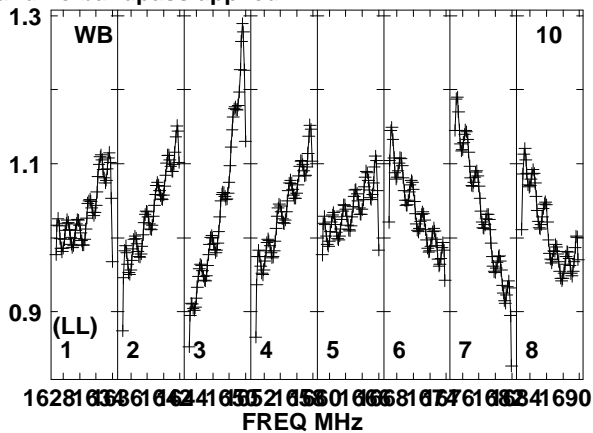
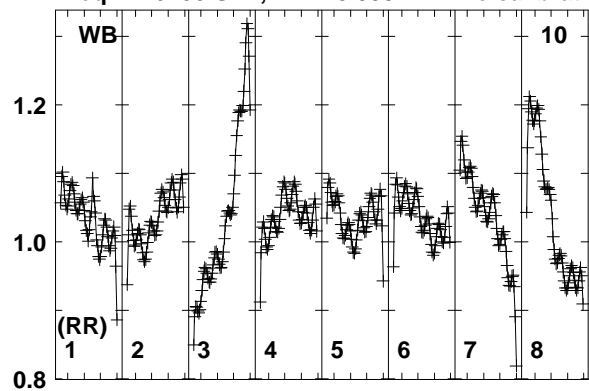

Lower frame: Real Jy
Total-power spectrum Antenna: WB (10)
Timerange: 00/16:26:03 to 00/16:28:29

Plot file version 43 created 01-AUG-2018 16:38:07
 PB-2-3 N18L1 2.UVDATA.1
 Freq = 1.6266 GHz, Bw = 8.000 MH No calibration applied and no bandpass applied

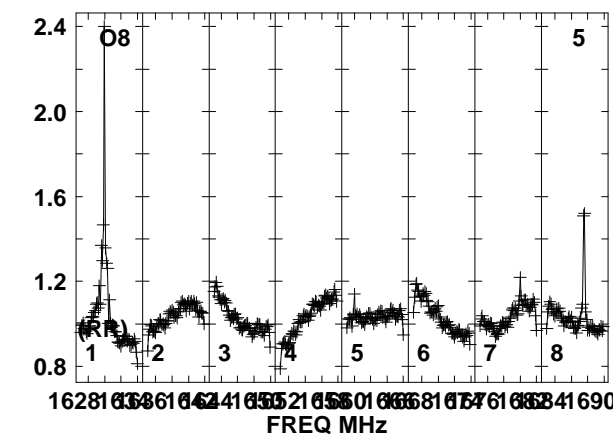
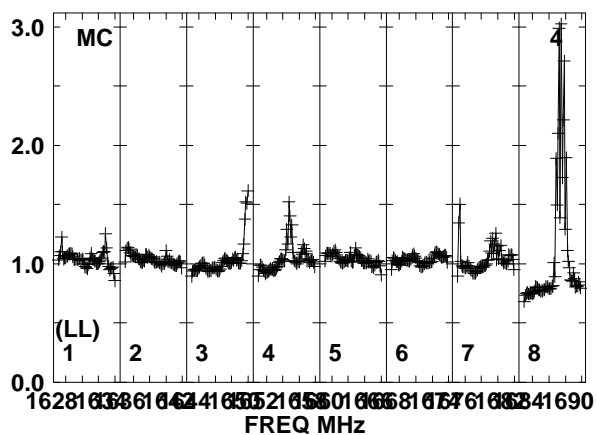
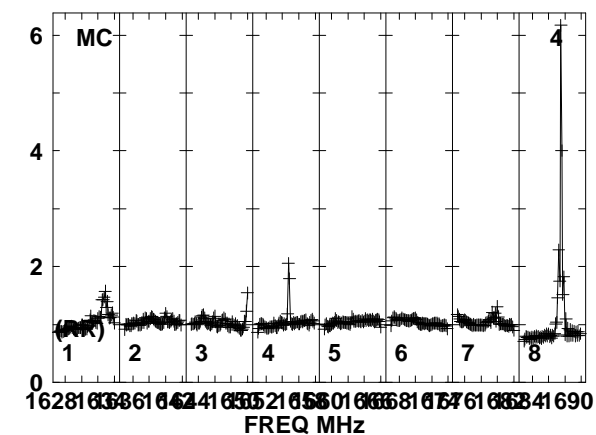
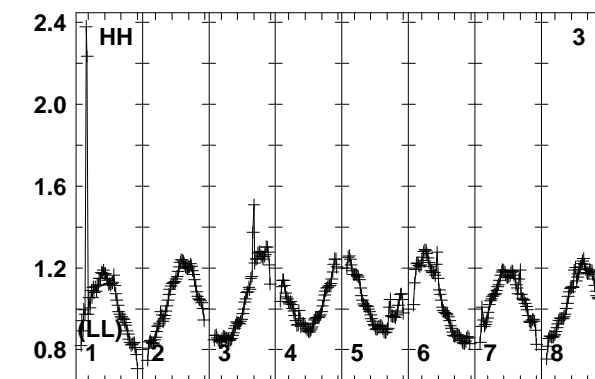
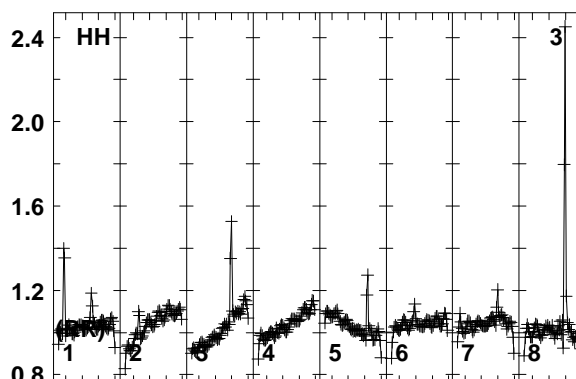
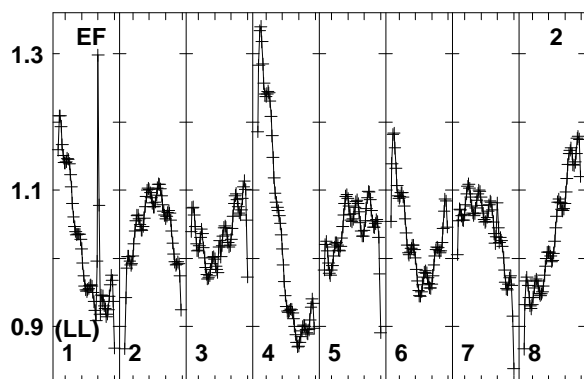
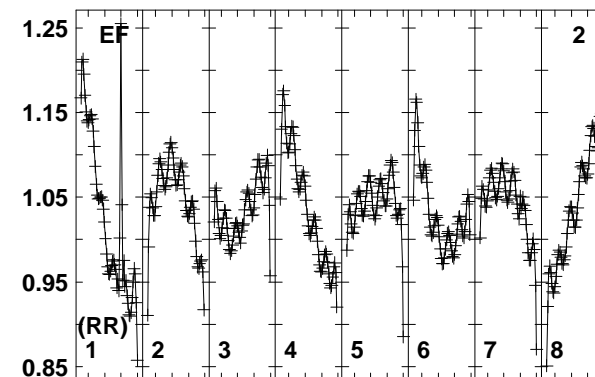
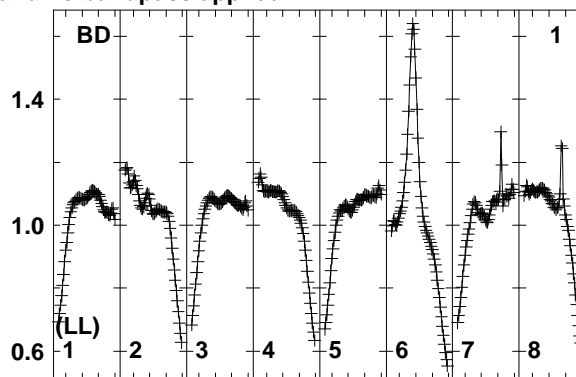
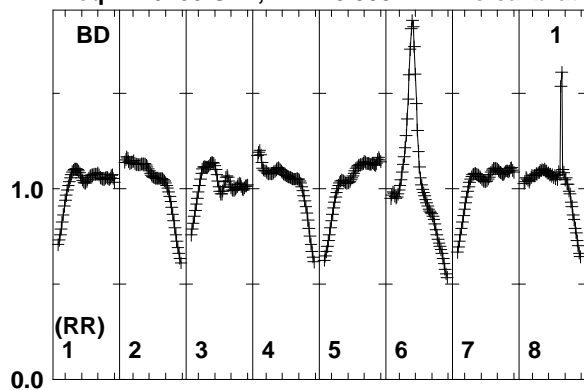

Lower frame: Real Jy
 Total-power spectrum Antenna: BD (01)
 Timerange: 00/16:28:33 to 00/16:30:59

Plot file version 44 created 01-AUG-2018 16:38:07
 PB-2-3 N18L1 2.UVDATA.1
 Freq = 1.6266 GHz, Bw = 8.000 MH No calibration applied and no bandpass applied

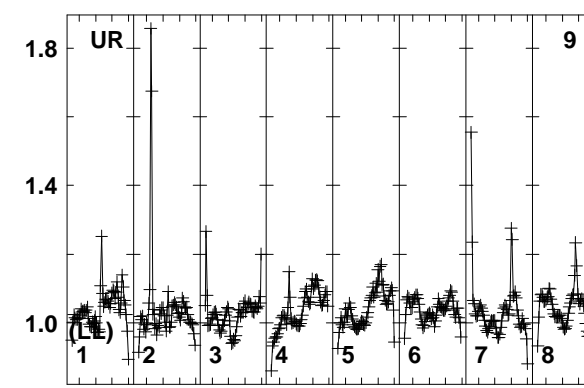
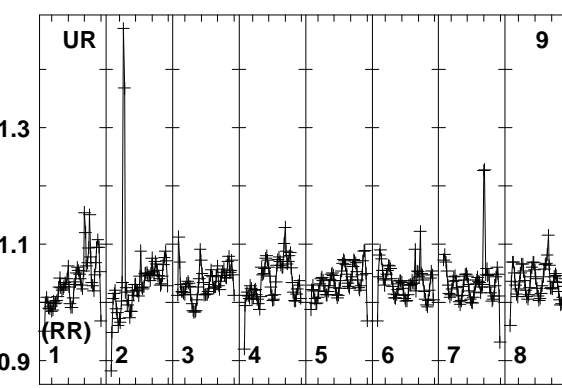
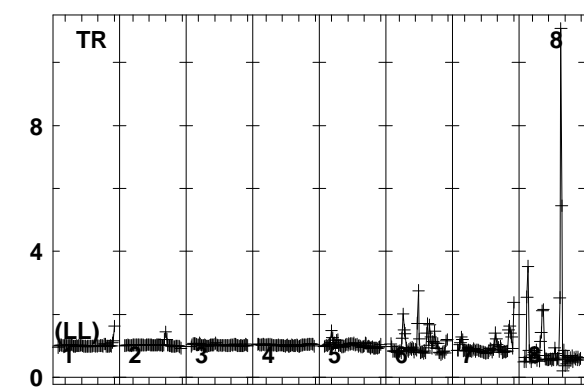
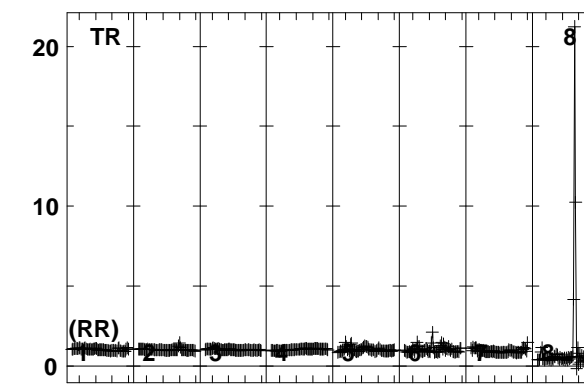
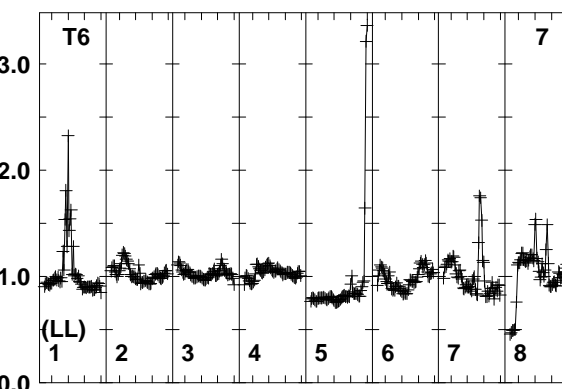
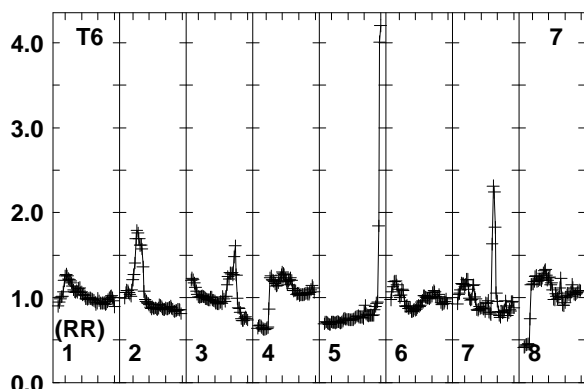
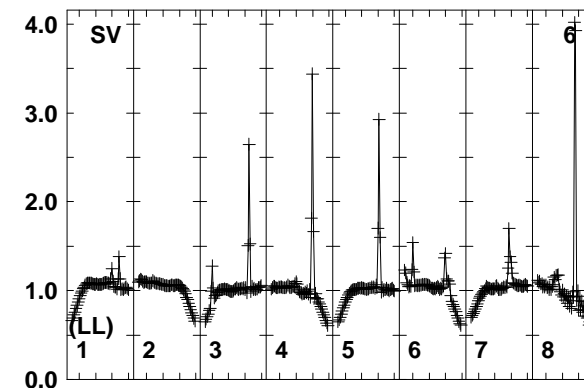
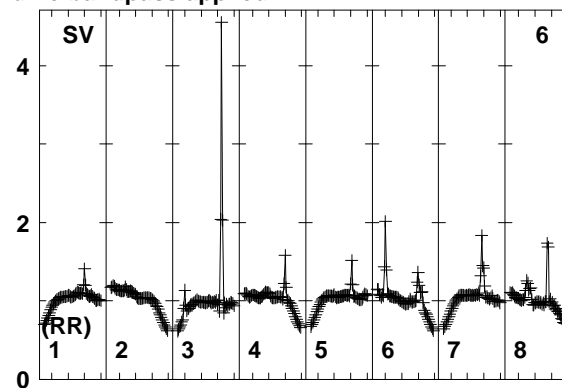
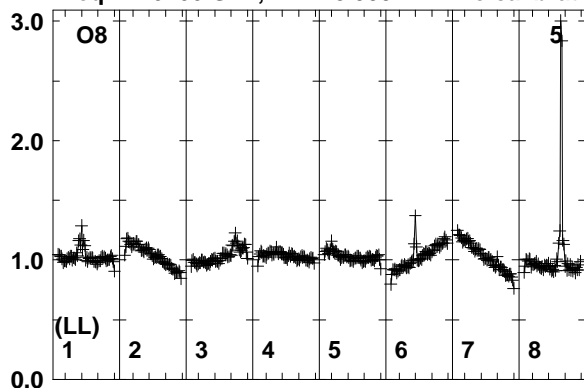

1628163861642416552165801666816746168241690
 FREQ MHz

1628163861642416552165801666816746168241690
 FREQ MHz

1628163861642416552165801666816746168241690
 FREQ MHz

Lower frame: Real Jy
 Total-power spectrum Antenna: O8 (05)
 Timerange: 00/16:28:33 to 00/16:30:59

Plot file version 45 created 01-AUG-2018 16:38:08

PB-2-3 N18L1 2.UVDATA.1

Freq = 1.6266 GHz, Bw = 8.000 MH No calibration applied and no bandpass applied

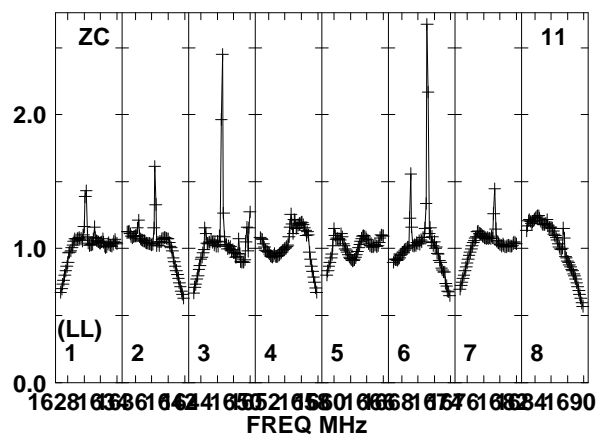
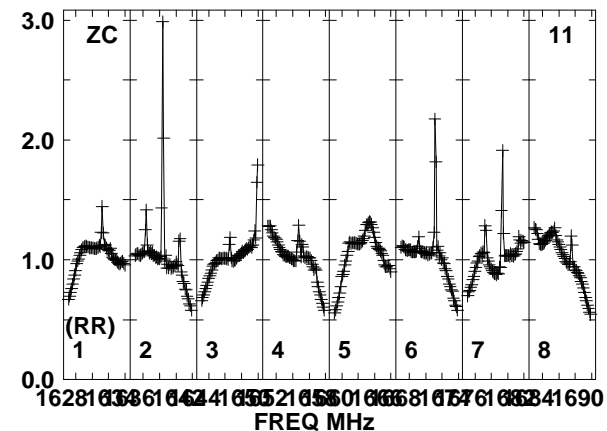
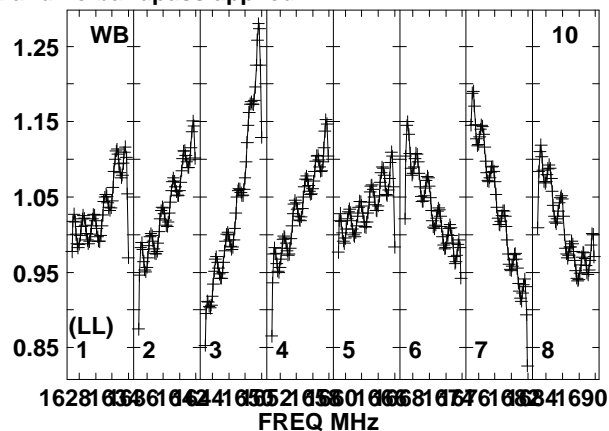
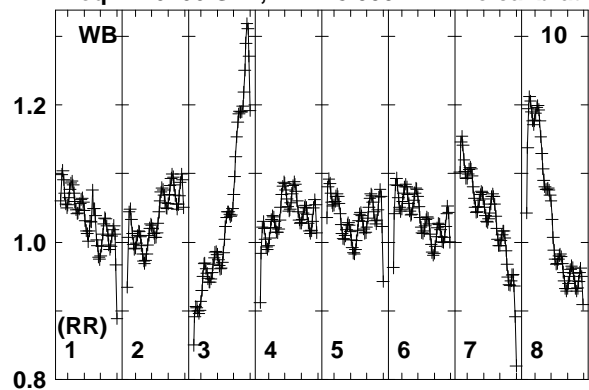

Lower frame: Real Jy
Total-power spectrum Antenna: WB (10)
Timerange: 00/16:28:33 to 00/16:30:59

Plot file version 46 created 01-AUG-2018 16:38:08
 J0530+1331 N18L1 2.UVDATA.1
 Freq = 1.6266 GHz, Bw = 8.000 MH No calibration applied and no bandpass applied

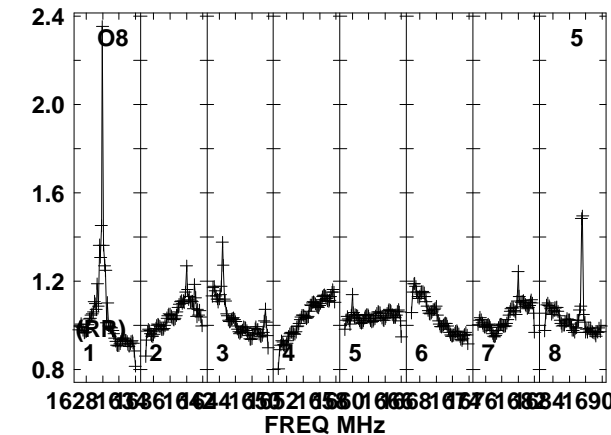
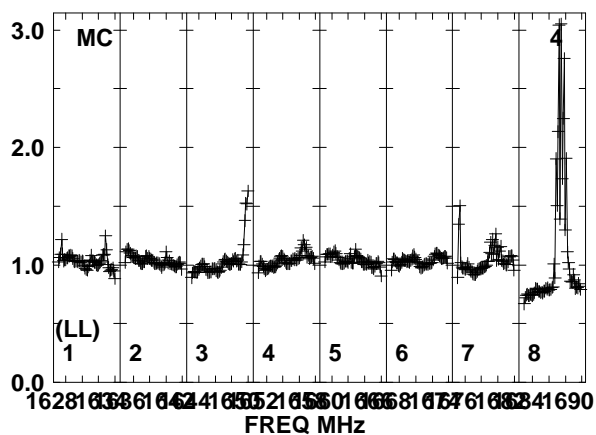
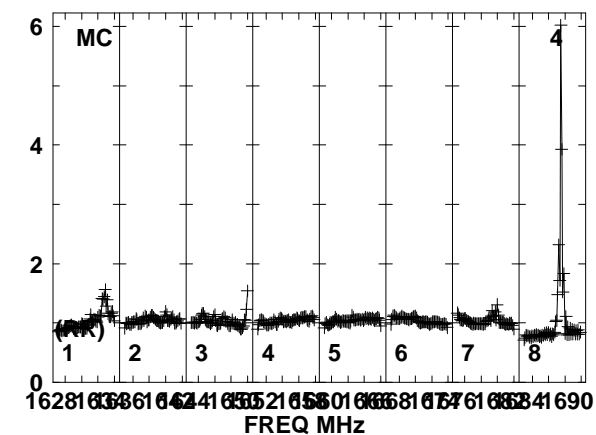
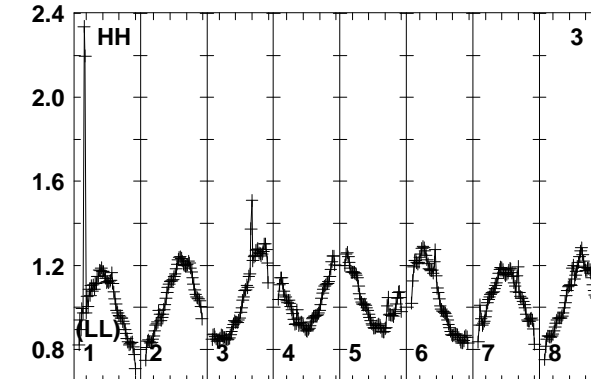
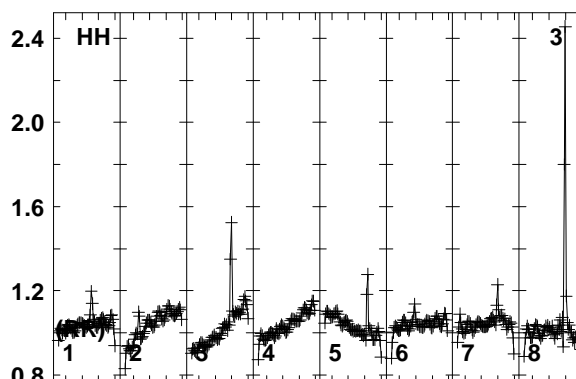
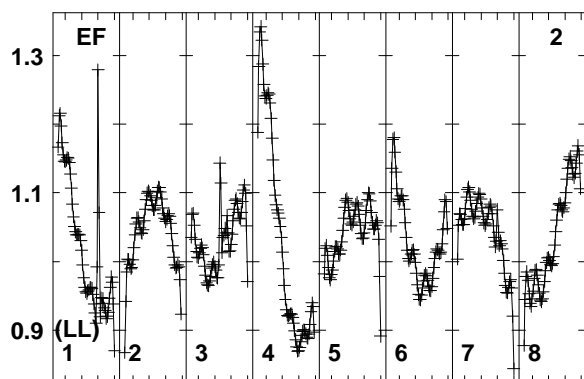
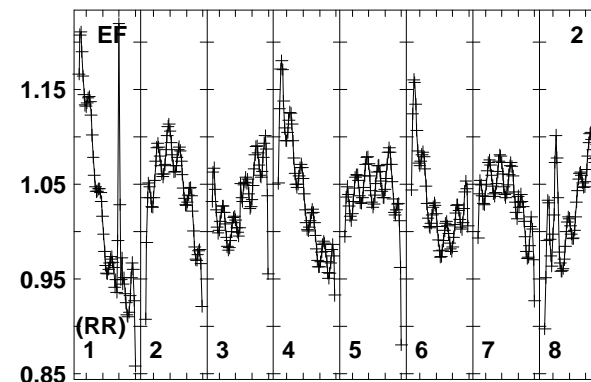
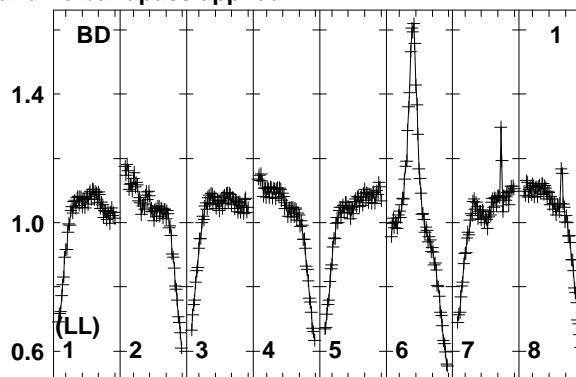
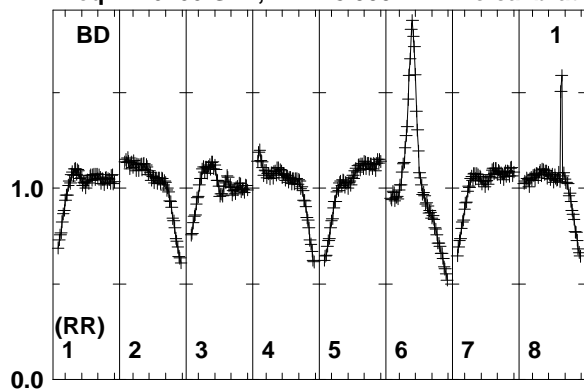

Lower frame: Real Jy
 Total-power spectrum Antenna: BD (01)
 Timerange: 00/16:31:41 to 00/16:32:59

Plot file version 47 created 01-AUG-2018 16:38:08
 J0530+1331 N18L1 2.UVDATA.1
 Freq = 1.6266 GHz, Bw = 8.000 MH No calibration applied and no bandpass applied

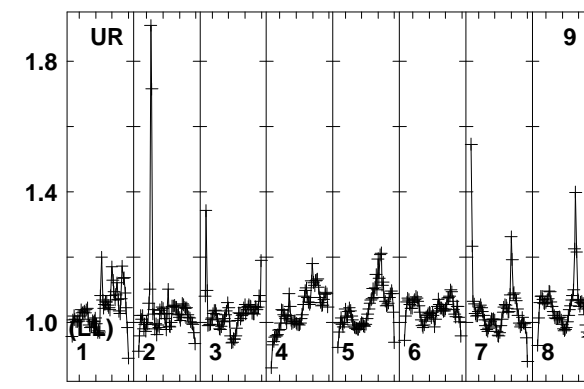
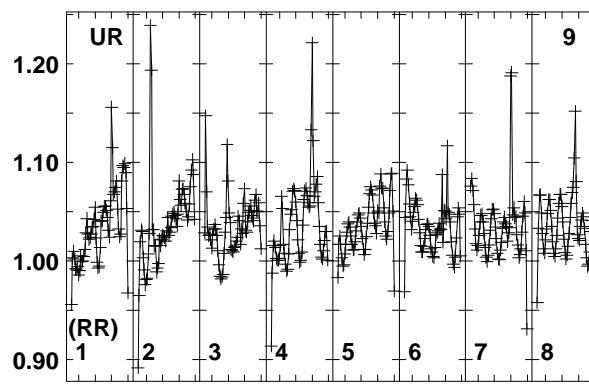
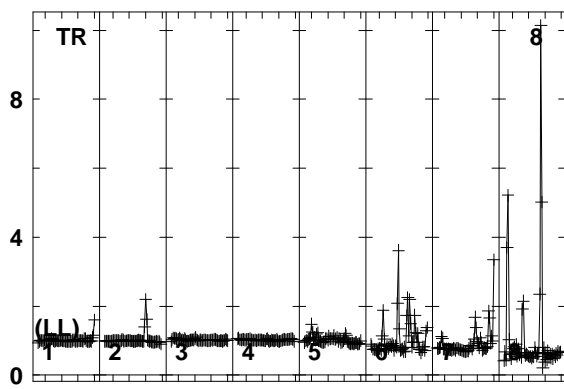
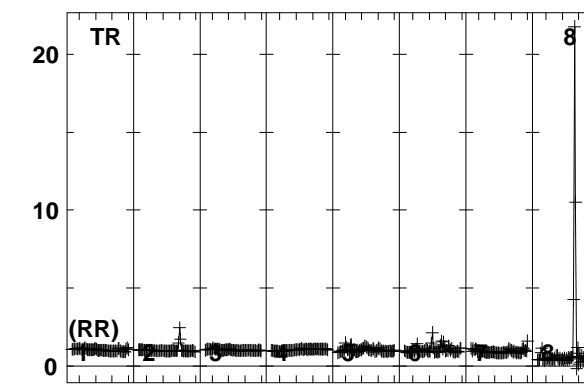
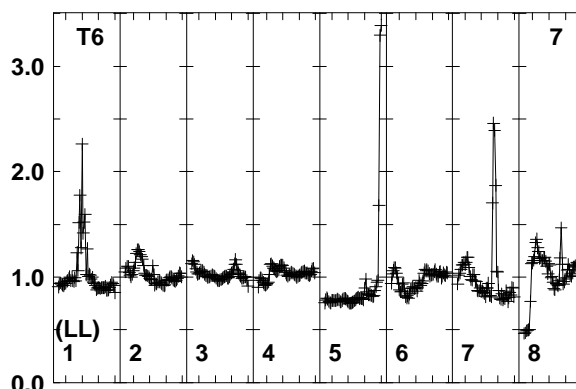
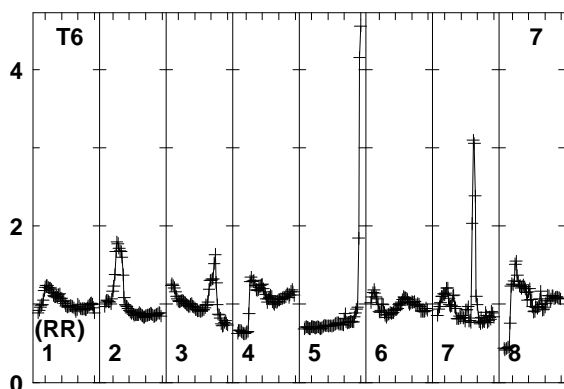
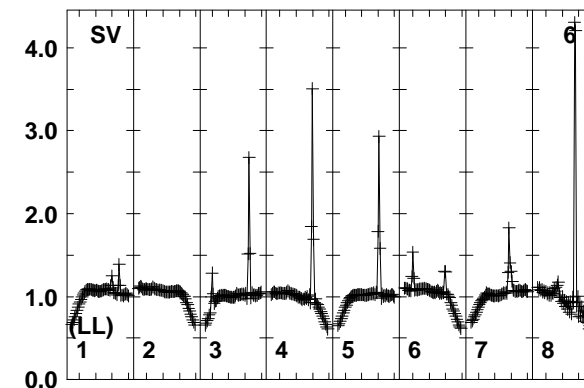
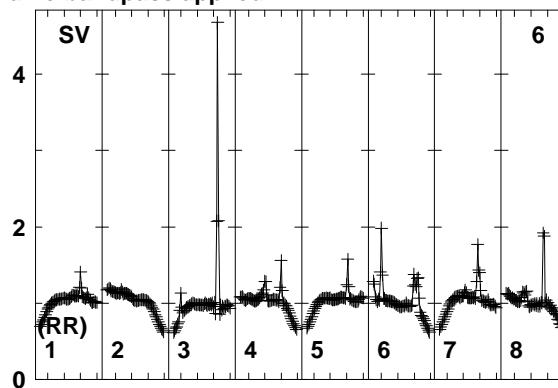
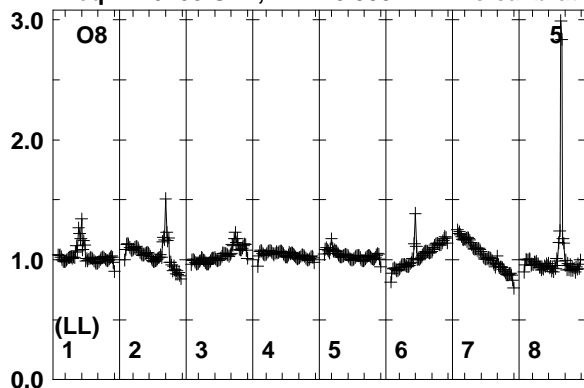

1628163861642416552165801666816746168241690
 FREQ MHz

1628163861642416552165801666816746168241690
 FREQ MHz

1628163861642416552165801666816746168241690
 FREQ MHz

Lower frame: Real Jy
 Total-power spectrum Antenna: O8 (05)
 Timerange: 00/16:31:41 to 00/16:32:59

Plot file version 48 created 01-AUG-2018 16:38:08

J0530+1331 N18L1 2.UVDATA.1

Freq = 1.6266 GHz, Bw = 8.000 MH No calibration applied and no bandpass applied

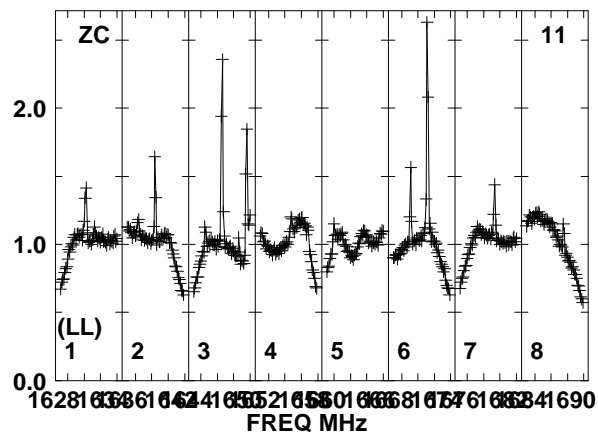
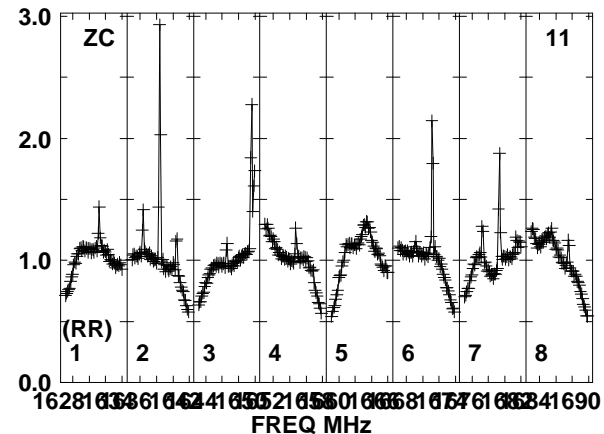
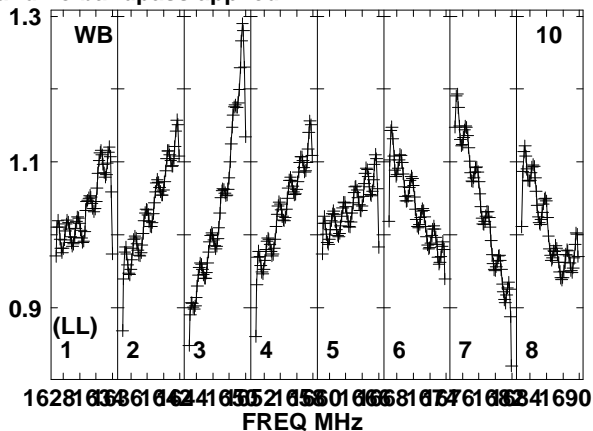
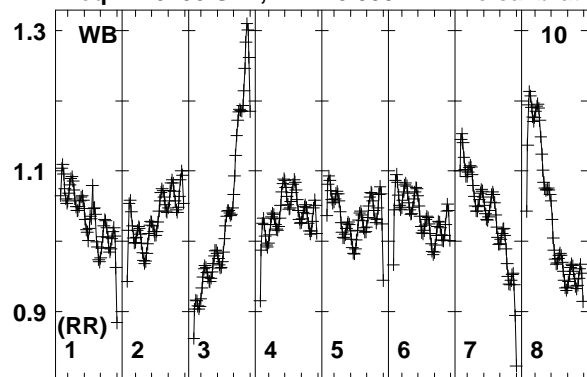

Lower frame: Real Jy
Total-power spectrum Antenna: WB (10)
Timerange: 00/16:31:41 to 00/16:32:59

Plot file version 49 created 01-AUG-2018 16:38:08
 PB-1-3 N18L1 2.UVDATA.1
 Freq = 1.6266 GHz, Bw = 8.000 MH No calibration applied and no bandpass applied

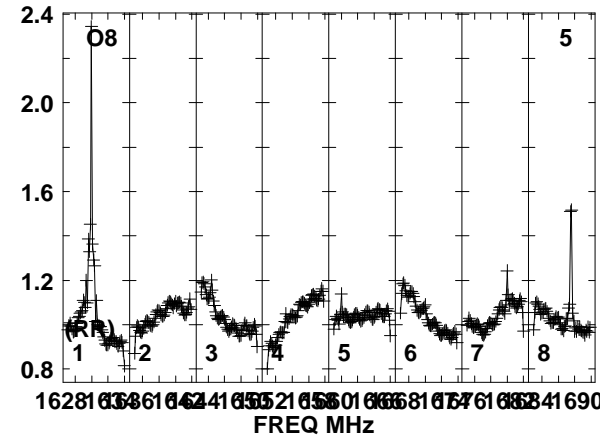
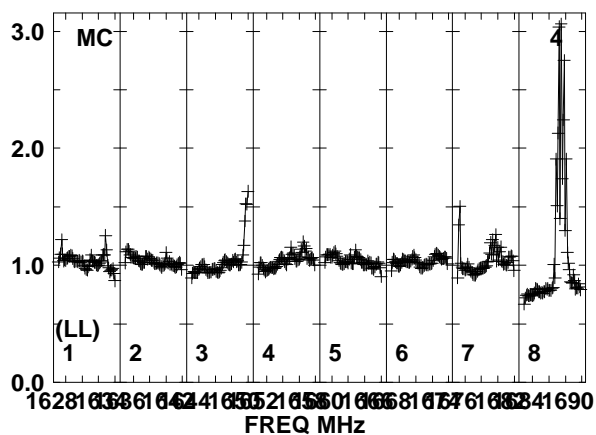
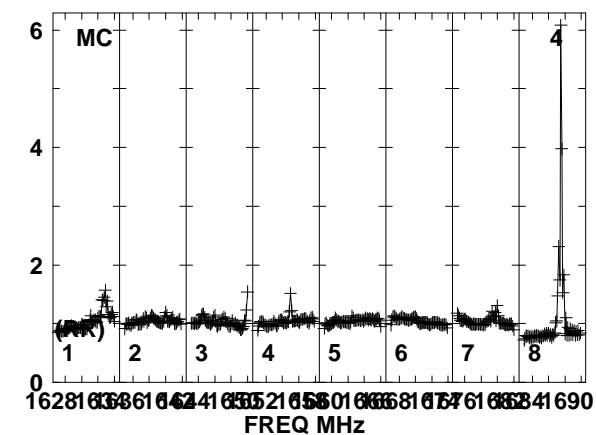
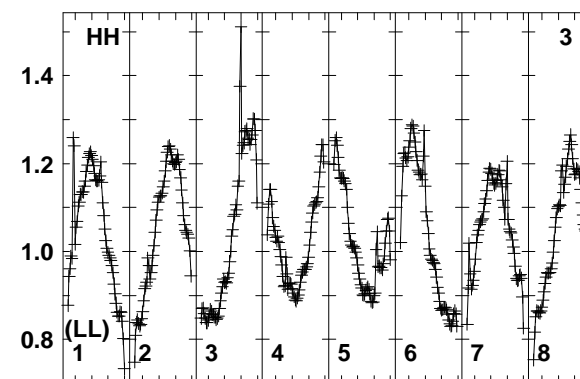
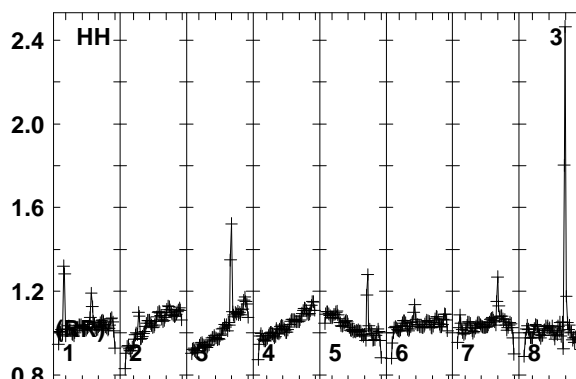
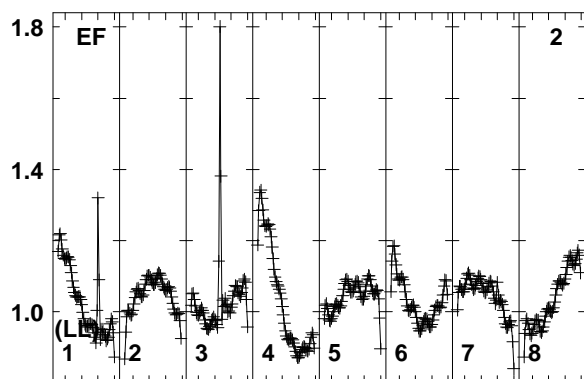
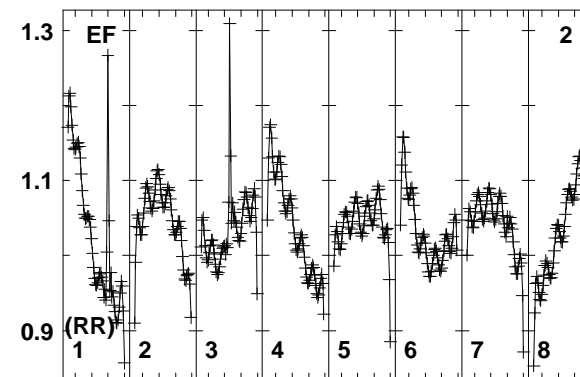
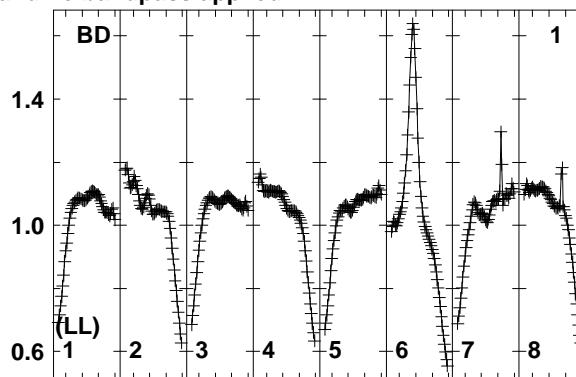
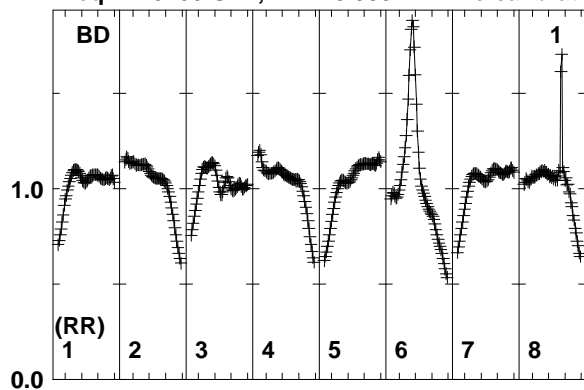

Lower frame: Real Jy
 Total-power spectrum Antenna: BD (01)
 Timerange: 00/16:33:03 to 00/16:35:29

Plot file version 50 created 01-AUG-2018 16:38:08
 PB-1-3 N18L1 2.UVDATA.1
 Freq = 1.6266 GHz, Bw = 8.000 MH No calibration applied and no bandpass applied

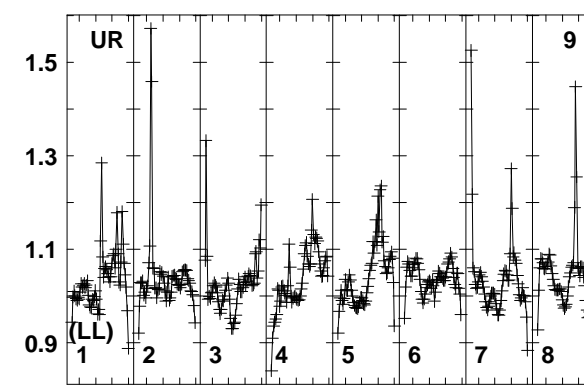
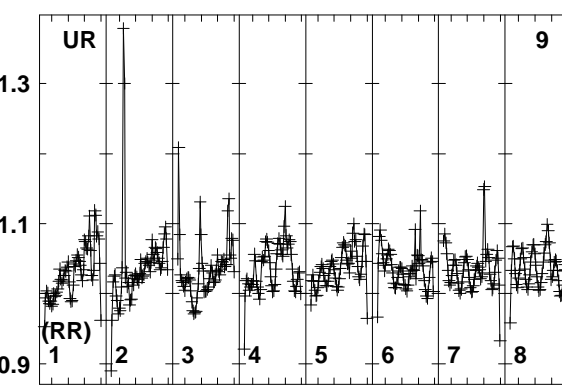
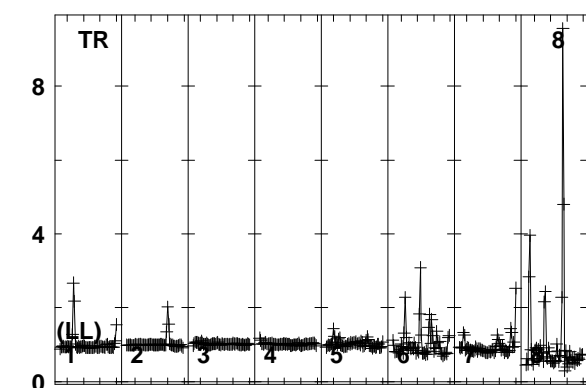
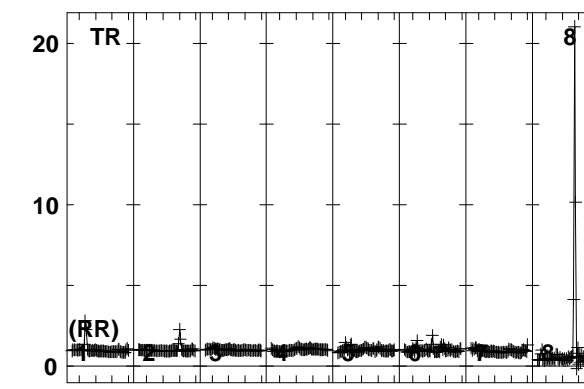
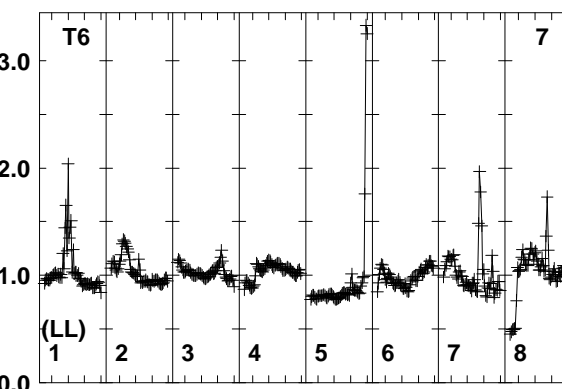
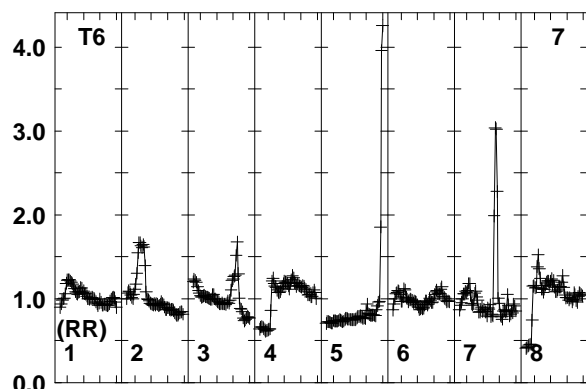
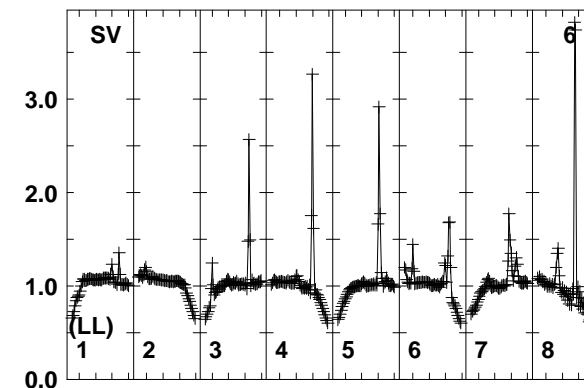
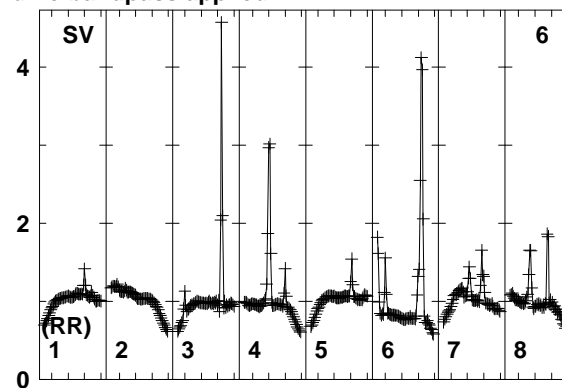
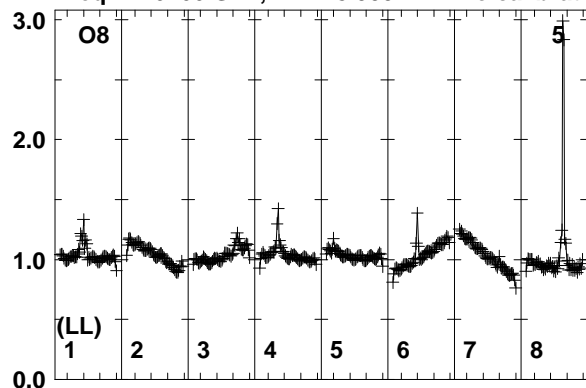

1628163861642416552165801666816746168241690
 FREQ MHz

1628163861642416552165801666816746168241690
 FREQ MHz

1628163861642416552165801666816746168241690
 FREQ MHz

Lower frame: Real Jy
 Total-power spectrum Antenna: O8 (05)
 Timerange: 00/16:33:03 to 00/16:35:29

Plot file version 51 created 01-AUG-2018 16:38:08

PB-1-3 N18L1 2.UVDATA.1

Freq = 1.6266 GHz, Bw = 8.000 MH No calibration applied and no bandpass applied

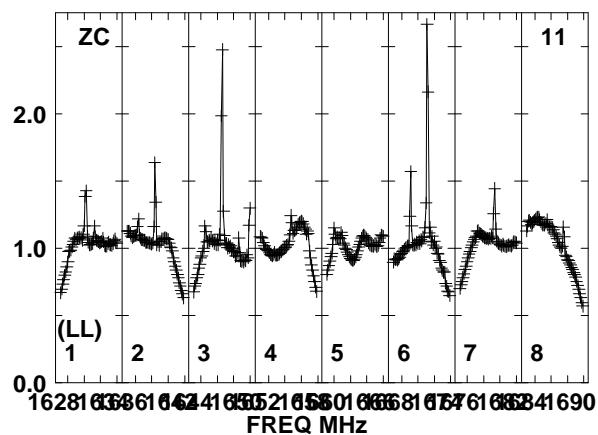
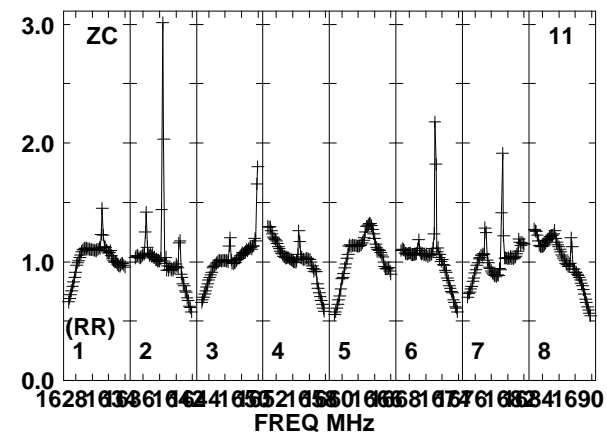
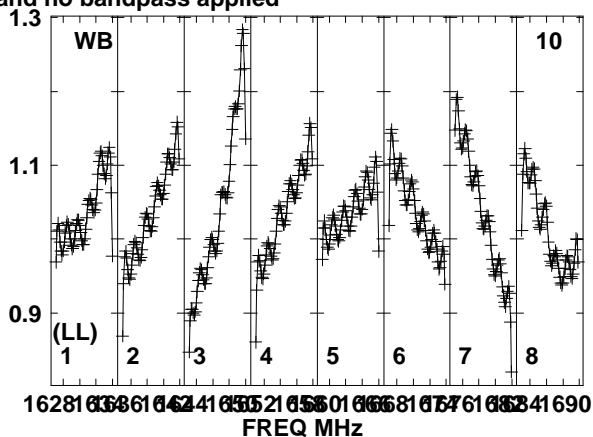
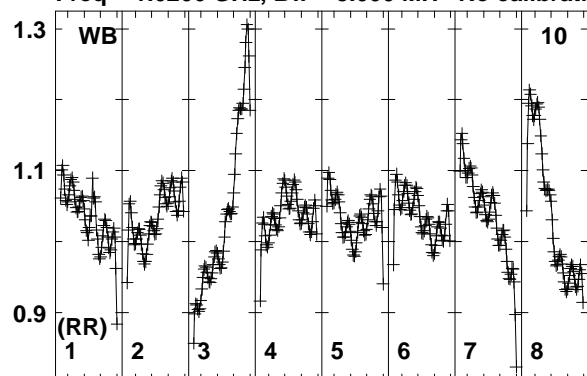

Lower frame: Real Jy
Total-power spectrum Antenna: WB (10)
Timerange: 00/16:33:03 to 00/16:35:29

Plot file version 52 created 01-AUG-2018 16:38:08
 PB+0-3 N18L1 2.UVDATA.1
 Freq = 1.6266 GHz, Bw = 8.000 MH No calibration applied and no bandpass applied

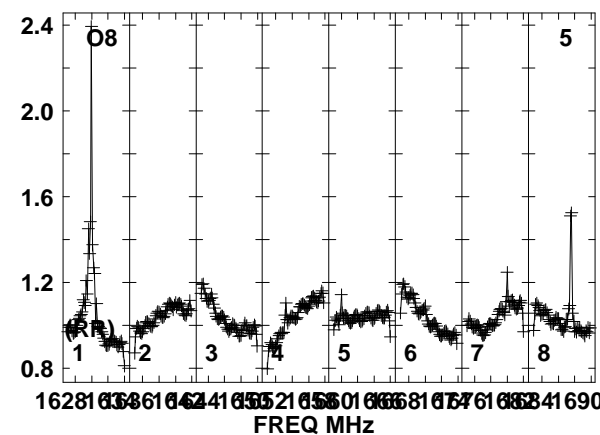
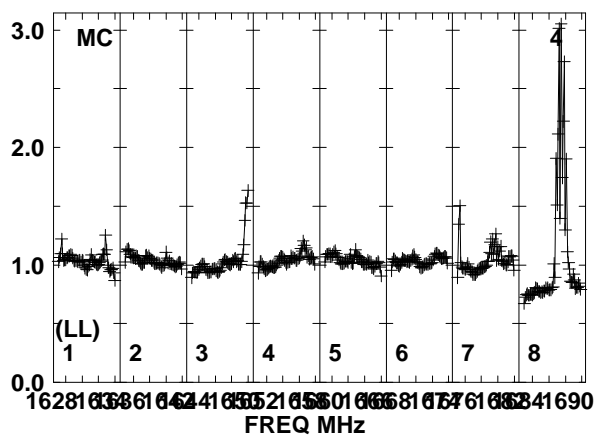
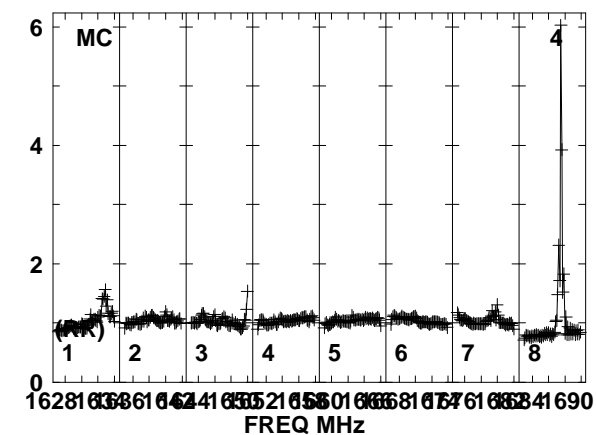
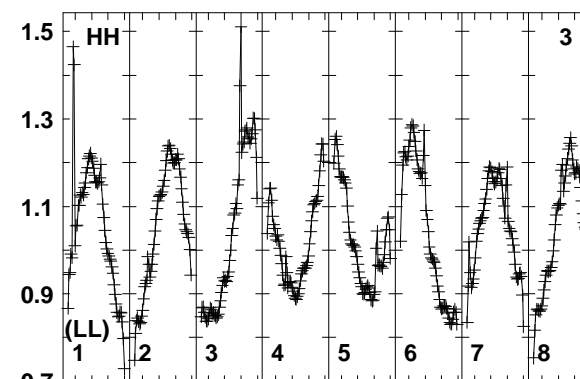
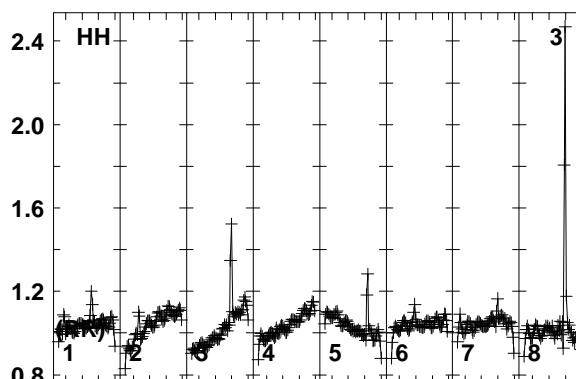
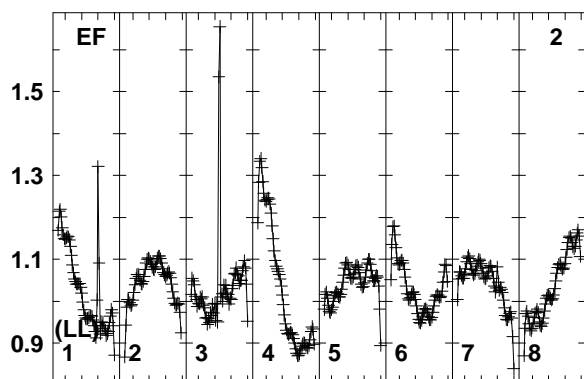
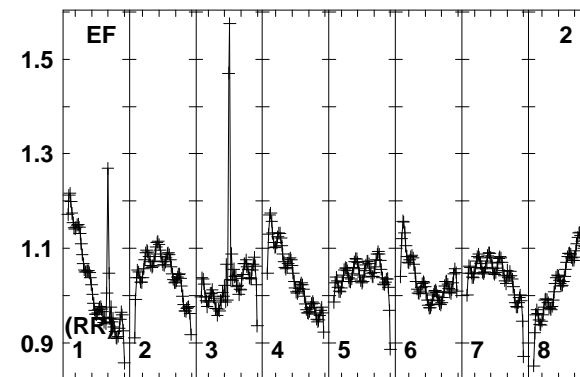
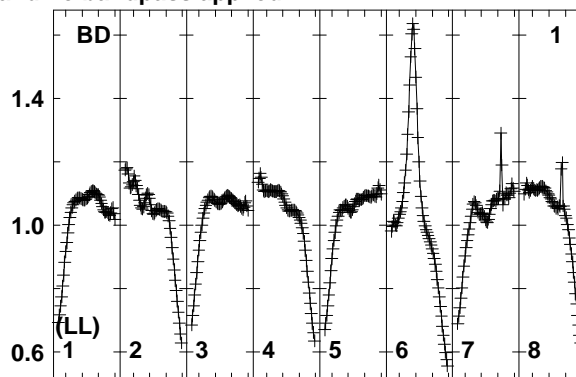
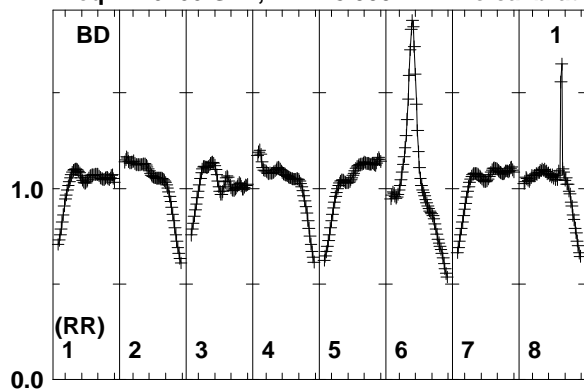

Lower frame: Real Jy
 Total-power spectrum Antenna: BD (01)
 Timerange: 00/16:35:33 to 00/16:37:59

Plot file version 53 created 01-AUG-2018 16:38:09
 PB+0-3 N18L1 2.UVDATA.1
 Freq = 1.6266 GHz, Bw = 8.000 MH No calibration applied and no bandpass applied

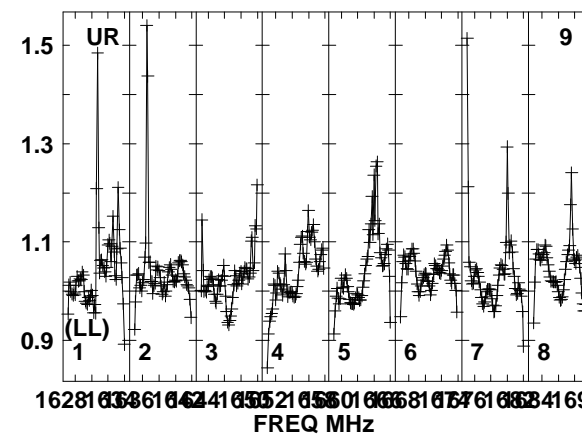
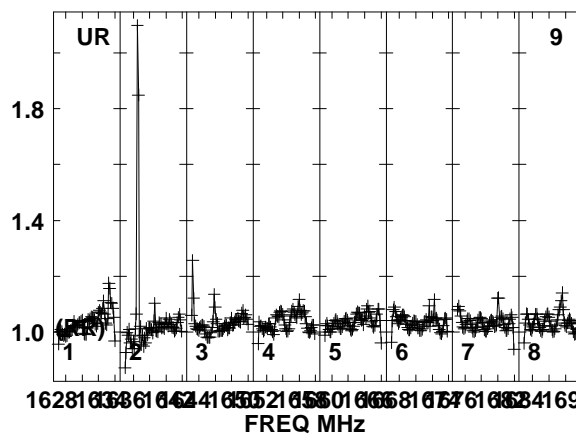
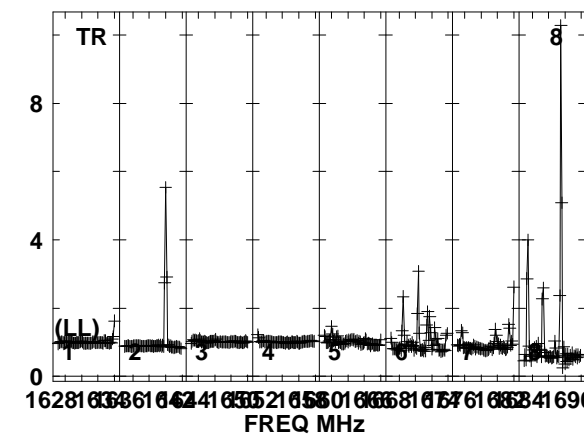
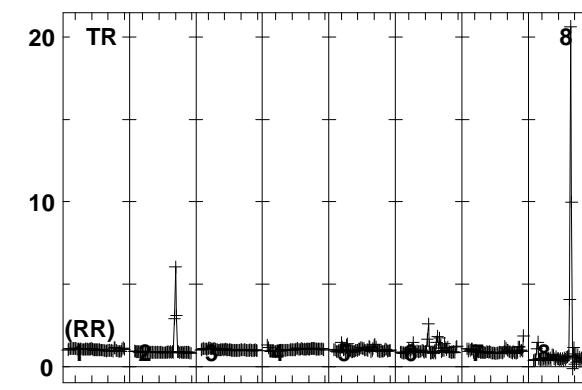
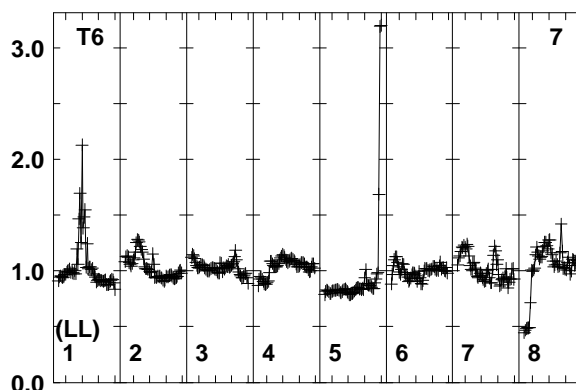
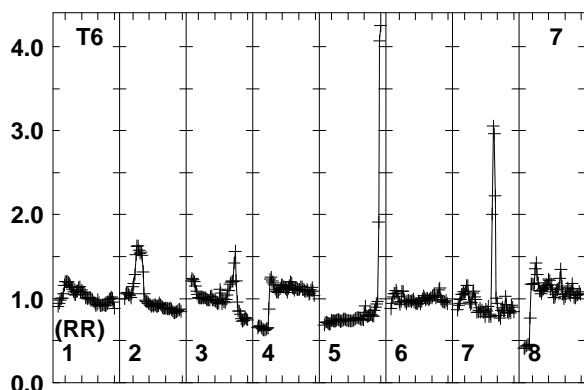
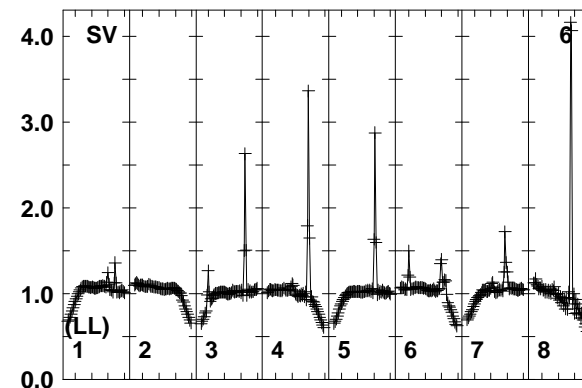
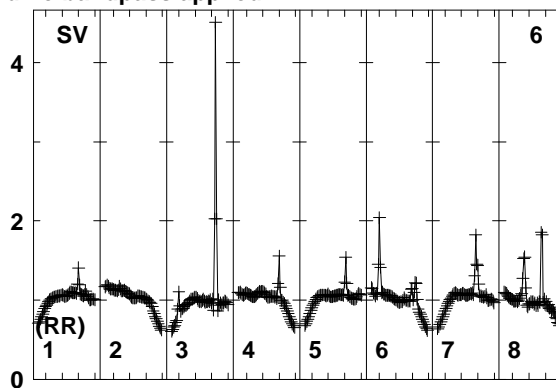
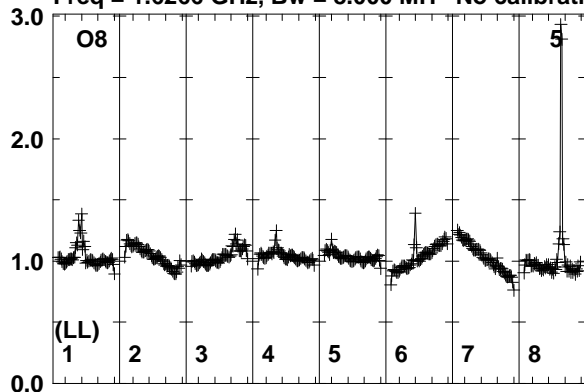

1628163861642416552165801666816746168241690
 FREQ MHz

1628163861642416552165801666816746168241690
 FREQ MHz

1628163861642416552165801666816746168241690
 FREQ MHz

Lower frame: Real Jy
 Total-power spectrum Antenna: O8 (05)
 Timerange: 00/16:35:33 to 00/16:37:59

Plot file version 54 created 01-AUG-2018 16:38:09

PB+0-3 N18L1 2.UVDATA.1

Freq = 1.6266 GHz, Bw = 8.000 MH No calibration applied and no bandpass applied

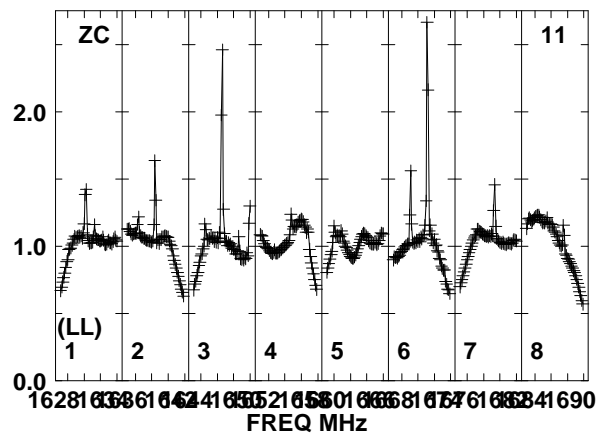
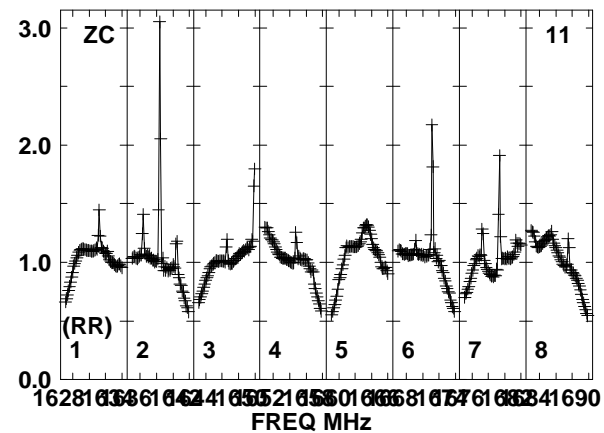
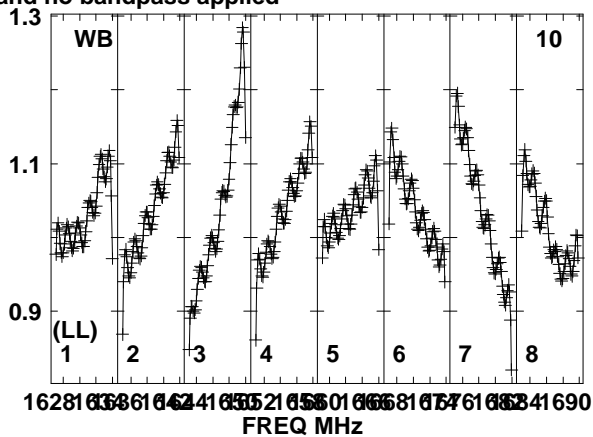
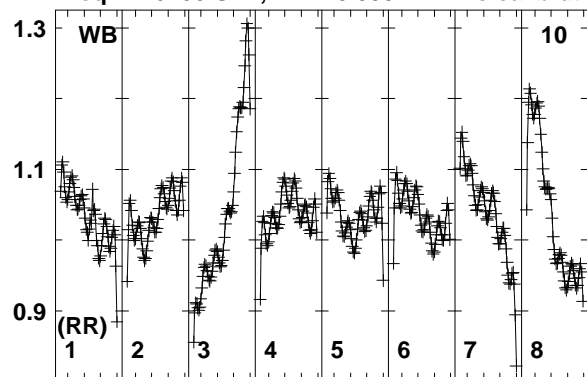

Lower frame: Real Jy
Total-power spectrum Antenna: WB (10)
Timerange: 00/16:35:33 to 00/16:37:59

Plot file version 55 created 01-AUG-2018 16:38:09

PB+1-3 N18L1 2.UVDATA.1

Freq = 1.6266 GHz, Bw = 8.000 MH No calibration applied and no bandpass applied

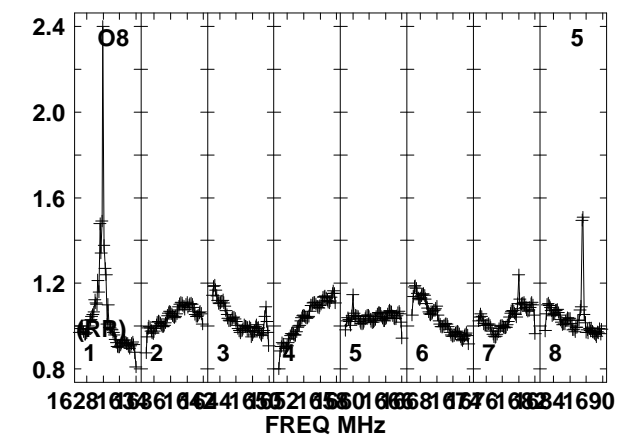
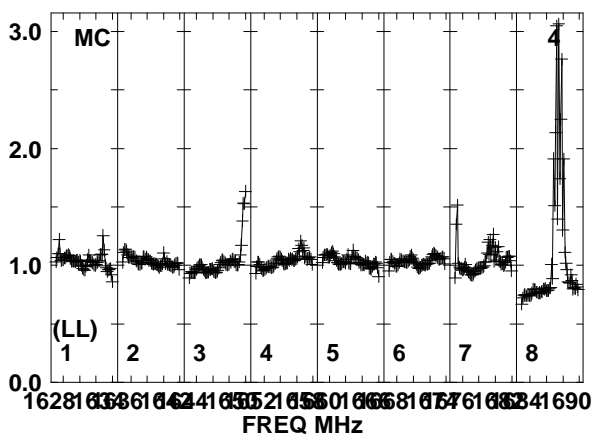
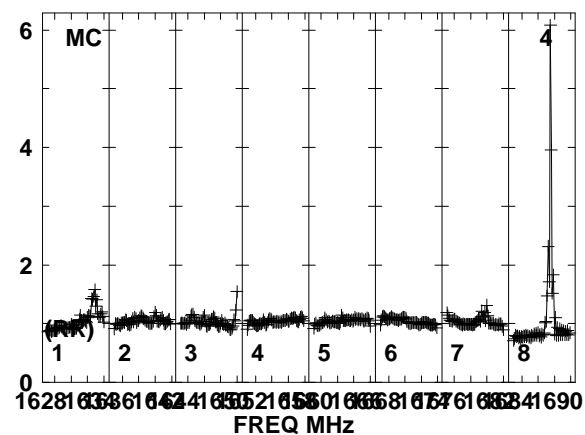
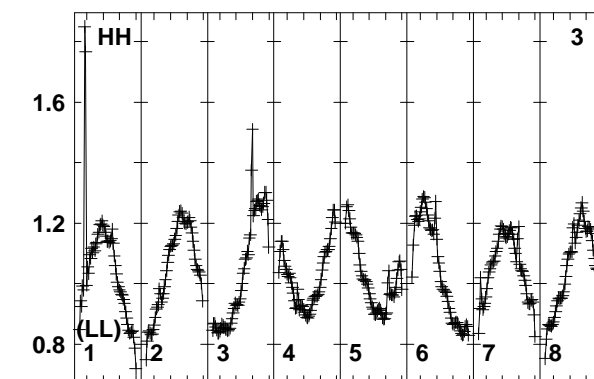
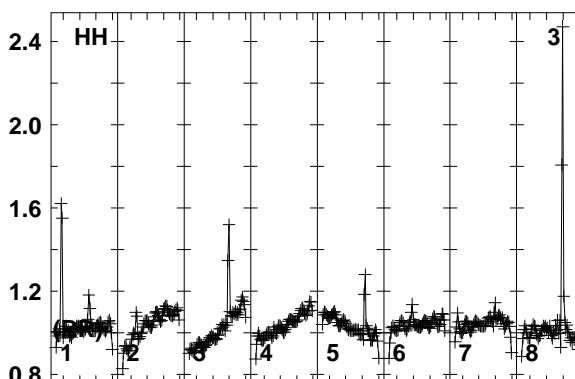
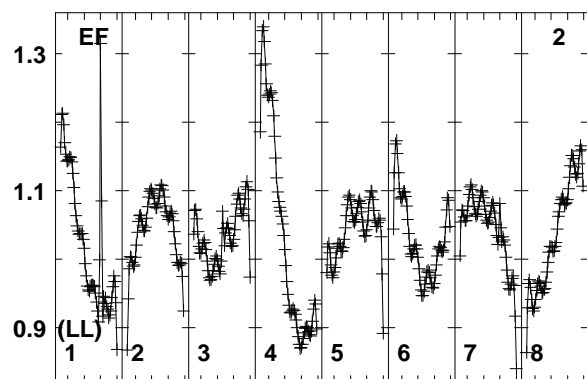
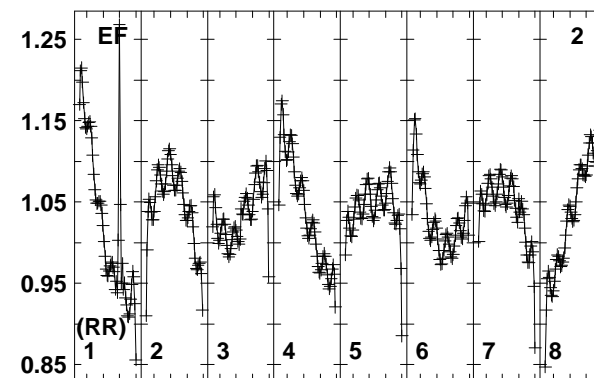
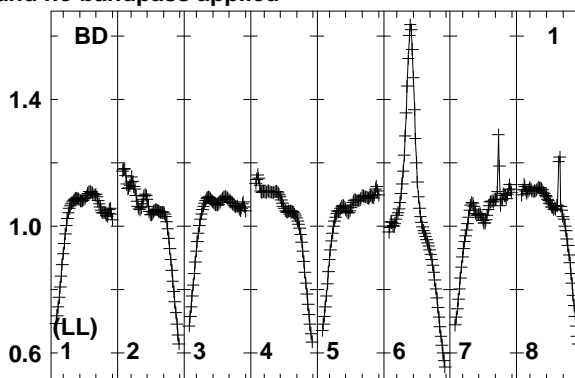
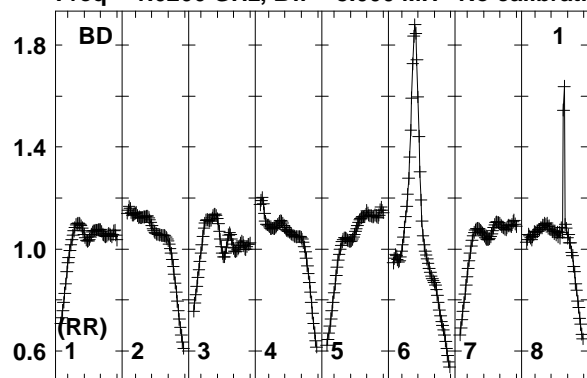

Lower frame: Real Jy
Total-power spectrum Antenna: BD (01)
Timerange: 00/16:38:03 to 00/16:40:29

Plot file version 56 created 01-AUG-2018 16:38:09

PB+1-3 N18L1 2.UVDATA.1

Freq = 1.6266 GHz, Bw = 8.000 MH No calibration applied and no bandpass applied

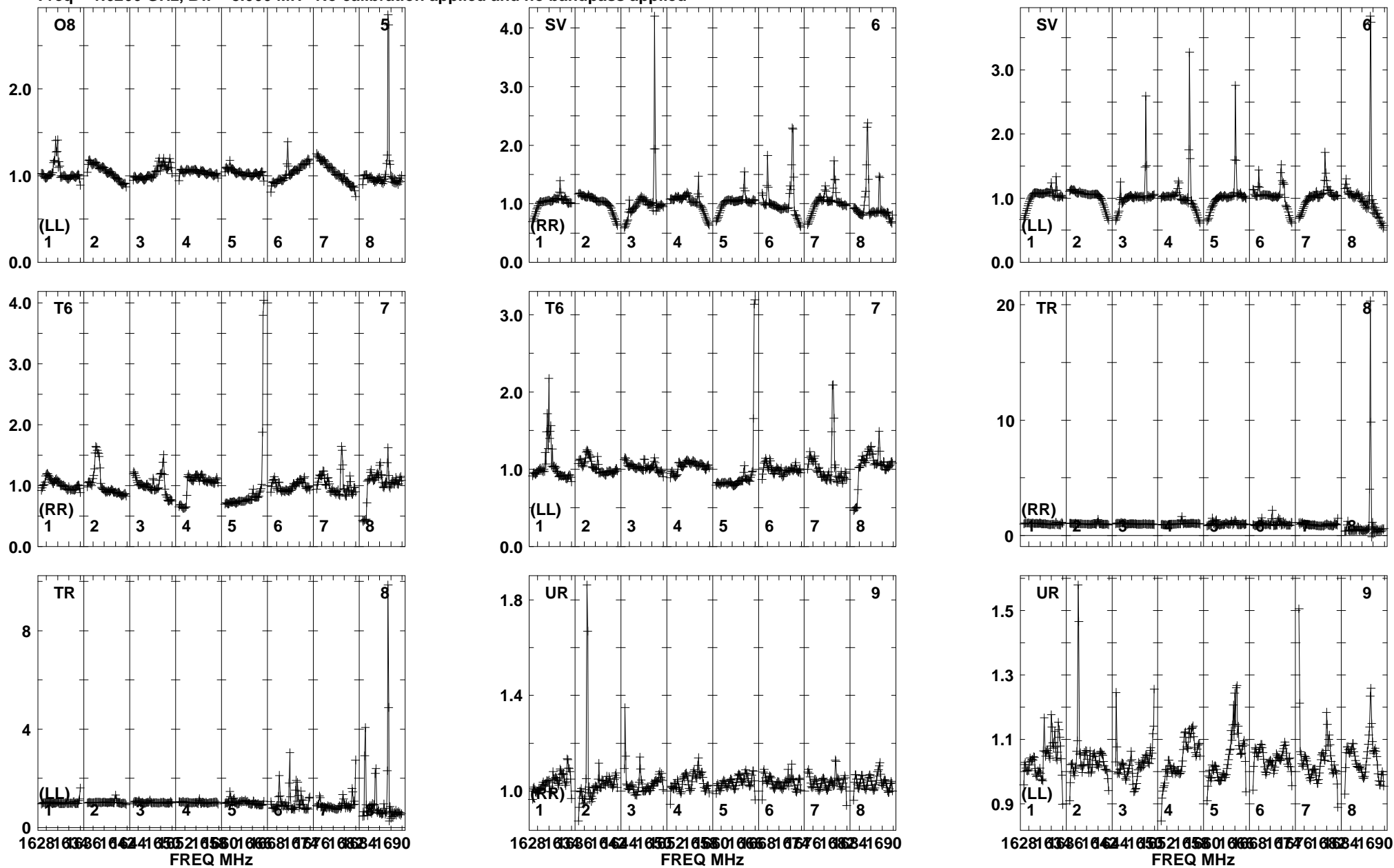

Lower frame: Real Jy
Total-power spectrum Antenna: O8 (05)
Timerange: 00/16:38:03 to 00/16:40:29

Plot file version 57 created 01-AUG-2018 16:38:09

PB+1-3 N18L1 2.UVDATA.1

Freq = 1.6266 GHz, Bw = 8.000 MH No calibration applied and no bandpass applied

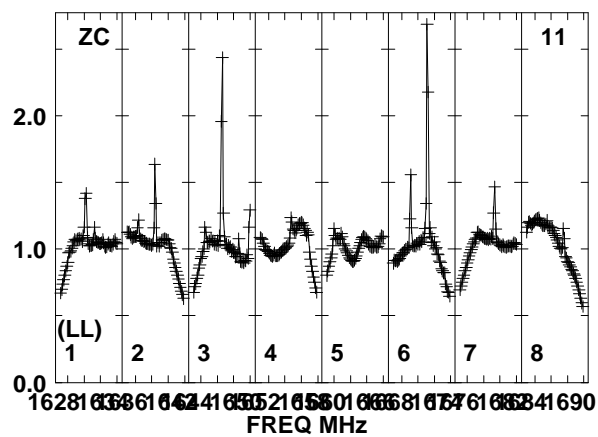
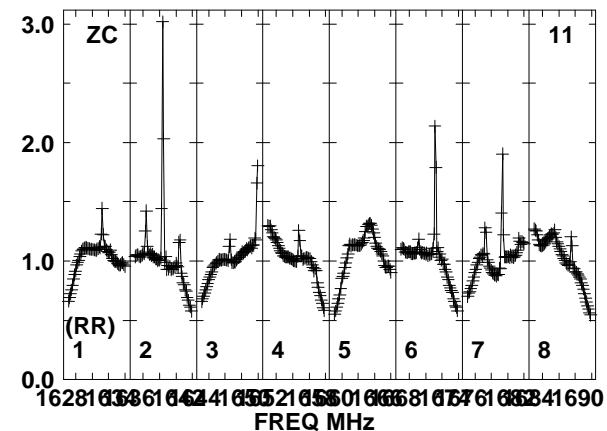
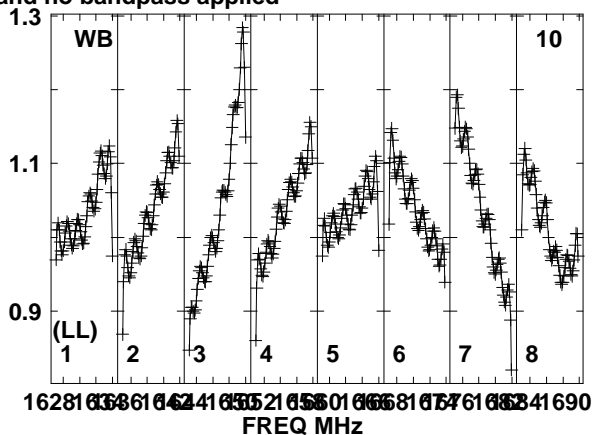
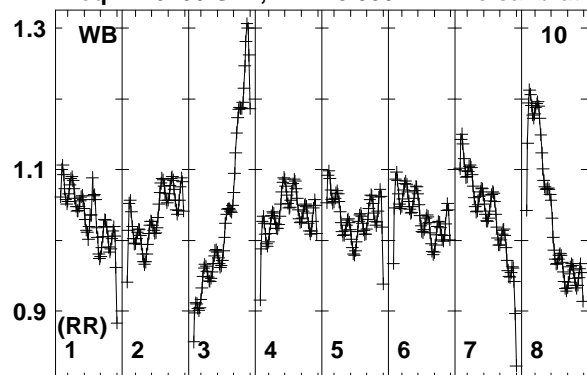

Lower frame: Real Jy
Total-power spectrum Antenna: WB (10)
Timerange: 00/16:38:03 to 00/16:40:29

Plot file version 58 created 01-AUG-2018 16:38:09

PB+2-3 N18L1 2.UVDATA.1

Freq = 1.6266 GHz, Bw = 8.000 MH No calibration applied and no bandpass applied

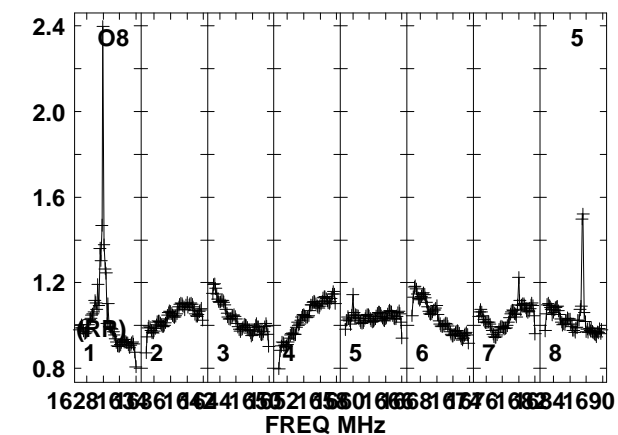
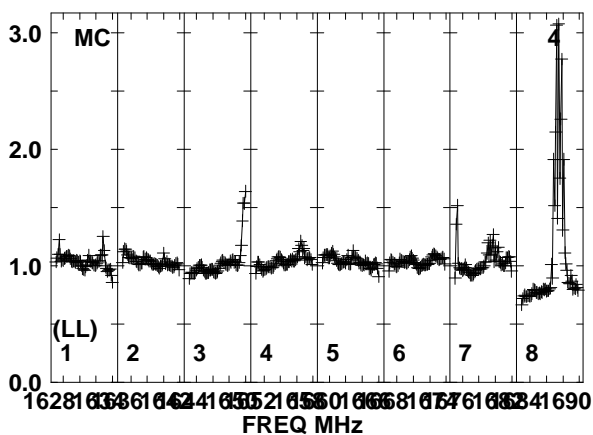
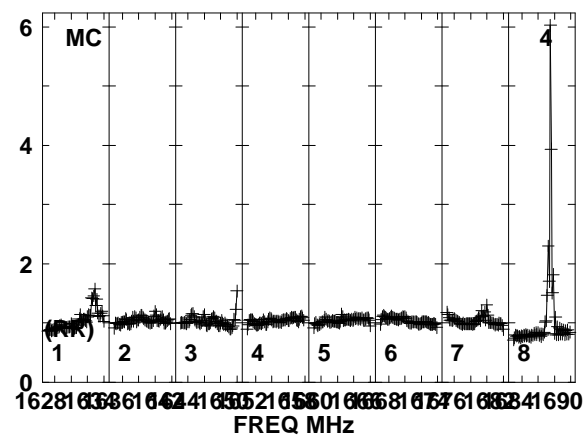
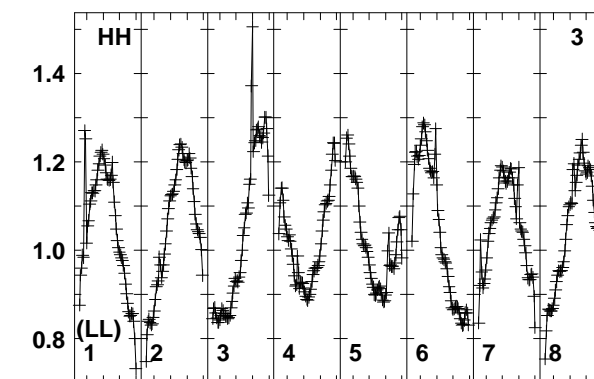
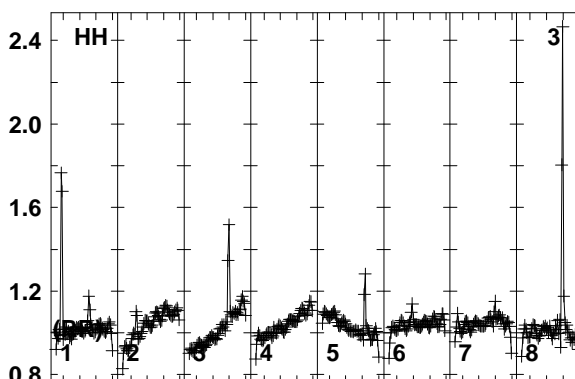
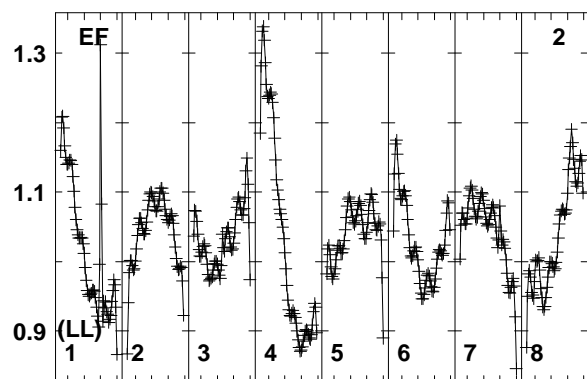
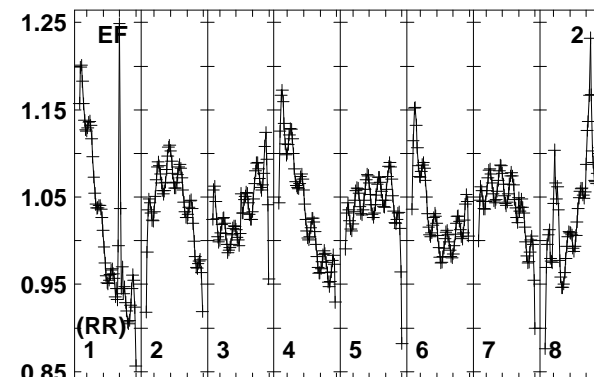
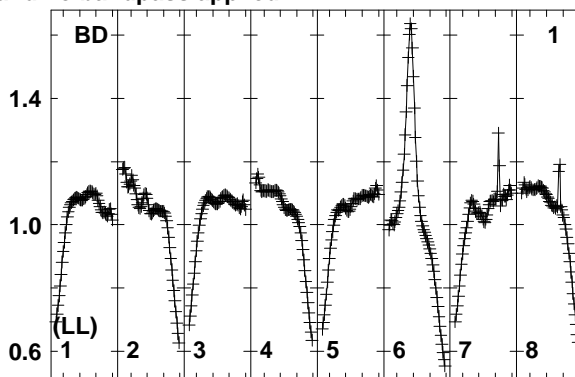
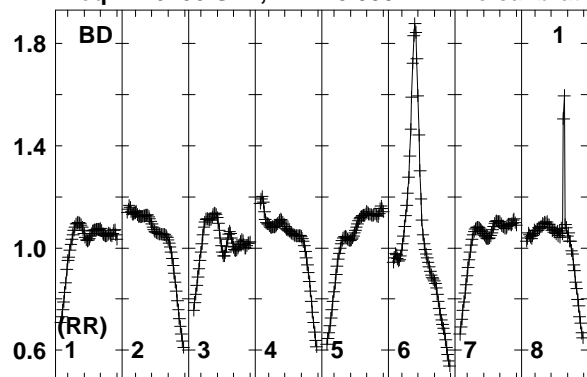

Lower frame: Real Jy
Total-power spectrum Antenna: BD (01)
Timerange: 00/16:40:33 to 00/16:42:59

Plot file version 59 created 01-AUG-2018 16:38:09

PB+2-3 N18L1 2.UVDATA.1

Freq = 1.6266 GHz, Bw = 8.000 MH No calibration applied and no bandpass applied

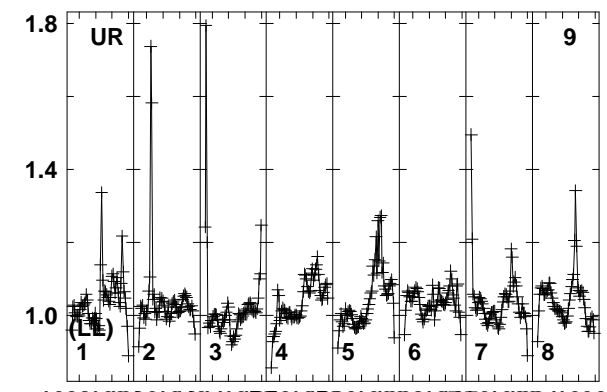
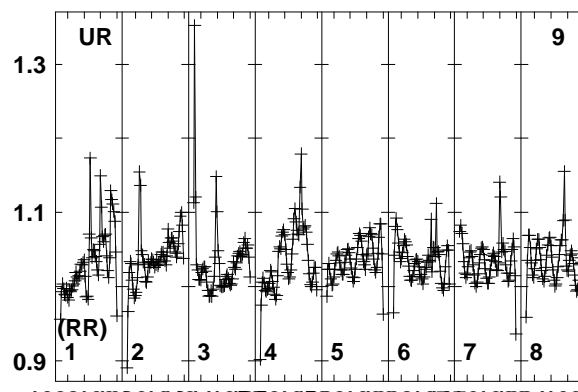
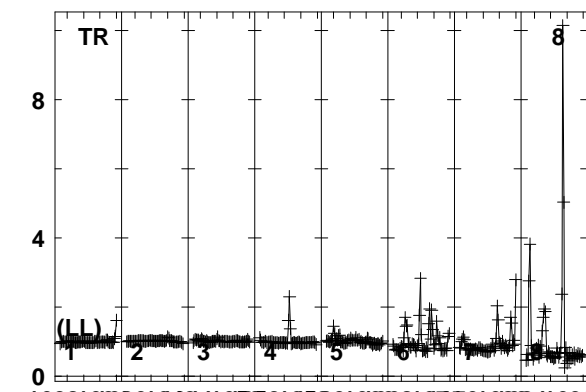
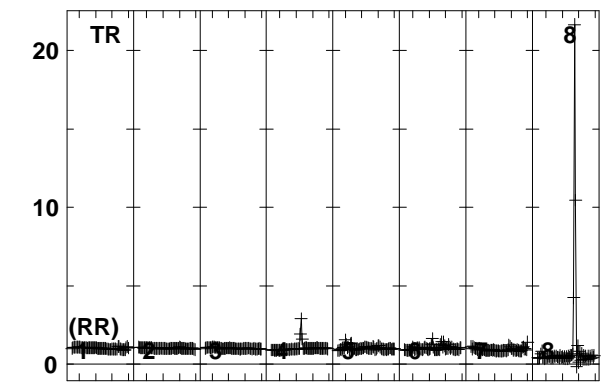
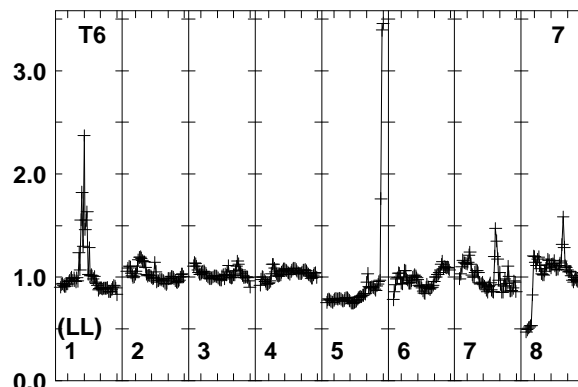
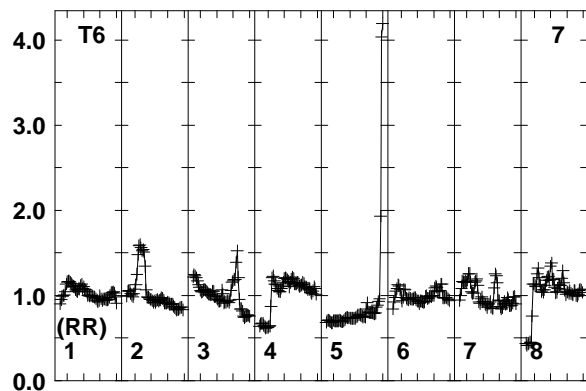
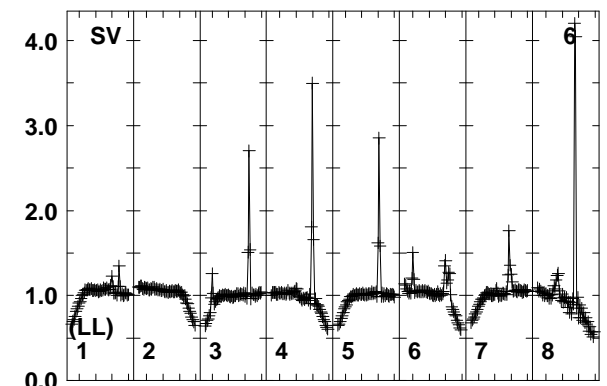
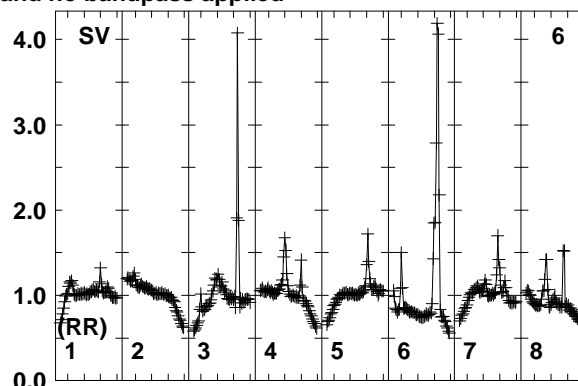
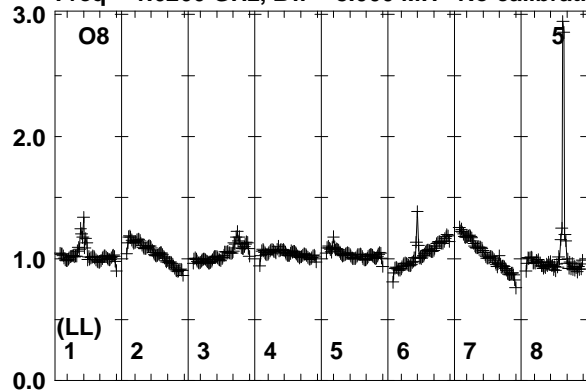

16281638616441652165801666816746168241690
FREQ MHz

16281638616441652165801666816746168241690
FREQ MHz

16281638616441652165801666816746168241690
FREQ MHz

Lower frame: Real Jy
Total-power spectrum Antenna: O8 (05)
Timerange: 00/16:40:33 to 00/16:42:59

Plot file version 60 created 01-AUG-2018 16:38:09

PB+2-3 N18L1 2.UVDATA.1

Freq = 1.6266 GHz, Bw = 8.000 MH No calibration applied and no bandpass applied

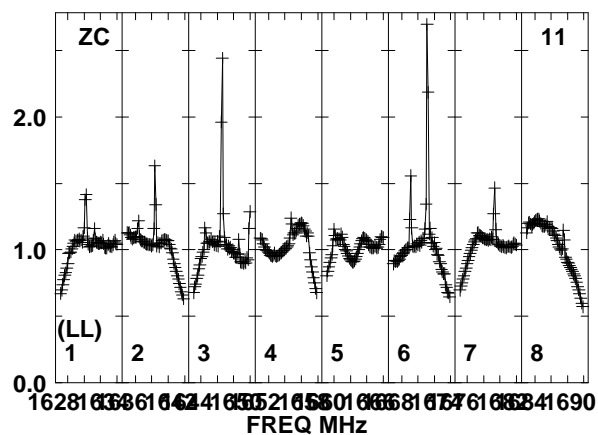
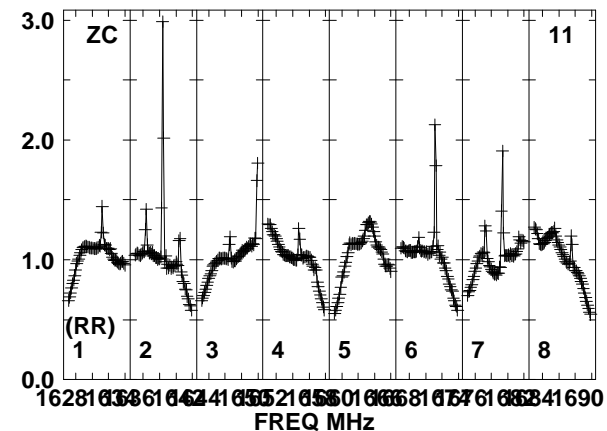
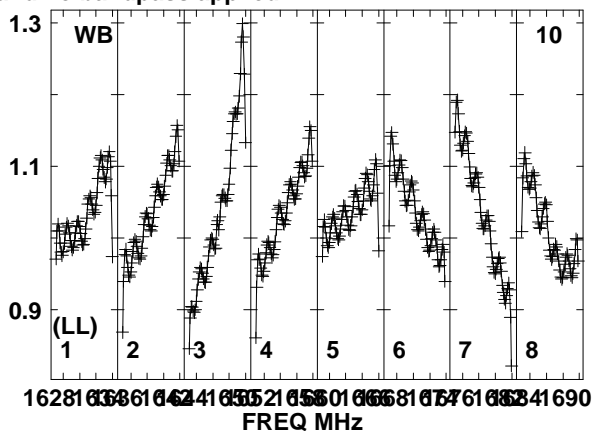
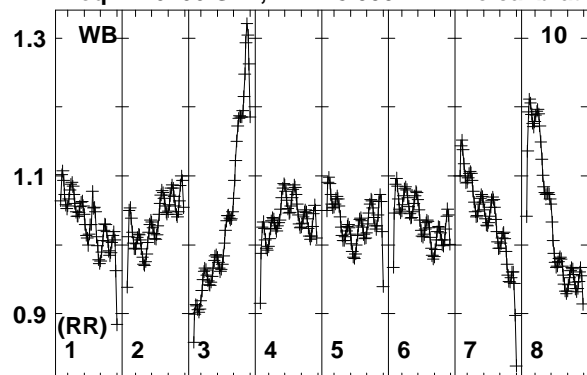

Lower frame: Real Jy
Total-power spectrum Antenna: WB (10)
Timerange: 00/16:40:33 to 00/16:42:59

Plot file version 61 created 01-AUG-2018 16:38:10

J0530+1331 N18L1 2.UVDATA.1

Freq = 1.6266 GHz, Bw = 8.000 MH No calibration applied and no bandpass applied

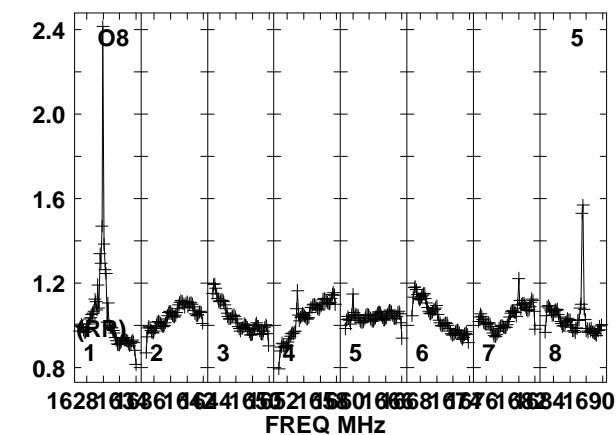
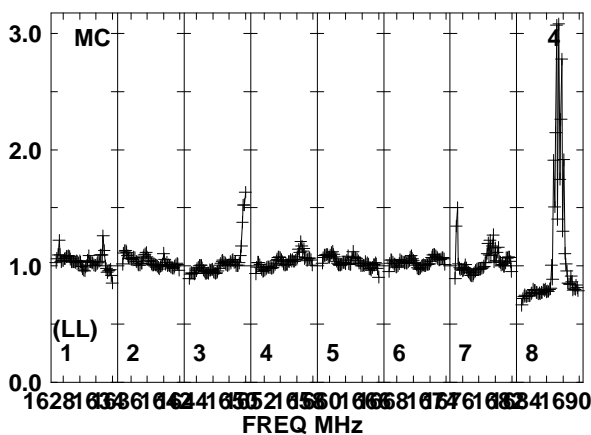
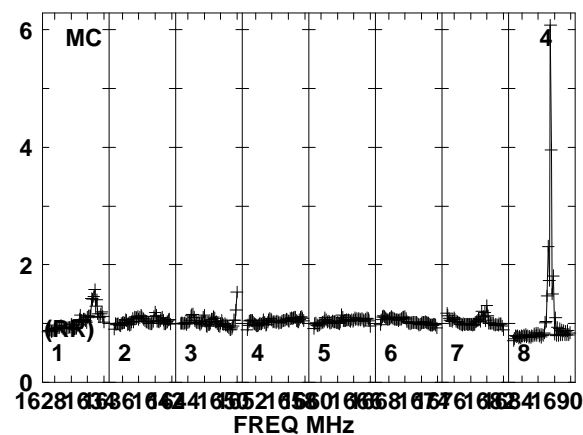
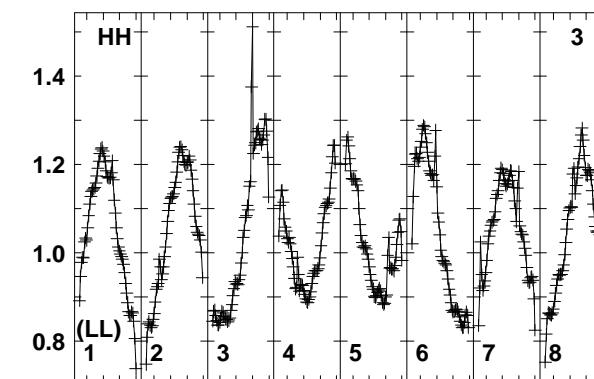
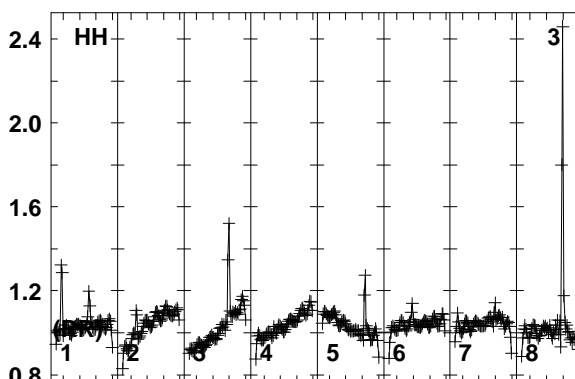
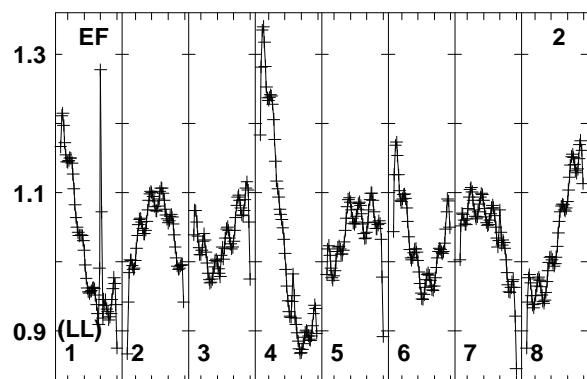
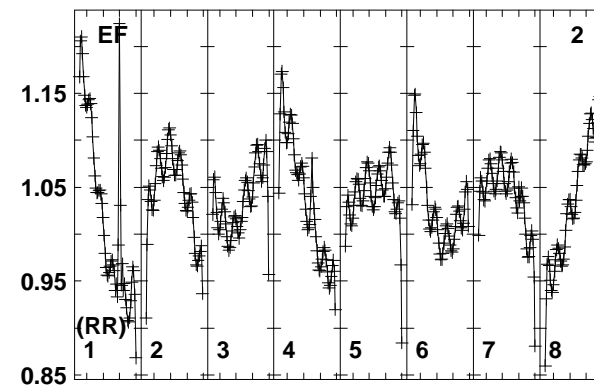
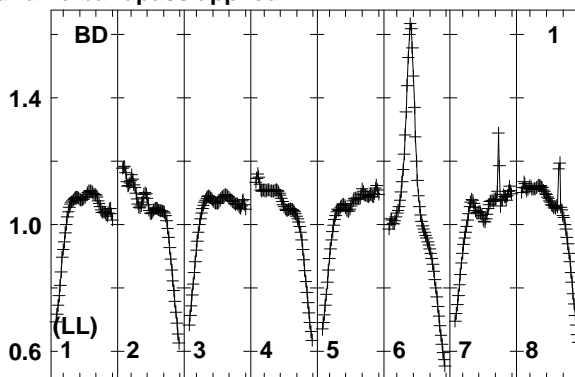
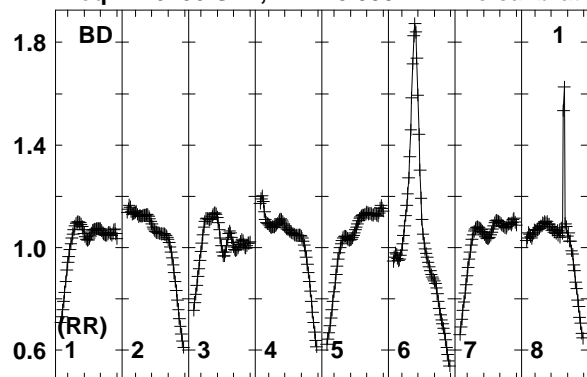

Lower frame: Real Jy
Total-power spectrum Antenna: BD (01)
Timerange: 00:16:43:41 to 00:16:44:59

Plot file version 62 created 01-AUG-2018 16:38:10
 J0530+1331 N18L1 2.UVDATA.1
 Freq = 1.6266 GHz, Bw = 8.000 MH No calibration applied and no bandpass applied

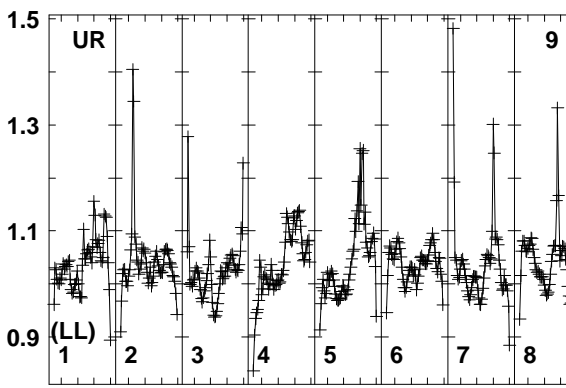
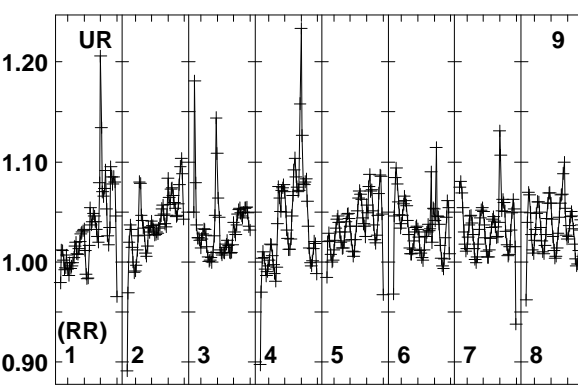
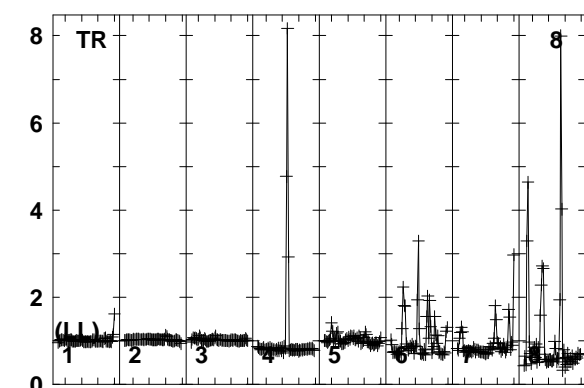
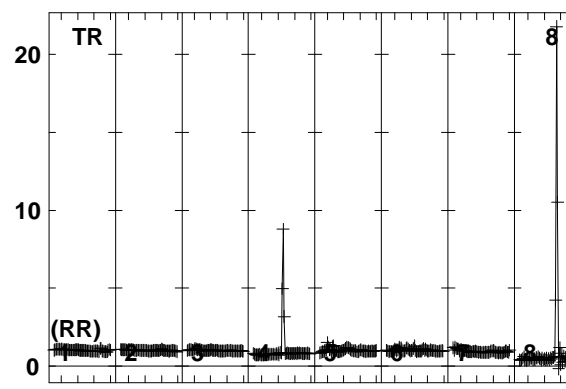
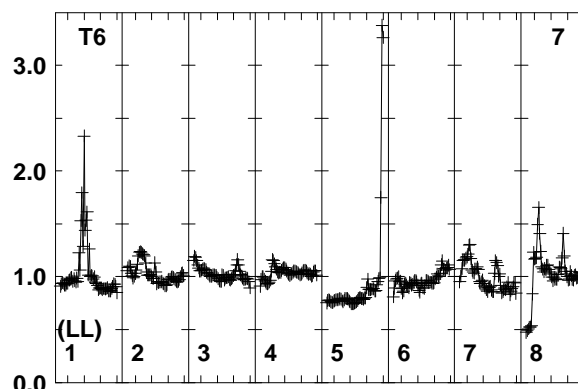
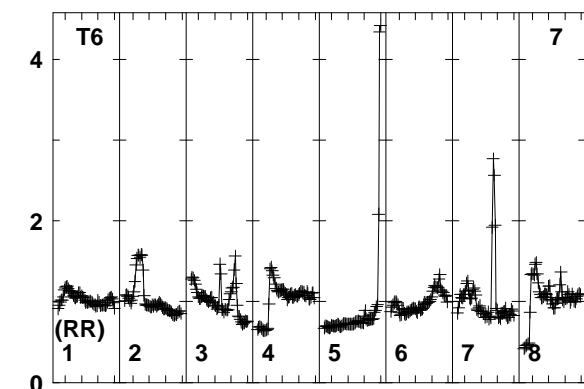
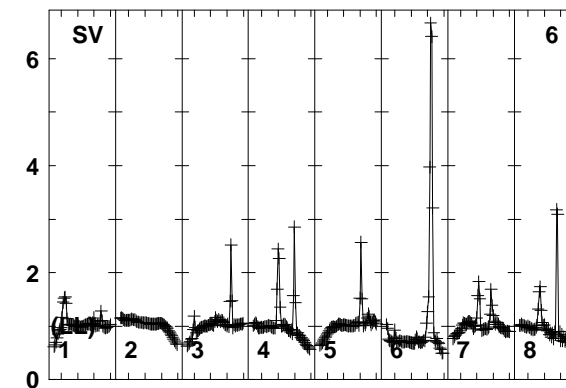
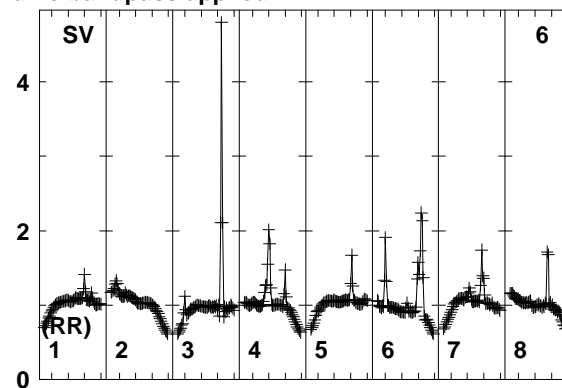
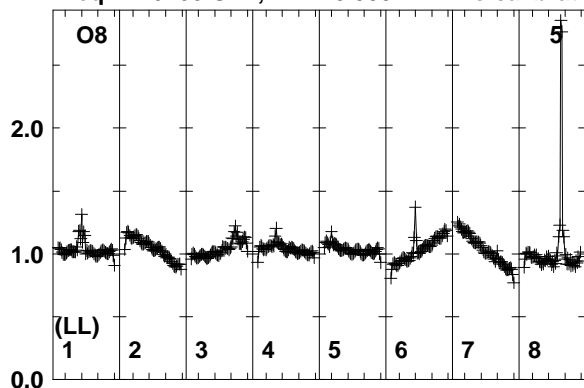

1628163861642416552165801666816746168241690
 FREQ MHz

1628163861642416552165801666816746168241690
 FREQ MHz

1628163861642416552165801666816746168241690
 FREQ MHz

Lower frame: Real Jy
 Total-power spectrum Antenna: O8 (05)
 Timerange: 00/16:43:41 to 00/16:44:59

Plot file version 63 created 01-AUG-2018 16:38:10

J0530+1331 N18L1 2.UVDATA.1

Freq = 1.6266 GHz, Bw = 8.000 MH No calibration applied and no bandpass applied

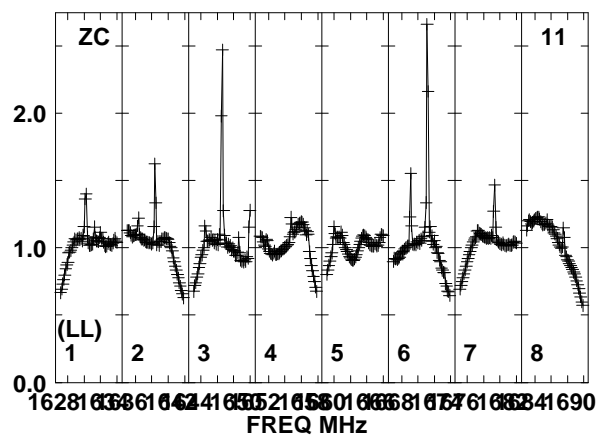
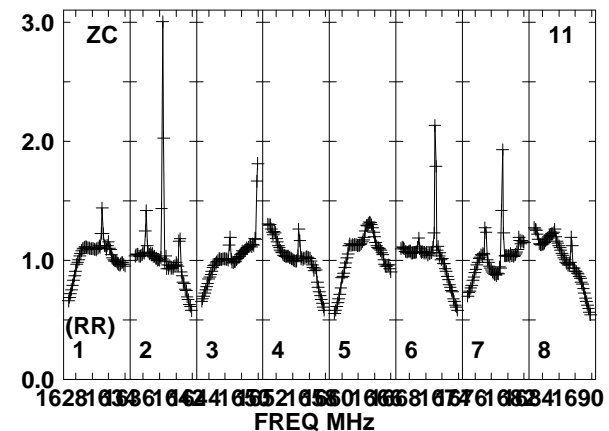
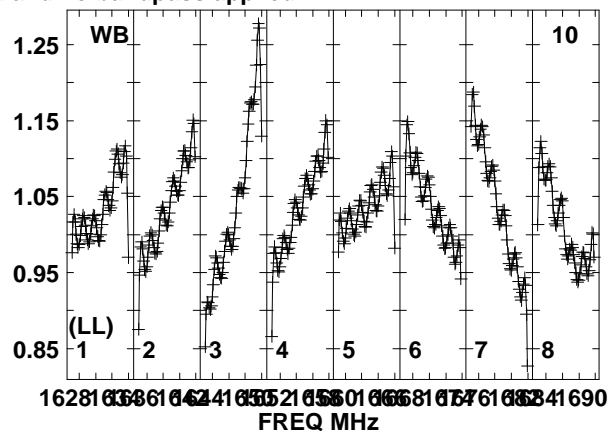
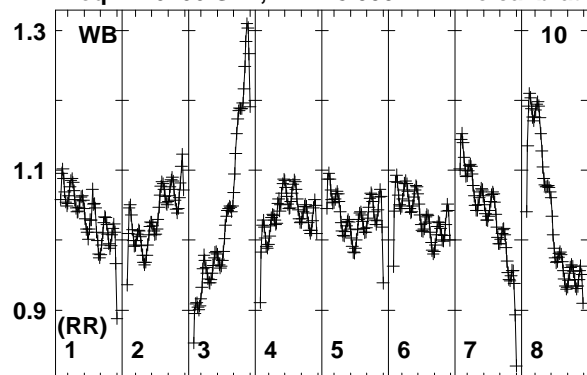

Lower frame: Real Jy
Total-power spectrum Antenna: WB (10)
Timerange: 00/16:43:41 to 00/16:44:59

Plot file version 64 created 01-AUG-2018 16:38:10

PB+3-3 N18L1 2.UVDATA.1

Freq = 1.6266 GHz, Bw = 8.000 MH No calibration applied and no bandpass applied

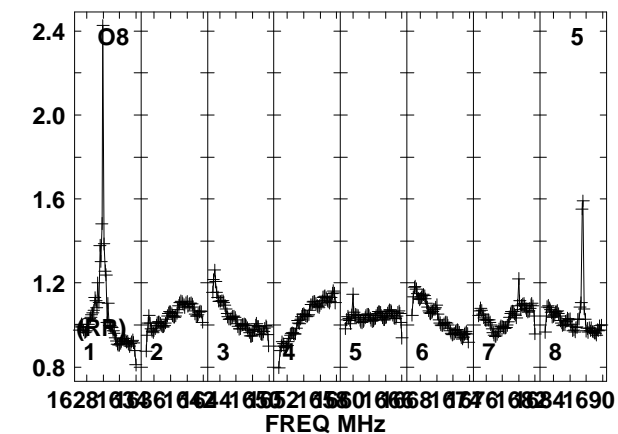
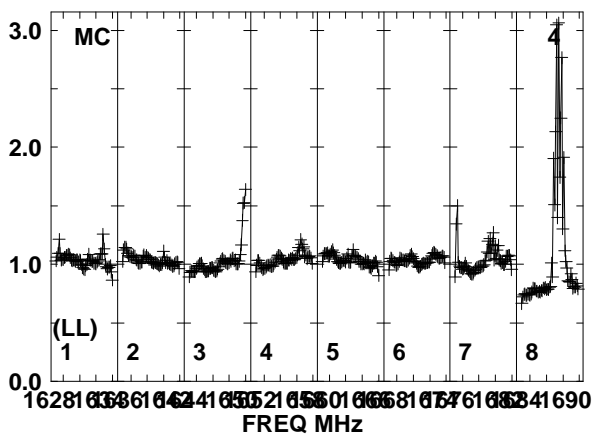
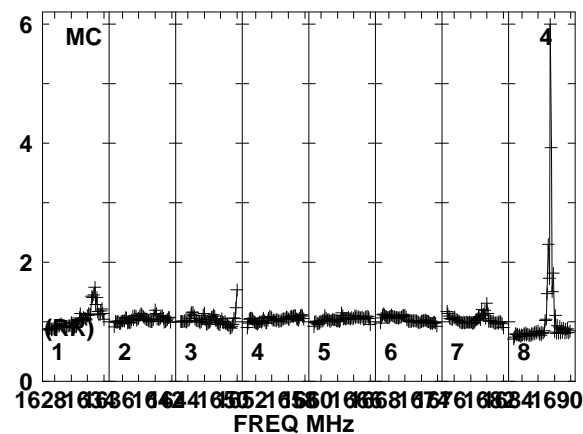
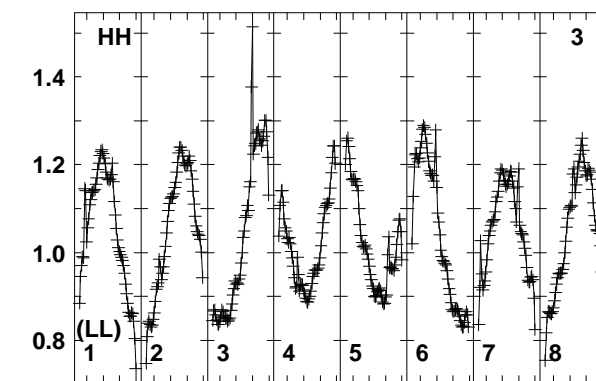
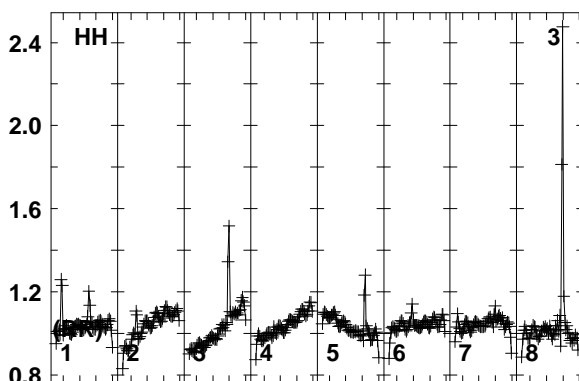
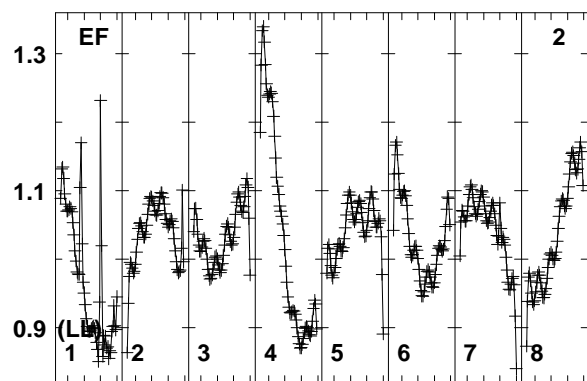
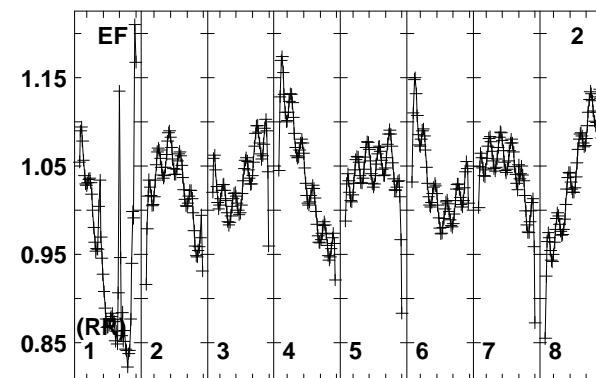
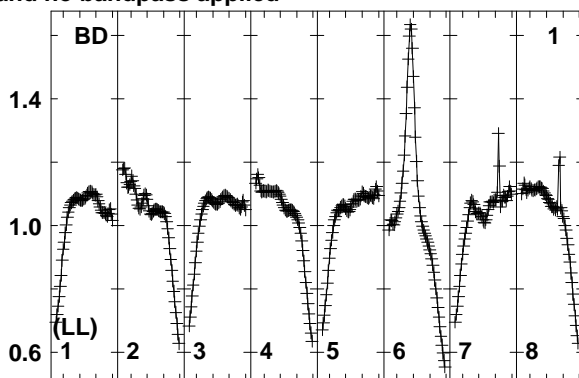
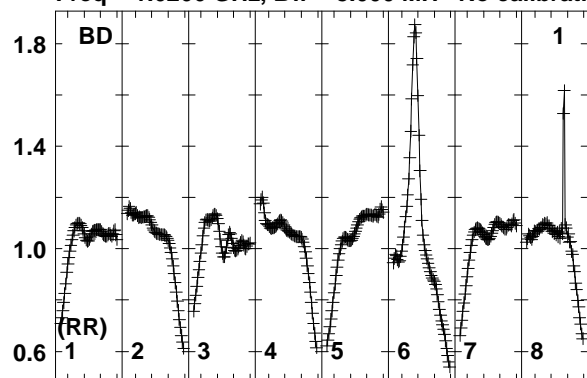

Lower frame: Real Jy
Total-power spectrum Antenna: BD (01)
Timerange: 00/16:45:05 to 00/16:47:29

Plot file version 65 created 01-AUG-2018 16:38:10

PB+3-3 N18L1 2.UVDATA.1

Freq = 1.6266 GHz, Bw = 8.000 MH No calibration applied and no bandpass applied

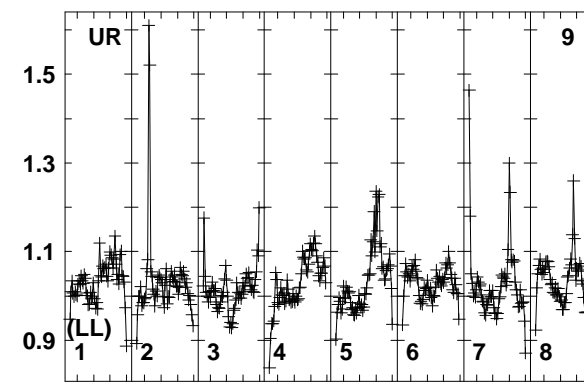
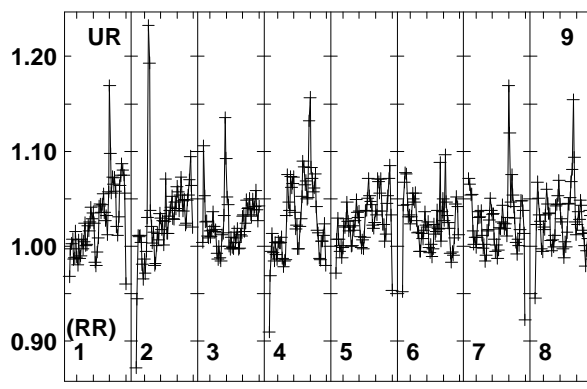
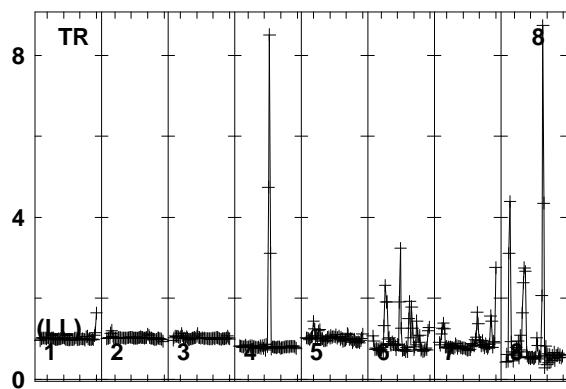
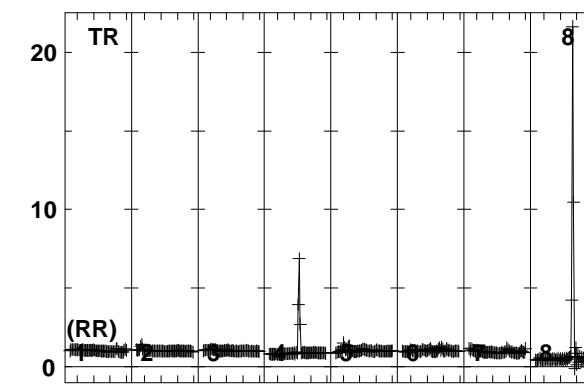
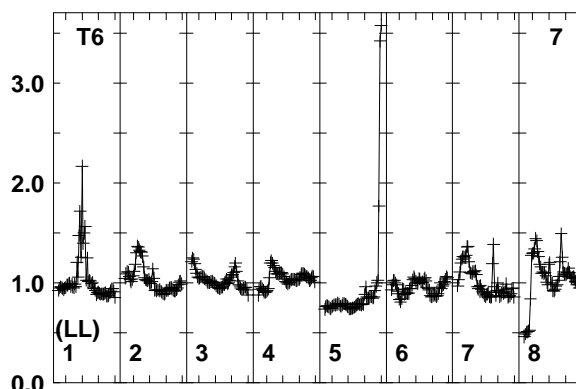
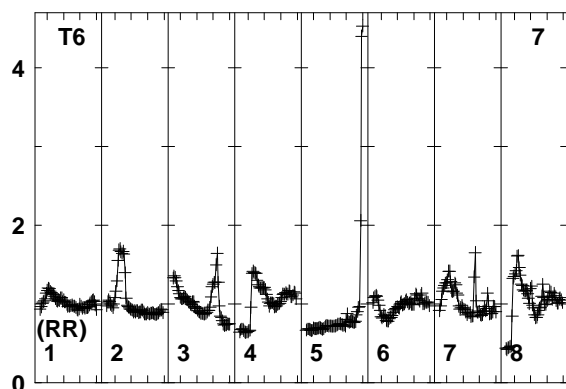
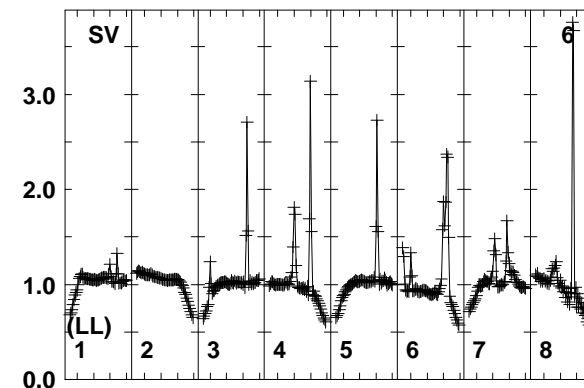
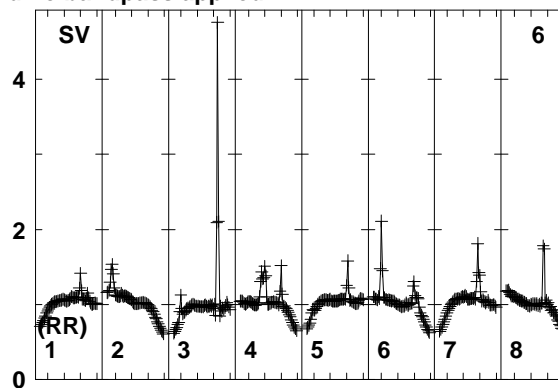
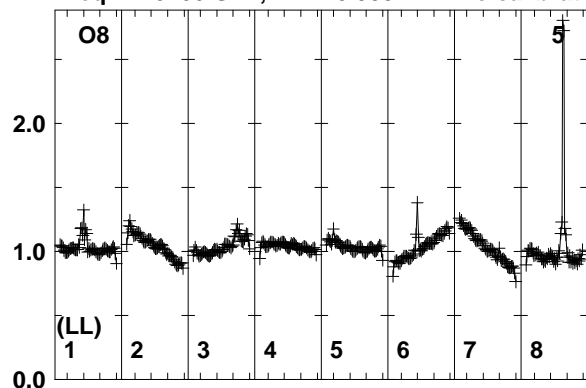

1628163861642416552165801666816746168241690
FREQ MHz

1628163861642416552165801666816746168241690
FREQ MHz

1628163861642416552165801666816746168241690
FREQ MHz

Lower frame: Real Jy
Total-power spectrum Antenna: O8 (05)
Timerange: 00/16:45:05 to 00/16:47:29

Plot file version 66 created 01-AUG-2018 16:38:10

PB+3-3 N18L1 2.UVDATA.1

Freq = 1.6266 GHz, Bw = 8.000 MH No calibration applied and no bandpass applied

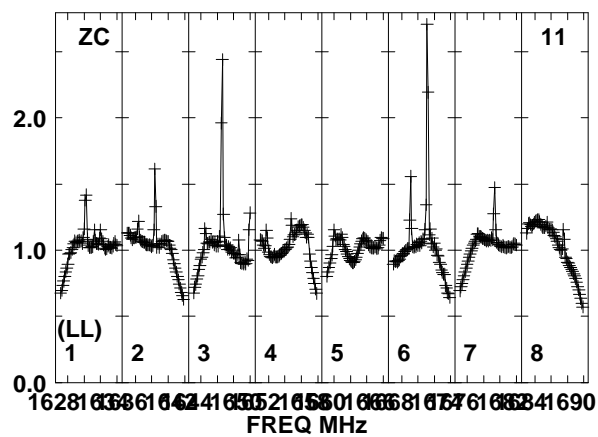
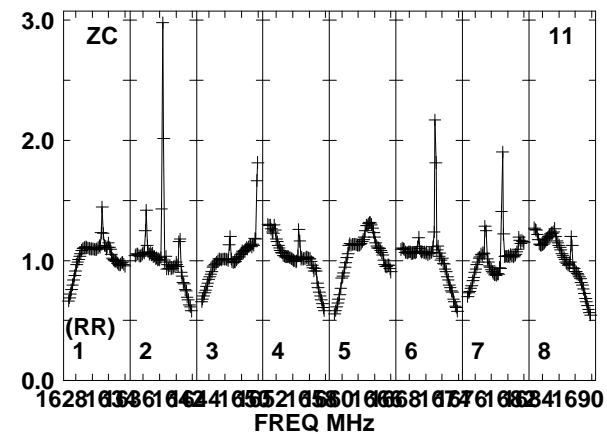
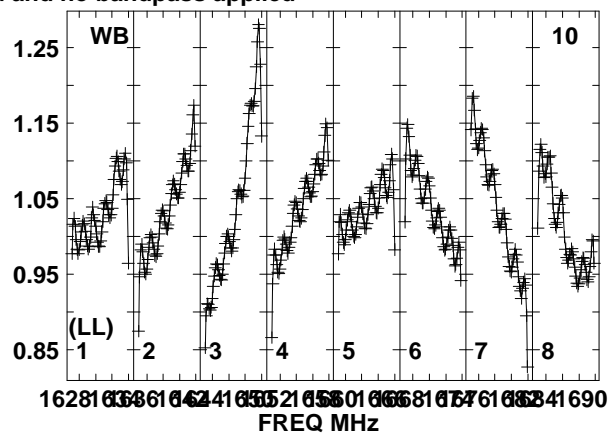
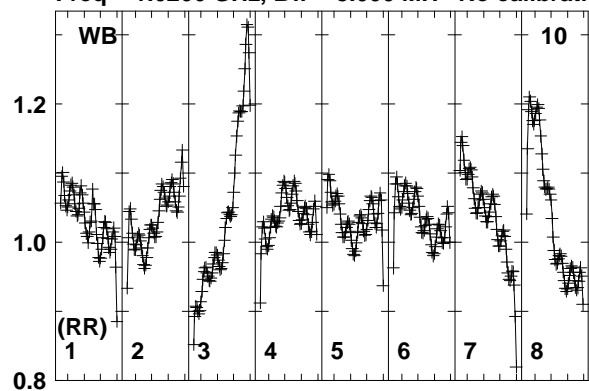

Lower frame: Real Jy
Total-power spectrum Antenna: WB (10)
Timerange: 00/16:45:05 to 00/16:47:29

Plot file version 67 created 01-AUG-2018 16:38:10

PB+4-3 N18L1 2.UVDATA.1

Freq = 1.6266 GHz, Bw = 8.000 MH No calibration applied and no bandpass applied

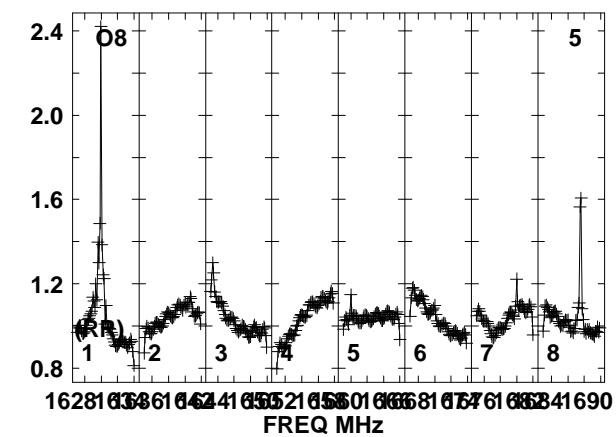
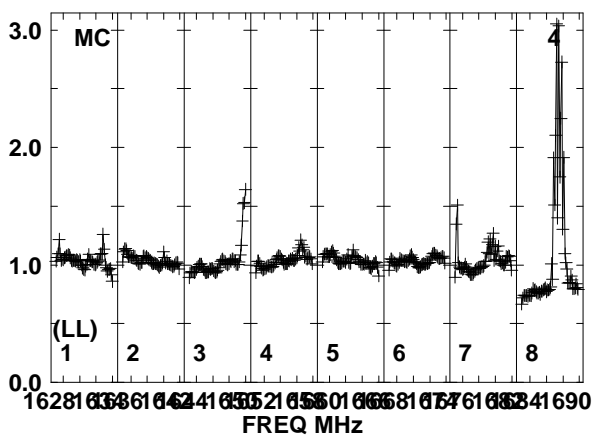
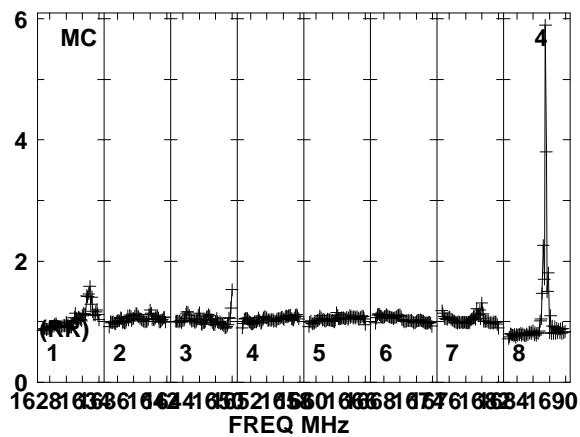
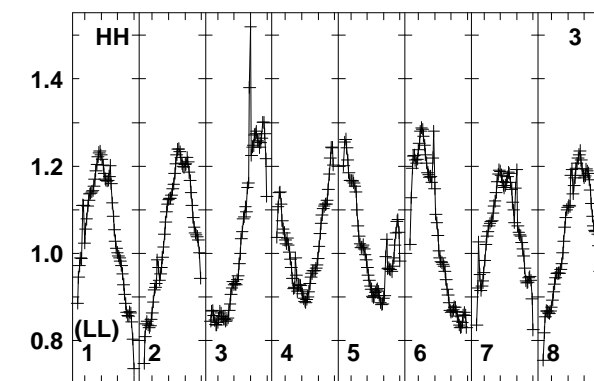
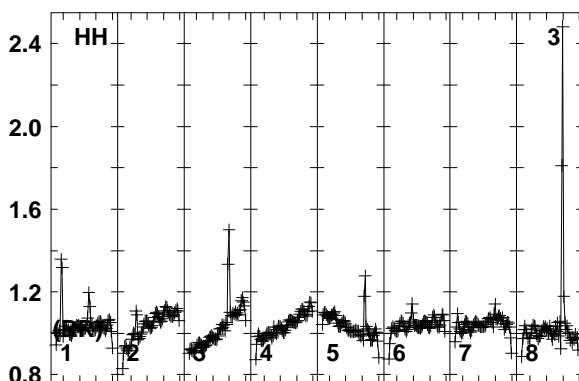
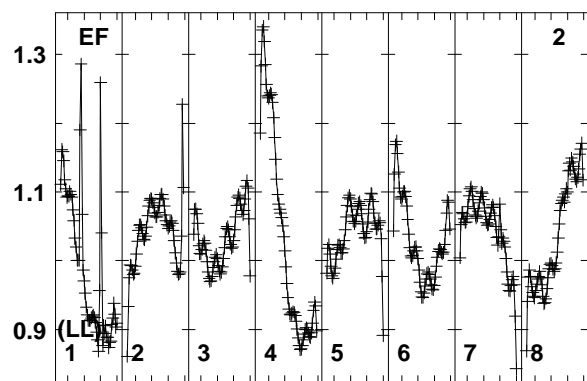
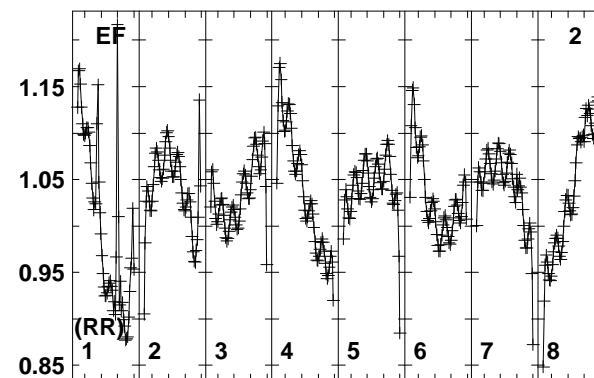
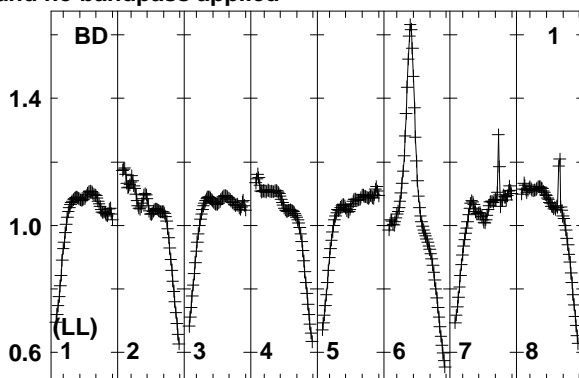
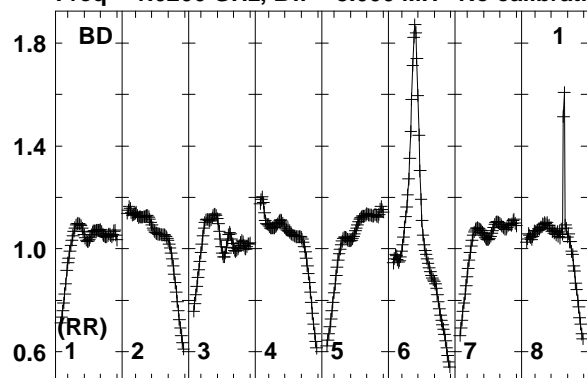

Lower frame: Real Jy
Total-power spectrum Antenna: BD (01)
Timerange: 00/16:47:33 to 00/16:49:59

Plot file version 68 created 01-AUG-2018 16:38:10
 PB+4-3 N18L1 2.UVDATA.1
 Freq = 1.6266 GHz, Bw = 8.000 MH No calibration applied and no bandpass applied

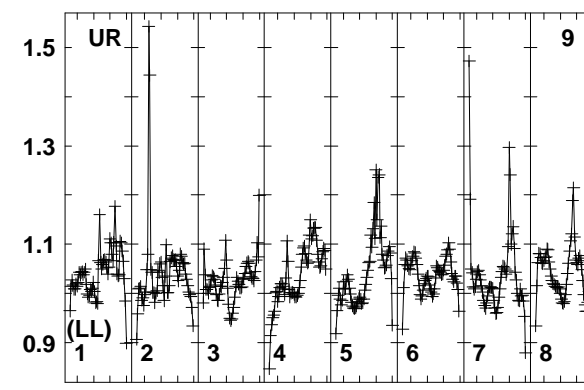
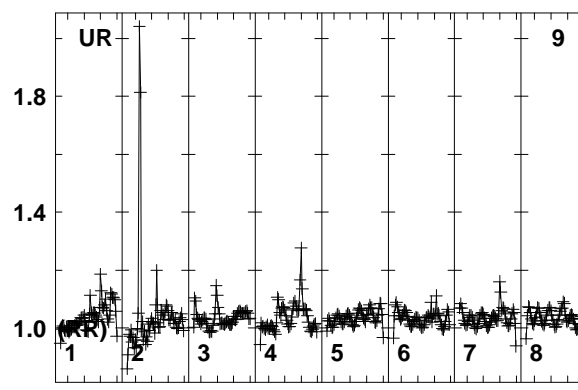
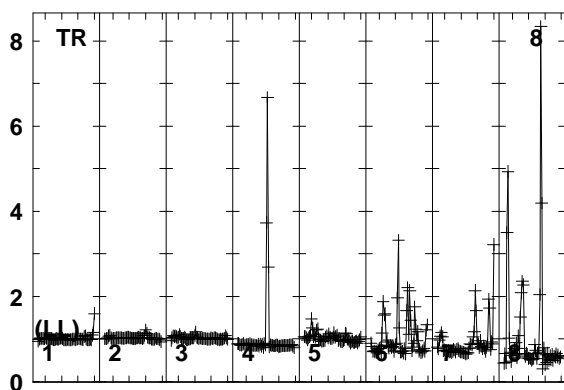
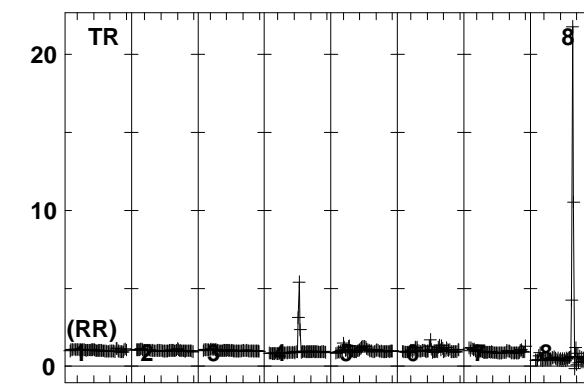
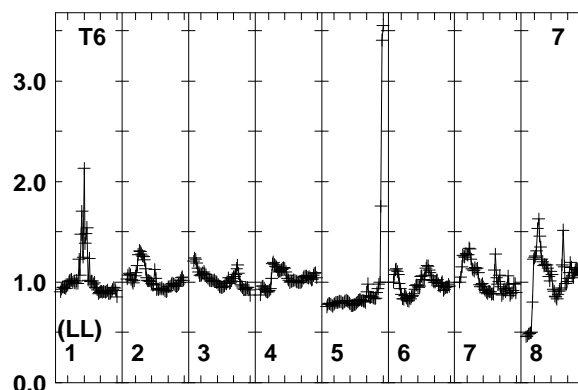
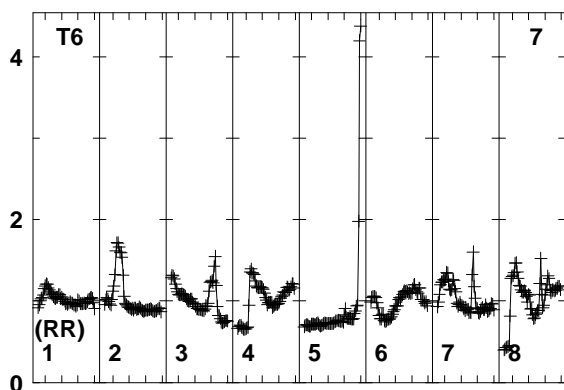
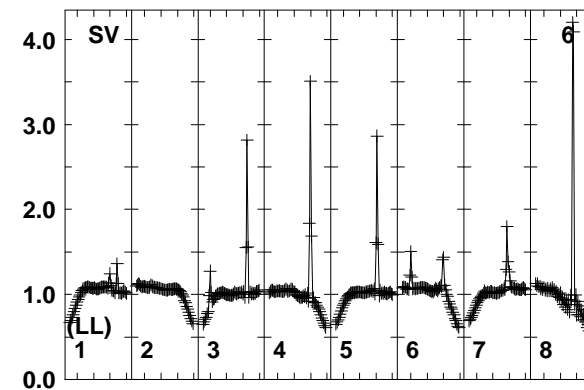
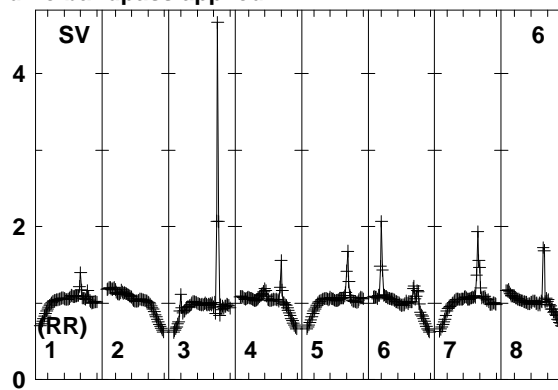
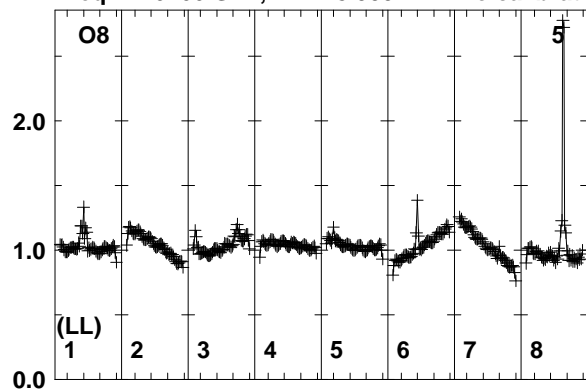

16281 16386 16441 16521 16580 16681 16761 16824 1690
 FREQ MHz

16281 16386 16441 16521 16580 16681 16761 16824 1690
 FREQ MHz

16281 16386 16441 16521 16580 16681 16761 16824 1690
 FREQ MHz

Lower frame: Real Jy
 Total-power spectrum Antenna: O8 (05)
 Timerange: 00/16:47:33 to 00/16:49:59

Plot file version 69 created 01-AUG-2018 16:38:11

PB+4-3 N18L1 2.UVDATA.1

Freq = 1.6266 GHz, Bw = 8.000 MH No calibration applied and no bandpass applied

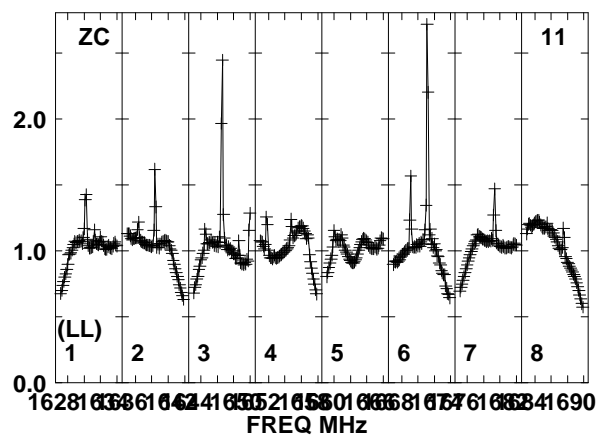
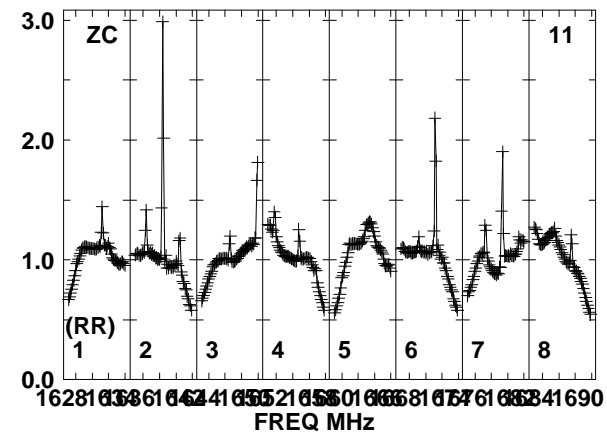
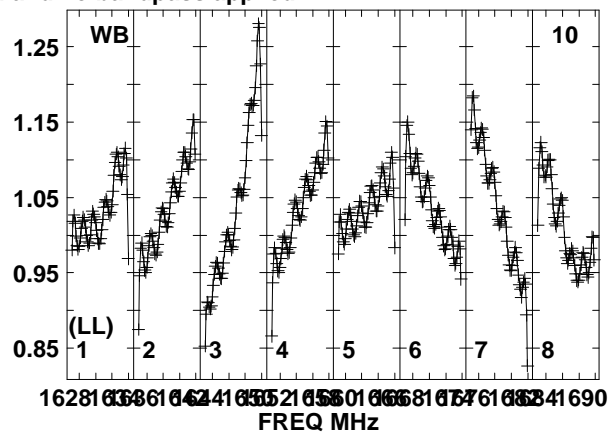
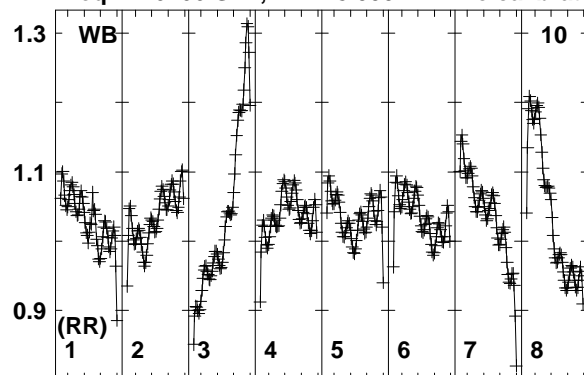

Lower frame: Real Jy
Total-power spectrum Antenna: WB (10)
Timerange: 00/16:47:33 to 00/16:49:59

Plot file version 70 created 01-AUG-2018 16:38:11

PB+4-2 N18L1 2.UVDATA.1

Freq = 1.6266 GHz, Bw = 8.000 MH No calibration applied and no bandpass applied

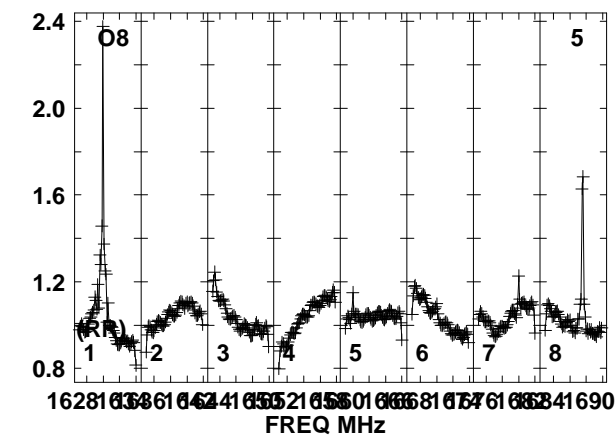
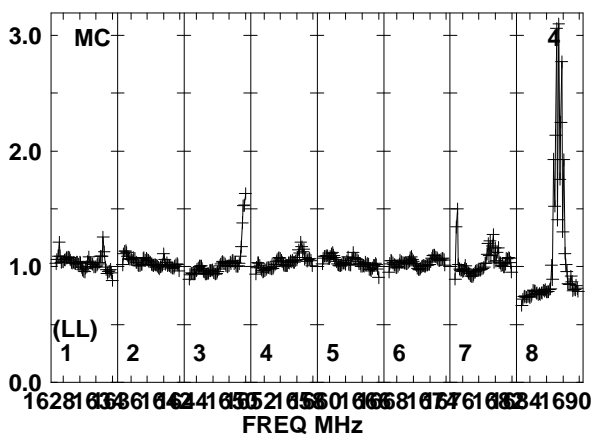
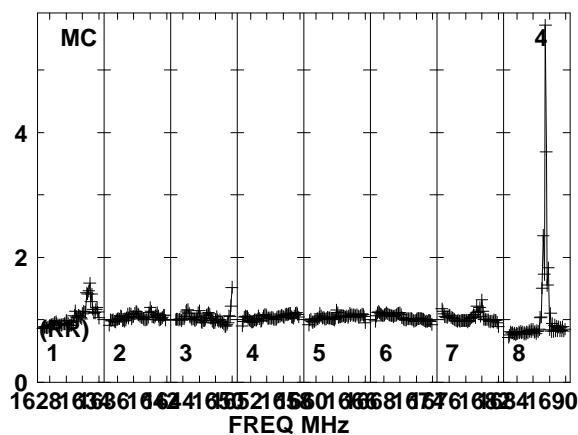
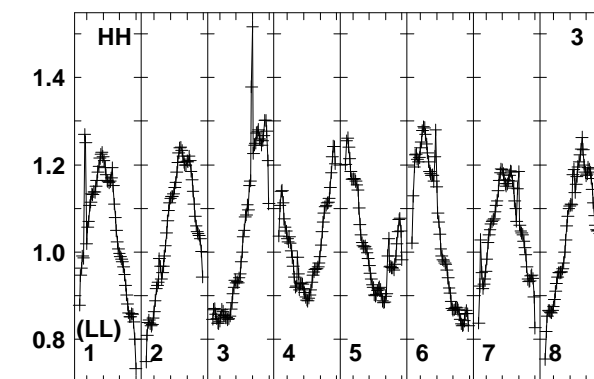
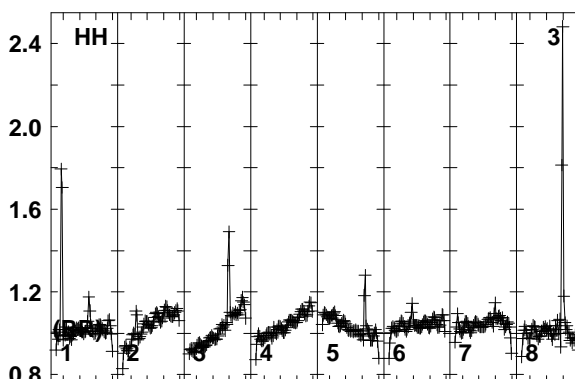
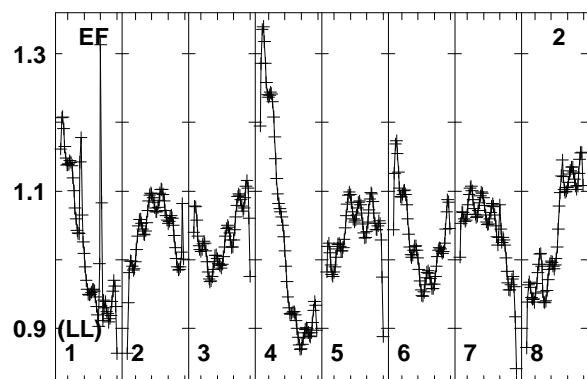
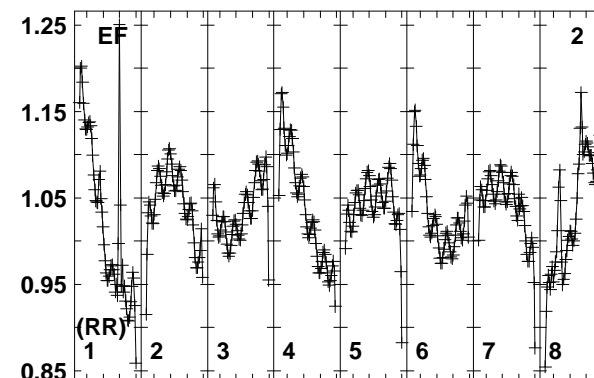
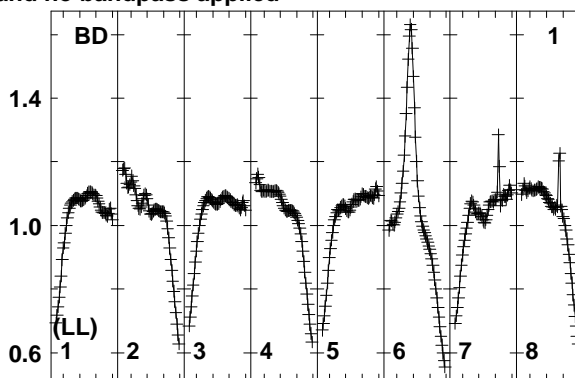
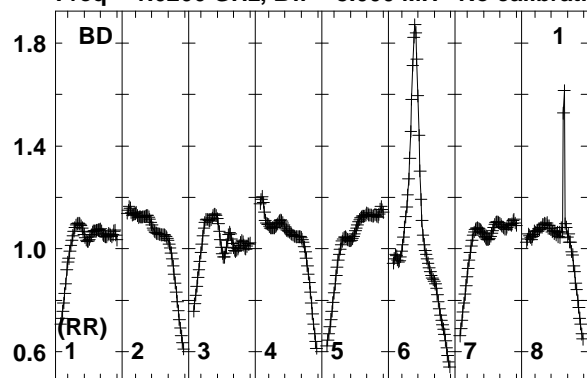

Lower frame: Real Jy
Total-power spectrum Antenna: BD (01)
Timerange: 00/16:50:03 to 00/16:52:29

Plot file version 71 created 01-AUG-2018 16:38:11

PB+4-2 N18L1 2.UVDATA.1

Freq = 1.6266 GHz, Bw = 8.000 MH No calibration applied and no bandpass applied

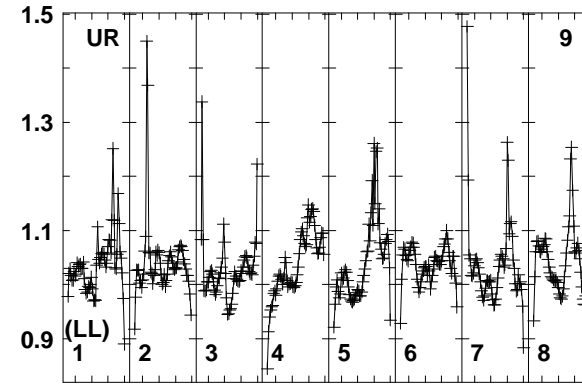
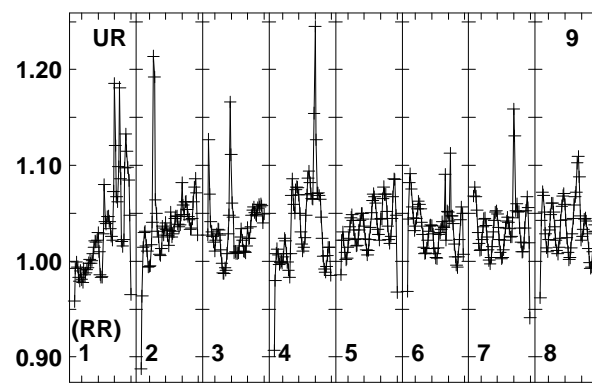
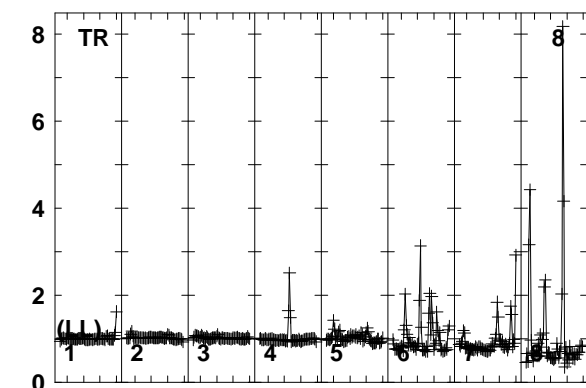
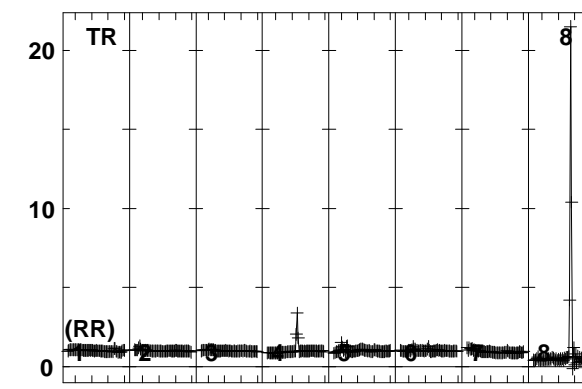
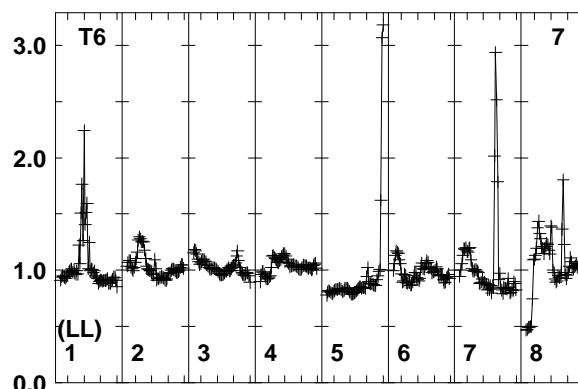
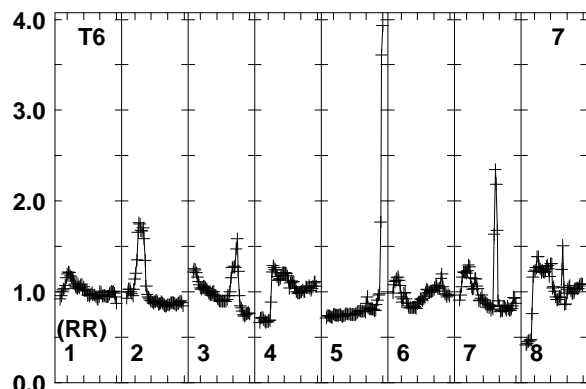
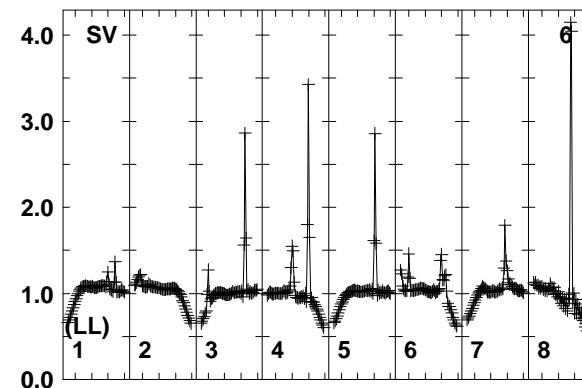
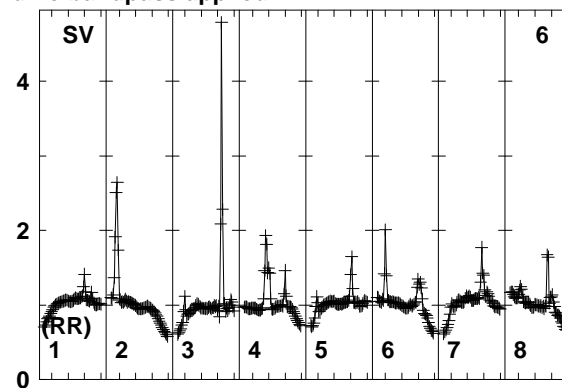
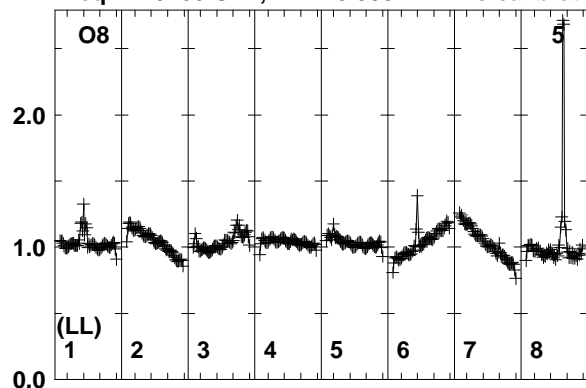

1628163861642416552165801666816746168241690
FREQ MHz

1628163861642416552165801666816746168241690
FREQ MHz

1628163861642416552165801666816746168241690
FREQ MHz

Lower frame: Real Jy
Total-power spectrum Antenna: O8 (05)
Timerange: 00/16:50:03 to 00/16:52:29

Plot file version 72 created 01-AUG-2018 16:38:11

PB+4-2 N18L1 2.UVDATA.1

Freq = 1.6266 GHz, Bw = 8.000 MH No calibration applied and no bandpass applied

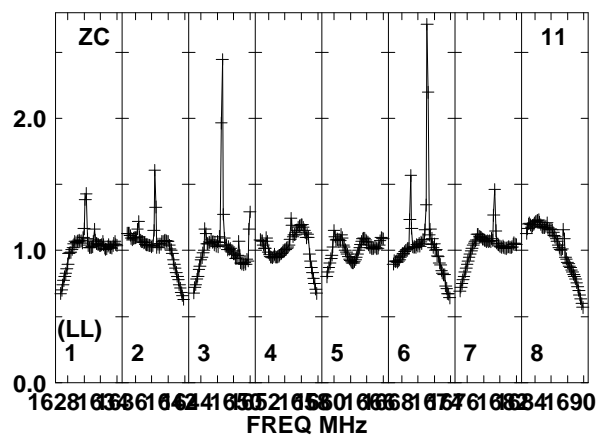
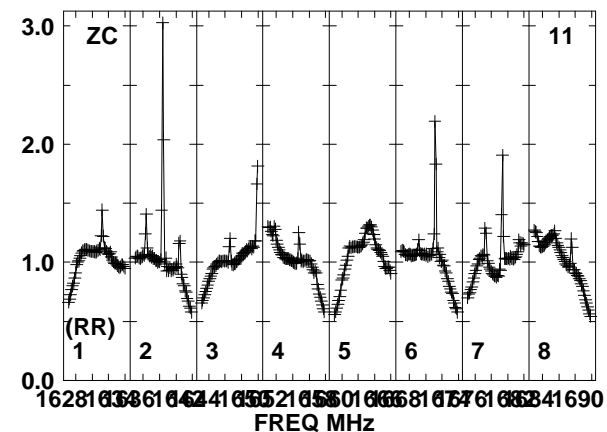
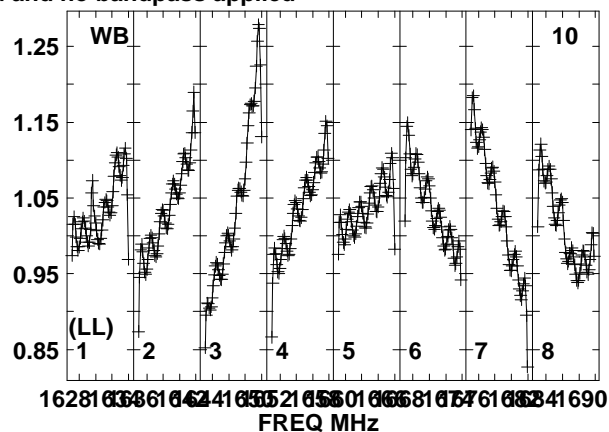
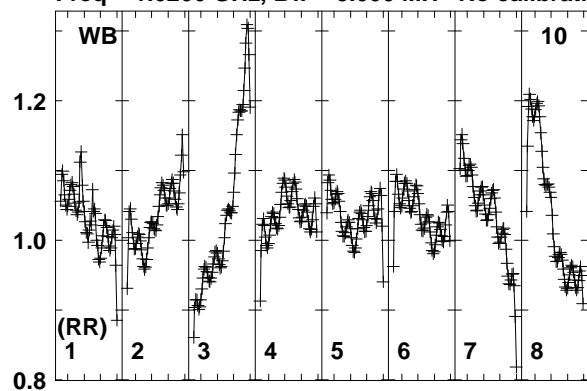

Lower frame: Real Jy
Total-power spectrum Antenna: WB (10)
Timerange: 00/16:50:03 to 00/16:52:29

Plot file version 73 created 01-AUG-2018 16:38:11

PB+3-2 N18L1 2.UVDATA.1

Freq = 1.6266 GHz, Bw = 8.000 MH No calibration applied and no bandpass applied

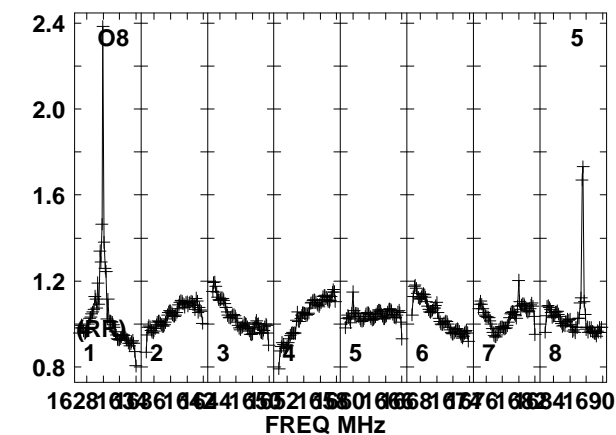
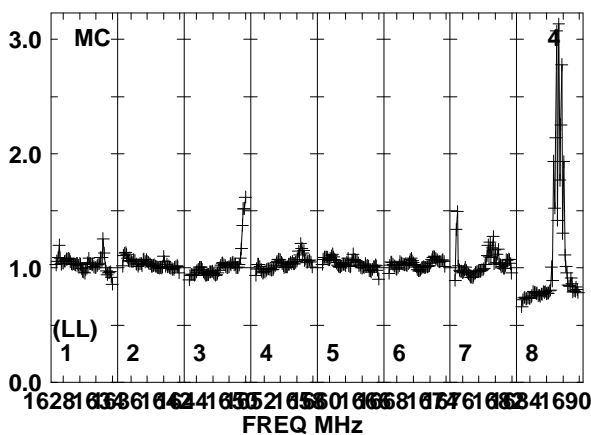
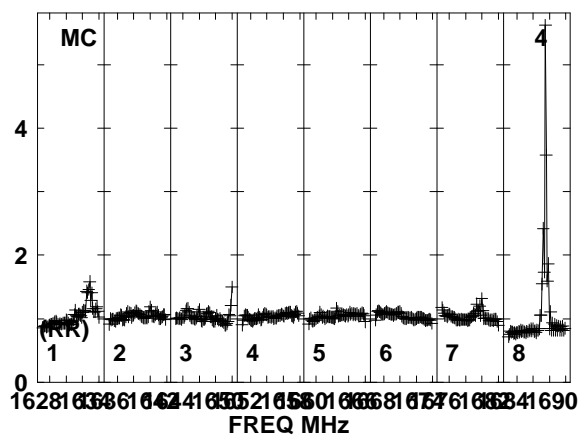
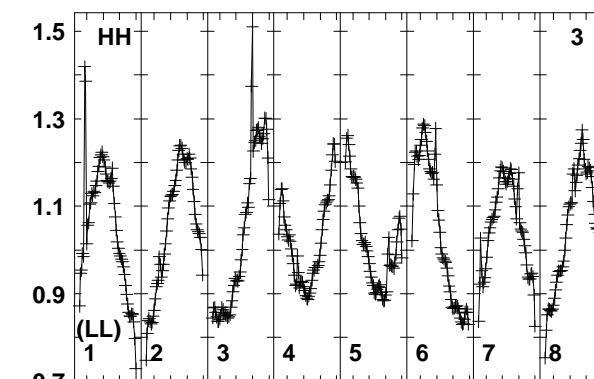
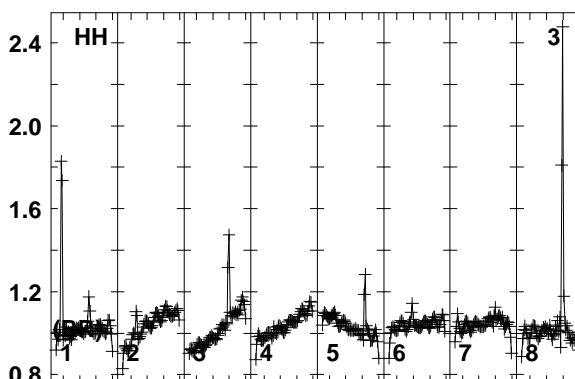
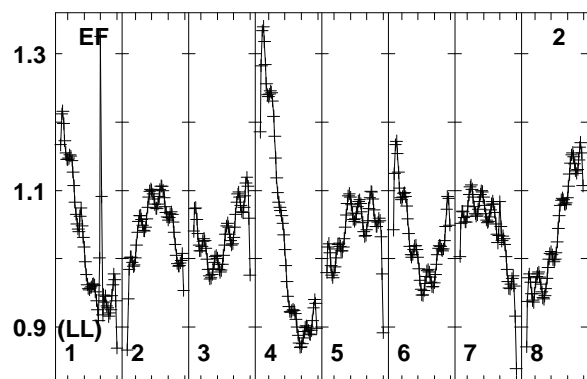
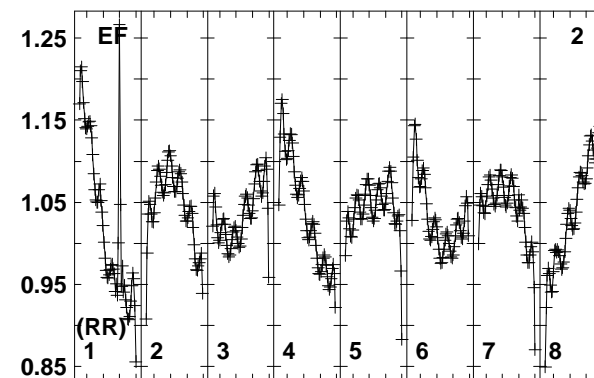
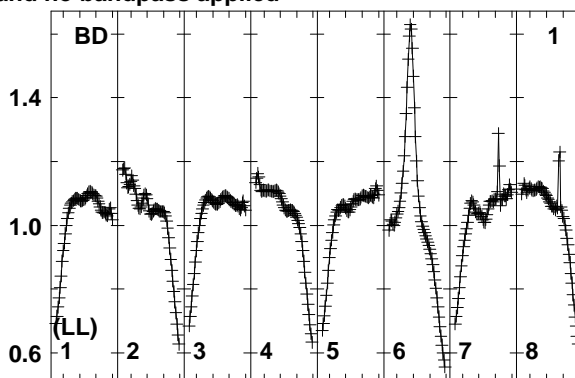
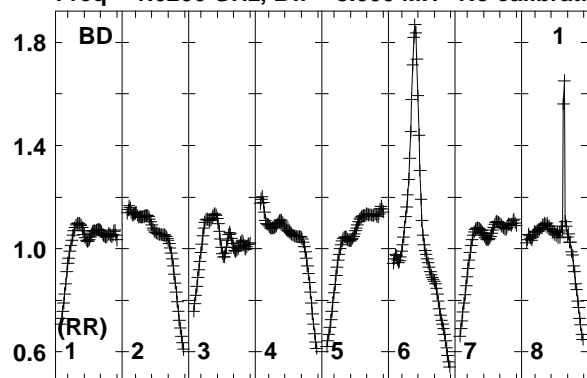

Lower frame: Real Jy
Total-power spectrum Antenna: BD (01)
Timerange: 00/16:52:33 to 00/16:54:59

Plot file version 74 created 01-AUG-2018 16:38:11
 PB+3-2 N18L1 2.UVDATA.1
 Freq = 1.6266 GHz, Bw = 8.000 MH No calibration applied and no bandpass applied

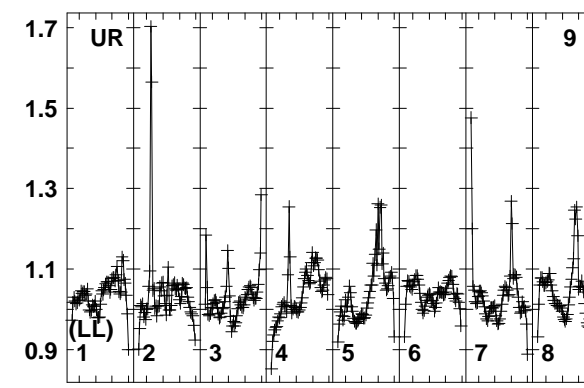
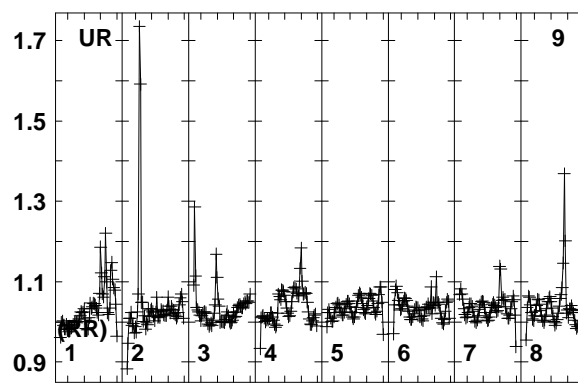
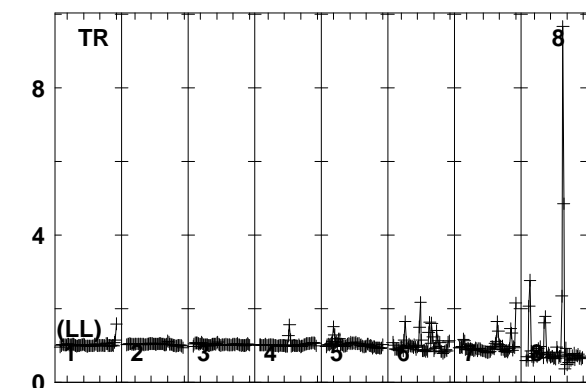
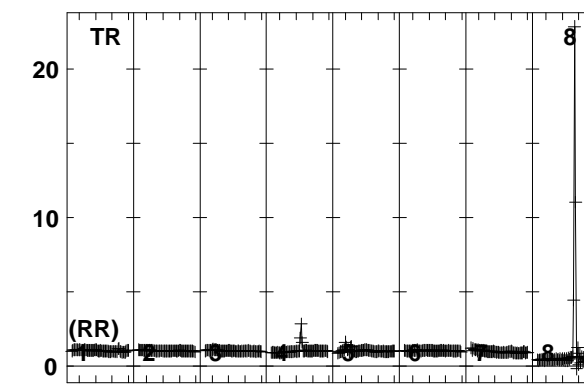
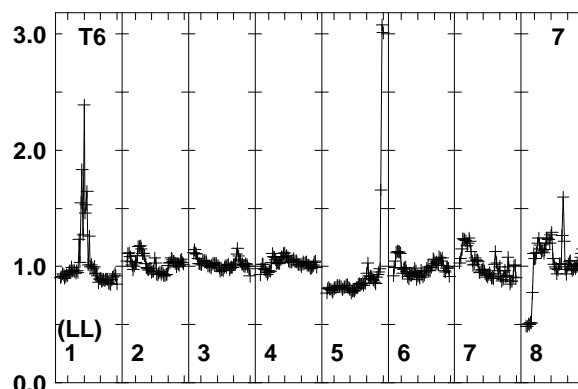
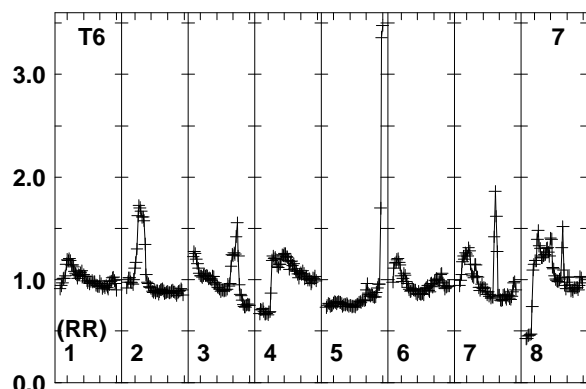
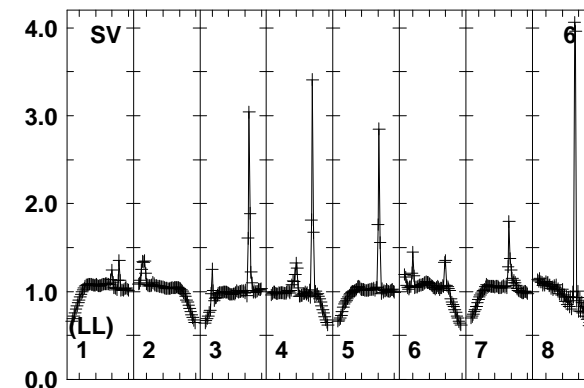
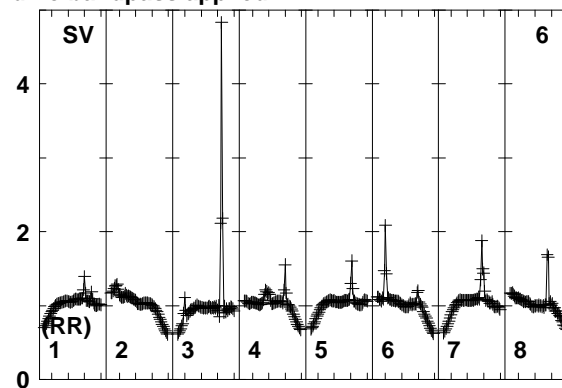
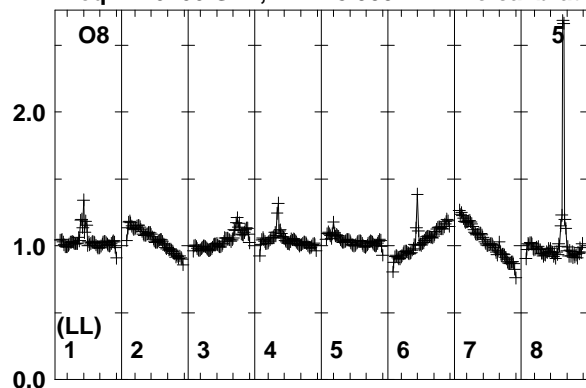

1628103861642416552165801666816746168241690
 FREQ MHz

1628103861642416552165801666816746168241690
 FREQ MHz

1628103861642416552165801666816746168241690
 FREQ MHz

Lower frame: Real Jy
 Total-power spectrum Antenna: O8 (05)
 Timerange: 00/16:52:33 to 00/16:54:59

Plot file version 75 created 01-AUG-2018 16:38:11

PB+3-2 N18L1 2.UVDATA.1

Freq = 1.6266 GHz, Bw = 8.000 MH No calibration applied and no bandpass applied

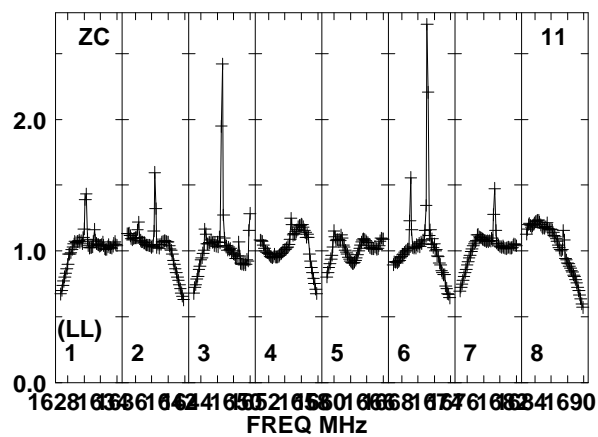
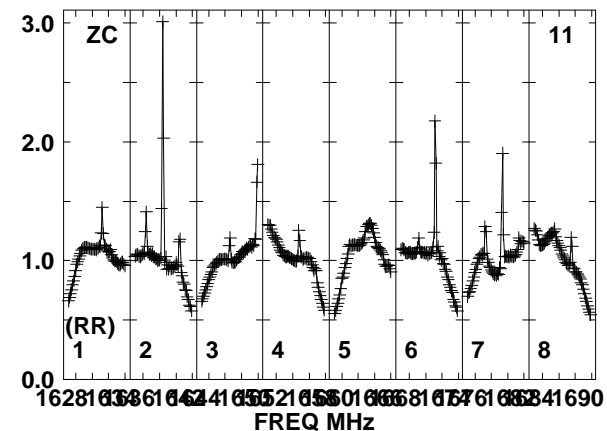
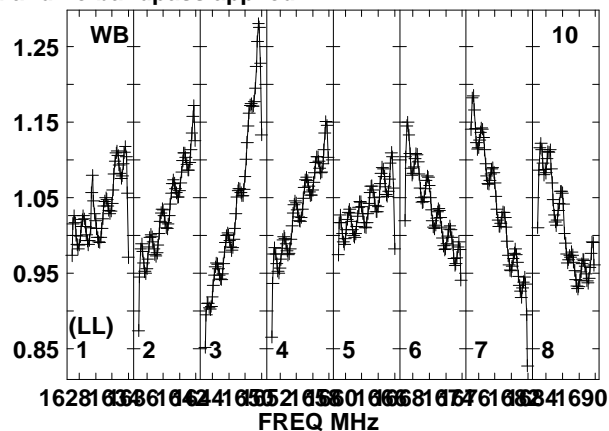
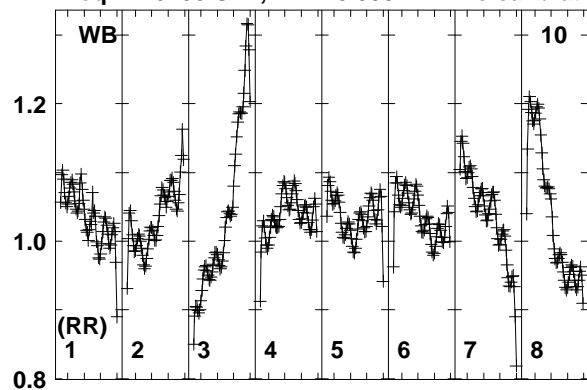

Lower frame: Real Jy
Total-power spectrum Antenna: WB (10)
Timerange: 00/16:52:33 to 00/16:54:59

Plot file version 76 created 01-AUG-2018 16:38:11

J0530+1331 N18L1 2.UVDATA.1

Freq = 1.6266 GHz, Bw = 8.000 MH No calibration applied and no bandpass applied

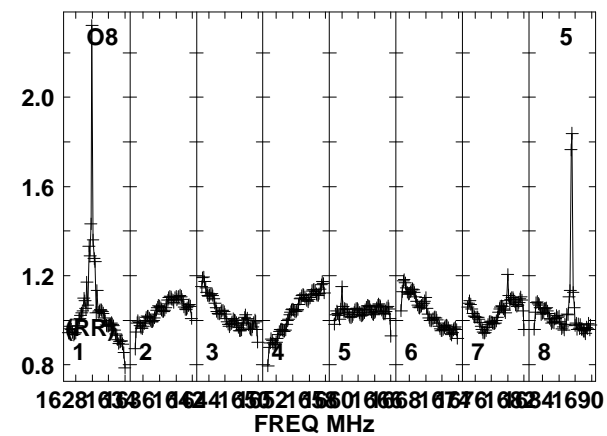
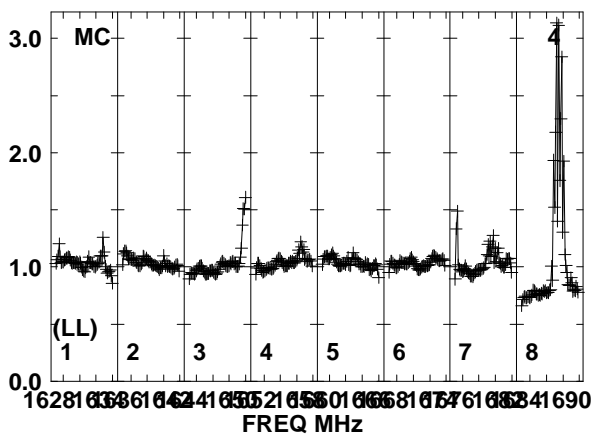
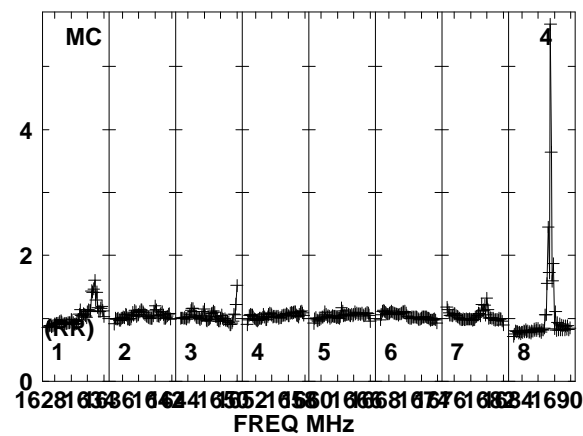
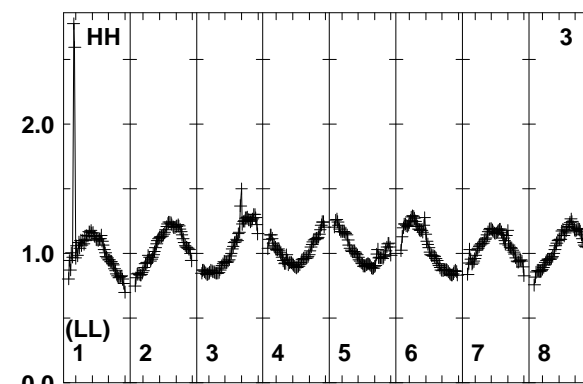
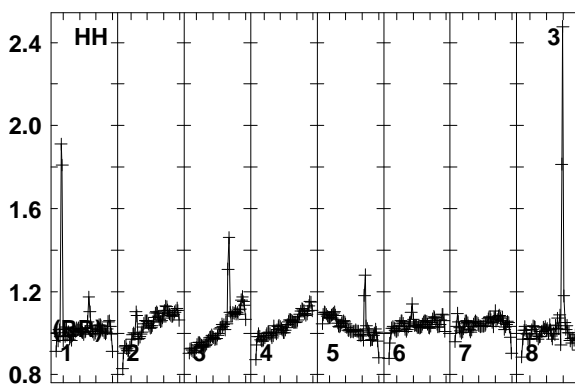
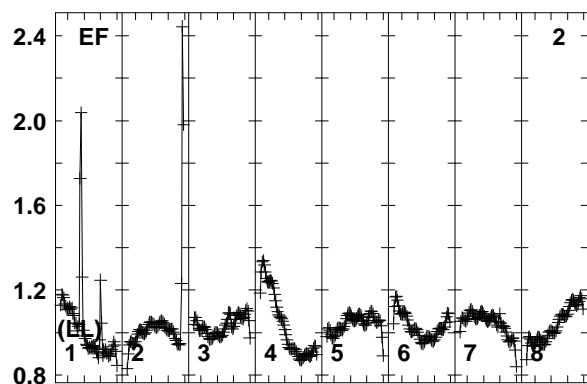
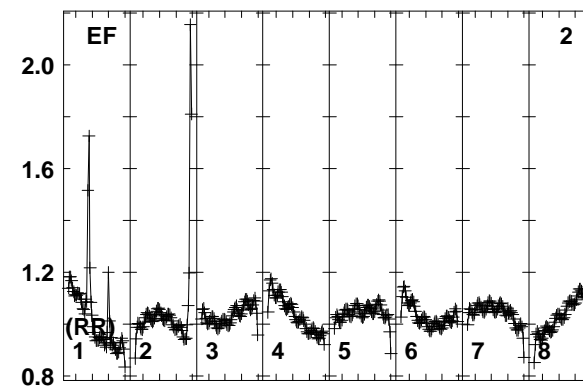
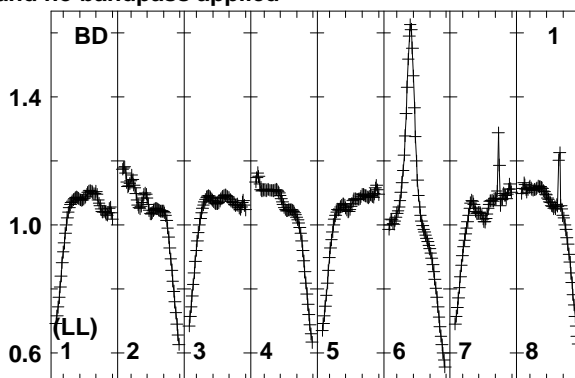
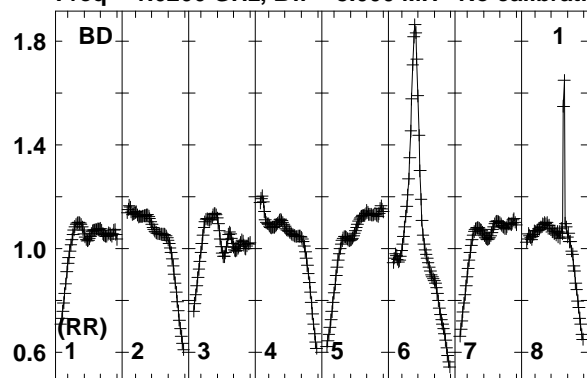

Lower frame: Real Jy
Total-power spectrum Antenna: BD (01)
Timerange: 00/16:55:41 to 00/16:56:59

Plot file version 77 created 01-AUG-2018 16:38:11
 J0530+1331 N18L1 2.UVDATA.1
 Freq = 1.6266 GHz, Bw = 8.000 MH No calibration applied and no bandpass applied

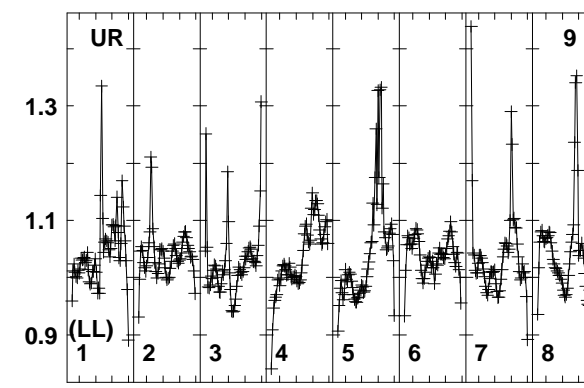
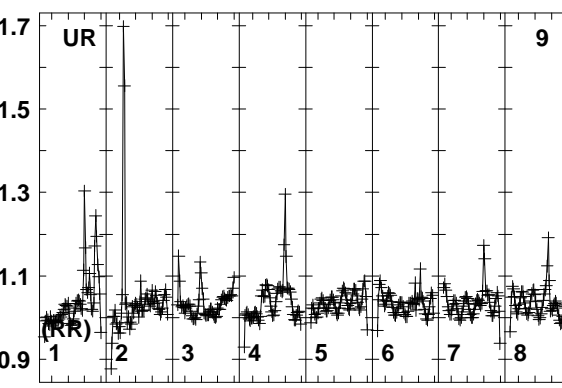
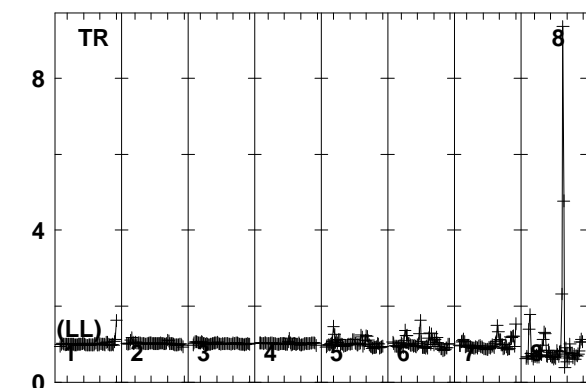
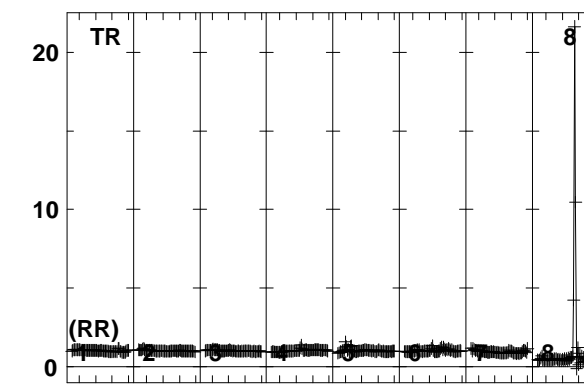
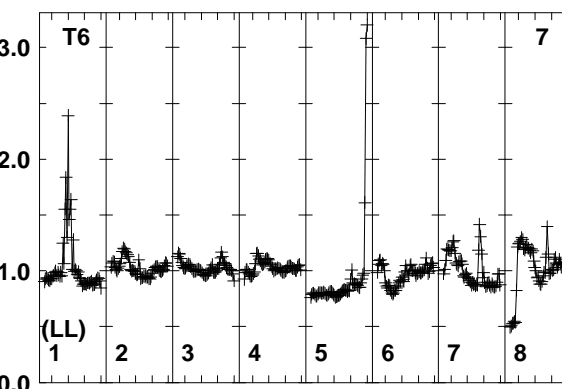
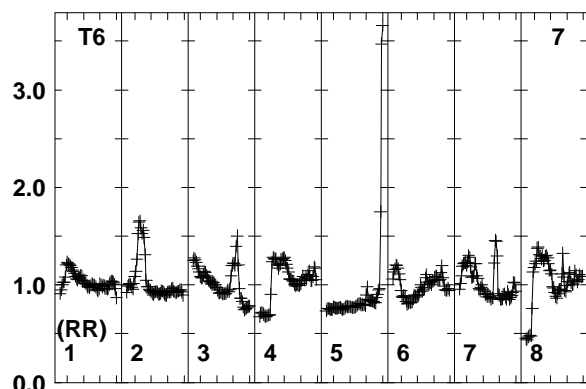
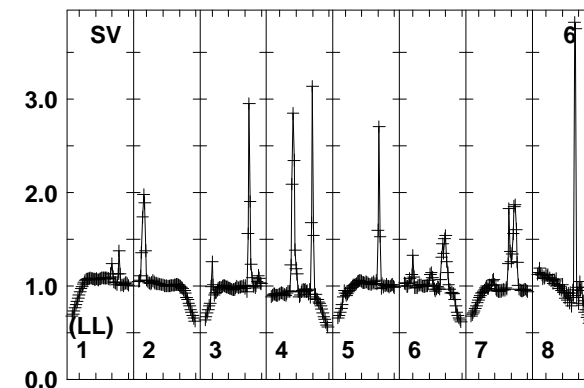
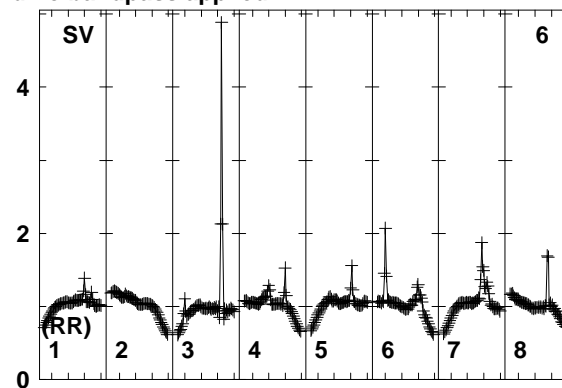
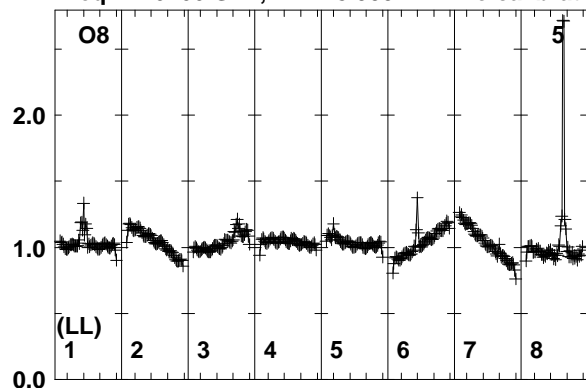

1628163861642416552165801666816746168241690
 FREQ MHz

1628163861642416552165801666816746168241690
 FREQ MHz

1628163861642416552165801666816746168241690
 FREQ MHz

Lower frame: Real Jy
 Total-power spectrum Antenna: O8 (05)
 Timerange: 00/16:55:41 to 00/16:56:59

Plot file version 78 created 01-AUG-2018 16:38:12

J0530+1331 N18L1 2.UVDATA.1

Freq = 1.6266 GHz, Bw = 8.000 MH No calibration applied and no bandpass applied

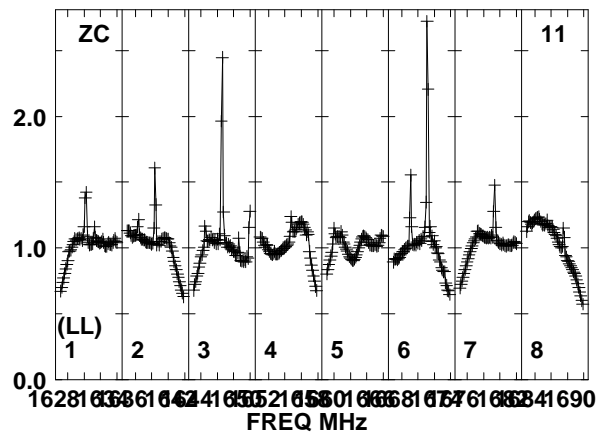
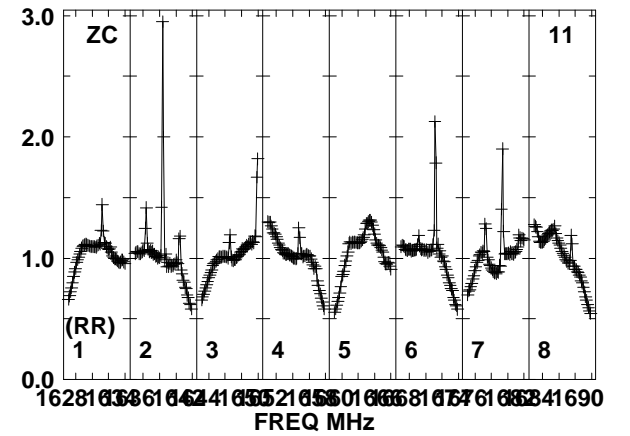
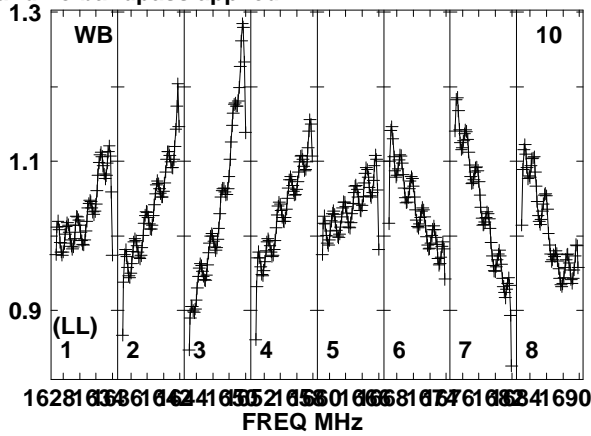
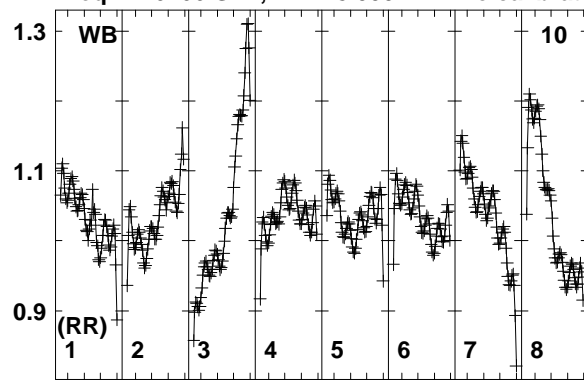

Lower frame: Real Jy
Total-power spectrum Antenna: WB (10)
Timerange: 00/16:55:41 to 00/16:56:59

Plot file version 79 created 01-AUG-2018 16:38:12

PB+2-2 N18L1 2.UVDATA.1

Freq = 1.6266 GHz, Bw = 8.000 MH No calibration applied and no bandpass applied

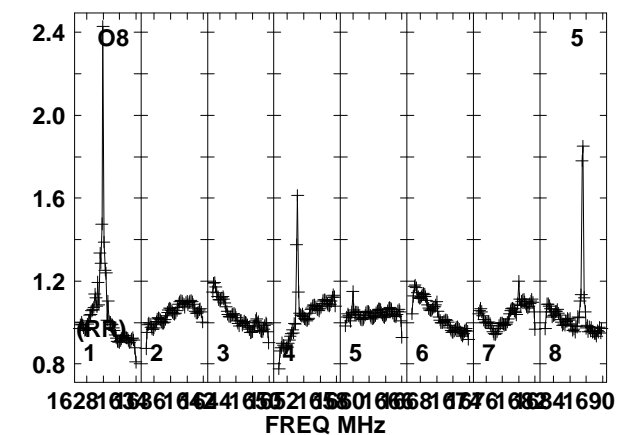
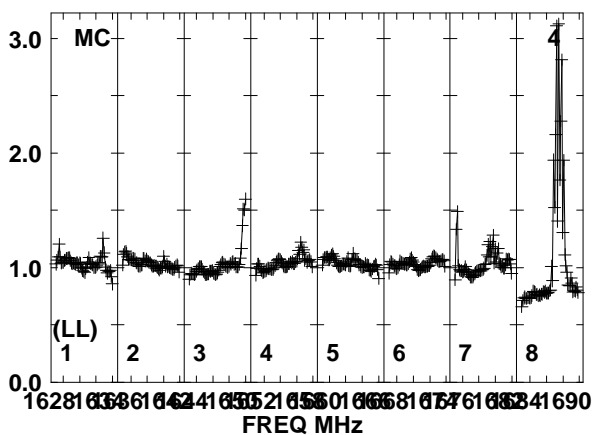
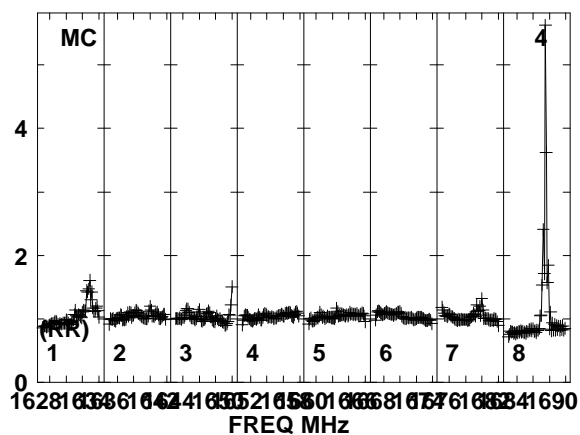
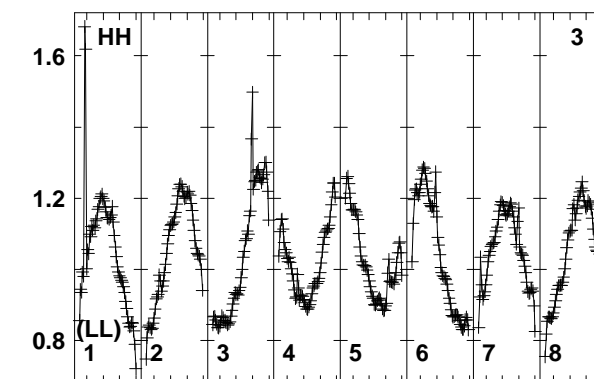
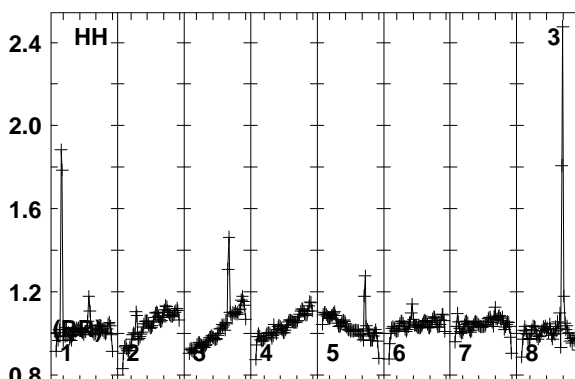
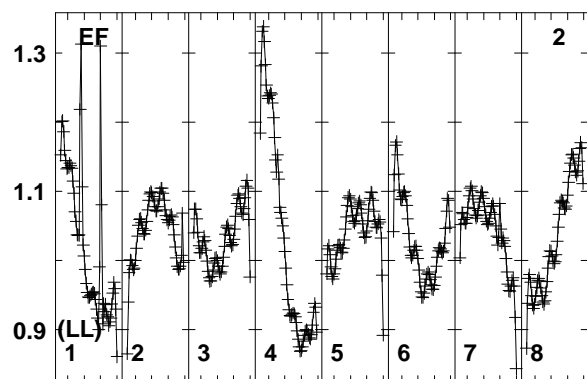
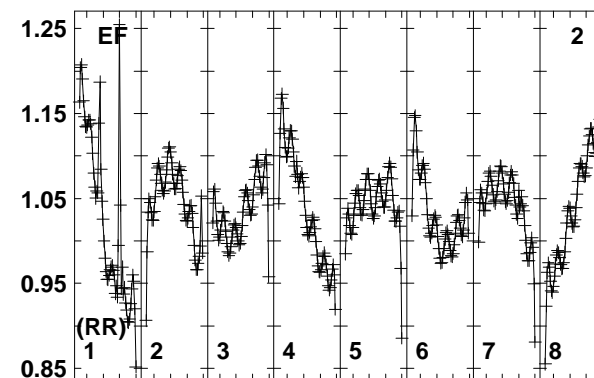
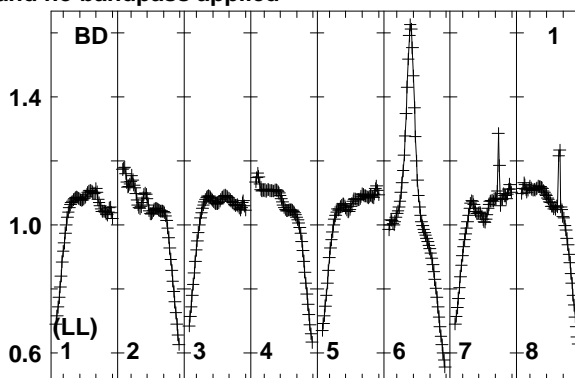
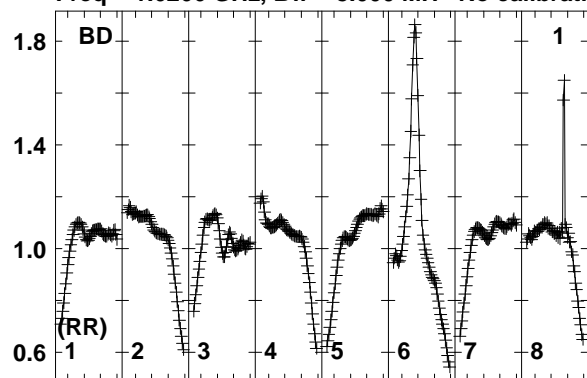

Lower frame: Real Jy
Total-power spectrum Antenna: BD (01)
Timerange: 00/16:57:03 to 00/16:59:29

Plot file version 80 created 01-AUG-2018 16:38:12
 PB+2-2 N18L1 2.UVDATA.1
 Freq = 1.6266 GHz, Bw = 8.000 MH No calibration applied and no bandpass applied

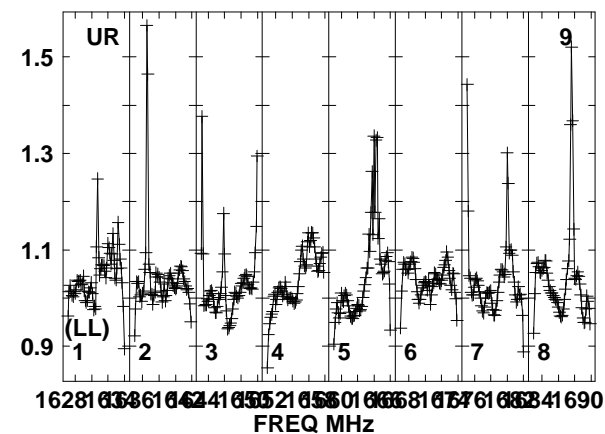
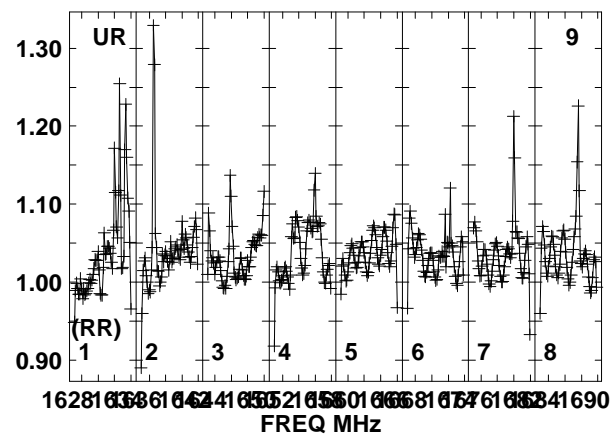
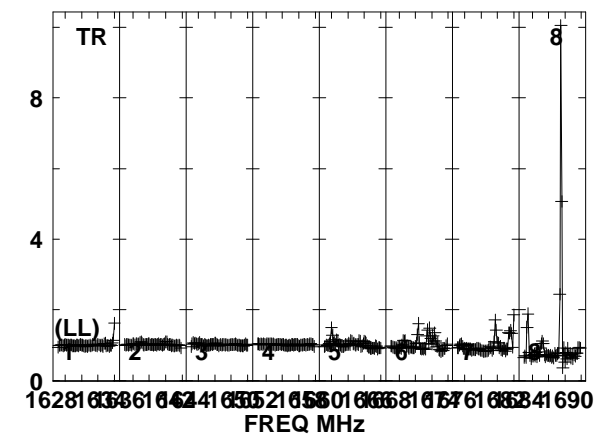
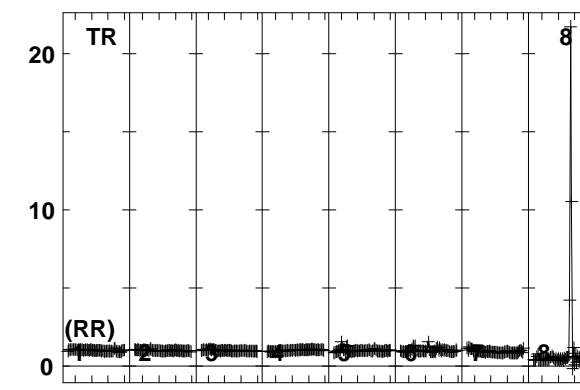
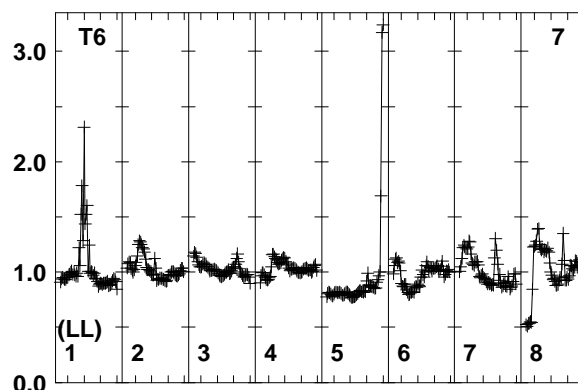
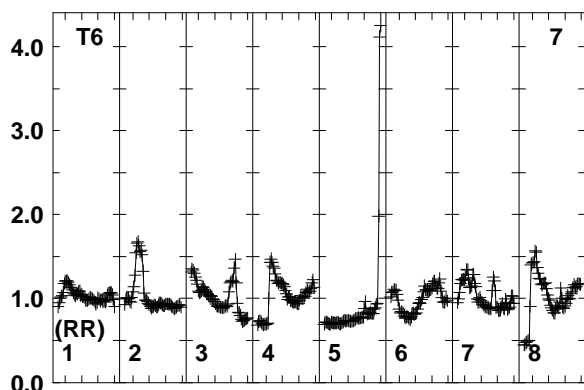
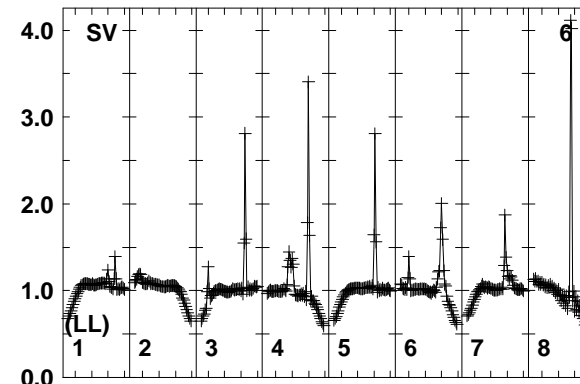
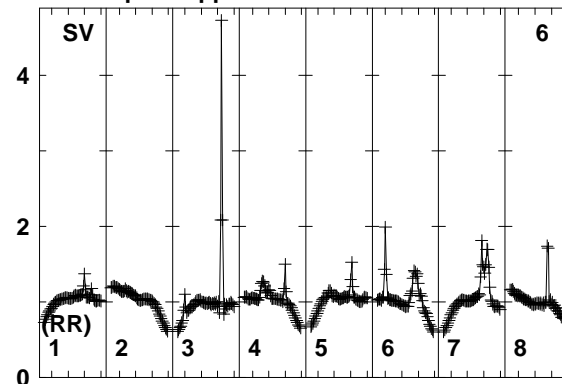
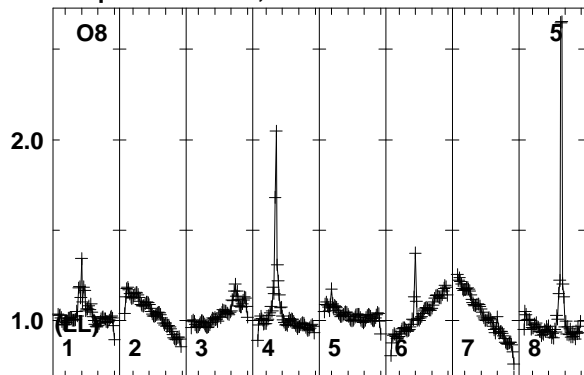

Lower frame: Real Jy
 Total-power spectrum Antenna: O8 (05)
 Timerange: 00/16:57:03 to 00/16:59:29

Plot file version 81 created 01-AUG-2018 16:38:12

PB+2-2 N18L1 2.UVDATA.1

Freq = 1.6266 GHz, Bw = 8.000 MH No calibration applied and no bandpass applied

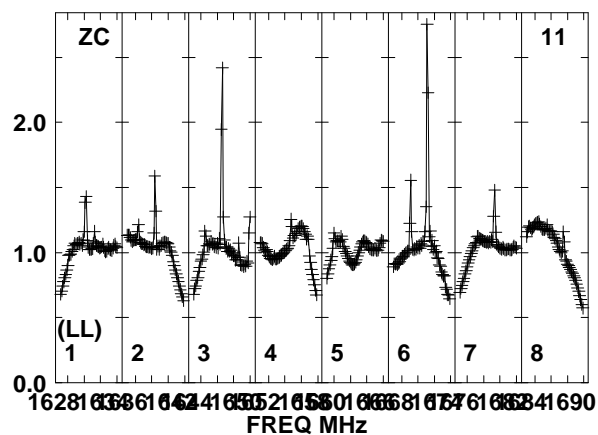
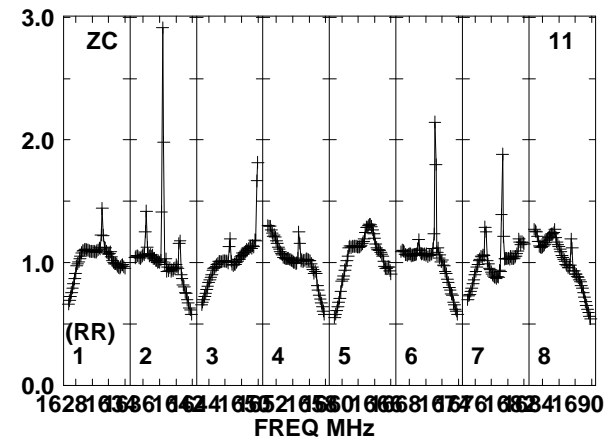
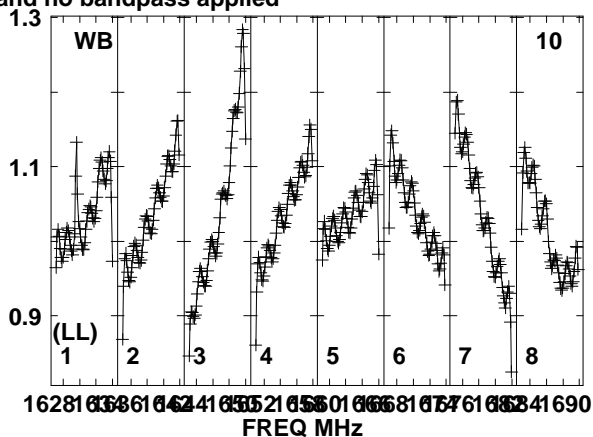
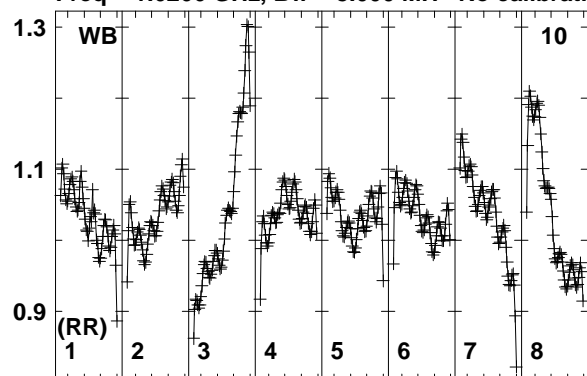

Lower frame: Real Jy
Total-power spectrum Antenna: WB (10)
Timerange: 00/16:57:03 to 00/16:59:29

Plot file version 82 created 01-AUG-2018 16:38:12

PB+1-2 N18L1 2.UVDATA.1

Freq = 1.6266 GHz, Bw = 8.000 MH No calibration applied and no bandpass applied

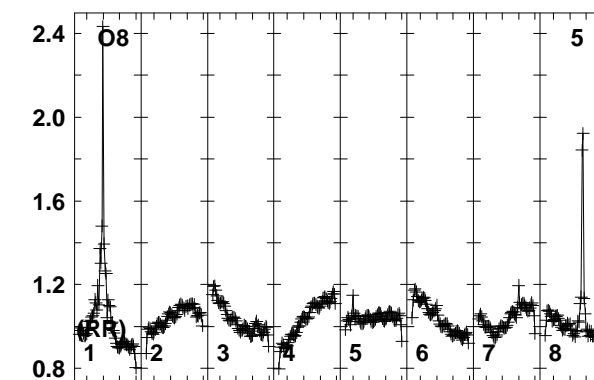
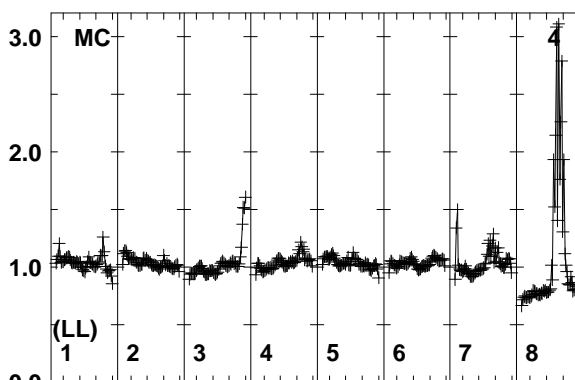
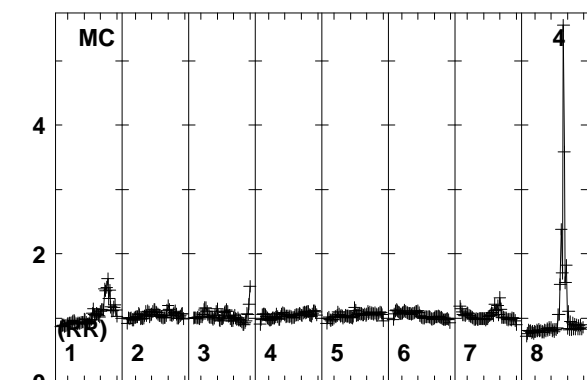
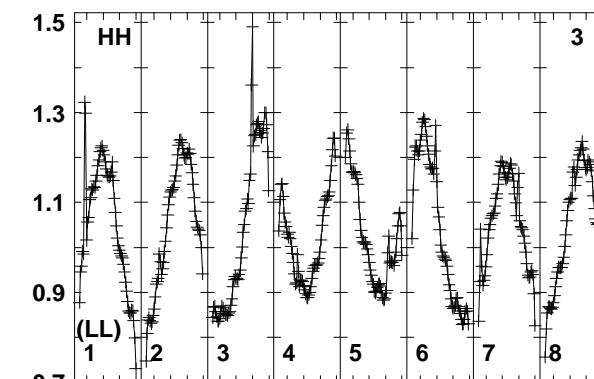
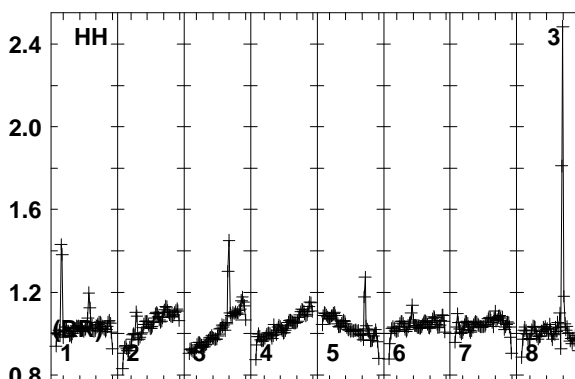
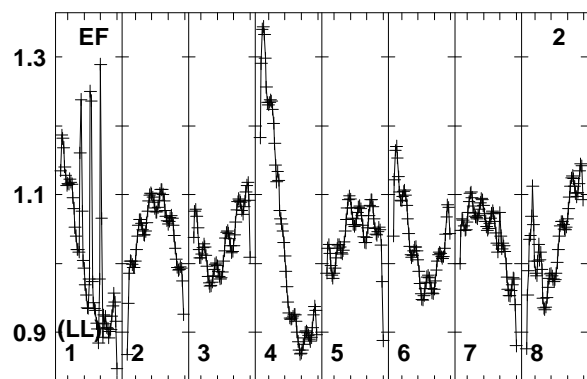
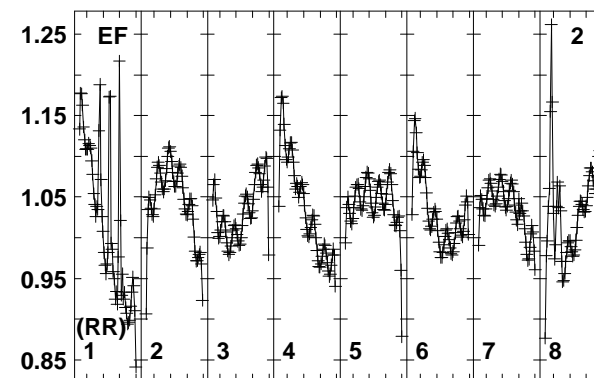
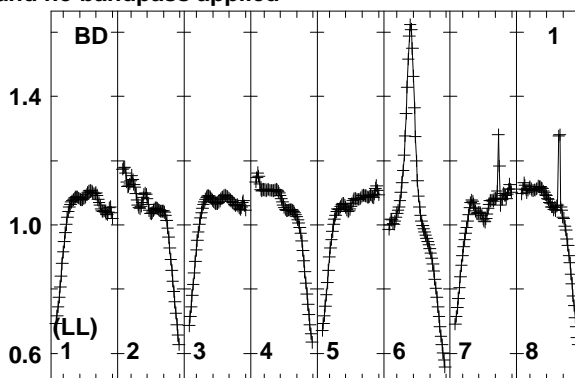
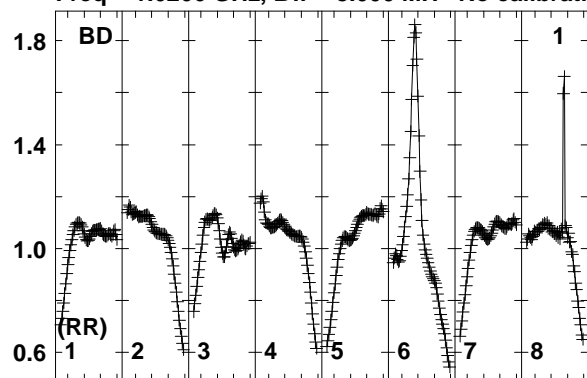

16281 03961 04241 0521 05501 06581 07761 08241 690
FREQ MHz

16281 03961 04241 0521 05501 06581 07761 08241 690
FREQ MHz

16281 03961 04241 0521 05501 06581 07761 08241 690
FREQ MHz

Lower frame: Real Jy
Total-power spectrum Antenna: BD (01)
Timerange: 00/16:59:33 to 00/17:01:59

Plot file version 83 created 01-AUG-2018 16:38:12
 PB+1-2 N18L1 2.UVDATA.1
 Freq = 1.6266 GHz, Bw = 8.000 MH No calibration applied and no bandpass applied

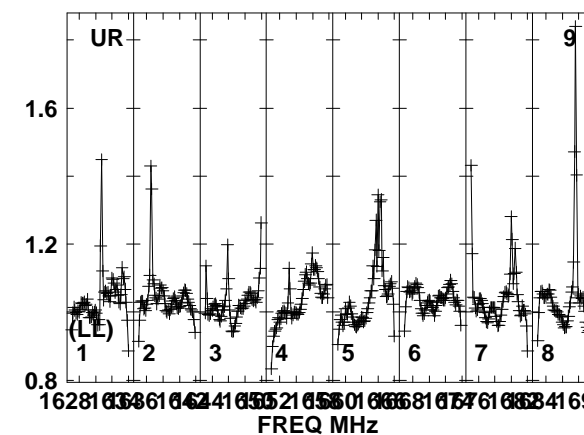
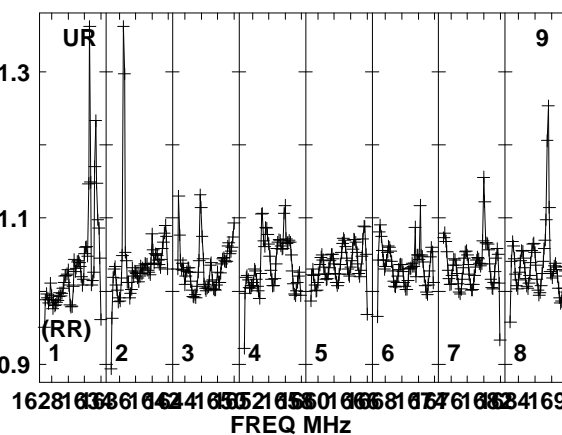
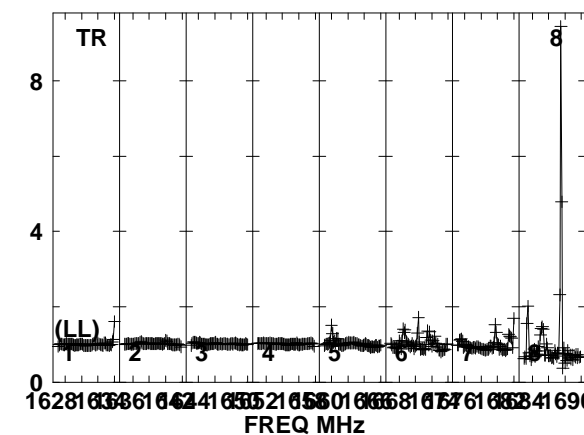
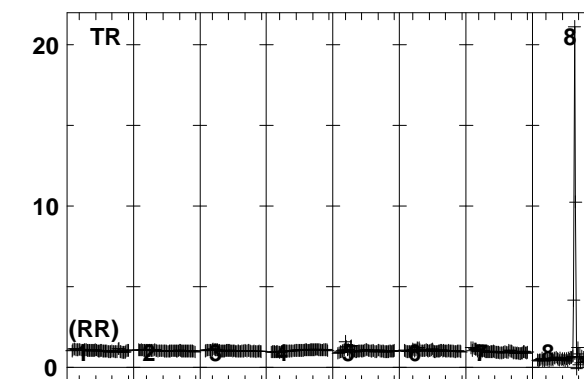
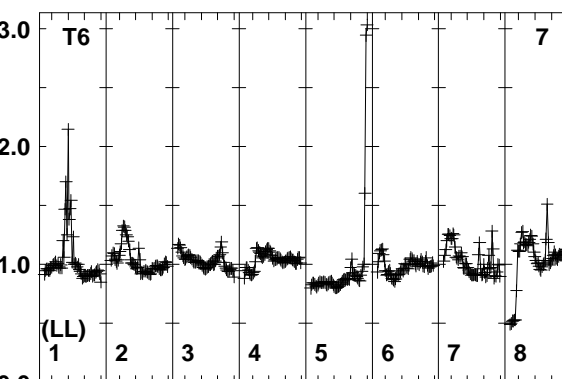
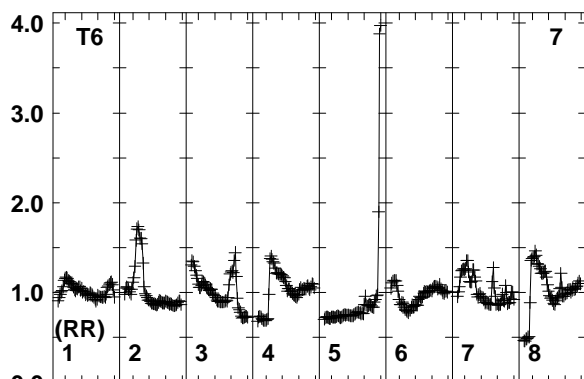
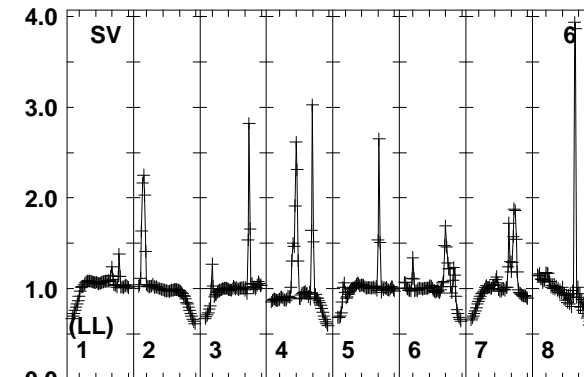
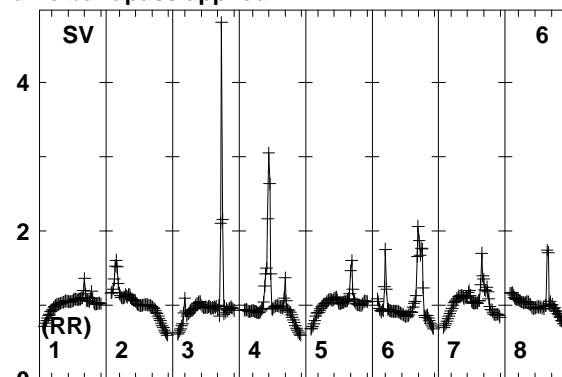
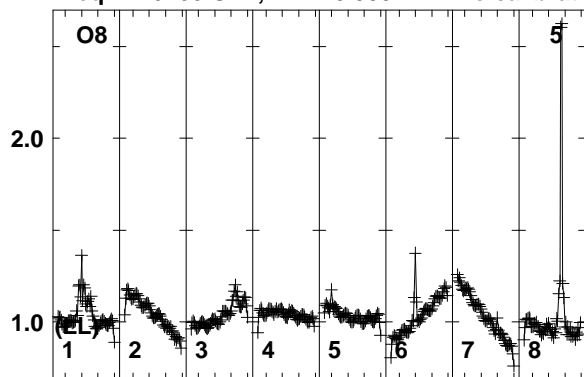

Lower frame: Real Jy
 Total-power spectrum Antenna: O8 (05)
 Timerange: 00/16:59:33 to 00/17:01:59

Plot file version 84 created 01-AUG-2018 16:38:12

PB+1-2 N18L1 2.UVDATA.1

Freq = 1.6266 GHz, Bw = 8.000 MH No calibration applied and no bandpass applied

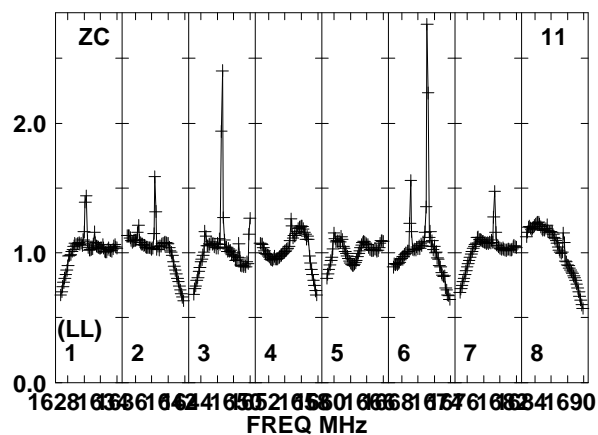
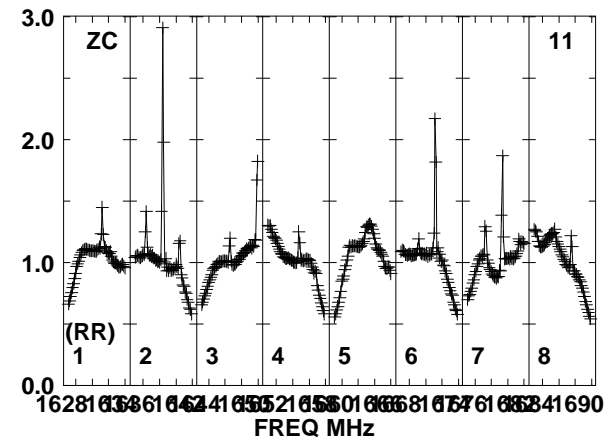
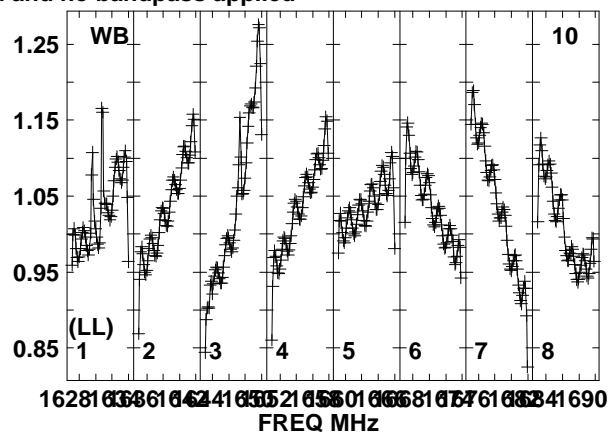
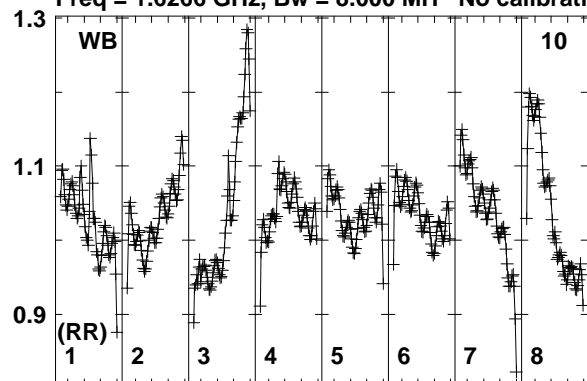

Lower frame: Real Jy
Total-power spectrum Antenna: WB (10)
Timerange: 00/16:59:33 to 00/17:01:59

Plot file version 85 created 01-AUG-2018 16:38:12

PB+0-2 N18L1 2.UVDATA.1

Freq = 1.6266 GHz, Bw = 8.000 MH No calibration applied and no bandpass applied

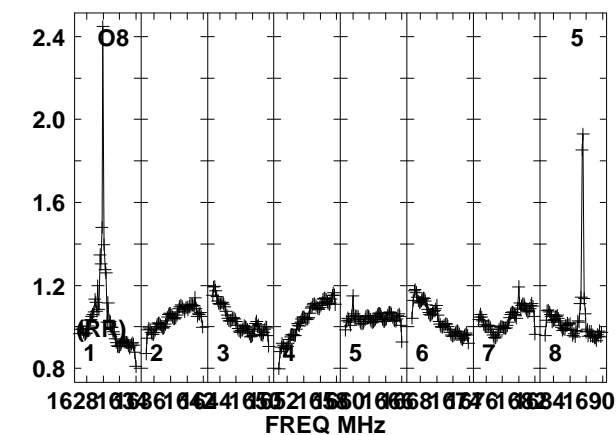
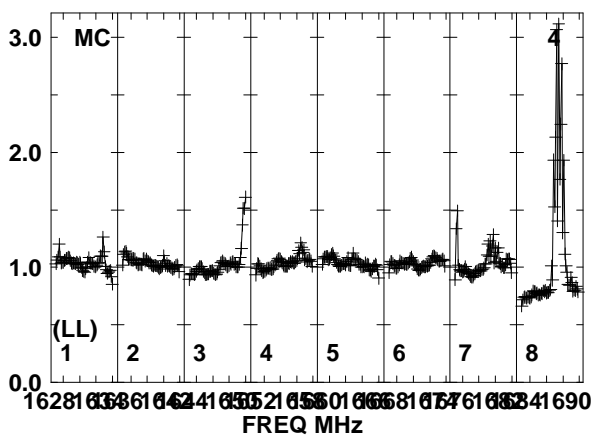
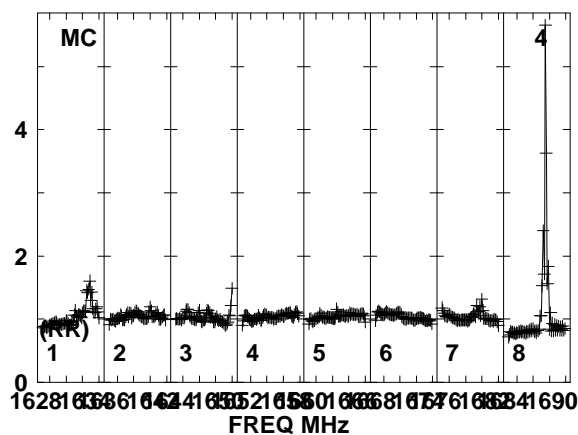
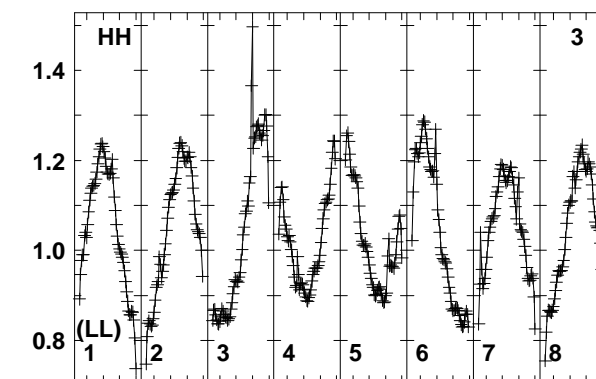
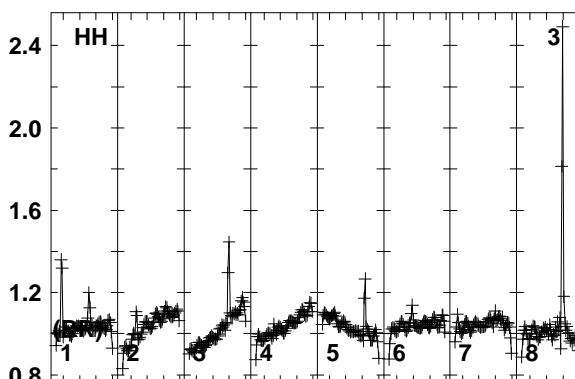
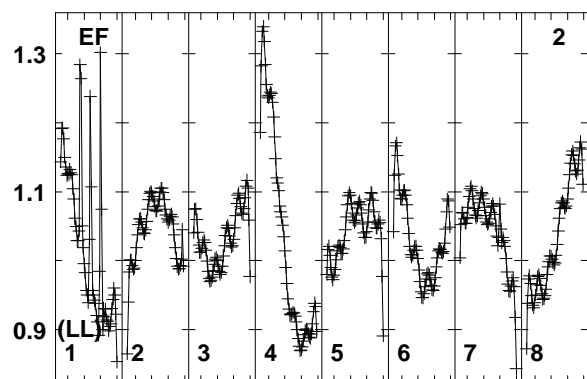
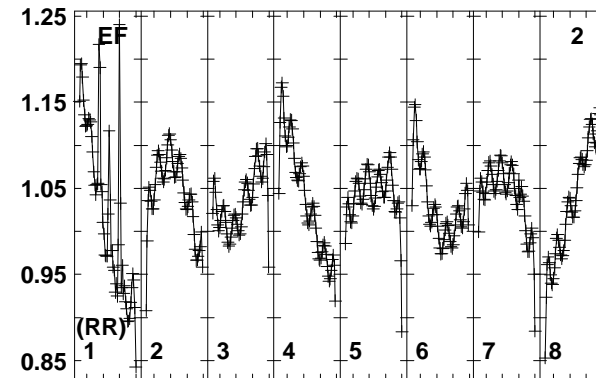
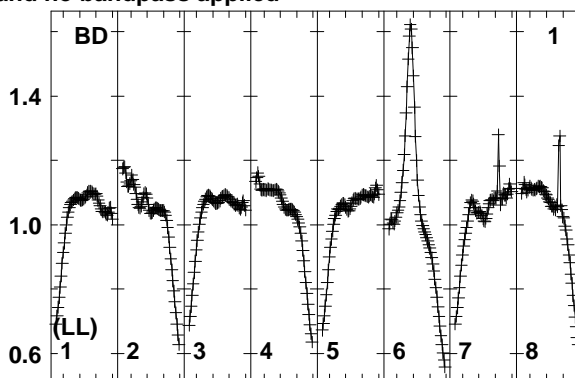
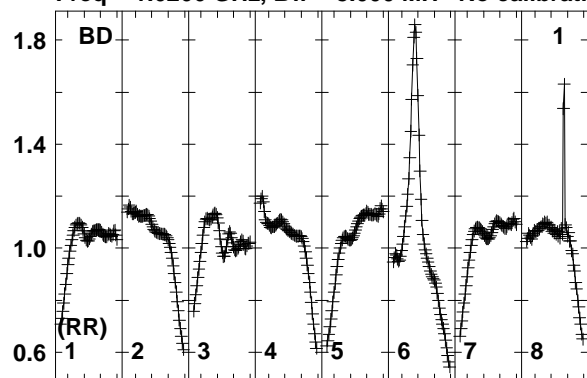

Lower frame: Real Jy
Total-power spectrum Antenna: BD (01)
Timerange: 00/17:02:03 to 00/17:04:29

Plot file version 86 created 01-AUG-2018 16:38:13
 PB+0-2 N18L1 2.UVDATA.1
 Freq = 1.6266 GHz, Bw = 8.000 MH No calibration applied and no bandpass applied

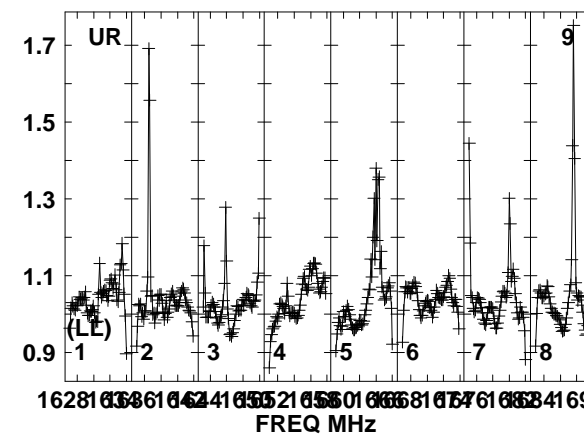
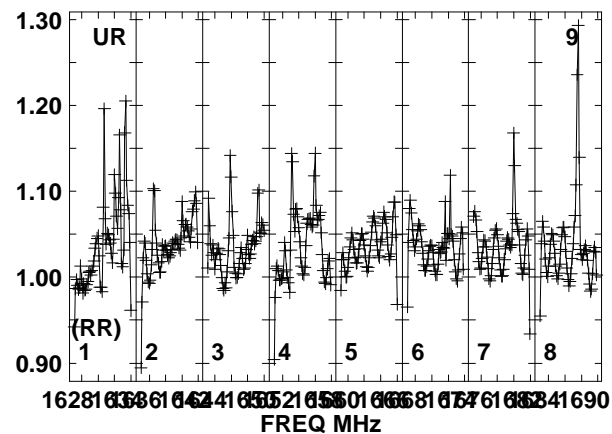
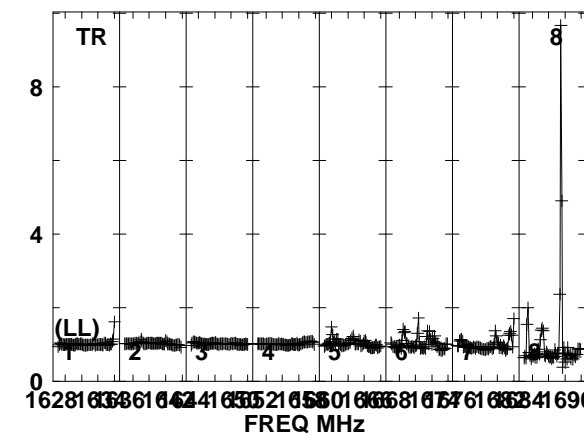
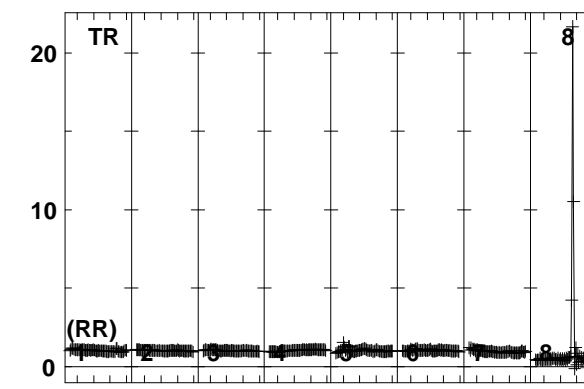
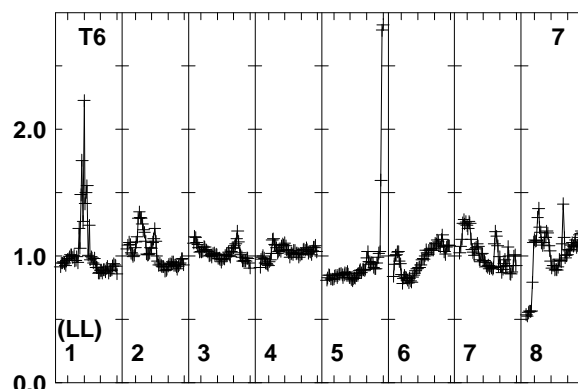
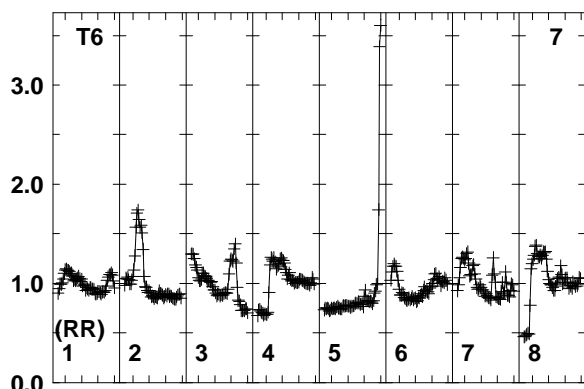
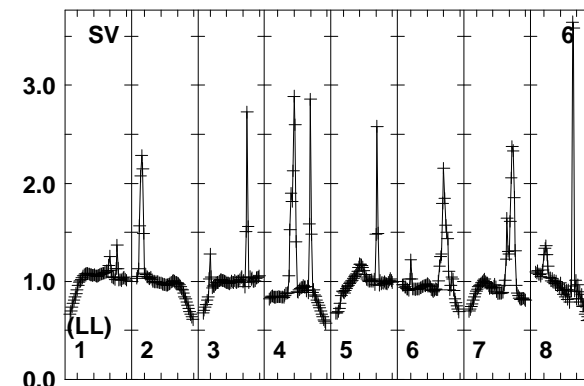
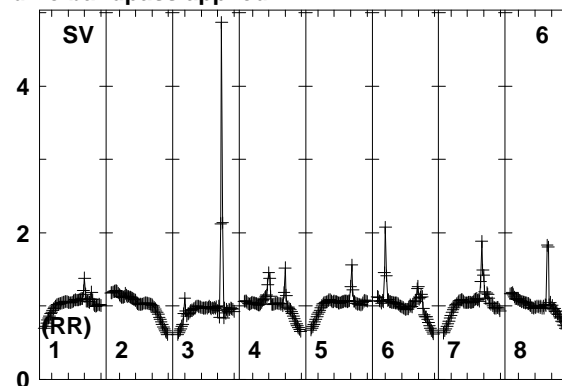
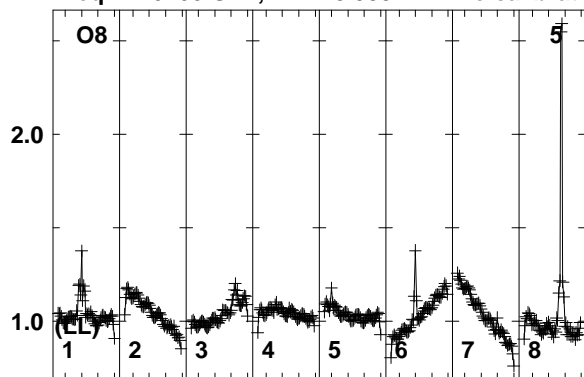

Lower frame: Real Jy
 Total-power spectrum Antenna: O8 (05)
 Timerange: 00/17:02:03 to 00/17:04:29

Plot file version 87 created 01-AUG-2018 16:38:13

PB+0-2 N18L1 2.UVDATA.1

Freq = 1.6266 GHz, Bw = 8.000 MH No calibration applied and no bandpass applied

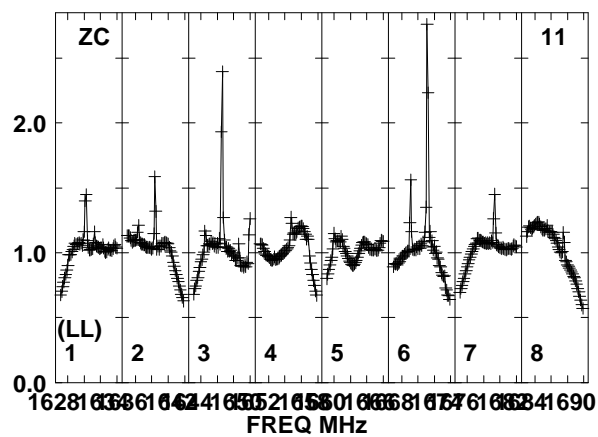
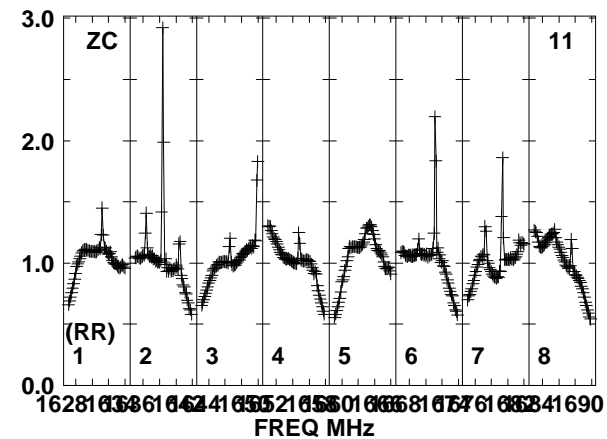
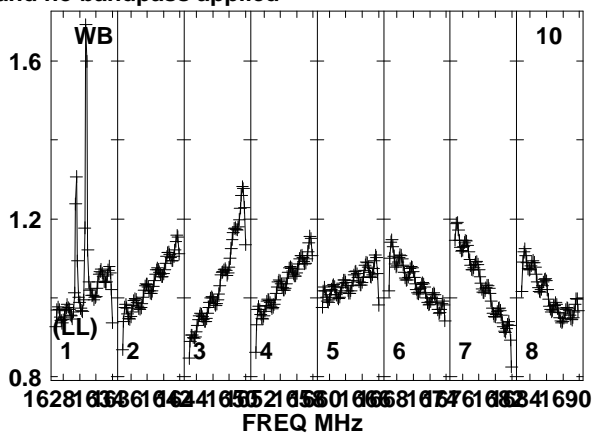
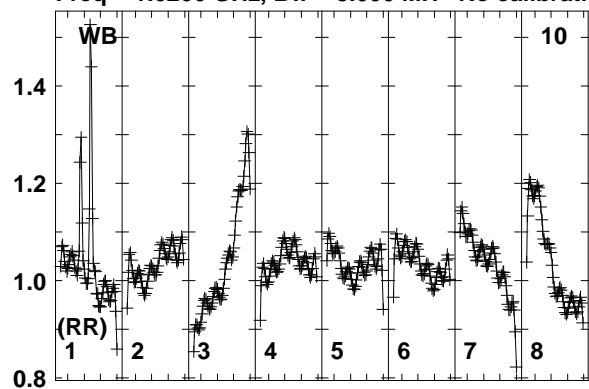

Lower frame: Real Jy
Total-power spectrum Antenna: WB (10)
Timerange: 00/17:02:03 to 00/17:04:29

Plot file version 88 created 01-AUG-2018 16:38:13

PB-1-2 N18L1 2.UVDATA.1

Freq = 1.6266 GHz, Bw = 8.000 MH No calibration applied and no bandpass applied

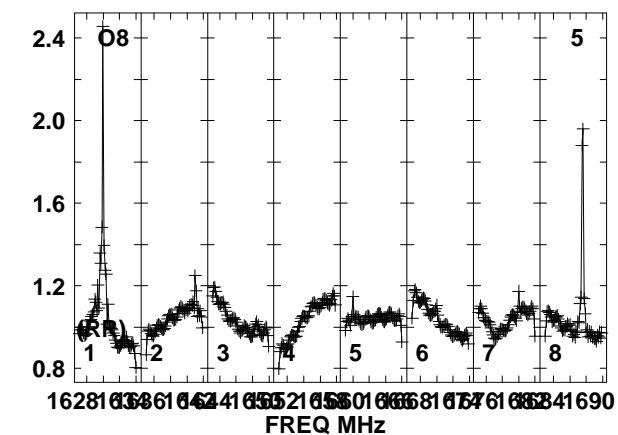
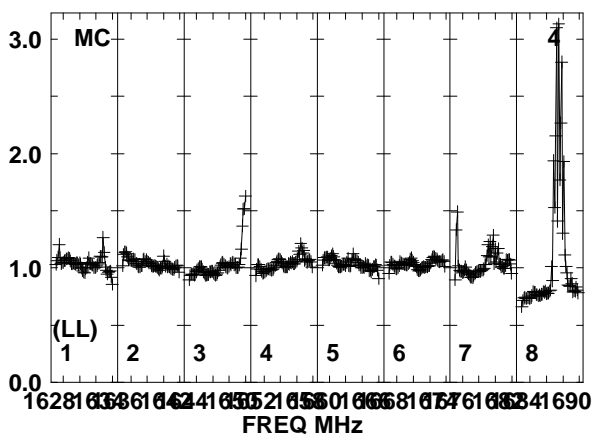
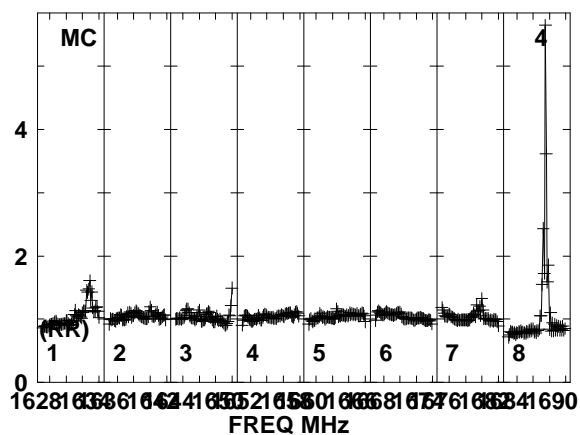
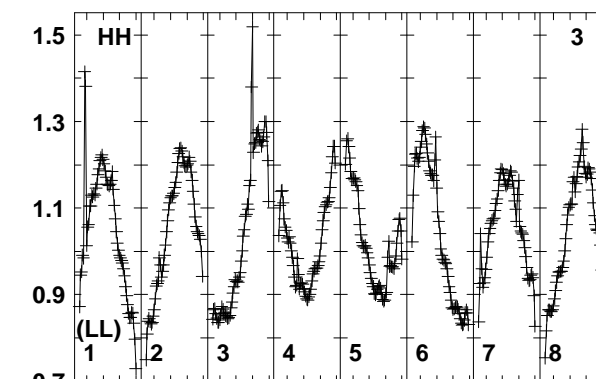
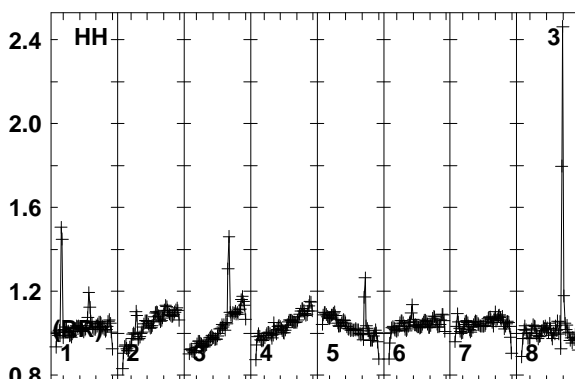
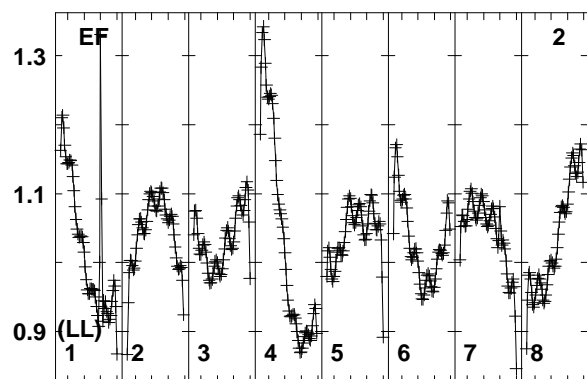
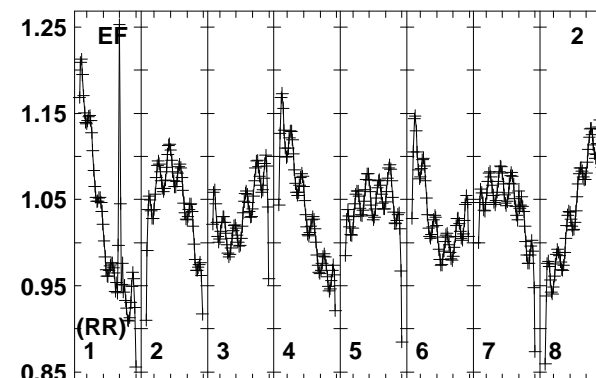
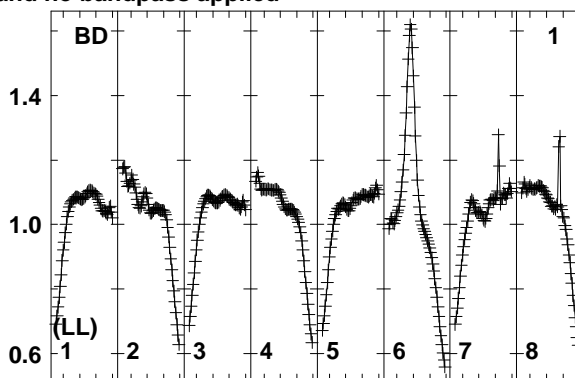
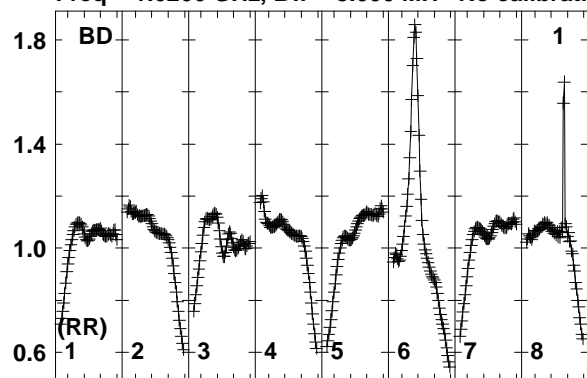

Lower frame: Real Jy
Total-power spectrum Antenna: BD (01)
Timerange: 00/17:04:33 to 00/17:06:59

Plot file version 89 created 01-AUG-2018 16:38:13
 PB-1-2 N18L1 2.UVDATA.1
 Freq = 1.6266 GHz, Bw = 8.000 MH No calibration applied and no bandpass applied

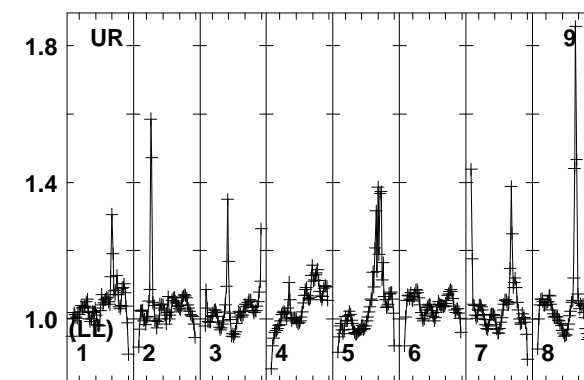
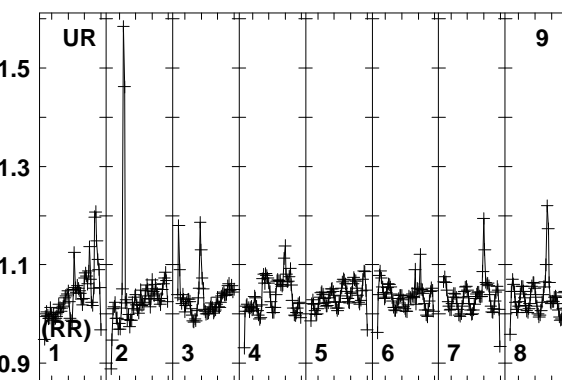
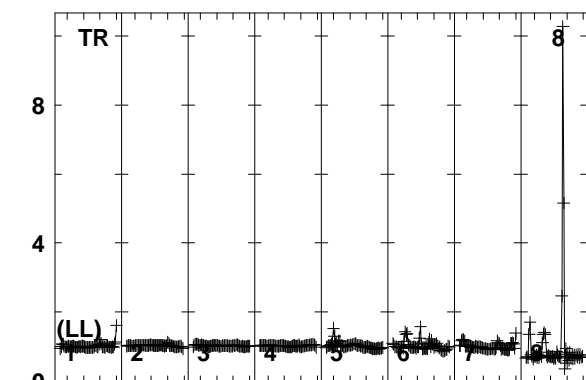
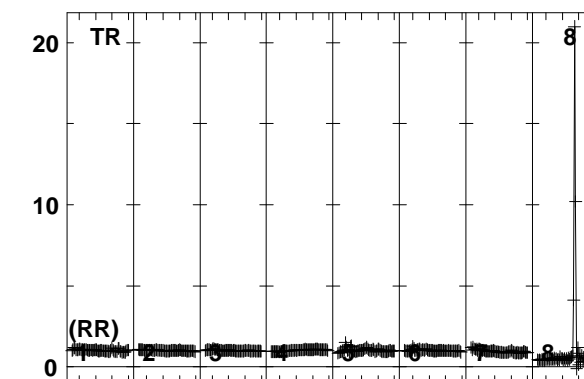
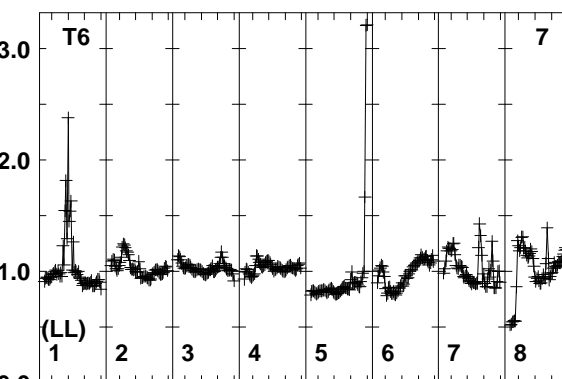
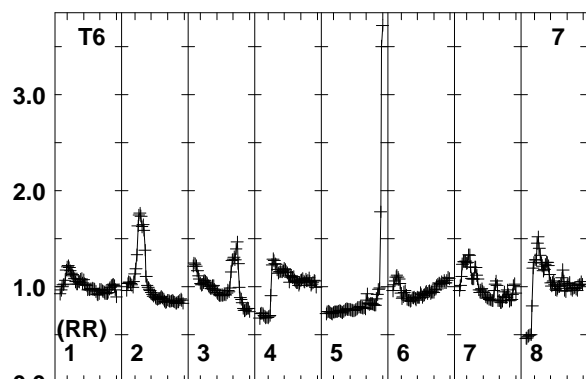
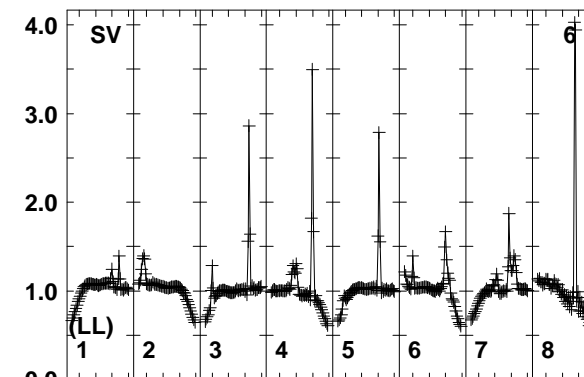
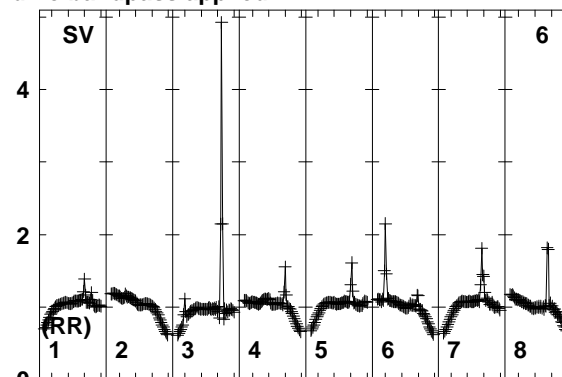
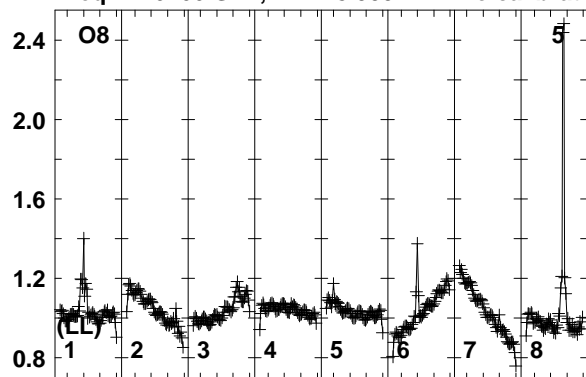

1628103861642416552165801666816746168241690
 FREQ MHz

1628103861642416552165801666816746168241690
 FREQ MHz

1628103861642416552165801666816746168241690
 FREQ MHz

Lower frame: Real Jy
 Total-power spectrum Antenna: O8 (05)
 Timerange: 00/17:04:33 to 00/17:06:59

Plot file version 90 created 01-AUG-2018 16:38:13

PB-1-2 N18L1 2.UVDATA.1

Freq = 1.6266 GHz, Bw = 8.000 MH No calibration applied and no bandpass applied

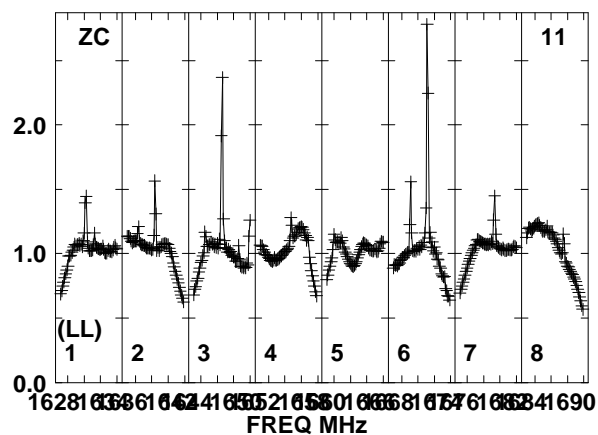
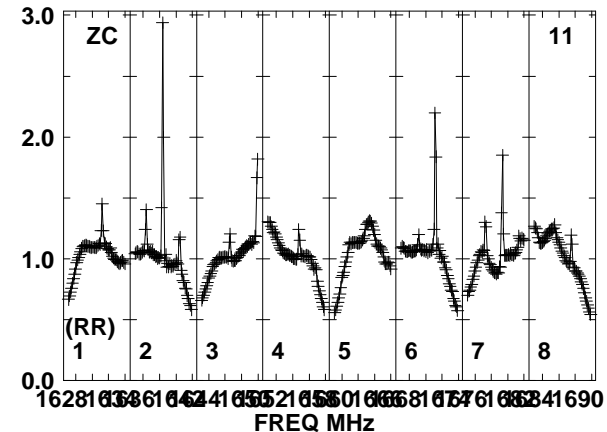
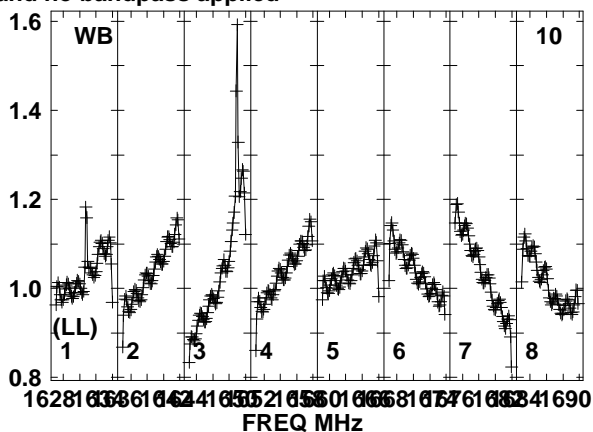
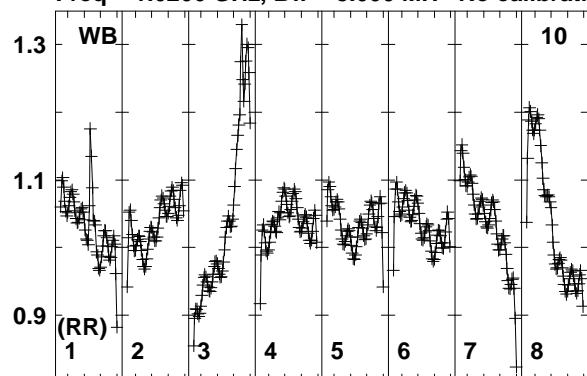

Lower frame: Real Jy
Total-power spectrum Antenna: WB (10)
Timerange: 00/17:04:33 to 00/17:06:59

Plot file version 91 created 01-AUG-2018 16:38:13

J0530+1331 N18L1 2.UVDATA.1

Freq = 1.6266 GHz, Bw = 8.000 MH No calibration applied and no bandpass applied

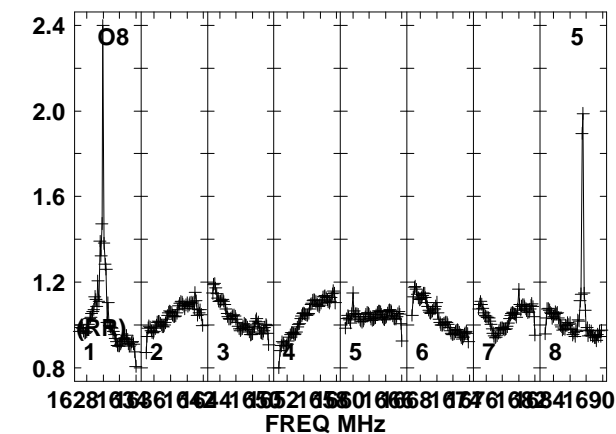
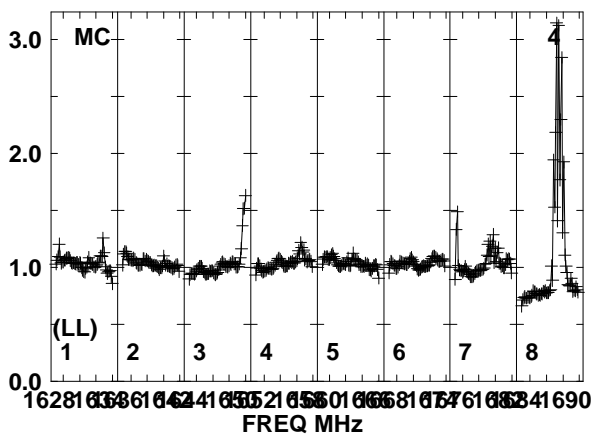
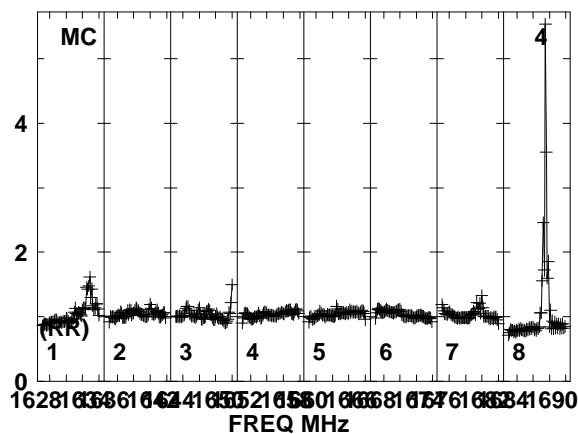
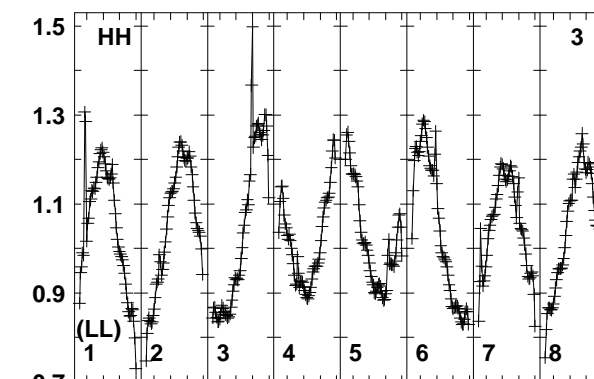
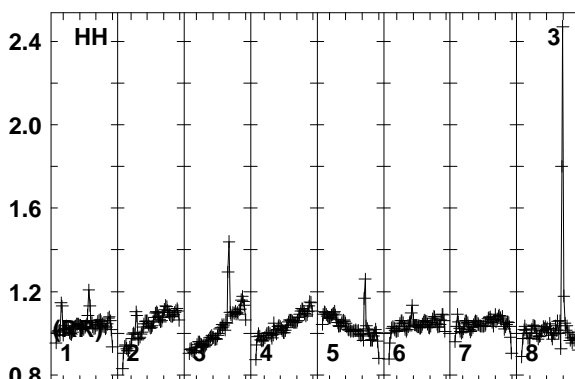
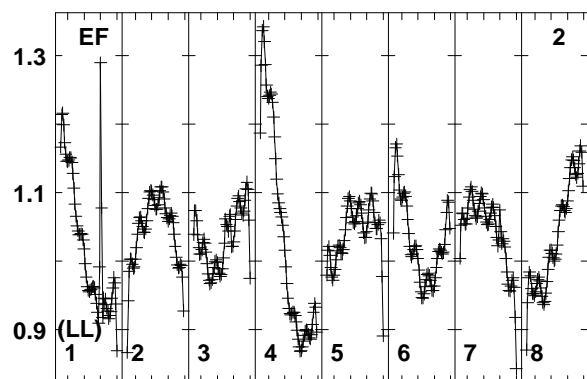
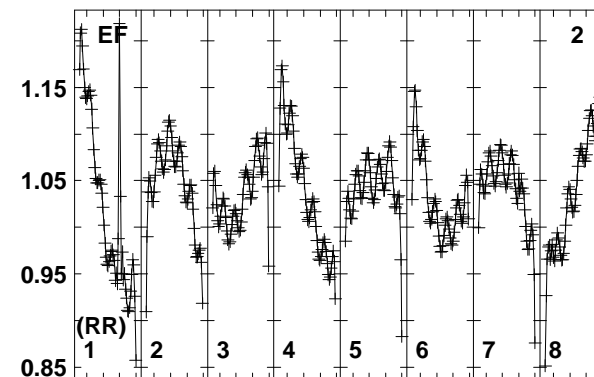
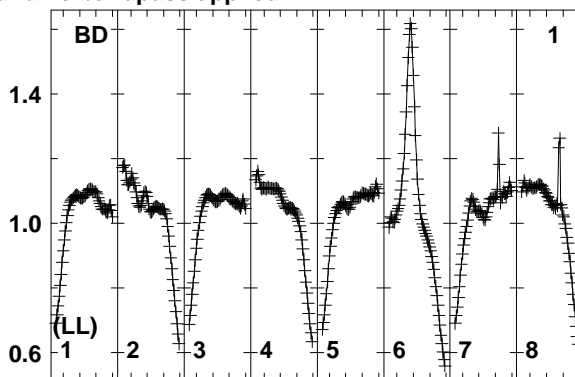
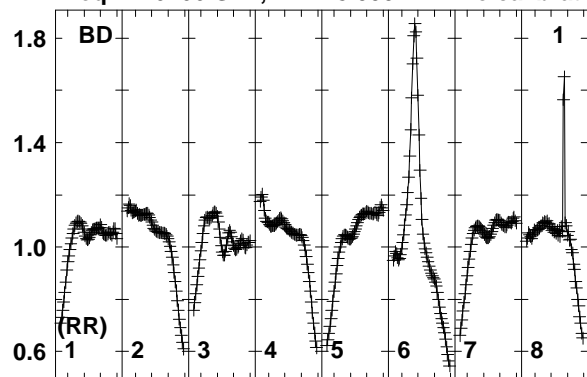

Lower frame: Real Jy
Total-power spectrum Antenna: BD (01)
Timerange: 00/17:07:41 to 00/17:08:59

Plot file version 92 created 01-AUG-2018 16:38:13

J0530+1331 N18L1 2.UVDATA.1

Freq = 1.6266 GHz, Bw = 8.000 MH No calibration applied and no bandpass applied

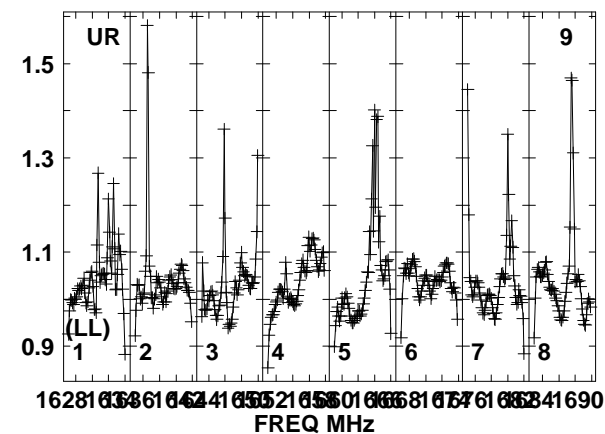
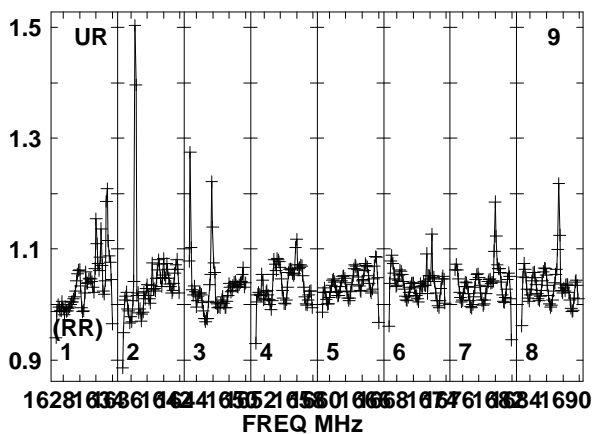
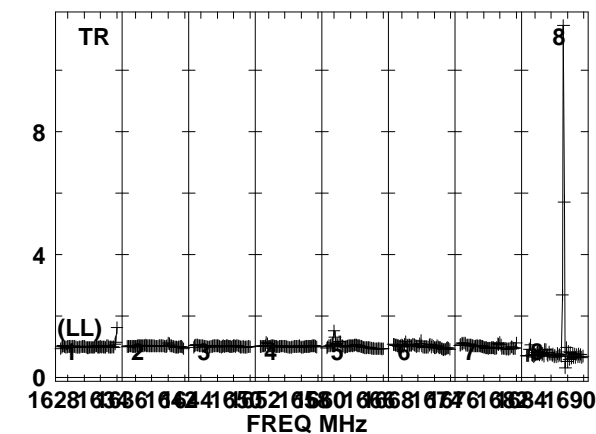
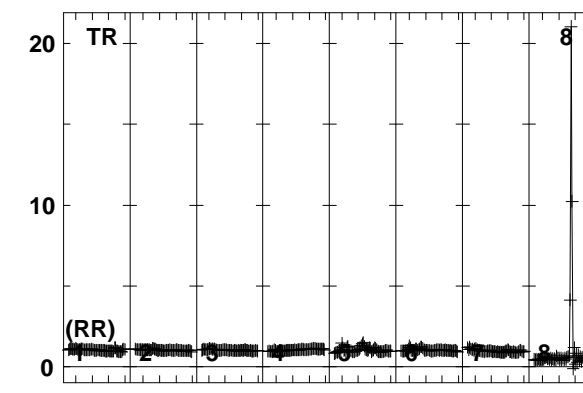
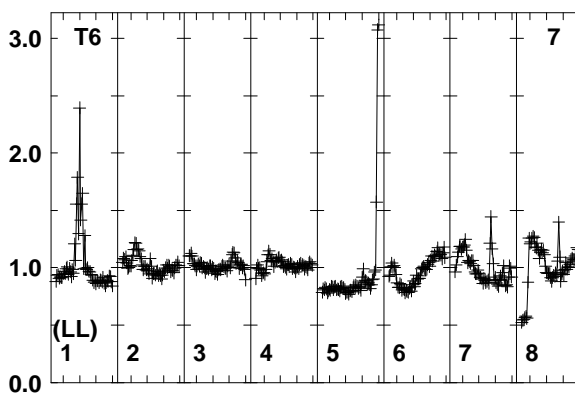
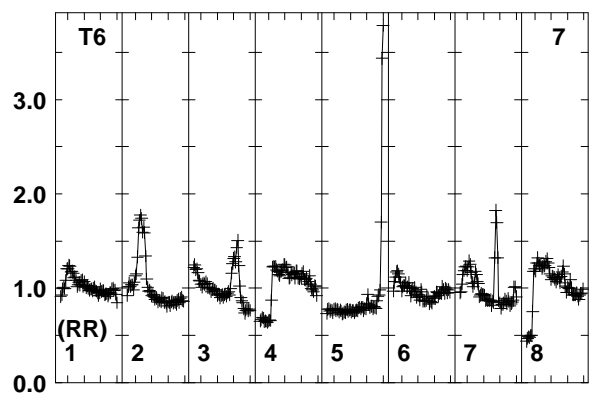
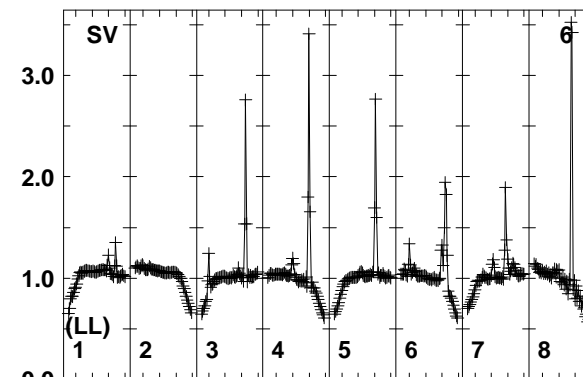
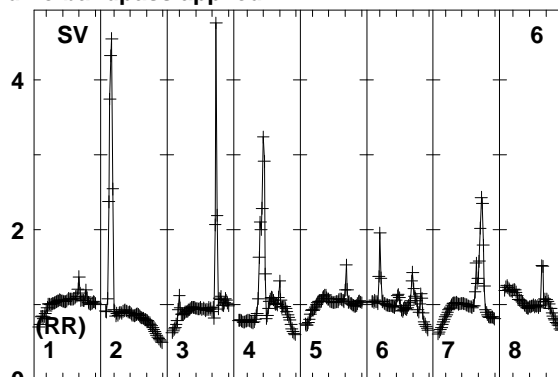
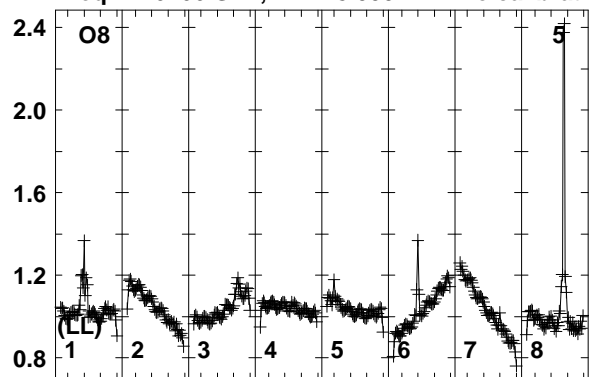

Lower frame: Real Jy
Total-power spectrum Antenna: O8 (05)
Timerange: 00/17:07:41 to 00/17:08:59

Plot file version 93 created 01-AUG-2018 16:38:13

J0530+1331 N18L1 2.UVDATA.1

Freq = 1.6266 GHz, Bw = 8.000 MH No calibration applied and no bandpass applied

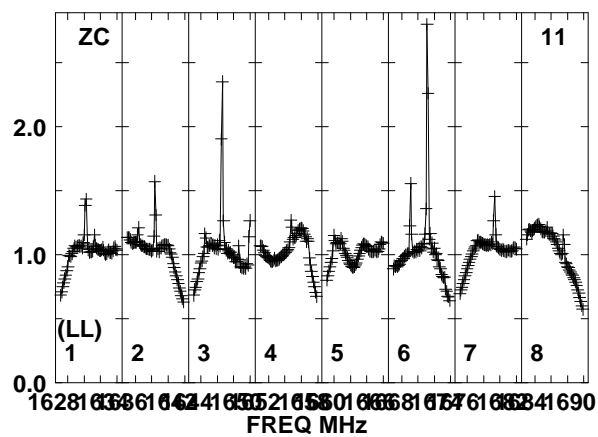
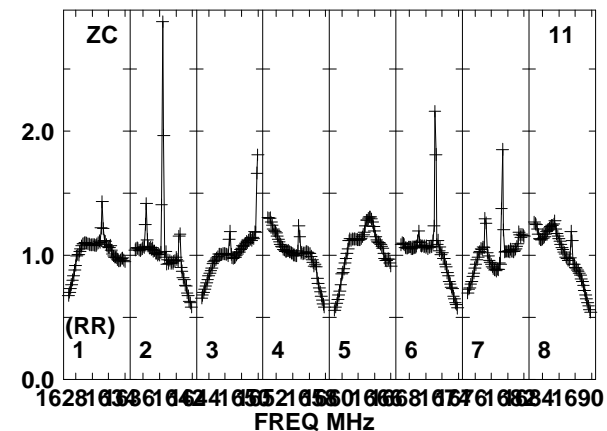
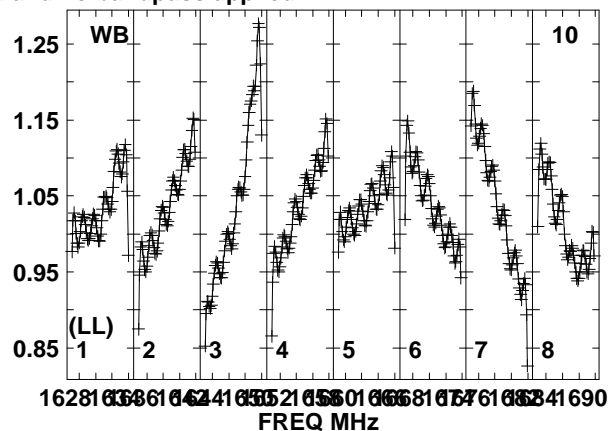
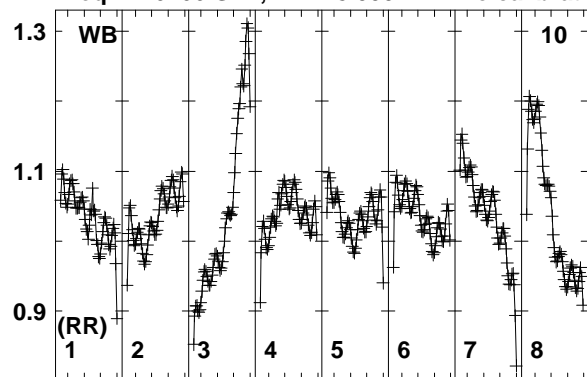

Lower frame: Real Jy
Total-power spectrum Antenna: WB (10)
Timerange: 00/17:07:41 to 00/17:08:59

Plot file version 94 created 01-AUG-2018 16:38:13

PB-2-2 N18L1 2.UVDATA.1

Freq = 1.6266 GHz, Bw = 8.000 MH No calibration applied and no bandpass applied

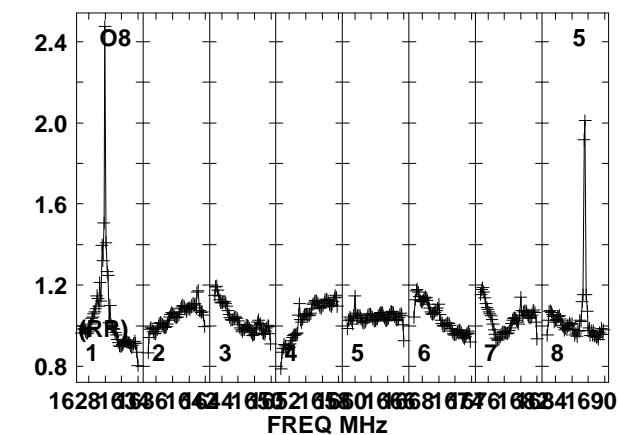
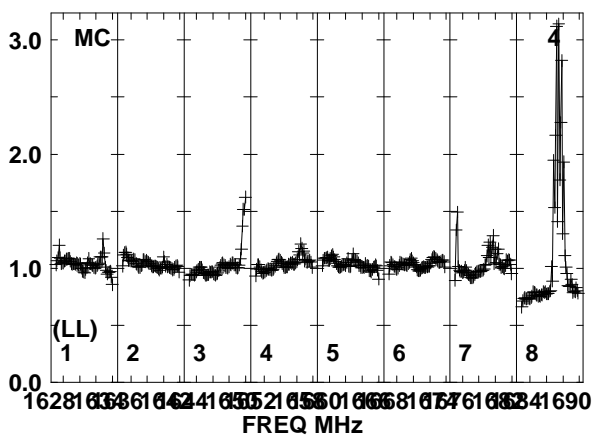
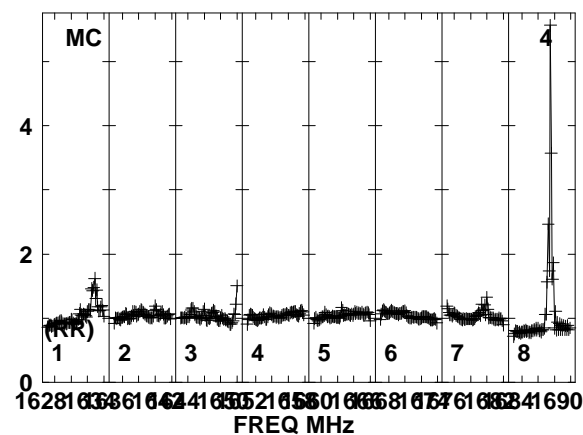
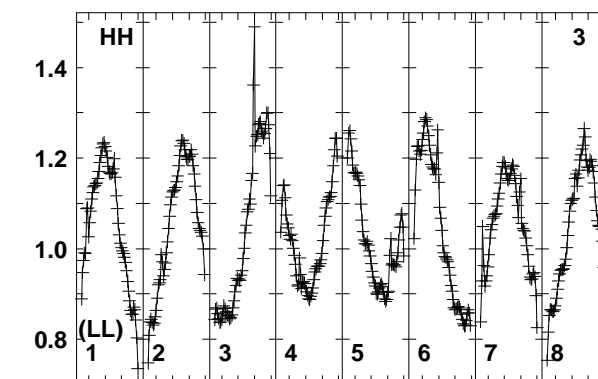
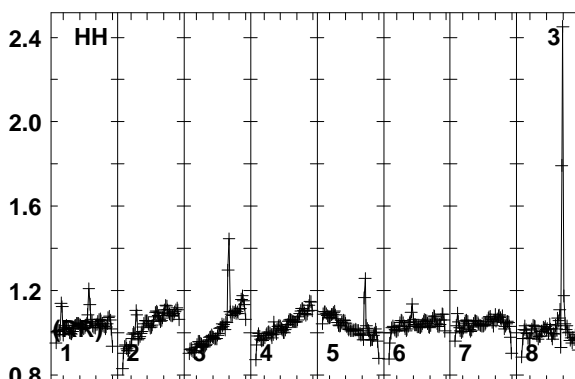
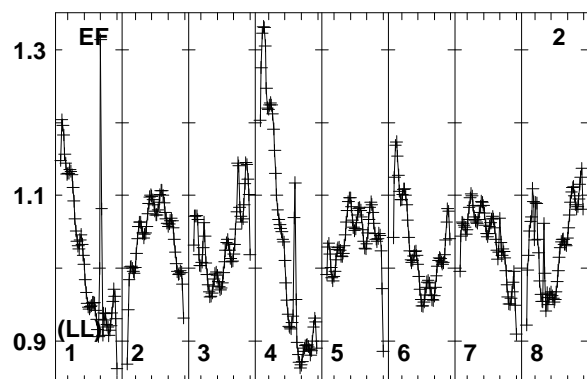
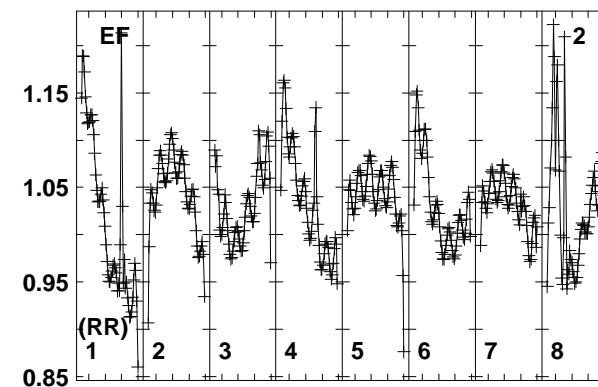
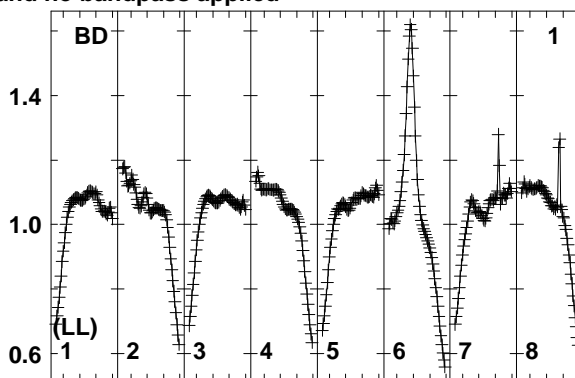
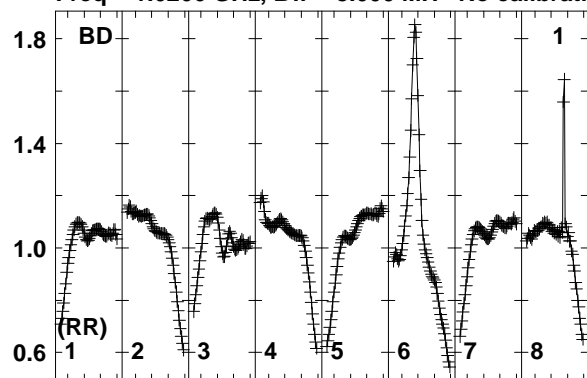

Lower frame: Real Jy
Total-power spectrum Antenna: BD (01)
Timerange: 00/17:09:03 to 00/17:11:29

Plot file version 95 created 01-AUG-2018 16:38:14

PB-2-2 N18L1 2.UVDATA.1

Freq = 1.6266 GHz, Bw = 8.000 MH No calibration applied and no bandpass applied

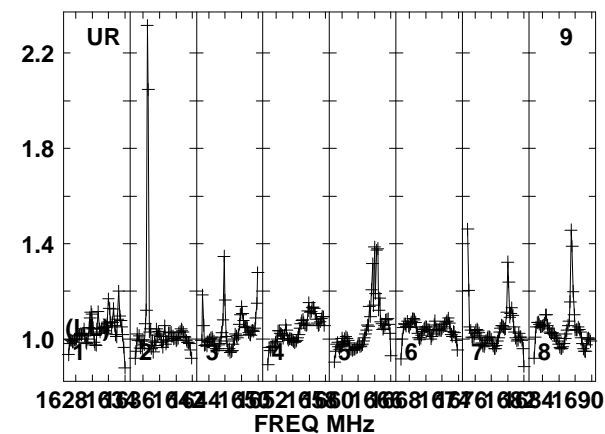
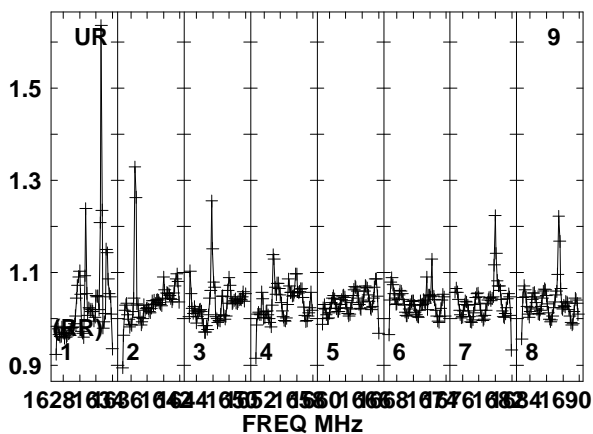
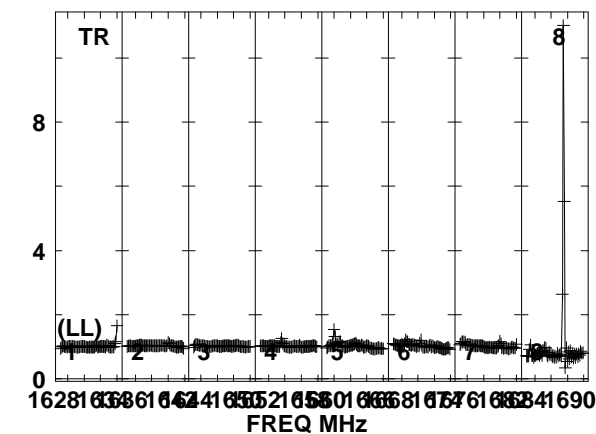
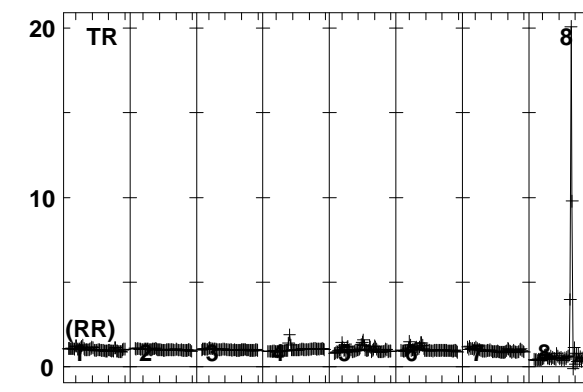
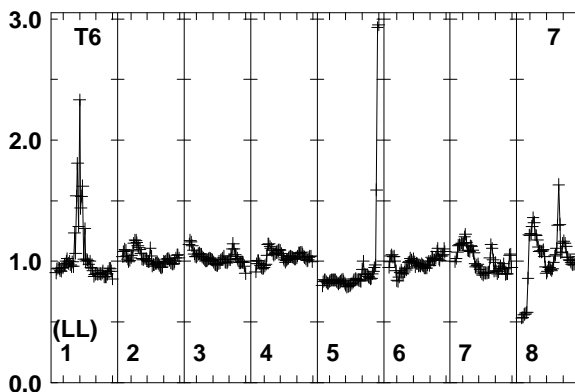
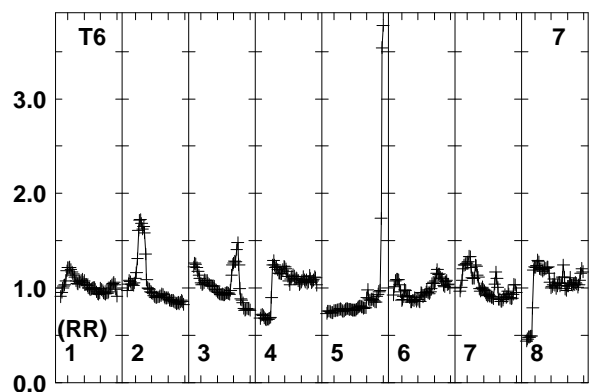
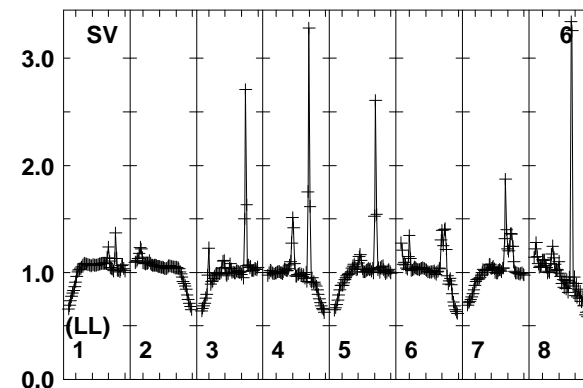
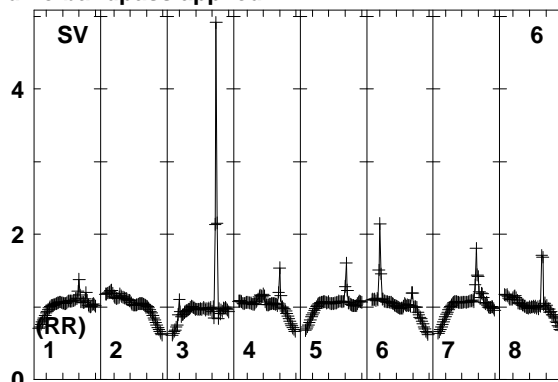
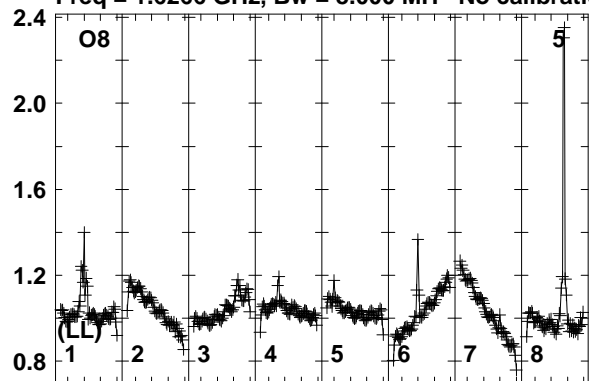

Lower frame: Real Jy
Total-power spectrum Antenna: O8 (05)
Timerange: 00/17:09:03 to 00/17:11:29

Plot file version 96 created 01-AUG-2018 16:38:14

PB-2-2 N18L1 2.UVDATA.1

Freq = 1.6266 GHz, Bw = 8.000 MH No calibration applied and no bandpass applied

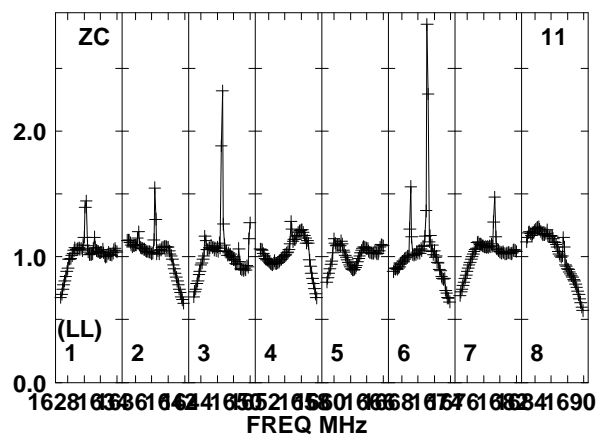
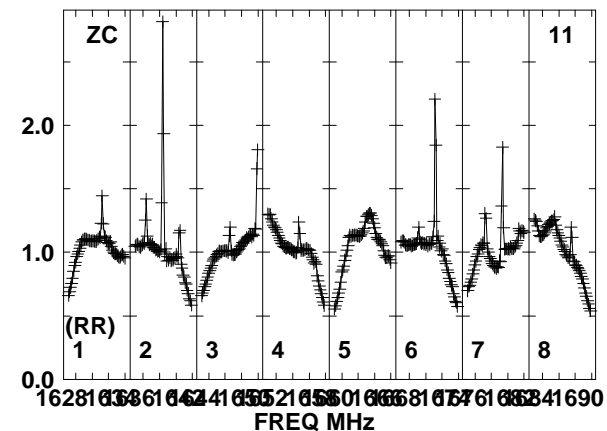
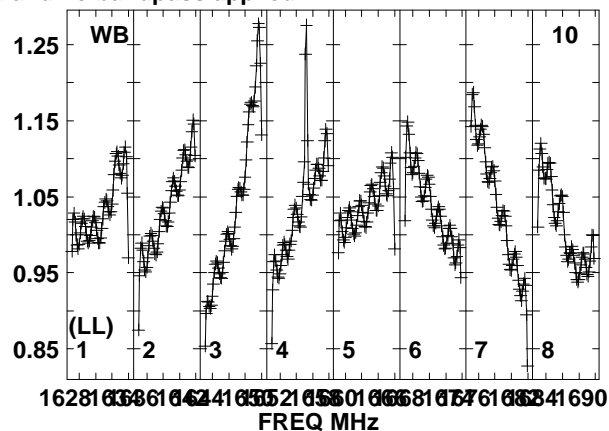
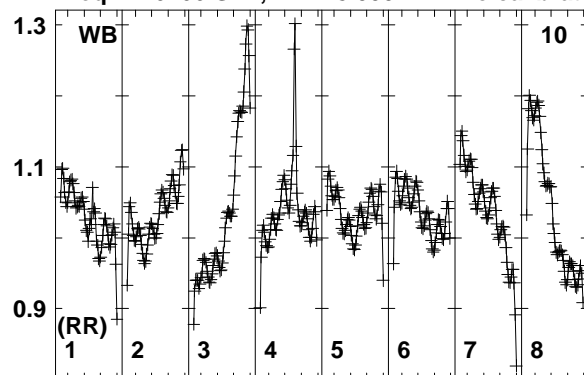

Lower frame: Real Jy
Total-power spectrum Antenna: WB (10)
Timerange: 00/17:09:03 to 00/17:11:29

Plot file version 97 created 01-AUG-2018 16:38:14

PB-3-2 N18L1 2.UVDATA.1

Freq = 1.6266 GHz, Bw = 8.000 MH No calibration applied and no bandpass applied

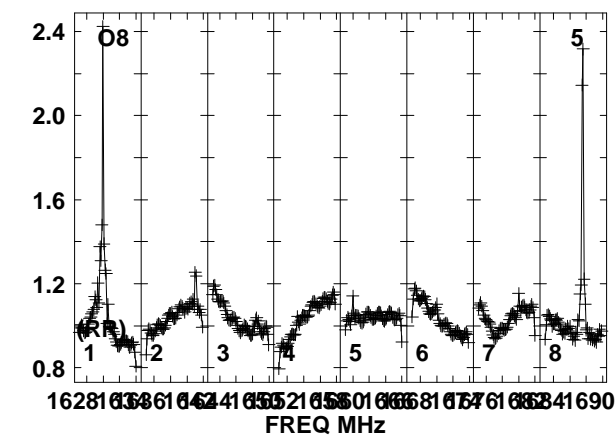
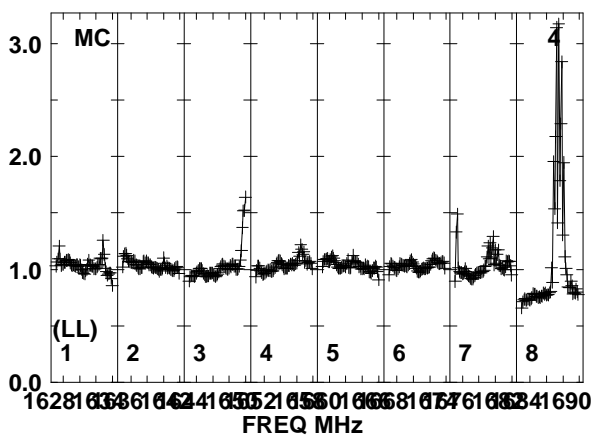
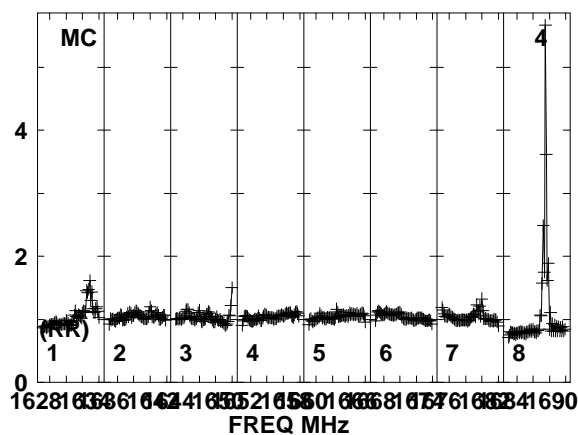
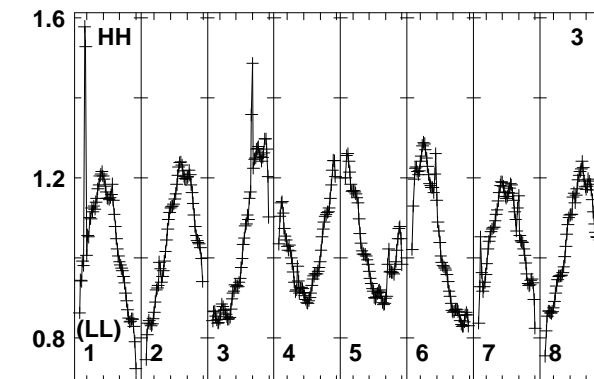
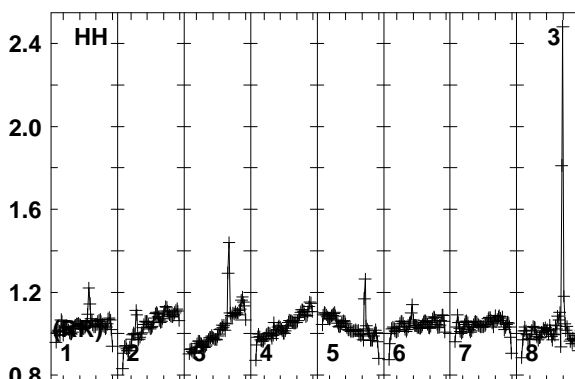
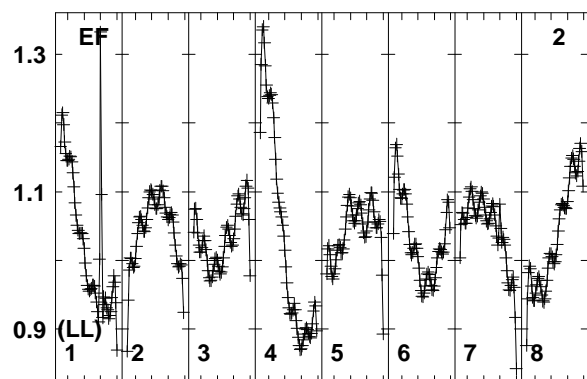
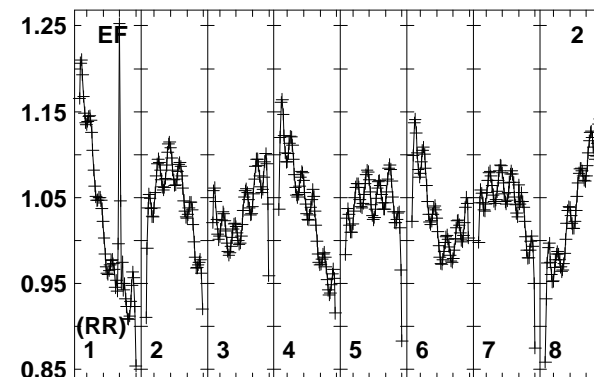
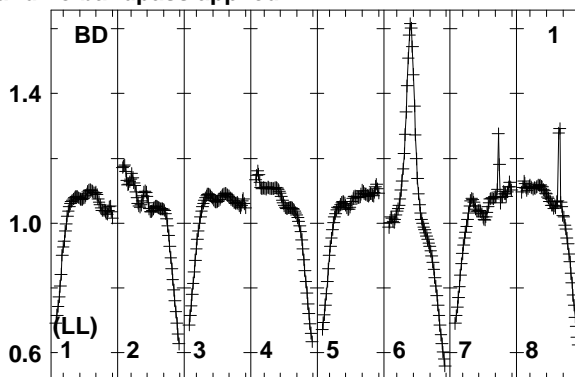
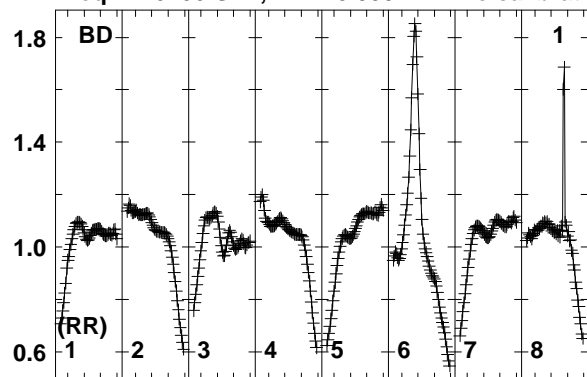

Lower frame: Real Jy
Total-power spectrum Antenna: BD (01)
Timerange: 00/17:11:33 to 00/17:13:59

Plot file version 98 created 01-AUG-2018 16:38:14

PB-3-2 N18L1 2.UVDATA.1

Freq = 1.6266 GHz, Bw = 8.000 MH No calibration applied and no bandpass applied

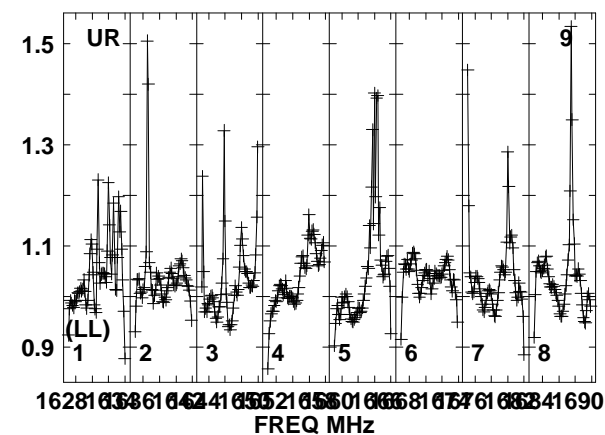
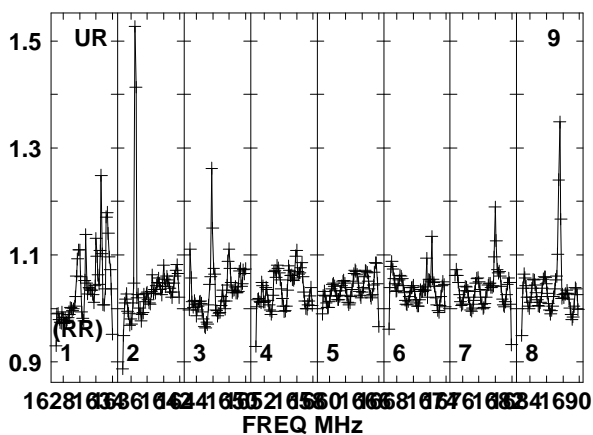
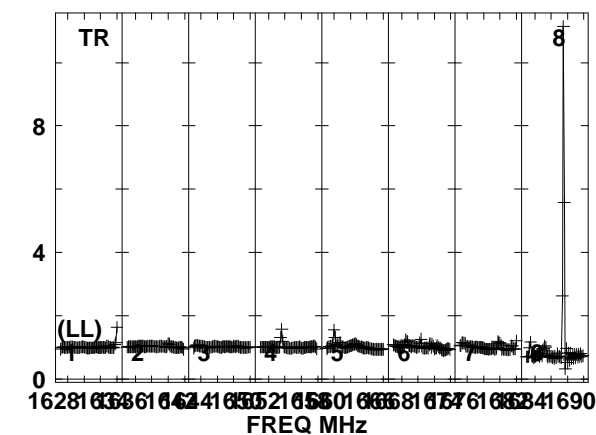
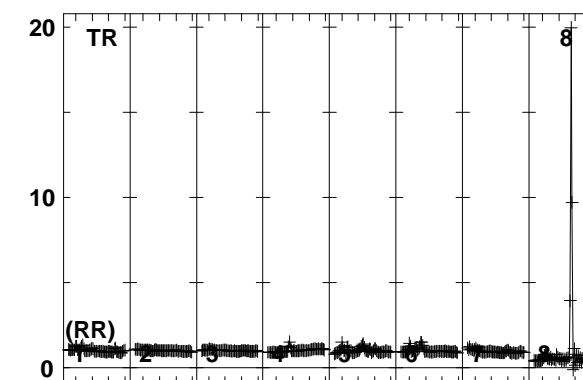
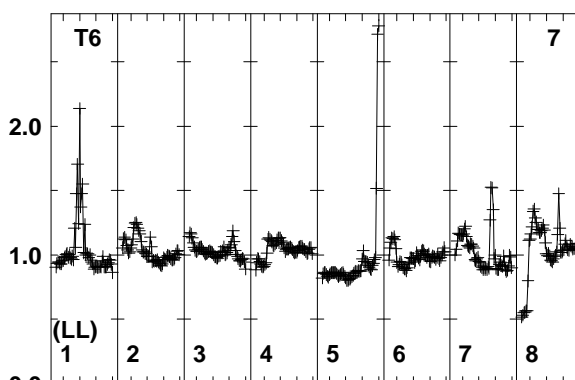
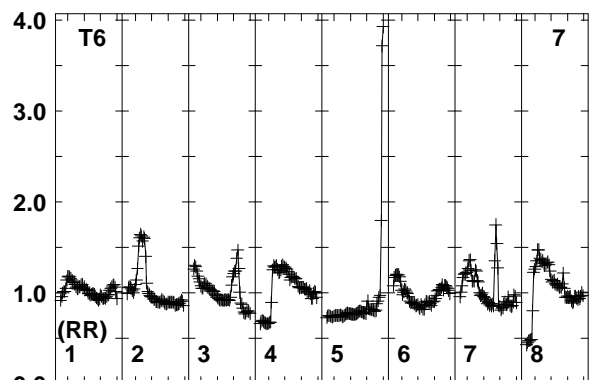
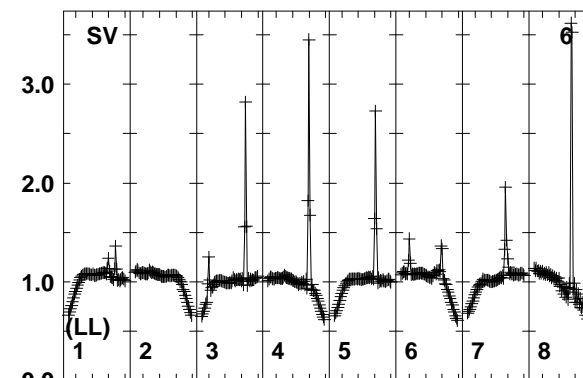
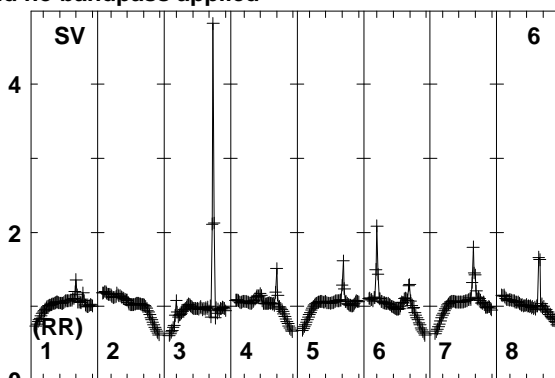
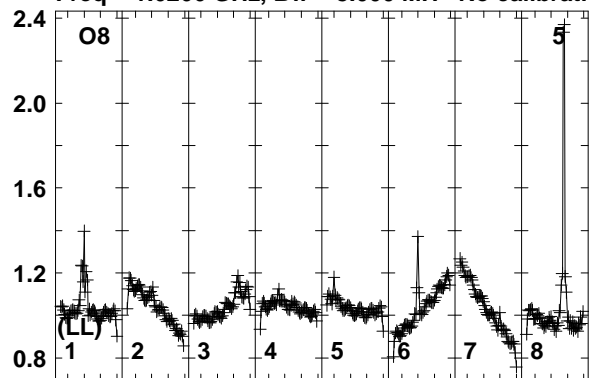

Lower frame: Real Jy
Total-power spectrum Antenna: O8 (05)
Timerange: 00/17:11:33 to 00/17:13:59

Plot file version 99 created 01-AUG-2018 16:38:14

PB-3-2 N18L1 2.UVDATA.1

Freq = 1.6266 GHz, Bw = 8.000 MH No calibration applied and no bandpass applied

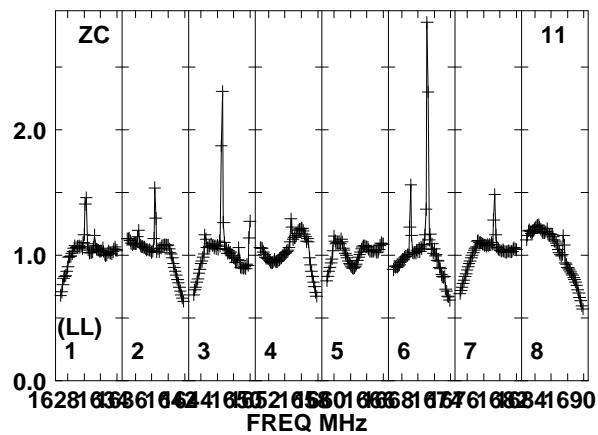
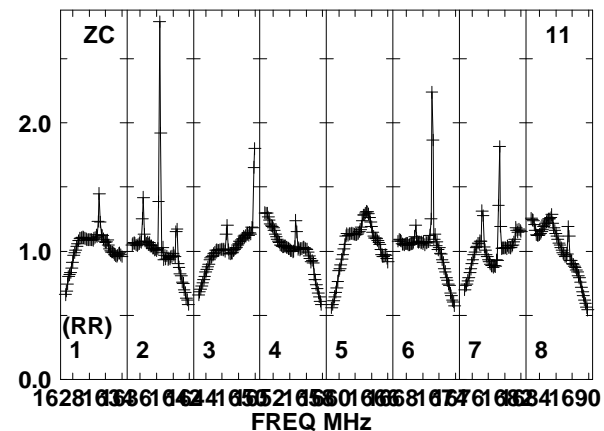
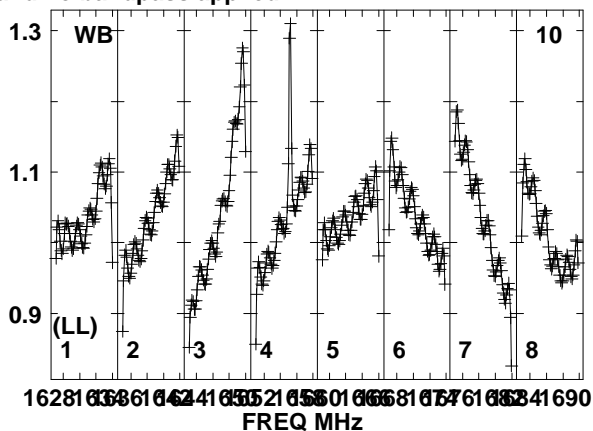
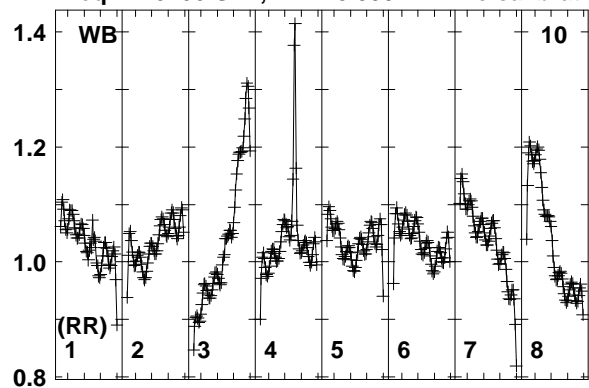

Lower frame: Real Jy
Total-power spectrum Antenna: WB (10)
Timerange: 00/17:11:33 to 00/17:13:59

Plot file version 100 created 01-AUG-2018 16:38:14

PB-4-2 N18L1 2.UVDATA.1

Freq = 1.6266 GHz, Bw = 8.000 MH No calibration applied and no bandpass applied

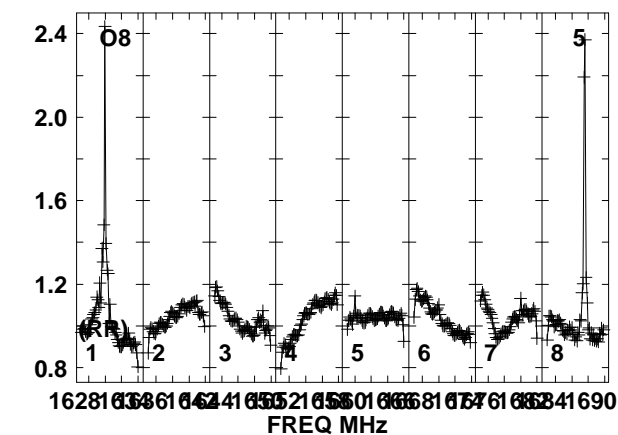
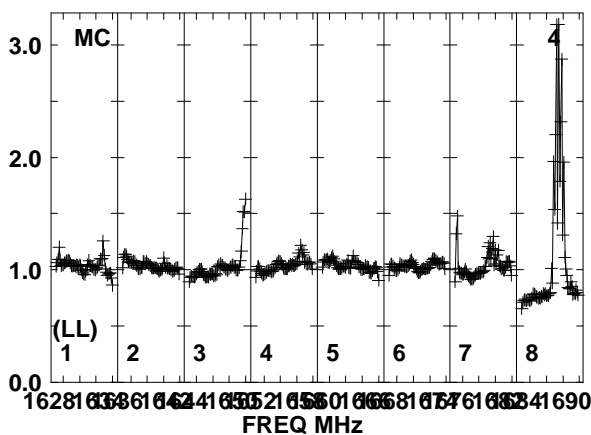
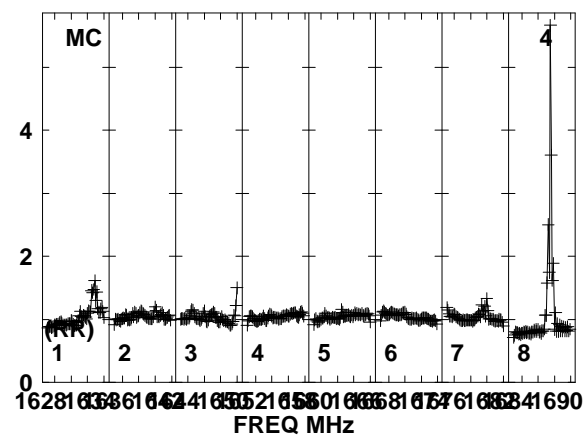
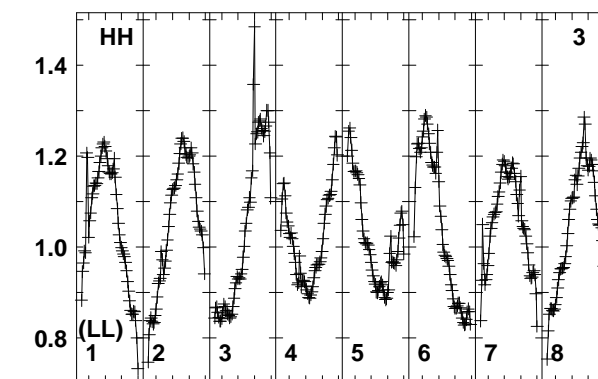
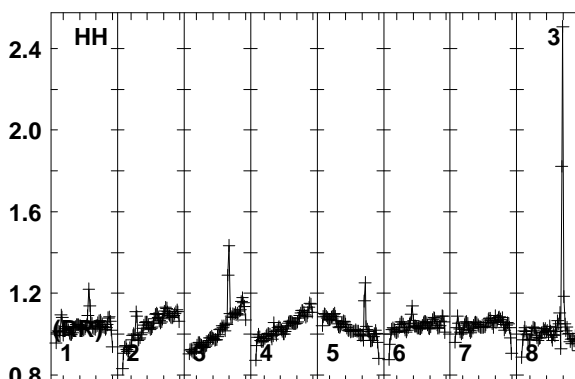
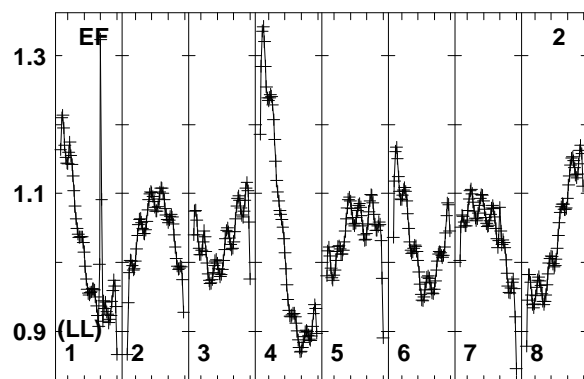
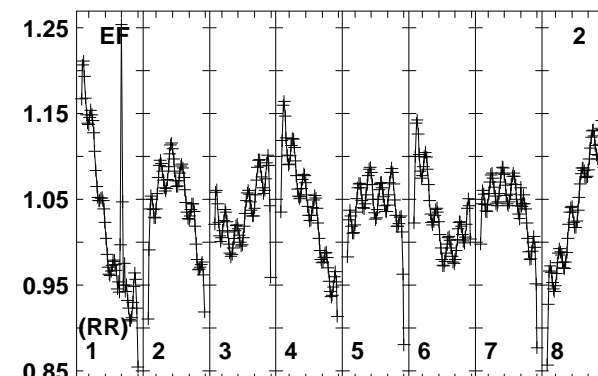
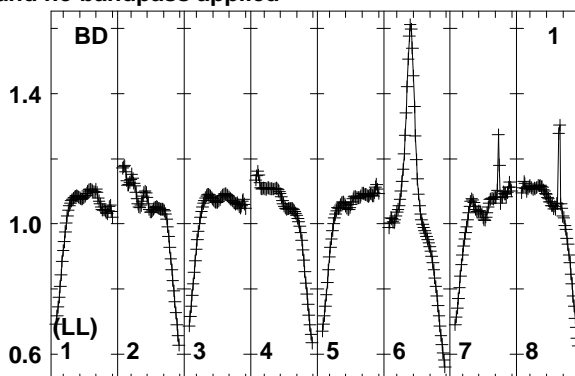
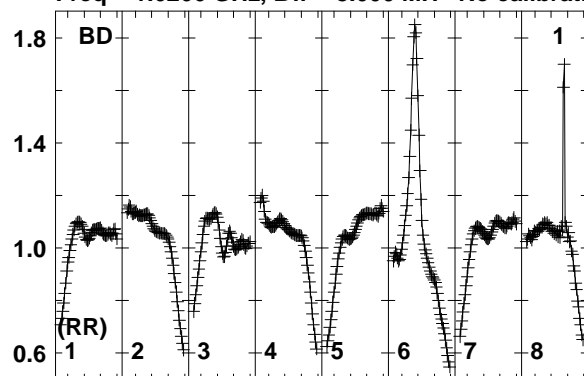

Lower frame: Real Jy
Total-power spectrum Antenna: BD (01)
Timerange: 00/17:14:03 to 00/17:16:29

Plot file version 101 created 01-AUG-2018 16:38:14

PB-4-2 N18L1 2.UVDATA.1

Freq = 1.6266 GHz, Bw = 8.000 MH No calibration applied and no bandpass applied

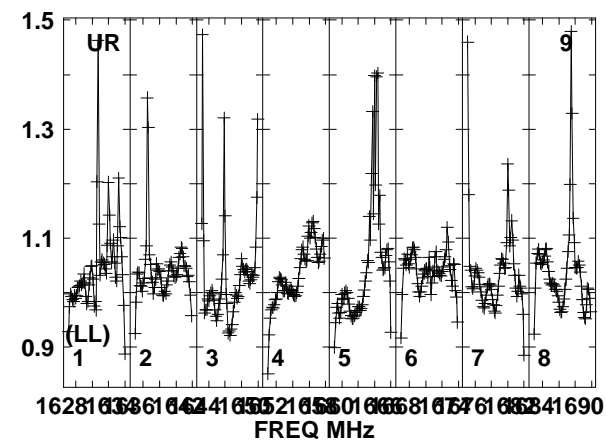
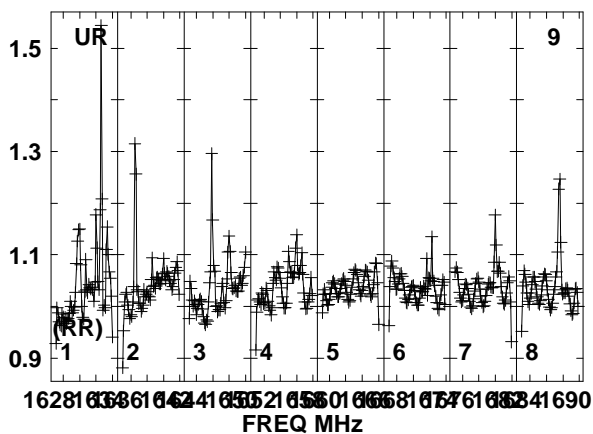
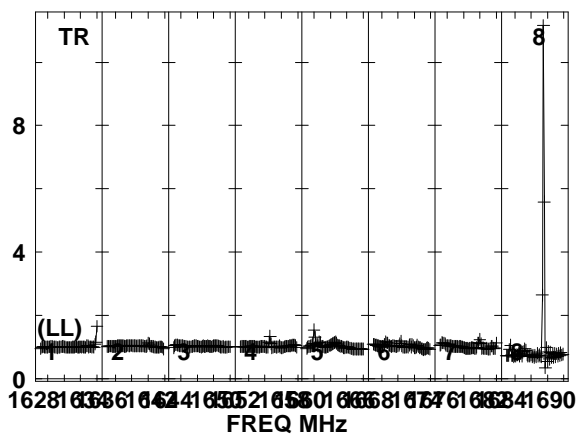
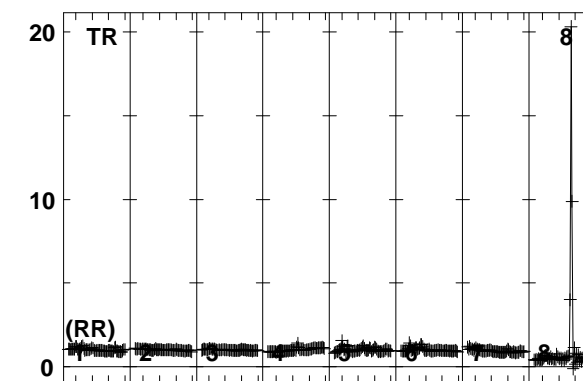
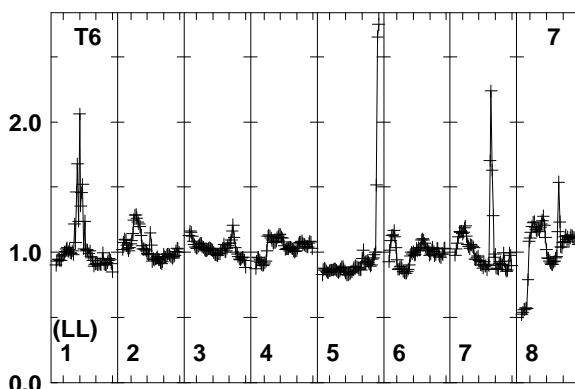
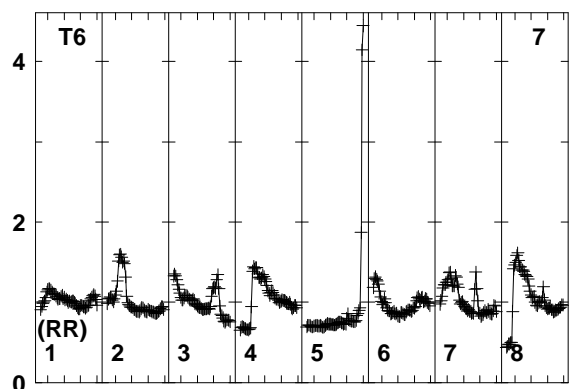
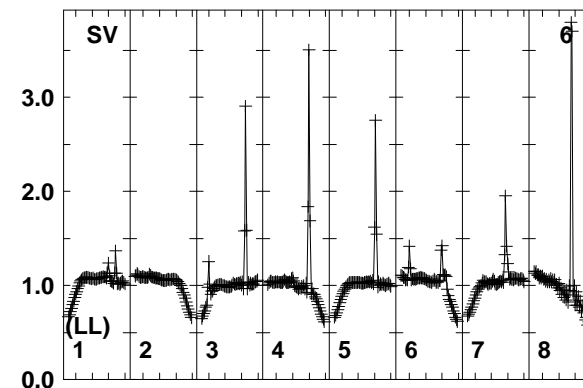
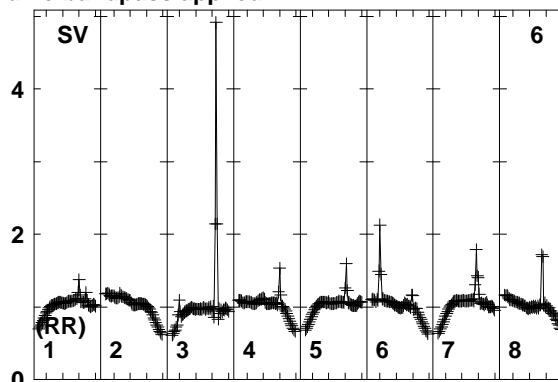
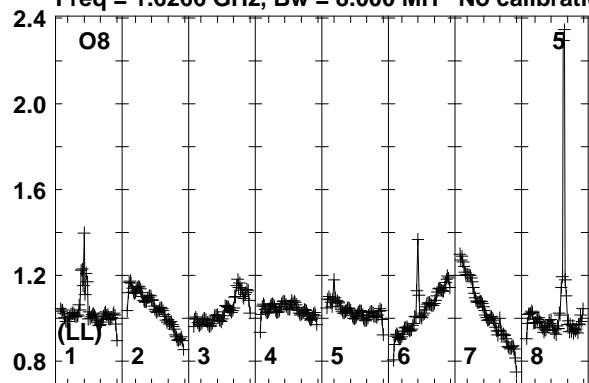

Lower frame: Real Jy
Total-power spectrum Antenna: O8 (05)
Timerange: 00/17:14:03 to 00/17:16:29

Plot file version 102 created 01-AUG-2018 16:38:15

PB-4-2 N18L1 2.UVDATA.1

Freq = 1.6266 GHz, Bw = 8.000 MH No calibration applied and no bandpass applied

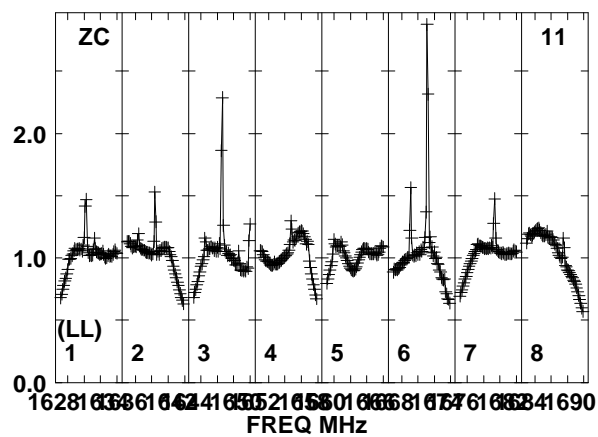
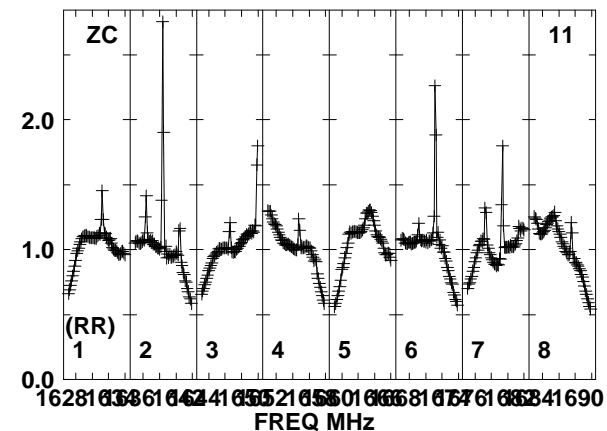
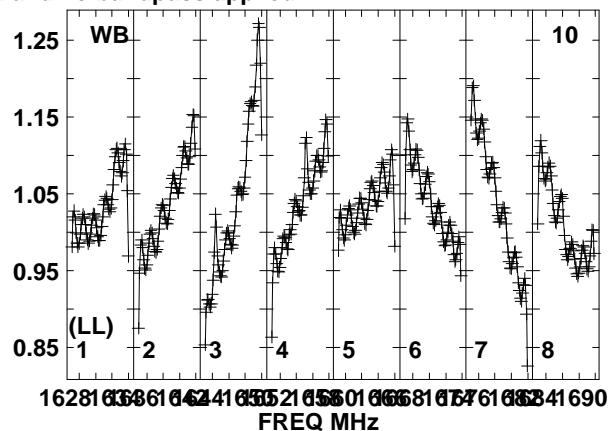
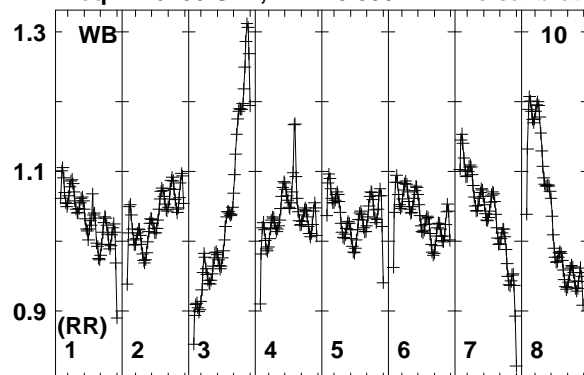

Lower frame: Real Jy
Total-power spectrum Antenna: WB (10)
Timerange: 00/17:14:03 to 00/17:16:29

Plot file version 103 created 01-AUG-2018 16:38:15

PB-4-1 N18L1 2.UVDATA.1

Freq = 1.6266 GHz, Bw = 8.000 MH No calibration applied and no bandpass applied

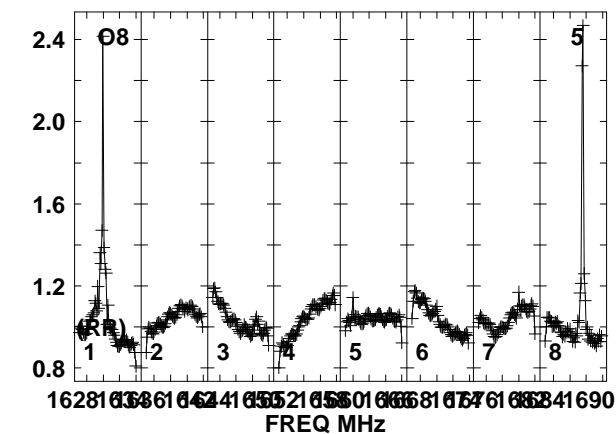
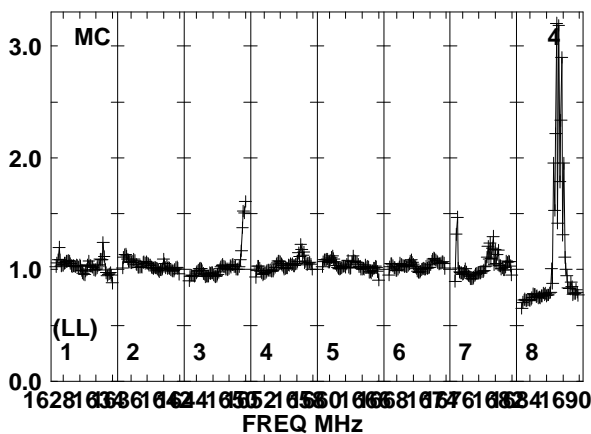
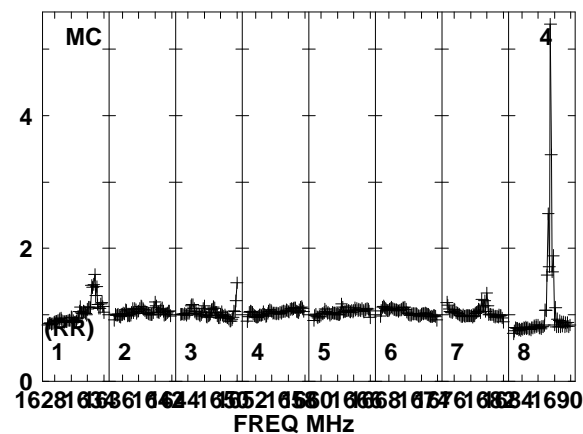
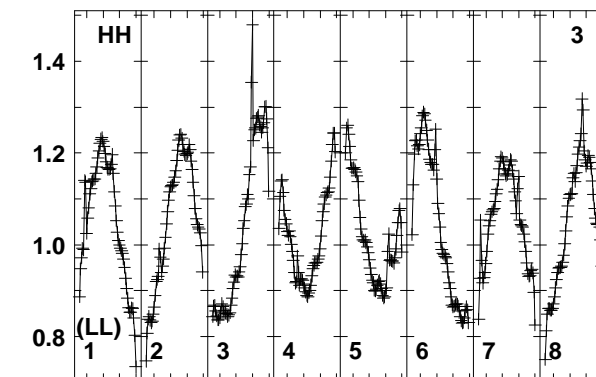
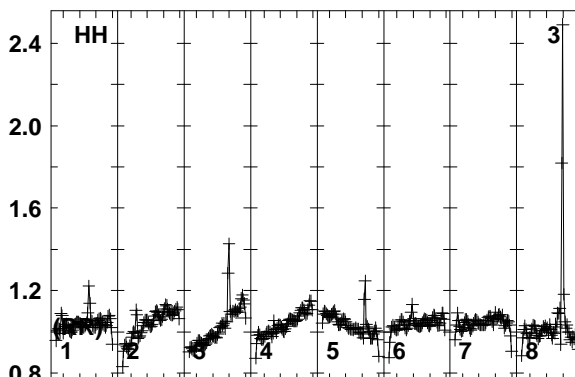
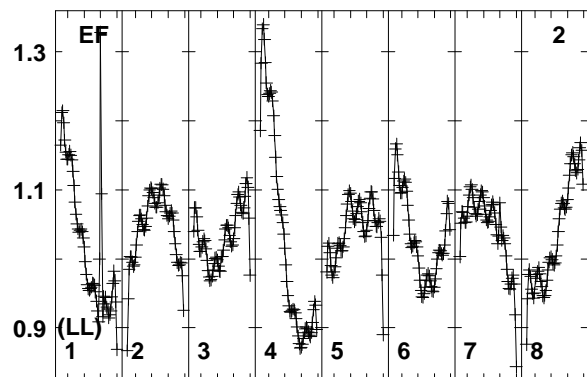
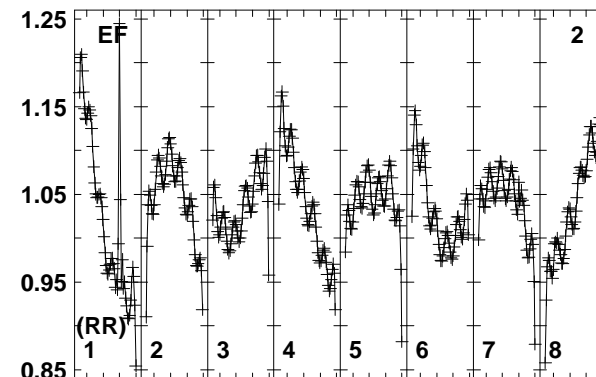
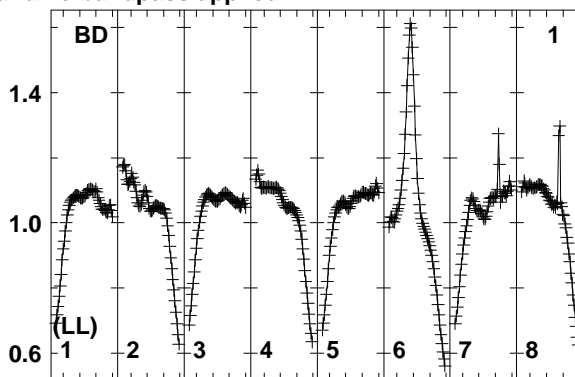
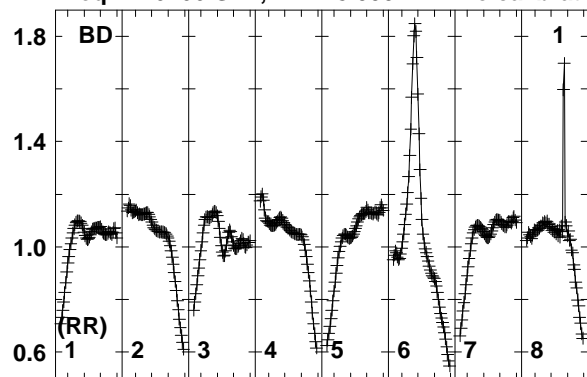

Lower frame: Real Jy
Total-power spectrum Antenna: BD (01)
Timerange: 00/17:16:33 to 00/17:18:59

Plot file version 104 created 01-AUG-2018 16:38:15

PB-4-1 N18L1 2.UVDATA.1

Freq = 1.6266 GHz, Bw = 8.000 MH No calibration applied and no bandpass applied

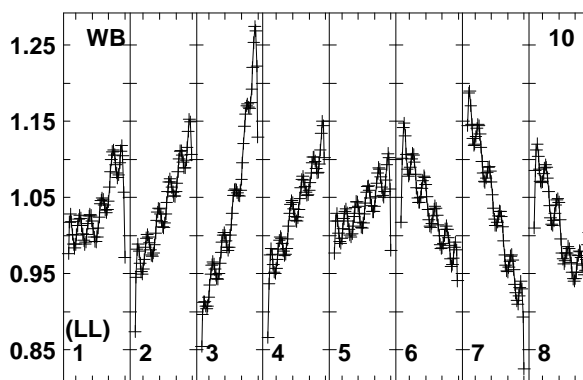
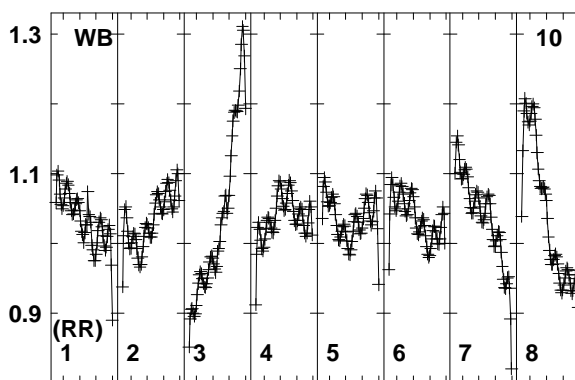
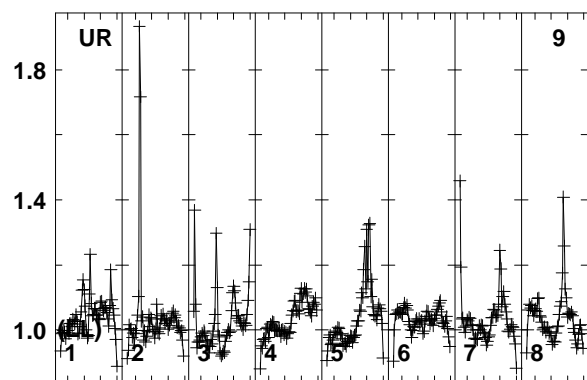
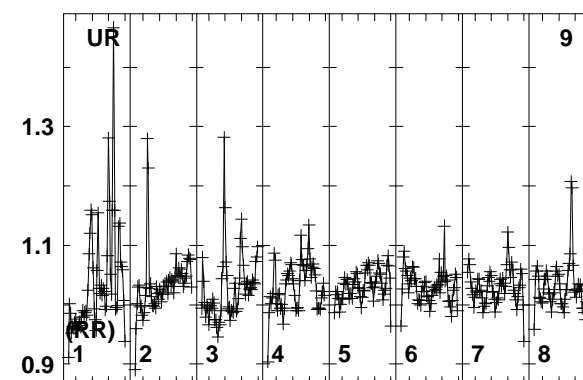
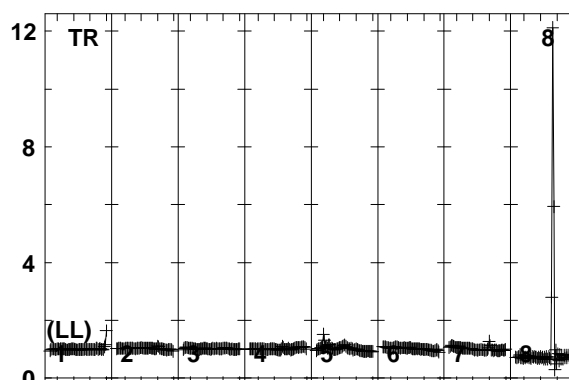
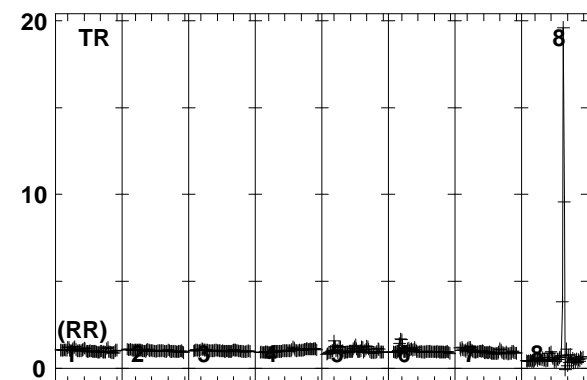
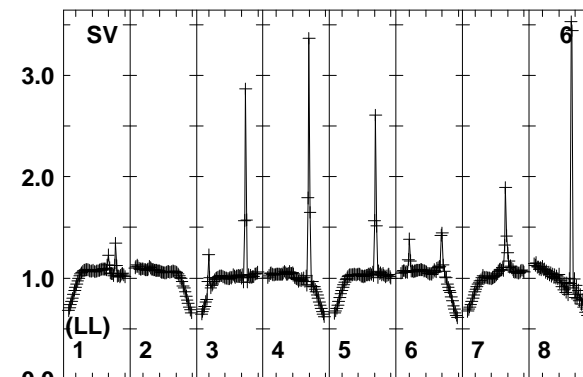
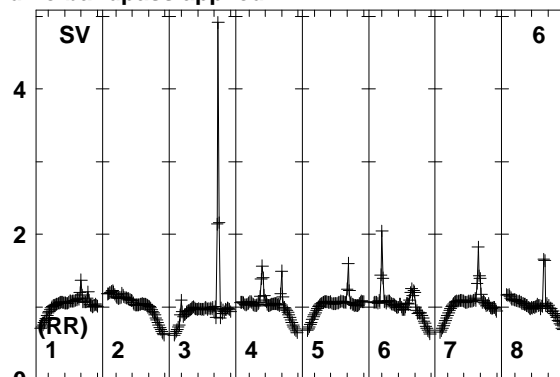
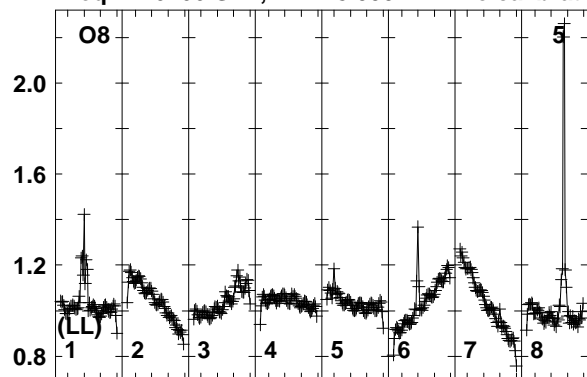

16281 63861 64241 65216 65810 66581 67461 68241 690

FREQ MHz

16281 63861 64241 65216 65810 66581 67461 68241 690

FREQ MHz

16281 63861 64241 65216 65810 66581 67461 68241 690

FREQ MHz

Lower frame: Real Jy
Total-power spectrum Antenna: O8 (05)
Timerange: 00/17:16:33 to 00/17:18:59

Plot file version 105 created 01-AUG-2018 16:38:15

PB-4-1 N18L1 2.UVDATA.1

Freq = 1.6266 GHz, Bw = 8.000 MH No calibration applied and no bandpass applied

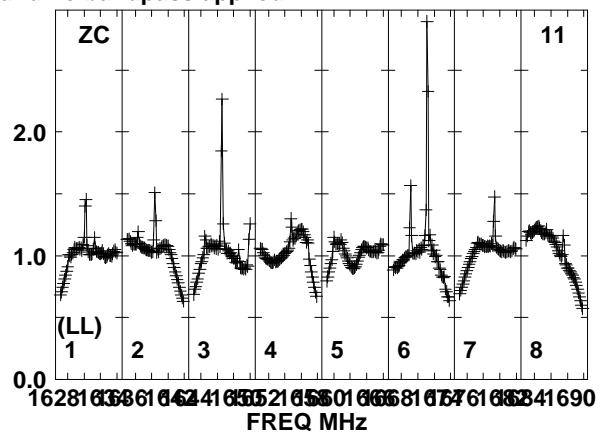
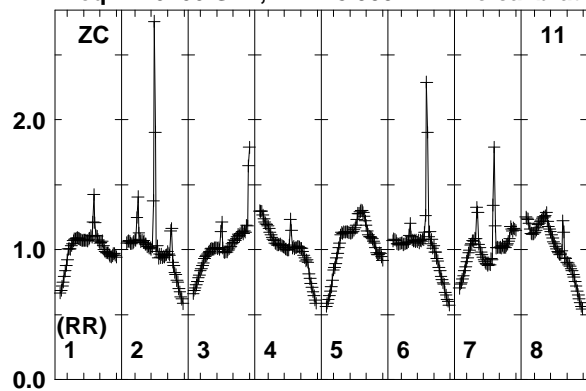

Lower frame: Real Jy
Total-power spectrum Antenna: ZC (11)
Timerange: 00/17:16:33 to 00/17:18:59

Plot file version 106 created 01-AUG-2018 16:38:15

J0530+1331 N18L1 2.UVDATA.1

Freq = 1.6266 GHz, Bw = 8.000 MH No calibration applied and no bandpass applied

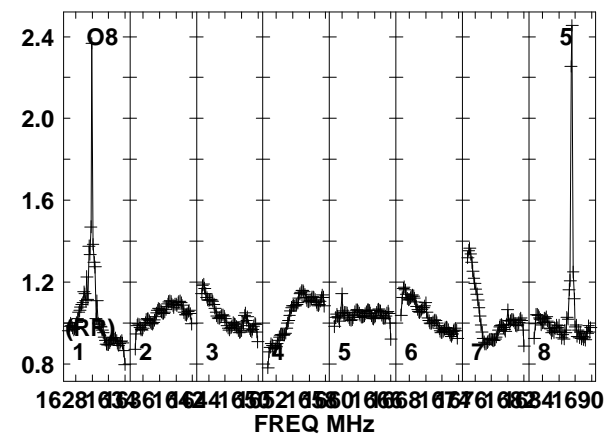
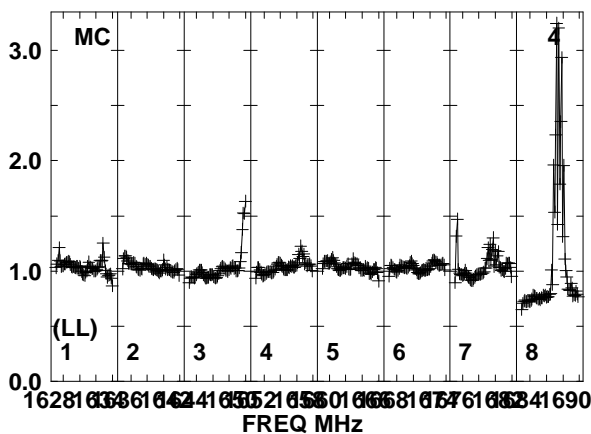
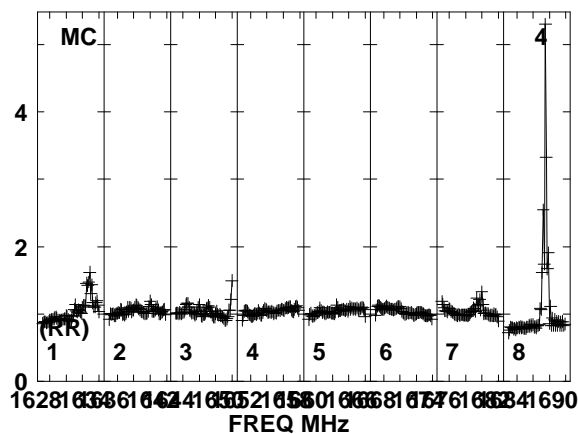
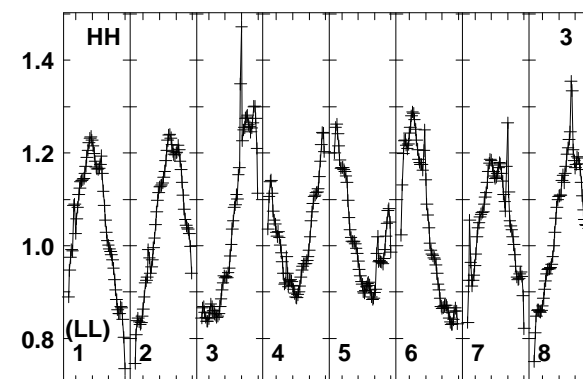
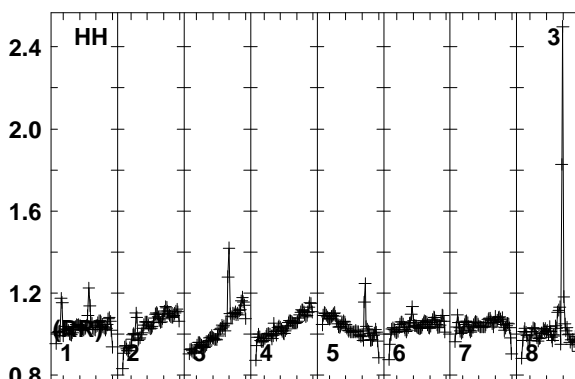
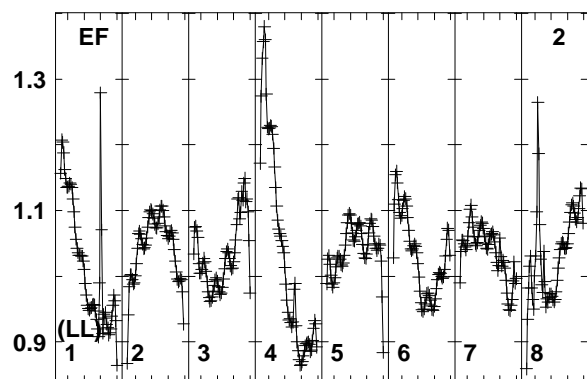
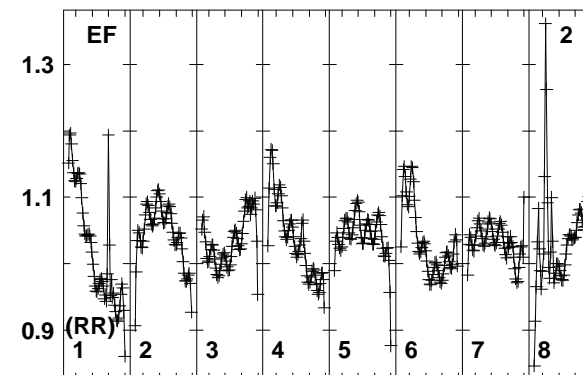
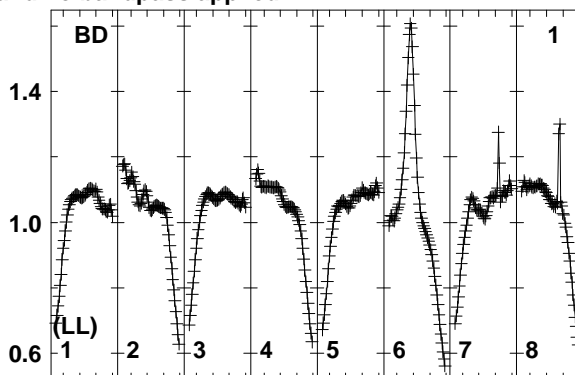
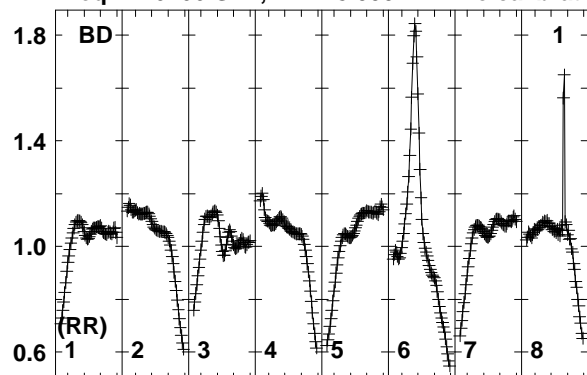

Lower frame: Real Jy
Total-power spectrum Antenna: BD (01)
Timerange: 00/17:19:41 to 00/17:20:59

Plot file version 107 created 01-AUG-2018 16:38:15

J0530+1331 N18L1 2.UVDATA.1

Freq = 1.6266 GHz, Bw = 8.000 MH No calibration applied and no bandpass applied

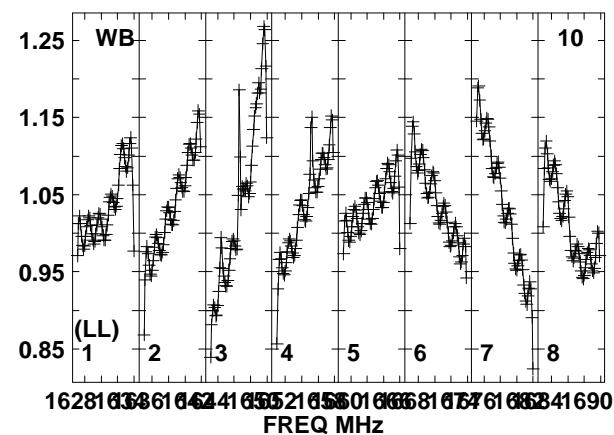
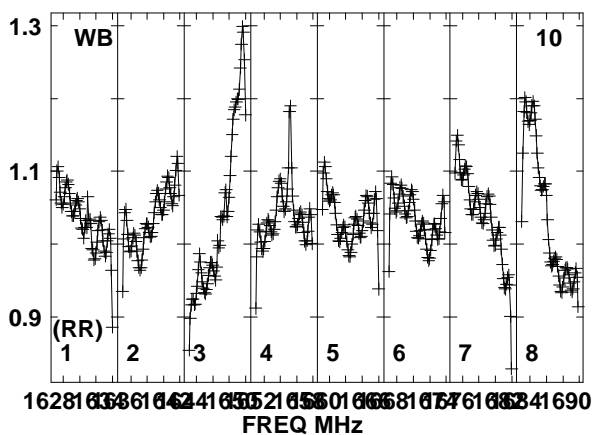
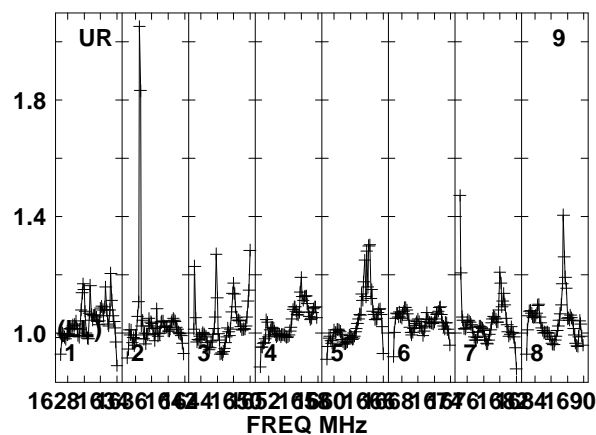
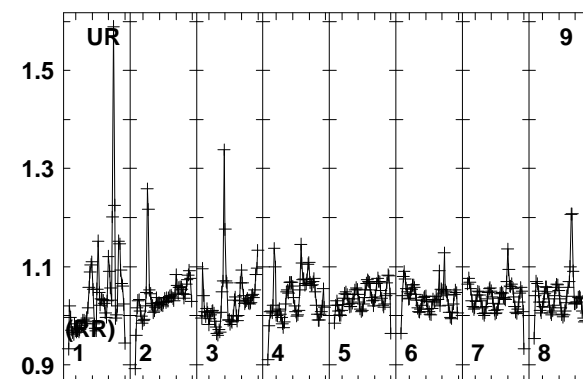
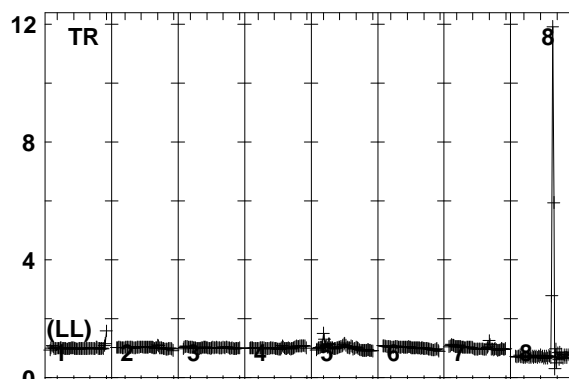
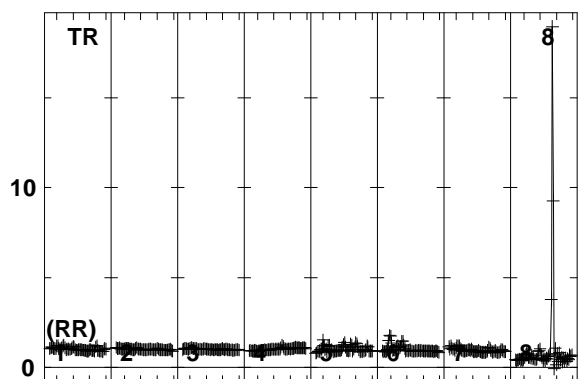
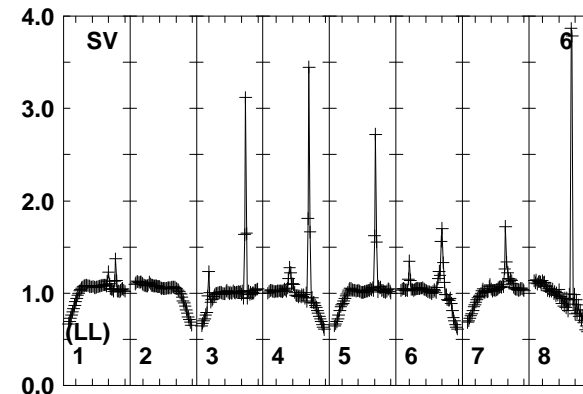
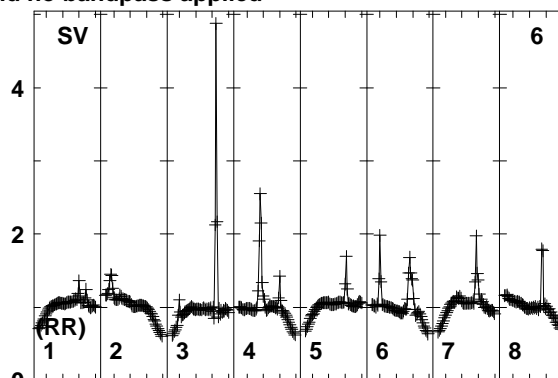
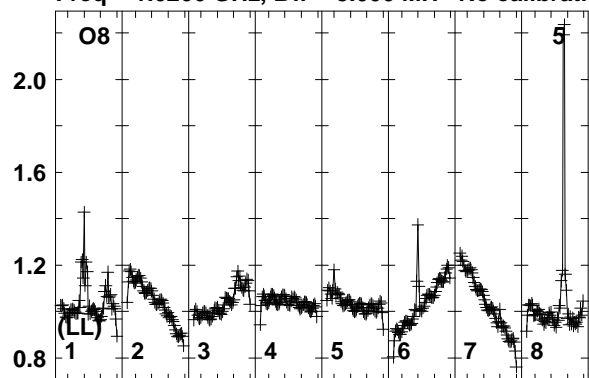

Lower frame: Real Jy
Total-power spectrum Antenna: O8 (05)
Timerange: 00/17:19:41 to 00/17:20:59

Plot file version 108 created 01-AUG-2018 16:38:15

J0530+1331 N18L1 2.UVDATA.1

Freq = 1.6266 GHz, Bw = 8.000 MH No calibration applied and no bandpass applied

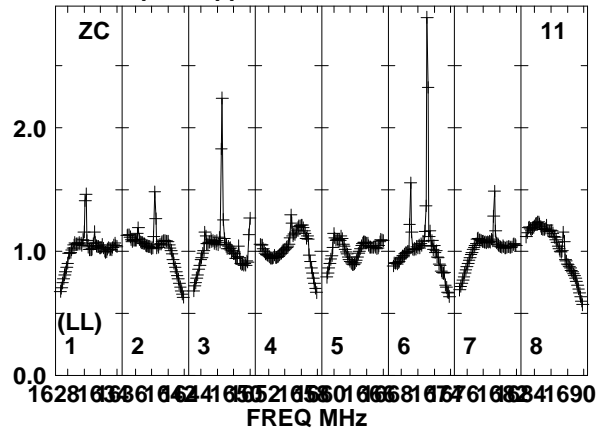
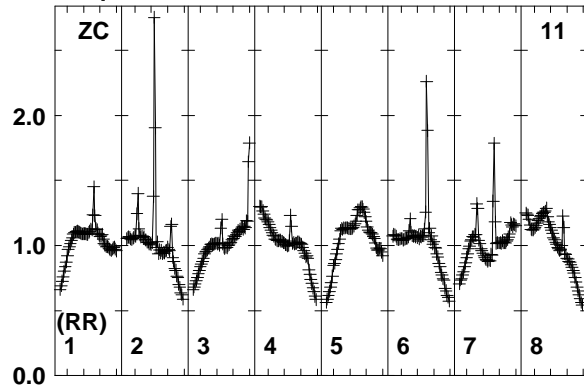

Lower frame: Real Jy
Total-power spectrum Antenna: ZC (11)
Timerange: 00/17:19:41 to 00/17:20:59

Plot file version 109 created 01-AUG-2018 16:38:15

PB-3-1 N18L1 2.UVDATA.1

Freq = 1.6266 GHz, Bw = 8.000 MH No calibration applied and no bandpass applied

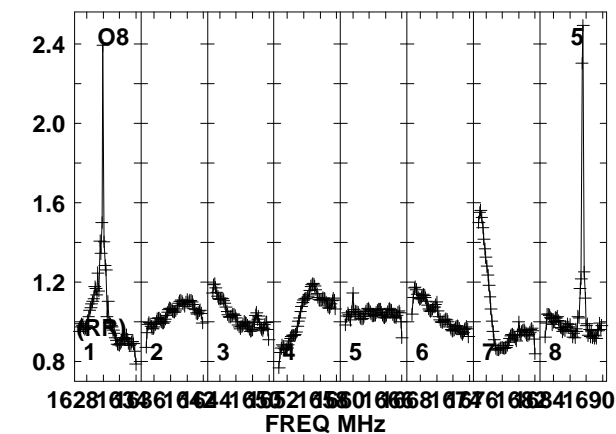
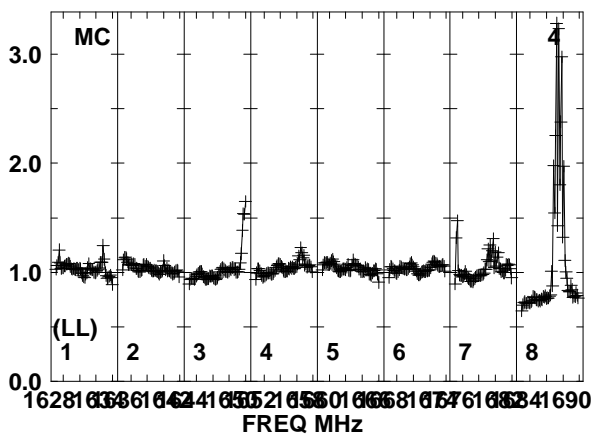
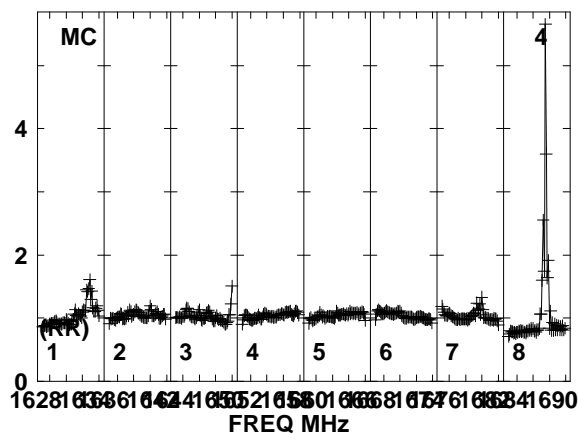
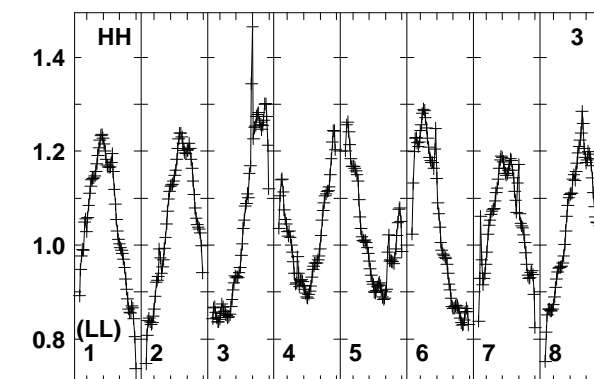
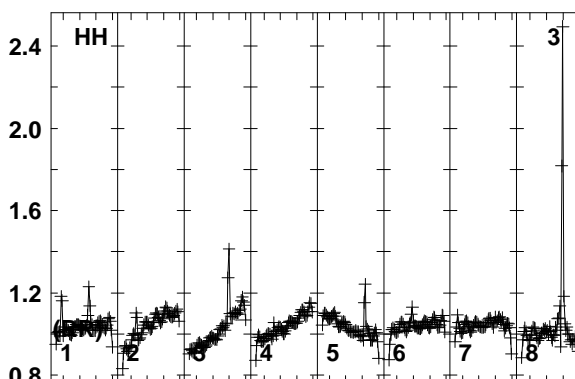
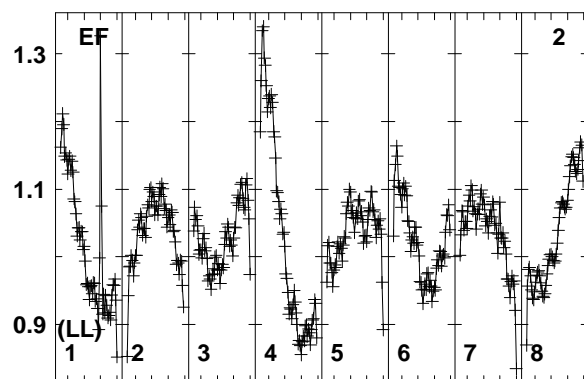
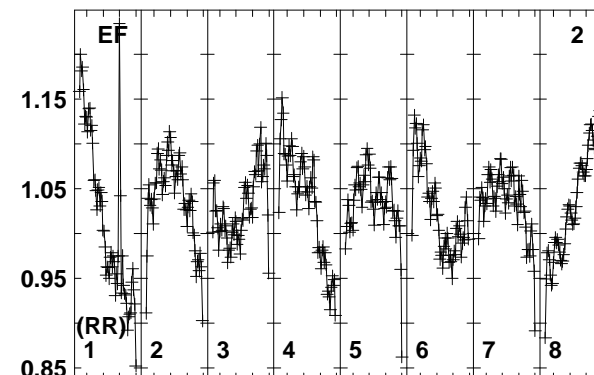
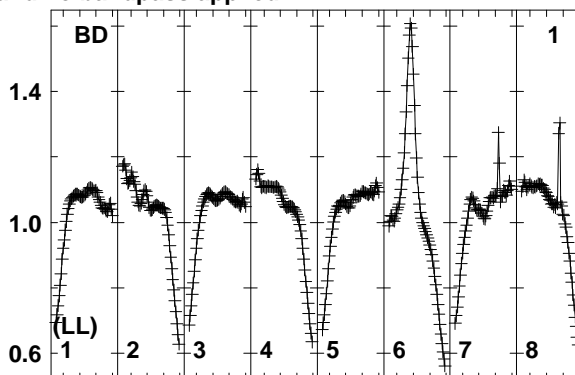
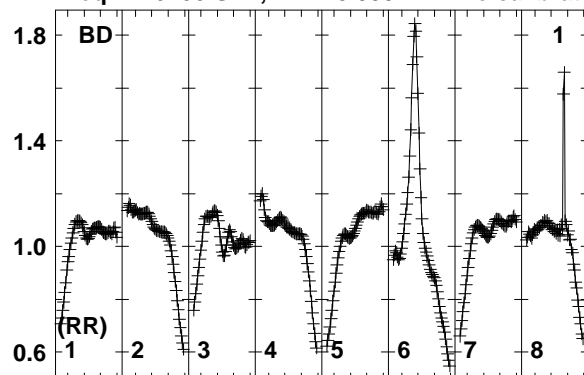

Lower frame: Real Jy
Total-power spectrum Antenna: BD (01)
Timerange: 00/17:21:05 to 00/17:23:29

Plot file version 110 created 01-AUG-2018 16:38:15

PB-3-1 N18L1 2.UVDATA.1

Freq = 1.6266 GHz, Bw = 8.000 MH No calibration applied and no bandpass applied

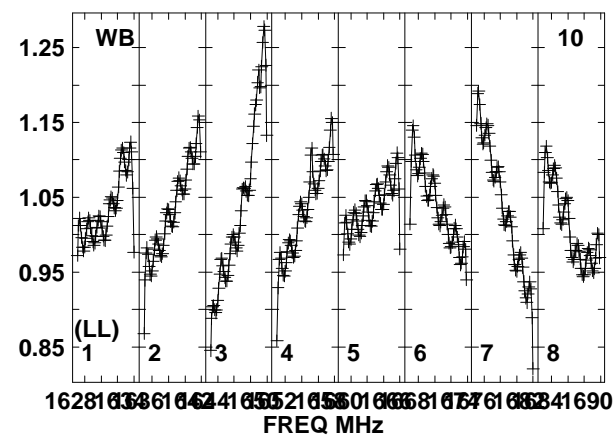
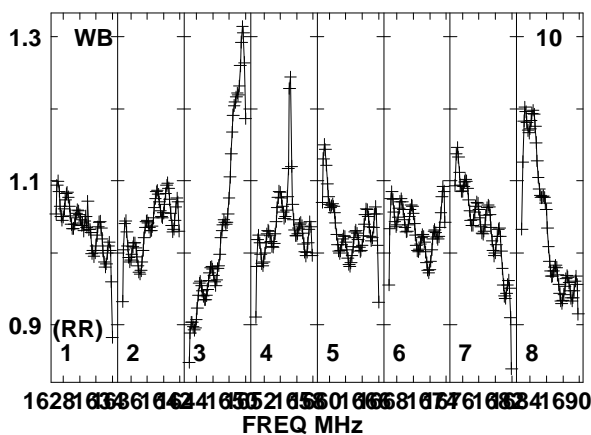
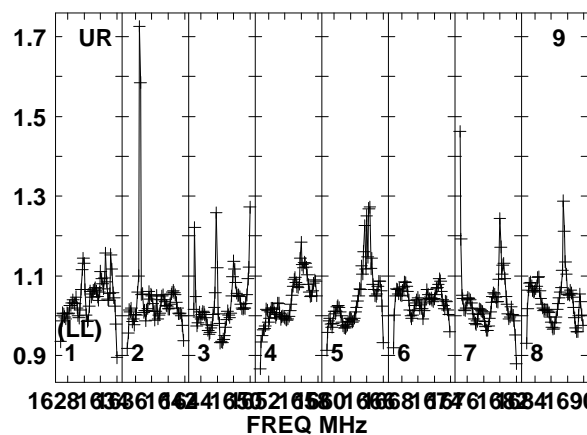
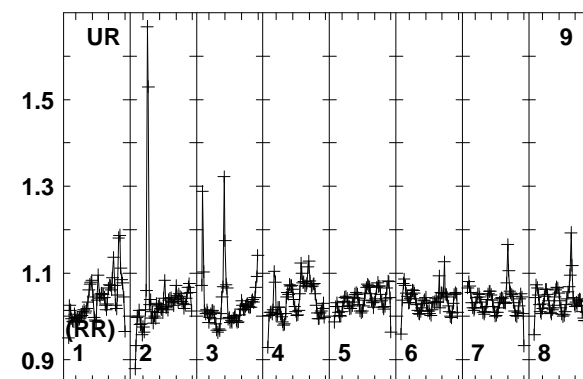
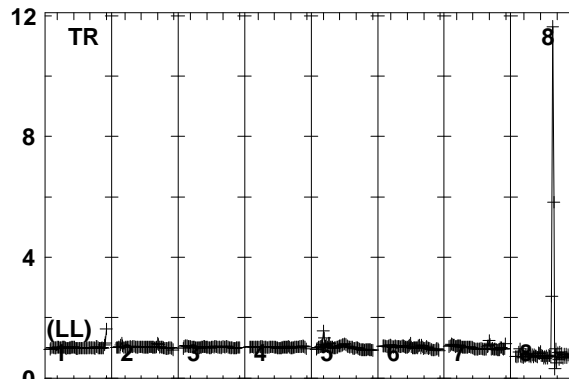
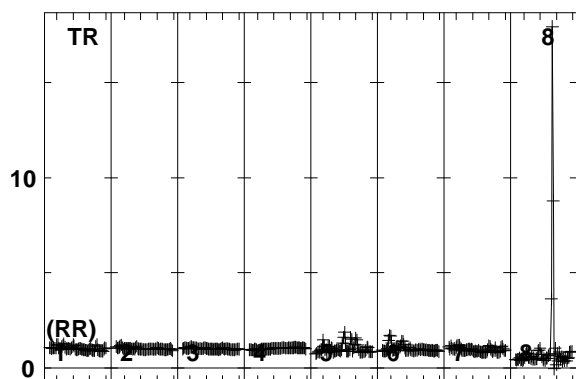
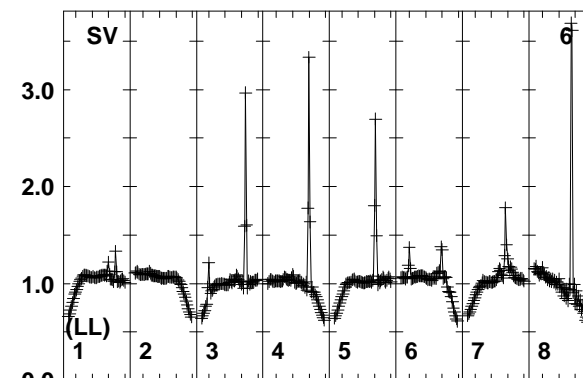
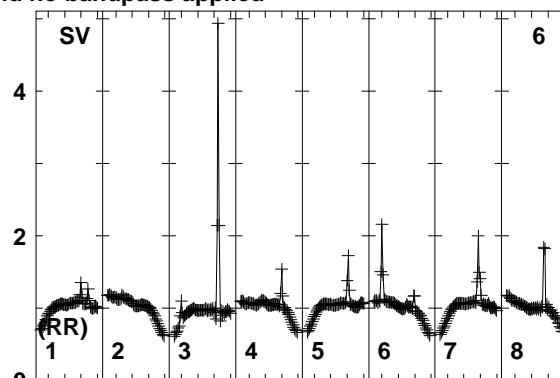
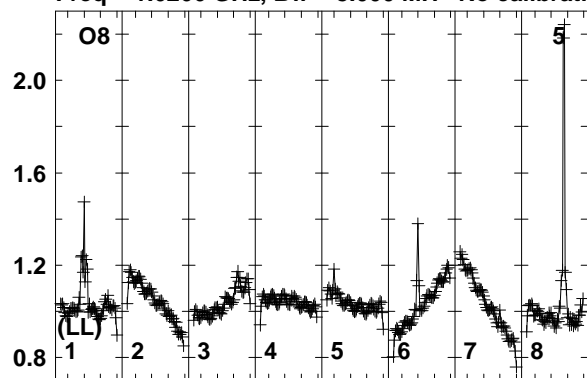

16281 63861 6441 65521 65801 66581 67461 68241 690
FREQ MHz

16281 63861 6441 65521 65801 66581 67461 68241 690
FREQ MHz

16281 63861 6441 65521 65801 66581 67461 68241 690
FREQ MHz

Lower frame: Real Jy
Total-power spectrum Antenna: O8 (05)
Timerange: 00/17:21:05 to 00/17:23:29

Plot file version 111 created 01-AUG-2018 16:38:16

PB-3-1 N18L1 2.UVDATA.1

Freq = 1.6266 GHz, Bw = 8.000 MH No calibration applied and no bandpass applied

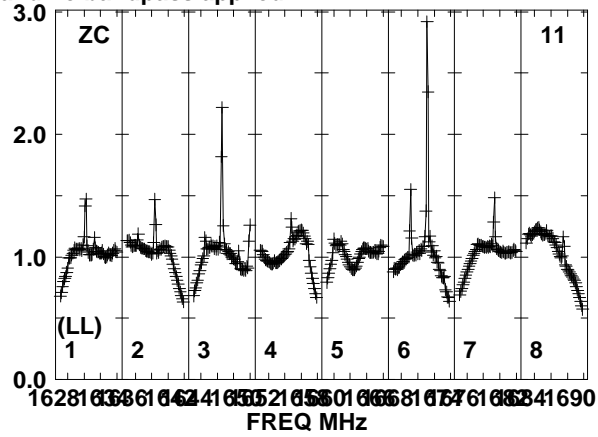
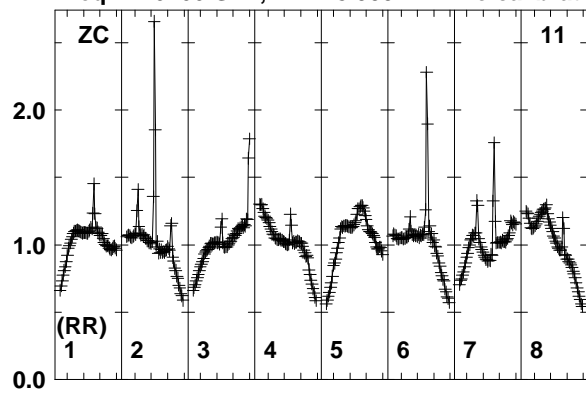

Lower frame: Real Jy
Total-power spectrum Antenna: ZC (11)
Timerange: 00/17:21:05 to 00/17:23:29

Plot file version 112 created 01-AUG-2018 16:38:16

PB-2-1 N18L1 2.UVDATA.1

Freq = 1.6266 GHz, Bw = 8.000 MH No calibration applied and no bandpass applied

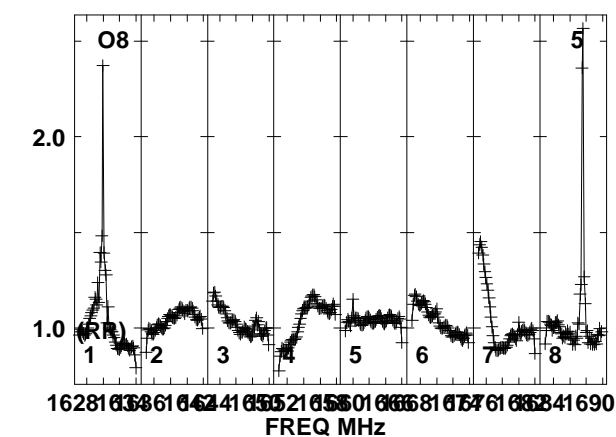
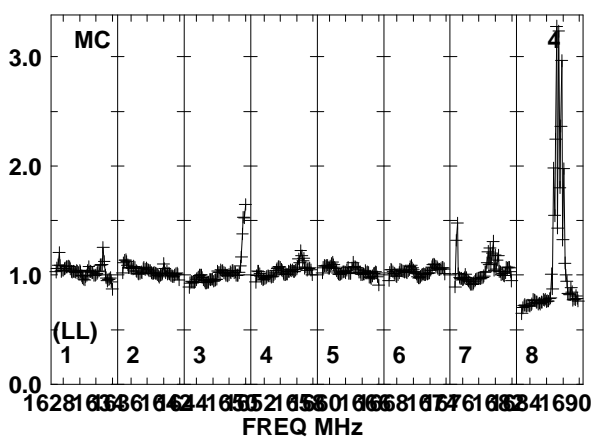
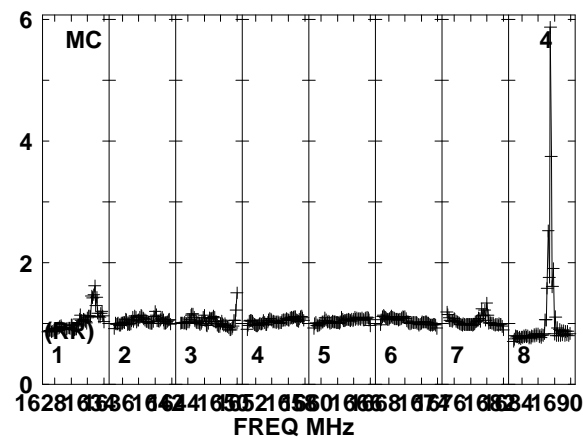
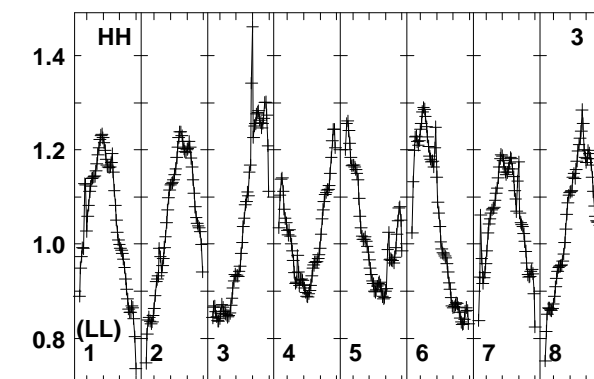
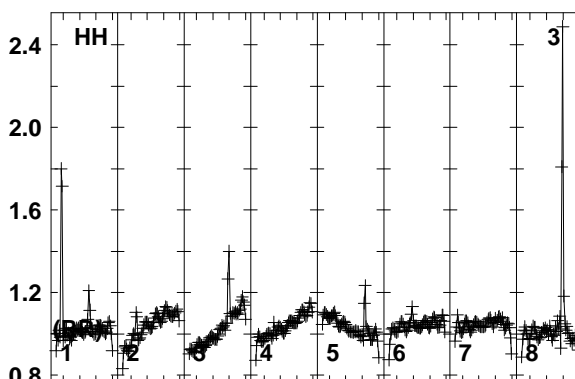
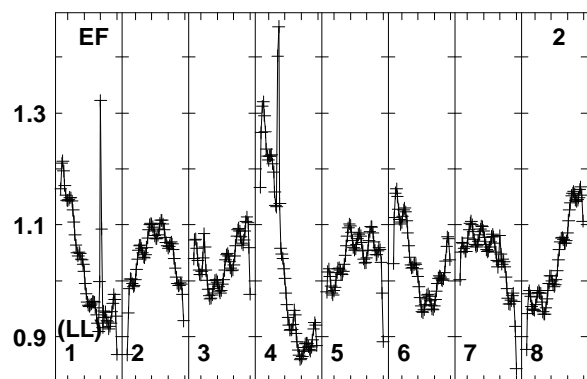
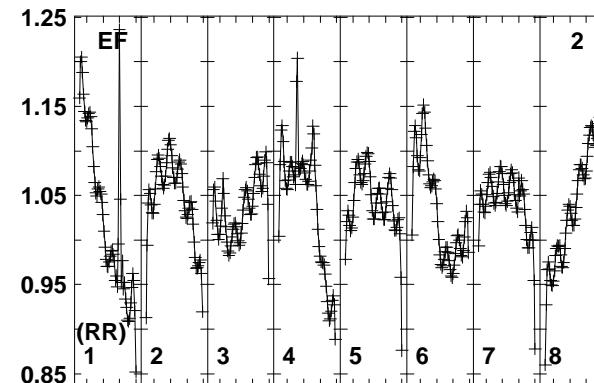
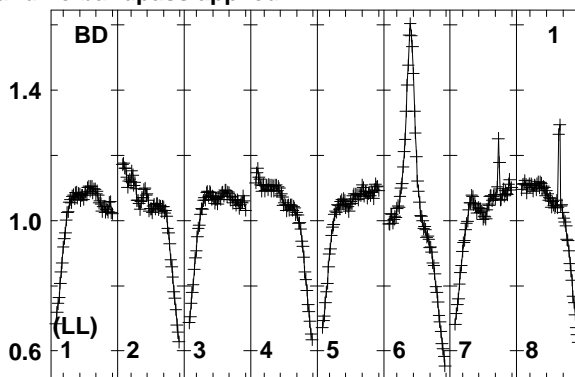
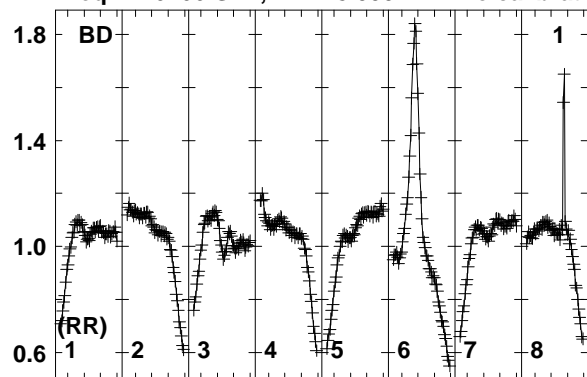

Lower frame: Real Jy
Total-power spectrum Antenna: BD (01)
Timerange: 00/17:23:35 to 00/17:25:59

Plot file version 113 created 01-AUG-2018 16:38:16

PB-2-1 N18L1 2.UVDATA.1

Freq = 1.6266 GHz, Bw = 8.000 MH No calibration applied and no bandpass applied

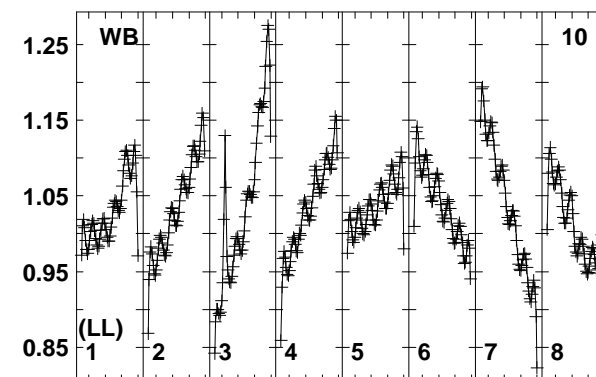
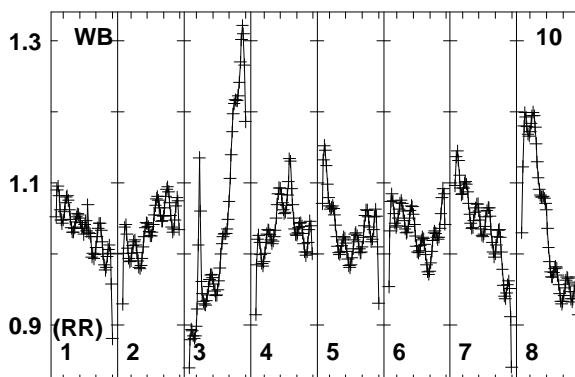
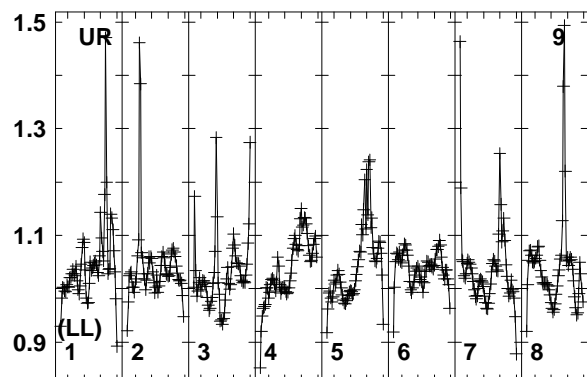
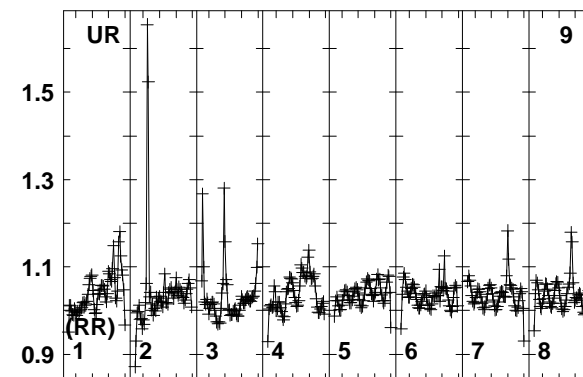
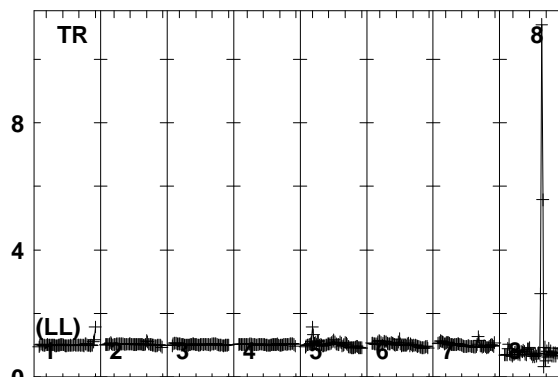
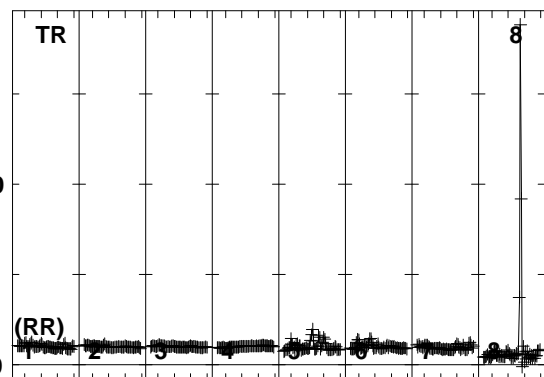
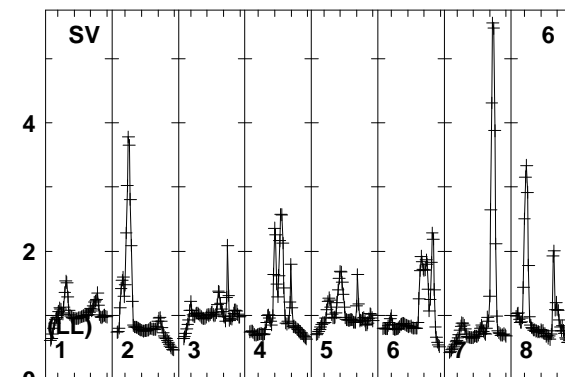
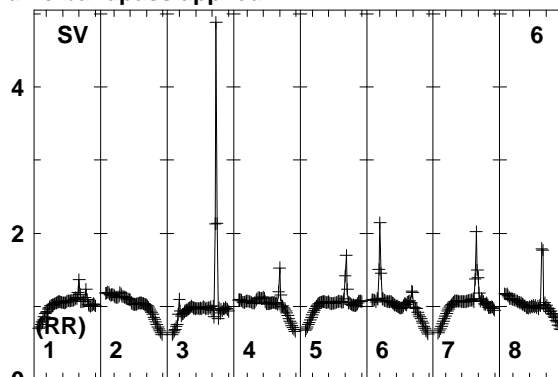
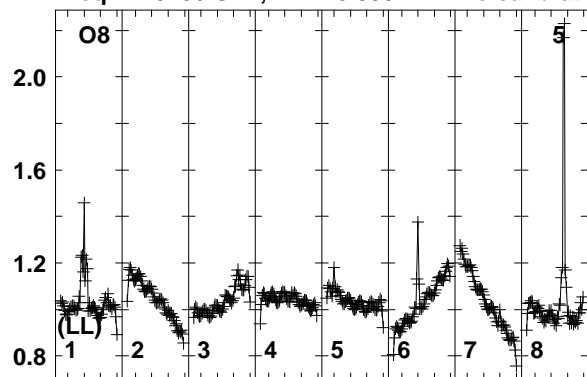

16281 63861 64416 65216 66016 66816 67616 68416 690

FREQ MHz

16281 63861 64416 65216 66016 66816 67616 68416 690

FREQ MHz

16281 63861 64416 65216 66016 66816 67616 68416 690

FREQ MHz

Lower frame: Real Jy
Total-power spectrum Antenna: O8 (05)
Timerange: 00/17:23:35 to 00/17:25:59

Plot file version 114 created 01-AUG-2018 16:38:16

PB-2-1 N18L1 2.UVDATA.1

Freq = 1.6266 GHz, Bw = 8.000 MH No calibration applied and no bandpass applied

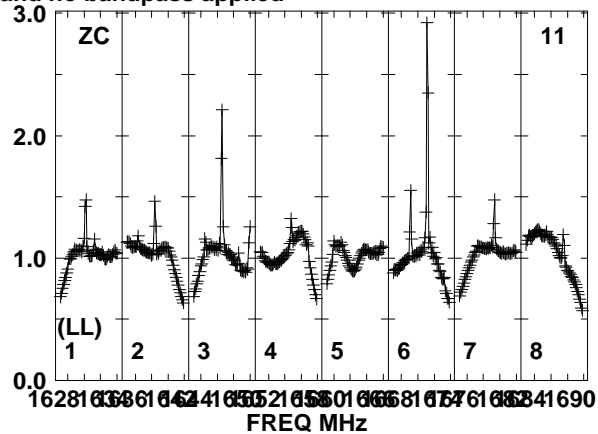
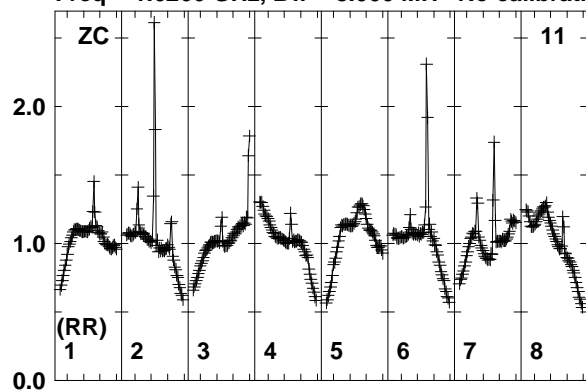

Lower frame: Real Jy
Total-power spectrum Antenna: ZC (11)
Timerange: 00/17:23:35 to 00/17:25:59

Plot file version 115 created 01-AUG-2018 16:38:16

PB-1-1 N18L1 2.UVDATA.1

Freq = 1.6266 GHz, Bw = 8.000 MH No calibration applied and no bandpass applied

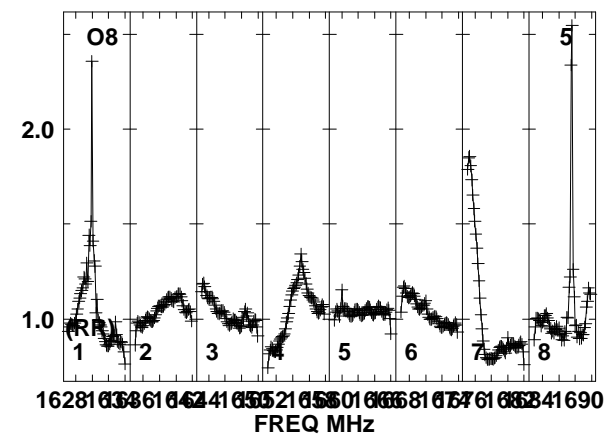
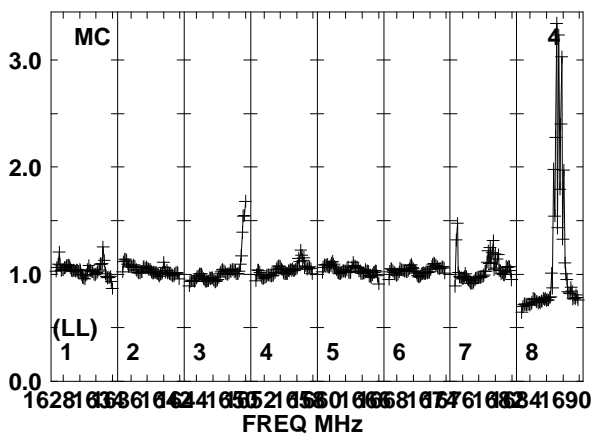
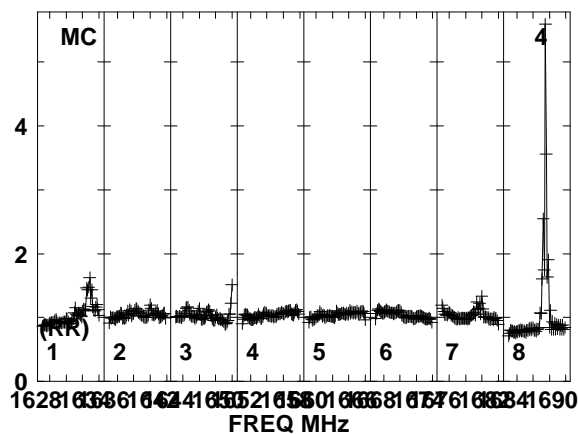
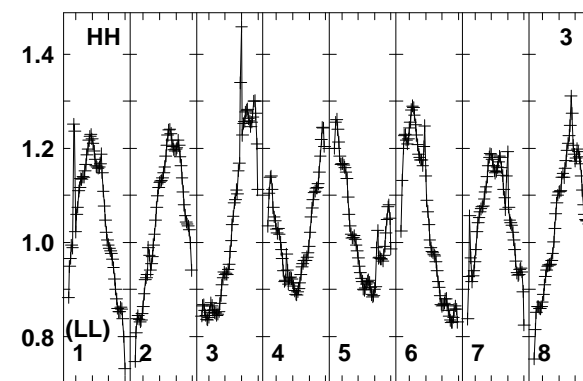
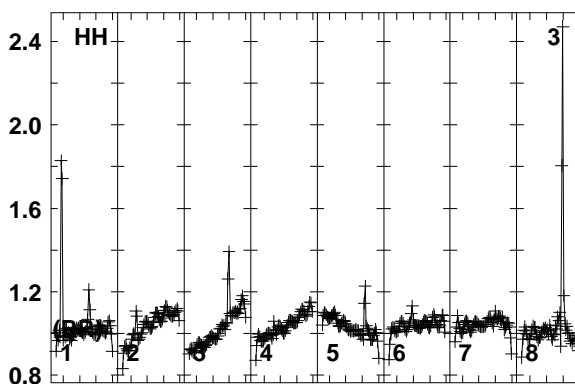
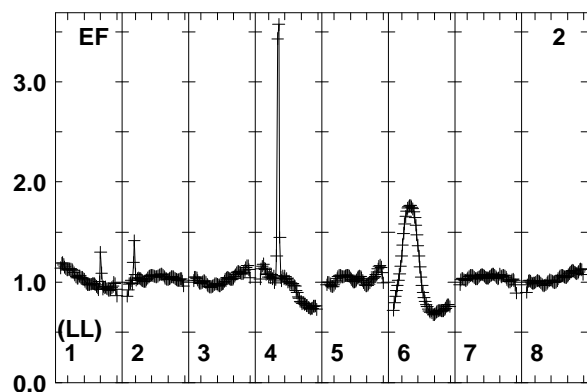
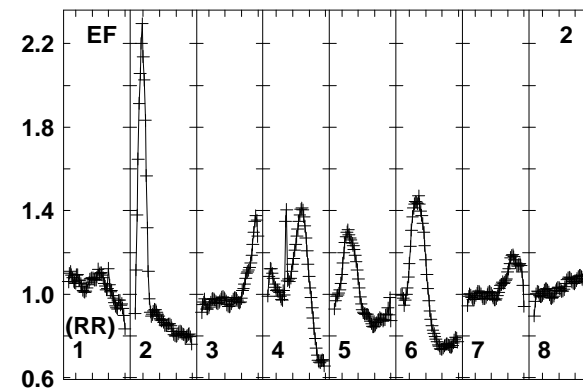
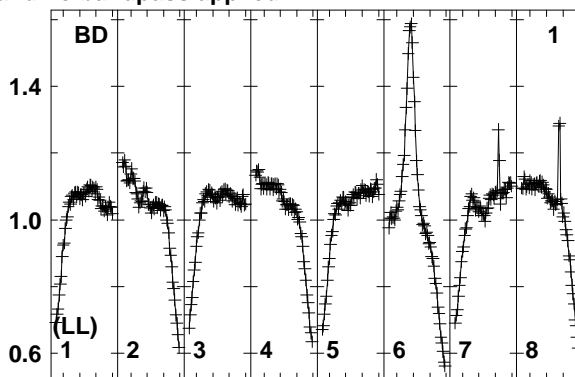
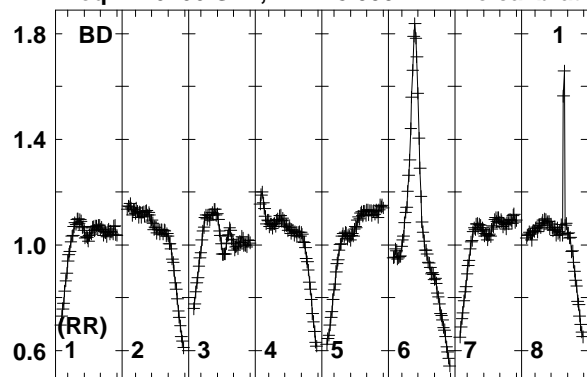

Lower frame: Real Jy
Total-power spectrum Antenna: BD (01)
Timerange: 00/17:26:05 to 00/17:28:29

Plot file version 116 created 01-AUG-2018 16:38:16

PB-1-1 N18L1 2.UVDATA.1

Freq = 1.6266 GHz, Bw = 8.000 MH No calibration applied and no bandpass applied

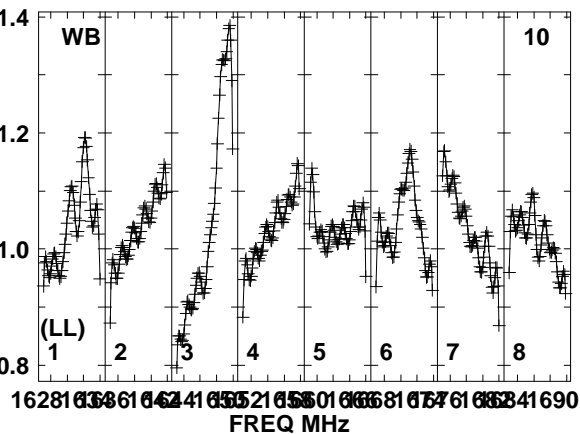
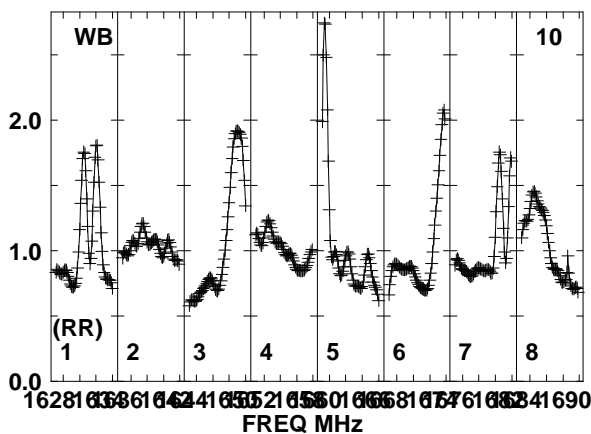
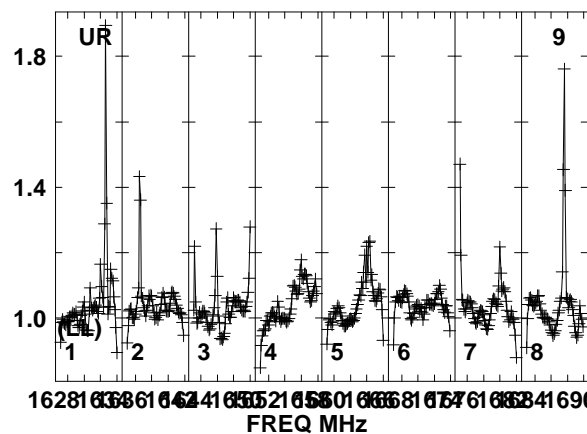
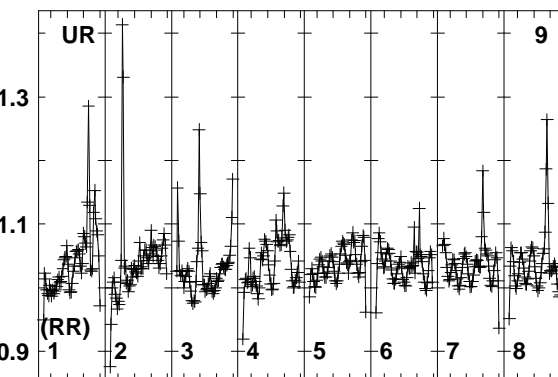
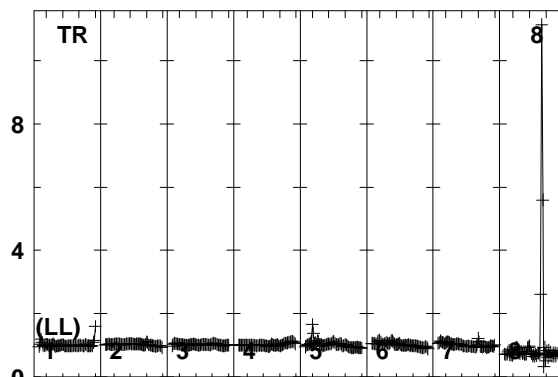
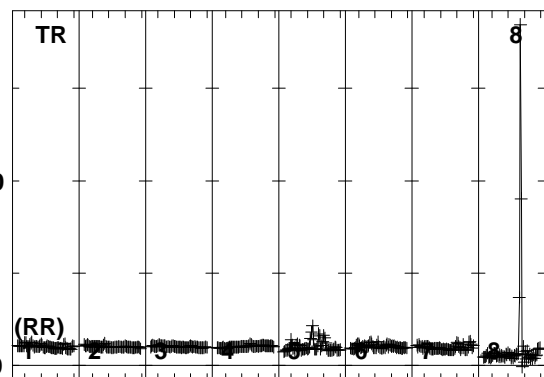
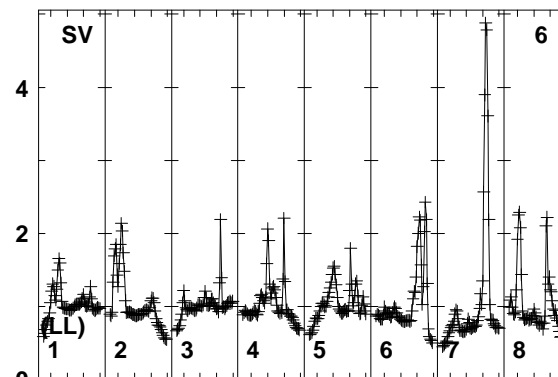
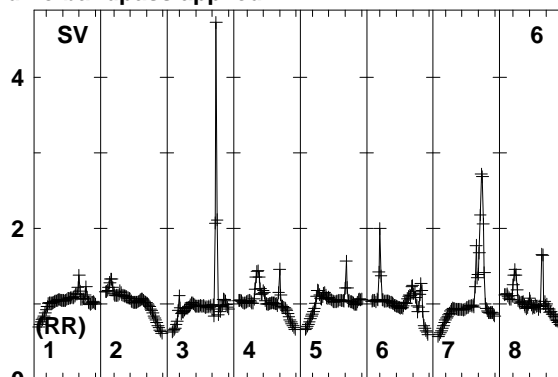
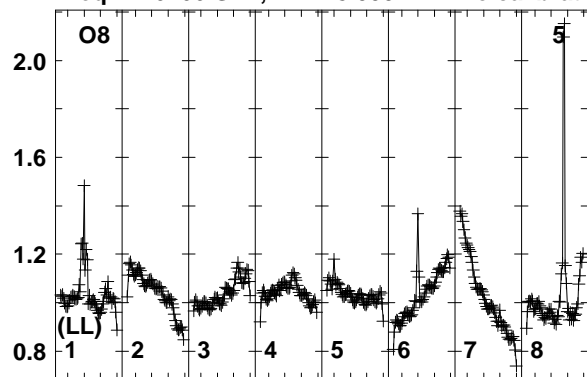

Lower frame: Real Jy
Total-power spectrum Antenna: O8 (05)
Timerange: 00/17:26:05 to 00/17:28:29

Plot file version 117 created 01-AUG-2018 16:38:16

PB-1-1 N18L1 2.UVDATA.1

Freq = 1.6266 GHz, Bw = 8.000 MH No calibration applied and no bandpass applied

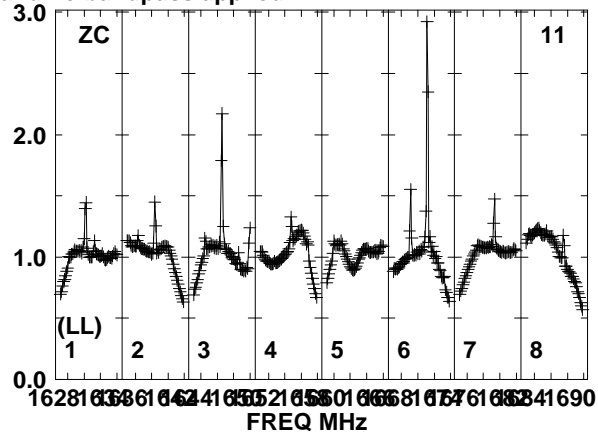
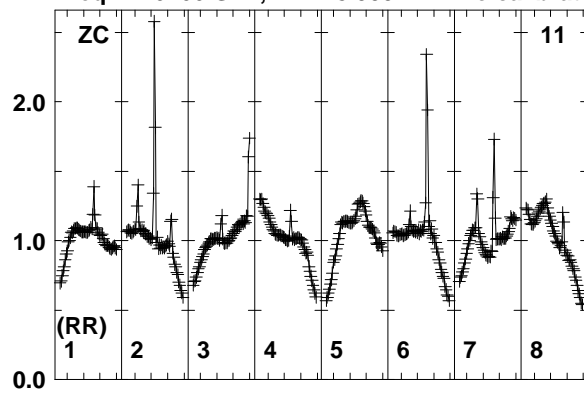

Lower frame: Real Jy
Total-power spectrum Antenna: ZC (11)
Timerange: 00/17:26:05 to 00/17:28:29

Plot file version 118 created 01-AUG-2018 16:38:16

PB+0-1 N18L1 2.UVDATA.1

Freq = 1.6266 GHz, Bw = 8.000 MH No calibration applied and no bandpass applied

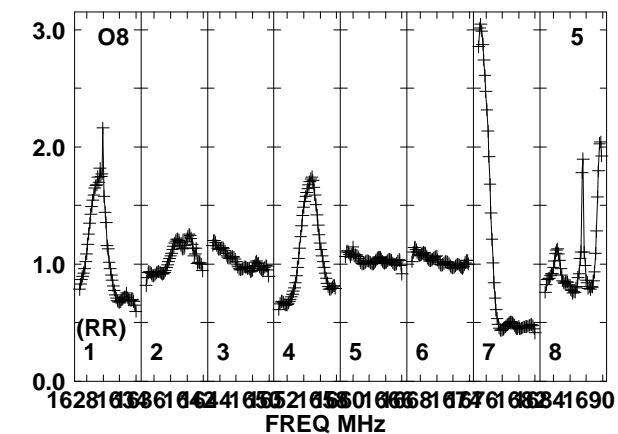
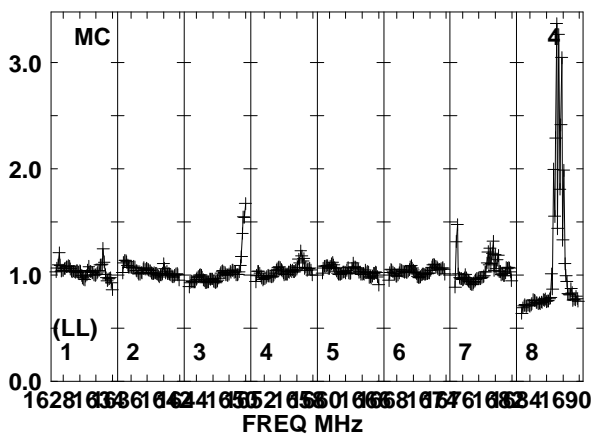
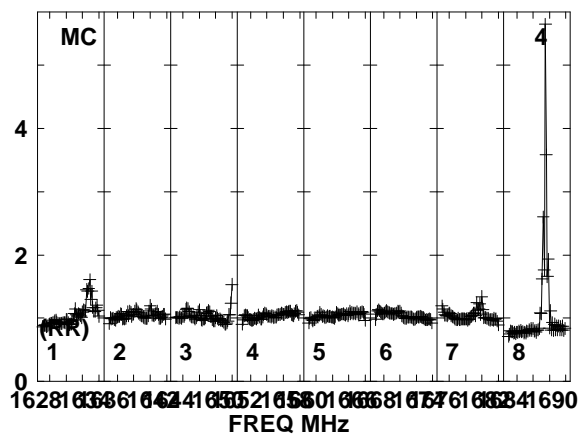
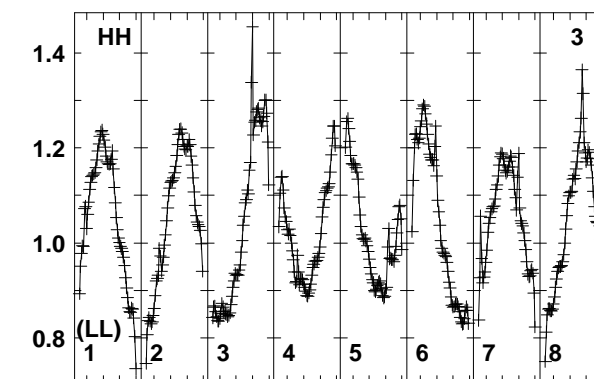
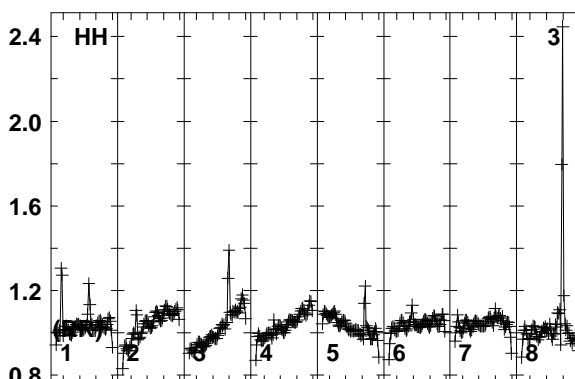
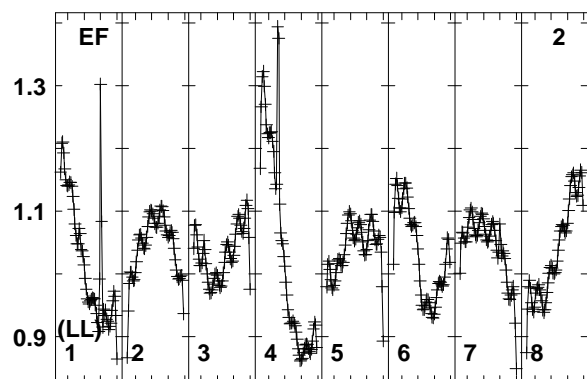
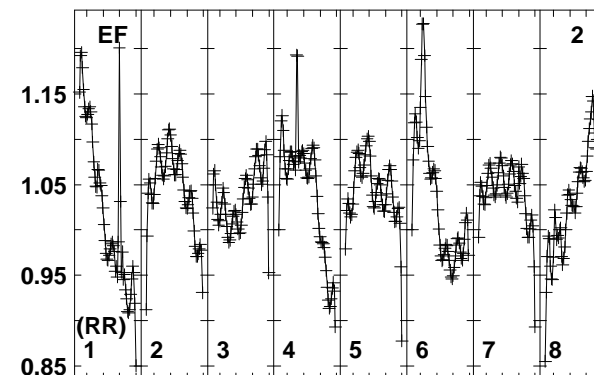
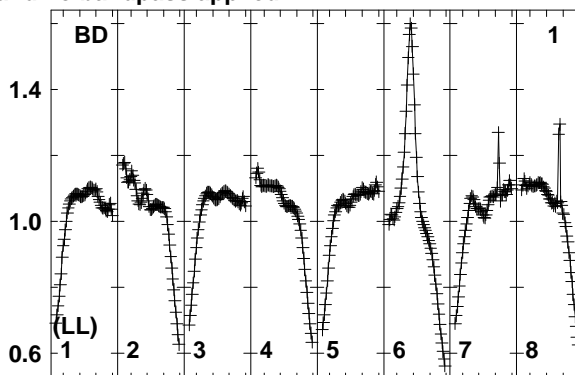
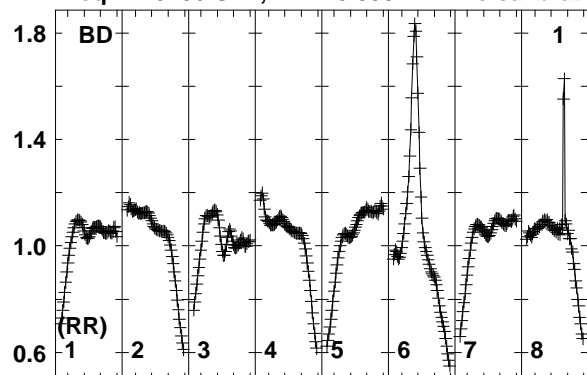

Lower frame: Real Jy
Total-power spectrum Antenna: BD (01)
Timerange: 00/17:28:33 to 00/17:30:59

Plot file version 119 created 01-AUG-2018 16:38:16

PB+0-1 N18L1 2.UVDATA.1

Freq = 1.6266 GHz, Bw = 8.000 MH No calibration applied and no bandpass applied

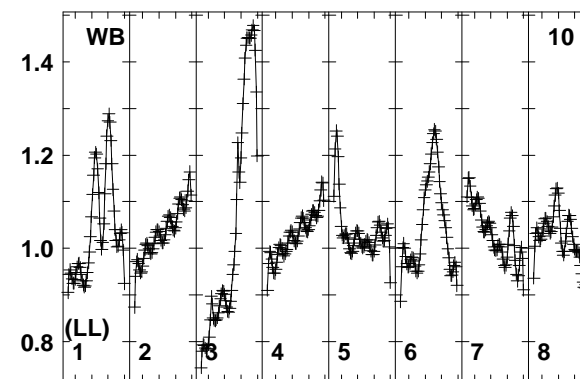
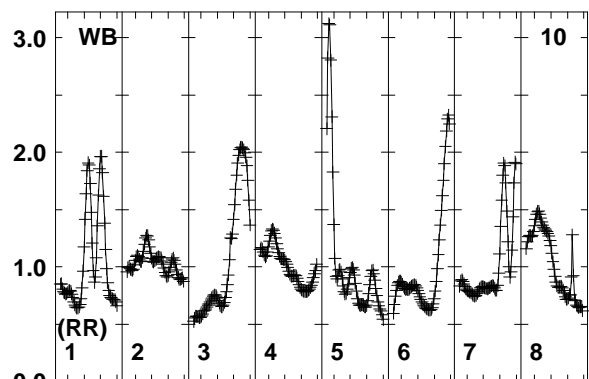
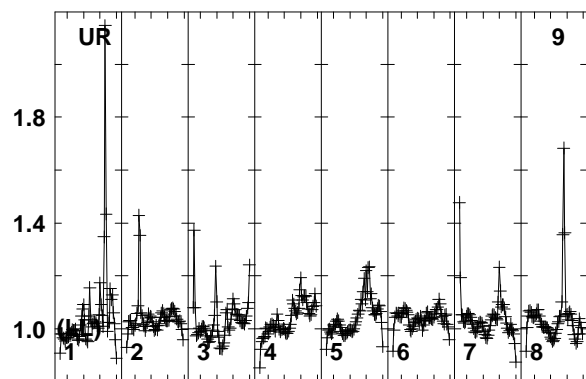
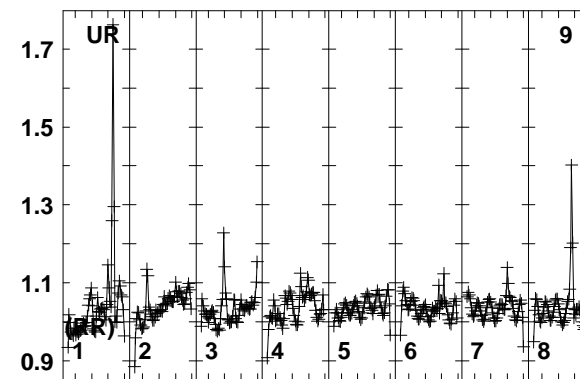
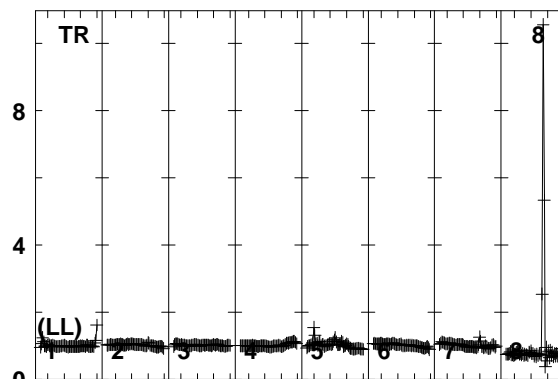
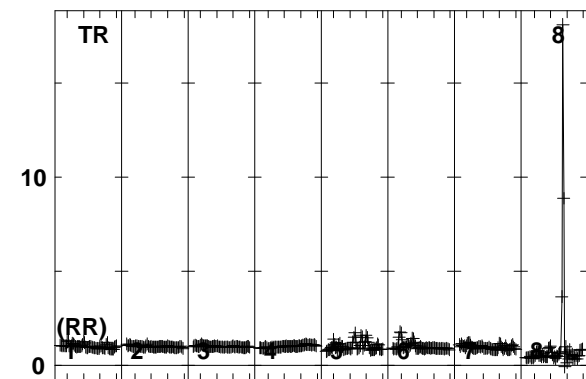
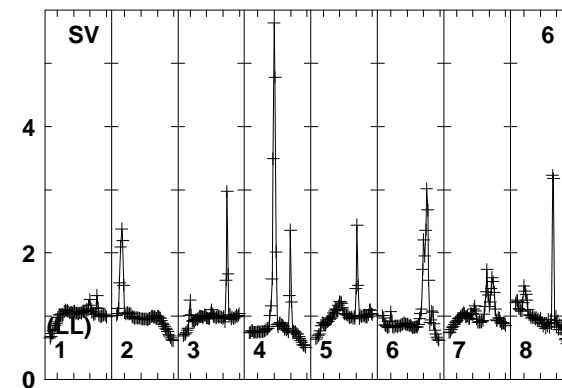
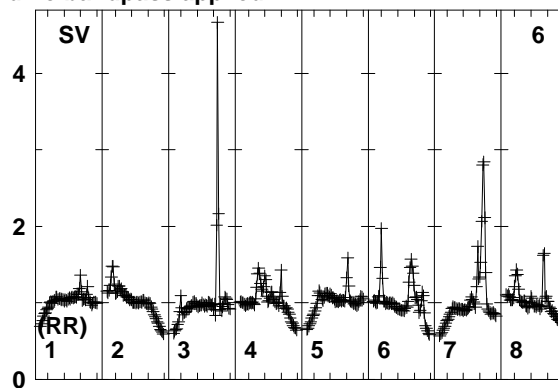
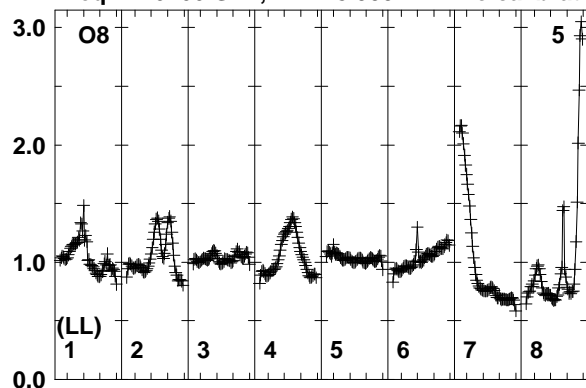

1628163861642416552165801666816746168241690
FREQ MHz

1628163861642416552165801666816746168241690
FREQ MHz

1628163861642416552165801666816746168241690
FREQ MHz

Lower frame: Real Jy
Total-power spectrum Antenna: O8 (05)
Timerange: 00/17:28:33 to 00/17:30:59

Plot file version 120 created 01-AUG-2018 16:38:17

PB+0-1 N18L1 2.UVDATA.1

Freq = 1.6266 GHz, Bw = 8.000 MH No calibration applied and no bandpass applied

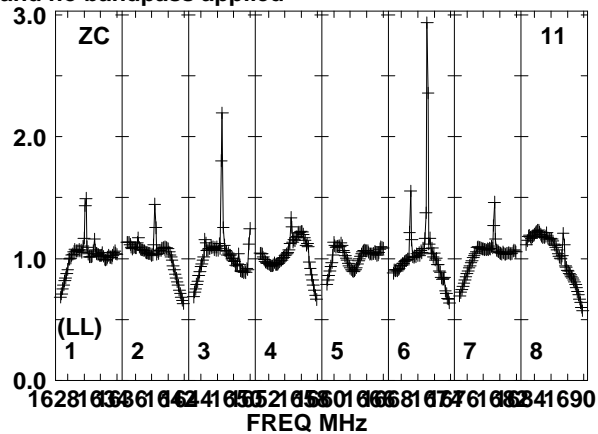
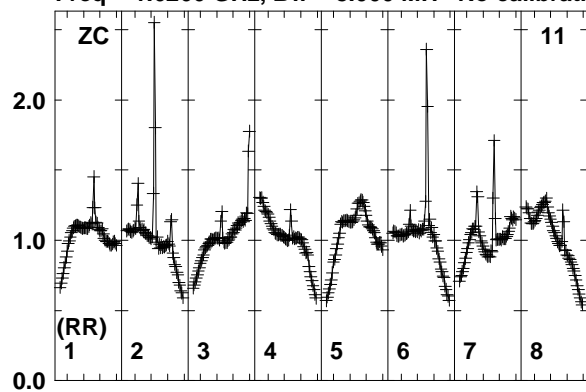

Lower frame: Real Jy
Total-power spectrum Antenna: ZC (11)
Timerange: 00/17:28:33 to 00/17:30:59

Plot file version 121 created 01-AUG-2018 16:38:17

J0530+1331 N18L1 2.UVDATA.1

Freq = 1.6266 GHz, Bw = 8.000 MH No calibration applied and no bandpass applied

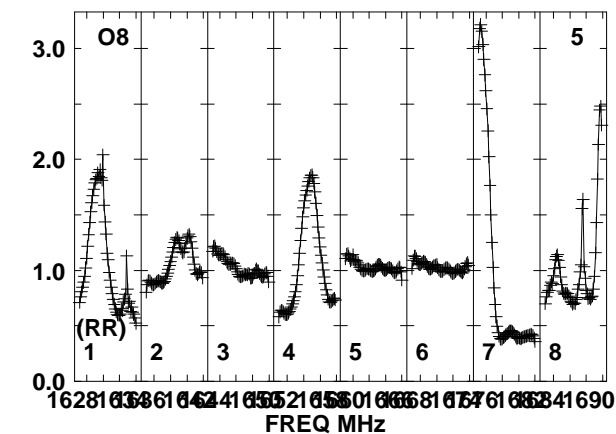
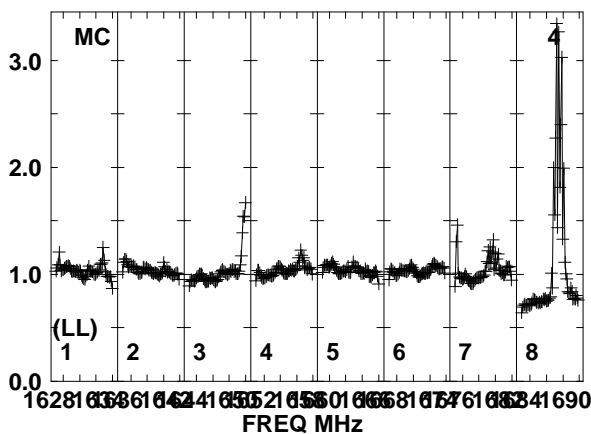
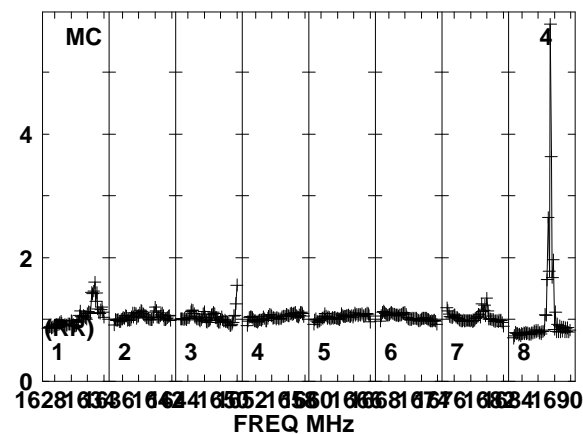
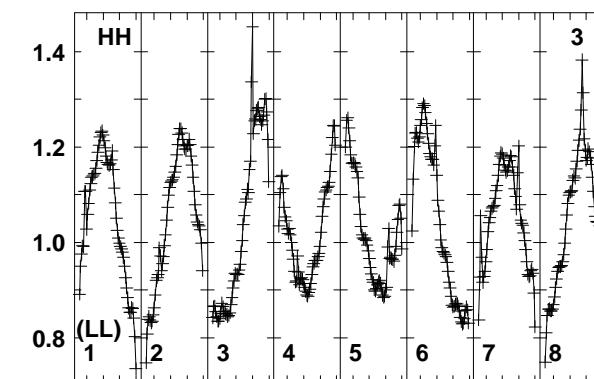
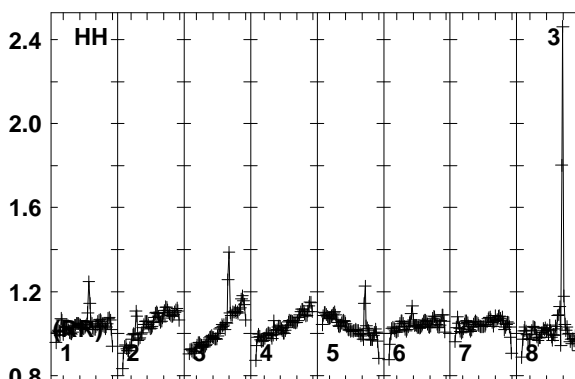
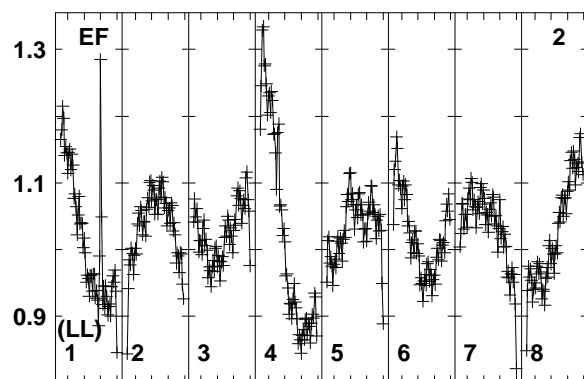
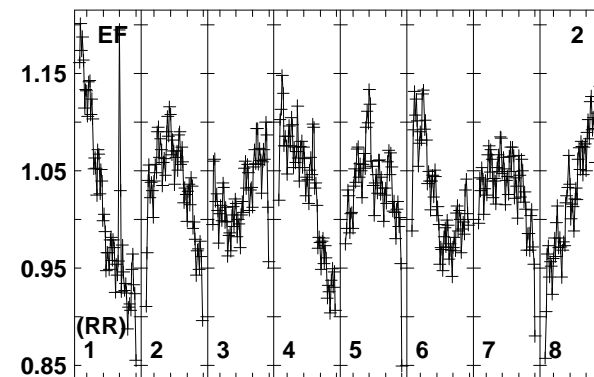
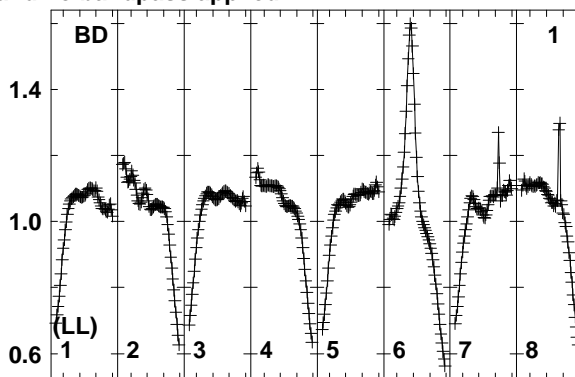
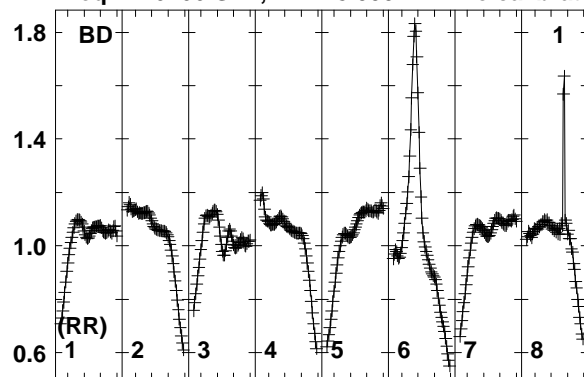

Lower frame: Real Jy
Total-power spectrum Antenna: BD (01)
Timerange: 00/17:31:41 to 00/17:32:59

Plot file version 122 created 01-AUG-2018 16:38:17

J0530+1331 N18L1 2.UVDATA.1

Freq = 1.6266 GHz, Bw = 8.000 MH No calibration applied and no bandpass applied

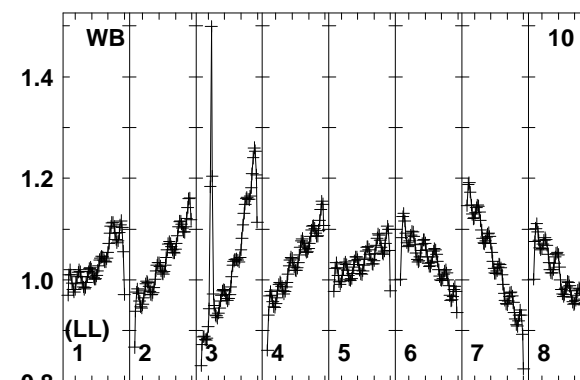
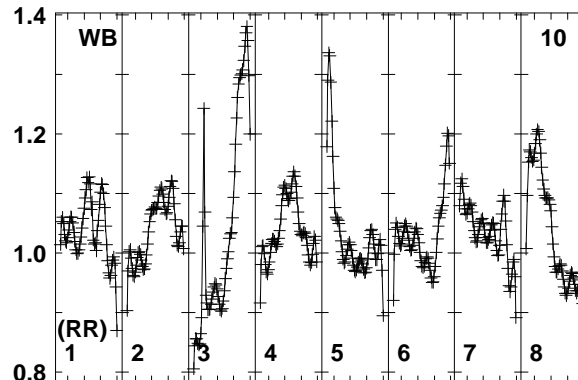
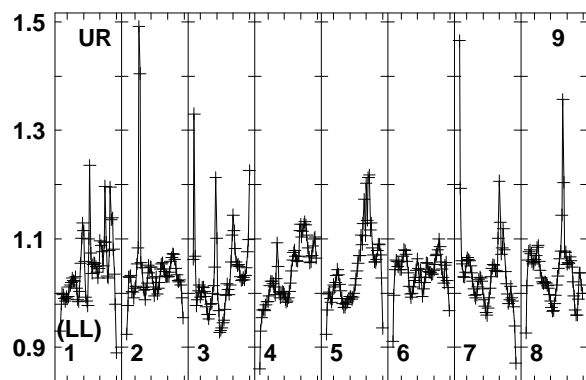
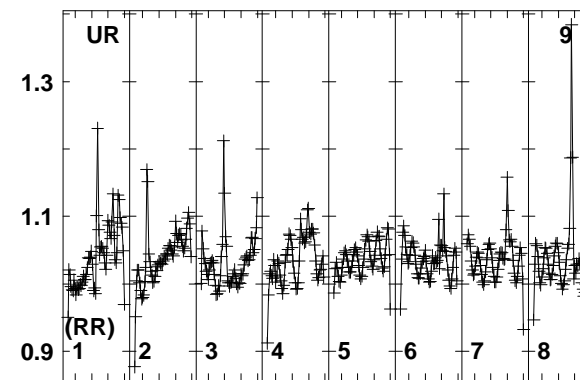
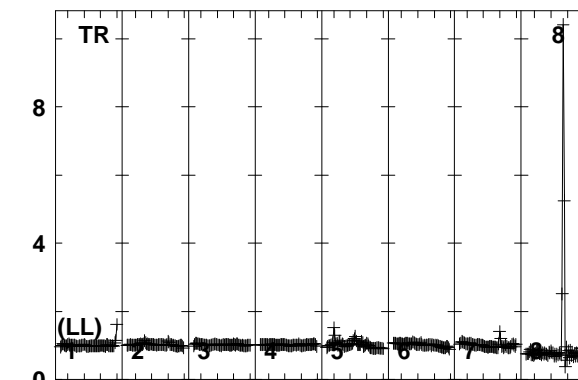
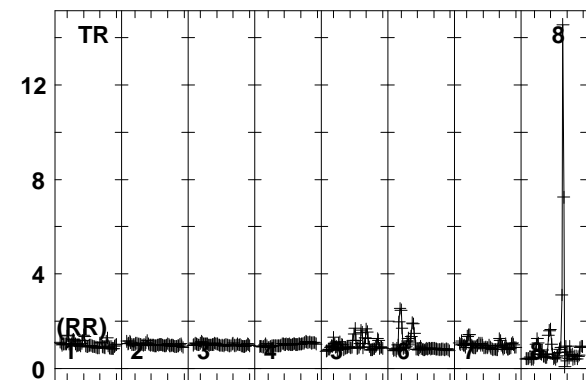
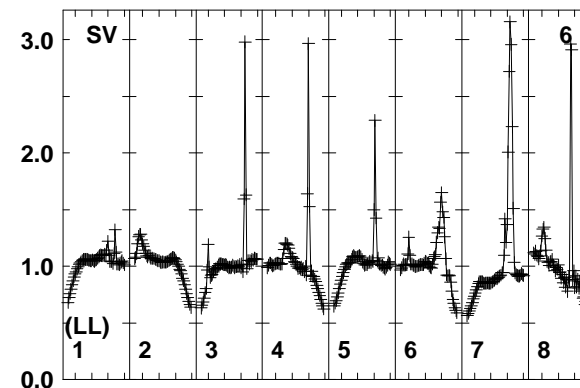
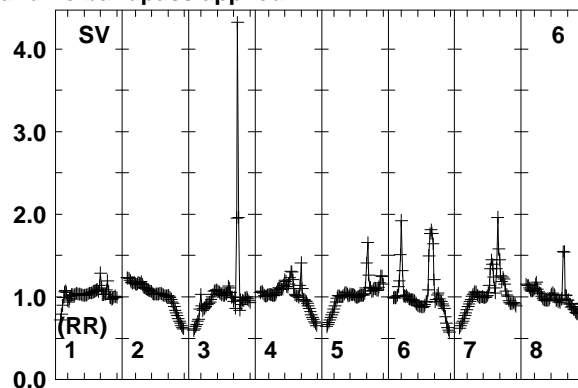
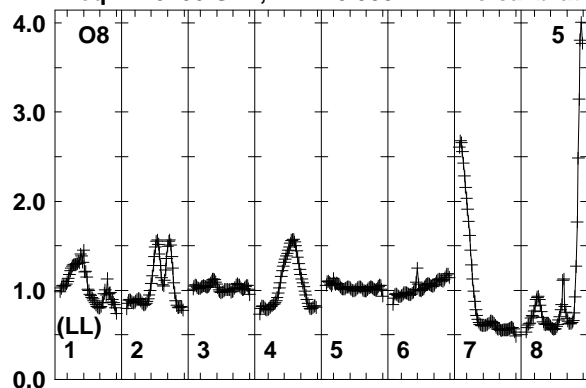

16281638616441652165816668167468241690
FREQ MHz

16281638616441652165816668167468241690
FREQ MHz

16281638616441652165816668167468241690
FREQ MHz

Lower frame: Real Jy
Total-power spectrum Antenna: O8 (05)
Timerange: 00/17:31:41 to 00/17:32:59

Plot file version 123 created 01-AUG-2018 16:38:17

J0530+1331 N18L1 2.UVDATA.1

Freq = 1.6266 GHz, Bw = 8.000 MH No calibration applied and no bandpass applied

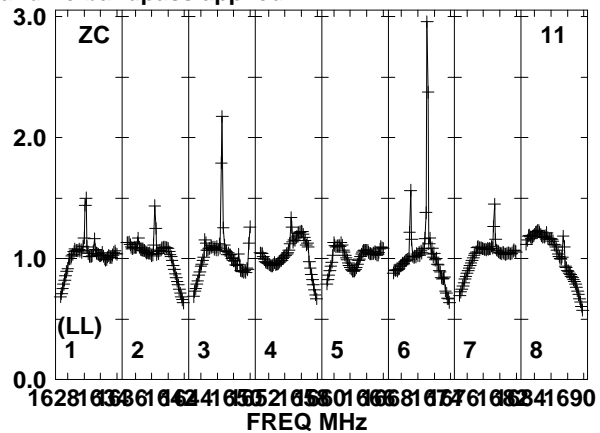
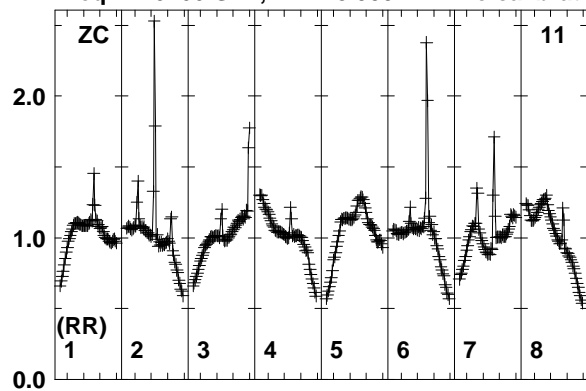

Lower frame: Real Jy
Total-power spectrum Antenna: ZC (11)
Timerange: 00/17:31:41 to 00/17:32:59

Plot file version 124 created 01-AUG-2018 16:38:17

PB+1-1 N18L1 2.UVDATA.1

Freq = 1.6266 GHz, Bw = 8.000 MH No calibration applied and no bandpass applied

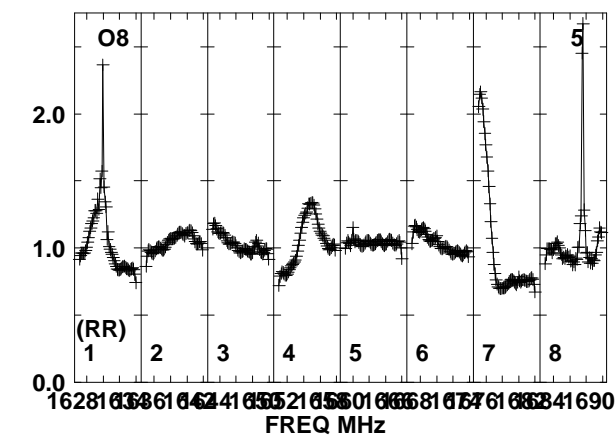
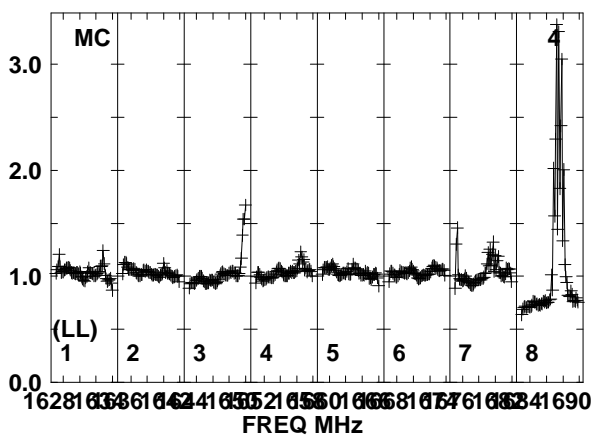
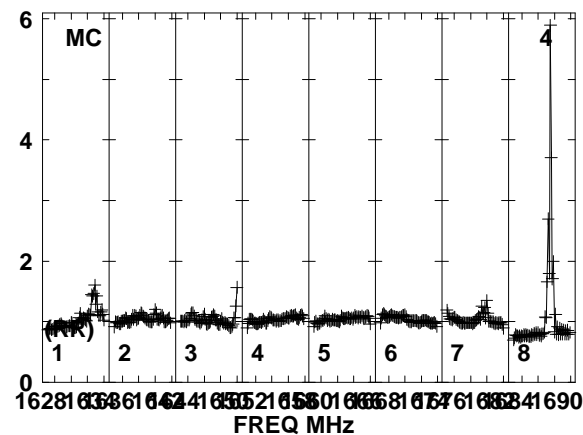
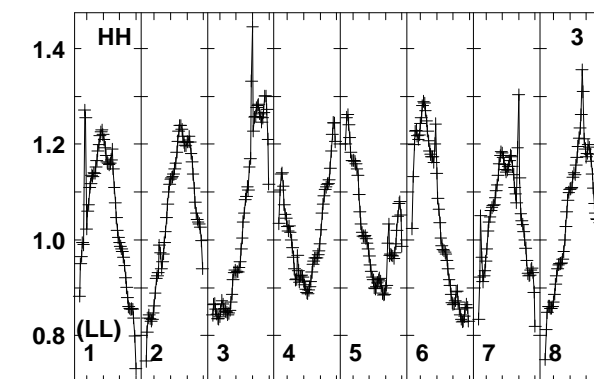
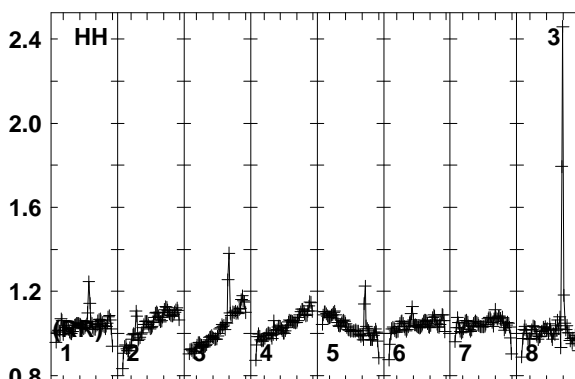
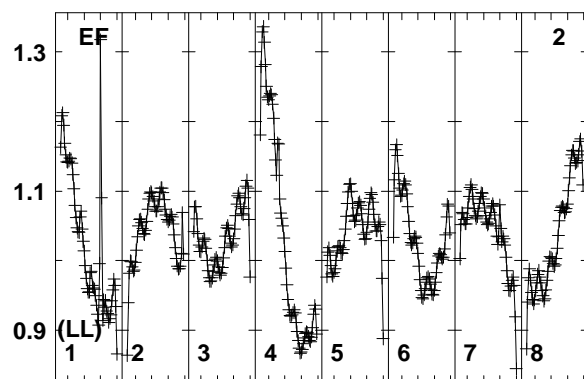
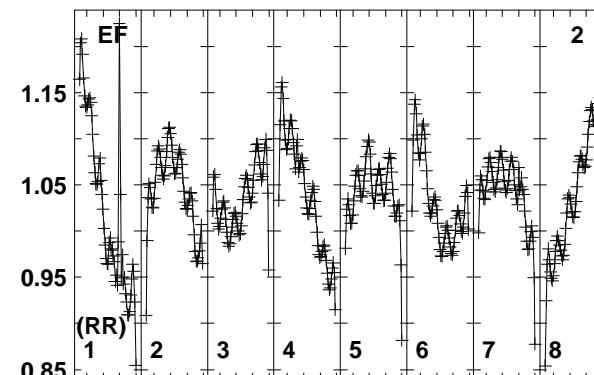
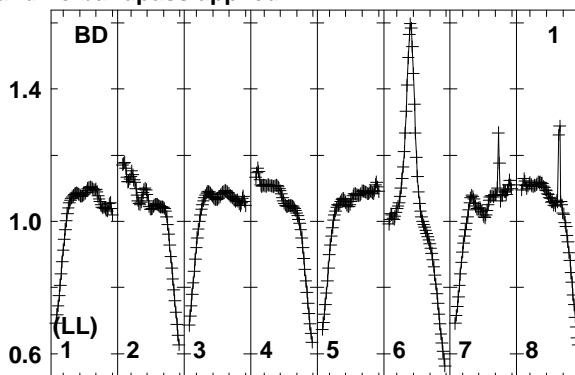
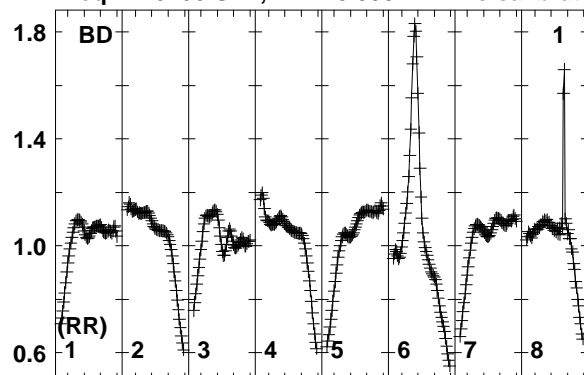

Lower frame: Real Jy
Total-power spectrum Antenna: BD (01)
Timerange: 00/17:33:03 to 00/17:35:29

Plot file version 125 created 01-AUG-2018 16:38:17

PB+1-1 N18L1 2.UVDATA.1

Freq = 1.6266 GHz, Bw = 8.000 MH No calibration applied and no bandpass applied

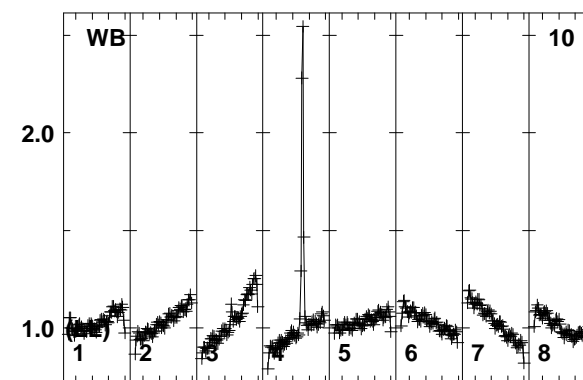
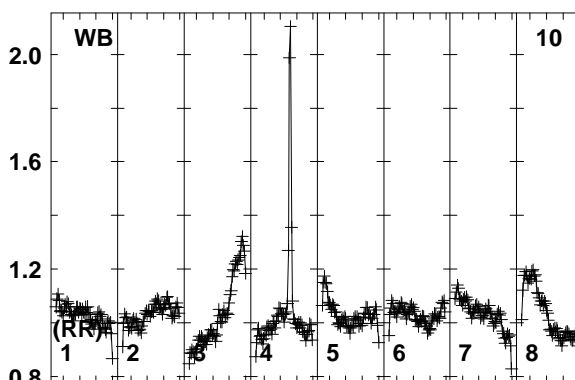
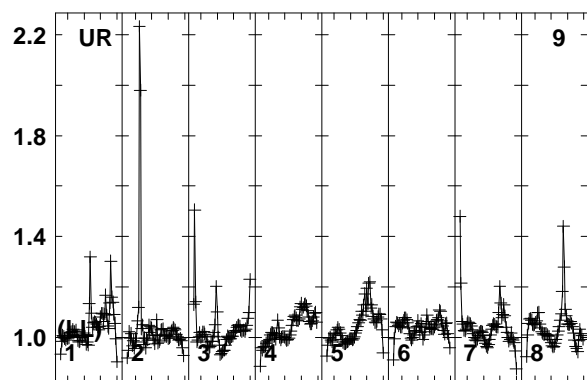
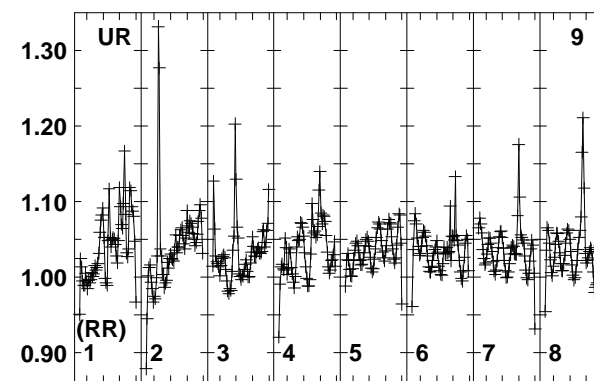
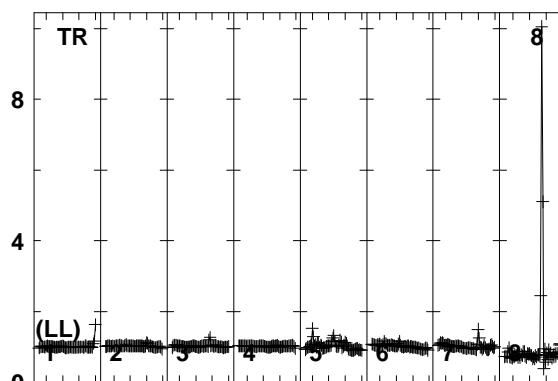
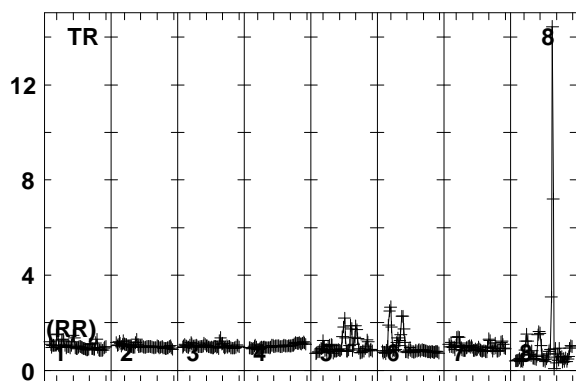
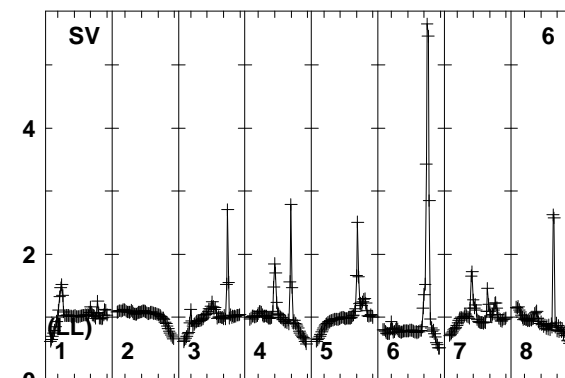
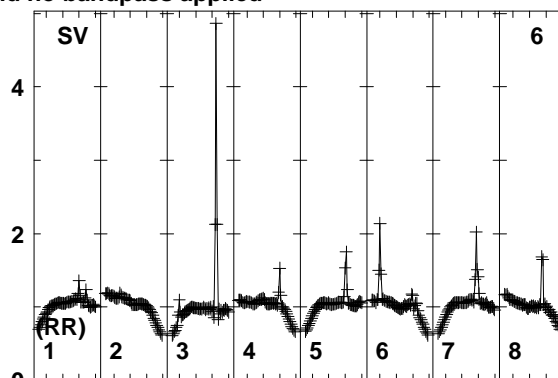
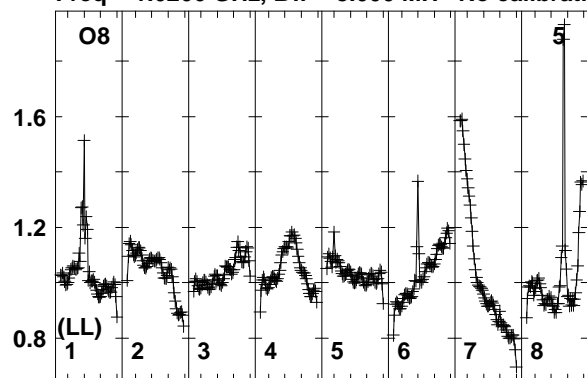

16281 16386 16441 16521 16550 16658 16746 16824 1690
FREQ MHz

16281 16386 16441 16521 16550 16658 16746 16824 1690
FREQ MHz

16281 16386 16441 16521 16550 16658 16746 16824 1690
FREQ MHz

Lower frame: Real Jy
Total-power spectrum Antenna: O8 (05)
Timerange: 00/17:33:03 to 00/17:35:29

Plot file version 126 created 01-AUG-2018 16:38:17

PB+1-1 N18L1 2.UVDATA.1

Freq = 1.6266 GHz, Bw = 8.000 MH No calibration applied and no bandpass applied

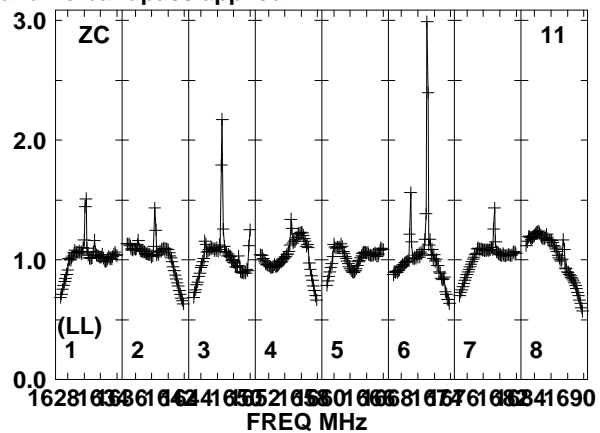
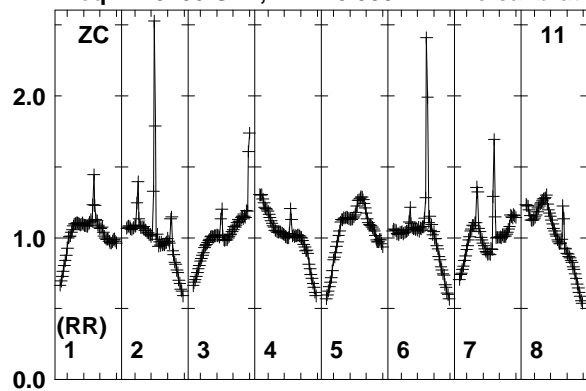

Lower frame: Real Jy
Total-power spectrum Antenna: ZC (11)
Timerange: 00/17:33:03 to 00/17:35:29

Plot file version 127 created 01-AUG-2018 16:38:17

PB+2-1 N18L1 2.UVDATA.1

Freq = 1.6266 GHz, Bw = 8.000 MH No calibration applied and no bandpass applied

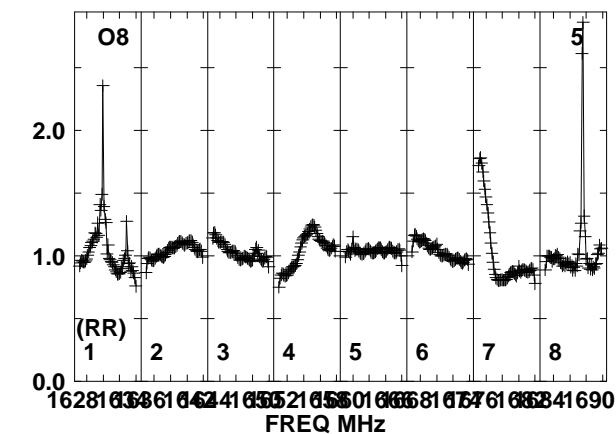
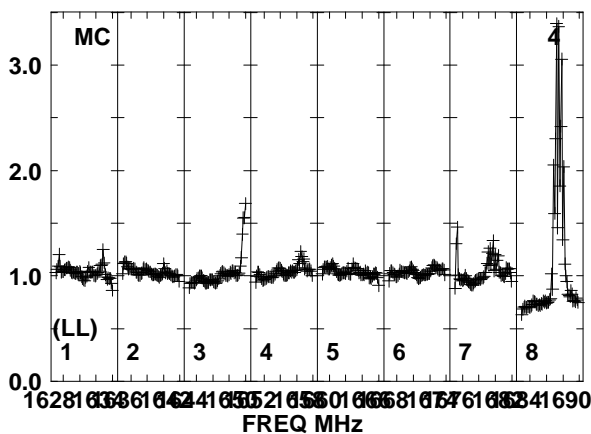
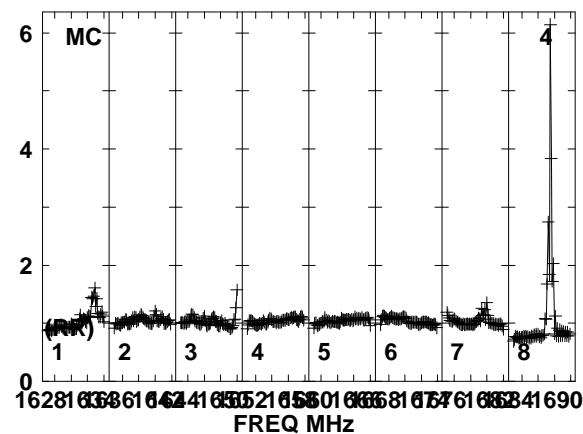
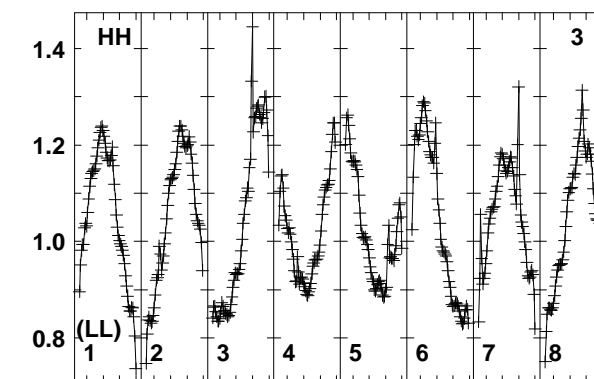
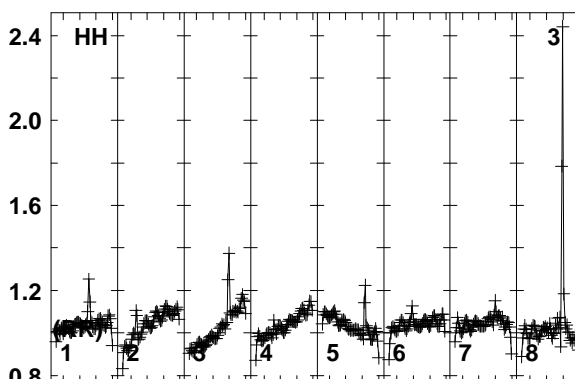
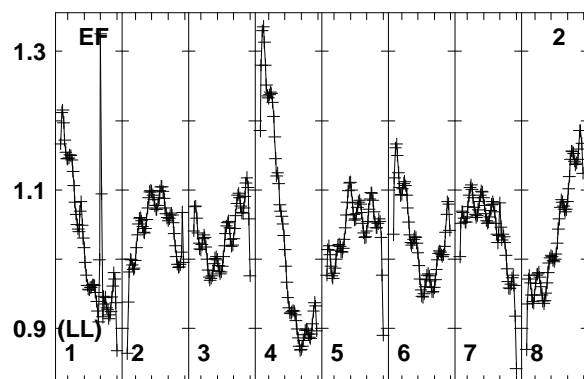
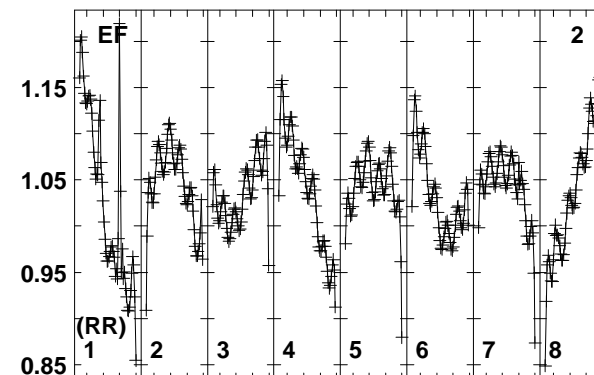
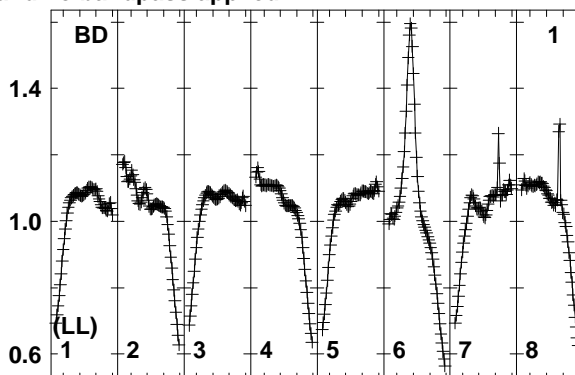
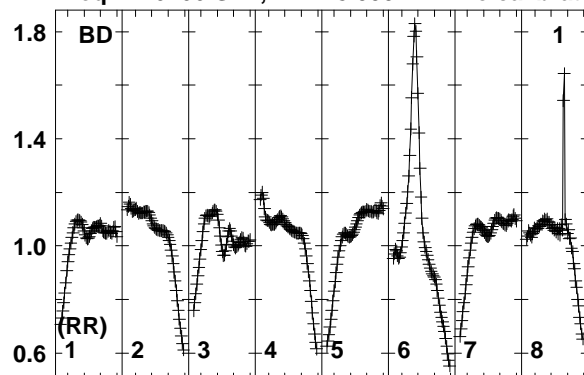

Lower frame: Real Jy
Total-power spectrum Antenna: BD (01)
Timerange: 00/17:35:35 to 00/17:37:59

Plot file version 128 created 01-AUG-2018 16:38:17

PB+2-1 N18L1 2.UVDATA.1

Freq = 1.6266 GHz, Bw = 8.000 MH No calibration applied and no bandpass applied

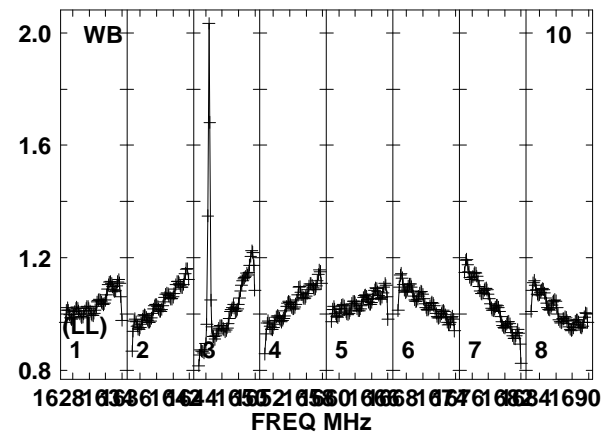
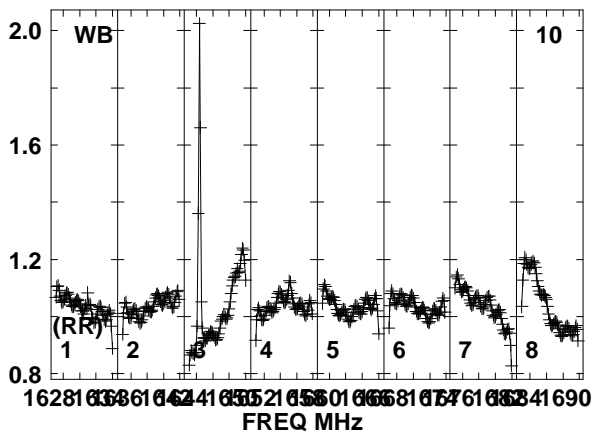
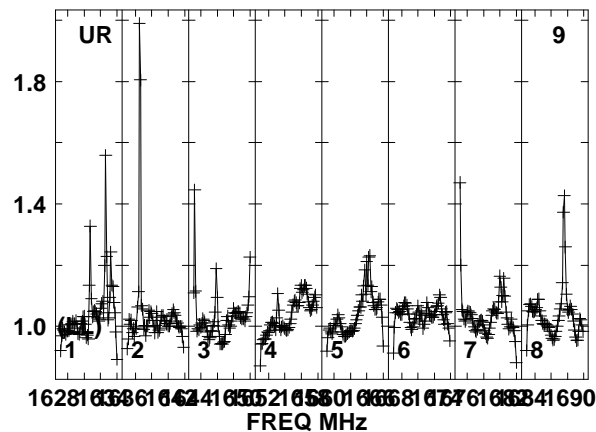
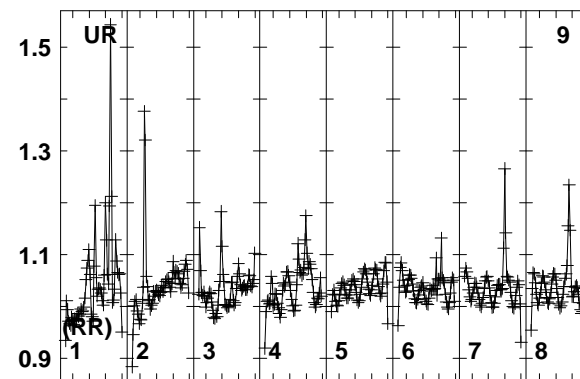
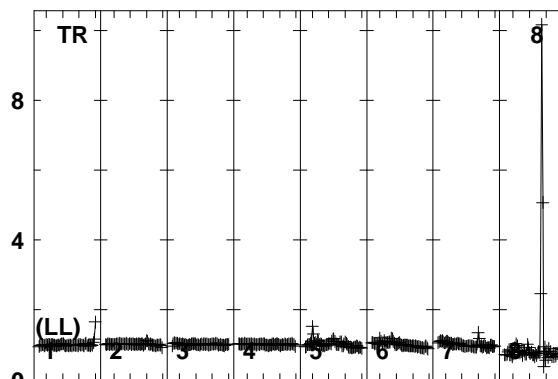
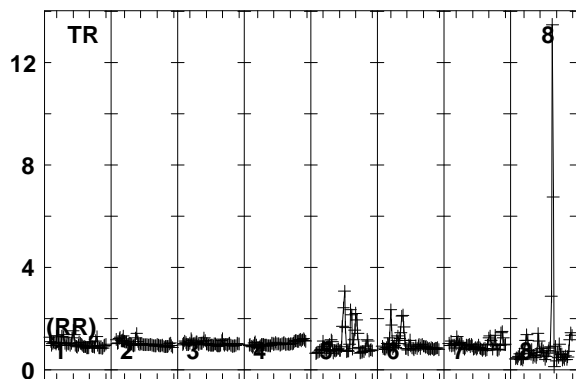
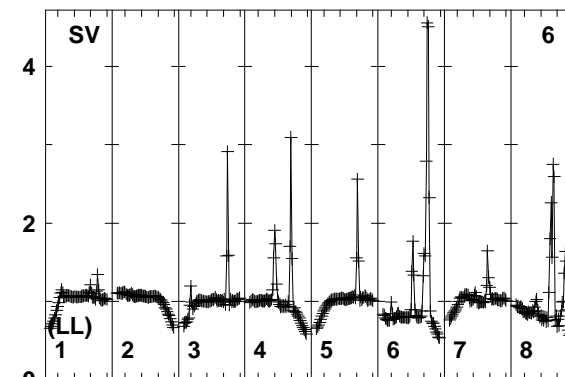
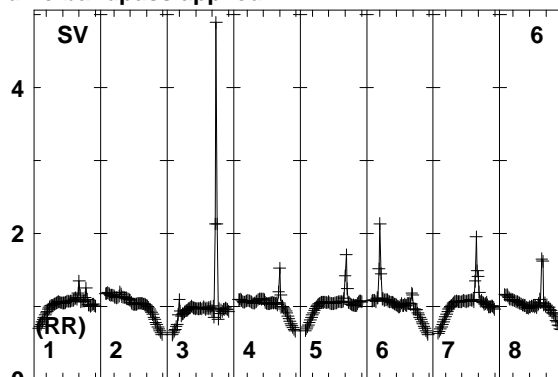
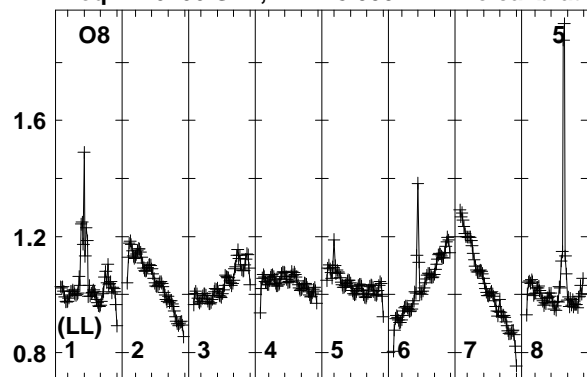

Lower frame: Real Jy
Total-power spectrum Antenna: O8 (05)
Timerange: 00:17:35:35 to 00:17:37:59

Plot file version 129 created 01-AUG-2018 16:38:18

PB+2-1 N18L1 2.UVDATA.1

Freq = 1.6266 GHz, Bw = 8.000 MH No calibration applied and no bandpass applied

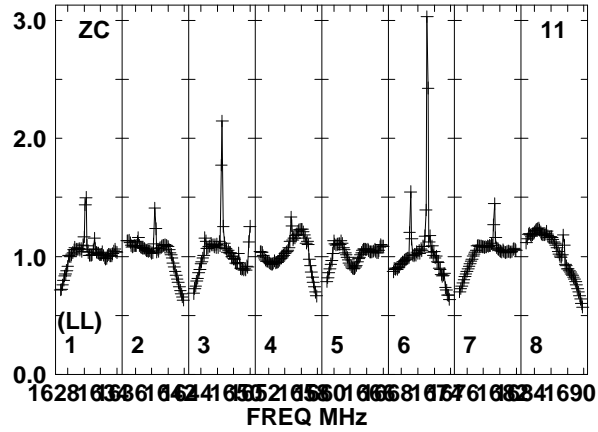
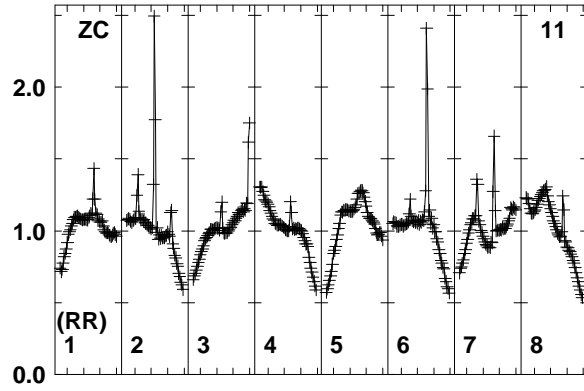

Lower frame: Real Jy
Total-power spectrum Antenna: ZC (11)
Timerange: 00/17:35:35 to 00/17:37:59

Plot file version 130 created 01-AUG-2018 16:38:18

PB+3-1 N18L1 2.UVDATA.1

Freq = 1.6266 GHz, Bw = 8.000 MH No calibration applied and no bandpass applied

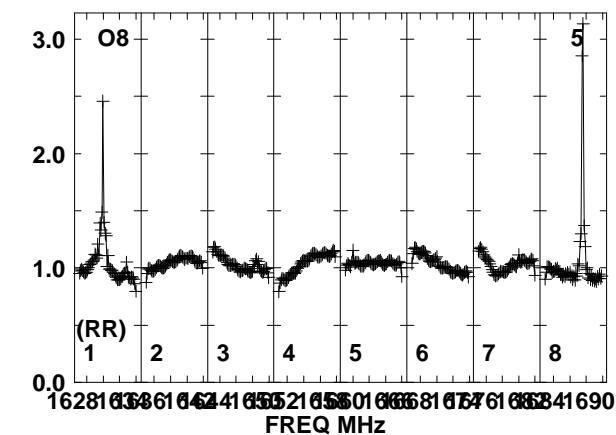
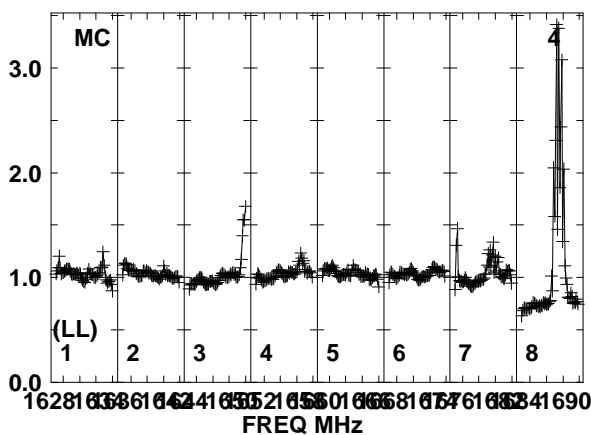
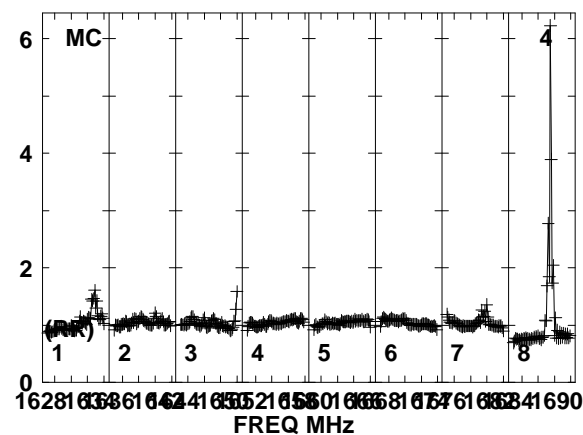
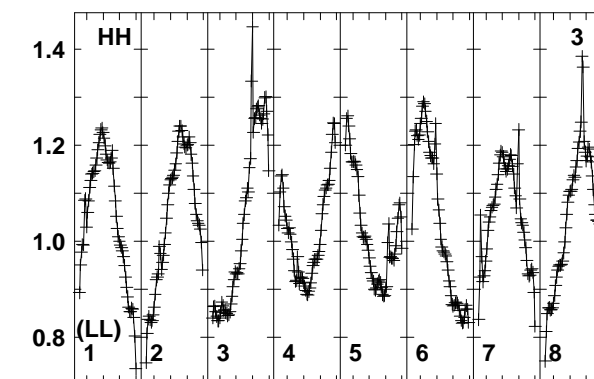
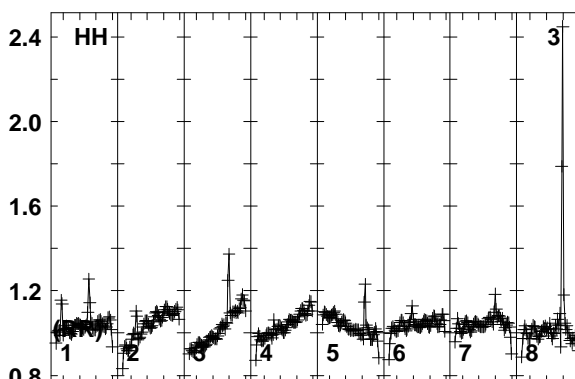
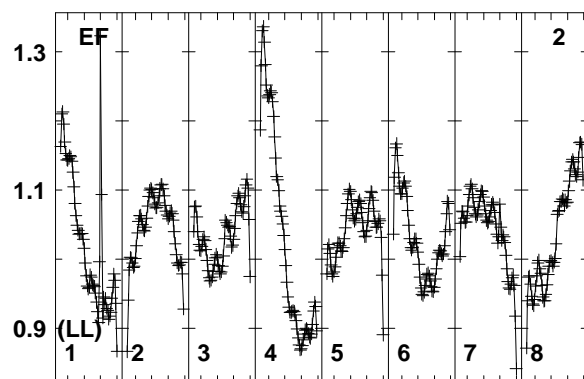
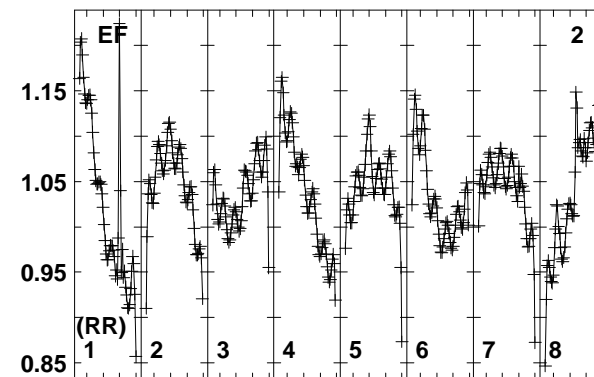
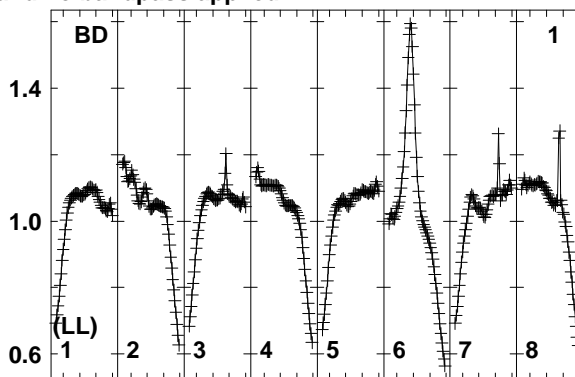
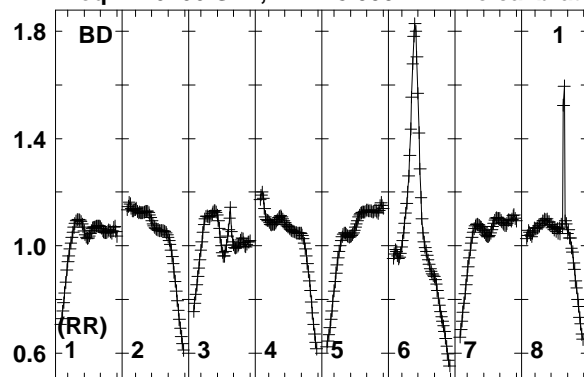

Lower frame: Real Jy
Total-power spectrum Antenna: BD (01)
Timerange: 00/17:38:05 to 00/17:40:29

Plot file version 131 created 01-AUG-2018 16:38:18

PB+3-1 N18L1 2.UVDATA.1

Freq = 1.6266 GHz, Bw = 8.000 MH No calibration applied and no bandpass applied

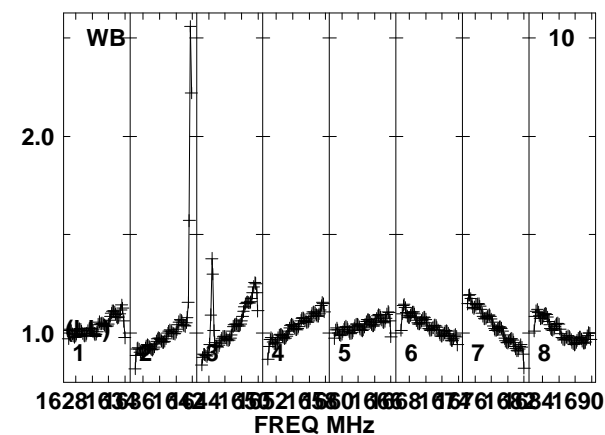
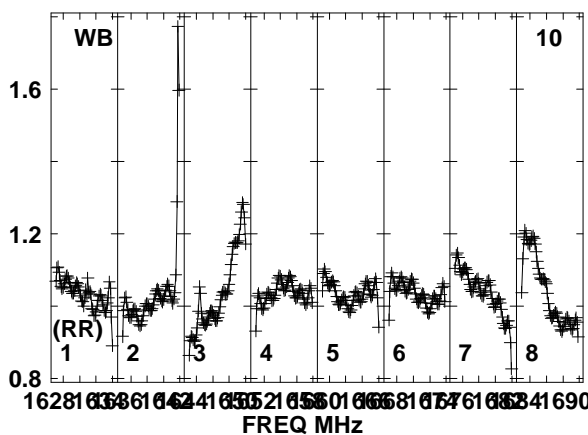
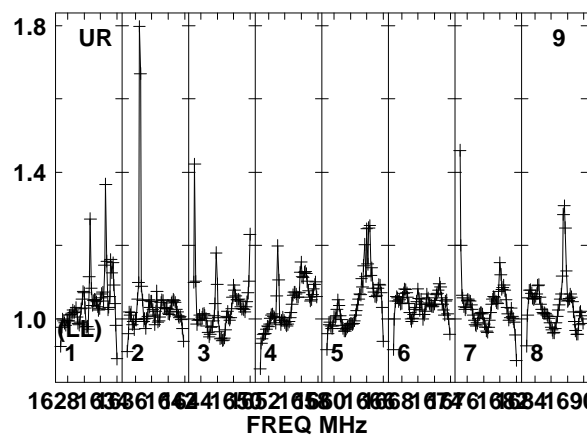
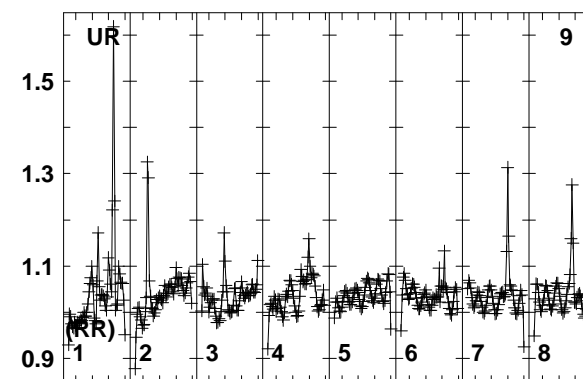
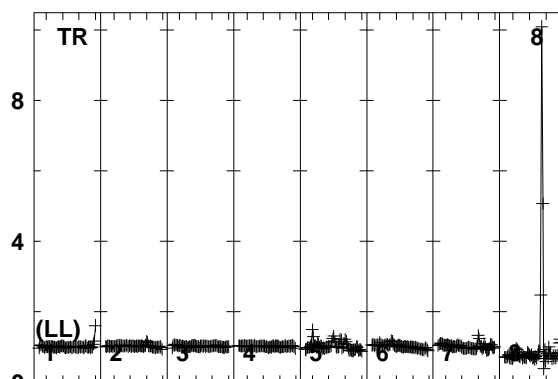
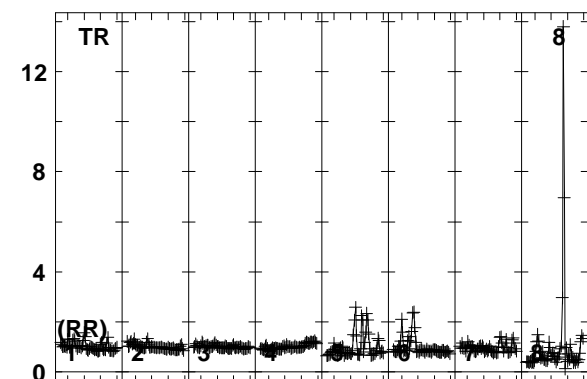
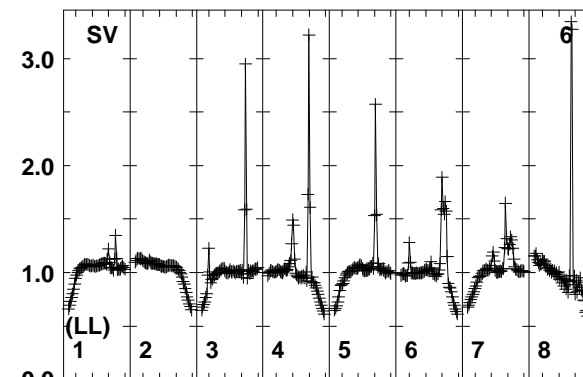
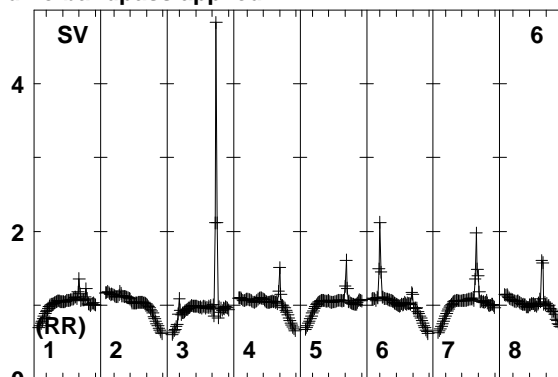
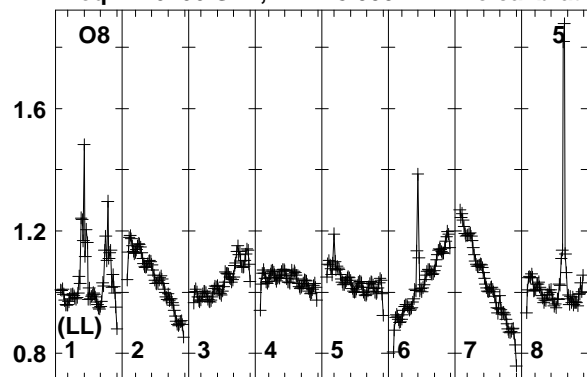

Lower frame: Real Jy
Total-power spectrum Antenna: O8 (05)
Timerange: 00:17:38:05 to 00:17:40:29

Plot file version 132 created 01-AUG-2018 16:38:18

PB+3-1 N18L1 2.UVDATA.1

Freq = 1.6266 GHz, Bw = 8.000 MH No calibration applied and no bandpass applied

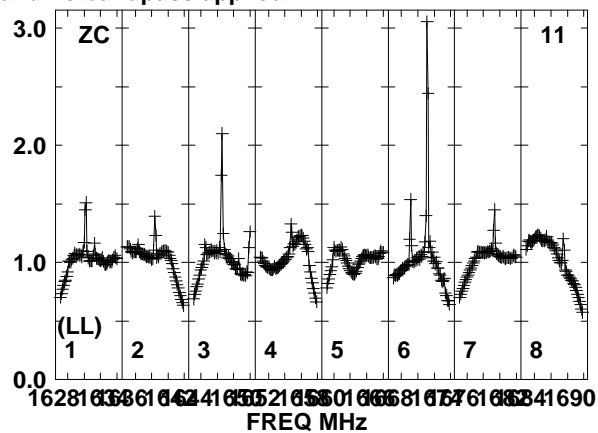
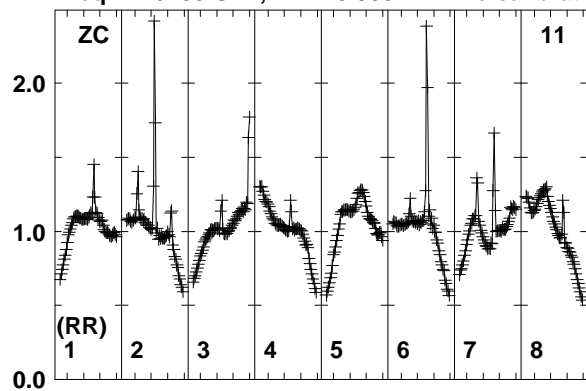

Lower frame: Real Jy
Total-power spectrum Antenna: ZC (11)
Timerange: 00/17:38:05 to 00/17:40:29

Plot file version 133 created 01-AUG-2018 16:38:18

PB+4-1 N18L1 2.UVDATA.1

Freq = 1.6266 GHz, Bw = 8.000 MH No calibration applied and no bandpass applied

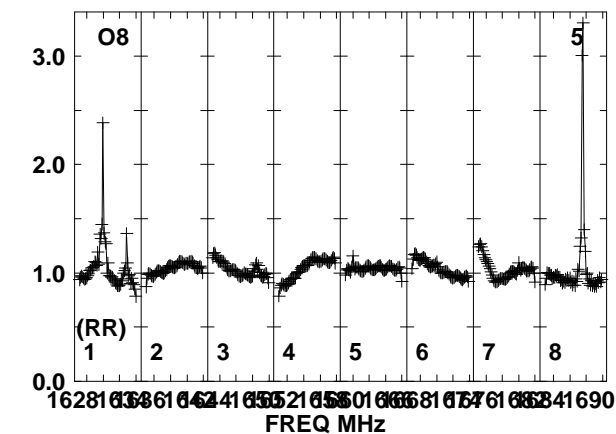
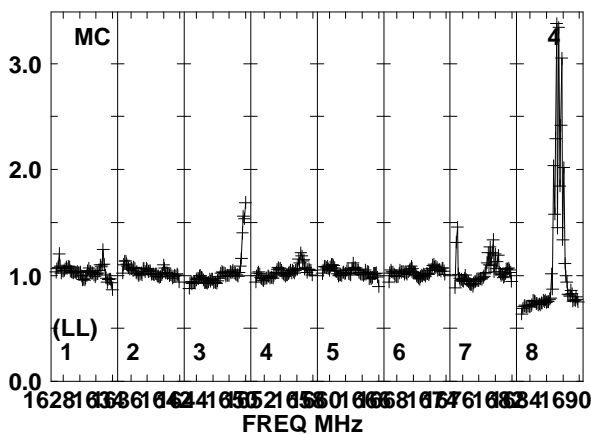
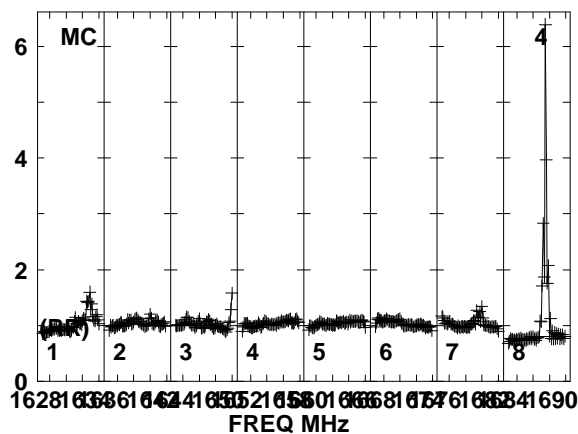
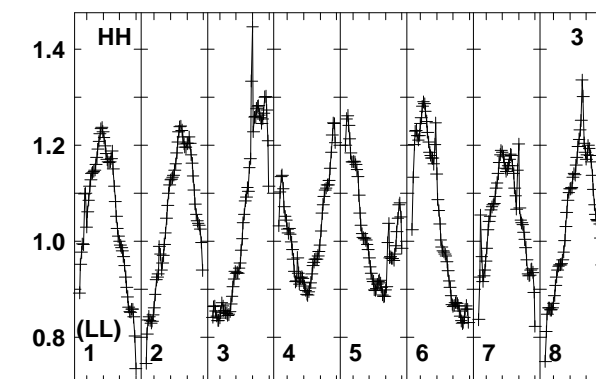
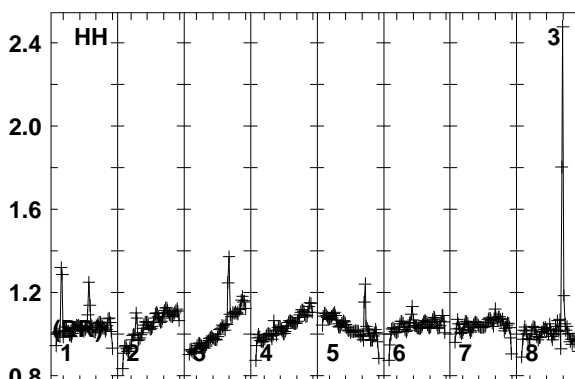
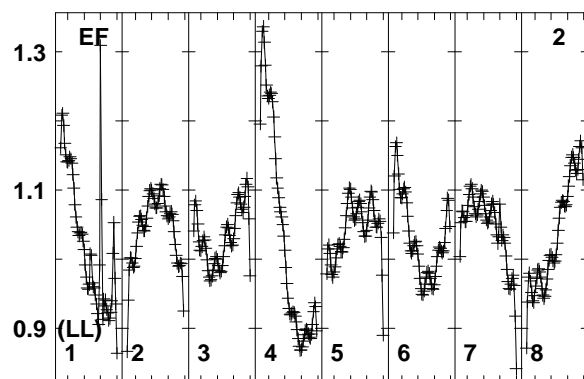
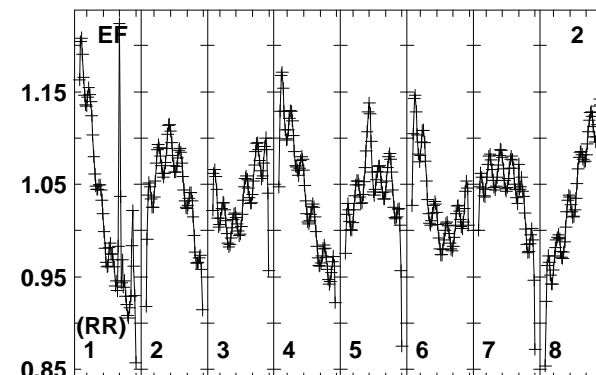
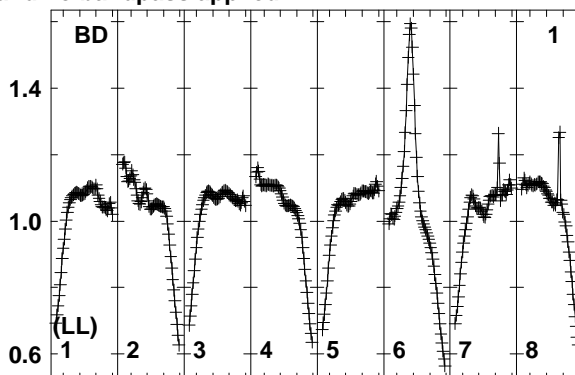
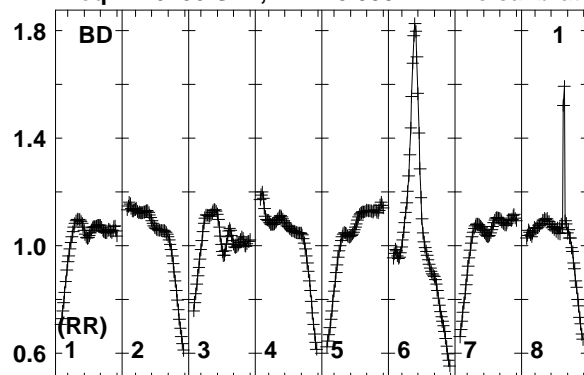

Lower frame: Real Jy
Total-power spectrum Antenna: BD (01)
Timerange: 00/17:40:33 to 00/17:42:59

Plot file version 134 created 01-AUG-2018 16:38:18

PB+4-1 N18L1 2.UVDATA.1

Freq = 1.6266 GHz, Bw = 8.000 MH No calibration applied and no bandpass applied

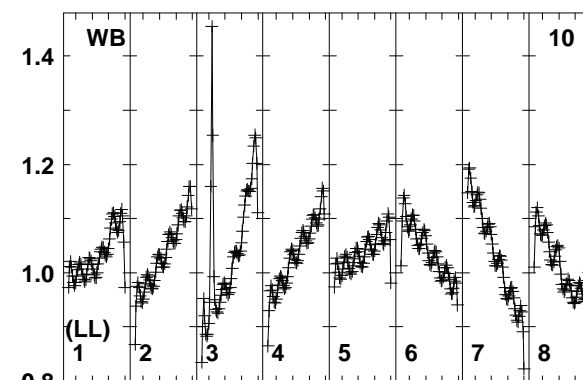
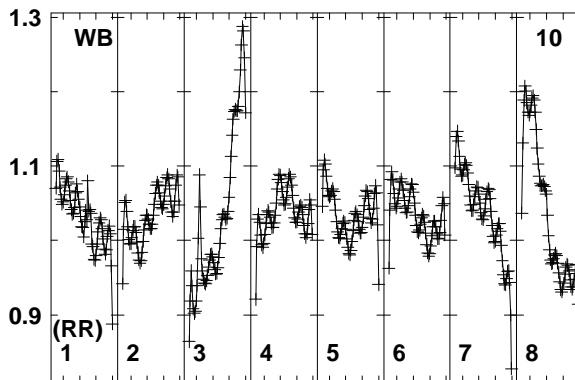
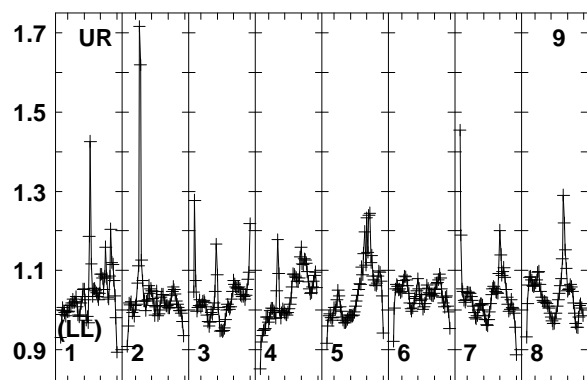
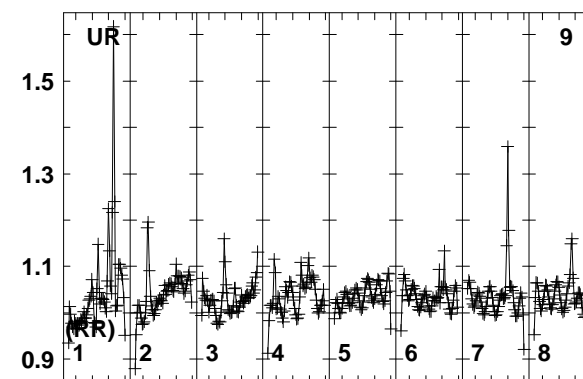
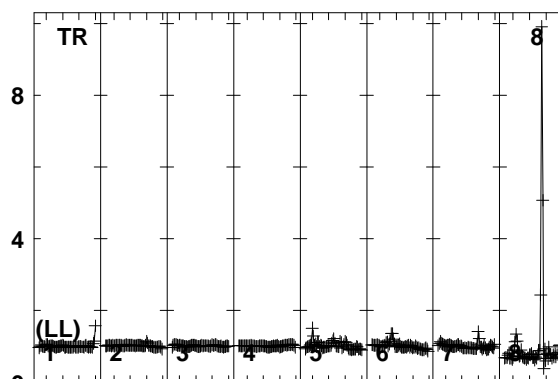
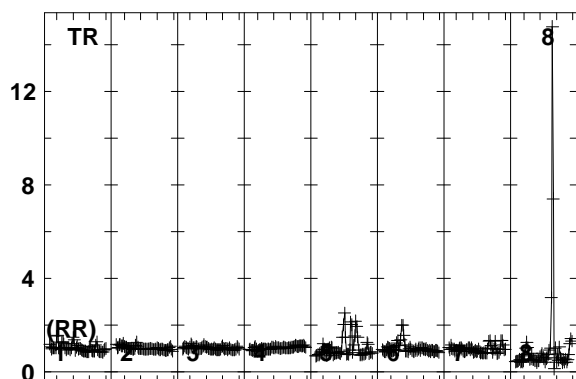
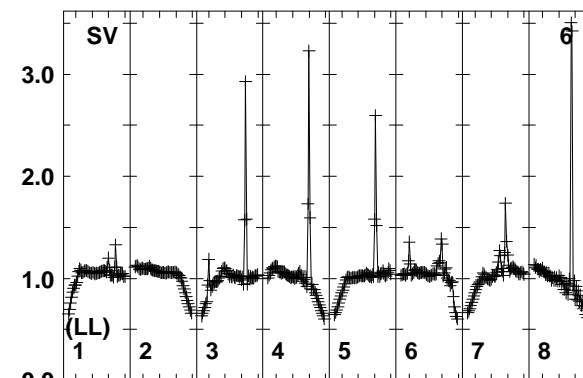
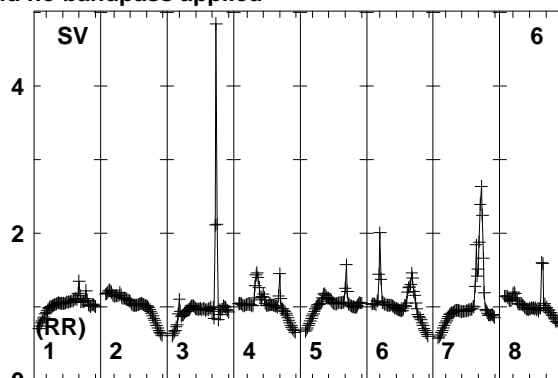
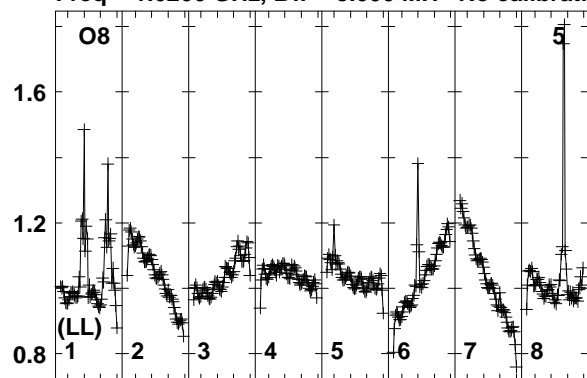

16281 63861 64416 52165 50166 58167 76168 241690
FREQ MHz

16281 63861 64416 52165 50166 58167 76168 241690
FREQ MHz

16281 63861 64416 52165 50166 58167 76168 241690
FREQ MHz

Lower frame: Real Jy
Total-power spectrum Antenna: O8 (05)
Timerange: 00/17:40:33 to 00/17:42:59

Plot file version 135 created 01-AUG-2018 16:38:18

PB+4-1 N18L1 2.UVDATA.1

Freq = 1.6266 GHz, Bw = 8.000 MH No calibration applied and no bandpass applied

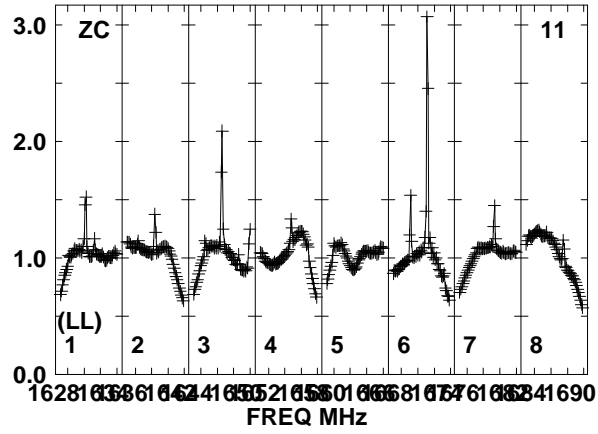
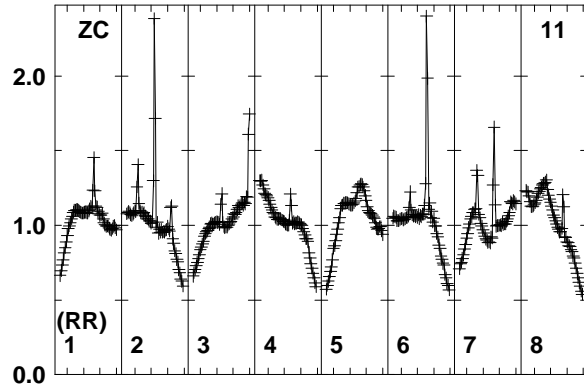

Lower frame: Real Jy
Total-power spectrum Antenna: ZC (11)
Timerange: 00/17:40:33 to 00/17:42:59

Plot file version 136 created 01-AUG-2018 16:38:18

J0530+1331 N18L1 2.UVDATA.1

Freq = 1.6266 GHz, Bw = 8.000 MH No calibration applied and no bandpass applied

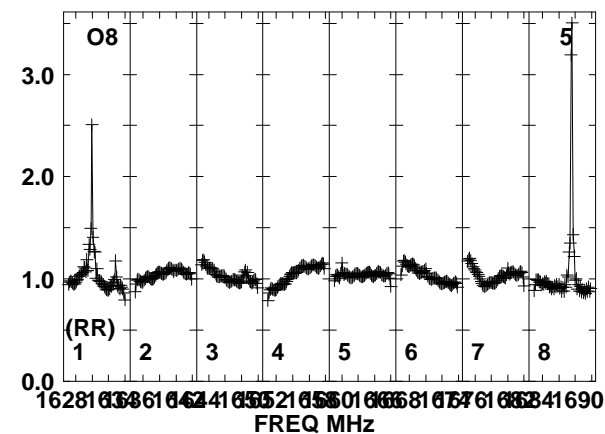
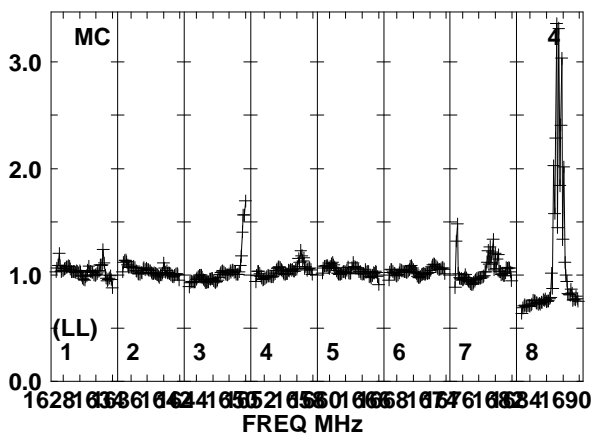
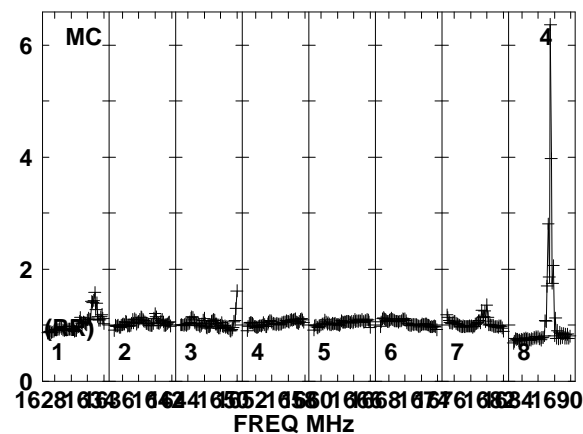
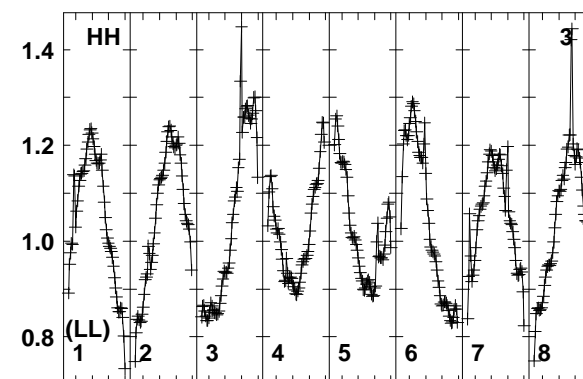
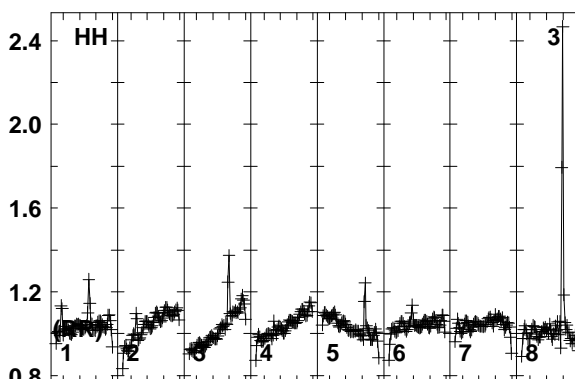
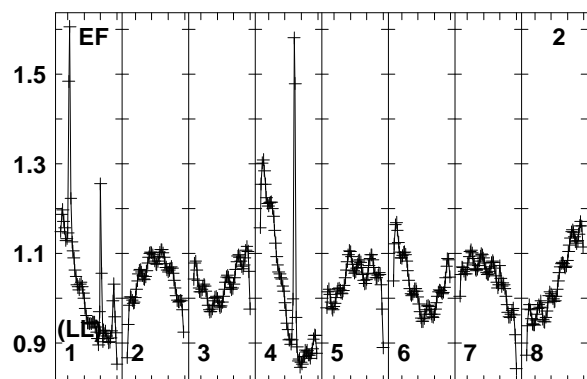
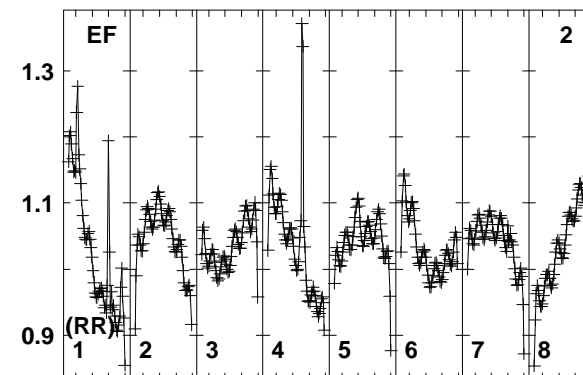
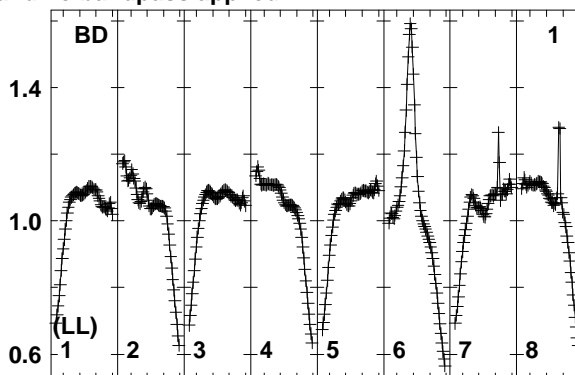
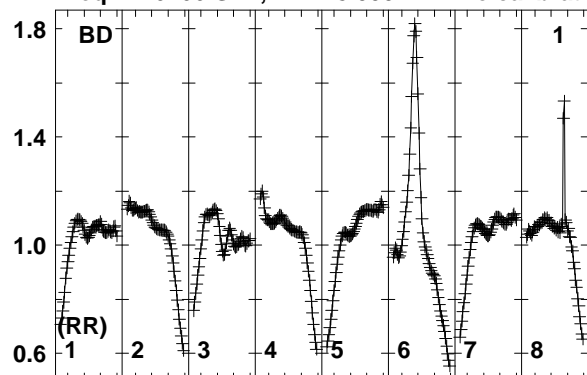

Lower frame: Real Jy
Total-power spectrum Antenna: BD (01)
Timerange: 00/17:43:41 to 00/17:44:59

Plot file version 137 created 01-AUG-2018 16:38:18

J0530+1331 N18L1 2.UVDATA.1

Freq = 1.6266 GHz, Bw = 8.000 MH No calibration applied and no bandpass applied

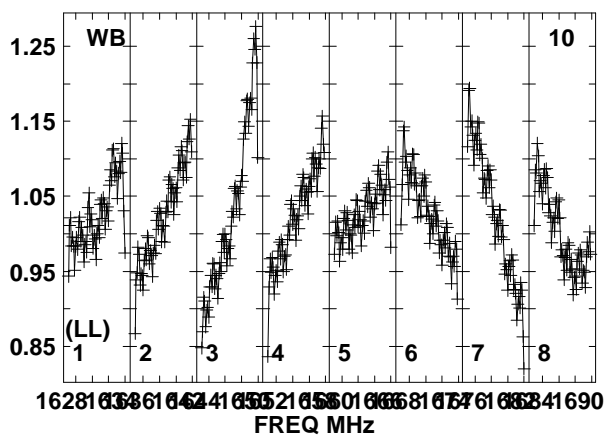
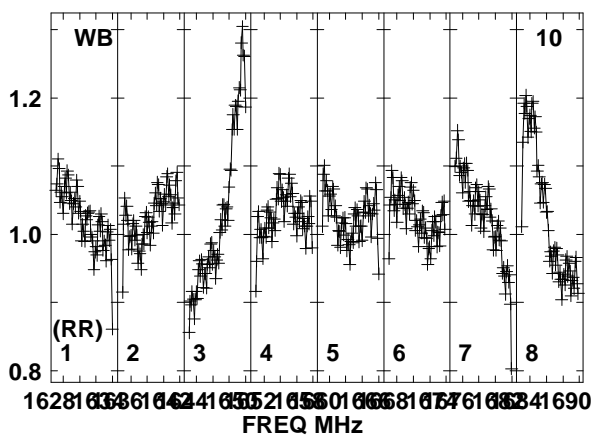
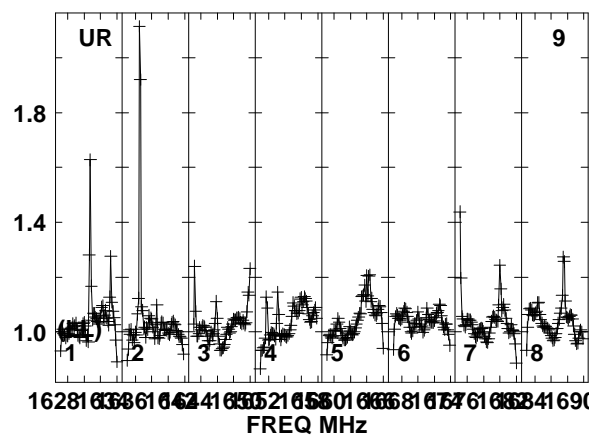
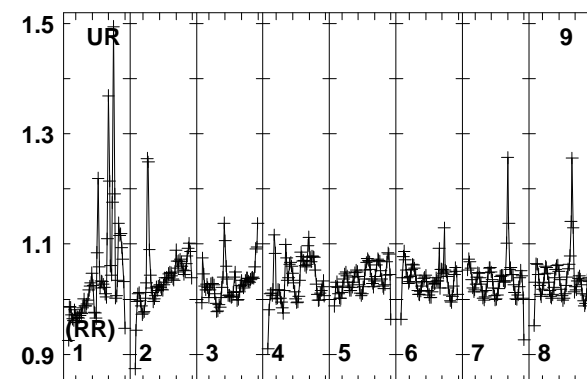
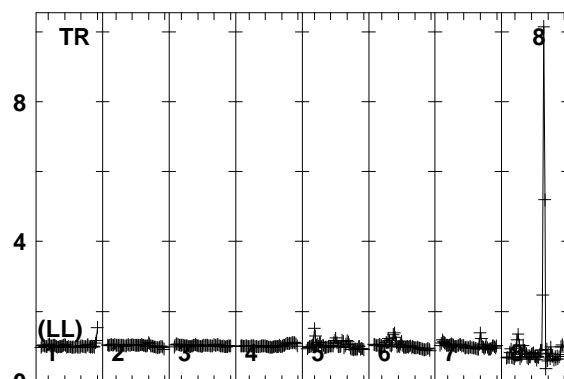
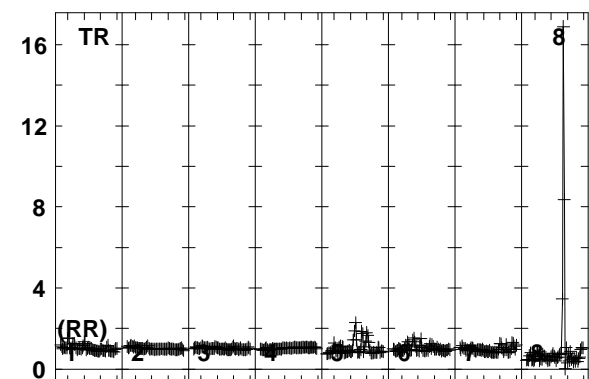
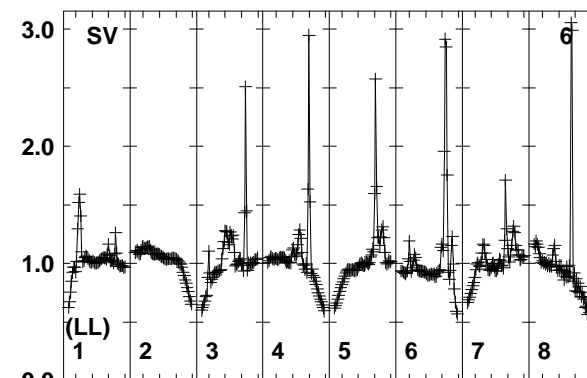
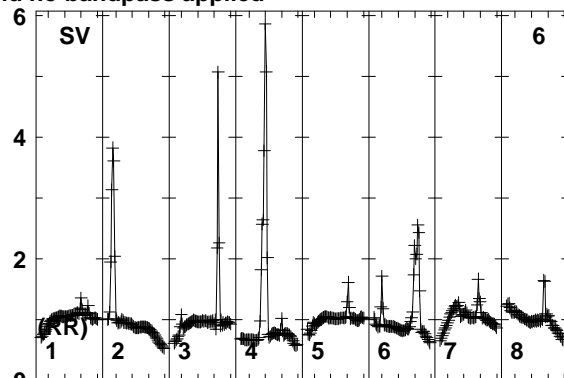
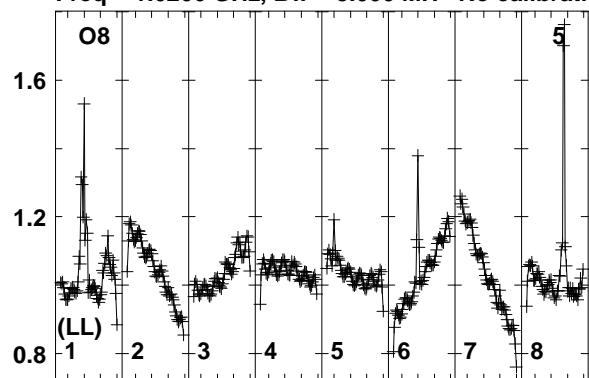

Lower frame: Real Jy
Total-power spectrum Antenna: O8 (05)
Timerange: 00/17:43:41 to 00/17:44:59

Plot file version 138 created 01-AUG-2018 16:38:19

J0530+1331 N18L1 2.UVDATA.1

Freq = 1.6266 GHz, Bw = 8.000 MH No calibration applied and no bandpass applied

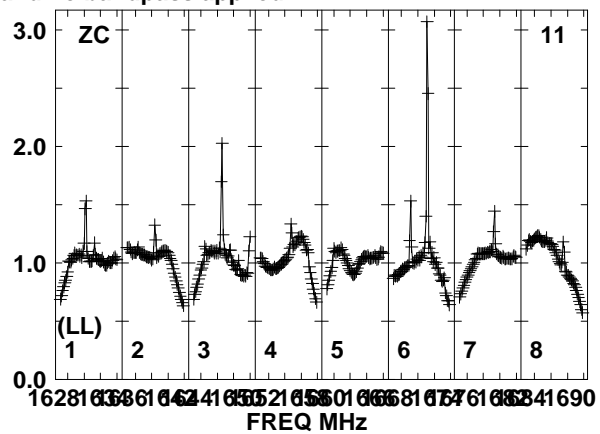
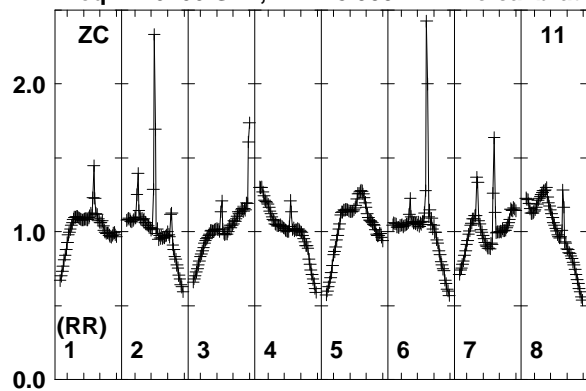

Lower frame: Real Jy
Total-power spectrum Antenna: ZC (11)
Timerange: 00/17:43:41 to 00/17:44:59

Plot file version 139 created 01-AUG-2018 16:38:19

PB+4+0 N18L1 2.UVDATA.1

Freq = 1.6266 GHz, Bw = 8.000 MH No calibration applied and no bandpass applied

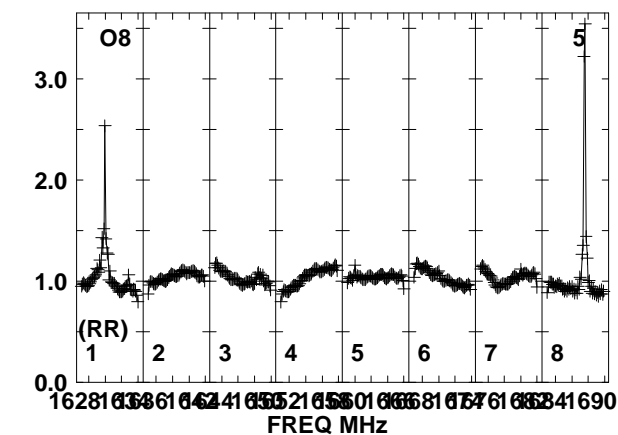
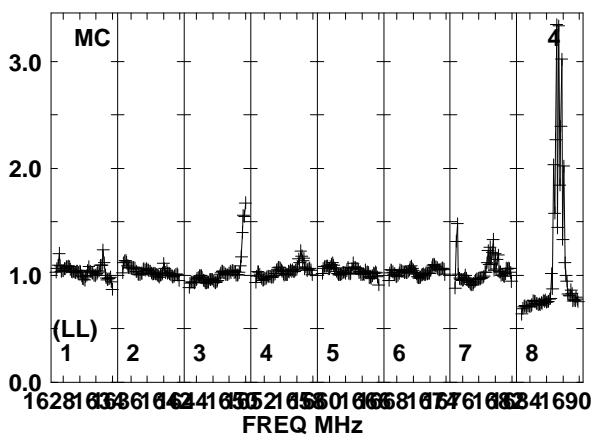
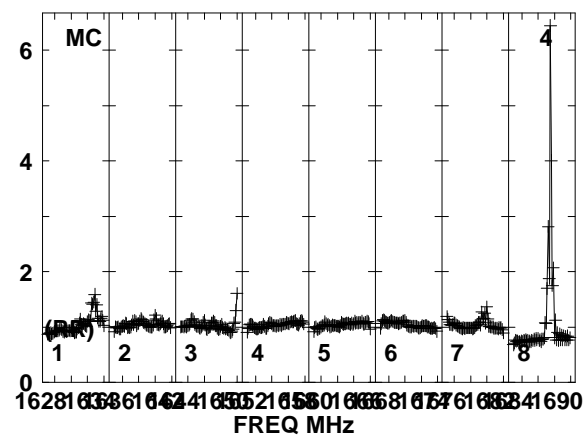
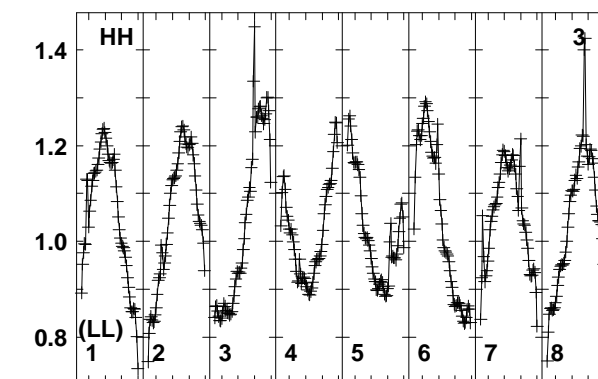
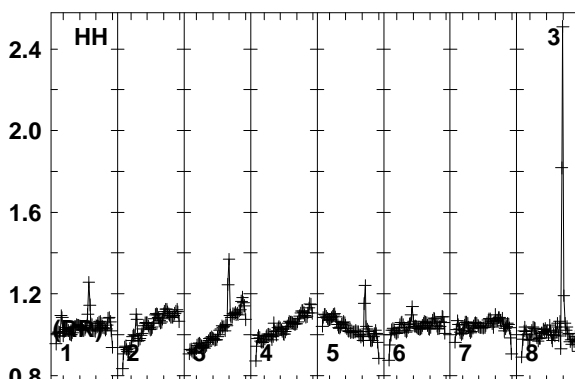
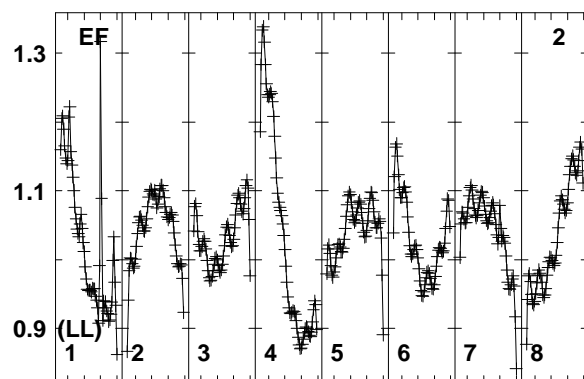
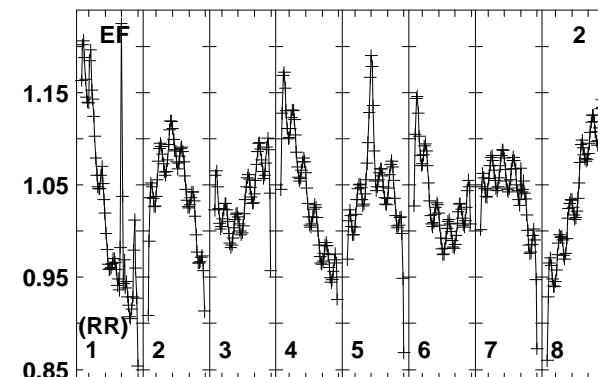
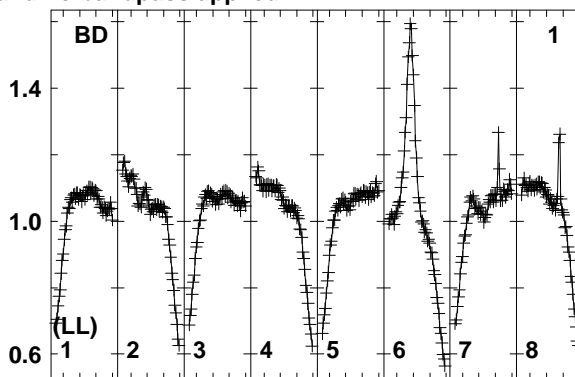
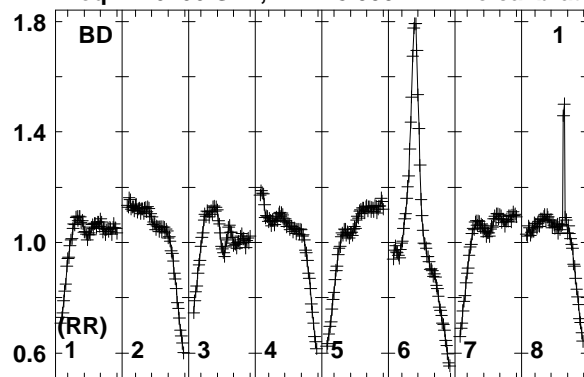

Lower frame: Real Jy
Total-power spectrum Antenna: BD (01)
Timerange: 00/17:45:03 to 00/17:47:29

Plot file version 140 created 01-AUG-2018 16:38:19

PB+4+0 N18L1 2.UVDATA.1

Freq = 1.6266 GHz, Bw = 8.000 MH No calibration applied and no bandpass applied

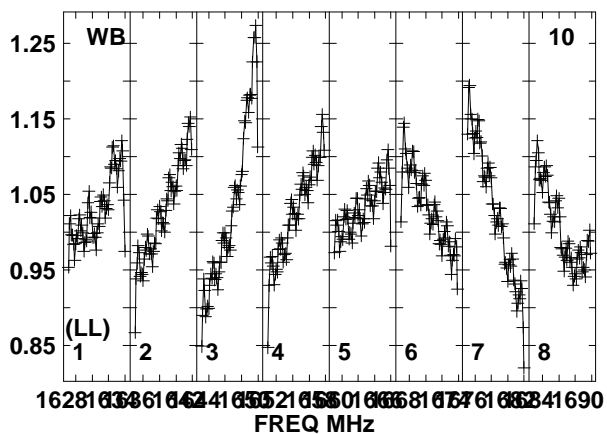
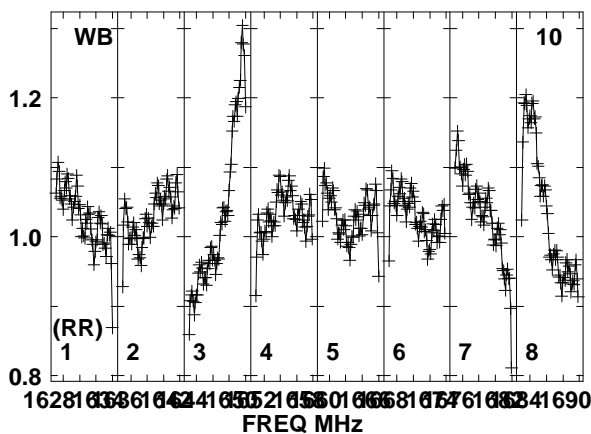
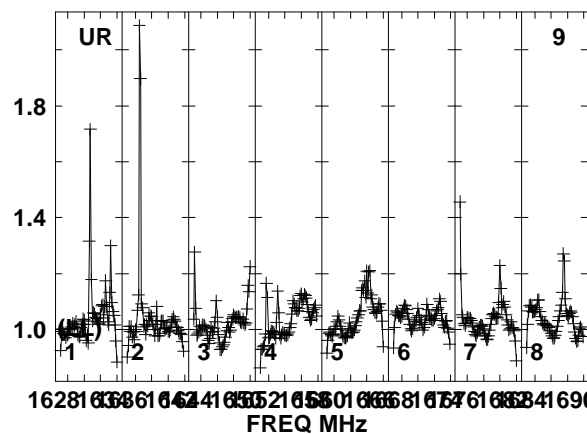
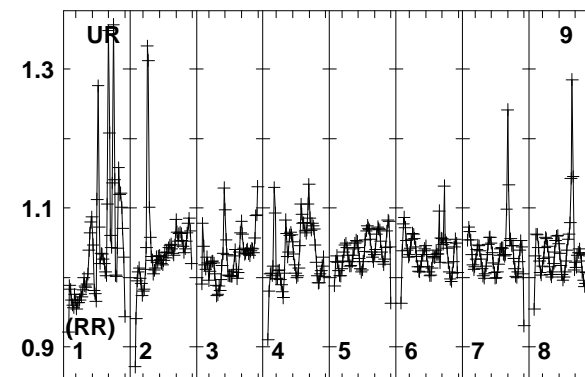
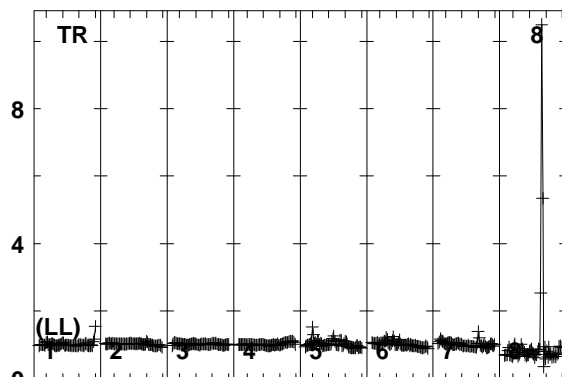
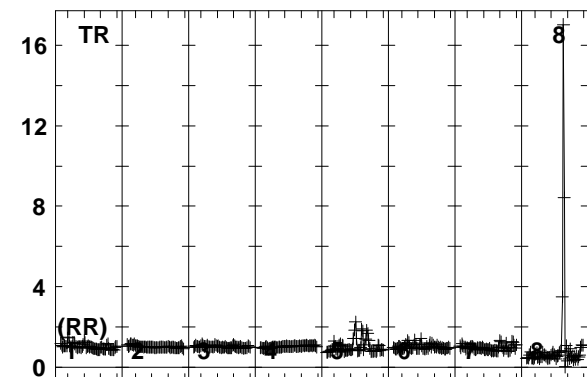
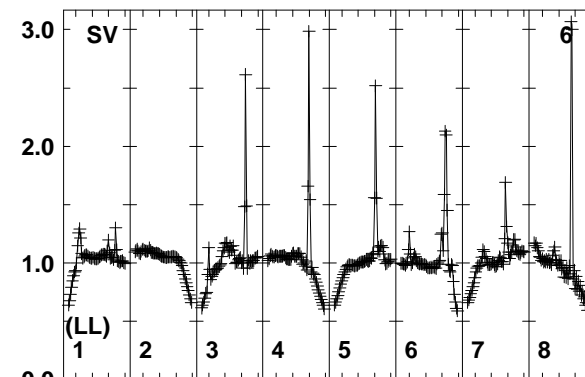
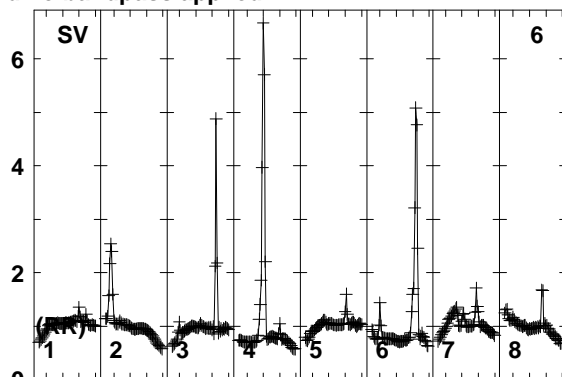
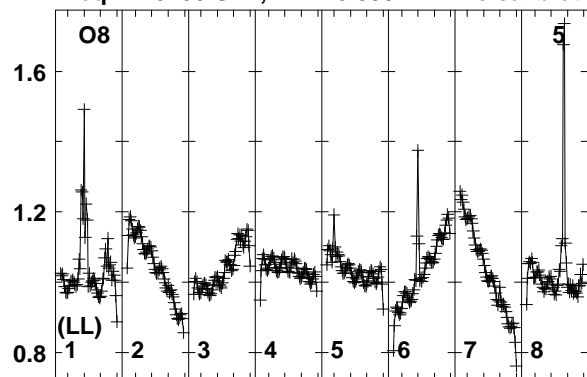

Lower frame: Real Jy
Total-power spectrum Antenna: O8 (05)
Timerange: 00/17:45:03 to 00/17:47:29

Plot file version 141 created 01-AUG-2018 16:38:19

PB+4+0 N18L1 2.UVDATA.1

Freq = 1.6266 GHz, Bw = 8.000 MH No calibration applied and no bandpass applied

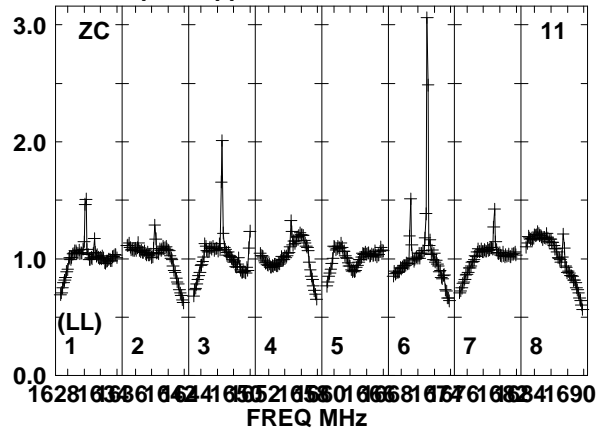
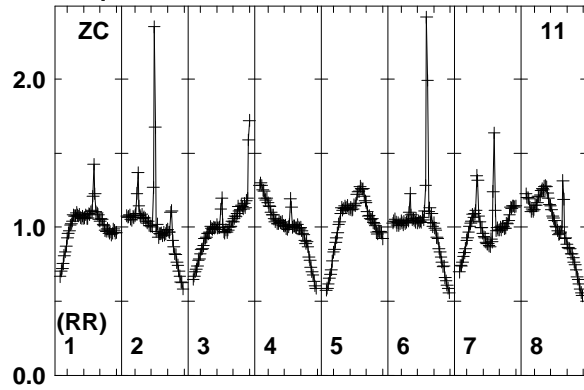

Lower frame: Real Jy
Total-power spectrum Antenna: ZC (11)
Timerange: 00/17:45:03 to 00/17:47:29

Plot file version 142 created 01-AUG-2018 16:38:19

PB+3+0 N18L1 2.UVDATA.1

Freq = 1.6266 GHz, Bw = 8.000 MH No calibration applied and no bandpass applied

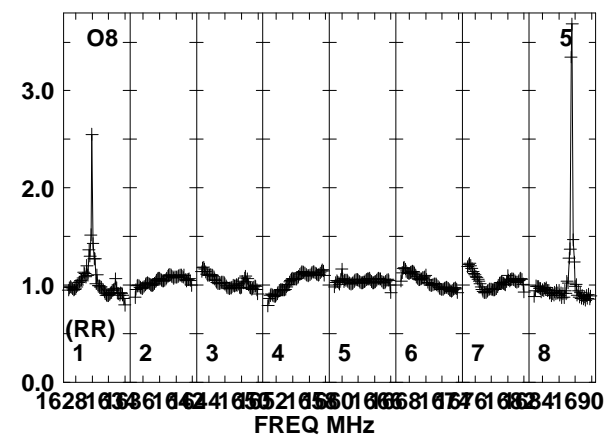
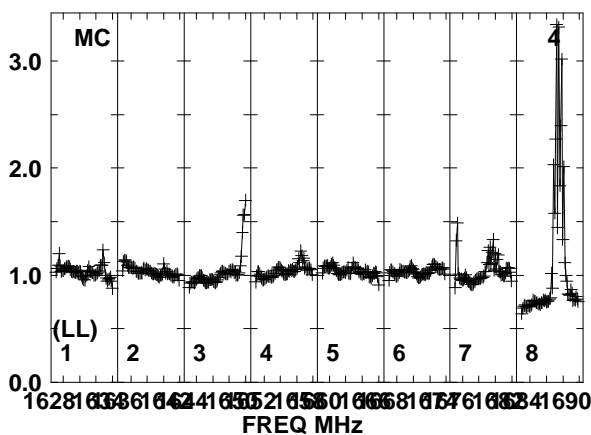
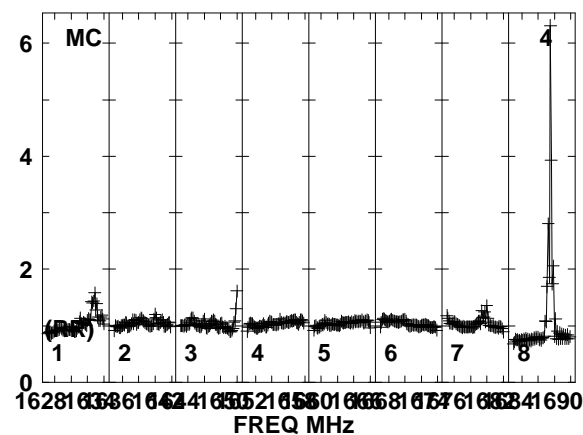
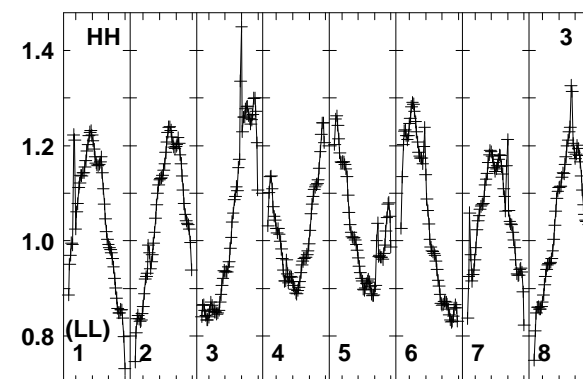
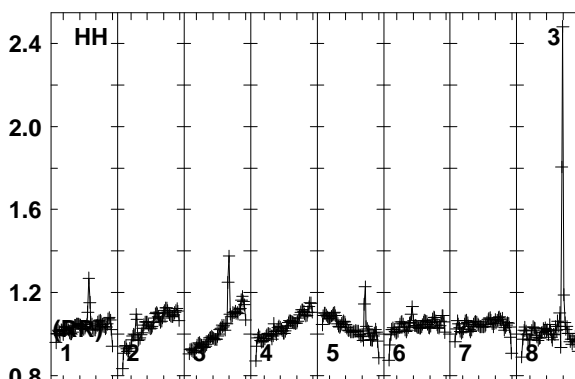
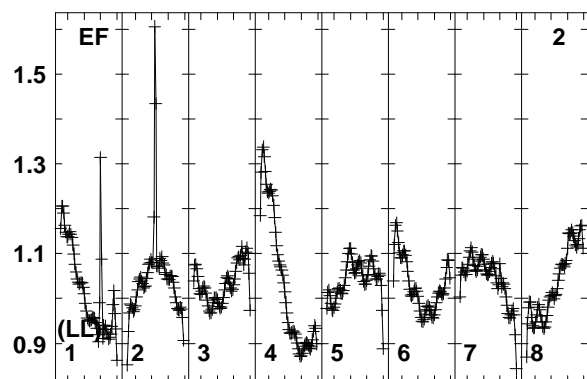
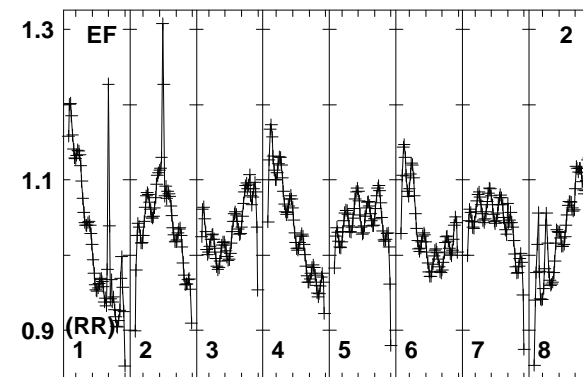
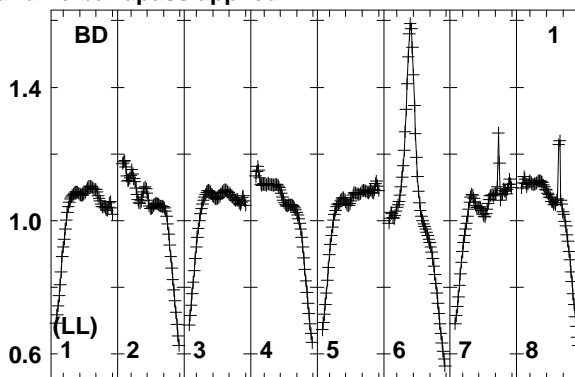
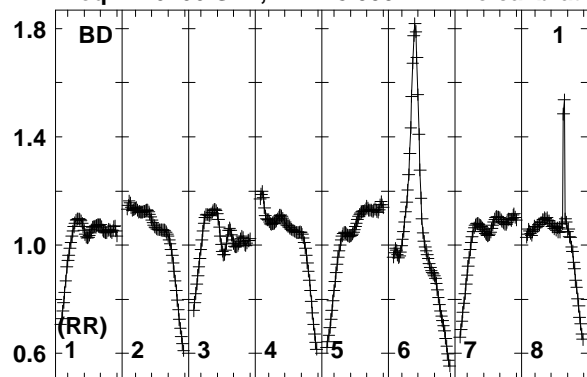

Lower frame: Real Jy
Total-power spectrum Antenna: BD (01)
Timerange: 00/17:47:33 to 00/17:49:59

Plot file version 143 created 01-AUG-2018 16:38:19

PB+3+0 N18L1 2.UVDATA.1

Freq = 1.6266 GHz, Bw = 8.000 MH No calibration applied and no bandpass applied

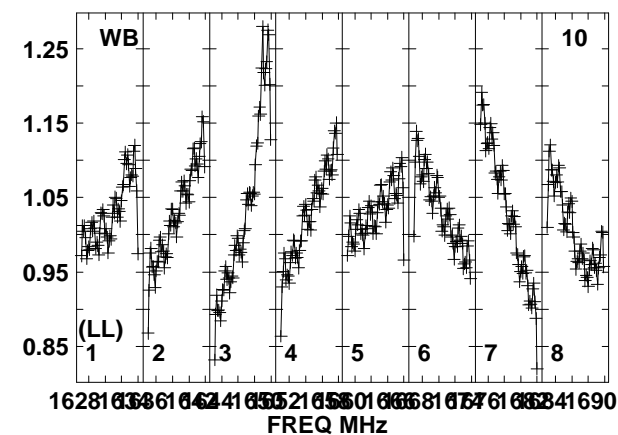
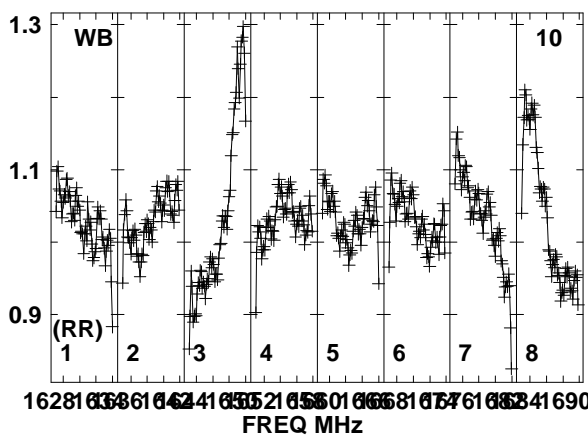
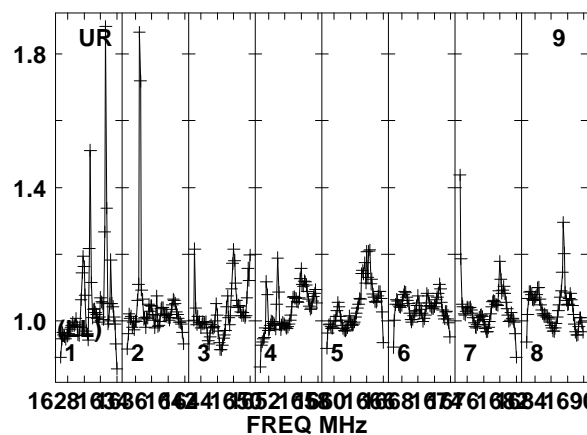
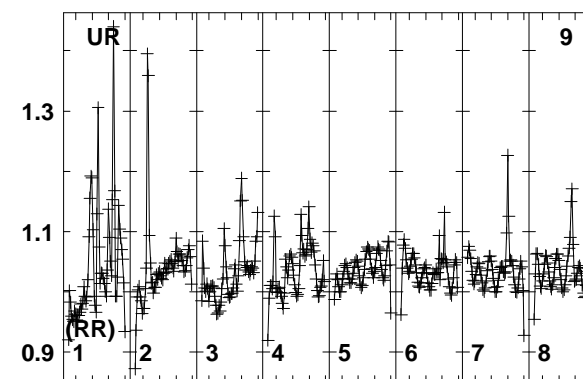
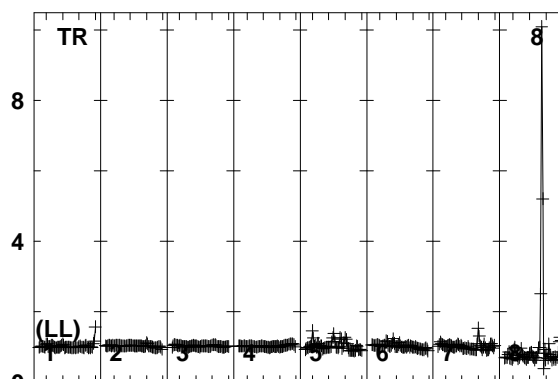
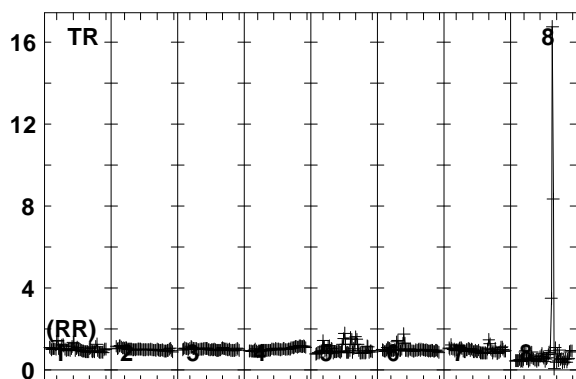
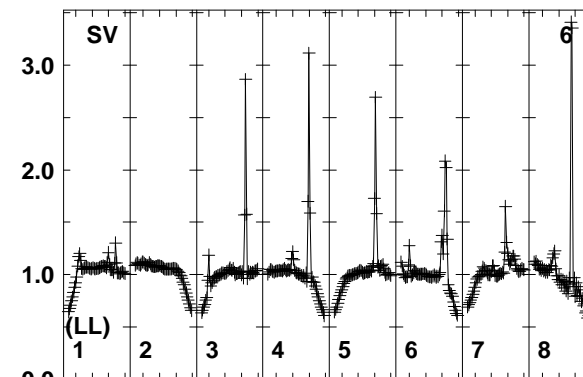
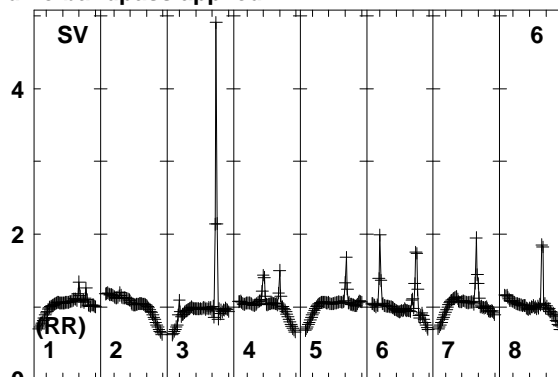
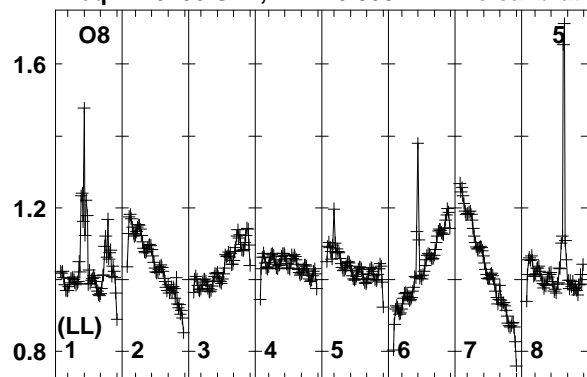

Lower frame: Real Jy
Total-power spectrum Antenna: O8 (05)
Timerange: 00/17:47:33 to 00/17:49:59

Plot file version 144 created 01-AUG-2018 16:38:19

PB+3+0 N18L1 2.UVDATA.1

Freq = 1.6266 GHz, Bw = 8.000 MH No calibration applied and no bandpass applied

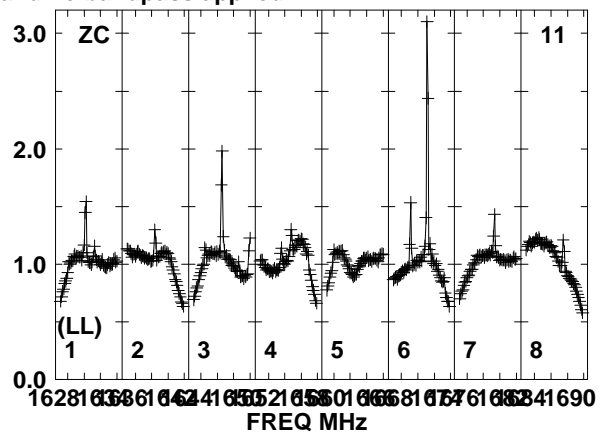
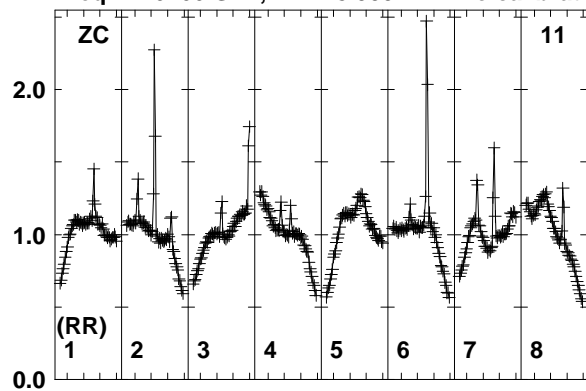

Lower frame: Real Jy
Total-power spectrum Antenna: ZC (11)
Timerange: 00/17:47:33 to 00/17:49:59

Plot file version 145 created 01-AUG-2018 16:38:19

PB+2+0 N18L1 2.UVDATA.1

Freq = 1.6266 GHz, Bw = 8.000 MH No calibration applied and no bandpass applied

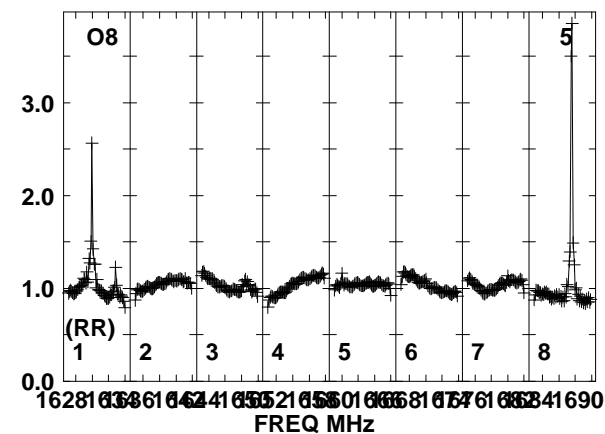
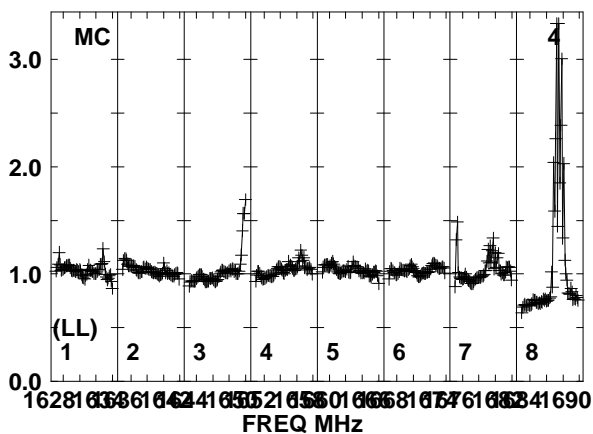
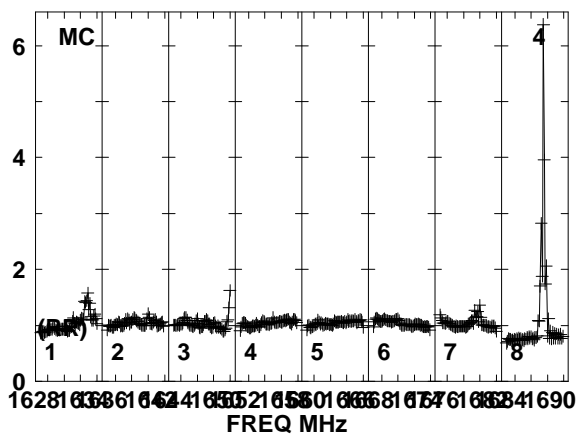
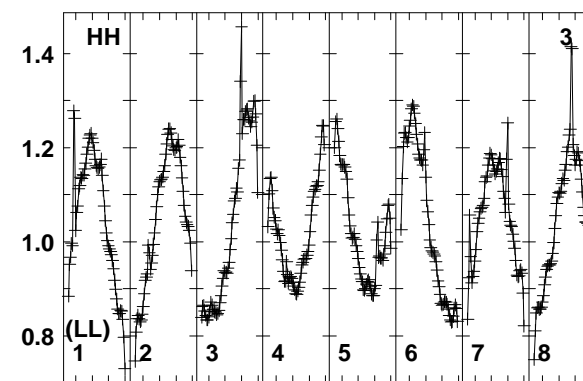
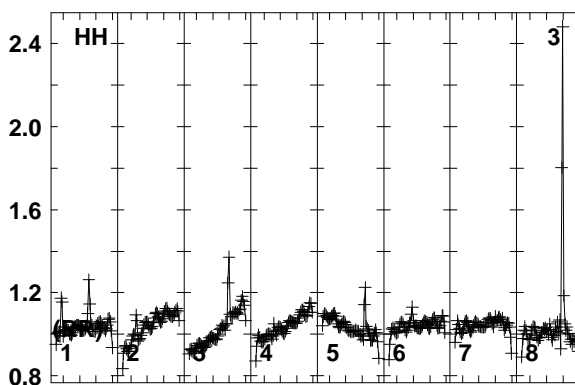
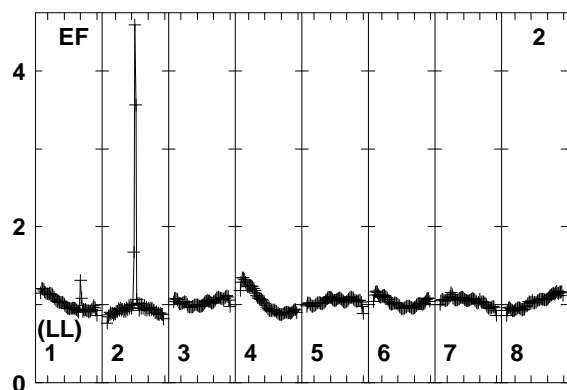
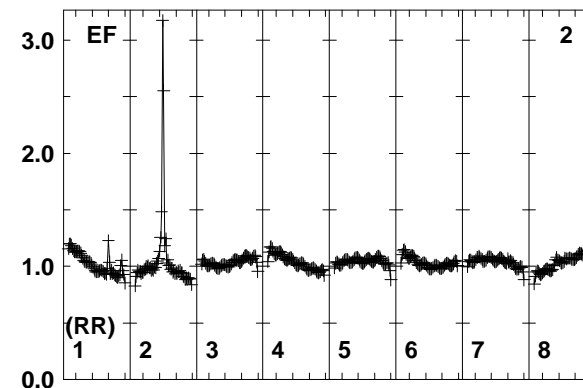
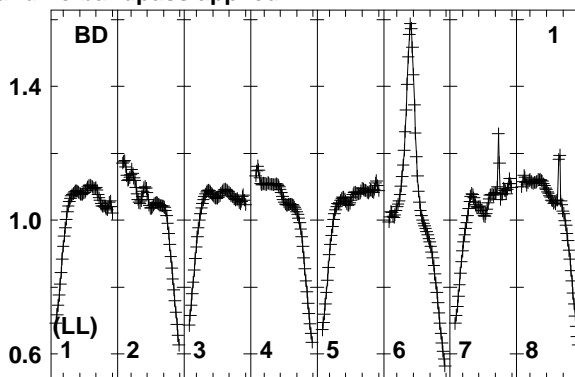
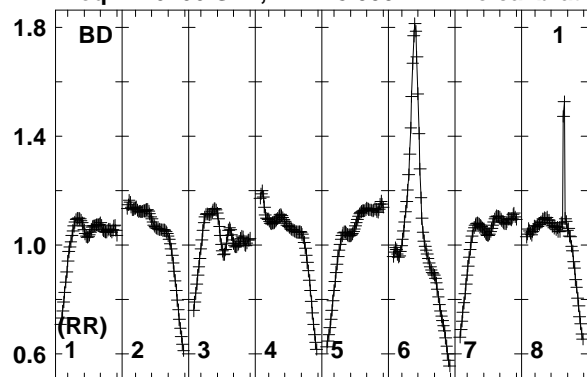

Lower frame: Real Jy
Total-power spectrum Antenna: BD (01)
Timerange: 00/17:50:05 to 00/17:52:29

Plot file version 146 created 01-AUG-2018 16:38:19

PB+2+0 N18L1 2.UVDATA.1

Freq = 1.6266 GHz, Bw = 8.000 MH No calibration applied and no bandpass applied

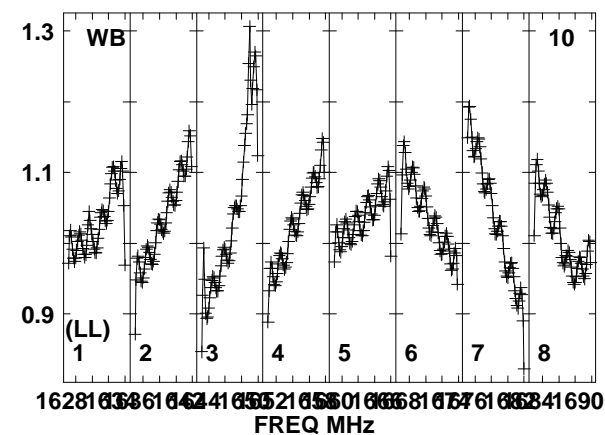
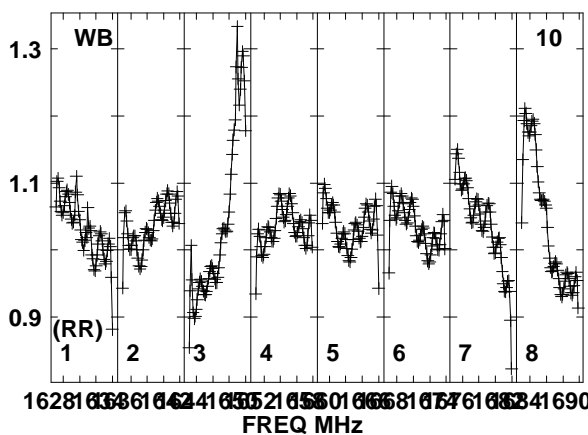
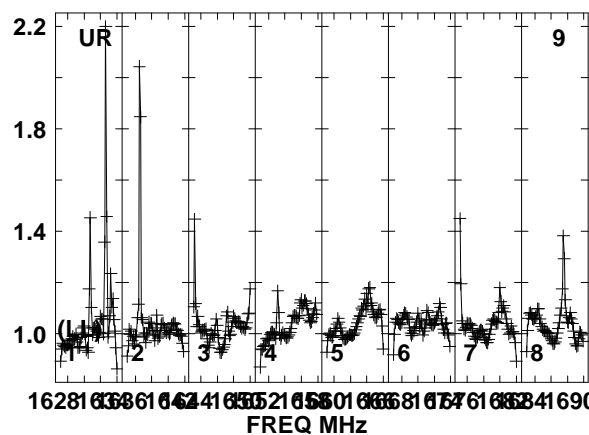
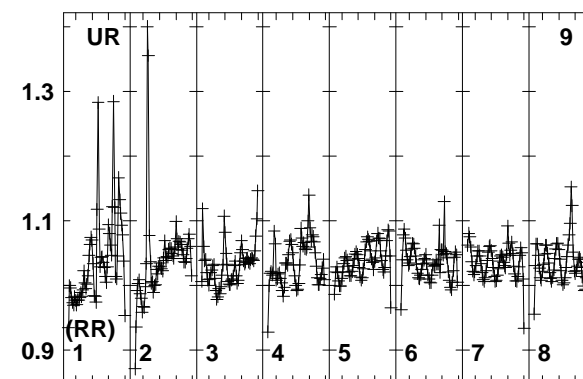
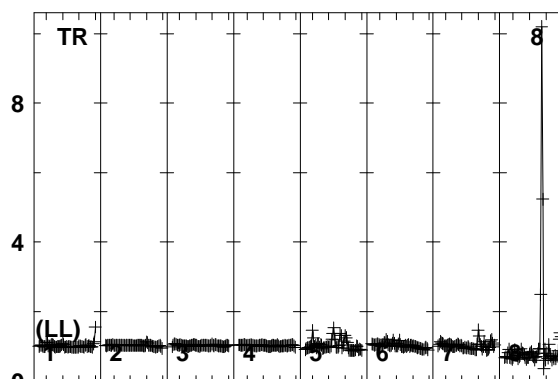
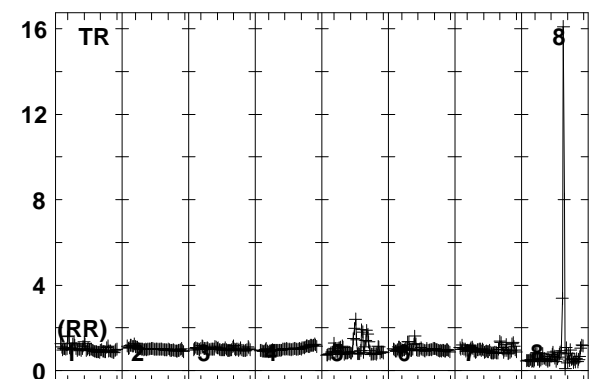
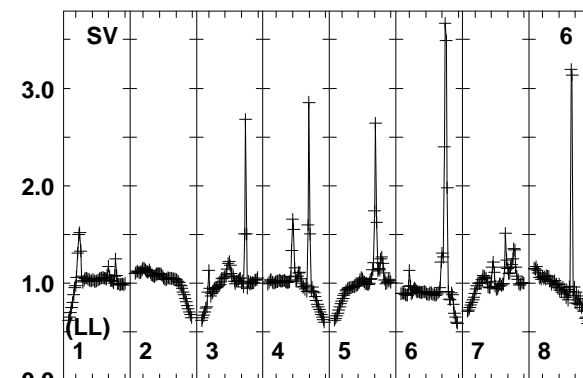
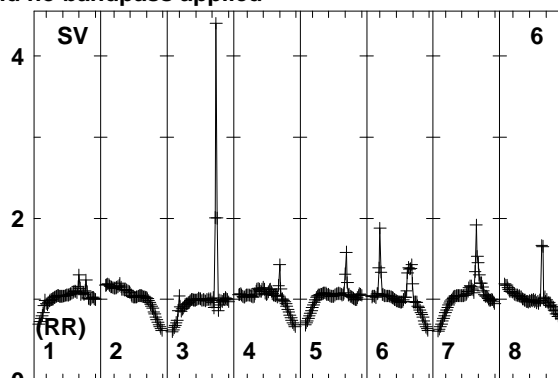
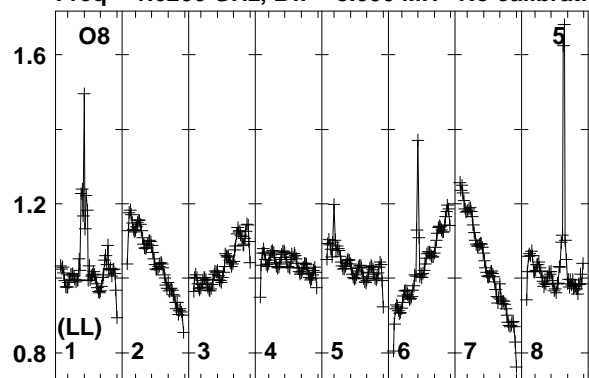

16281 63861 64241 65216 66166 67168 68241 690

FREQ MHz

16281 63861 64241 65216 66166 67168 68241 690

FREQ MHz

16281 63861 64241 65216 66166 67168 68241 690

FREQ MHz

Lower frame: Real Jy
Total-power spectrum Antenna: O8 (05)
Timerange: 00/17:50:05 to 00/17:52:29

Plot file version 147 created 01-AUG-2018 16:38:20

PB+2+0 N18L1 2.UVDATA.1

Freq = 1.6266 GHz, Bw = 8.000 MH No calibration applied and no bandpass applied

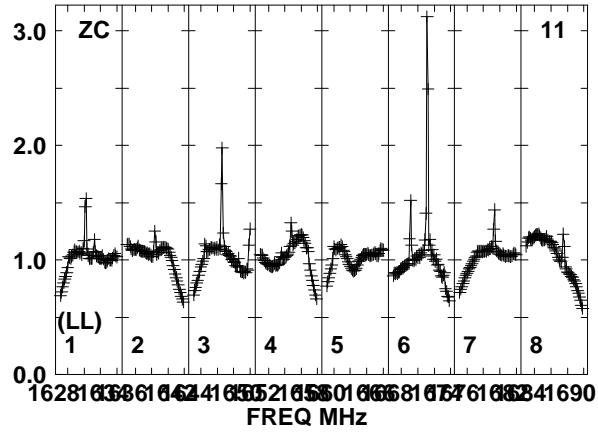
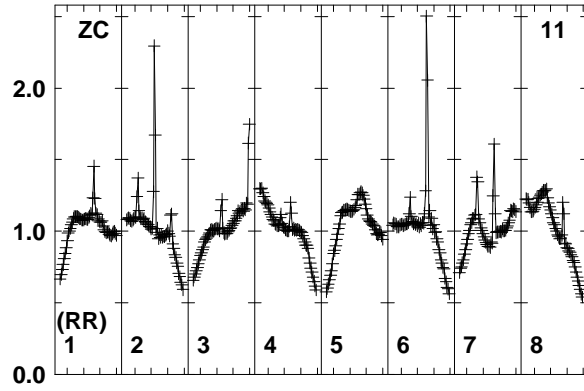

Lower frame: Real Jy
Total-power spectrum Antenna: ZC (11)
Timerange: 00/17:50:05 to 00/17:52:29

Plot file version 148 created 01-AUG-2018 16:38:20

PB+1+0 N18L1 2.UVDATA.1

Freq = 1.6266 GHz, Bw = 8.000 MH No calibration applied and no bandpass applied

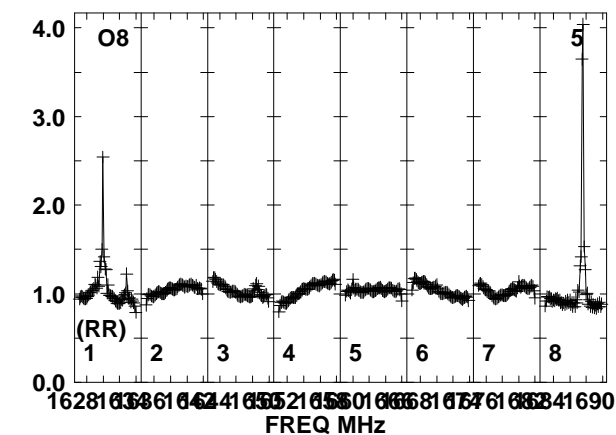
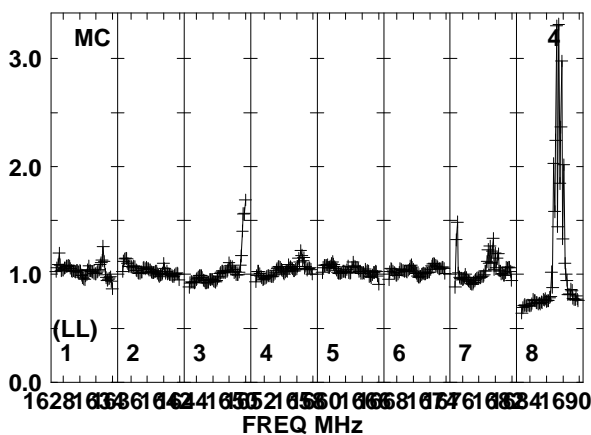
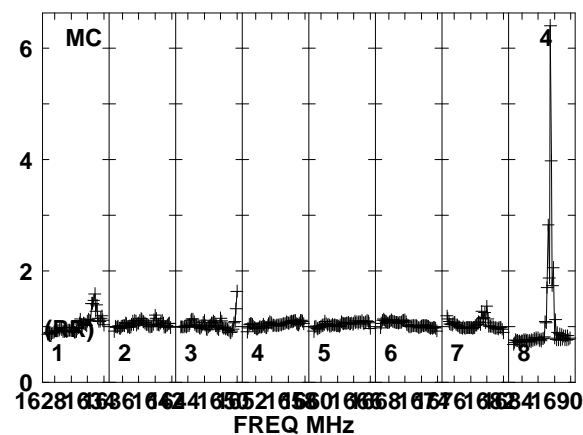
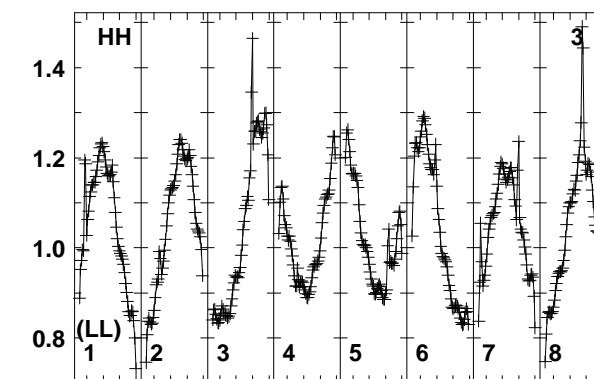
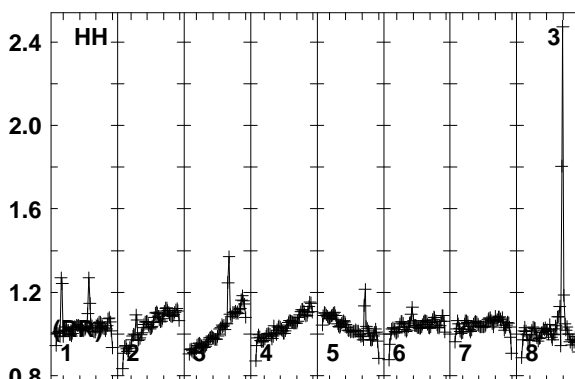
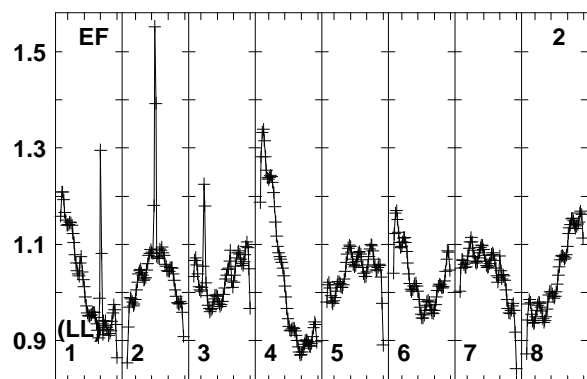
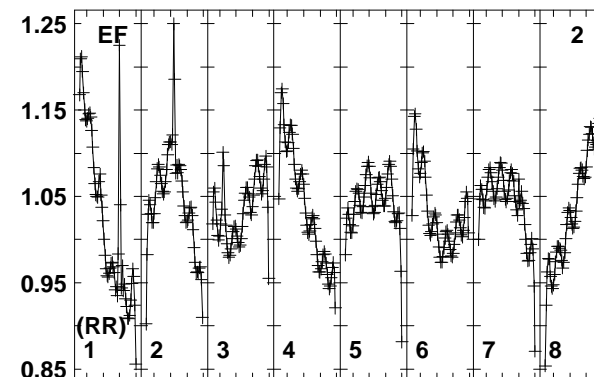
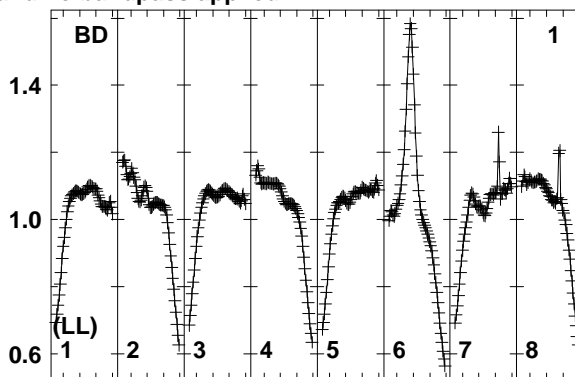
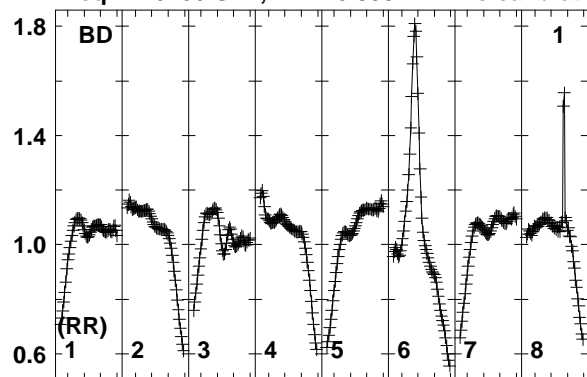

Lower frame: Real Jy
Total-power spectrum Antenna: BD (01)
Timerange: 00/17:52:33 to 00/17:54:59

Plot file version 149 created 01-AUG-2018 16:38:20

PB+1+0 N18L1 2.UVDATA.1

Freq = 1.6266 GHz, Bw = 8.000 MH No calibration applied and no bandpass applied

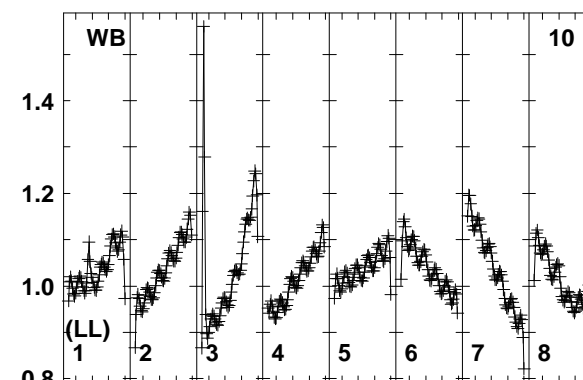
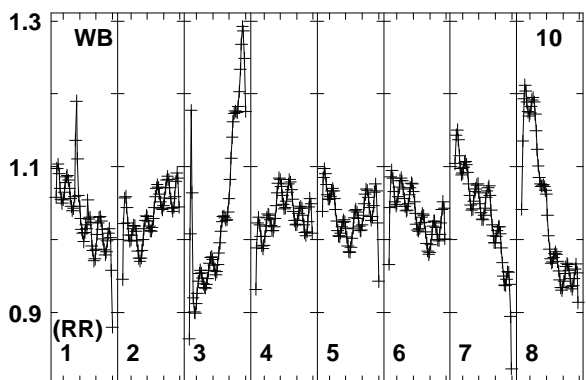
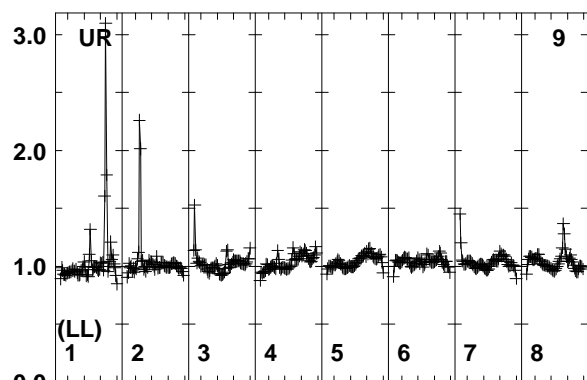
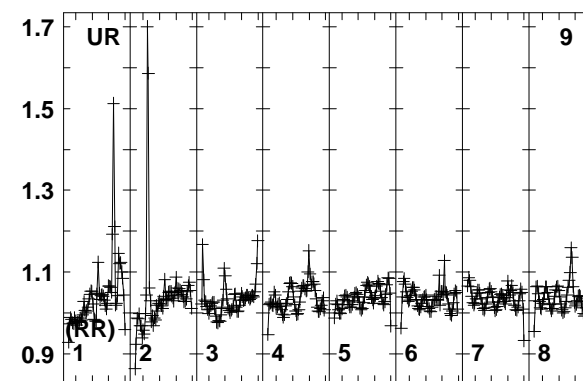
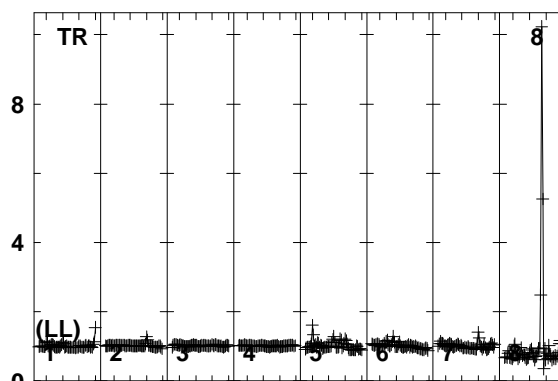
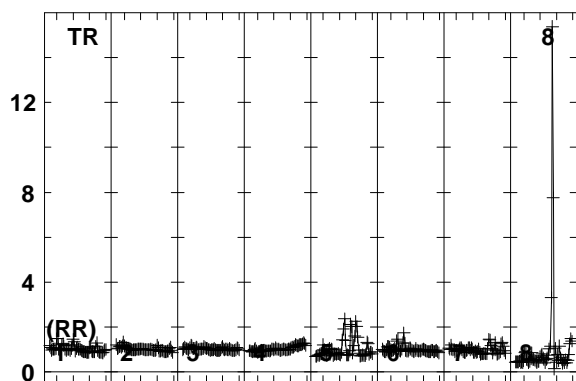
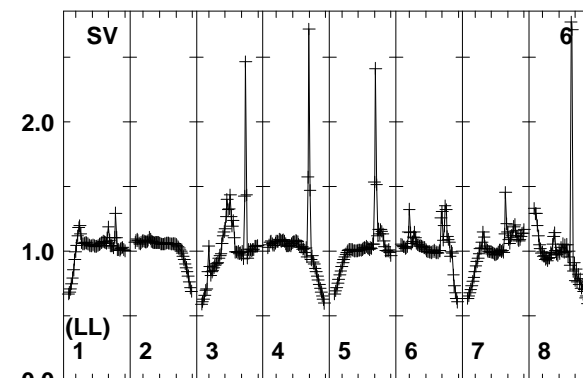
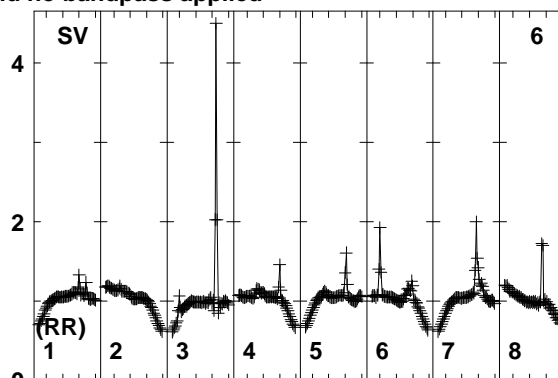
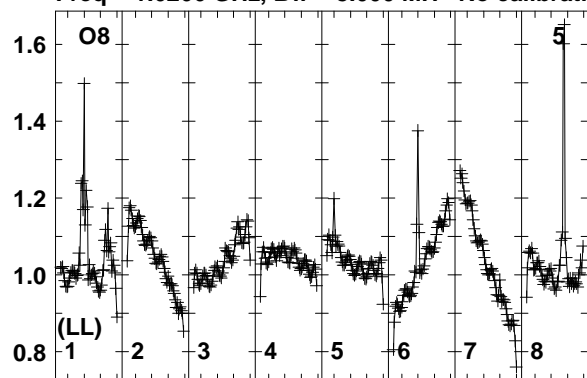

16281 63961 64241 65216 55016 66816 77616 82416 90
FREQ MHz

16281 63961 64241 65216 55016 66816 77616 82416 90
FREQ MHz

16281 63961 64241 65216 55016 66816 77616 82416 90
FREQ MHz

Lower frame: Real Jy
Total-power spectrum Antenna: O8 (05)
Timerange: 00/17:52:33 to 00/17:54:59

Plot file version 150 created 01-AUG-2018 16:38:20

PB+1+0 N18L1 2.UVDATA.1

Freq = 1.6266 GHz, Bw = 8.000 MH No calibration applied and no bandpass applied

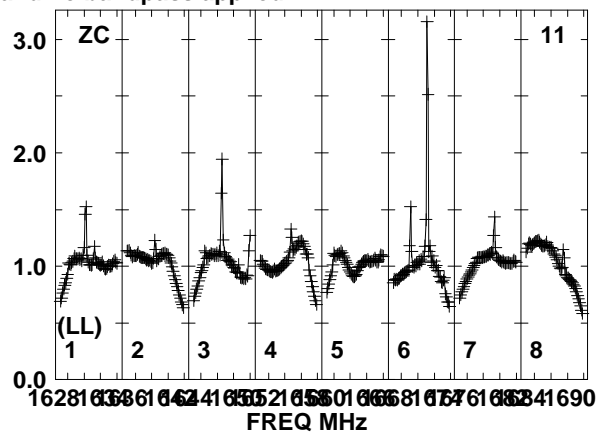
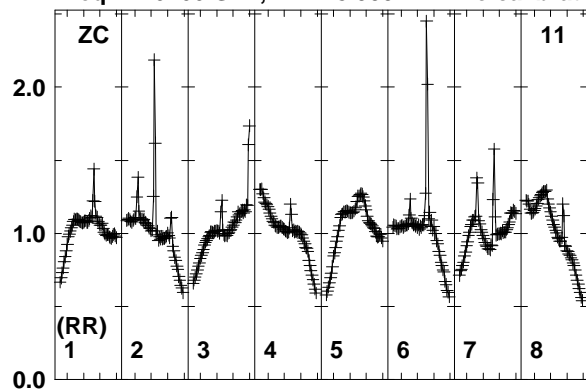

Lower frame: Real Jy
Total-power spectrum Antenna: ZC (11)
Timerange: 00/17:52:33 to 00/17:54:59

Plot file version 151 created 01-AUG-2018 16:38:20

J0530+1331 N18L1 2.UVDATA.1

Freq = 1.6266 GHz, Bw = 8.000 MH No calibration applied and no bandpass applied

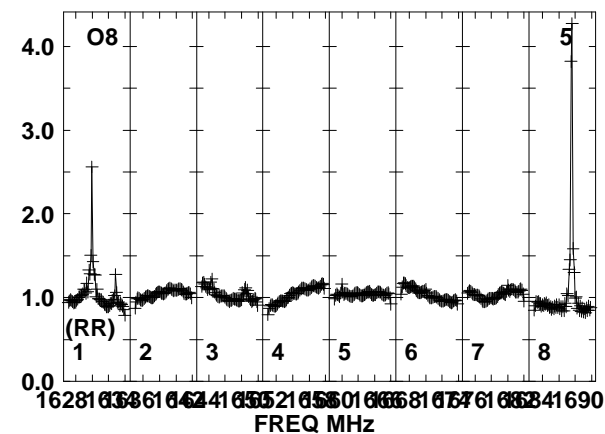
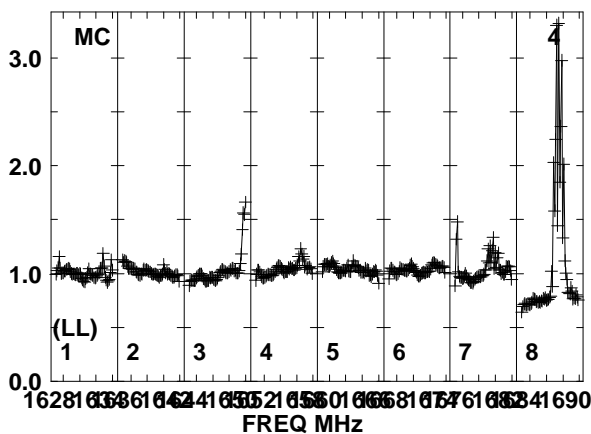
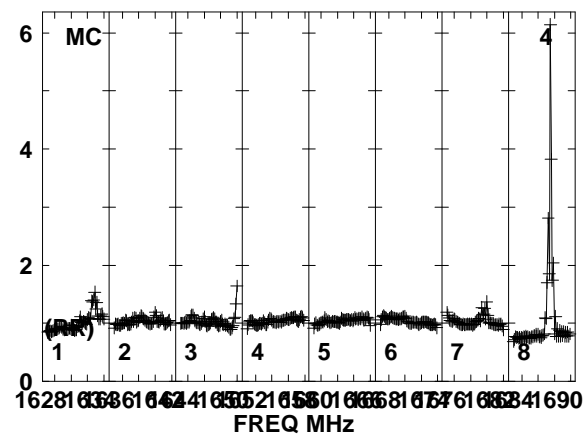
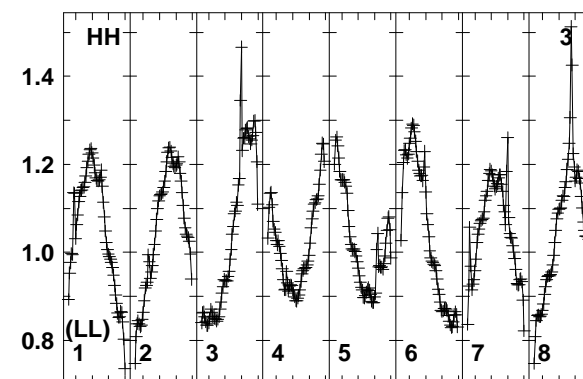
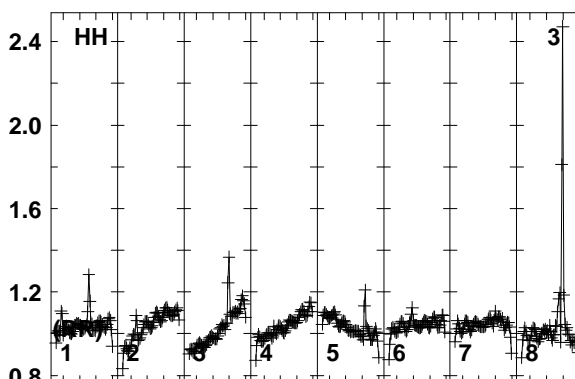
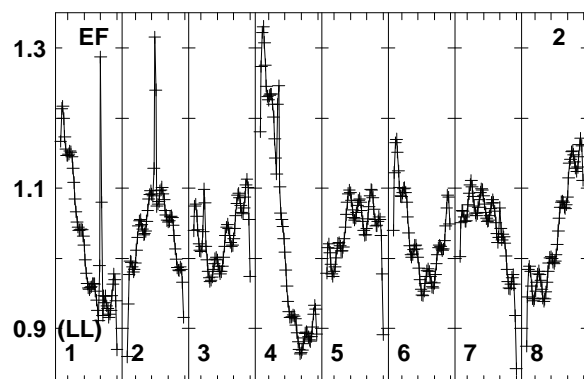
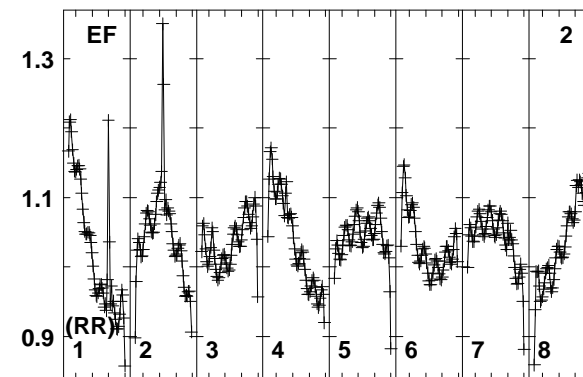
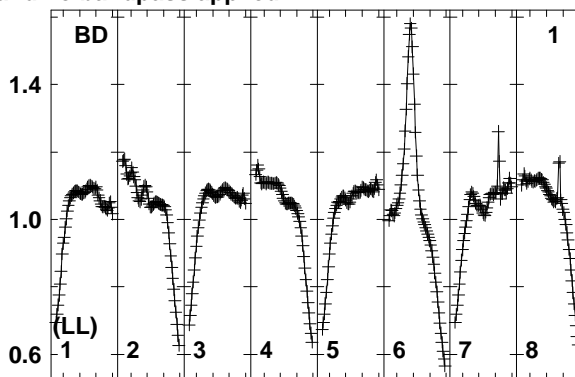
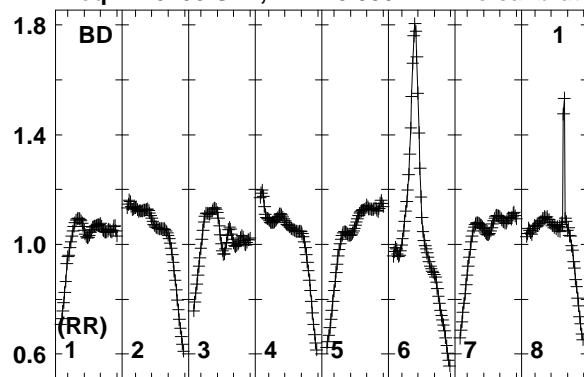

Lower frame: Real Jy
Total-power spectrum Antenna: BD (01)
Timerange: 00/17:55:41 to 00/17:56:59

Plot file version 152 created 01-AUG-2018 16:38:20

J0530+1331 N18L1 2.UVDATA.1

Freq = 1.6266 GHz, Bw = 8.000 MH No calibration applied and no bandpass applied

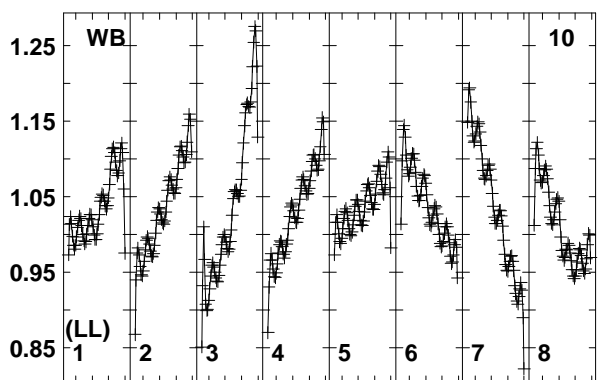
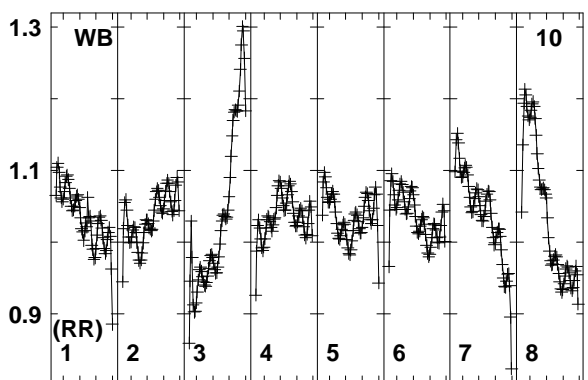
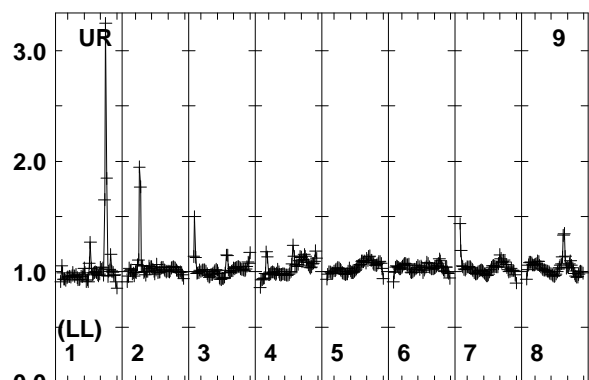
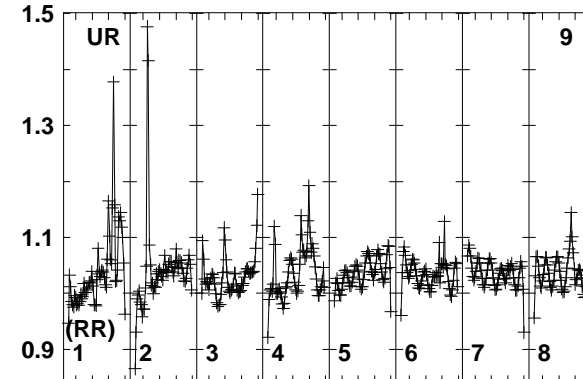
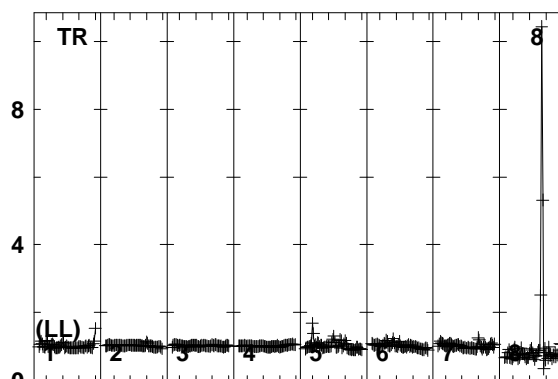
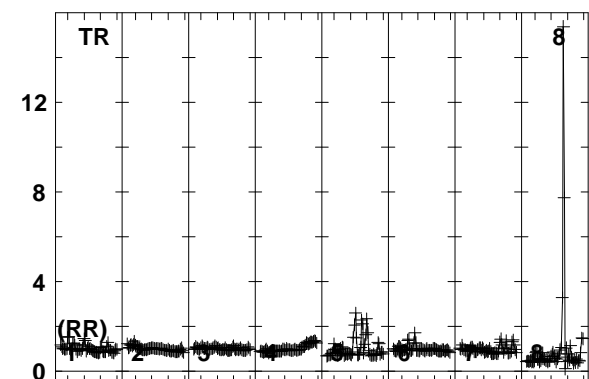
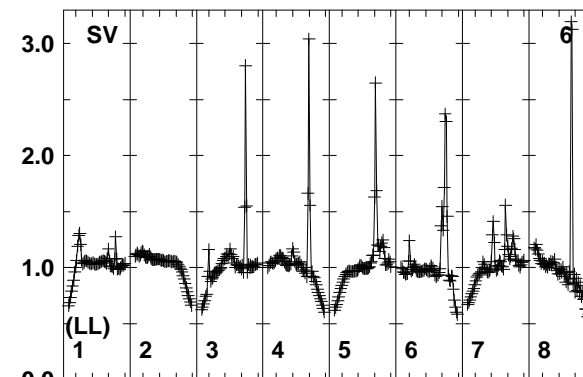
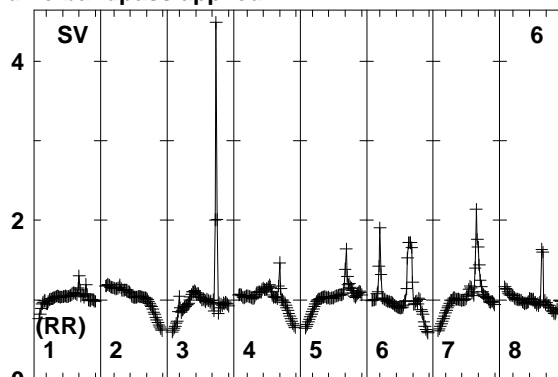
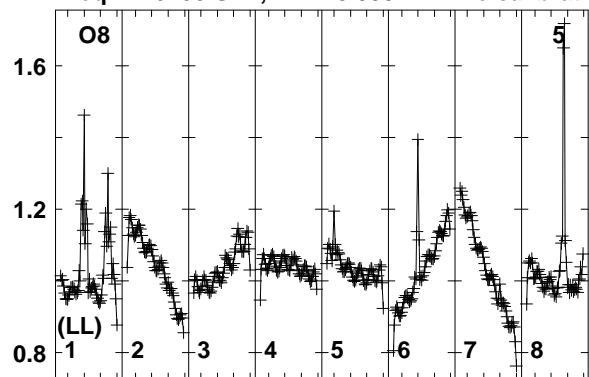

162816386164241652165801665816746168241690
FREQ MHz

162816386164241652165801665816746168241690
FREQ MHz

162816386164241652165801665816746168241690
FREQ MHz

Lower frame: Real Jy
Total-power spectrum Antenna: O8 (05)
Timerange: 00/17:55:41 to 00/17:56:59

Plot file version 153 created 01-AUG-2018 16:38:20

J0530+1331 N18L1 2.UVDATA.1

Freq = 1.6266 GHz, Bw = 8.000 MH No calibration applied and no bandpass applied

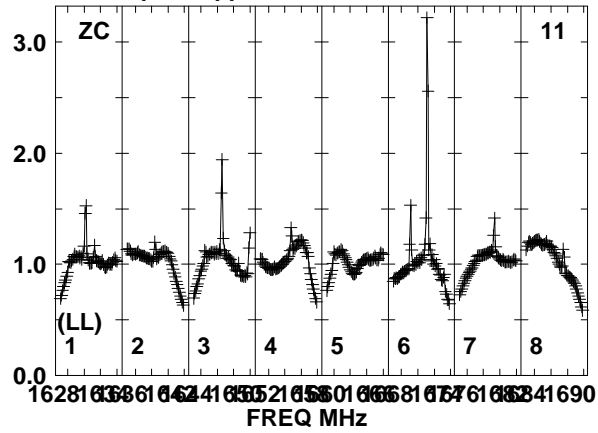
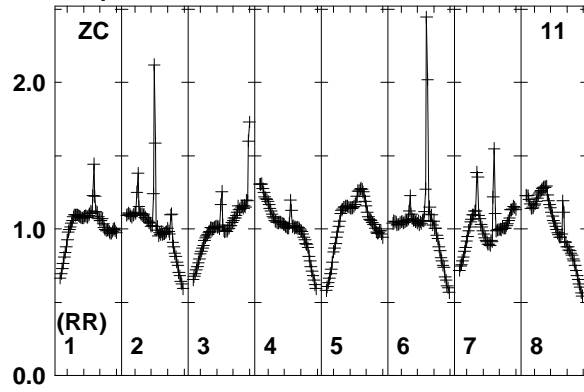

Lower frame: Real Jy
Total-power spectrum Antenna: ZC (11)
Timerange: 00/17:55:41 to 00/17:56:59

Plot file version 154 created 01-AUG-2018 16:38:20

PB-1+0 N18L1 2.UVDATA.1

Freq = 1.6266 GHz, Bw = 8.000 MH No calibration applied and no bandpass applied

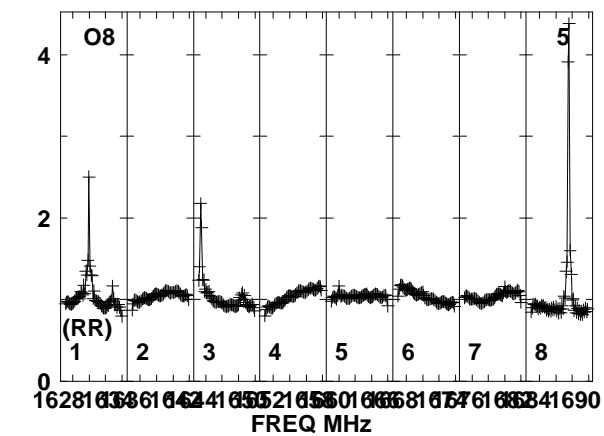
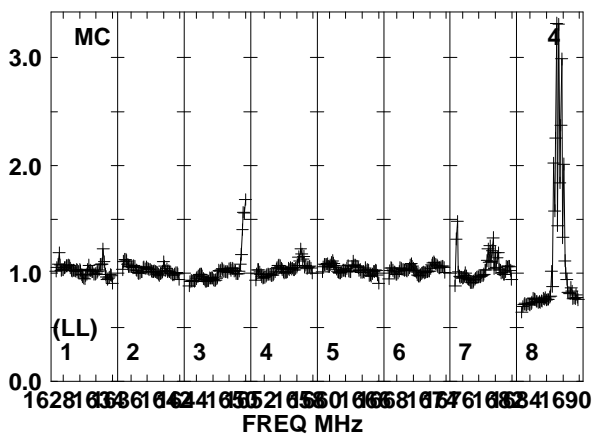
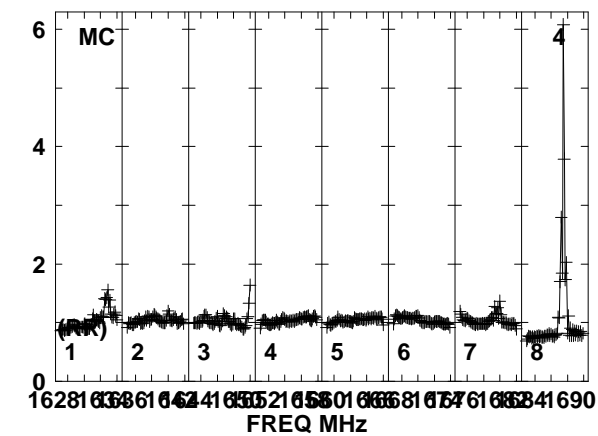
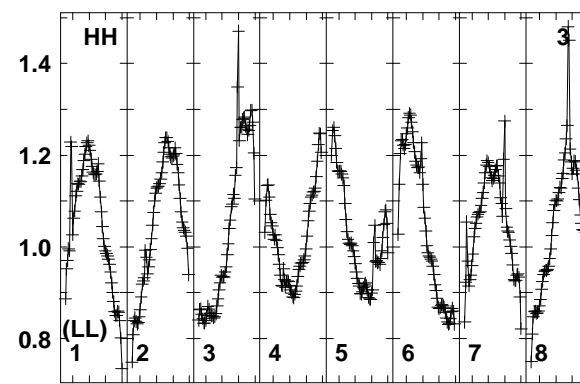
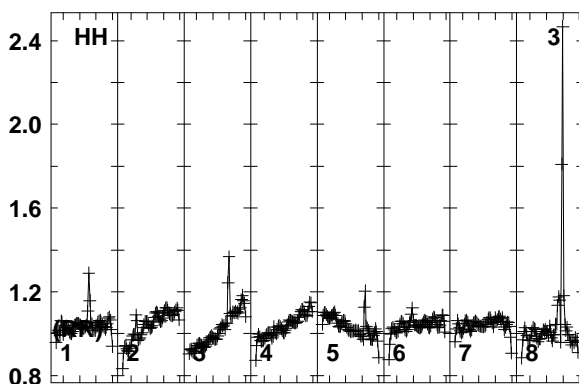
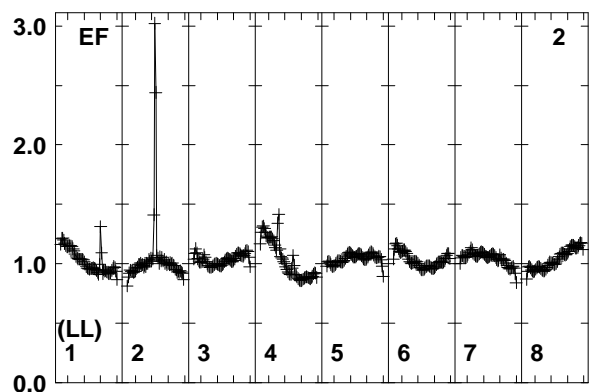
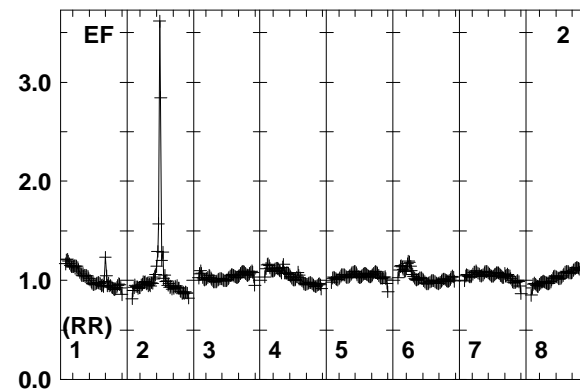
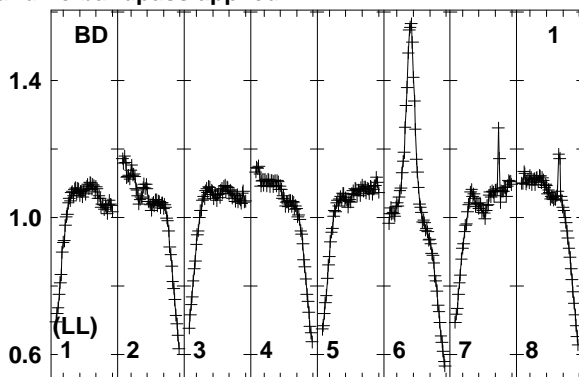
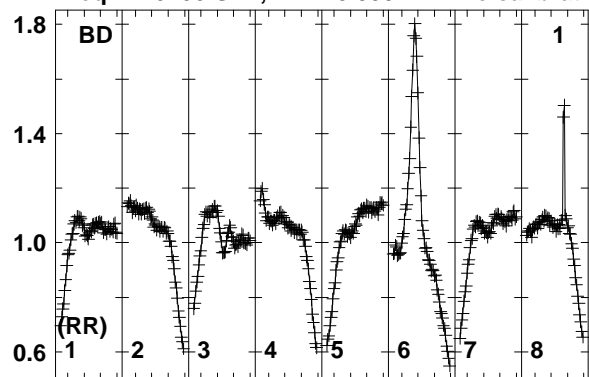

Lower frame: Real Jy
Total-power spectrum Antenna: BD (01)
Timerange: 00/17:57:03 to 00/17:59:29

Plot file version 155 created 01-AUG-2018 16:38:21

PB-1+0 N18L1 2.UVDATA.1

Freq = 1.6266 GHz, Bw = 8.000 MH No calibration applied and no bandpass applied

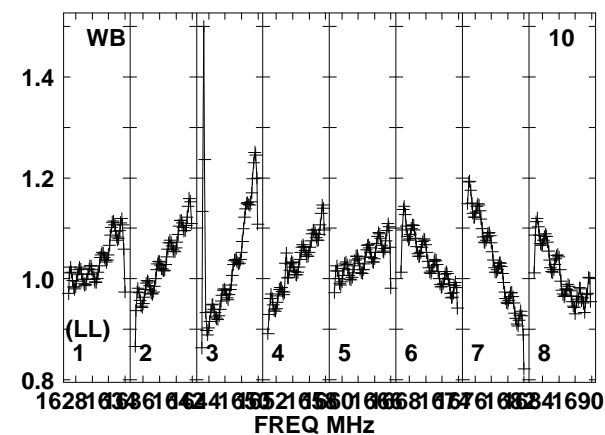
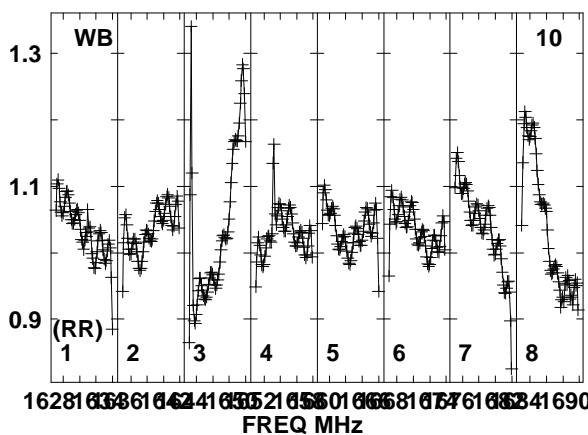
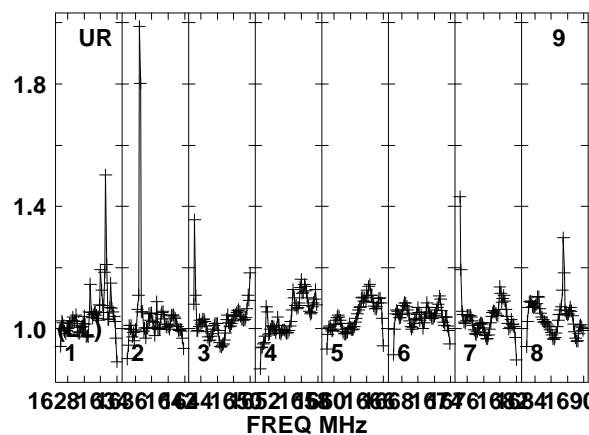
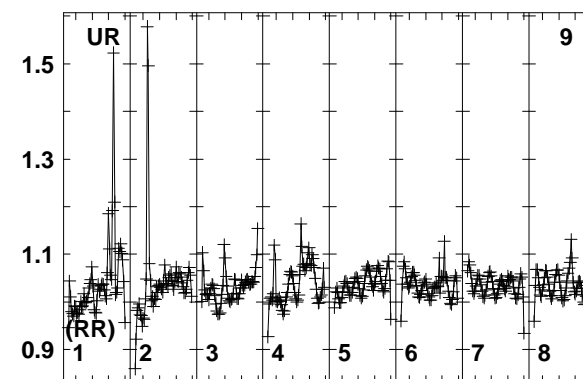
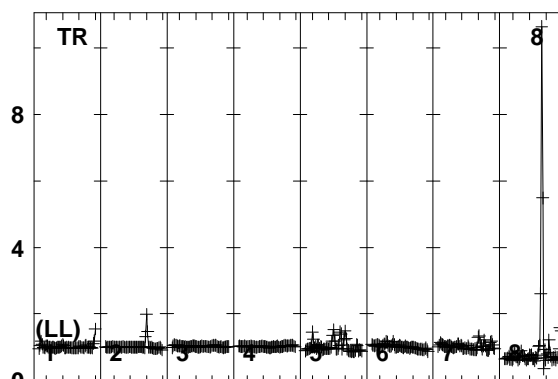
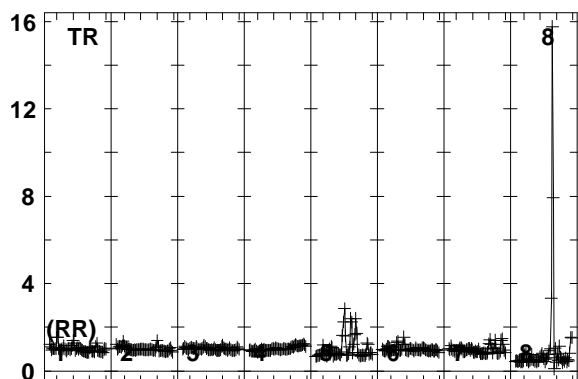
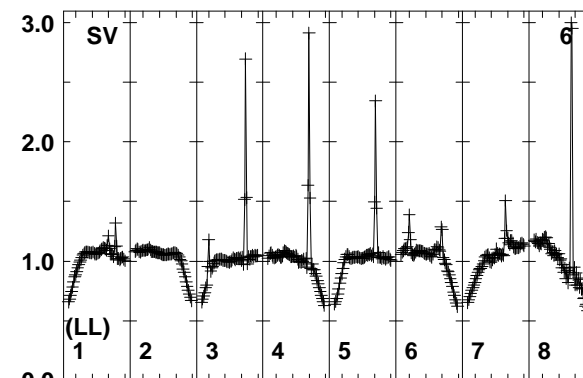
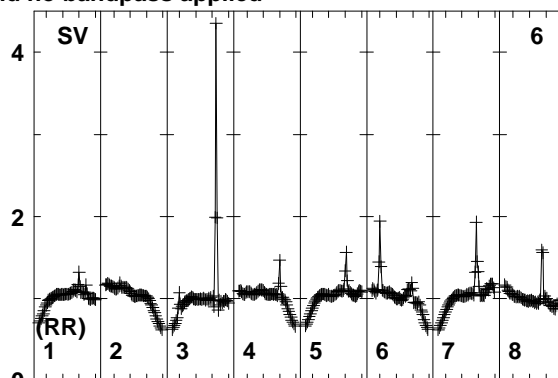
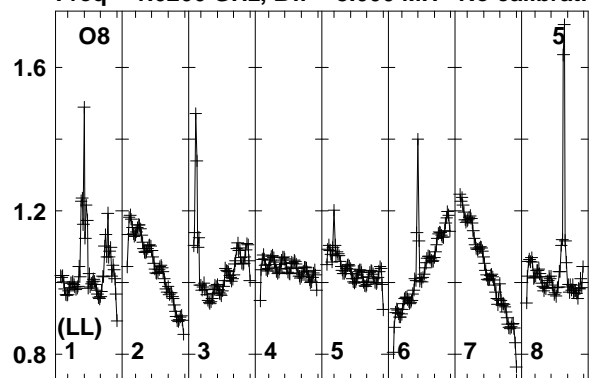

Lower frame: Real Jy
Total-power spectrum Antenna: O8 (05)
Timerange: 00/17:57:03 to 00/17:59:29

Plot file version 156 created 01-AUG-2018 16:38:21

PB-1+0 N18L1 2.UVDATA.1

Freq = 1.6266 GHz, Bw = 8.000 MH No calibration applied and no bandpass applied

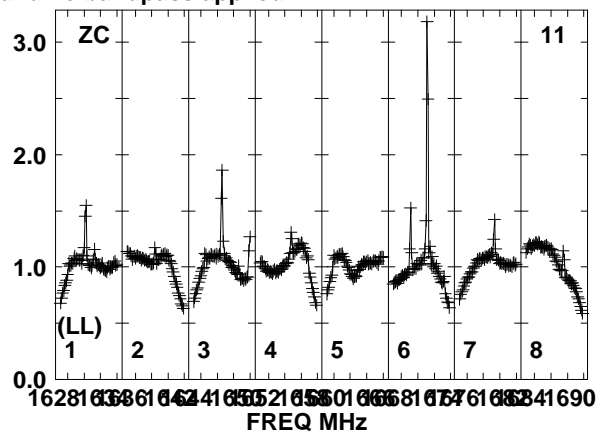
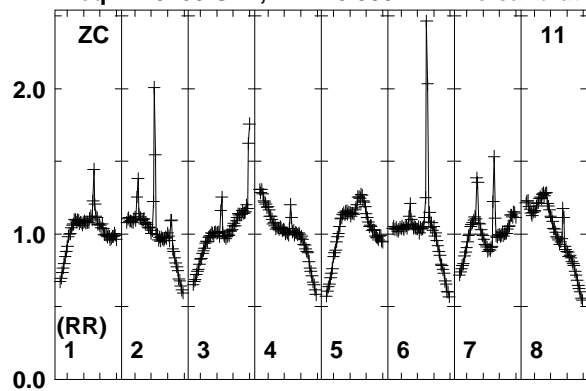

Lower frame: Real Jy
Total-power spectrum Antenna: ZC (11)
Timerange: 00/17:57:03 to 00/17:59:29

Plot file version 157 created 01-AUG-2018 16:38:21

PB-2+0 N18L1 2.UVDATA.1

Freq = 1.6266 GHz, Bw = 8.000 MH No calibration applied and no bandpass applied

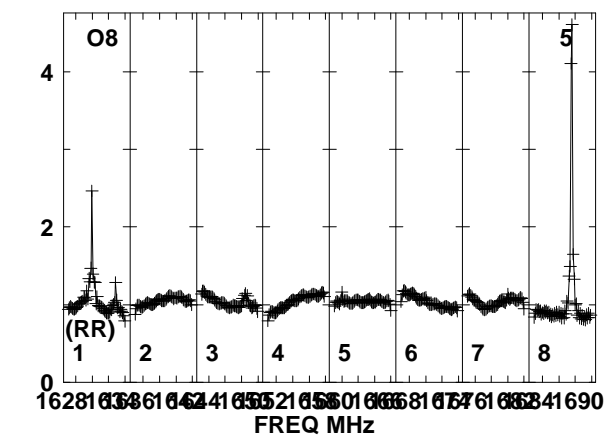
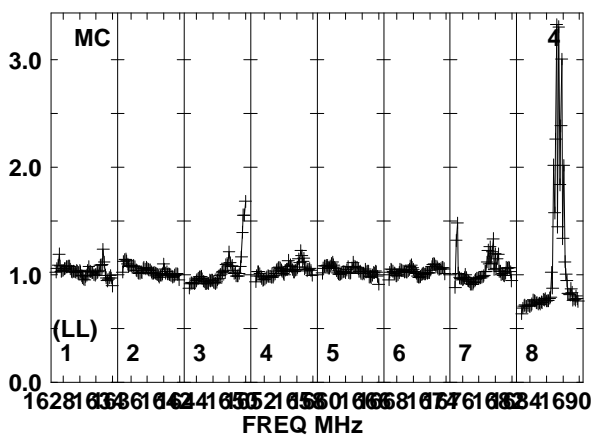
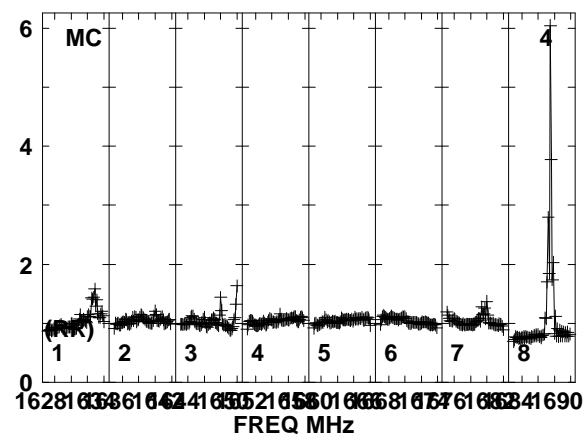
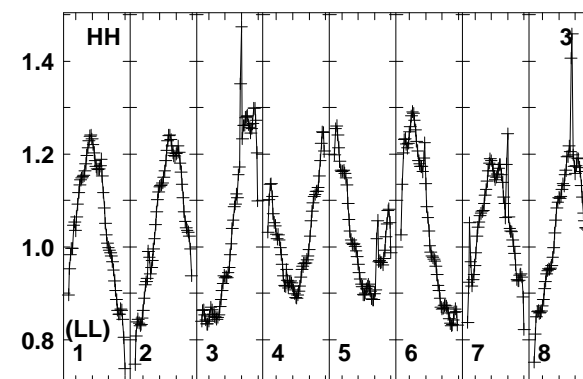
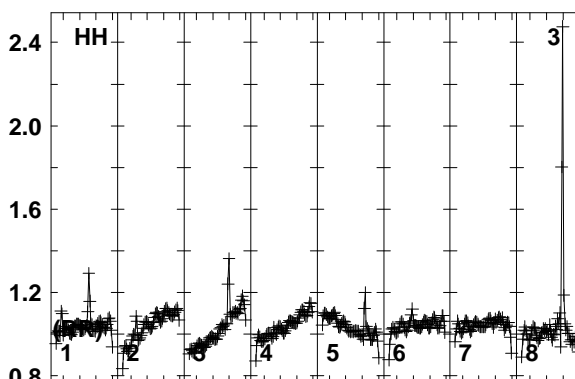
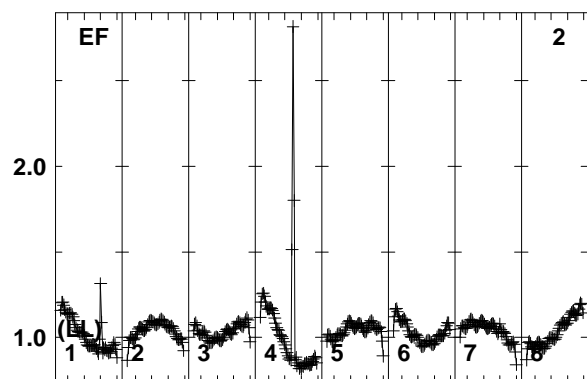
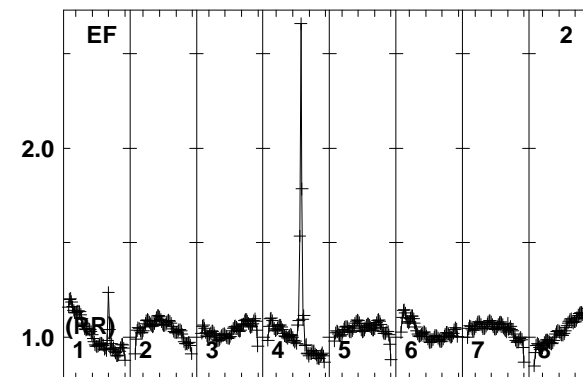
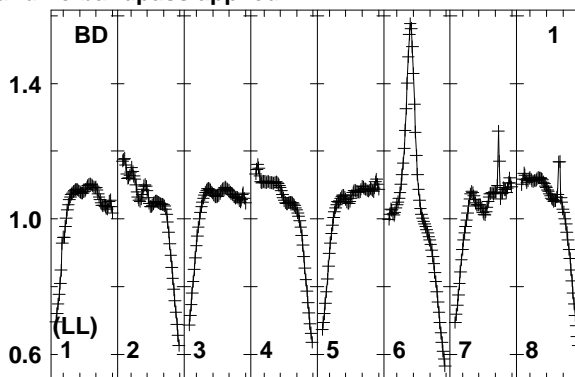
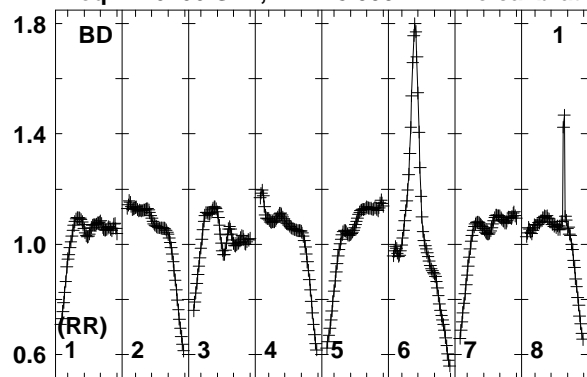

Lower frame: Real Jy
Total-power spectrum Antenna: BD (01)
Timerange: 00/17:59:33 to 00/18:01:59

Plot file version 158 created 01-AUG-2018 16:38:21

PB-2+0 N18L1 2.UVDATA.1

Freq = 1.6266 GHz, Bw = 8.000 MH No calibration applied and no bandpass applied

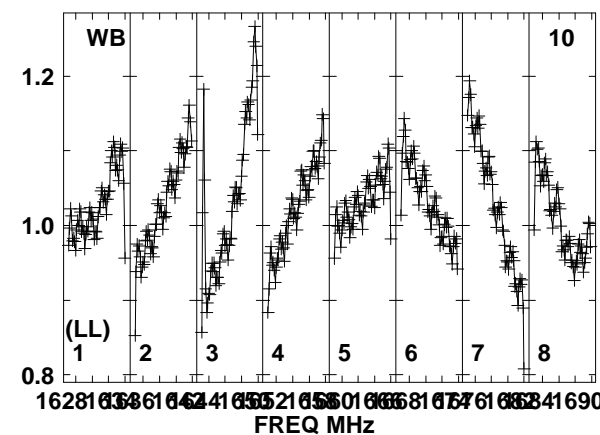
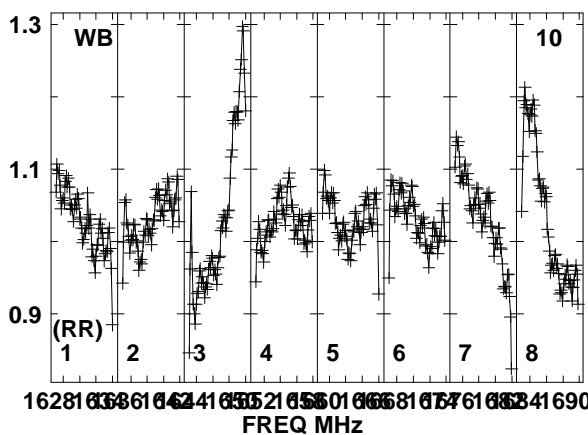
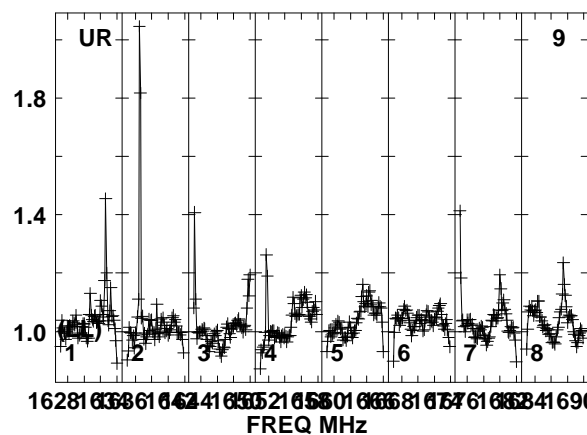
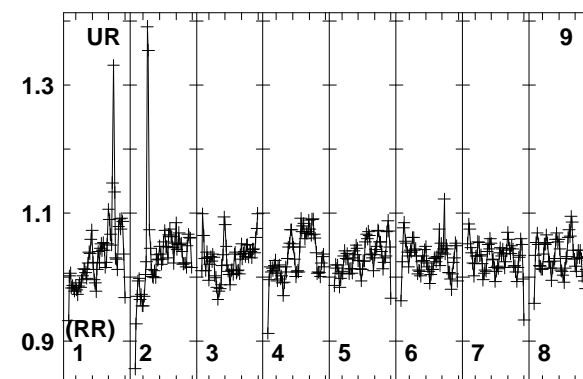
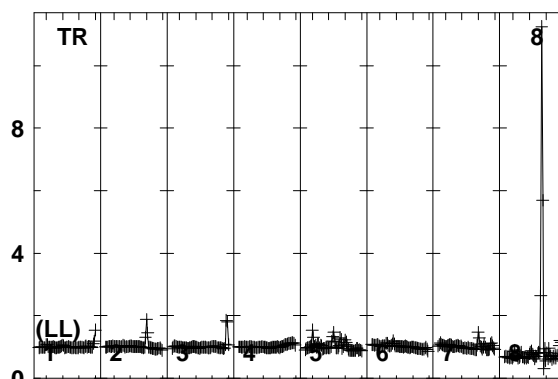
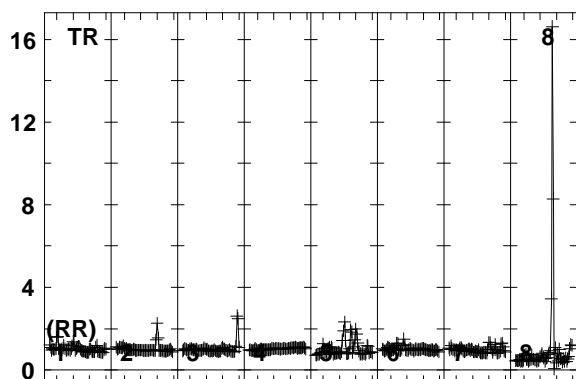
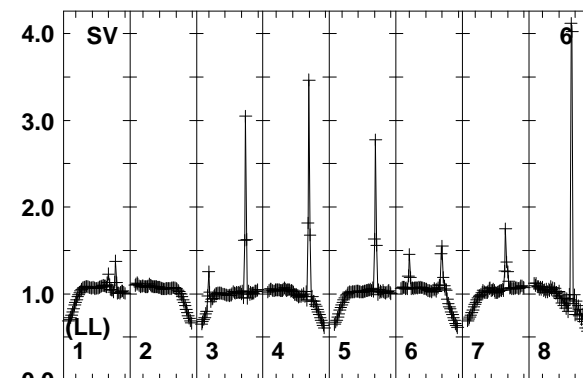
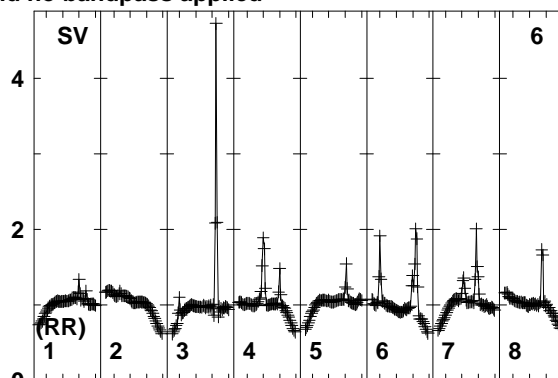
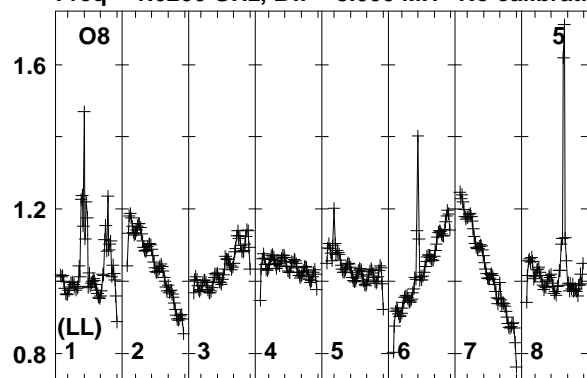

16281 63861 64241 65216 66106 66816 67616 68241 690
FREQ MHz

16281 63861 64241 65216 66106 66816 67616 68241 690
FREQ MHz

16281 63861 64241 65216 66106 66816 67616 68241 690
FREQ MHz

Lower frame: Real Jy
Total-power spectrum Antenna: O8 (05)
Timerange: 00/17:59:33 to 00/18:01:59

Plot file version 159 created 01-AUG-2018 16:38:22

PB-2+0 N18L1 2.UVDATA.1

Freq = 1.6266 GHz, Bw = 8.000 MH No calibration applied and no bandpass applied

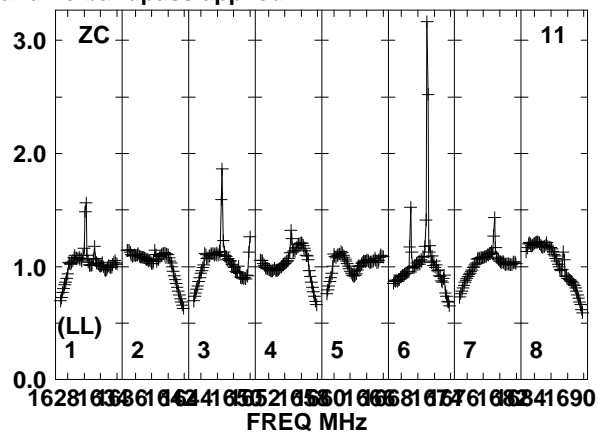
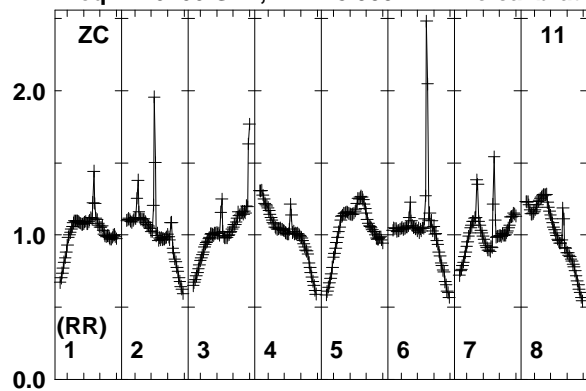

Lower frame: Real Jy
Total-power spectrum Antenna: ZC (11)
Timerange: 00/17:59:33 to 00/18:01:59

Plot file version 160 created 01-AUG-2018 16:38:22

PB-3+0 N18L1 2.UVDATA.1

Freq = 1.6266 GHz, Bw = 8.000 MH No calibration applied and no bandpass applied

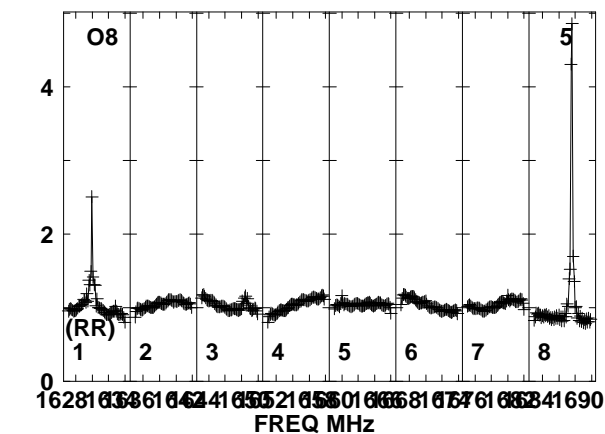
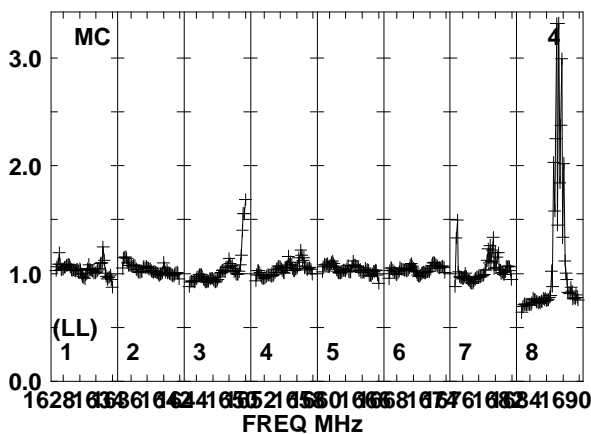
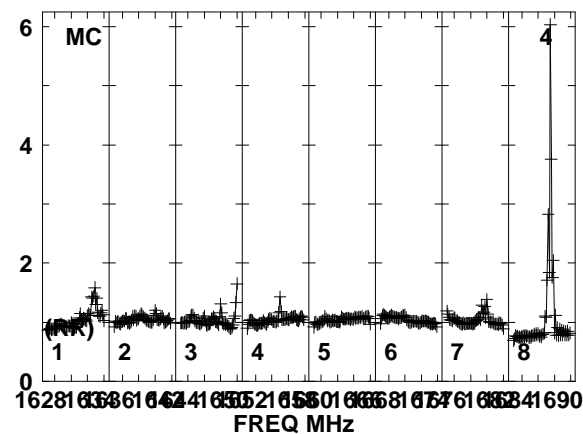
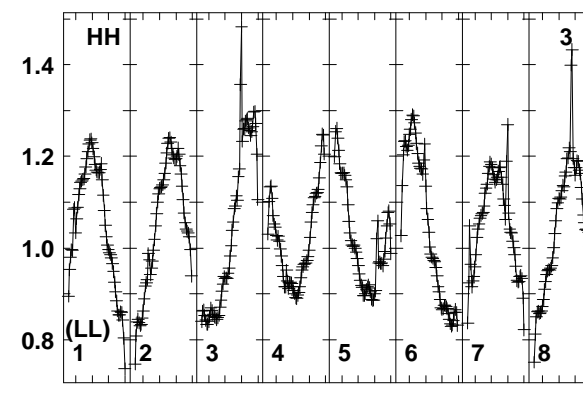
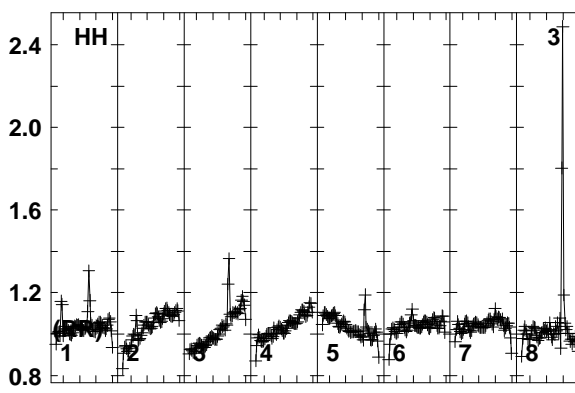
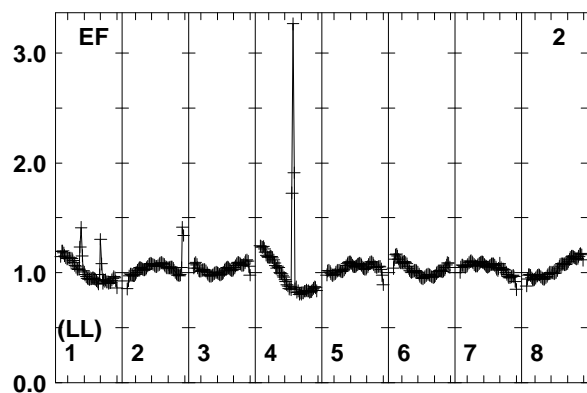
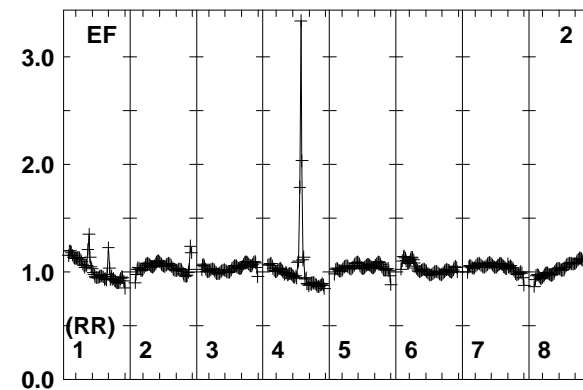
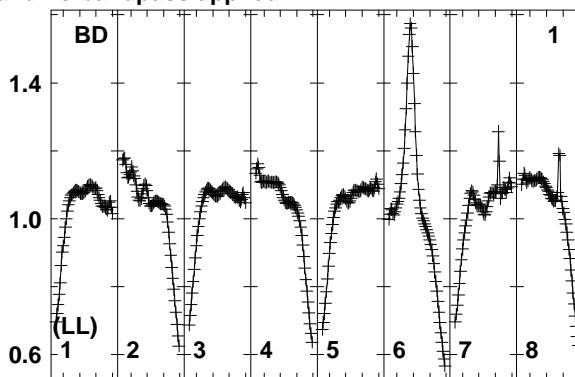
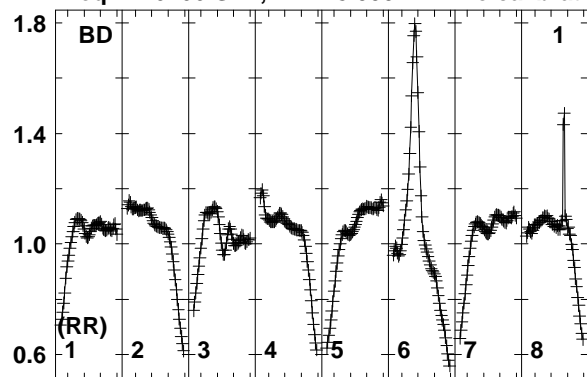

Lower frame: Real Jy
Total-power spectrum Antenna: BD (01)
Timerange: 00/18:02:03 to 00/18:04:29

Plot file version 161 created 01-AUG-2018 16:38:22

PB-3+0 N18L1 2.UVDATA.1

Freq = 1.6266 GHz, Bw = 8.000 MH No calibration applied and no bandpass applied

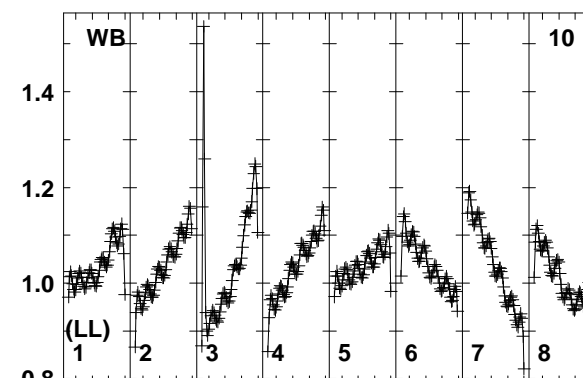
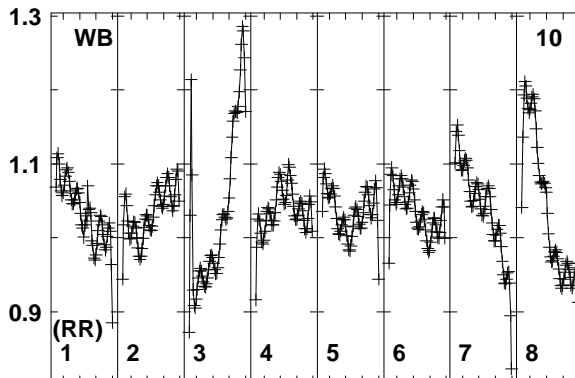
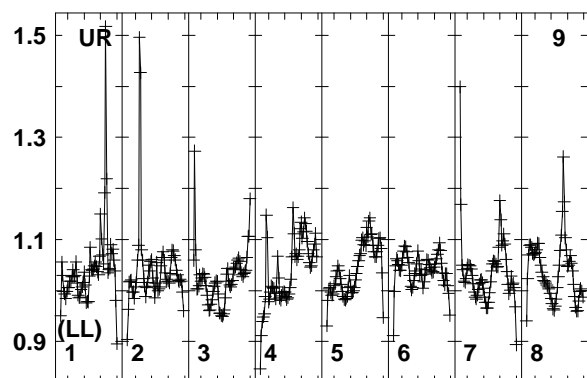
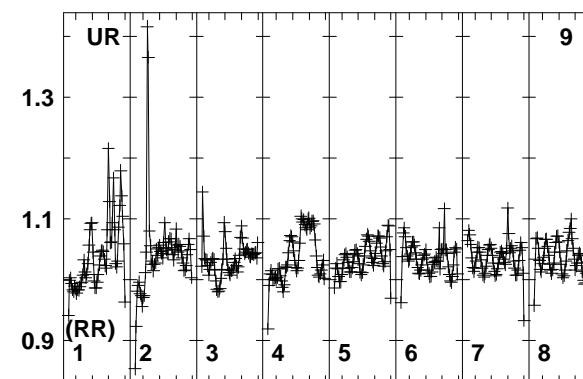
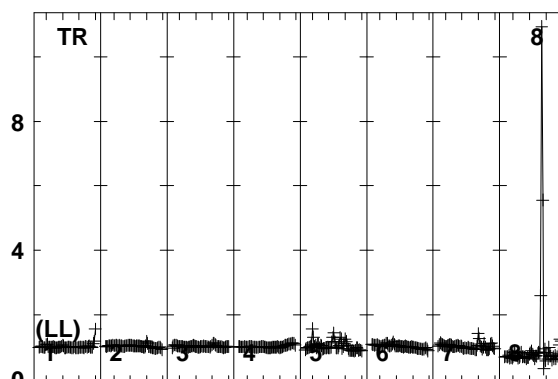
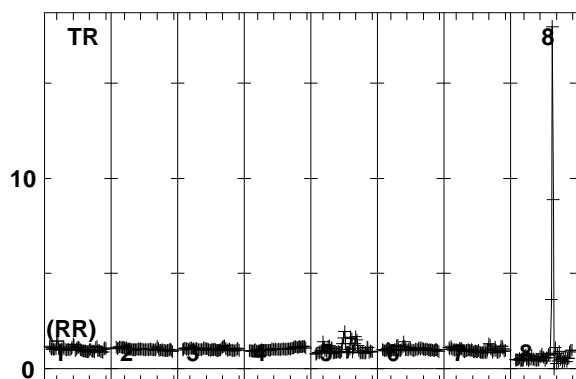
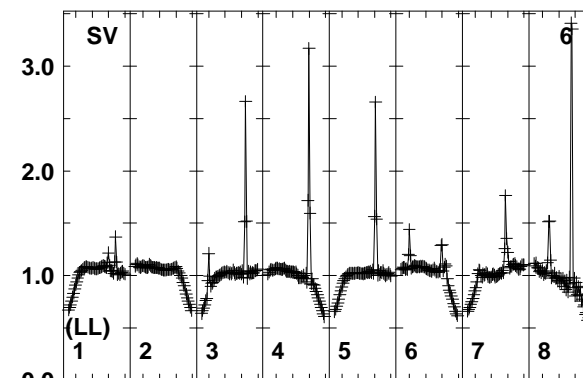
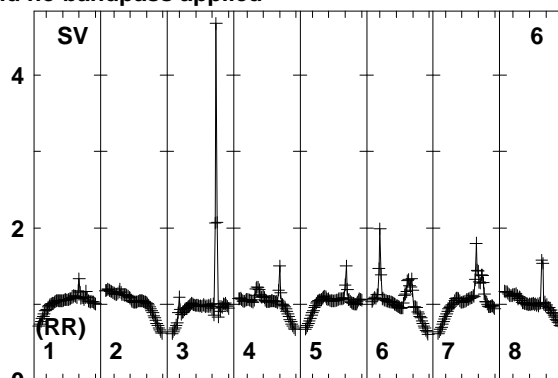
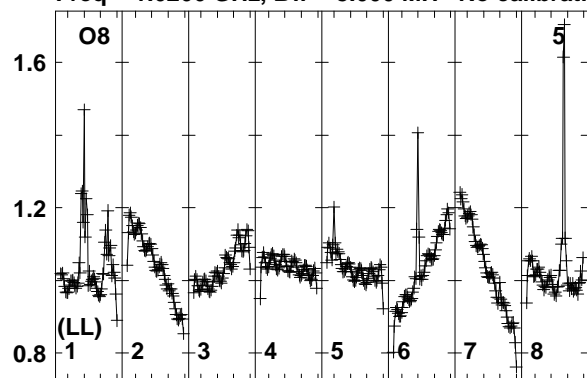

1628163861644165216581666816746168241690
FREQ MHz

1628163861644165216581666816746168241690
FREQ MHz

1628163861644165216581666816746168241690
FREQ MHz

Lower frame: Real Jy
Total-power spectrum Antenna: O8 (05)
Timerange: 00/18:02:03 to 00/18:04:29

Plot file version 162 created 01-AUG-2018 16:38:22

PB-3+0 N18L1 2.UVDATA.1

Freq = 1.6266 GHz, Bw = 8.000 MH No calibration applied and no bandpass applied

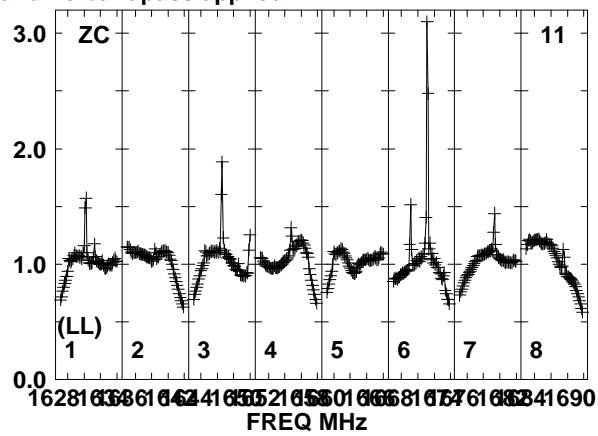
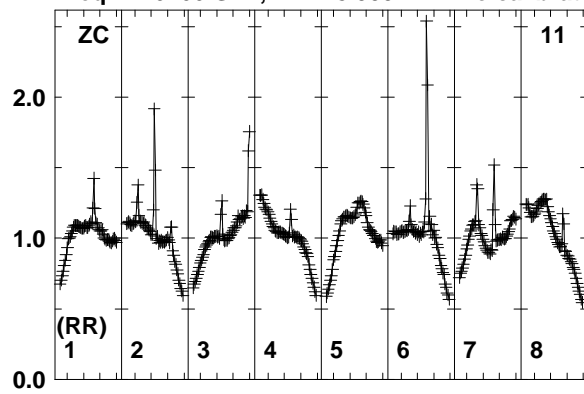

Lower frame: Real Jy
Total-power spectrum Antenna: ZC (11)
Timerange: 00/18:02:03 to 00/18:04:29

Plot file version 163 created 01-AUG-2018 16:38:22

J0530+1331 N18L1 2.UVDATA.1

Freq = 1.6266 GHz, Bw = 8.000 MH No calibration applied and no bandpass applied

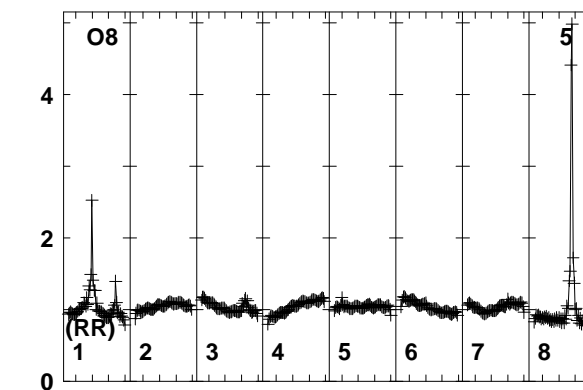
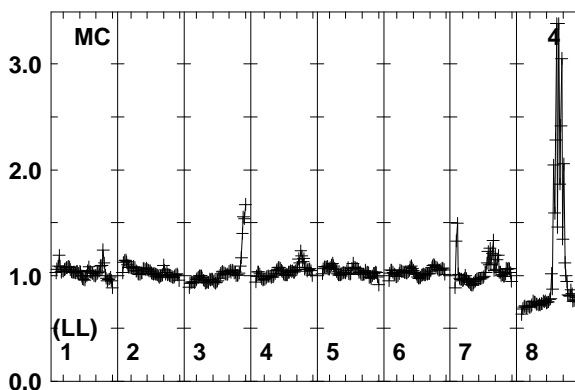
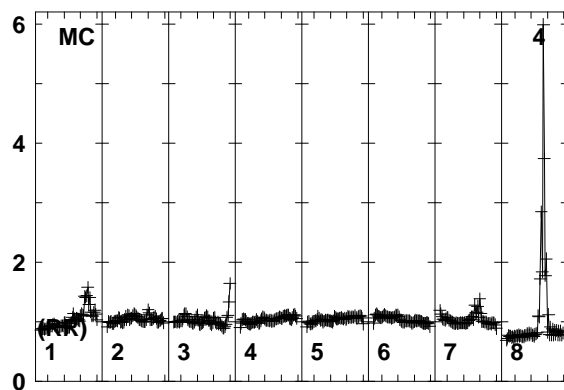
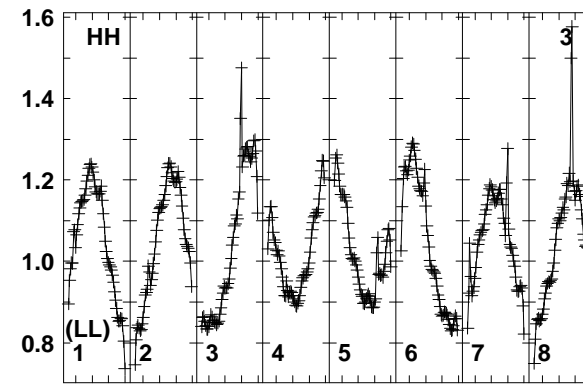
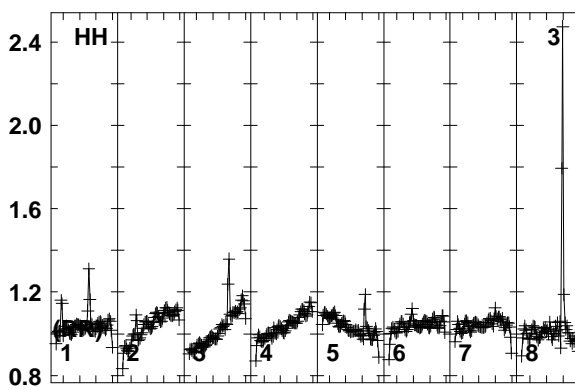
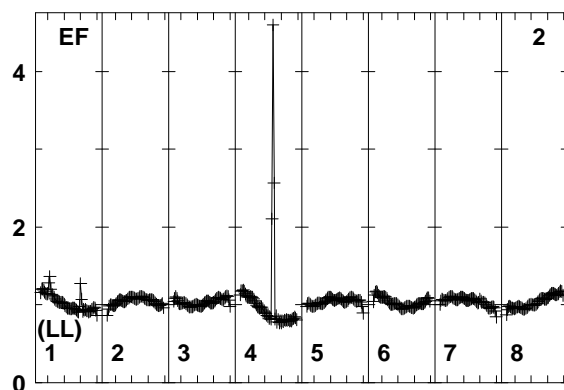
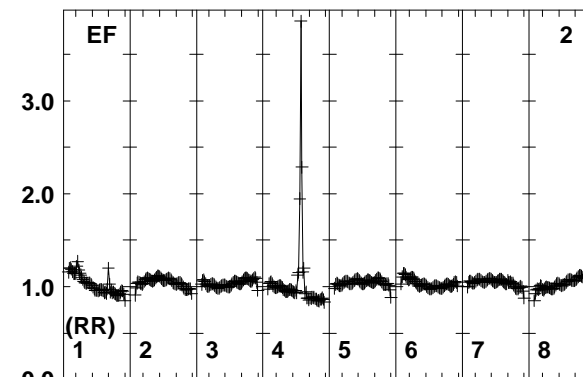
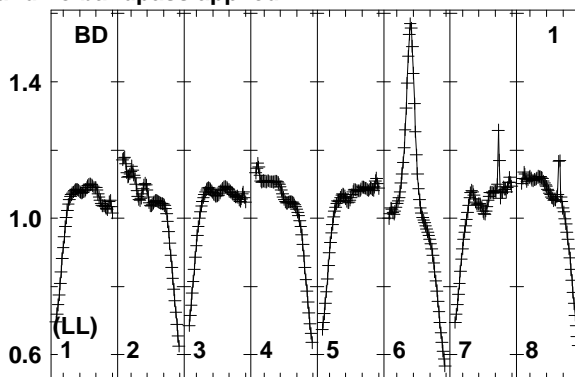
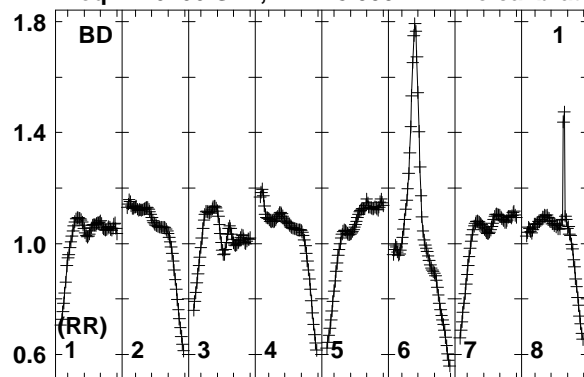

16281 63861 64241 65216 66016 66816 67616 68416 690
FREQ MHz

16281 63861 64241 65216 66016 66816 67616 68416 690
FREQ MHz

16281 63861 64241 65216 66016 66816 67616 68416 690
FREQ MHz

Lower frame: Real Jy
Total-power spectrum Antenna: BD (01)
Timerange: 00/18:05:11 to 00/18:06:29

Plot file version 164 created 01-AUG-2018 16:38:22

J0530+1331 N18L1 2.UVDATA.1

Freq = 1.6266 GHz, Bw = 8.000 MH No calibration applied and no bandpass applied

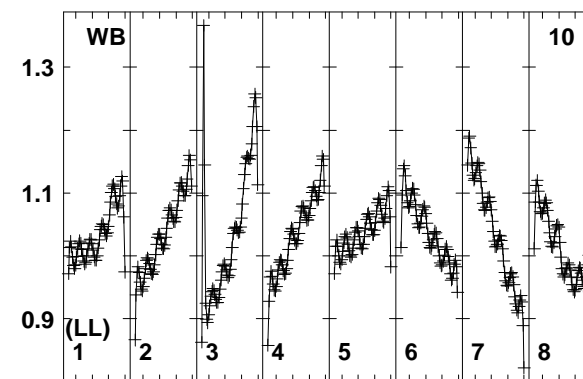
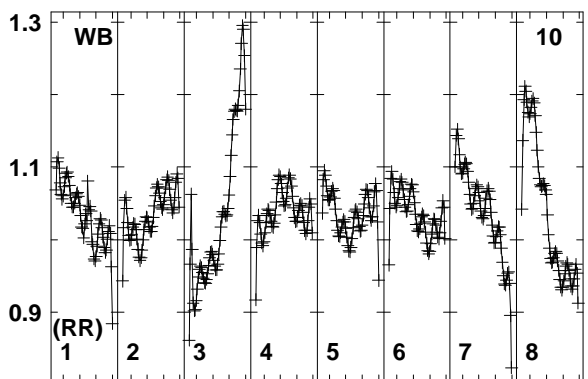
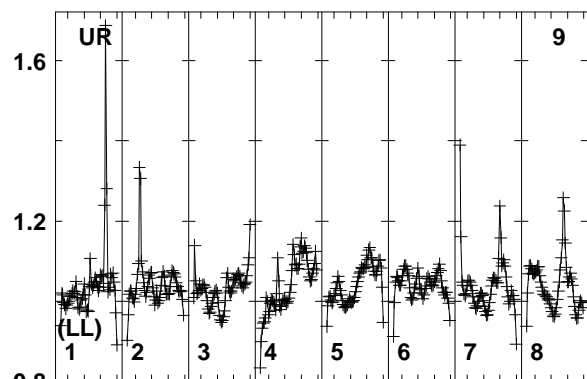
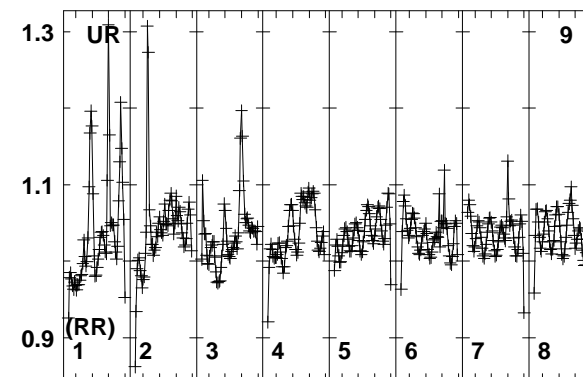
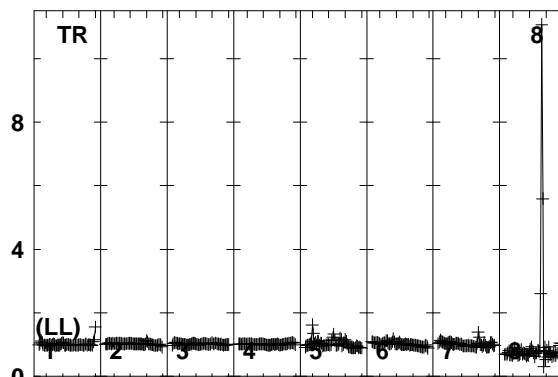
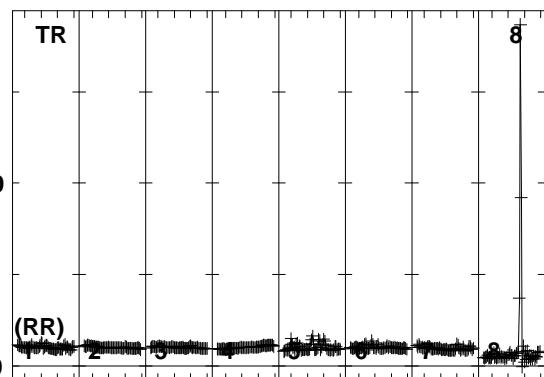
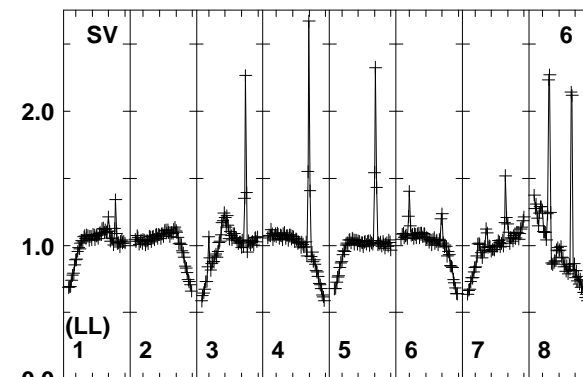
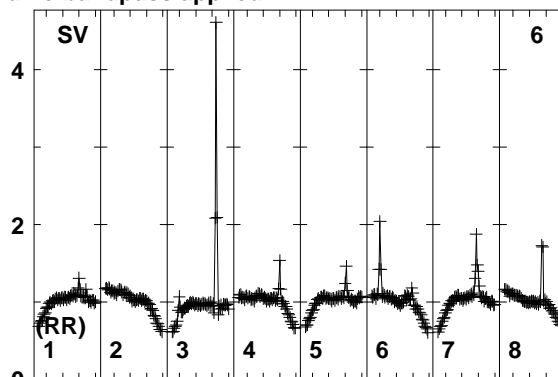
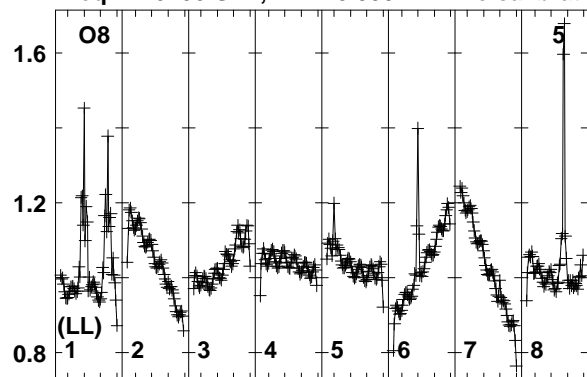

162816386164416521658166581674168241690
FREQ MHz

162816386164416521658166581674168241690
FREQ MHz

162816386164416521658166581674168241690
FREQ MHz

Lower frame: Real Jy
Total-power spectrum Antenna: O8 (05)
Timerange: 00/18:05:11 to 00/18:06:29

Plot file version 165 created 01-AUG-2018 16:38:22

J0530+1331 N18L1 2.UVDATA.1

Freq = 1.6266 GHz, Bw = 8.000 MH No calibration applied and no bandpass applied

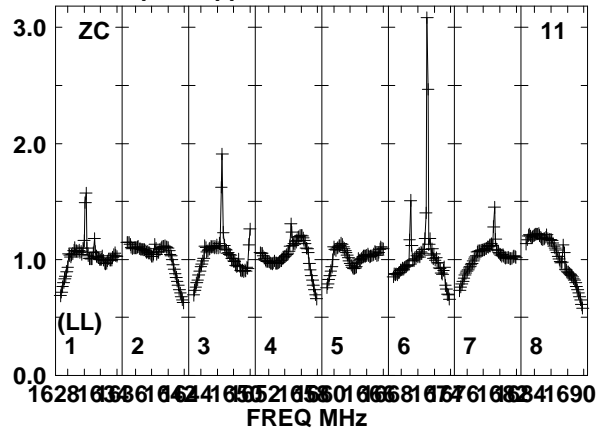
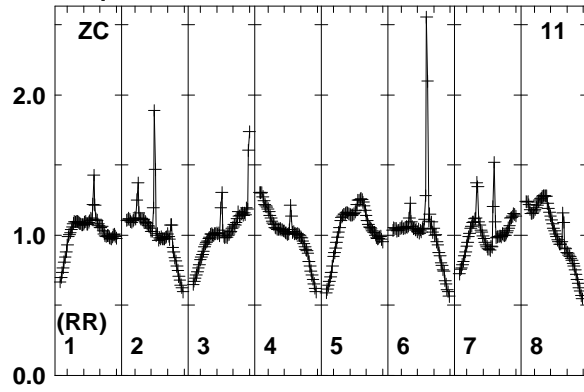

Lower frame: Real Jy
Total-power spectrum Antenna: ZC (11)
Timerange: 00/18:05:11 to 00/18:06:29

Plot file version 166 created 01-AUG-2018 16:38:22

PB-4+0 N18L1 2.UVDATA.1

Freq = 1.6266 GHz, Bw = 8.000 MH No calibration applied and no bandpass applied

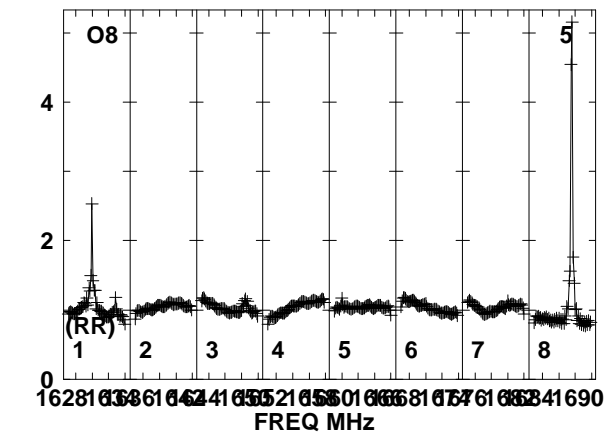
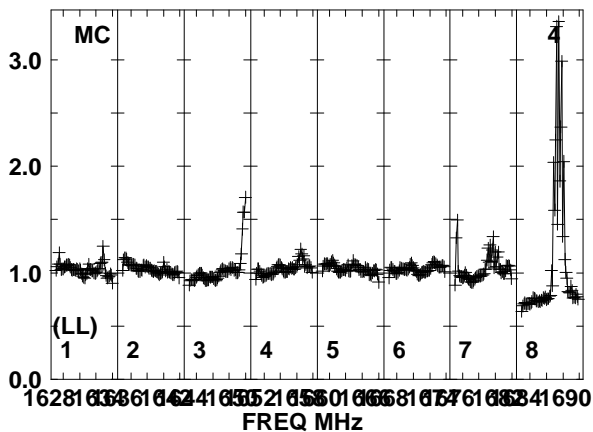
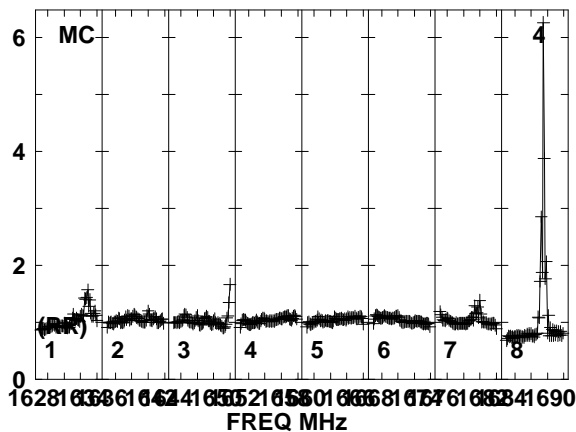
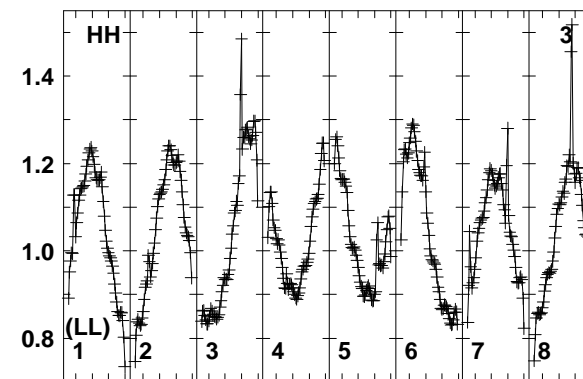
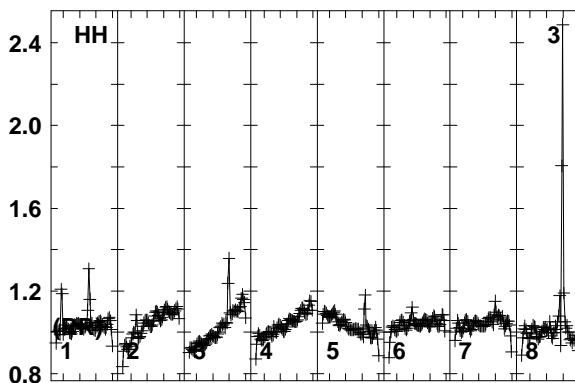
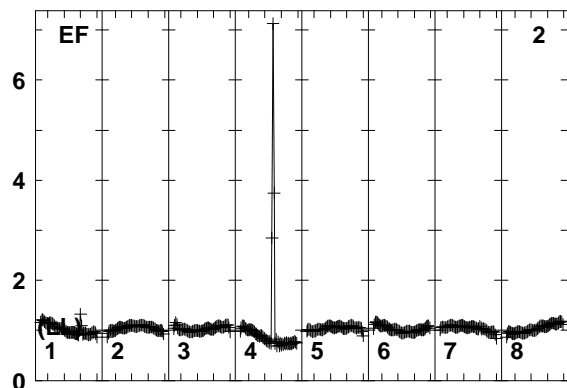
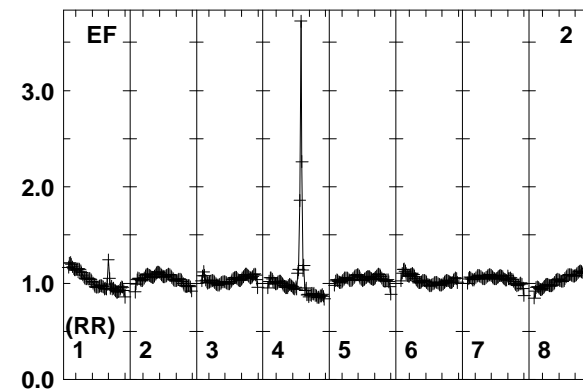
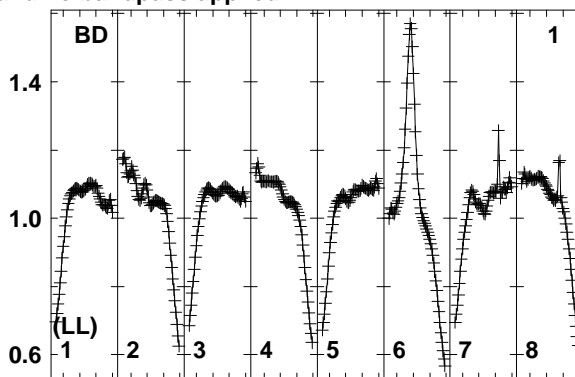
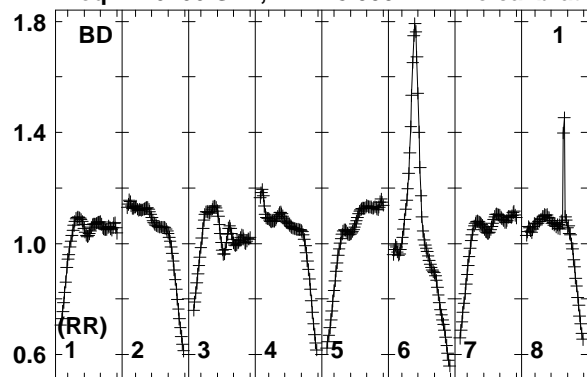

Lower frame: Real Jy
Total-power spectrum Antenna: BD (01)
Timerange: 00/18:06:35 to 00/18:08:59

Plot file version 167 created 01-AUG-2018 16:38:22

PB-4+0 N18L1 2.UVDATA.1

Freq = 1.6266 GHz, Bw = 8.000 MH No calibration applied and no bandpass applied

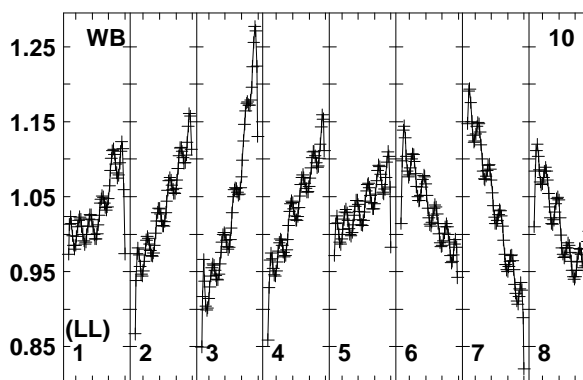
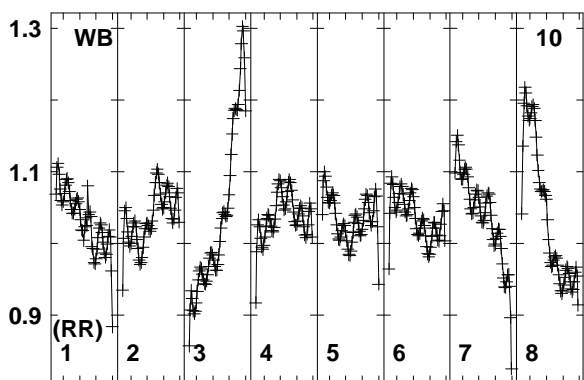
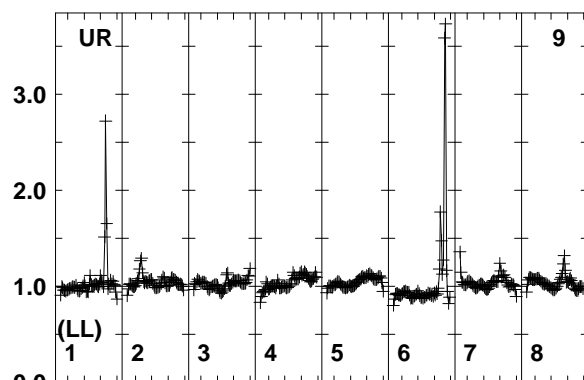
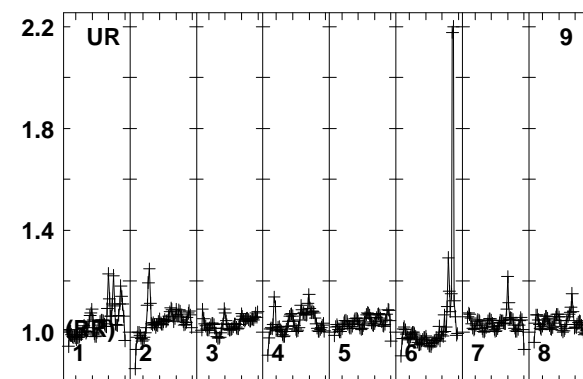
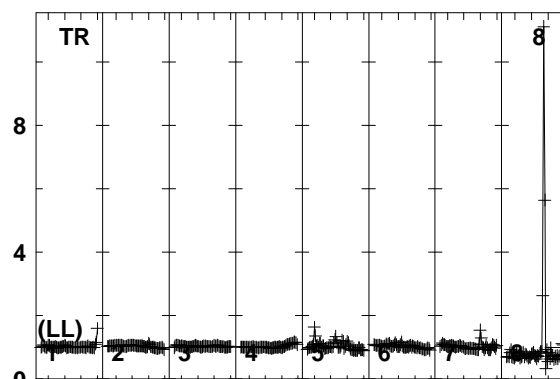
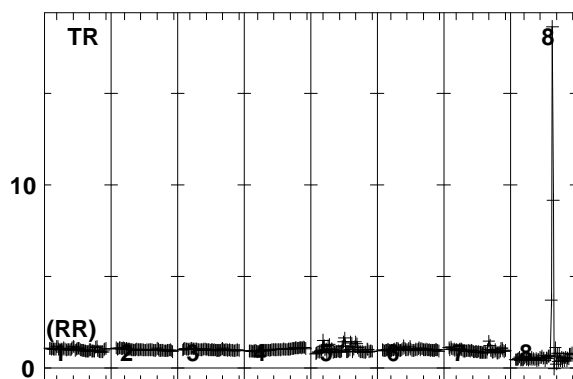
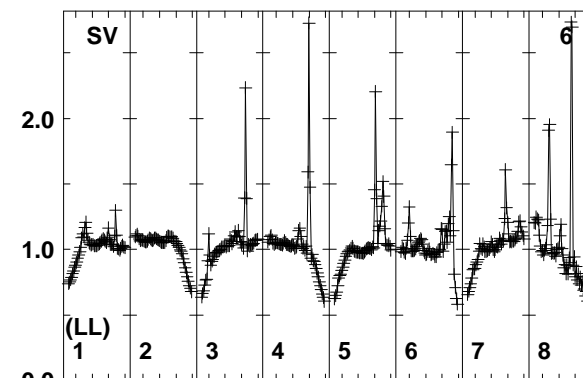
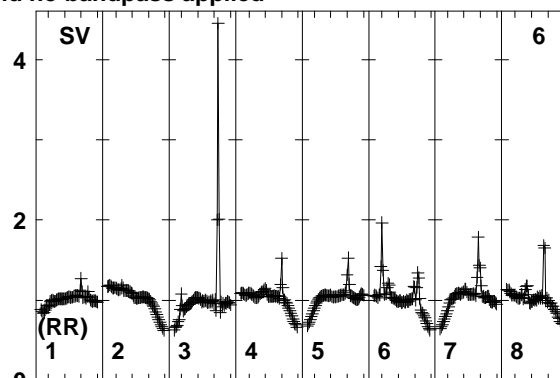
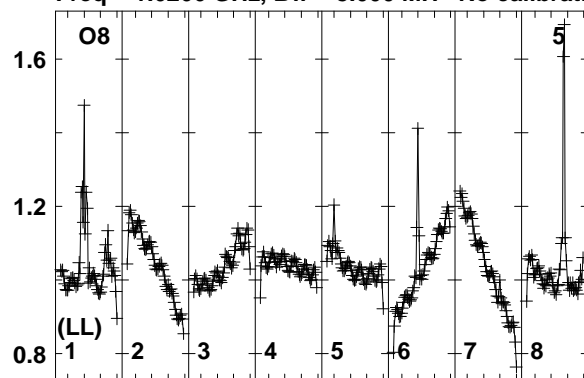

16281 63861 64241 65216 65801 66581 67416 68241 690

FREQ MHz

16281 63861 64241 65216 65801 66581 67416 68241 690

FREQ MHz

16281 63861 64241 65216 65801 66581 67416 68241 690

FREQ MHz

Lower frame: Real Jy
Total-power spectrum Antenna: O8 (05)
Timerange: 00/18:06:35 to 00/18:08:59

Plot file version 168 created 01-AUG-2018 16:38:22

PB-4+0 N18L1 2.UVDATA.1

Freq = 1.6266 GHz, Bw = 8.000 MH No calibration applied and no bandpass applied

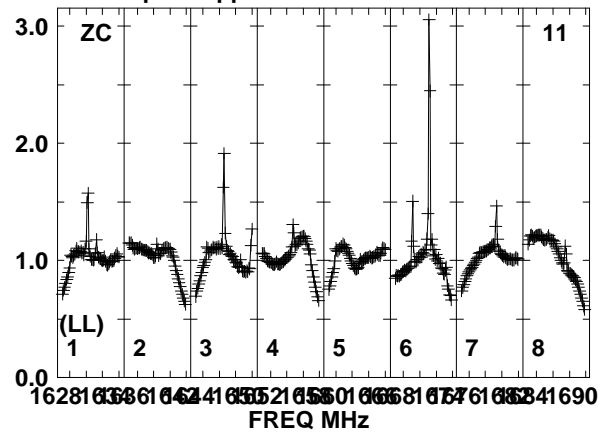
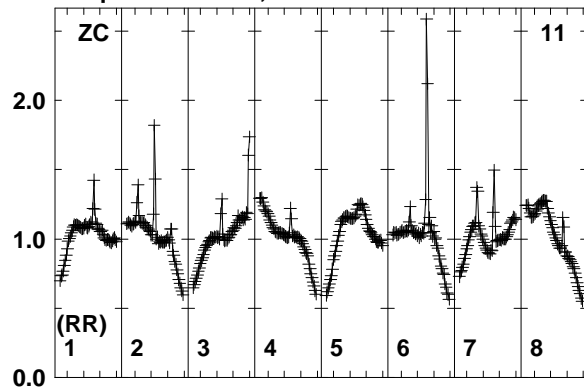

Lower frame: Real Jy
Total-power spectrum Antenna: ZC (11)
Timerange: 00/18:06:35 to 00/18:08:59

Plot file version 169 created 01-AUG-2018 16:38:22

PB-4+1 N18L1 2.UVDATA.1

Freq = 1.6266 GHz, Bw = 8.000 MH No calibration applied and no bandpass applied

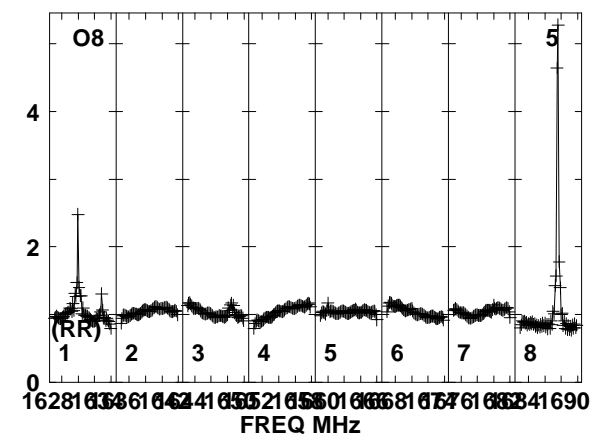
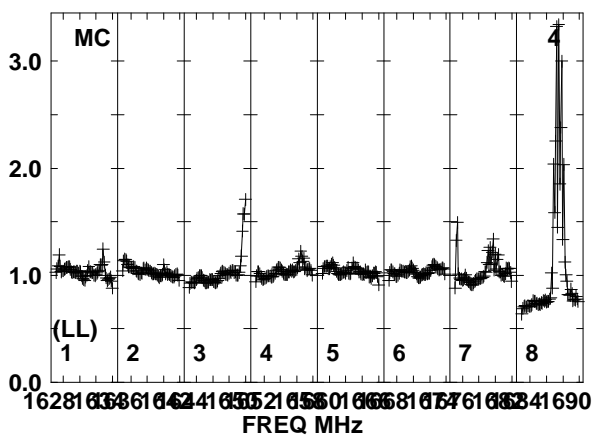
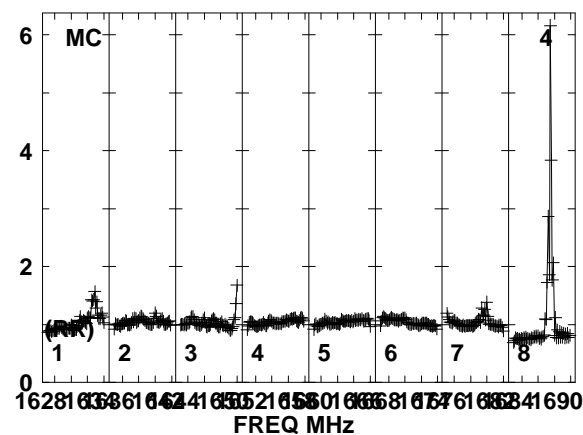
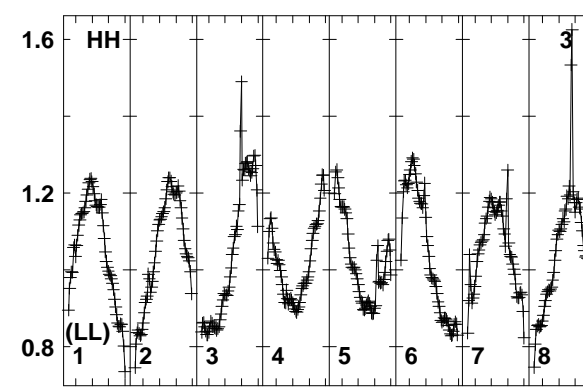
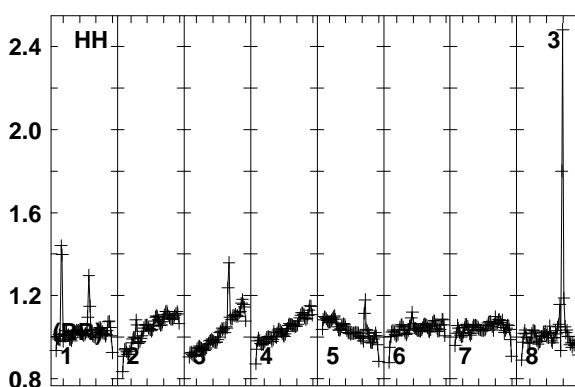
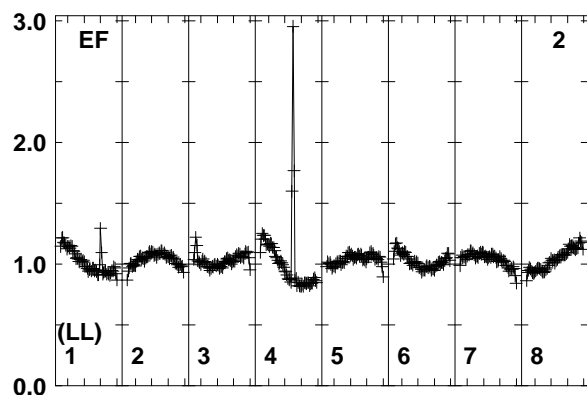
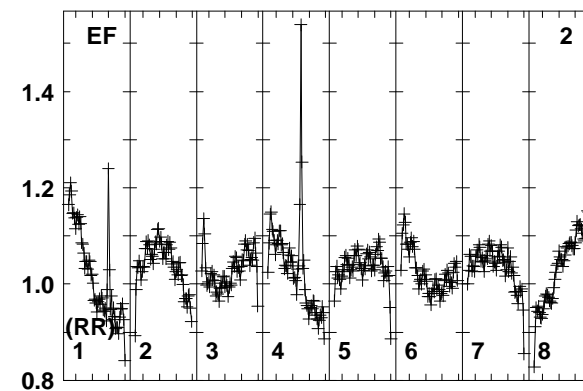
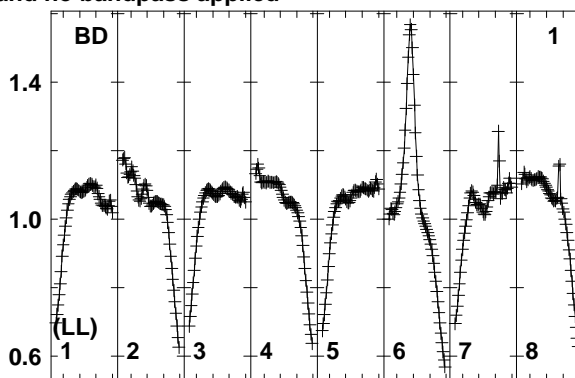
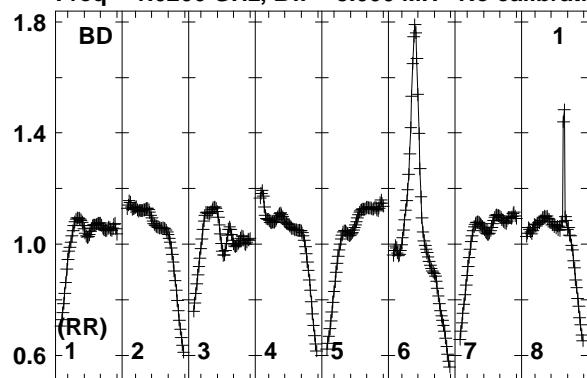

Lower frame: Real Jy
Total-power spectrum Antenna: BD (01)
Timerange: 00/18:09:05 to 00/18:11:29

Plot file version 170 created 01-AUG-2018 16:38:23

PB-4+1 N18L1 2.UVDATA.1

Freq = 1.6266 GHz, Bw = 8.000 MH No calibration applied and no bandpass applied

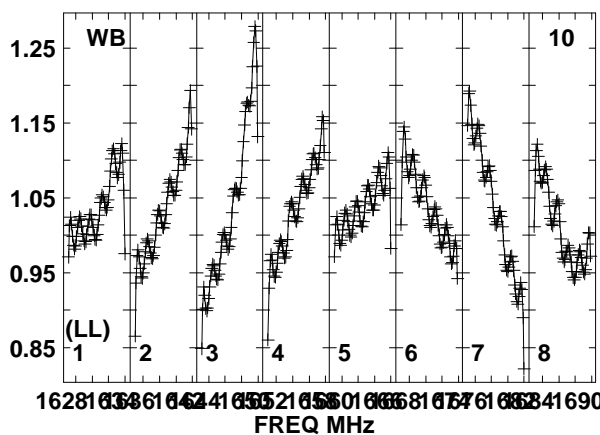
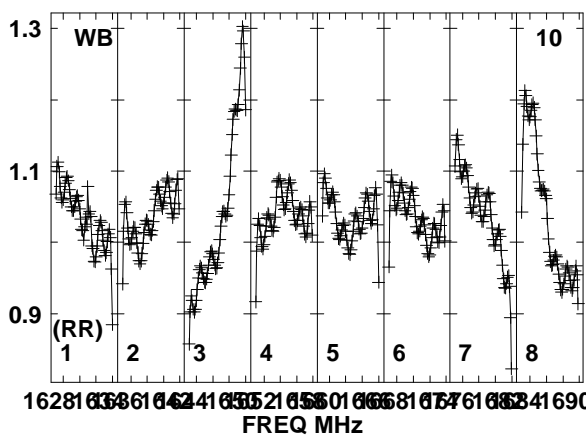
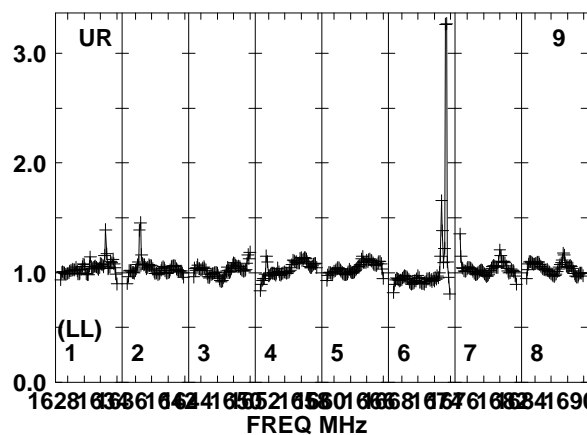
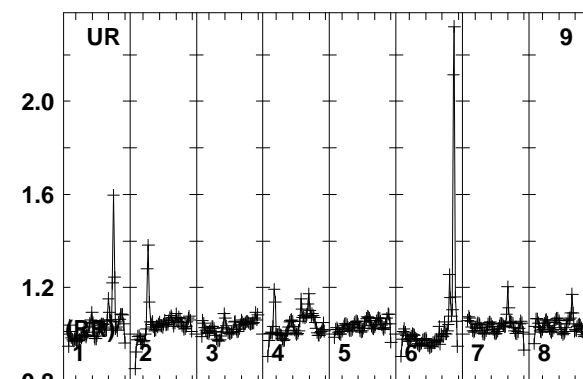
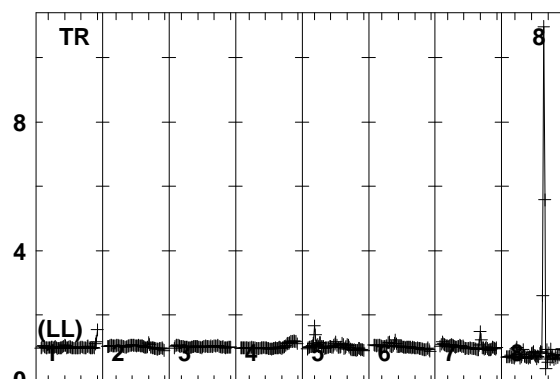
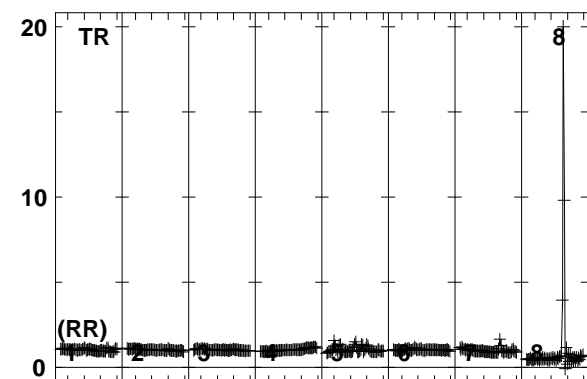
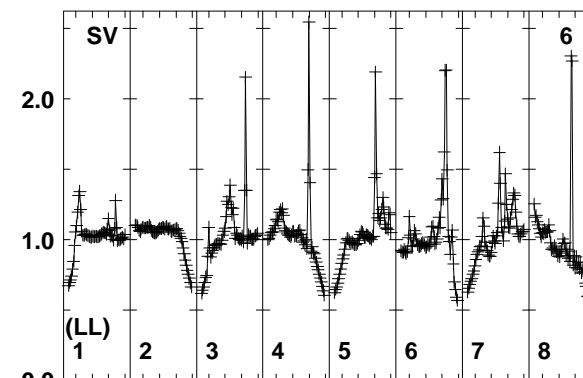
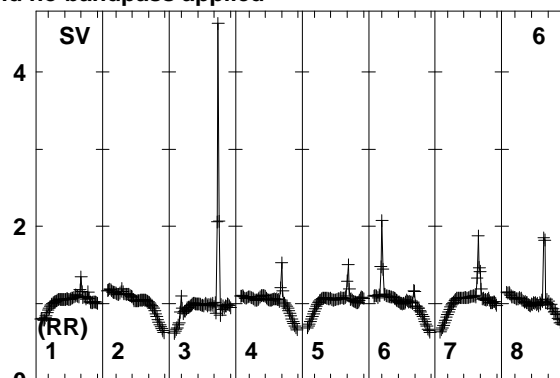
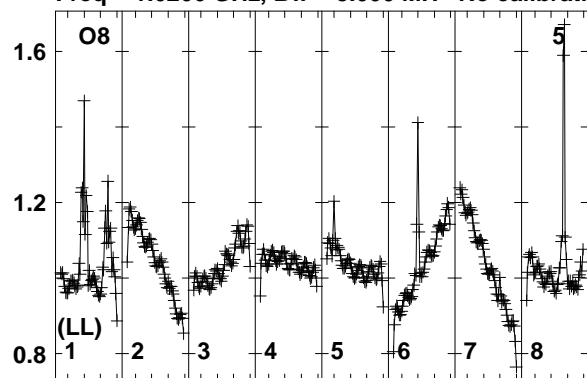

Lower frame: Real Jy
Total-power spectrum Antenna: O8 (05)
Timerange: 00/18:09:05 to 00/18:11:29

Plot file version 171 created 01-AUG-2018 16:38:23

PB-4+1 N18L1 2.UVDATA.1

Freq = 1.6266 GHz, Bw = 8.000 MH No calibration applied and no bandpass applied

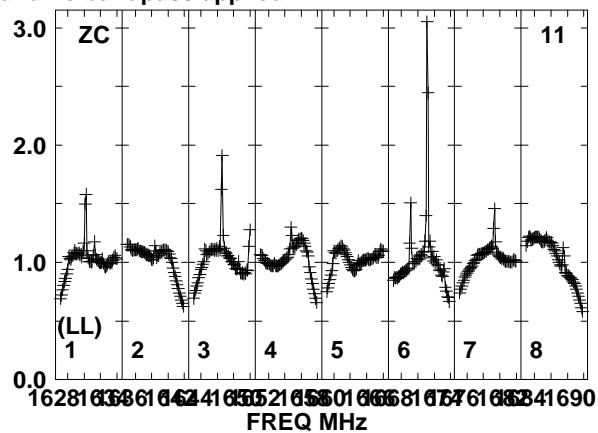
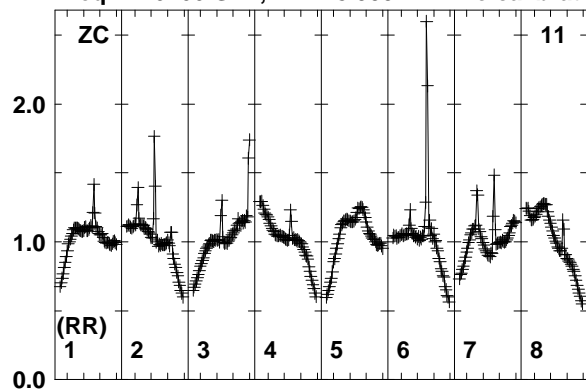

Lower frame: Real Jy
Total-power spectrum Antenna: ZC (11)
Timerange: 00/18:09:05 to 00/18:11:29

Plot file version 172 created 01-AUG-2018 16:38:23

PB-3+1 N18L1 2.UVDATA.1

Freq = 1.6266 GHz, Bw = 8.000 MH No calibration applied and no bandpass applied

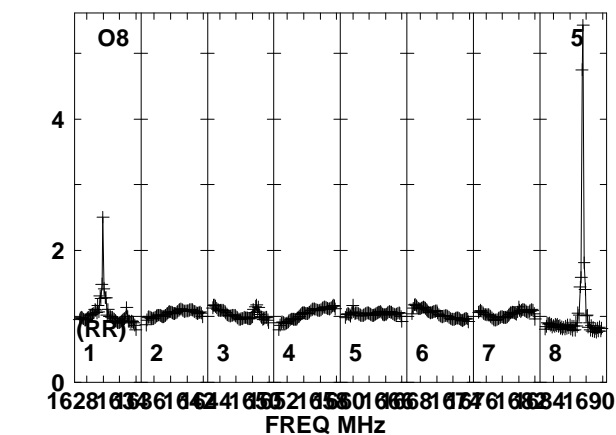
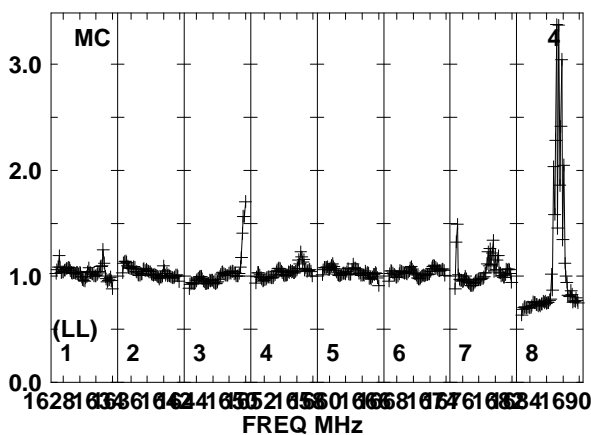
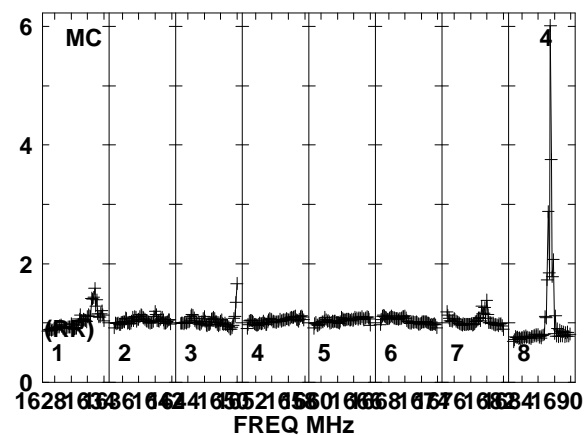
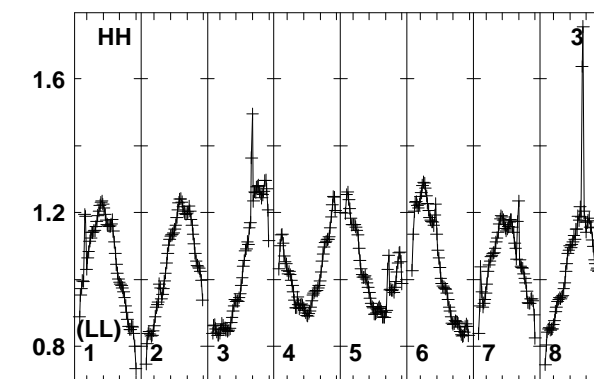
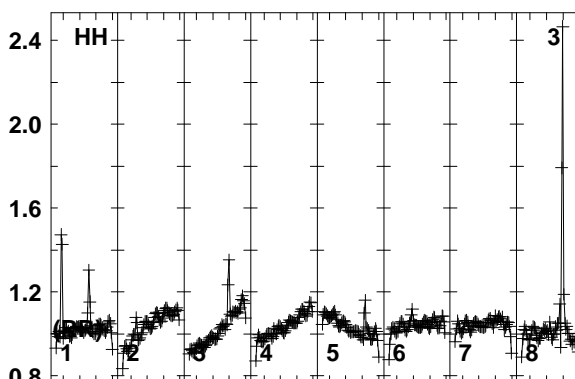
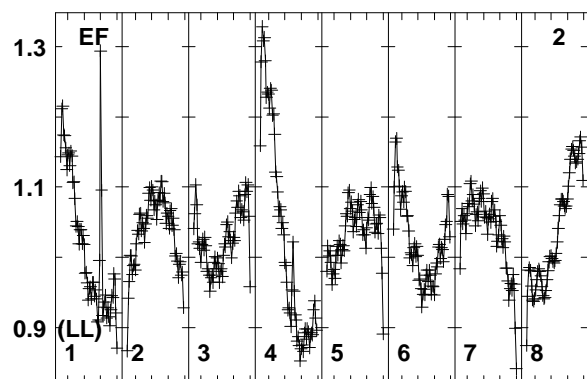
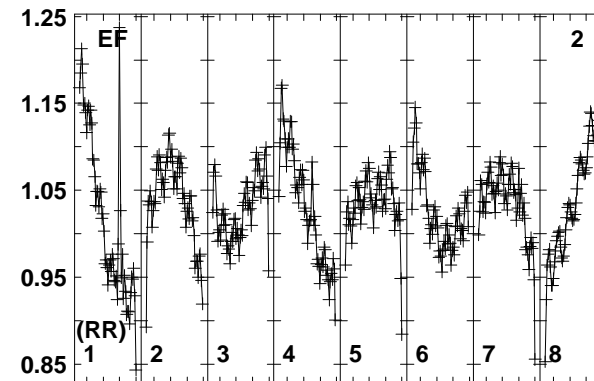
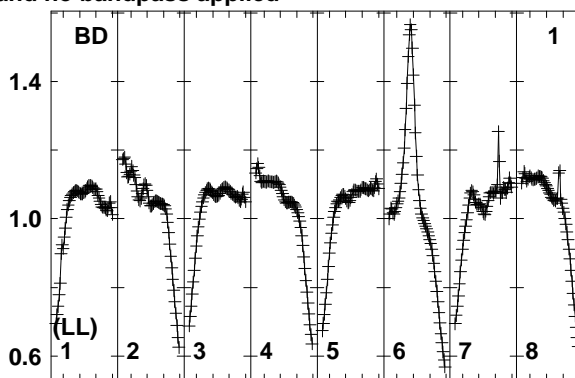
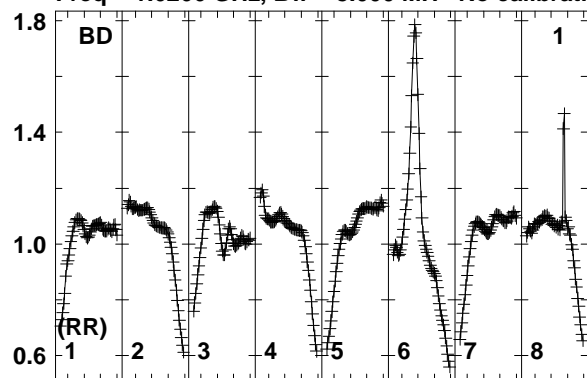

Lower frame: Real Jy
Total-power spectrum Antenna: BD (01)
Timerange: 00/18:11:35 to 00/18:13:59

Plot file version 173 created 01-AUG-2018 16:38:23

PB-3+1 N18L1 2.UVDATA.1

Freq = 1.6266 GHz, Bw = 8.000 MH No calibration applied and no bandpass applied

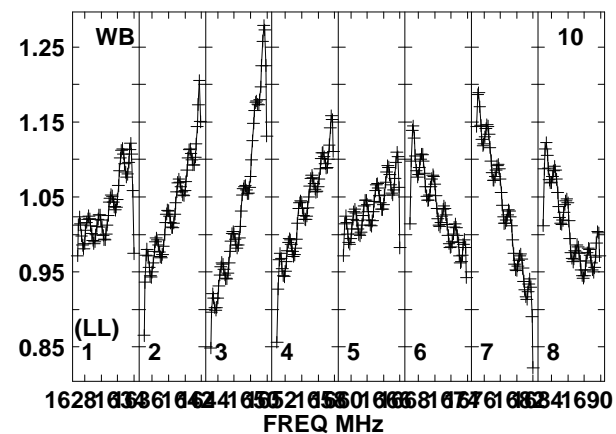
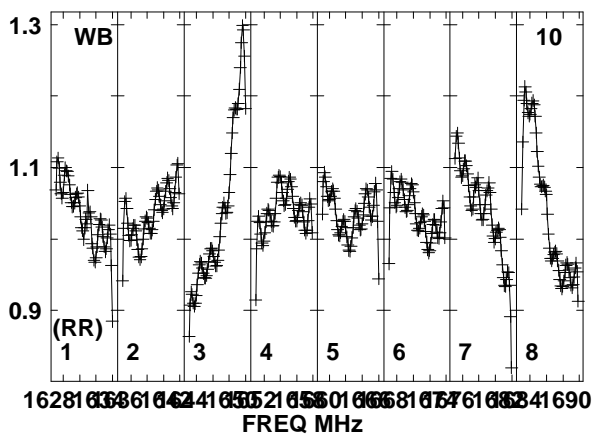
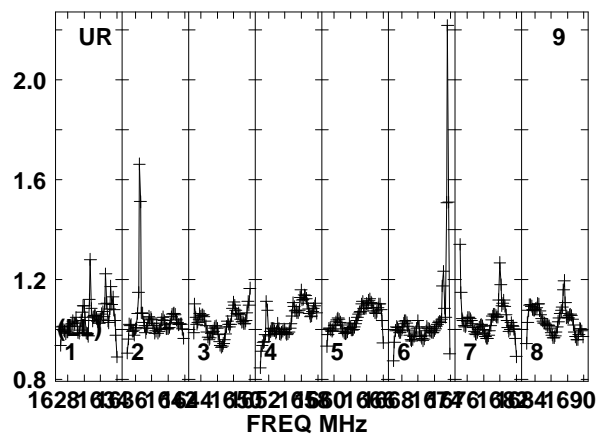
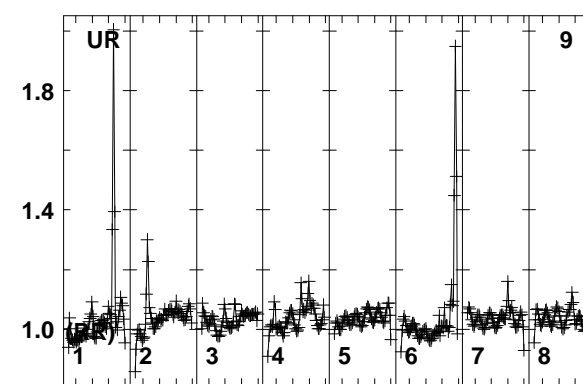
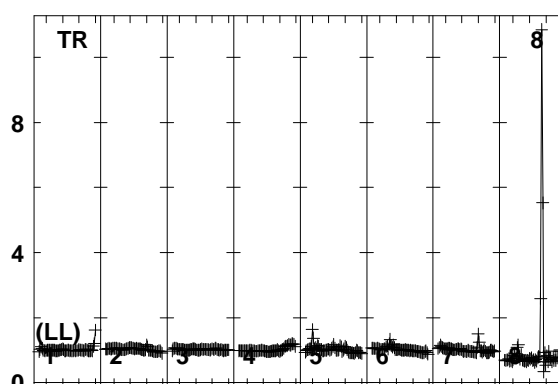
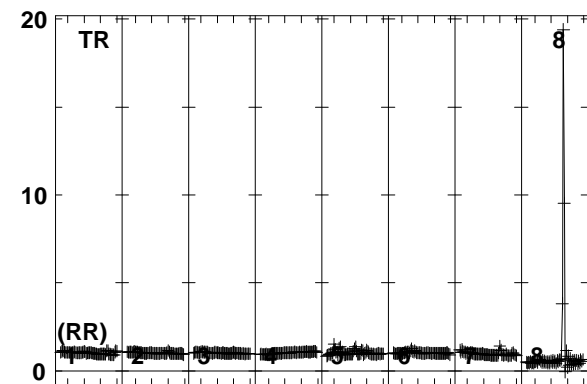
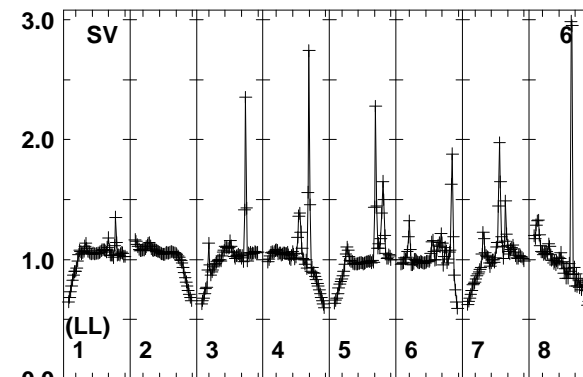
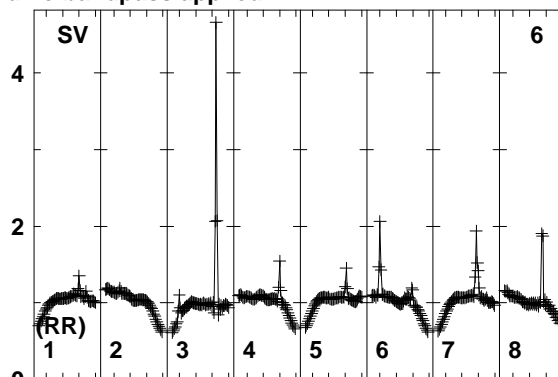
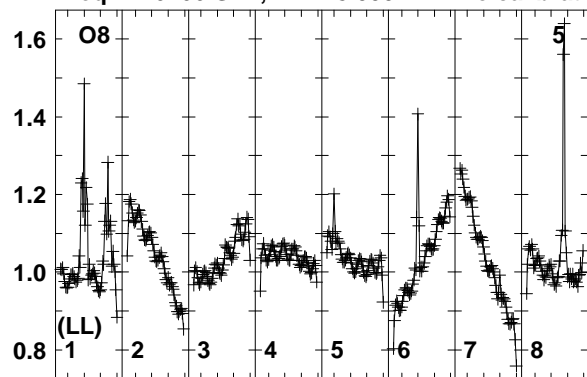

Lower frame: Real Jy
Total-power spectrum Antenna: O8 (05)
Timerange: 00/18:11:35 to 00/18:13:59

Plot file version 174 created 01-AUG-2018 16:38:23

PB-3+1 N18L1 2.UVDATA.1

Freq = 1.6266 GHz, Bw = 8.000 MH No calibration applied and no bandpass applied

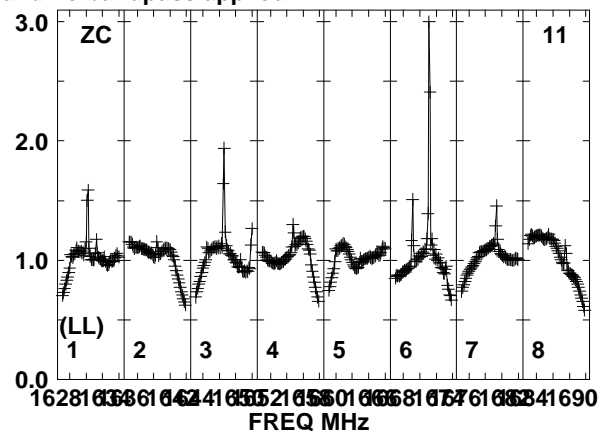
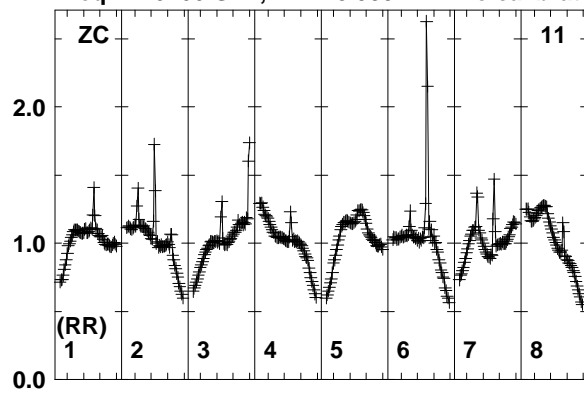

Lower frame: Real Jy
Total-power spectrum Antenna: ZC (11)
Timerange: 00/18:11:35 to 00/18:13:59

Plot file version 175 created 01-AUG-2018 16:38:23

PB-2+1 N18L1 2.UVDATA.1

Freq = 1.6266 GHz, Bw = 8.000 MH No calibration applied and no bandpass applied

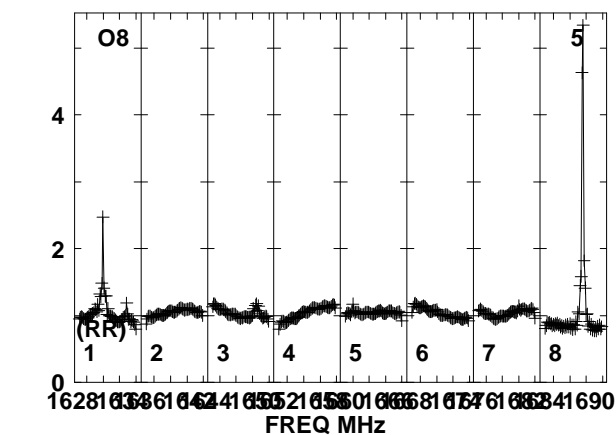
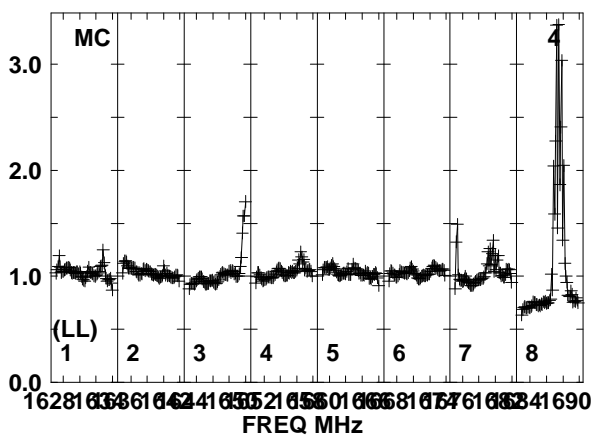
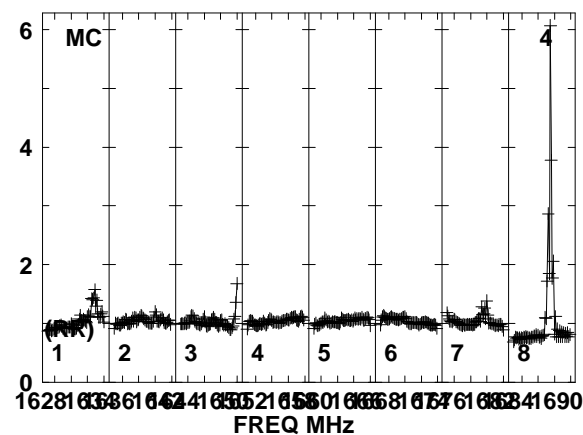
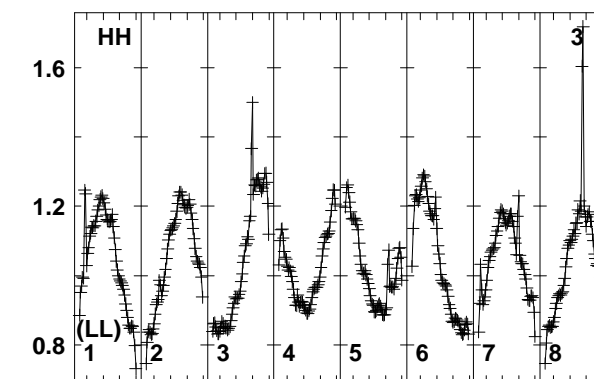
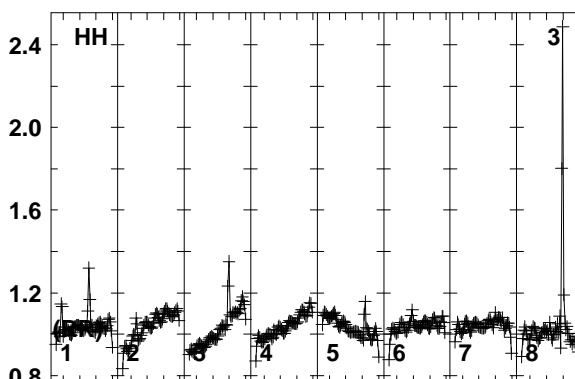
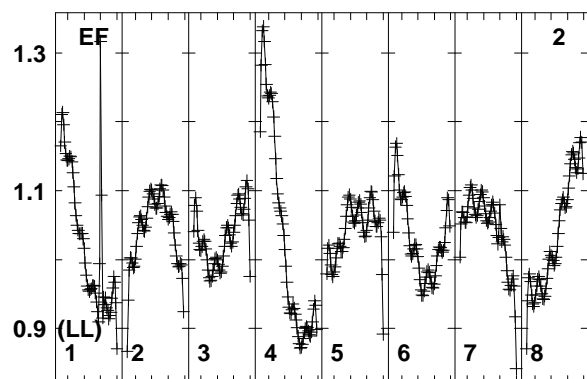
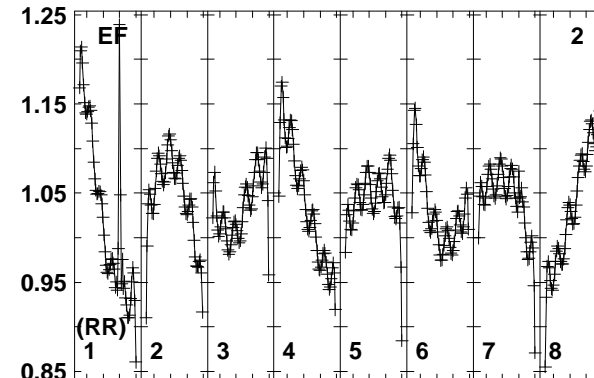
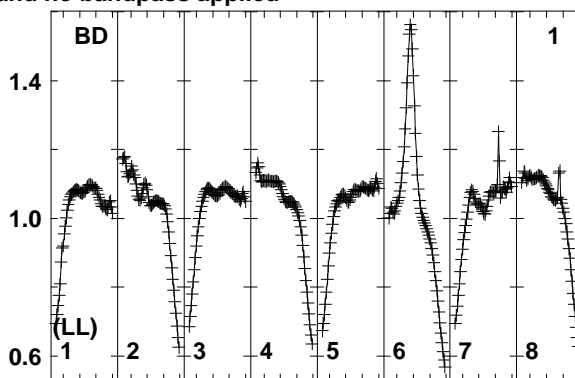
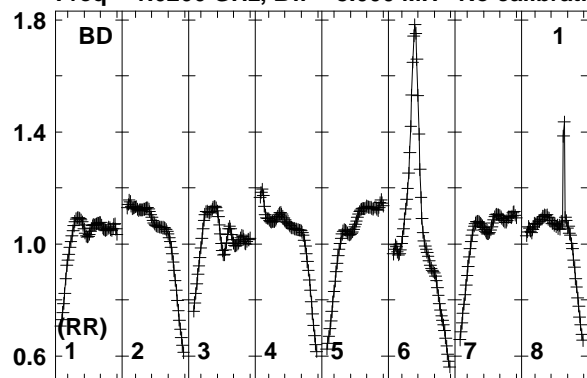

Lower frame: Real Jy
Total-power spectrum Antenna: BD (01)
Timerange: 00/18:14:03 to 00/18:16:29

Plot file version 176 created 01-AUG-2018 16:38:23

PB-2+1 N18L1 2.UVDATA.1

Freq = 1.6266 GHz, Bw = 8.000 MH No calibration applied and no bandpass applied

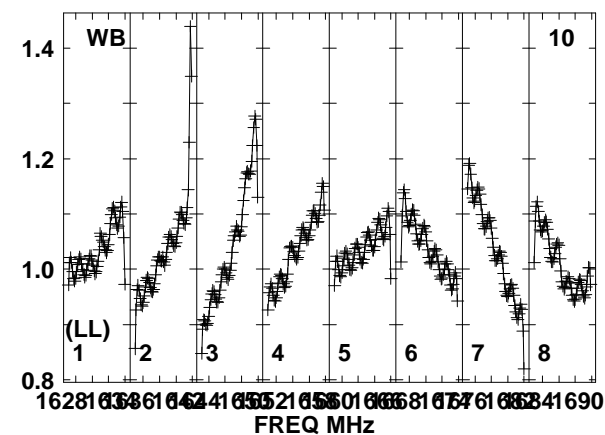
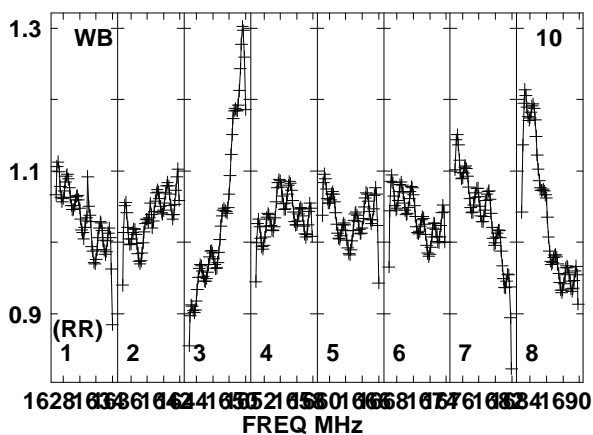
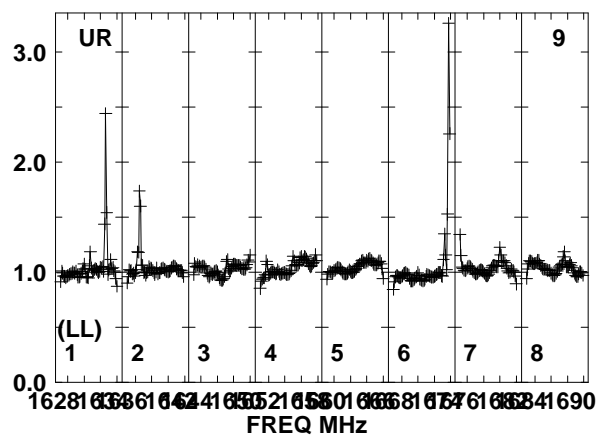
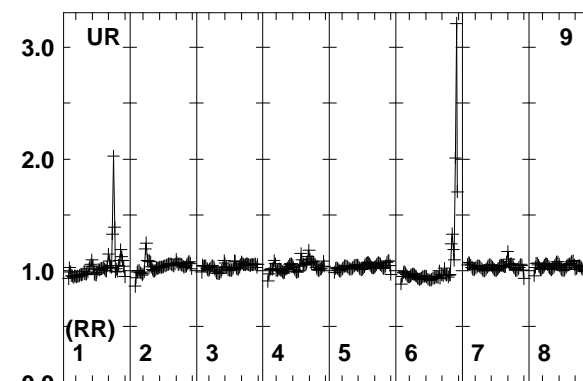
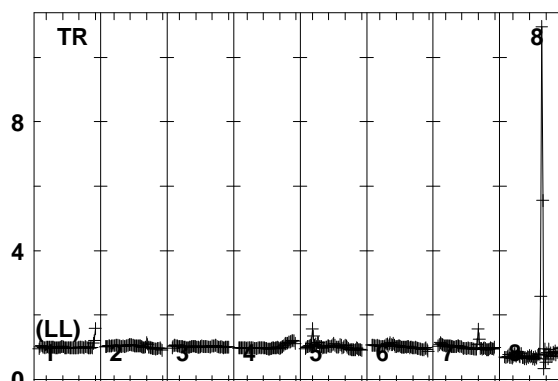
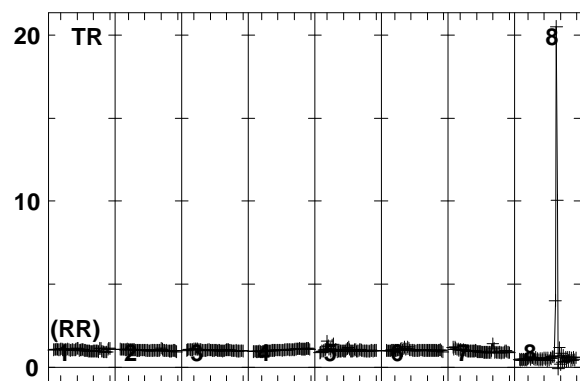
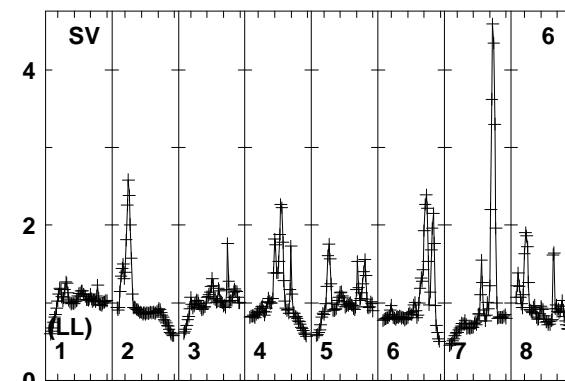
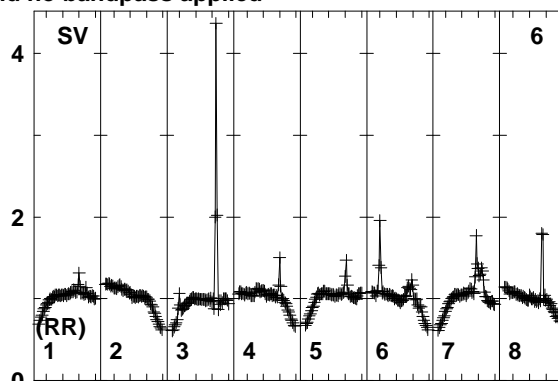
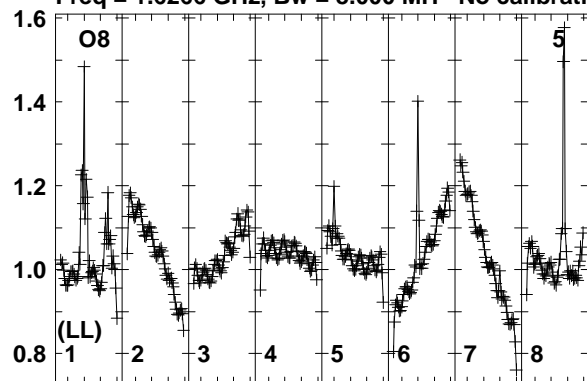

Lower frame: Real Jy
Total-power spectrum Antenna: O8 (05)
Timerange: 00/18:14:03 to 00/18:16:29

Plot file version 177 created 01-AUG-2018 16:38:23

PB-2+1 N18L1 2.UVDATA.1

Freq = 1.6266 GHz, Bw = 8.000 MH No calibration applied and no bandpass applied

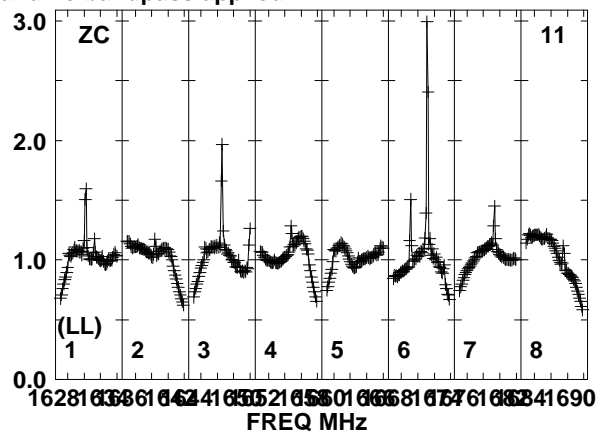
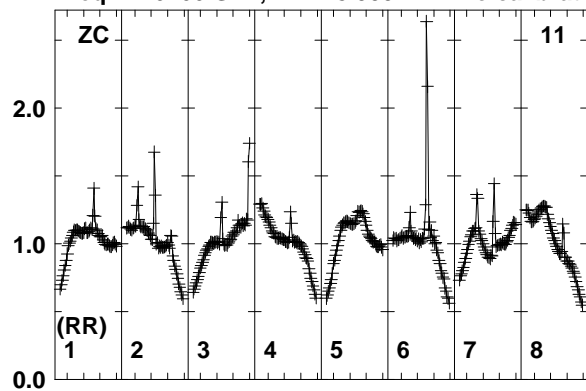

Lower frame: Real Jy
Total-power spectrum Antenna: ZC (11)
Timerange: 00/18:14:03 to 00/18:16:29

Plot file version 178 created 01-AUG-2018 16:38:23

J0530+1331 N18L1 2.UVDATA.1

Freq = 1.6266 GHz, Bw = 8.000 MH No calibration applied and no bandpass applied

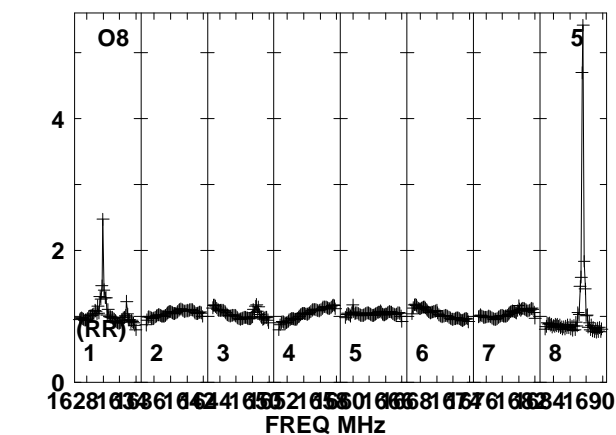
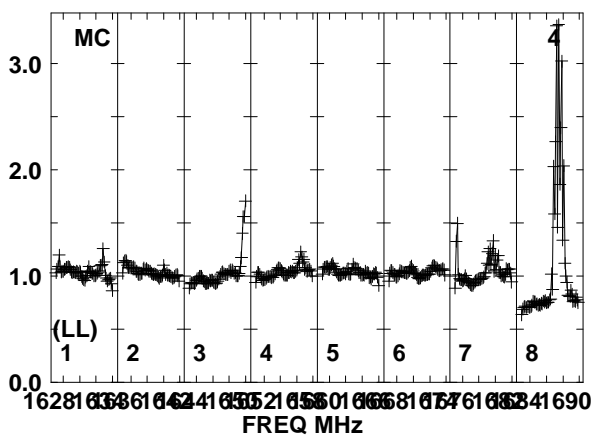
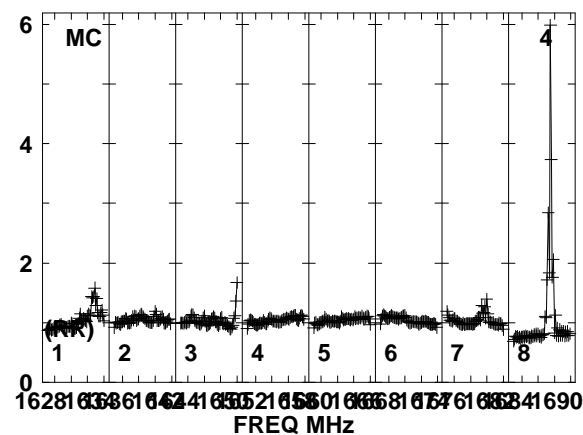
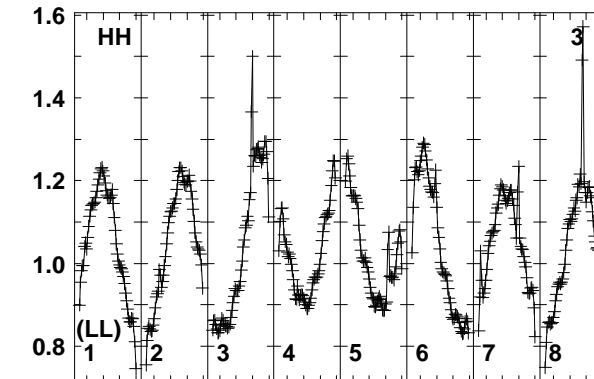
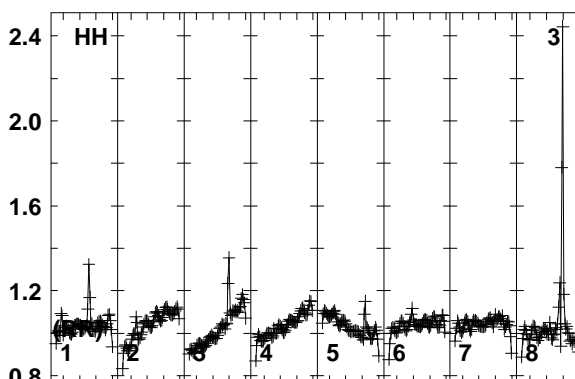
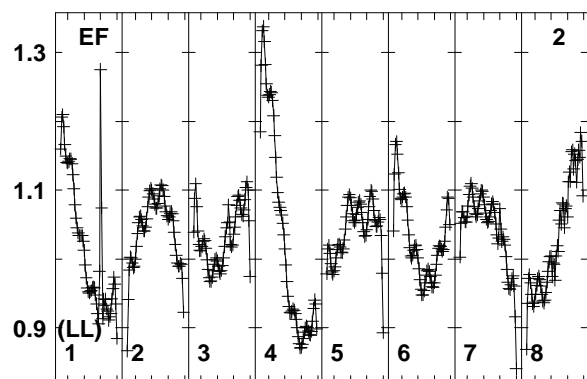
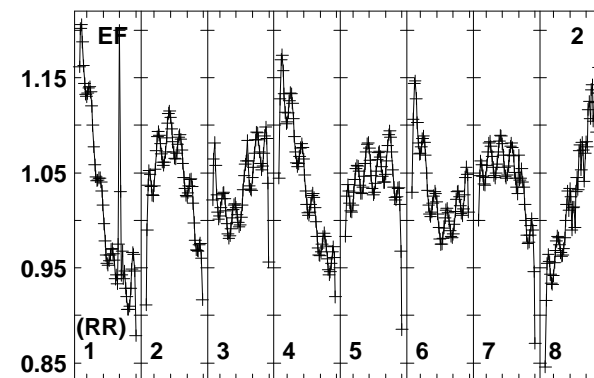
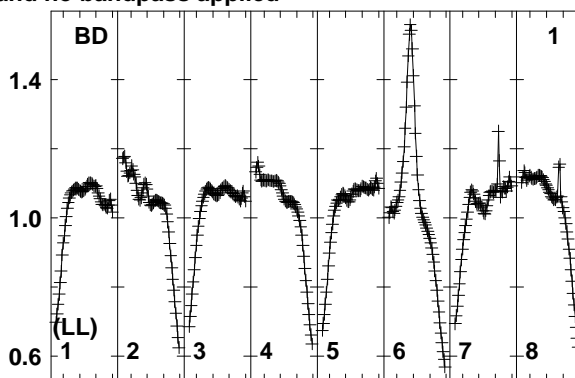
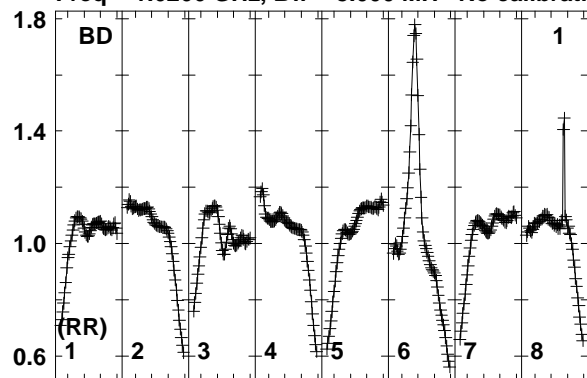

Lower frame: Real Jy
Total-power spectrum Antenna: BD (01)
Timerange: 00/18:17:11 to 00/18:18:29

Plot file version 179 created 01-AUG-2018 16:38:24

J0530+1331 N18L1 2.UVDATA.1

Freq = 1.6266 GHz, Bw = 8.000 MH No calibration applied and no bandpass applied

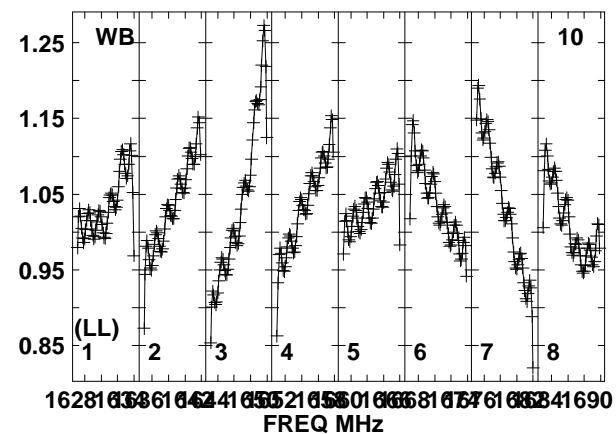
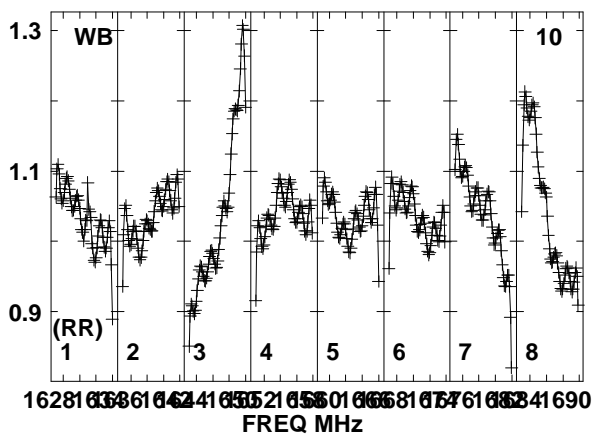
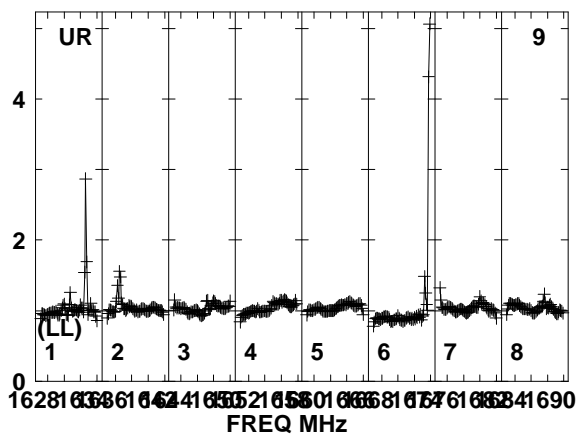
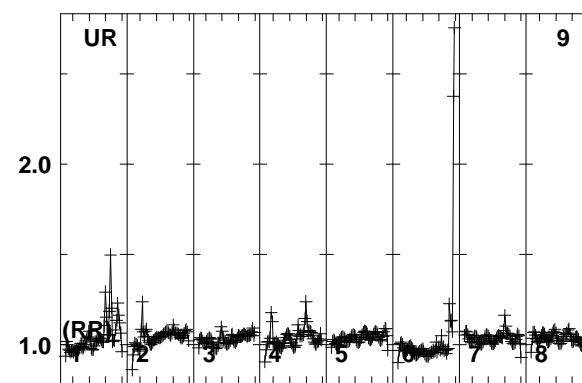
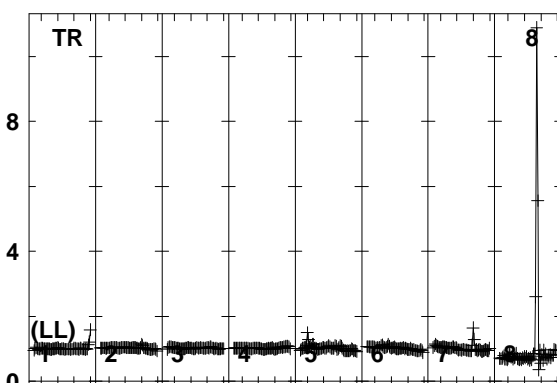
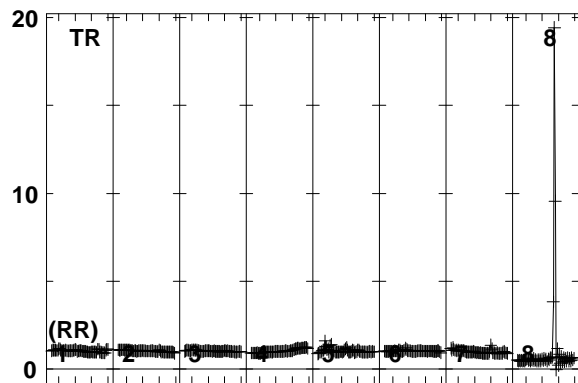
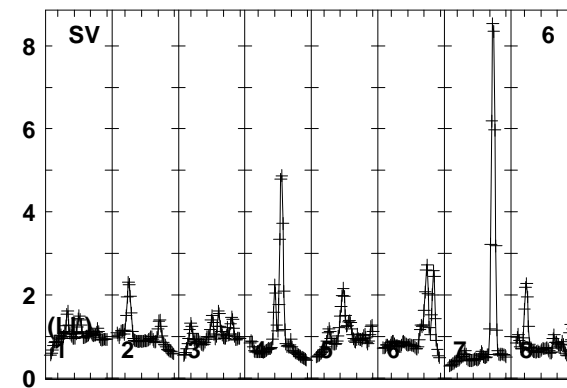
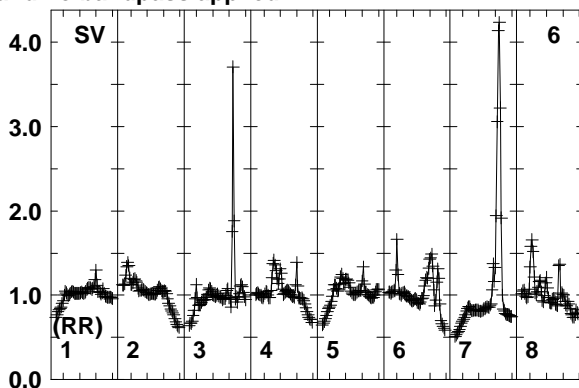
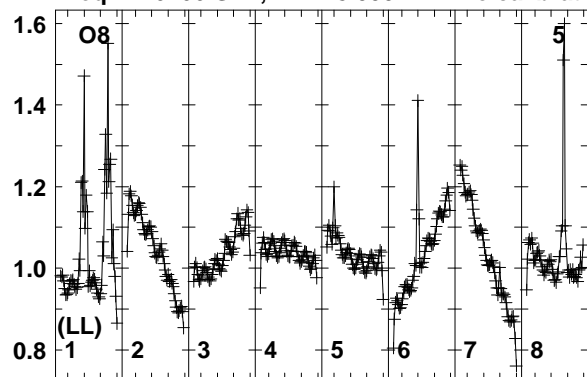

Lower frame: Real Jy
Total-power spectrum Antenna: O8 (05)
Timerange: 00/18:17:11 to 00/18:18:29

Plot file version 180 created 01-AUG-2018 16:38:24

J0530+1331 N18L1 2.UVDATA.1

Freq = 1.6266 GHz, Bw = 8.000 MH No calibration applied and no bandpass applied

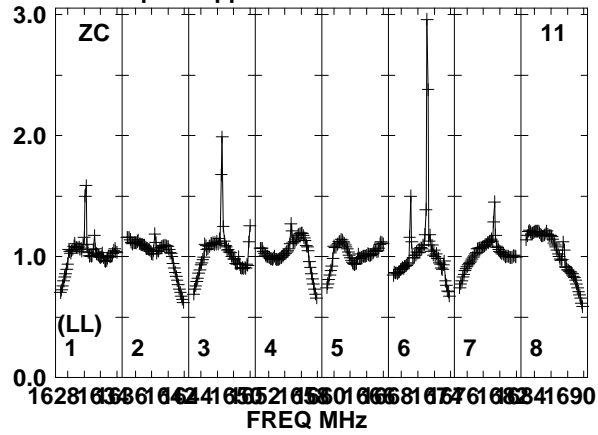
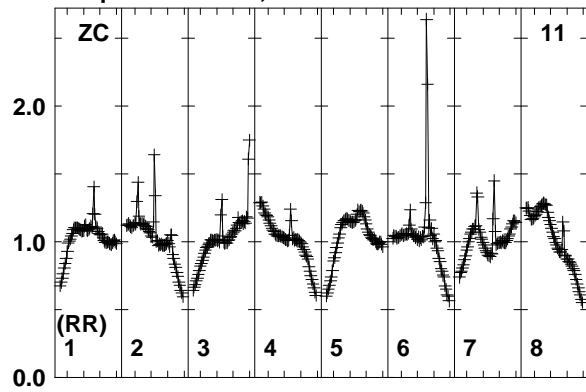

Lower frame: Real Jy
Total-power spectrum Antenna: ZC (11)
Timerange: 00/18:17:11 to 00/18:18:29

Plot file version 181 created 01-AUG-2018 16:38:24

PB-1+1 N18L1 2.UVDATA.1

Freq = 1.6266 GHz, Bw = 8.000 MH No calibration applied and no bandpass applied

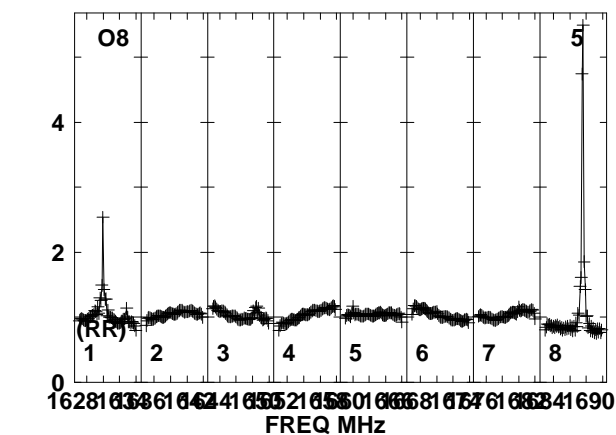
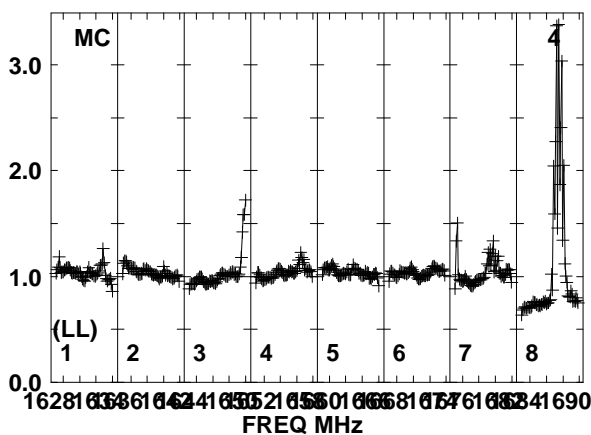
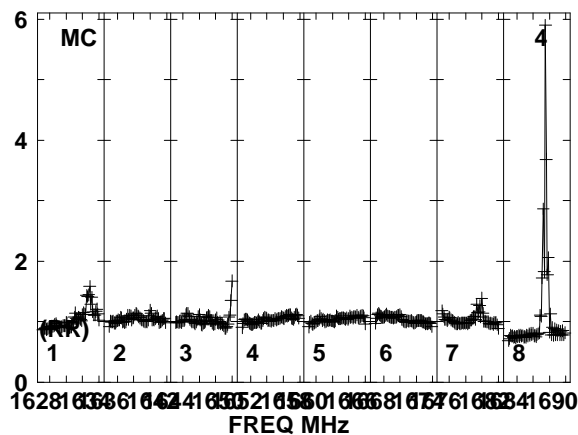
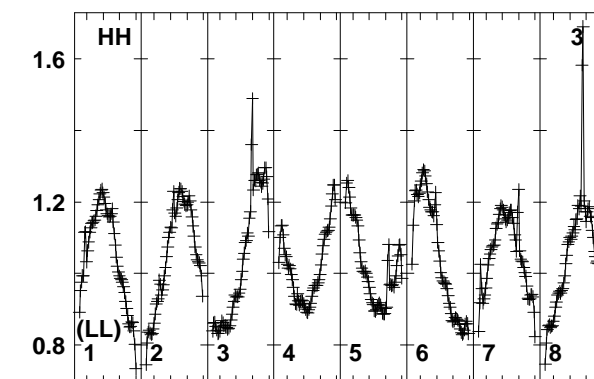
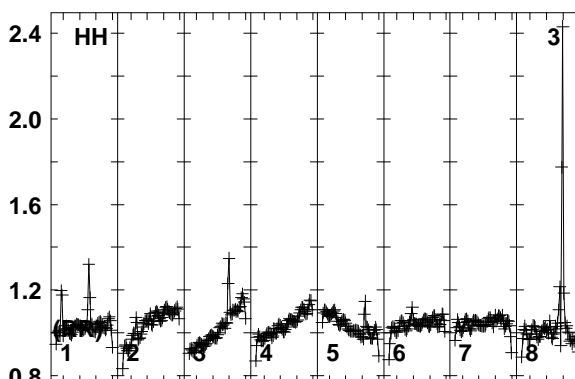
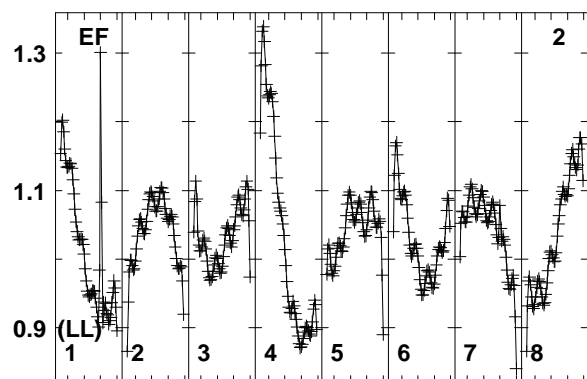
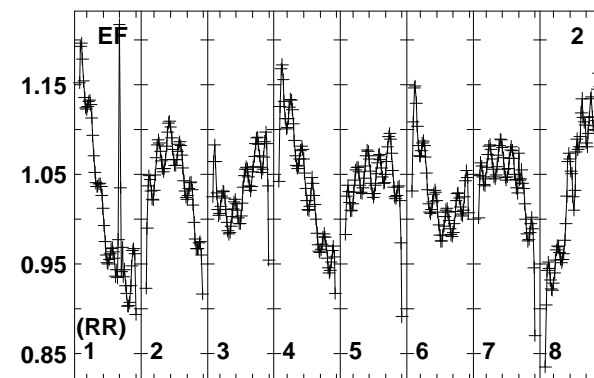
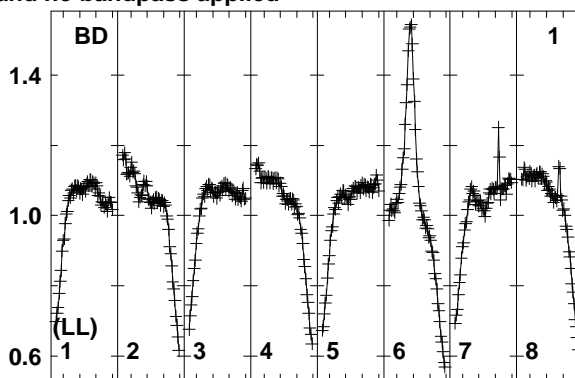
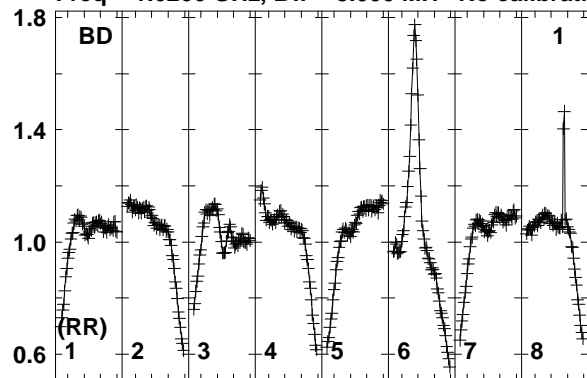

Lower frame: Real Jy
Total-power spectrum Antenna: BD (01)
Timerange: 00/18:18:33 to 00/18:20:59

Plot file version 182 created 01-AUG-2018 16:38:24

PB-1+1 N18L1 2.UVDATA.1

Freq = 1.6266 GHz, Bw = 8.000 MH No calibration applied and no bandpass applied

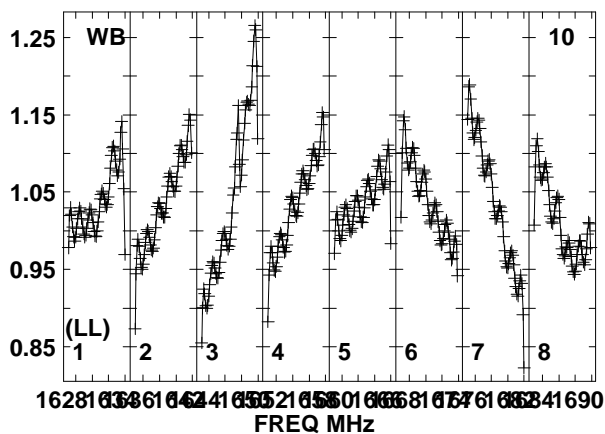
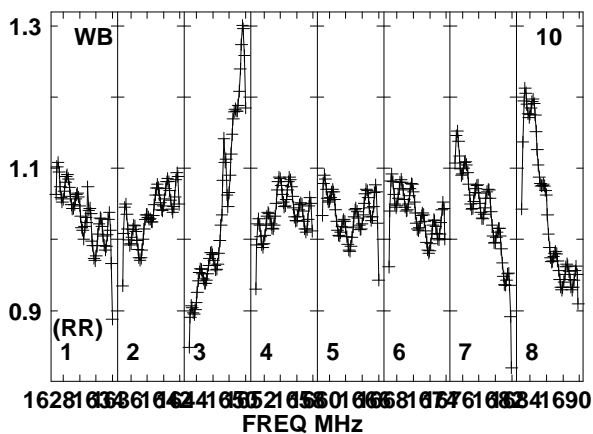
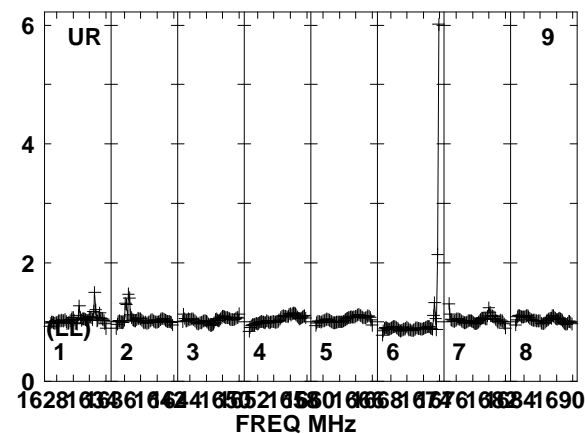
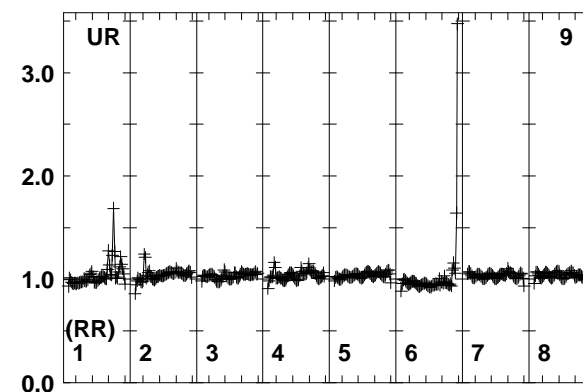
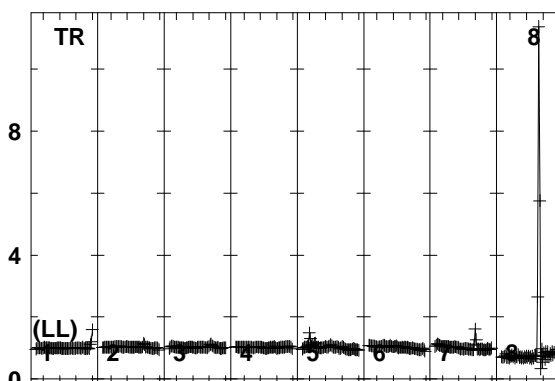
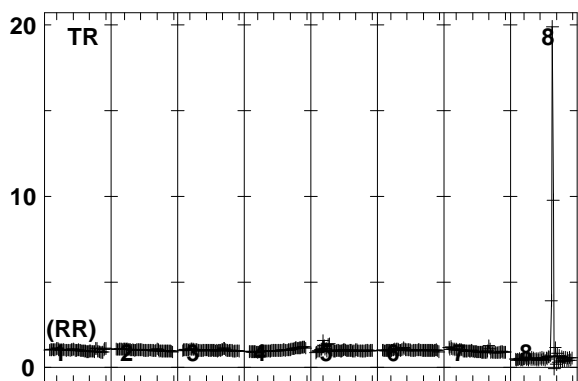
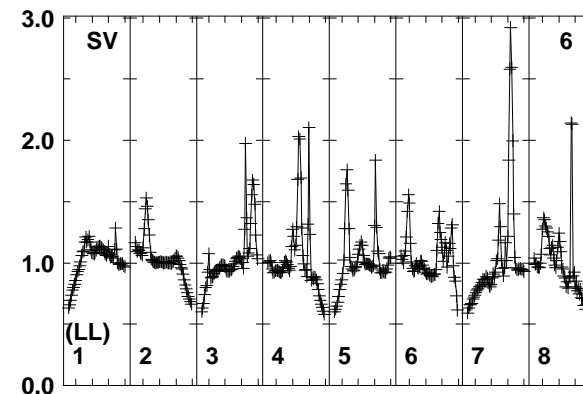
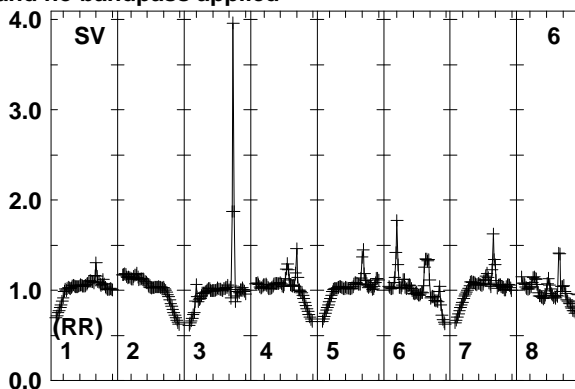
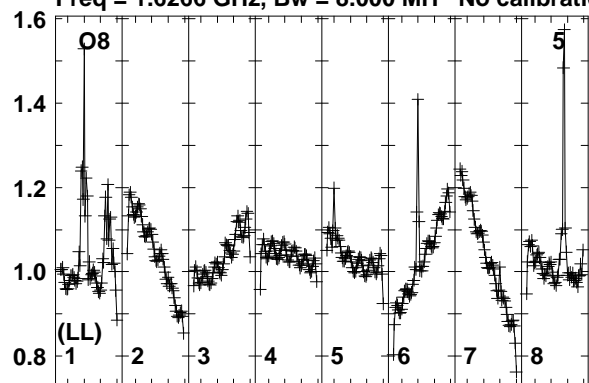

Lower frame: Real Jy
Total-power spectrum Antenna: O8 (05)
Timerange: 00/18:18:33 to 00/18:20:59

Plot file version 183 created 01-AUG-2018 16:38:24

PB-1+1 N18L1 2.UVDATA.1

Freq = 1.6266 GHz, Bw = 8.000 MH No calibration applied and no bandpass applied

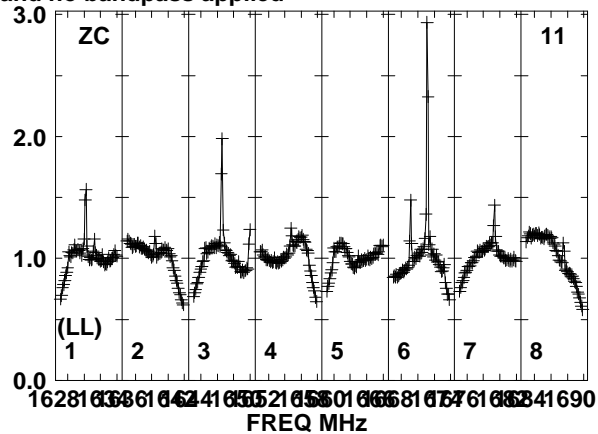
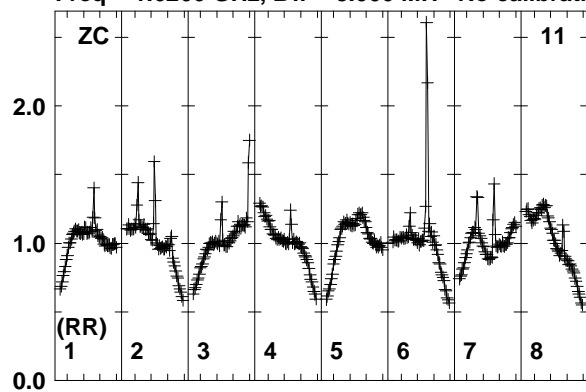

Lower frame: Real Jy
Total-power spectrum Antenna: ZC (11)
Timerange: 00/18:18:33 to 00/18:20:59

Plot file version 184 created 01-AUG-2018 16:38:24

PB+0+1 N18L1 2.UVDATA.1

Freq = 1.6266 GHz, Bw = 8.000 MH No calibration applied and no bandpass applied

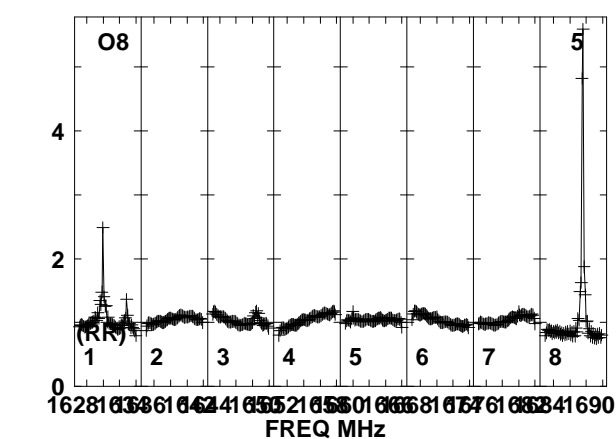
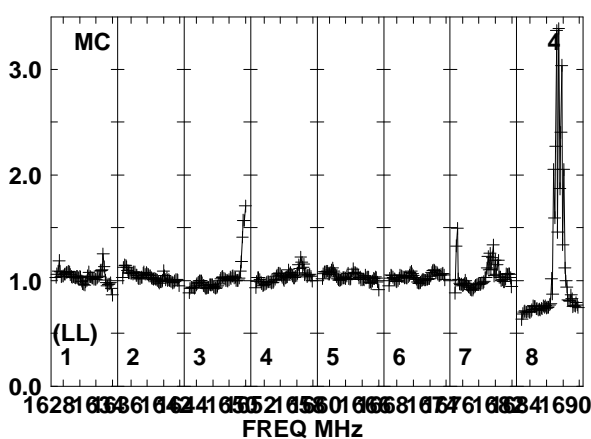
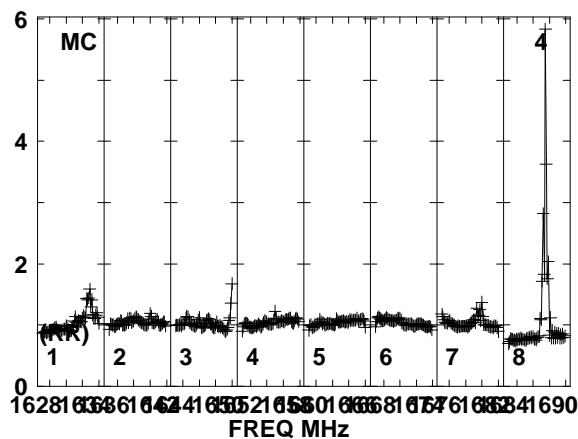
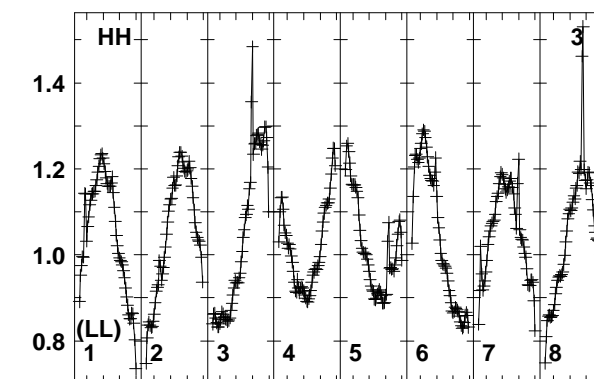
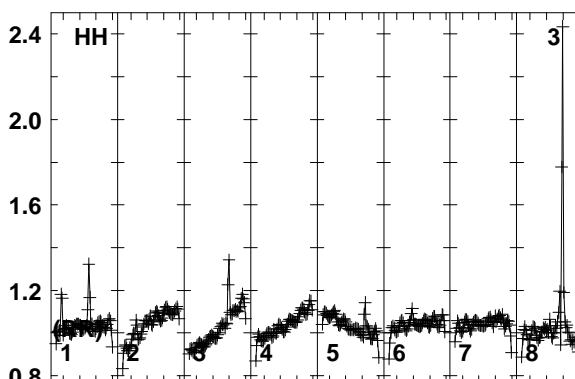
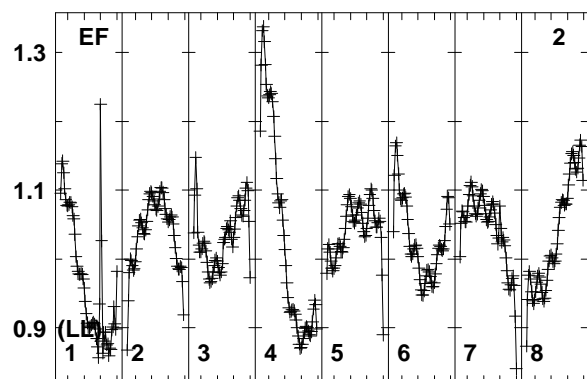
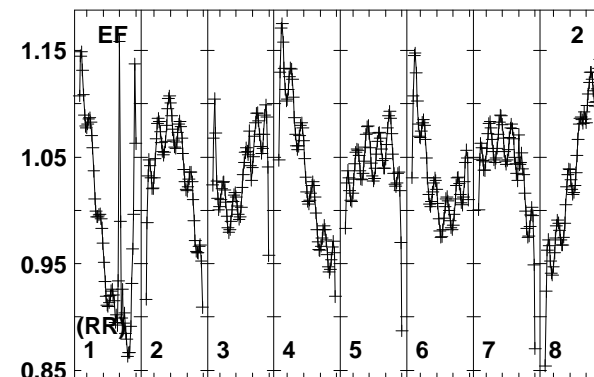
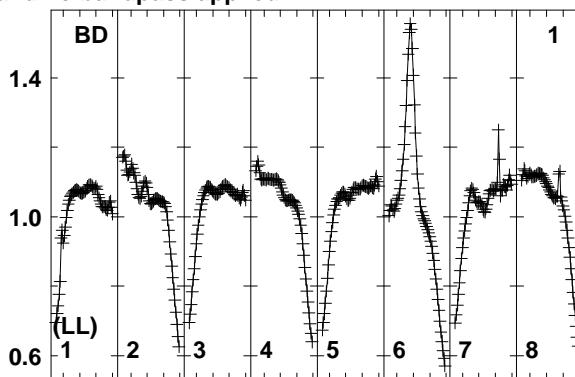
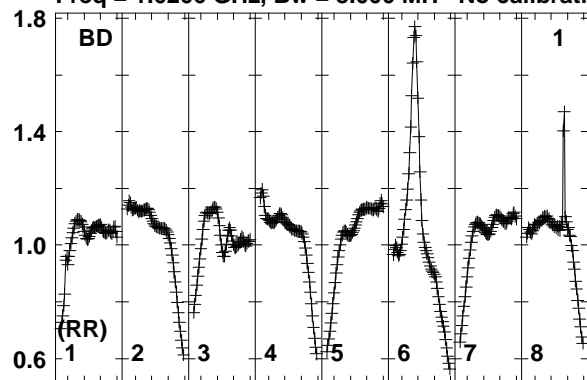

Lower frame: Real Jy
Total-power spectrum Antenna: BD (01)
Timerange: 00/18:21:05 to 00/18:23:29

Plot file version 185 created 01-AUG-2018 16:38:24

PB+0+1 N18L1 2.UVDATA.1

Freq = 1.6266 GHz, Bw = 8.000 MH No calibration applied and no bandpass applied

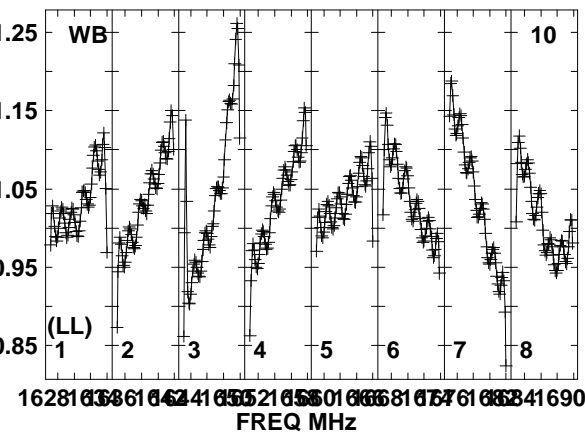
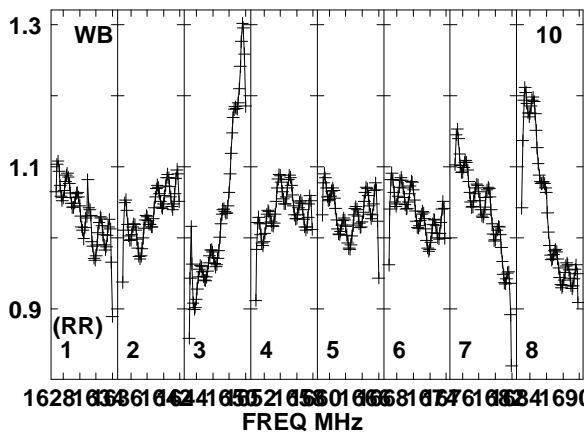
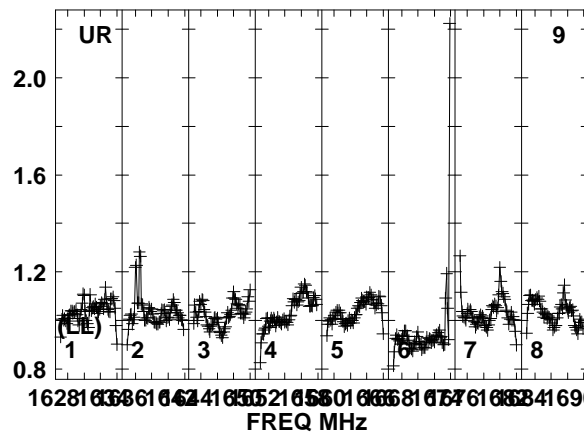
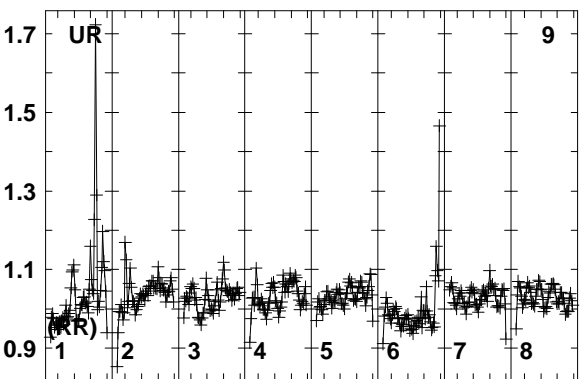
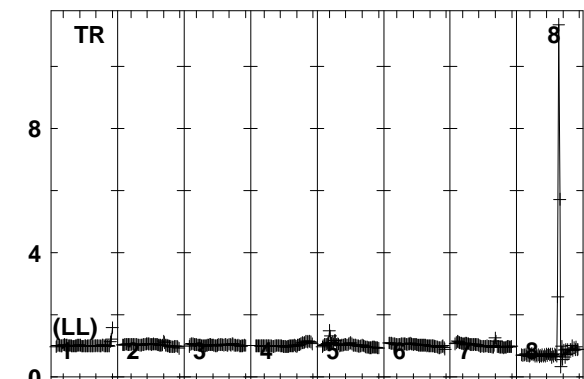
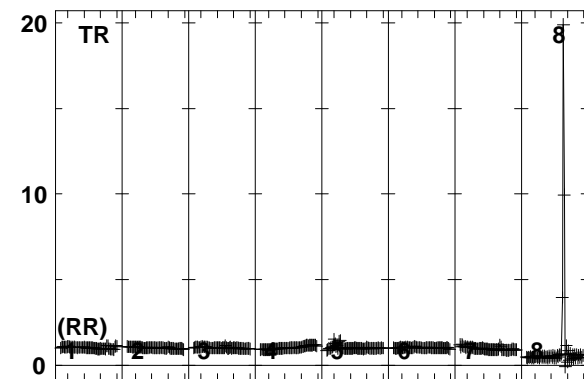
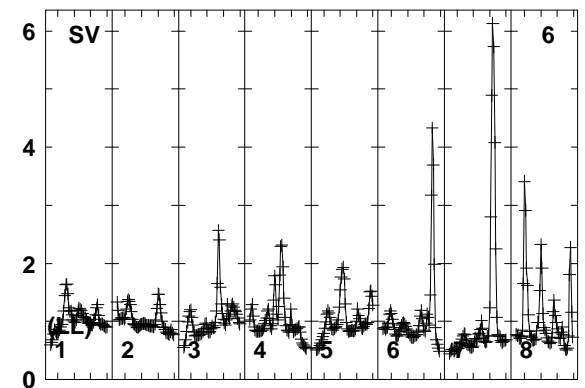
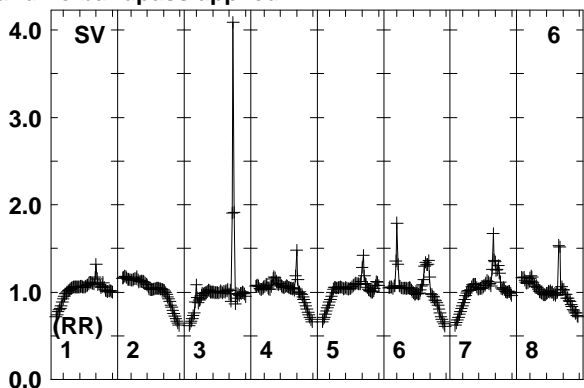
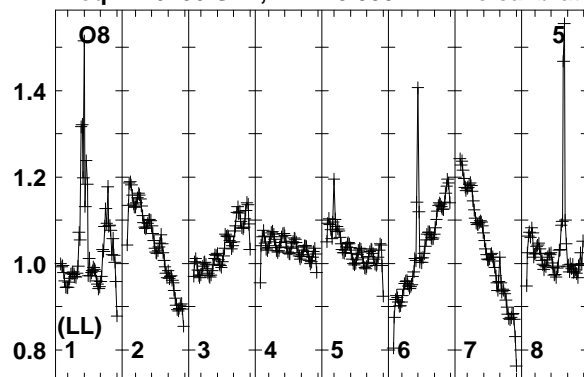

Lower frame: Real Jy
Total-power spectrum Antenna: O8 (05)
Timerange: 00/18:21:05 to 00/18:23:29

Plot file version 186 created 01-AUG-2018 16:38:24

PB+0+1 N18L1 2.UVDATA.1

Freq = 1.6266 GHz, Bw = 8.000 MH No calibration applied and no bandpass applied

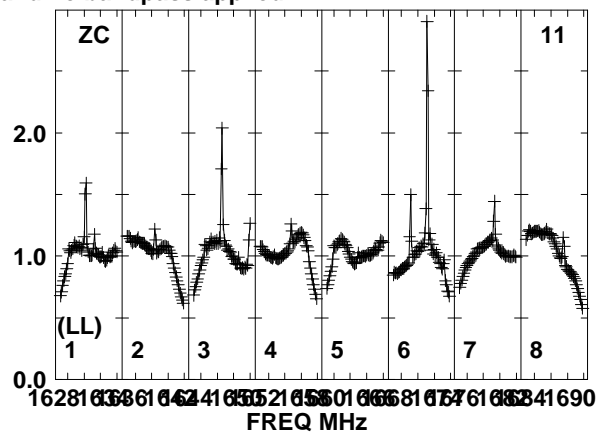
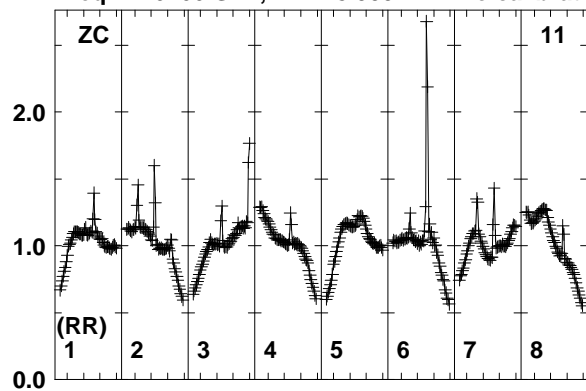

Lower frame: Real Jy
Total-power spectrum Antenna: ZC (11)
Timerange: 00/18:21:05 to 00/18:23:29

Plot file version 187 created 01-AUG-2018 16:38:24

PB+1+1 N18L1 2.UVDATA.1

Freq = 1.6266 GHz, Bw = 8.000 MH No calibration applied and no bandpass applied

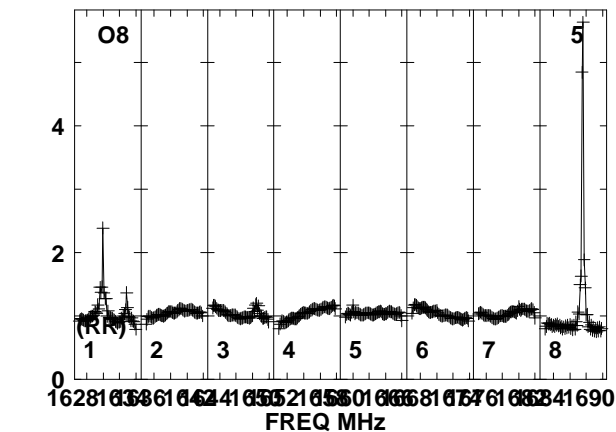
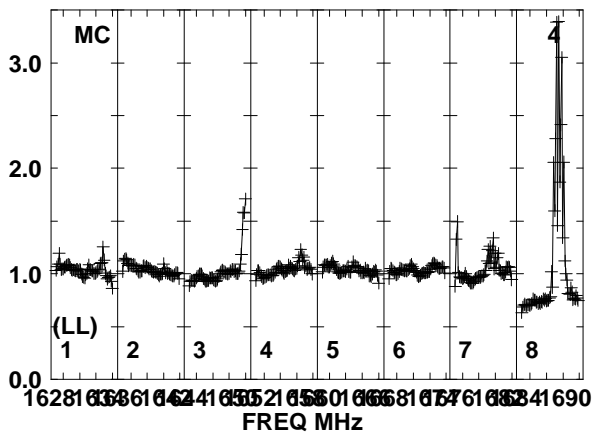
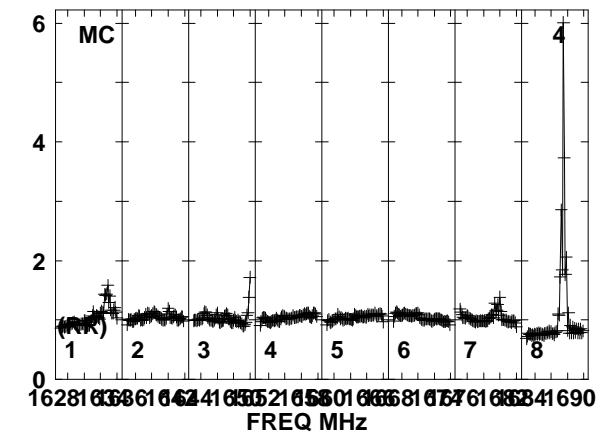
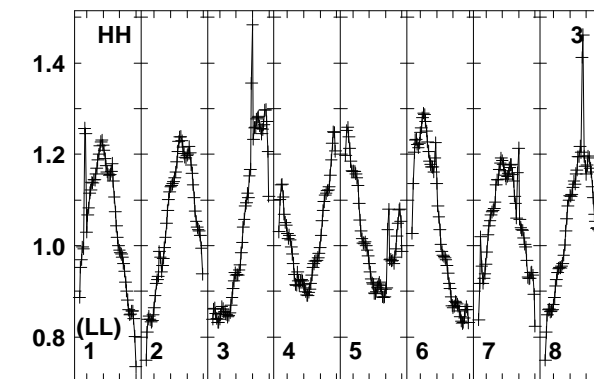
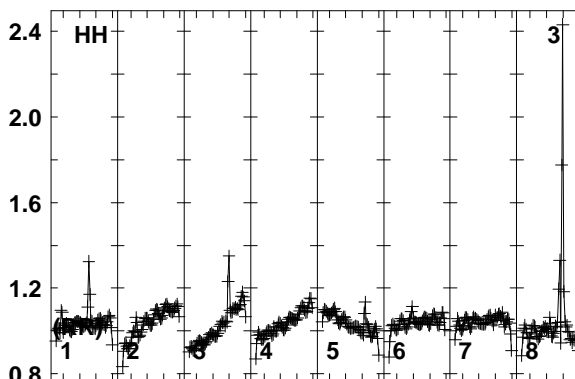
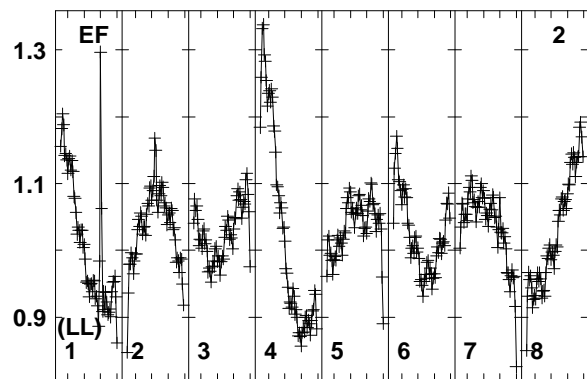
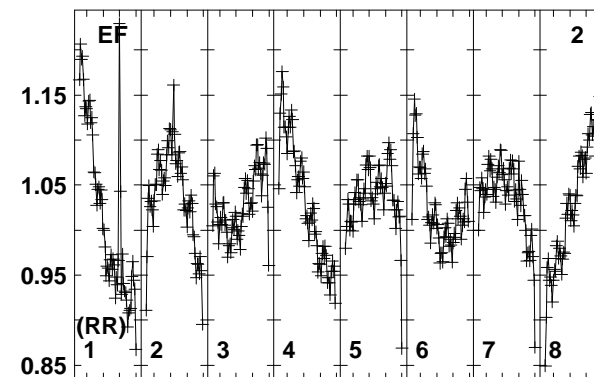
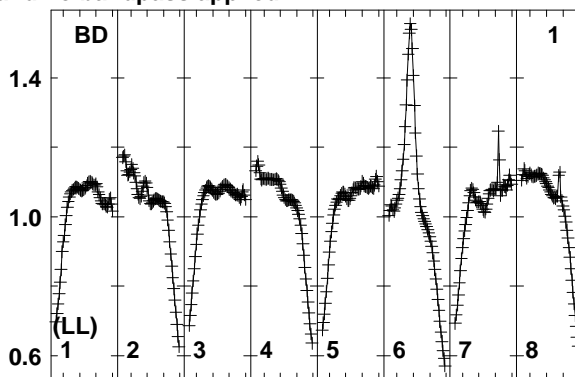
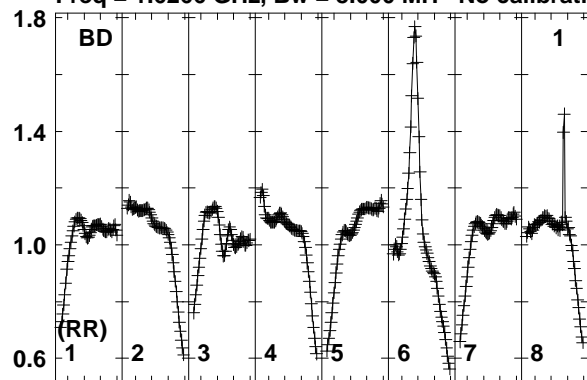

Lower frame: Real Jy
Total-power spectrum Antenna: BD (01)
Timerange: 00/18:23:33 to 00/18:25:59

Plot file version 188 created 01-AUG-2018 16:38:24

PB+1+1 N18L1 2.UVDATA.1

Freq = 1.6266 GHz, Bw = 8.000 MH No calibration applied and no bandpass applied

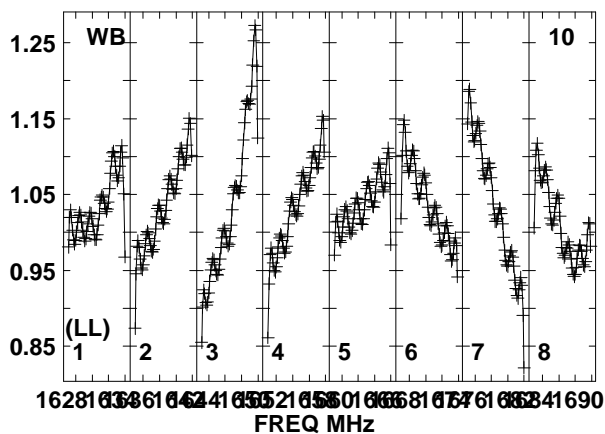
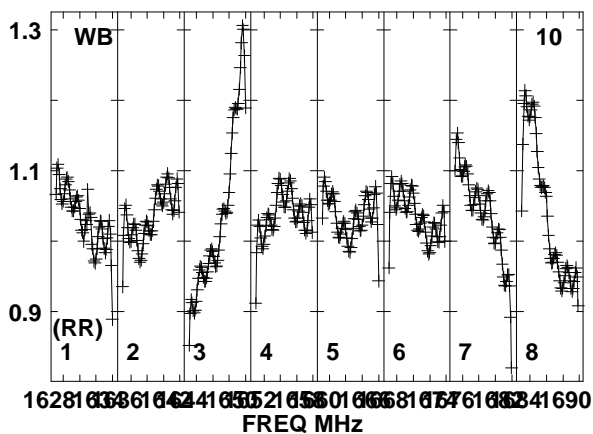
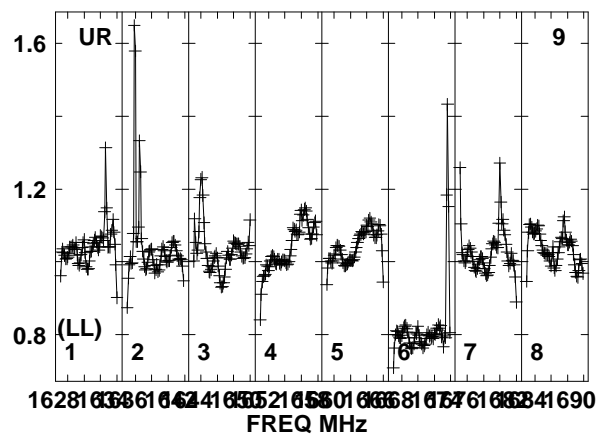
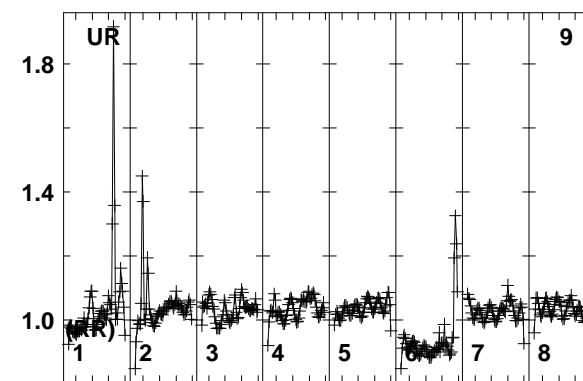
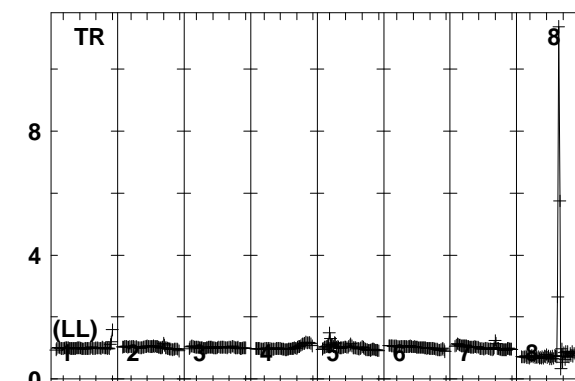
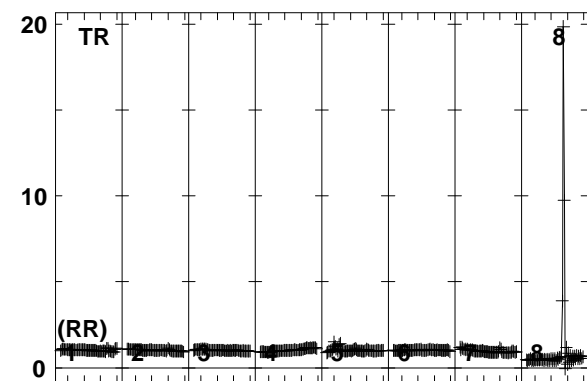
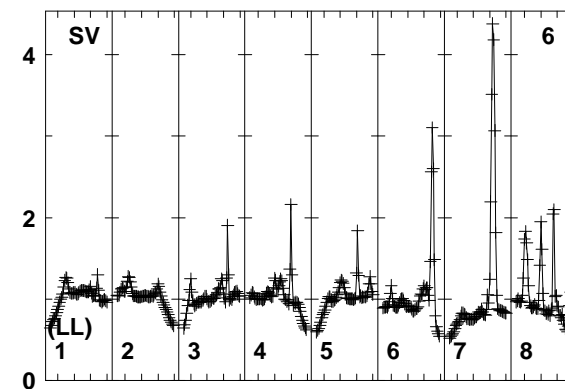
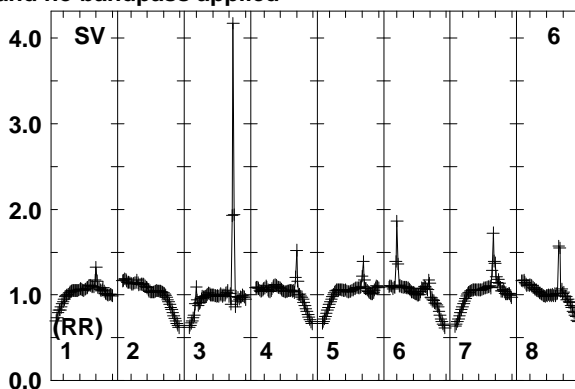
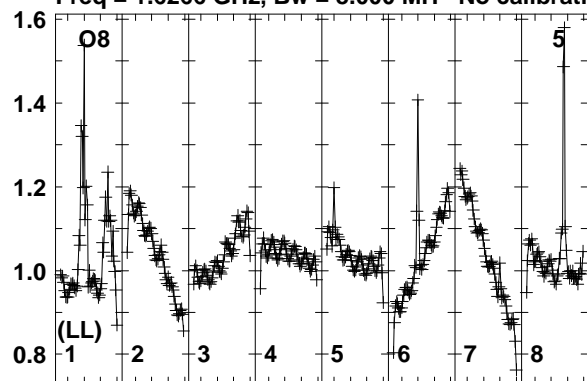

Lower frame: Real Jy
Total-power spectrum Antenna: O8 (05)
Timerange: 00/18:23:33 to 00/18:25:59

Plot file version 189 created 01-AUG-2018 16:38:25

PB+1+1 N18L1 2.UVDATA.1

Freq = 1.6266 GHz, Bw = 8.000 MH No calibration applied and no bandpass applied

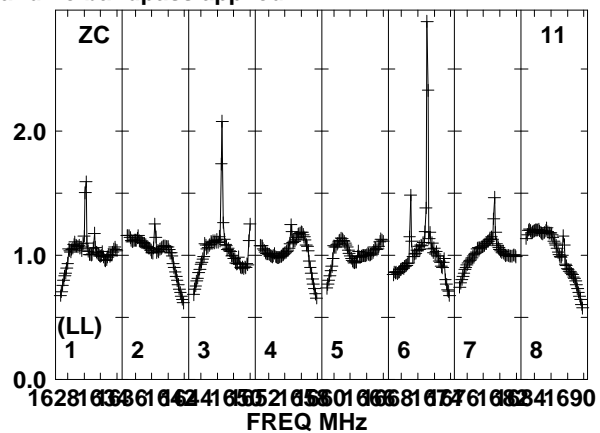
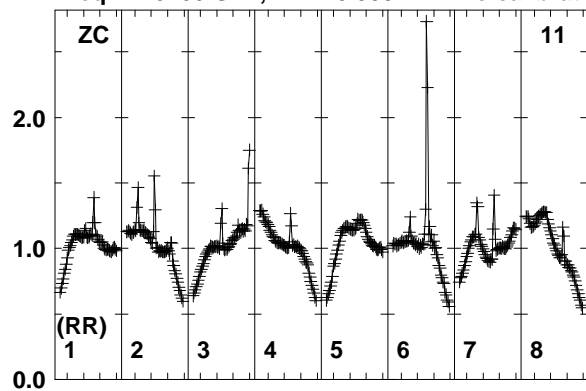

Lower frame: Real Jy
Total-power spectrum Antenna: ZC (11)
Timerange: 00/18:23:33 to 00/18:25:59

Plot file version 190 created 01-AUG-2018 16:38:25

PB+2+1 N18L1 2.UVDATA.1

Freq = 1.6266 GHz, Bw = 8.000 MH No calibration applied and no bandpass applied

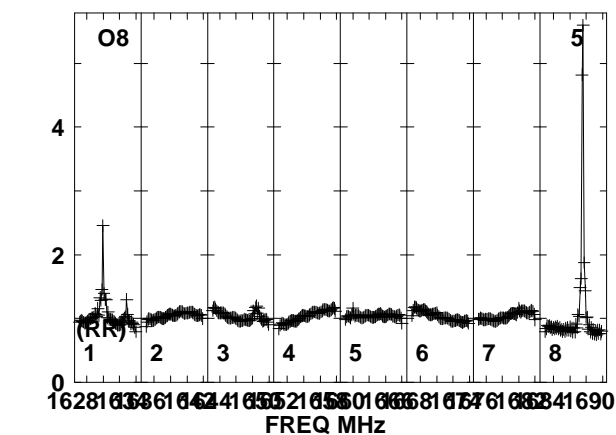
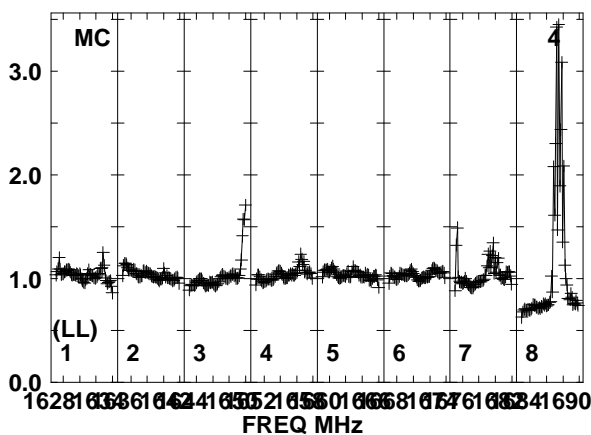
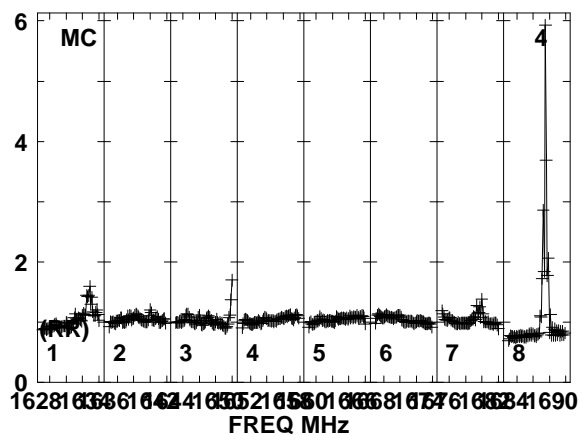
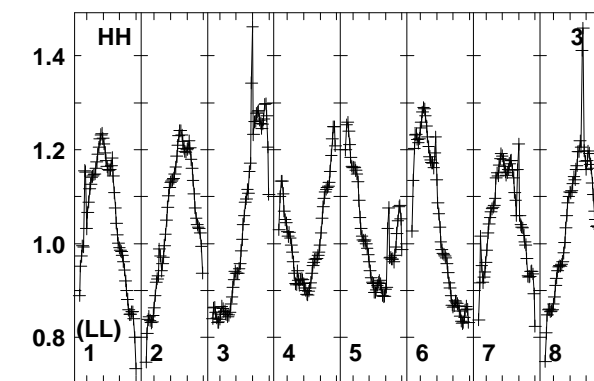
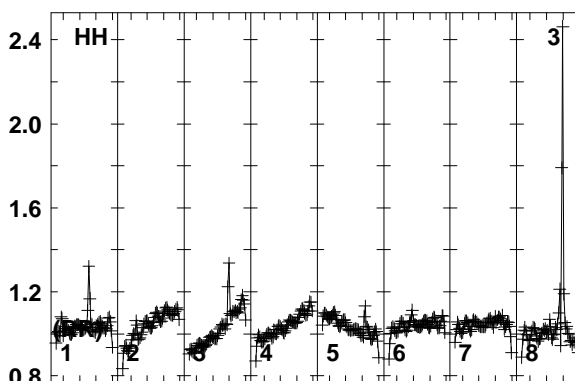
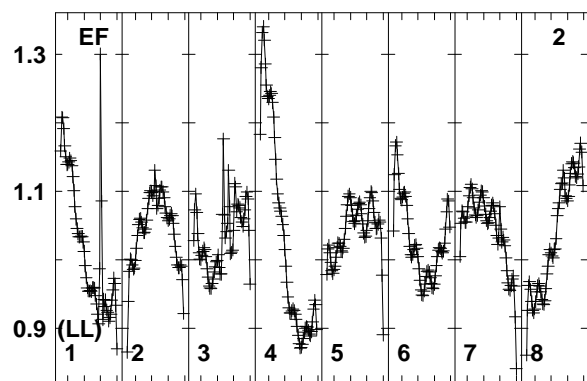
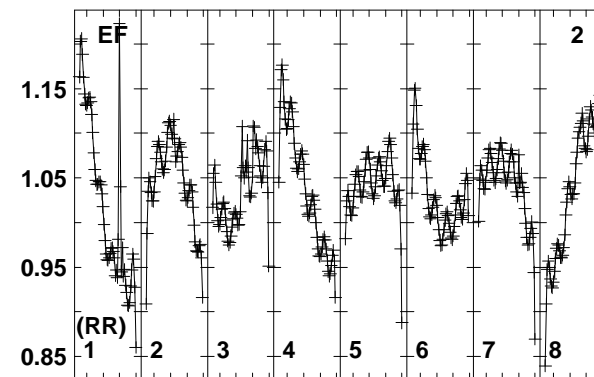
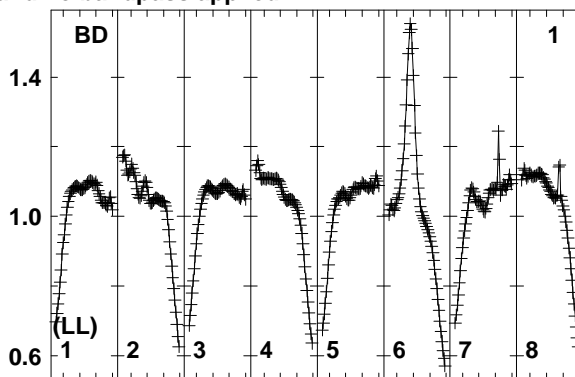
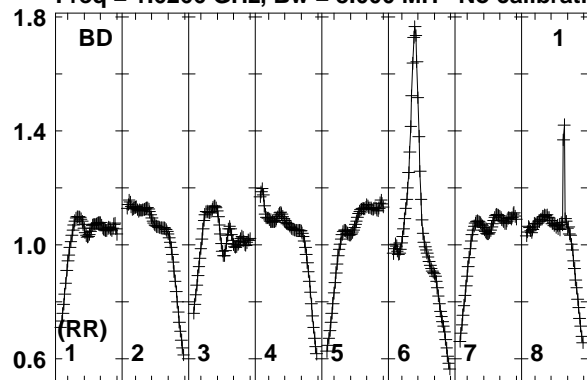

Lower frame: Real Jy
Total-power spectrum Antenna: BD (01)
Timerange: 00/18:26:03 to 00/18:28:29

Plot file version 191 created 01-AUG-2018 16:38:25

PB+2+1 N18L1 2.UVDATA.1

Freq = 1.6266 GHz, Bw = 8.000 MH No calibration applied and no bandpass applied

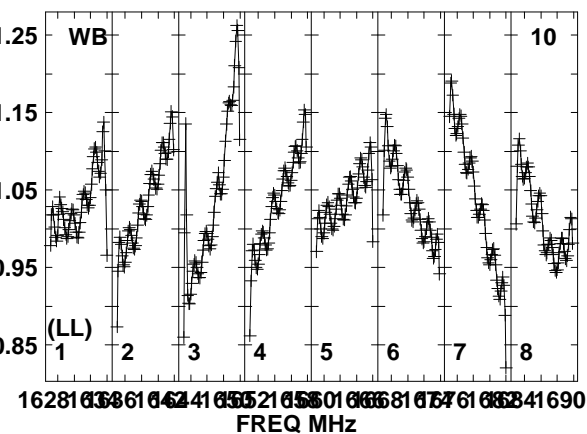
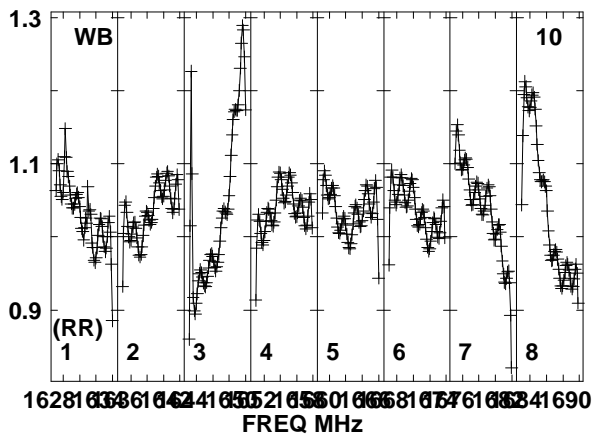
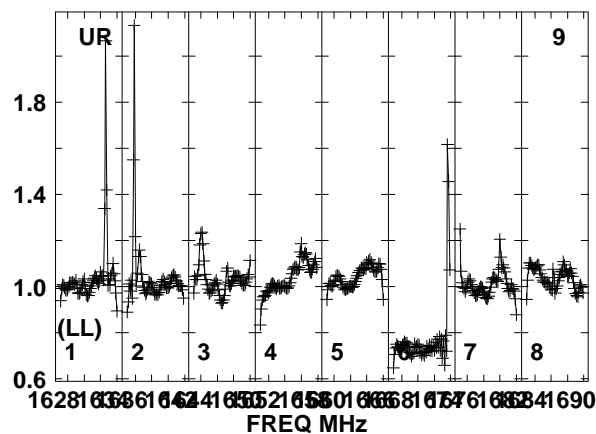
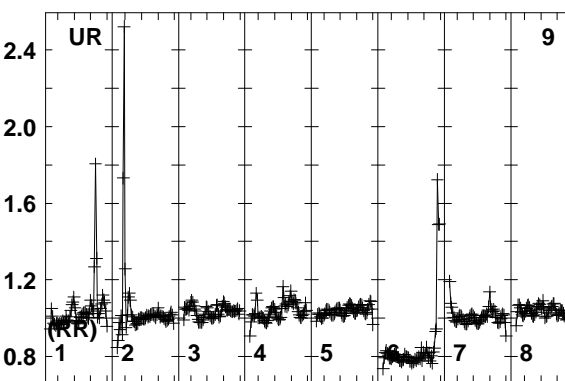
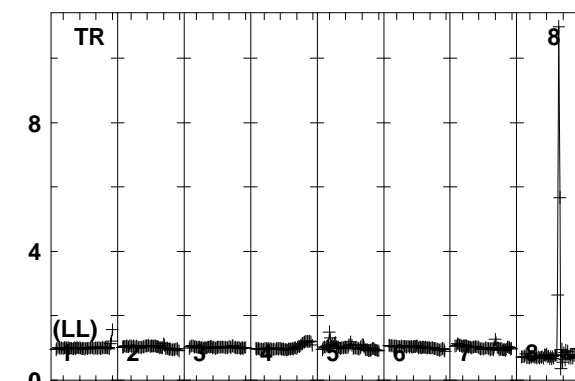
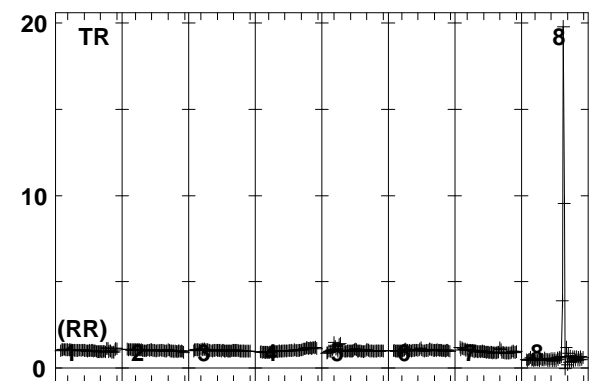
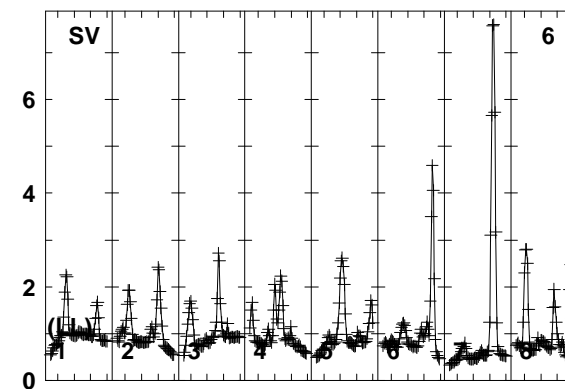
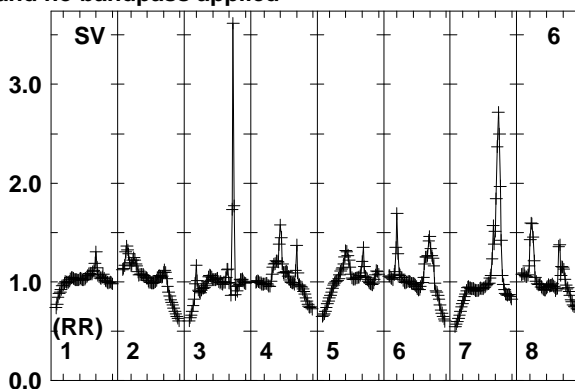
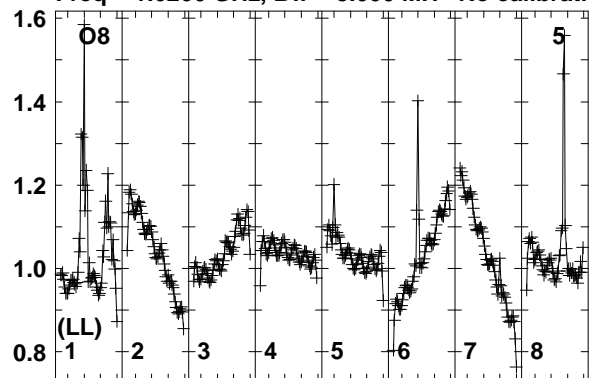

Lower frame: Real Jy
Total-power spectrum Antenna: O8 (05)
Timerange: 00/18:26:03 to 00/18:28:29

Plot file version 192 created 01-AUG-2018 16:38:25

PB+2+1 N18L1 2.UVDATA.1

Freq = 1.6266 GHz, Bw = 8.000 MH No calibration applied and no bandpass applied

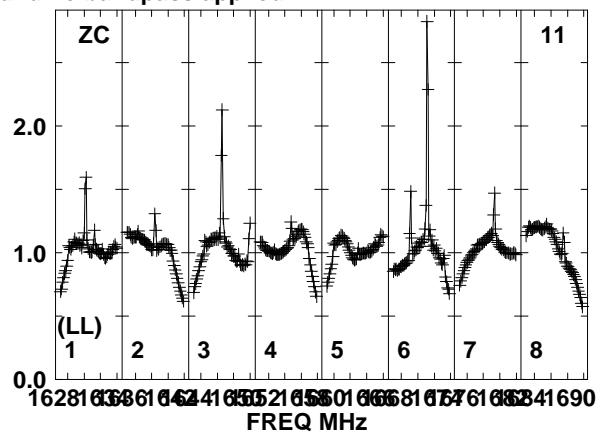
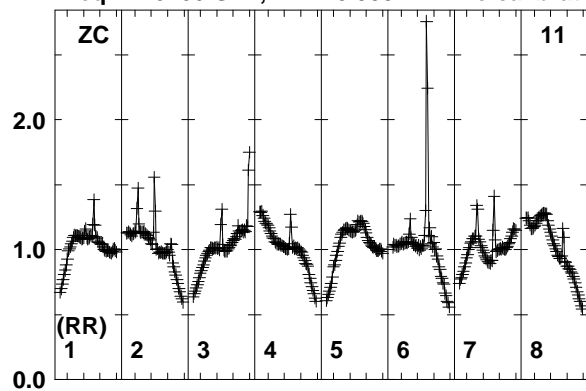

Lower frame: Real Jy
Total-power spectrum Antenna: ZC (11)
Timerange: 00/18:26:03 to 00/18:28:29

Plot file version 193 created 01-AUG-2018 16:38:25

J0530+1331 N18L1 2.UVDATA.1

Freq = 1.6266 GHz, Bw = 8.000 MH No calibration applied and no bandpass applied

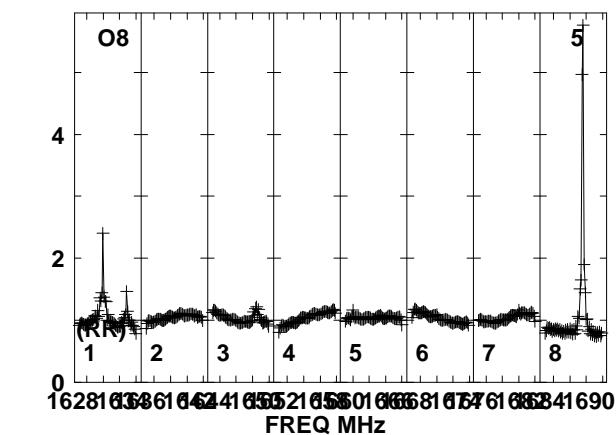
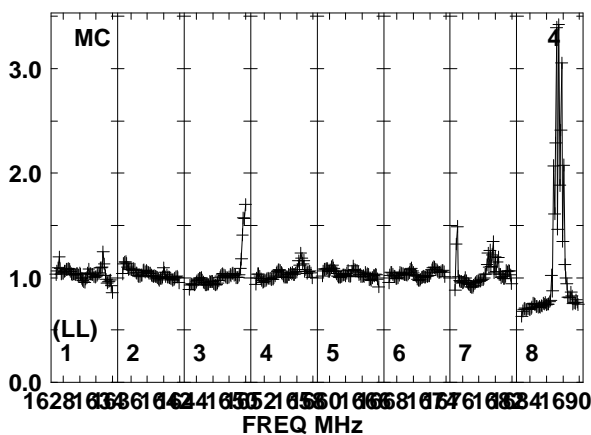
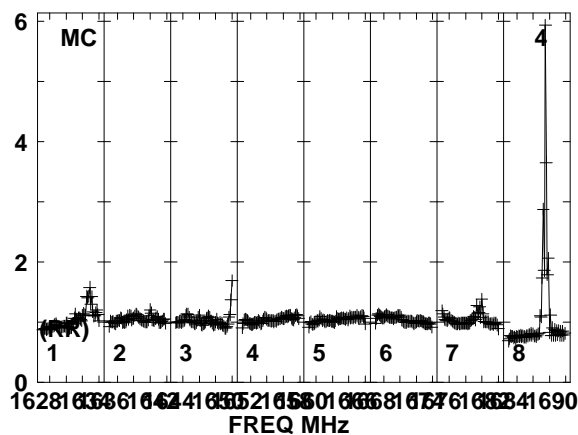
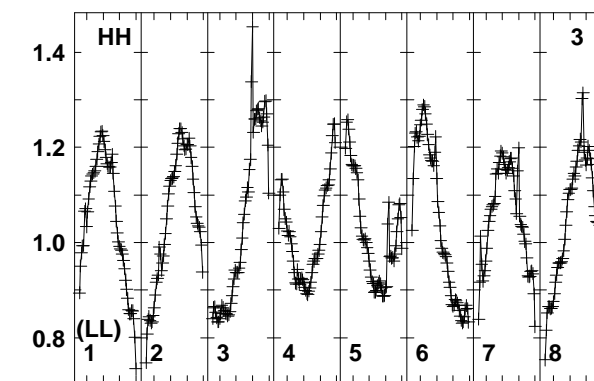
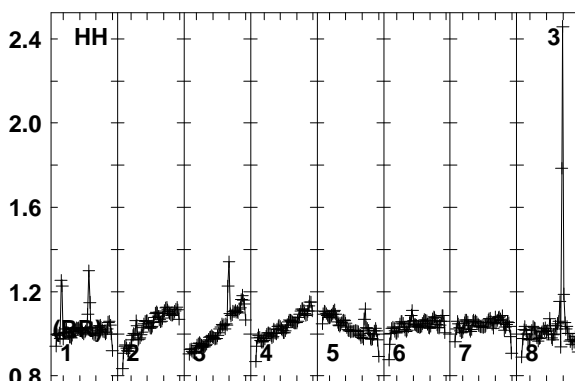
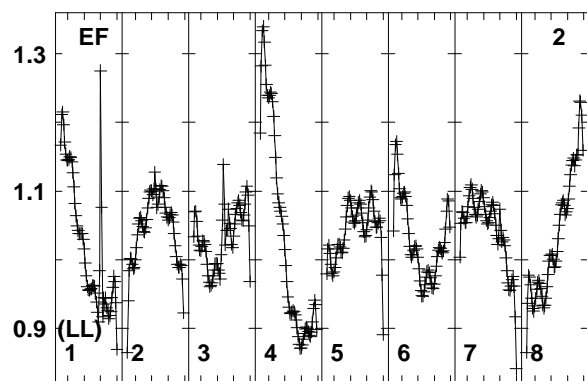
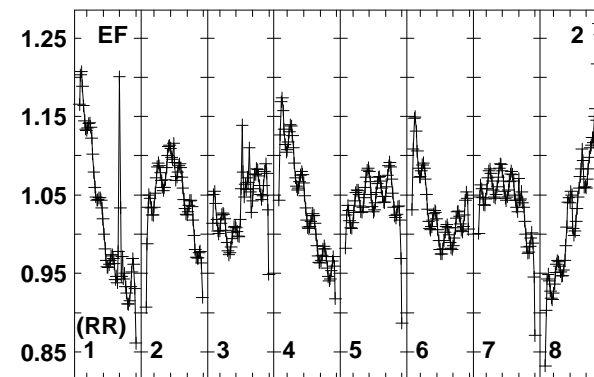
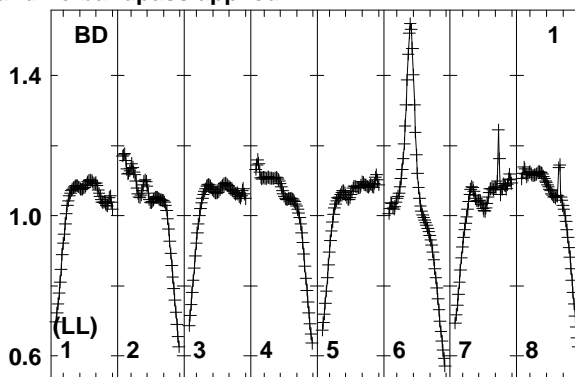
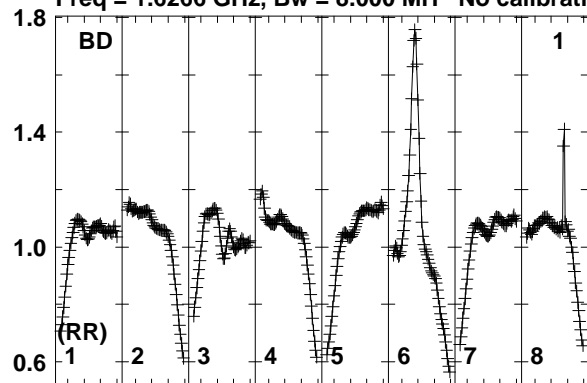

Lower frame: Real Jy
Total-power spectrum Antenna: BD (01)
Timerange: 00/18:29:11 to 00/18:30:29

Plot file version 194 created 01-AUG-2018 16:38:25

J0530+1331 N18L1 2.UVDATA.1

Freq = 1.6266 GHz, Bw = 8.000 MH No calibration applied and no bandpass applied

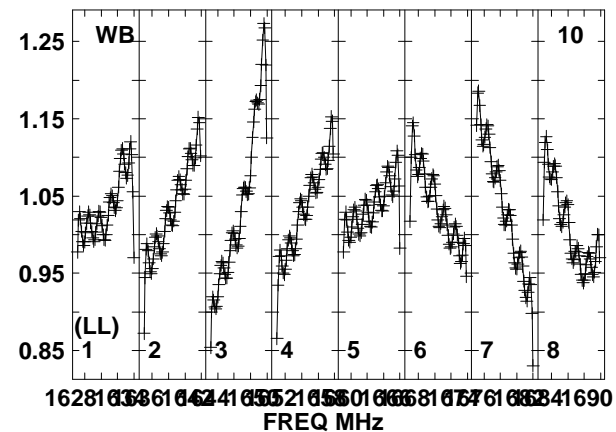
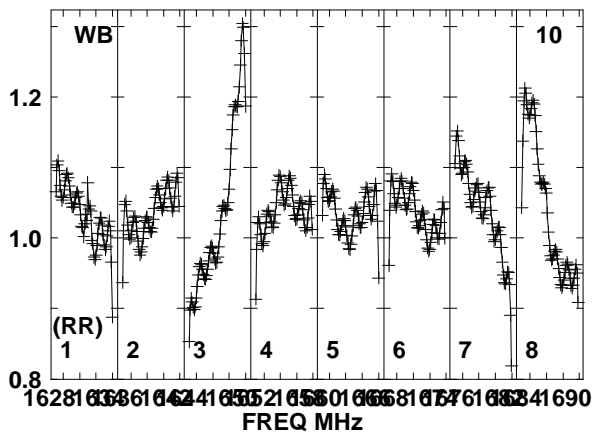
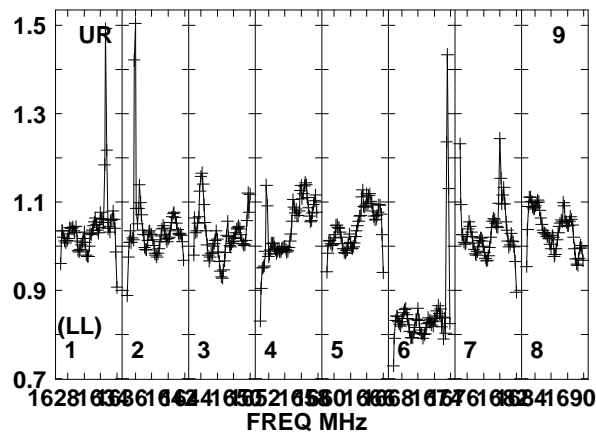
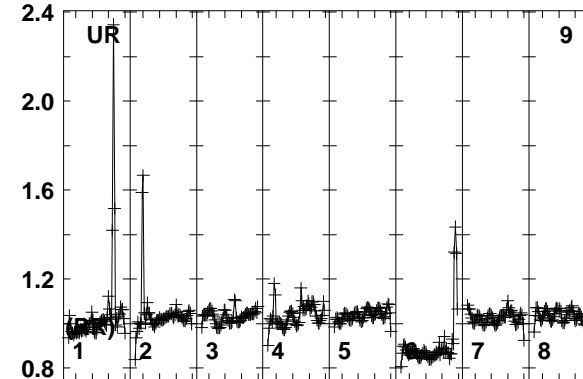
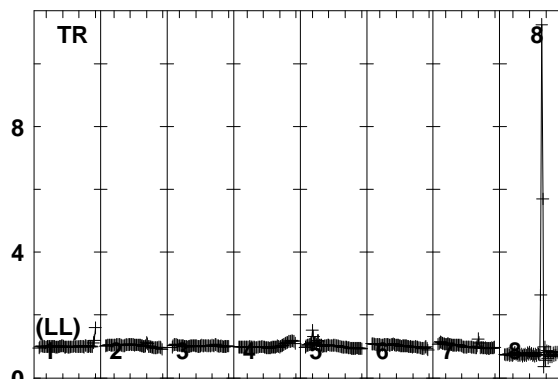
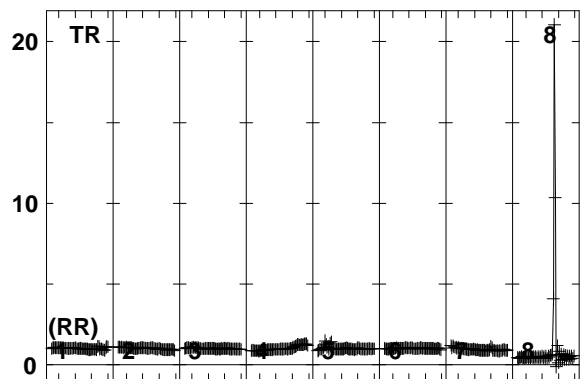
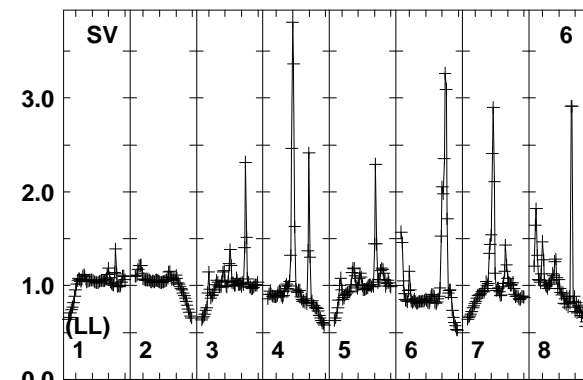
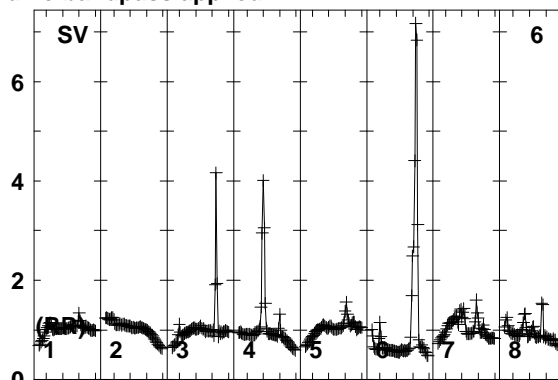
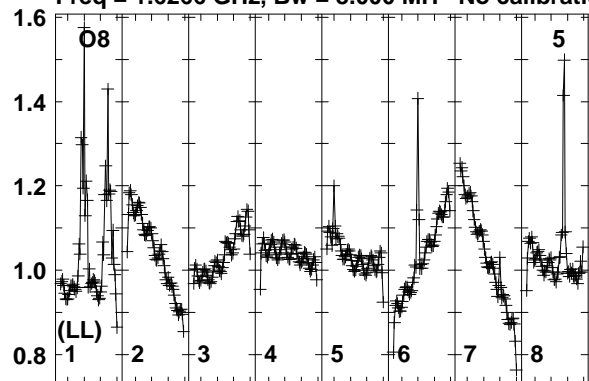

Lower frame: Real Jy
Total-power spectrum Antenna: O8 (05)
Timerange: 00/18:29:11 to 00/18:30:29

Plot file version 195 created 01-AUG-2018 16:38:25

J0530+1331 N18L1 2.UVDATA.1

Freq = 1.6266 GHz, Bw = 8.000 MH No calibration applied and no bandpass applied

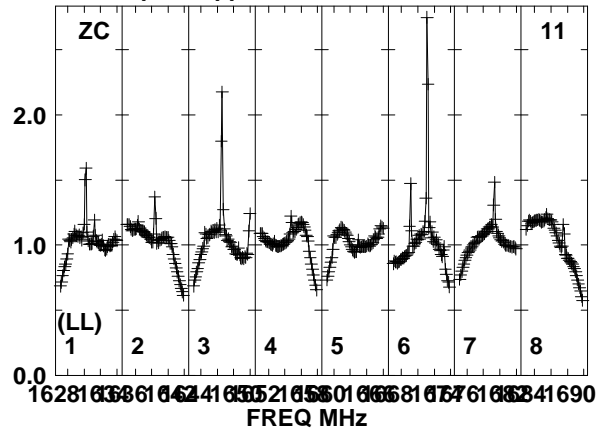
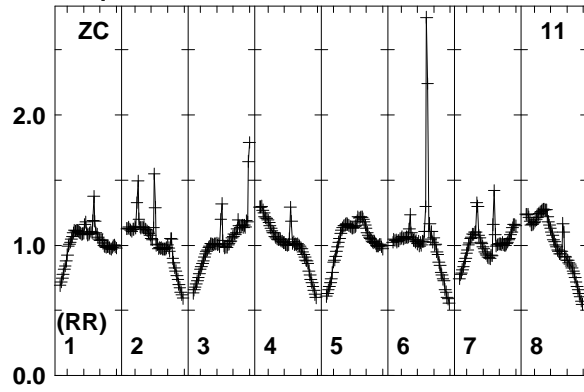

Lower frame: Real Jy
Total-power spectrum Antenna: ZC (11)
Timerange: 00/18:29:11 to 00/18:30:29

Plot file version 196 created 01-AUG-2018 16:38:25

PB+3+1 N18L1 2.UVDATA.1

Freq = 1.6266 GHz, Bw = 8.000 MH No calibration applied and no bandpass applied

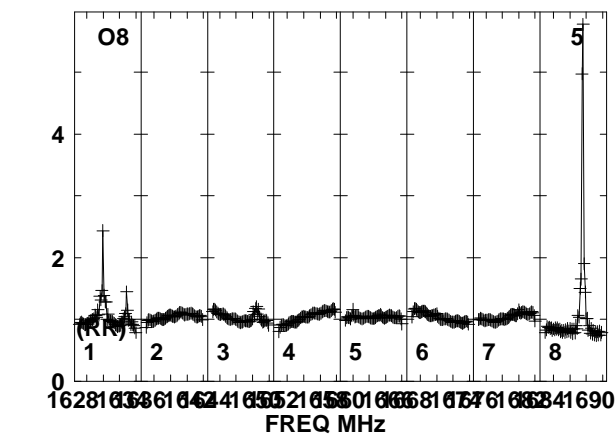
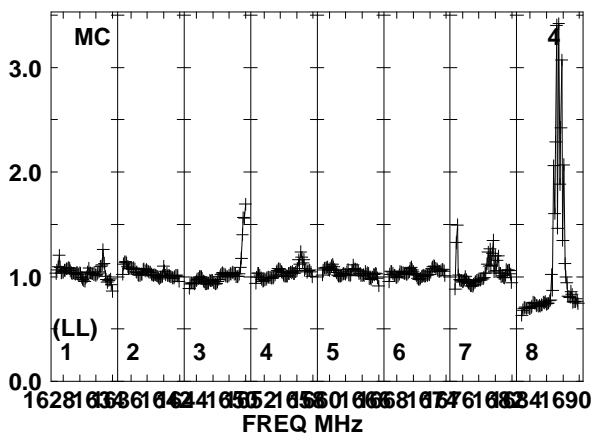
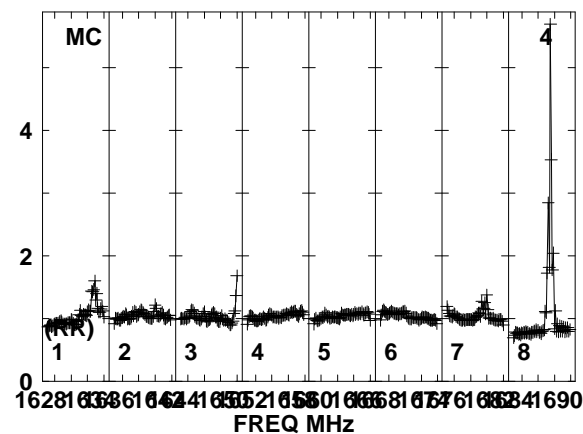
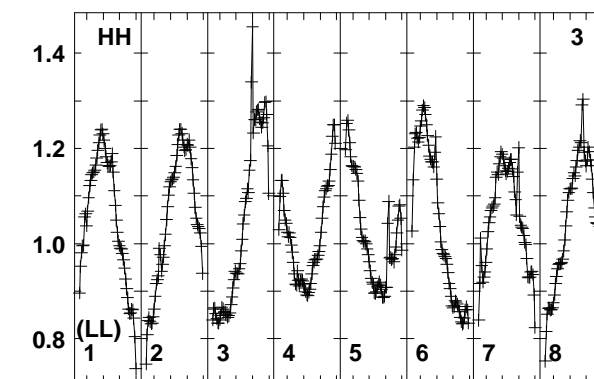
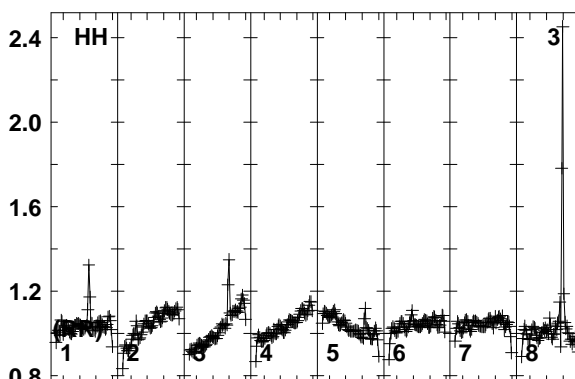
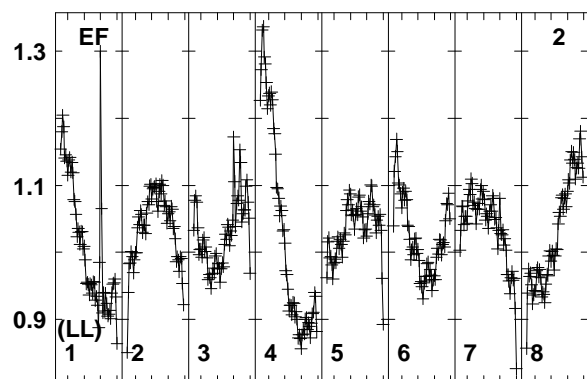
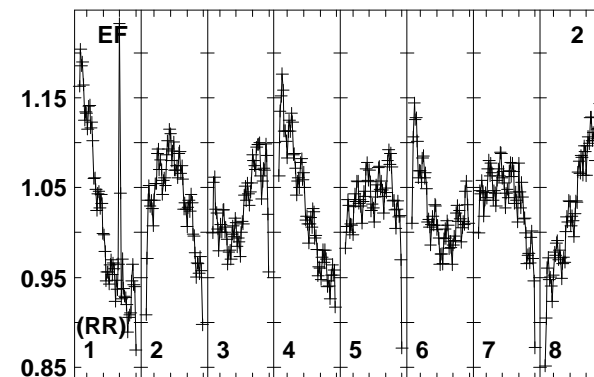
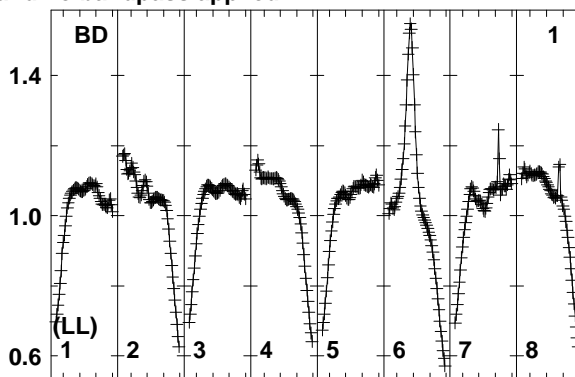
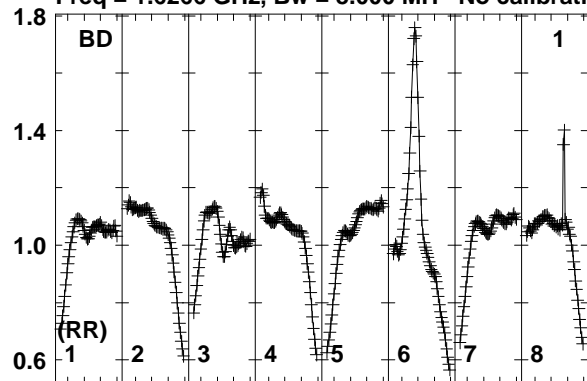

Lower frame: Real Jy
Total-power spectrum Antenna: BD (01)
Timerange: 00/18:30:35 to 00/18:32:59

Plot file version 197 created 01-AUG-2018 16:38:25

PB+3+1 N18L1 2.UVDATA.1

Freq = 1.6266 GHz, Bw = 8.000 MH No calibration applied and no bandpass applied

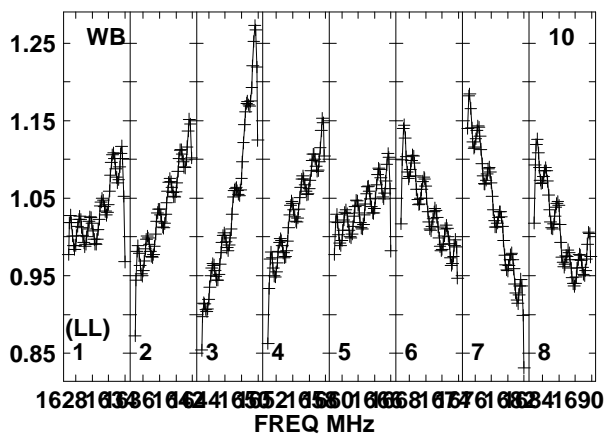
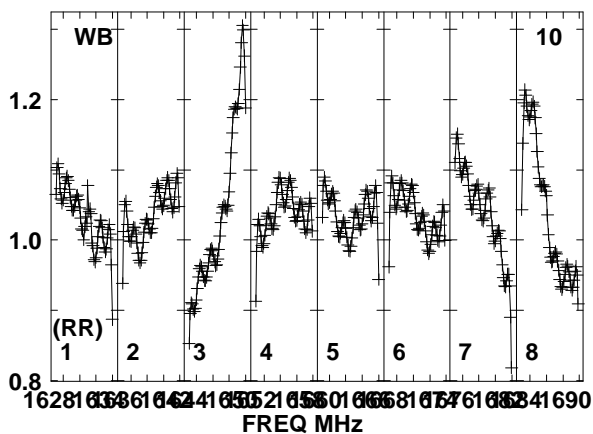
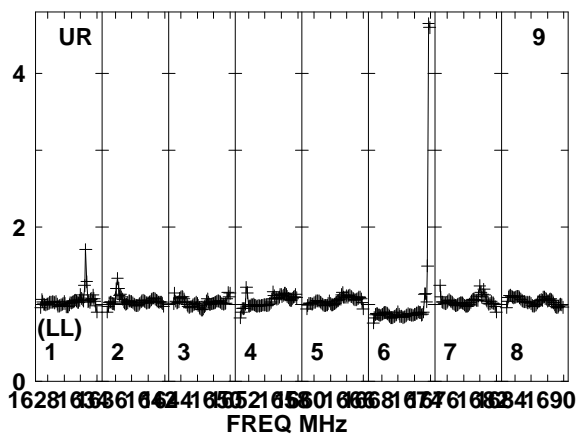
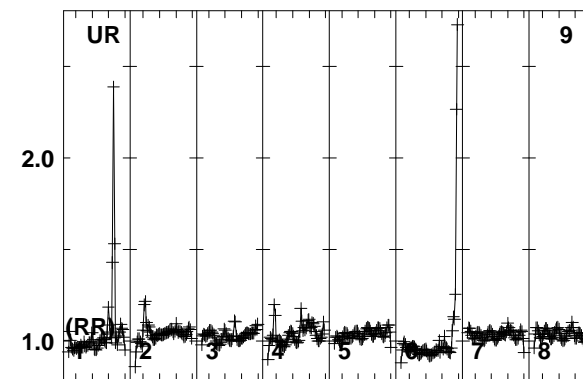
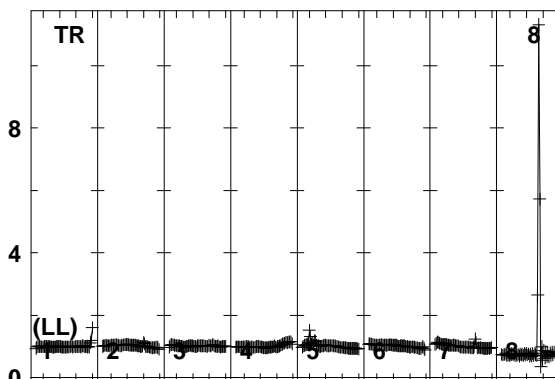
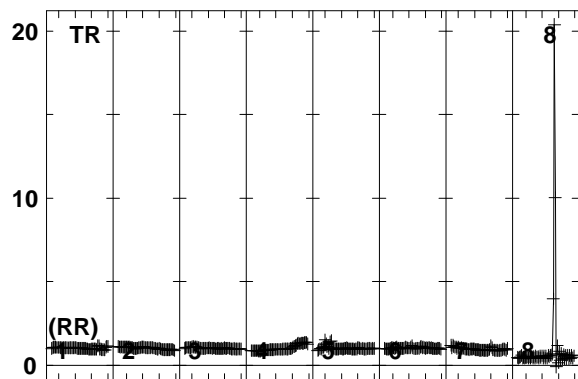
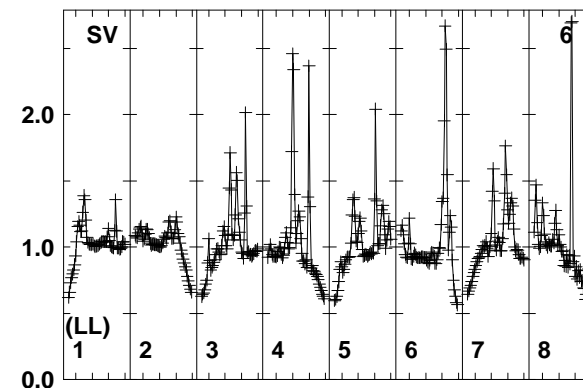
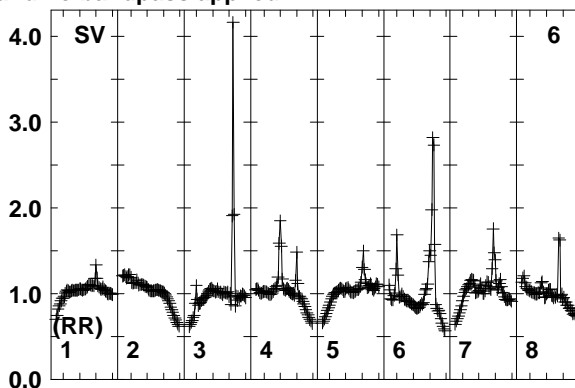
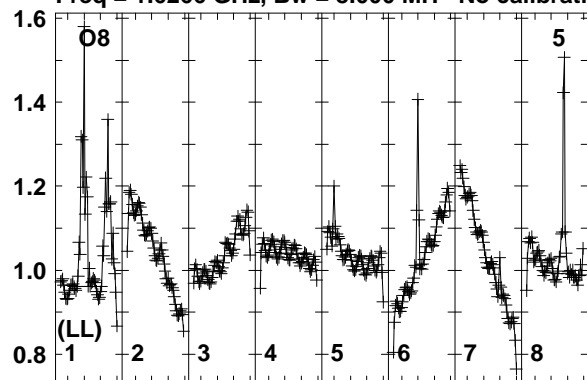

Lower frame: Real Jy
Total-power spectrum Antenna: O8 (05)
Timerange: 00/18:30:35 to 00/18:32:59

Plot file version 198 created 01-AUG-2018 16:38:26

PB+3+1 N18L1 2.UVDATA.1

Freq = 1.6266 GHz, Bw = 8.000 MH No calibration applied and no bandpass applied

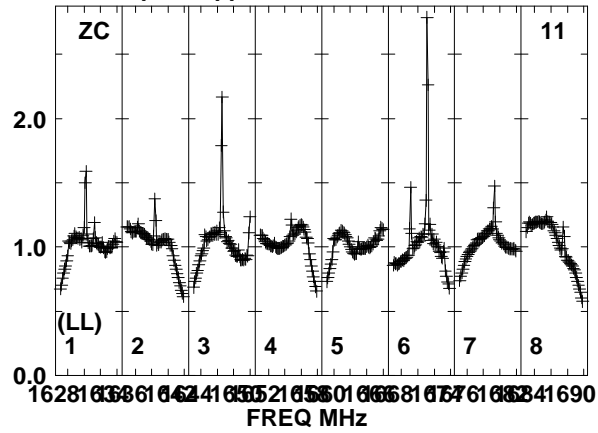
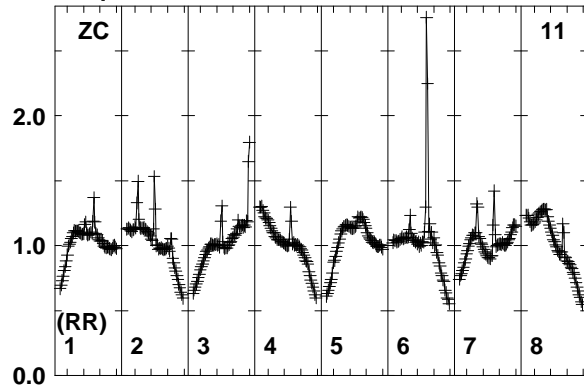

Lower frame: Real Jy
Total-power spectrum Antenna: ZC (11)
Timerange: 00/18:30:35 to 00/18:32:59

Plot file version 199 created 01-AUG-2018 16:38:26

PB+4+1 N18L1 2.UVDATA.1

Freq = 1.6266 GHz, Bw = 8.000 MH No calibration applied and no bandpass applied

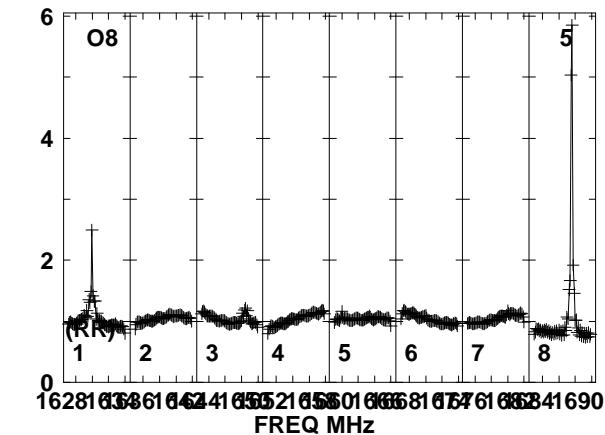
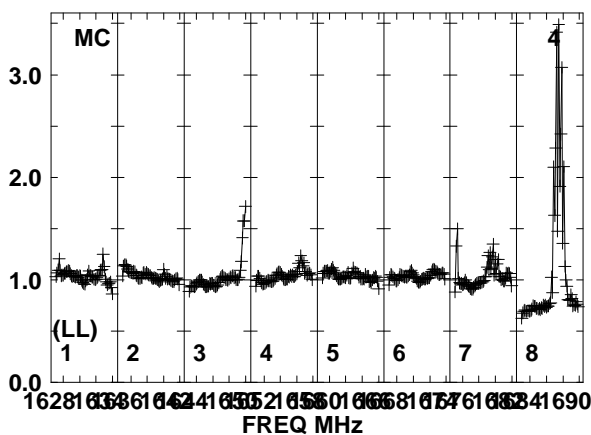
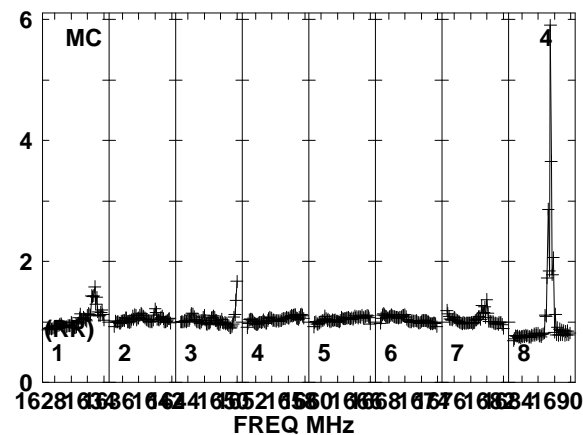
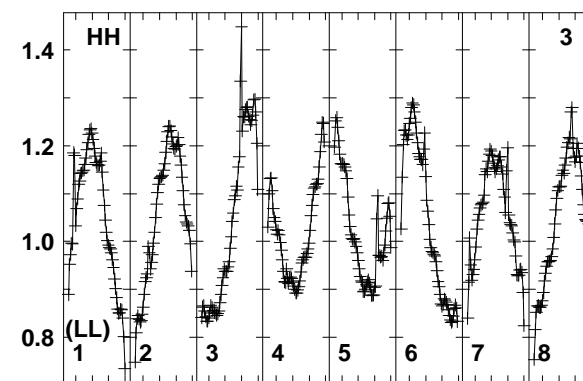
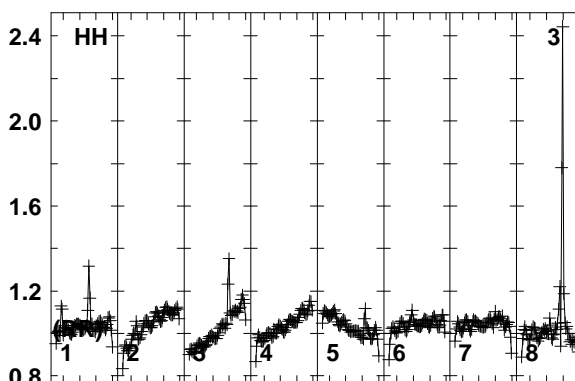
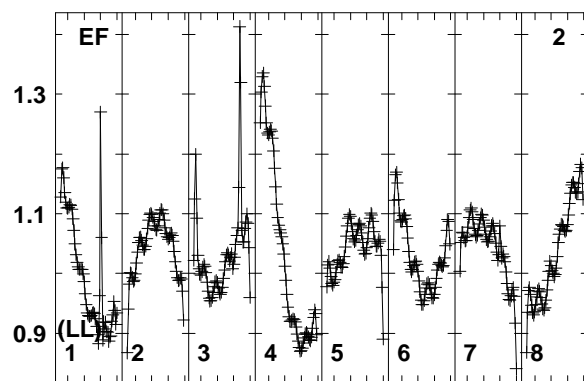
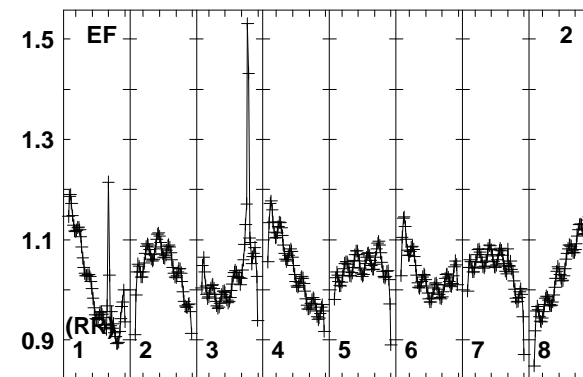
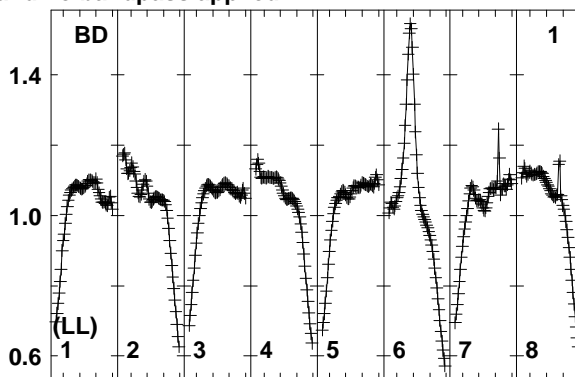
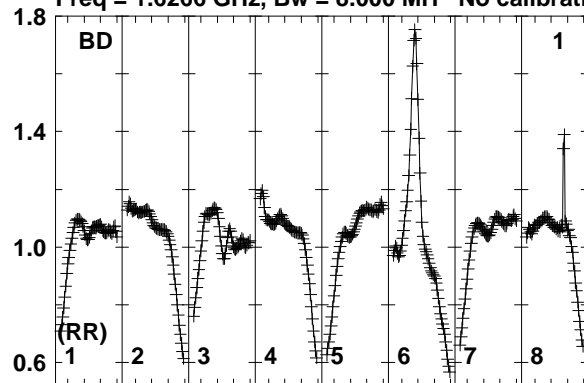

Lower frame: Real Jy
Total-power spectrum Antenna: BD (01)
Timerange: 00/18:33:05 to 00/18:35:29

Plot file version 200 created 01-AUG-2018 16:38:26

PB+4+1 N18L1 2.UVDATA.1

Freq = 1.6266 GHz, Bw = 8.000 MH No calibration applied and no bandpass applied

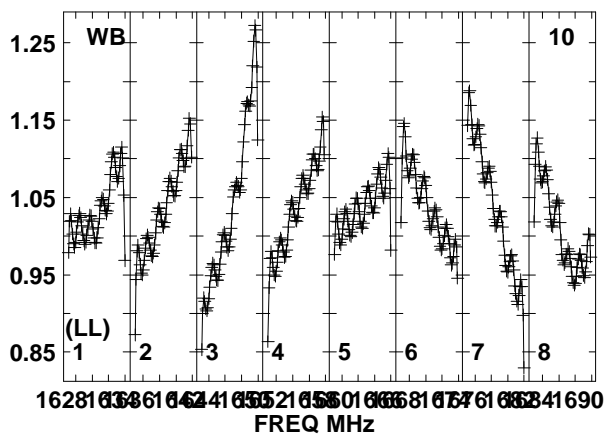
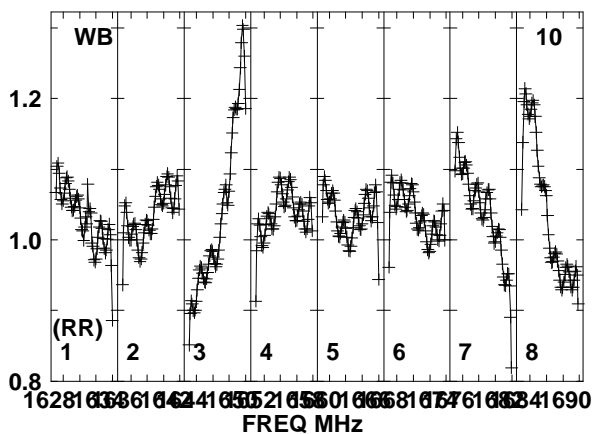
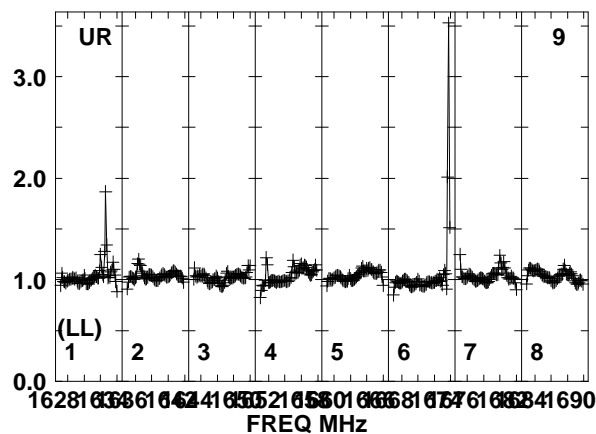
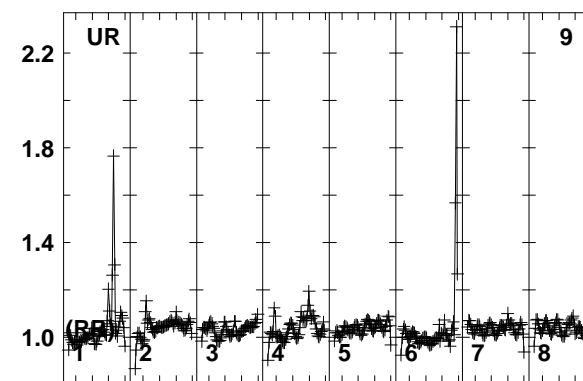
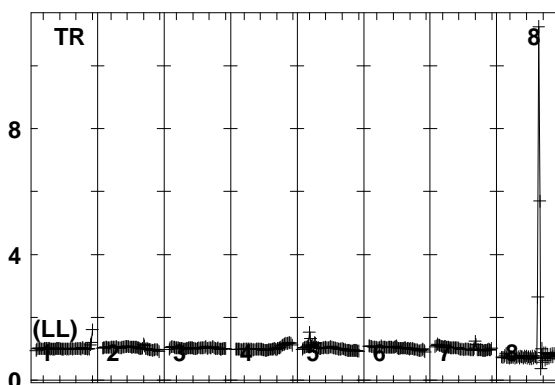
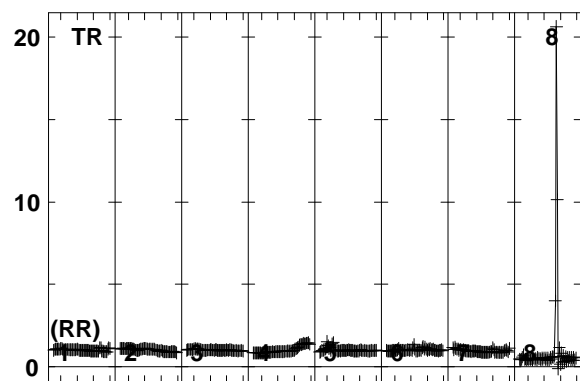
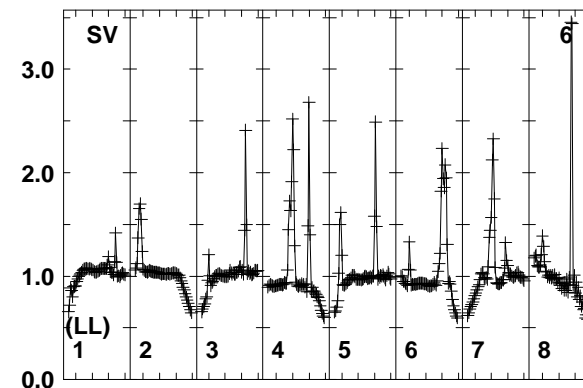
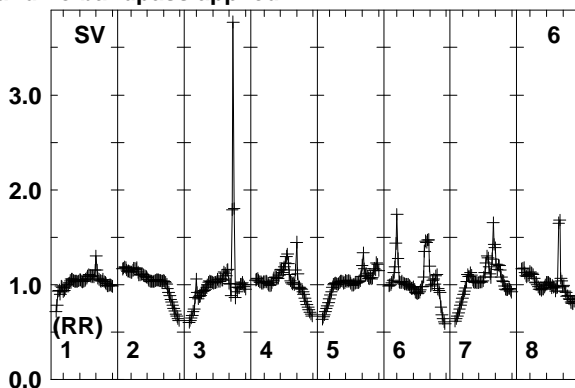
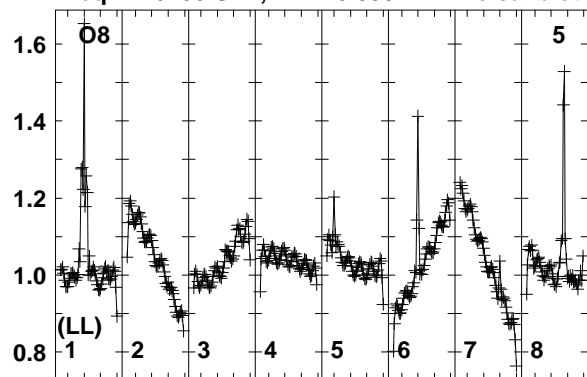

Lower frame: Real Jy
Total-power spectrum Antenna: O8 (05)
Timerange: 00/18:33:05 to 00/18:35:29

Plot file version 201 created 01-AUG-2018 16:38:26

PB+4+1 N18L1 2.UVDATA.1

Freq = 1.6266 GHz, Bw = 8.000 MH No calibration applied and no bandpass applied

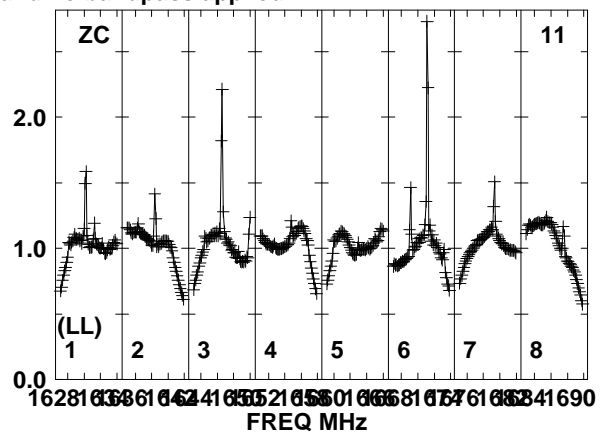
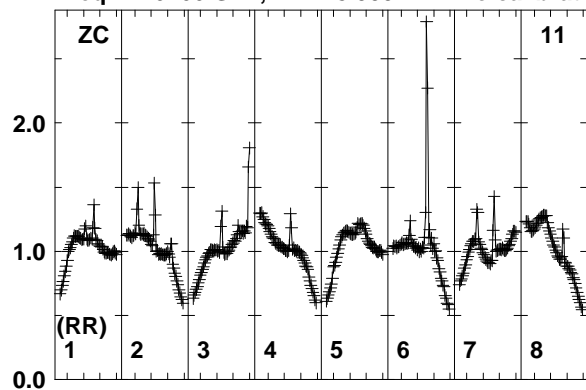

Lower frame: Real Jy
Total-power spectrum Antenna: ZC (11)
Timerange: 00/18:33:05 to 00/18:35:29

Plot file version 202 created 01-AUG-2018 16:38:26

PB+4+2 N18L1 2.UVDATA.1

Freq = 1.6266 GHz, Bw = 8.000 MH No calibration applied and no bandpass applied

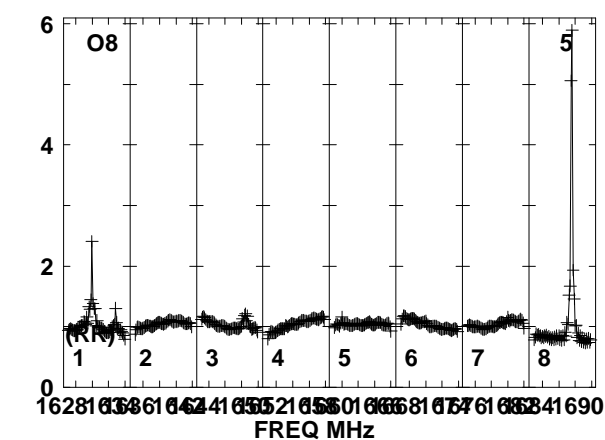
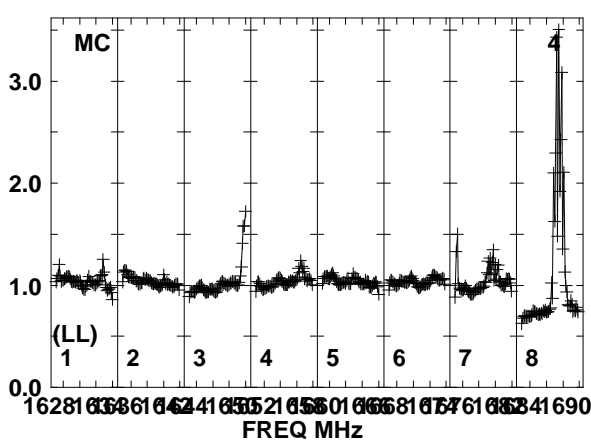
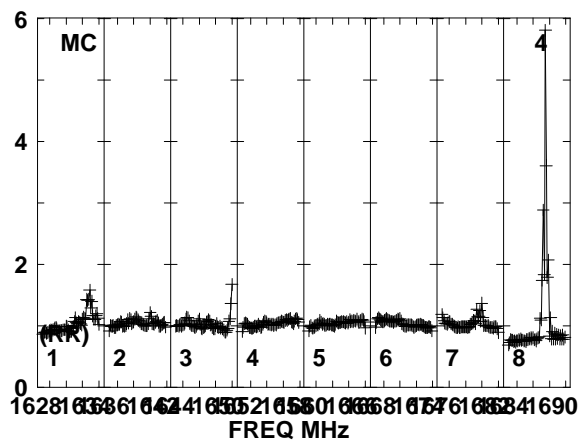
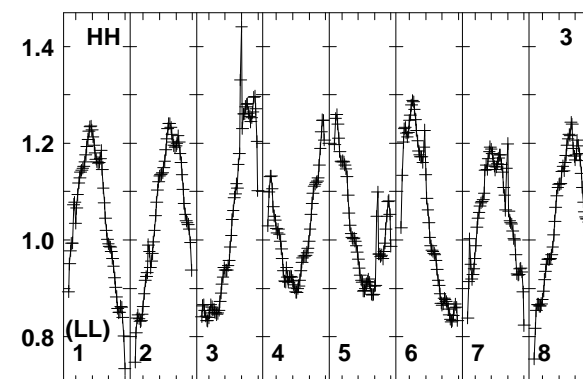
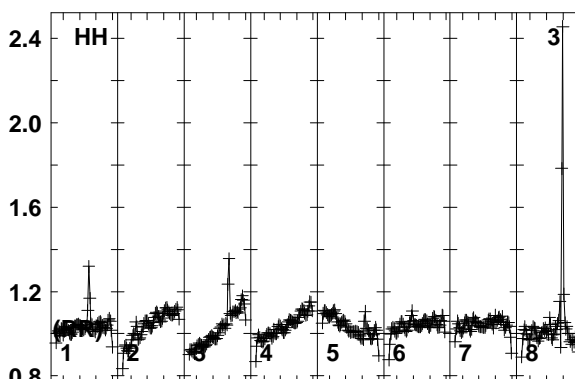
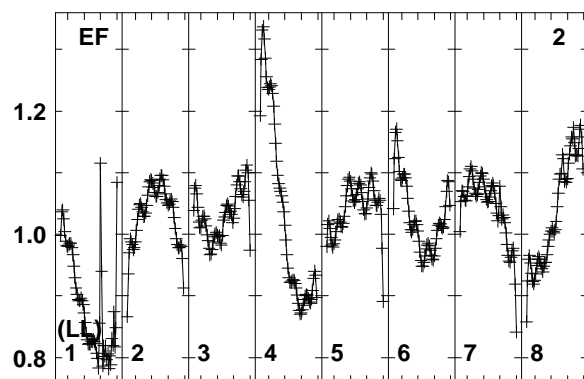
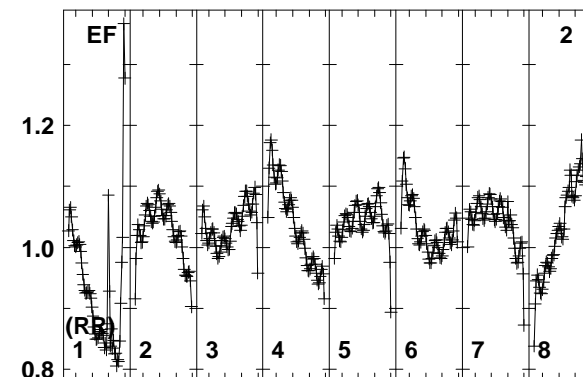
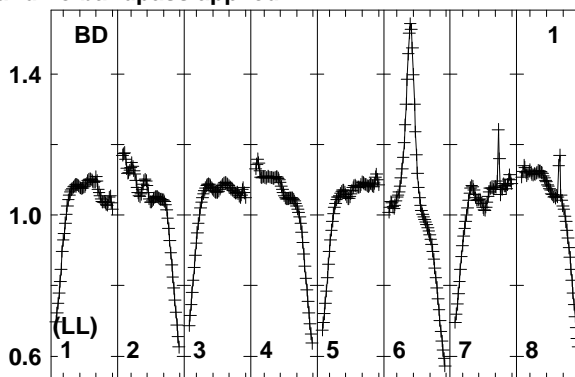
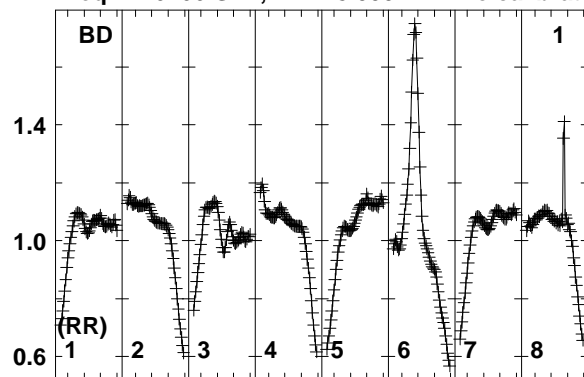

Lower frame: Real Jy
Total-power spectrum Antenna: BD (01)
Timerange: 00/18:35:33 to 00/18:37:59

Plot file version 203 created 01-AUG-2018 16:38:26

PB+4+2 N18L1 2.UVDATA.1

Freq = 1.6266 GHz, Bw = 8.000 MH No calibration applied and no bandpass applied

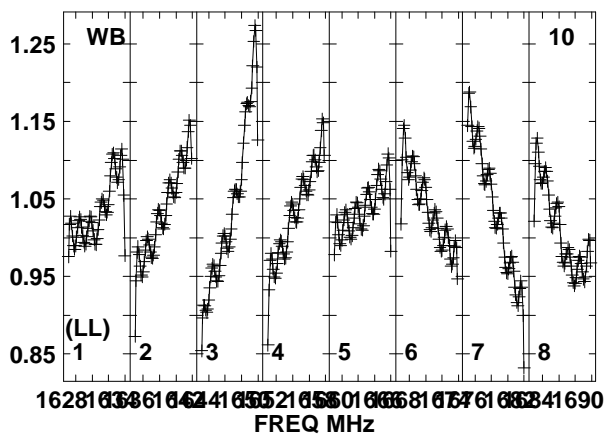
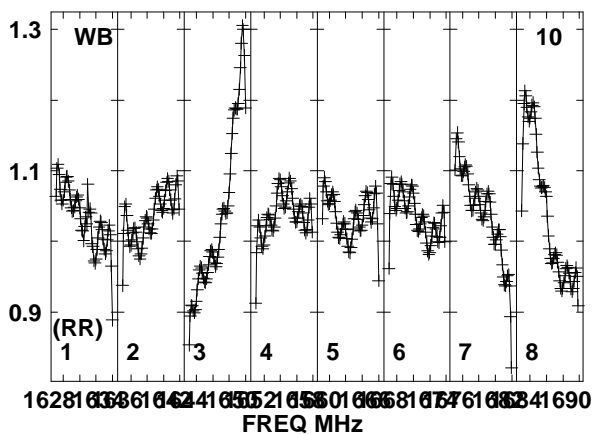
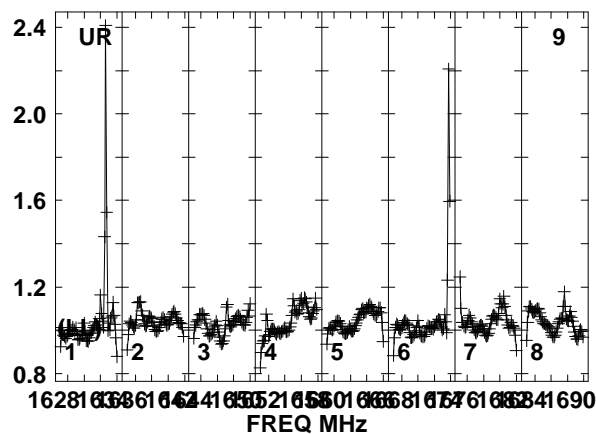
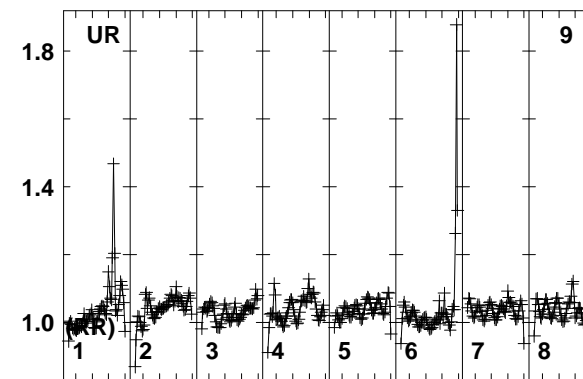
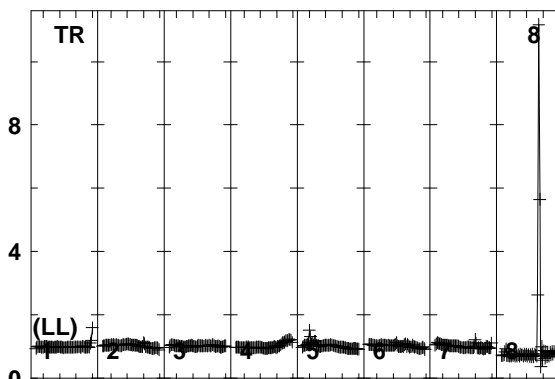
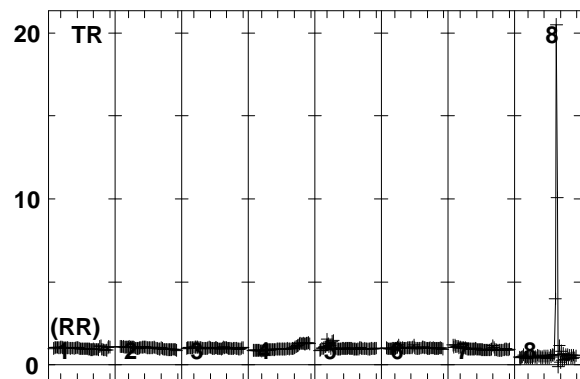
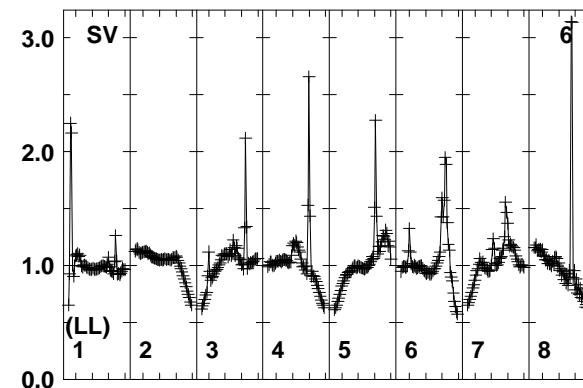
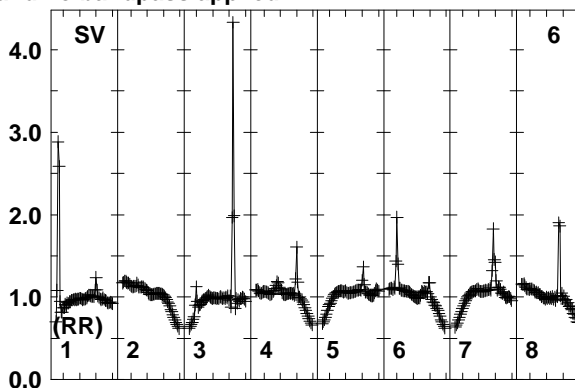
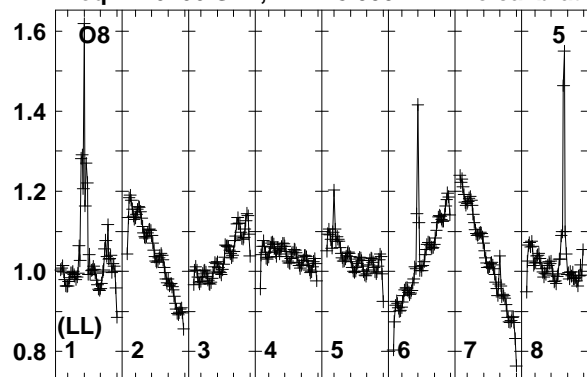

Lower frame: Real Jy
Total-power spectrum Antenna: O8 (05)
Timerange: 00/18:35:33 to 00/18:37:59

Plot file version 204 created 01-AUG-2018 16:38:26

PB+4+2 N18L1 2.UVDATA.1

Freq = 1.6266 GHz, Bw = 8.000 MH No calibration applied and no bandpass applied

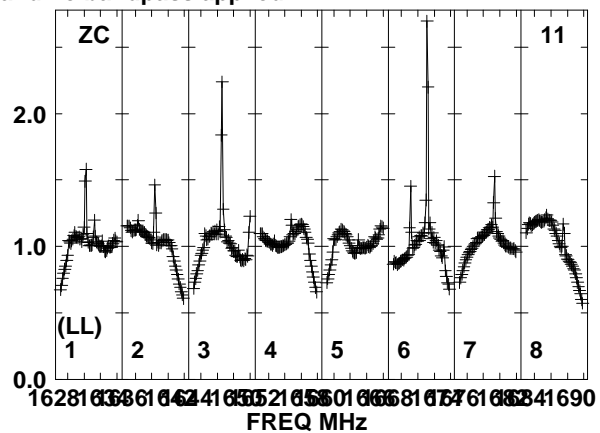
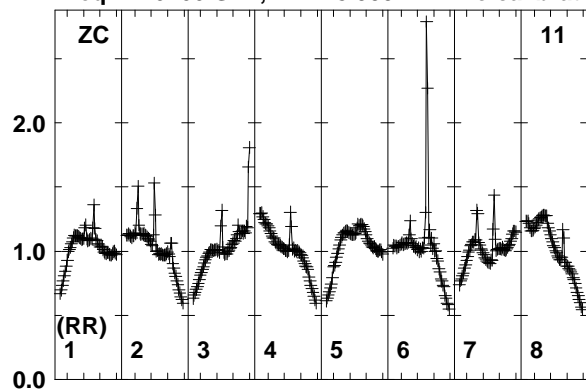

Lower frame: Real Jy
Total-power spectrum Antenna: ZC (11)
Timerange: 00/18:35:33 to 00/18:37:59

Plot file version 205 created 01-AUG-2018 16:38:26

PB+3+2 N18L1 2.UVDATA.1

Freq = 1.6266 GHz, Bw = 8.000 MH No calibration applied and no bandpass applied

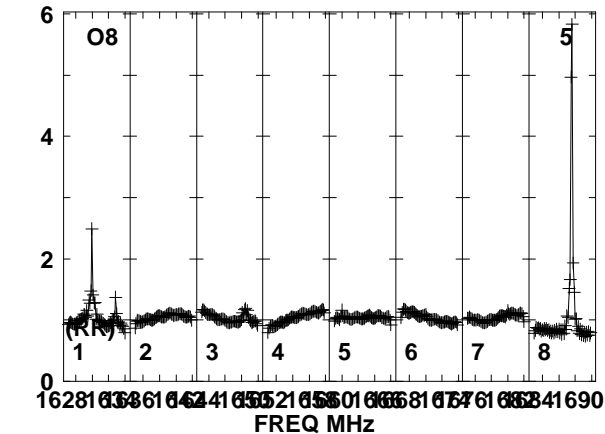
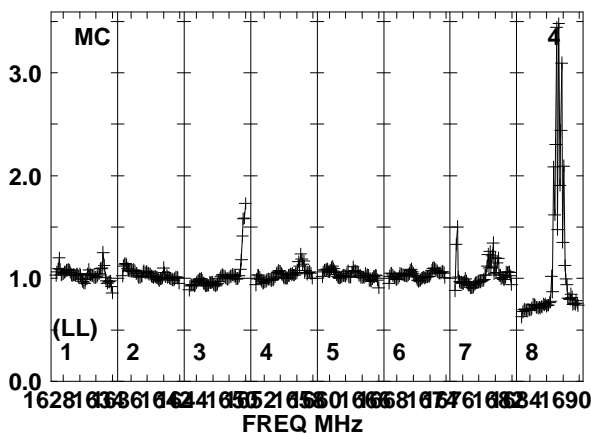
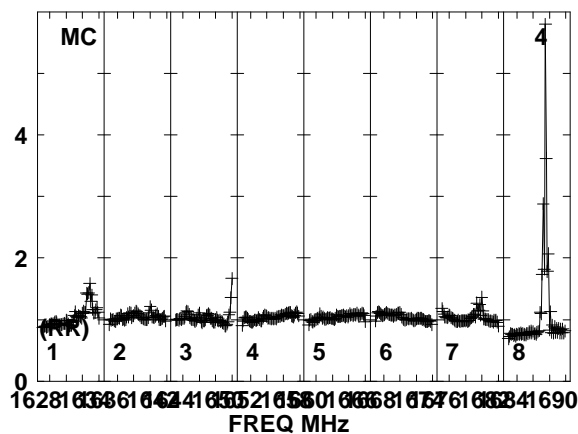
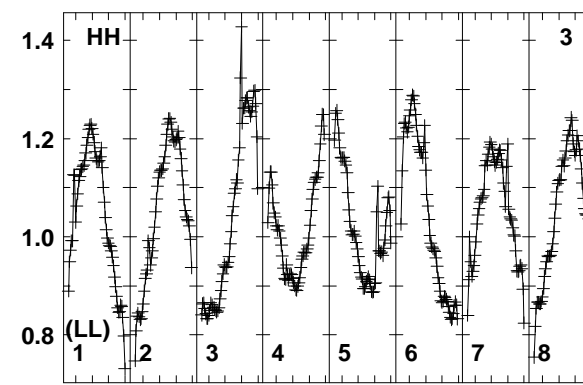
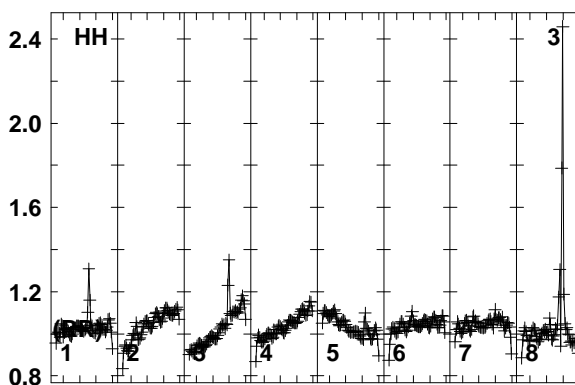
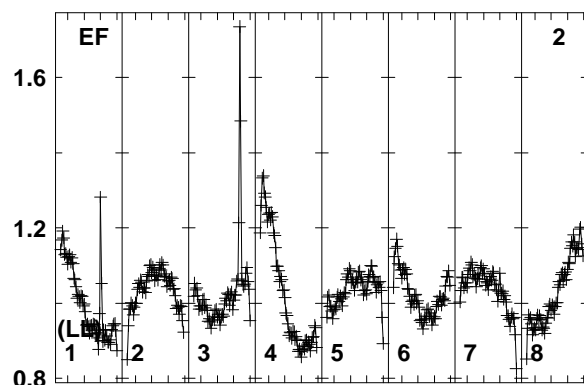
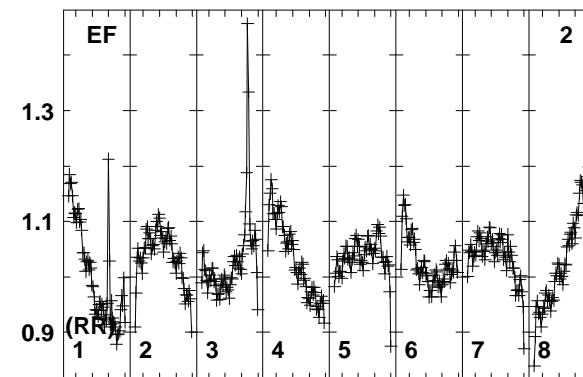
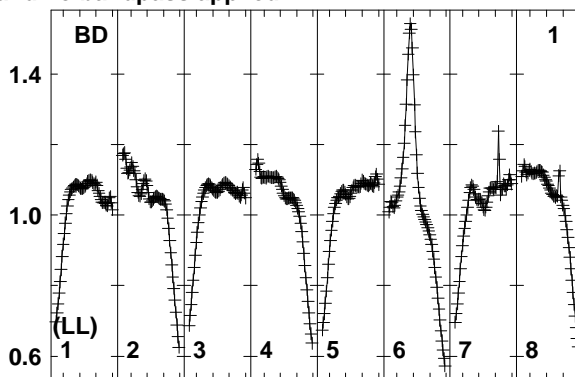
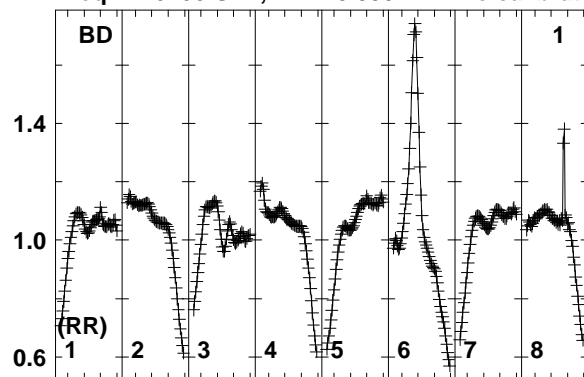

Lower frame: Real Jy
Total-power spectrum Antenna: BD (01)
Timerange: 00/18:38:03 to 00/18:40:29

Plot file version 206 created 01-AUG-2018 16:38:26

PB+3+2 N18L1 2.UVDATA.1

Freq = 1.6266 GHz, Bw = 8.000 MH No calibration applied and no bandpass applied

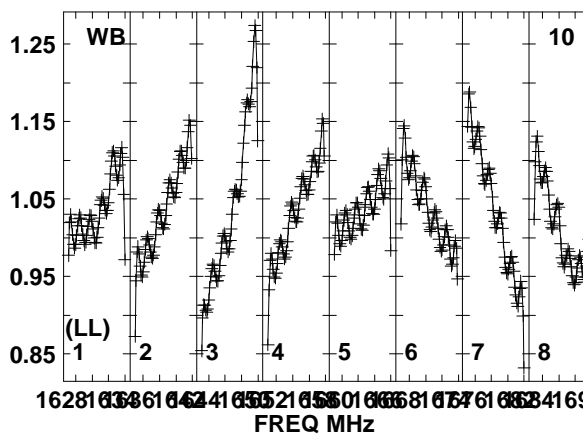
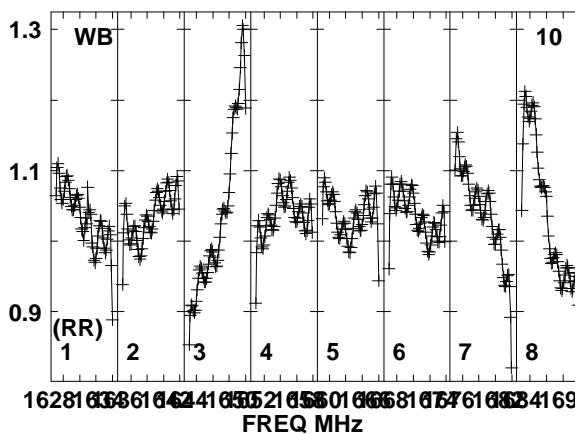
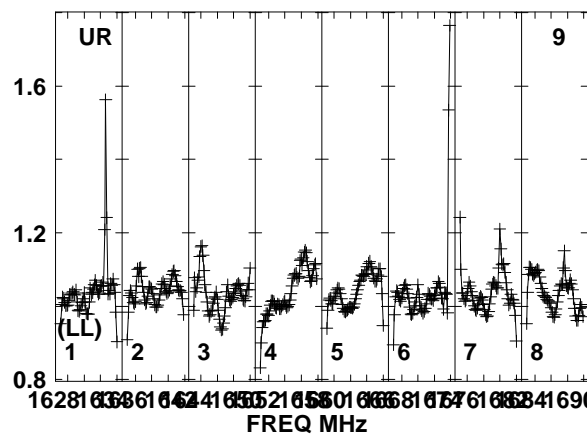
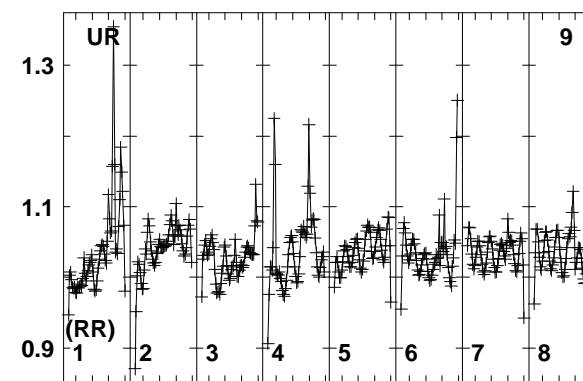
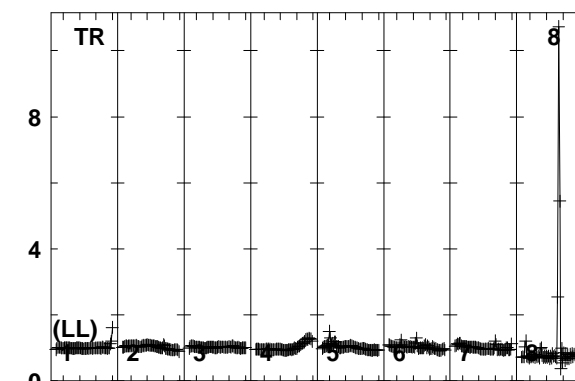
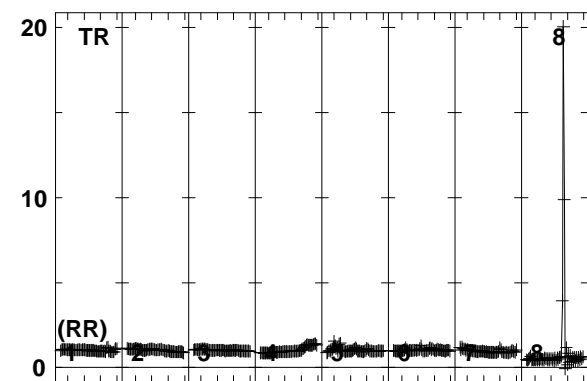
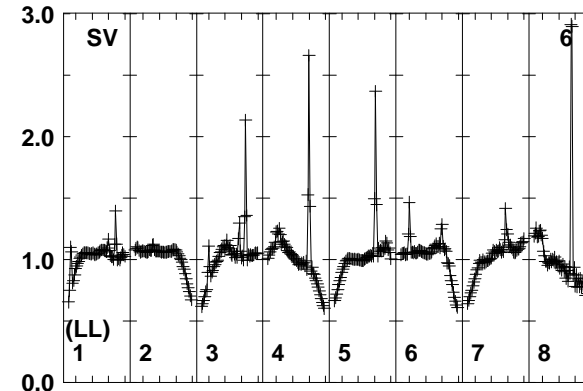
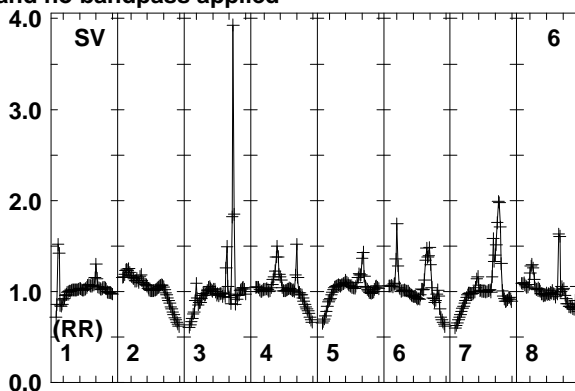
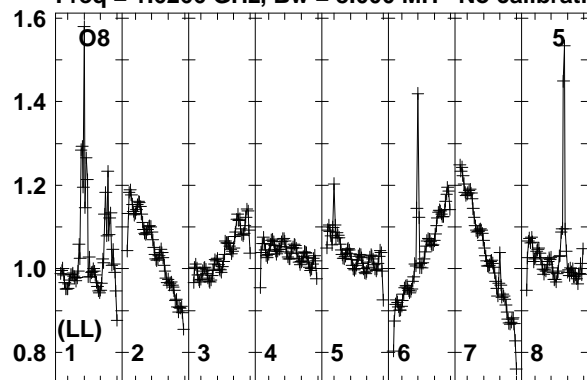

Lower frame: Real Jy
Total-power spectrum Antenna: O8 (05)
Timerange: 00/18:38:03 to 00/18:40:29

Plot file version 207 created 01-AUG-2018 16:38:27

PB+3+2 N18L1 2.UVDATA.1

Freq = 1.6266 GHz, Bw = 8.000 MH No calibration applied and no bandpass applied

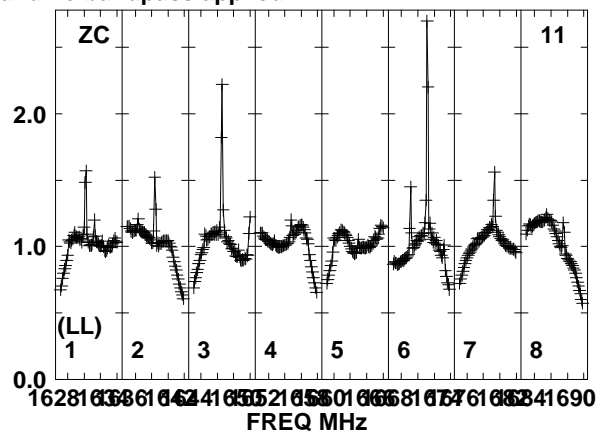
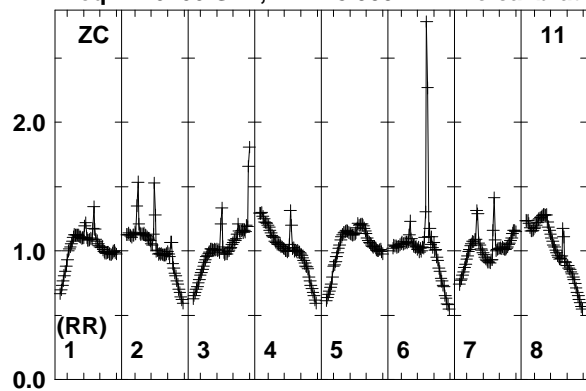

Lower frame: Real Jy
Total-power spectrum Antenna: ZC (11)
Timerange: 00/18:38:03 to 00/18:40:29

Plot file version 208 created 01-AUG-2018 16:38:27

J0530+1331 N18L1 2.UVDATA.1

Freq = 1.6266 GHz, Bw = 8.000 MH No calibration applied and no bandpass applied

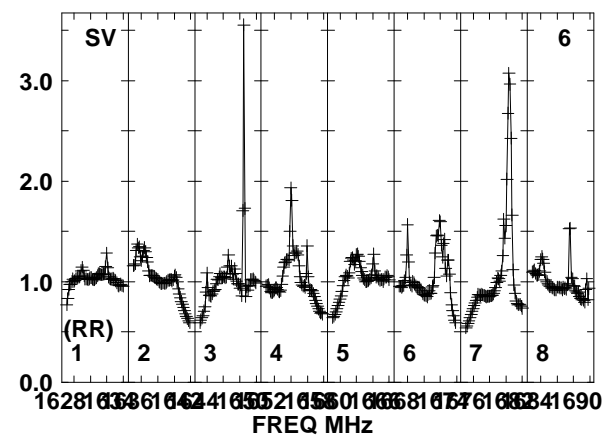
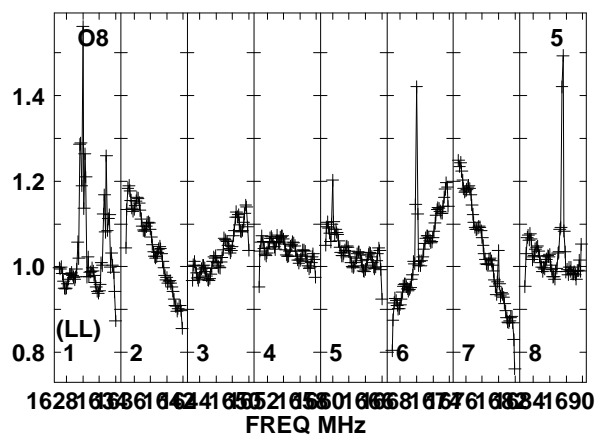
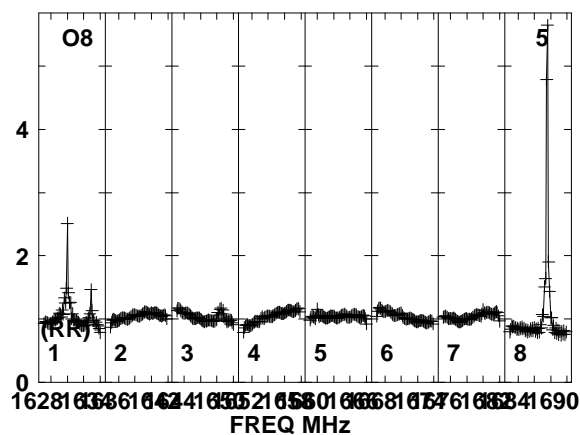
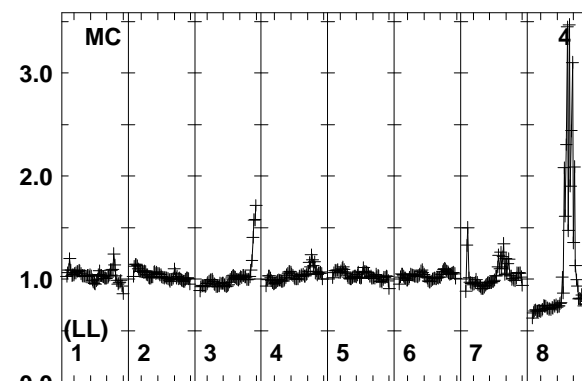
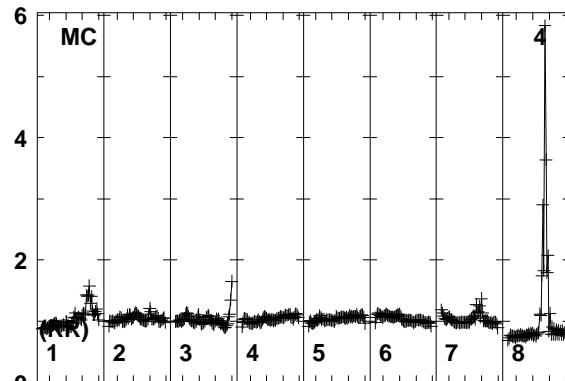
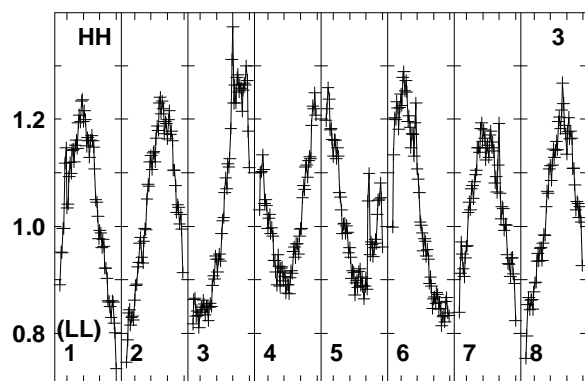
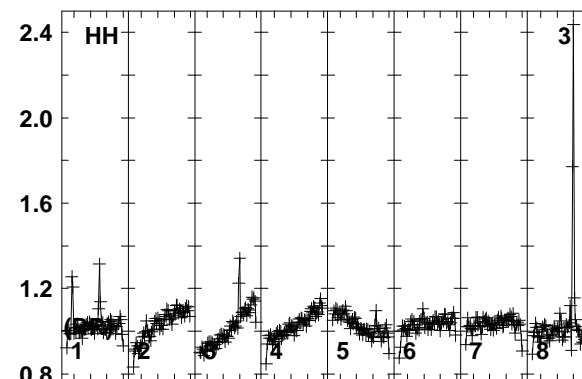
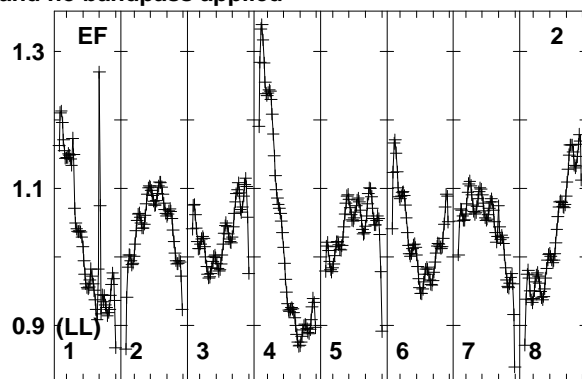
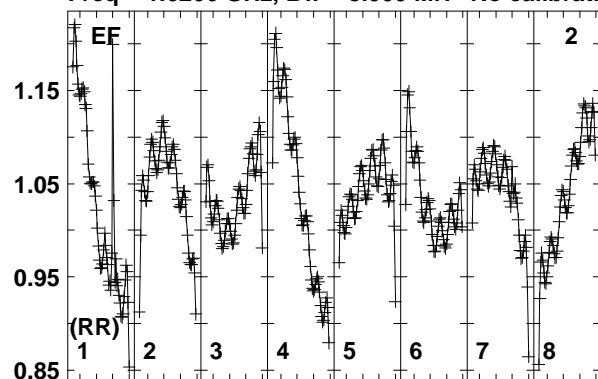

Lower frame: Real Jy
Total-power spectrum Antenna: EF (02)
Timerange: 00:18:41:11 to 00:18:42:29

Plot file version 209 created 01-AUG-2018 16:38:27

J0530+1331 N18L1 2.UVDATA.1

Freq = 1.6266 GHz, Bw = 8.000 MH No calibration applied and no bandpass applied

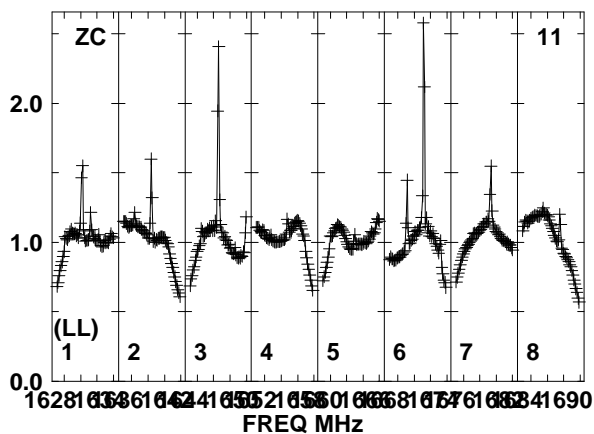
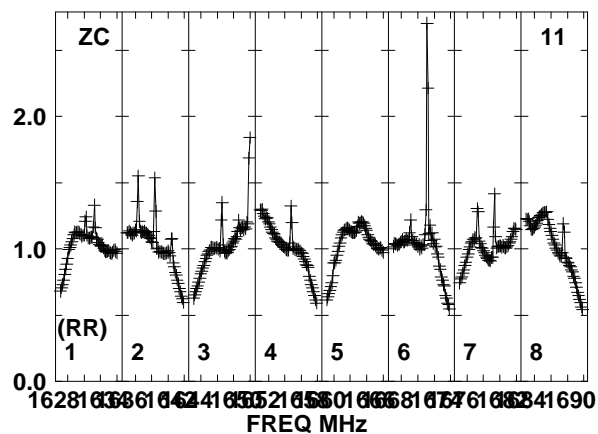
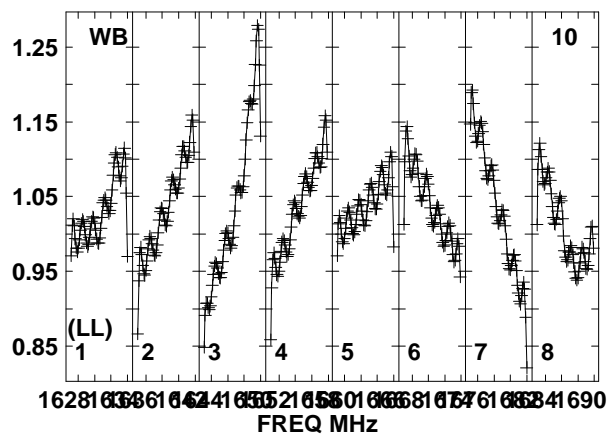
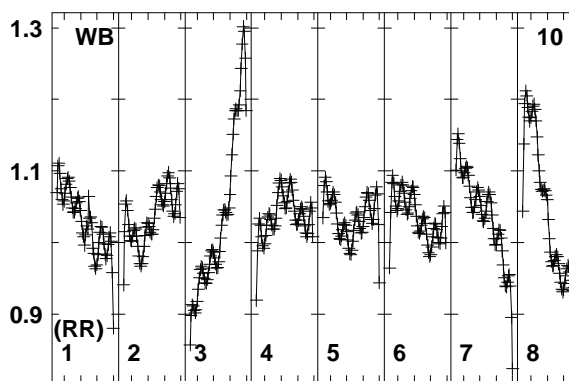
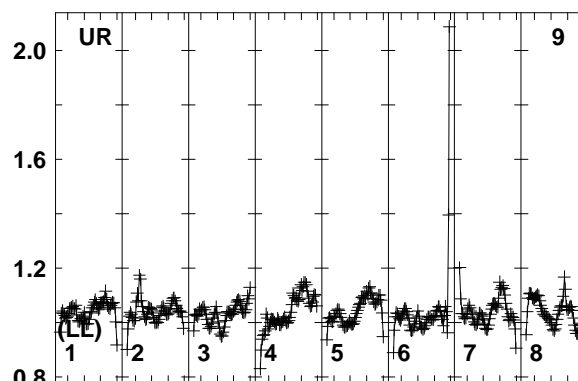
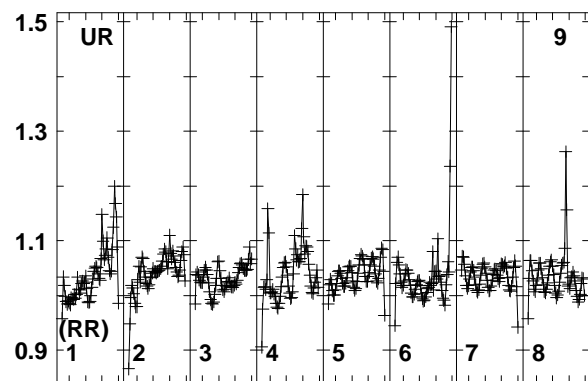
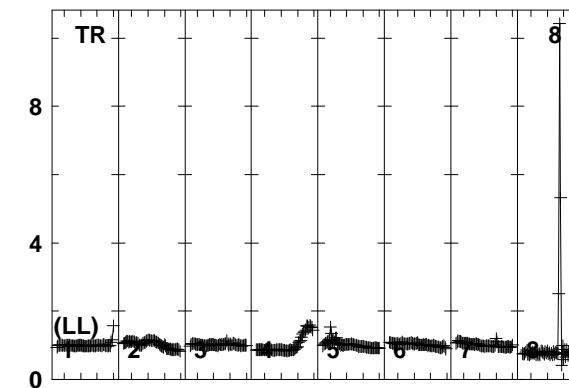
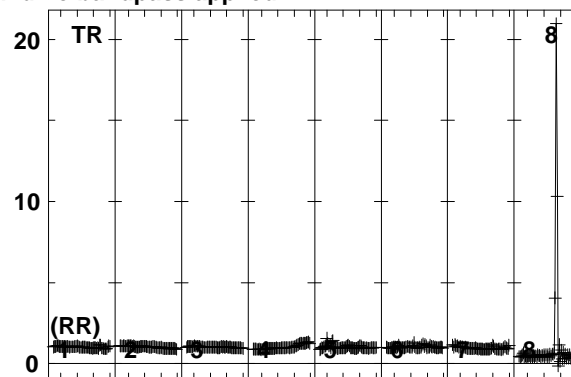
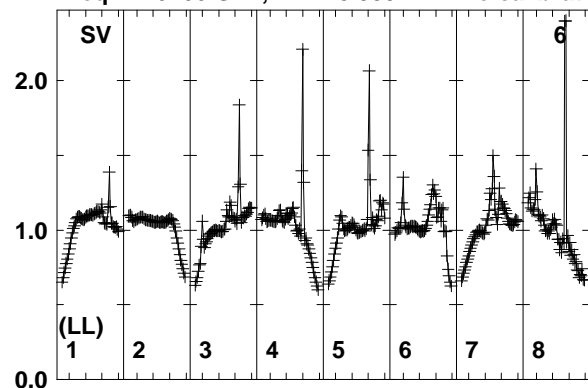

Lower frame: Real Jy
Total-power spectrum Antenna: SV (06)
Timerange: 00/18:41:11 to 00/18:42:29

Plot file version 210 created 01-AUG-2018 16:38:27

PB+2+2 N18L1 2.UVDATA.1

Freq = 1.6266 GHz, Bw = 8.000 MH No calibration applied and no bandpass applied

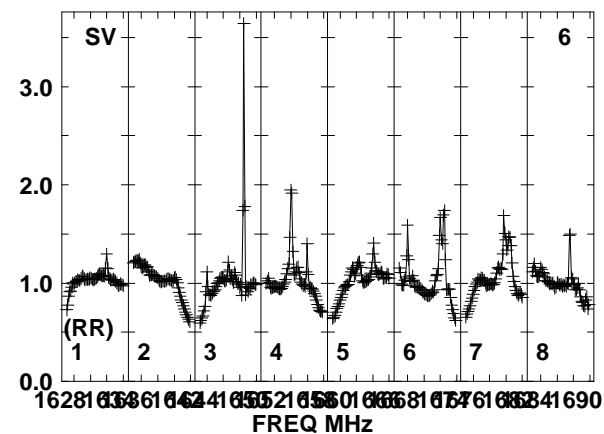
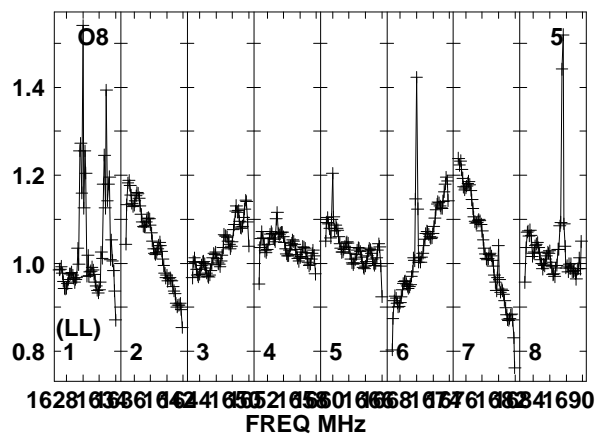
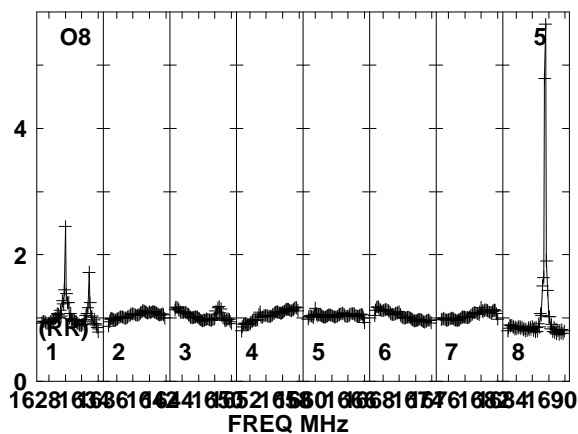
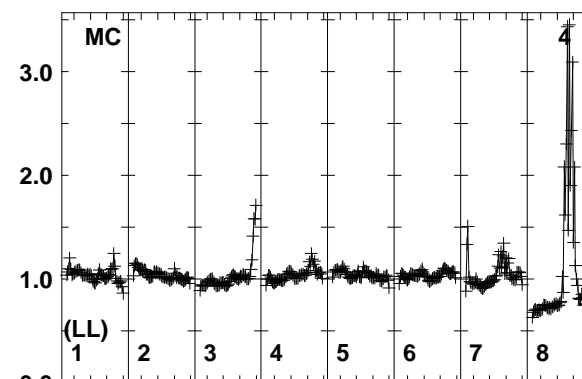
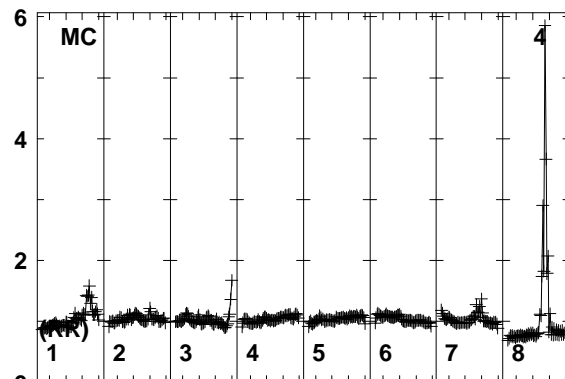
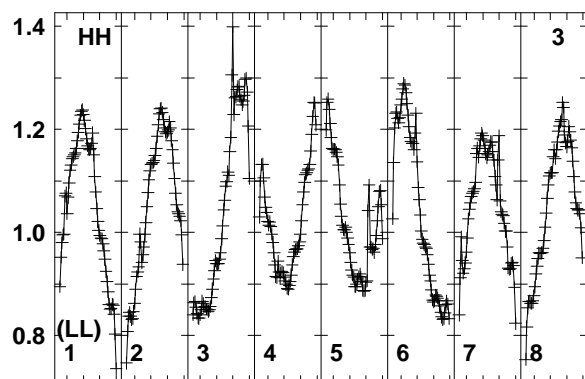
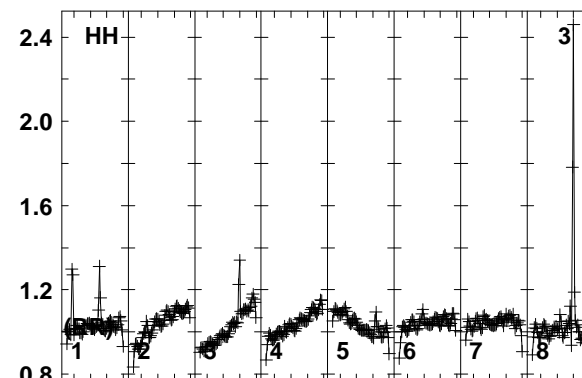
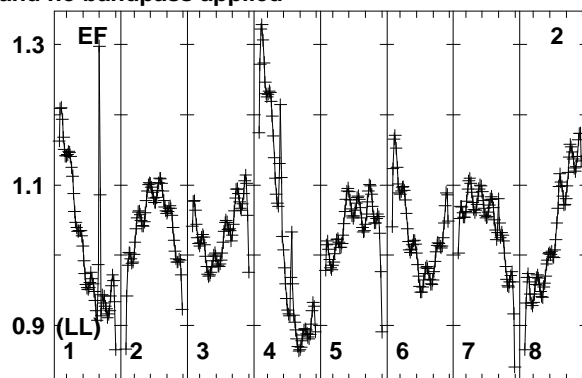
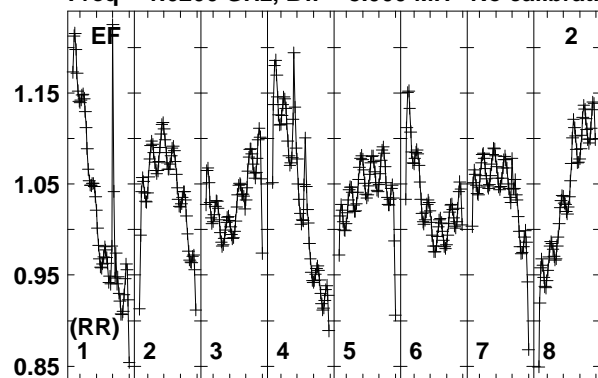

Lower frame: Real Jy
Total-power spectrum Antenna: EF (02)
Timerange: 00/18:42:33 to 00/18:44:59

Plot file version 211 created 01-AUG-2018 16:38:27

PB+2+2 N18L1 2.UVDATA.1

Freq = 1.6266 GHz, Bw = 8.000 MH No calibration applied and no bandpass applied

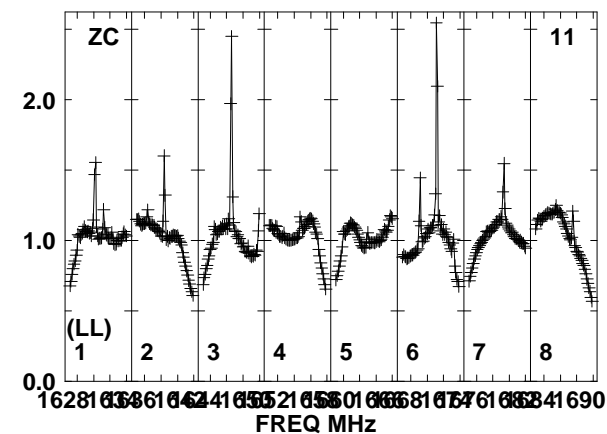
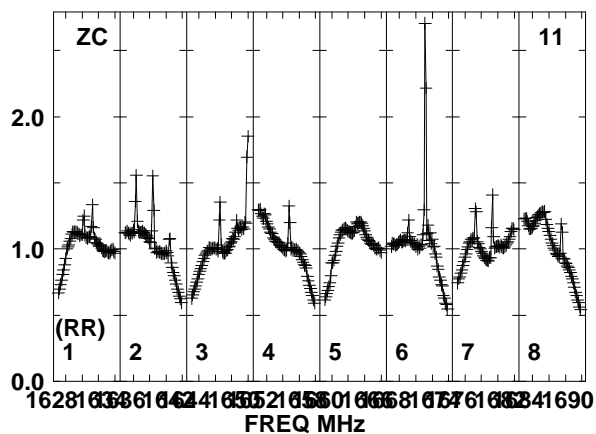
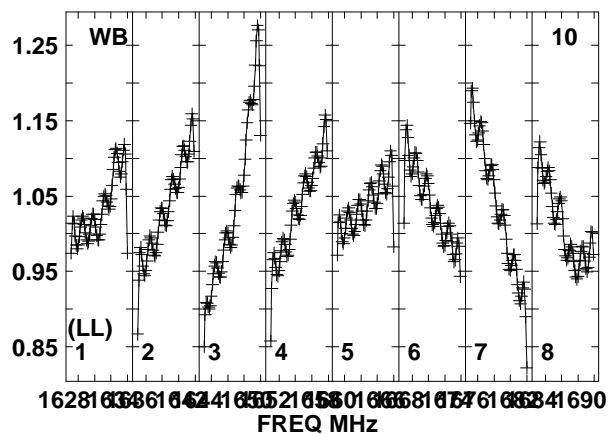
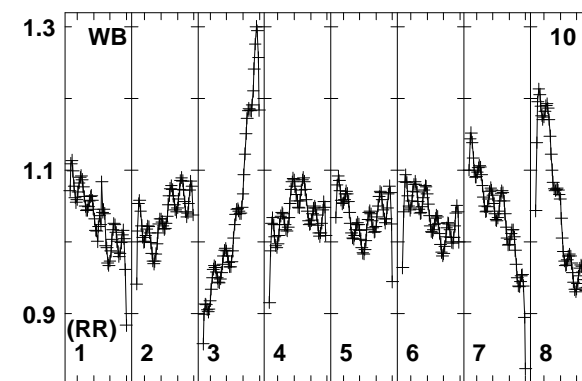
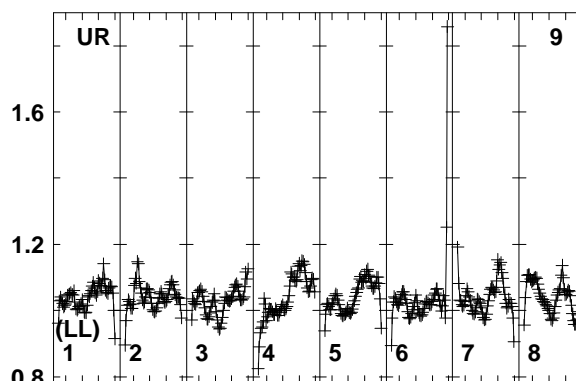
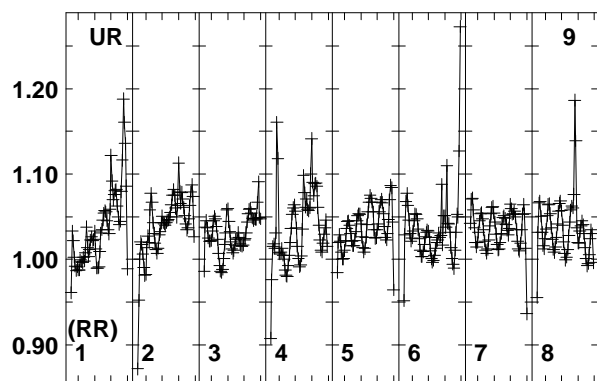
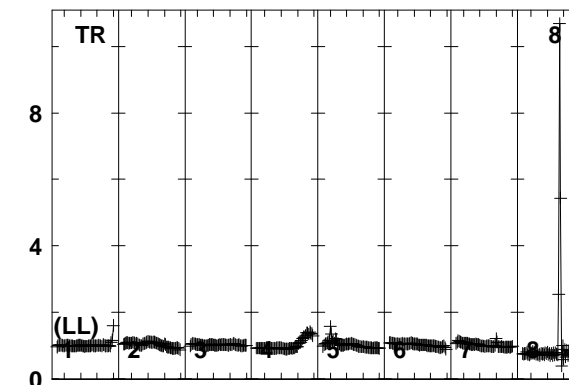
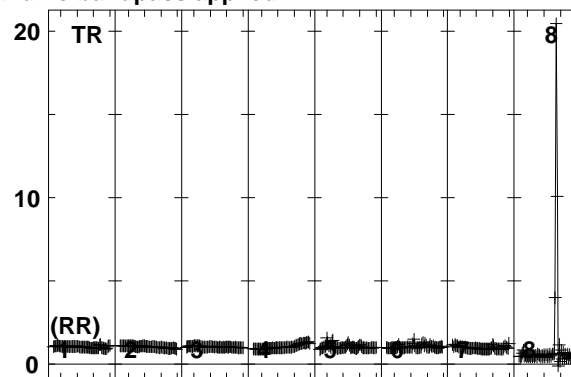
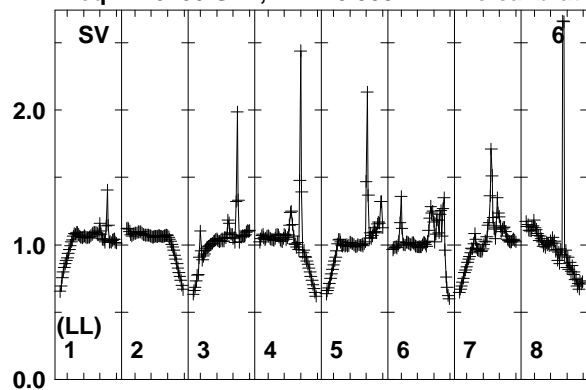

Lower frame: Real Jy
Total-power spectrum Antenna: SV (06)
Timerange: 00/18:42:33 to 00/18:44:59

Plot file version 212 created 01-AUG-2018 16:38:27

PB+1+2 N18L1 2.UVDATA.1

Freq = 1.6266 GHz, Bw = 8.000 MH No calibration applied and no bandpass applied

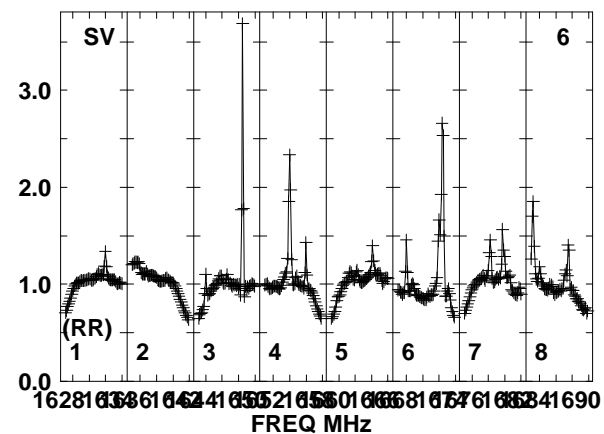
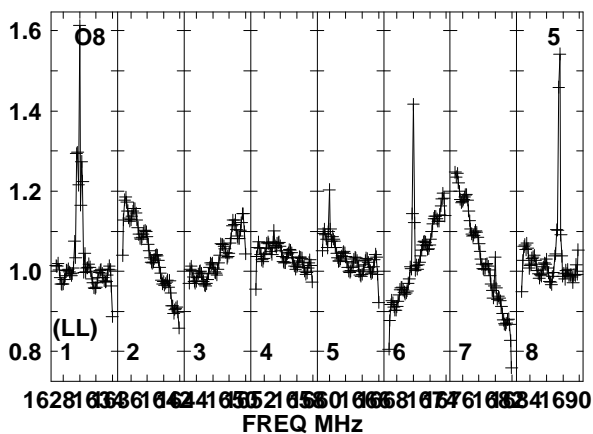
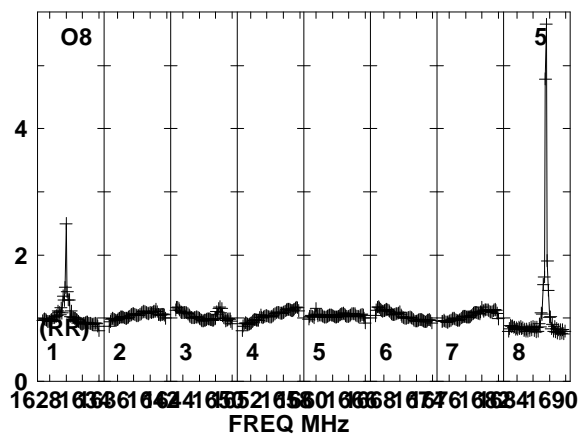
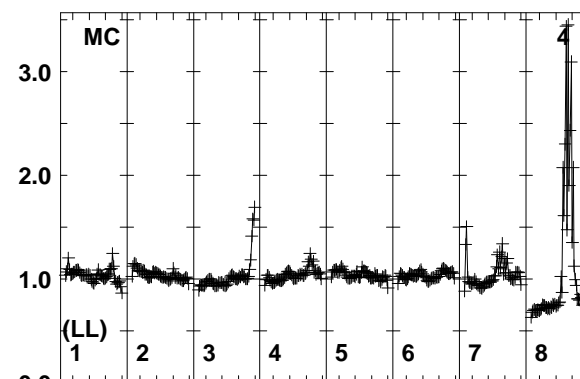
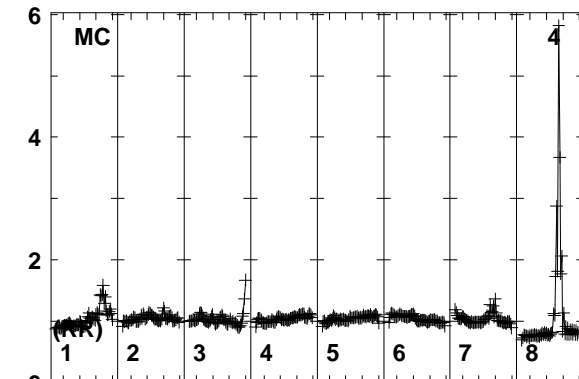
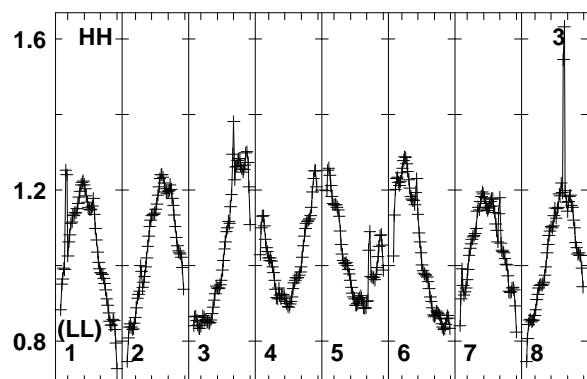
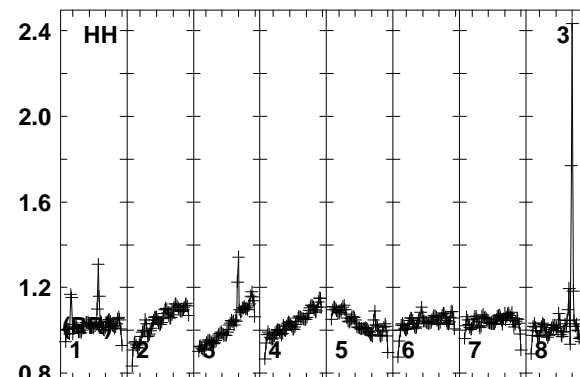
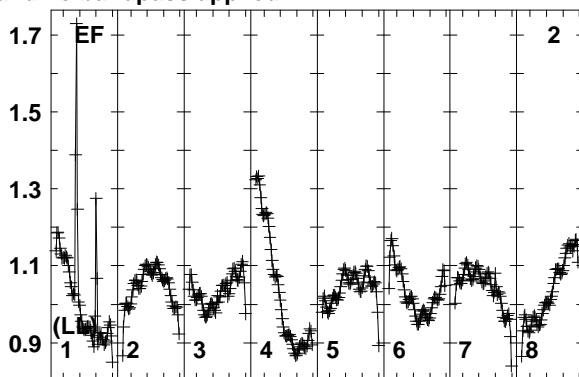
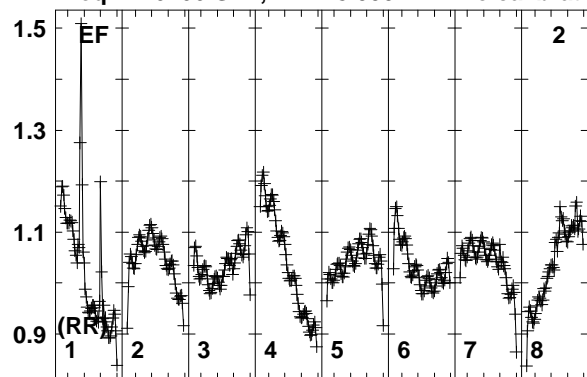

Lower frame: Real Jy
Total-power spectrum Antenna: EF (02)
Timerange: 00/18:45:03 to 00/18:47:29

Plot file version 213 created 01-AUG-2018 16:38:27

PB+1+2 N18L1 2.UVDATA.1

Freq = 1.6266 GHz, Bw = 8.000 MH No calibration applied and no bandpass applied

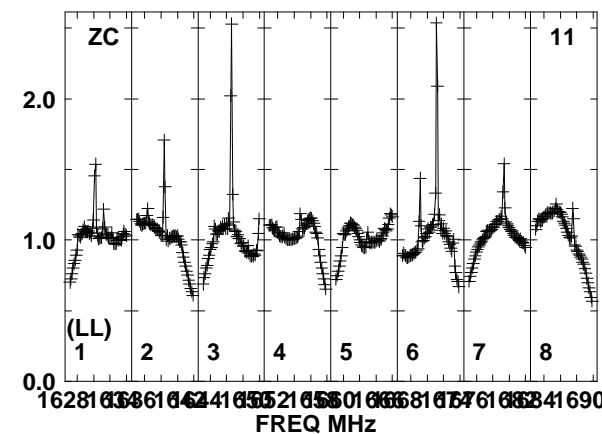
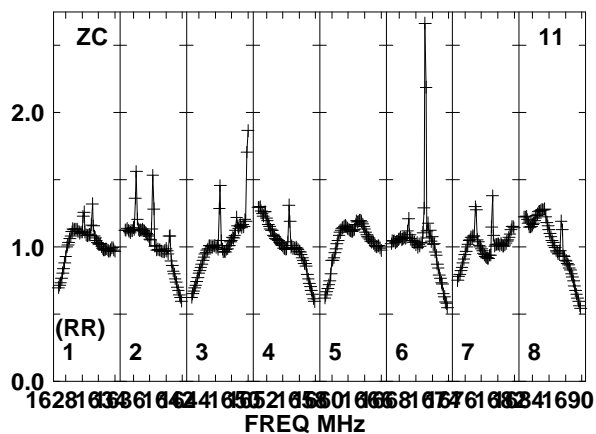
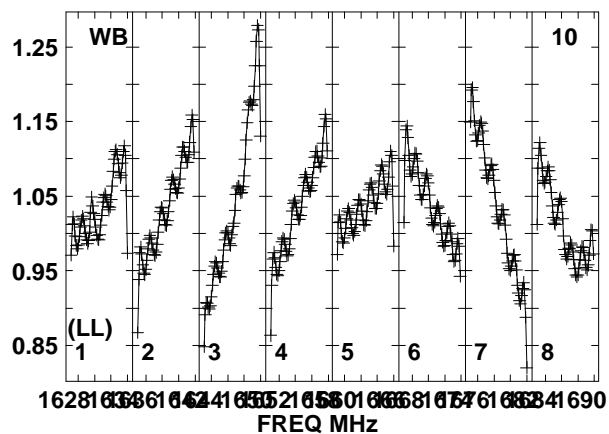
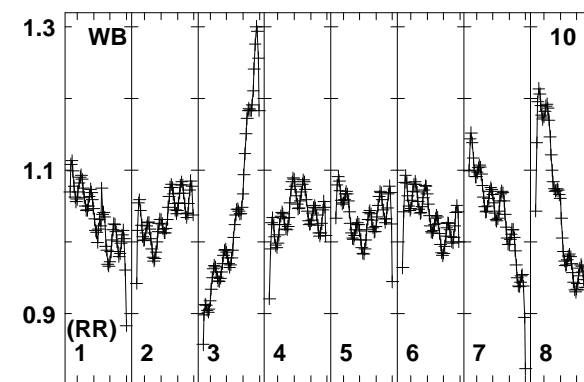
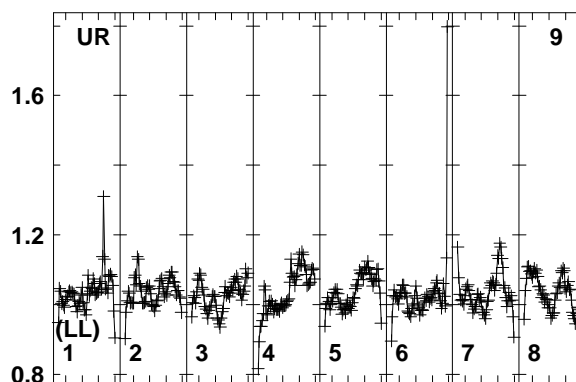
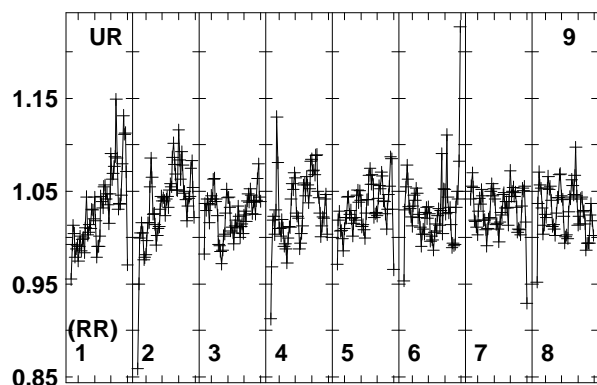
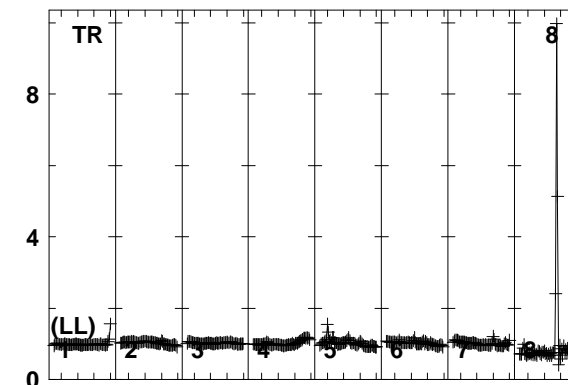
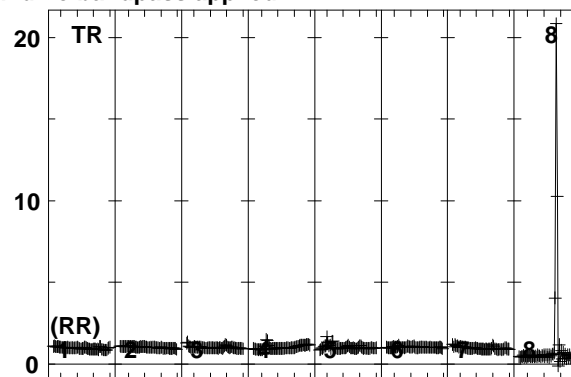
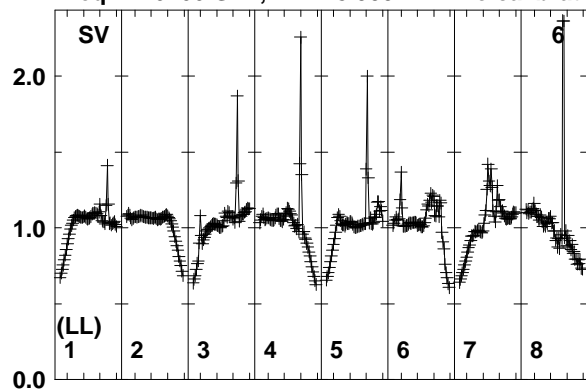

Lower frame: Real Jy
Total-power spectrum Antenna: SV (06)
Timerange: 00/18:45:03 to 00/18:47:29

Plot file version 214 created 01-AUG-2018 16:38:27

PB+0+2 N18L1 2.UVDATA.1

Freq = 1.6266 GHz, Bw = 8.000 MH No calibration applied and no bandpass applied

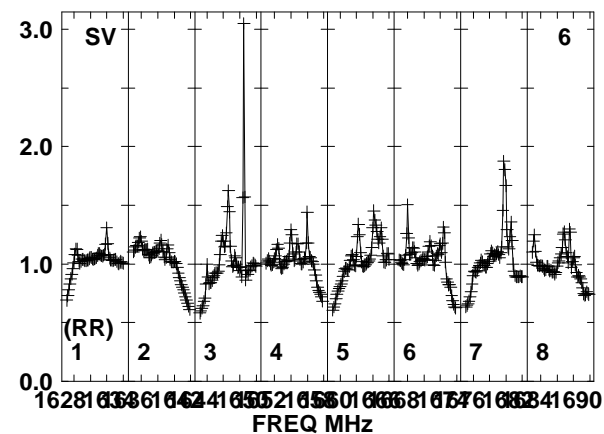
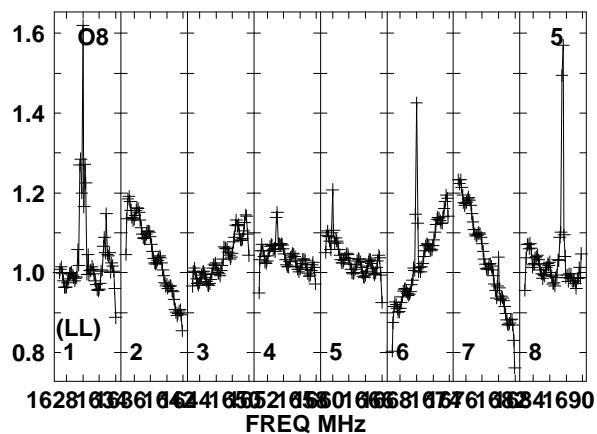
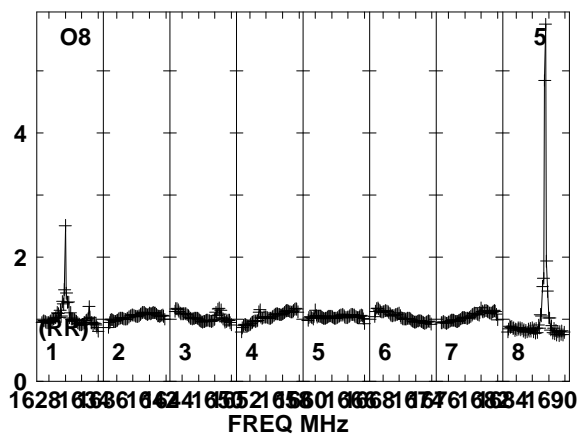
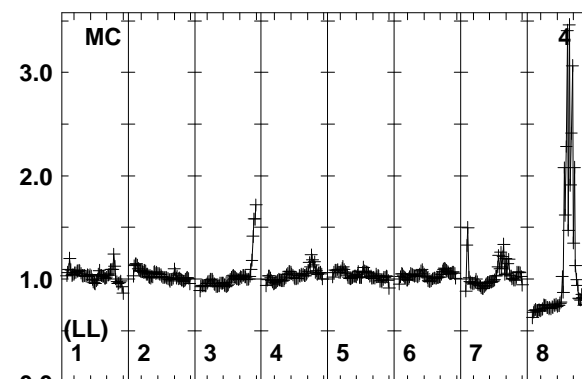
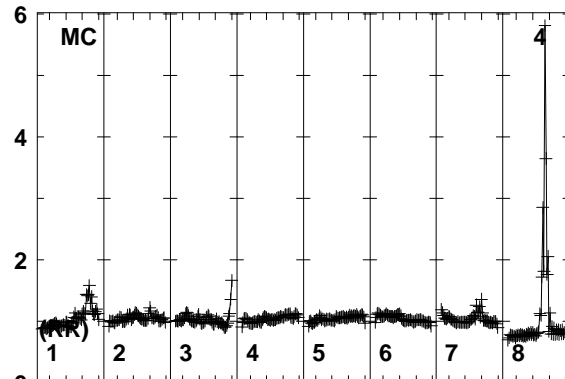
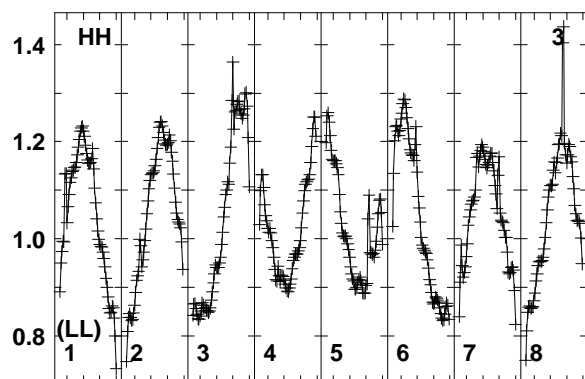
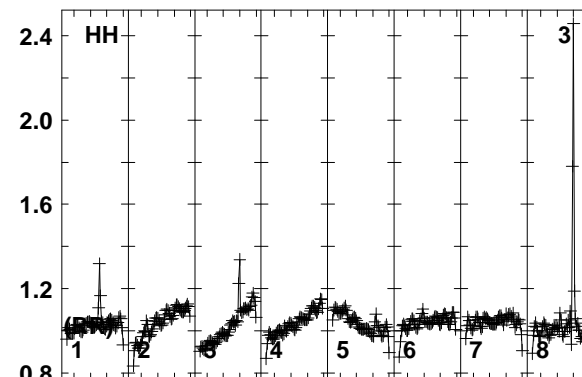
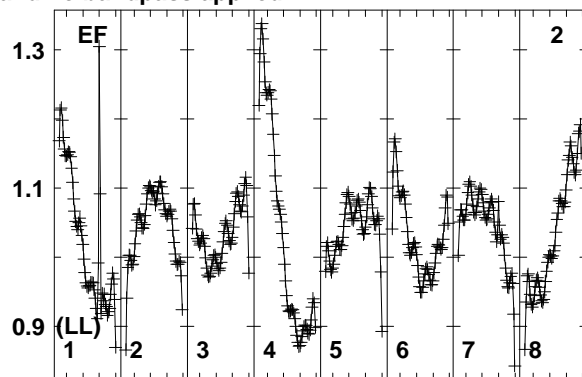
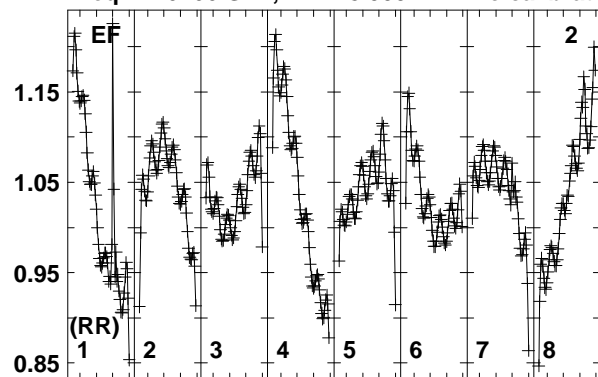

Lower frame: Real Jy
Total-power spectrum Antenna: EF (02)
Timerange: 00:18:47:35 to 00:18:49:59

Plot file version 215 created 01-AUG-2018 16:38:28

PB+0+2 N18L1 2.UVDATA.1

Freq = 1.6266 GHz, Bw = 8.000 MH No calibration applied and no bandpass applied

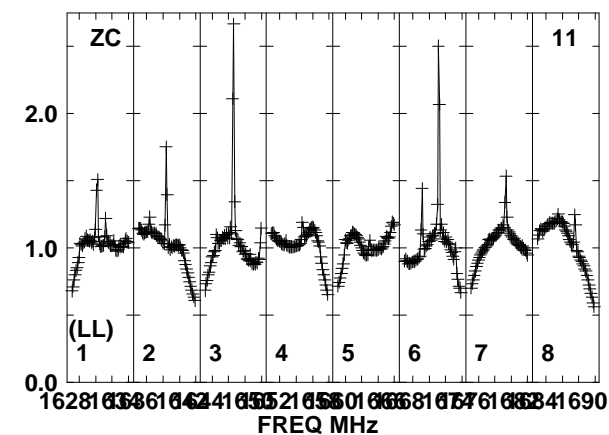
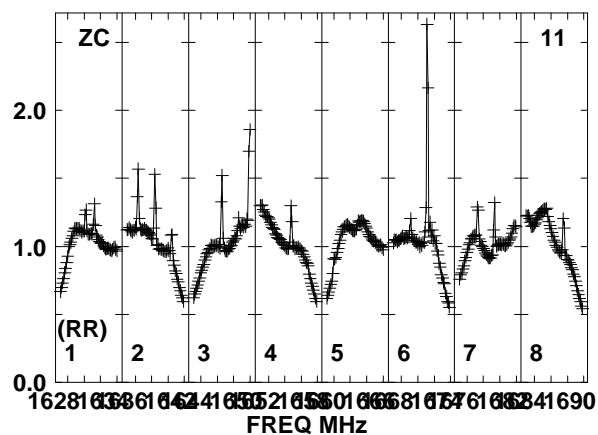
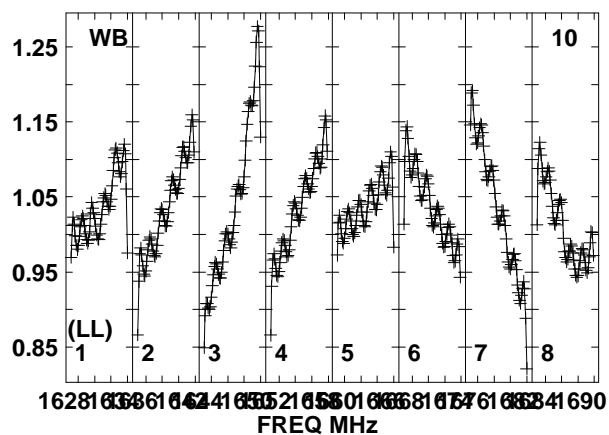
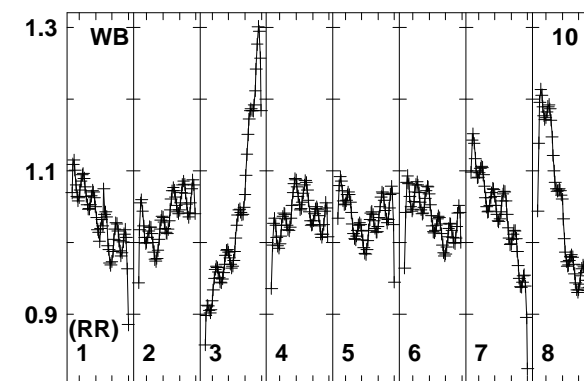
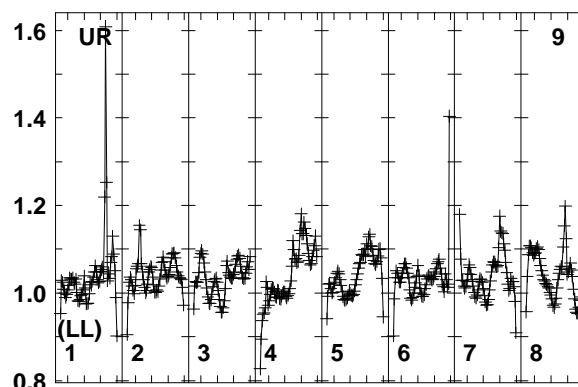
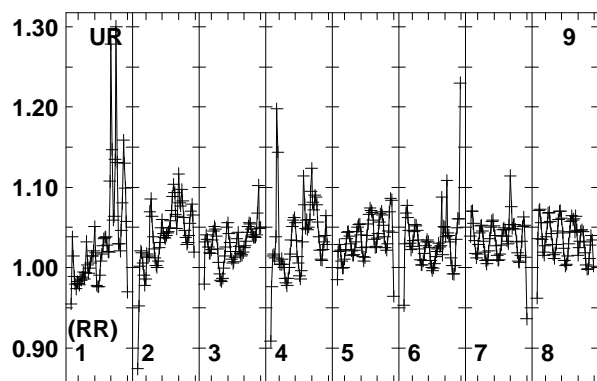
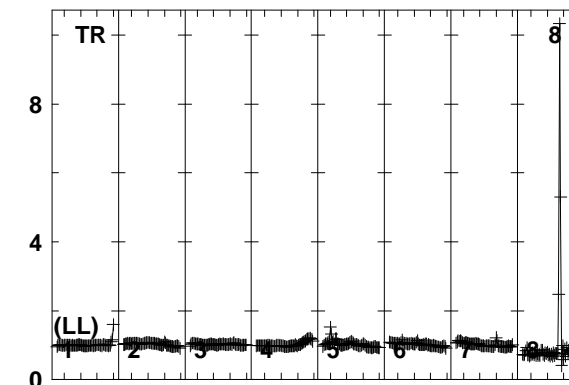
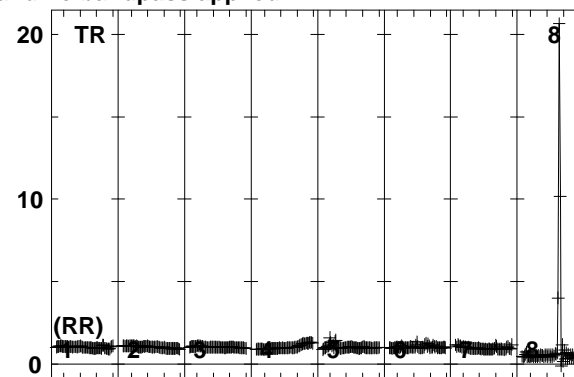
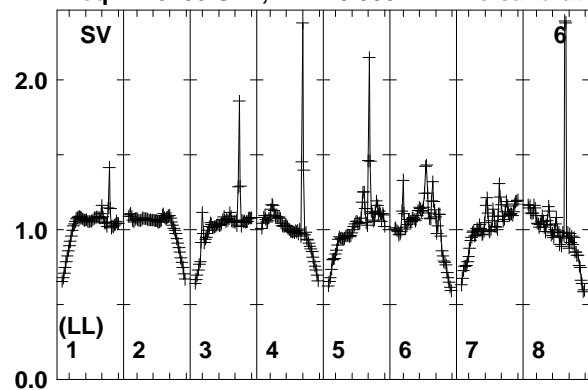

Lower frame: Real Jy
Total-power spectrum Antenna: SV (06)
Timerange: 00/18:47:35 to 00/18:49:59

Plot file version 216 created 01-AUG-2018 16:38:28

PB-1+2 N18L1 2.UVDATA.1

Freq = 1.6266 GHz, Bw = 8.000 MH No calibration applied and no bandpass applied

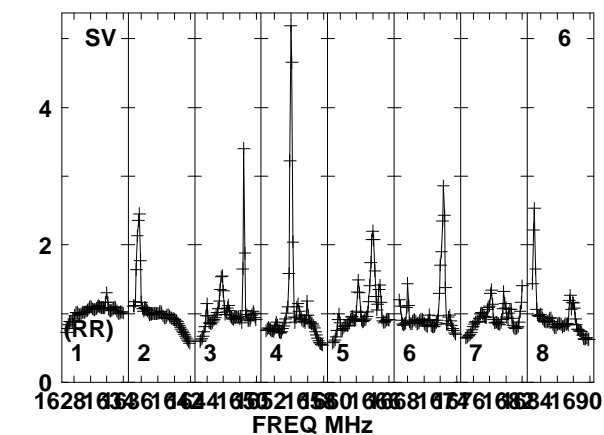
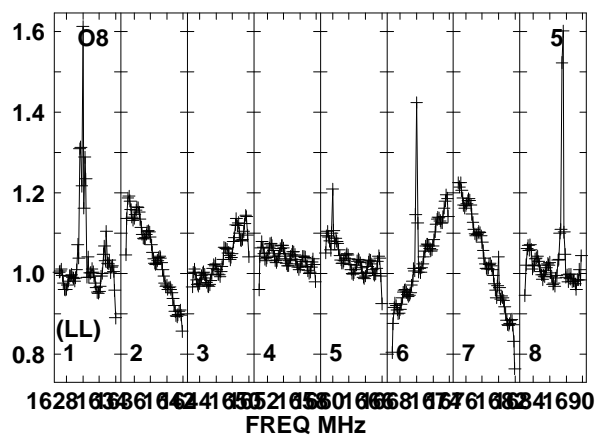
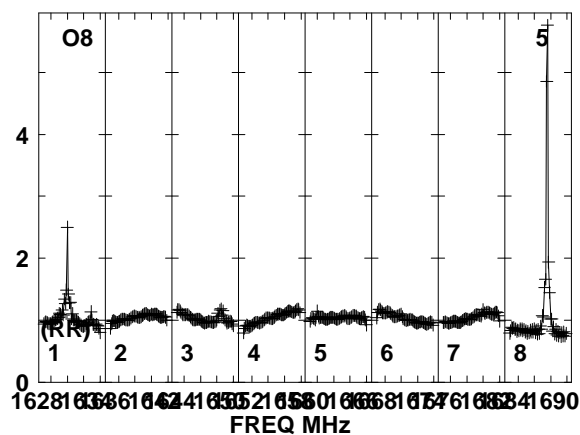
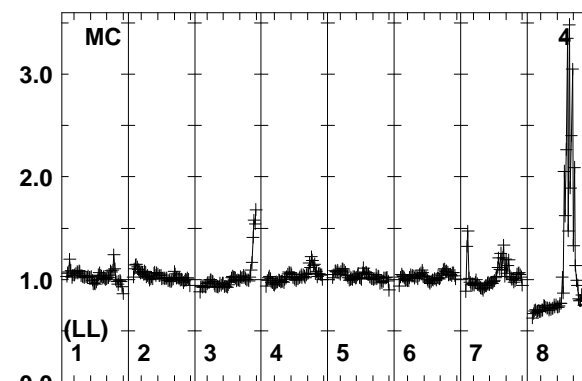
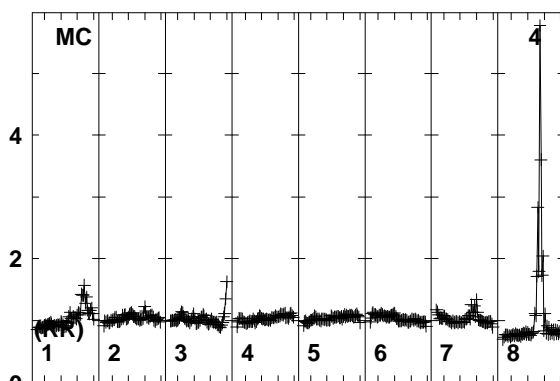
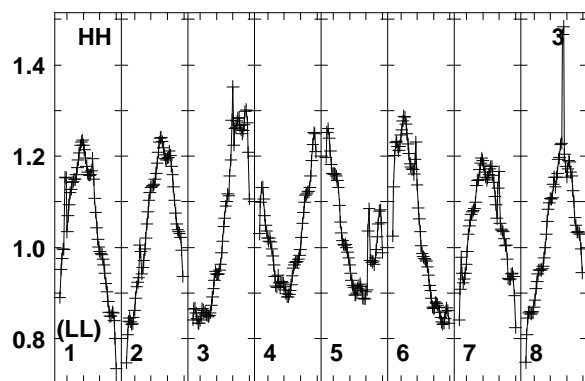
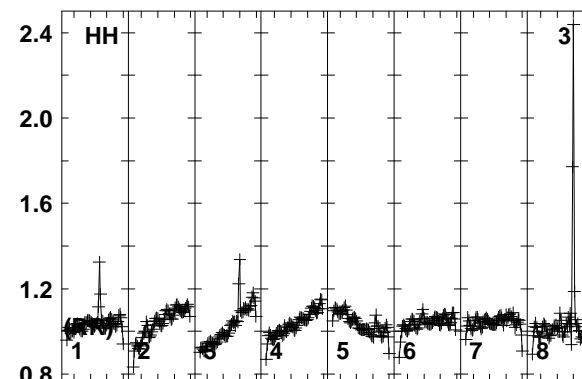
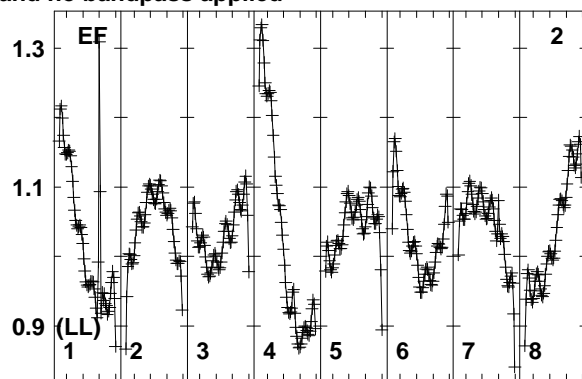
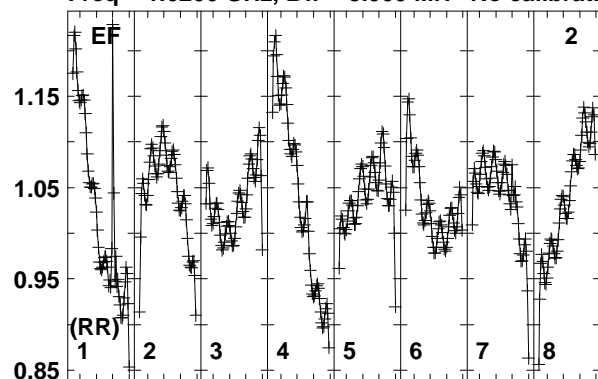

Lower frame: Real Jy
Total-power spectrum Antenna: EF (02)
Timerange: 00/18:50:03 to 00/18:52:29

Plot file version 217 created 01-AUG-2018 16:38:28

PB-1+2 N18L1 2.UVDATA.1

Freq = 1.6266 GHz, Bw = 8.000 MH No calibration applied and no bandpass applied

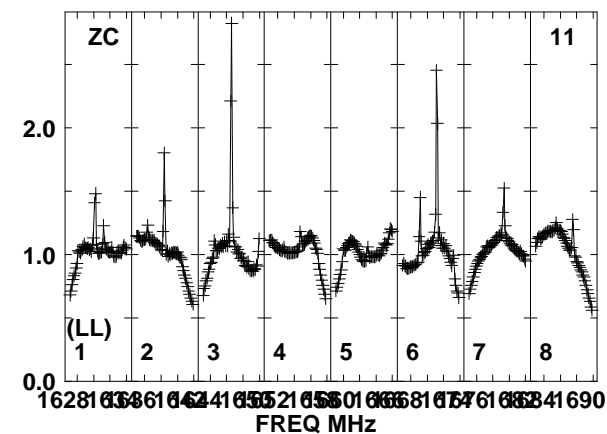
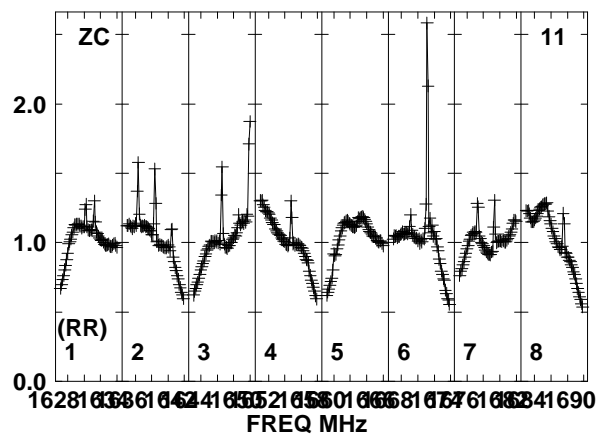
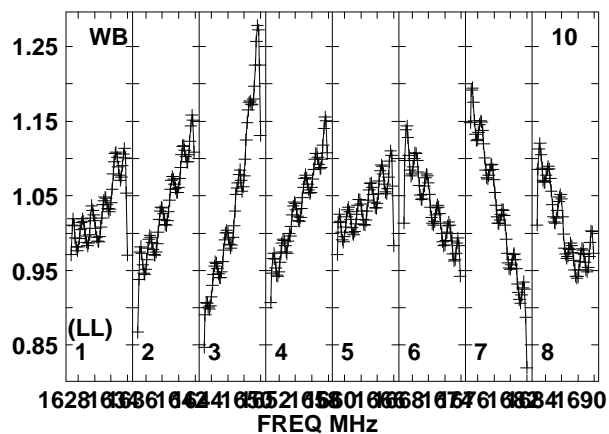
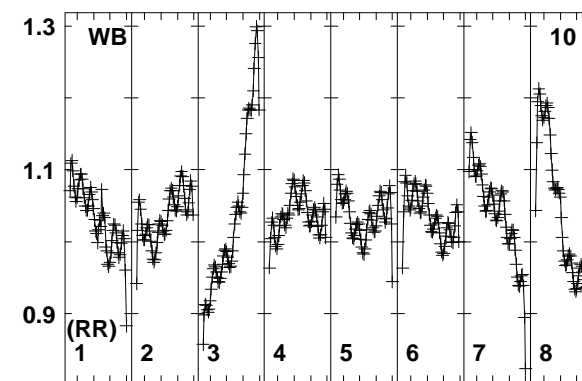
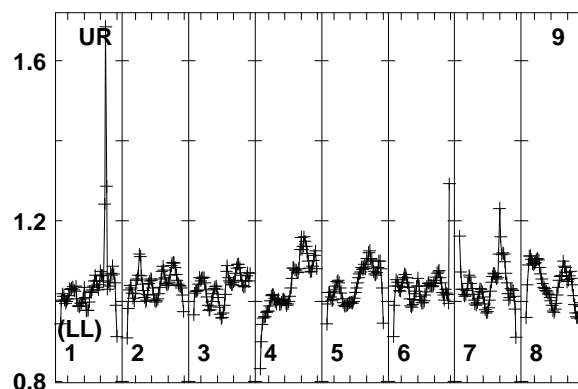
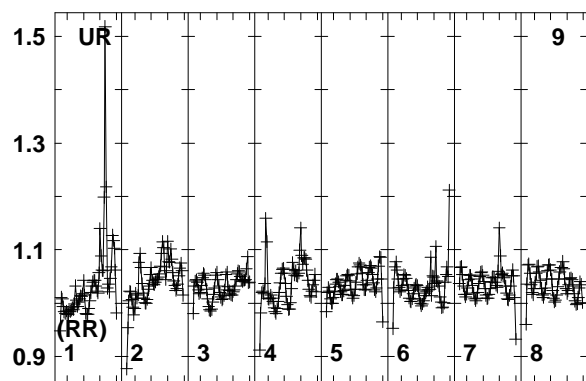
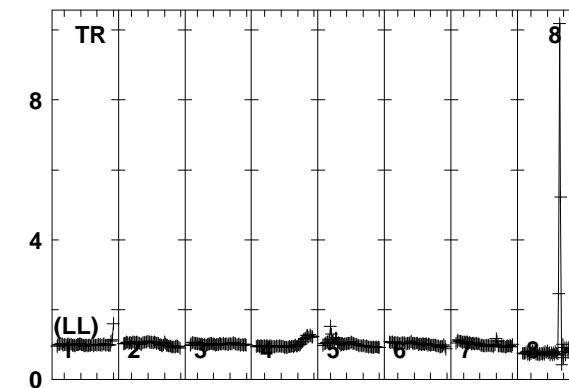
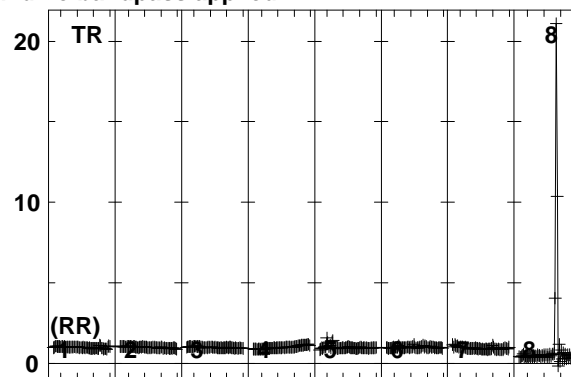
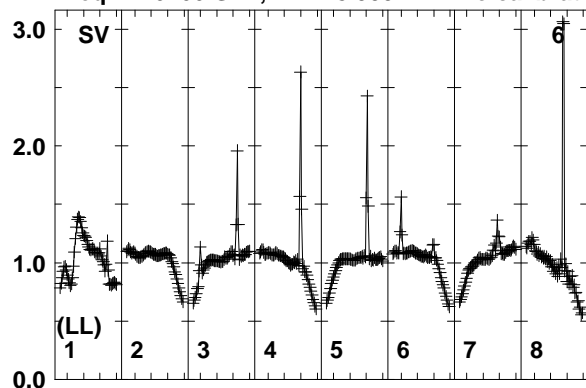

Lower frame: Real Jy
Total-power spectrum Antenna: SV (06)
Timerange: 00/18:50:03 to 00/18:52:29

Plot file version 218 created 01-AUG-2018 16:38:28

J0530+1331 N18L1 2.UVDATA.1

Freq = 1.6266 GHz, Bw = 8.000 MH No calibration applied and no bandpass applied

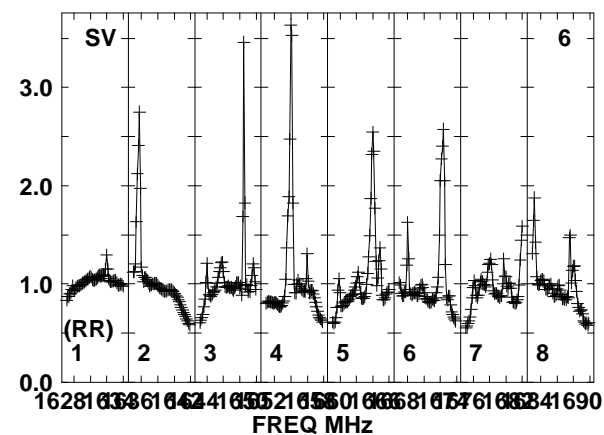
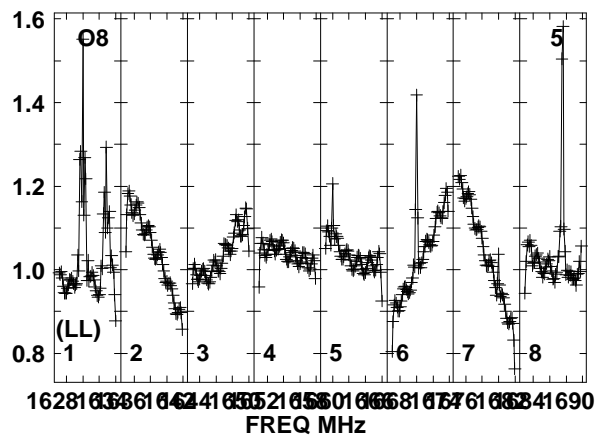
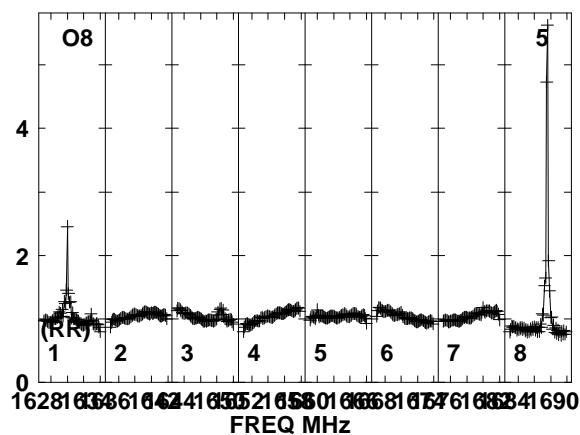
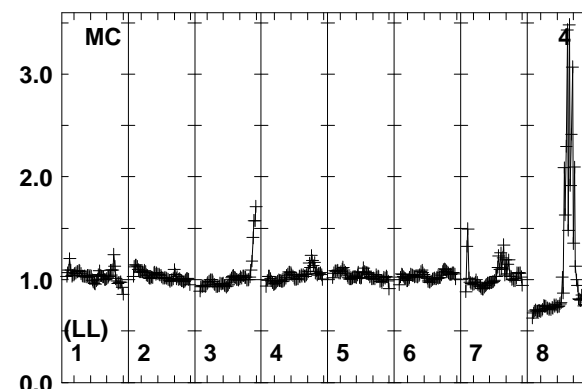
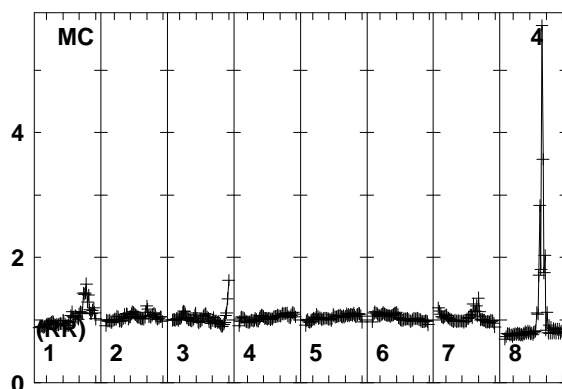
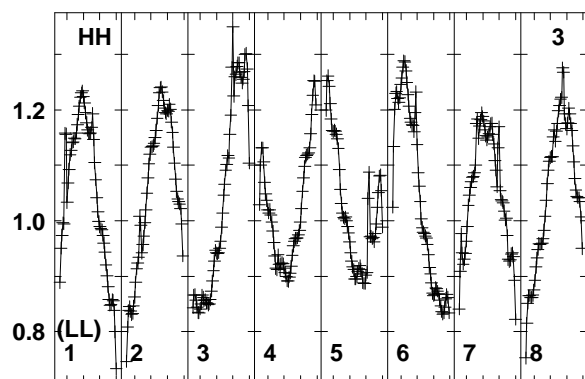
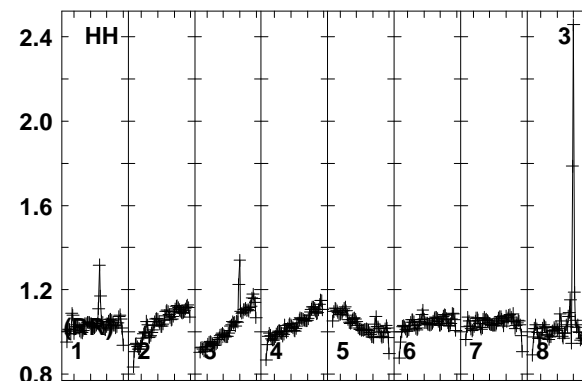
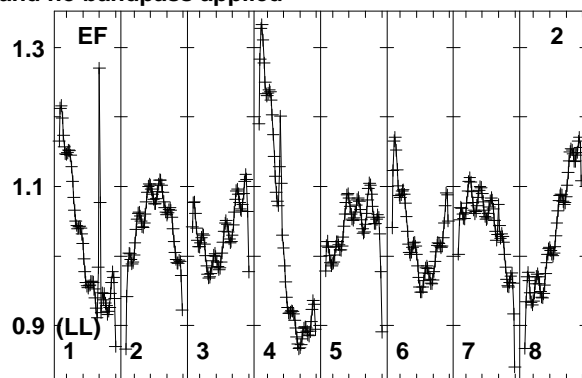
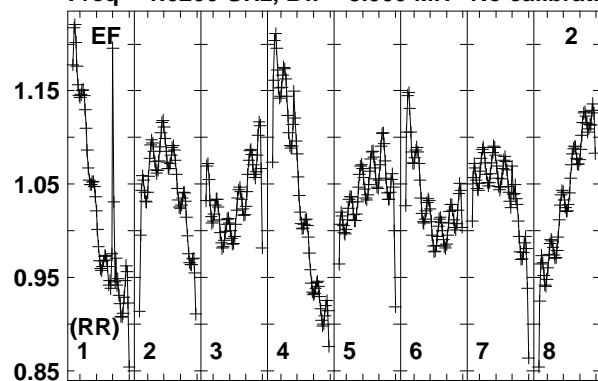

Lower frame: Real Jy
Total-power spectrum Antenna: EF (02)
Timerange: 00:18:53:11 to 00:18:54:29

Plot file version 219 created 01-AUG-2018 16:38:28

J0530+1331 N18L1 2.UVDATA.1

Freq = 1.6266 GHz, Bw = 8.000 MH No calibration applied and no bandpass applied

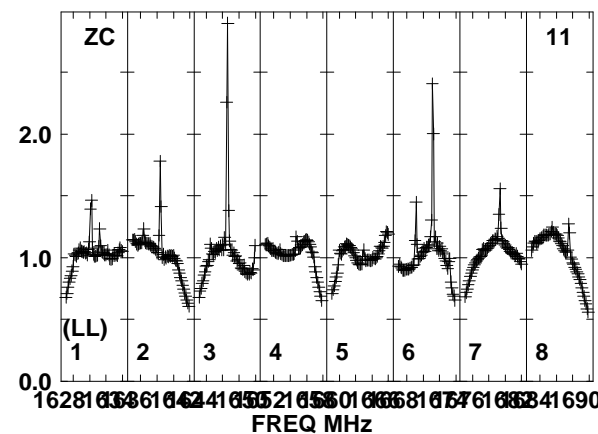
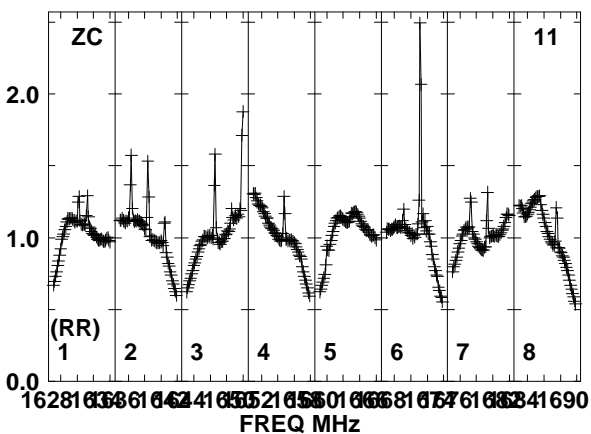
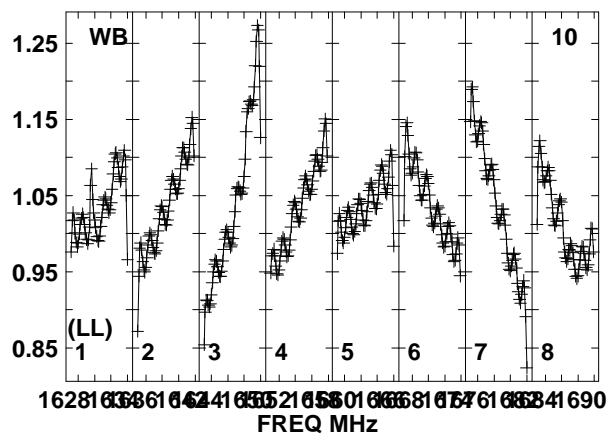
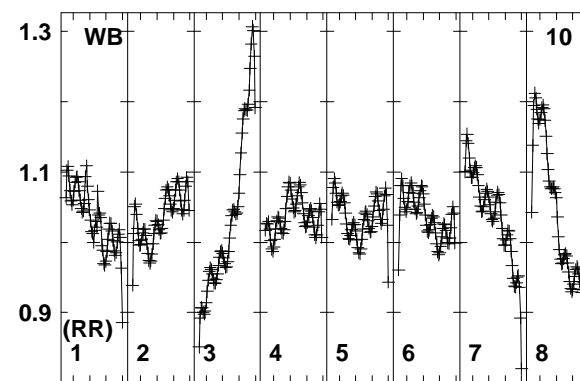
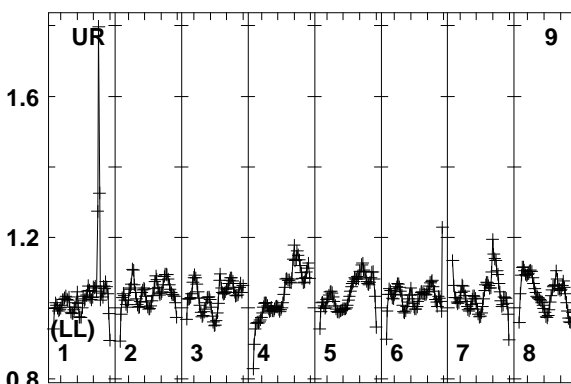
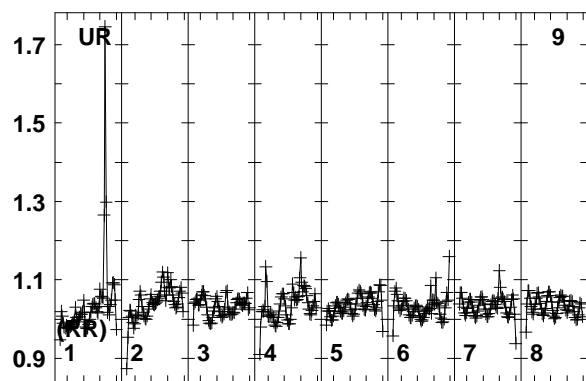
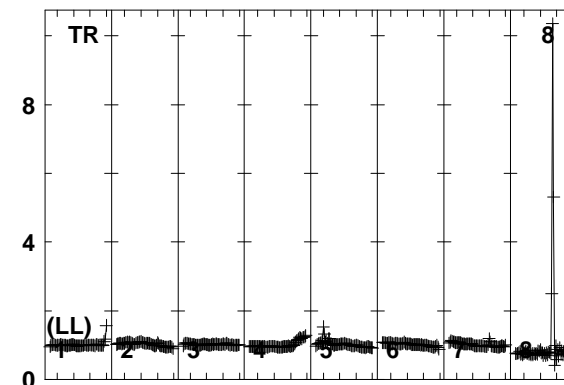
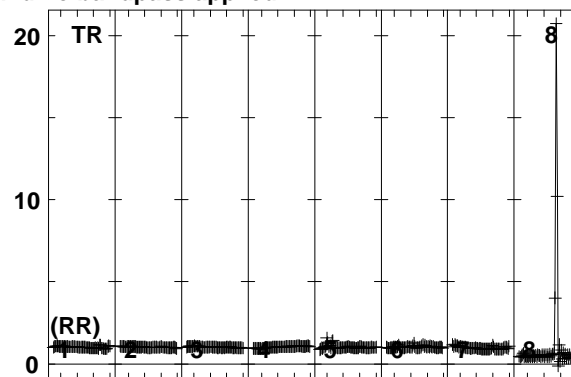
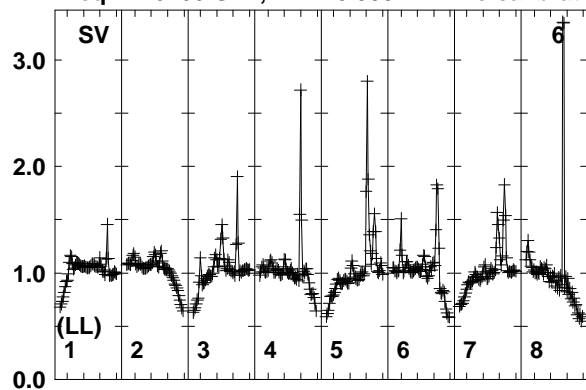

Lower frame: Real Jy
Total-power spectrum Antenna: SV (06)
Timerange: 00/18:53:11 to 00/18:54:29

Plot file version 220 created 01-AUG-2018 16:38:28

PB-2+2 N18L1 2.UVDATA.1

Freq = 1.6266 GHz, Bw = 8.000 MH No calibration applied and no bandpass applied

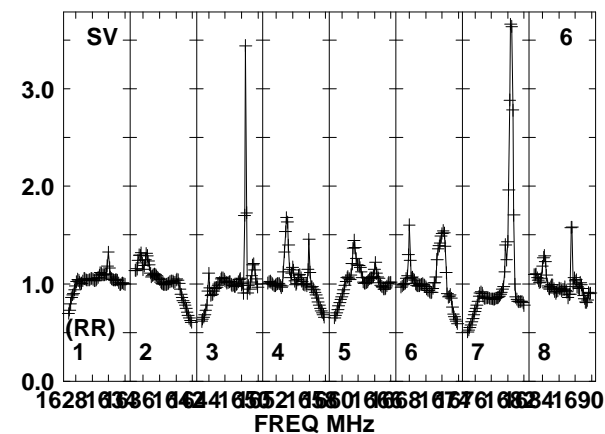
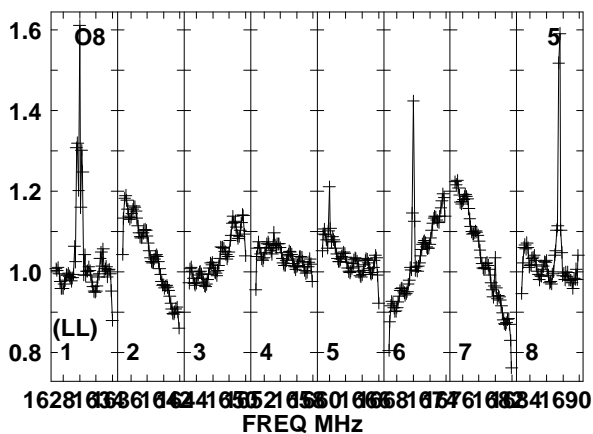
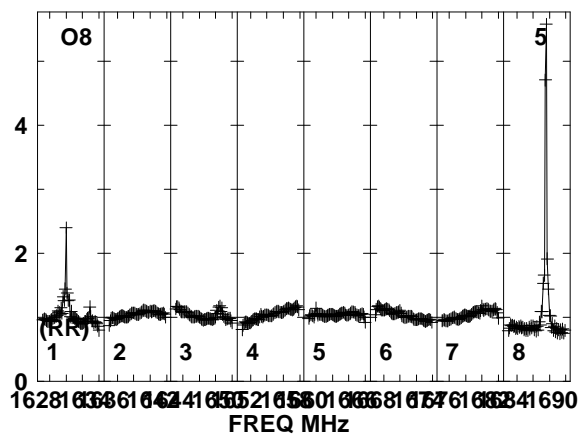
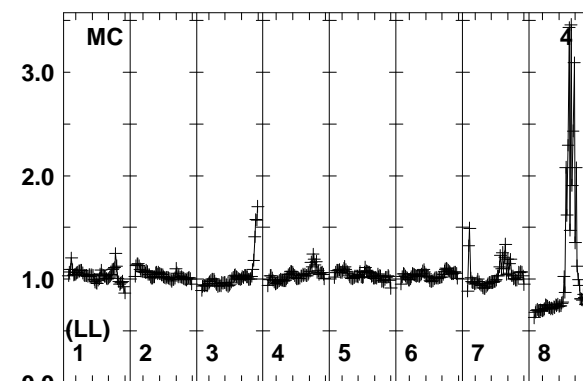
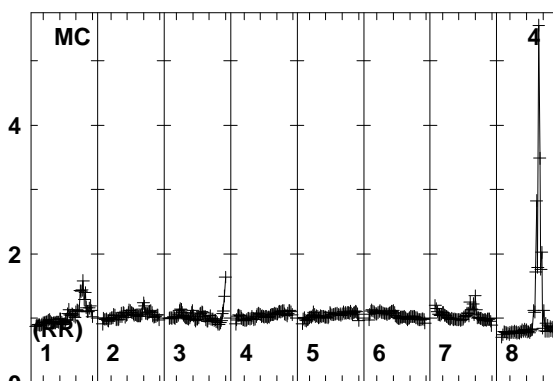
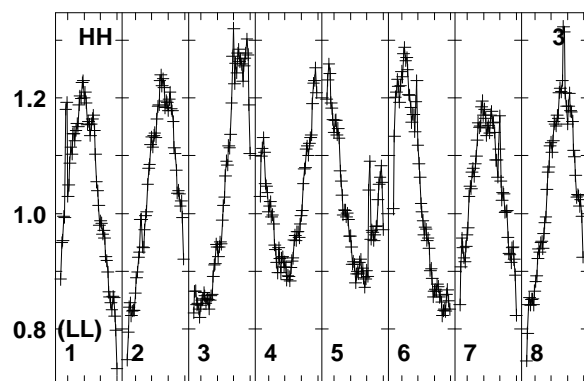
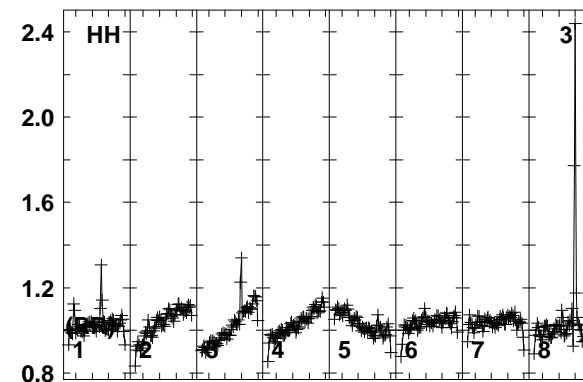
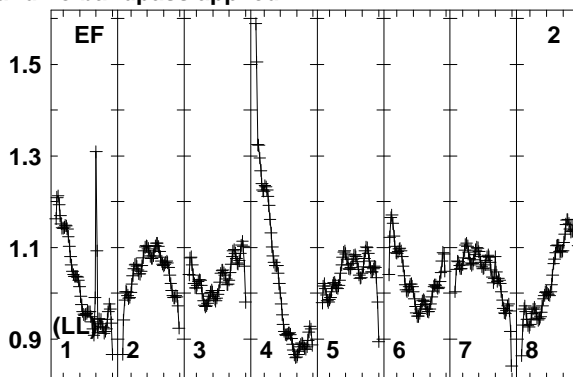
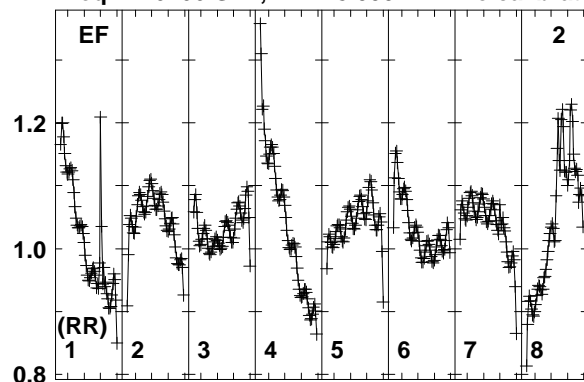

Lower frame: Real Jy
Total-power spectrum Antenna: EF (02)
Timerange: 00/18:54:35 to 00/18:56:59

Plot file version 221 created 01-AUG-2018 16:38:28

PB-2+2 N18L1 2.UVDATA.1

Freq = 1.6266 GHz, Bw = 8.000 MH No calibration applied and no bandpass applied

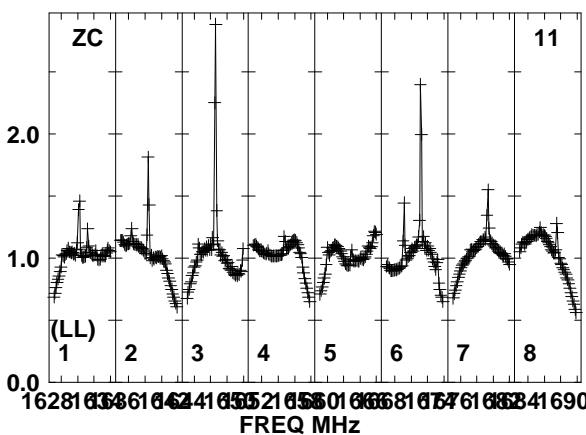
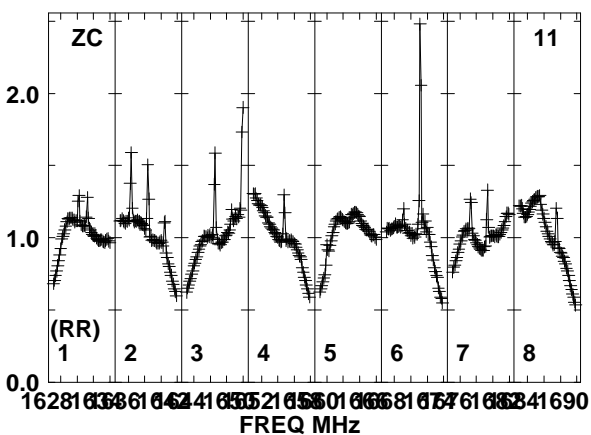
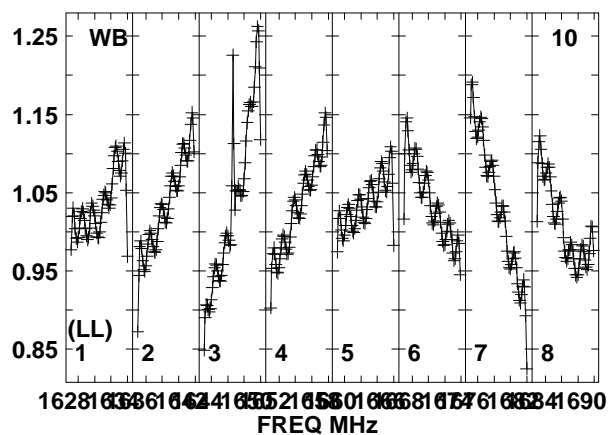
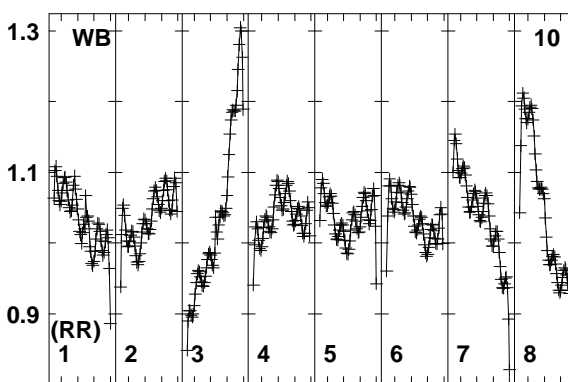
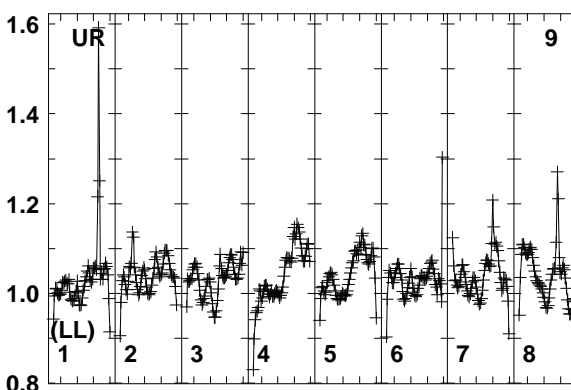
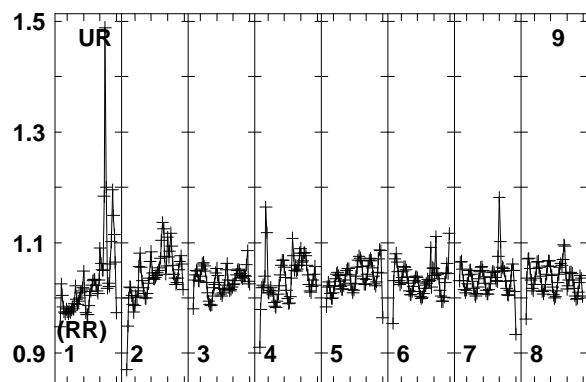
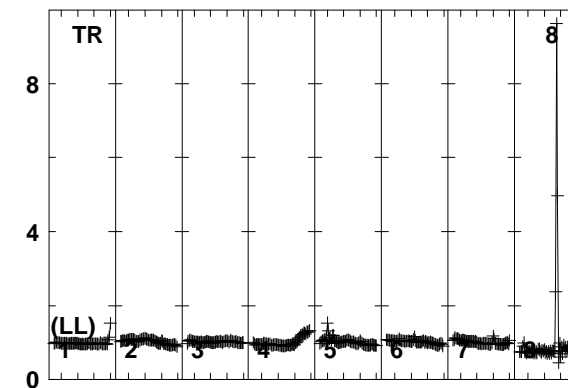
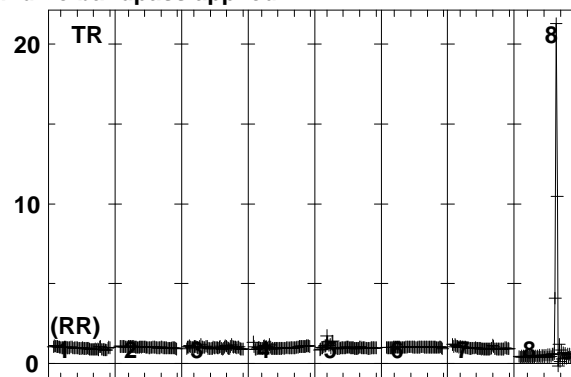
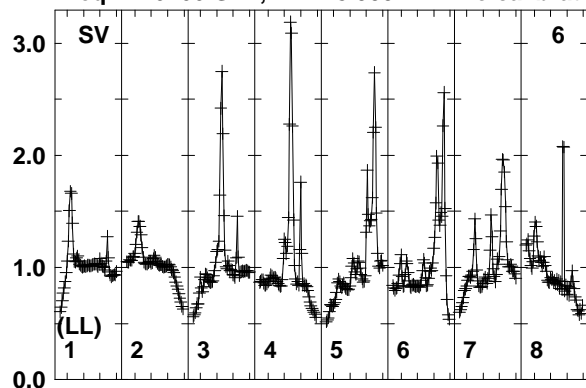

Lower frame: Real Jy
Total-power spectrum Antenna: SV (06)
Timerange: 00/18:54:35 to 00/18:56:59

Plot file version 222 created 01-AUG-2018 16:38:29

PB-3+2 N18L1 2.UVDATA.1

Freq = 1.6266 GHz, Bw = 8.000 MH No calibration applied and no bandpass applied

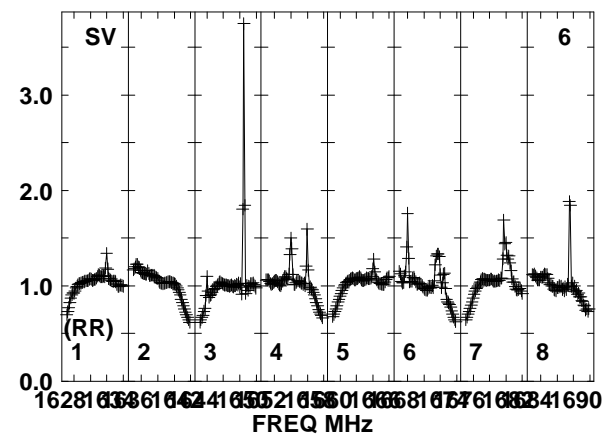
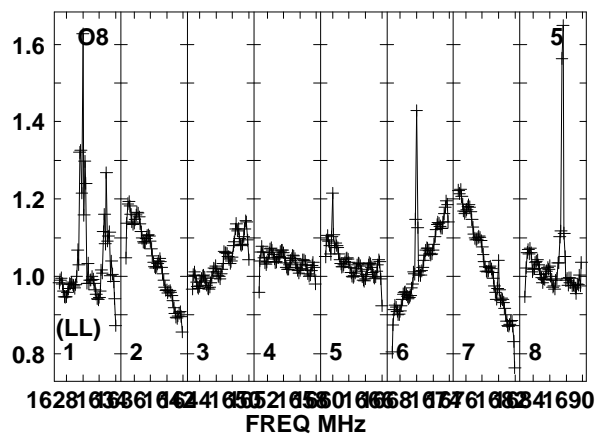
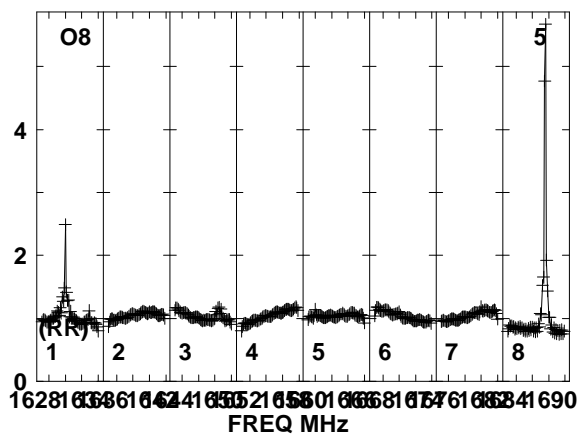
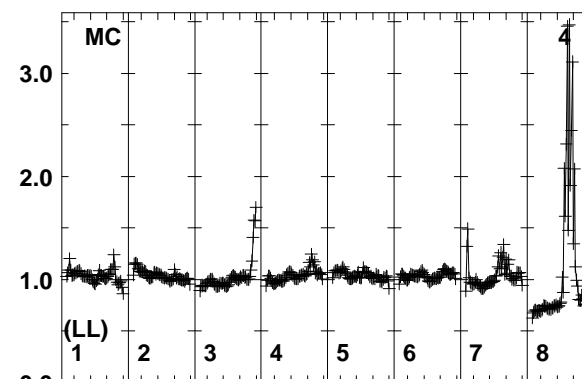
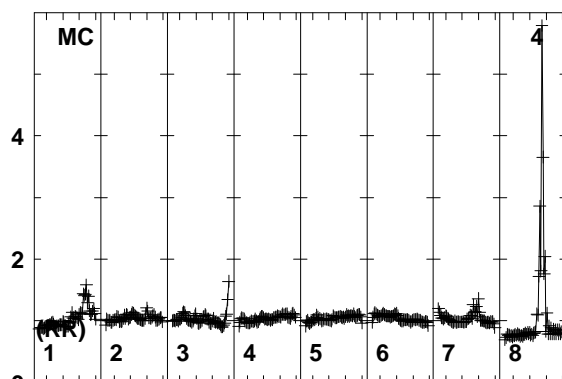
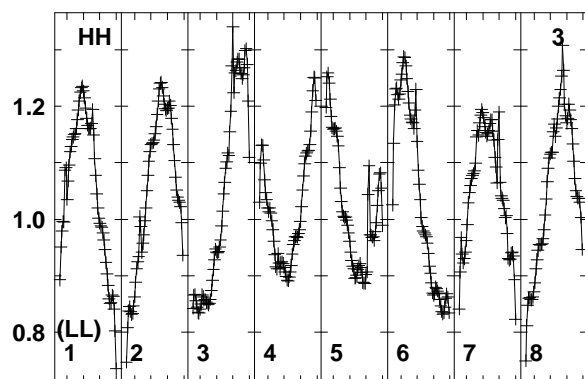
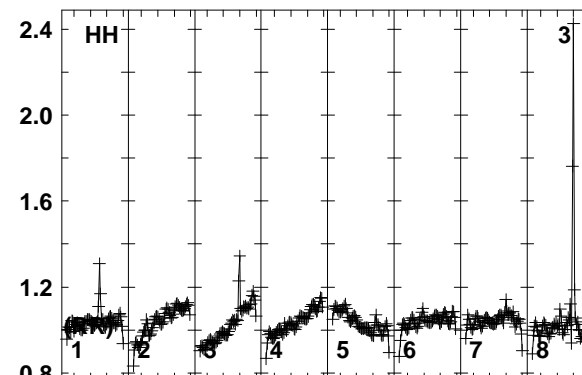
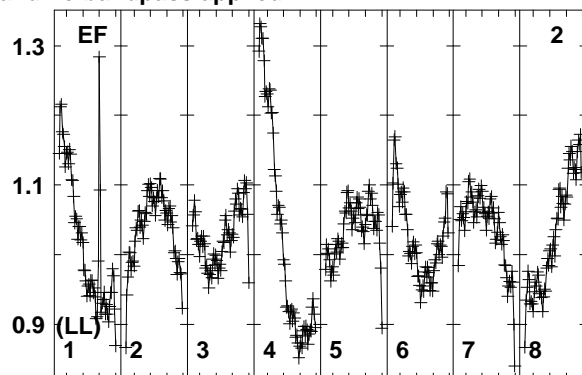
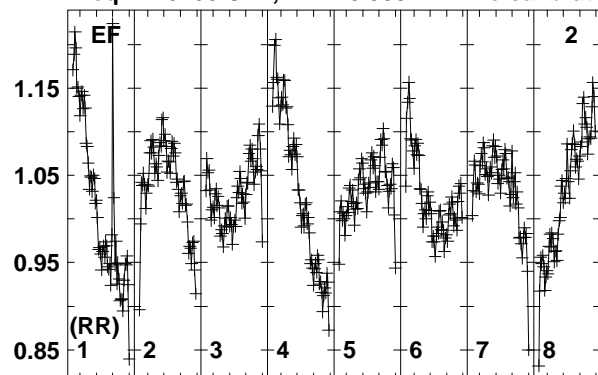

Lower frame: Real Jy
Total-power spectrum Antenna: EF (02)
Timerange: 00:18:57:05 to 00:18:59:29

Plot file version 223 created 01-AUG-2018 16:38:29

PB-3+2 N18L1 2.UVDATA.1

Freq = 1.6266 GHz, Bw = 8.000 MH No calibration applied and no bandpass applied

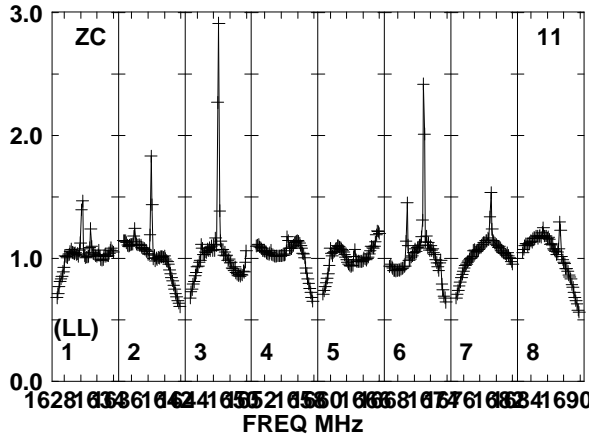
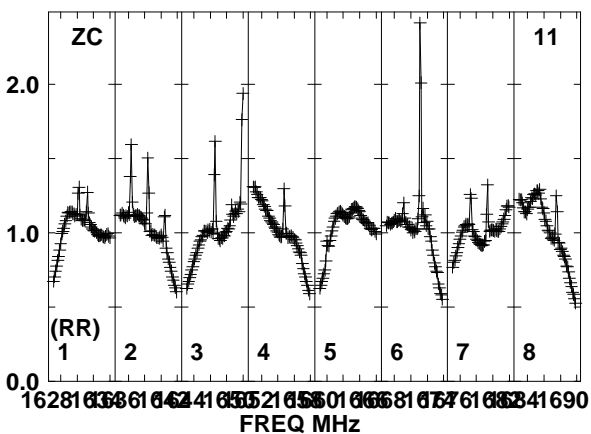
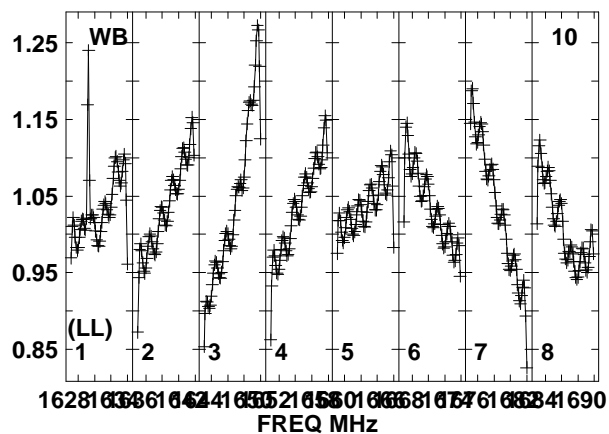
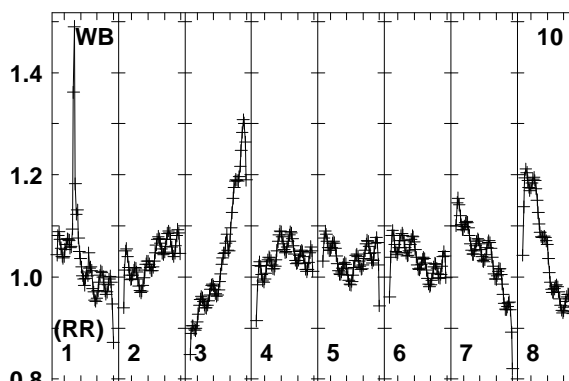
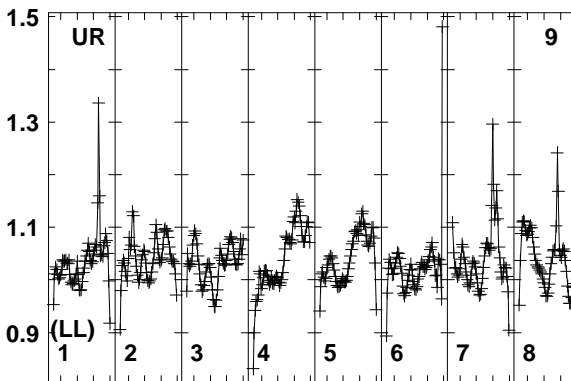
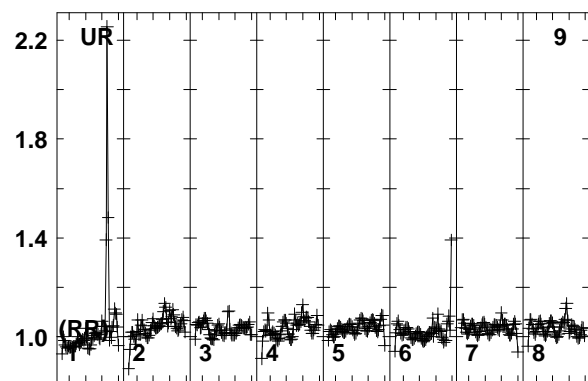
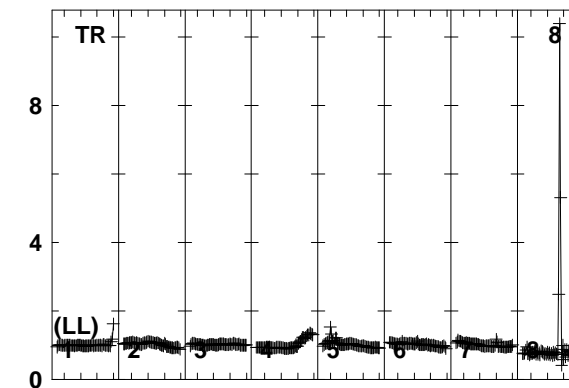
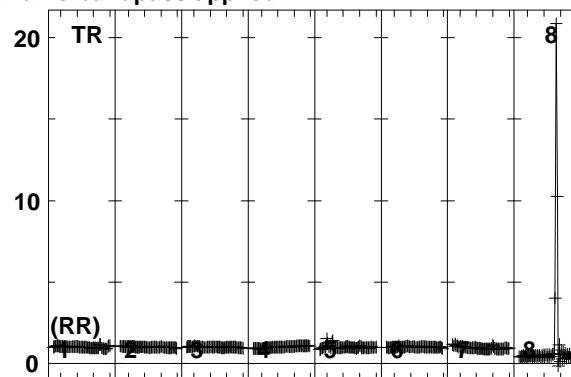
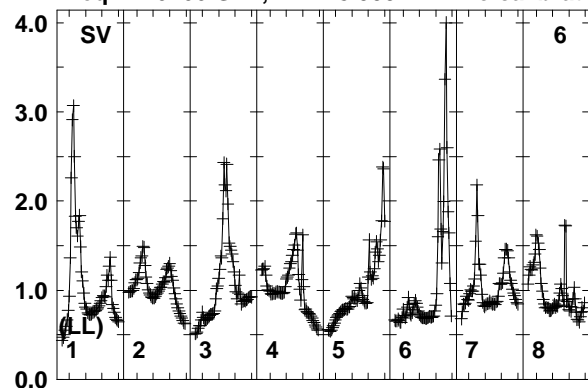

Lower frame: Real Jy
Total-power spectrum Antenna: SV (06)
Timerange: 00/18:57:05 to 00/18:59:29

Plot file version 224 created 01-AUG-2018 16:38:29

PB-4+2 N18L1 2.UVDATA.1

Freq = 1.6266 GHz, Bw = 8.000 MH No calibration applied and no bandpass applied

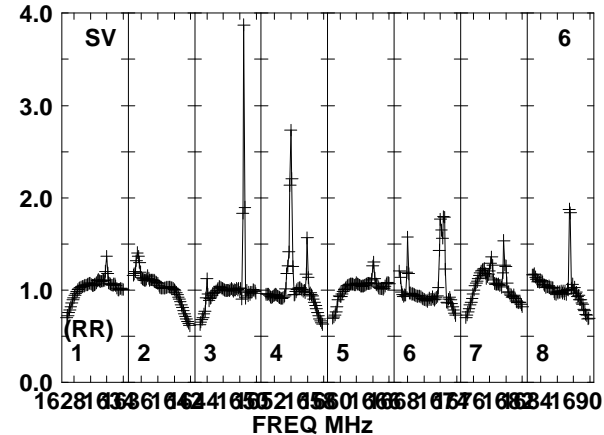
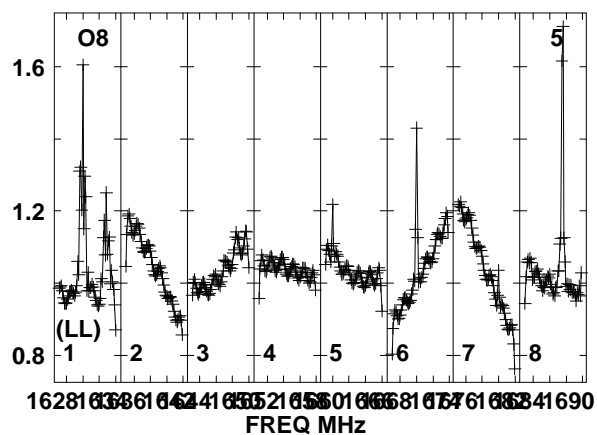
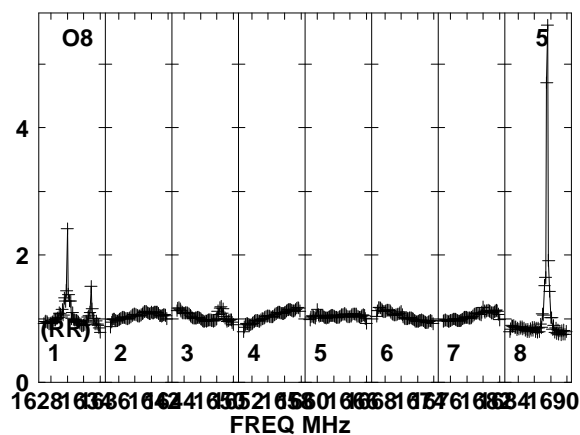
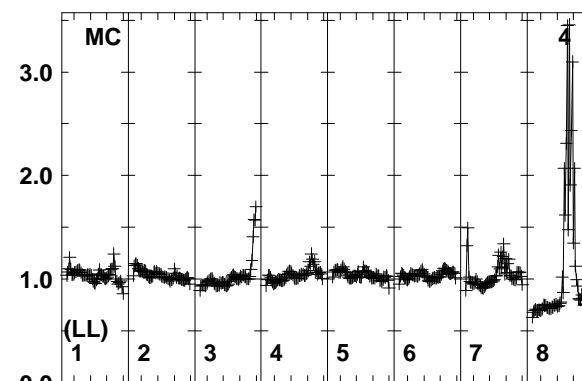
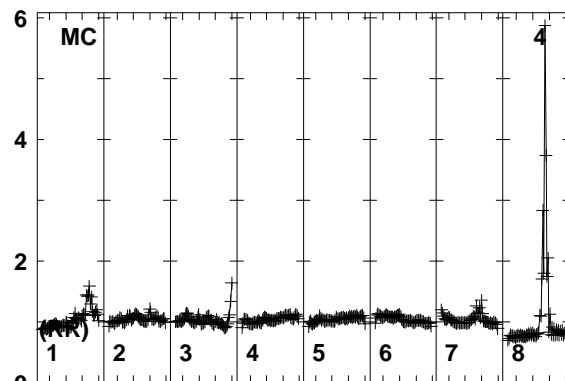
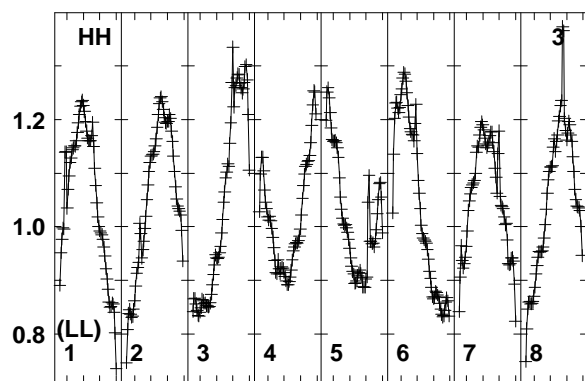
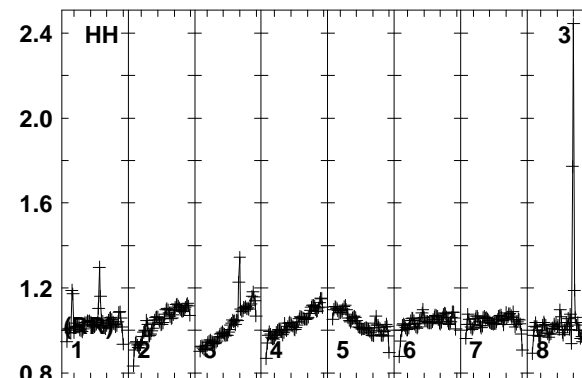
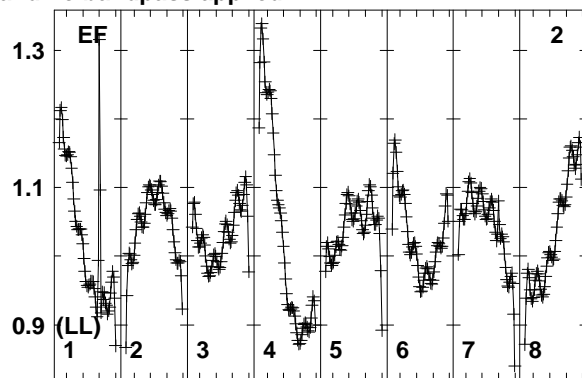
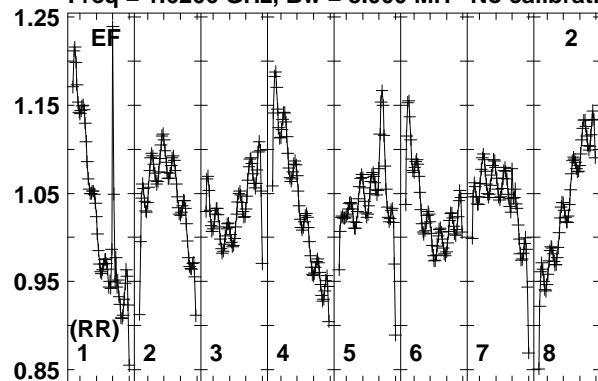

Lower frame: Real Jy
Total-power spectrum Antenna: EF (02)
Timerange: 00:18:59:35 to 00:19:01:59

Plot file version 225 created 01-AUG-2018 16:38:29

PB-4+2 N18L1 2.UVDATA.1

Freq = 1.6266 GHz, Bw = 8.000 MH No calibration applied and no bandpass applied

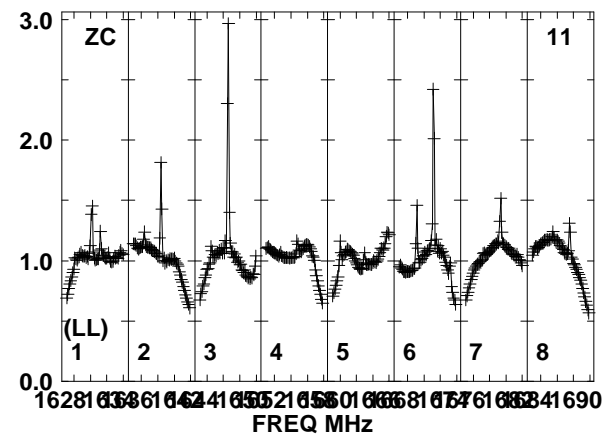
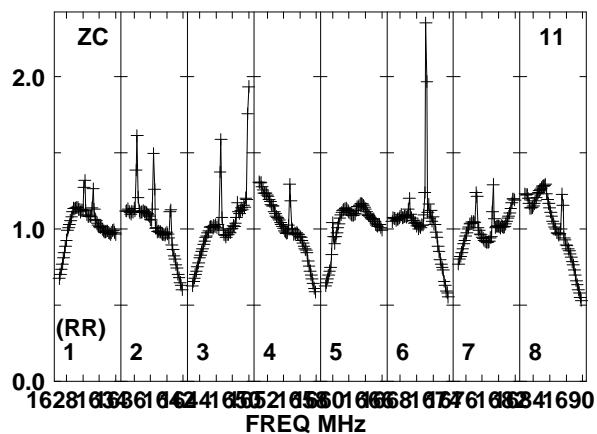
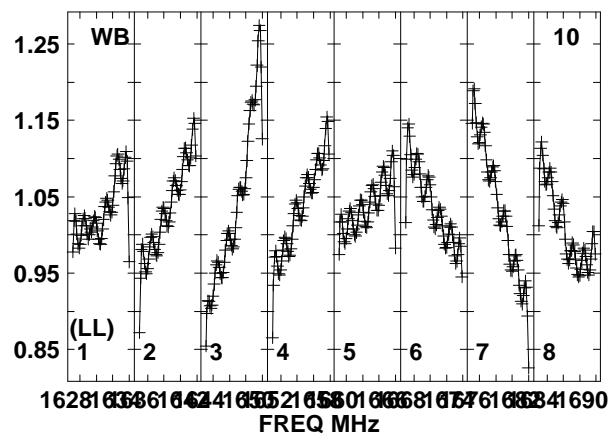
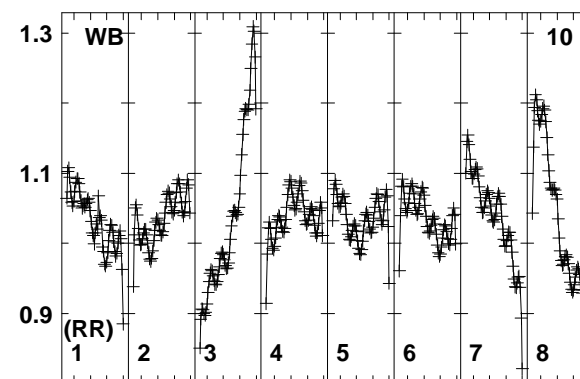
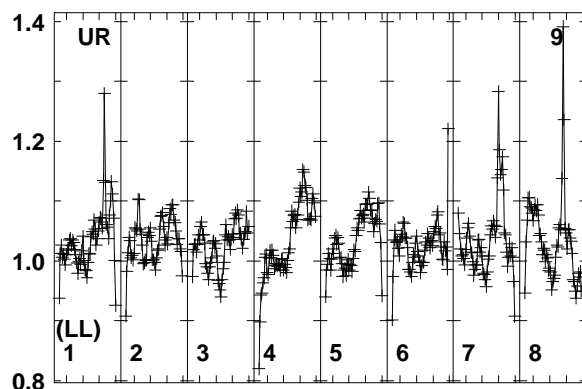
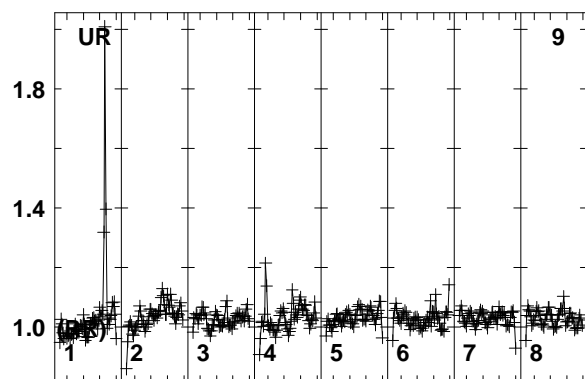
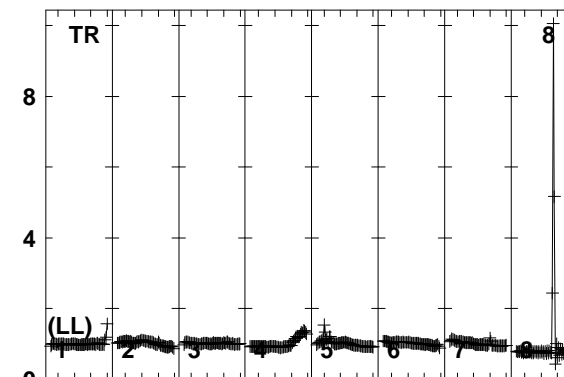
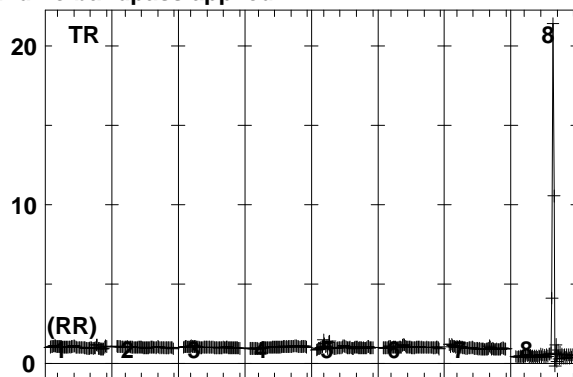
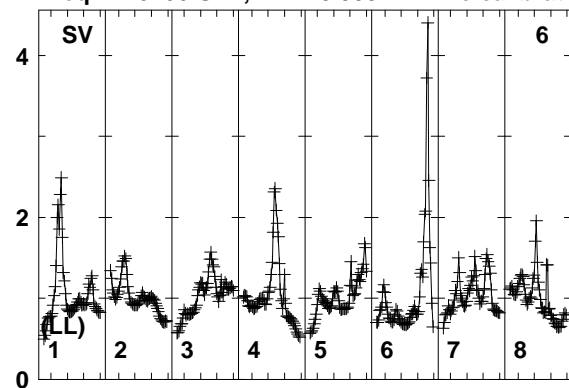

16281 63961 64241 65521 65801 66681 67461 68241 690
FREQ MHz

16281 63961 64241 65521 65801 66681 67461 68241 690
FREQ MHz

16281 63961 64241 65521 65801 66681 67461 68241 690
FREQ MHz

Lower frame: Real Jy
Total-power spectrum Antenna: SV (06)
Timerange: 00/18:59:35 to 00/19:01:59

Plot file version 226 created 01-AUG-2018 16:38:29

PB-4+3 N18L1 2.UVDATA.1

Freq = 1.6266 GHz, Bw = 8.000 MH No calibration applied and no bandpass applied

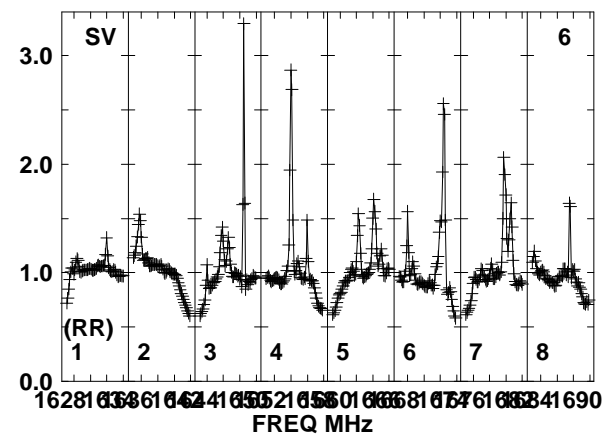
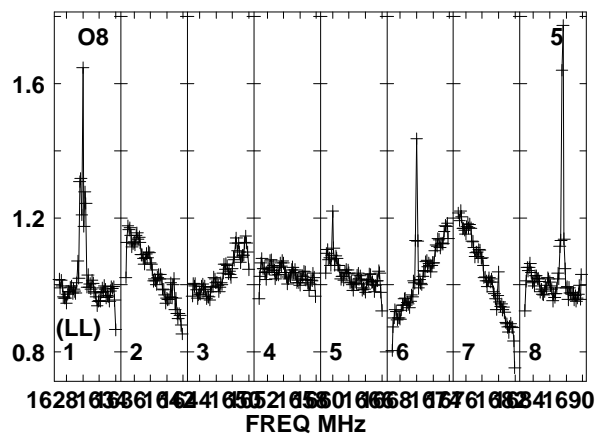
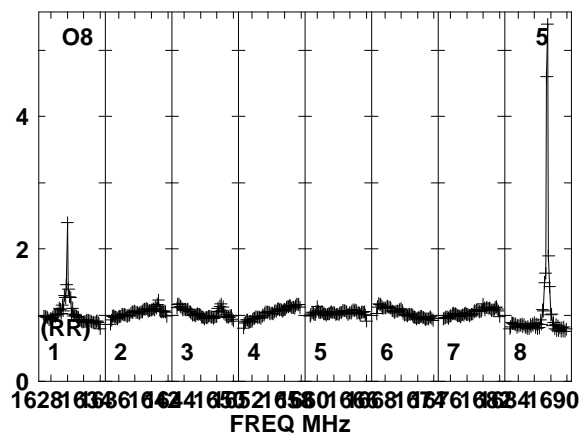
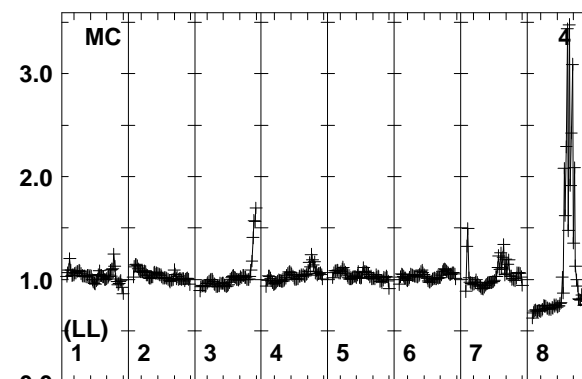
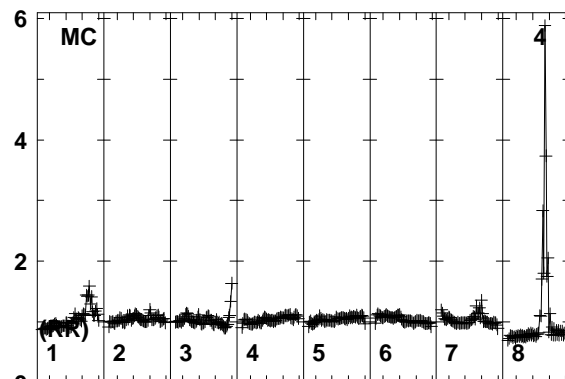
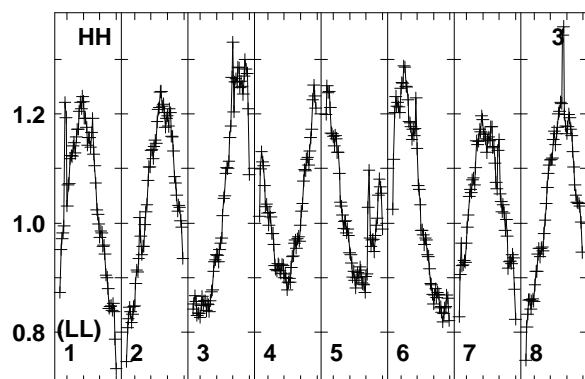
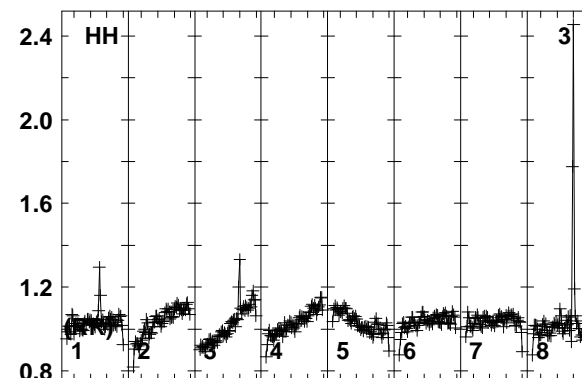
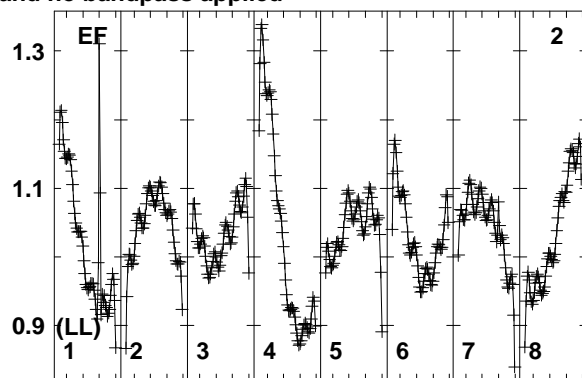
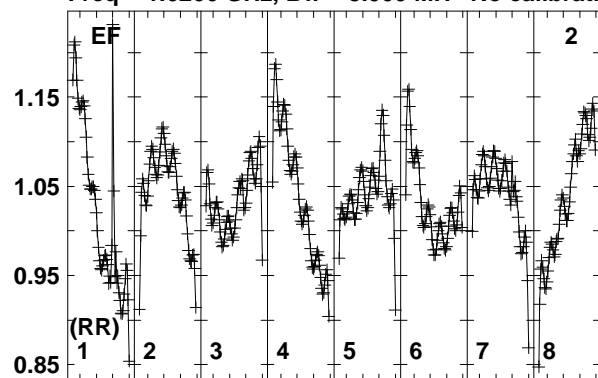

Lower frame: Real Jy
Total-power spectrum Antenna: EF (02)
Timerange: 00/19:02:03 to 00/19:04:29

Plot file version 227 created 01-AUG-2018 16:38:29

PB-4+3 N18L1 2.UVDATA.1

Freq = 1.6266 GHz, Bw = 8.000 MH No calibration applied and no bandpass applied

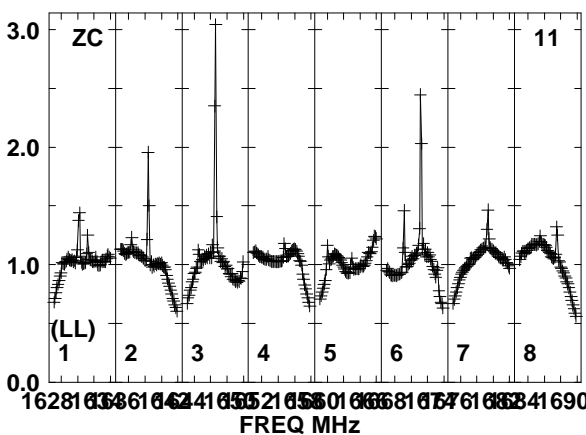
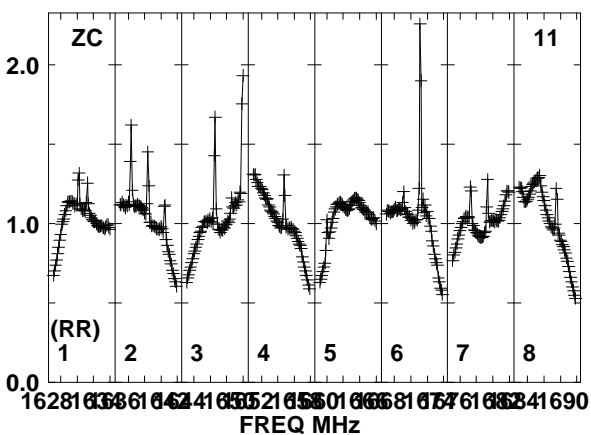
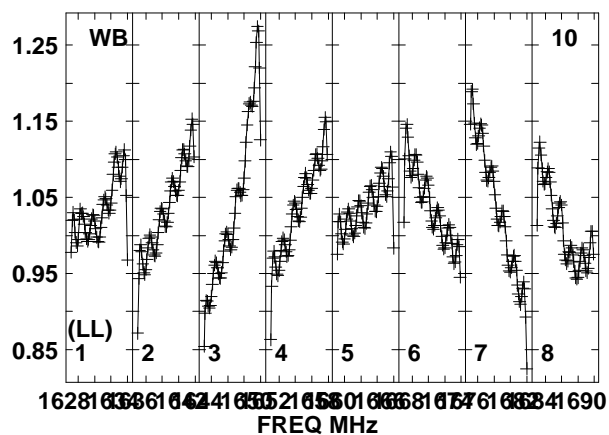
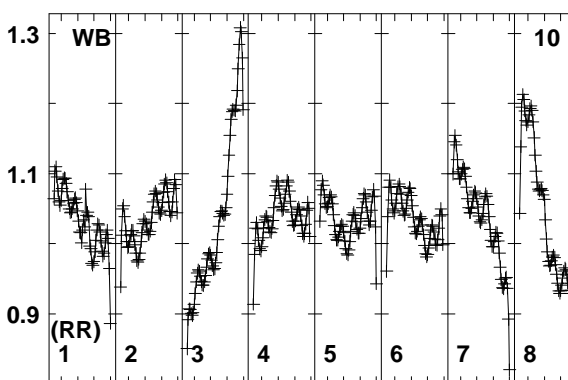
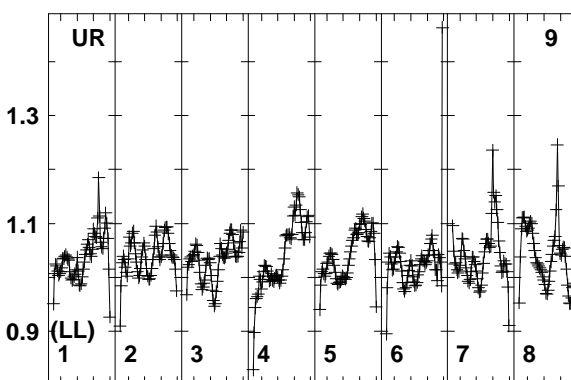
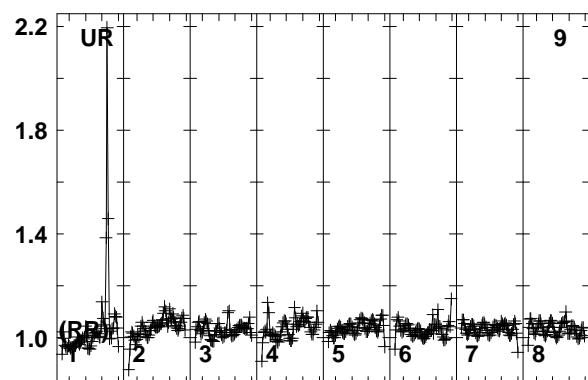
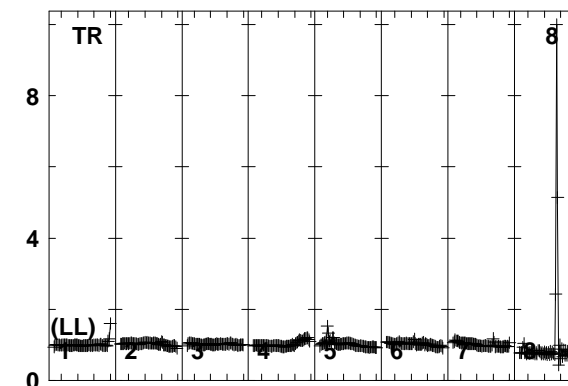
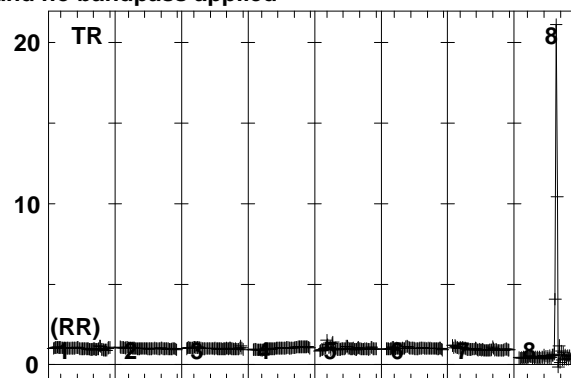
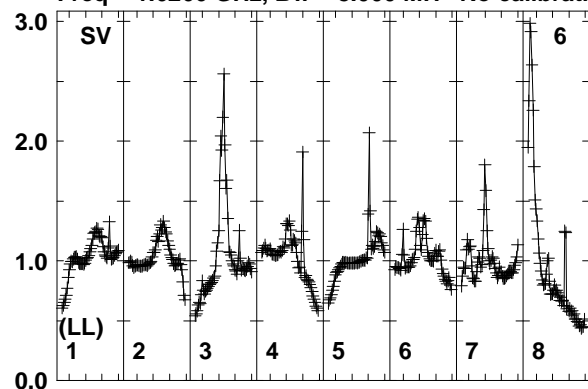

Lower frame: Real Jy
Total-power spectrum Antenna: SV (06)
Timerange: 00/19:02:03 to 00/19:04:29

Plot file version 228 created 01-AUG-2018 16:38:29

J0530+1331 N18L1 2.UVDATA.1

Freq = 1.6266 GHz, Bw = 8.000 MH No calibration applied and no bandpass applied

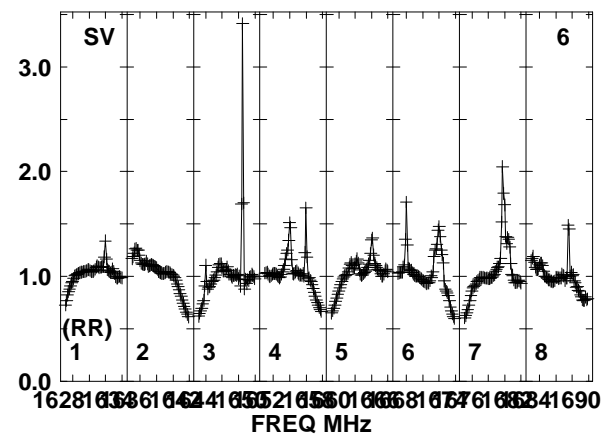
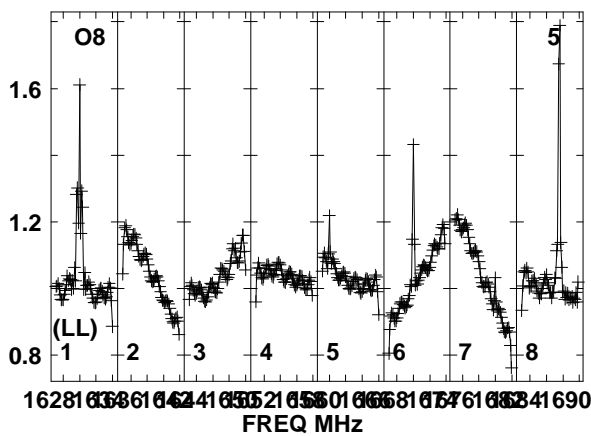
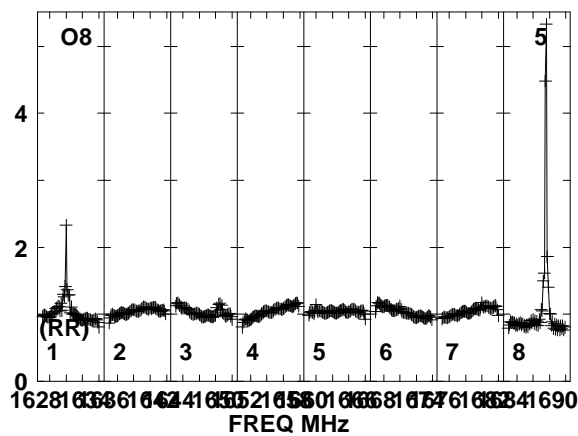
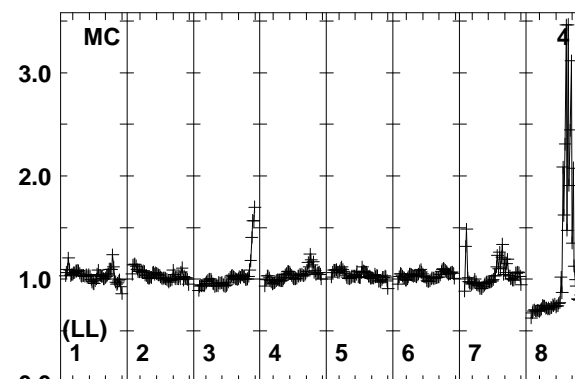
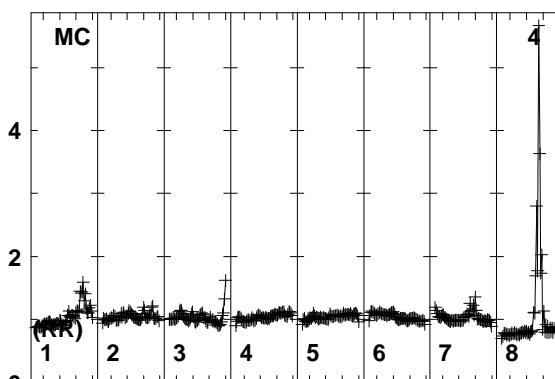
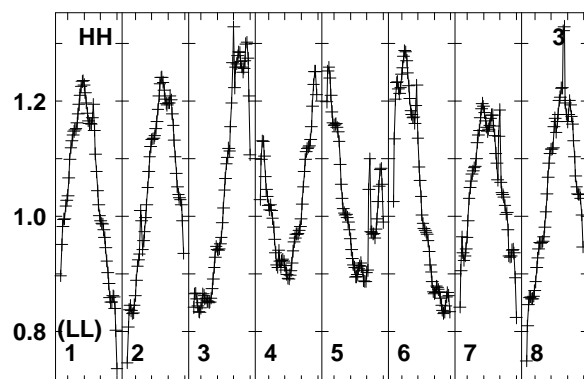
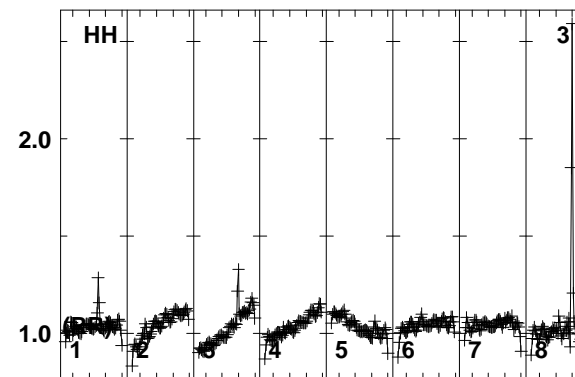
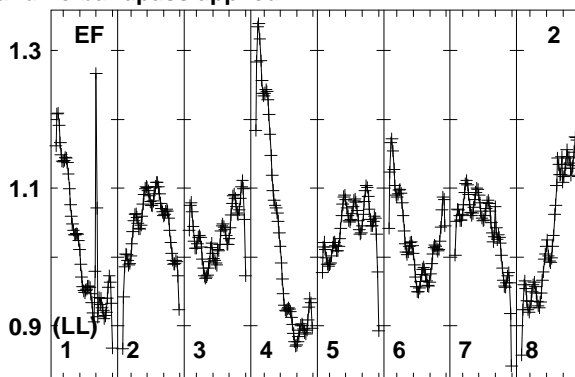
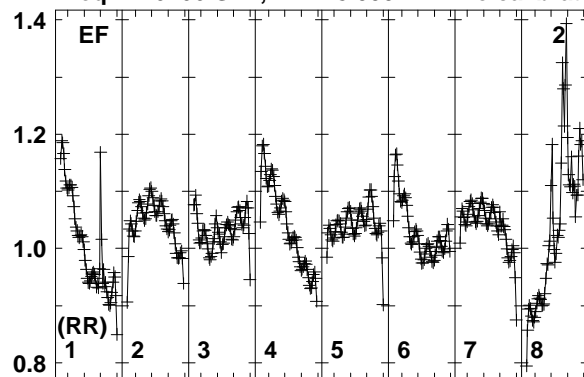

Lower frame: Real Jy
Total-power spectrum Antenna: EF (02)
Timerange: 00/19:05:11 to 00/19:06:29

Plot file version 229 created 01-AUG-2018 16:38:29

J0530+1331 N18L1 2.UVDATA.1

Freq = 1.6266 GHz, Bw = 8.000 MH No calibration applied and no bandpass applied

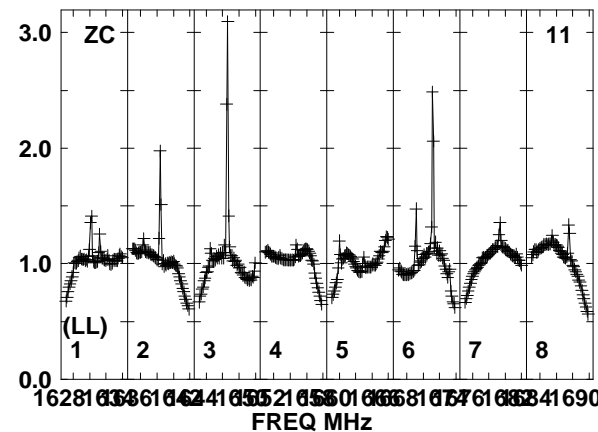
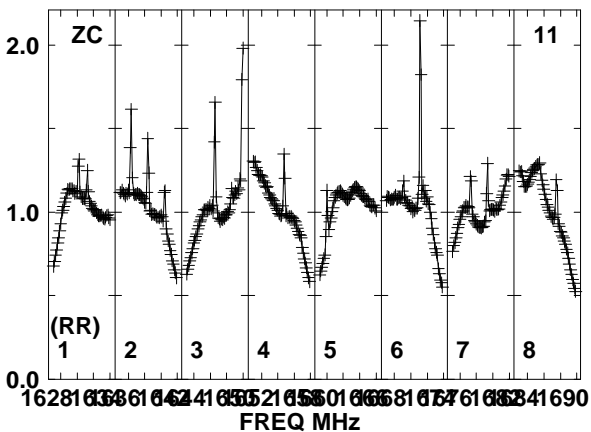
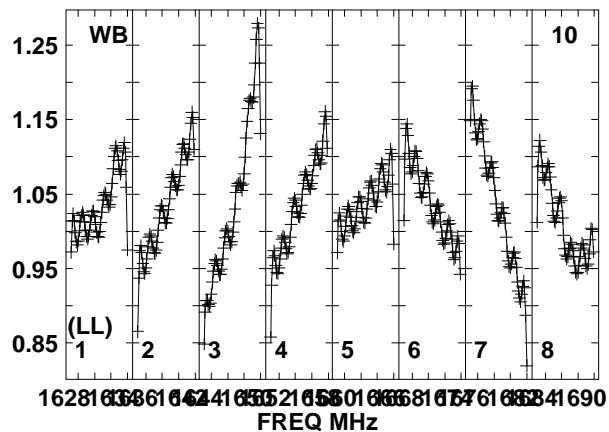
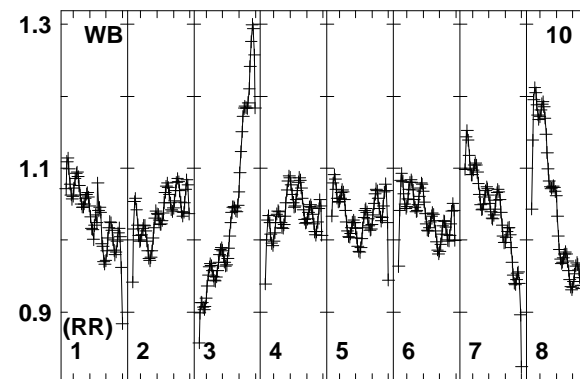
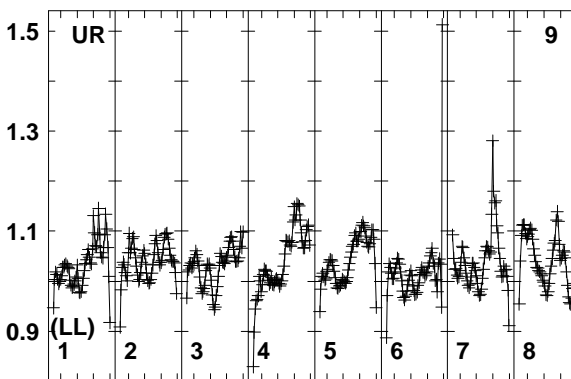
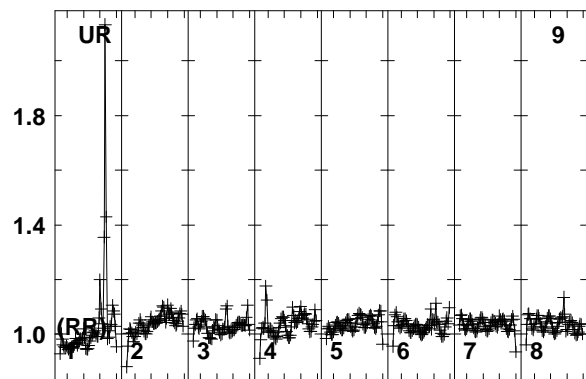
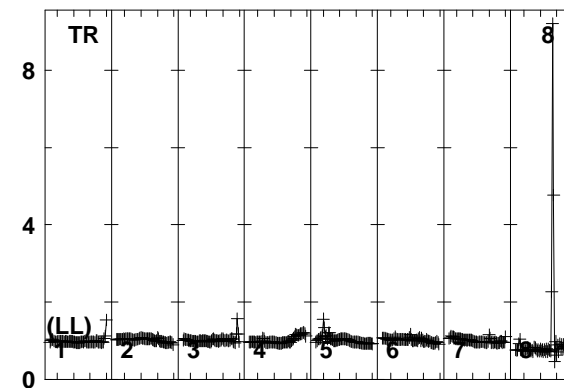
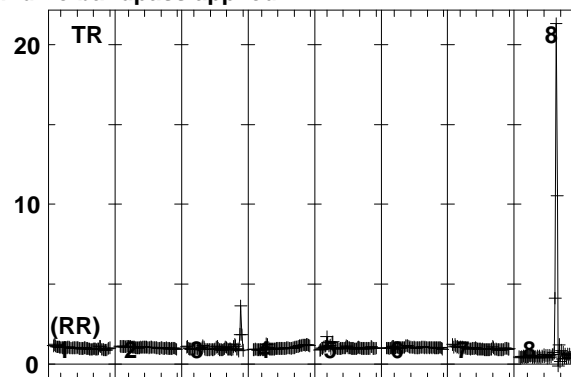
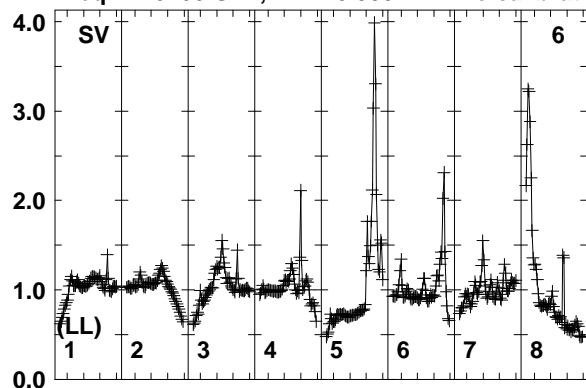

Lower frame: Real Jy
Total-power spectrum Antenna: SV (06)
Timerange: 00/19:05:11 to 00/19:06:29

Plot file version 230 created 01-AUG-2018 16:38:30

PB-3+3 N18L1 2.UVDATA.1

Freq = 1.6266 GHz, Bw = 8.000 MH No calibration applied and no bandpass applied

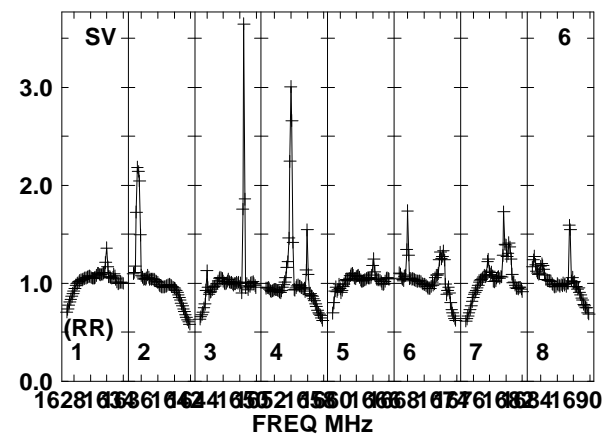
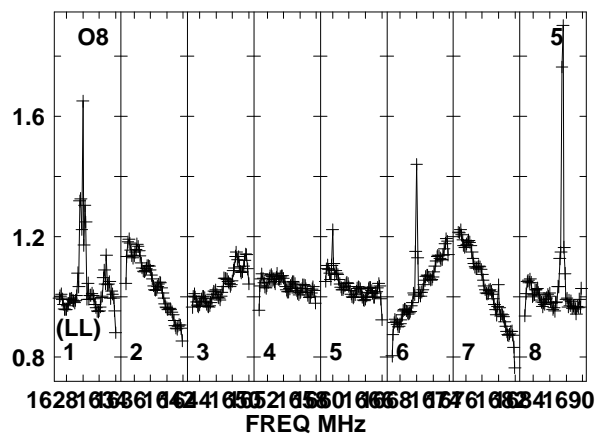
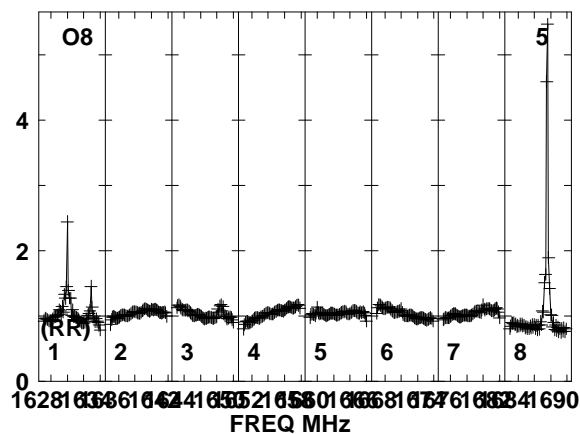
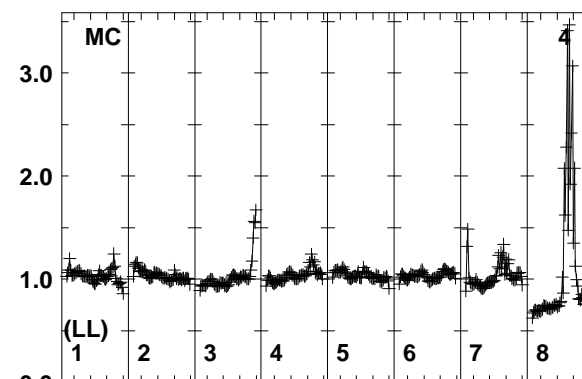
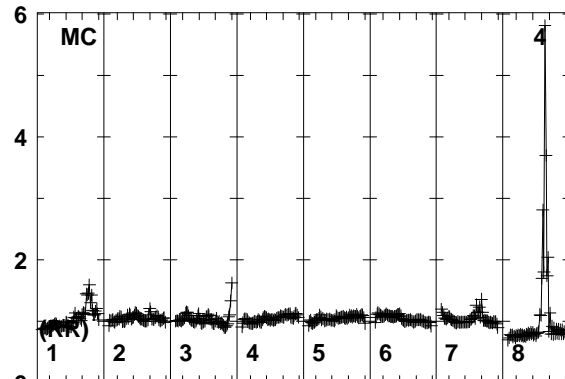
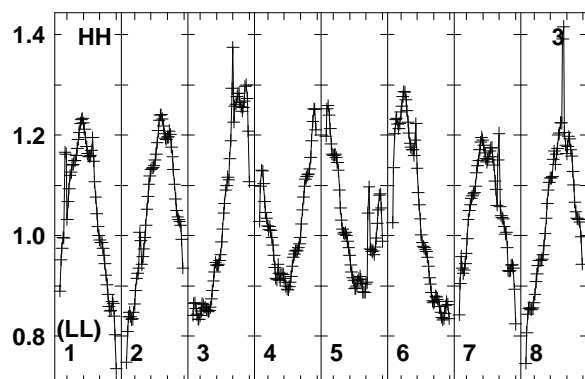
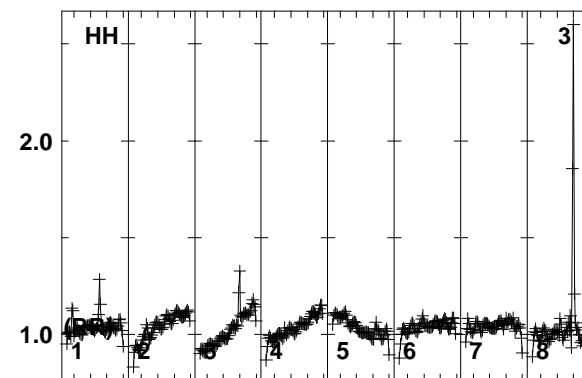
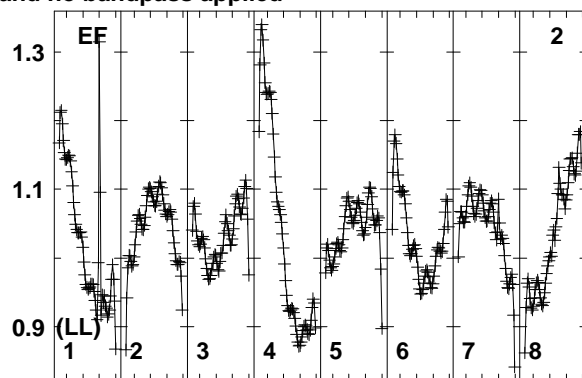
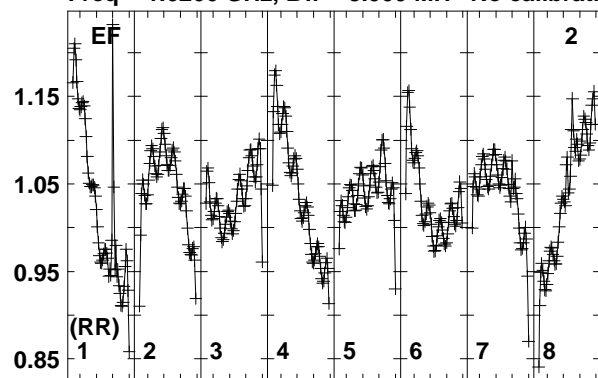

Lower frame: Real Jy
Total-power spectrum Antenna: EF (02)
Timerange: 00/19:06:35 to 00/19:08:59

Plot file version 231 created 01-AUG-2018 16:38:30

PB-3+3 N18L1 2.UVDATA.1

Freq = 1.6266 GHz, Bw = 8.000 MH No calibration applied and no bandpass applied

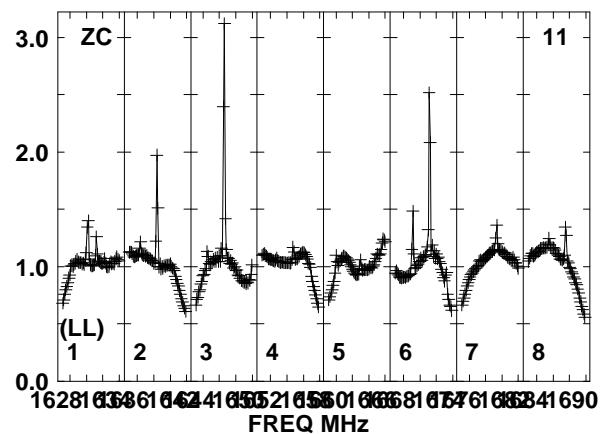
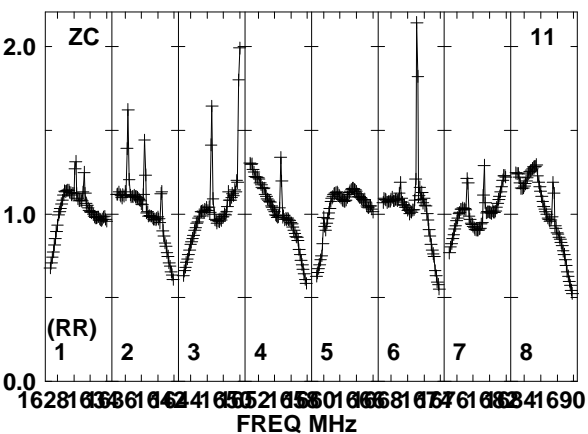
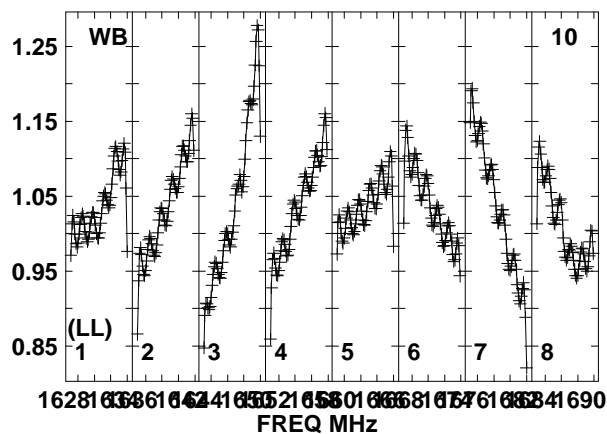
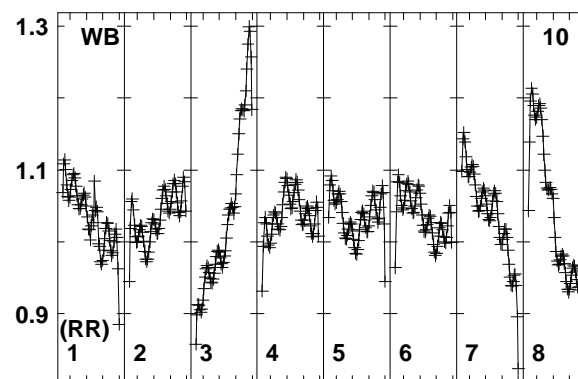
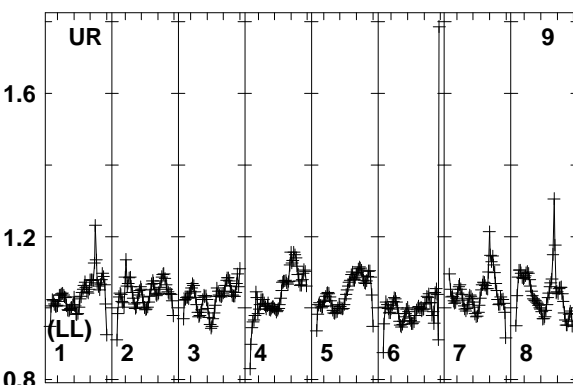
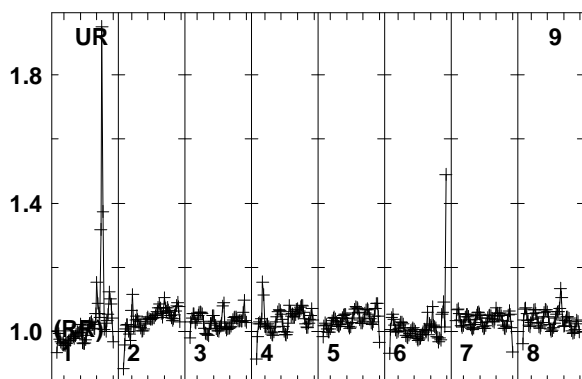
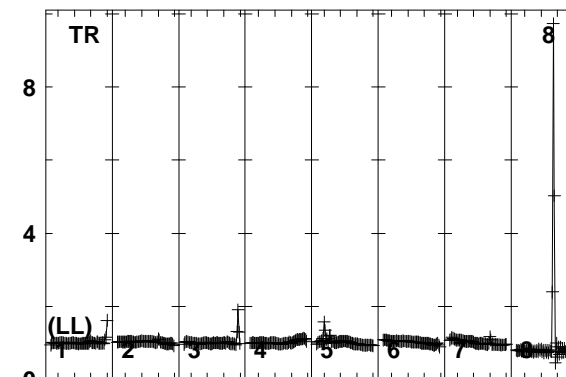
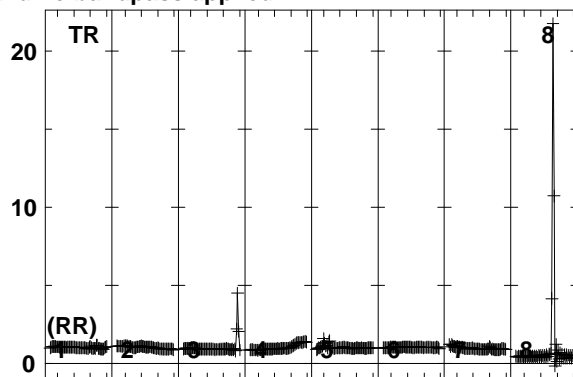
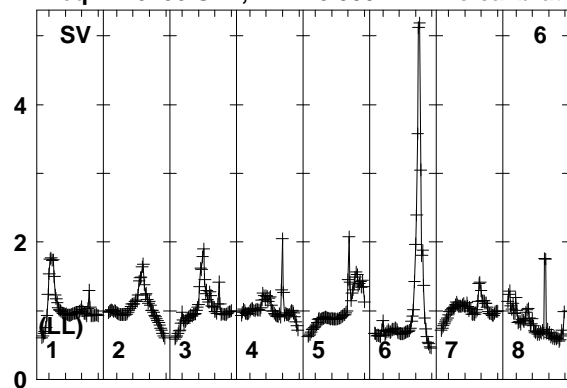

Lower frame: Real Jy
Total-power spectrum Antenna: SV (06)
Timerange: 00/19:06:35 to 00/19:08:59

Plot file version 232 created 01-AUG-2018 16:38:30

PB-2+3 N18L1 2.UVDATA.1

Freq = 1.6266 GHz, Bw = 8.000 MH No calibration applied and no bandpass applied

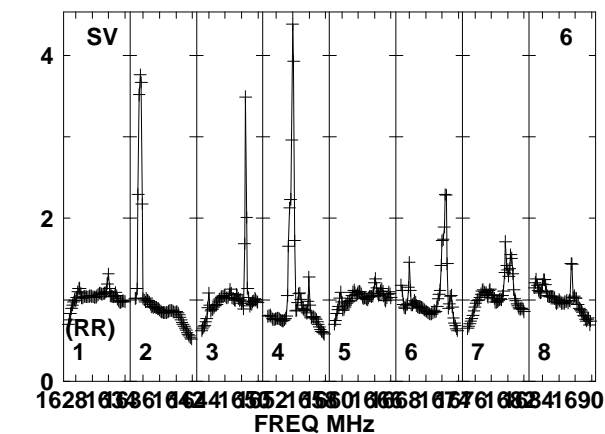
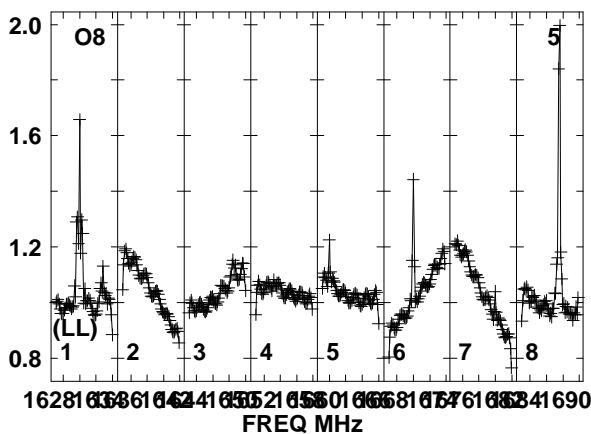
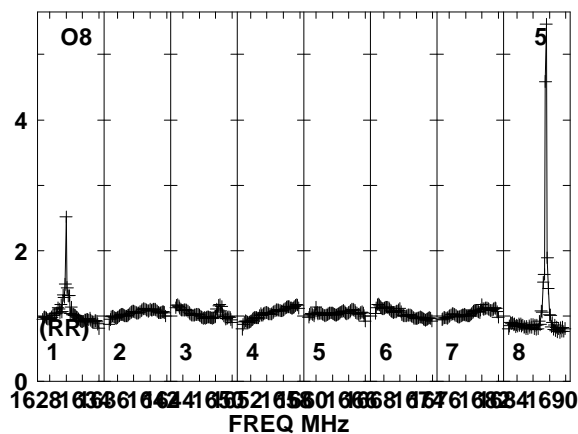
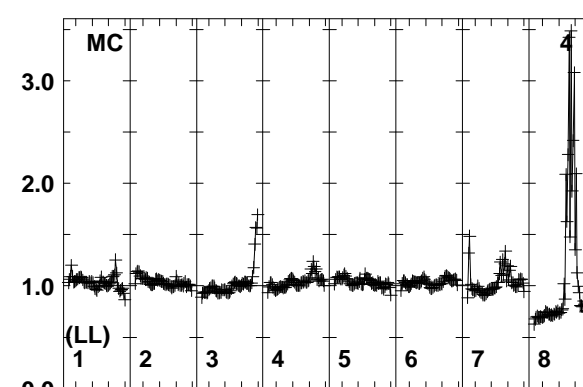
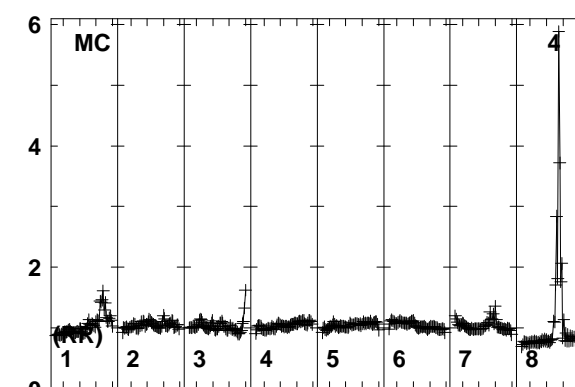
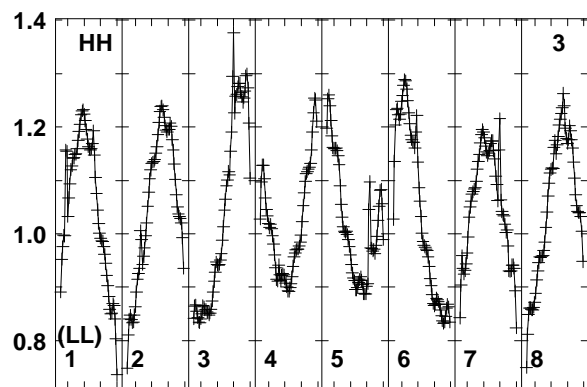
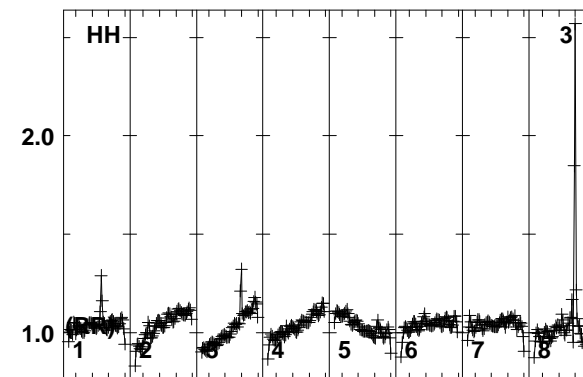
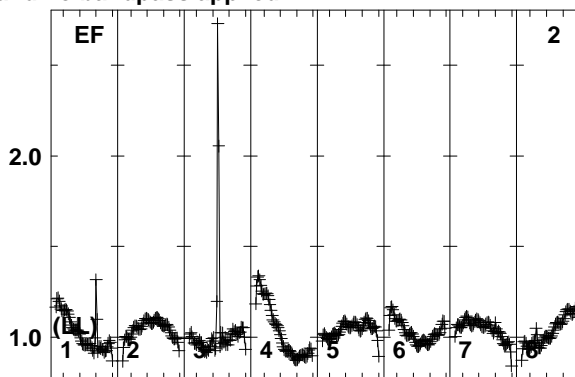
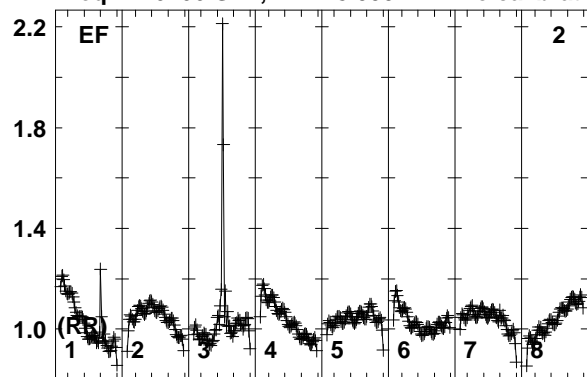

Lower frame: Real Jy
Total-power spectrum Antenna: EF (02)
Timerange: 00/19:09:03 to 00/19:11:29

Plot file version 233 created 01-AUG-2018 16:38:30

PB-2+3 N18L1 2.UVDATA.1

Freq = 1.6266 GHz, Bw = 8.000 MH No calibration applied and no bandpass applied

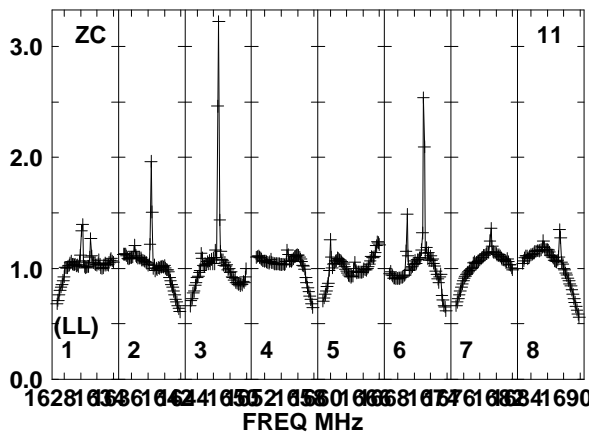
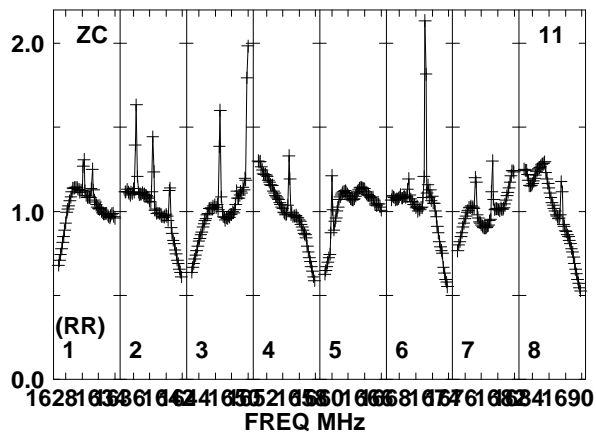
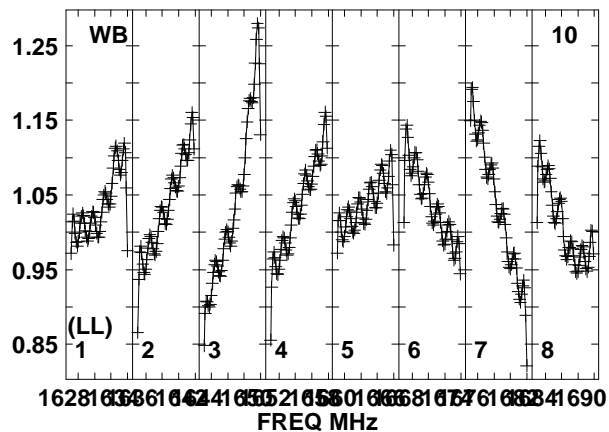
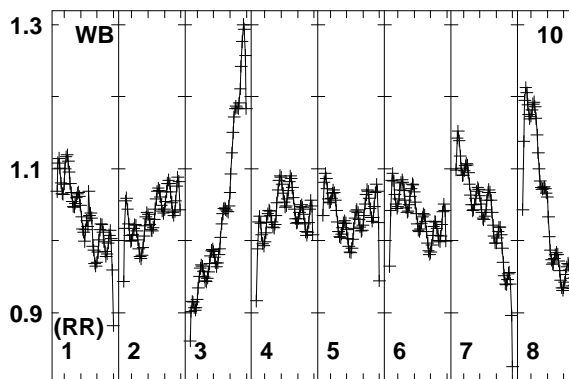
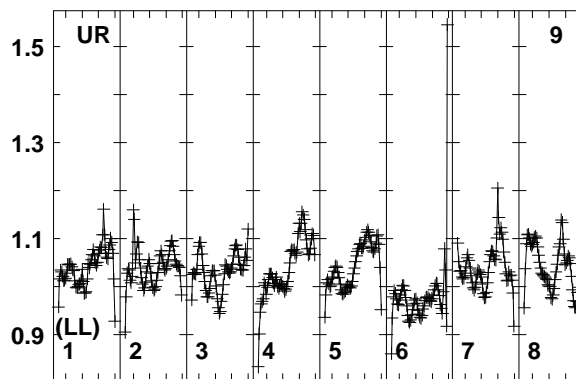
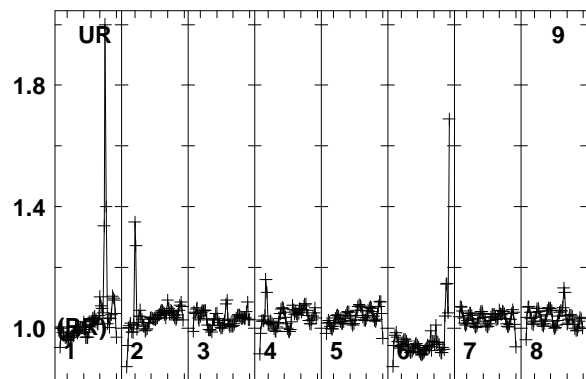
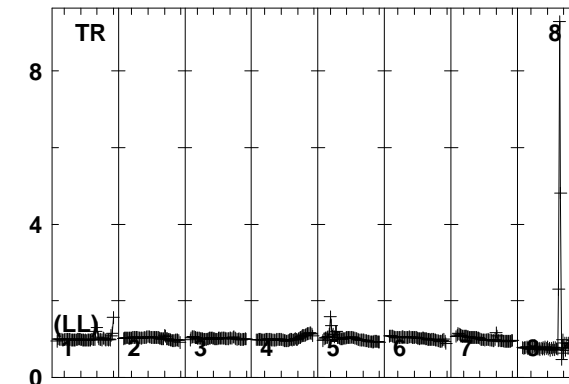
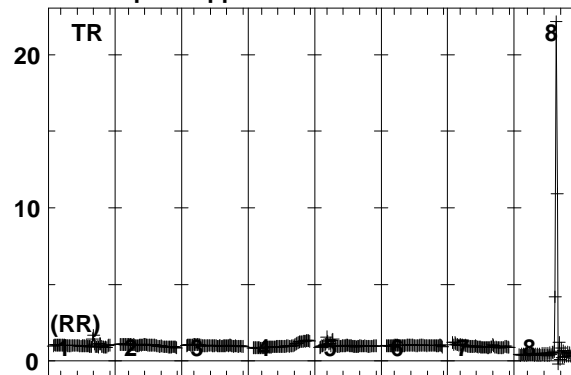
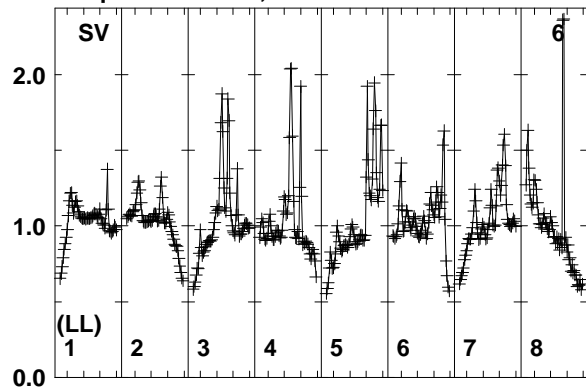

Lower frame: Real Jy
Total-power spectrum Antenna: SV (06)
Timerange: 00/19:09:03 to 00/19:11:29

Plot file version 234 created 01-AUG-2018 16:38:30

PB-1+3 N18L1 2.UVDATA.1

Freq = 1.6266 GHz, Bw = 8.000 MH No calibration applied and no bandpass applied

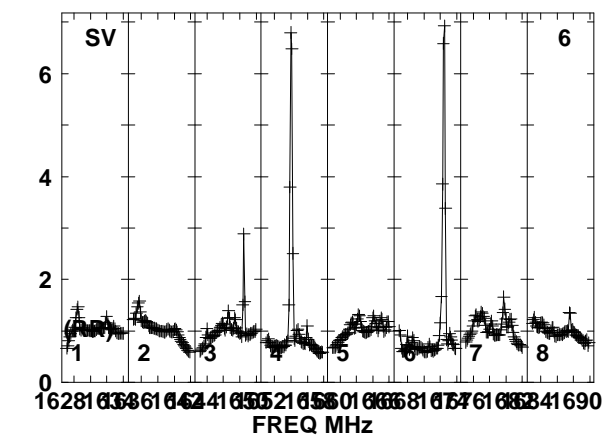
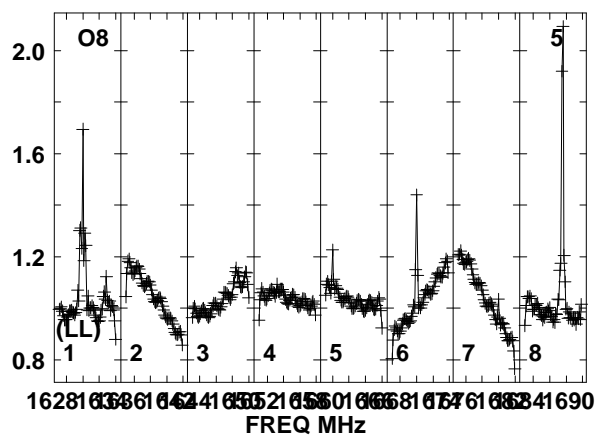
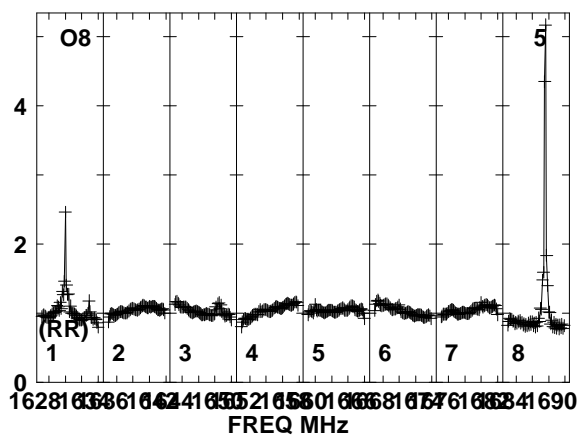
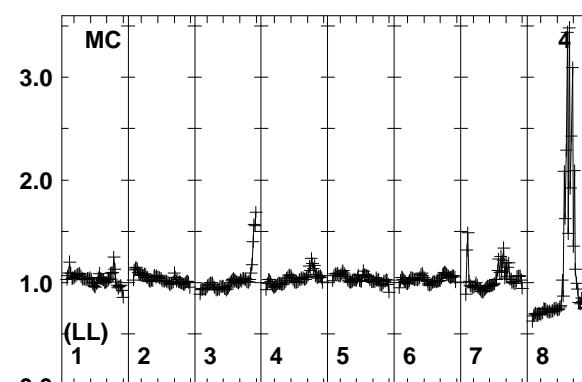
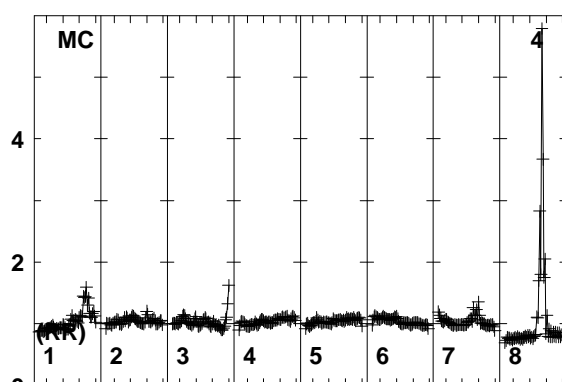
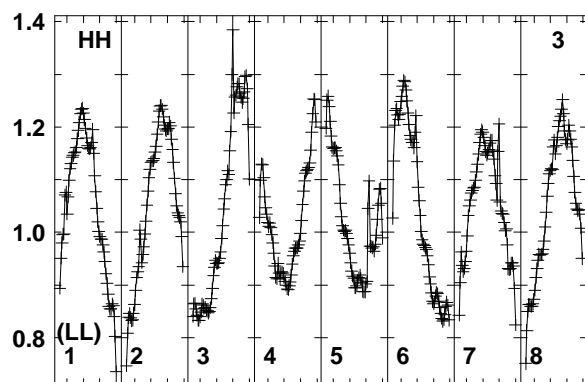
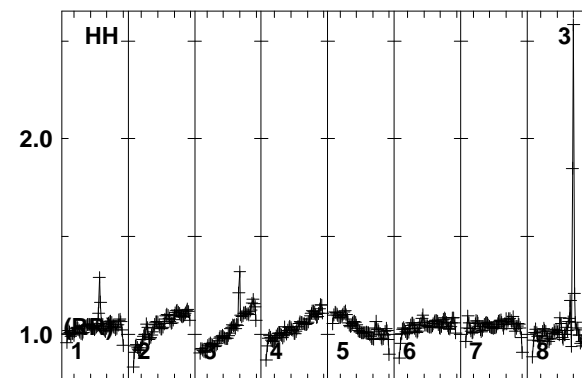
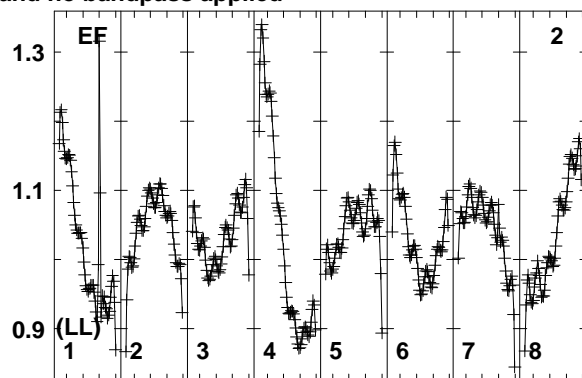
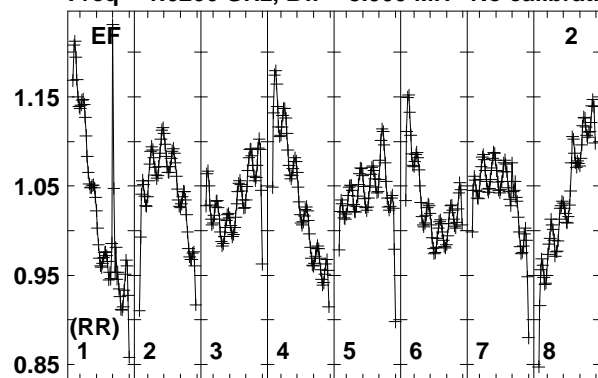

Lower frame: Real Jy
Total-power spectrum Antenna: EF (02)
Timerange: 00/19:11:33 to 00/19:13:59

Plot file version 235 created 01-AUG-2018 16:38:30

PB-1+3 N18L1 2.UVDATA.1

Freq = 1.6266 GHz, Bw = 8.000 MH No calibration applied and no bandpass applied

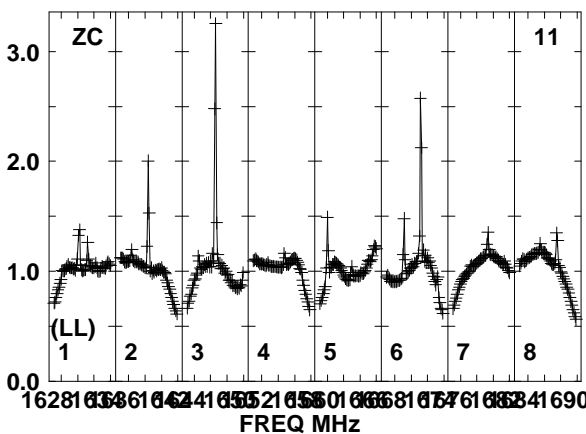
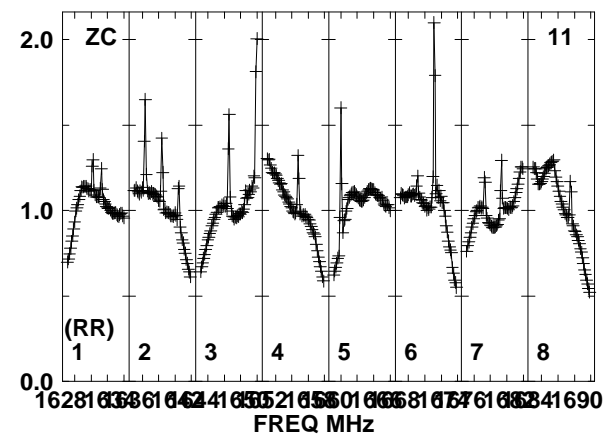
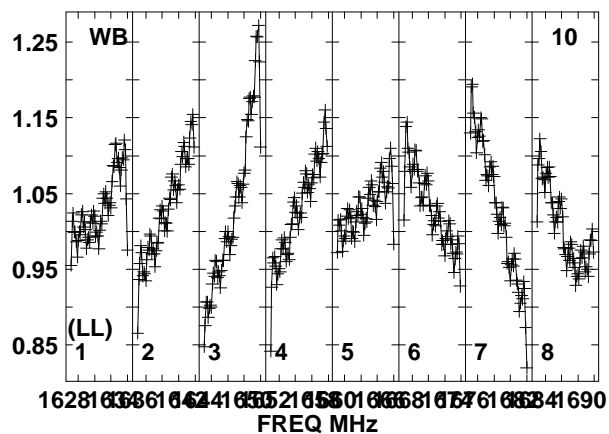
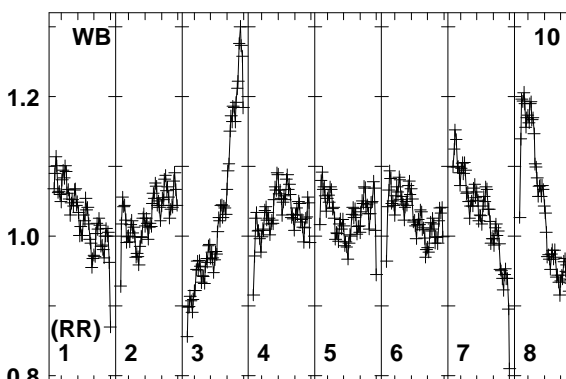
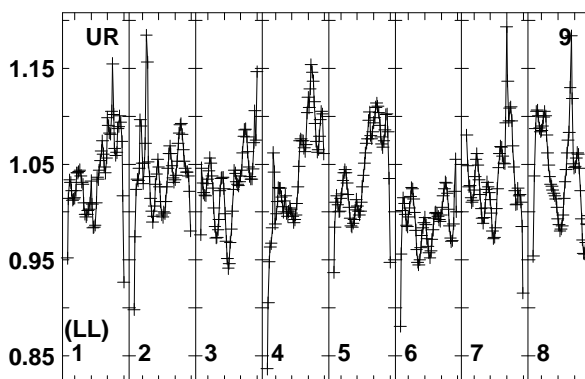
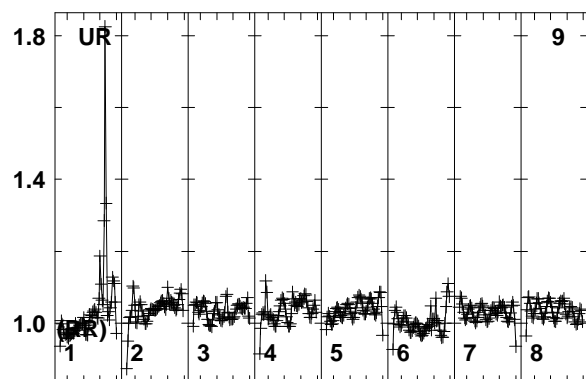
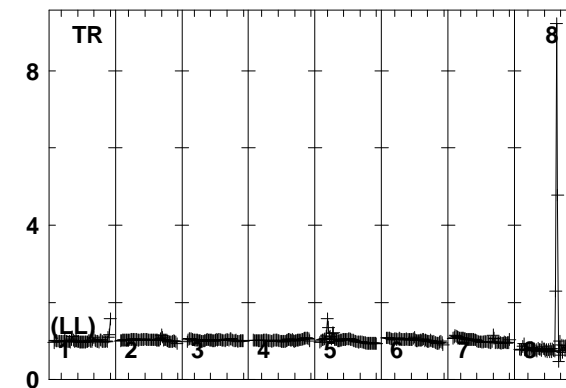
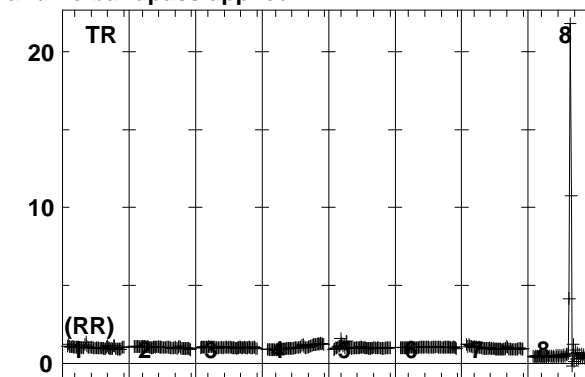
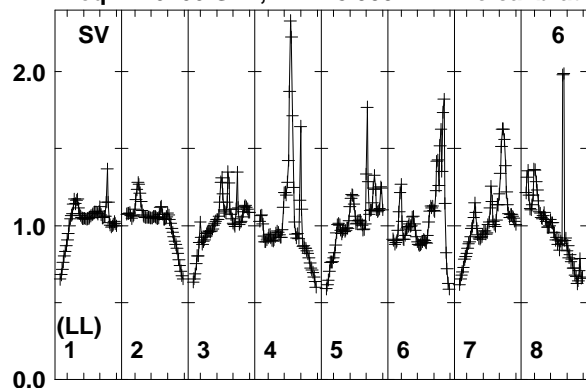

Lower frame: Real Jy
Total-power spectrum Antenna: SV (06)
Timerange: 00/19:11:33 to 00/19:13:59

Plot file version 236 created 01-AUG-2018 16:38:31

PB+0+3 N18L1 2.UVDATA.1

Freq = 1.6266 GHz, Bw = 8.000 MH No calibration applied and no bandpass applied

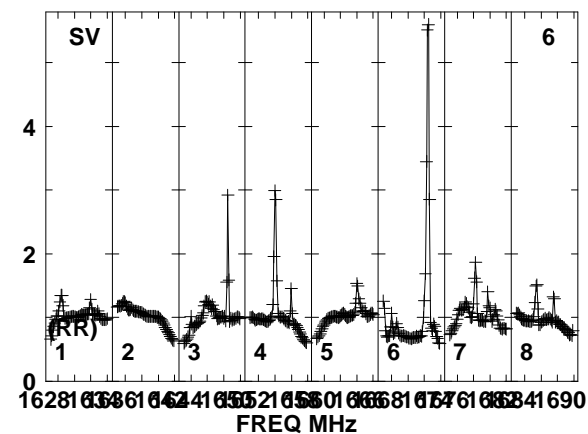
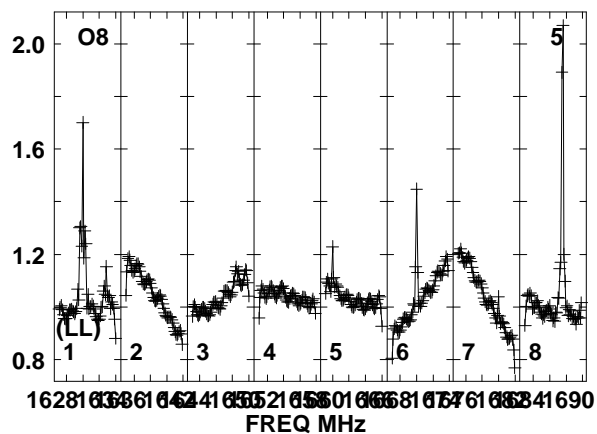
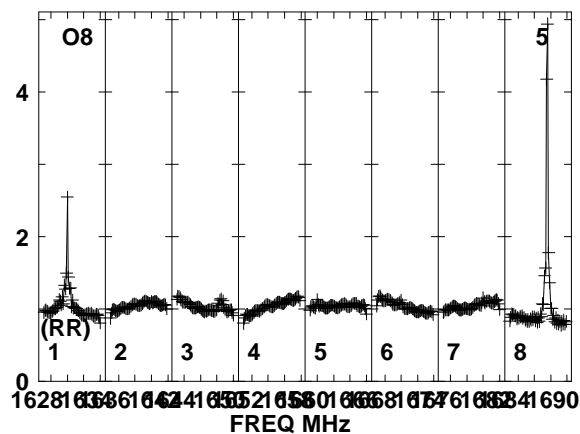
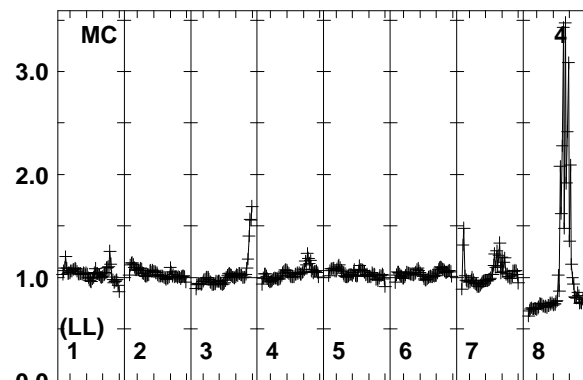
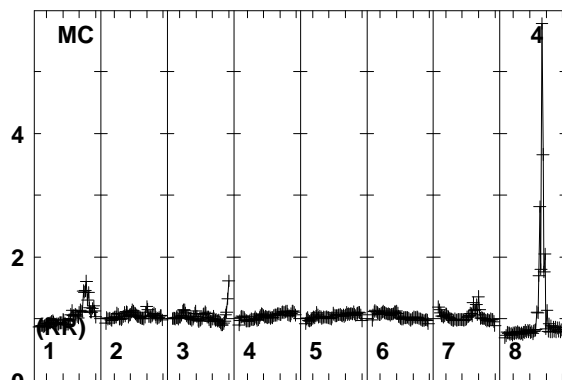
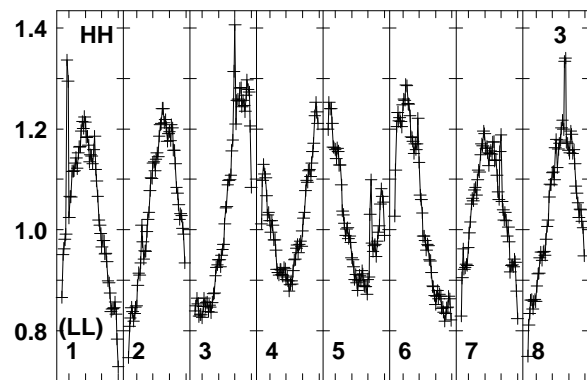
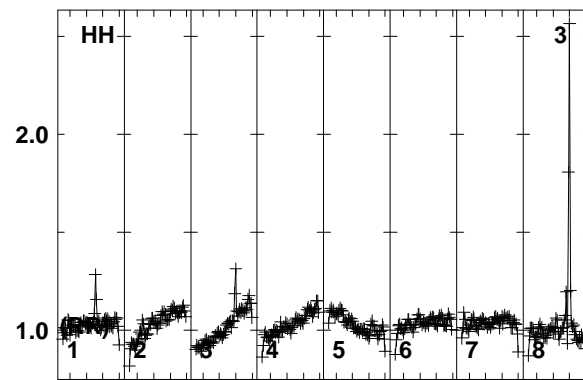
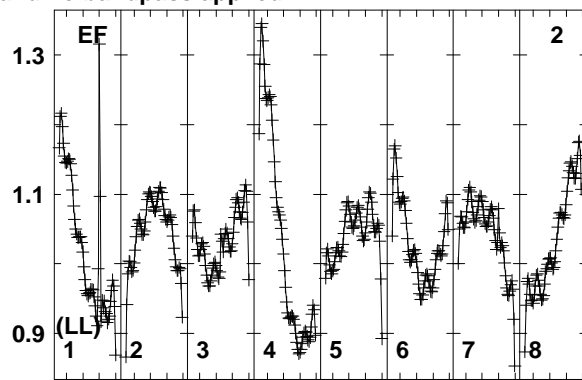
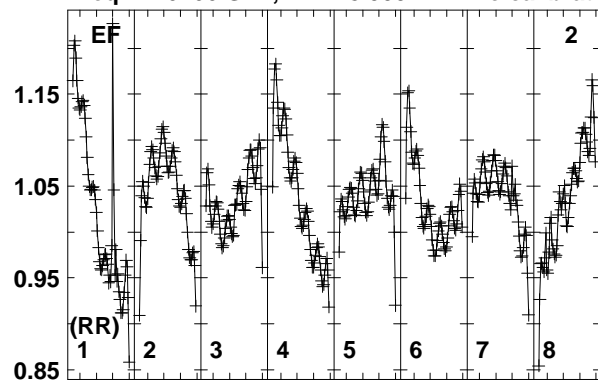

Lower frame: Real Jy
Total-power spectrum Antenna: EF (02)
Timerange: 00/19:14:03 to 00/19:16:29

Plot file version 237 created 01-AUG-2018 16:38:31

PB+0+3 N18L1 2.UVDATA.1

Freq = 1.6266 GHz, Bw = 8.000 MH No calibration applied and no bandpass applied

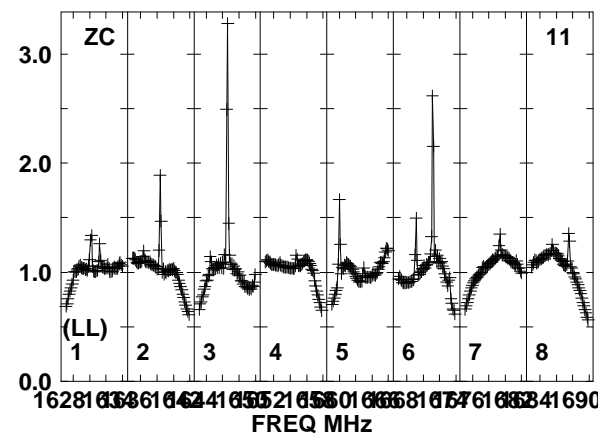
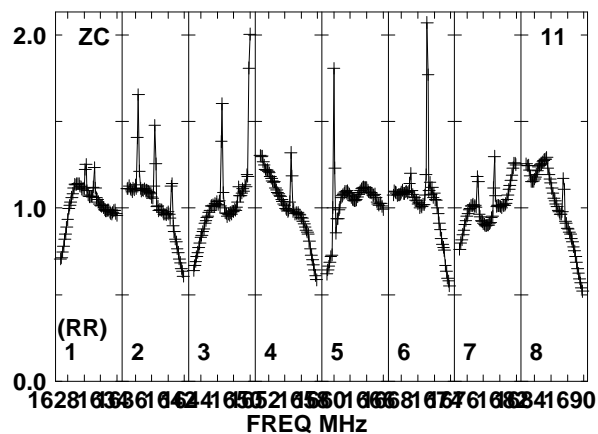
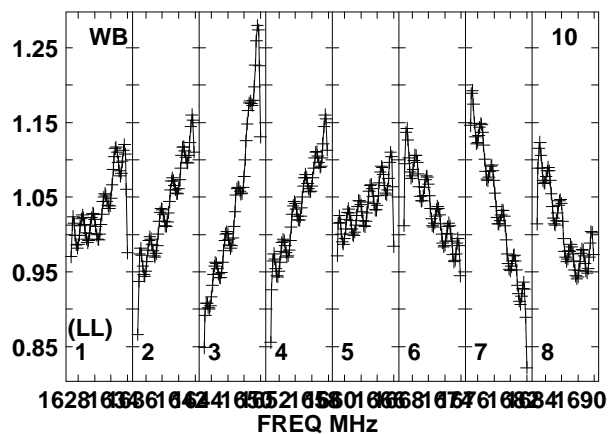
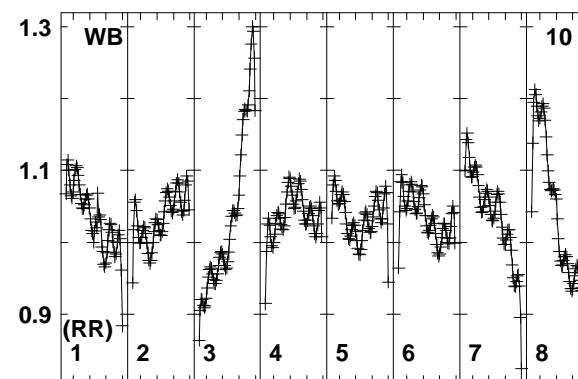
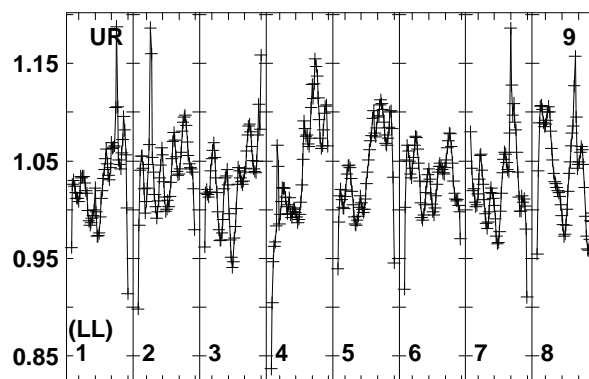
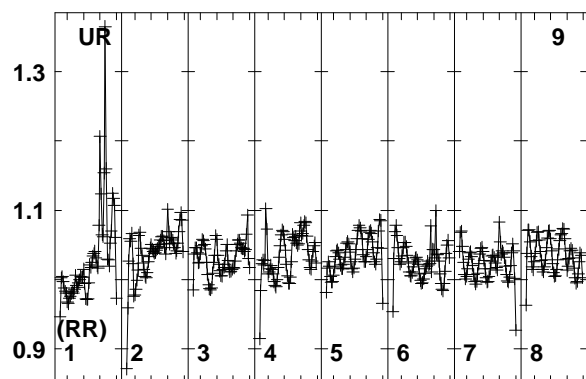
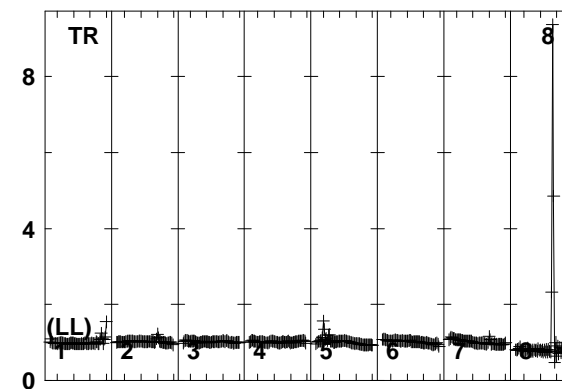
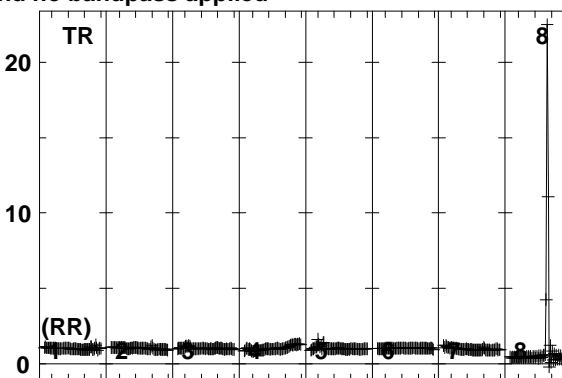
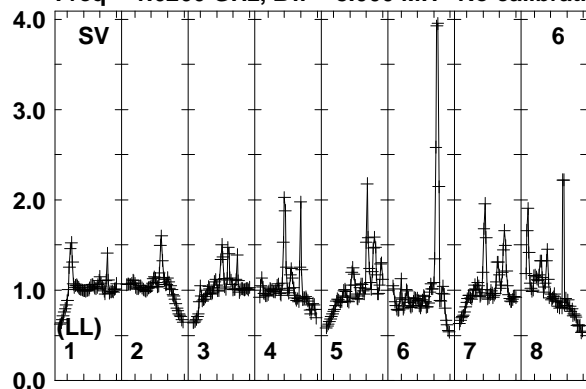

Lower frame: Real Jy
Total-power spectrum Antenna: SV (06)
Timerange: 00/19:14:03 to 00/19:16:29

Plot file version 238 created 01-AUG-2018 16:38:31

J0530+1331 N18L1 2.UVDATA.1

Freq = 1.6266 GHz, Bw = 8.000 MH No calibration applied and no bandpass applied

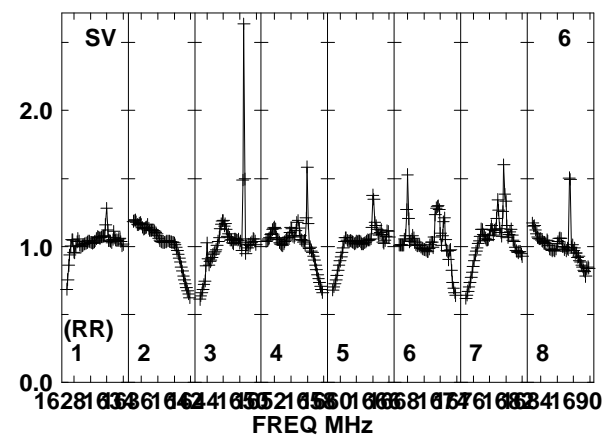
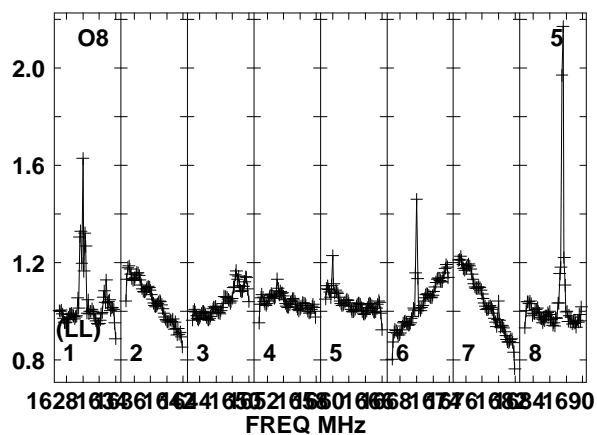
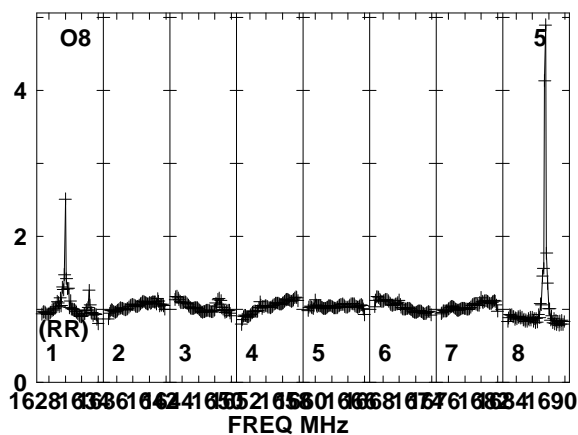
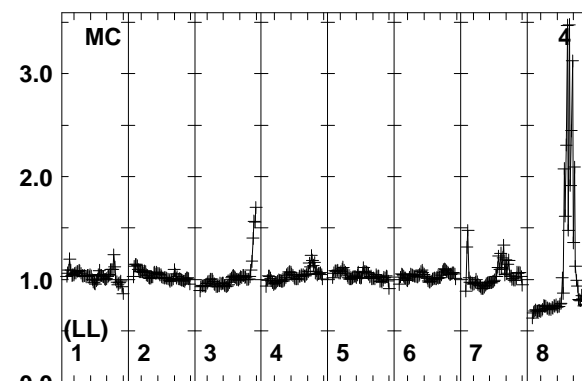
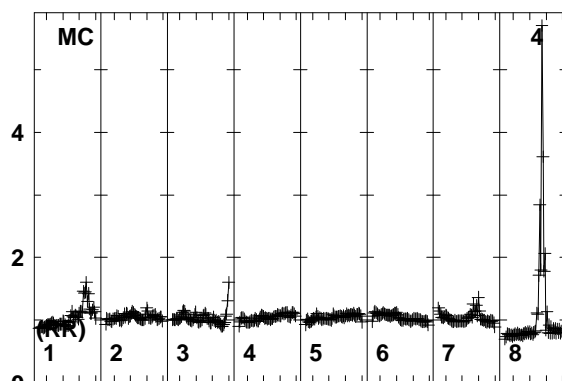
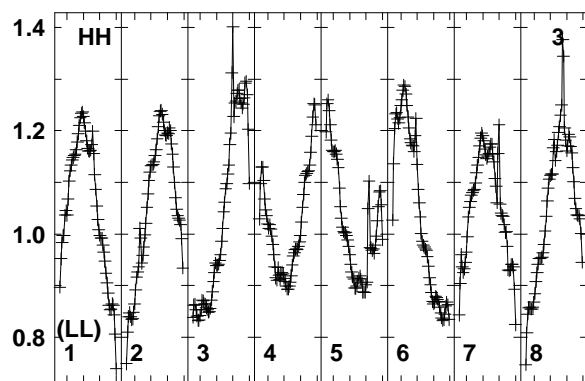
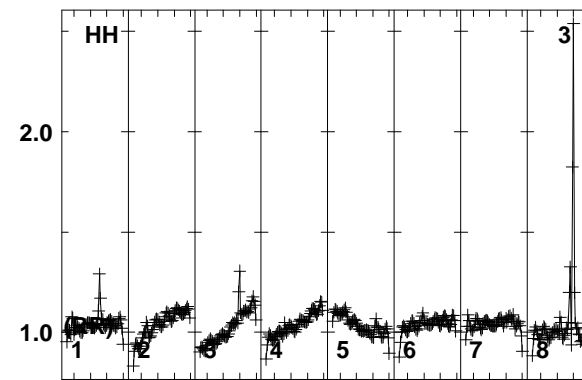
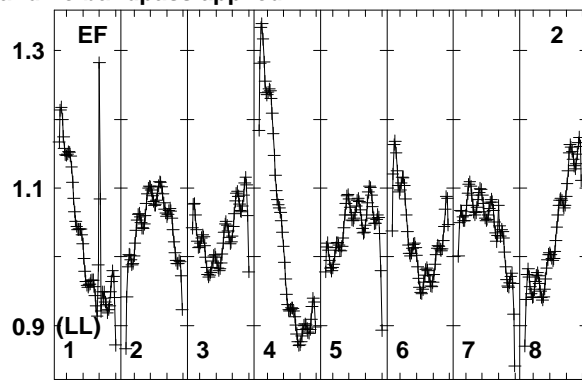
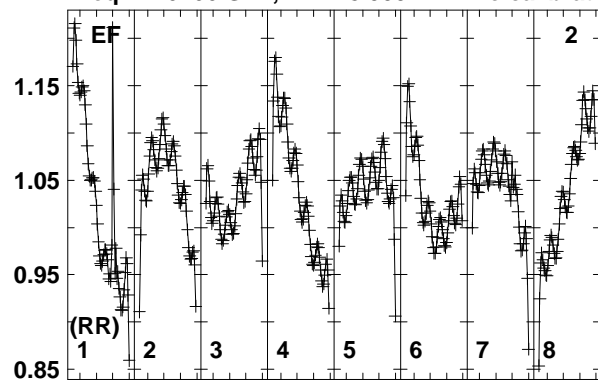

Lower frame: Real Jy
Total-power spectrum Antenna: EF (02)
Timerange: 00/19:17:11 to 00/19:18:29

Plot file version 239 created 01-AUG-2018 16:38:31

J0530+1331 N18L1 2.UVDATA.1

Freq = 1.6266 GHz, Bw = 8.000 MH No calibration applied and no bandpass applied

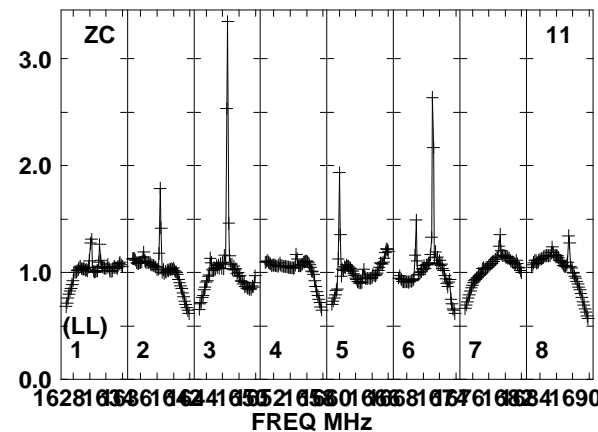
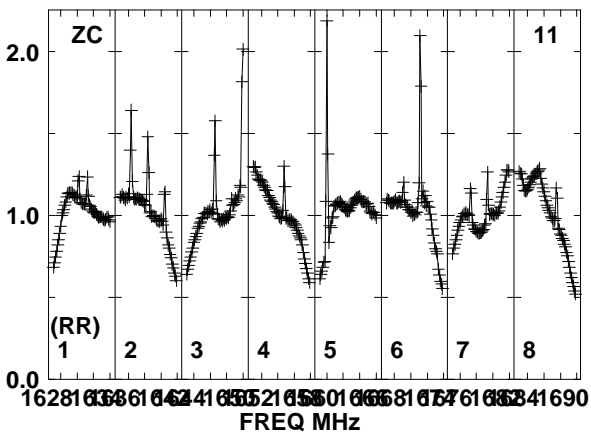
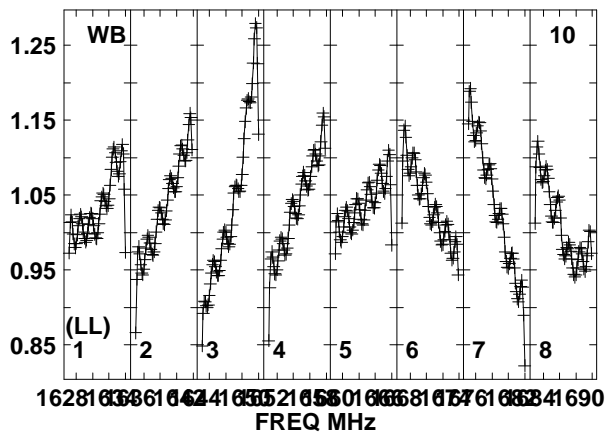
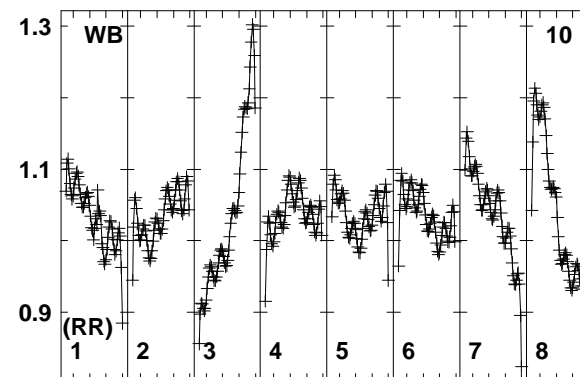
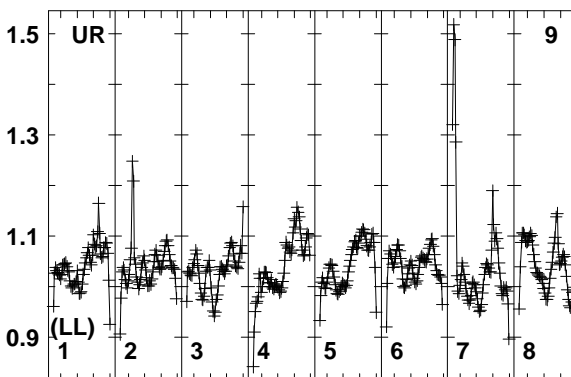
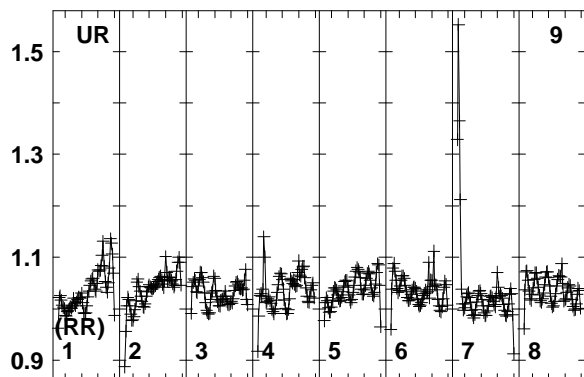
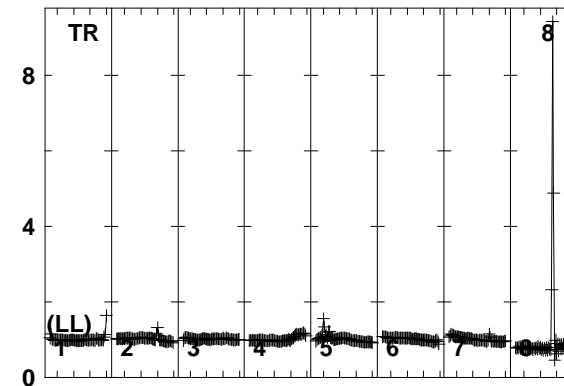
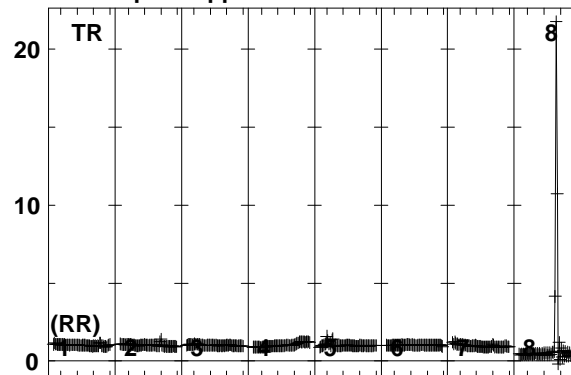
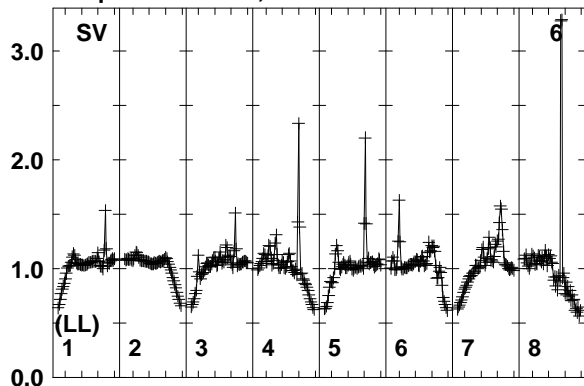

Lower frame: Real Jy
Total-power spectrum Antenna: SV (06)
Timerange: 00/19:17:11 to 00/19:18:29

Plot file version 240 created 01-AUG-2018 16:38:31

PB+1+3 N18L1 2.UVDATA.1

Freq = 1.6266 GHz, Bw = 8.000 MH No calibration applied and no bandpass applied

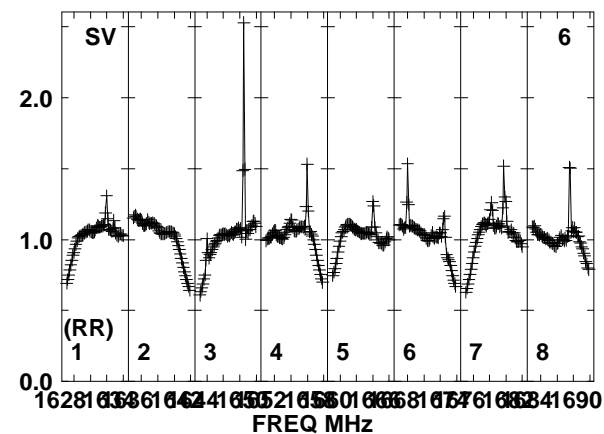
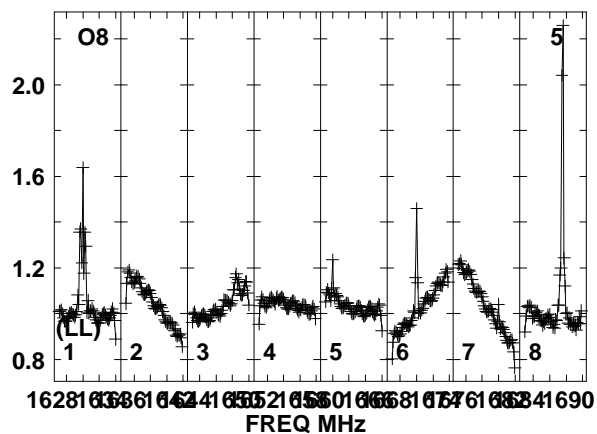
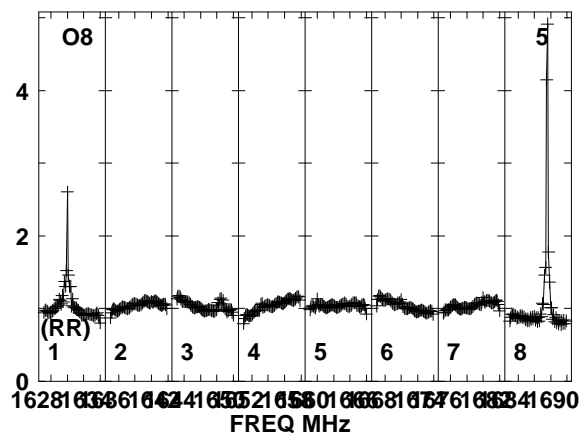
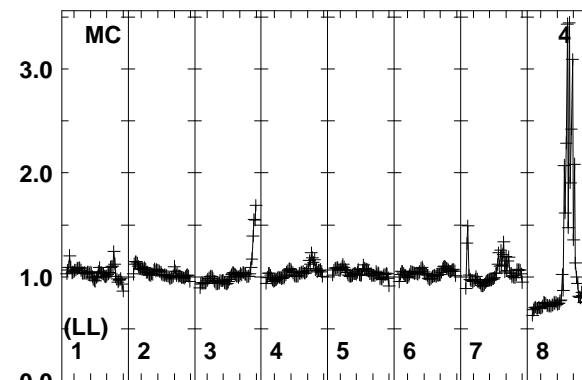
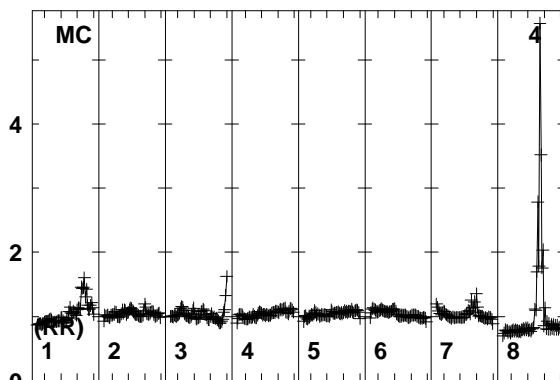
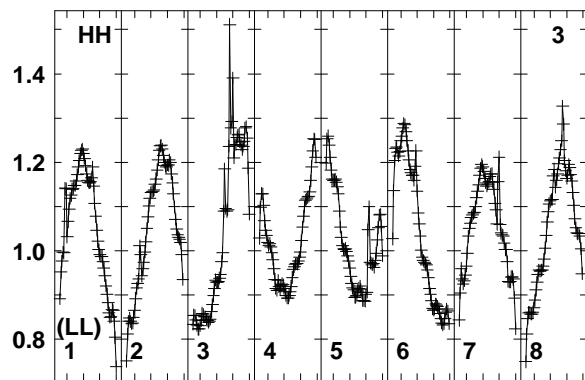
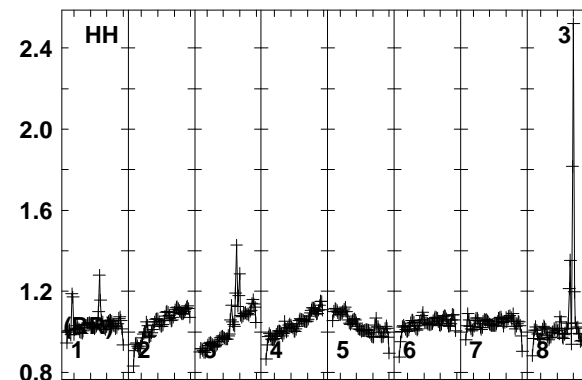
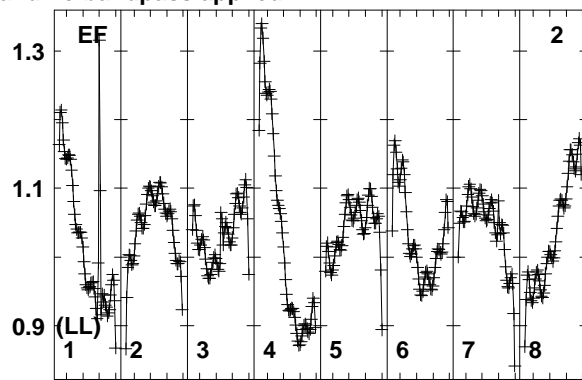
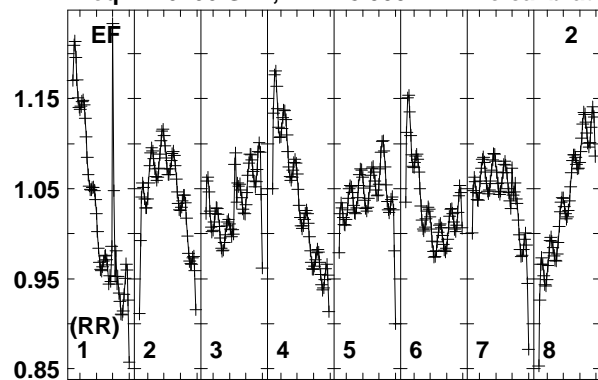

Lower frame: Real Jy
Total-power spectrum Antenna: EF (02)
Timerange: 00/19:18:35 to 00/19:20:59

Plot file version 241 created 01-AUG-2018 16:38:31
PB+1+3 N18L1 2.UVDATA.1
Freq = 1.6266 GHz, Bw = 8.000 MH No calibration applied and no bandpass applied

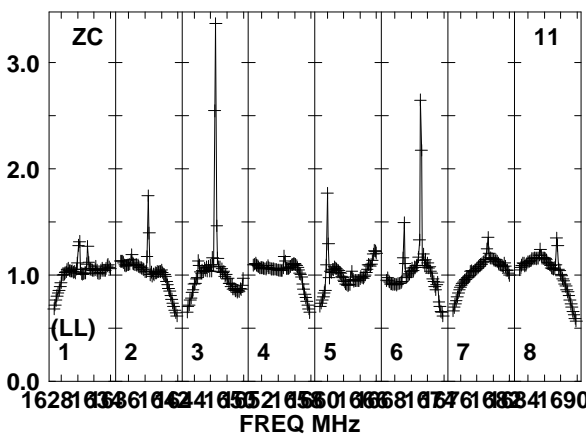
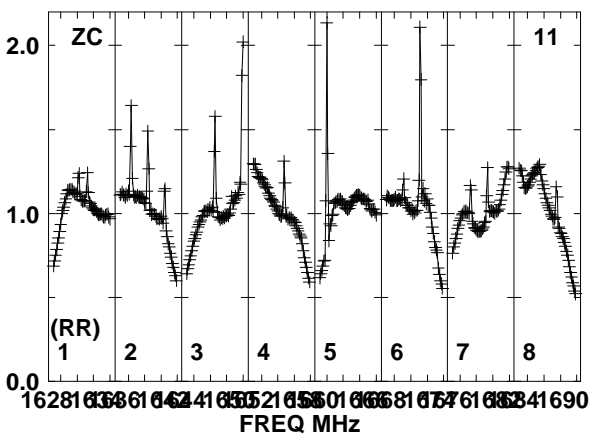
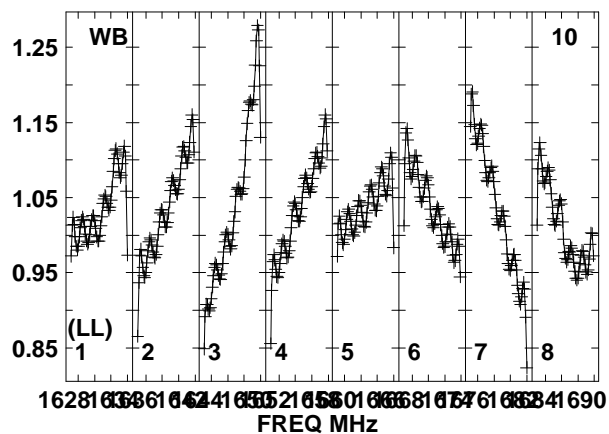
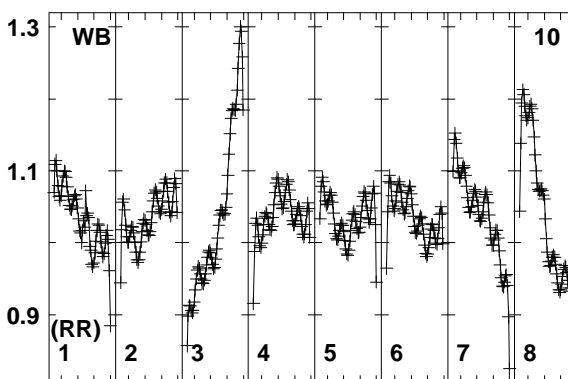
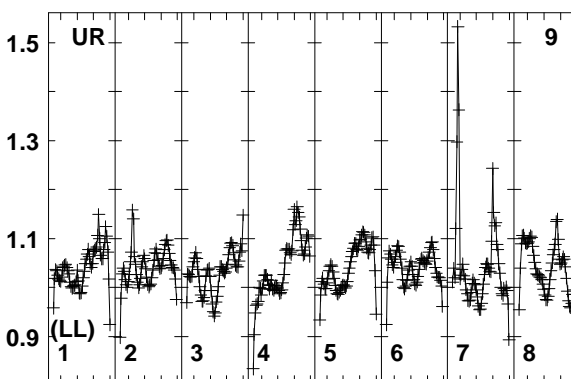
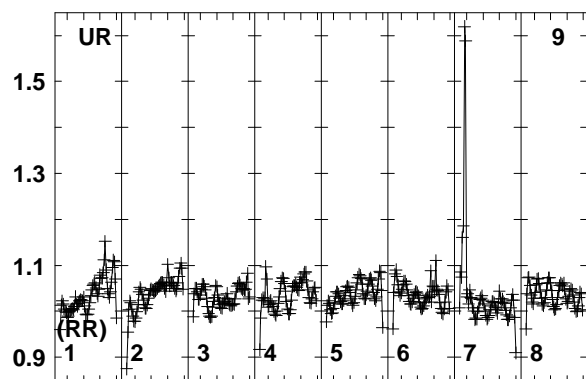
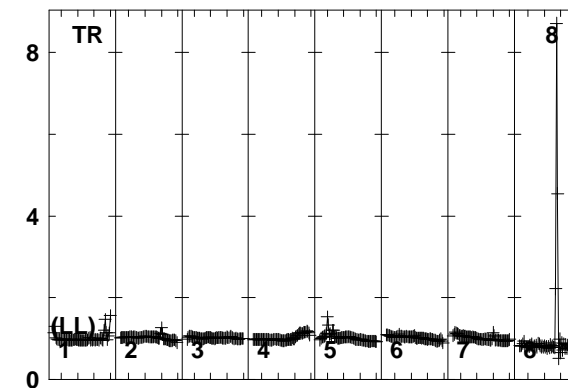
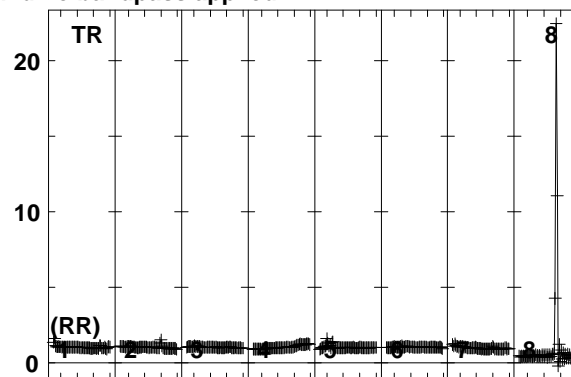
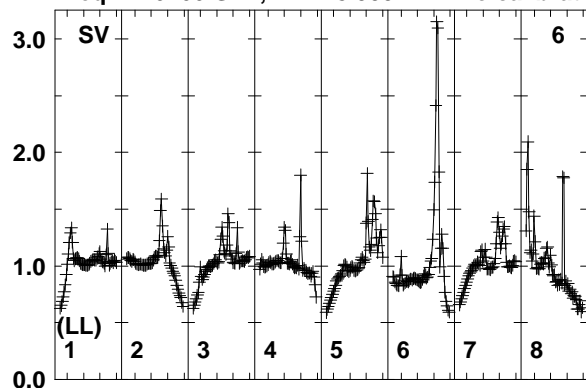

Lower frame: Real Jy
Total-power spectrum Antenna: SV (06)
Timerange: 00/19:18:35 to 00/19:20:59

Plot file version 242 created 01-AUG-2018 16:38:31

PB+2+3 N18L1 2.UVDATA.1

Freq = 1.6266 GHz, Bw = 8.000 MH No calibration applied and no bandpass applied

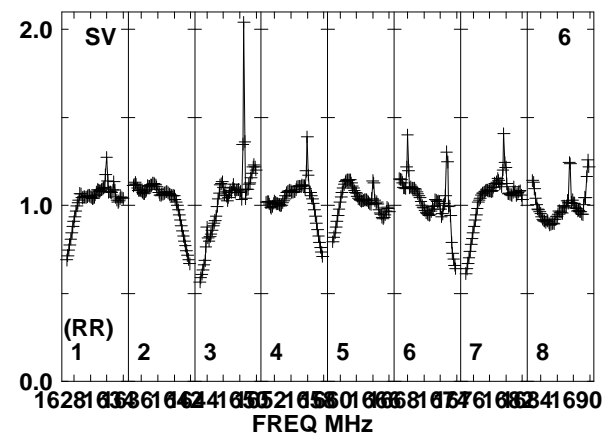
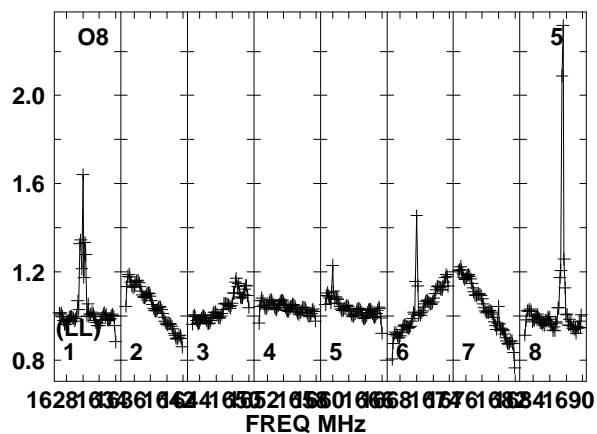
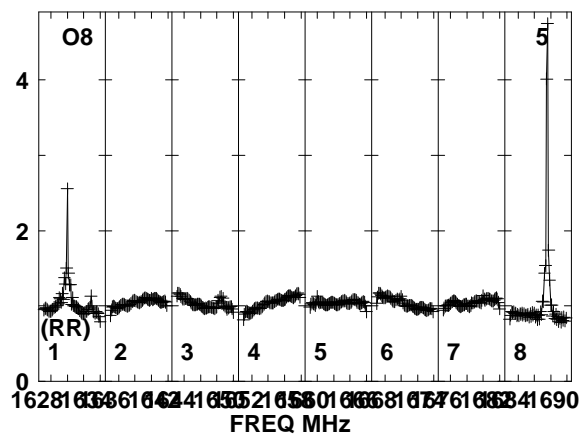
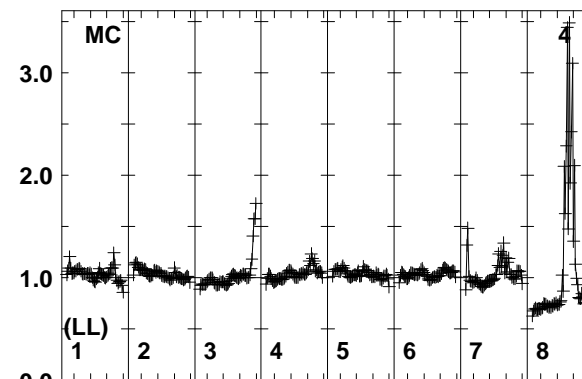
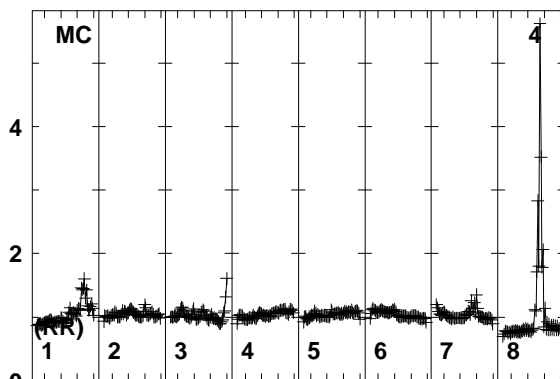
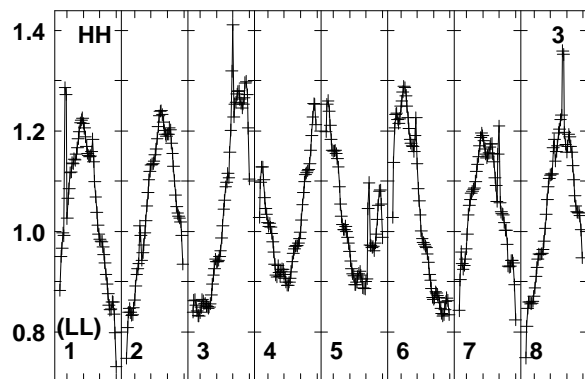
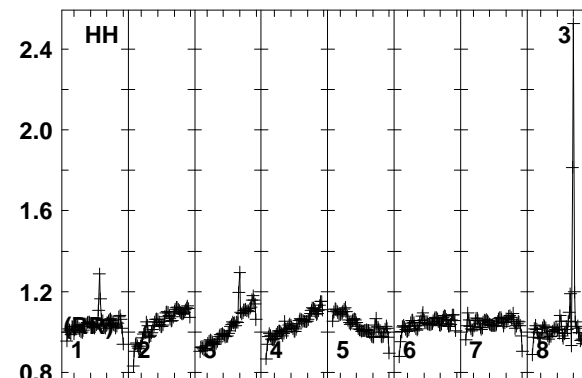
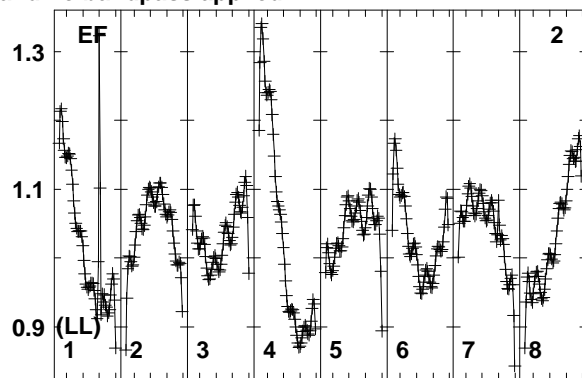
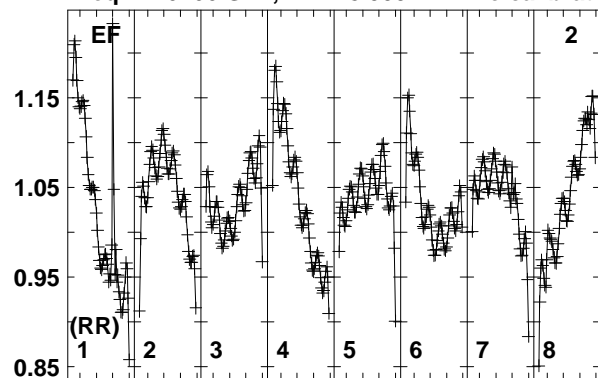

Lower frame: Real Jy
Total-power spectrum Antenna: EF (02)
Timerange: 00/19:21:05 to 00/19:23:29

Plot file version 243 created 01-AUG-2018 16:38:32
 PB+2+3 N18L1 2.UVDATA.1
 Freq = 1.6266 GHz, Bw = 8.000 MH No calibration applied and no bandpass applied

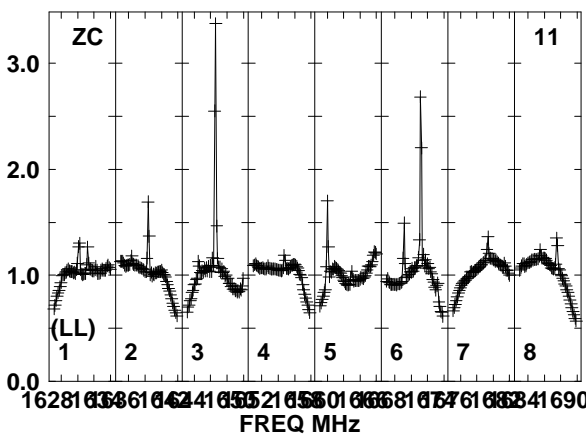
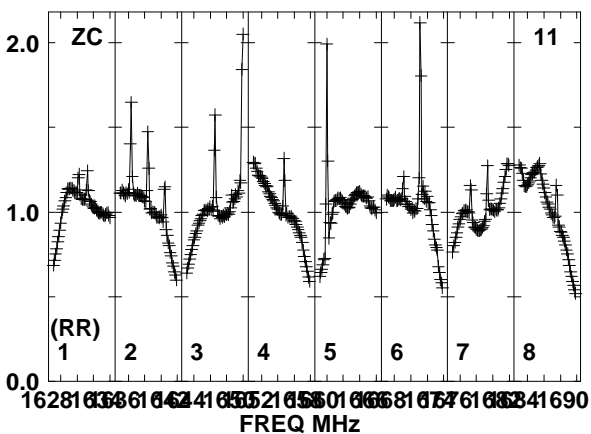
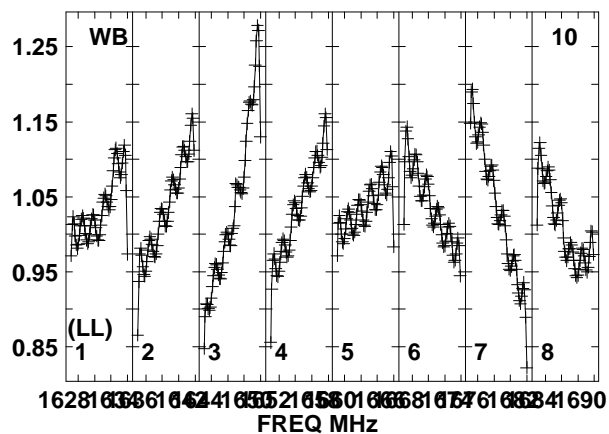
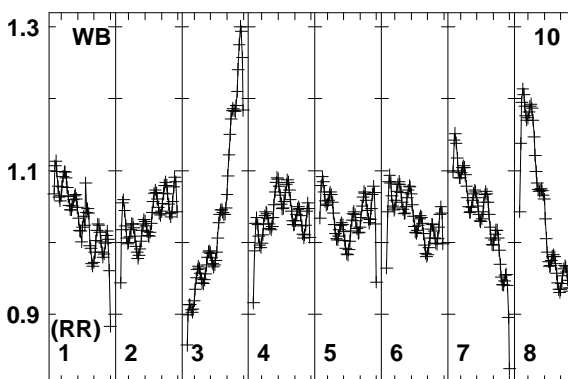
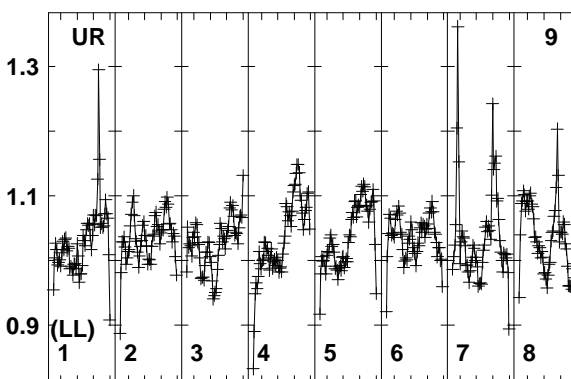
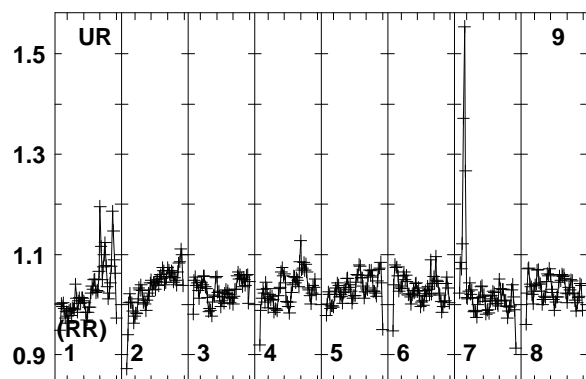
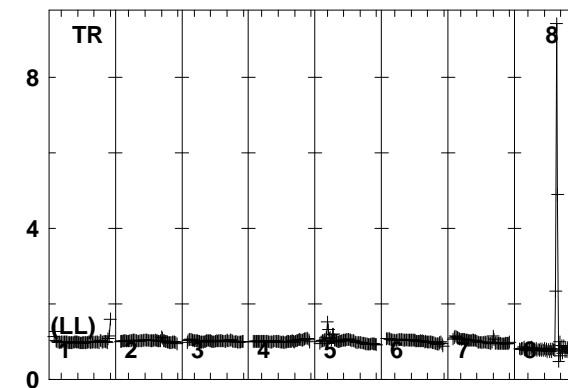
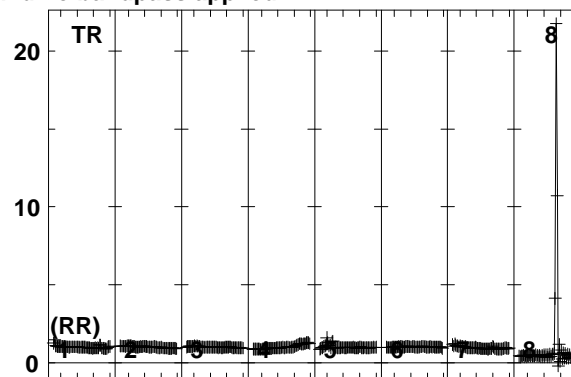
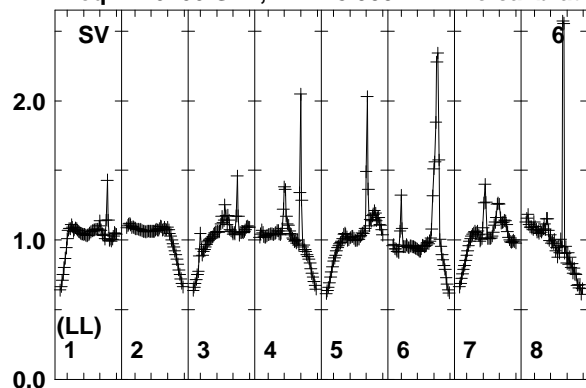

Lower frame: Real Jy
 Total-power spectrum Antenna: SV (06)
 Timerange: 00/19:21:05 to 00/19:23:29

Plot file version 244 created 01-AUG-2018 16:38:32

PB+3+3 N18L1 2.UVDATA.1

Freq = 1.6266 GHz, Bw = 8.000 MH No calibration applied and no bandpass applied

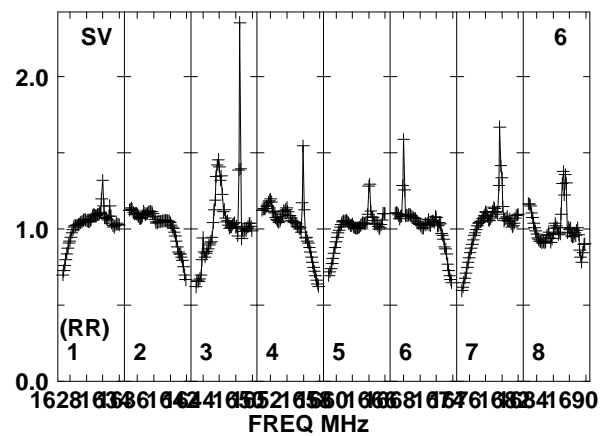
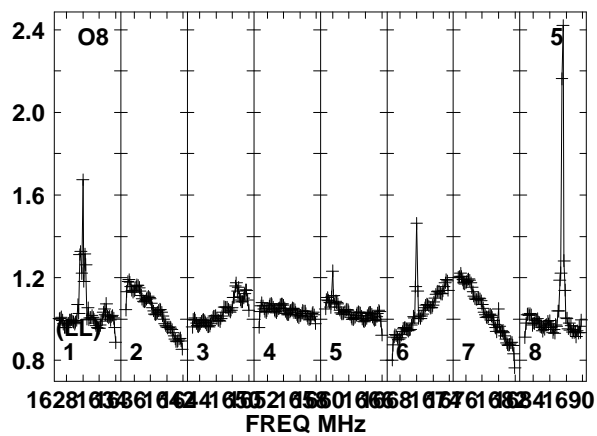
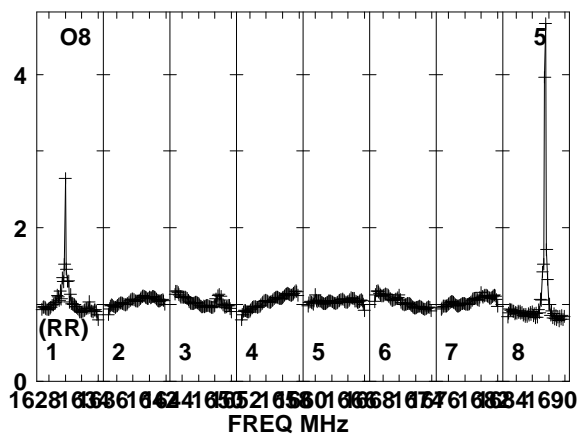
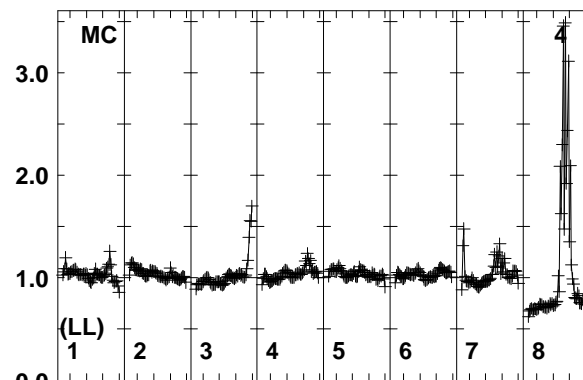
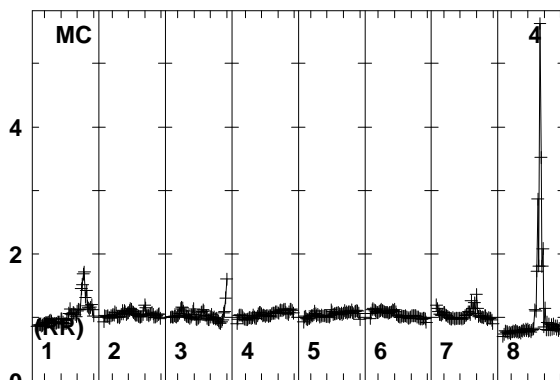
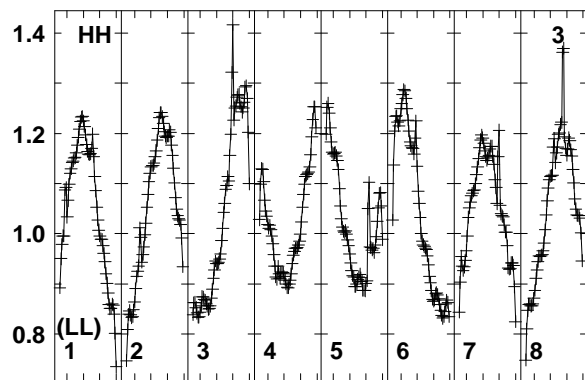
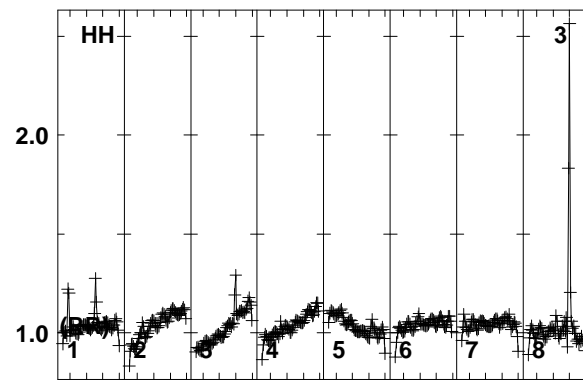
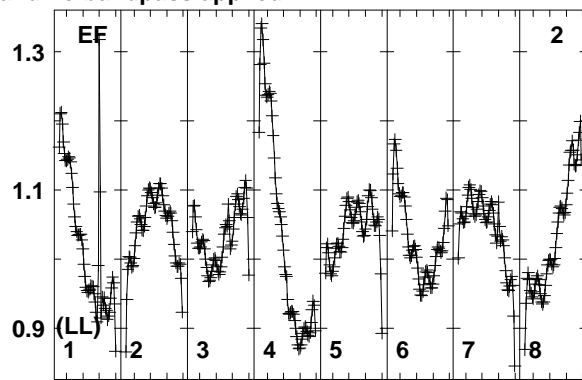
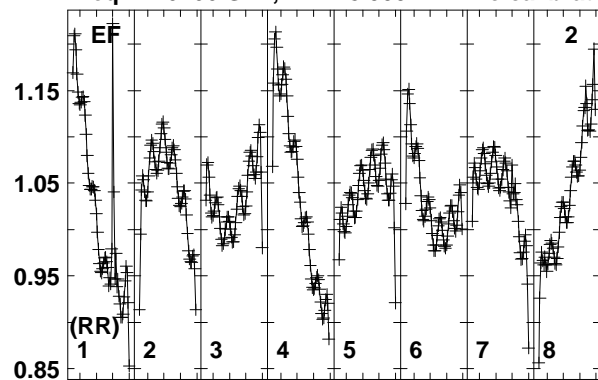

Lower frame: Real Jy
Total-power spectrum Antenna: EF (02)
Timerange: 00/19:23:33 to 00/19:25:59

Plot file version 245 created 01-AUG-2018 16:38:32
 PB+3+3 N18L1 2.UVDATA.1
 Freq = 1.6266 GHz, Bw = 8.000 MH No calibration applied and no bandpass applied

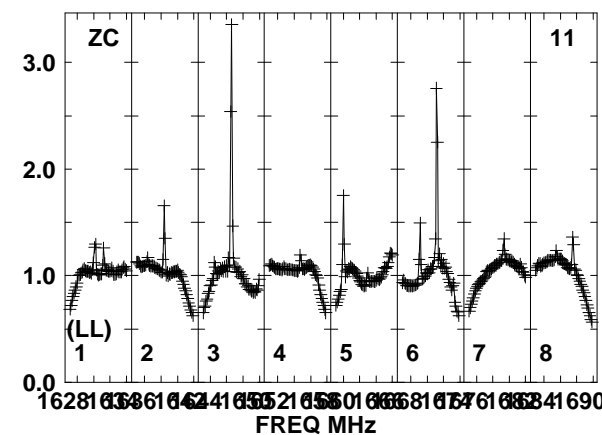
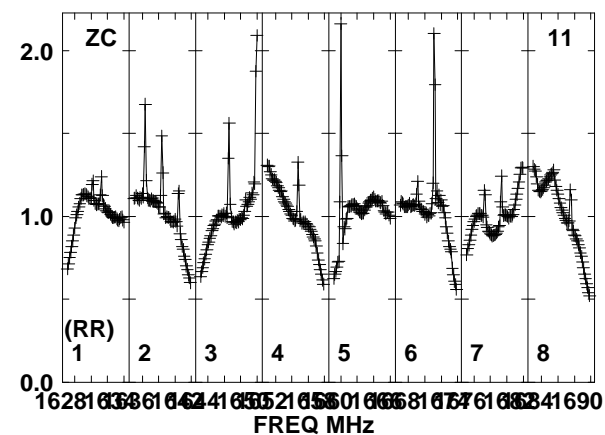
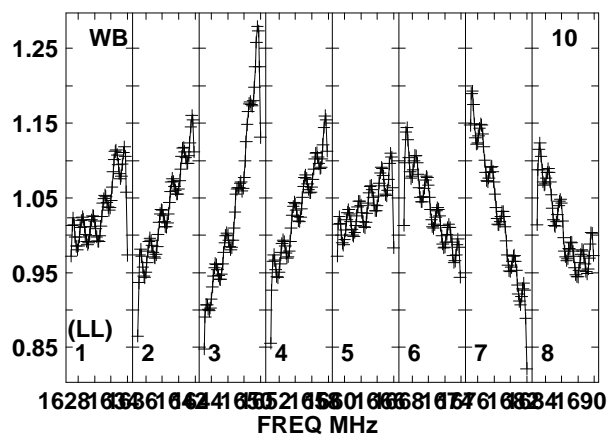
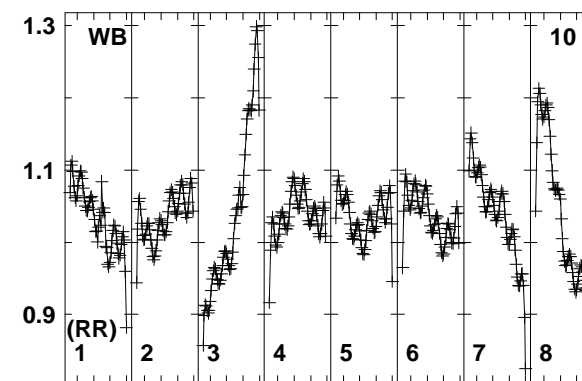
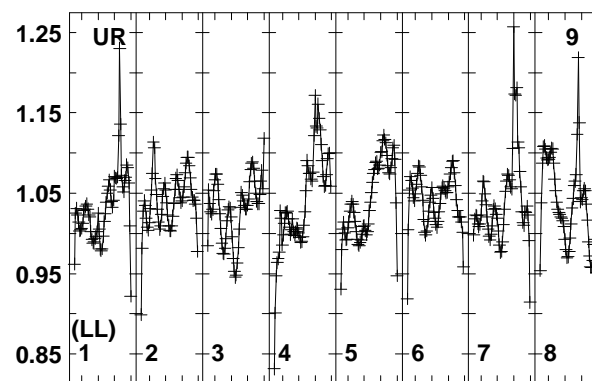
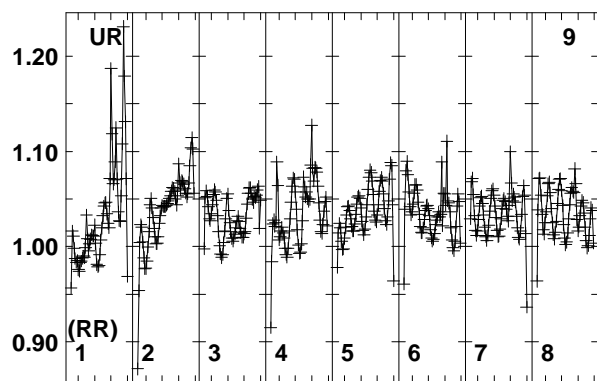
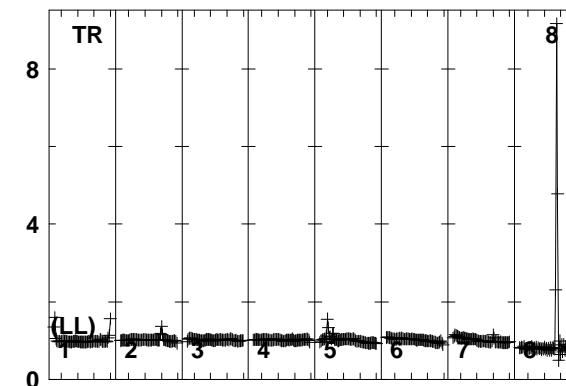
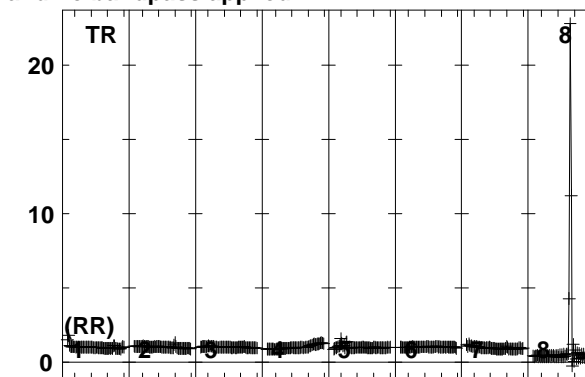
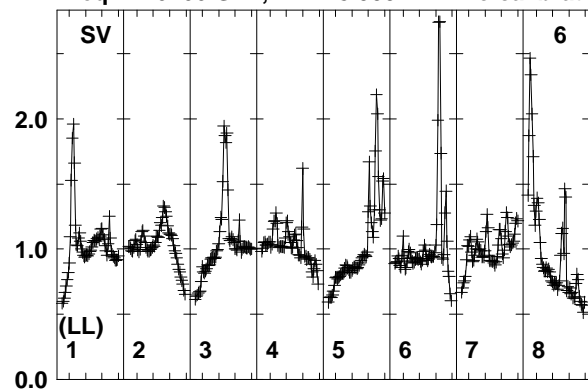

Lower frame: Real Jy
 Total-power spectrum Antenna: SV (06)
 Timerange: 00/19:23:33 to 00/19:25:59

Plot file version 246 created 01-AUG-2018 16:38:32

PB+4+3 N18L1 2.UVDATA.1

Freq = 1.6266 GHz, Bw = 8.000 MH No calibration applied and no bandpass applied

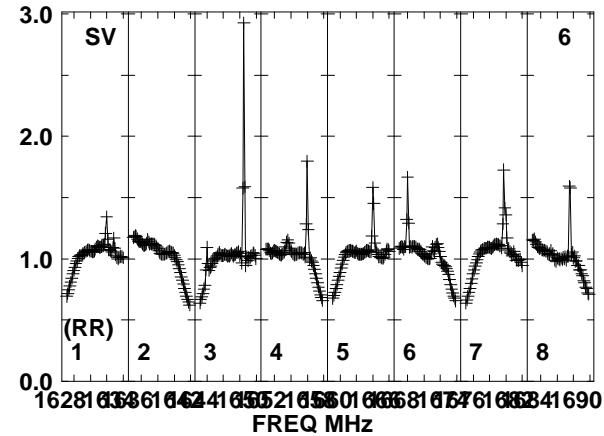
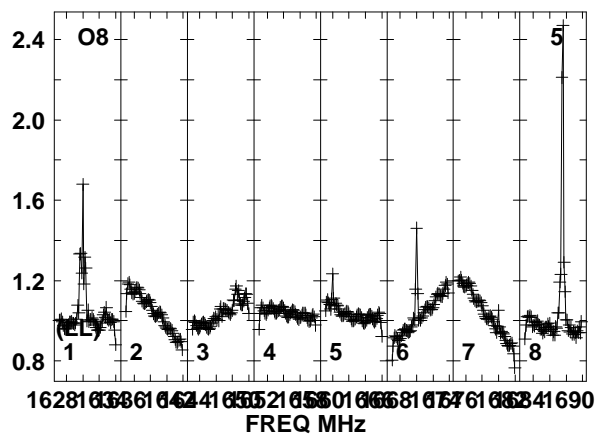
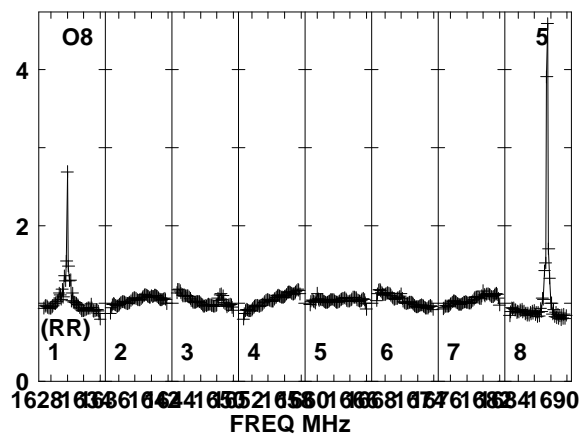
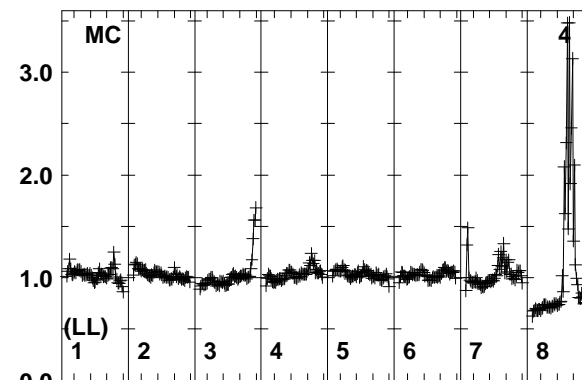
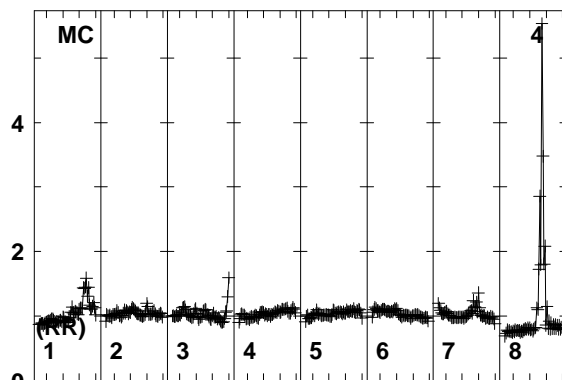
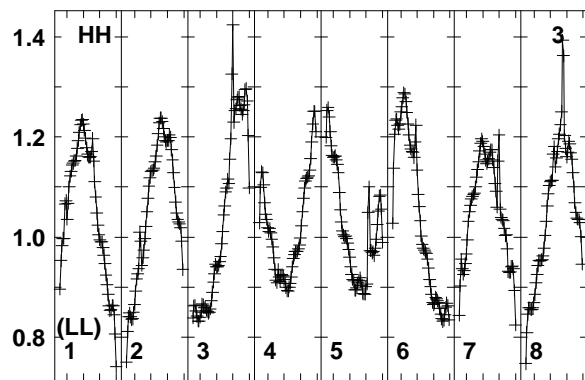
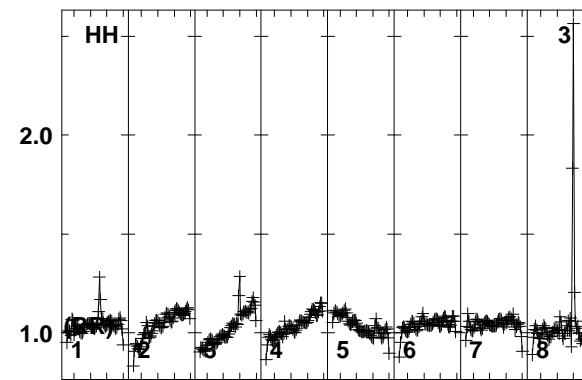
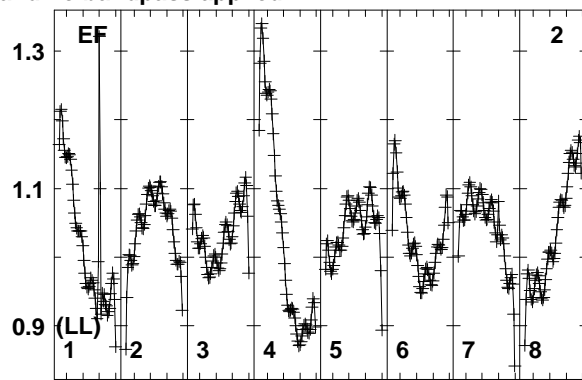
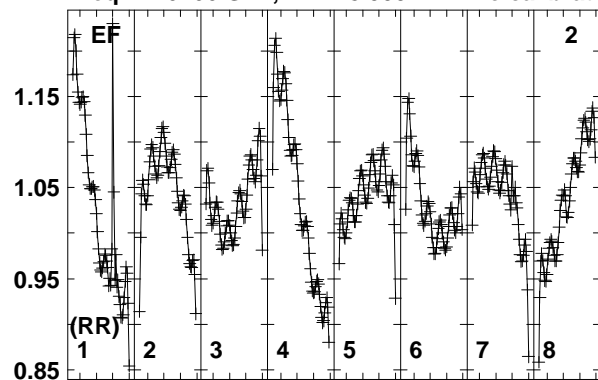

Lower frame: Real Jy
Total-power spectrum Antenna: EF (02)
Timerange: 00/19:26:03 to 00/19:28:29

Plot file version 247 created 01-AUG-2018 16:38:32

PB+4+3 N18L1 2.UVDATA.1

Freq = 1.6266 GHz, Bw = 8.000 MH No calibration applied and no bandpass applied

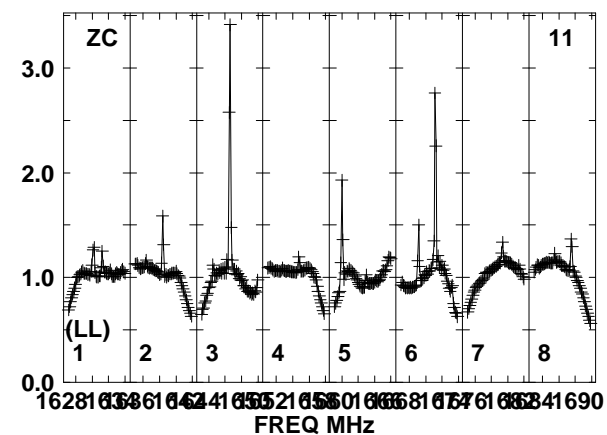
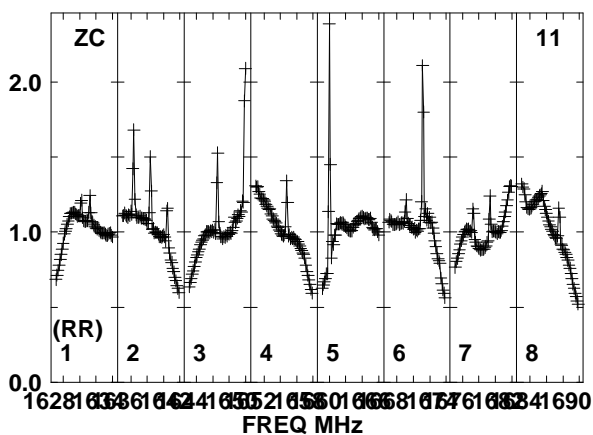
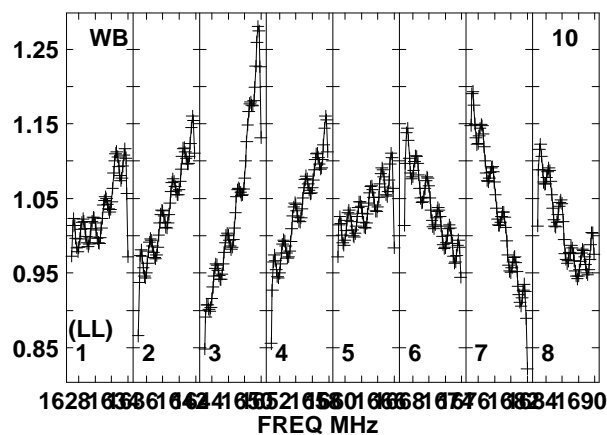
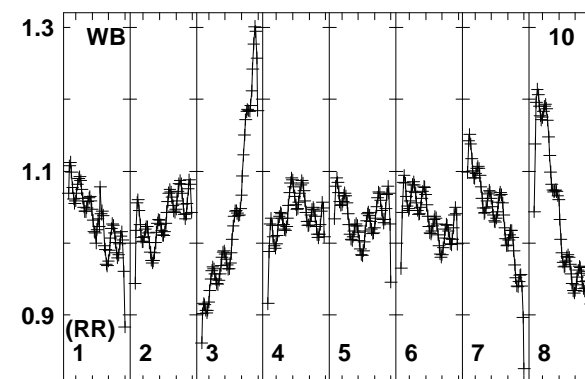
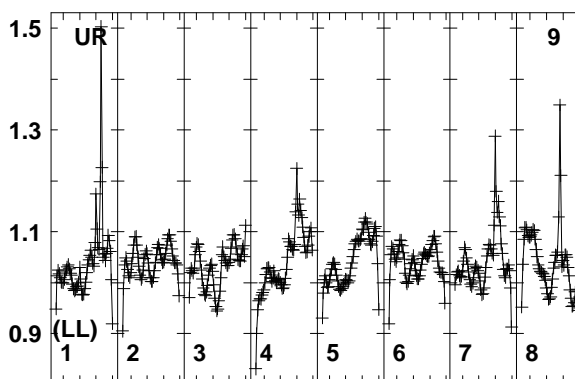
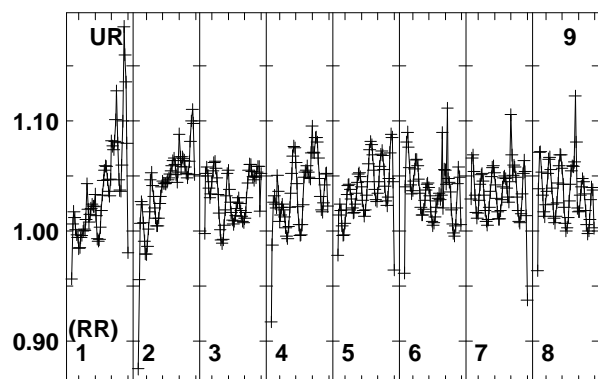
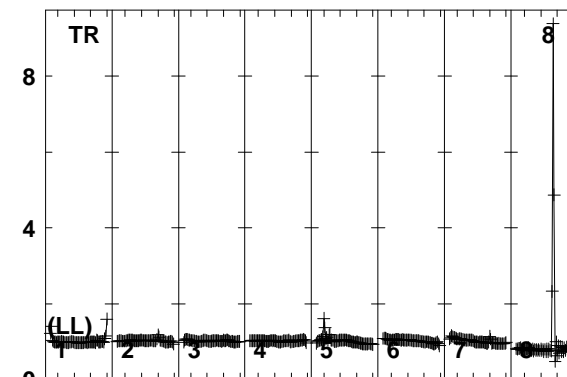
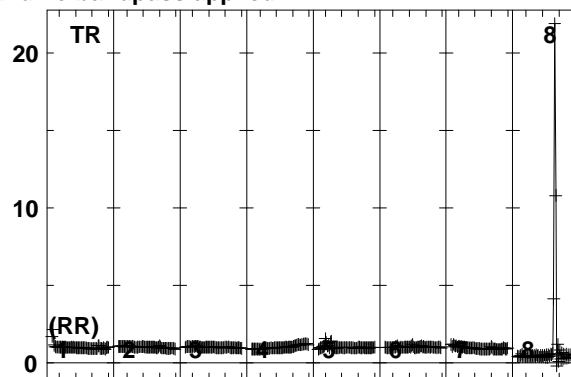
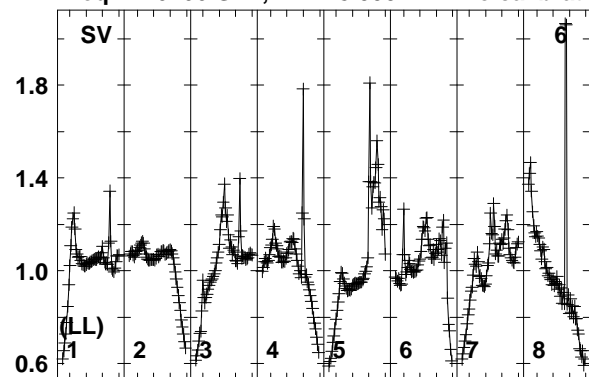

Lower frame: Real Jy
Total-power spectrum Antenna: SV (06)
Timerange: 00/19:26:03 to 00/19:28:29

Plot file version 248 created 01-AUG-2018 16:38:32

J0530+1331 N18L1 2.UVDATA.1

Freq = 1.6266 GHz, Bw = 8.000 MH No calibration applied and no bandpass applied

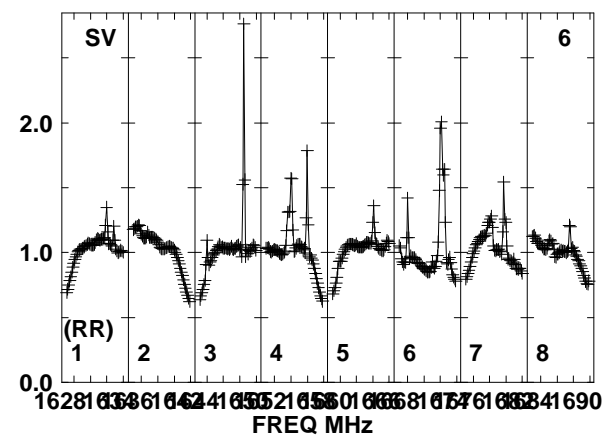
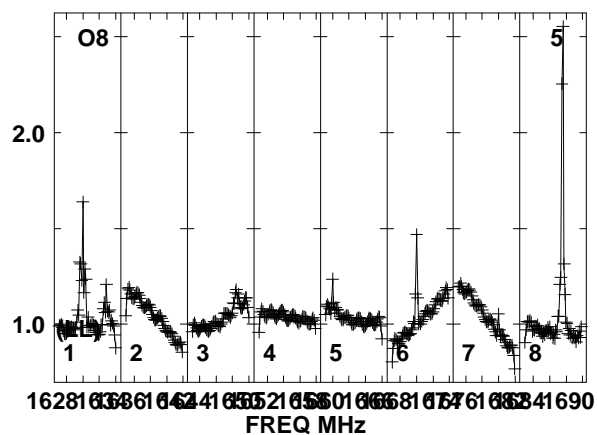
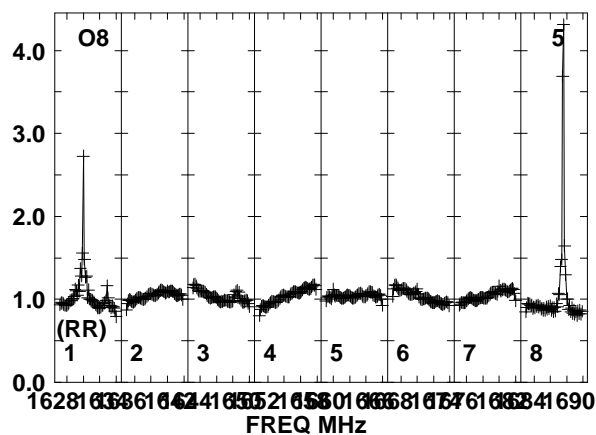
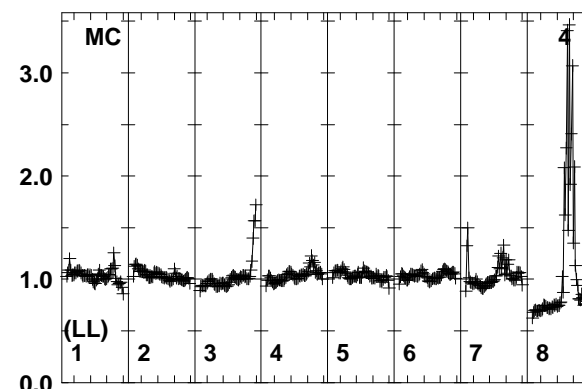
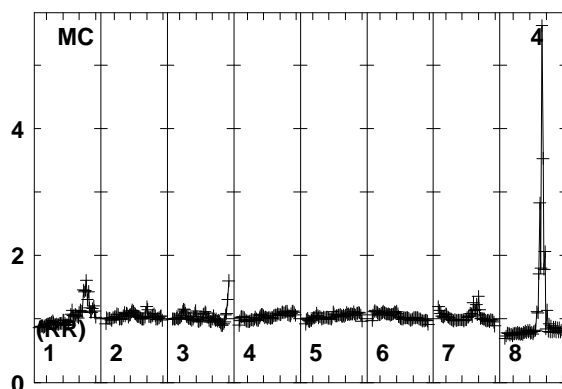
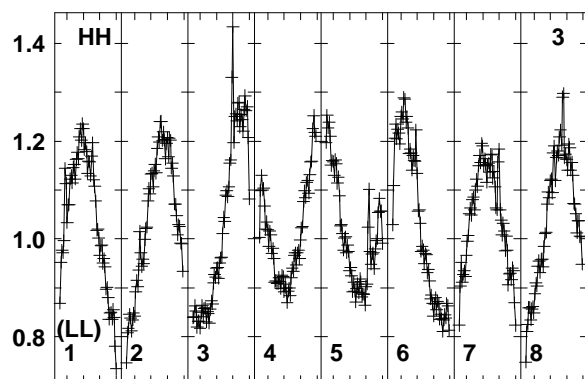
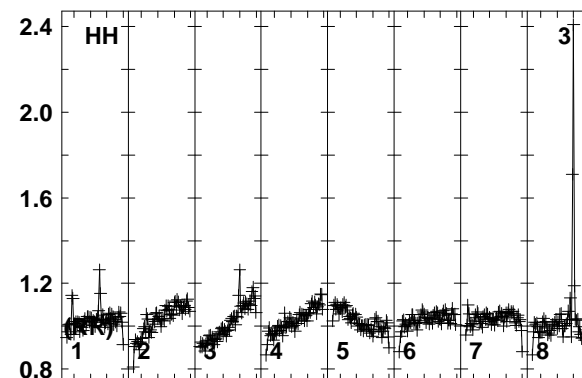
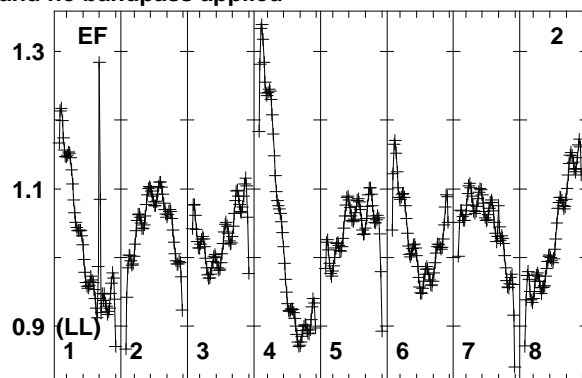
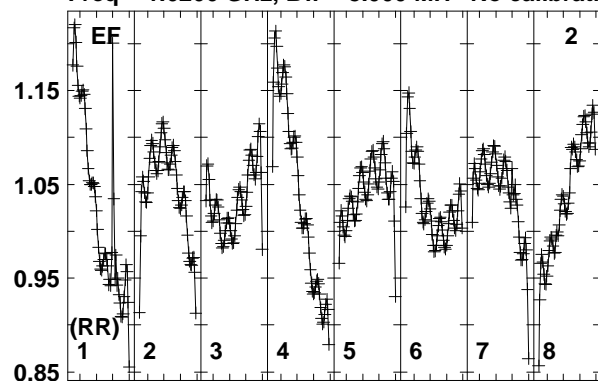

Lower frame: Real Jy
Total-power spectrum Antenna: EF (02)
Timerange: 00/19:29:11 to 00/19:30:29

Plot file version 249 created 01-AUG-2018 16:38:32
 J0530+1331 N18L1 2.UVDATA.1
 Freq = 1.6266 GHz, Bw = 8.000 MH No calibration applied and no bandpass applied

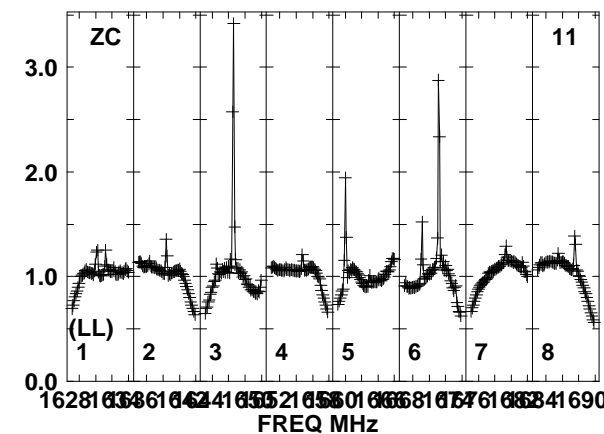
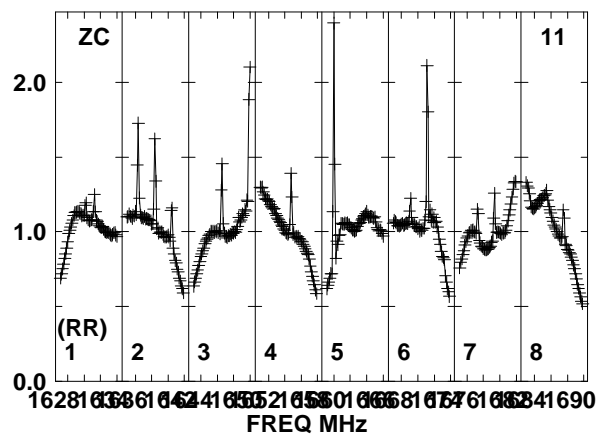
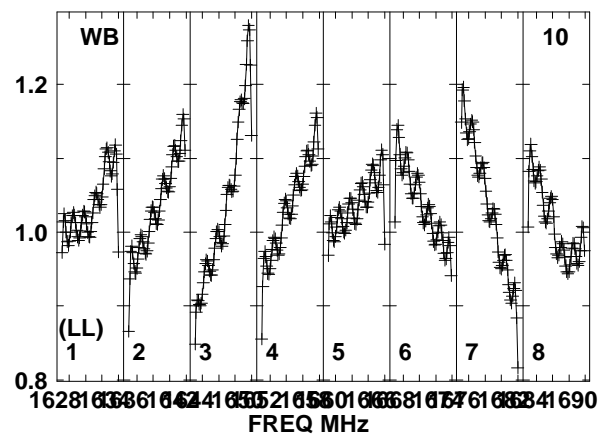
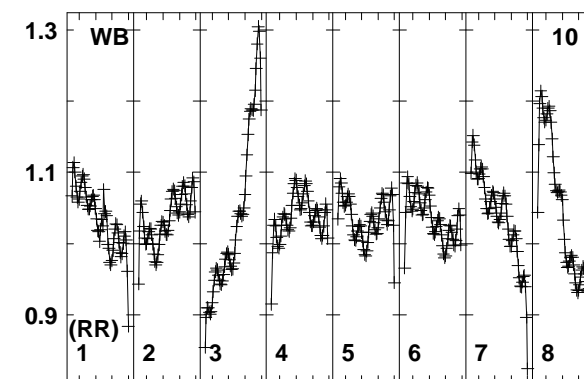
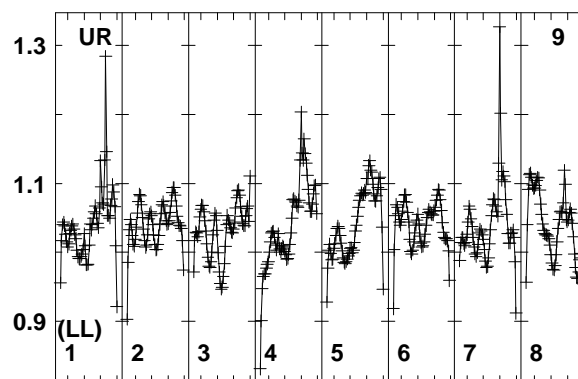
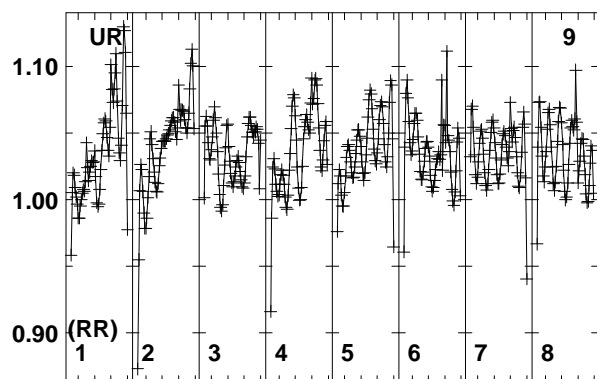
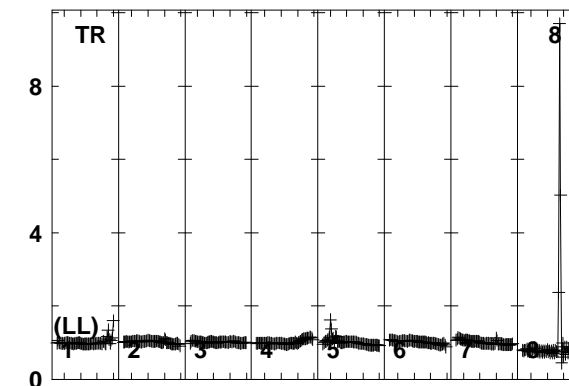
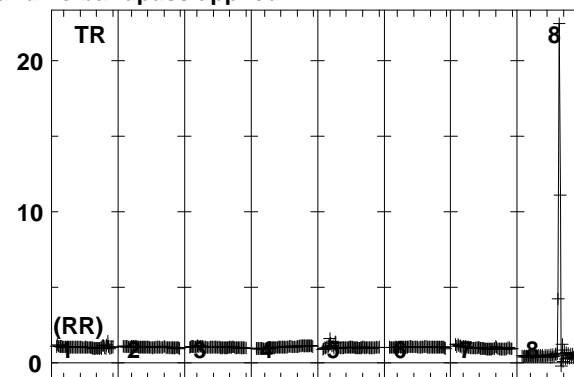
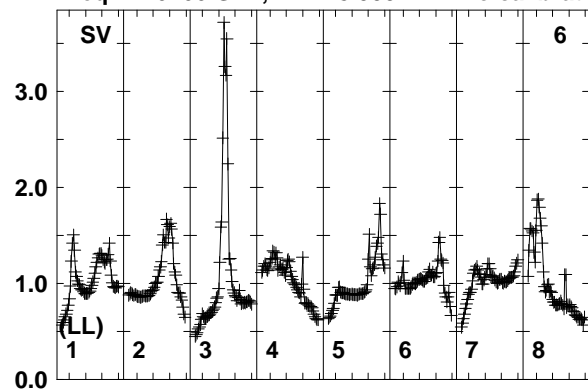

Lower frame: Real Jy
 Total-power spectrum Antenna: SV (06)
 Timerange: 00/19:29:11 to 00/19:30:29

Plot file version 250 created 01-AUG-2018 16:38:33

PB+4+4 N18L1 2.UVDATA.1

Freq = 1.6266 GHz, Bw = 8.000 MH No calibration applied and no bandpass applied

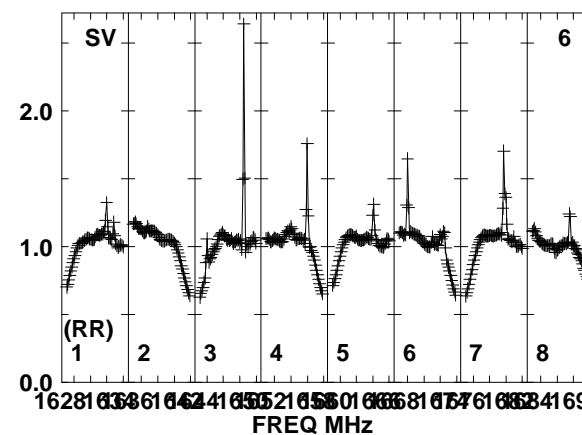
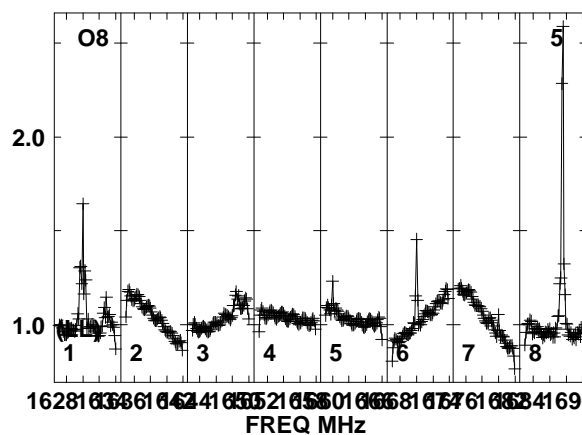
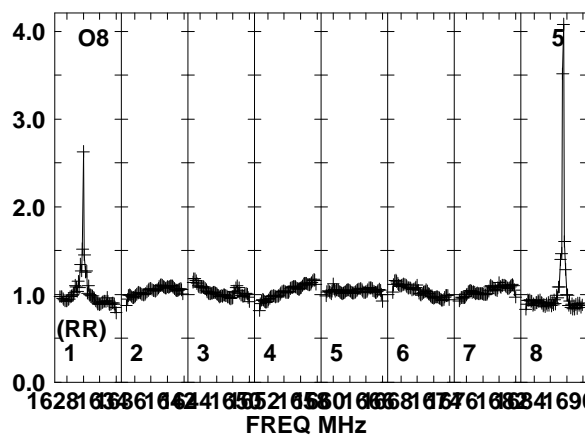
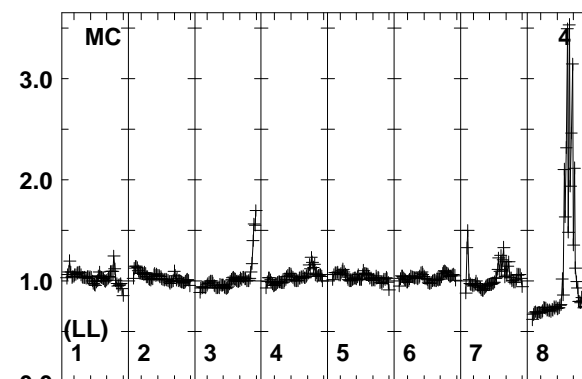
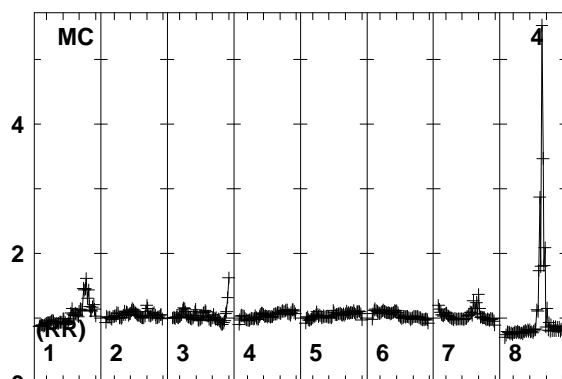
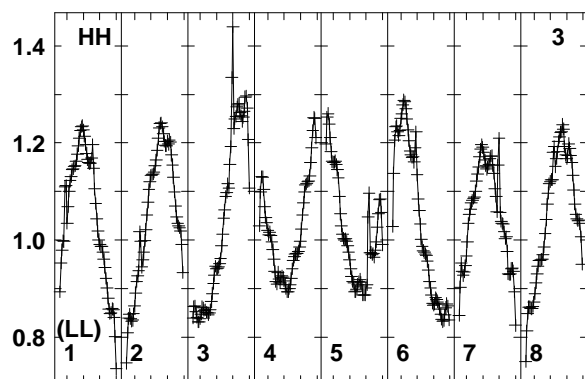
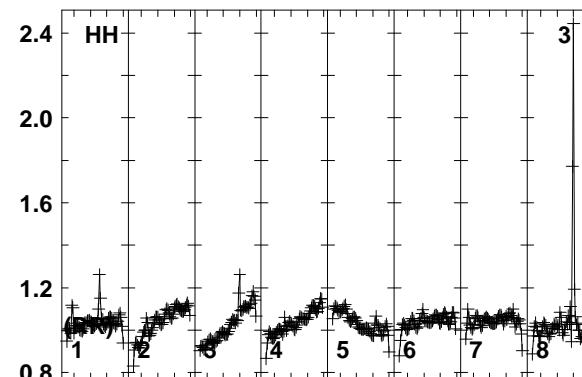
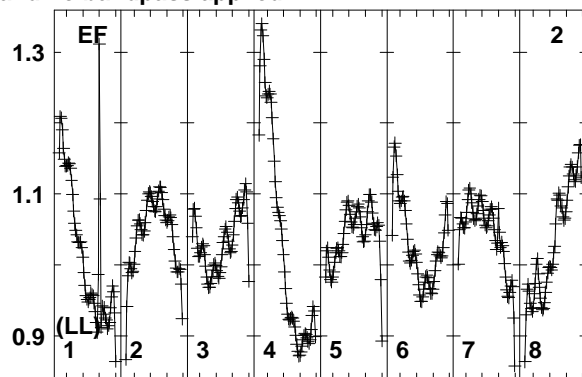
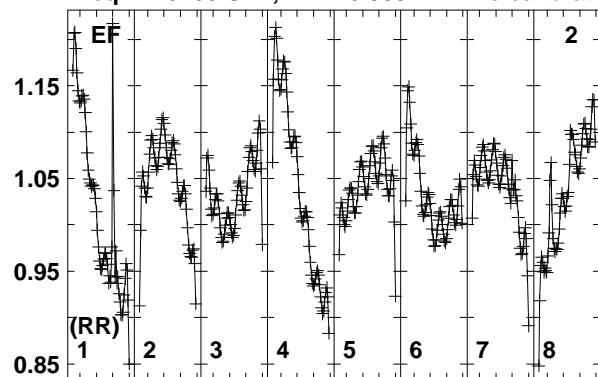

Lower frame: Real Jy
Total-power spectrum Antenna: EF (02)
Timerange: 00/19:30:35 to 00/19:32:59

Plot file version 251 created 01-AUG-2018 16:38:33
 PB+4+4 N18L1 2.UVDATA.1
 Freq = 1.6266 GHz, Bw = 8.000 MH No calibration applied and no bandpass applied

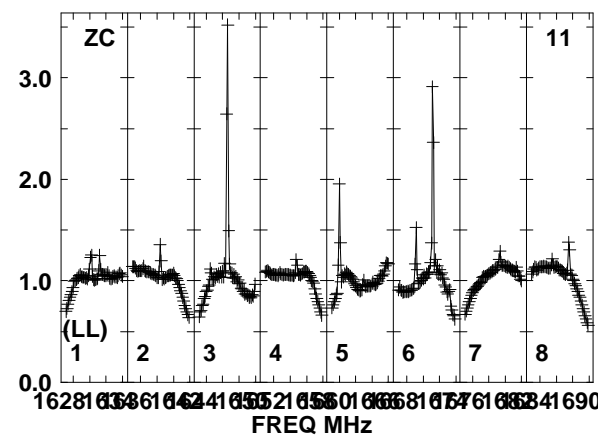
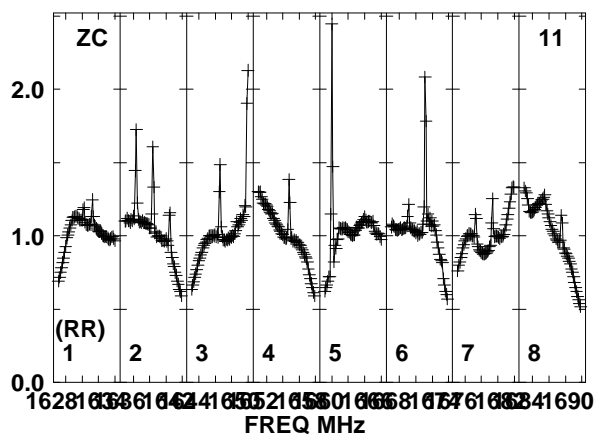
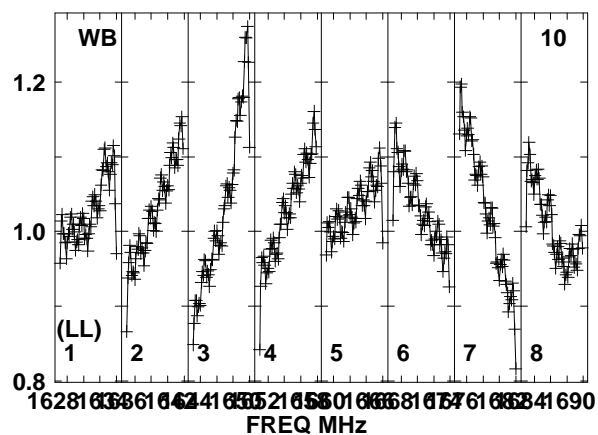
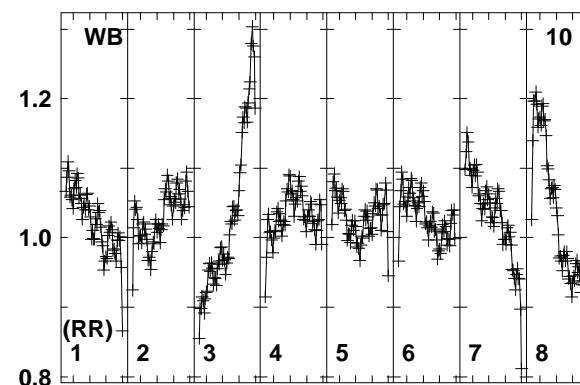
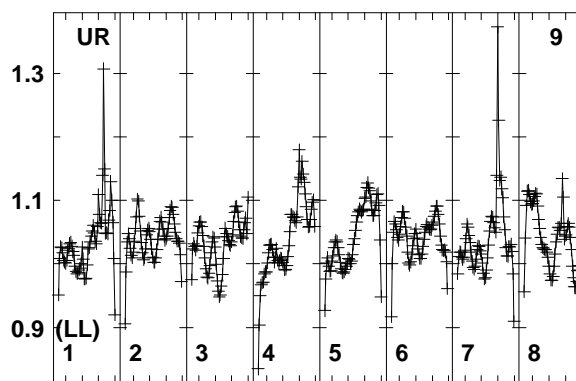
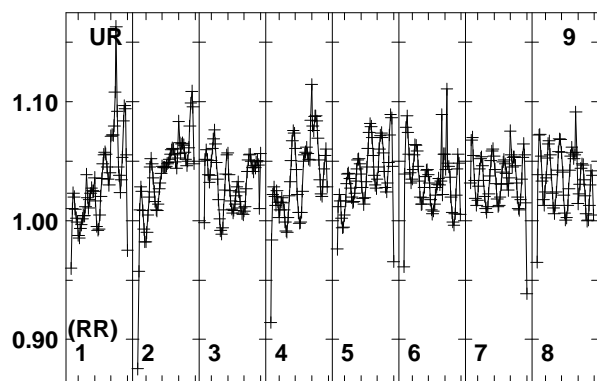
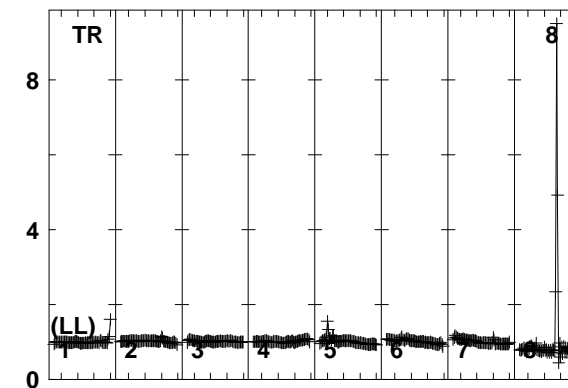
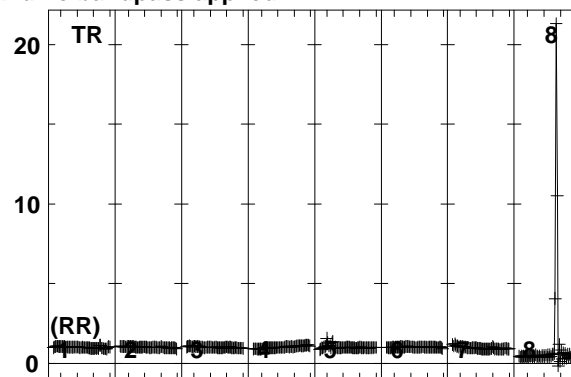
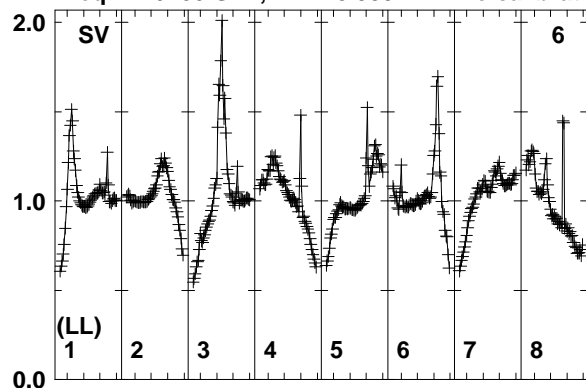

Lower frame: Real Jy
 Total-power spectrum Antenna: SV (06)
 Timerange: 00/19:30:35 to 00/19:32:59

Plot file version 252 created 01-AUG-2018 16:38:33

PB+3+4 N18L1 2.UVDATA.1

Freq = 1.6266 GHz, Bw = 8.000 MH No calibration applied and no bandpass applied

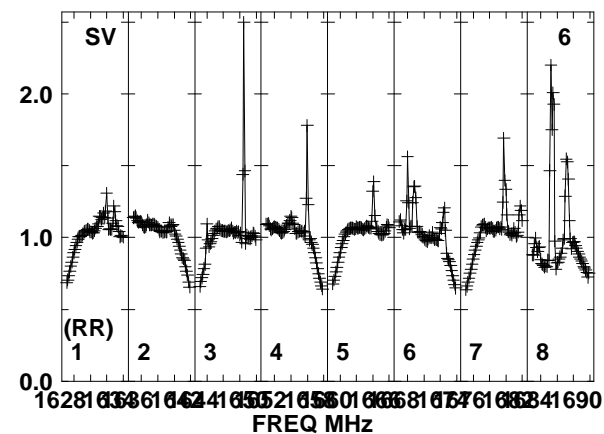
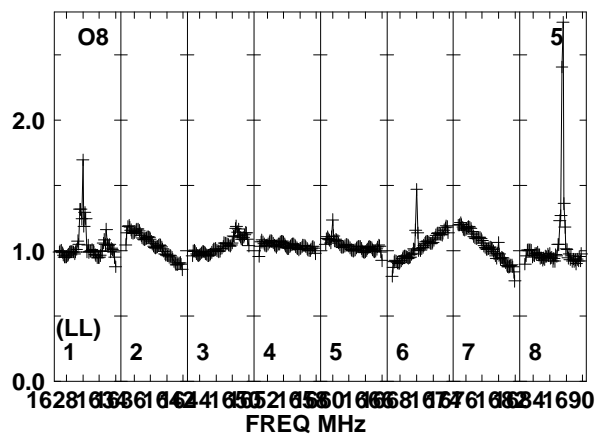
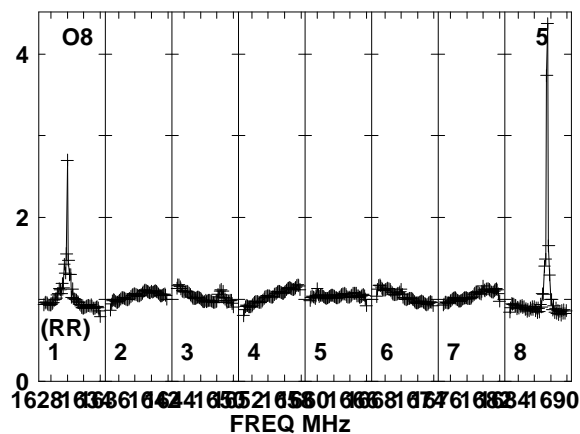
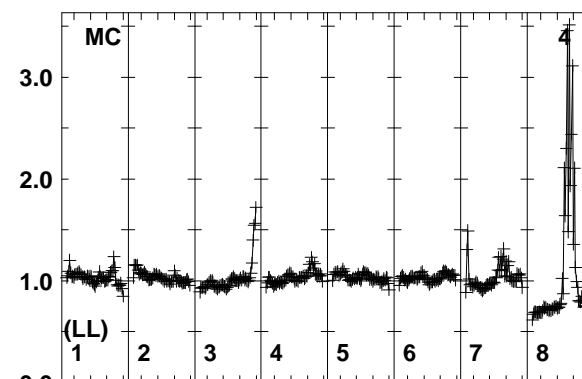
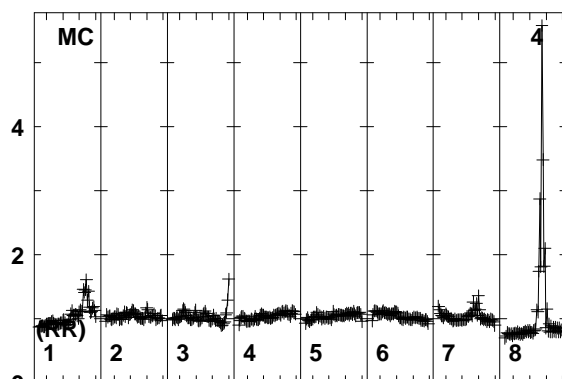
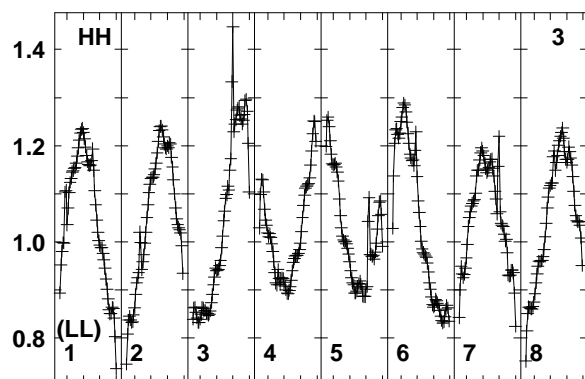
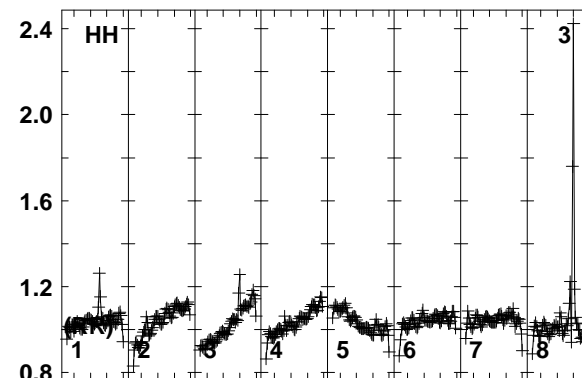
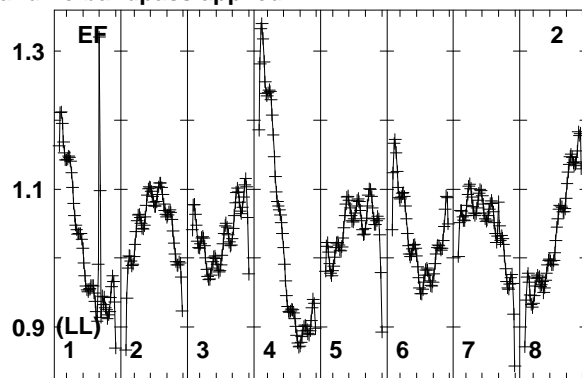
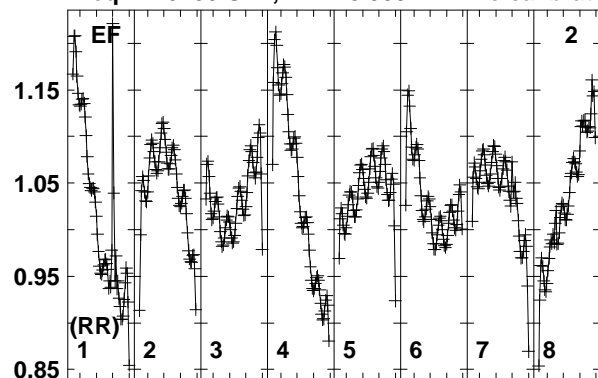

Lower frame: Real Jy
Total-power spectrum Antenna: EF (02)
Timerange: 00/19:33:05 to 00/19:35:29

Plot file version 253 created 01-AUG-2018 16:38:33
 PB+3+4 N18L1 2.UVDATA.1
 Freq = 1.6266 GHz, Bw = 8.000 MH No calibration applied and no bandpass applied

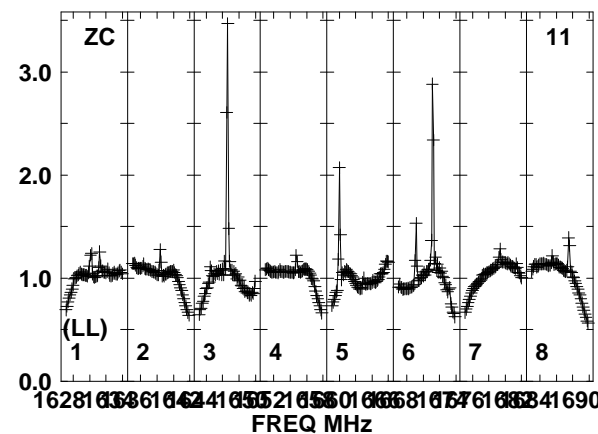
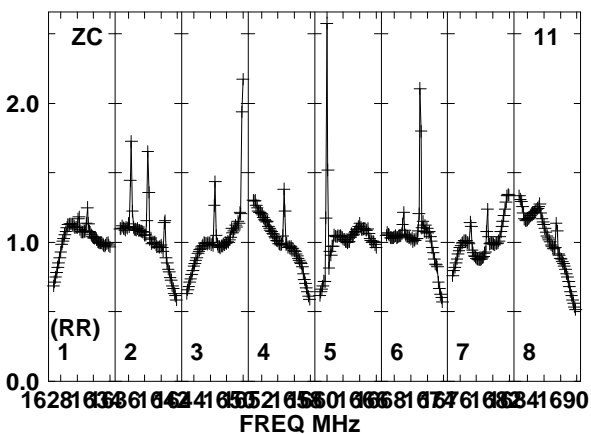
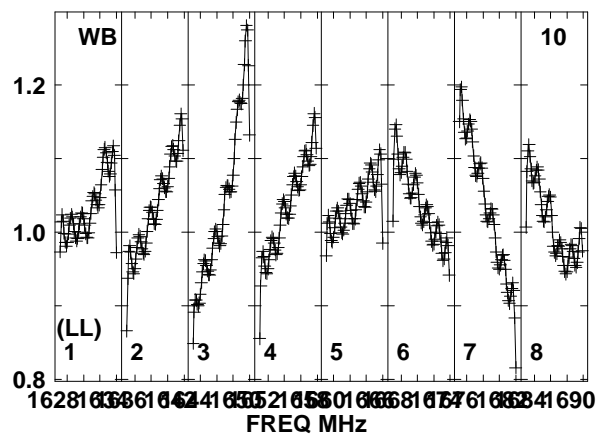
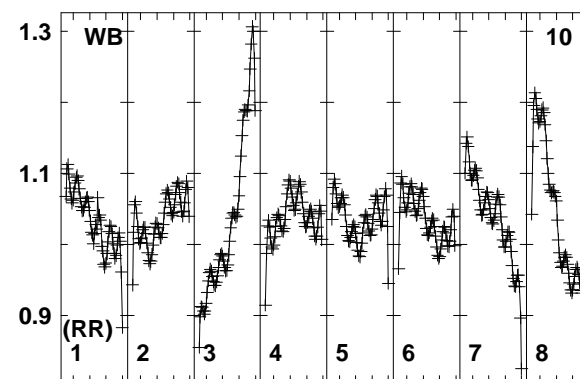
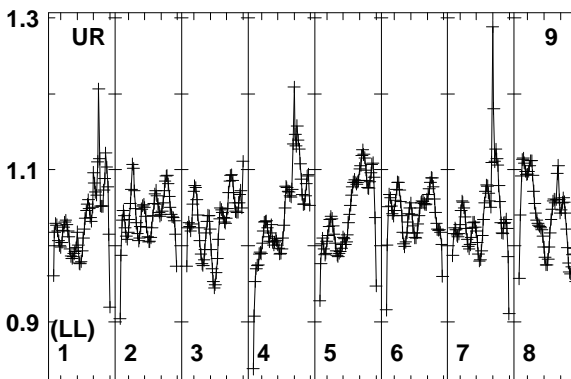
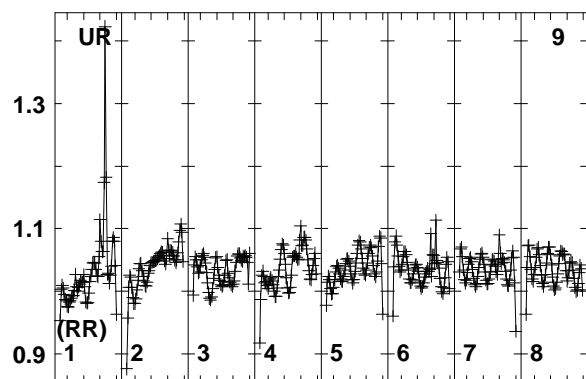
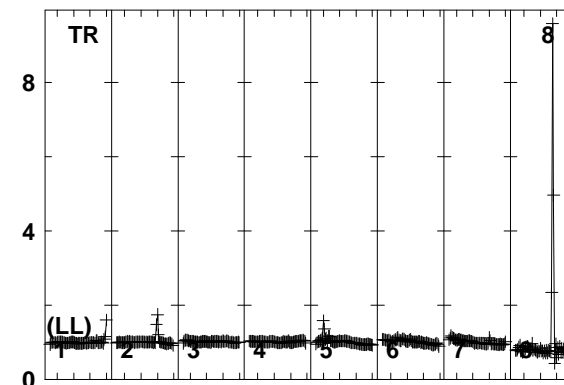
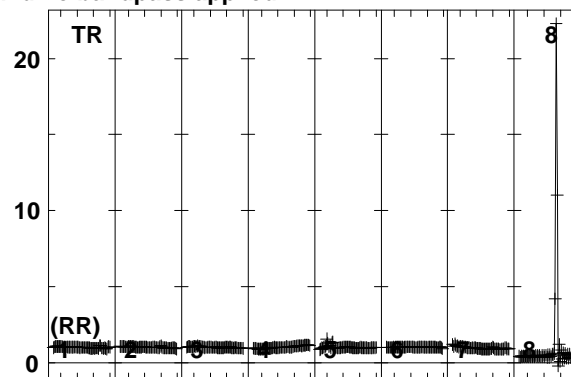
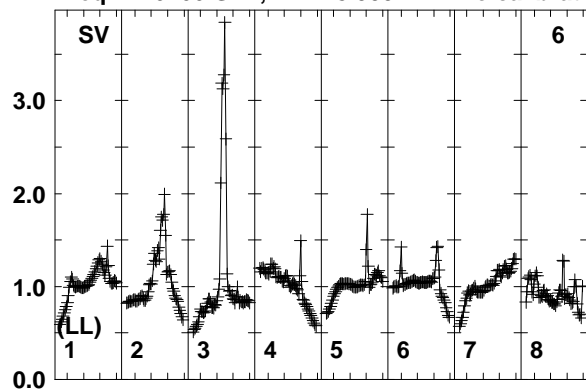

Lower frame: Real Jy
 Total-power spectrum Antenna: SV (06)
 Timerange: 00/19:33:05 to 00/19:35:29

Plot file version 254 created 01-AUG-2018 16:38:33

PB+2+4 N18L1 2.UVDATA.1

Freq = 1.6266 GHz, Bw = 8.000 MH No calibration applied and no bandpass applied

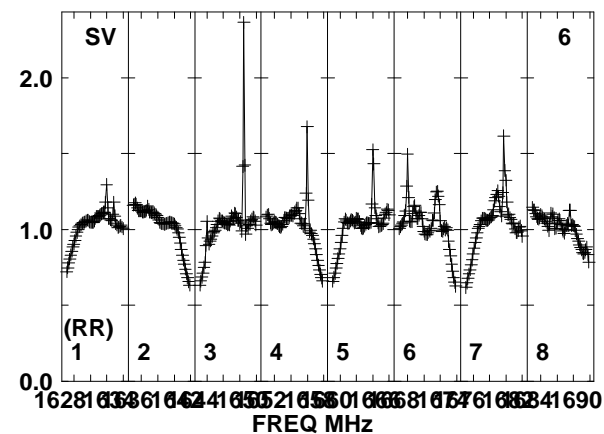
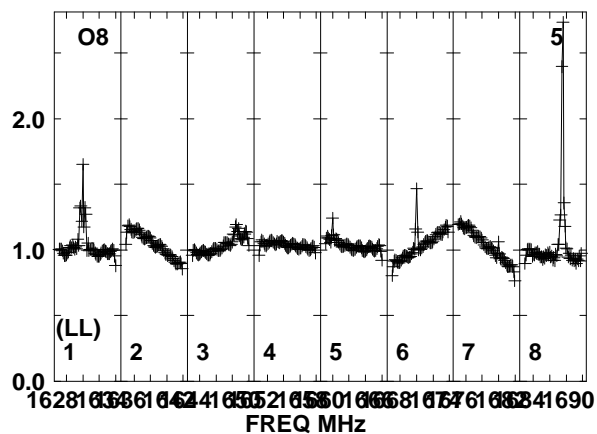
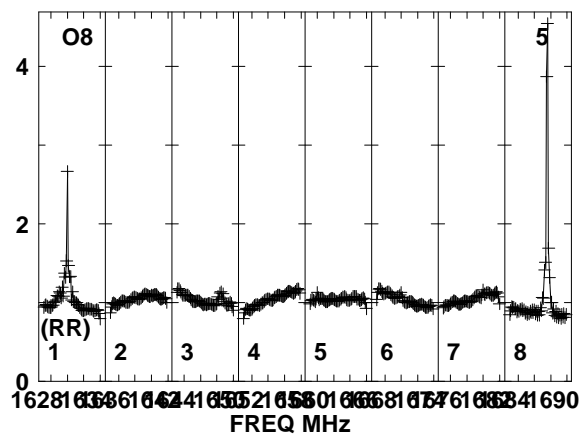
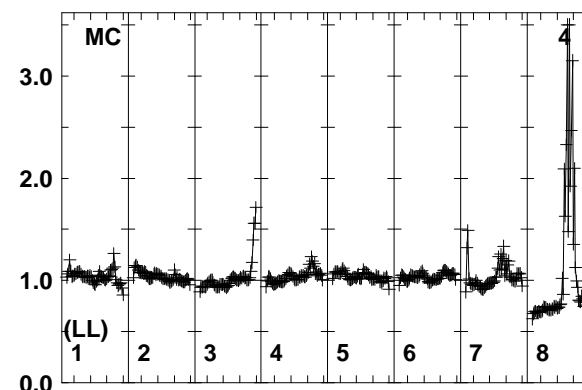
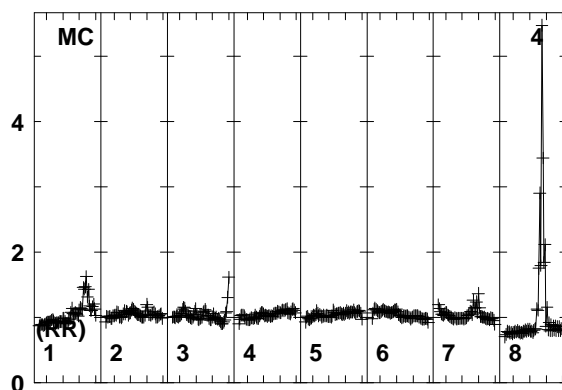
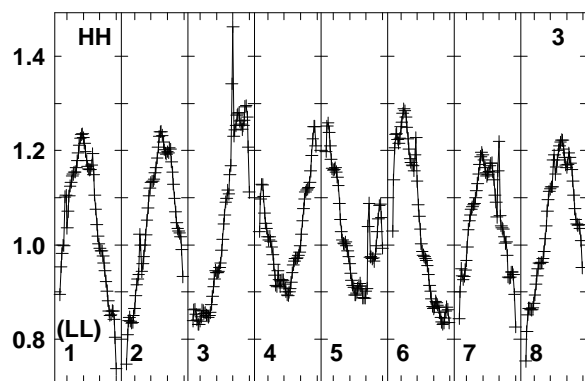
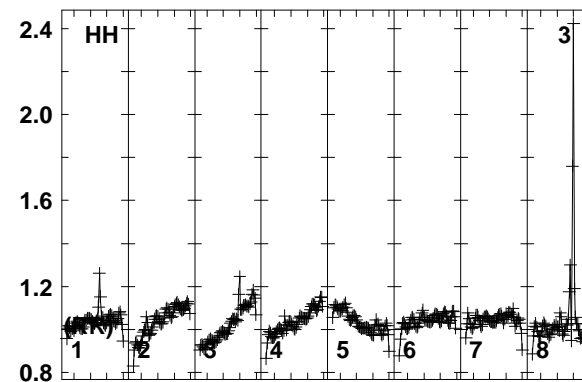
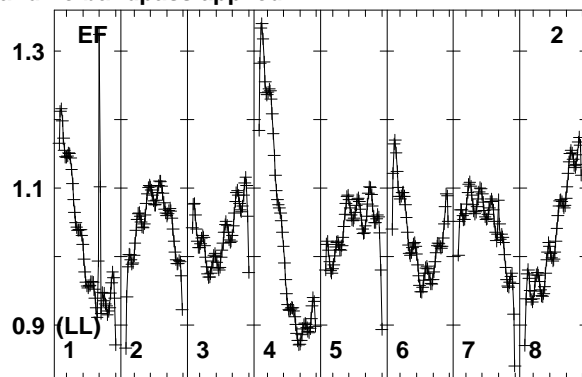
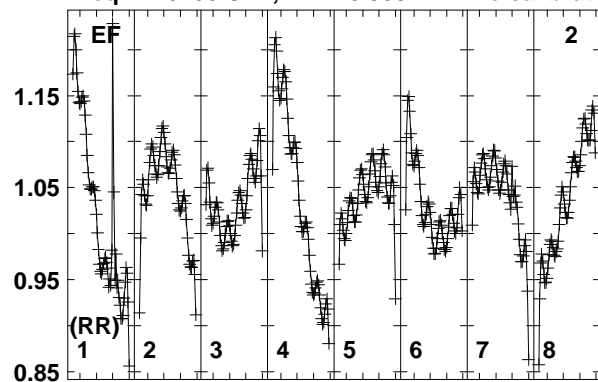

Lower frame: Real Jy
Total-power spectrum Antenna: EF (02)
Timerange: 00/19:35:35 to 00/19:37:59

Plot file version 255 created 01-AUG-2018 16:38:33

PB+2+4 N18L1 2.UVDATA.1

Freq = 1.6266 GHz, Bw = 8.000 MH No calibration applied and no bandpass applied

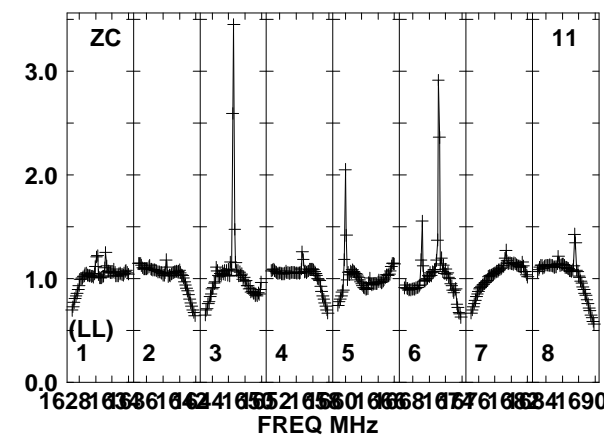
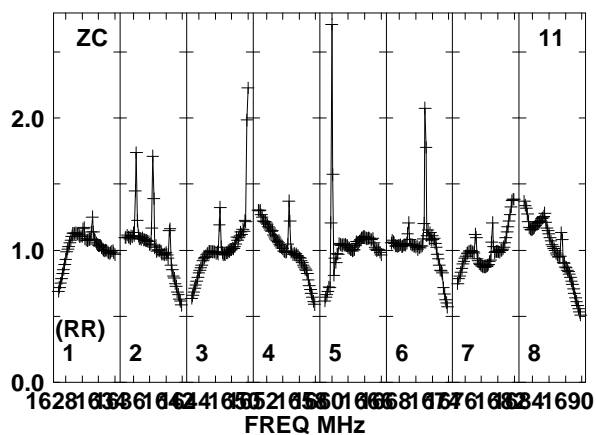
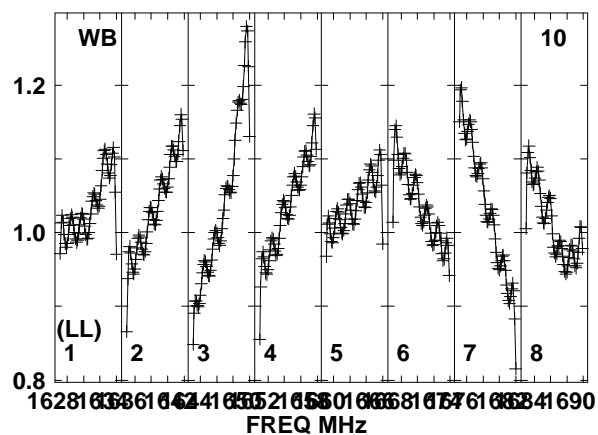
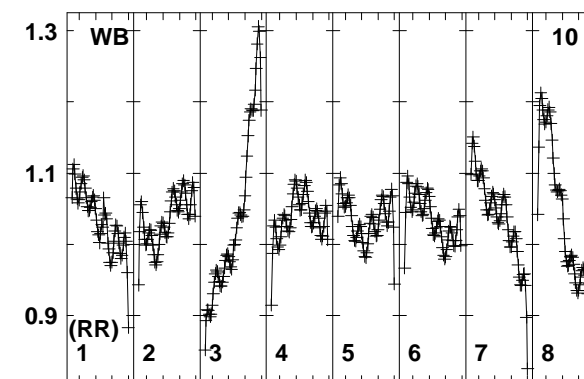
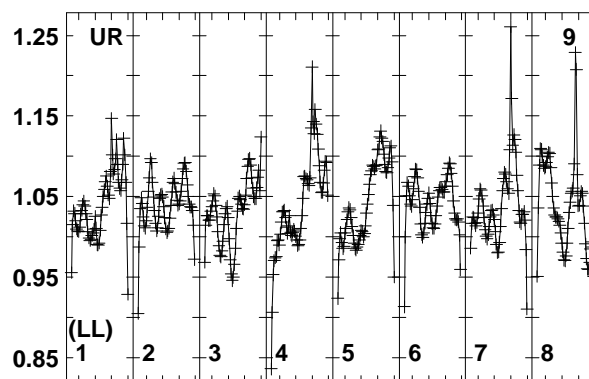
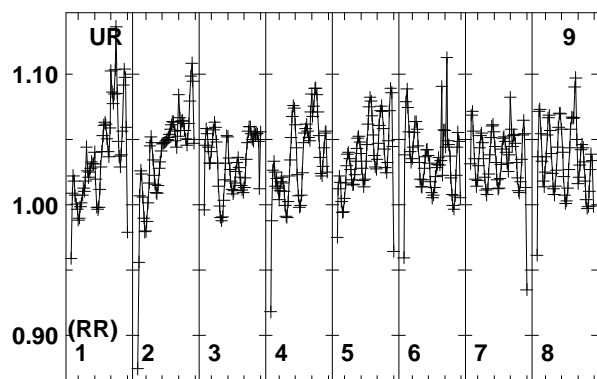
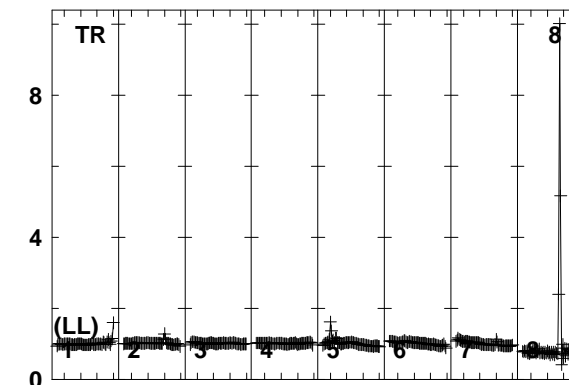
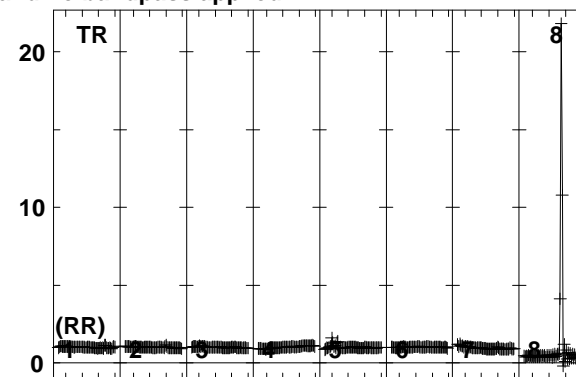
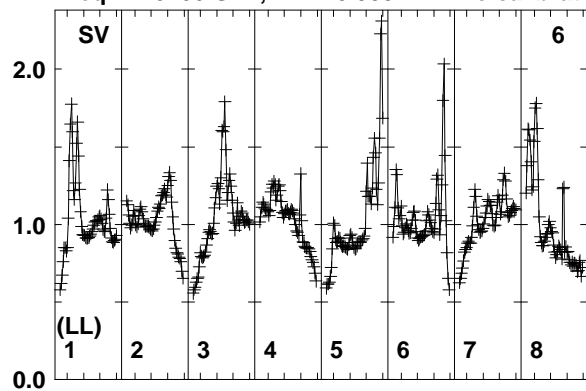

Lower frame: Real Jy
Total-power spectrum Antenna: SV (06)
Timerange: 00/19:35:35 to 00/19:37:59

Plot file version 256 created 01-AUG-2018 16:38:33

PB+1+4 N18L1 2.UVDATA.1

Freq = 1.6266 GHz, Bw = 8.000 MH No calibration applied and no bandpass applied

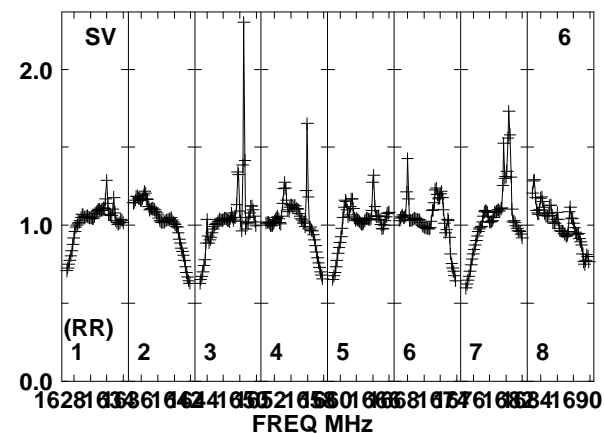
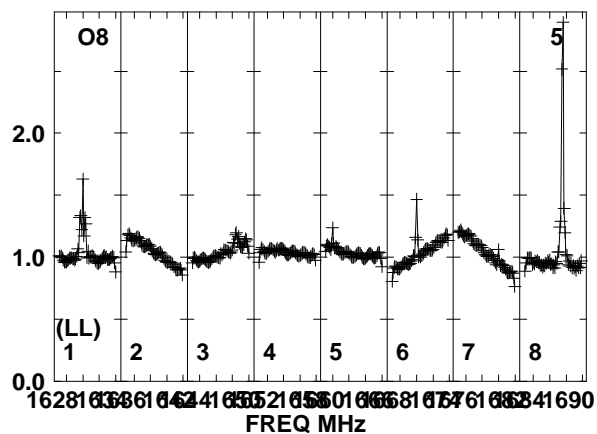
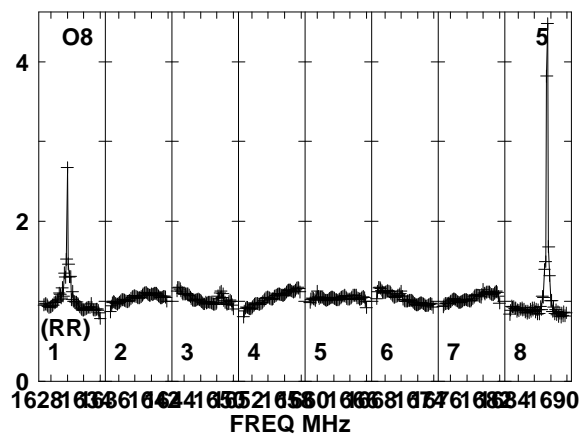
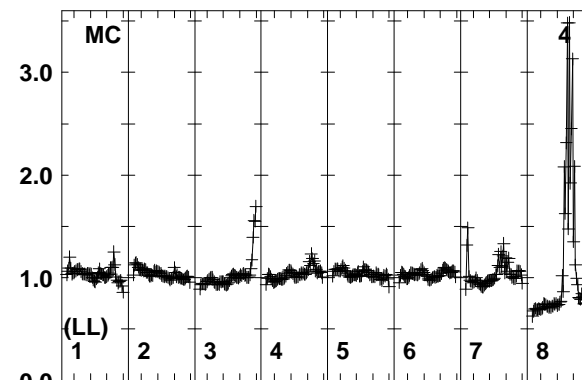
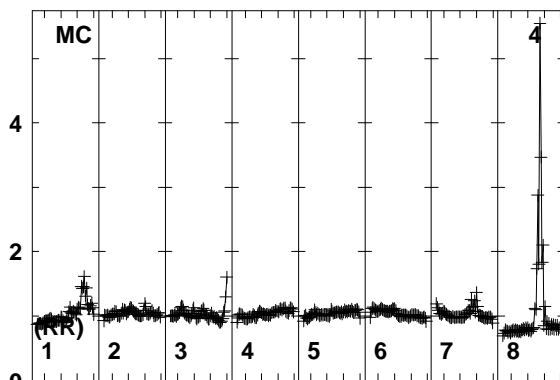
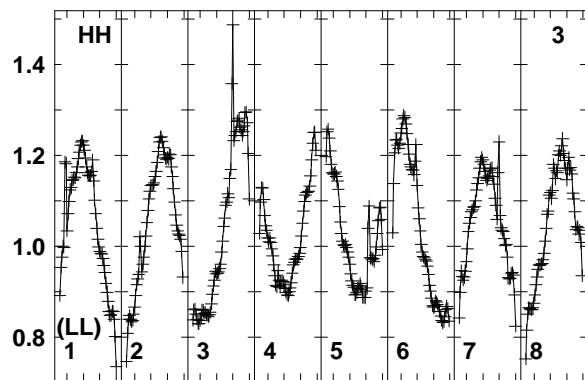
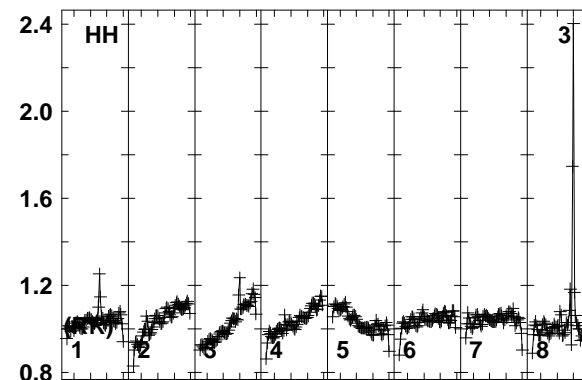
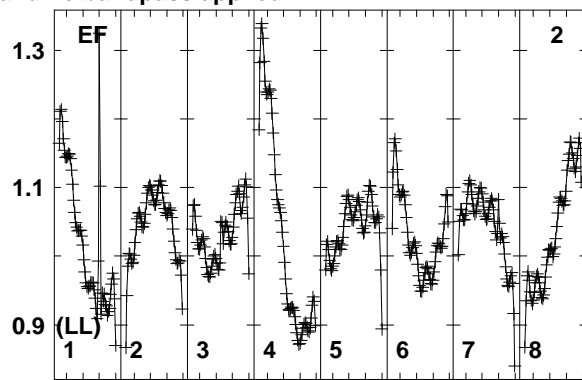
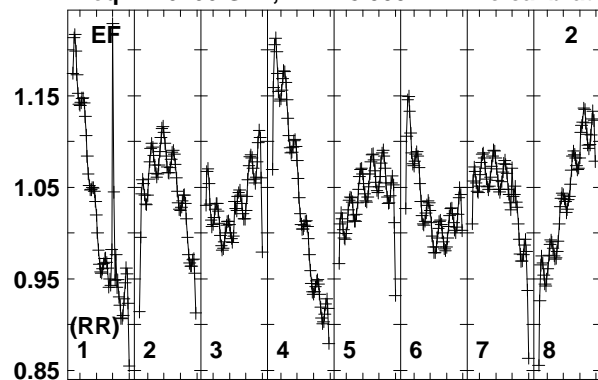

Lower frame: Real Jy
Total-power spectrum Antenna: EF (02)
Timerange: 00/19:38:03 to 00/19:40:29

Plot file version 257 created 01-AUG-2018 16:38:34
 PB+1+4 N18L1 2.UVDATA.1
 Freq = 1.6266 GHz, Bw = 8.000 MH No calibration applied and no bandpass applied

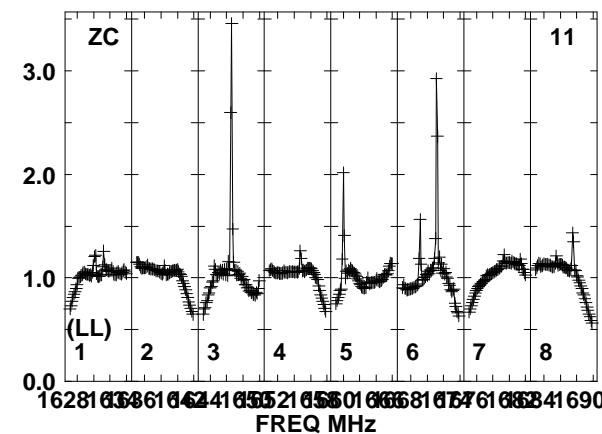
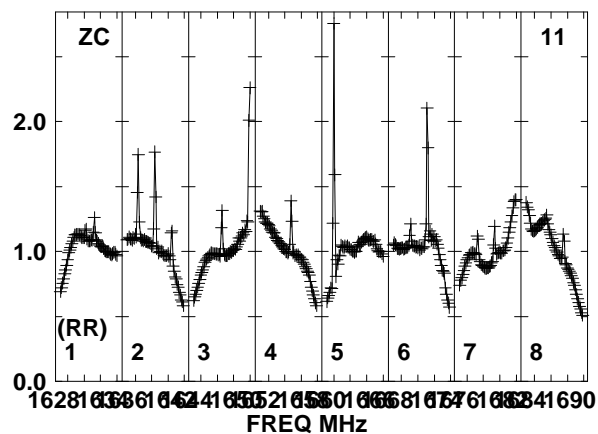
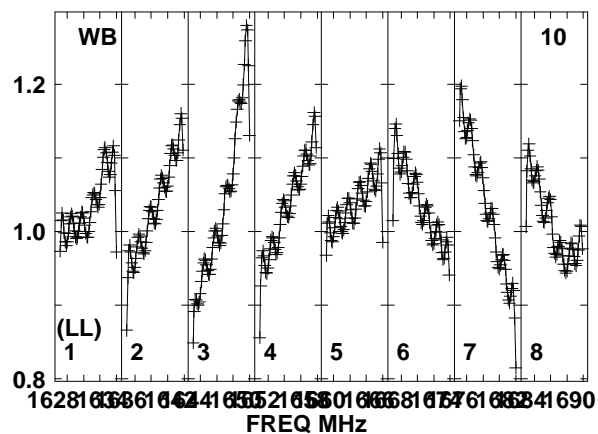
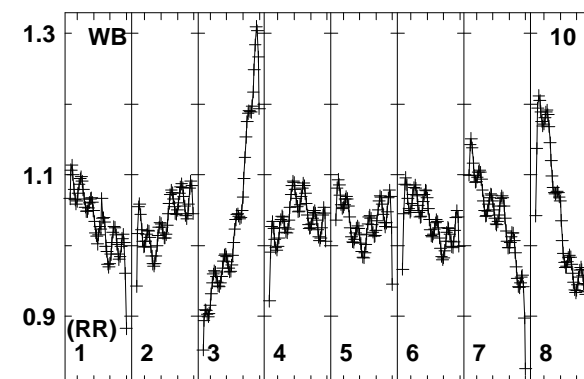
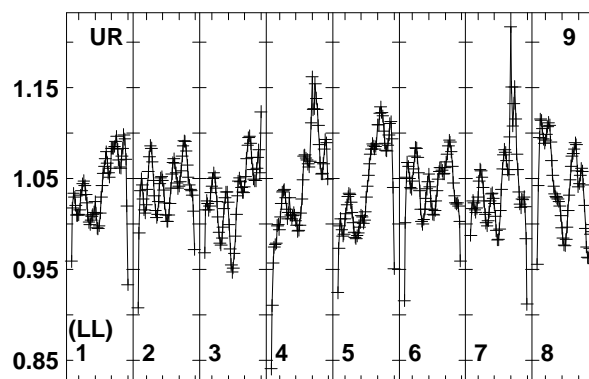
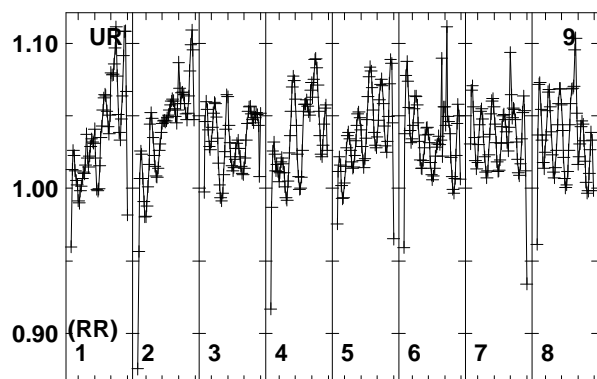
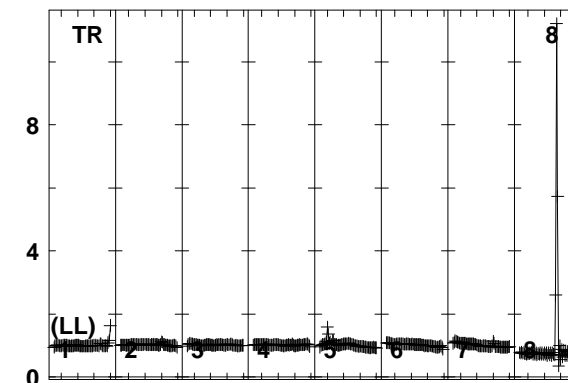
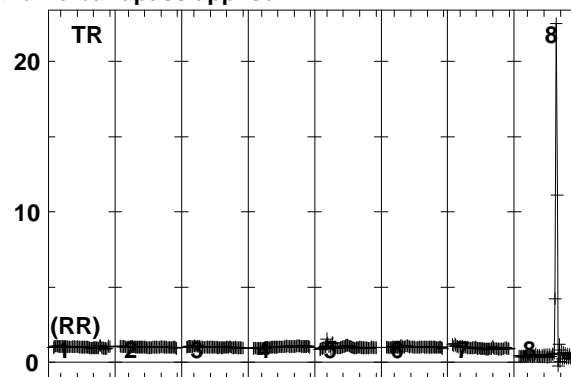
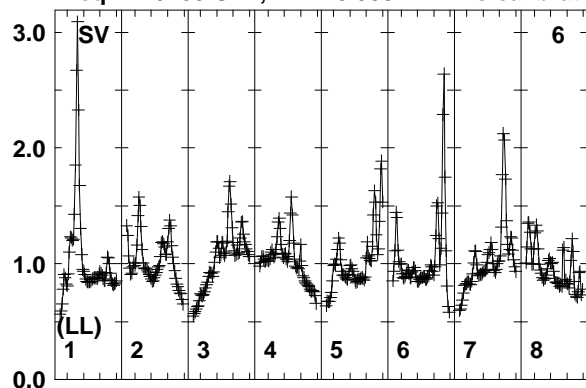

Lower frame: Real Jy
 Total-power spectrum Antenna: SV (06)
 Timerange: 00/19:38:03 to 00/19:40:29

Plot file version 258 created 01-AUG-2018 16:38:34

J0530+1331 N18L1 2.UVDATA.1

Freq = 1.6266 GHz, Bw = 8.000 MH No calibration applied and no bandpass applied

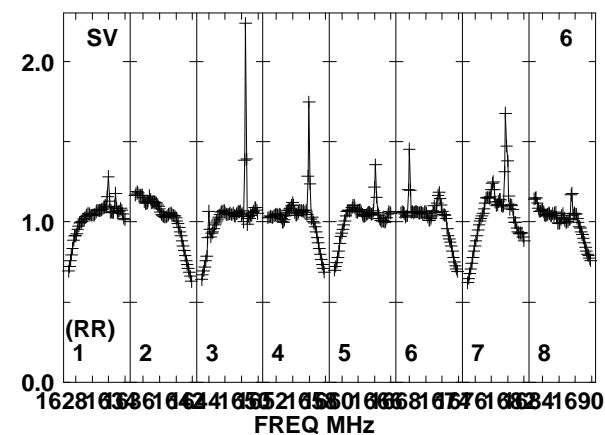
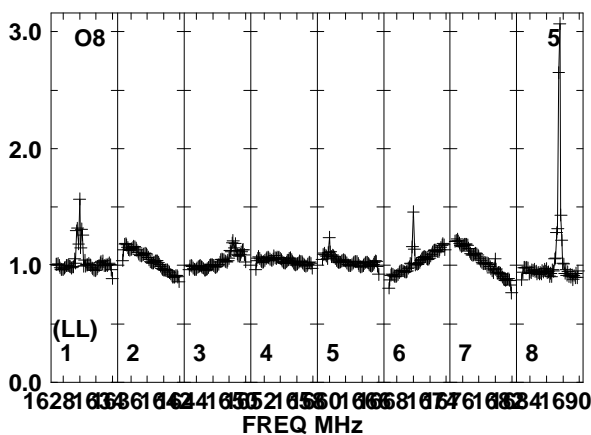
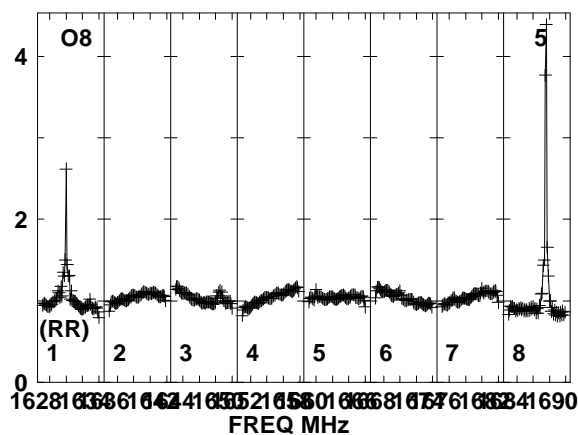
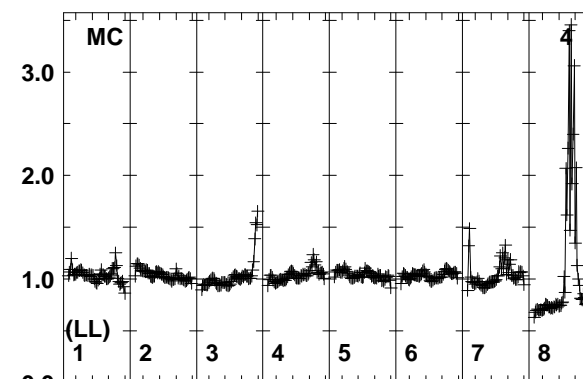
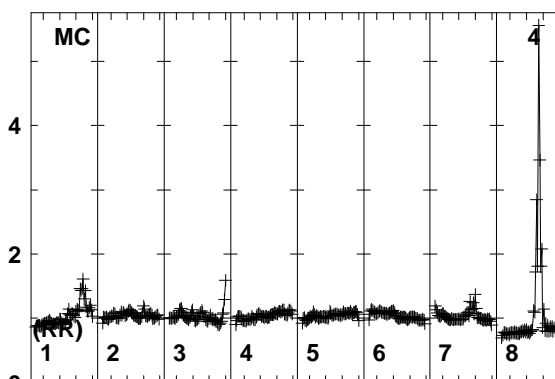
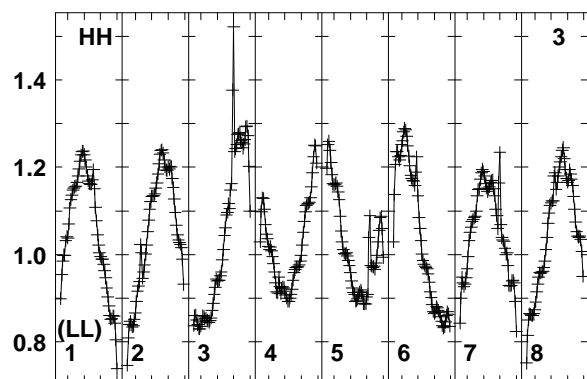
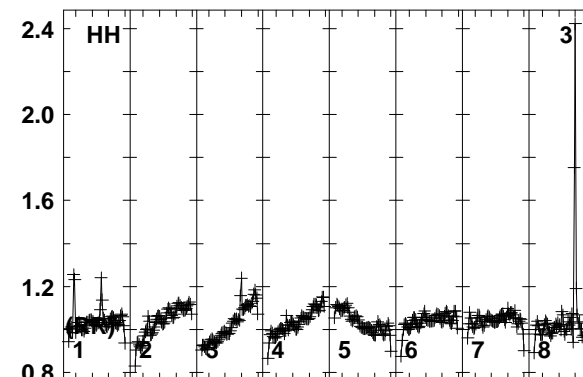
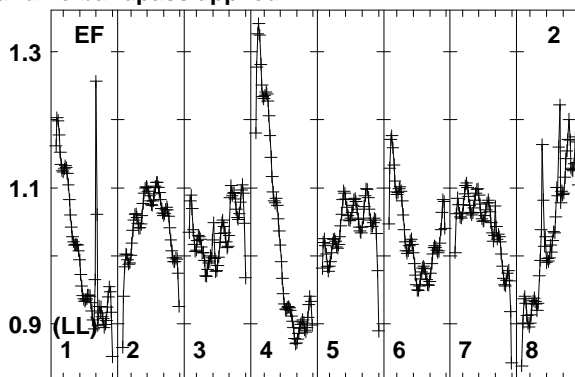
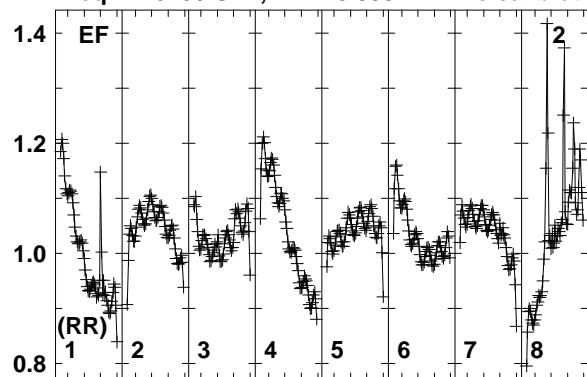

Lower frame: Real Jy
Total-power spectrum Antenna: EF (02)
Timerange: 00/19:41:11 to 00/19:42:29

Plot file version 259 created 01-AUG-2018 16:38:34
 J0530+1331 N18L1 2.UVDATA.1
 Freq = 1.6266 GHz, Bw = 8.000 MH No calibration applied and no bandpass applied

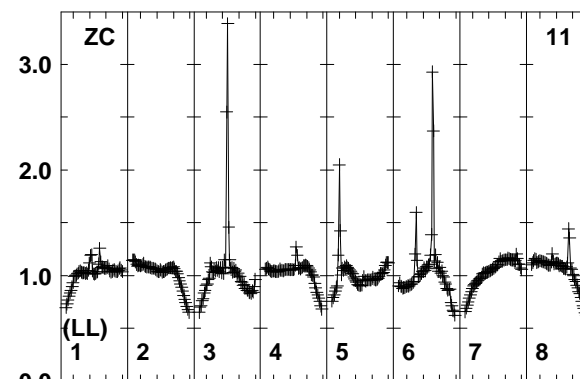
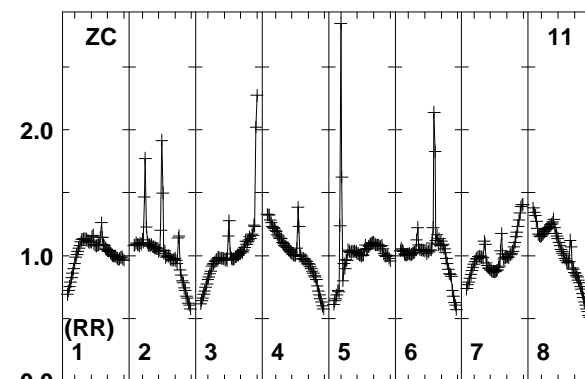
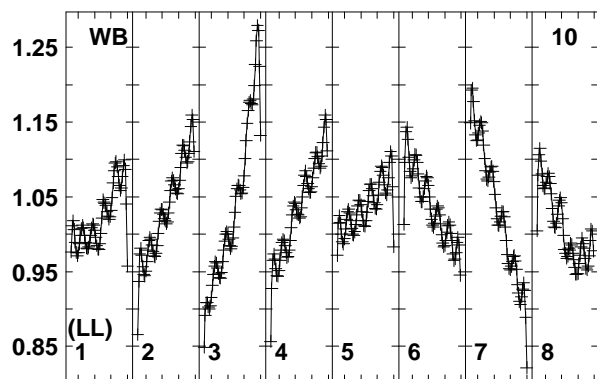
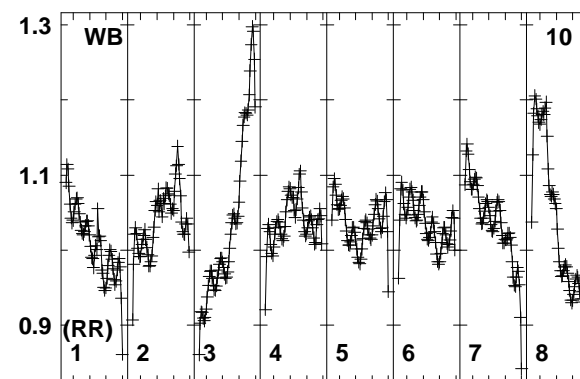
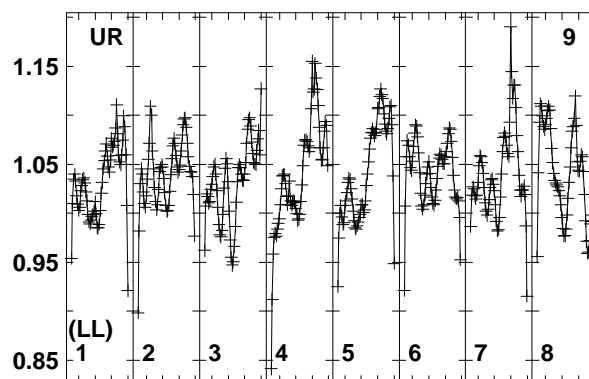
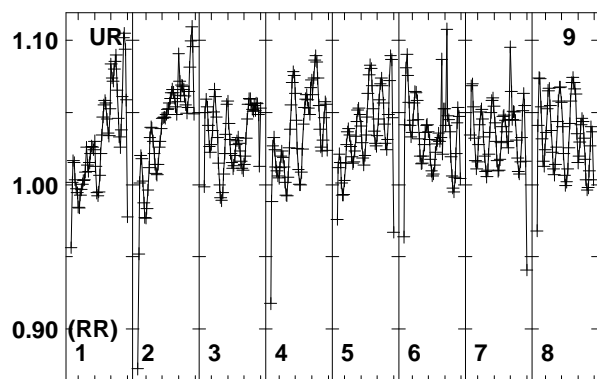
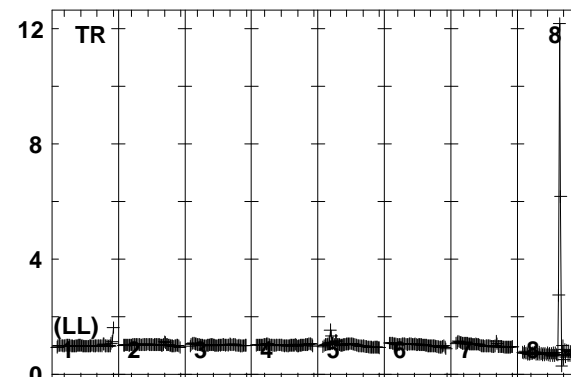
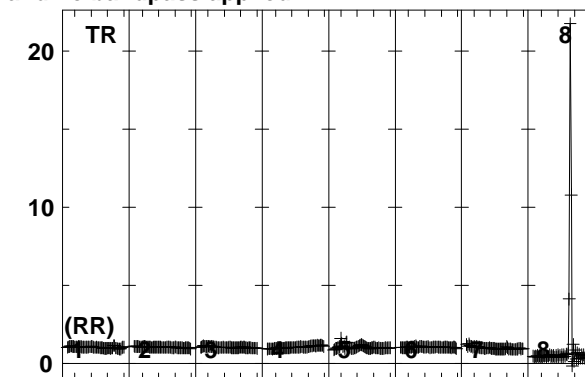
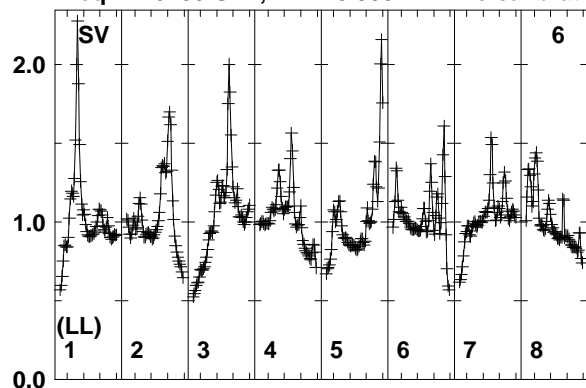

16281 16386 16441 16521 16580 16681 16761 16824 1690
 FREQ MHz

16281 16386 16441 16521 16580 16681 16761 16824 1690
 FREQ MHz

16281 16386 16441 16521 16580 16681 16761 16824 1690
 FREQ MHz

Lower frame: Real Jy
 Total-power spectrum Antenna: SV (06)
 Timerange: 00/19:41:11 to 00/19:42:29

Plot file version 260 created 01-AUG-2018 16:38:34

PB+0+4 N18L1 2.UVDATA.1

Freq = 1.6266 GHz, Bw = 8.000 MH No calibration applied and no bandpass applied

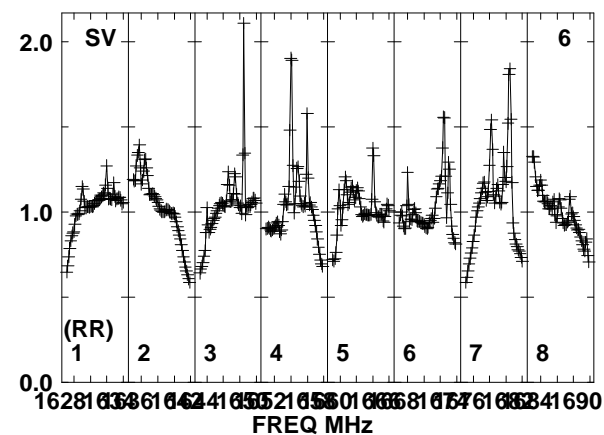
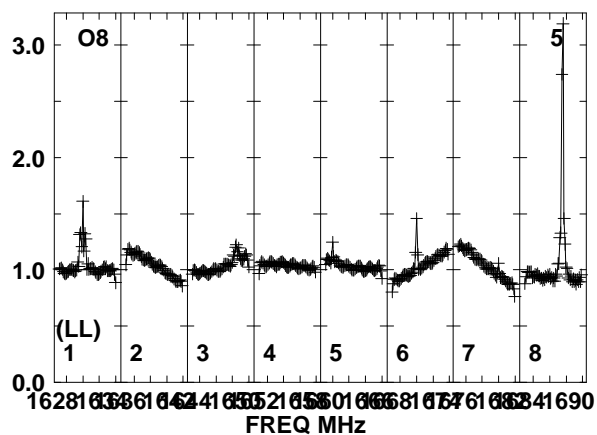
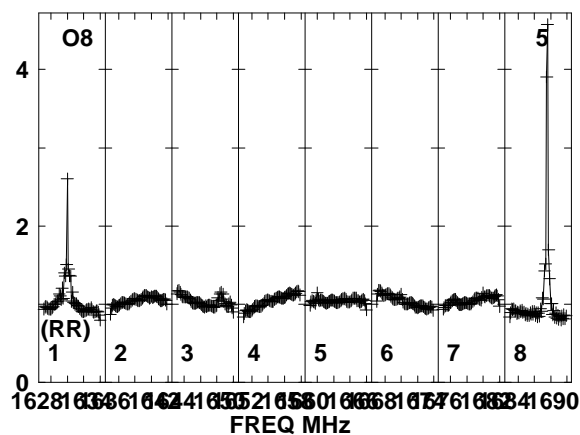
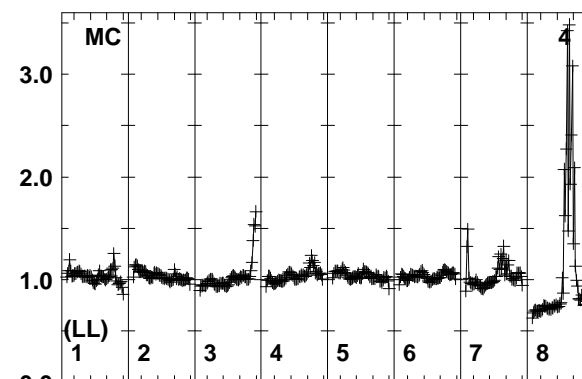
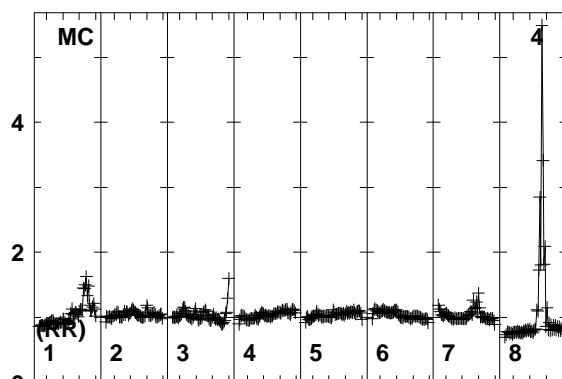
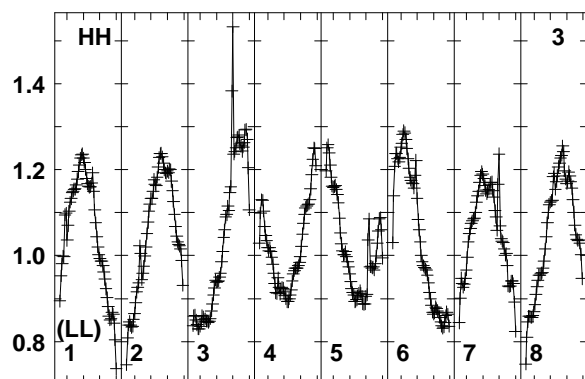
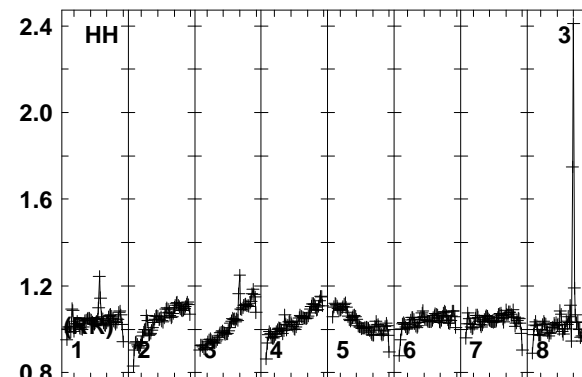
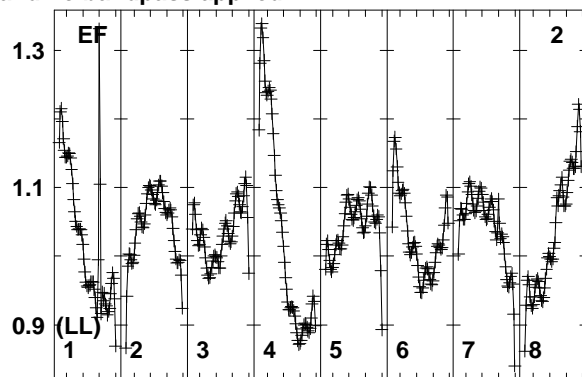
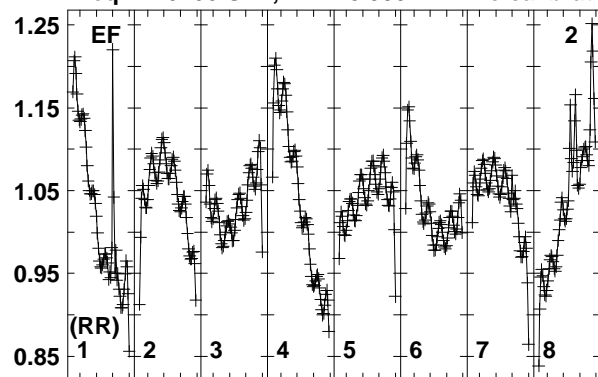

Lower frame: Real Jy
Total-power spectrum Antenna: EF (02)
Timerange: 00/19:42:33 to 00/19:44:59

Plot file version 261 created 01-AUG-2018 16:38:34
PB+0+4 N18L1 2.UVDATA.1
Freq = 1.6266 GHz, Bw = 8.000 MH No calibration applied and no bandpass applied

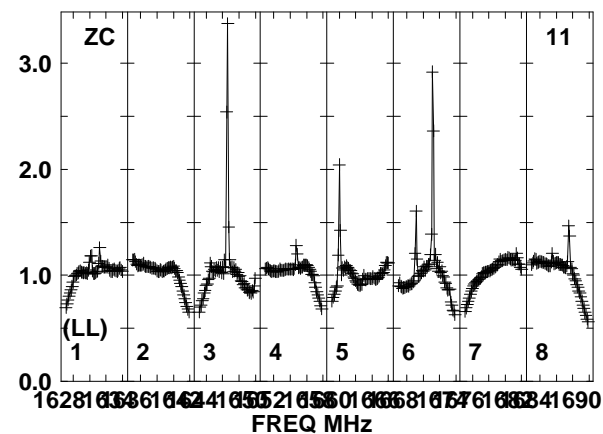
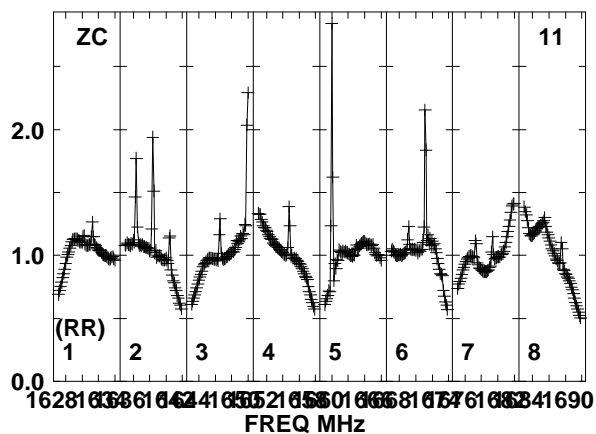
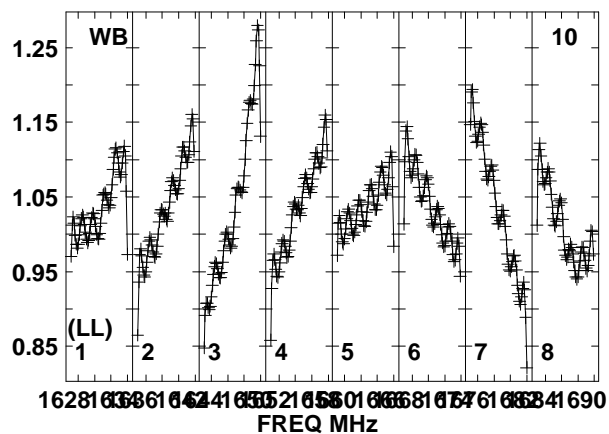
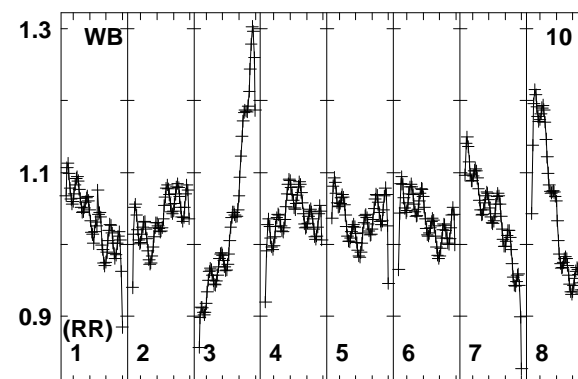
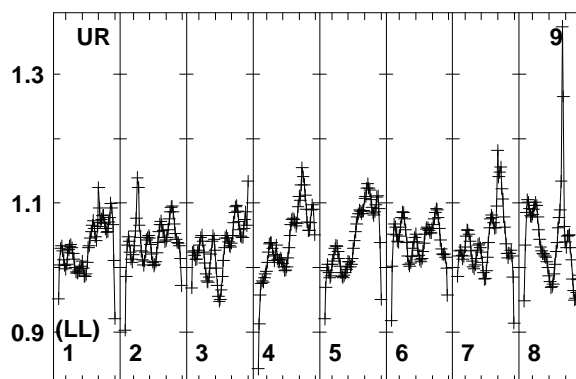
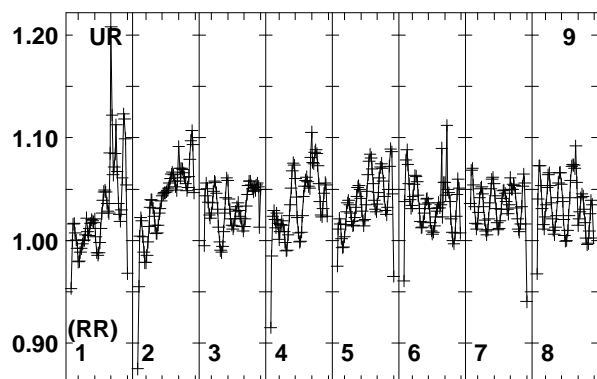
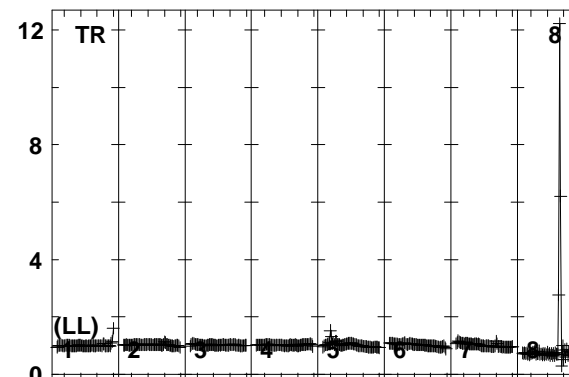
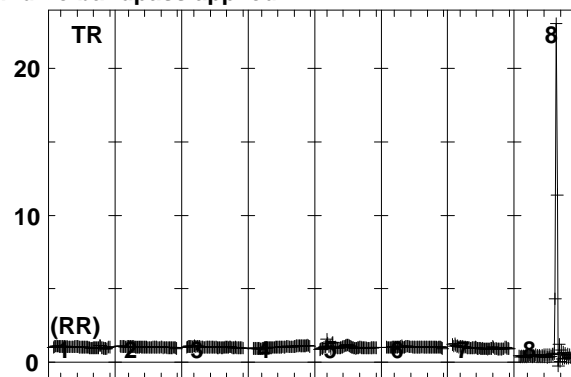
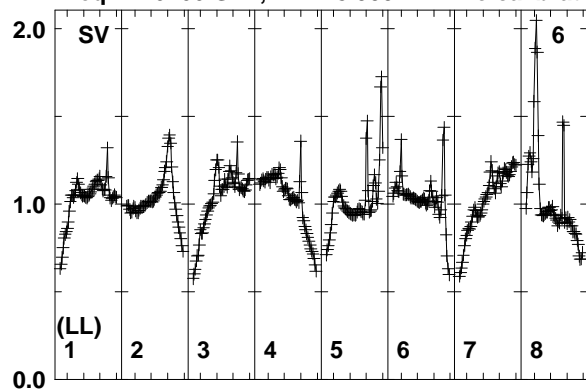

Lower frame: Real Jy
Total-power spectrum Antenna: SV (06)
Timerange: 00/19:42:33 to 00/19:44:59

Plot file version 262 created 01-AUG-2018 16:38:34

PB-1+4 N18L1 2.UVDATA.1

Freq = 1.6266 GHz, Bw = 8.000 MH No calibration applied and no bandpass applied

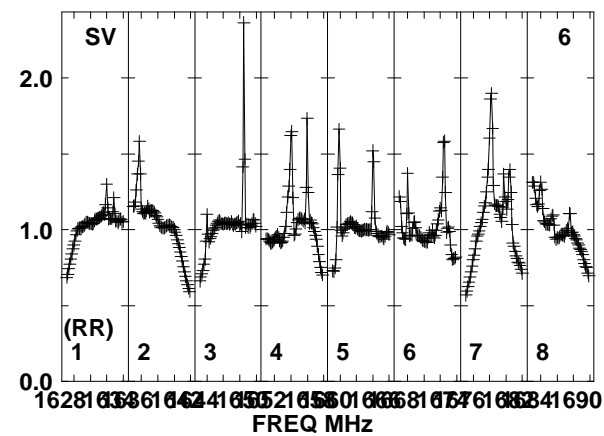
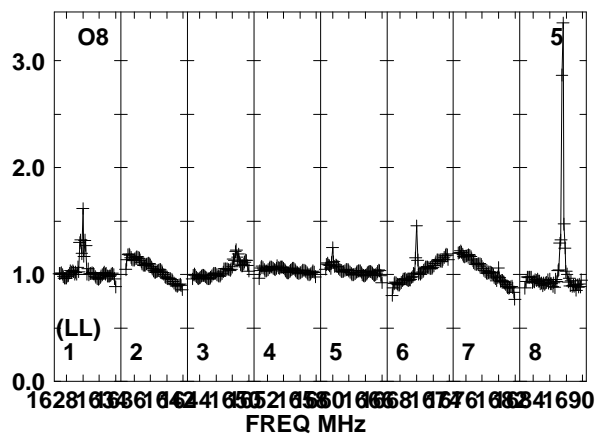
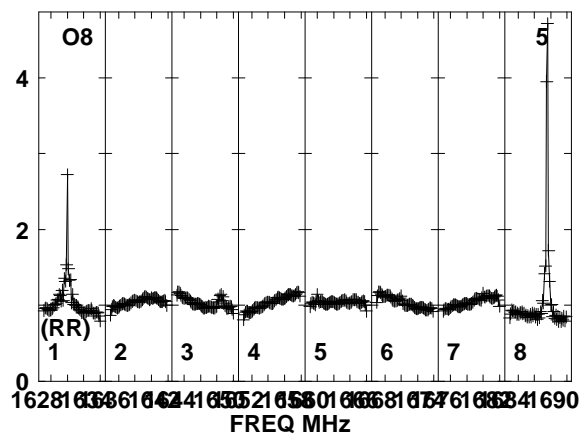
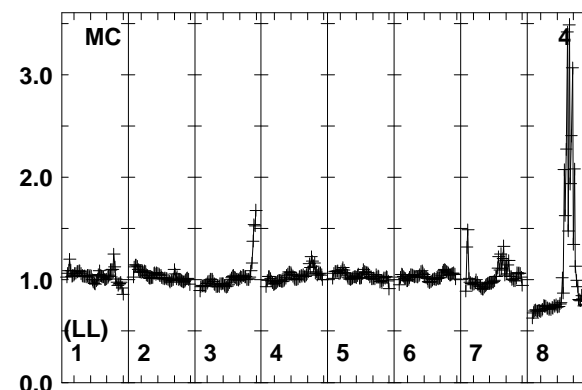
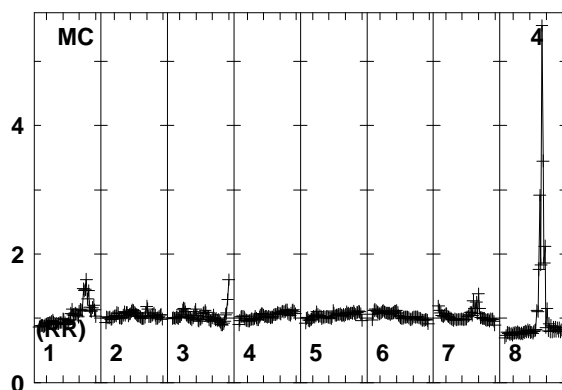
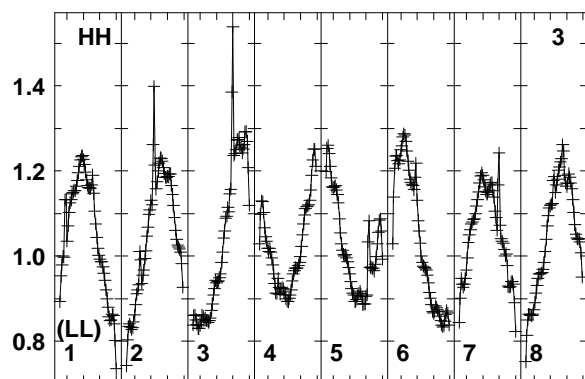
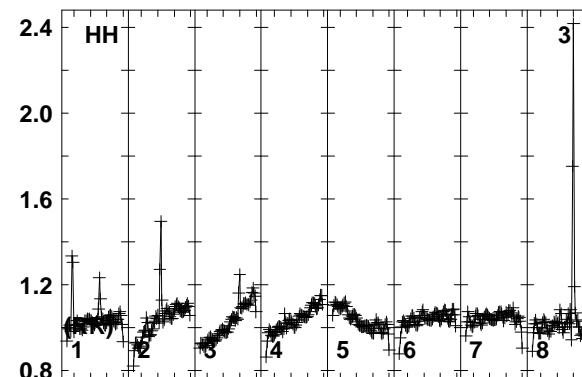
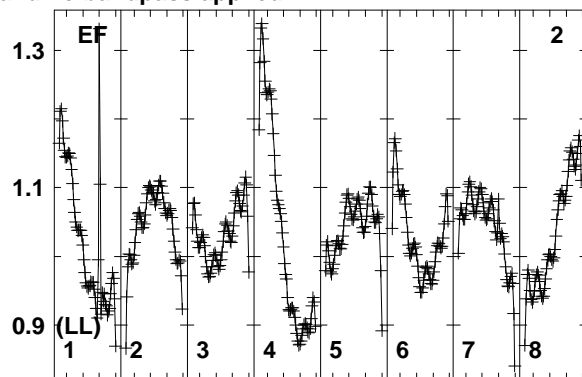
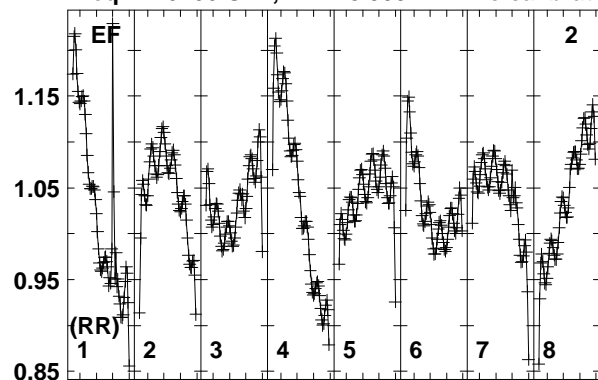

Lower frame: Real Jy
Total-power spectrum Antenna: EF (02)
Timerange: 00/19:45:05 to 00/19:47:29

Plot file version 263 created 01-AUG-2018 16:38:35
 PB-1+4 N18L1 2.UVDATA.1
 Freq = 1.6266 GHz, Bw = 8.000 MH No calibration applied and no bandpass applied

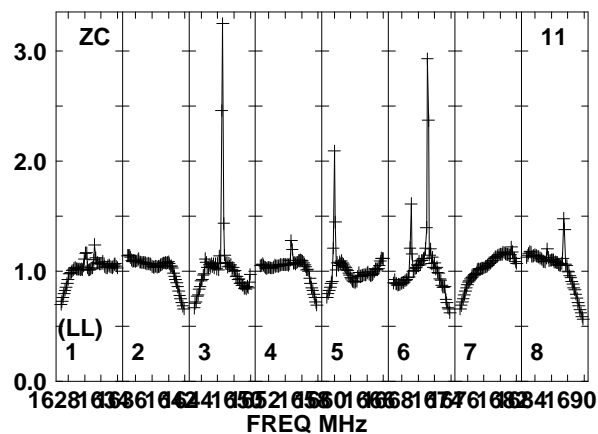
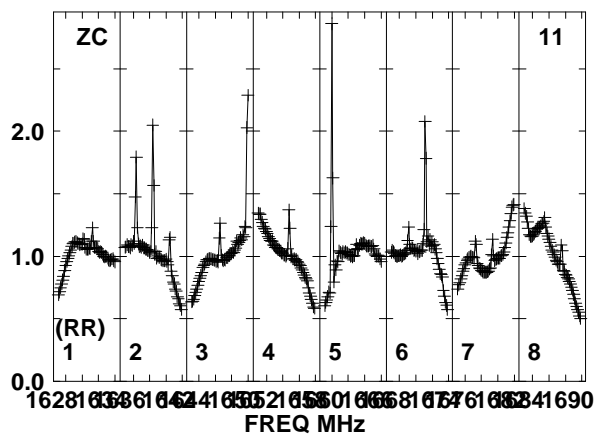
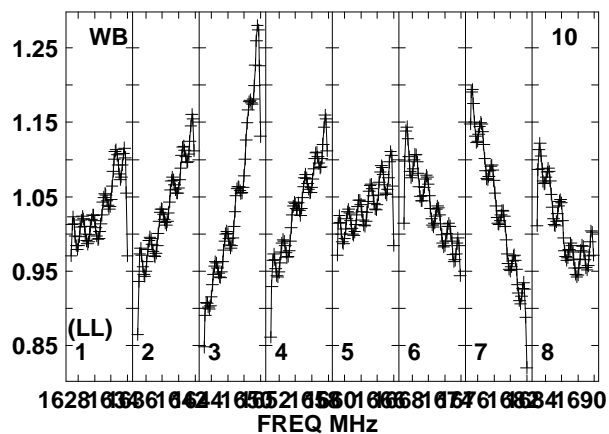
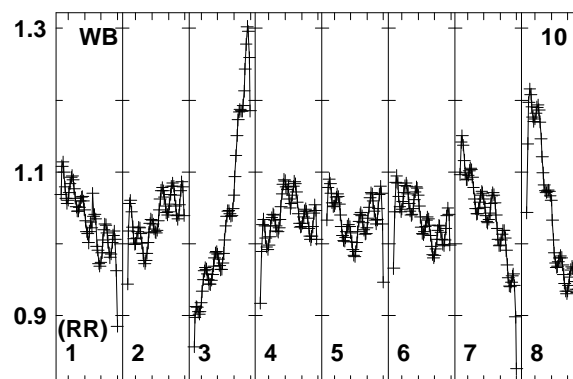
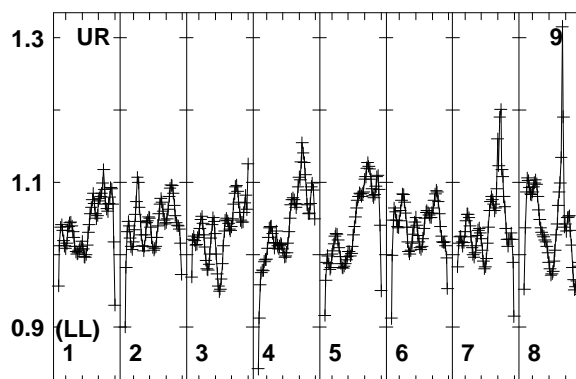
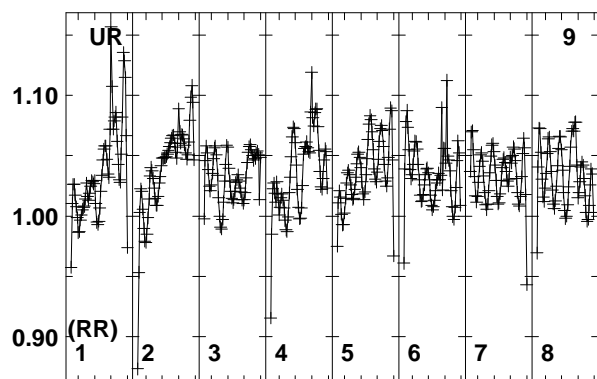
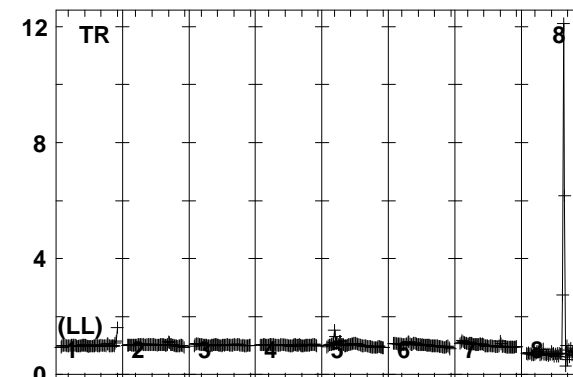
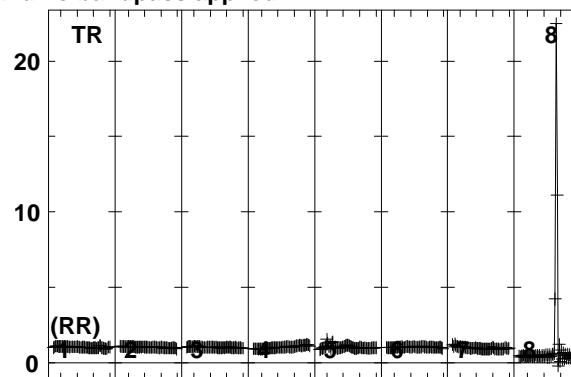
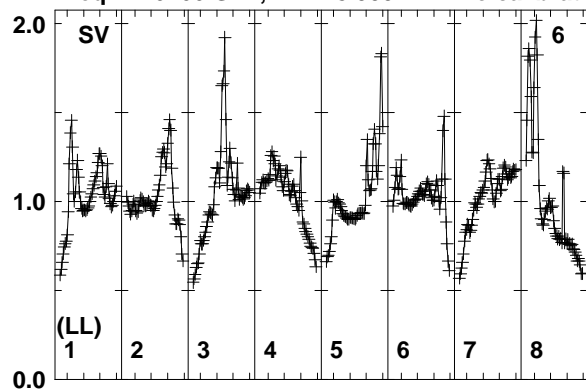

Lower frame: Real Jy
 Total-power spectrum Antenna: SV (06)
 Timerange: 00/19:45:05 to 00/19:47:29

Plot file version 264 created 01-AUG-2018 16:38:35

PB-2+4 N18L1 2.UVDATA.1

Freq = 1.6266 GHz, Bw = 8.000 MH No calibration applied and no bandpass applied

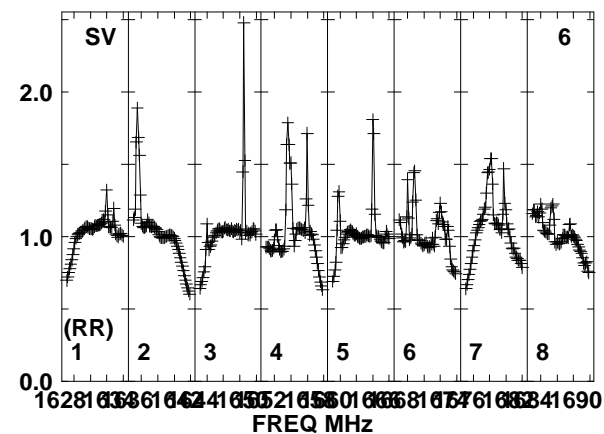
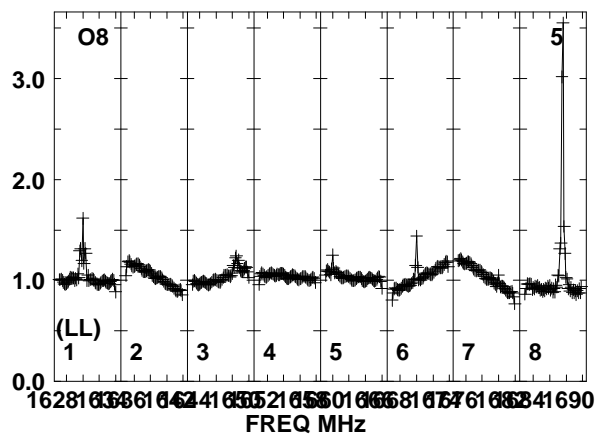
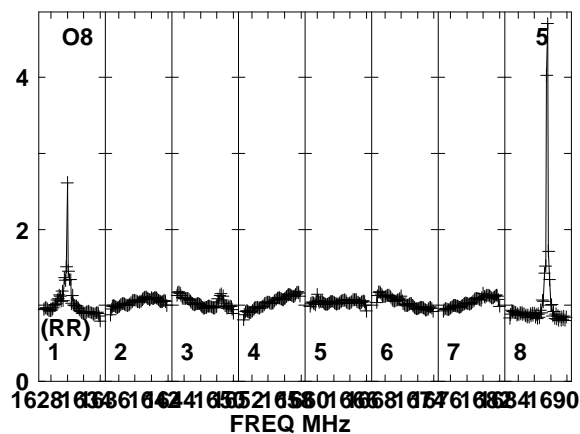
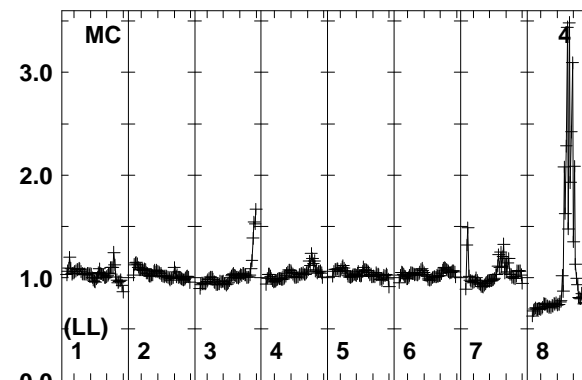
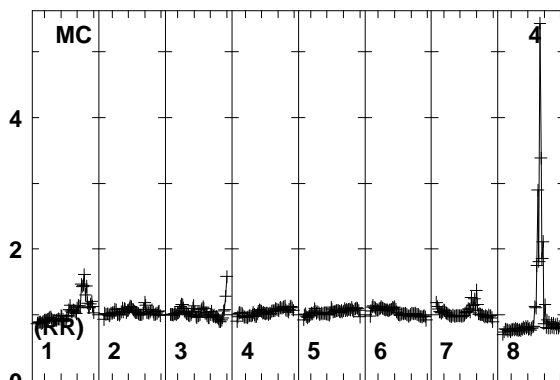
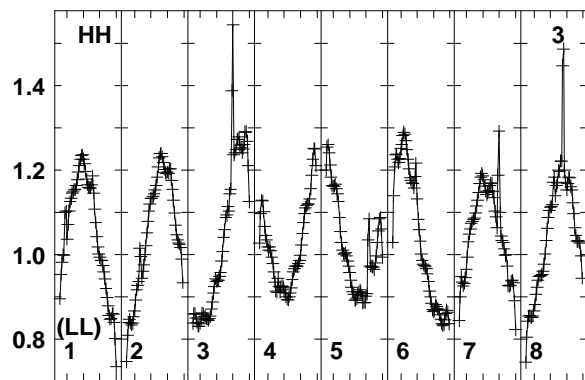
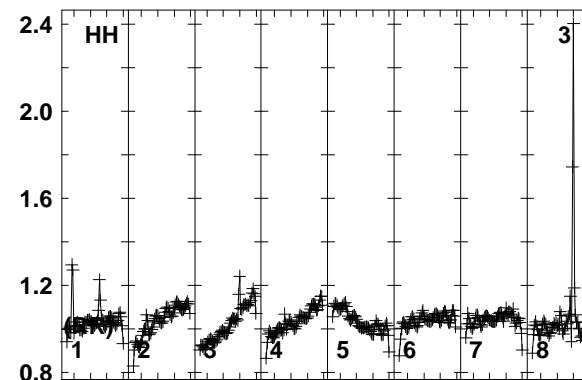
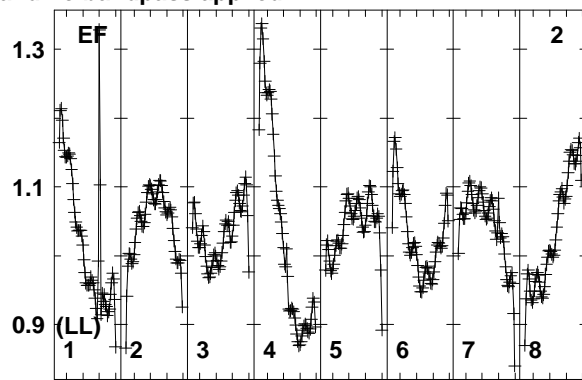
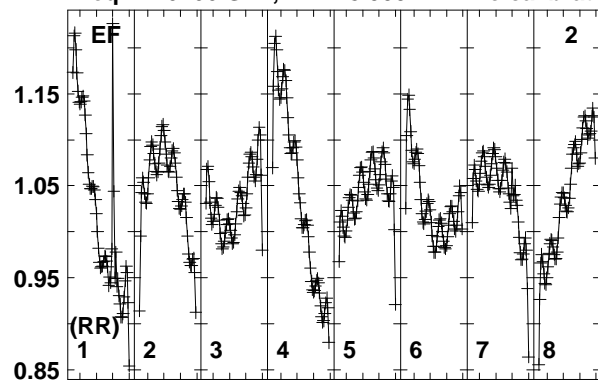

Lower frame: Real Jy
Total-power spectrum Antenna: EF (02)
Timerange: 00/19:47:35 to 00/19:49:59

Plot file version 265 created 01-AUG-2018 16:38:35

PB-2+4 N18L1 2.UVDATA.1

Freq = 1.6266 GHz, Bw = 8.000 MH No calibration applied and no bandpass applied

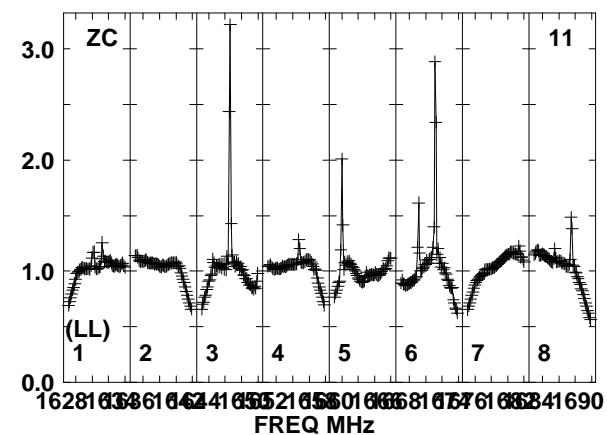
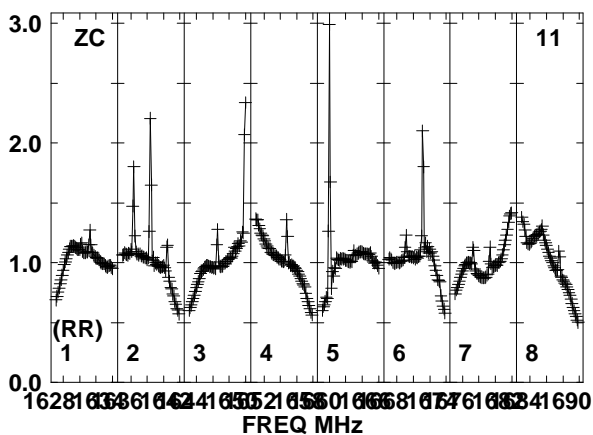
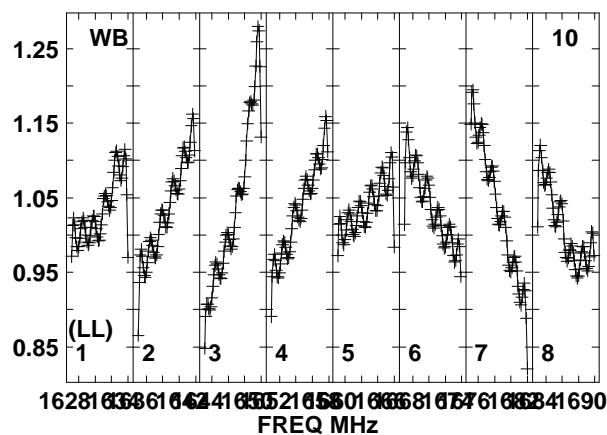
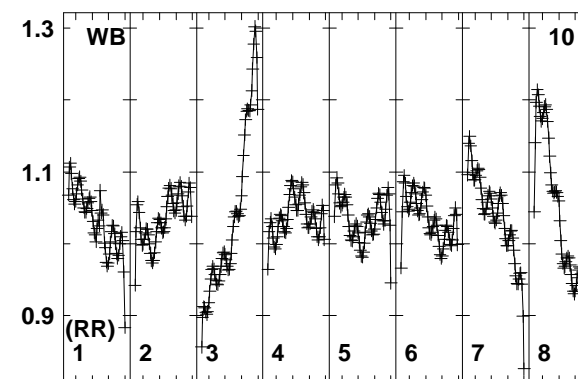
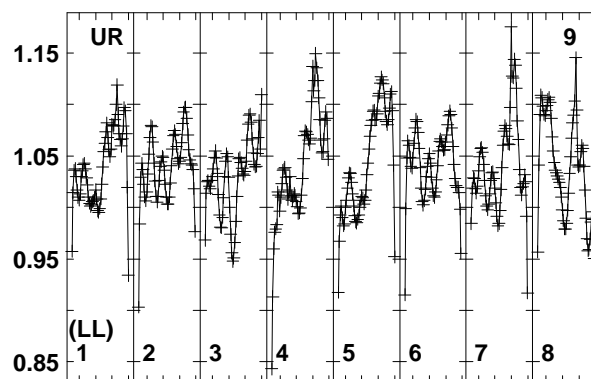
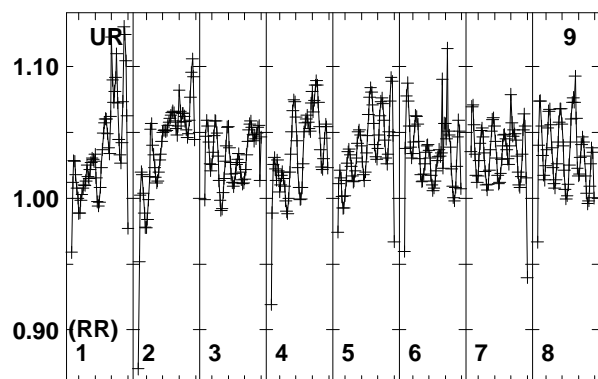
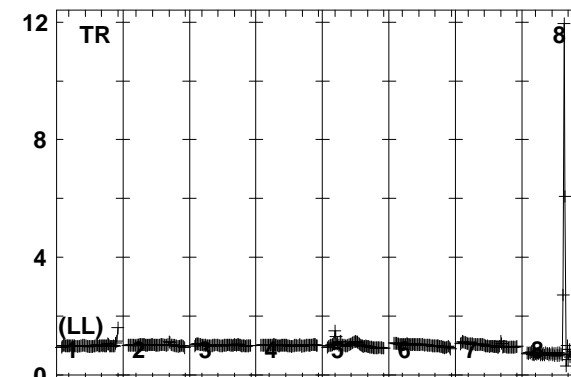
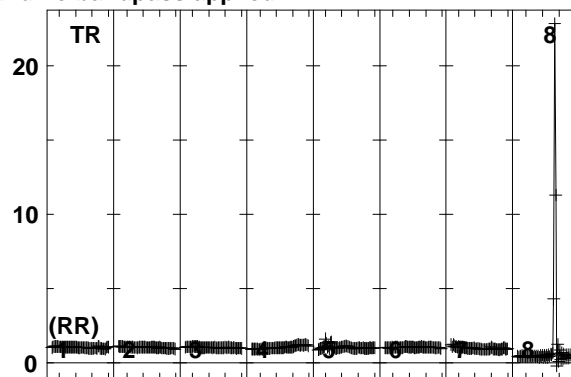
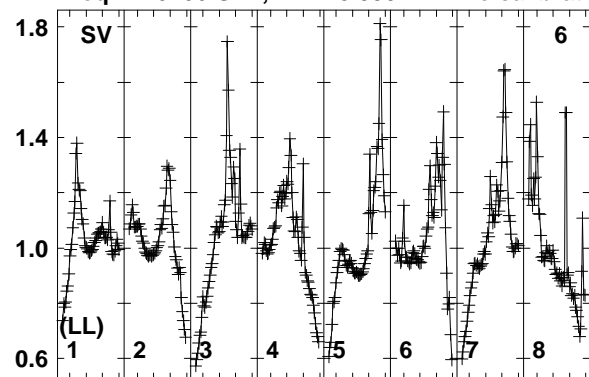

Lower frame: Real Jy
Total-power spectrum Antenna: SV (06)
Timerange: 00/19:47:35 to 00/19:49:59

Plot file version 266 created 01-AUG-2018 16:38:35

J0530+1331 N18L1 2.UVDATA.1

Freq = 1.6266 GHz, Bw = 8.000 MH No calibration applied and no bandpass applied

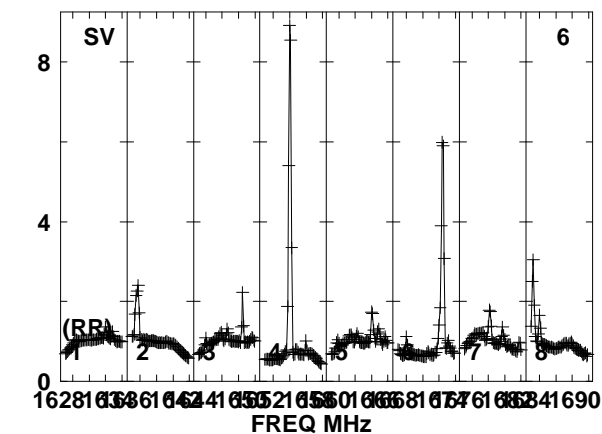
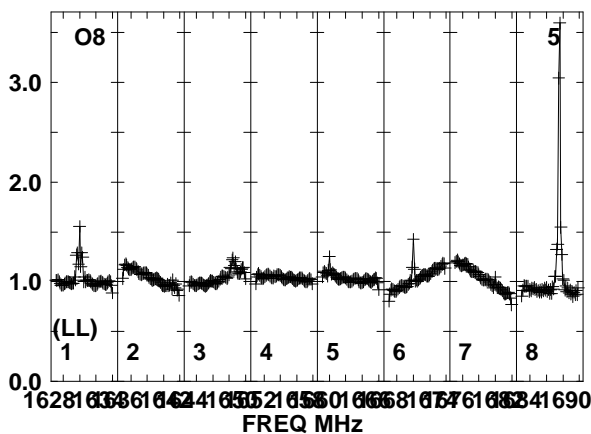
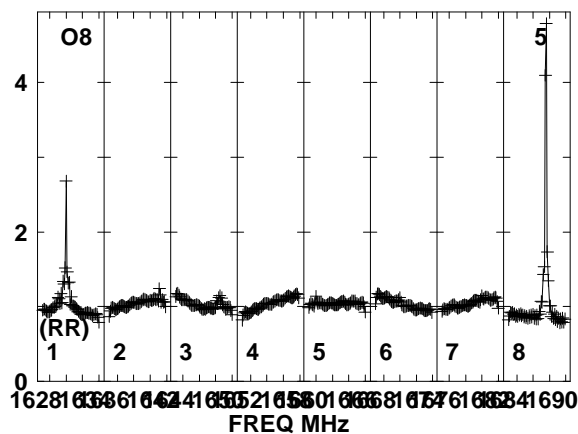
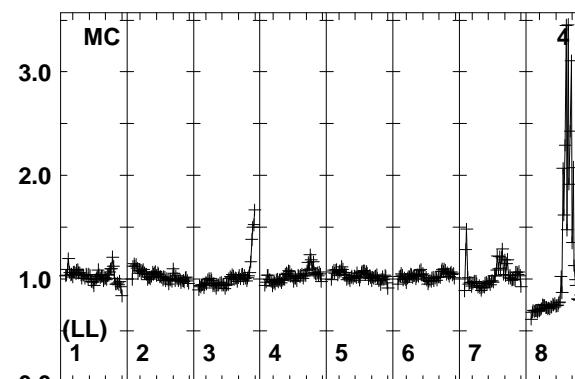
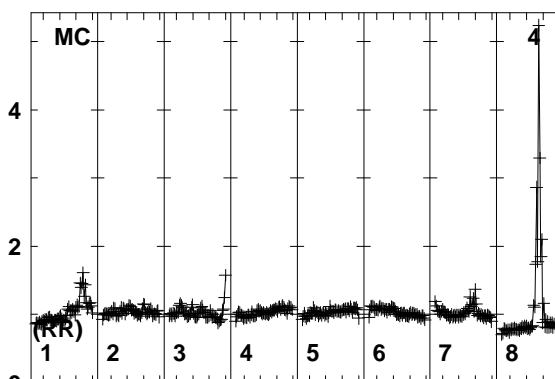
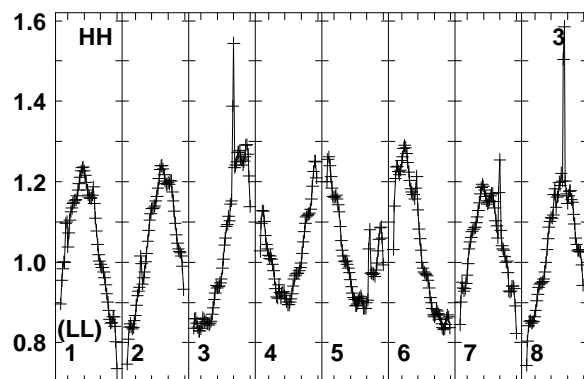
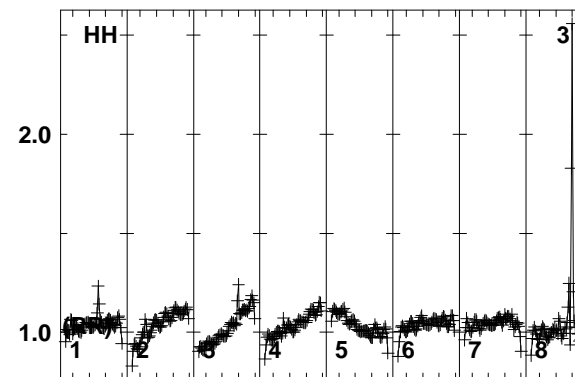
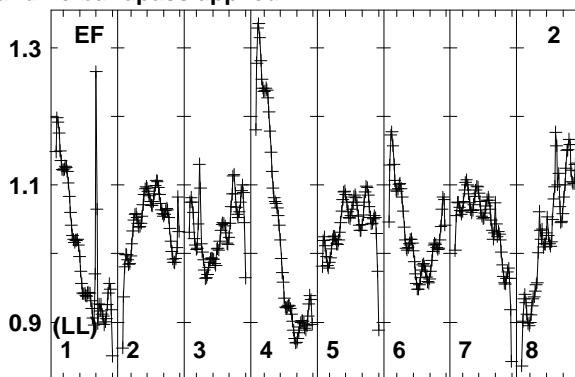
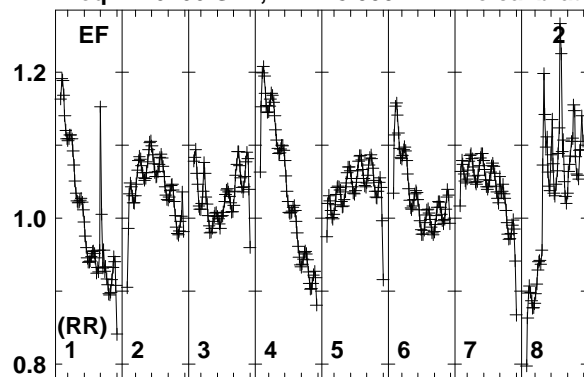

Lower frame: Real Jy
Total-power spectrum Antenna: EF (02)
Timerange: 00/19:50:41 to 00/19:51:59

Plot file version 267 created 01-AUG-2018 16:38:35
J0530+1331 N18L1 2.UVDATA.1
Freq = 1.6266 GHz, Bw = 8.000 MH No calibration applied and no bandpass applied

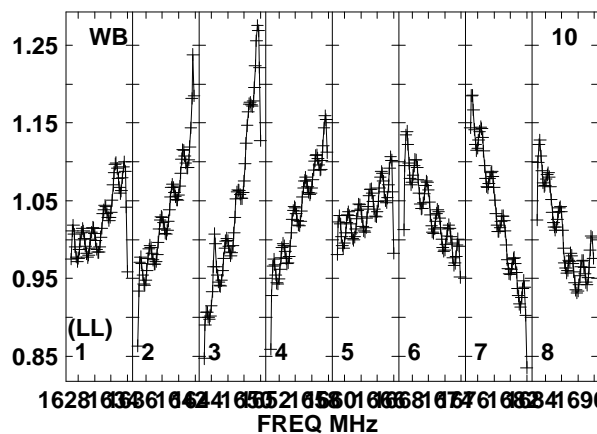
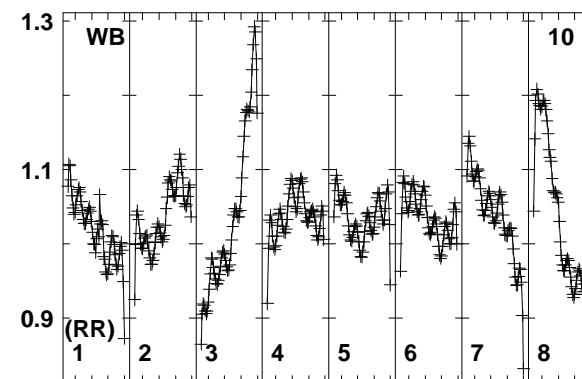
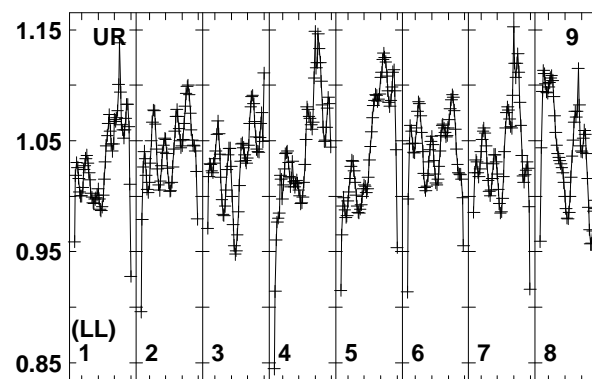
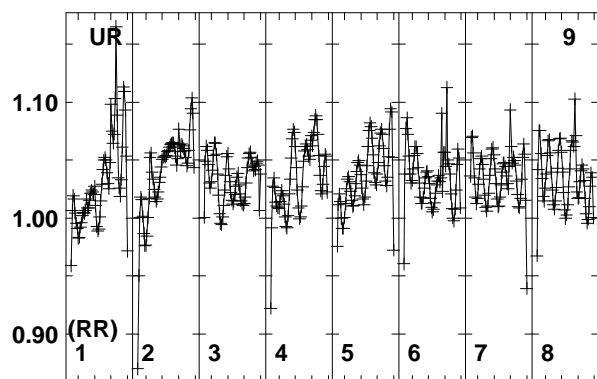
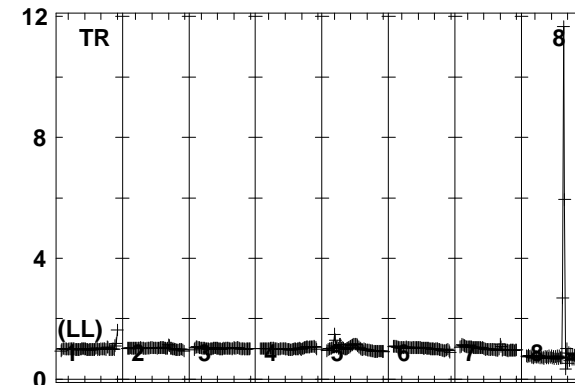
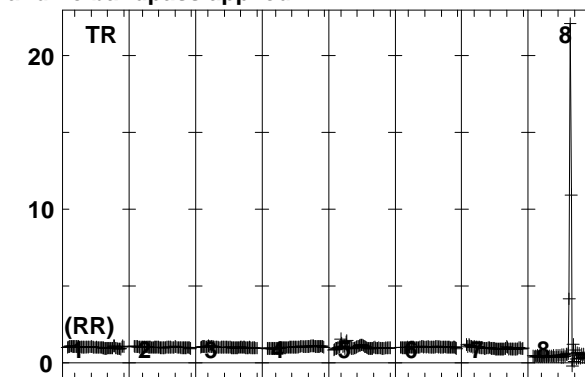
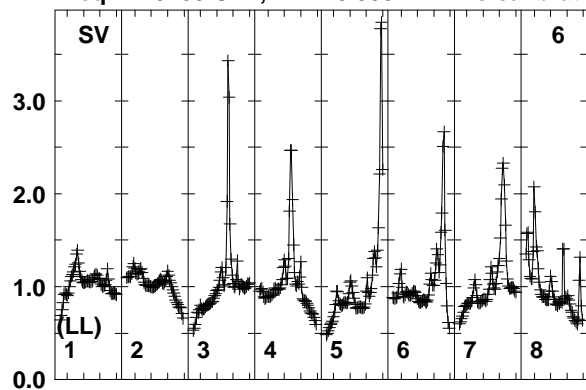

1628163861644165216601668167616841690
FREQ MHz

Lower frame: Real Jy
Total-power spectrum Antenna: SV (06)
Timerange: 00/19:50:41 to 00/19:51:59

Plot file version 268 created 01-AUG-2018 16:38:35

PB-3+4 N18L1 2.UVDATA.1

Freq = 1.6266 GHz, Bw = 8.000 MH No calibration applied and no bandpass applied

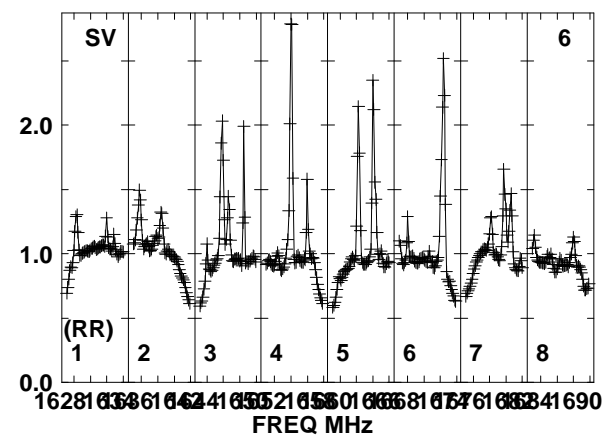
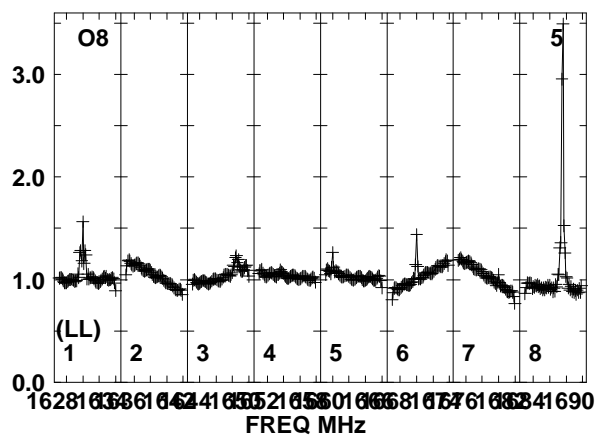
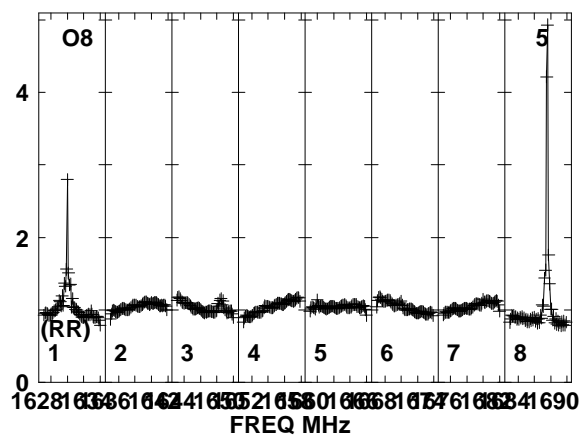
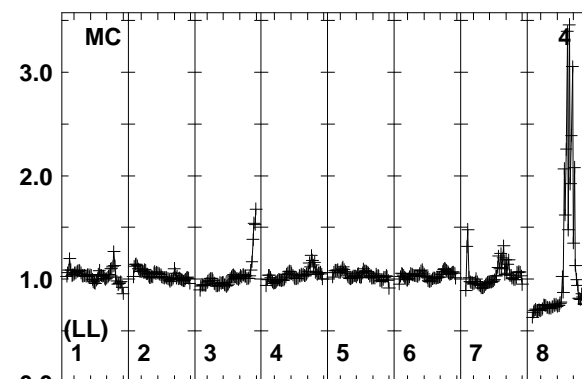
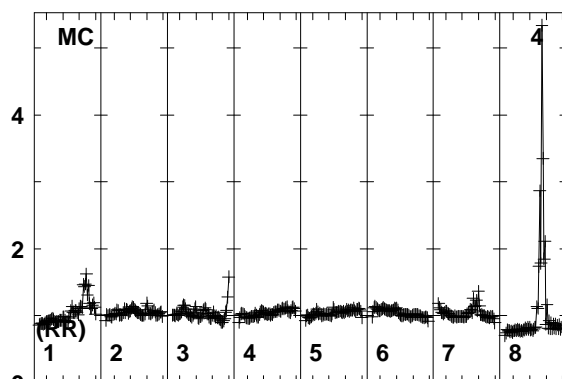
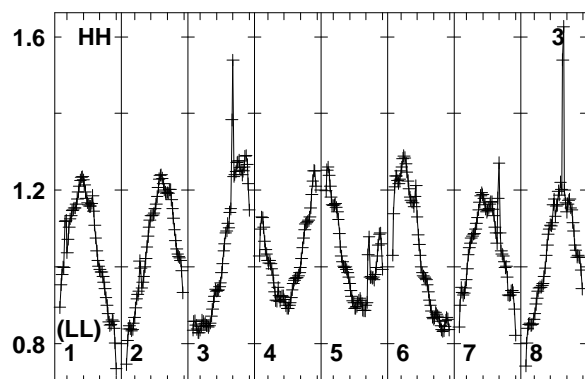
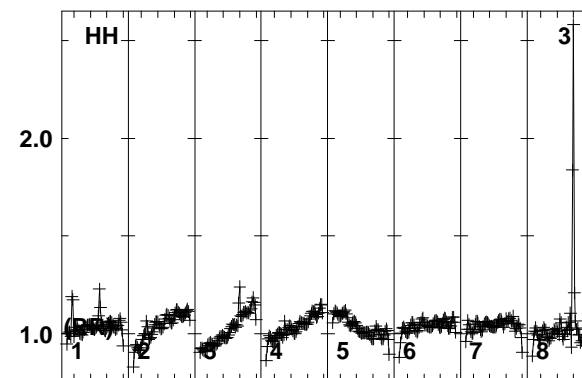
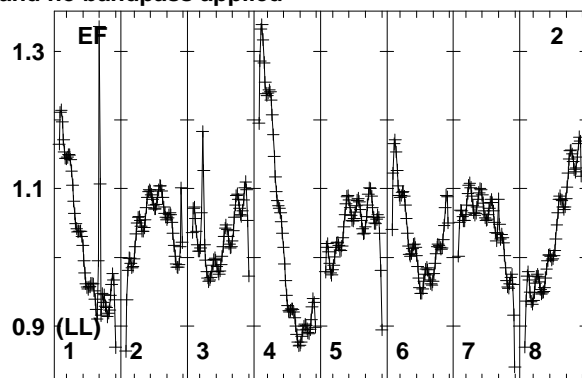
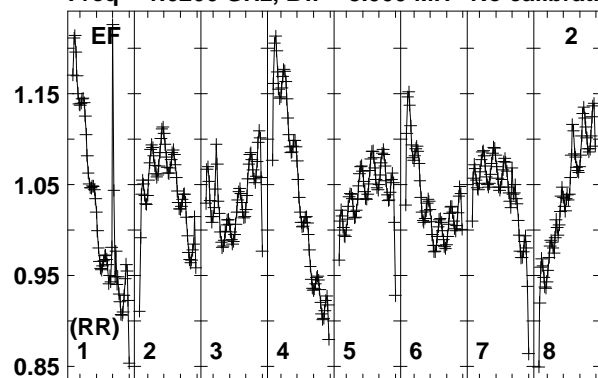

Lower frame: Real Jy

Total-power spectrum Antenna: EF (02)

Timerange: 00/19:52:05 to 00/19:54:29

Plot file version 269 created 01-AUG-2018 16:38:35
 PB-3+4 N18L1 2.UVDATA.1
 Freq = 1.6266 GHz, Bw = 8.000 MH No calibration applied and no bandpass applied

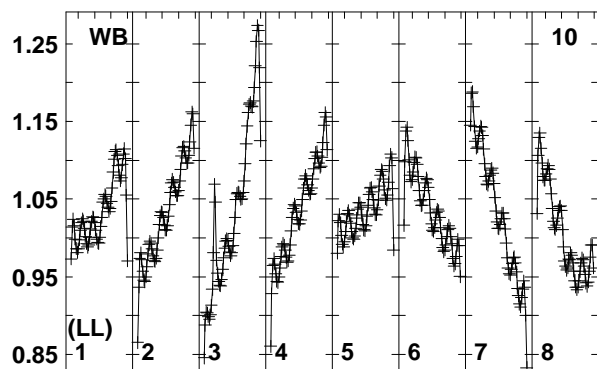
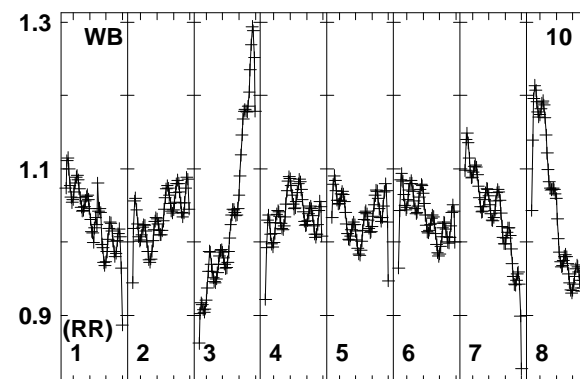
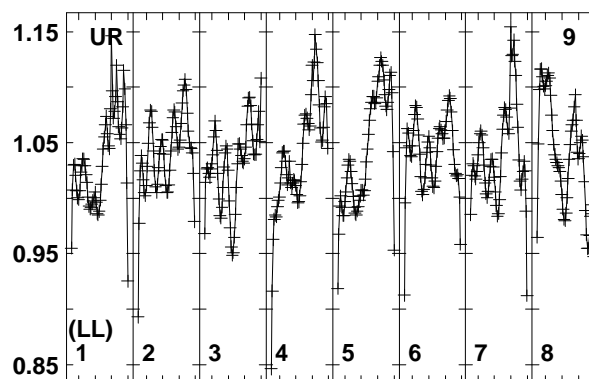
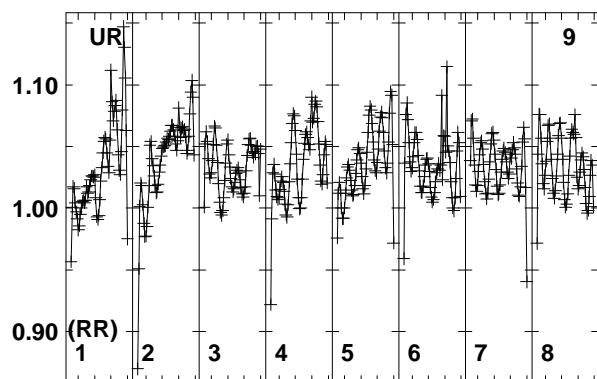
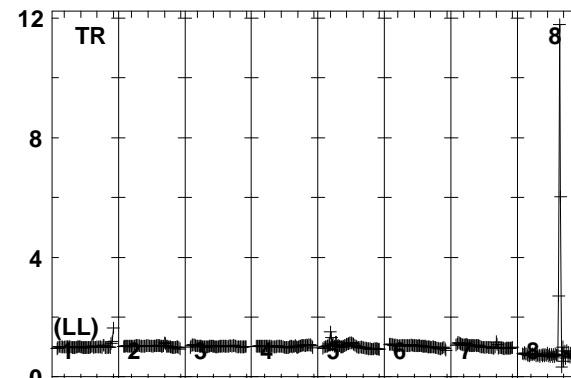
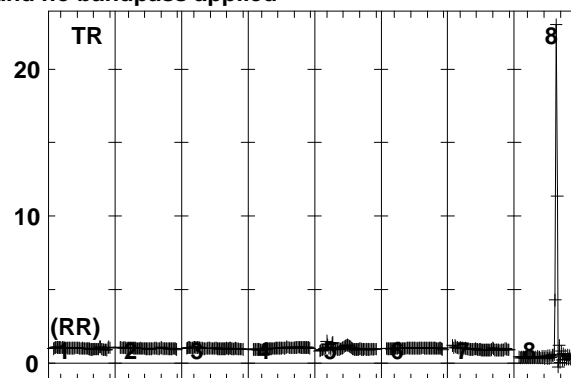
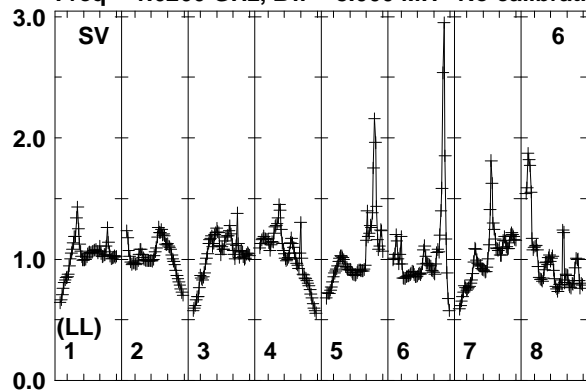

162816381644165216581668167616841690
 FREQ MHz

Lower frame: Real Jy
 Total-power spectrum Antenna: SV (06)
 Timerange: 00/19:52:05 to 00/19:54:29

Plot file version 270 created 01-AUG-2018 16:38:36

PB-4+4 N18L1 2.UVDATA.1

Freq = 1.6266 GHz, Bw = 8.000 MH No calibration applied and no bandpass applied

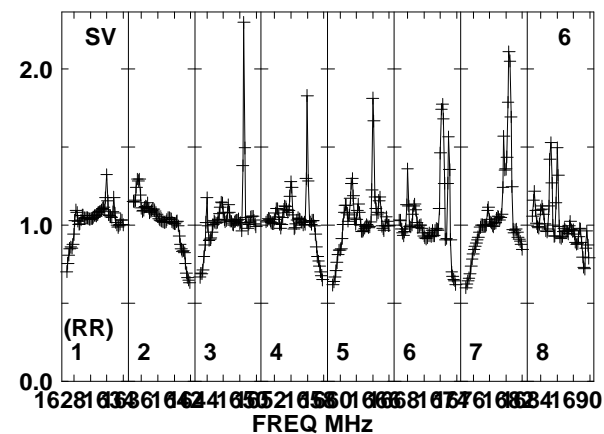
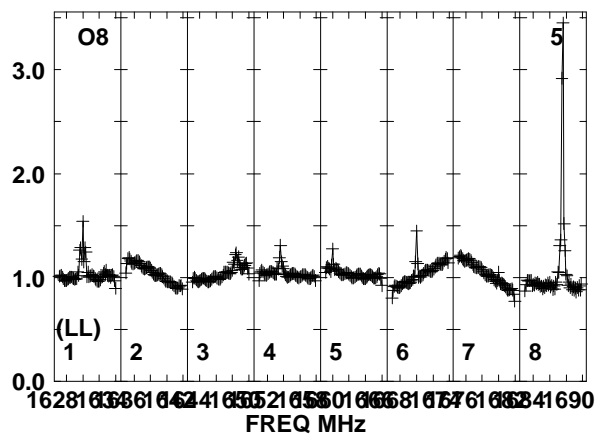
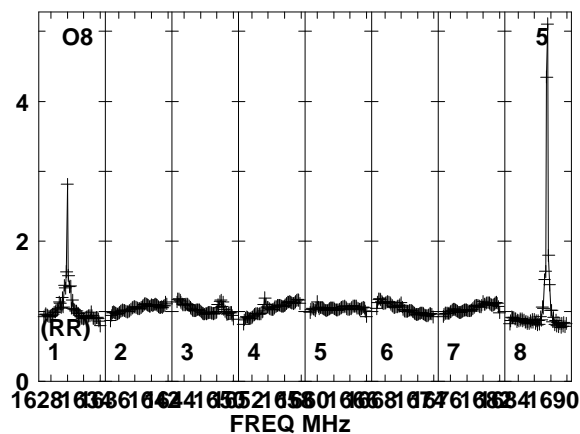
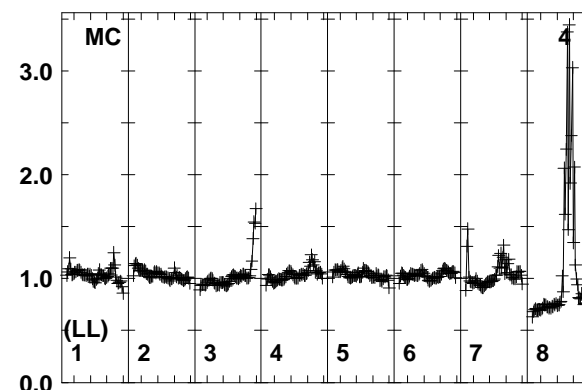
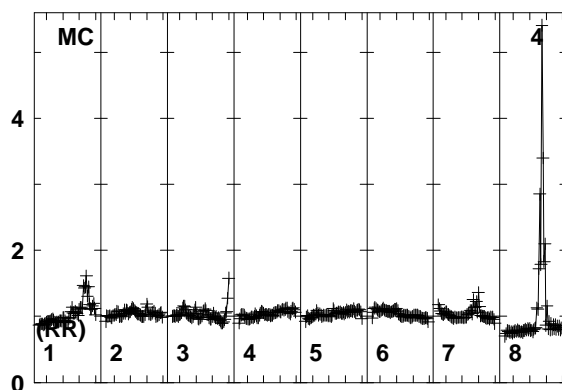
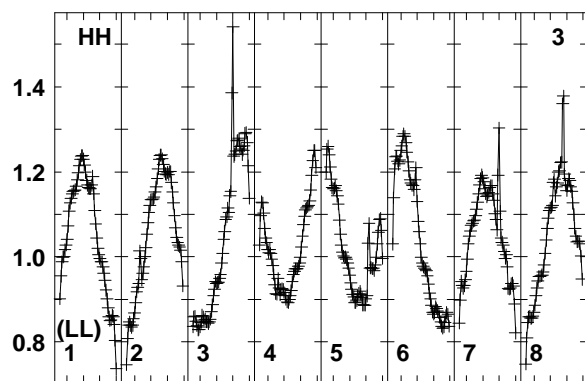
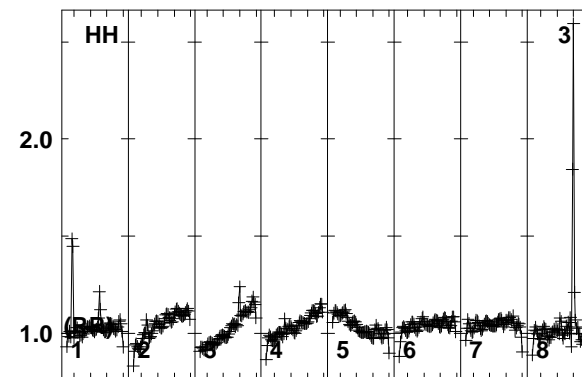
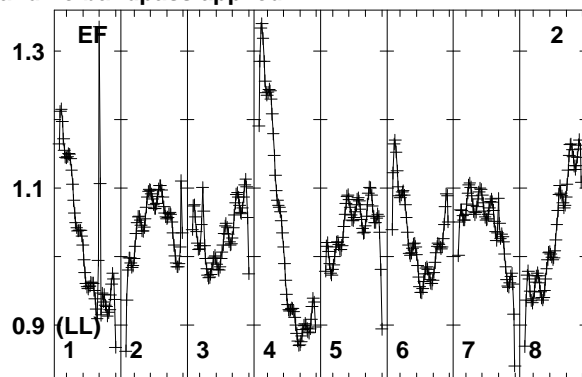
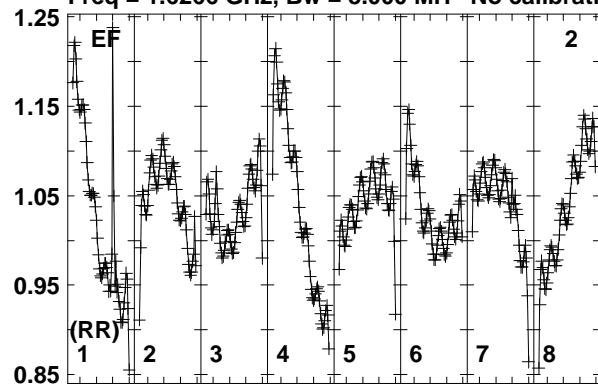

Lower frame: Real Jy
Total-power spectrum Antenna: EF (02)
Timerange: 00/19:54:35 to 00/19:56:59

Plot file version 271 created 01-AUG-2018 16:38:36
 PB-4+4 N18L1 2.UVDATA.1
 Freq = 1.6266 GHz, Bw = 8.000 MH No calibration applied and no bandpass applied

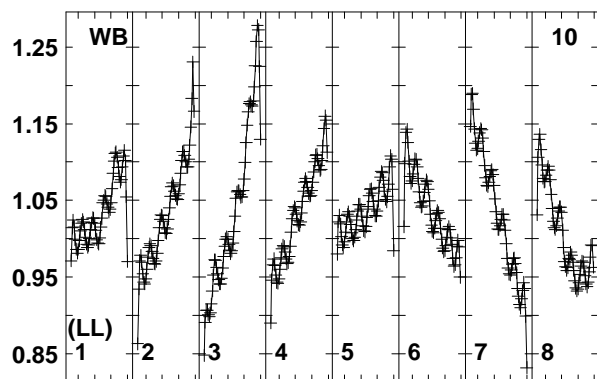
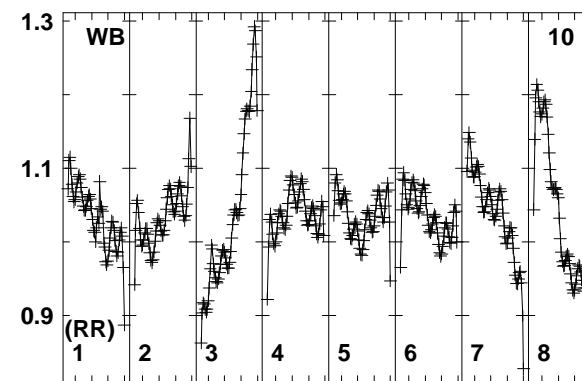
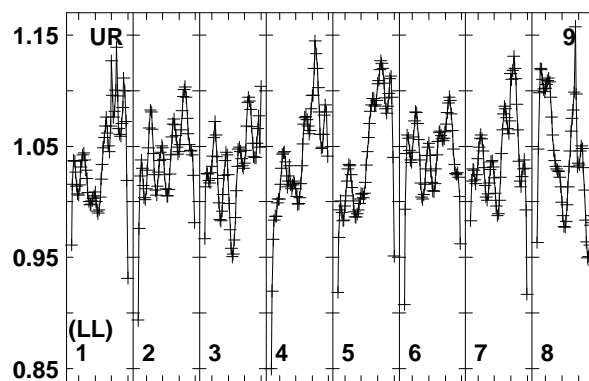
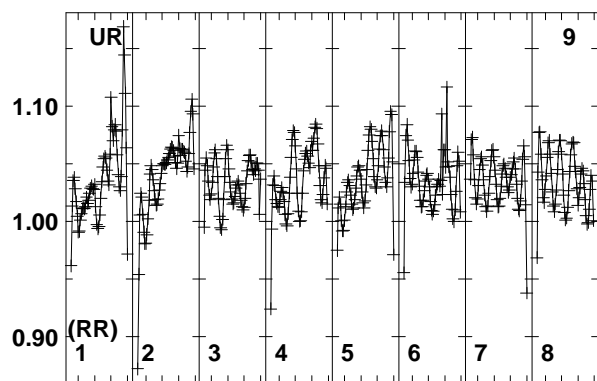
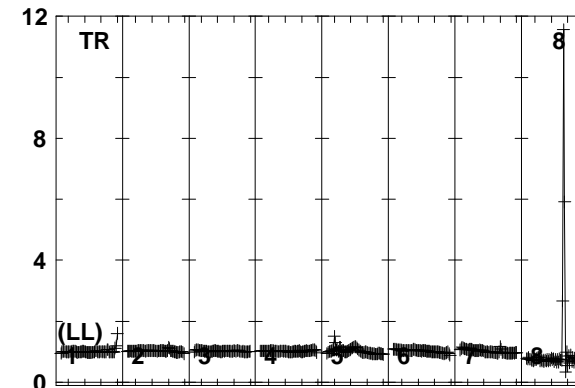
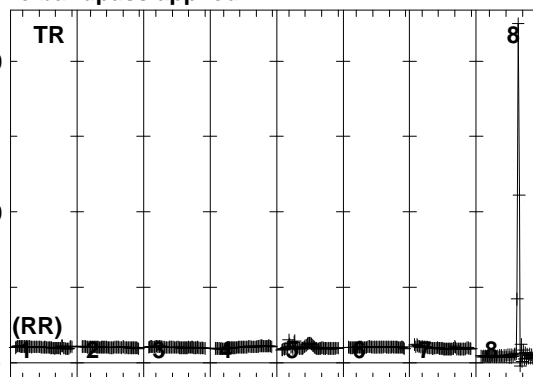
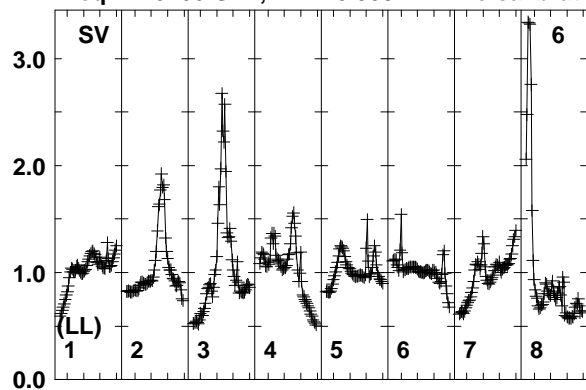

1628163861642416552165801666816746168241690
 FREQ MHz

Lower frame: Real Jy
 Total-power spectrum Antenna: SV (06)
 Timerange: 00/19:54:35 to 00/19:56:59

Plot file version 272 created 01-AUG-2018 16:38:36

J0530+1331 N18L1 2.UVDATA.1

Freq = 1.6266 GHz, Bw = 8.000 MH No calibration applied and no bandpass applied

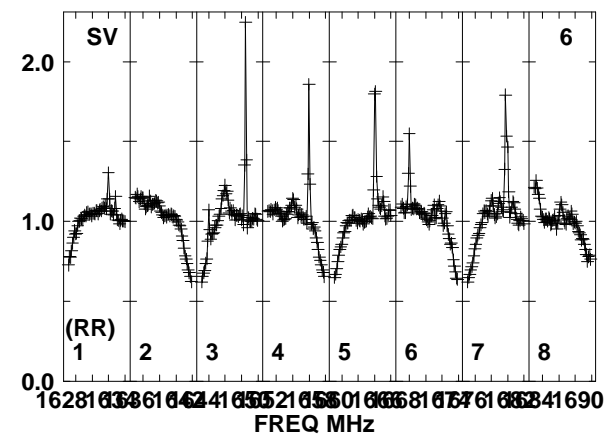
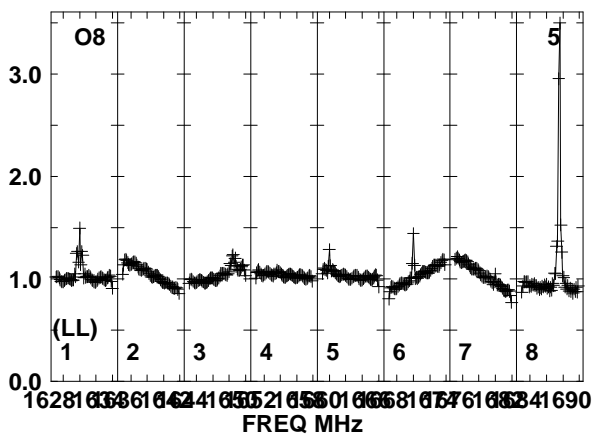
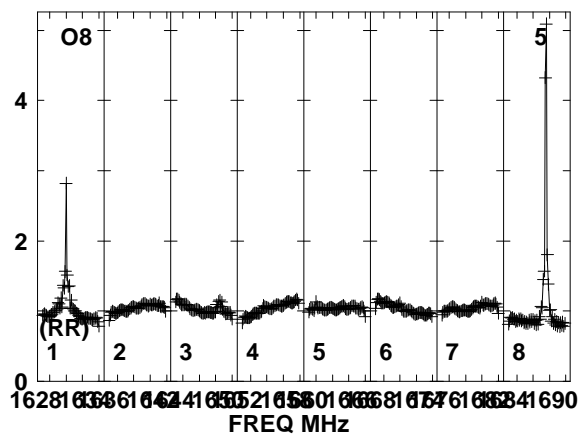
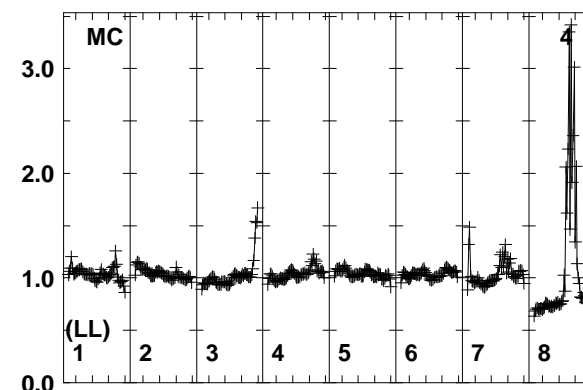
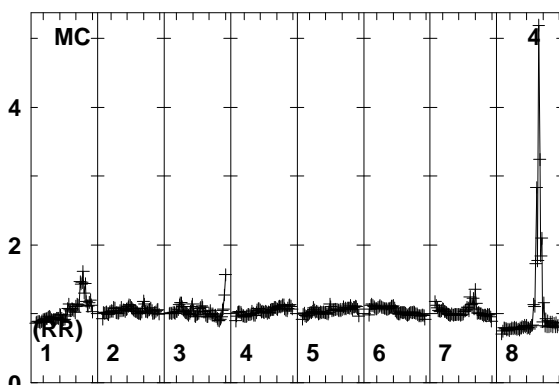
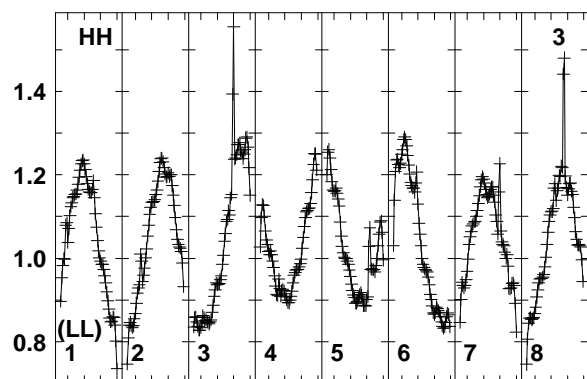
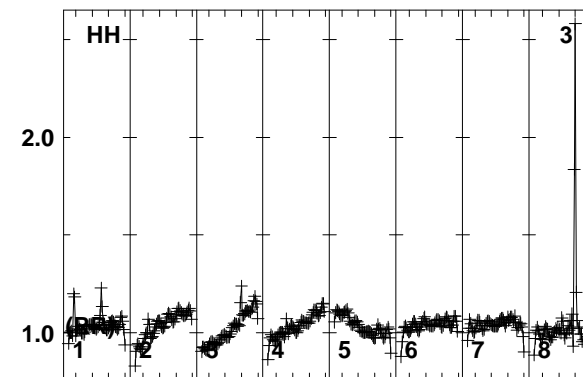
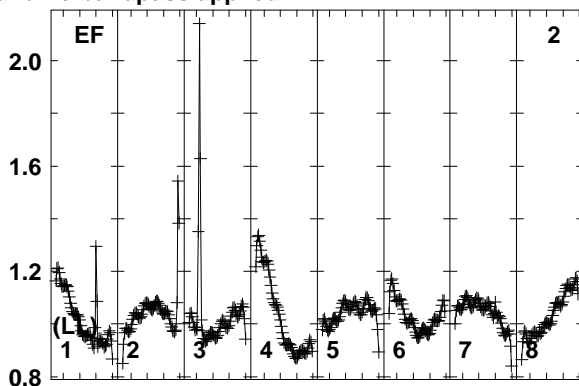
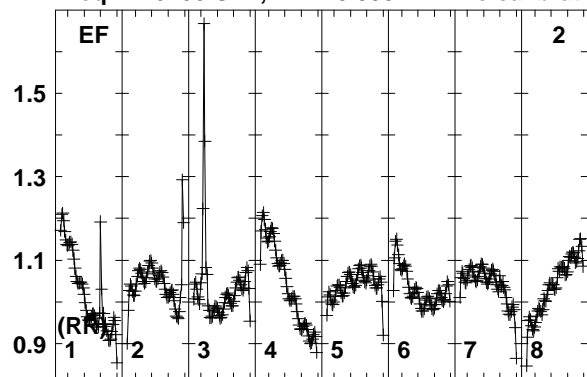

Lower frame: Real Jy
Total-power spectrum Antenna: EF (02)
Timerange: 00/19:57:05 to 00/19:59:59

Plot file version 273 created 01-AUG-2018 16:38:36

J0530+1331 N18L1 2.UVDATA.1

Freq = 1.6266 GHz, Bw = 8.000 MH No calibration applied and no bandpass applied

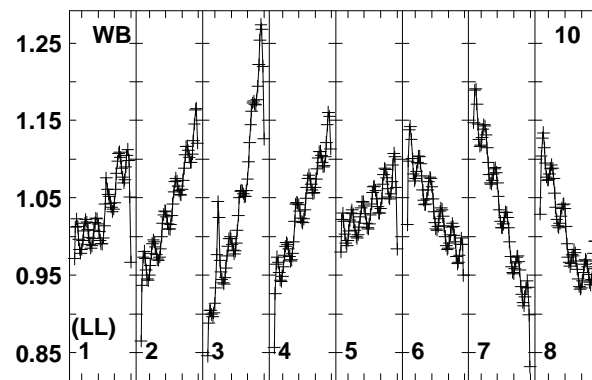
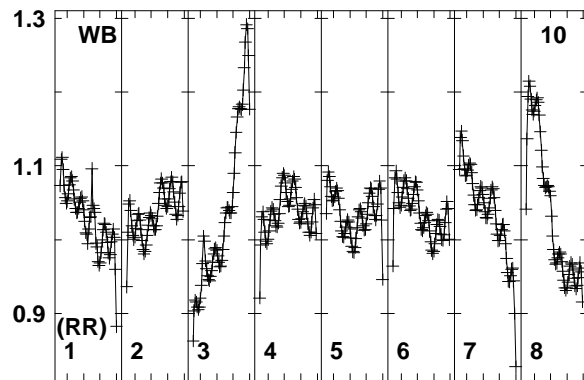
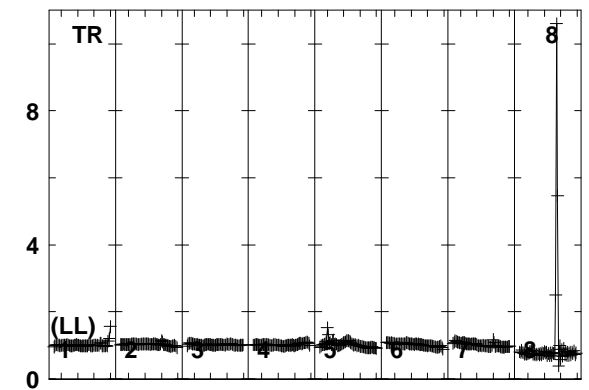
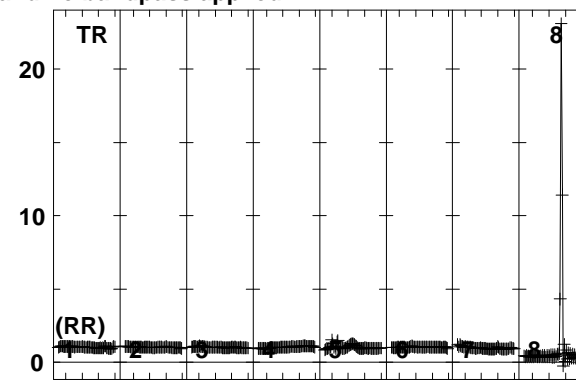
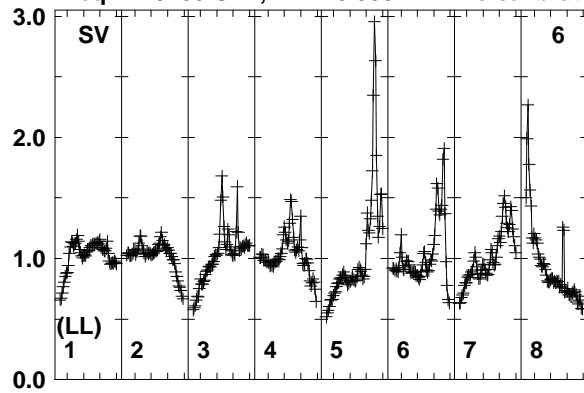

Lower frame: Real Jy
Total-power spectrum Antenna: SV (06)
Timerange: 00/19:57:05 to 00/19:59:59