

Plot file version 1 created 01-JUL-2010 13:23:56

OQ208 RG006B.UVDATA.1

Freq = 1.6015 GHz, Bw = 16.000 MH No calibration applied and no bandpass applied

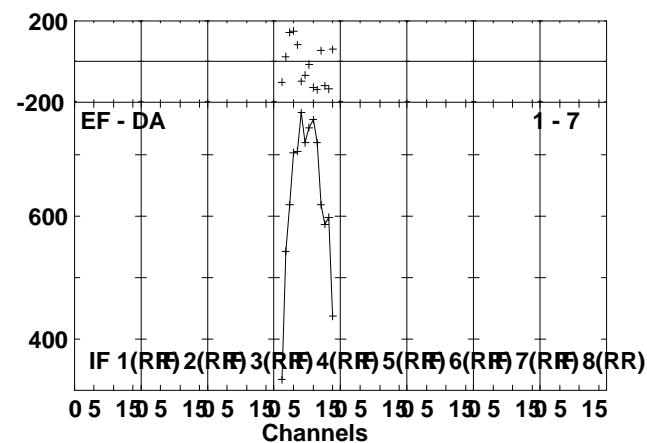
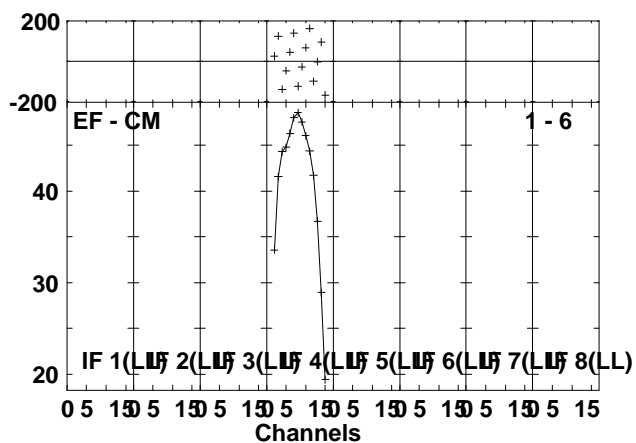
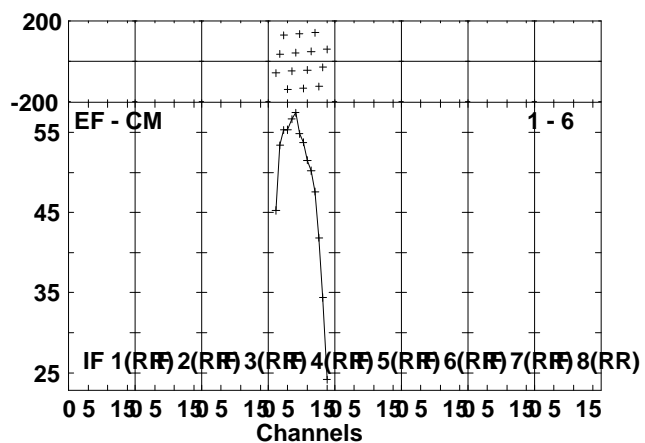
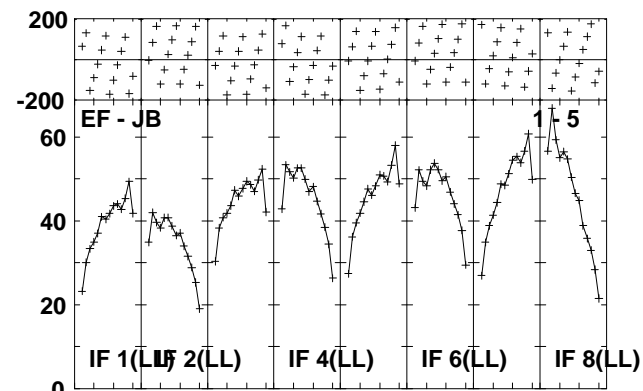
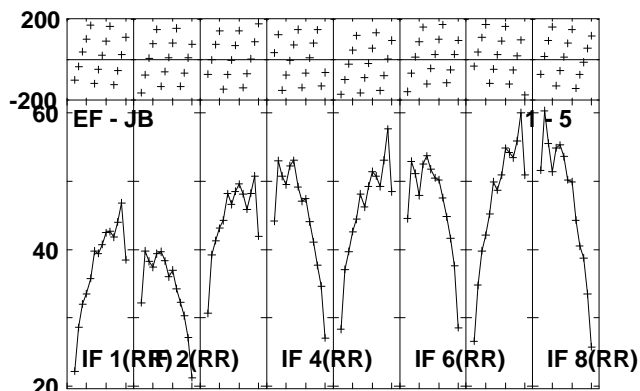
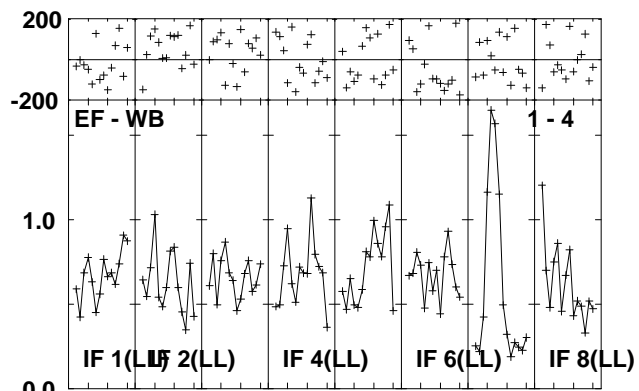
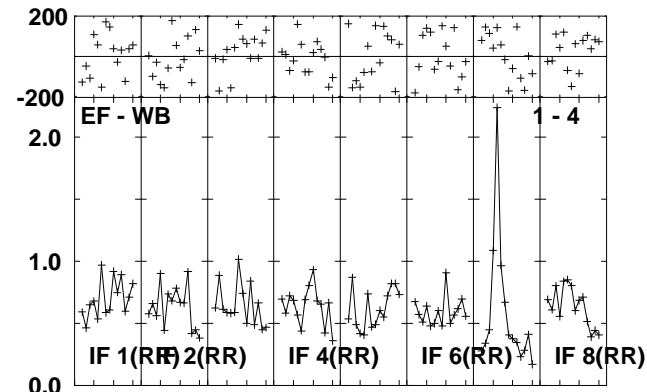
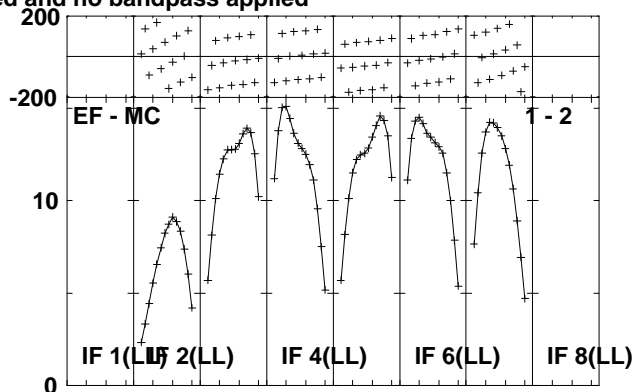
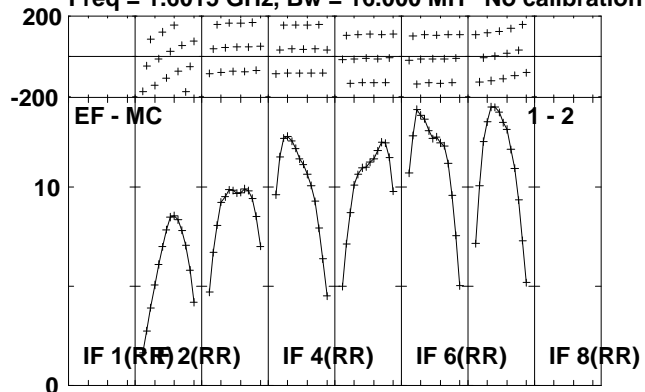

Lower frame: Milli Ampl Jy Top frame: Phas deg
Scalar averaged cross-power spectrum Several baselines displayed
Timerange: 00/17:34:36 to 00/17:43:00

Plot file version 2 created 01-JUL-2010 13:23:57

OQ208 RG006B.UVDATA.1

Freq = 1.6015 GHz, Bw = 16.000 MH No calibration applied and no bandpass applied

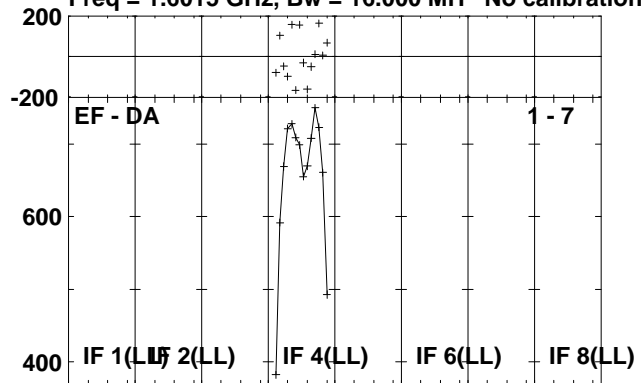

Lower frame: Micro Ampl Jy Top frame: Phas deg
Scalar averaged cross-power spectrum Several baselines displayed
Timerange: 00/17:34:36 to 00/17:43:00

Plot file version 3 created 01-JUL-2010 13:23:58

3C345 RG006B.UVDATA.1

Freq = 1.6015 GHz, Bw = 16.000 MH No calibration applied and no bandpass applied

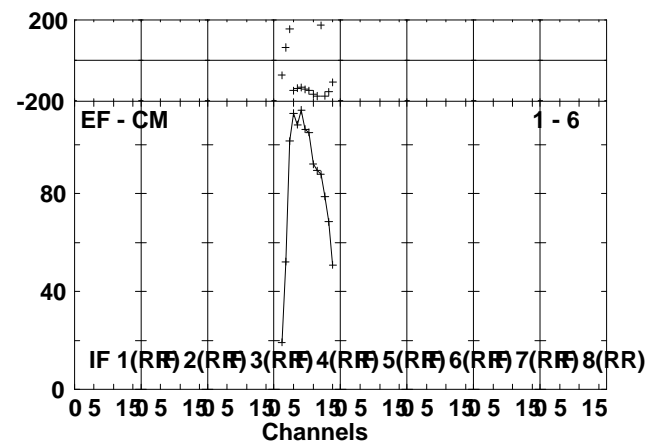
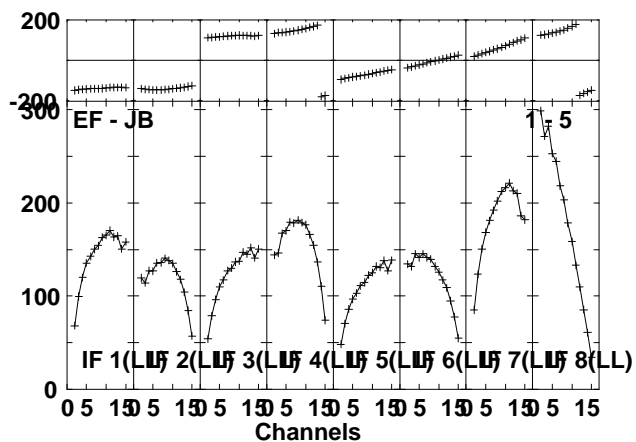
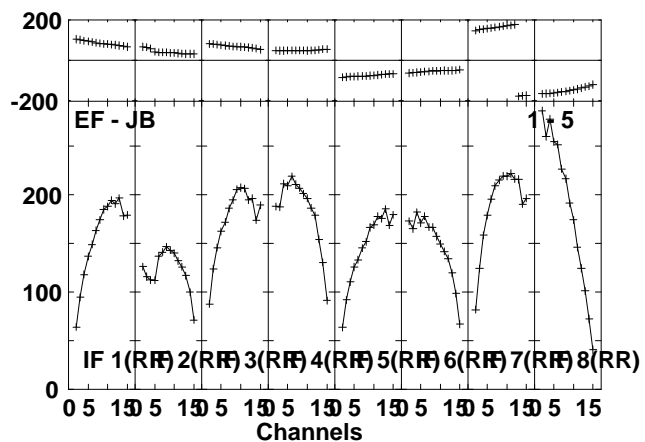
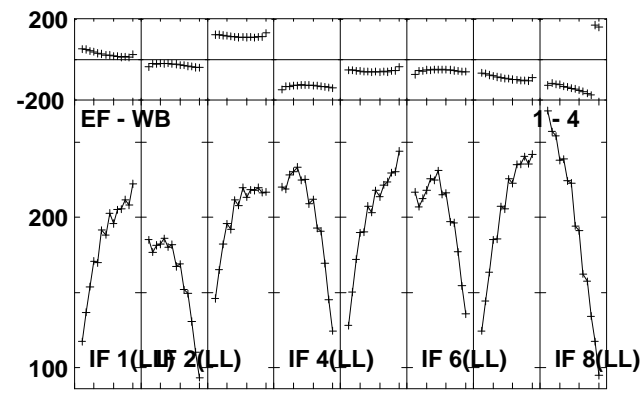
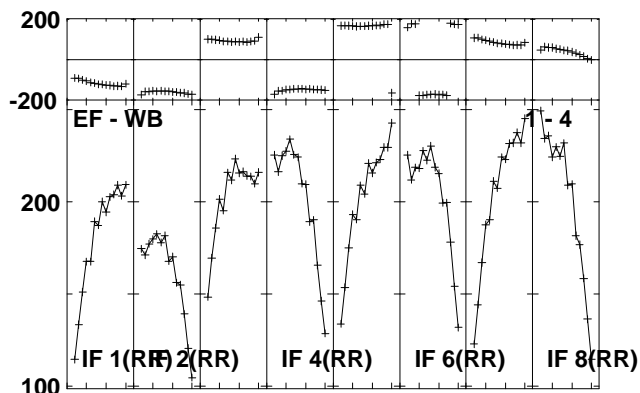
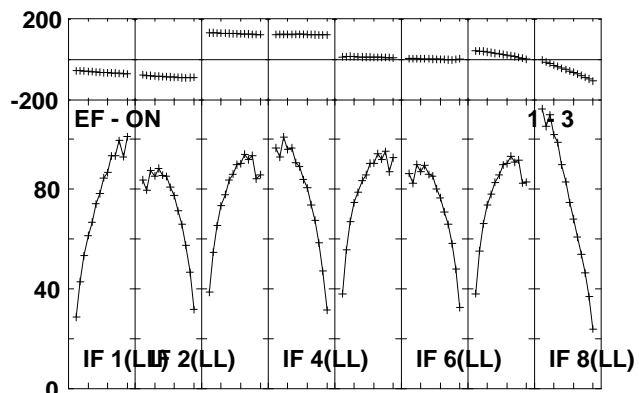
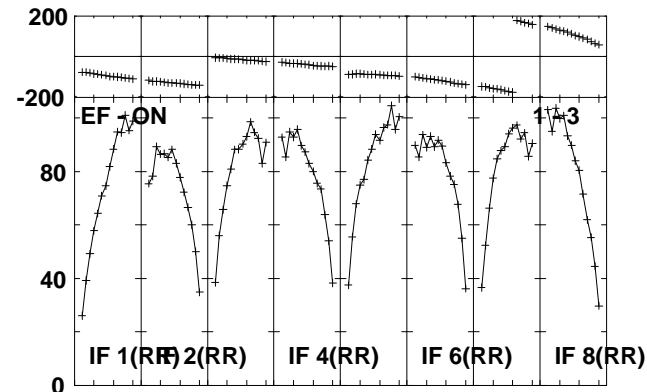
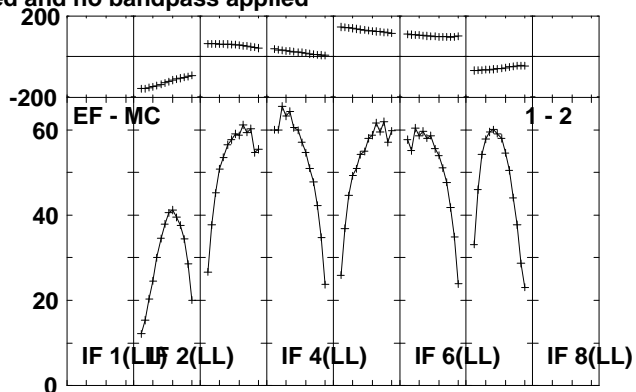
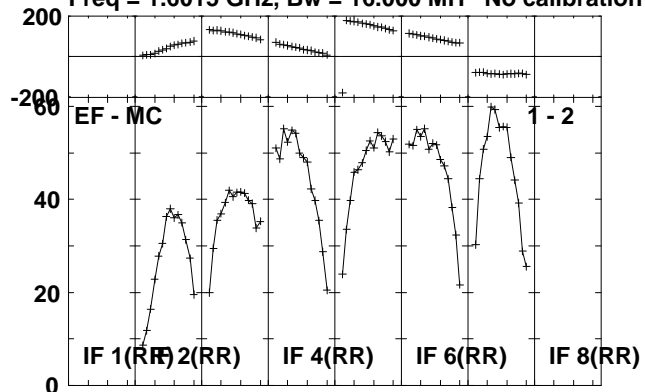

Lower frame: Milli Ampl Jy Top frame: Phas deg
Scalar averaged cross-power spectrum Several baselines displayed
Timerange: 00/20:30:15 to 00/20:52:11

Plot file version 4 created 01-JUL-2010 13:24:02
3C345 RG006B.UVDATA.1

Freq = 1.6015 GHz, Bw = 16.000 MH No calibration applied and no bandpass applied

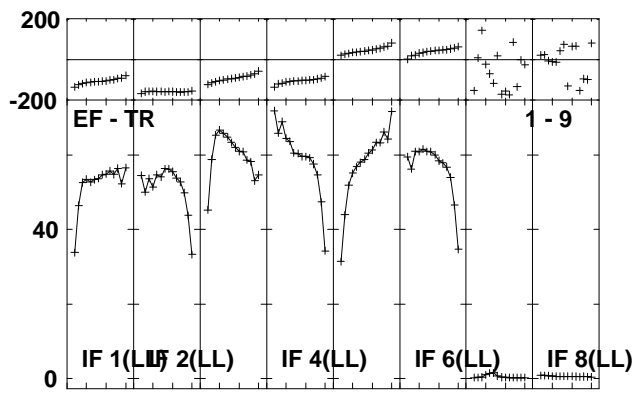
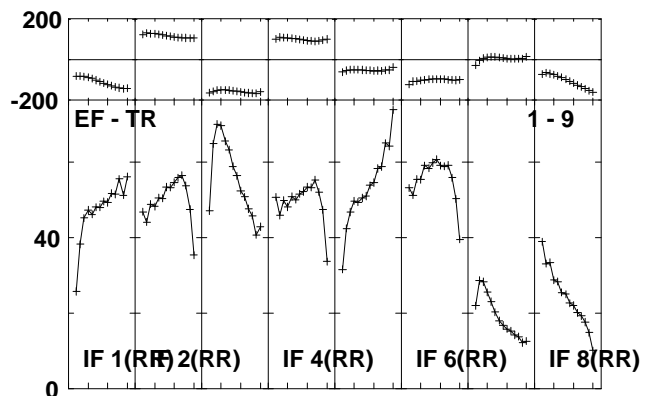
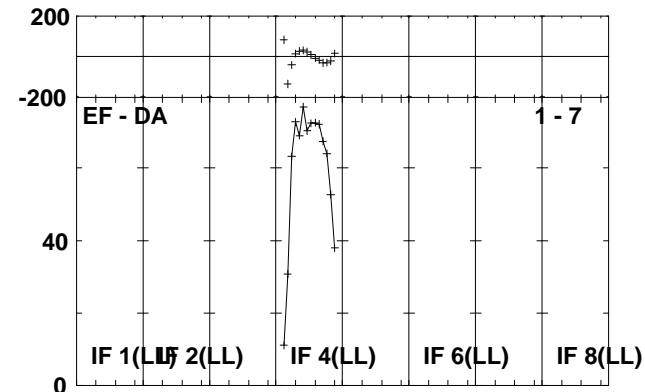
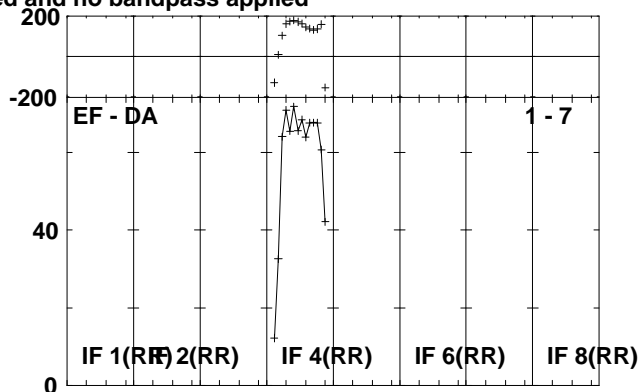
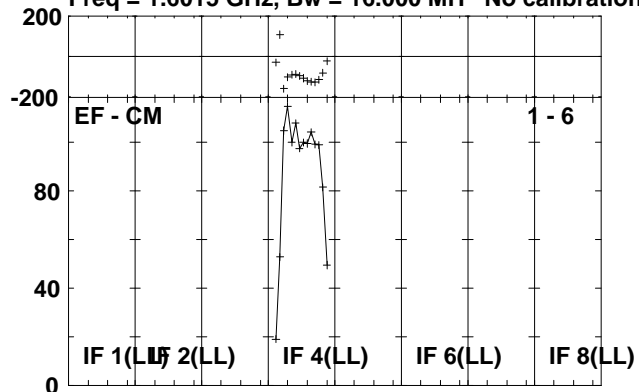

Lower frame: Milli Ampl Jy Top frame: Phas deg
Scalar averaged cross-power spectrum Several baselines displayed
Timerange: 00/20:30:15 to 00/20:52:11

Plot file version 5 created 01-JUL-2010 13:24:05

3C345 RG006B.UVDATA.1

Freq = 1.6015 GHz, Bw = 16.000 MH No calibration applied and no bandpass applied

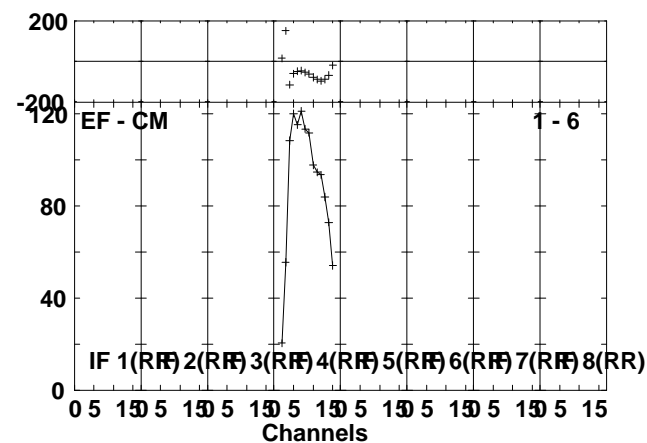
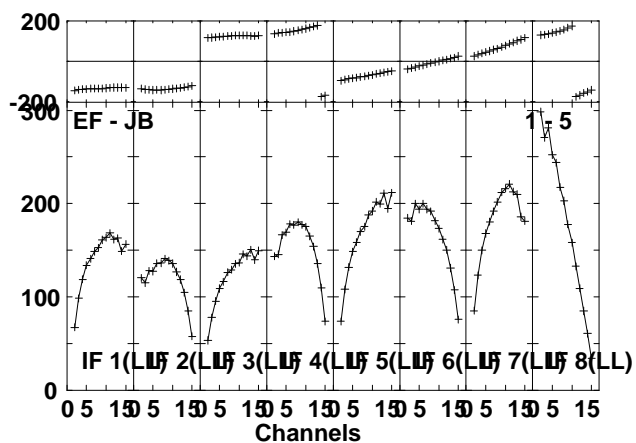
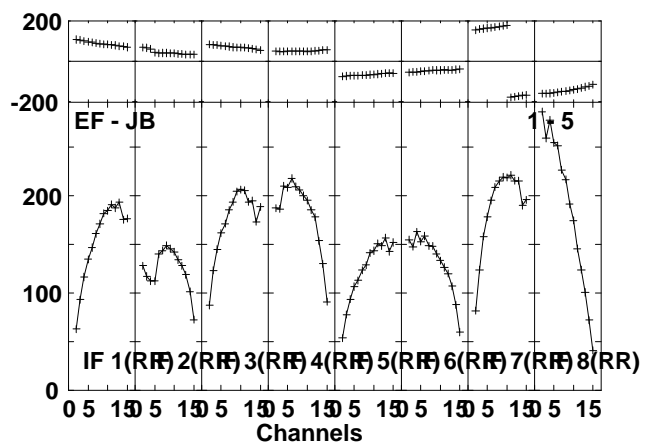
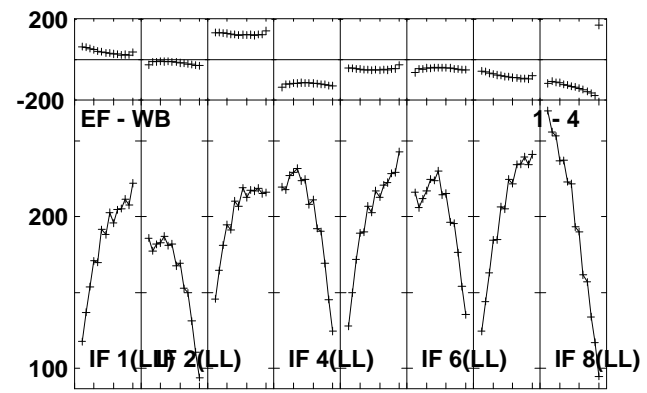
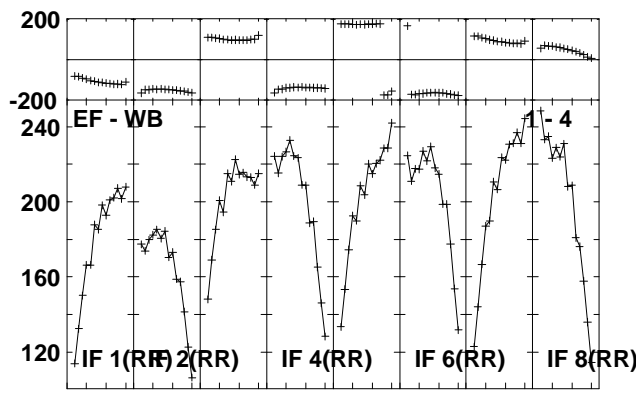
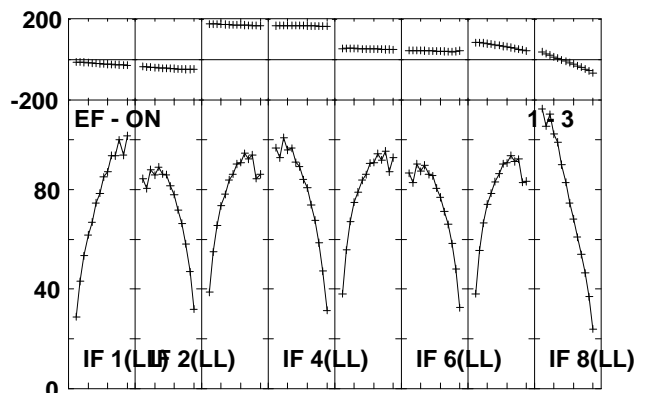
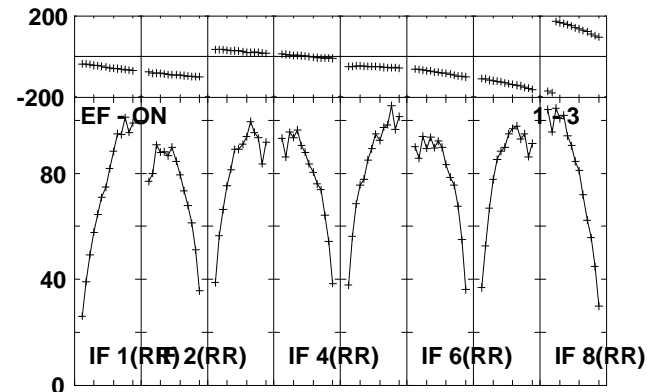
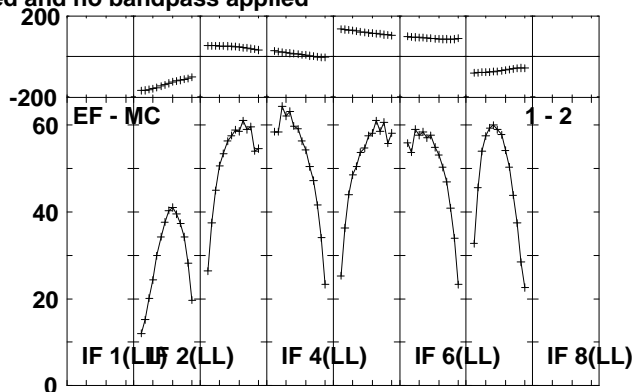
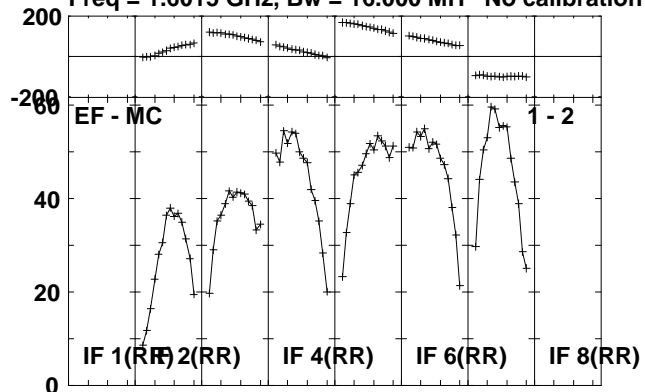

Lower frame: Milli Ampl Jy Top frame: Phas deg
Scalar averaged cross-power spectrum Several baselines displayed
Timerange: 00/20:52:15 to 00/20:54:19

Plot file version 6 created 01-JUL-2010 13:24:05

3C345 RG006B.UVDATA.1

Freq = 1.6015 GHz, Bw = 16.000 MH No calibration applied and no bandpass applied

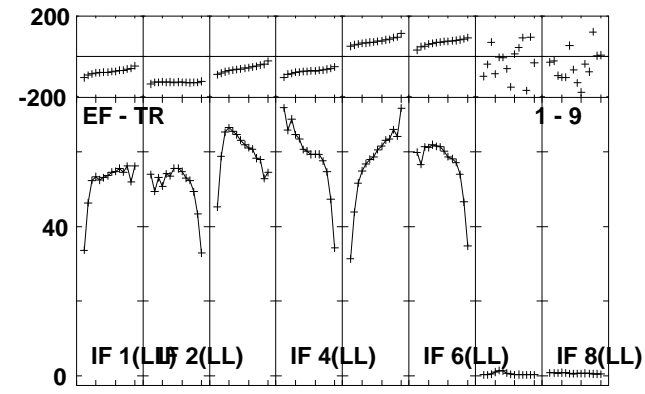
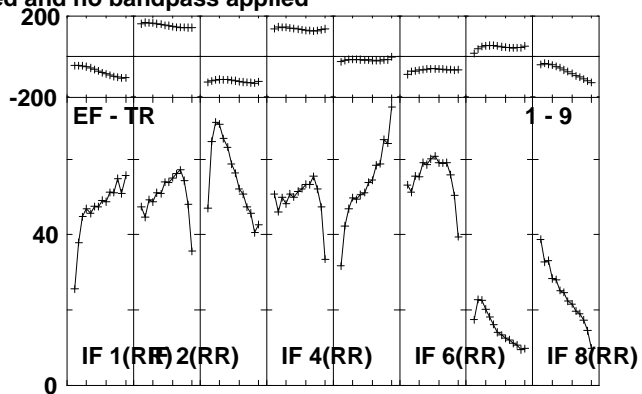
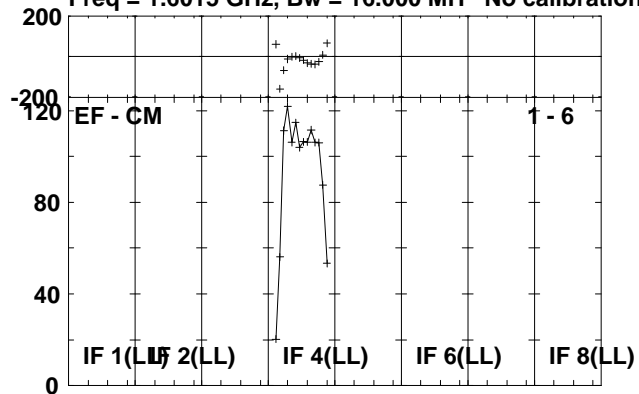

Lower frame: Milli Ampl Jy Top frame: Phas deg
Scalar averaged cross-power spectrum Several baselines displayed
Timerange: 00/20:52:15 to 00/20:54:19

Plot file version 7 created 01-JUL-2010 13:24:06

J2002+47 RG006B.UVDATA.1

Freq = 1.6015 GHz, Bw = 16.000 MH No calibration applied and no bandpass applied

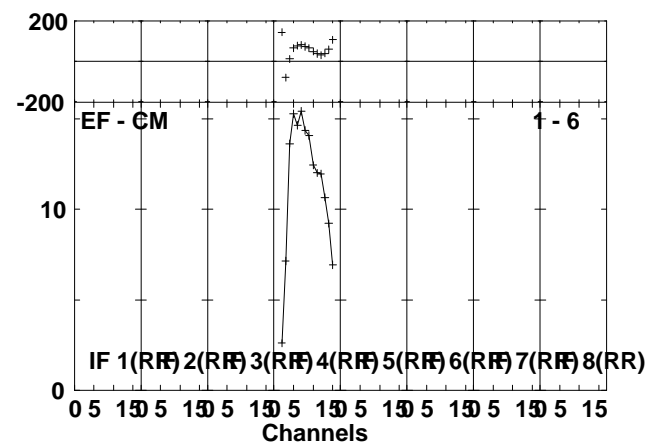
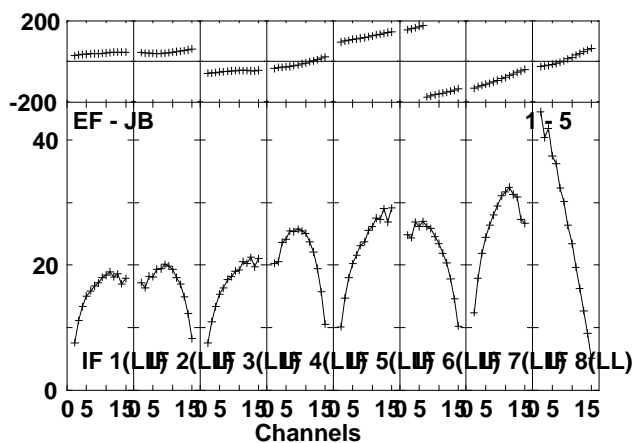
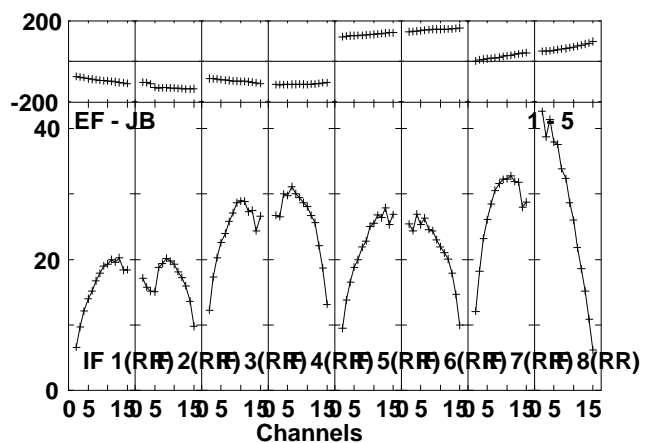
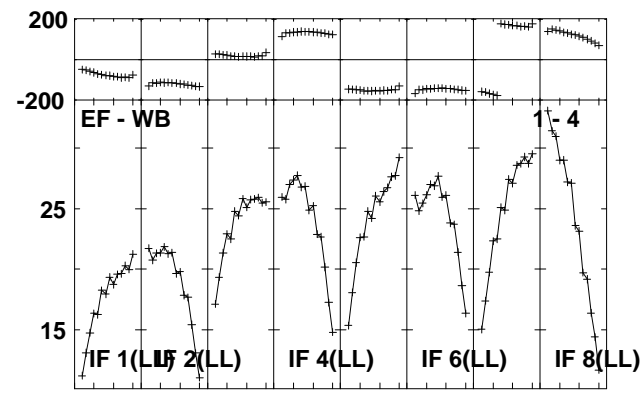
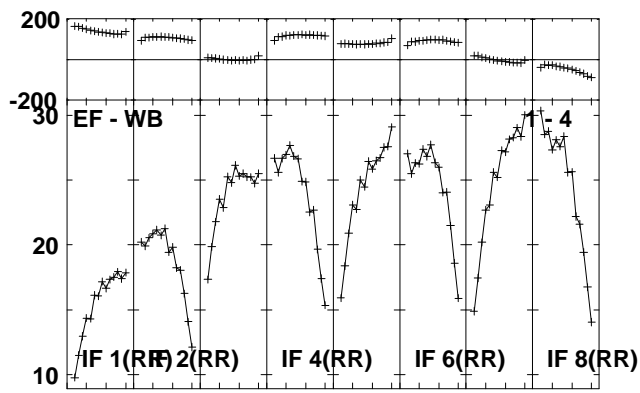
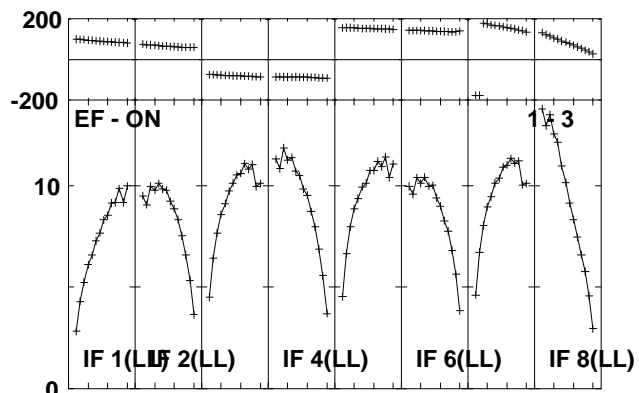
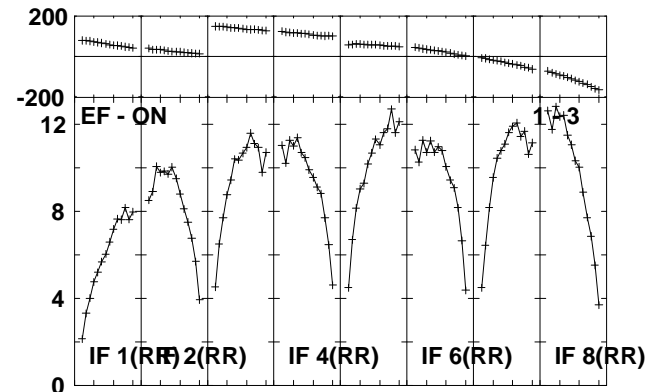
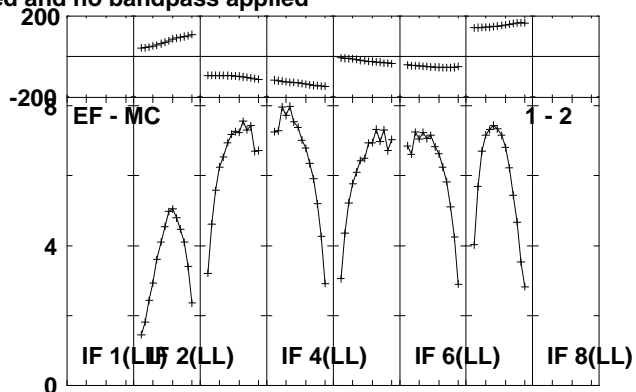
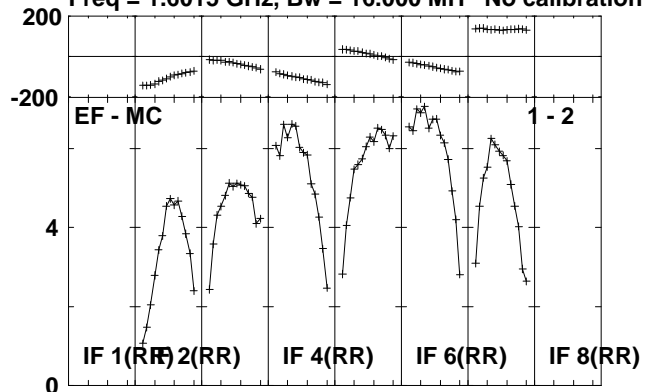

Lower frame: Milli Ampl Jy Top frame: Phas deg
Scalar averaged cross-power spectrum Several baselines displayed
Timerange: 00/21:07:59 to 00/21:29:19

Plot file version 8 created 01-JUL-2010 13:24:10
J2002+47 RG006B.UVDATA.1

Freq = 1.6015 GHz, Bw = 16.000 MH No calibration applied and no bandpass applied

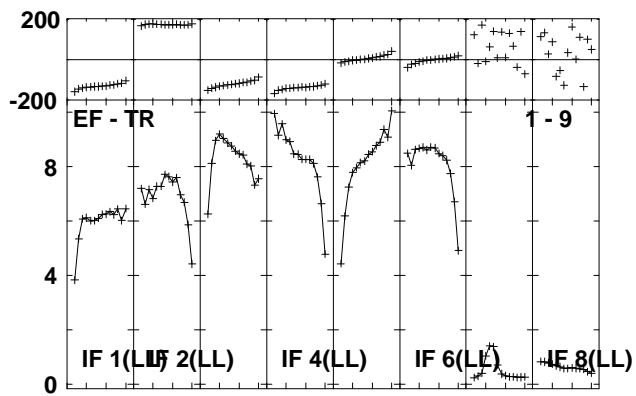
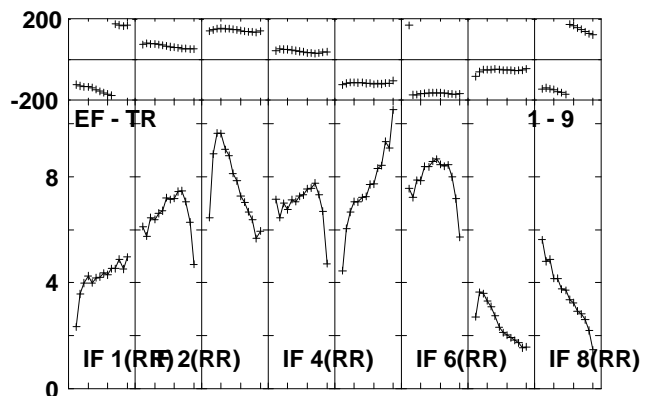
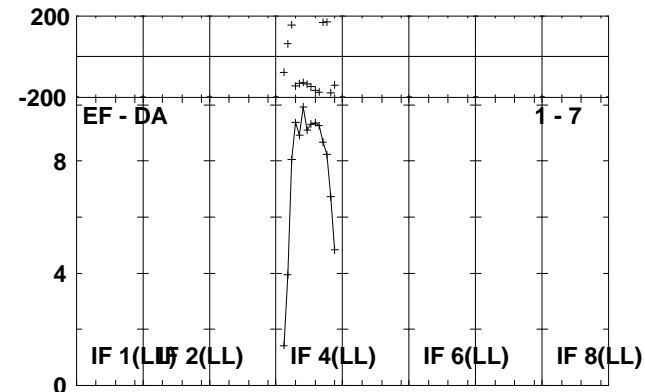
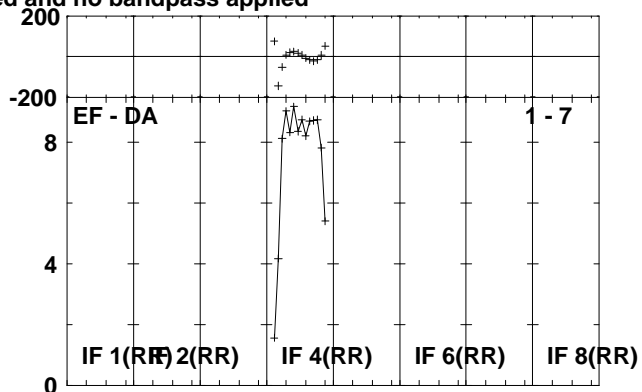
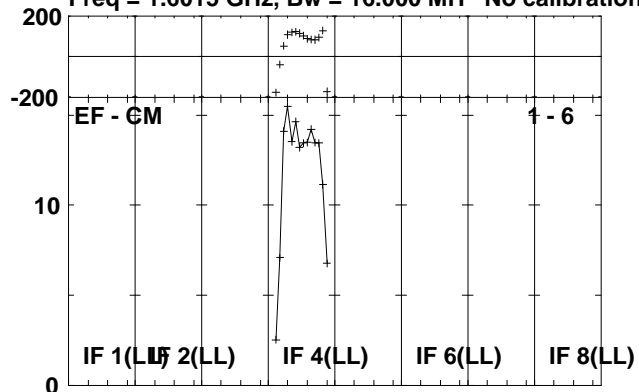

Lower frame: Milli Ampl Jy Top frame: Phas deg
Scalar averaged cross-power spectrum Several baselines displayed
Timerange: 00/21:07:59 to 00/21:29:19

Plot file version 9 created 01-JUL-2010 13:24:13

J2102+47 RG006B.UVDATA.1

Freq = 1.6015 GHz, Bw = 16.000 MH No calibration applied and no bandpass applied

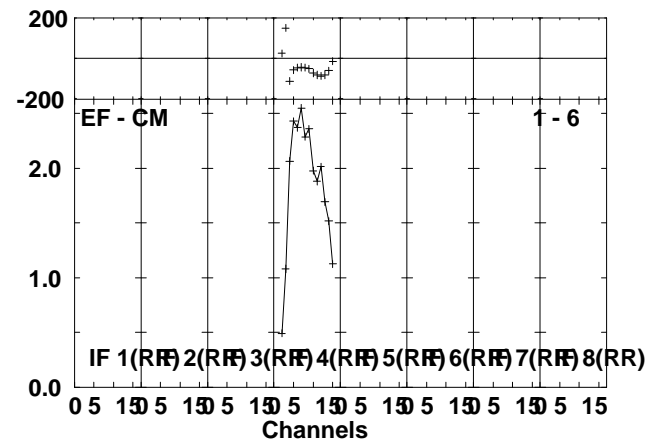
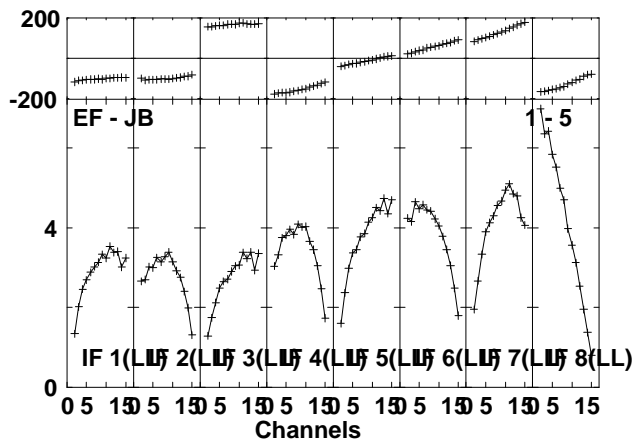
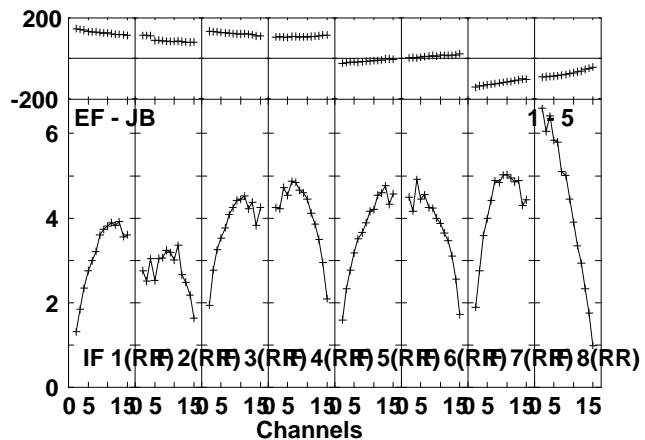
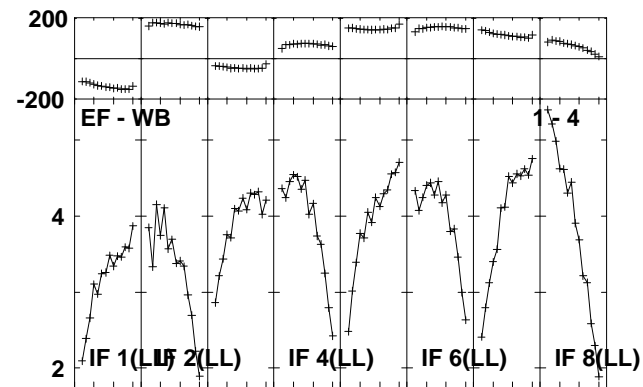
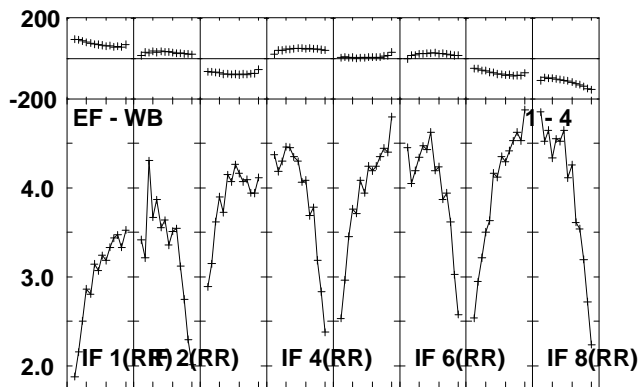
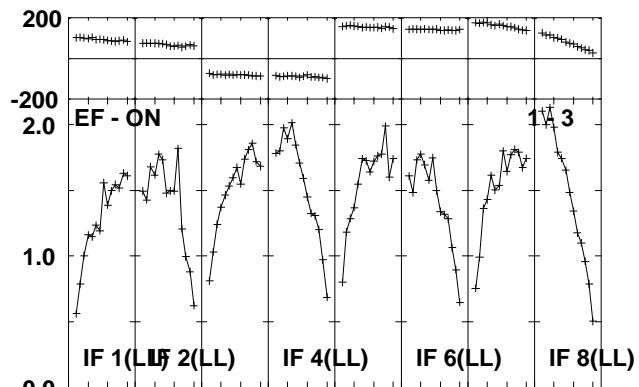
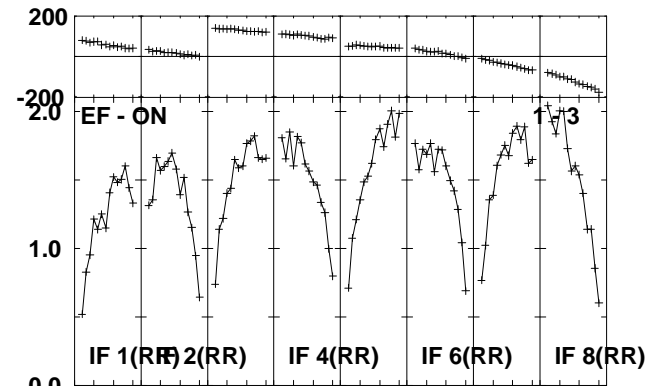
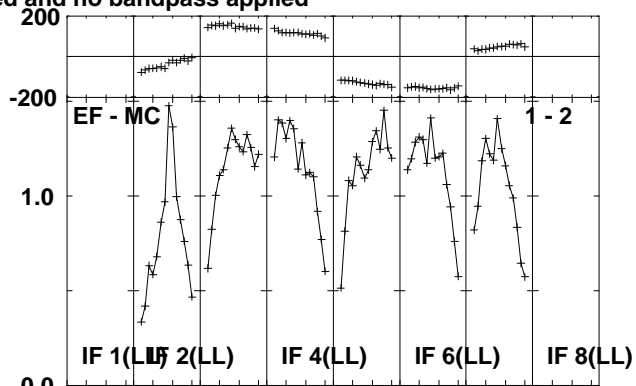
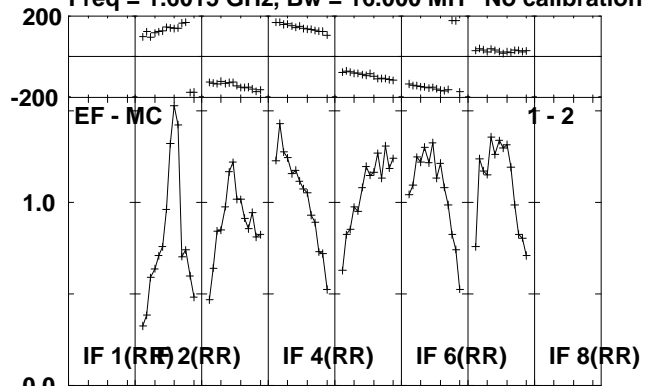

Lower frame: Milli Ampl Jy Top frame: Phas deg
Scalar averaged cross-power spectrum Several baselines displayed
Timerange: 00/21:30:51 to 00/21:34:47

Plot file version 10 created 01-JUL-2010 13:24:14
J2102+47 RG006B.UVDATA.1

Freq = 1.6015 GHz, Bw = 16.000 MH No calibration applied and no bandpass applied

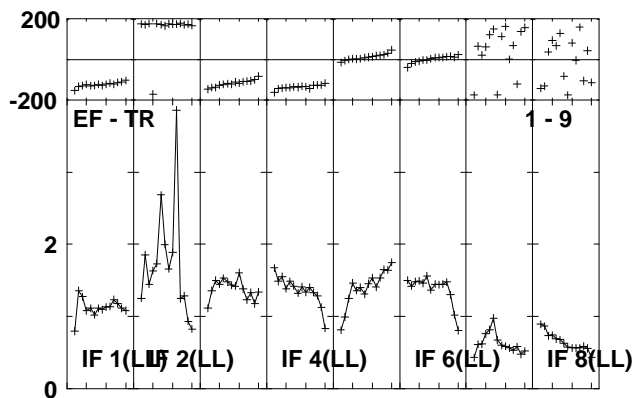
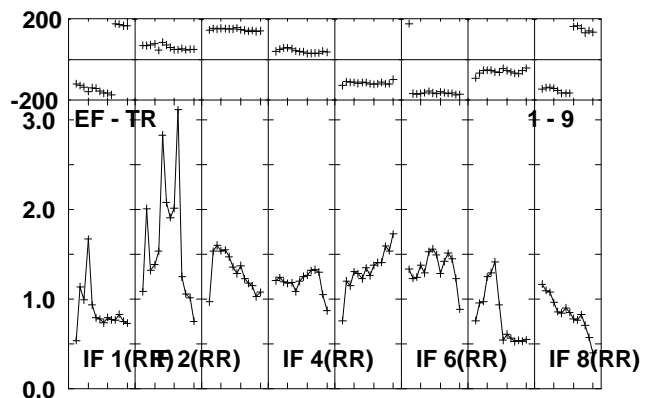
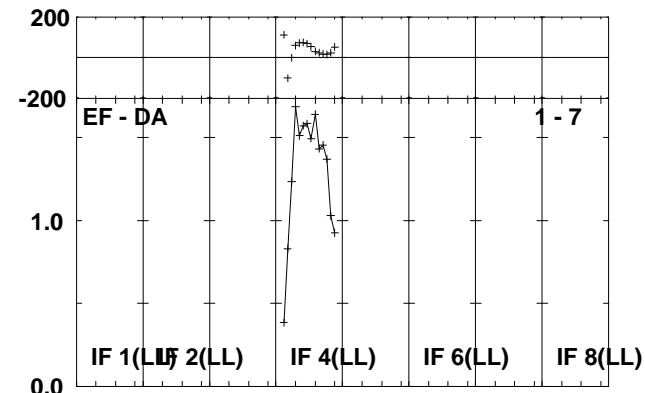
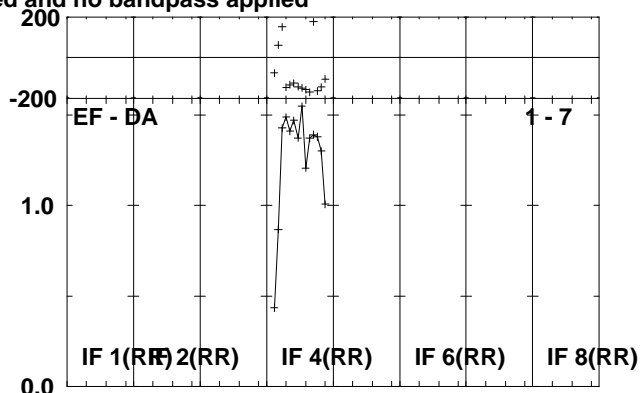
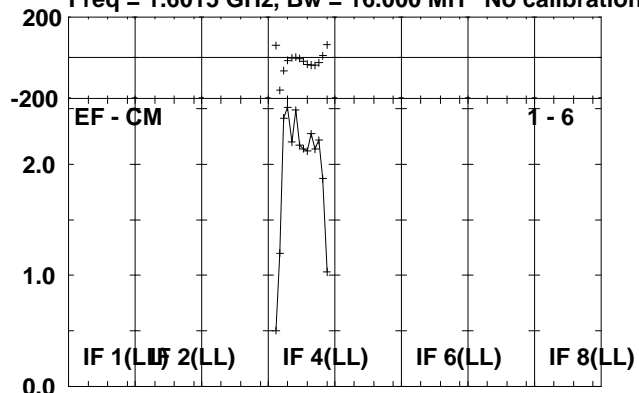

Lower frame: Milli Ampl Jy Top frame: Phas deg
Scalar averaged cross-power spectrum Several baselines displayed
Timerange: 00/21:30:51 to 00/21:34:47

Plot file version 11 created 01-JUL-2010 13:24:14

V407CYG RG006B.UVDATA.1

Freq = 1.6015 GHz, Bw = 16.000 MH No calibration applied and no bandpass applied

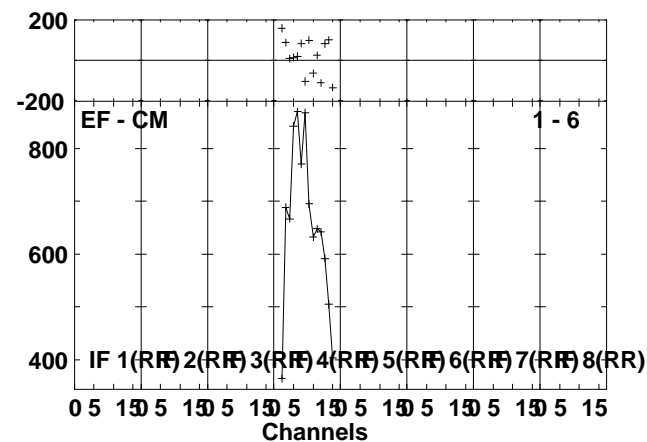
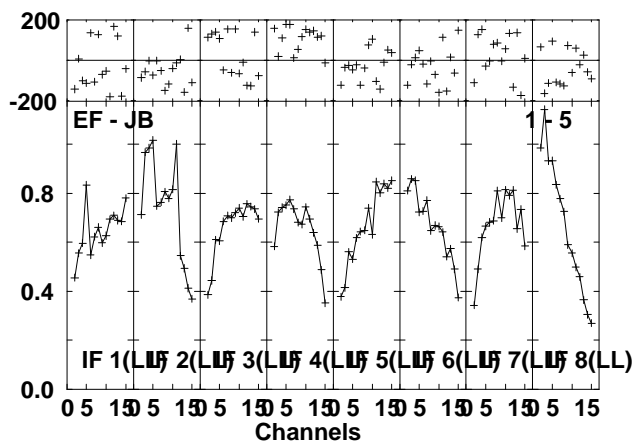
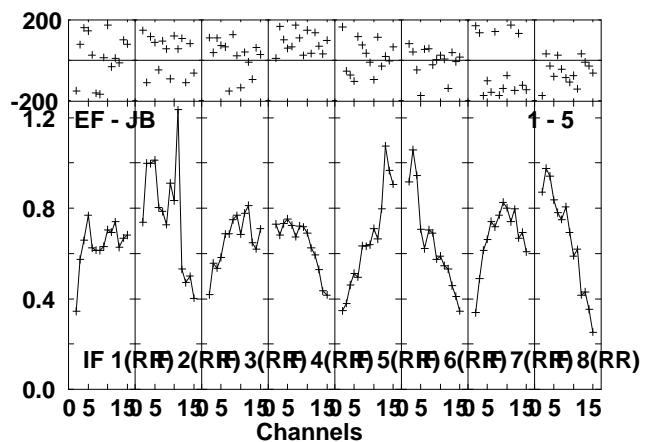
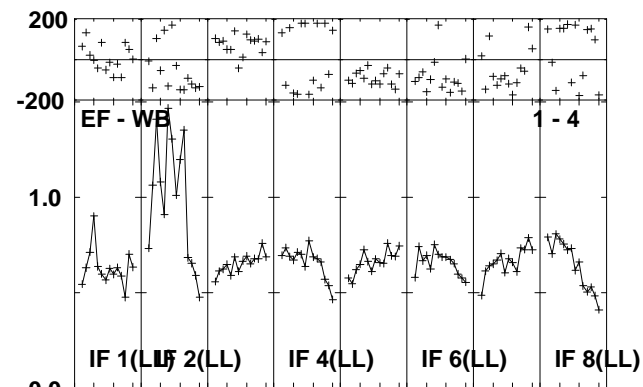
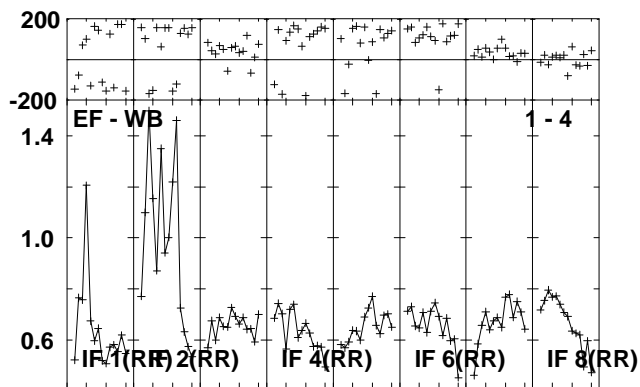
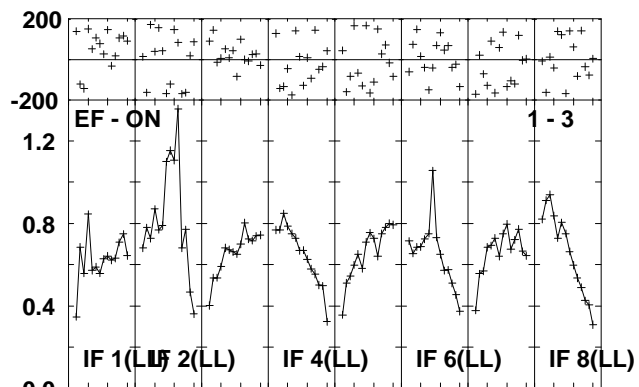
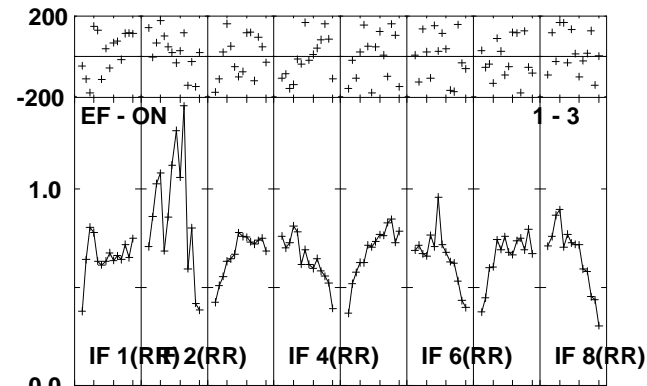
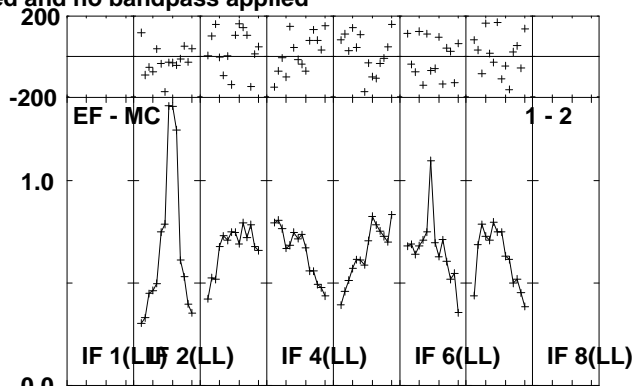
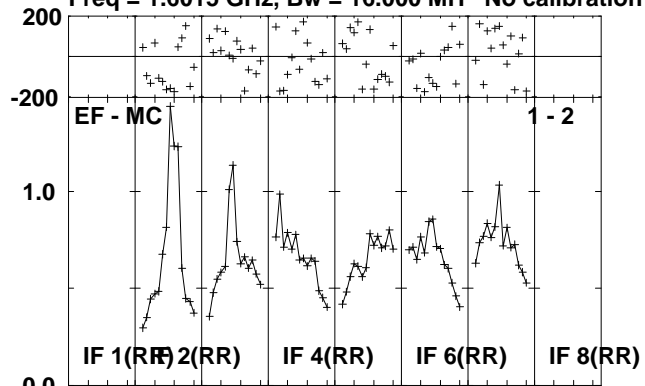

Lower frame: Milli Ampl Jy Top frame: Phas deg
Scalar averaged cross-power spectrum Several baselines displayed
Timerange: 00/21:34:51 to 00/21:39:47

Plot file version 12 created 01-JUL-2010 13:24:15
V407CYG RG006B.UVDATA.1

Freq = 1.6015 GHz, Bw = 16.000 MH No calibration applied and no bandpass applied

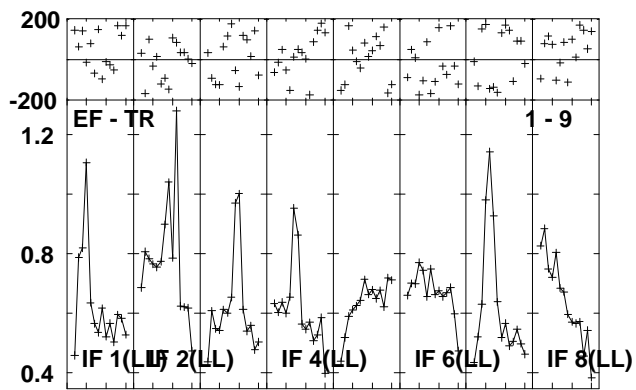
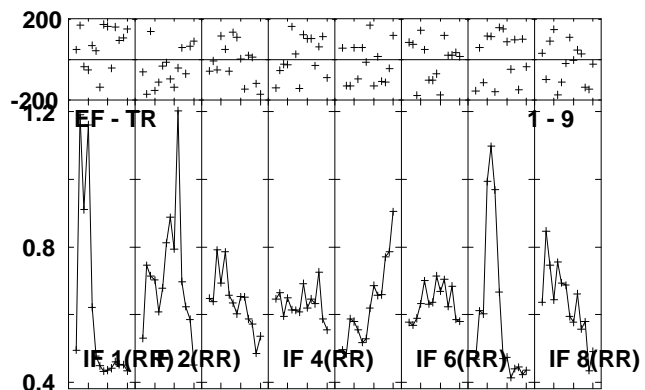
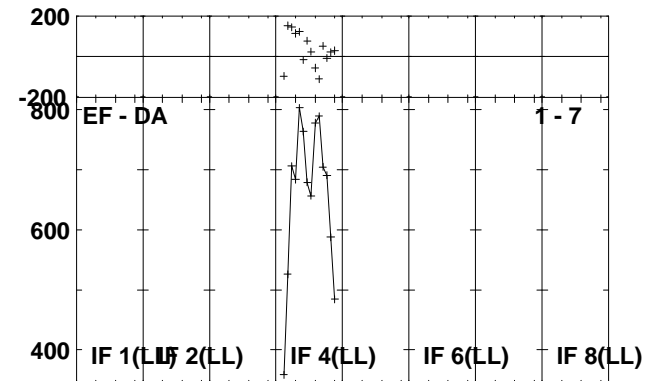
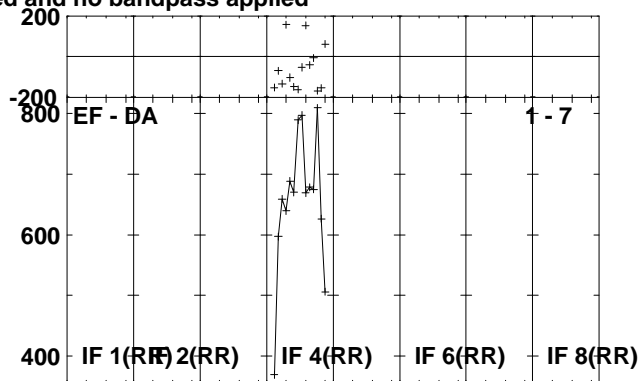
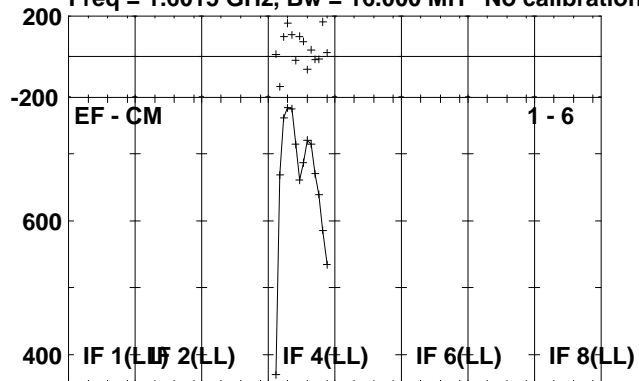

Lower frame: Micro Ampl Jy Top frame: Phas deg
Scalar averaged cross-power spectrum Several baselines displayed
Timerange: 00/21:34:51 to 00/21:39:47

Plot file version 13 created 01-JUL-2010 13:24:16

J2102+47 RG006B.UVDATA.1

Freq = 1.6015 GHz, Bw = 16.000 MH No calibration applied and no bandpass applied

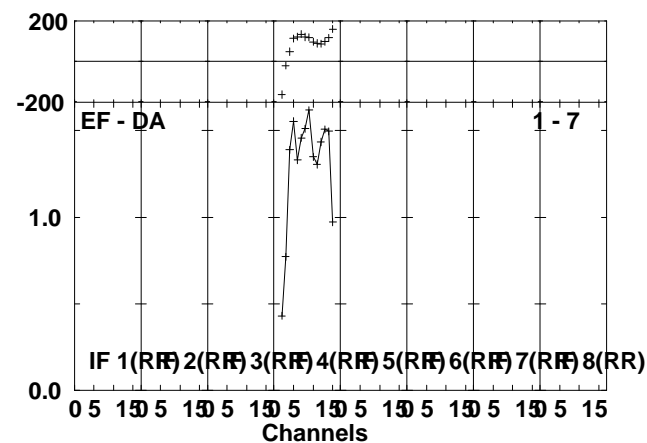
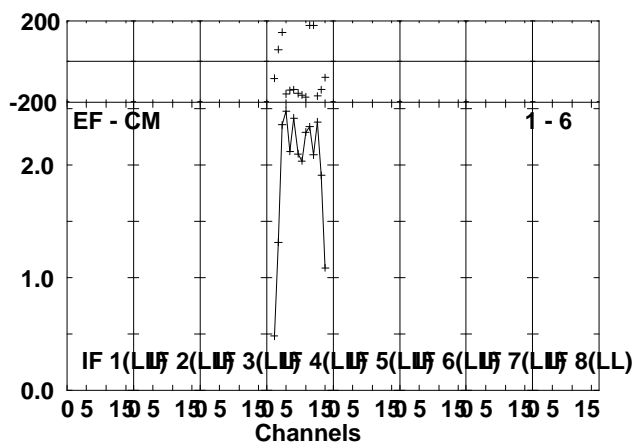
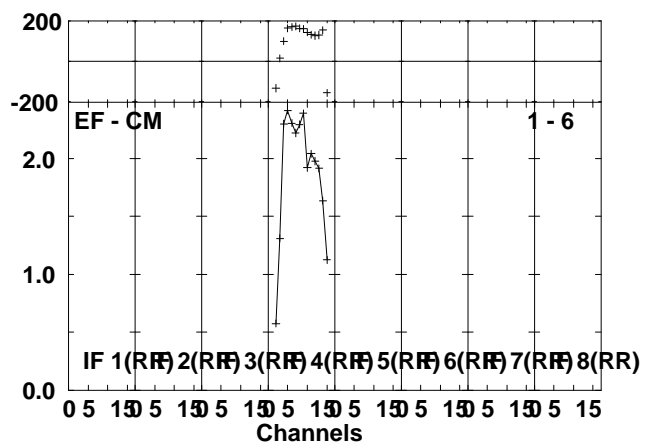
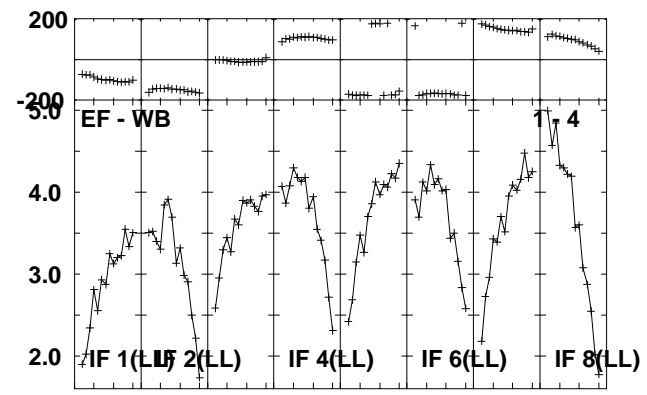
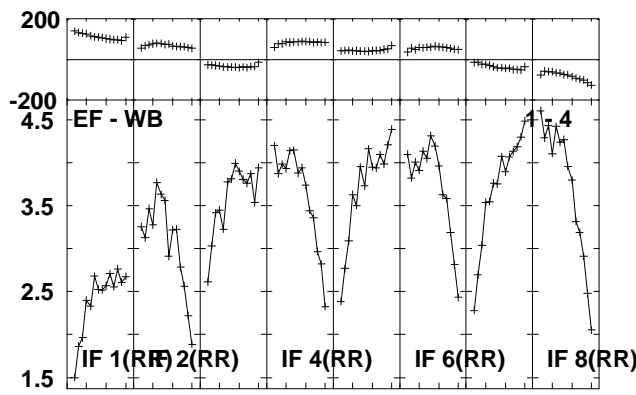
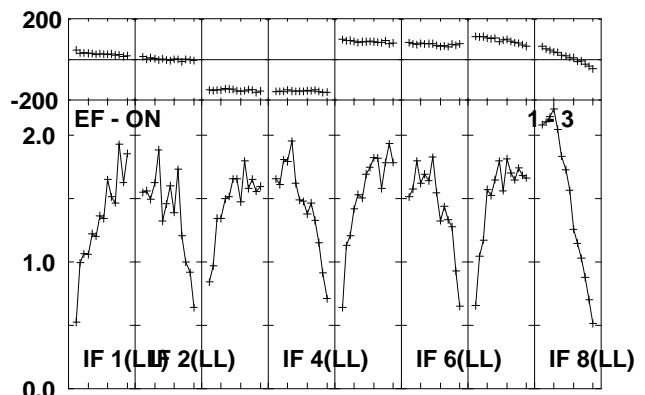
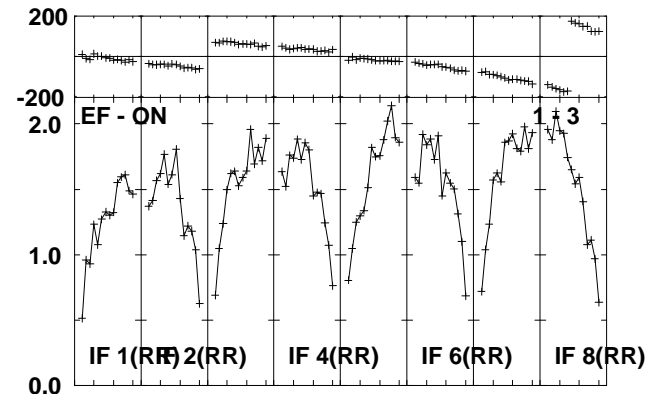
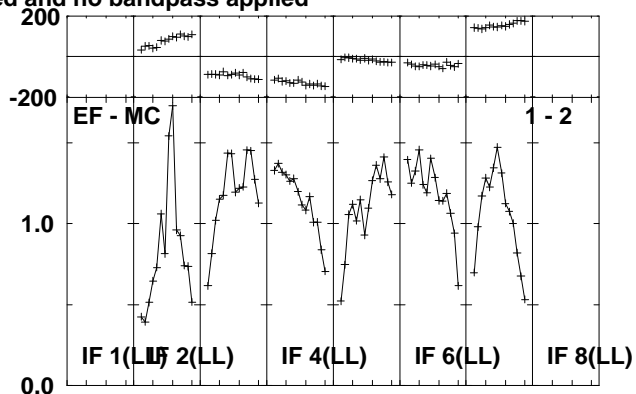
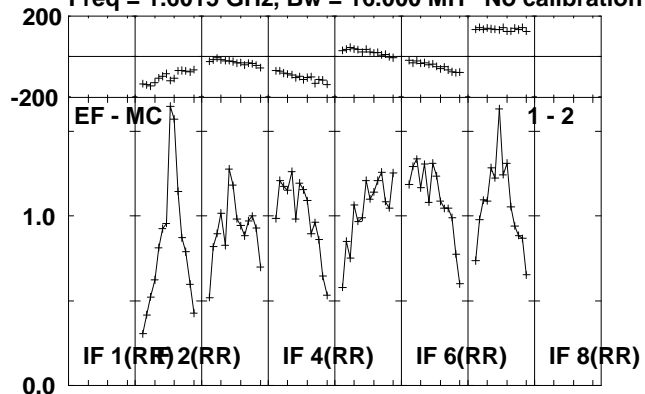

Lower frame: Milli Ampl Jy Top frame: Phas deg
Scalar averaged cross-power spectrum Several baselines displayed
Timerange: 00/21:39:51 to 00/21:42:03

Plot file version 14 created 01-JUL-2010 13:24:16
J2102+47 RG006B.UVDATA.1

Freq = 1.6015 GHz, Bw = 16.000 MH No calibration applied and no bandpass applied

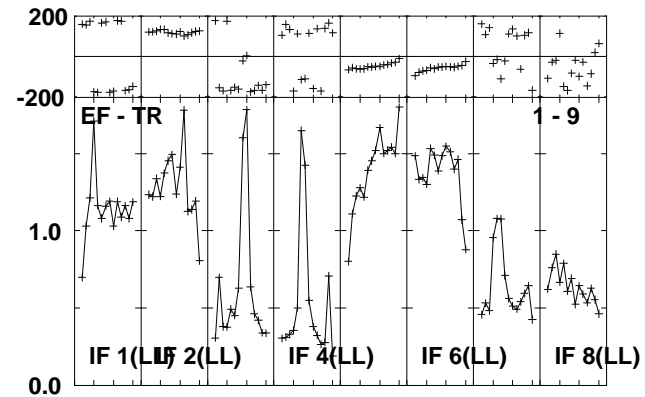
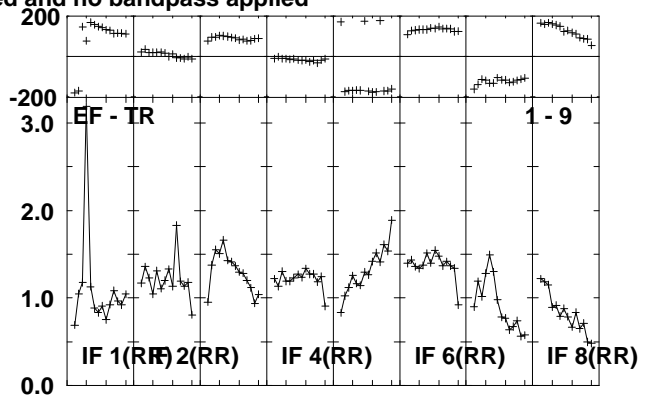
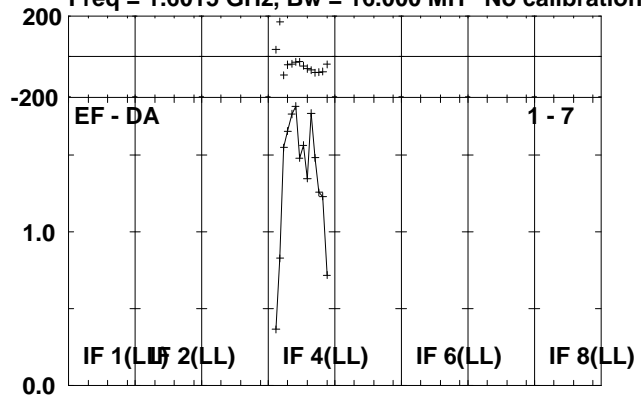

Lower frame: Milli Ampl Jy Top frame: Phas deg
Scalar averaged cross-power spectrum Several baselines displayed
Timerange: 00/21:39:51 to 00/21:42:03

Plot file version 15 created 01-JUL-2010 13:24:17
 V407CYG RG006B.UVDATA.1

Freq = 1.6015 GHz, Bw = 16.000 MH No calibration applied and no bandpass applied

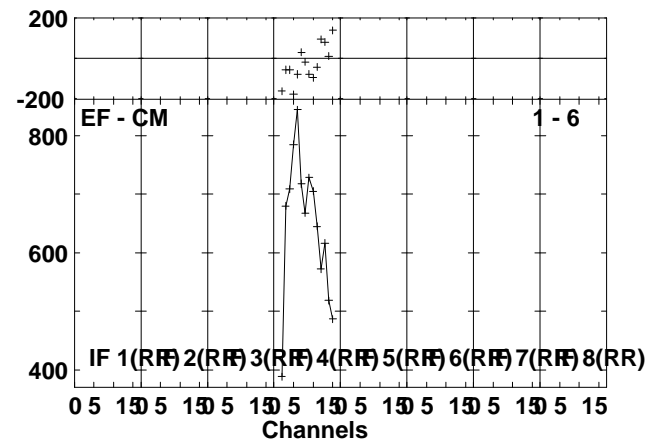
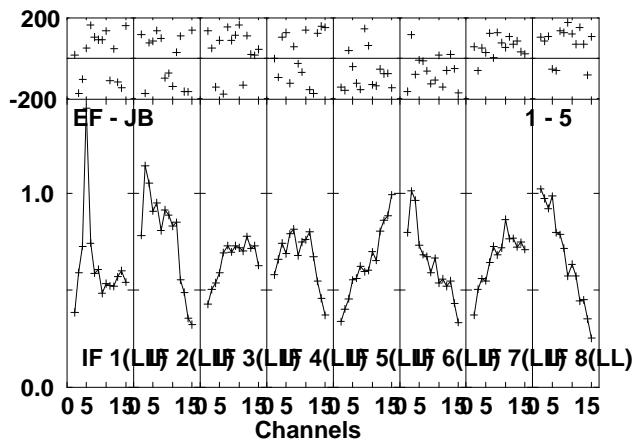
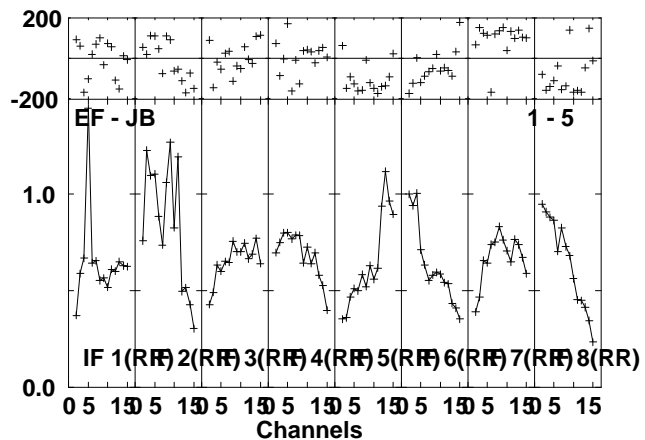
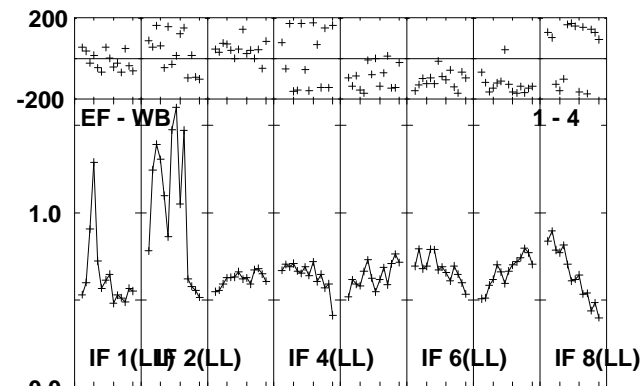
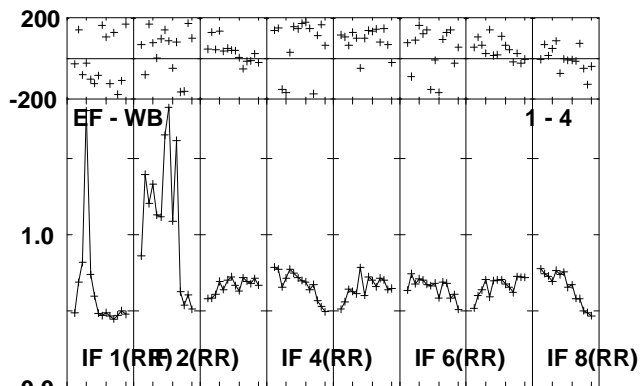
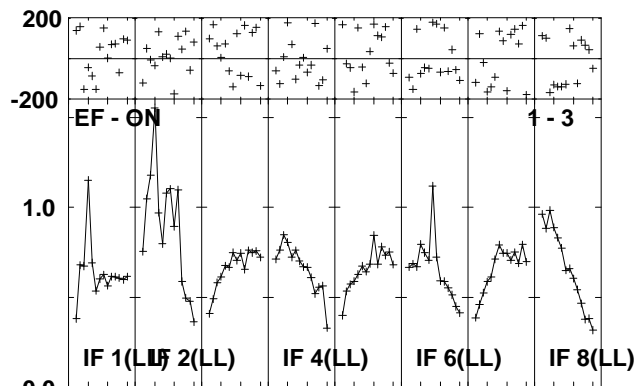
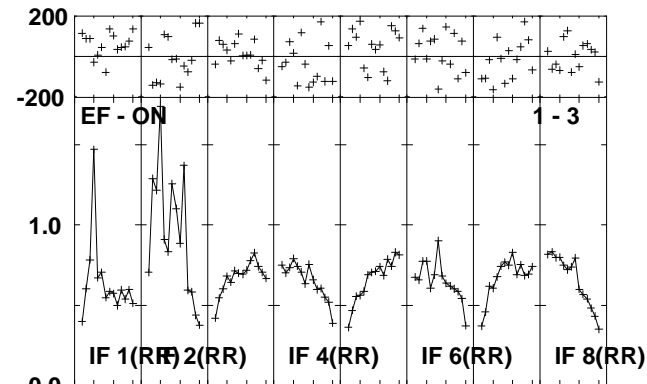
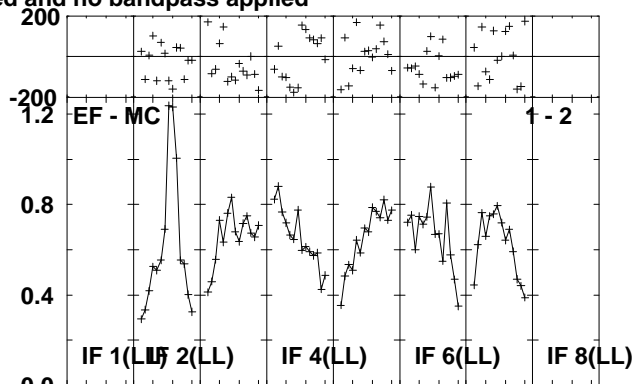
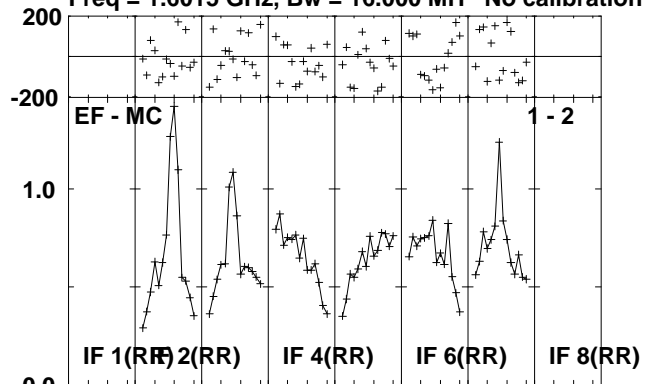

Lower frame: Milli Ampl Jy Top frame: Phas deg
 Scalar averaged cross-power spectrum Several baselines displayed
 Timerange: 00/21:42:07 to 00/21:47:03

Plot file version 16 created 01-JUL-2010 13:24:18

V407CYG RG006B.UVDATA.1

Freq = 1.6015 GHz, Bw = 16.000 MH No calibration applied and no bandpass applied

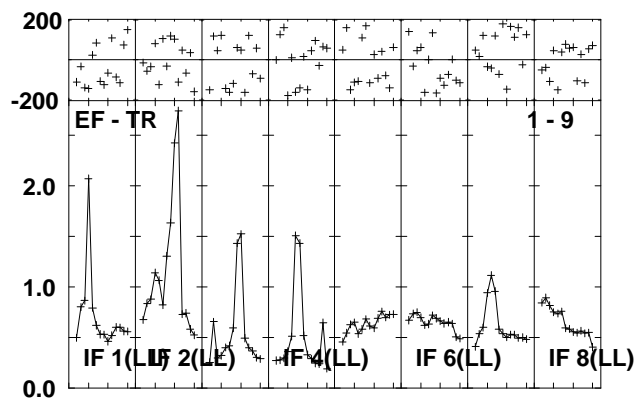
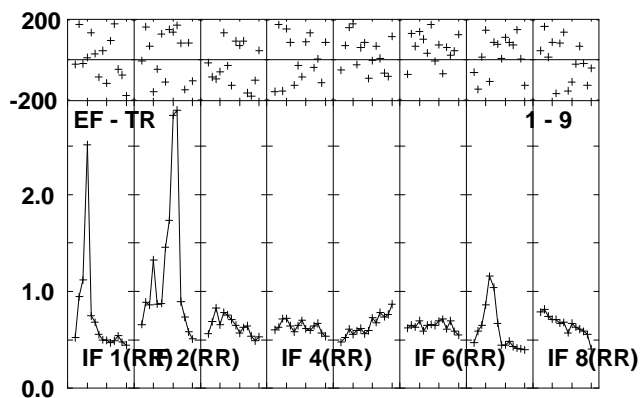
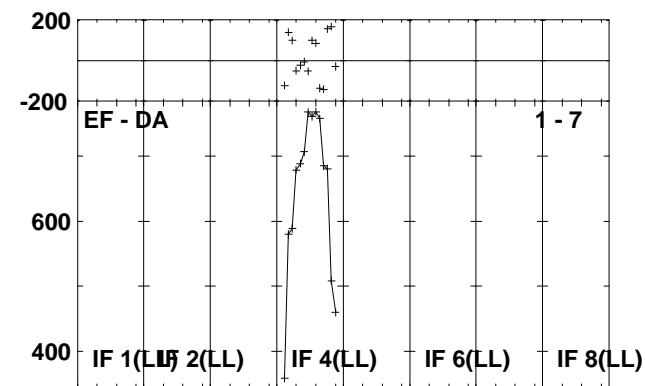
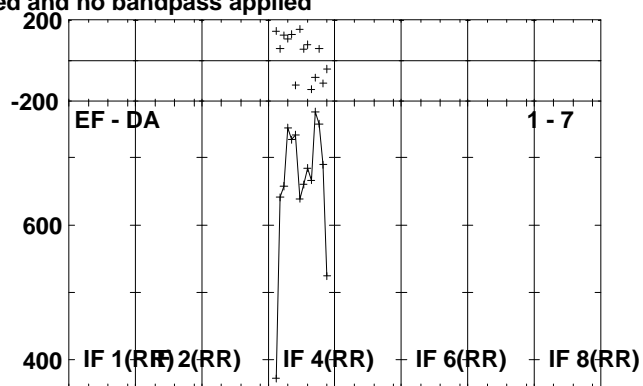
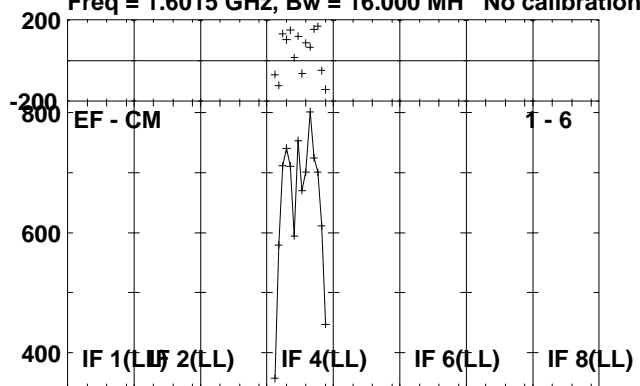

Lower frame: Micro Ampl Jy Top frame: Phas deg
Scalar averaged cross-power spectrum Several baselines displayed
Timerange: 00/21:42:07 to 00/21:47:03

Plot file version 17 created 01-JUL-2010 13:24:19

J2102+47 RG006B.UVDATA.1

Freq = 1.6015 GHz, Bw = 16.000 MH No calibration applied and no bandpass applied

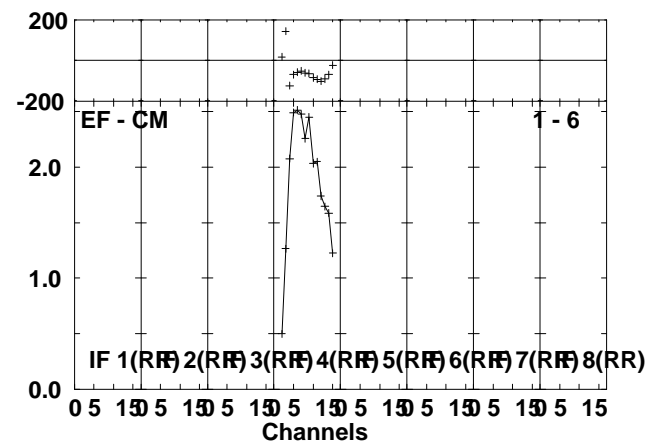
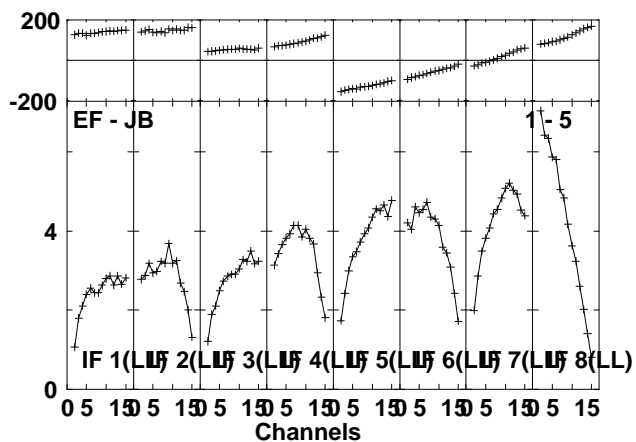
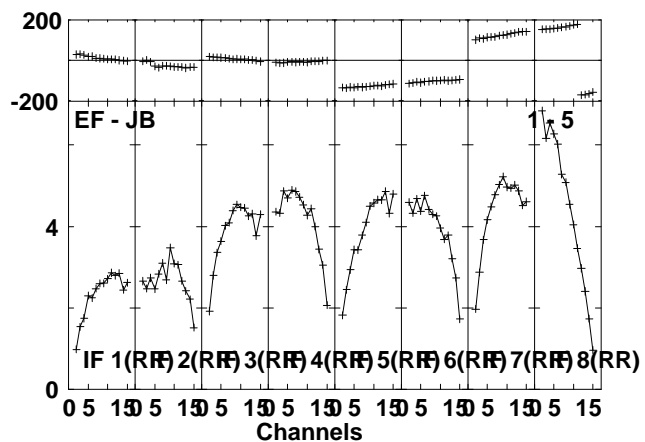
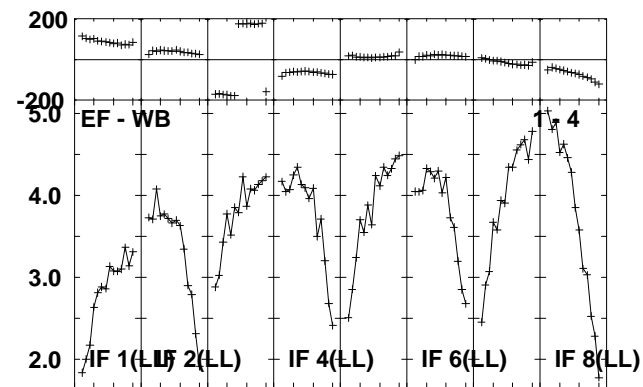
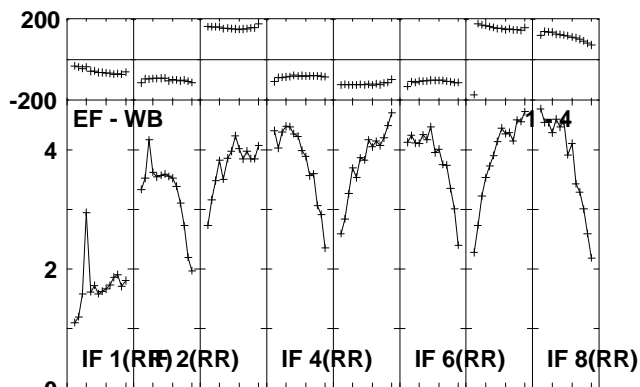
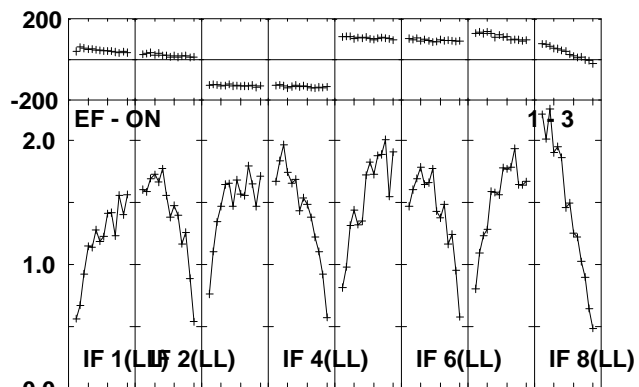
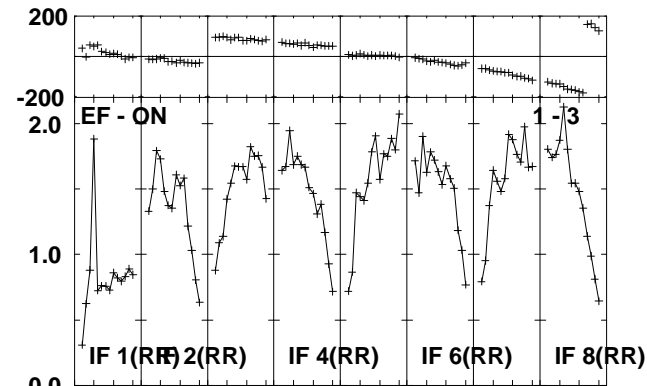
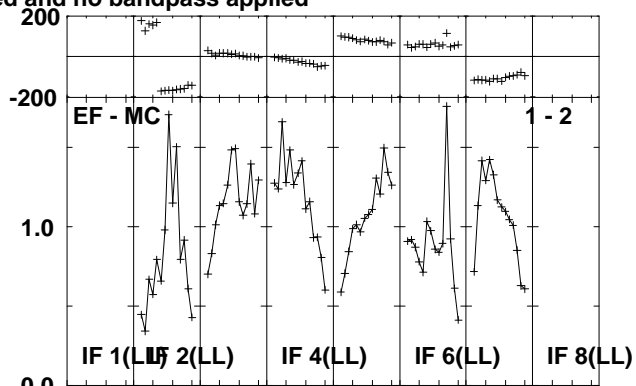
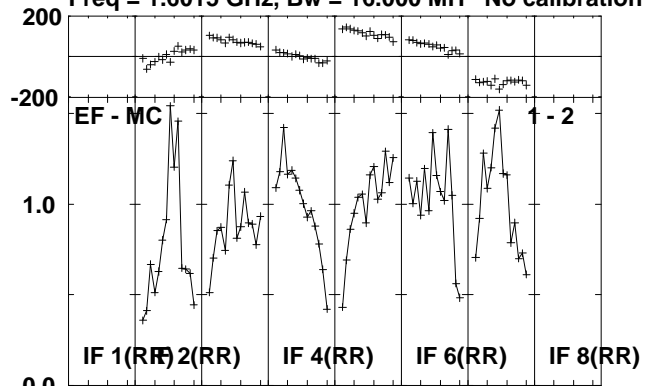

Lower frame: Milli Ampl Jy Top frame: Phas deg
Scalar averaged cross-power spectrum Several baselines displayed
Timerange: 00/21:48:07 to 00/21:49:47

Plot file version 18 created 01-JUL-2010 13:24:19
J2102+47 RG006B.UVDATA.1

Freq = 1.6015 GHz, Bw = 16.000 MH No calibration applied and no bandpass applied

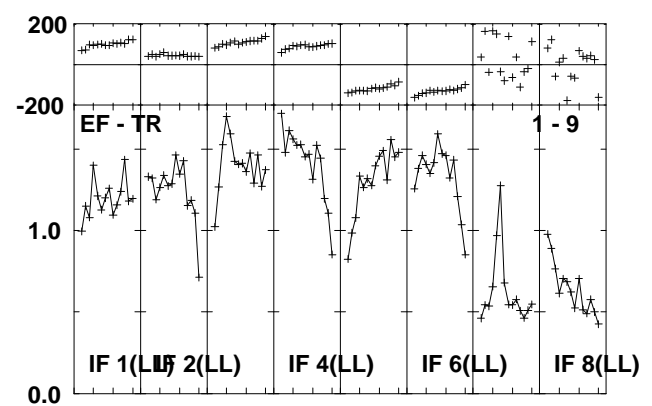
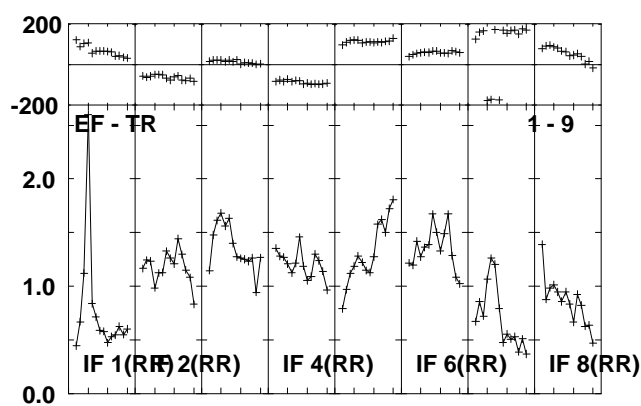
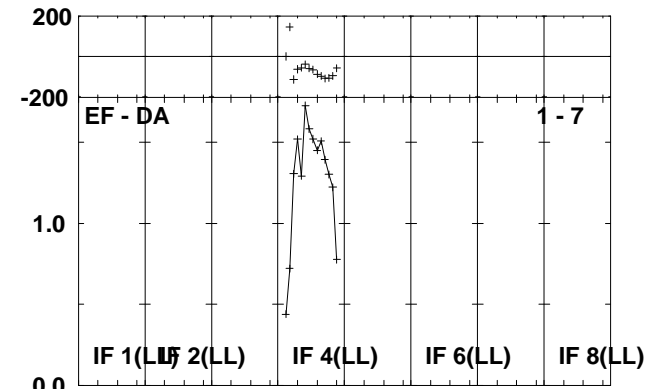
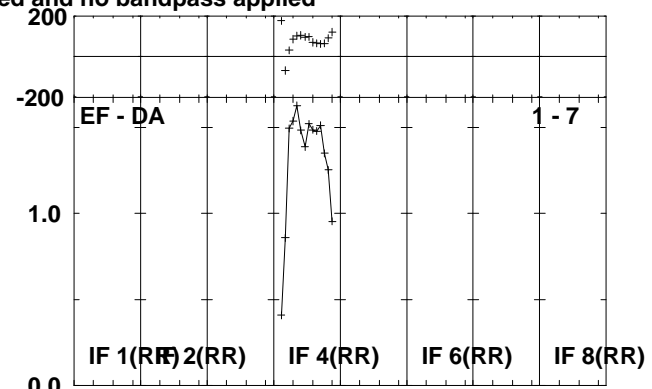
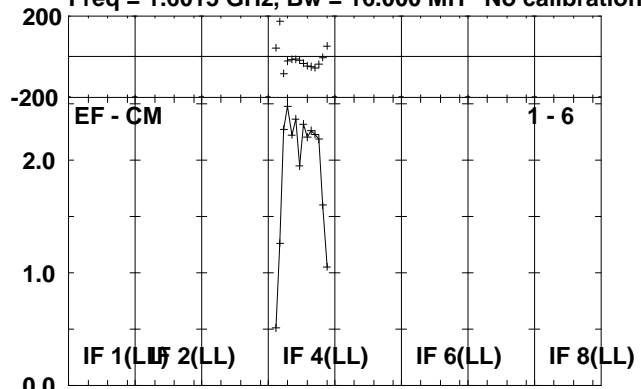

Lower frame: Milli Ampl Jy Top frame: Phas deg
Scalar averaged cross-power spectrum Several baselines displayed
Timerange: 00/21:48:07 to 00/21:49:47

Plot file version 19 created 01-JUL-2010 13:24:19
 V407CYG RG006B.UVDATA.1

Freq = 1.6015 GHz, Bw = 16.000 MH No calibration applied and no bandpass applied

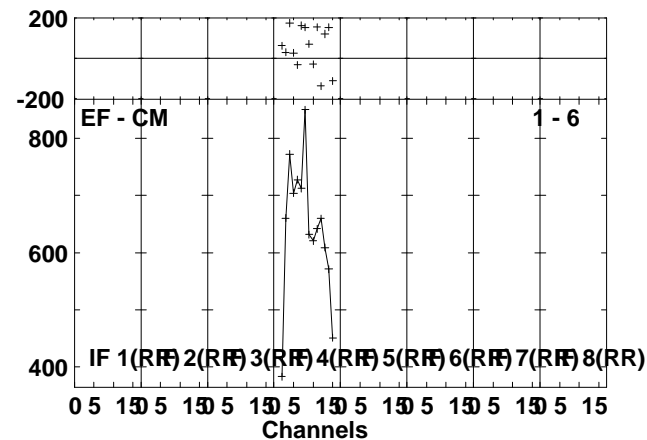
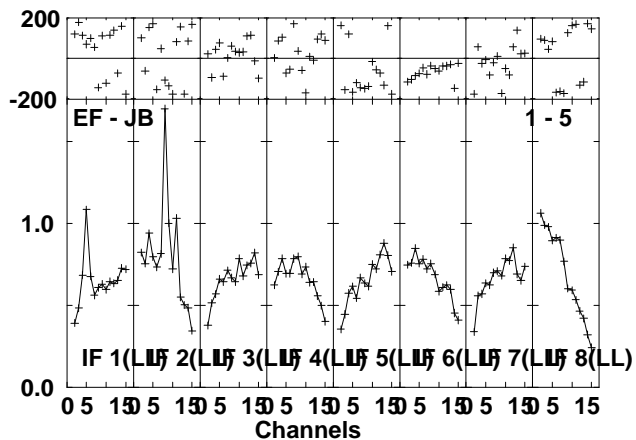
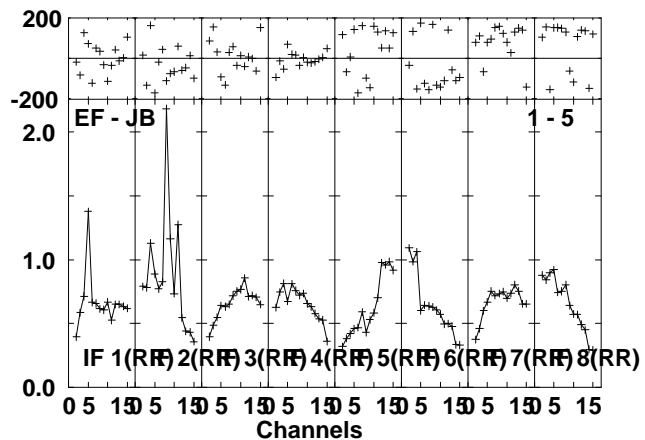
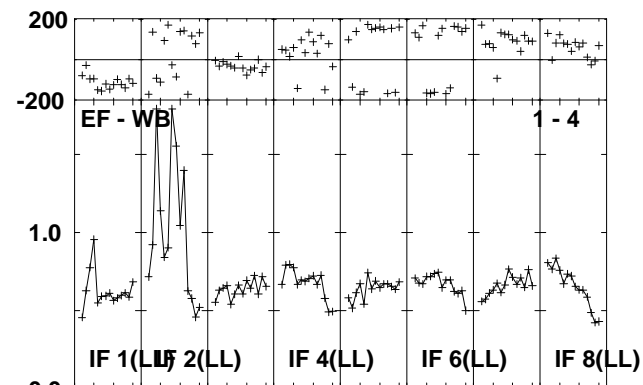
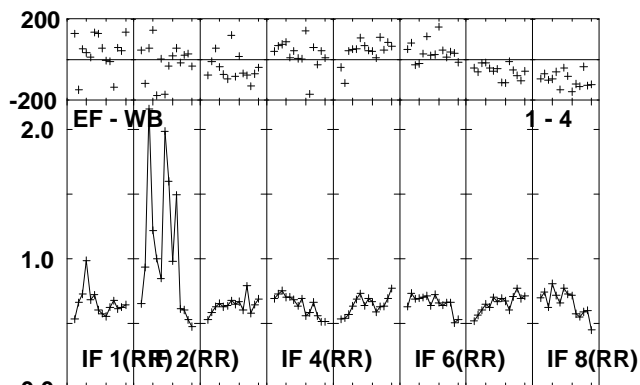
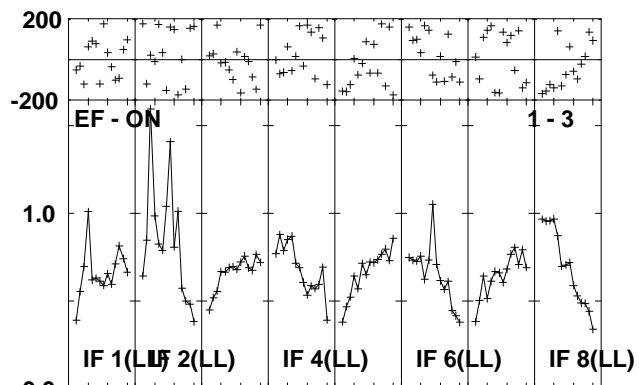
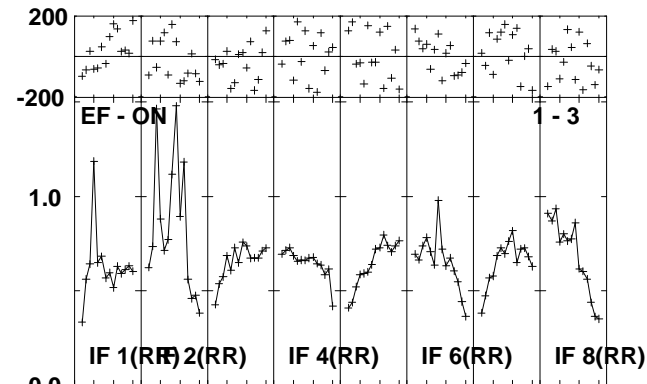
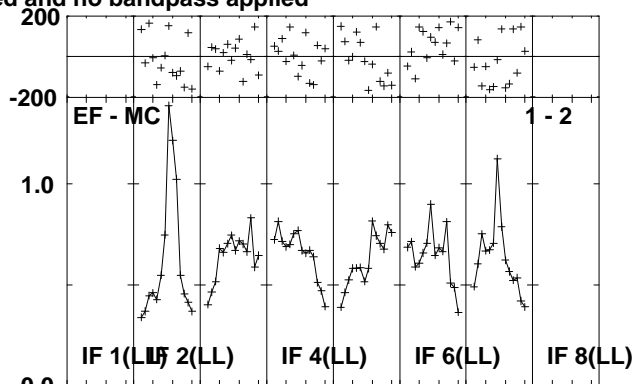
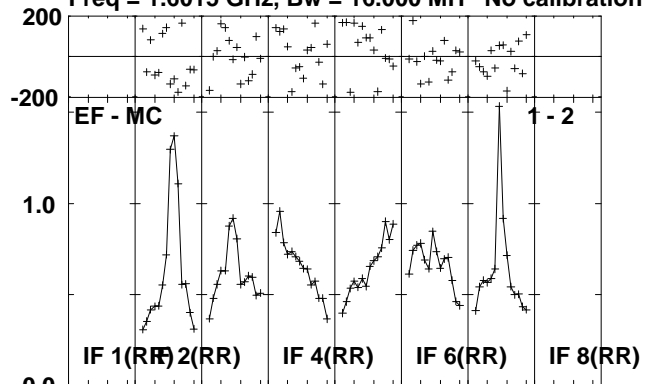

Lower frame: Milli Ampl Jy Top frame: Phas deg
 Scalar averaged cross-power spectrum Several baselines displayed
 Timerange: 00/21:49:51 to 00/21:54:47

Plot file version 20 created 01-JUL-2010 13:24:20

V407CYG RG006B.UVDATA.1

Freq = 1.6015 GHz, Bw = 16.000 MH No calibration applied and no bandpass applied

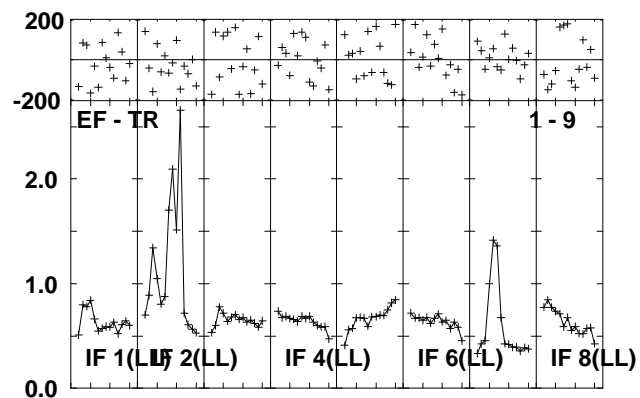
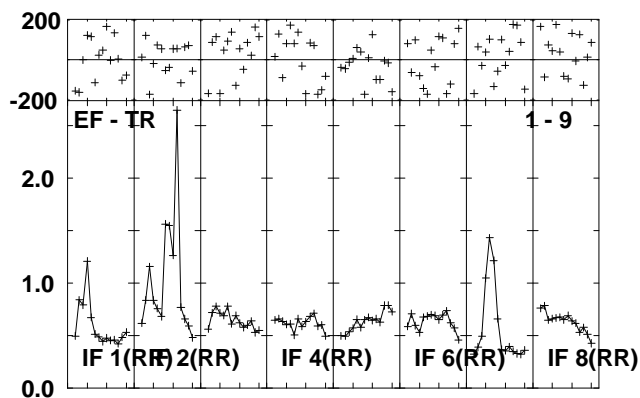
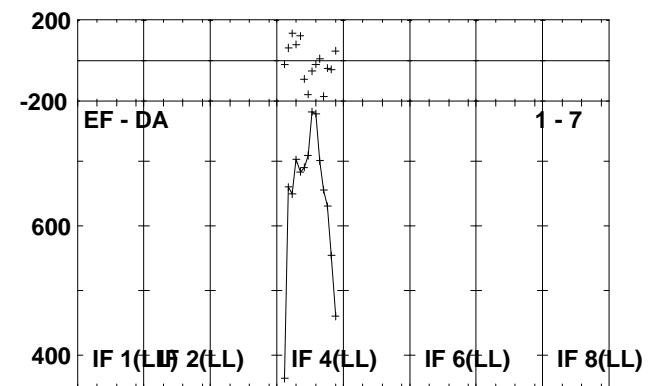
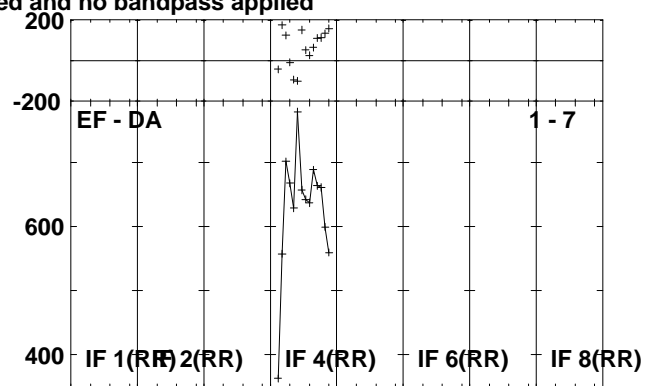
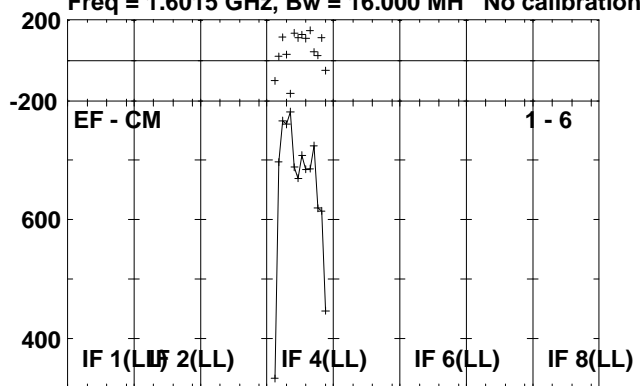

Lower frame: Micro Ampl Jy Top frame: Phas deg
Scalar averaged cross-power spectrum Several baselines displayed
Timerange: 00/21:49:51 to 00/21:54:47

Plot file version 21 created 01-JUL-2010 13:24:21
 J2102+47 RG006B.UVDATA.1

Freq = 1.6015 GHz, Bw = 16.000 MH No calibration applied and no bandpass applied

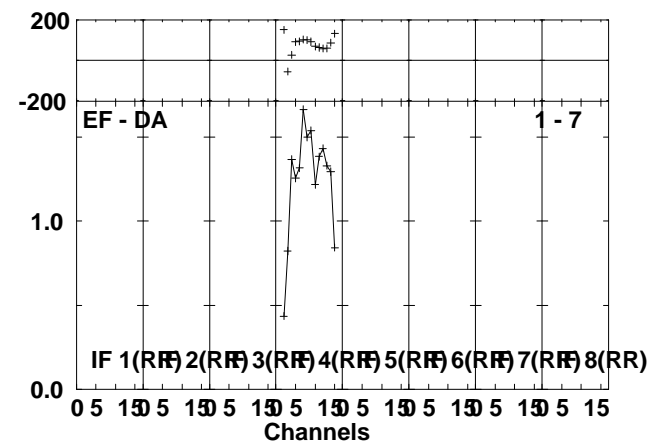
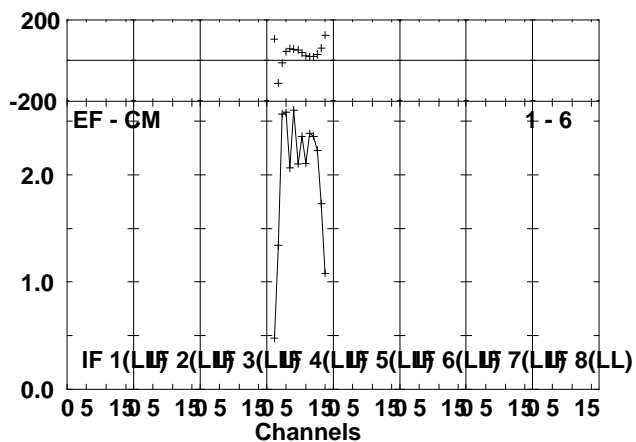
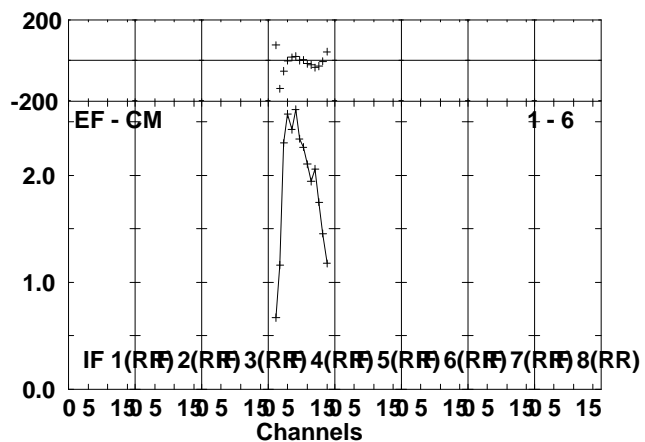
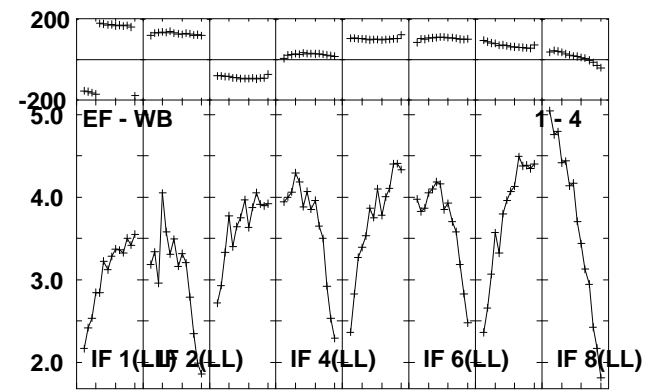
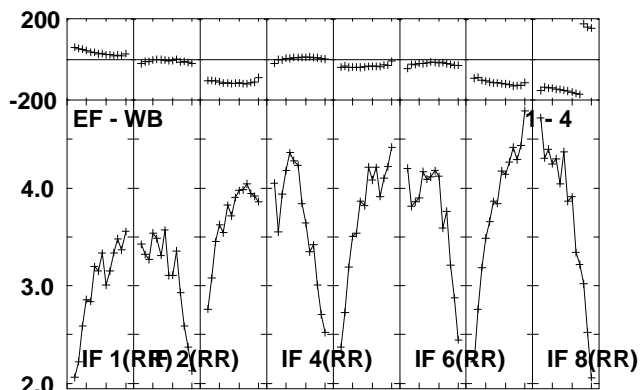
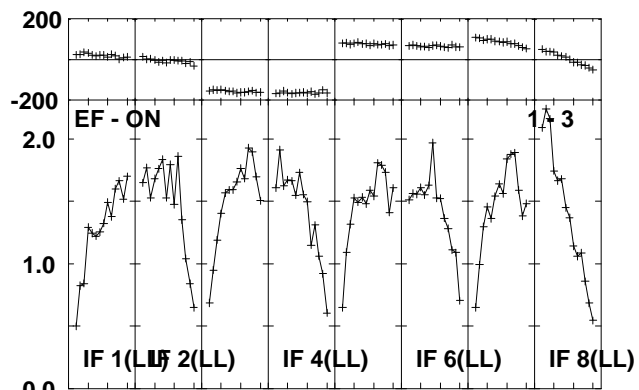
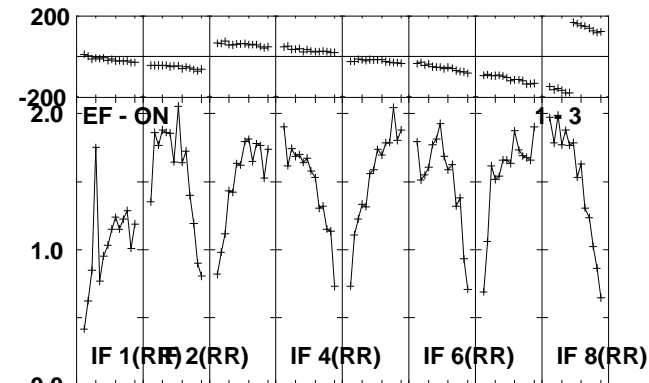
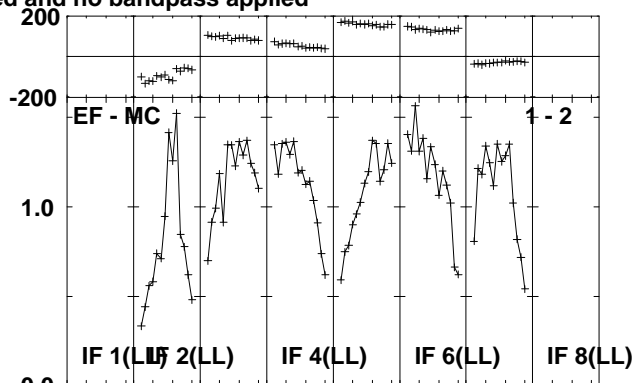
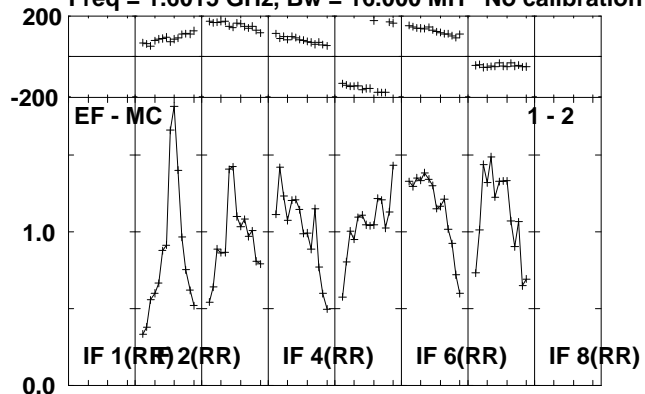

Lower frame: Milli Ampl Jy Top frame: Phas deg
 Scalar averaged cross-power spectrum Several baselines displayed
 Timerange: 00/21:54:51 to 00/21:57:03

Plot file version 22 created 01-JUL-2010 13:24:22
J2102+47 RG006B.UVDATA.1

Freq = 1.6015 GHz, Bw = 16.000 MH No calibration applied and no bandpass applied

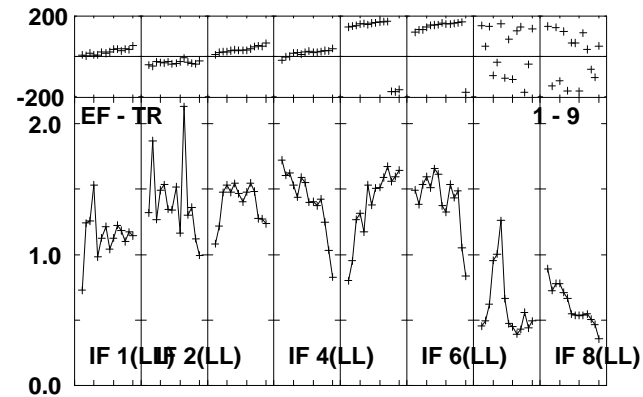
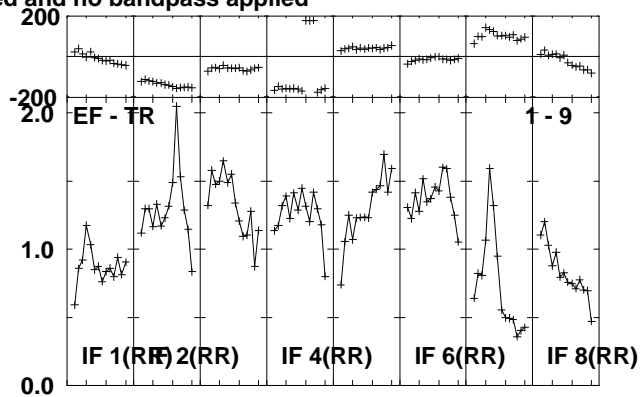
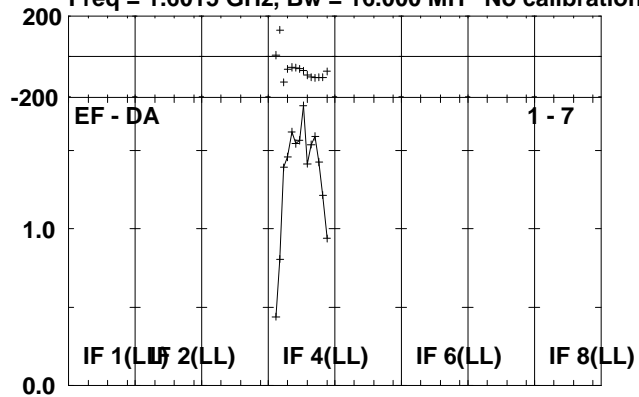

Lower frame: Milli Ampl Jy Top frame: Phas deg
Scalar averaged cross-power spectrum Several baselines displayed
Timerange: 00/21:54:51 to 00/21:57:03

Plot file version 23 created 01-JUL-2010 13:24:22

V407CYG RG006B.UVDATA.1

Freq = 1.6015 GHz, Bw = 16.000 MH No calibration applied and no bandpass applied

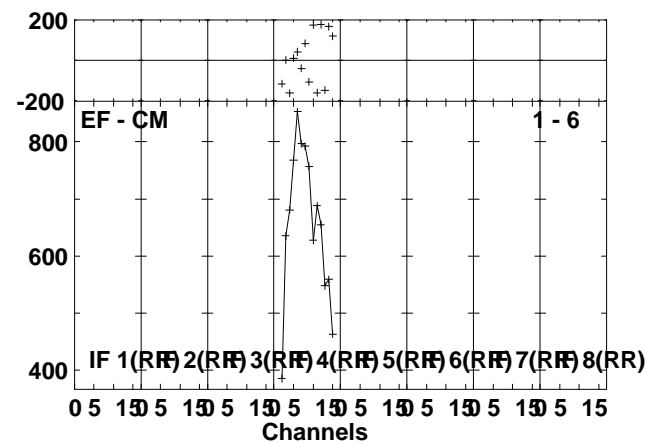
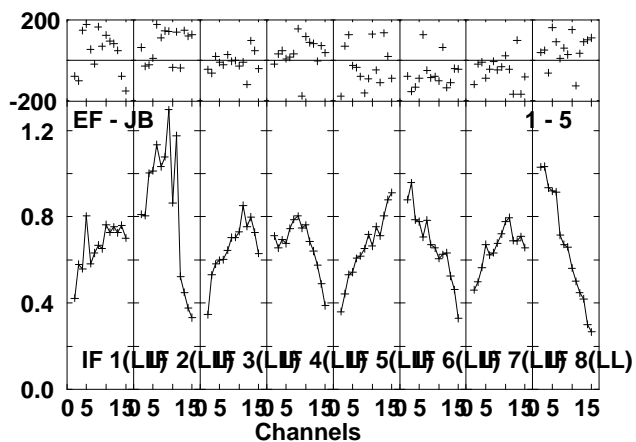
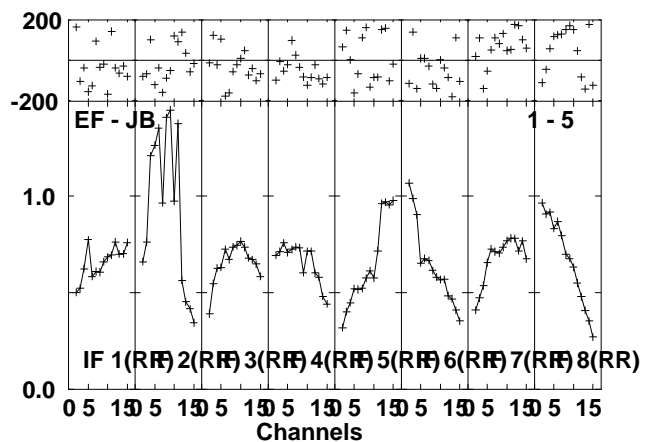
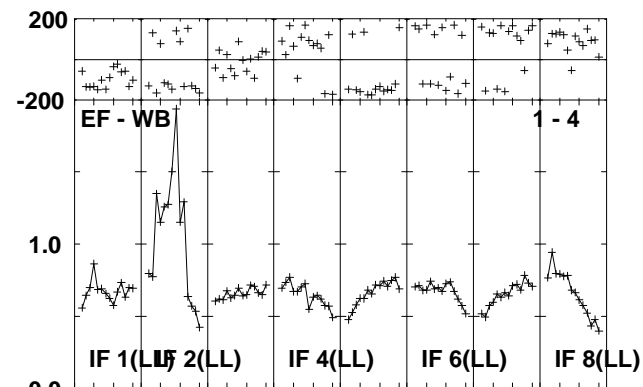
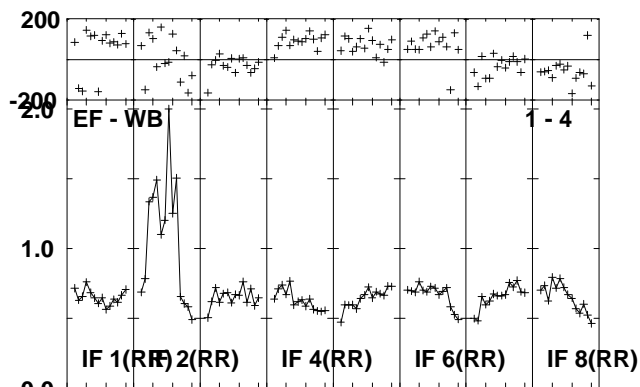
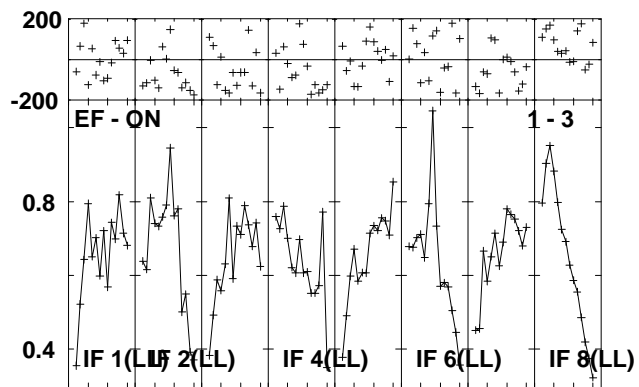
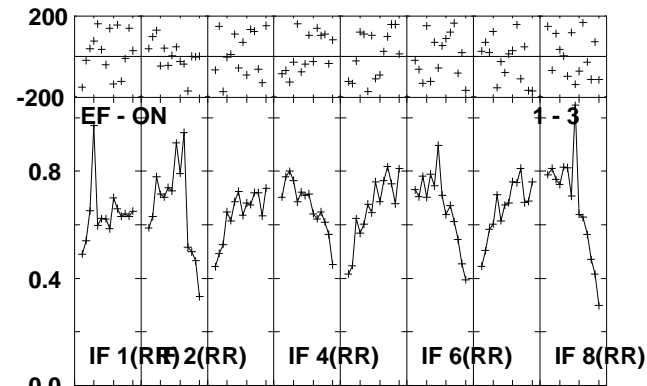
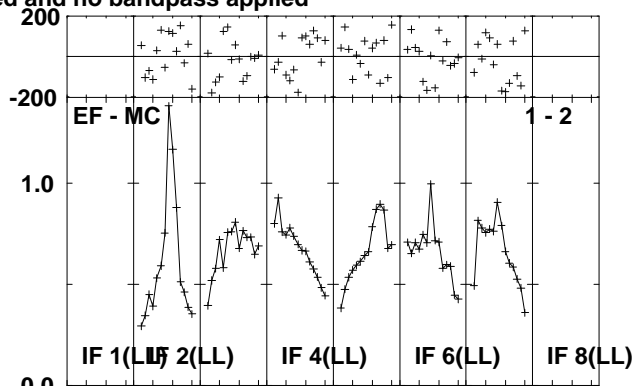
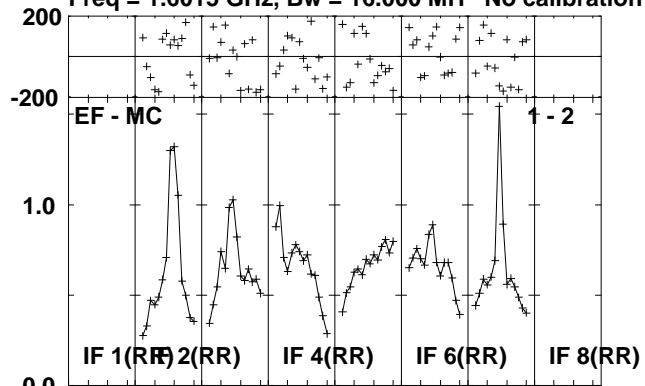

Lower frame: Milli Ampl Jy Top frame: Phas deg
Scalar averaged cross-power spectrum Several baselines displayed
Timerange: 00/21:57:07 to 00/22:02:03

Plot file version 24 created 01-JUL-2010 13:24:23
V407CYG RG006B.UVDATA.1

Freq = 1.6015 GHz, Bw = 16.000 MH No calibration applied and no bandpass applied

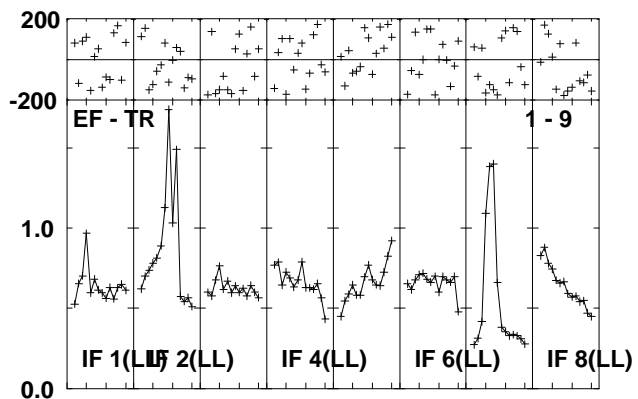
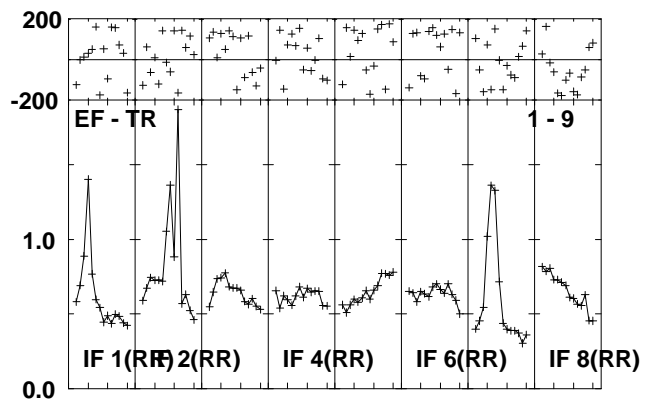
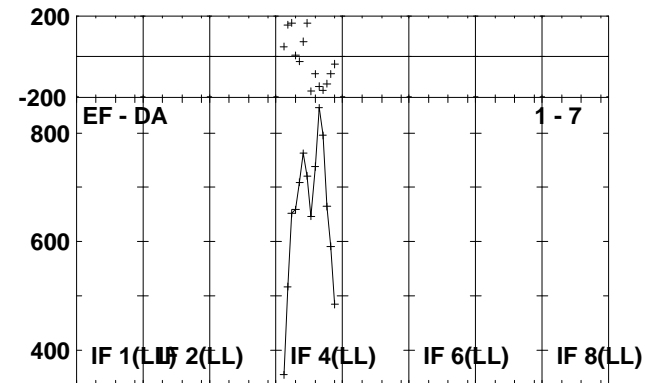
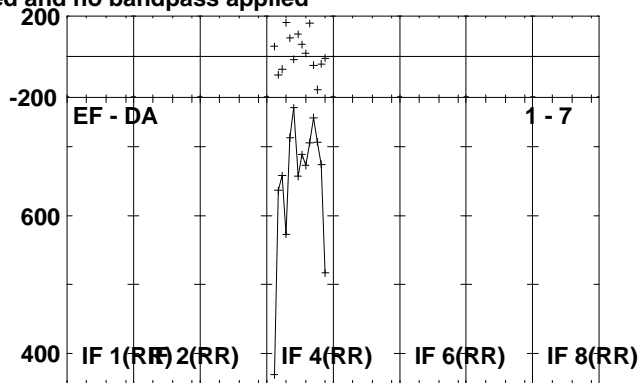
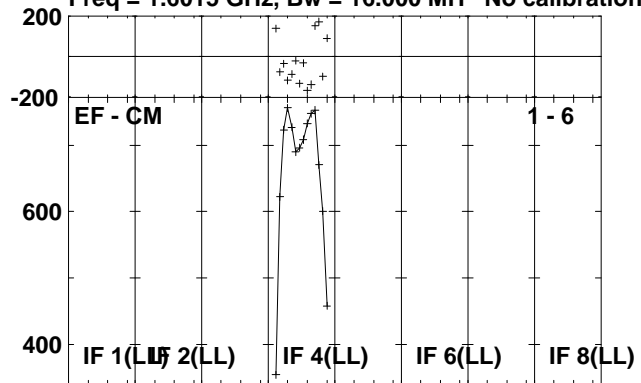

Lower frame: Micro Ampl Jy Top frame: Phas deg
Scalar averaged cross-power spectrum Several baselines displayed
Timerange: 00/21:57:07 to 00/22:02:03

Plot file version 25 created 01-JUL-2010 13:24:24
 J2102+47 RG006B.UVDATA.1

Freq = 1.6015 GHz, Bw = 16.000 MH No calibration applied and no bandpass applied

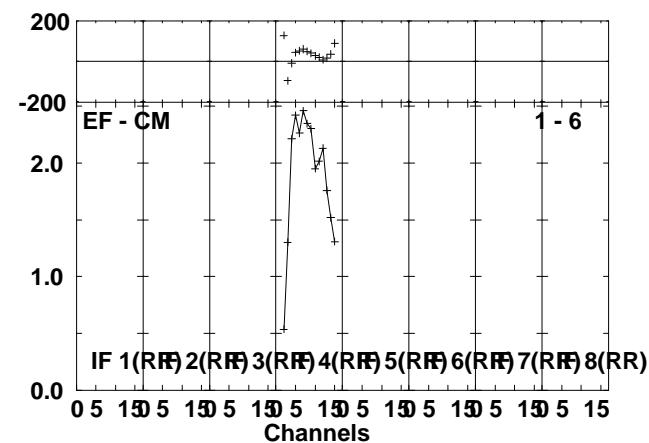
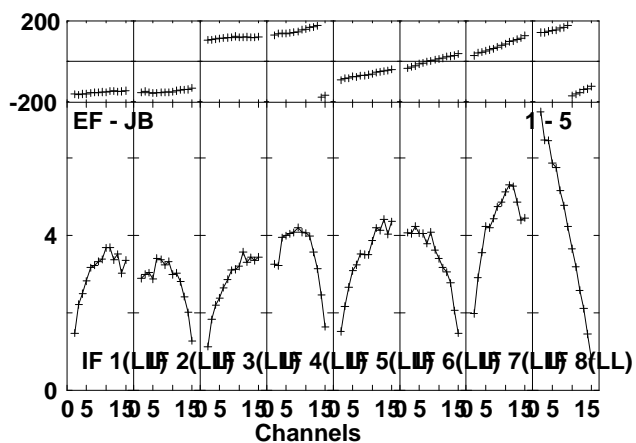
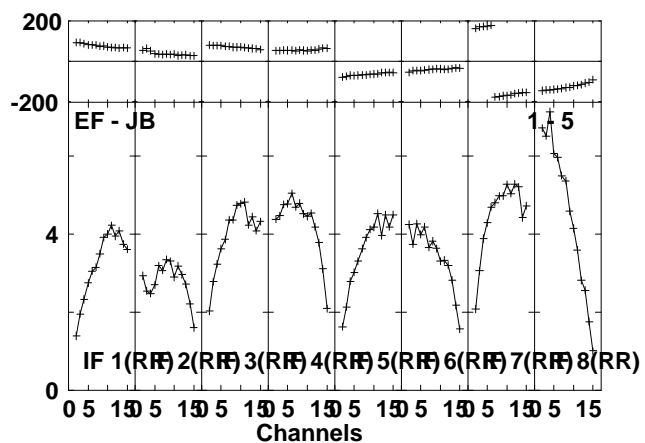
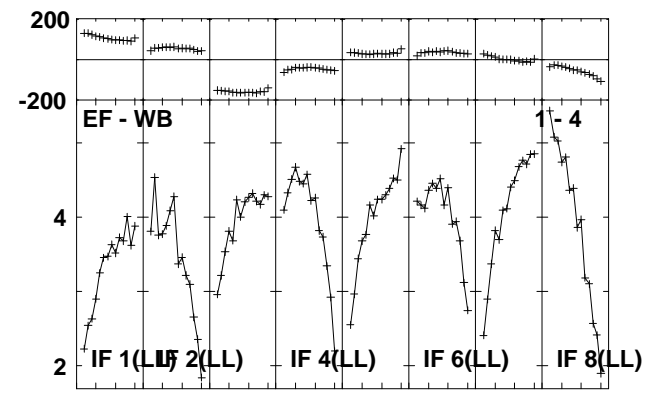
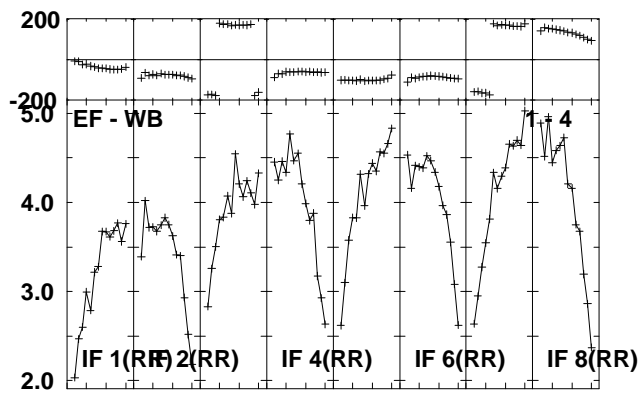
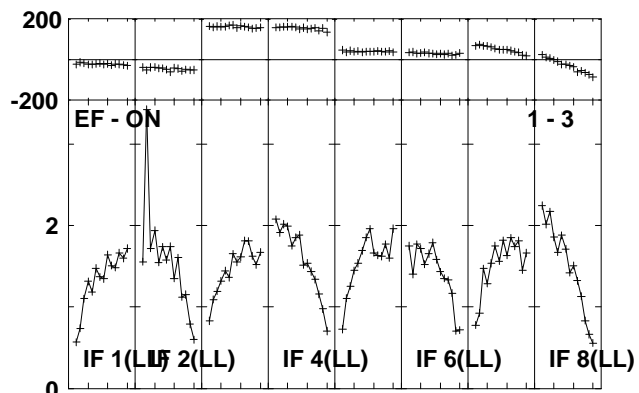
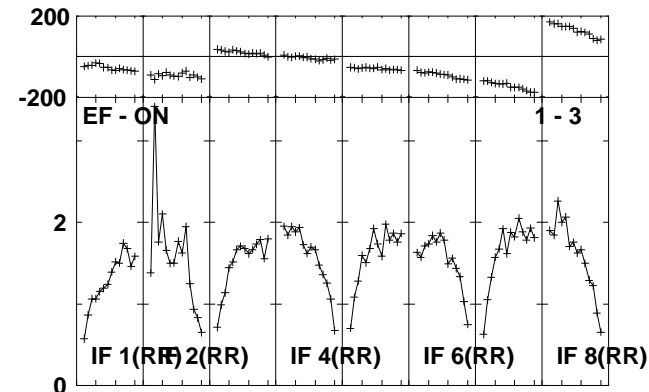
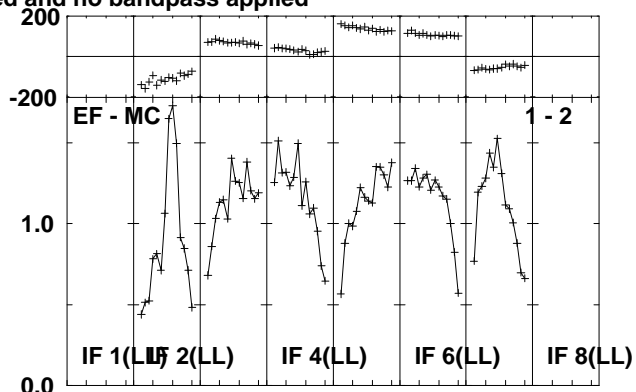
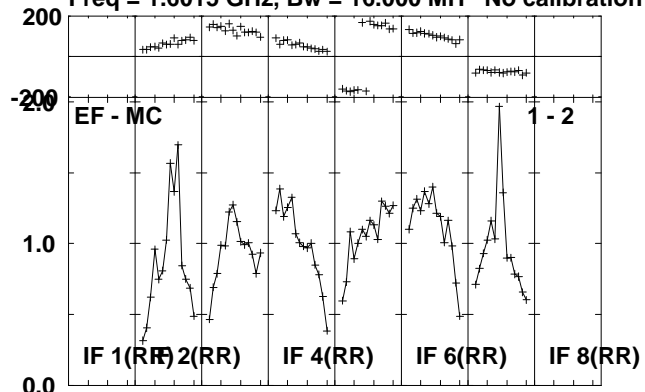

Lower frame: Milli Ampl Jy Top frame: Phas deg
 Scalar averaged cross-power spectrum Several baselines displayed
 Timerange: 00/22:03:07 to 00/22:04:47

Plot file version 26 created 01-JUL-2010 13:24:24
J2102+47 RG006B.UVDATA.1

Freq = 1.6015 GHz, Bw = 16.000 MH No calibration applied and no bandpass applied

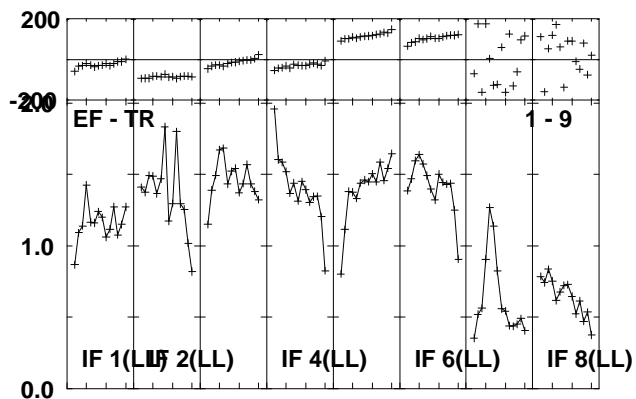
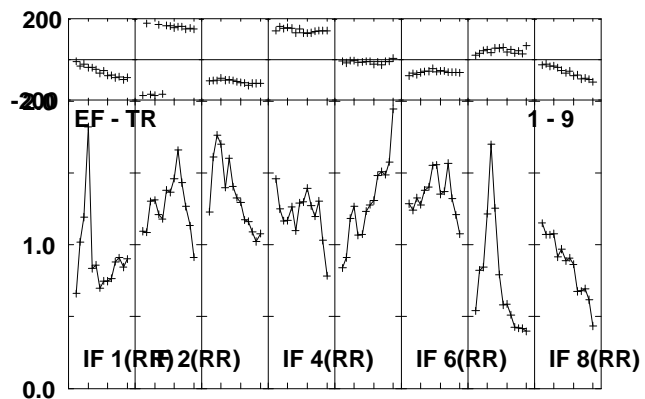
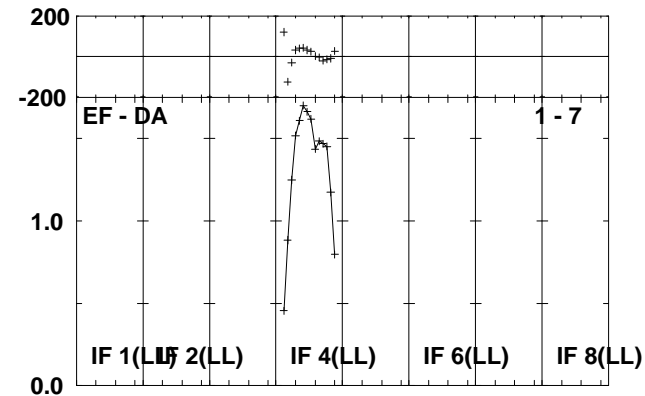
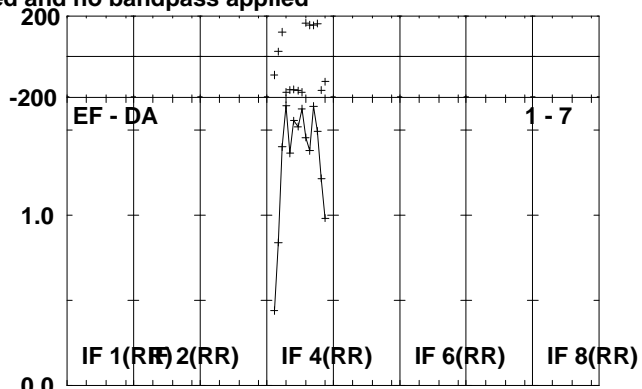
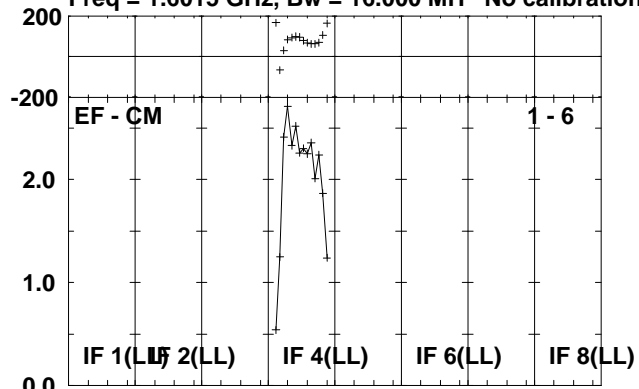

Lower frame: Milli Ampl Jy Top frame: Phas deg
Scalar averaged cross-power spectrum Several baselines displayed
Timerange: 00/22:03:07 to 00/22:04:47

Plot file version 27 created 01-JUL-2010 13:24:25

V407CYG RG006B.UVDATA.1

Freq = 1.6015 GHz, Bw = 16.000 MH No calibration applied and no bandpass applied

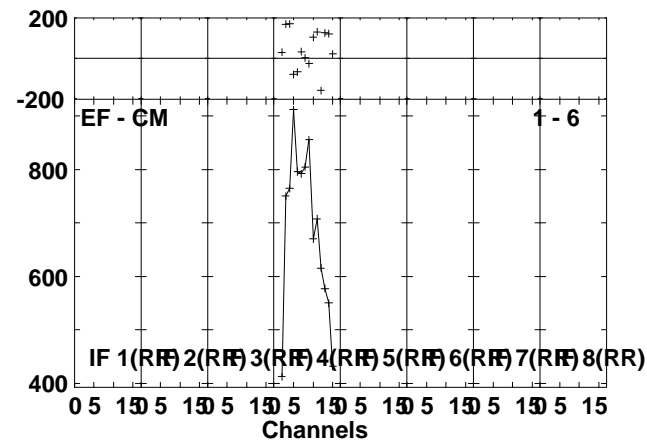
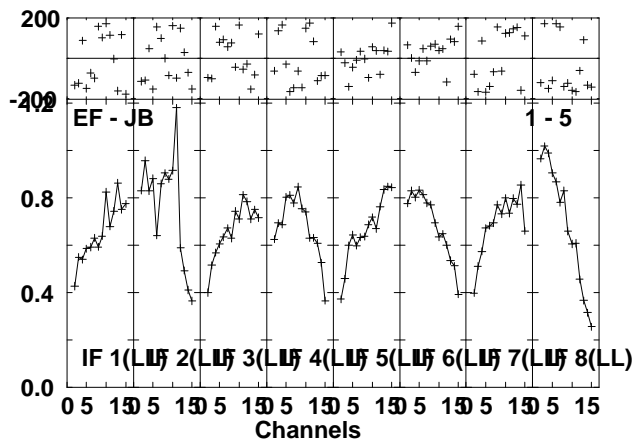
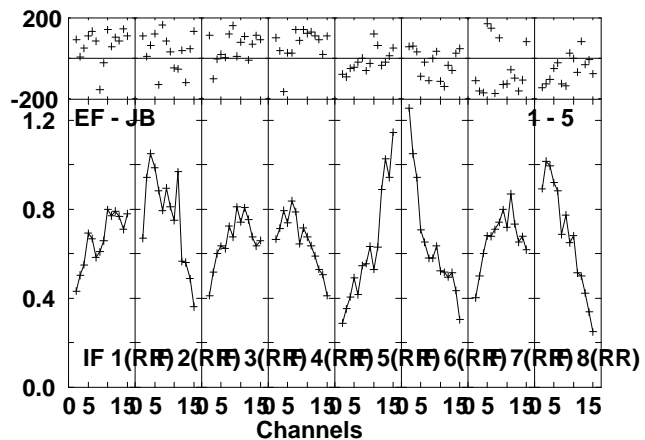
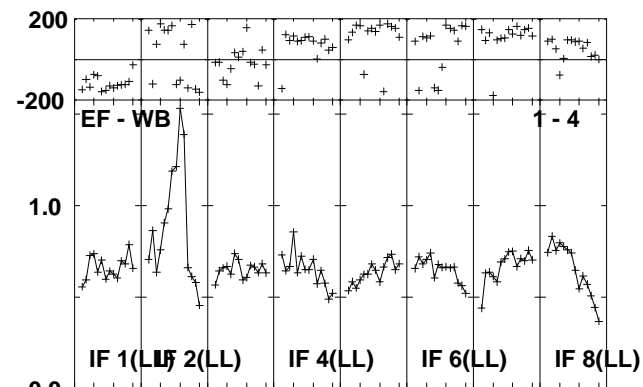
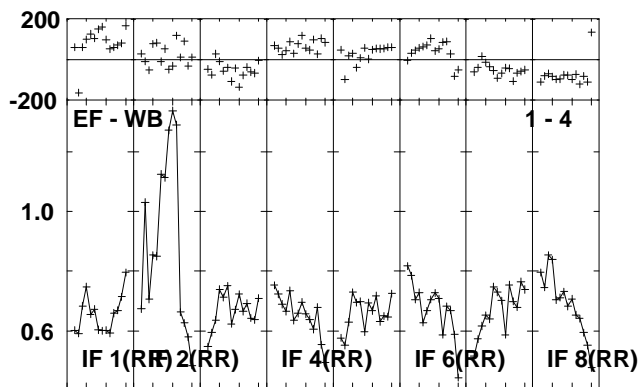
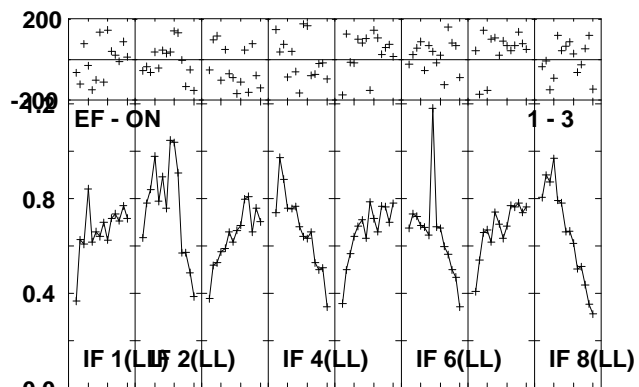
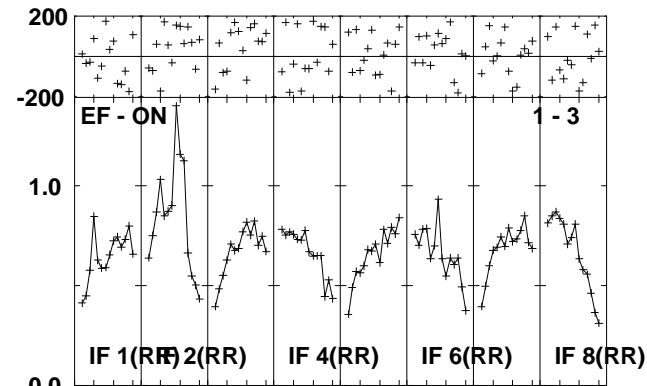
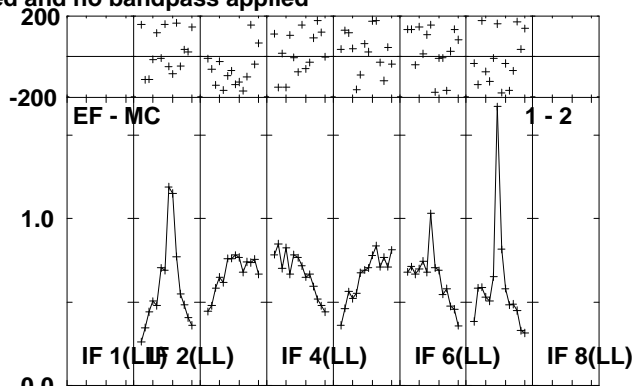
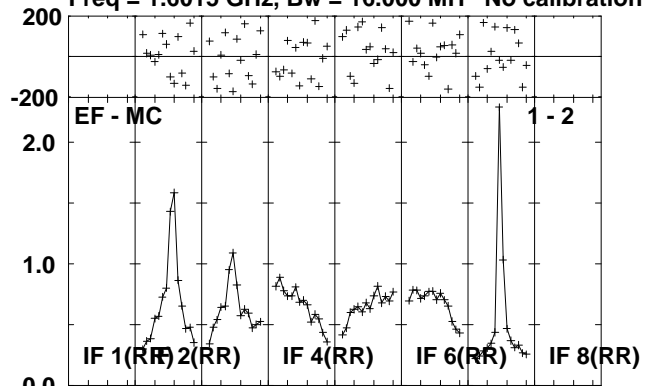

Lower frame: Milli Ampl Jy Top frame: Phas deg
Scalar averaged cross-power spectrum Several baselines displayed
Timerange: 00/22:04:51 to 00/22:09:47

Plot file version 28 created 01-JUL-2010 13:24:26

V407CYG RG006B.UVDATA.1

Freq = 1.6015 GHz, Bw = 16.000 MH No calibration applied and no bandpass applied

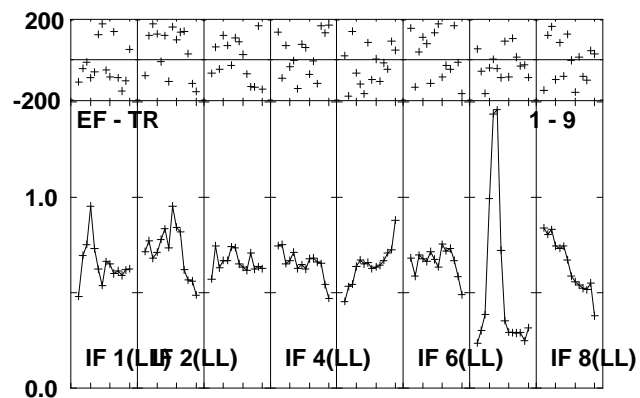
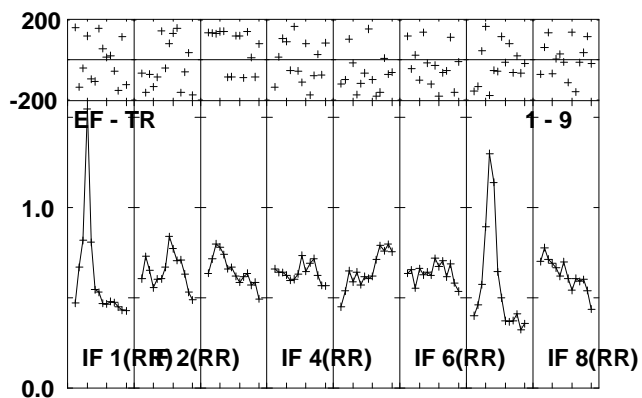
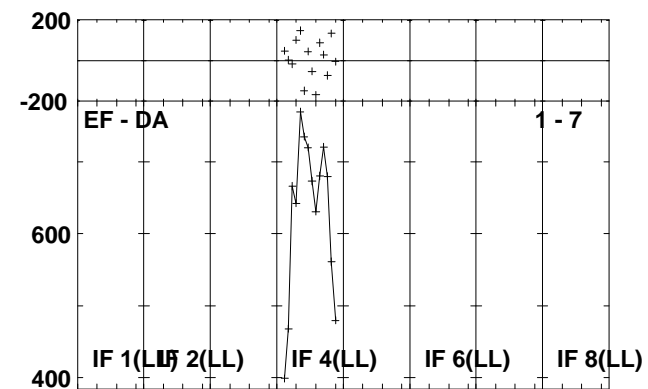
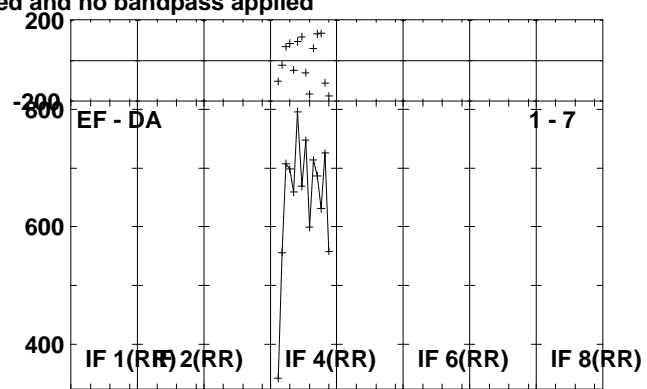
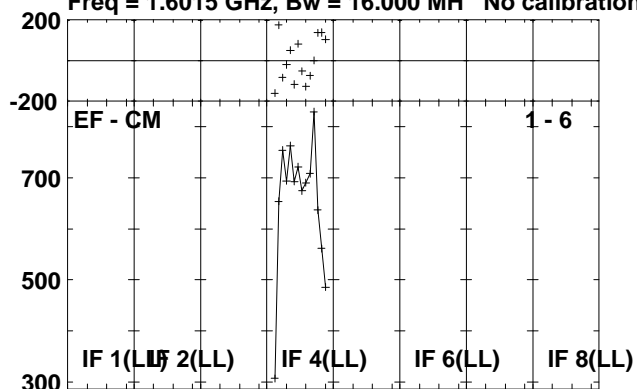

Lower frame: Micro Ampl Jy Top frame: Phas deg
Scalar averaged cross-power spectrum Several baselines displayed
Timerange: 00/22:04:51 to 00/22:09:47

Plot file version 29 created 01-JUL-2010 13:24:26

J2102+47 RG006B.UVDATA.1

Freq = 1.6015 GHz, Bw = 16.000 MH No calibration applied and no bandpass applied

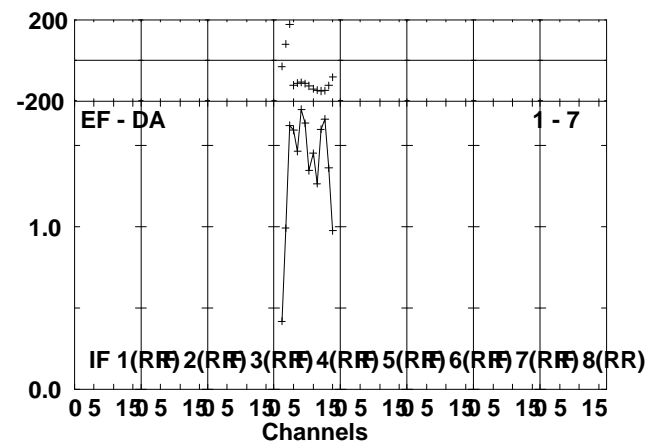
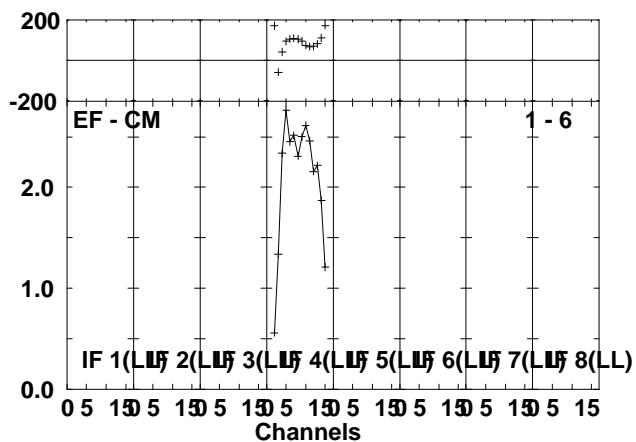
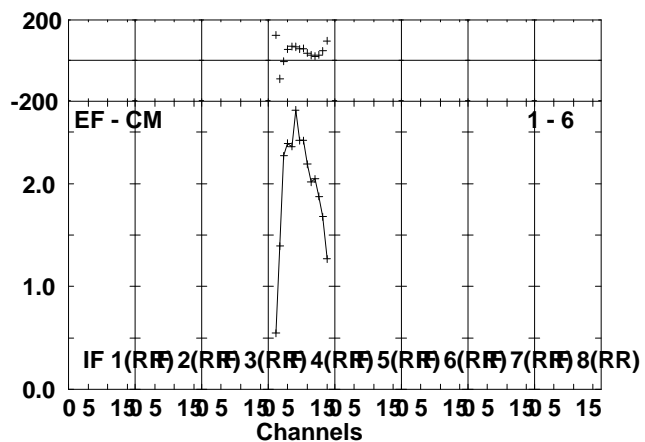
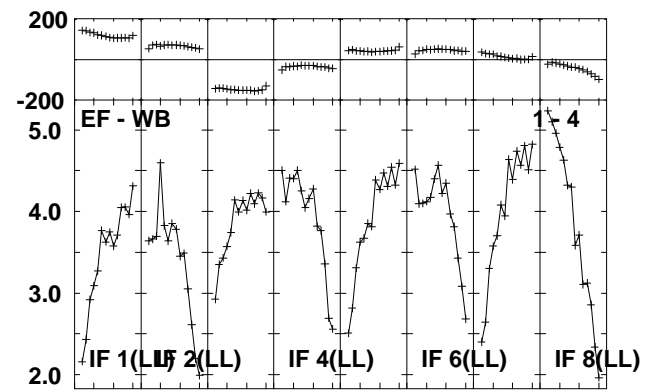
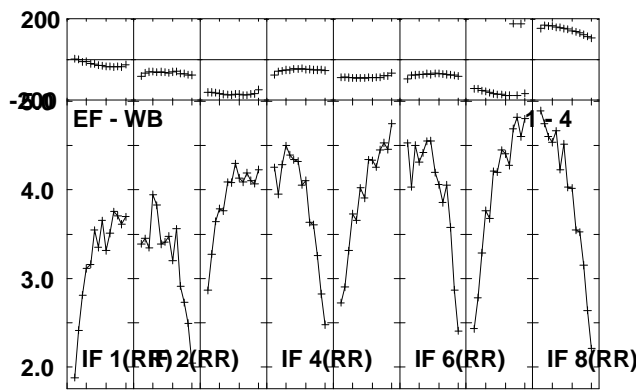
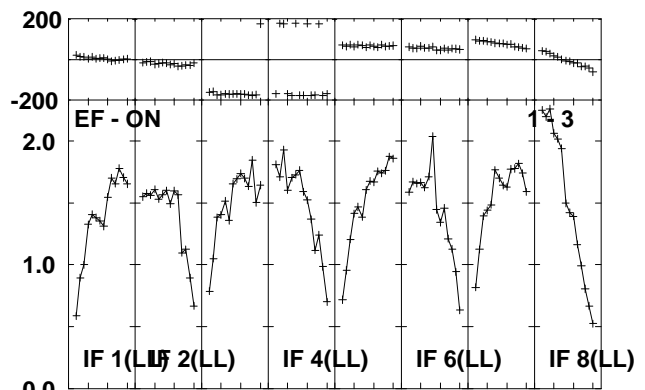
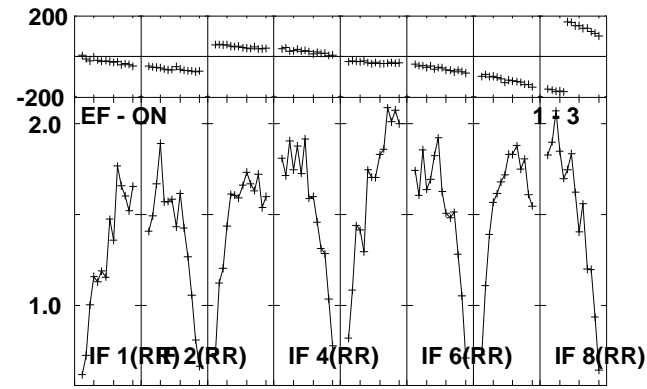
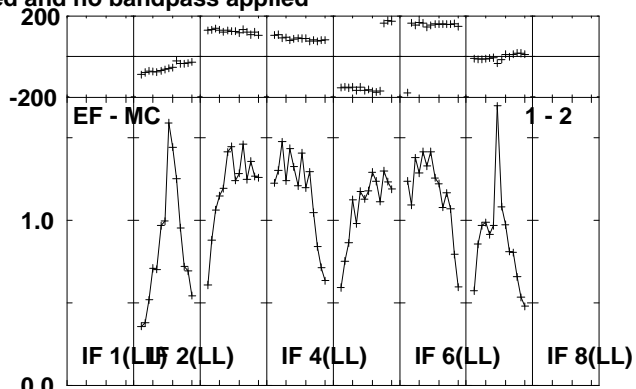
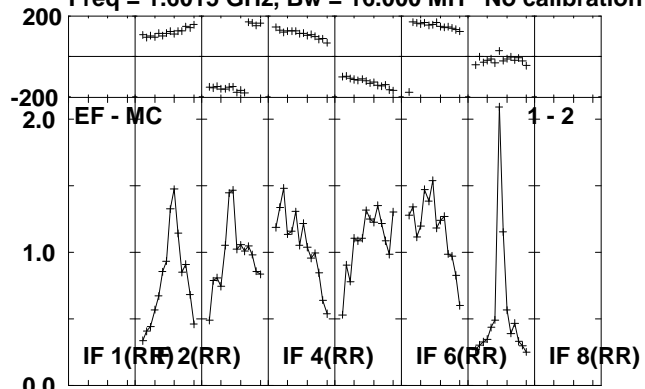

Lower frame: Milli Ampl Jy Top frame: Phas deg
Scalar averaged cross-power spectrum Several baselines displayed
Timerange: 00/22:09:51 to 00/22:12:03

Plot file version 30 created 01-JUL-2010 13:24:27
J2102+47 RG006B.UVDATA.1

Freq = 1.6015 GHz, Bw = 16.000 MH No calibration applied and no bandpass applied

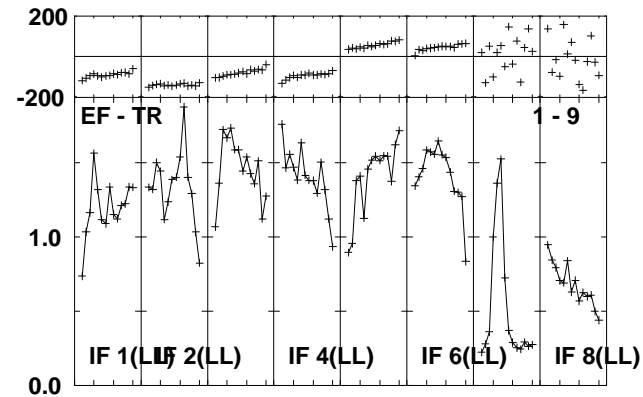
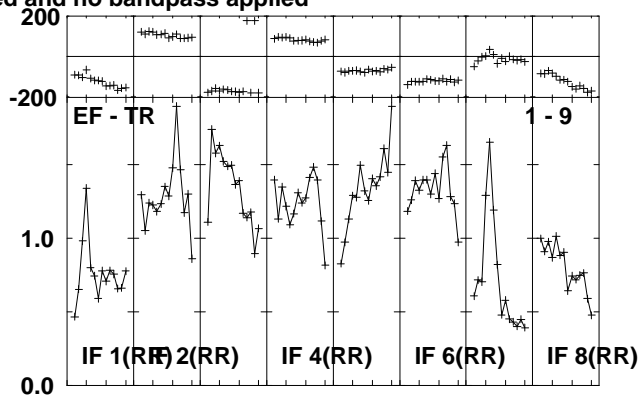
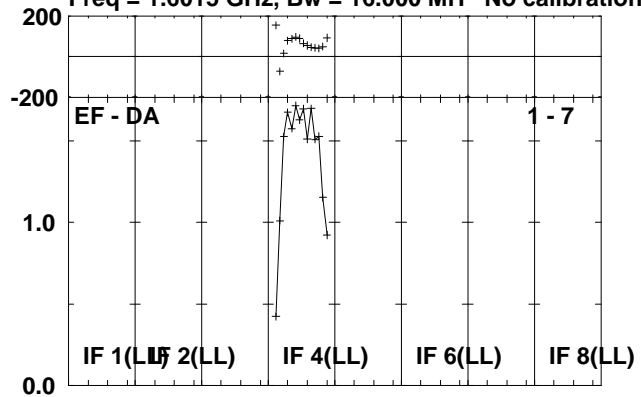

Lower frame: Milli Ampl Jy Top frame: Phas deg
Scalar averaged cross-power spectrum Several baselines displayed
Timerange: 00/22:09:51 to 00/22:12:03

Plot file version 31 created 01-JUL-2010 13:24:27
 V407CYG RG006B.UVDATA.1

Freq = 1.6015 GHz, Bw = 16.000 MH No calibration applied and no bandpass applied

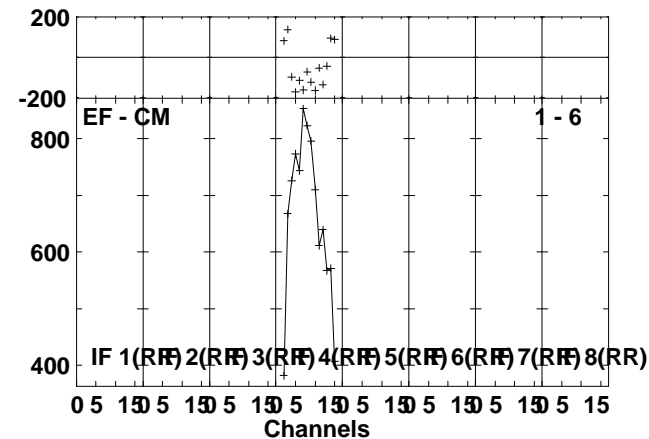
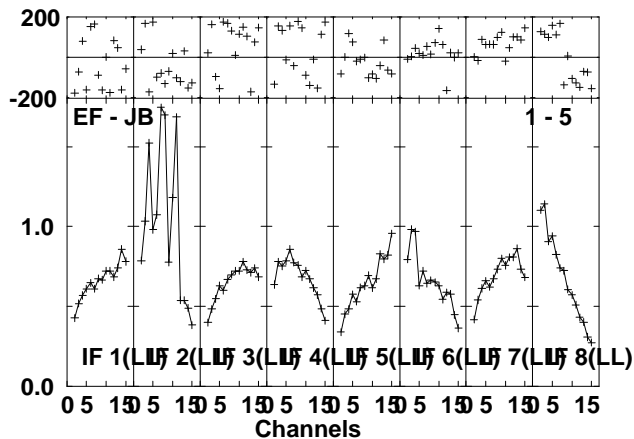
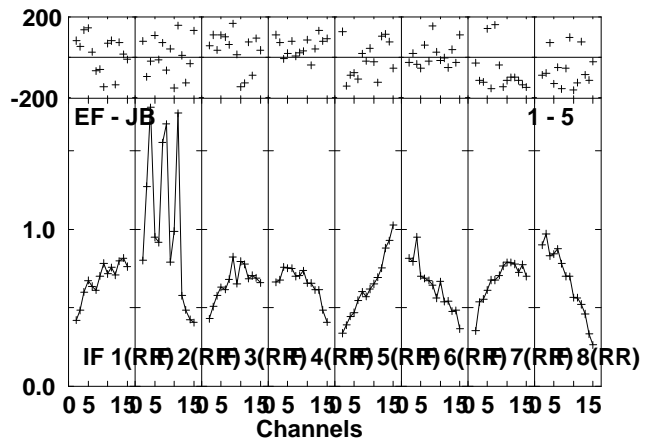
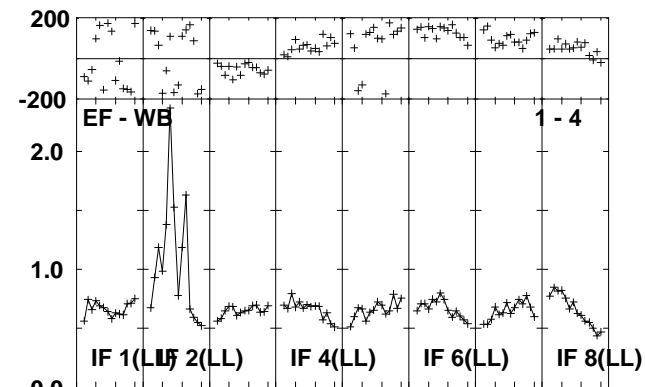
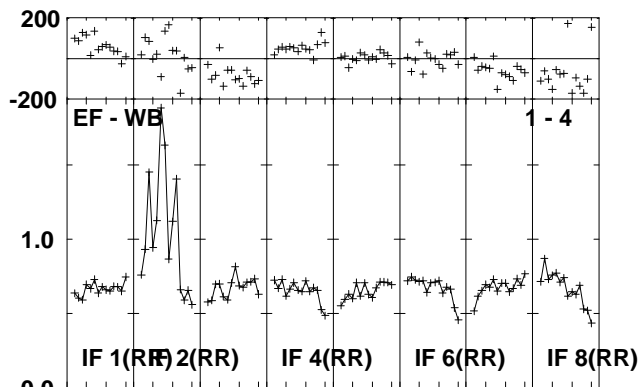
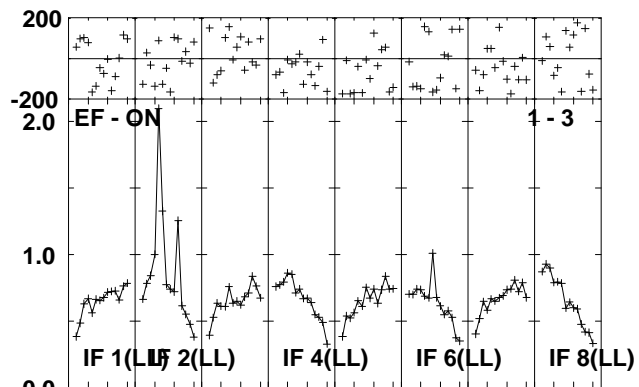
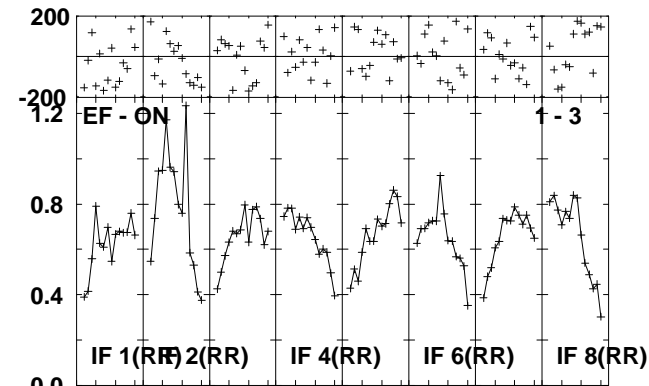
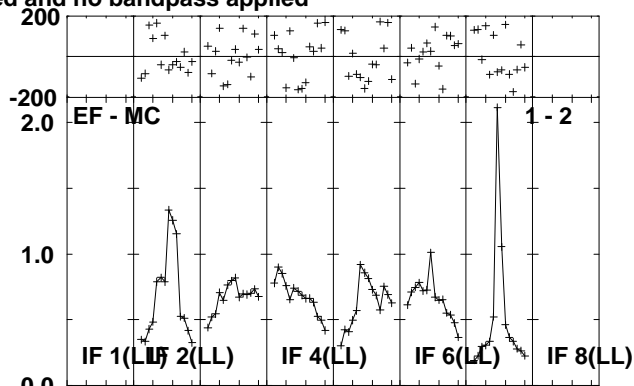
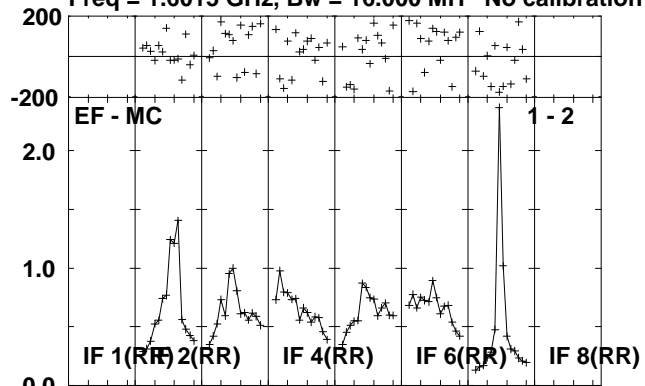

Lower frame: Milli Ampl Jy Top frame: Phas deg
 Scalar averaged cross-power spectrum Several baselines displayed
 Timerange: 00/22:12:07 to 00/22:17:03

Plot file version 32 created 01-JUL-2010 13:24:28

V407CYG RG006B.UVDATA.1

Freq = 1.6015 GHz, Bw = 16.000 MH No calibration applied and no bandpass applied

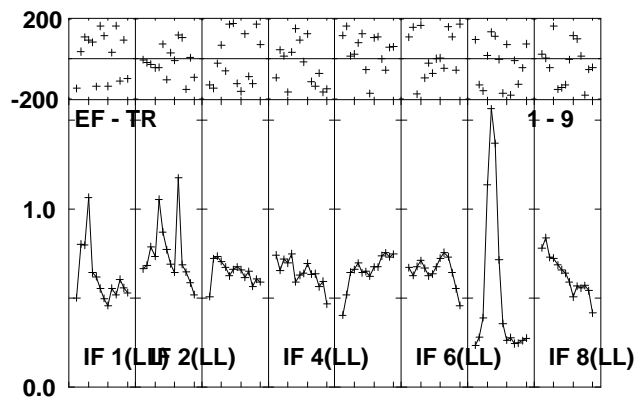
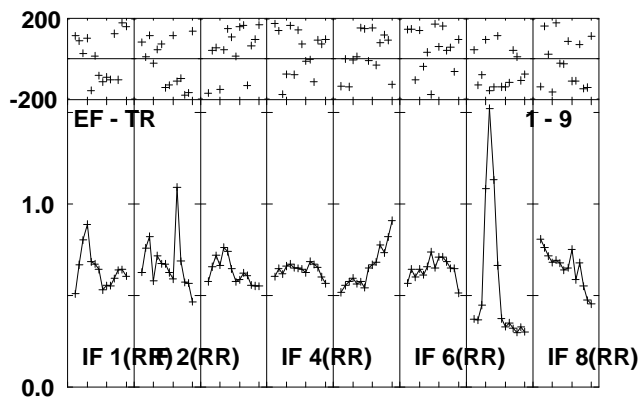
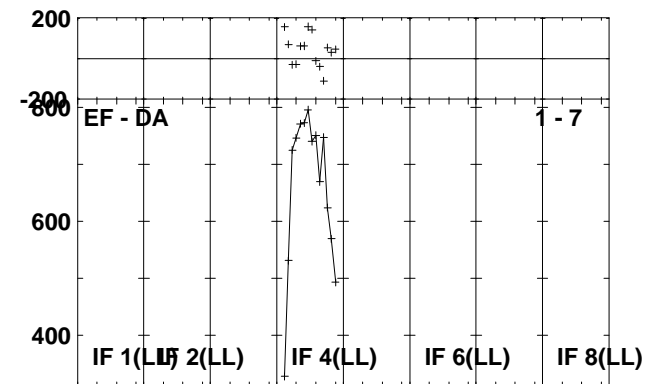
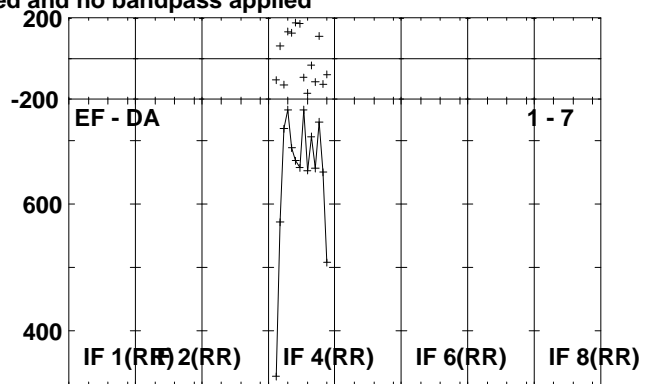
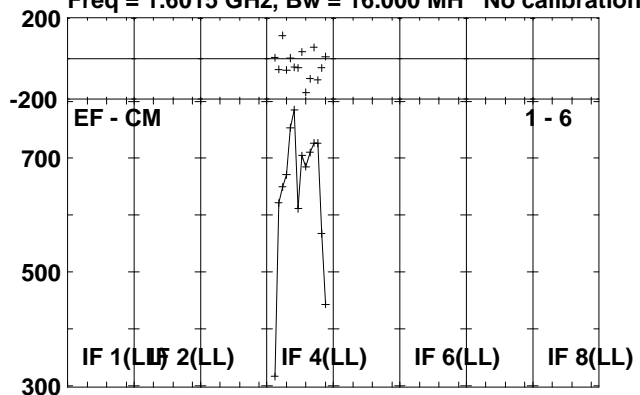

Lower frame: Micro Ampl Jy Top frame: Phas deg
Scalar averaged cross-power spectrum Several baselines displayed
Timerange: 00/22:12:07 to 00/22:17:03

Plot file version 33 created 01-JUL-2010 13:24:29

J2102+47 RG006B.UVDATA.1

Freq = 1.6015 GHz, Bw = 16.000 MH No calibration applied and no bandpass applied

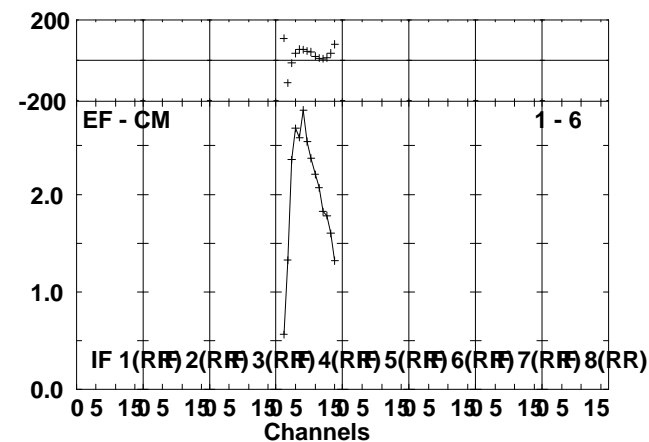
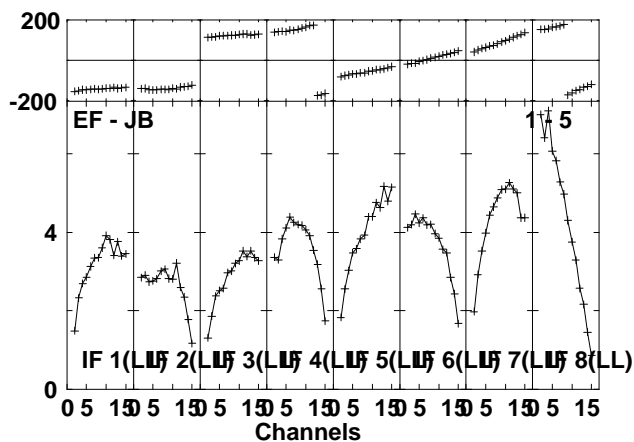
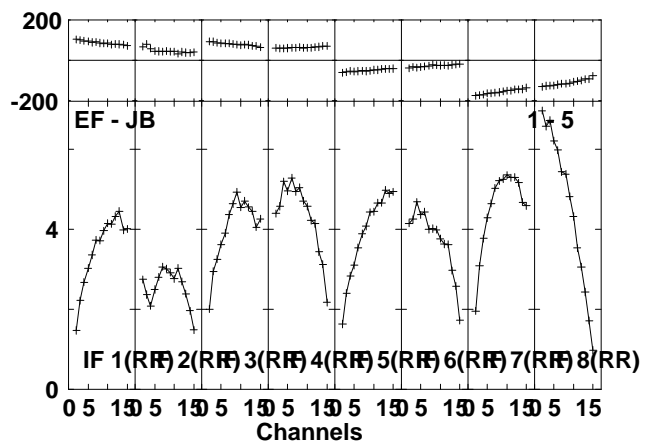
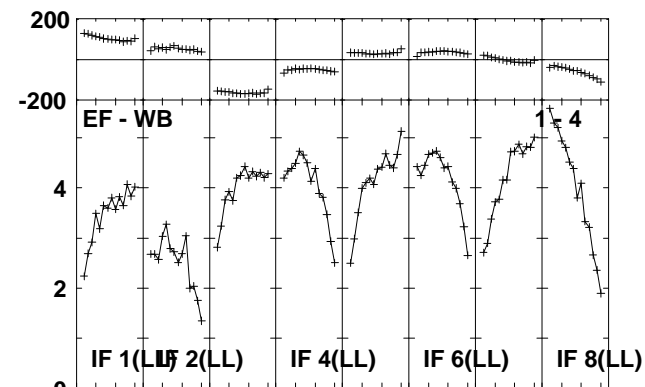
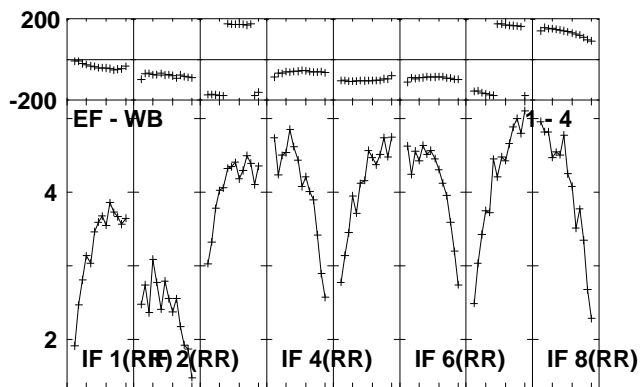
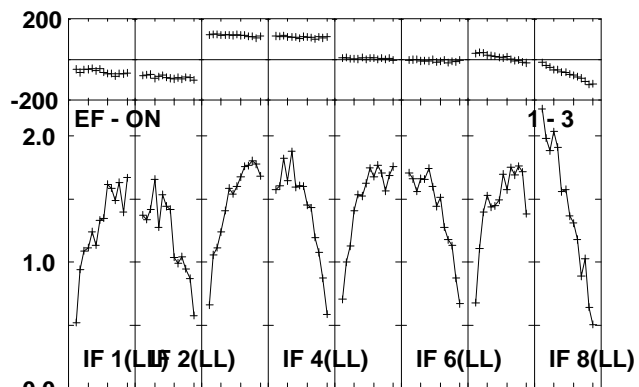
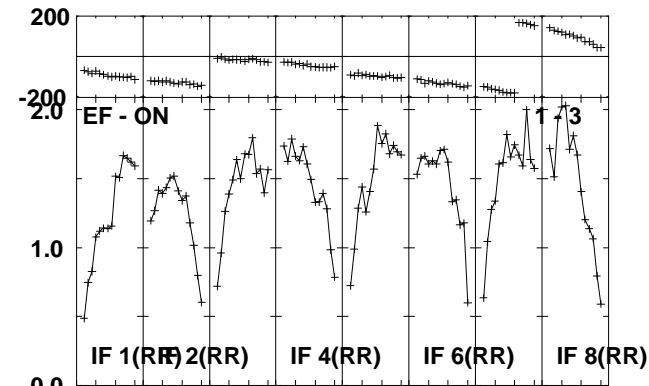
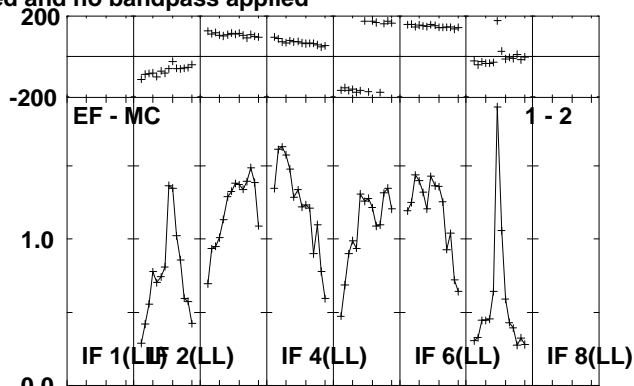
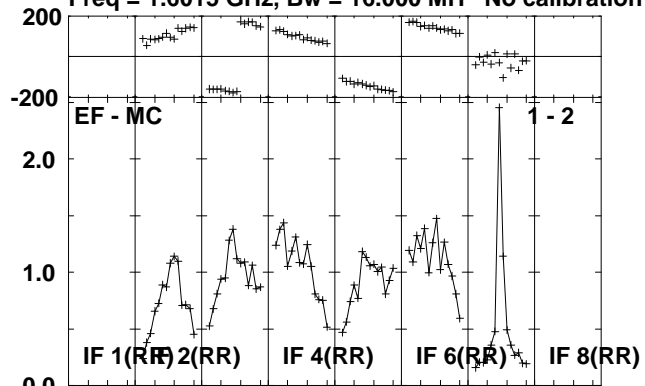

Lower frame: Milli Ampl Jy Top frame: Phas deg
Scalar averaged cross-power spectrum Several baselines displayed
Timerange: 00/22:18:07 to 00/22:19:47

Plot file version 34 created 01-JUL-2010 13:24:29
J2102+47 RG006B.UVDATA.1

Freq = 1.6015 GHz, Bw = 16.000 MH No calibration applied and no bandpass applied

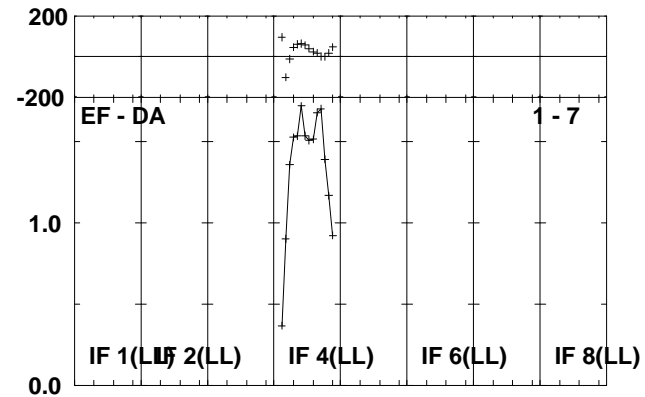
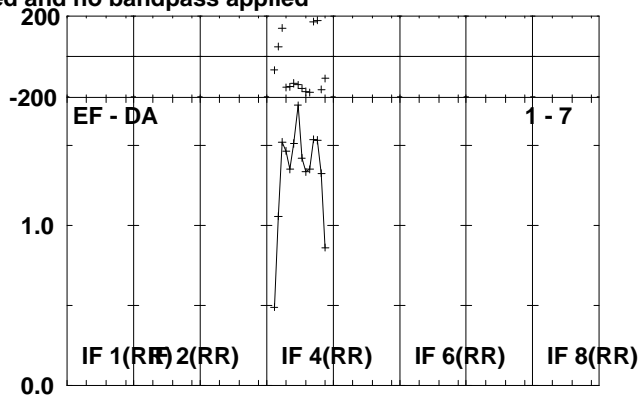
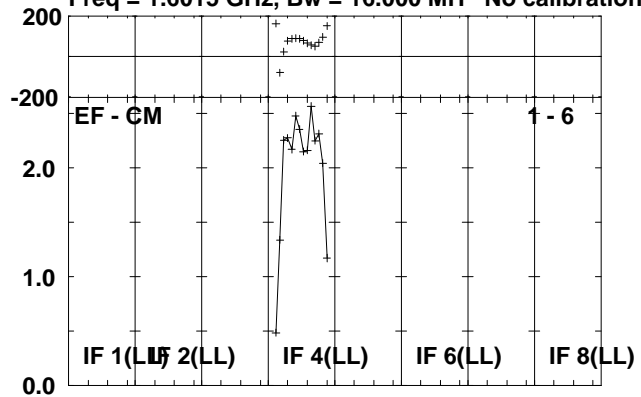

Lower frame: Milli Ampl Jy Top frame: Phas deg
Scalar averaged cross-power spectrum Several baselines displayed
Timerange: 00/22:18:07 to 00/22:19:47

Plot file version 35 created 01-JUL-2010 13:24:29

V407CYG RG006B.UVDATA.1

Freq = 1.6015 GHz, Bw = 16.000 MH No calibration applied and no bandpass applied

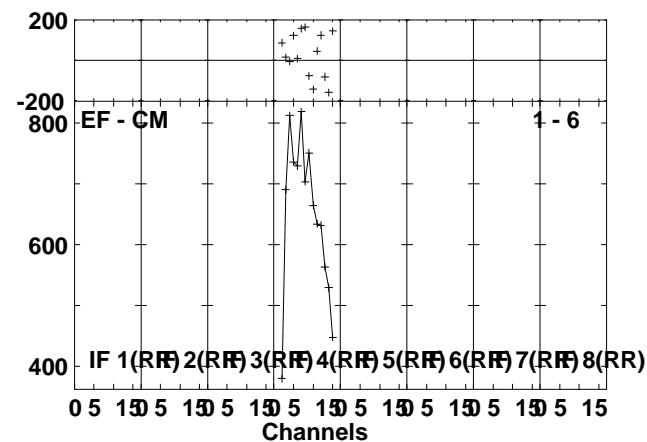
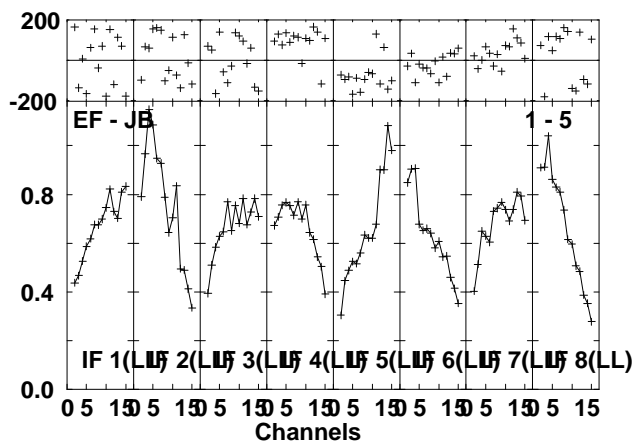
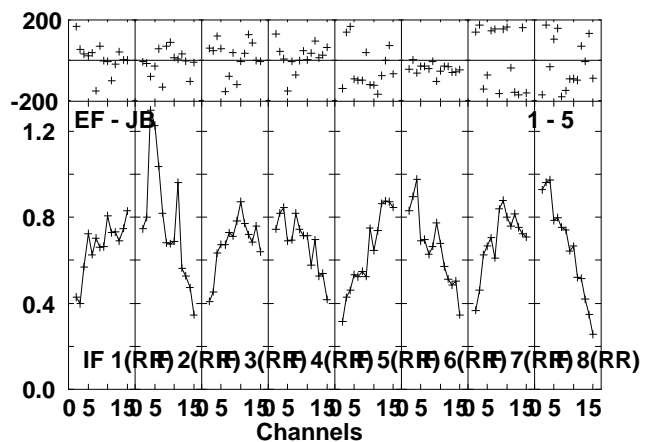
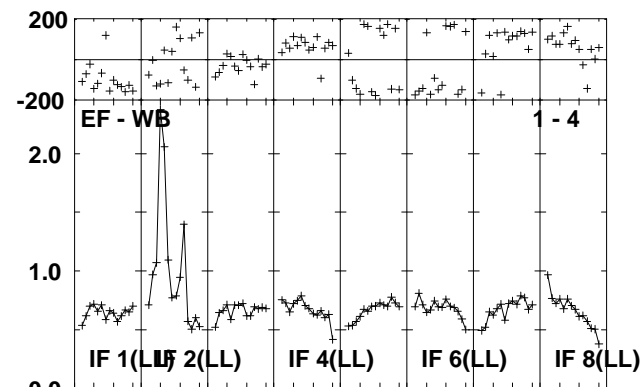
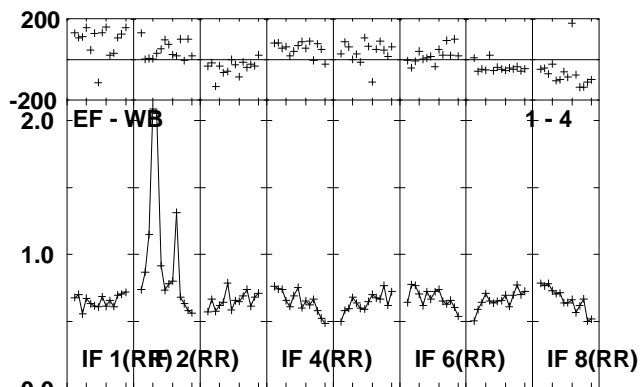
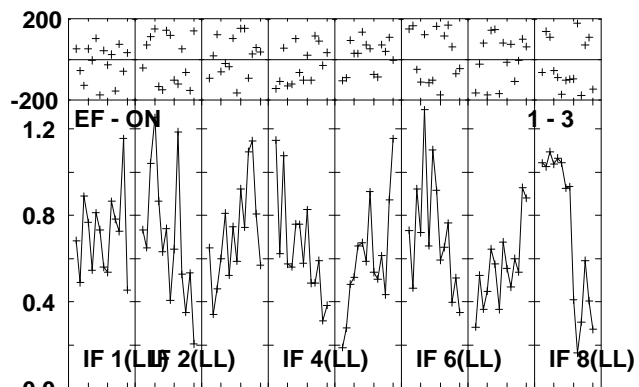
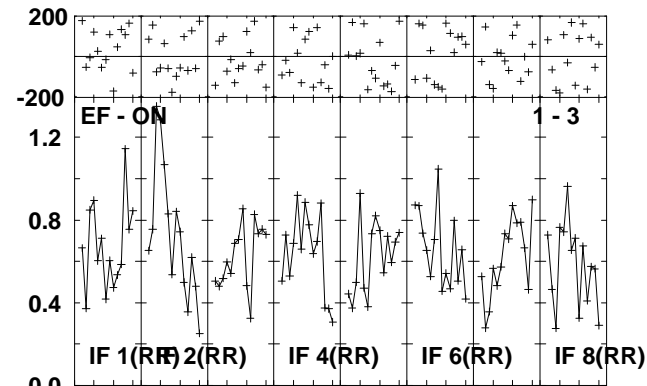
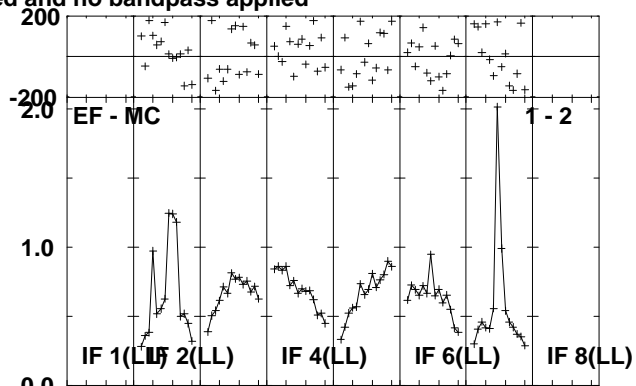
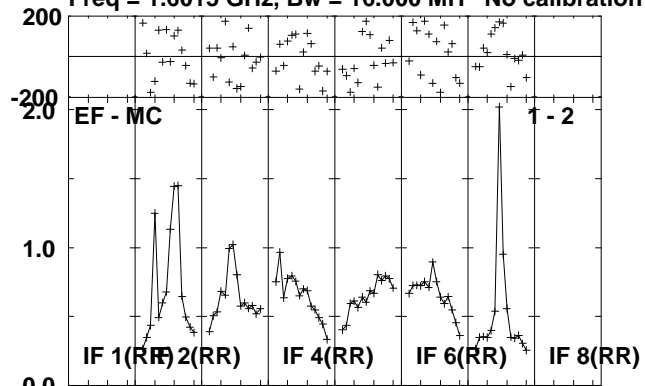

Lower frame: Milli Ampl Jy Top frame: Phas deg
Scalar averaged cross-power spectrum Several baselines displayed
Timerange: 00/22:19:51 to 00/22:24:47

Plot file version 36 created 01-JUL-2010 13:24:30

V407CYG RG006B.UVDATA.1

Freq = 1.6015 GHz, Bw = 16.000 MH No calibration applied and no bandpass applied

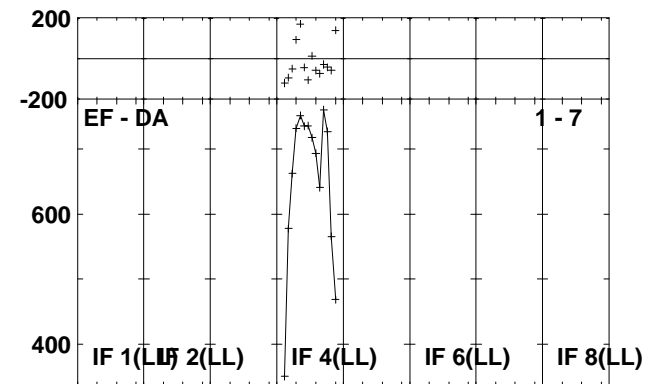
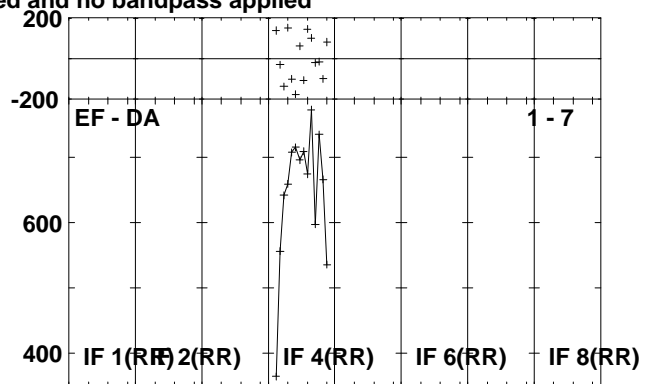
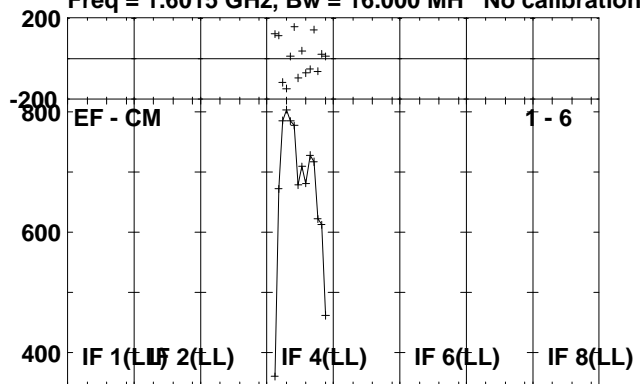

Lower frame: Micro Ampl Jy Top frame: Phas deg
Scalar averaged cross-power spectrum Several baselines displayed
Timerange: 00/22:19:51 to 00/22:24:47

Plot file version 37 created 01-JUL-2010 13:24:30

J2102+47 RG006B.UVDATA.1

Freq = 1.6015 GHz, Bw = 16.000 MH No calibration applied and no bandpass applied

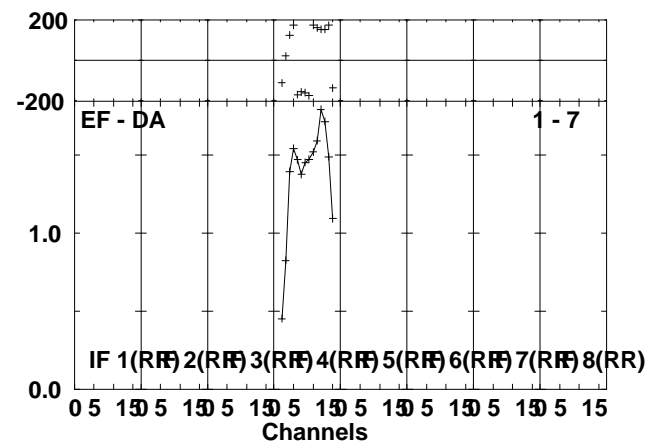
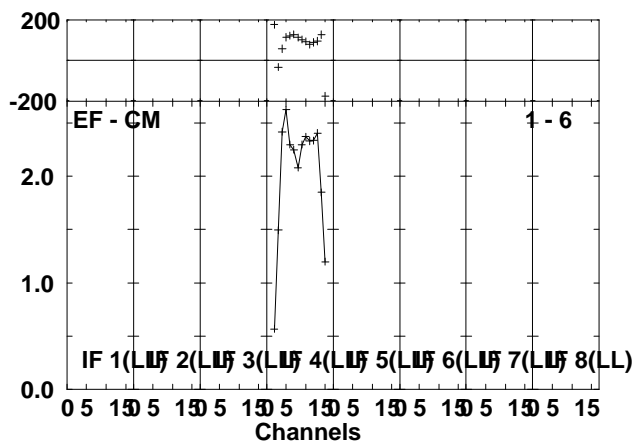
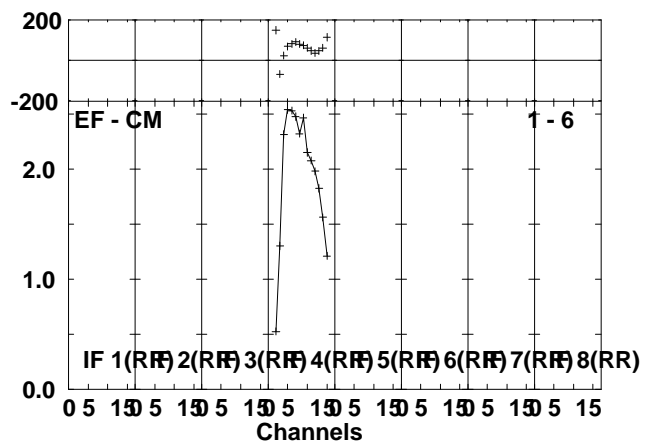
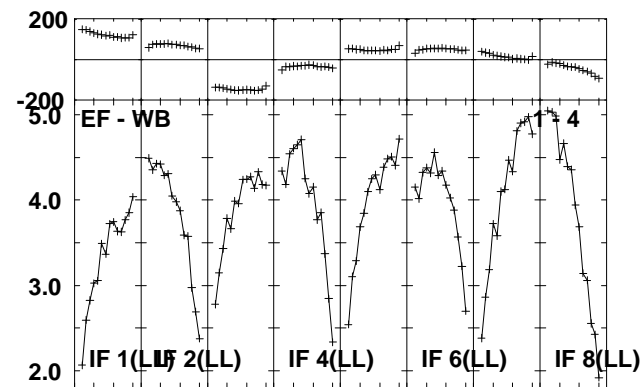
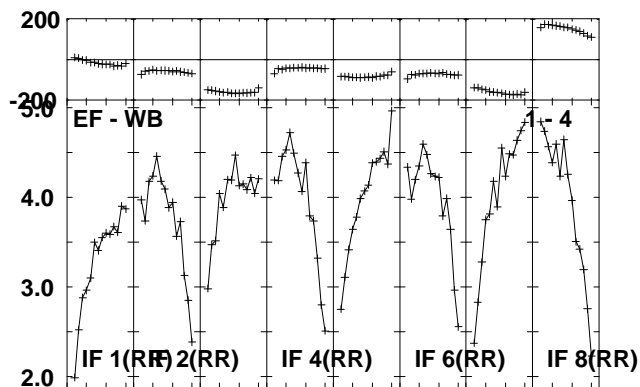
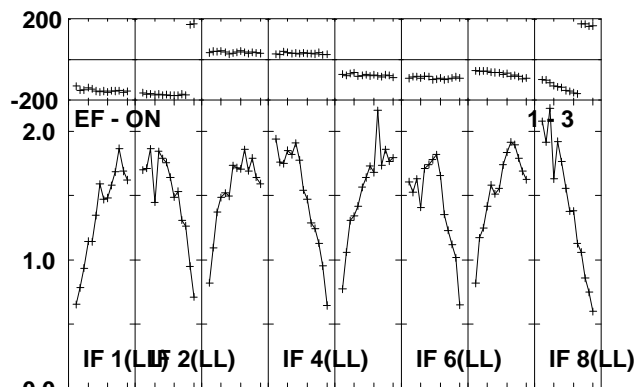
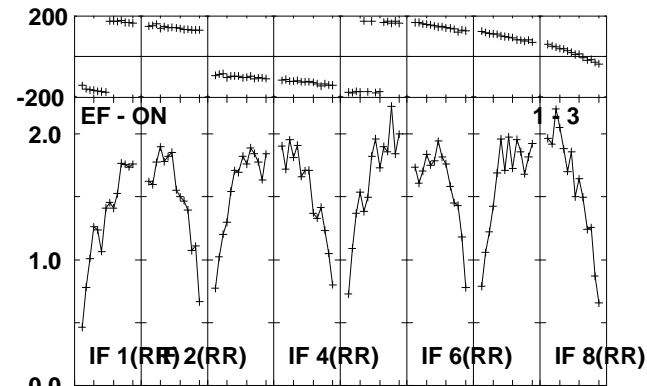
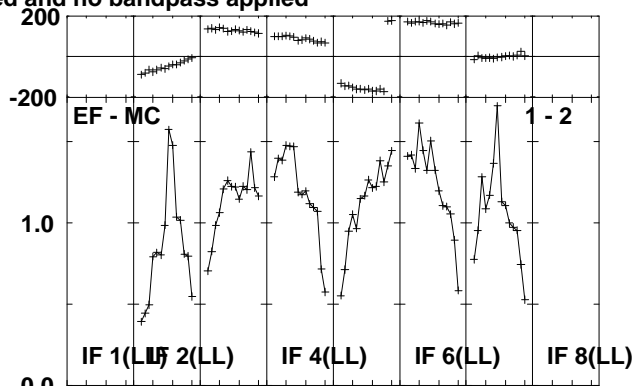
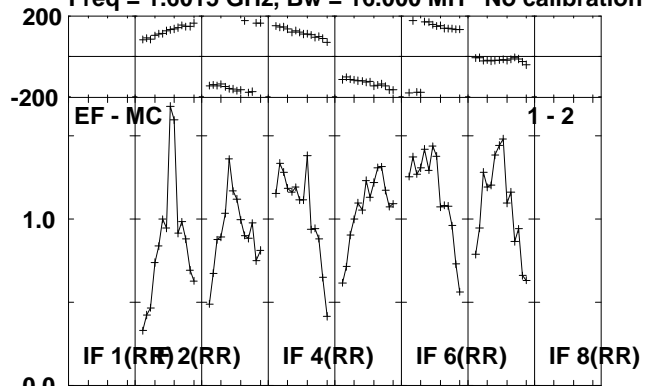

Lower frame: Milli Ampl Jy Top frame: Phas deg
Scalar averaged cross-power spectrum Several baselines displayed
Timerange: 00/22:24:51 to 00/22:27:03

Plot file version 38 created 01-JUL-2010 13:24:31
J2102+47 RG006B.UVDATA.1
Freq = 1.6015 GHz, Bw = 16.000 MH No calibration applied and no bandpass applied

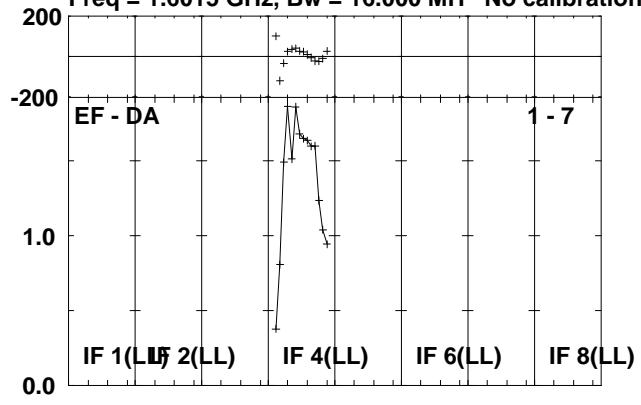

Lower frame: Milli Ampl Jy Top frame: Phas deg
Scalar averaged cross-power spectrum Several baselines displayed
Timerange: 00/22:24:51 to 00/22:27:03

Plot file version 39 created 01-JUL-2010 13:24:31
 V407CYG RG006B.UVDATA.1

Freq = 1.6015 GHz, Bw = 16.000 MH No calibration applied and no bandpass applied

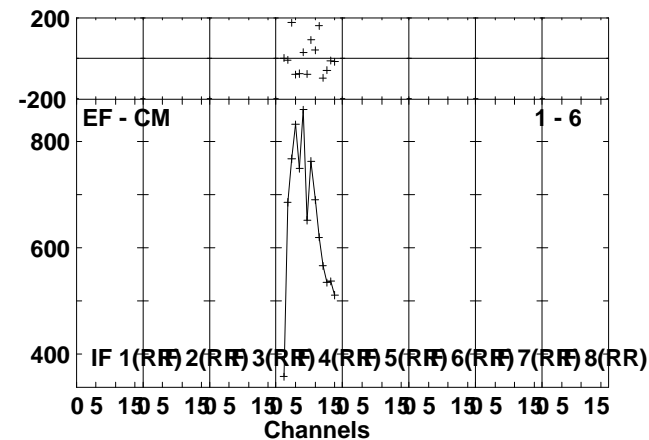
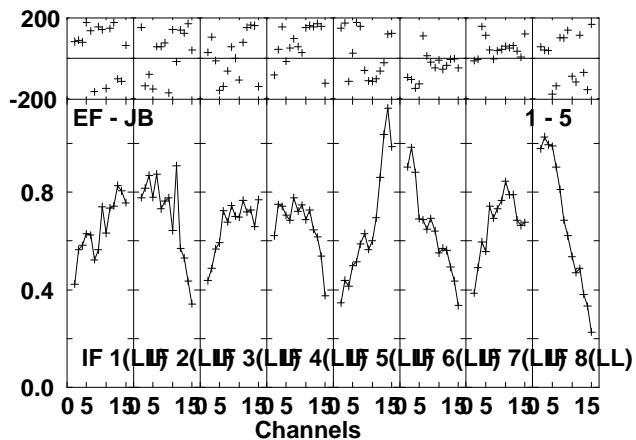
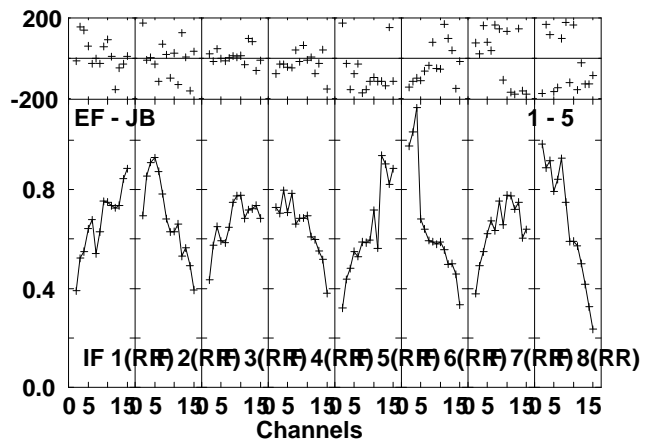
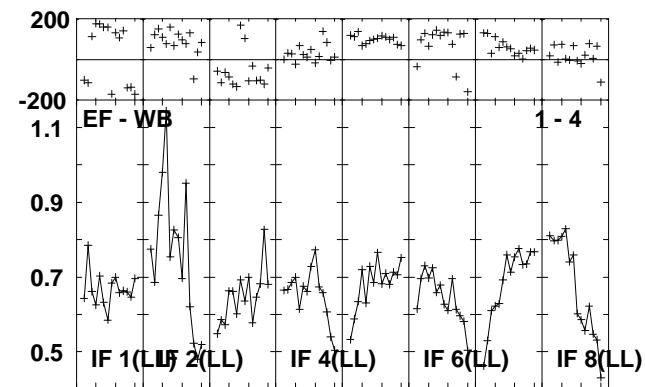
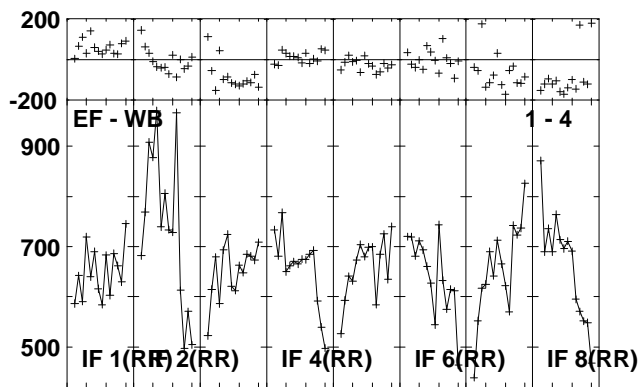
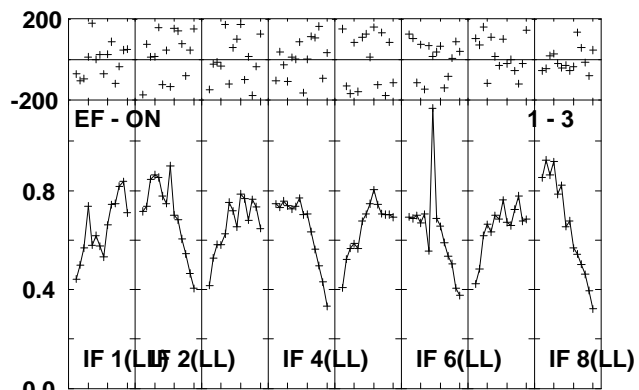
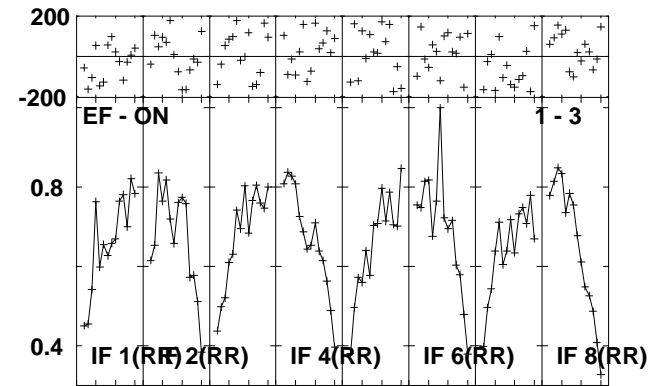
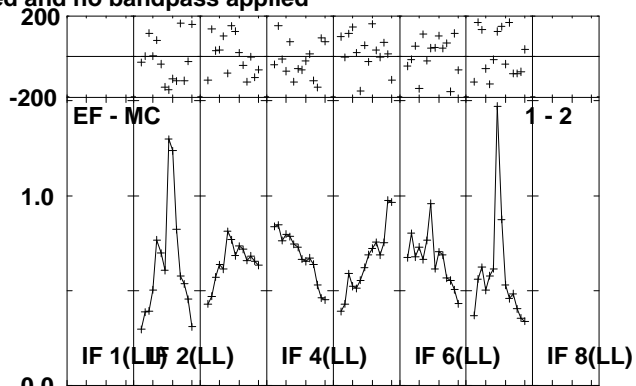
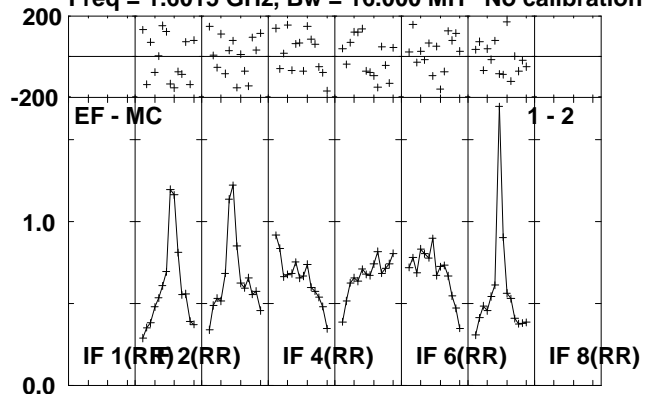

Lower frame: Milli Ampl Jy Top frame: Phas deg
 Scalar averaged cross-power spectrum Several baselines displayed
 Timerange: 00/22:27:07 to 00/22:32:03

Plot file version 40 created 01-JUL-2010 13:24:32
V407CYG RG006B.UVDATA.1

Freq = 1.6015 GHz, Bw = 16.000 MH No calibration applied and no bandpass applied

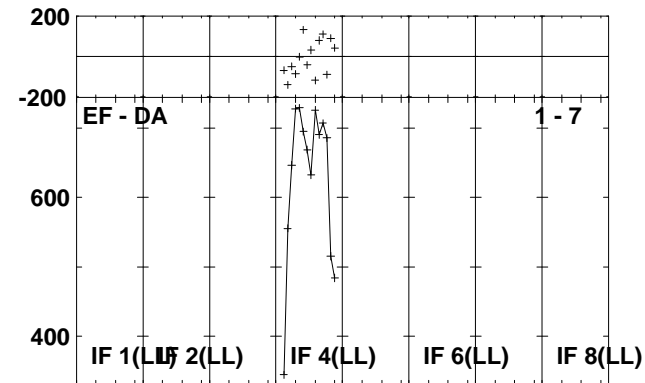
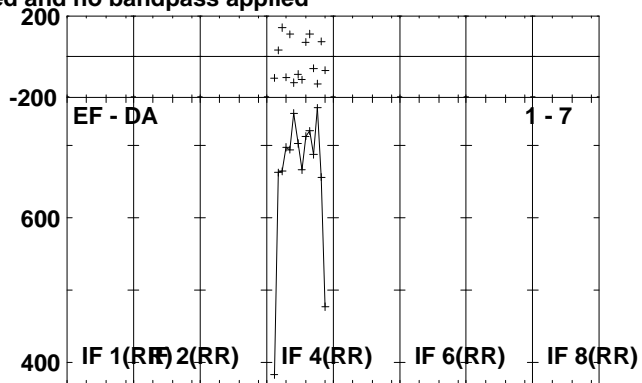
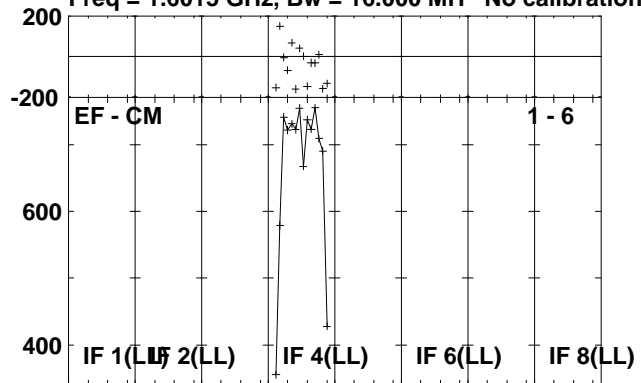

Lower frame: Micro Ampl Jy Top frame: Phas deg
Scalar averaged cross-power spectrum Several baselines displayed
Timerange: 00/22:27:07 to 00/22:32:03

Plot file version 41 created 01-JUL-2010 13:24:32

J2102+47 RG006B.UVDATA.1

Freq = 1.6015 GHz, Bw = 16.000 MH No calibration applied and no bandpass applied

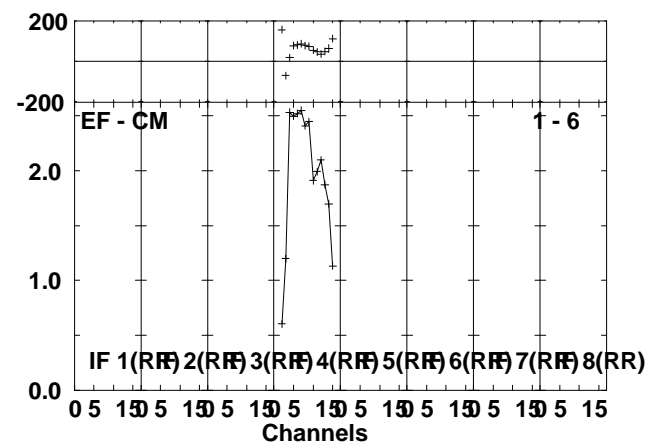
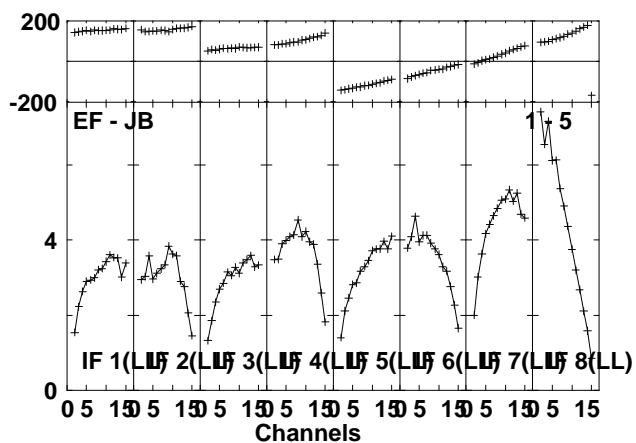
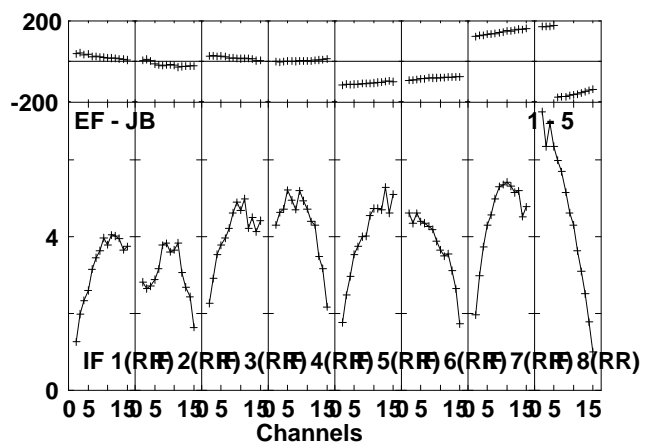
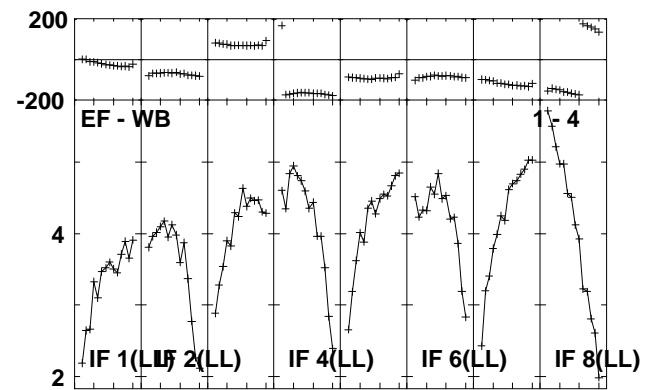
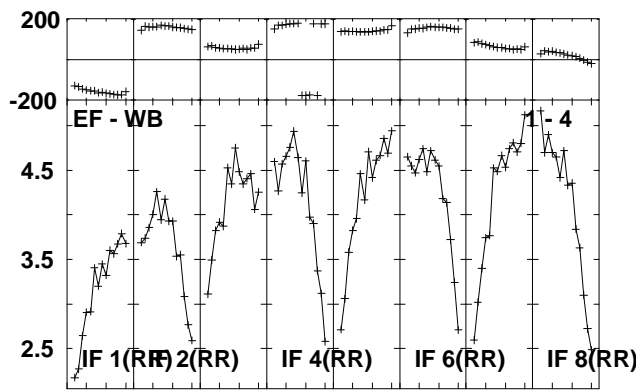
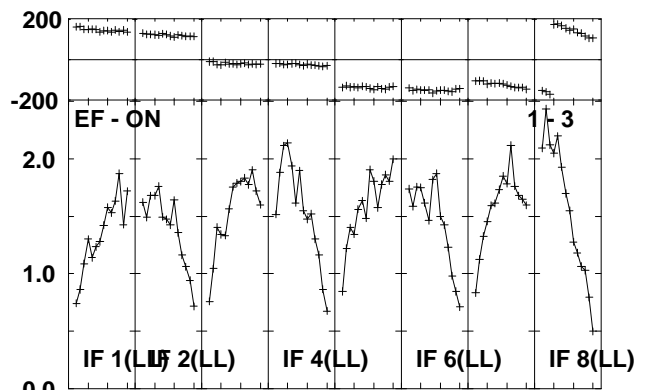
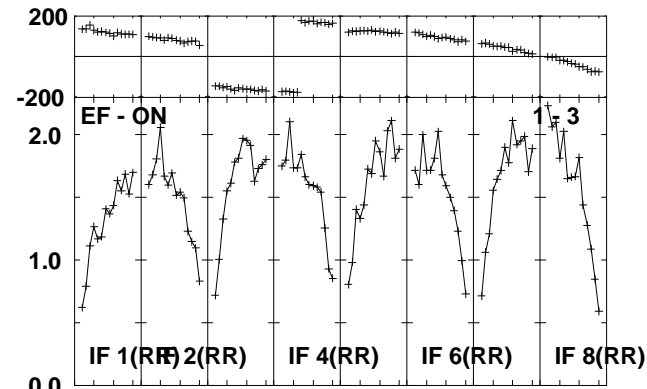
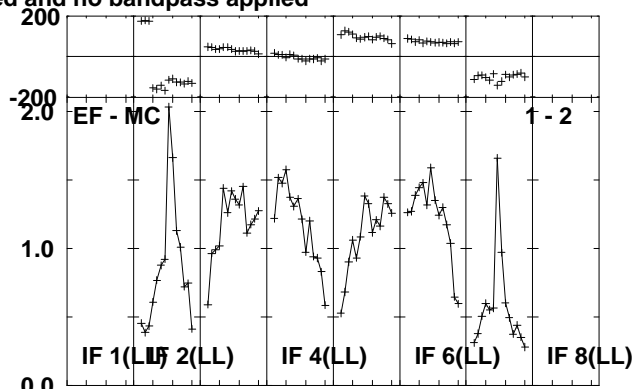
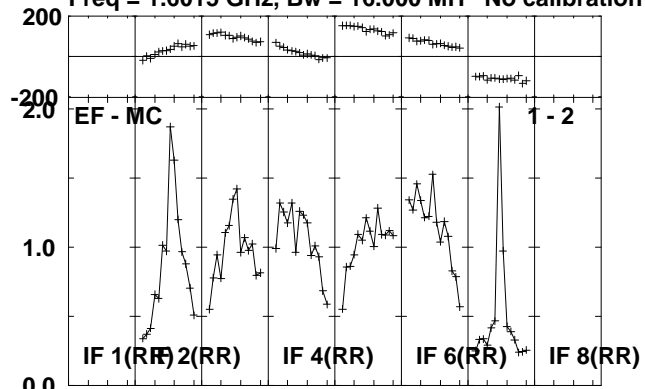

Lower frame: Milli Ampl Jy Top frame: Phas deg
Scalar averaged cross-power spectrum Several baselines displayed
Timerange: 00/22:33:07 to 00/22:34:47

Plot file version 42 created 01-JUL-2010 13:24:33
J2102+47 RG006B.UVDATA.1

Freq = 1.6015 GHz, Bw = 16.000 MH No calibration applied and no bandpass applied

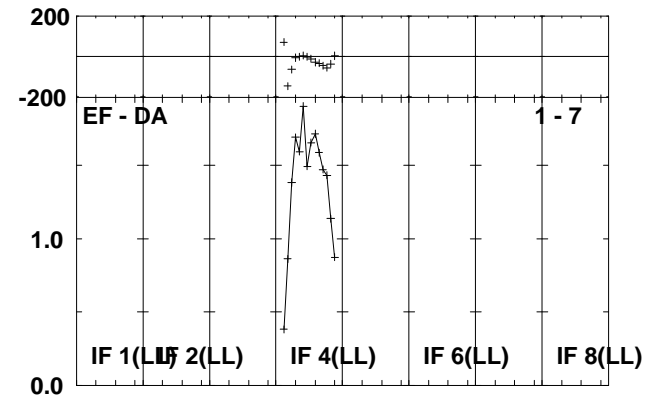
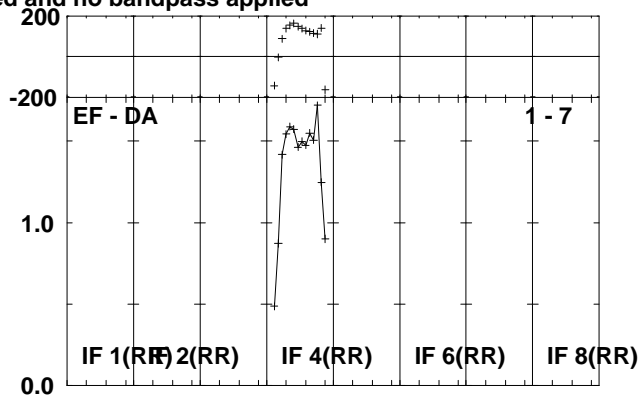
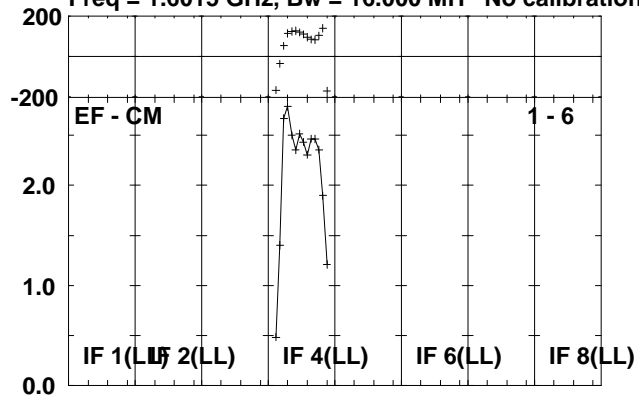

Lower frame: Milli Ampl Jy Top frame: Phas deg
Scalar averaged cross-power spectrum Several baselines displayed
Timerange: 00/22:33:07 to 00/22:34:47

Plot file version 43 created 01-JUL-2010 13:24:33

V407CYG RG006B.UVDATA.1

Freq = 1.6015 GHz, Bw = 16.000 MH No calibration applied and no bandpass applied

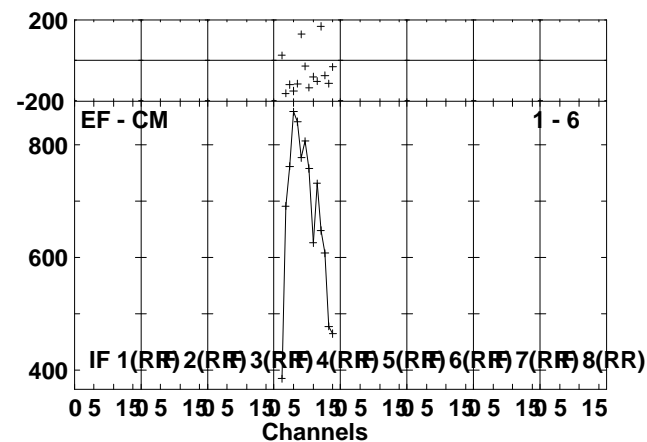
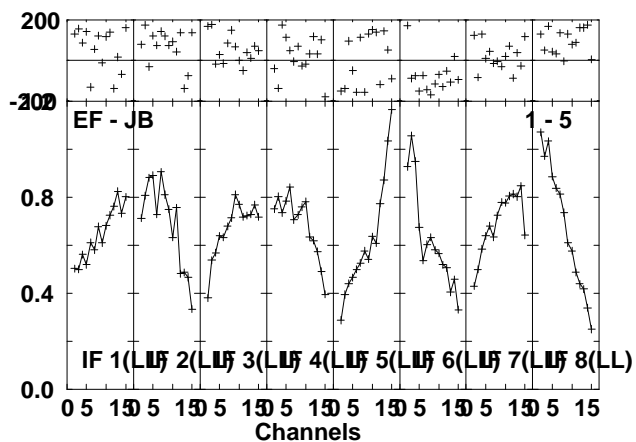
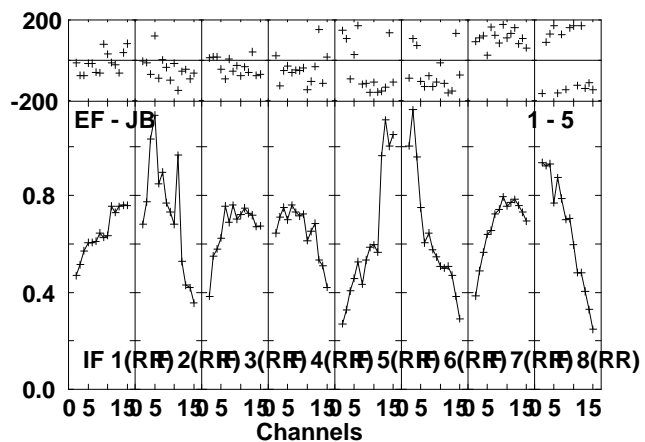
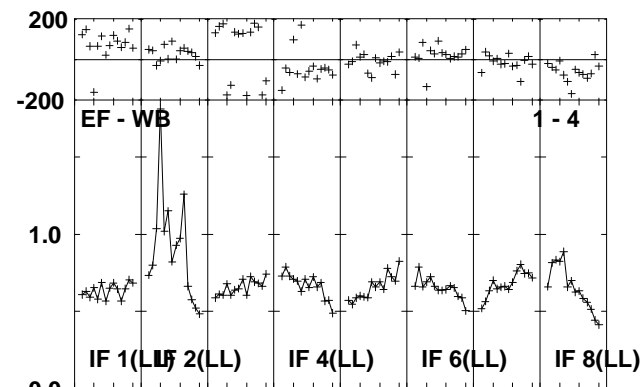
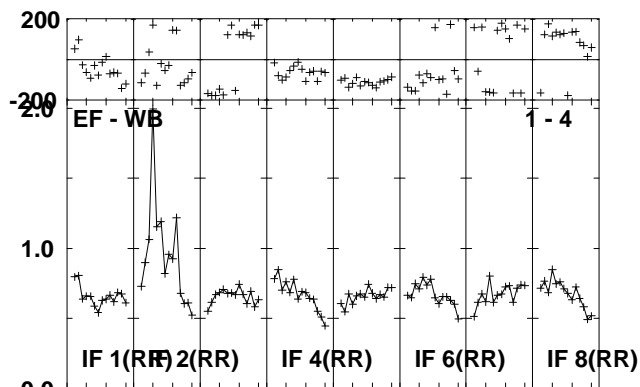
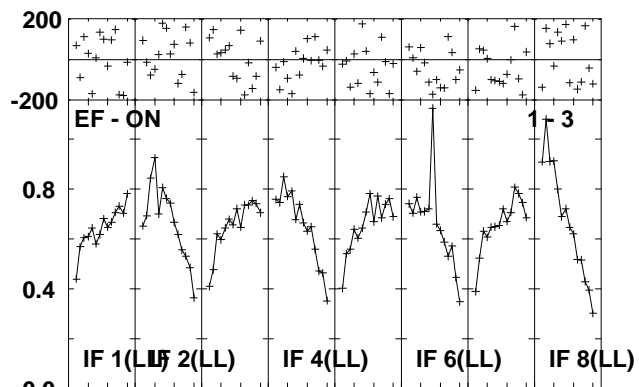
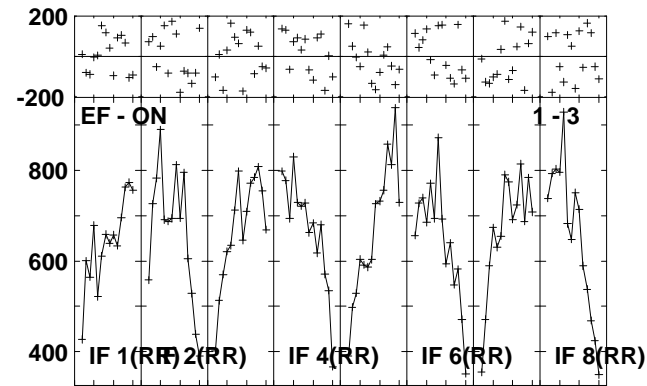
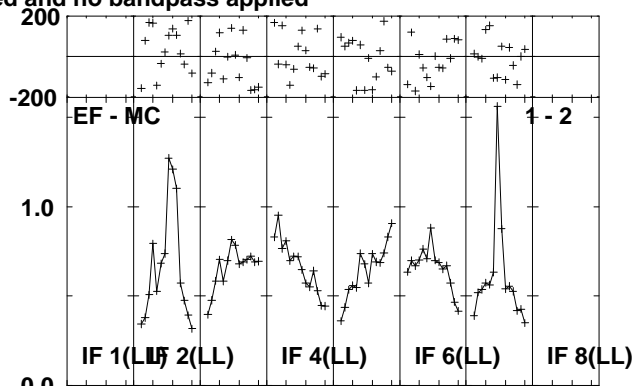
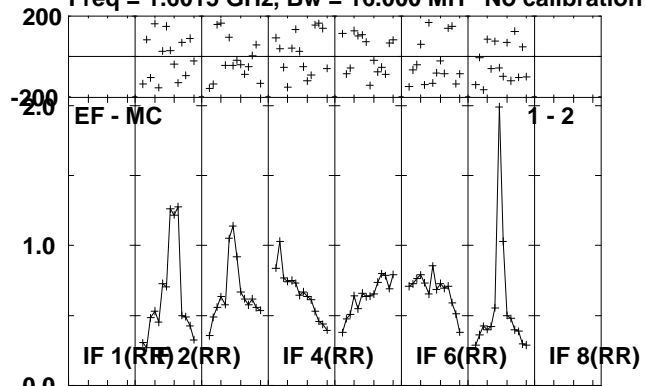

Lower frame: Milli Ampl Jy Top frame: Phas deg
Scalar averaged cross-power spectrum Several baselines displayed
Timerange: 00/22:34:51 to 00/22:39:47

Plot file version 44 created 01-JUL-2010 13:24:34

V407CYG RG006B.UVDATA.1

Freq = 1.6015 GHz, Bw = 16.000 MH No calibration applied and no bandpass applied

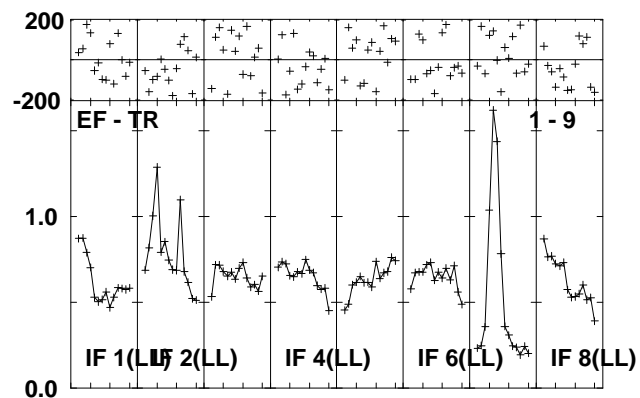
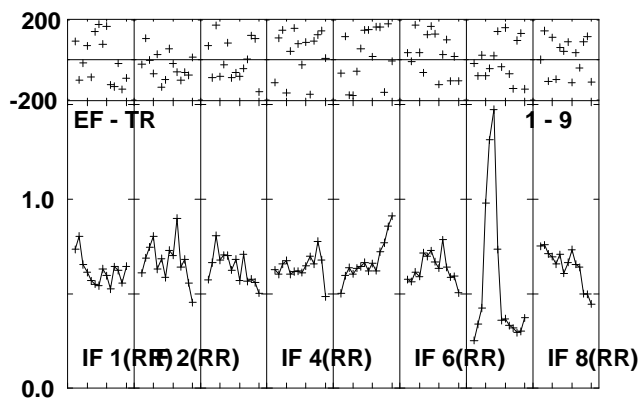
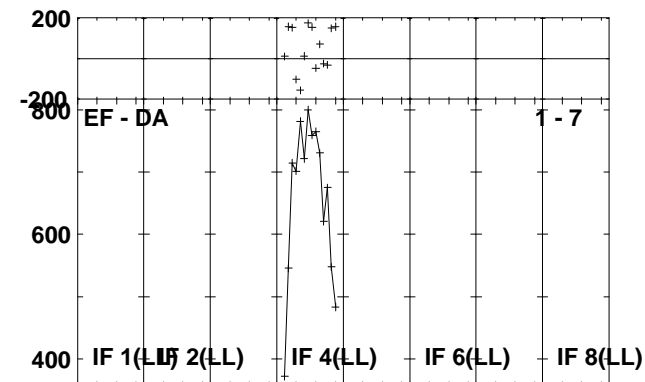
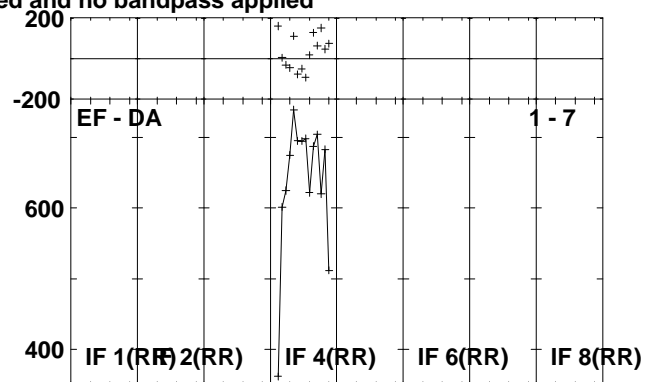
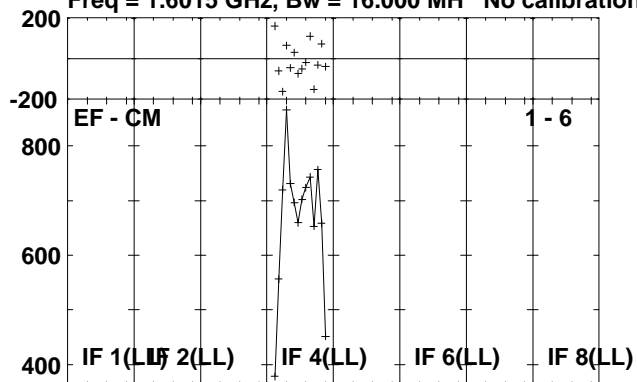

Lower frame: Micro Ampl Jy Top frame: Phas deg
Scalar averaged cross-power spectrum Several baselines displayed
Timerange: 00/22:34:51 to 00/22:39:47

Plot file version 45 created 01-JUL-2010 13:24:35

J2102+47 RG006B.UVDATA.1

Freq = 1.6015 GHz, Bw = 16.000 MH No calibration applied and no bandpass applied

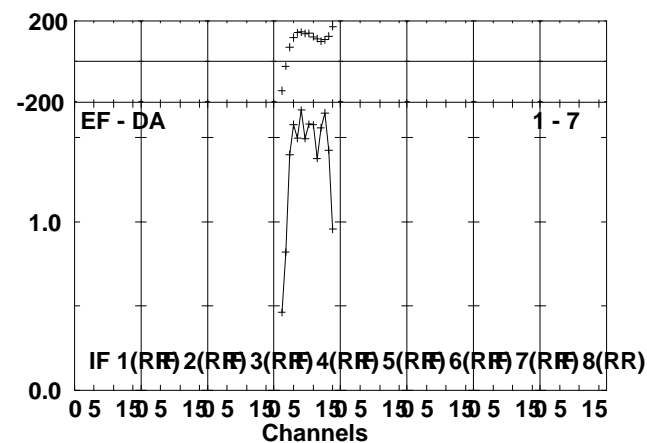
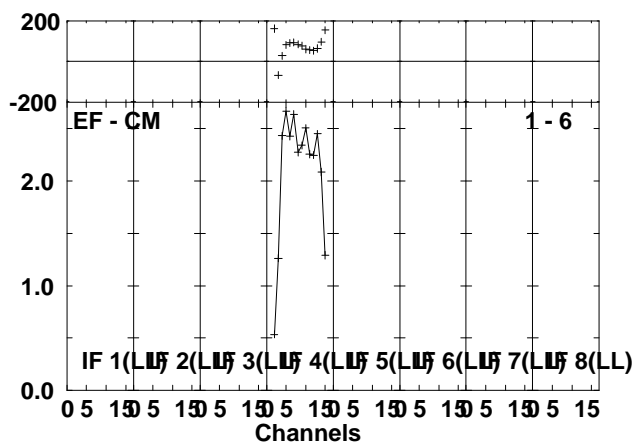
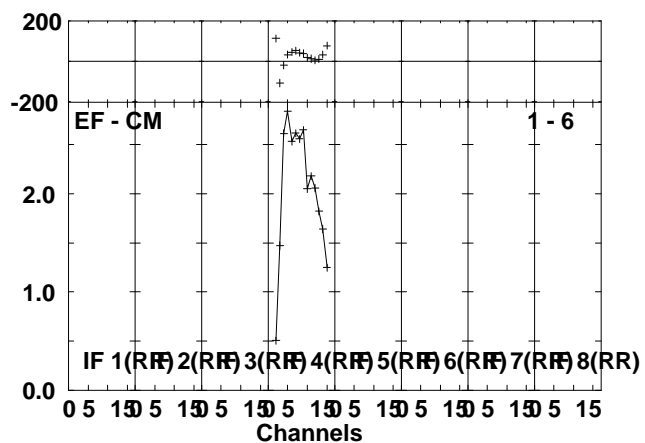
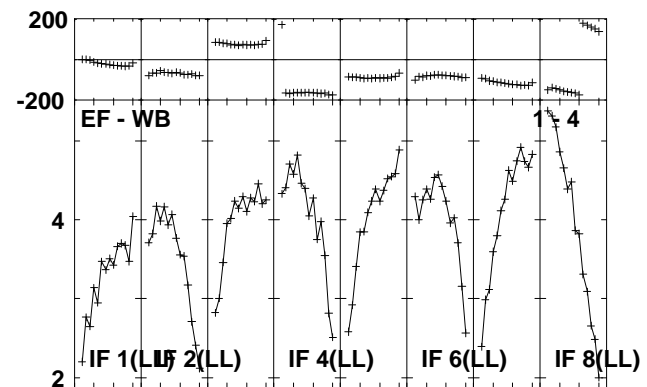
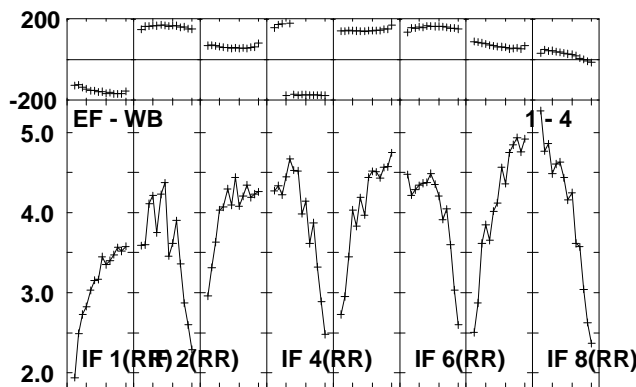
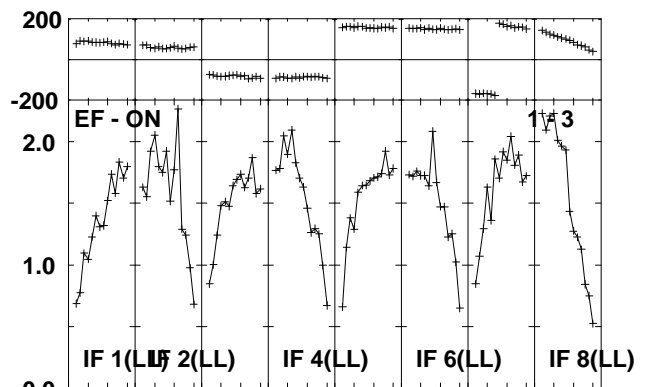
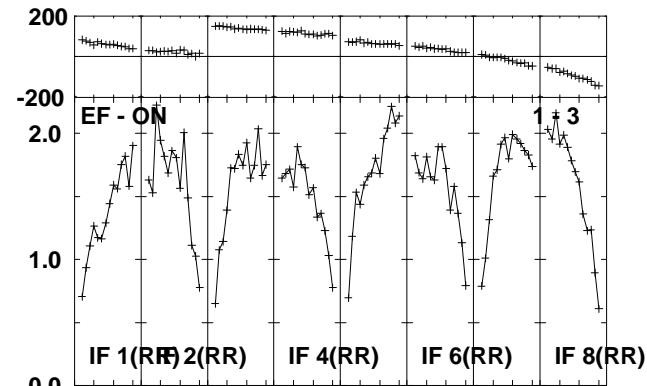
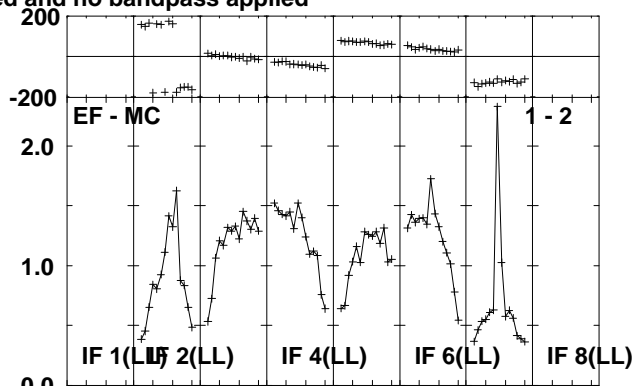
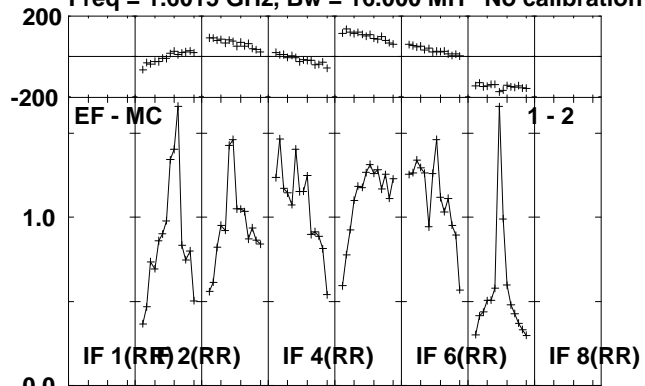

Lower frame: Milli Ampl Jy Top frame: Phas deg
 Scalar averaged cross-power spectrum Several baselines displayed
 Timerange: 00/22:39:51 to 00/22:42:03

Plot file version 46 created 01-JUL-2010 13:24:35
J2102+47 RG006B.UVDATA.1

Freq = 1.6015 GHz, Bw = 16.000 MH No calibration applied and no bandpass applied

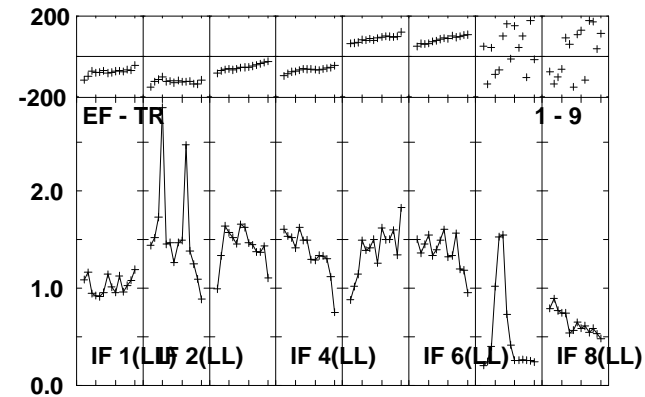
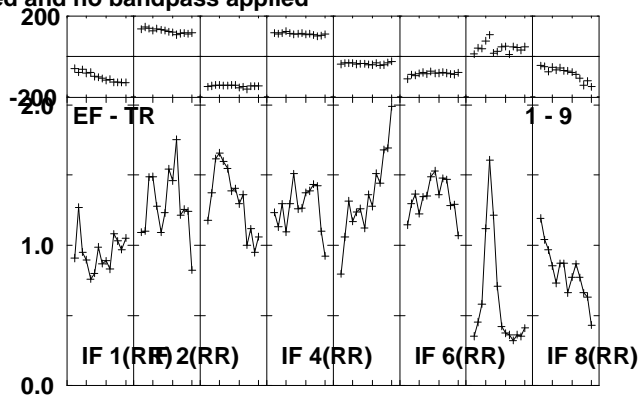
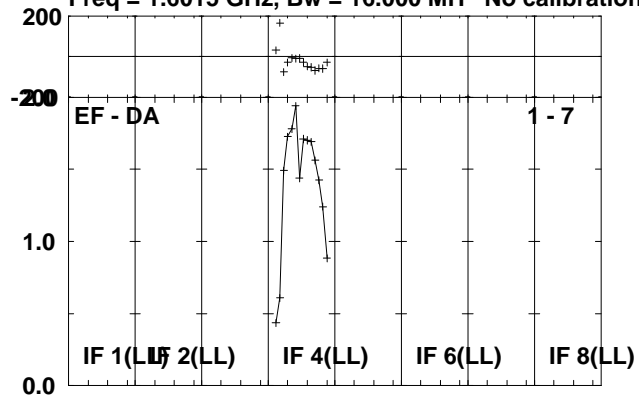

Lower frame: Milli Ampl Jy Top frame: Phas deg
Scalar averaged cross-power spectrum Several baselines displayed
Timerange: 00/22:39:51 to 00/22:42:03

Plot file version 47 created 01-JUL-2010 13:24:35

V407CYG RG006B.UVDATA.1

Freq = 1.6015 GHz, Bw = 16.000 MH No calibration applied and no bandpass applied

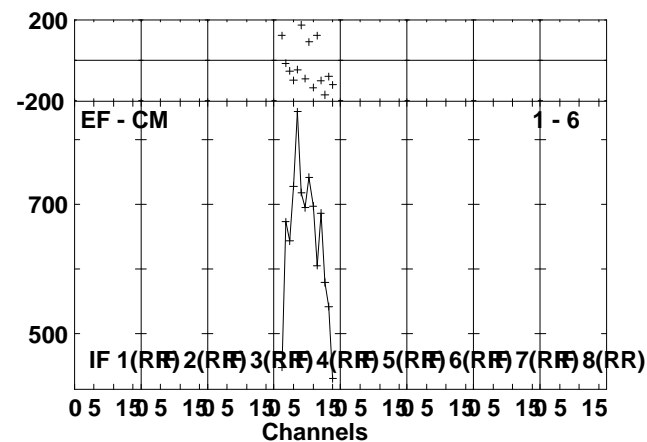
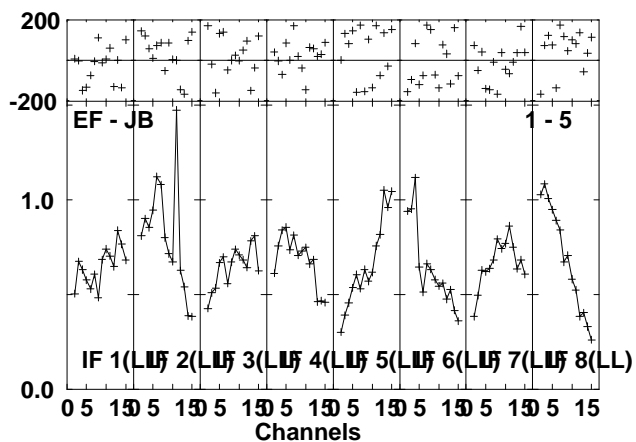
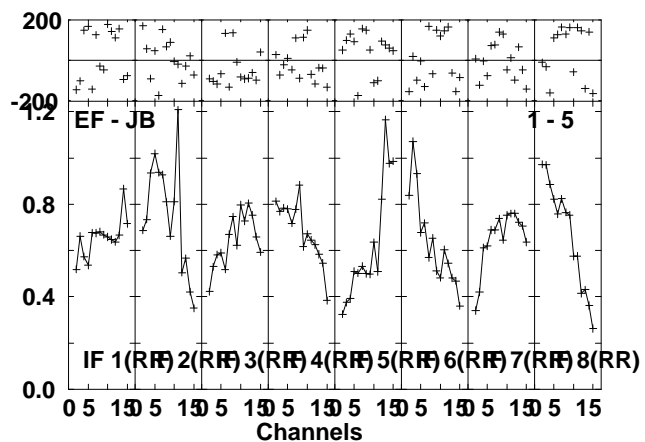
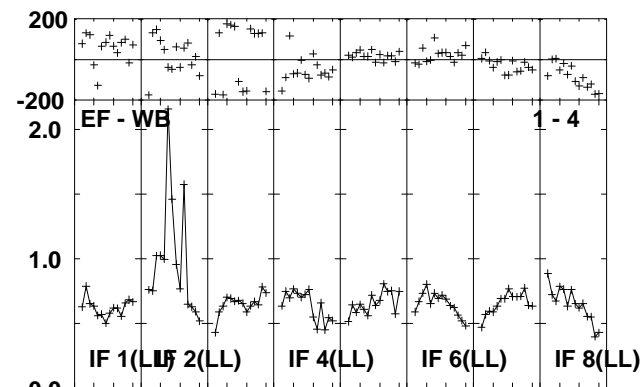
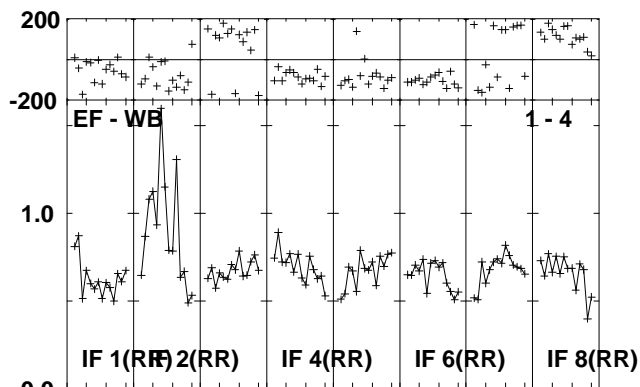
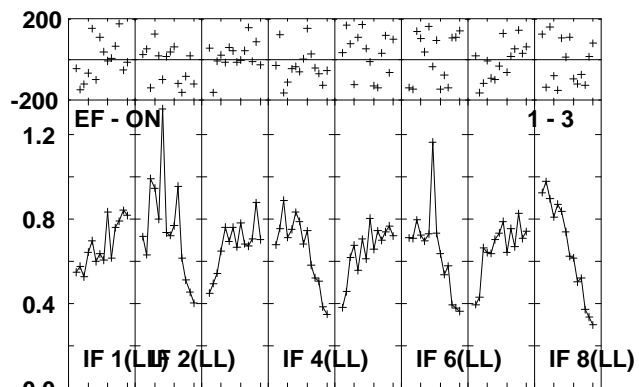
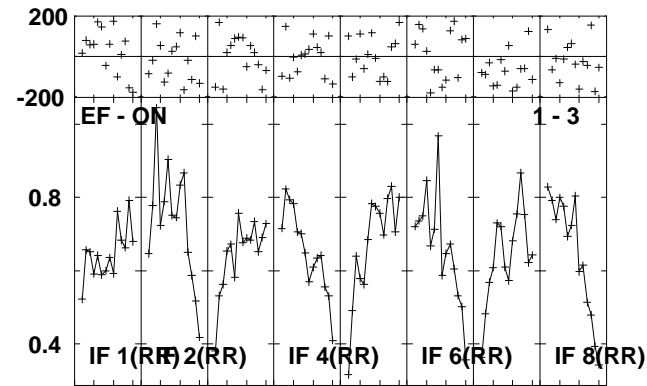
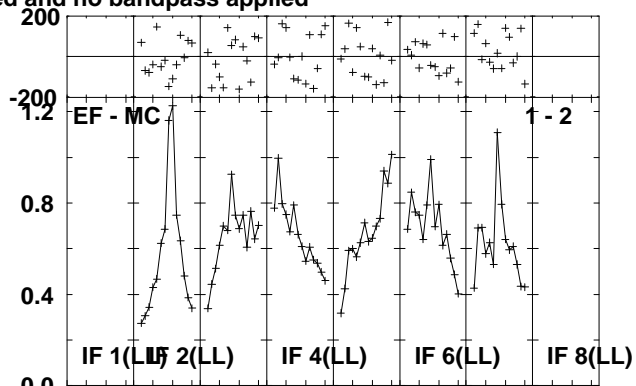
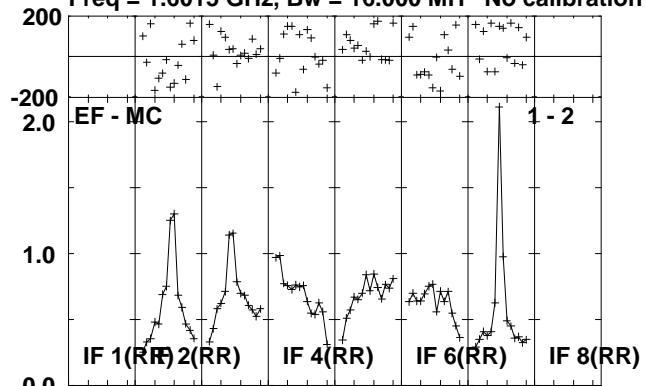

Lower frame: Milli Ampl Jy Top frame: Phas deg
Scalar averaged cross-power spectrum Several baselines displayed
Timerange: 00/22:42:07 to 00/22:44:43

Plot file version 48 created 01-JUL-2010 13:24:36
 V407CYG RG006B.UVDATA.1

Freq = 1.6015 GHz, Bw = 16.000 MH No calibration applied and no bandpass applied

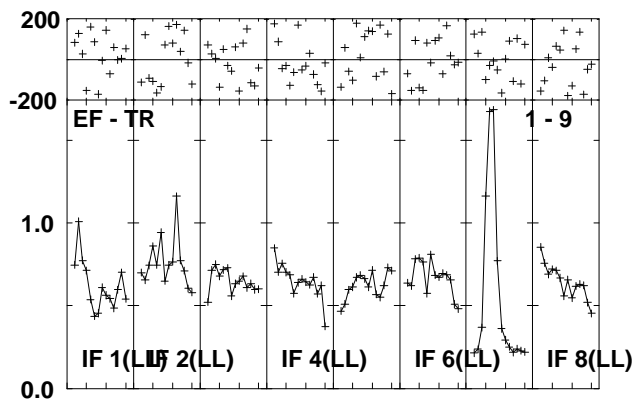
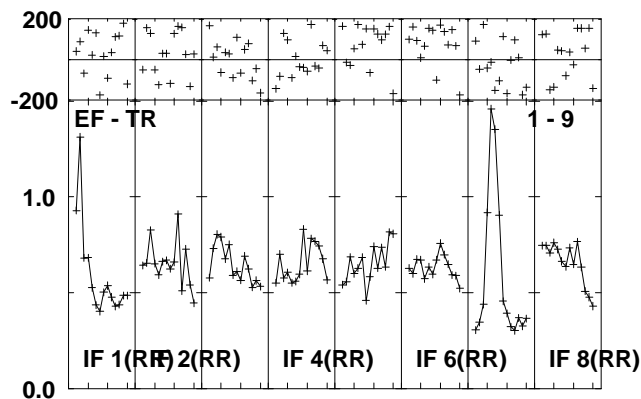
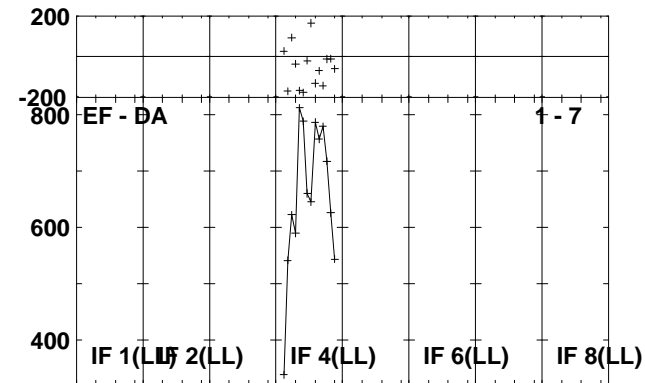
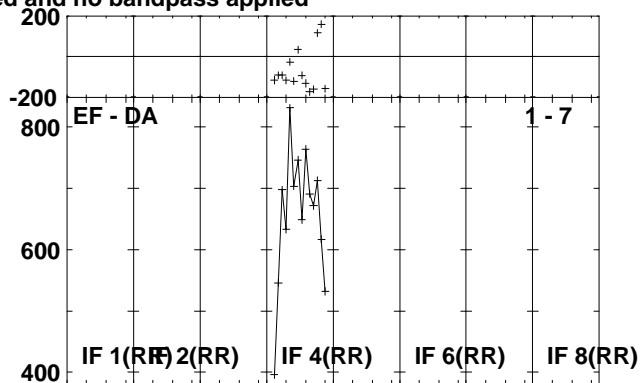
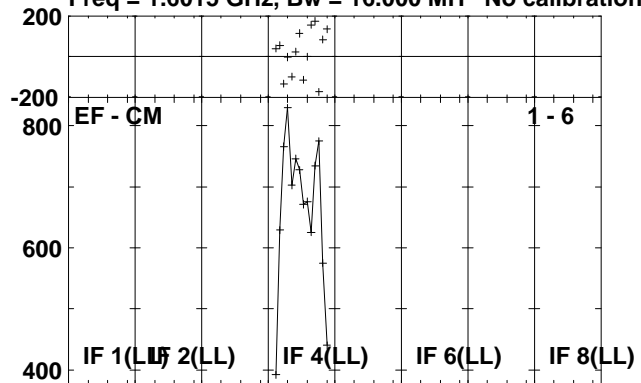

Lower frame: Micro Ampl Jy Top frame: Phas deg
 Scalar averaged cross-power spectrum Several baselines displayed
 Timerange: 00/22:42:07 to 00/22:44:43

Plot file version 49 created 01-JUL-2010 13:24:36

V407CYG RG006B.UVDATA.1

Freq = 1.6015 GHz, Bw = 16.000 MH No calibration applied and no bandpass applied

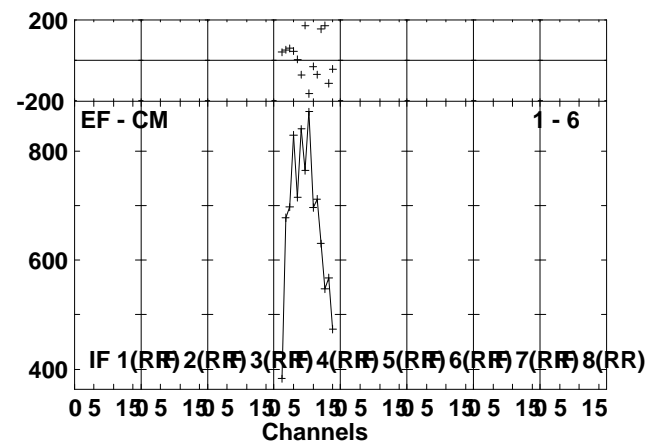
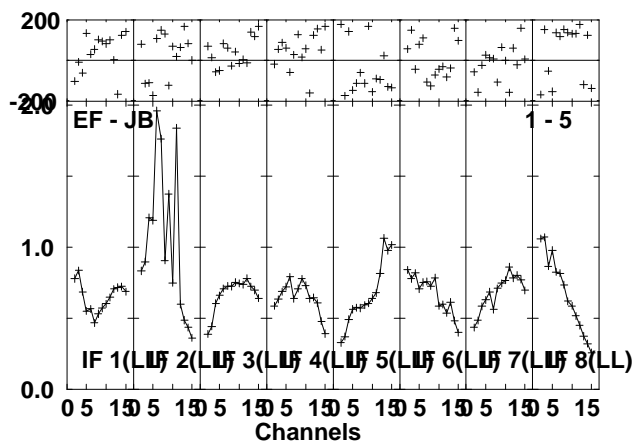
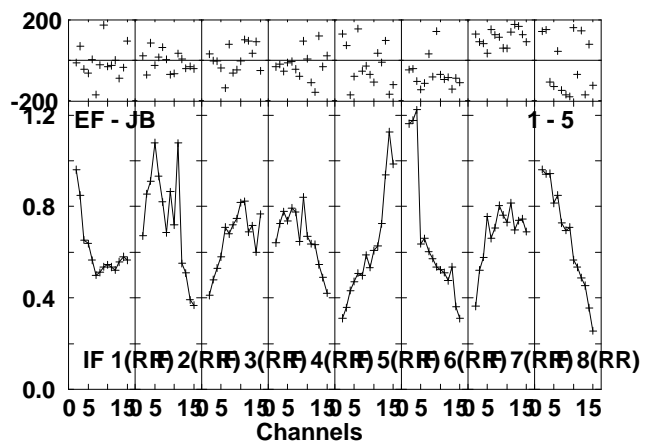
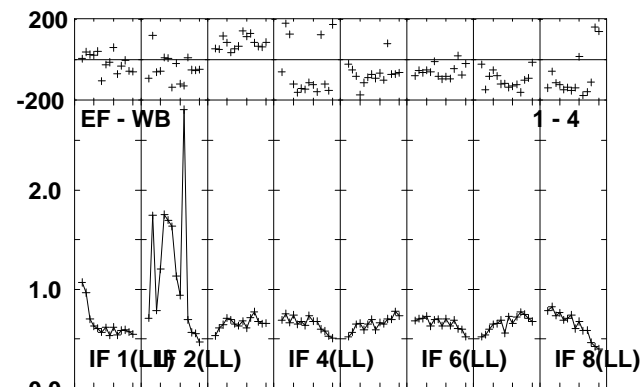
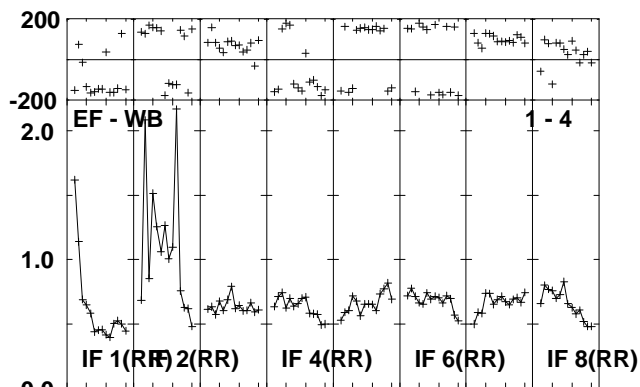
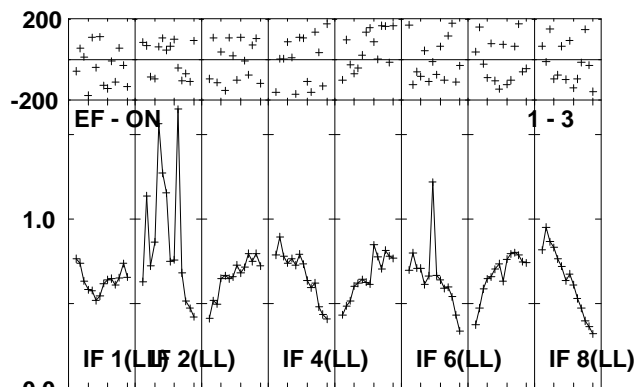
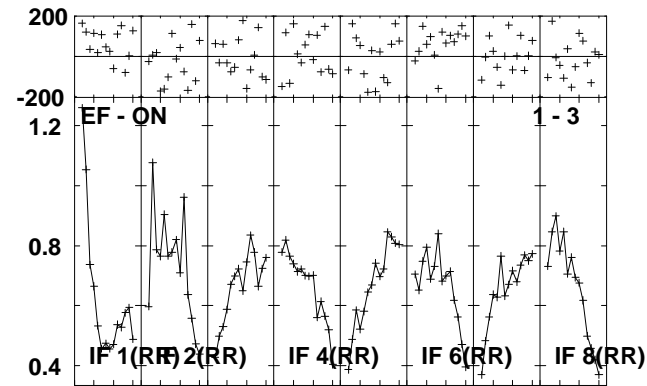
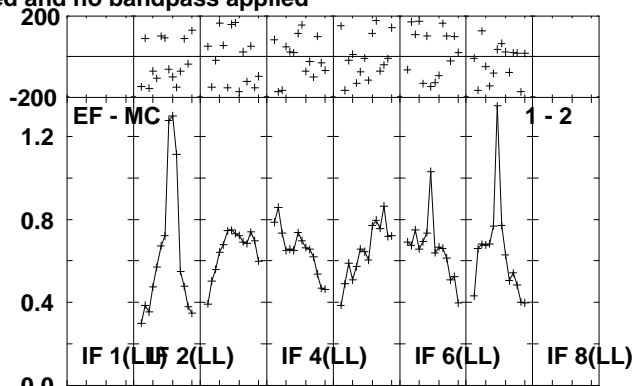
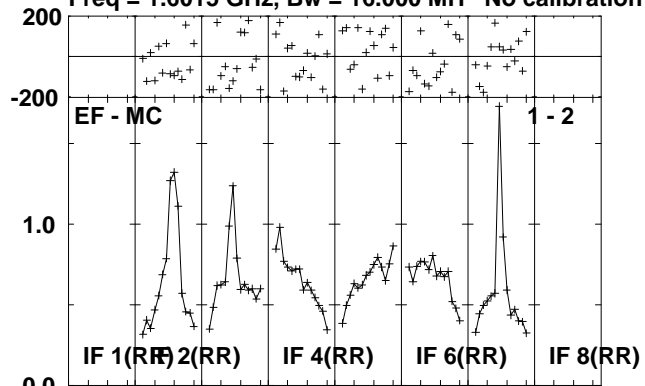

Lower frame: Milli Ampl Jy Top frame: Phas deg
Scalar averaged cross-power spectrum Several baselines displayed
Timerange: 00/22:57:41 to 00/23:02:01

Plot file version 50 created 01-JUL-2010 13:24:37

V407CYG RG006B.UVDATA.1

Freq = 1.6015 GHz, Bw = 16.000 MH No calibration applied and no bandpass applied

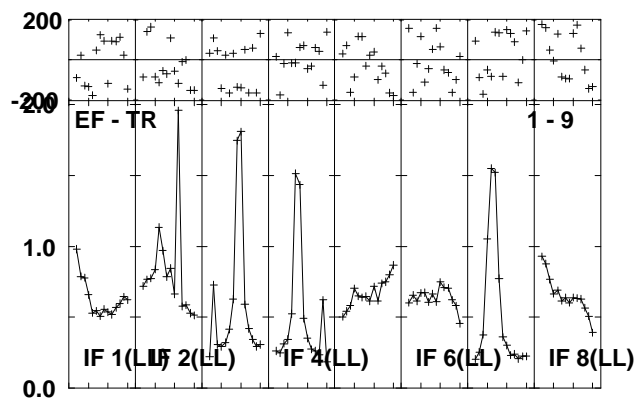
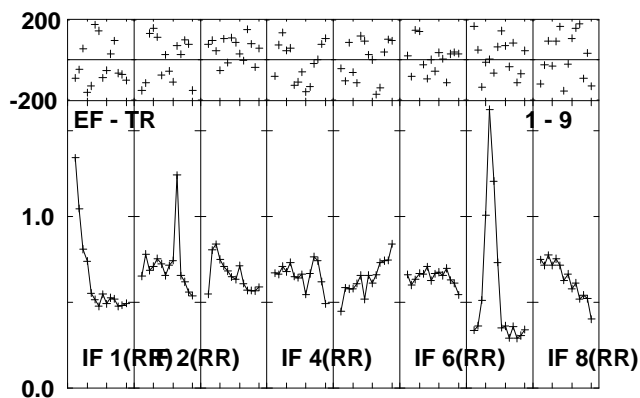
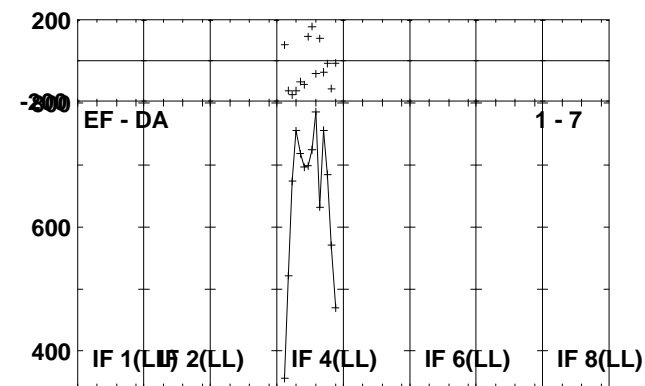
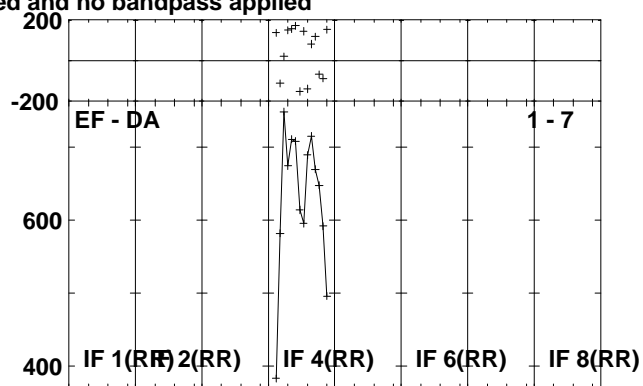
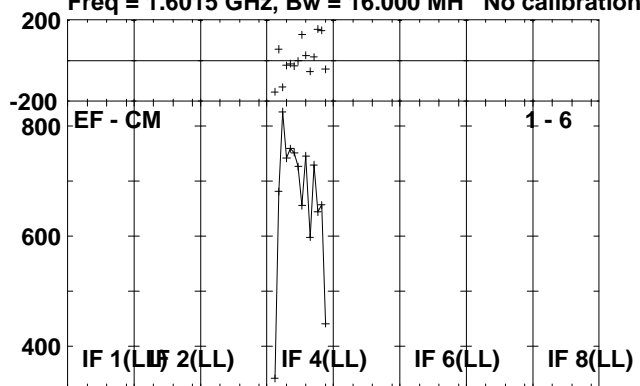

Lower frame: Micro Ampl Jy Top frame: Phas deg
Scalar averaged cross-power spectrum Several baselines displayed
Timerange: 00/22:57:41 to 00/23:02:01

Plot file version 51 created 01-JUL-2010 13:24:38

J2102+47 RG006B.UVDATA.1

Freq = 1.6015 GHz, Bw = 16.000 MH No calibration applied and no bandpass applied

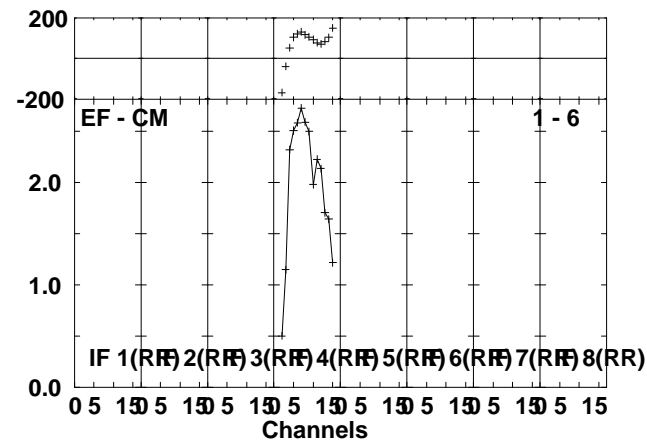
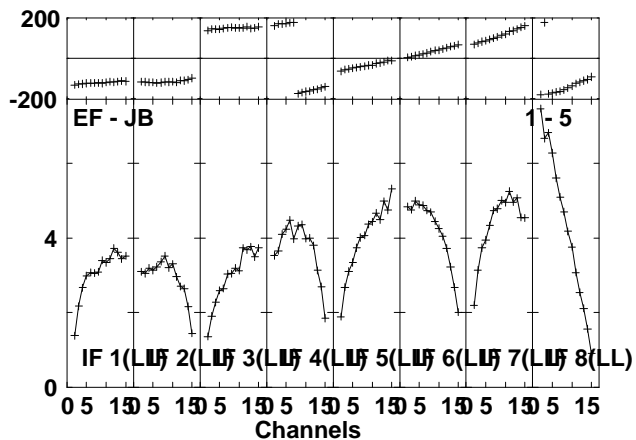
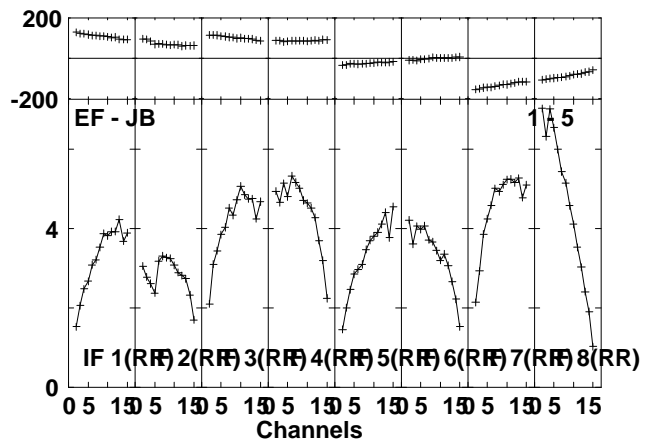
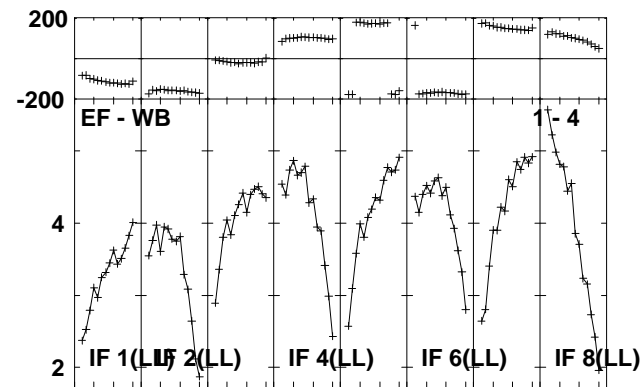
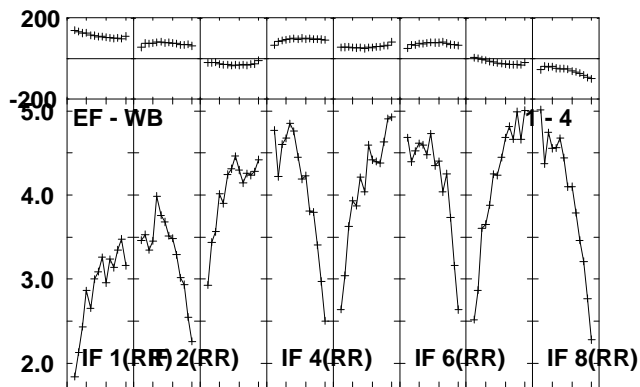
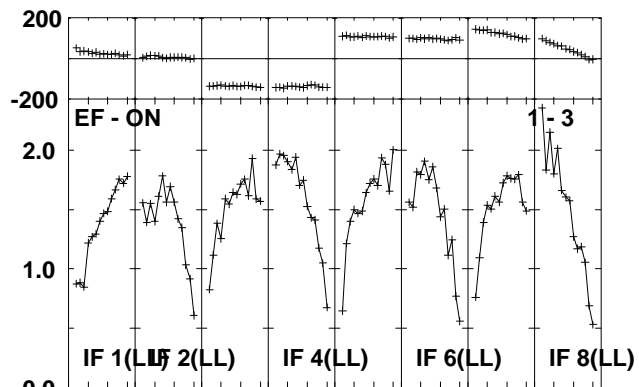
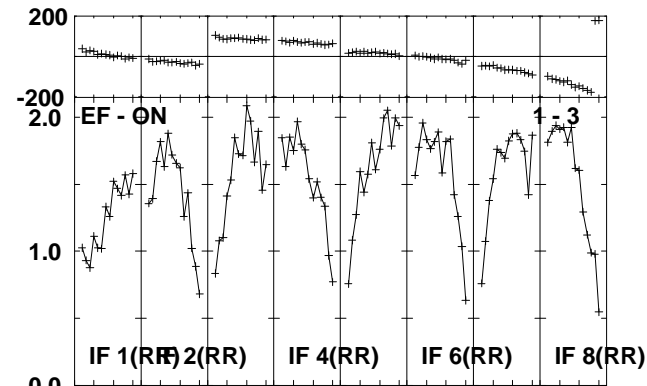
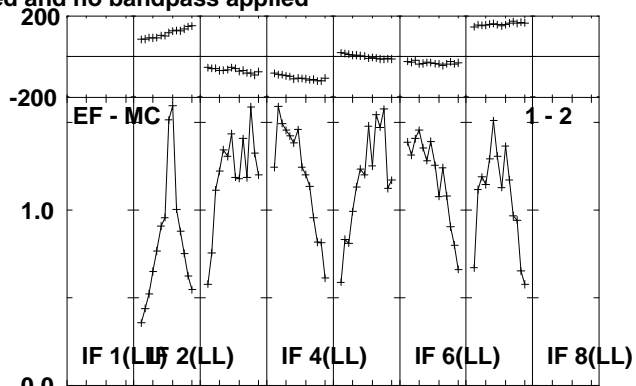
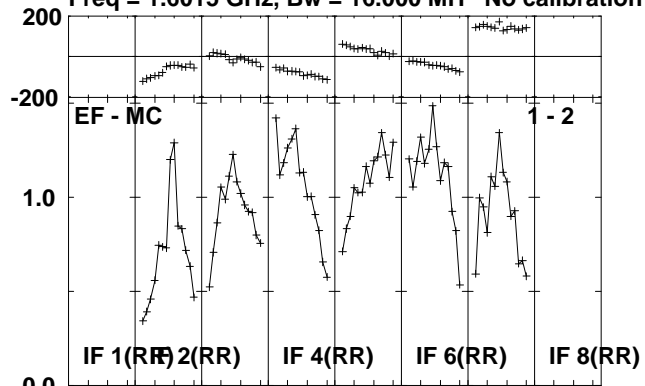

Lower frame: Milli Ampl Jy Top frame: Phas deg
Scalar averaged cross-power spectrum Several baselines displayed
Timerange: 00/23:03:05 to 00/23:04:49

Plot file version 52 created 01-JUL-2010 13:24:38
J2102+47 RG006B.UVDATA.1

Freq = 1.6015 GHz, Bw = 16.000 MH No calibration applied and no bandpass applied

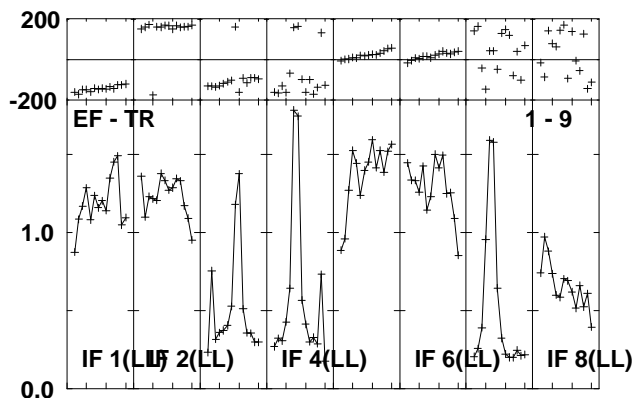
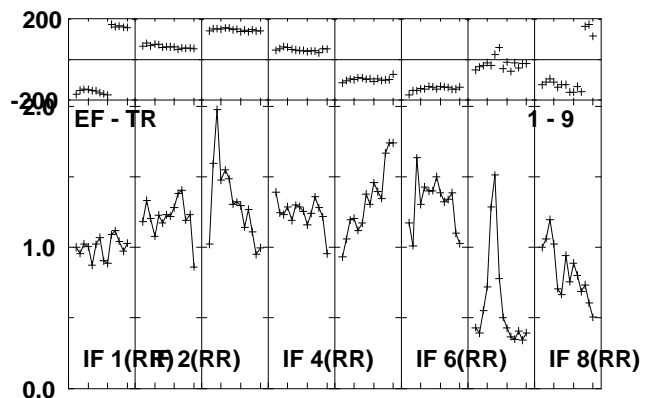
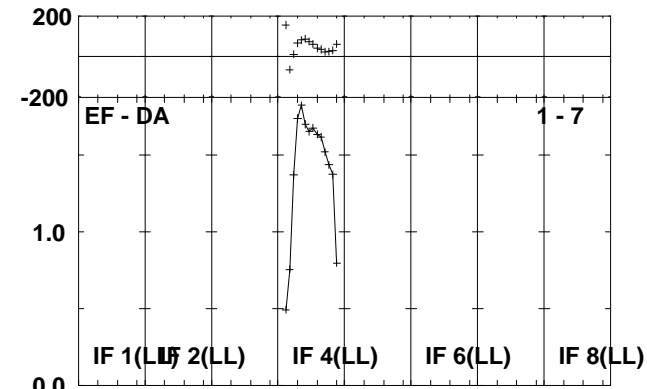
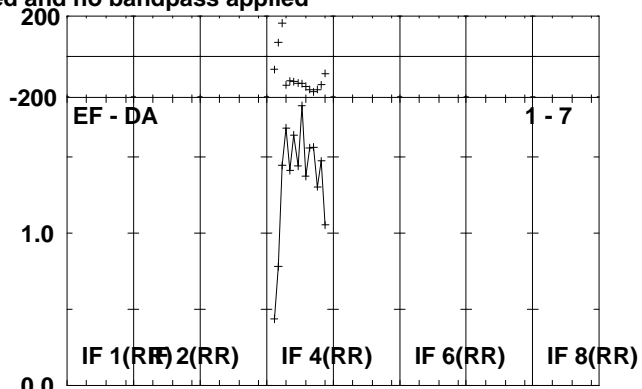
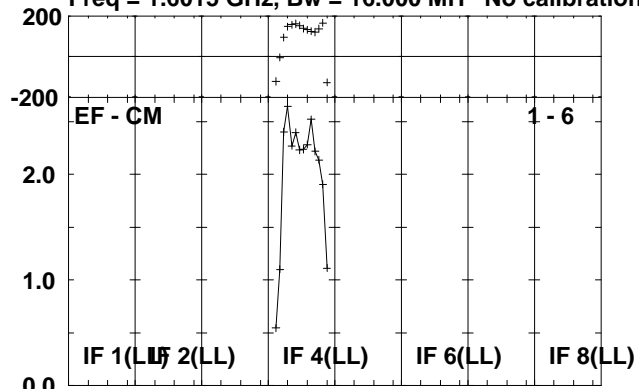

Lower frame: Milli Ampl Jy Top frame: Phas deg
Scalar averaged cross-power spectrum Several baselines displayed
Timerange: 00/23:03:05 to 00/23:04:49

Plot file version 53 created 01-JUL-2010 13:24:39

V407CYG RG006B.UVDATA.1

Freq = 1.6015 GHz, Bw = 16.000 MH No calibration applied and no bandpass applied

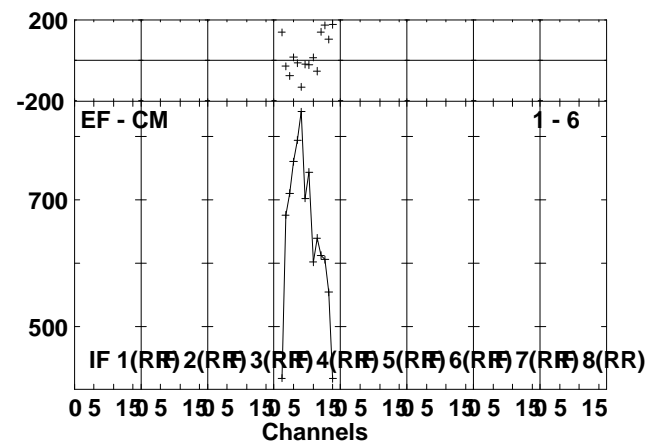
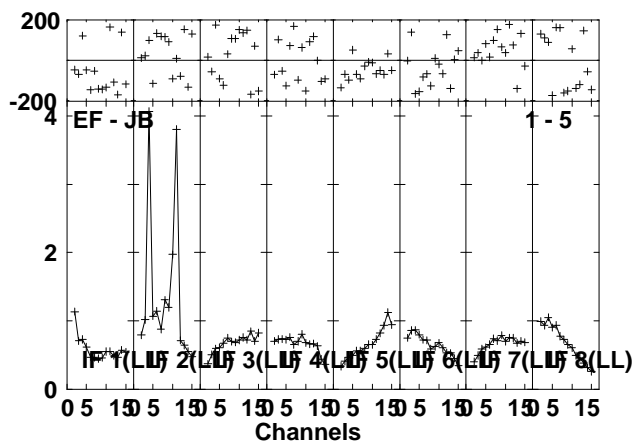
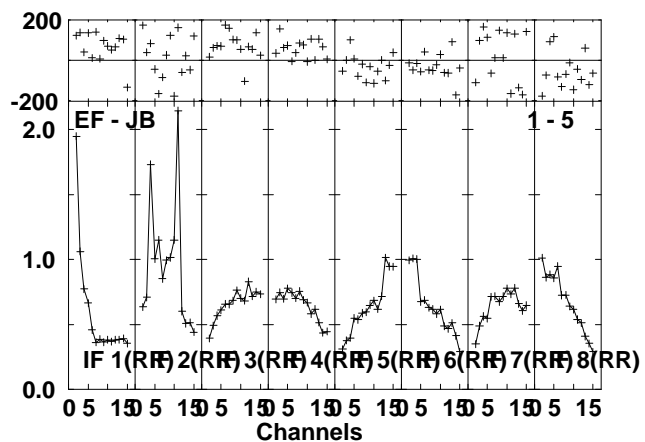
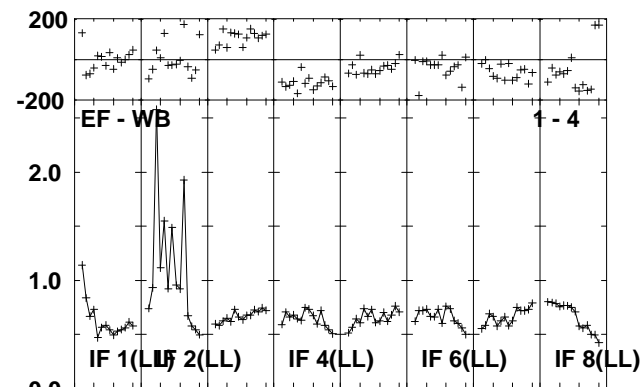
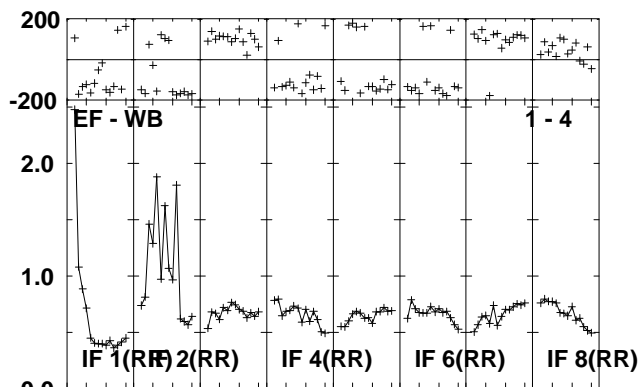
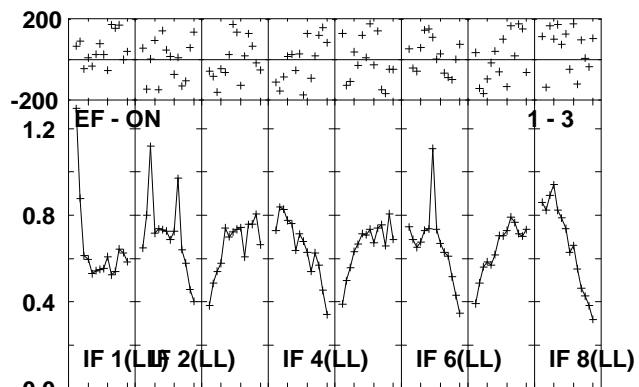
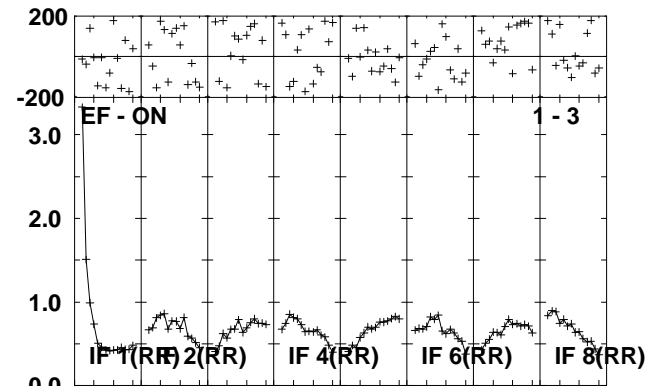
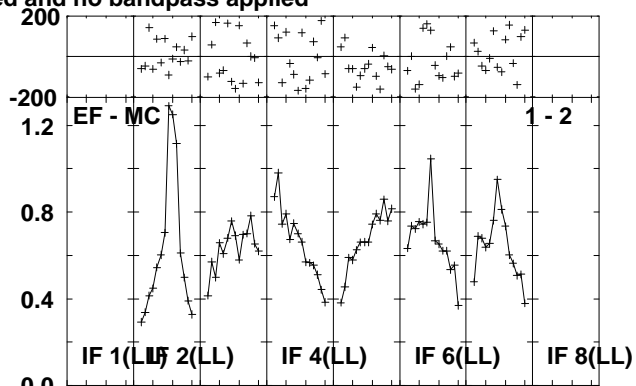
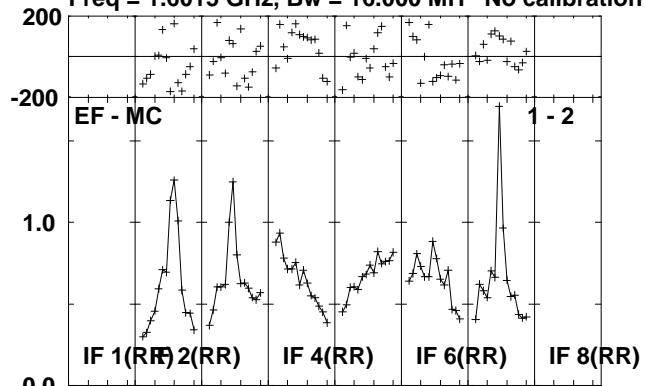

Lower frame: Milli Ampl Jy Top frame: Phas deg
Scalar averaged cross-power spectrum Several baselines displayed
Timerange: 00/23:04:53 to 00/23:09:49

Plot file version 54 created 01-JUL-2010 13:24:40
V407CYG RG006B.UVDATA.1

Freq = 1.6015 GHz, Bw = 16.000 MH No calibration applied and no bandpass applied

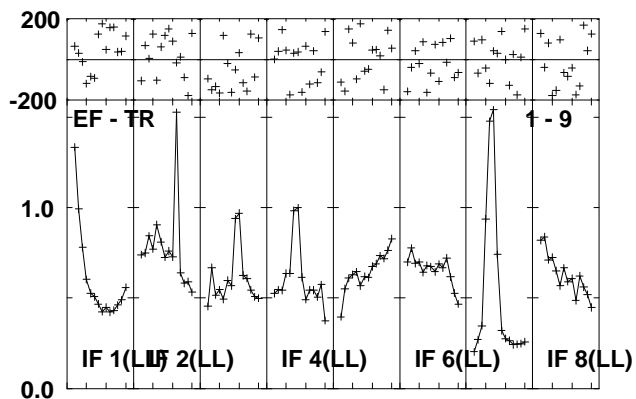
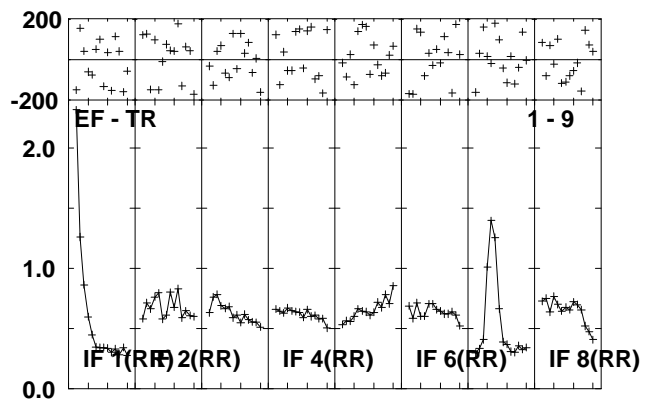
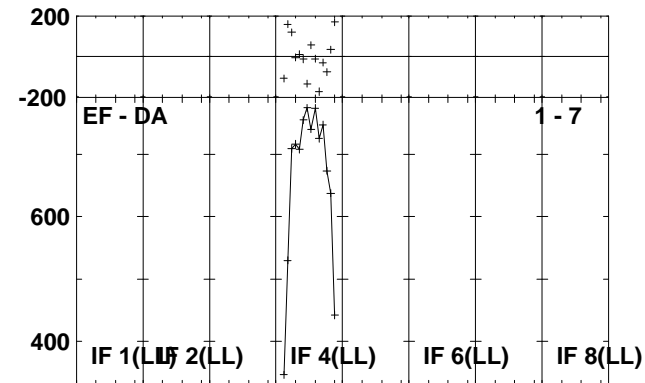
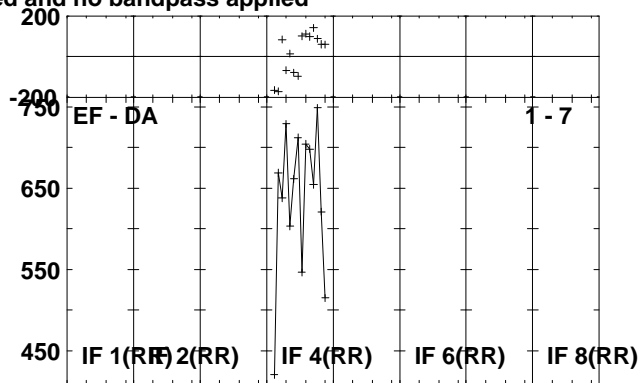
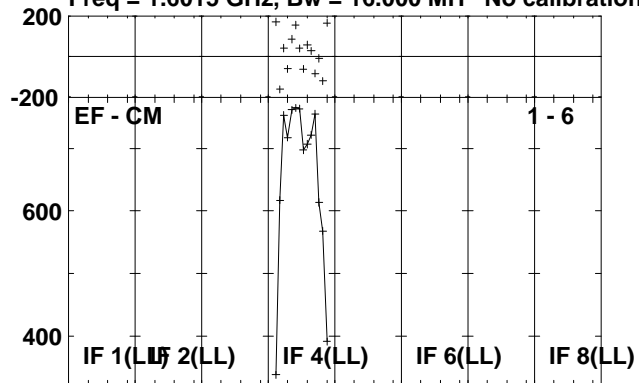

Lower frame: Micro Ampl Jy Top frame: Phas deg
Scalar averaged cross-power spectrum Several baselines displayed
Timerange: 00/23:04:53 to 00/23:09:49

Plot file version 55 created 01-JUL-2010 13:24:41

J2102+47 RG006B.UVDATA.1

Freq = 1.6015 GHz, Bw = 16.000 MH No calibration applied and no bandpass applied

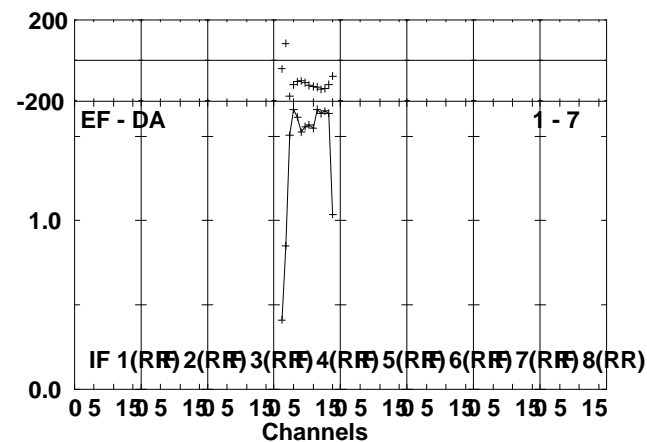
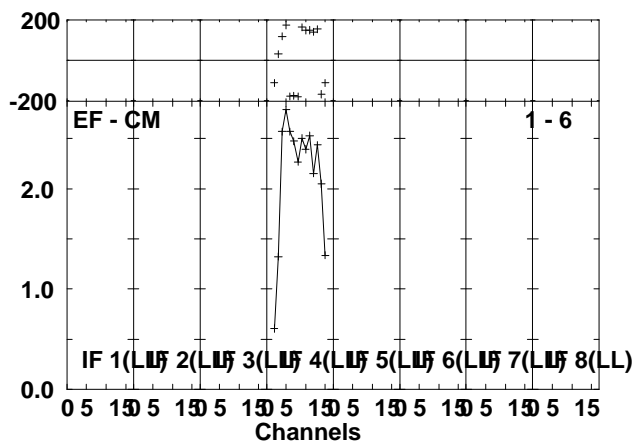
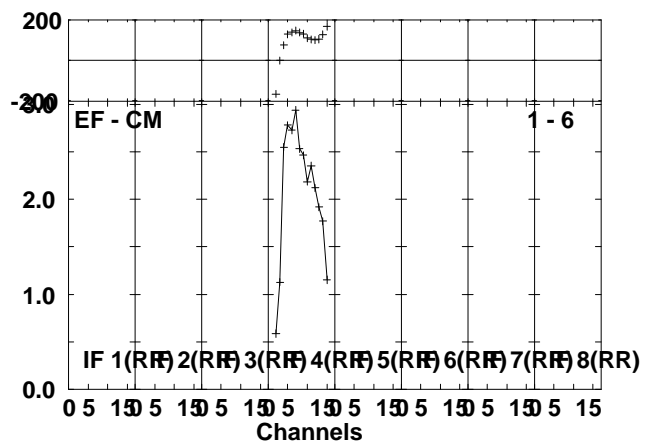
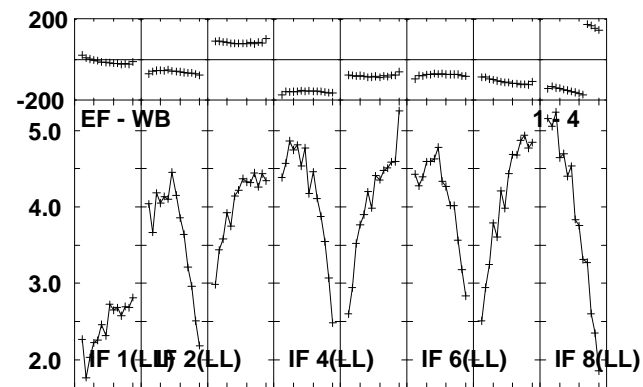
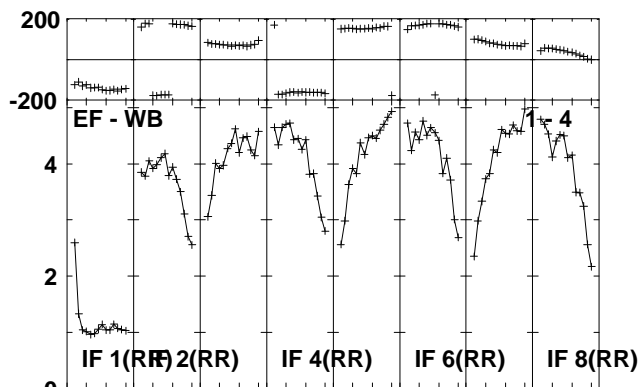
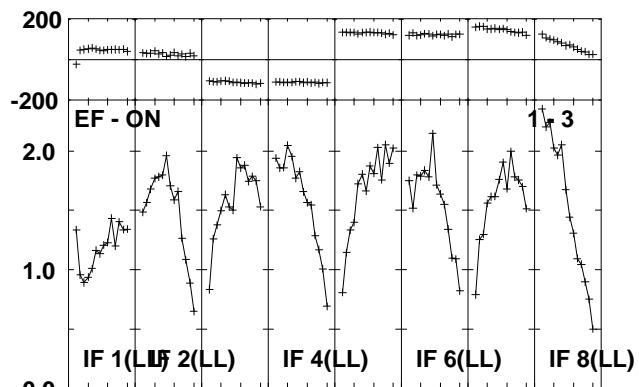
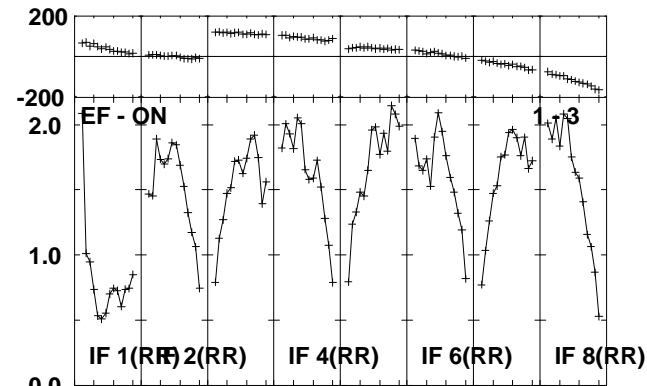
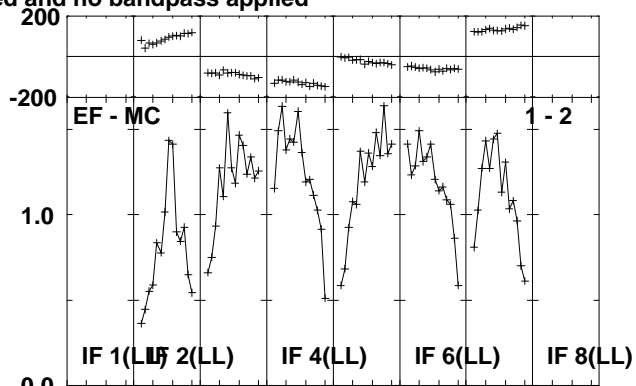
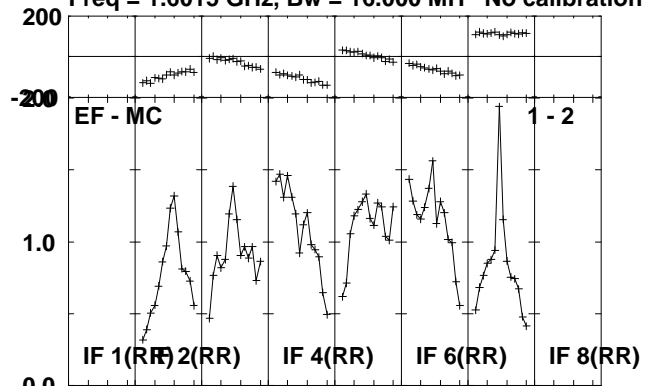

Lower frame: Milli Ampl Jy Top frame: Phas deg
Scalar averaged cross-power spectrum Several baselines displayed
Timerange: 00/23:09:53 to 00/23:12:01

Plot file version 56 created 01-JUL-2010 13:24:41
J2102+47 RG006B.UVDATA.1

Freq = 1.6015 GHz, Bw = 16.000 MH No calibration applied and no bandpass applied

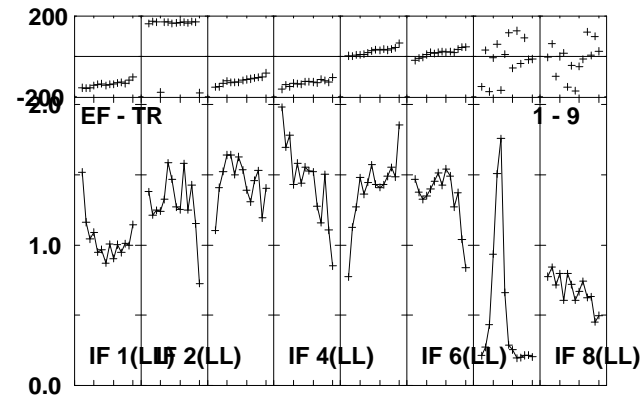
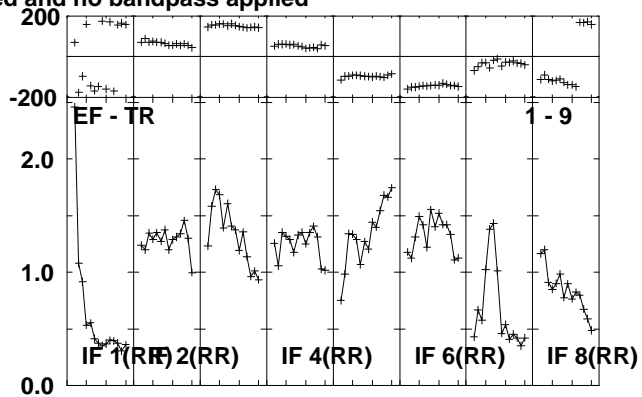
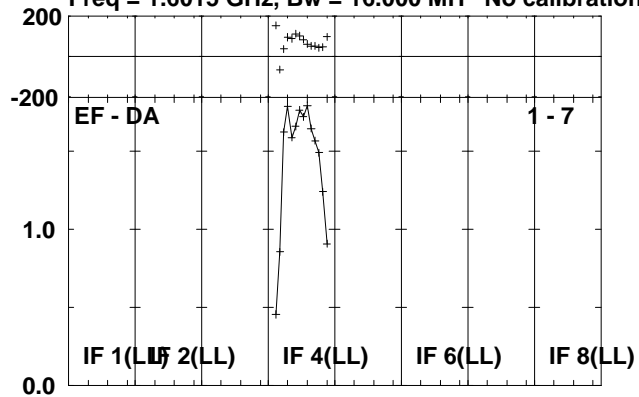

Lower frame: Milli Ampl Jy Top frame: Phas deg
Scalar averaged cross-power spectrum Several baselines displayed
Timerange: 00/23:09:53 to 00/23:12:01

Plot file version 57 created 01-JUL-2010 13:24:41
 V407CYG RG006B.UVDATA.1

Freq = 1.6015 GHz, Bw = 16.000 MH No calibration applied and no bandpass applied

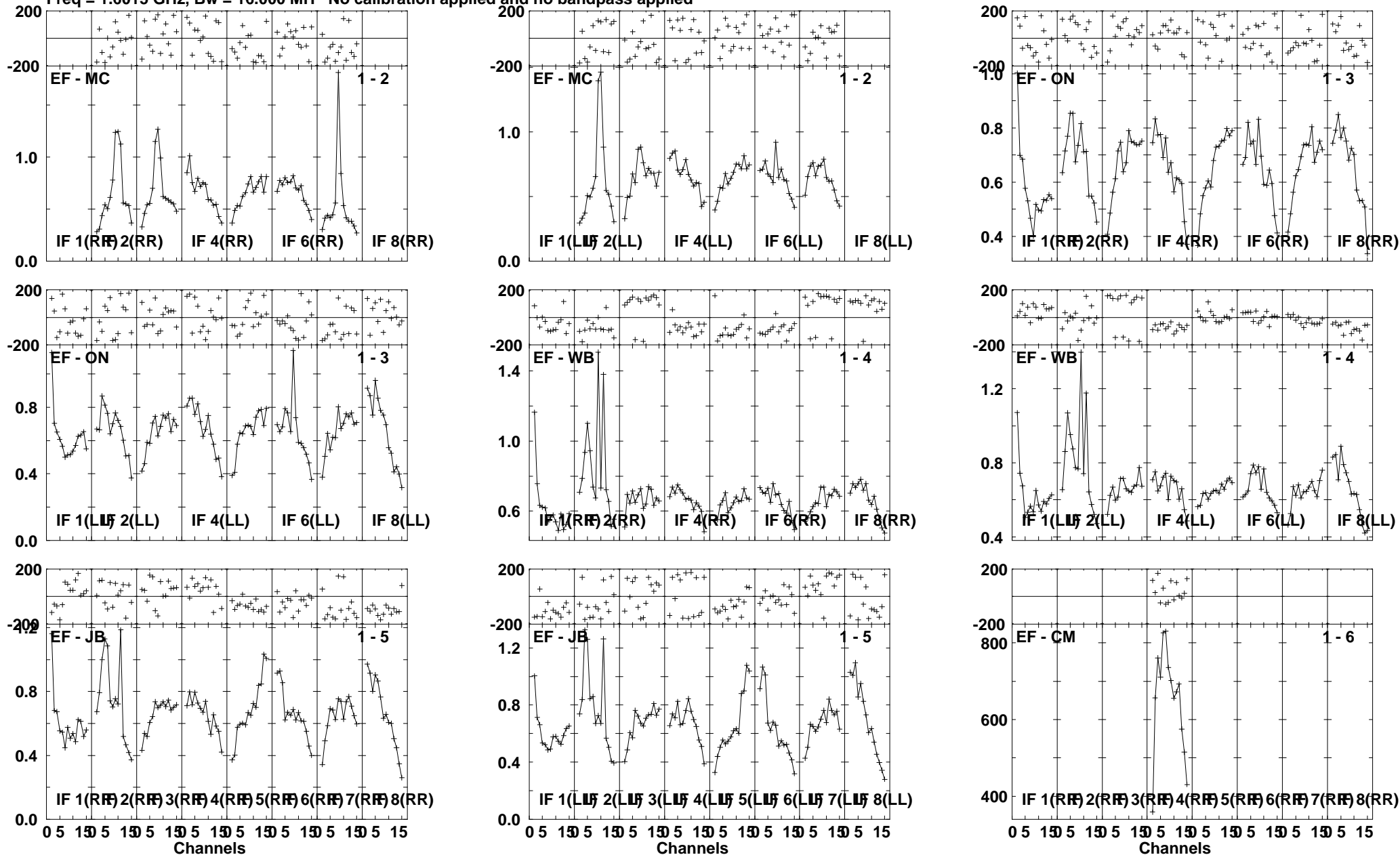

Lower frame: Milli Ampl Jy Top frame: Phas deg
 Scalar averaged cross-power spectrum Several baselines displayed
 Timerange: 00/23:12:05 to 00/23:17:01

Plot file version 58 created 01-JUL-2010 13:24:42
V407CYG RG006B.UVDATA.1

Freq = 1.6015 GHz, Bw = 16.000 MH No calibration applied and no bandpass applied

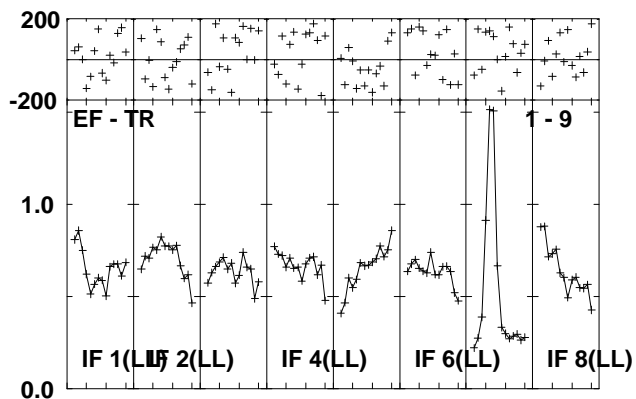
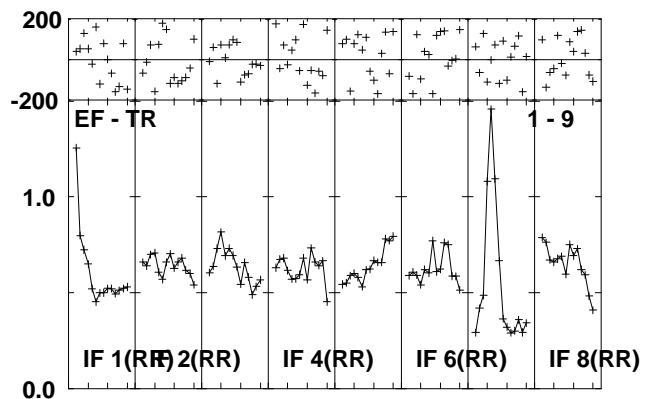
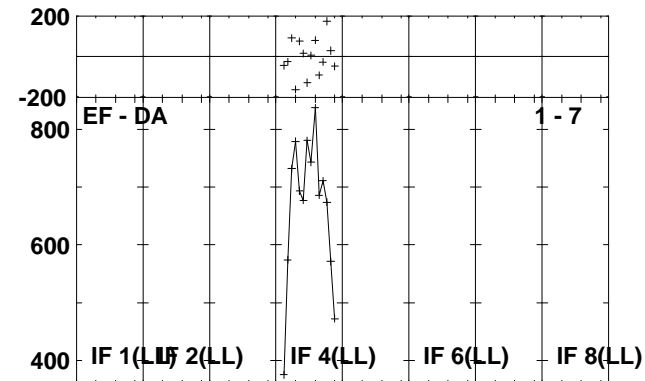
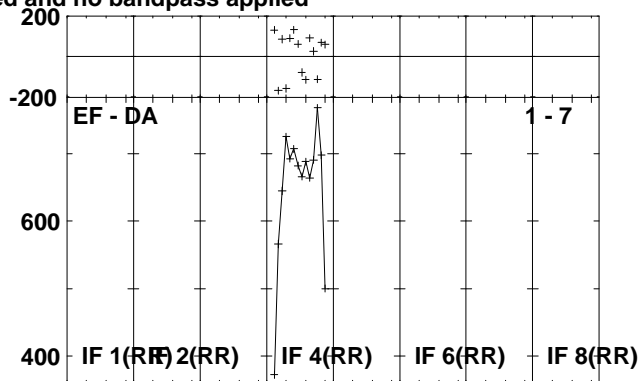
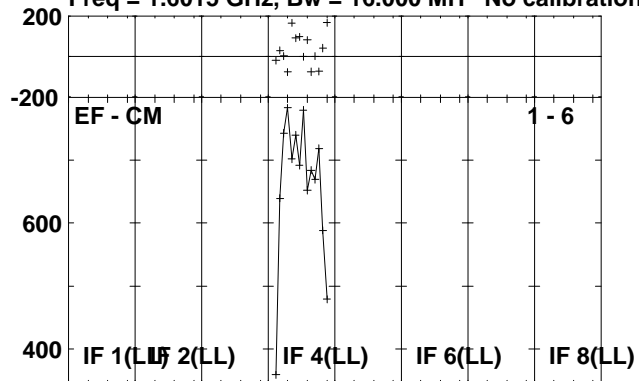

Lower frame: Micro Ampl Jy Top frame: Phas deg
Scalar averaged cross-power spectrum Several baselines displayed
Timerange: 00/23:12:05 to 00/23:17:01

Plot file version 59 created 01-JUL-2010 13:24:43

J2102+47 RG006B.UVDATA.1

Freq = 1.6015 GHz, Bw = 16.000 MH No calibration applied and no bandpass applied

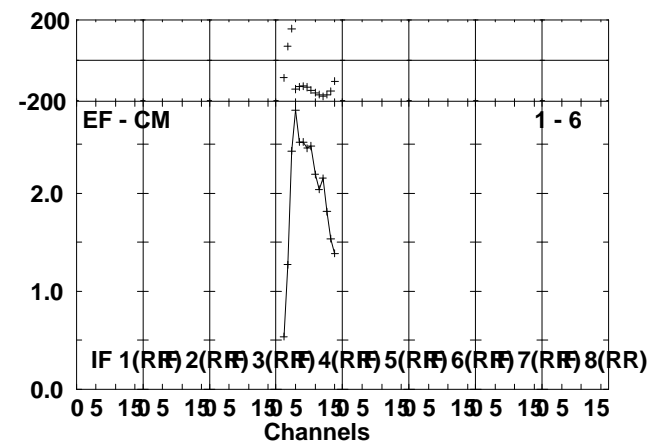
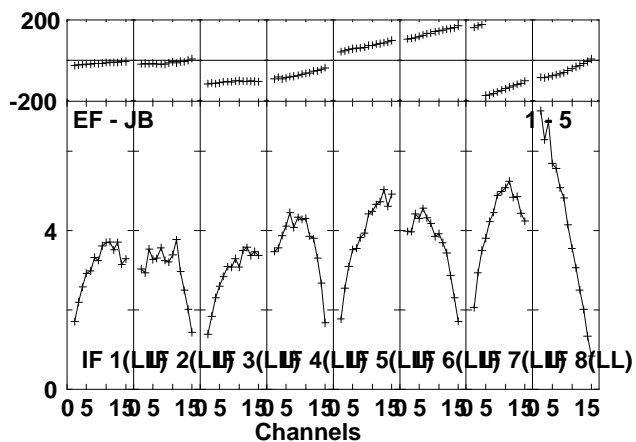
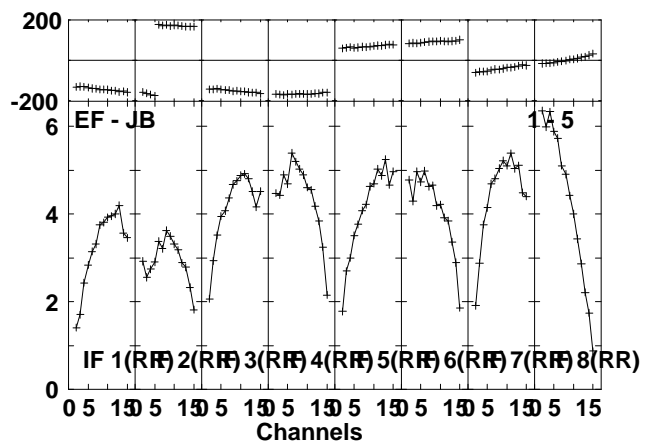
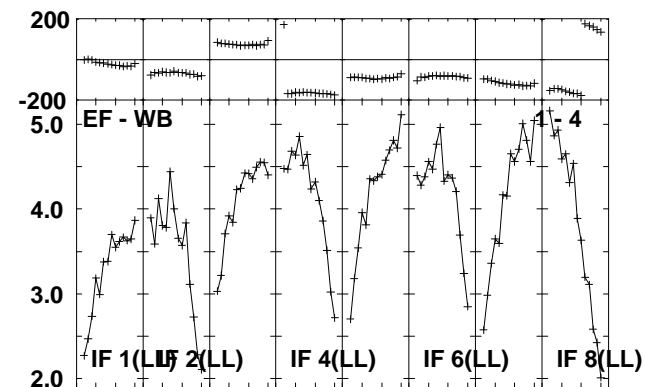
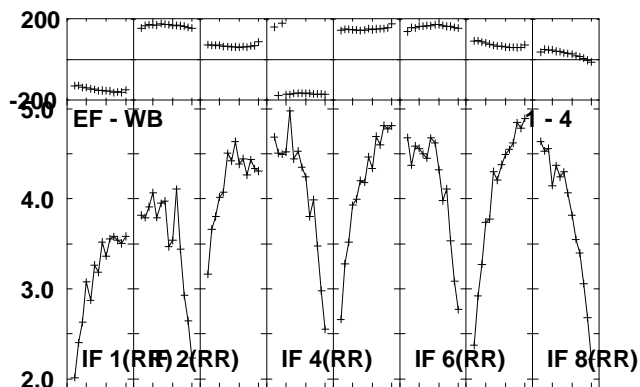
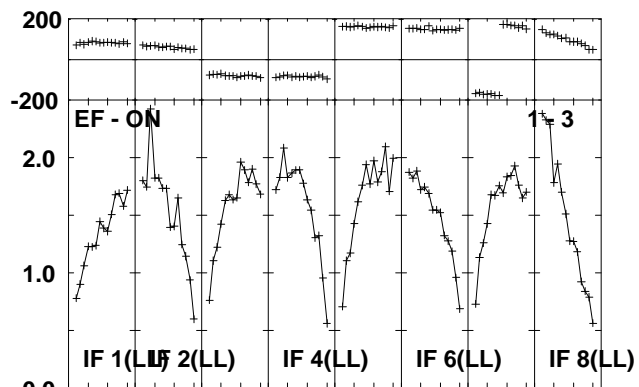
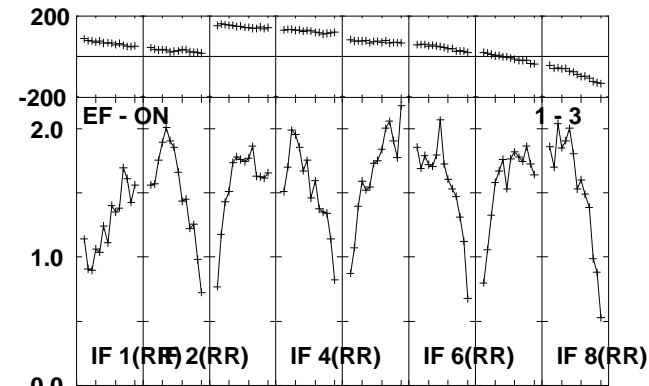
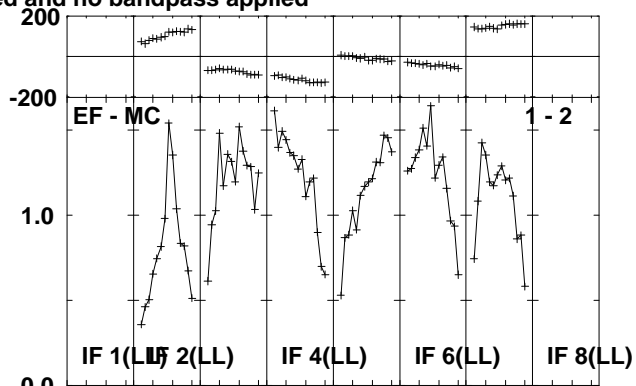
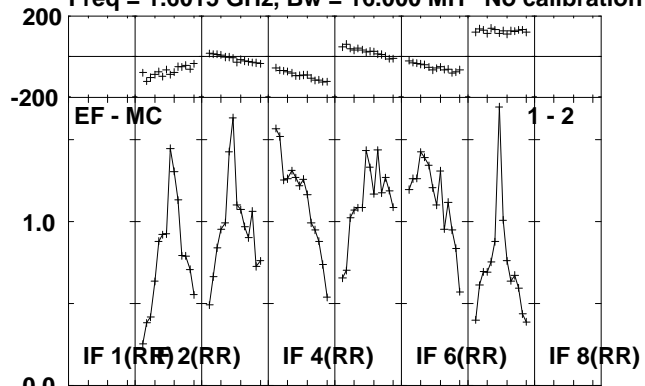

Lower frame: Milli Ampl Jy Top frame: Phas deg
Scalar averaged cross-power spectrum Several baselines displayed
Timerange: 00/23:18:05 to 00/23:19:49

Plot file version 60 created 01-JUL-2010 13:24:43
J2102+47 RG006B.UVDATA.1

Freq = 1.6015 GHz, Bw = 16.000 MH No calibration applied and no bandpass applied

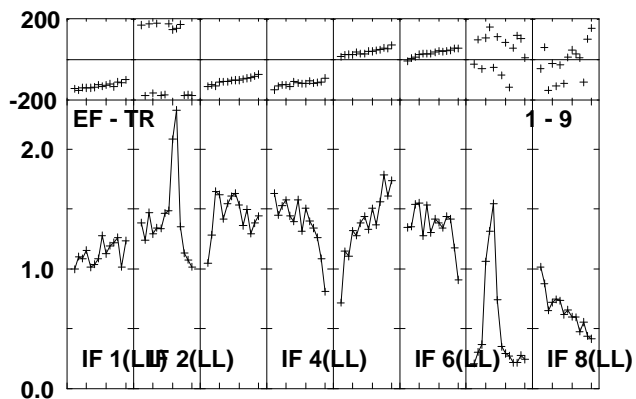
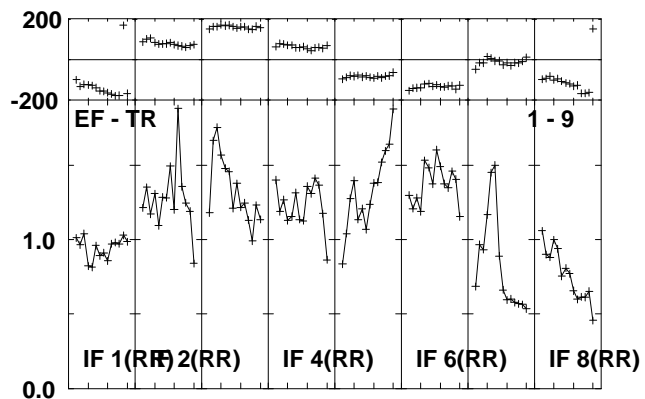
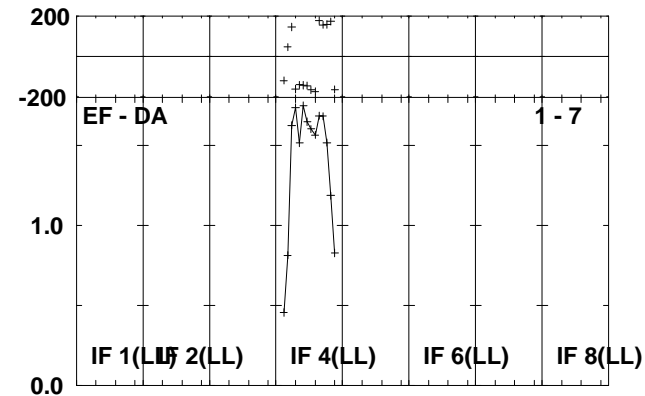
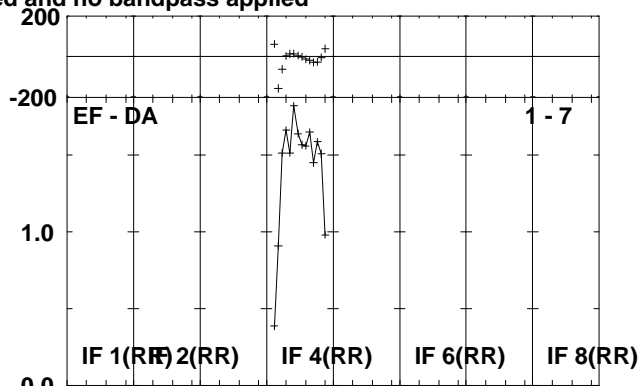
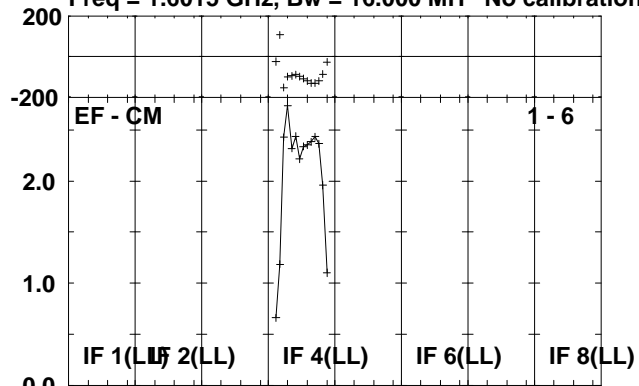

Lower frame: Milli Ampl Jy Top frame: Phas deg
Scalar averaged cross-power spectrum Several baselines displayed
Timerange: 00/23:18:05 to 00/23:19:49

Plot file version 61 created 01-JUL-2010 13:24:44
 V407CYG RG006B.UVDATA.1

Freq = 1.6015 GHz, Bw = 16.000 MH No calibration applied and no bandpass applied

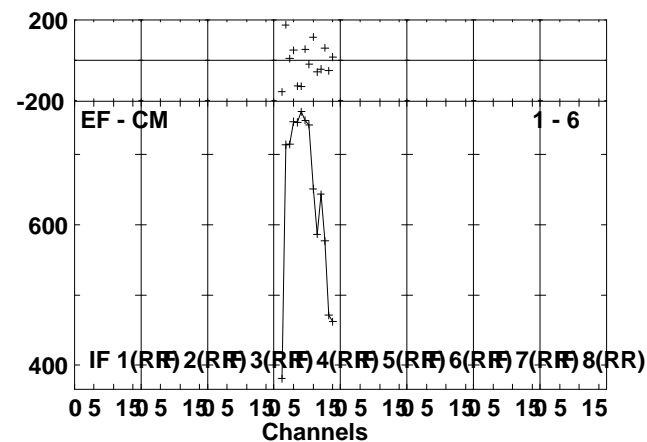
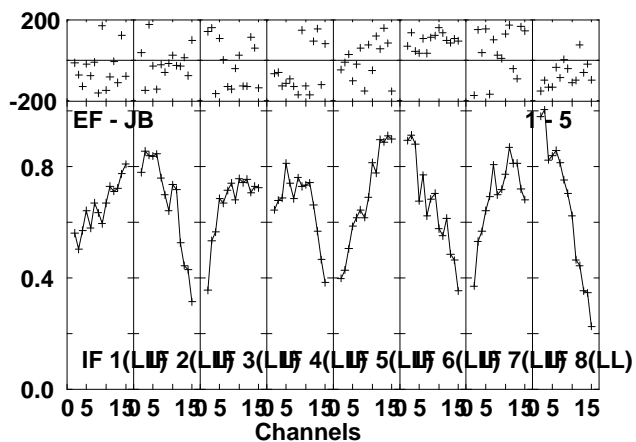
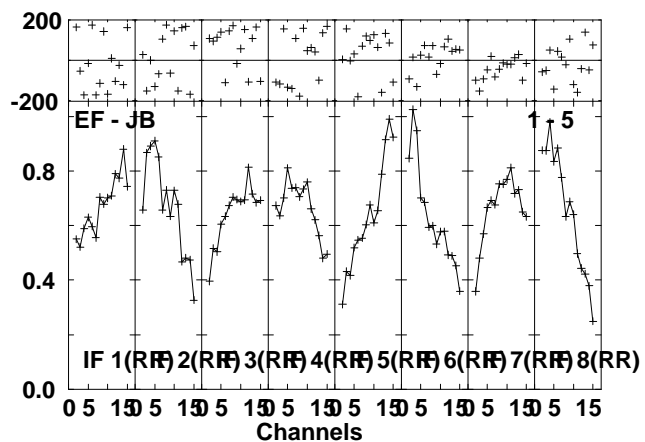
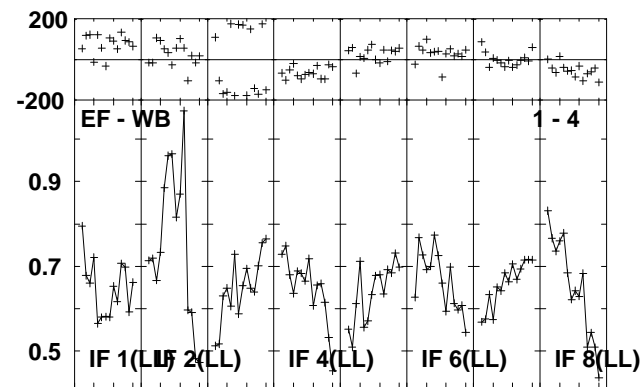
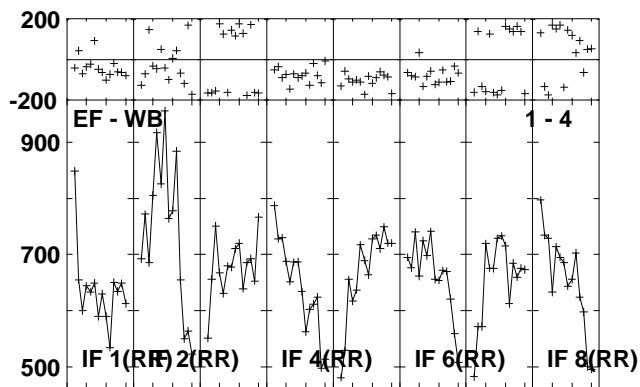
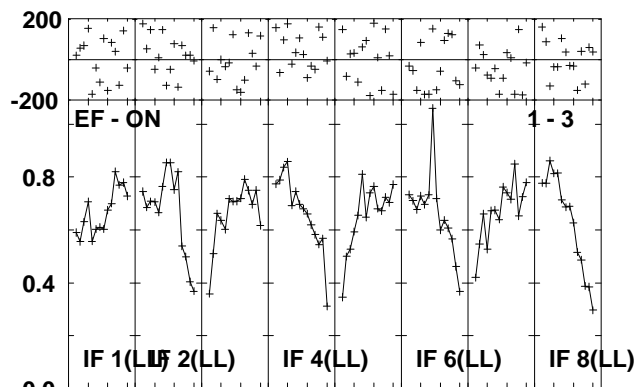
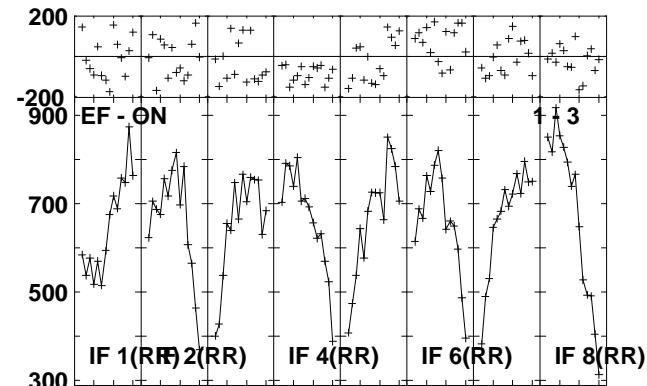
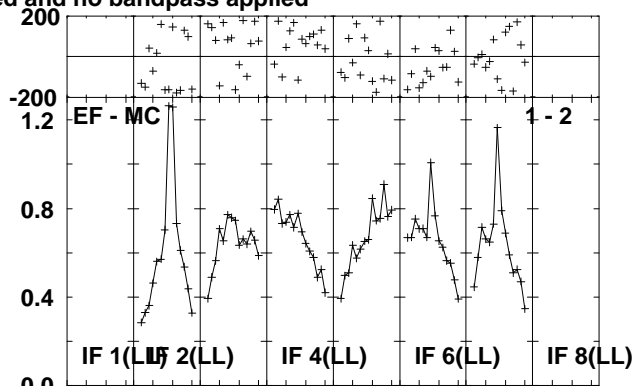
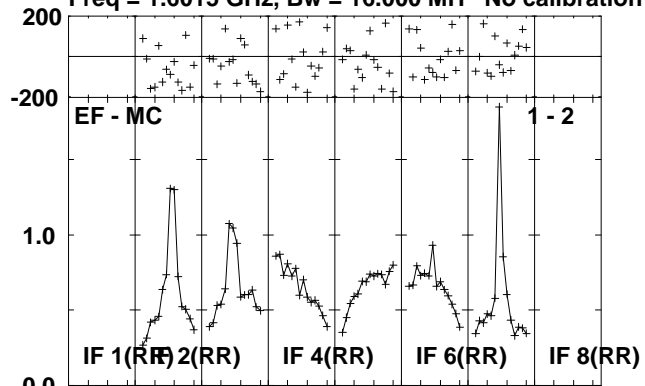

Lower frame: Milli Ampl Jy Top frame: Phas deg
 Scalar averaged cross-power spectrum Several baselines displayed
 Timerange: 00/23:19:53 to 00/23:24:49

Plot file version 62 created 01-JUL-2010 13:24:45
 V407CYG RG006B.UVDATA.1

Freq = 1.6015 GHz, Bw = 16.000 MH No calibration applied and no bandpass applied

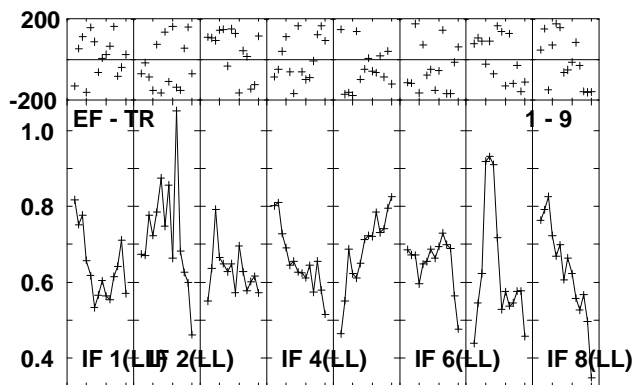
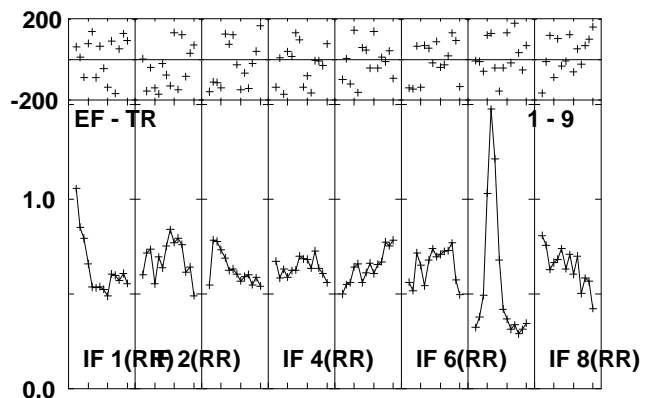
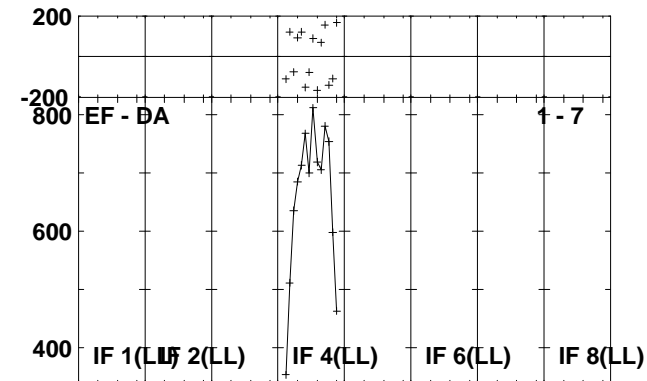
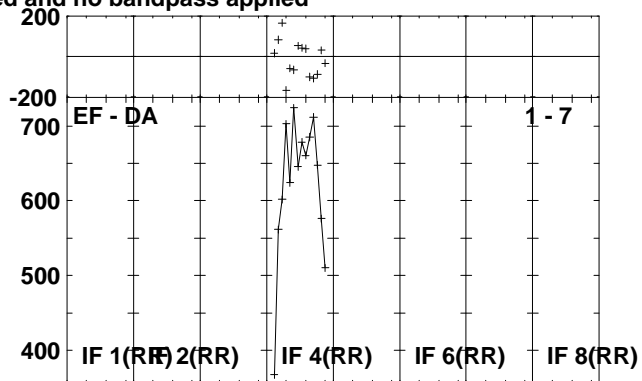
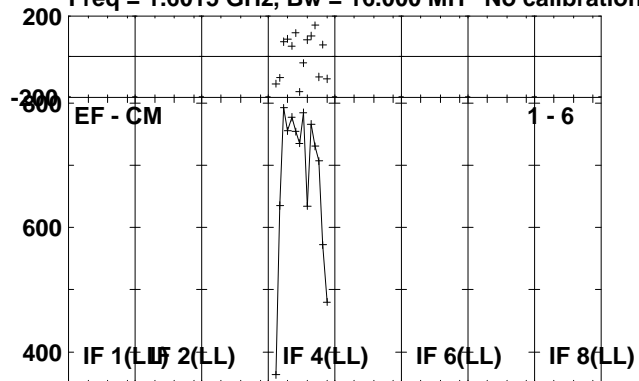

Lower frame: Micro Ampl Jy Top frame: Phas deg
 Scalar averaged cross-power spectrum Several baselines displayed
 Timerange: 00/23:19:53 to 00/23:24:49

Plot file version 63 created 01-JUL-2010 13:24:46

J2102+47 RG006B.UVDATA.1

Freq = 1.6015 GHz, Bw = 16.000 MH No calibration applied and no bandpass applied

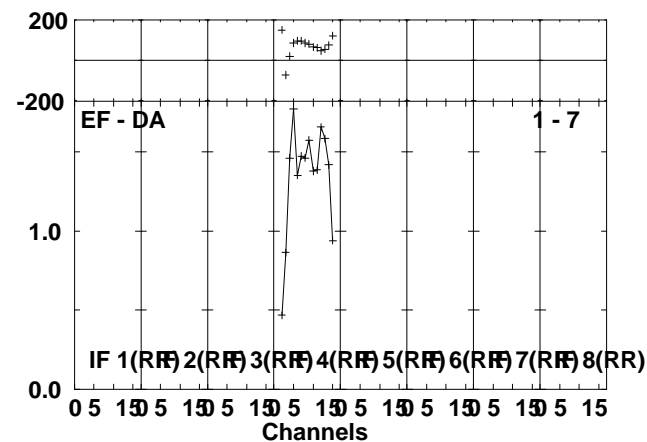
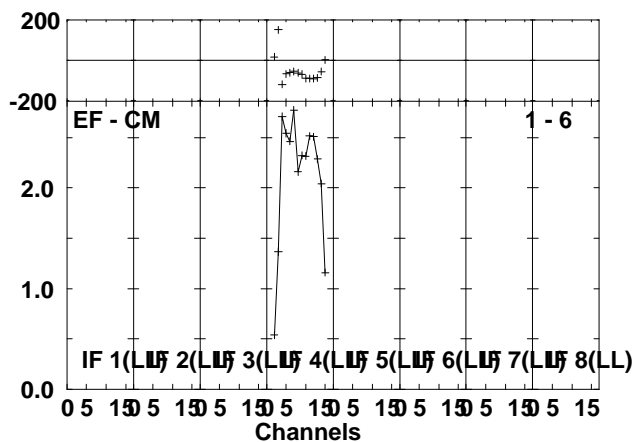
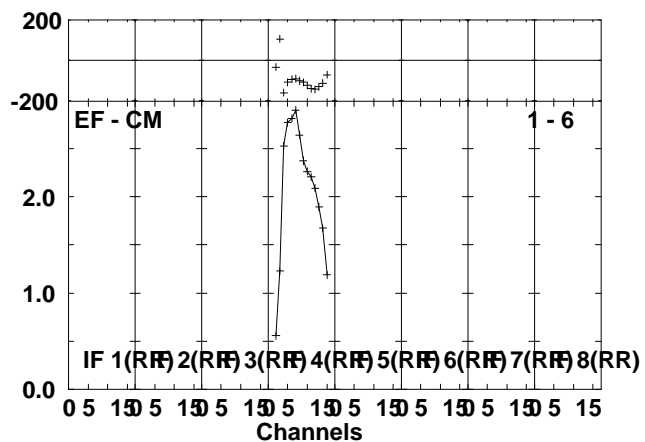
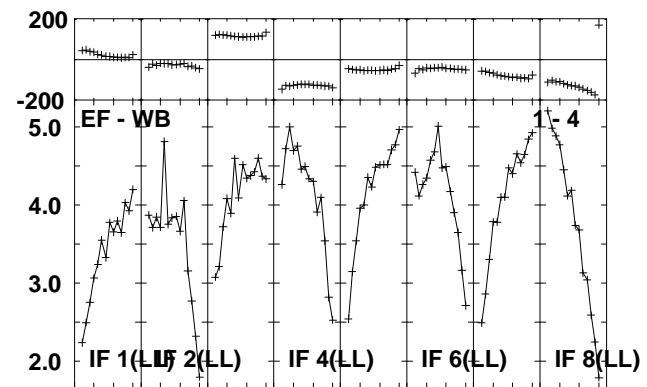
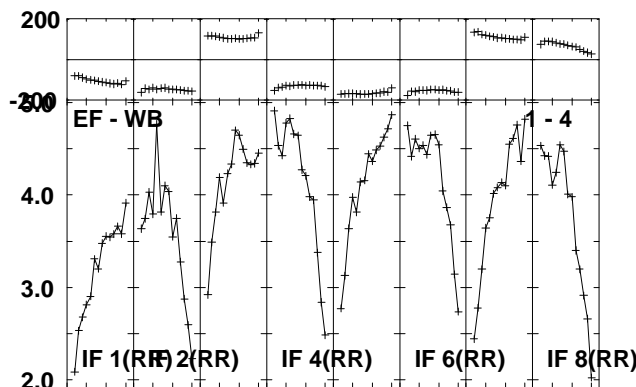
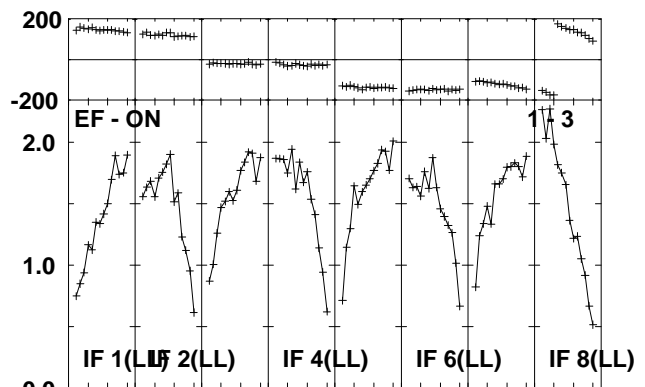
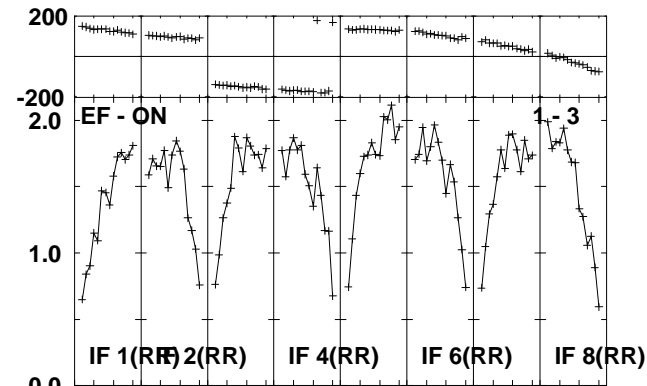
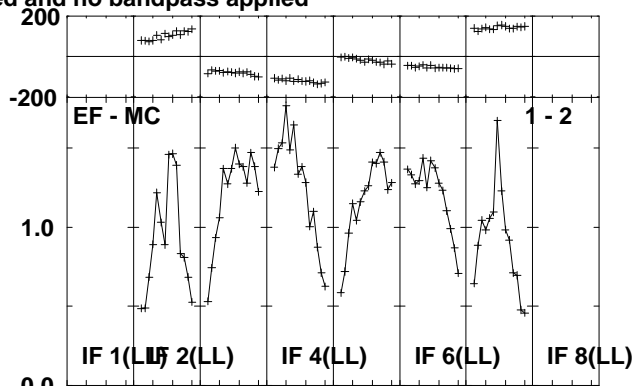
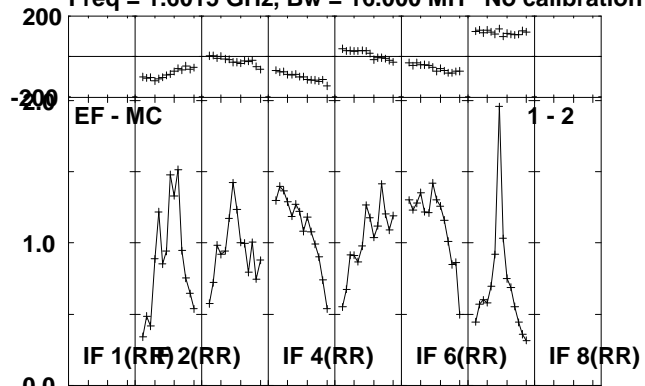

Lower frame: Milli Ampl Jy Top frame: Phas deg
Scalar averaged cross-power spectrum Several baselines displayed
Timerange: 00/23:24:53 to 00/23:27:01

Plot file version 64 created 01-JUL-2010 13:24:46
J2102+47 RG006B.UVDATA.1

Freq = 1.6015 GHz, Bw = 16.000 MH No calibration applied and no bandpass applied

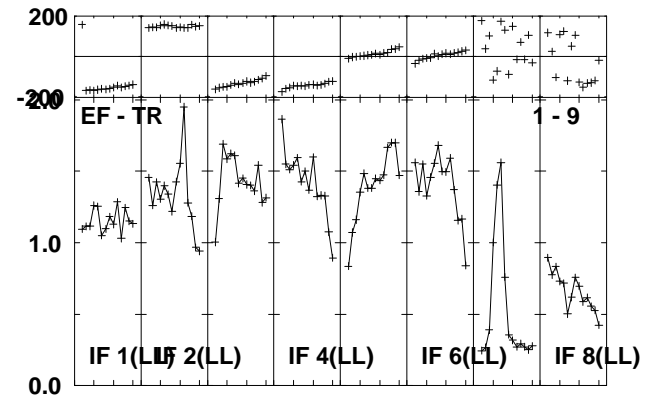
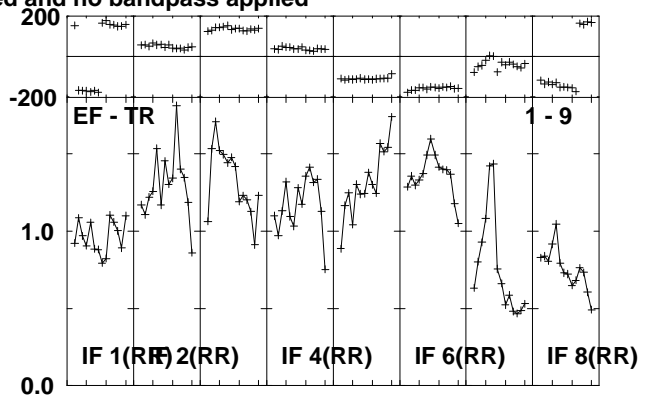
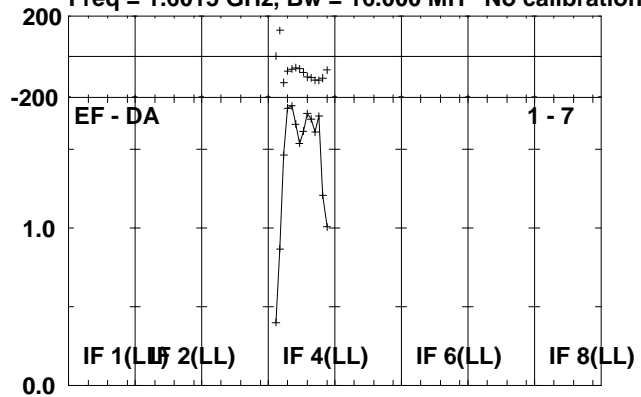

Lower frame: Milli Ampl Jy Top frame: Phas deg
Scalar averaged cross-power spectrum Several baselines displayed
Timerange: 00/23:24:53 to 00/23:27:01

Plot file version 65 created 01-JUL-2010 13:24:46
 V407CYG RG006B.UVDATA.1

Freq = 1.6015 GHz, Bw = 16.000 MH No calibration applied and no bandpass applied

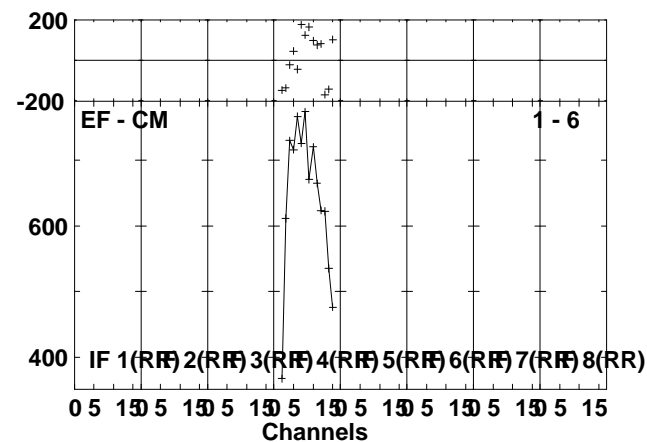
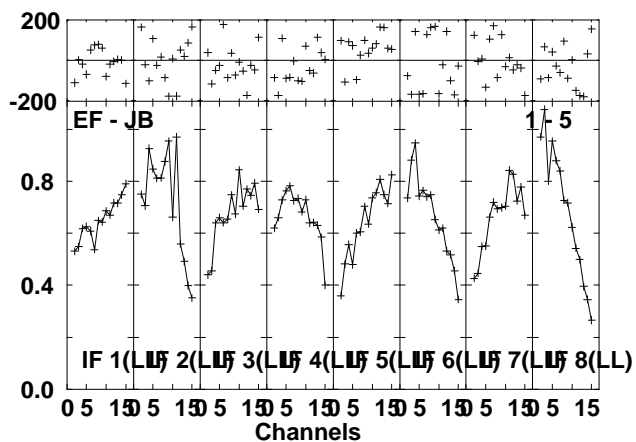
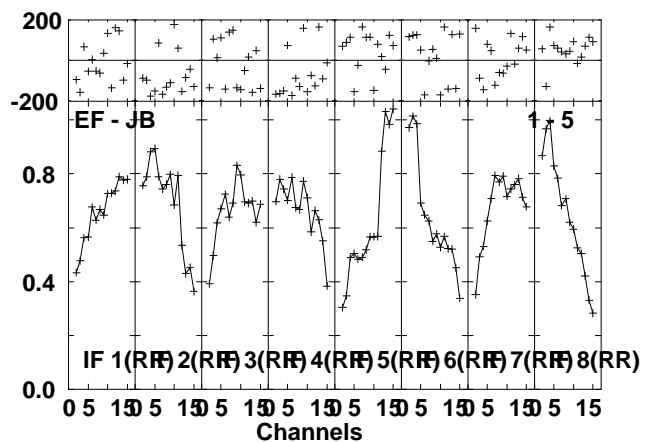
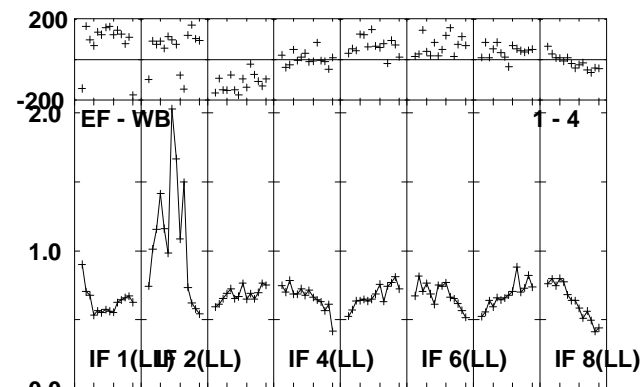
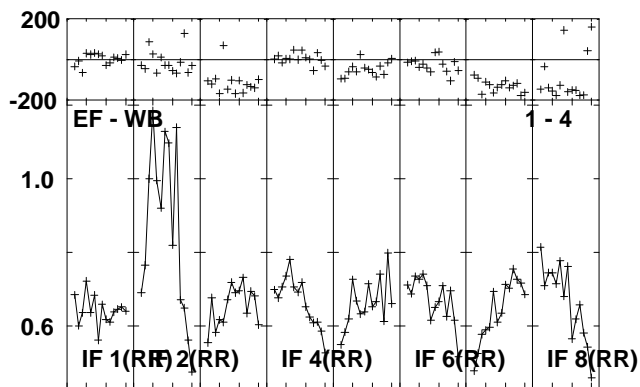
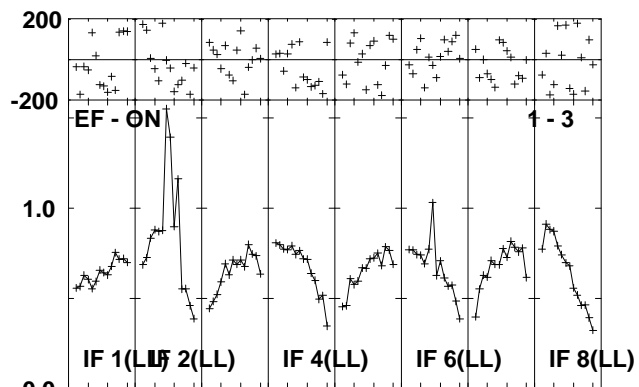
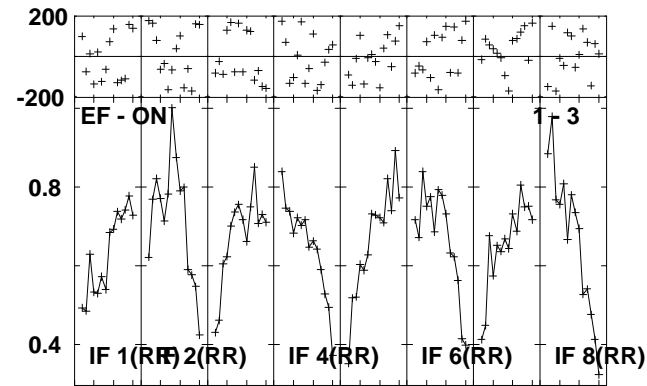
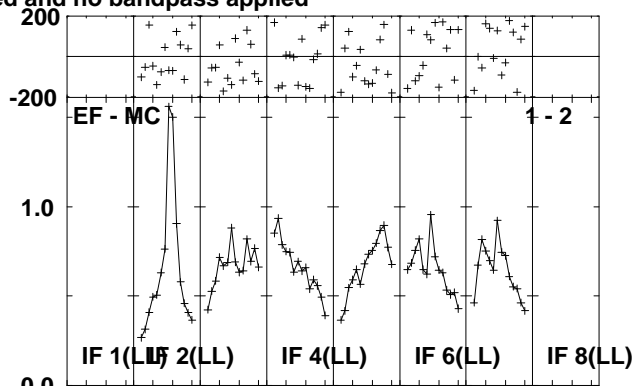
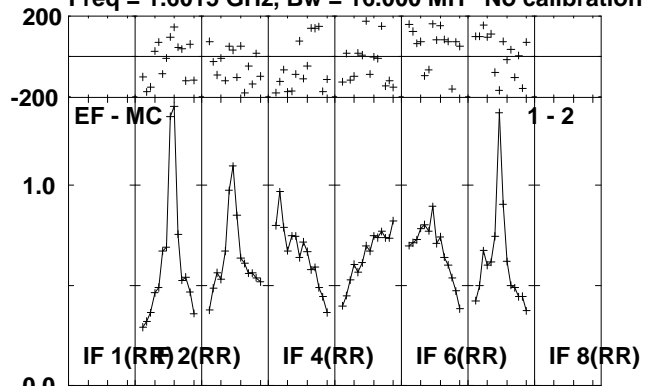

Lower frame: Milli Ampl Jy Top frame: Phas deg
 Scalar averaged cross-power spectrum Several baselines displayed
 Timerange: 00/23:27:05 to 00/23:32:01

Plot file version 66 created 01-JUL-2010 13:24:47
V407CYG RG006B.UVDATA.1

Freq = 1.6015 GHz, Bw = 16.000 MH No calibration applied and no bandpass applied

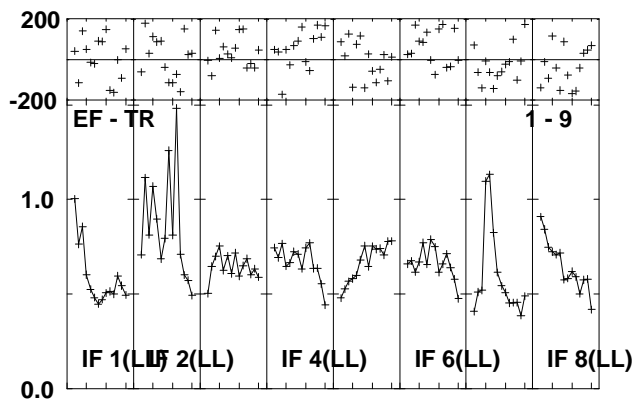
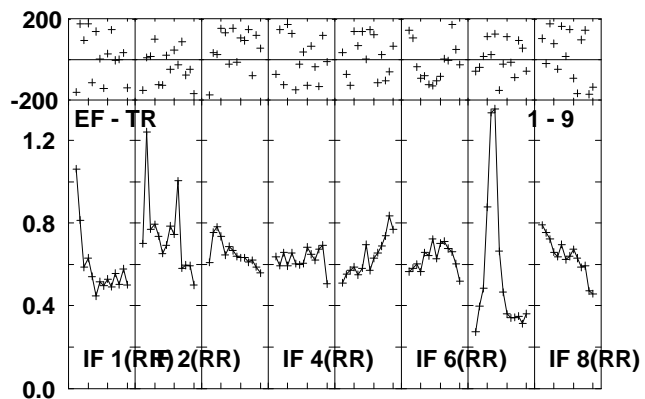
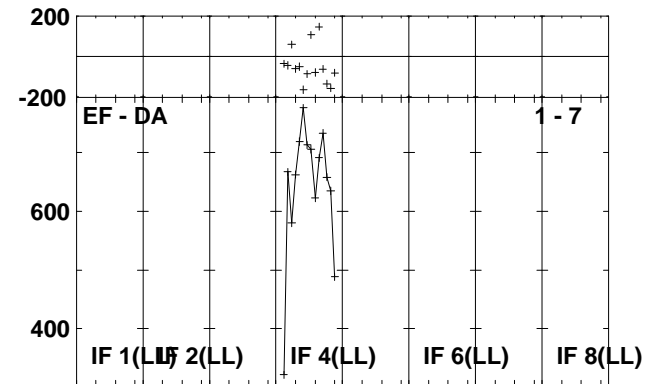
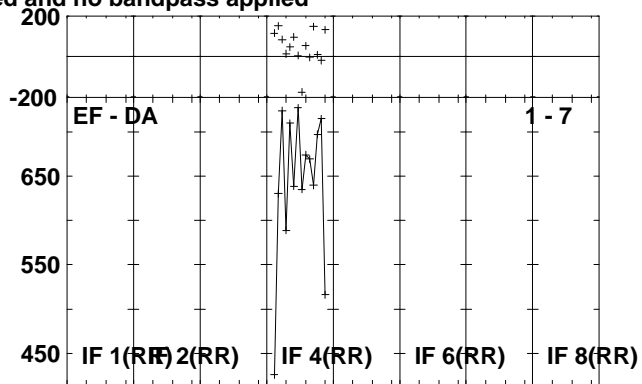
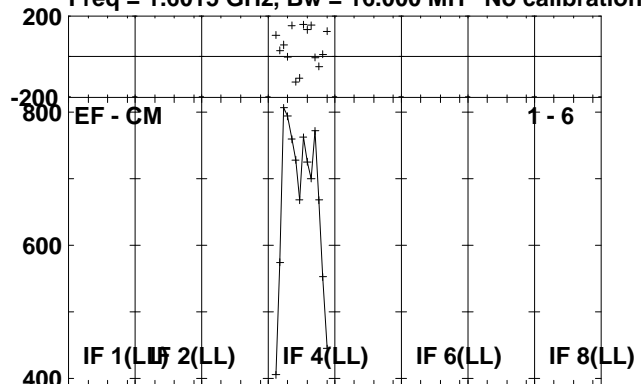

Lower frame: Micro Ampl Jy Top frame: Phas deg
Scalar averaged cross-power spectrum Several baselines displayed
Timerange: 00/23:27:05 to 00/23:32:01

Plot file version 67 created 01-JUL-2010 13:24:48

J2102+47 RG006B.UVDATA.1

Freq = 1.6015 GHz, Bw = 16.000 MH No calibration applied and no bandpass applied

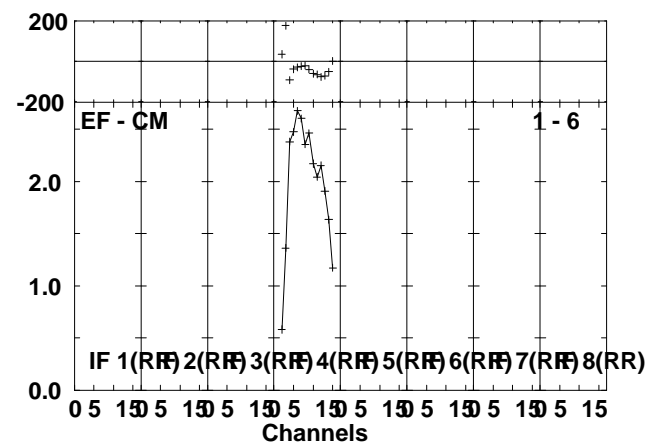
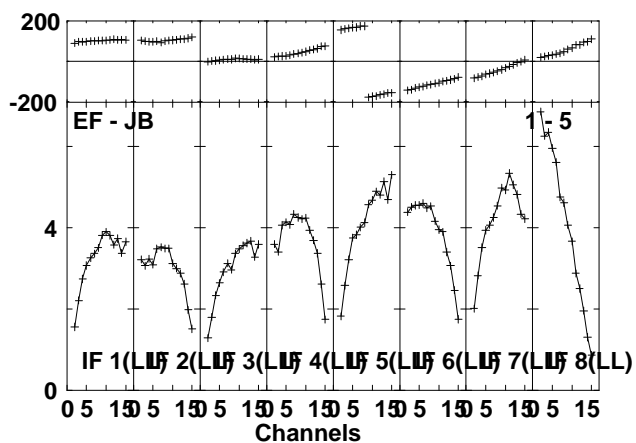
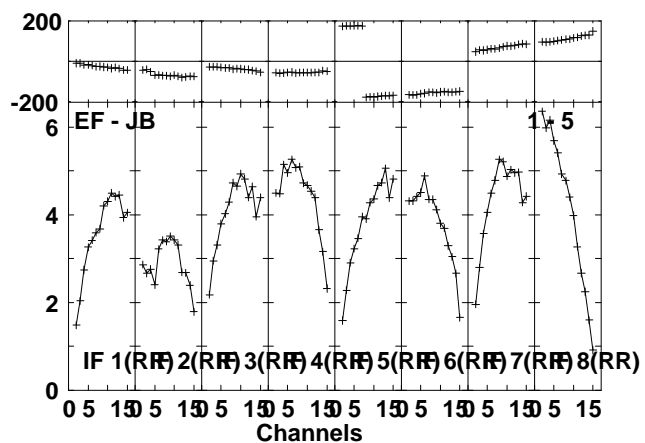
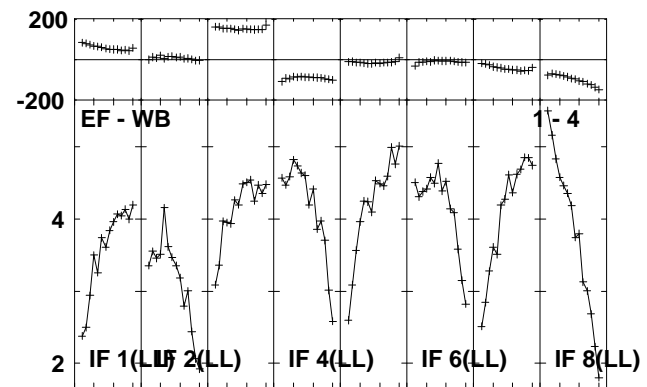
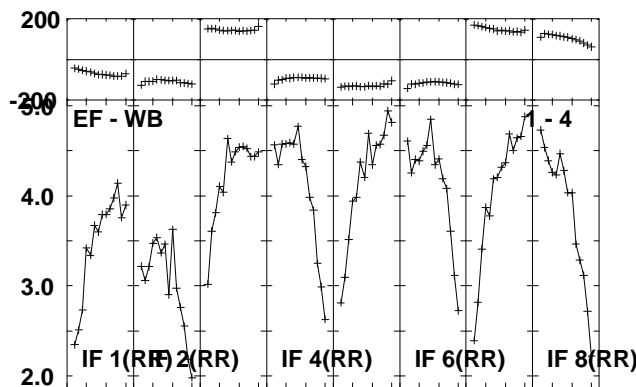
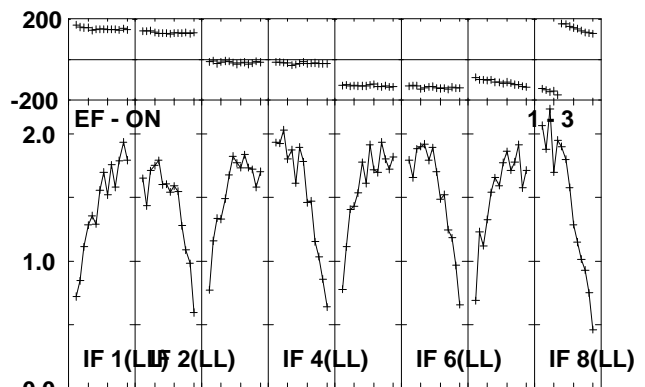
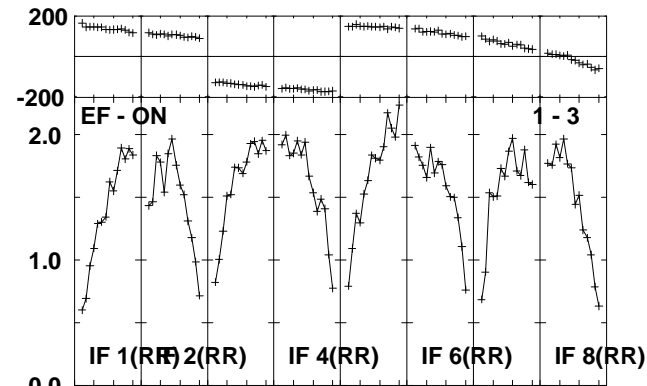
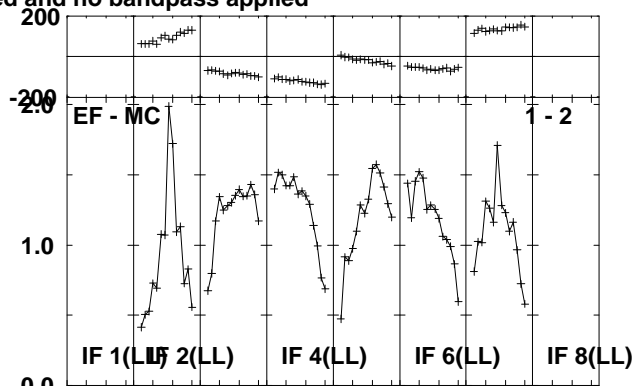
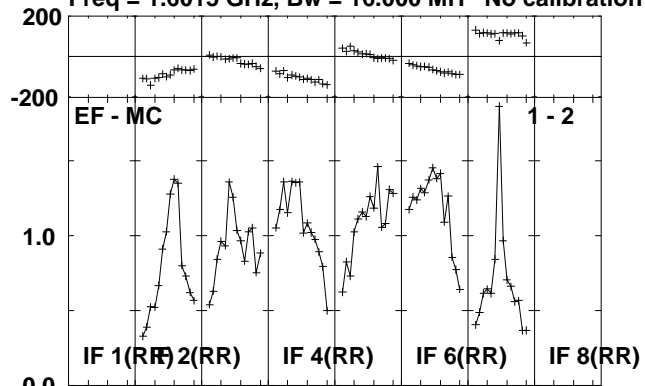

Lower frame: Milli Ampl Jy Top frame: Phas deg
Scalar averaged cross-power spectrum Several baselines displayed
Timerange: 00/23:33:05 to 00/23:34:49

Plot file version 68 created 01-JUL-2010 13:24:49

J2102+47 RG006B.UVDATA.1

Freq = 1.6015 GHz, Bw = 16.000 MH No calibration applied and no bandpass applied

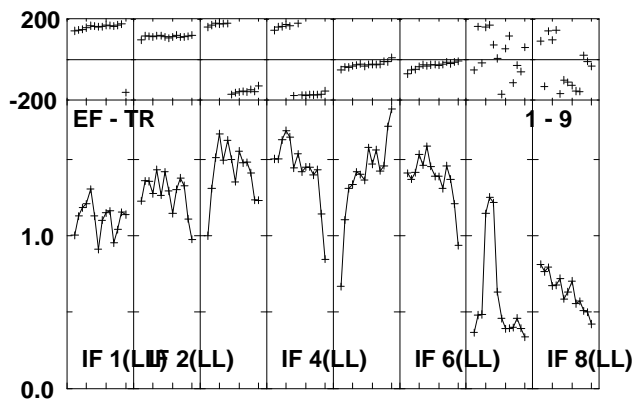
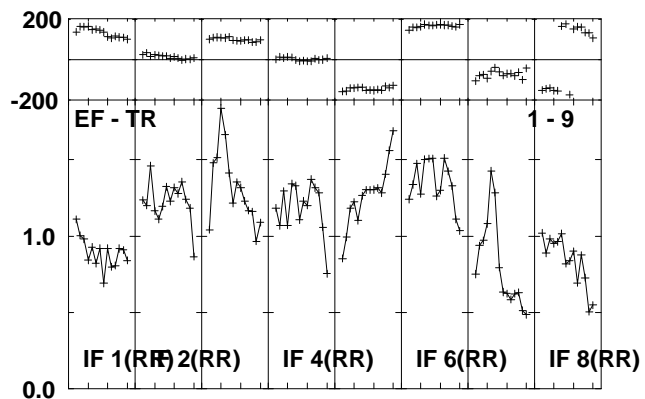
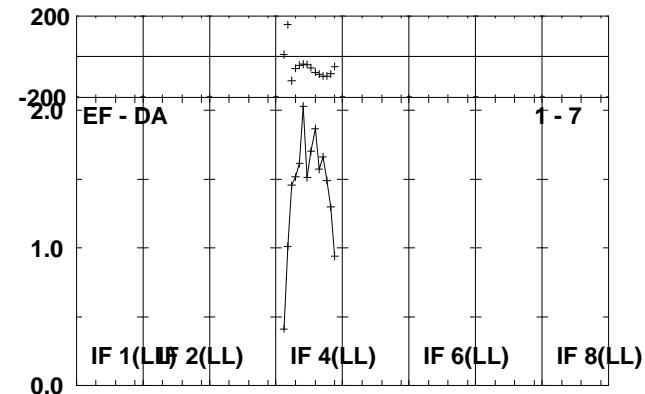
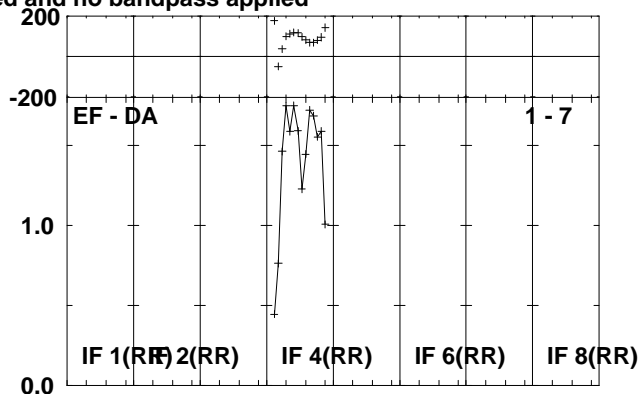
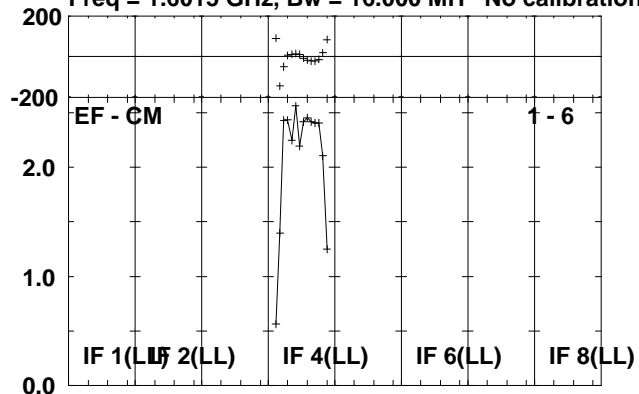

Lower frame: Milli Ampl Jy Top frame: Phas deg
Scalar averaged cross-power spectrum Several baselines displayed
Timerange: 00/23:33:05 to 00/23:34:49

Plot file version 69 created 01-JUL-2010 13:24:49

V407CYG RG006B.UVDATA.1

Freq = 1.6015 GHz, Bw = 16.000 MH No calibration applied and no bandpass applied

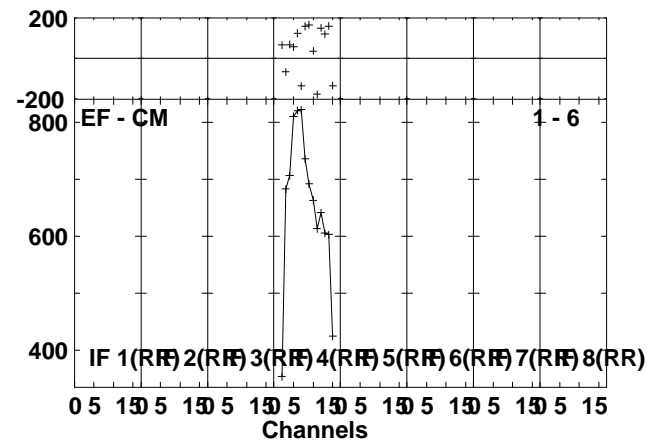
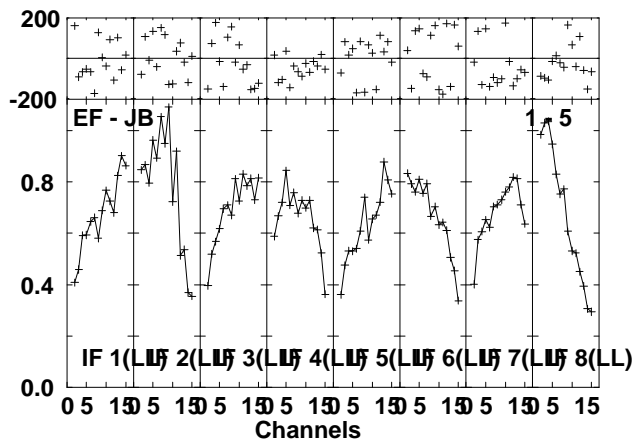
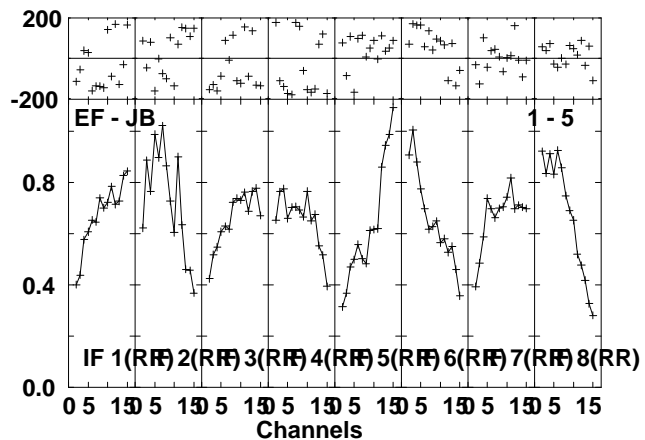
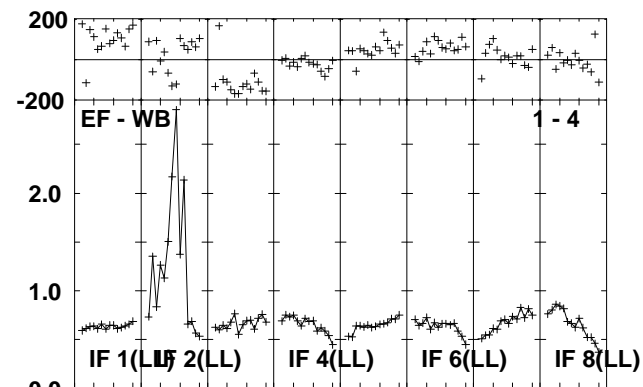
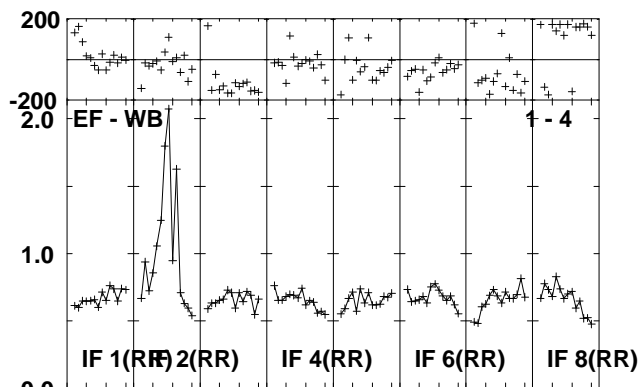
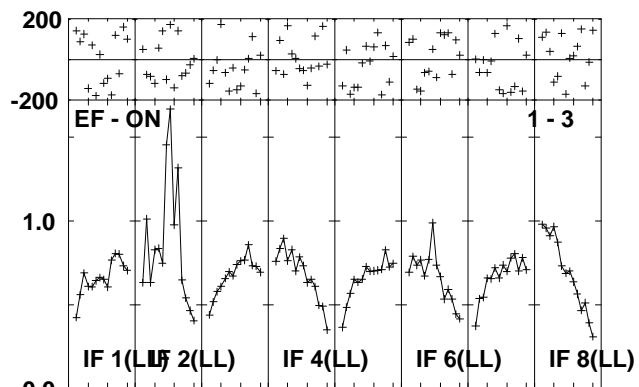
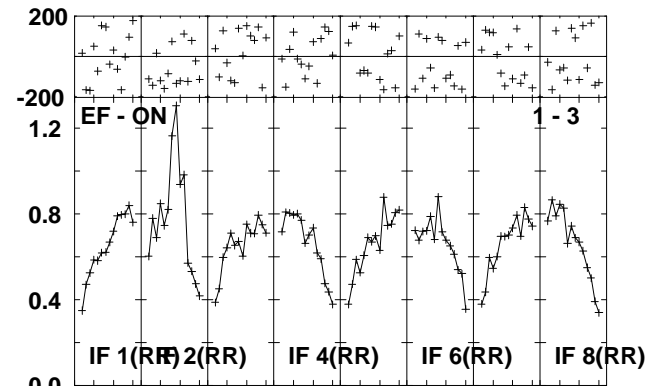
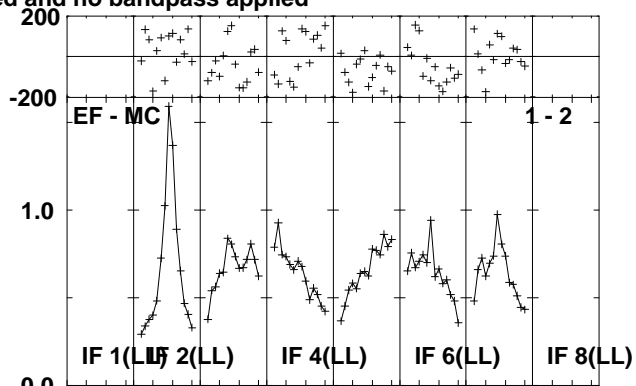
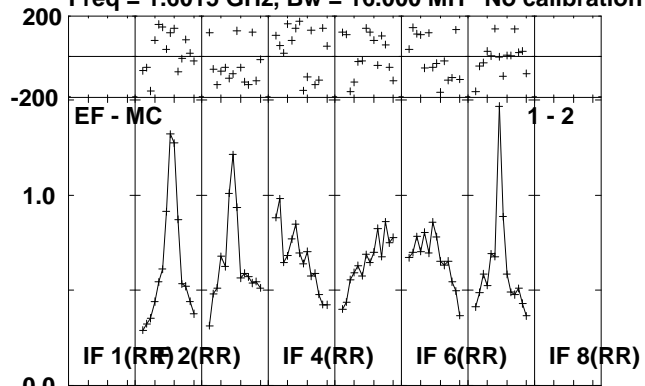

Lower frame: Milli Ampl Jy Top frame: Phas deg
Scalar averaged cross-power spectrum Several baselines displayed
Timerange: 00/23:34:53 to 00/23:39:49

Plot file version 70 created 01-JUL-2010 13:24:50
V407CYG RG006B.UVDATA.1

Freq = 1.6015 GHz, Bw = 16.000 MH No calibration applied and no bandpass applied

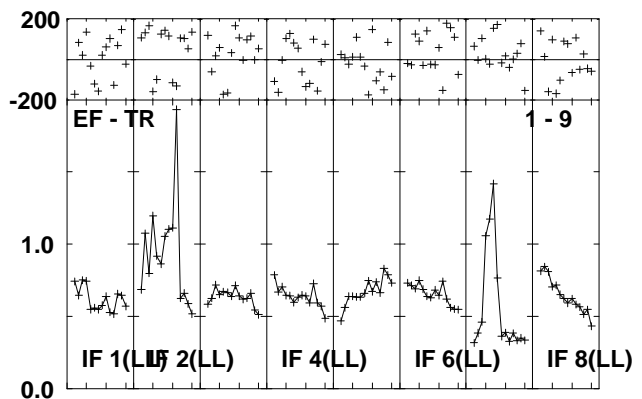
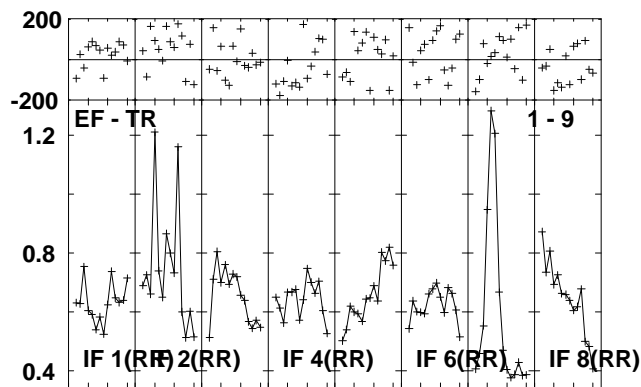
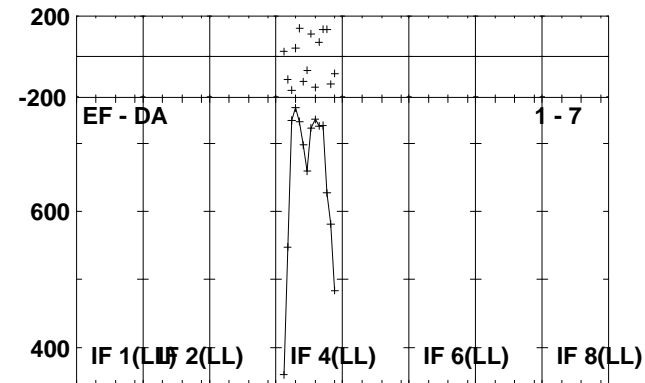
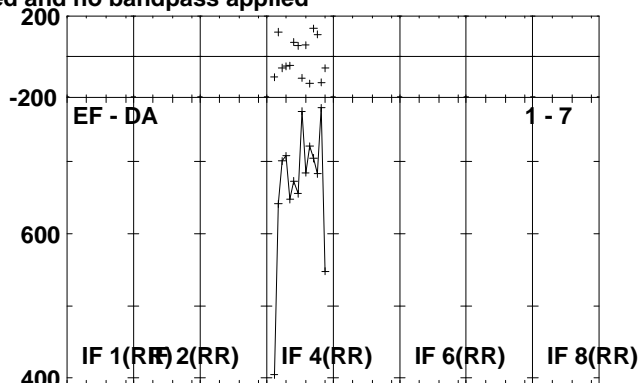
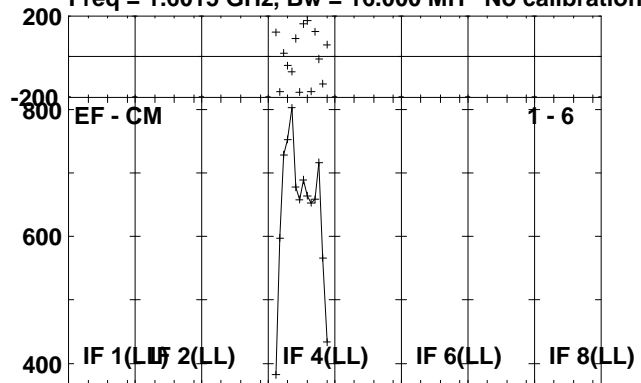

Lower frame: Micro Ampl Jy Top frame: Phas deg
Scalar averaged cross-power spectrum Several baselines displayed
Timerange: 00/23:34:53 to 00/23:39:49

Plot file version 71 created 01-JUL-2010 13:24:51

J2102+47 RG006B.UVDATA.1

Freq = 1.6015 GHz, Bw = 16.000 MH No calibration applied and no bandpass applied

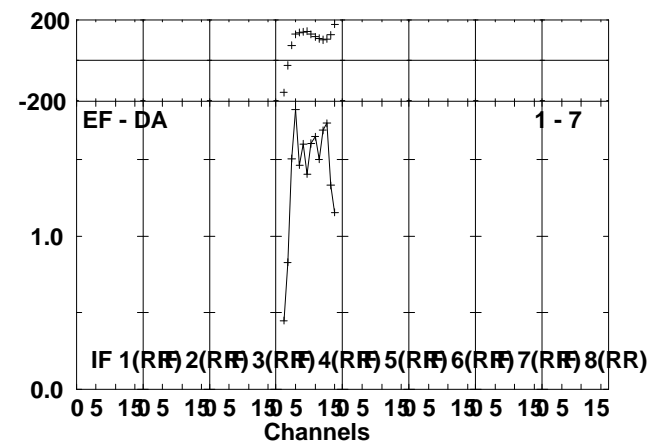
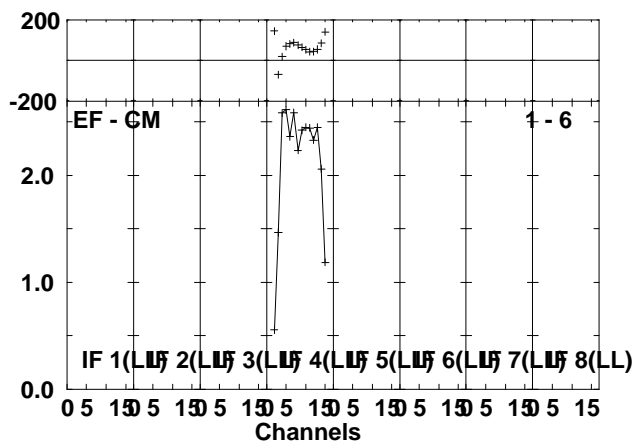
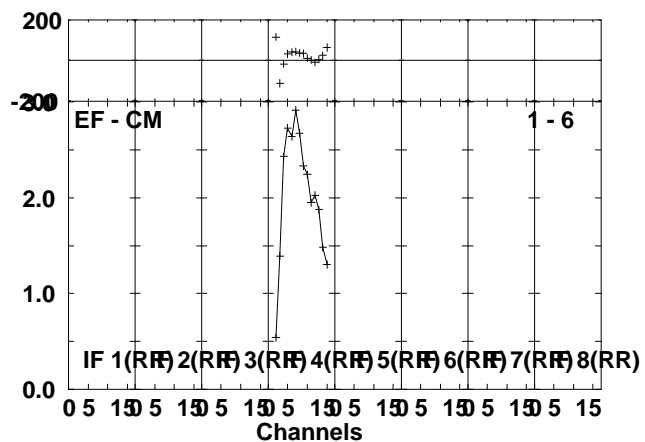
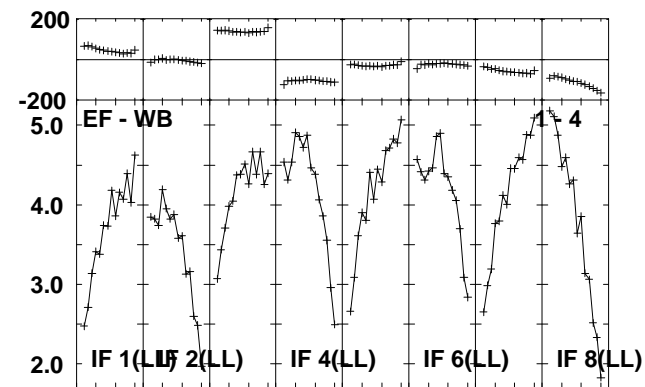
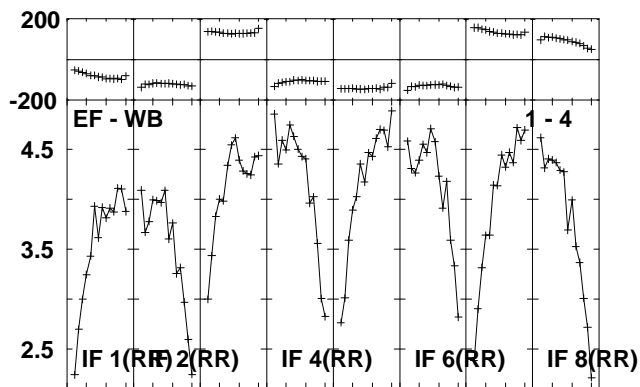
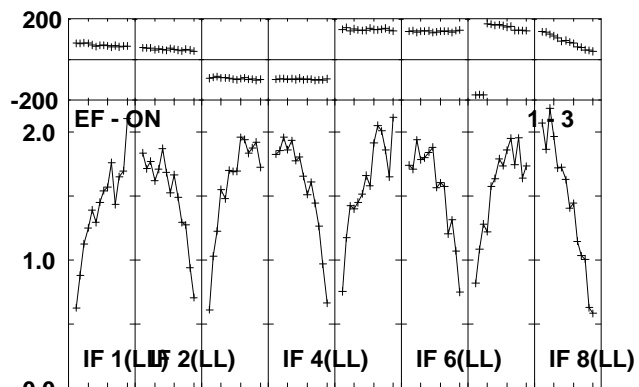
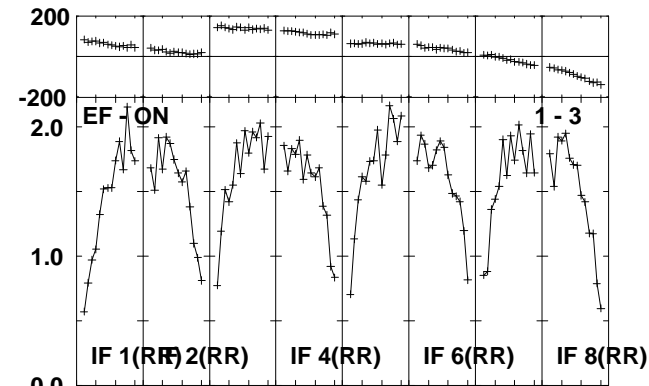
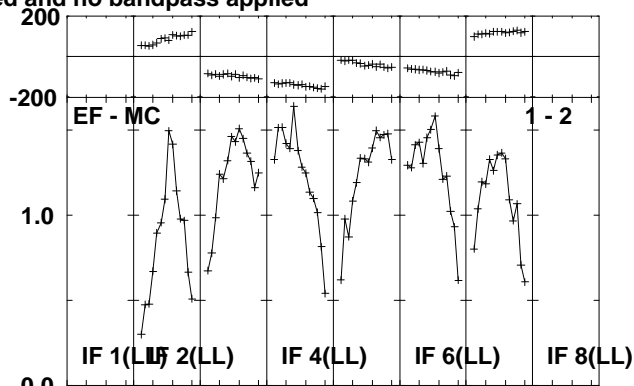
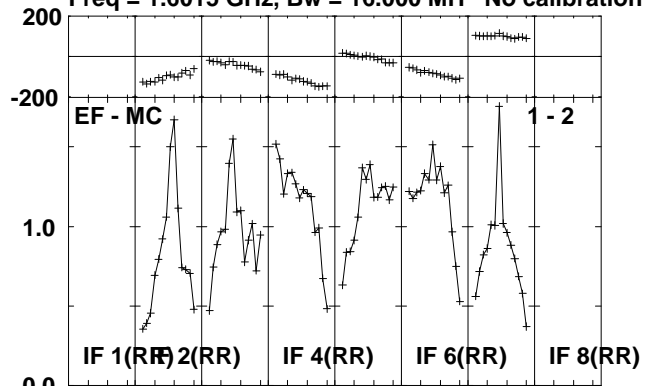

Lower frame: Milli Ampl Jy Top frame: Phas deg
Scalar averaged cross-power spectrum Several baselines displayed
Timerange: 00/23:39:53 to 00/23:42:01

Plot file version 72 created 01-JUL-2010 13:24:51
J2102+47 RG006B.UVDATA.1

Freq = 1.6015 GHz, Bw = 16.000 MH No calibration applied and no bandpass applied

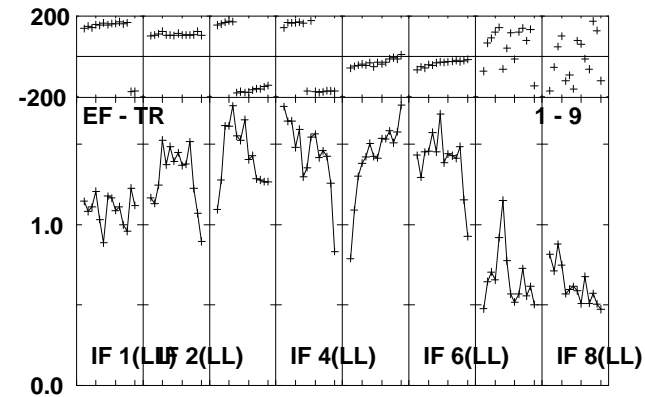
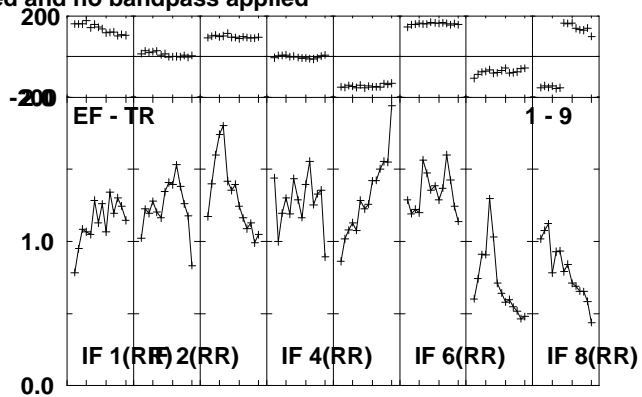
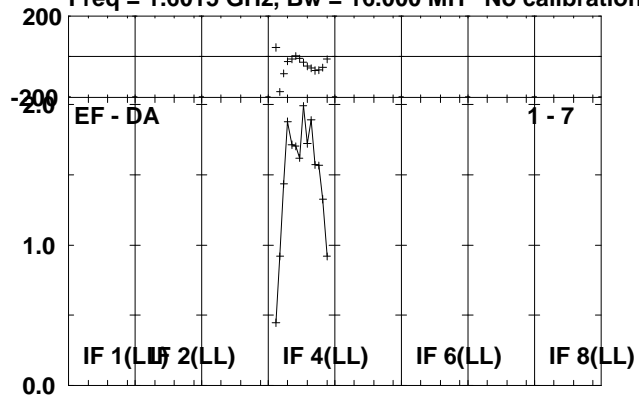

Lower frame: Milli Ampl Jy Top frame: Phas deg
Scalar averaged cross-power spectrum Several baselines displayed
Timerange: 00/23:39:53 to 00/23:42:01

Plot file version 73 created 01-JUL-2010 13:24:52

V407CYG RG006B.UVDATA.1

Freq = 1.6015 GHz, Bw = 16.000 MH No calibration applied and no bandpass applied

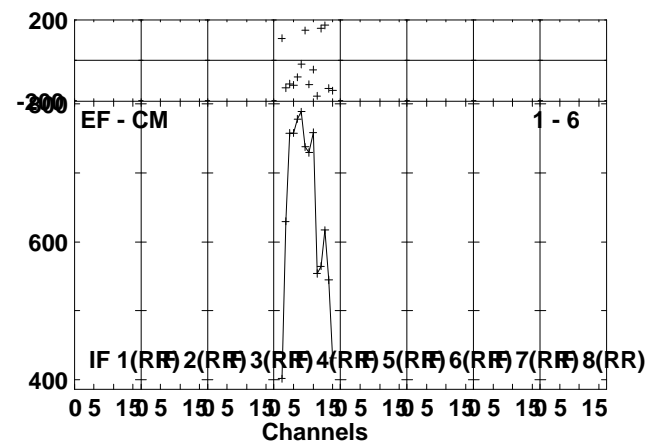
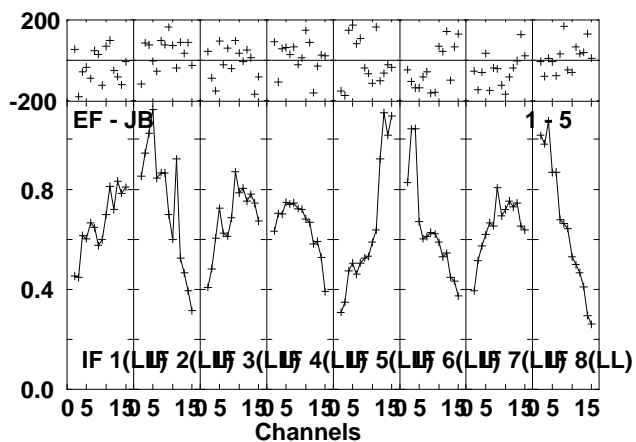
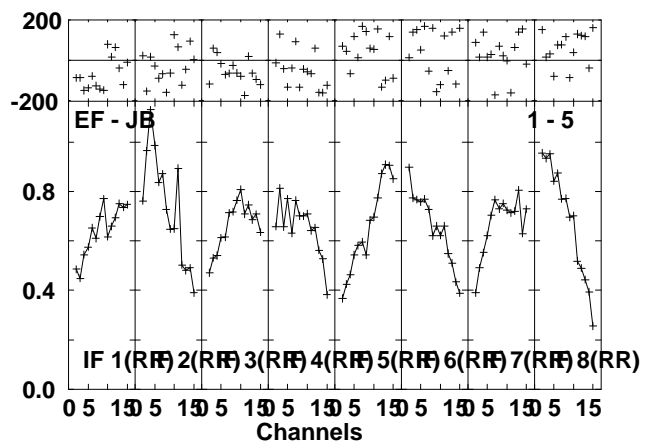
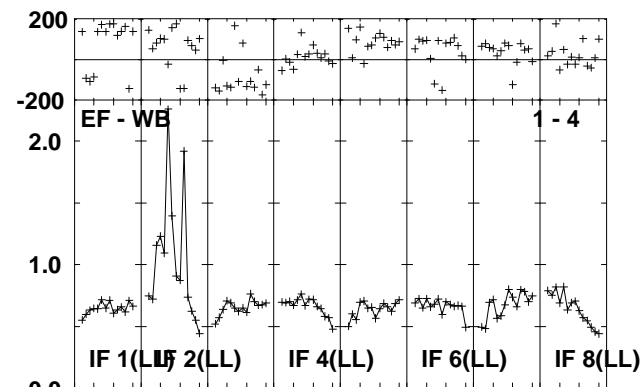
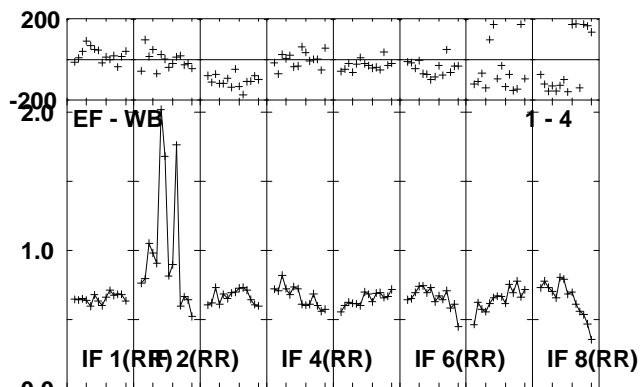
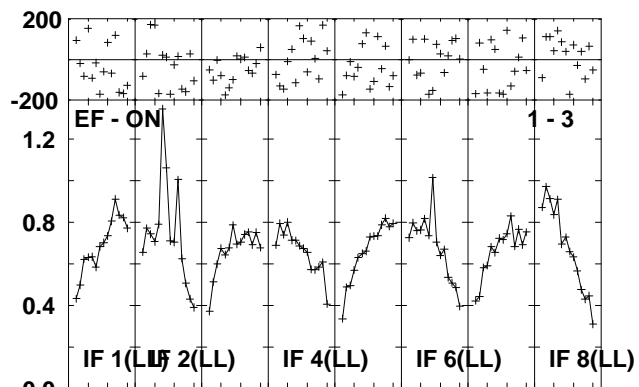
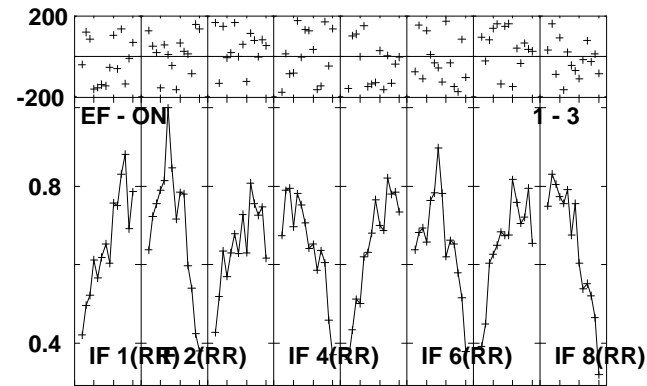
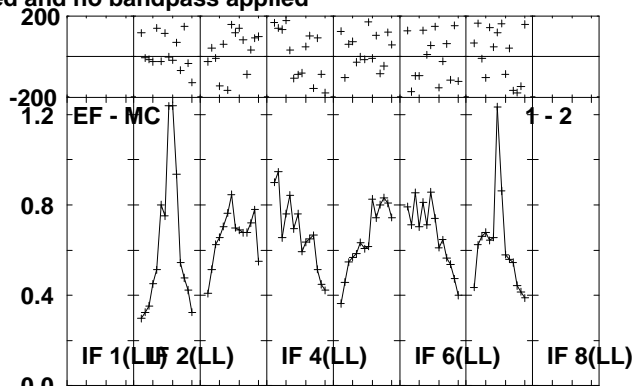
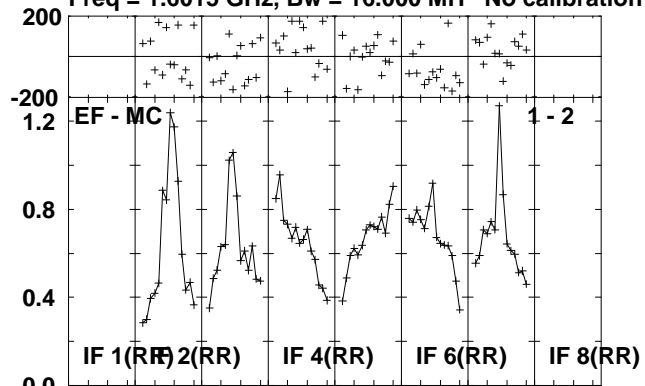

Lower frame: Milli Ampl Jy Top frame: Phas deg
Scalar averaged cross-power spectrum Several baselines displayed
Timerange: 00/23:42:05 to 00/23:47:01

Plot file version 74 created 01-JUL-2010 13:24:53

V407CYG RG006B.UVDATA.1

Freq = 1.6015 GHz, Bw = 16.000 MH No calibration applied and no bandpass applied

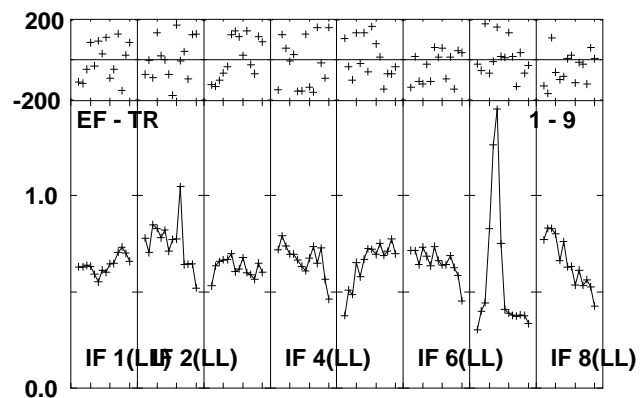
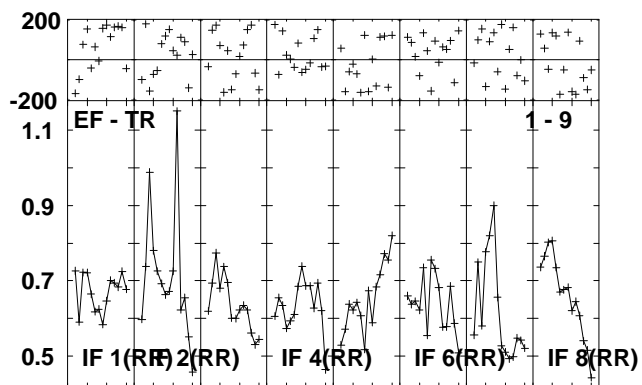
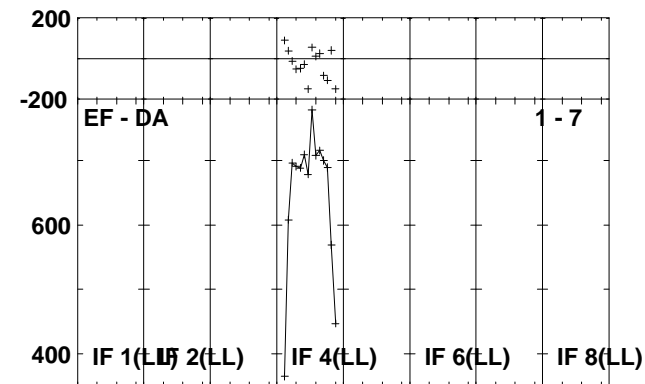
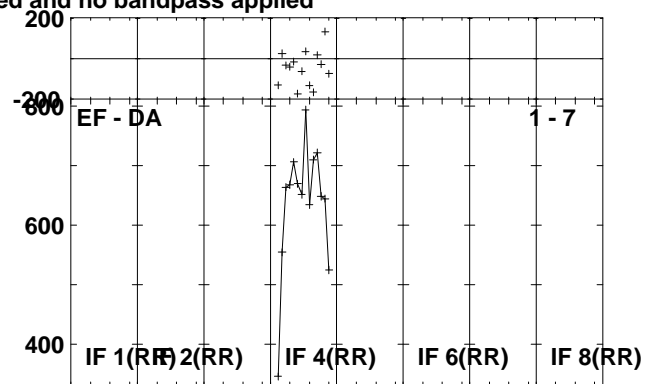
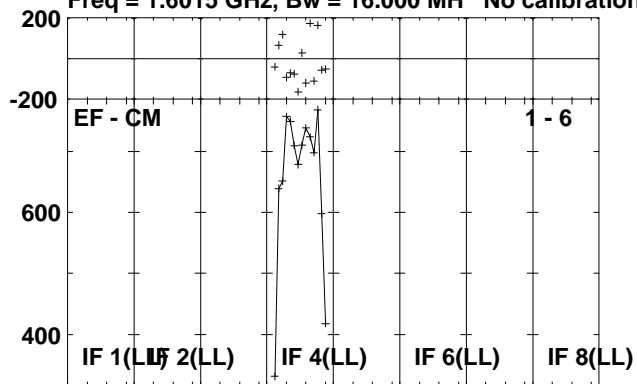

Lower frame: Micro Ampl Jy Top frame: Phas deg
Scalar averaged cross-power spectrum Several baselines displayed
Timerange: 00/23:42:05 to 00/23:47:01

Plot file version 75 created 01-JUL-2010 13:24:53

J2102+47 RG006B.UVDATA.1

Freq = 1.6015 GHz, Bw = 16.000 MH No calibration applied and no bandpass applied

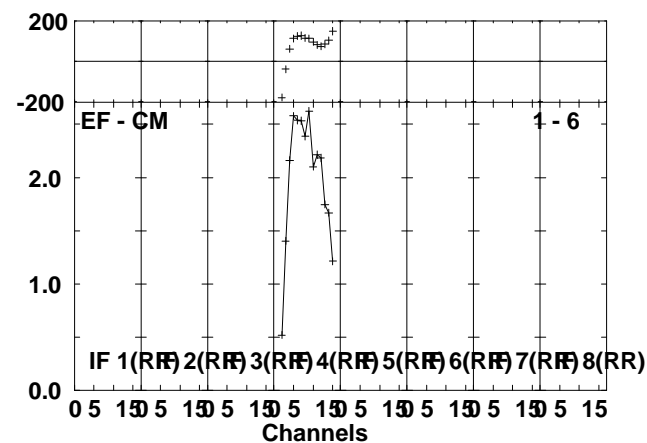
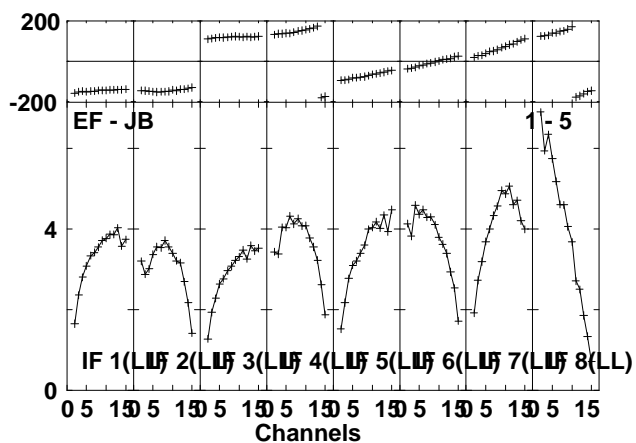
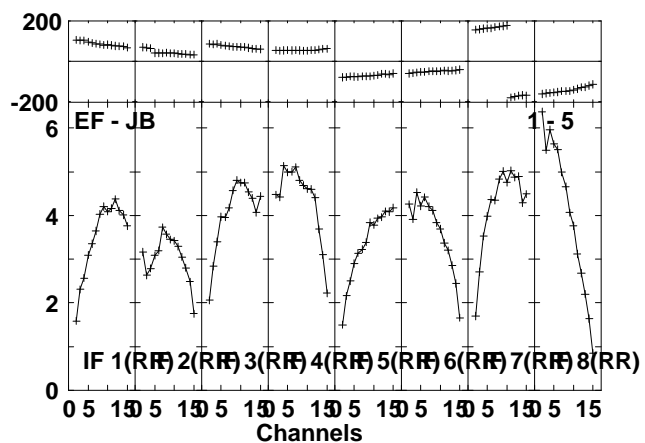
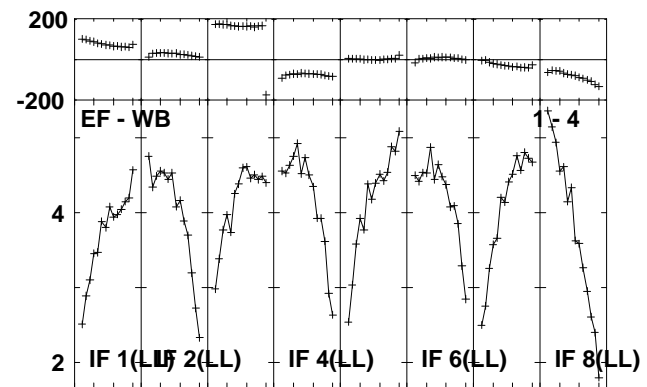
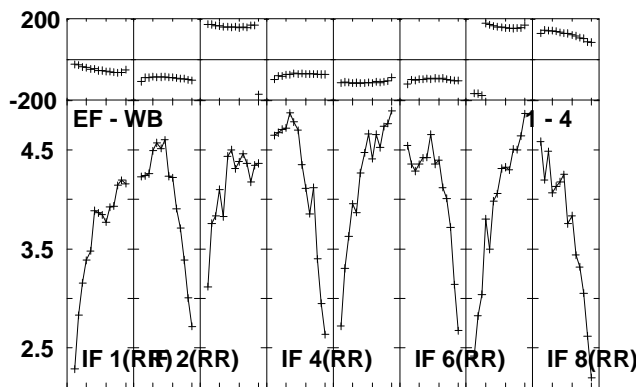
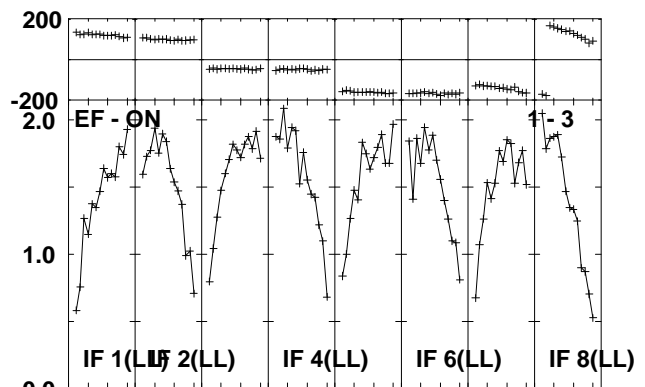
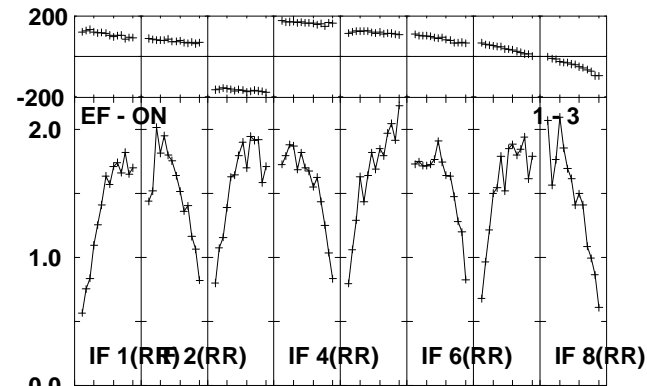
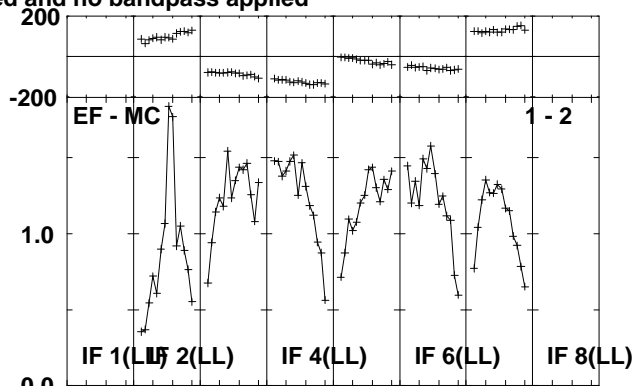
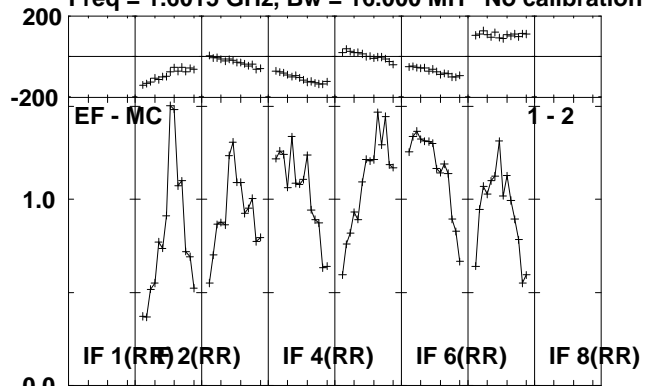

Lower frame: Milli Ampl Jy Top frame: Phas deg
Scalar averaged cross-power spectrum Several baselines displayed
Timerange: 00/23:48:05 to 00/23:49:49

Plot file version 76 created 01-JUL-2010 13:24:54
J2102+47 RG006B.UVDATA.1

Freq = 1.6015 GHz, Bw = 16.000 MH No calibration applied and no bandpass applied

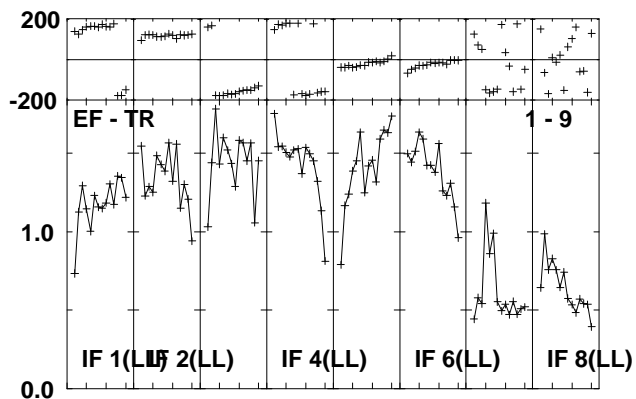
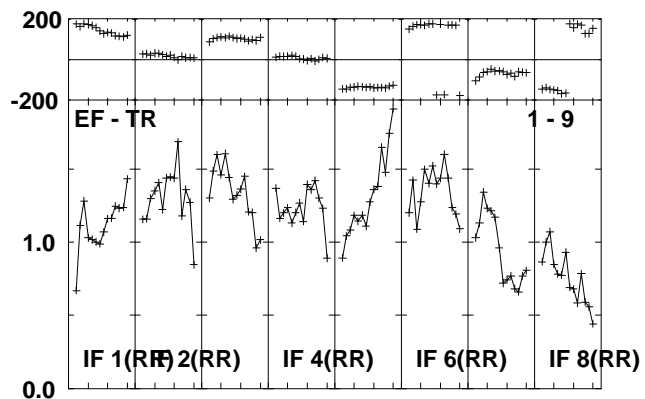
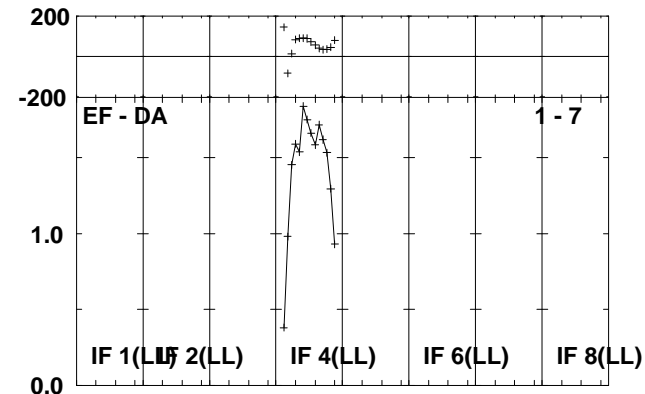
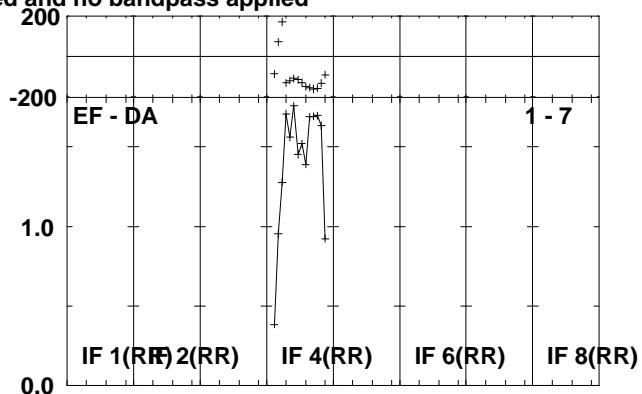
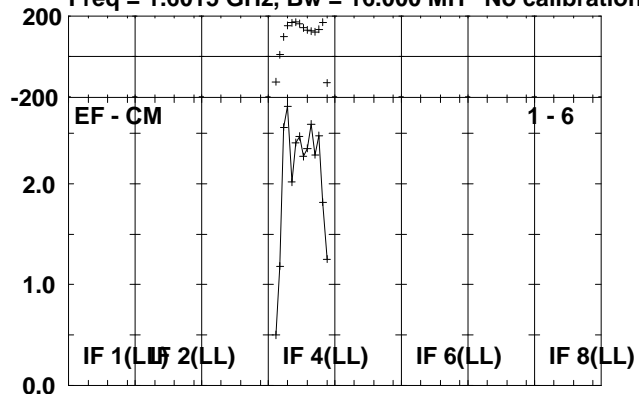

Lower frame: Milli Ampl Jy Top frame: Phas deg
Scalar averaged cross-power spectrum Several baselines displayed
Timerange: 00/23:48:05 to 00/23:49:49

Plot file version 77 created 01-JUL-2010 13:24:54
 V407CYG RG006B.UVDATA.1

Freq = 1.6015 GHz, Bw = 16.000 MH No calibration applied and no bandpass applied

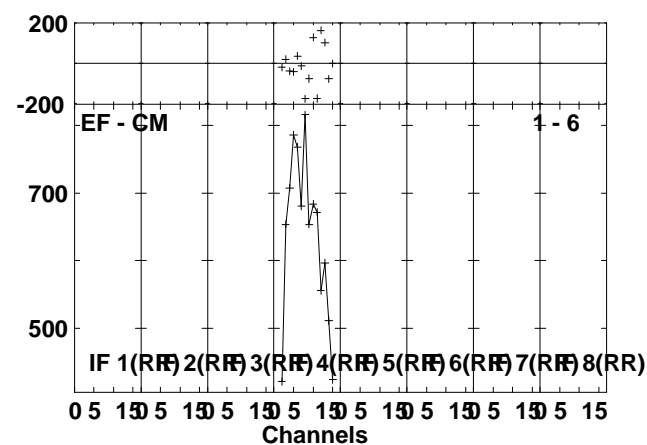
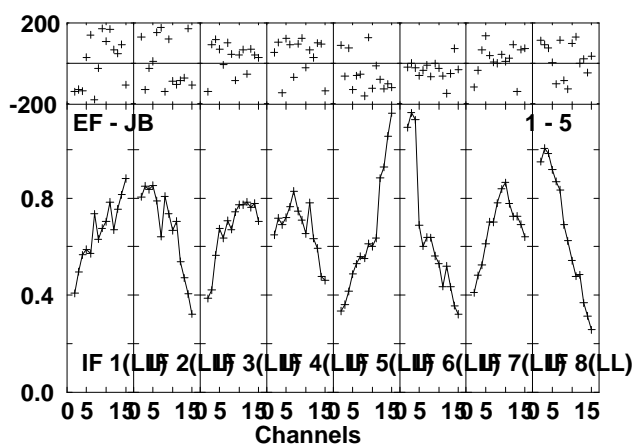
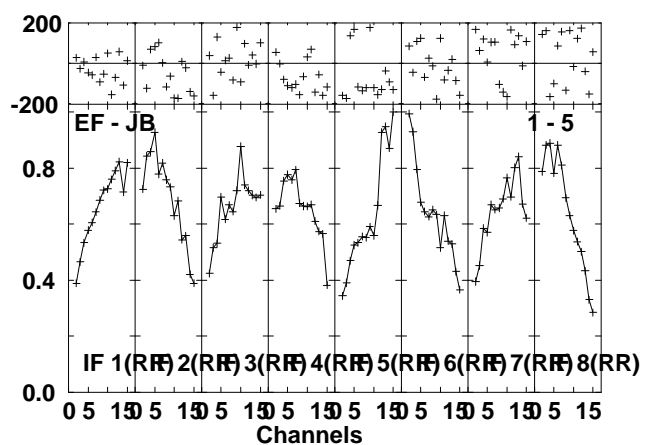
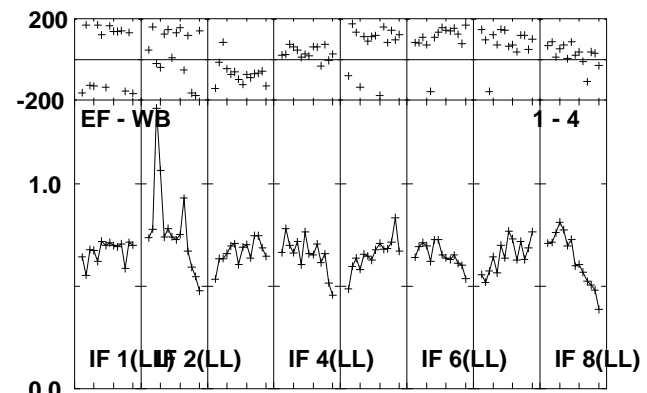
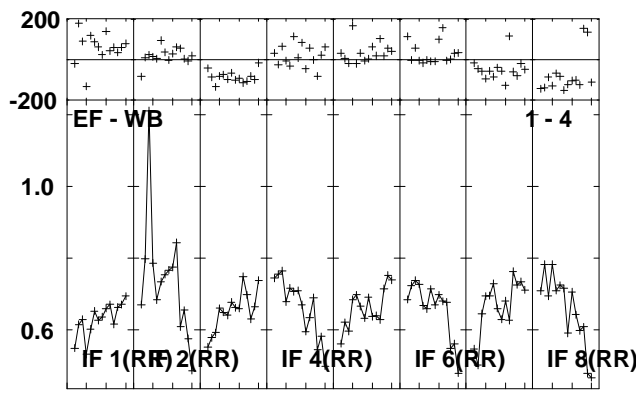
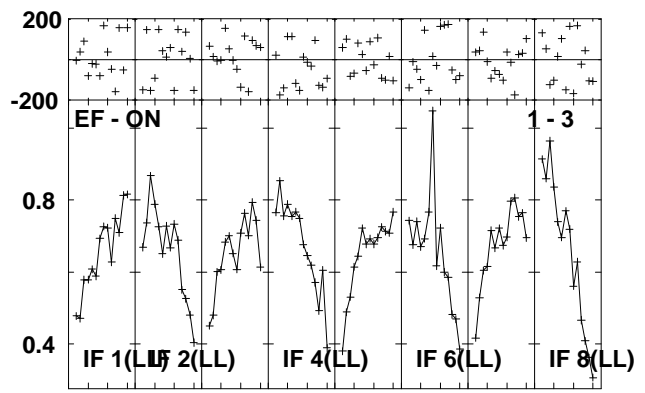
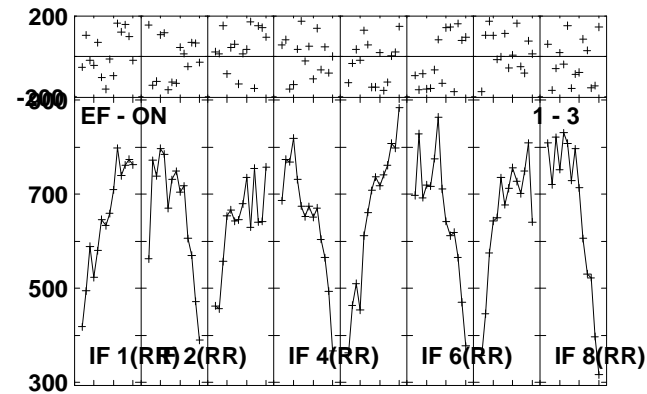
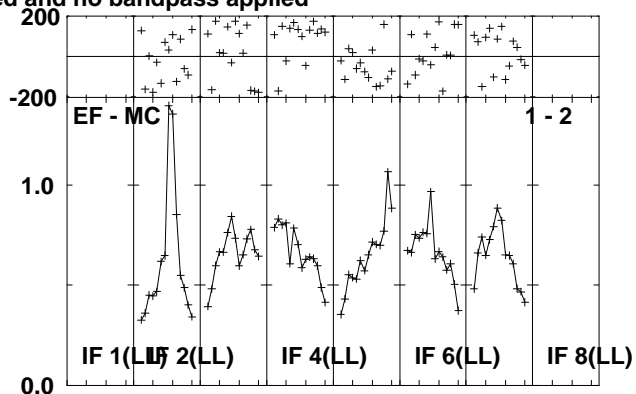
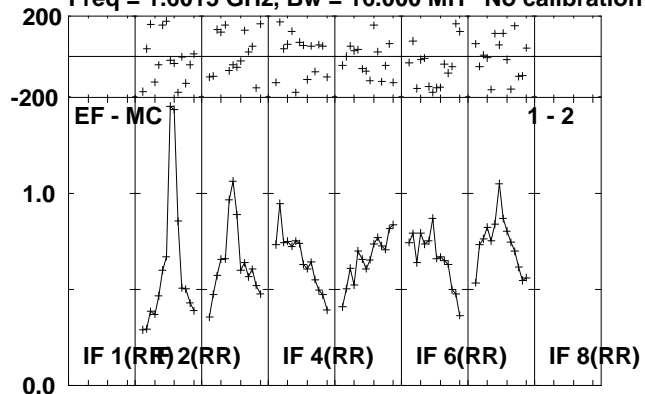

Lower frame: Milli Ampl Jy Top frame: Phas deg
 Scalar averaged cross-power spectrum Several baselines displayed
 Timerange: 00/23:49:53 to 00/23:54:49

Plot file version 78 created 01-JUL-2010 13:24:55
V407CYG RG006B.UVDATA.1

Freq = 1.6015 GHz, Bw = 16.000 MH No calibration applied and no bandpass applied

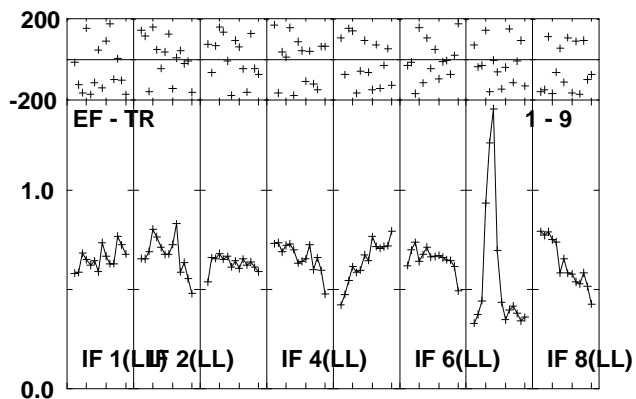
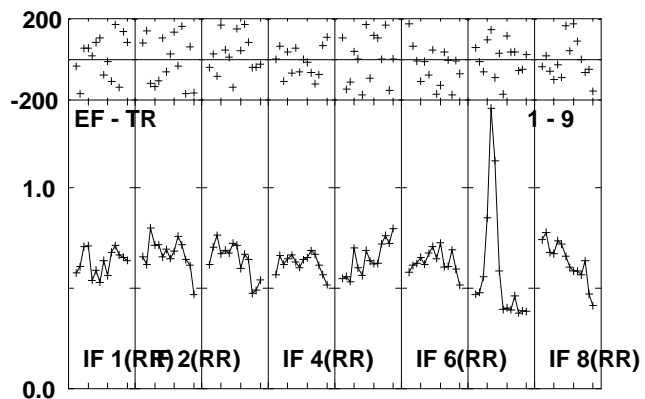
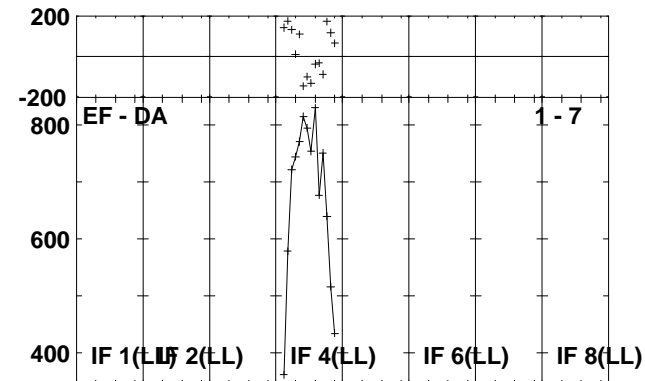
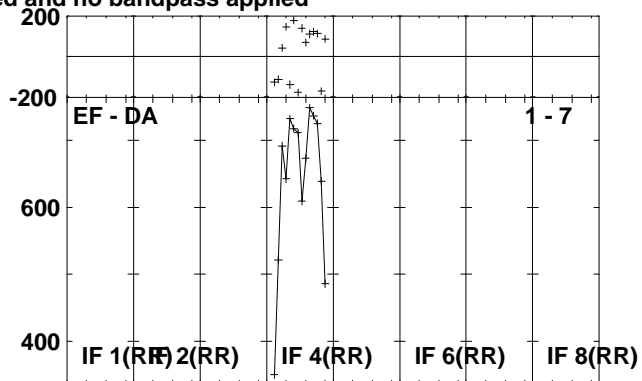
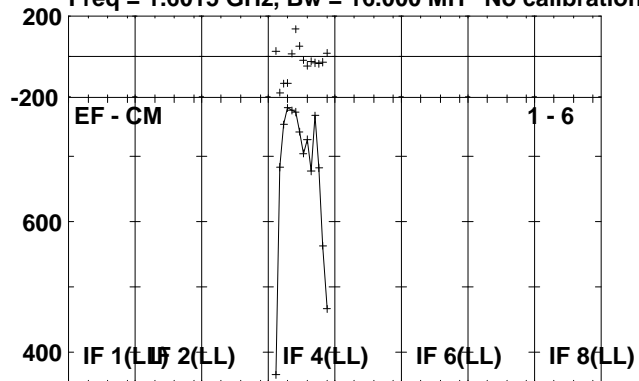

Lower frame: Micro Ampl Jy Top frame: Phas deg
Scalar averaged cross-power spectrum Several baselines displayed
Timerange: 00/23:49:53 to 00/23:54:49

Plot file version 79 created 01-JUL-2010 13:24:56

J2102+47 RG006B.UVDATA.1

Freq = 1.6015 GHz, Bw = 16.000 MH No calibration applied and no bandpass applied

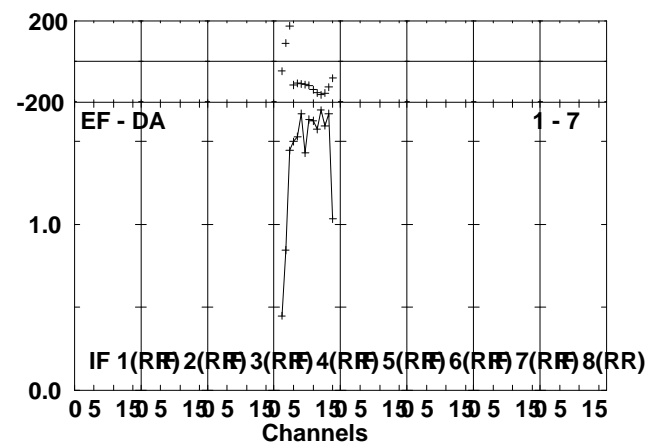
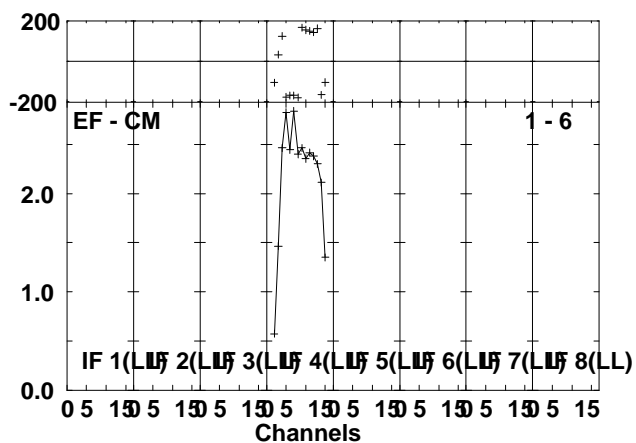
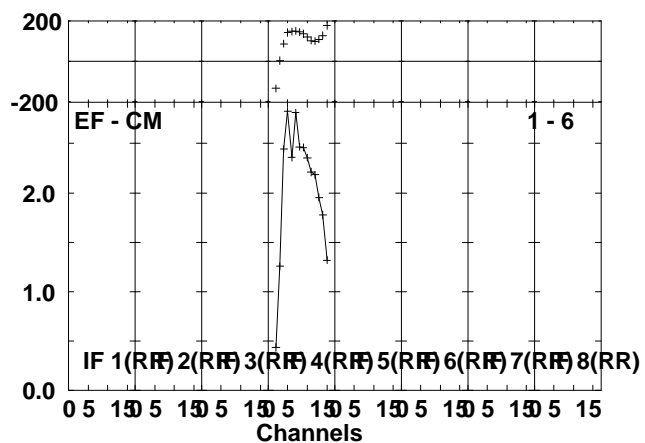
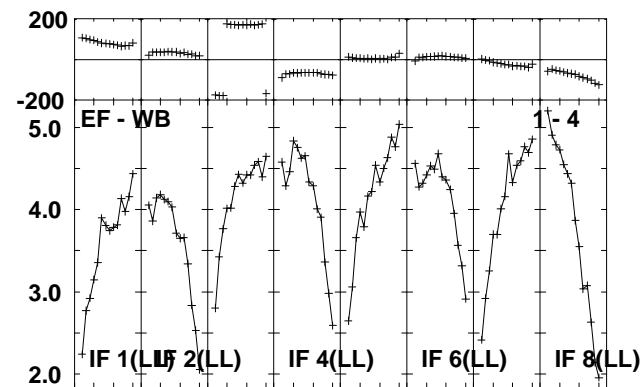
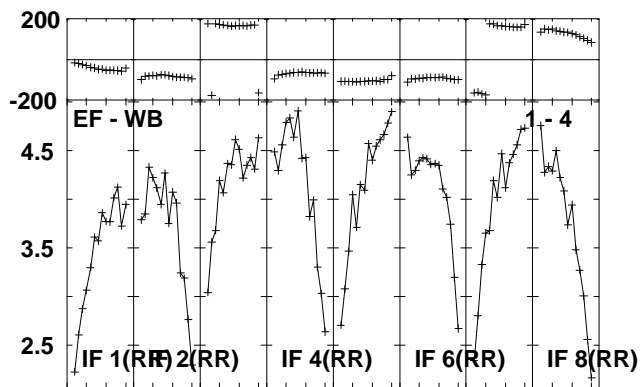
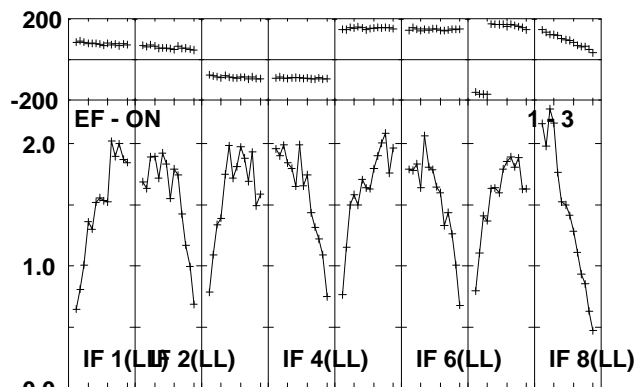
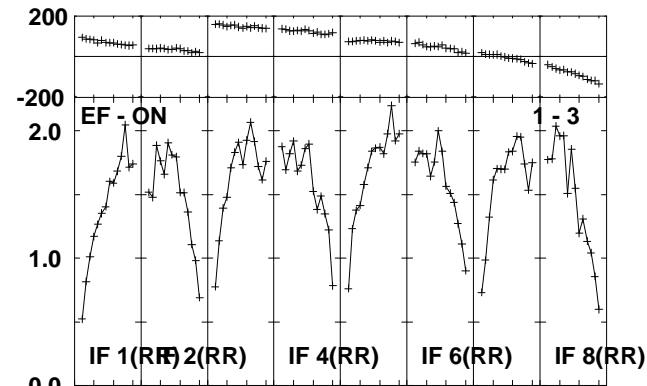
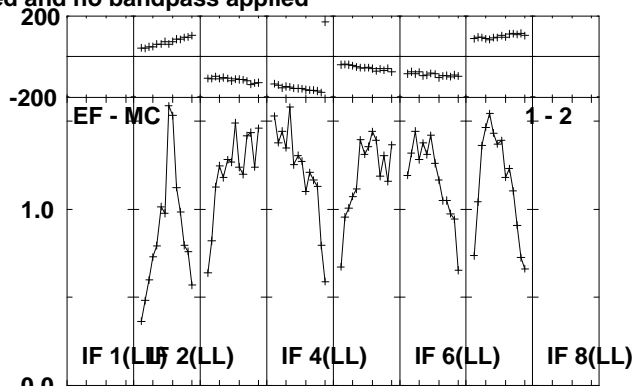
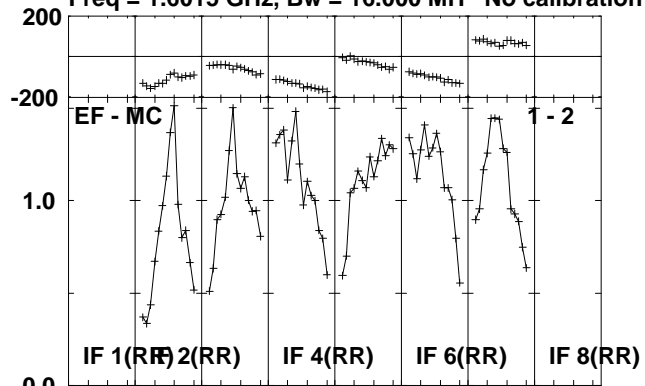

Lower frame: Milli Ampl Jy Top frame: Phas deg
Scalar averaged cross-power spectrum Several baselines displayed
Timerange: 00/23:54:53 to 00/23:57:01

Plot file version 80 created 01-JUL-2010 13:24:56
J2102+47 RG006B.UVDATA.1

Freq = 1.6015 GHz, Bw = 16.000 MH No calibration applied and no bandpass applied

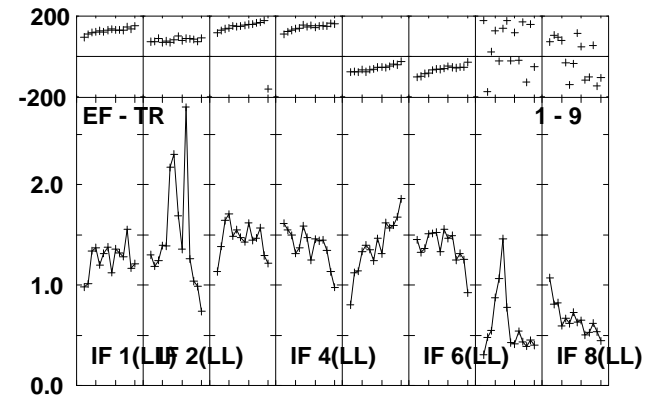
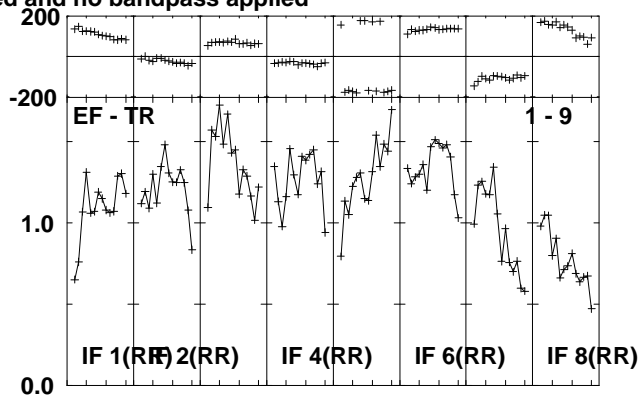
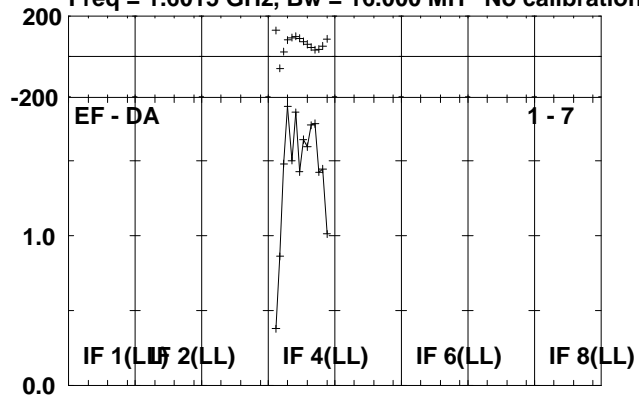

Lower frame: Milli Ampl Jy Top frame: Phas deg
Scalar averaged cross-power spectrum Several baselines displayed
Timerange: 00/23:54:53 to 00/23:57:01

Plot file version 81 created 01-JUL-2010 13:24:57

V407CYG RG006B.UVDATA.1

Freq = 1.6015 GHz, Bw = 16.000 MH No calibration applied and no bandpass applied

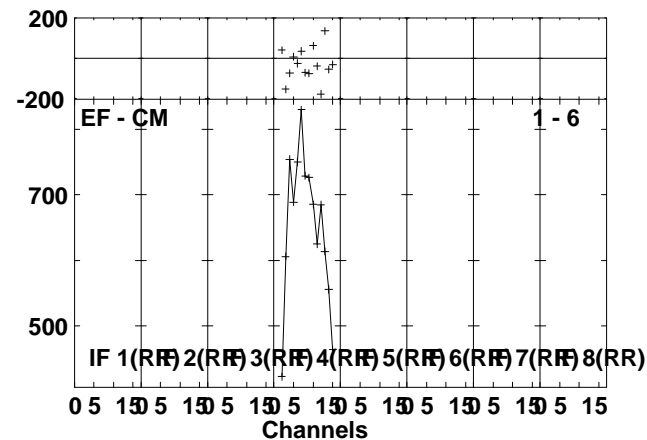
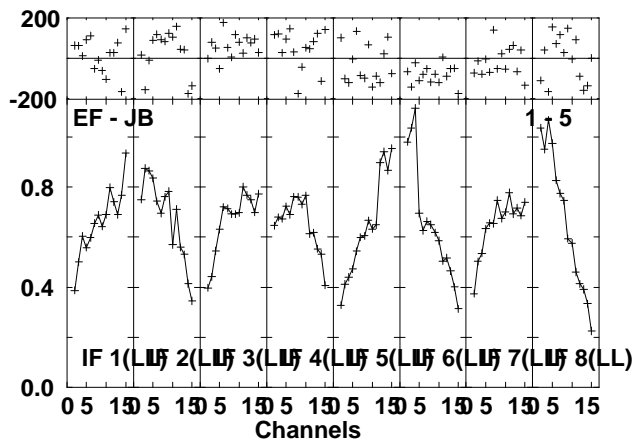
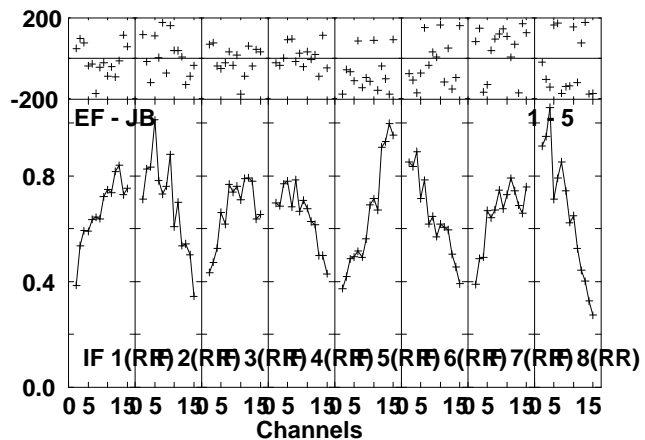
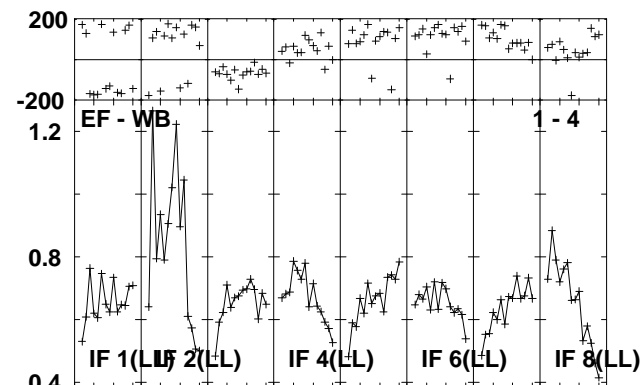
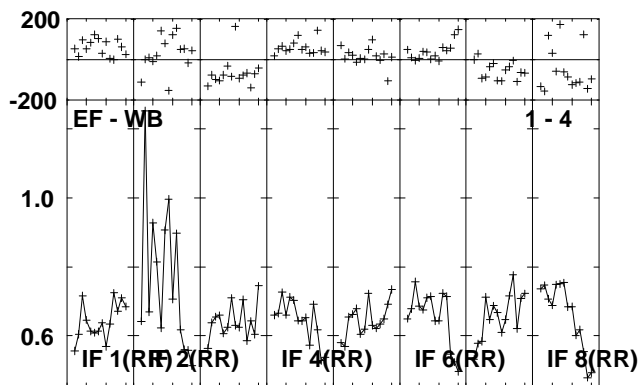
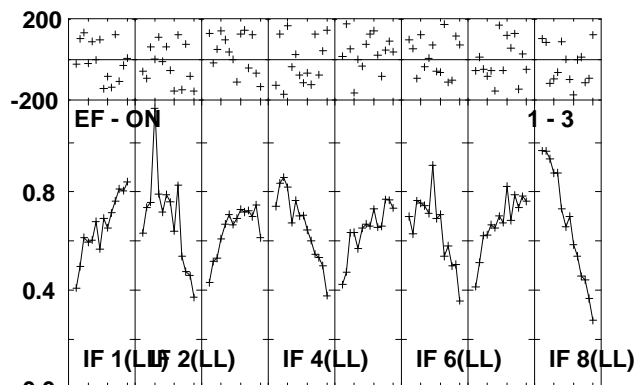
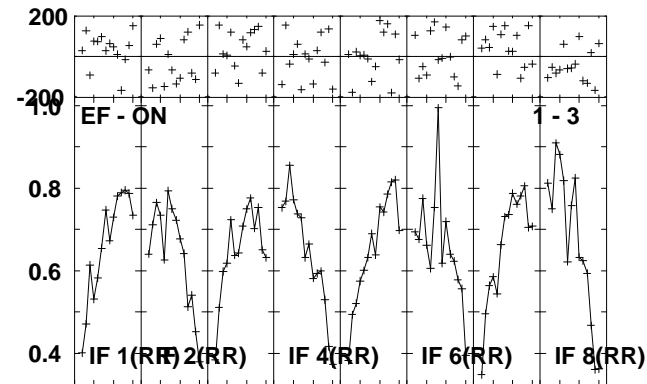
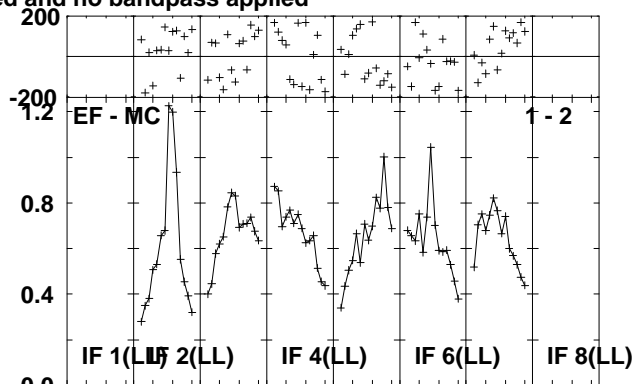
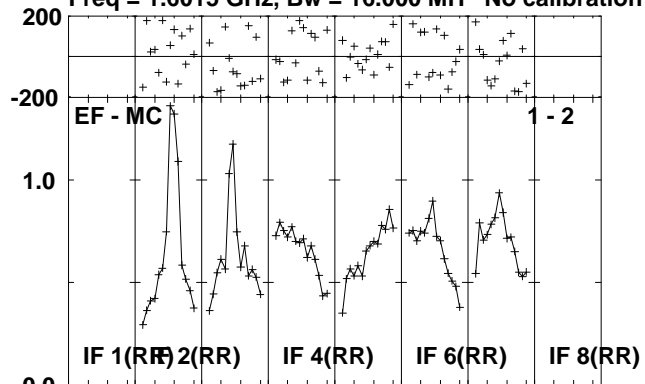

Lower frame: Milli Ampl Jy Top frame: Phas deg
Scalar averaged cross-power spectrum Several baselines displayed
Timerange: 00/23:57:05 to 01/00:02:01

Plot file version 82 created 01-JUL-2010 13:24:58

V407CYG RG006B.UVDATA.1

Freq = 1.6015 GHz, Bw = 16.000 MH No calibration applied and no bandpass applied

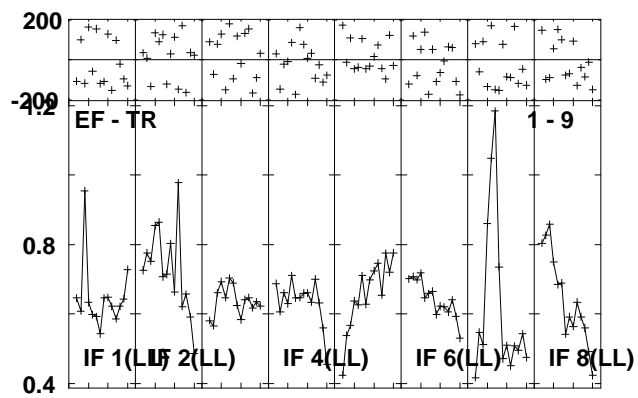
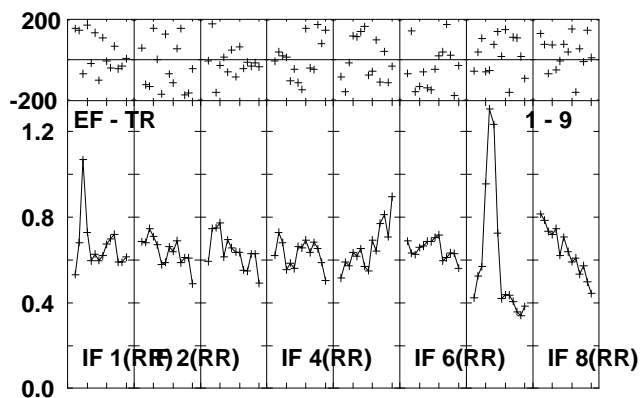
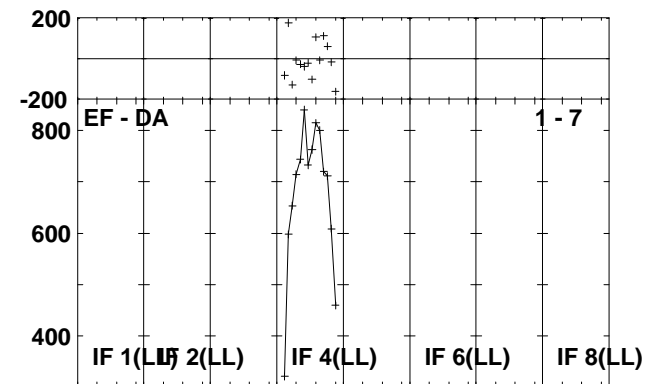
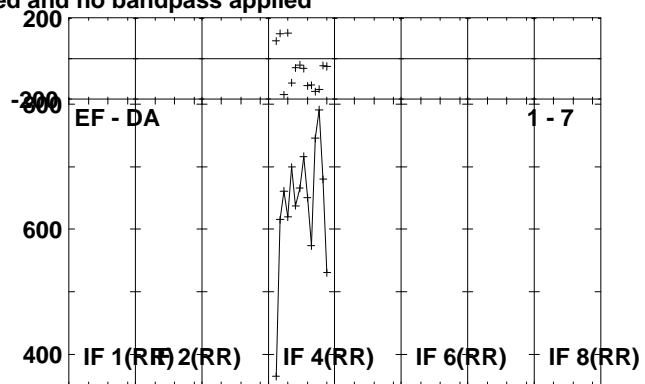
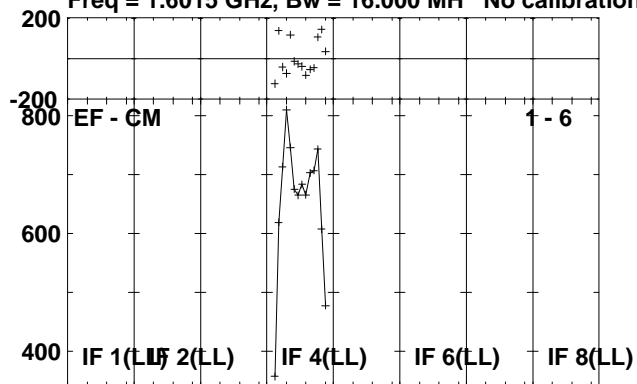

Lower frame: Micro Ampl Jy Top frame: Phas deg
Scalar averaged cross-power spectrum Several baselines displayed
Timerange: 00/23:57:05 to 01/00:02:01

Plot file version 83 created 01-JUL-2010 13:24:58

J2102+47 RG006B.UVDATA.1

Freq = 1.6015 GHz, Bw = 16.000 MH No calibration applied and no bandpass applied

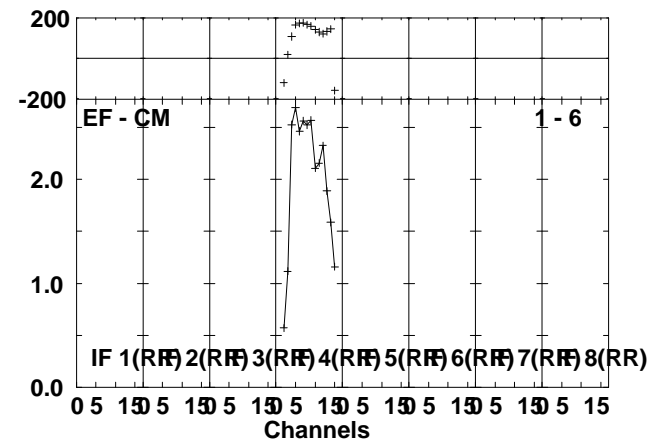
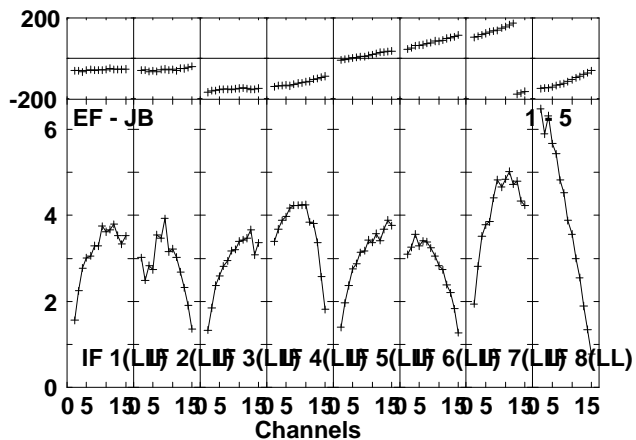
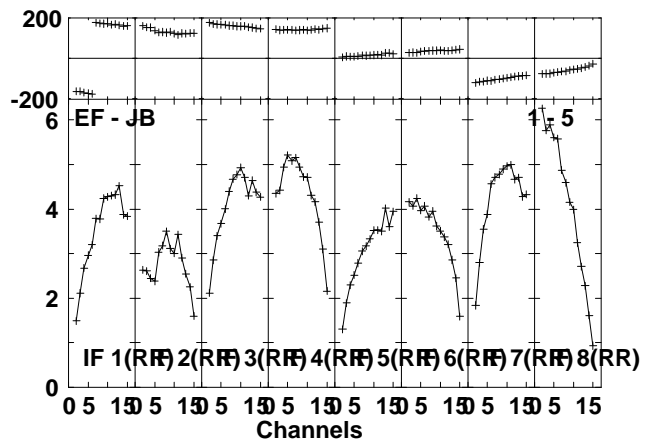
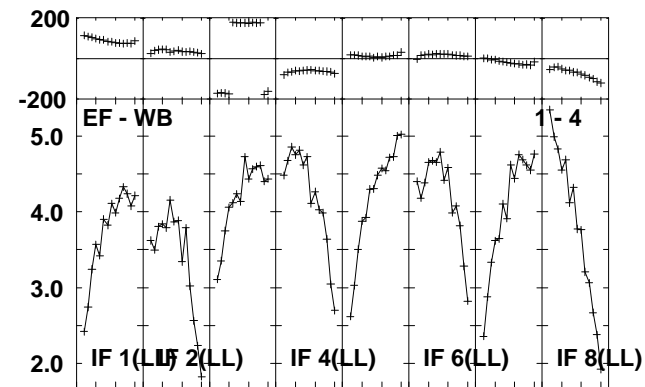
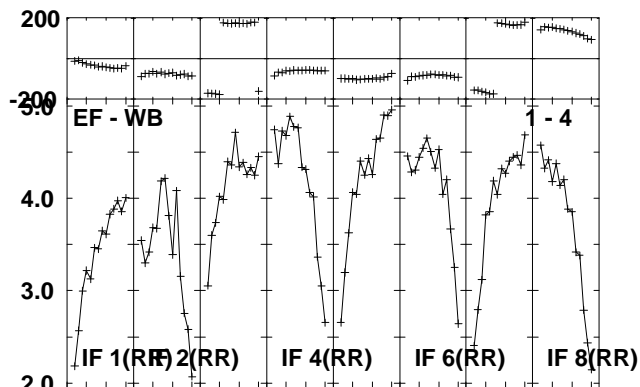
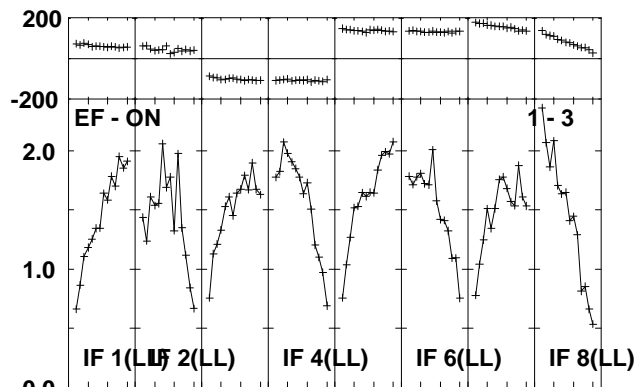
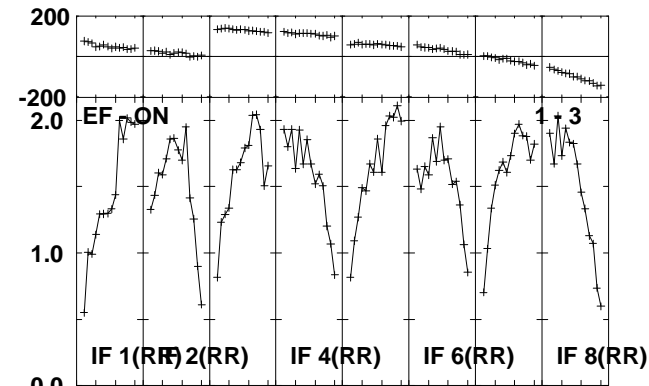
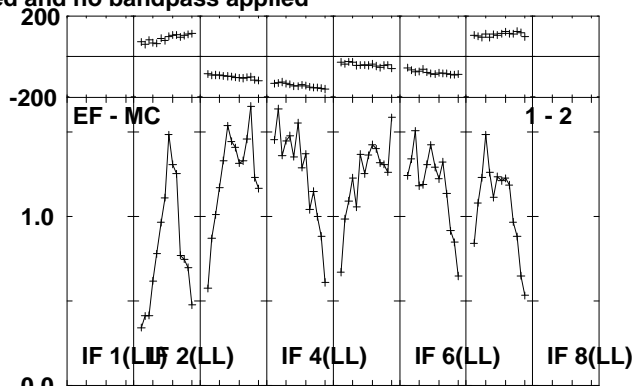
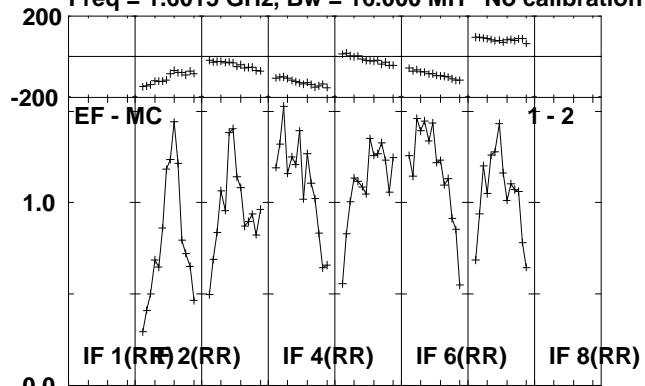

Lower frame: Milli Ampl Jy Top frame: Phas deg
Scalar averaged cross-power spectrum Several baselines displayed
Timerange: 01/00:03:05 to 01/00:04:49

Plot file version 84 created 01-JUL-2010 13:24:59
J2102+47 RG006B.UVDATA.1

Freq = 1.6015 GHz, Bw = 16.000 MH No calibration applied and no bandpass applied

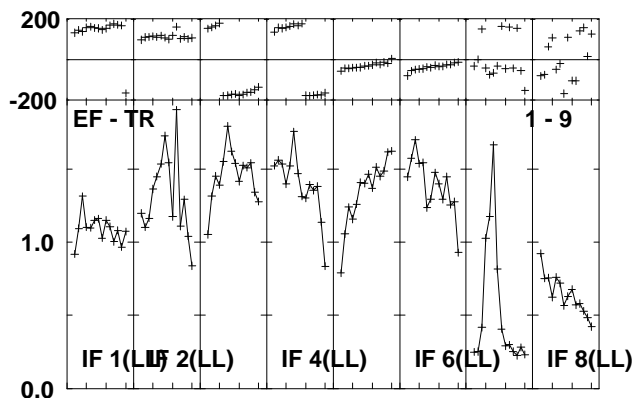
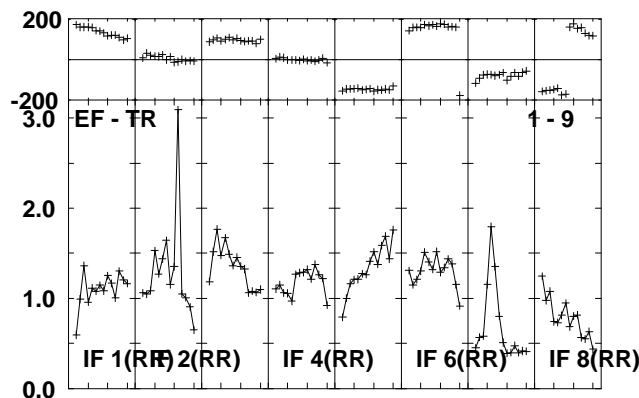
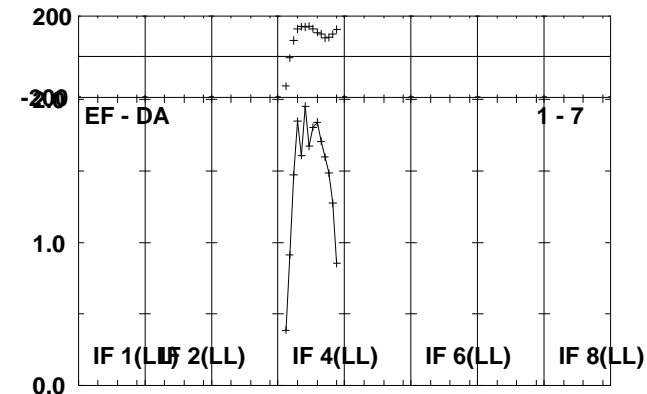
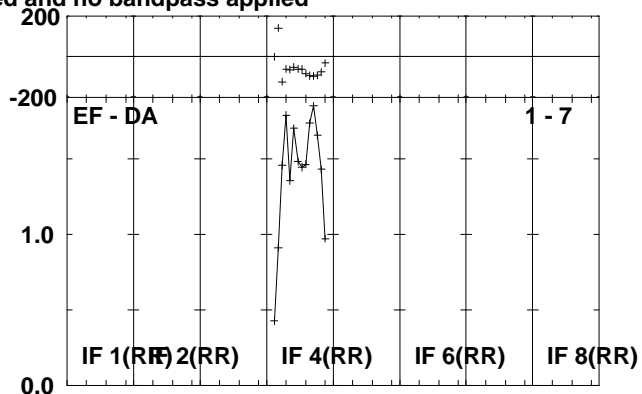
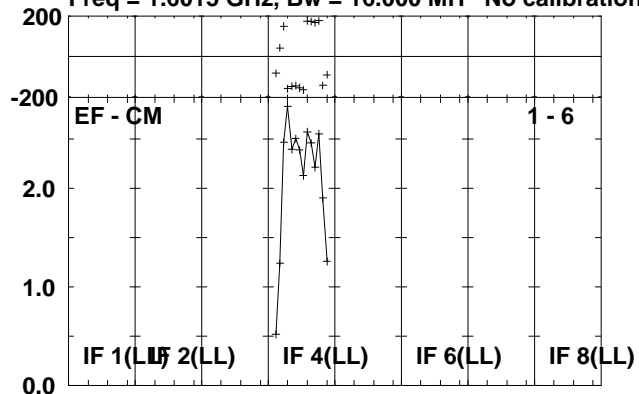

Lower frame: Milli Ampl Jy Top frame: Phas deg
Scalar averaged cross-power spectrum Several baselines displayed
Timerange: 01/00:03:05 to 01/00:04:49

Plot file version 85 created 01-JUL-2010 13:24:59

V407CYG RG006B.UVDATA.1

Freq = 1.6015 GHz, Bw = 16.000 MH No calibration applied and no bandpass applied

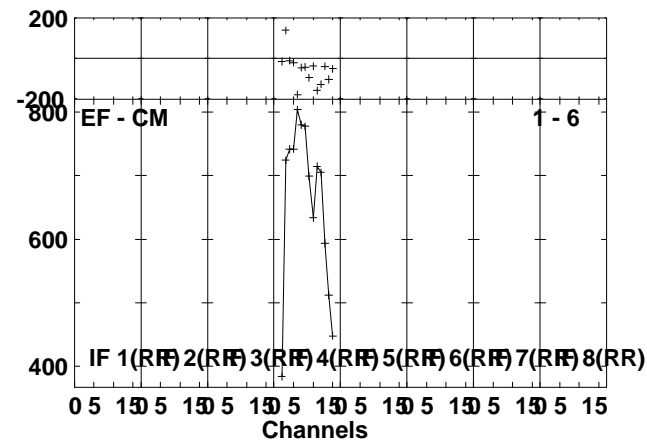
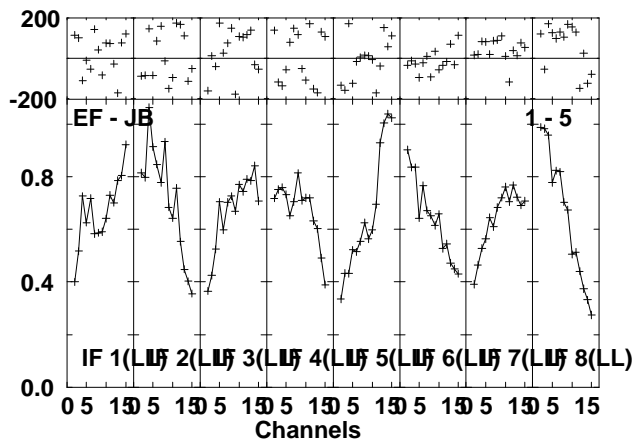
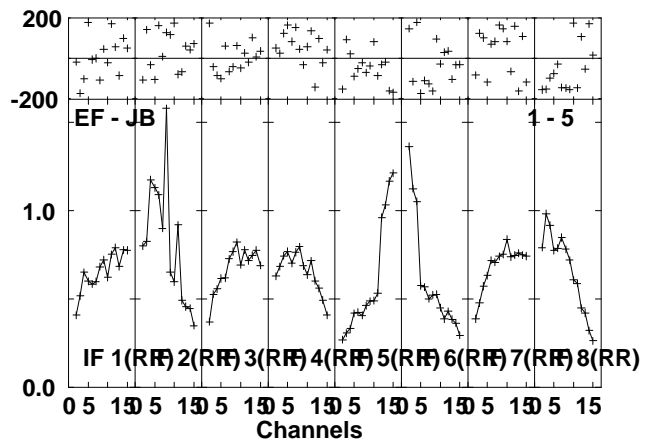
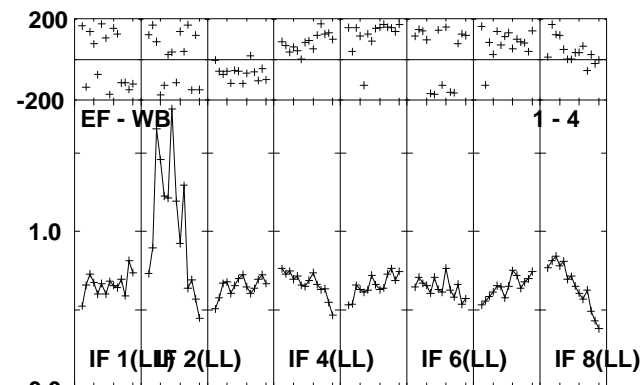
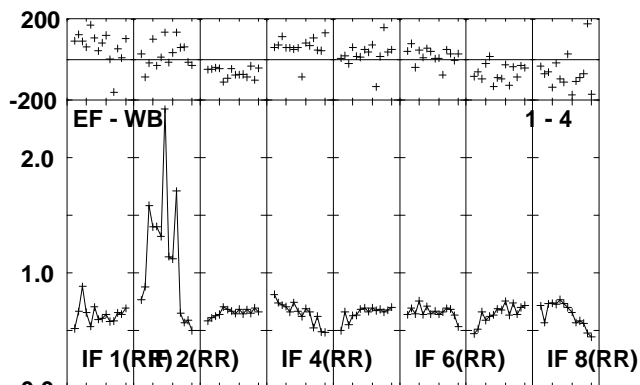
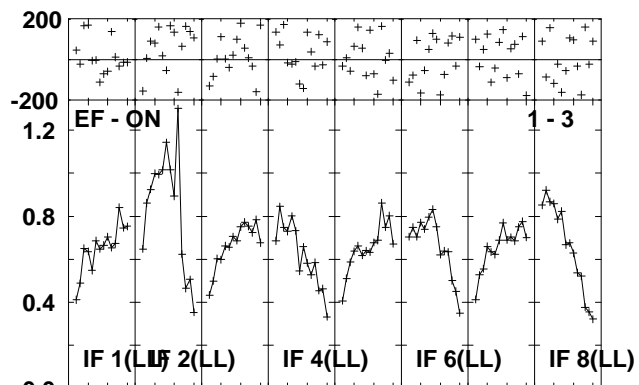
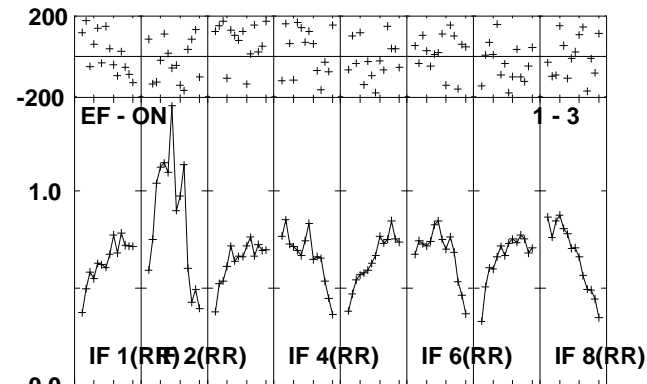
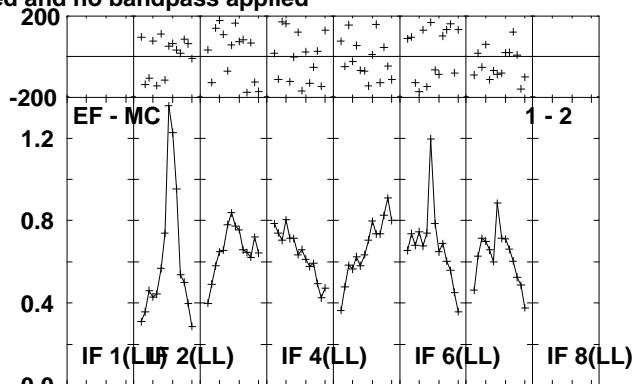
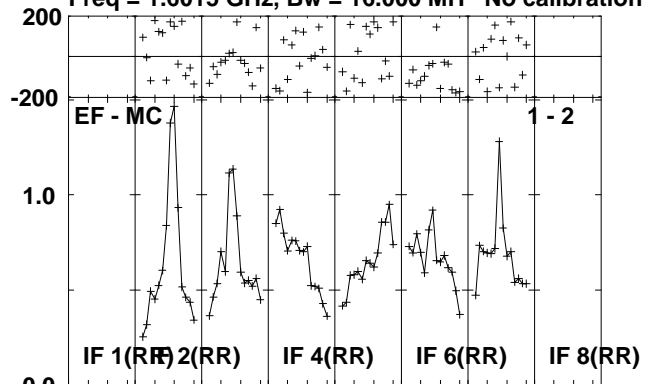

Lower frame: Milli Ampl Jy Top frame: Phas deg
Scalar averaged cross-power spectrum Several baselines displayed
Timerange: 01/00:04:53 to 01/00:09:49

Plot file version 86 created 01-JUL-2010 13:25:00

V407CYG RG006B.UVDATA.1

Freq = 1.6015 GHz, Bw = 16.000 MH No calibration applied and no bandpass applied

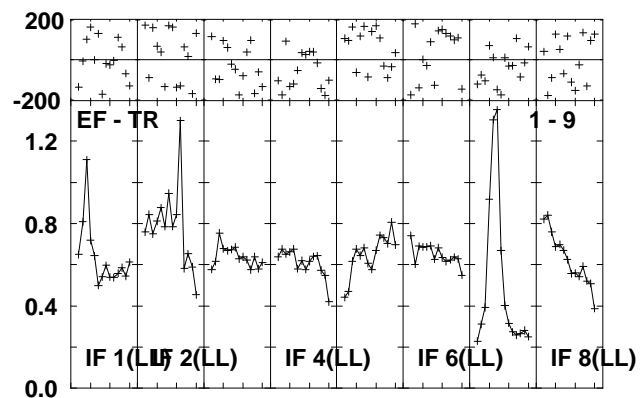
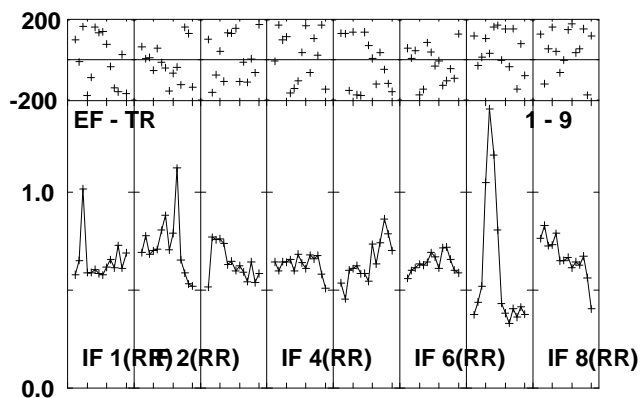
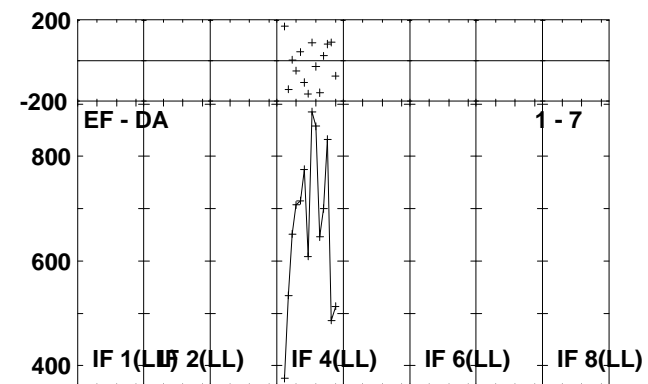
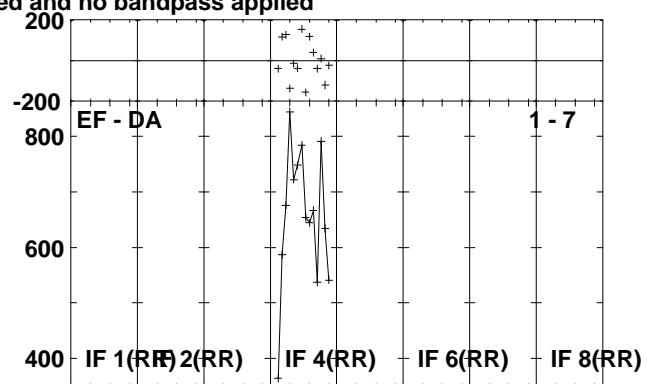
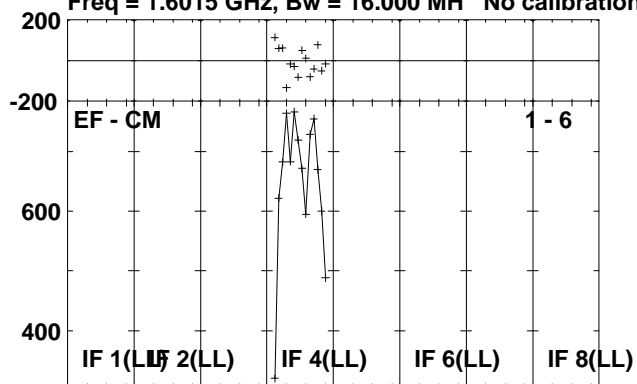

Lower frame: Micro Ampl Jy Top frame: Phas deg
Scalar averaged cross-power spectrum Several baselines displayed
Timerange: 01/00:04:53 to 01/00:09:49

Plot file version 87 created 01-JUL-2010 13:25:01
 J2102+47 RG006B.UVDATA.1

Freq = 1.6015 GHz, Bw = 16.000 MH No calibration applied and no bandpass applied

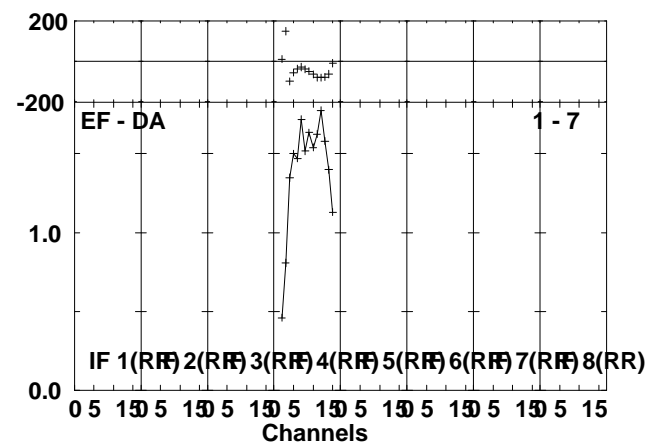
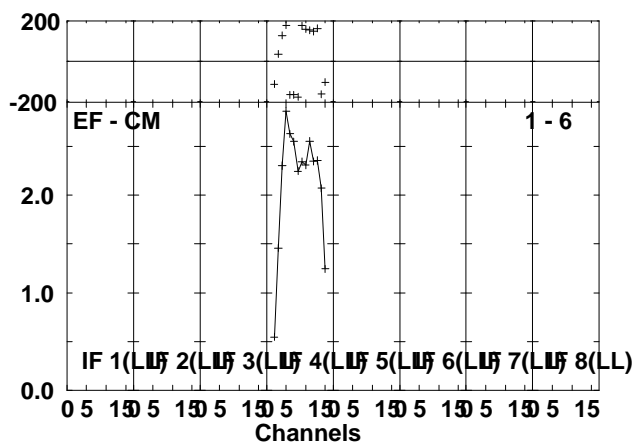
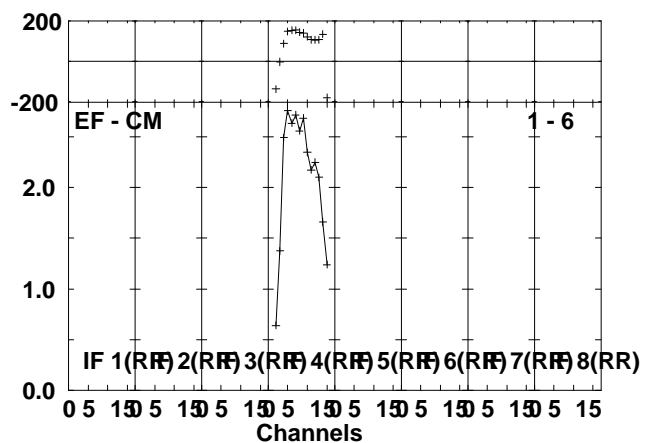
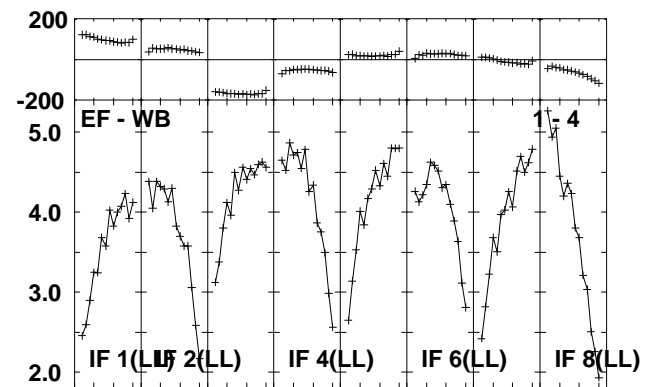
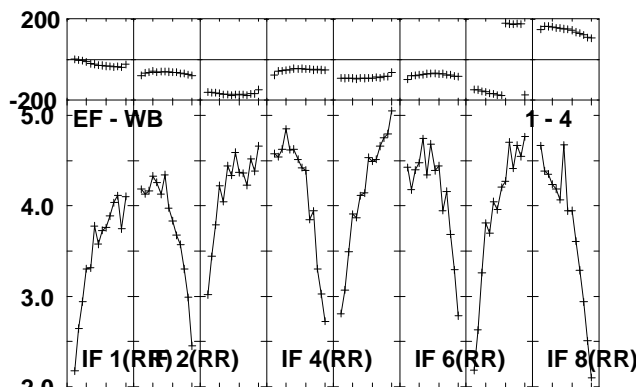
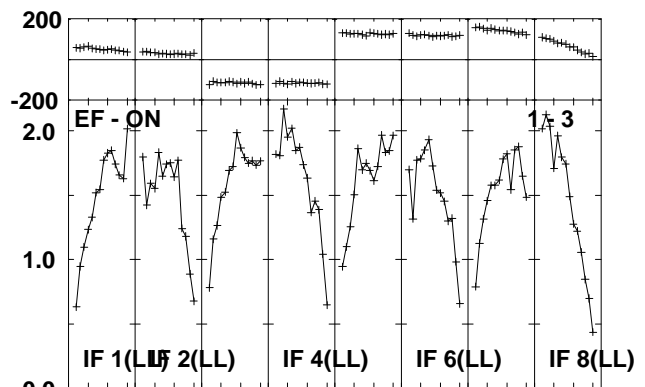
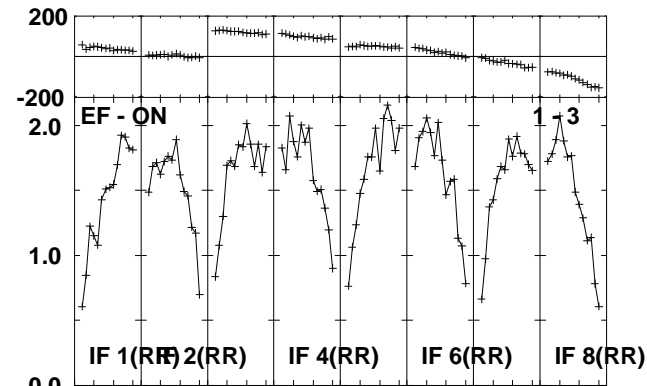
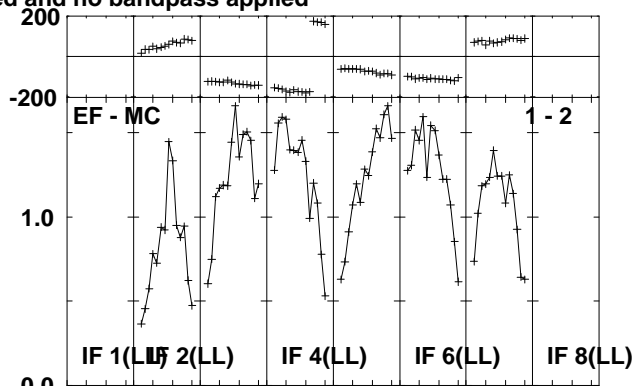
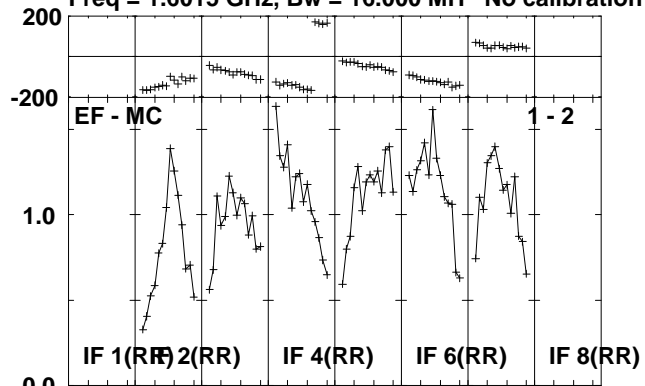

Lower frame: Milli Ampl Jy Top frame: Phas deg
 Scalar averaged cross-power spectrum Several baselines displayed
 Timerange: 01/00:09:53 to 01/00:12:01

Plot file version 88 created 01-JUL-2010 13:25:01

J2102+47 RG006B.UVDATA.1

Freq = 1.6015 GHz, Bw = 16.000 MH No calibration applied and no bandpass applied

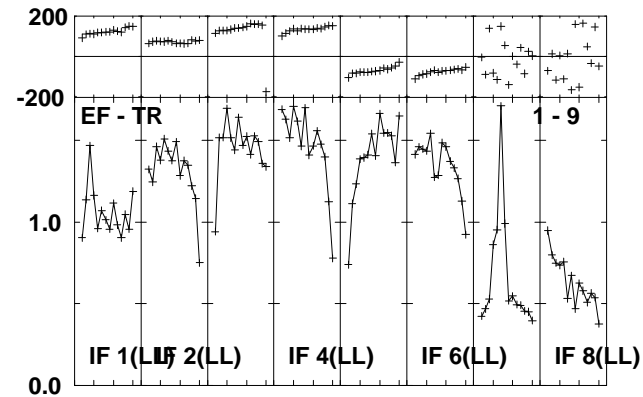
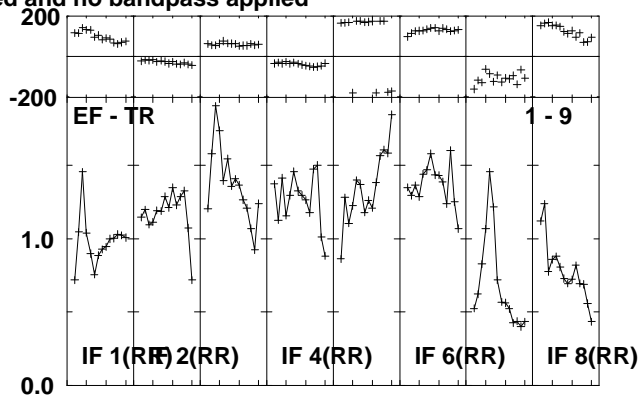
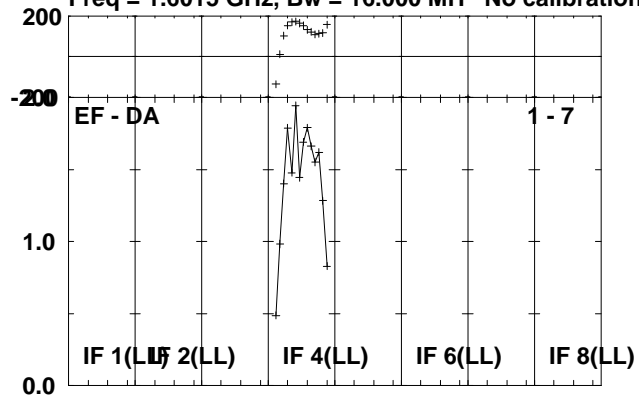

Lower frame: Milli Ampl Jy Top frame: Phas deg
Scalar averaged cross-power spectrum Several baselines displayed
Timerange: 01/00:09:53 to 01/00:12:01

Plot file version 89 created 01-JUL-2010 13:25:02
 V407CYG RG006B.UVDATA.1

Freq = 1.6015 GHz, Bw = 16.000 MH No calibration applied and no bandpass applied

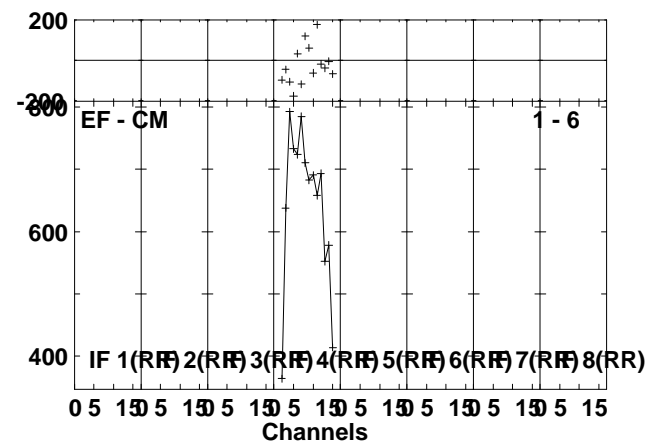
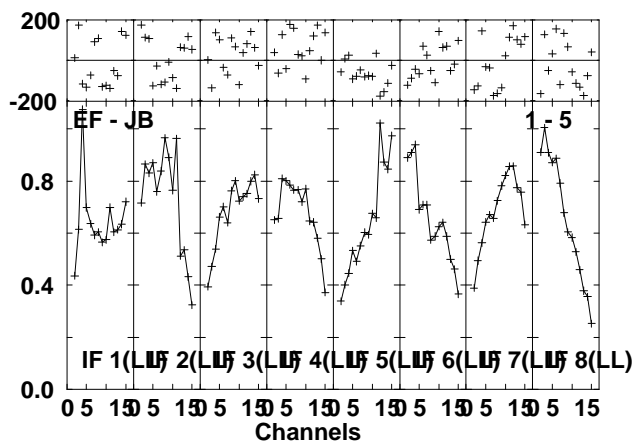
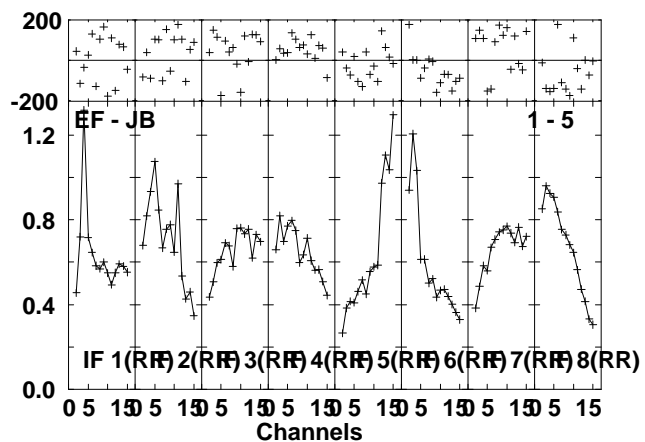
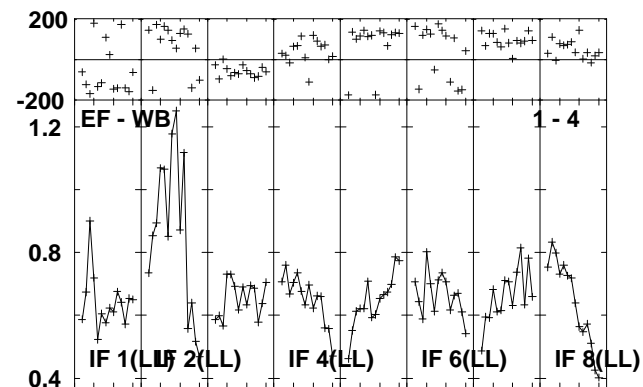
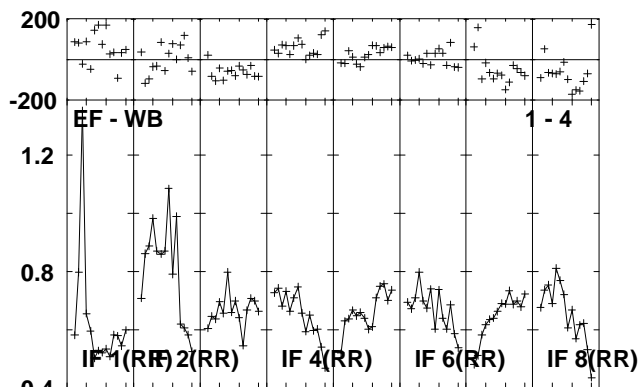
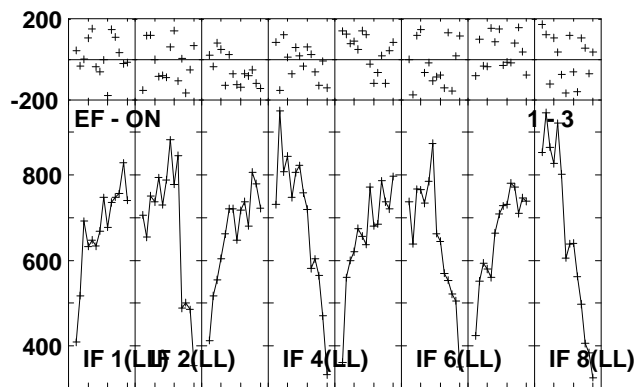
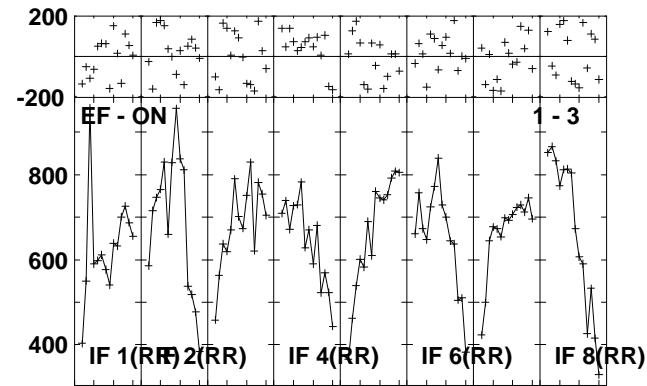
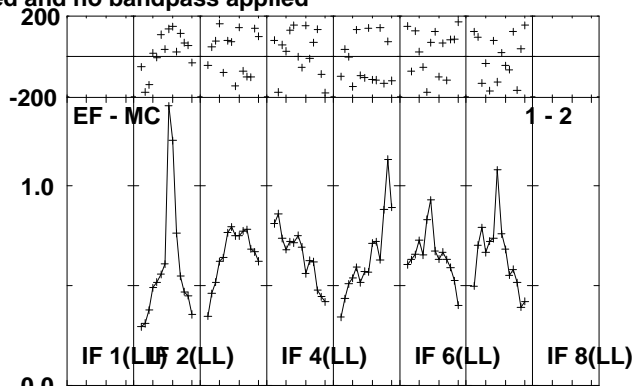
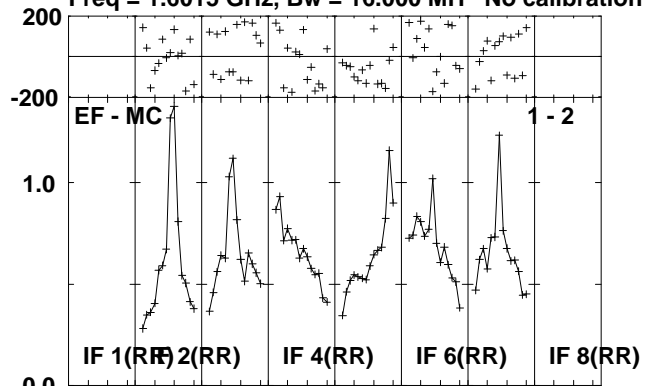

Lower frame: Milli Ampl Jy Top frame: Phas deg
 Scalar averaged cross-power spectrum Several baselines displayed
 Timerange: 01/00:12:05 to 01/00:17:01

Plot file version 90 created 01-JUL-2010 13:25:03

V407CYG RG006B.UVDATA.1

Freq = 1.6015 GHz, Bw = 16.000 MH No calibration applied and no bandpass applied

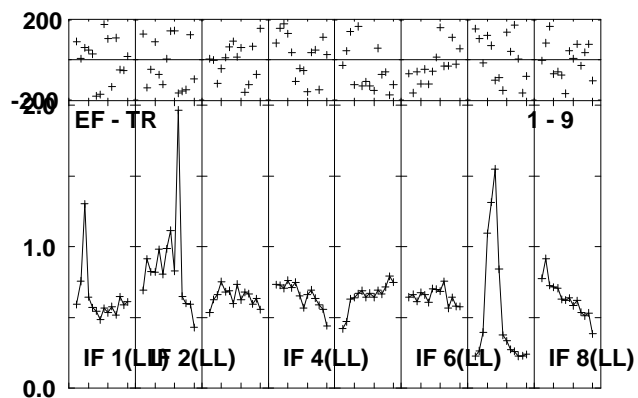
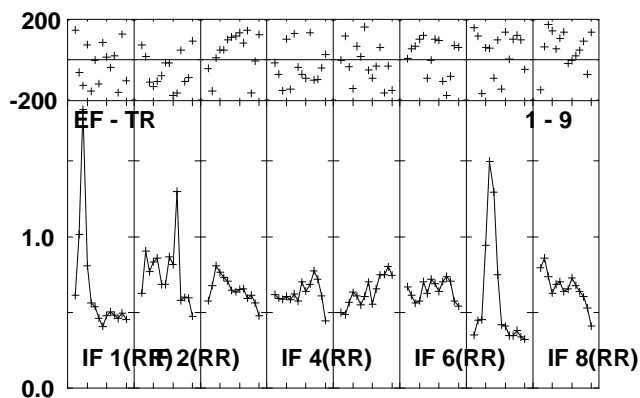
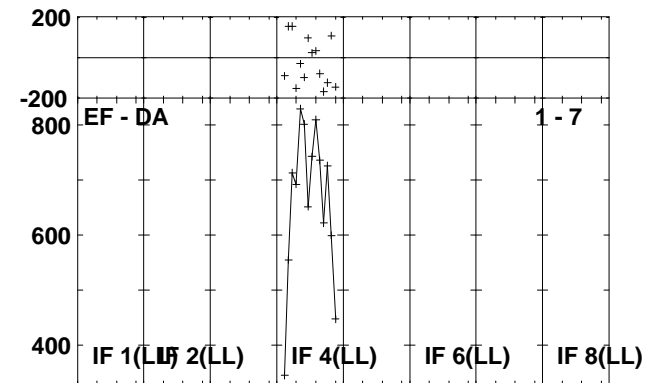
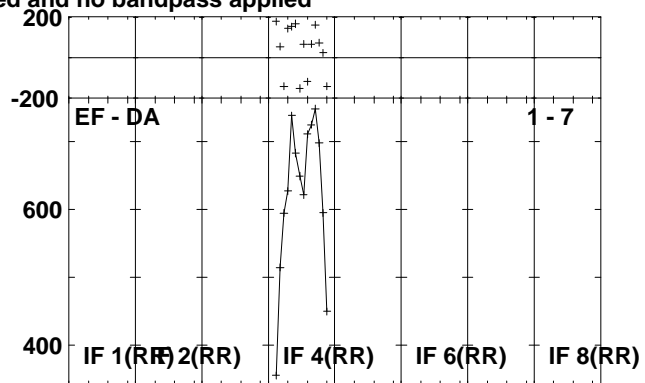
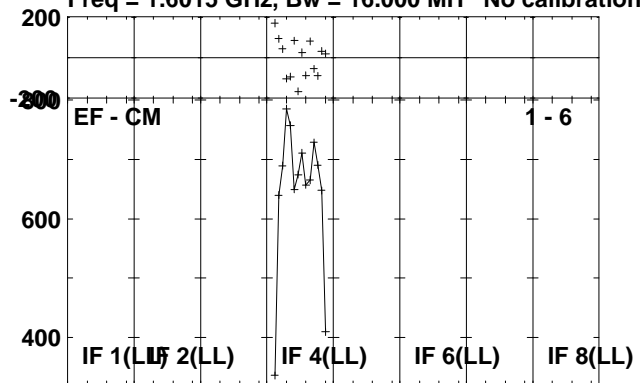

Lower frame: Micro Ampl Jy Top frame: Phas deg
Scalar averaged cross-power spectrum Several baselines displayed
Timerange: 01/00:12:05 to 01/00:17:01

Plot file version 91 created 01-JUL-2010 13:25:03

J2102+47 RG006B.UVDATA.1

Freq = 1.6015 GHz, Bw = 16.000 MH No calibration applied and no bandpass applied

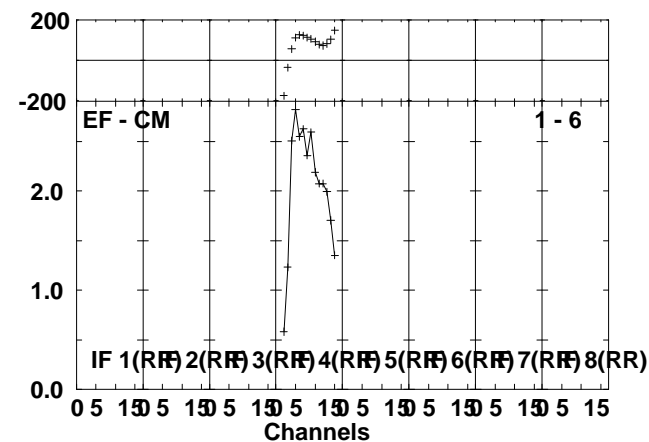
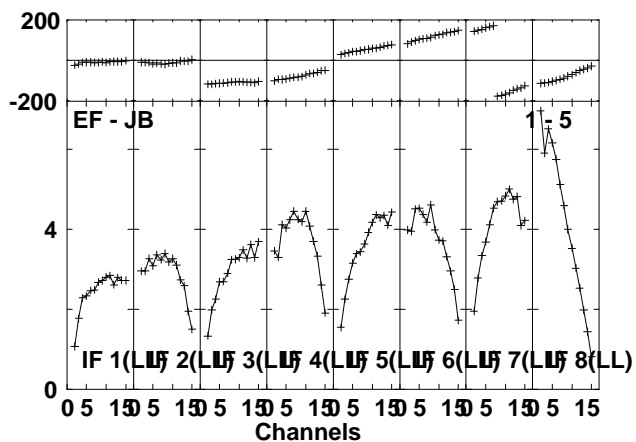
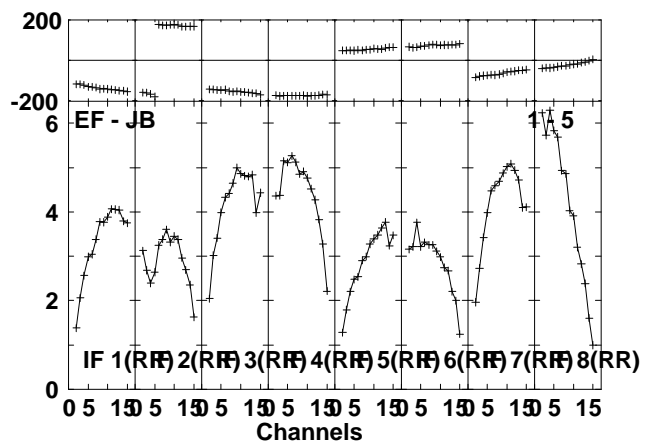
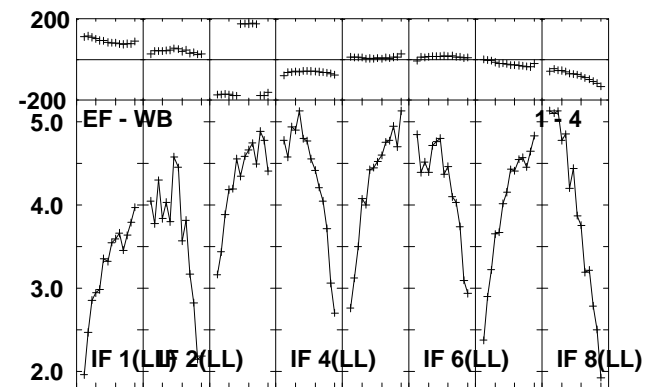
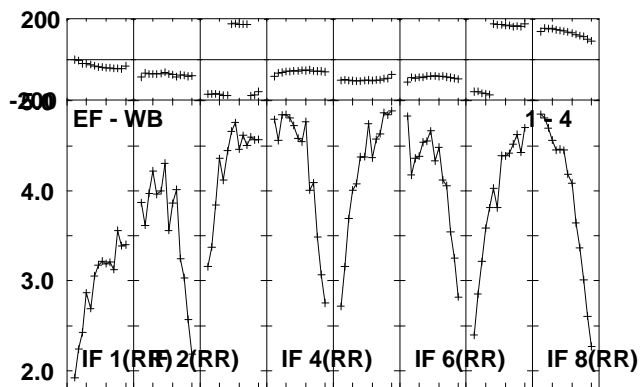
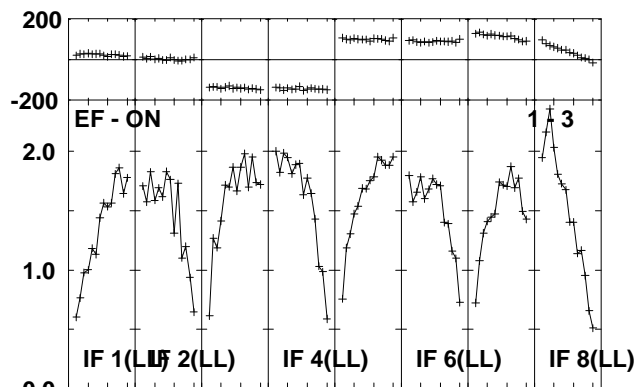
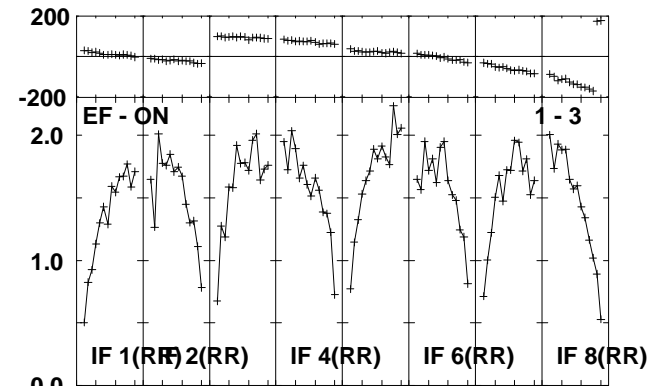
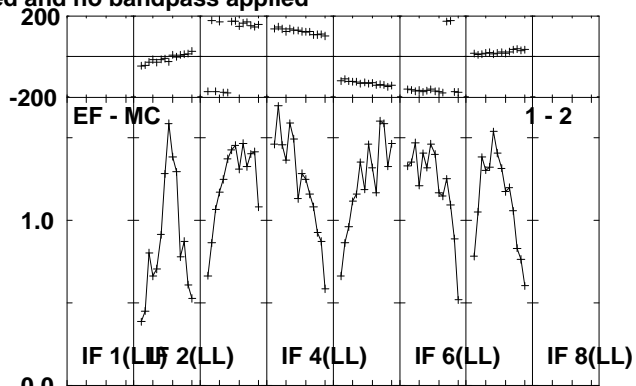
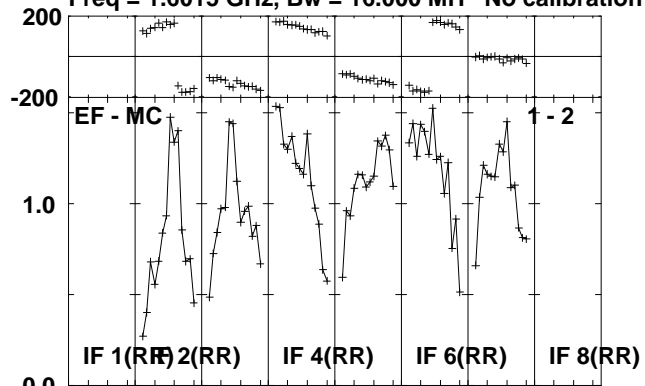

Lower frame: Milli Ampl Jy Top frame: Phas deg
Scalar averaged cross-power spectrum Several baselines displayed
Timerange: 01/00:18:05 to 01/00:19:49

Plot file version 92 created 01-JUL-2010 13:25:04
J2102+47 RG006B.UVDATA.1

Freq = 1.6015 GHz, Bw = 16.000 MH No calibration applied and no bandpass applied

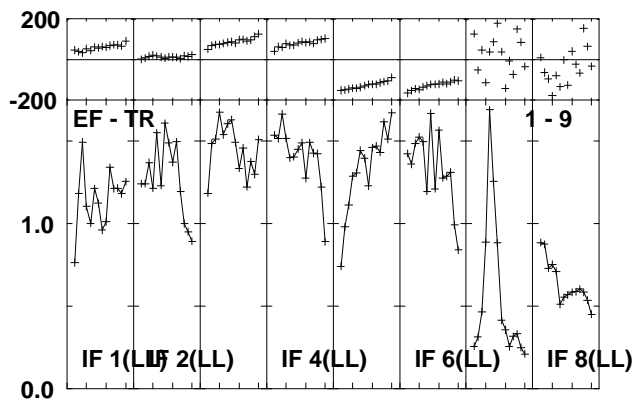
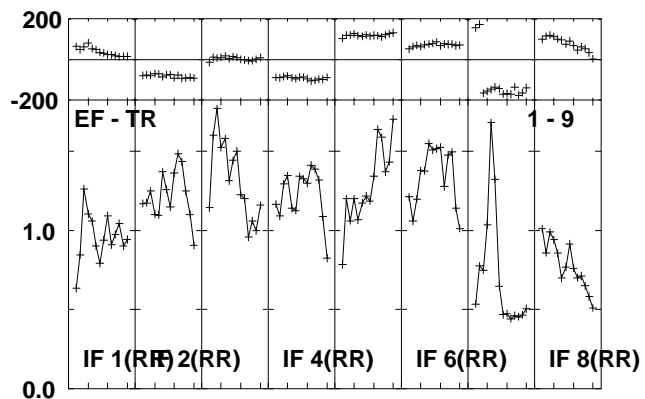
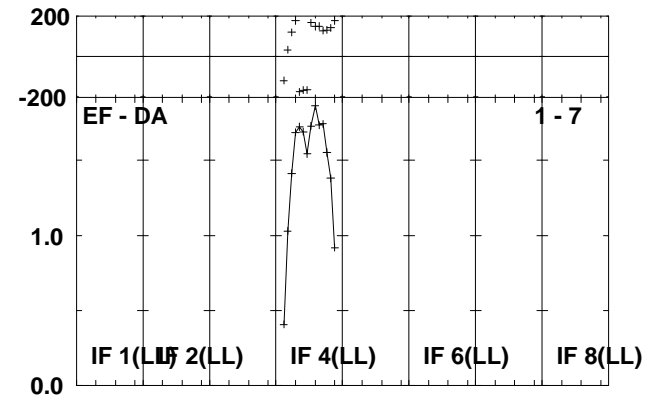
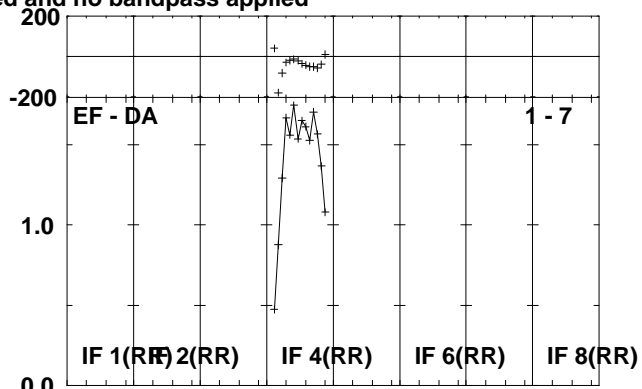
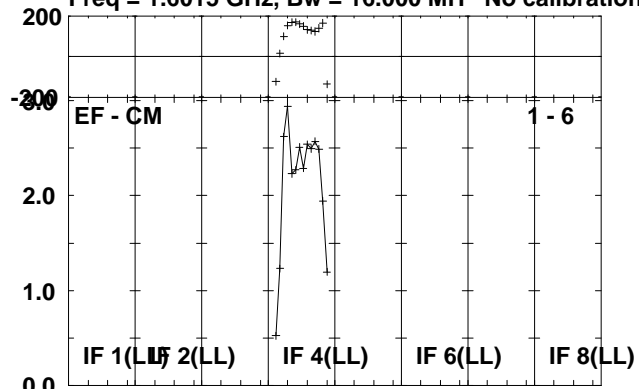

Lower frame: Milli Ampl Jy Top frame: Phas deg
Scalar averaged cross-power spectrum Several baselines displayed
Timerange: 01/00:18:05 to 01/00:19:49

Plot file version 93 created 01-JUL-2010 13:25:04
 V407CYG RG006B.UVDATA.1

Freq = 1.6015 GHz, Bw = 16.000 MH No calibration applied and no bandpass applied

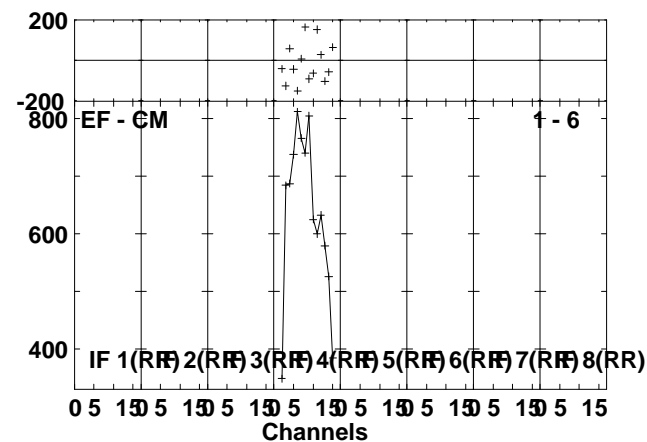
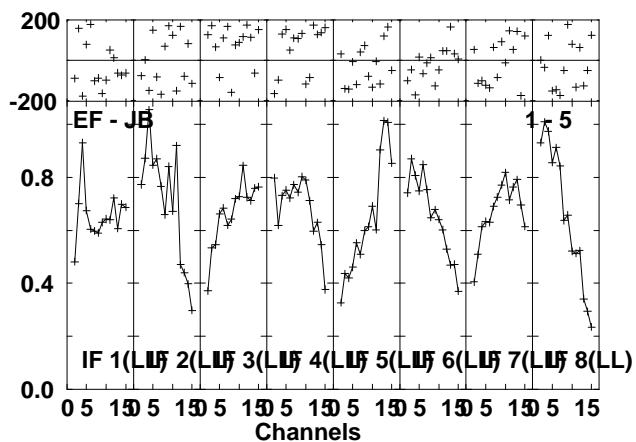
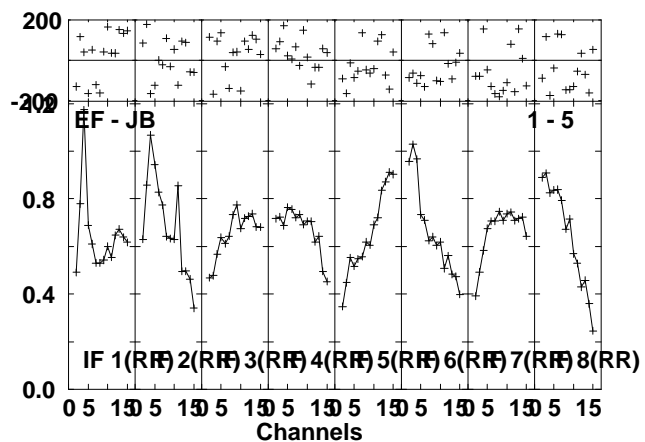
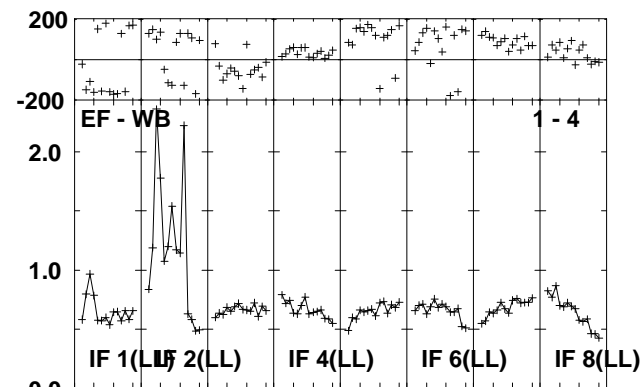
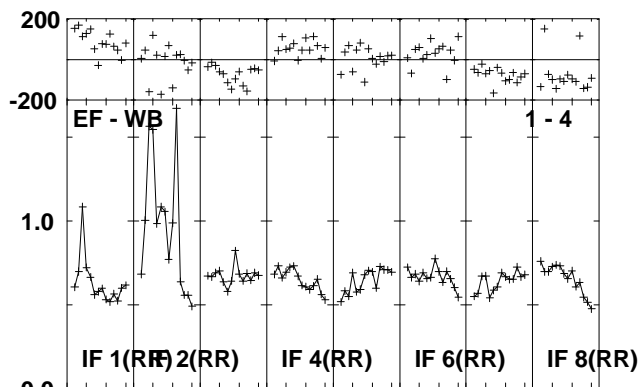
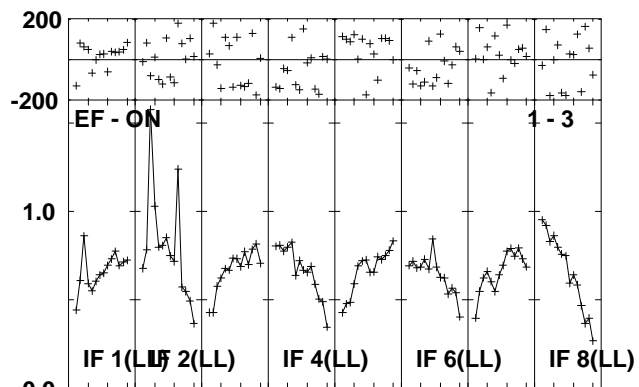
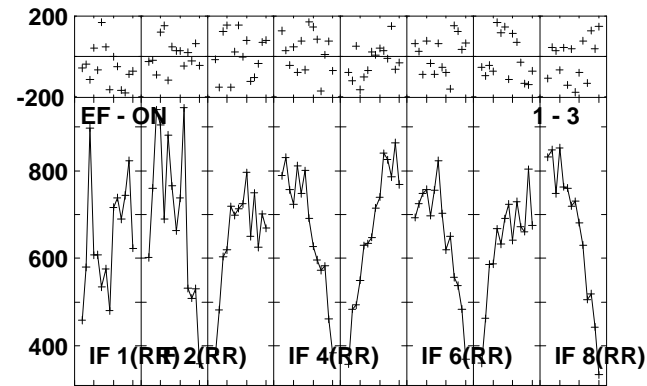
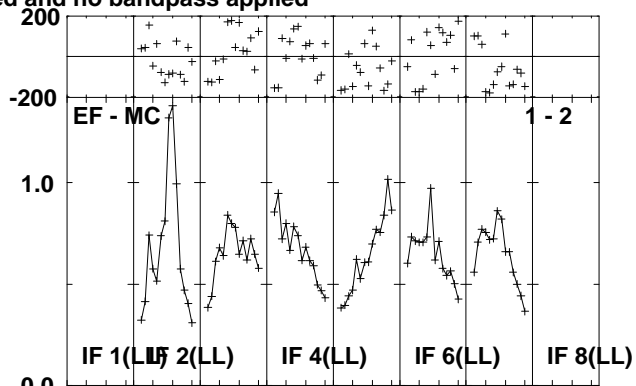
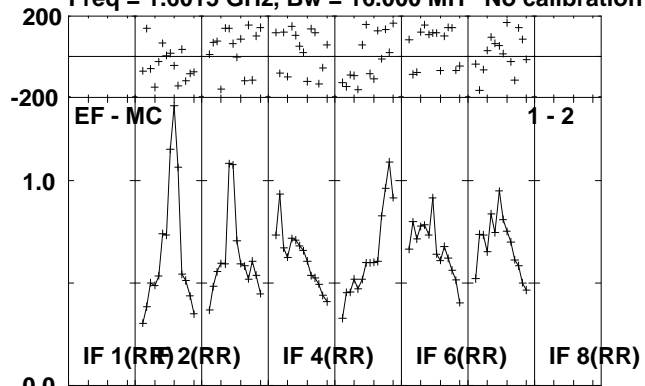

Lower frame: Milli Ampl Jy Top frame: Phas deg
 Scalar averaged cross-power spectrum Several baselines displayed
 Timerange: 01/00:19:53 to 01/00:24:49

Plot file version 94 created 01-JUL-2010 13:25:05

V407CYG RG006B.UVDATA.1

Freq = 1.6015 GHz, Bw = 16.000 MH No calibration applied and no bandpass applied

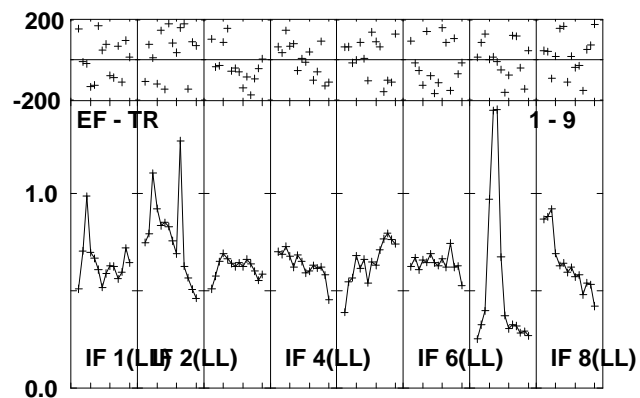
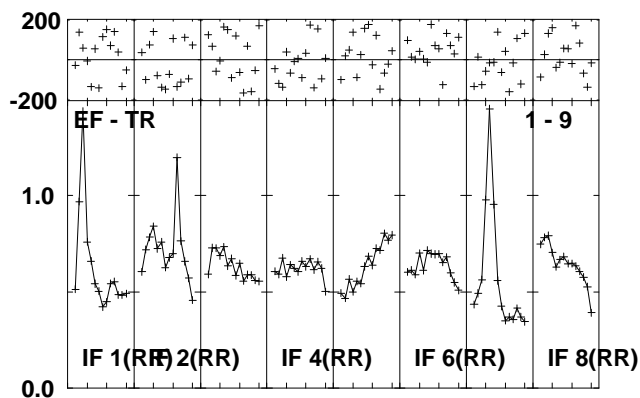
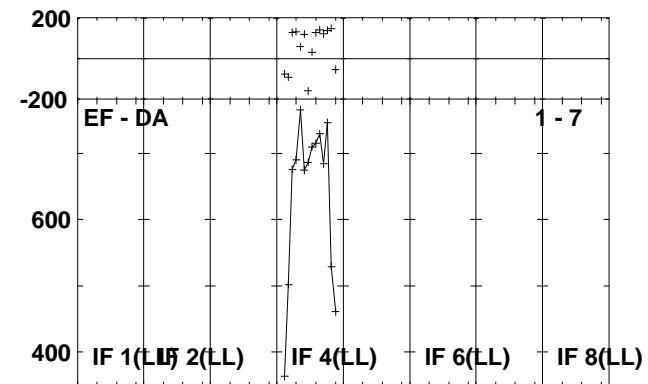
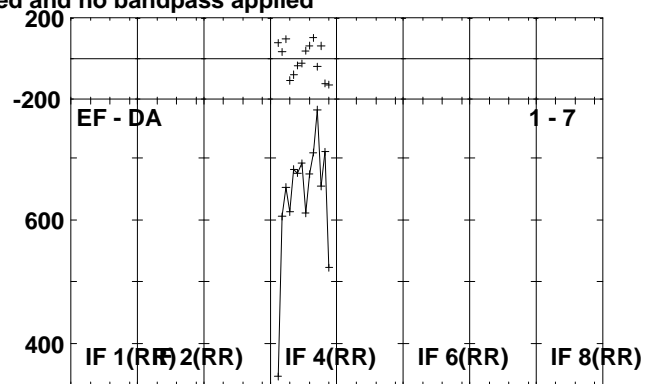
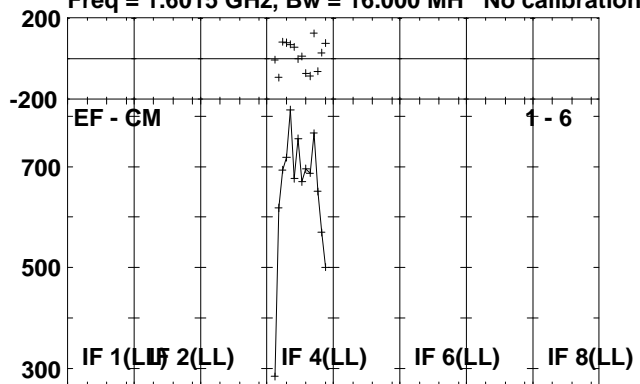

Lower frame: Micro Ampl Jy Top frame: Phas deg
Scalar averaged cross-power spectrum Several baselines displayed
Timerange: 01/00:19:53 to 01/00:24:49

Plot file version 95 created 01-JUL-2010 13:25:06

J2102+47 RG006B.UVDATA.1

Freq = 1.6015 GHz, Bw = 16.000 MH No calibration applied and no bandpass applied

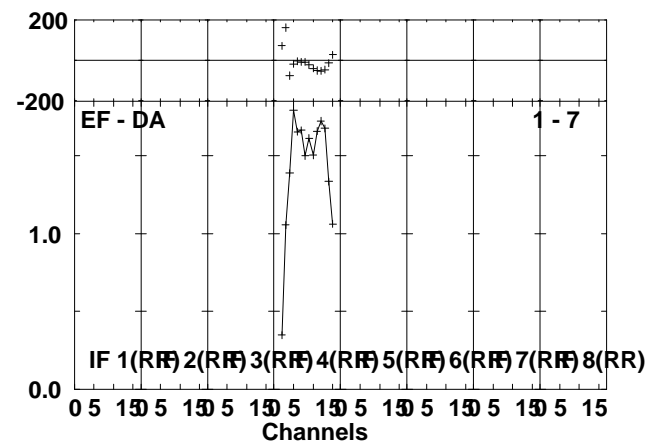
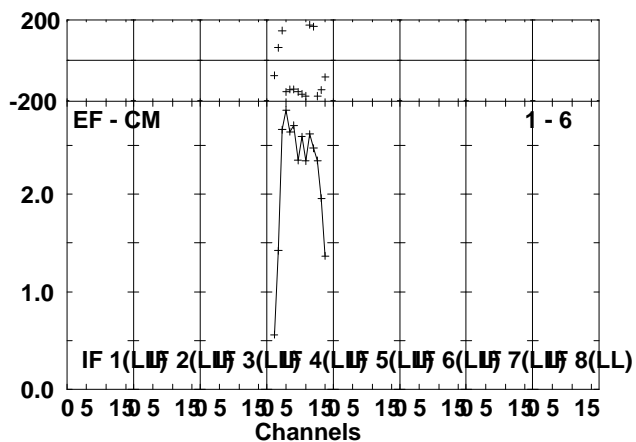
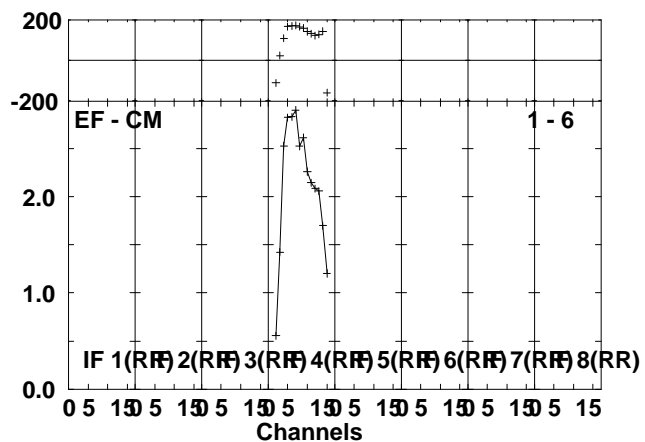
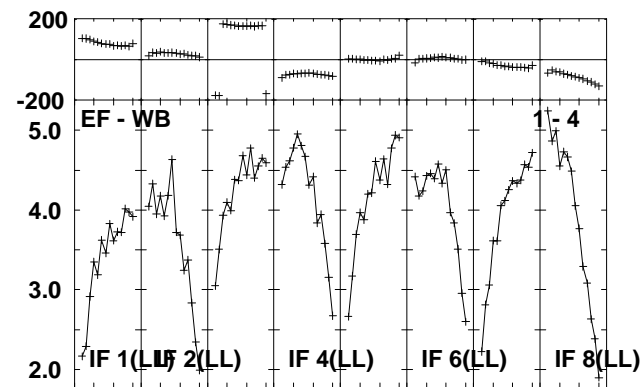
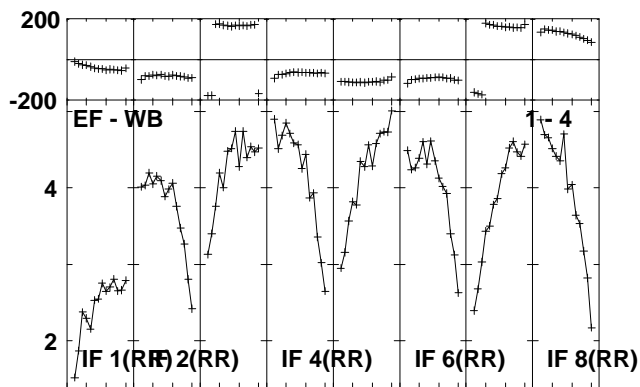
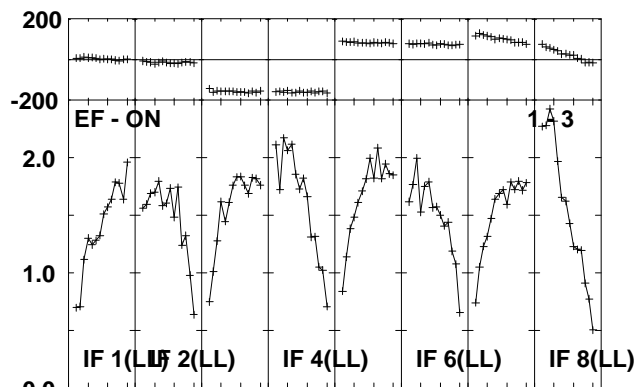
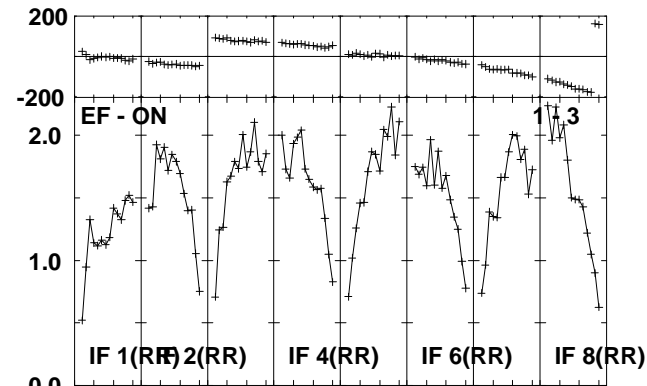
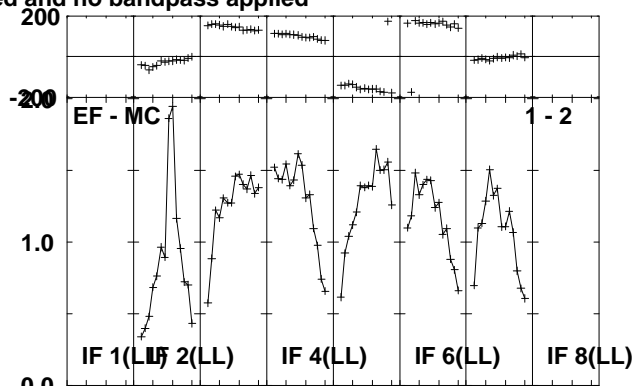
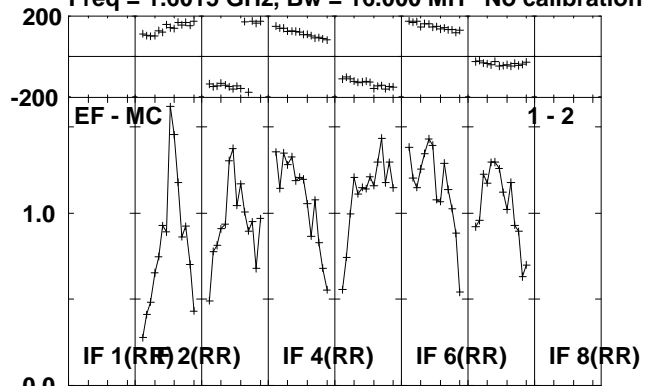

Lower frame: Milli Ampl Jy Top frame: Phas deg
Scalar averaged cross-power spectrum Several baselines displayed
Timerange: 01/00:24:53 to 01/00:27:01

Plot file version 96 created 01-JUL-2010 13:25:11
J2102+47 RG006B.UVDATA.1

Freq = 1.6015 GHz, Bw = 16.000 MH No calibration applied and no bandpass applied

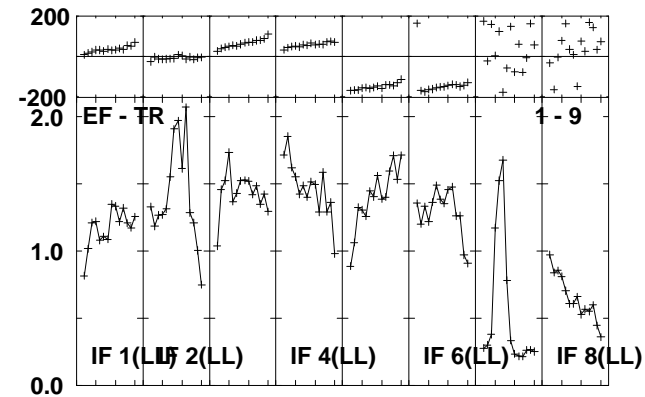
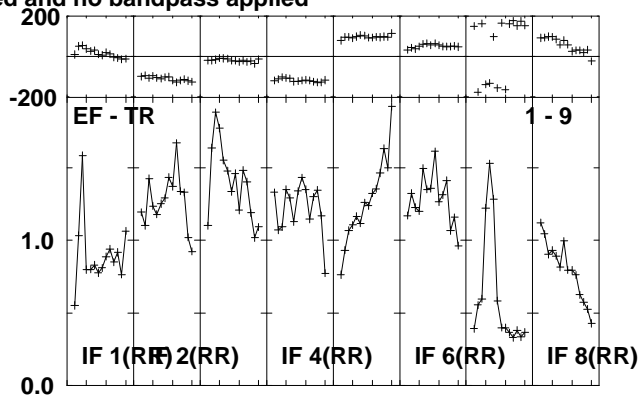
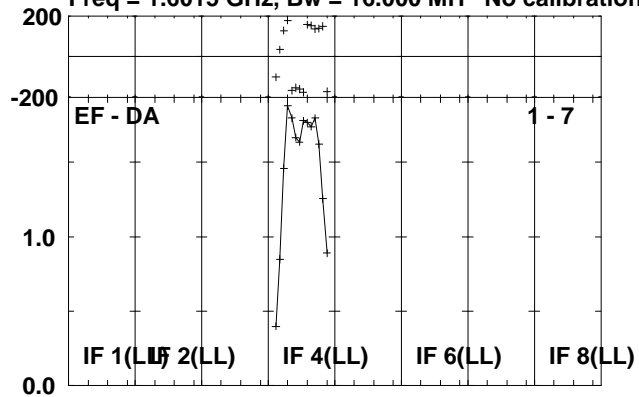

Lower frame: Milli Ampl Jy Top frame: Phas deg
Scalar averaged cross-power spectrum Several baselines displayed
Timerange: 01/00:24:53 to 01/00:27:01

Plot file version 97 created 01-JUL-2010 13:25:12

V407CYG RG006B.UVDATA.1

Freq = 1.6015 GHz, Bw = 16.000 MH No calibration applied and no bandpass applied

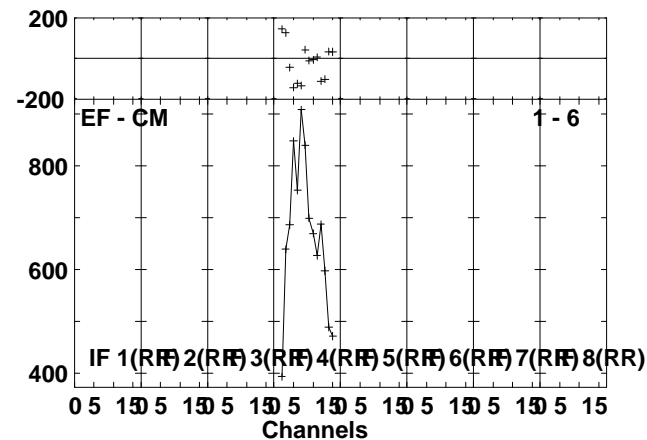
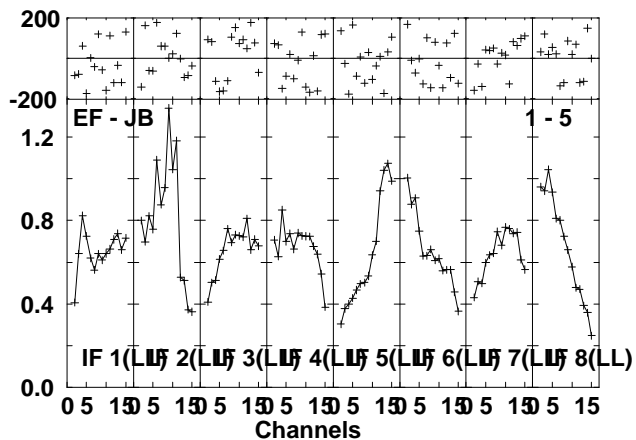
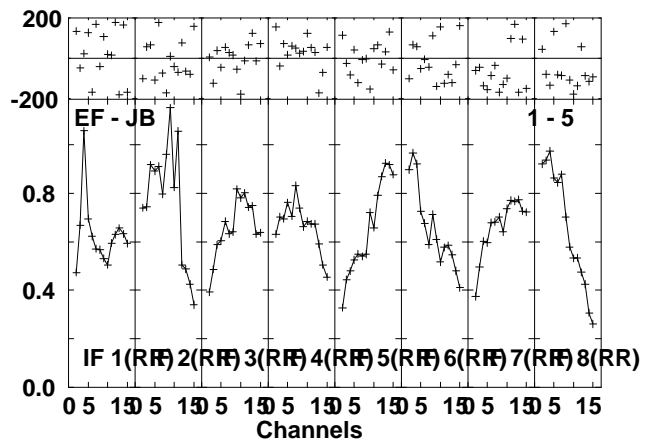
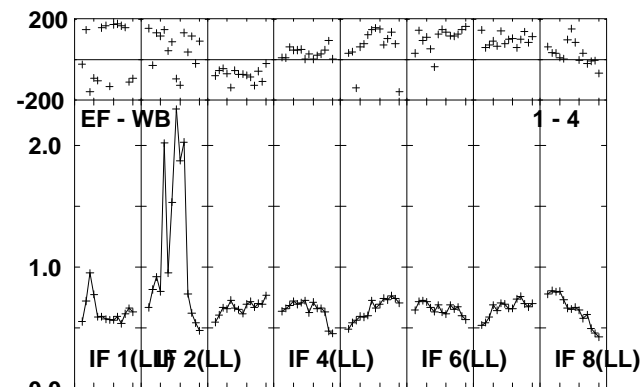
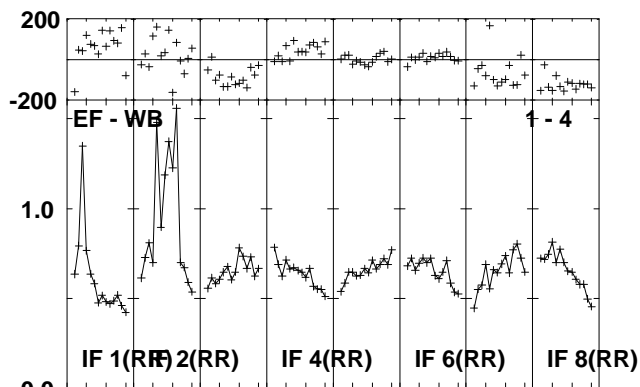
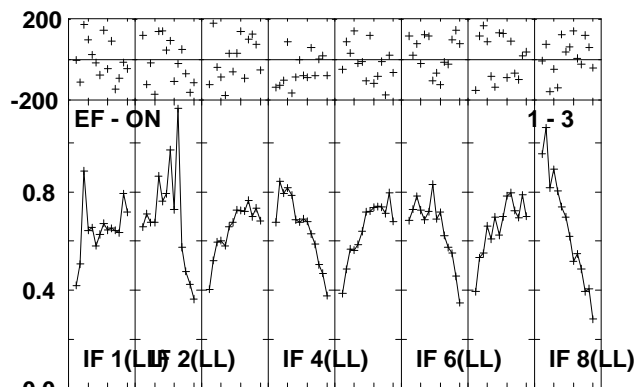
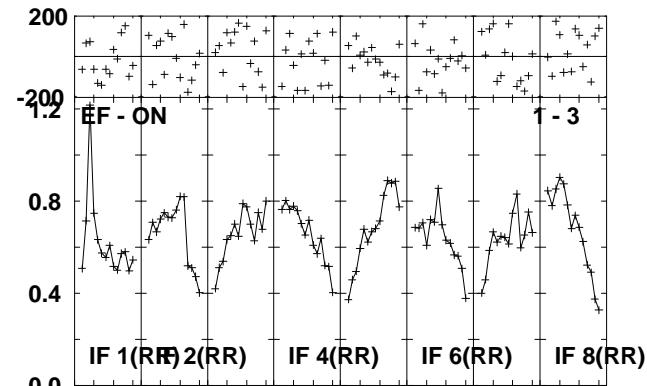
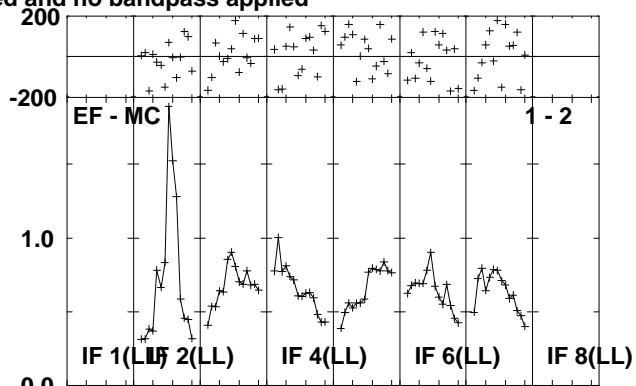
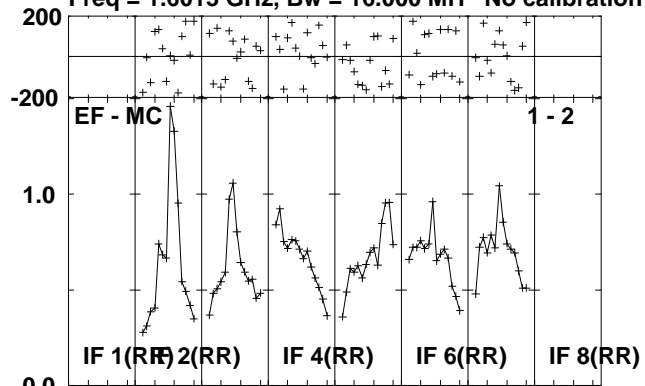

Lower frame: Milli Ampl Jy Top frame: Phas deg
Scalar averaged cross-power spectrum Several baselines displayed
Timerange: 01/00:27:05 to 01/00:32:01

Plot file version 98 created 01-JUL-2010 13:25:13
 V407CYG RG006B.UVDATA.1

Freq = 1.6015 GHz, Bw = 16.000 MH No calibration applied and no bandpass applied

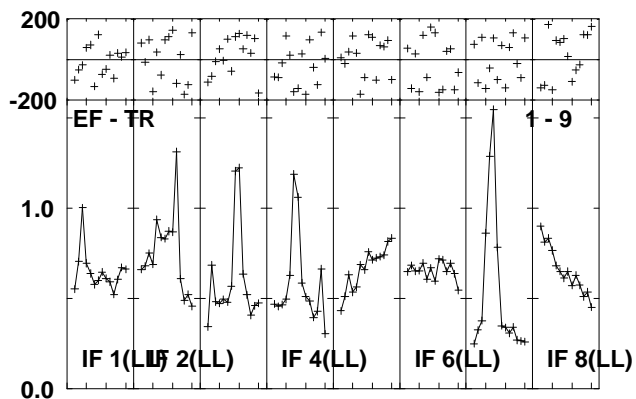
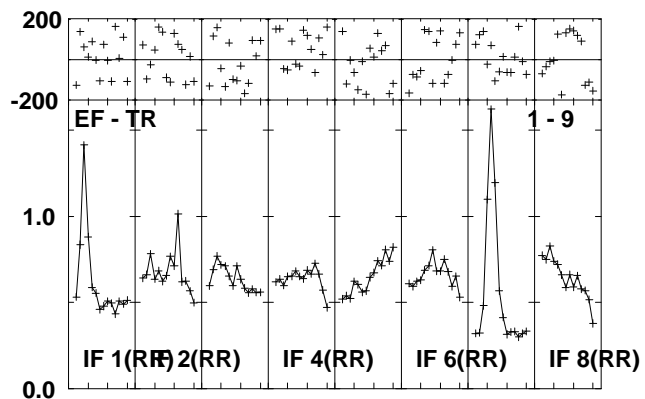
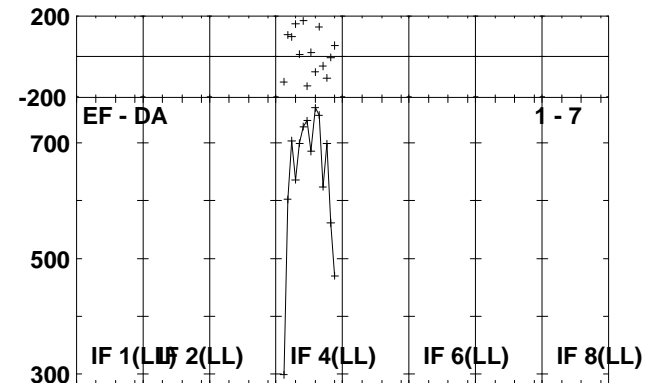
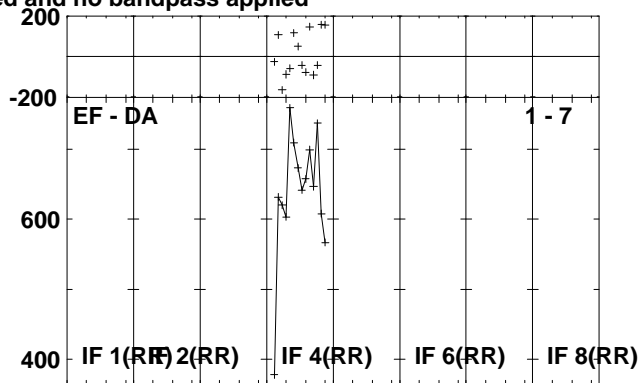
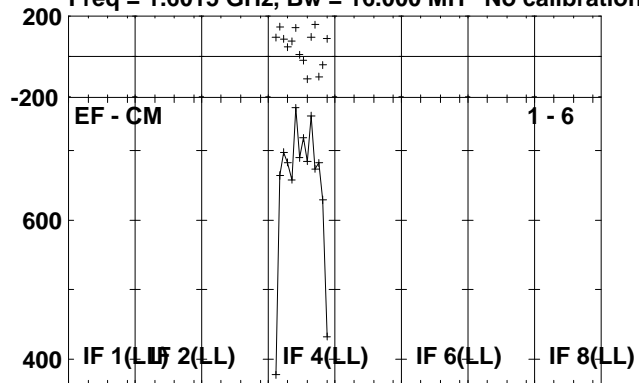

Lower frame: Micro Ampl Jy Top frame: Phas deg
 Scalar averaged cross-power spectrum Several baselines displayed
 Timerange: 01/00:27:05 to 01/00:32:01

Plot file version 99 created 01-JUL-2010 13:25:14

J2102+47 RG006B.UVDATA.1

Freq = 1.6015 GHz, Bw = 16.000 MH No calibration applied and no bandpass applied

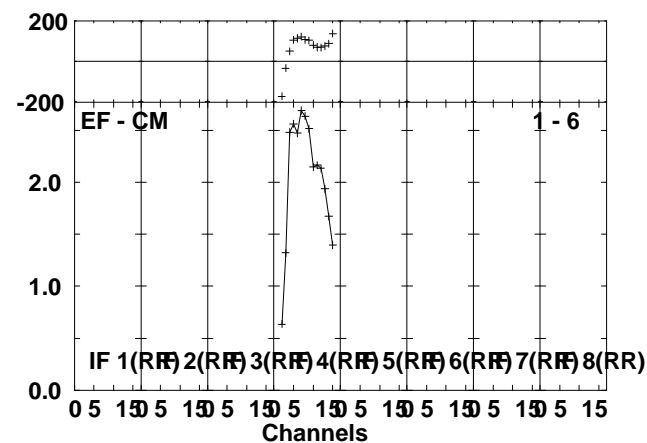
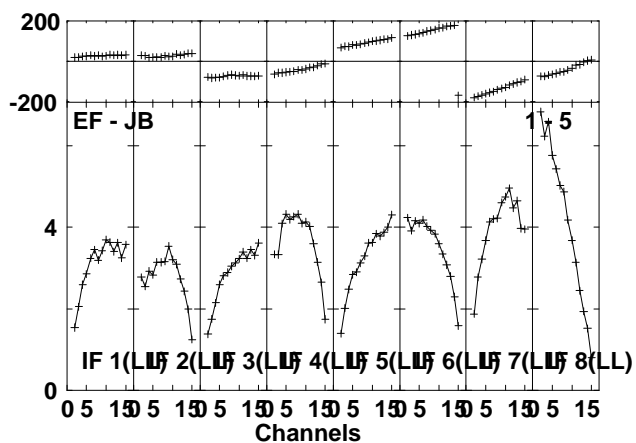
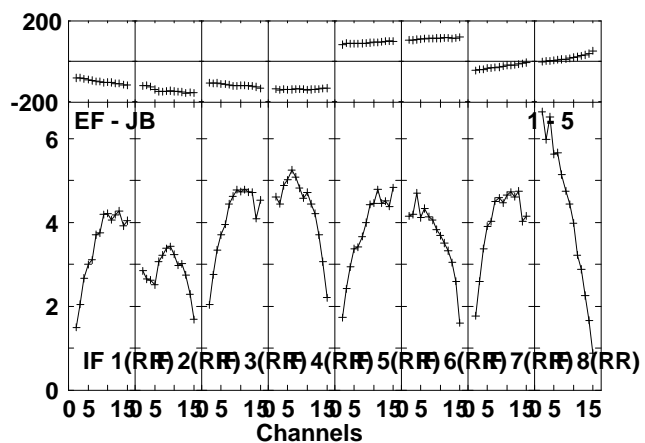
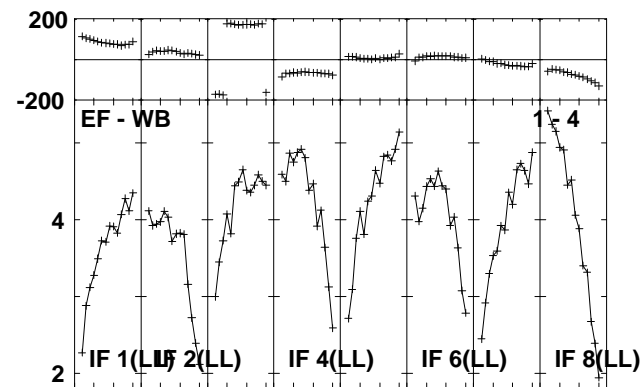
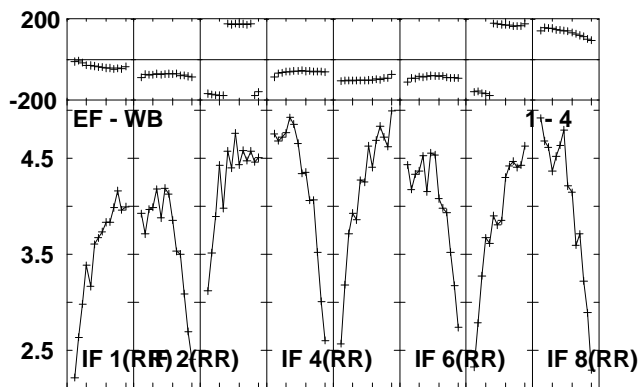
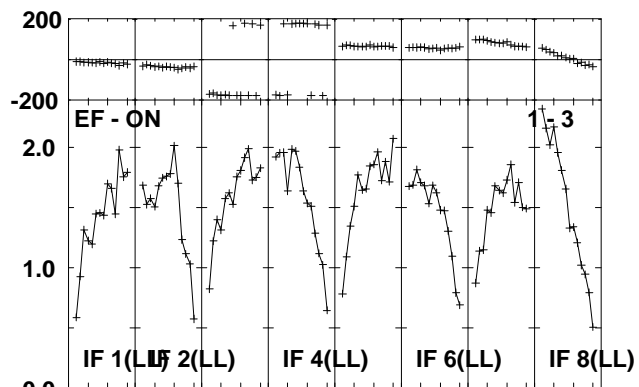
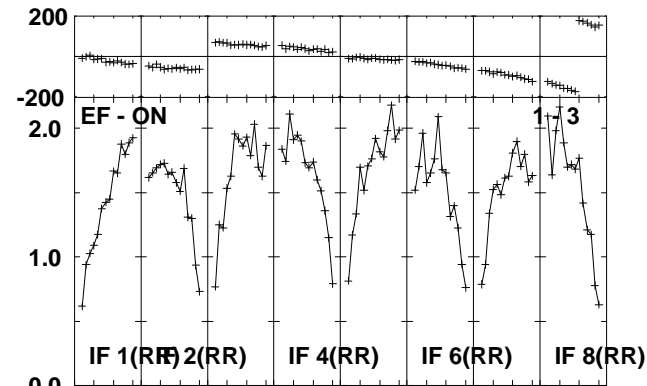
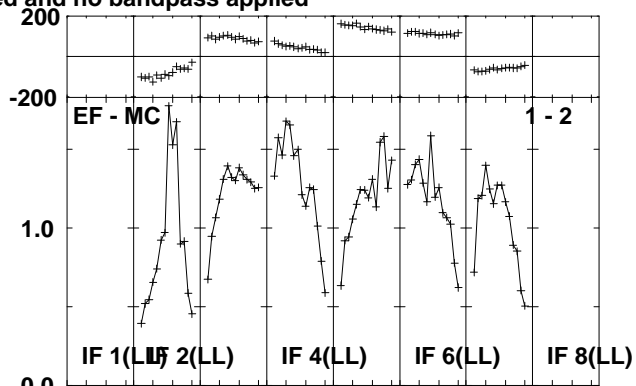
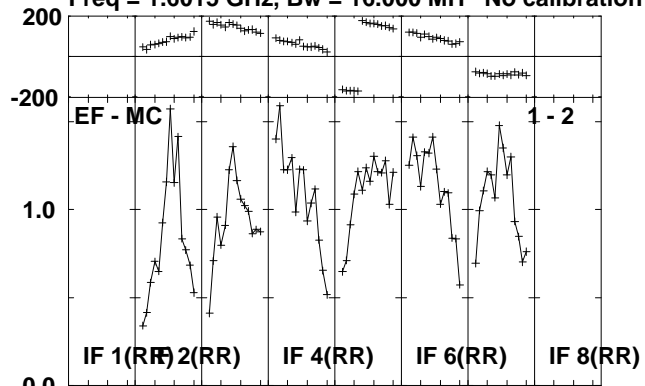

Lower frame: Milli Ampl Jy Top frame: Phas deg
Scalar averaged cross-power spectrum Several baselines displayed
Timerange: 01/00:33:05 to 01/00:34:49

Plot file version 100 created 01-JUL-2010 13:25:14
J2102+47 RG006B.UVDATA.1

Freq = 1.6015 GHz, Bw = 16.000 MH No calibration applied and no bandpass applied

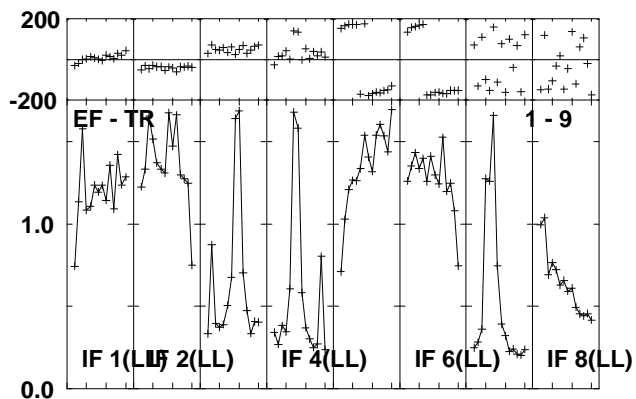
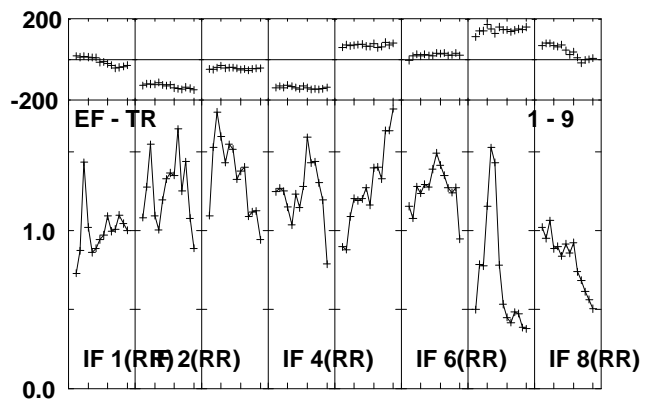
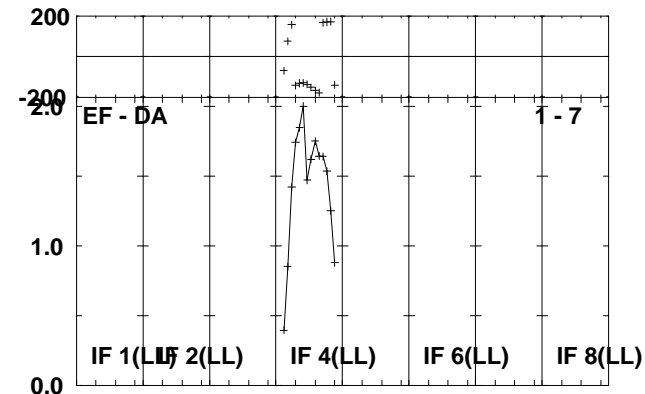
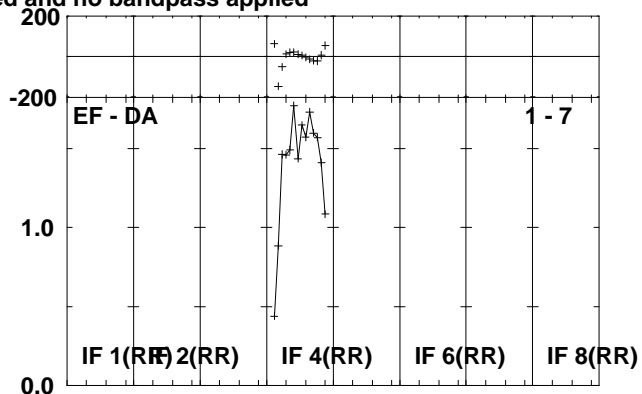
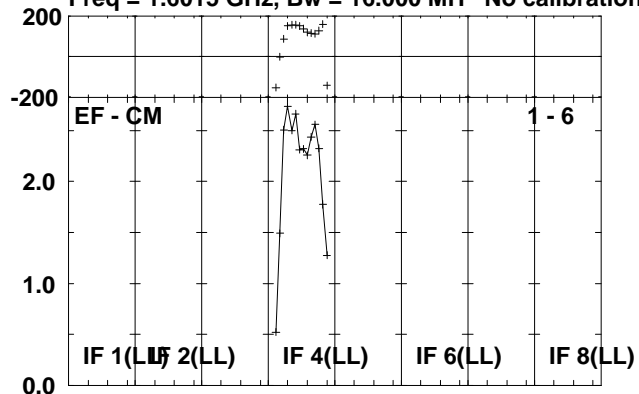

Lower frame: Milli Ampl Jy Top frame: Phas deg
Scalar averaged cross-power spectrum Several baselines displayed
Timerange: 01/00:33:05 to 01/00:34:49

Plot file version 101 created 01-JUL-2010 13:25:15

J2002+47 RG006B.UVDATA.1

Freq = 1.6015 GHz, Bw = 16.000 MH No calibration applied and no bandpass applied

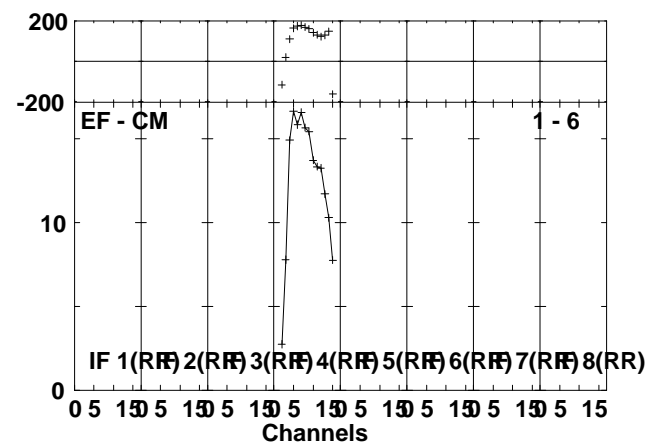
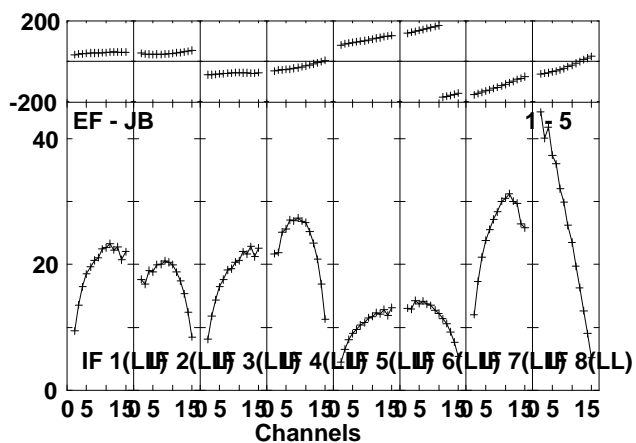
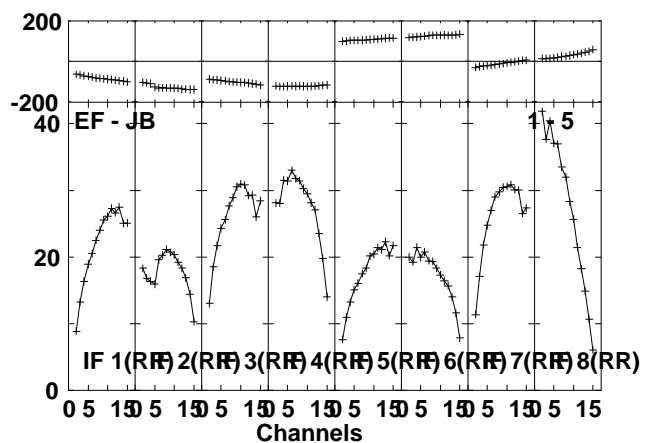
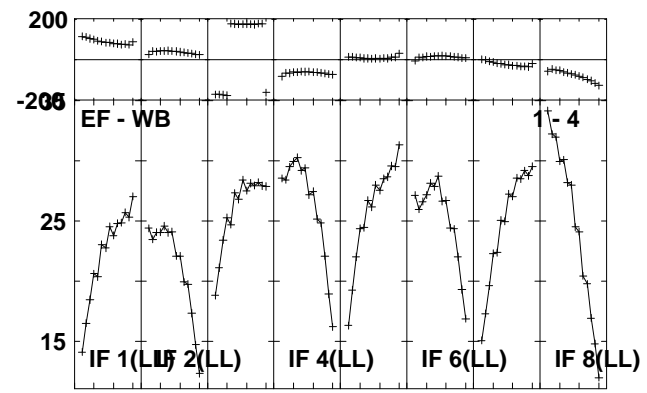
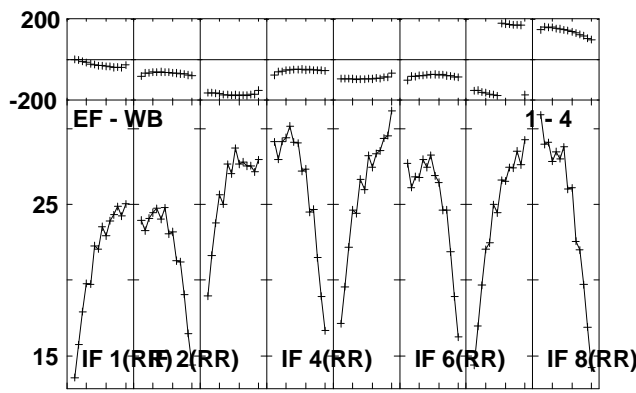
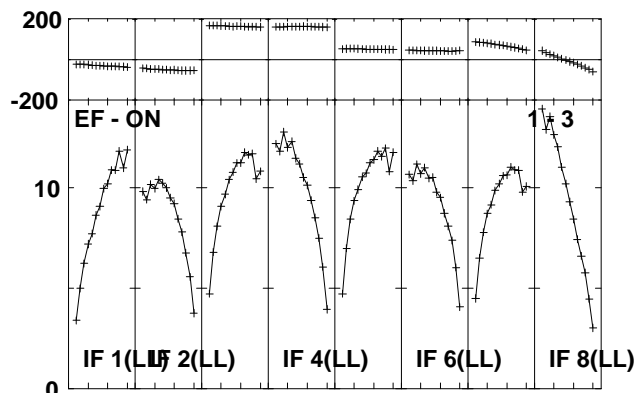
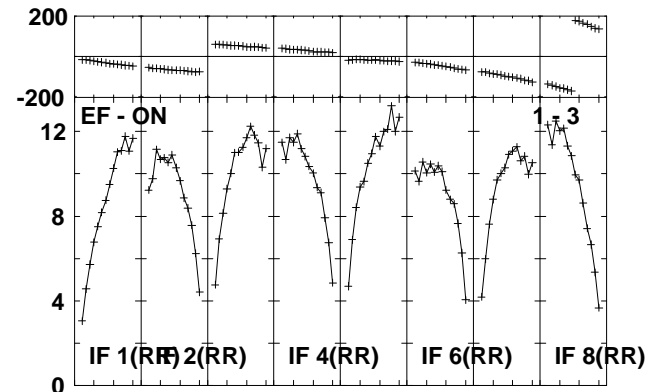
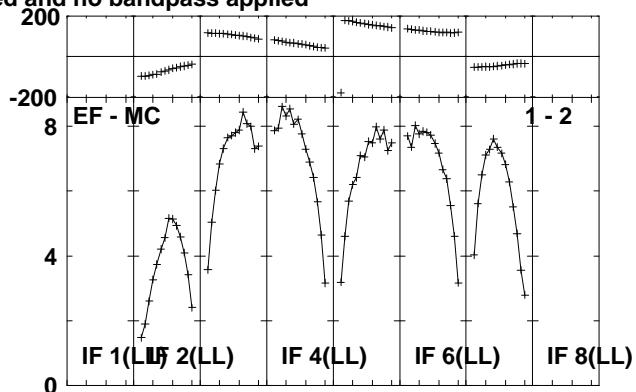
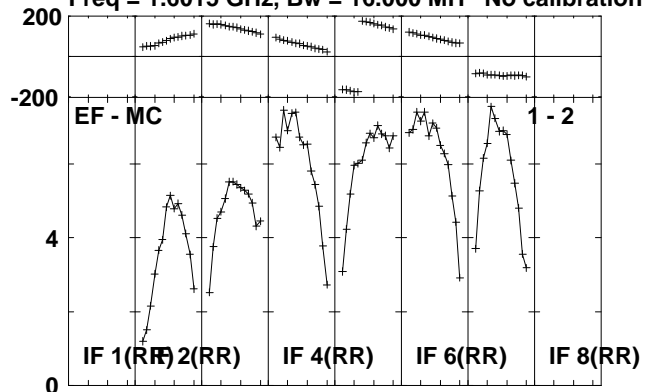

Lower frame: Milli Ampl Jy Top frame: Phas deg
Scalar averaged cross-power spectrum Several baselines displayed
Timerange: 01/00:36:21 to 01/00:40:17

Plot file version 102 created 01-JUL-2010 13:25:15

J2002+47 RG006B.UVDATA.1

Freq = 1.6015 GHz, Bw = 16.000 MH No calibration applied and no bandpass applied

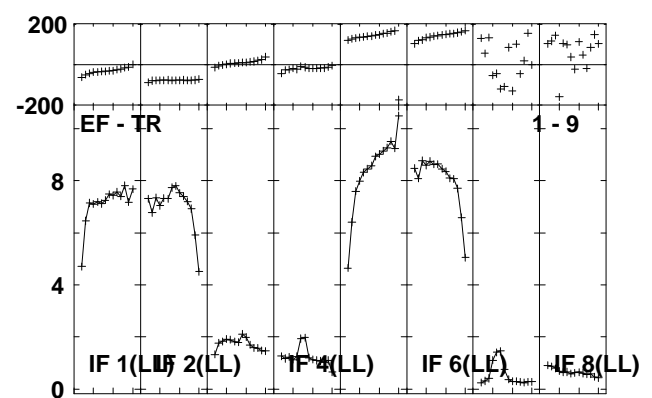
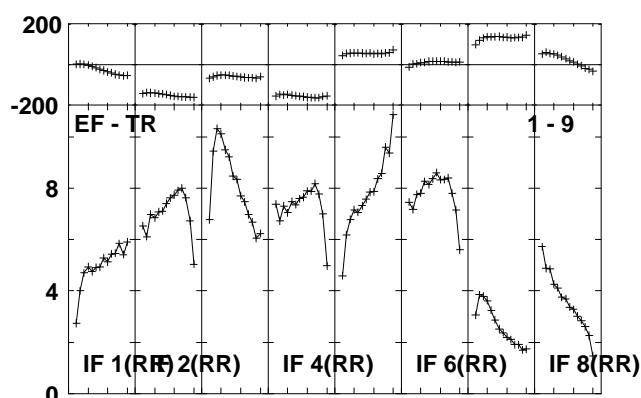
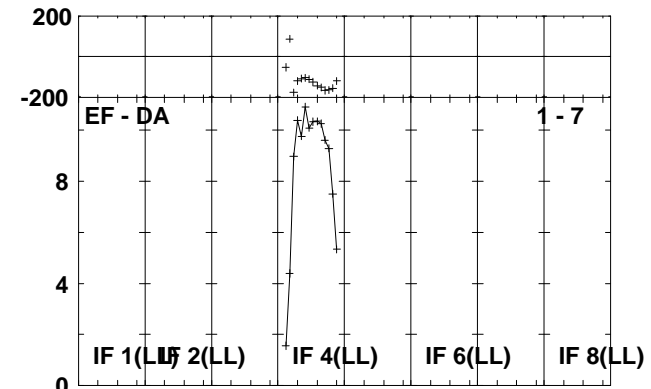
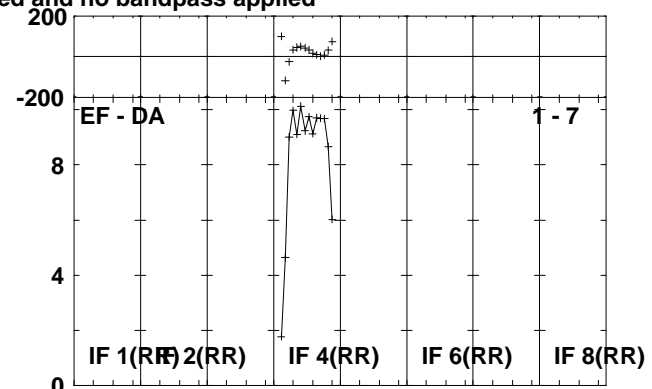
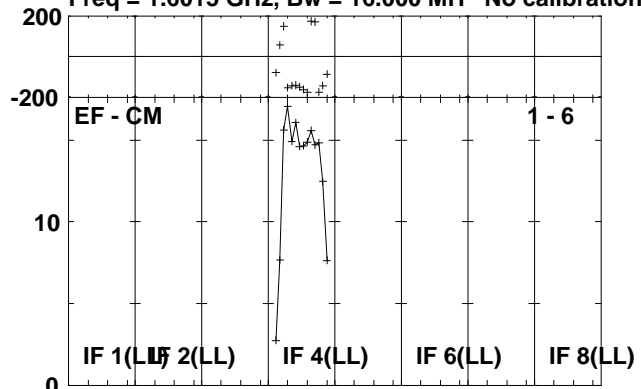

Lower frame: Milli Ampl Jy Top frame: Phas deg
Scalar averaged cross-power spectrum Several baselines displayed
Timerange: 01/00:36:21 to 01/00:40:17

Plot file version 103 created 01-JUL-2010 13:25:16

J2102+47 RG006B.UVDATA.1

Freq = 1.6015 GHz, Bw = 16.000 MH No calibration applied and no bandpass applied

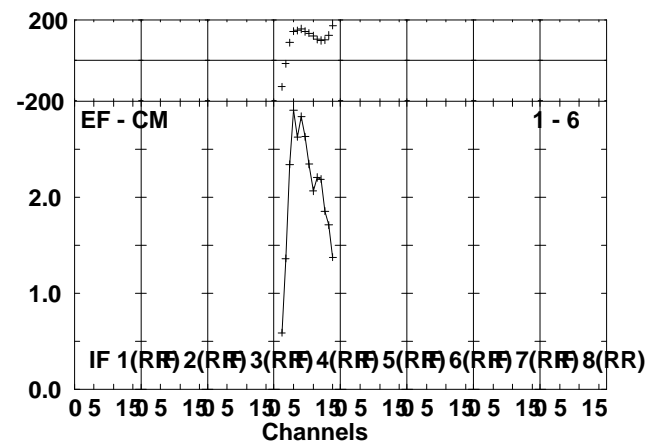
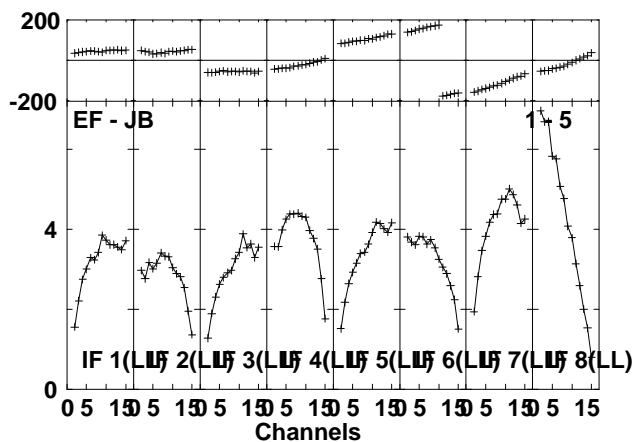
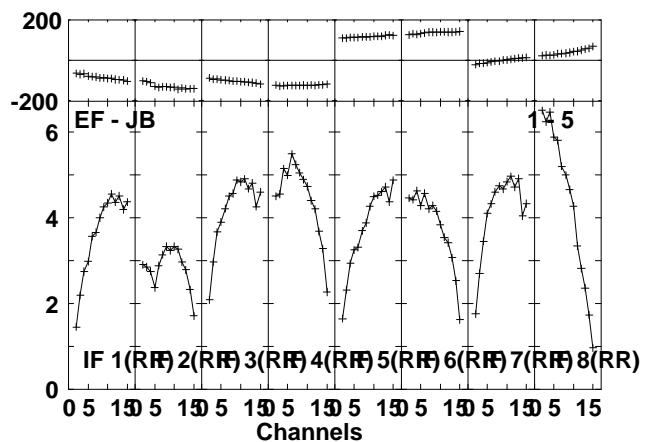
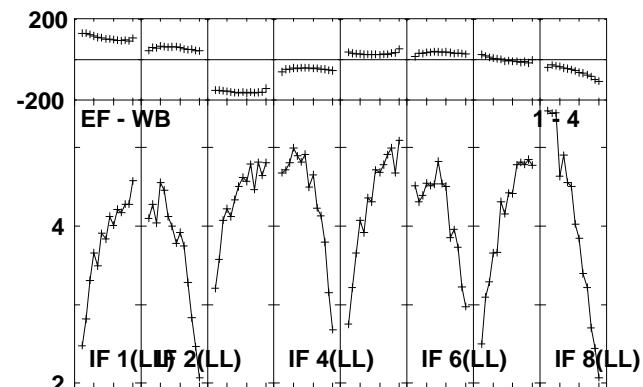
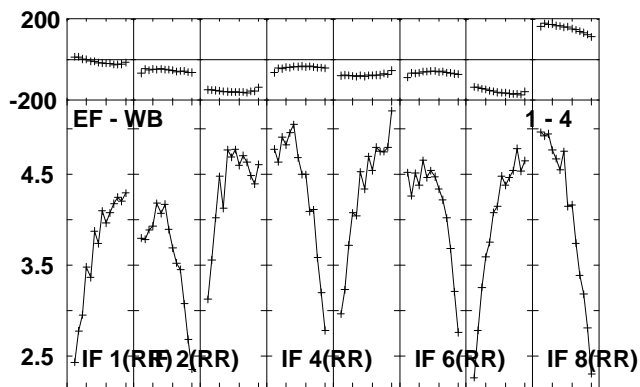
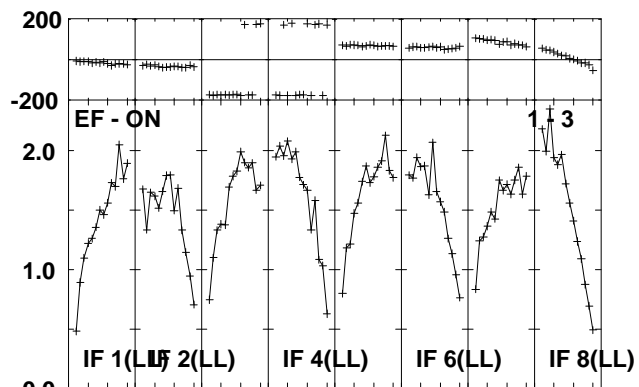
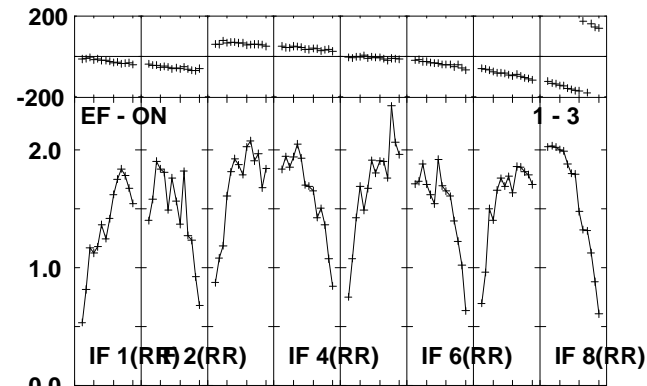
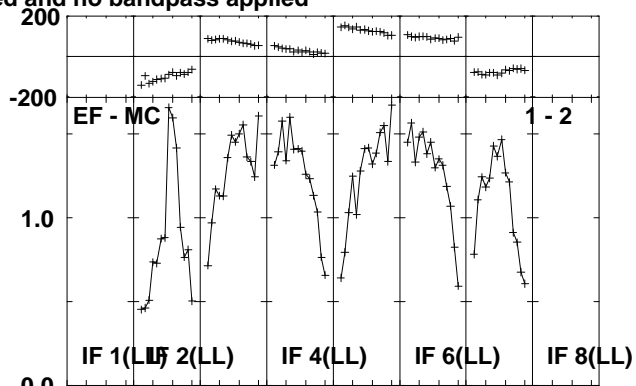
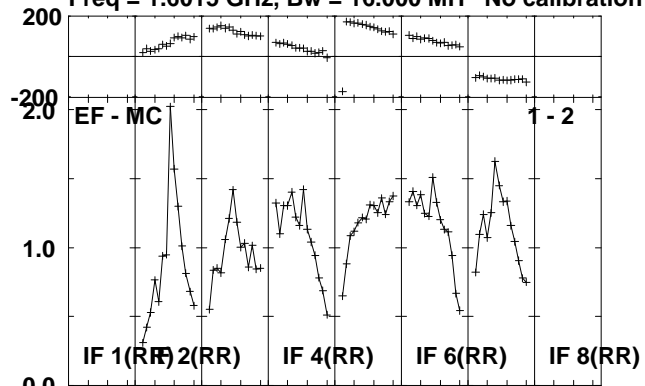

Lower frame: Milli Ampl Jy Top frame: Phas deg
Scalar averaged cross-power spectrum Several baselines displayed
Timerange: 01/00:41:53 to 01/00:43:49

Plot file version 104 created 01-JUL-2010 13:25:16

J2102+47 RG006B.UVDATA.1

Freq = 1.6015 GHz, Bw = 16.000 MH No calibration applied and no bandpass applied

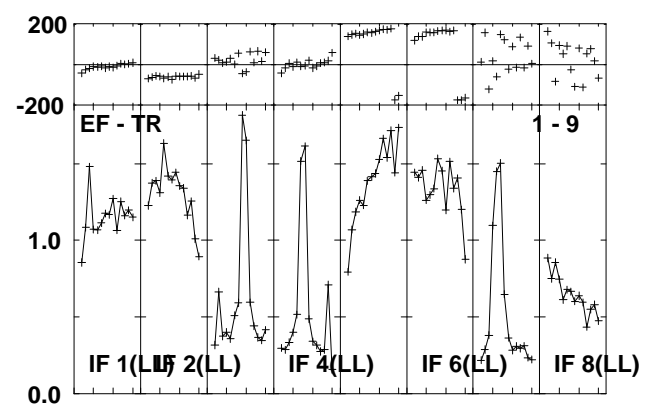
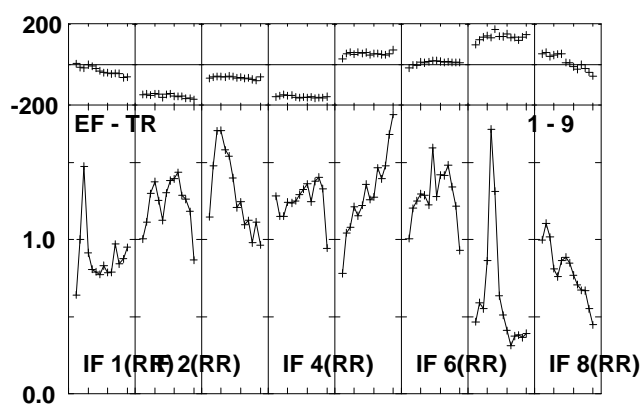
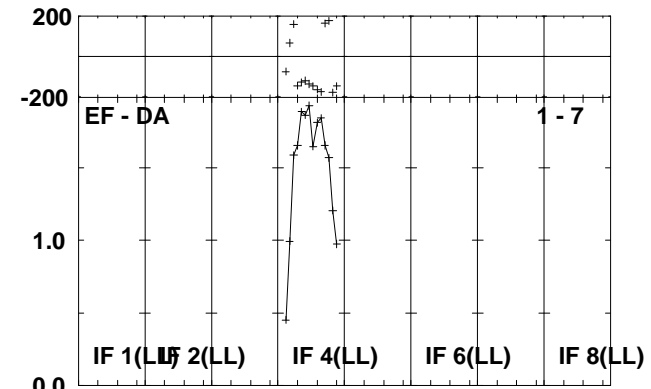
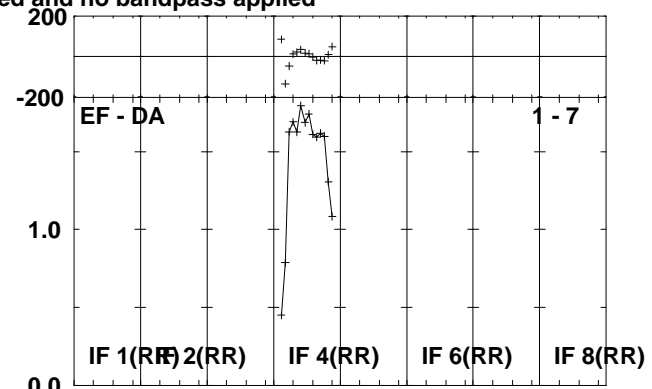
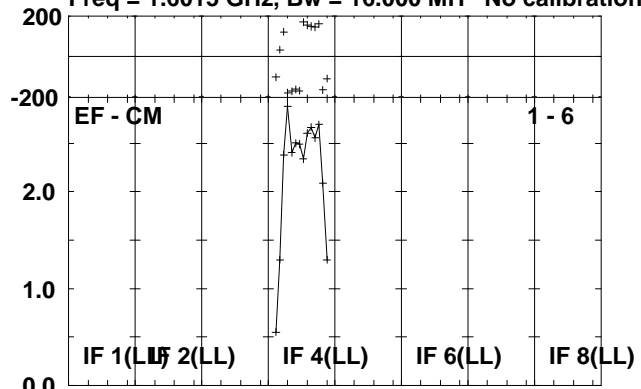

Lower frame: Milli Ampl Jy Top frame: Phas deg
Scalar averaged cross-power spectrum Several baselines displayed
Timerange: 01/00:41:53 to 01/00:43:49

Plot file version 105 created 01-JUL-2010 13:25:17

V407CYG RG006B.UVDATA.1

Freq = 1.6015 GHz, Bw = 16.000 MH No calibration applied and no bandpass applied

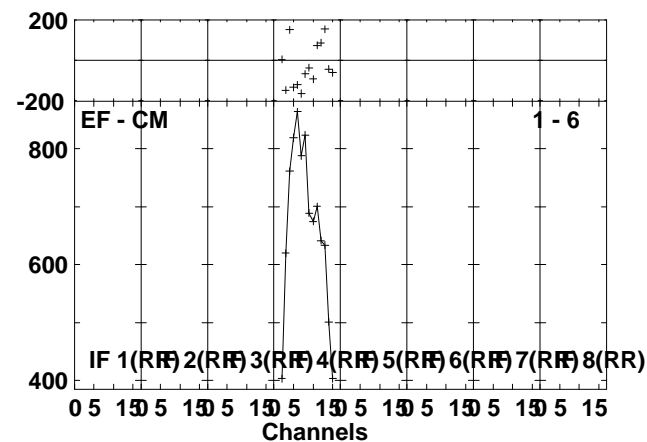
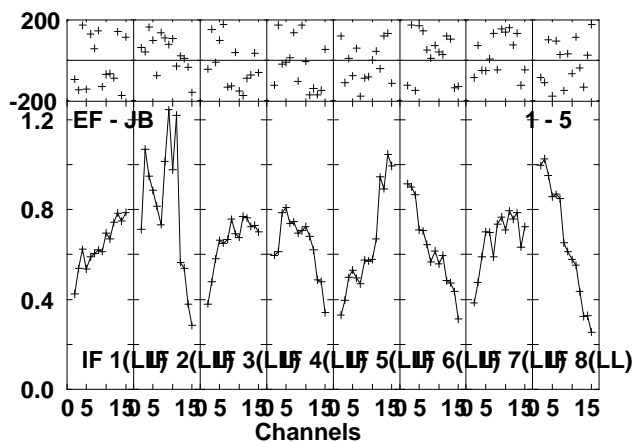
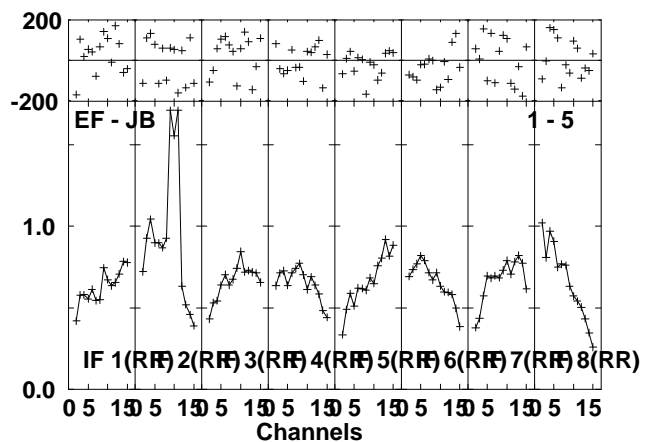
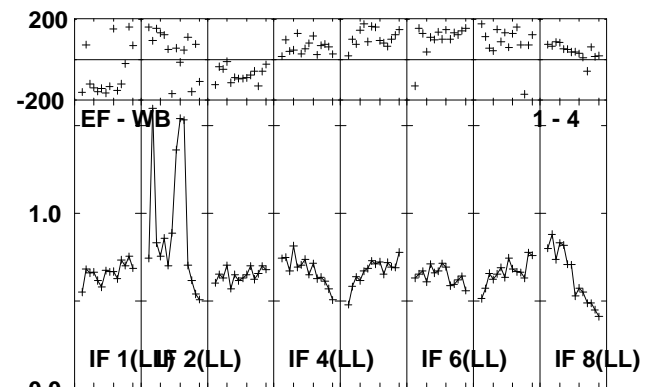
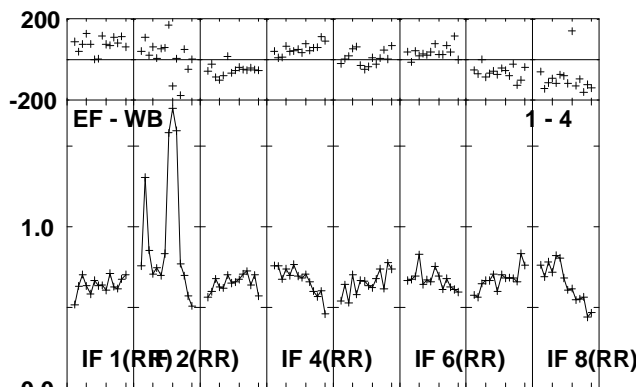
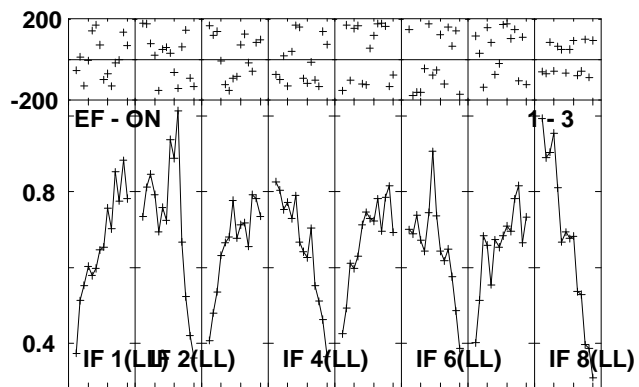
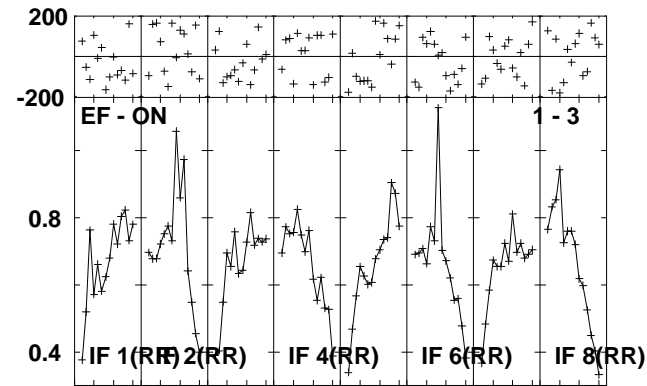
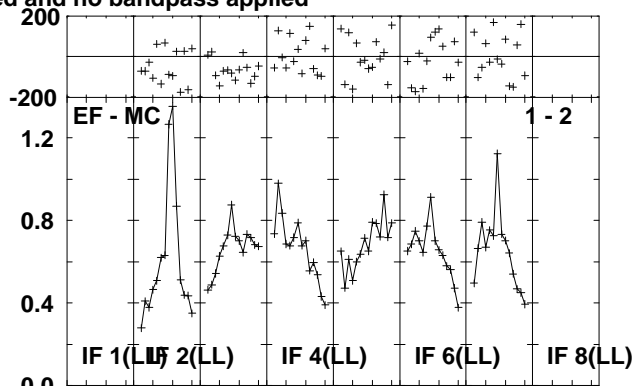
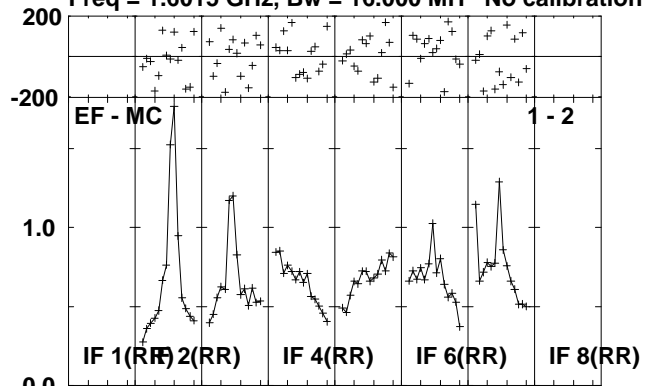

Lower frame: Milli Ampl Jy Top frame: Phas deg
Scalar averaged cross-power spectrum Several baselines displayed
Timerange: 01/00:43:53 to 01/00:48:49

Plot file version 106 created 01-JUL-2010 13:25:18

V407CYG RG006B.UVDATA.1

Freq = 1.6015 GHz, Bw = 16.000 MH No calibration applied and no bandpass applied

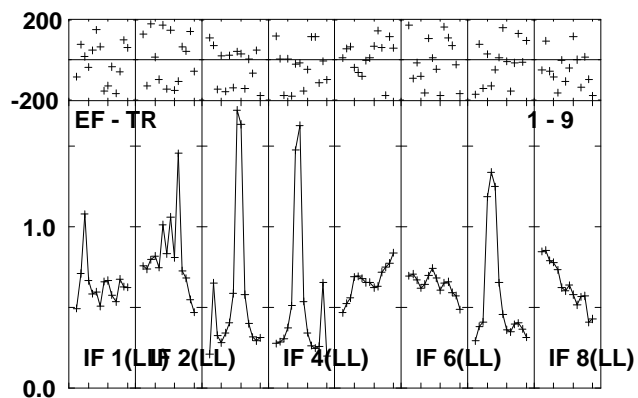
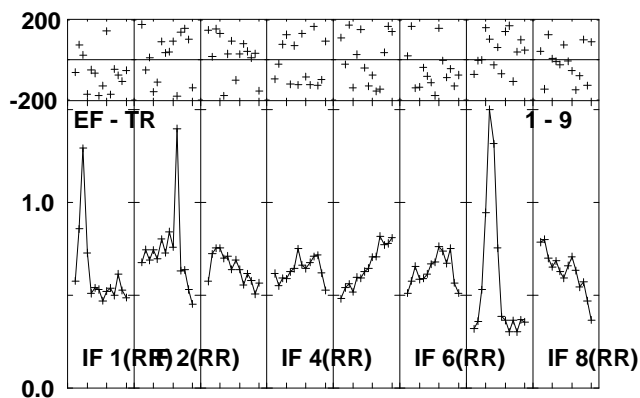
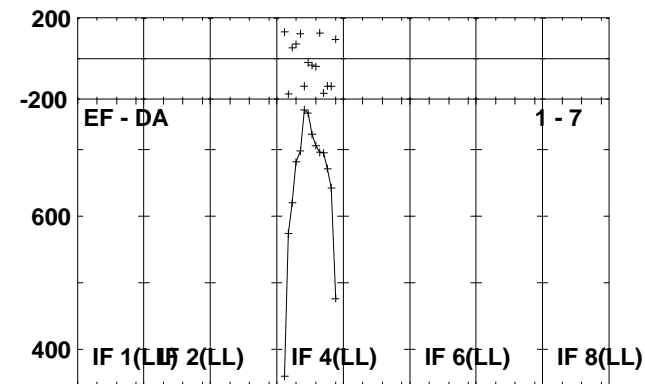
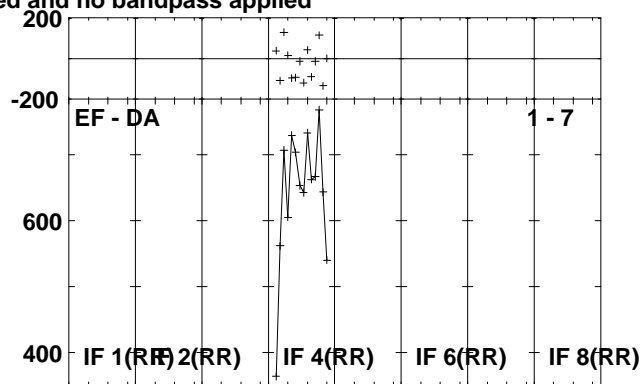
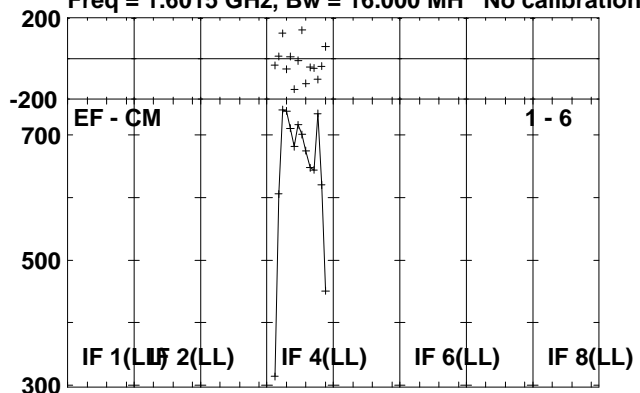

Lower frame: Micro Ampl Jy Top frame: Phas deg
Scalar averaged cross-power spectrum Several baselines displayed
Timerange: 01/00:43:53 to 01/00:48:49

Plot file version 107 created 01-JUL-2010 13:25:19

J2102+47 RG006B.UVDATA.1

Freq = 1.6015 GHz, Bw = 16.000 MH No calibration applied and no bandpass applied

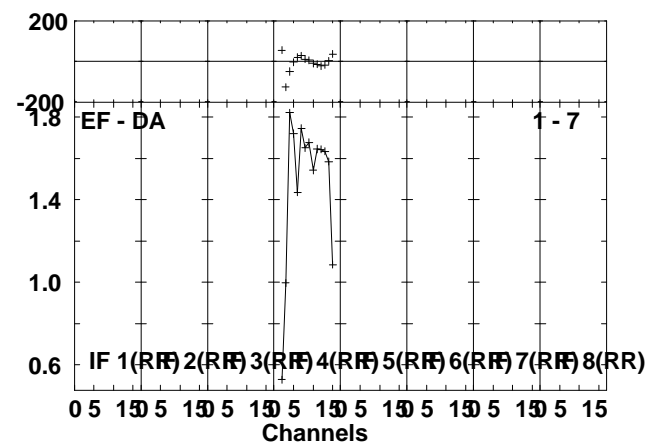
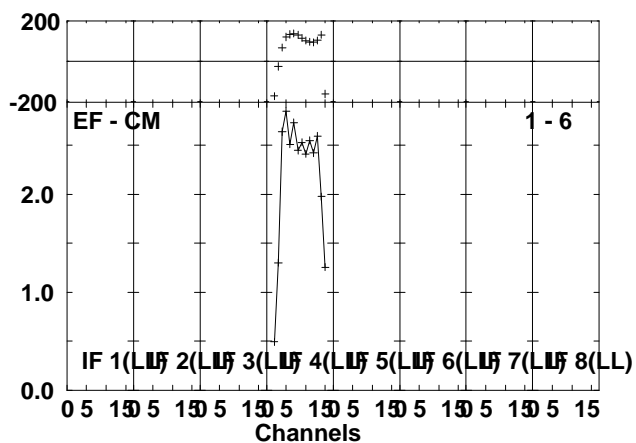
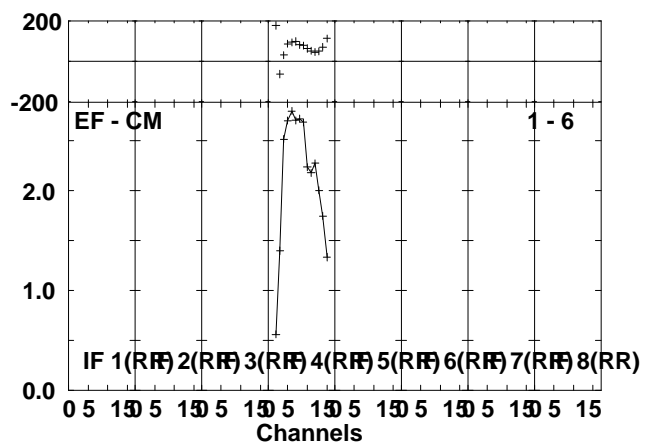
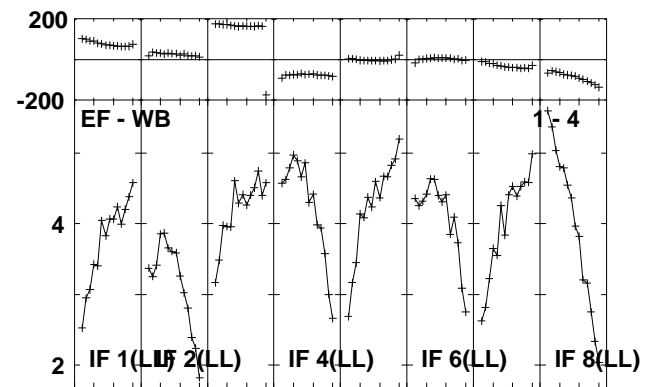
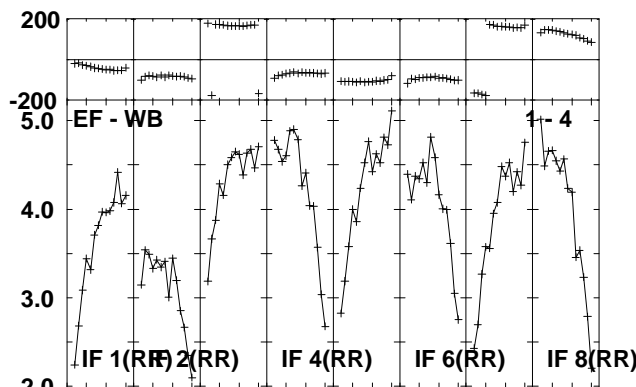
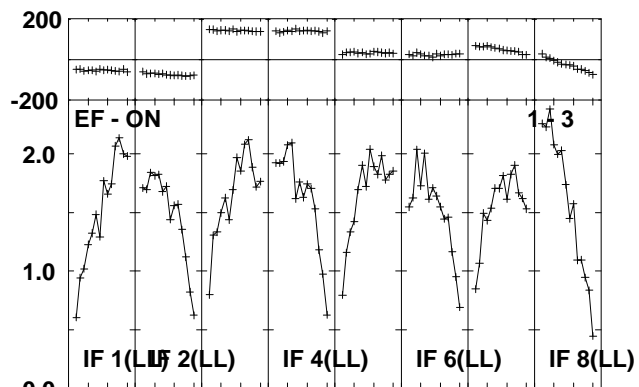
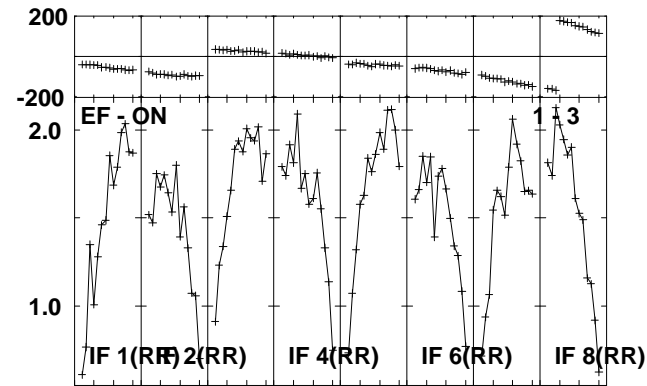
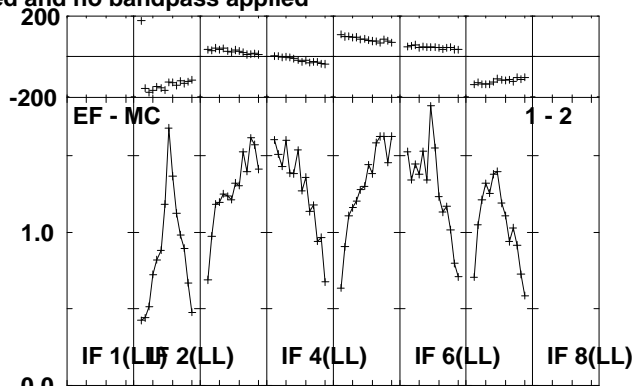
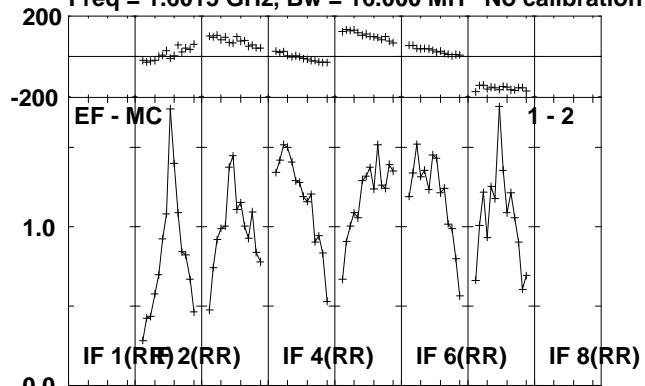

Lower frame: Milli Ampl Jy Top frame: Phas deg
Scalar averaged cross-power spectrum Several baselines displayed
Timerange: 01/00:48:53 to 01/00:51:01

Plot file version 108 created 01-JUL-2010 13:25:19

J2102+47 RG006B.UVDATA.1

Freq = 1.6015 GHz, Bw = 16.000 MH No calibration applied and no bandpass applied

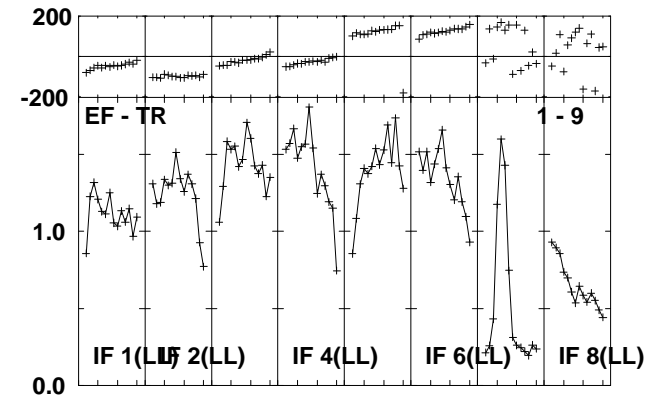
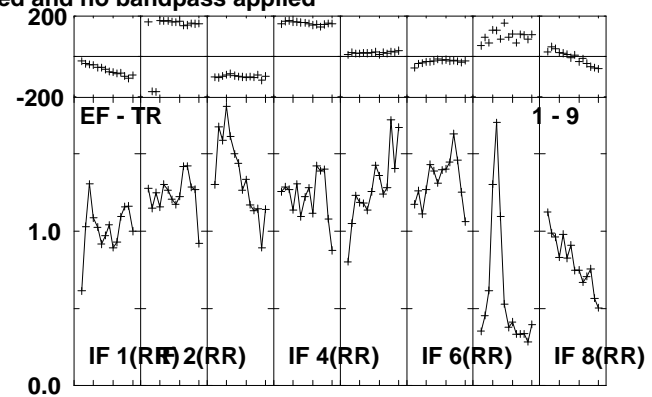
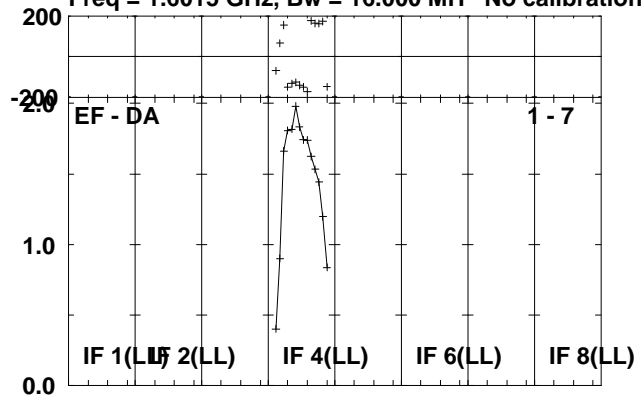

Lower frame: Milli Ampl Jy Top frame: Phas deg
Scalar averaged cross-power spectrum Several baselines displayed
Timerange: 01/00:48:53 to 01/00:51:01

Plot file version 109 created 01-JUL-2010 13:25:19

V407CYG RG006B.UVDATA.1

Freq = 1.6015 GHz, Bw = 16.000 MH No calibration applied and no bandpass applied

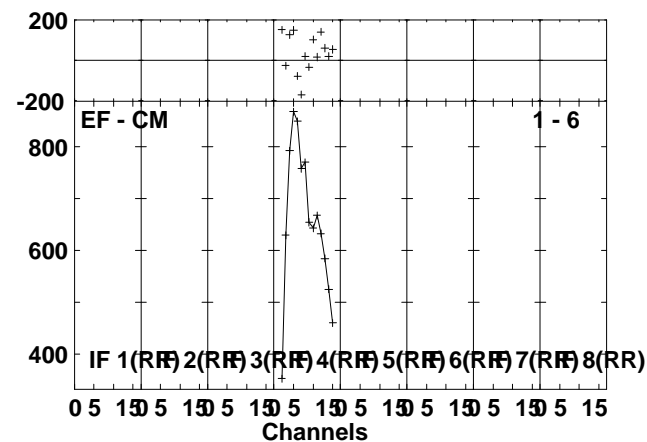
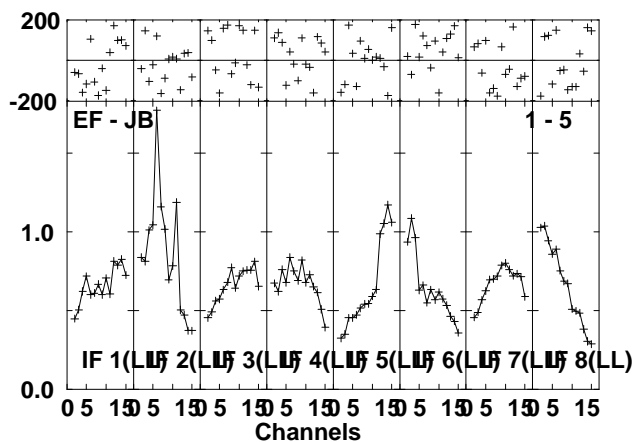
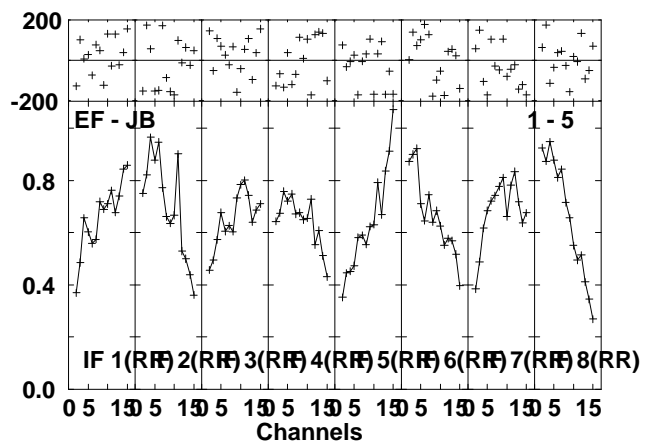
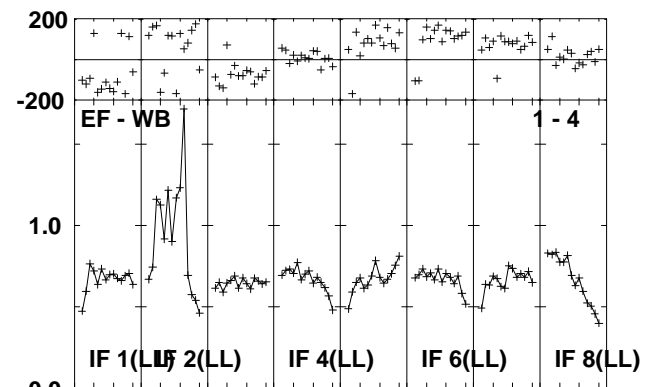
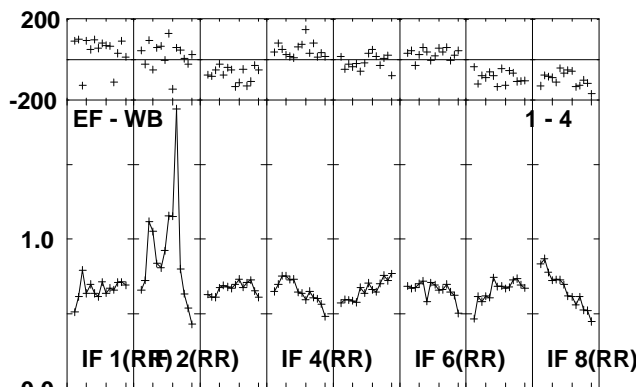
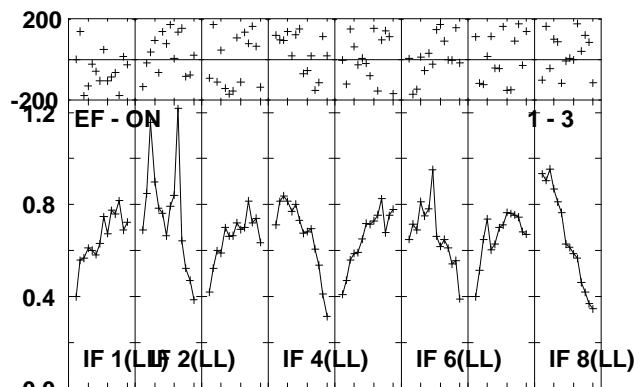
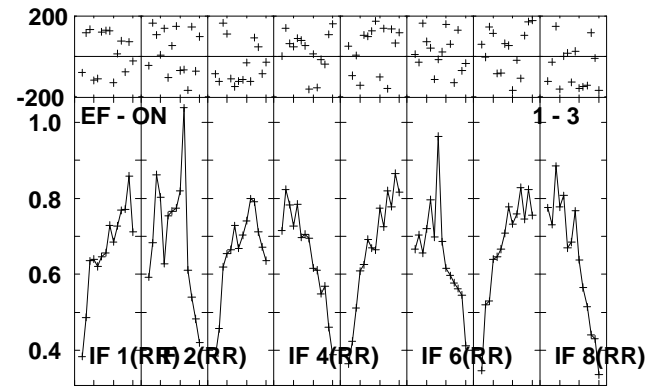
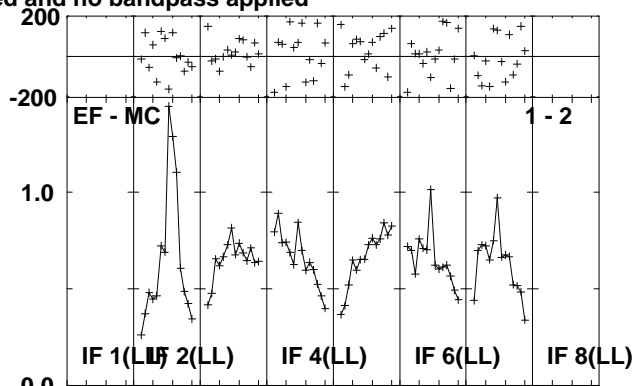
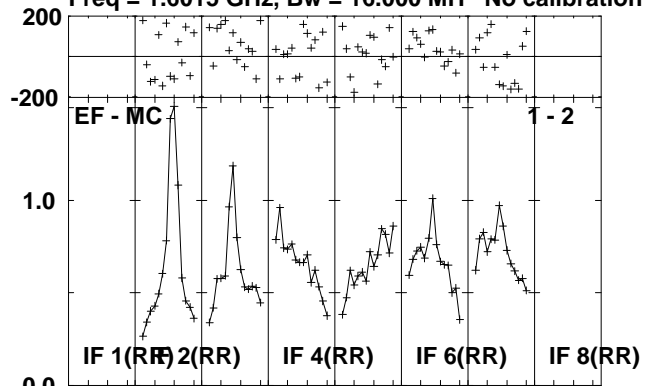

Lower frame: Milli Ampl Jy Top frame: Phas deg
Scalar averaged cross-power spectrum Several baselines displayed
Timerange: 01/00:51:05 to 01/00:56:01

Plot file version 110 created 01-JUL-2010 13:25:20

V407CYG RG006B.UVDATA.1

Freq = 1.6015 GHz, Bw = 16.000 MH No calibration applied and no bandpass applied

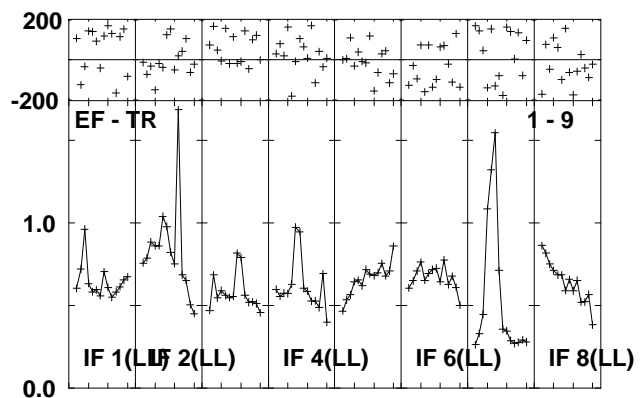
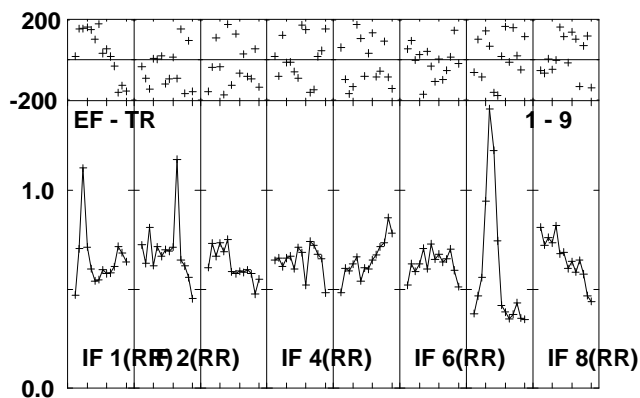
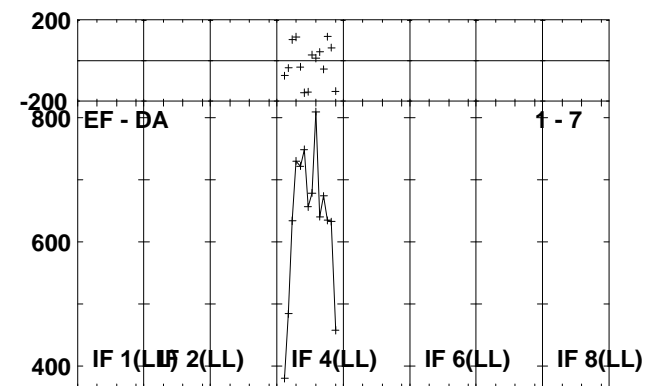
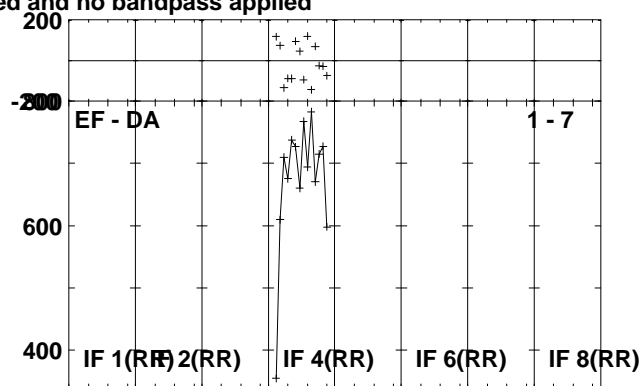
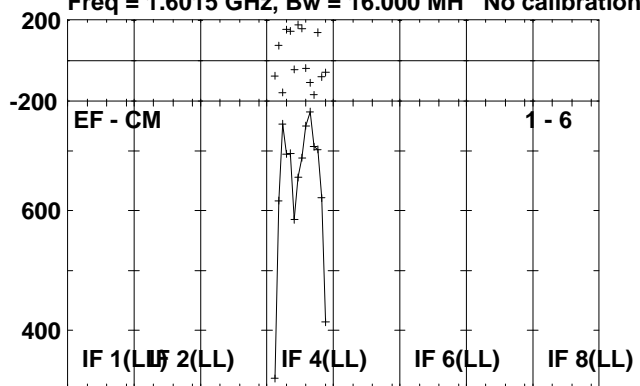

Lower frame: Micro Ampl Jy Top frame: Phas deg
Scalar averaged cross-power spectrum Several baselines displayed
Timerange: 01/00:51:05 to 01/00:56:01

Plot file version 111 created 01-JUL-2010 13:25:21

J2102+47 RG006B.UVDATA.1

Freq = 1.6015 GHz, Bw = 16.000 MH No calibration applied and no bandpass applied

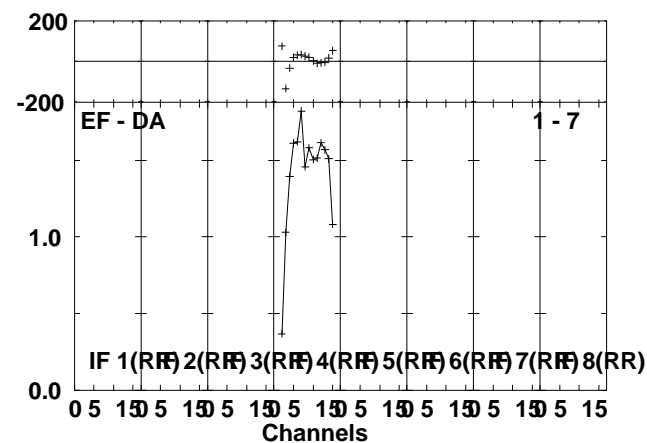
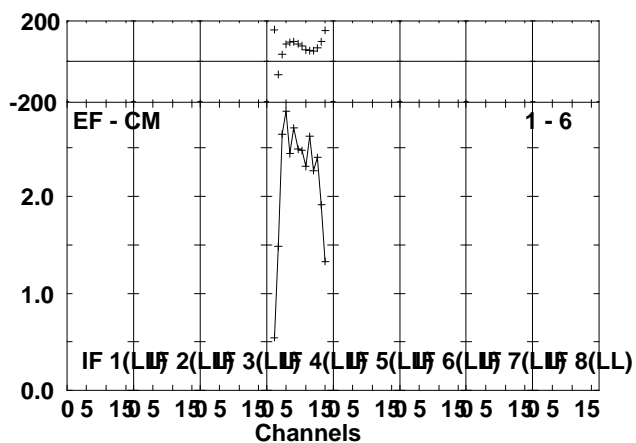
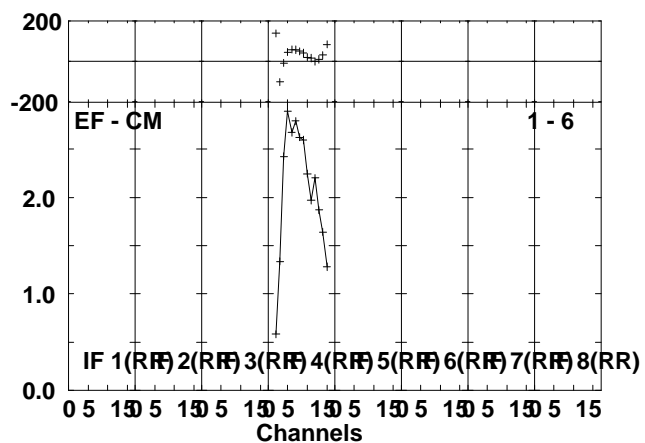
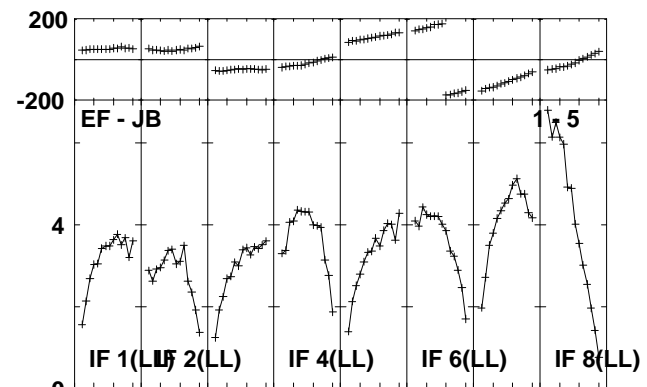
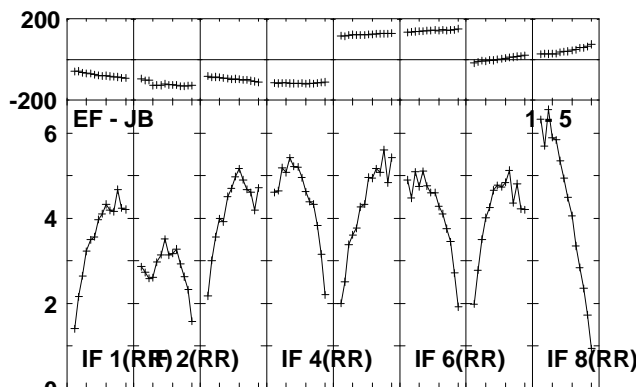
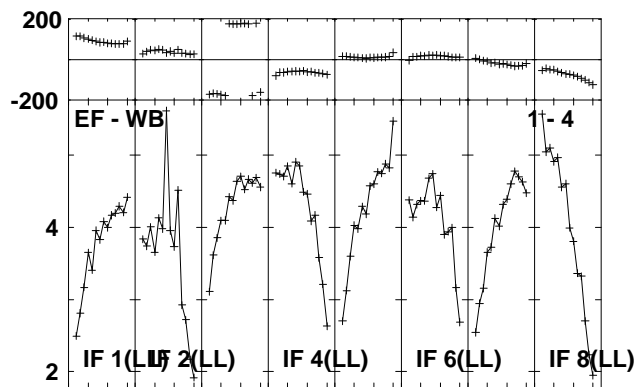
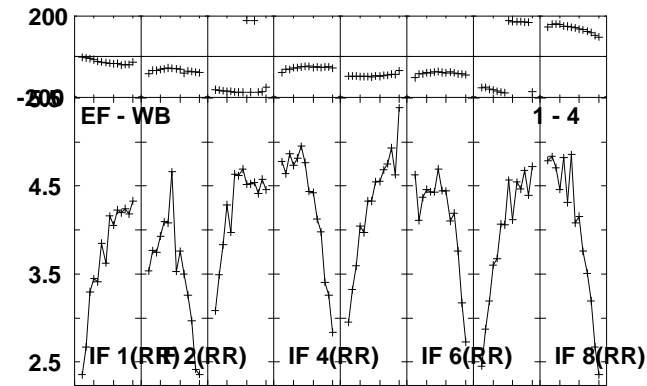
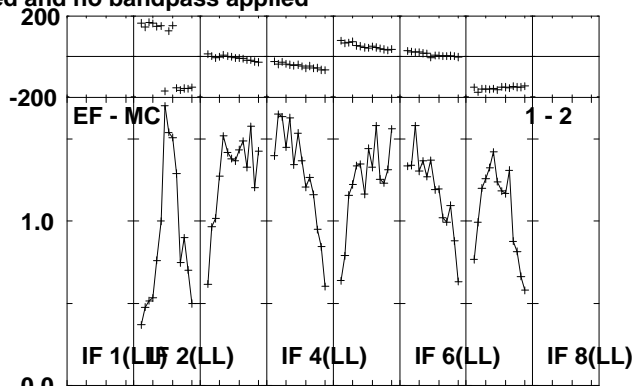
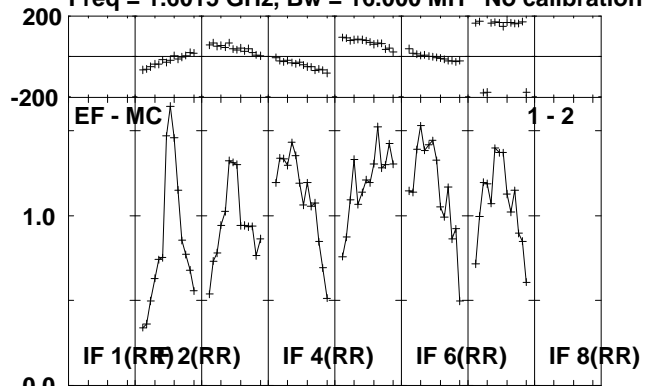

Lower frame: Milli Ampl Jy Top frame: Phas deg
Scalar averaged cross-power spectrum Several baselines displayed
Timerange: 01/00:57:05 to 01/00:58:49

Plot file version 112 created 01-JUL-2010 13:25:21

J2102+47 RG006B.UVDATA.1

Freq = 1.6015 GHz, Bw = 16.000 MH No calibration applied and no bandpass applied

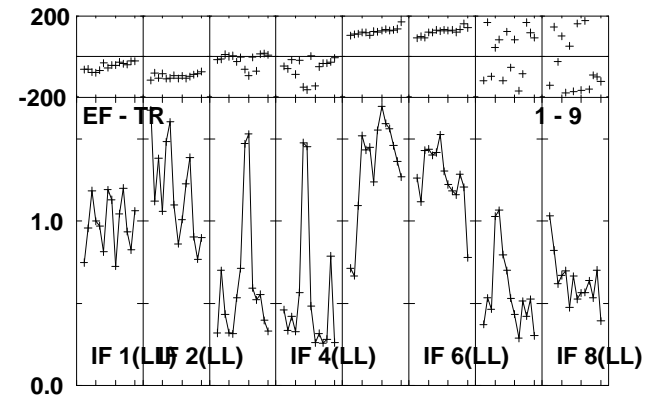
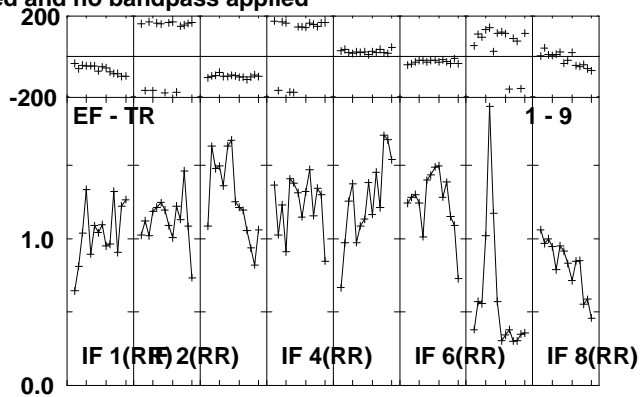
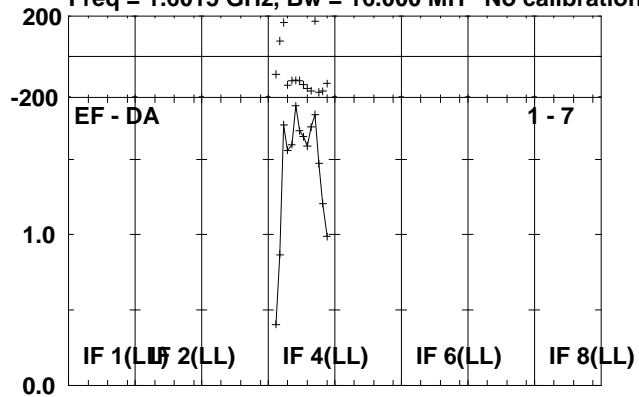

Lower frame: Milli Ampl Jy Top frame: Phas deg
Scalar averaged cross-power spectrum Several baselines displayed
Timerange: 01/00:57:05 to 01/00:58:49

Plot file version 113 created 01-JUL-2010 13:25:22

V407CYG RG006B.UVDATA.1

Freq = 1.6015 GHz, Bw = 16.000 MH No calibration applied and no bandpass applied

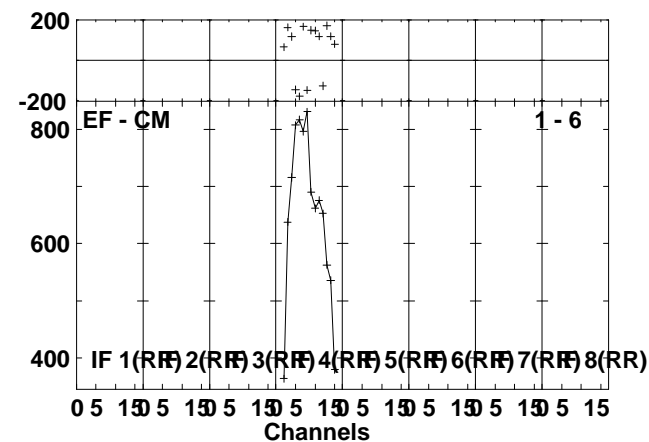
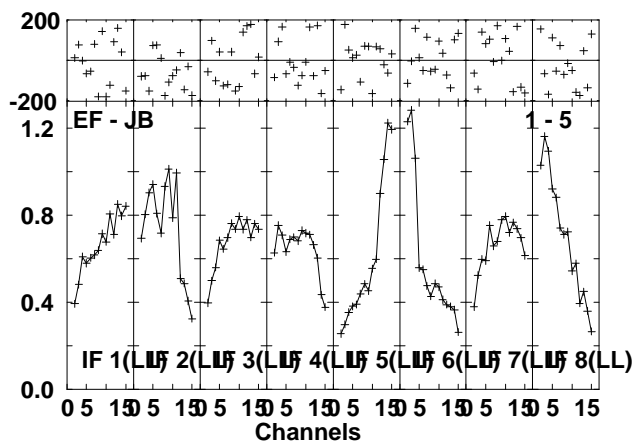
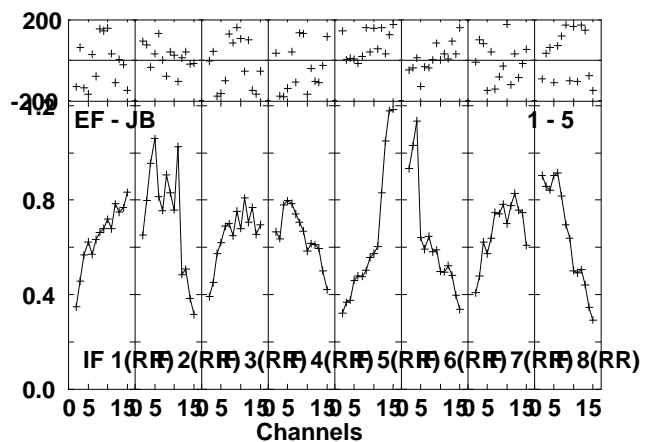
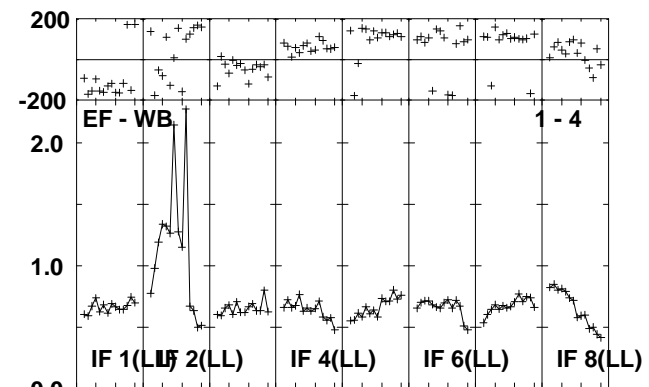
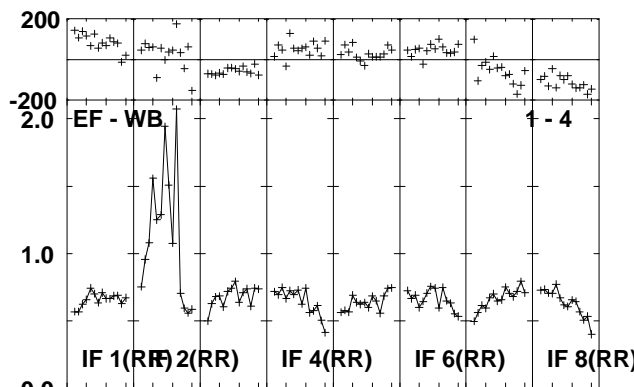
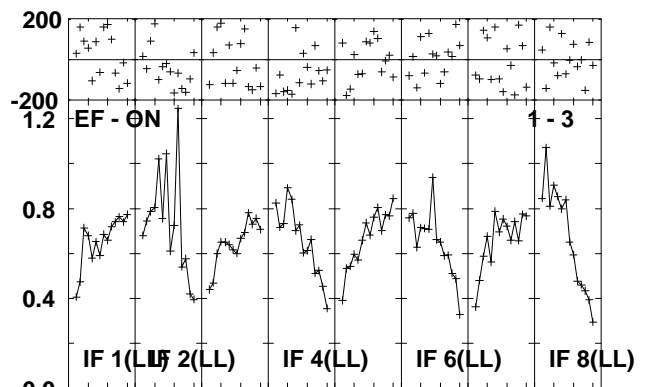
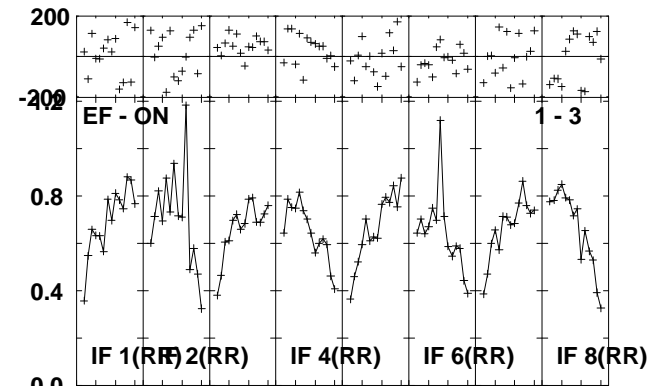
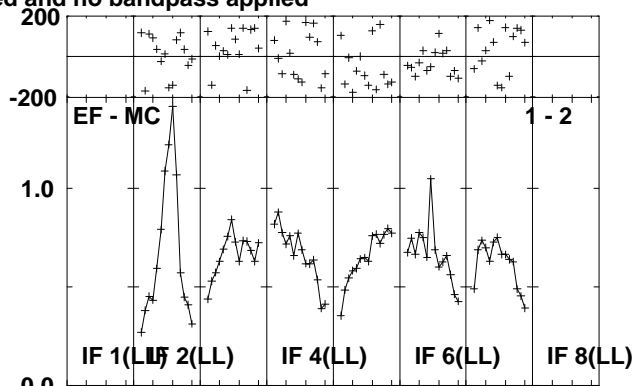
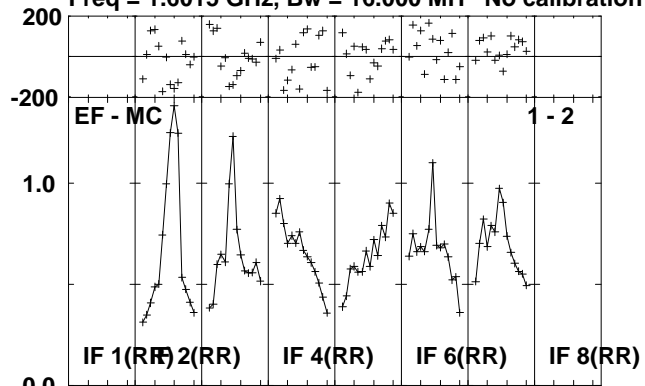

Lower frame: Milli Ampl Jy Top frame: Phas deg
Scalar averaged cross-power spectrum Several baselines displayed
Timerange: 01/00:59:05 to 01/01:03:41

Plot file version 114 created 01-JUL-2010 13:25:22

V407CYG RG006B.UVDATA.1

Freq = 1.6015 GHz, Bw = 16.000 MH No calibration applied and no bandpass applied

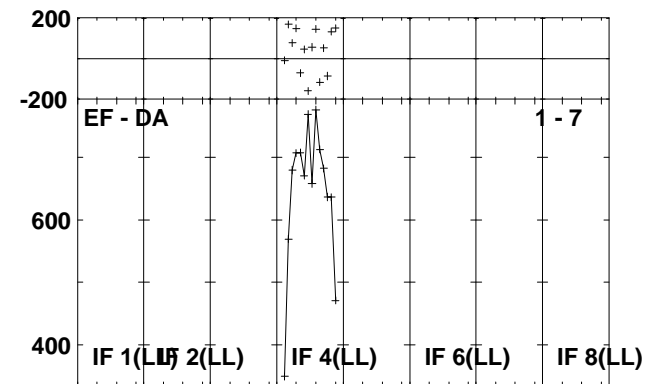
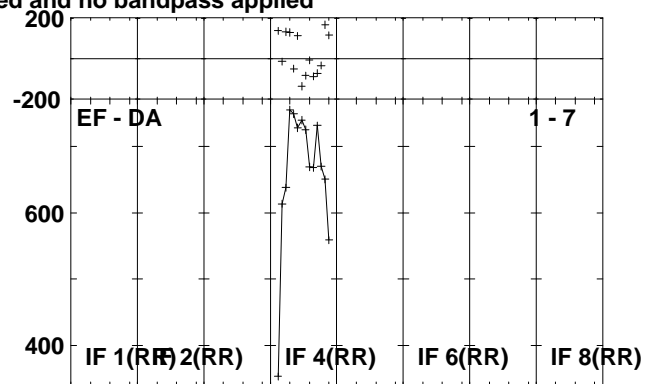
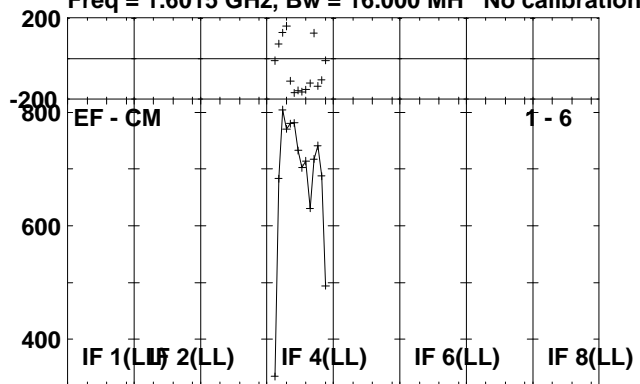

Lower frame: Micro Ampl Jy Top frame: Phas deg
Scalar averaged cross-power spectrum Several baselines displayed
Timerange: 01/00:59:05 to 01/01:03:41

Plot file version 115 created 01-JUL-2010 13:25:23

J2102+47 RG006B.UVDATA.1

Freq = 1.6015 GHz, Bw = 16.000 MH No calibration applied and no bandpass applied

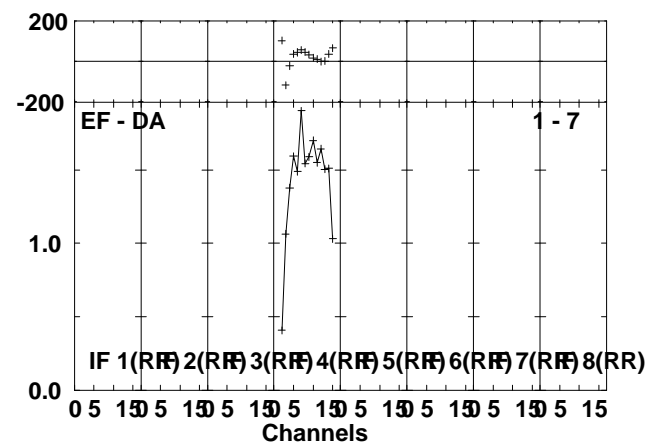
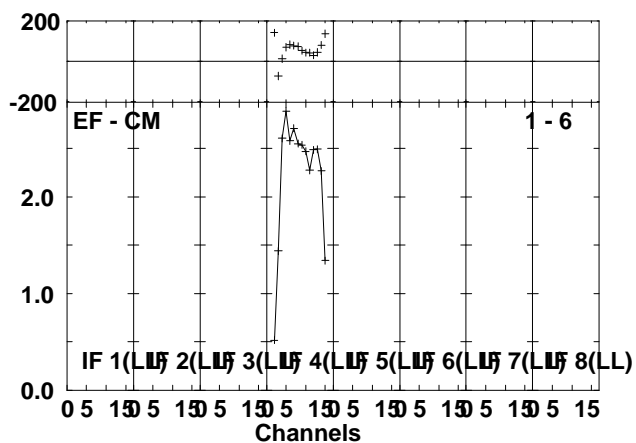
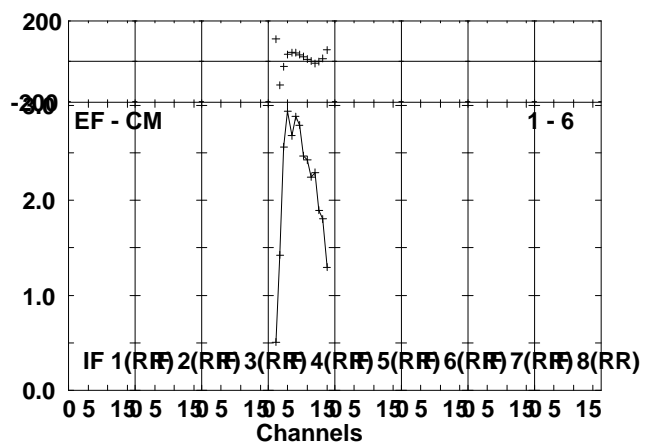
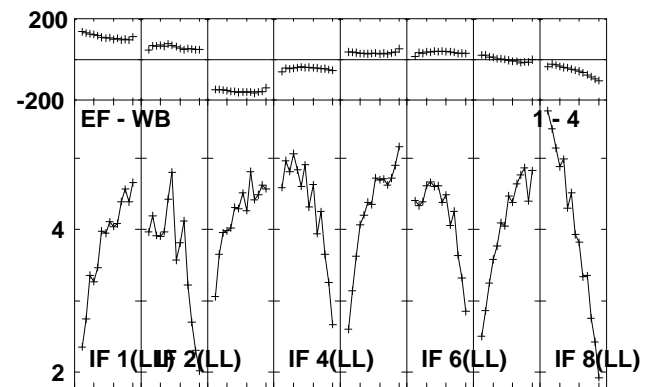
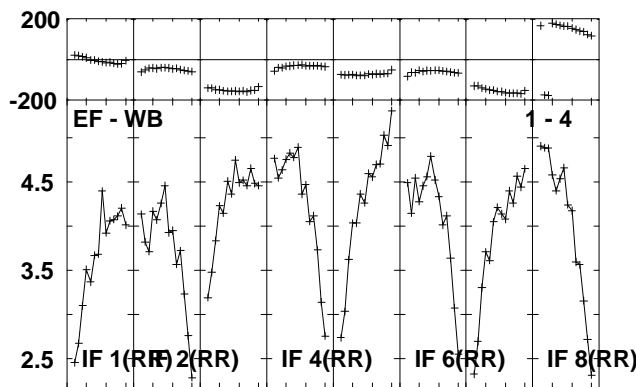
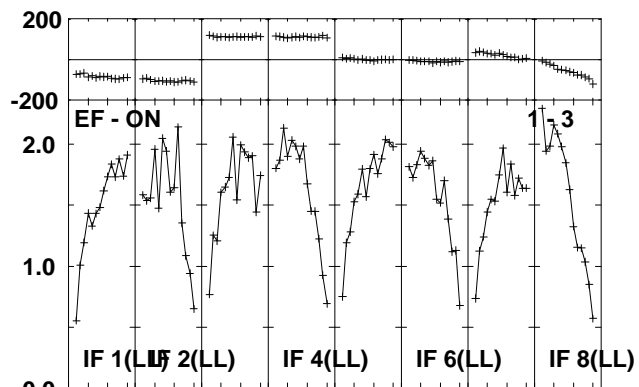
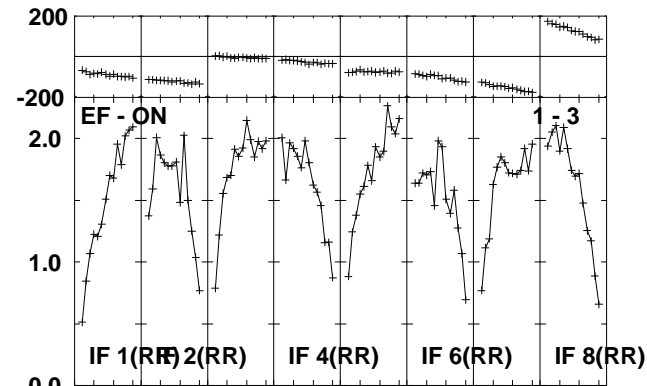
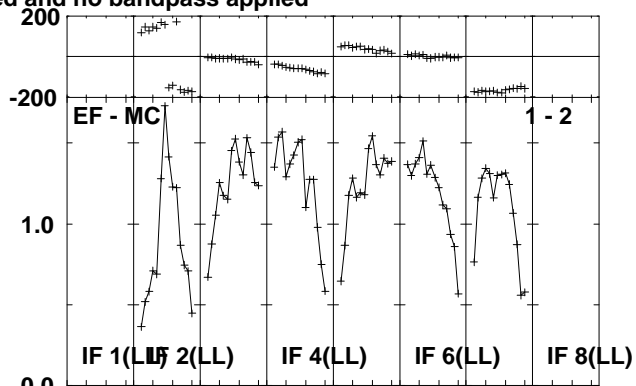
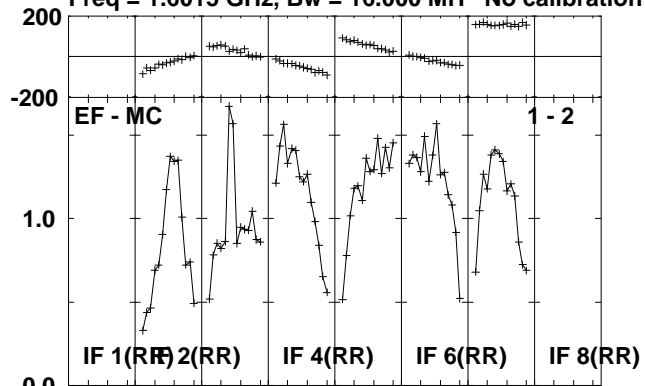

Lower frame: Milli Ampl Jy Top frame: Phas deg
Scalar averaged cross-power spectrum Several baselines displayed
Timerange: 01/01:03:57 to 01/01:06:01

Plot file version 116 created 01-JUL-2010 13:25:23

J2102+47 RG006B.UVDATA.1

Freq = 1.6015 GHz, Bw = 16.000 MH No calibration applied and no bandpass applied

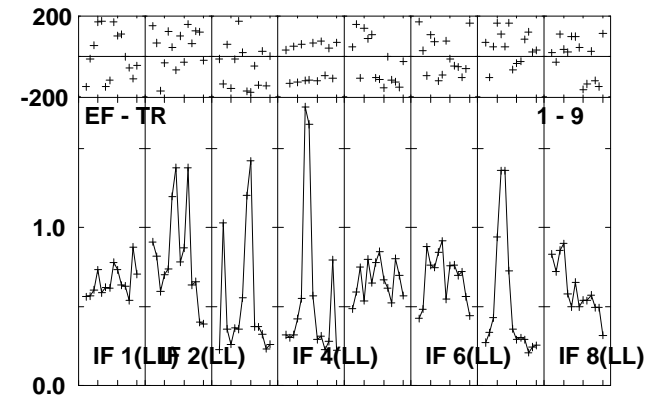
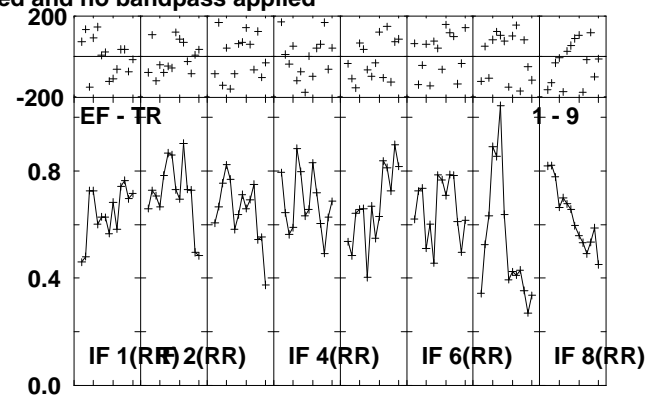
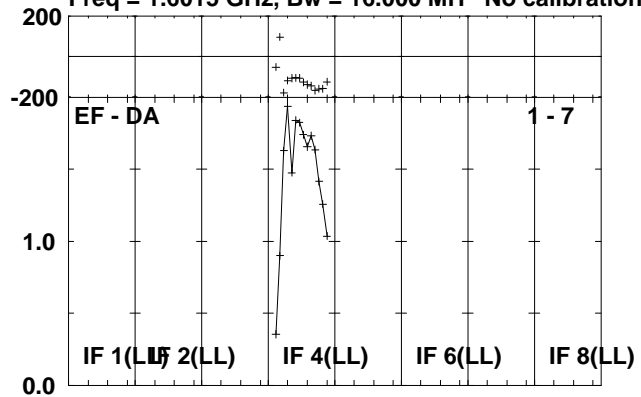

Lower frame: Milli Ampl Jy Top frame: Phas deg
Scalar averaged cross-power spectrum Several baselines displayed
Timerange: 01/01:03:57 to 01/01:06:01

Plot file version 117 created 01-JUL-2010 13:25:24

V407CYG RG006B.UVDATA.1

Freq = 1.6015 GHz, Bw = 16.000 MH No calibration applied and no bandpass applied

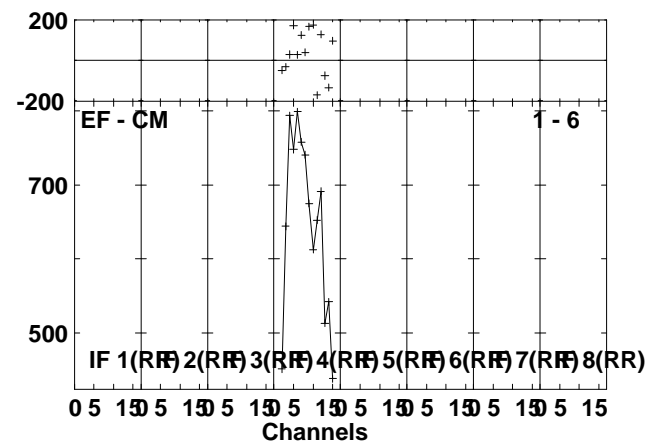
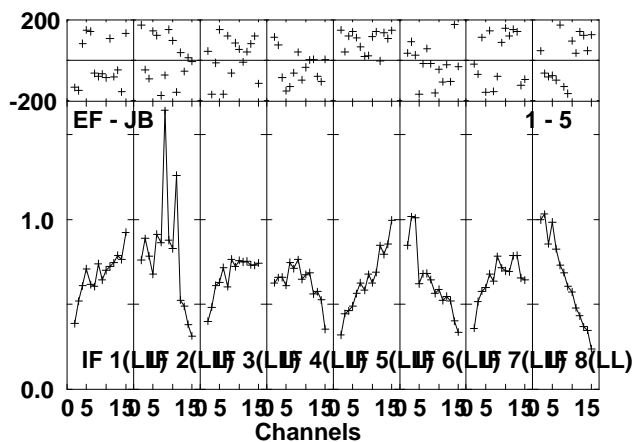
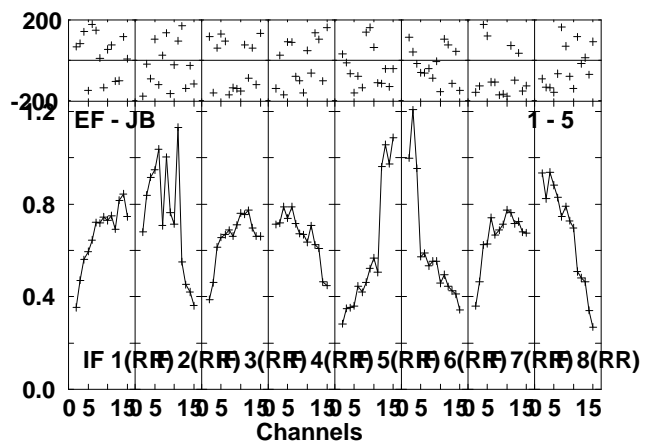
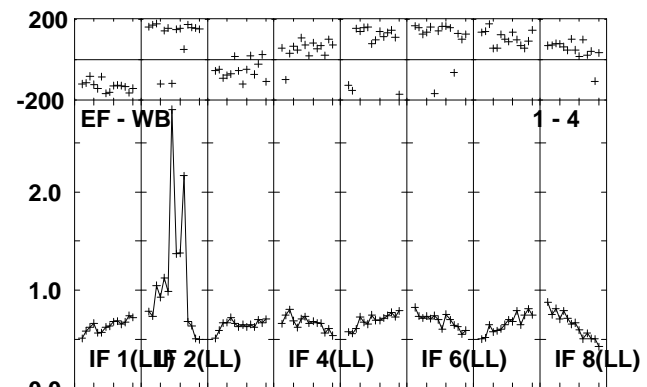
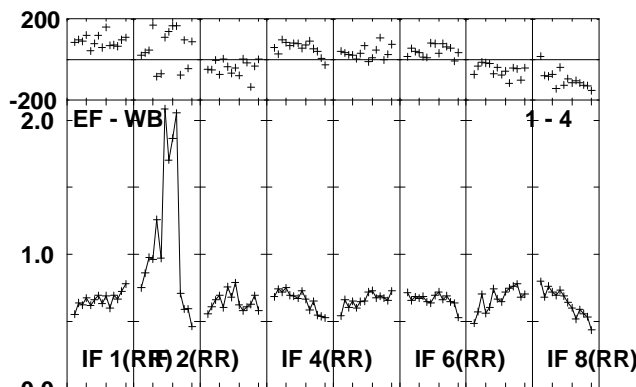
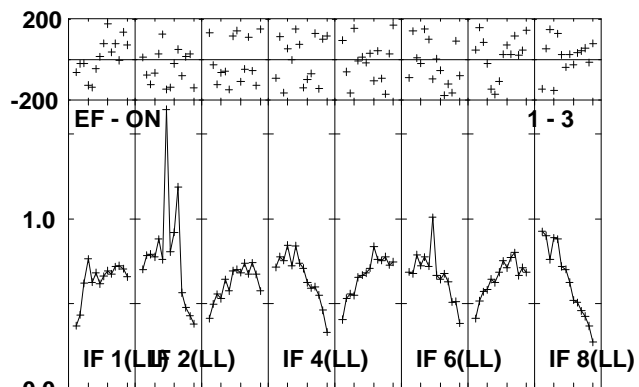
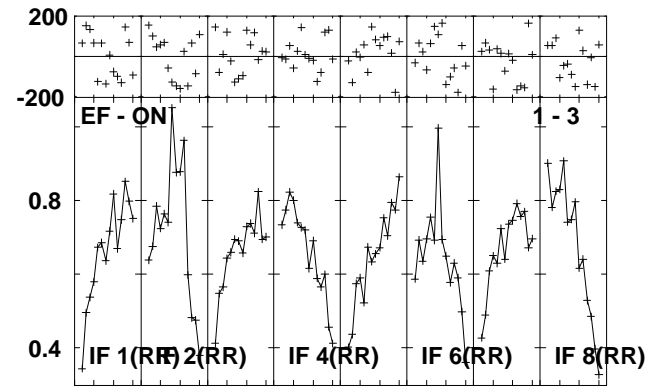
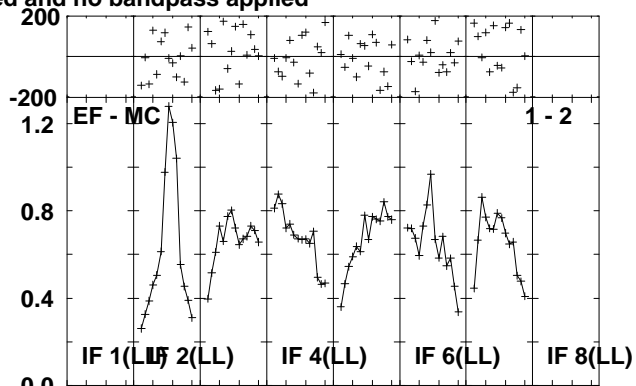
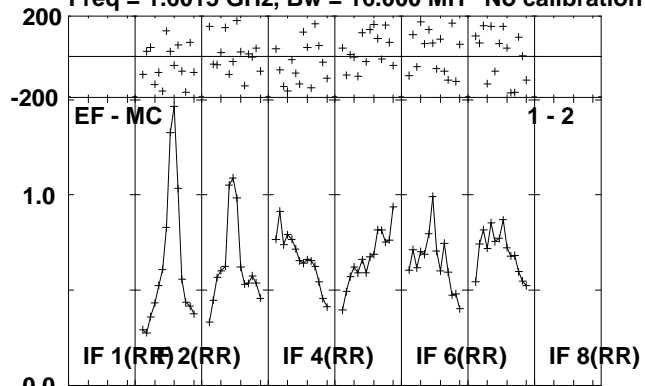

Lower frame: Milli Ampl Jy Top frame: Phas deg
Scalar averaged cross-power spectrum Several baselines displayed
Timerange: 01/01:06:05 to 01/01:11:01

Plot file version 118 created 01-JUL-2010 13:25:24

V407CYG RG006B.UVDATA.1

Freq = 1.6015 GHz, Bw = 16.000 MH No calibration applied and no bandpass applied

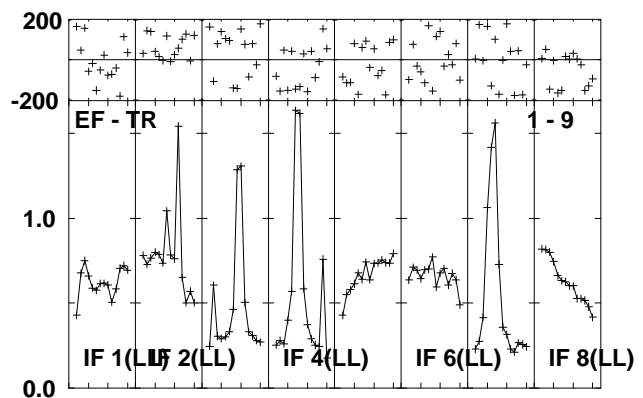
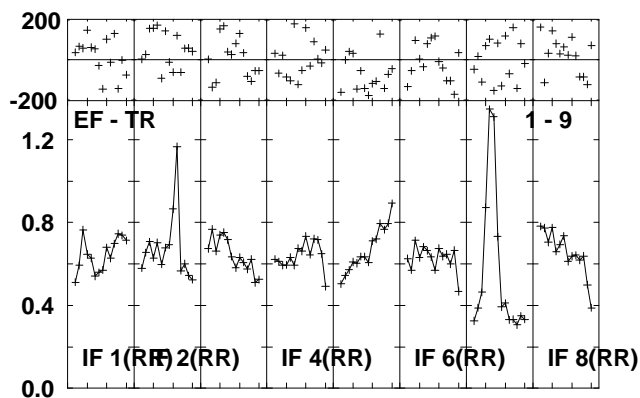
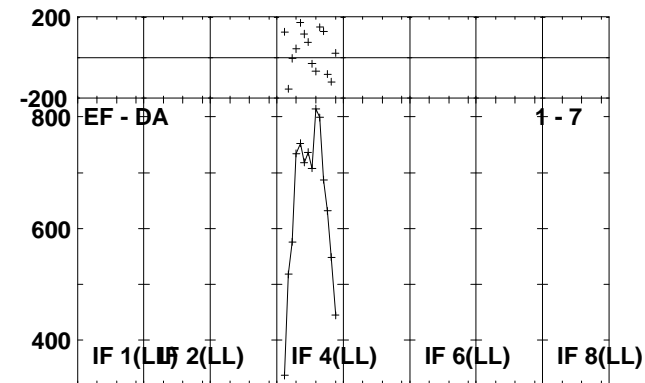
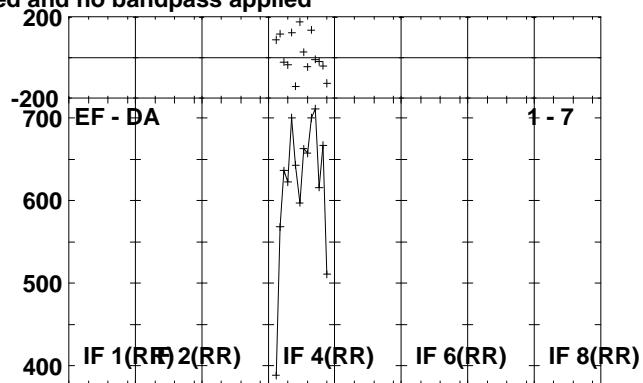
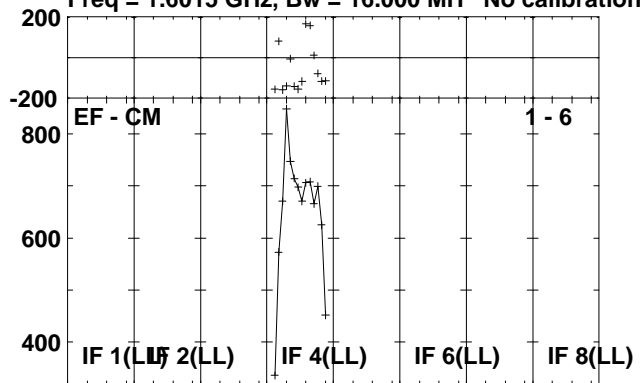

Lower frame: Micro Ampl Jy Top frame: Phas deg
Scalar averaged cross-power spectrum Several baselines displayed
Timerange: 01/01:06:05 to 01/01:11:01

Plot file version 119 created 01-JUL-2010 13:25:25

J2102+47 RG006B.UVDATA.1

Freq = 1.6015 GHz, Bw = 16.000 MH No calibration applied and no bandpass applied

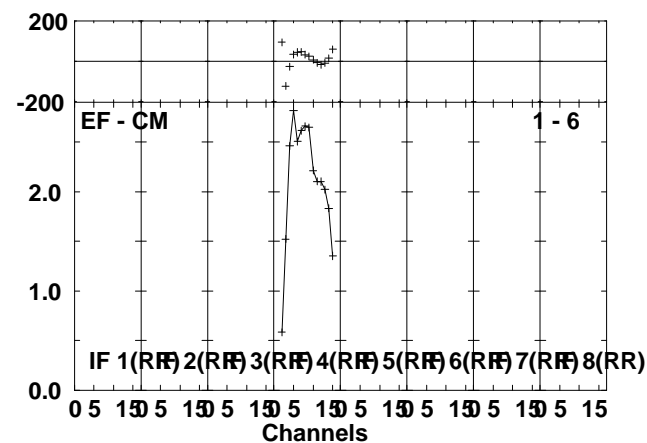
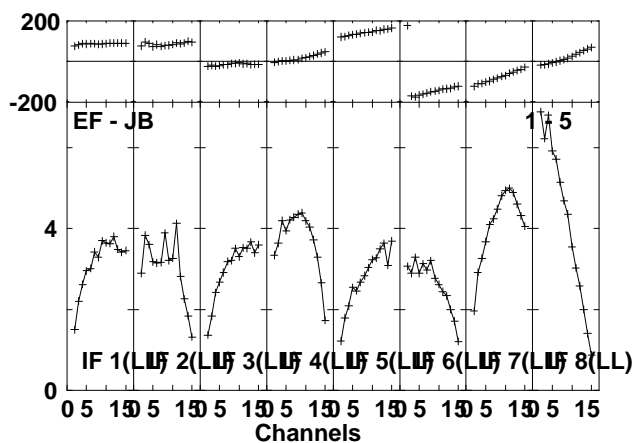
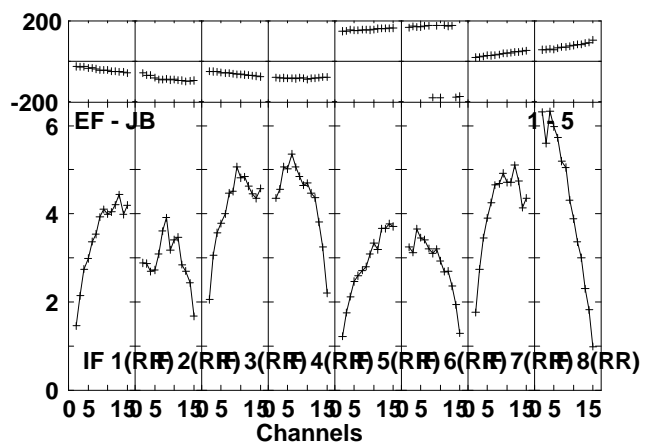
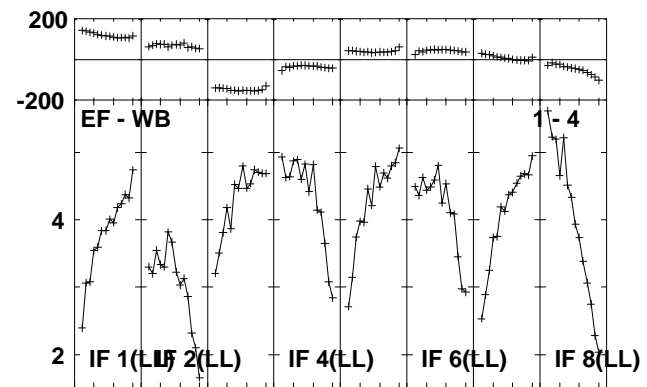
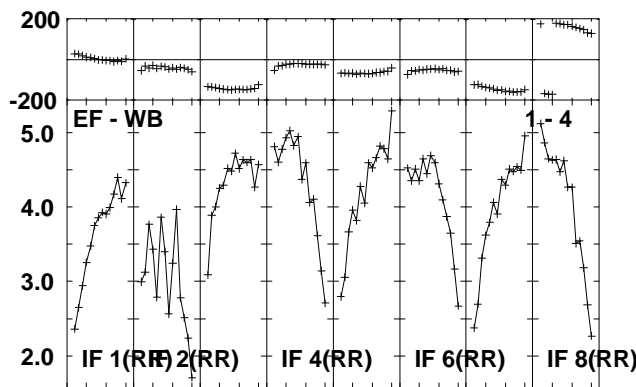
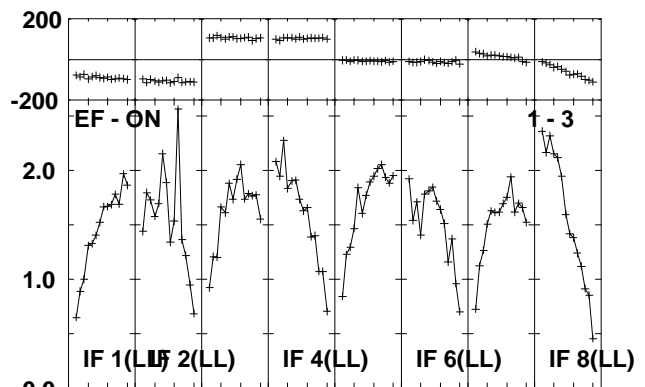
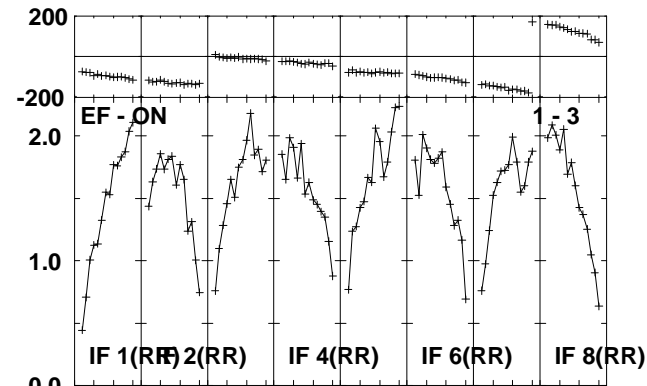
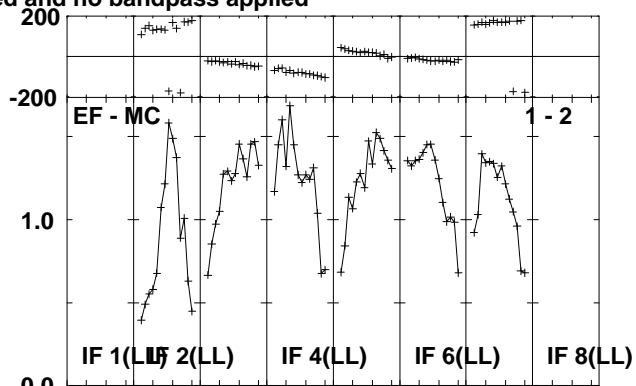
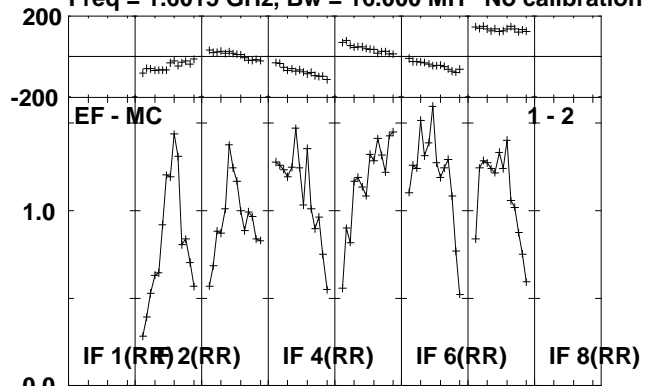

Lower frame: Milli Ampl Jy Top frame: Phas deg
Scalar averaged cross-power spectrum Several baselines displayed
Timerange: 01/01:12:05 to 01/01:13:49

Plot file version 120 created 01-JUL-2010 13:25:26

J2102+47 RG006B.UVDATA.1

Freq = 1.6015 GHz, Bw = 16.000 MH No calibration applied and no bandpass applied

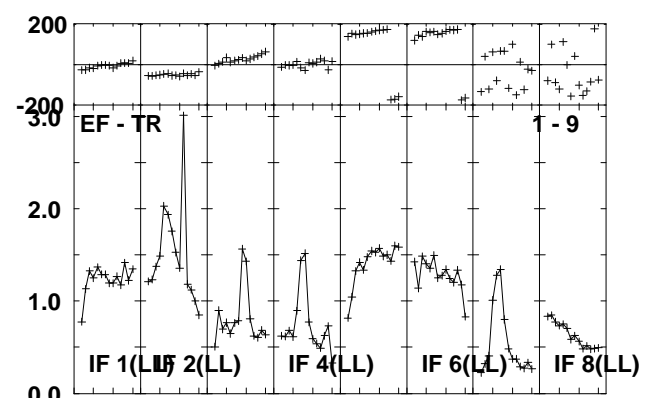
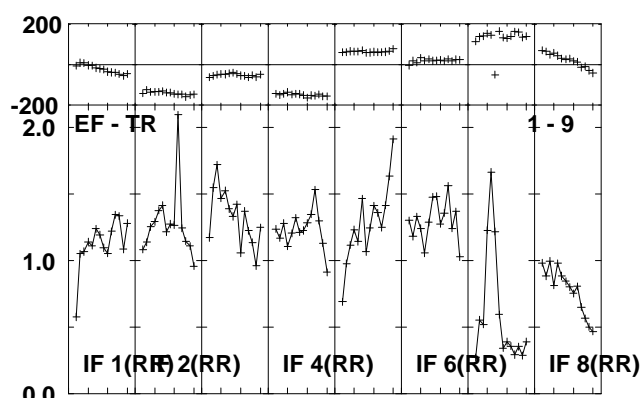
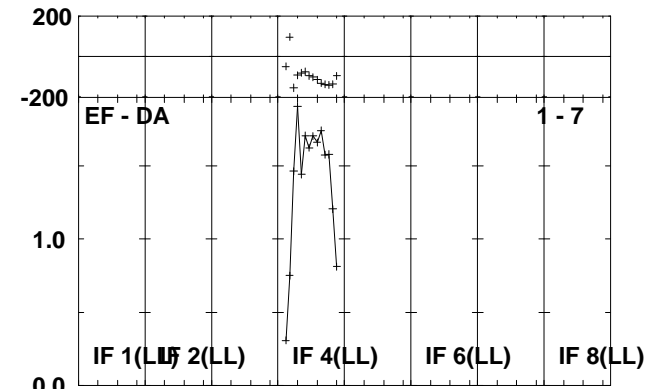
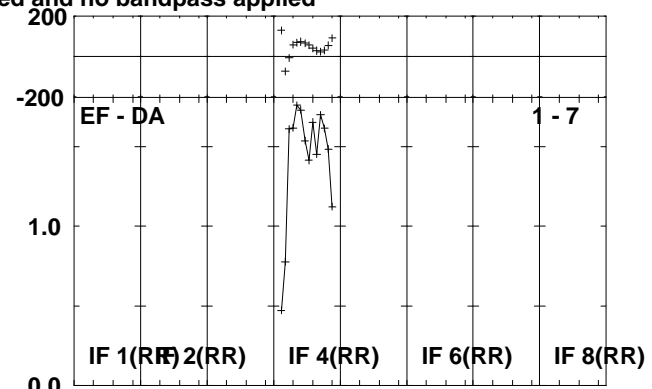
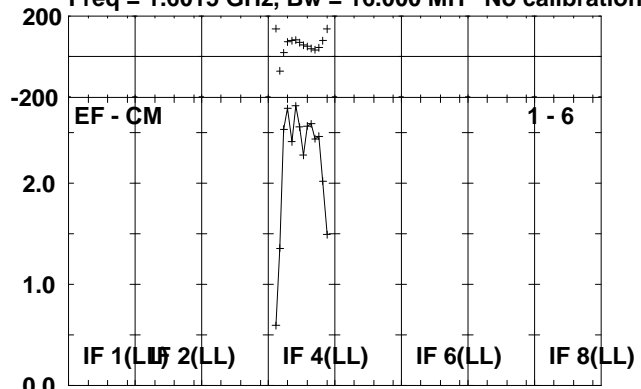

Lower frame: Milli Ampl Jy Top frame: Phas deg
Scalar averaged cross-power spectrum Several baselines displayed
Timerange: 01/01:12:05 to 01/01:13:49

Plot file version 121 created 01-JUL-2010 13:25:26

V407CYG RG006B.UVDATA.1

Freq = 1.6015 GHz, Bw = 16.000 MH No calibration applied and no bandpass applied

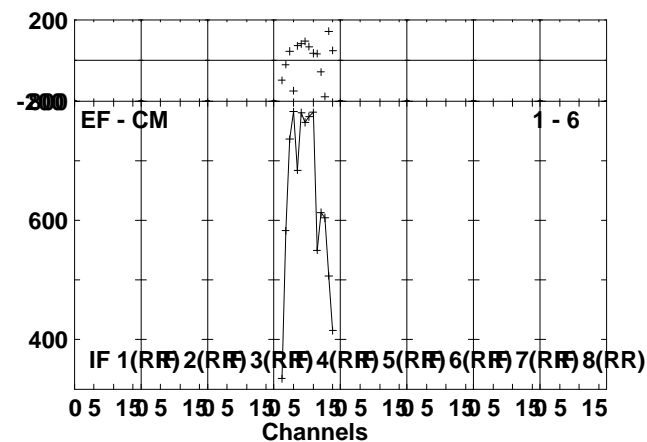
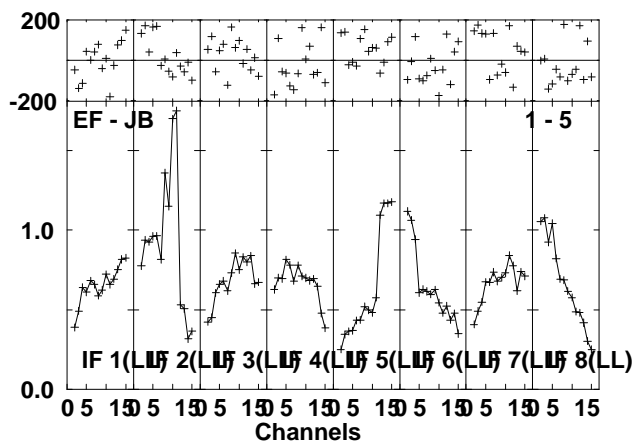
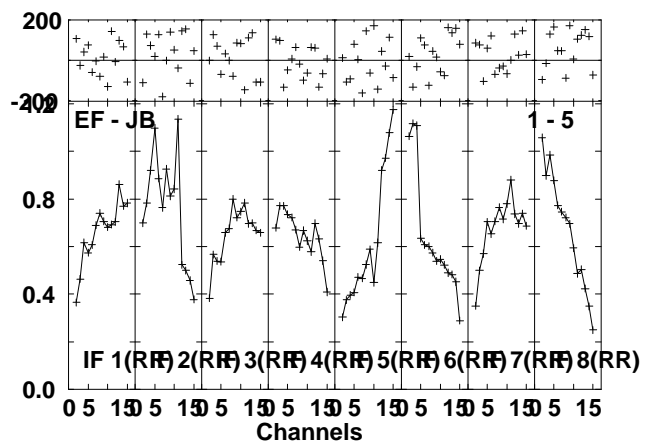
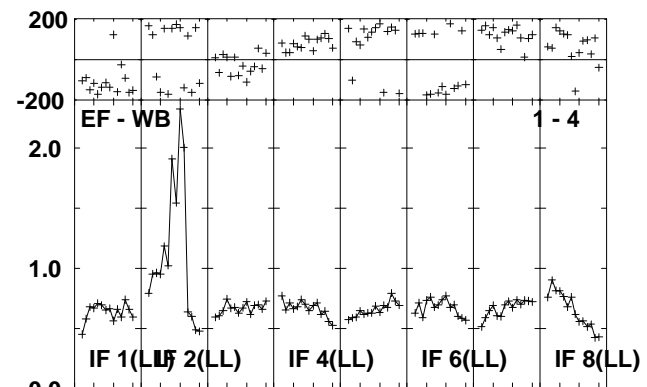
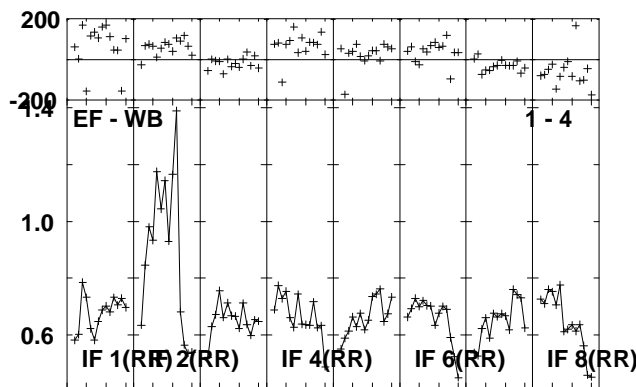
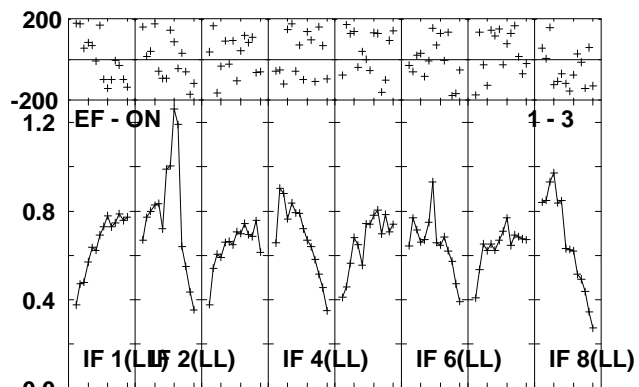
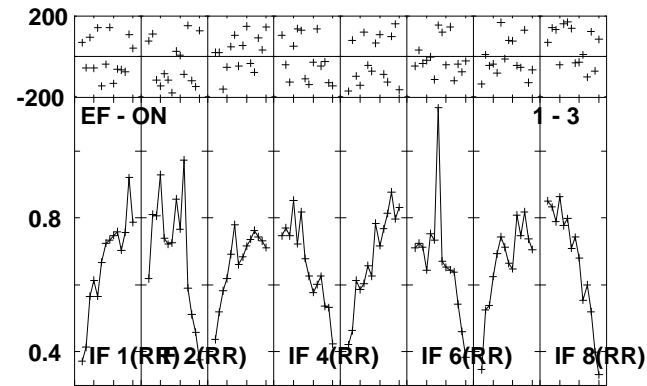
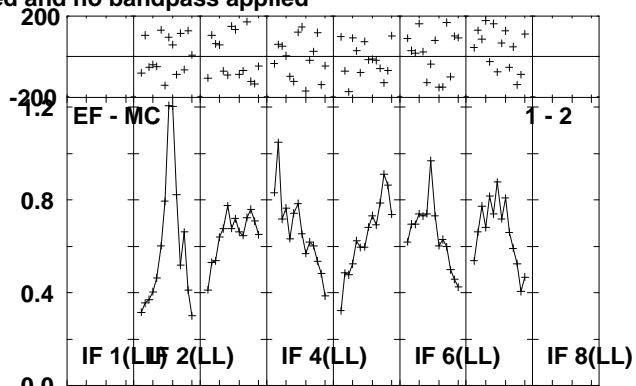
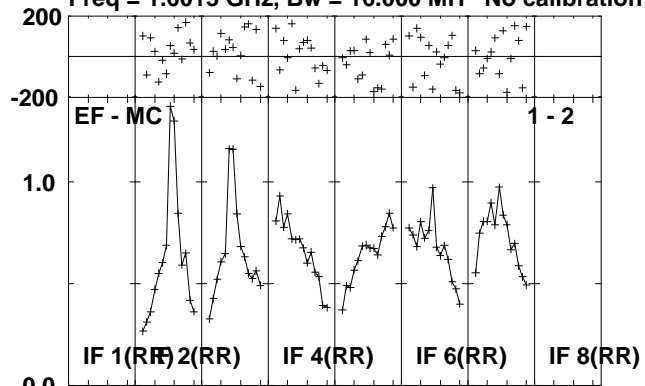

Lower frame: Milli Ampl Jy Top frame: Phas deg
Scalar averaged cross-power spectrum Several baselines displayed
Timerange: 01/01:13:53 to 01/01:18:49

Plot file version 122 created 01-JUL-2010 13:25:27

V407CYG RG006B.UVDATA.1

Freq = 1.6015 GHz, Bw = 16.000 MH No calibration applied and no bandpass applied

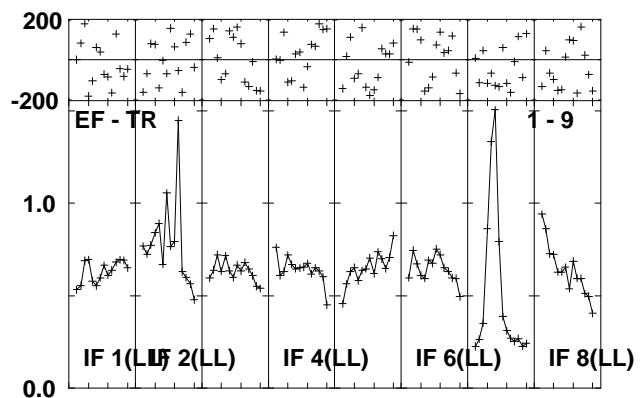
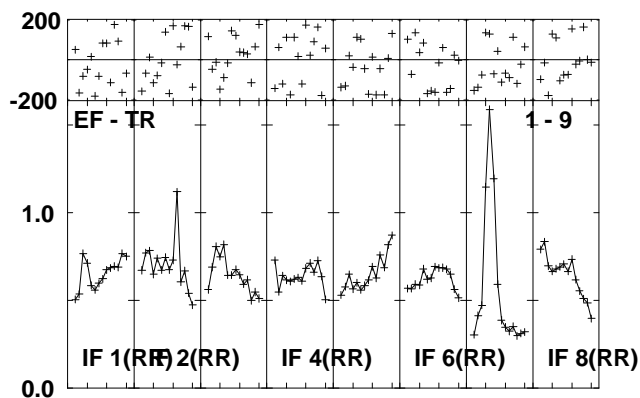
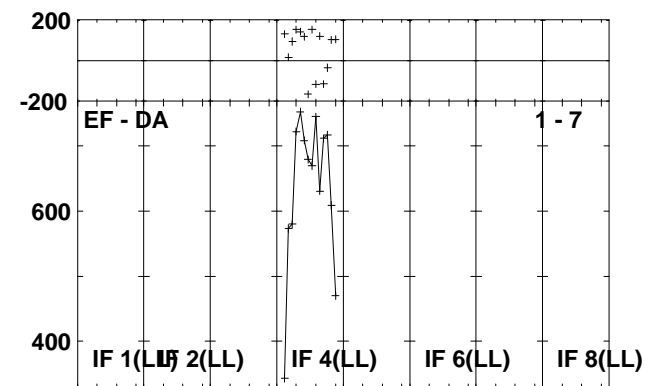
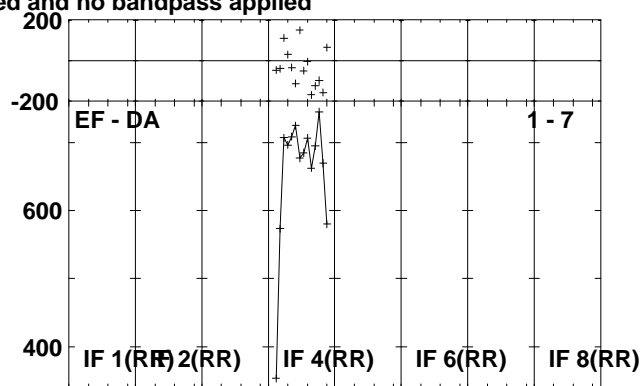
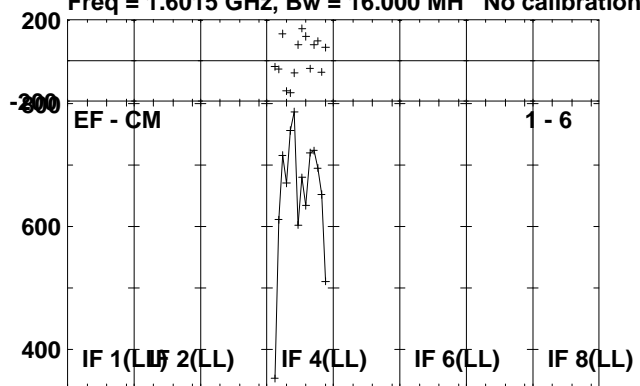

Lower frame: Micro Ampl Jy Top frame: Phas deg
Scalar averaged cross-power spectrum Several baselines displayed
Timerange: 01/01:13:53 to 01/01:18:49

Plot file version 123 created 01-JUL-2010 13:25:28

J2102+47 RG006B.UVDATA.1

Freq = 1.6015 GHz, Bw = 16.000 MH No calibration applied and no bandpass applied

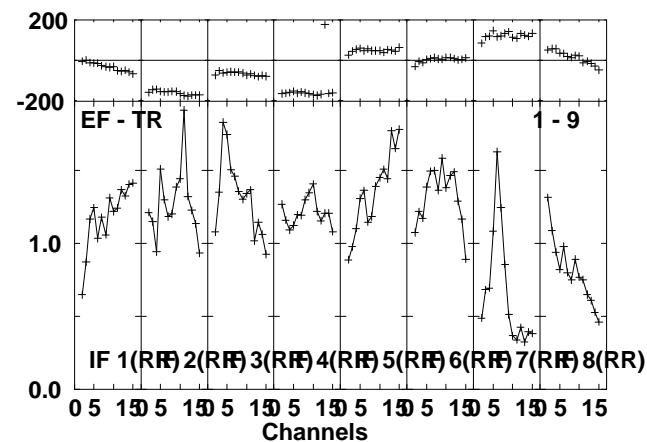
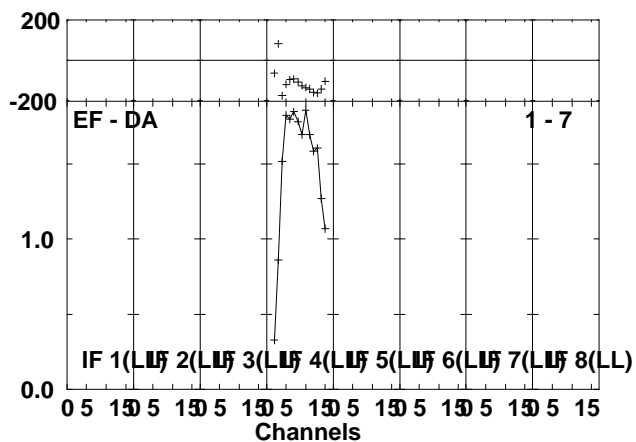
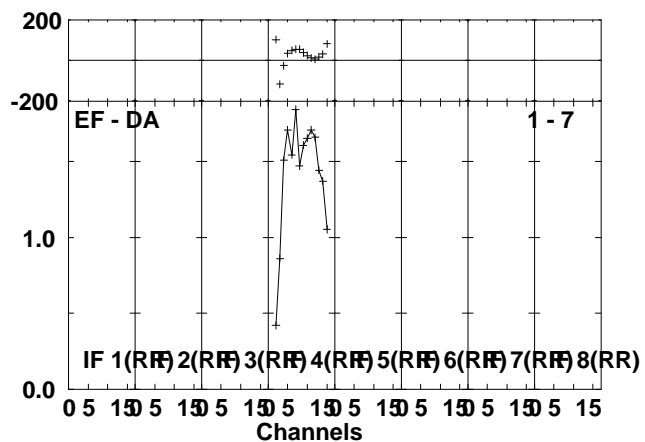
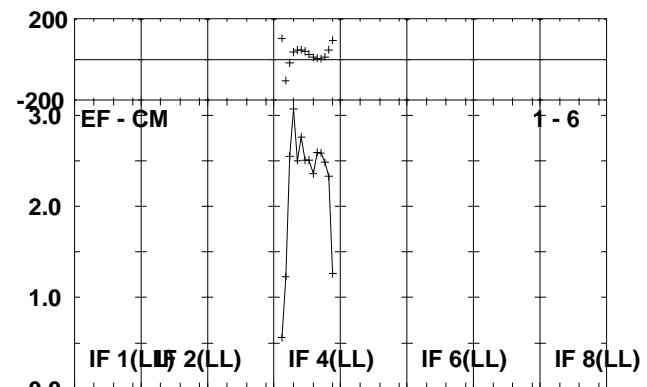
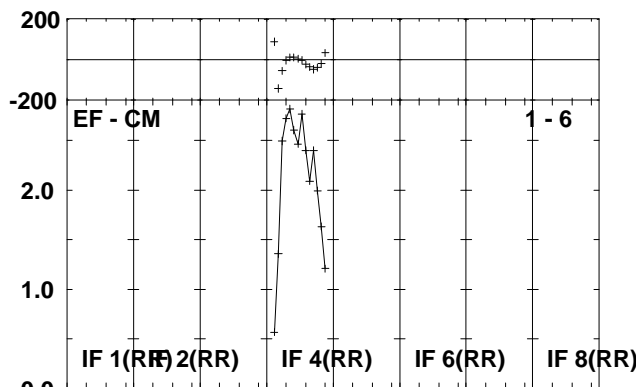
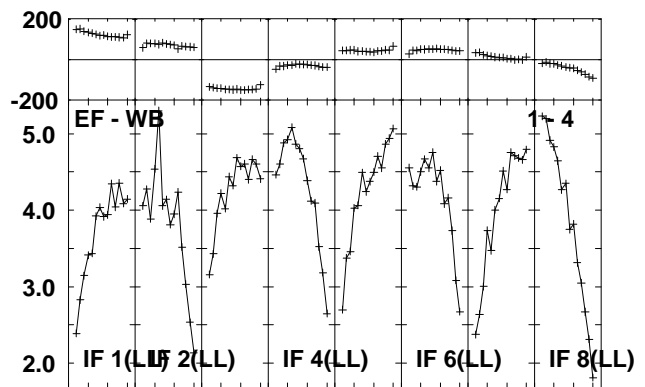
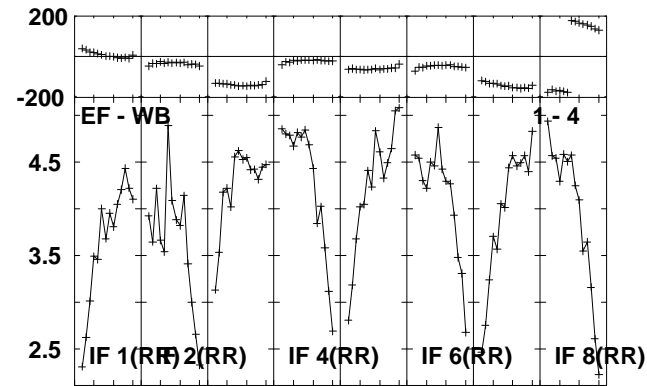
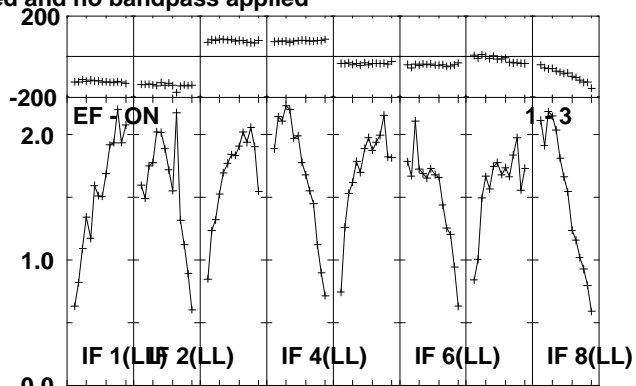
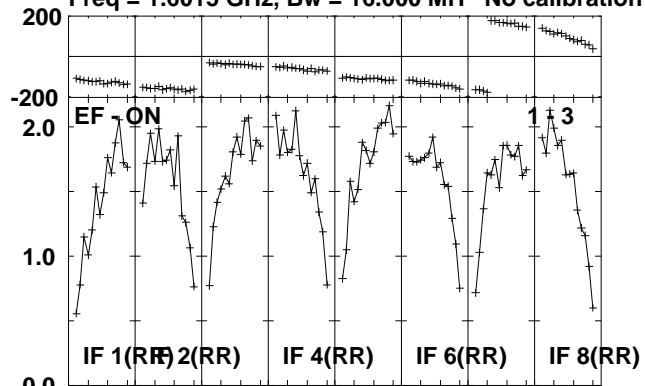

Lower frame: Milli Ampl Jy Top frame: Phas deg
Scalar averaged cross-power spectrum Several baselines displayed
Timerange: 01/01:18:53 to 01/01:21:01

Plot file version 124 created 01-JUL-2010 13:25:28
J2102+47 RG006B.UVDATA.1
Freq = 1.6015 GHz, Bw = 16.000 MH No calibration applied and no bandpass applied

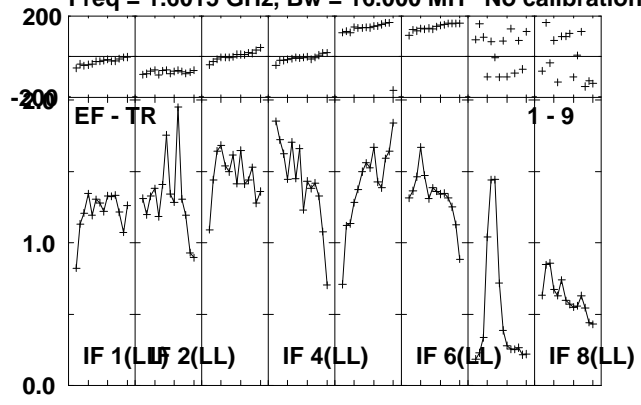

Lower frame: Milli Ampl Jy Top frame: Phas deg
Scalar averaged cross-power spectrum Several baselines displayed
Timerange: 01/01:18:53 to 01/01:21:01

Plot file version 125 created 01-JUL-2010 13:25:29

V407CYG RG006B.UVDATA.1

Freq = 1.6015 GHz, Bw = 16.000 MH No calibration applied and no bandpass applied

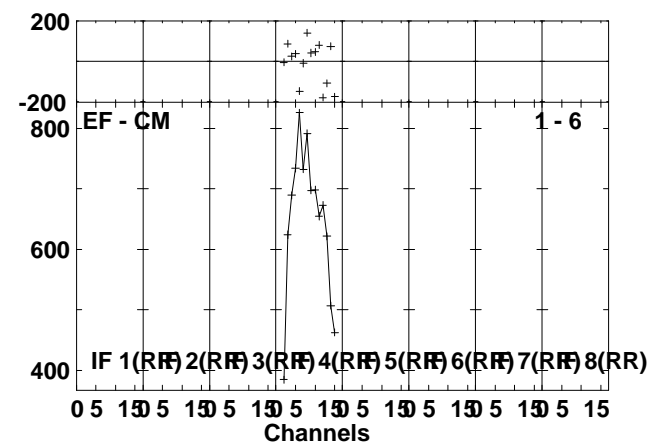
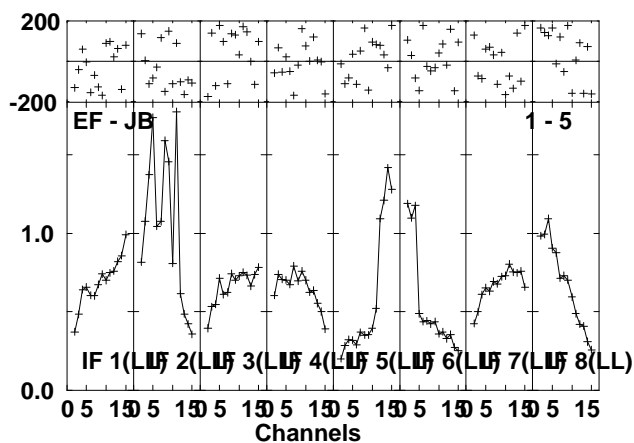
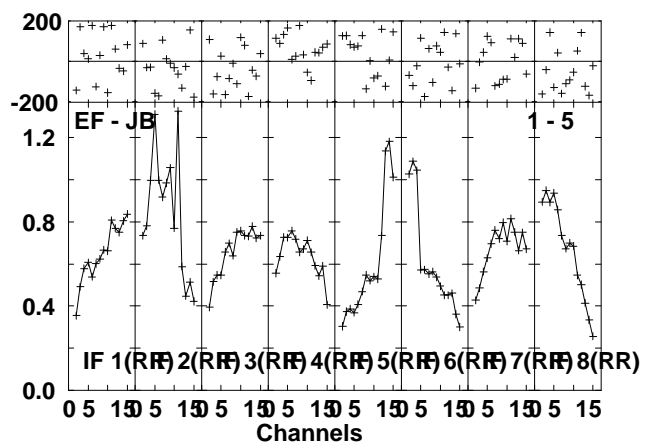
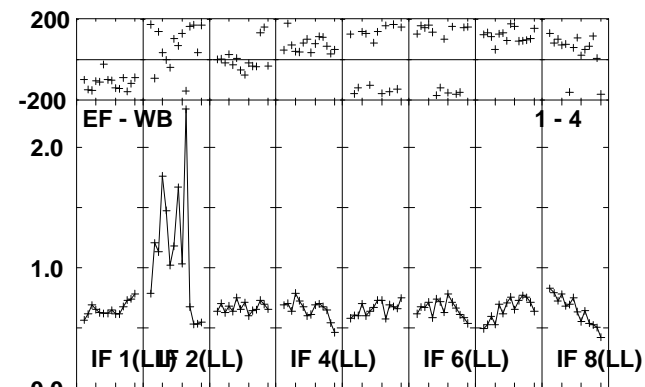
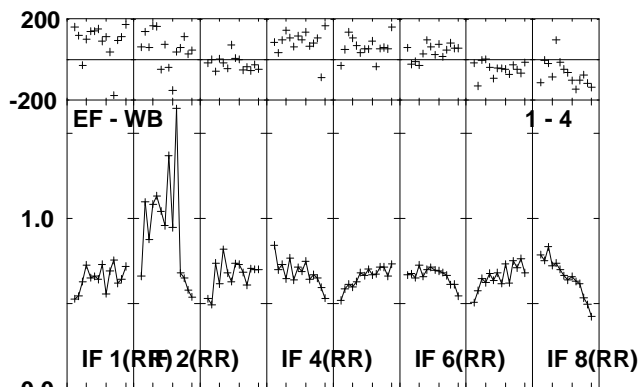
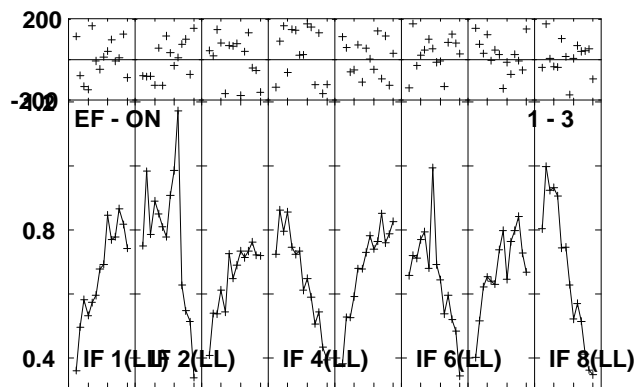
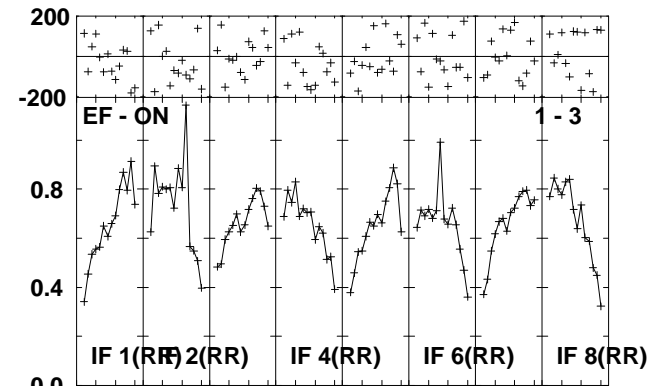
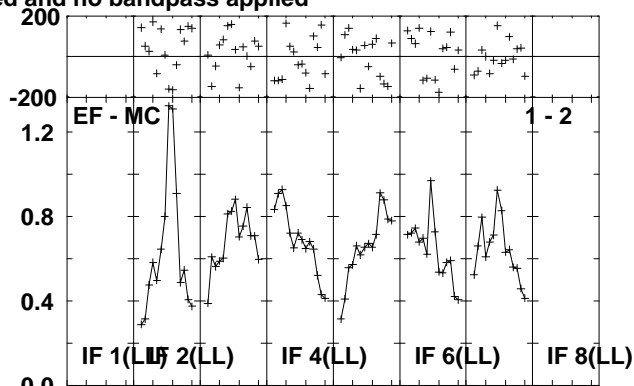
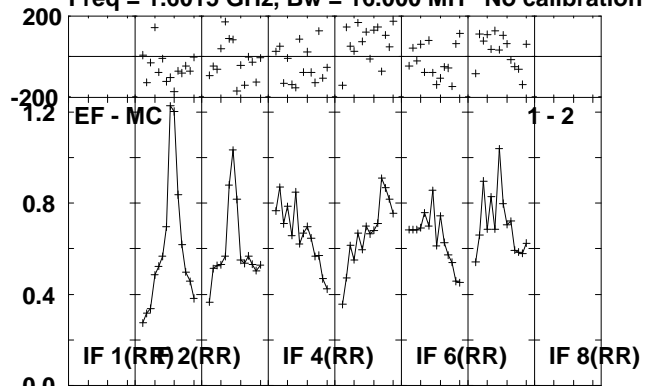

Lower frame: Milli Ampl Jy Top frame: Phas deg
Scalar averaged cross-power spectrum Several baselines displayed
Timerange: 01/01:21:05 to 01/01:26:01

Plot file version 126 created 01-JUL-2010 13:25:29
V407CYG RG006B.UVDATA.1

Freq = 1.6015 GHz, Bw = 16.000 MH No calibration applied and no bandpass applied

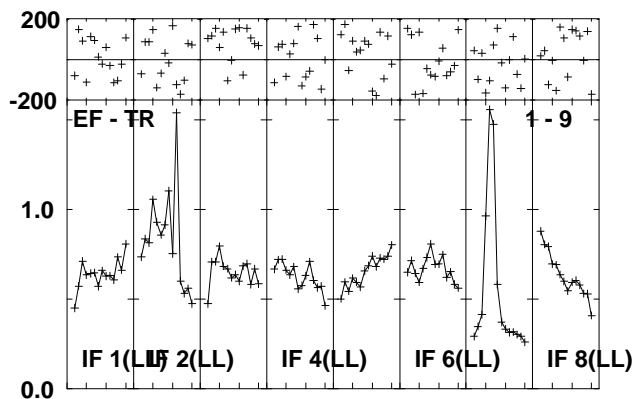
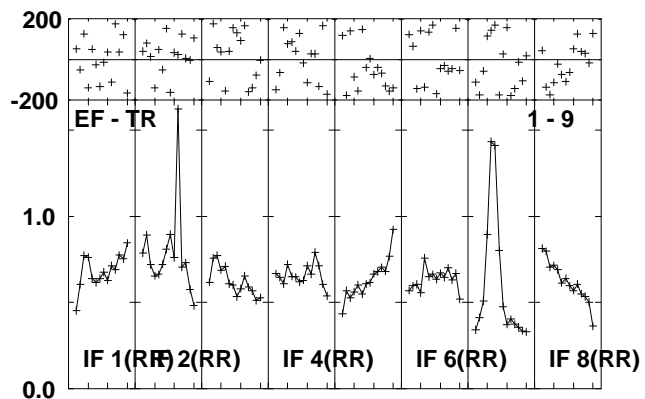
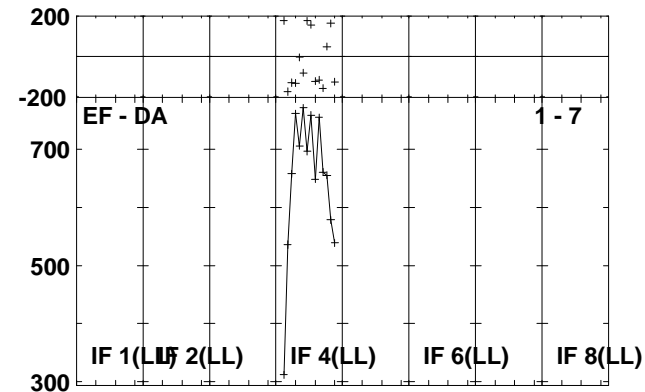
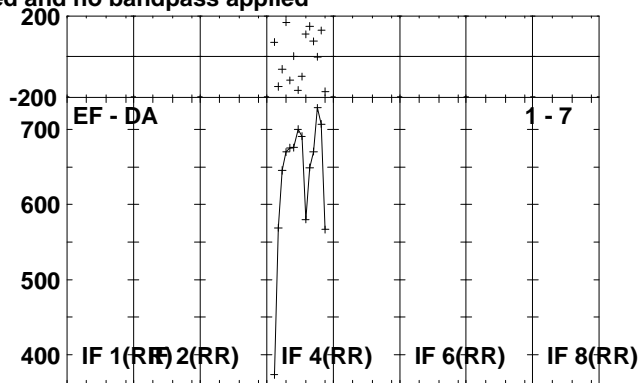
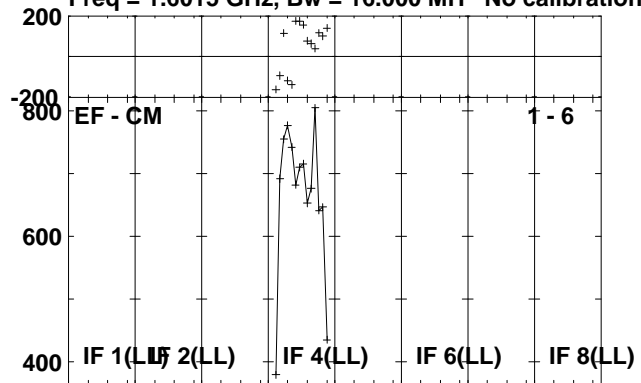

Lower frame: Micro Ampl Jy Top frame: Phas deg
Scalar averaged cross-power spectrum Several baselines displayed
Timerange: 01/01:21:05 to 01/01:26:01

Plot file version 127 created 01-JUL-2010 13:25:30

J2102+47 RG006B.UVDATA.1

Freq = 1.6015 GHz, Bw = 16.000 MH No calibration applied and no bandpass applied

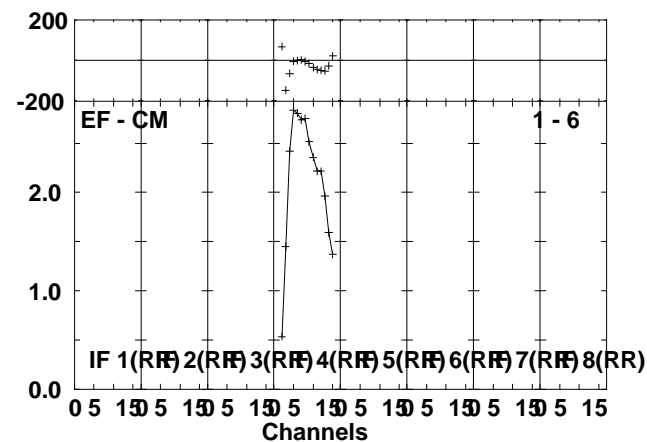
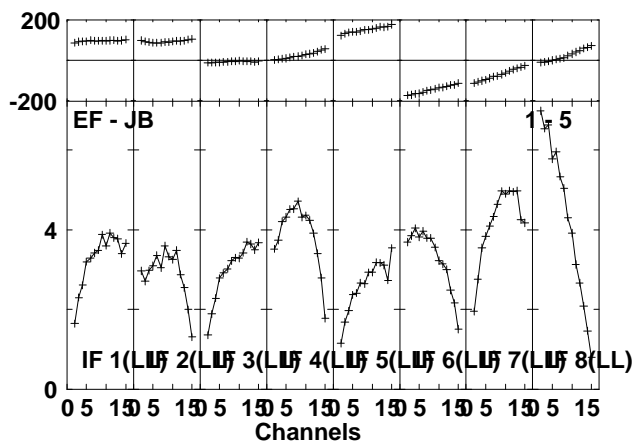
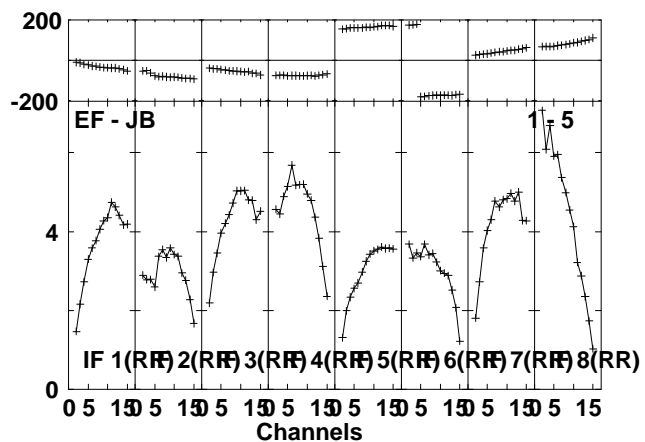
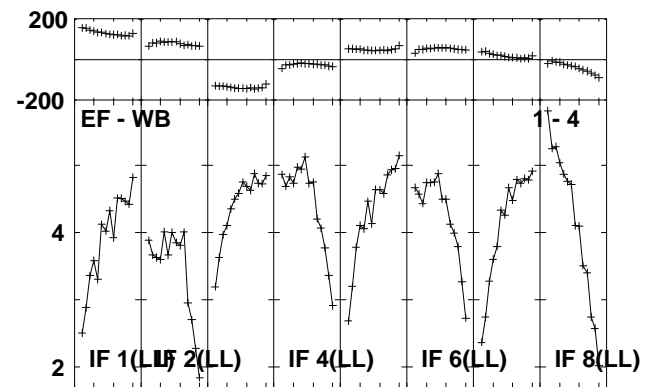
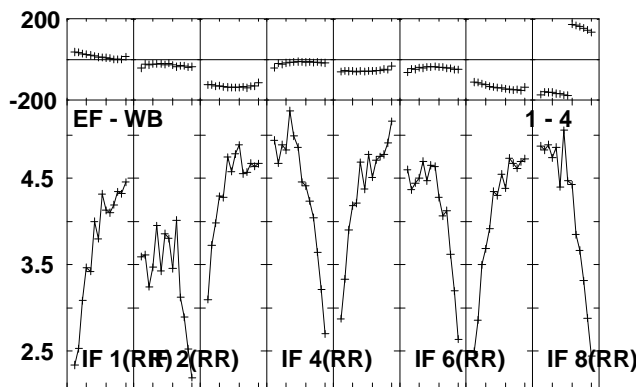
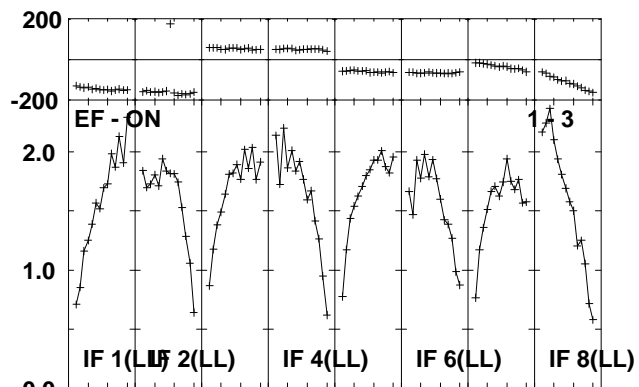
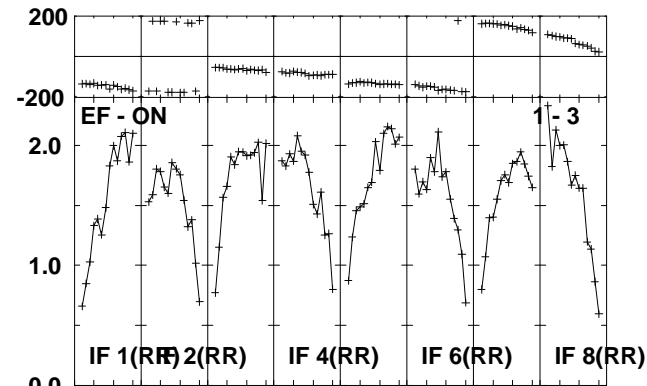
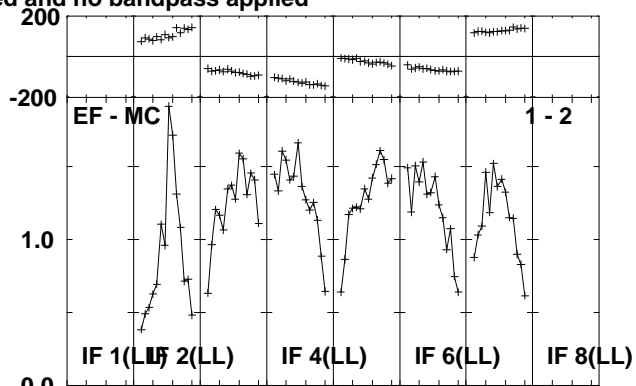
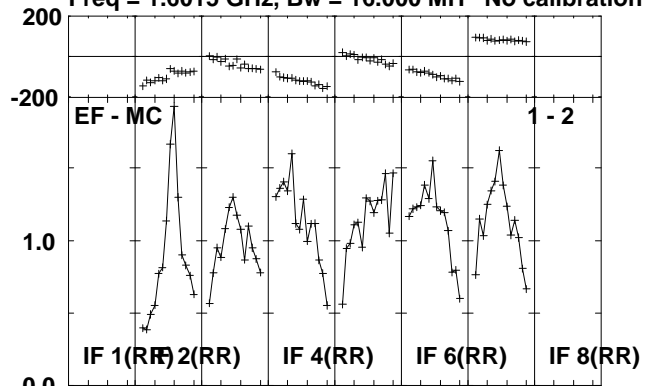

Lower frame: Milli Ampl Jy Top frame: Phas deg
Scalar averaged cross-power spectrum Several baselines displayed
Timerange: 01/01:27:05 to 01/01:28:49

Plot file version 128 created 01-JUL-2010 13:25:30

J2102+47 RG006B.UVDATA.1

Freq = 1.6015 GHz, Bw = 16.000 MH No calibration applied and no bandpass applied

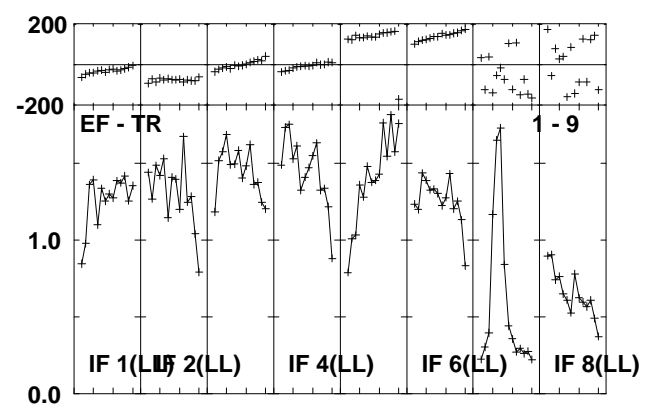
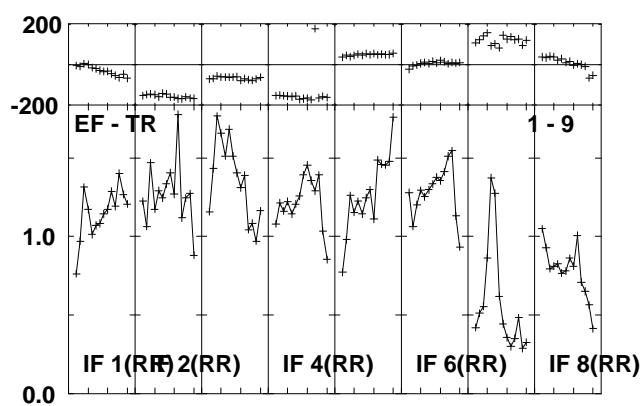
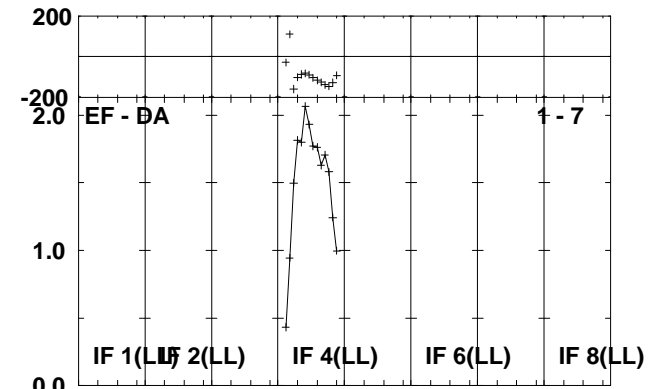
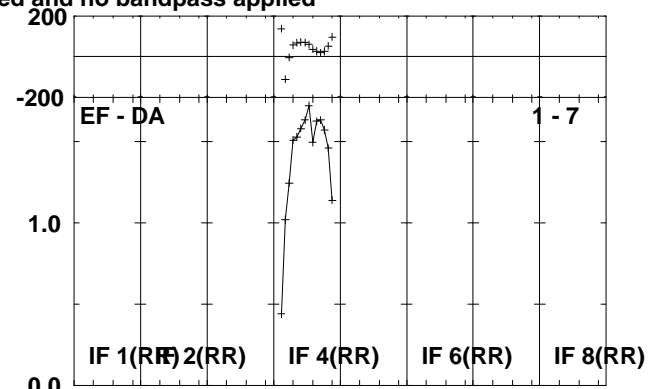
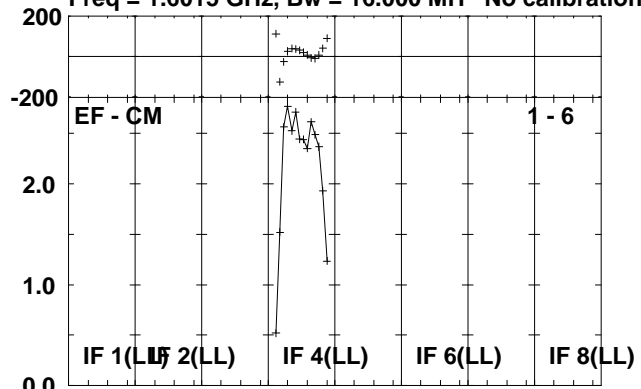

Lower frame: Milli Ampl Jy Top frame: Phas deg
Scalar averaged cross-power spectrum Several baselines displayed
Timerange: 01/01:27:05 to 01/01:28:49

Plot file version 129 created 01-JUL-2010 13:25:31

V407CYG RG006B.UVDATA.1

Freq = 1.6015 GHz, Bw = 16.000 MH No calibration applied and no bandpass applied

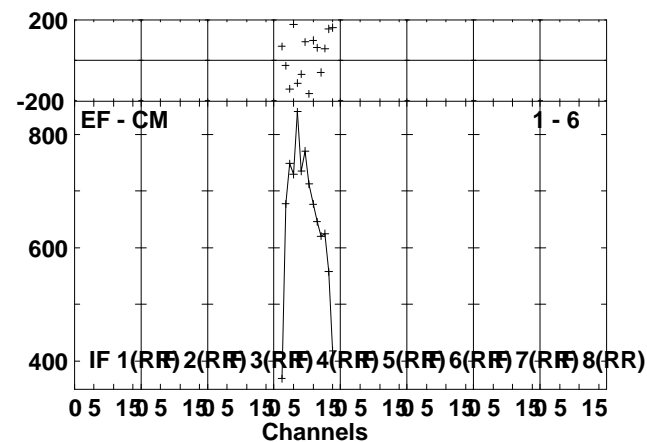
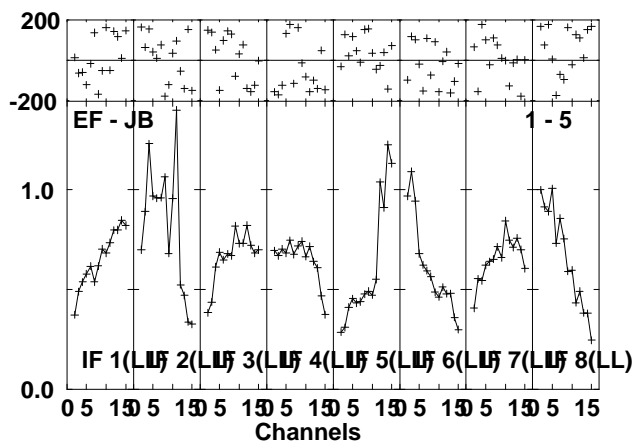
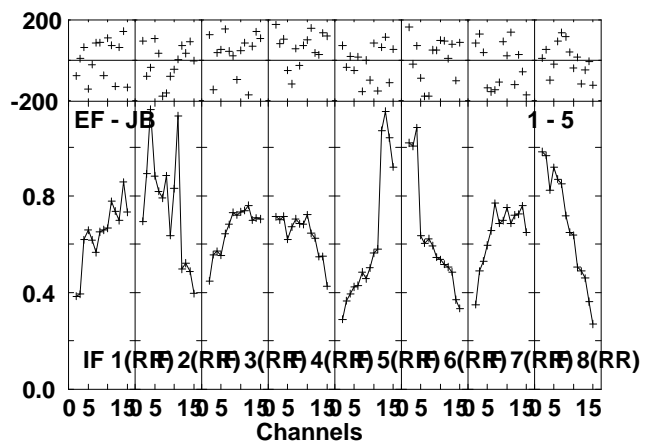
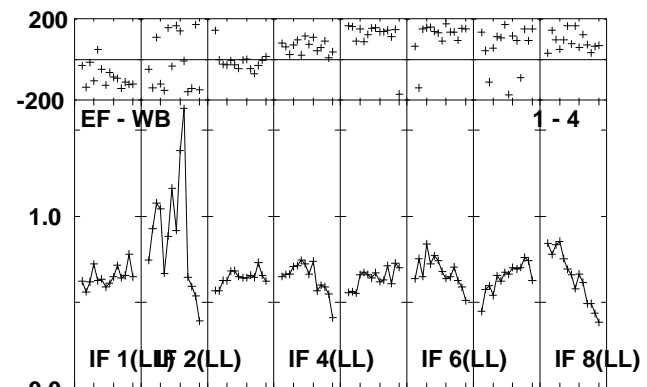
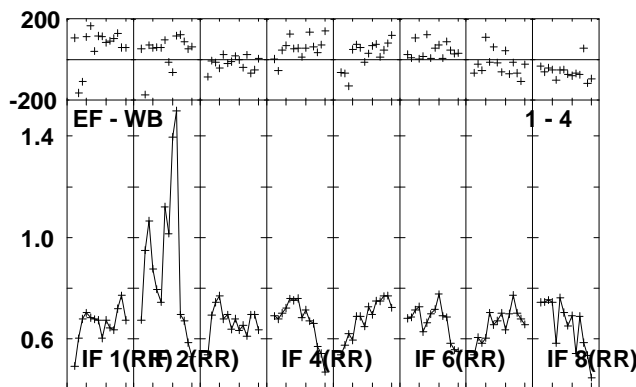
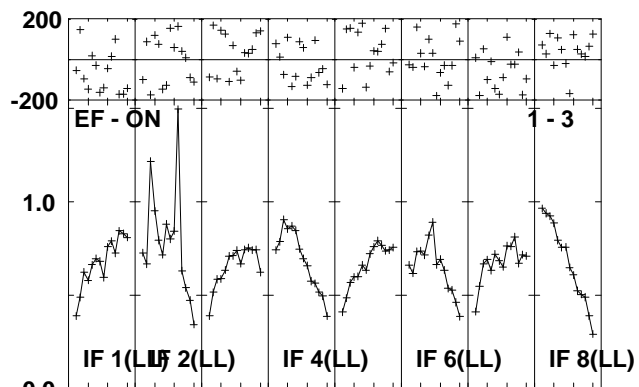
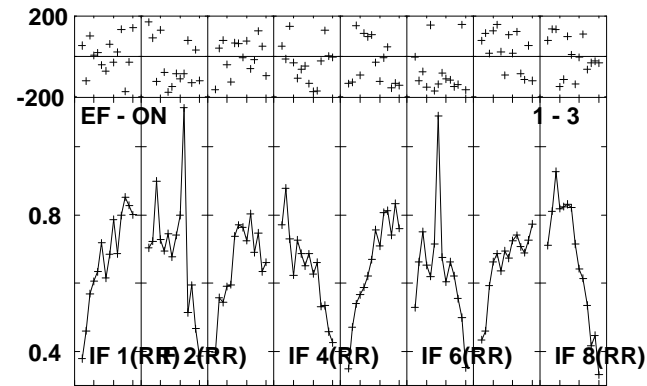
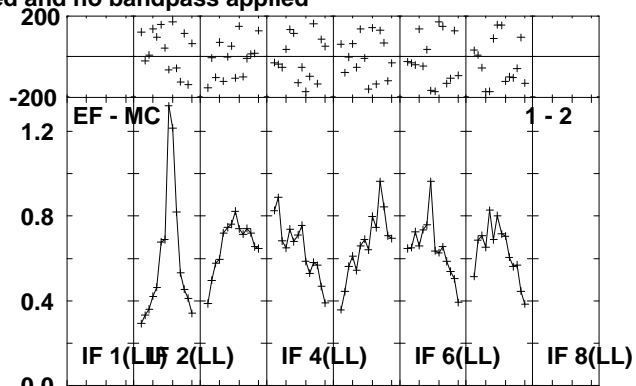
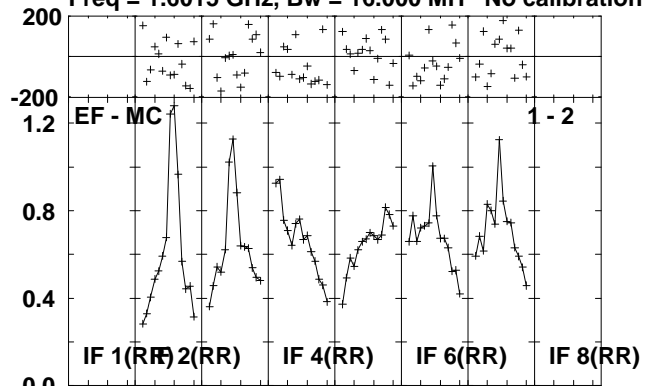

Lower frame: Milli Ampl Jy Top frame: Phas deg
Scalar averaged cross-power spectrum Several baselines displayed
Timerange: 01/01:28:53 to 01/01:33:49

Plot file version 130 created 01-JUL-2010 13:25:32

V407CYG RG006B.UVDATA.1

Freq = 1.6015 GHz, Bw = 16.000 MH No calibration applied and no bandpass applied

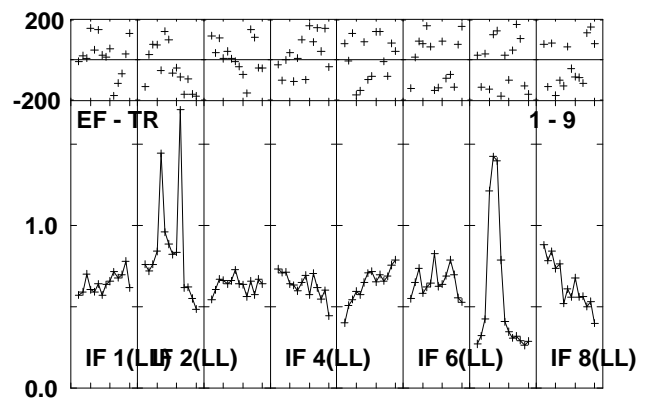
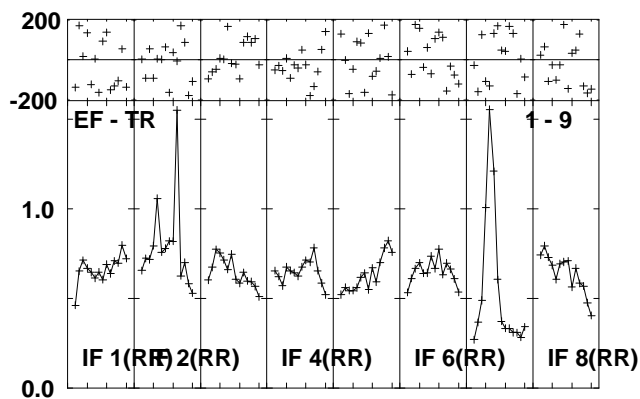
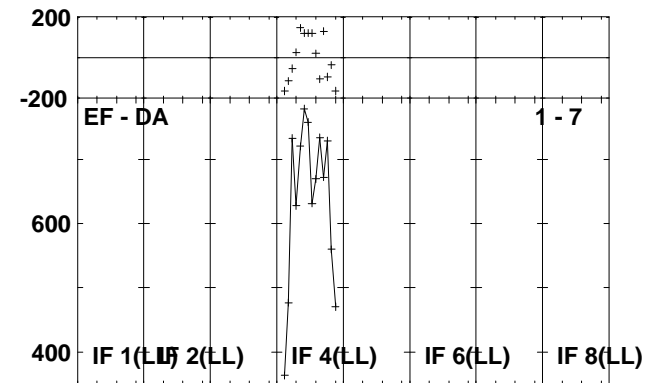
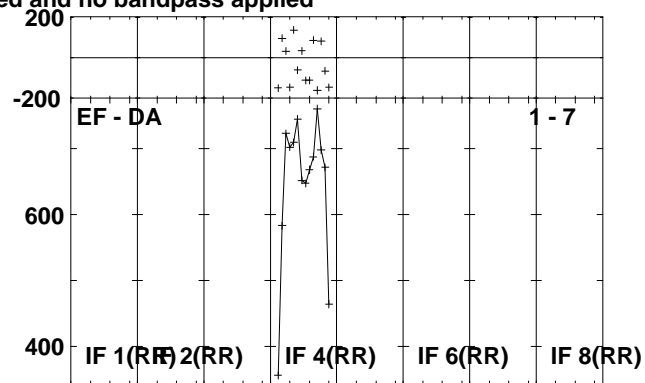
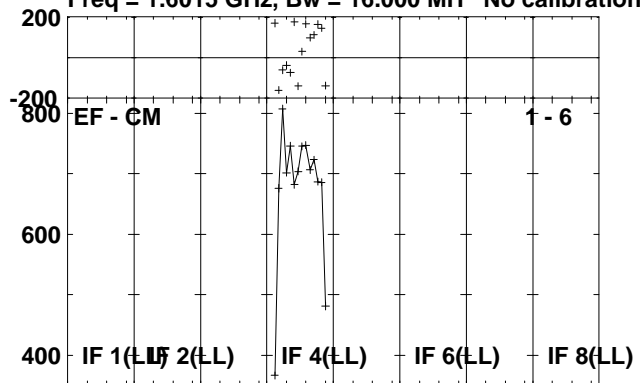

Lower frame: Micro Ampl Jy Top frame: Phas deg
Scalar averaged cross-power spectrum Several baselines displayed
Timerange: 01/01:28:53 to 01/01:33:49

Plot file version 131 created 01-JUL-2010 13:25:33

J2102+47 RG006B.UVDATA.1

Freq = 1.6015 GHz, Bw = 16.000 MH No calibration applied and no bandpass applied

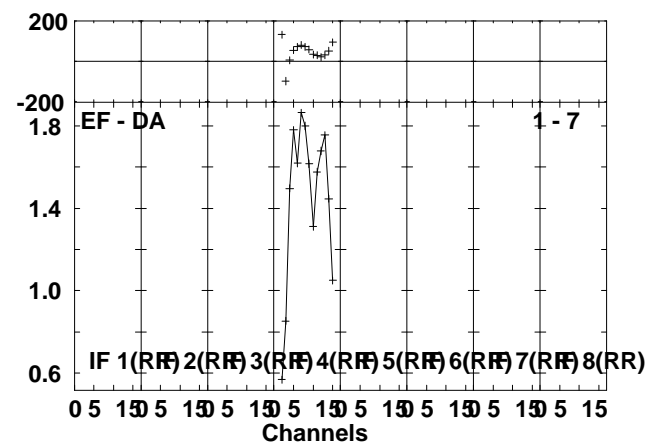
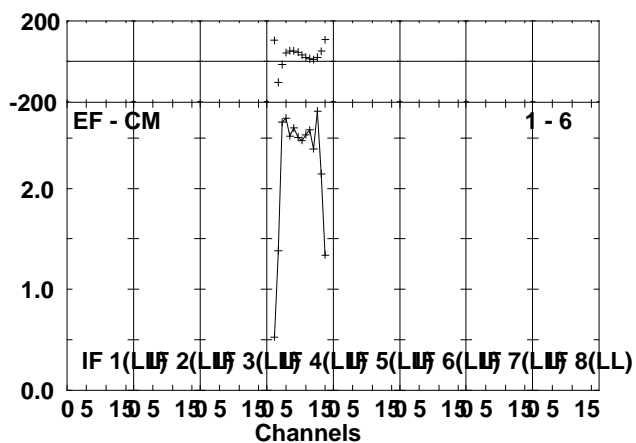
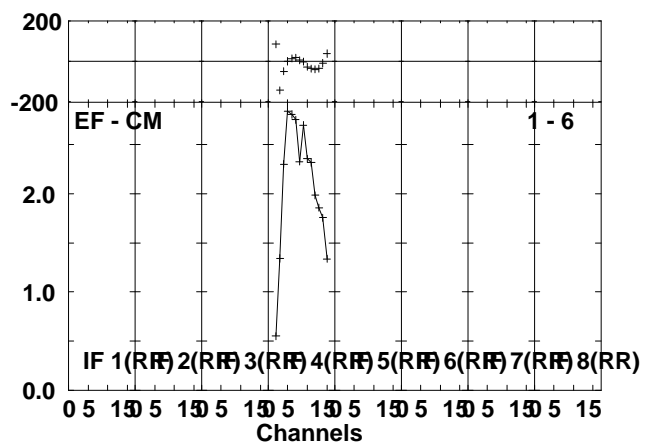
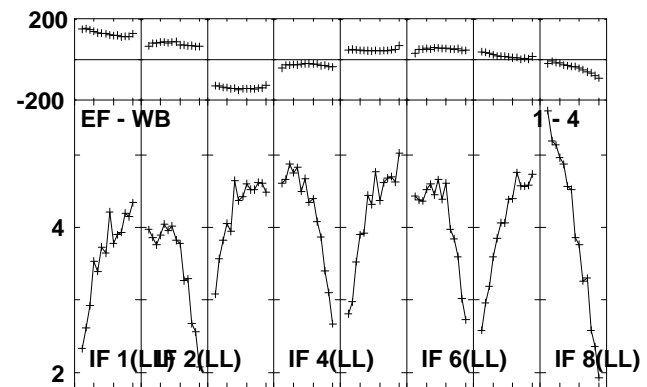
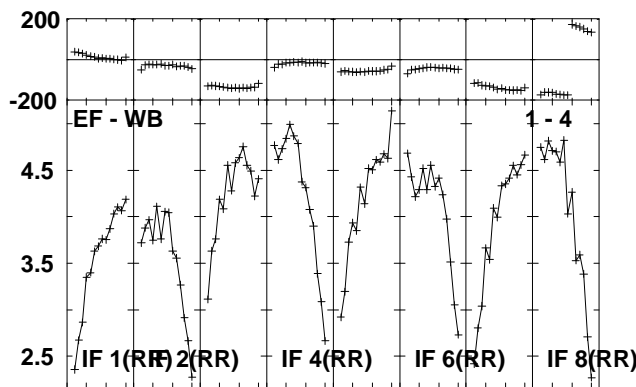
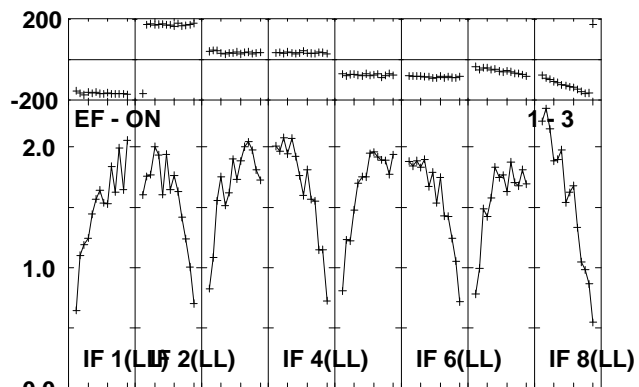
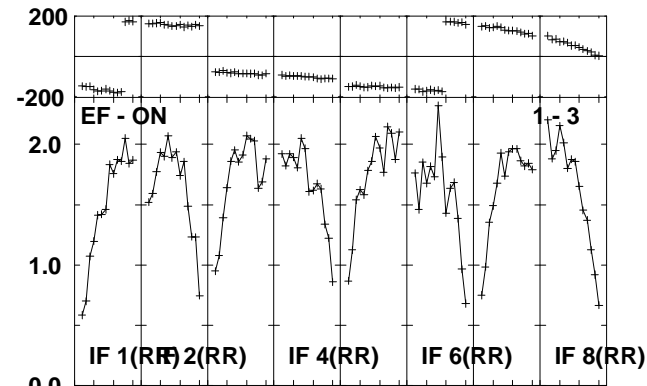
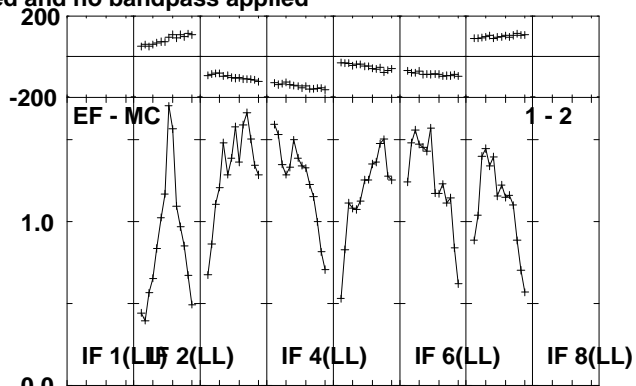
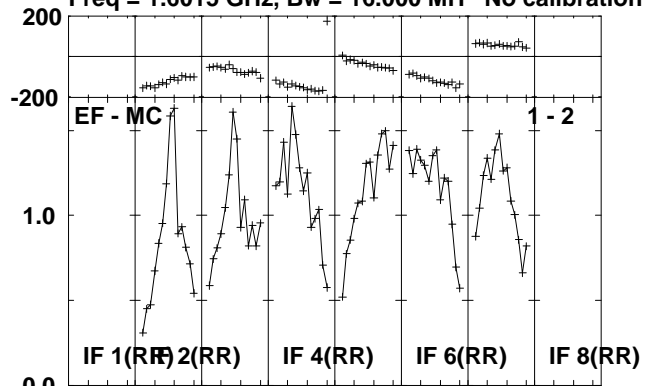

Lower frame: Milli Ampl Jy Top frame: Phas deg
Scalar averaged cross-power spectrum Several baselines displayed
Timerange: 01/01:33:53 to 01/01:36:01

Plot file version 132 created 01-JUL-2010 13:25:33

J2102+47 RG006B.UVDATA.1

Freq = 1.6015 GHz, Bw = 16.000 MH No calibration applied and no bandpass applied

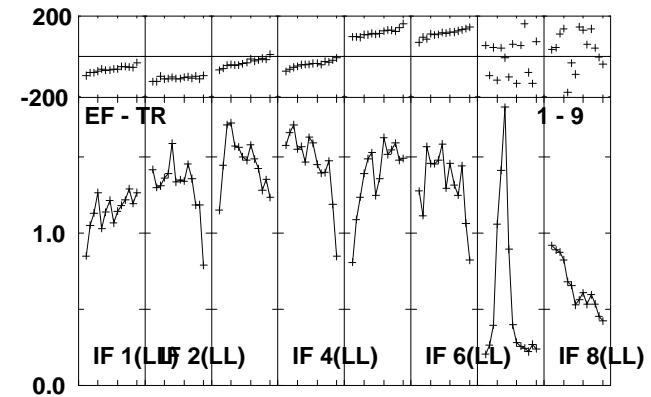
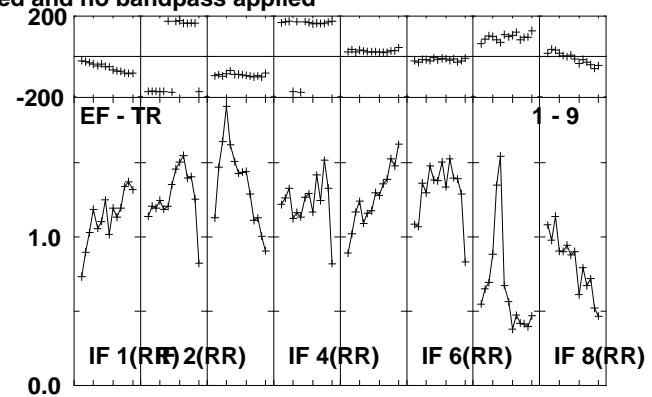
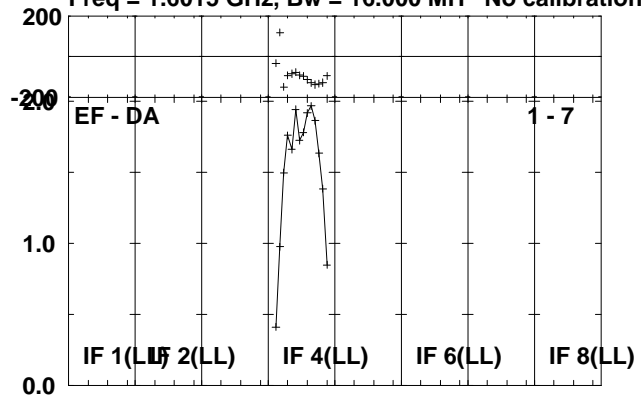

Lower frame: Milli Amp Jy Top frame: Phas deg
Scalar averaged cross-power spectrum Several baselines displayed
Timerange: 01/01:33:53 to 01/01:36:01

Plot file version 133 created 01-JUL-2010 13:25:34

V407CYG RG006B.UVDATA.1

Freq = 1.6015 GHz, Bw = 16.000 MH No calibration applied and no bandpass applied

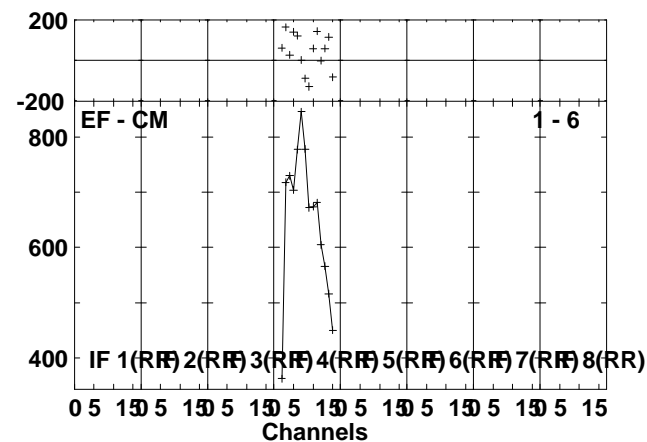
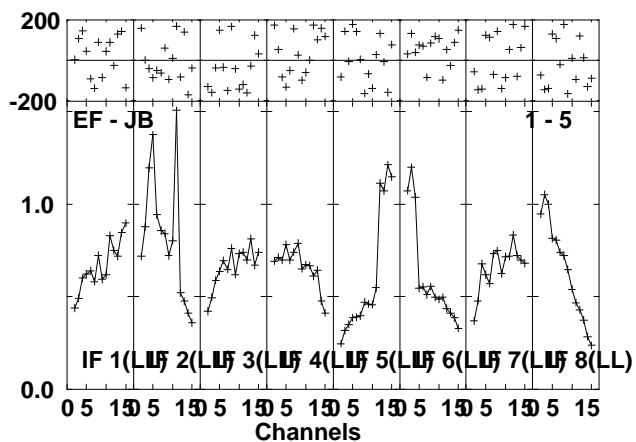
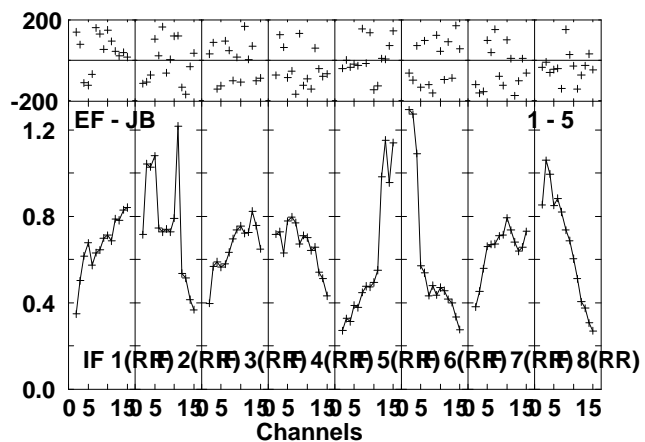
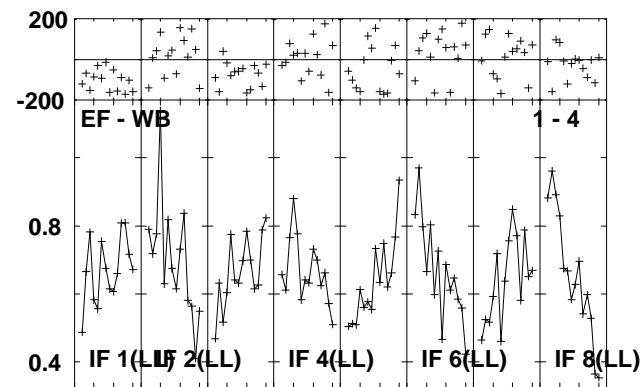
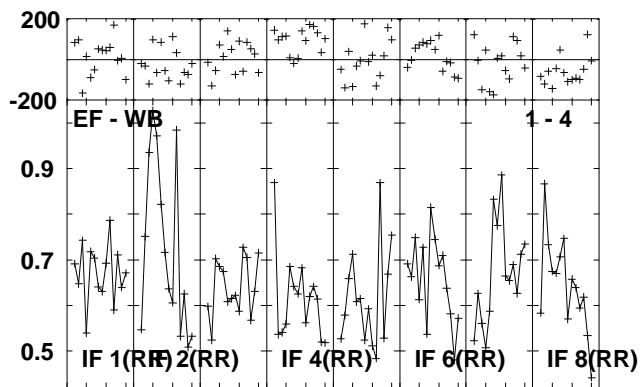
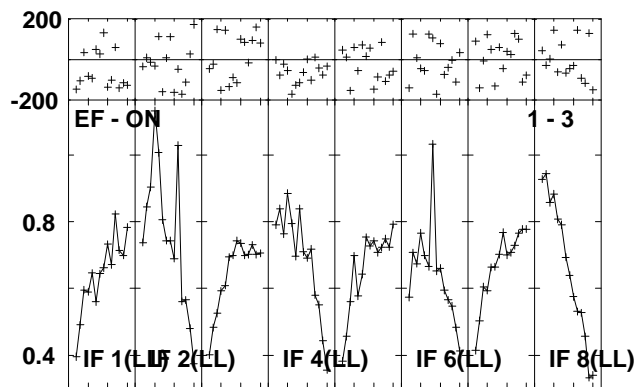
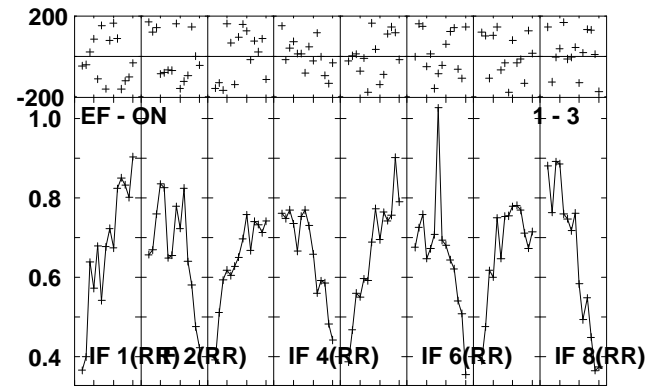
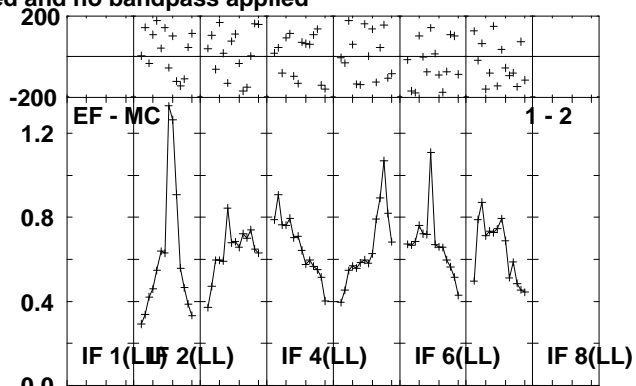
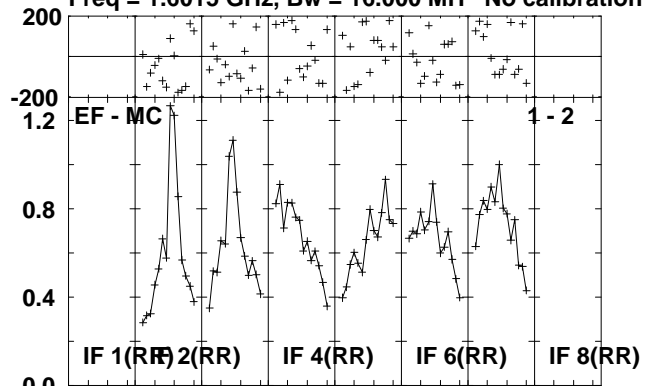

Lower frame: Milli Ampl Jy Top frame: Phas deg
Scalar averaged cross-power spectrum Several baselines displayed
Timerange: 01/01:36:05 to 01/01:41:01

Plot file version 134 created 01-JUL-2010 13:25:34
V407CYG RG006B.UVDATA.1

Freq = 1.6015 GHz, Bw = 16.000 MH No calibration applied and no bandpass applied

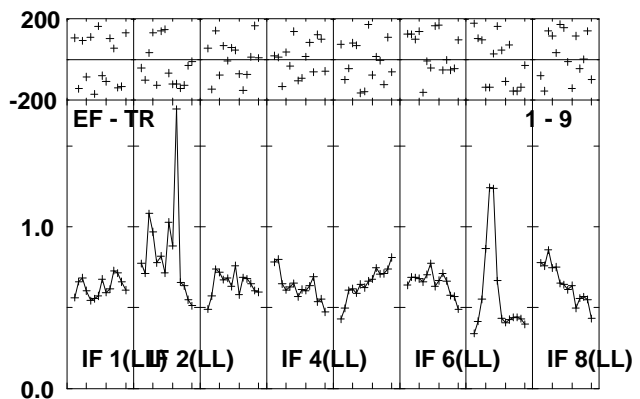
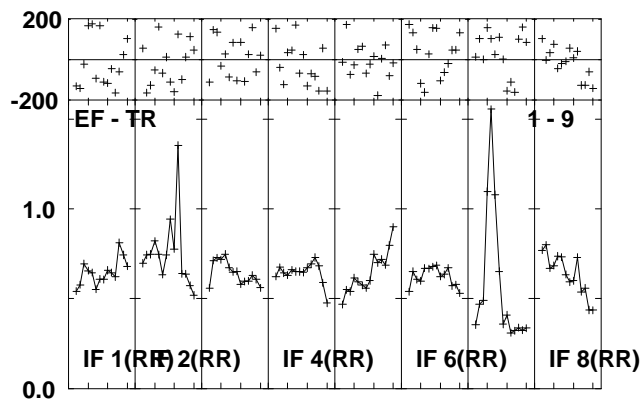
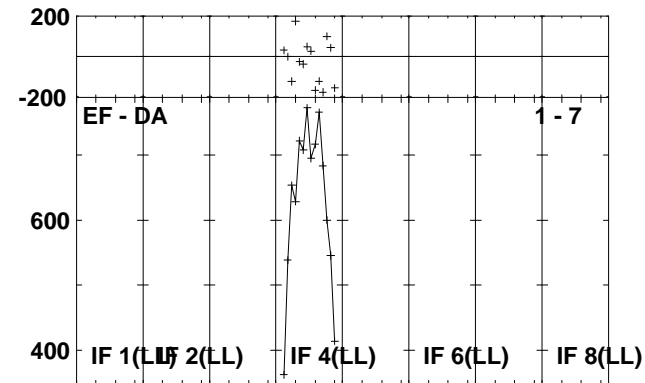
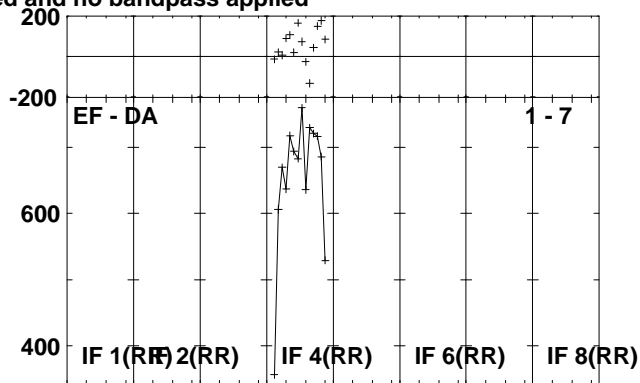
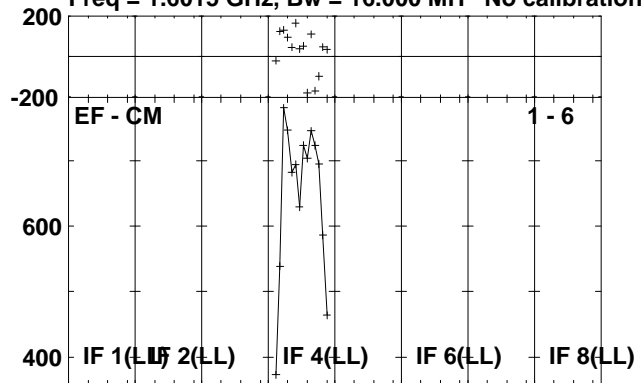

Lower frame: Micro Ampl Jy Top frame: Phas deg
Scalar averaged cross-power spectrum Several baselines displayed
Timerange: 01/01:36:05 to 01/01:41:01

Plot file version 135 created 01-JUL-2010 13:25:35

J2102+47 RG006B.UVDATA.1

Freq = 1.6015 GHz, Bw = 16.000 MH No calibration applied and no bandpass applied

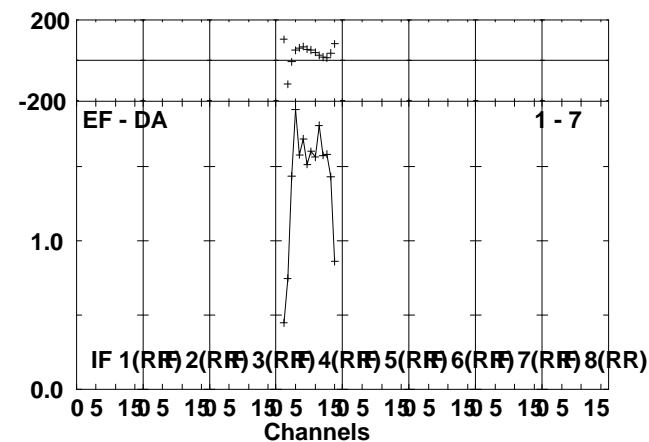
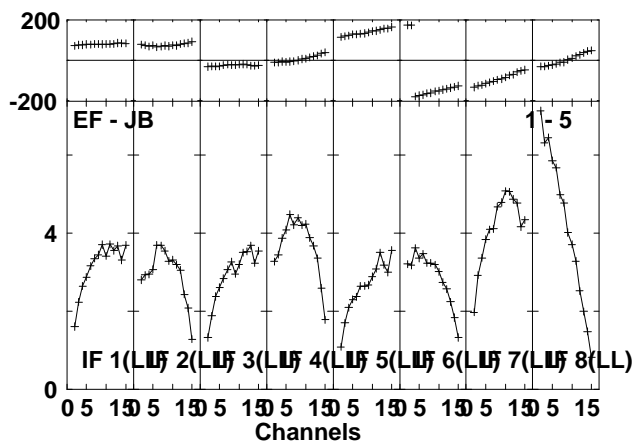
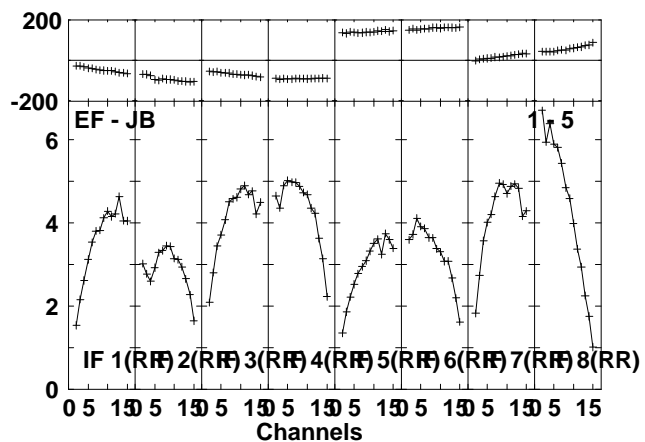
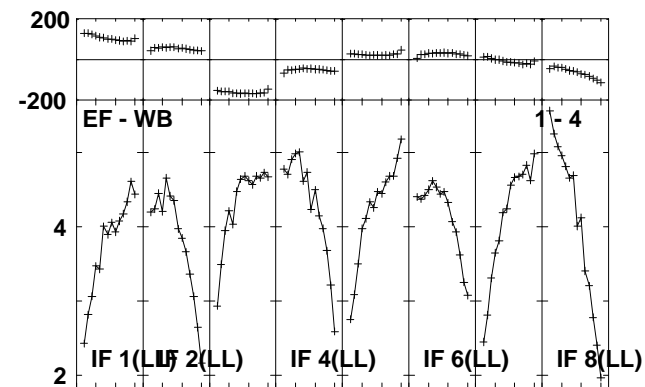
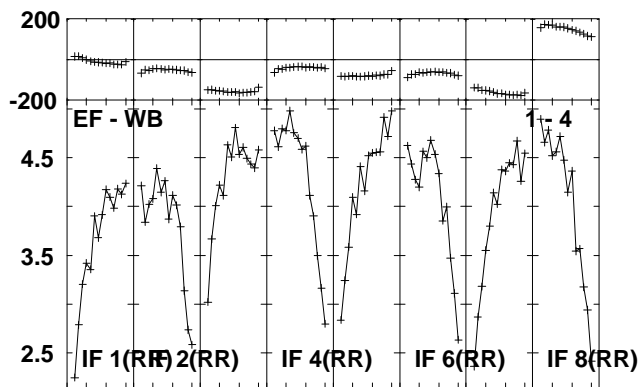
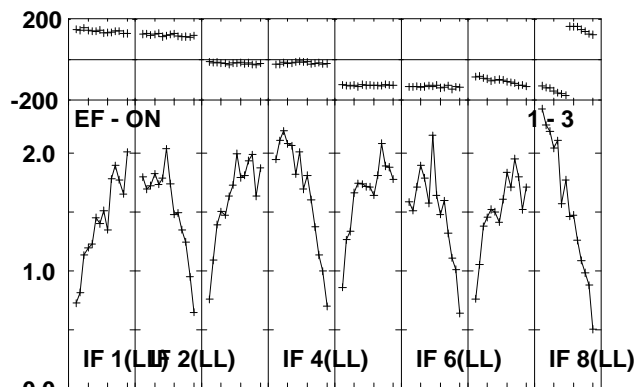
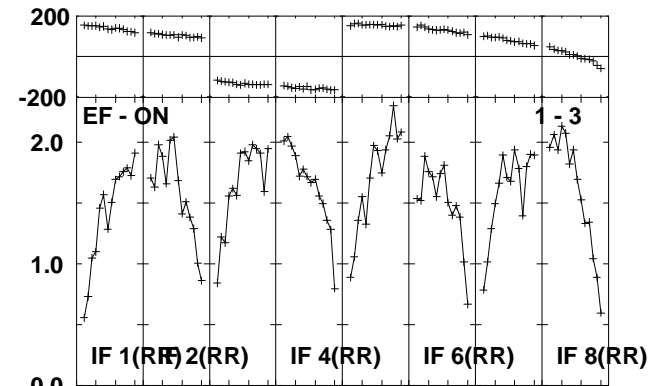
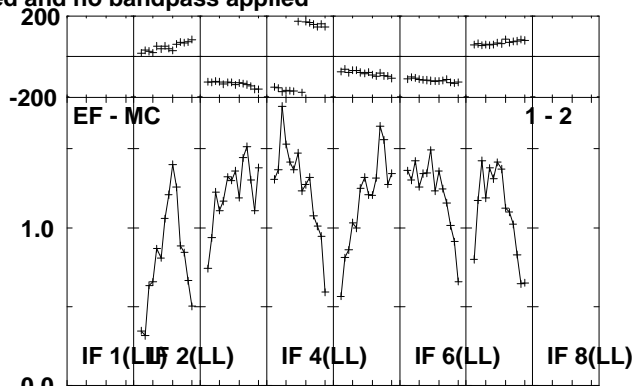
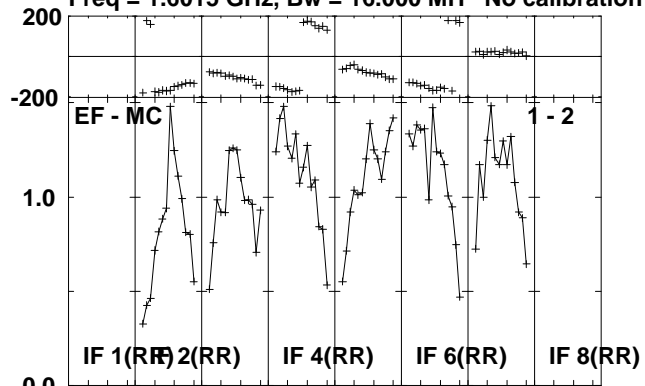

Lower frame: Milli Ampl Jy Top frame: Phas deg
Scalar averaged cross-power spectrum Several baselines displayed
Timerange: 01/01:42:05 to 01/01:43:49

Plot file version 136 created 01-JUL-2010 13:25:35

J2102+47 RG006B.UVDATA.1

Freq = 1.6015 GHz, Bw = 16.000 MH No calibration applied and no bandpass applied

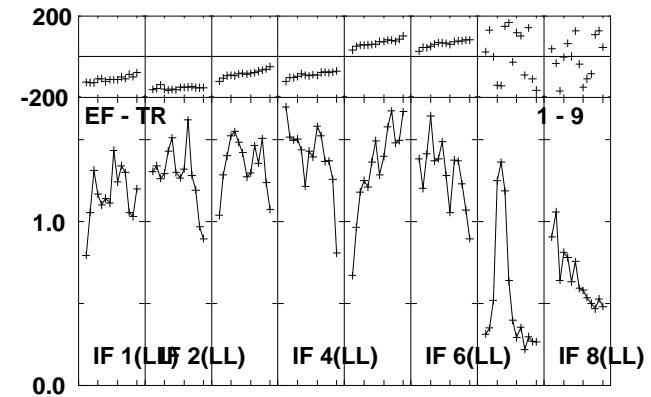
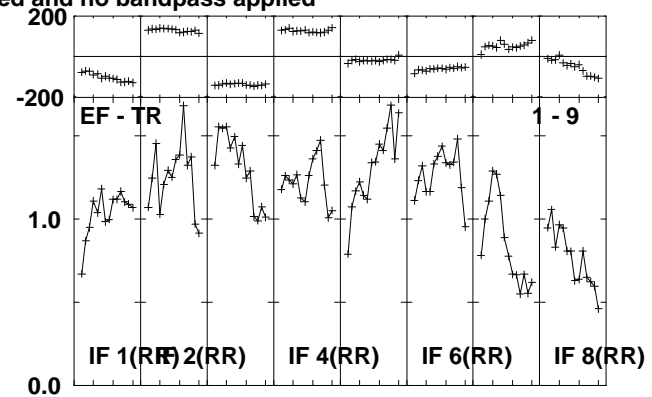
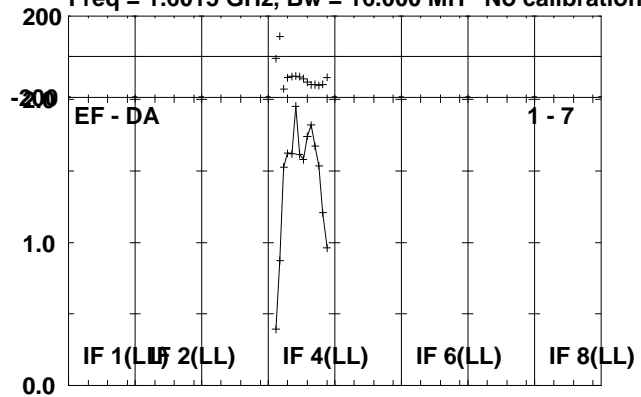

Lower frame: Milli Ampl Jy Top frame: Phas deg
Scalar averaged cross-power spectrum Several baselines displayed
Timerange: 01/01:42:05 to 01/01:43:49

Plot file version 137 created 01-JUL-2010 13:25:36

V407CYG RG006B.UVDATA.1

Freq = 1.6015 GHz, Bw = 16.000 MH No calibration applied and no bandpass applied

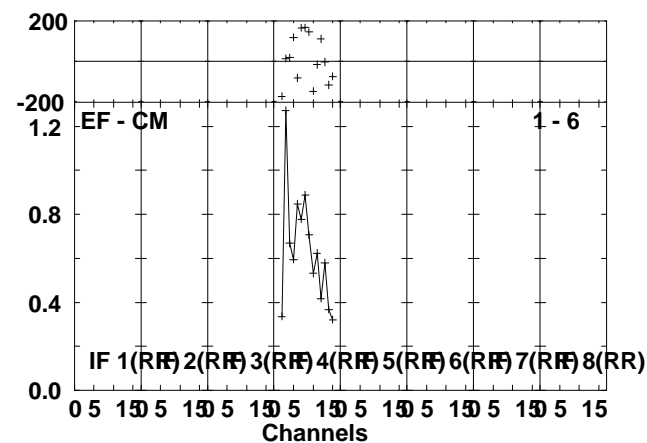
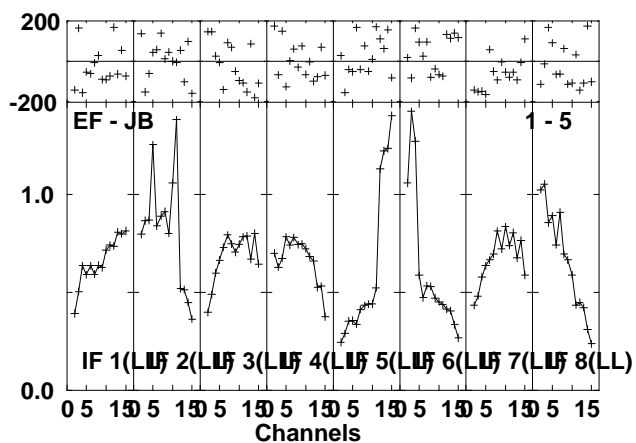
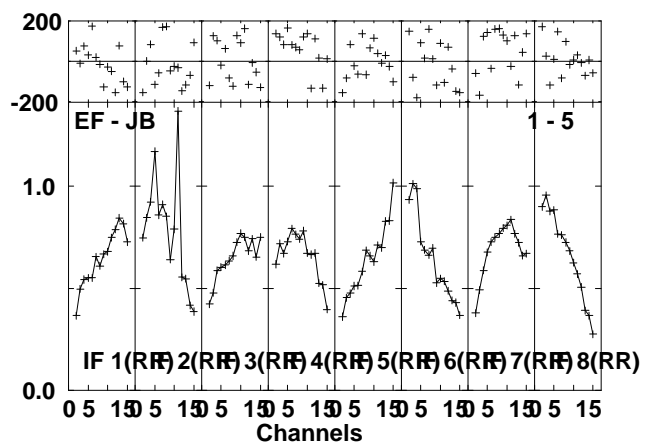
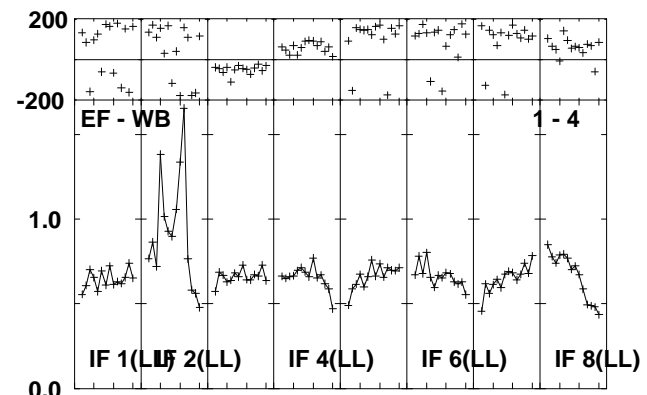
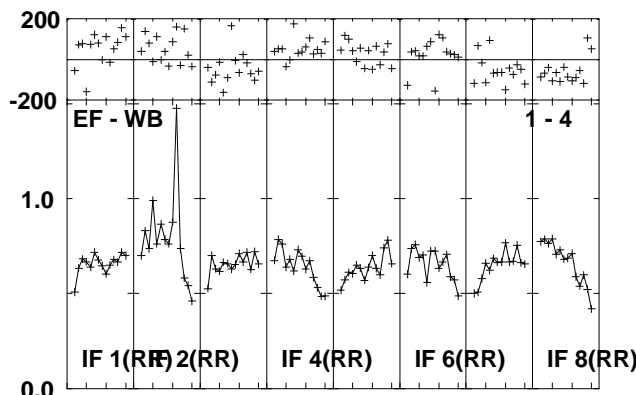
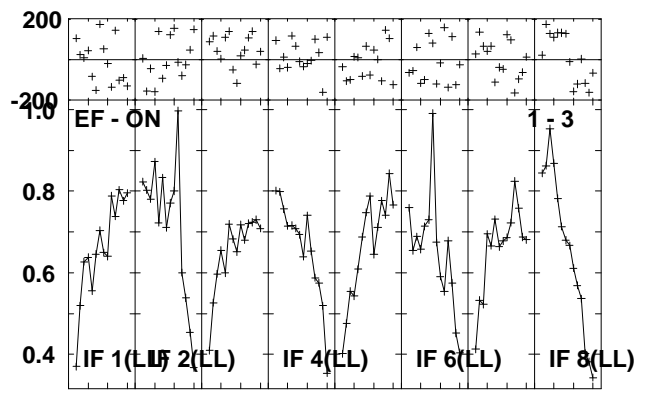
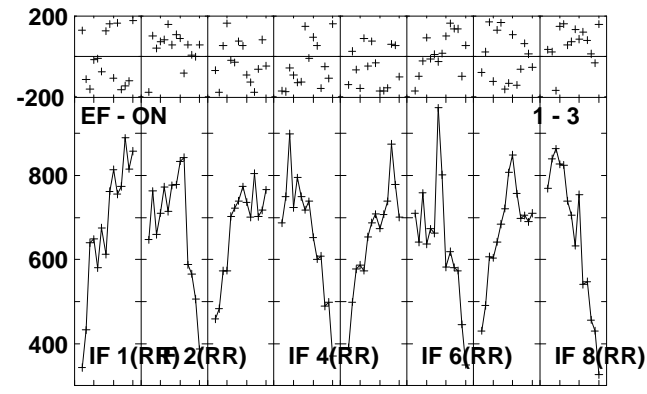
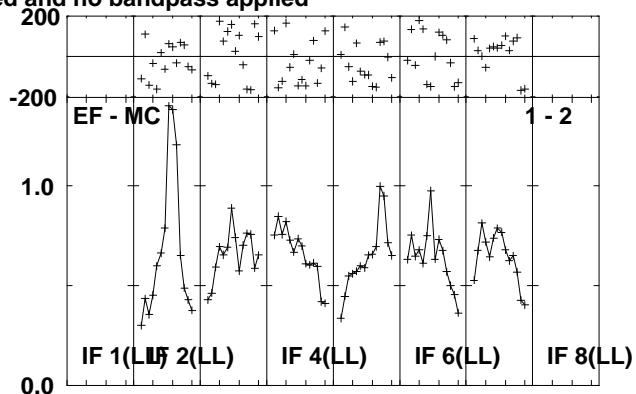
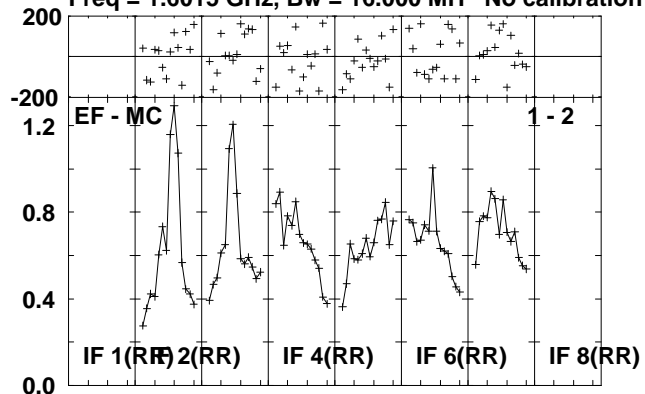

Lower frame: Milli Ampl Jy Top frame: Phas deg
Scalar averaged cross-power spectrum Several baselines displayed
Timerange: 01/01:43:53 to 01/01:48:49

Plot file version 138 created 01-JUL-2010 13:25:36

V407CYG RG006B.UVDATA.1

Freq = 1.6015 GHz, Bw = 16.000 MH No calibration applied and no bandpass applied

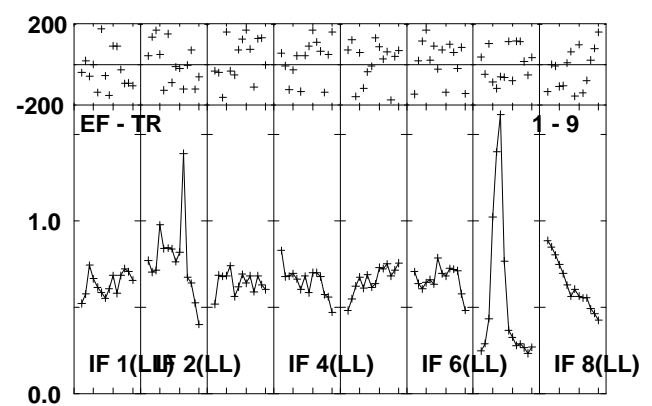
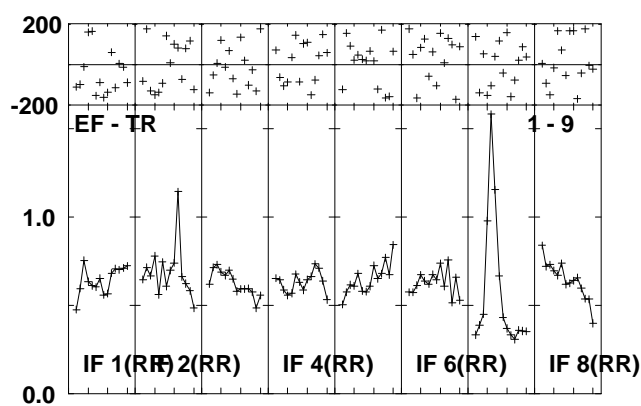
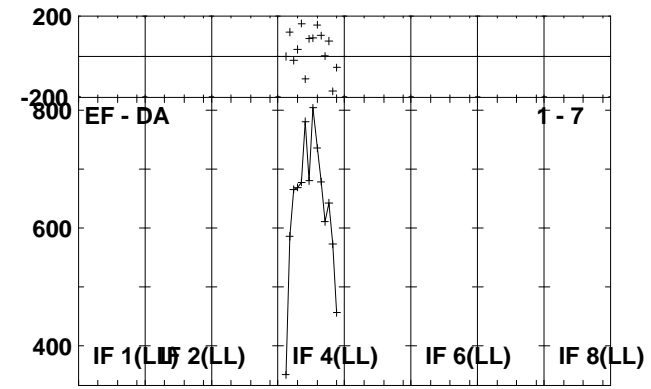
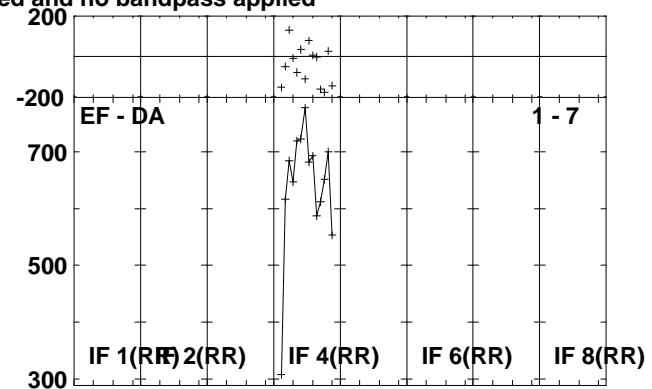
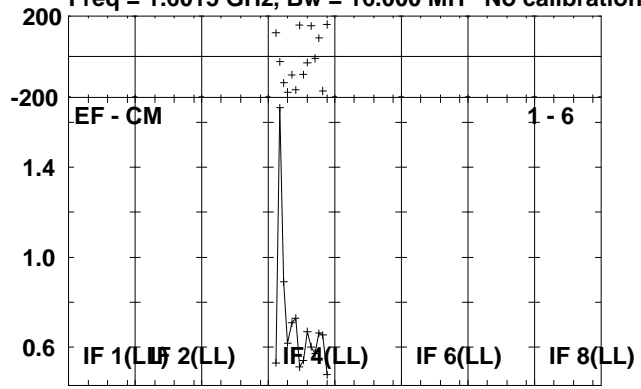

Lower frame: Milli Ampl Jy Top frame: Phas deg
Scalar averaged cross-power spectrum Several baselines displayed
Timerange: 01/01:43:53 to 01/01:48:49

Plot file version 139 created 01-JUL-2010 13:25:37

J2102+47 RG006B.UVDATA.1

Freq = 1.6015 GHz, Bw = 16.000 MH No calibration applied and no bandpass applied

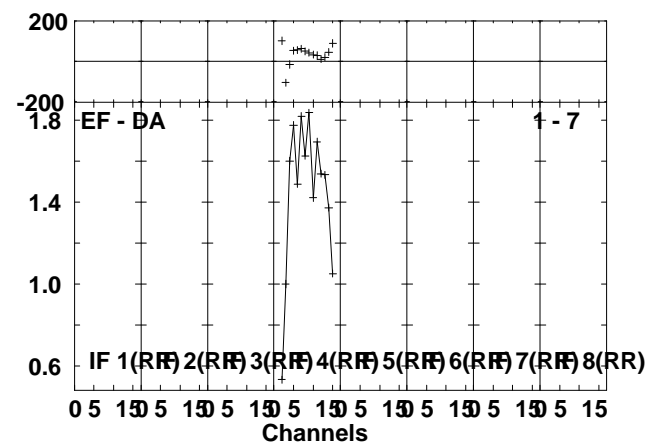
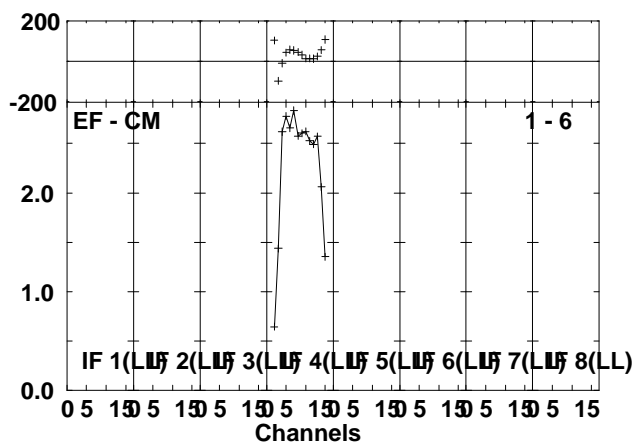
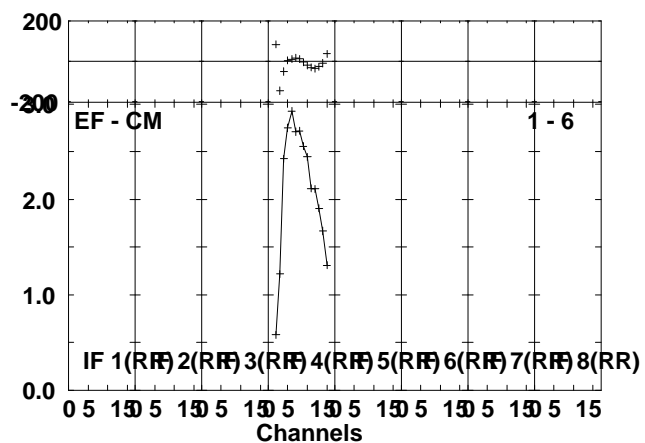
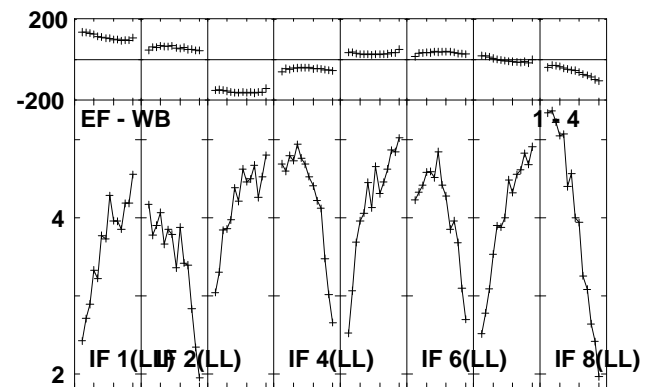
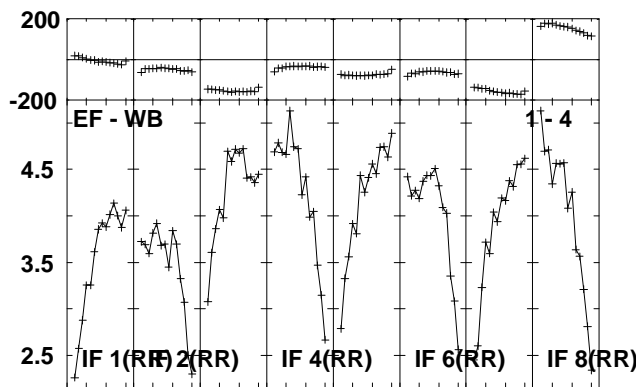
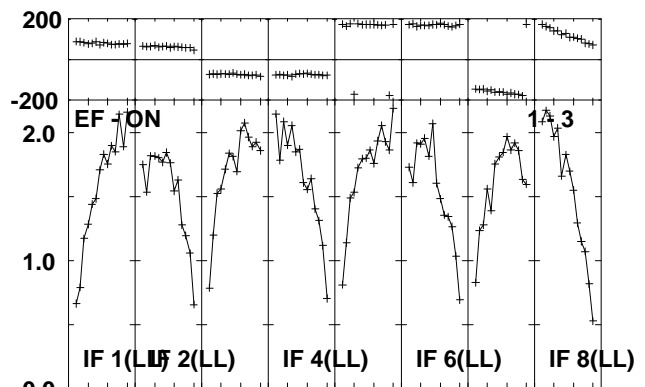
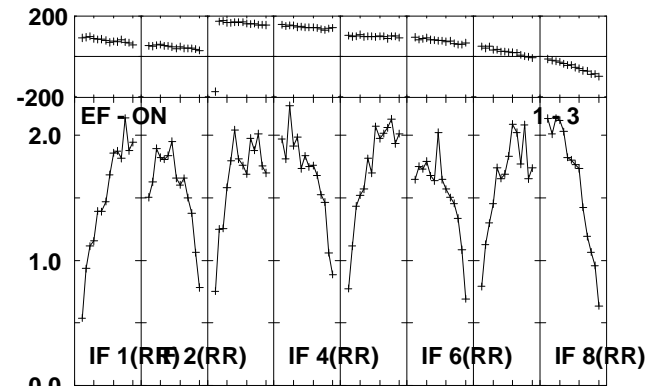
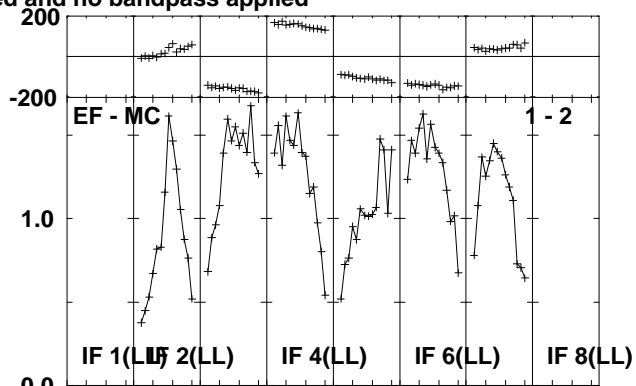
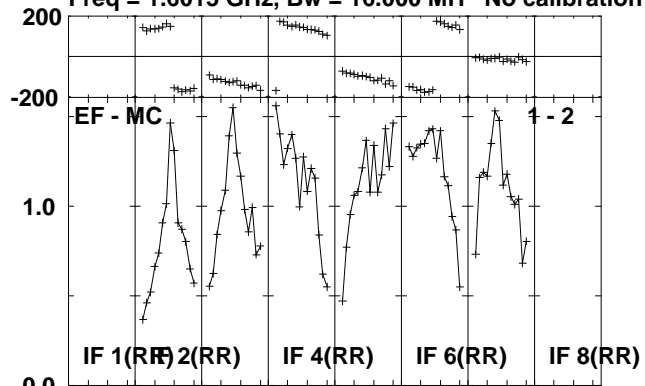

Lower frame: Milli Ampl Jy Top frame: Phas deg
Scalar averaged cross-power spectrum Several baselines displayed
Timerange: 01/01:48:53 to 01/01:51:01

Plot file version 140 created 01-JUL-2010 13:25:37

J2102+47 RG006B.UVDATA.1

Freq = 1.6015 GHz, Bw = 16.000 MH No calibration applied and no bandpass applied

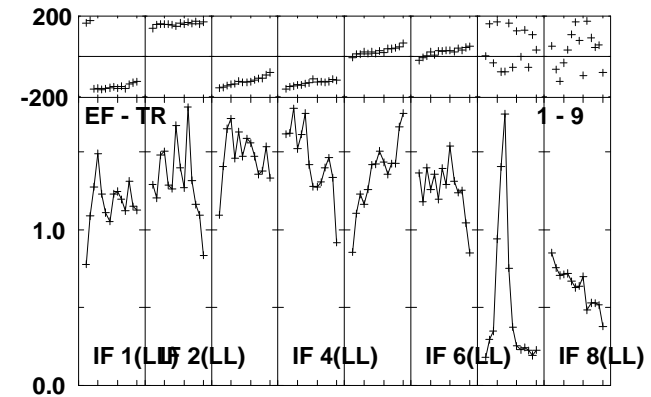
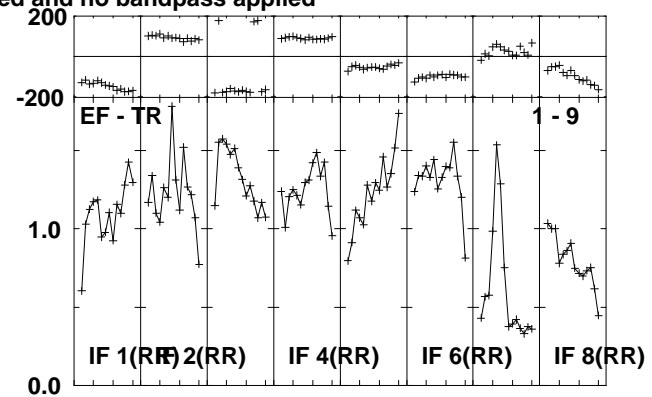
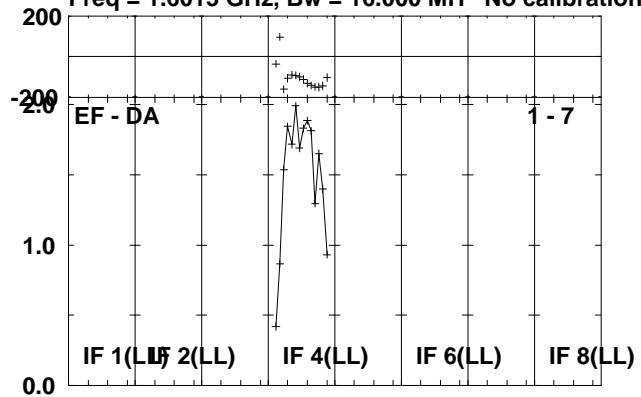

Lower frame: Milli Ampl Jy Top frame: Phas deg
Scalar averaged cross-power spectrum Several baselines displayed
Timerange: 01/01:48:53 to 01/01:51:01

Plot file version 141 created 01-JUL-2010 13:25:38

V407CYG RG006B.UVDATA.1

Freq = 1.6015 GHz, Bw = 16.000 MH No calibration applied and no bandpass applied

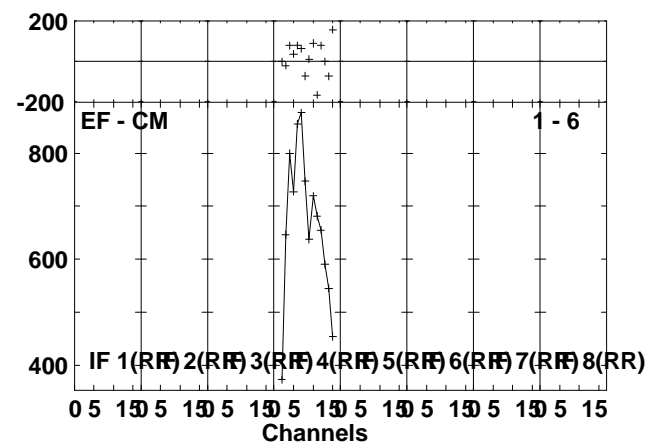
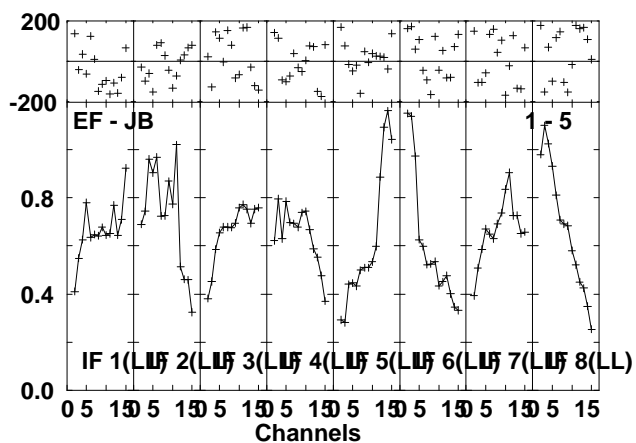
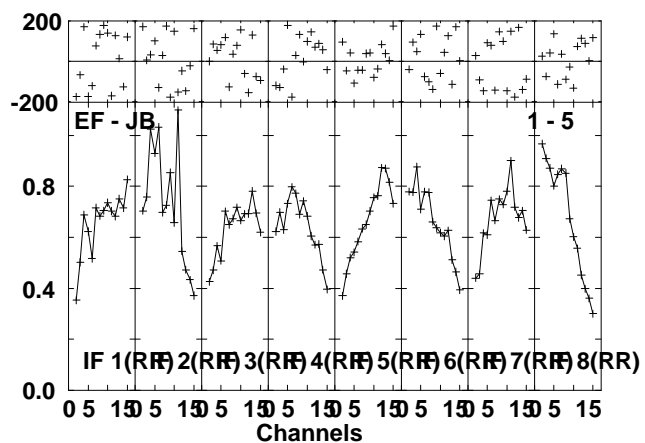
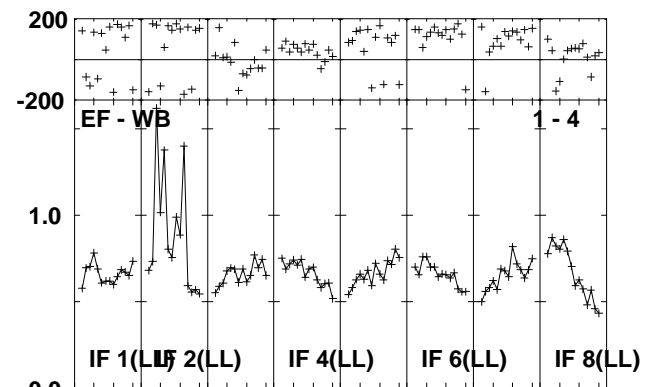
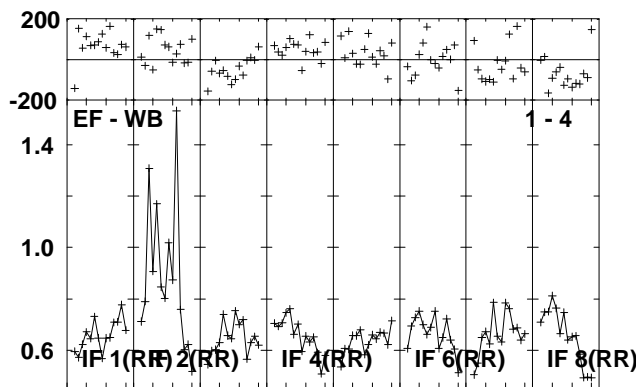
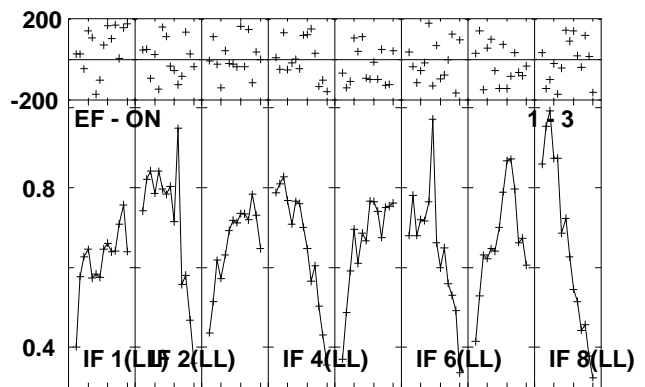
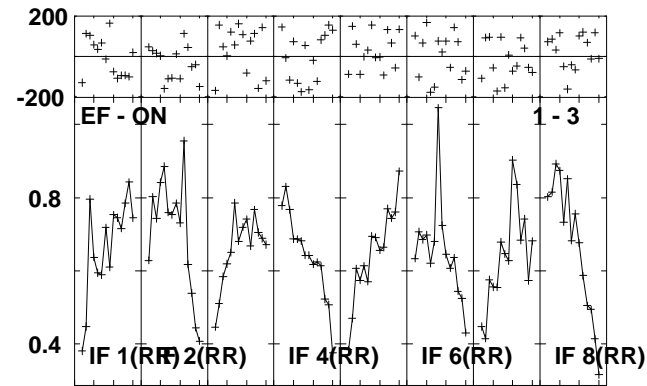
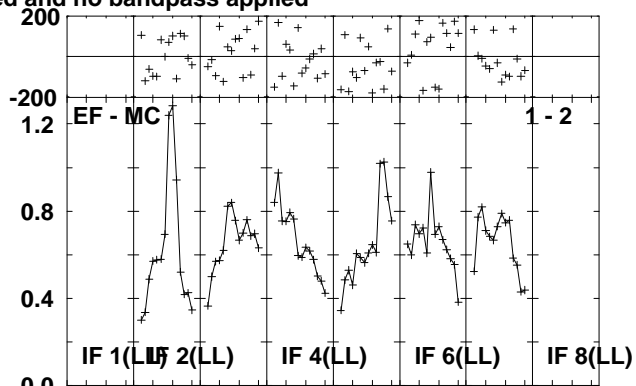
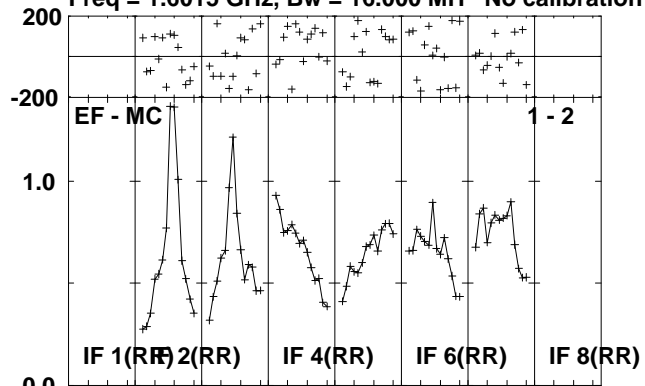

Lower frame: Milli Ampl Jy Top frame: Phas deg
Scalar averaged cross-power spectrum Several baselines displayed
Timerange: 01/01:51:05 to 01/01:56:01

Plot file version 142 created 01-JUL-2010 13:25:39
V407CYG RG006B.UVDATA.1

Freq = 1.6015 GHz, Bw = 16.000 MH No calibration applied and no bandpass applied

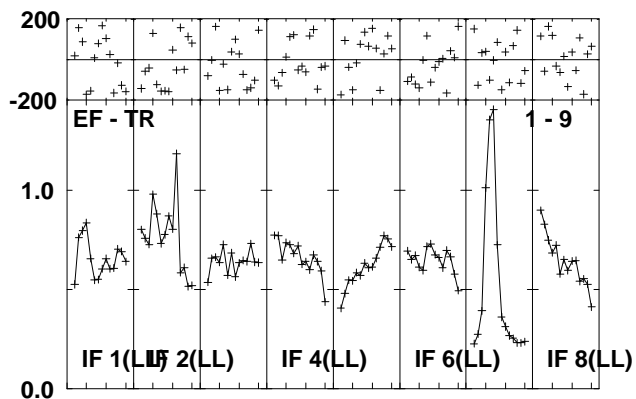
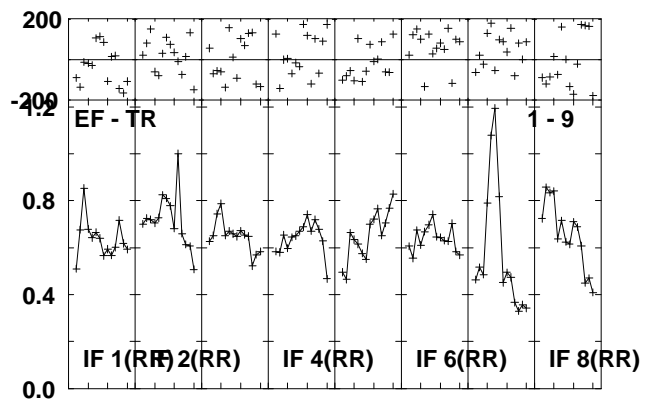
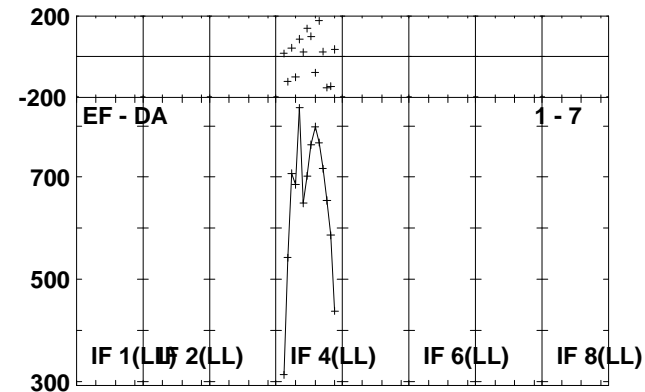
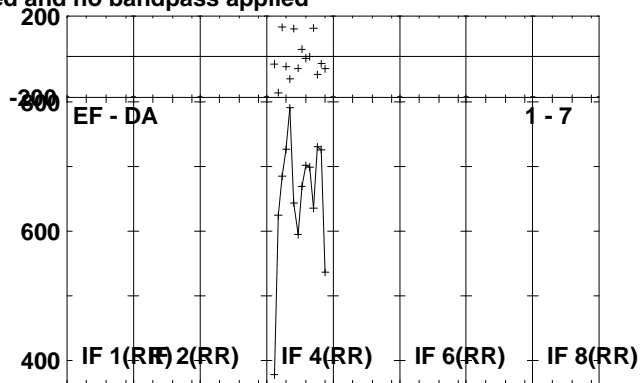
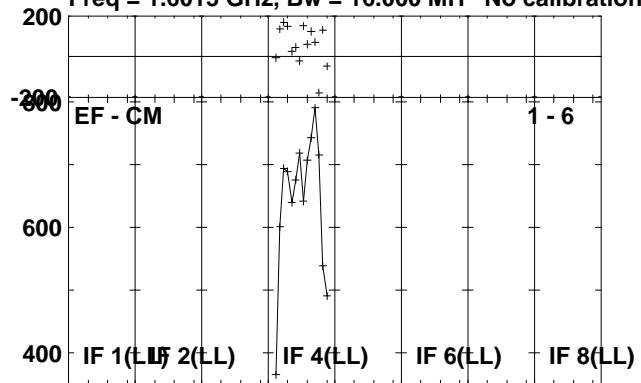

Lower frame: Micro Ampl Jy Top frame: Phas deg
Scalar averaged cross-spectrum Several baselines displayed
Timerange: 01/01:51:05 to 01/01:56:01

Plot file version 143 created 01-JUL-2010 13:25:39

J2102+47 RG006B.UVDATA.1

Freq = 1.6015 GHz, Bw = 16.000 MH No calibration applied and no bandpass applied

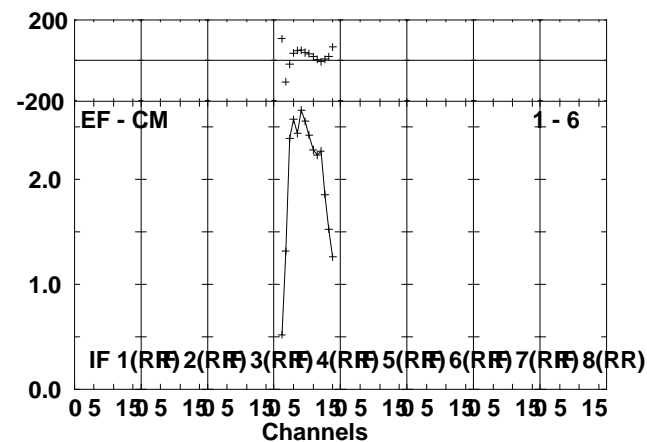
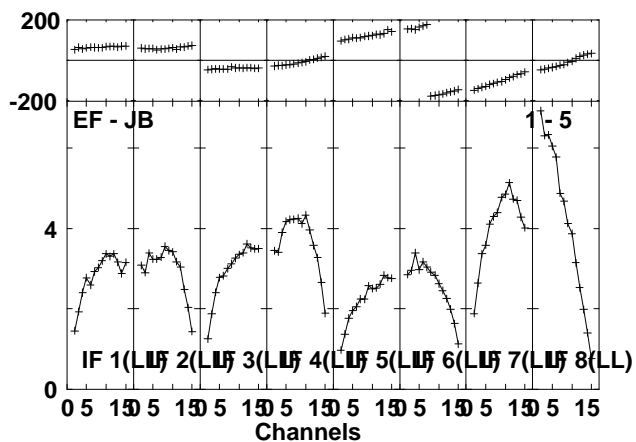
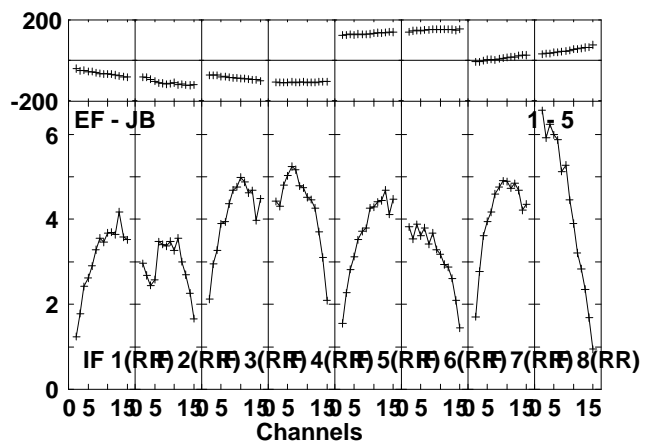
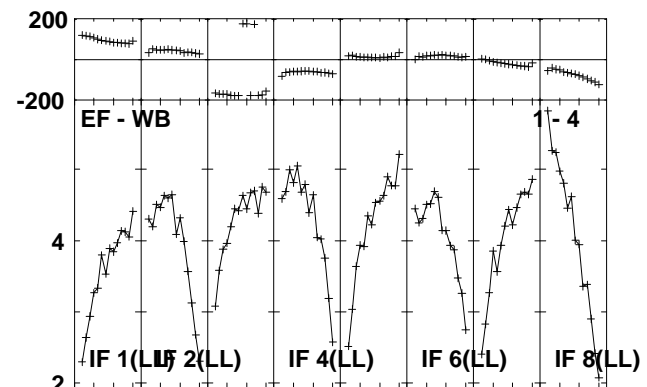
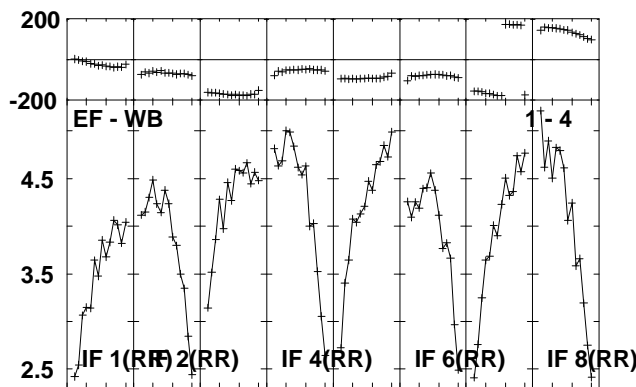
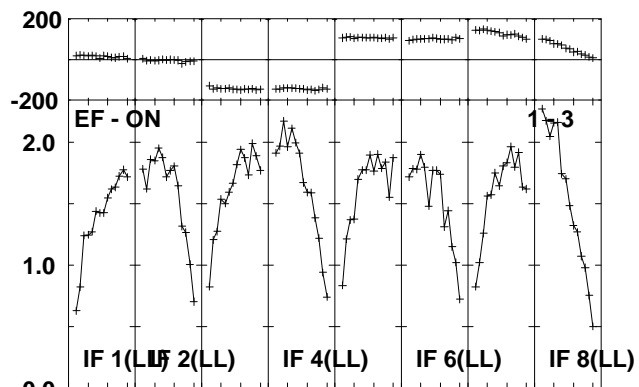
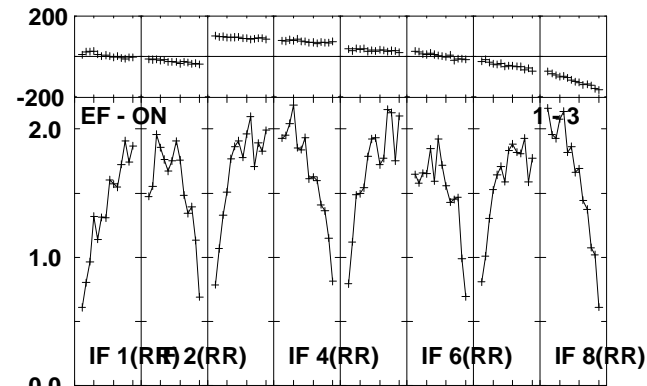
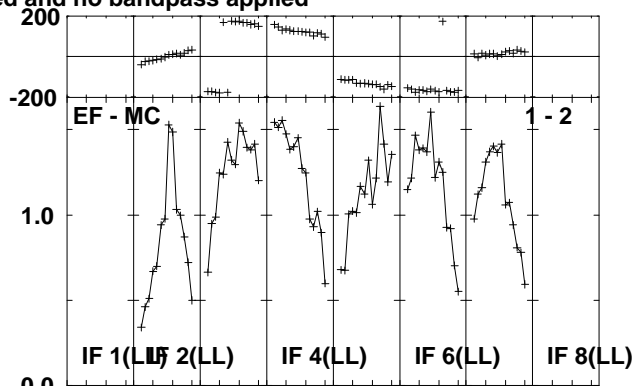
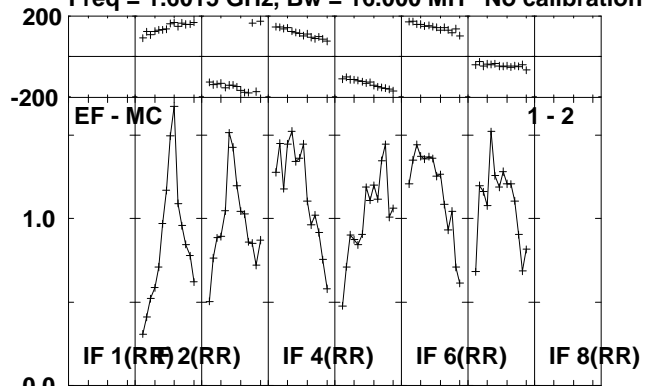

Lower frame: Milli Ampl Jy Top frame: Phas deg
Scalar averaged cross-power spectrum Several baselines displayed
Timerange: 01/01:57:05 to 01/01:58:49

Plot file version 144 created 01-JUL-2010 13:25:40

J2102+47 RG006B.UVDATA.1

Freq = 1.6015 GHz, Bw = 16.000 MH No calibration applied and no bandpass applied

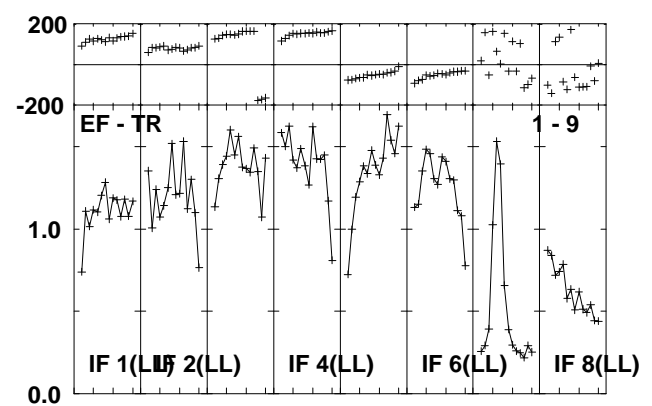
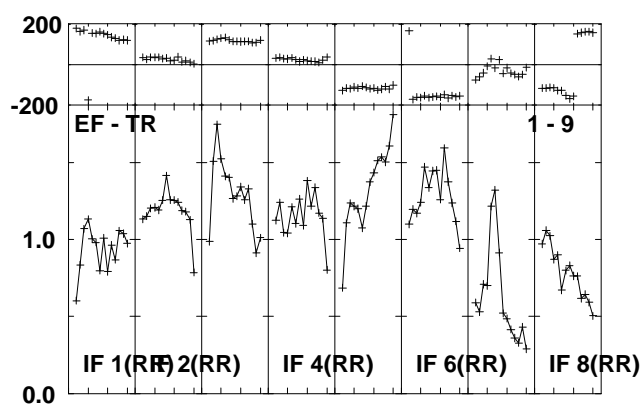
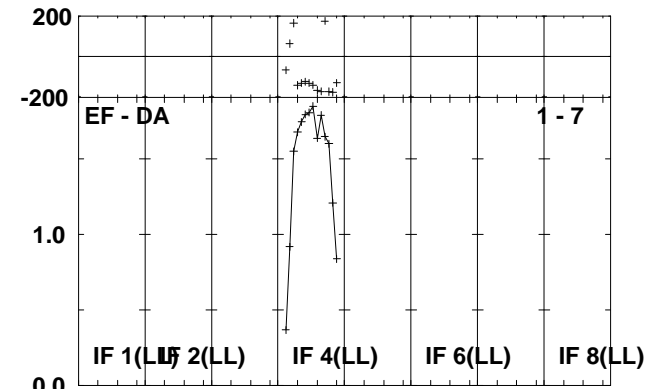
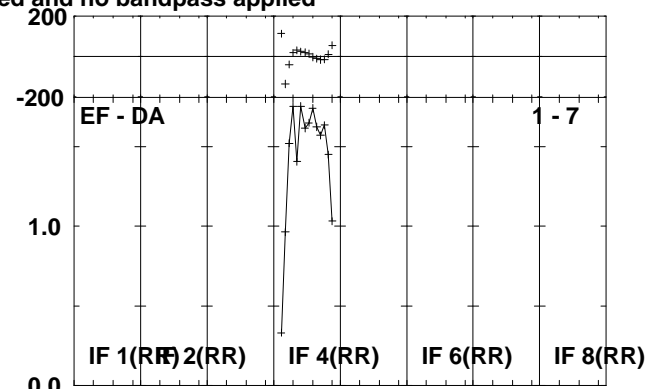
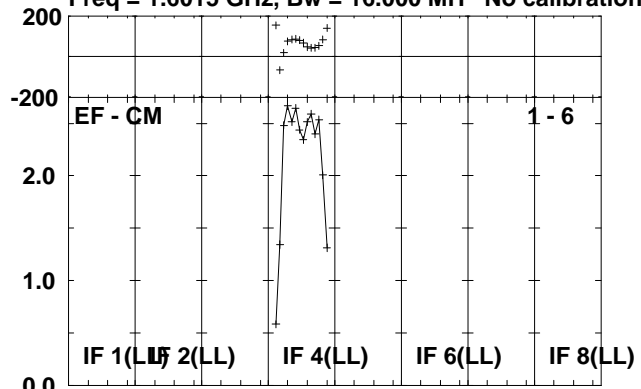

Lower frame: Milli Ampl Jy Top frame: Phas deg
Scalar averaged cross-power spectrum Several baselines displayed
Timerange: 01/01:57:05 to 01/01:58:49

Plot file version 145 created 01-JUL-2010 13:25:40

V407CYG RG006B.UVDATA.1

Freq = 1.6015 GHz, Bw = 16.000 MH No calibration applied and no bandpass applied

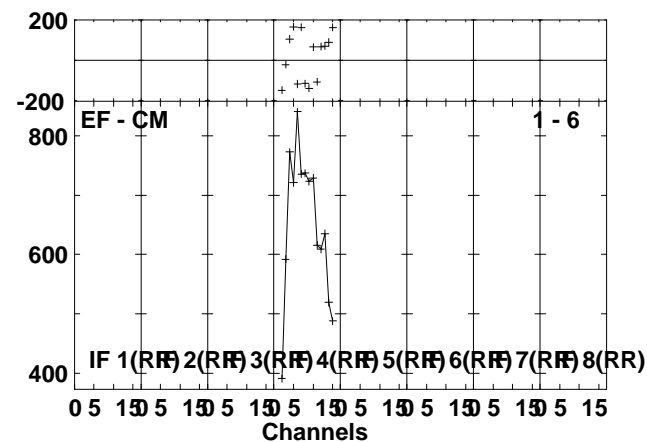
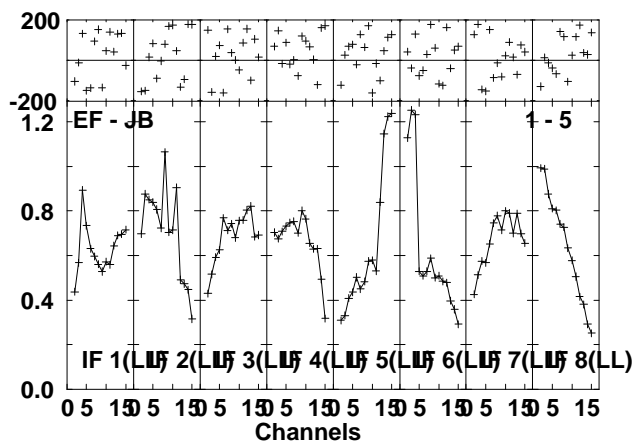
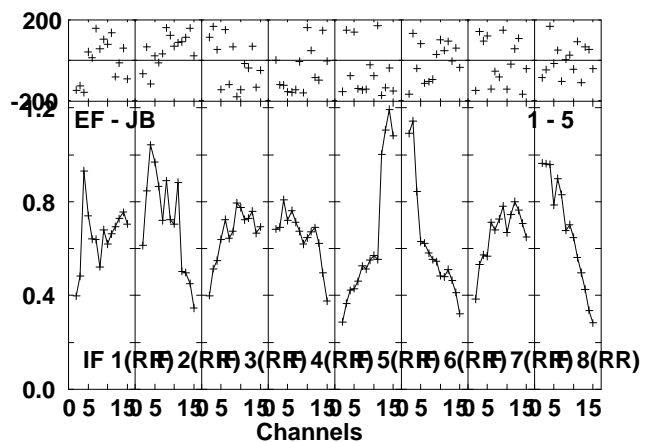
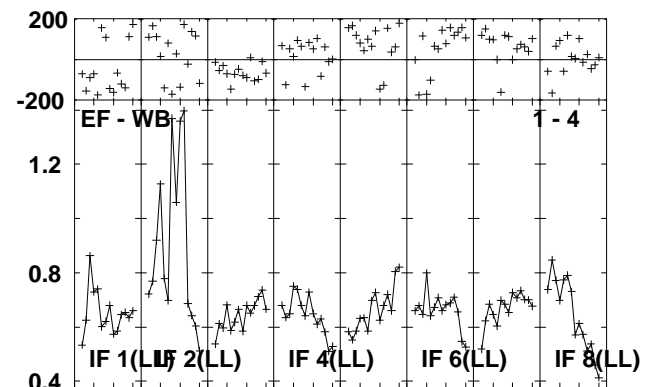
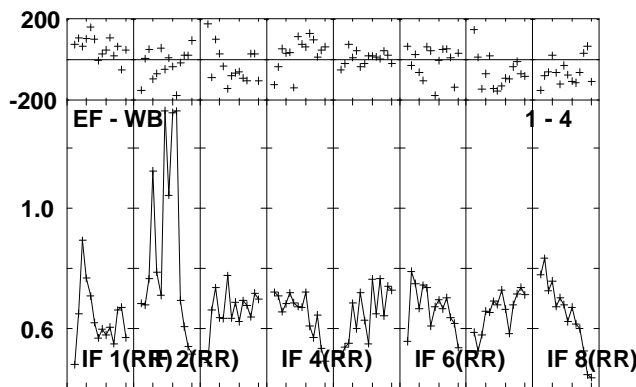
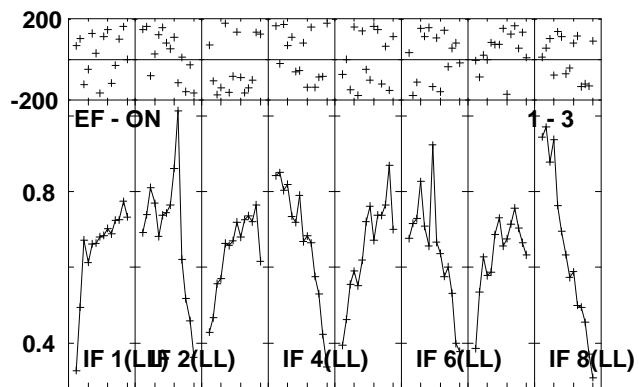
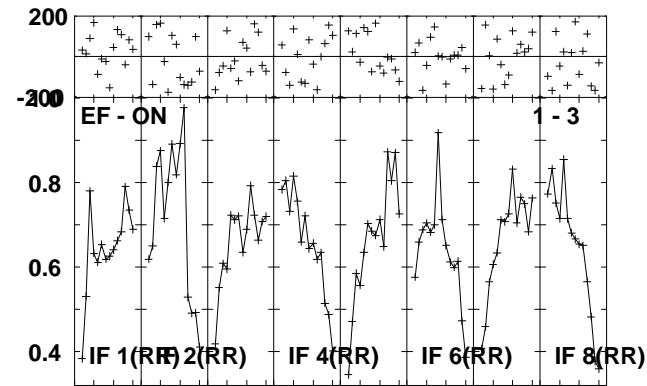
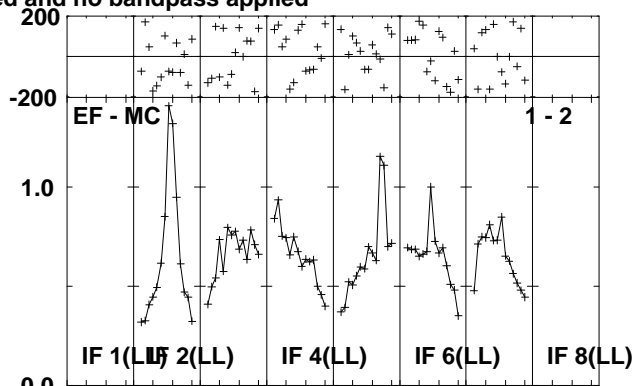
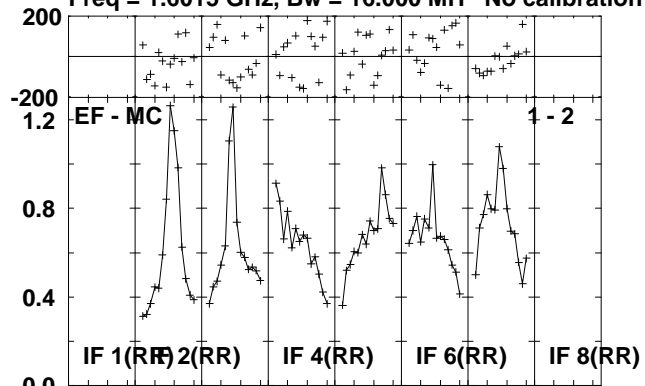

Lower frame: Milli Ampl Jy Top frame: Phas deg
Scalar averaged cross-power spectrum Several baselines displayed
Timerange: 01/01:58:53 to 01/02:03:49

Plot file version 146 created 01-JUL-2010 13:25:41
V407CYG RG006B.UVDATA.1

Freq = 1.6015 GHz, Bw = 16.000 MH No calibration applied and no bandpass applied

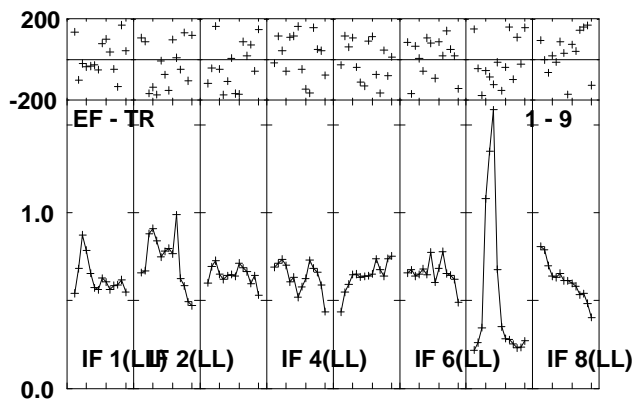
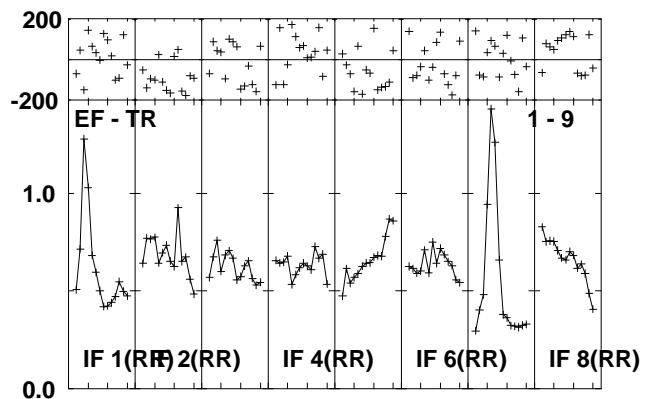
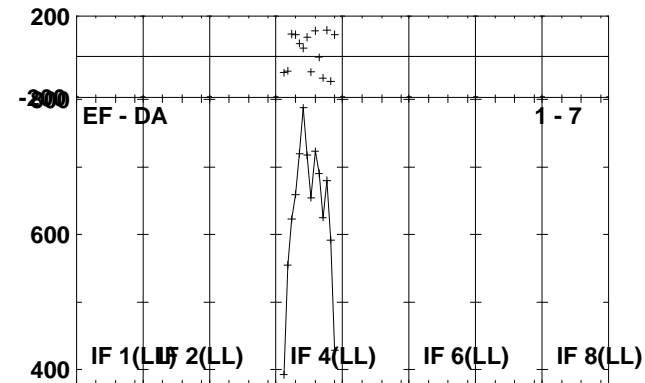
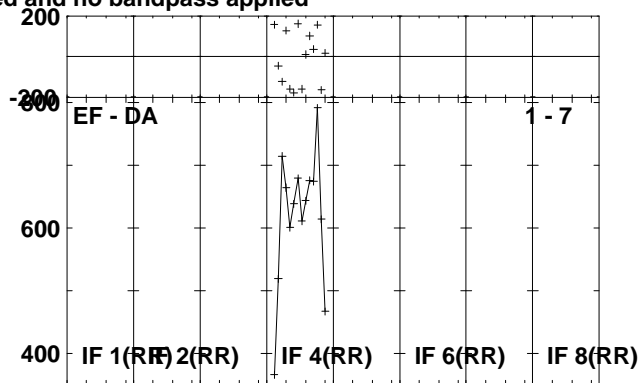
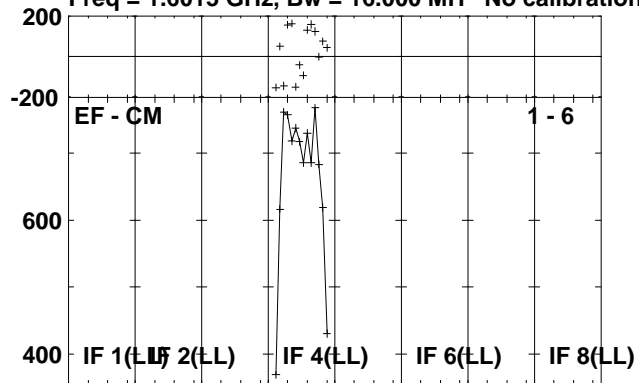

Lower frame: Micro Ampl Jy Top frame: Phas deg
Scalar averaged cross-power spectrum Several baselines displayed
Timerange: 01/01:58:53 to 01/02:03:49

Plot file version 147 created 01-JUL-2010 13:25:42

J2102+47 RG006B.UVDATA.1

Freq = 1.6015 GHz, Bw = 16.000 MH No calibration applied and no bandpass applied

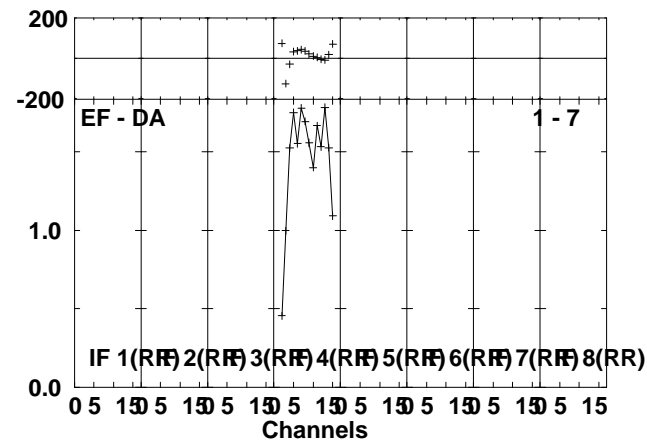
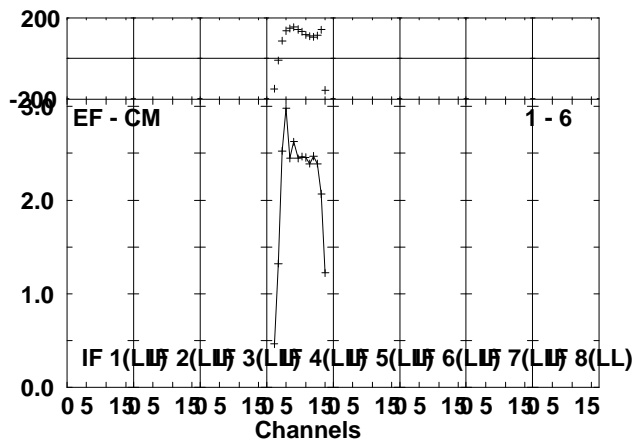
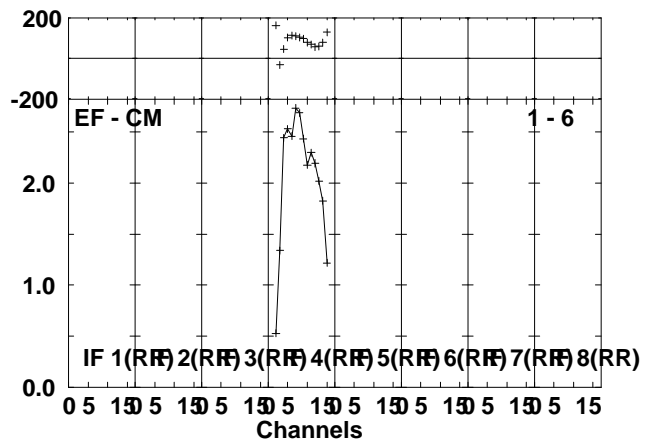
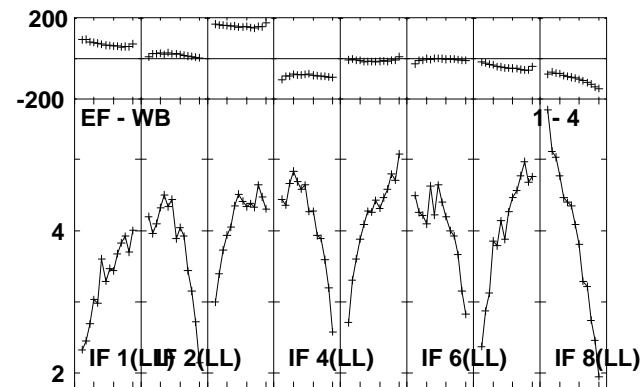
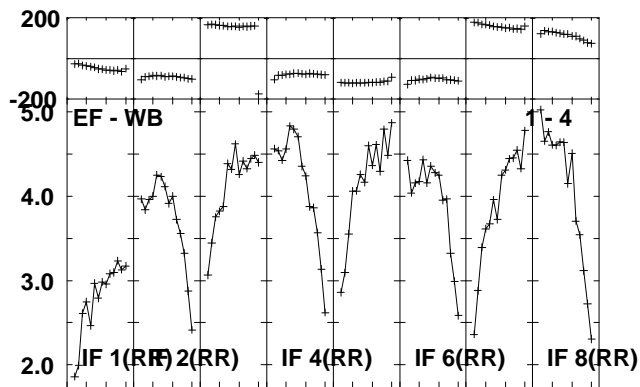
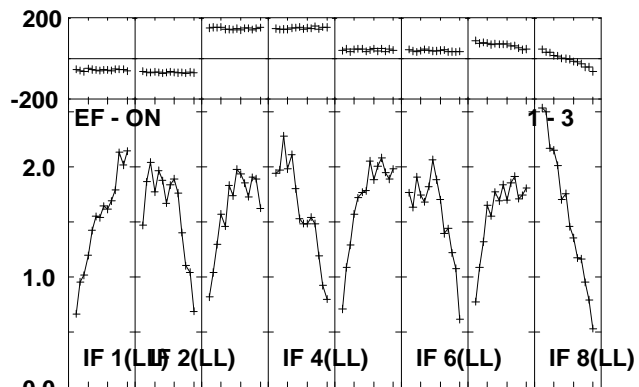
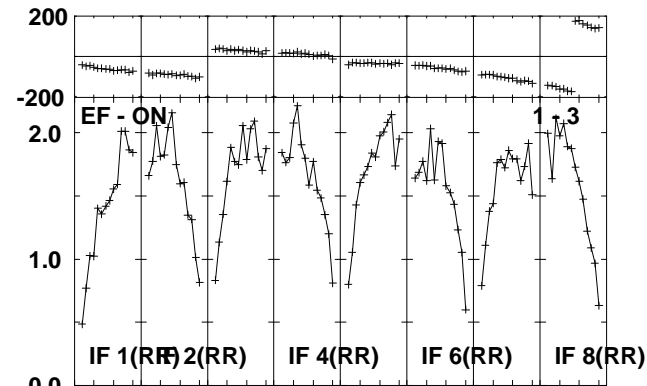
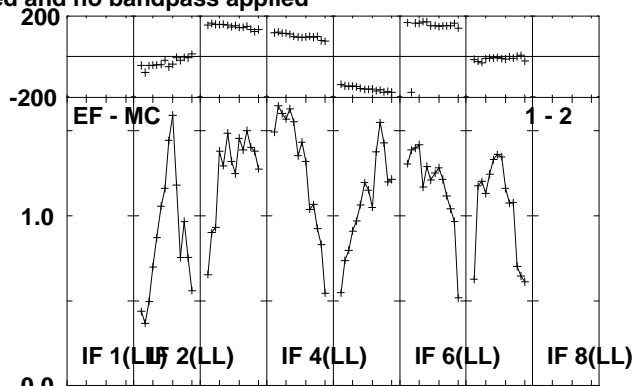
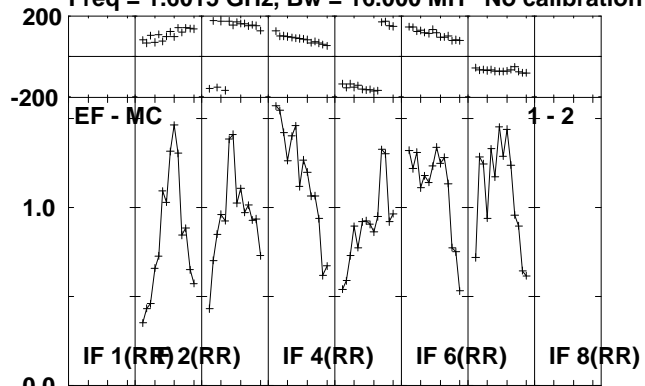

Lower frame: Milli Ampl Jy Top frame: Phas deg
Scalar averaged cross-power spectrum Several baselines displayed
Timerange: 01/02:03:53 to 01/02:06:01

Plot file version 148 created 01-JUL-2010 13:25:42

J2102+47 RG006B.UVDATA.1

Freq = 1.6015 GHz, Bw = 16.000 MH No calibration applied and no bandpass applied

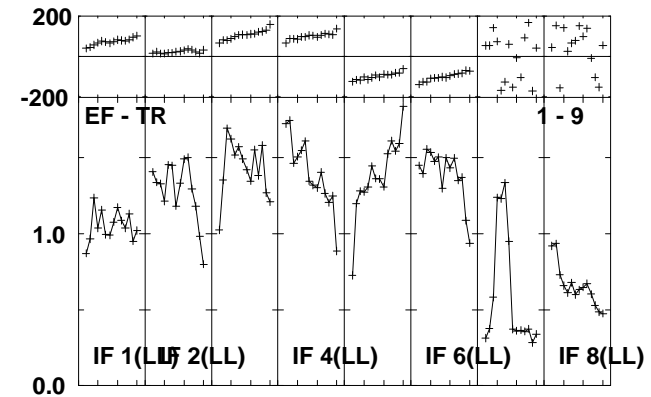
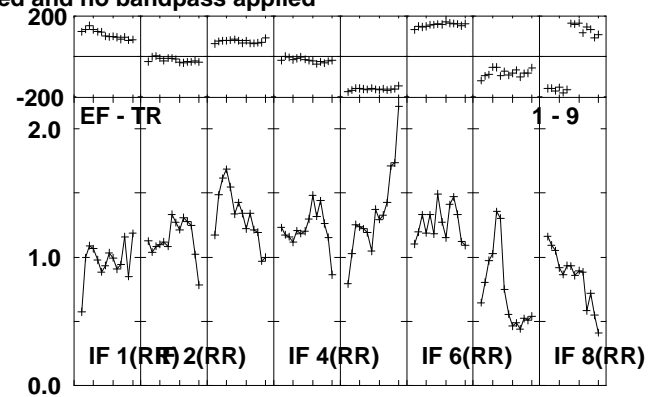
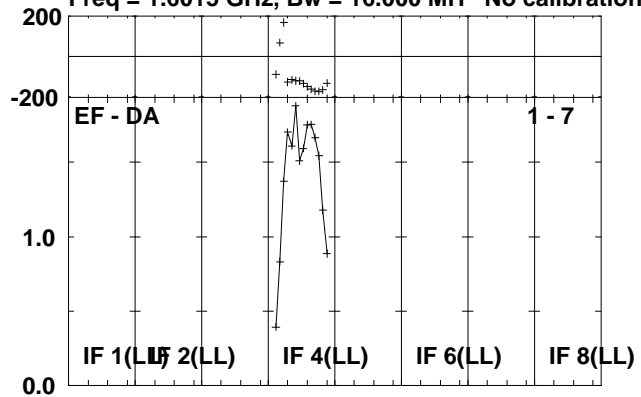

Lower frame: Milli Ampl Jy Top frame: Phas deg
Scalar averaged cross-power spectrum Several baselines displayed
Timerange: 01/02:03:53 to 01/02:06:01

Plot file version 149 created 01-JUL-2010 13:25:43

V407CYG RG006B.UVDATA.1

Freq = 1.6015 GHz, Bw = 16.000 MH No calibration applied and no bandpass applied

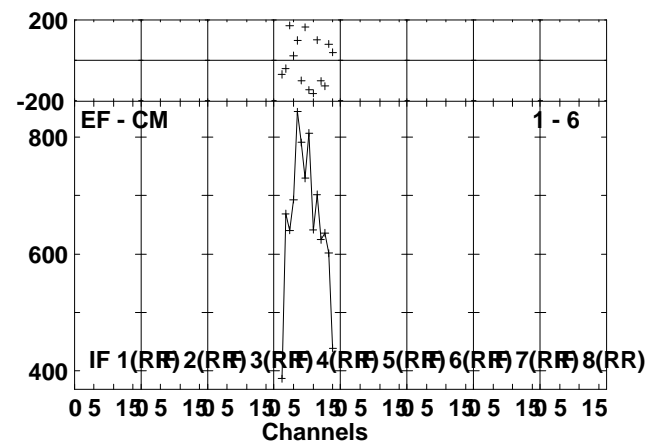
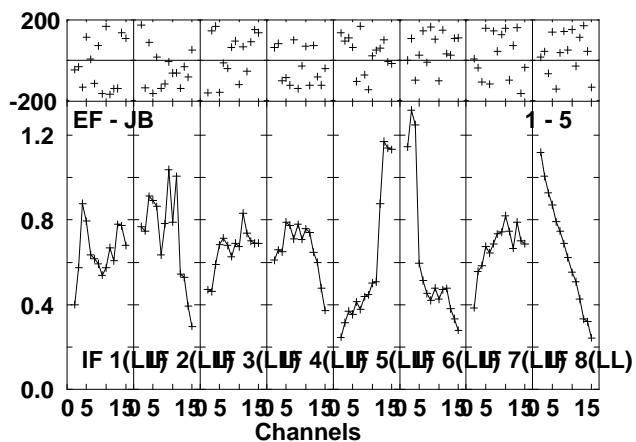
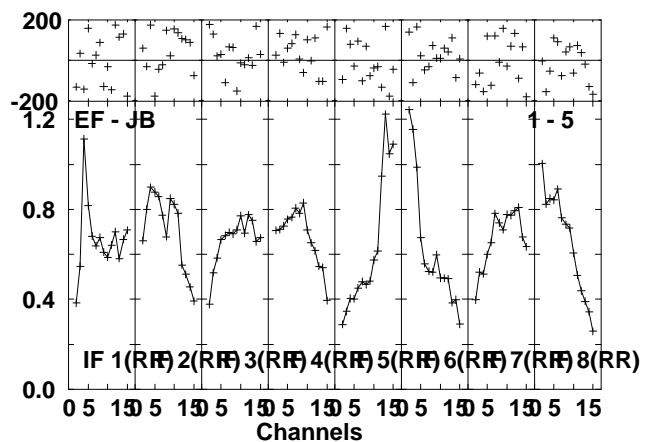
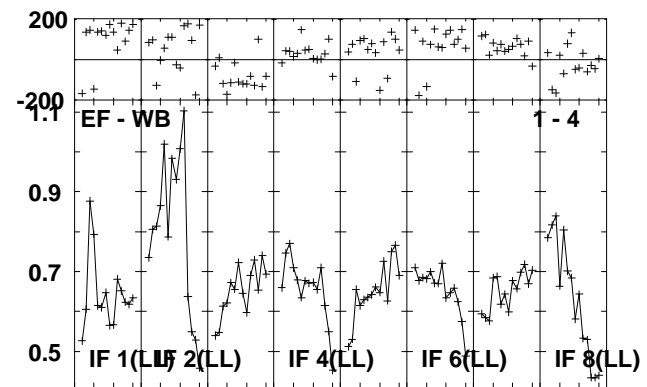
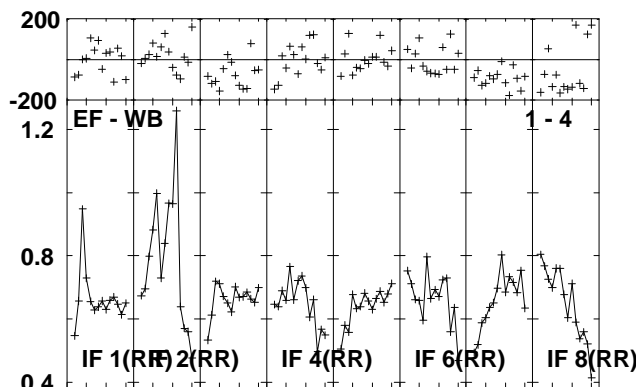
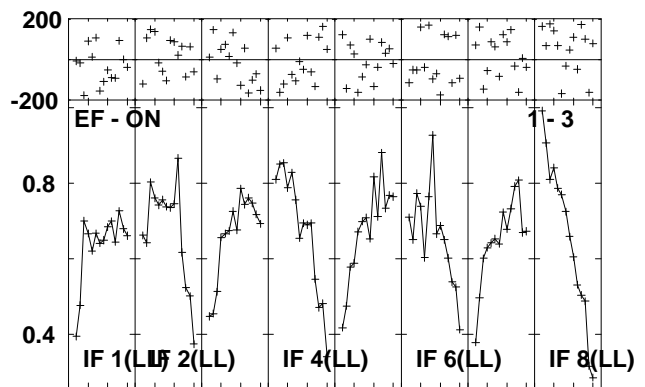
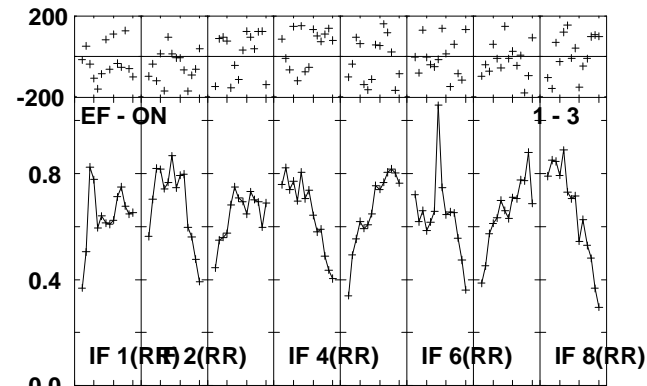
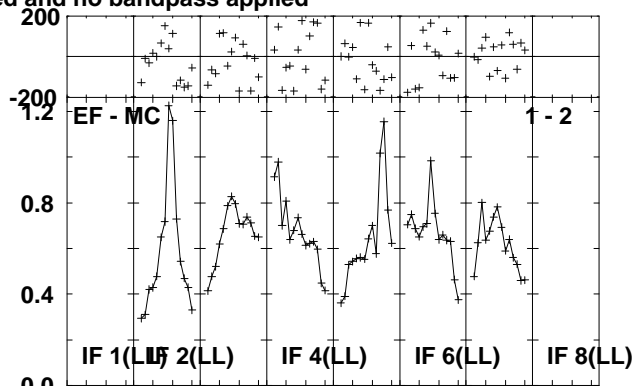
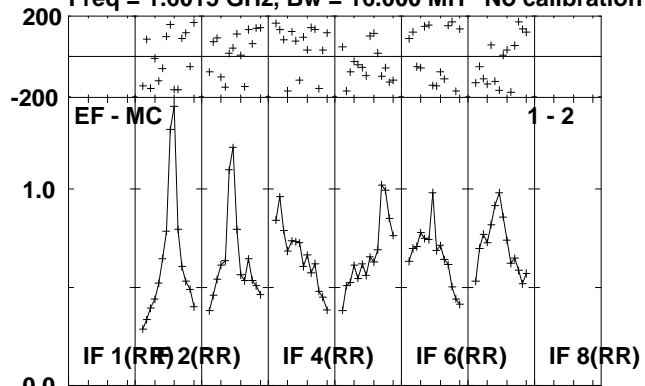

Lower frame: Milli Ampl Jy Top frame: Phas deg
Scalar averaged cross-power spectrum Several baselines displayed
Timerange: 01/02:06:05 to 01/02:11:01

Plot file version 150 created 01-JUL-2010 13:25:44
V407CYG RG006B.UVDATA.1

Freq = 1.6015 GHz, Bw = 16.000 MH No calibration applied and no bandpass applied

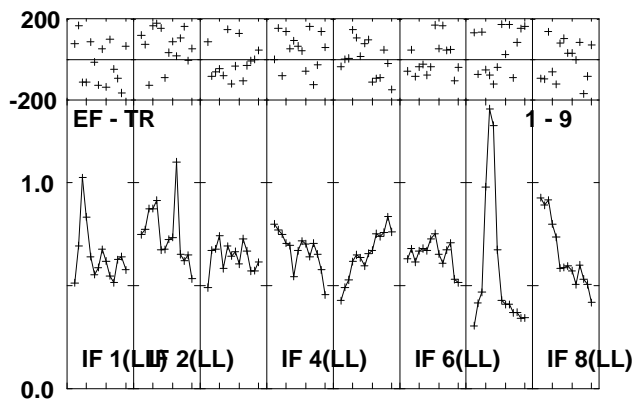
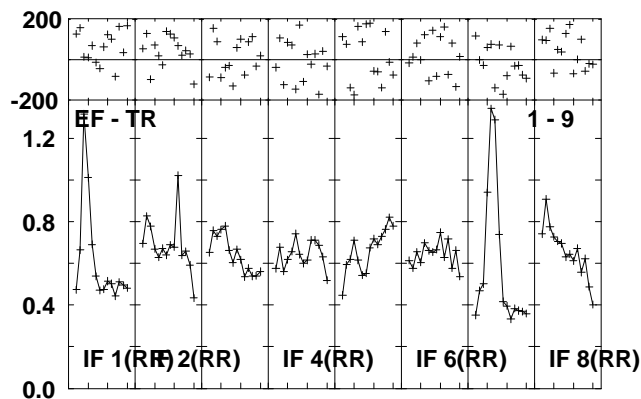
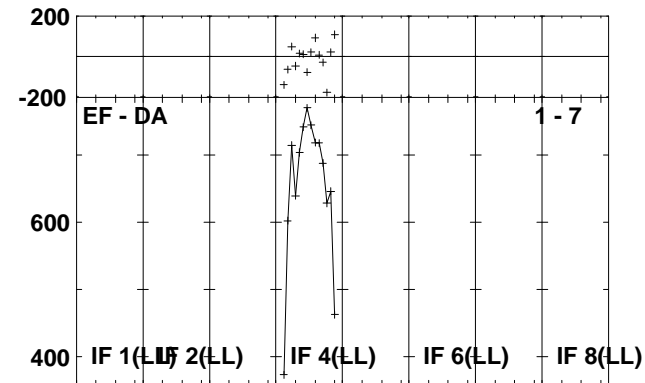
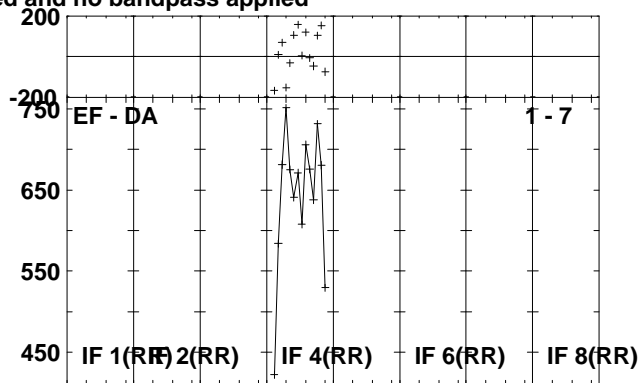
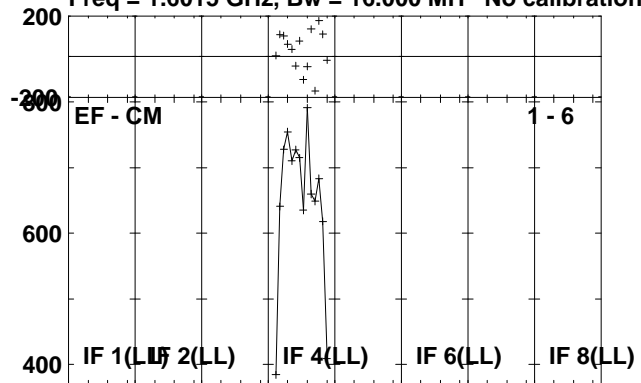

Lower frame: Micro Ampl Jy Top frame: Phas deg
Scalar averaged cross-power spectrum Several baselines displayed
Timerange: 01/02:06:05 to 01/02:11:01

Plot file version 151 created 01-JUL-2010 13:25:44

J2102+47 RG006B.UVDATA.1

Freq = 1.6015 GHz, Bw = 16.000 MH No calibration applied and no bandpass applied

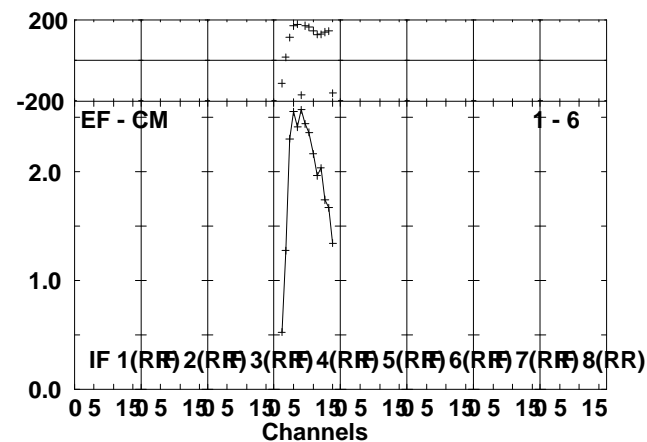
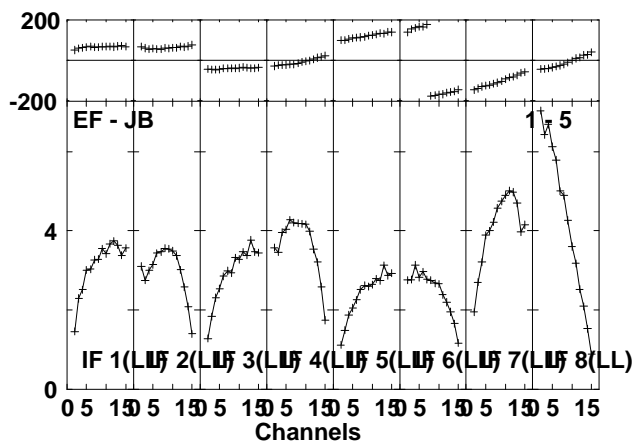
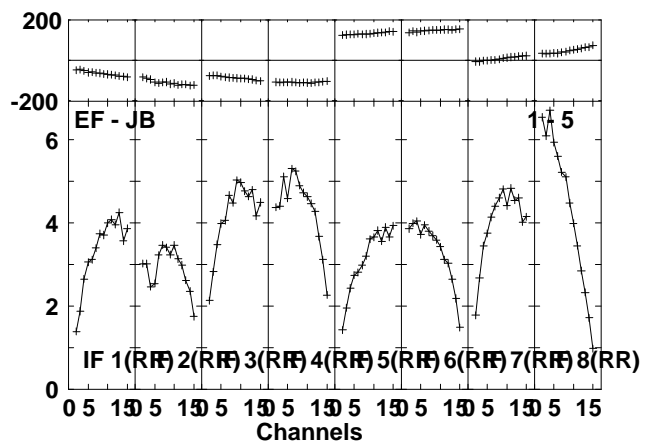
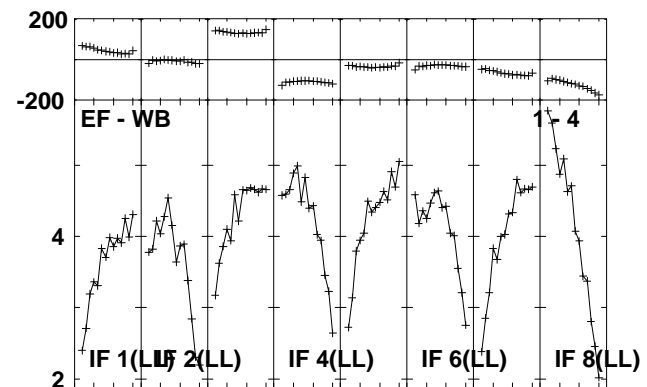
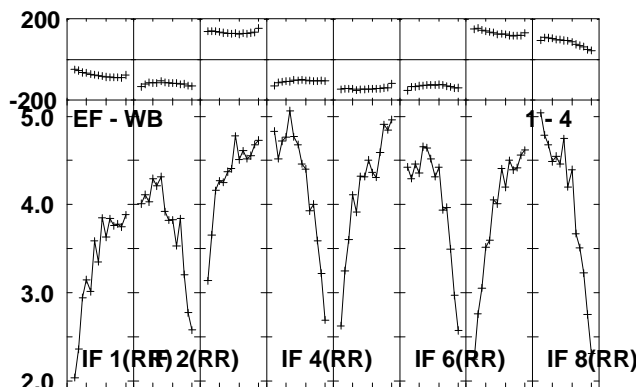
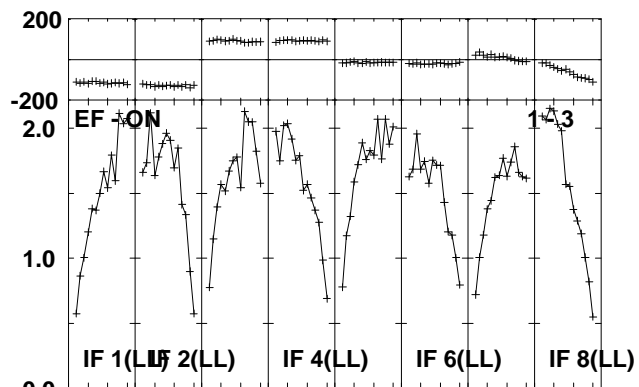
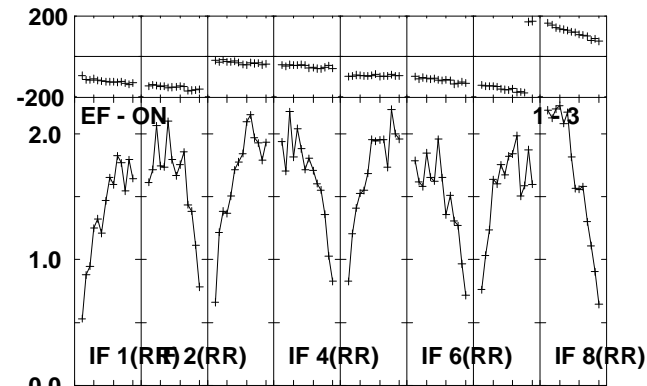
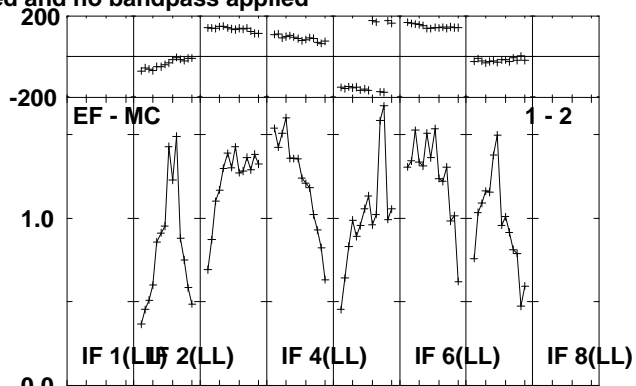
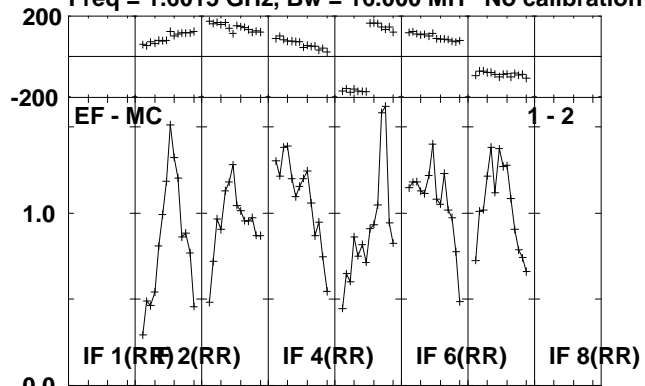

Lower frame: Milli Ampl Jy Top frame: Phas deg
Scalar averaged cross-power spectrum Several baselines displayed
Timerange: 01/02:12:05 to 01/02:13:49

Plot file version 152 created 01-JUL-2010 13:25:45

J2102+47 RG006B.UVDATA.1

Freq = 1.6015 GHz, Bw = 16.000 MH No calibration applied and no bandpass applied

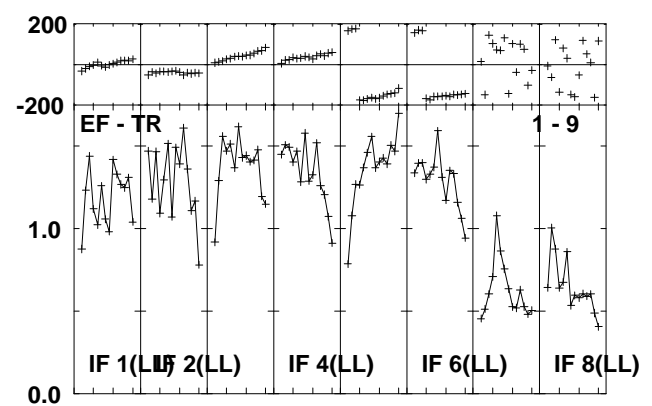
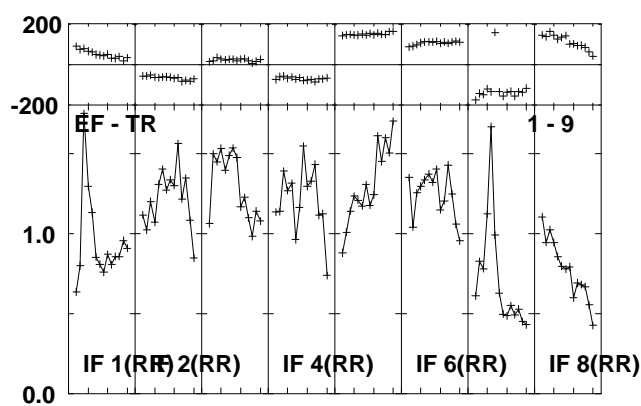
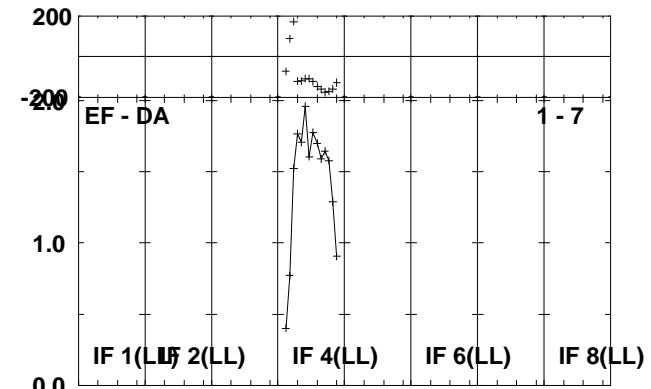
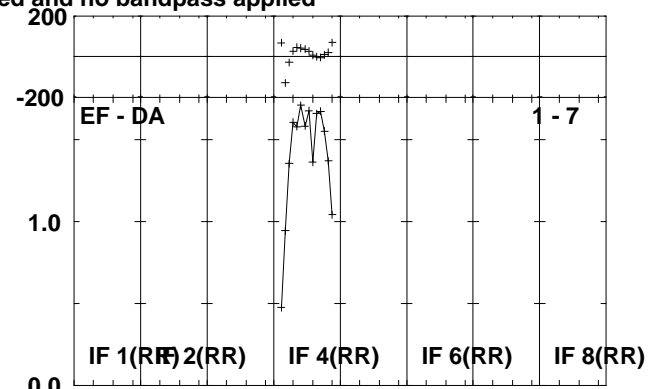
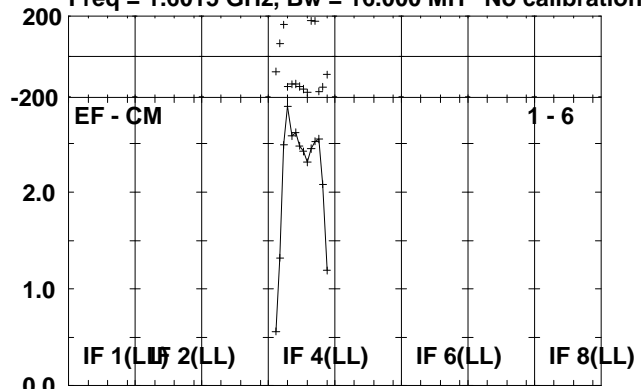

Lower frame: Milli Ampl Jy Top frame: Phas deg
Scalar averaged cross-power spectrum Several baselines displayed
Timerange: 01/02:12:05 to 01/02:13:49

Plot file version 153 created 01-JUL-2010 13:25:45

V407CYG RG006B.UVDATA.1

Freq = 1.6015 GHz, Bw = 16.000 MH No calibration applied and no bandpass applied

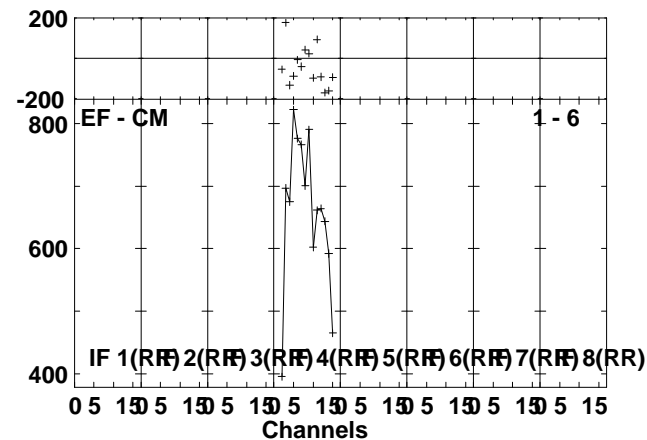
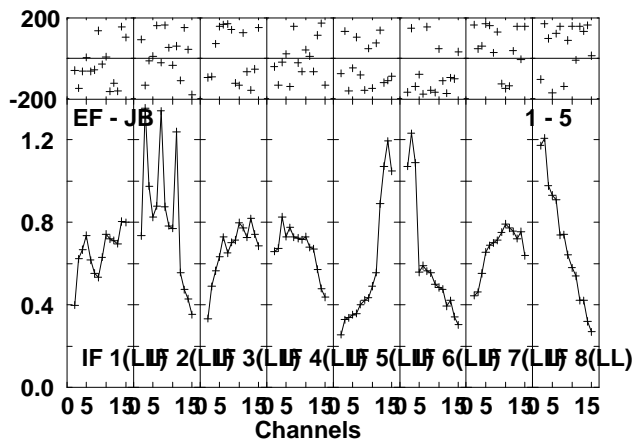
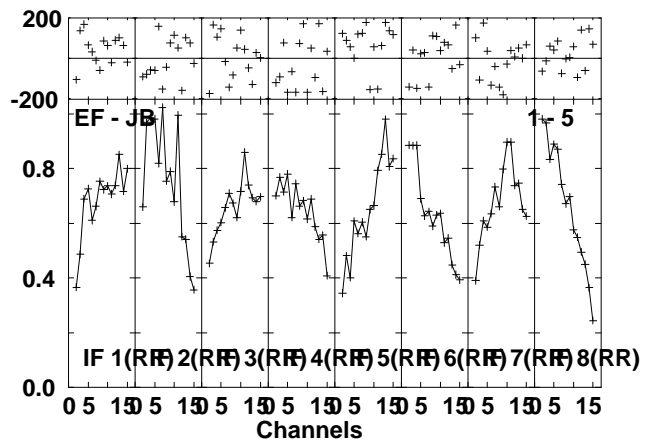
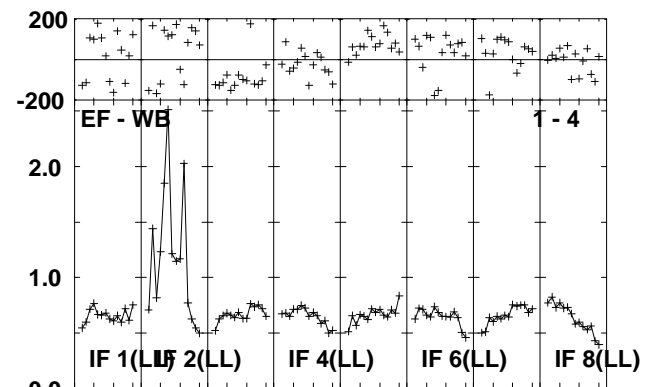
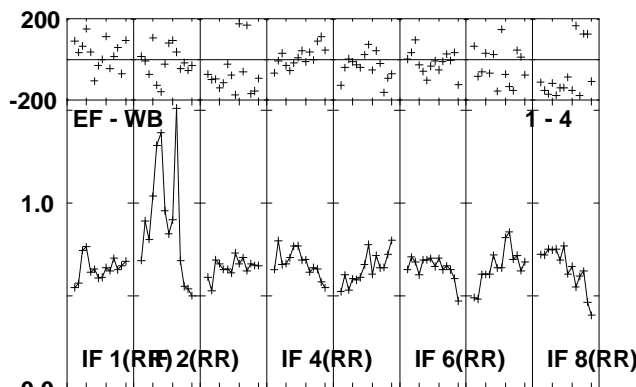
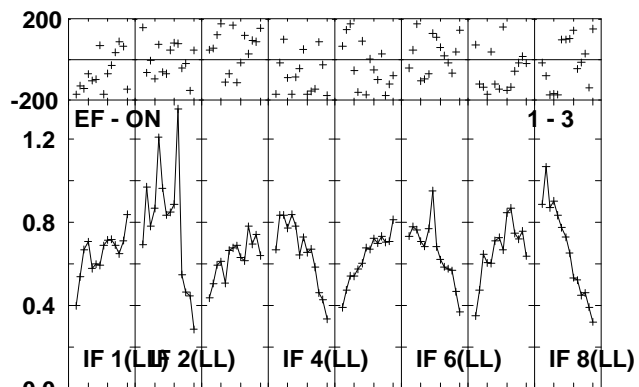
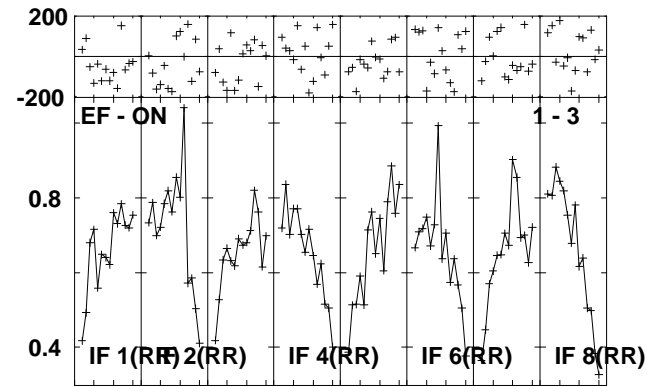
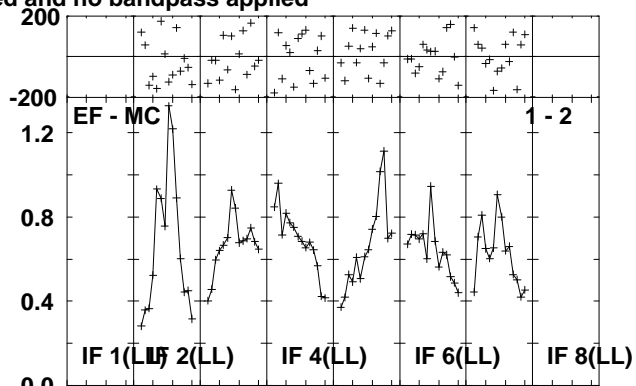
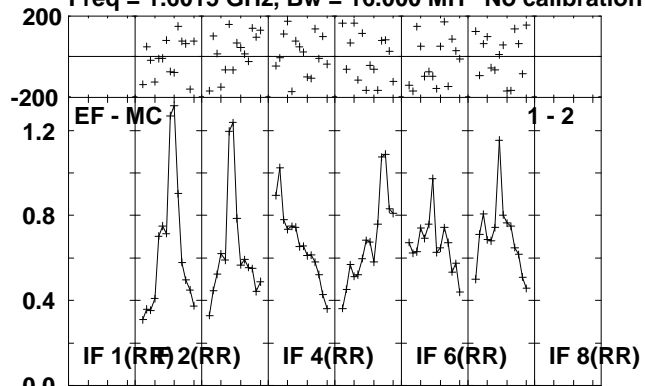

Lower frame: Milli Ampl Jy Top frame: Phas deg
Scalar averaged cross-power spectrum Several baselines displayed
Timerange: 01/02:13:53 to 01/02:18:49

Plot file version 154 created 01-JUL-2010 13:25:46

V407CYG RG006B.UVDATA.1

Freq = 1.6015 GHz, Bw = 16.000 MH No calibration applied and no bandpass applied

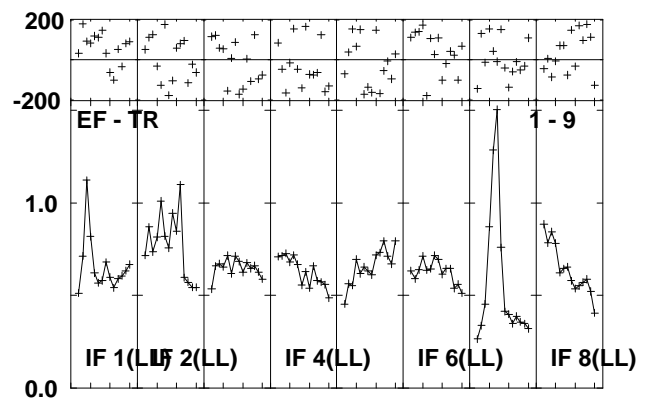
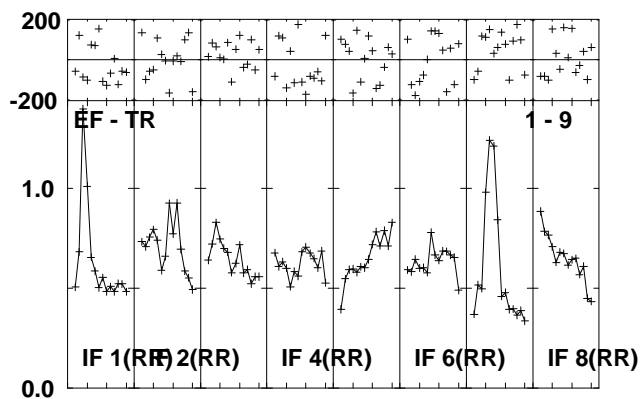
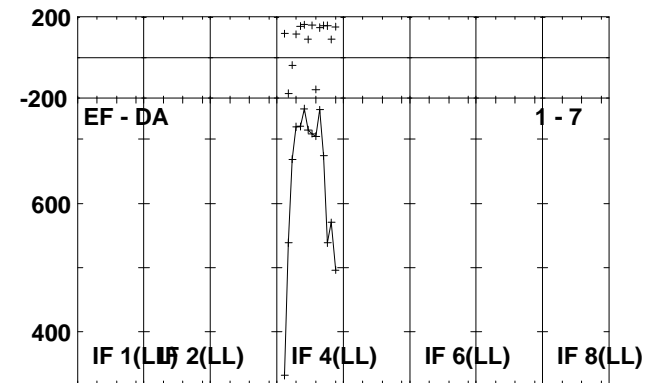
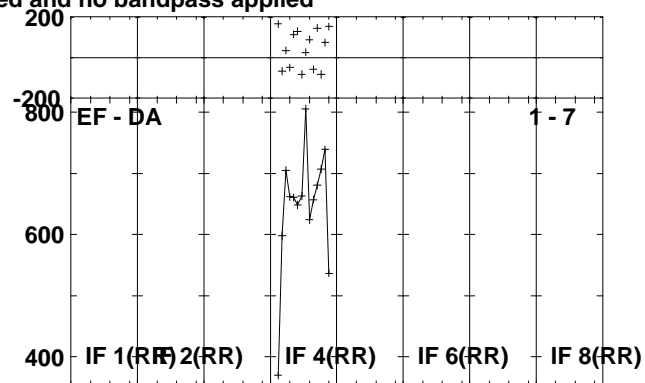
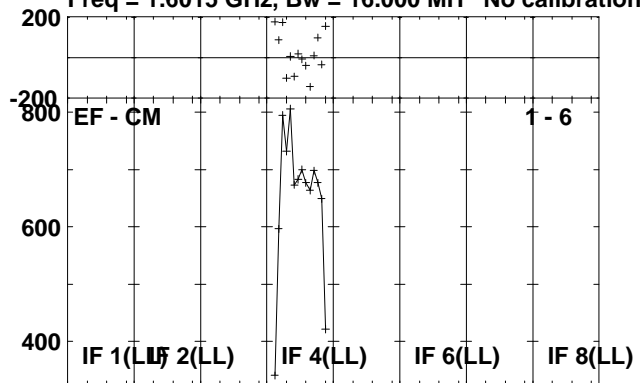

Lower frame: Micro Ampl Jy Top frame: Phas deg
Scalar averaged cross-power spectrum Several baselines displayed
Timerange: 01/02:13:53 to 01/02:18:49

Plot file version 155 created 01-JUL-2010 13:25:47

J2102+47 RG006B.UVDATA.1

Freq = 1.6015 GHz, Bw = 16.000 MH No calibration applied and no bandpass applied

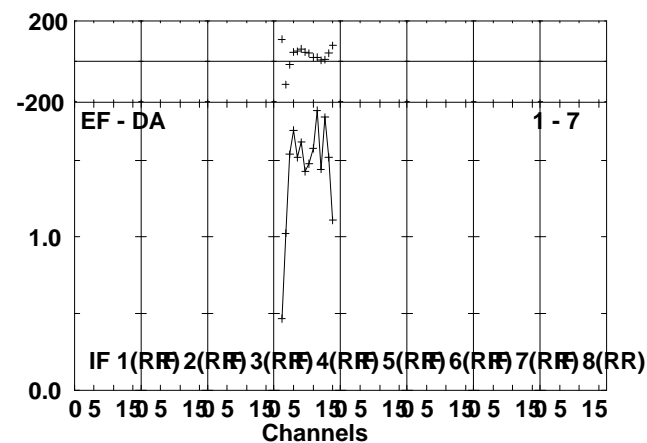
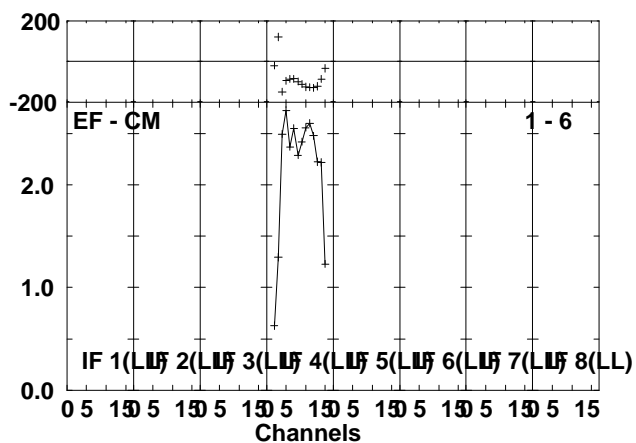
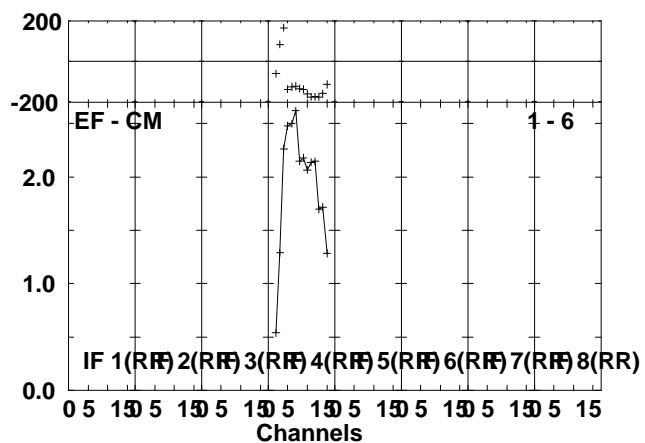
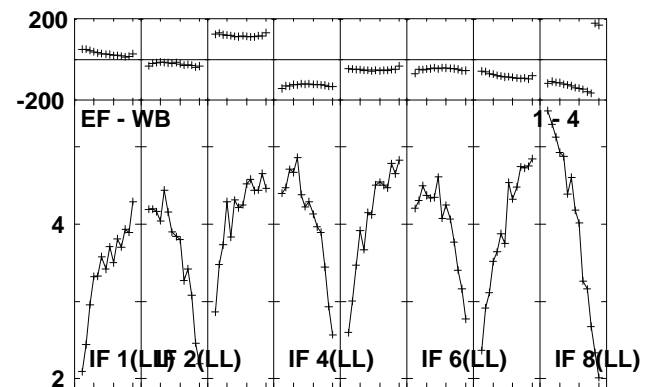
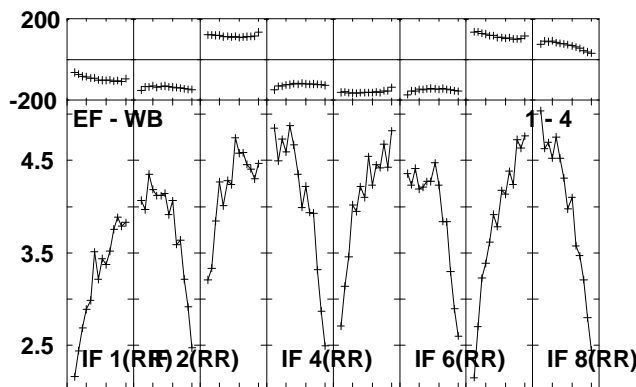
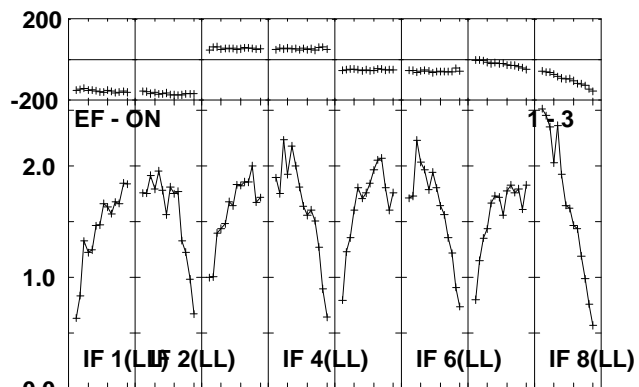
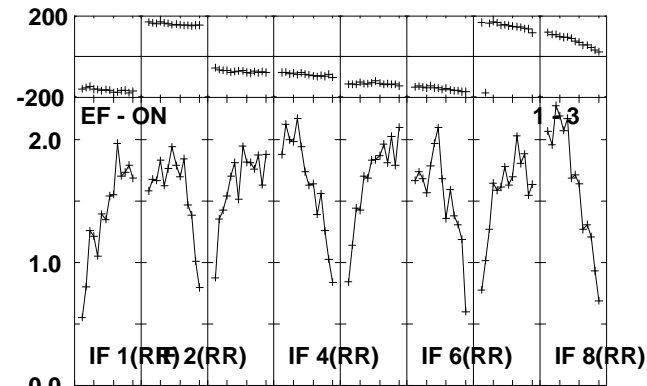
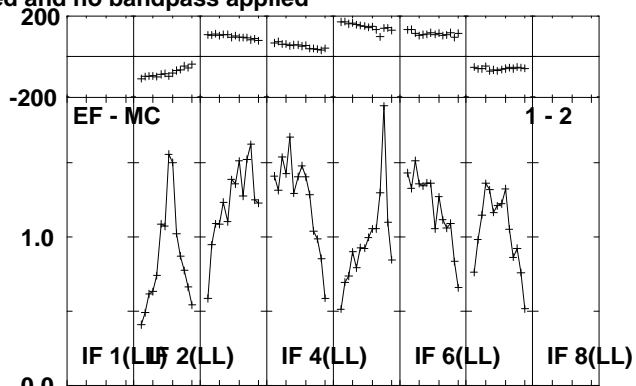
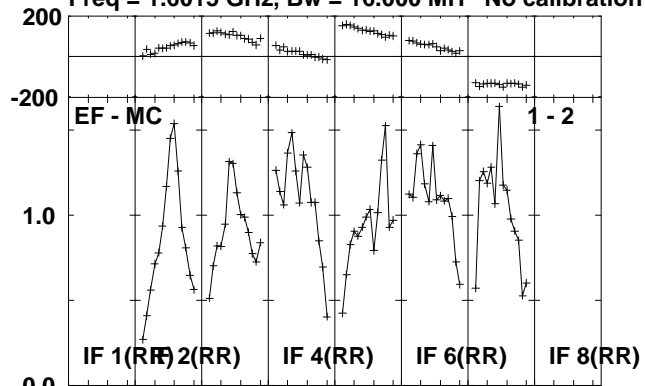

Lower frame: Milli Ampl Jy Top frame: Phas deg
Scalar averaged cross-power spectrum Several baselines displayed
Timerange: 01/02:18:53 to 01/02:21:01

Plot file version 156 created 01-JUL-2010 13:25:47

J2102+47 RG006B.UVDATA.1

Freq = 1.6015 GHz, Bw = 16.000 MH No calibration applied and no bandpass applied

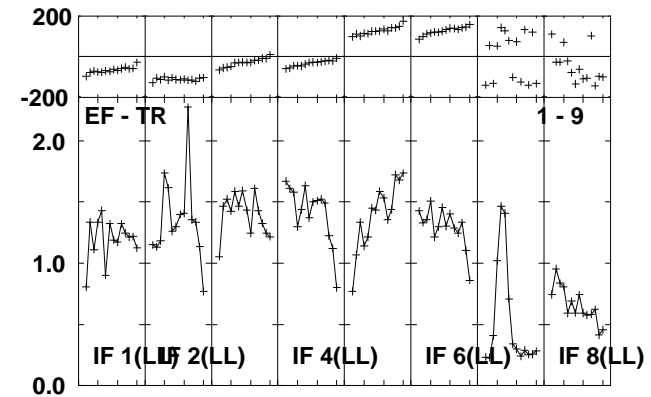
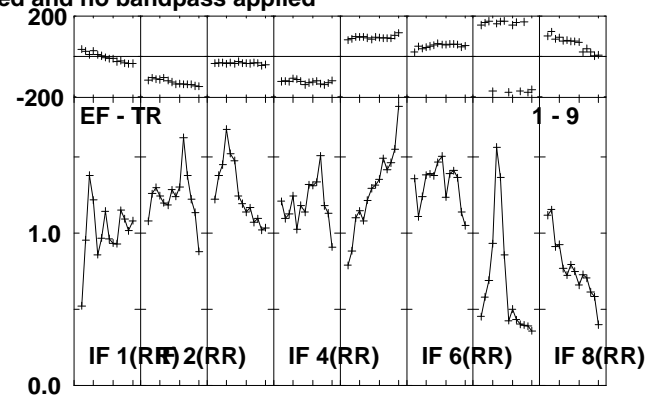
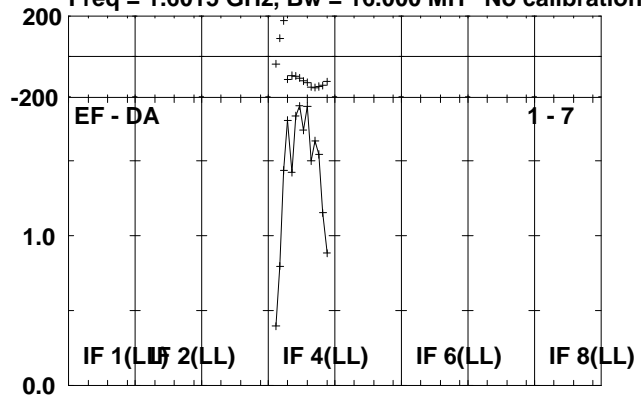

Lower frame: Milli Ampl Jy Top frame: Phas deg
Scalar averaged cross-power spectrum Several baselines displayed
Timerange: 01/02:18:53 to 01/02:21:01

Plot file version 157 created 01-JUL-2010 13:25:48

V407CYG RG006B.UVDATA.1

Freq = 1.6015 GHz, Bw = 16.000 MH No calibration applied and no bandpass applied

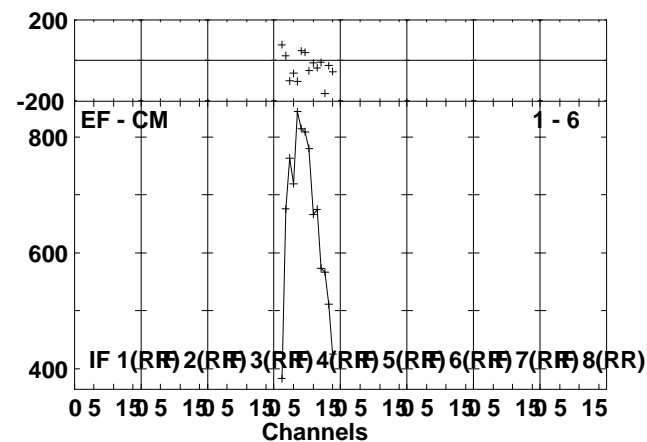
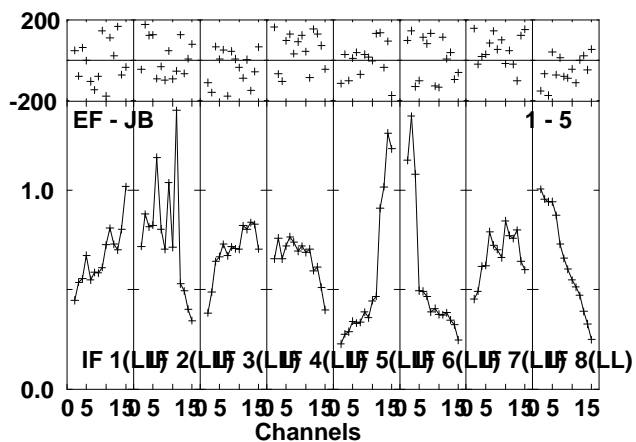
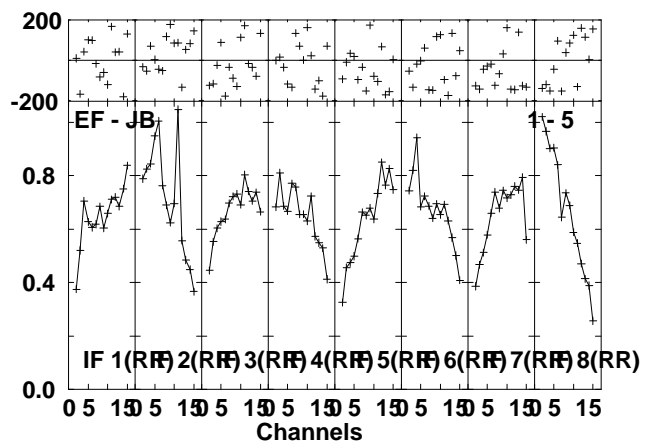
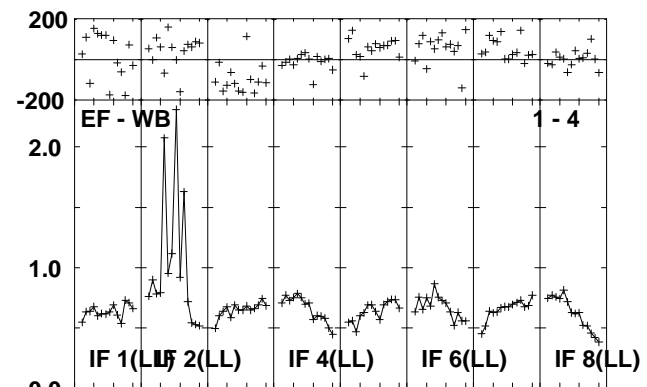
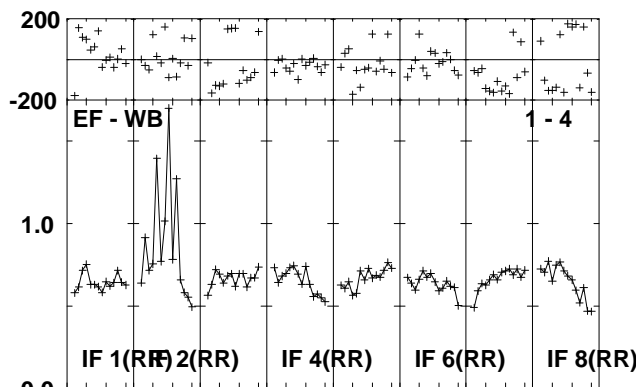
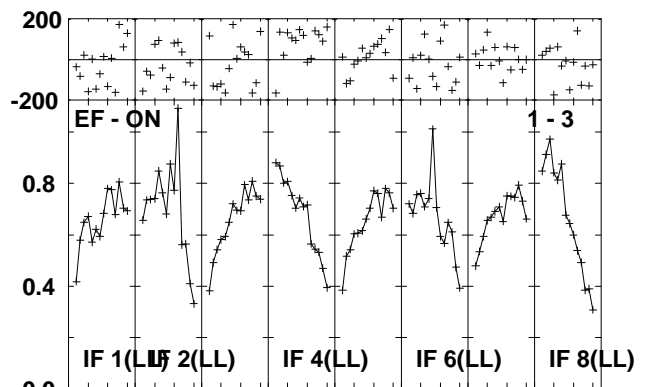
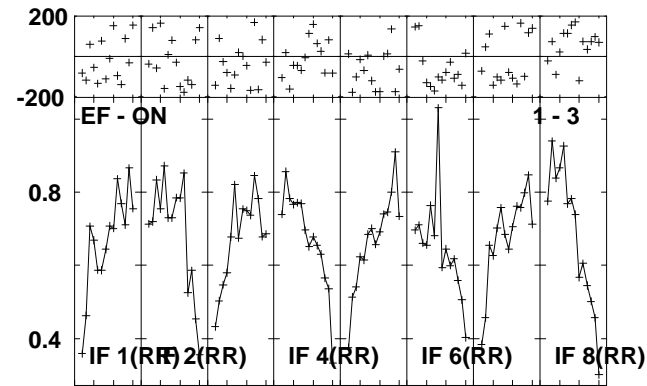
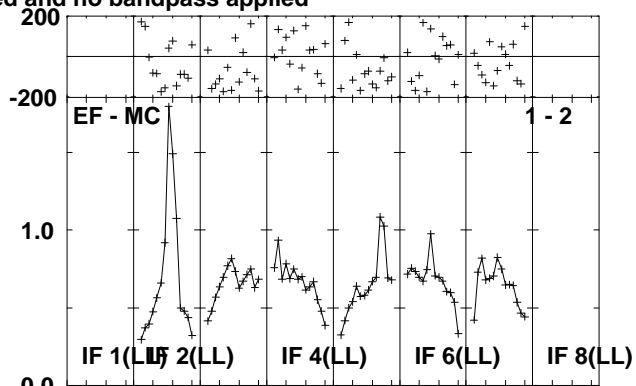
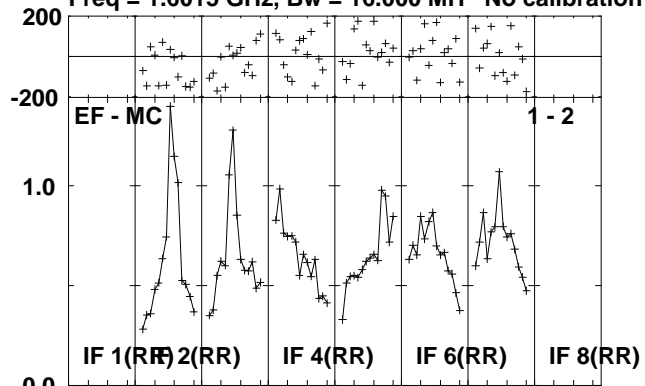

Lower frame: Milli Ampl Jy Top frame: Phas deg
Scalar averaged cross-power spectrum Several baselines displayed
Timerange: 01/02:21:05 to 01/02:26:01

Plot file version 158 created 01-JUL-2010 13:25:49

V407CYG RG006B.UVDATA.1

Freq = 1.6015 GHz, Bw = 16.000 MH No calibration applied and no bandpass applied

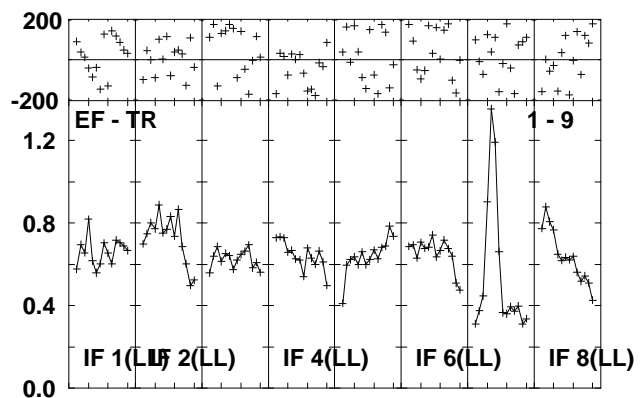
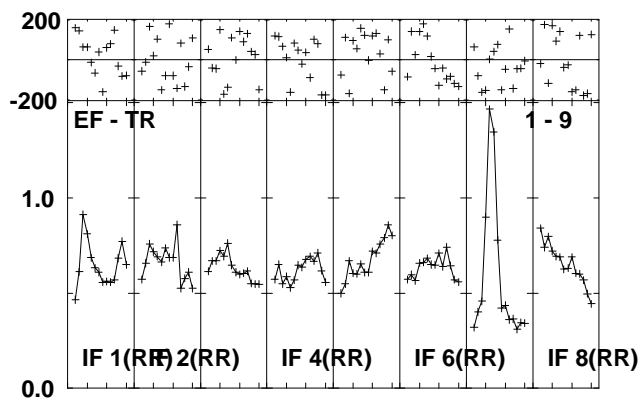
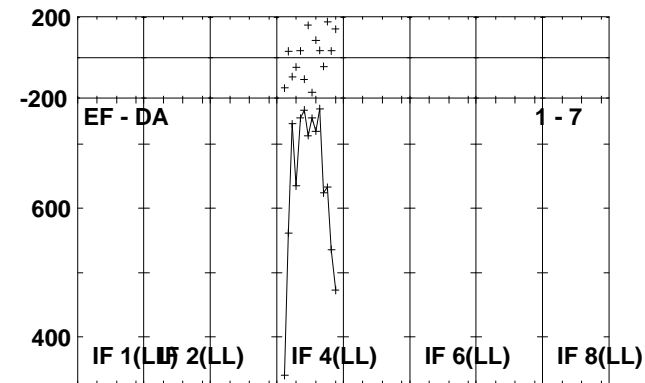
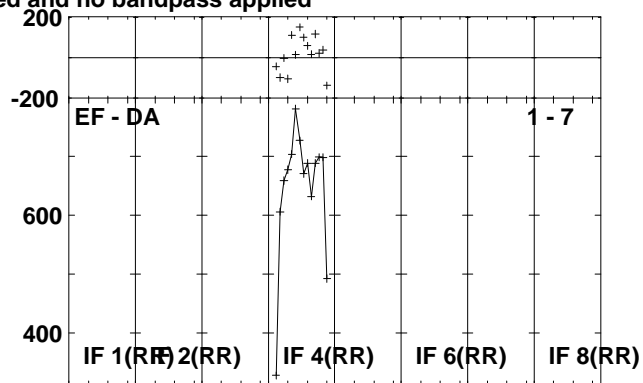
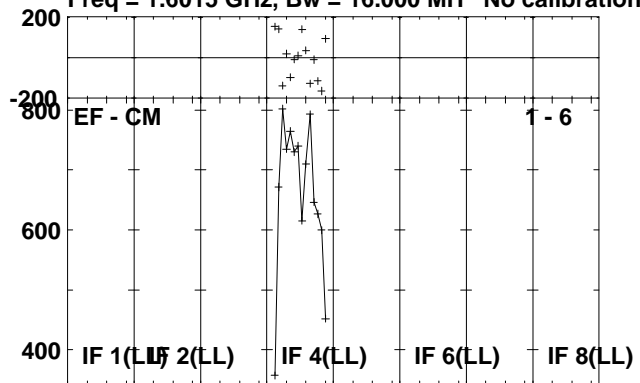

Lower frame: Micro Ampl Jy Top frame: Phas deg
Scalar averaged cross-power spectrum Several baselines displayed
Timerange: 01/02:21:05 to 01/02:26:01

Plot file version 159 created 01-JUL-2010 13:25:50

J2102+47 RG006B.UVDATA.1

Freq = 1.6015 GHz, Bw = 16.000 MH No calibration applied and no bandpass applied

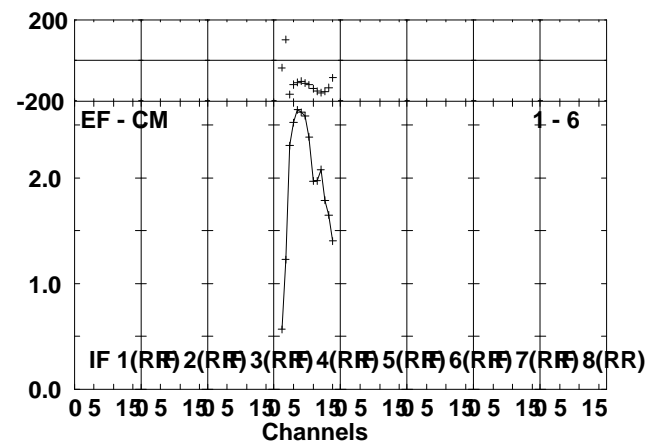
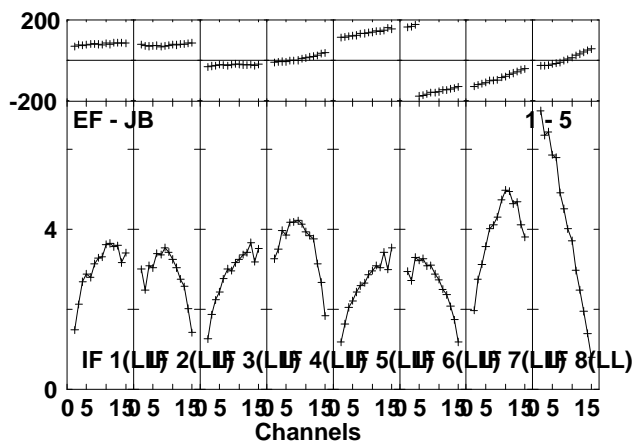
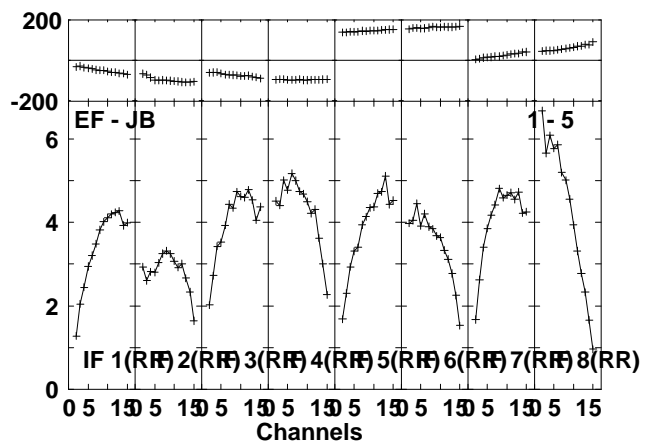
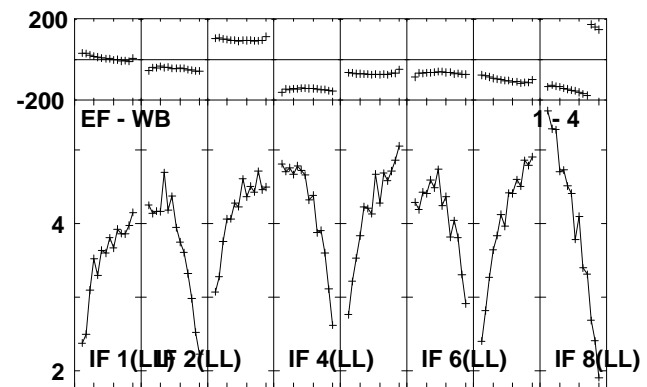
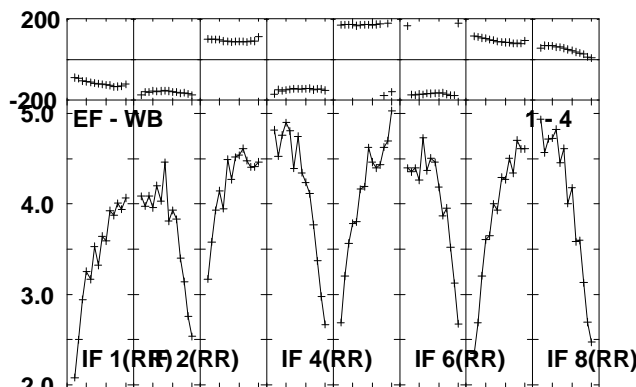
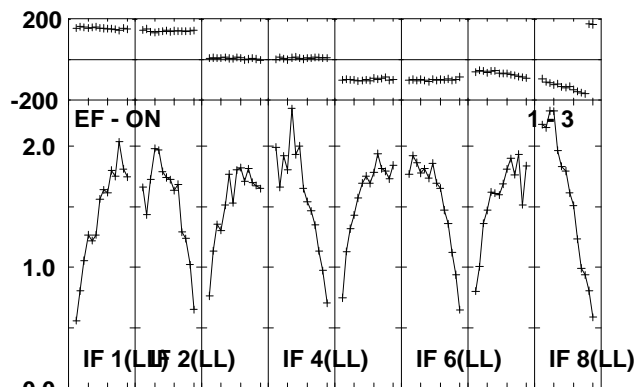
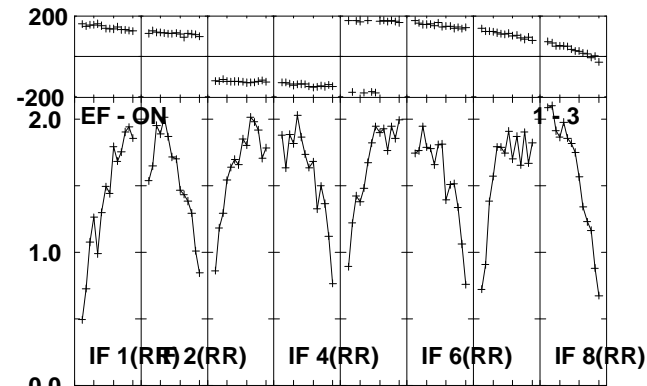
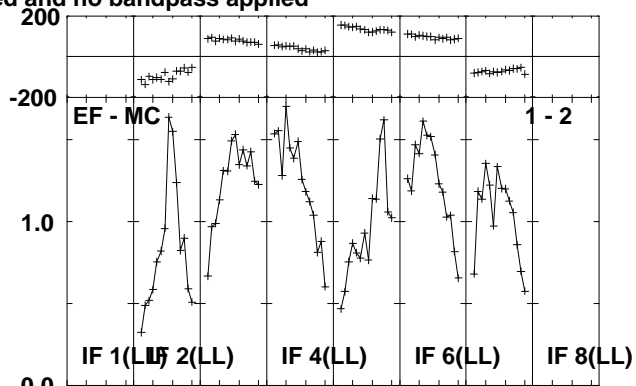
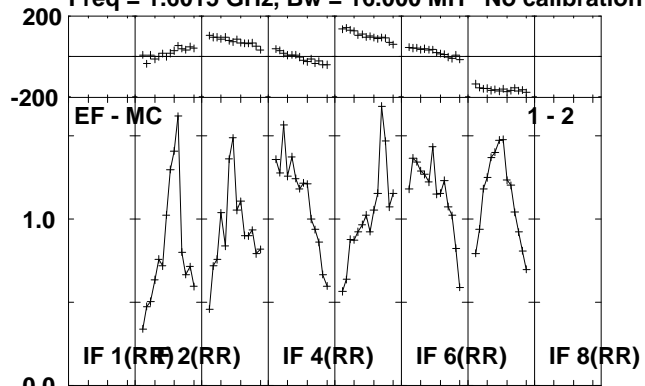

Lower frame: Milli Ampl Jy Top frame: Phas deg
Scalar averaged cross-power spectrum Several baselines displayed
Timerange: 01/02:27:05 to 01/02:28:49

Plot file version 160 created 01-JUL-2010 13:25:50

J2102+47 RG006B.UVDATA.1

Freq = 1.6015 GHz, Bw = 16.000 MH No calibration applied and no bandpass applied

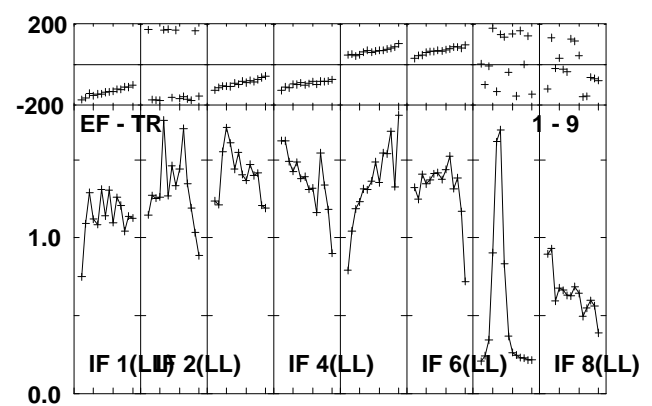
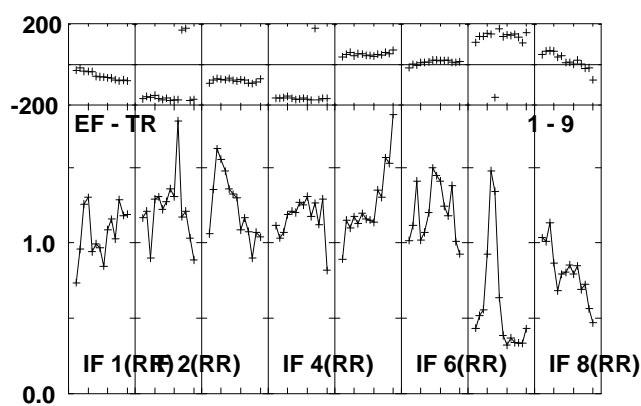
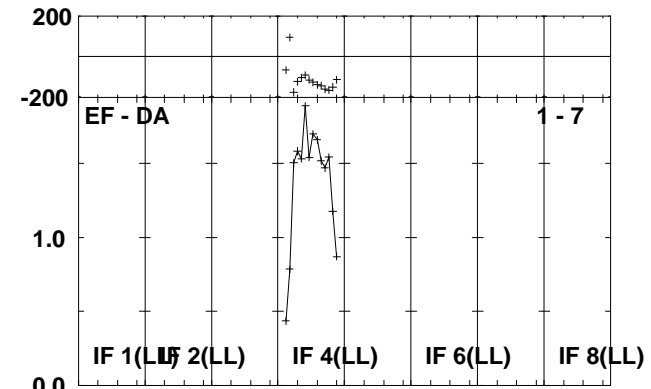
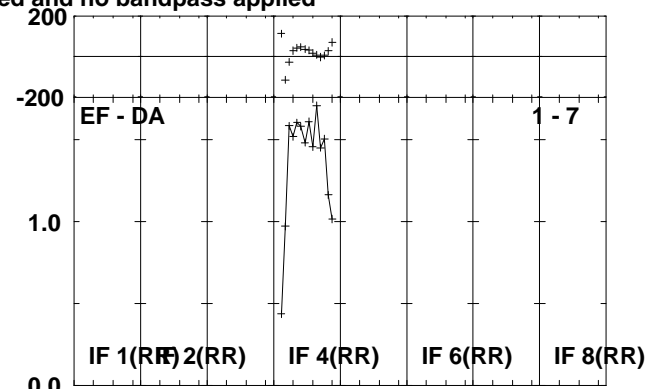
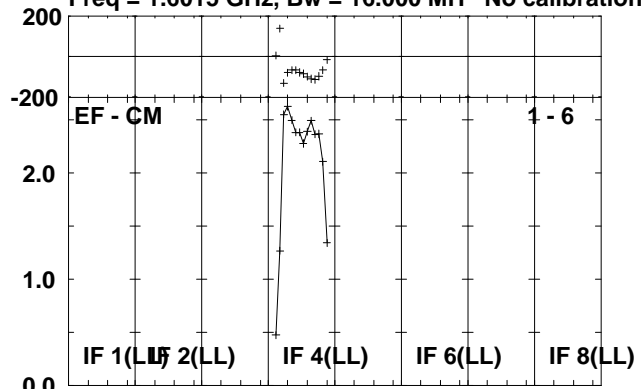

Lower frame: Milli Ampl Jy Top frame: Phas deg
Scalar averaged cross-power spectrum Several baselines displayed
Timerange: 01/02:27:05 to 01/02:28:49

Plot file version 161 created 01-JUL-2010 13:25:50

V407CYG RG006B.UVDATA.1

Freq = 1.6015 GHz, Bw = 16.000 MH No calibration applied and no bandpass applied

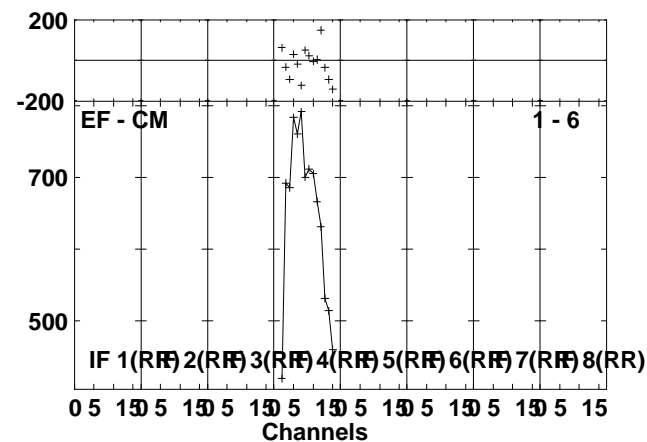
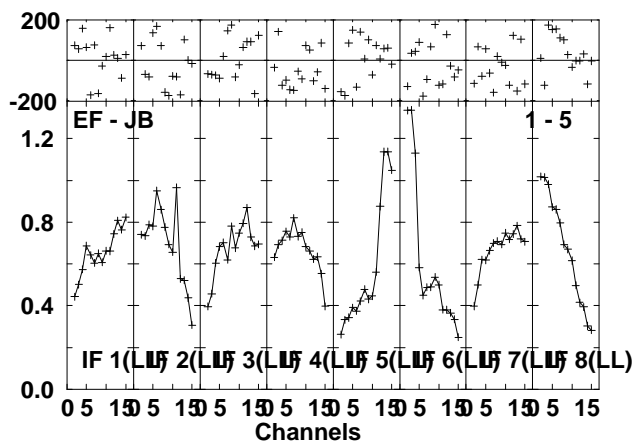
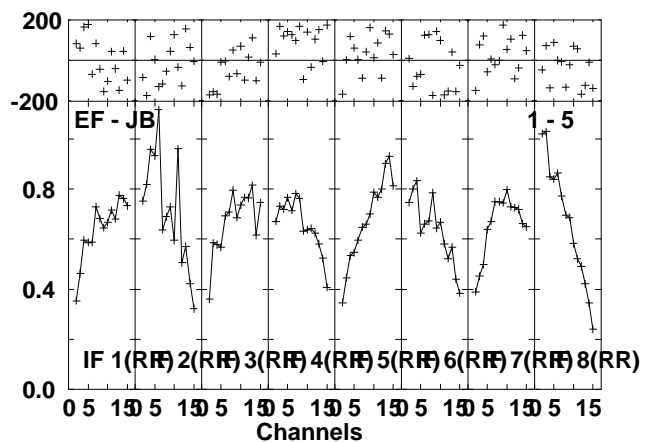
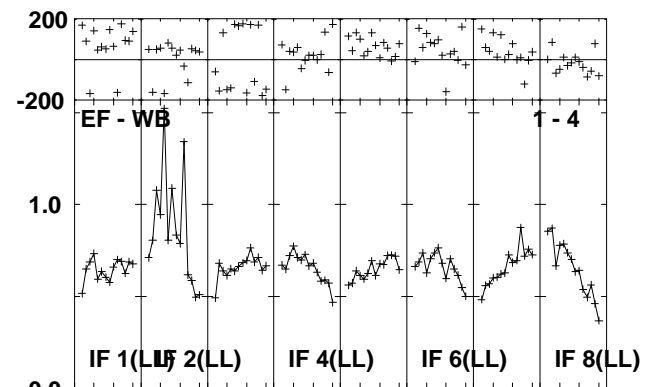
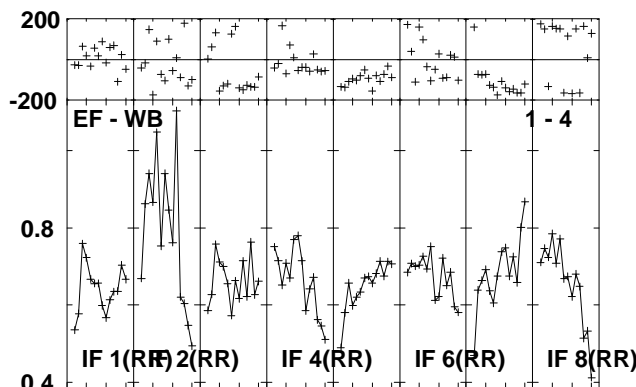
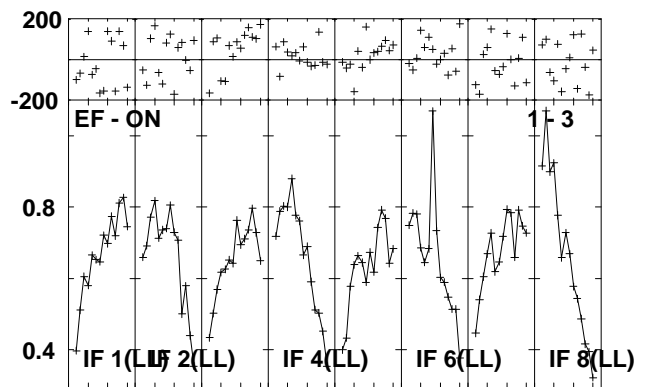
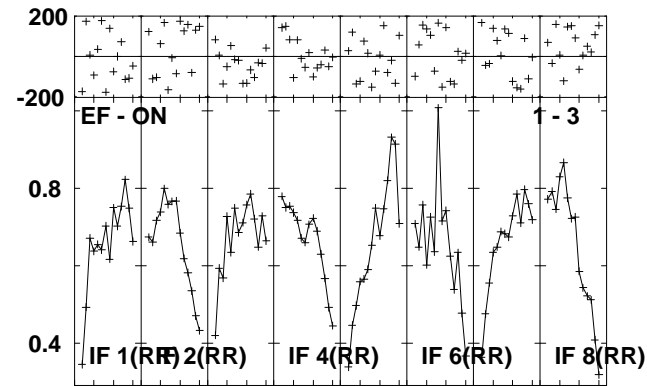
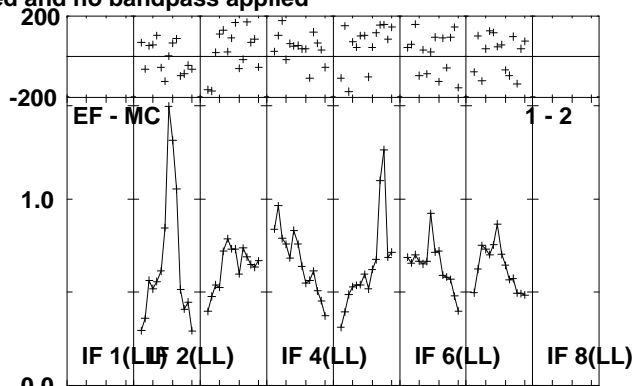
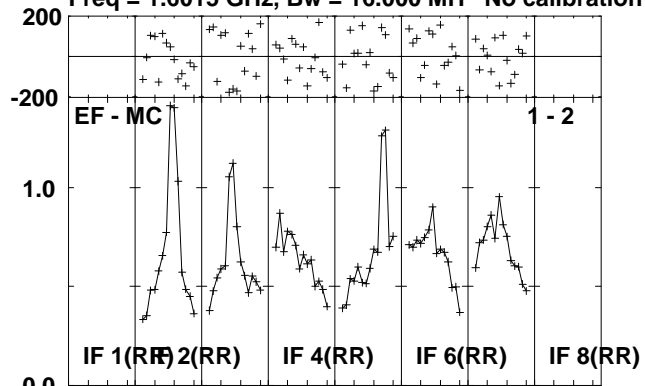

Lower frame: Milli Ampl Jy Top frame: Phas deg
Scalar averaged cross-power spectrum Several baselines displayed
Timerange: 01/02:28:53 to 01/02:33:49

Plot file version 162 created 01-JUL-2010 13:25:51

V407CYG RG006B.UVDATA.1

Freq = 1.6015 GHz, Bw = 16.000 MH No calibration applied and no bandpass applied

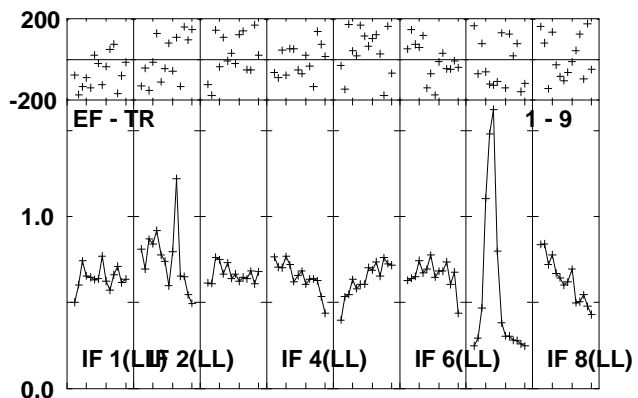
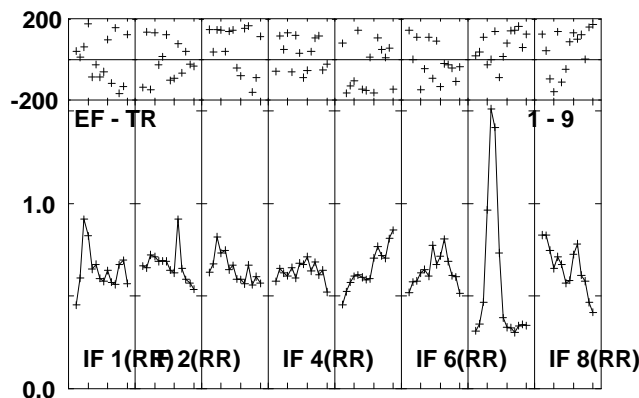
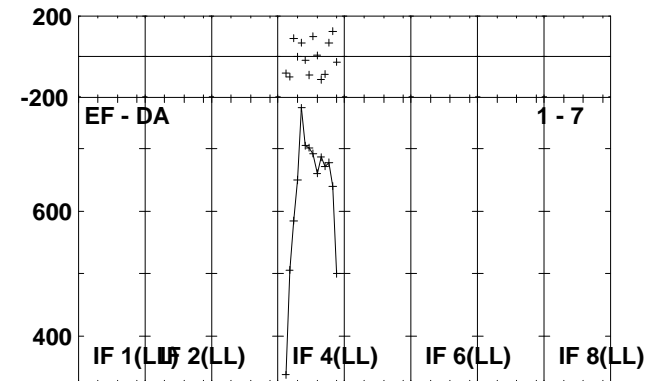
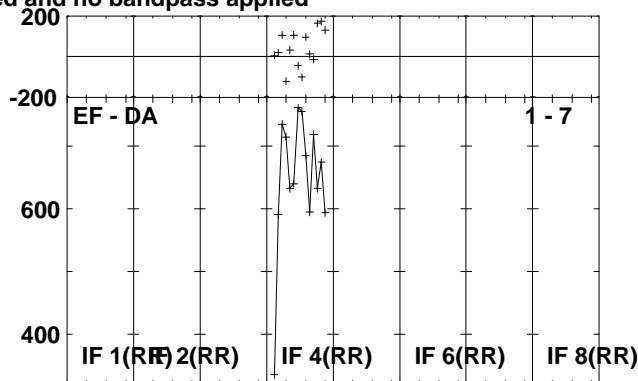
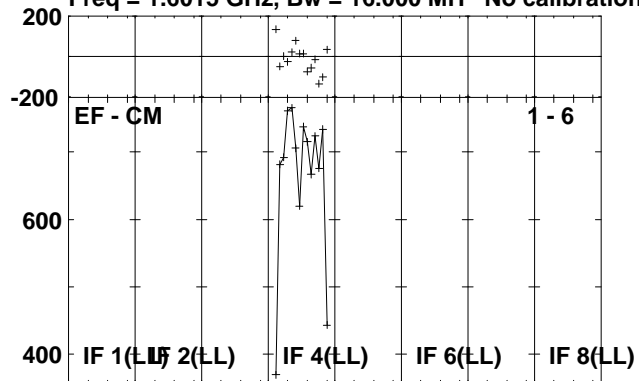

Lower frame: Micro Ampl Jy Top frame: Phas deg
Scalar averaged cross-power spectrum Several baselines displayed
Timerange: 01/02:28:53 to 01/02:33:49

Plot file version 163 created 01-JUL-2010 13:25:52

J2102+47 RG006B.UVDATA.1

Freq = 1.6015 GHz, Bw = 16.000 MH No calibration applied and no bandpass applied

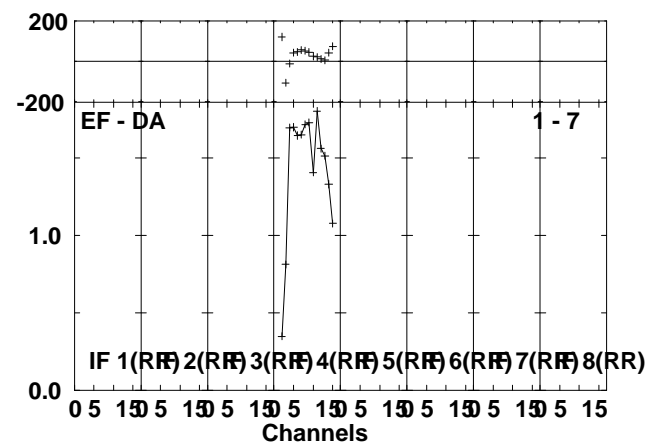
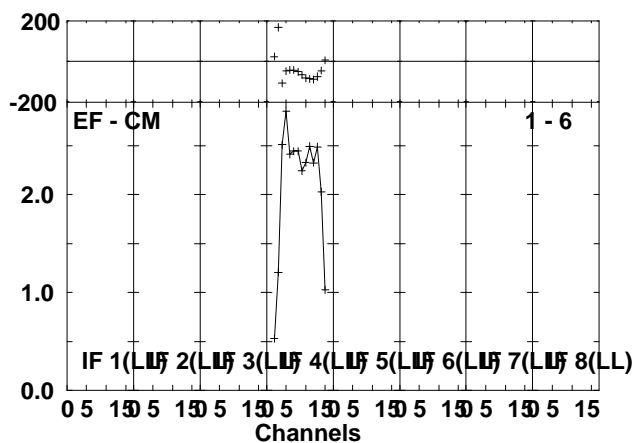
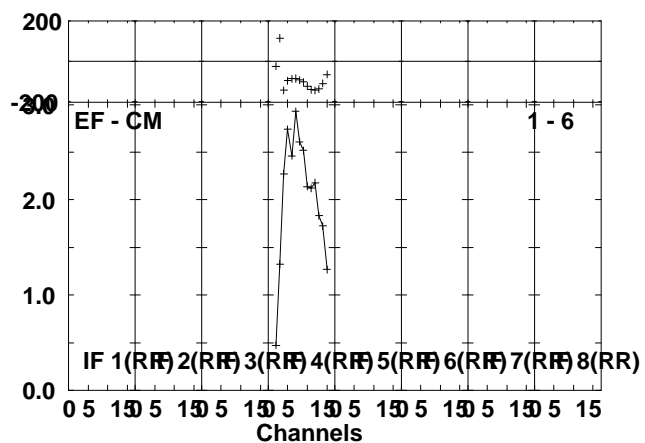
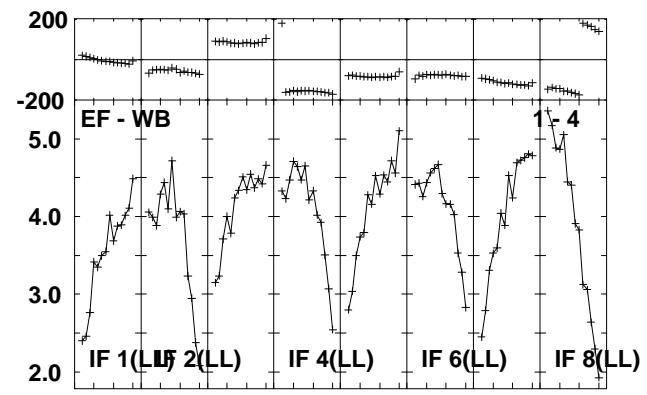
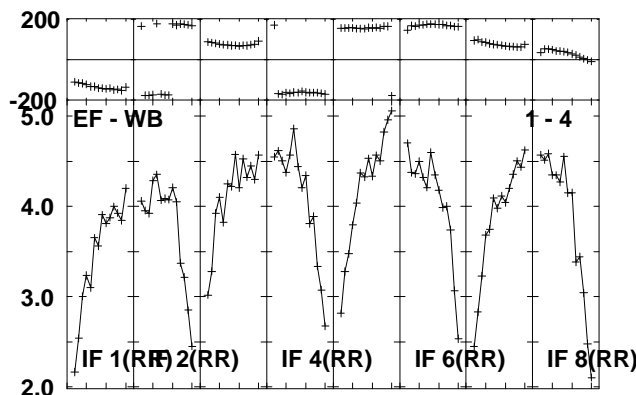
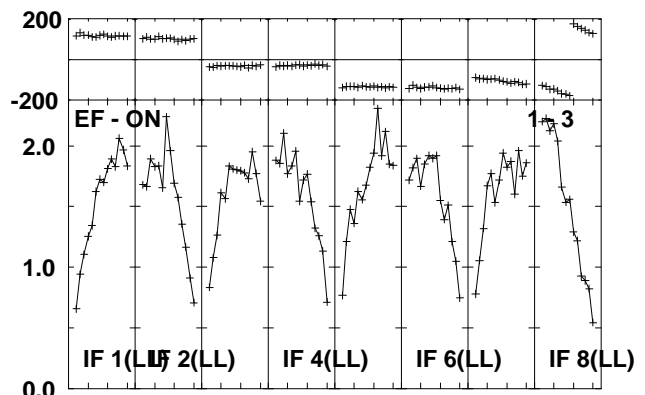
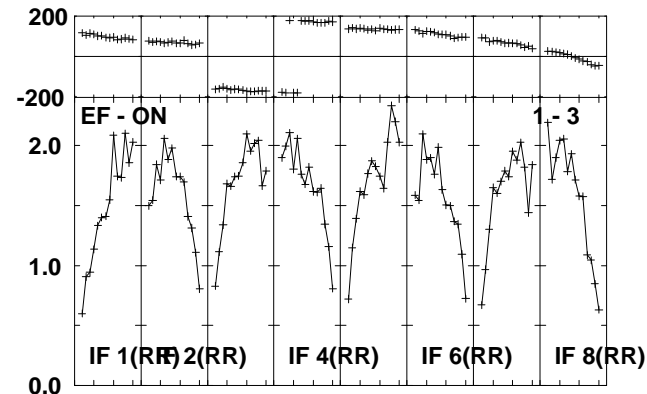
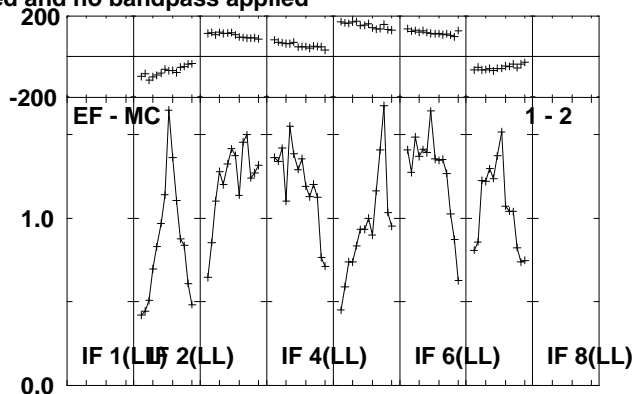
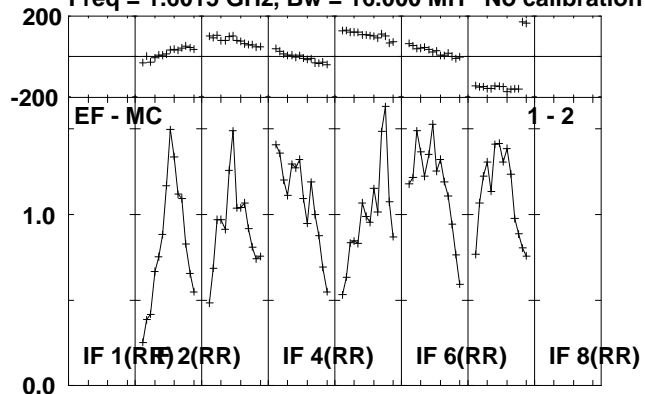

Lower frame: Milli Ampl Jy Top frame: Phas deg
Scalar averaged cross-power spectrum Several baselines displayed
Timerange: 01/02:33:53 to 01/02:36:01

Plot file version 164 created 01-JUL-2010 13:25:53

J2102+47 RG006B.UVDATA.1

Freq = 1.6015 GHz, Bw = 16.000 MH No calibration applied and no bandpass applied

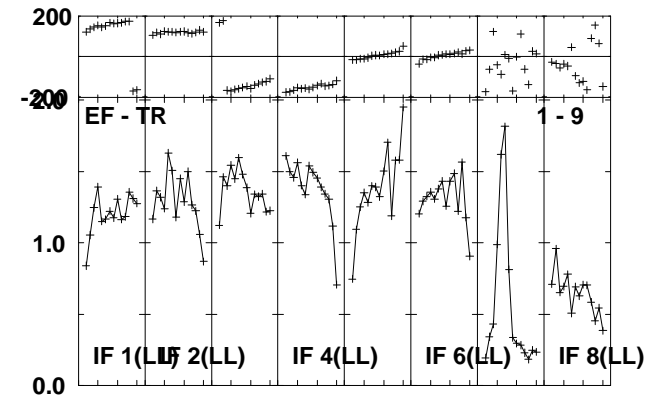
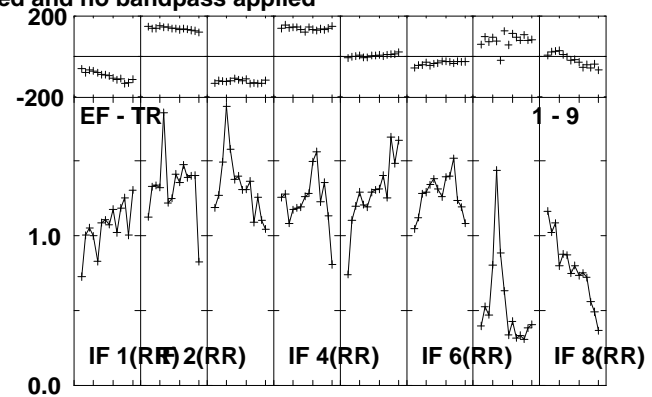
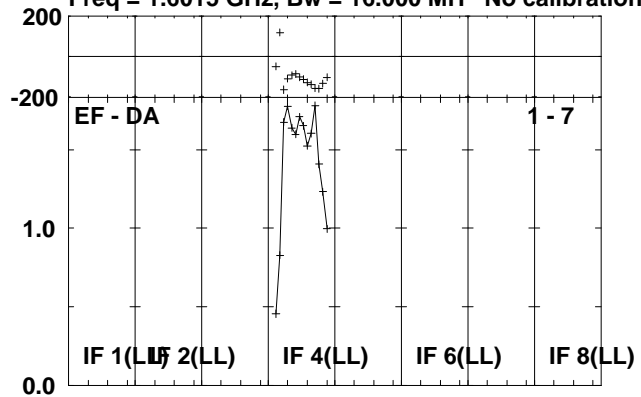

Lower frame: Milli Ampl Jy Top frame: Phas deg
Scalar averaged cross-power spectrum Several baselines displayed
Timerange: 01/02:33:53 to 01/02:36:01

Plot file version 165 created 01-JUL-2010 13:25:53

V407CYG RG006B.UVDATA.1

Freq = 1.6015 GHz, Bw = 16.000 MH No calibration applied and no bandpass applied

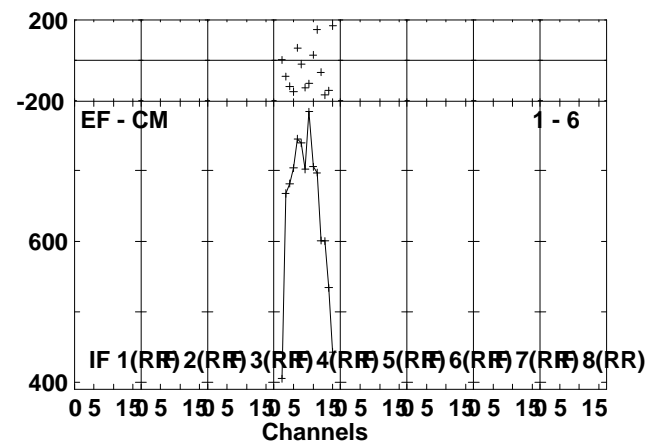
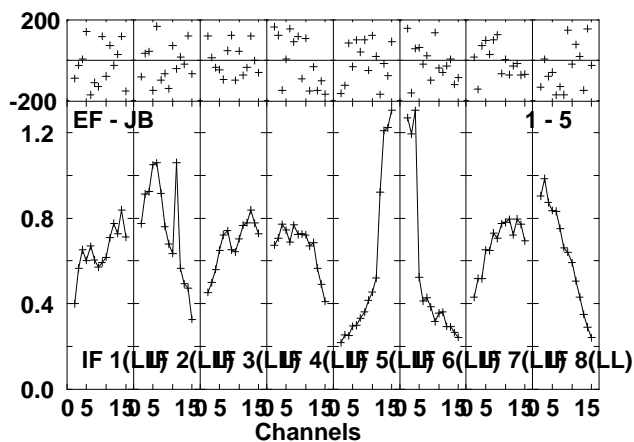
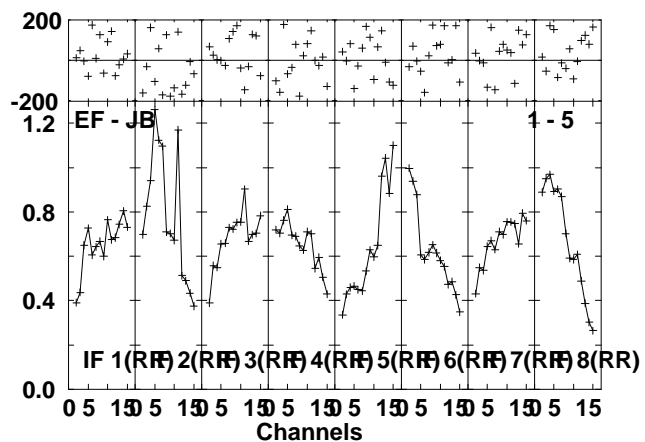
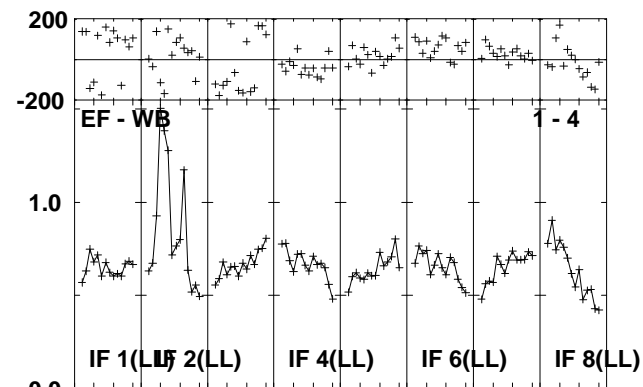
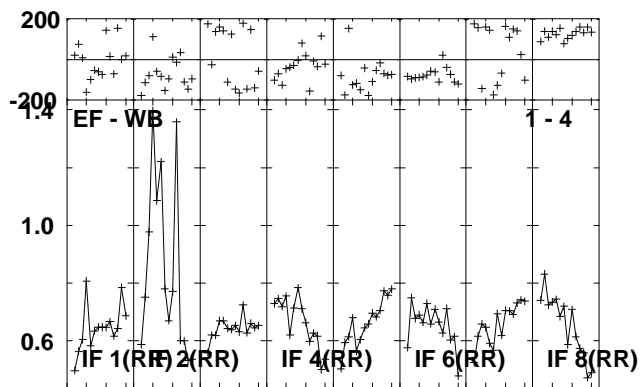
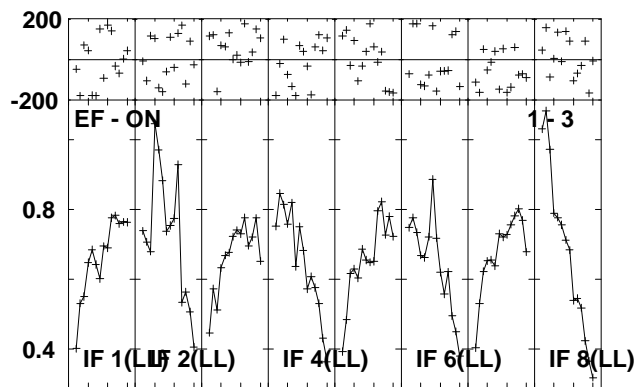
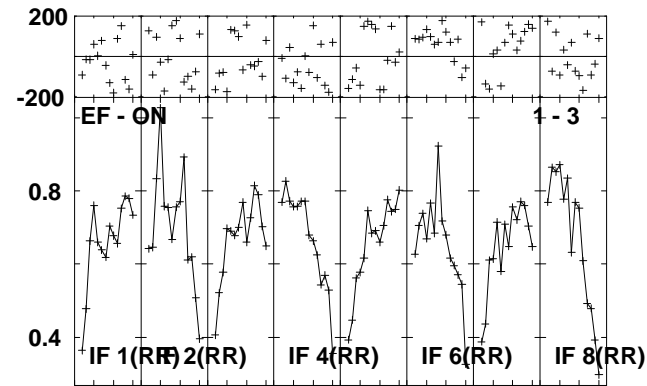
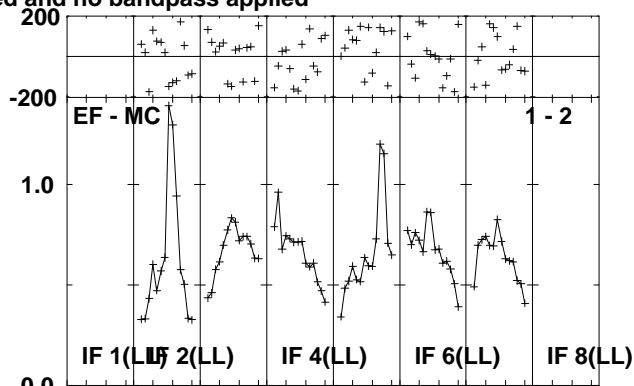
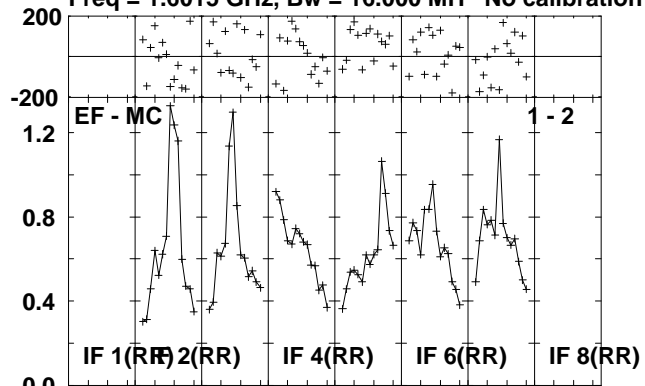

Lower frame: Milli Ampl Jy Top frame: Phas deg
Scalar averaged cross-power spectrum Several baselines displayed
Timerange: 01/02:36:05 to 01/02:41:01

Plot file version 166 created 01-JUL-2010 13:25:54

V407CYG RG006B.UVDATA.1

Freq = 1.6015 GHz, Bw = 16.000 MH No calibration applied and no bandpass applied

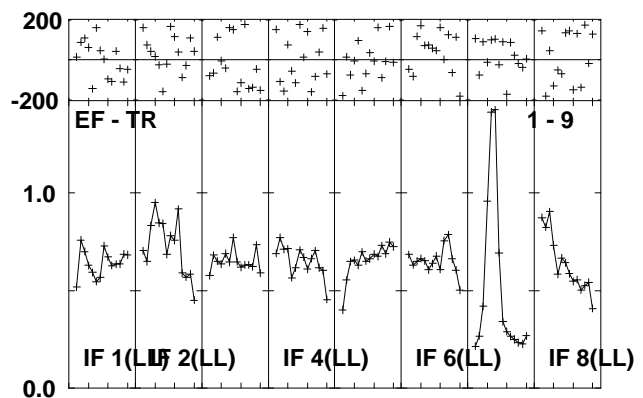
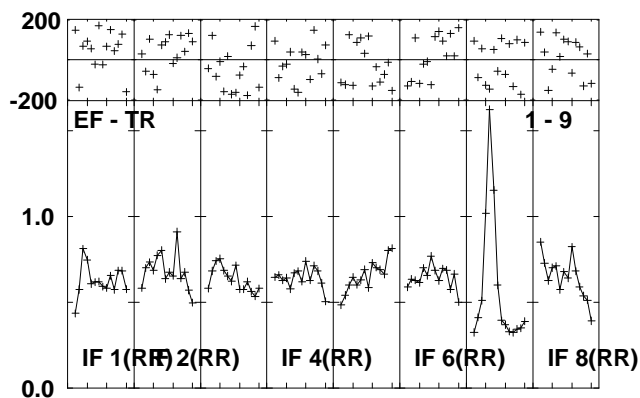
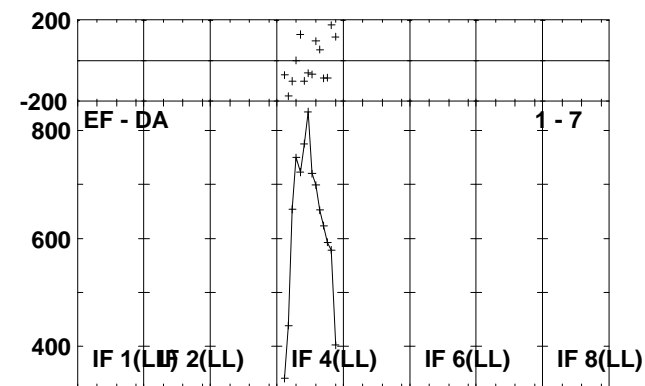
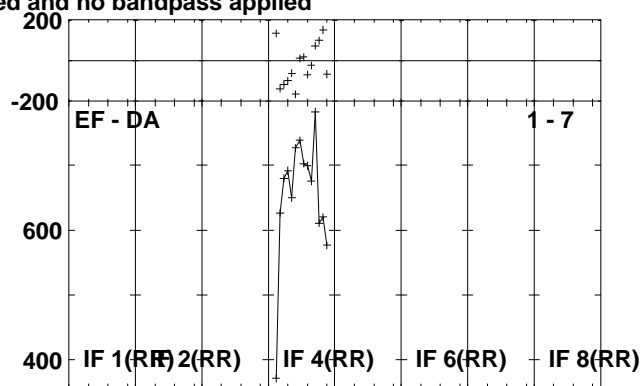
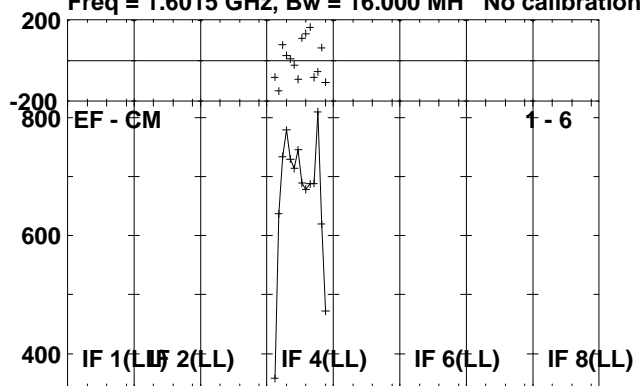

Lower frame: Micro Ampl Jy Top frame: Phas deg
Scalar averaged cross-power spectrum Several baselines displayed
Timerange: 01/02:36:05 to 01/02:41:01

Plot file version 167 created 01-JUL-2010 13:25:55

J2102+47 RG006B.UVDATA.1

Freq = 1.6015 GHz, Bw = 16.000 MH No calibration applied and no bandpass applied

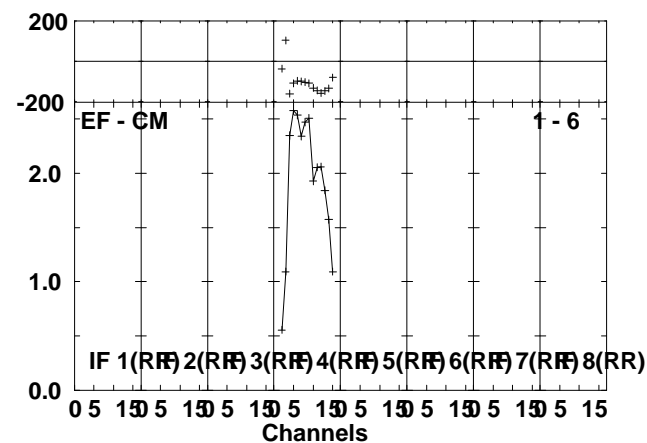
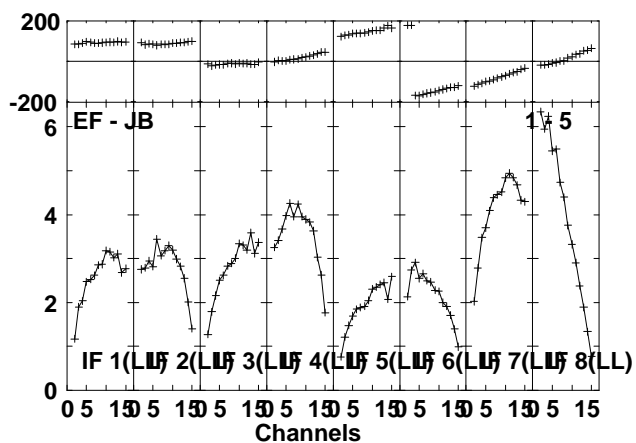
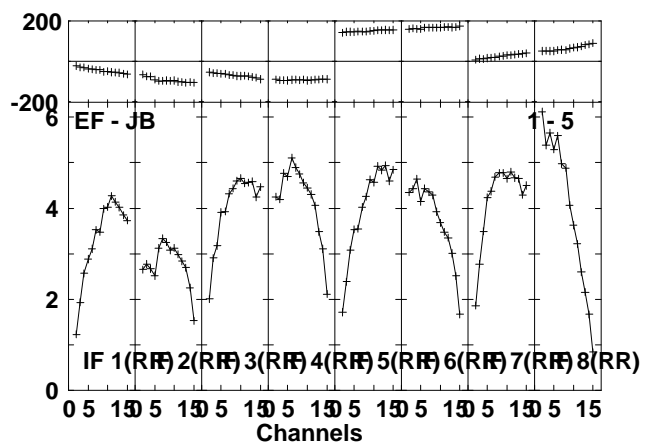
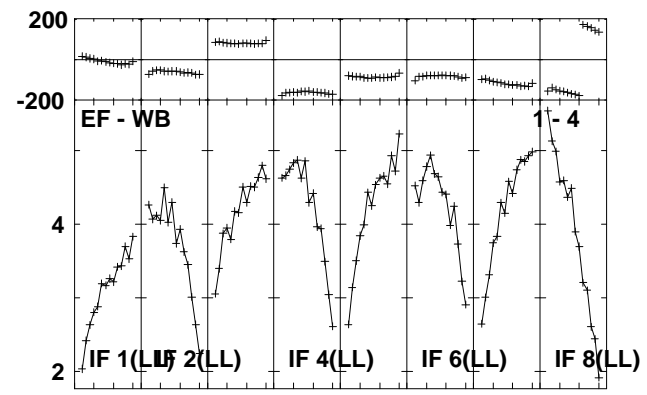
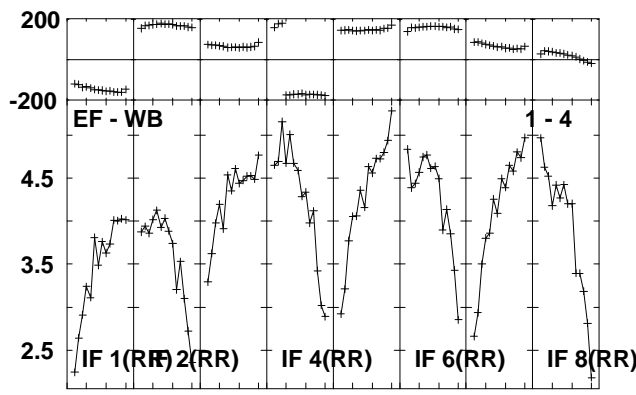
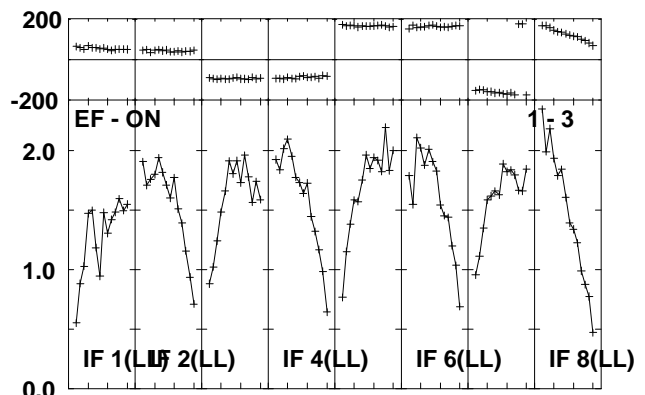
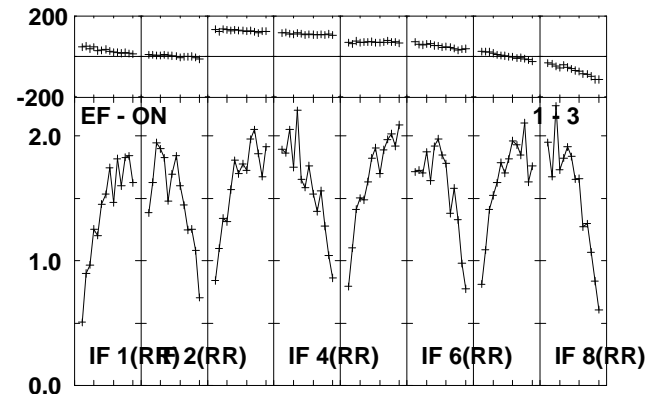
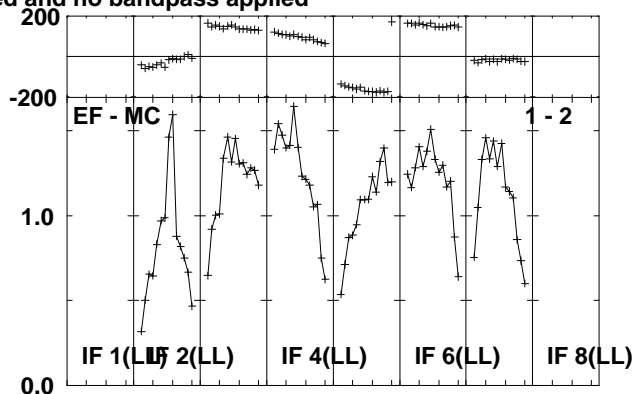
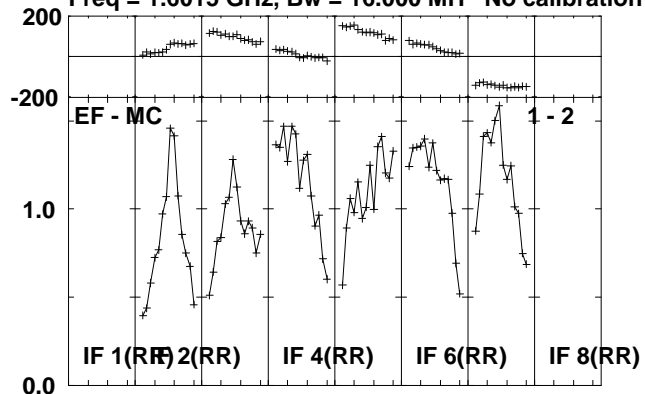

Lower frame: Milli Ampl Jy Top frame: Phas deg
Scalar averaged cross-power spectrum Several baselines displayed
Timerange: 01/02:42:05 to 01/02:43:49

Plot file version 168 created 01-JUL-2010 13:25:55

J2102+47 RG006B.UVDATA.1

Freq = 1.6015 GHz, Bw = 16.000 MH No calibration applied and no bandpass applied

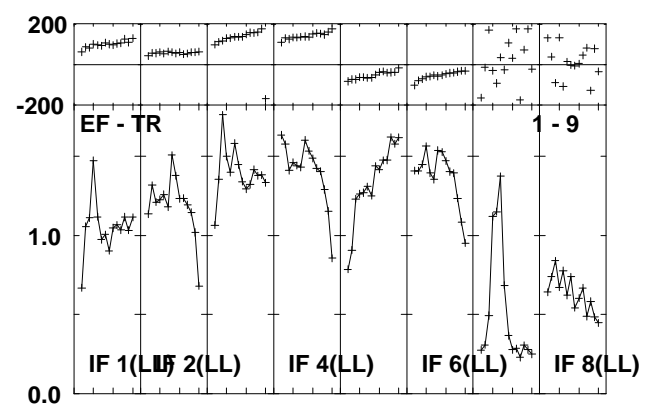
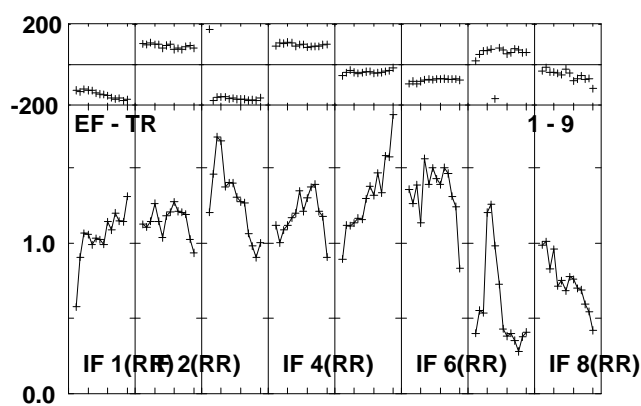
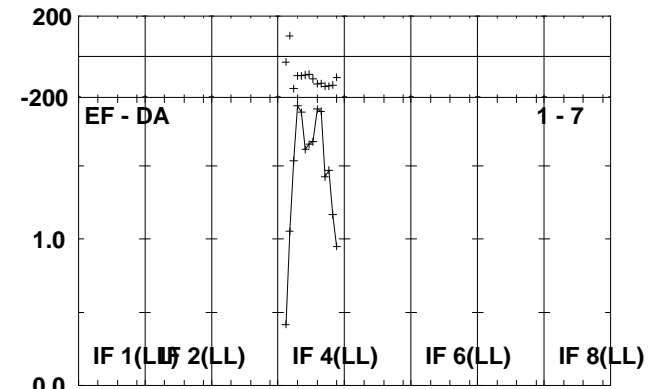
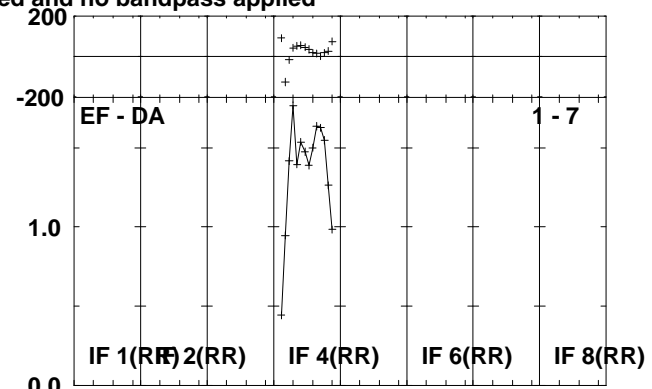
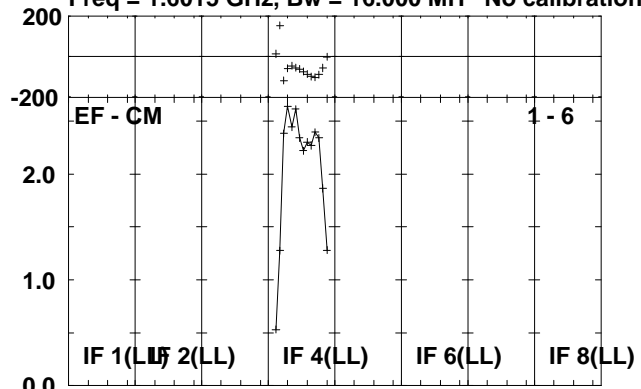

Lower frame: Milli Ampl Jy Top frame: Phas deg
Scalar averaged cross-power spectrum Several baselines displayed
Timerange: 01/02:42:05 to 01/02:43:49

Plot file version 169 created 01-JUL-2010 13:25:56

V407CYG RG006B.UVDATA.1

Freq = 1.6015 GHz, Bw = 16.000 MH No calibration applied and no bandpass applied

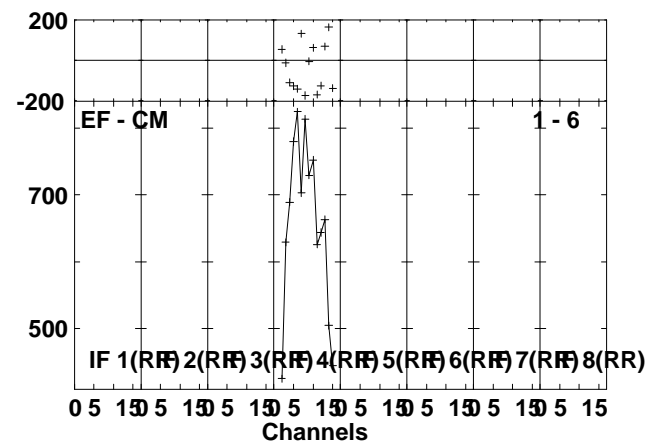
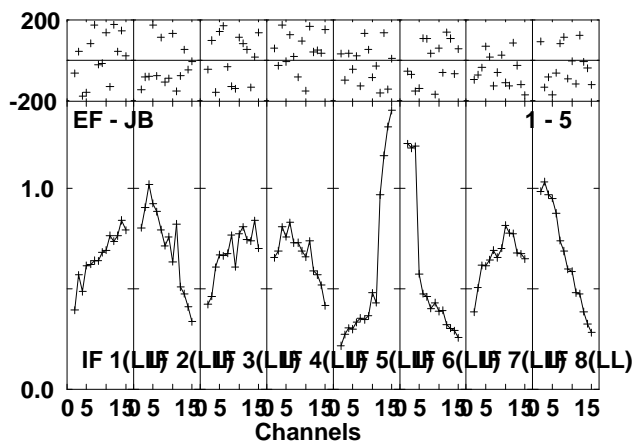
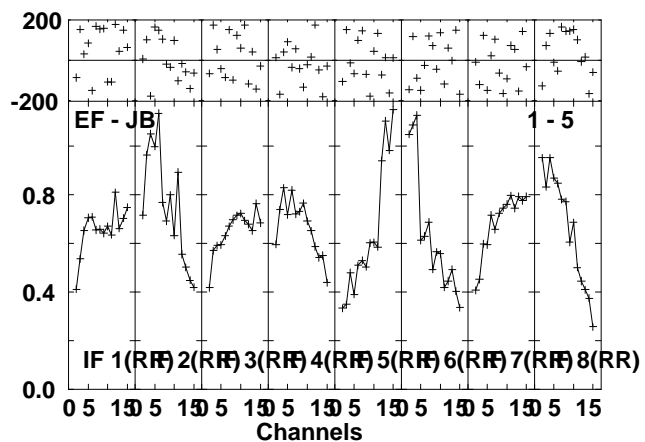
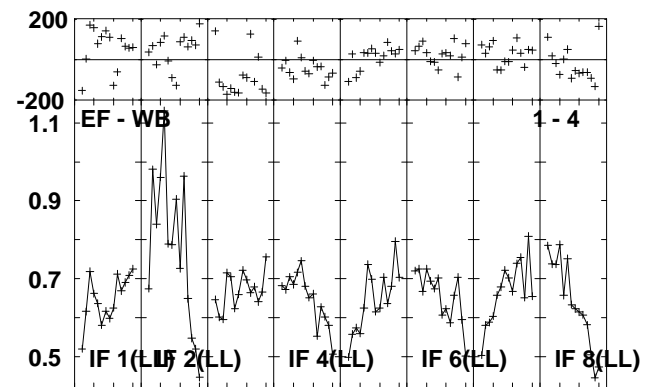
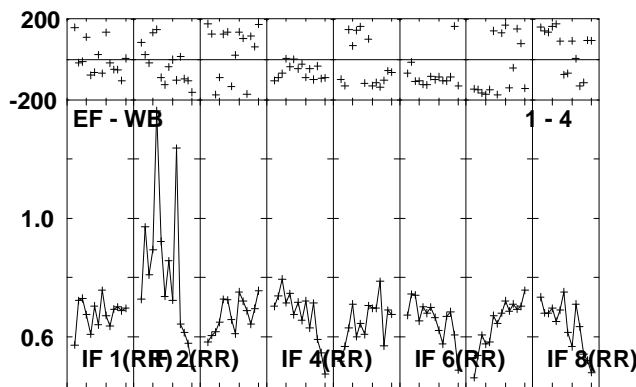
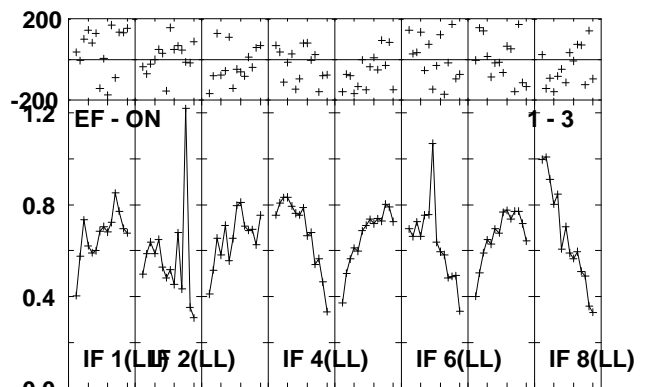
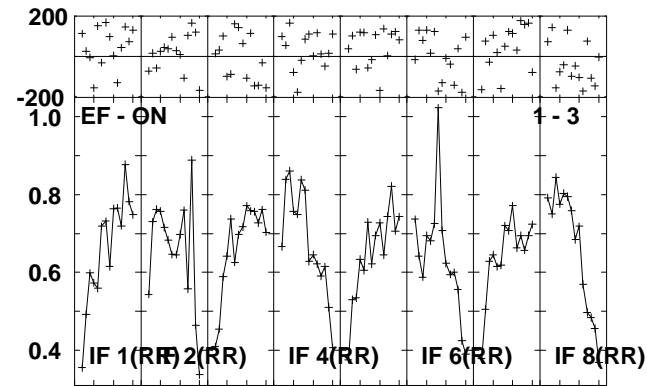
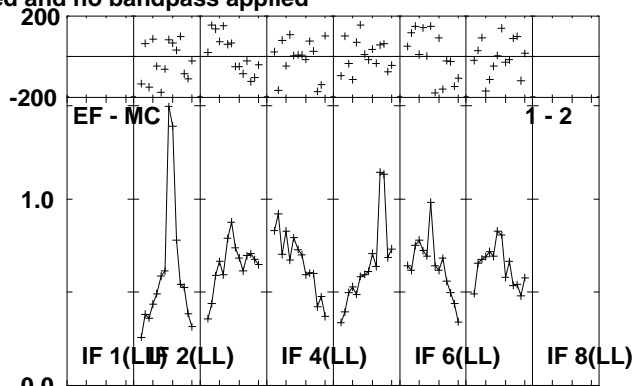
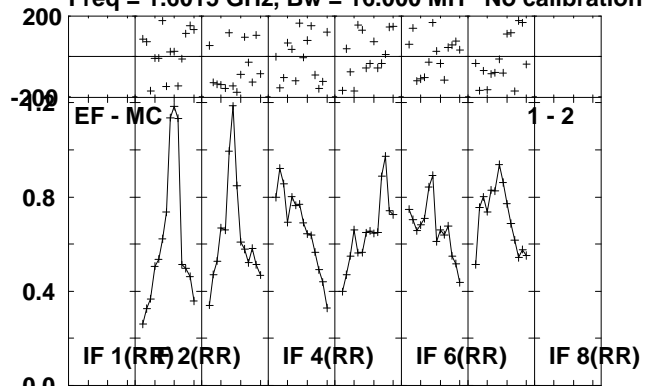

Lower frame: Milli Ampl Jy Top frame: Phas deg
Scalar averaged cross-power spectrum Several baselines displayed
Timerange: 01/02:43:53 to 01/02:48:49

Plot file version 170 created 01-JUL-2010 13:25:56

V407CYG RG006B.UVDATA.1

Freq = 1.6015 GHz, Bw = 16.000 MH No calibration applied and no bandpass applied

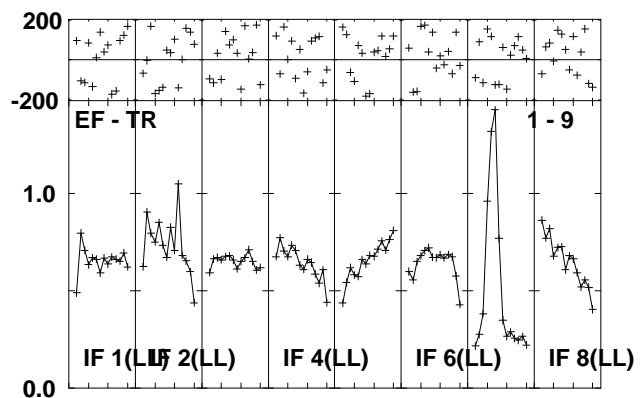
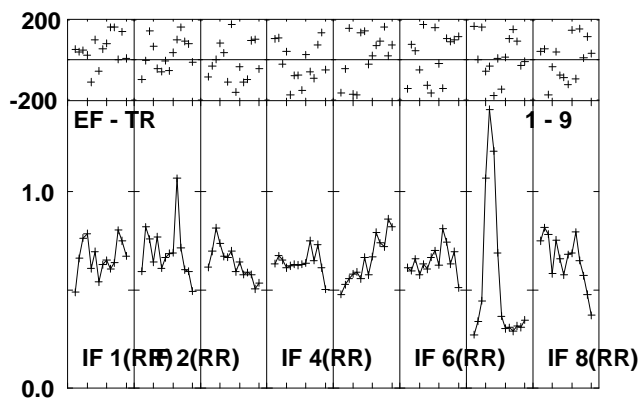
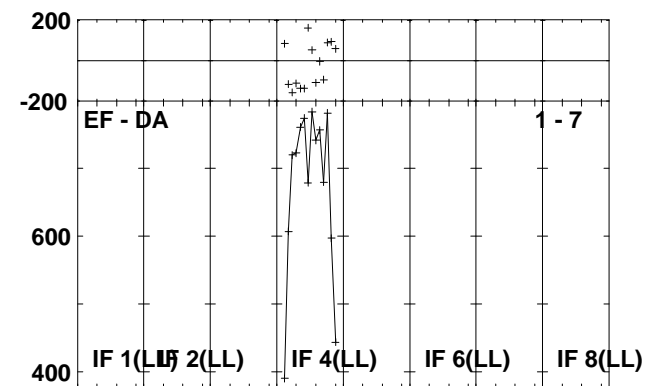
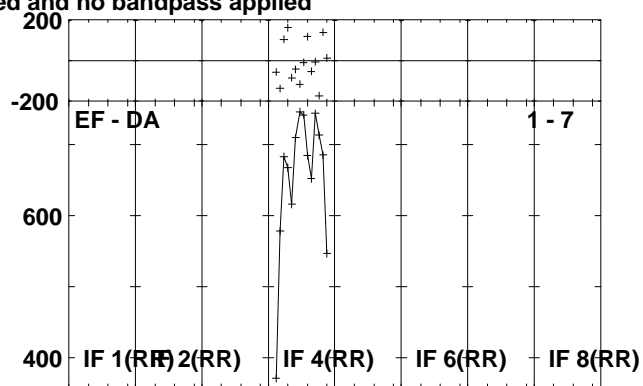
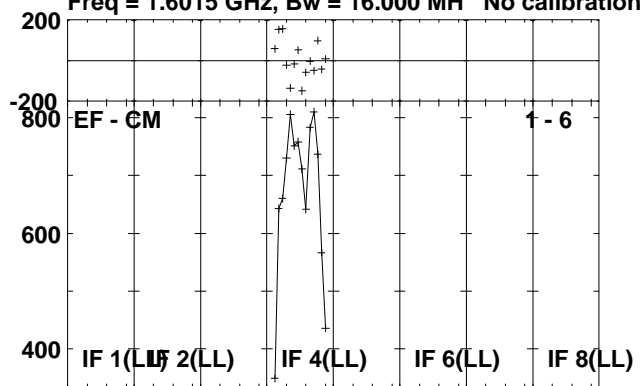

Lower frame: Micro Ampl Jy Top frame: Phas deg
Scalar averaged cross-power spectrum Several baselines displayed
Timerange: 01/02:43:53 to 01/02:48:49

Plot file version 171 created 01-JUL-2010 13:25:57

J2102+47 RG006B.UVDATA.1

Freq = 1.6015 GHz, Bw = 16.000 MH No calibration applied and no bandpass applied

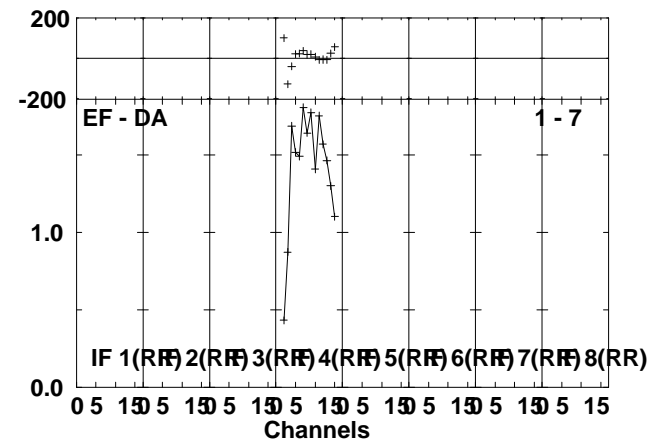
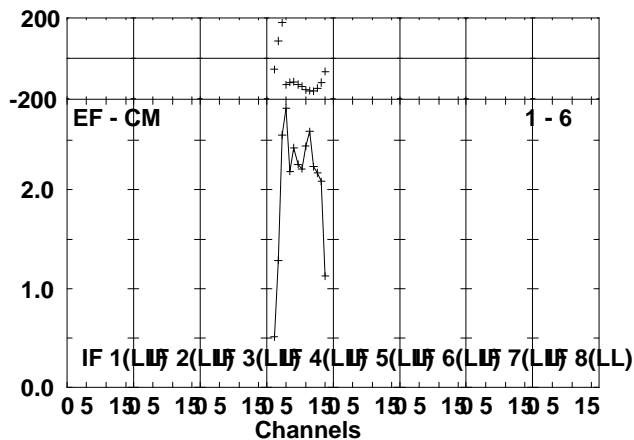
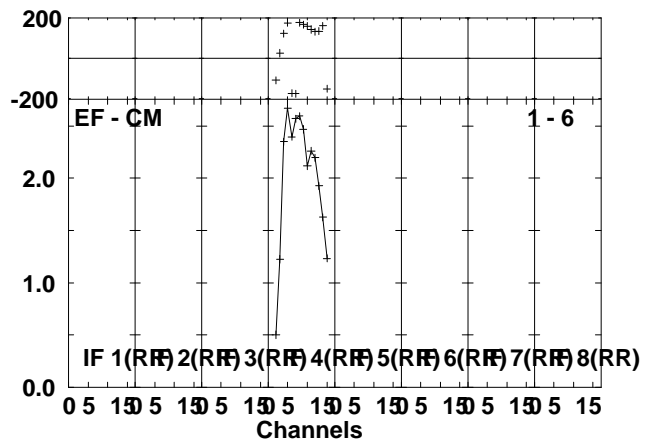
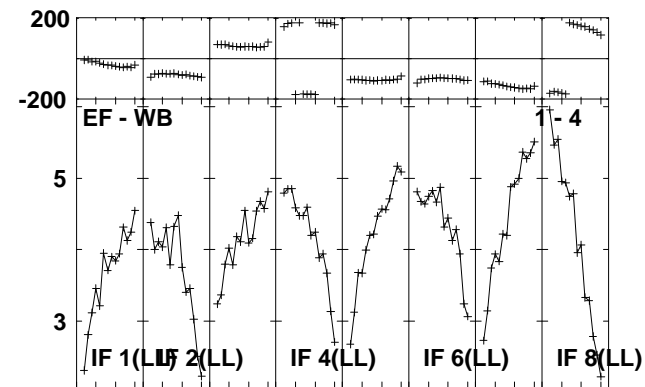
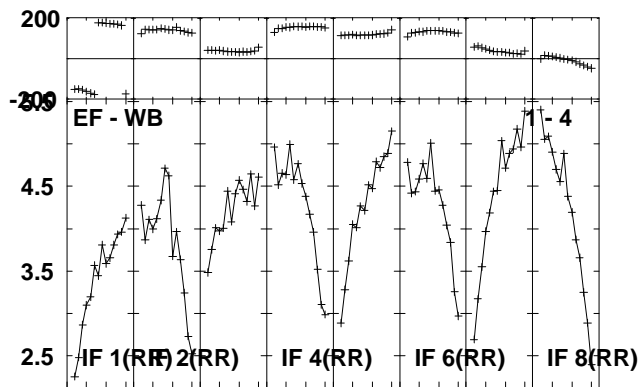
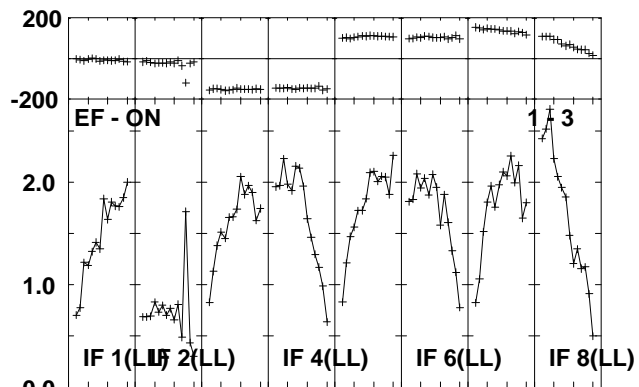
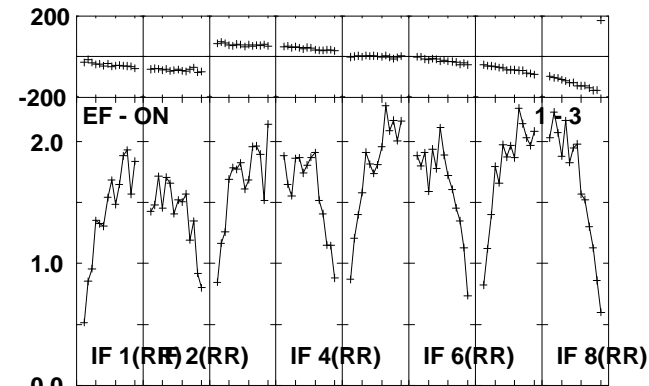
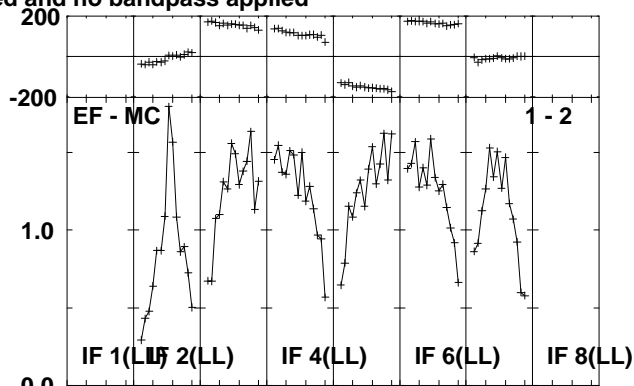
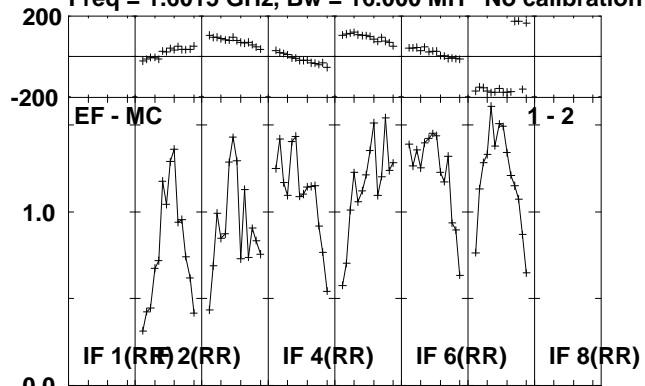

Lower frame: Milli Ampl Jy Top frame: Phas deg
Scalar averaged cross-power spectrum Several baselines displayed
Timerange: 01/02:48:53 to 01/02:51:01

Plot file version 172 created 01-JUL-2010 13:25:58

J2102+47 RG006B.UVDATA.1

Freq = 1.6015 GHz, Bw = 16.000 MH No calibration applied and no bandpass applied

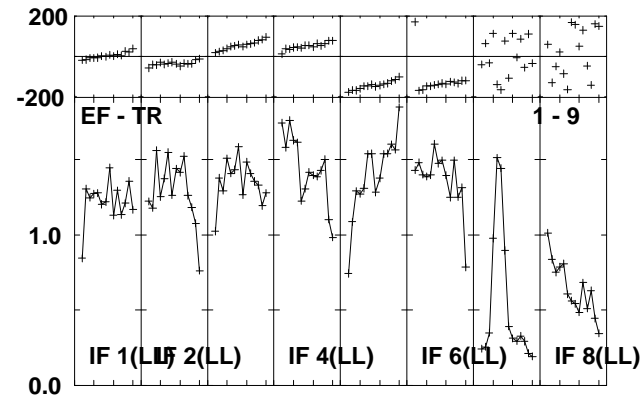
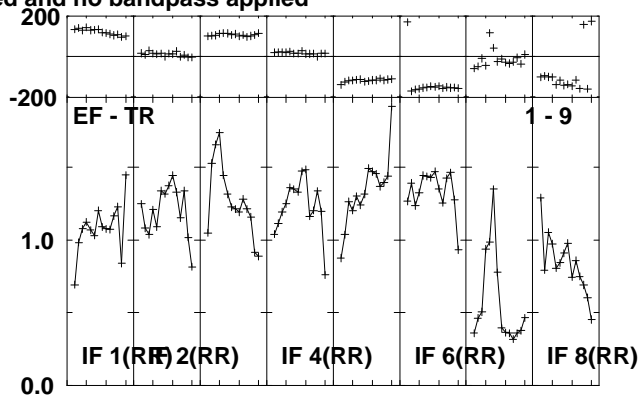
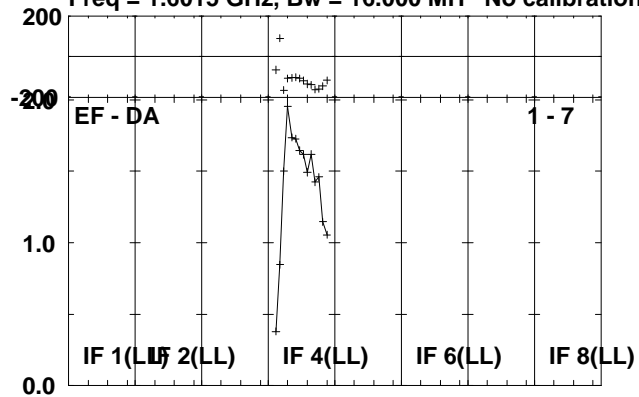

Lower frame: Milli Ampl Jy Top frame: Phas deg
Scalar averaged cross-power spectrum Several baselines displayed
Timerange: 01/02:48:53 to 01/02:51:01

Plot file version 173 created 01-JUL-2010 13:25:58

V407CYG RG006B.UVDATA.1

Freq = 1.6015 GHz, Bw = 16.000 MH No calibration applied and no bandpass applied

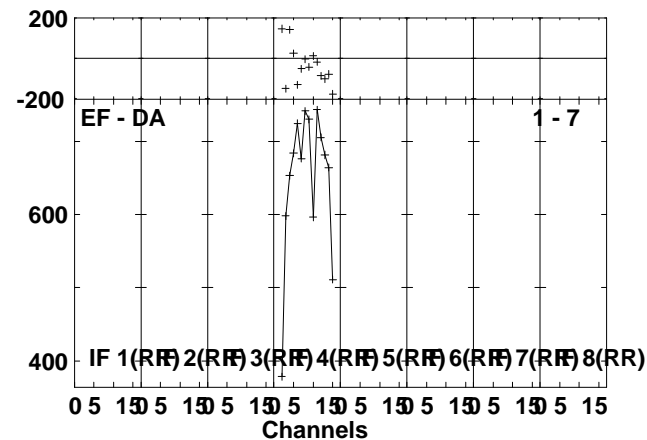
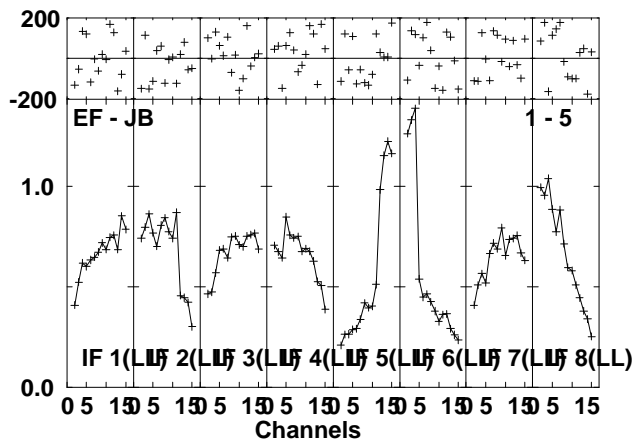
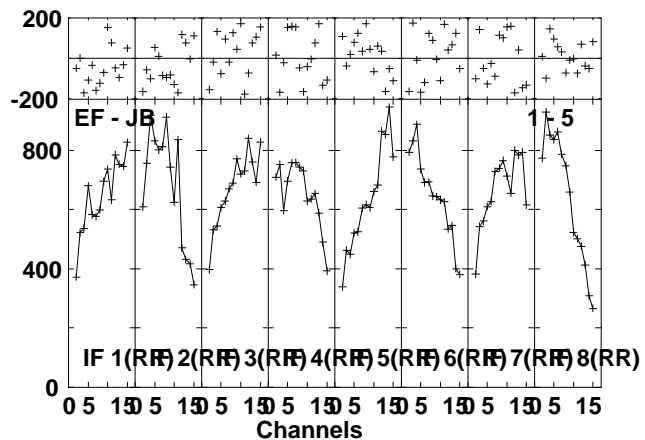
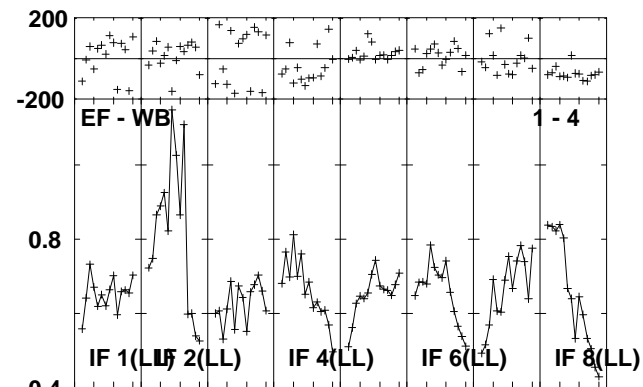
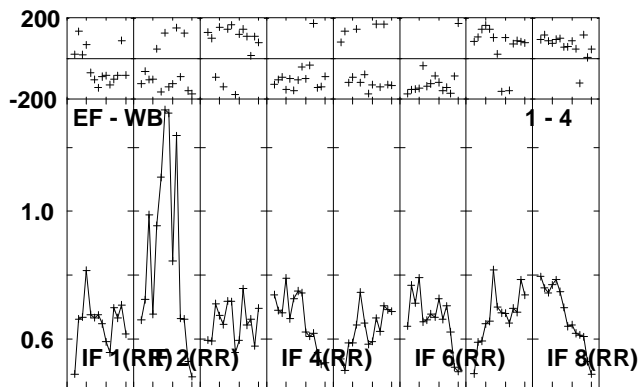
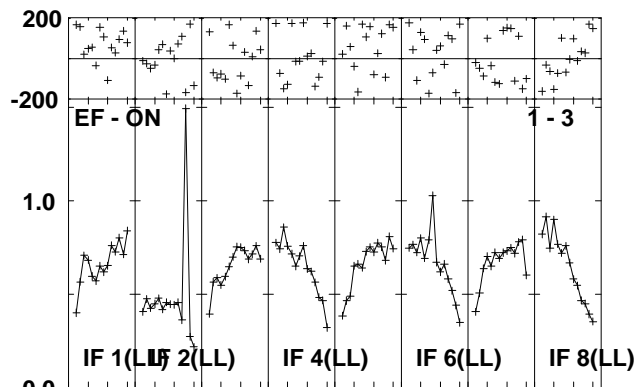
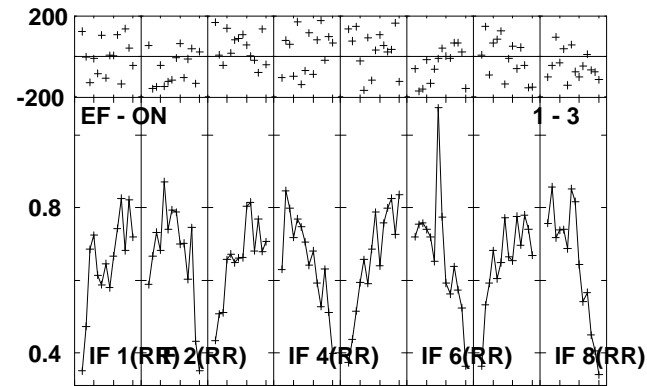
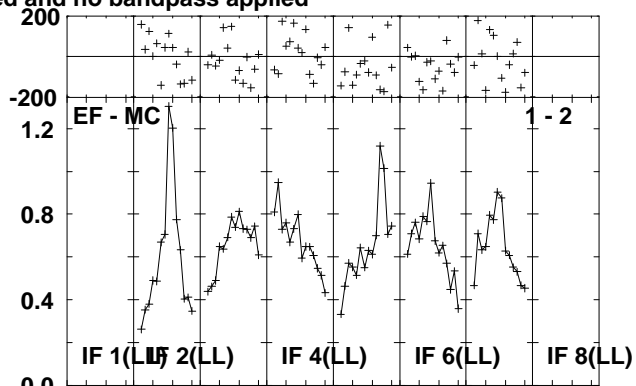
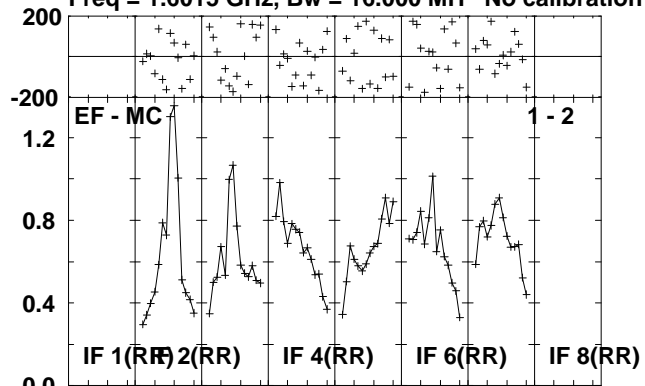

Lower frame: Milli Ampl Jy Top frame: Phas deg
Scalar averaged cross-power spectrum Several baselines displayed
Timerange: 01/02:51:05 to 01/02:56:01

Plot file version 174 created 01-JUL-2010 13:25:59

V407CYG RG006B.UVDATA.1

Freq = 1.6015 GHz, Bw = 16.000 MH No calibration applied and no bandpass applied

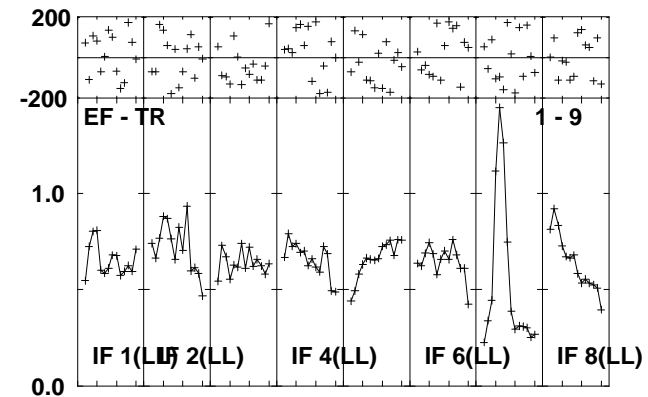
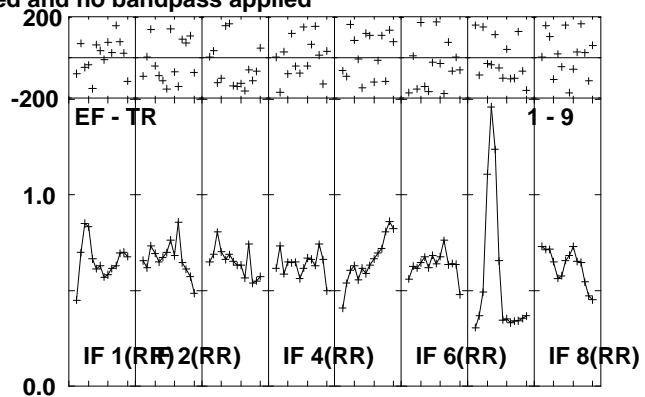
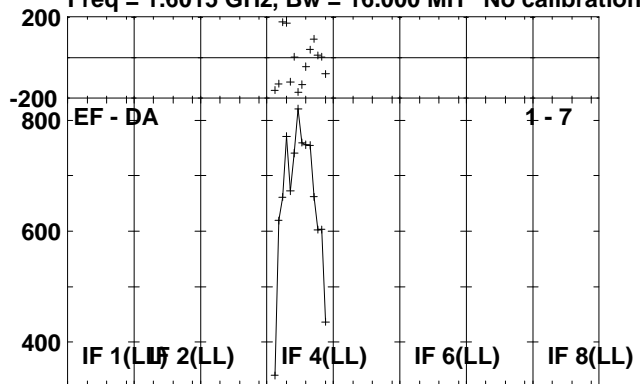

Lower frame: Micro Ampl Jy Top frame: Phas deg
Scalar averaged cross-power spectrum Several baselines displayed
Timerange: 01/02:51:05 to 01/02:56:01

Plot file version 175 created 01-JUL-2010 13:26:00

J2102+47 RG006B.UVDATA.1

Freq = 1.6015 GHz, Bw = 16.000 MH No calibration applied and no bandpass applied

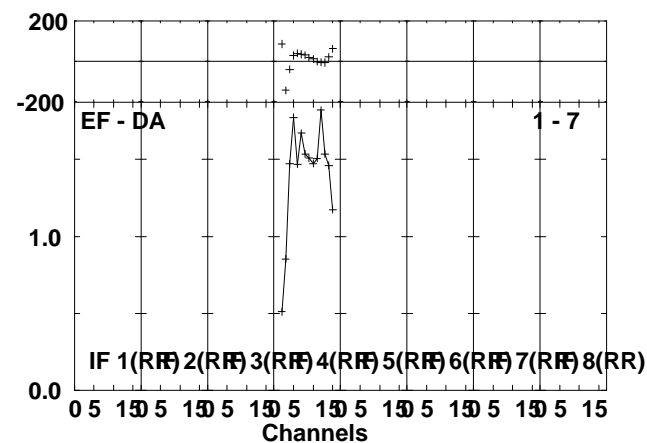
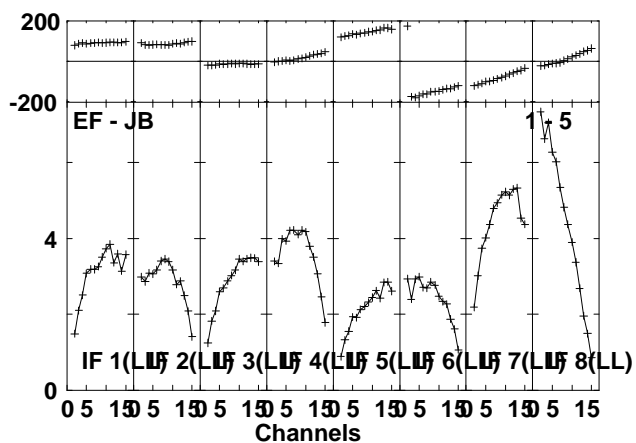
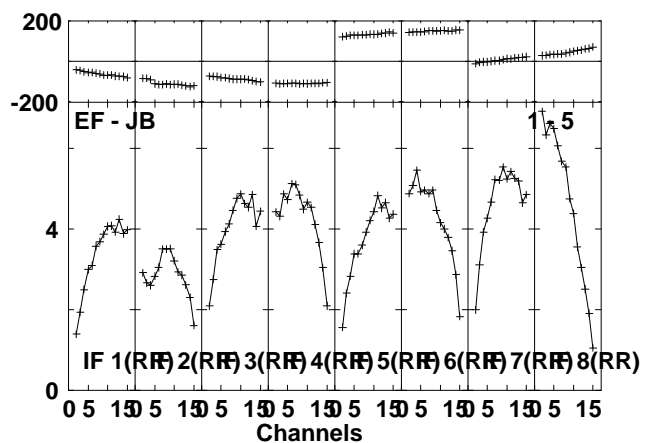
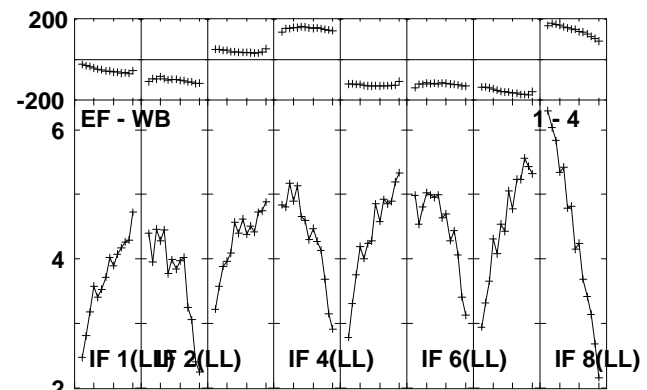
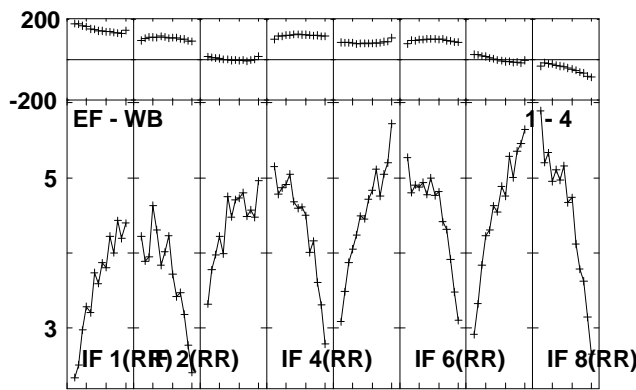
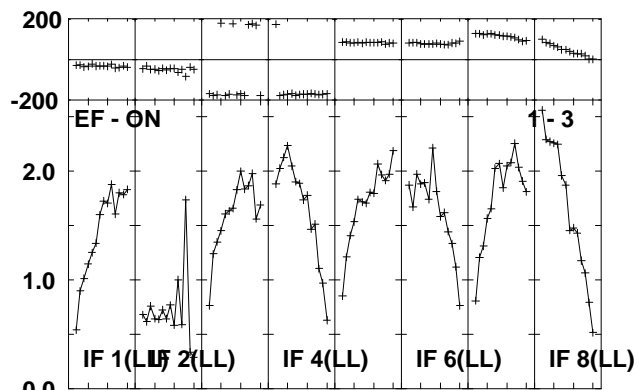
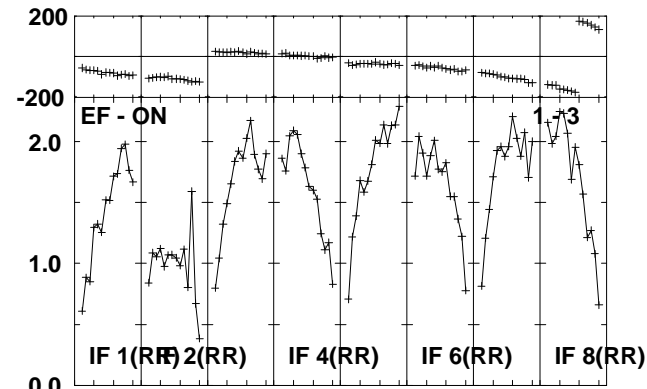
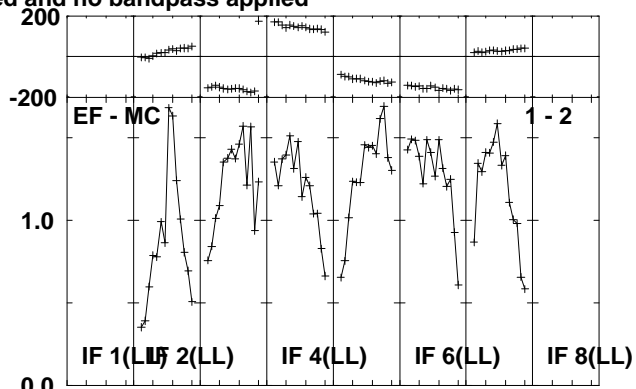
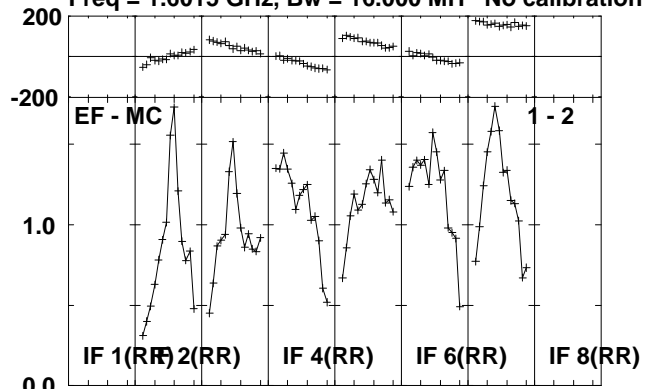

Lower frame: Milli Ampl Jy Top frame: Phas deg
Scalar averaged cross-power spectrum Several baselines displayed
Timerange: 01/02:57:05 to 01/02:58:49

Plot file version 176 created 01-JUL-2010 13:26:00

J2102+47 RG006B.UVDATA.1

Freq = 1.6015 GHz, Bw = 16.000 MH No calibration applied and no bandpass applied

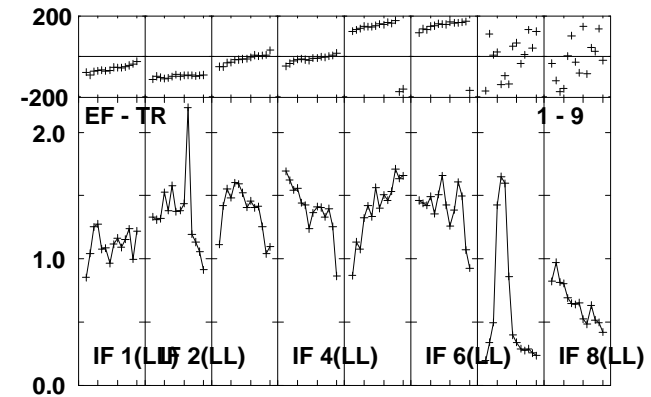
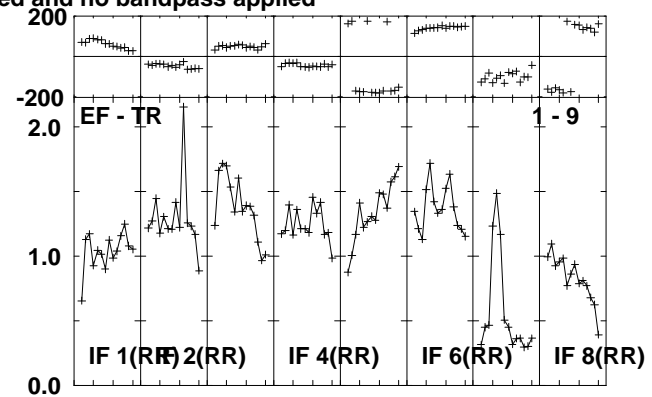
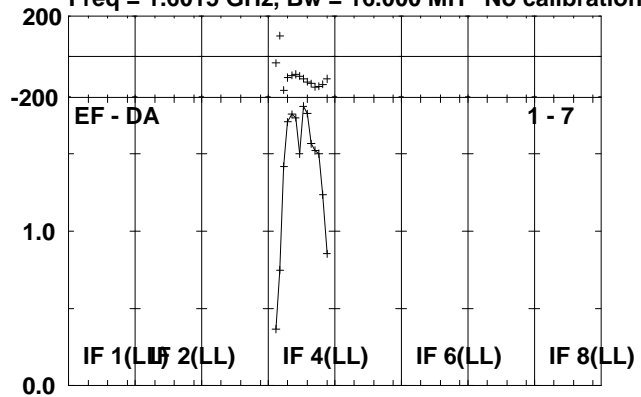

Lower frame: Milli Ampl Jy Top frame: Phas deg
Scalar averaged cross-power spectrum Several baselines displayed
Timerange: 01/02:57:05 to 01/02:58:49

Plot file version 177 created 01-JUL-2010 13:26:01

V407CYG RG006B.UVDATA.1

Freq = 1.6015 GHz, Bw = 16.000 MH No calibration applied and no bandpass applied

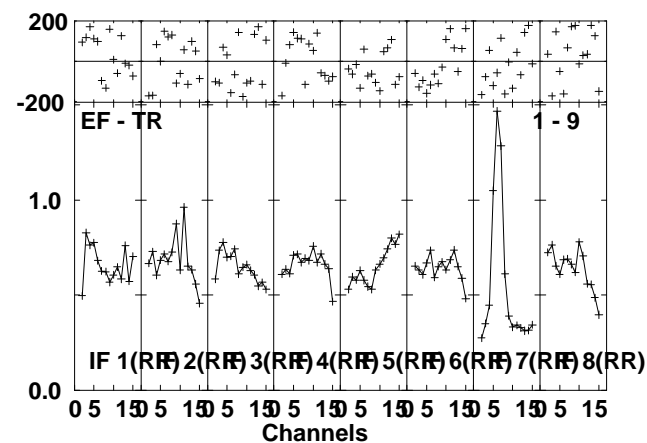
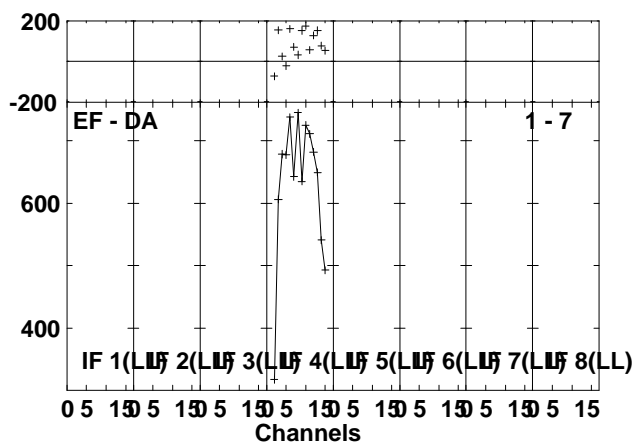
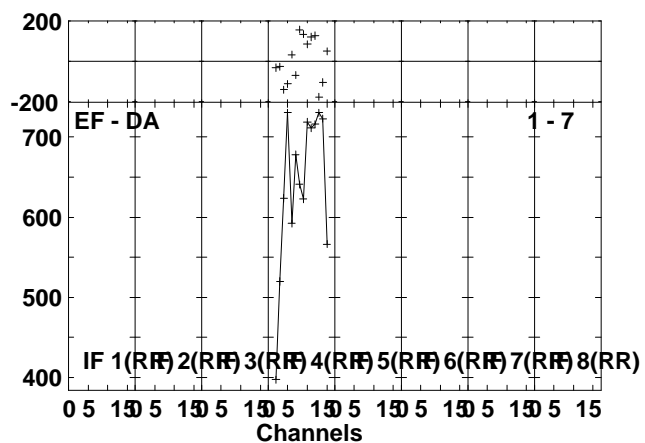
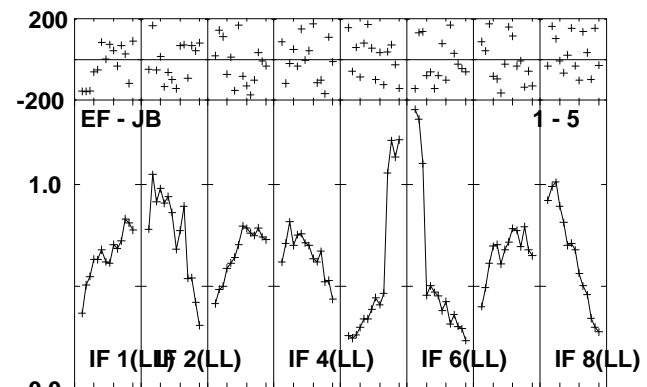
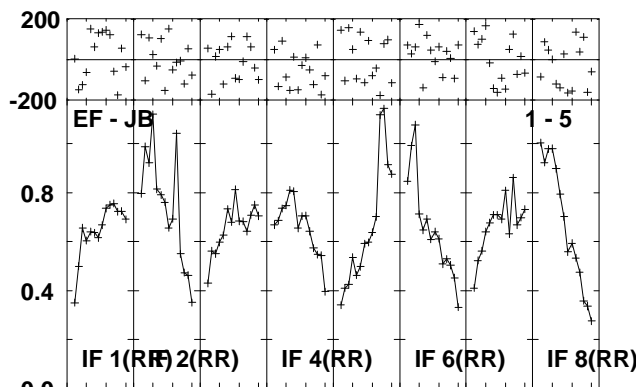
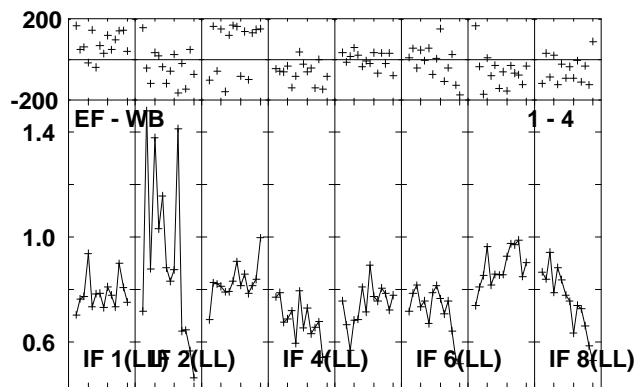
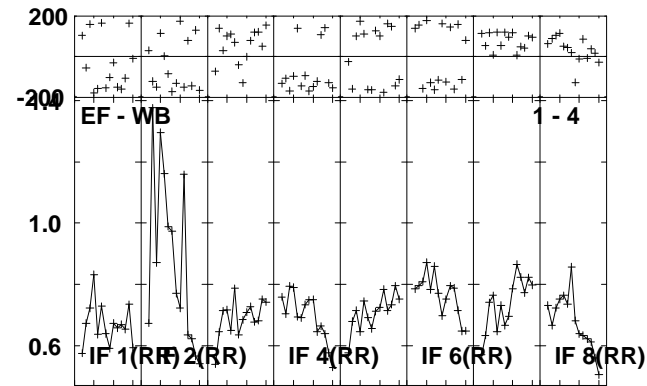
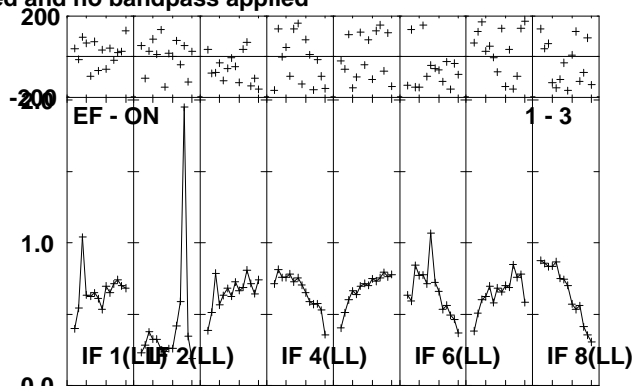
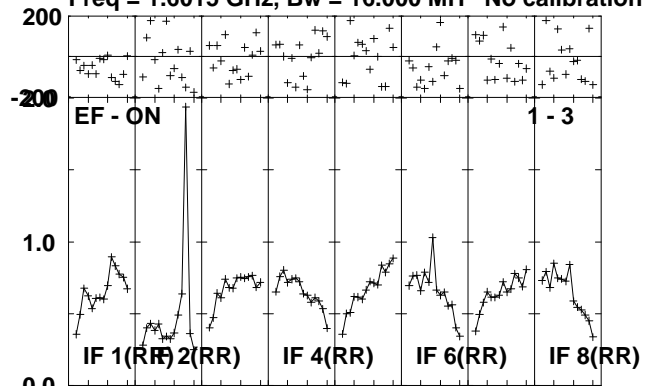

Lower frame: Milli Ampl Jy Top frame: Phas deg
Scalar averaged cross-power spectrum Several baselines displayed
Timerange: 01/02:58:53 to 01/03:03:49

Plot file version 178 created 01-JUL-2010 13:26:02

V407CYG RG006B.UVDATA.1

Freq = 1.6015 GHz, Bw = 16.000 MH No calibration applied and no bandpass applied

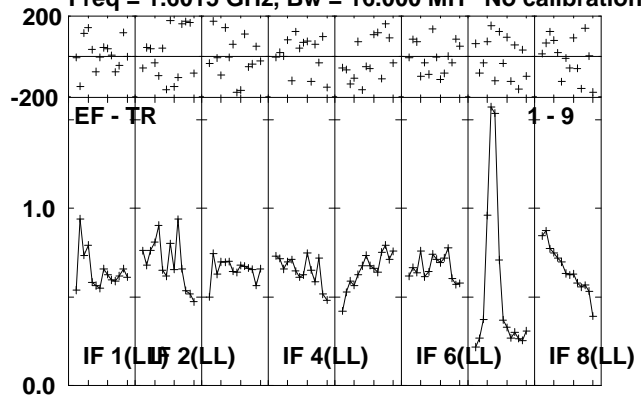

Lower frame: Milli Ampl Jy Top frame: Phas deg
Scalar averaged cross-power spectrum Several baselines displayed
Timerange: 01/02:58:53 to 01/03:03:49

Plot file version 179 created 01-JUL-2010 13:26:02

J2102+47 RG006B.UVDATA.1

Freq = 1.6015 GHz, Bw = 16.000 MH No calibration applied and no bandpass applied

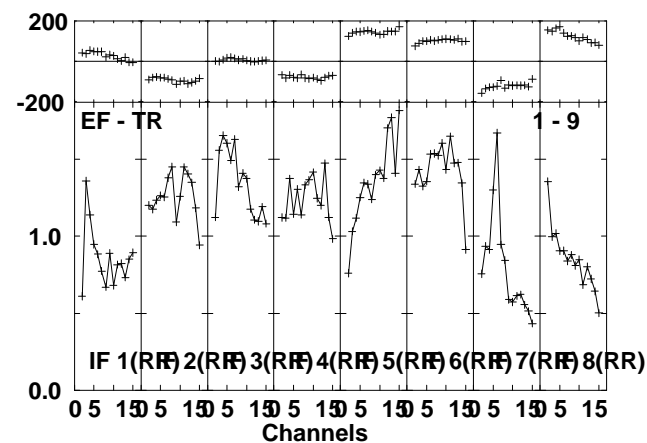
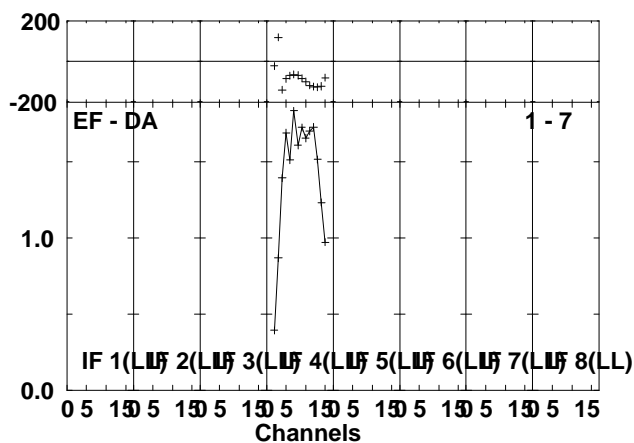
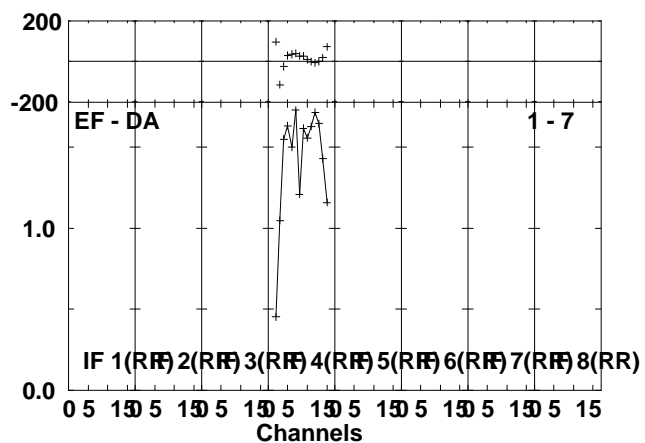
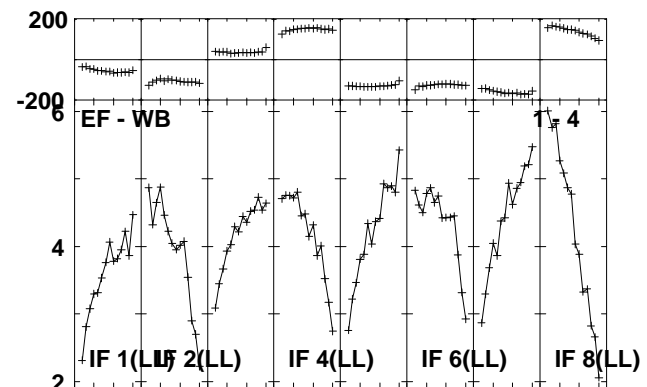
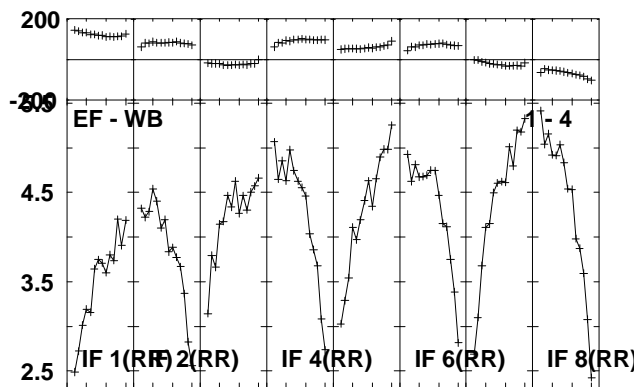
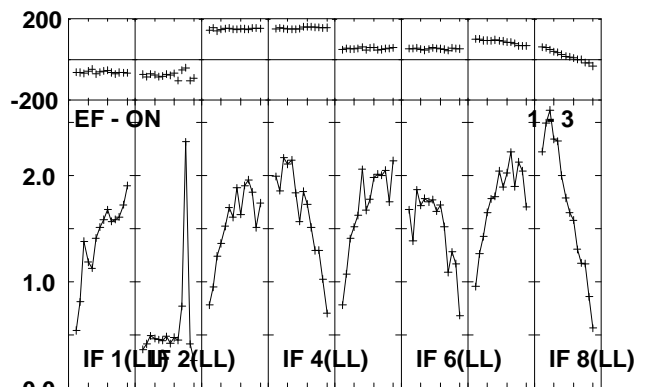
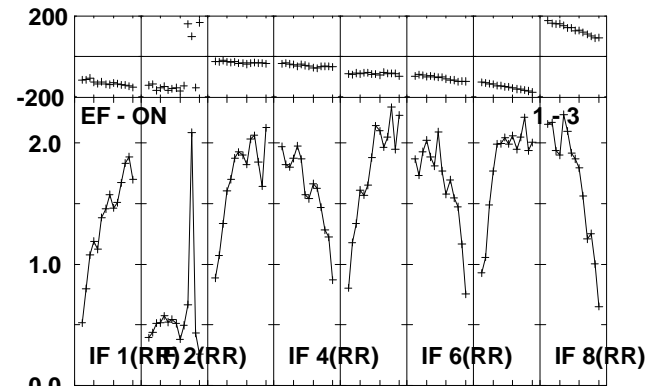
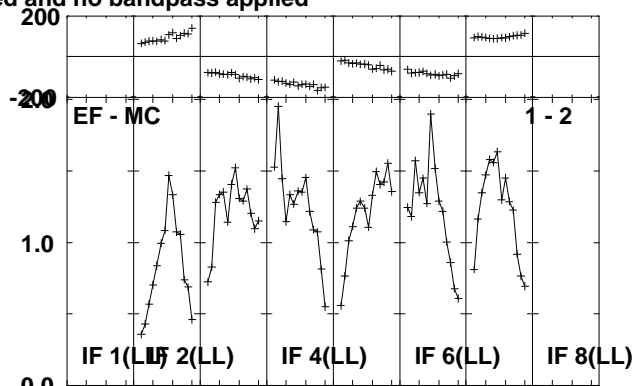
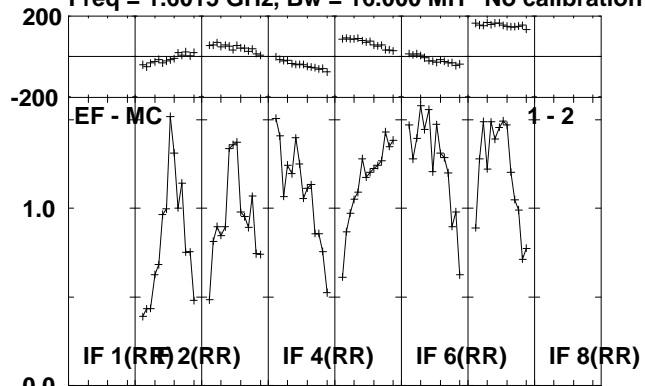

Lower frame: Milli Ampl Jy Top frame: Phas deg
Scalar averaged cross-power spectrum Several baselines displayed
Timerange: 01/03:03:53 to 01/03:06:01

Plot file version 180 created 01-JUL-2010 13:26:03
J2102+47 RG006B.UVDATA.1
Freq = 1.6015 GHz, Bw = 16.000 MH No calibration applied and no bandpass applied

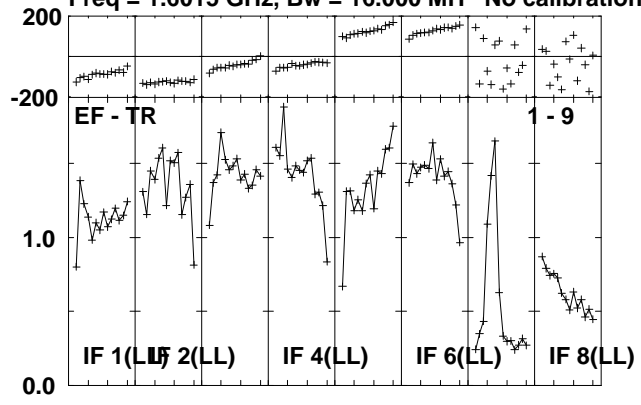

Lower frame: Milli Ampl Jy Top frame: Phas deg
Scalar averaged cross-power spectrum Several baselines displayed
Timerange: 01/03:03:53 to 01/03:06:01

Plot file version 181 created 01-JUL-2010 13:26:03

V407CYG RG006B.UVDATA.1

Freq = 1.6015 GHz, Bw = 16.000 MH No calibration applied and no bandpass applied

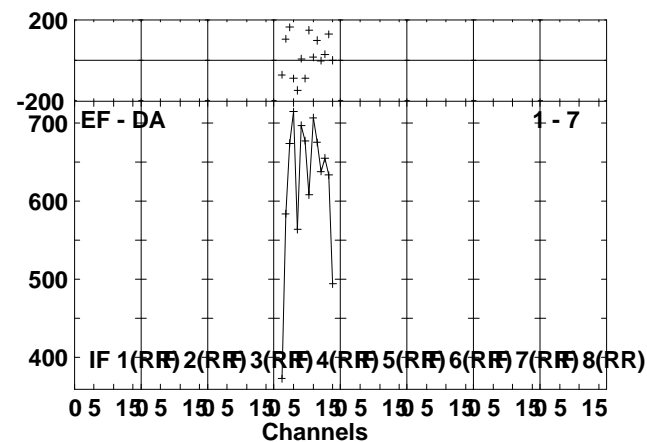
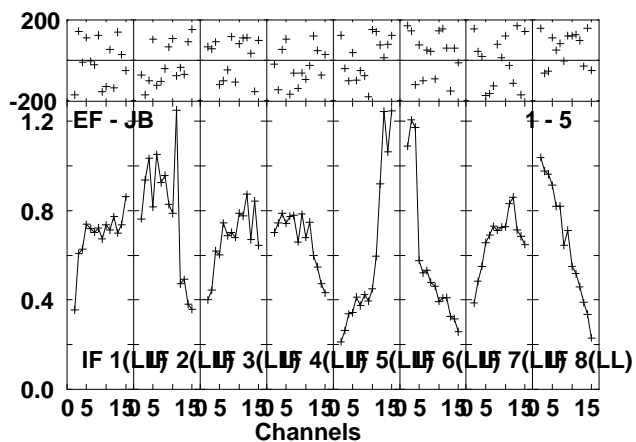
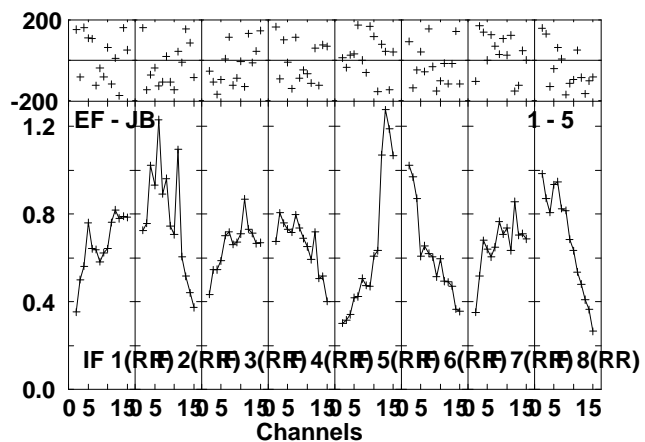
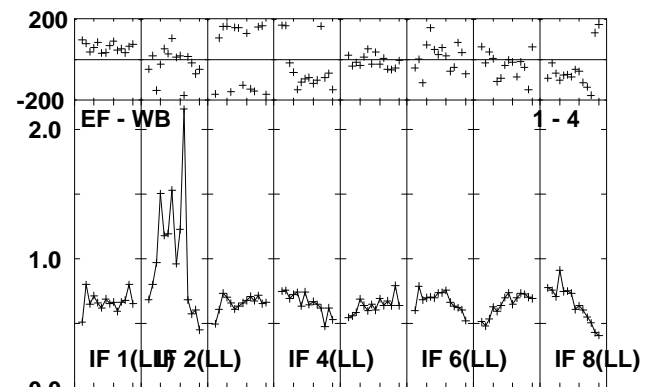
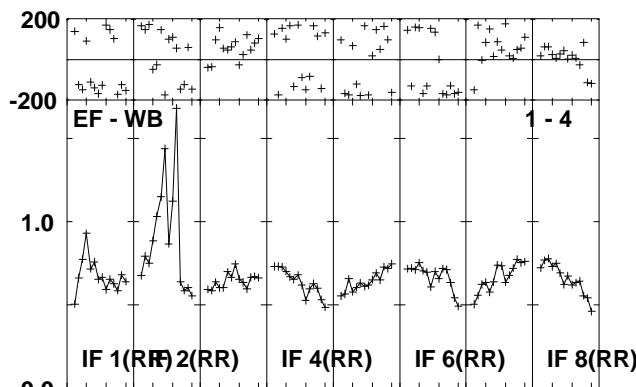
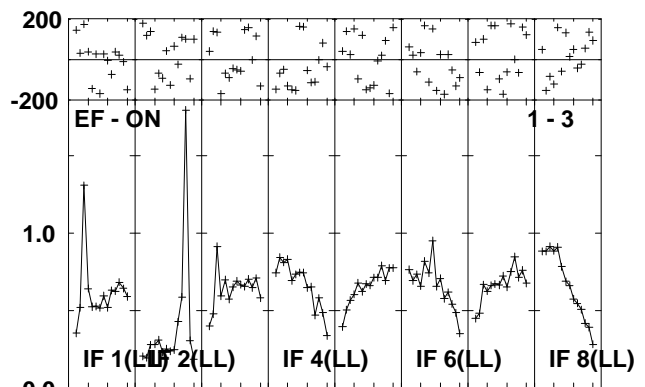
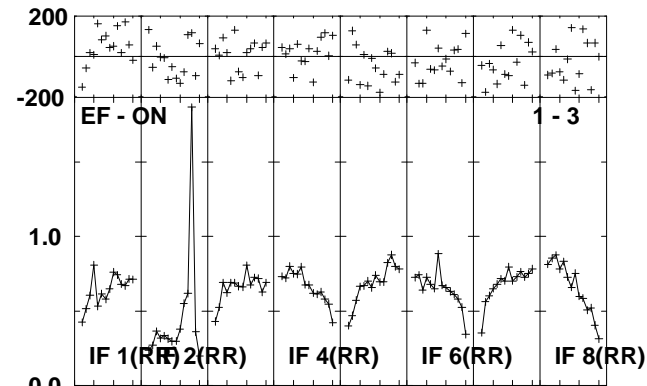
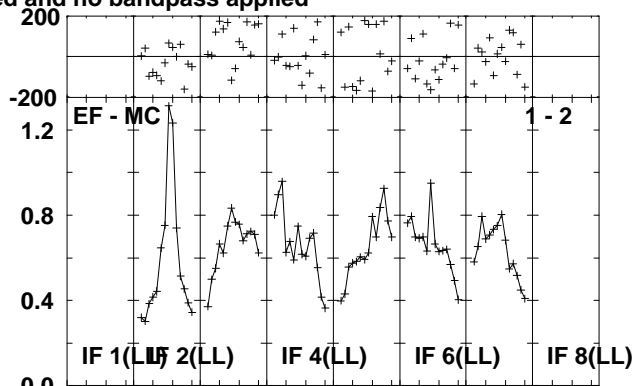
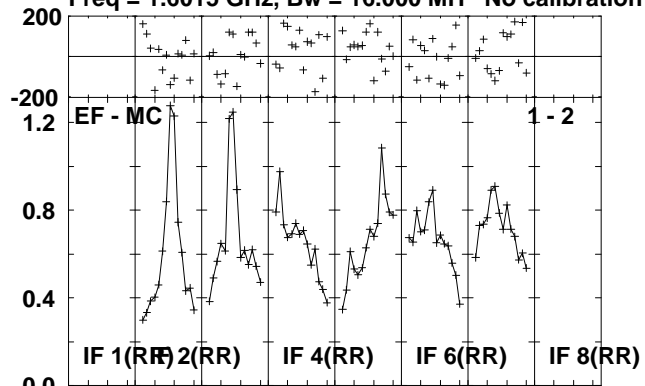

Lower frame: Milli Ampl Jy Top frame: Phas deg
Scalar averaged cross-power spectrum Several baselines displayed
Timerange: 01/03:06:05 to 01/03:11:01

Plot file version 182 created 01-JUL-2010 13:26:04

V407CYG RG006B.UVDATA.1

Freq = 1.6015 GHz, Bw = 16.000 MH No calibration applied and no bandpass applied

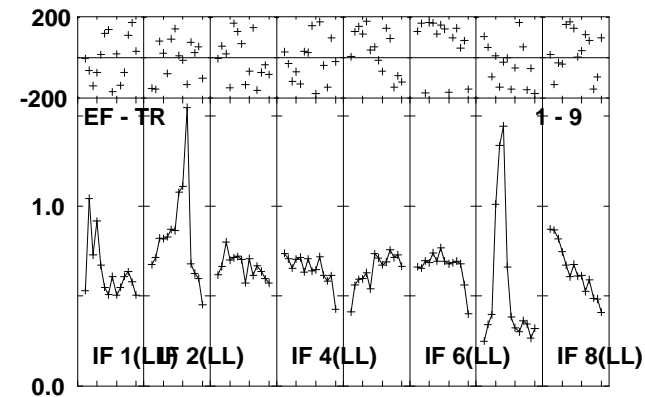
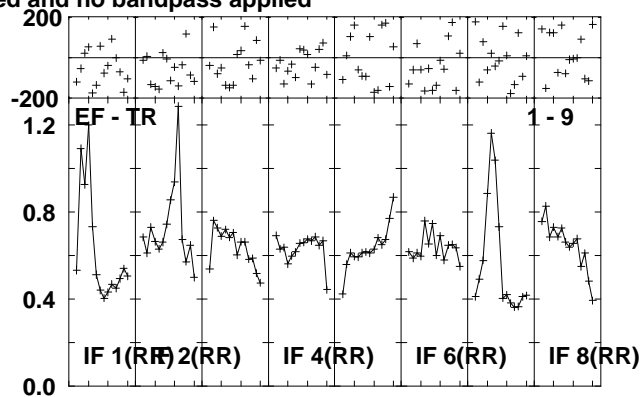
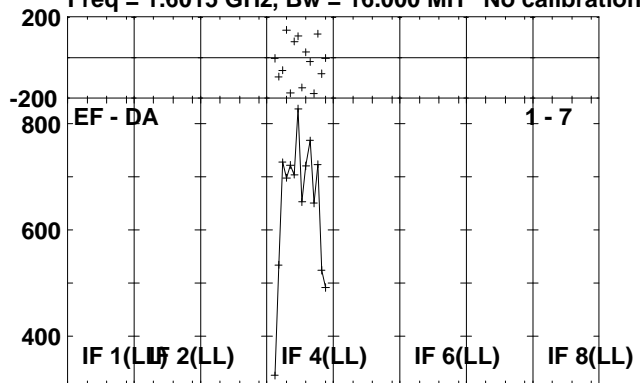

Lower frame: Micro Ampl Jy Top frame: Phas deg
Scalar averaged cross-power spectrum Several baselines displayed
Timerange: 01/03:06:05 to 01/03:11:01

Plot file version 183 created 01-JUL-2010 13:26:05

J2102+47 RG006B.UVDATA.1

Freq = 1.6015 GHz, Bw = 16.000 MH No calibration applied and no bandpass applied

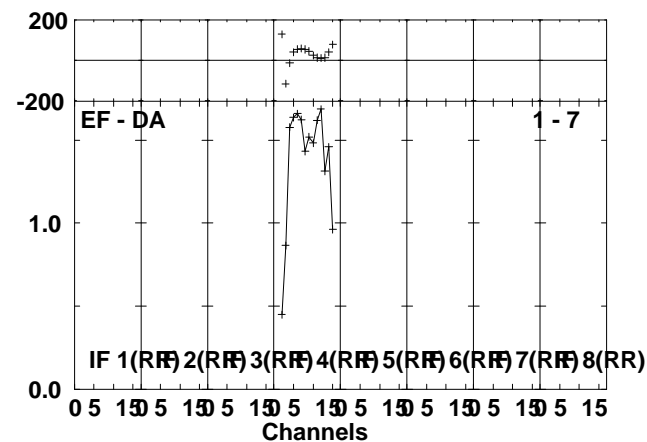
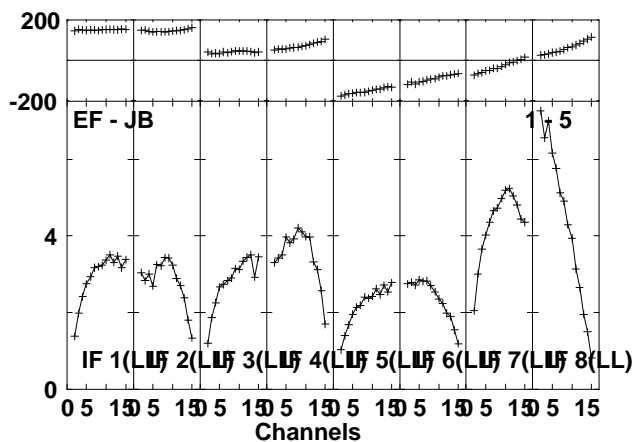
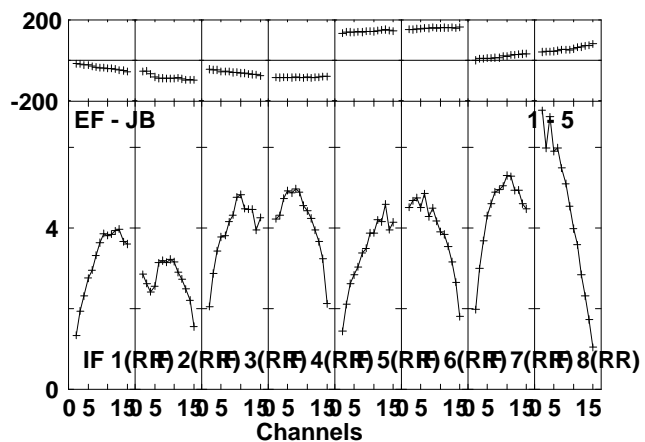
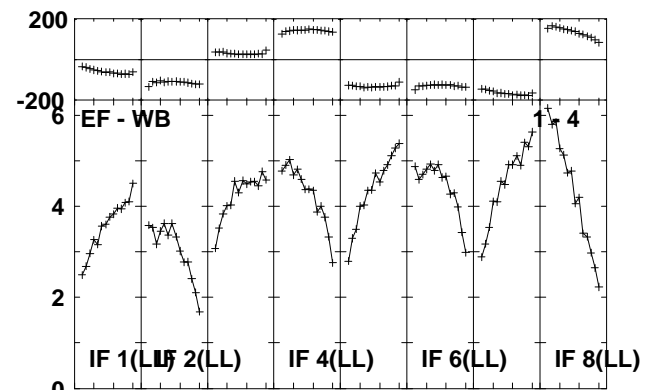
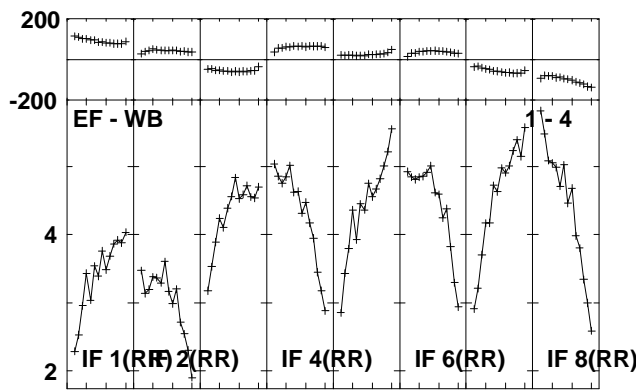
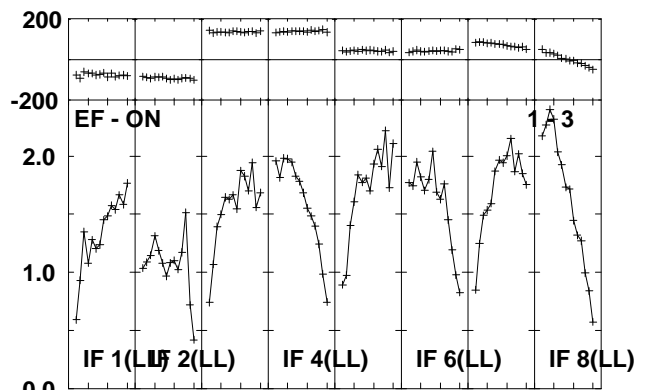
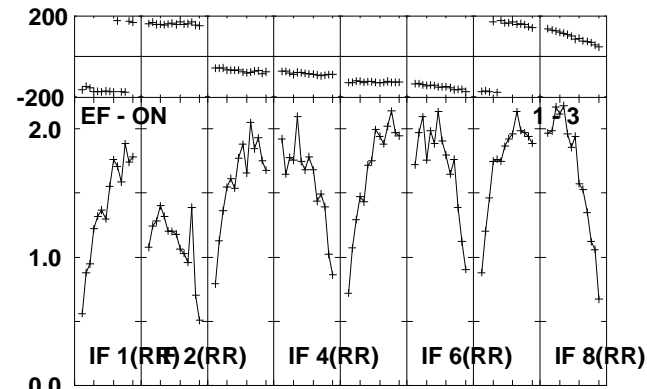
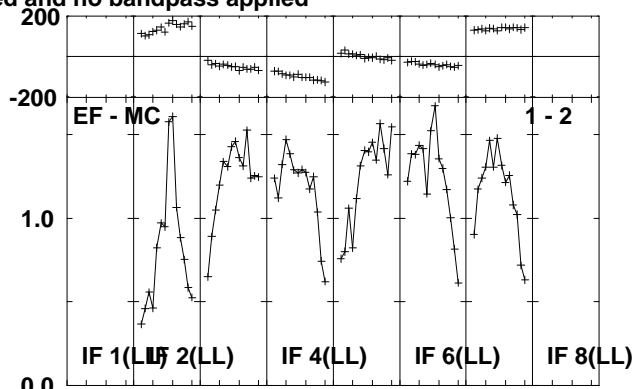
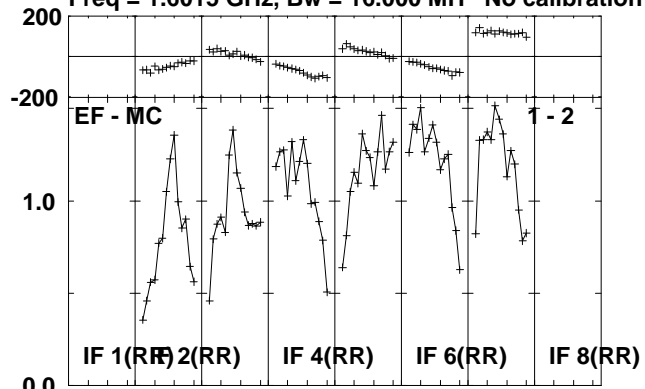

Lower frame: Milli Ampl Jy Top frame: Phas deg
Scalar averaged cross-power spectrum Several baselines displayed
Timerange: 01/03:12:05 to 01/03:13:49

Plot file version 184 created 01-JUL-2010 13:26:05

J2102+47 RG006B.UVDATA.1

Freq = 1.6015 GHz, Bw = 16.000 MH No calibration applied and no bandpass applied

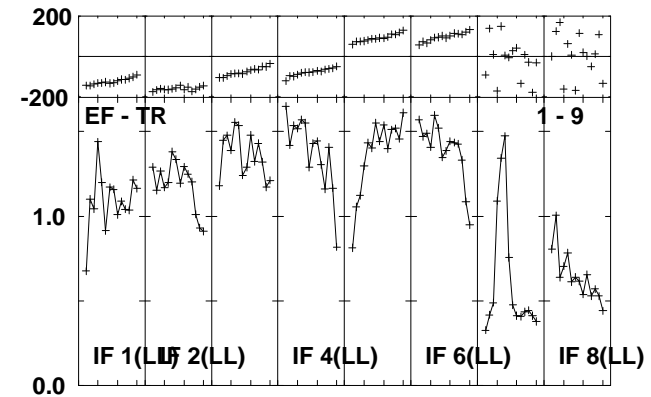
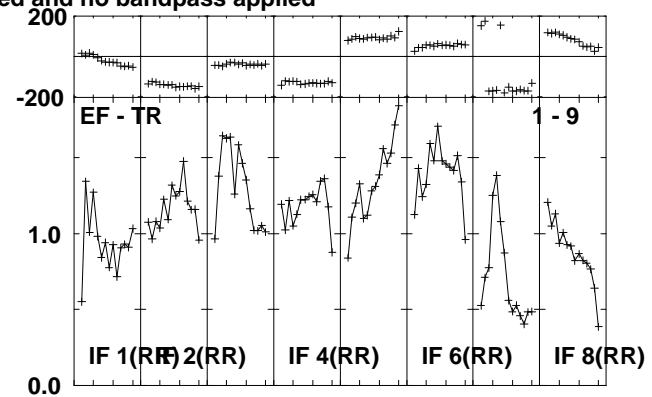
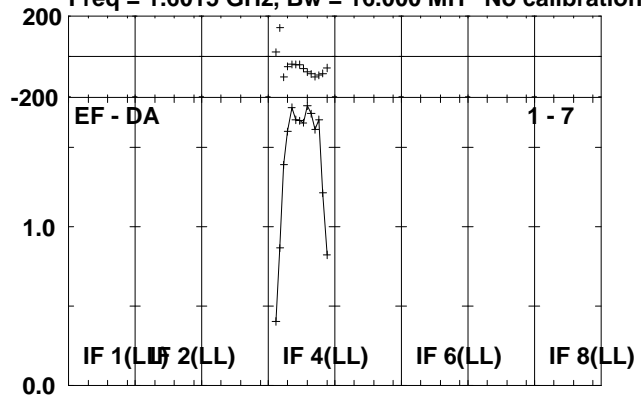

Lower frame: Milli Ampl Jy Top frame: Phas deg
Scalar averaged cross-power spectrum Several baselines displayed
Timerange: 01/03:12:05 to 01/03:13:49

Plot file version 185 created 01-JUL-2010 13:26:06

V407CYG RG006B.UVDATA.1

Freq = 1.6015 GHz, Bw = 16.000 MH No calibration applied and no bandpass applied

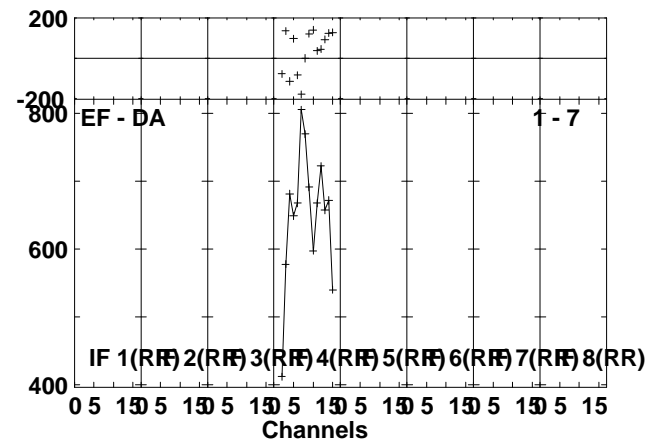
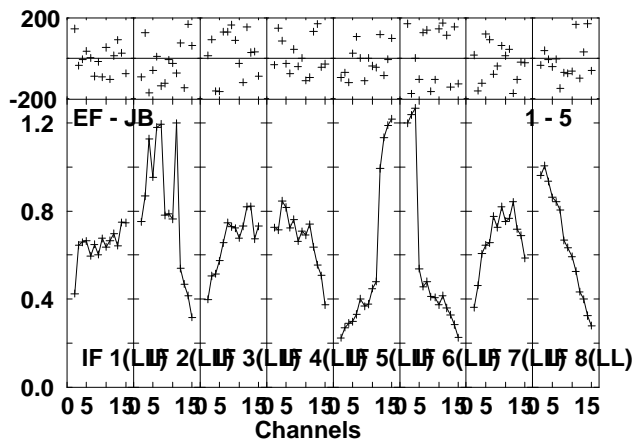
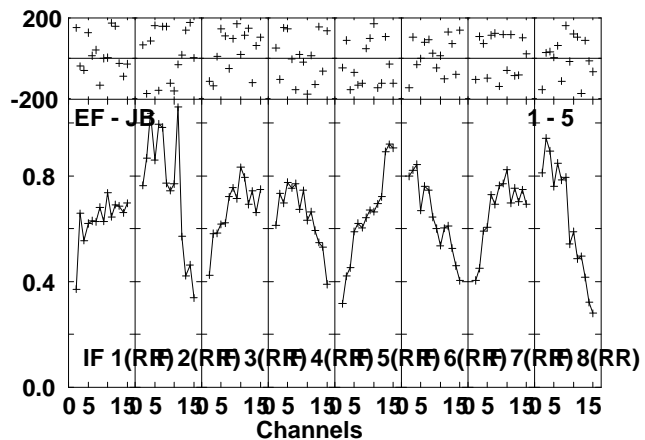
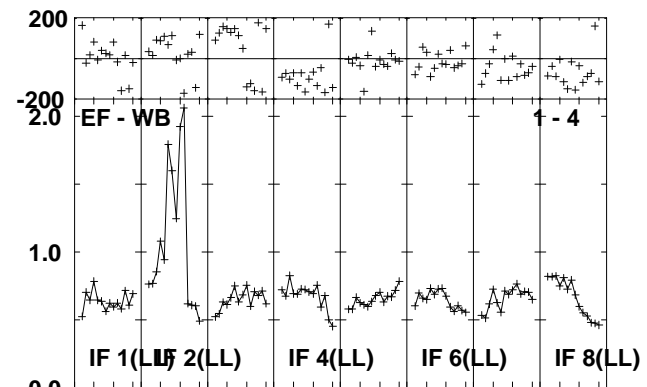
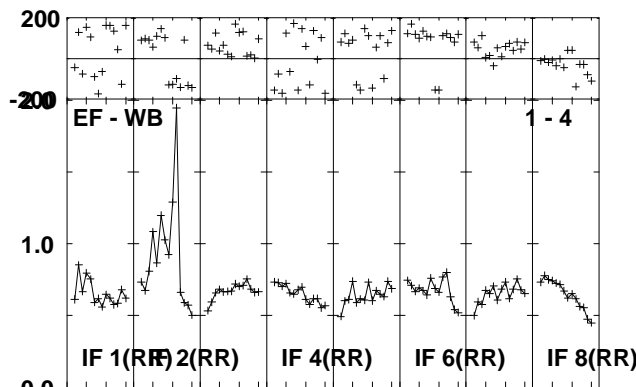
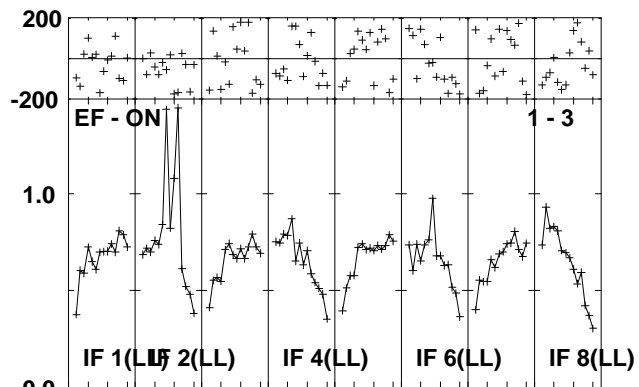
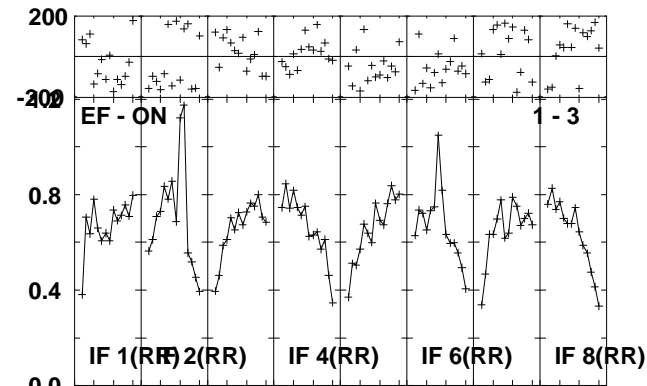
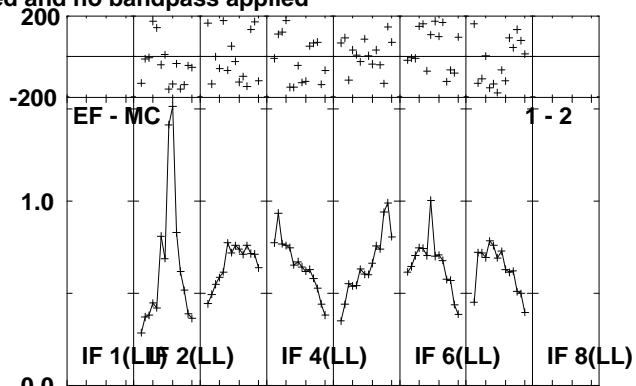
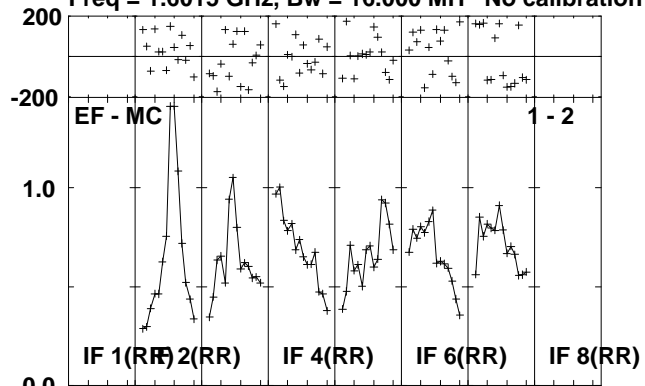

Lower frame: Milli Ampl Jy Top frame: Phas deg
Scalar averaged cross-power spectrum Several baselines displayed
Timerange: 01/03:13:53 to 01/03:18:49

Plot file version 186 created 01-JUL-2010 13:26:07

V407CYG RG006B.UVDATA.1

Freq = 1.6015 GHz, Bw = 16.000 MH No calibration applied and no bandpass applied

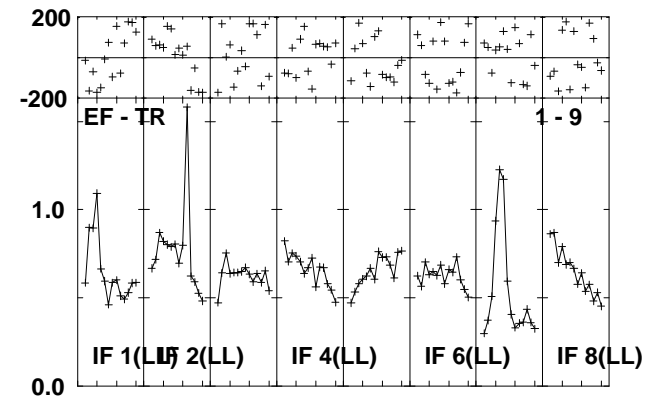
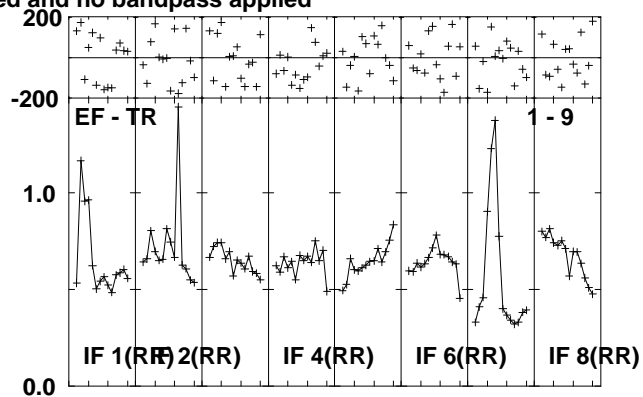
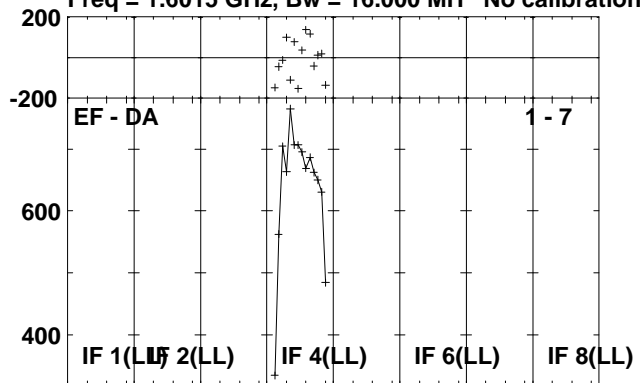

Lower frame: Micro Ampl Jy Top frame: Phas deg
Scalar averaged cross-power spectrum Several baselines displayed
Timerange: 01/03:13:53 to 01/03:18:49

Plot file version 187 created 01-JUL-2010 13:26:07

J2102+47 RG006B.UVDATA.1

Freq = 1.6015 GHz, Bw = 16.000 MH No calibration applied and no bandpass applied

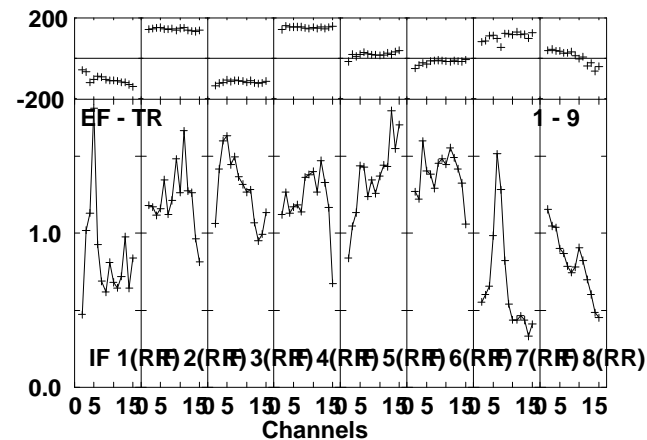
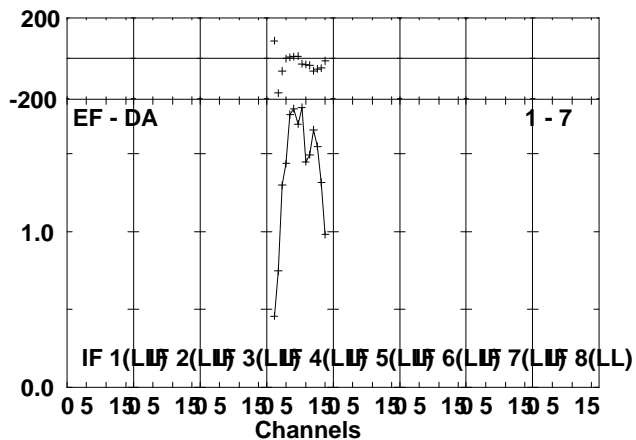
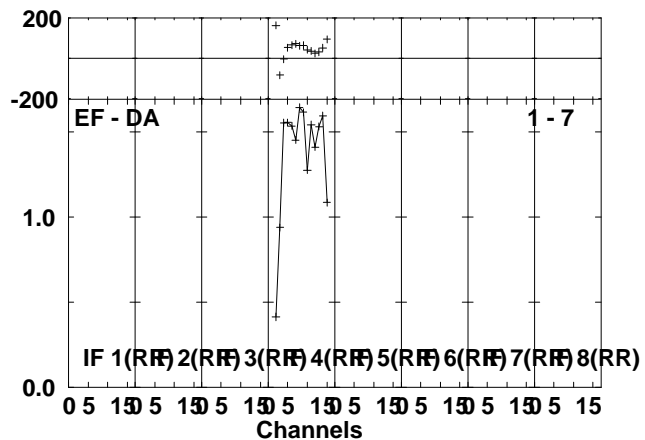
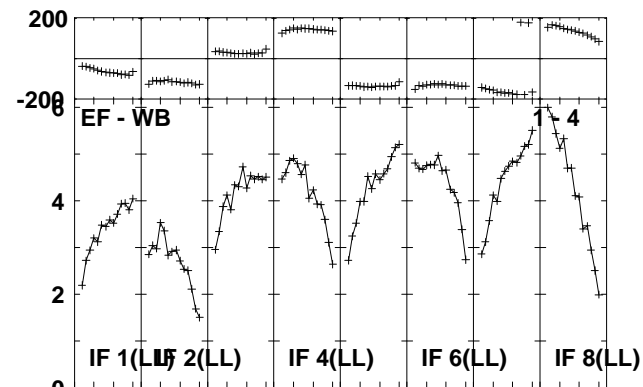
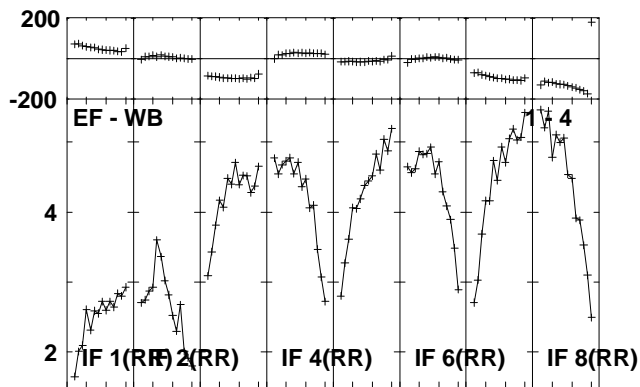
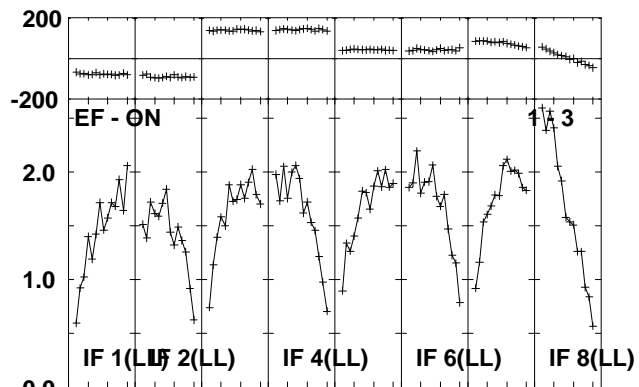
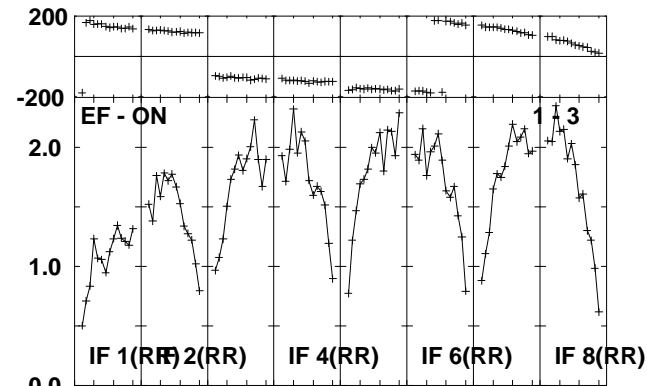
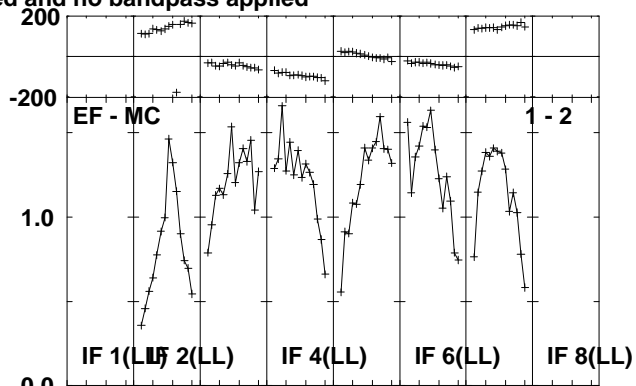
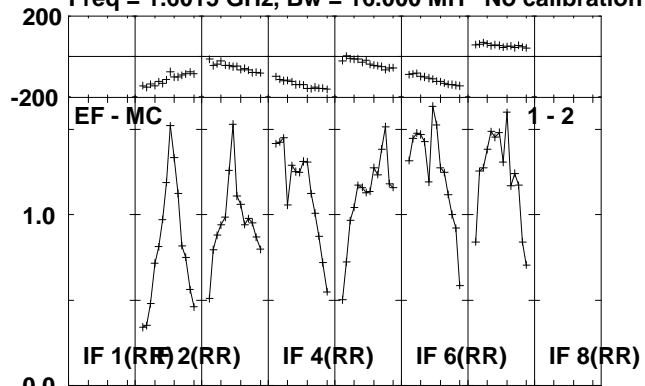

Lower frame: Milli Ampl Jy Top frame: Phas deg
Scalar averaged cross-power spectrum Several baselines displayed
Timerange: 01/03:18:53 to 01/03:21:01

Plot file version 188 created 01-JUL-2010 13:26:08
J2102+47 RG006B.UVDATA.1
Freq = 1.6015 GHz, Bw = 16.000 MH No calibration applied and no bandpass applied

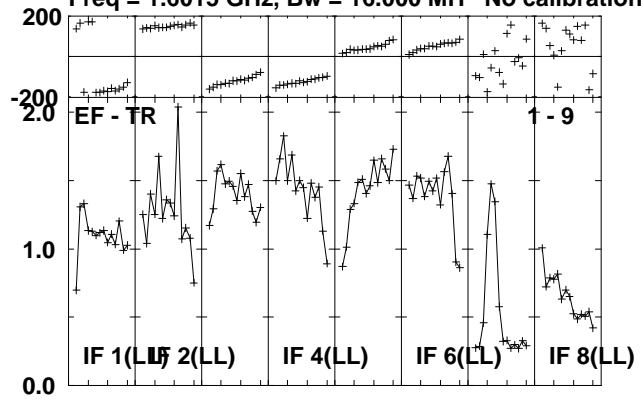

Lower frame: Milli Ampl Jy Top frame: Phas deg
Scalar averaged cross-power spectrum Several baselines displayed
Timerange: 01/03:18:53 to 01/03:21:01

Plot file version 189 created 01-JUL-2010 13:26:08

V407CYG RG006B.UVDATA.1

Freq = 1.6015 GHz, Bw = 16.000 MH No calibration applied and no bandpass applied

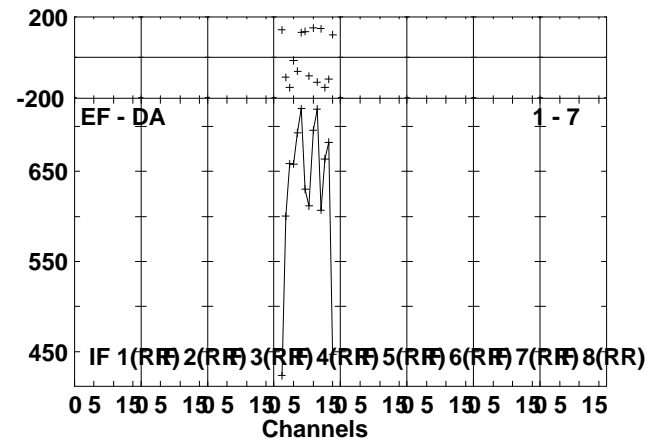
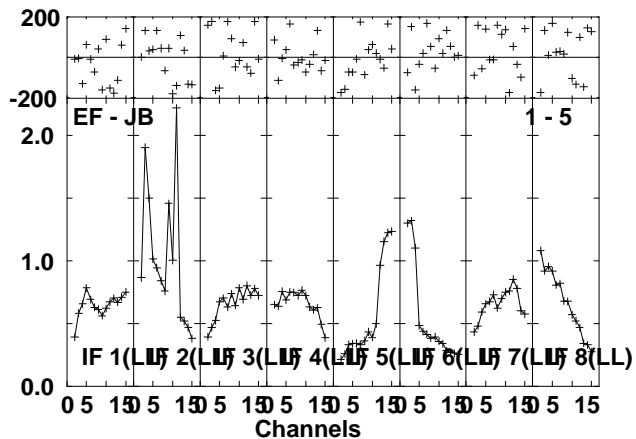
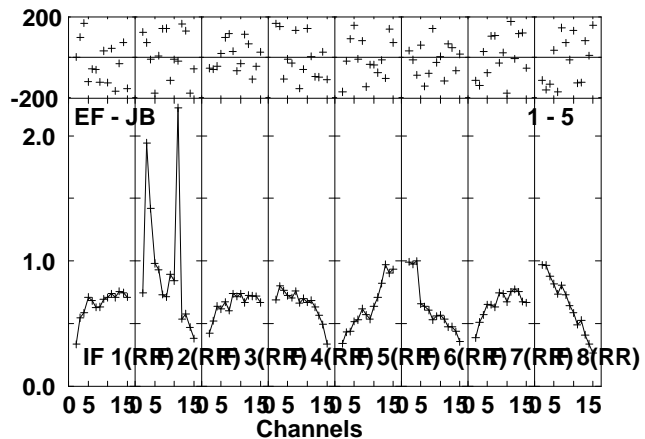
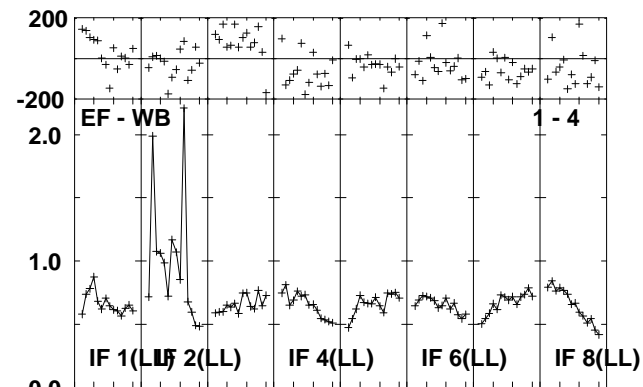
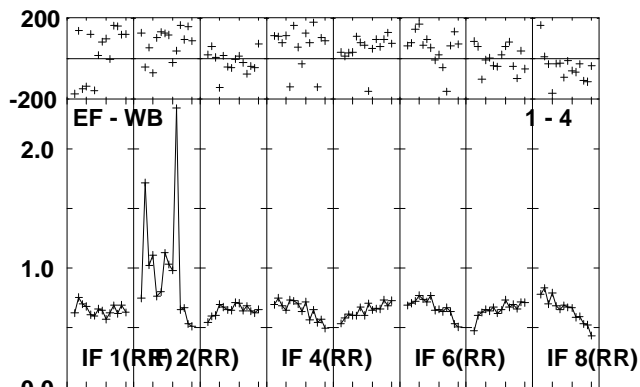
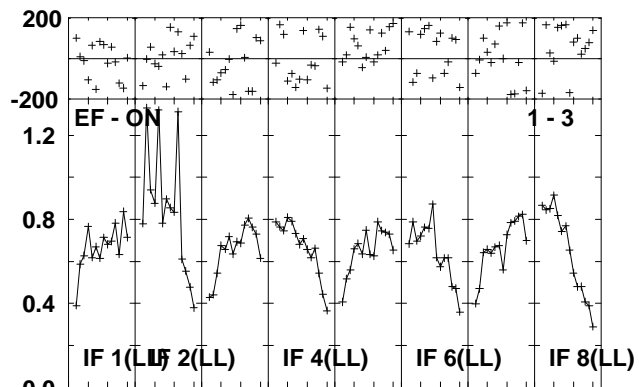
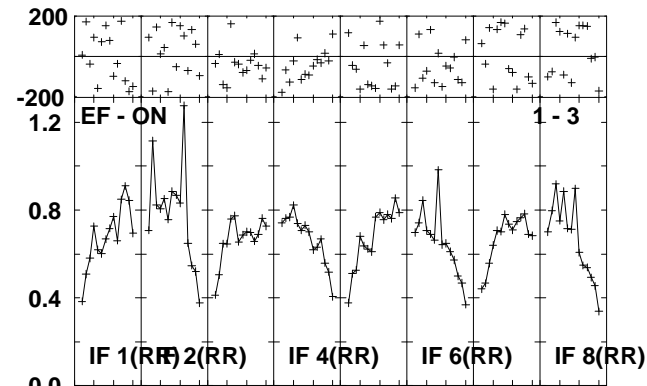
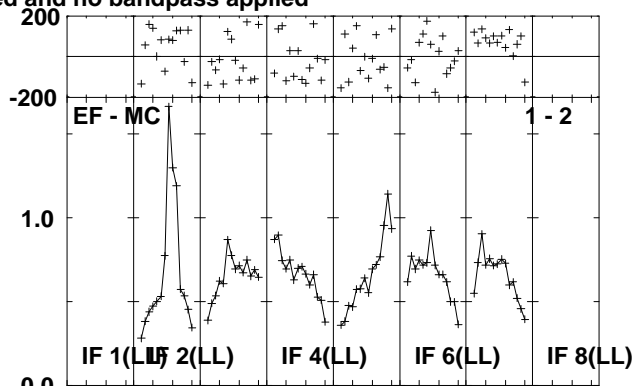
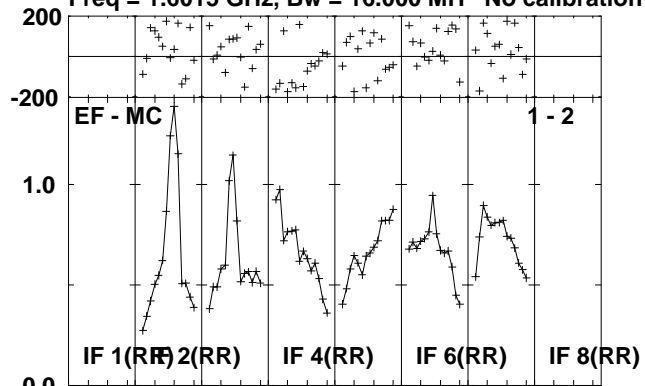

Lower frame: Milli Ampl Jy Top frame: Phas deg
Scalar averaged cross-power spectrum Several baselines displayed
Timerange: 01/03:21:05 to 01/03:26:01

Plot file version 190 created 01-JUL-2010 13:26:09

V407CYG RG006B.UVDATA.1

Freq = 1.6015 GHz, Bw = 16.000 MH No calibration applied and no bandpass applied

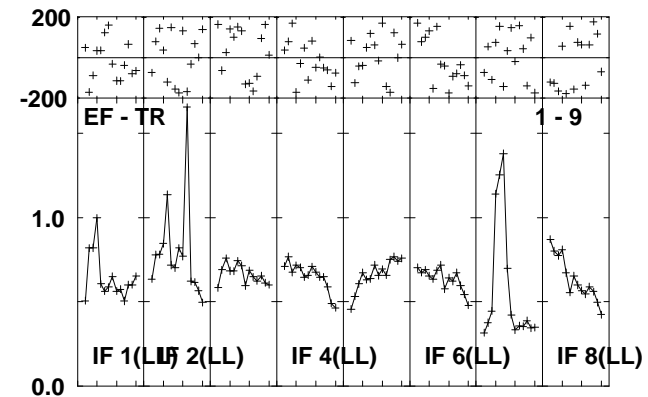
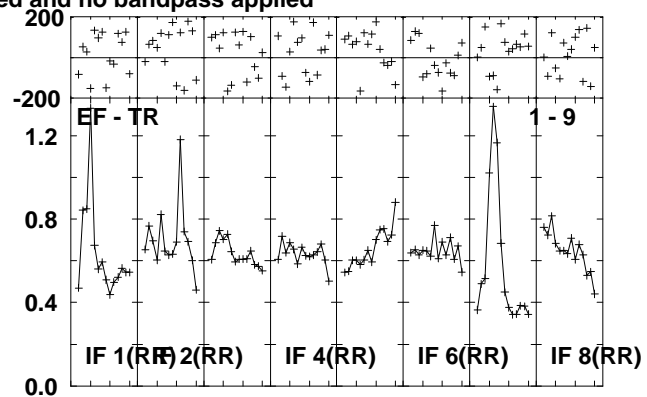
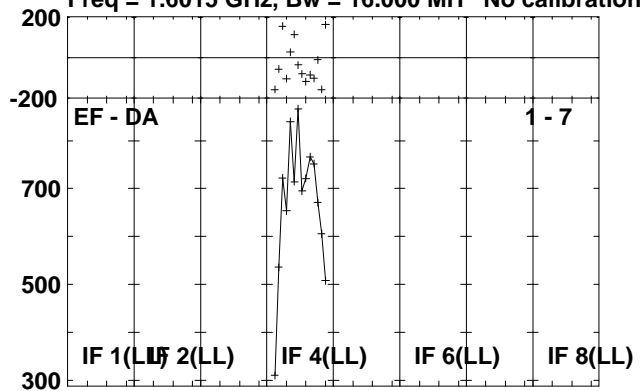

Lower frame: Micro Ampl Jy Top frame: Phas deg
Scalar averaged cross-power spectrum Several baselines displayed
Timerange: 01/03:21:05 to 01/03:26:01

Plot file version 191 created 01-JUL-2010 13:26:10

J2102+47 RG006B.UVDATA.1

Freq = 1.6015 GHz, Bw = 16.000 MH No calibration applied and no bandpass applied

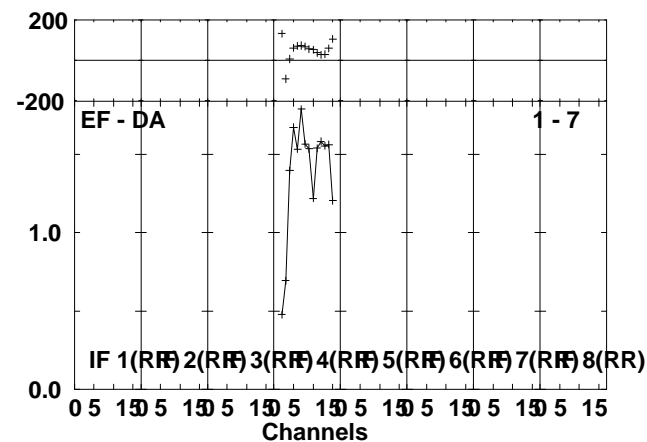
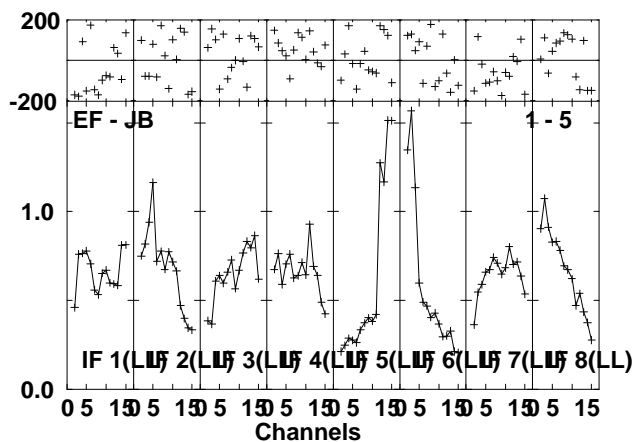
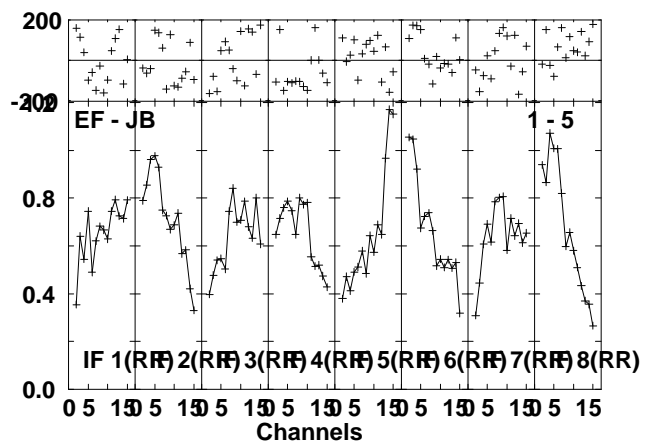
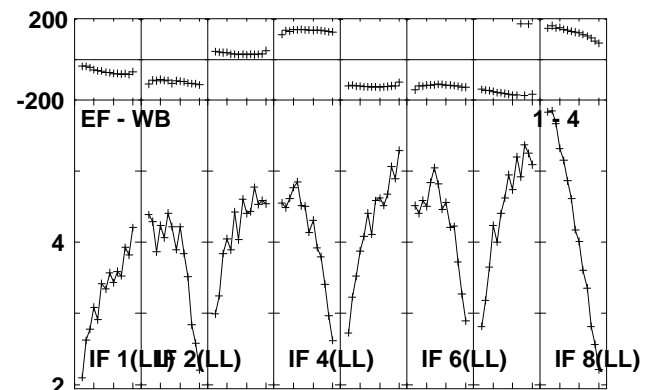
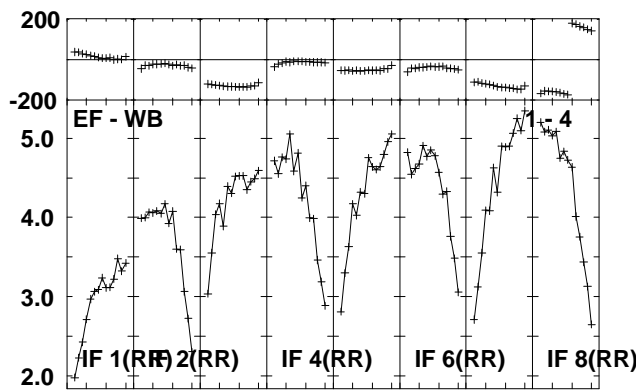
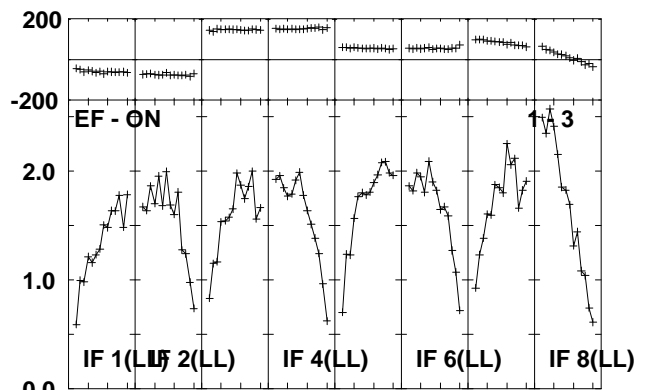
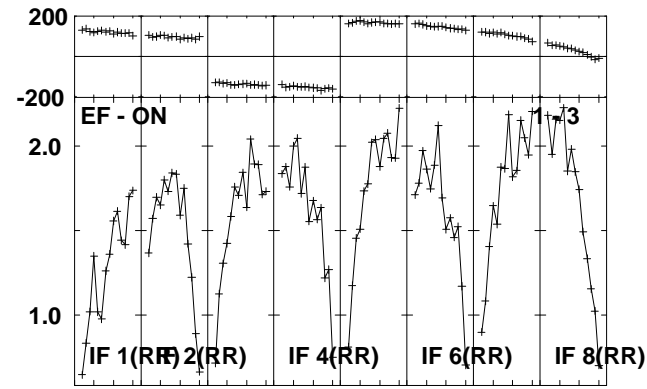
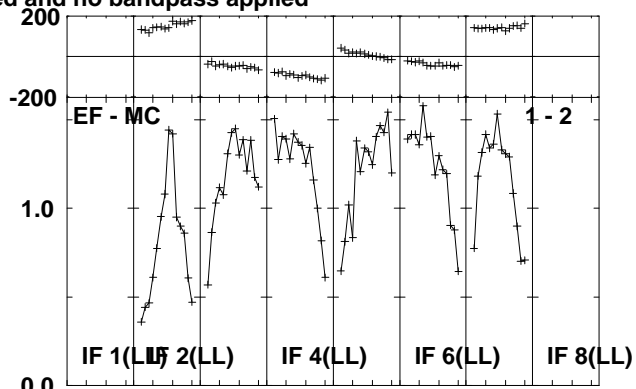
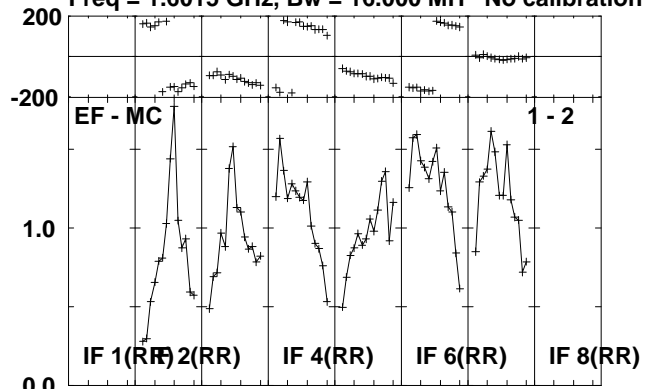

Lower frame: Milli Ampl Jy Top frame: Phas deg
Scalar averaged cross-power spectrum Several baselines displayed
Timerange: 01/03:27:05 to 01/03:28:49

Plot file version 192 created 01-JUL-2010 13:26:10
J2102+47 RG006B.UVDATA.1

Freq = 1.6015 GHz, Bw = 16.000 MH No calibration applied and no bandpass applied

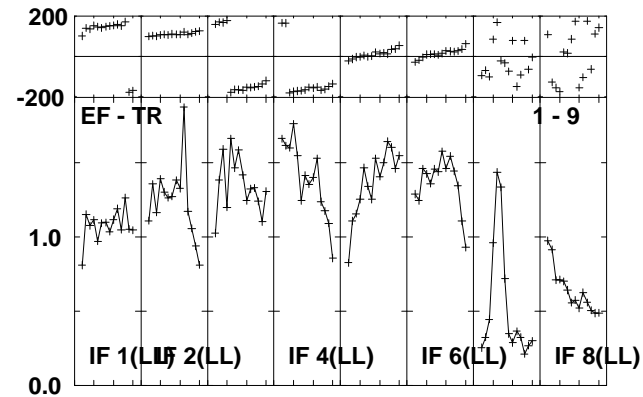
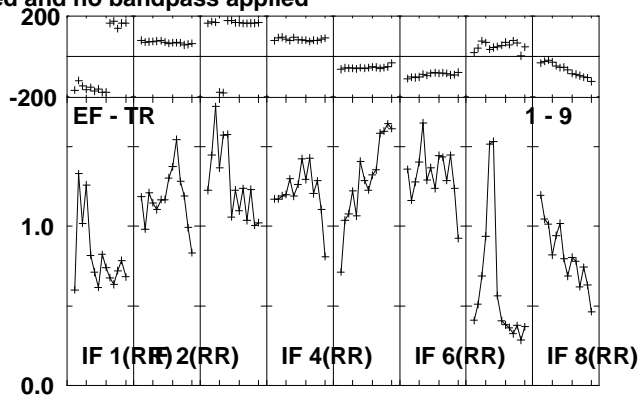
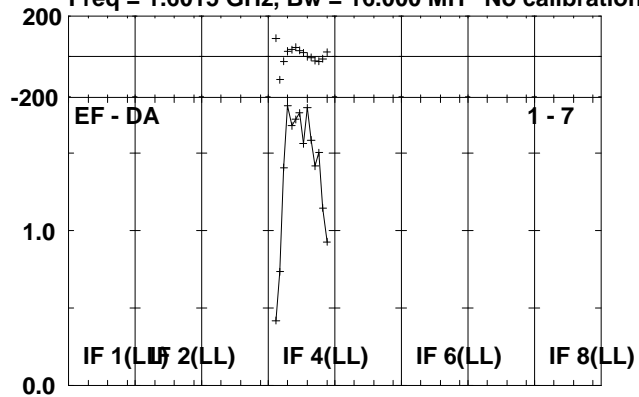

Lower frame: Milli Ampl Jy Top frame: Phas deg
Scalar averaged cross-power spectrum Several baselines displayed
Timerange: 01/03:27:05 to 01/03:28:49

Plot file version 193 created 01-JUL-2010 13:26:11

V407CYG RG006B.UVDATA.1

Freq = 1.6015 GHz, Bw = 16.000 MH No calibration applied and no bandpass applied

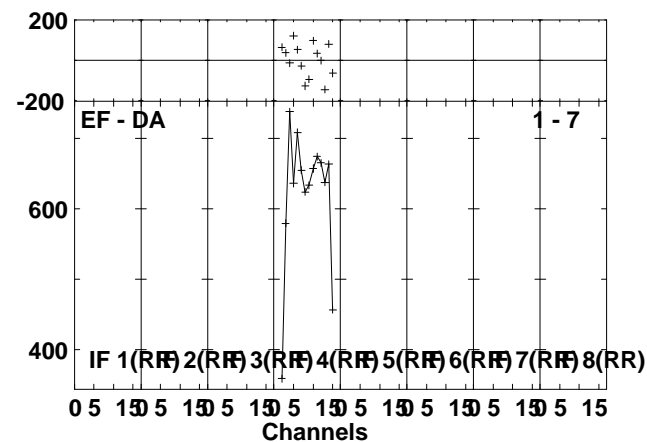
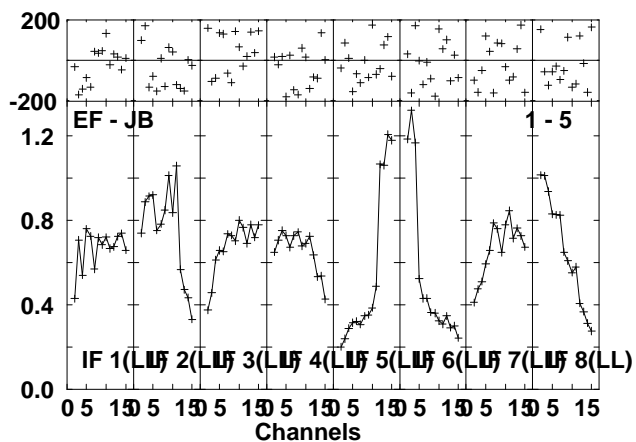
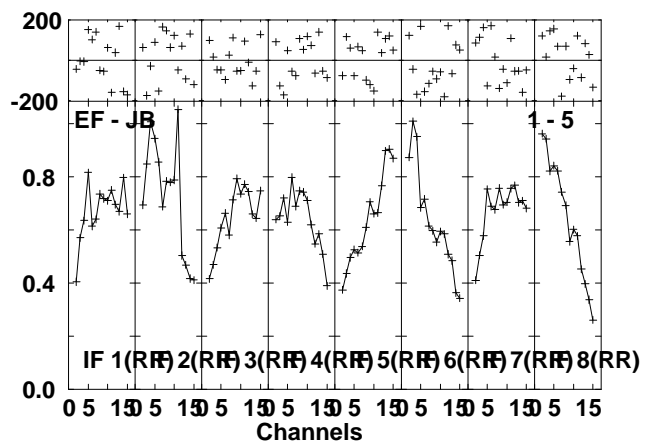
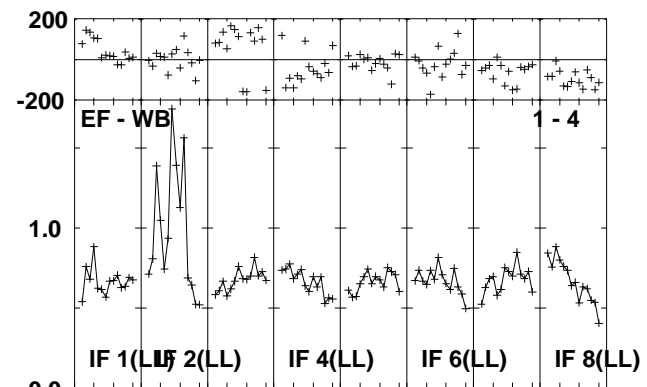
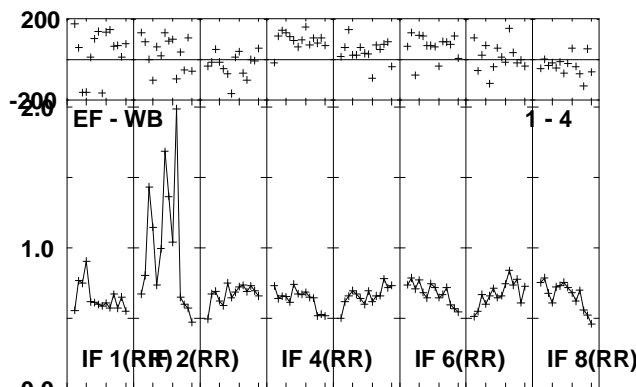
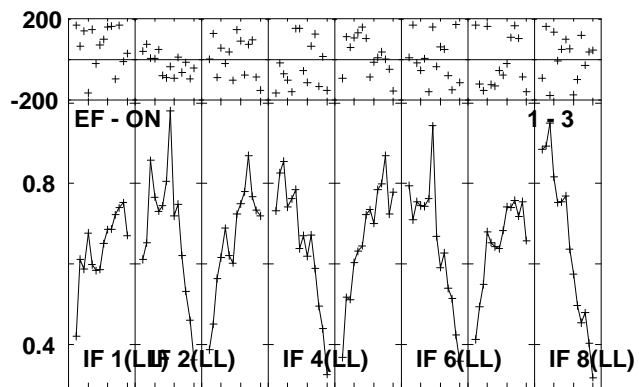
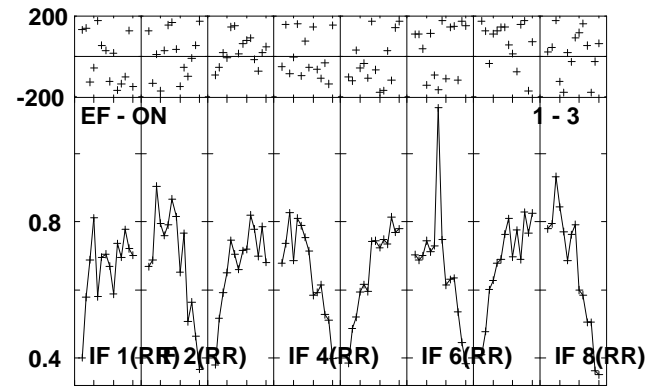
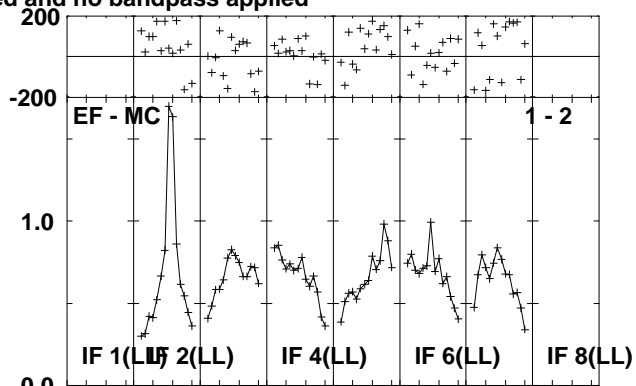
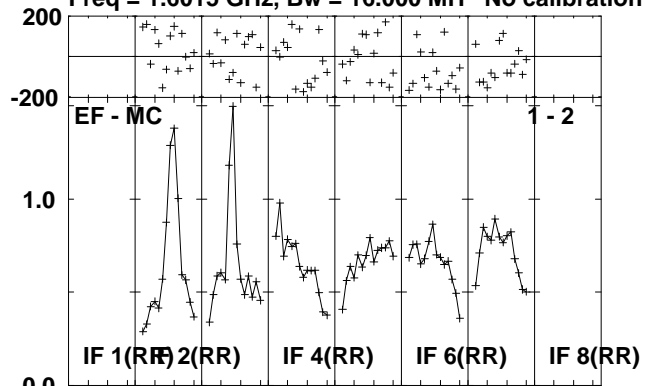

Lower frame: Milli Ampl Jy Top frame: Phas deg
Scalar averaged cross-power spectrum Several baselines displayed
Timerange: 01/03:28:53 to 01/03:33:49

Plot file version 194 created 01-JUL-2010 13:26:12

V407CYG RG006B.UVDATA.1

Freq = 1.6015 GHz, Bw = 16.000 MH No calibration applied and no bandpass applied

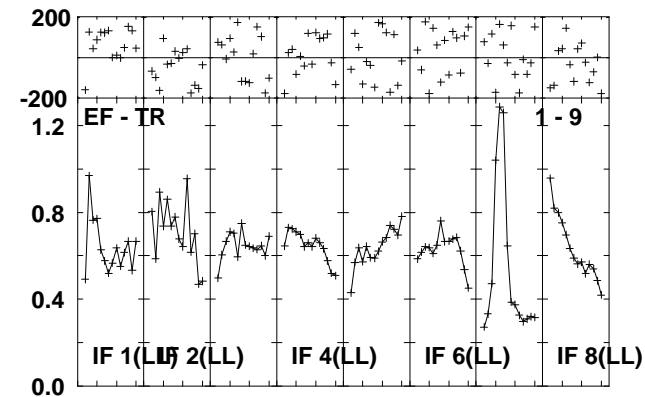
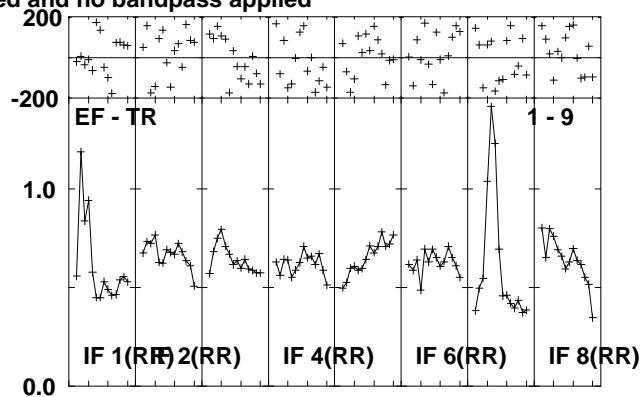
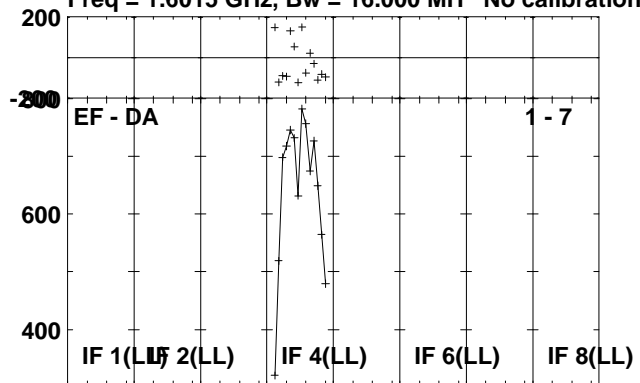

Lower frame: Micro Ampl Jy Top frame: Phas deg
Scalar averaged cross-power spectrum Several baselines displayed
Timerange: 01/03:28:53 to 01/03:33:49

Plot file version 195 created 01-JUL-2010 13:26:12

J2102+47 RG006B.UVDATA.1

Freq = 1.6015 GHz, Bw = 16.000 MH No calibration applied and no bandpass applied

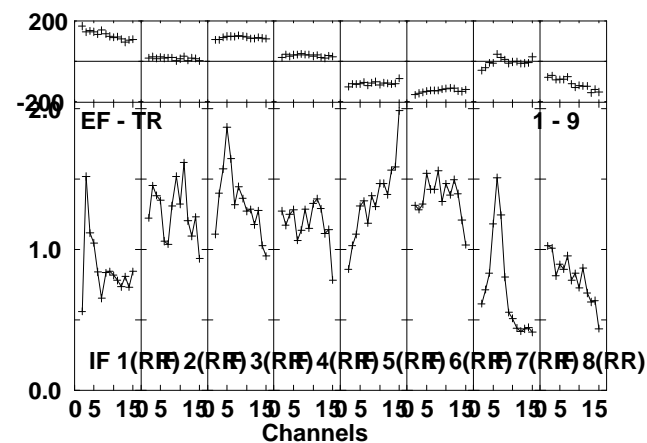
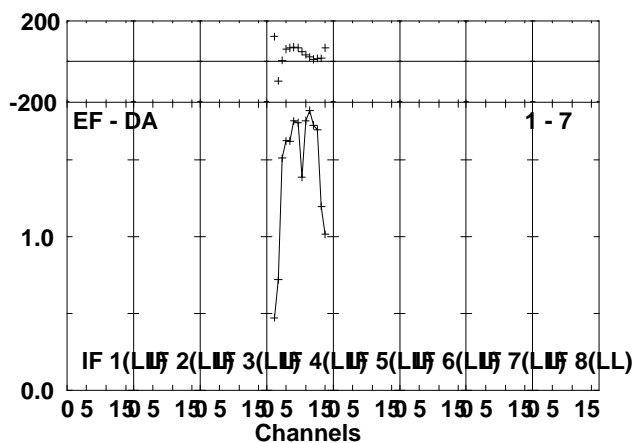
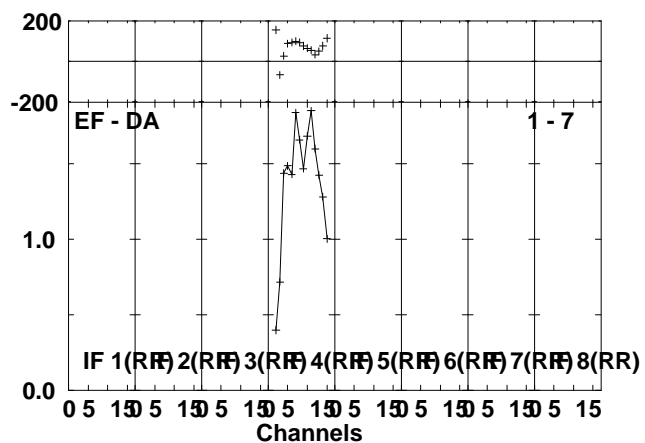
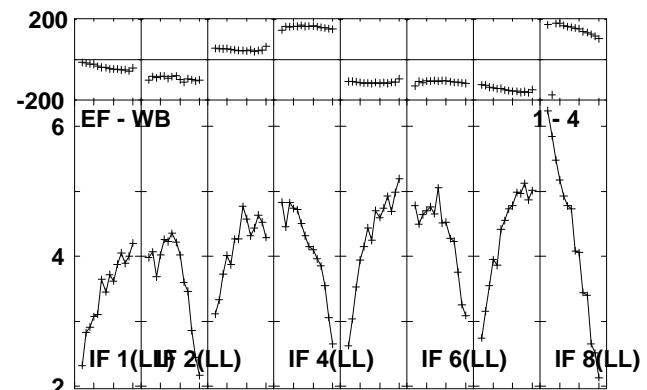
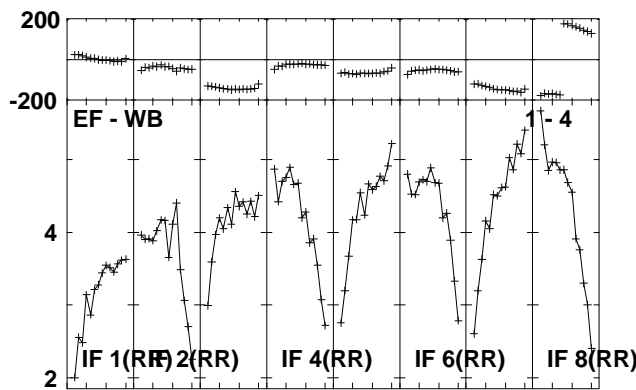
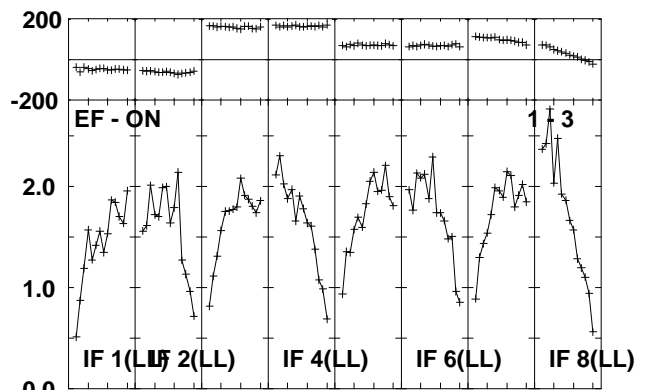
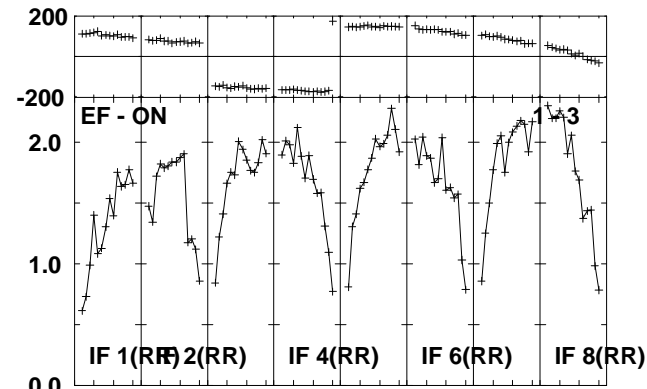
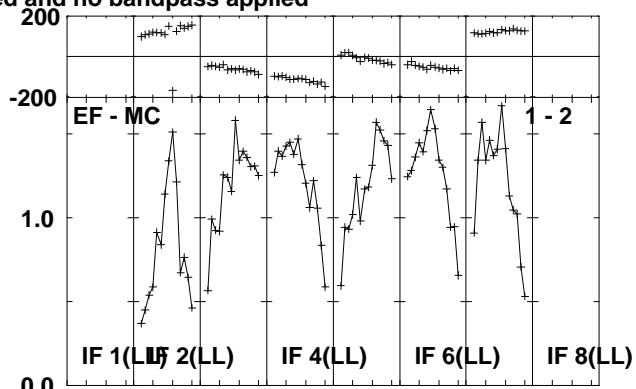
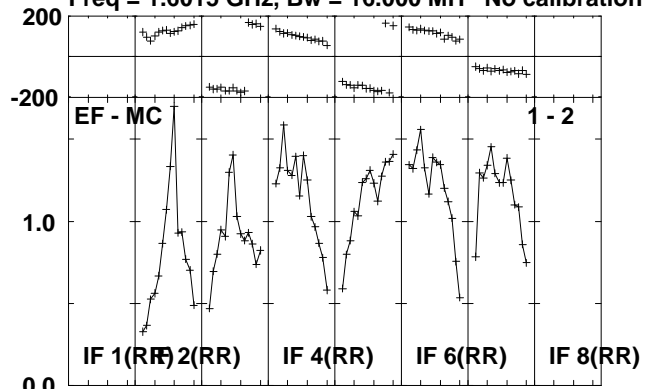

Lower frame: Milli Ampl Jy Top frame: Phas deg
Scalar averaged cross-power spectrum Several baselines displayed
Timerange: 01/03:33:53 to 01/03:36:01

Plot file version 196 created 01-JUL-2010 13:26:13
J2102+47 RG006B.UVDATA.1
Freq = 1.6015 GHz, Bw = 16.000 MH No calibration applied and no bandpass applied

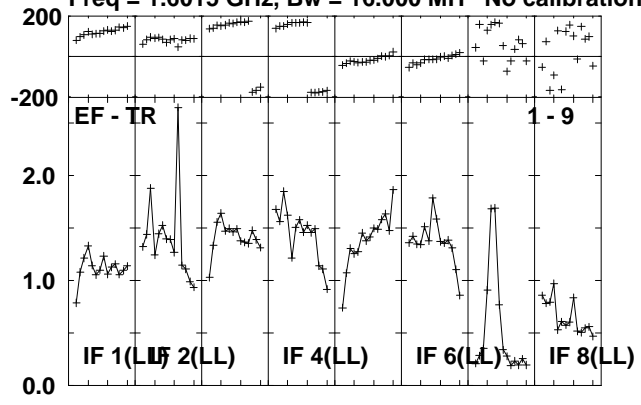

Lower frame: Milli Ampl Jy Top frame: Phas deg
Scalar averaged cross-power spectrum Several baselines displayed
Timerange: 01/03:33:53 to 01/03:36:01

Plot file version 197 created 01-JUL-2010 13:26:13

V407CYG RG006B.UVDATA.1

Freq = 1.6015 GHz, Bw = 16.000 MH No calibration applied and no bandpass applied

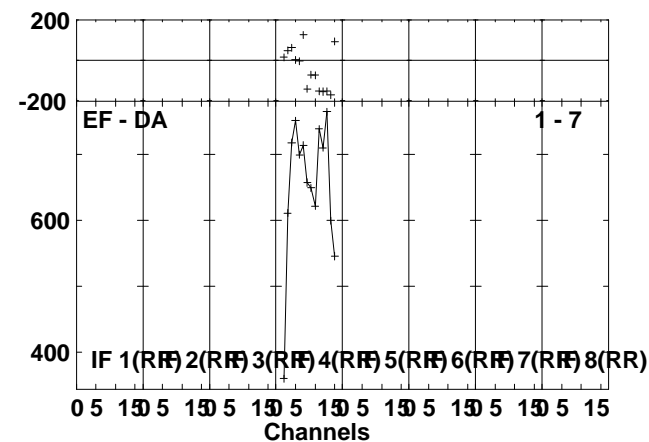
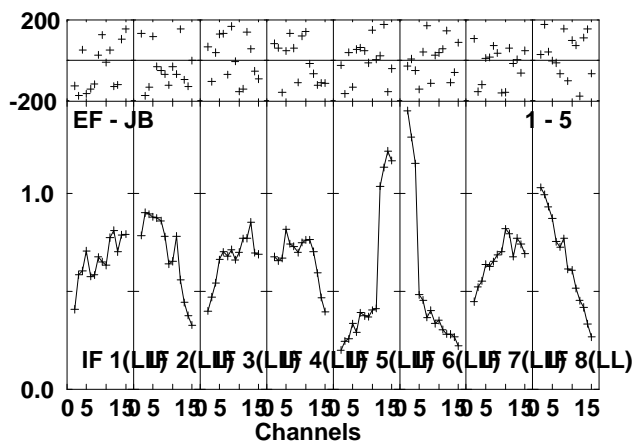
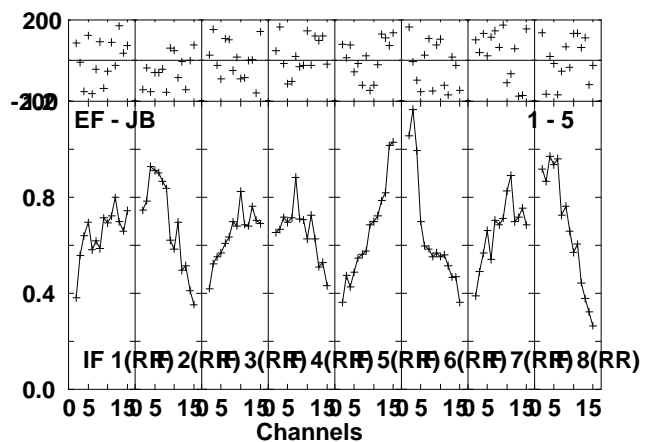
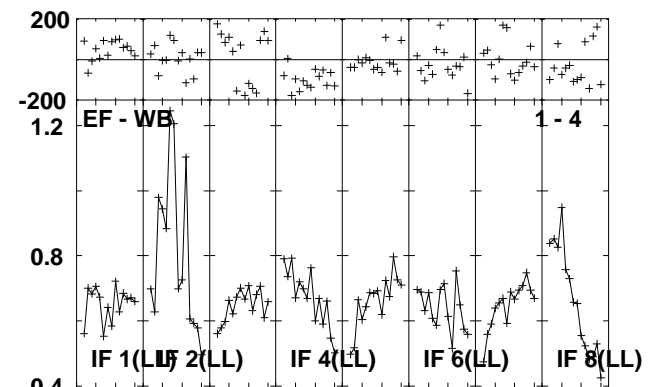
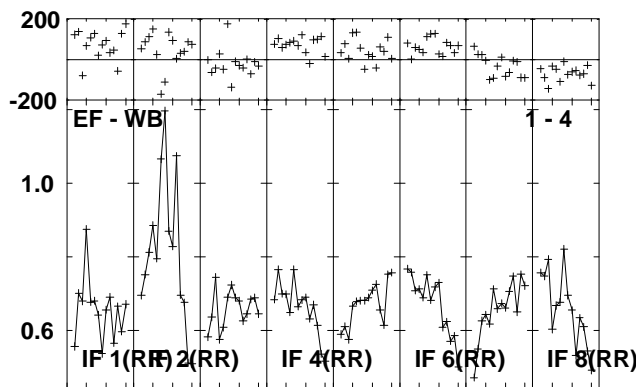
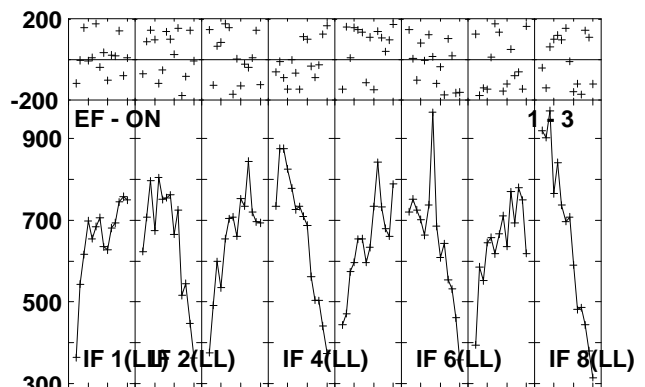
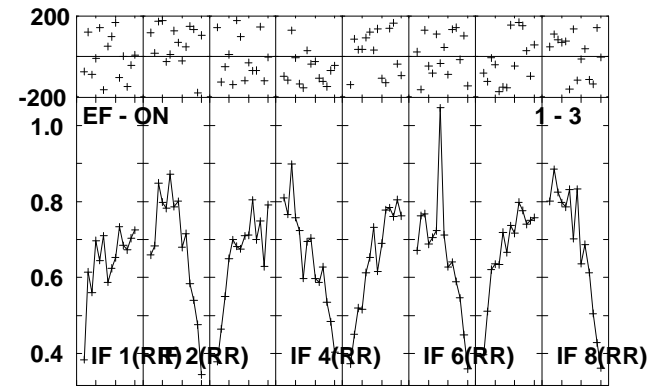
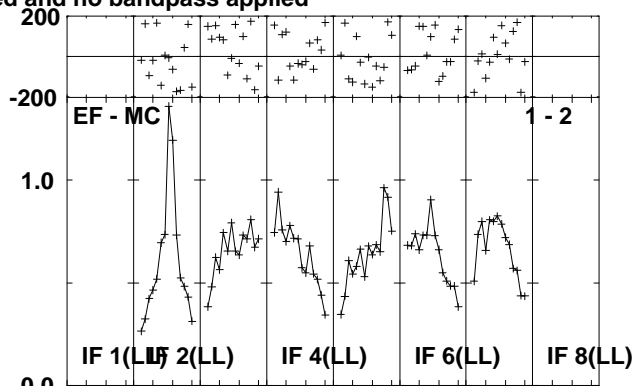
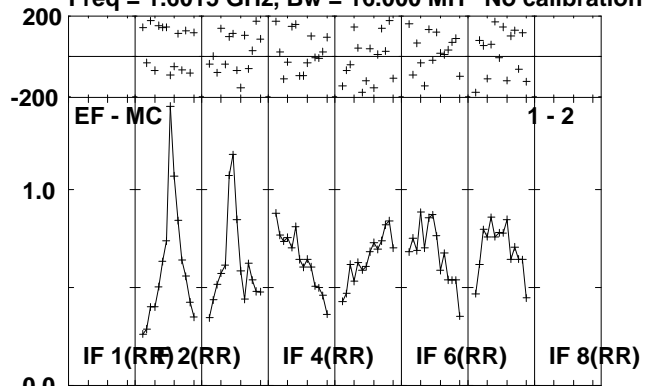

Lower frame: Milli Ampl Jy Top frame: Phas deg
Scalar averaged cross-power spectrum Several baselines displayed
Timerange: 01/03:36:05 to 01/03:41:01

Plot file version 198 created 01-JUL-2010 13:26:14

V407CYG RG006B.UVDATA.1

Freq = 1.6015 GHz, Bw = 16.000 MH No calibration applied and no bandpass applied

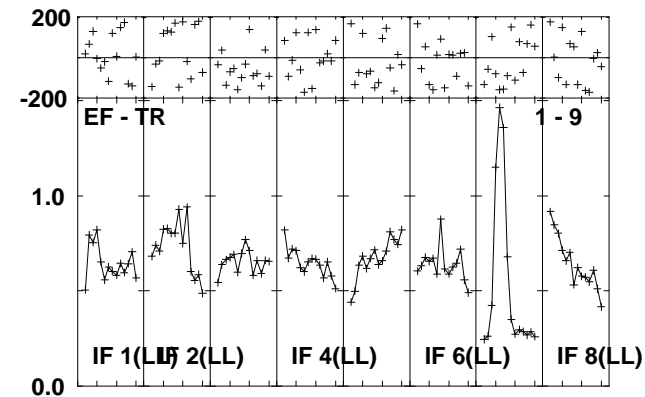
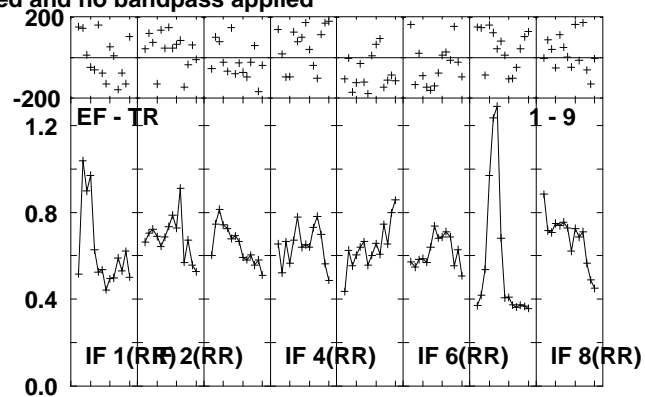
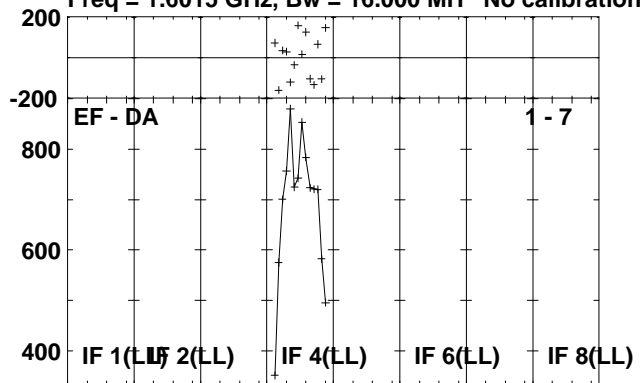

Lower frame: Micro Ampl Jy Top frame: Phas deg
Scalar averaged cross-power spectrum Several baselines displayed
Timerange: 01/03:36:05 to 01/03:41:01

Plot file version 199 created 01-JUL-2010 13:26:15

J2102+47 RG006B.UVDATA.1

Freq = 1.6015 GHz, Bw = 16.000 MH No calibration applied and no bandpass applied

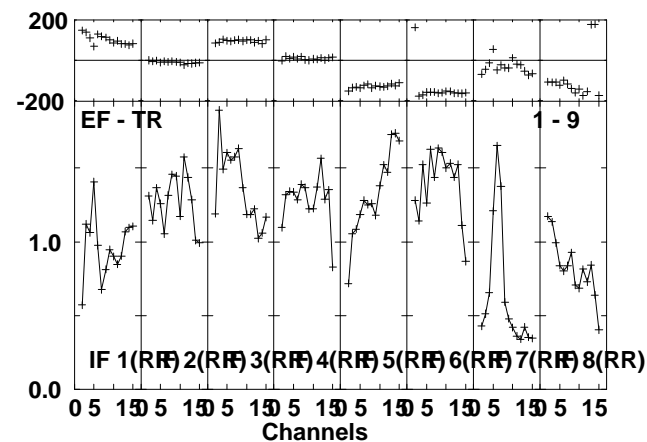
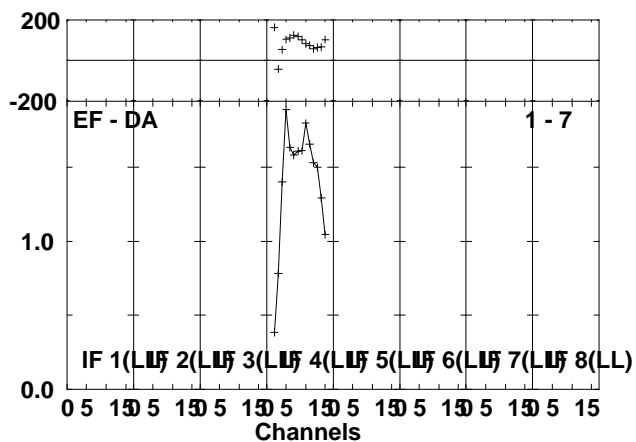
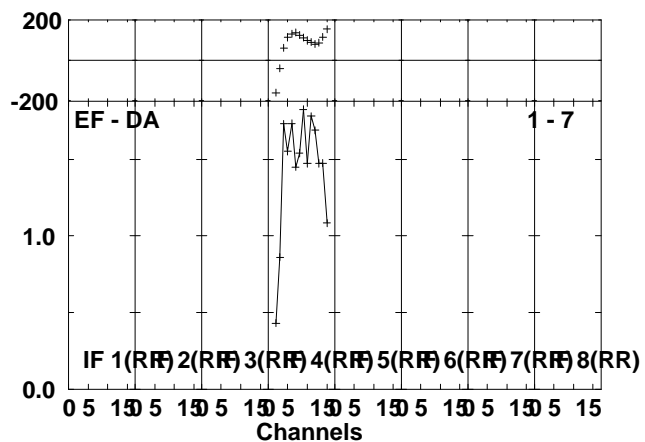
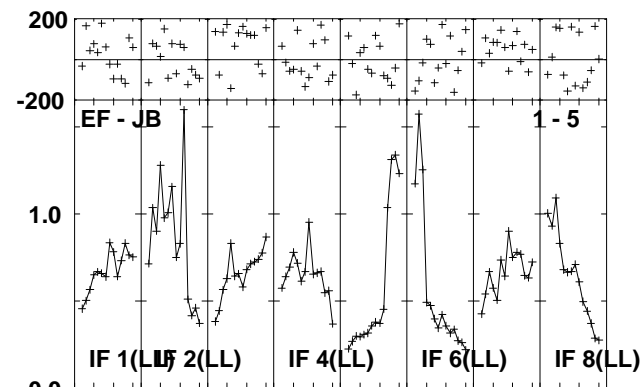
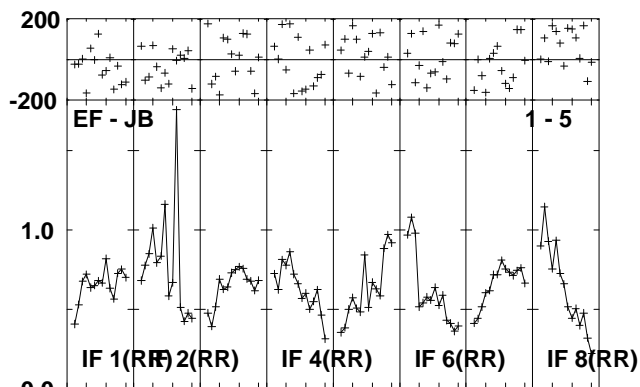
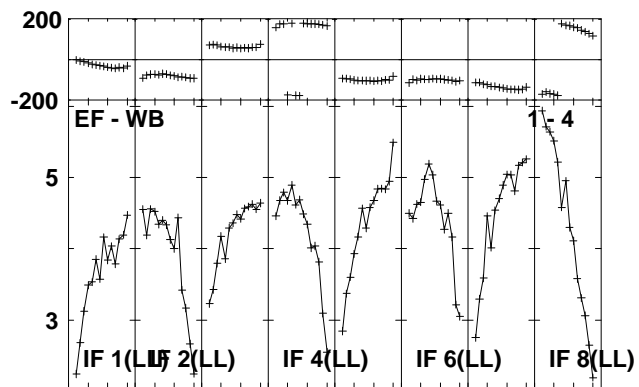
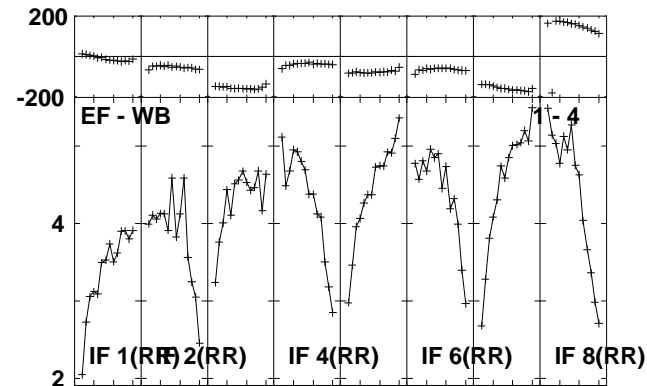
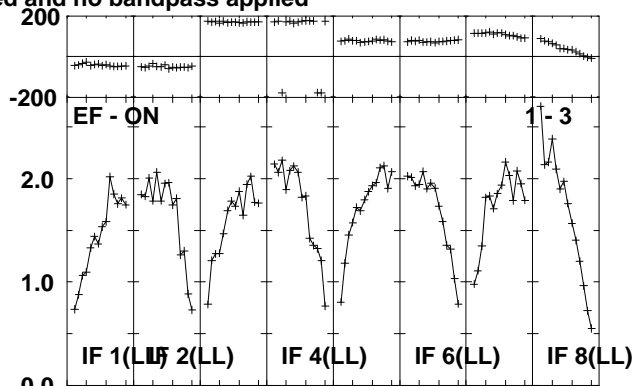
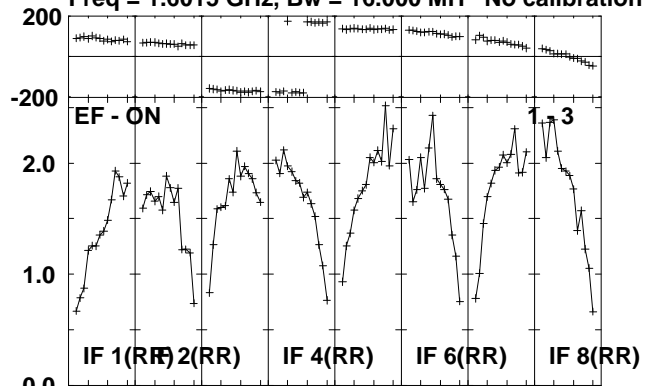

Lower frame: Milli Ampl Jy Top frame: Phas deg
Scalar averaged cross-power spectrum Several baselines displayed
Timerange: 01/03:42:05 to 01/03:43:49

Plot file version 200 created 01-JUL-2010 13:26:15
J2102+47 RG006B.UVDATA.1
Freq = 1.6015 GHz, Bw = 16.000 MH No calibration applied and no bandpass applied

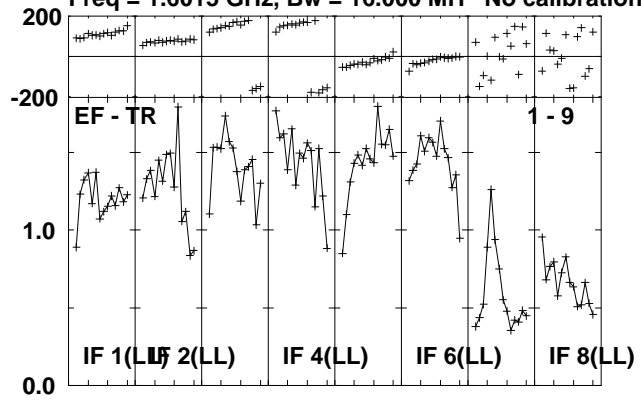

Lower frame: Milli Ampl Jy Top frame: Phas deg
Scalar averaged cross-power spectrum Several baselines displayed
Timerange: 01/03:42:05 to 01/03:43:49

Plot file version 201 created 01-JUL-2010 13:26:15

V407CYG RG006B.UVDATA.1

Freq = 1.6015 GHz, Bw = 16.000 MH No calibration applied and no bandpass applied

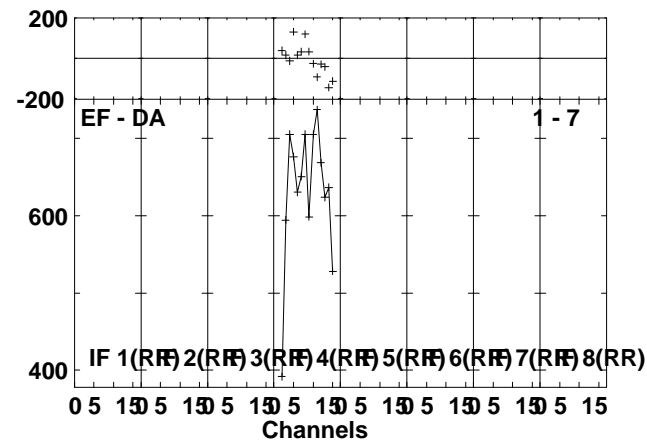
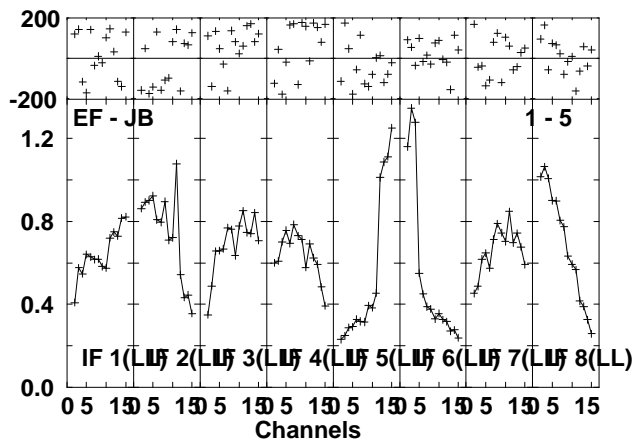
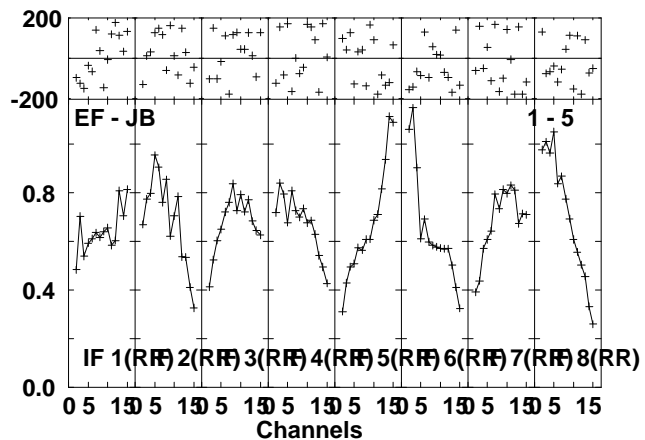
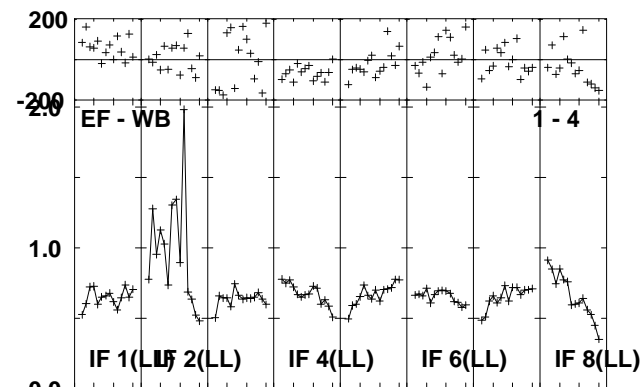
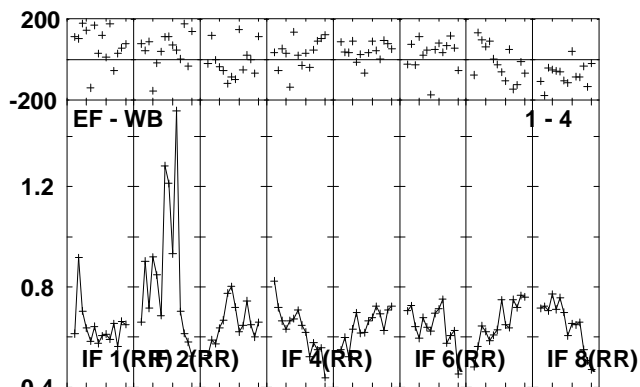
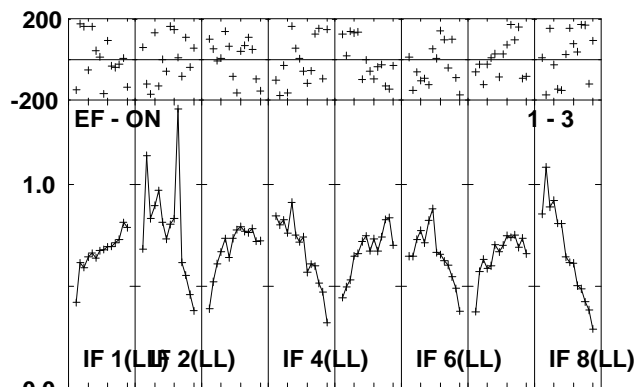
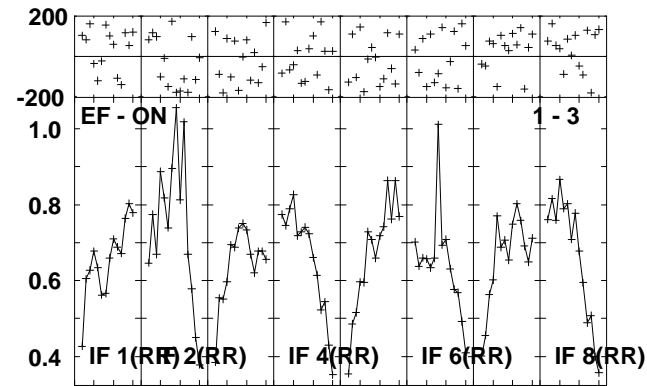
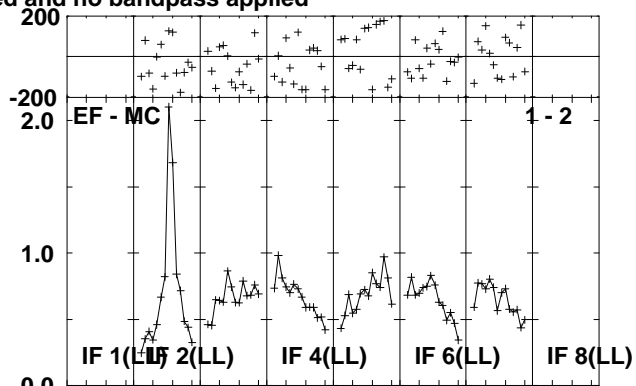
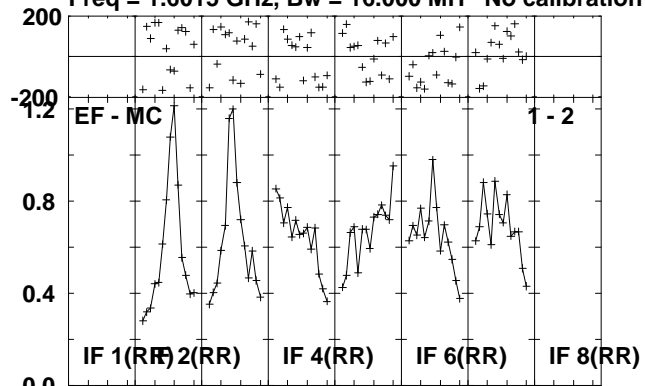

Lower frame: Milli Ampl Jy Top frame: Phas deg
Scalar averaged cross-power spectrum Several baselines displayed
Timerange: 01/03:43:53 to 01/03:48:49

Plot file version 202 created 01-JUL-2010 13:26:16

V407CYG RG006B.UVDATA.1

Freq = 1.6015 GHz, Bw = 16.000 MH No calibration applied and no bandpass applied

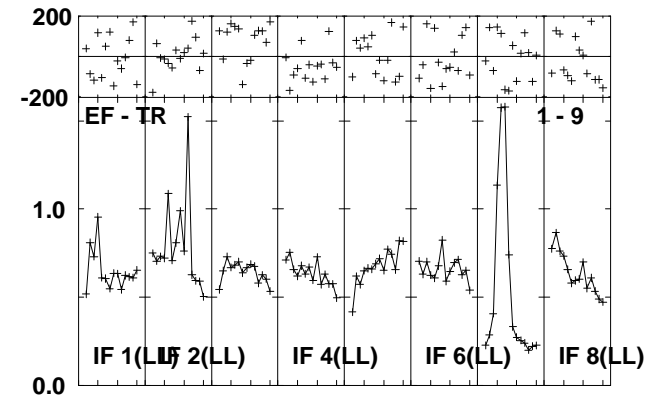
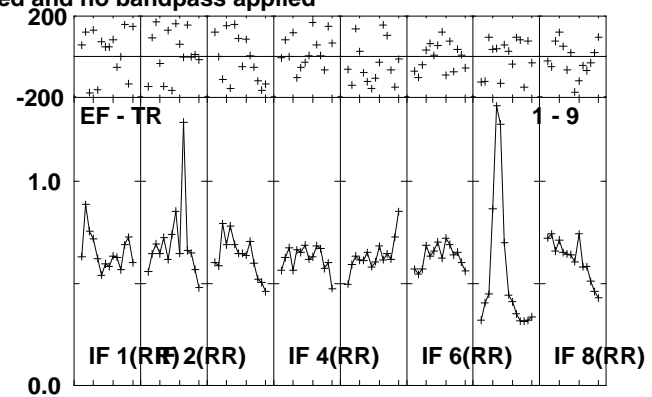
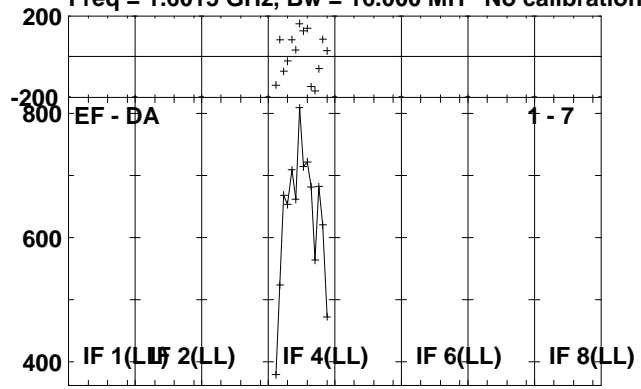

Lower frame: Micro Ampl Jy Top frame: Phas deg
Scalar averaged cross-power spectrum Several baselines displayed
Timerange: 01/03:43:53 to 01/03:48:49

Plot file version 203 created 01-JUL-2010 13:26:17

J2102+47 RG006B.UVDATA.1

Freq = 1.6015 GHz, Bw = 16.000 MH No calibration applied and no bandpass applied

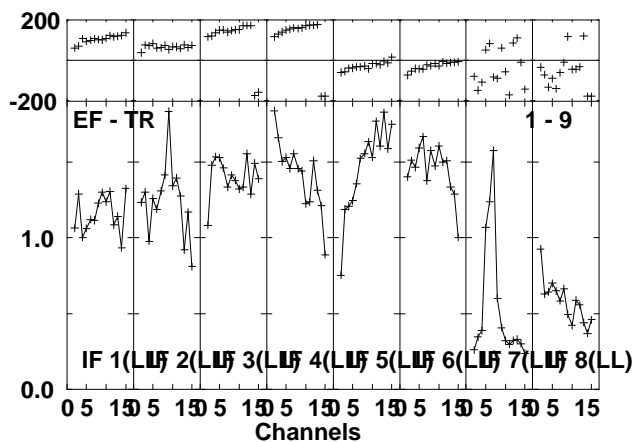
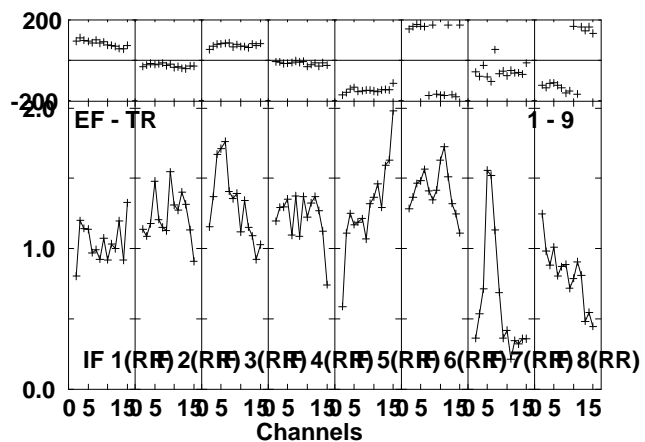
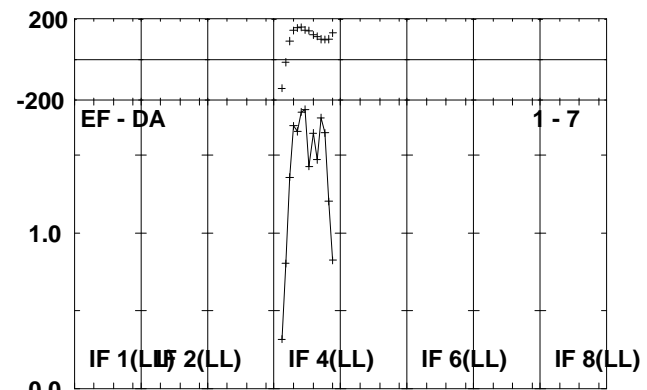
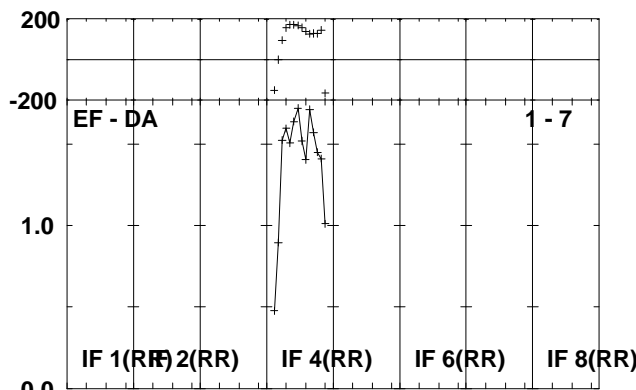
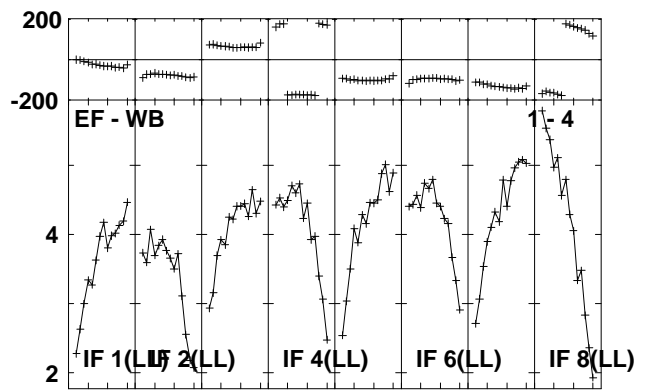
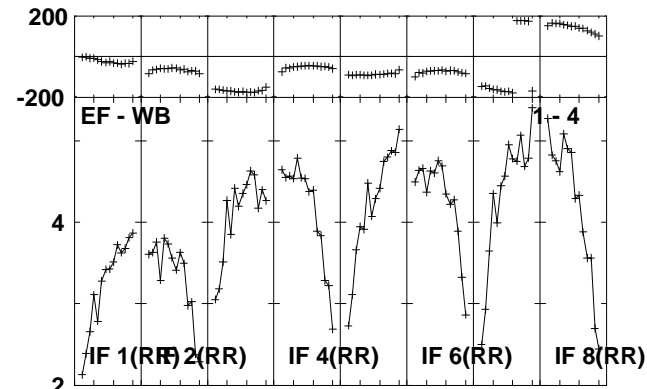
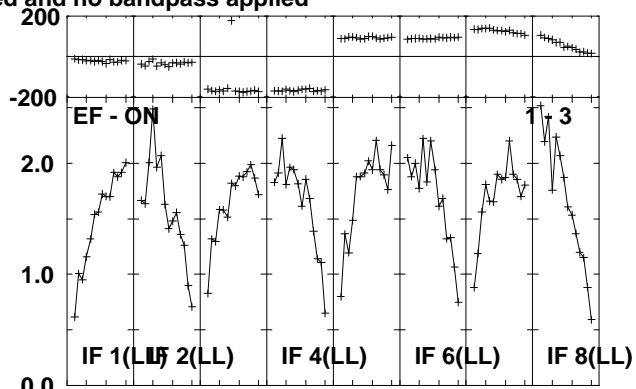
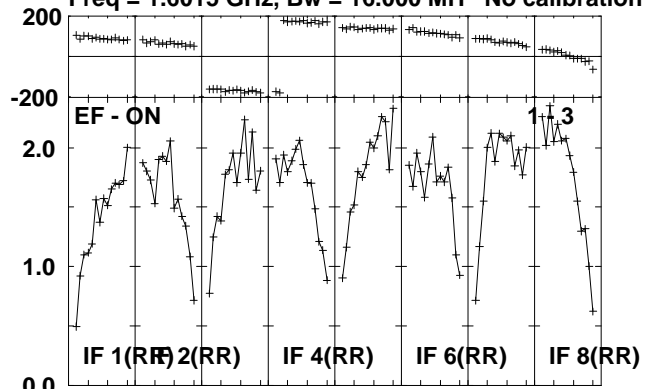

Lower frame: Milli Ampl Jy Top frame: Phas deg
Scalar averaged cross-power spectrum Several baselines displayed
Timerange: 01/03:48:53 to 01/03:51:01

Plot file version 204 created 01-JUL-2010 13:26:17

V407CYG RG006B.UVDATA.1

Freq = 1.6015 GHz, Bw = 16.000 MH No calibration applied and no bandpass applied

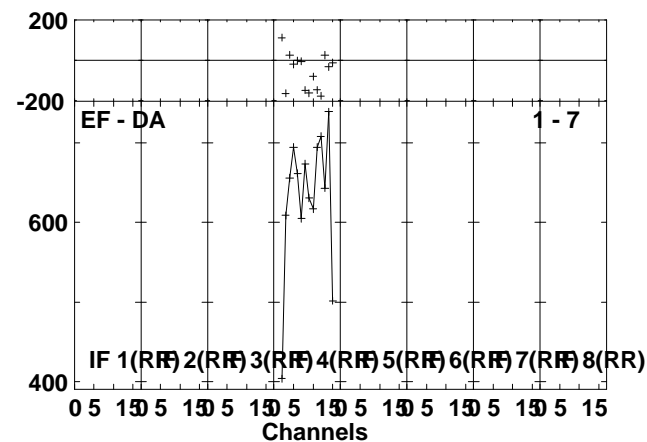
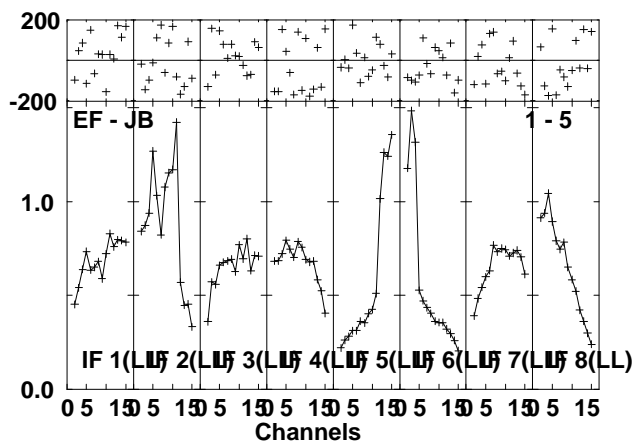
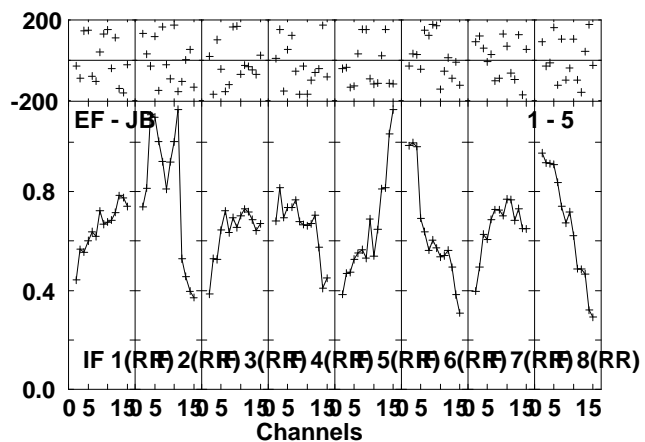
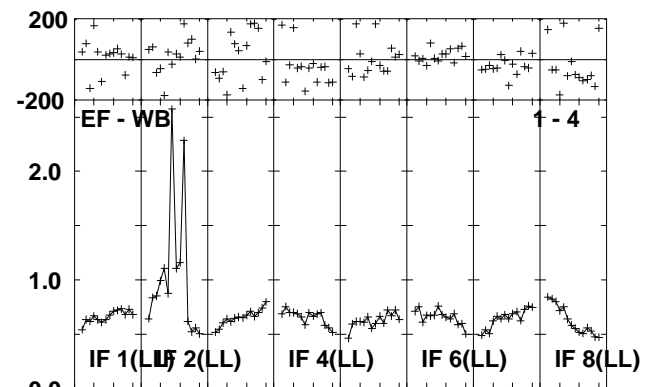
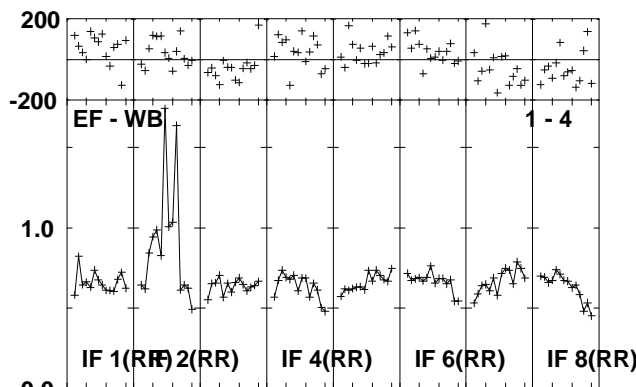
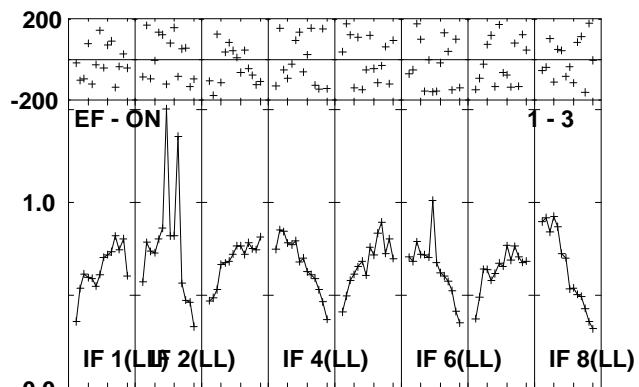
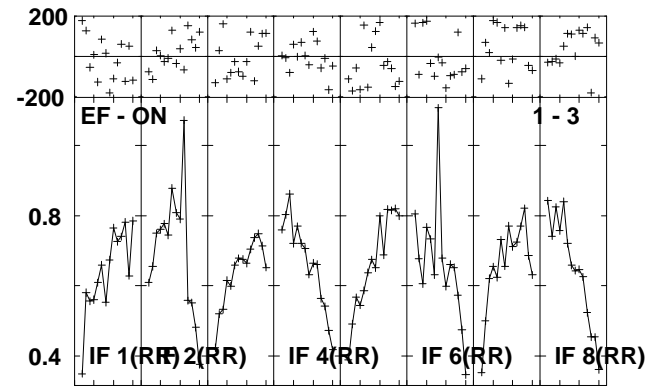
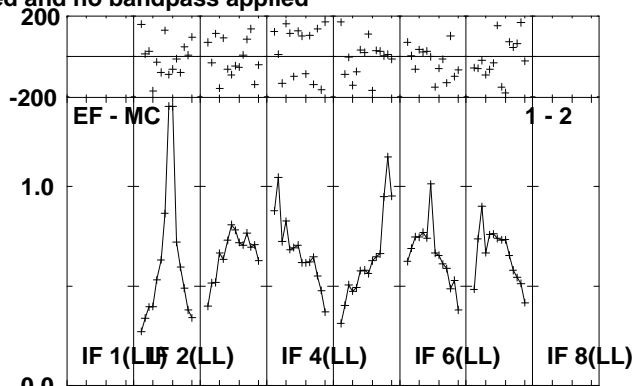
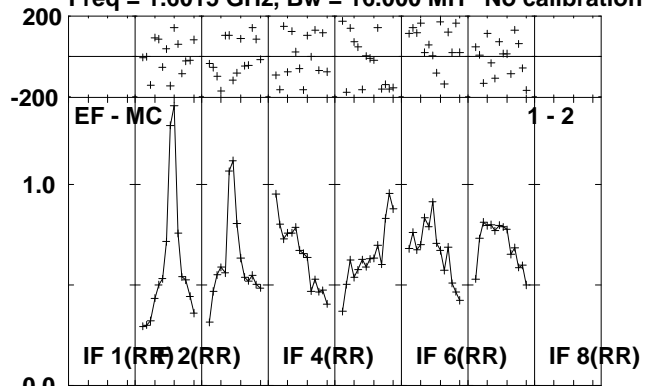

Lower frame: Milli Ampl Jy Top frame: Phas deg
Scalar averaged cross-power spectrum Several baselines displayed
Timerange: 01/03:51:05 to 01/03:56:01

Plot file version 205 created 01-JUL-2010 13:26:19

V407CYG RG006B.UVDATA.1

Freq = 1.6015 GHz, Bw = 16.000 MH No calibration applied and no bandpass applied

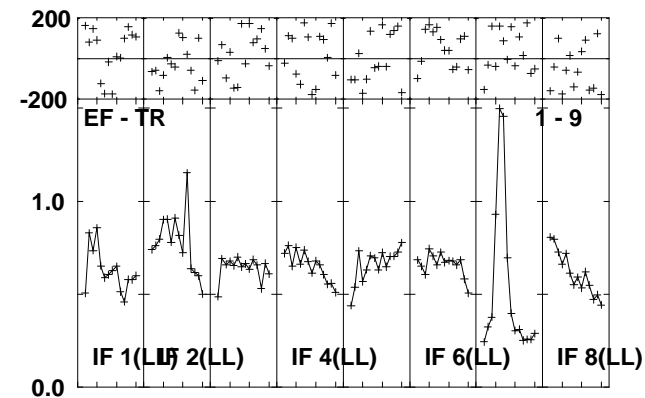
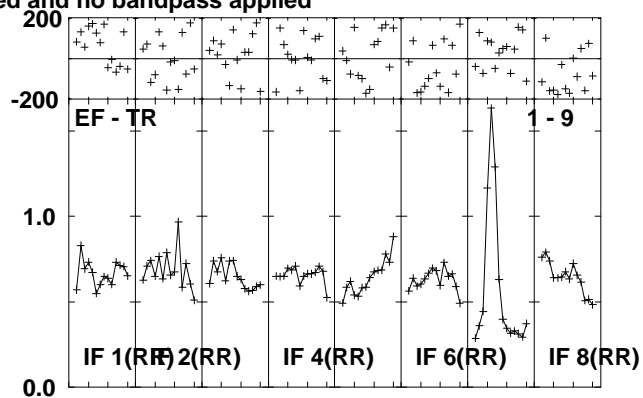
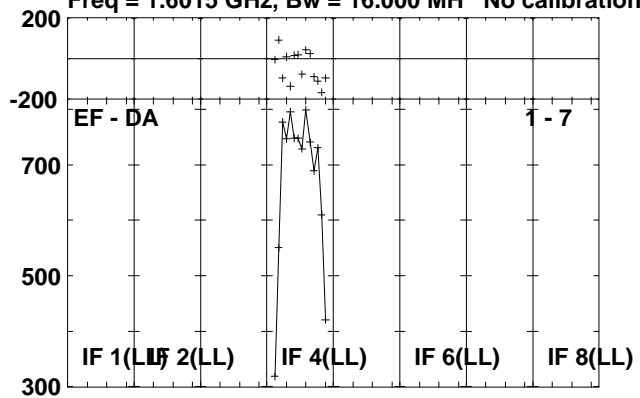

Lower frame: Micro Ampl Jy Top frame: Phas deg
Scalar averaged cross-power spectrum Several baselines displayed
Timerange: 01/03:51:05 to 01/03:56:01

Plot file version 206 created 01-JUL-2010 13:26:19

J2102+47 RG006B.UVDATA.1

Freq = 1.6015 GHz, Bw = 16.000 MH No calibration applied and no bandpass applied

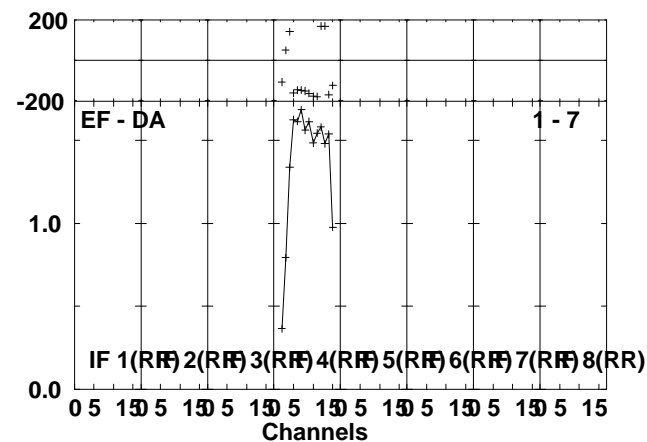
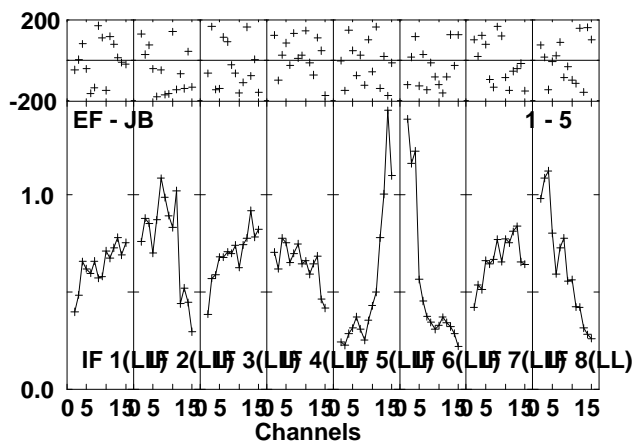
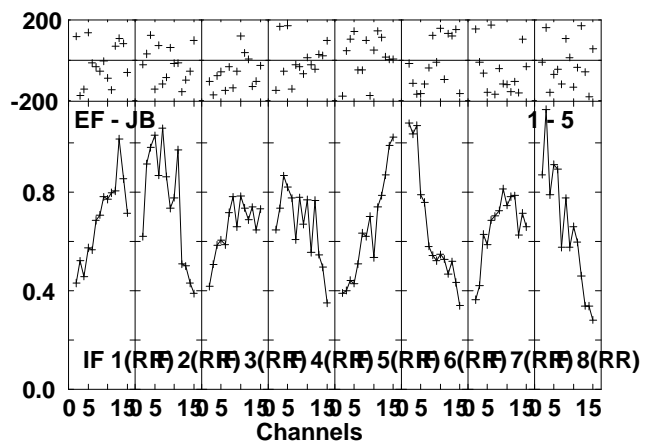
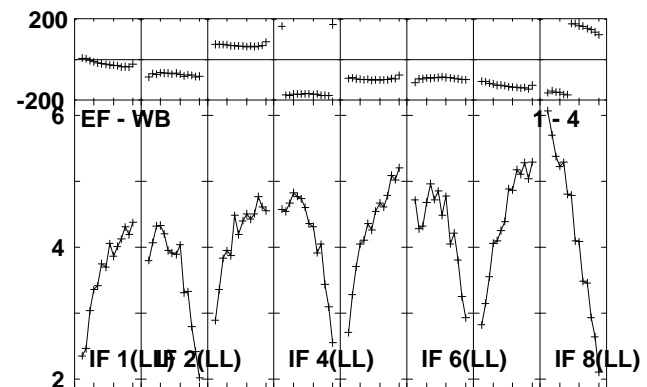
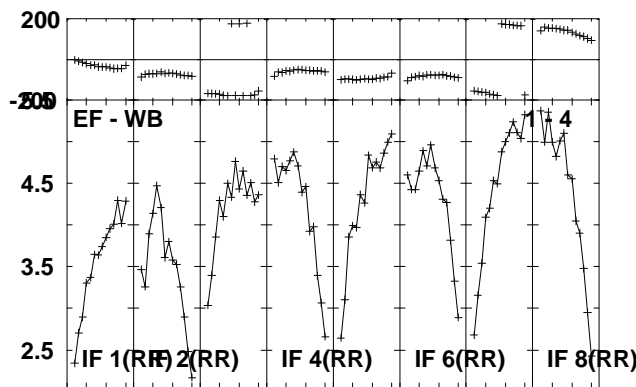
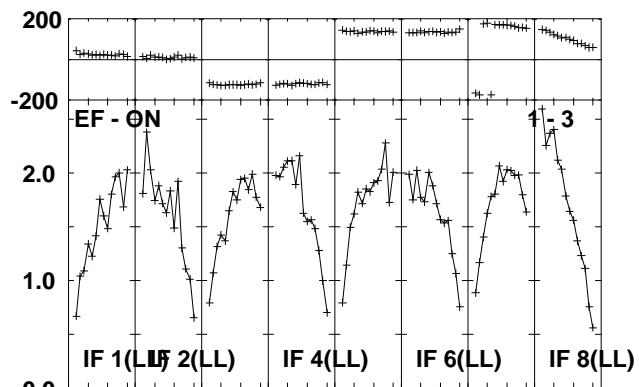
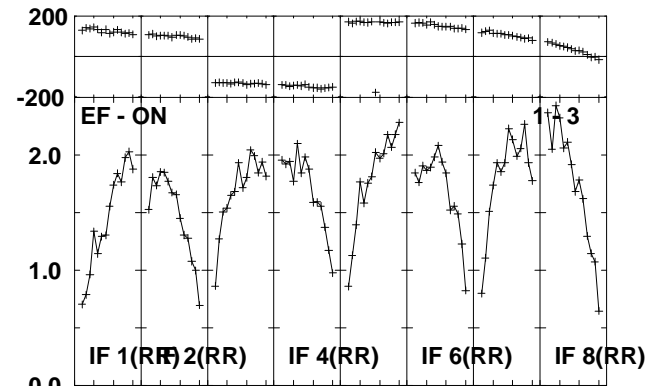
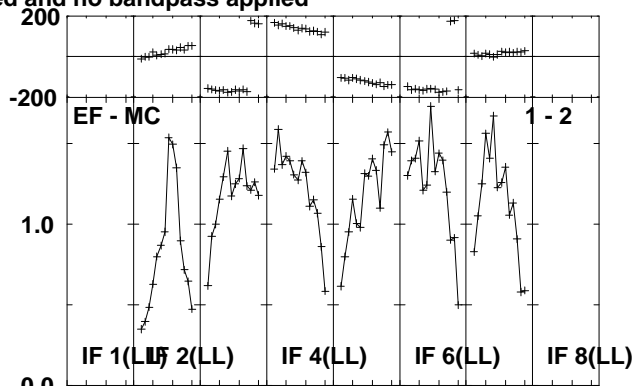
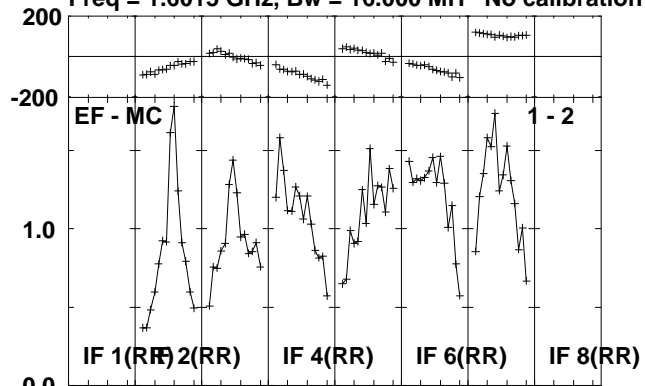

Lower frame: Milli Ampl Jy Top frame: Phas deg
Scalar averaged cross-power spectrum Several baselines displayed
Timerange: 01/03:57:05 to 01/03:58:49

Plot file version 207 created 01-JUL-2010 13:26:19

J2102+47 RG006B.UVDATA.1

Freq = 1.6015 GHz, Bw = 16.000 MH No calibration applied and no bandpass applied

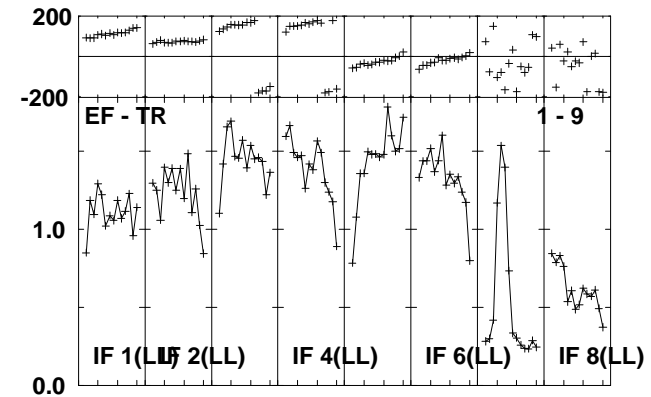
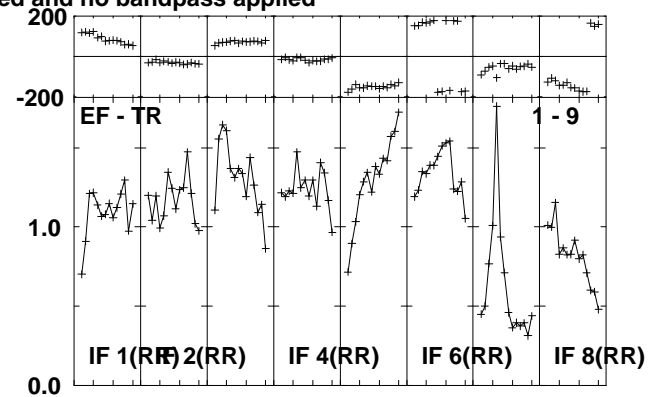
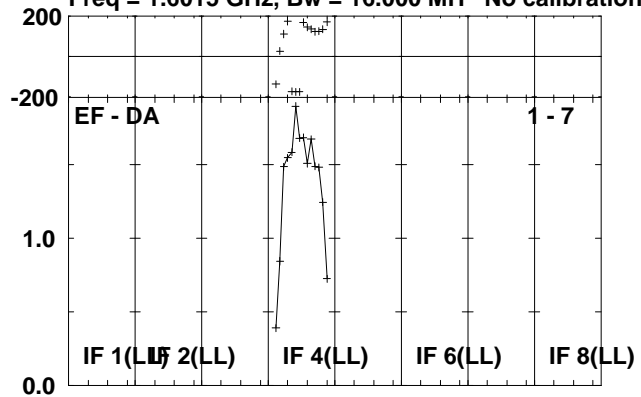

Lower frame: Milli Ampl Jy Top frame: Phas deg
Scalar averaged cross-power spectrum Several baselines displayed
Timerange: 01/03:57:05 to 01/03:58:49

Plot file version 208 created 01-JUL-2010 13:26:20

V407CYG RG006B.UVDATA.1

Freq = 1.6015 GHz, Bw = 16.000 MH No calibration applied and no bandpass applied

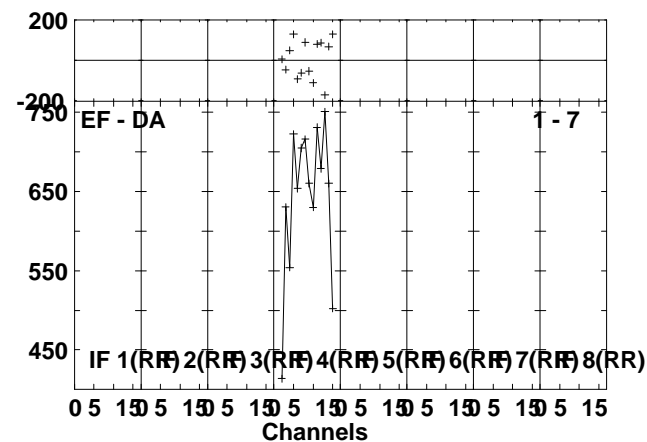
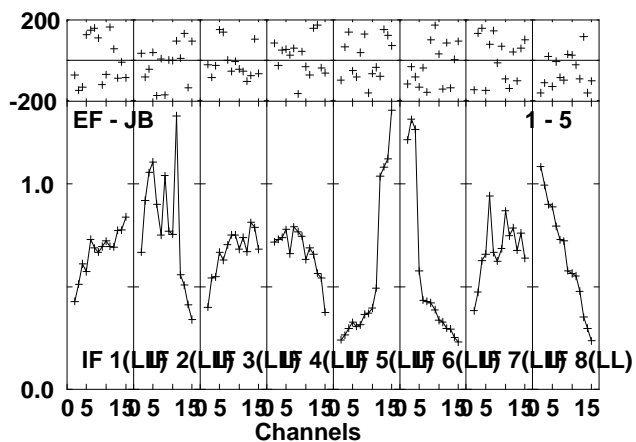
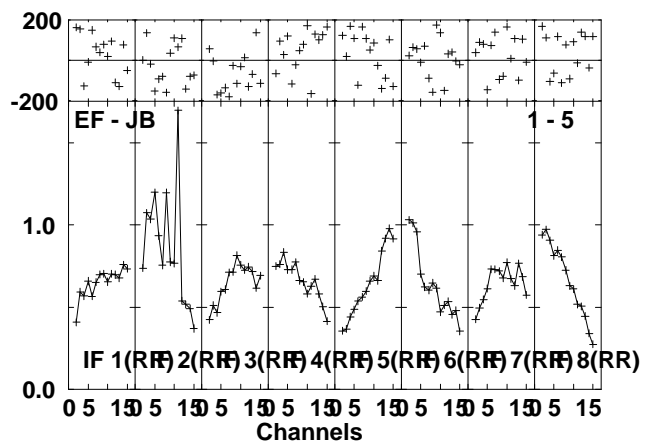
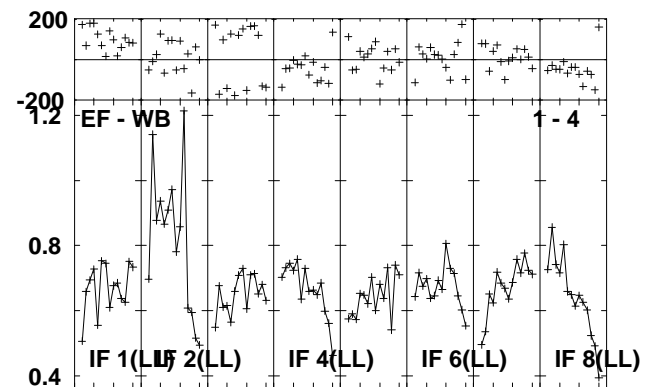
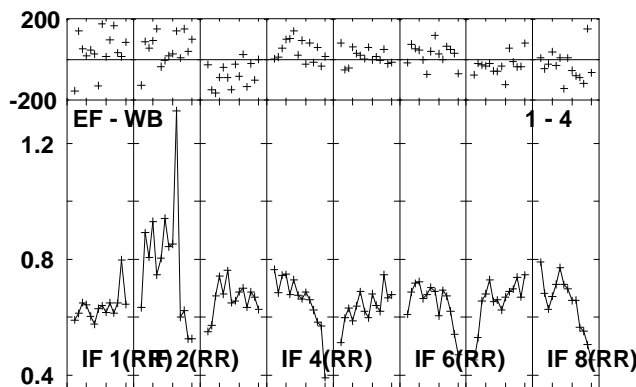
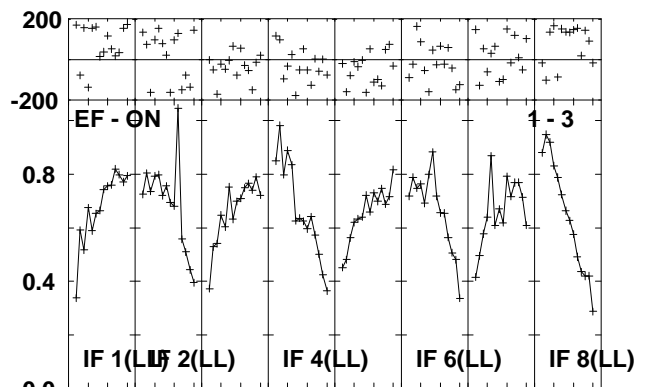
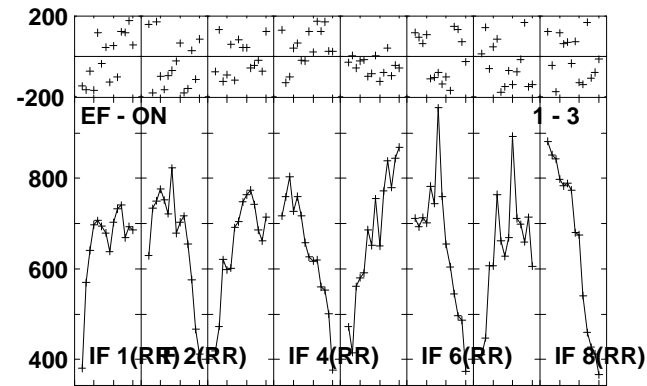
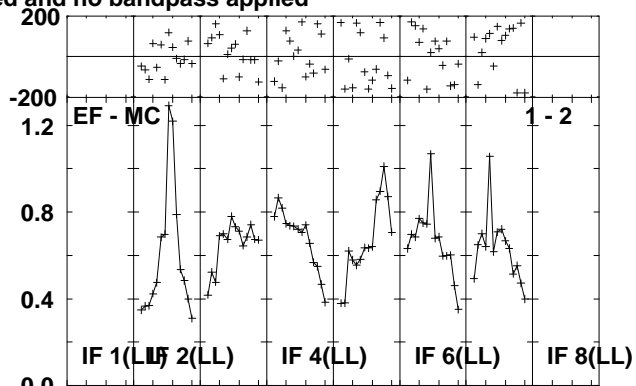
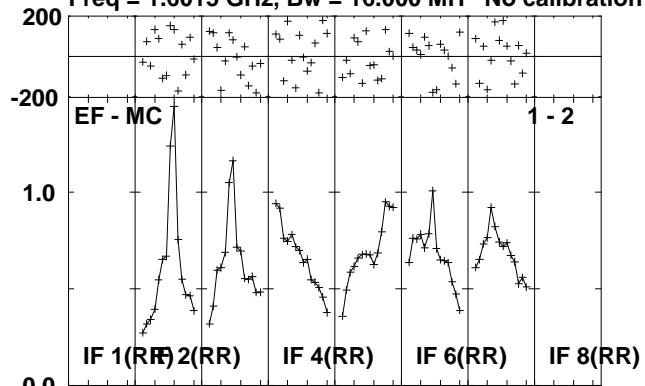

Lower frame: Milli Ampl Jy Top frame: Phas deg
Scalar averaged cross-power spectrum Several baselines displayed
Timerange: 01/03:58:53 to 01/04:03:49

Plot file version 209 created 01-JUL-2010 13:26:21

V407CYG RG006B.UVDATA.1

Freq = 1.6015 GHz, Bw = 16.000 MH No calibration applied and no bandpass applied

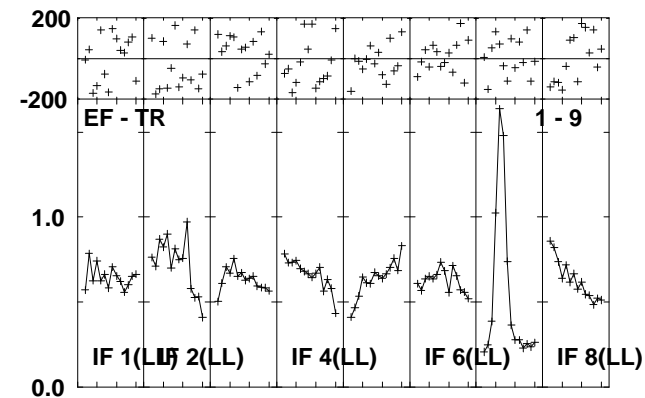
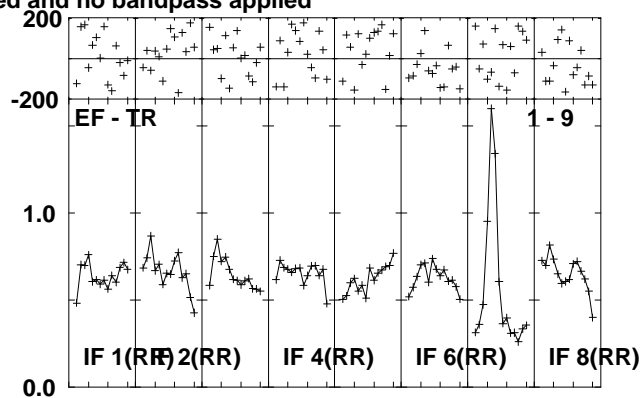
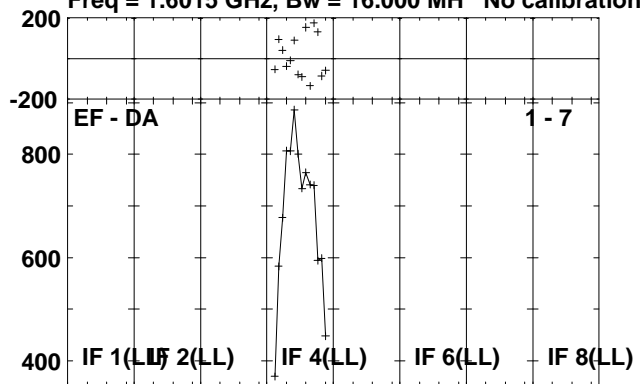

Lower frame: Micro Ampl Jy Top frame: Phas deg
Scalar averaged cross-power spectrum Several baselines displayed
Timerange: 01/03:58:53 to 01/04:03:49

Plot file version 210 created 01-JUL-2010 13:26:22

J2102+47 RG006B.UVDATA.1

Freq = 1.6015 GHz, Bw = 16.000 MH No calibration applied and no bandpass applied

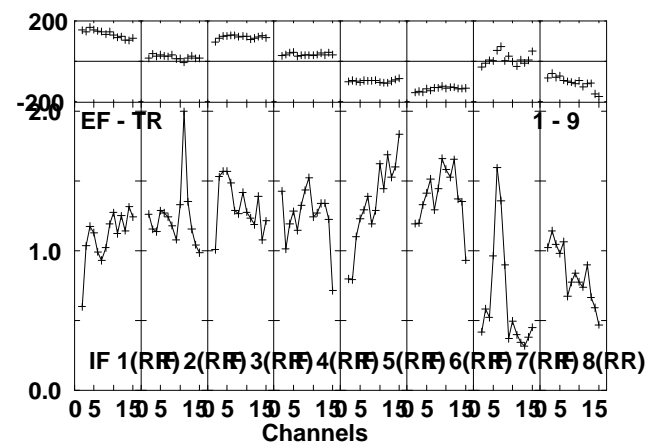
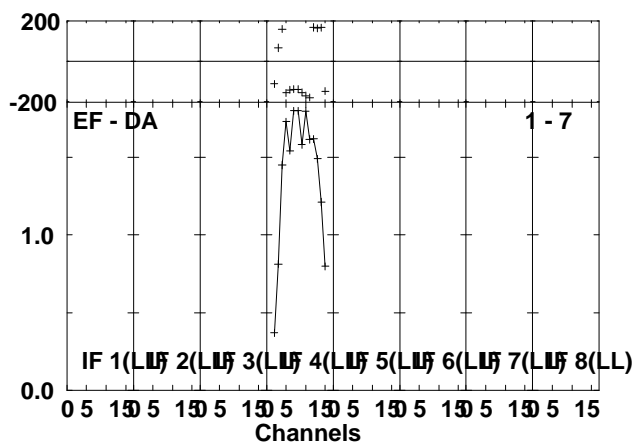
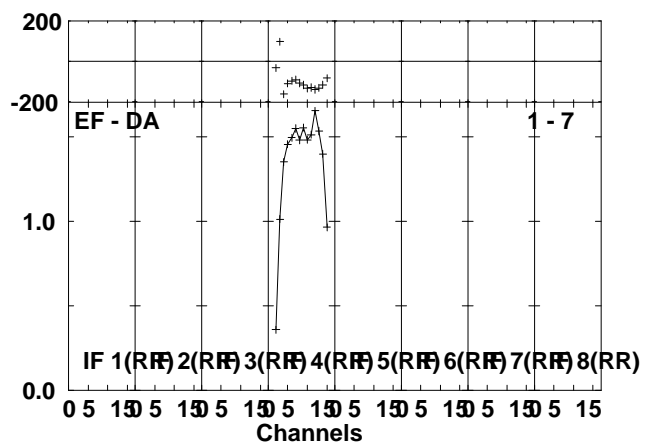
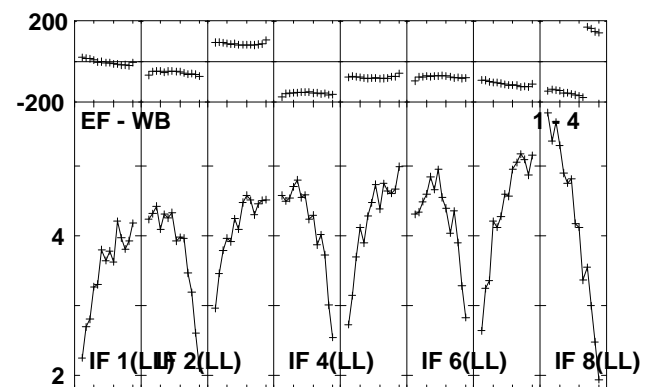
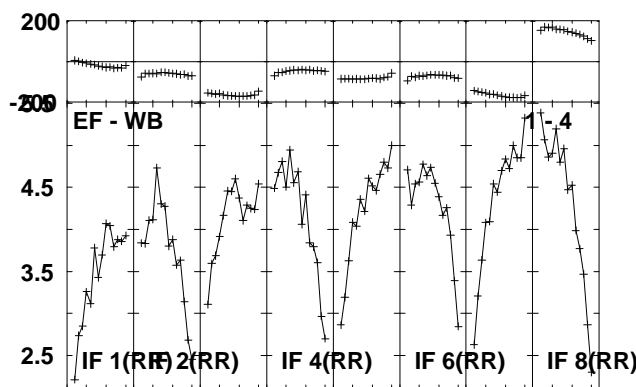
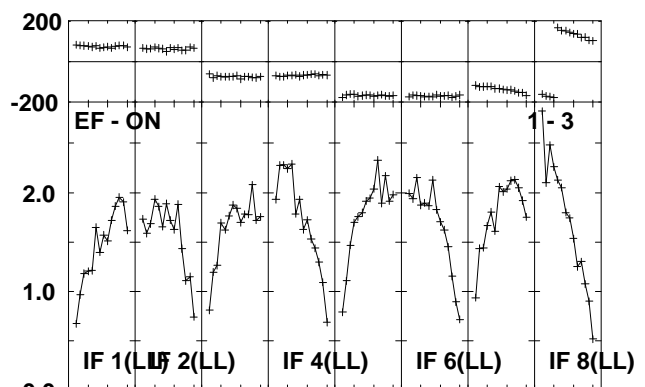
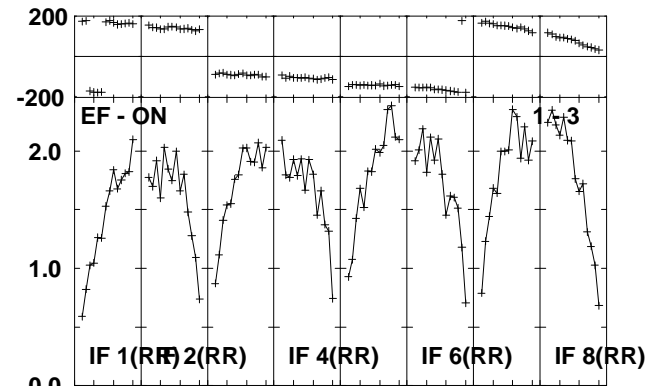
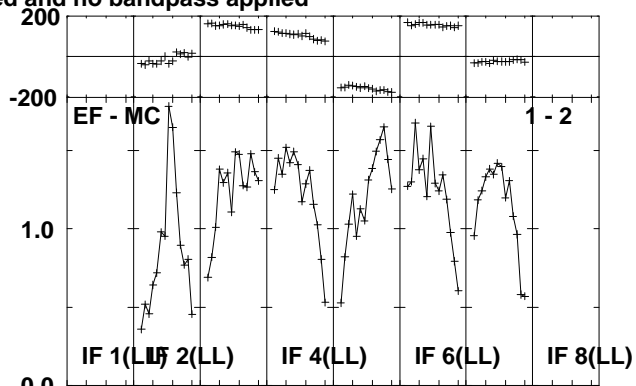
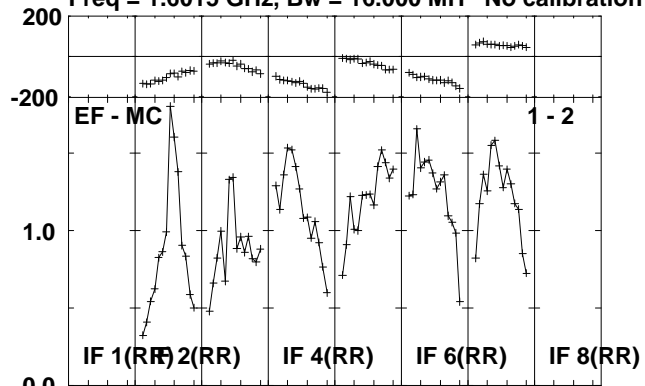

Lower frame: Milli Ampl Jy Top frame: Phas deg
Scalar averaged cross-power spectrum Several baselines displayed
Timerange: 01/04:03:53 to 01/04:06:01

Plot file version 211 created 01-JUL-2010 13:26:22

J2102+47 RG006B.UVDATA.1

Freq = 1.6015 GHz, Bw = 16.000 MH No calibration applied and no bandpass applied

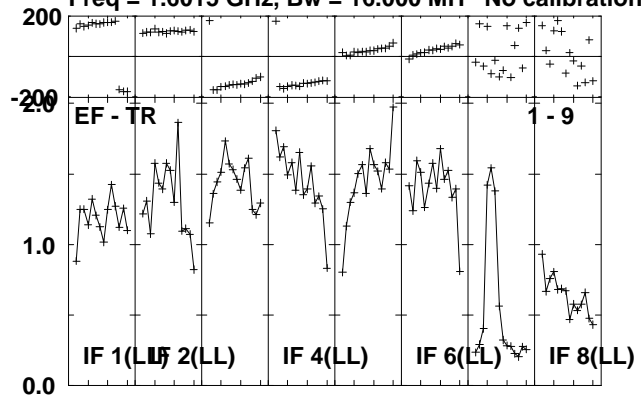

Lower frame: Milli Ampl Jy Top frame: Phas deg
Scalar averaged cross-power spectrum Several baselines displayed
Timerange: 01/04:03:53 to 01/04:06:01

Plot file version 212 created 01-JUL-2010 13:26:22

V407CYG RG006B.UVDATA.1

Freq = 1.6015 GHz, Bw = 16.000 MH No calibration applied and no bandpass applied

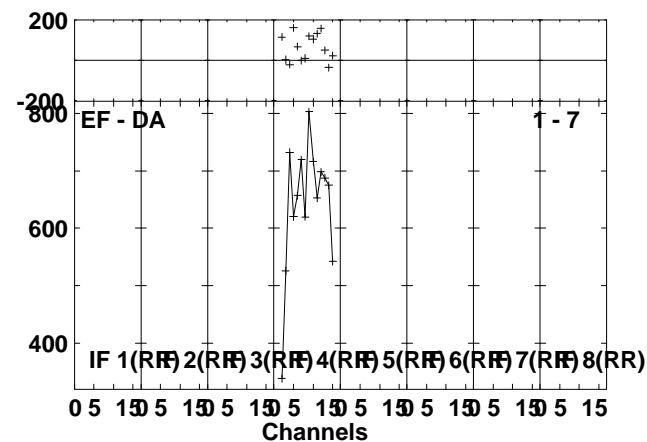
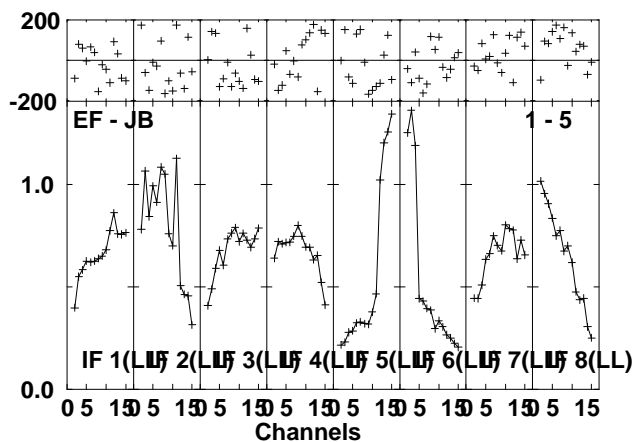
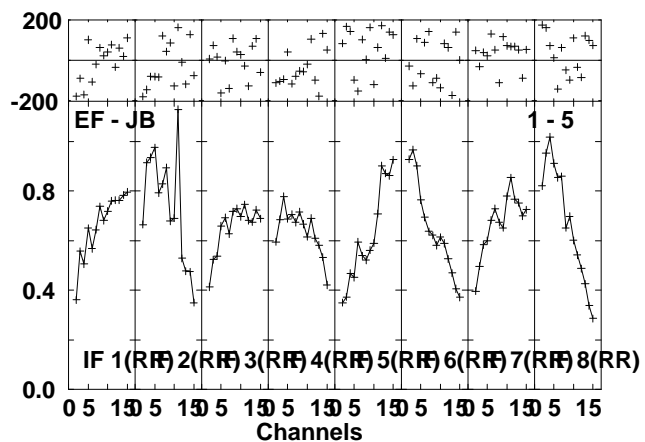
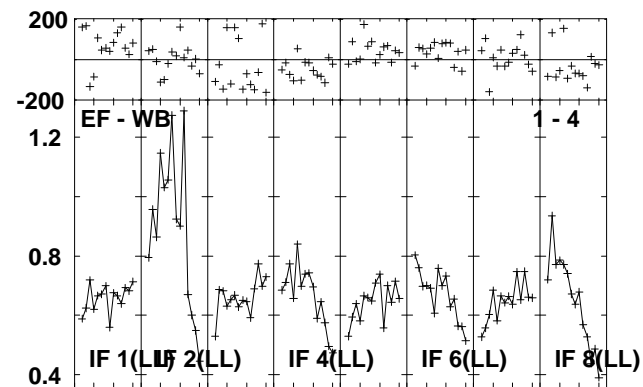
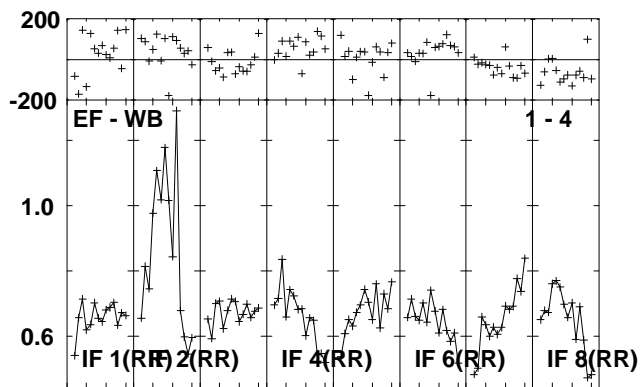
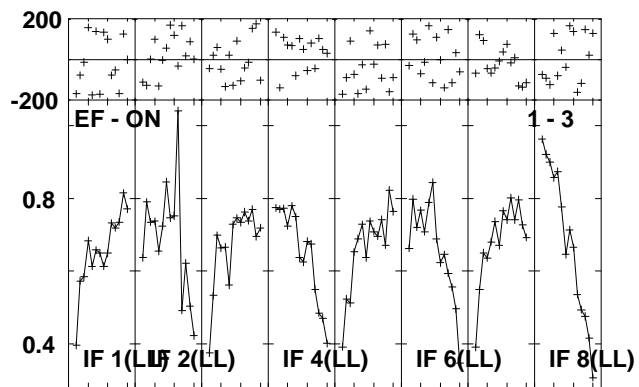
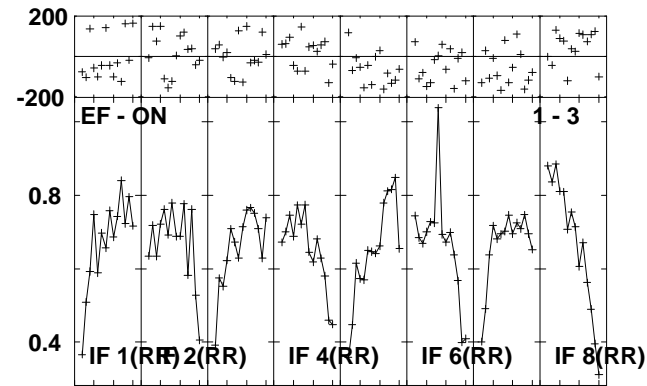
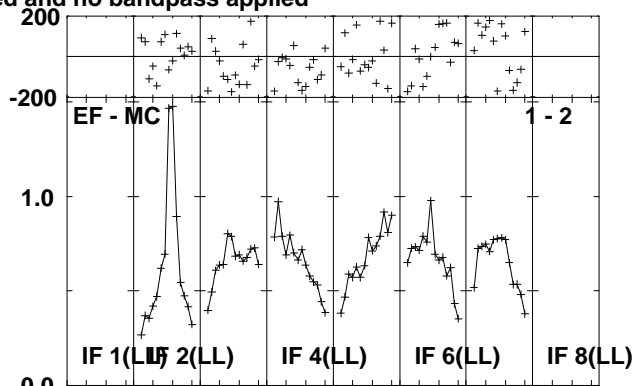
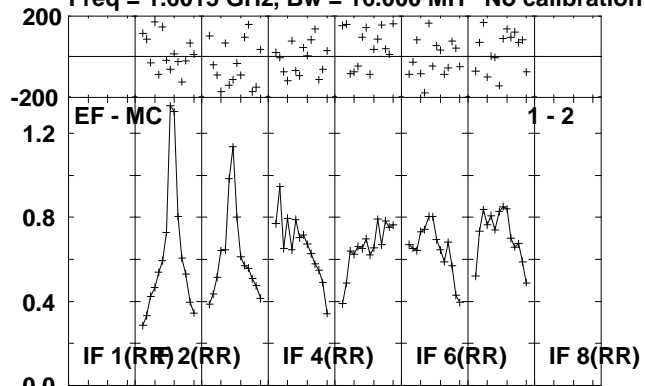

Lower frame: Milli Ampl Jy Top frame: Phas deg
Scalar averaged cross-power spectrum Several baselines displayed
Timerange: 01/04:06:05 to 01/04:11:01

Plot file version 213 created 01-JUL-2010 13:26:23

V407CYG RG006B.UVDATA.1

Freq = 1.6015 GHz, Bw = 16.000 MH No calibration applied and no bandpass applied

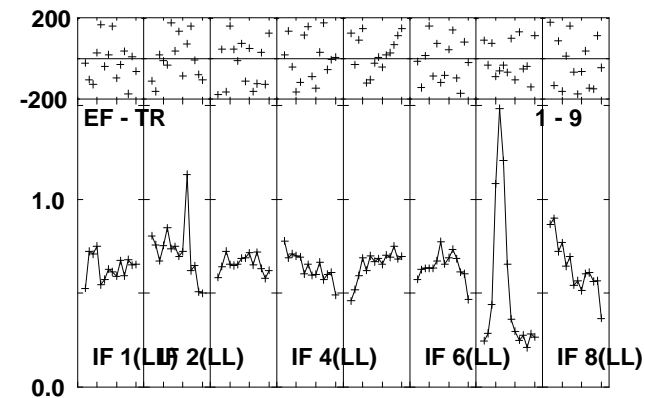
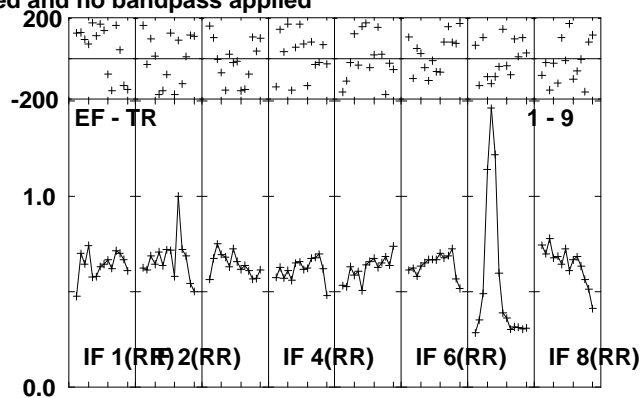
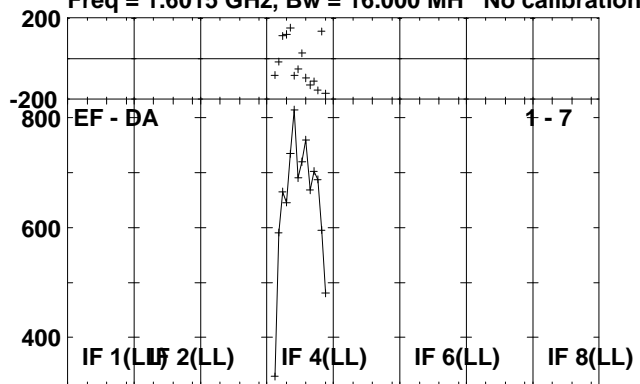

Lower frame: Micro Ampl Jy Top frame: Phas deg
Scalar averaged cross-power spectrum Several baselines displayed
Timerange: 01/04:06:05 to 01/04:11:01

Plot file version 214 created 01-JUL-2010 13:26:24

J2102+47 RG006B.UVDATA.1

Freq = 1.6015 GHz, Bw = 16.000 MH No calibration applied and no bandpass applied

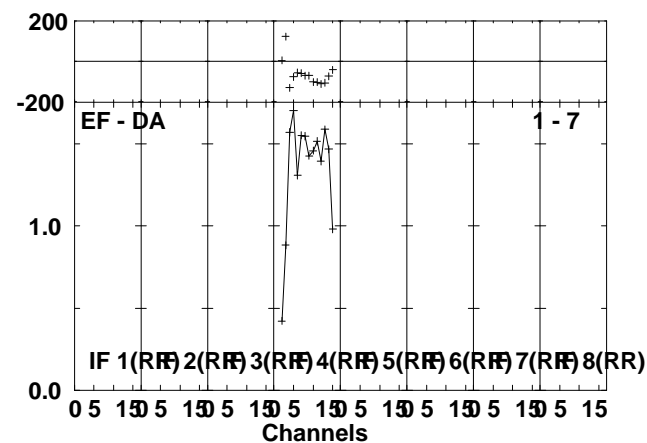
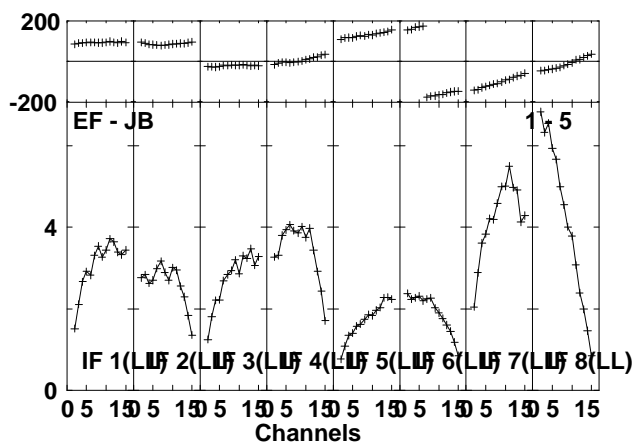
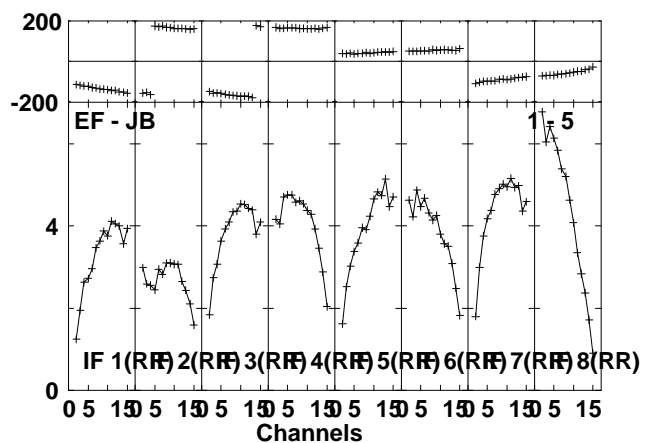
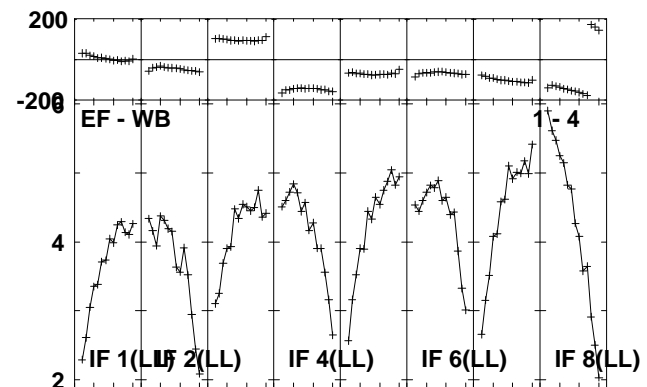
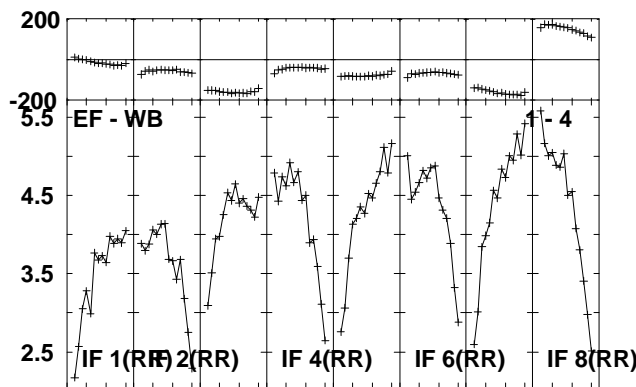
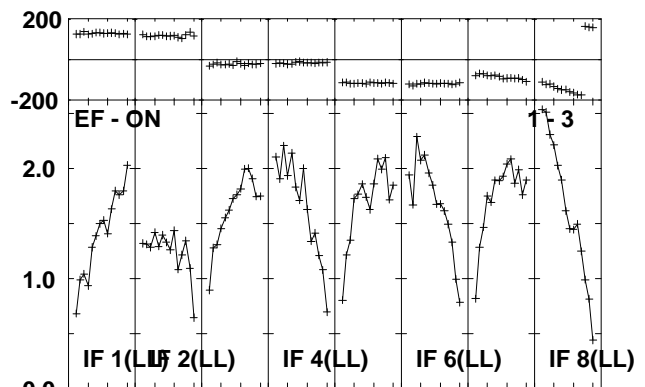
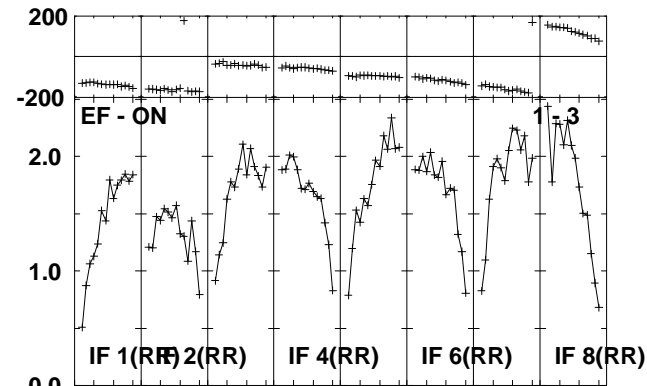
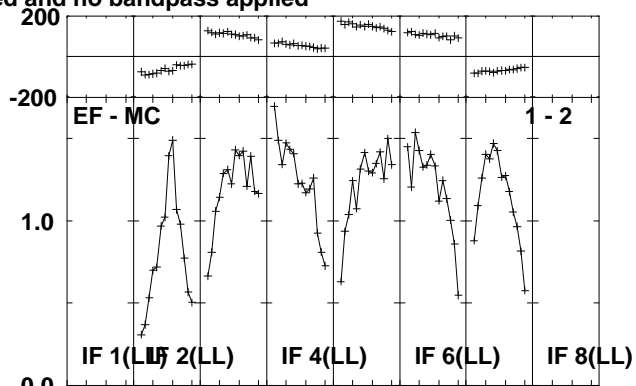
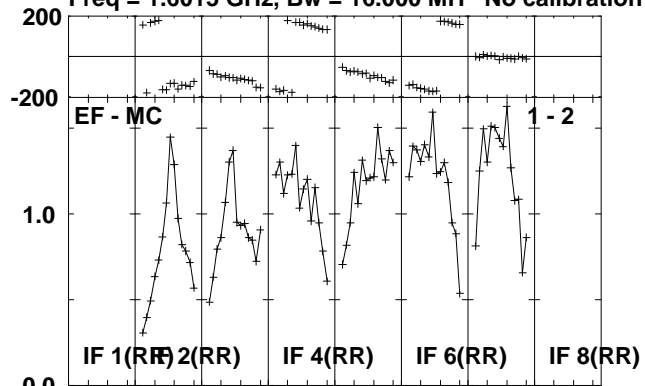

Lower frame: Milli Ampl Jy Top frame: Phas deg
Scalar averaged cross-power spectrum Several baselines displayed
Timerange: 01/04:12:05 to 01/04:13:49

Plot file version 215 created 01-JUL-2010 13:26:25

J2102+47 RG006B.UVDATA.1

Freq = 1.6015 GHz, Bw = 16.000 MH No calibration applied and no bandpass applied

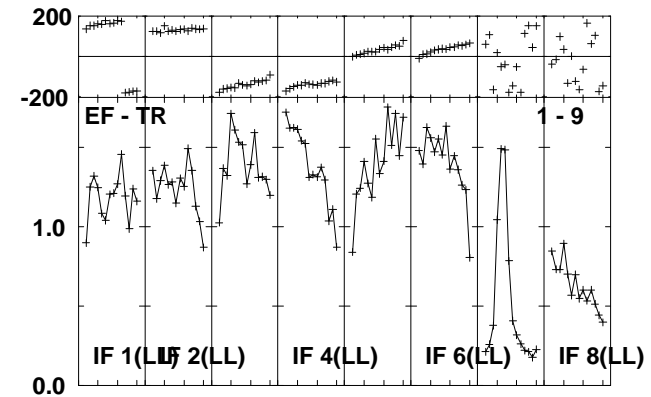
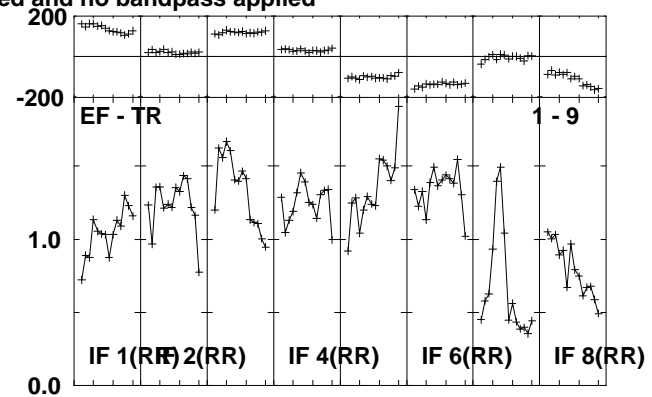
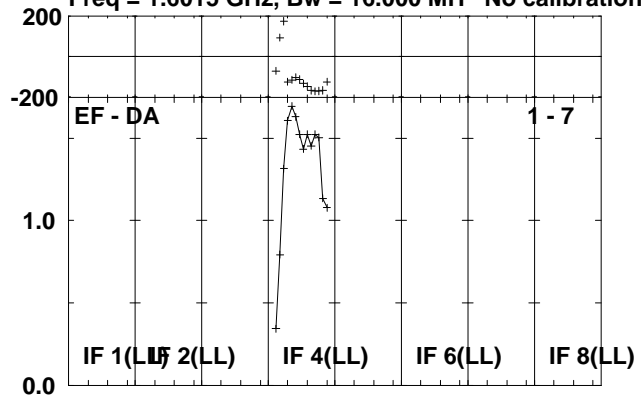

Lower frame: Milli Ampl Jy Top frame: Phas deg
Scalar averaged cross-power spectrum Several baselines displayed
Timerange: 01/04:12:05 to 01/04:13:49

Plot file version 216 created 01-JUL-2010 13:26:25

V407CYG RG006B.UVDATA.1

Freq = 1.6015 GHz, Bw = 16.000 MH No calibration applied and no bandpass applied

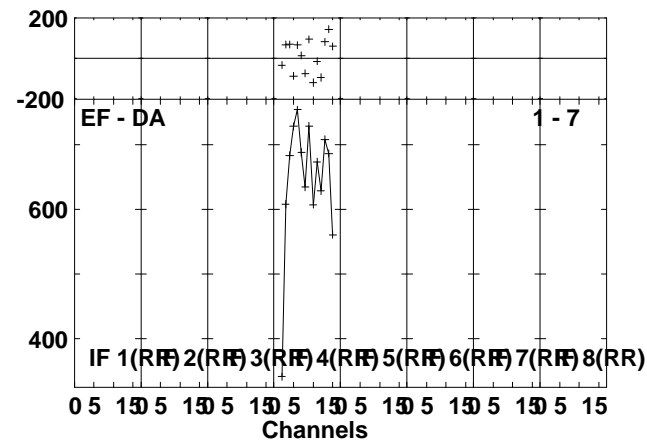
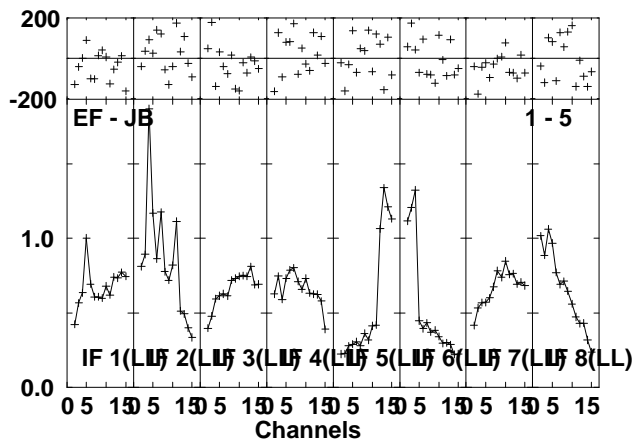
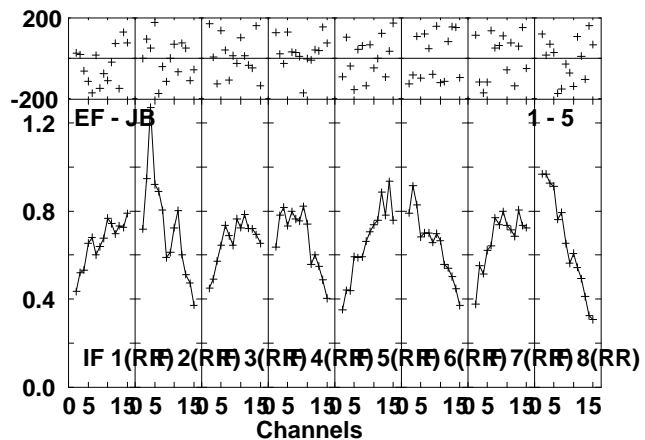
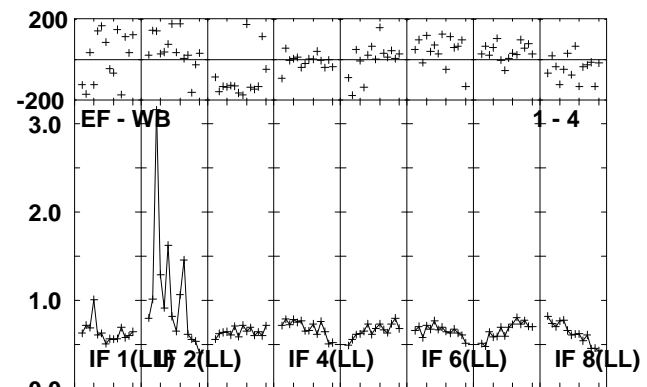
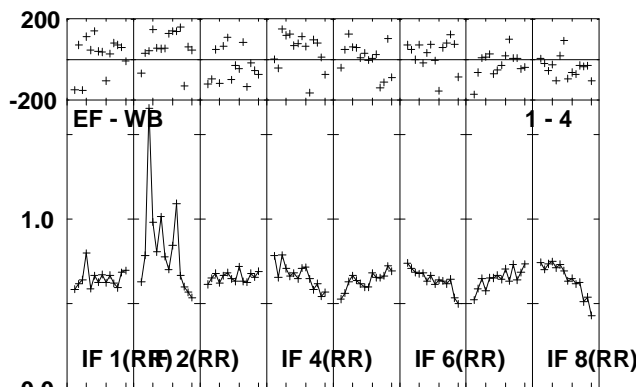
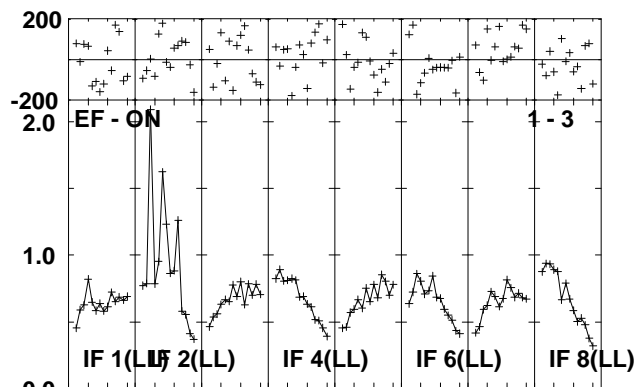
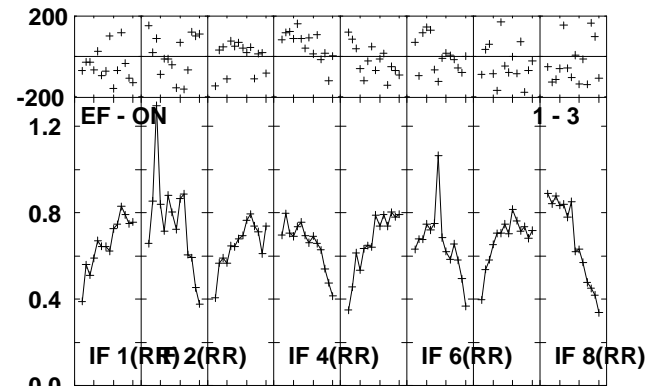
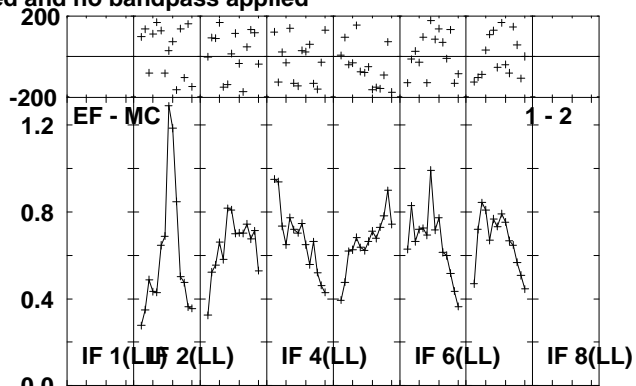
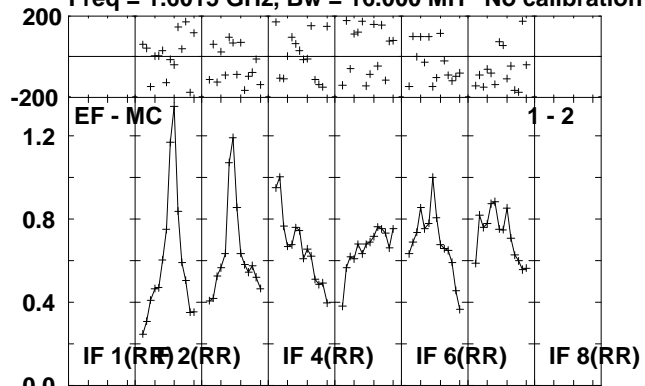

Lower frame: Milli Ampl Jy Top frame: Phas deg
Scalar averaged cross-power spectrum Several baselines displayed
Timerange: 01/04:13:53 to 01/04:18:49

Plot file version 217 created 01-JUL-2010 13:26:26

V407CYG RG006B.UVDATA.1

Freq = 1.6015 GHz, Bw = 16.000 MH No calibration applied and no bandpass applied

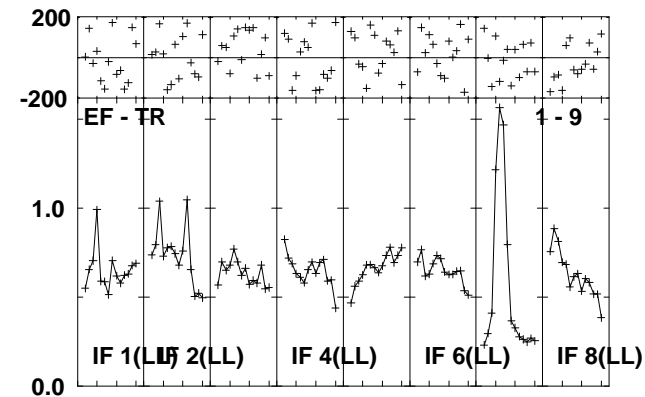
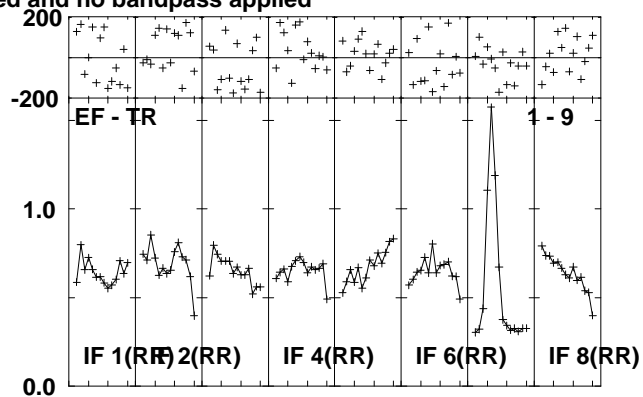
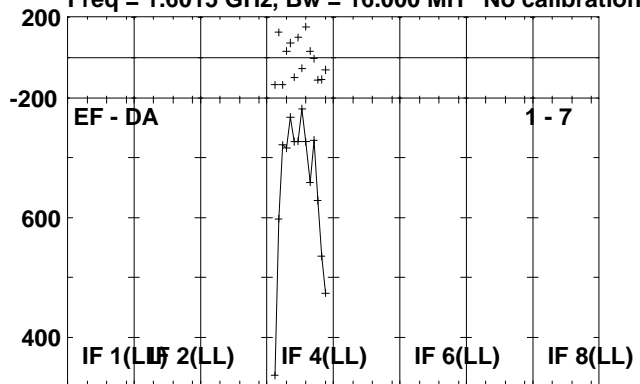

Lower frame: Micro Ampl Jy Top frame: Phas deg
Scalar averaged cross-power spectrum Several baselines displayed
Timerange: 01/04:13:53 to 01/04:18:49

Plot file version 218 created 01-JUL-2010 13:26:27

J2102+47 RG006B.UVDATA.1

Freq = 1.6015 GHz, Bw = 16.000 MH No calibration applied and no bandpass applied

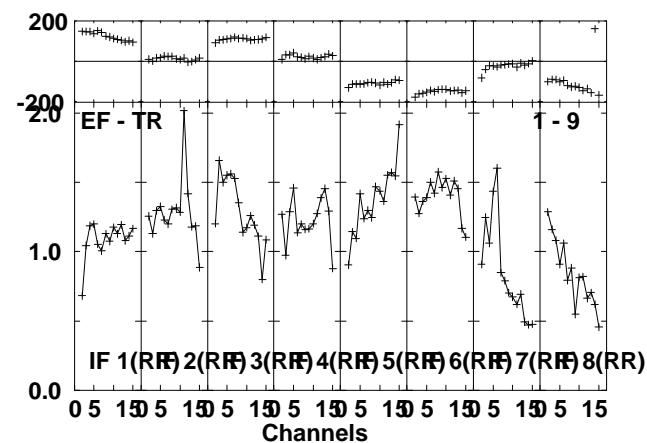
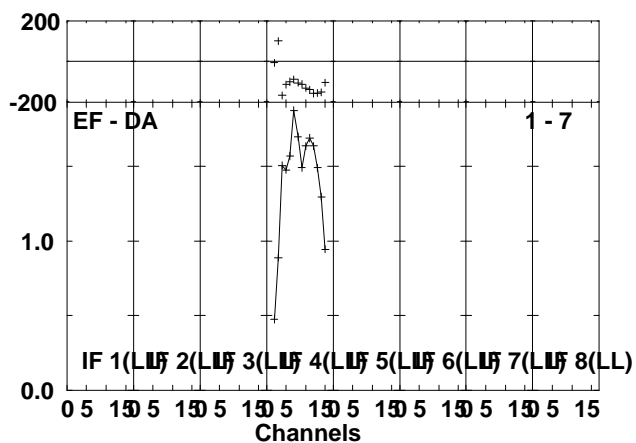
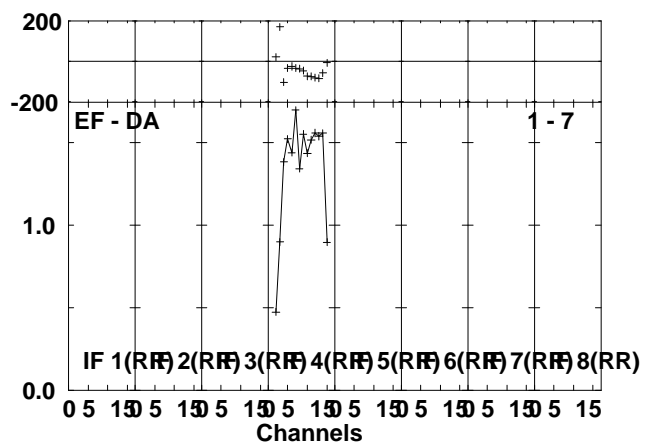
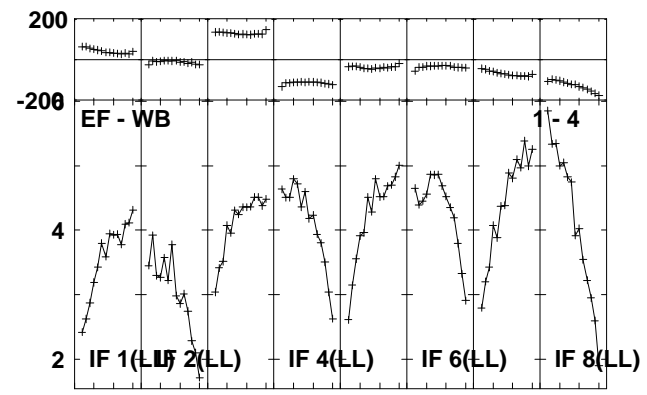
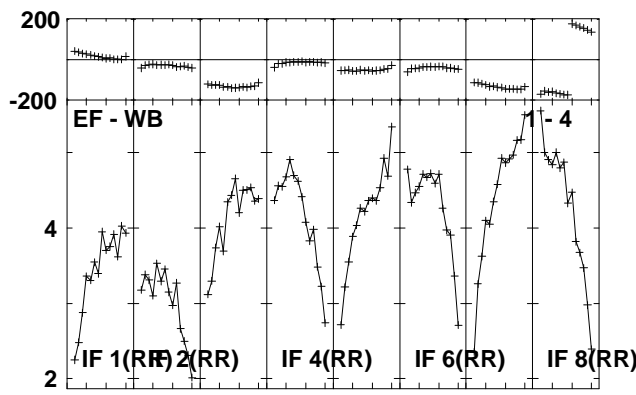
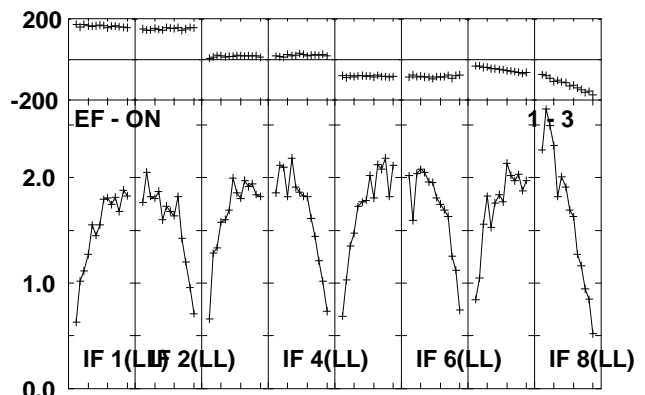
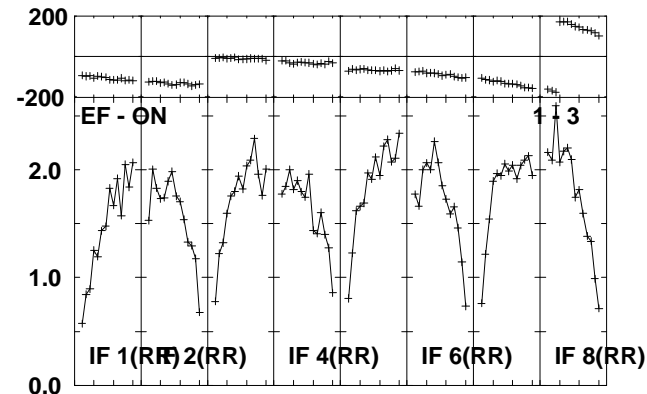
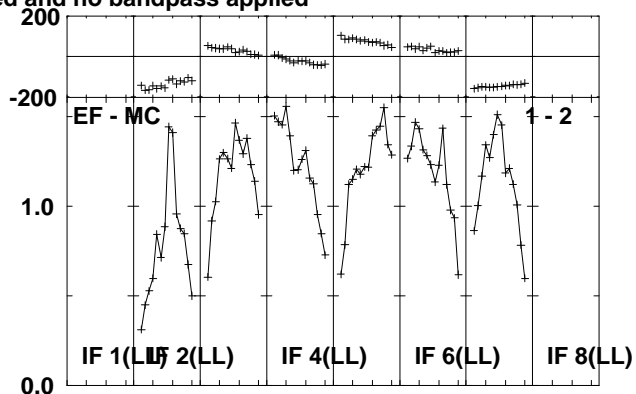
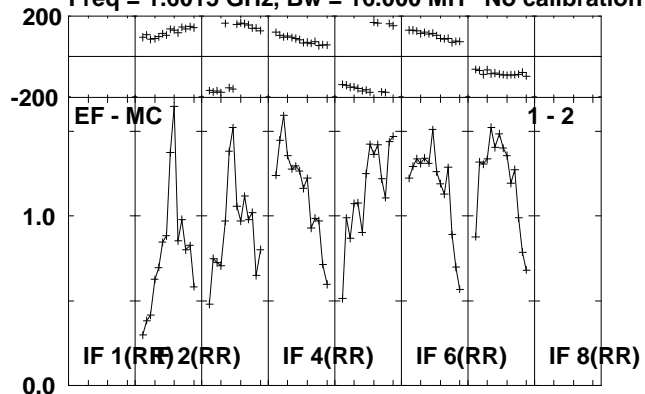

Lower frame: Milli Ampl Jy Top frame: Phas deg
Scalar averaged cross-power spectrum Several baselines displayed
Timerange: 01/04:18:53 to 01/04:21:01

Plot file version 219 created 01-JUL-2010 13:26:28
J2102+47 RG006B.UVDATA.1
Freq = 1.6015 GHz, Bw = 16.000 MH No calibration applied and no bandpass applied

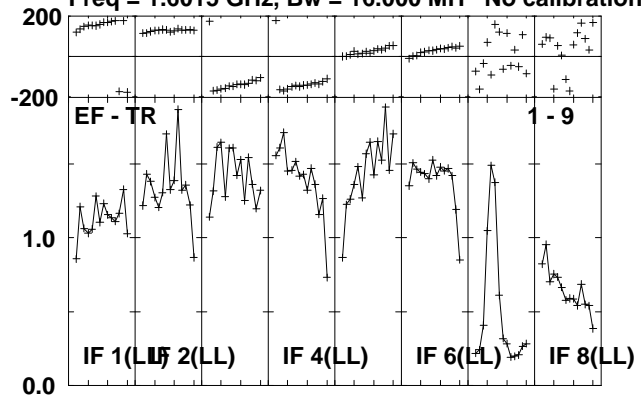

Lower frame: Milli Ampl Jy Top frame: Phas deg
Scalar averaged cross-power spectrum Several baselines displayed
Timerange: 01/04:18:53 to 01/04:21:01

Plot file version 220 created 01-JUL-2010 13:26:28

V407CYG RG006B.UVDATA.1

Freq = 1.6015 GHz, Bw = 16.000 MH No calibration applied and no bandpass applied

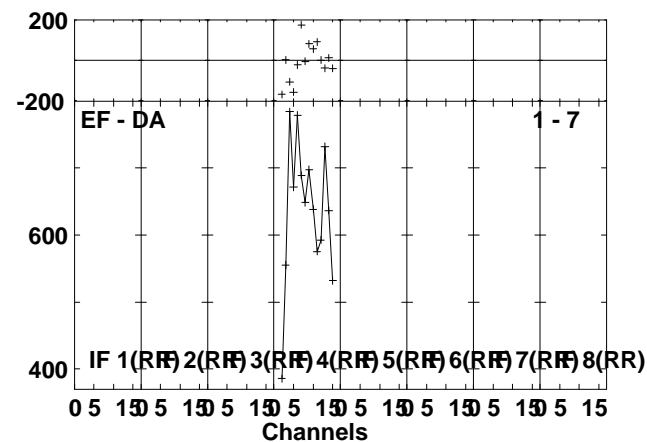
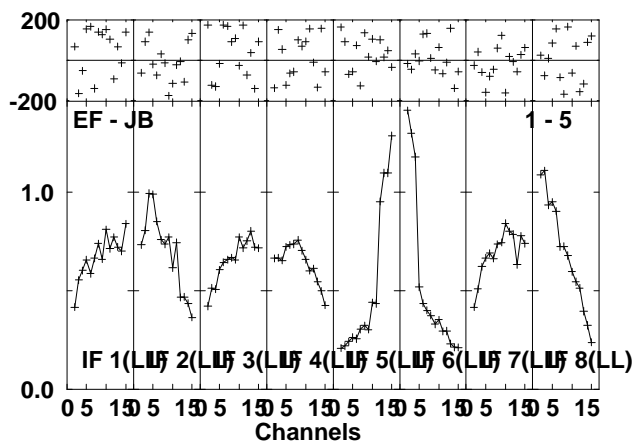
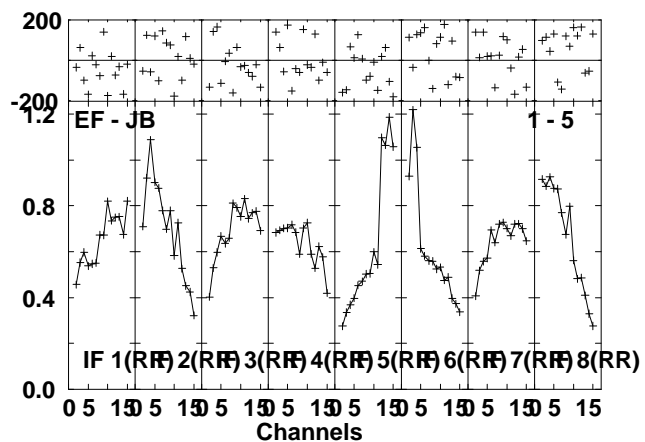
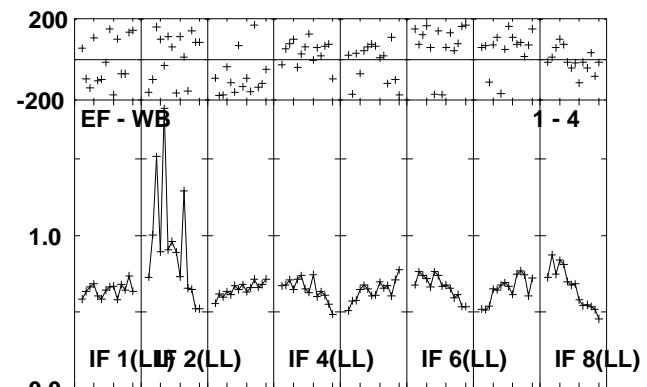
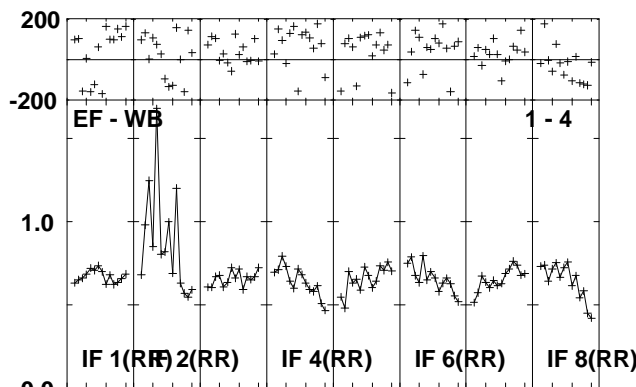
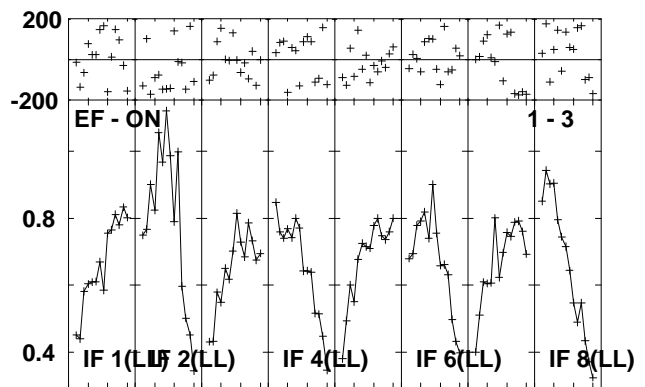
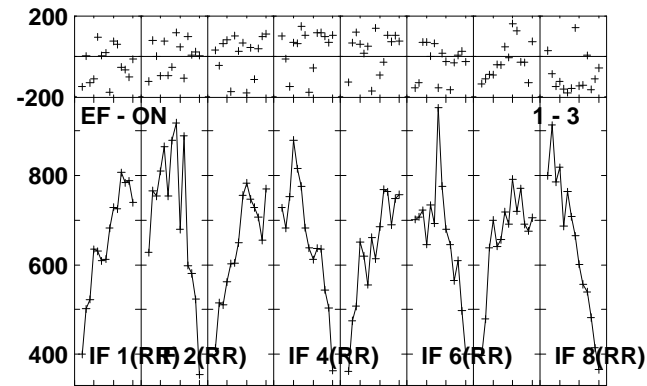
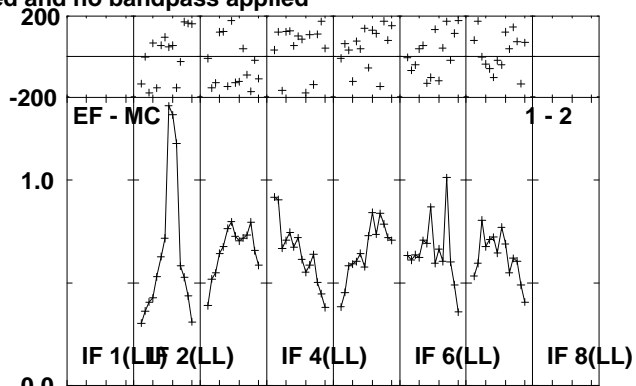
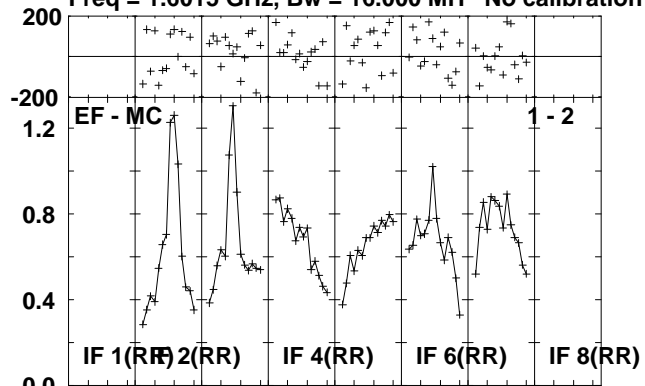

Lower frame: Milli Ampl Jy Top frame: Phas deg
Scalar averaged cross-power spectrum Several baselines displayed
Timerange: 01/04:21:05 to 01/04:26:01

Plot file version 221 created 01-JUL-2010 13:26:29

V407CYG RG006B.UVDATA.1

Freq = 1.6015 GHz, Bw = 16.000 MH No calibration applied and no bandpass applied

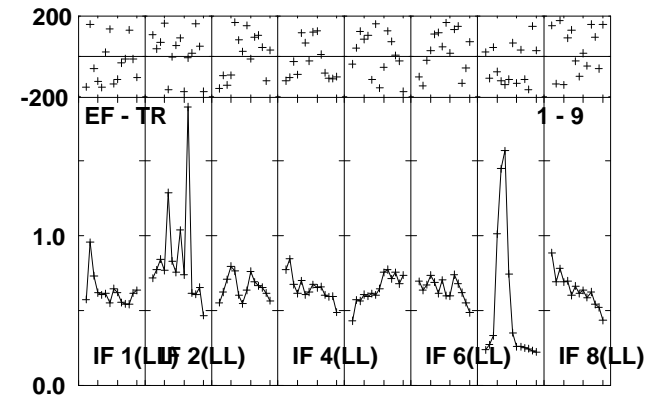
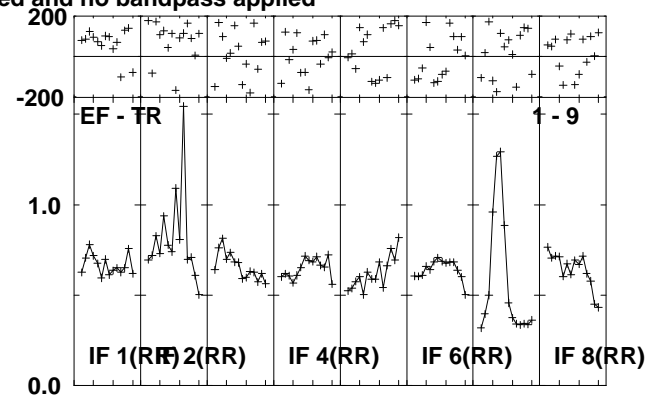
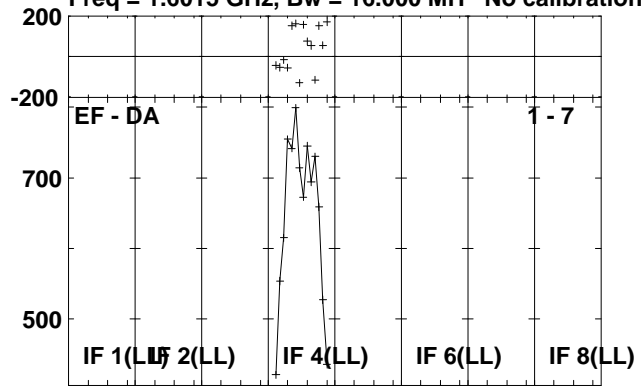

Lower frame: Micro Ampl Jy Top frame: Phas deg
Scalar averaged cross-power spectrum Several baselines displayed
Timerange: 01/04:21:05 to 01/04:26:01

Plot file version 222 created 01-JUL-2010 13:26:30

J2102+47 RG006B.UVDATA.1

Freq = 1.6015 GHz, Bw = 16.000 MH No calibration applied and no bandpass applied

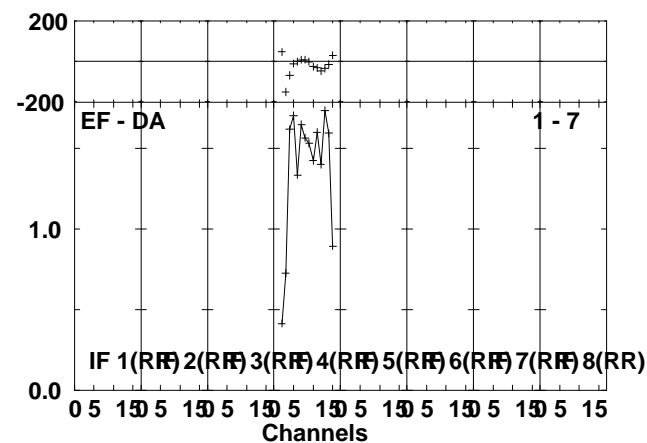
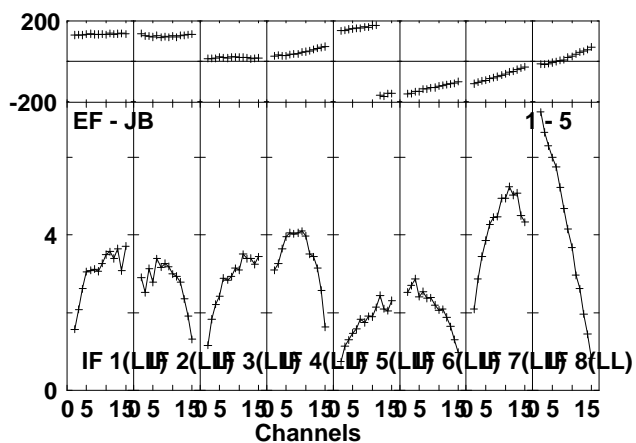
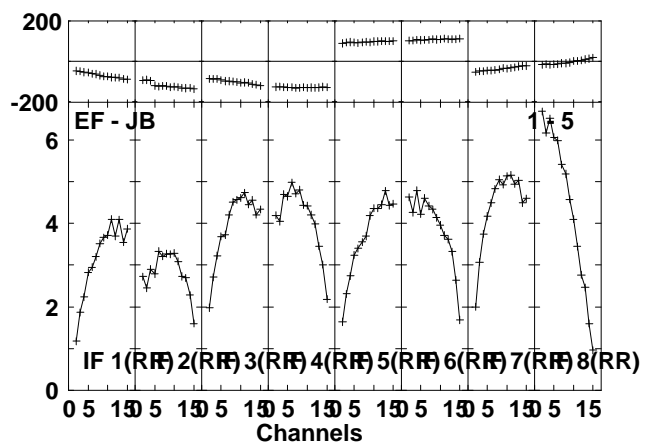
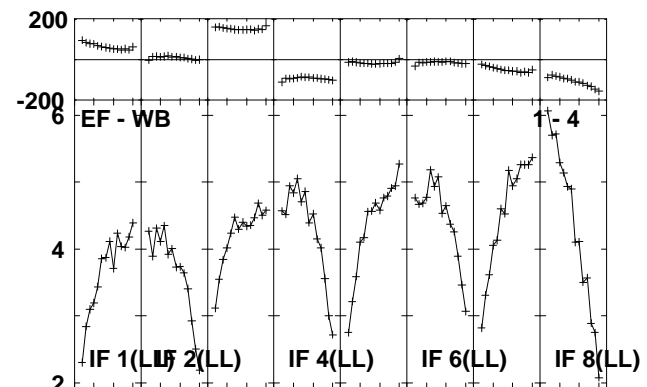
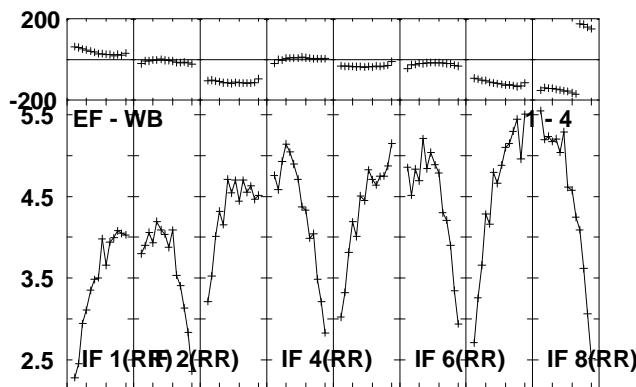
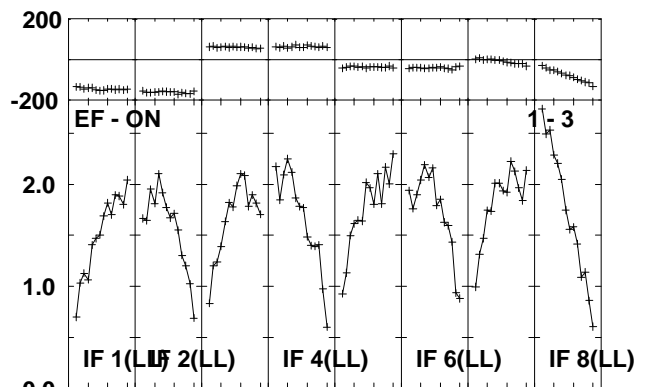
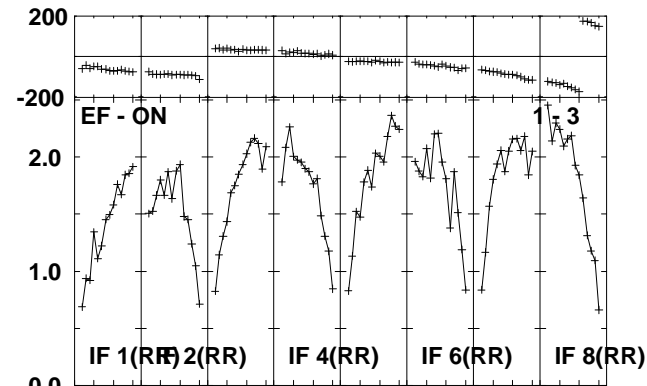
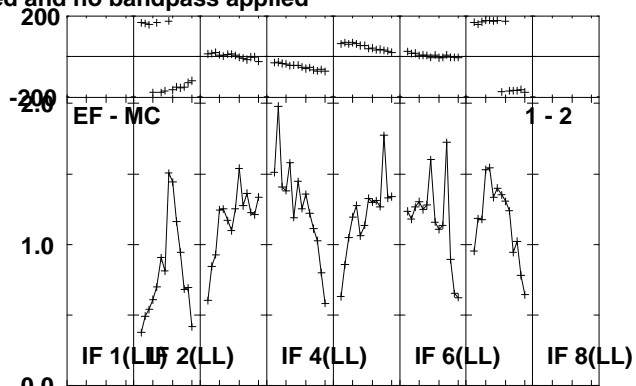
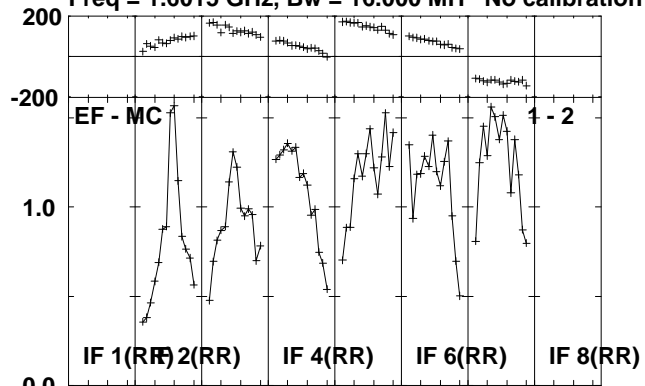

Lower frame: Milli Ampl Jy Top frame: Phas deg
Scalar averaged cross-power spectrum Several baselines displayed
Timerange: 01/04:27:05 to 01/04:28:49

Plot file version 223 created 01-JUL-2010 13:26:30
J2102+47 RG006B.UVDATA.1

Freq = 1.6015 GHz, Bw = 16.000 MH No calibration applied and no bandpass applied

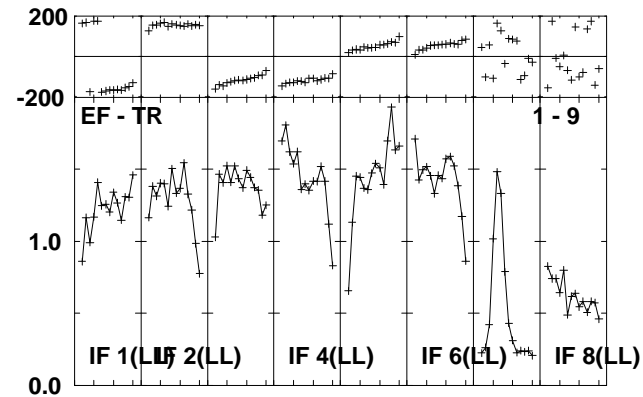
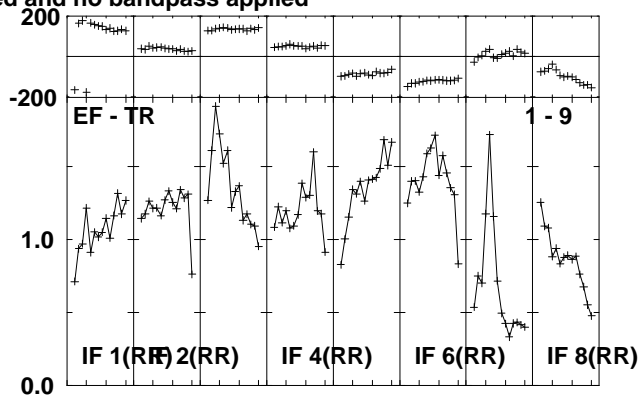
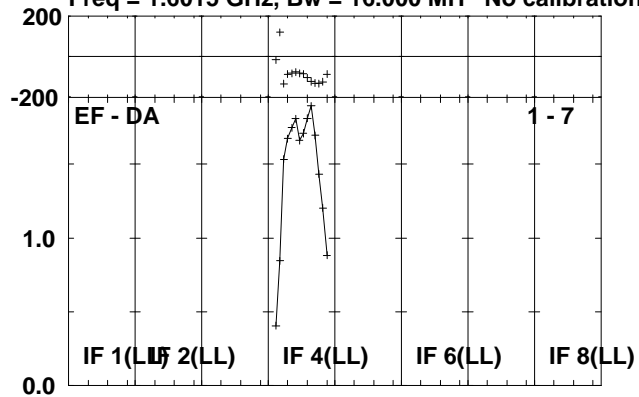

Lower frame: Milli Ampl Jy Top frame: Phas deg
Scalar averaged cross-power spectrum Several baselines displayed
Timerange: 01/04:27:05 to 01/04:28:49

Plot file version 224 created 01-JUL-2010 13:26:30

V407CYG RG006B.UVDATA.1

Freq = 1.6015 GHz, Bw = 16.000 MH No calibration applied and no bandpass applied

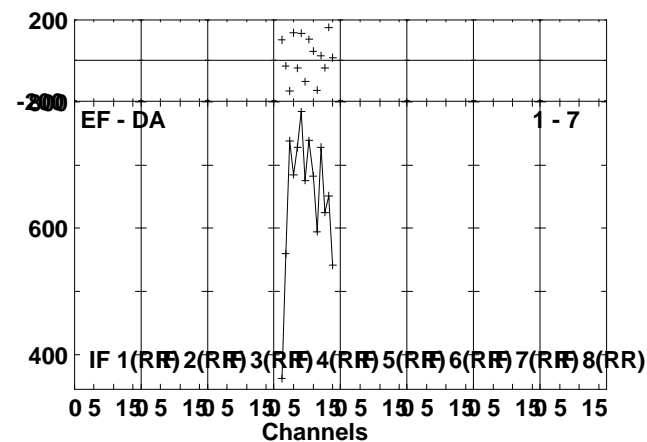
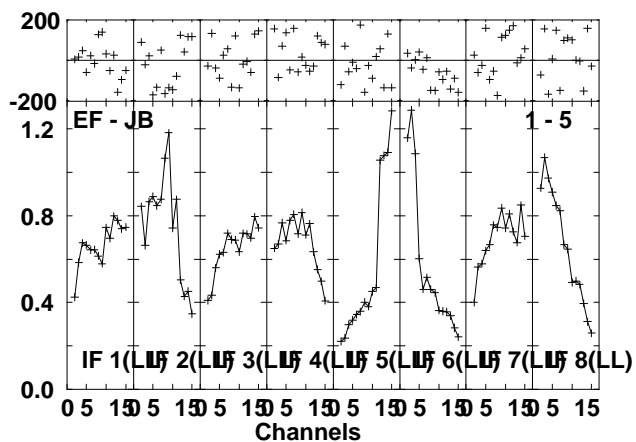
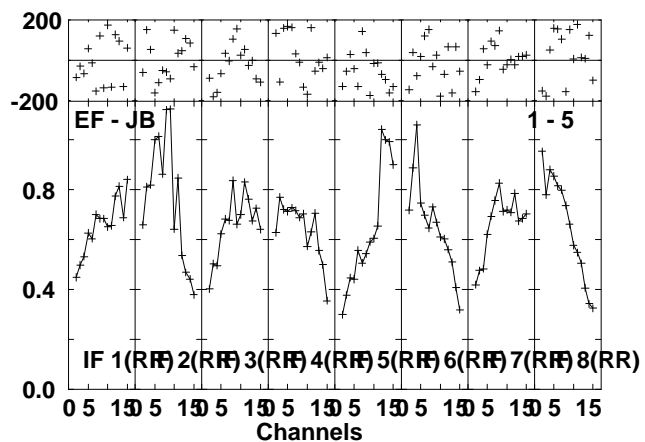
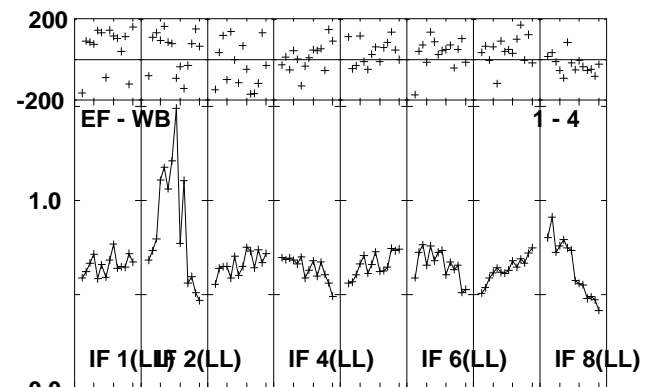
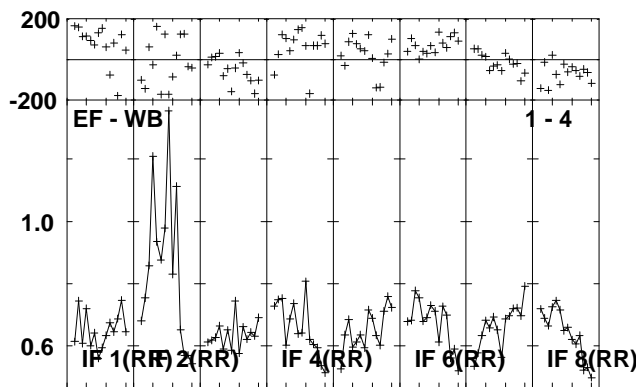
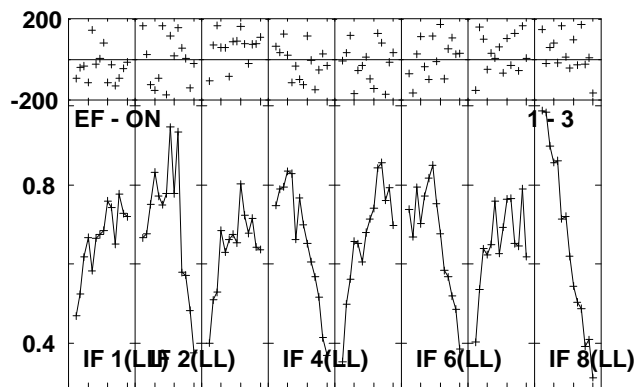
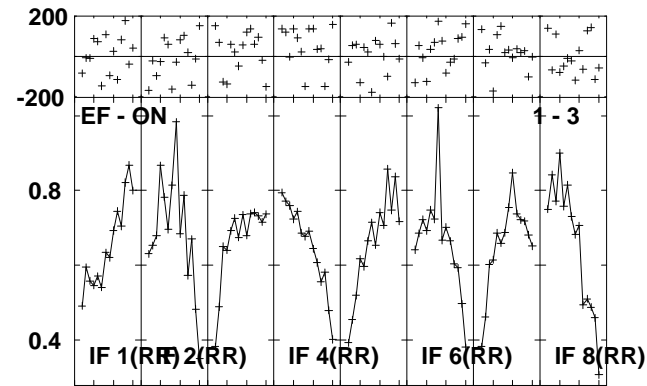
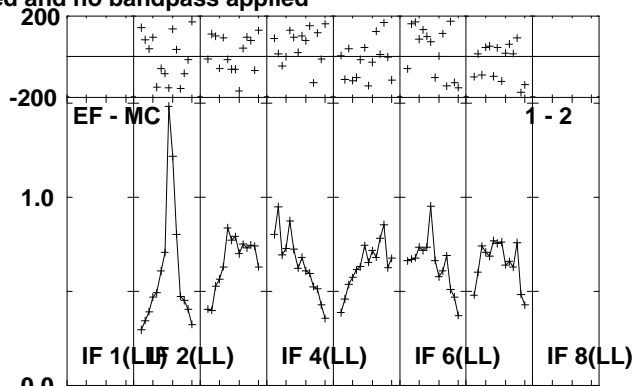
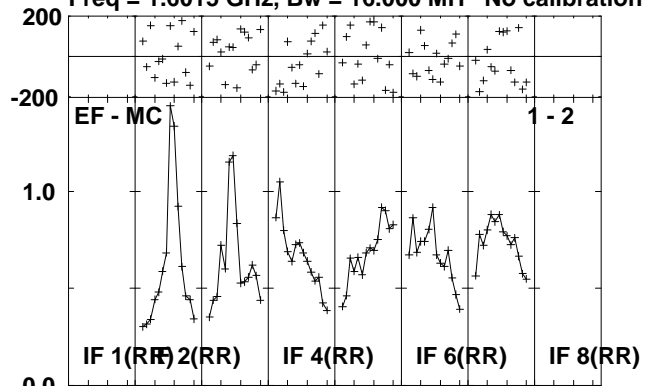

Lower frame: Milli Ampl Jy Top frame: Phas deg
Scalar averaged cross-power spectrum Several baselines displayed
Timerange: 01/04:28:53 to 01/04:33:49

Plot file version 225 created 01-JUL-2010 13:26:32

V407CYG RG006B.UVDATA.1

Freq = 1.6015 GHz, Bw = 16.000 MH No calibration applied and no bandpass applied

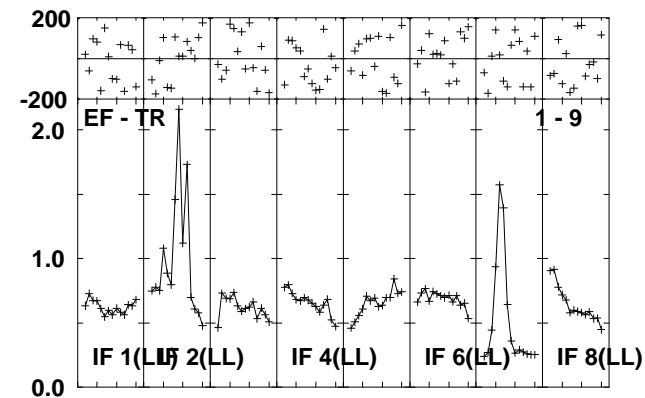
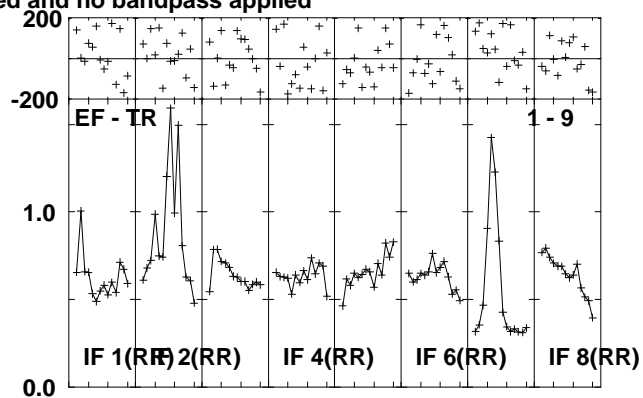
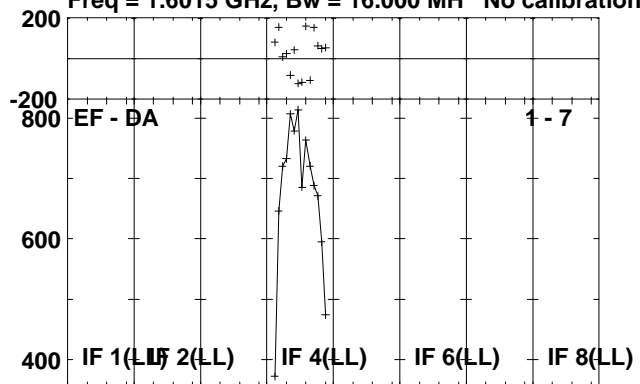

Lower frame: Micro Ampl Jy Top frame: Phas deg
Scalar averaged cross-power spectrum Several baselines displayed
Timerange: 01/04:28:53 to 01/04:33:49

Plot file version 226 created 01-JUL-2010 13:26:32

J2102+47 RG006B.UVDATA.1

Freq = 1.6015 GHz, Bw = 16.000 MH No calibration applied and no bandpass applied

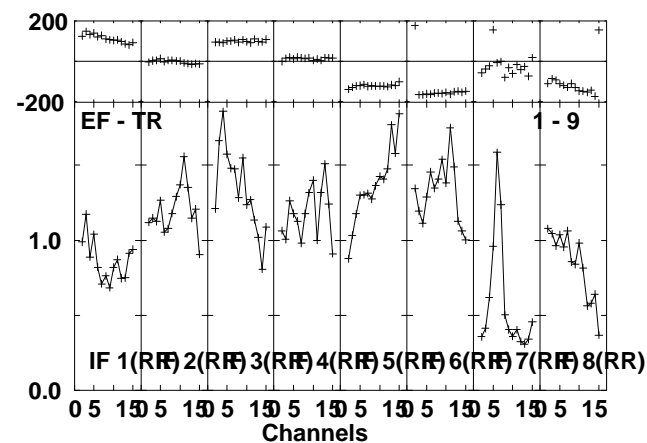
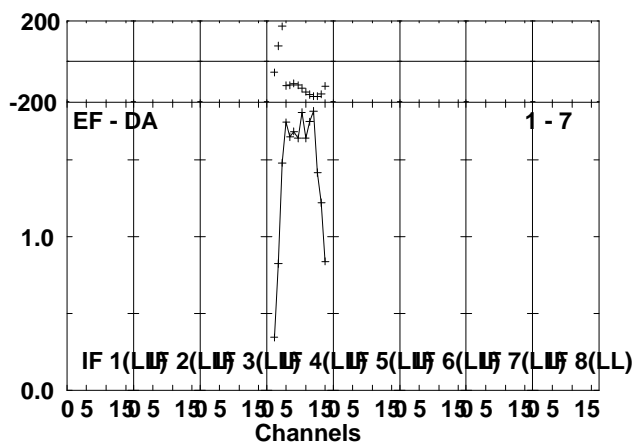
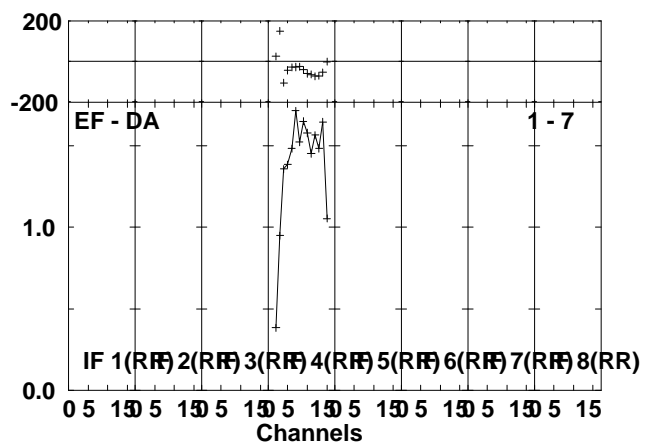
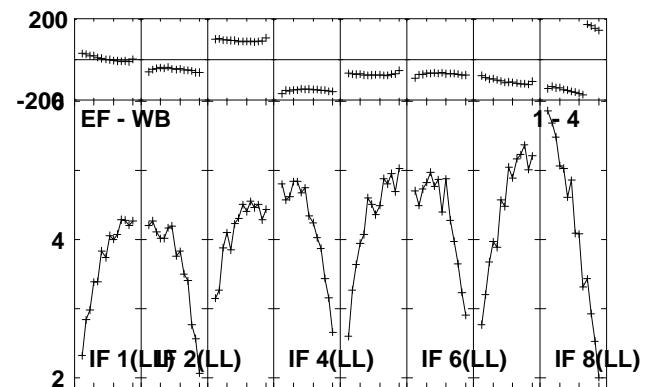
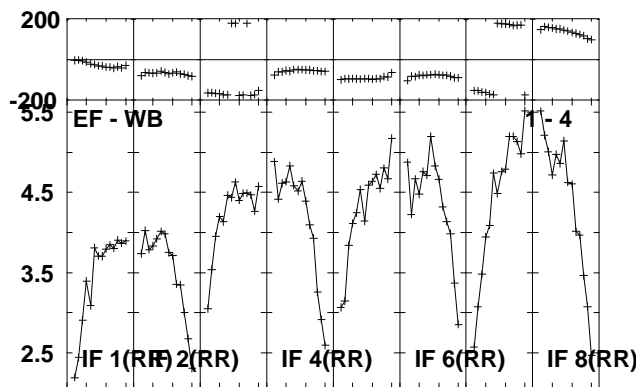
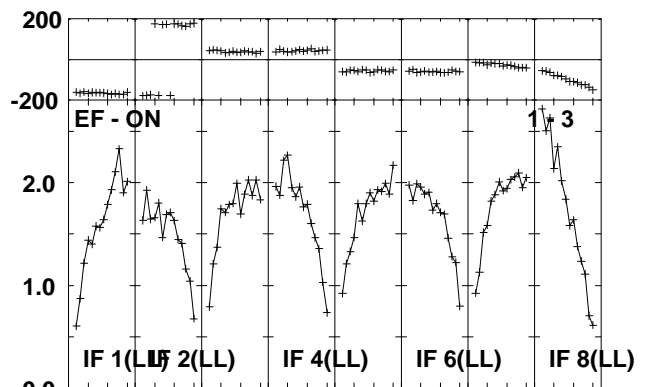
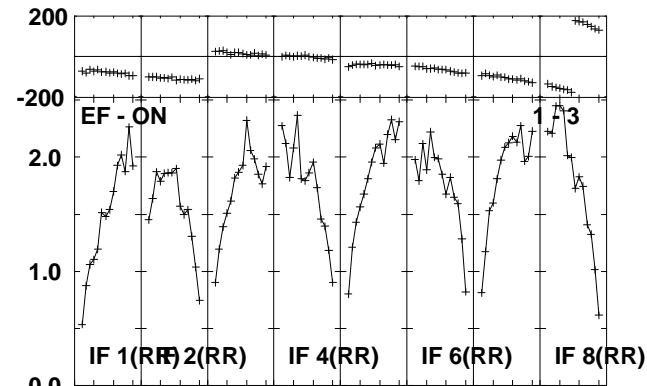
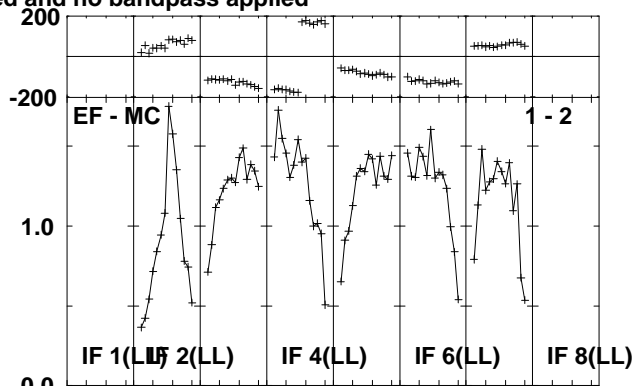
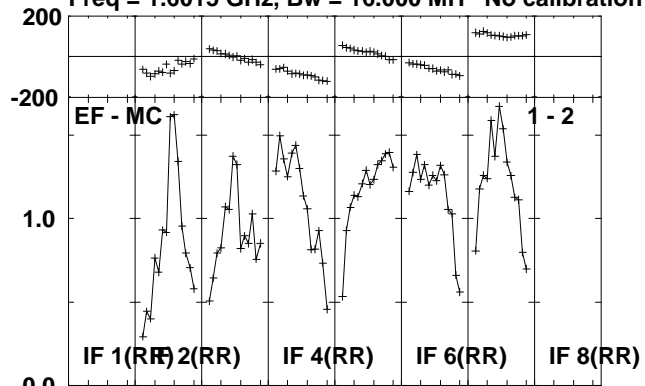

Lower frame: Milli Ampl Jy Top frame: Phas deg
Scalar averaged cross-power spectrum Several baselines displayed
Timerange: 01/04:33:53 to 01/04:36:01

Plot file version 227 created 01-JUL-2010 13:26:33
J2102+47 RG006B.UVDATA.1
Freq = 1.6015 GHz, Bw = 16.000 MH No calibration applied and no bandpass applied

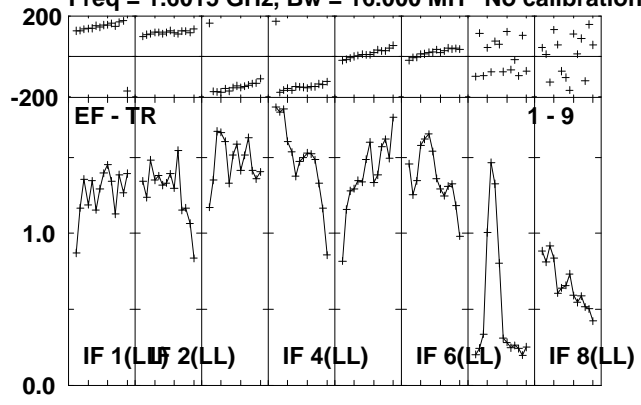

Lower frame: Milli Ampl Jy Top frame: Phas deg
Scalar averaged cross-power spectrum Several baselines displayed
Timerange: 01/04:33:53 to 01/04:36:01

Plot file version 228 created 01-JUL-2010 13:26:33

V407CYG RG006B.UVDATA.1

Freq = 1.6015 GHz, Bw = 16.000 MH No calibration applied and no bandpass applied

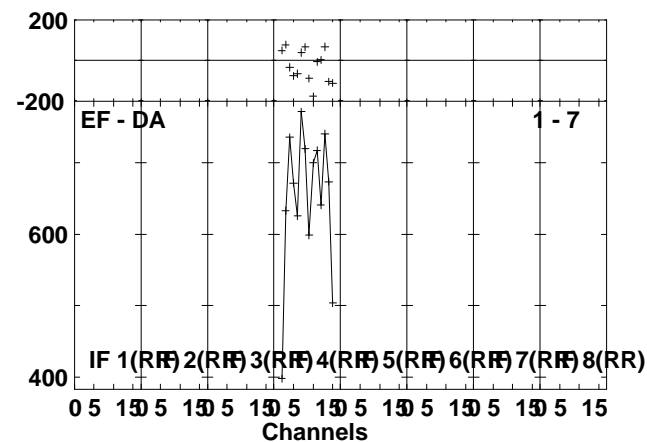
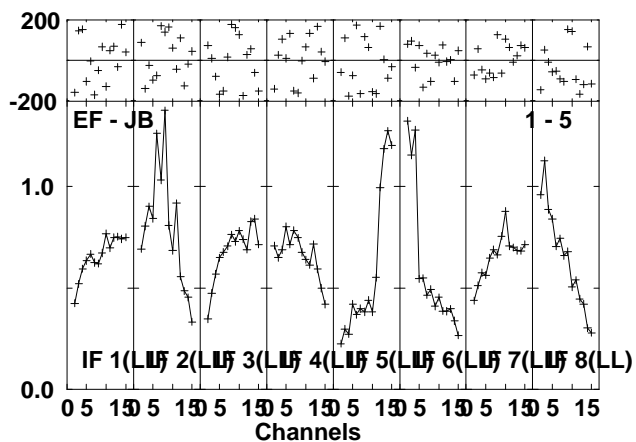
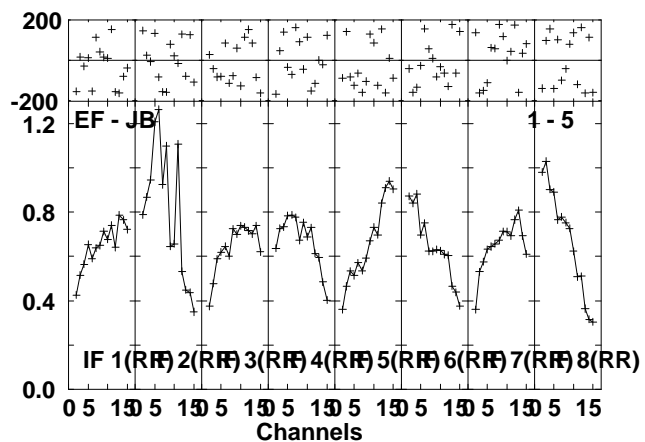
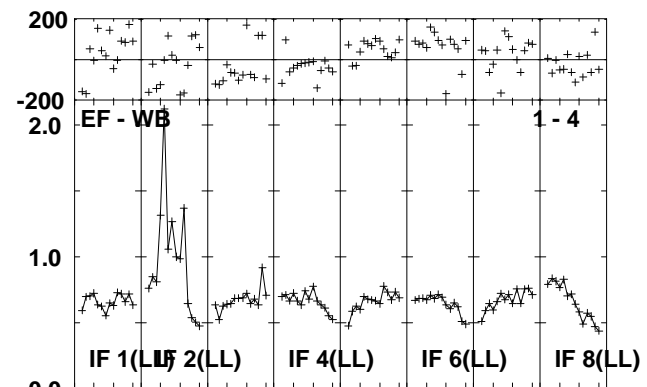
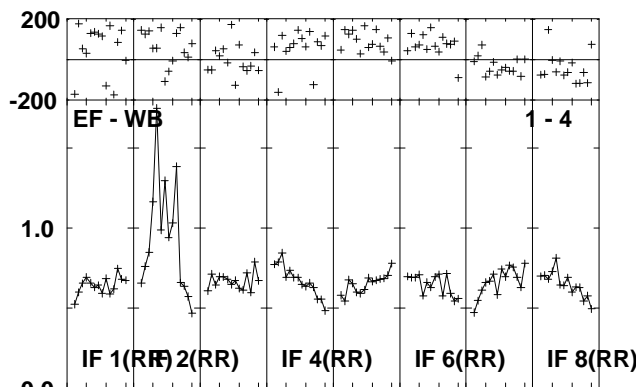
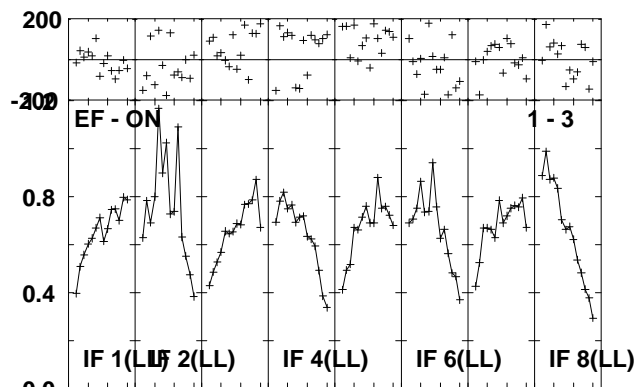
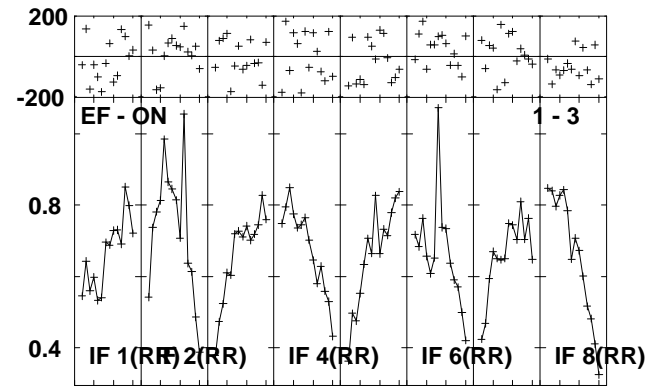
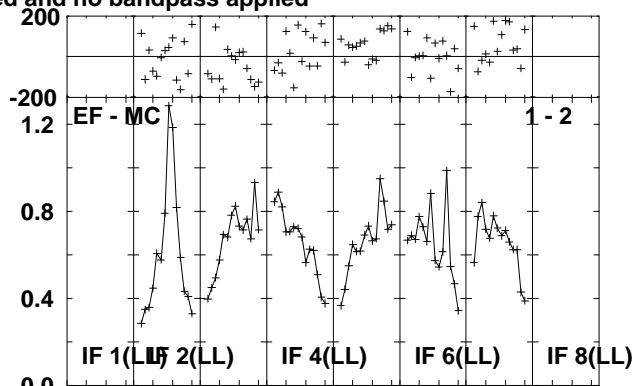
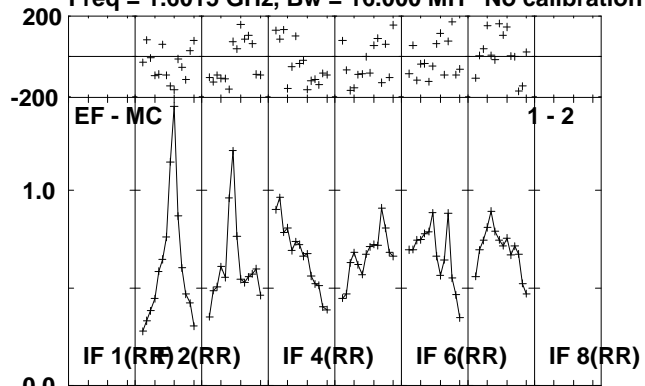

Lower frame: Milli Ampl Jy Top frame: Phas deg
Scalar averaged cross-power spectrum Several baselines displayed
Timerange: 01/04:36:05 to 01/04:41:01

Plot file version 229 created 01-JUL-2010 13:26:34

V407CYG RG006B.UVDATA.1

Freq = 1.6015 GHz, Bw = 16.000 MH No calibration applied and no bandpass applied

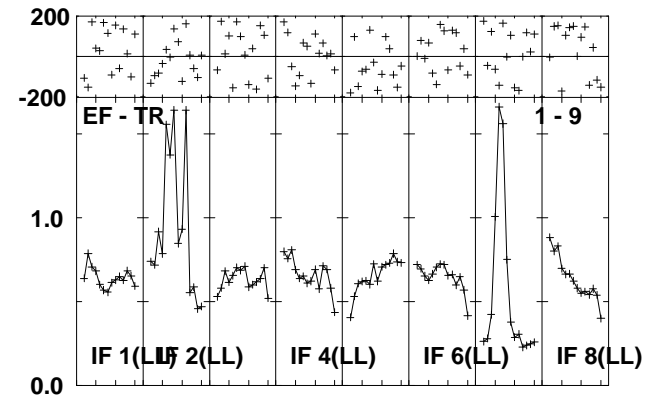
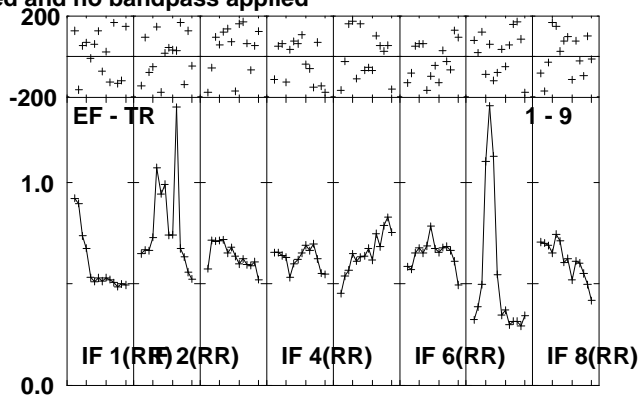
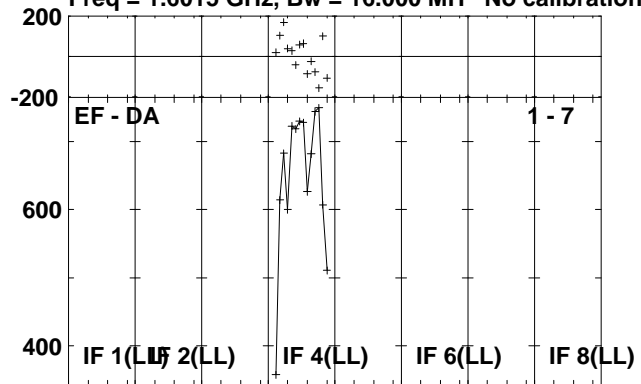

Lower frame: Micro Ampl Jy Top frame: Phas deg
Scalar averaged cross-power spectrum Several baselines displayed
Timerange: 01/04:36:05 to 01/04:41:01

Plot file version 230 created 01-JUL-2010 13:26:35

J2102+47 RG006B.UVDATA.1

Freq = 1.6015 GHz, Bw = 16.000 MH No calibration applied and no bandpass applied

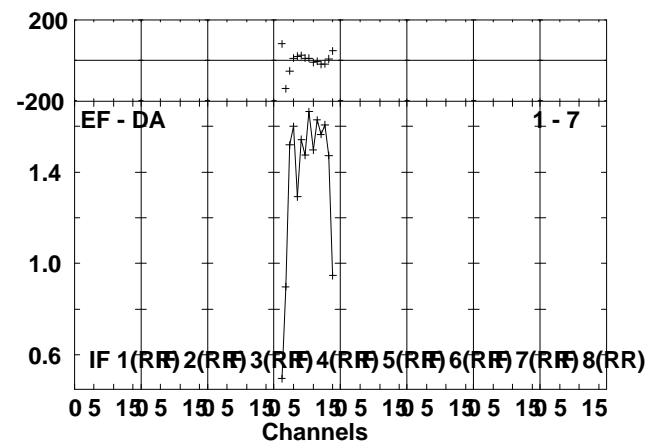
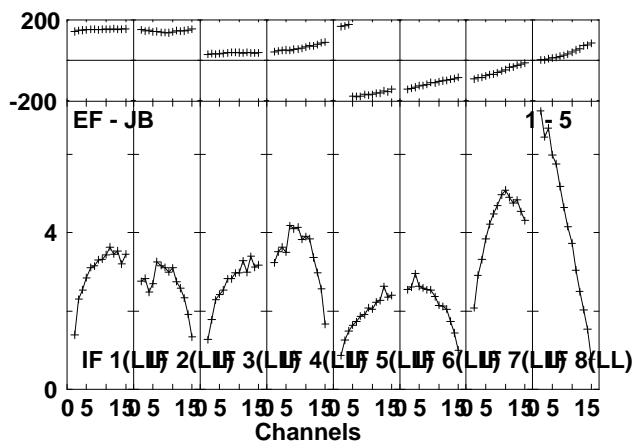
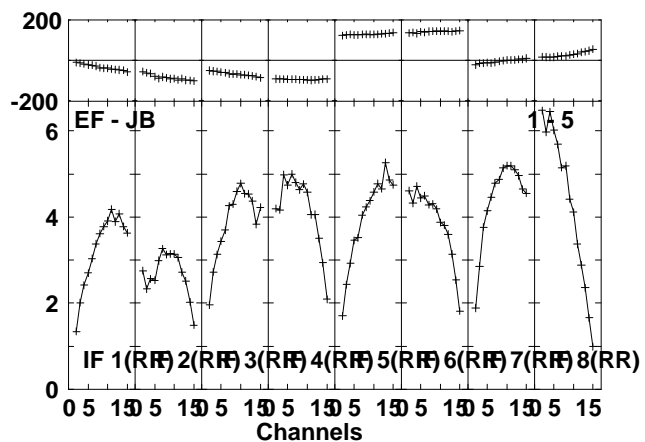
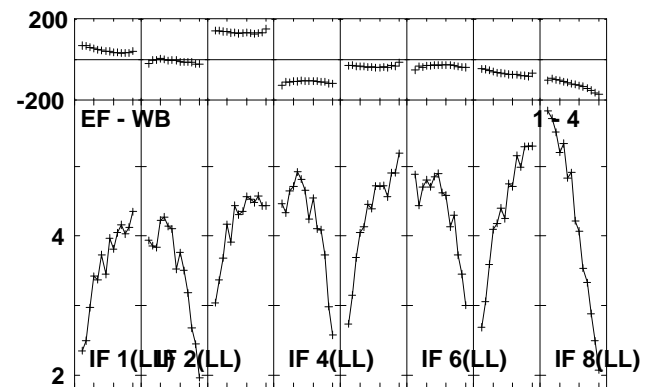
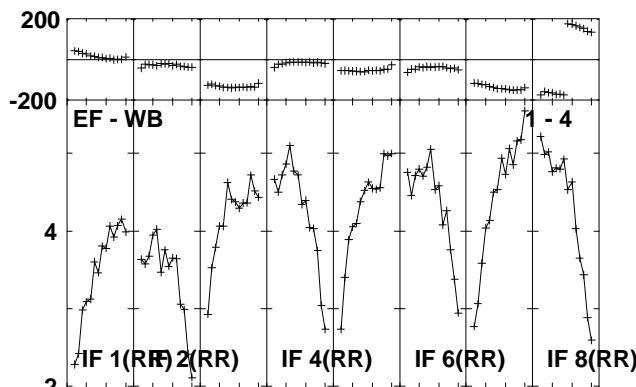
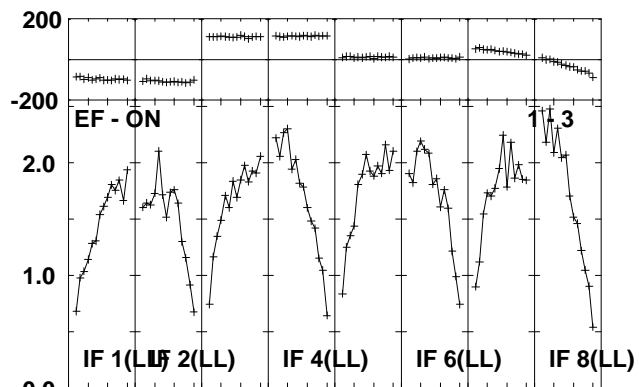
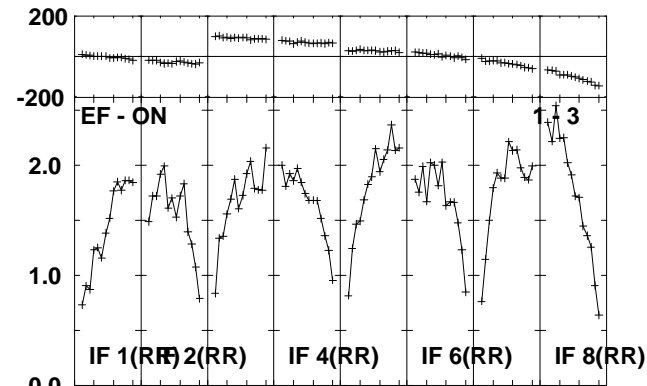
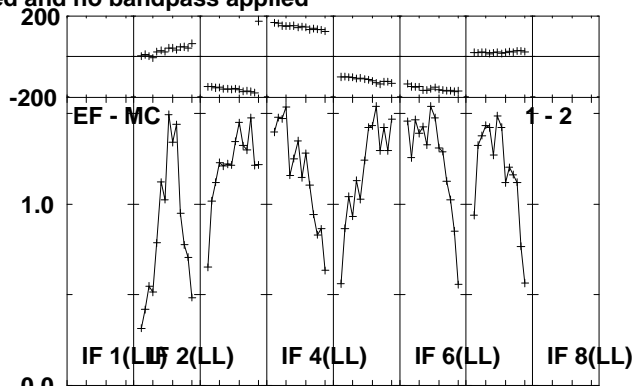
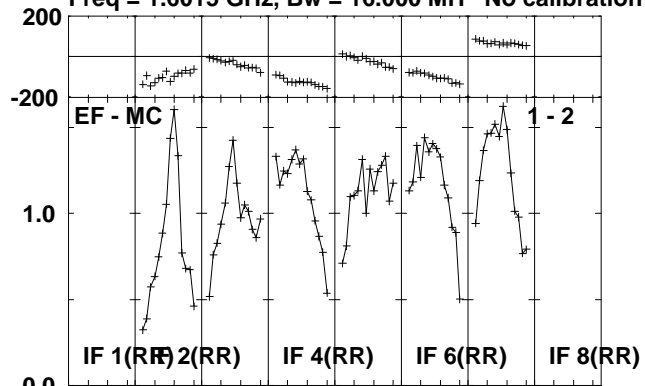

Lower frame: Milli Ampl Jy Top frame: Phas deg
Scalar averaged cross-power spectrum Several baselines displayed
Timerange: 01/04:42:05 to 01/04:43:49

Plot file version 231 created 01-JUL-2010 13:26:35

J2102+47 RG006B.UVDATA.1

Freq = 1.6015 GHz, Bw = 16.000 MH No calibration applied and no bandpass applied

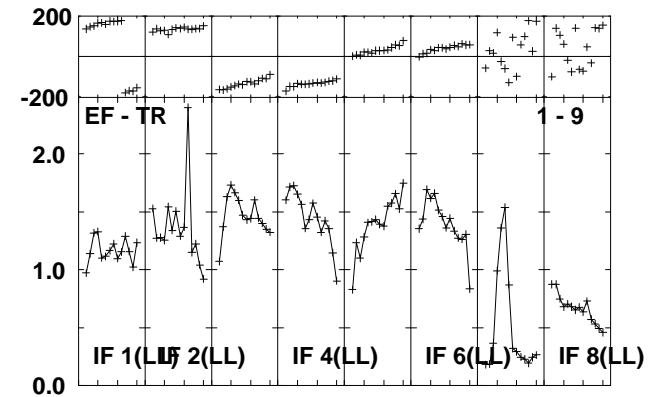
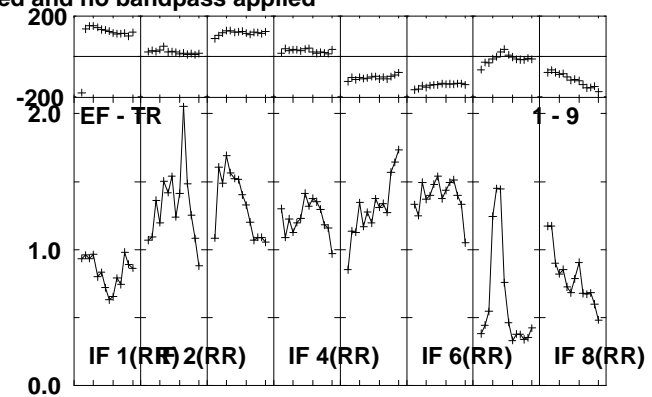
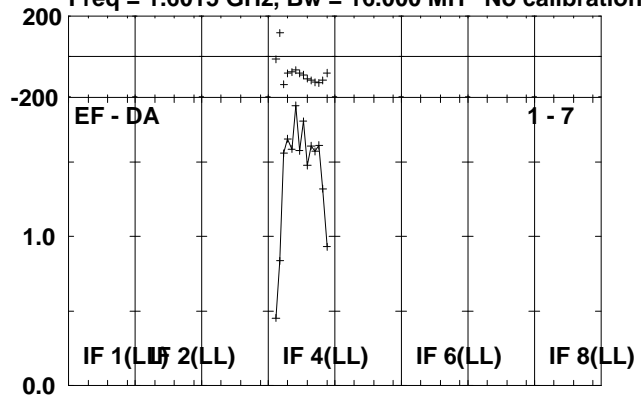

Lower frame: Milli Ampl Jy Top frame: Phas deg
Scalar averaged cross-power spectrum Several baselines displayed
Timerange: 01/04:42:05 to 01/04:43:49

Plot file version 232 created 01-JUL-2010 13:26:35

J2002+47 RG006B.UVDATA.1

Freq = 1.6015 GHz, Bw = 16.000 MH No calibration applied and no bandpass applied

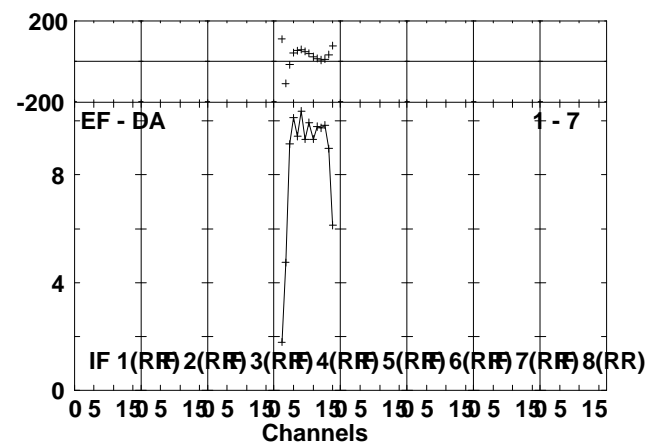
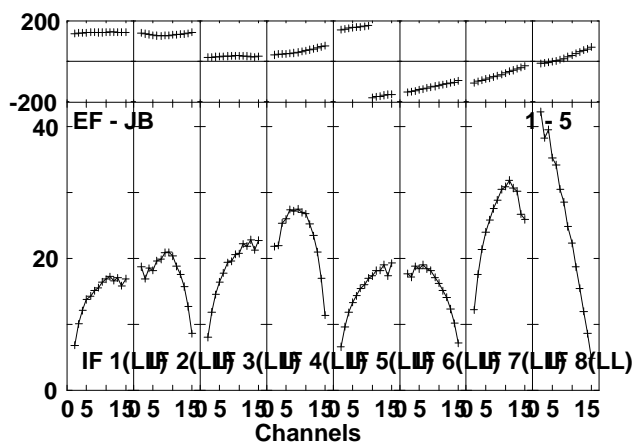
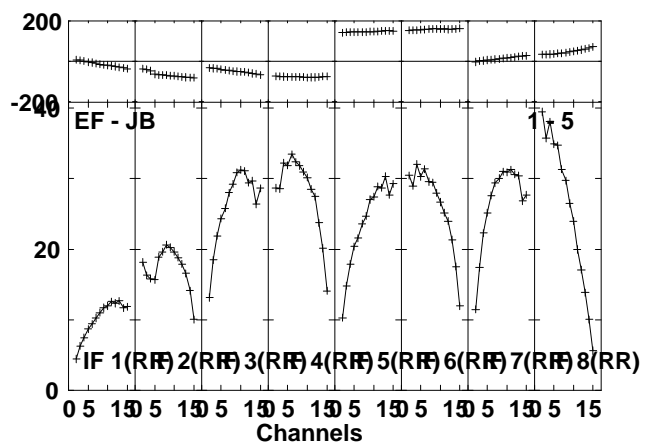
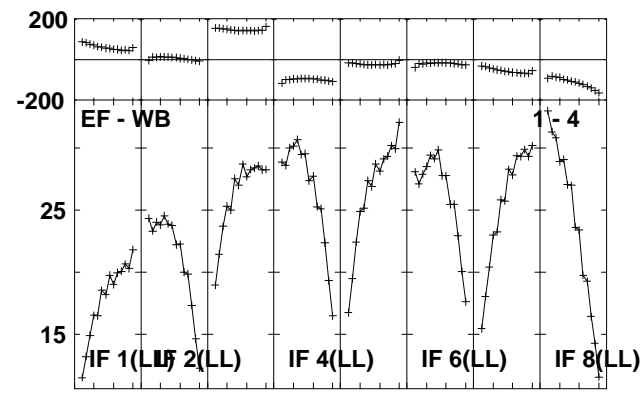
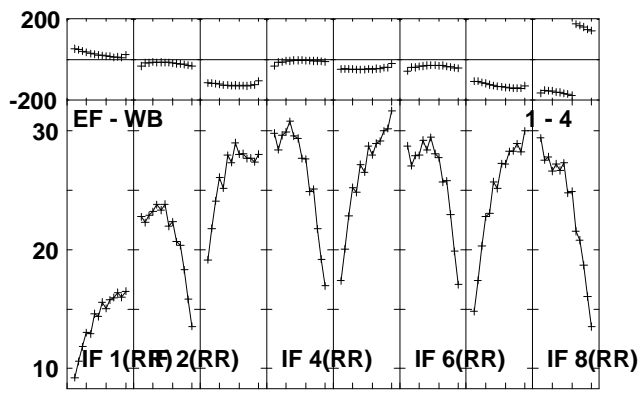
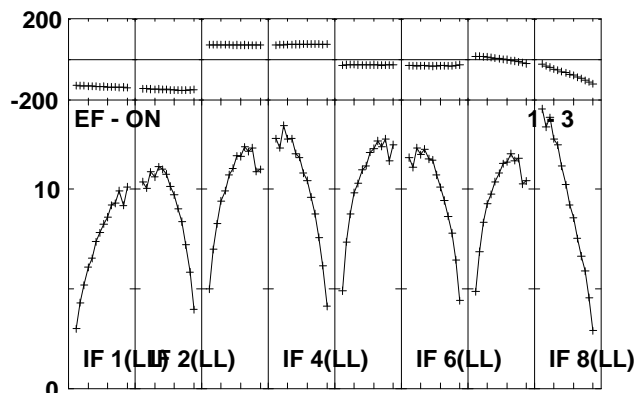
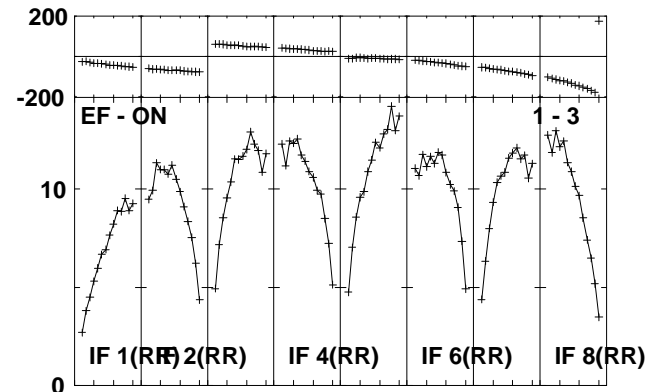
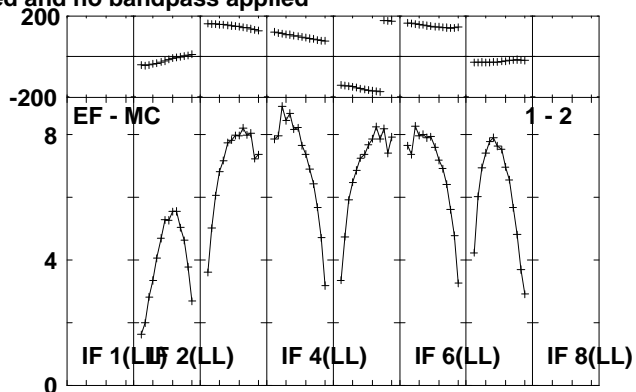
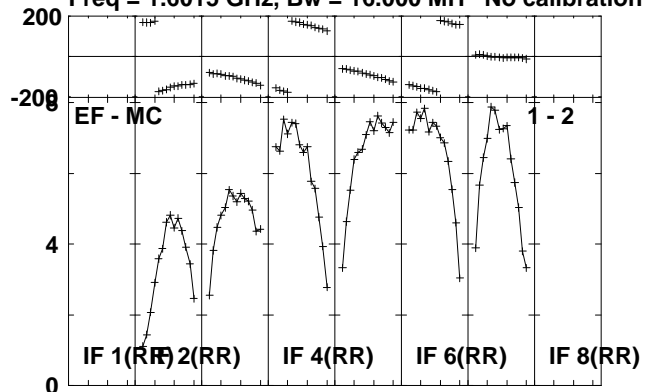

Lower frame: Milli Ampl Jy Top frame: Phas deg
Scalar averaged cross-power spectrum Several baselines displayed
Timerange: 01/04:45:21 to 01/04:49:17

Plot file version 233 created 01-JUL-2010 13:26:36

J2002+47 RG006B.UVDATA.1

Freq = 1.6015 GHz, Bw = 16.000 MH No calibration applied and no bandpass applied

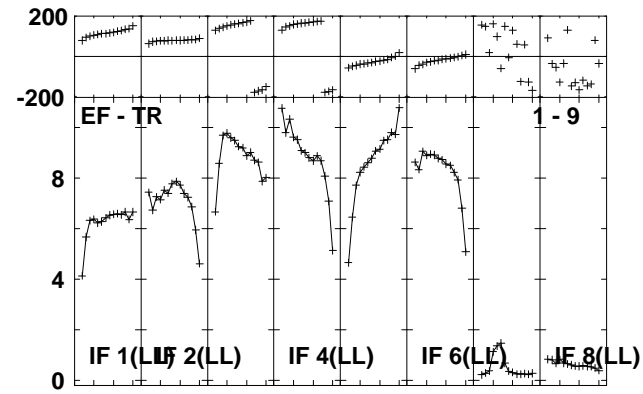
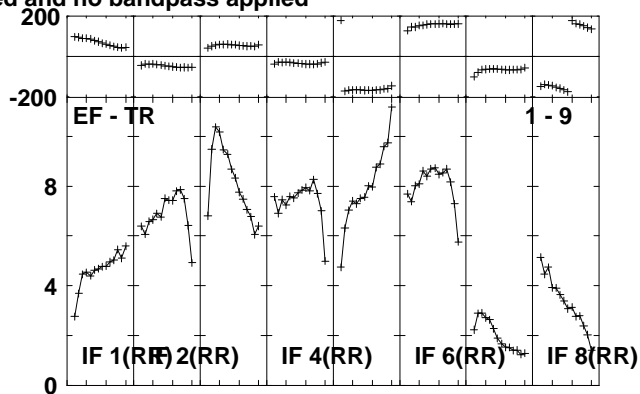
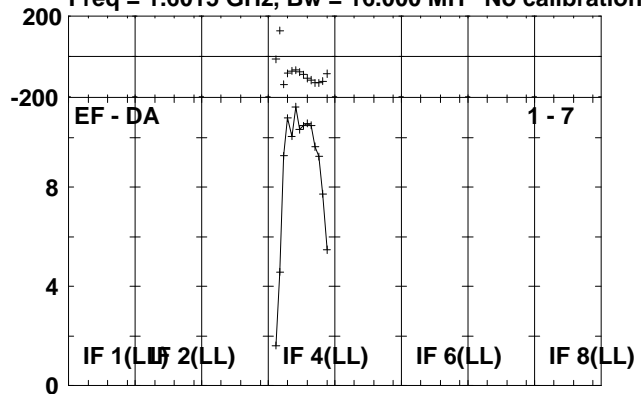

Lower frame: Milli Ampl Jy Top frame: Phas deg
Scalar averaged cross-power spectrum Several baselines displayed
Timerange: 01/04:45:21 to 01/04:49:17

Plot file version 234 created 01-JUL-2010 13:26:37

J2102+47 RG006B.UVDATA.1

Freq = 1.6015 GHz, Bw = 16.000 MH No calibration applied and no bandpass applied

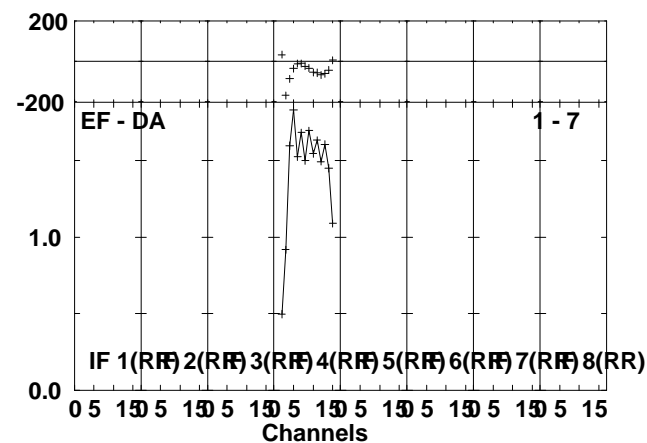
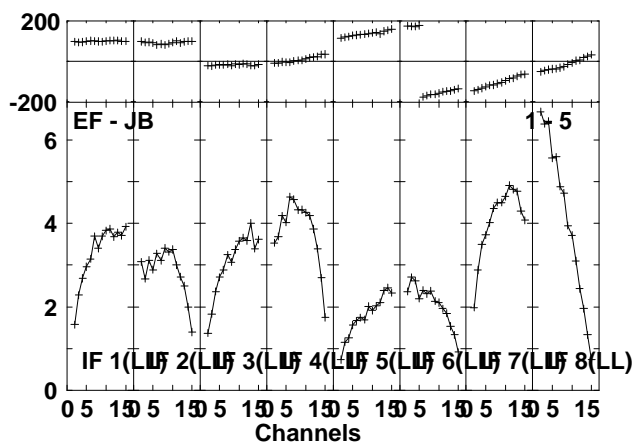
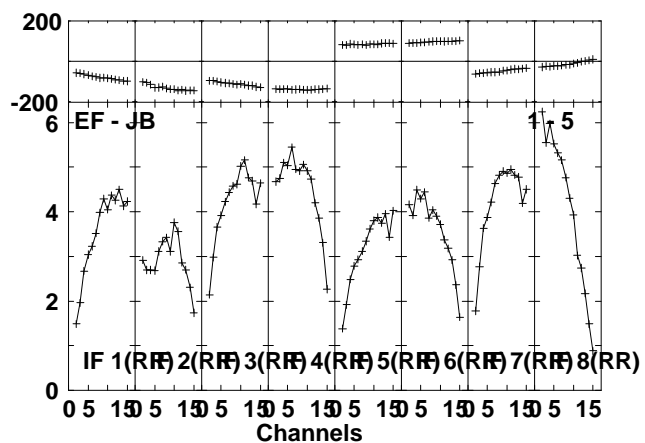
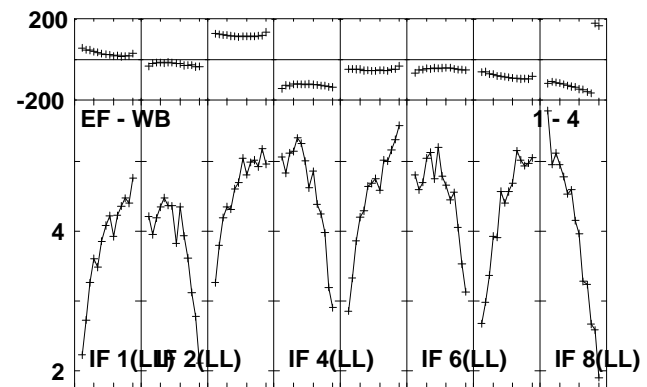
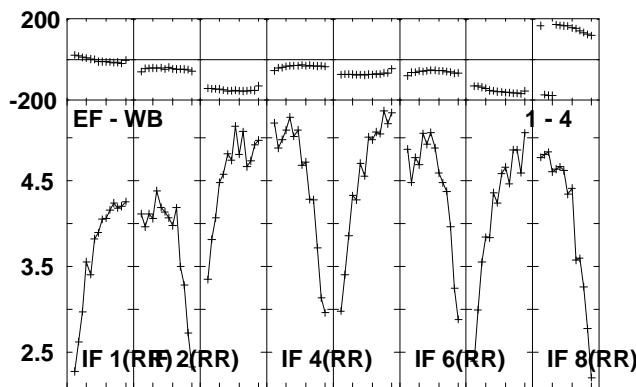
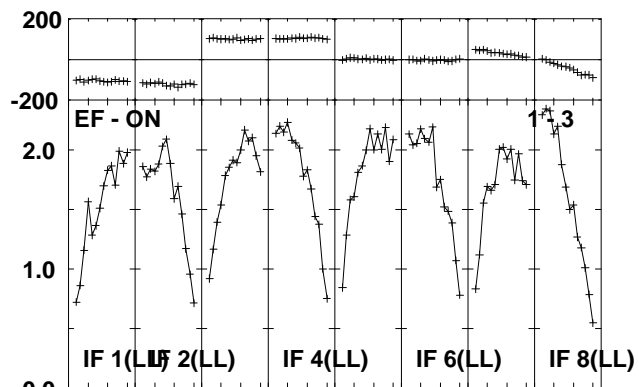
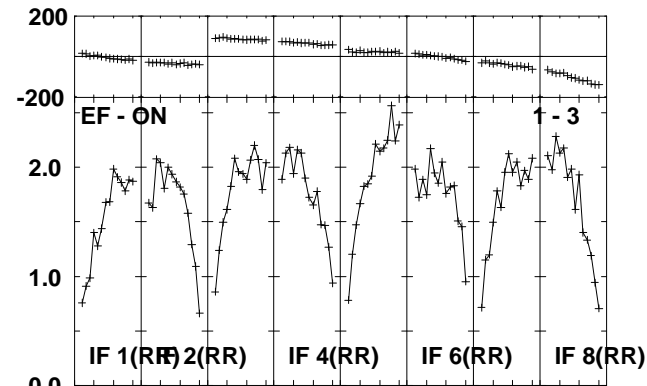
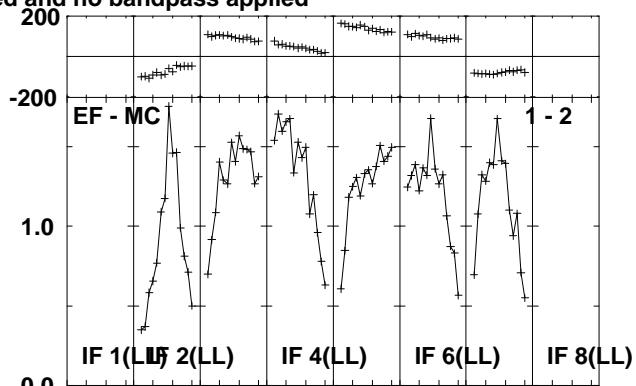
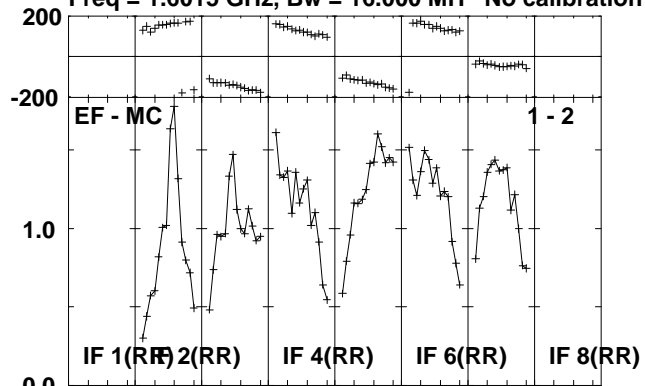

Lower frame: Milli Ampl Jy Top frame: Phas deg
Scalar averaged cross-power spectrum Several baselines displayed
Timerange: 01/04:50:53 to 01/04:52:49

Plot file version 235 created 01-JUL-2010 13:26:37

J2102+47 RG006B.UVDATA.1

Freq = 1.6015 GHz, Bw = 16.000 MH No calibration applied and no bandpass applied

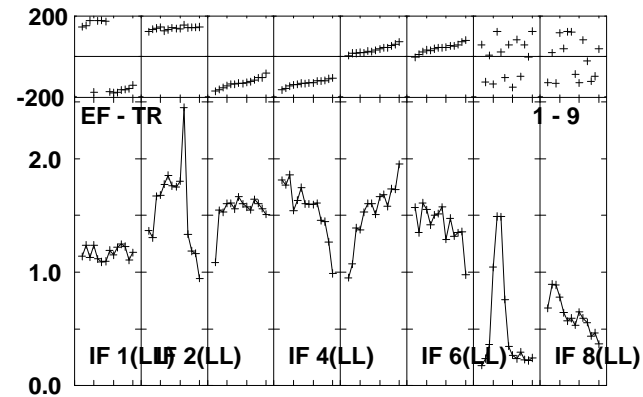
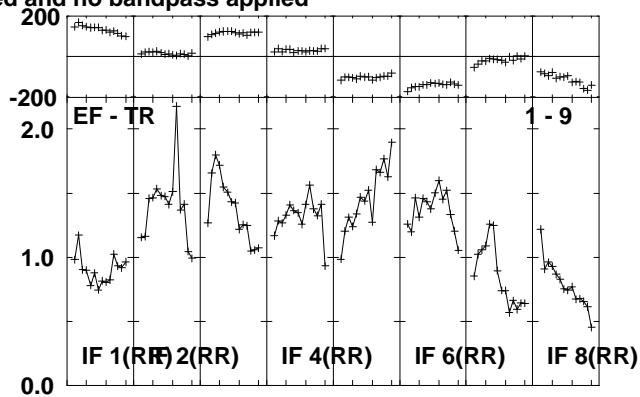
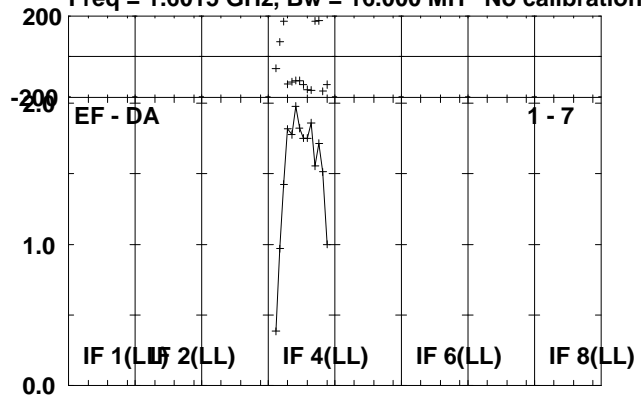

Lower frame: Milli Ampl Jy Top frame: Phas deg
Scalar averaged cross-power spectrum Several baselines displayed
Timerange: 01/04:50:53 to 01/04:52:49

Plot file version 236 created 01-JUL-2010 13:26:38

V407CYG RG006B.UVDATA.1

Freq = 1.6015 GHz, Bw = 16.000 MH No calibration applied and no bandpass applied

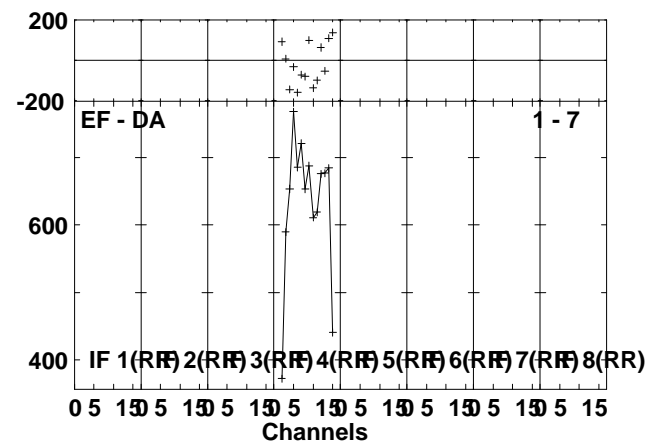
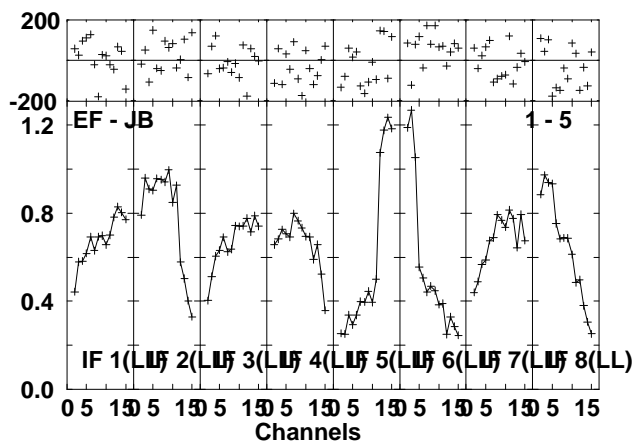
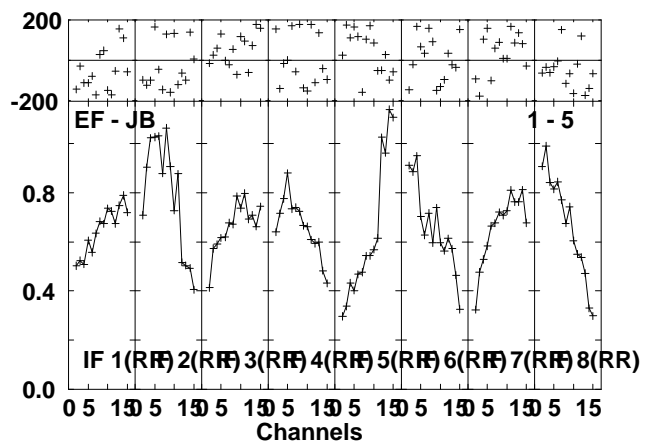
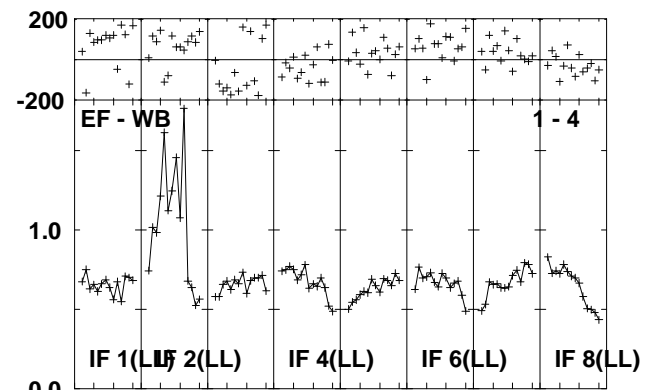
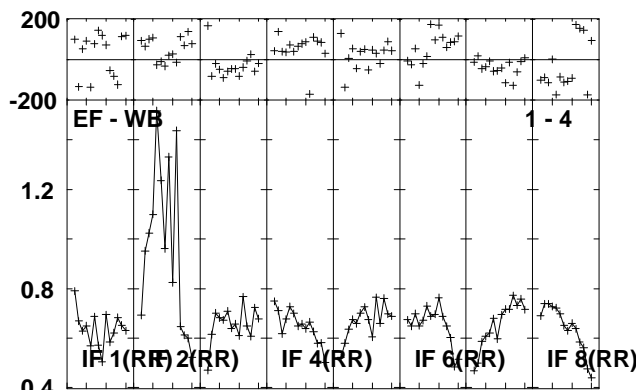
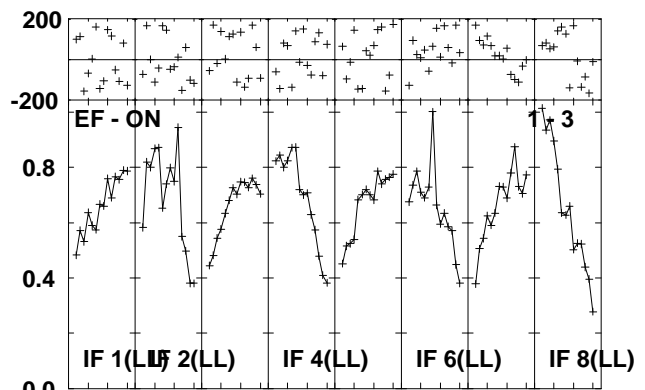
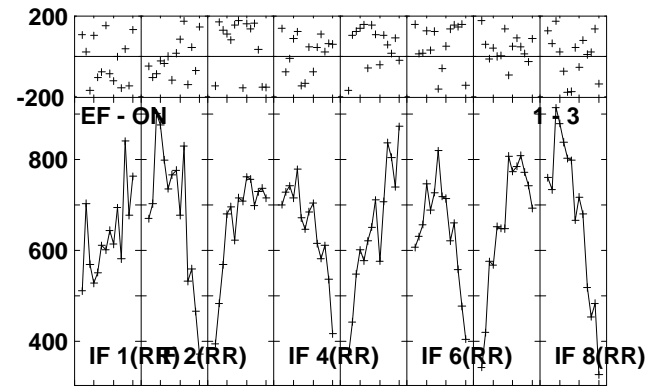
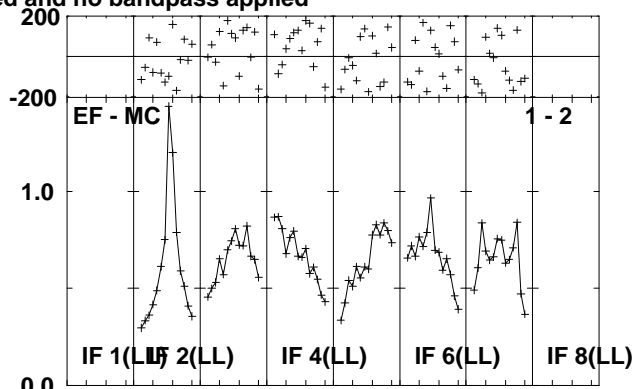
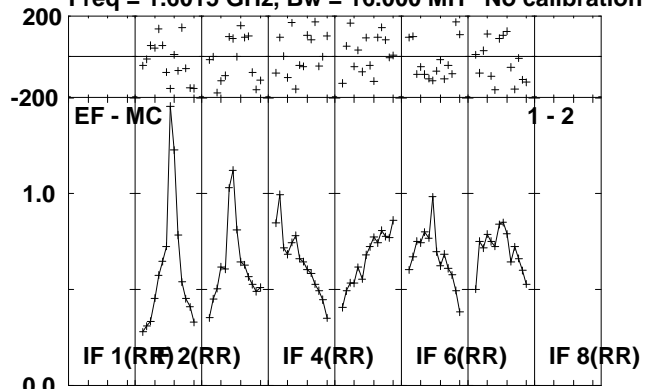

Lower frame: Milli Ampl Jy Top frame: Phas deg
Scalar averaged cross-power spectrum Several baselines displayed
Timerange: 01/04:52:53 to 01/04:57:49

Plot file version 237 created 01-JUL-2010 13:26:39

V407CYG RG006B.UVDATA.1

Freq = 1.6015 GHz, Bw = 16.000 MH No calibration applied and no bandpass applied

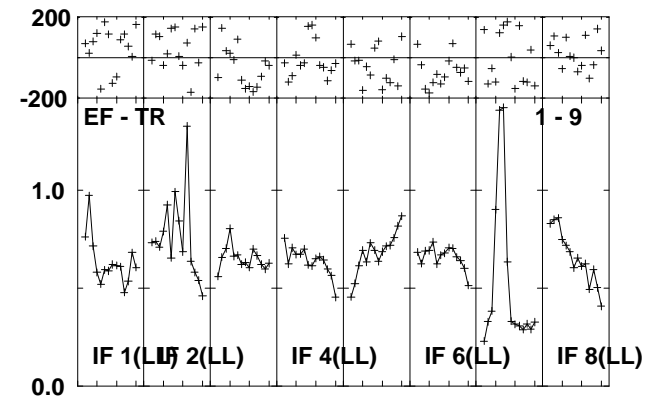
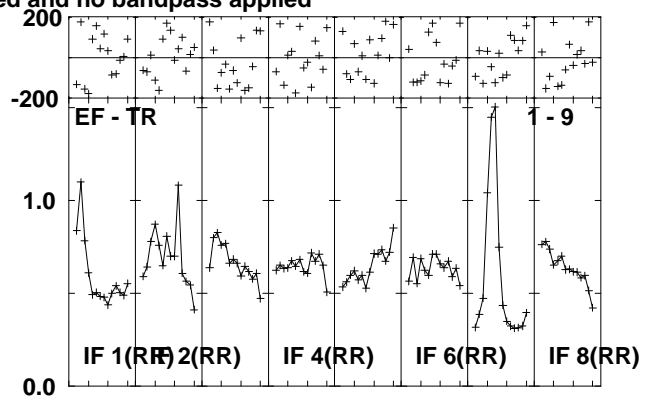
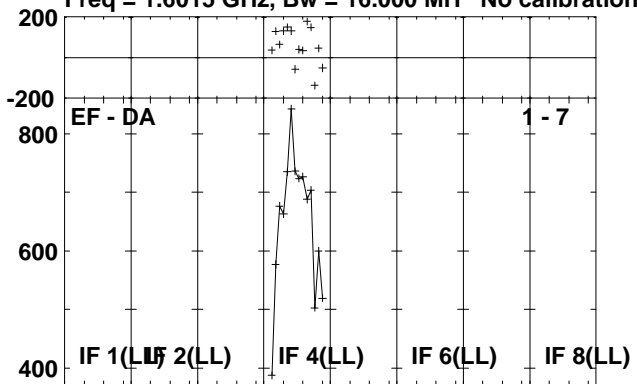

Lower frame: Micro Ampl Jy Top frame: Phas deg
Scalar averaged cross-power spectrum Several baselines displayed
Timerange: 01/04:52:53 to 01/04:57:49

Plot file version 238 created 01-JUL-2010 13:26:39

J2102+47 RG006B.UVDATA.1

Freq = 1.6015 GHz, Bw = 16.000 MH No calibration applied and no bandpass applied

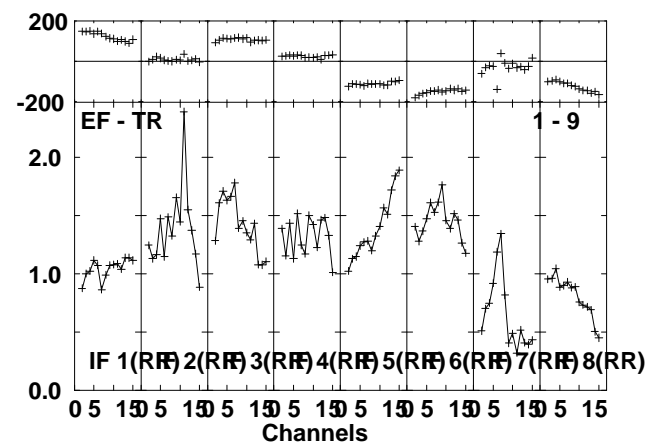
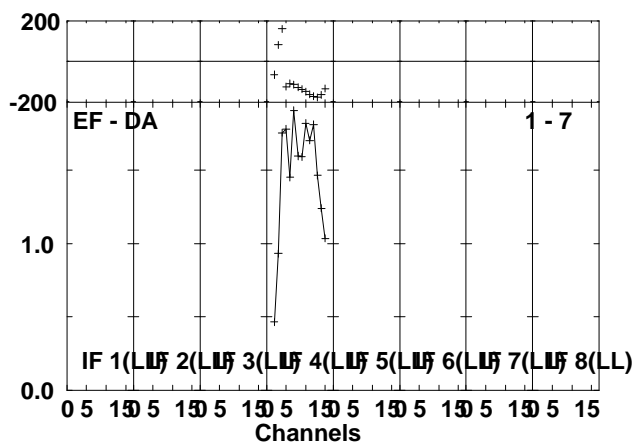
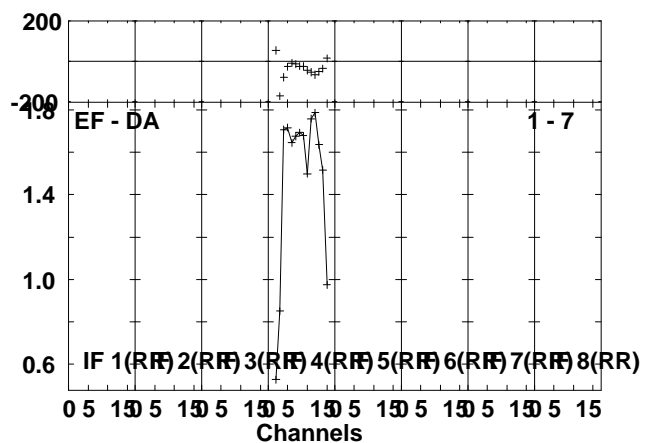
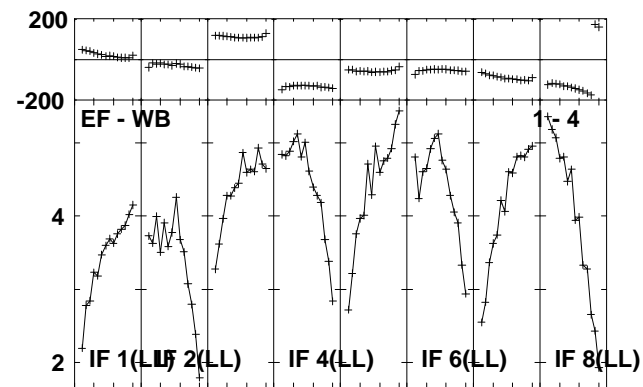
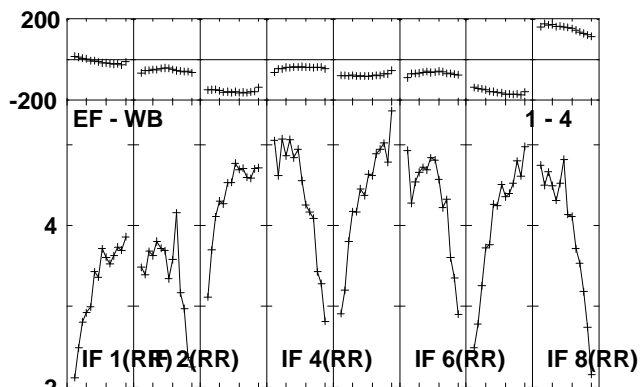
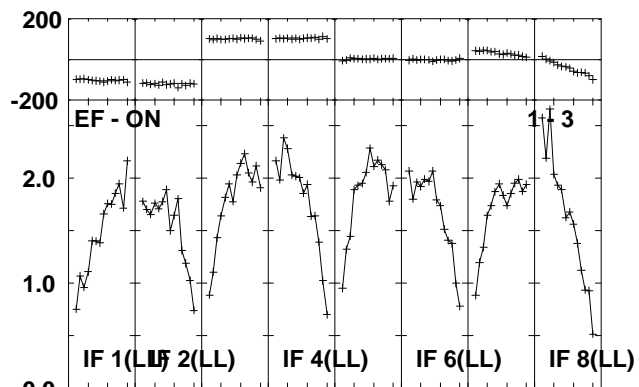
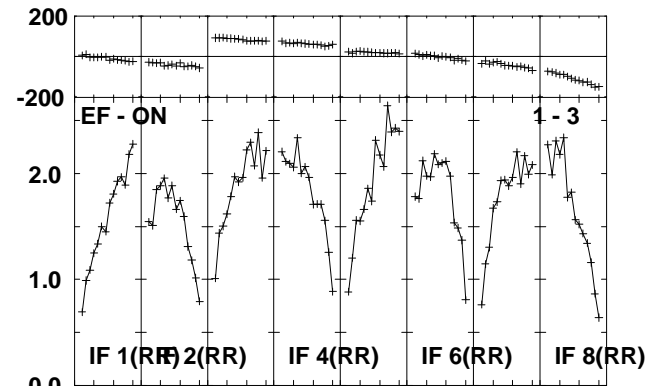
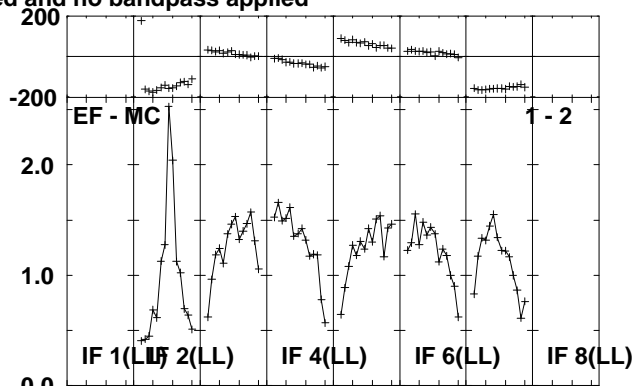
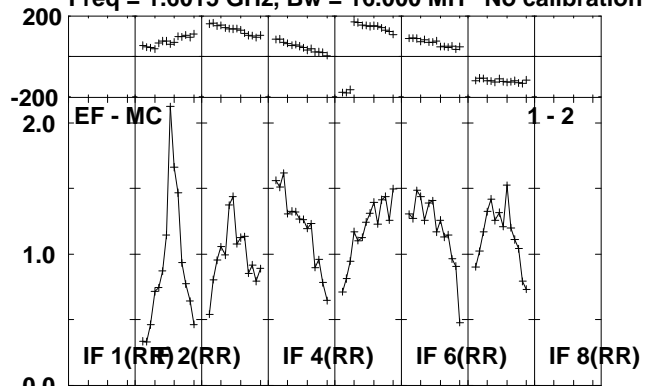

Lower frame: Milli Ampl Jy Top frame: Phas deg
Scalar averaged cross-power spectrum Several baselines displayed
Timerange: 01/04:57:53 to 01/05:00:01

Plot file version 239 created 01-JUL-2010 13:26:40
J2102+47 RG006B.UVDATA.1
Freq = 1.6015 GHz, Bw = 16.000 MH No calibration applied and no bandpass applied

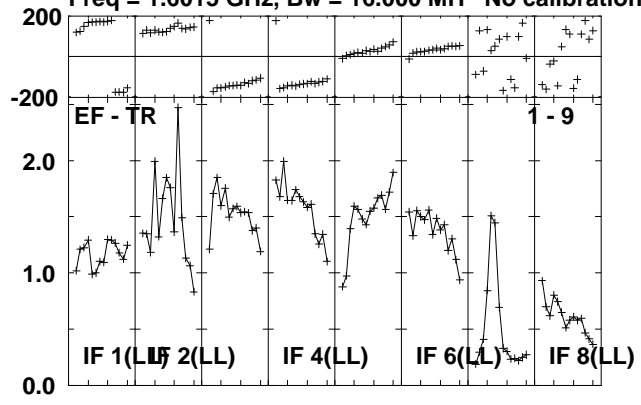

Lower frame: Milli Ampl Jy Top frame: Phas deg
Scalar averaged cross-power spectrum Several baselines displayed
Timerange: 01/04:57:53 to 01/05:00:01

Plot file version 240 created 01-JUL-2010 13:26:40

V407CYG RG006B.UVDATA.1

Freq = 1.6015 GHz, Bw = 16.000 MH No calibration applied and no bandpass applied

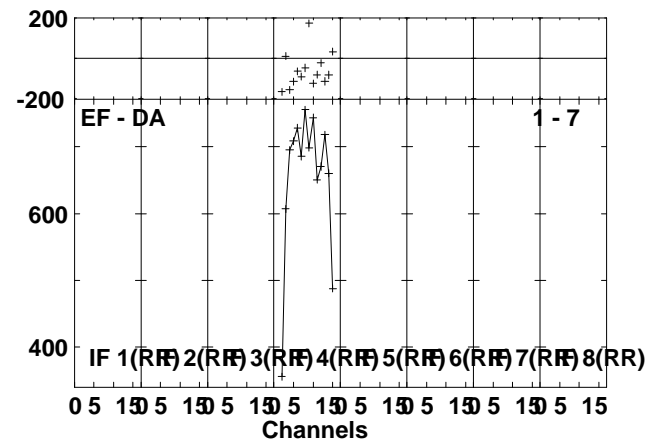
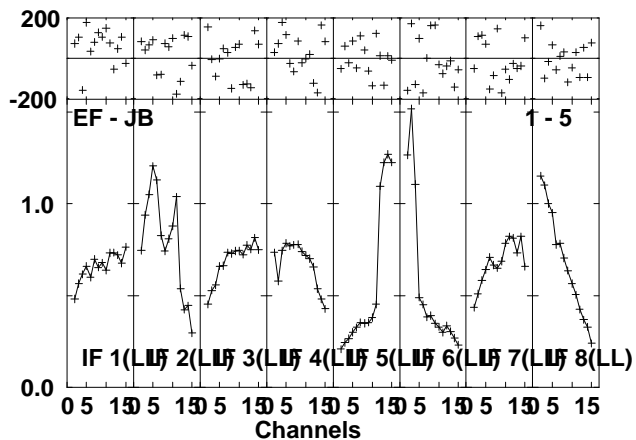
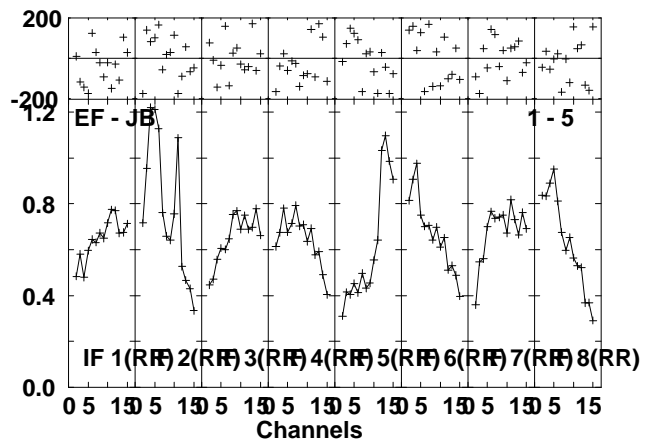
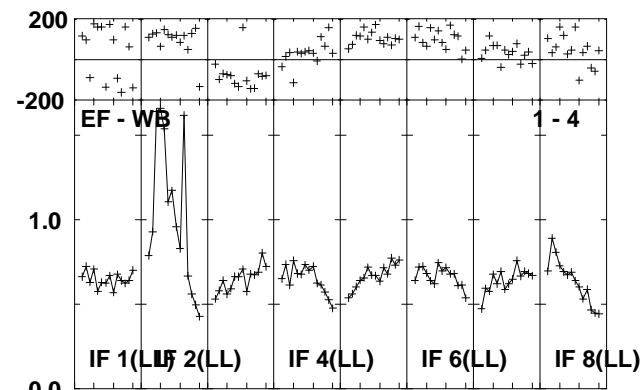
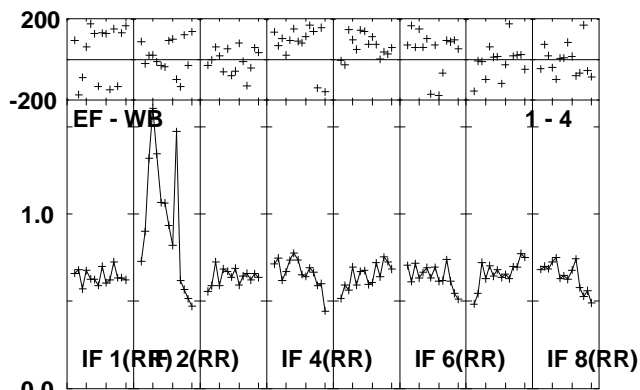
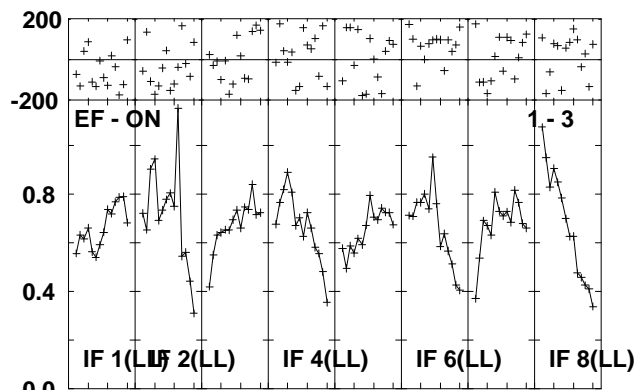
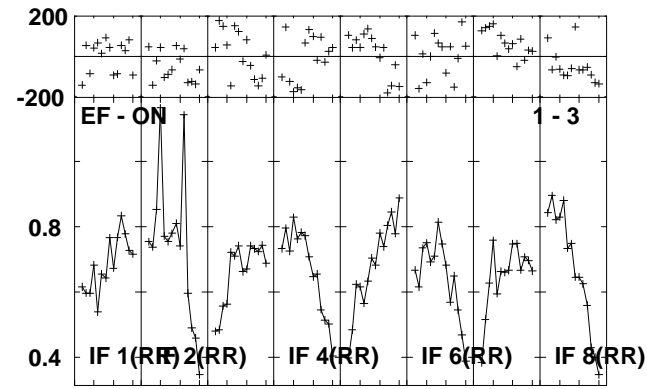
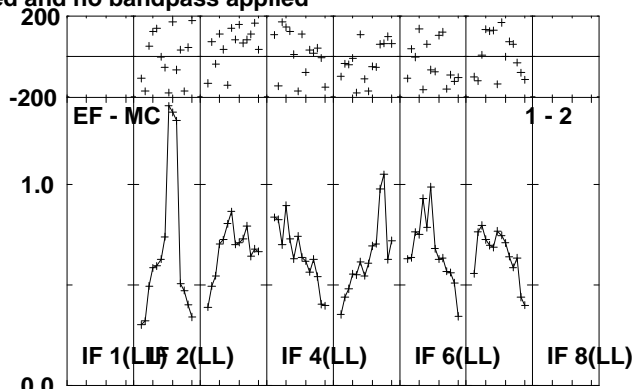
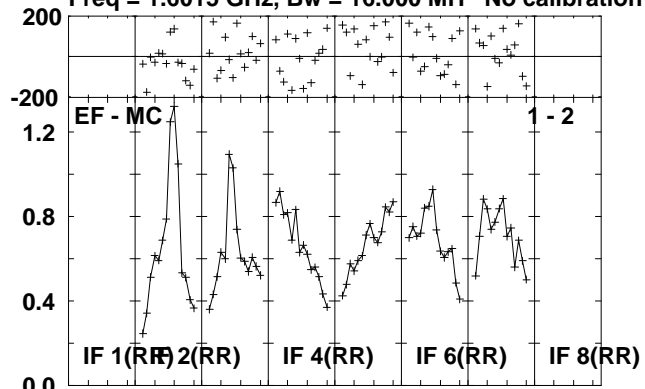

Lower frame: Milli Ampl Jy Top frame: Phas deg
Scalar averaged cross-power spectrum Several baselines displayed
Timerange: 01/05:00:05 to 01/05:05:01

Plot file version 241 created 01-JUL-2010 13:26:41

V407CYG RG006B.UVDATA.1

Freq = 1.6015 GHz, Bw = 16.000 MH No calibration applied and no bandpass applied

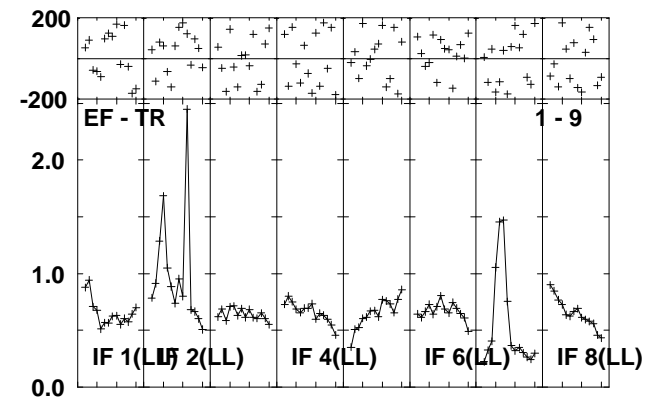
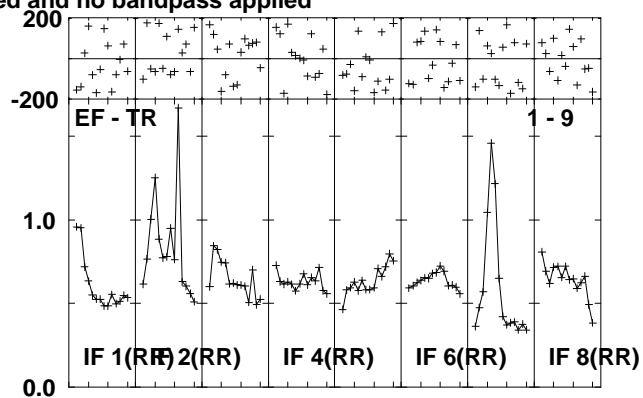
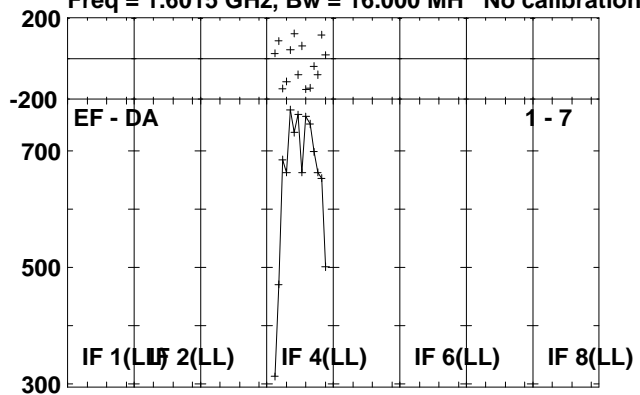

Lower frame: Micro Ampl Jy Top frame: Phas deg
Scalar averaged cross-power spectrum Several baselines displayed
Timerange: 01/05:00:05 to 01/05:05:01

Plot file version 242 created 01-JUL-2010 13:26:42

J2102+47 RG006B.UVDATA.1

Freq = 1.6015 GHz, Bw = 16.000 MH No calibration applied and no bandpass applied

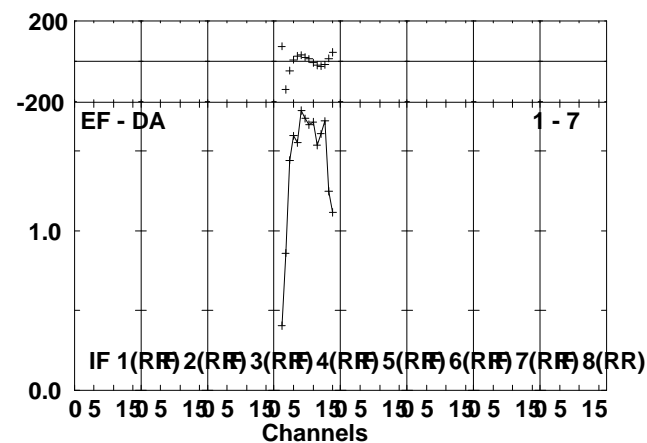
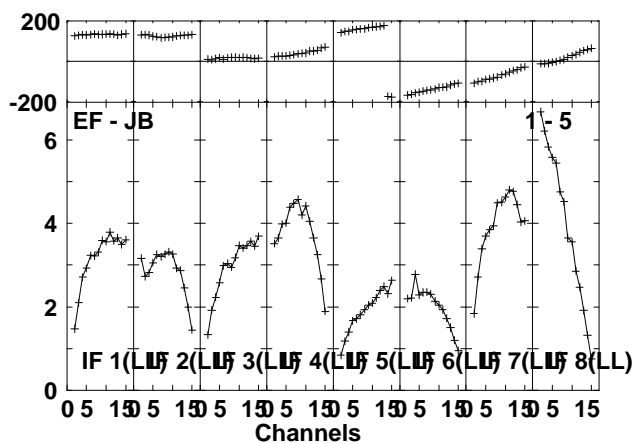
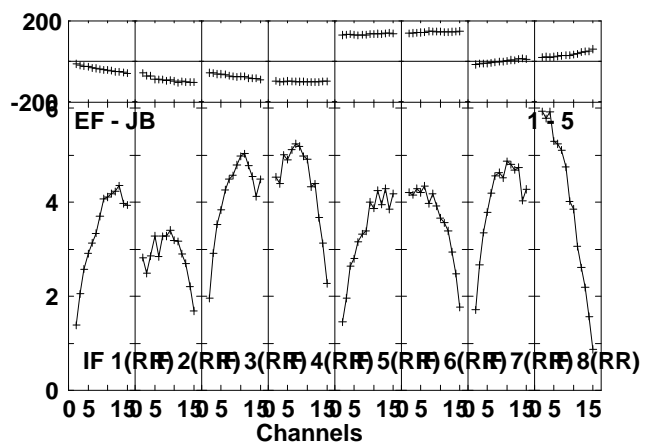
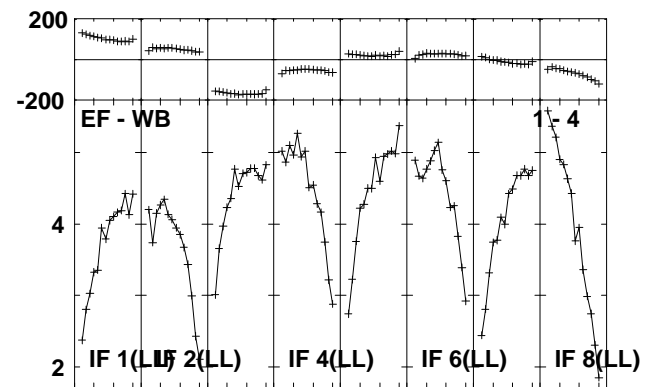
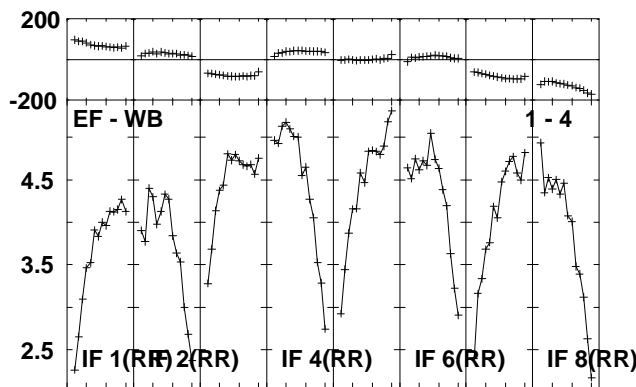
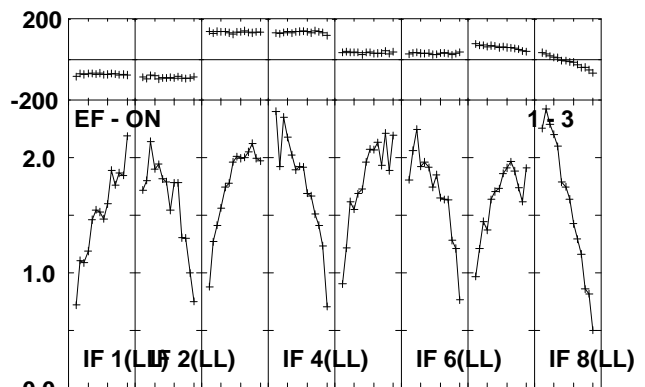
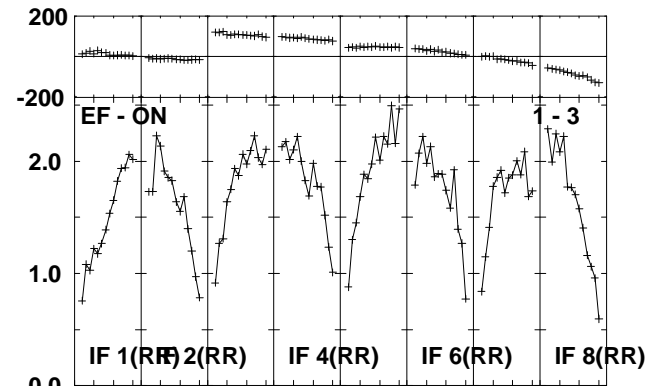
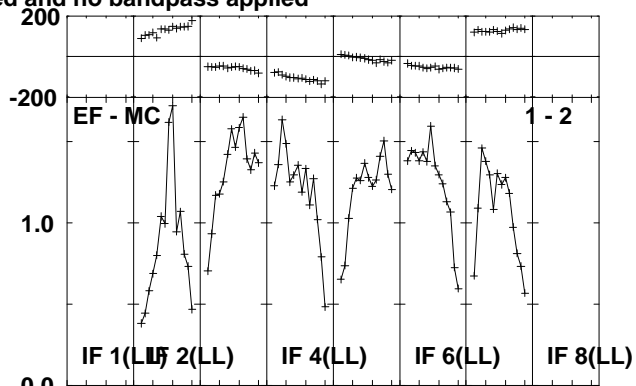
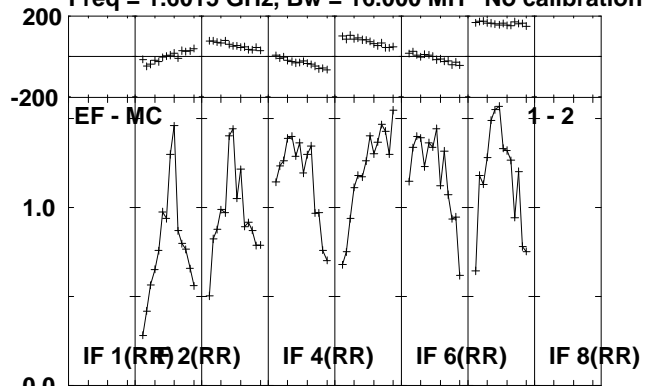

Lower frame: Milli Ampl Jy Top frame: Phas deg
Scalar averaged cross-power spectrum Several baselines displayed
Timerange: 01/05:06:05 to 01/05:07:49

Plot file version 243 created 01-JUL-2010 13:26:42

J2102+47 RG006B.UVDATA.1

Freq = 1.6015 GHz, Bw = 16.000 MH No calibration applied and no bandpass applied

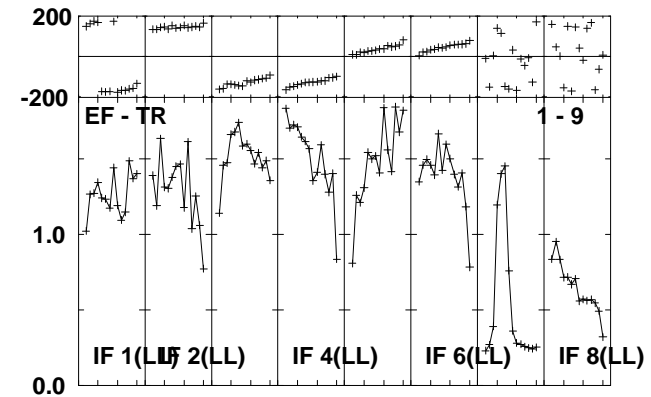
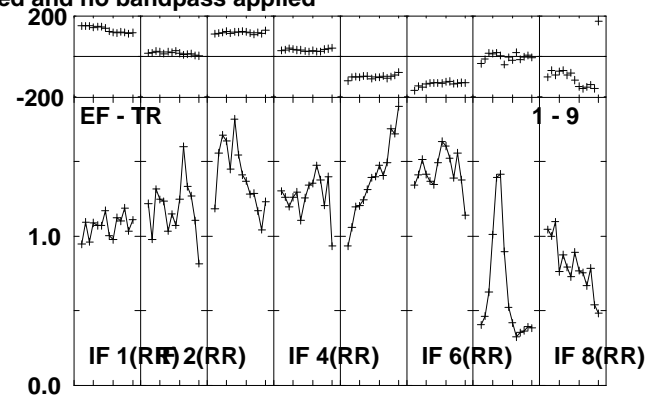
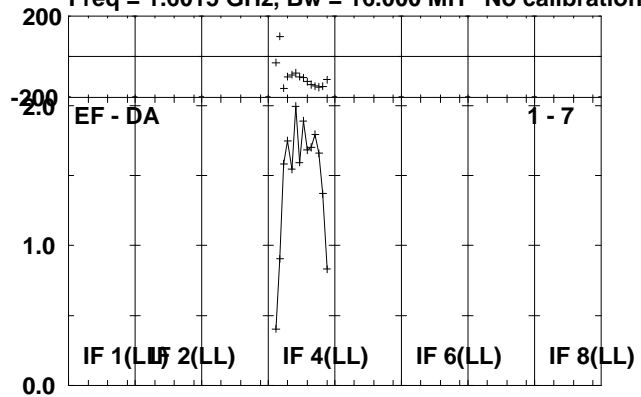

Lower frame: Milli Ampl Jy Top frame: Phas deg
Scalar averaged cross-power spectrum Several baselines displayed
Timerange: 01/05:06:05 to 01/05:07:49

Plot file version 244 created 01-JUL-2010 13:26:48

V407CYG RG006B.UVDATA.1

Freq = 1.6015 GHz, Bw = 16.000 MH No calibration applied and no bandpass applied

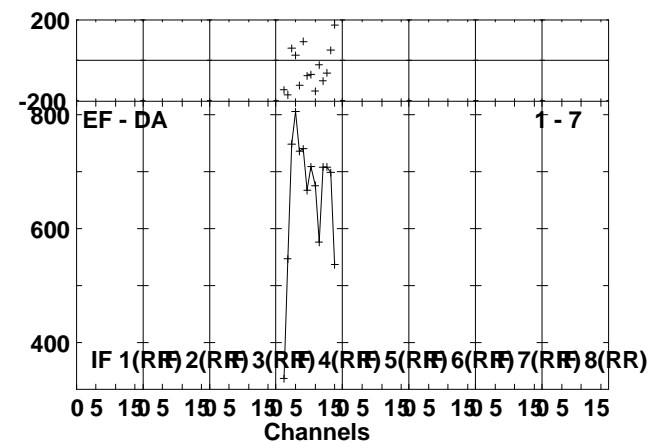
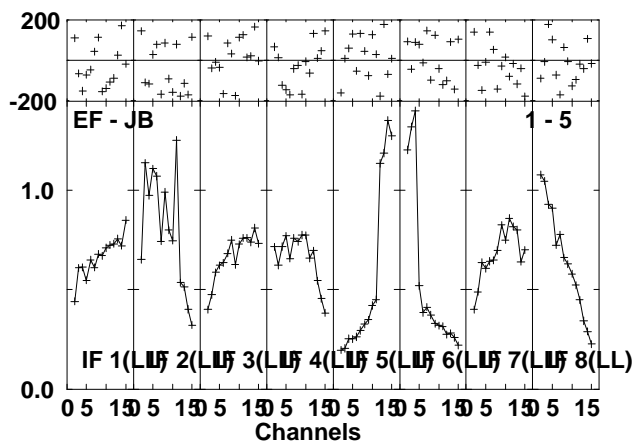
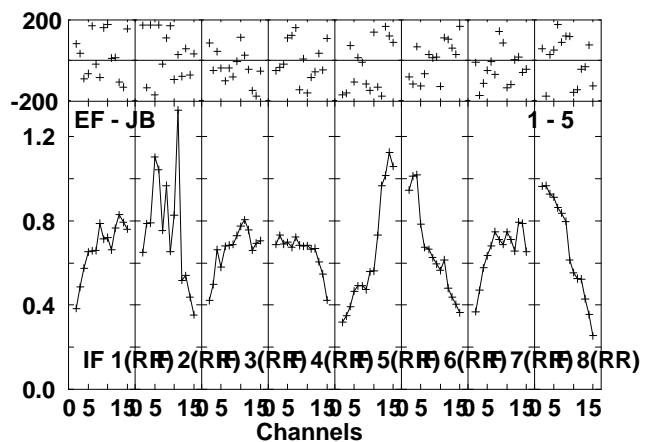
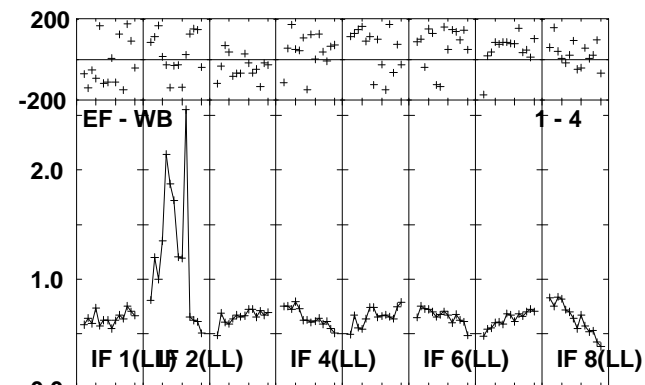
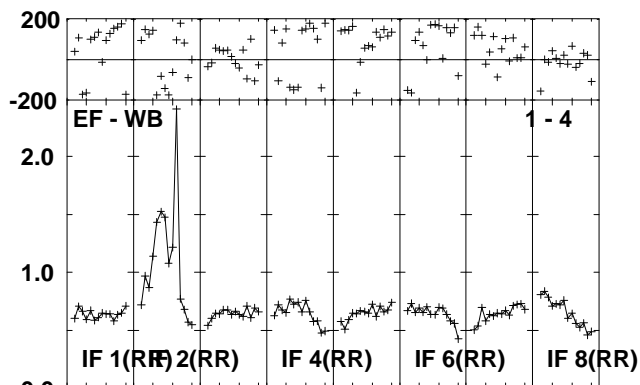
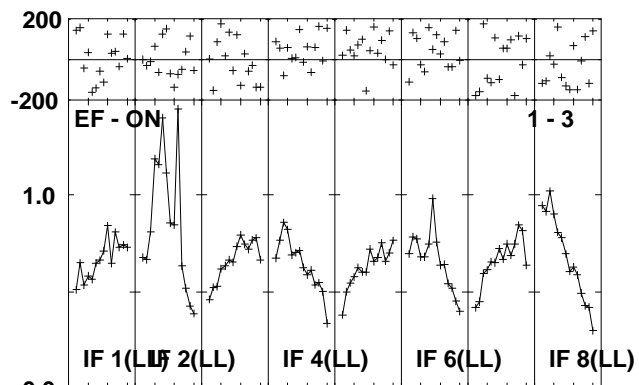
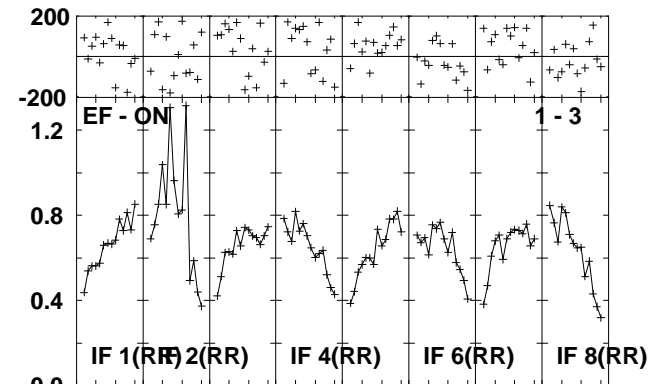
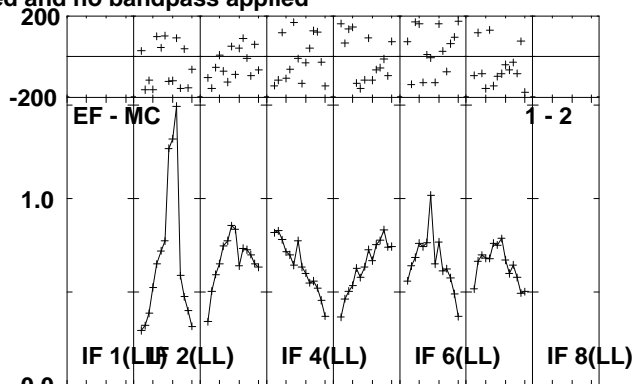
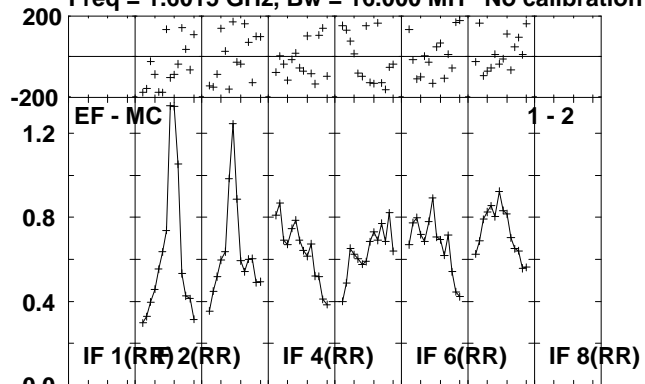

Lower frame: Milli Ampl Jy Top frame: Phas deg
Scalar averaged cross-power spectrum Several baselines displayed
Timerange: 01/05:07:53 to 01/05:12:49

Plot file version 245 created 01-JUL-2010 13:26:49

V407CYG RG006B.UVDATA.1

Freq = 1.6015 GHz, Bw = 16.000 MH No calibration applied and no bandpass applied

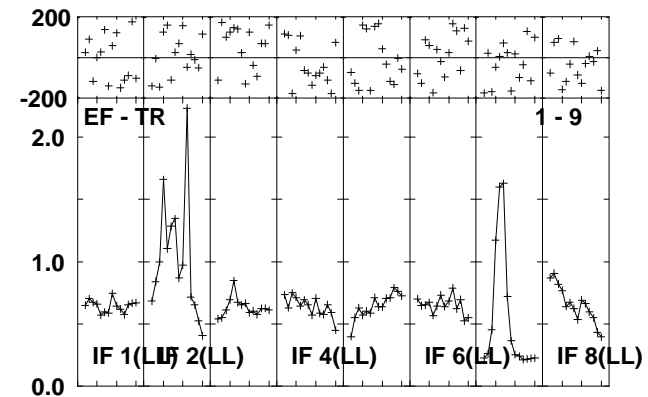
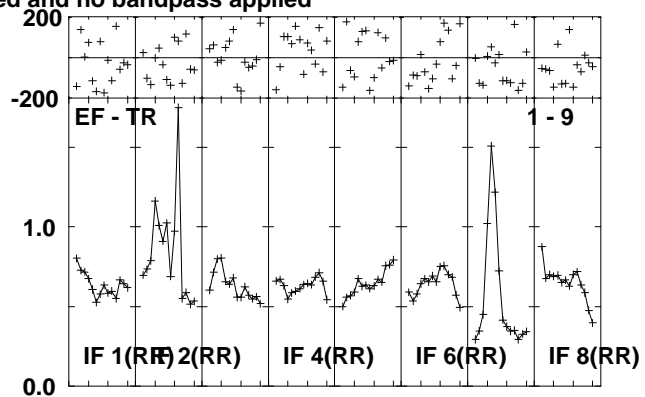
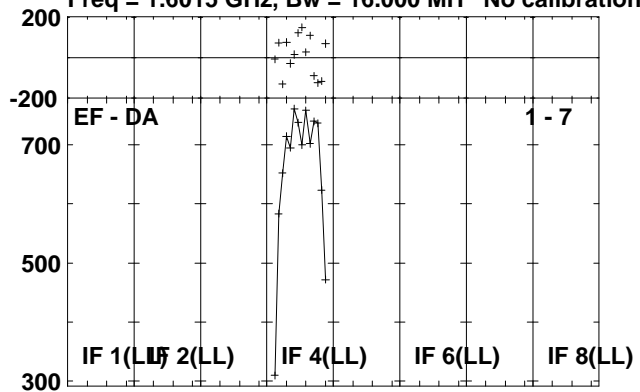

Lower frame: Micro Ampl Jy Top frame: Phas deg
Scalar averaged cross-power spectrum Several baselines displayed
Timerange: 01/05:07:53 to 01/05:12:49

Plot file version 246 created 01-JUL-2010 13:26:50

J2102+47 RG006B.UVDATA.1

Freq = 1.6015 GHz, Bw = 16.000 MH No calibration applied and no bandpass applied

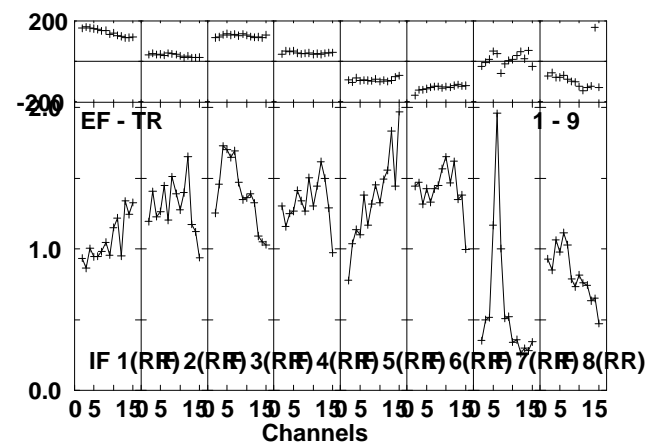
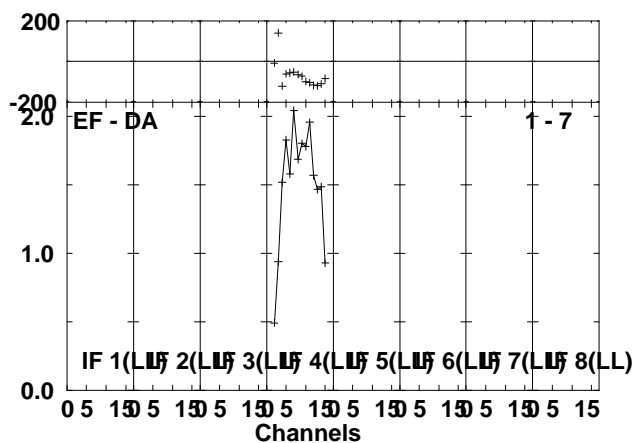
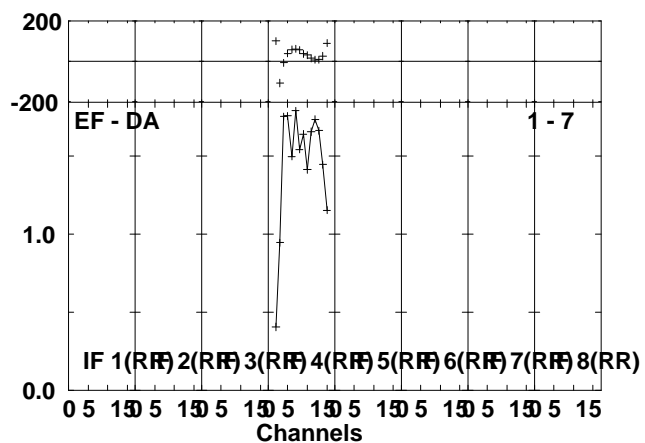
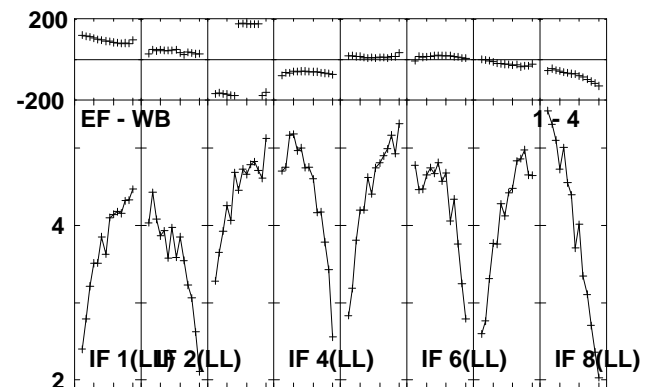
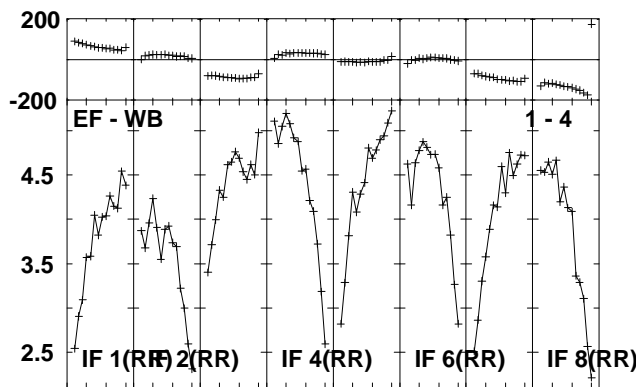
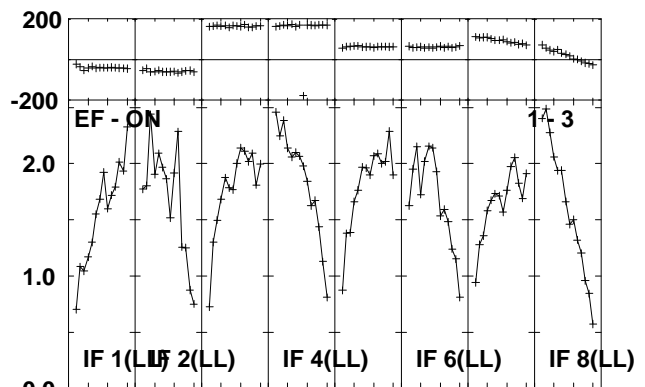
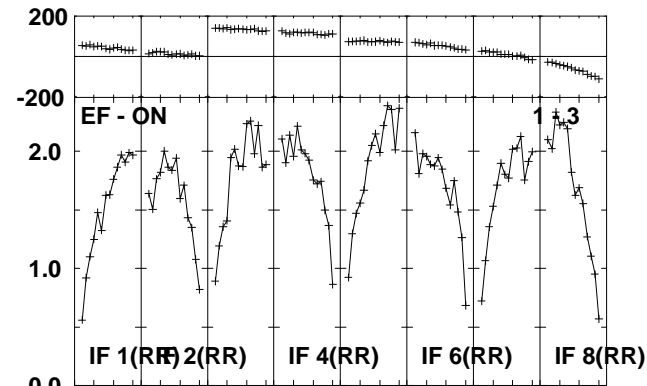
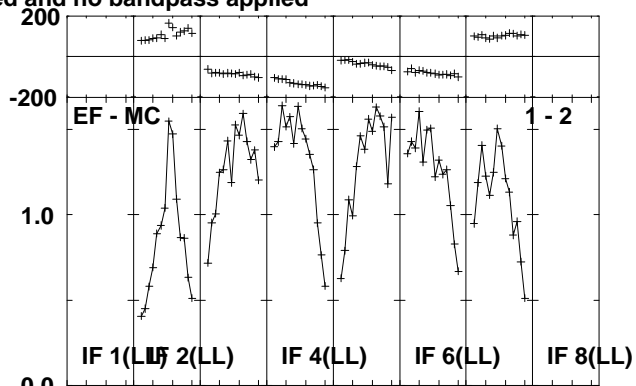
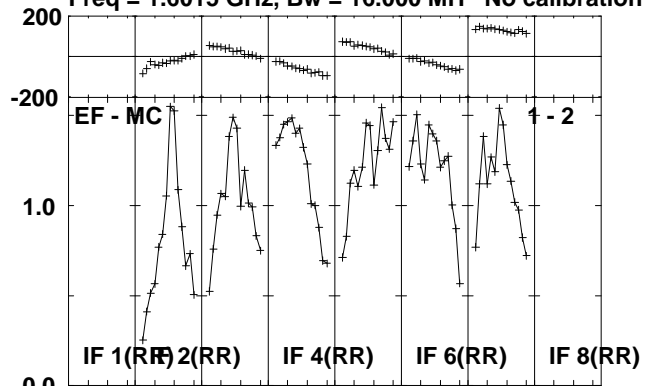

Lower frame: Milli Ampl Jy Top frame: Phas deg
Scalar averaged cross-power spectrum Several baselines displayed
Timerange: 01/05:12:53 to 01/05:15:01

Plot file version 247 created 01-JUL-2010 13:26:50
J2102+47 RG006B.UVDATA.1
Freq = 1.6015 GHz, Bw = 16.000 MH No calibration applied and no bandpass applied

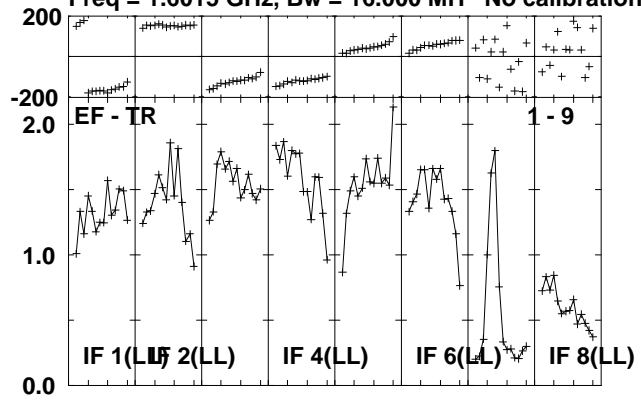

Lower frame: Milli Ampl Jy Top frame: Phas deg
Scalar averaged cross-power spectrum Several baselines displayed
Timerange: 01/05:12:53 to 01/05:15:01

Plot file version 248 created 01-JUL-2010 13:26:51

V407CYG RG006B.UVDATA.1

Freq = 1.6015 GHz, Bw = 16.000 MH No calibration applied and no bandpass applied

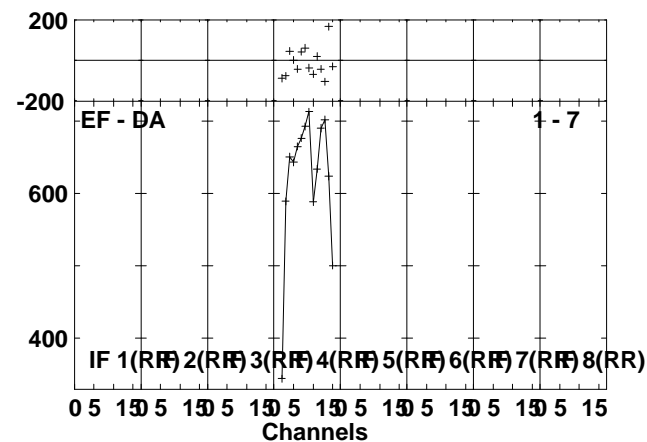
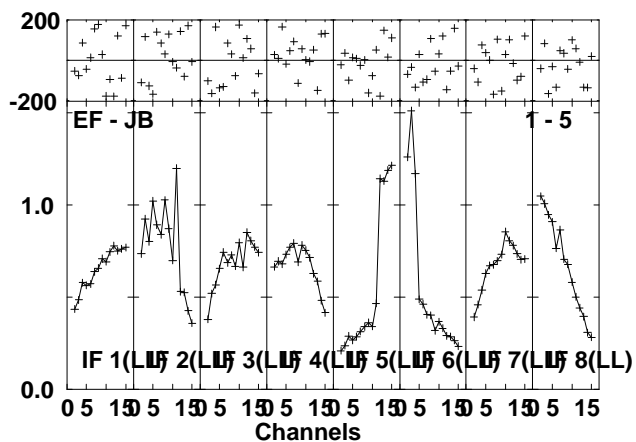
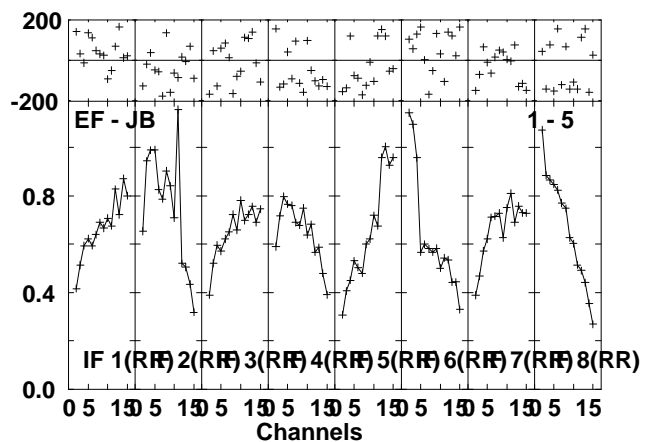
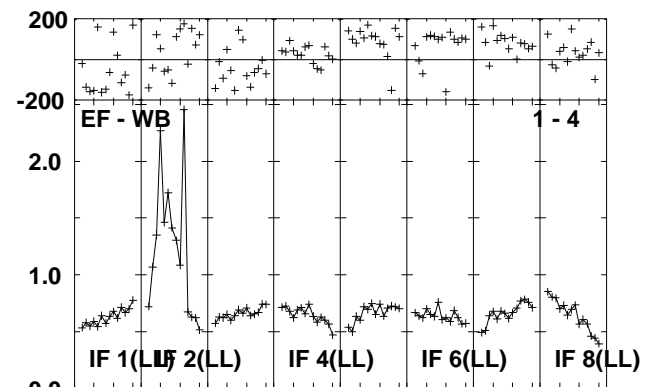
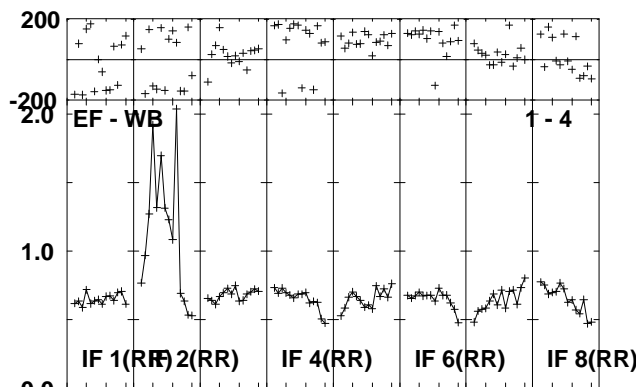
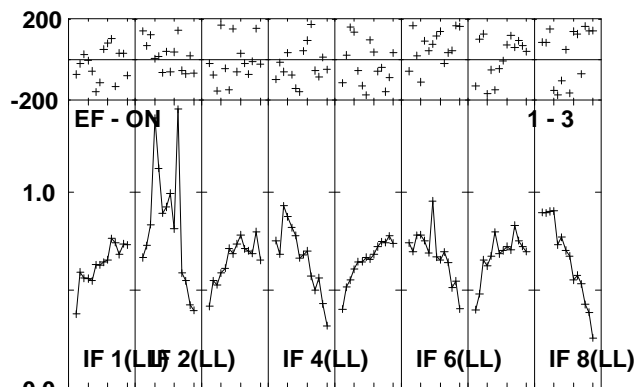
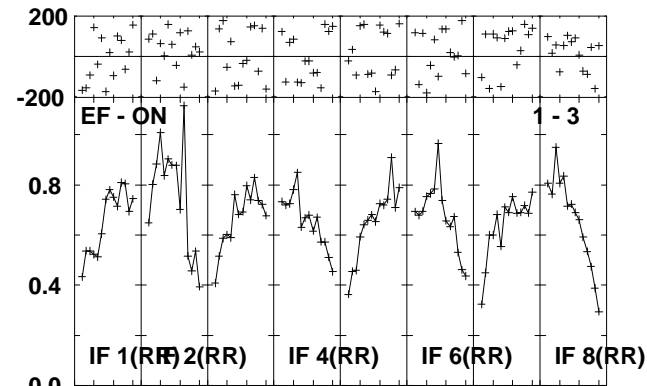
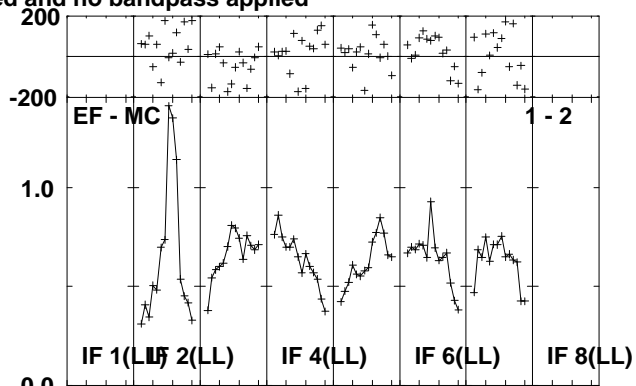
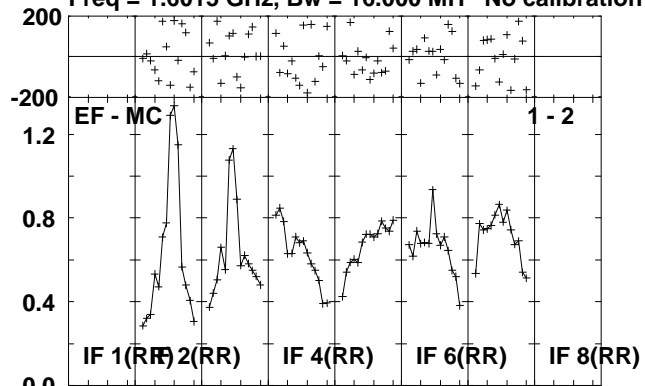

Lower frame: Milli Ampl Jy Top frame: Phas deg
Scalar averaged cross-power spectrum Several baselines displayed
Timerange: 01/05:15:05 to 01/05:20:01

Plot file version 249 created 01-JUL-2010 13:26:52

V407CYG RG006B.UVDATA.1

Freq = 1.6015 GHz, Bw = 16.000 MH No calibration applied and no bandpass applied

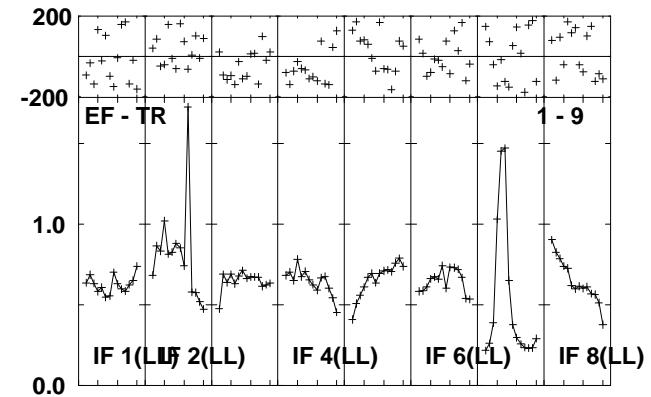
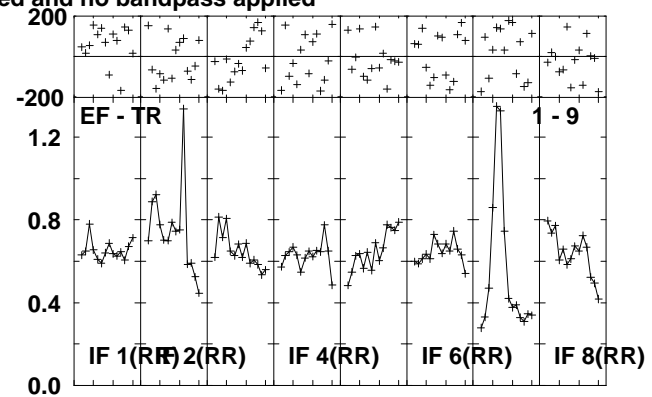
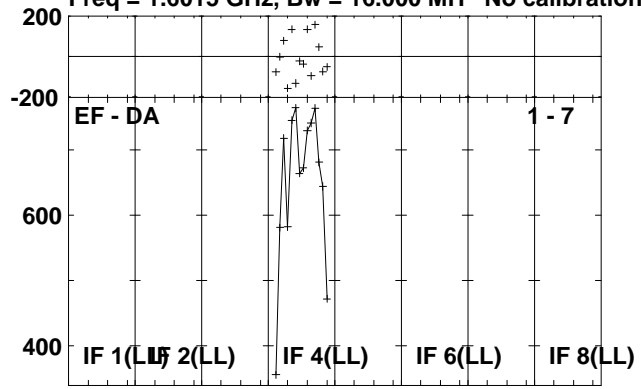

Lower frame: Micro Ampl Jy Top frame: Phas deg
Scalar averaged cross-power spectrum Several baselines displayed
Timerange: 01/05:15:05 to 01/05:20:01

Plot file version 250 created 01-JUL-2010 13:26:52

J2102+47 RG006B.UVDATA.1

Freq = 1.6015 GHz, Bw = 16.000 MH No calibration applied and no bandpass applied

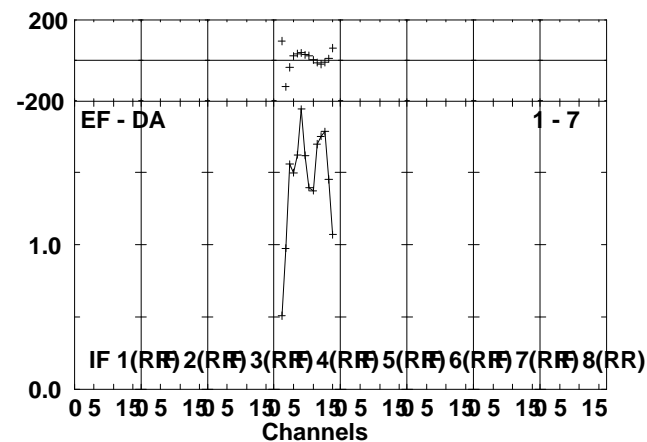
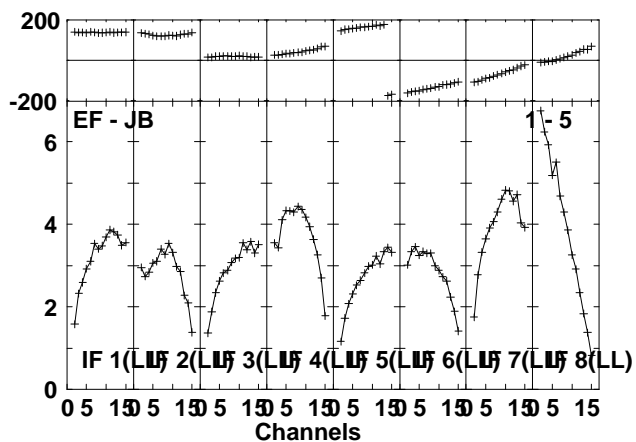
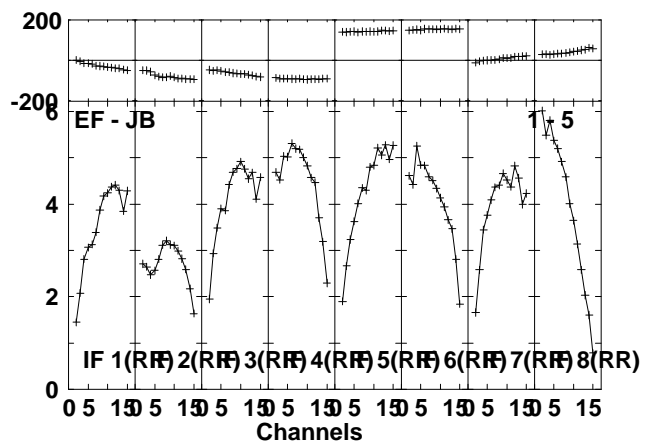
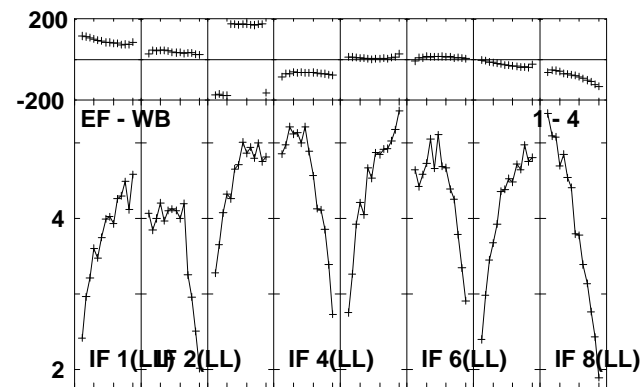
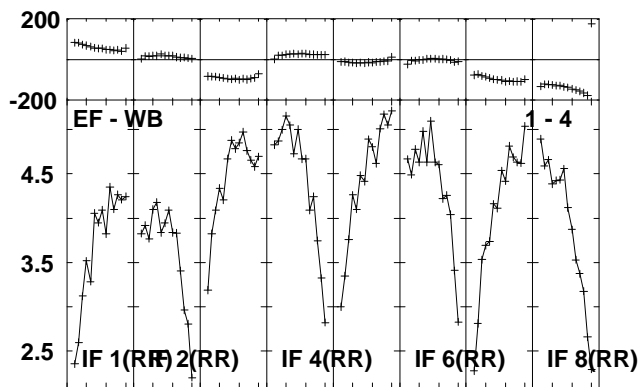
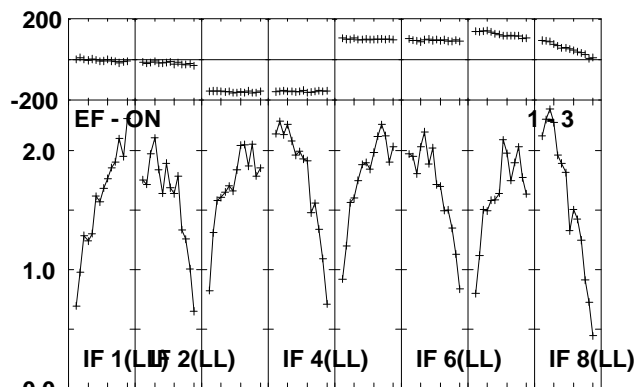
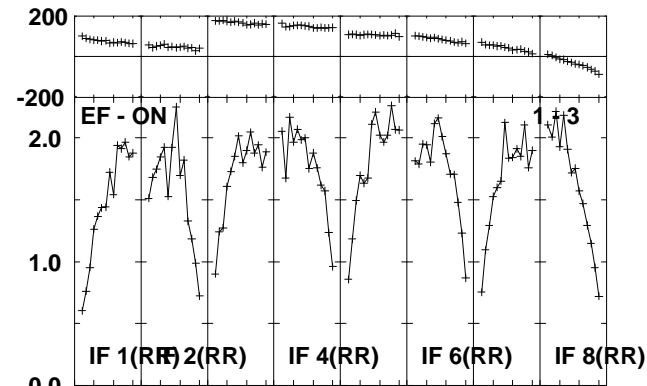
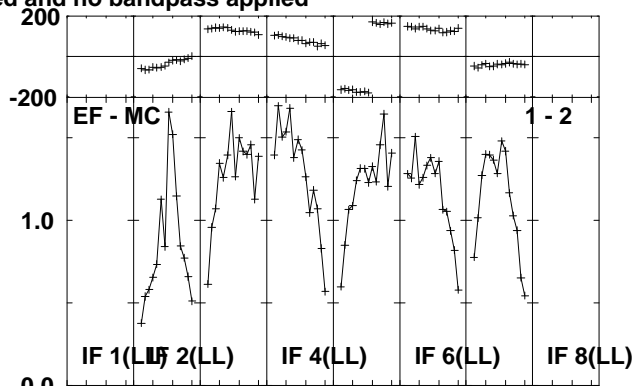
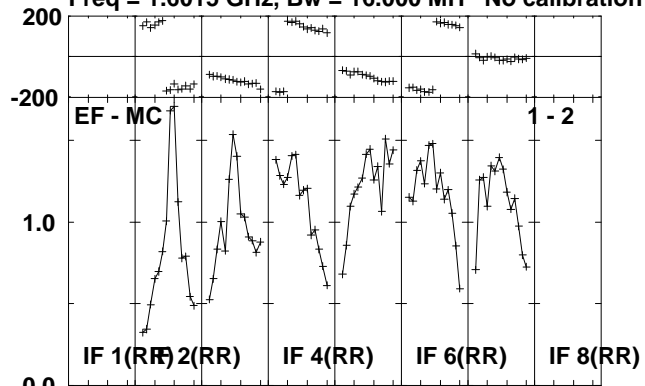

Lower frame: Milli Ampl Jy Top frame: Phas deg
Scalar averaged cross-power spectrum Several baselines displayed
Timerange: 01/05:21:05 to 01/05:22:49

Plot file version 251 created 01-JUL-2010 13:26:53

J2102+47 RG006B.UVDATA.1

Freq = 1.6015 GHz, Bw = 16.000 MH No calibration applied and no bandpass applied

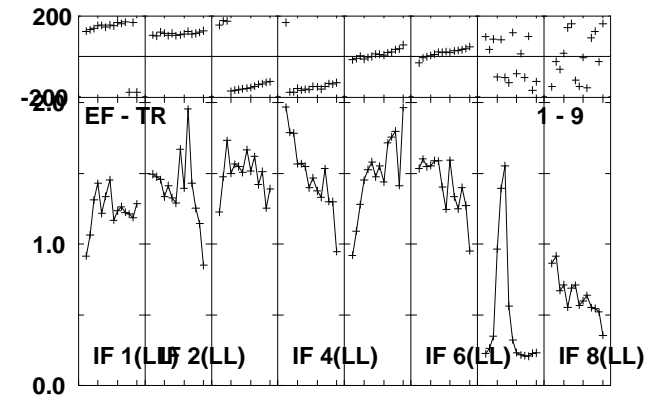
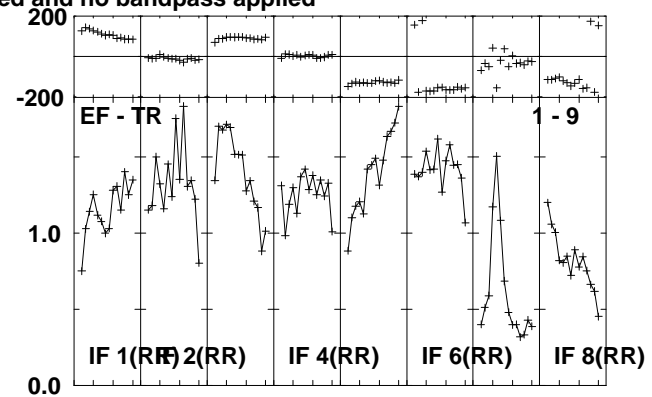
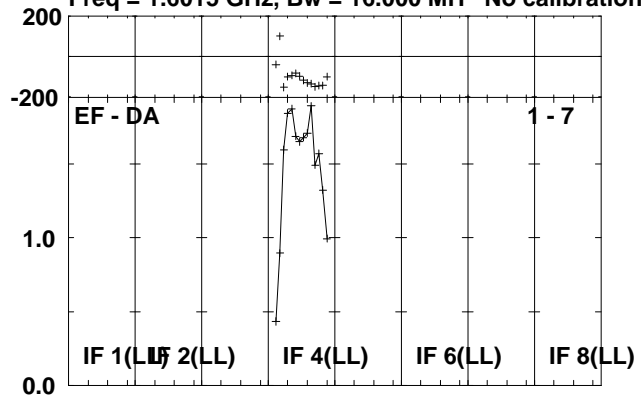

Lower frame: Milli Ampl Jy Top frame: Phas deg
Scalar averaged cross-power spectrum Several baselines displayed
Timerange: 01/05:21:05 to 01/05:22:49

Plot file version 252 created 01-JUL-2010 13:26:53

V407CYG RG006B.UVDATA.1

Freq = 1.6015 GHz, Bw = 16.000 MH No calibration applied and no bandpass applied

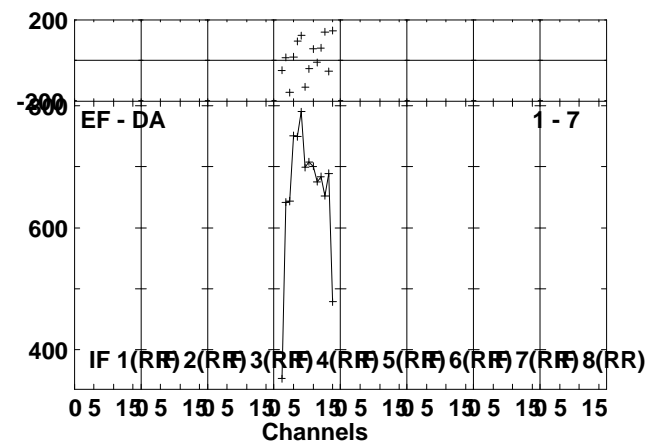
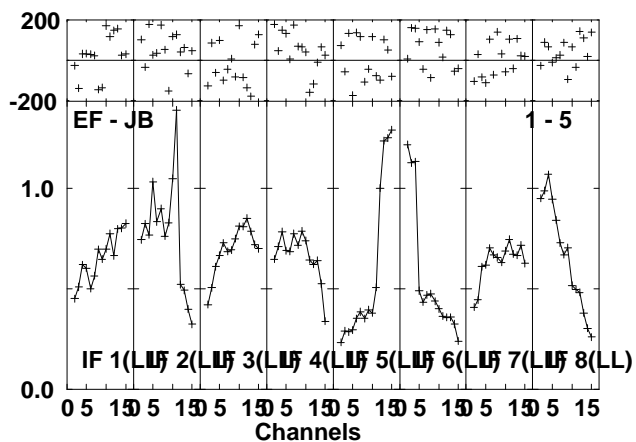
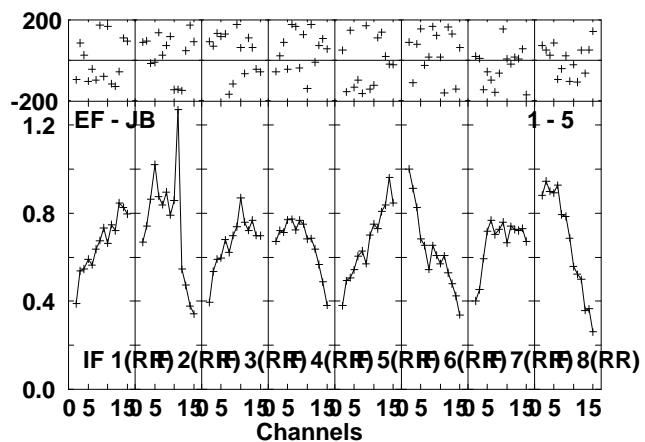
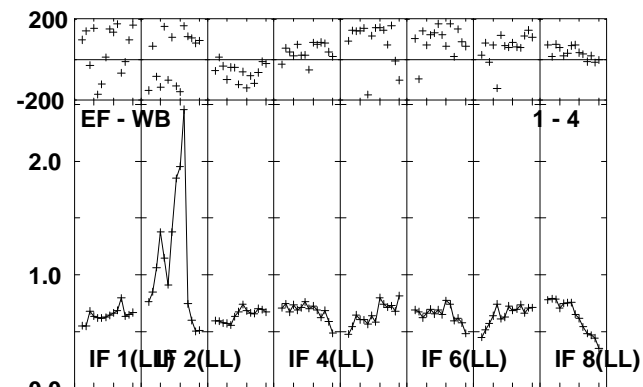
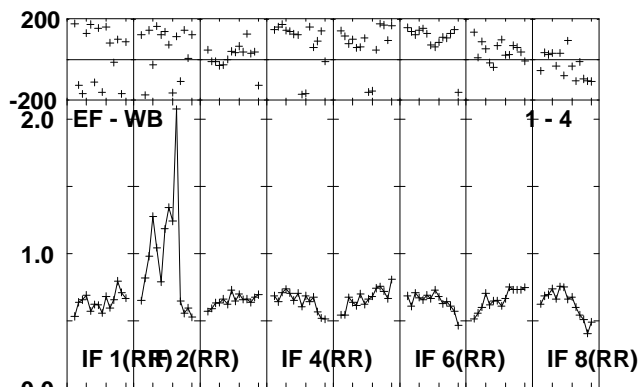
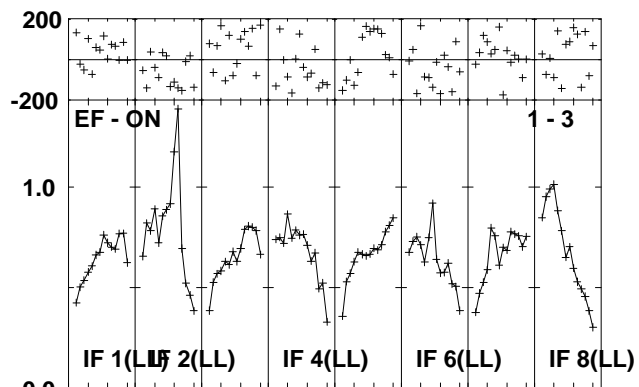
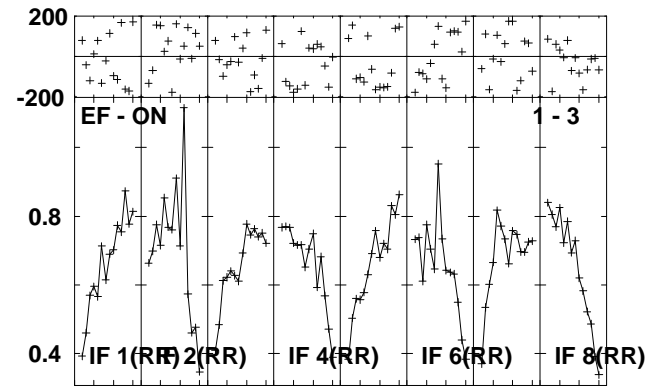
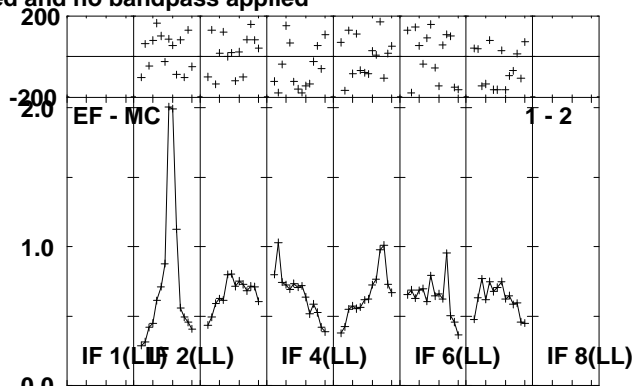
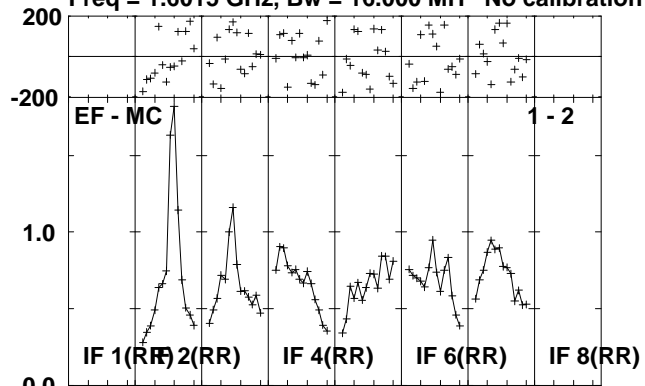

Lower frame: Milli Ampl Jy Top frame: Phas deg
Scalar averaged cross-power spectrum Several baselines displayed
Timerange: 01/05:22:53 to 01/05:27:49

Plot file version 253 created 01-JUL-2010 13:26:54

V407CYG RG006B.UVDATA.1

Freq = 1.6015 GHz, Bw = 16.000 MH No calibration applied and no bandpass applied

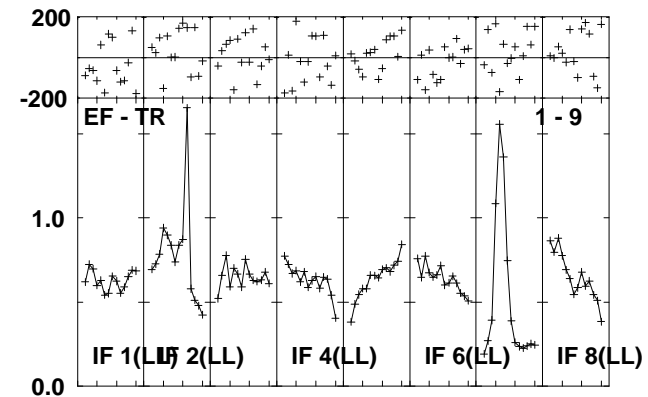
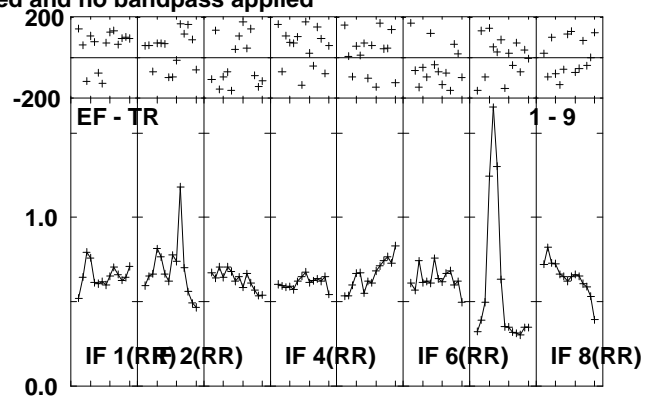
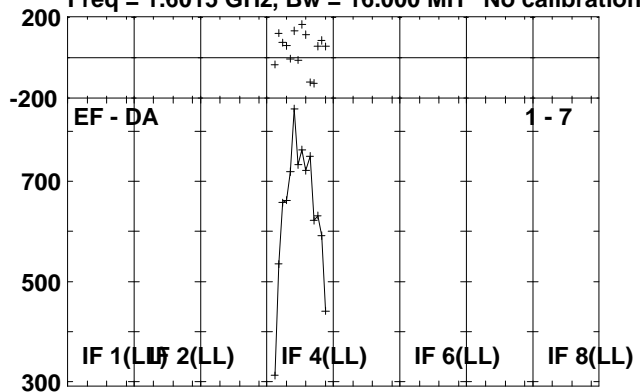

Lower frame: Micro Ampl Jy Top frame: Phas deg
Scalar averaged cross-power spectrum Several baselines displayed
Timerange: 01/05:22:53 to 01/05:27:49

Plot file version 254 created 01-JUL-2010 13:26:55

J2102+47 RG006B.UVDATA.1

Freq = 1.6015 GHz, Bw = 16.000 MH No calibration applied and no bandpass applied

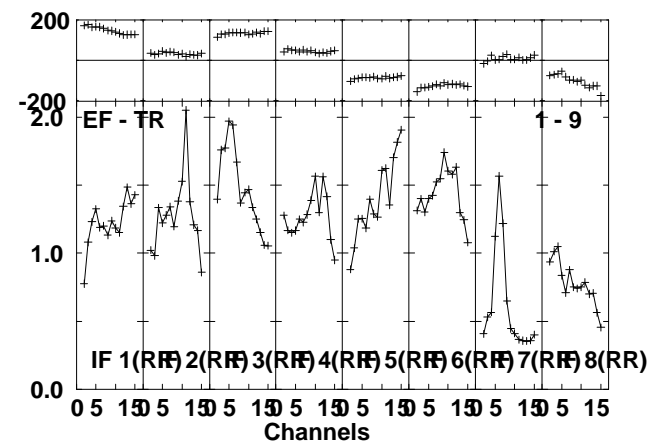
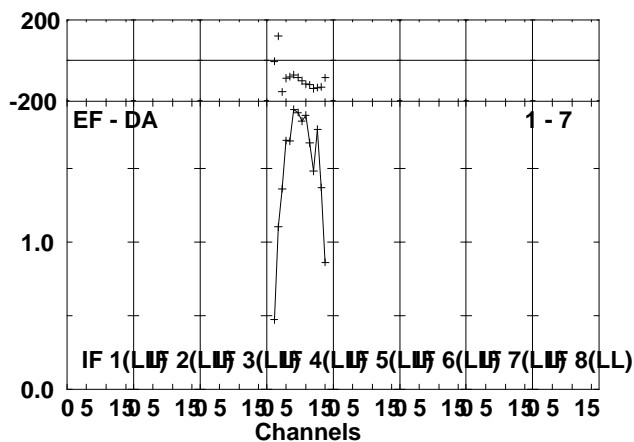
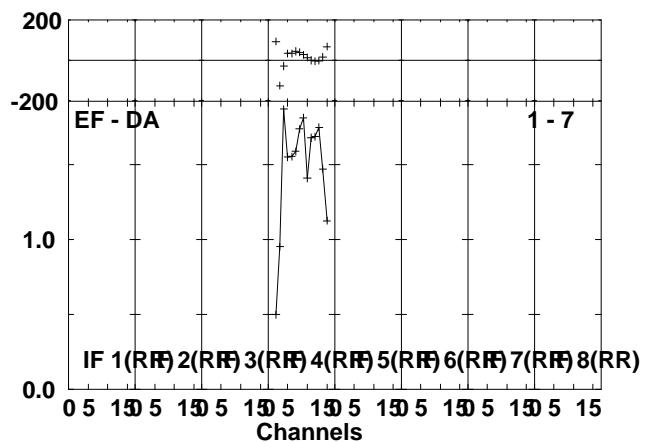
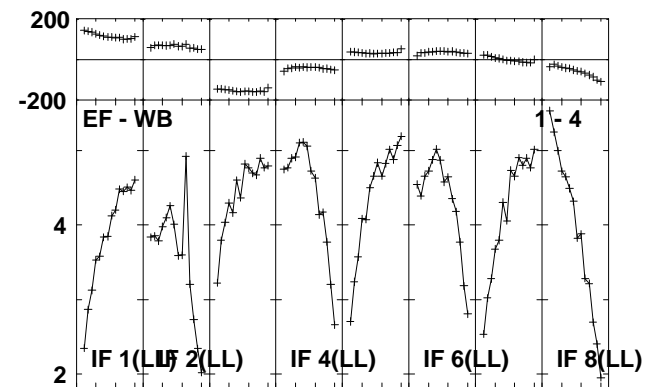
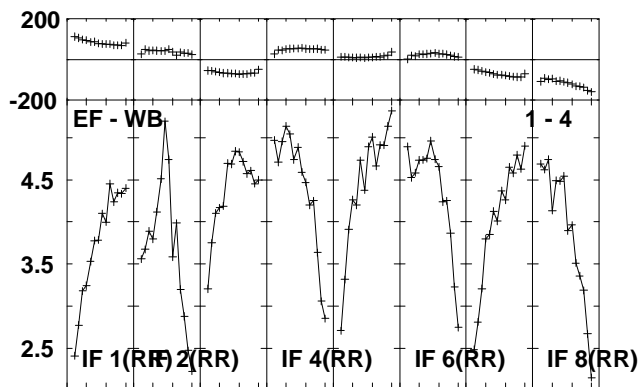
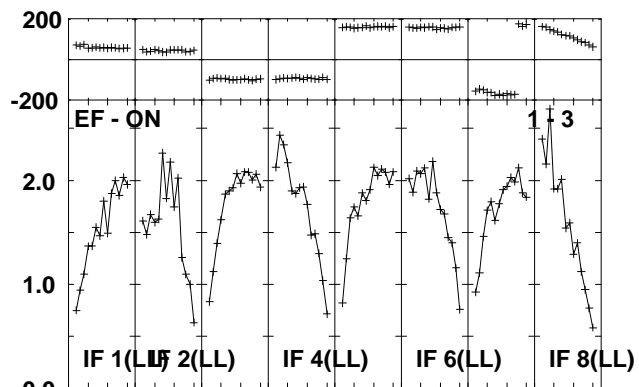
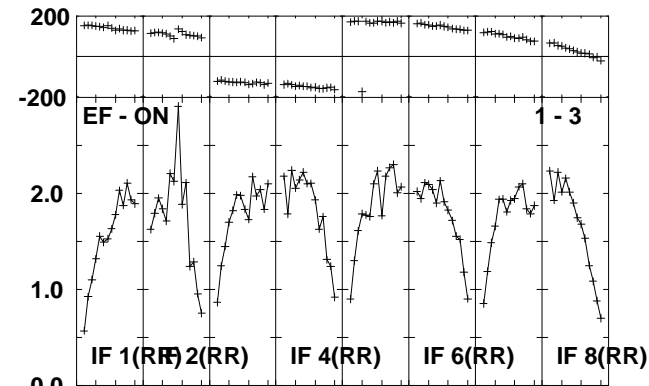
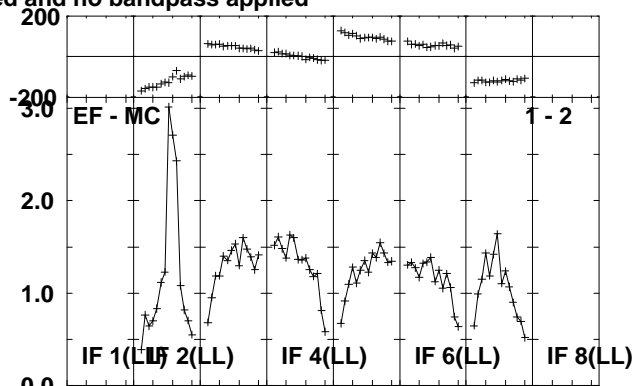
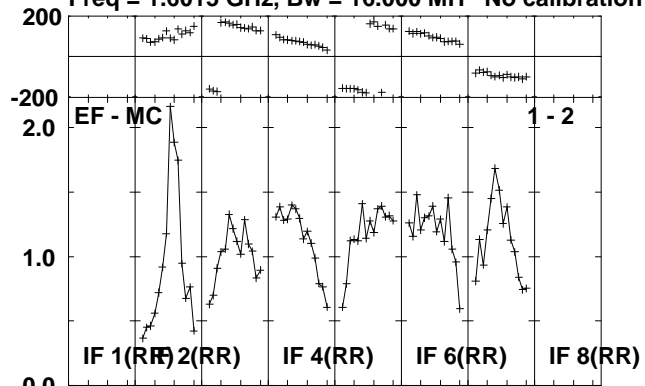

Lower frame: Milli Ampl Jy Top frame: Phas deg
Scalar averaged cross-power spectrum Several baselines displayed
Timerange: 01/05:27:53 to 01/05:30:01

Plot file version 255 created 01-JUL-2010 13:26:55
J2102+47 RG006B.UVDATA.1
Freq = 1.6015 GHz, Bw = 16.000 MH No calibration applied and no bandpass applied

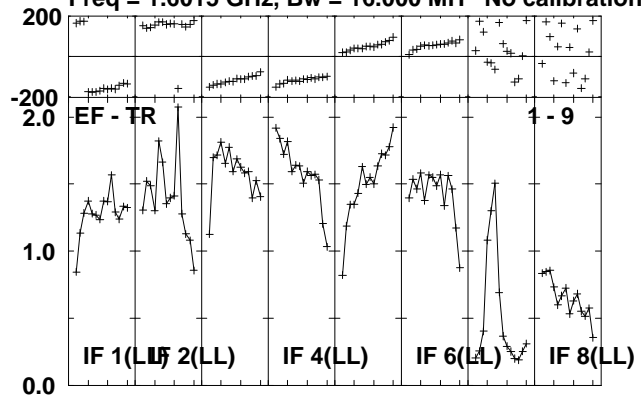

Lower frame: Milli Ampl Jy Top frame: Phas deg
Scalar averaged cross-power spectrum Several baselines displayed
Timerange: 01/05:27:53 to 01/05:30:01

Plot file version 256 created 01-JUL-2010 13:26:55

V407CYG RG006B.UVDATA.1

Freq = 1.6015 GHz, Bw = 16.000 MH No calibration applied and no bandpass applied

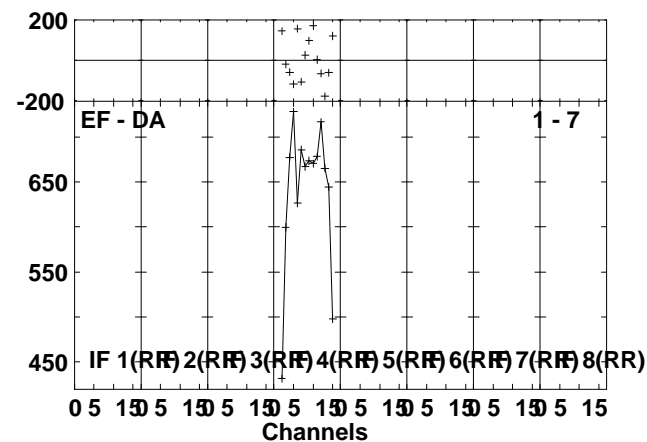
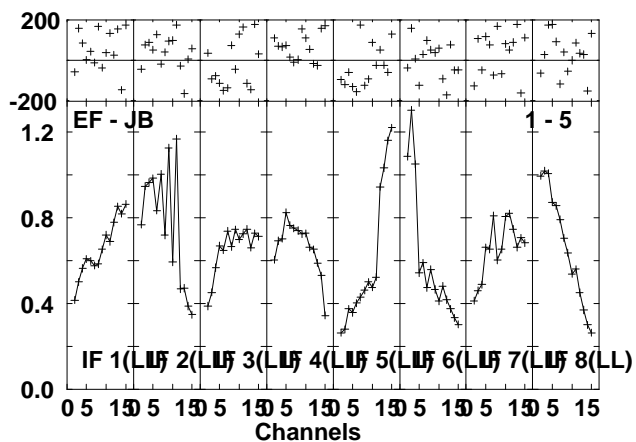
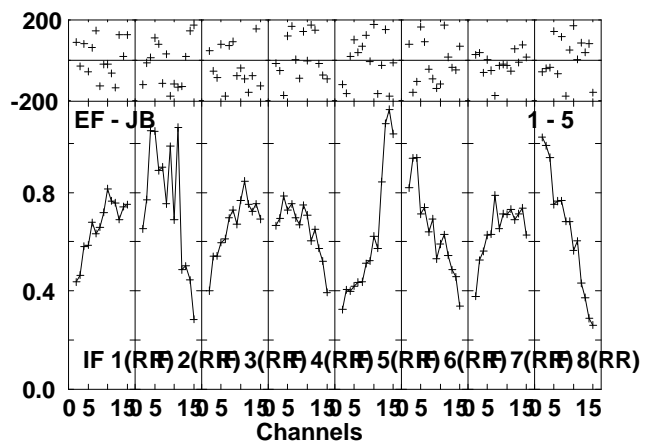
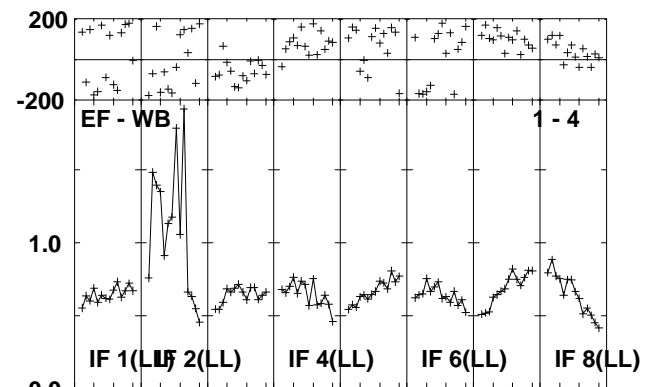
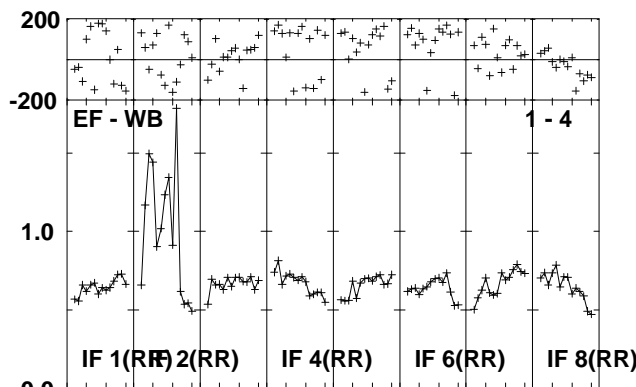
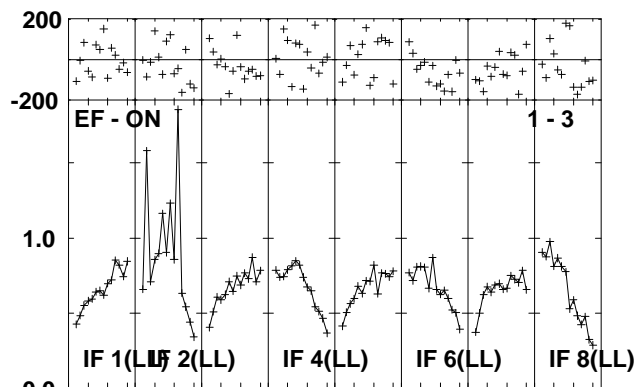
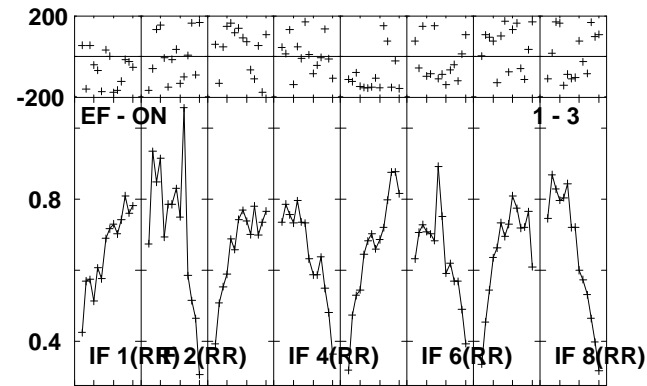
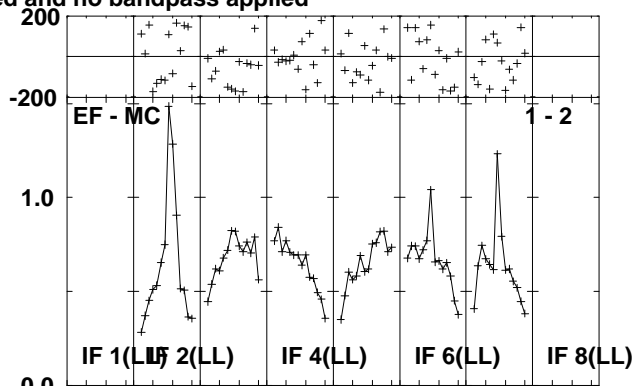
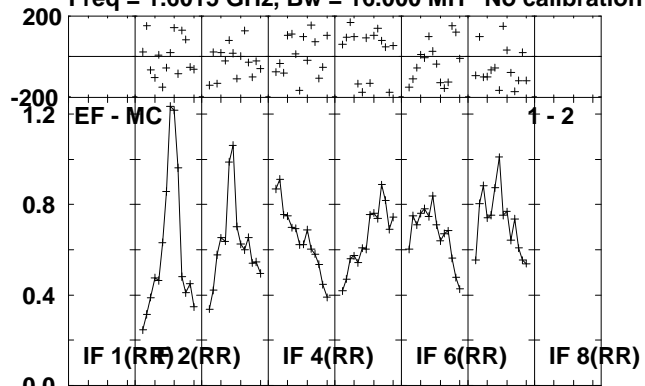

Lower frame: Milli Ampl Jy Top frame: Phas deg
Scalar averaged cross-power spectrum Several baselines displayed
Timerange: 01/05:30:05 to 01/05:35:01

Plot file version 257 created 01-JUL-2010 13:26:57

V407CYG RG006B.UVDATA.1

Freq = 1.6015 GHz, Bw = 16.000 MH No calibration applied and no bandpass applied

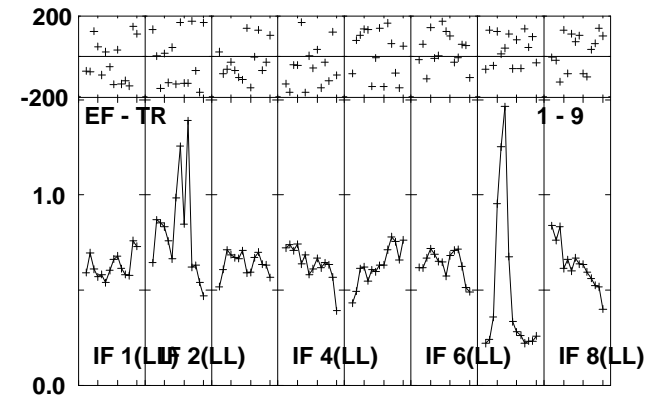
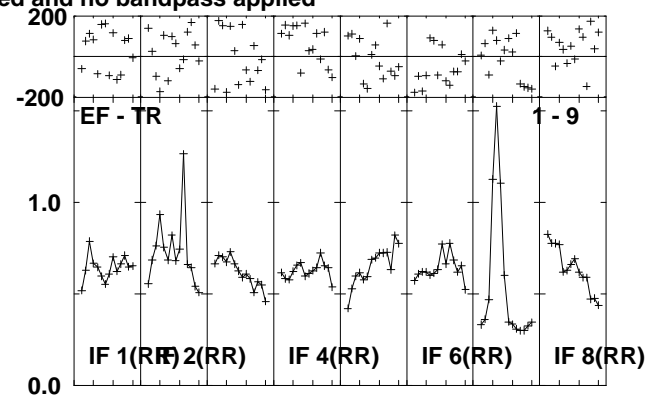
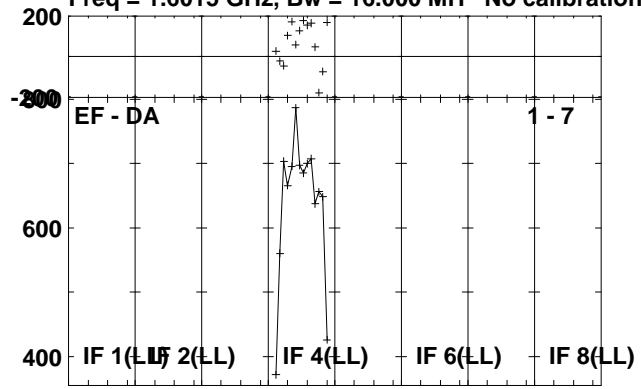

Lower frame: Micro Ampl Jy Top frame: Phas deg
Scalar averaged cross-power spectrum Several baselines displayed
Timerange: 01/05:30:05 to 01/05:35:01

Plot file version 258 created 01-JUL-2010 13:26:57

J2102+47 RG006B.UVDATA.1

Freq = 1.6015 GHz, Bw = 16.000 MH No calibration applied and no bandpass applied

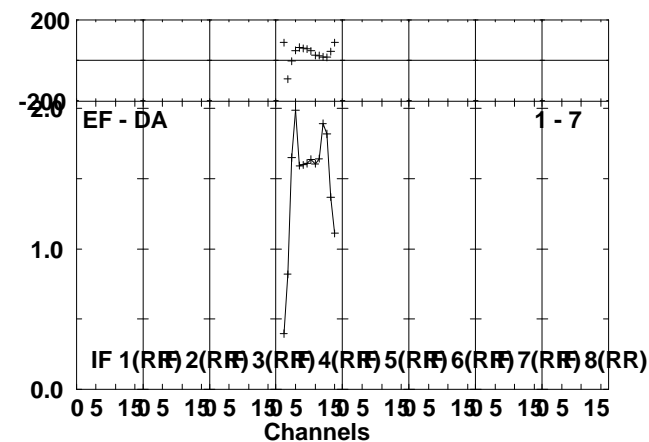
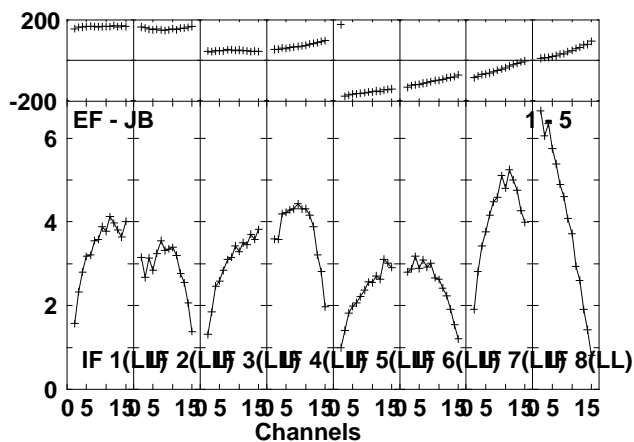
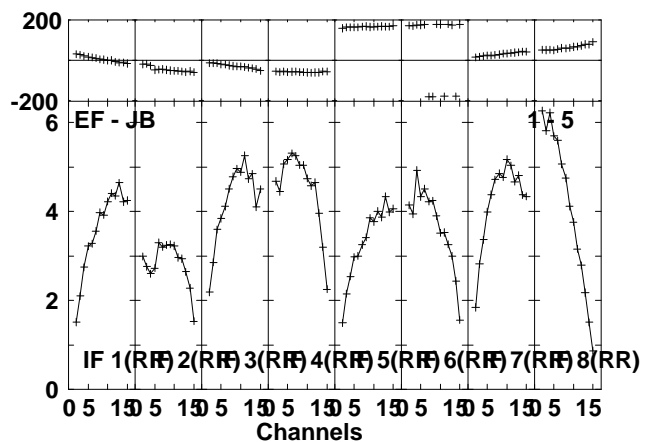
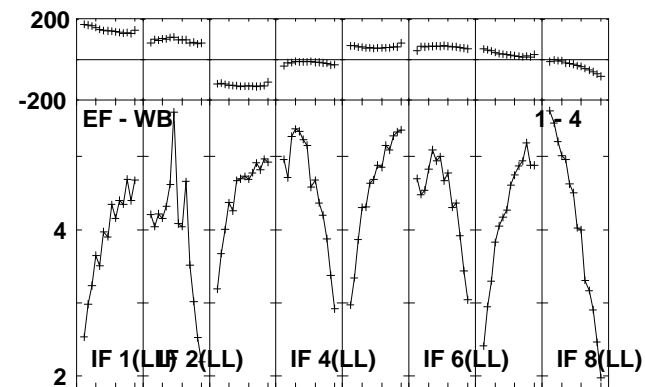
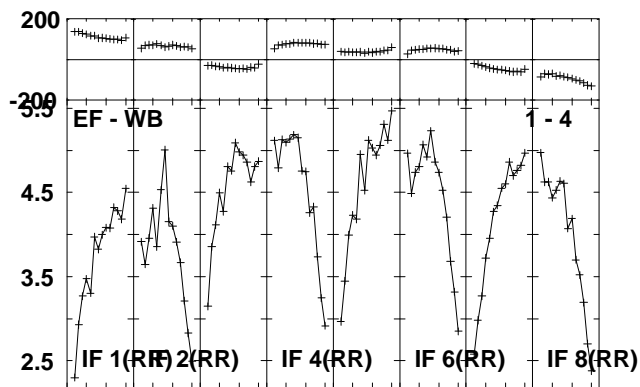
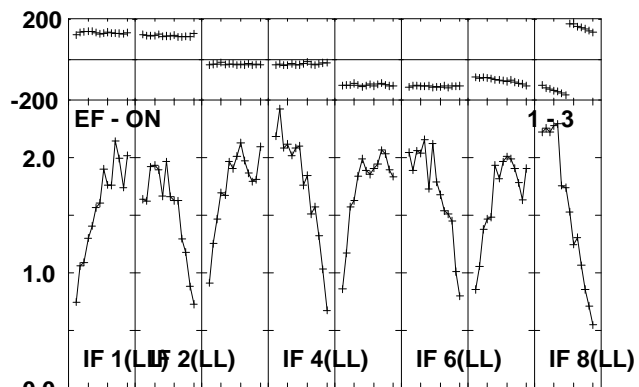
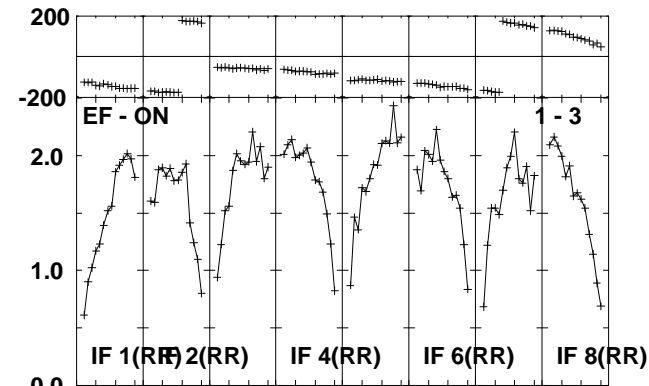
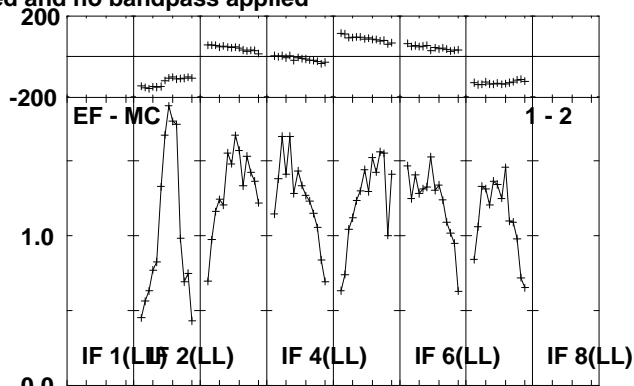
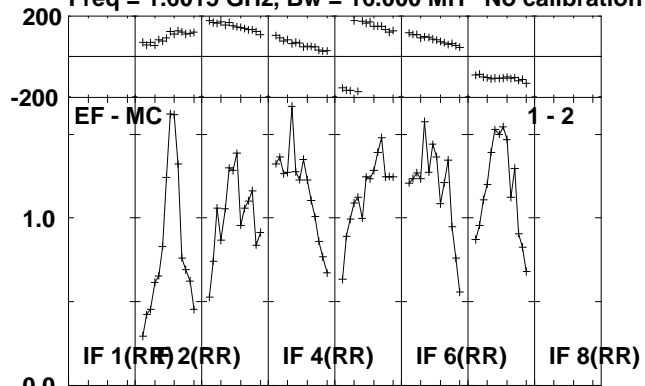

Lower frame: Milli Ampl Jy Top frame: Phas deg
Scalar averaged cross-power spectrum Several baselines displayed
Timerange: 01/05:36:05 to 01/05:37:49

Plot file version 259 created 01-JUL-2010 13:26:58

J2102+47 RG006B.UVDATA.1

Freq = 1.6015 GHz, Bw = 16.000 MH No calibration applied and no bandpass applied

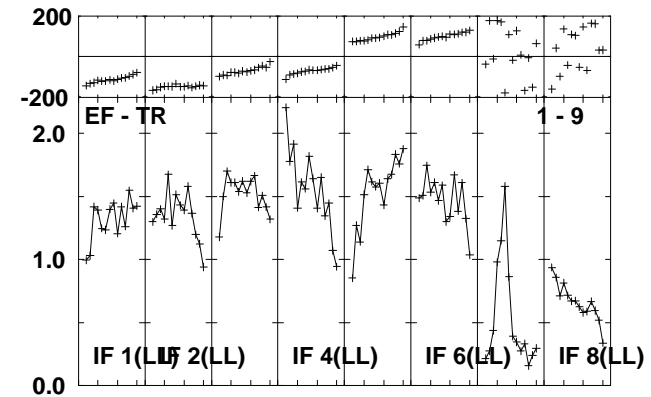
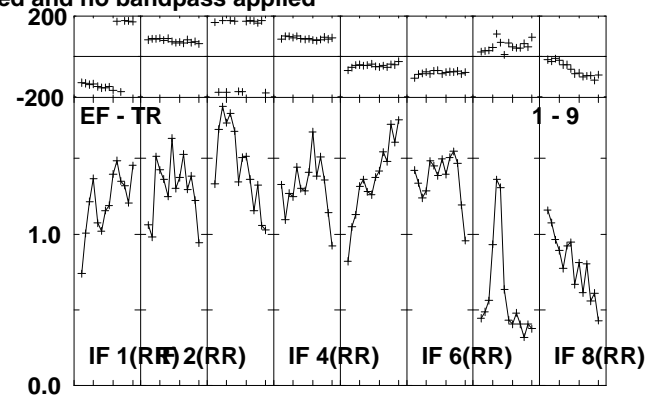
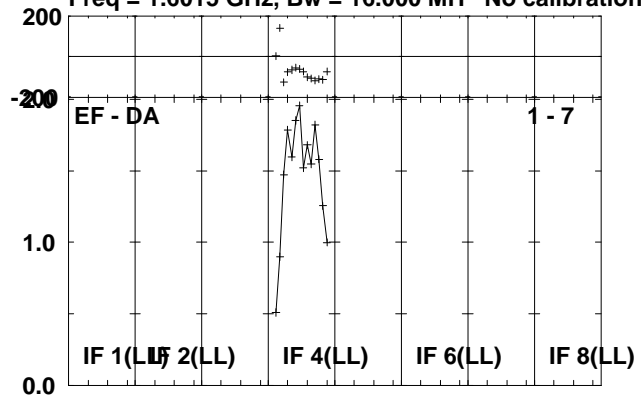

Lower frame: Milli Ampl Jy Top frame: Phas deg
Scalar averaged cross-power spectrum Several baselines displayed
Timerange: 01/05:36:05 to 01/05:37:49

Plot file version 260 created 01-JUL-2010 13:26:58

V407CYG RG006B.UVDATA.1

Freq = 1.6015 GHz, Bw = 16.000 MH No calibration applied and no bandpass applied

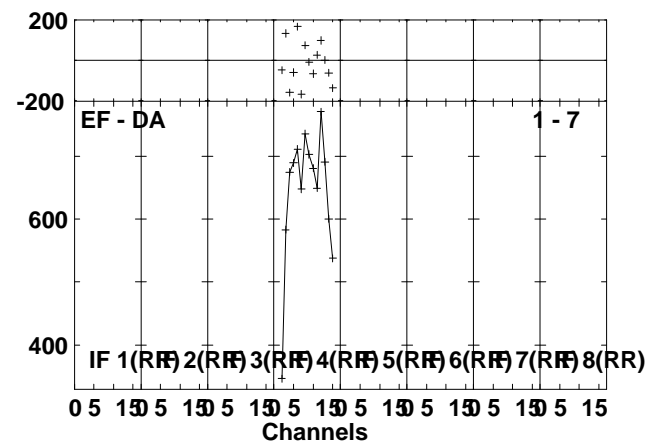
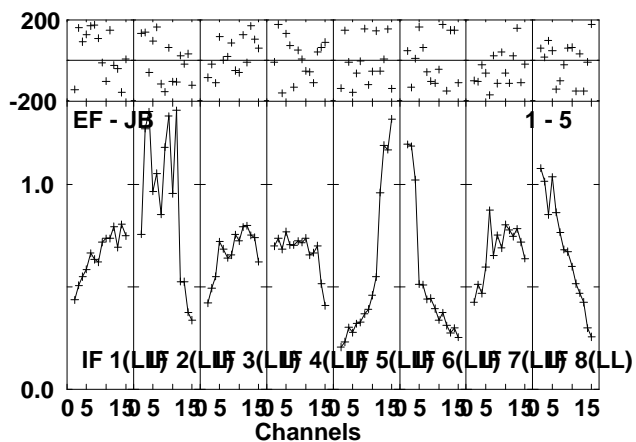
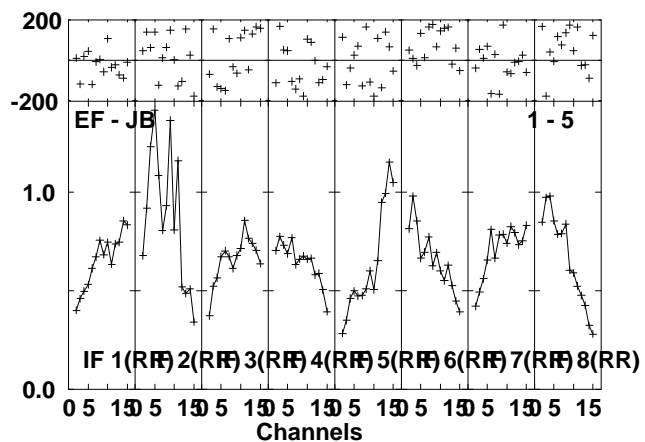
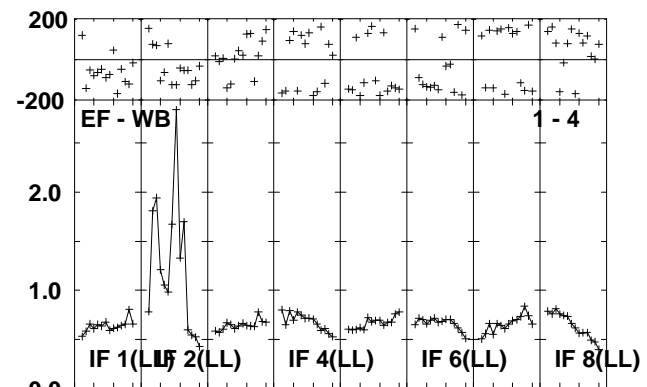
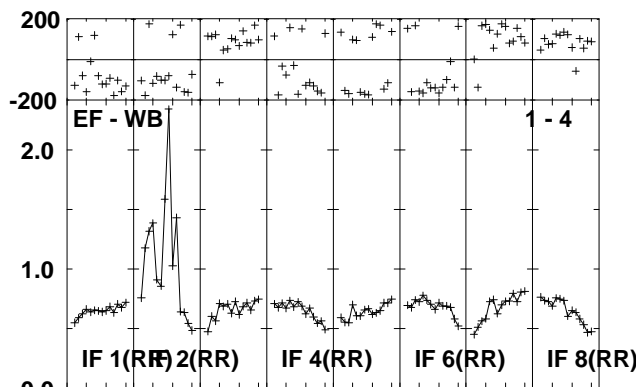
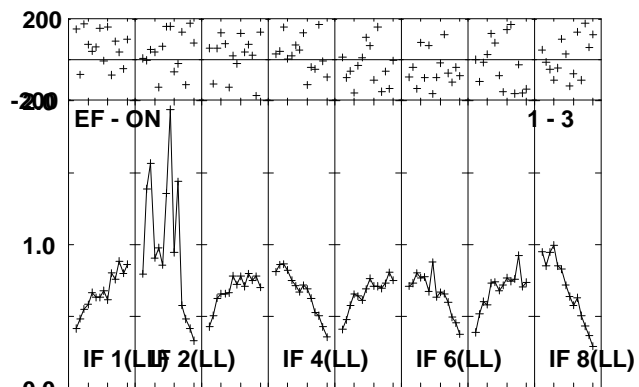
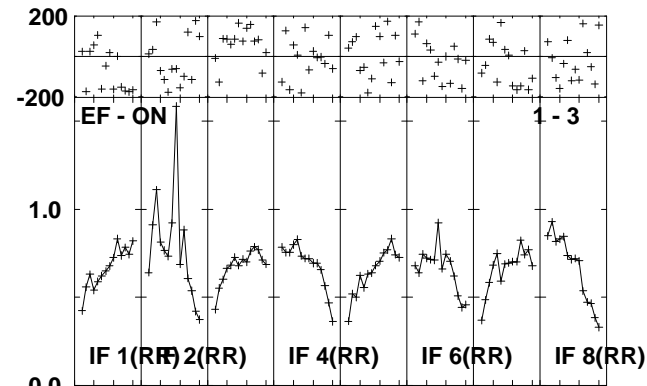
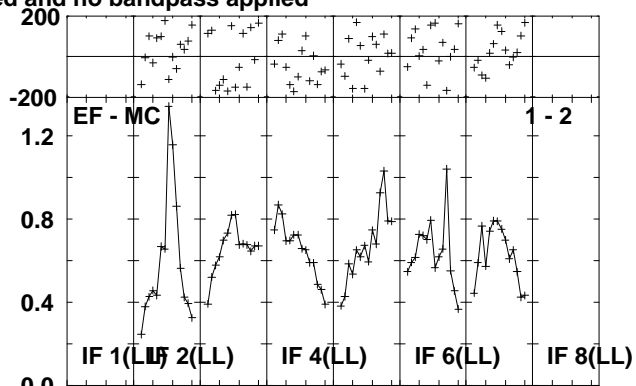
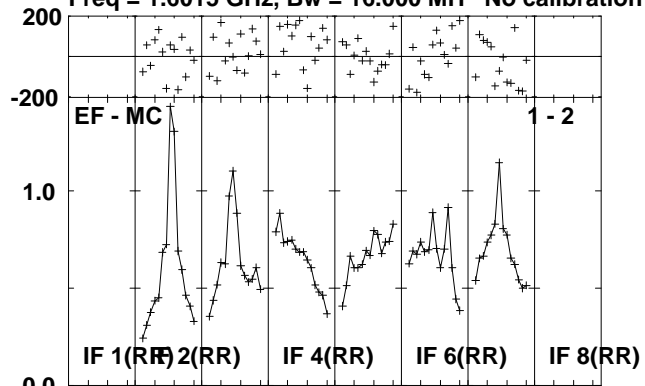

Lower frame: Milli Ampl Jy Top frame: Phas deg
Scalar averaged cross-power spectrum Several baselines displayed
Timerange: 01/05:37:53 to 01/05:42:49

Plot file version 261 created 01-JUL-2010 13:26:59

V407CYG RG006B.UVDATA.1

Freq = 1.6015 GHz, Bw = 16.000 MH No calibration applied and no bandpass applied

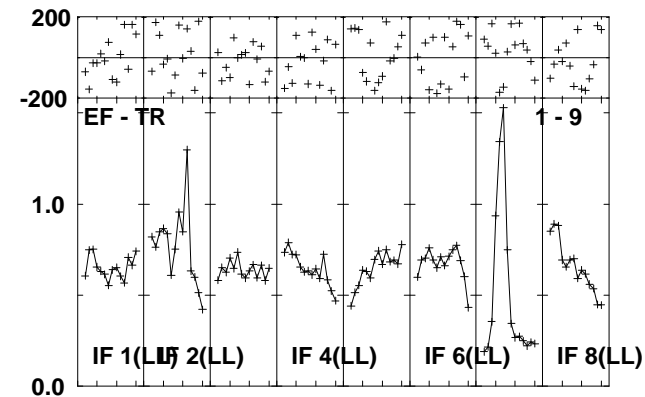
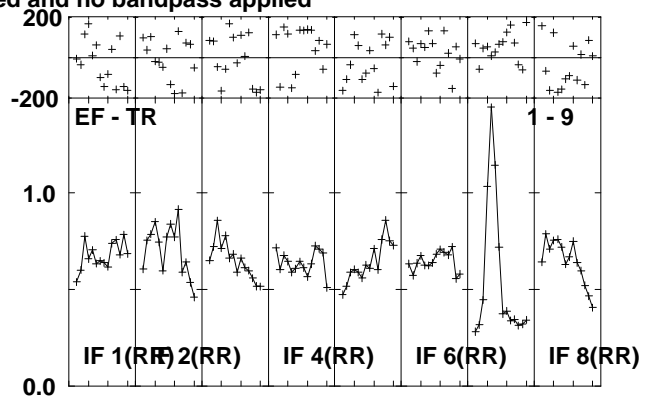
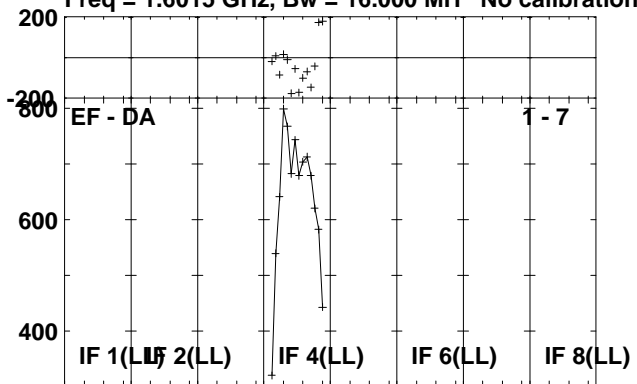

Lower frame: Micro Ampl Jy Top frame: Phas deg
Scalar averaged cross-power spectrum Several baselines displayed
Timerange: 01/05:37:53 to 01/05:42:49

Plot file version 262 created 01-JUL-2010 13:27:00

J2102+47 RG006B.UVDATA.1

Freq = 1.6015 GHz, Bw = 16.000 MH No calibration applied and no bandpass applied

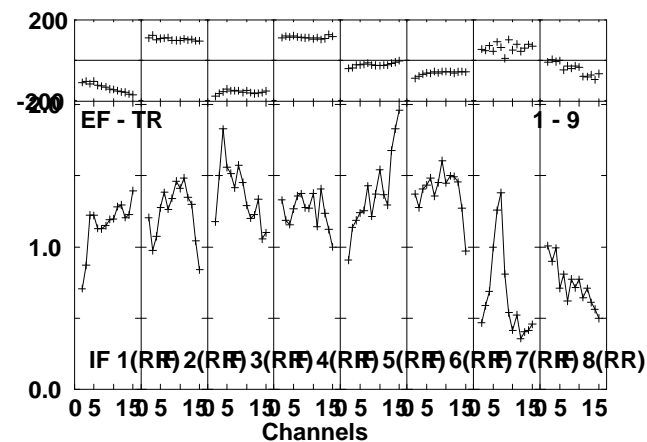
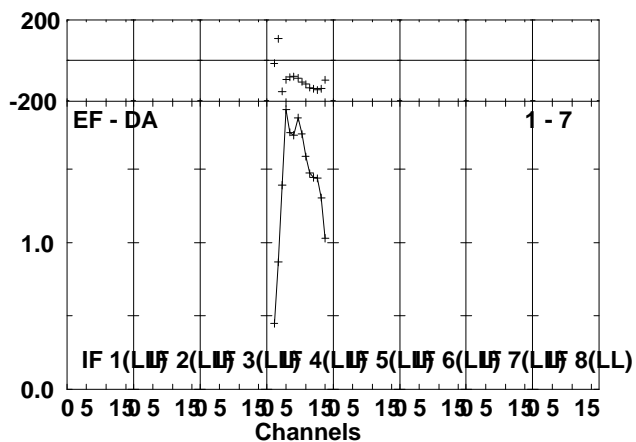
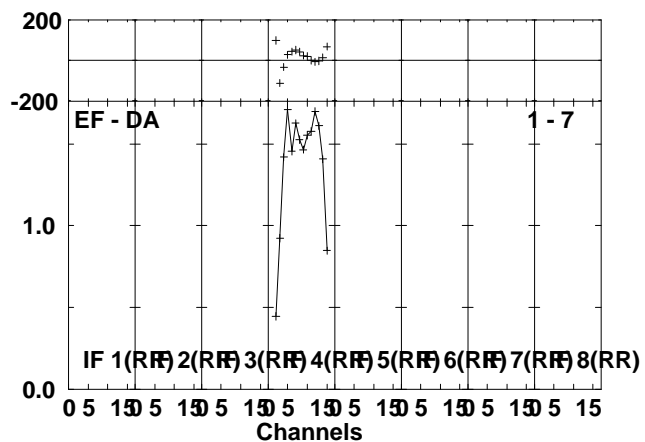
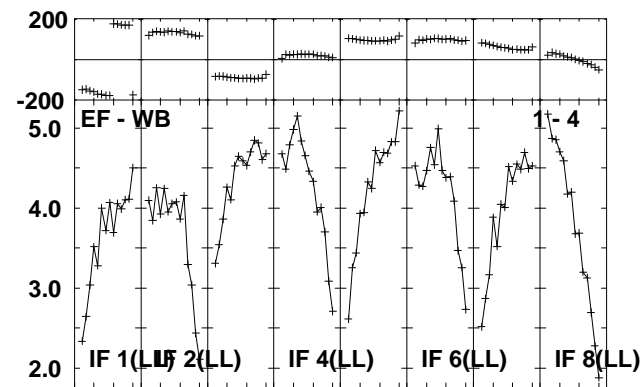
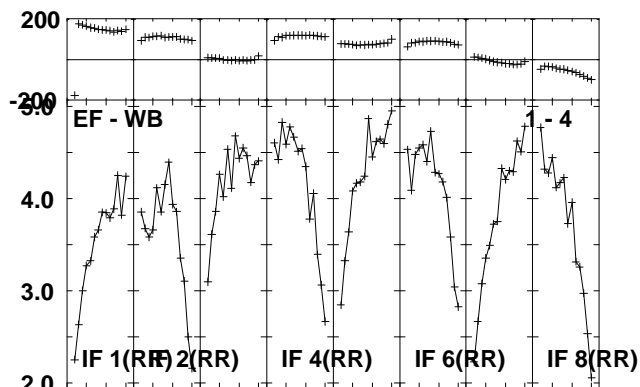
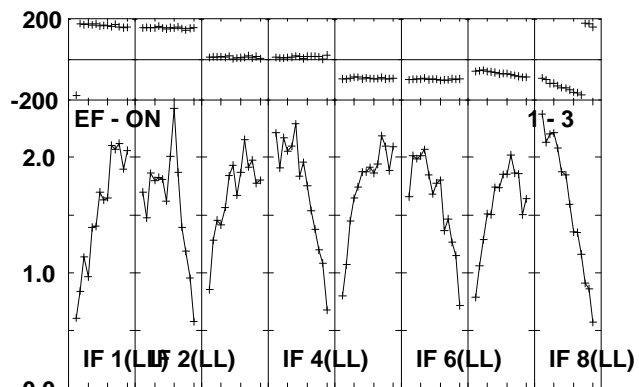
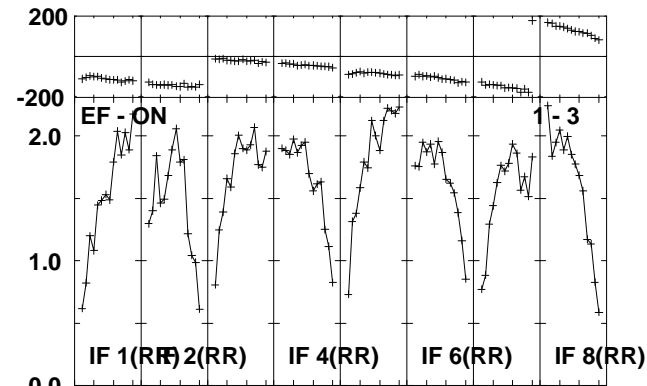
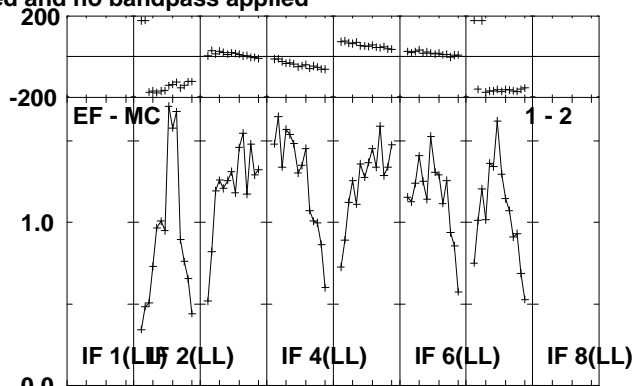
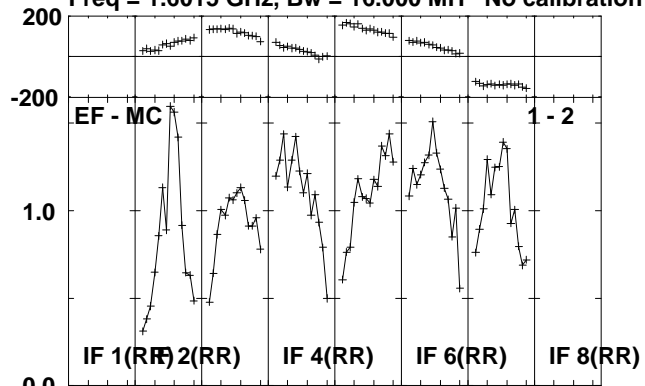

Lower frame: Milli Ampl Jy Top frame: Phas deg
Scalar averaged cross-power spectrum Several baselines displayed
Timerange: 01/05:42:53 to 01/05:45:01

Plot file version 263 created 01-JUL-2010 13:27:00
J2102+47 RG006B.UVDATA.1
Freq = 1.6015 GHz, Bw = 16.000 MH No calibration applied and no bandpass applied

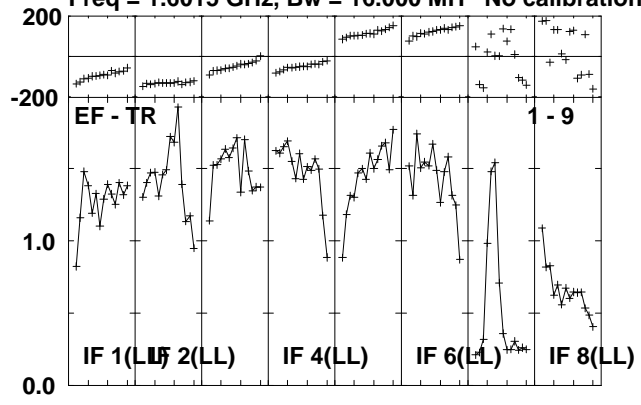

Lower frame: Milli Ampl Jy Top frame: Phas deg
Scalar averaged cross-power spectrum Several baselines displayed
Timerange: 01/05:42:53 to 01/05:45:01

Plot file version 264 created 01-JUL-2010 13:27:00

V407CYG RG006B.UVDATA.1

Freq = 1.6015 GHz, Bw = 16.000 MH No calibration applied and no bandpass applied

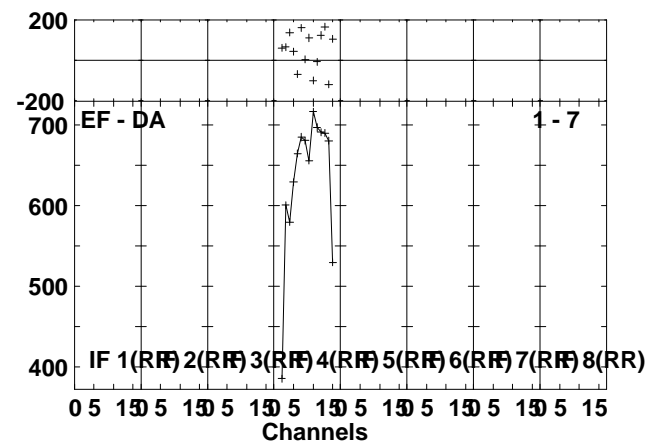
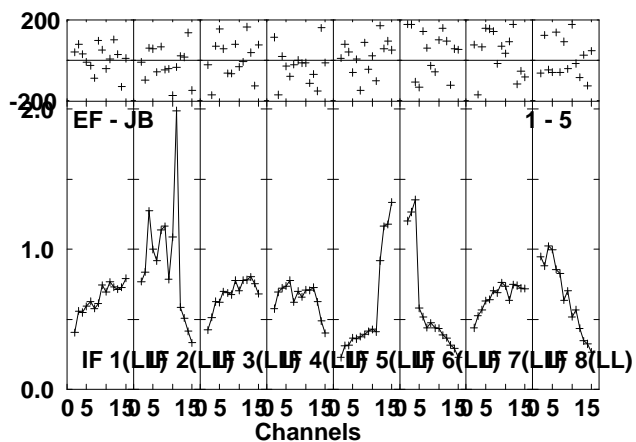
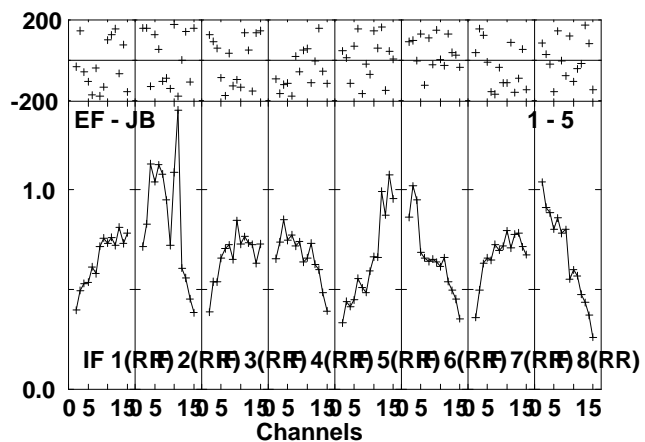
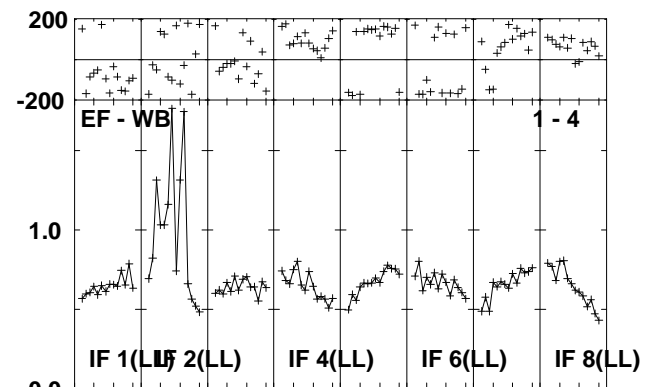
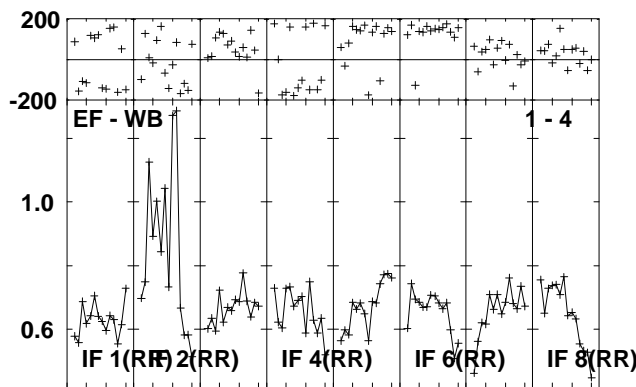
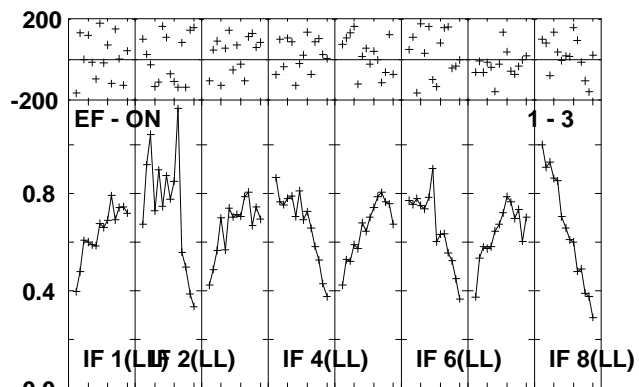
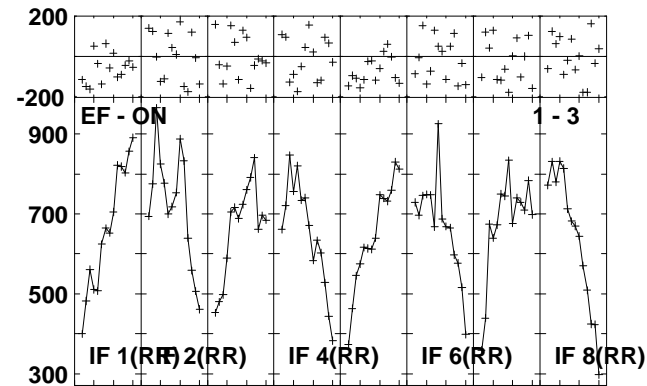
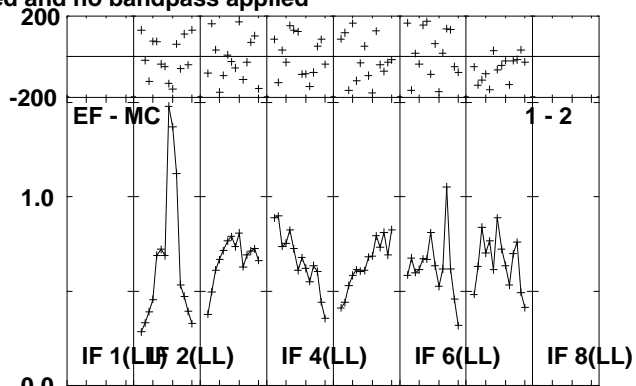
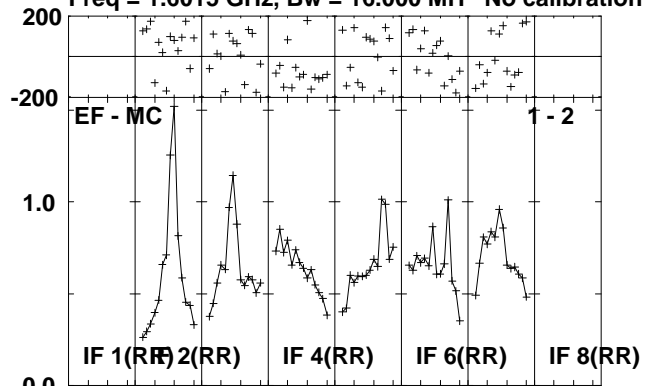

Lower frame: Milli Ampl Jy Top frame: Phas deg
Scalar averaged cross-power spectrum Several baselines displayed
Timerange: 01/05:45:05 to 01/05:50:01

Plot file version 265 created 01-JUL-2010 13:27:02

V407CYG RG006B.UVDATA.1

Freq = 1.6015 GHz, Bw = 16.000 MH No calibration applied and no bandpass applied

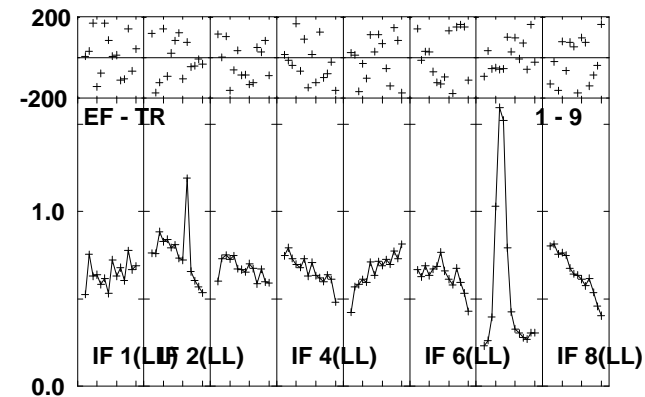
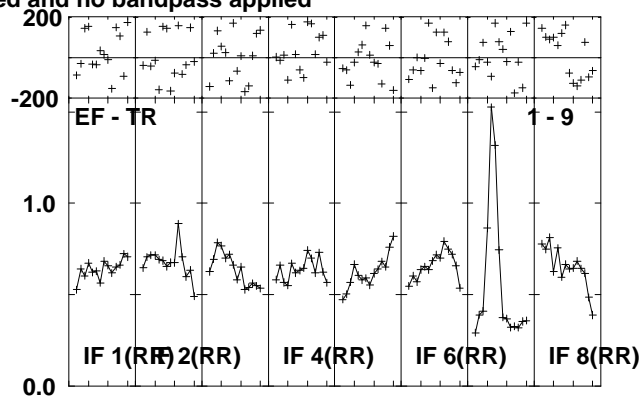
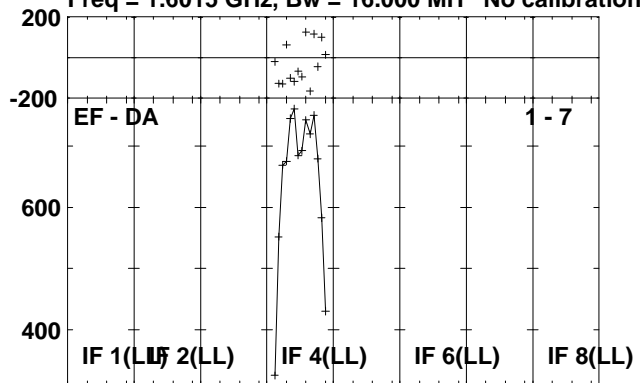

Lower frame: Micro Ampl Jy Top frame: Phas deg
Scalar averaged cross-power spectrum Several baselines displayed
Timerange: 01/05:45:05 to 01/05:50:01

Plot file version 266 created 01-JUL-2010 13:27:02

J2102+47 RG006B.UVDATA.1

Freq = 1.6015 GHz, Bw = 16.000 MH No calibration applied and no bandpass applied

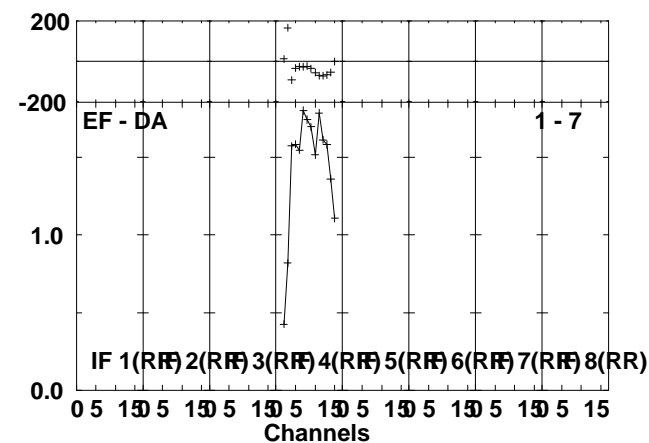
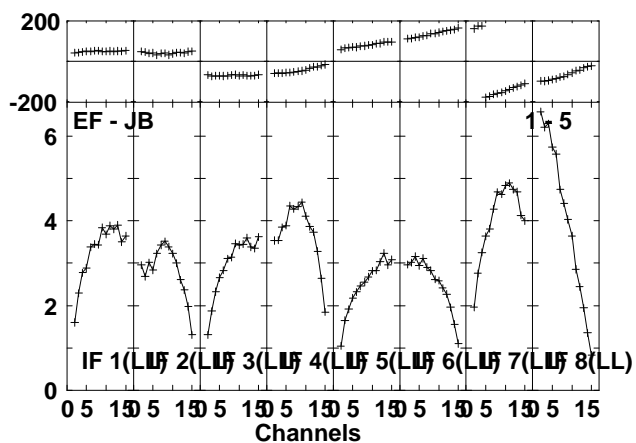
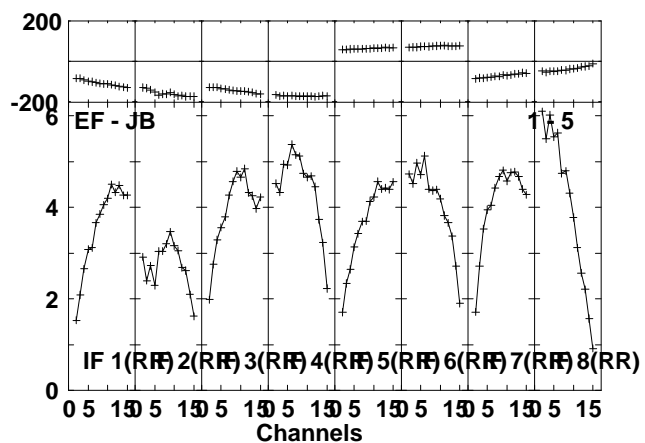
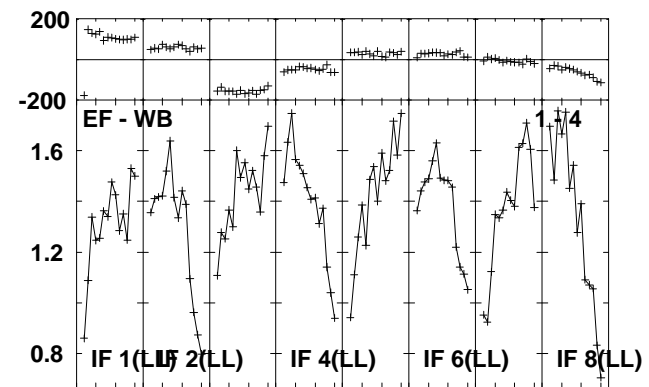
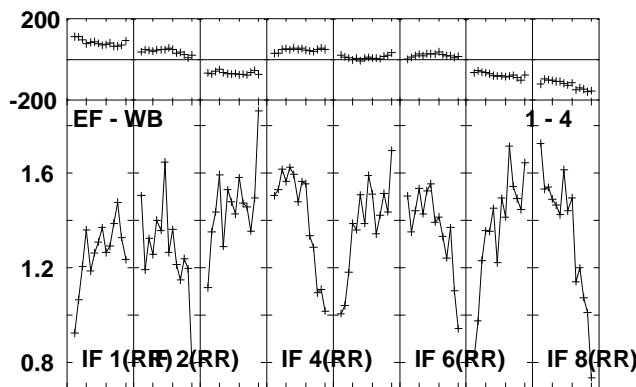
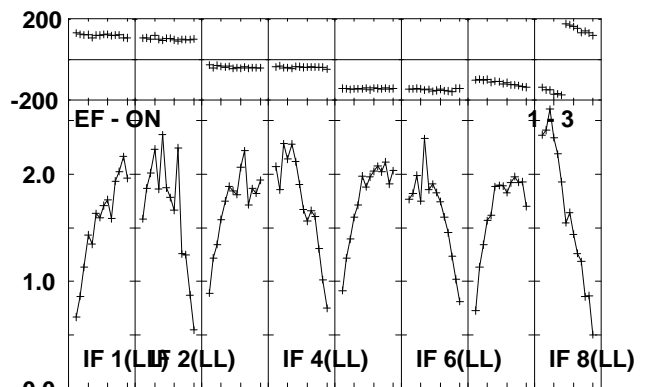
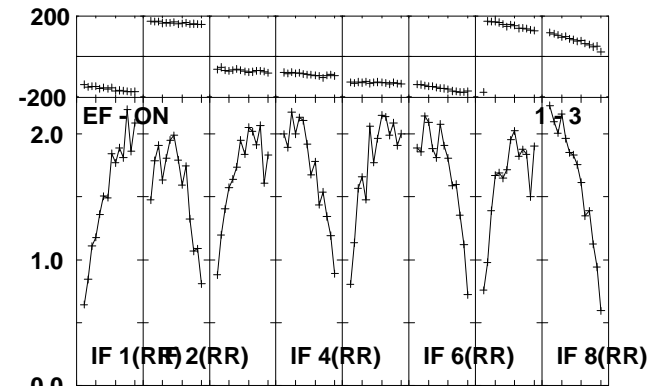
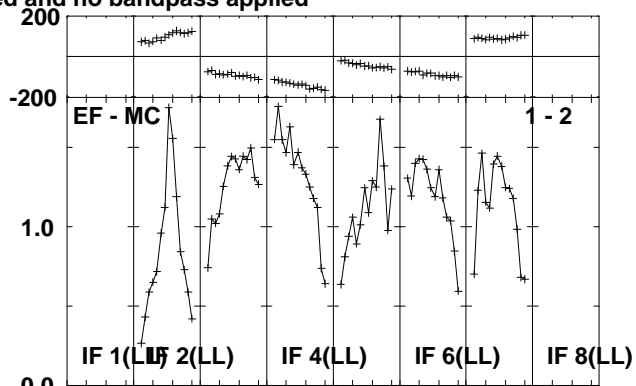
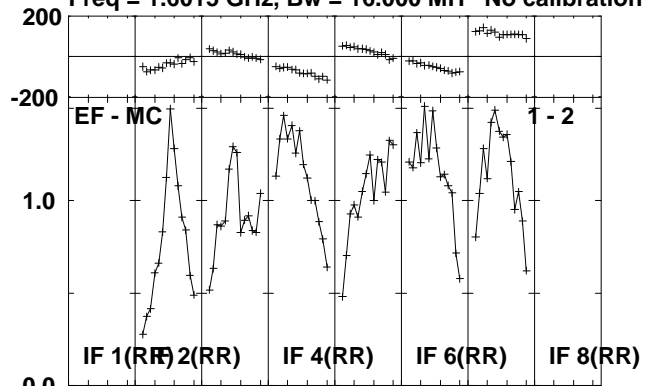

Lower frame: Milli Ampl Jy Top frame: Phas deg
Scalar averaged cross-power spectrum Several baselines displayed
Timerange: 01/05:51:05 to 01/05:52:49

Plot file version 267 created 01-JUL-2010 13:27:03

J2102+47 RG006B.UVDATA.1

Freq = 1.6015 GHz, Bw = 16.000 MH No calibration applied and no bandpass applied

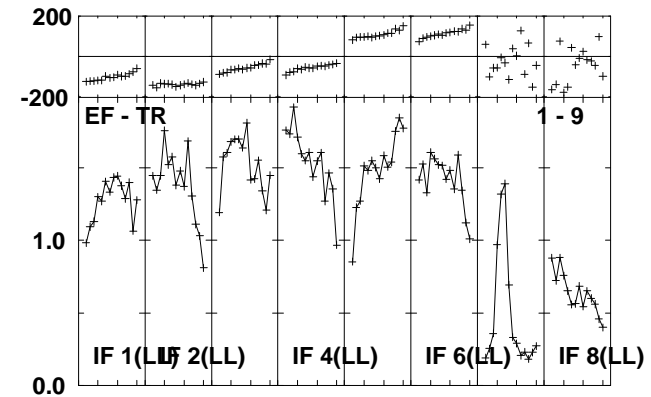
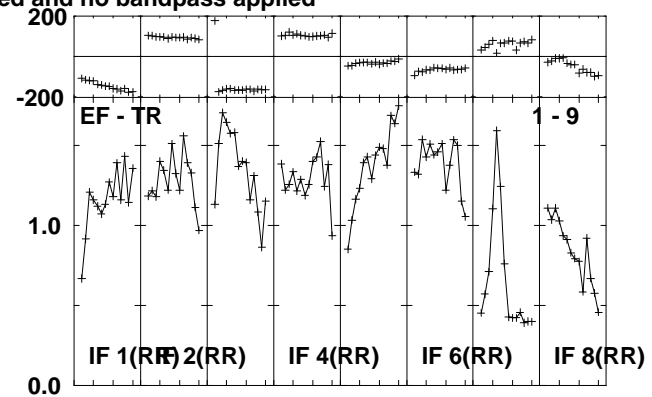
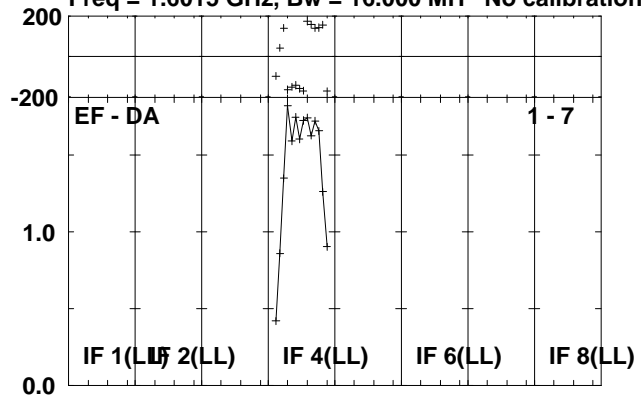

Lower frame: Milli Ampl Jy Top frame: Phas deg
Scalar averaged cross-power spectrum Several baselines displayed
Timerange: 01/05:51:05 to 01/05:52:49

Plot file version 268 created 01-JUL-2010 13:27:03

V407CYG RG006B.UVDATA.1

Freq = 1.6015 GHz, Bw = 16.000 MH No calibration applied and no bandpass applied

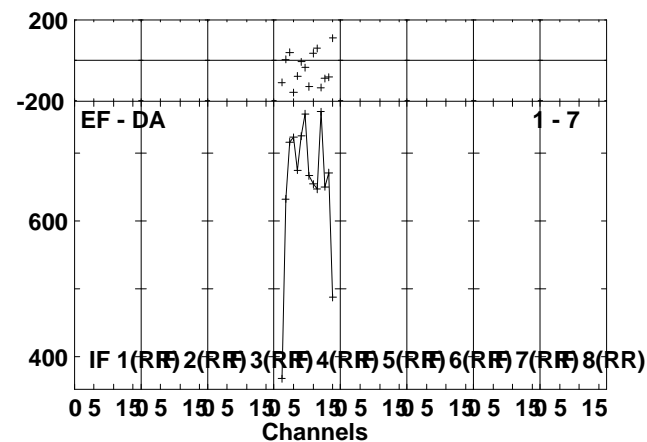
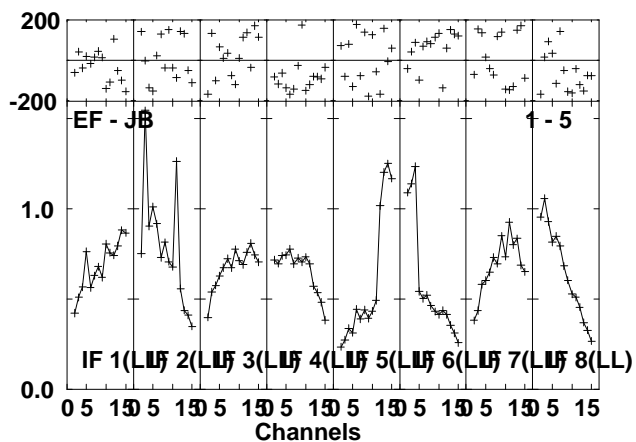
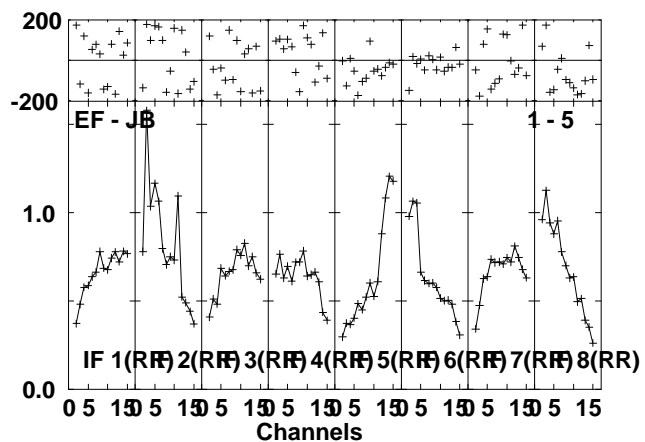
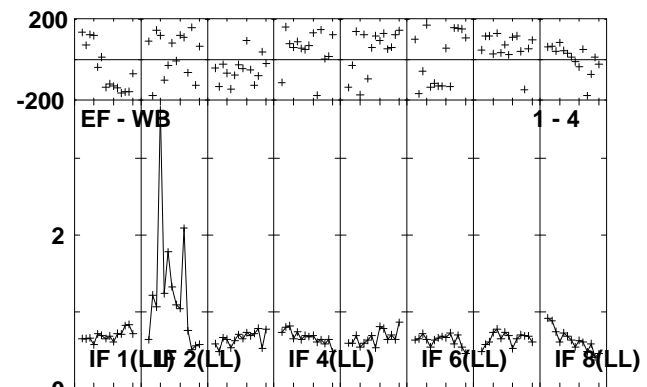
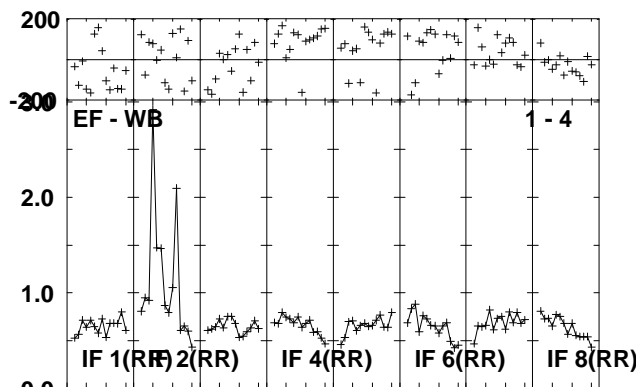
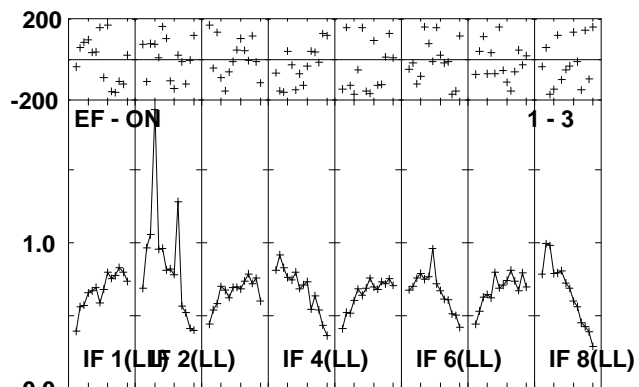
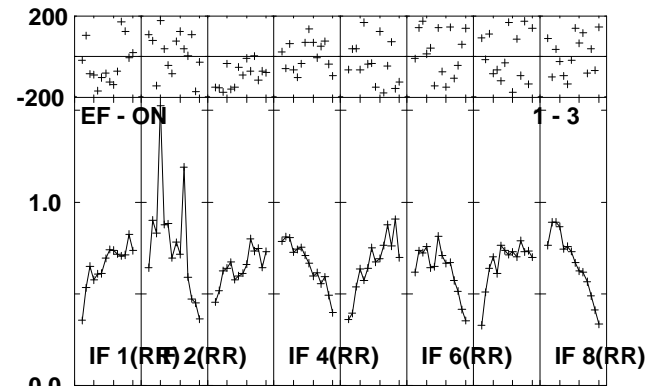
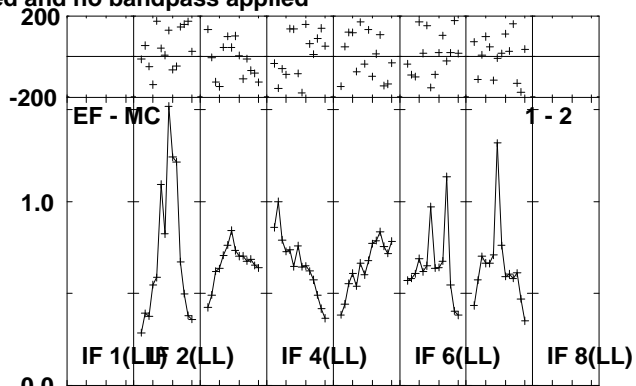
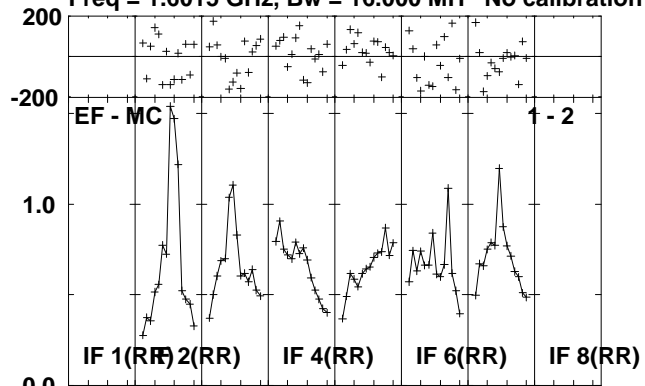

Lower frame: Milli Ampl Jy Top frame: Phas deg
Scalar averaged cross-power spectrum Several baselines displayed
Timerange: 01/05:52:53 to 01/05:57:49

Plot file version 269 created 01-JUL-2010 13:27:04

V407CYG RG006B.UVDATA.1

Freq = 1.6015 GHz, Bw = 16.000 MH No calibration applied and no bandpass applied

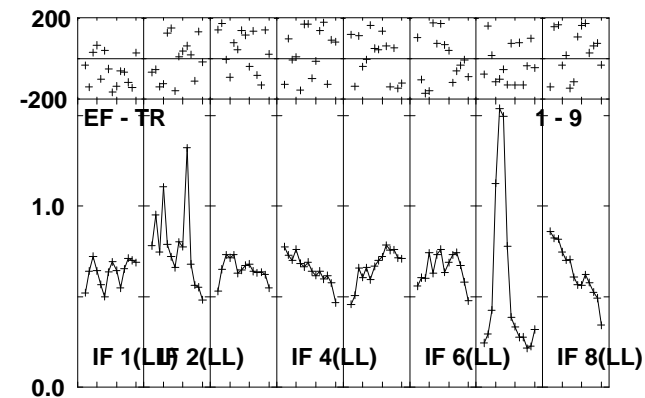
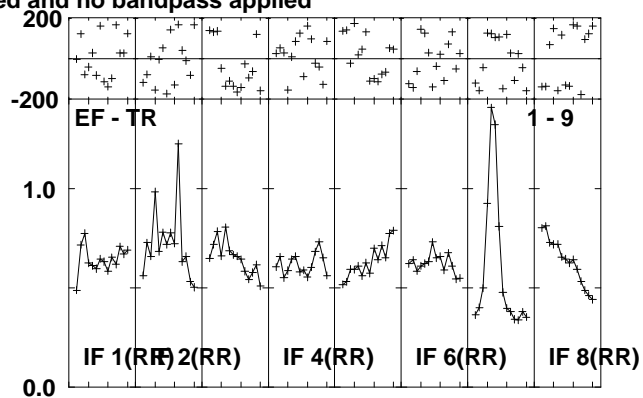
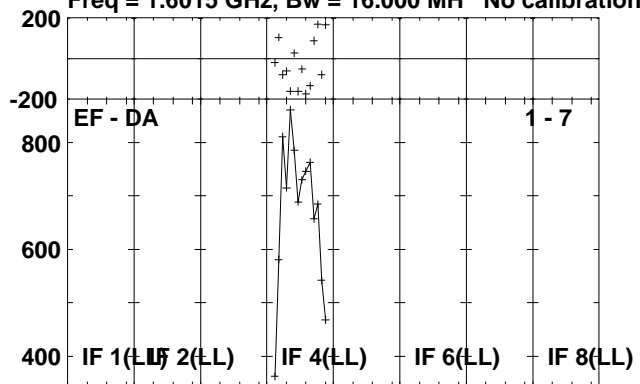

Lower frame: Micro Ampl Jy Top frame: Phas deg
Scalar averaged cross-power spectrum Several baselines displayed
Timerange: 01/05:52:53 to 01/05:57:49

Plot file version 270 created 01-JUL-2010 13:27:04

J2102+47 RG006B.UVDATA.1

Freq = 1.6015 GHz, Bw = 16.000 MH No calibration applied and no bandpass applied

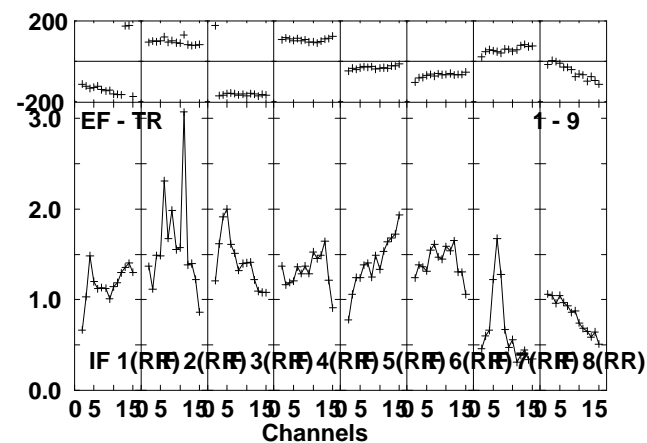
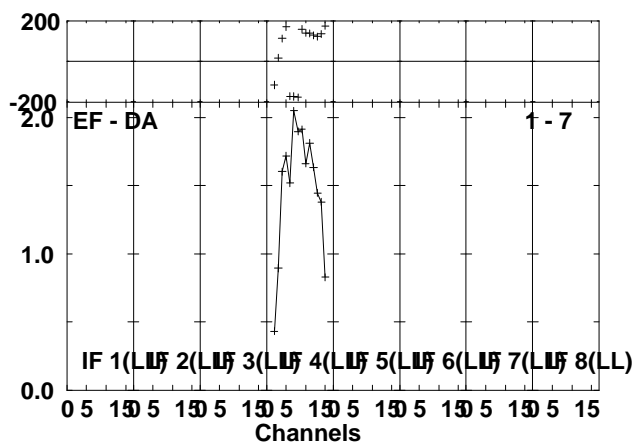
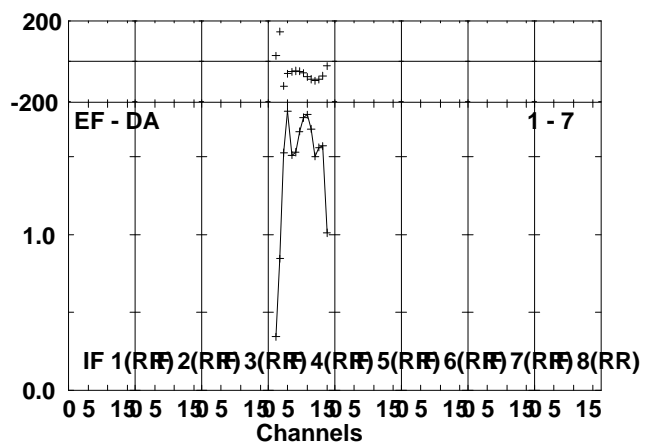
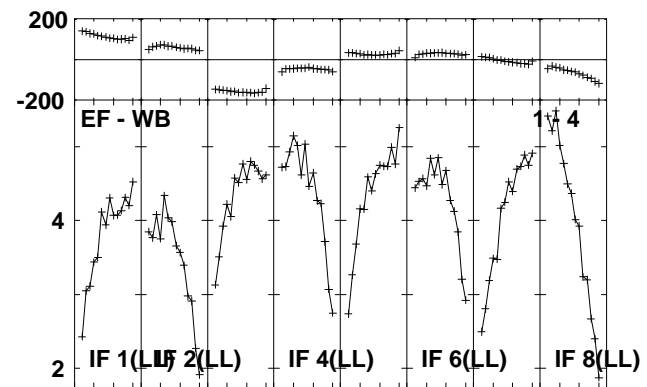
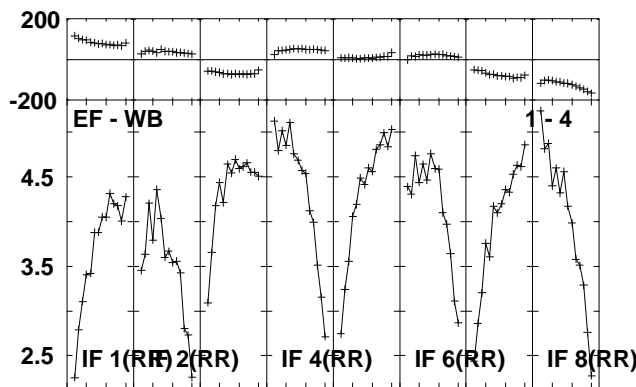
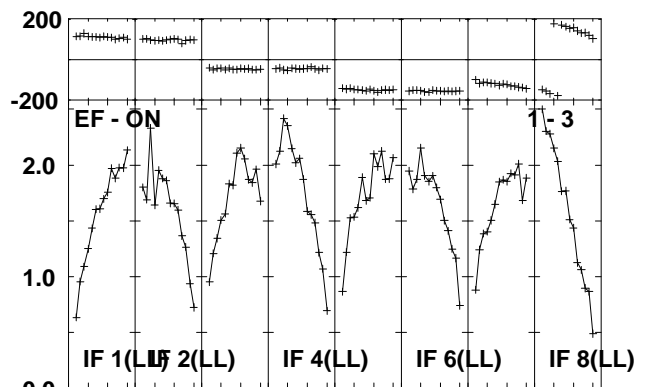
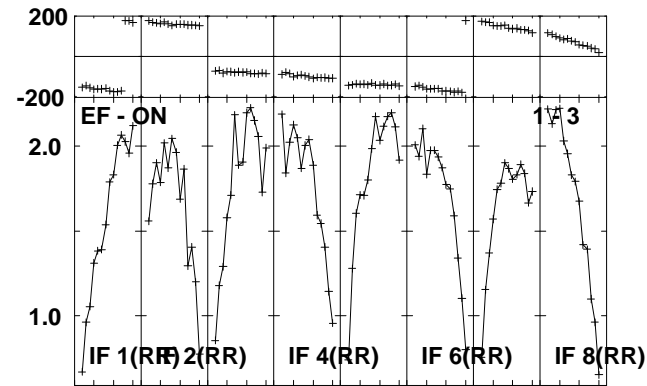
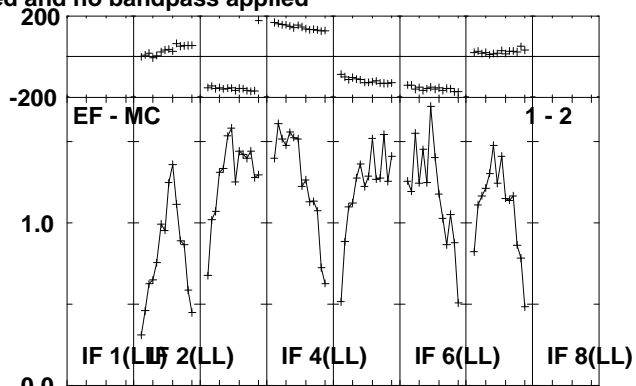
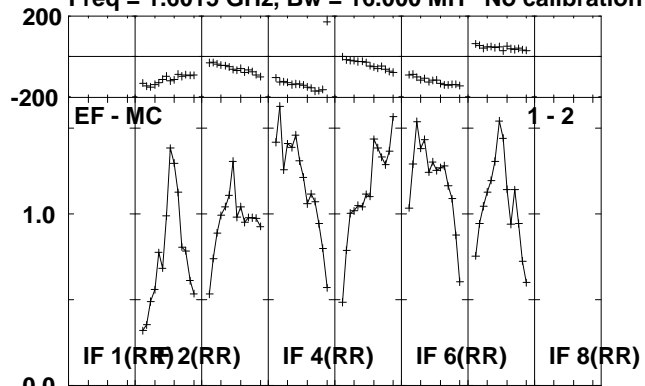

Lower frame: Milli Ampl Jy Top frame: Phas deg
Scalar averaged cross-power spectrum Several baselines displayed
Timerange: 01/05:57:53 to 01/06:00:01

Plot file version 271 created 01-JUL-2010 13:27:05
J2102+47 RG006B.UVDATA.1
Freq = 1.6015 GHz, Bw = 16.000 MH No calibration applied and no bandpass applied

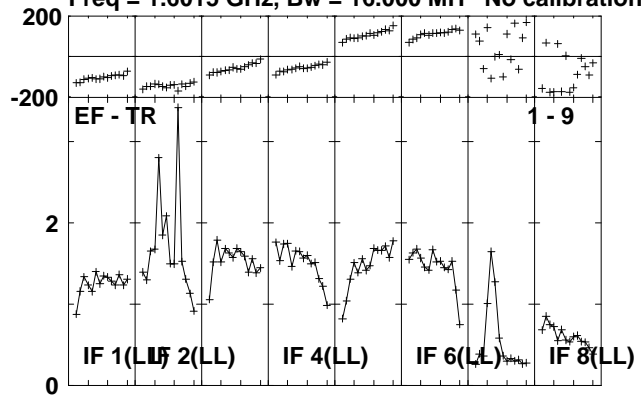

Lower frame: Milli Ampl Jy Top frame: Phas deg
Scalar averaged cross-power spectrum Several baselines displayed
Timerange: 01/05:57:53 to 01/06:00:01

Plot file version 272 created 01-JUL-2010 13:27:05

V407CYG RG006B.UVDATA.1

Freq = 1.6015 GHz, Bw = 16.000 MH No calibration applied and no bandpass applied

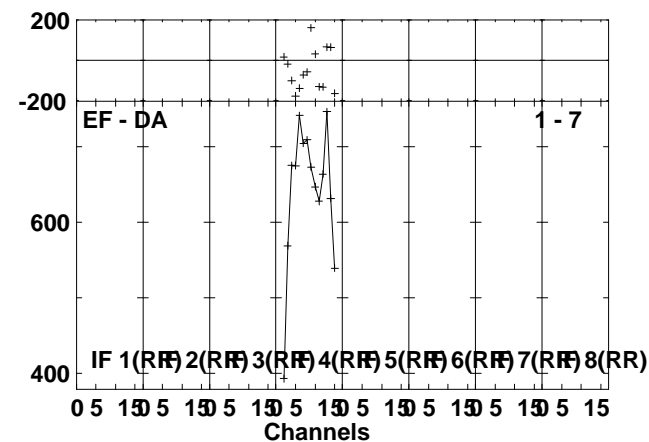
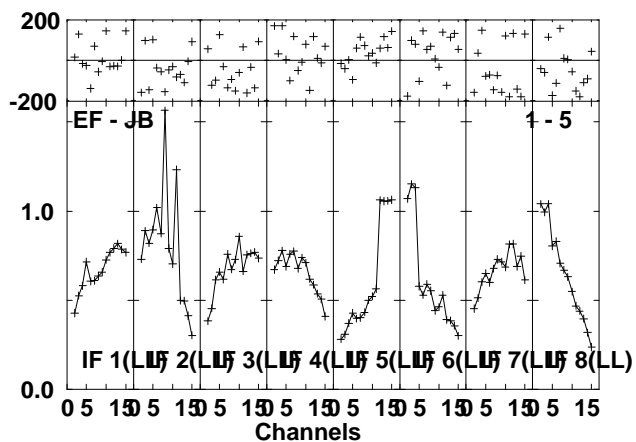
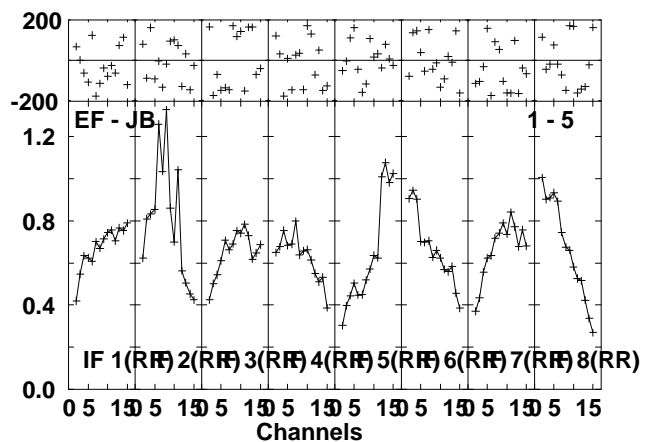
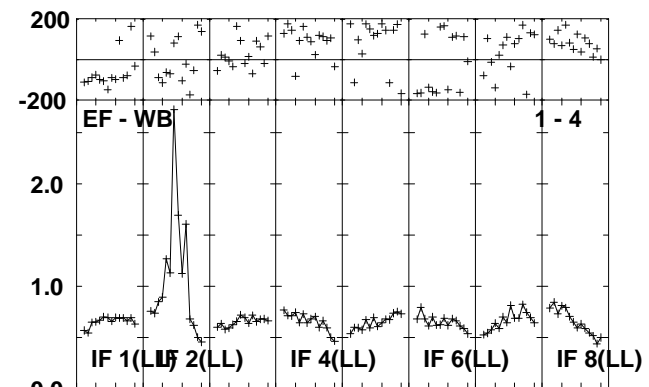
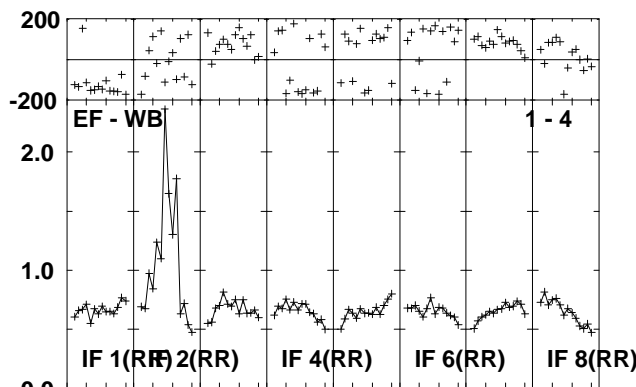
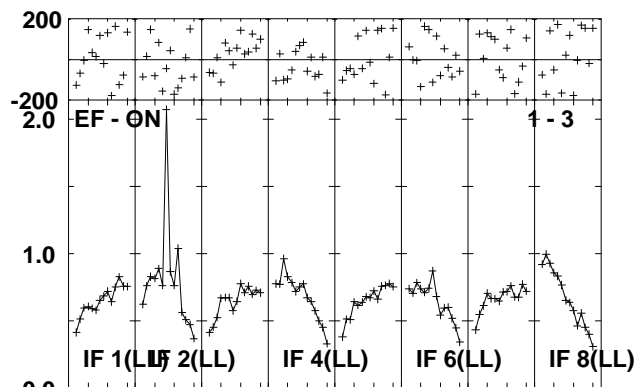
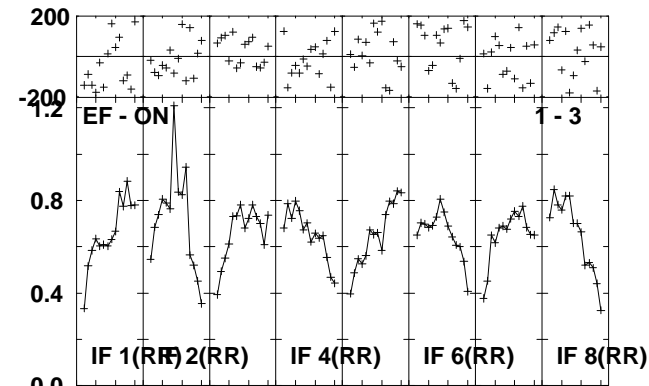
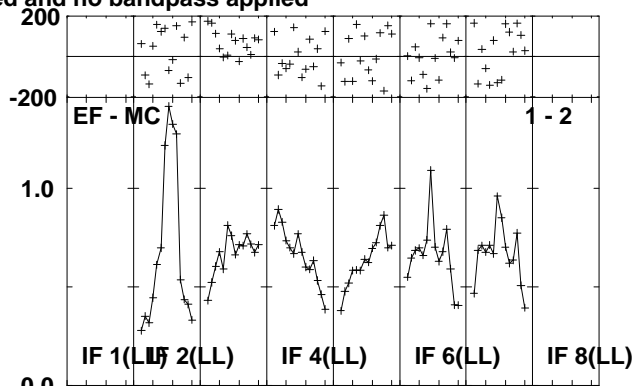
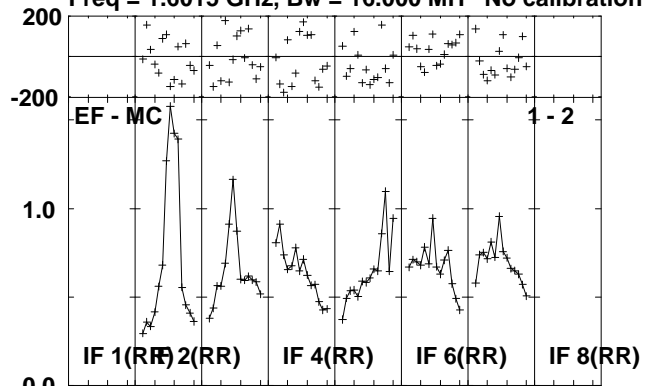

Lower frame: Milli Ampl Jy Top frame: Phas deg
Scalar averaged cross-power spectrum Several baselines displayed
Timerange: 01/06:00:05 to 01/06:05:01

Plot file version 273 created 01-JUL-2010 13:27:06

V407CYG RG006B.UVDATA.1

Freq = 1.6015 GHz, Bw = 16.000 MH No calibration applied and no bandpass applied

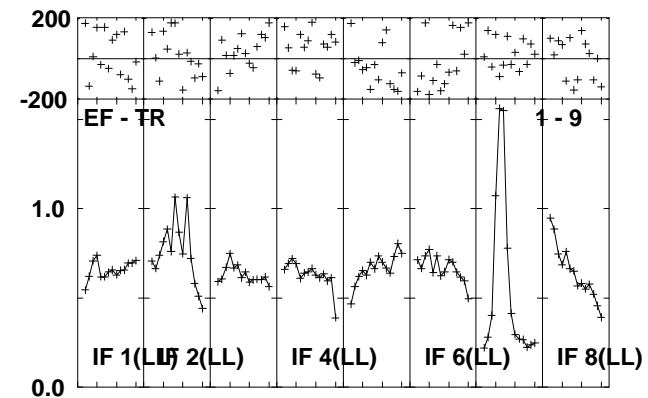
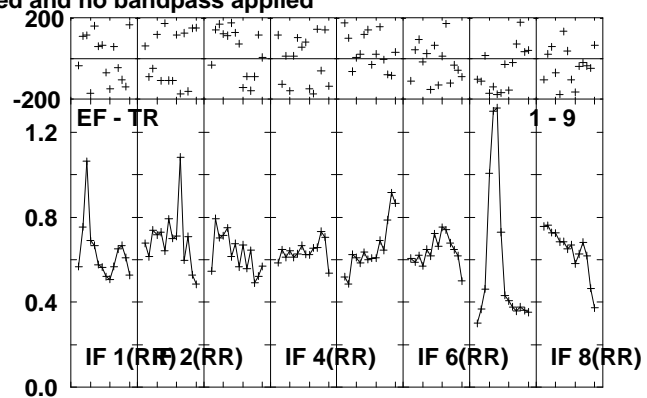
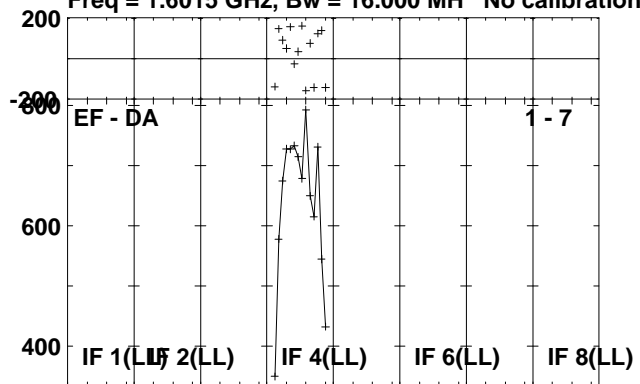

Lower frame: Micro Ampl Jy Top frame: Phas deg
Scalar averaged cross-power spectrum Several baselines displayed
Timerange: 01/06:00:05 to 01/06:05:01

Plot file version 274 created 01-JUL-2010 13:27:07

J2102+47 RG006B.UVDATA.1

Freq = 1.6015 GHz, Bw = 16.000 MH No calibration applied and no bandpass applied

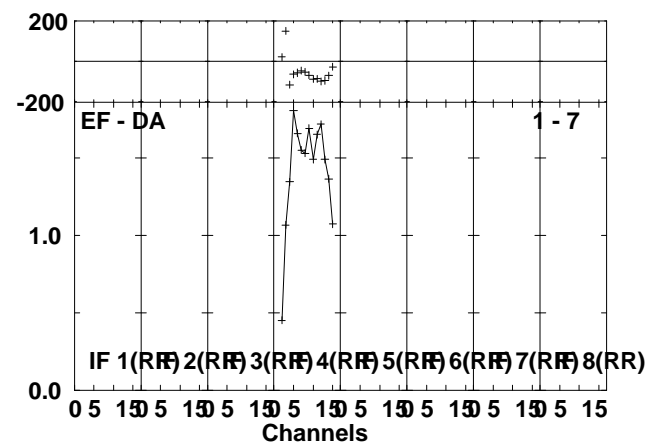
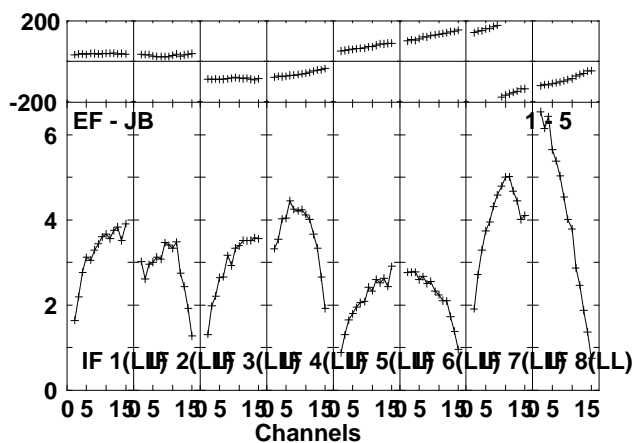
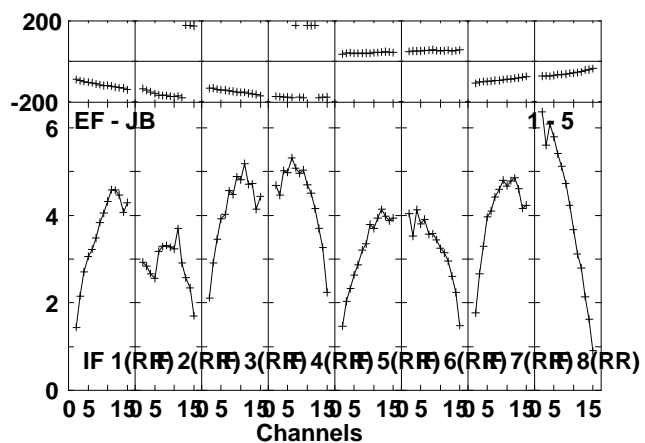
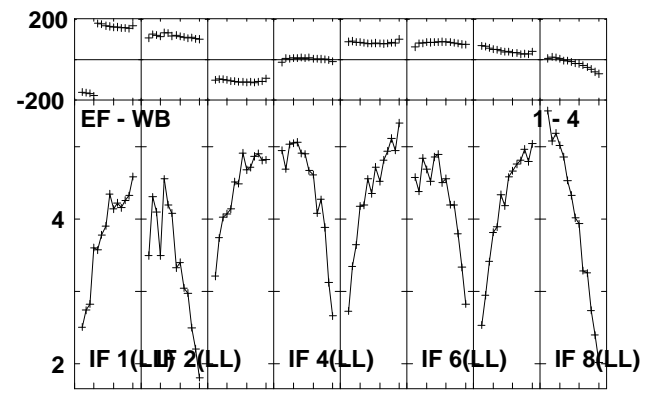
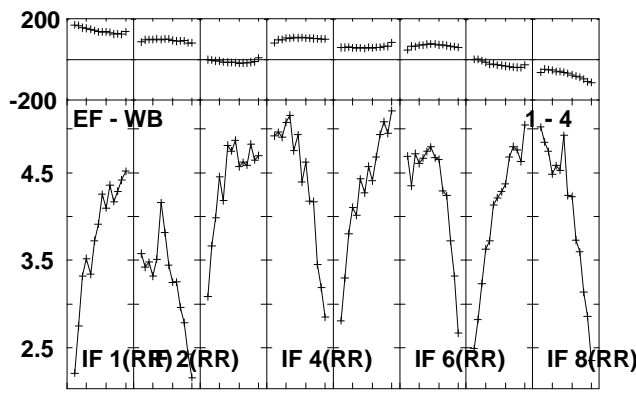
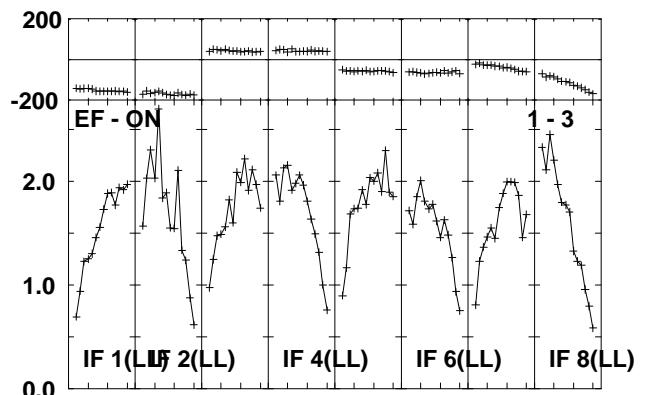
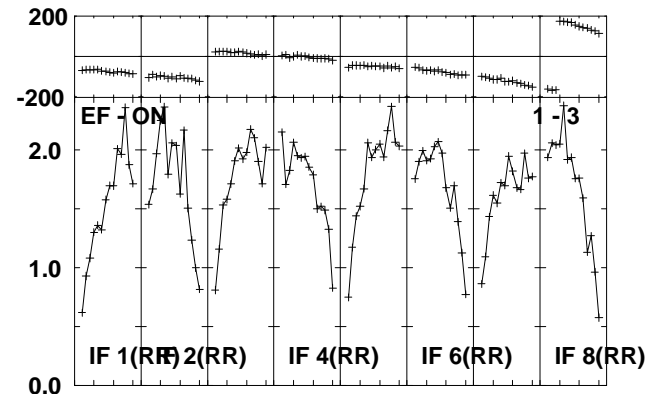
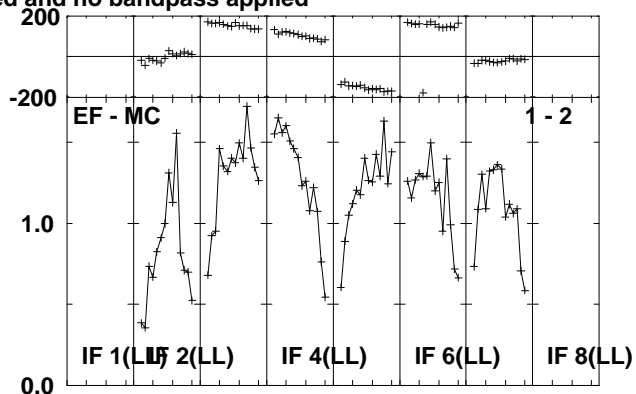
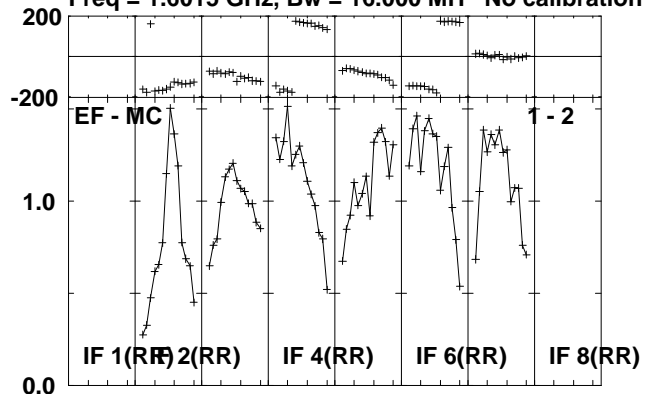

Lower frame: Milli Ampl Jy Top frame: Phas deg
Scalar averaged cross-power spectrum Several baselines displayed
Timerange: 01/06:06:05 to 01/06:07:49

Plot file version 275 created 01-JUL-2010 13:27:07

J2102+47 RG006B.UVDATA.1

Freq = 1.6015 GHz, Bw = 16.000 MH No calibration applied and no bandpass applied

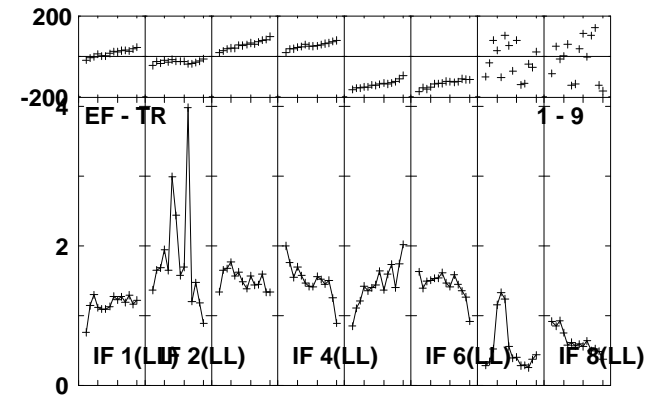
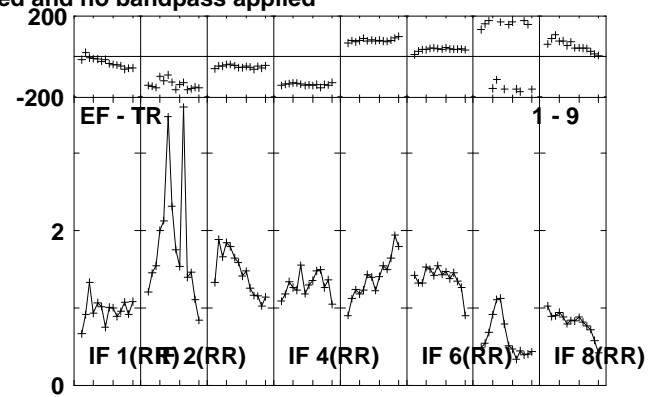
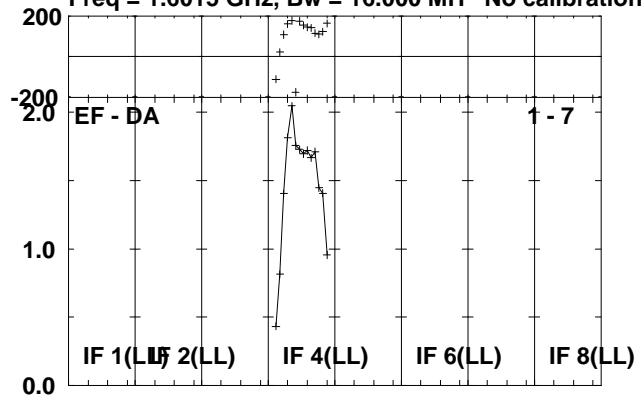

Lower frame: Milli Ampl Jy Top frame: Phas deg
Scalar averaged cross-power spectrum Several baselines displayed
Timerange: 01/06:06:05 to 01/06:07:49

Plot file version 276 created 01-JUL-2010 13:27:08

V407CYG RG006B.UVDATA.1

Freq = 1.6015 GHz, Bw = 16.000 MH No calibration applied and no bandpass applied

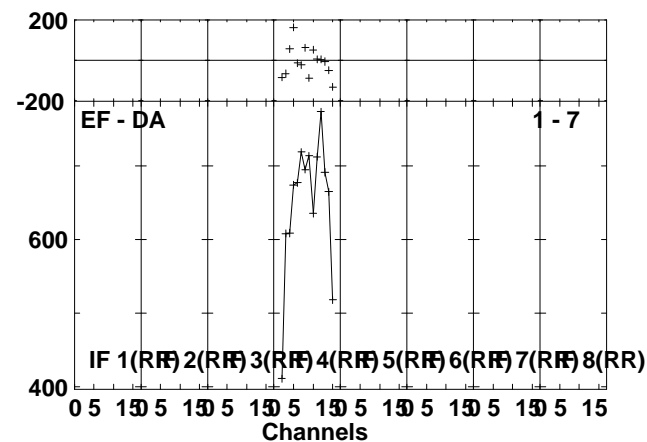
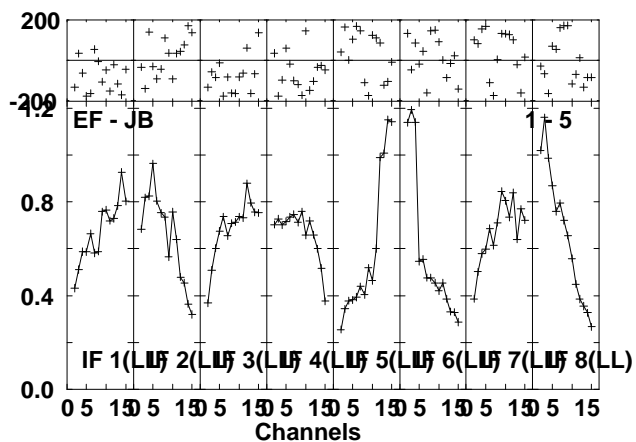
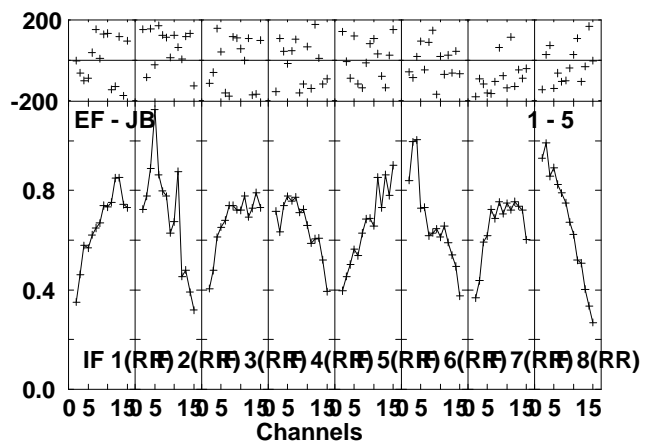
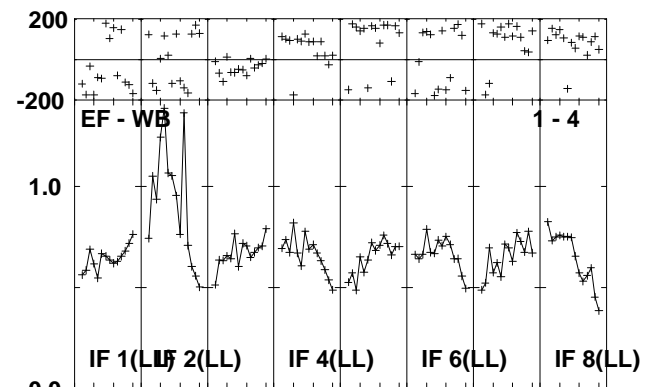
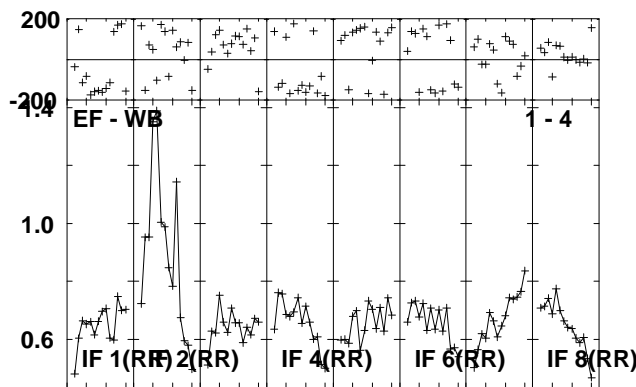
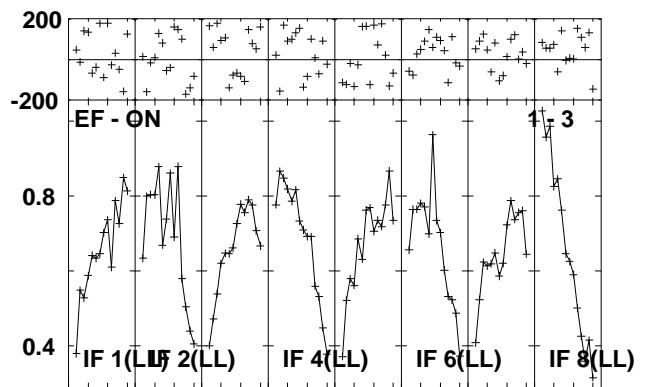
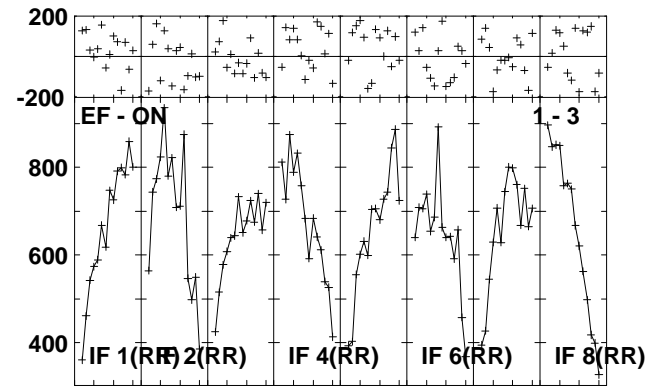
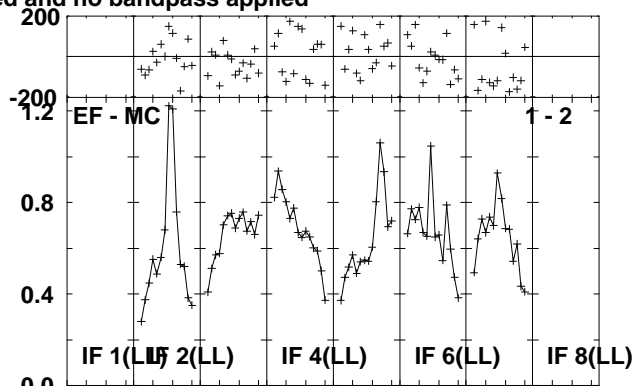
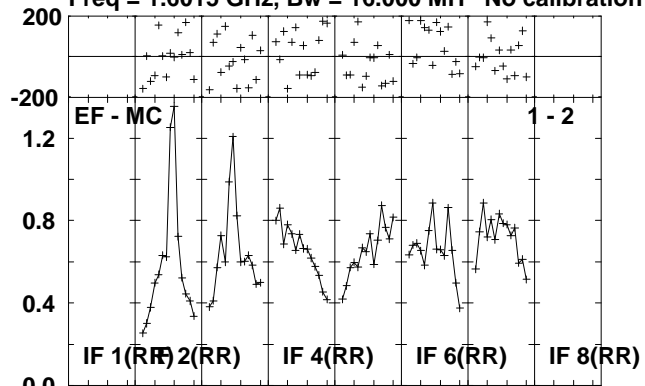

Lower frame: Milli Ampl Jy Top frame: Phas deg
Scalar averaged cross-power spectrum Several baselines displayed
Timerange: 01/06:07:53 to 01/06:12:49

Plot file version 277 created 01-JUL-2010 13:27:09

V407CYG RG006B.UVDATA.1

Freq = 1.6015 GHz, Bw = 16.000 MH No calibration applied and no bandpass applied

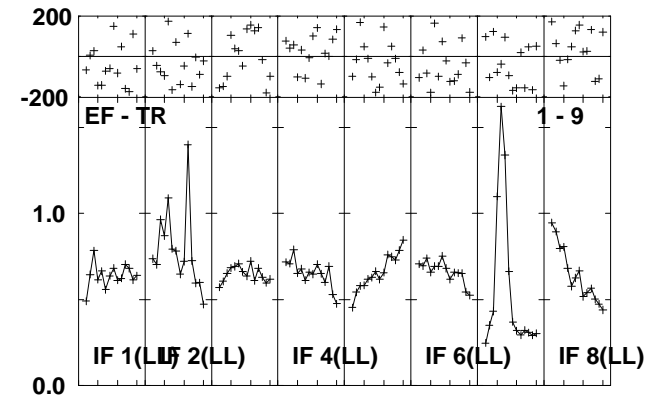
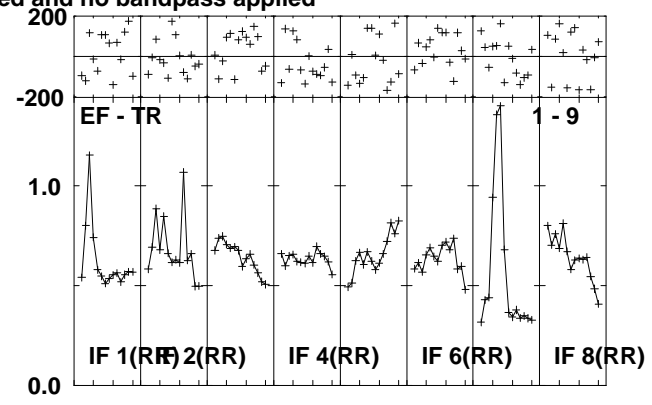
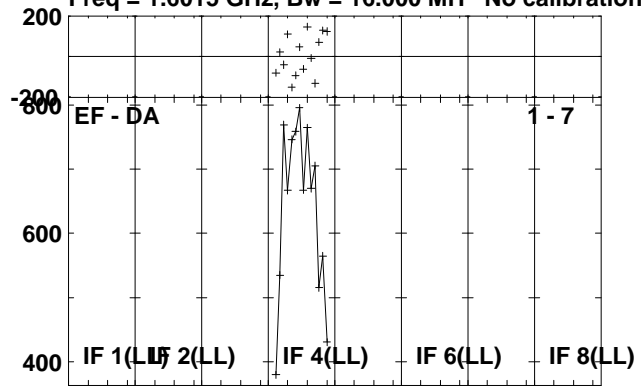

Lower frame: Micro Ampl Jy Top frame: Phas deg
Scalar averaged cross-power spectrum Several baselines displayed
Timerange: 01/06:07:53 to 01/06:12:49

Plot file version 278 created 01-JUL-2010 13:27:09

J2102+47 RG006B.UVDATA.1

Freq = 1.6015 GHz, Bw = 16.000 MH No calibration applied and no bandpass applied

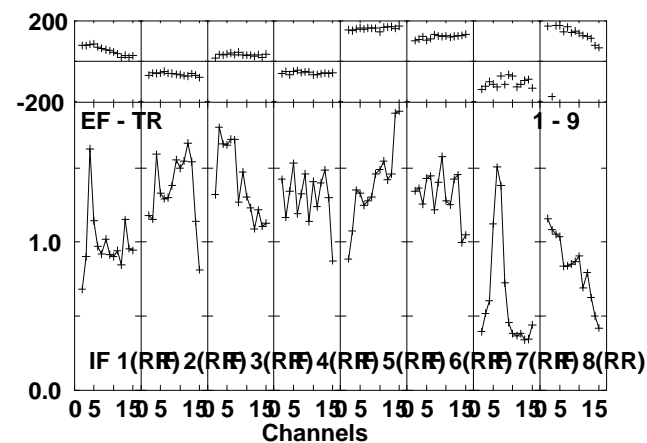
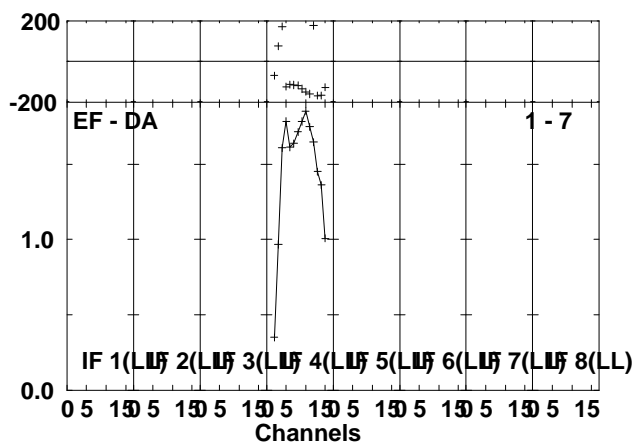
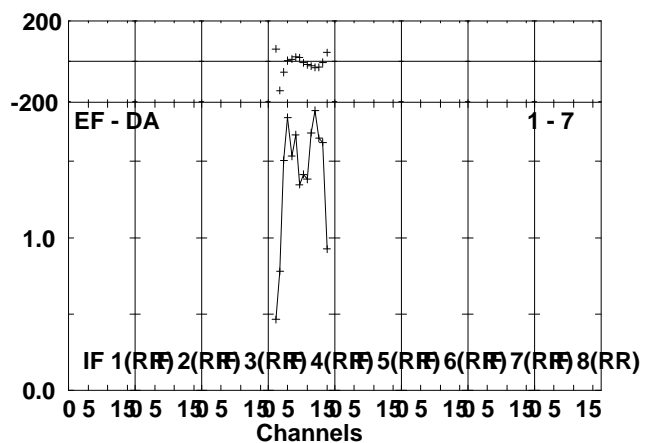
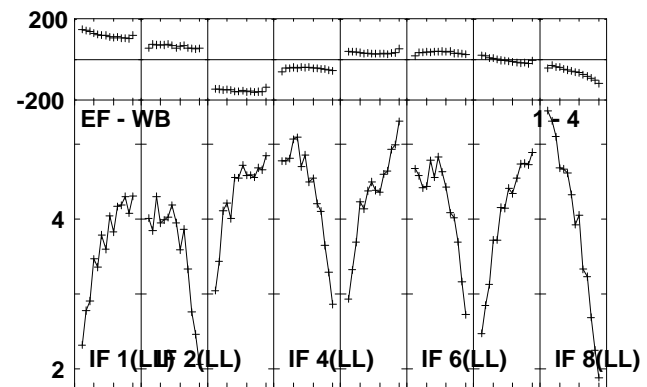
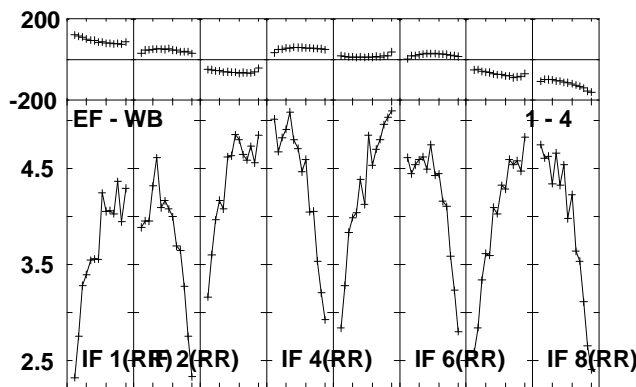
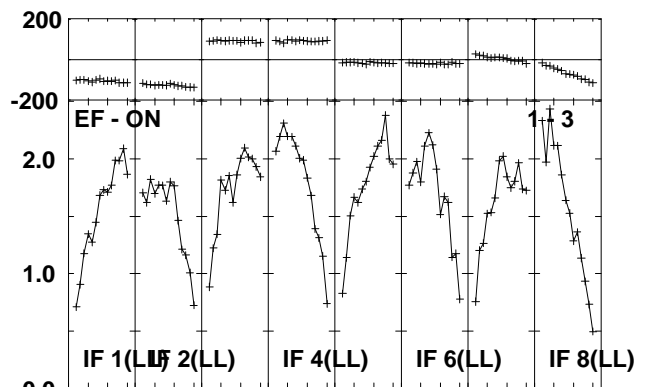
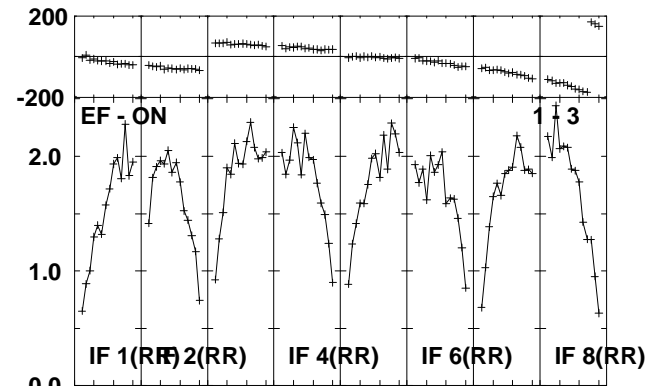
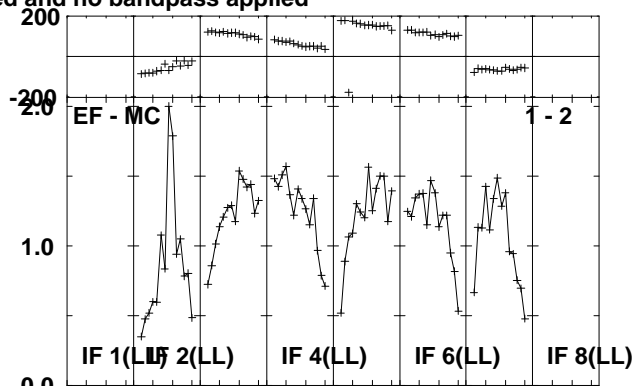
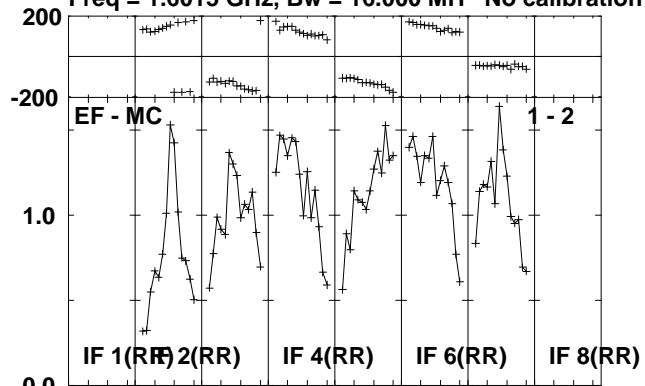

Lower frame: Milli Ampl Jy Top frame: Phas deg
Scalar averaged cross-power spectrum Several baselines displayed
Timerange: 01/06:12:53 to 01/06:15:01

Plot file version 279 created 01-JUL-2010 13:27:10
J2102+47 RG006B.UVDATA.1
Freq = 1.6015 GHz, Bw = 16.000 MH No calibration applied and no bandpass applied

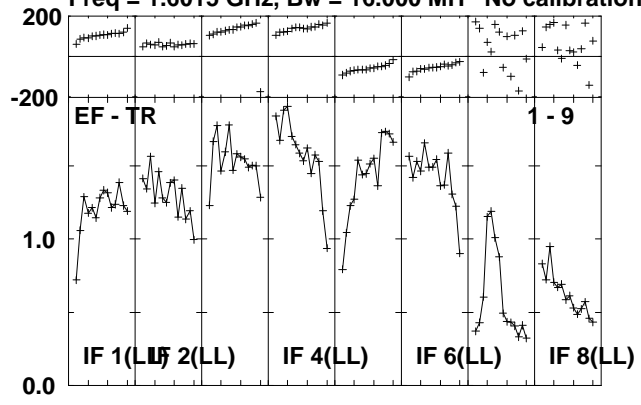

Lower frame: Milli Ampl Jy Top frame: Phas deg
Scalar averaged cross-power spectrum Several baselines displayed
Timerange: 01/06:12:53 to 01/06:15:01

Plot file version 280 created 01-JUL-2010 13:27:10

V407CYG RG006B.UVDATA.1

Freq = 1.6015 GHz, Bw = 16.000 MH No calibration applied and no bandpass applied

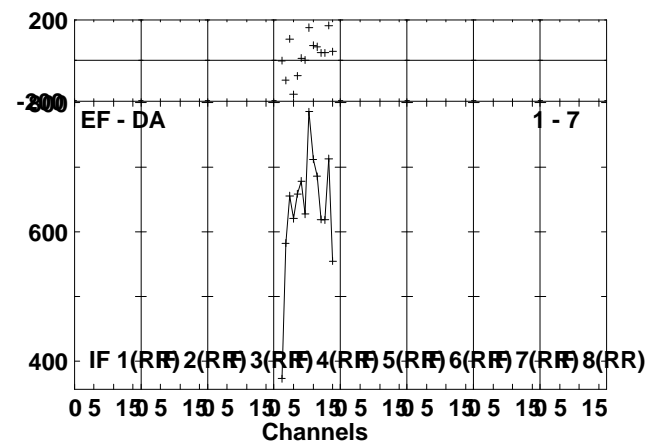
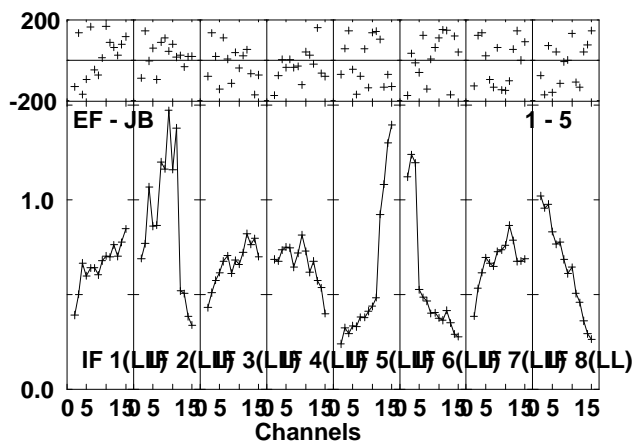
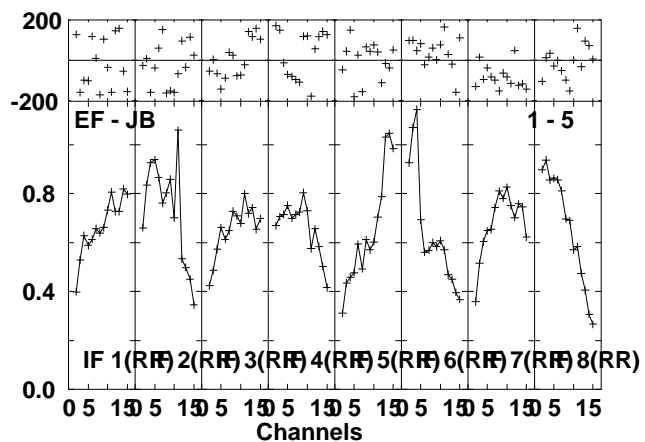
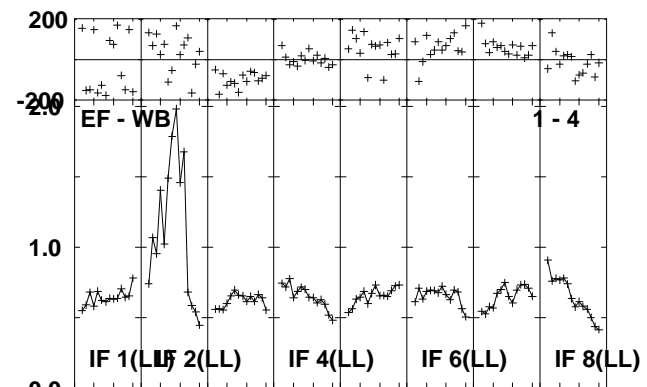
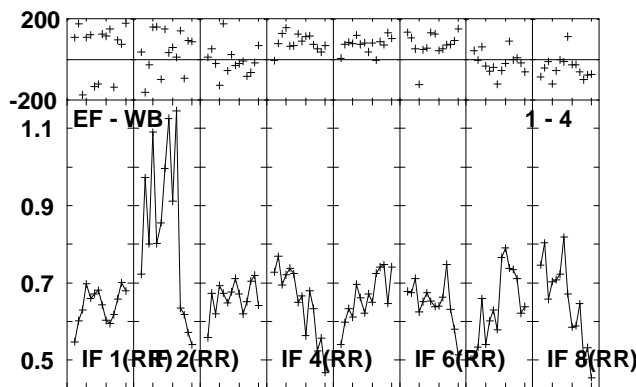
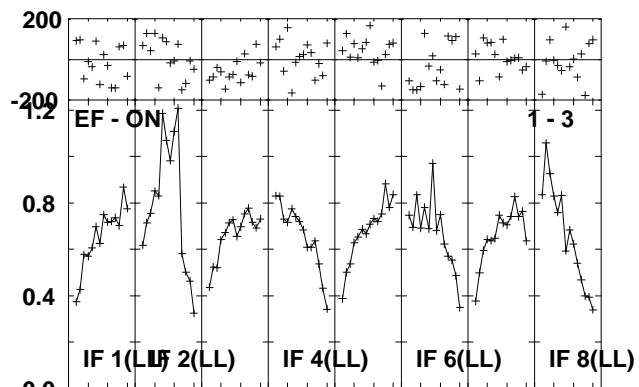
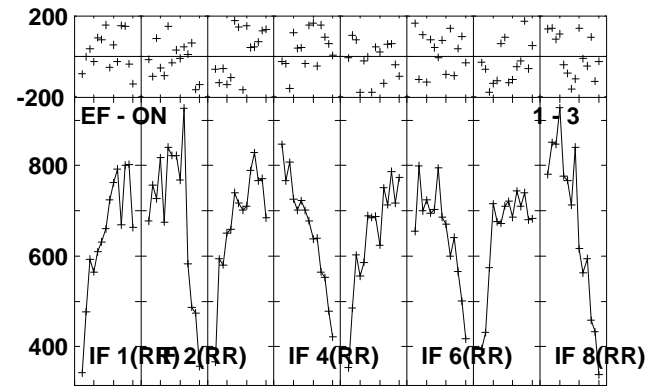
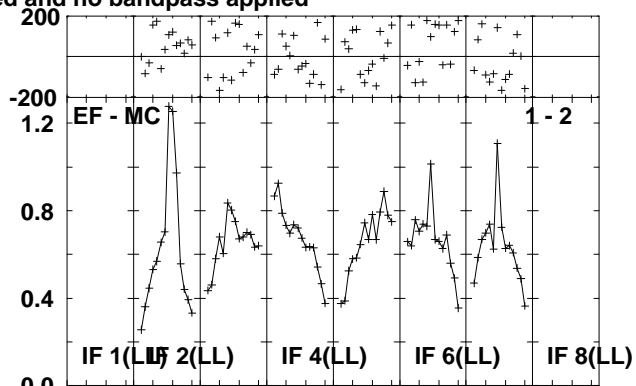
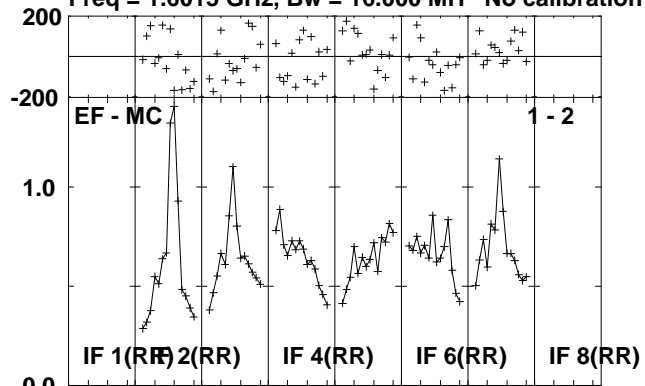

Lower frame: Milli Ampl Jy Top frame: Phas deg
Scalar averaged cross-power spectrum Several baselines displayed
Timerange: 01/06:15:05 to 01/06:20:01

Plot file version 281 created 01-JUL-2010 13:27:11

V407CYG RG006B.UVDATA.1

Freq = 1.6015 GHz, Bw = 16.000 MH No calibration applied and no bandpass applied

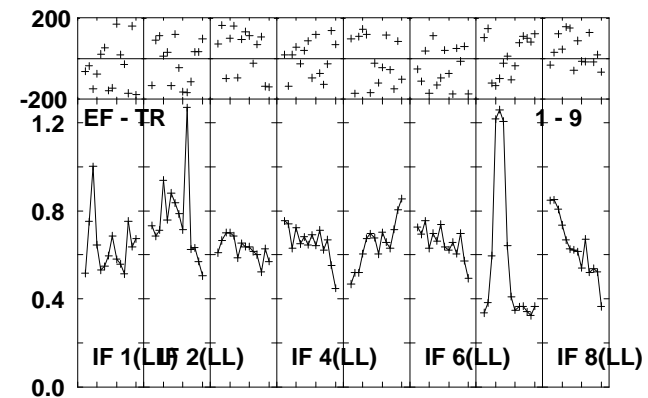
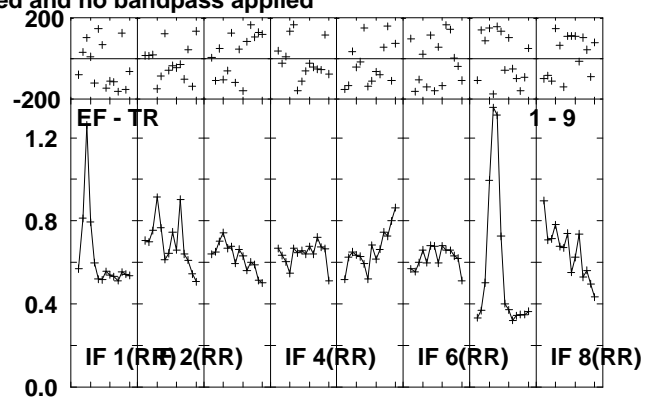
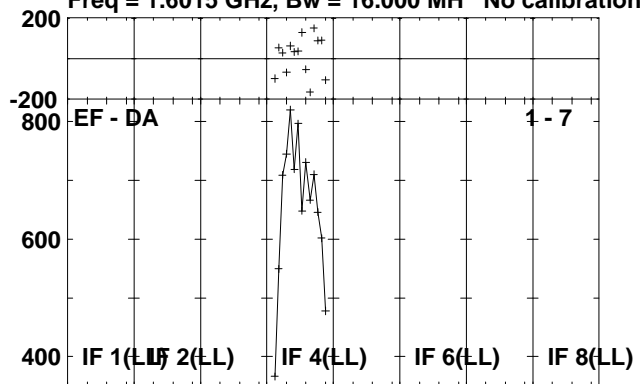

Lower frame: Micro Ampl Jy Top frame: Phas deg
Scalar averaged cross-power spectrum Several baselines displayed
Timerange: 01/06:15:05 to 01/06:20:01

Plot file version 282 created 01-JUL-2010 13:27:12

J2102+47 RG006B.UVDATA.1

Freq = 1.6015 GHz, Bw = 16.000 MH No calibration applied and no bandpass applied

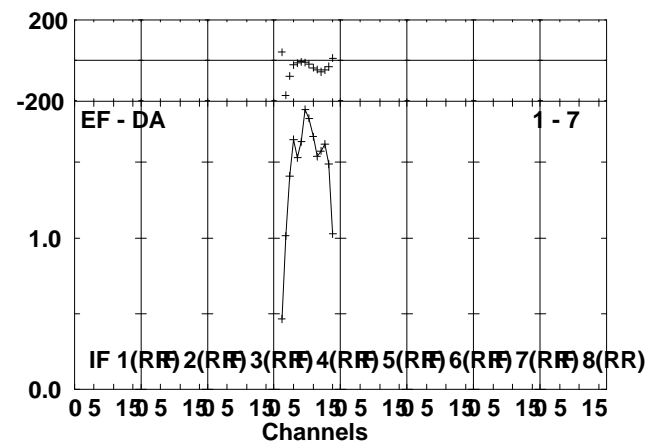
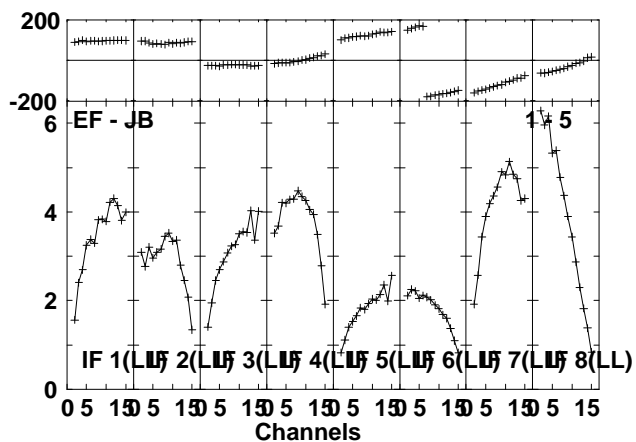
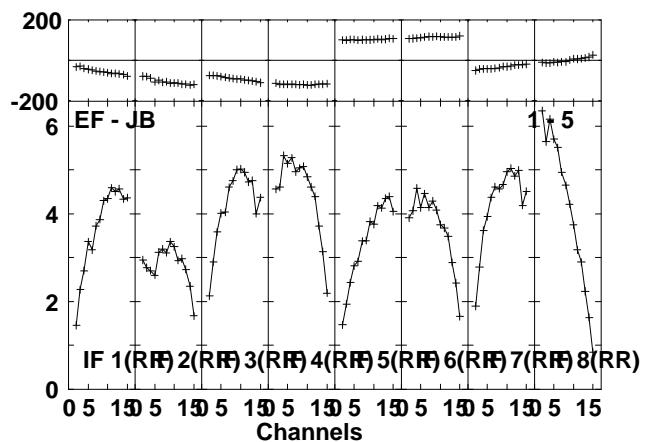
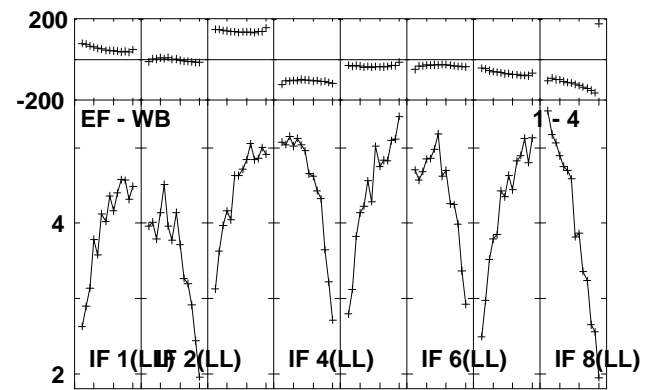
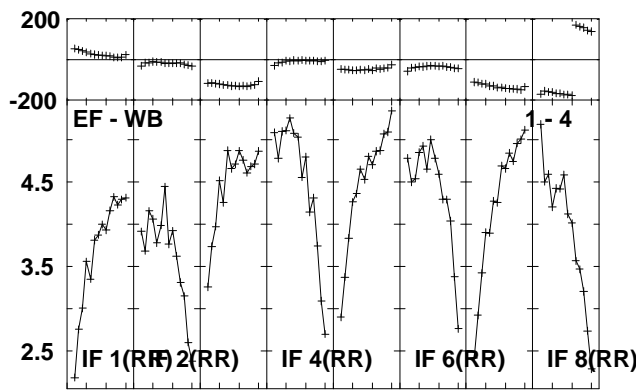
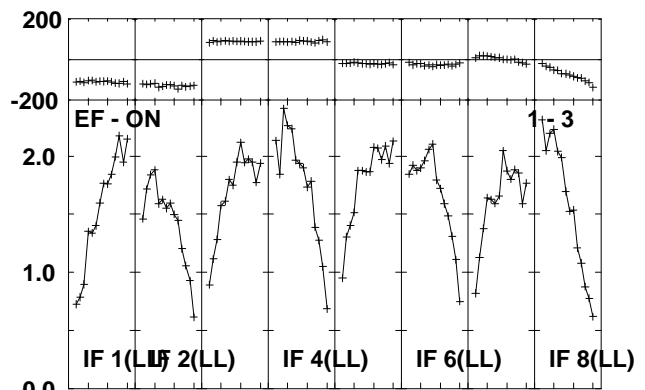
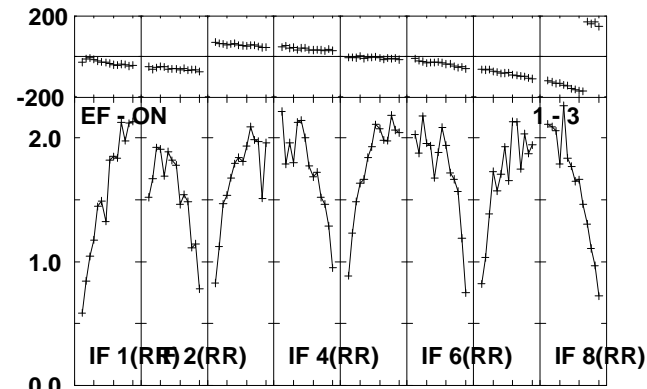
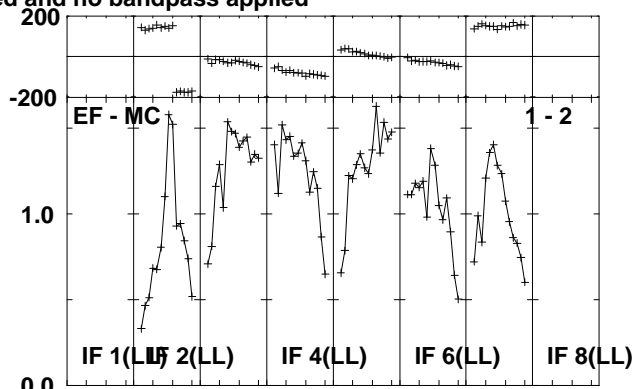
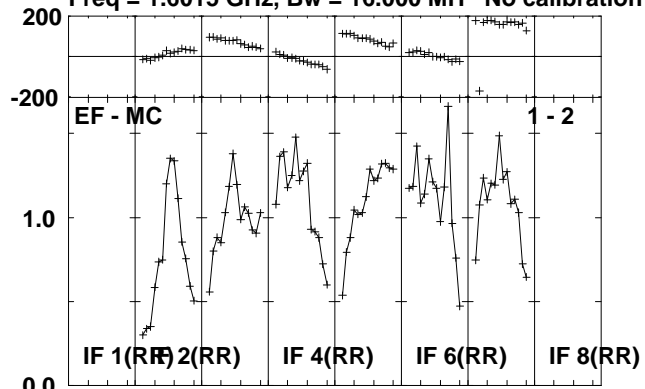

Lower frame: Milli Ampl Jy Top frame: Phas deg
Scalar averaged cross-power spectrum Several baselines displayed
Timerange: 01/06:21:05 to 01/06:22:49

Plot file version 283 created 01-JUL-2010 13:27:12

J2102+47 RG006B.UVDATA.1

Freq = 1.6015 GHz, Bw = 16.000 MH No calibration applied and no bandpass applied

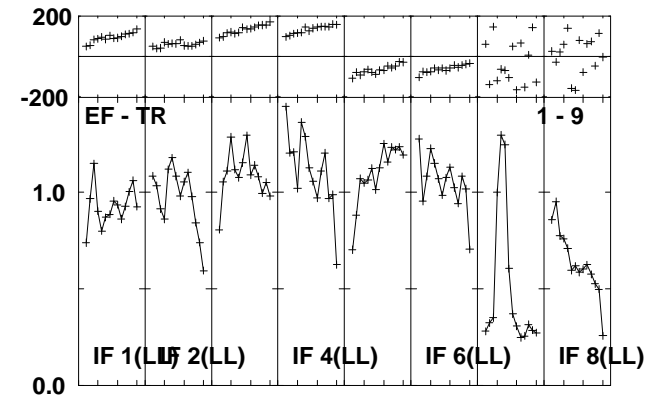
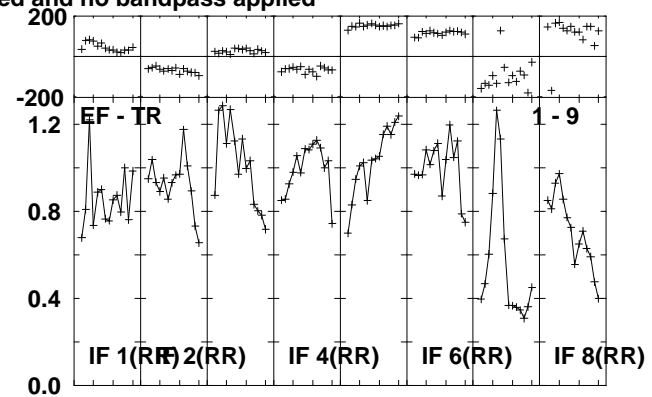
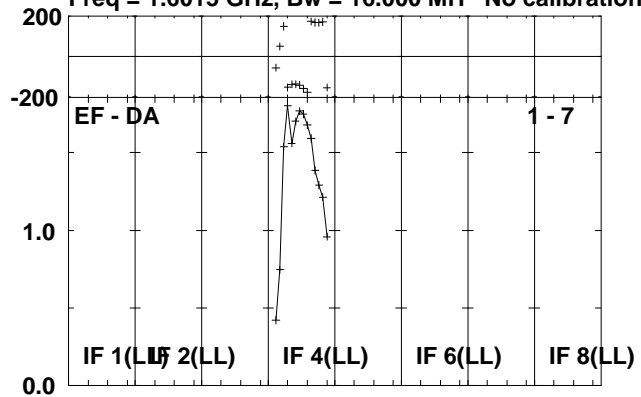

Lower frame: Milli Ampl Jy Top frame: Phas deg
Scalar averaged cross-power spectrum Several baselines displayed
Timerange: 01/06:21:05 to 01/06:22:49

Plot file version 284 created 01-JUL-2010 13:27:13

V407CYG RG006B.UVDATA.1

Freq = 1.6015 GHz, Bw = 16.000 MH No calibration applied and no bandpass applied

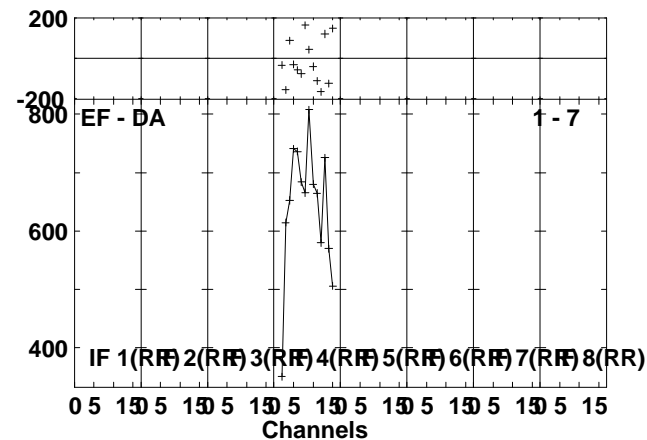
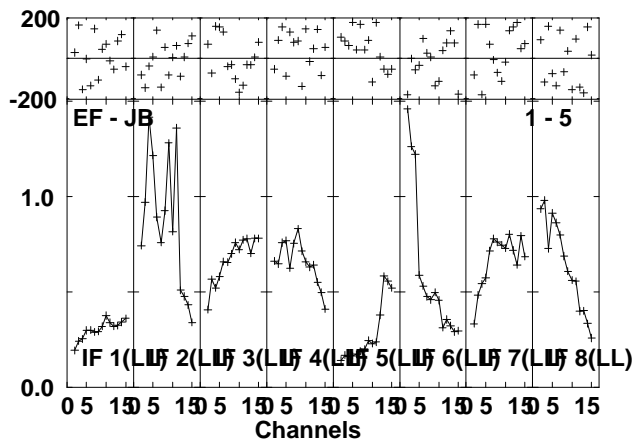
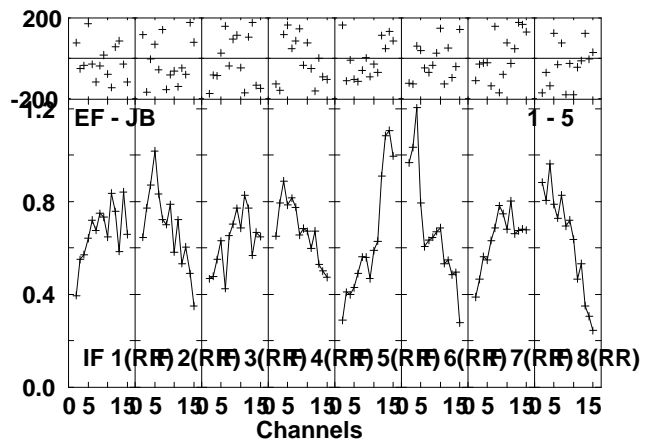
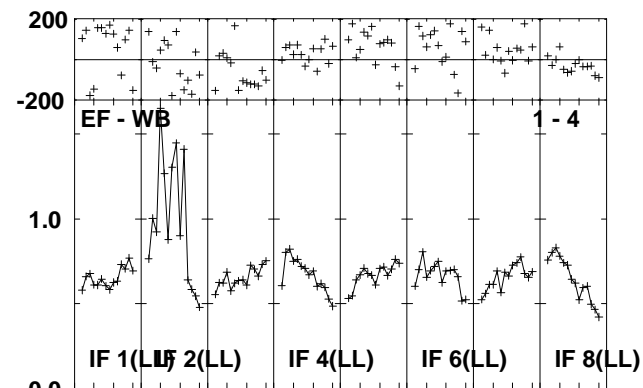
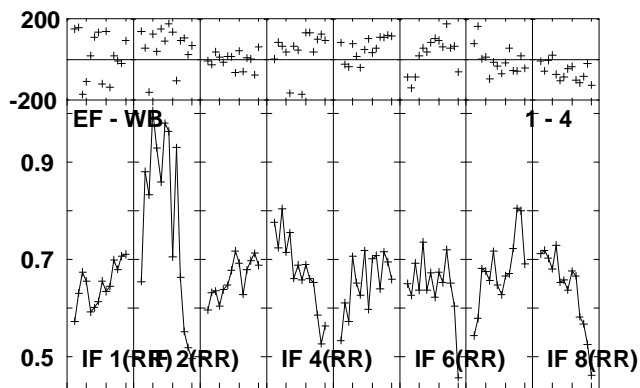
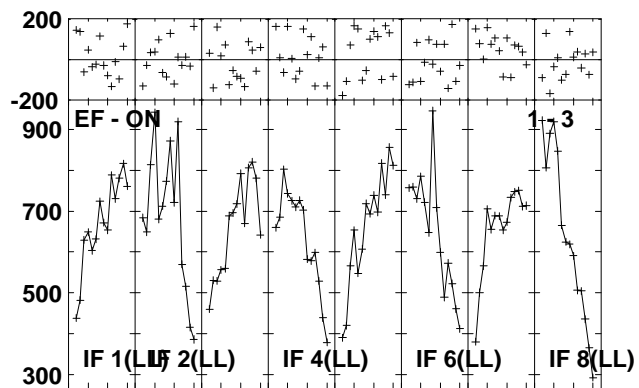
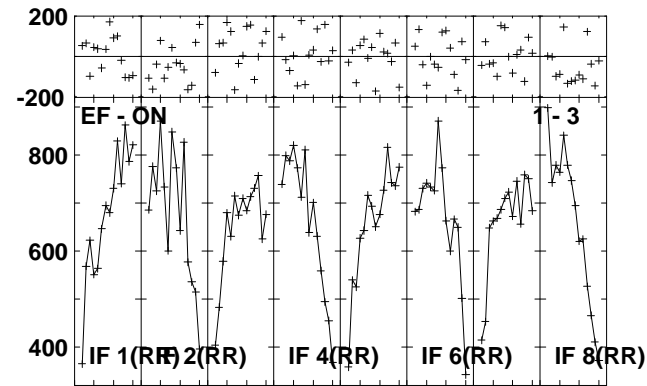
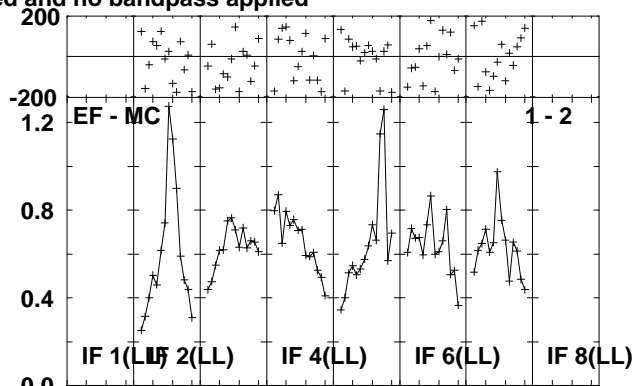
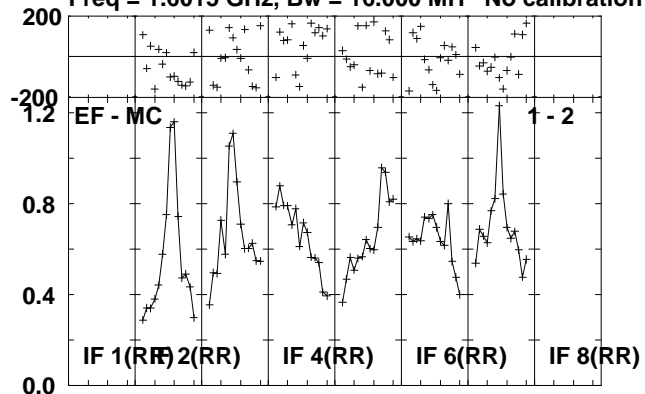

Lower frame: Milli Ampl Jy Top frame: Phas deg
Scalar averaged cross-power spectrum Several baselines displayed
Timerange: 01/06:22:53 to 01/06:27:49

Plot file version 285 created 01-JUL-2010 13:27:14

V407CYG RG006B.UVDATA.1

Freq = 1.6015 GHz, Bw = 16.000 MH No calibration applied and no bandpass applied

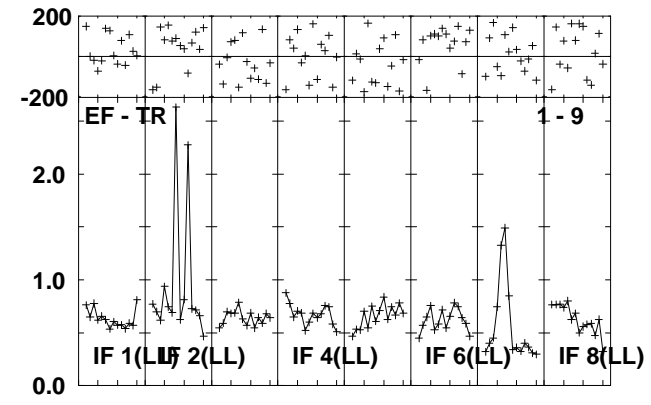
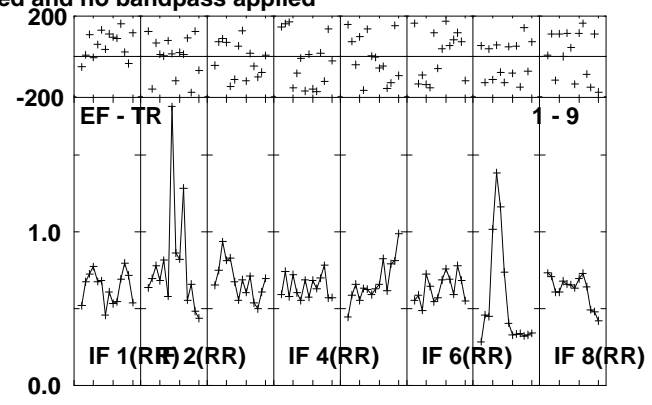
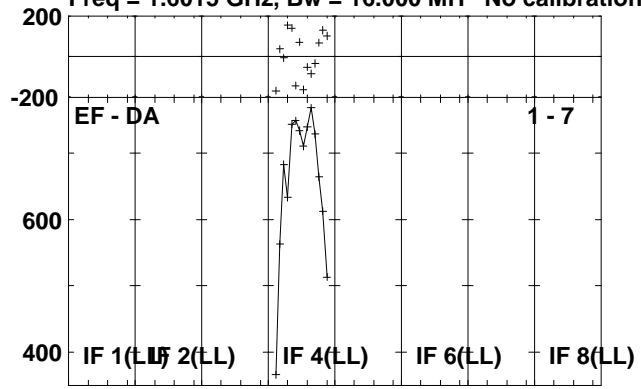

Lower frame: Micro Ampl Jy Top frame: Phas deg
Scalar averaged cross-power spectrum Several baselines displayed
Timerange: 01/06:22:53 to 01/06:27:49

Plot file version 286 created 01-JUL-2010 13:27:14

J2102+47 RG006B.UVDATA.1

Freq = 1.6015 GHz, Bw = 16.000 MH No calibration applied and no bandpass applied

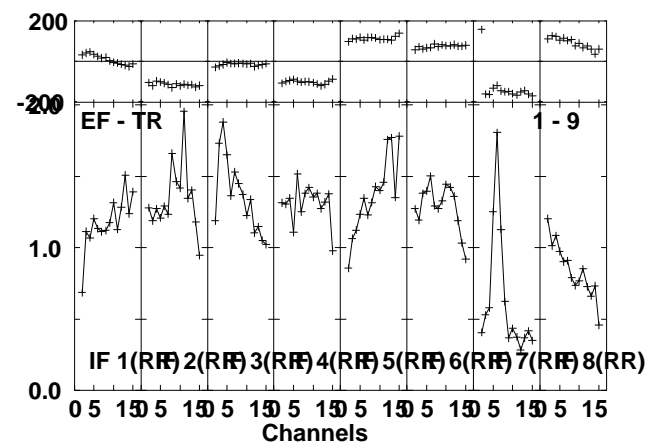
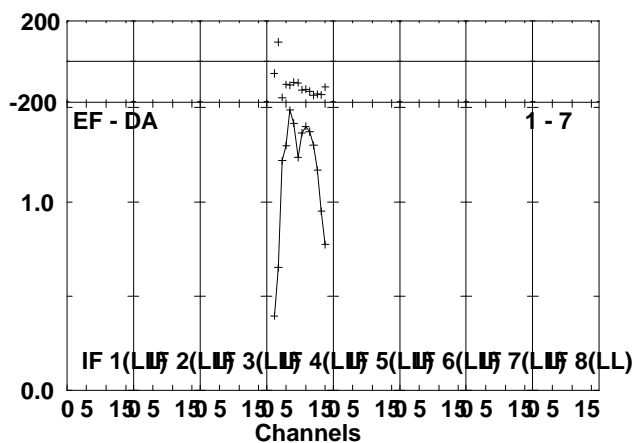
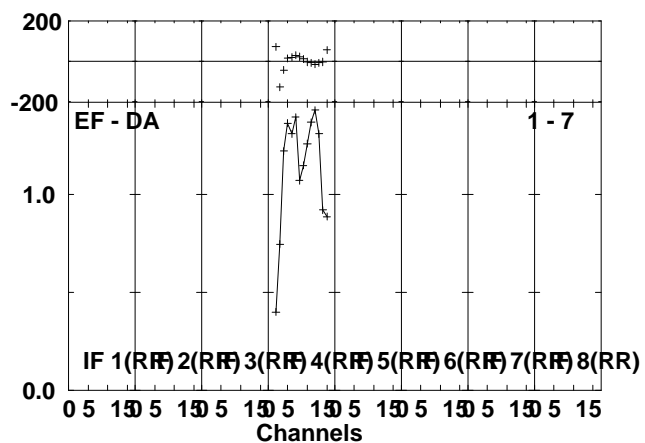
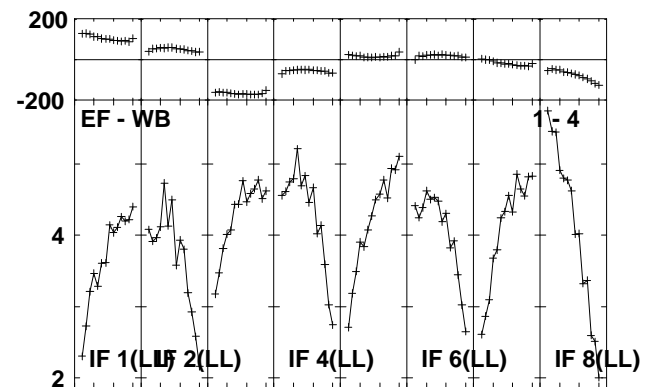
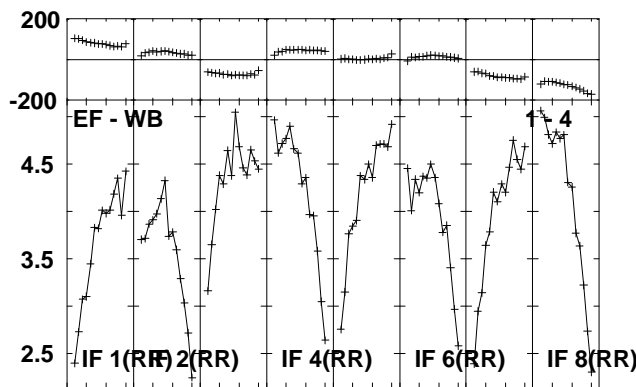
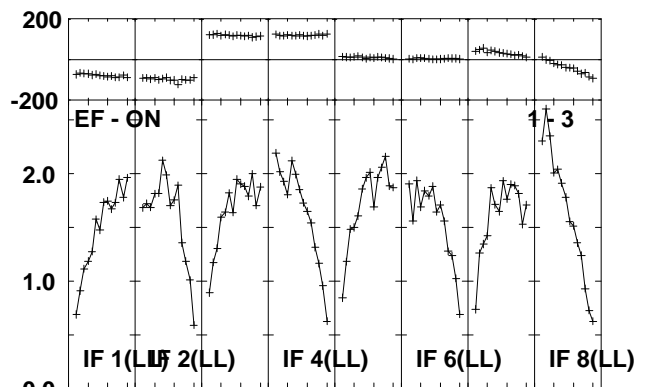
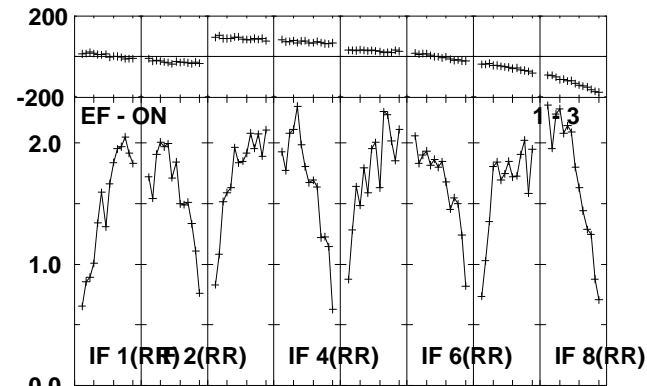
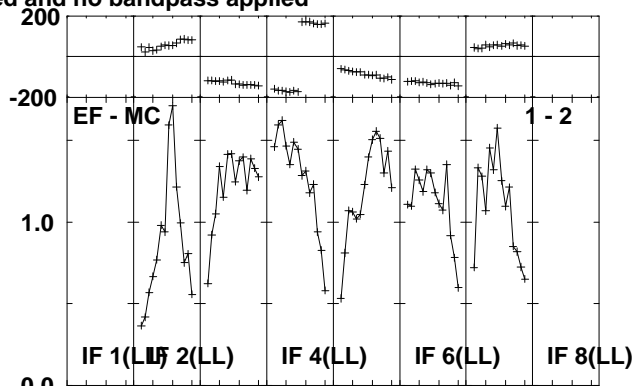
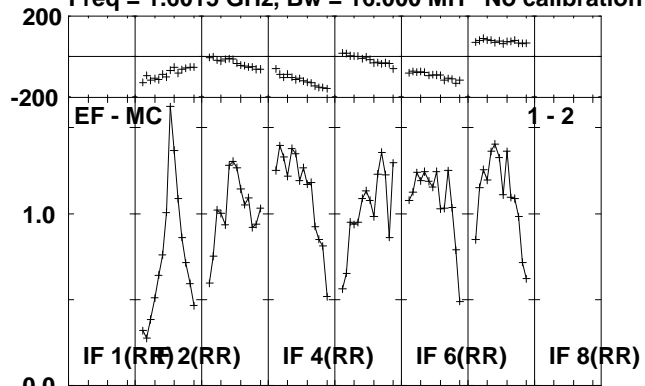

Lower frame: Milli Ampl Jy Top frame: Phas deg
Scalar averaged cross-power spectrum Several baselines displayed
Timerange: 01/06:27:53 to 01/06:30:01

Plot file version 287 created 01-JUL-2010 13:27:15
J2102+47 RG006B.UVDATA.1
Freq = 1.6015 GHz, Bw = 16.000 MH No calibration applied and no bandpass applied

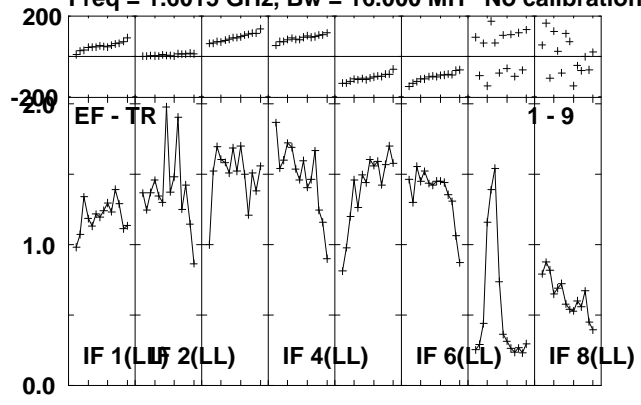

Lower frame: Milli Ampl Jy Top frame: Phas deg
Scalar averaged cross-power spectrum Several baselines displayed
Timerange: 01/06:27:53 to 01/06:30:01

Plot file version 288 created 01-JUL-2010 13:27:15

V407CYG RG006B.UVDATA.1

Freq = 1.6015 GHz, Bw = 16.000 MH No calibration applied and no bandpass applied

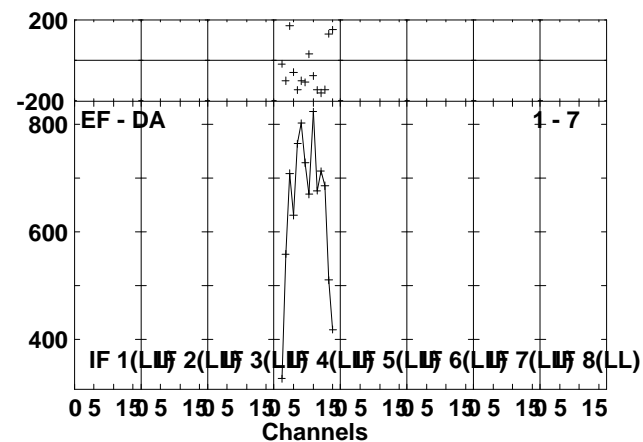
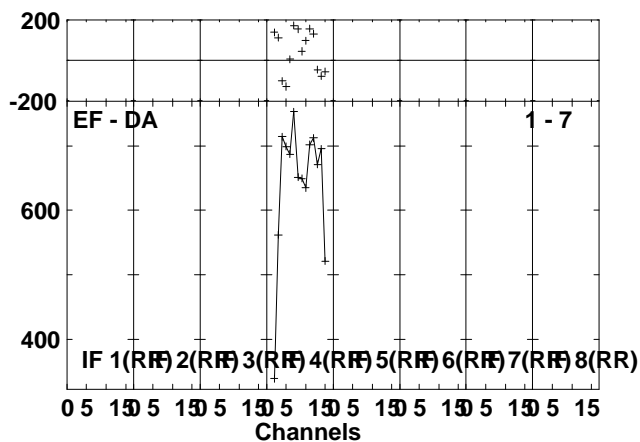
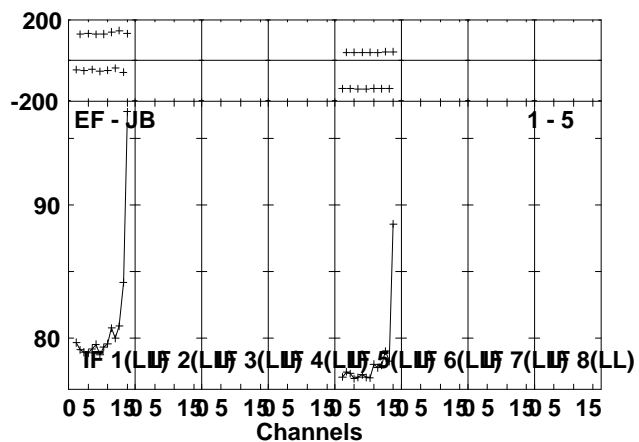
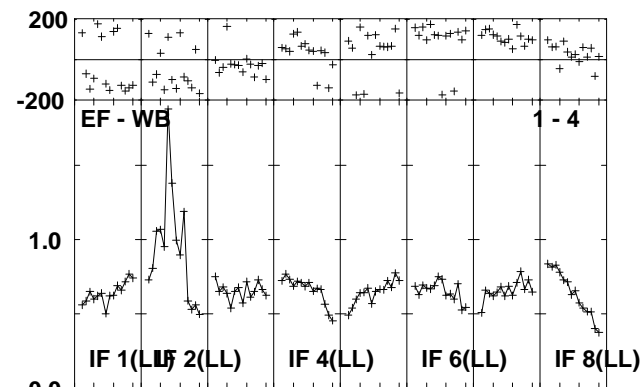
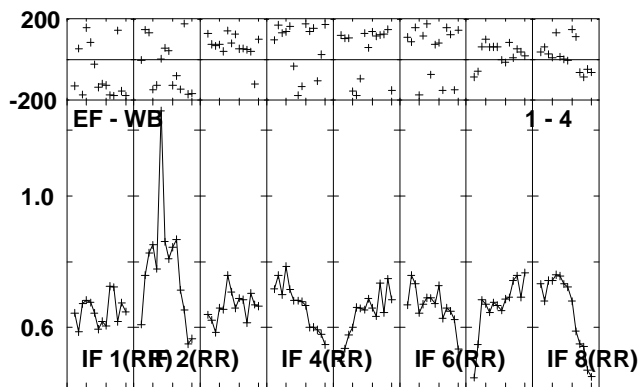
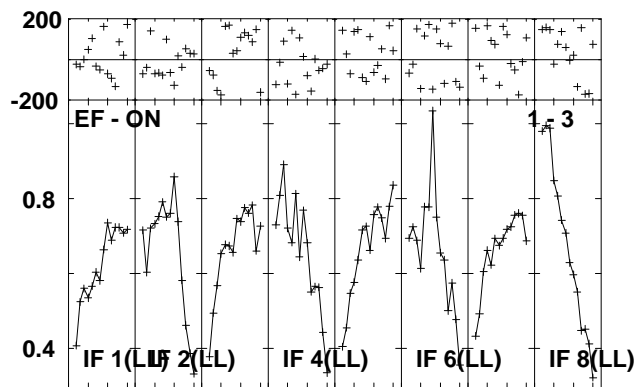
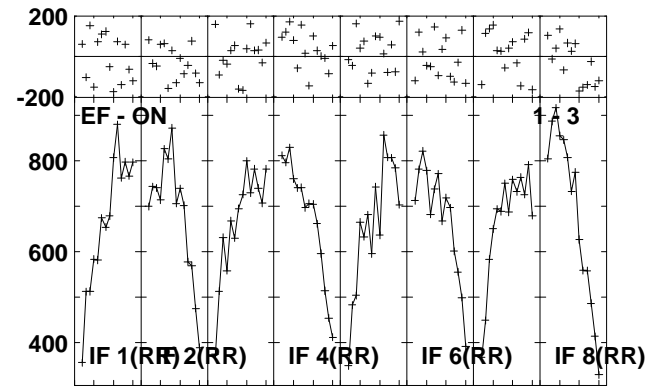
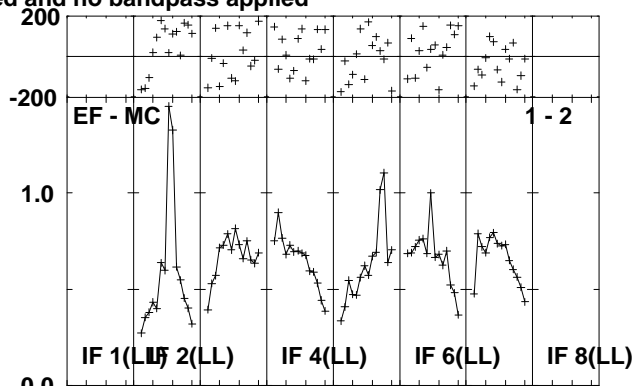
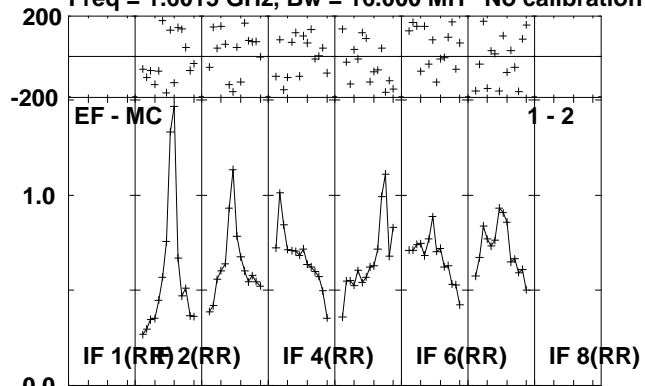

Lower frame: Milli Ampl Jy Top frame: Phas deg
Scalar averaged cross-power spectrum Several baselines displayed
Timerange: 01/06:30:05 to 01/06:35:01

Plot file version 289 created 01-JUL-2010 13:27:16

V407CYG RG006B.UVDATA.1

Freq = 1.6015 GHz, Bw = 16.000 MH No calibration applied and no bandpass applied

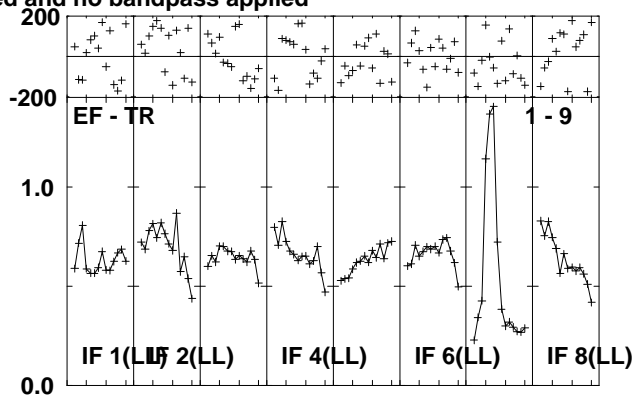
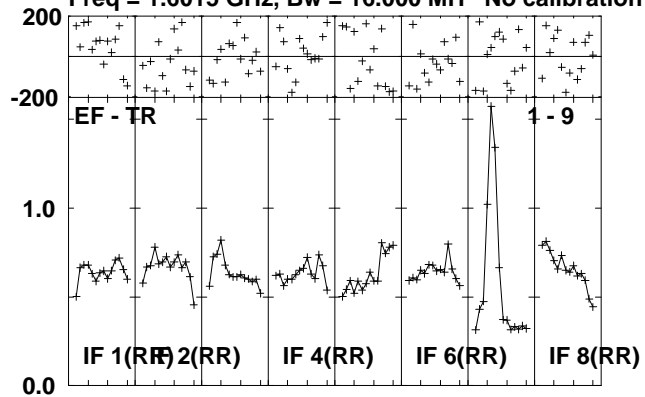

Lower frame: Milli Ampl Jy Top frame: Phas deg
Scalar averaged cross-power spectrum Several baselines displayed
Timerange: 01/06:30:05 to 01/06:35:01

Plot file version 290 created 01-JUL-2010 13:27:17

J2102+47 RG006B.UVDATA.1

Freq = 1.6015 GHz, Bw = 16.000 MH No calibration applied and no bandpass applied

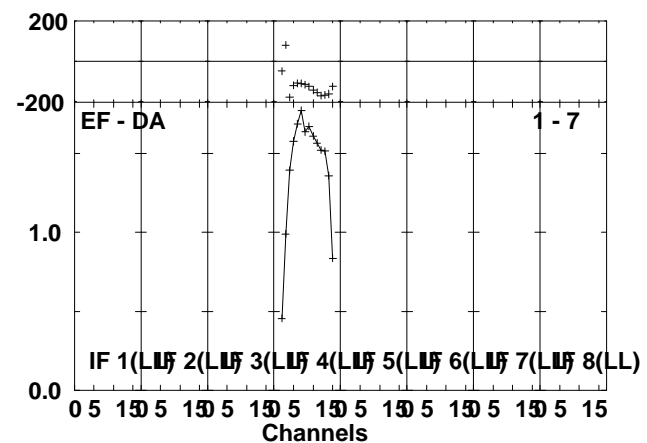
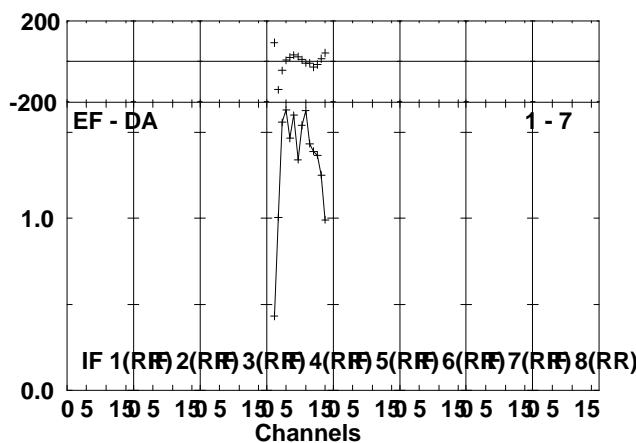
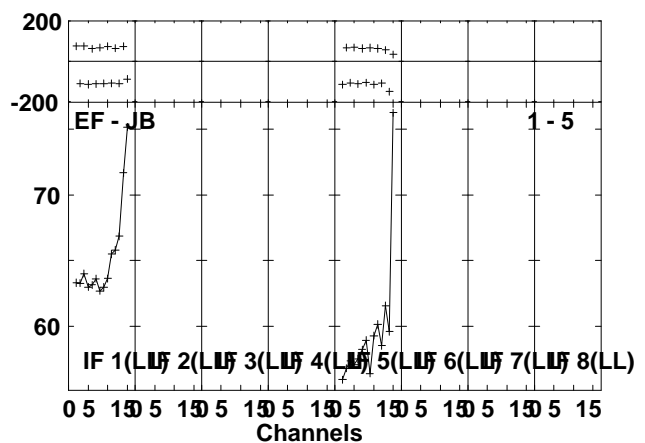
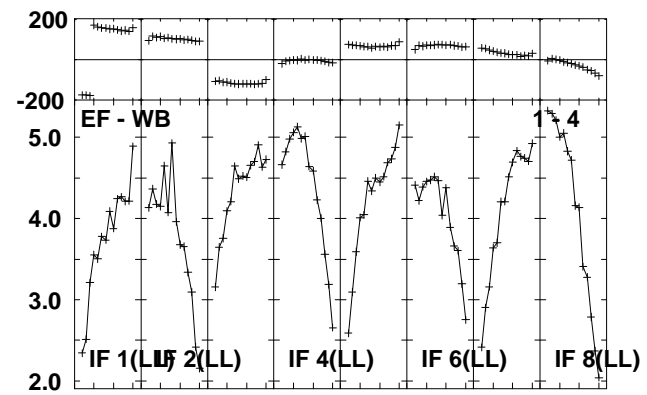
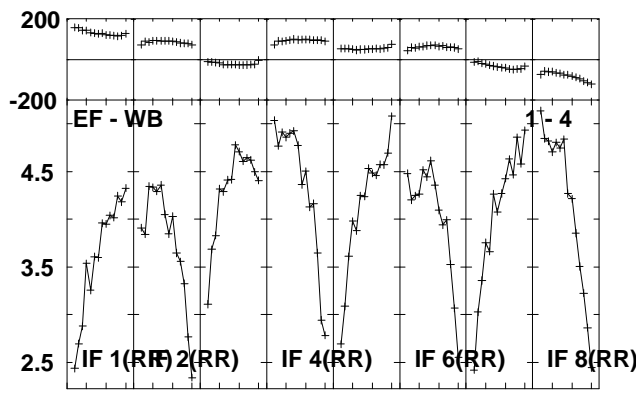
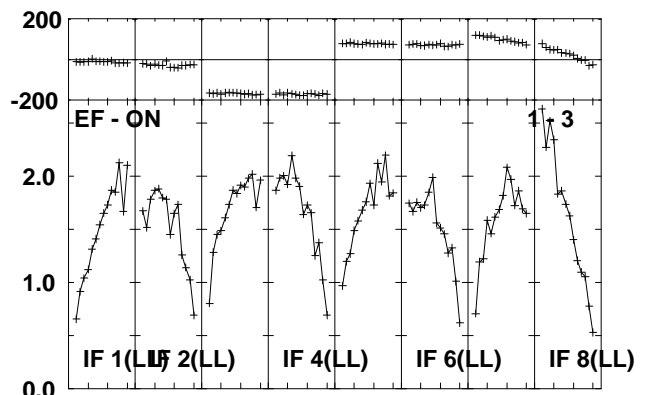
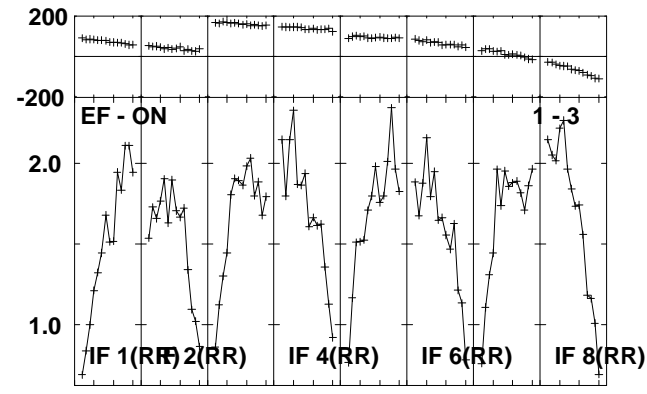
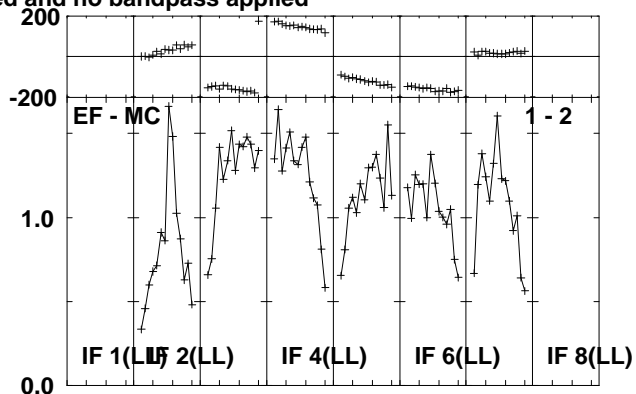
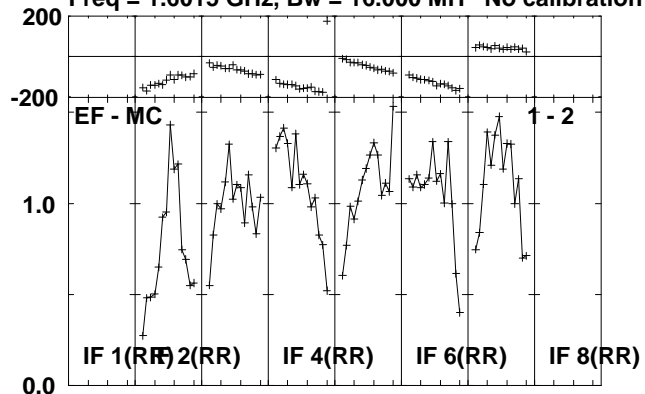

Lower frame: Milli Ampl Jy Top frame: Phas deg
Scalar averaged cross-power spectrum Several baselines displayed
Timerange: 01/06:36:05 to 01/06:37:49

Plot file version 291 created 01-JUL-2010 13:27:17
J2102+47 RG006B.UVDATA.1

Freq = 1.6015 GHz, Bw = 16.000 MH No calibration applied and no bandpass applied

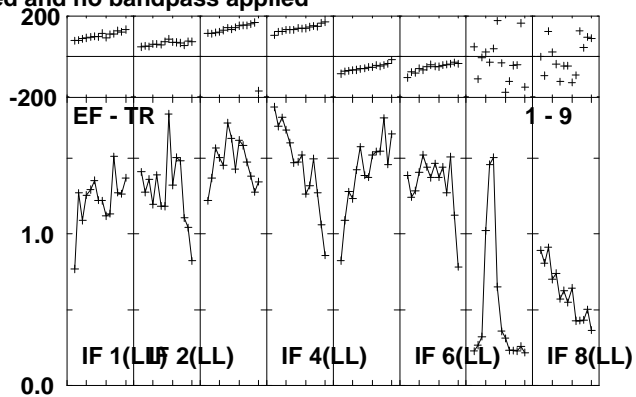
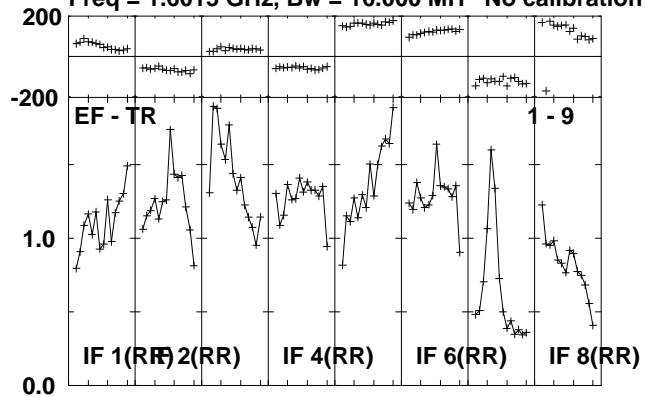

Lower frame: Milli Ampl Jy Top frame: Phas deg
Scalar averaged cross-power spectrum Several baselines displayed
Timerange: 01/06:36:05 to 01/06:37:49

Plot file version 292 created 01-JUL-2010 13:27:17

V407CYG RG006B.UVDATA.1

Freq = 1.6015 GHz, Bw = 16.000 MH No calibration applied and no bandpass applied

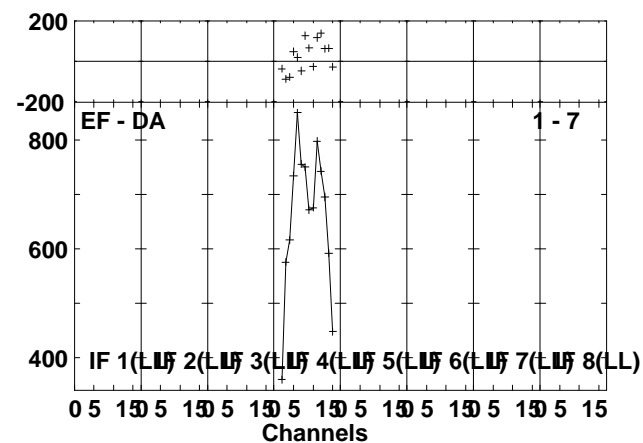
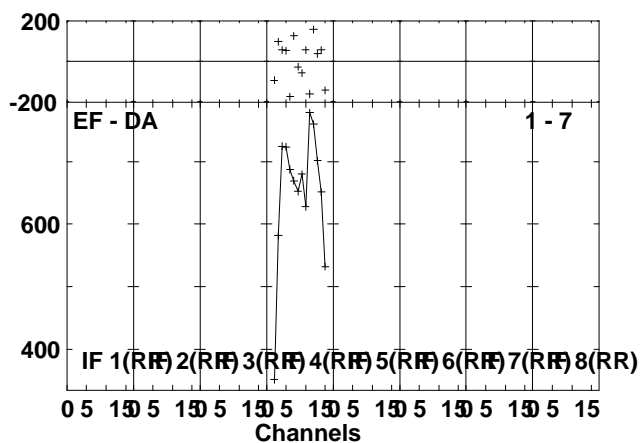
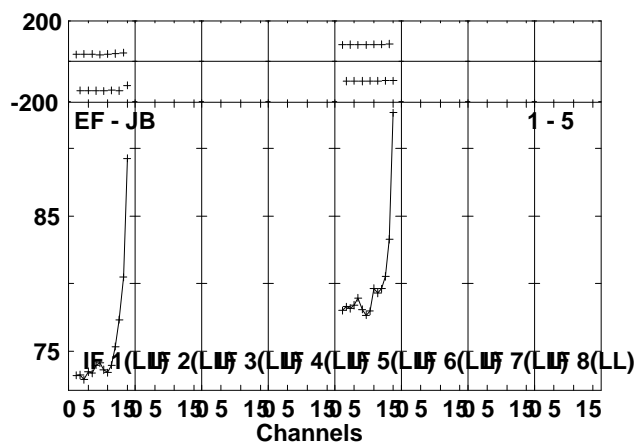
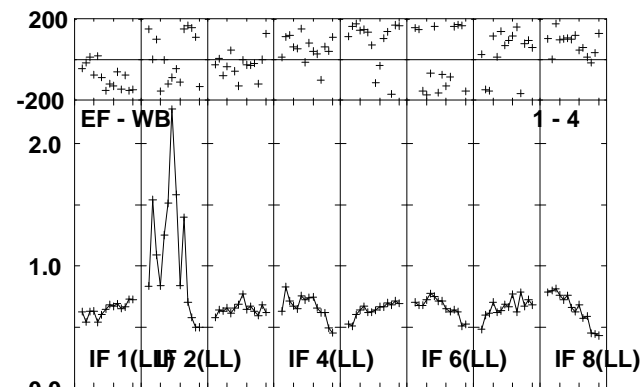
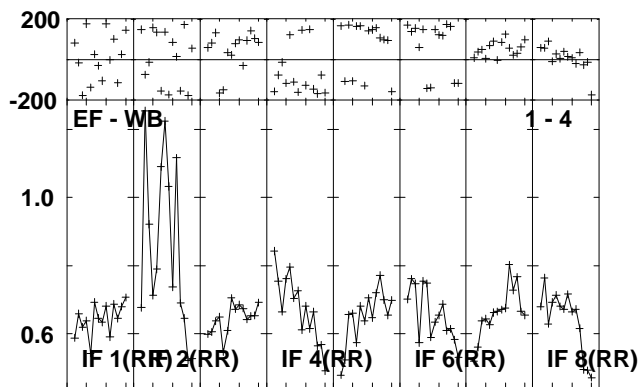
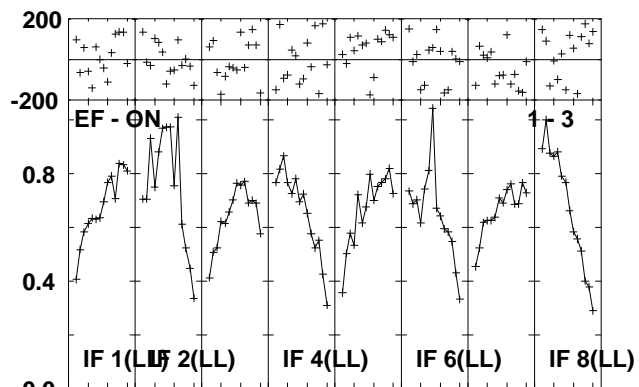
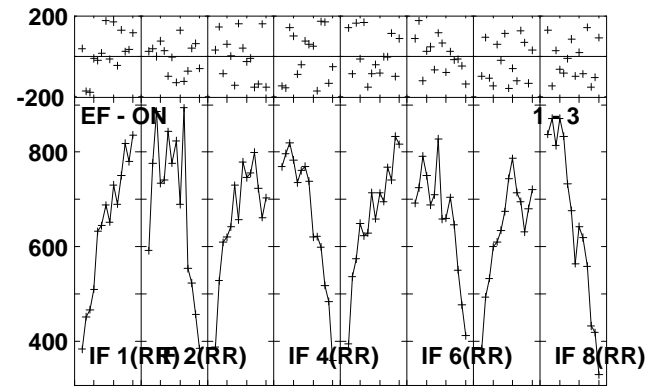
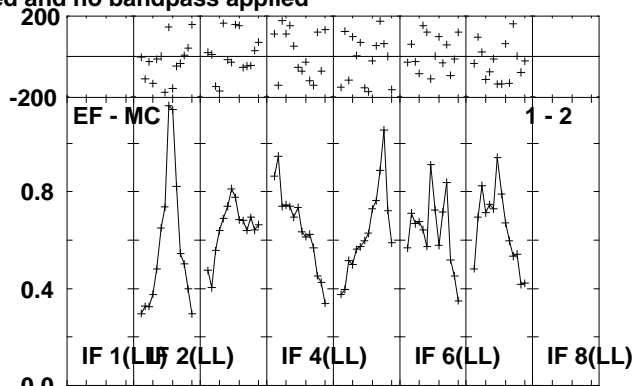
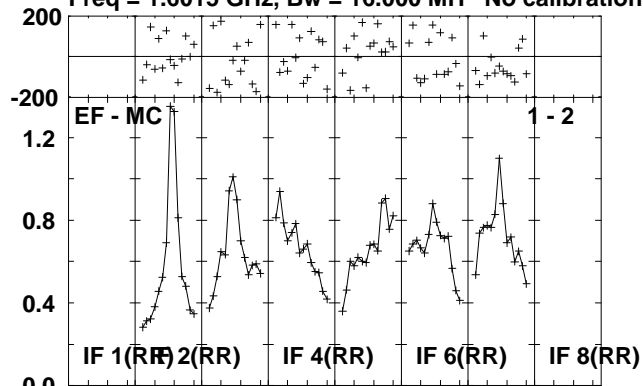

Lower frame: Milli Ampl Jy Top frame: Phas deg
Scalar averaged cross-power spectrum Several baselines displayed
Timerange: 01/06:37:53 to 01/06:42:49

Plot file version 293 created 01-JUL-2010 13:27:19

V407CYG RG006B.UVDATA.1

Freq = 1.6015 GHz, Bw = 16.000 MH No calibration applied and no bandpass applied

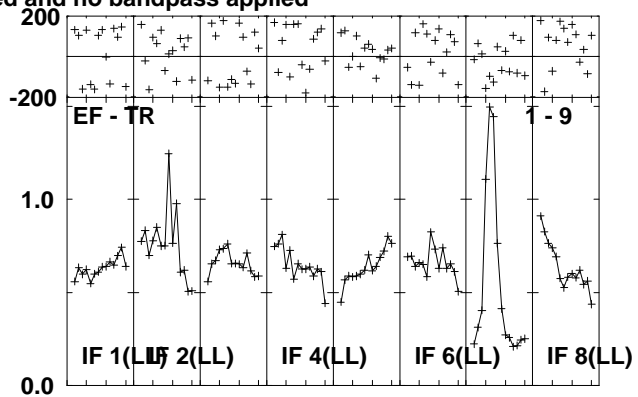
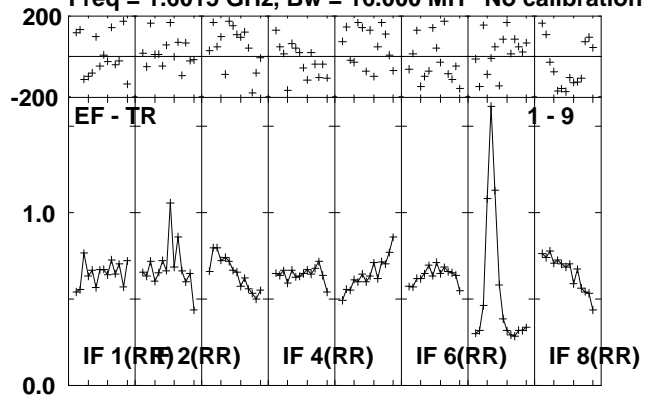

Lower frame: Milli Ampl Jy Top frame: Phas deg
Scalar averaged cross-power spectrum Several baselines displayed
Timerange: 01/06:37:53 to 01/06:42:49

Plot file version 294 created 01-JUL-2010 13:27:19

J2102+47 RG006B.UVDATA.1

Freq = 1.6015 GHz, Bw = 16.000 MH No calibration applied and no bandpass applied

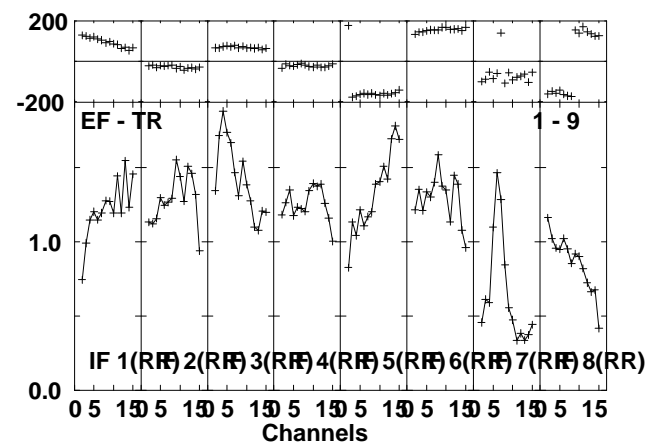
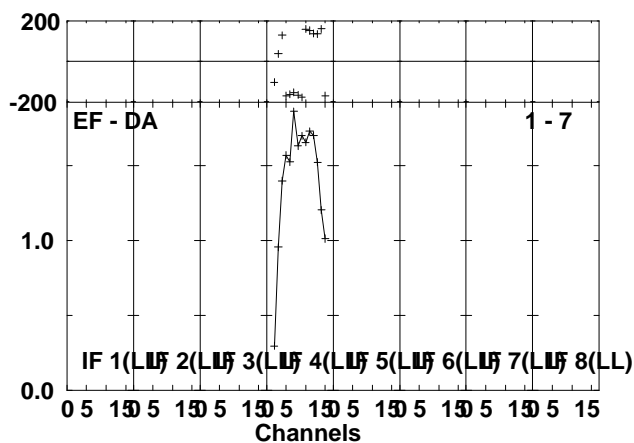
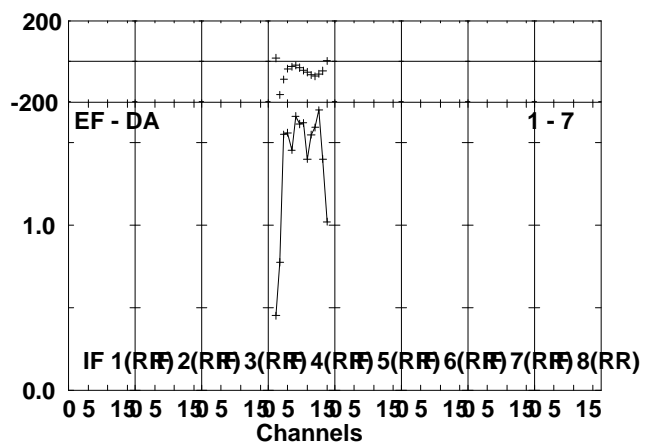
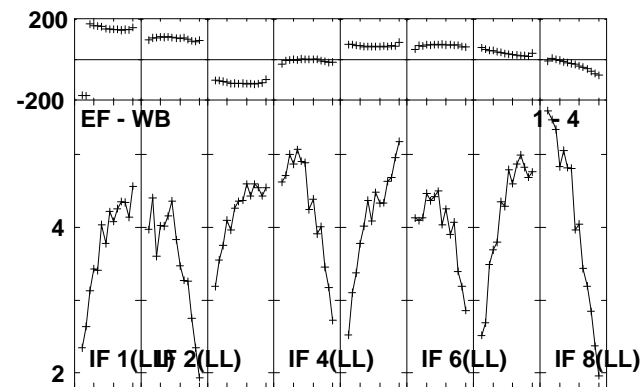
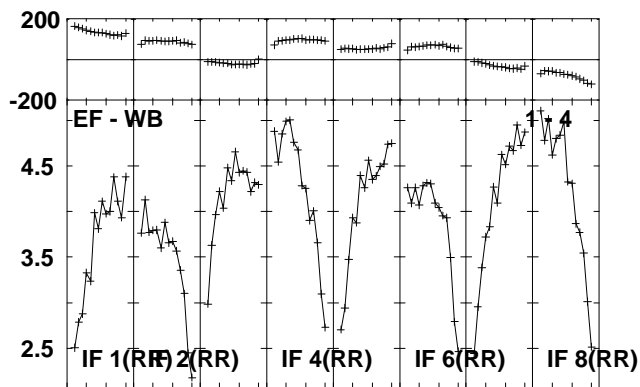
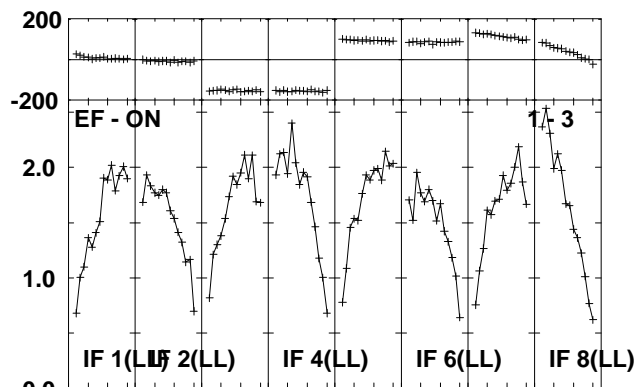
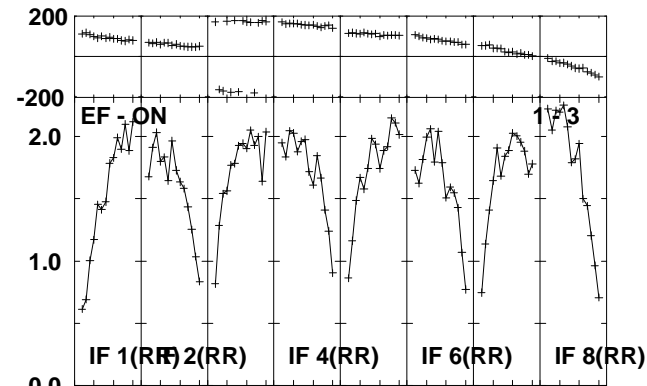
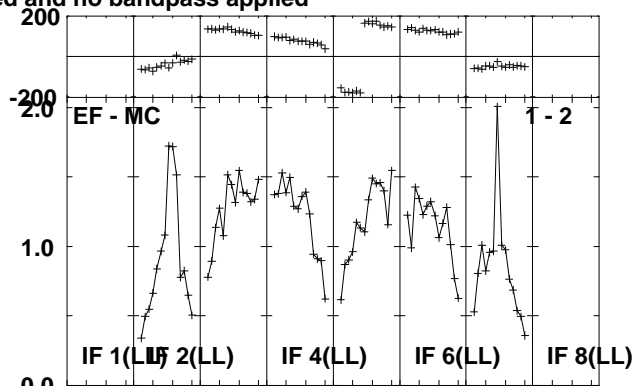
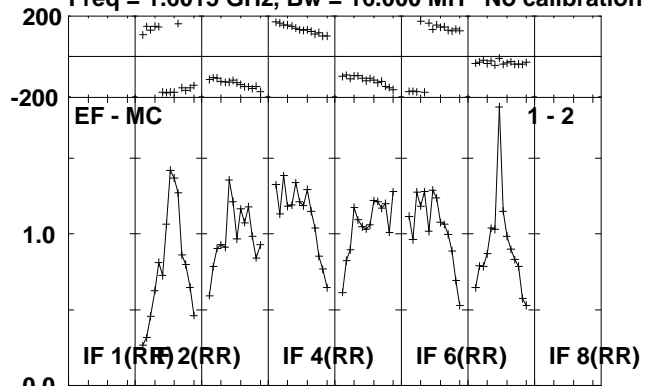

Lower frame: Milli Ampl Jy Top frame: Phas deg
Scalar averaged cross-power spectrum Several baselines displayed
Timerange: 01/06:42:53 to 01/06:45:01

Plot file version 295 created 01-JUL-2010 13:27:20
J2102+47 RG006B.UVDATA.1
Freq = 1.6015 GHz, Bw = 16.000 MH No calibration applied and no bandpass applied

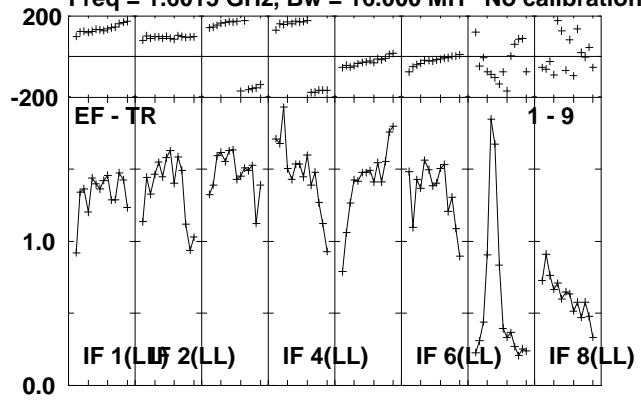

Lower frame: Milli Ampl Jy Top frame: Phas deg
Scalar averaged cross-power spectrum Several baselines displayed
Timerange: 01/06:42:53 to 01/06:45:01

Plot file version 296 created 01-JUL-2010 13:27:20

V407CYG RG006B.UVDATA.1

Freq = 1.6015 GHz, Bw = 16.000 MH No calibration applied and no bandpass applied

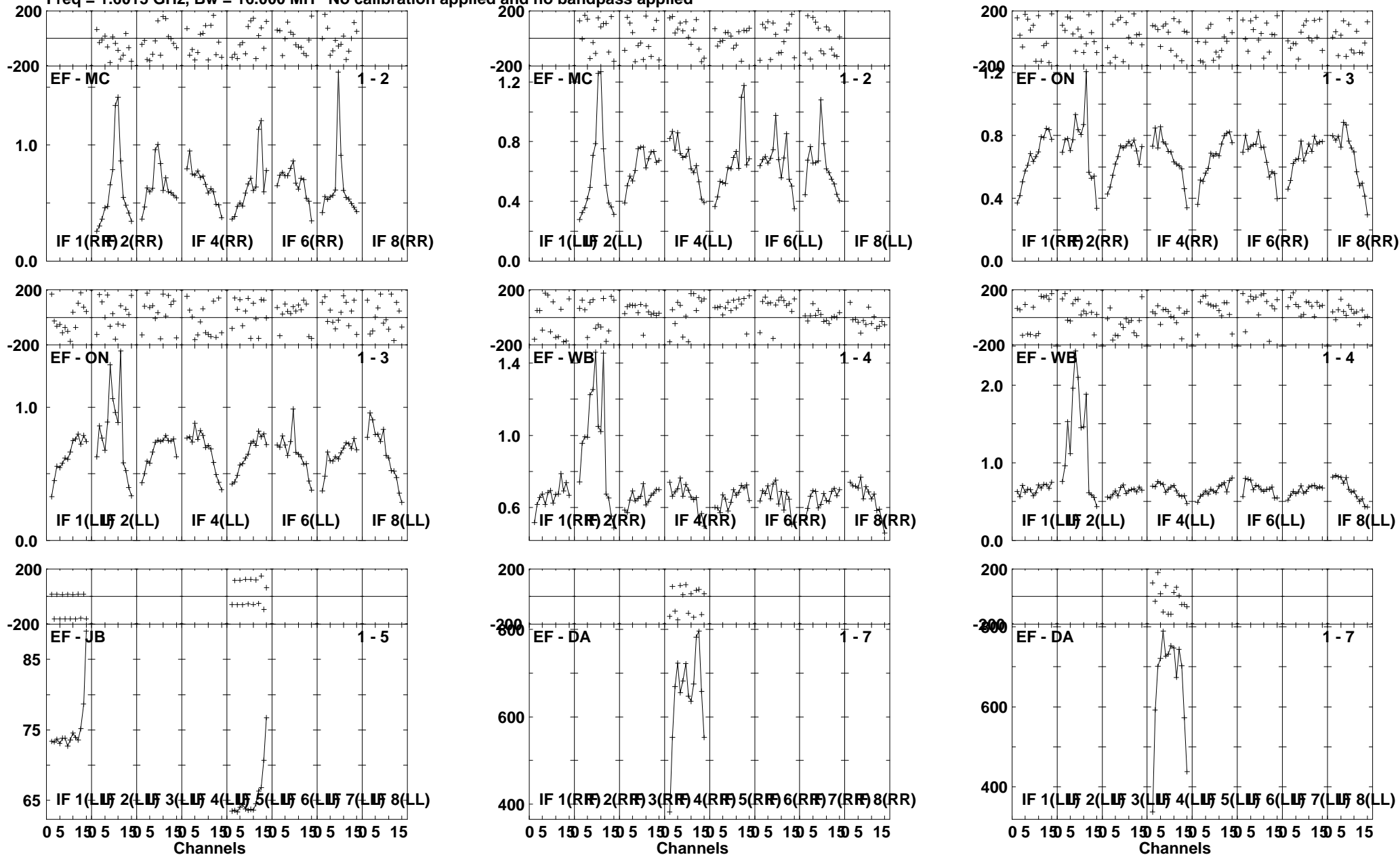

Lower frame: Milli Ampl Jy Top frame: Phas deg
Scalar averaged cross-power spectrum Several baselines displayed
Timerange: 01/06:45:05 to 01/06:50:01

Plot file version 297 created 01-JUL-2010 13:27:22

V407CYG RG006B.UVDATA.1

Freq = 1.6015 GHz, Bw = 16.000 MH No calibration applied and no bandpass applied

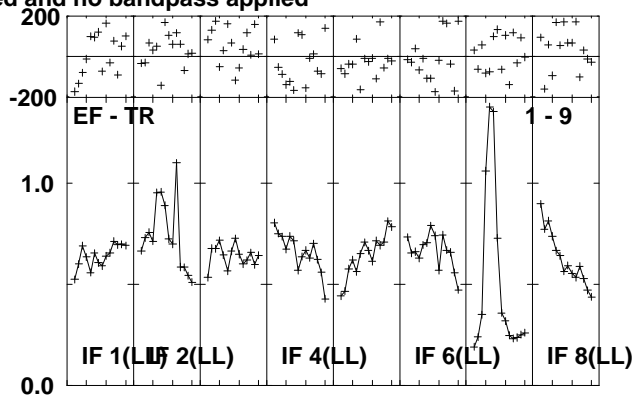
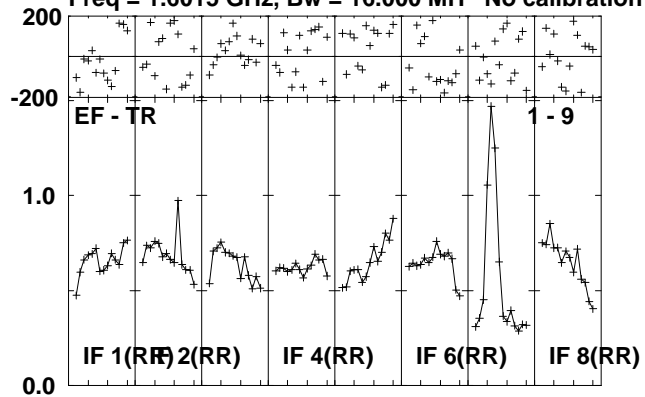

Lower frame: Milli Ampl Jy Top frame: Phas deg
Scalar averaged cross-power spectrum Several baselines displayed
Timerange: 01/06:45:05 to 01/06:50:01

Plot file version 298 created 01-JUL-2010 13:27:22

J2102+47 RG006B.UVDATA.1

Freq = 1.6015 GHz, Bw = 16.000 MH No calibration applied and no bandpass applied

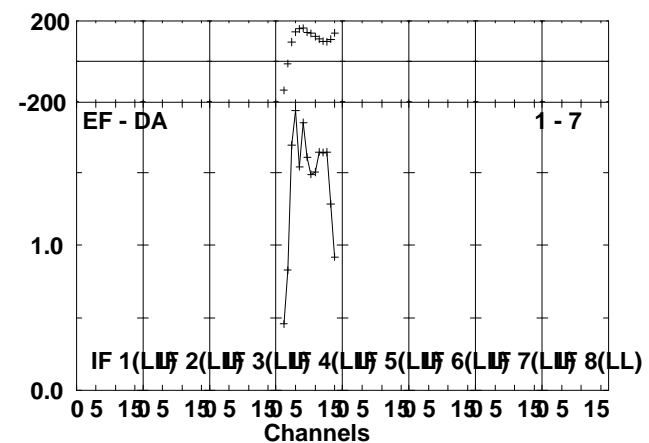
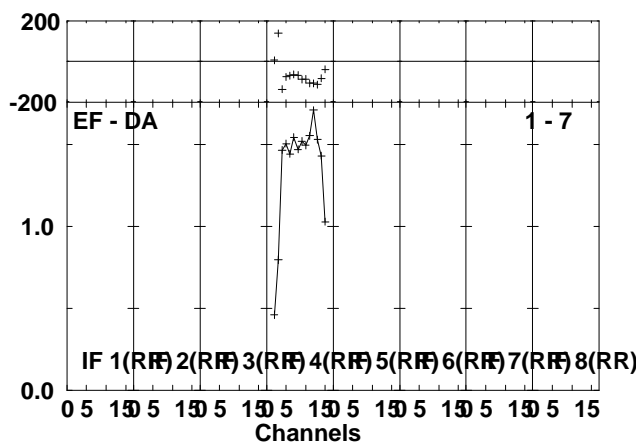
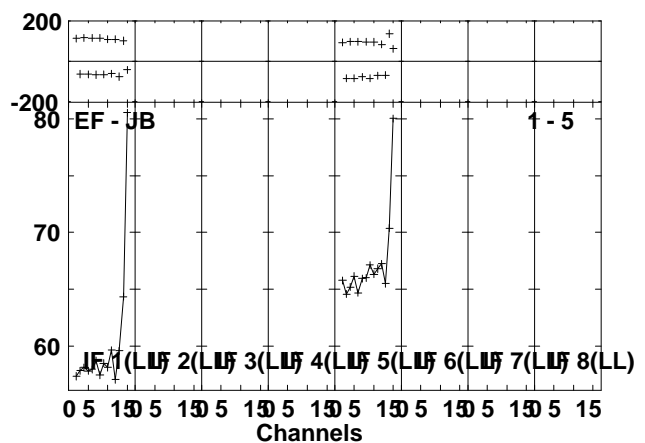
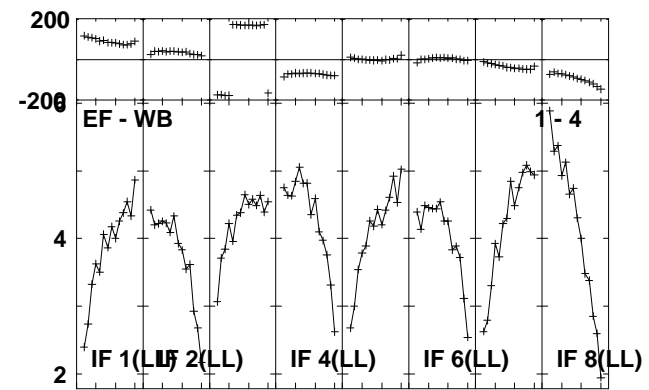
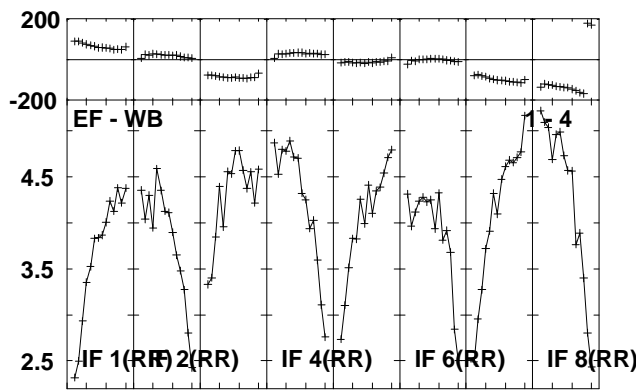
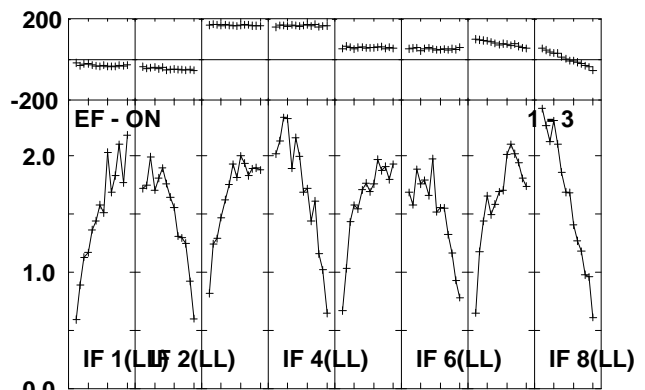
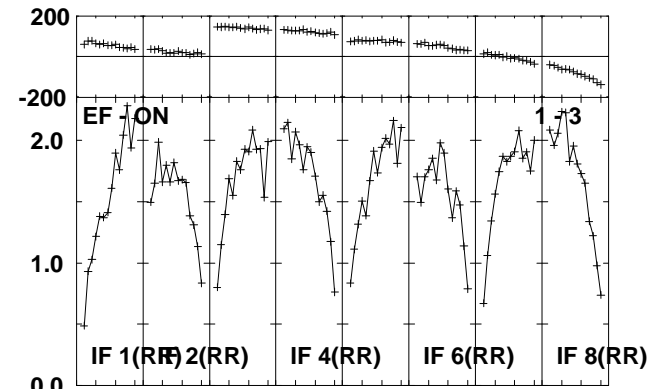
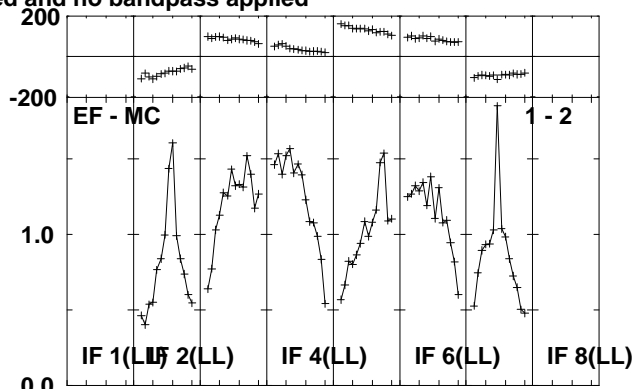
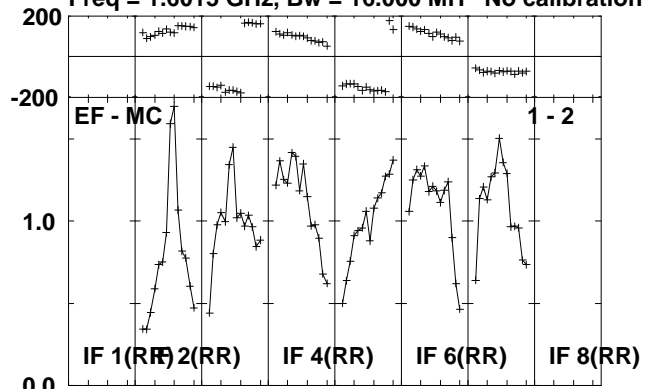

Lower frame: Milli Ampl Jy Top frame: Phas deg
Scalar averaged cross-power spectrum Several baselines displayed
Timerange: 01/06:51:05 to 01/06:52:49

Plot file version 299 created 01-JUL-2010 13:27:22

J2102+47 RG006B.UVDATA.1

Freq = 1.6015 GHz, Bw = 16.000 MH No calibration applied and no bandpass applied

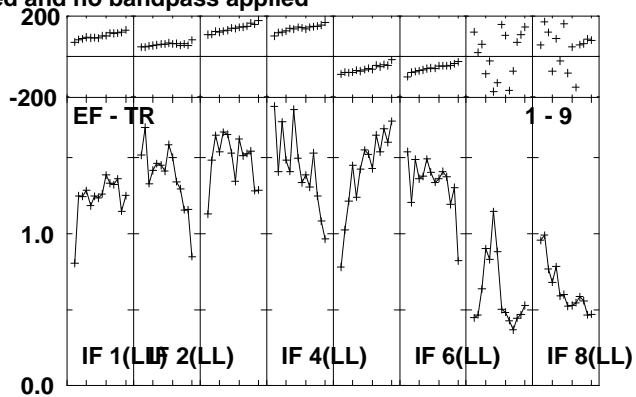
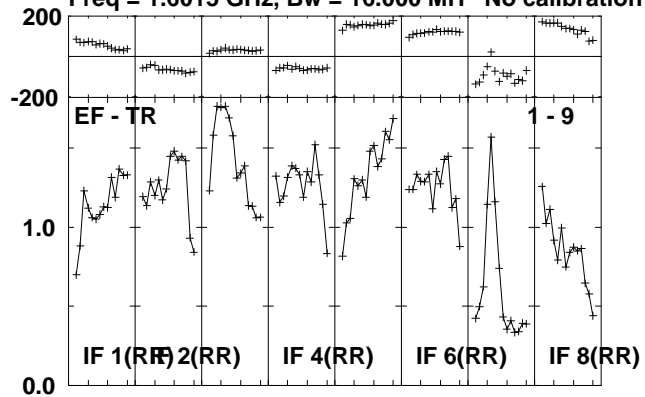

Lower frame: Milli Ampl Jy Top frame: Phas deg
Scalar averaged cross-power spectrum Several baselines displayed
Timerange: 01/06:51:05 to 01/06:52:49

Plot file version 300 created 01-JUL-2010 13:27:22

V407CYG RG006B.UVDATA.1

Freq = 1.6015 GHz, Bw = 16.000 MH No calibration applied and no bandpass applied

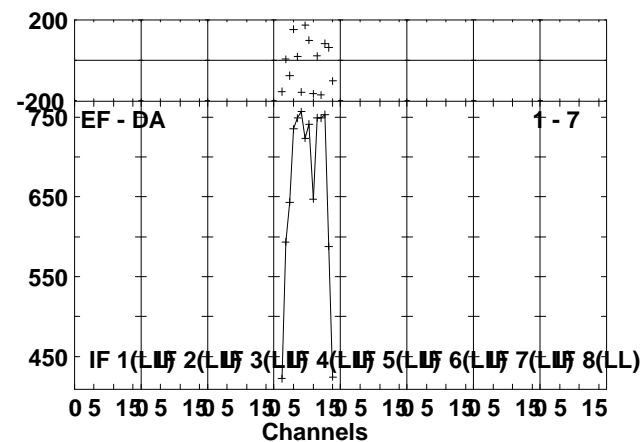
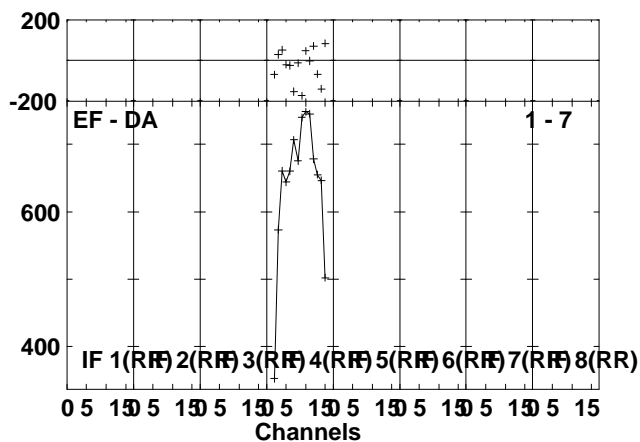
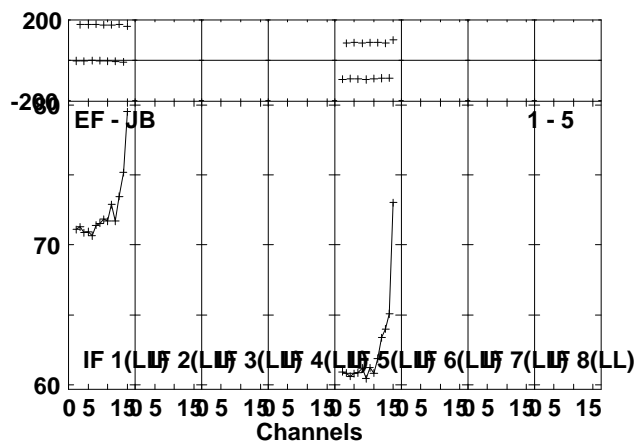
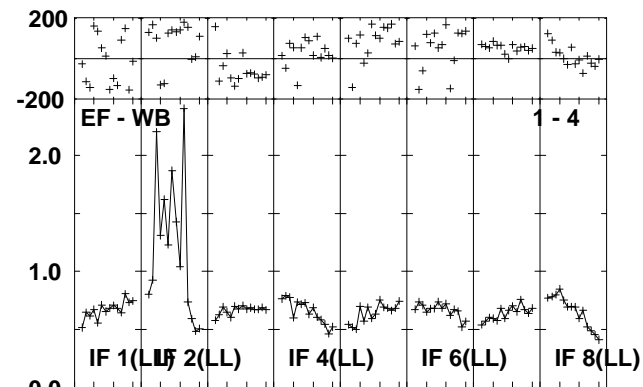
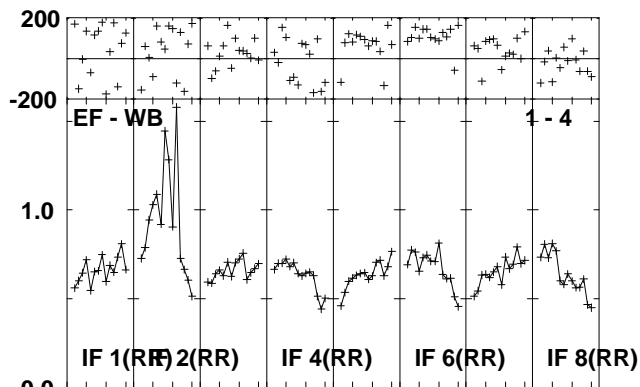
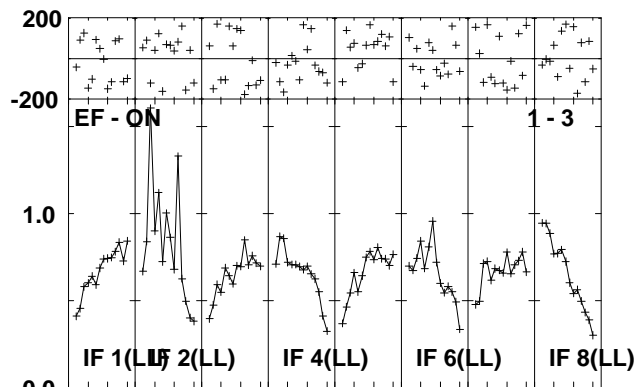
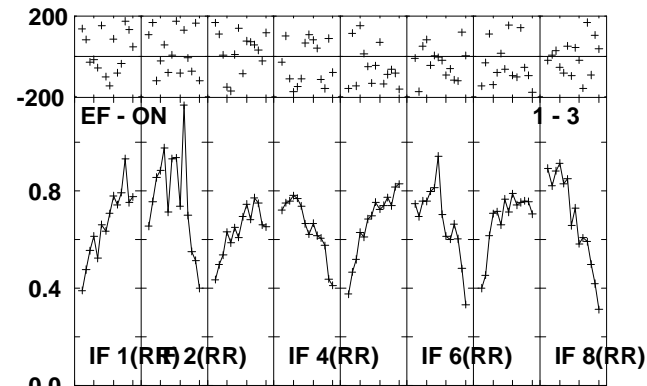
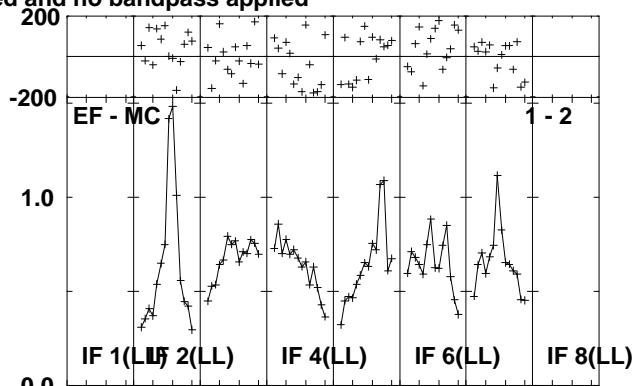
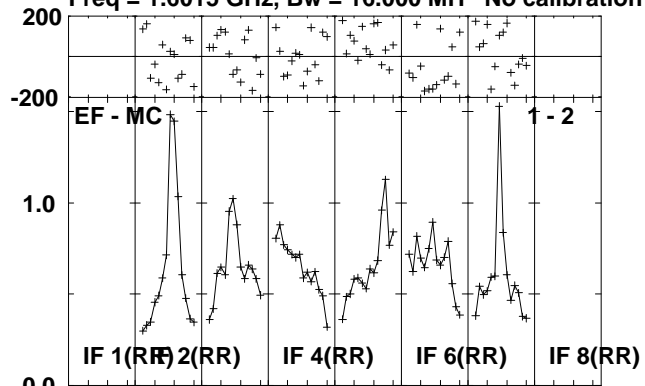

Lower frame: Milli Ampl Jy Top frame: Phas deg
Scalar averaged cross-power spectrum Several baselines displayed
Timerange: 01/06:52:53 to 01/06:57:49

Plot file version 301 created 01-JUL-2010 13:27:24

V407CYG RG006B.UVDATA.1

Freq = 1.6015 GHz, Bw = 16.000 MH No calibration applied and no bandpass applied

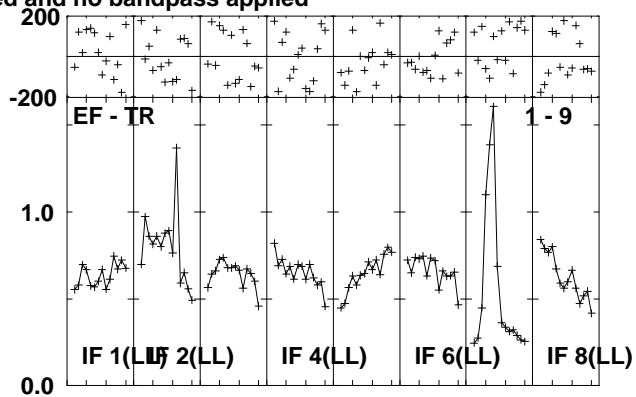
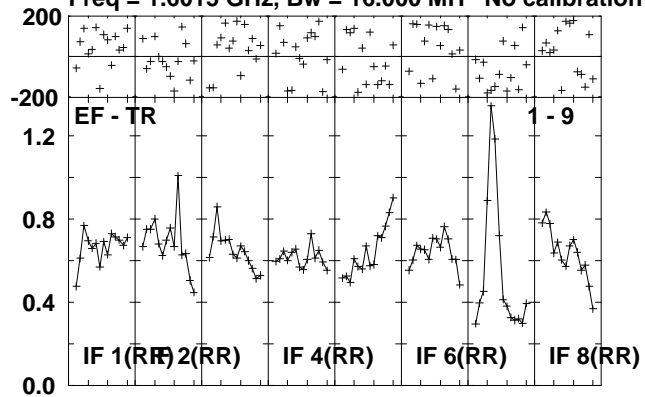

Lower frame: Milli Ampl Jy Top frame: Phas deg
Scalar averaged cross-power spectrum Several baselines displayed
Timerange: 01/06:52:53 to 01/06:57:49

Plot file version 302 created 01-JUL-2010 13:27:24

J2102+47 RG006B.UVDATA.1

Freq = 1.6015 GHz, Bw = 16.000 MH No calibration applied and no bandpass applied

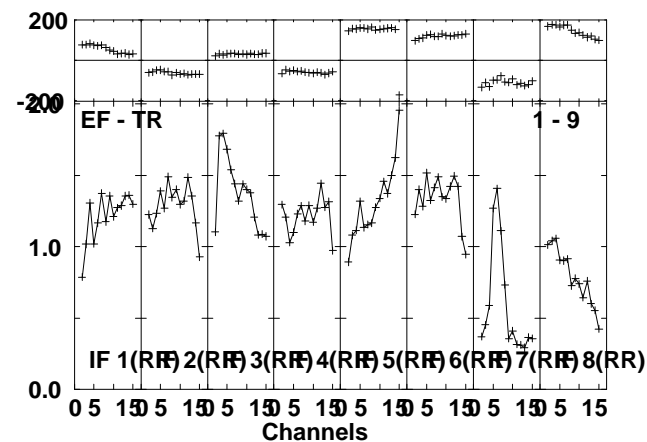
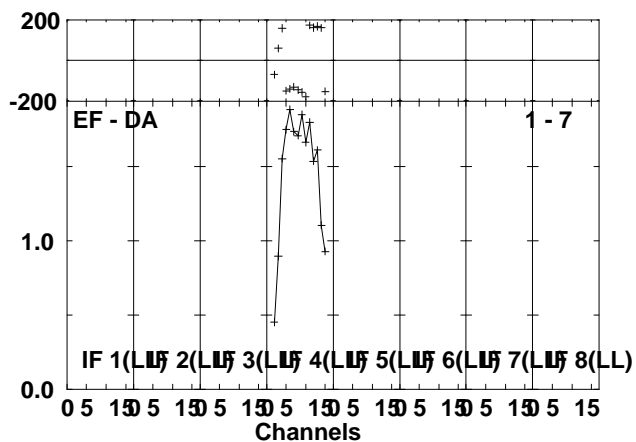
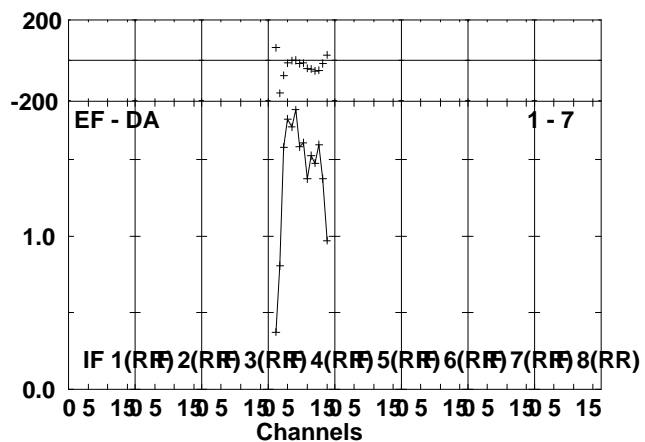
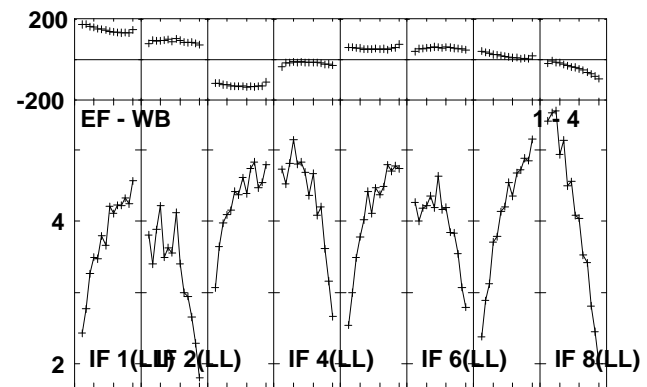
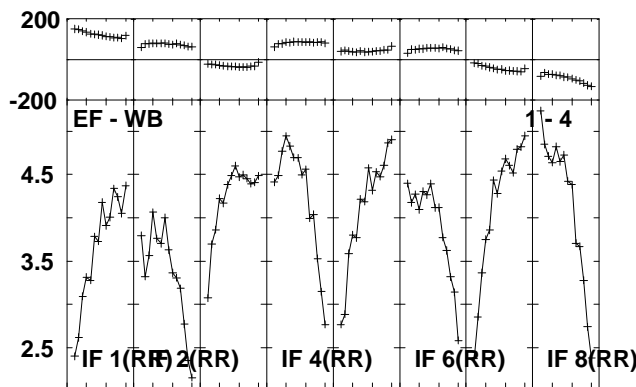
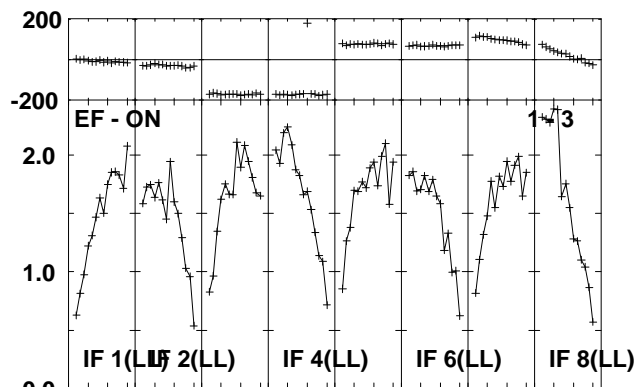
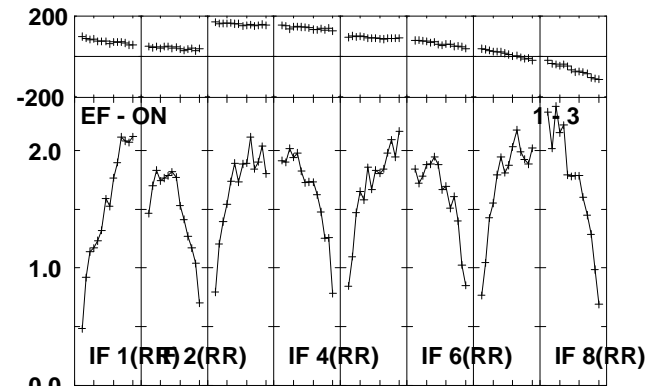
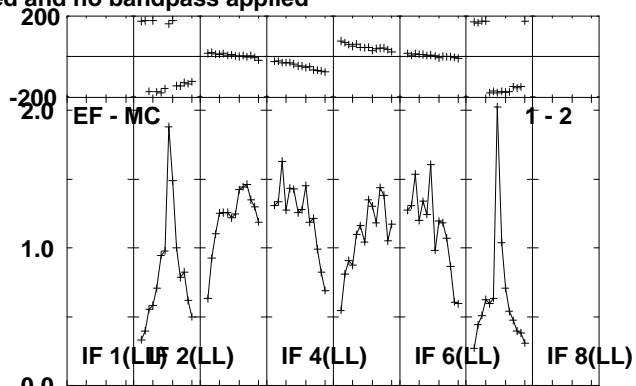
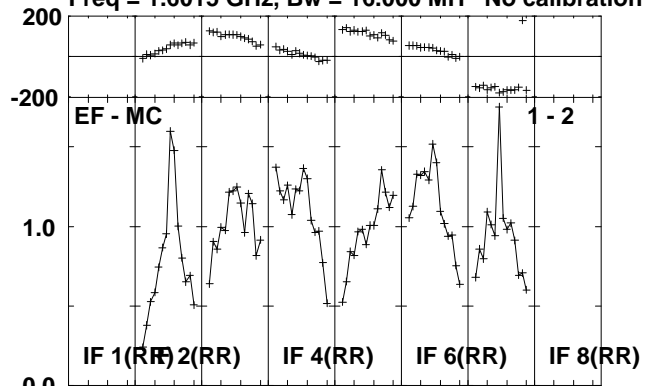

Lower frame: Milli Ampl Jy Top frame: Phas deg
Scalar averaged cross-power spectrum Several baselines displayed
Timerange: 01/06:57:53 to 01/07:00:01

Plot file version 303 created 01-JUL-2010 13:27:25
J2102+47 RG006B.UVDATA.1
Freq = 1.6015 GHz, Bw = 16.000 MH No calibration applied and no bandpass applied

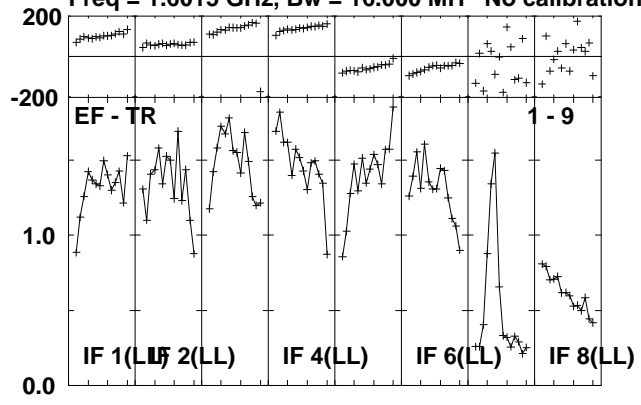

Lower frame: Milli Ampl Jy Top frame: Phas deg
Scalar averaged cross-power spectrum Several baselines displayed
Timerange: 01/06:57:53 to 01/07:00:01

Plot file version 304 created 01-JUL-2010 13:27:25

V407CYG RG006B.UVDATA.1

Freq = 1.6015 GHz, Bw = 16.000 MH No calibration applied and no bandpass applied

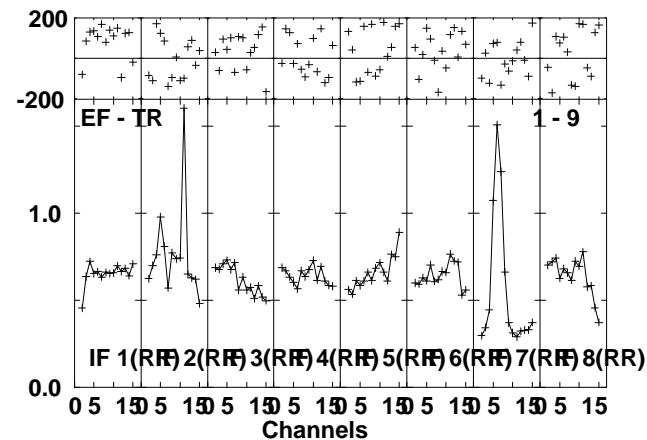
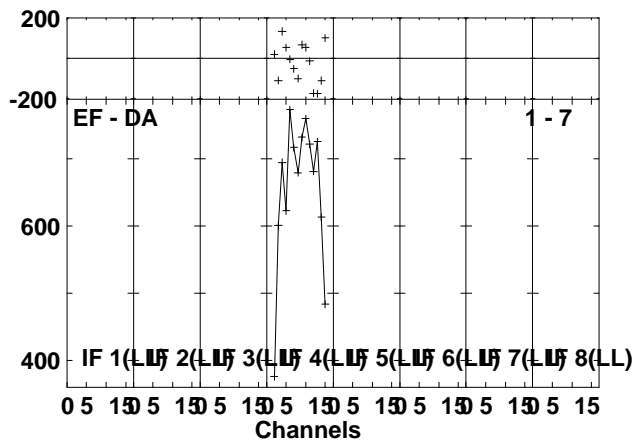
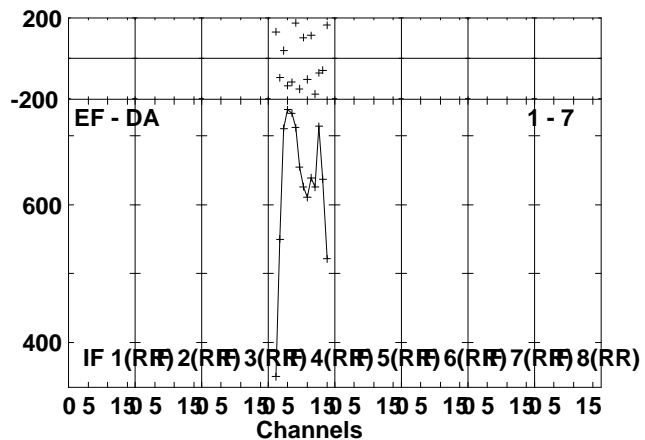
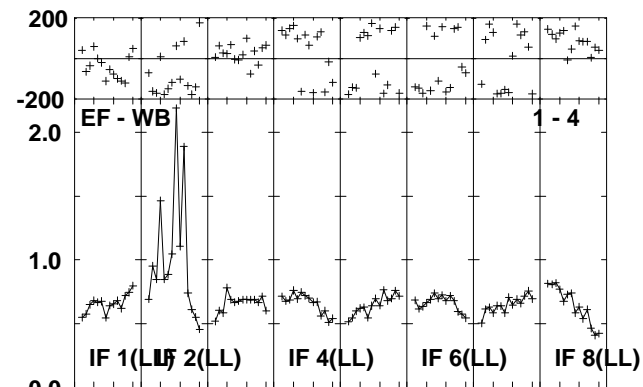
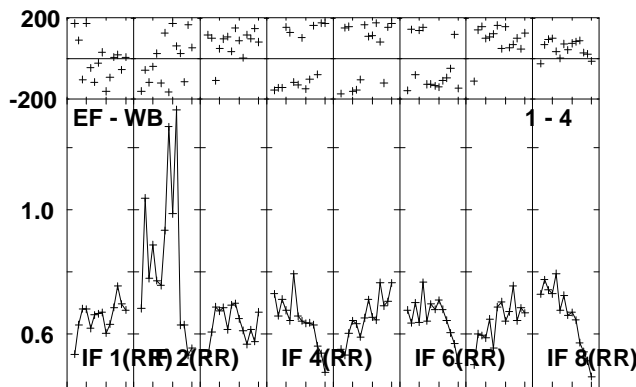
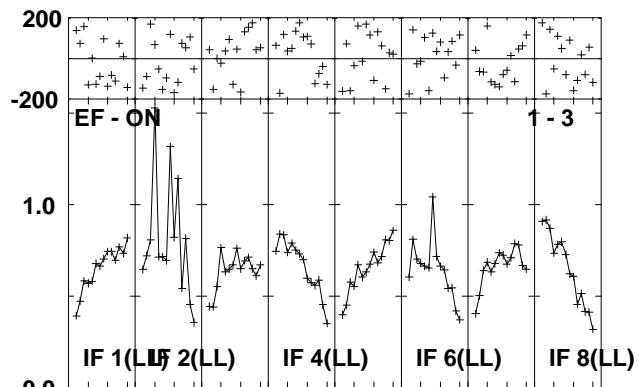
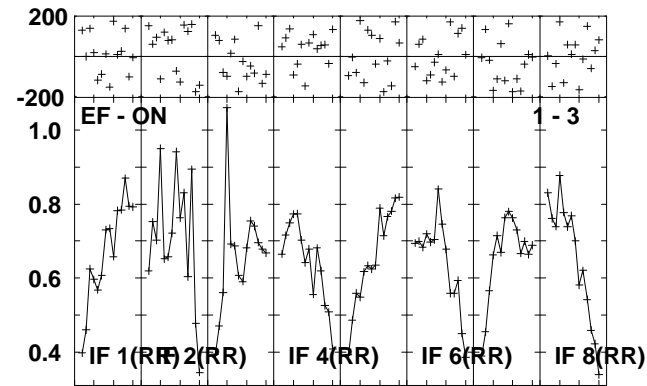
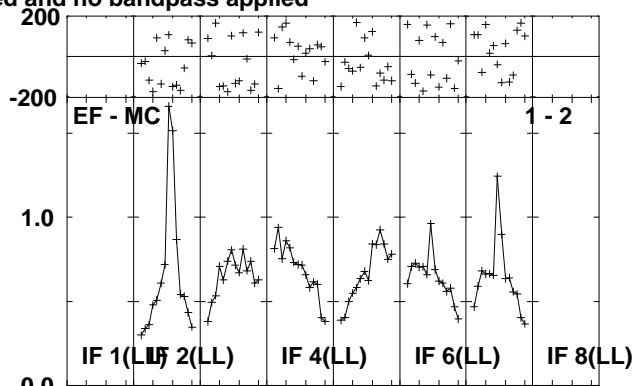
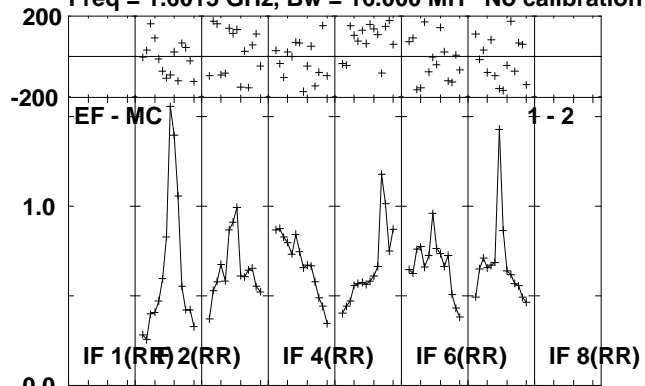

Lower frame: Milli Ampl Jy Top frame: Phas deg
Scalar averaged cross-power spectrum Several baselines displayed
Timerange: 01/07:00:05 to 01/07:05:01

Plot file version 305 created 01-JUL-2010 13:27:26
V407CYG RG006B.UVDATA.1
Freq = 1.6015 GHz, Bw = 16.000 MH No calibration applied and no bandpass applied

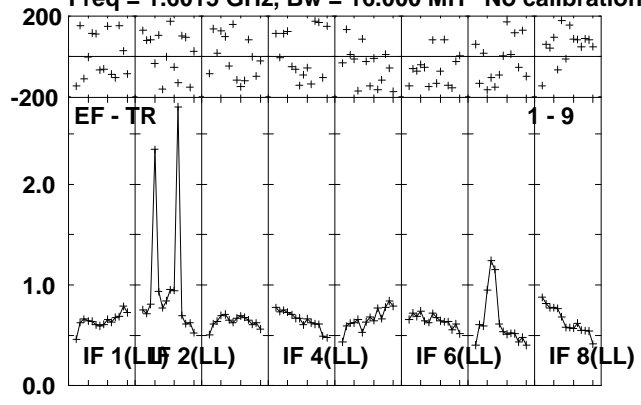

Lower frame: Milli Ampl Jy Top frame: Phas deg
Scalar averaged cross-power spectrum Several baselines displayed
Timerange: 01/07:00:05 to 01/07:05:01

Plot file version 306 created 01-JUL-2010 13:27:26

J2102+47 RG006B.UVDATA.1

Freq = 1.6015 GHz, Bw = 16.000 MH No calibration applied and no bandpass applied

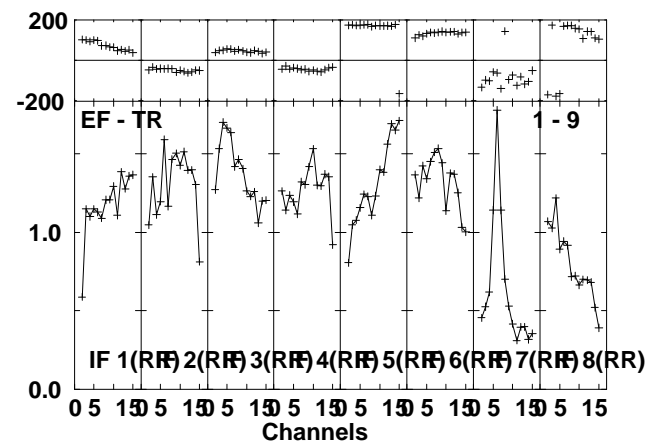
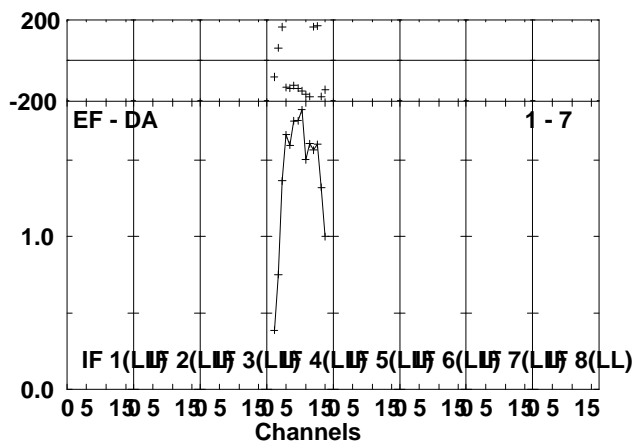
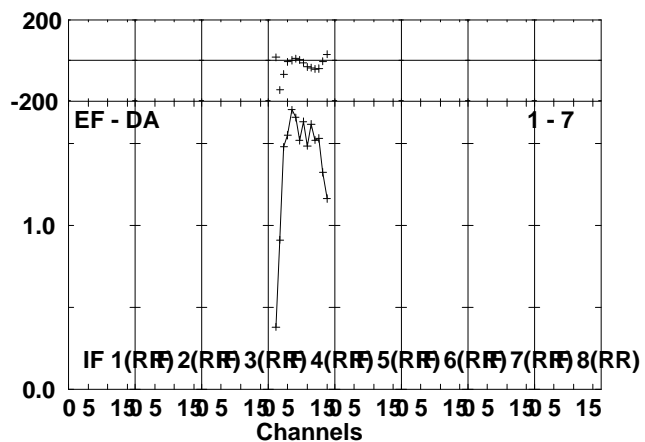
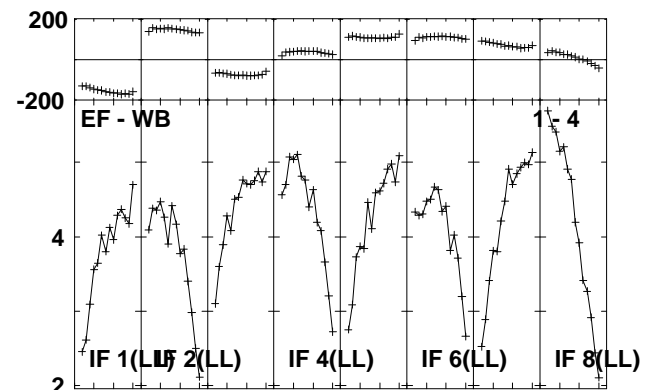
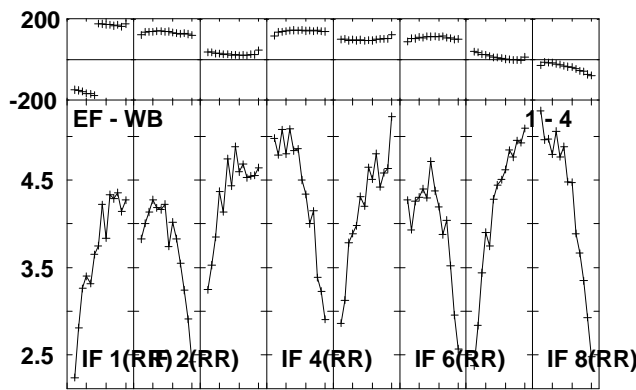
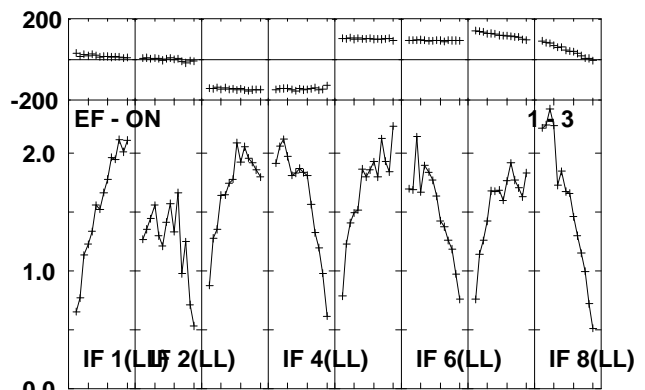
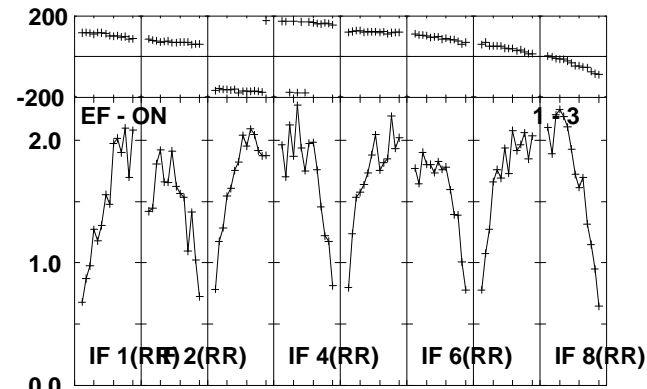
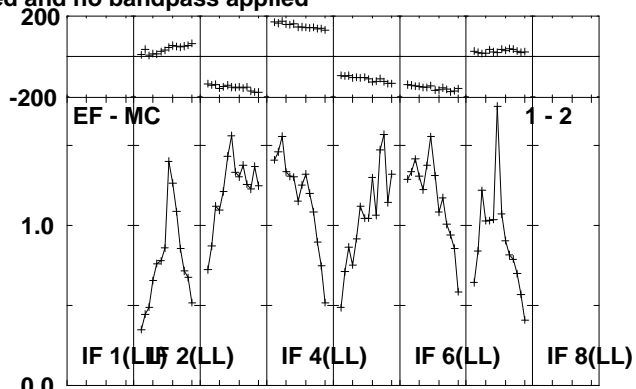
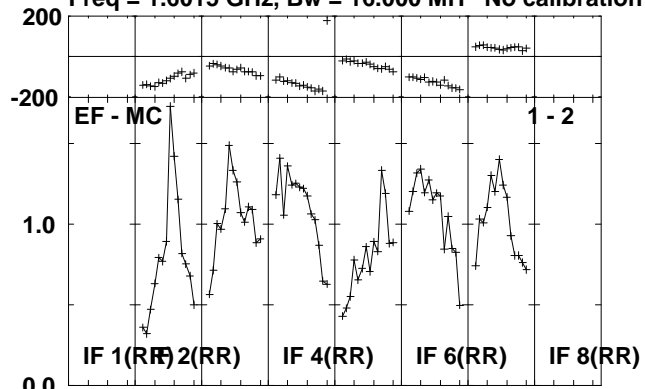

Lower frame: Milli Ampl Jy Top frame: Phas deg
Scalar averaged cross-power spectrum Several baselines displayed
Timerange: 01/07:06:05 to 01/07:07:49

Plot file version 307 created 01-JUL-2010 13:27:27
J2102+47 RG006B.UVDATA.1
Freq = 1.6015 GHz, Bw = 16.000 MH No calibration applied and no bandpass applied

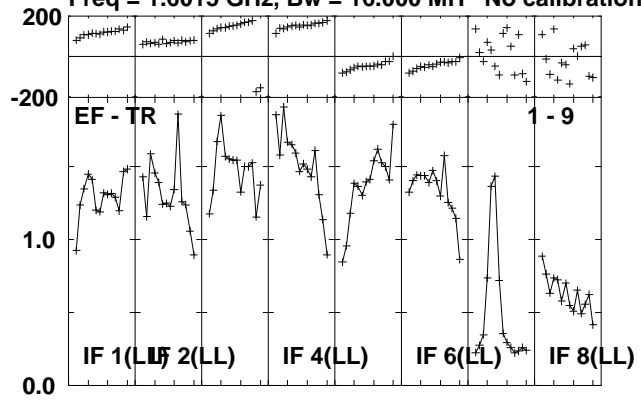

Lower frame: Milli Ampl Jy Top frame: Phas deg
Scalar averaged cross-power spectrum Several baselines displayed
Timerange: 01/07:06:05 to 01/07:07:49

Plot file version 308 created 01-JUL-2010 13:27:27

V407CYG RG006B.UVDATA.1

Freq = 1.6015 GHz, Bw = 16.000 MH No calibration applied and no bandpass applied

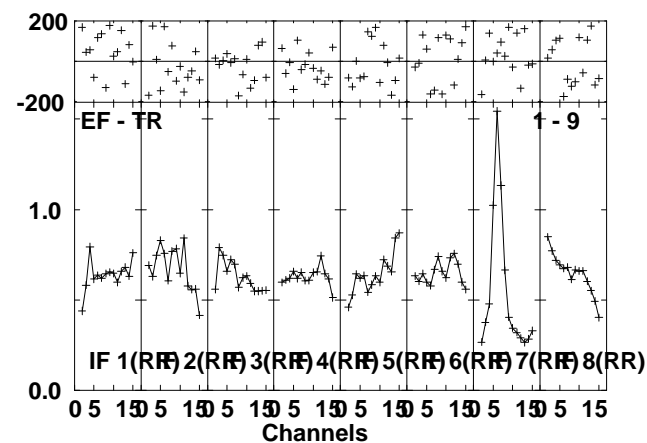
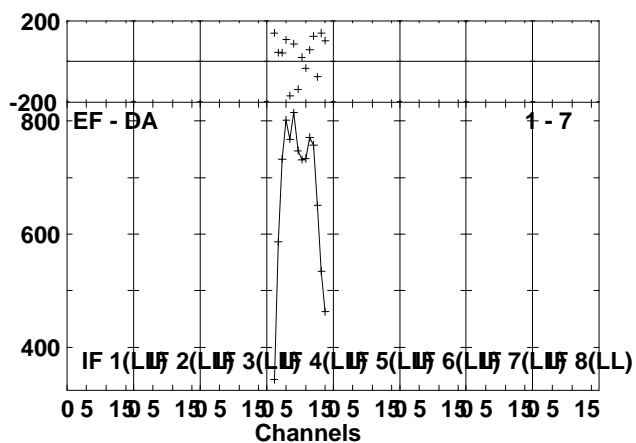
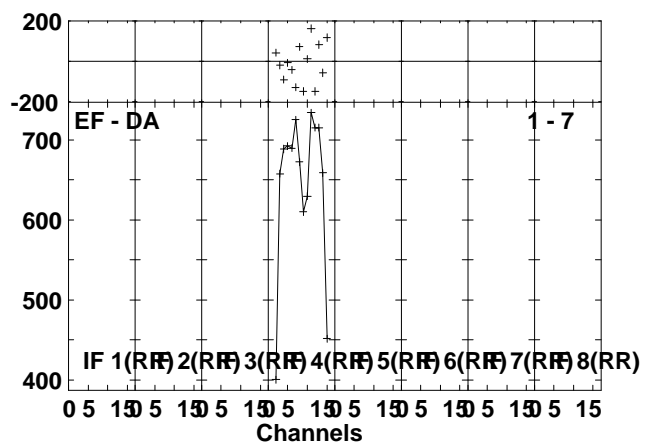
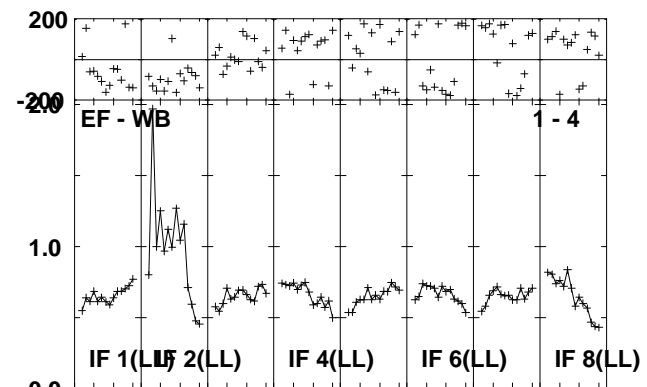
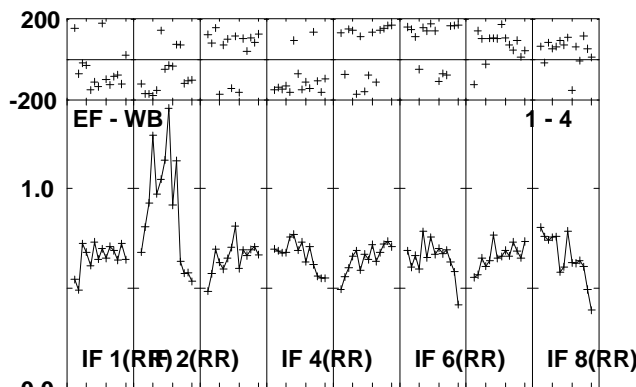
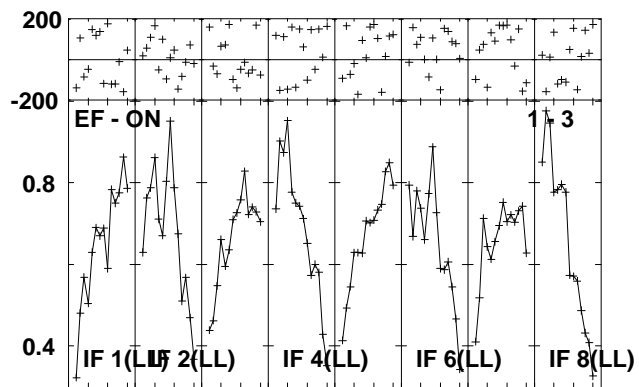
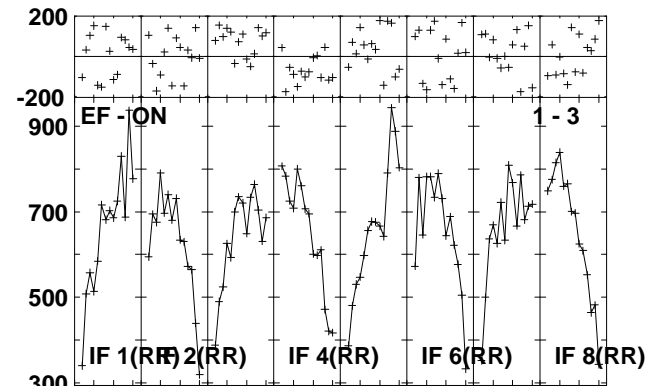
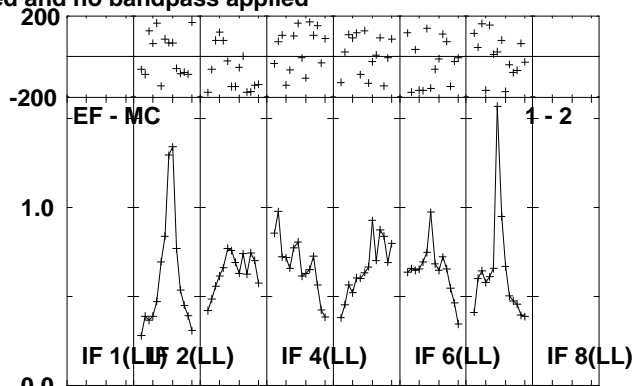
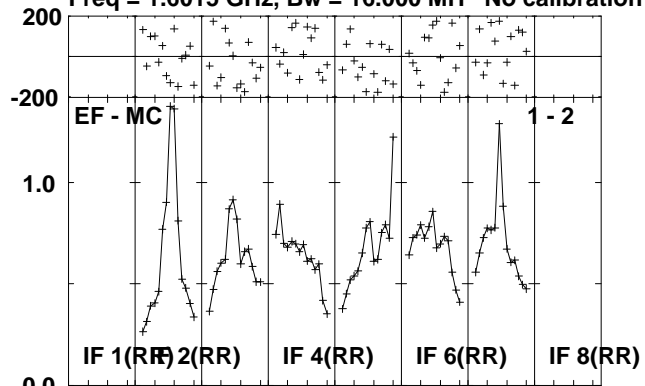

Lower frame: Milli Ampl Jy Top frame: Phas deg
Scalar averaged cross-power spectrum Several baselines displayed
Timerange: 01/07:07:53 to 01/07:12:49

Plot file version 309 created 01-JUL-2010 13:27:28
V407CYG RG006B.UVDATA.1
Freq = 1.6015 GHz, Bw = 16.000 MH No calibration applied and no bandpass applied

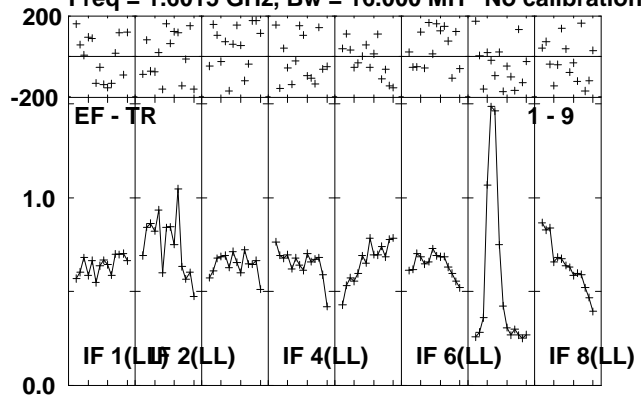

Lower frame: Milli Ampl Jy Top frame: Phas deg
Scalar averaged cross-power spectrum Several baselines displayed
Timerange: 01/07:07:53 to 01/07:12:49

Plot file version 310 created 01-JUL-2010 13:27:28

J2102+47 RG006B.UVDATA.1

Freq = 1.6015 GHz, Bw = 16.000 MH No calibration applied and no bandpass applied

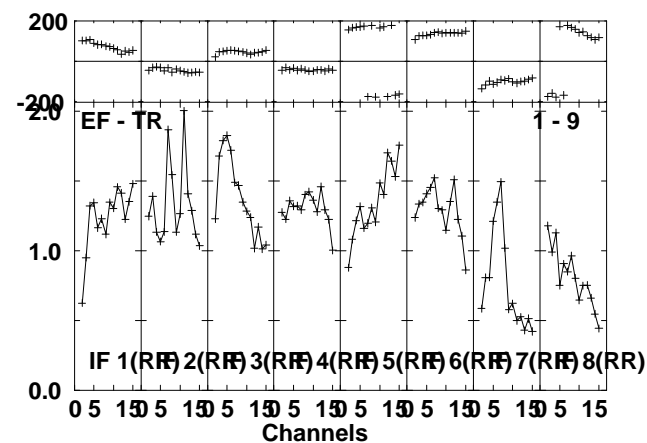
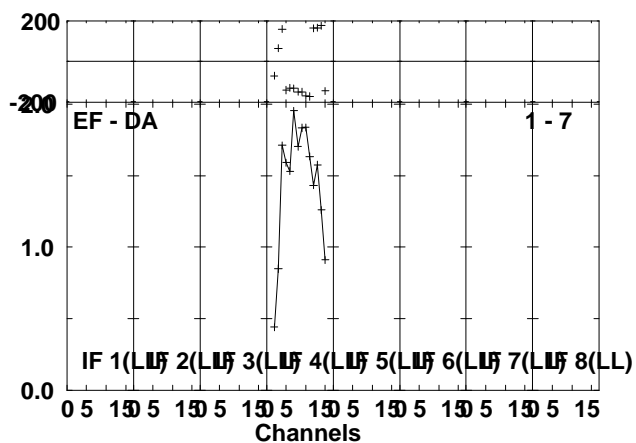
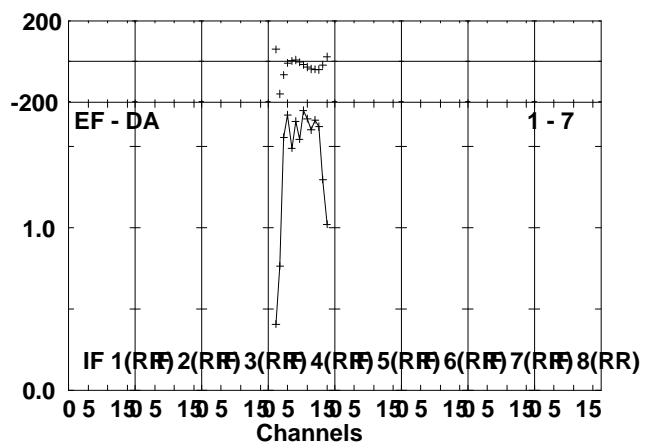
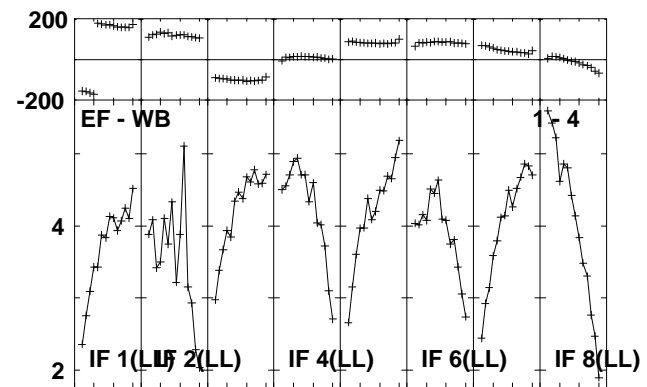
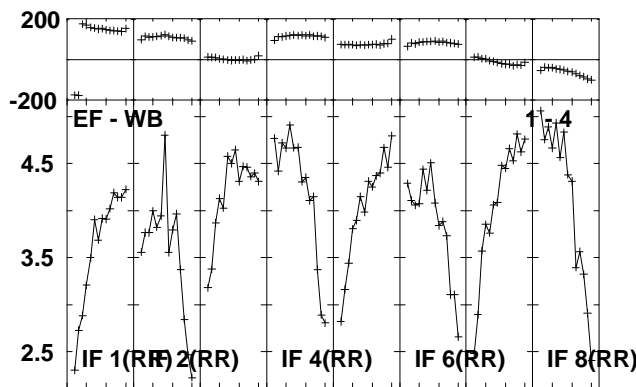
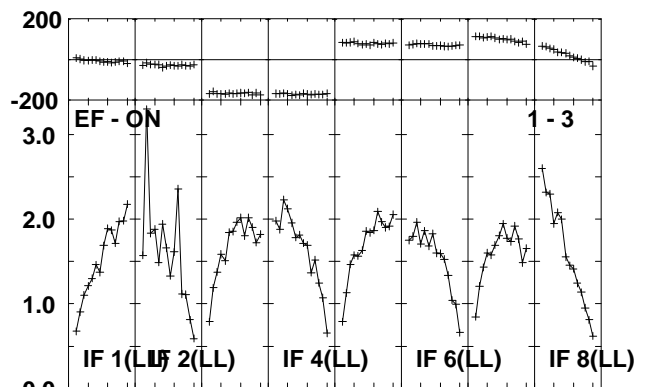
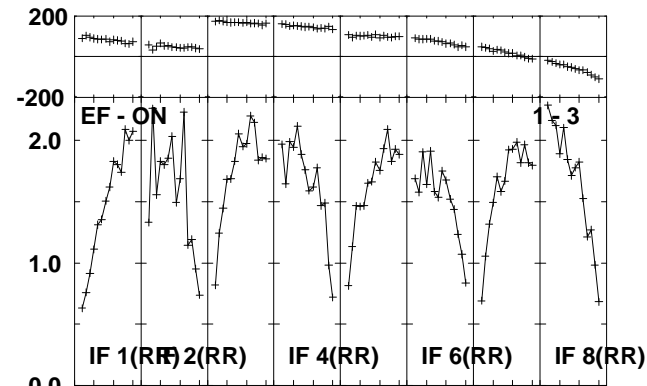
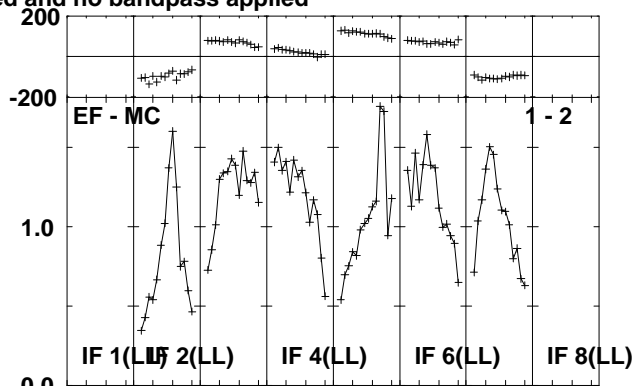
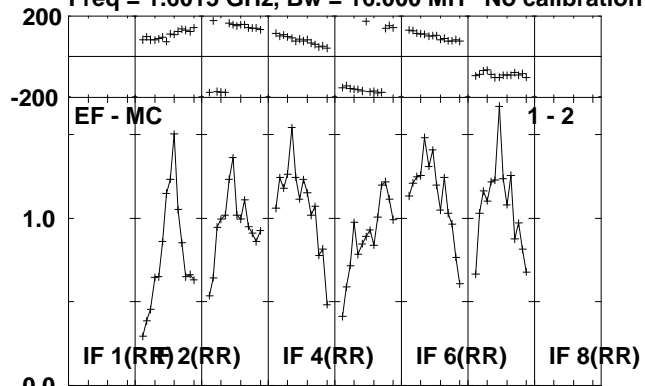

Lower frame: Milli Ampl Jy Top frame: Phas deg
Scalar averaged cross-power spectrum Several baselines displayed
Timerange: 01/07:12:53 to 01/07:15:01

Plot file version 311 created 01-JUL-2010 13:27:29
J2102+47 RG006B.UVDATA.1
Freq = 1.6015 GHz, Bw = 16.000 MH No calibration applied and no bandpass applied

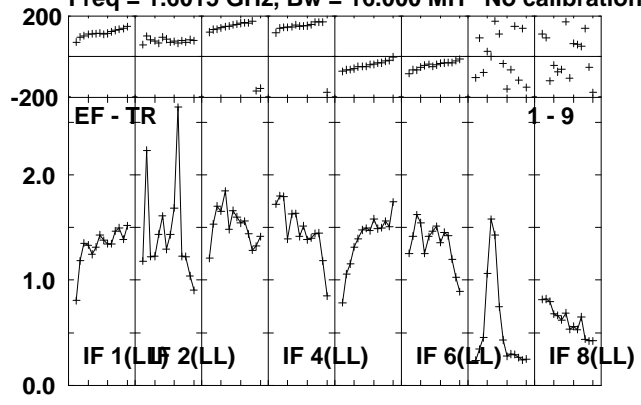

Lower frame: Milli Ampl Jy Top frame: Phas deg
Scalar averaged cross-power spectrum Several baselines displayed
Timerange: 01/07:12:53 to 01/07:15:01

Plot file version 312 created 01-JUL-2010 13:27:29

V407CYG RG006B.UVDATA.1

Freq = 1.6015 GHz, Bw = 16.000 MH No calibration applied and no bandpass applied

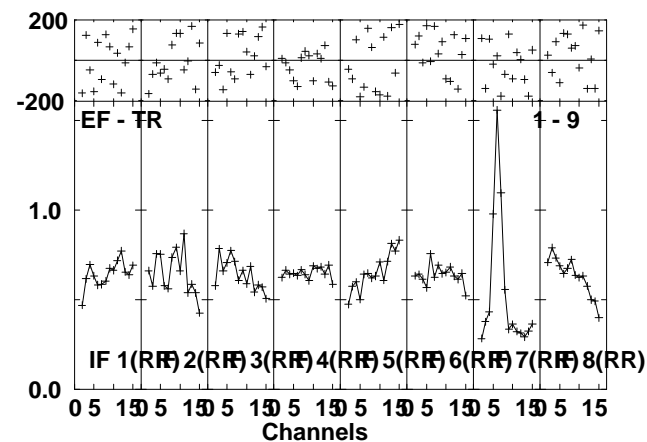
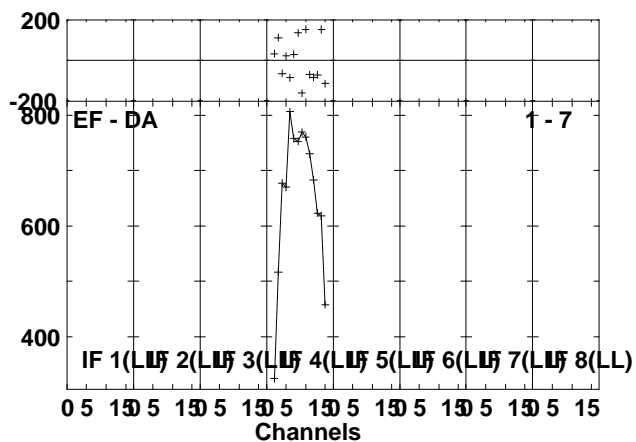
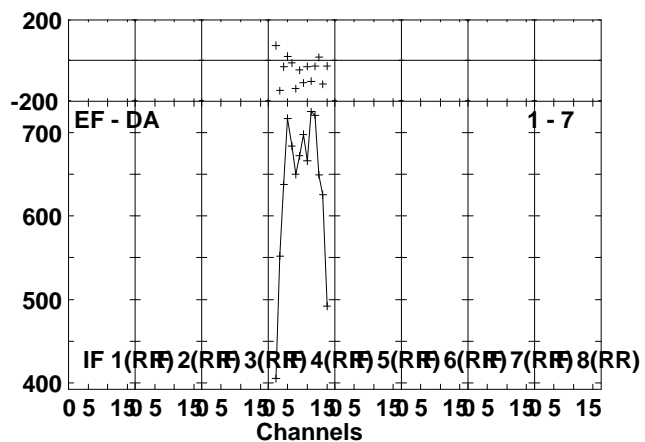
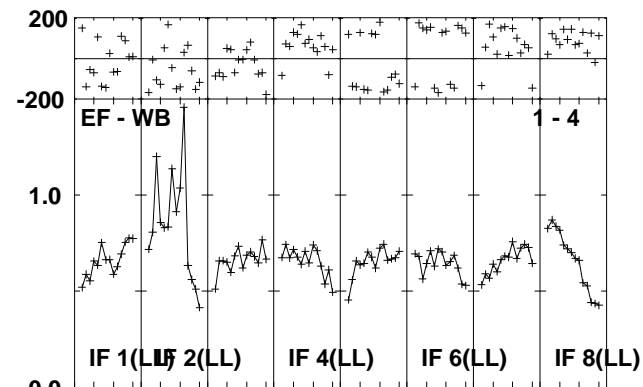
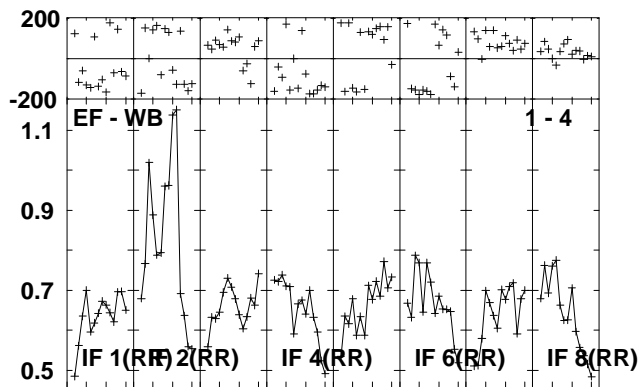
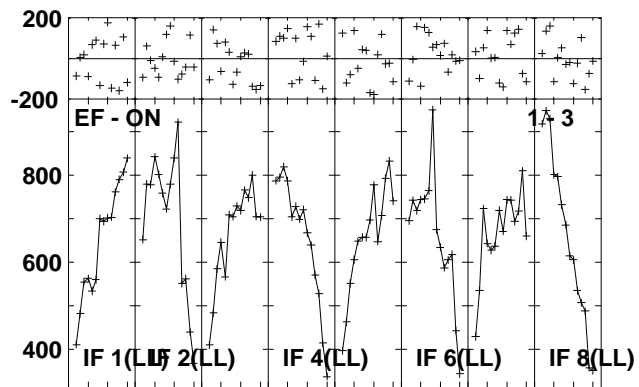
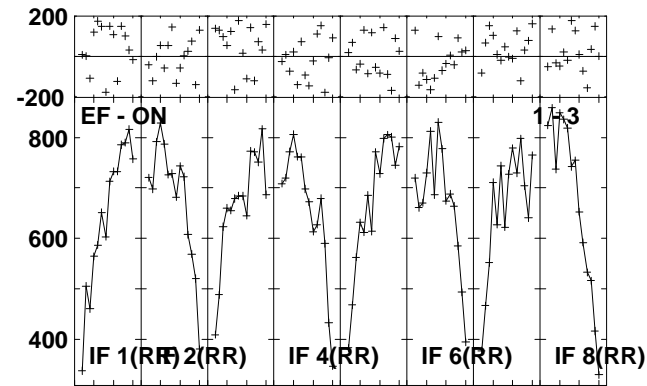
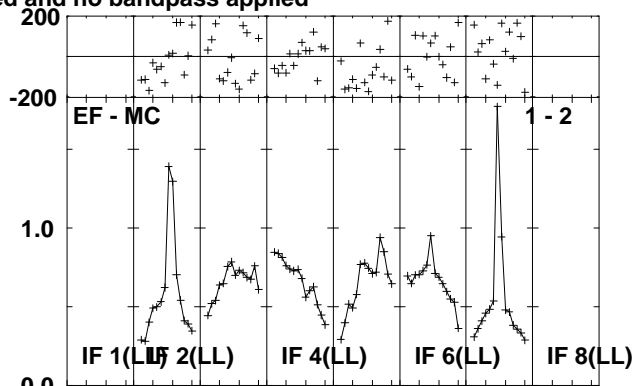
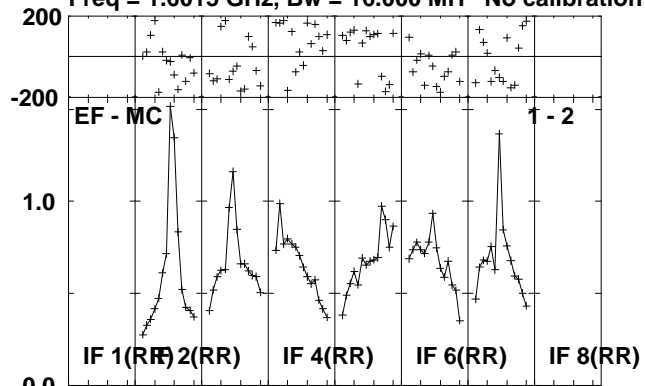

Lower frame: Milli Ampl Jy Top frame: Phas deg
Scalar averaged cross-power spectrum Several baselines displayed
Timerange: 01/07:15:05 to 01/07:20:01

Plot file version 313 created 01-JUL-2010 13:27:30
V407CYG RG006B.UVDATA.1
Freq = 1.6015 GHz, Bw = 16.000 MH No calibration applied and no bandpass applied

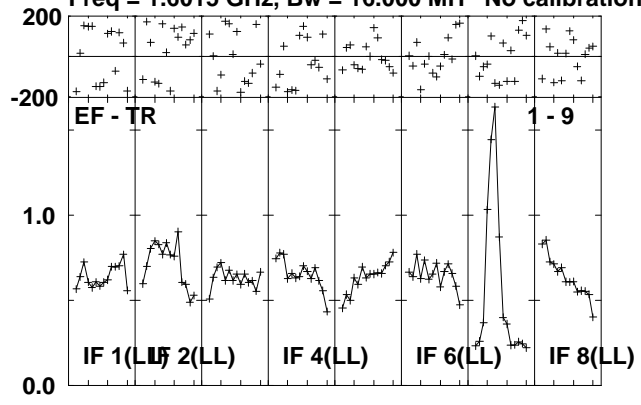

Lower frame: Milli Ampl Jy Top frame: Phas deg
Scalar averaged cross-power spectrum Several baselines displayed
Timerange: 01/07:15:05 to 01/07:20:01

Plot file version 314 created 01-JUL-2010 13:27:30

J2102+47 RG006B.UVDATA.1

Freq = 1.6015 GHz, Bw = 16.000 MH No calibration applied and no bandpass applied

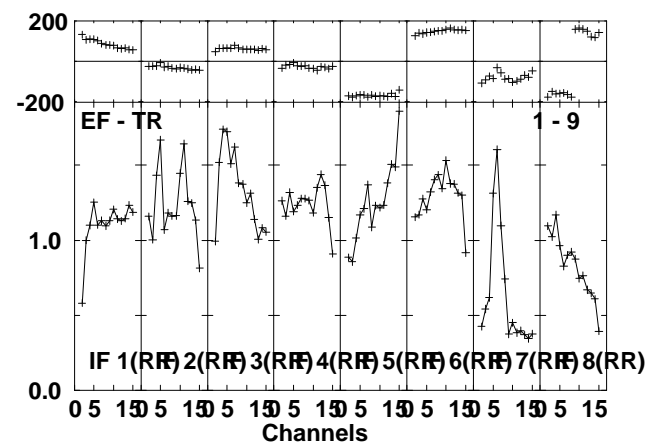
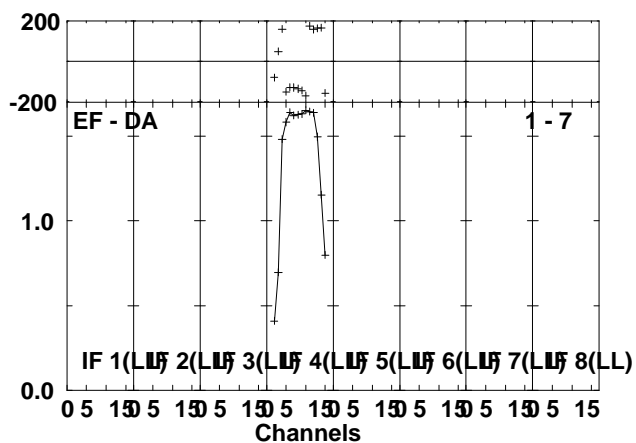
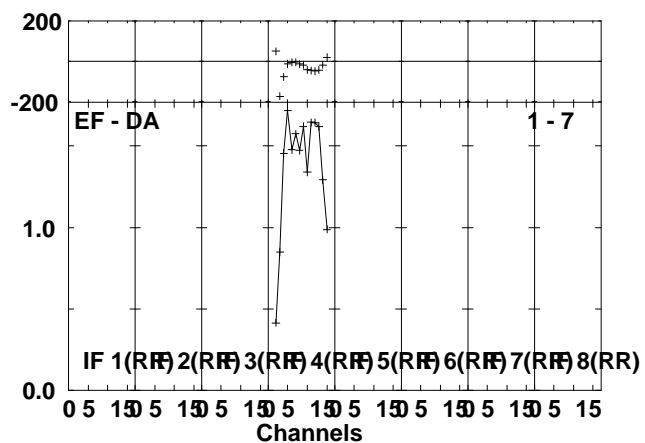
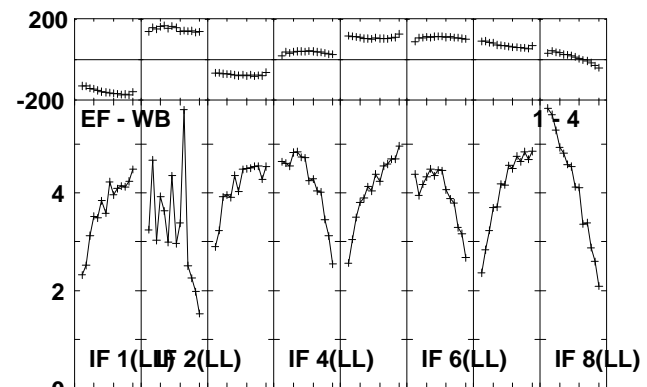
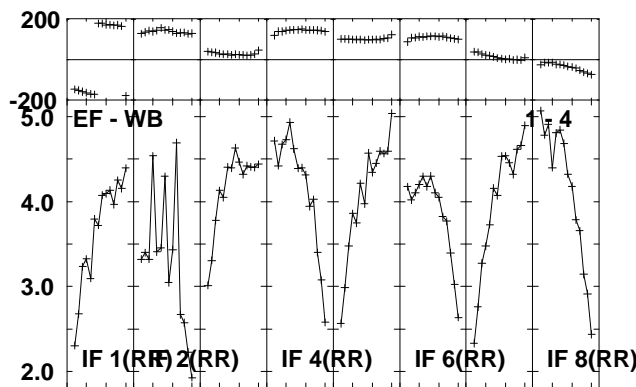
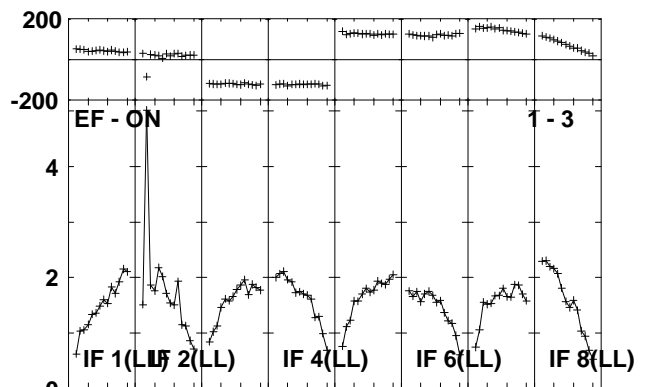
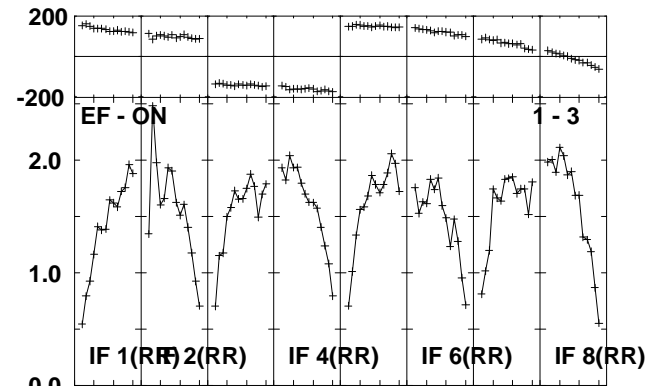
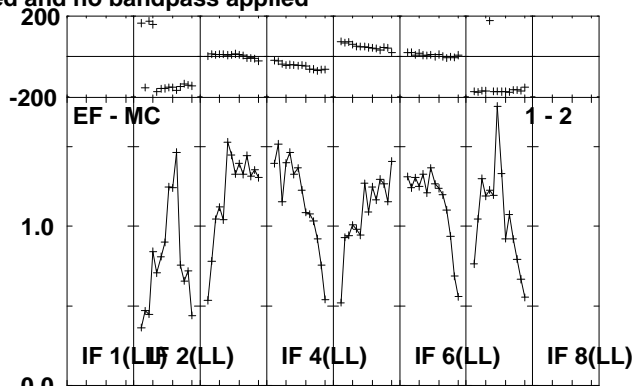
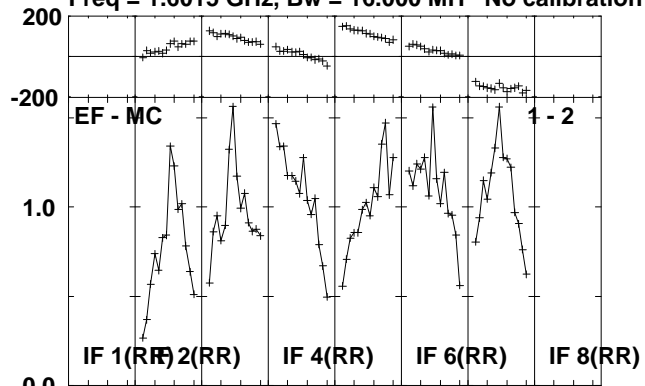

Lower frame: Milli Ampl Jy Top frame: Phas deg
Scalar averaged cross-power spectrum Several baselines displayed
Timerange: 01/07:21:05 to 01/07:22:49

Plot file version 315 created 01-JUL-2010 13:27:31

J2102+47 RG006B.UVDATA.1

Freq = 1.6015 GHz, Bw = 16.000 MH No calibration applied and no bandpass applied

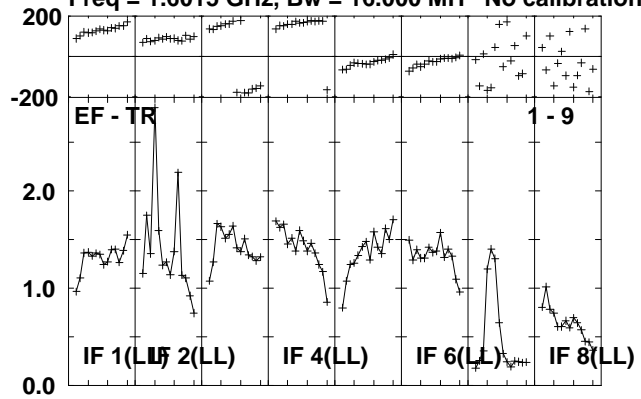

Lower frame: Milli Ampl Jy Top frame: Phas deg
Scalar averaged cross-power spectrum Several baselines displayed
Timerange: 01/07:21:05 to 01/07:22:49

Plot file version 316 created 01-JUL-2010 13:27:31

V407CYG RG006B.UVDATA.1

Freq = 1.6015 GHz, Bw = 16.000 MH No calibration applied and no bandpass applied

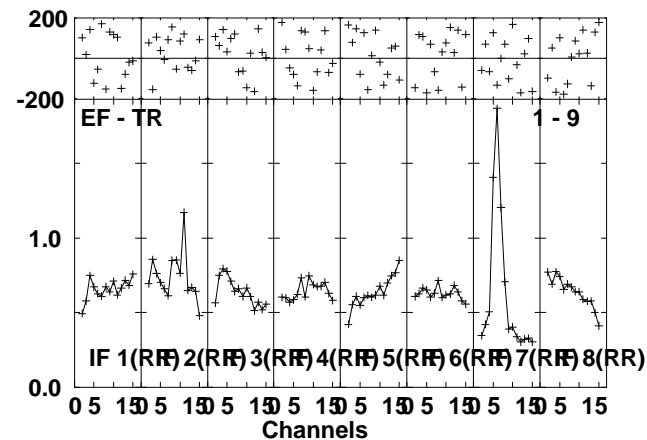
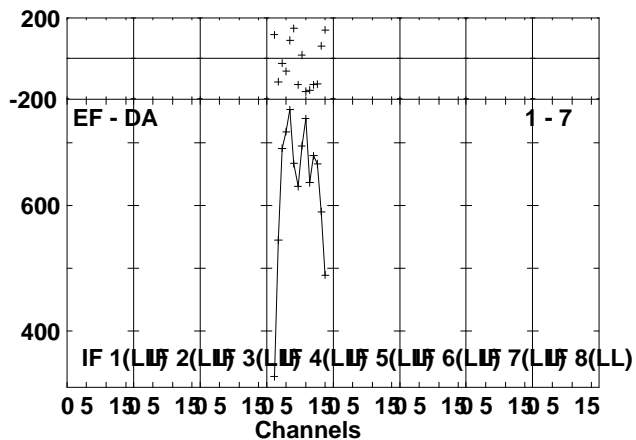
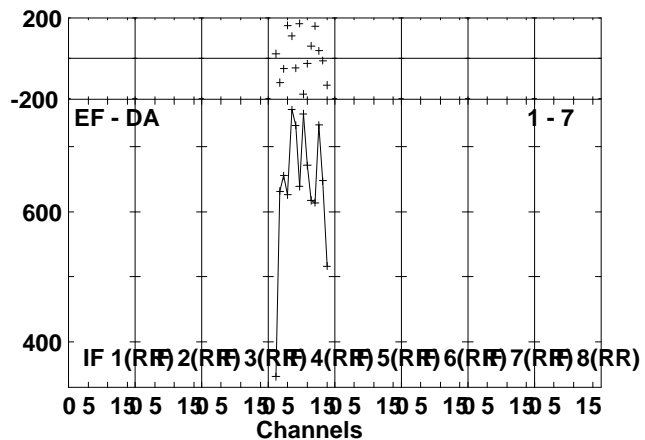
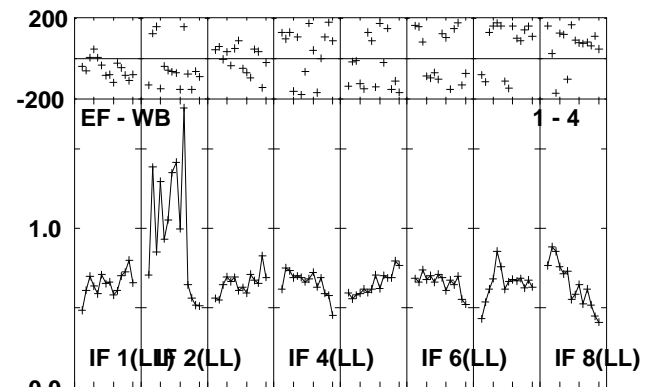
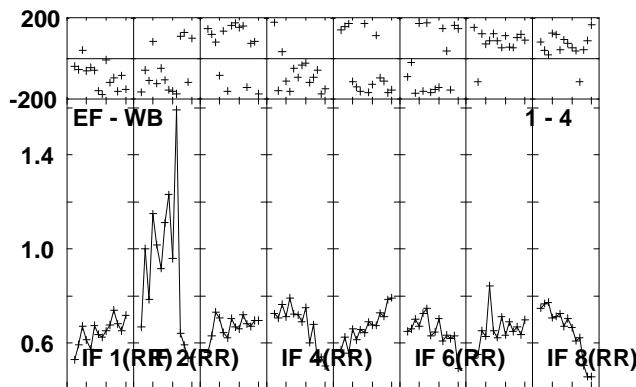
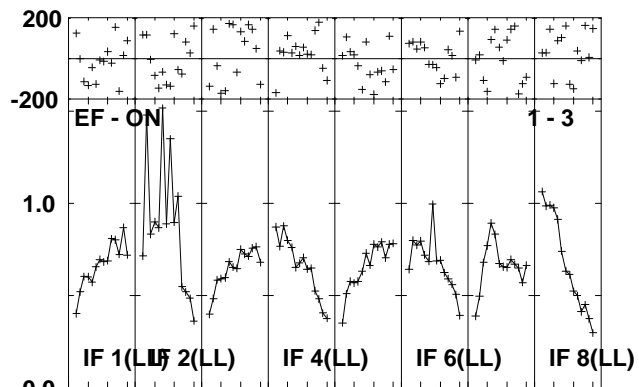
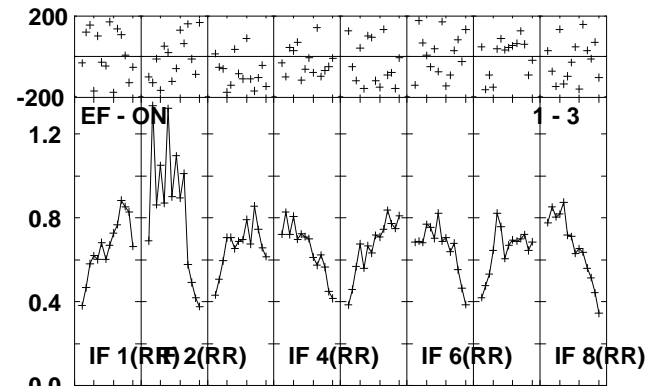
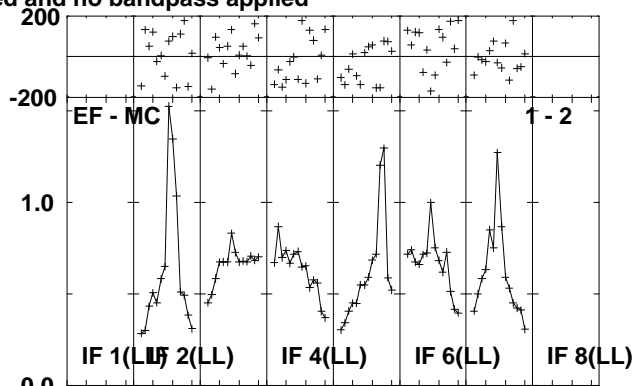
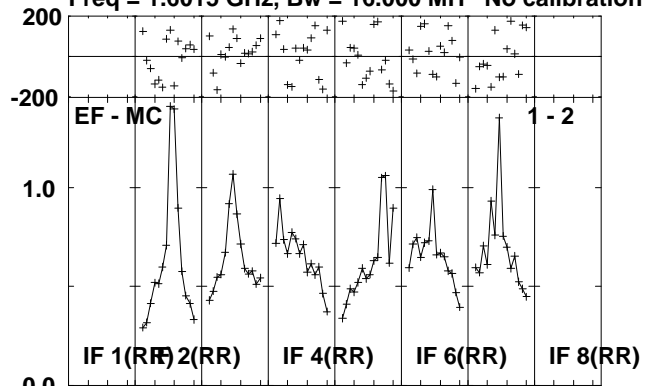

Lower frame: Milli Ampl Jy Top frame: Phas deg
Scalar averaged cross-power spectrum Several baselines displayed
Timerange: 01/07:22:53 to 01/07:27:49

Plot file version 317 created 01-JUL-2010 13:27:32
V407CYG RG006B.UVDATA.1
Freq = 1.6015 GHz, Bw = 16.000 MH No calibration applied and no bandpass applied

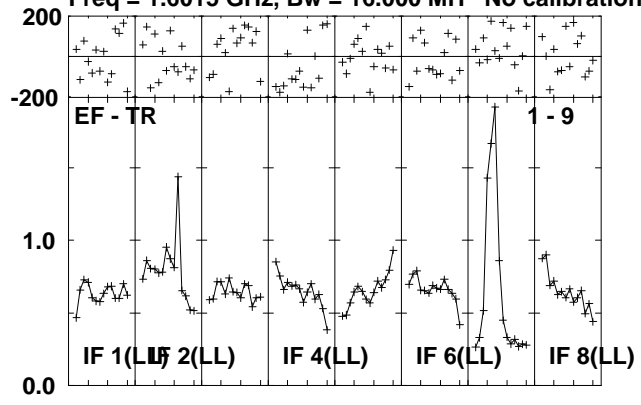

Lower frame: Milli Ampl Jy Top frame: Phas deg
Scalar averaged cross-power spectrum Several baselines displayed
Timerange: 01/07:22:53 to 01/07:27:49

Plot file version 319 created 01-JUL-2010 13:27:33
J2102+47 RG006B.UVDATA.1
Freq = 1.6015 GHz, Bw = 16.000 MH No calibration applied and no bandpass applied

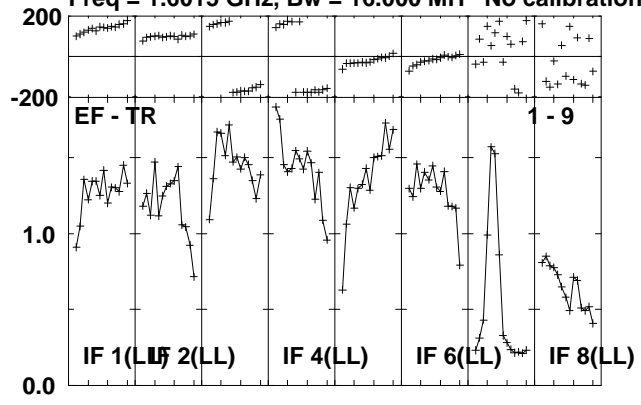

Lower frame: Milli Ampl Jy Top frame: Phas deg
Scalar averaged cross-power spectrum Several baselines displayed
Timerange: 01/07:27:53 to 01/07:30:01

Plot file version 320 created 01-JUL-2010 13:27:33

V407CYG RG006B.UVDATA.1

Freq = 1.6015 GHz, Bw = 16.000 MH No calibration applied and no bandpass applied

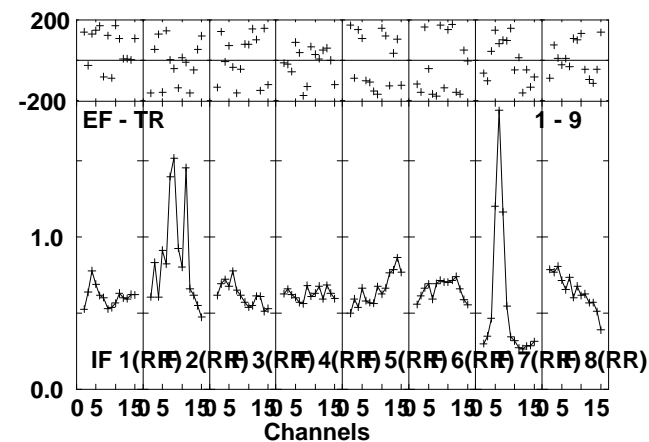
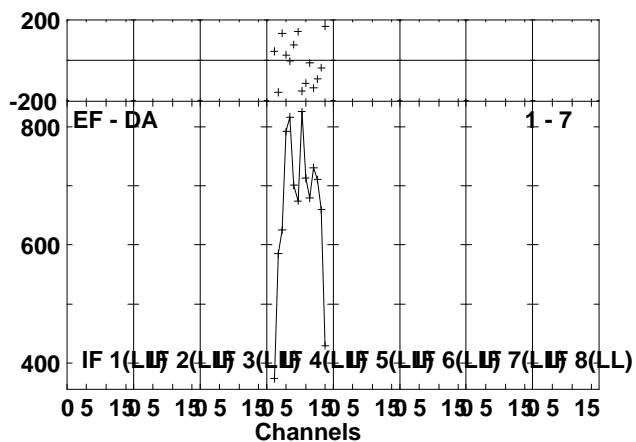
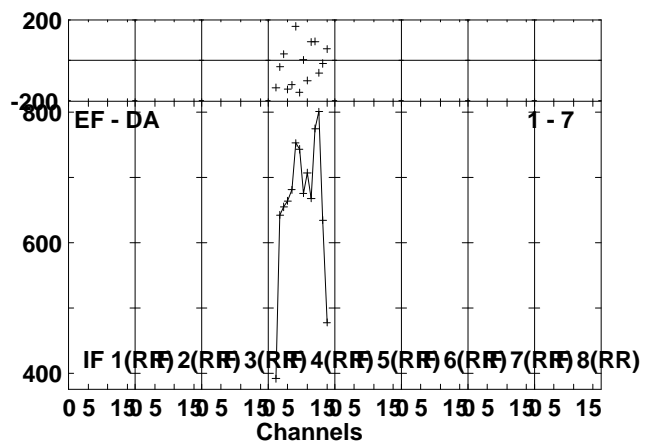
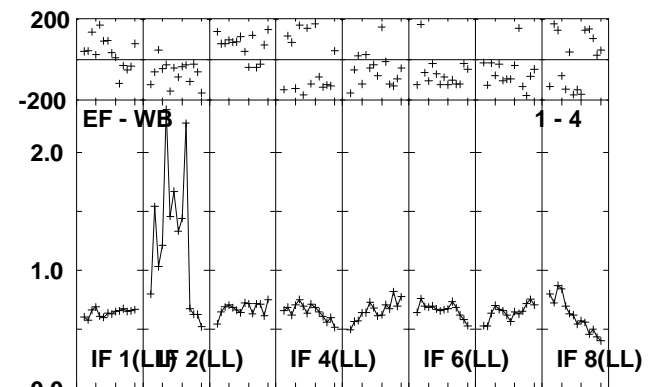
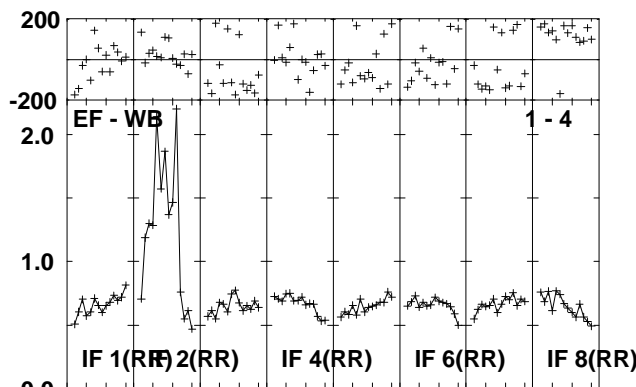
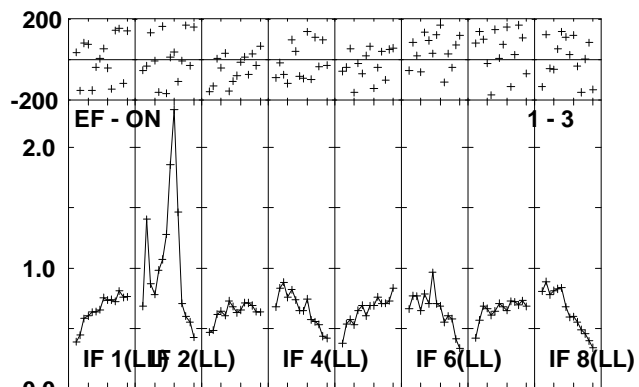
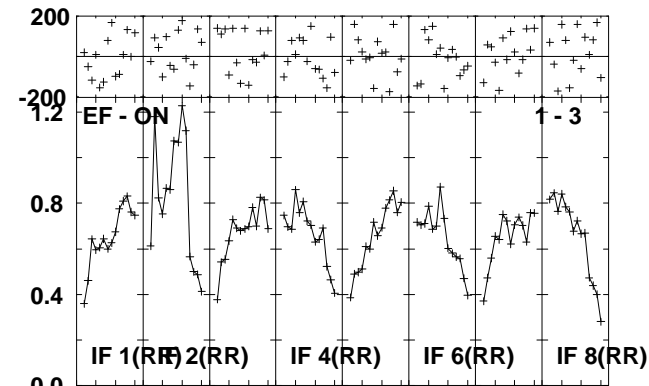
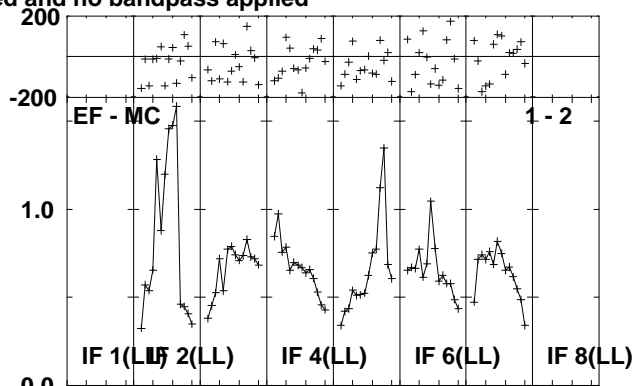
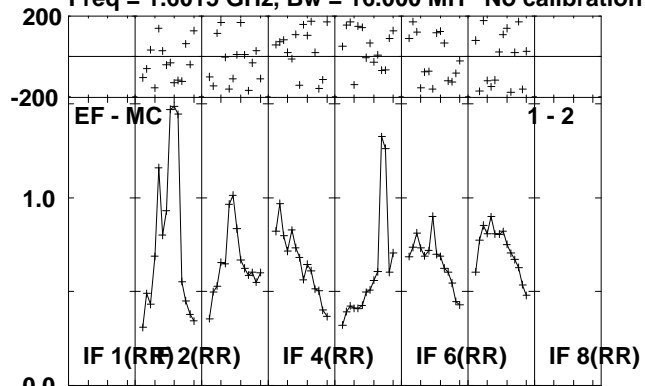

Lower frame: Milli Ampl Jy Top frame: Phas deg
Scalar averaged cross-power spectrum Several baselines displayed
Timerange: 01/07:30:05 to 01/07:35:01

Plot file version 321 created 01-JUL-2010 13:27:34
V407CYG RG006B.UVDATA.1
Freq = 1.6015 GHz, Bw = 16.000 MH No calibration applied and no bandpass applied

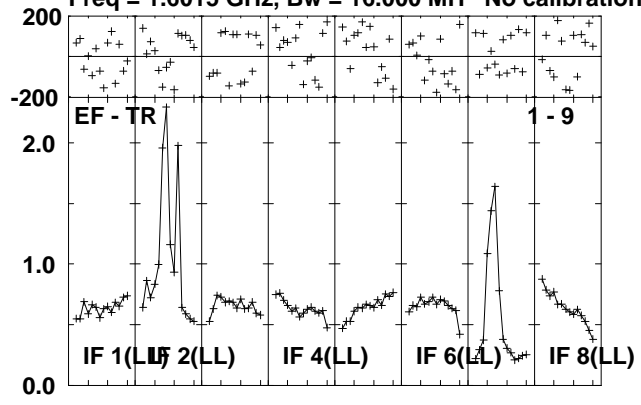

Lower frame: Milli Ampl Jy Top frame: Phas deg
Scalar averaged cross-power spectrum Several baselines displayed
Timerange: 01/07:30:05 to 01/07:35:01

Plot file version 322 created 01-JUL-2010 13:27:34

J2102+47 RG006B.UVDATA.1

Freq = 1.6015 GHz, Bw = 16.000 MH No calibration applied and no bandpass applied

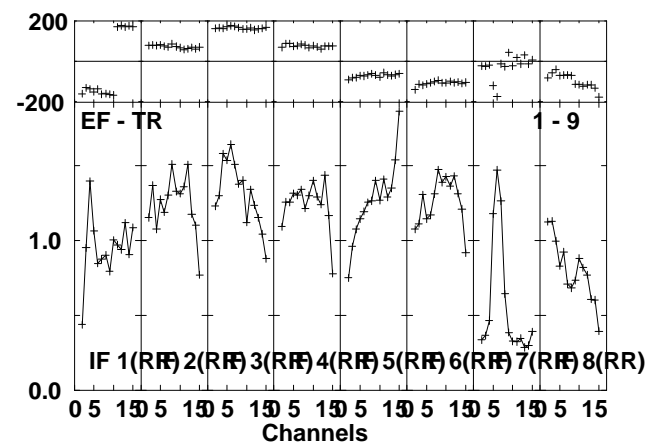
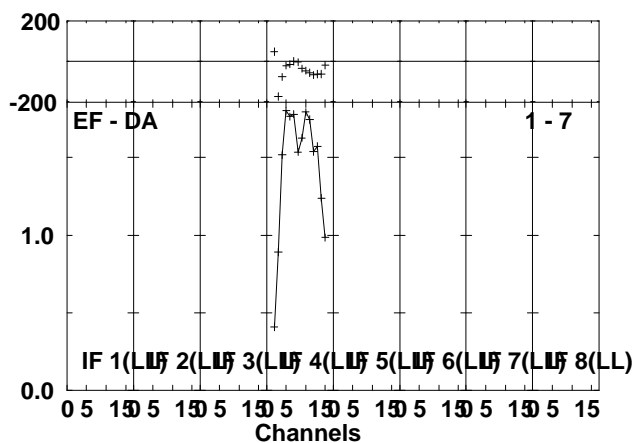
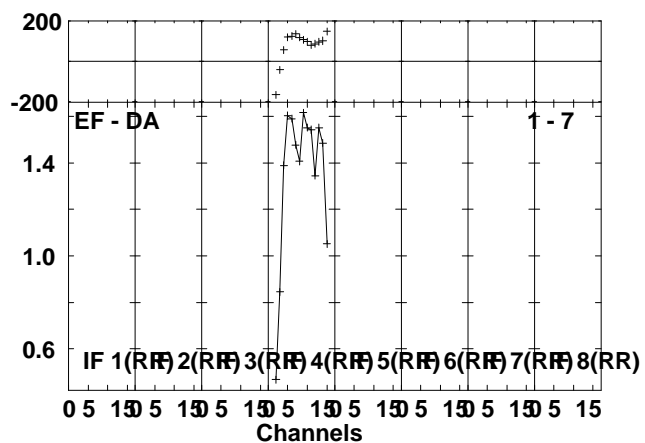
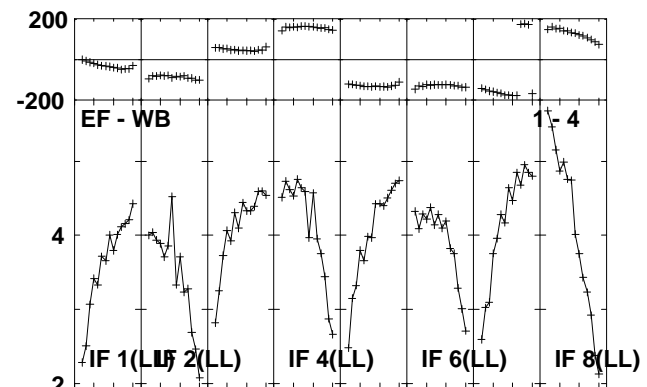
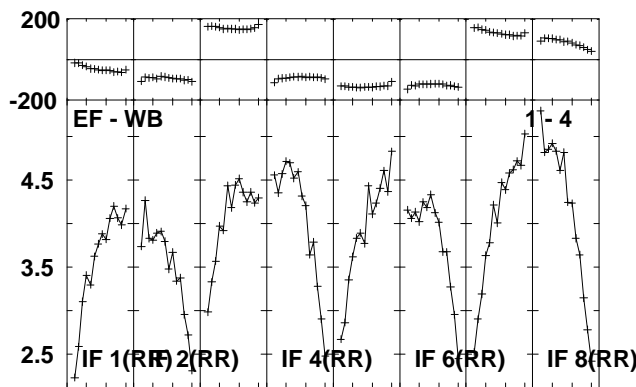
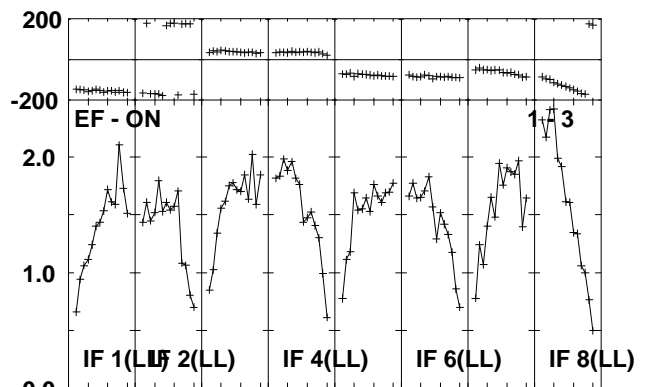
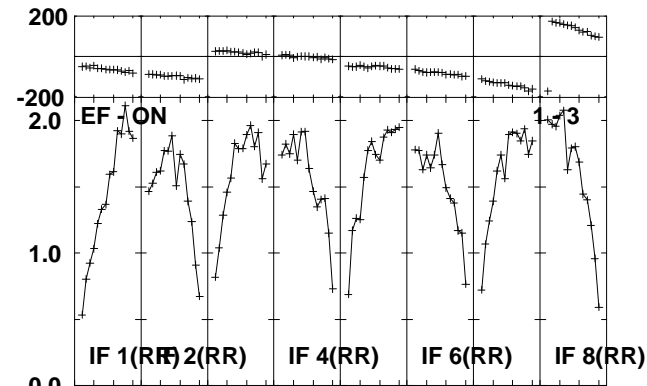
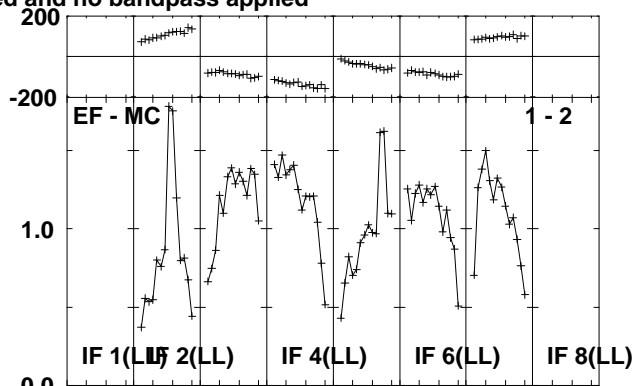
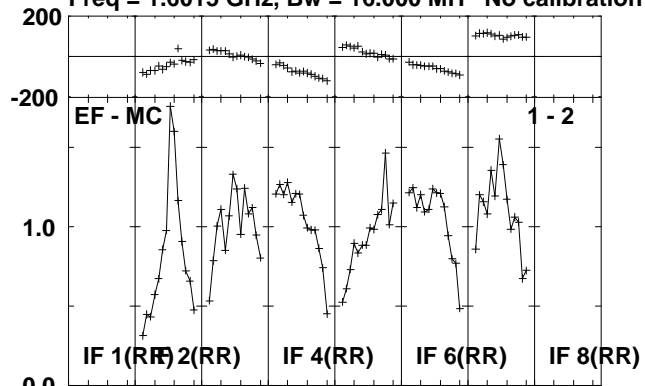

Lower frame: Milli Ampl Jy Top frame: Phas deg
Scalar averaged cross-power spectrum Several baselines displayed
Timerange: 01/07:36:05 to 01/07:37:49

Plot file version 323 created 01-JUL-2010 13:27:34
J2102+47 RG006B.UVDATA.1
Freq = 1.6015 GHz, Bw = 16.000 MH No calibration applied and no bandpass applied

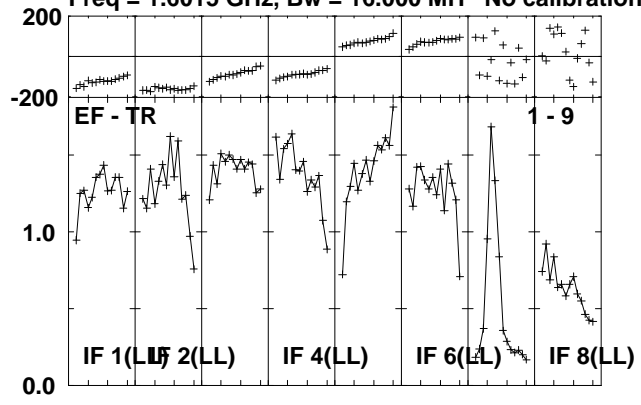

Lower frame: Milli Ampl Jy Top frame: Phas deg
Scalar averaged cross-power spectrum Several baselines displayed
Timerange: 01/07:36:05 to 01/07:37:49

Plot file version 324 created 01-JUL-2010 13:27:35

V407CYG RG006B.UVDATA.1

Freq = 1.6015 GHz, Bw = 16.000 MH No calibration applied and no bandpass applied

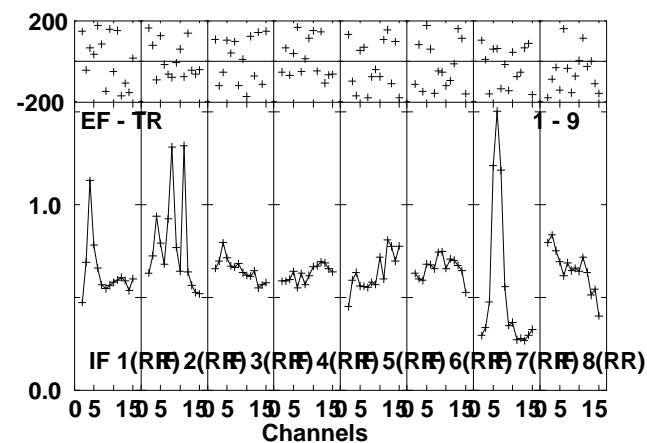
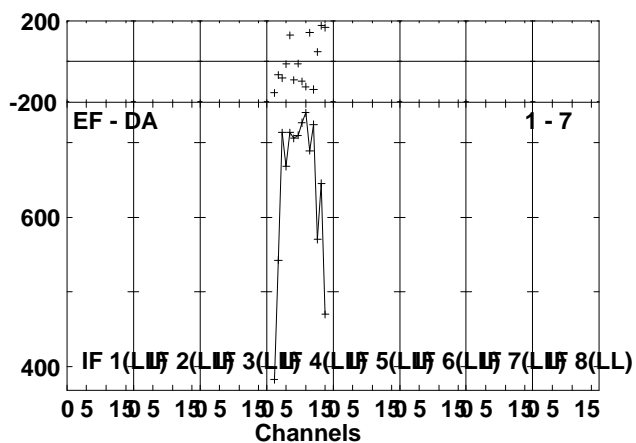
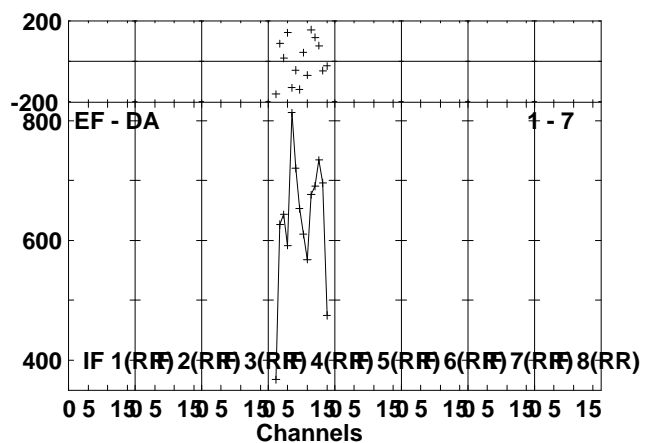
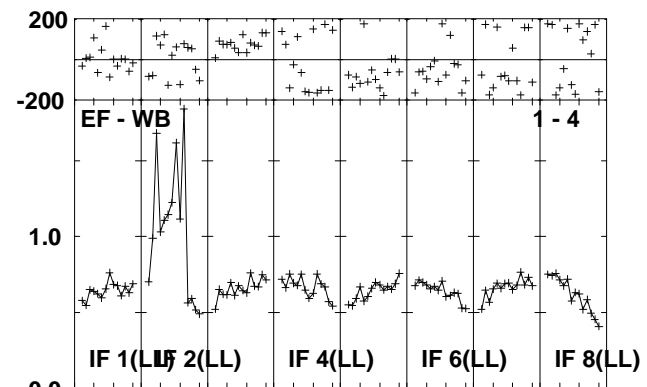
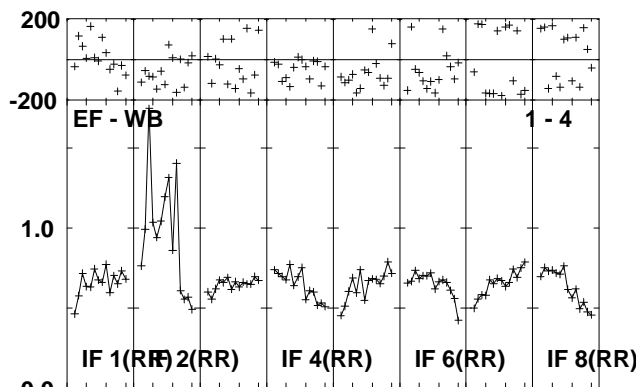
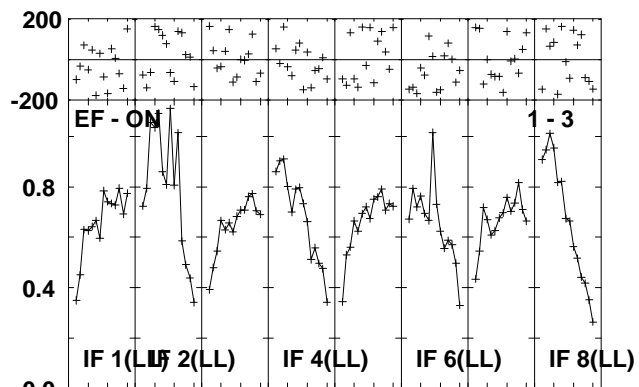
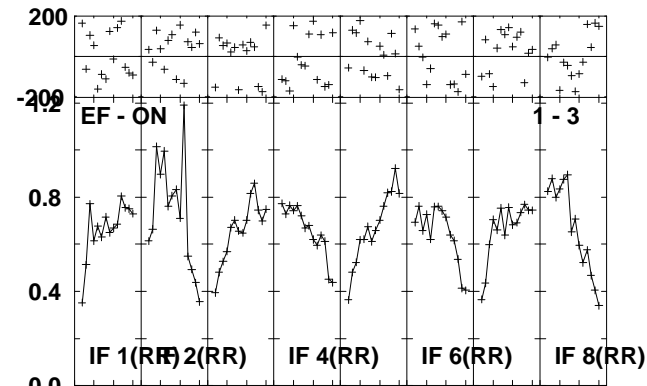
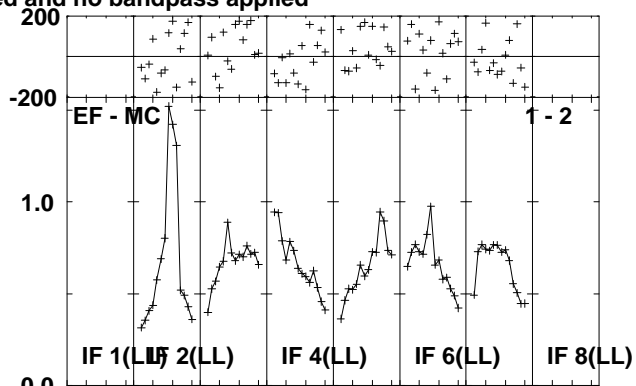
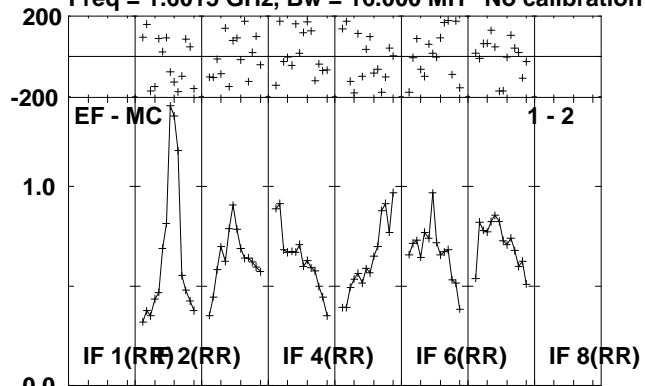

Lower frame: Milli Ampl Jy Top frame: Phas deg
Scalar averaged cross-power spectrum Several baselines displayed
Timerange: 01/07:37:53 to 01/07:42:49

Plot file version 325 created 01-JUL-2010 13:27:36
V407CYG RG006B.UVDATA.1
Freq = 1.6015 GHz, Bw = 16.000 MH No calibration applied and no bandpass applied

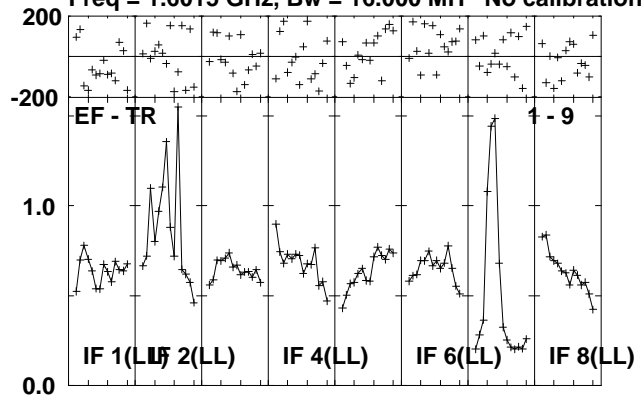

Lower frame: Milli Ampl Jy Top frame: Phas deg
Scalar averaged cross-power spectrum Several baselines displayed
Timerange: 01/07:37:53 to 01/07:42:49

Plot file version 326 created 01-JUL-2010 13:27:36

J2102+47 RG006B.UVDATA.1

Freq = 1.6015 GHz, Bw = 16.000 MH No calibration applied and no bandpass applied

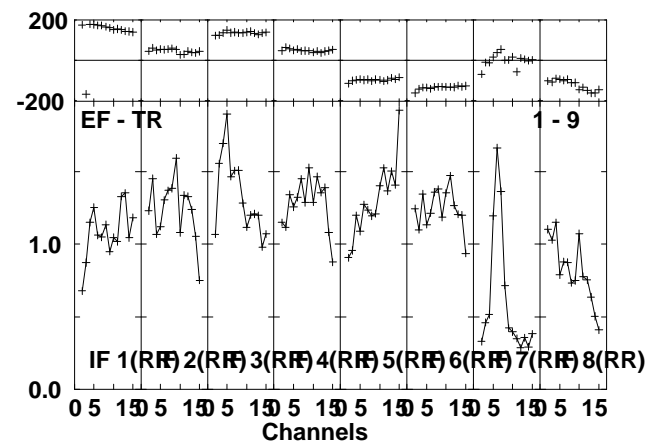
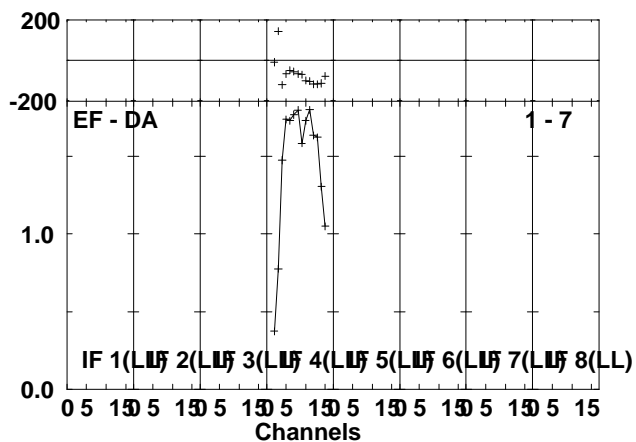
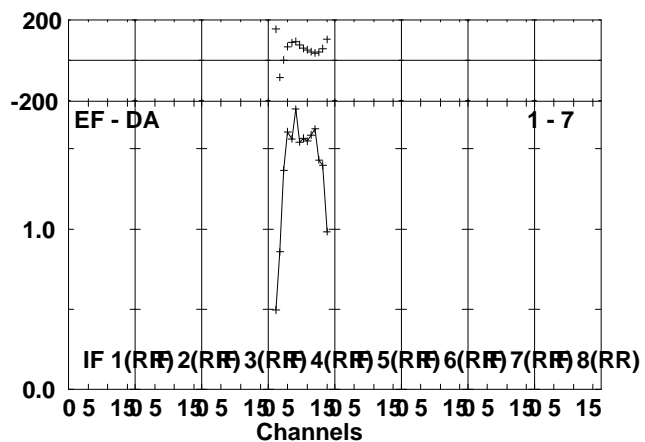
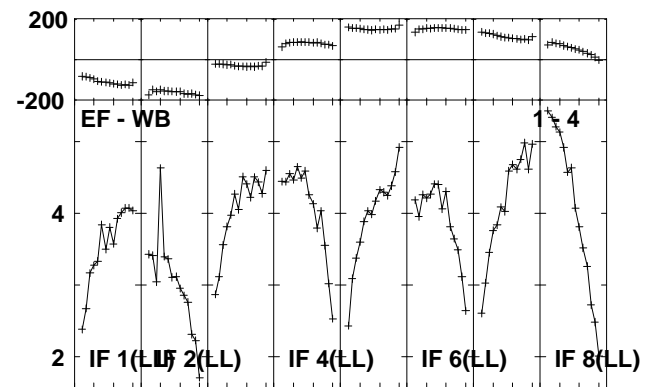
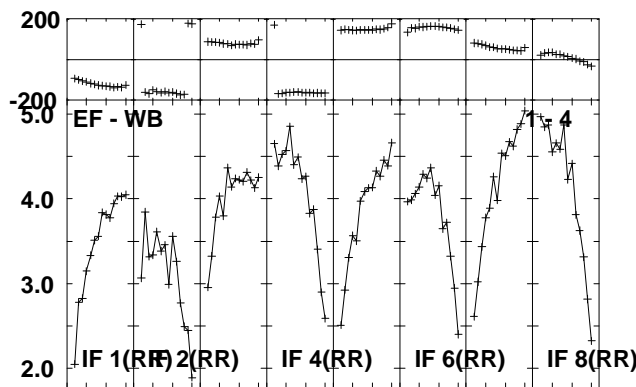
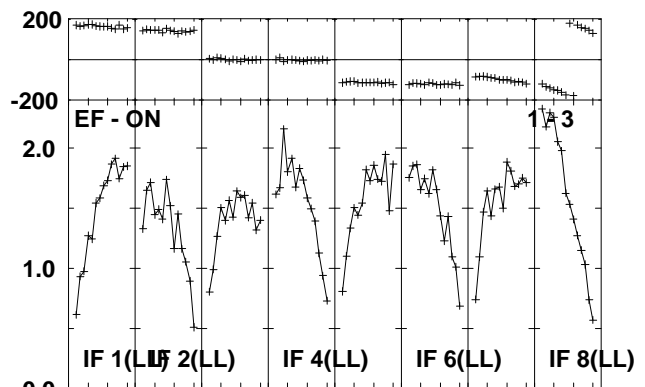
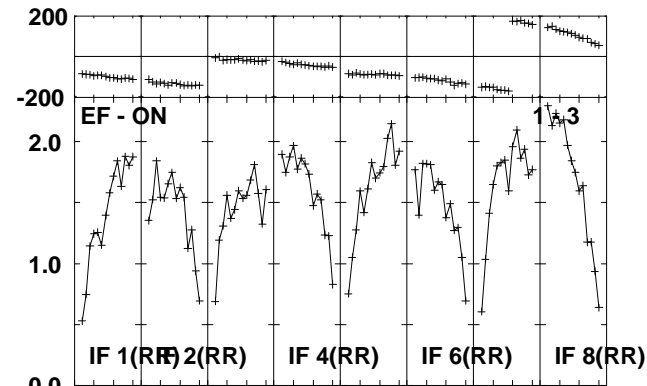
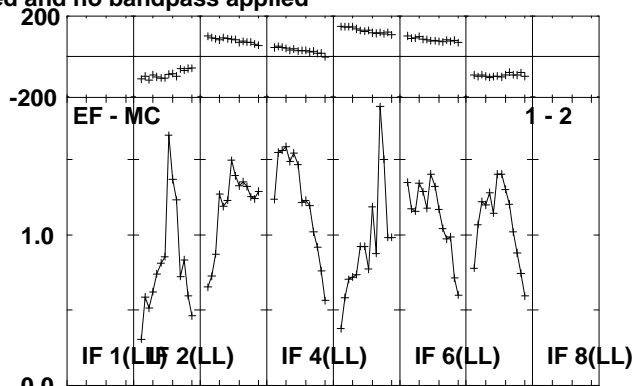
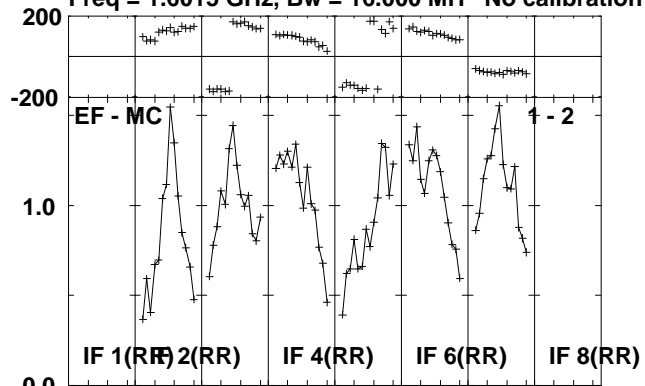

Lower frame: Milli Ampl Jy Top frame: Phas deg
Scalar averaged cross-power spectrum Several baselines displayed
Timerange: 01/07:42:53 to 01/07:45:01

Plot file version 327 created 01-JUL-2010 13:27:36
J2102+47 RG006B.UVDATA.1
Freq = 1.6015 GHz, Bw = 16.000 MH No calibration applied and no bandpass applied

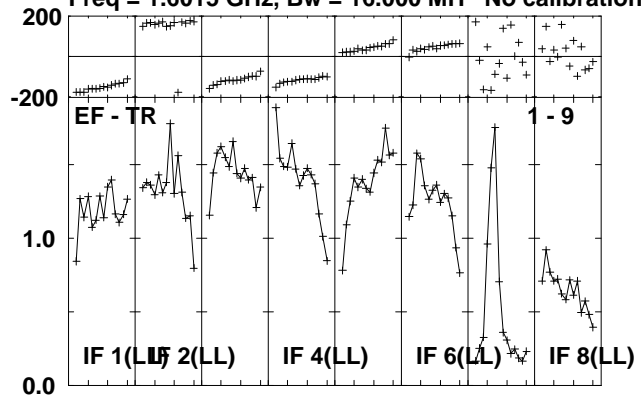

Lower frame: Milli Ampl Jy Top frame: Phas deg
Scalar averaged cross-power spectrum Several baselines displayed
Timerange: 01/07:42:53 to 01/07:45:01

Plot file version 328 created 01-JUL-2010 13:27:37

V407CYG RG006B.UVDATA.1

Freq = 1.6015 GHz, Bw = 16.000 MH No calibration applied and no bandpass applied

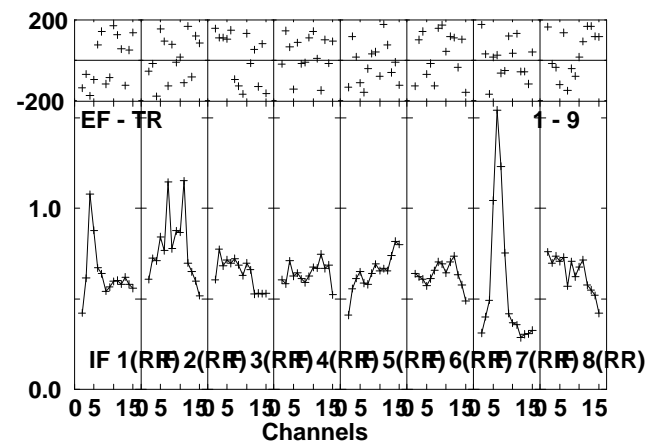
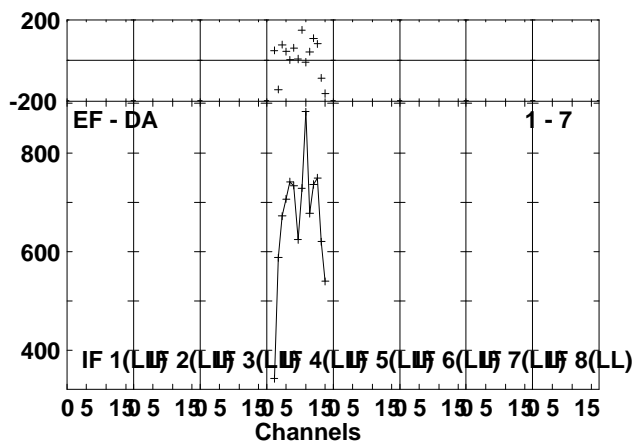
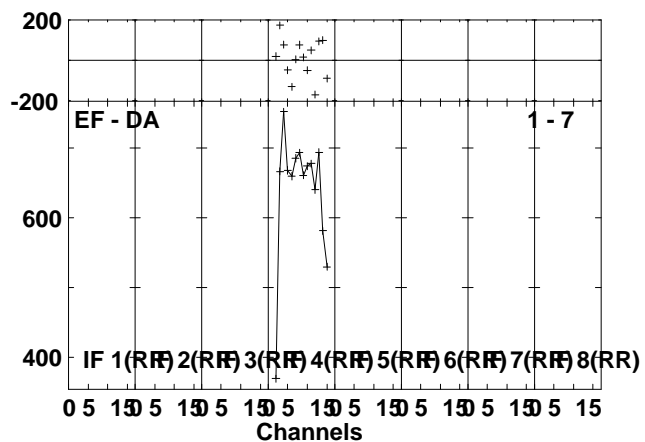
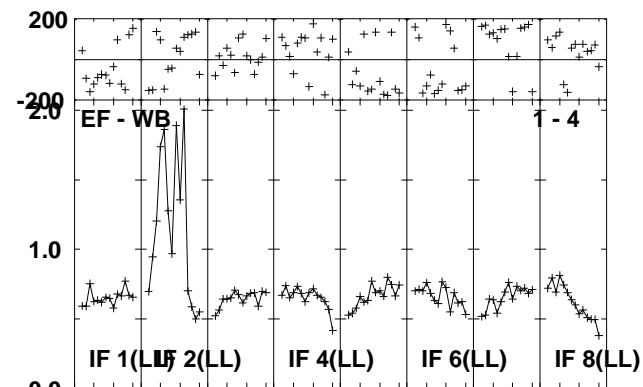
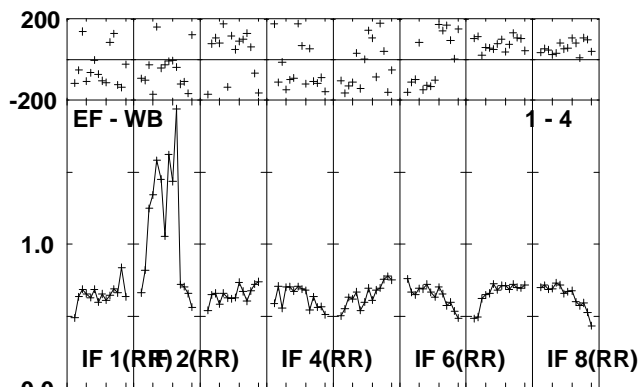
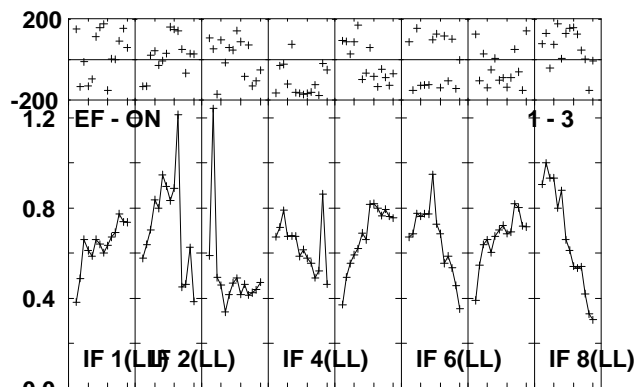
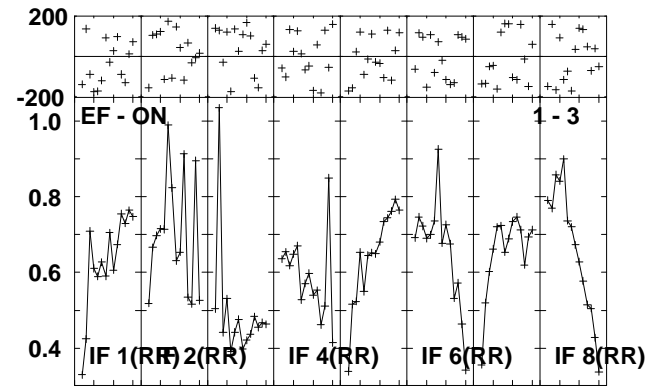
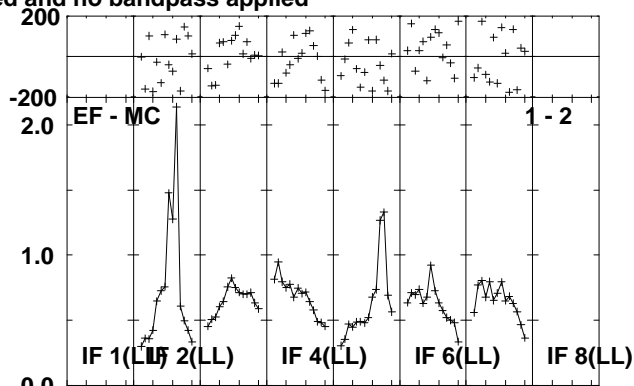
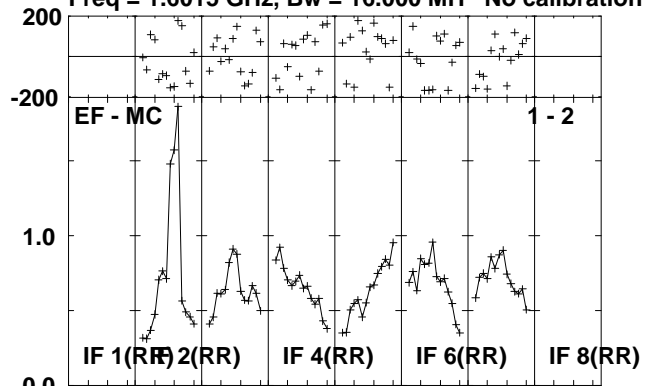

Lower frame: Milli Ampl Jy Top frame: Phas deg
Scalar averaged cross-power spectrum Several baselines displayed
Timerange: 01/07:45:05 to 01/07:50:01

Plot file version 329 created 01-JUL-2010 13:27:38

V407CYG RG006B.UVDATA.1

Freq = 1.6015 GHz, Bw = 16.000 MH No calibration applied and no bandpass applied

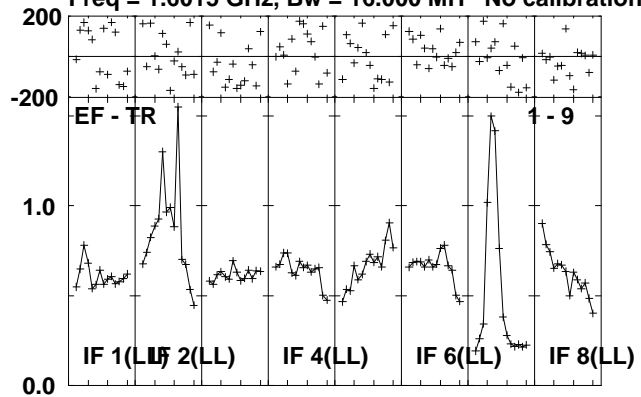

Lower frame: Milli Ampl Jy Top frame: Phas deg
Scalar averaged cross-power spectrum Several baselines displayed
Timerange: 01/07:45:05 to 01/07:50:01

Plot file version 330 created 01-JUL-2010 13:27:38

J2102+47 RG006B.UVDATA.1

Freq = 1.6015 GHz, Bw = 16.000 MH No calibration applied and no bandpass applied

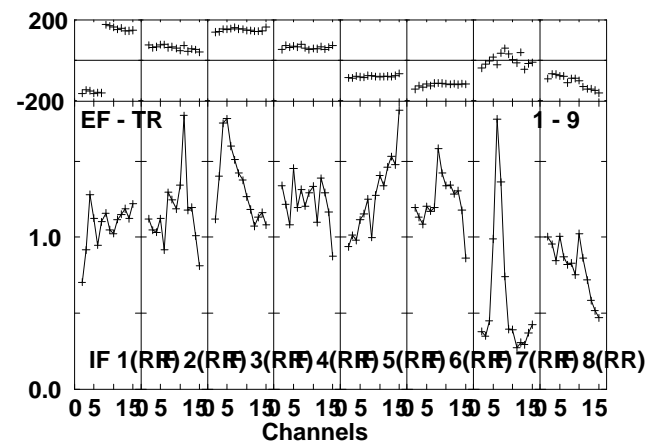
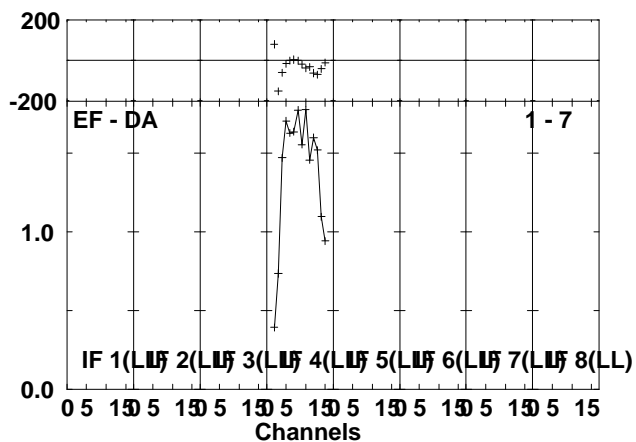
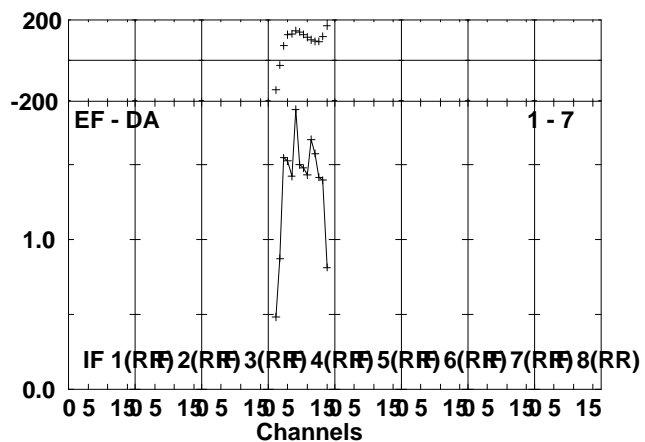
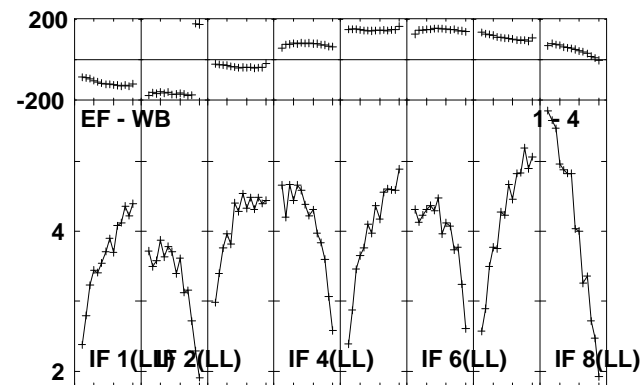
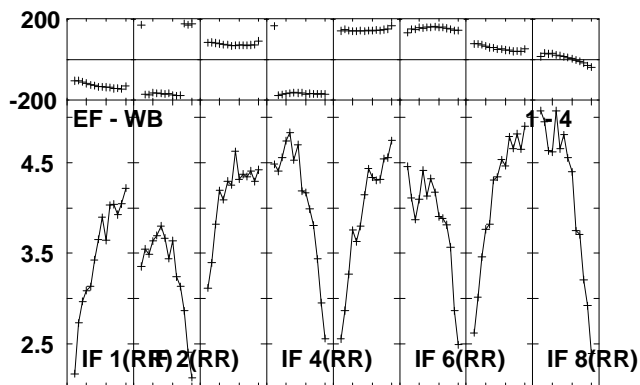
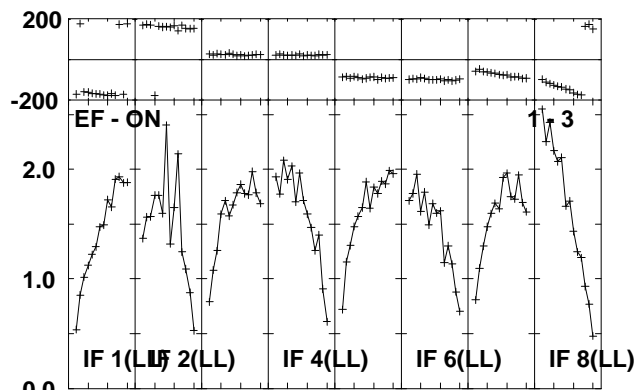
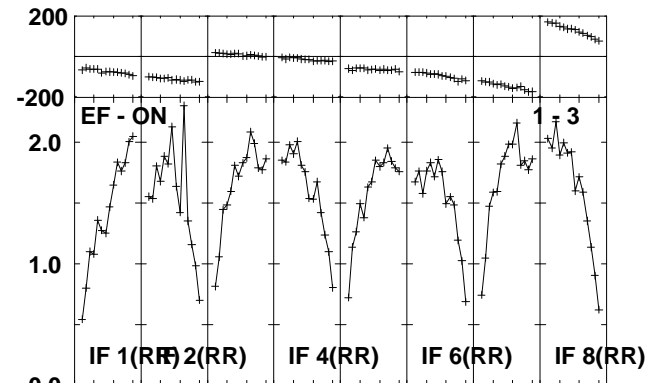
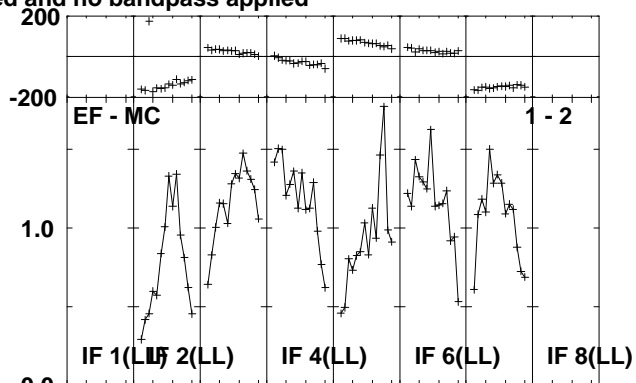
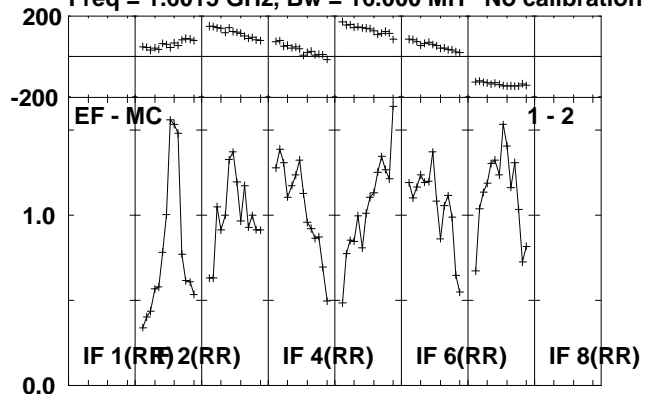

Lower frame: Milli Ampl Jy Top frame: Phas deg
Scalar averaged cross-power spectrum Several baselines displayed
Timerange: 01/07:51:05 to 01/07:52:49

Plot file version 331 created 01-JUL-2010 13:27:38
J2102+47 RG006B.UVDATA.1
Freq = 1.6015 GHz, Bw = 16.000 MH No calibration applied and no bandpass applied

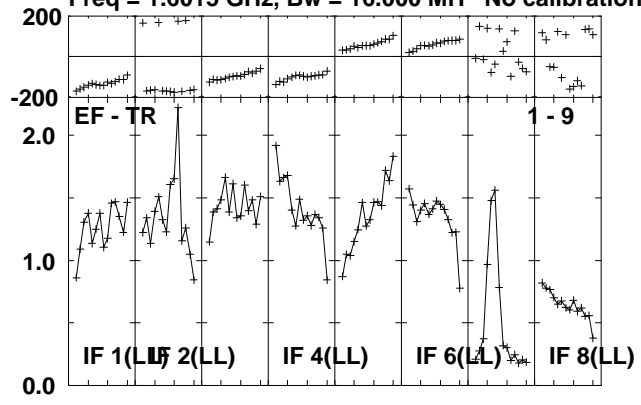

Lower frame: Milli Ampl Jy Top frame: Phas deg
Scalar averaged cross-power spectrum Several baselines displayed
Timerange: 01/07:51:05 to 01/07:52:49

Plot file version 332 created 01-JUL-2010 13:27:38

J2002+47 RG006B.UVDATA.1

Freq = 1.6015 GHz, Bw = 16.000 MH No calibration applied and no bandpass applied

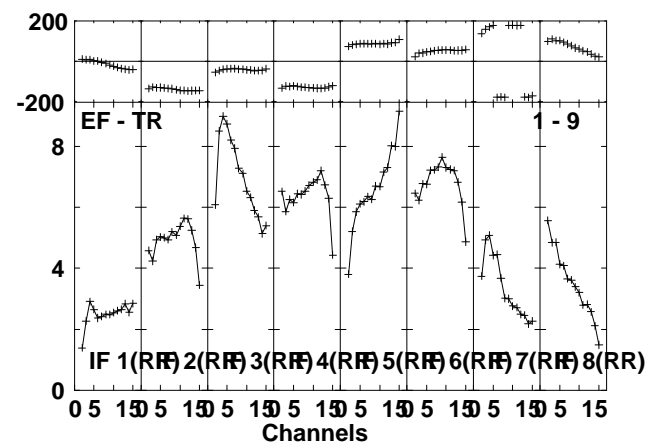
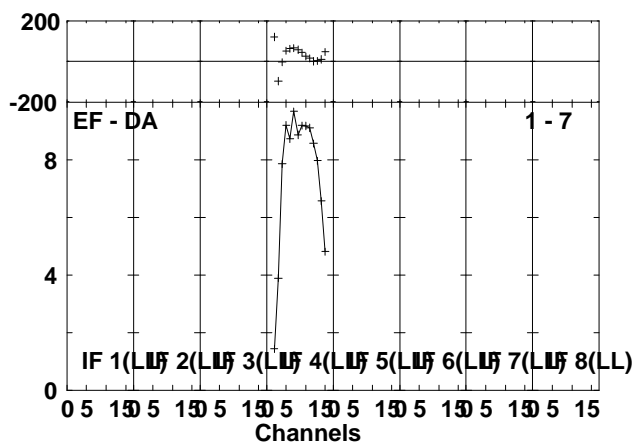
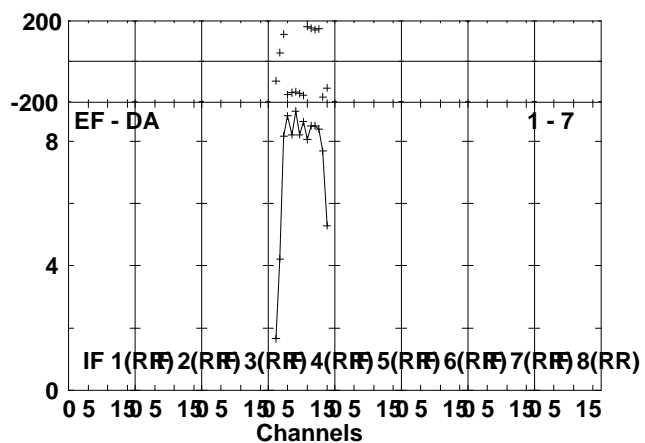
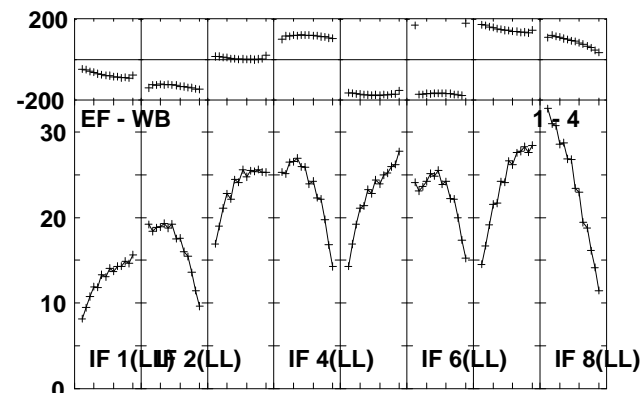
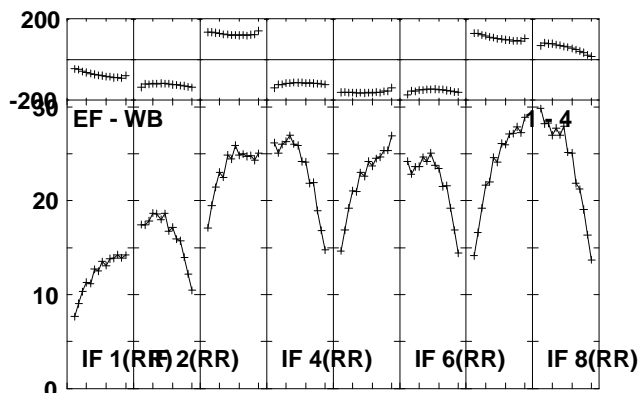
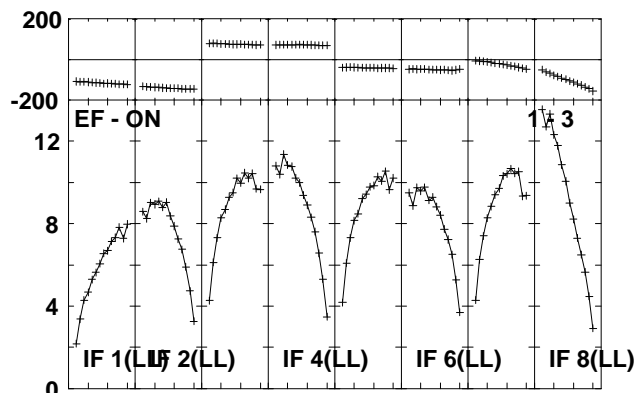
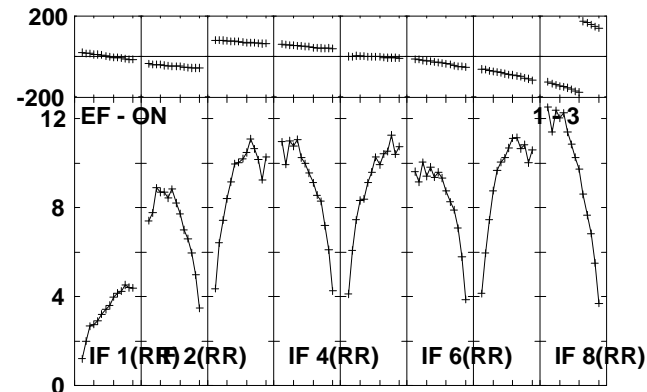
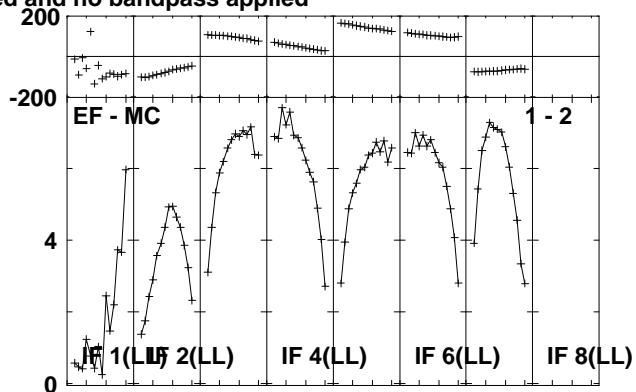
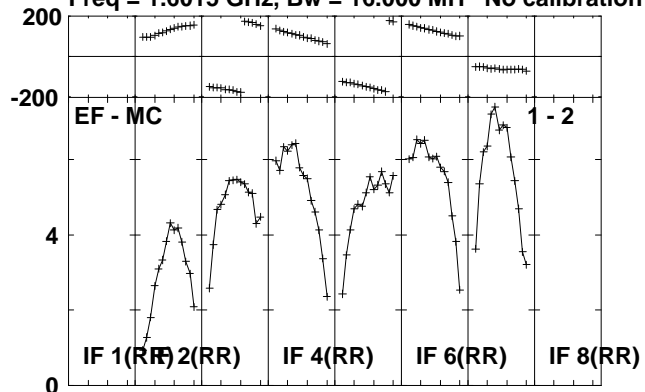

Lower frame: Milli Ampl Jy Top frame: Phas deg
Scalar averaged cross-power spectrum Several baselines displayed
Timerange: 01/07:54:21 to 01/07:58:17

Plot file version 333 created 01-JUL-2010 13:27:39
J2002+47 RG006B.UVDATA.1
Freq = 1.6015 GHz, Bw = 16.000 MH No calibration applied and no bandpass applied

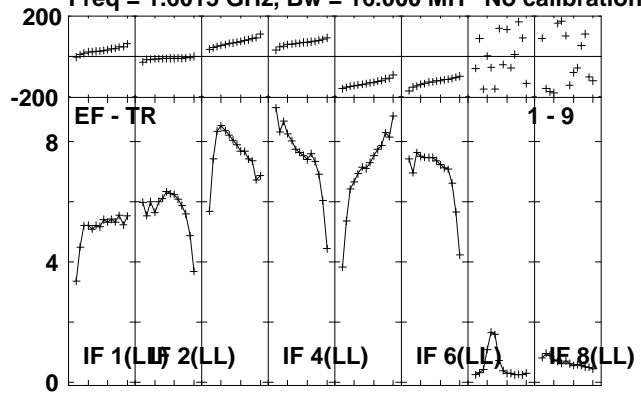

Lower frame: Milli Ampl Jy Top frame: Phas deg
Scalar averaged cross-power spectrum Several baselines displayed
Timerange: 01/07:54:21 to 01/07:58:17

Plot file version 334 created 01-JUL-2010 13:27:39

J2102+47 RG006B.UVDATA.1

Freq = 1.6015 GHz, Bw = 16.000 MH No calibration applied and no bandpass applied

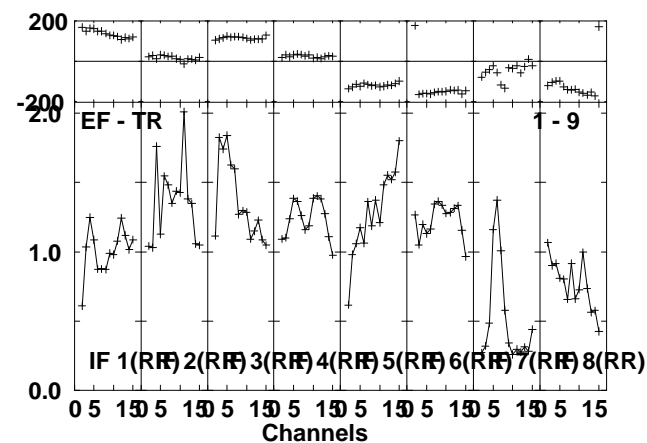
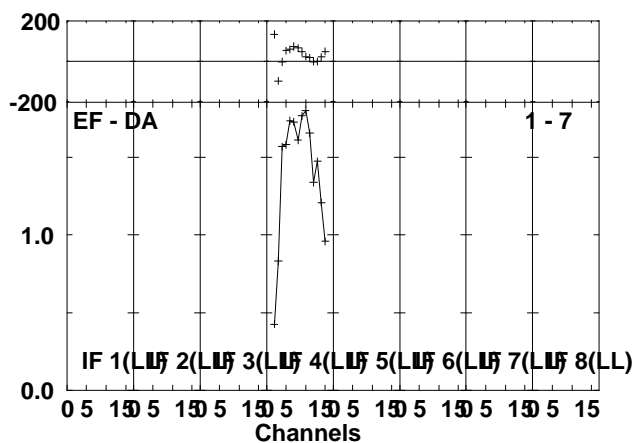
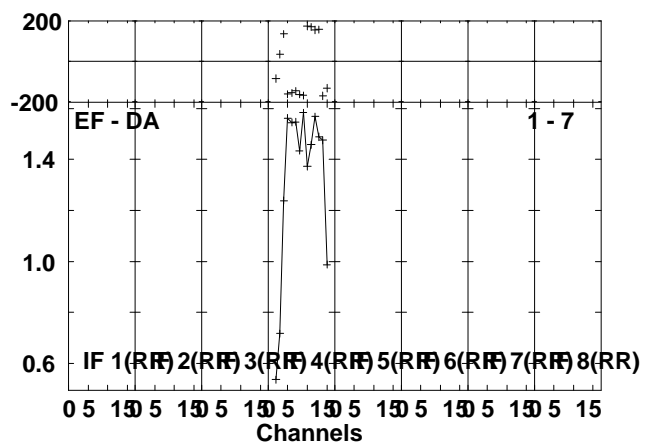
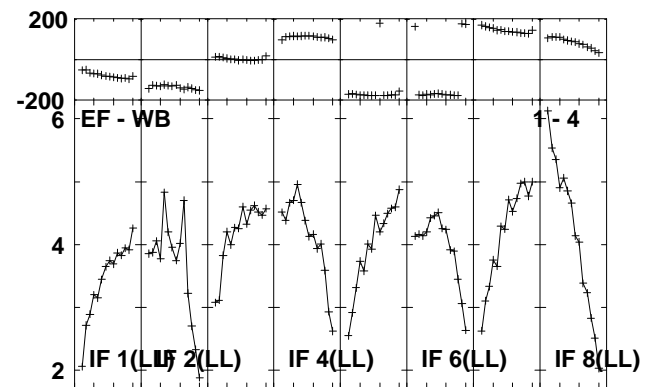
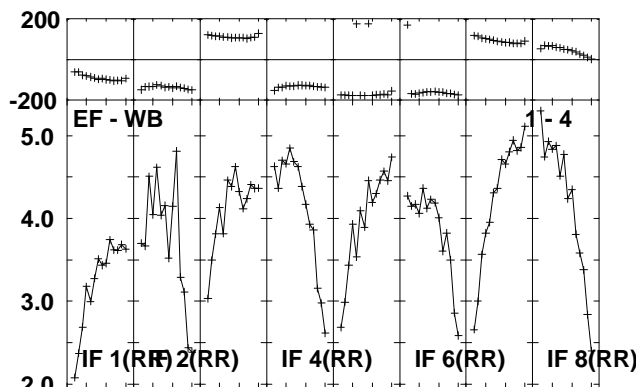
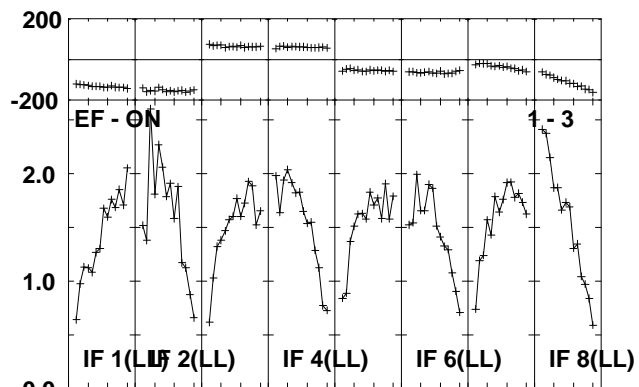
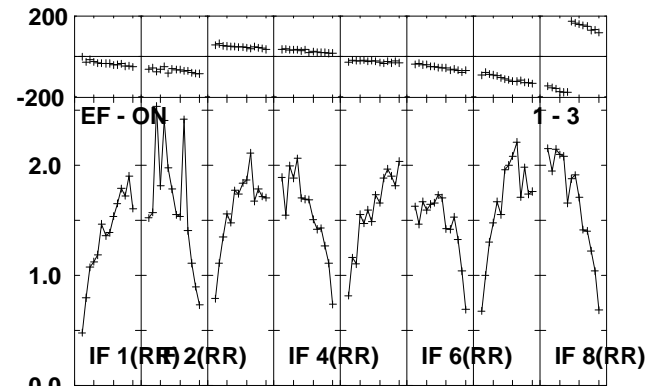
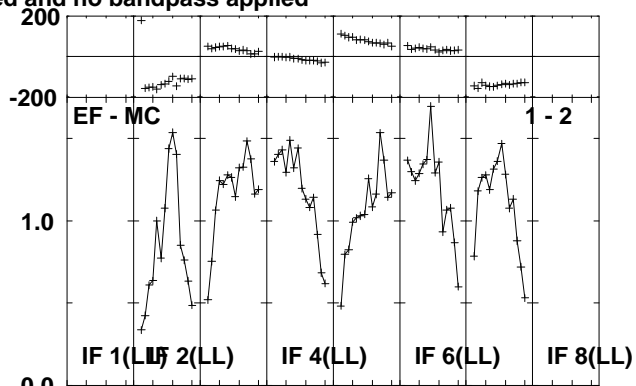
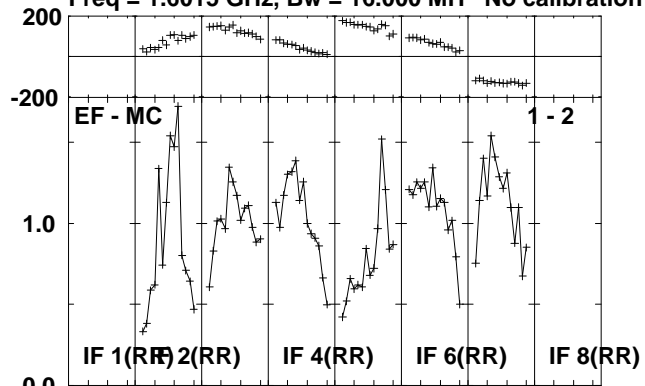

Lower frame: Milli Ampl Jy Top frame: Phas deg
Scalar averaged cross-power spectrum Several baselines displayed
Timerange: 01/07:59:53 to 01/08:01:49

Plot file version 335 created 01-JUL-2010 13:27:40
J2102+47 RG006B.UVDATA.1
Freq = 1.6015 GHz, Bw = 16.000 MH No calibration applied and no bandpass applied

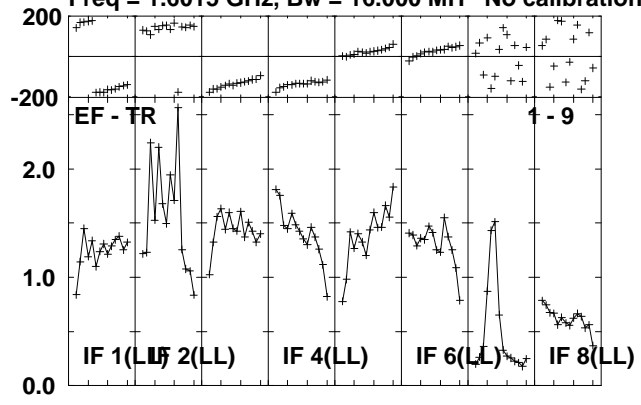

Lower frame: Milli Ampl Jy Top frame: Phas deg
Scalar averaged cross-power spectrum Several baselines displayed
Timerange: 01/07:59:53 to 01/08:01:49

Plot file version 336 created 01-JUL-2010 13:27:40

V407CYG RG006B.UVDATA.1

Freq = 1.6015 GHz, Bw = 16.000 MH No calibration applied and no bandpass applied

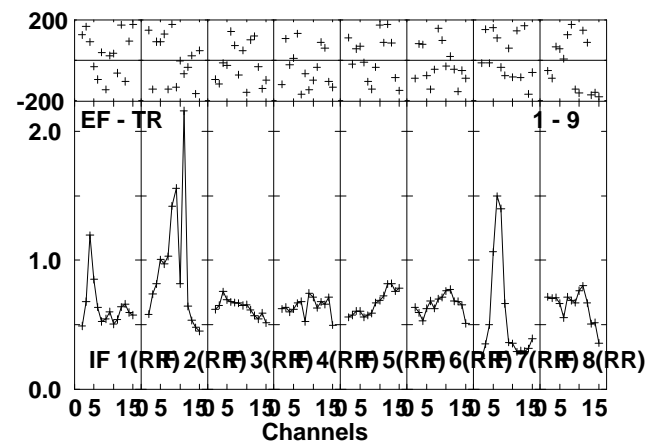
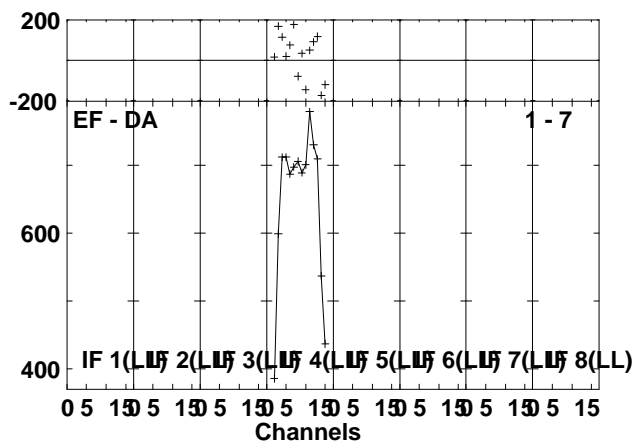
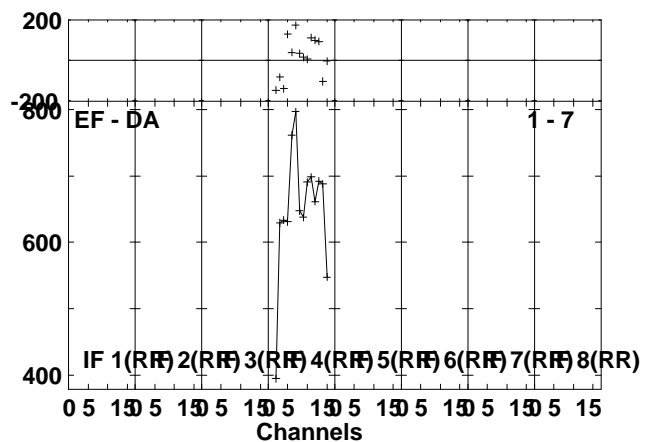
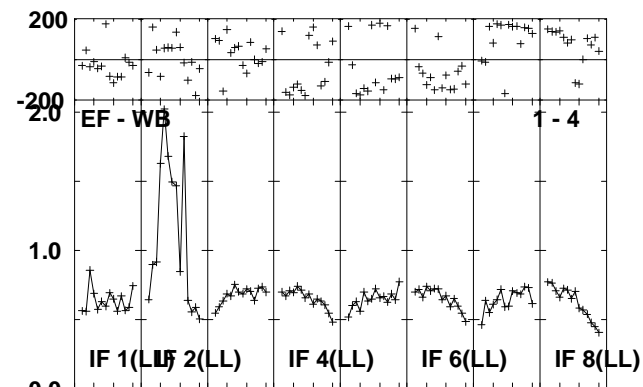
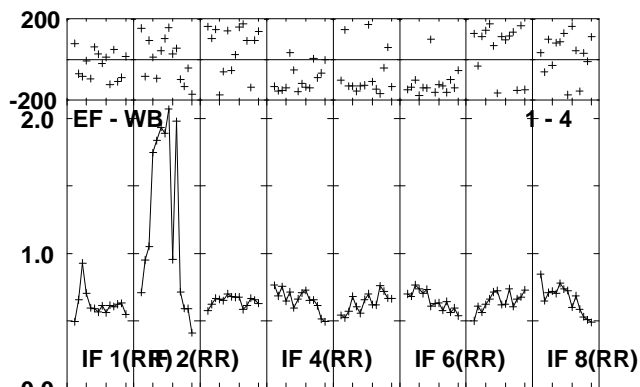
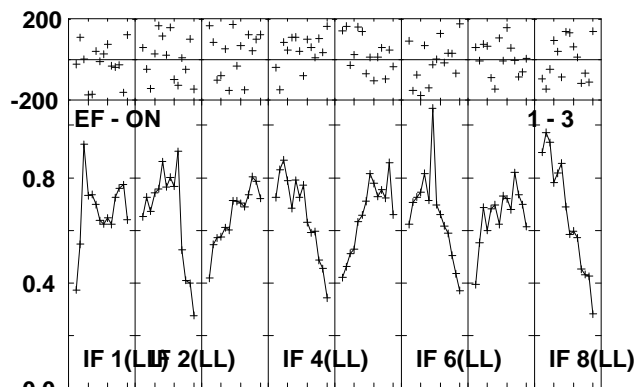
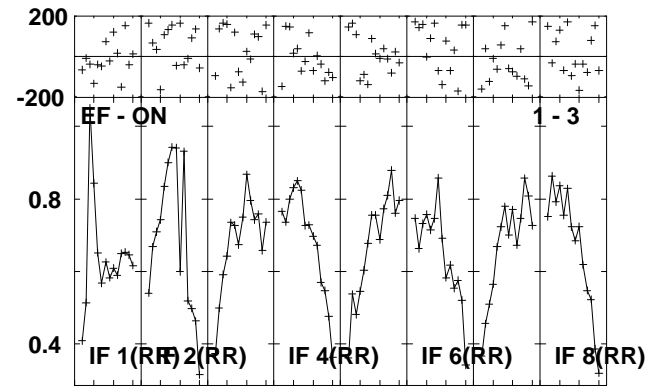
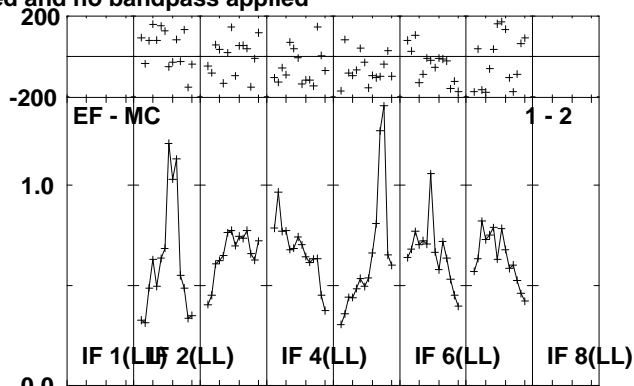
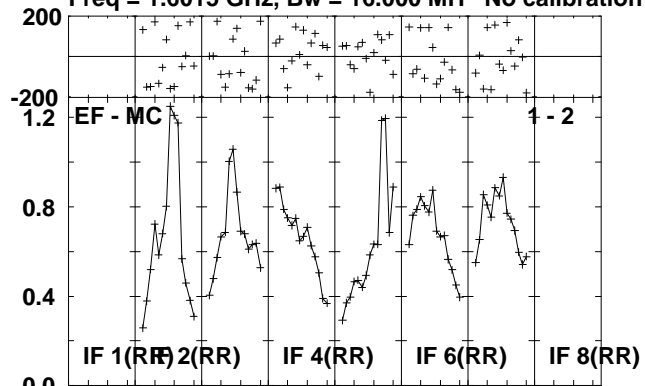

Lower frame: Milli Ampl Jy Top frame: Phas deg
Scalar averaged cross-power spectrum Several baselines displayed
Timerange: 01/08:01:53 to 01/08:06:49

Plot file version 337 created 01-JUL-2010 13:27:41
V407CYG RG006B.UVDATA.1
Freq = 1.6015 GHz, Bw = 16.000 MH No calibration applied and no bandpass applied

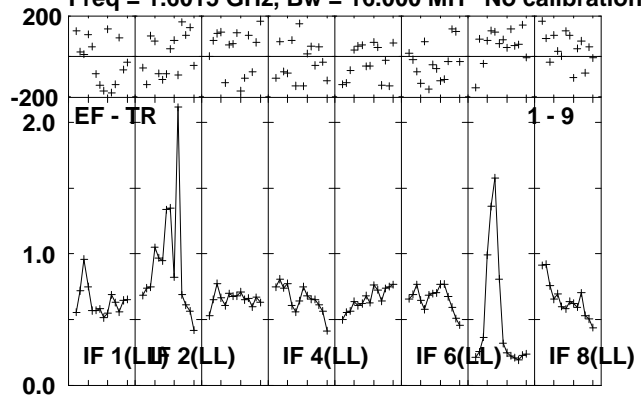

Lower frame: Milli Ampl Jy Top frame: Phas deg
Scalar averaged cross-power spectrum Several baselines displayed
Timerange: 01/08:01:53 to 01/08:06:49

Plot file version 338 created 01-JUL-2010 13:27:41

J2102+47 RG006B.UVDATA.1

Freq = 1.6015 GHz, Bw = 16.000 MH No calibration applied and no bandpass applied

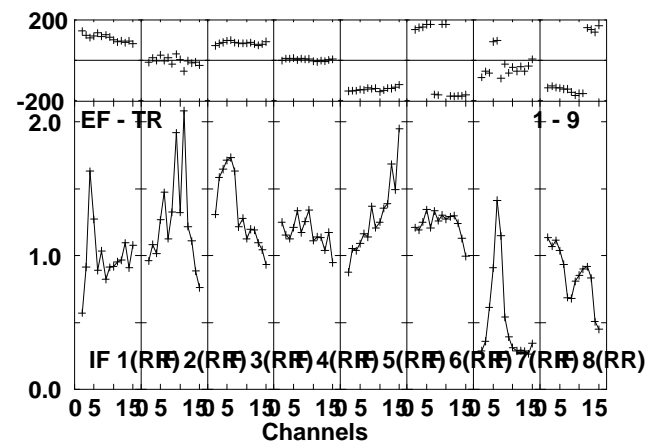
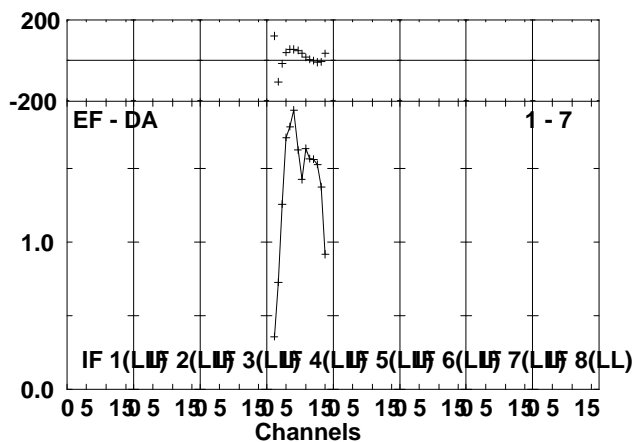
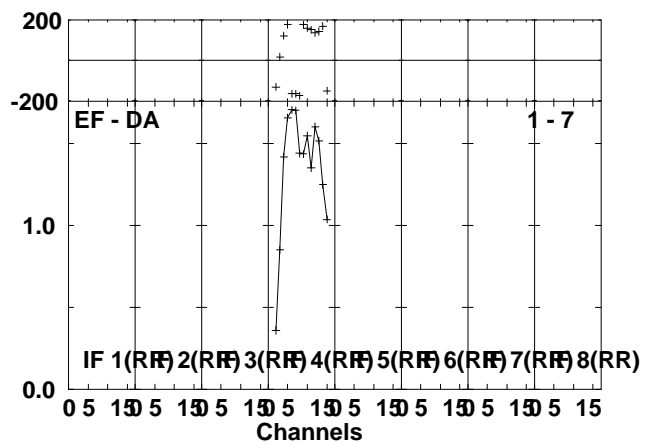
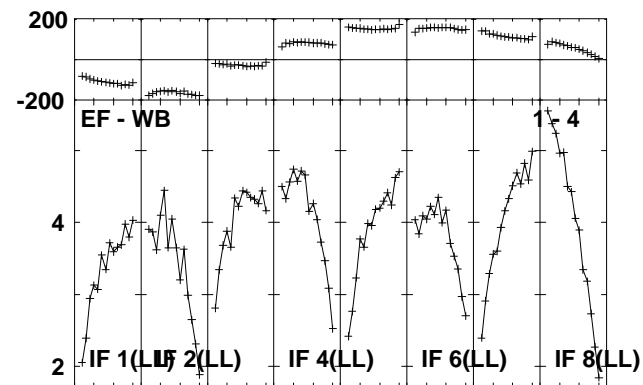
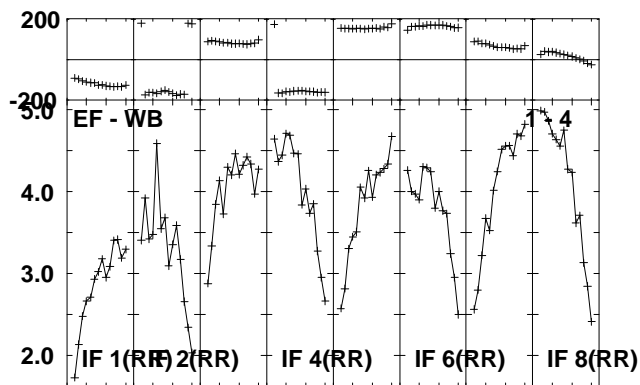
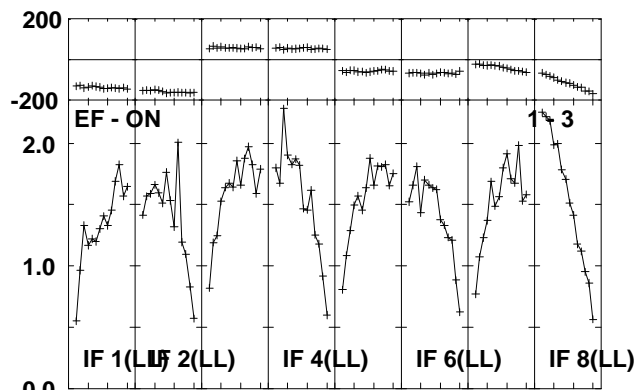
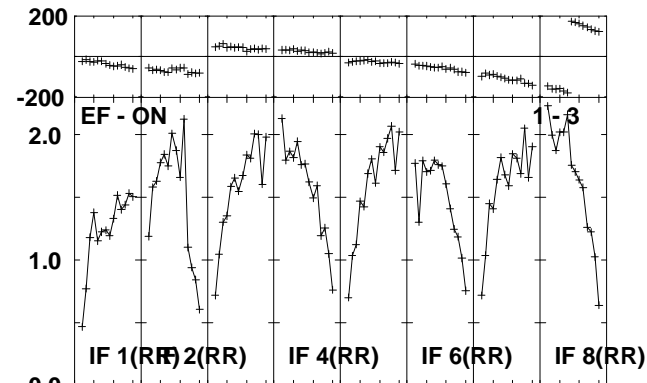
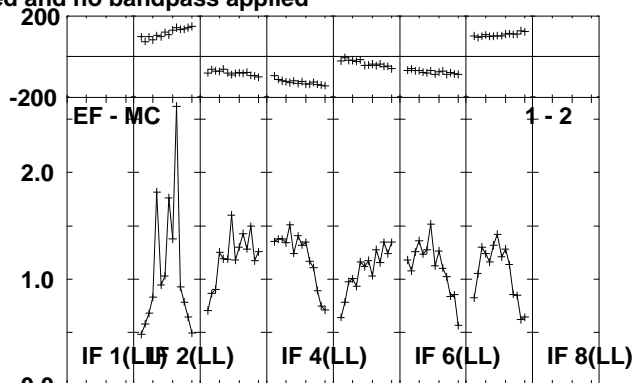
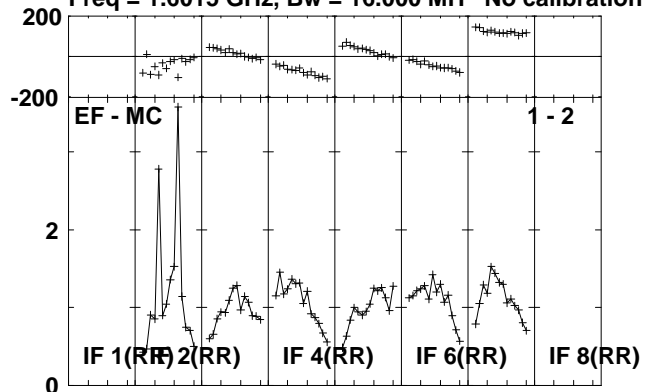

Lower frame: Milli Ampl Jy Top frame: Phas deg
Scalar averaged cross-power spectrum Several baselines displayed
Timerange: 01/08:06:53 to 01/08:09:01

Plot file version 339 created 01-JUL-2010 13:27:42
J2102+47 RG006B.UVDATA.1
Freq = 1.6015 GHz, Bw = 16.000 MH No calibration applied and no bandpass applied

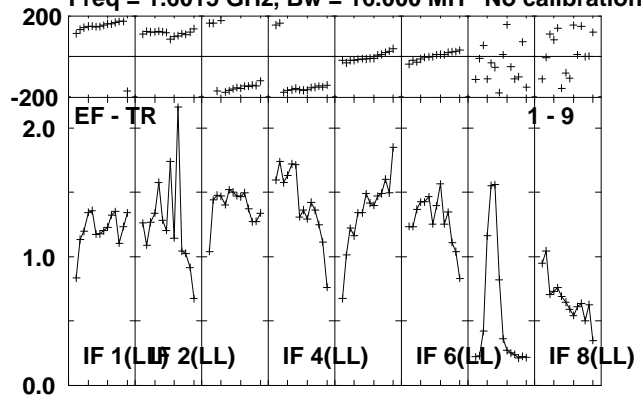

Lower frame: Milli Ampl Jy Top frame: Phas deg
Scalar averaged cross-power spectrum Several baselines displayed
Timerange: 01/08:06:53 to 01/08:09:01

Plot file version 340 created 01-JUL-2010 13:27:42

V407CYG RG006B.UVDATA.1

Freq = 1.6015 GHz, Bw = 16.000 MH No calibration applied and no bandpass applied

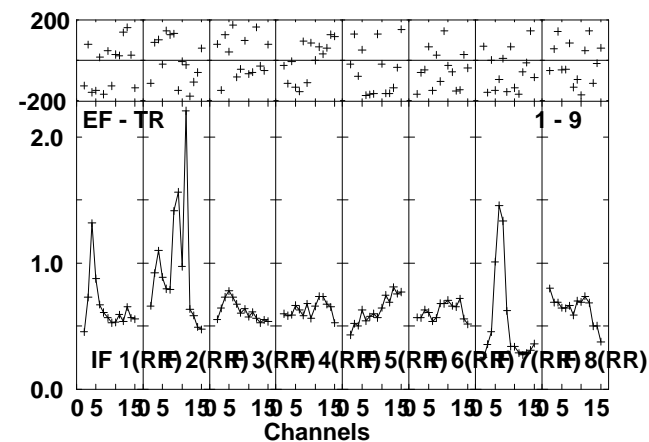
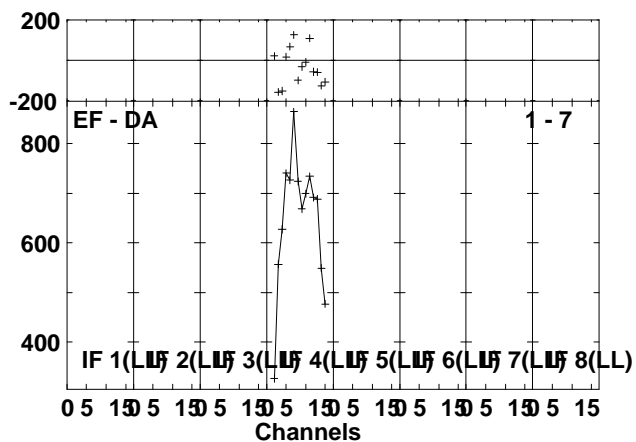
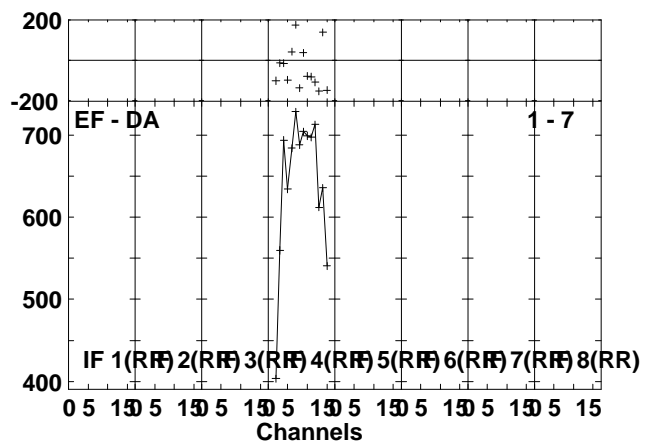
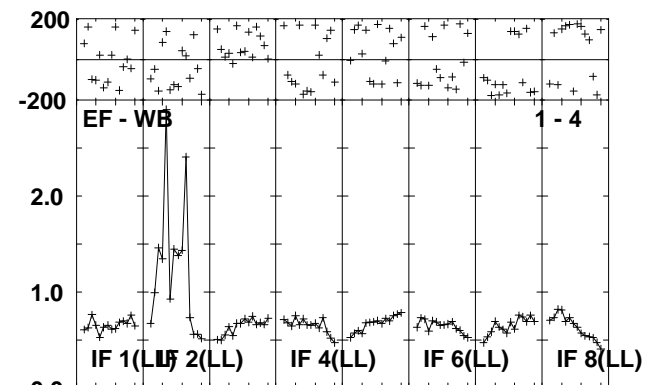
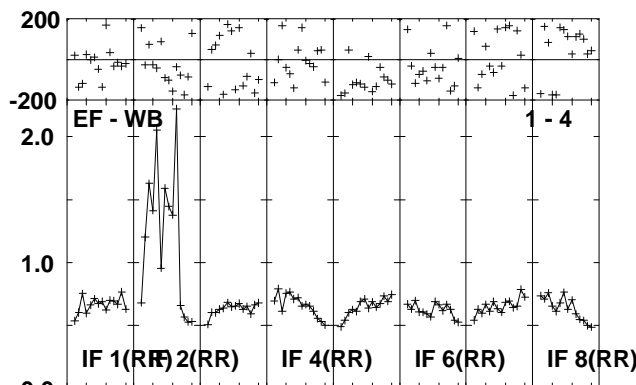
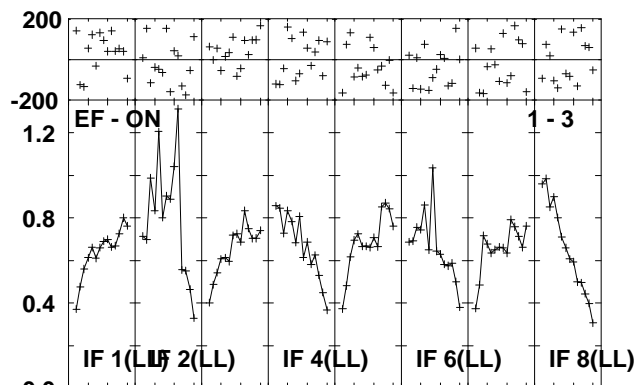
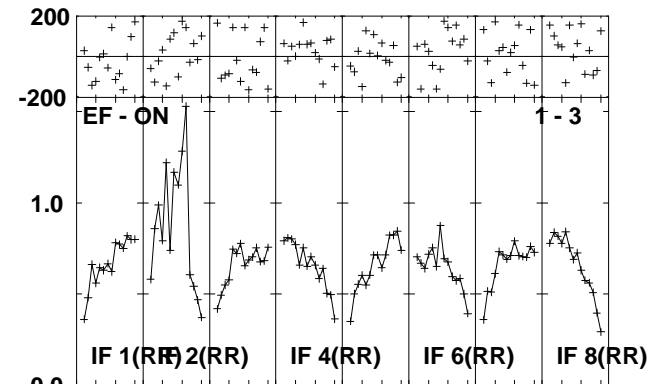
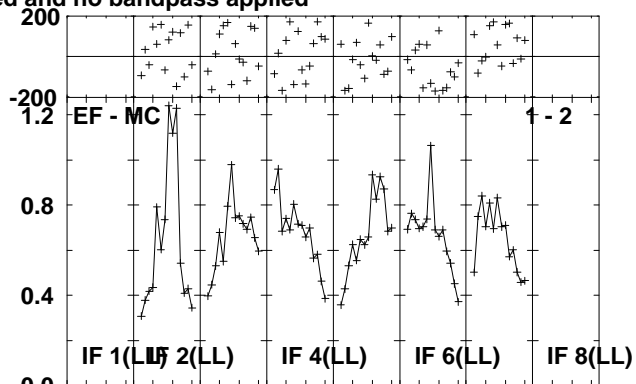
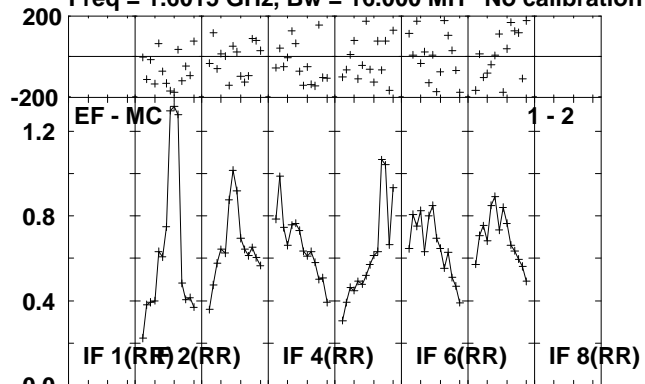

Lower frame: Milli Ampl Jy Top frame: Phas deg
Scalar averaged cross-power spectrum Several baselines displayed
Timerange: 01/08:09:05 to 01/08:14:01

Plot file version 341 created 01-JUL-2010 13:27:43
V407CYG RG006B.UVDATA.1
Freq = 1.6015 GHz, Bw = 16.000 MH No calibration applied and no bandpass applied

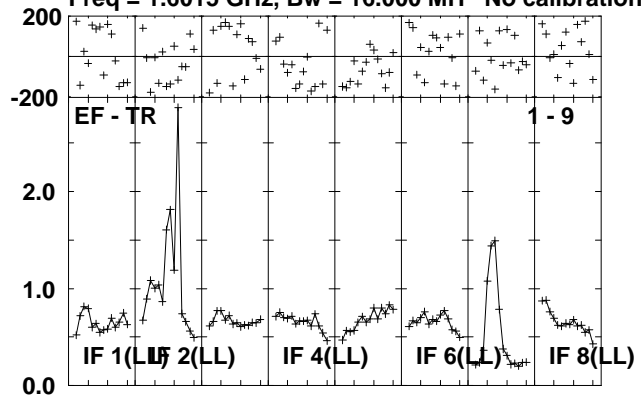

Lower frame: Milli Ampl Jy Top frame: Phas deg
Scalar averaged cross-power spectrum Several baselines displayed
Timerange: 01/08:09:05 to 01/08:14:01

Plot file version 342 created 01-JUL-2010 13:27:43

J2102+47 RG006B.UVDATA.1

Freq = 1.6015 GHz, Bw = 16.000 MH No calibration applied and no bandpass applied

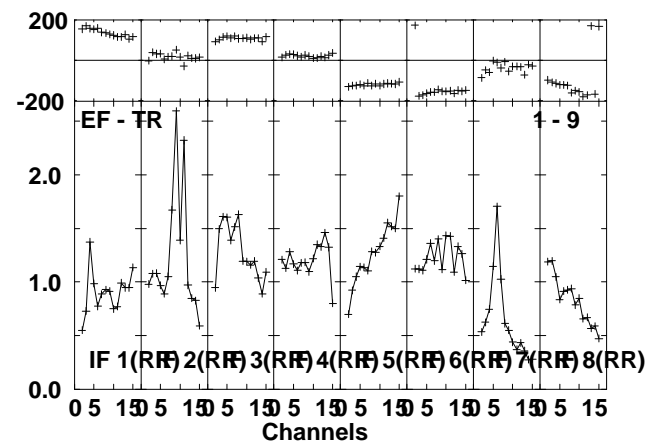
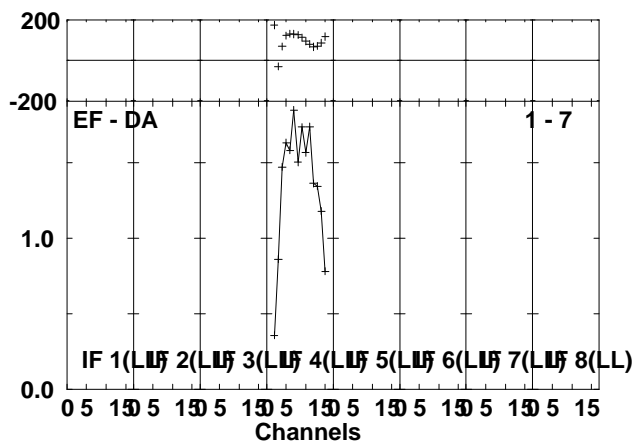
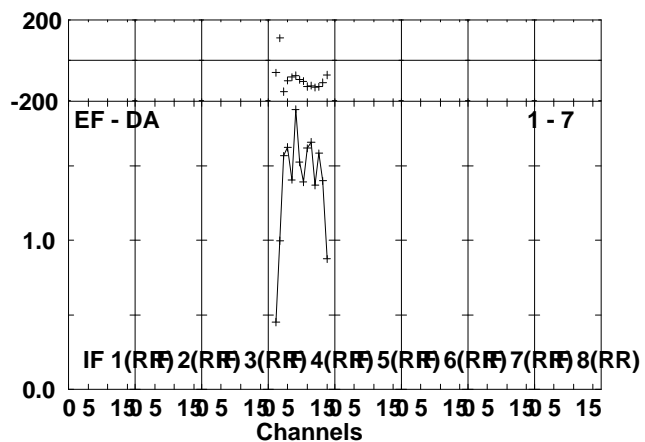
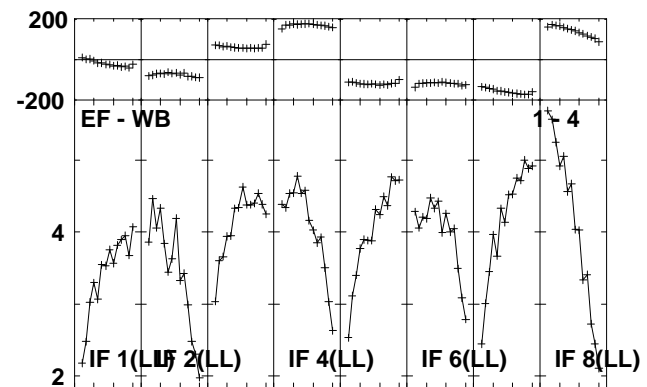
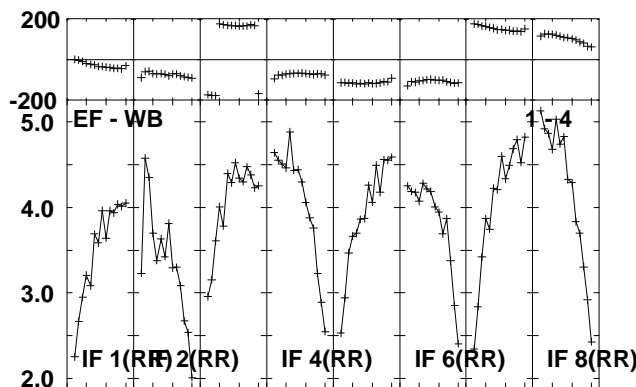
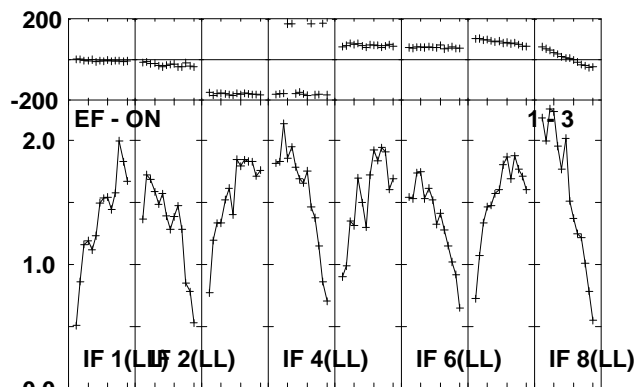
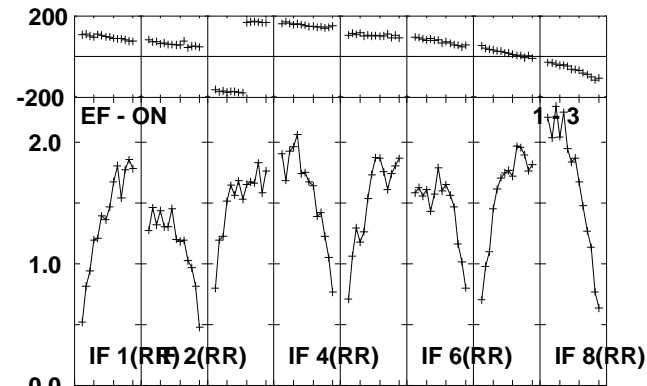
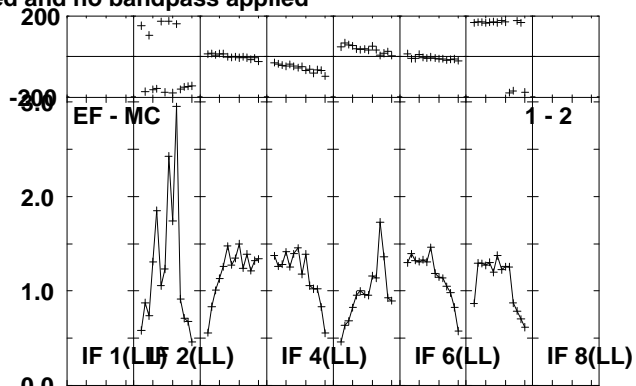
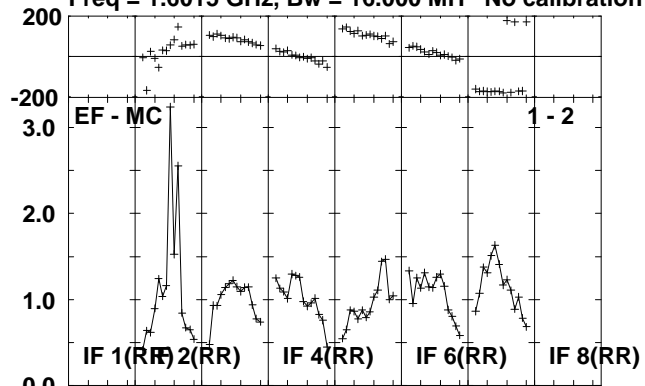

Lower frame: Milli Ampl Jy Top frame: Phas deg
Scalar averaged cross-power spectrum Several baselines displayed
Timerange: 01/08:15:05 to 01/08:16:49

Plot file version 343 created 01-JUL-2010 13:27:44
J2102+47 RG006B.UVDATA.1
Freq = 1.6015 GHz, Bw = 16.000 MH No calibration applied and no bandpass applied

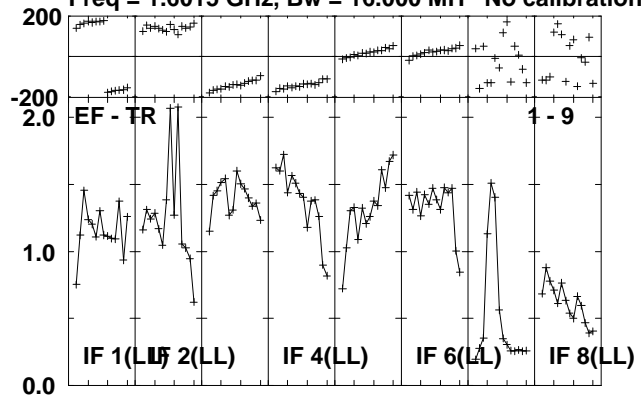

Lower frame: Milli Ampl Jy Top frame: Phas deg
Scalar averaged cross-power spectrum Several baselines displayed
Timerange: 01/08:15:05 to 01/08:16:49

Plot file version 344 created 01-JUL-2010 13:27:44

V407CYG RG006B.UVDATA.1

Freq = 1.6015 GHz, Bw = 16.000 MH No calibration applied and no bandpass applied

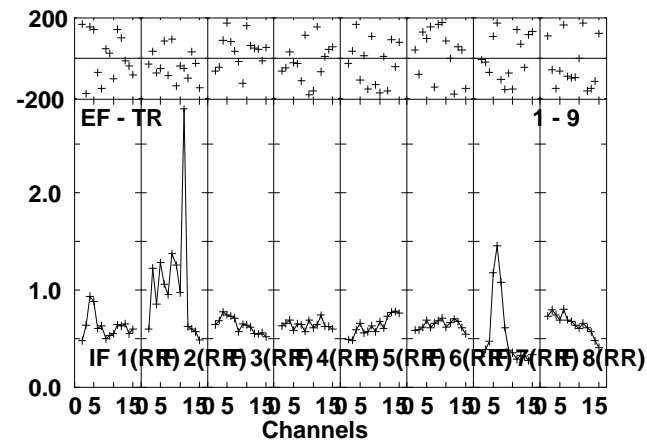
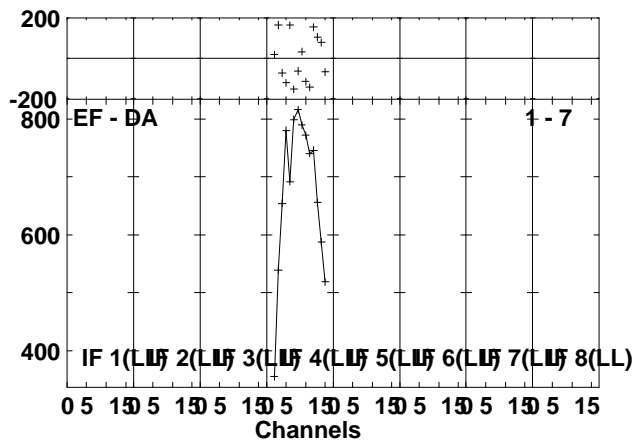
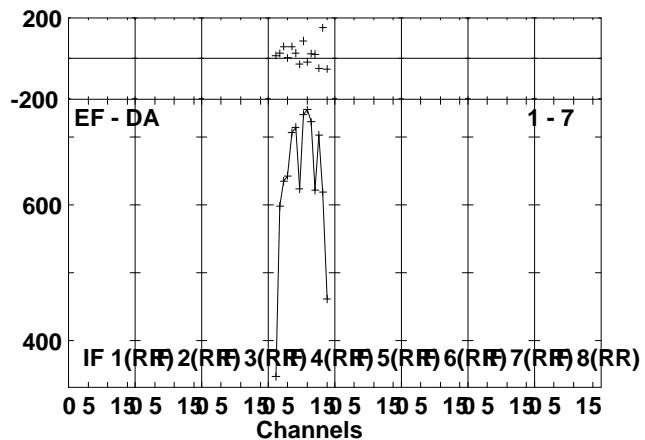
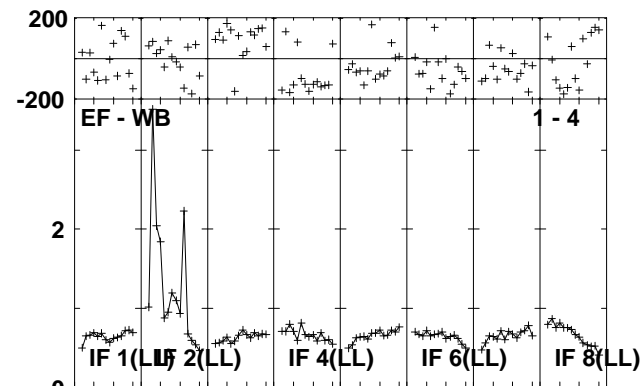
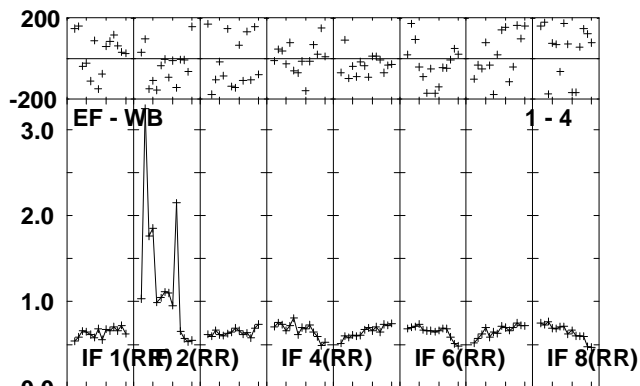
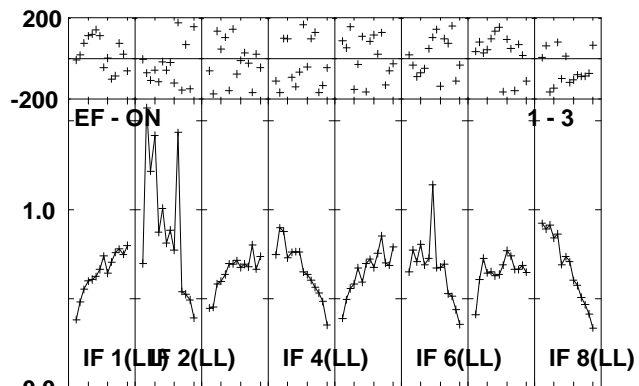
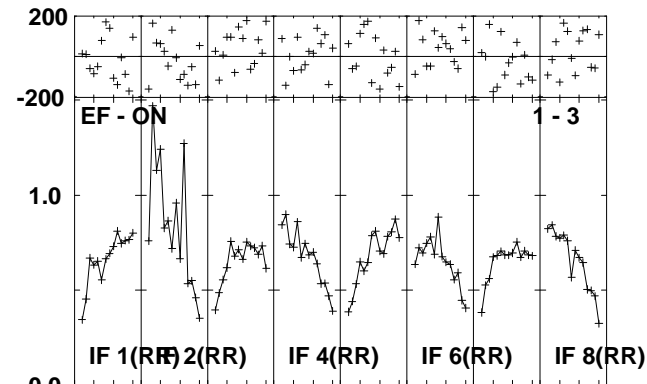
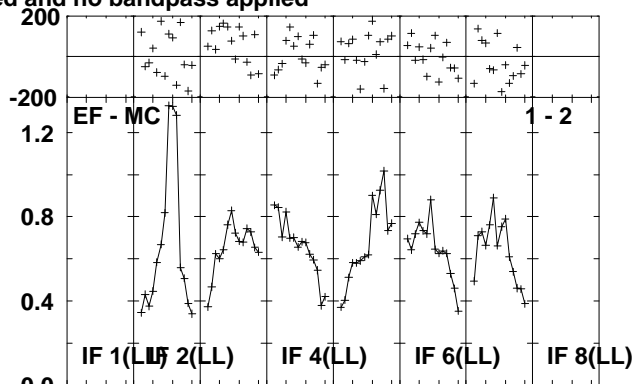
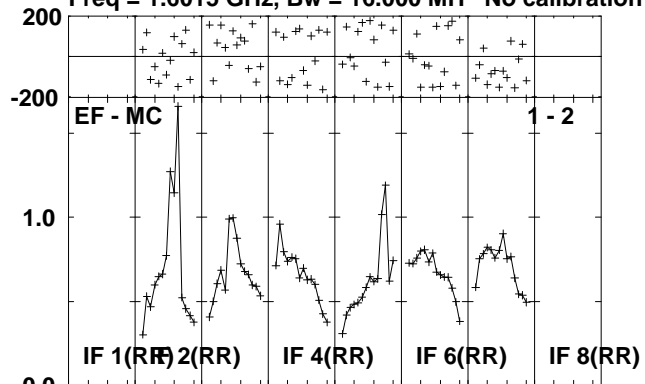

Lower frame: Milli Ampl Jy Top frame: Phas deg
Scalar averaged cross-power spectrum Several baselines displayed
Timerange: 01/08:16:53 to 01/08:21:49

Plot file version 345 created 01-JUL-2010 13:27:45

V407CYG RG006B.UVDATA.1

Freq = 1.6015 GHz, Bw = 16.000 MH No calibration applied and no bandpass applied

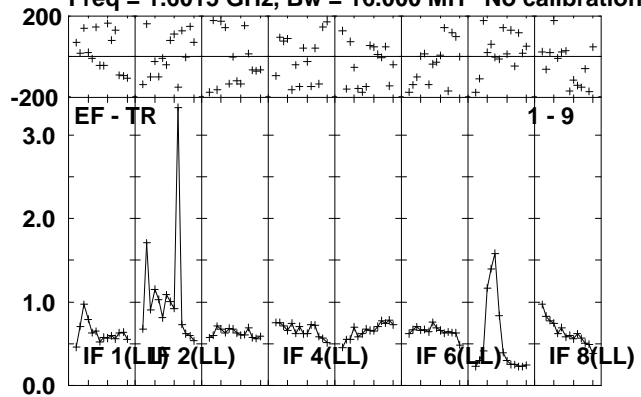

Lower frame: Milli Ampl Jy Top frame: Phas deg
Scalar averaged cross-power spectrum Several baselines displayed
Timerange: 01/08:16:53 to 01/08:21:49

Plot file version 346 created 01-JUL-2010 13:27:45

J2102+47 RG006B.UVDATA.1

Freq = 1.6015 GHz, Bw = 16.000 MH No calibration applied and no bandpass applied

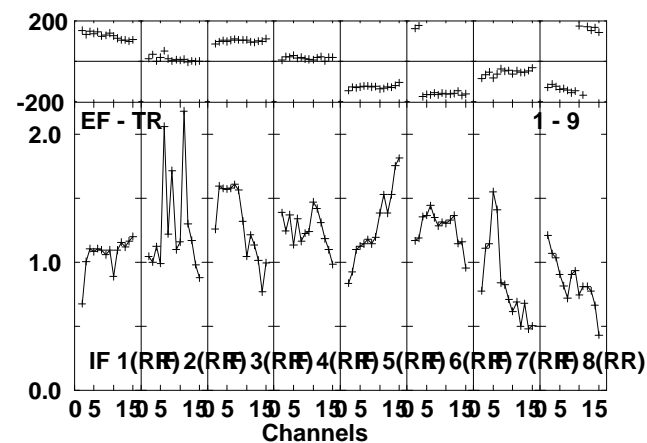
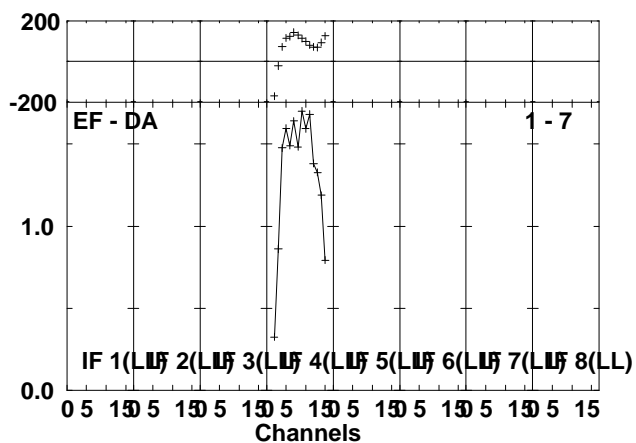
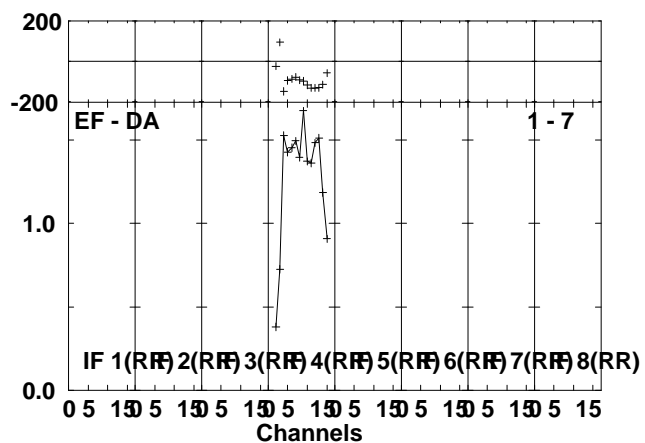
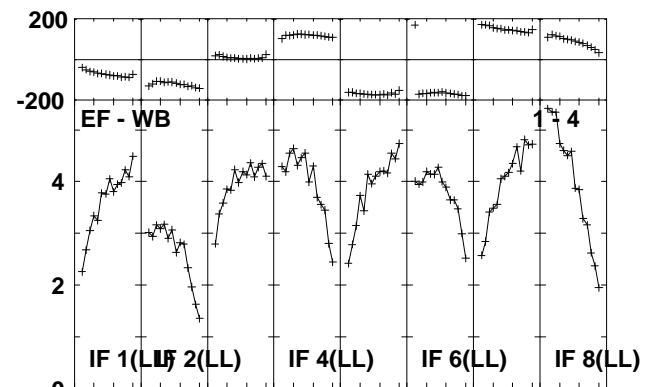
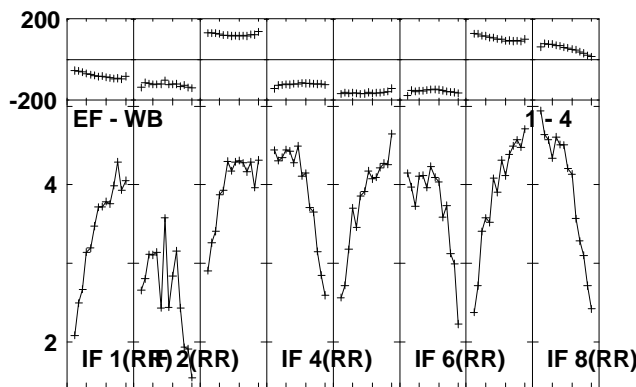
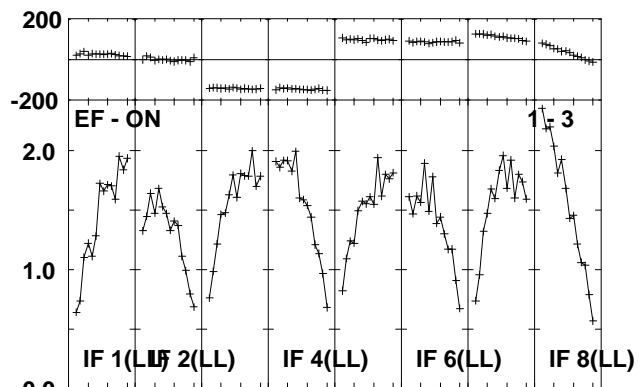
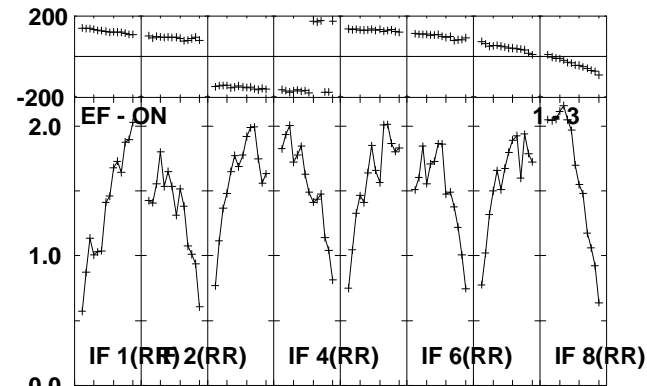
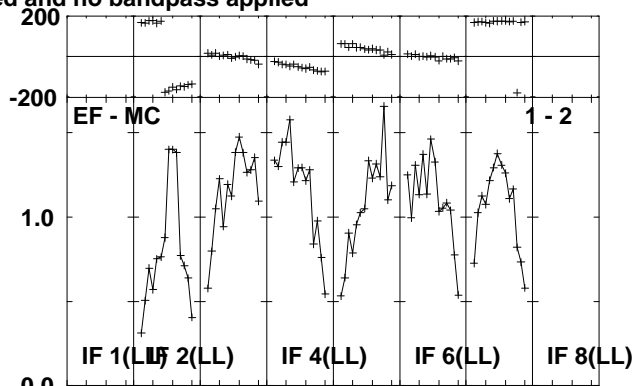
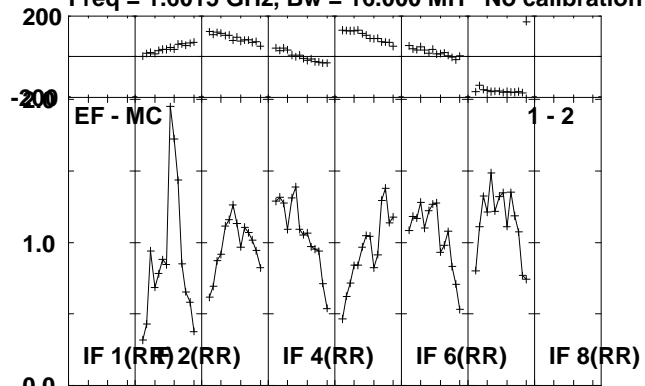

Lower frame: Milli Ampl Jy Top frame: Phas deg
Scalar averaged cross-power spectrum Several baselines displayed
Timerange: 01/08:21:53 to 01/08:24:01

Plot file version 347 created 01-JUL-2010 13:27:46
J2102+47 RG006B.UVDATA.1
Freq = 1.6015 GHz, Bw = 16.000 MH No calibration applied and no bandpass applied

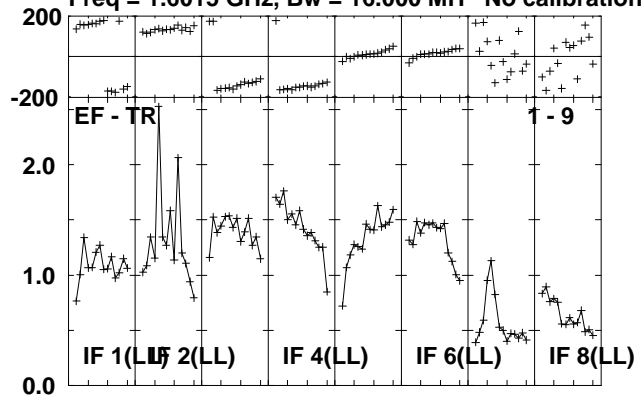

Lower frame: Milli Ampl Jy Top frame: Phas deg
Scalar averaged cross-power spectrum Several baselines displayed
Timerange: 01/08:21:53 to 01/08:24:01

Plot file version 348 created 01-JUL-2010 13:27:46

V407CYG RG006B.UVDATA.1

Freq = 1.6015 GHz, Bw = 16.000 MH No calibration applied and no bandpass applied

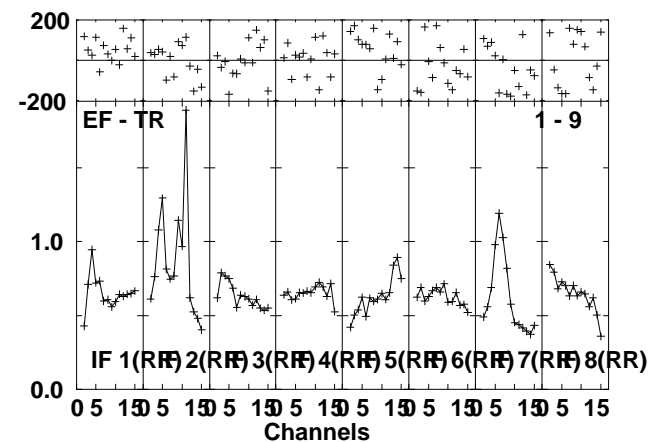
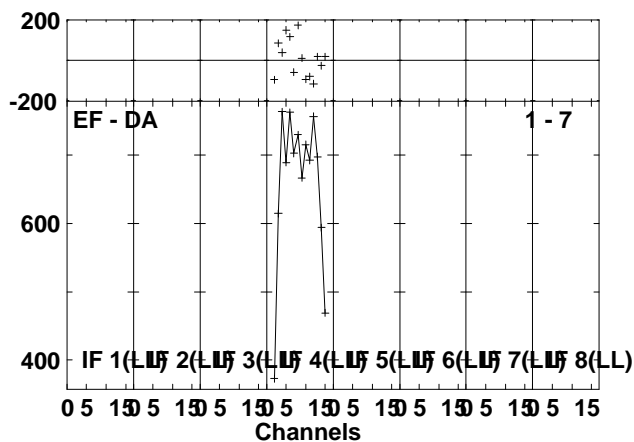
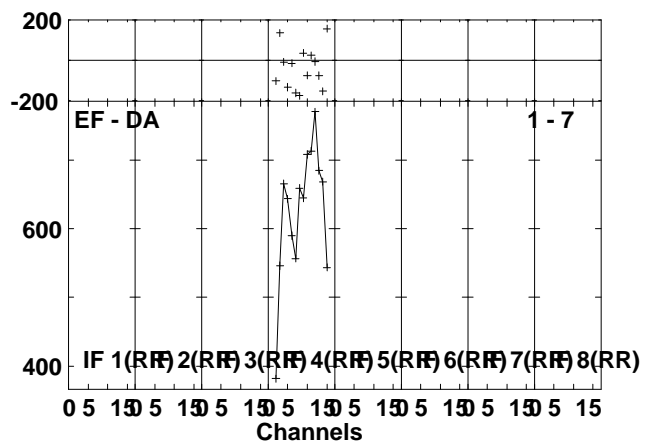
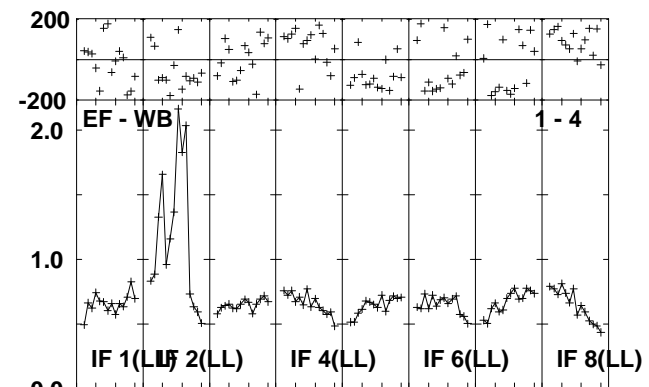
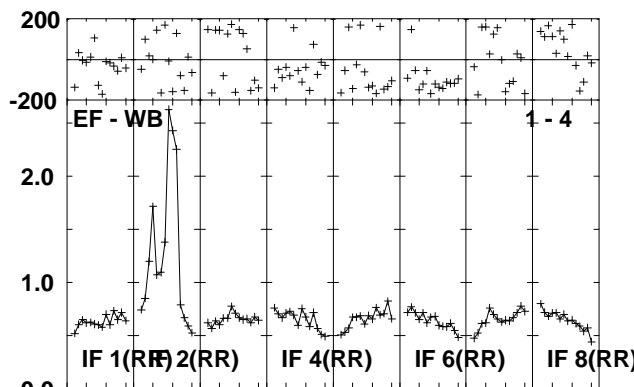
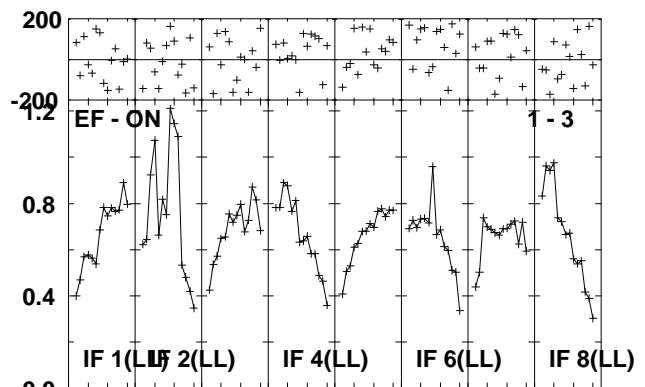
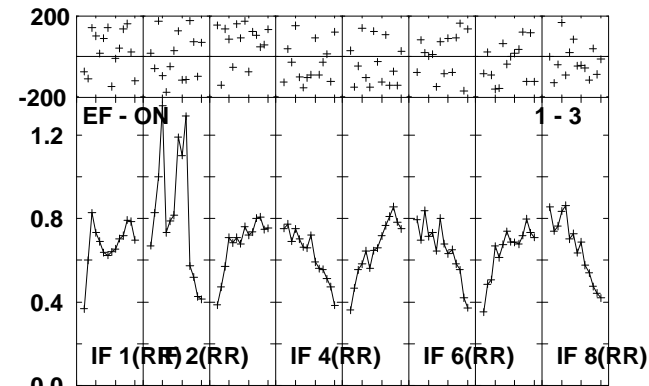
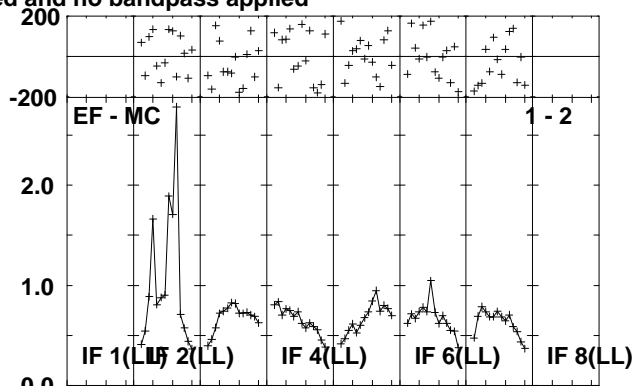
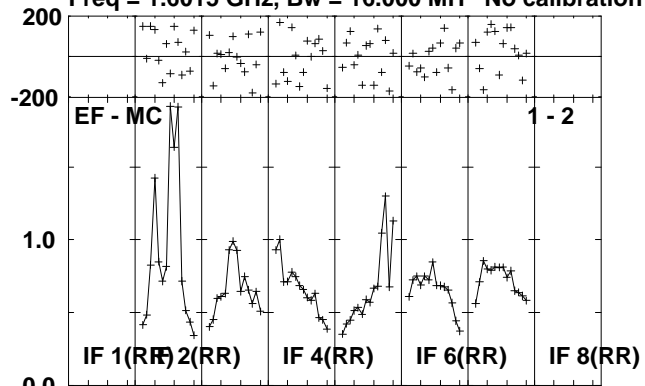

Lower frame: Milli Ampl Jy Top frame: Phas deg
Scalar averaged cross-power spectrum Several baselines displayed
Timerange: 01/08:24:05 to 01/08:29:01

Plot file version 349 created 01-JUL-2010 13:27:47

V407CYG RG006B.UVDATA.1

Freq = 1.6015 GHz, Bw = 16.000 MH No calibration applied and no bandpass applied

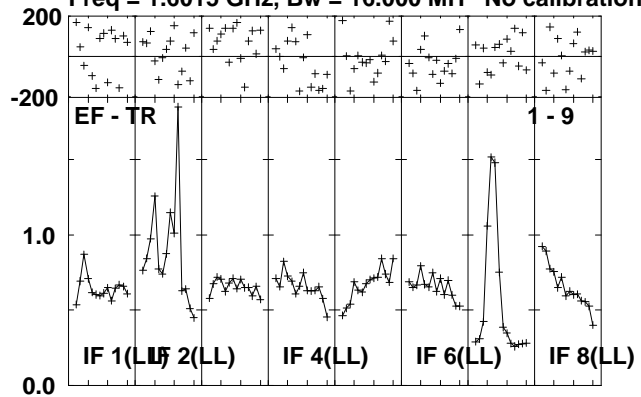

Lower frame: Milli Ampl Jy Top frame: Phas deg
Scalar averaged cross-power spectrum Several baselines displayed
Timerange: 01/08:24:05 to 01/08:29:01

Plot file version 350 created 01-JUL-2010 13:27:47

J2102+47 RG006B.UVDATA.1

Freq = 1.6015 GHz, Bw = 16.000 MH No calibration applied and no bandpass applied

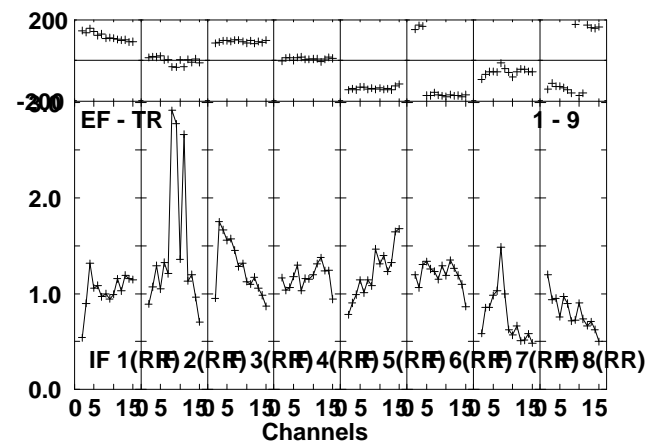
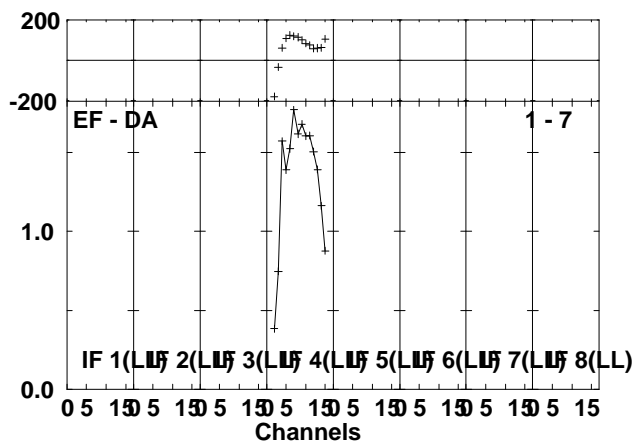
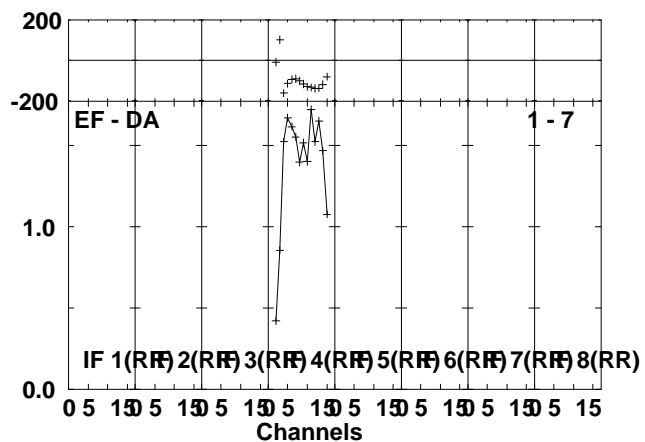
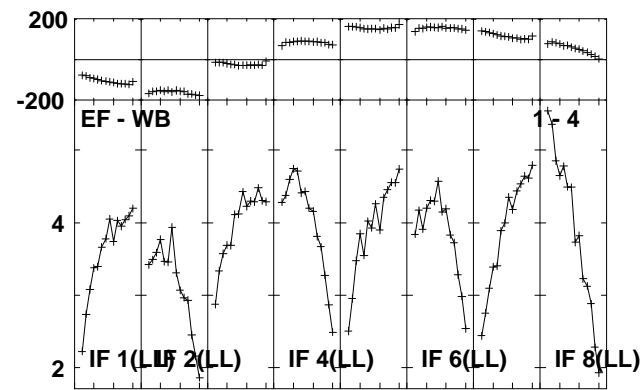
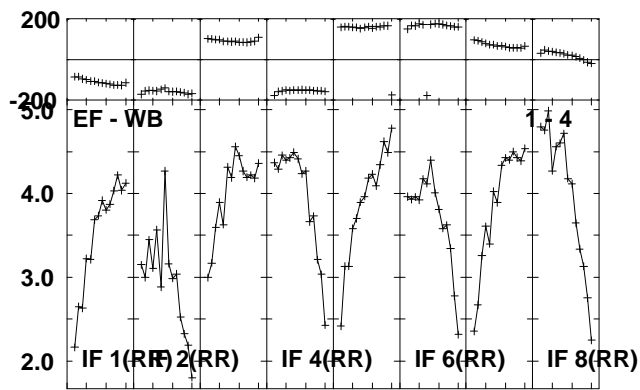
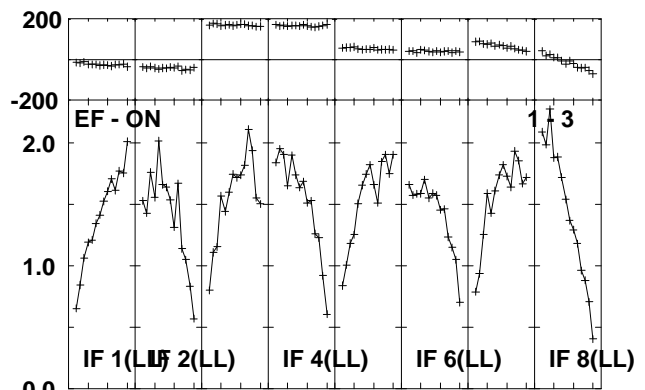
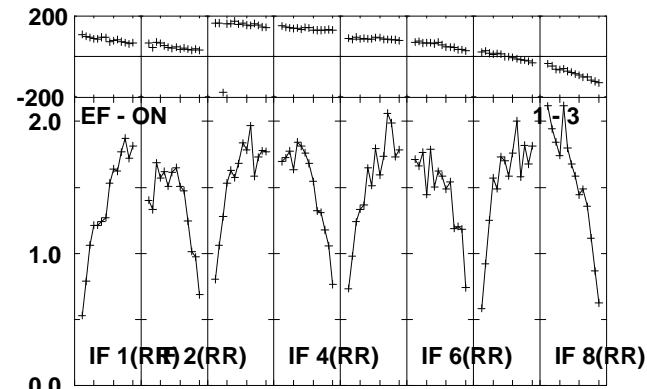
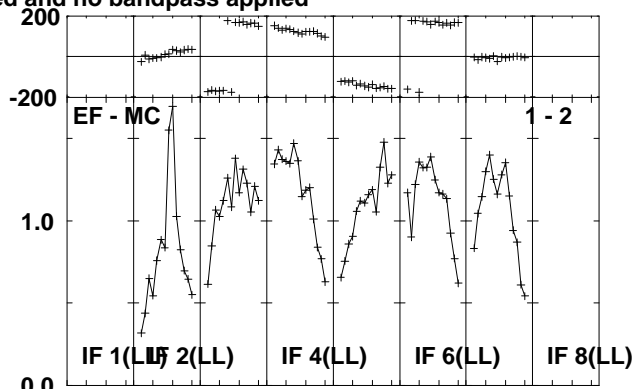
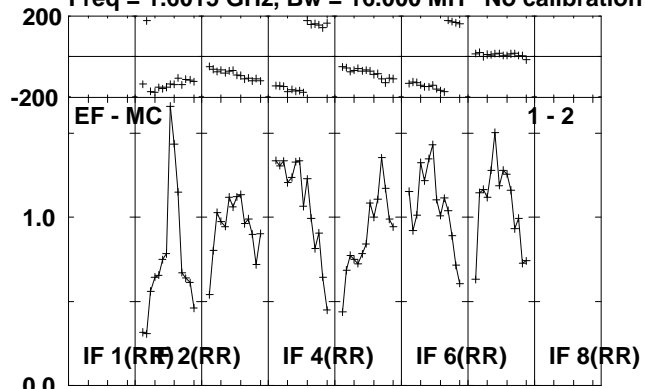

Lower frame: Milli Ampl Jy Top frame: Phas deg
Scalar averaged cross-power spectrum Several baselines displayed
Timerange: 01/08:30:05 to 01/08:31:49

Plot file version 351 created 01-JUL-2010 13:27:48
J2102+47 RG006B.UVDATA.1
Freq = 1.6015 GHz, Bw = 16.000 MH No calibration applied and no bandpass applied

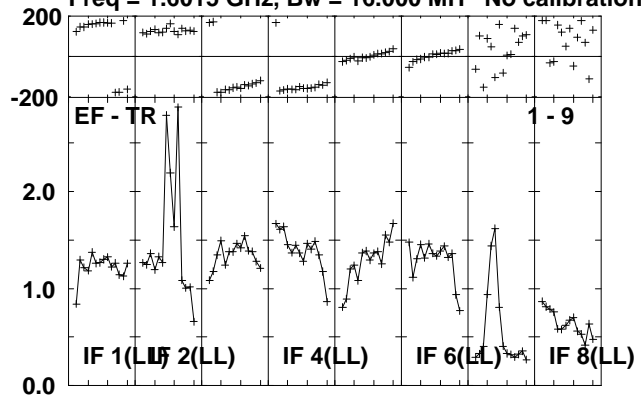

Lower frame: Milli Ampl Jy Top frame: Phas deg
Scalar averaged cross-power spectrum Several baselines displayed
Timerange: 01/08:30:05 to 01/08:31:49

Plot file version 352 created 01-JUL-2010 13:27:48

V407CYG RG006B.UVDATA.1

Freq = 1.6015 GHz, Bw = 16.000 MH No calibration applied and no bandpass applied

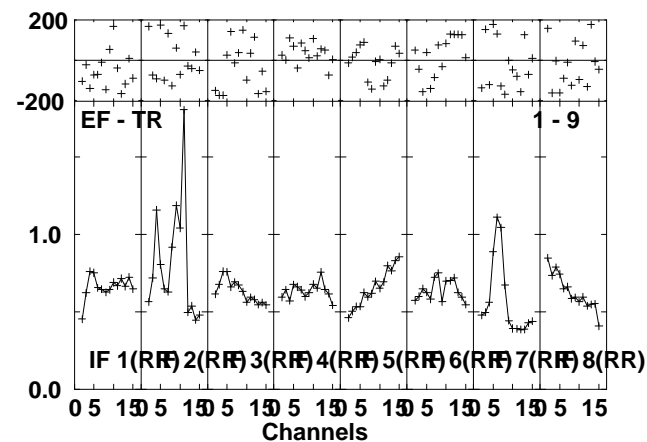
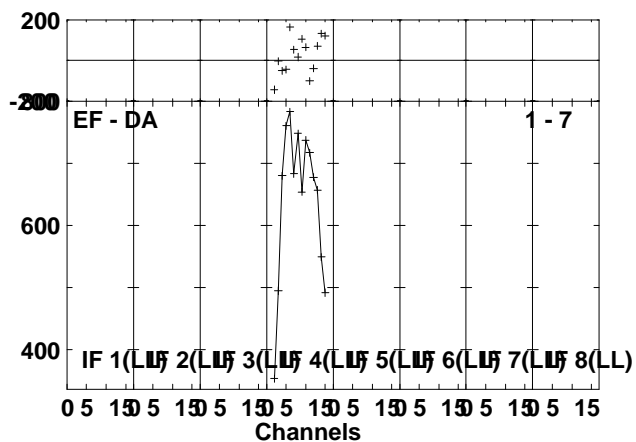
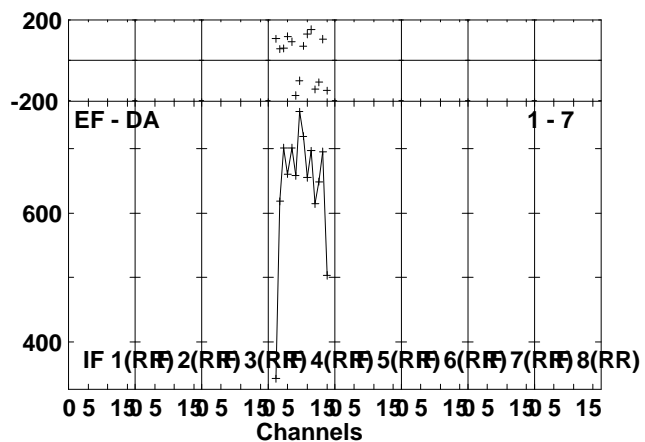
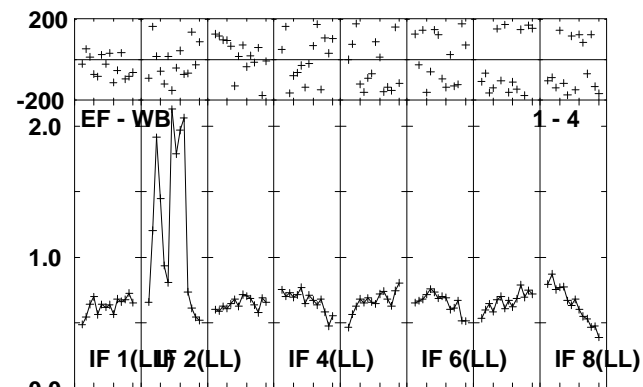
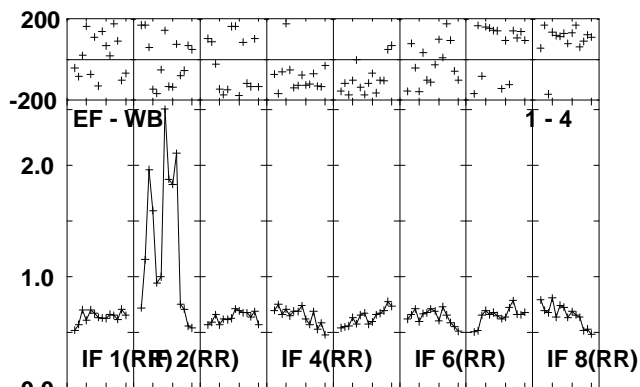
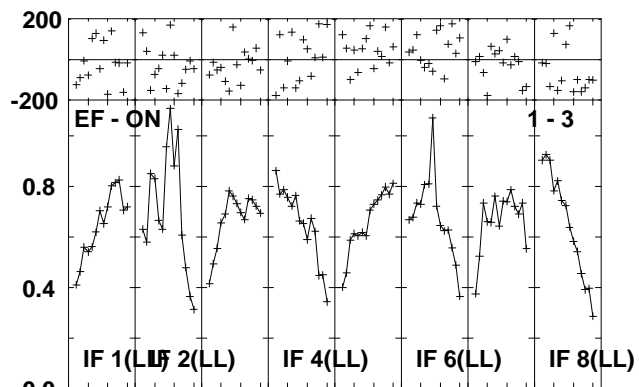
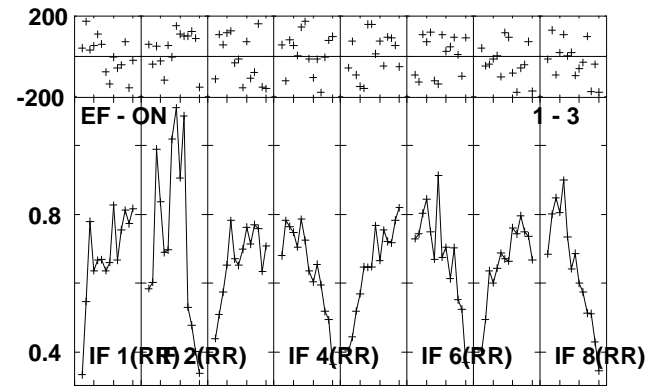
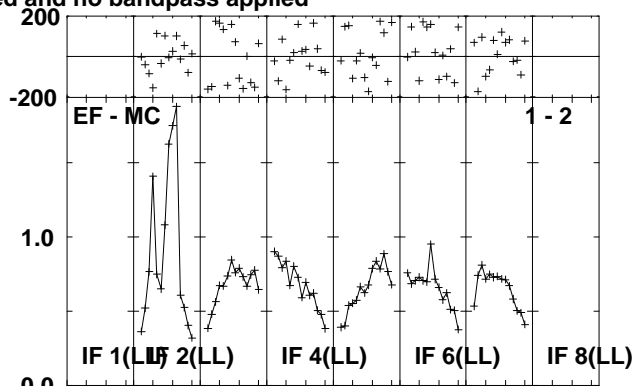
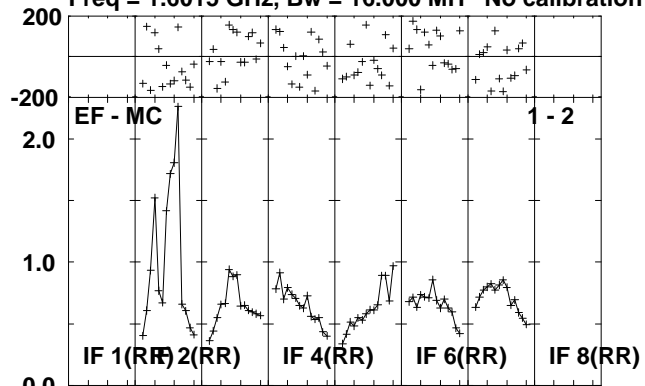

Lower frame: Milli Ampl Jy Top frame: Phas deg
Scalar averaged cross-power spectrum Several baselines displayed
Timerange: 01/08:31:53 to 01/08:36:49

Plot file version 353 created 01-JUL-2010 13:27:49
V407CYG RG006B.UVDATA.1
Freq = 1.6015 GHz, Bw = 16.000 MH No calibration applied and no bandpass applied

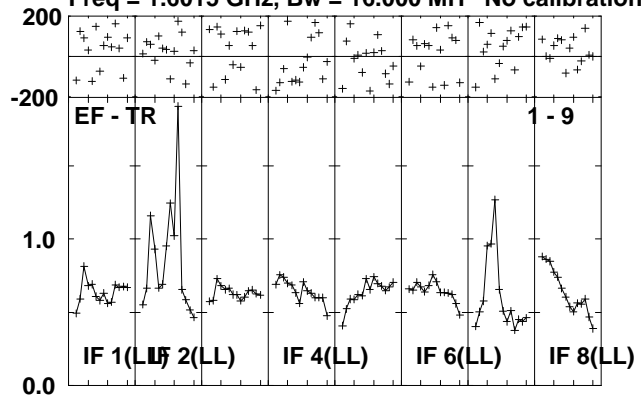

Lower frame: Milli Ampl Jy Top frame: Phas deg
Scalar averaged cross-power spectrum Several baselines displayed
Timerange: 01/08:31:53 to 01/08:36:49

Plot file version 354 created 01-JUL-2010 13:27:49

J2102+47 RG006B.UVDATA.1

Freq = 1.6015 GHz, Bw = 16.000 MH No calibration applied and no bandpass applied

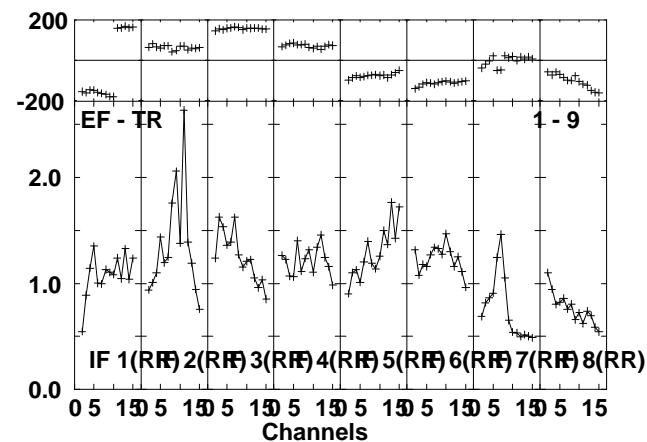
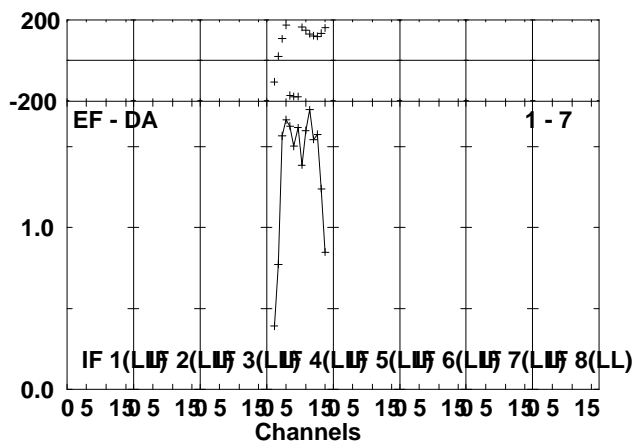
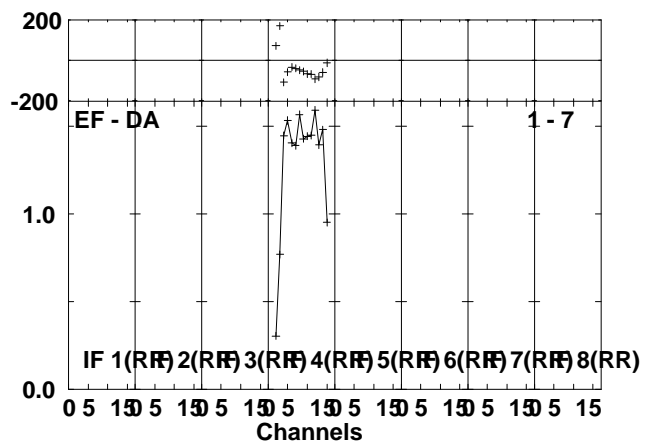
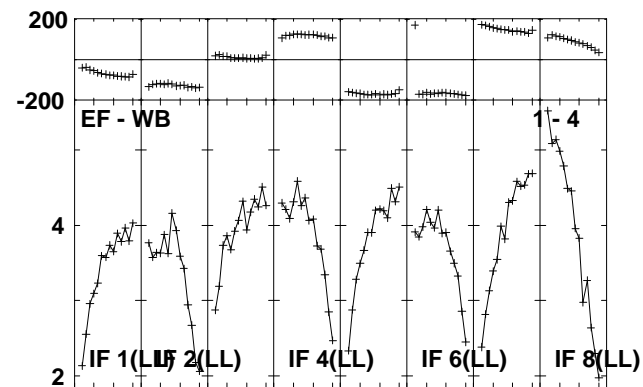
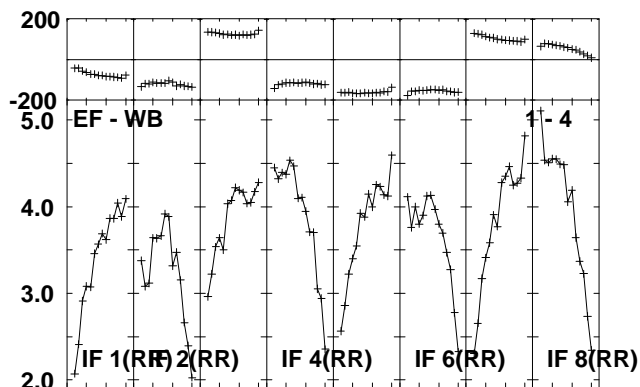
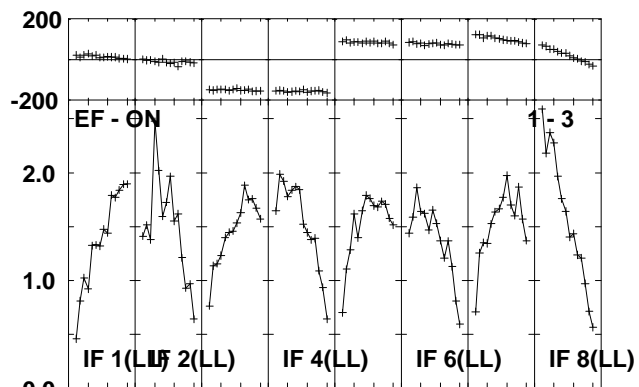
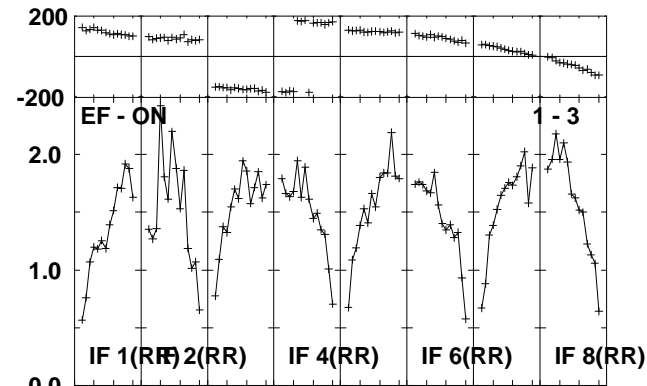
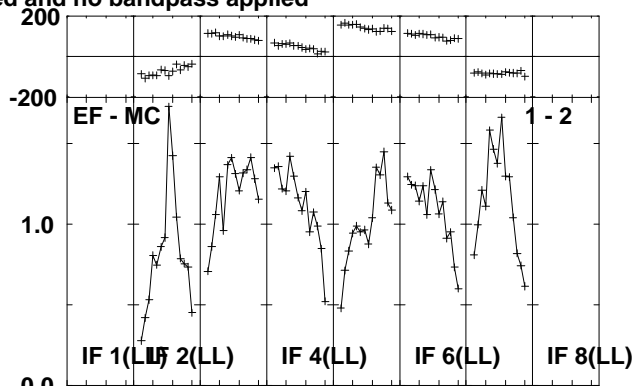
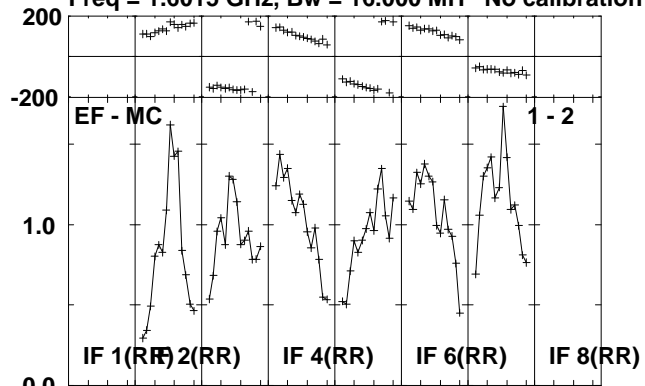

Lower frame: Milli Ampl Jy Top frame: Phas deg
Scalar averaged cross-power spectrum Several baselines displayed
Timerange: 01/08:36:53 to 01/08:39:01

Plot file version 355 created 01-JUL-2010 13:27:50

J2102+47 RG006B.UVDATA.1

Freq = 1.6015 GHz, Bw = 16.000 MH No calibration applied and no bandpass applied

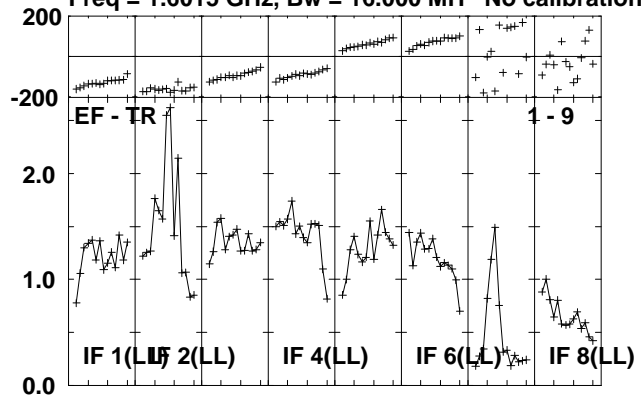

Lower frame: Milli Ampl Jy Top frame: Phas deg
Scalar averaged cross-power spectrum Several baselines displayed
Timerange: 01/08:36:53 to 01/08:39:01

Plot file version 356 created 01-JUL-2010 13:27:50

V407CYG RG006B.UVDATA.1

Freq = 1.6015 GHz, Bw = 16.000 MH No calibration applied and no bandpass applied

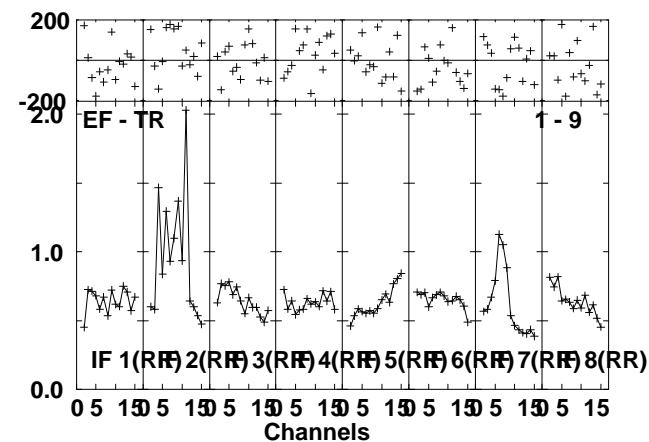
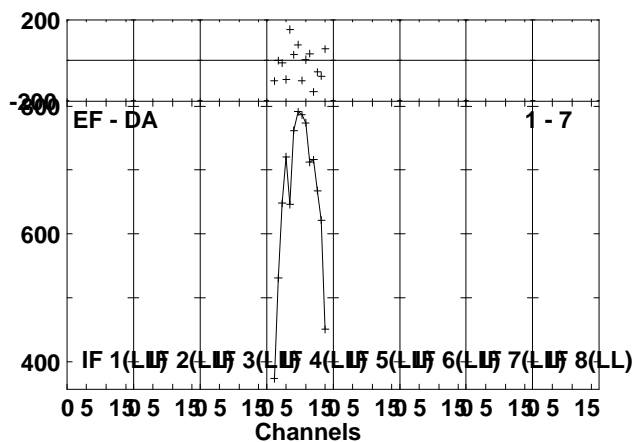
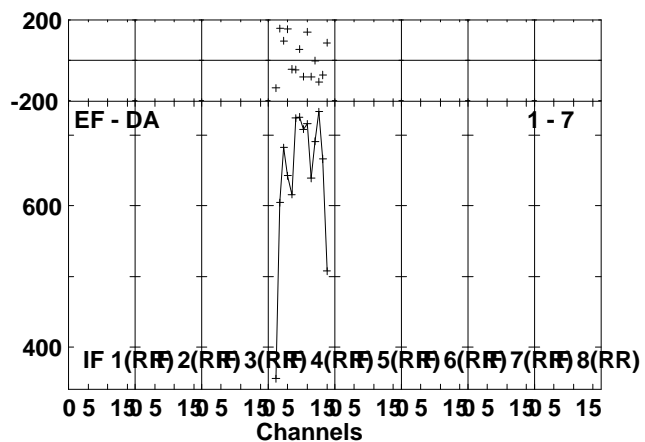
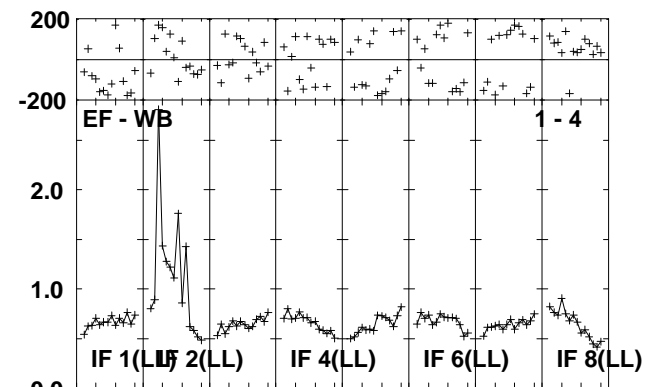
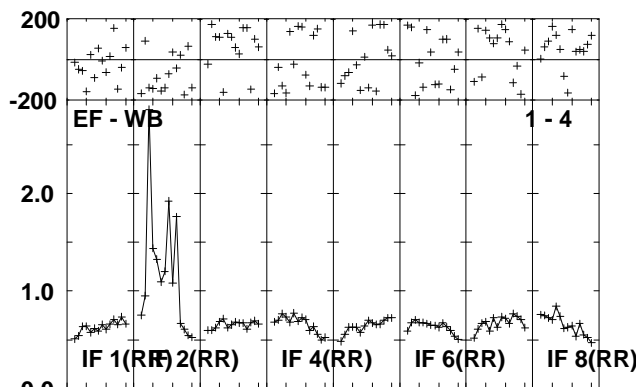
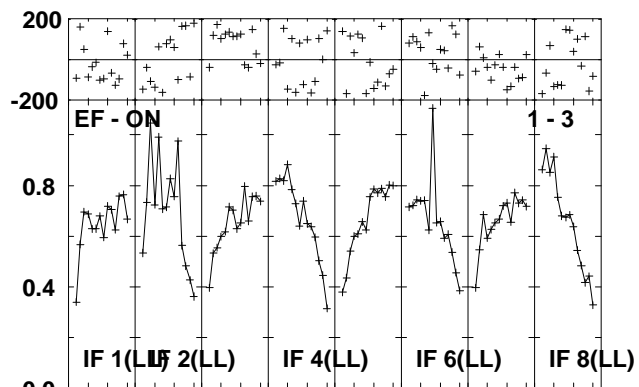
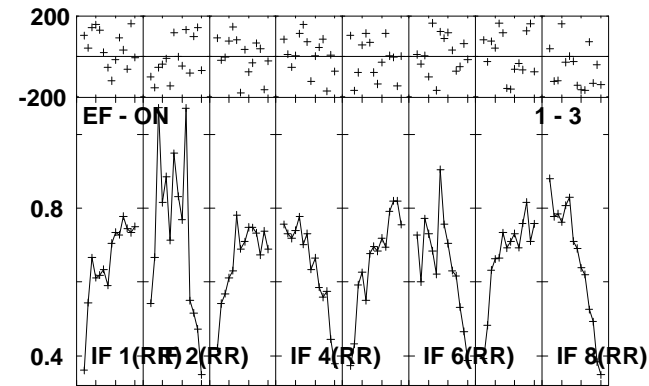
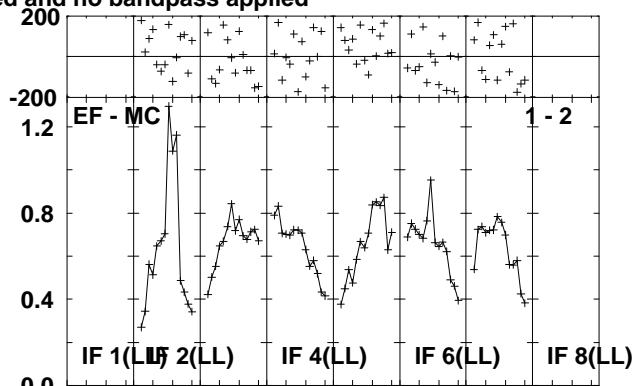
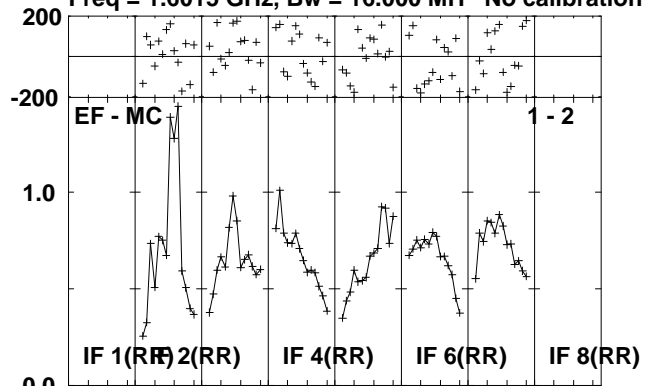

Lower frame: Milli Ampl Jy Top frame: Phas deg
Scalar averaged cross-power spectrum Several baselines displayed
Timerange: 01/08:39:05 to 01/08:44:01

Plot file version 357 created 01-JUL-2010 13:27:51

V407CYG RG006B.UVDATA.1

Freq = 1.6015 GHz, Bw = 16.000 MH No calibration applied and no bandpass applied

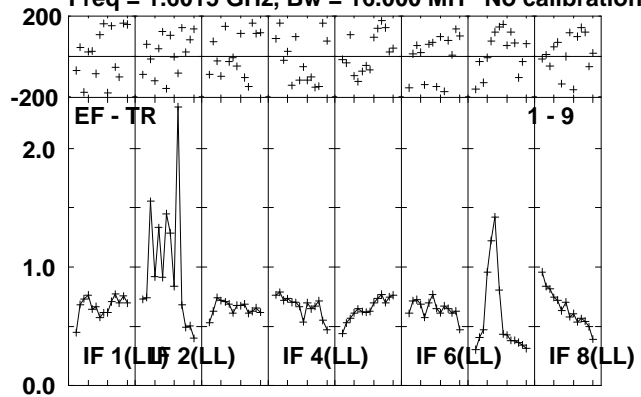

Lower frame: Milli Ampl Jy Top frame: Phas deg
Scalar averaged cross-power spectrum Several baselines displayed
Timerange: 01/08:39:05 to 01/08:44:01

Plot file version 358 created 01-JUL-2010 13:27:51

J2102+47 RG006B.UVDATA.1

Freq = 1.6015 GHz, Bw = 16.000 MH No calibration applied and no bandpass applied

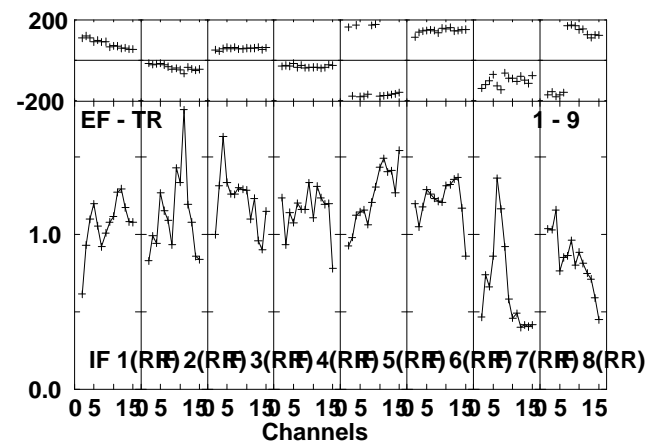
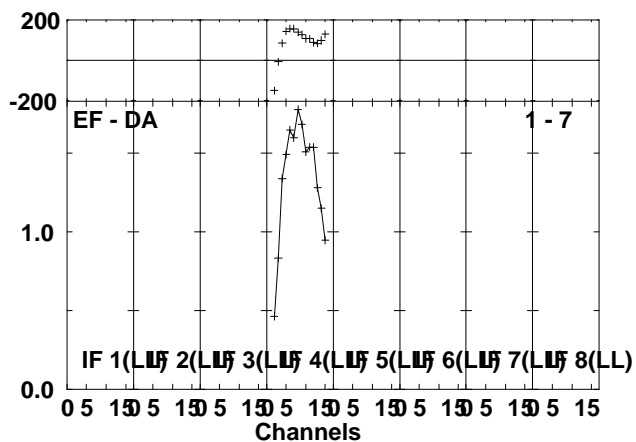
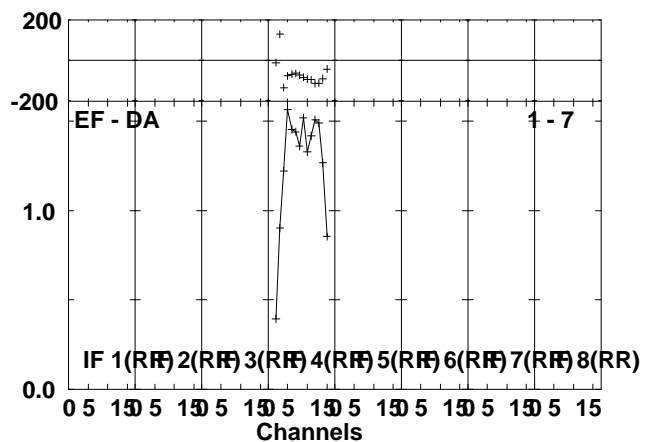
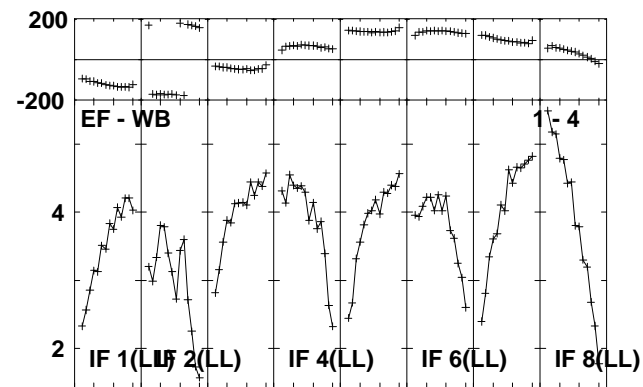
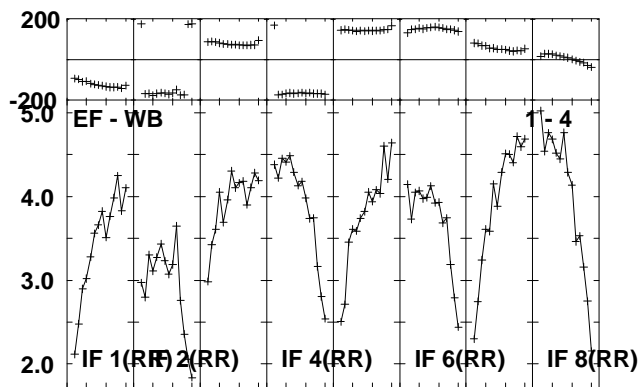
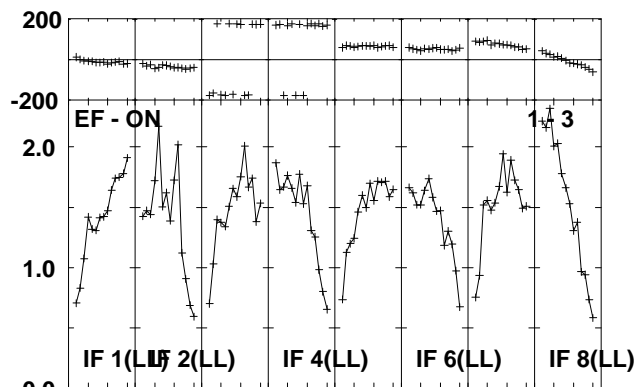
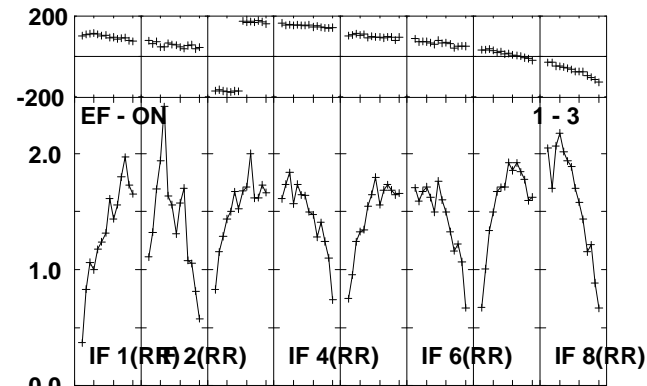
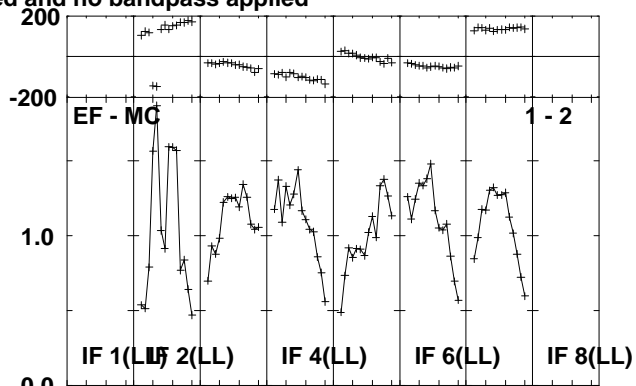
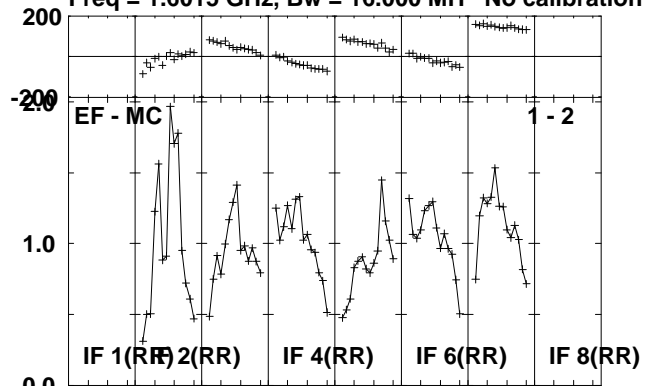

Lower frame: Milli Ampl Jy Top frame: Phas deg
Scalar averaged cross-power spectrum Several baselines displayed
Timerange: 01/08:45:05 to 01/08:46:49

Plot file version 359 created 01-JUL-2010 13:27:52
J2102+47 RG006B.UVDATA.1
Freq = 1.6015 GHz, Bw = 16.000 MH No calibration applied and no bandpass applied

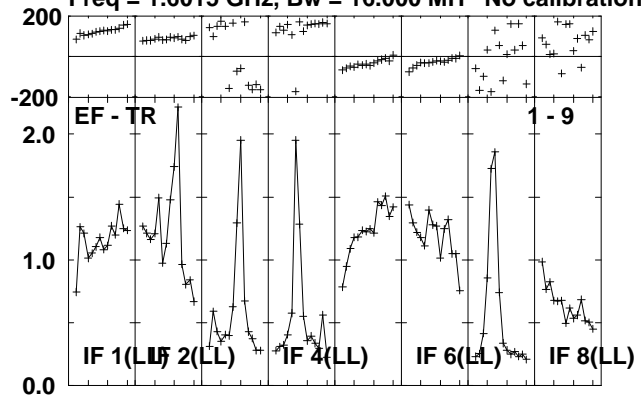

Lower frame: Milli Ampl Jy Top frame: Phas deg
Scalar averaged cross-power spectrum Several baselines displayed
Timerange: 01/08:45:05 to 01/08:46:49

Plot file version 360 created 01-JUL-2010 13:27:52

V407CYG RG006B.UVDATA.1

Freq = 1.6015 GHz, Bw = 16.000 MH No calibration applied and no bandpass applied

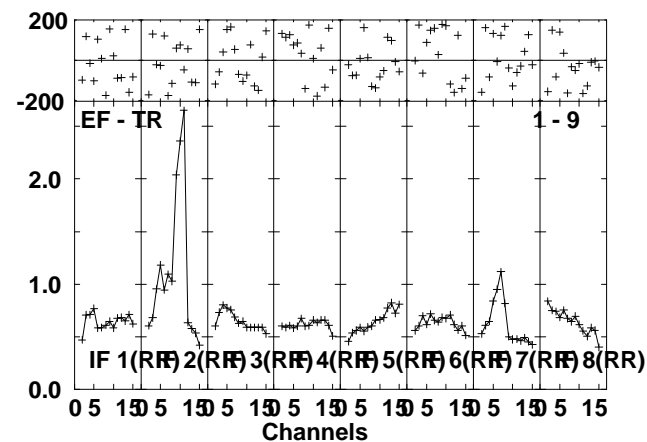
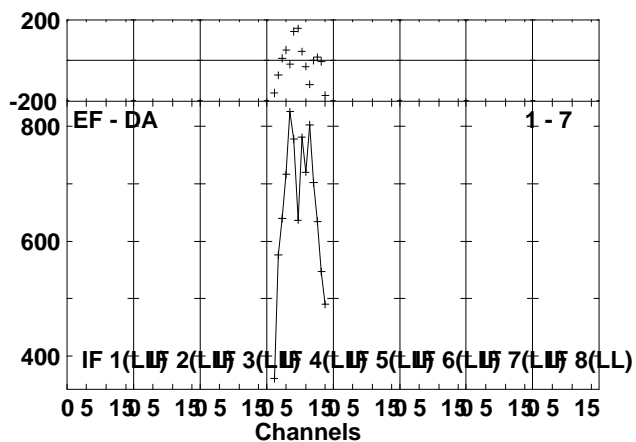
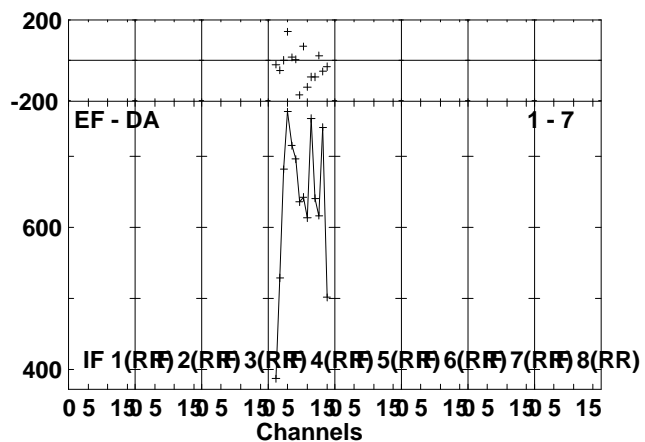
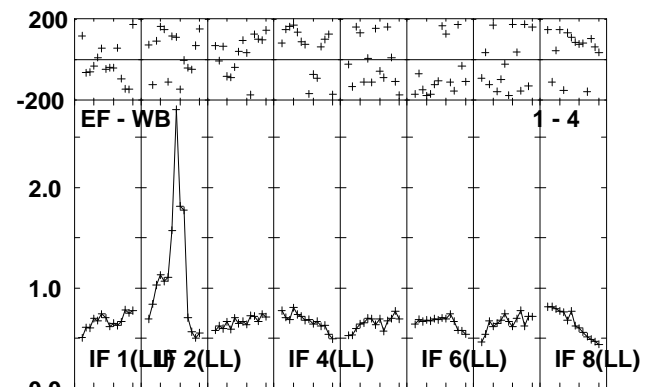
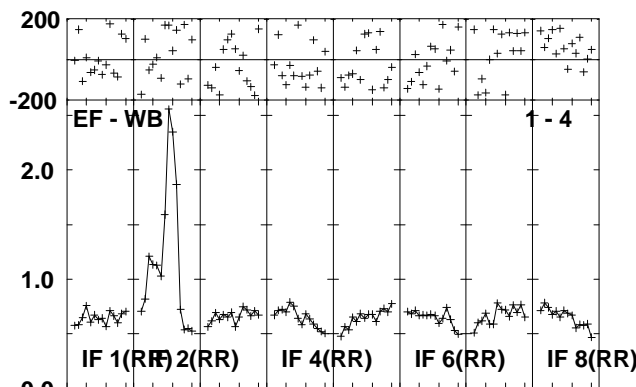
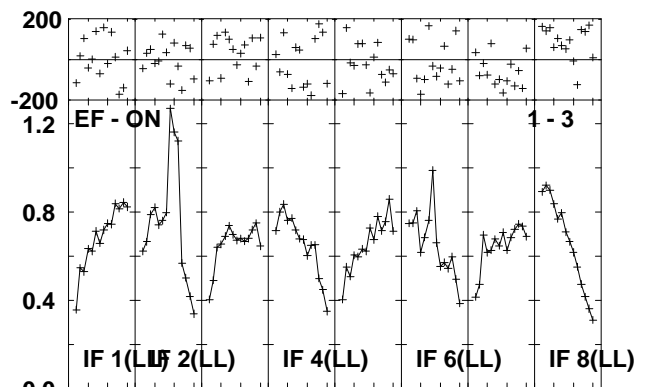
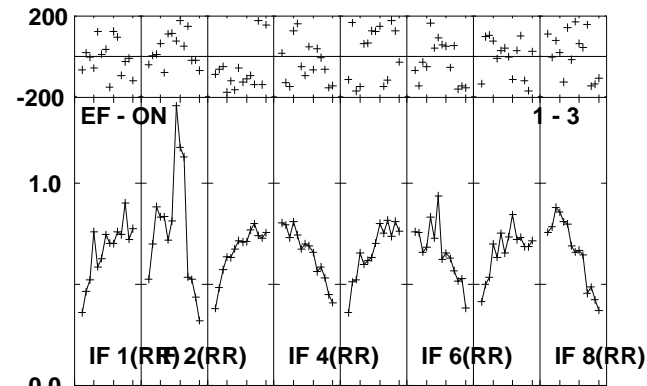
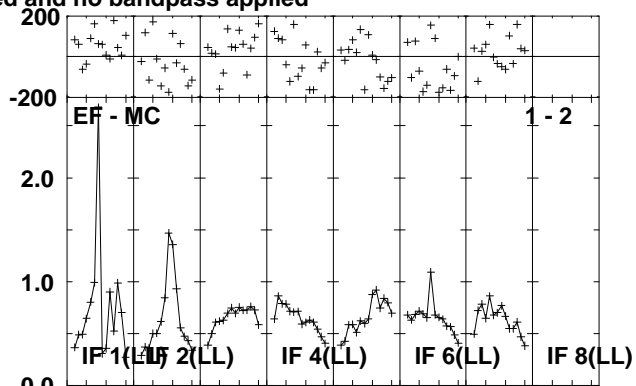
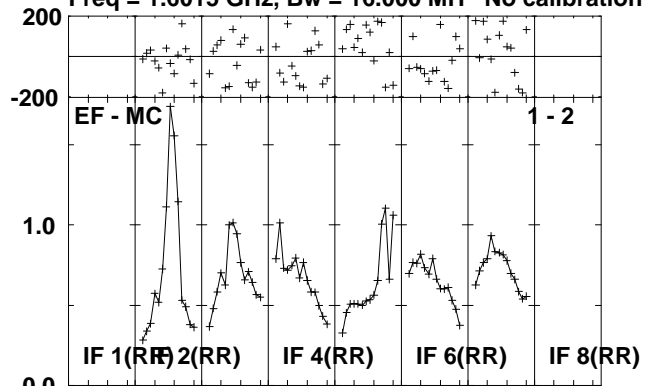

Lower frame: Milli Ampl Jy Top frame: Phas deg
Scalar averaged cross-power spectrum Several baselines displayed
Timerange: 01/08:46:53 to 01/08:51:49

Plot file version 361 created 01-JUL-2010 13:27:53

V407CYG RG006B.UVDATA.1

Freq = 1.6015 GHz, Bw = 16.000 MH No calibration applied and no bandpass applied

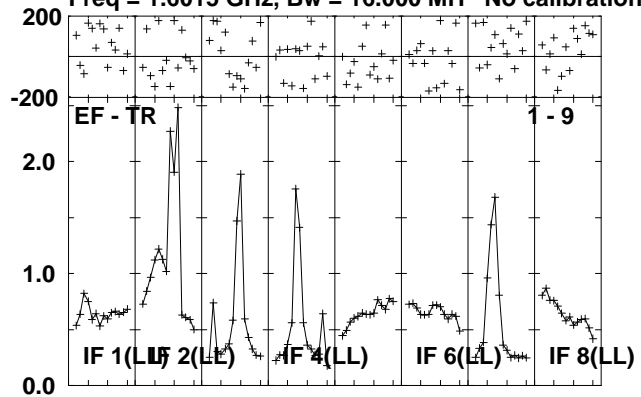

Lower frame: Milli Ampl Jy Top frame: Phas deg
Scalar averaged cross-power spectrum Several baselines displayed
Timerange: 01/08:46:53 to 01/08:51:49

Plot file version 362 created 01-JUL-2010 13:27:53

J2102+47 RG006B.UVDATA.1

Freq = 1.6015 GHz, Bw = 16.000 MH No calibration applied and no bandpass applied

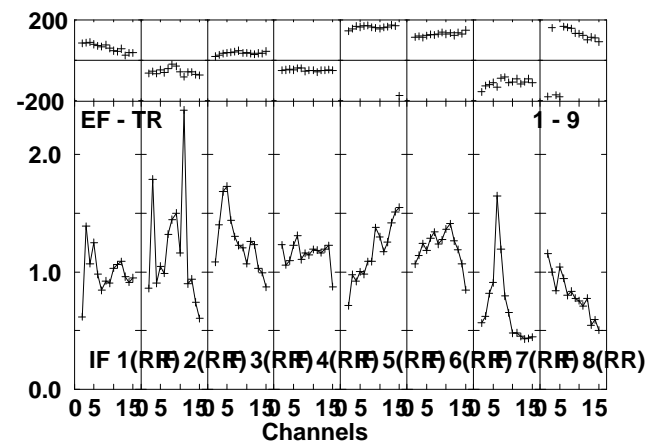
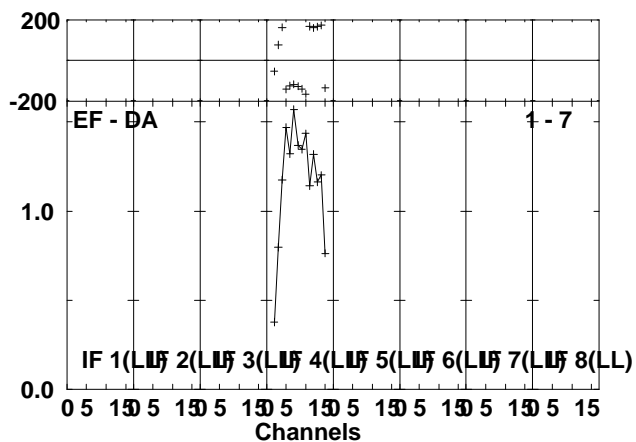
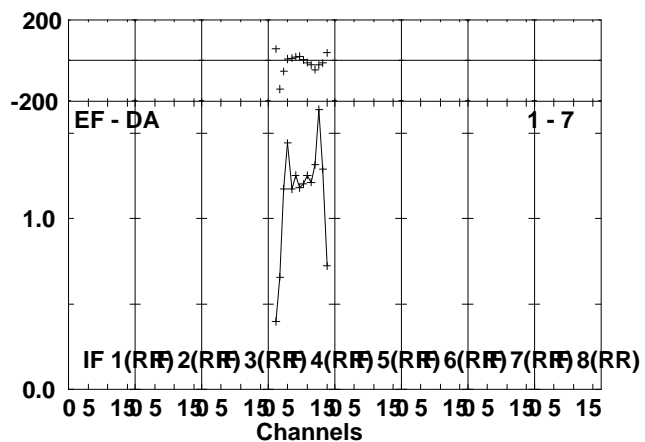
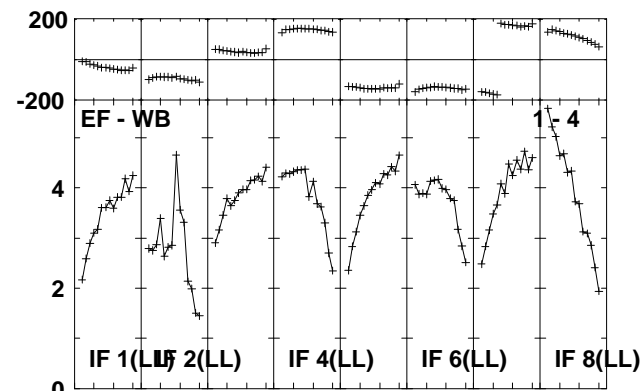
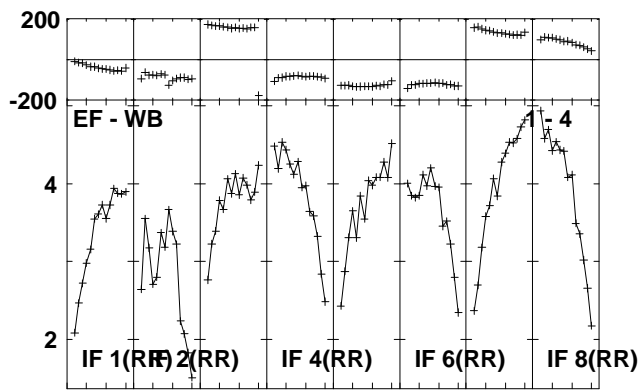
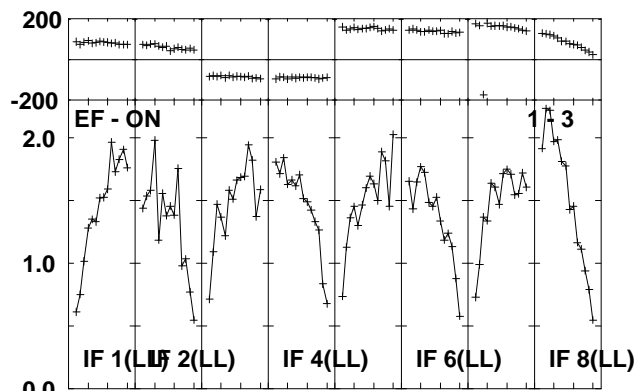
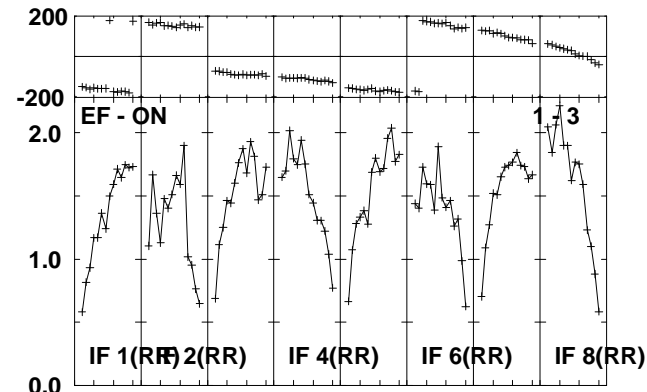
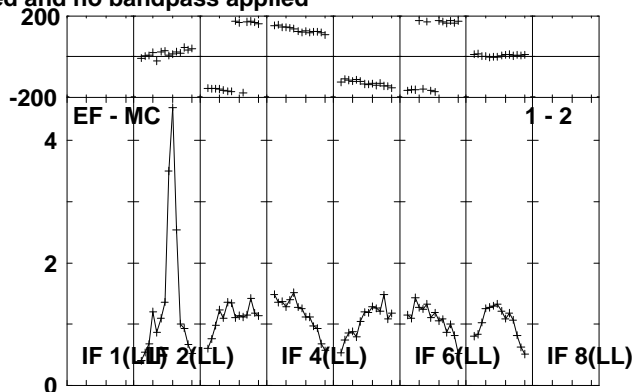
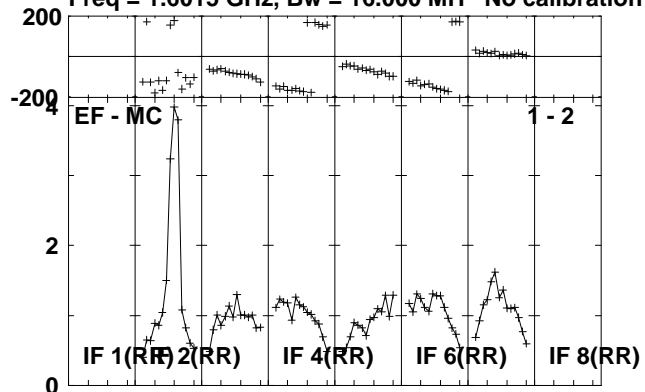

Lower frame: Milli Ampl Jy Top frame: Phas deg
Scalar averaged cross-power spectrum Several baselines displayed
Timerange: 01/08:51:53 to 01/08:54:01

Plot file version 363 created 01-JUL-2010 13:27:54
J2102+47 RG006B.UVDATA.1
Freq = 1.6015 GHz, Bw = 16.000 MH No calibration applied and no bandpass applied

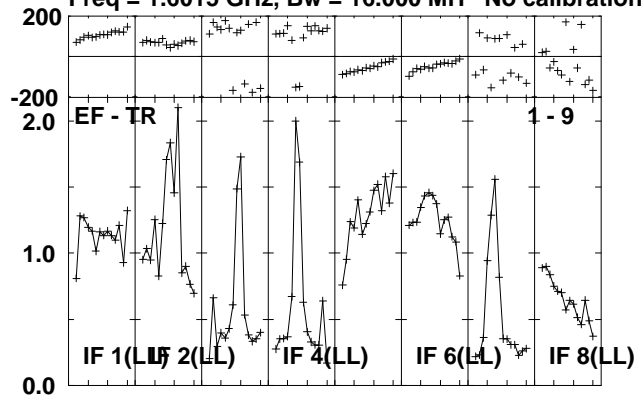

Lower frame: Milli Ampl Jy Top frame: Phas deg
Scalar averaged cross-power spectrum Several baselines displayed
Timerange: 01/08:51:53 to 01/08:54:01

Plot file version 364 created 01-JUL-2010 13:27:54

V407CYG RG006B.UVDATA.1

Freq = 1.6015 GHz, Bw = 16.000 MH No calibration applied and no bandpass applied

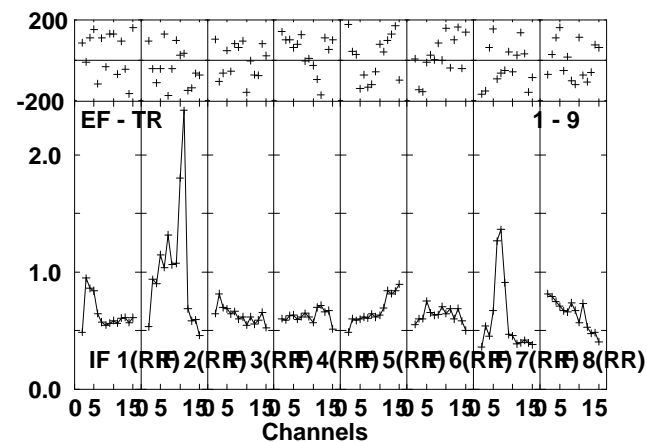
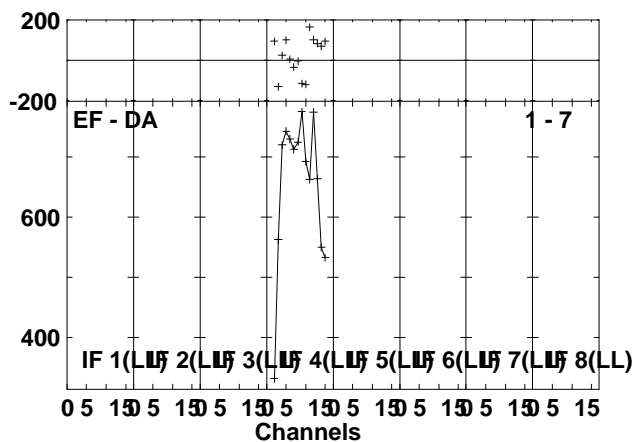
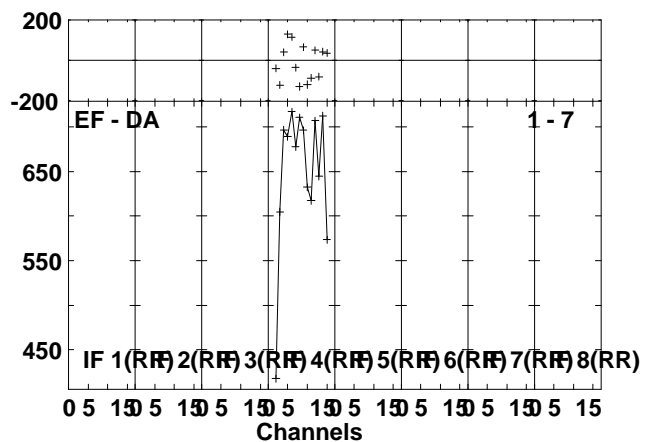
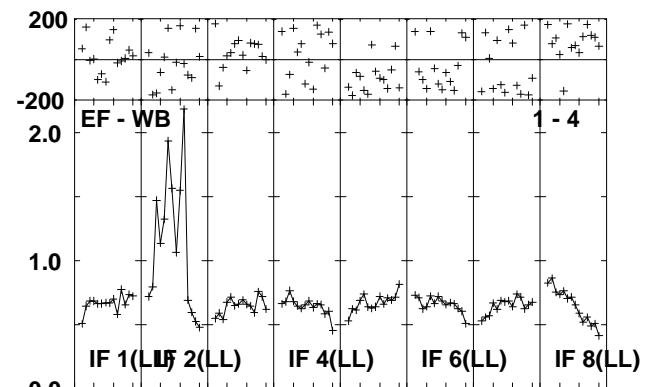
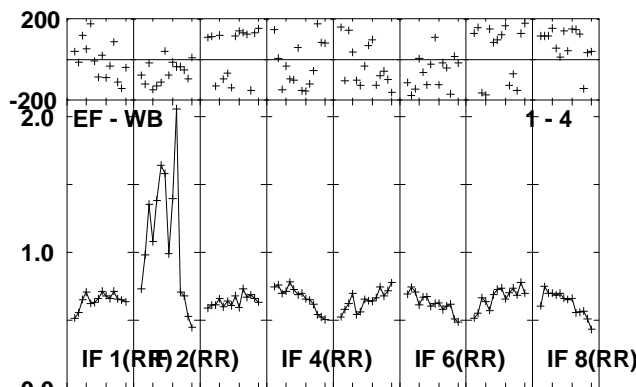
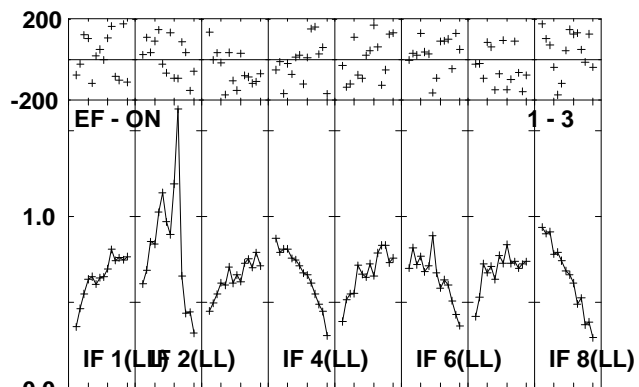
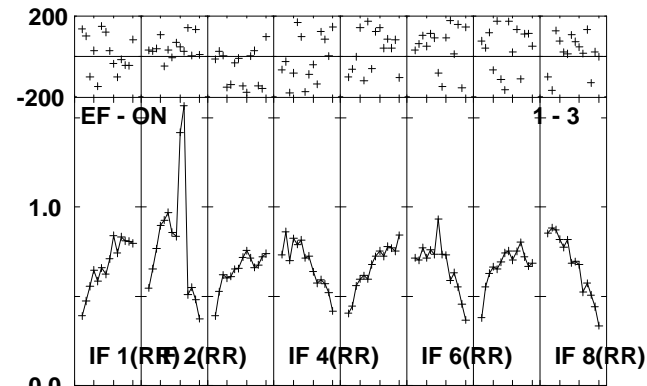
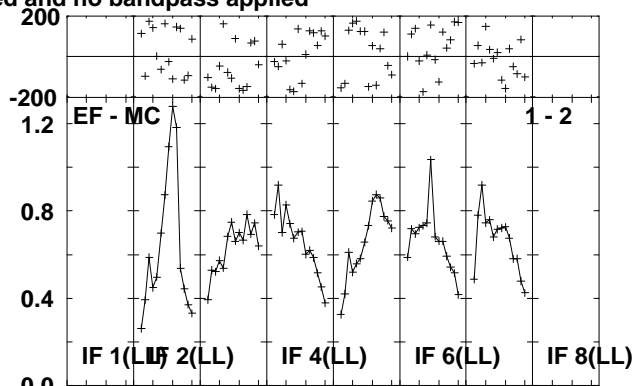
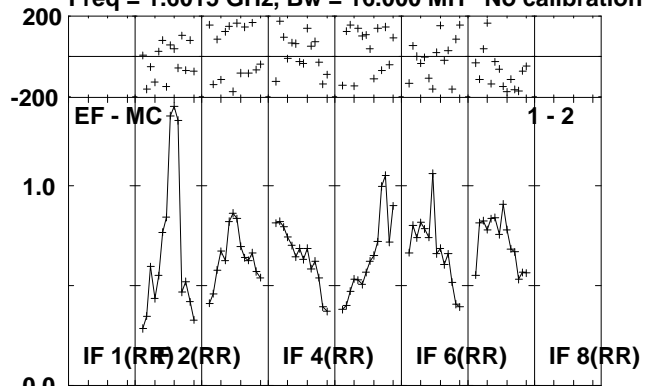

Lower frame: Milli Ampl Jy Top frame: Phas deg
Scalar averaged cross-power spectrum Several baselines displayed
Timerange: 01/08:54:05 to 01/08:59:01

Plot file version 365 created 01-JUL-2010 13:27:55
V407CYG RG006B.UVDATA.1
Freq = 1.6015 GHz, Bw = 16.000 MH No calibration applied and no bandpass applied

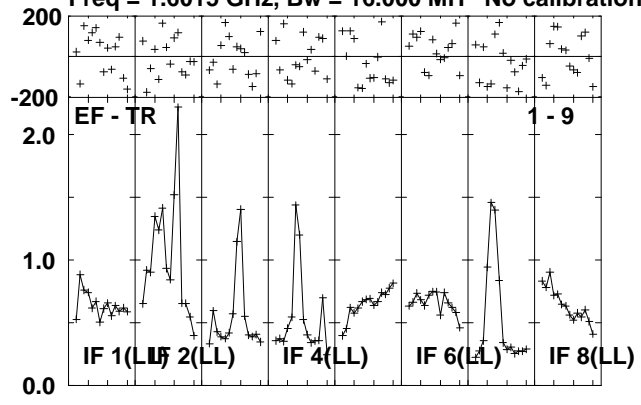

Lower frame: Milli Ampl Jy Top frame: Phas deg
Scalar averaged cross-power spectrum Several baselines displayed
Timerange: 01/08:54:05 to 01/08:59:01

Plot file version 366 created 01-JUL-2010 13:27:55

J2102+47 RG006B.UVDATA.1

Freq = 1.6015 GHz, Bw = 16.000 MH No calibration applied and no bandpass applied

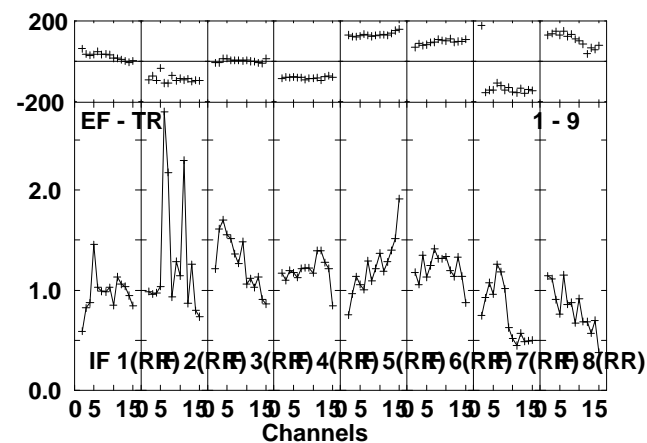
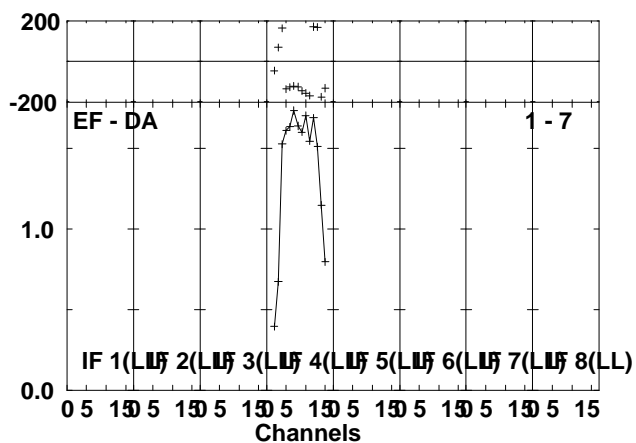
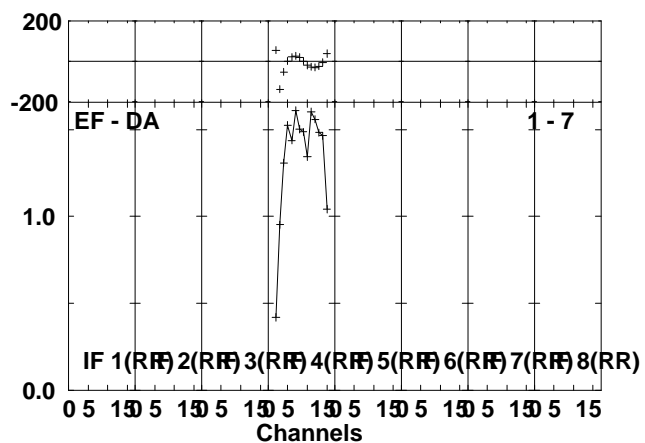
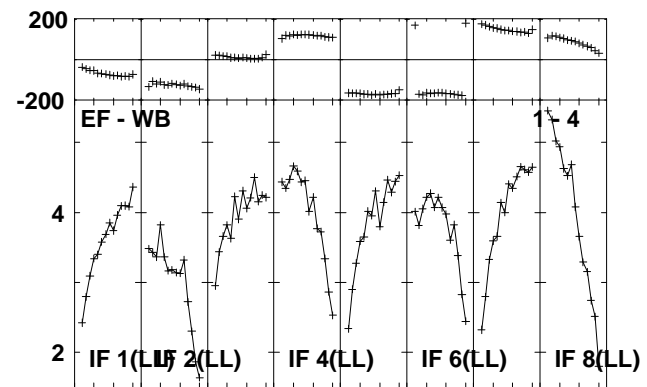
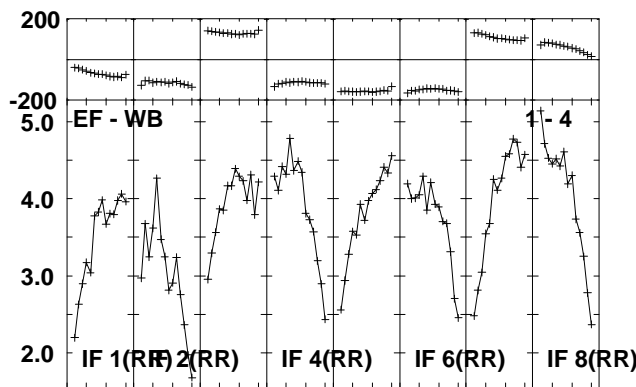
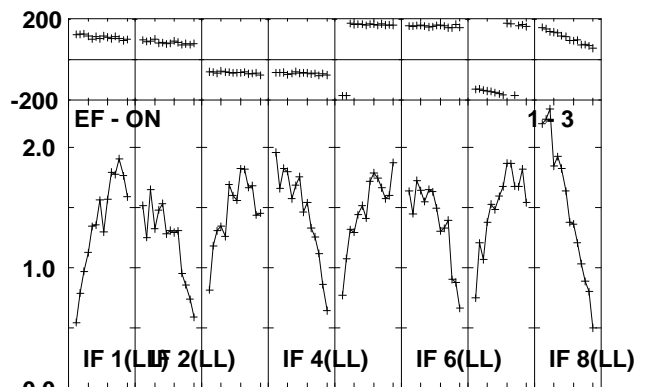
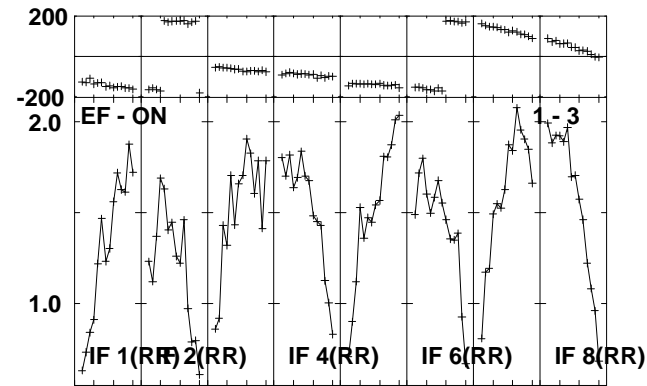
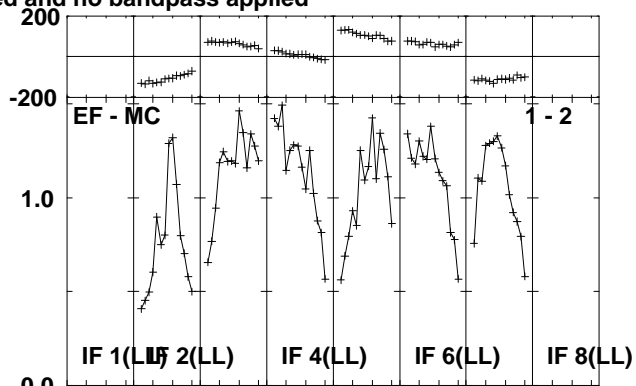
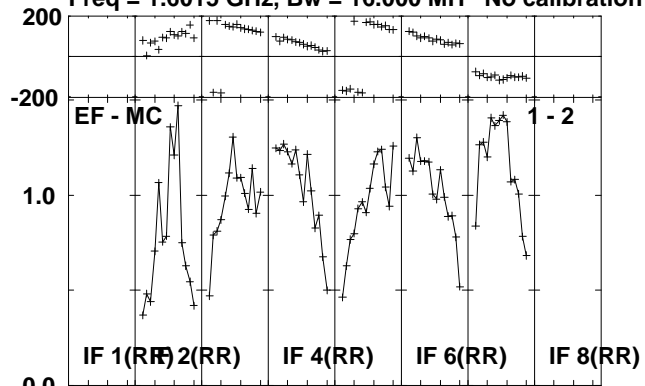

Lower frame: Milli Ampl Jy Top frame: Phas deg
Scalar averaged cross-power spectrum Several baselines displayed
Timerange: 01/09:00:05 to 01/09:01:49

Plot file version 367 created 01-JUL-2010 13:27:56
J2102+47 RG006B.UVDATA.1
Freq = 1.6015 GHz, Bw = 16.000 MH No calibration applied and no bandpass applied

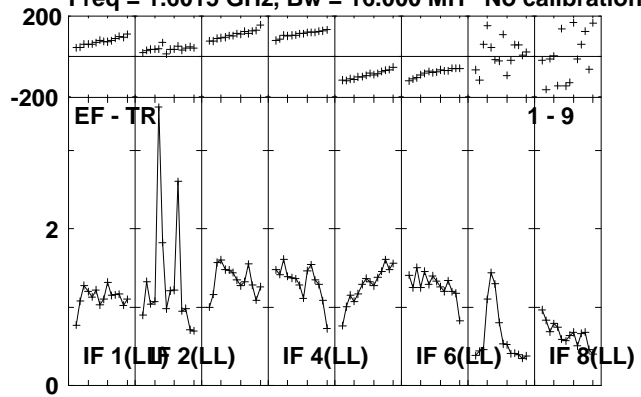

Lower frame: Milli Ampl Jy Top frame: Phas deg
Scalar averaged cross-power spectrum Several baselines displayed
Timerange: 01/09:00:05 to 01/09:01:49

Plot file version 368 created 01-JUL-2010 13:27:56

V407CYG RG006B.UVDATA.1

Freq = 1.6015 GHz, Bw = 16.000 MH No calibration applied and no bandpass applied

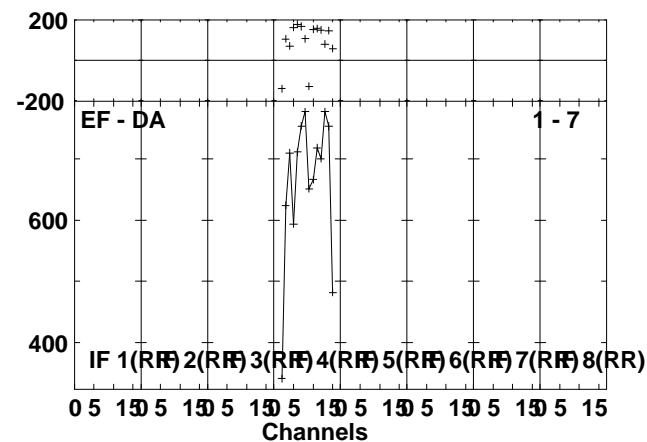
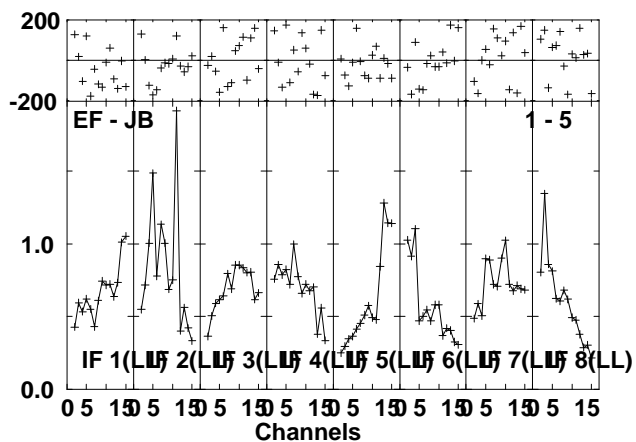
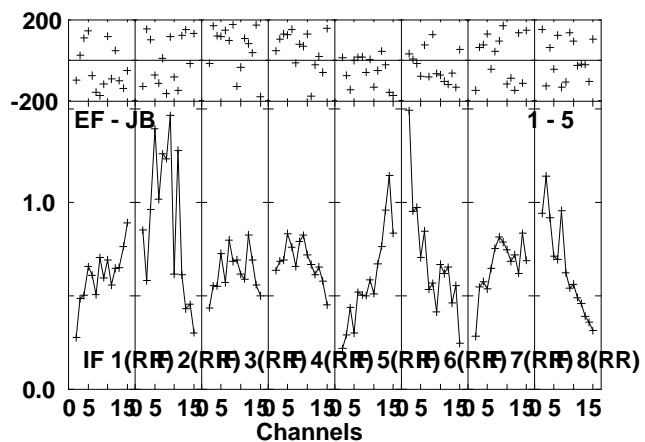
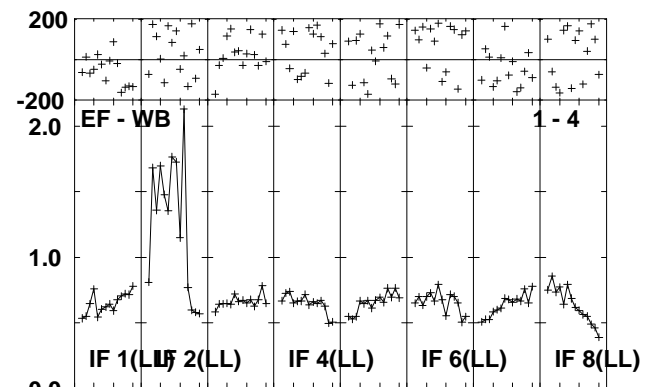
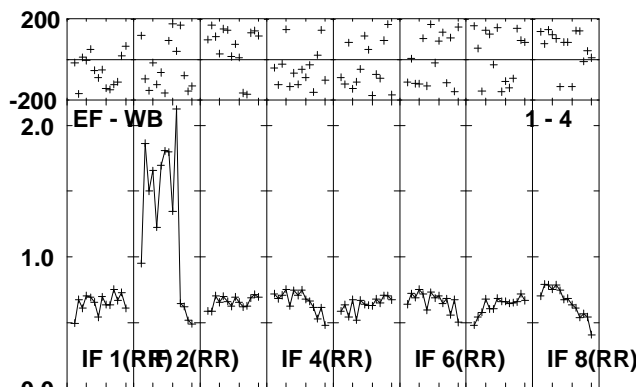
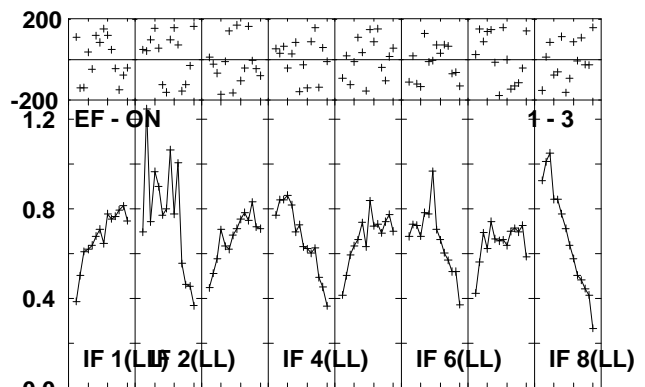
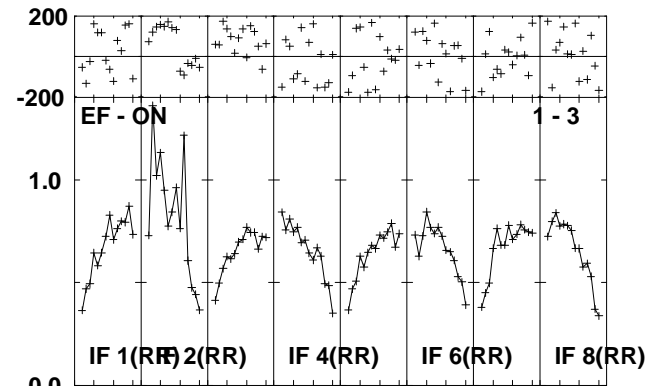
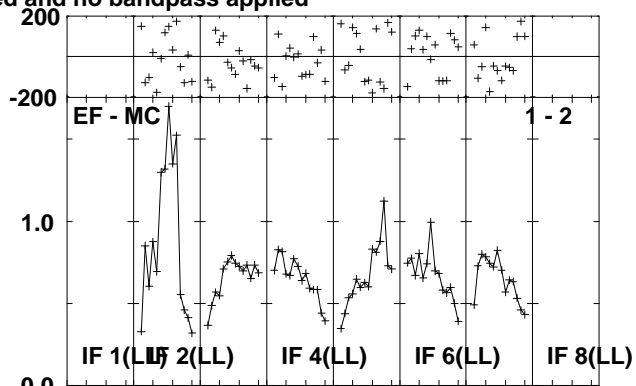
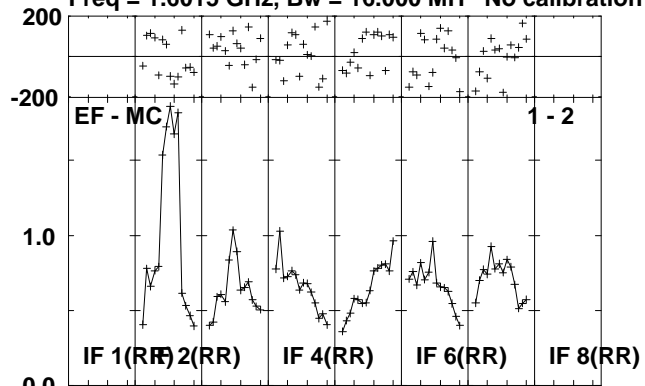

Lower frame: Milli Ampl Jy Top frame: Phas deg
Scalar averaged cross-power spectrum Several baselines displayed
Timerange: 01/09:01:53 to 01/09:06:49

Plot file version 369 created 01-JUL-2010 13:27:57

V407CYG RG006B.UVDATA.1

Freq = 1.6015 GHz, Bw = 16.000 MH No calibration applied and no bandpass applied

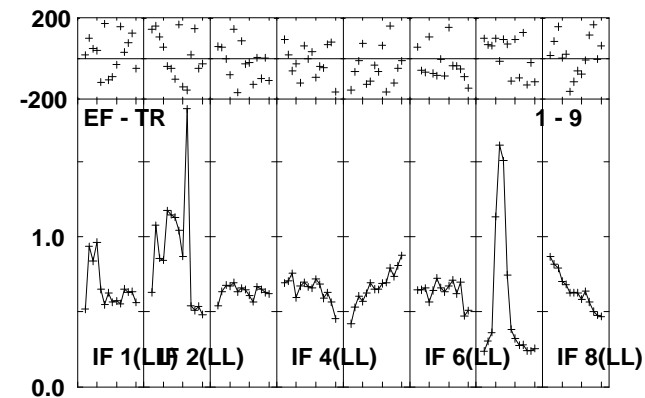
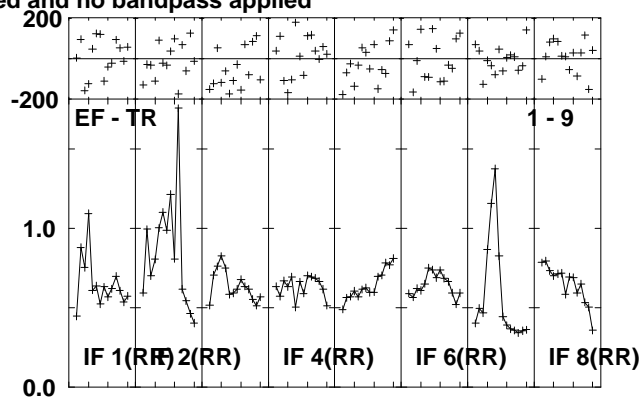
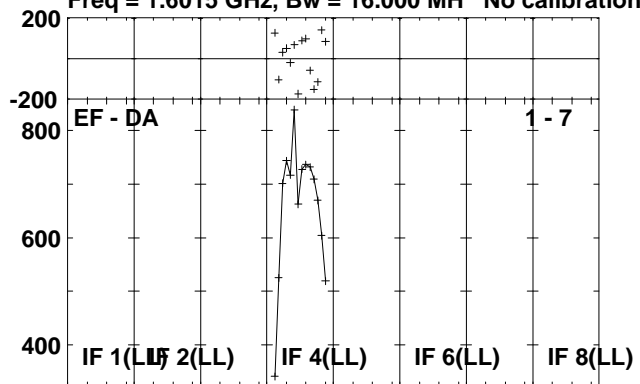

Lower frame: Micro Ampl Jy Top frame: Phas deg
Scalar averaged cross-power spectrum Several baselines displayed
Timerange: 01/09:01:53 to 01/09:06:49

Plot file version 370 created 01-JUL-2010 13:27:57

J2102+47 RG006B.UVDATA.1

Freq = 1.6015 GHz, Bw = 16.000 MH No calibration applied and no bandpass applied

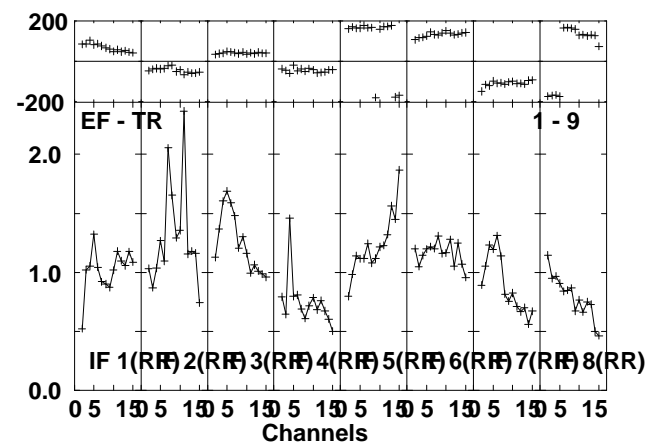
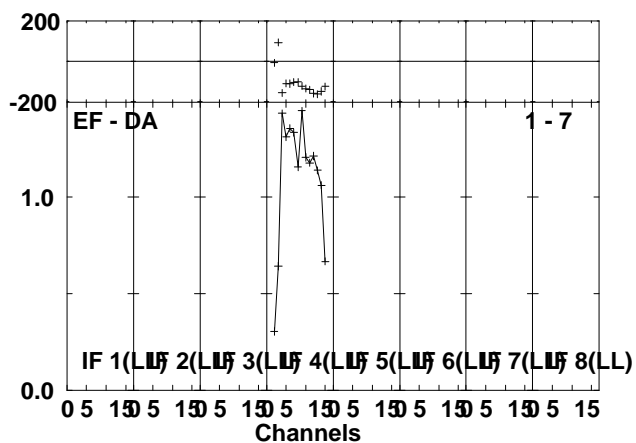
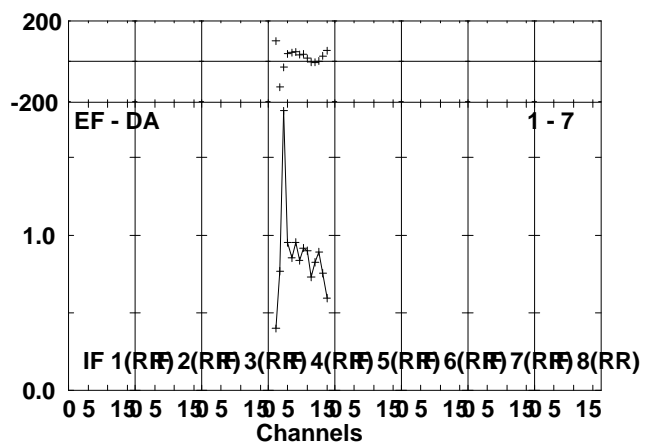
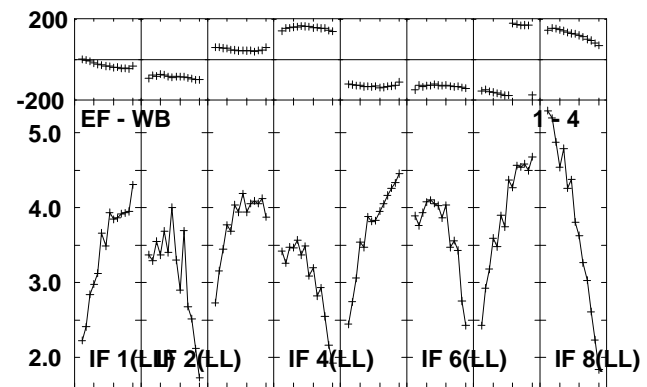
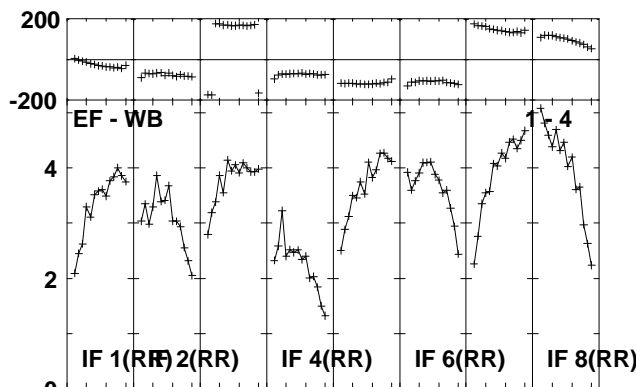
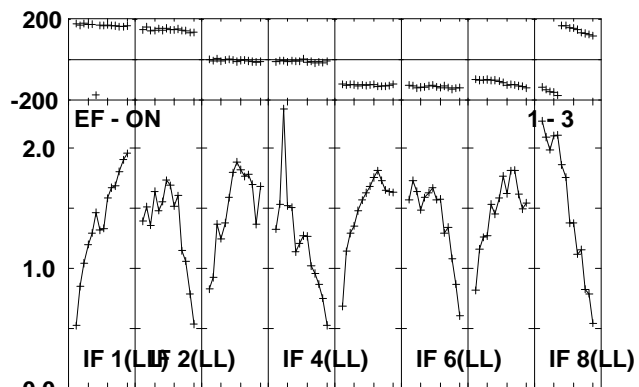
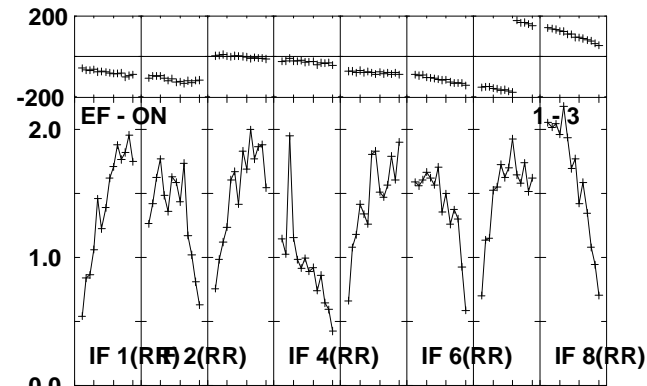
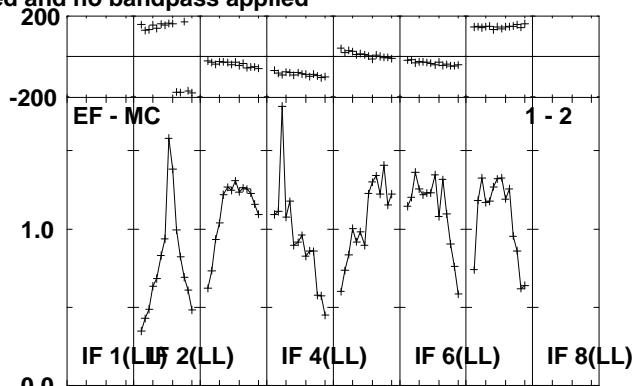
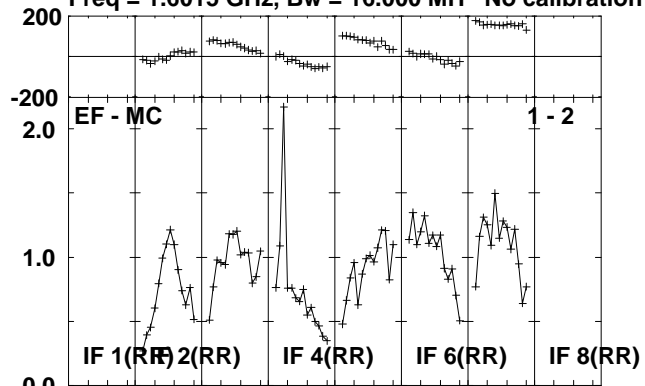

Lower frame: Milli Ampl Jy Top frame: Phas deg
Scalar averaged cross-power spectrum Several baselines displayed
Timerange: 01/09:06:53 to 01/09:09:01

Plot file version 371 created 01-JUL-2010 13:27:58
J2102+47 RG006B.UVDATA.1
Freq = 1.6015 GHz, Bw = 16.000 MH No calibration applied and no bandpass applied

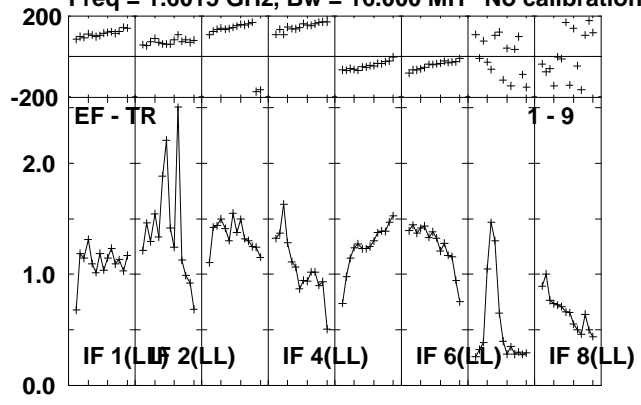

Lower frame: Milli Ampl Jy Top frame: Phas deg
Scalar averaged cross-power spectrum Several baselines displayed
Timerange: 01/09:06:53 to 01/09:09:01

Plot file version 372 created 01-JUL-2010 13:27:58

V407CYG RG006B.UVDATA.1

Freq = 1.6015 GHz, Bw = 16.000 MH No calibration applied and no bandpass applied

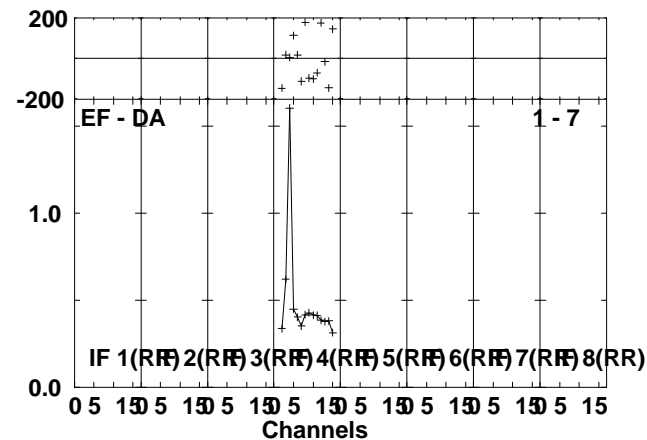
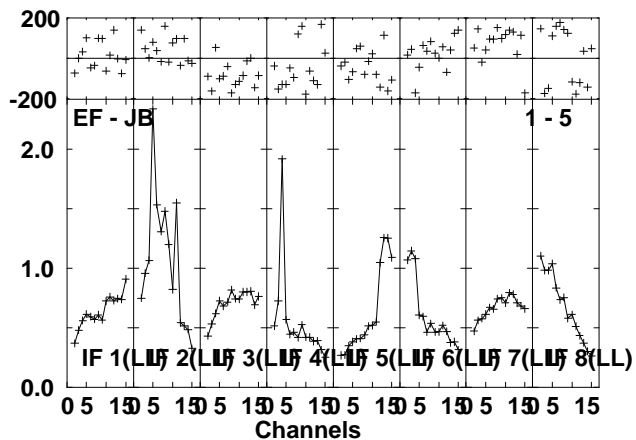
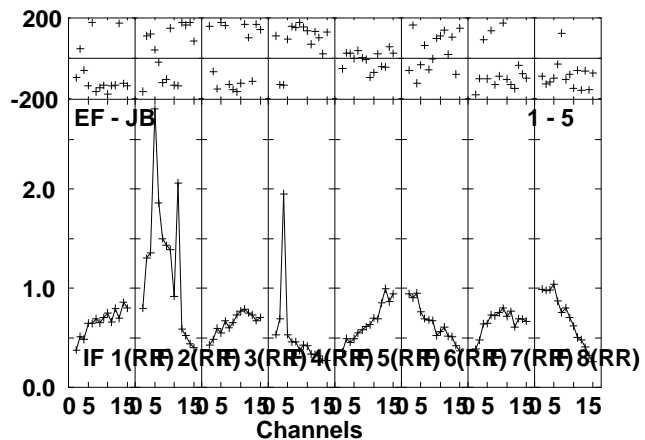
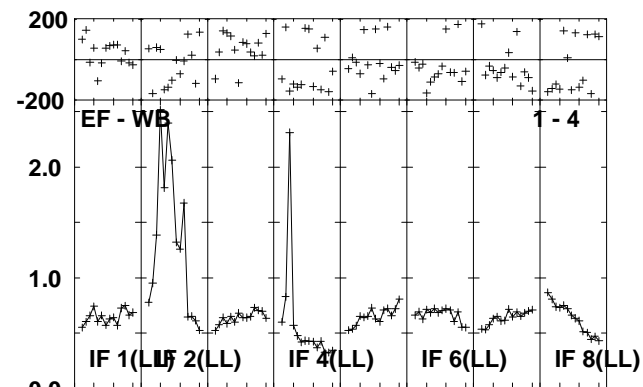
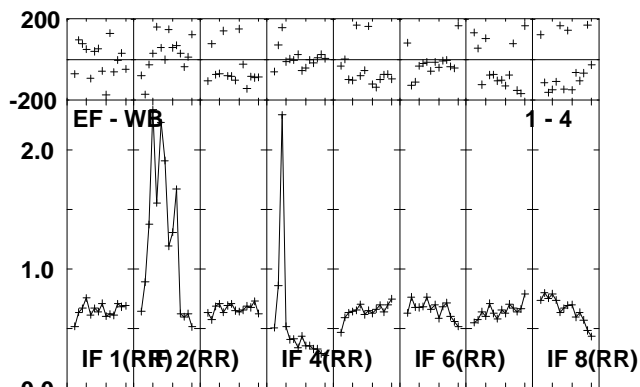
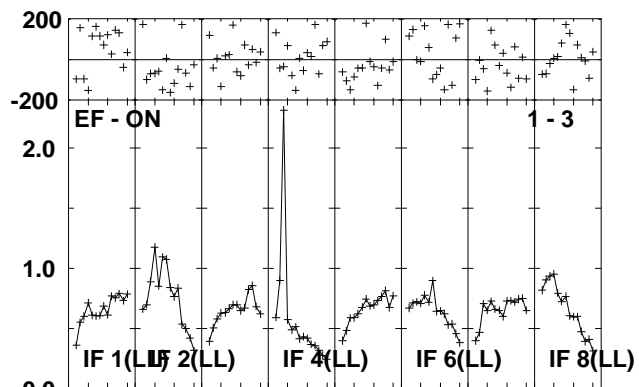
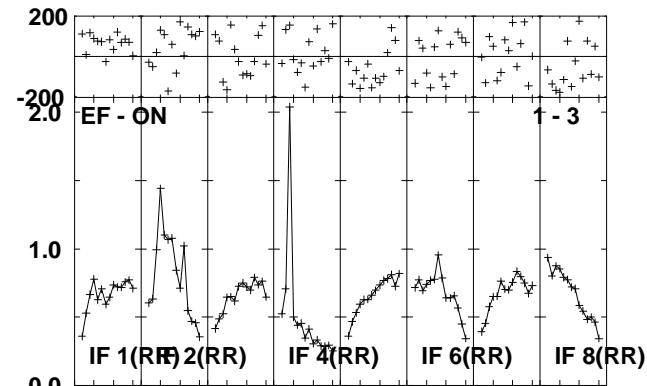
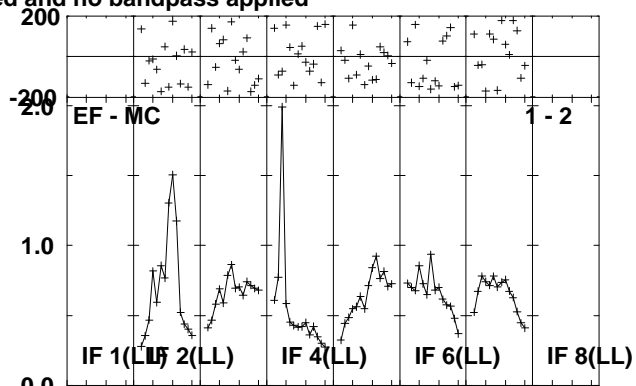
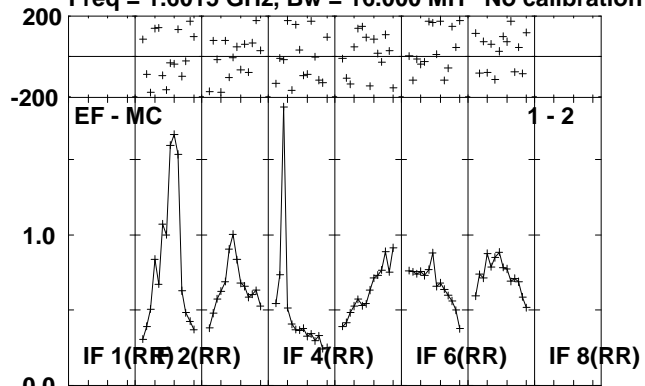

Lower frame: Milli Ampl Jy Top frame: Phas deg
Scalar averaged cross-power spectrum Several baselines displayed
Timerange: 01/09:09:05 to 01/09:14:01

Plot file version 373 created 01-JUL-2010 13:27:59
V407CYG RG006B.UVDATA.1

Freq = 1.6015 GHz, Bw = 16.000 MH No calibration applied and no bandpass applied

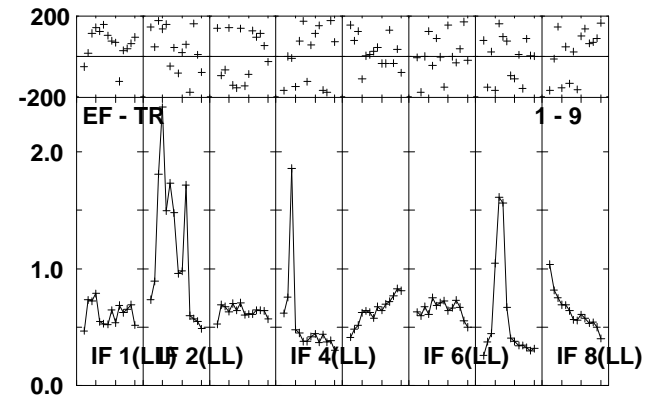
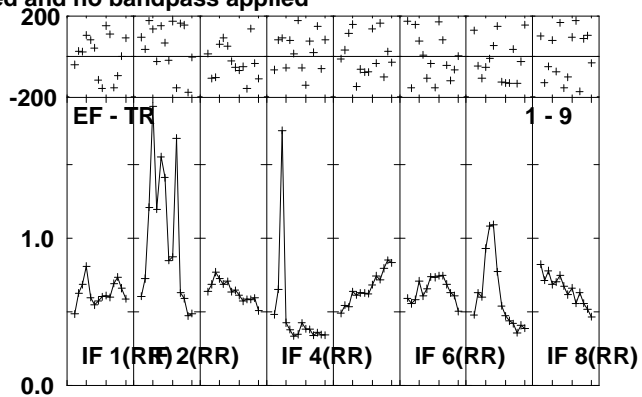
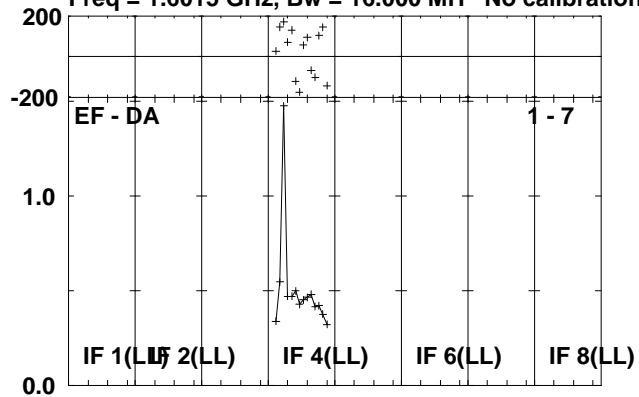

Lower frame: Milli Ampl Jy Top frame: Phas deg
Scalar averaged cross-power spectrum Several baselines displayed
Timerange: 01/09:09:05 to 01/09:14:01

Plot file version 374 created 01-JUL-2010 13:28:00

J2102+47 RG006B.UVDATA.1

Freq = 1.6015 GHz, Bw = 16.000 MH No calibration applied and no bandpass applied

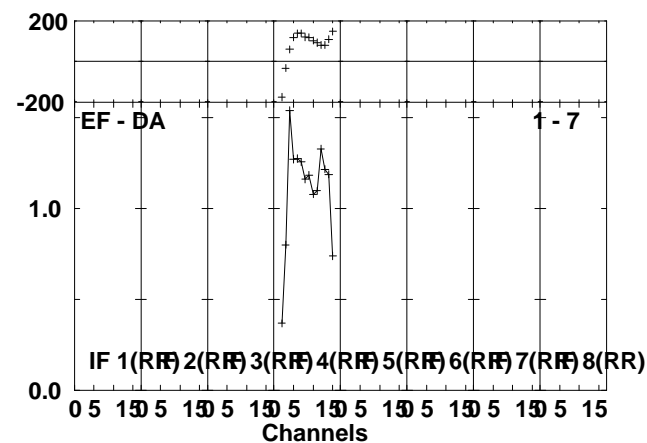
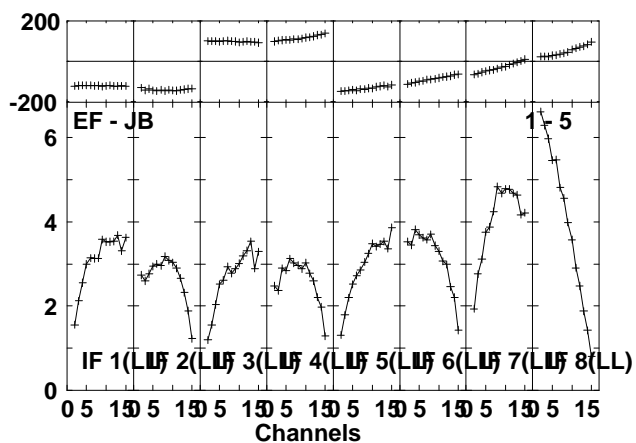
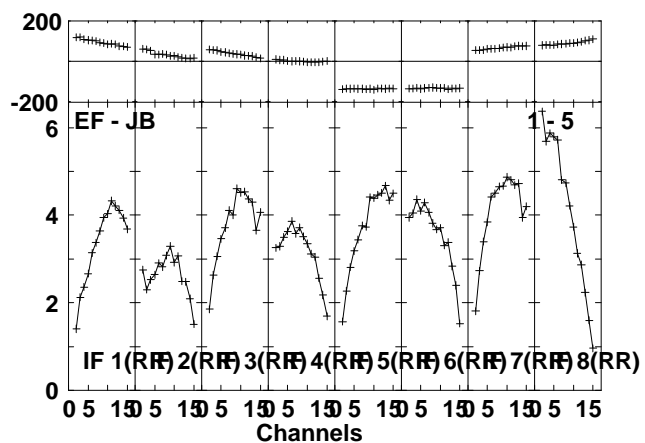
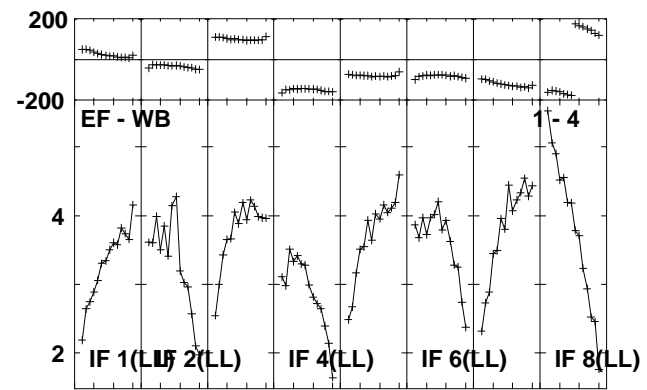
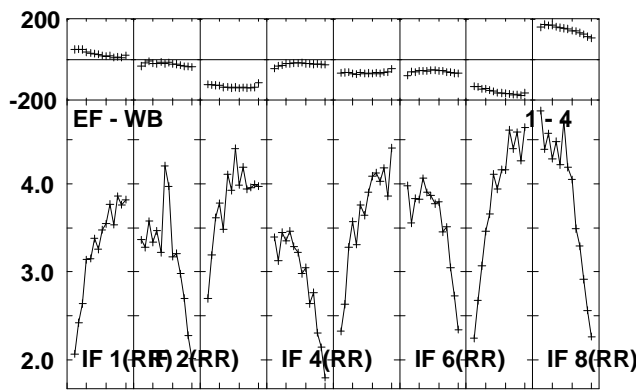
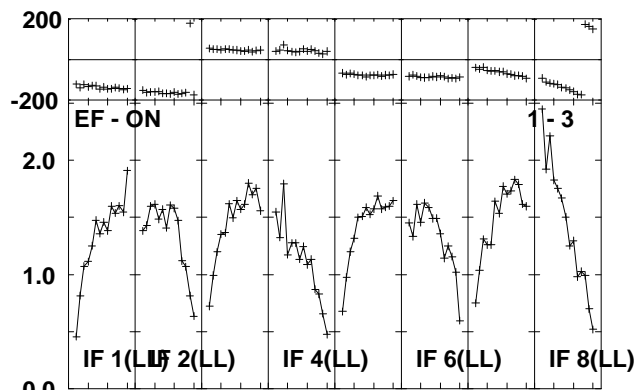
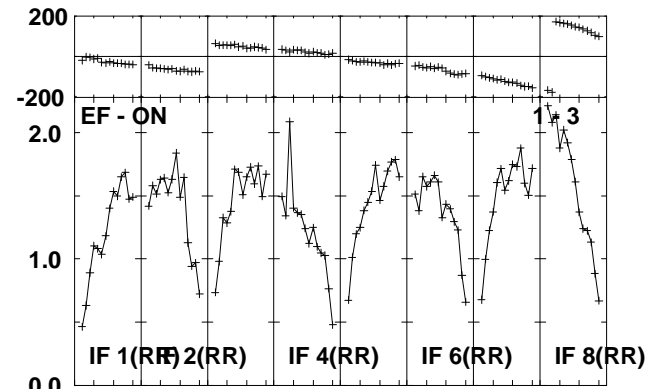
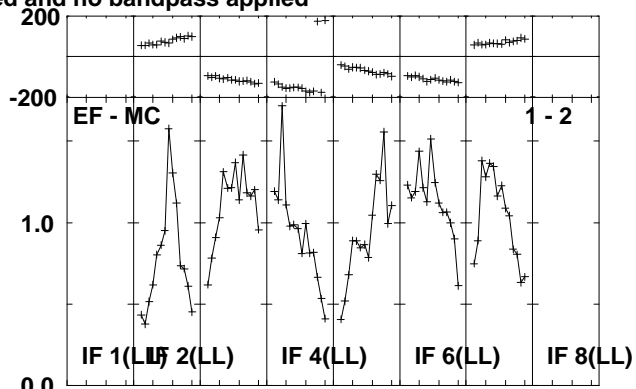
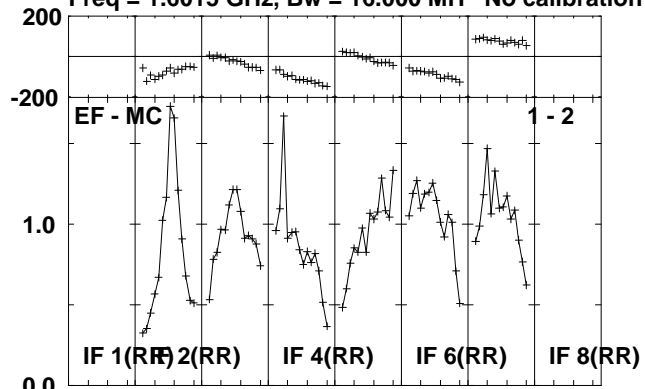

Lower frame: Milli Ampl Jy Top frame: Phas deg
Scalar averaged cross-power spectrum Several baselines displayed
Timerange: 01/09:15:05 to 01/09:16:49

Plot file version 375 created 01-JUL-2010 13:28:00

J2102+47 RG006B.UVDATA.1

Freq = 1.6015 GHz, Bw = 16.000 MH No calibration applied and no bandpass applied

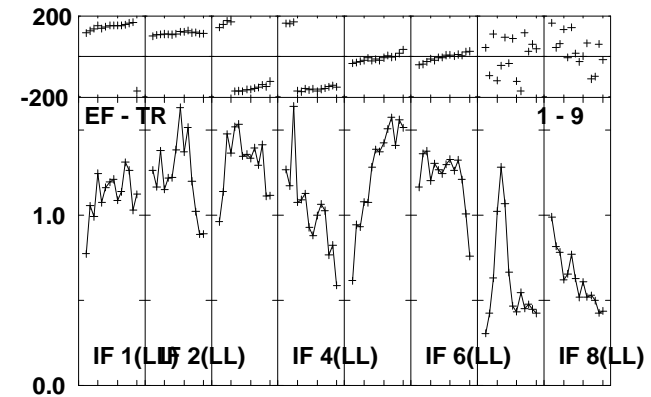
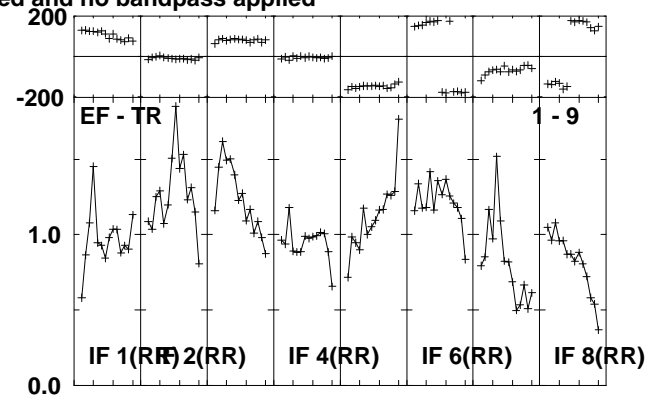
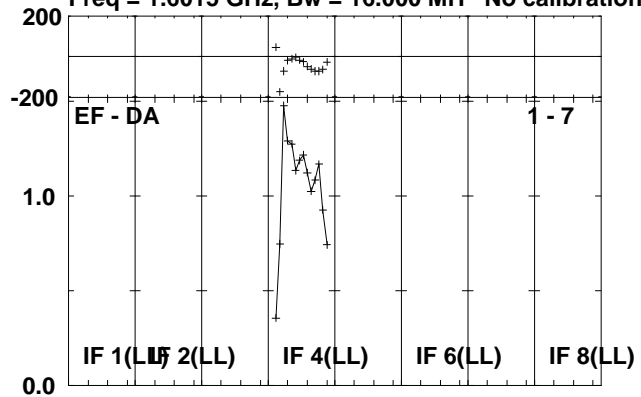

Lower frame: Milli Ampl Jy Top frame: Phas deg
Scalar averaged cross-power spectrum Several baselines displayed
Timerange: 01/09:15:05 to 01/09:16:49

Plot file version 376 created 01-JUL-2010 13:28:01

BLLAC RG006B.UVDATA.1

Freq = 1.6015 GHz, Bw = 16.000 MH No calibration applied and no bandpass applied

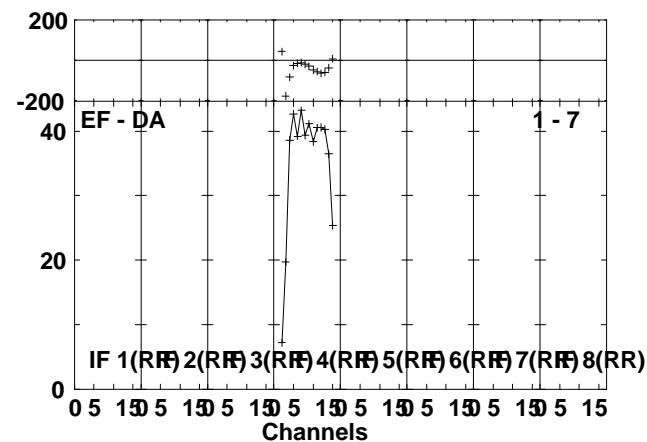
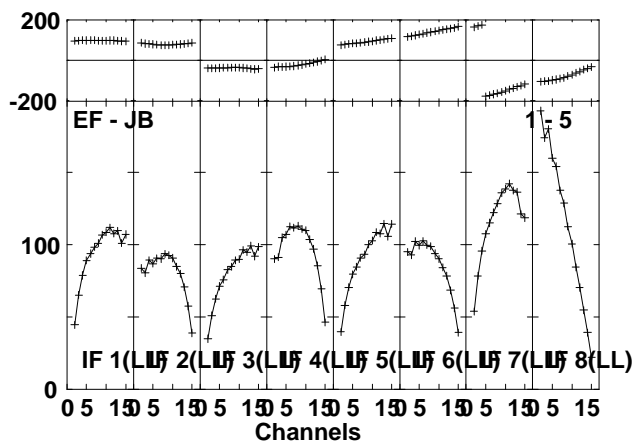
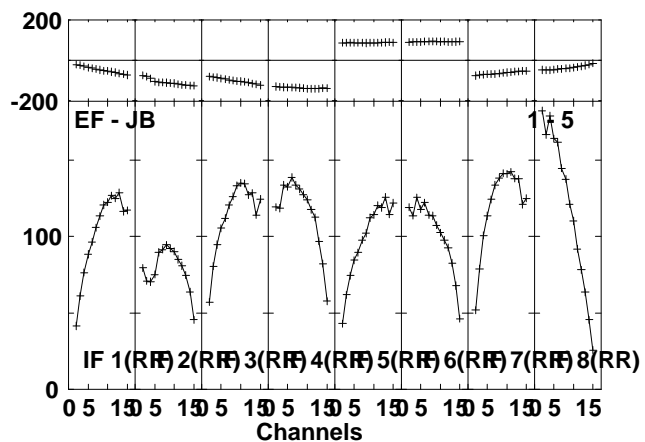
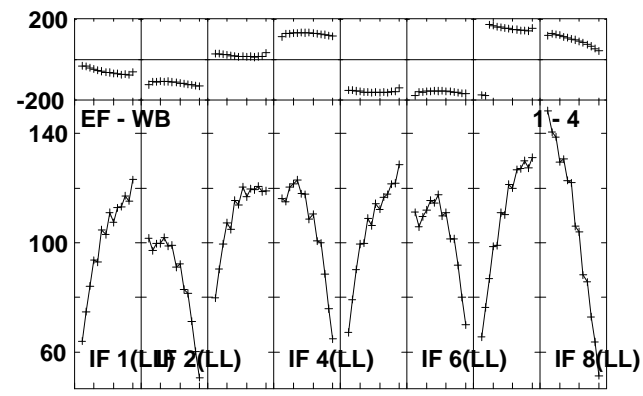
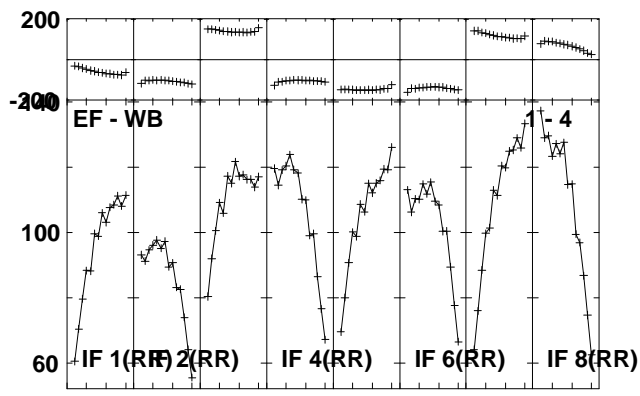
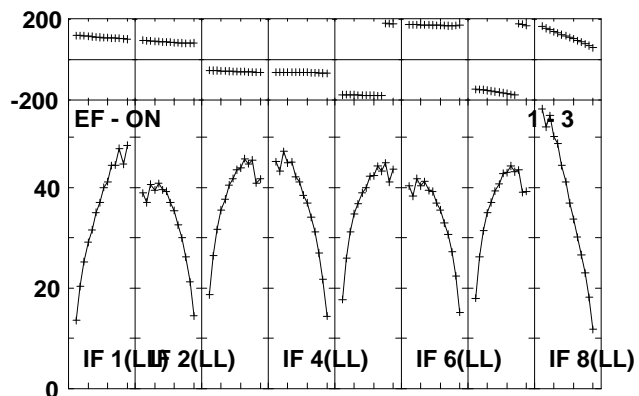
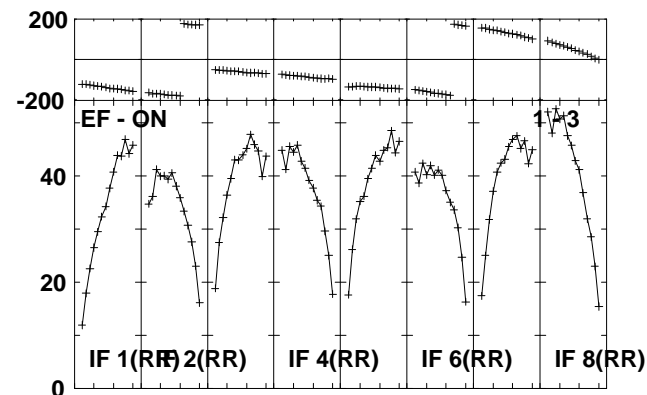
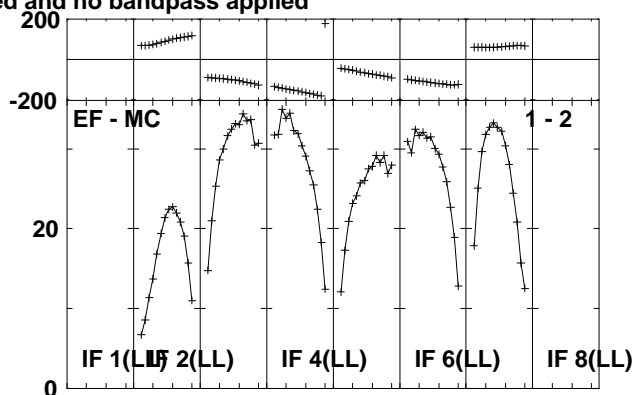
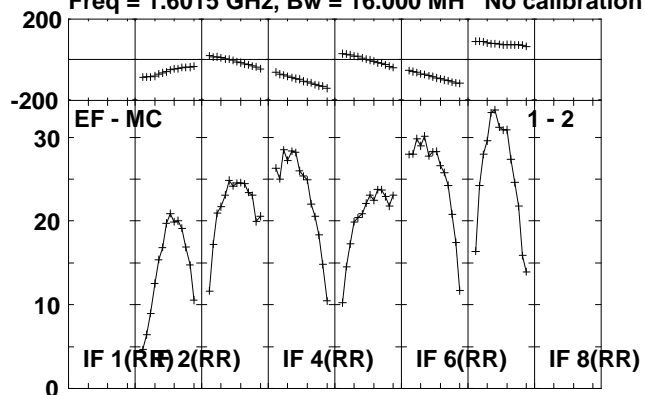

Lower frame: Milli Ampl Jy Top frame: Phas deg
Scalar averaged cross-power spectrum Several baselines displayed
Timerange: 01/09:18:21 to 01/09:29:41

Plot file version 377 created 01-JUL-2010 13:28:04
BLLAC RG006B.UVDATA.1

Freq = 1.6015 GHz, Bw = 16.000 MH No calibration applied and no bandpass applied

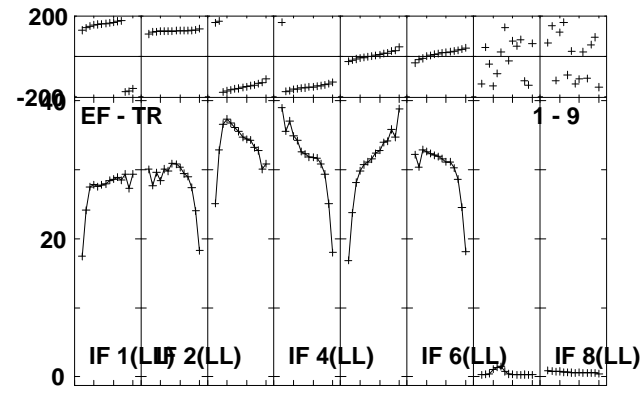
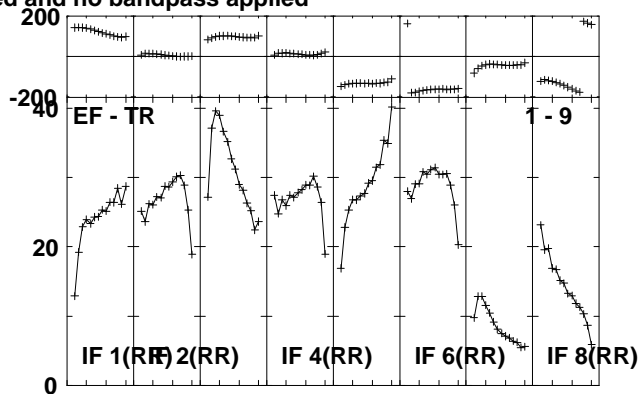
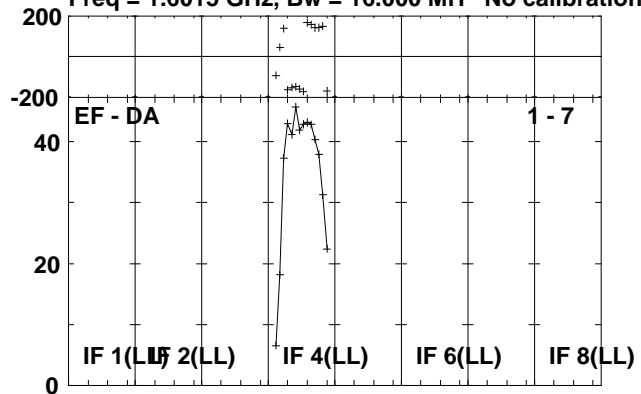

Lower frame: Milli Ampl Jy Top frame: Phas deg
Scalar averaged cross-power spectrum Several baselines displayed
Timerange: 01/09:18:21 to 01/09:29:41