

Plot file version 1 created 10-JUN-2016 15:29:14

DA193 RG008C.UVDATA.1

Freq = 4.9270 GHz, Bw = 16.000 MH No calibration applied and no bandpass applied

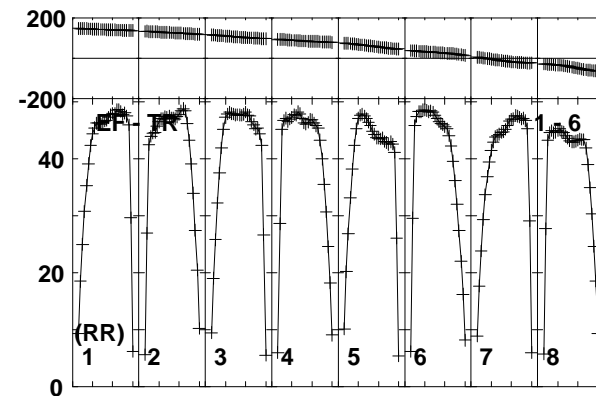
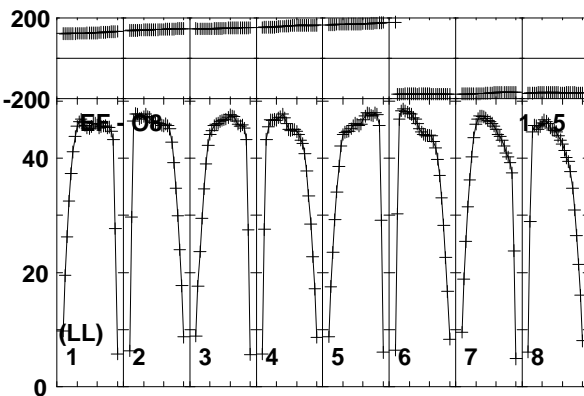
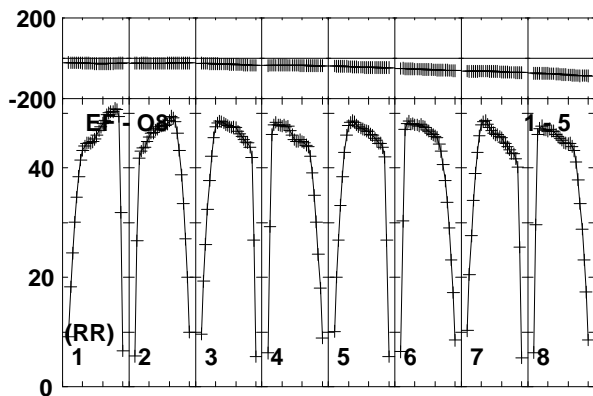
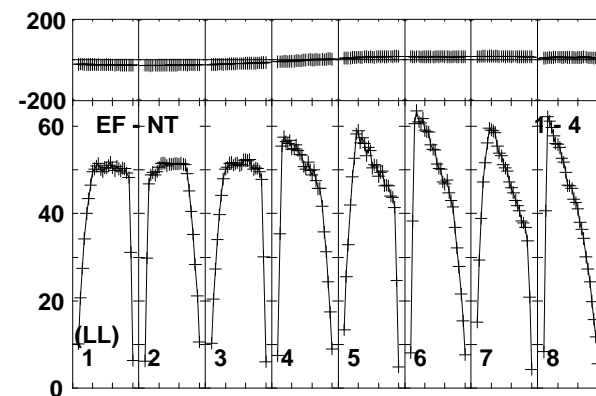
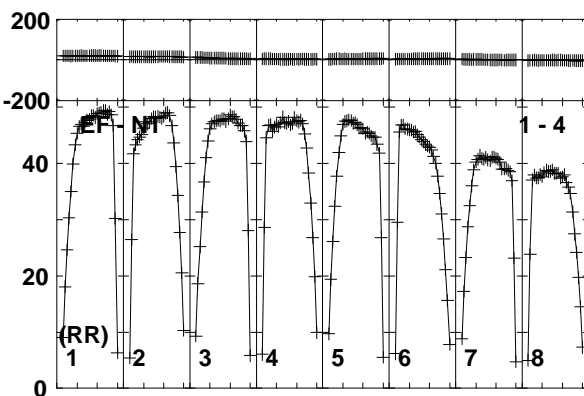
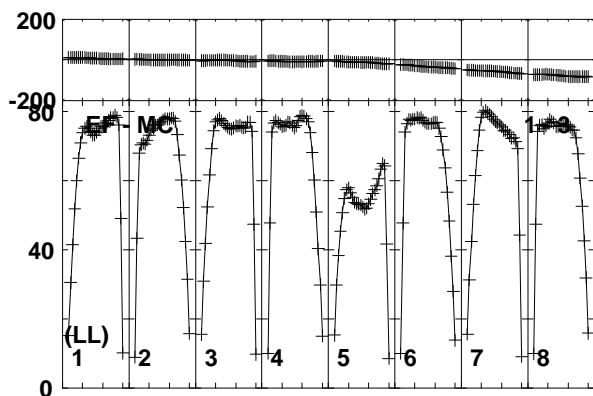
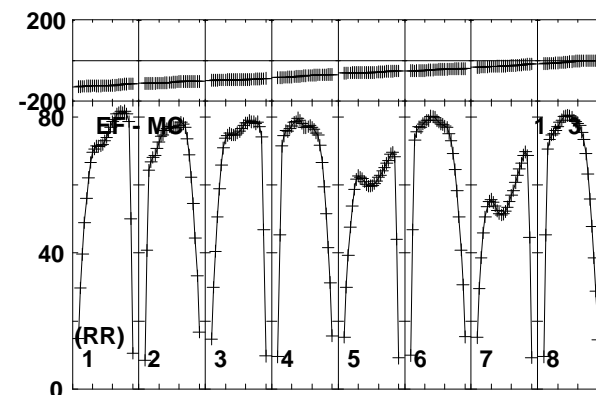
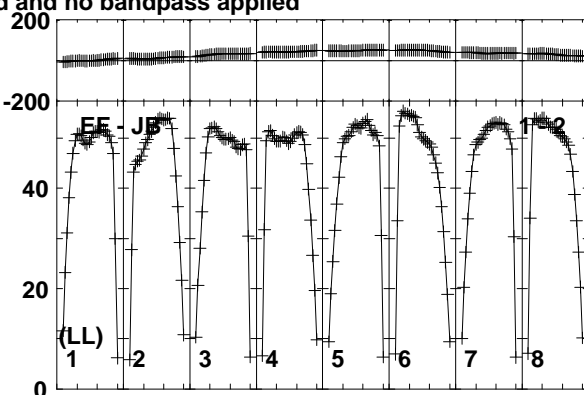
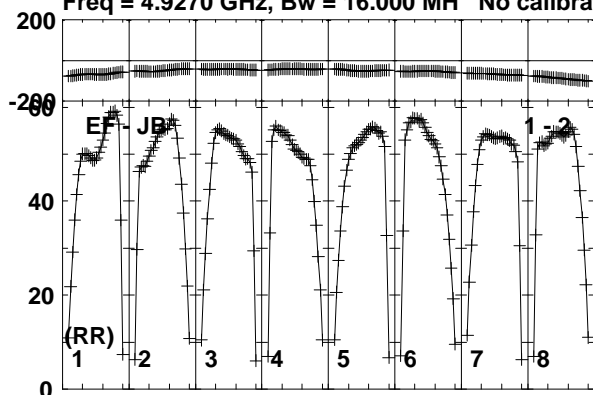

Lower frame: Milli Ampl Jy Top frame: Phas deg  
Vector averaged cross-power spectrum Baseline: EF (01) - JB (02)  
Timerange: 00/11:40:10 to 00/11:44:20

Plot file version 2 created 10-JUN-2016 15:29:14

DA193 RG008C.UVDATA.1

Freq = 4.9270 GHz, Bw = 16.000 MH No calibration applied and no bandpass applied

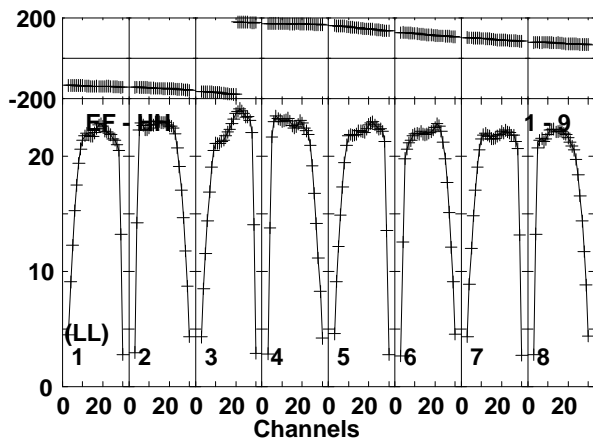
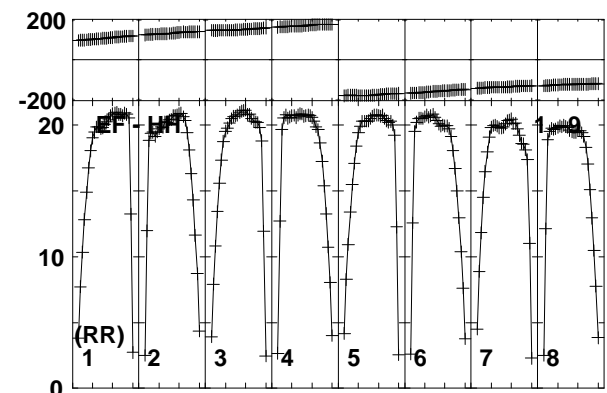
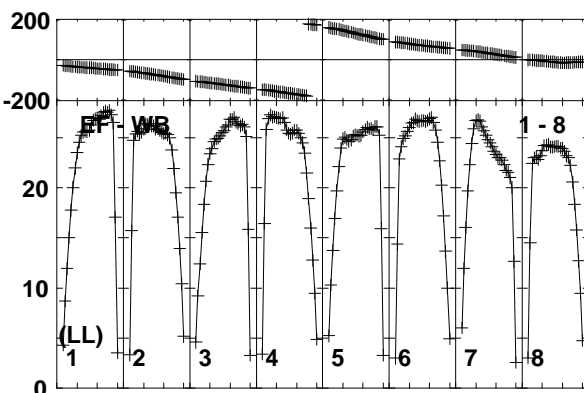
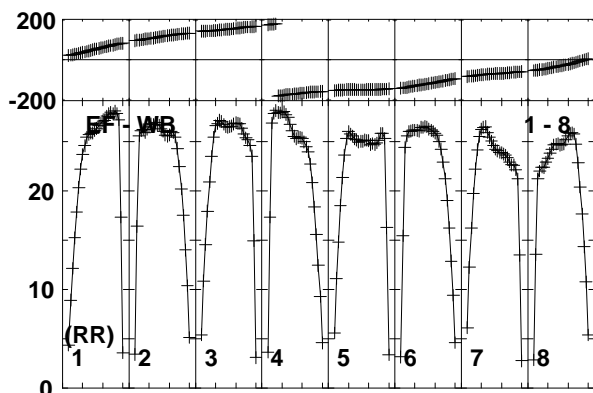
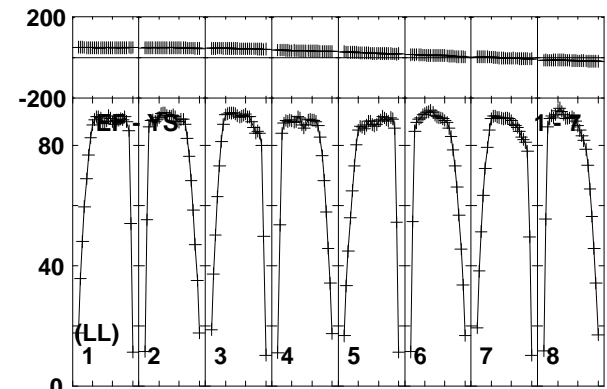
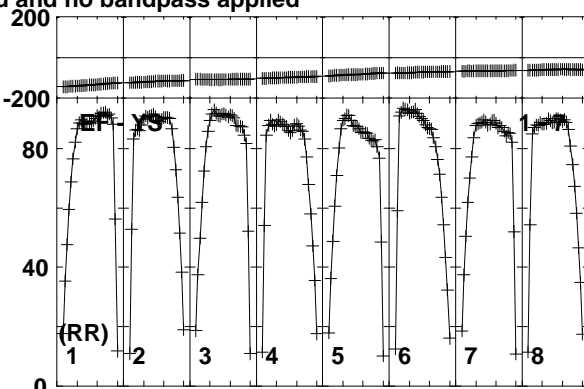
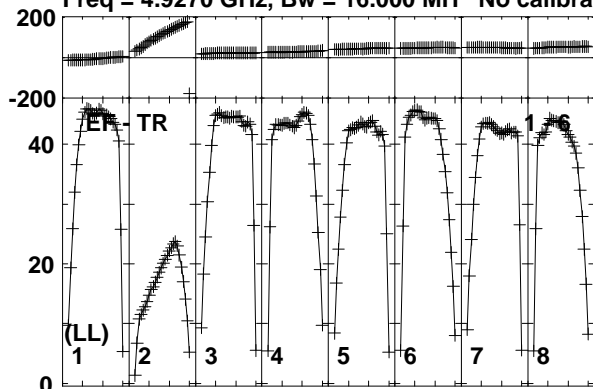

Lower frame: Milli Ampl Jy Top frame: Phas deg  
Vector averaged cross-power spectrum Baseline: EF (01) - TR (06)  
Timerange: 00/11:40:10 to 00/11:44:20

Plot file version 3 created 10-JUN-2016 15:29:14

J0718-1813 RG008C.UVDATA.1

Freq = 4.9270 GHz, Bw = 16.000 MH No calibration applied and no bandpass applied

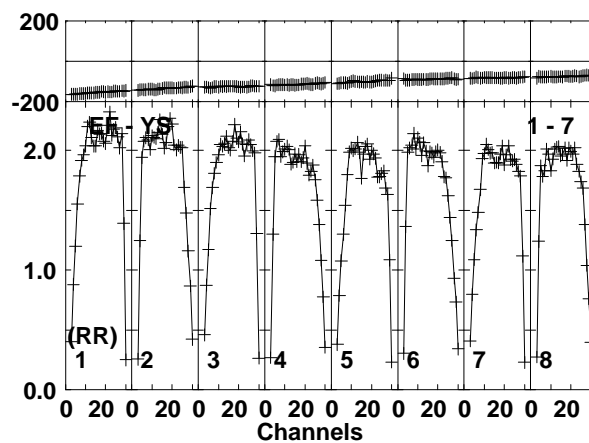
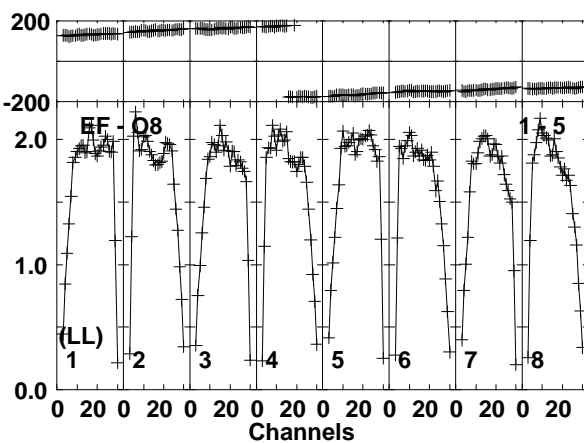
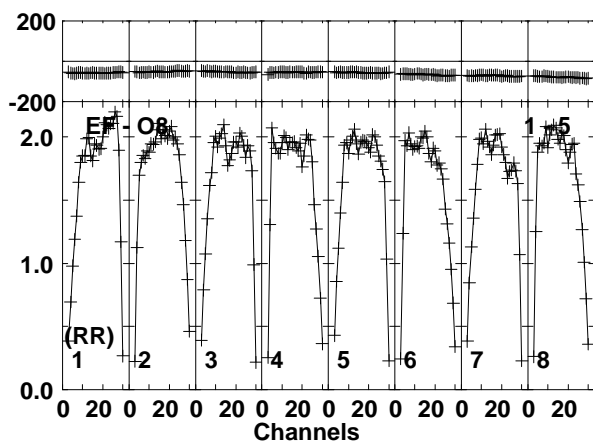
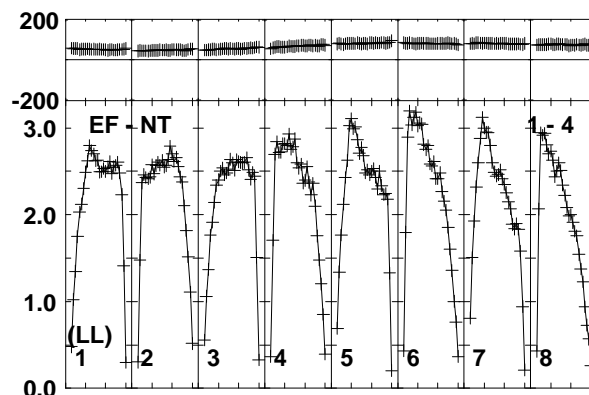
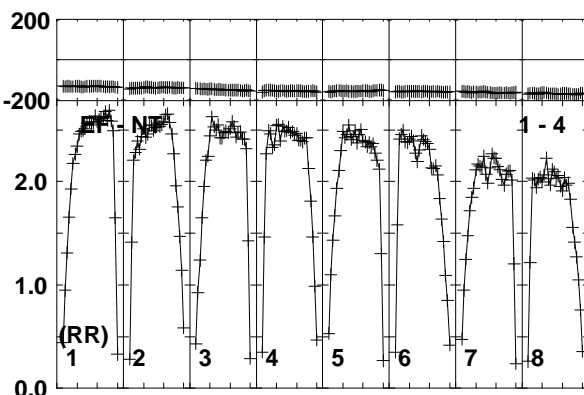
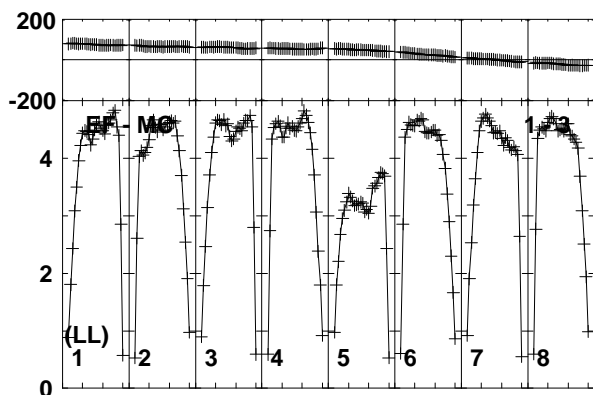
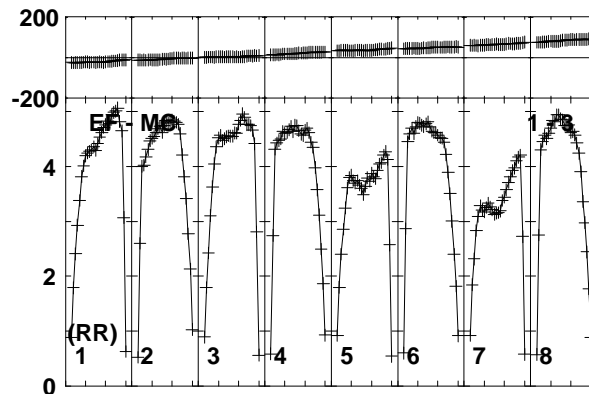
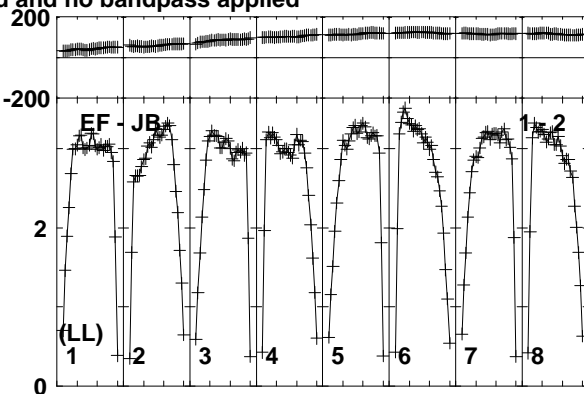
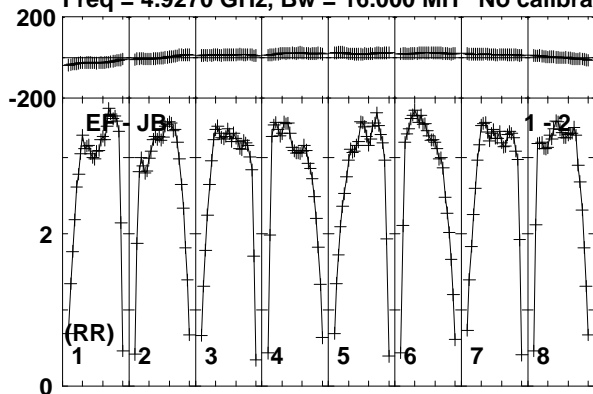

Lower frame: Milli Ampl Jy Top frame: Phas deg  
Vector averaged cross-power spectrum Baseline: EF (01) - JB (02)  
Timerange: 00/11:48:51 to 00/11:51:49

Plot file version 4 created 10-JUN-2016 15:29:15

J0718-1813 RG008C.UVDATA.1

Freq = 4.9270 GHz, Bw = 16.000 MH No calibration applied and no bandpass applied

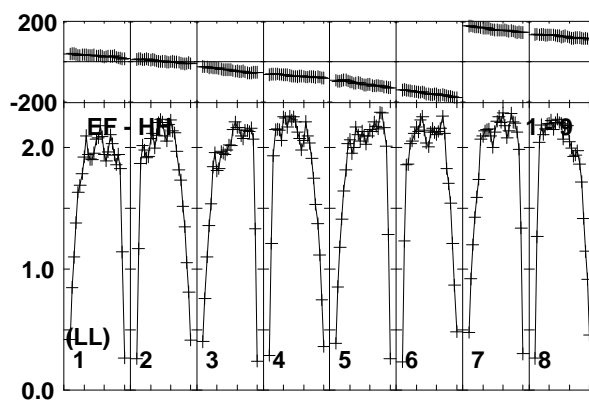
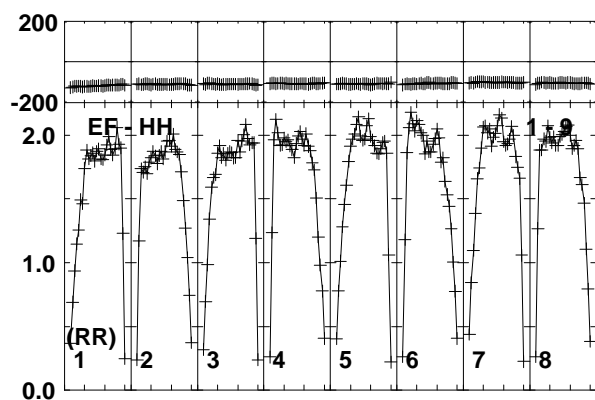
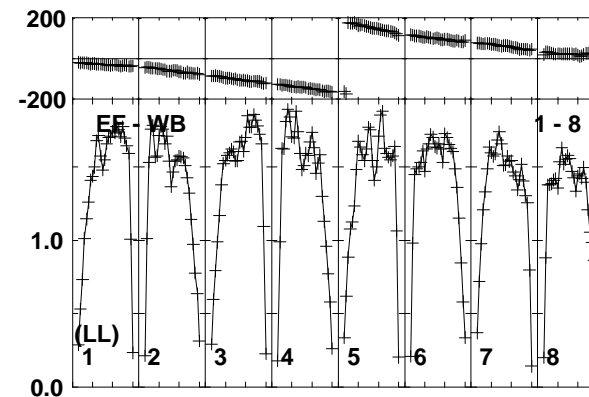
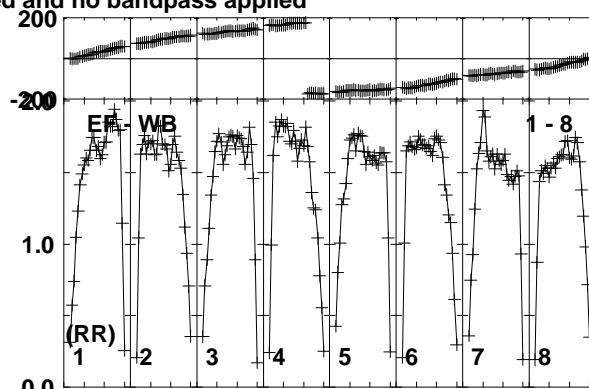
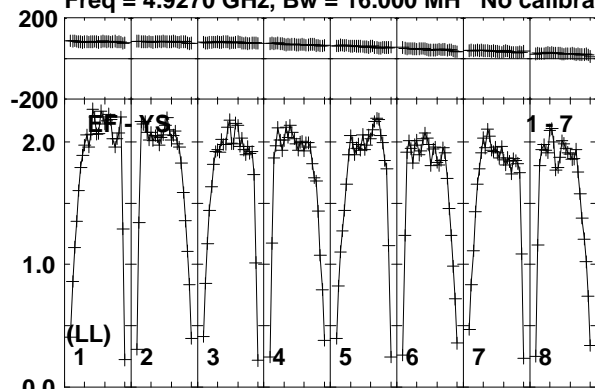

Lower frame: Milli Ampl Jy Top frame: Phas deg  
Vector averaged cross-power spectrum Baseline: EF (01) - YS (07)  
Timerange: 00/11:48:51 to 00/11:51:49

Plot file version 5 created 10-JUN-2016 15:29:15

FRB150418 RG008C.UVDATA.1

Freq = 4.9270 GHz, Bw = 16.000 MH No calibration applied and no bandpass applied

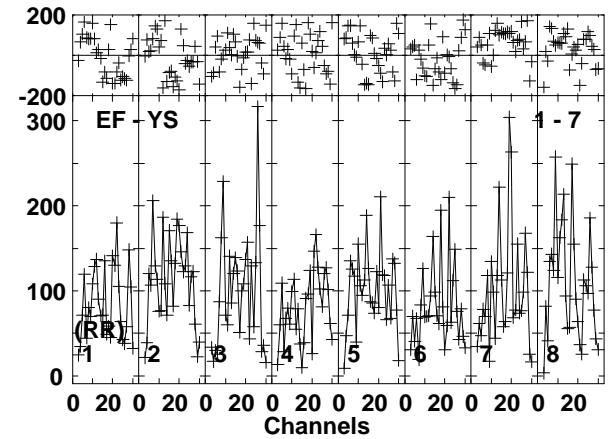
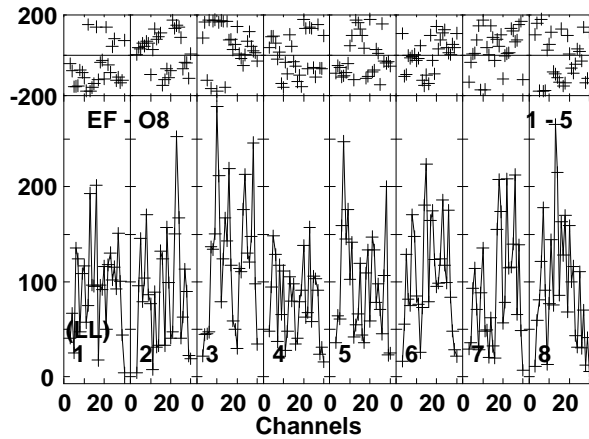
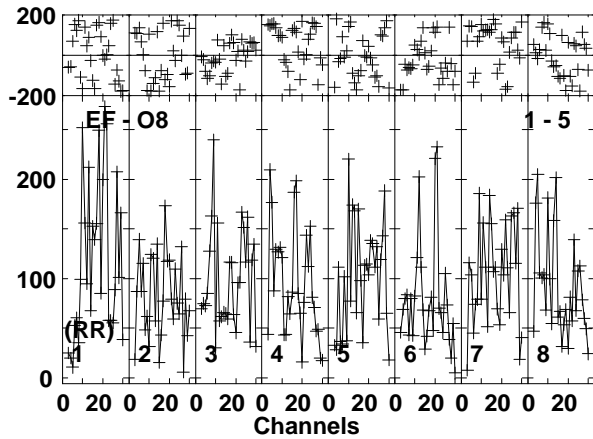
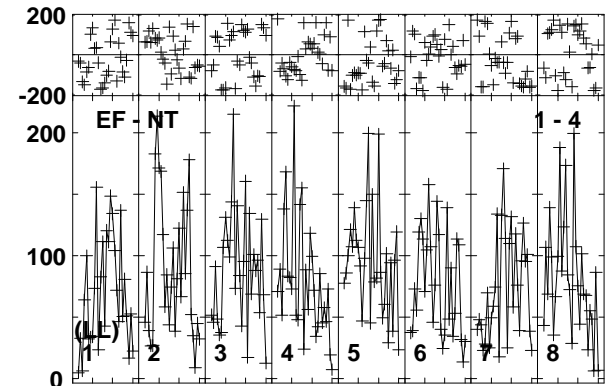
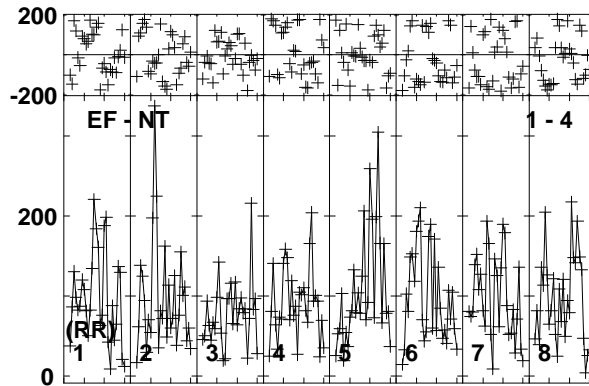
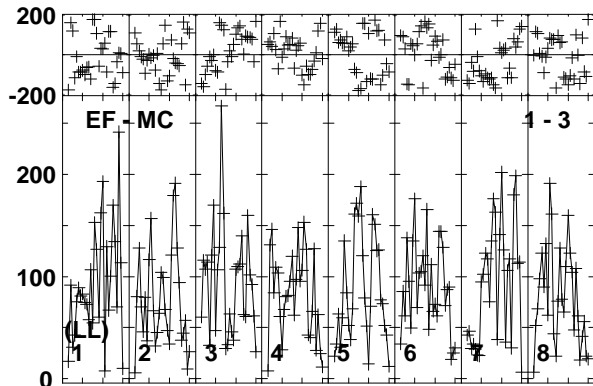
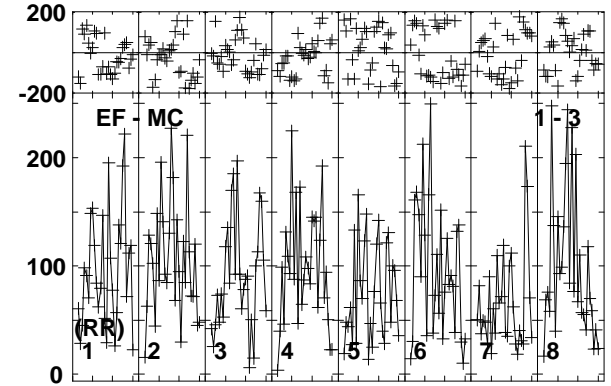
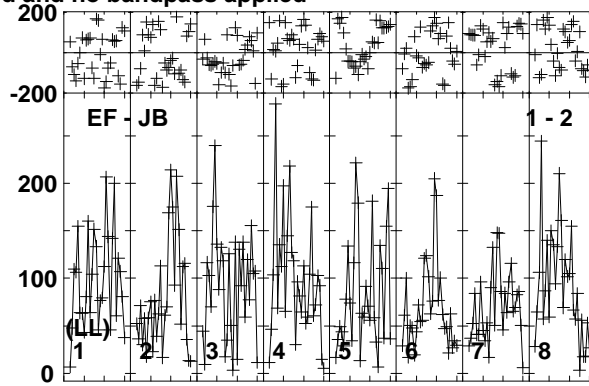
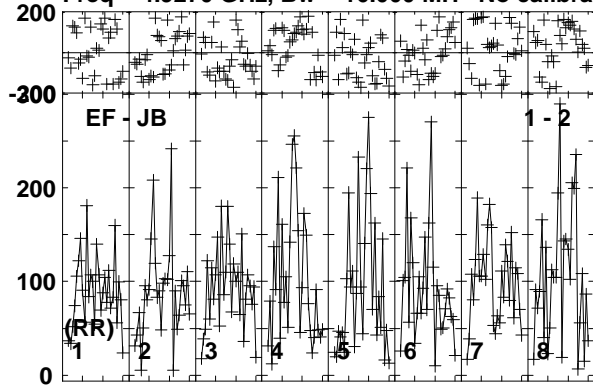

Lower frame: Micro Ampl Jy Top frame: Phas deg  
Vector averaged cross-power spectrum Baseline: EF (01) - JB (02)  
Timerange: 00/11:51:51 to 00/11:54:49

Plot file version 6 created 10-JUN-2016 15:29:15

FRB150418 RG008C.UVDATA.1

Freq = 4.9270 GHz, Bw = 16.000 MH No calibration applied and no bandpass applied

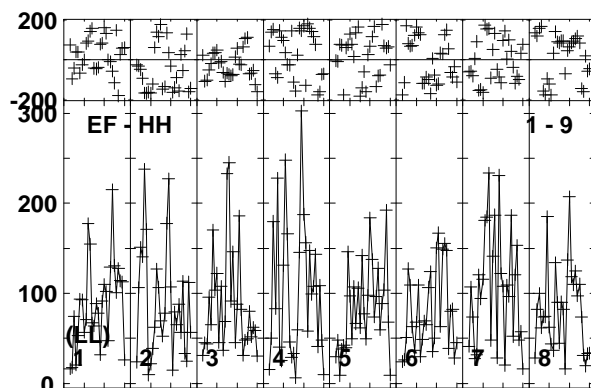
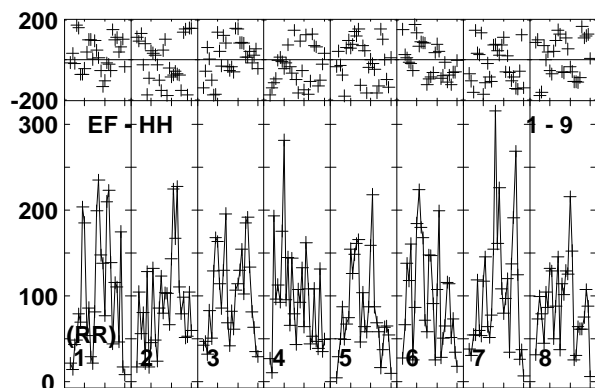
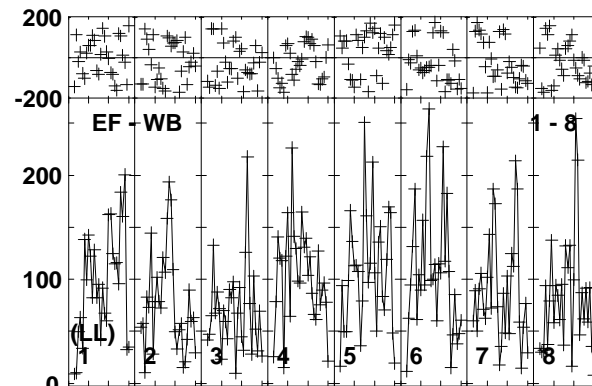
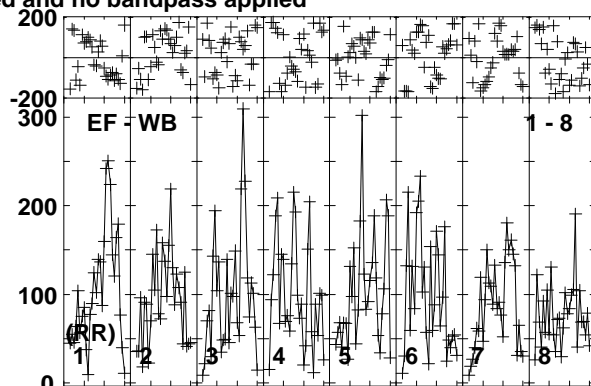
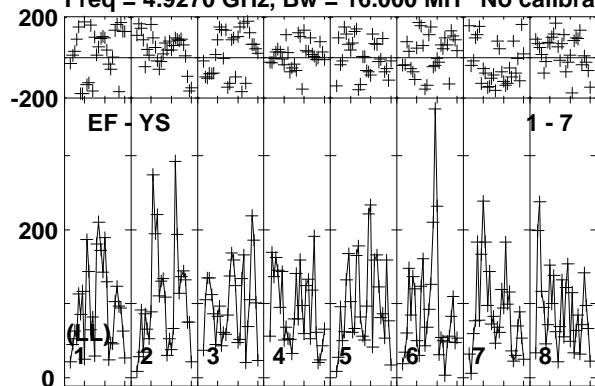

Lower frame: Micro Ampl Jy Top frame: Phas deg  
Vector averaged cross-power spectrum Baseline: EF (01) - YS (07)  
Timerange: 00/11:51:51 to 00/11:54:49

Plot file version 7 created 10-JUN-2016 15:29:15

J0718-1813 RG008C.UVDATA.1

Freq = 4.9270 GHz, Bw = 16.000 MH No calibration applied and no bandpass applied

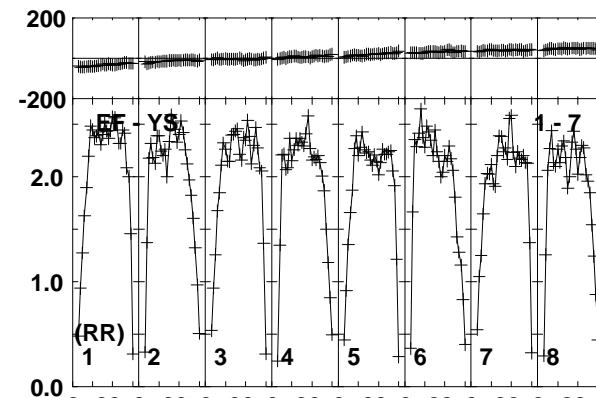
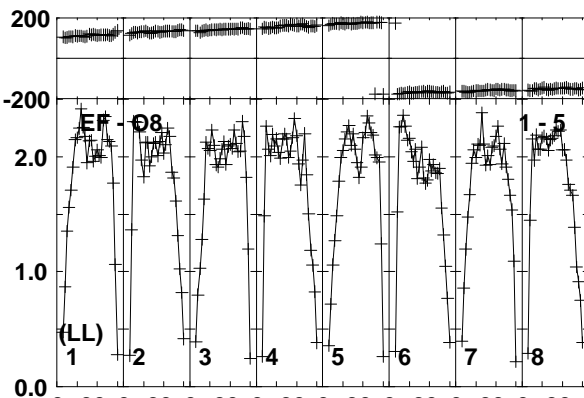
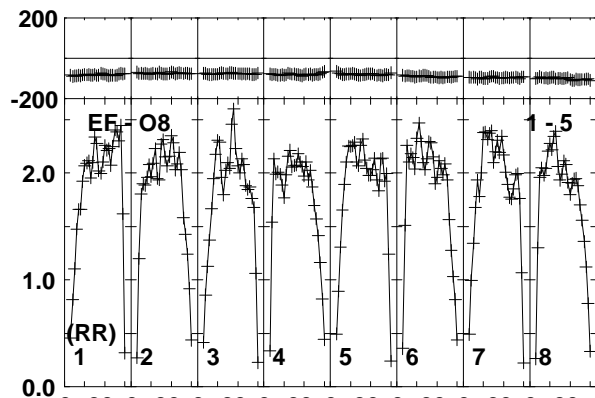
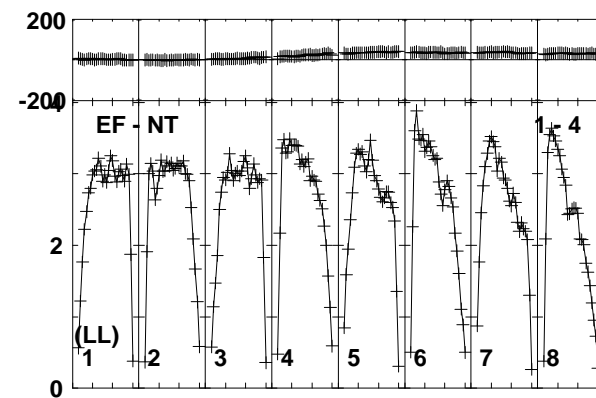
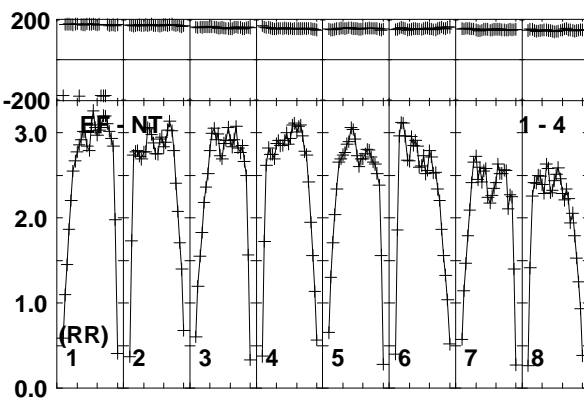
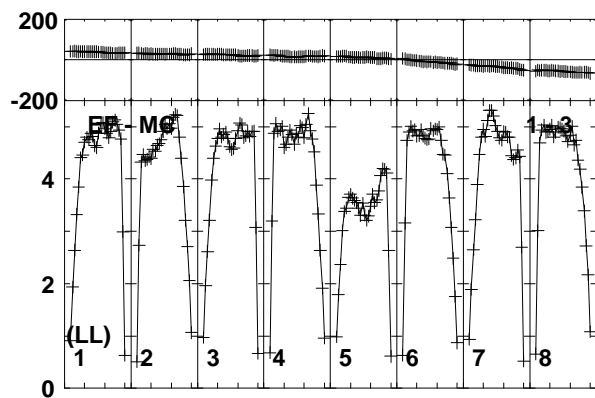
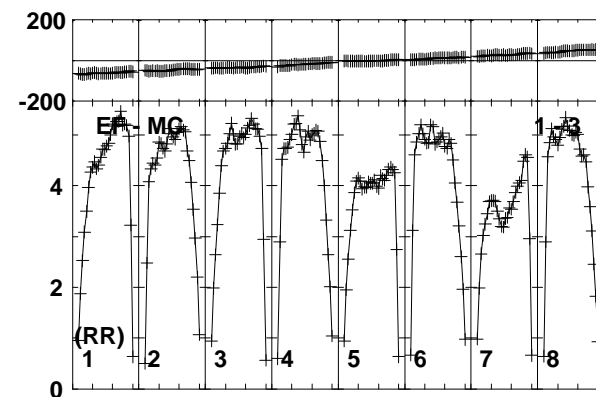
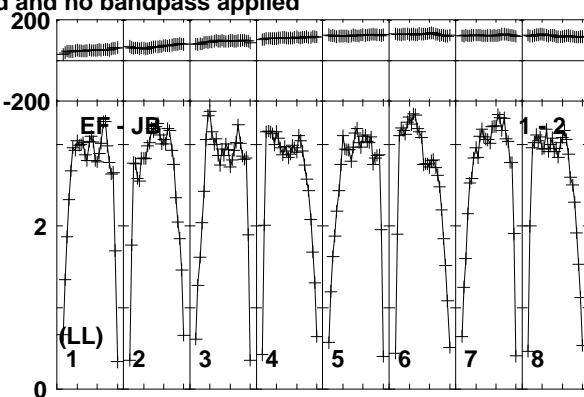
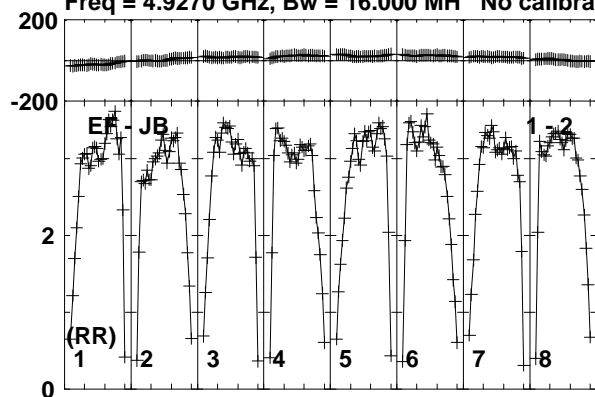

Lower frame: Milli Ampl Jy Top frame: Phas deg  
Vector averaged cross-power spectrum Baseline: EF (01) - JB (02)  
Timerange: 00/11:54:51 to 00/11:56:19

Plot file version 8 created 10-JUN-2016 15:29:15

J0718-1813 RG008C.UVDATA.1

Freq = 4.9270 GHz, Bw = 16.000 MH No calibration applied and no bandpass applied

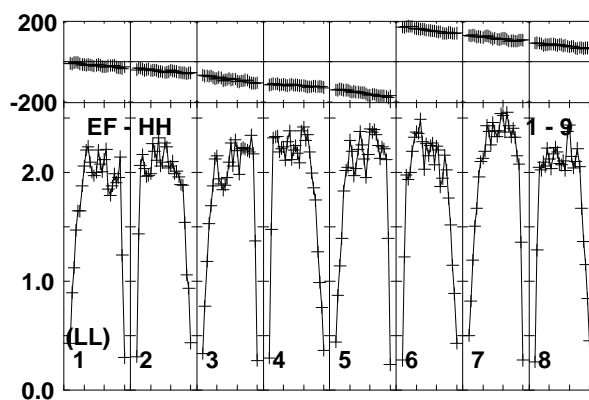
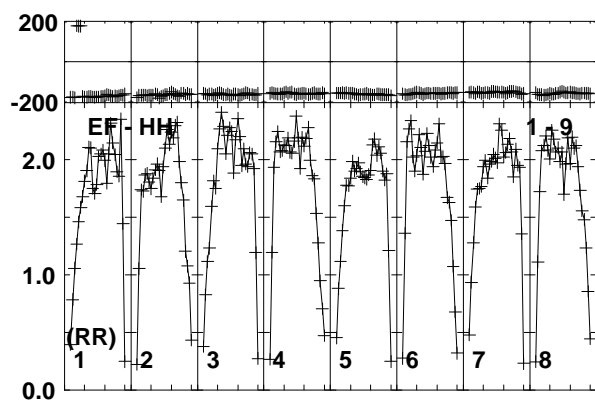
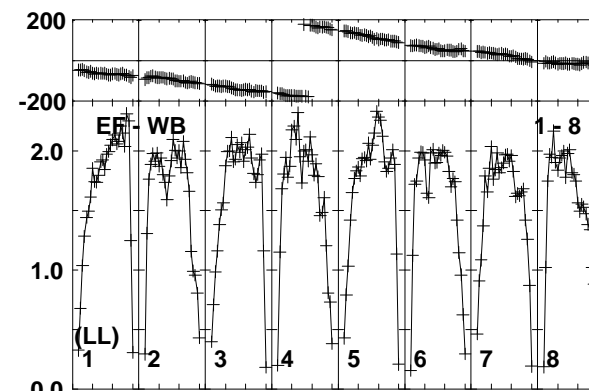
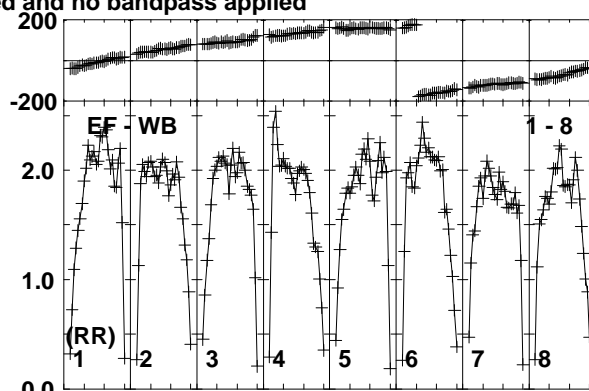
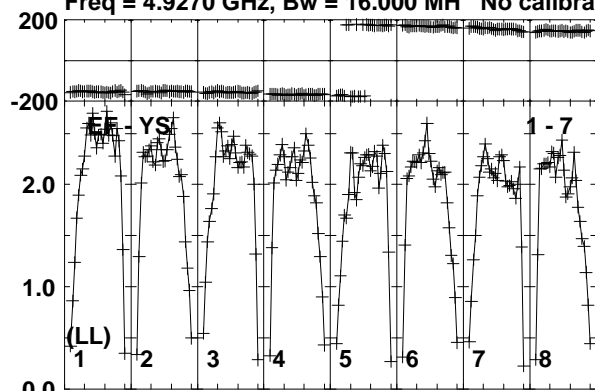

Lower frame: Milli Ampl Jy Top frame: Phas deg  
Vector averaged cross-power spectrum Baseline: EF (01) - YS (07)  
Timerange: 00/11:54:51 to 00/11:56:19



Plot file version 9 created 10-JUN-2016 15:29:15

FRB150418 RG008C.UVDATA.1

Freq = 4.9270 GHz, Bw = 16.000 MH No calibration applied and no bandpass applied

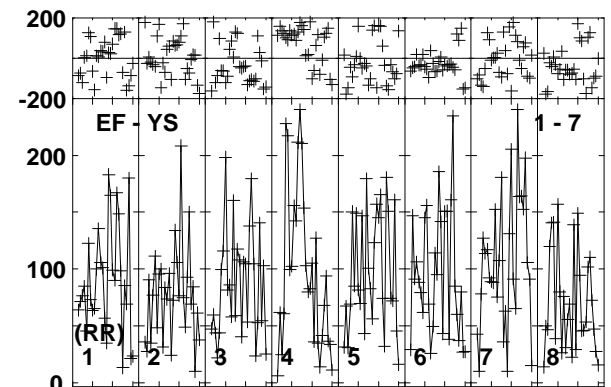
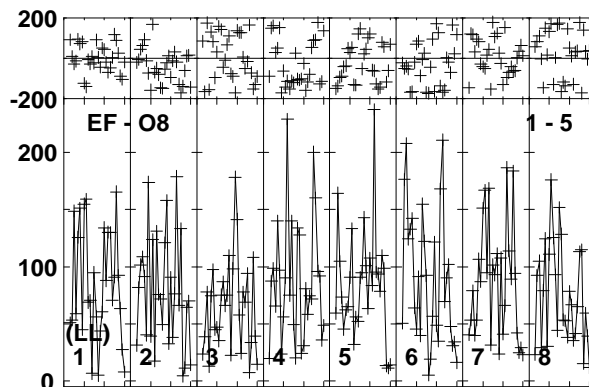
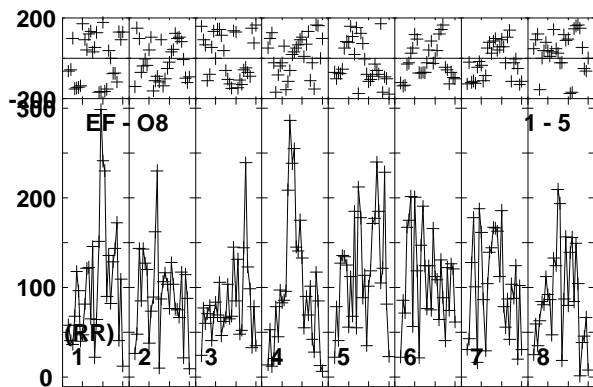
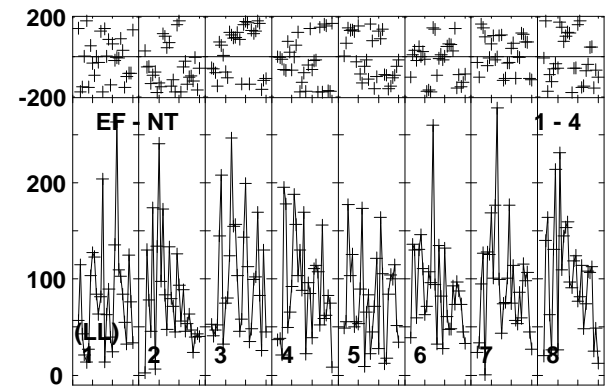
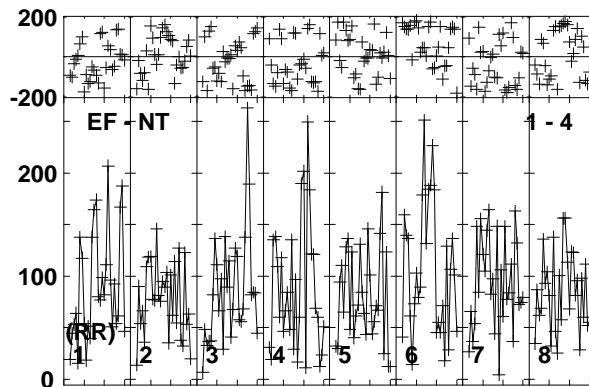
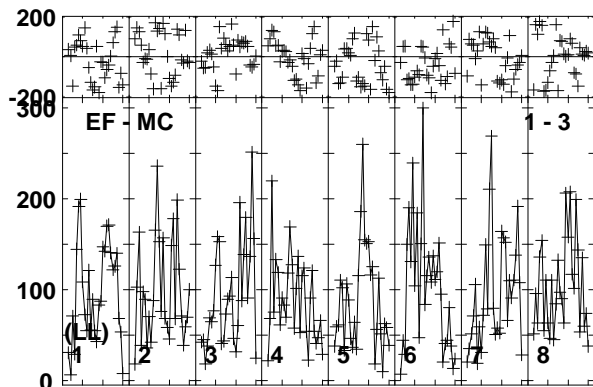
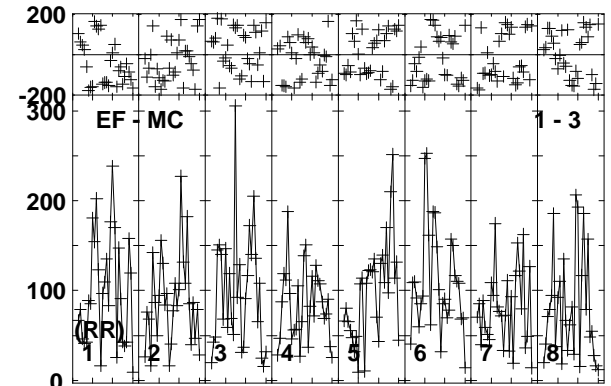
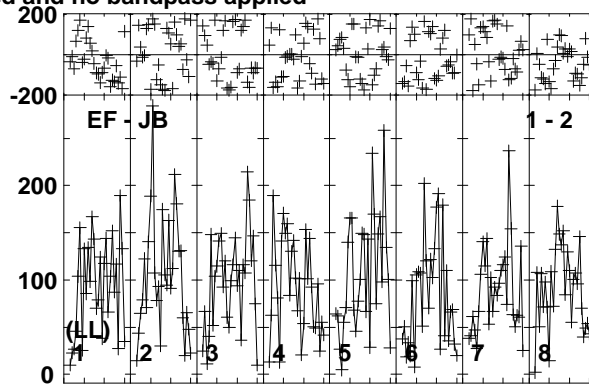
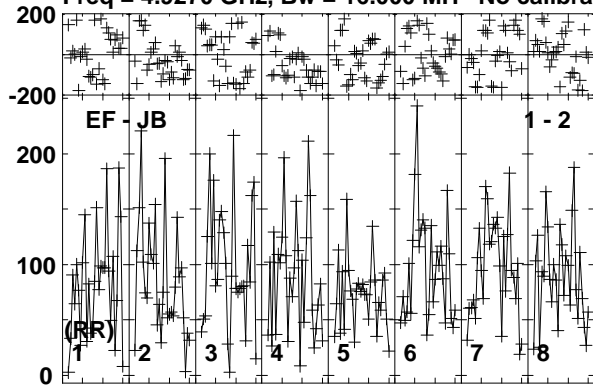

Lower frame: Micro Ampl Jy Top frame: Phas deg  
Vector averaged cross-power spectrum Baseline: EF (01) - JB (02)  
Timerange: 00/11:56:21 to 00/11:59:19

Plot file version 10 created 10-JUN-2016 15:29:15

FRB150418 RG008C.UVDATA.1

Freq = 4.9270 GHz, Bw = 16.000 MH No calibration applied and no bandpass applied

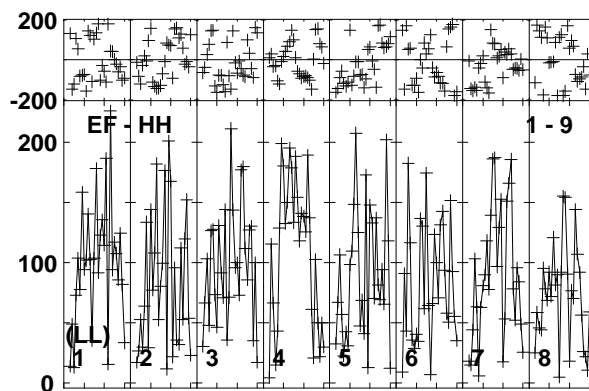
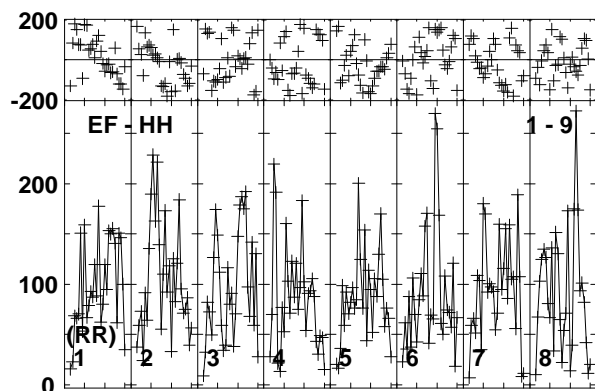
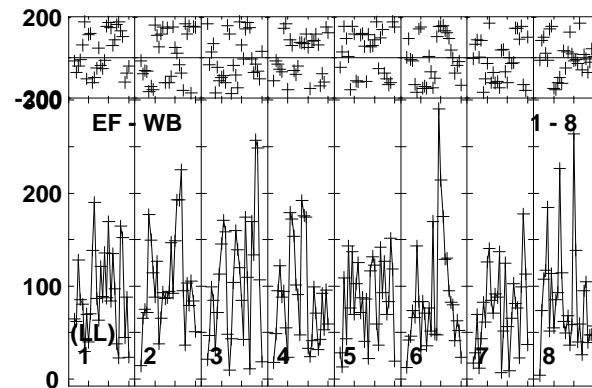
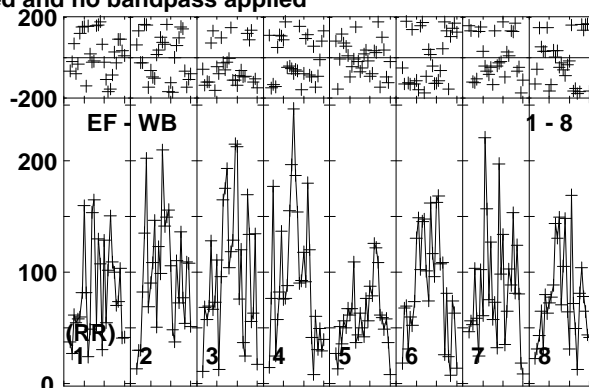
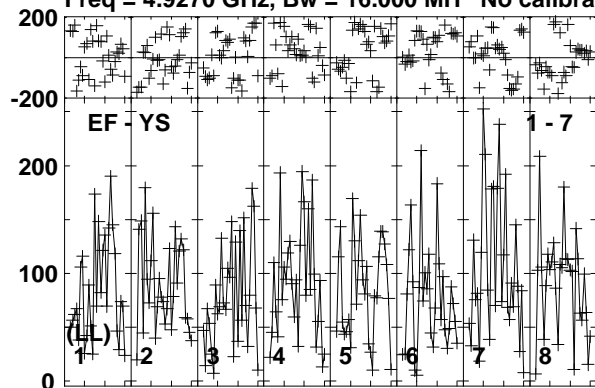

Lower frame: Micro Ampl Jy Top frame: Phas deg  
Vector averaged cross-power spectrum Baseline: EF (01) - YS (07)  
Timerange: 00/11:56:21 to 00/11:59:19

Plot file version 11 created 10-JUN-2016 15:29:16

J0718-1813 RG008C.UVDATA.1

Freq = 4.9270 GHz, Bw = 16.000 MH No calibration applied and no bandpass applied

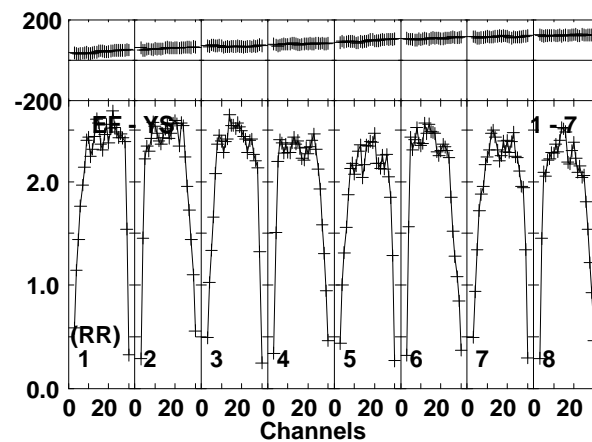
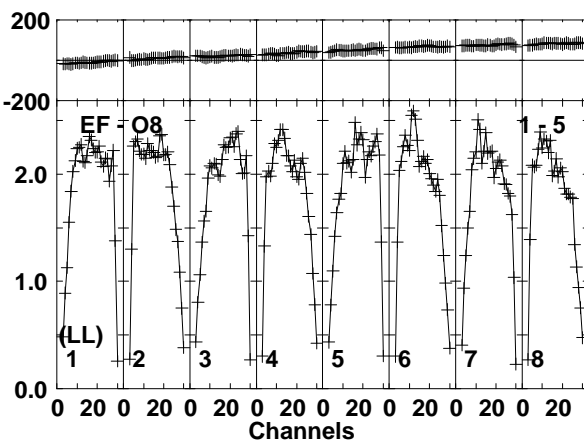
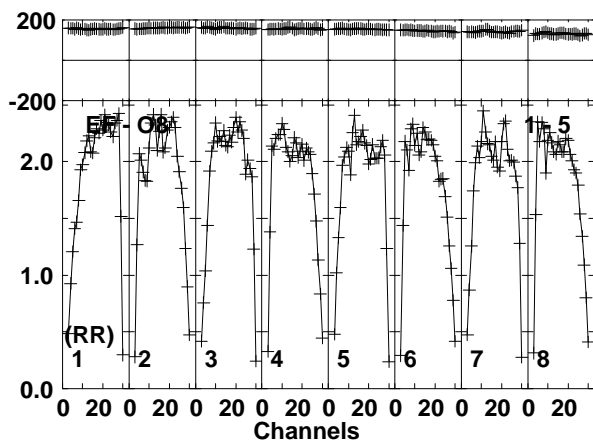
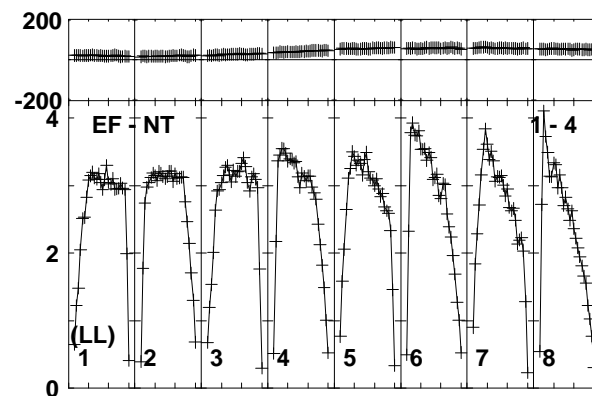
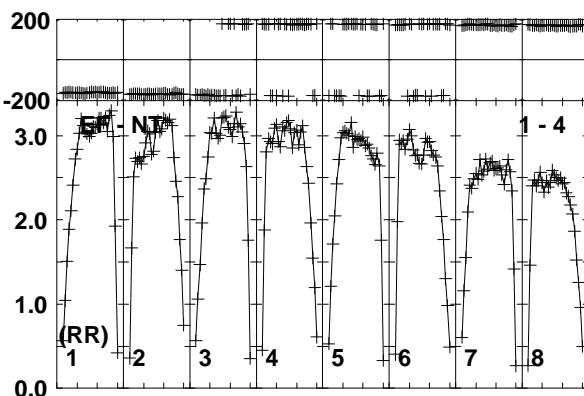
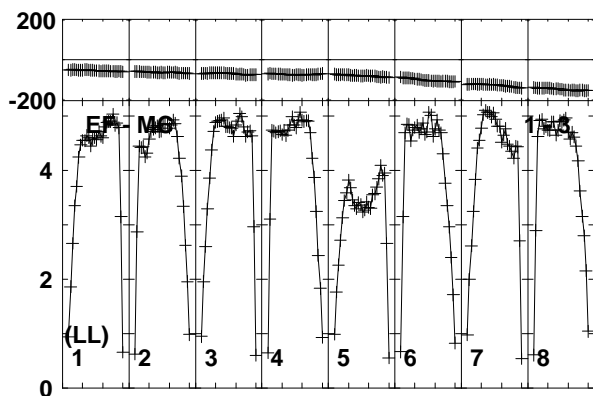
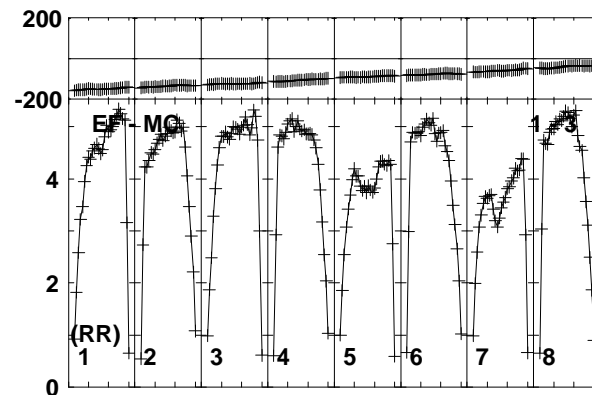
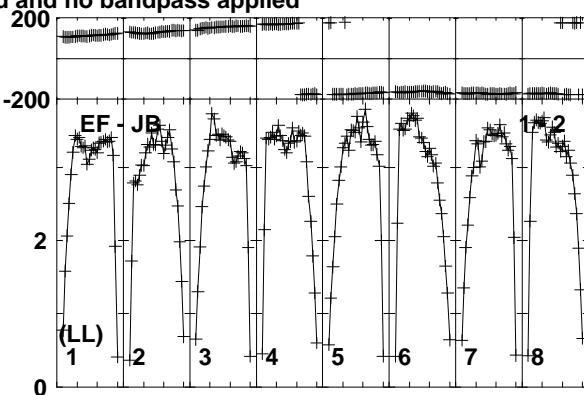
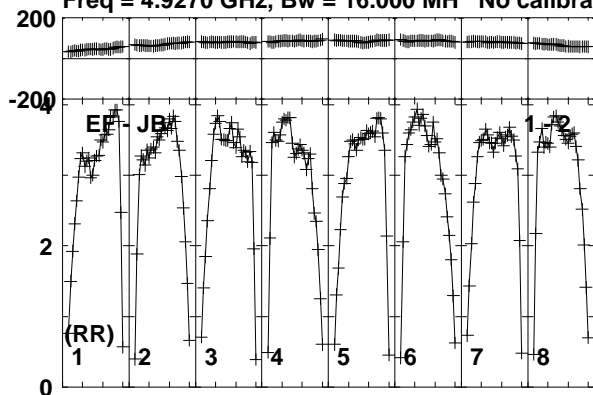

Lower frame: Milli Ampl Jy Top frame: Phas deg  
Vector averaged cross-power spectrum Baseline: EF (01) - JB (02)  
Timerange: 00:12:00:01 to 00:12:01:19

Plot file version 12 created 10-JUN-2016 15:29:16

J0718-1813 RG008C.UVDATA.1

Freq = 4.9270 GHz, Bw = 16.000 MH No calibration applied and no bandpass applied

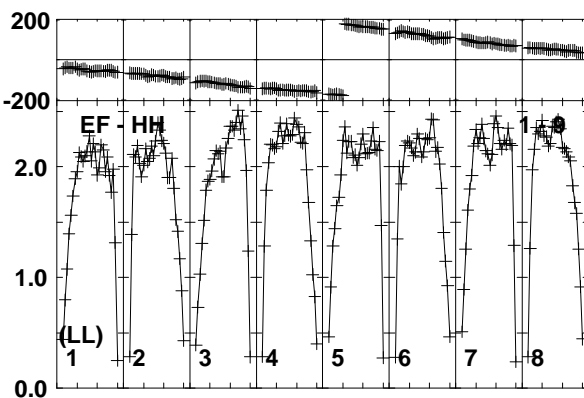
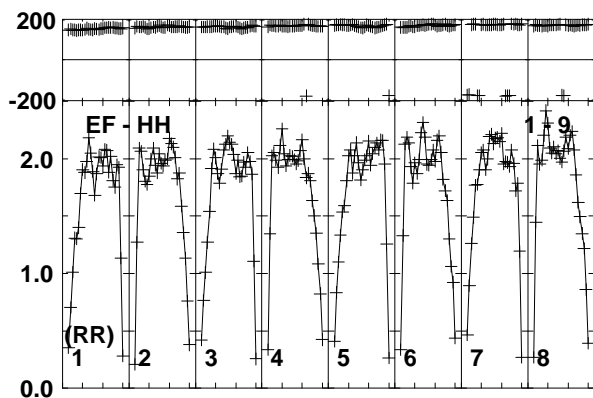
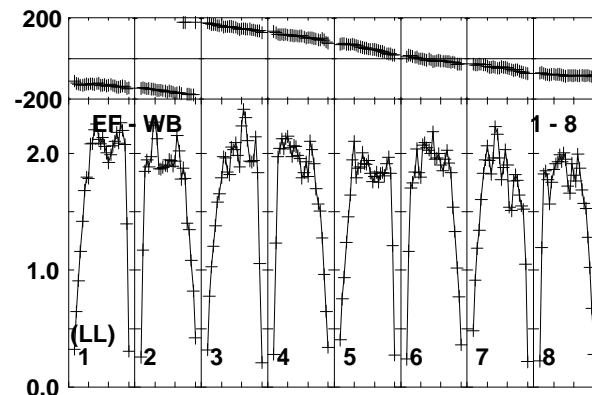
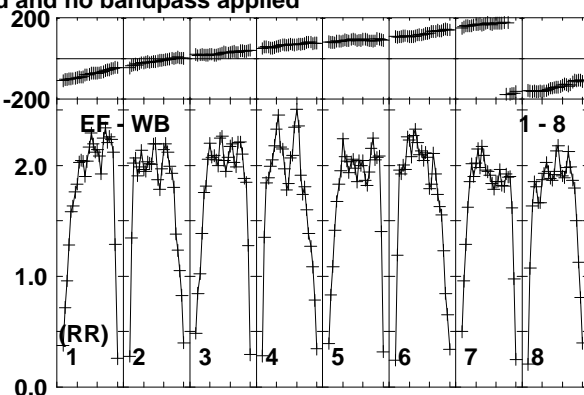
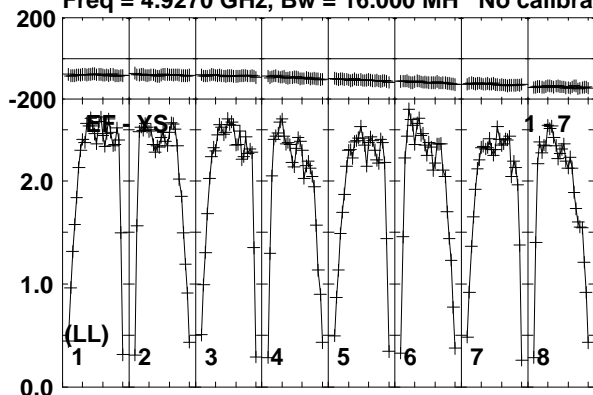

Lower frame: Milli Ampl Jy Top frame: Phas deg  
Vector averaged cross-power spectrum Baseline: EF (01) - YS (07)  
Timerange: 00:12:00:01 to 00:12:01:19

Plot file version 13 created 10-JUN-2016 15:29:16

J0716-1856 RG008C.UVDATA.1

Freq = 4.9270 GHz, Bw = 16.000 MH No calibration applied and no bandpass applied

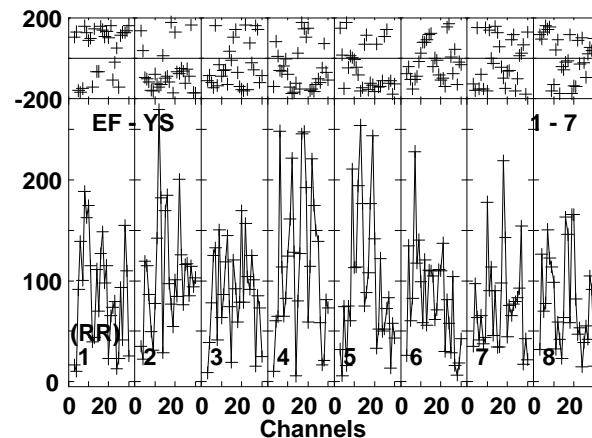
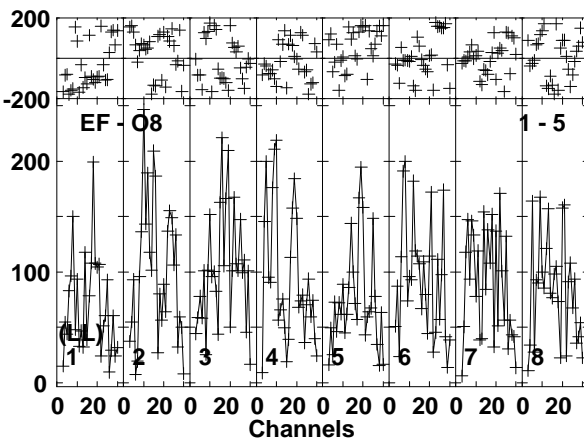
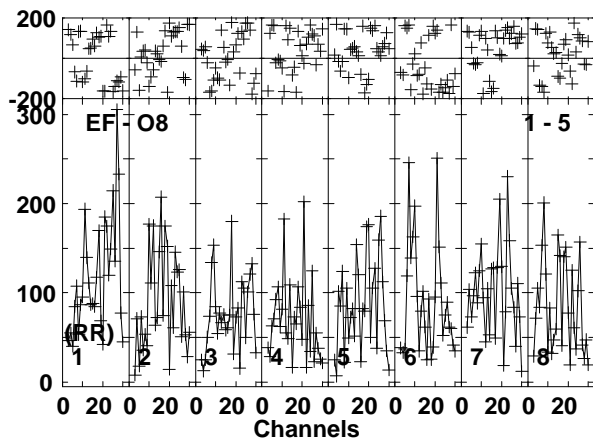
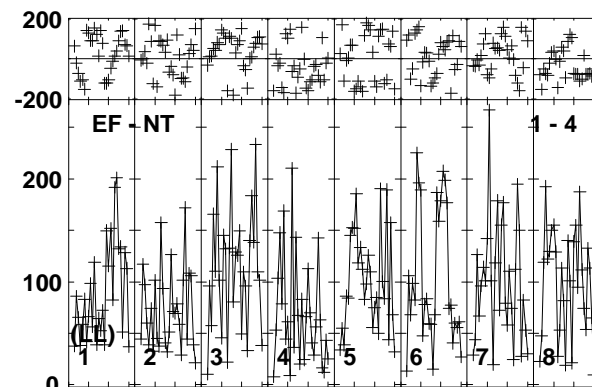
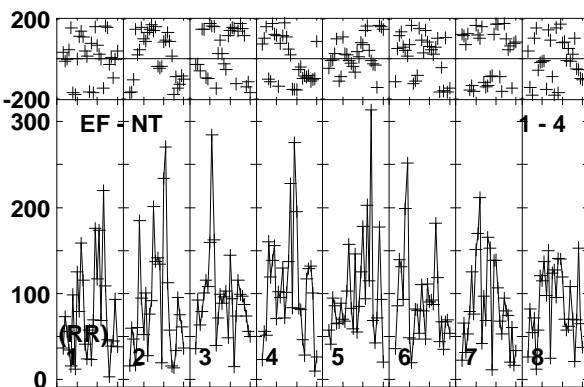
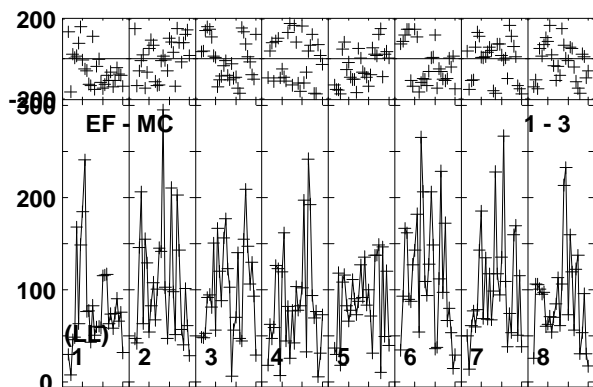
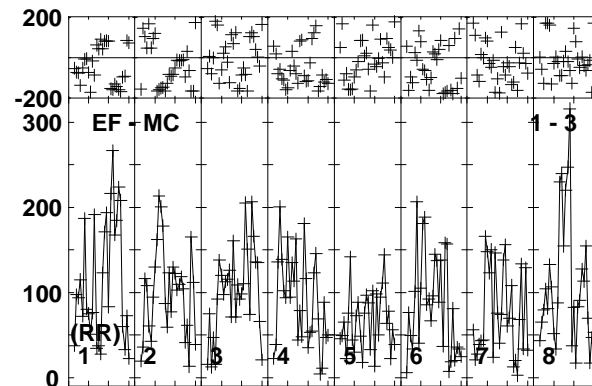
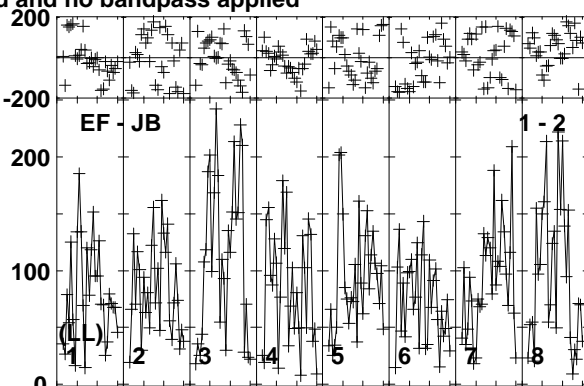
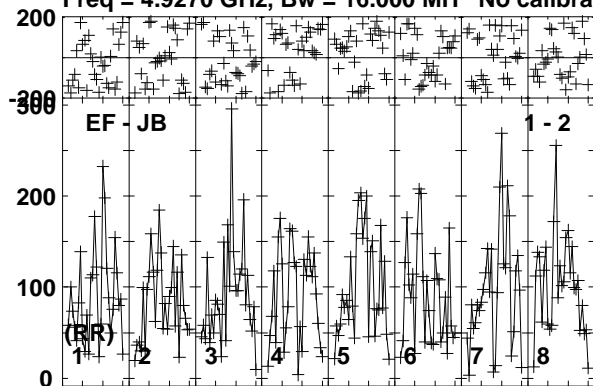

Lower frame: Micro Ampl Jy Top frame: Phas deg  
Vector averaged cross-power spectrum Baseline: EF (01) - JB (02)  
Timerange: 00:12:01:21 to 00:12:04:20

Plot file version 14 created 10-JUN-2016 15:29:16

J0716-1856 RG008C.UVDATA.1

Freq = 4.9270 GHz, Bw = 16.000 MH No calibration applied and no bandpass applied

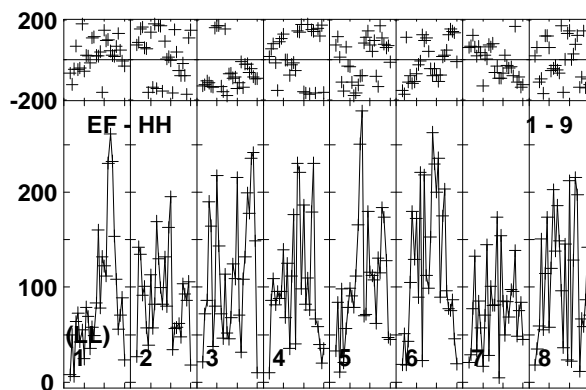
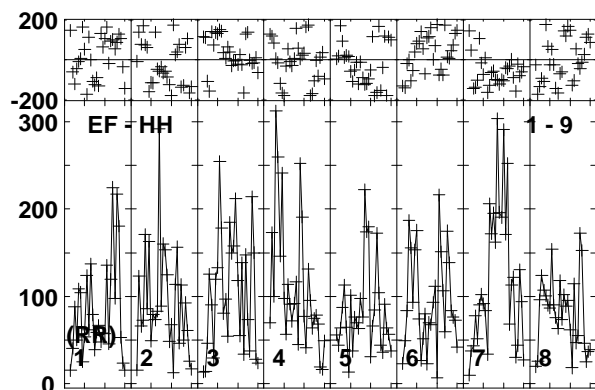
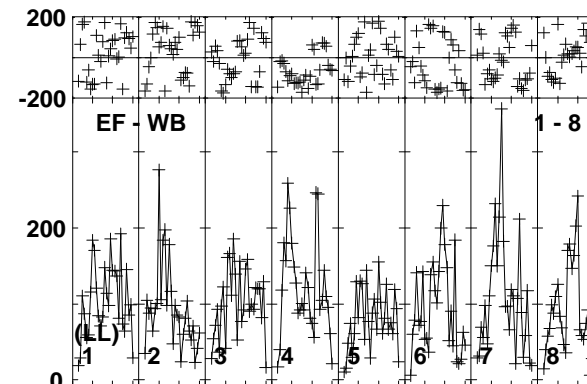
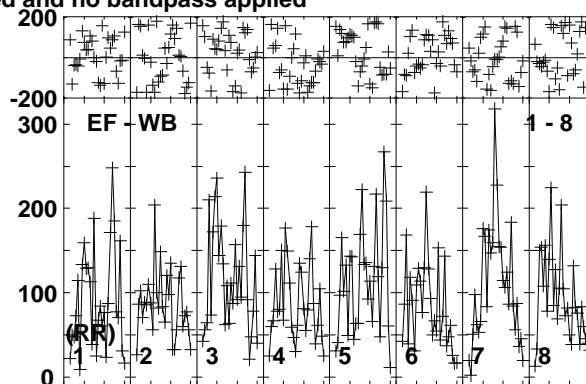
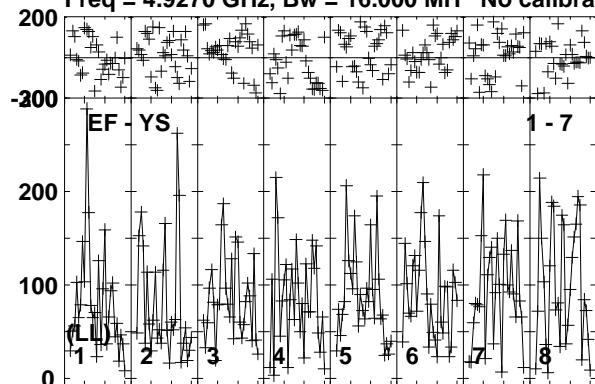

Lower frame: Micro Ampl Jy Top frame: Phas deg  
Vector averaged cross-power spectrum Baseline: EF (01) - YS (07)  
Timerange: 00/12:01:21 to 00/12:04:20

Plot file version 15 created 10-JUN-2016 15:29:16

J0718-1813 RG008C.UVDATA.1

Freq = 4.9270 GHz, Bw = 16.000 MH No calibration applied and no bandpass applied

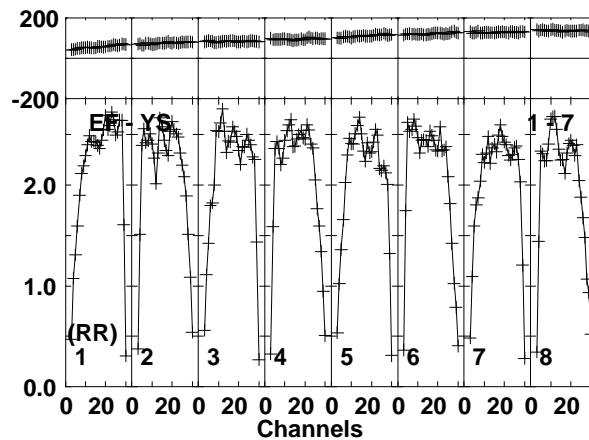
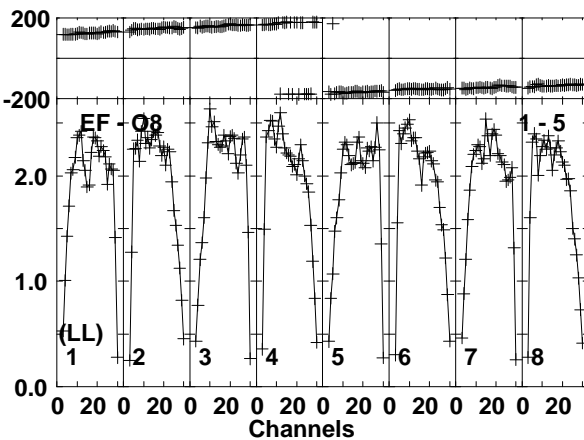
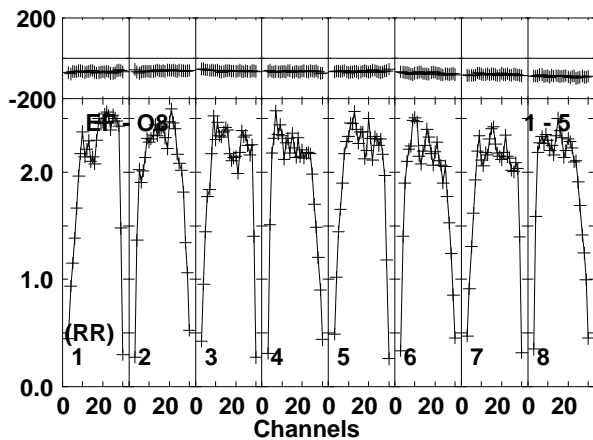
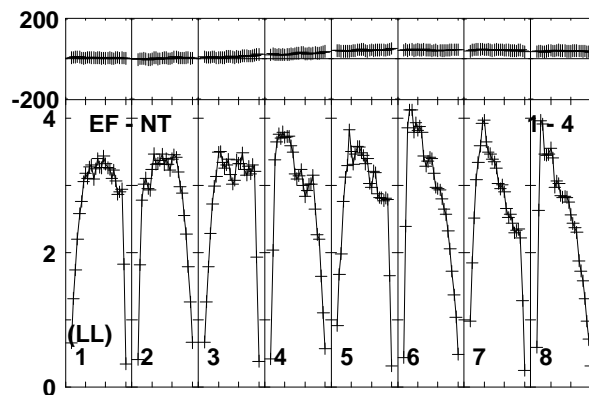
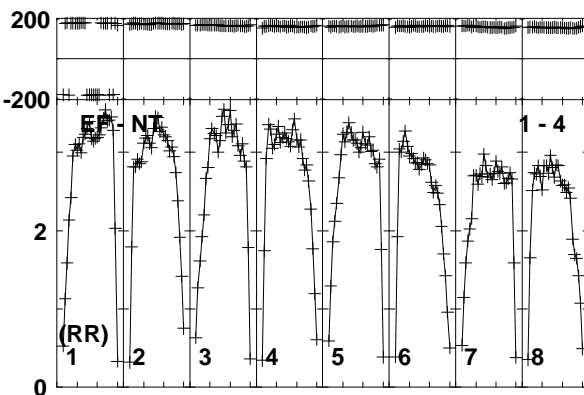
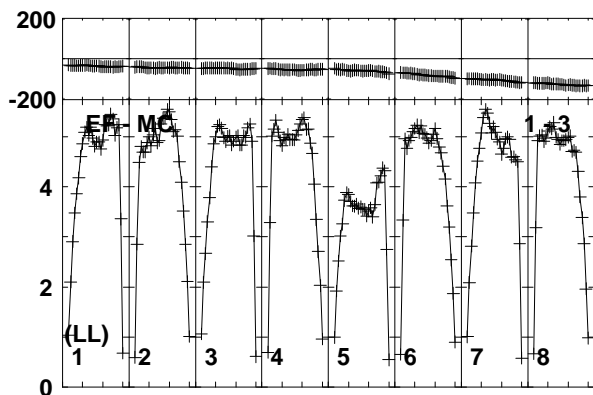
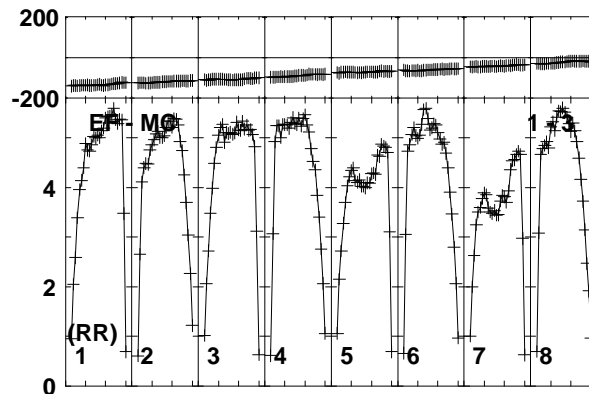
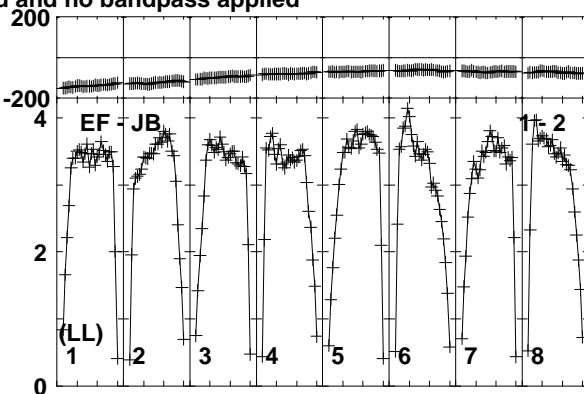
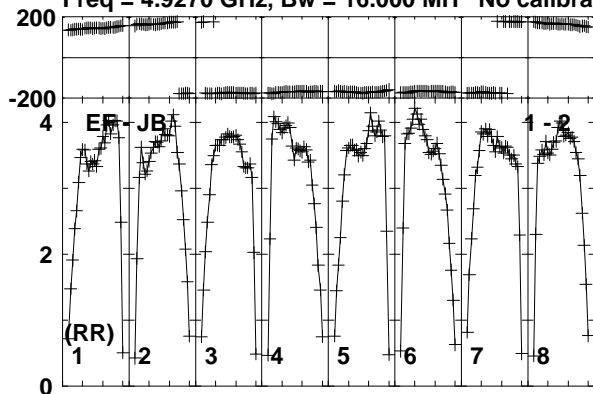

Lower frame: Milli Ampl Jy Top frame: Phas deg  
Vector averaged cross-power spectrum Baseline: EF (01) - JB (02)  
Timerange: 00:12:04:20 to 00:12:05:49

Plot file version 16 created 10-JUN-2016 15:29:16

J0718-1813 RG008C.UVDATA.1

Freq = 4.9270 GHz, Bw = 16.000 MH No calibration applied and no bandpass applied

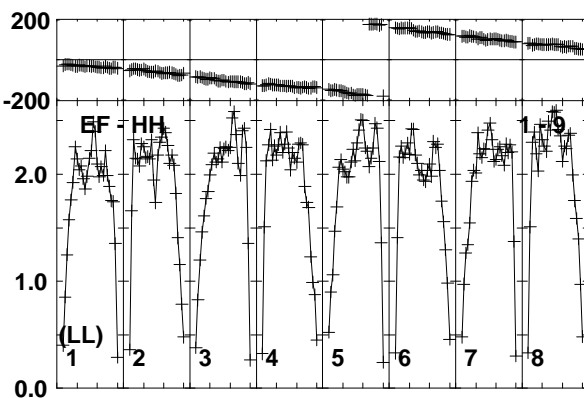
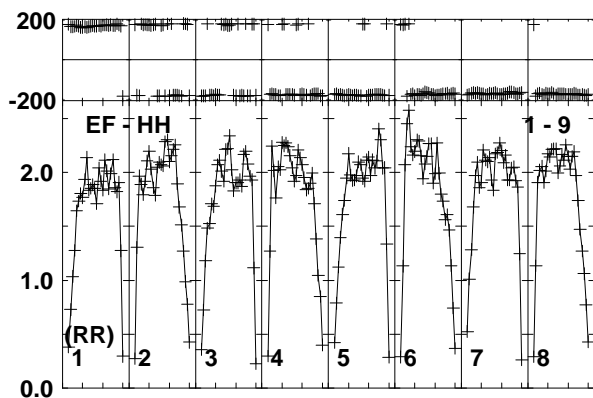
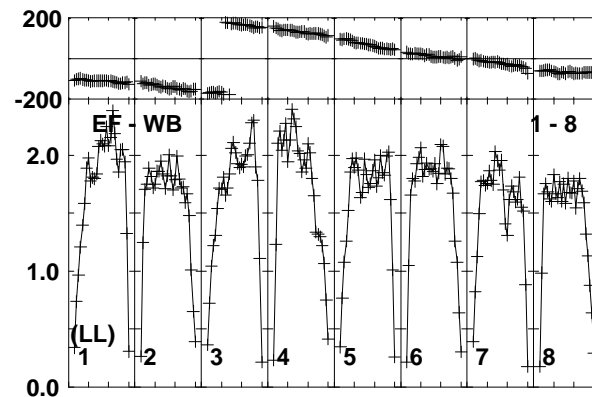
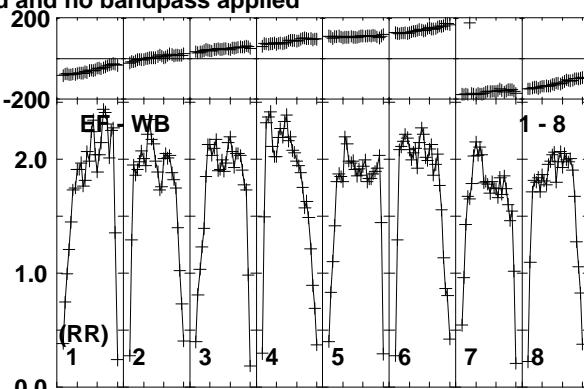
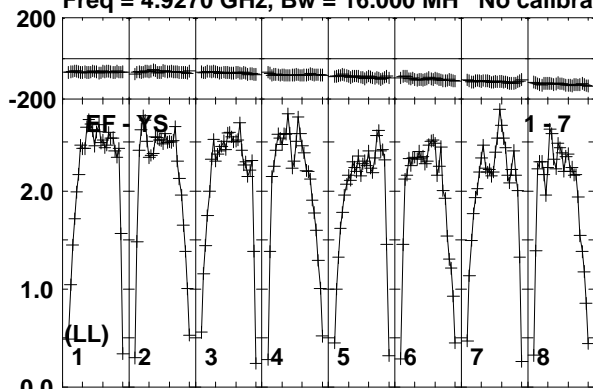

Lower frame: Milli Ampl Jy Top frame: Phas deg  
Vector averaged cross-power spectrum Baseline: EF (01) - YS (07)  
Timerange: 00/12:04:20 to 00/12:05:49



Plot file version 17 created 10-JUN-2016 15:29:16

FRB150418 RG008C.UVDATA.1

Freq = 4.9270 GHz, Bw = 16.000 MH No calibration applied and no bandpass applied

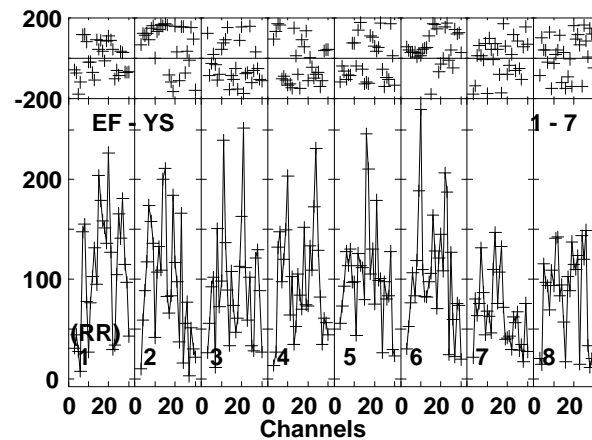
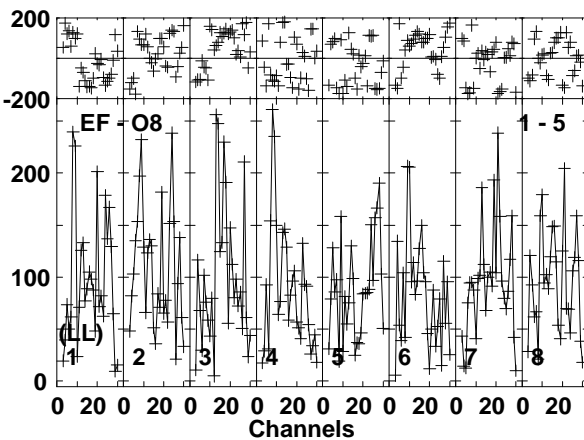
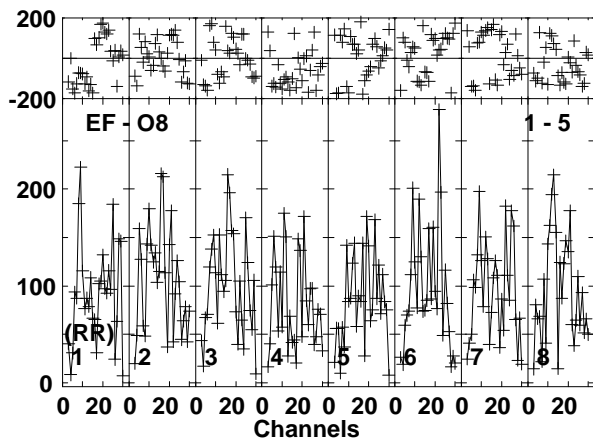
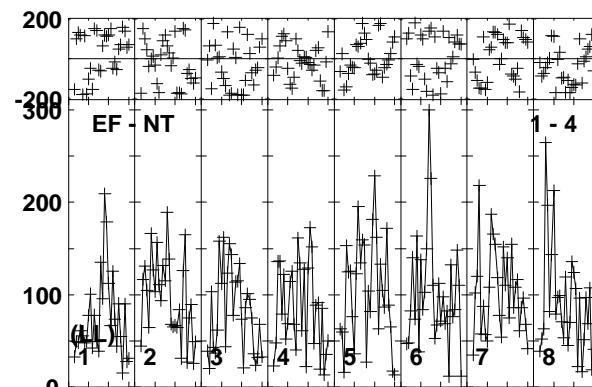
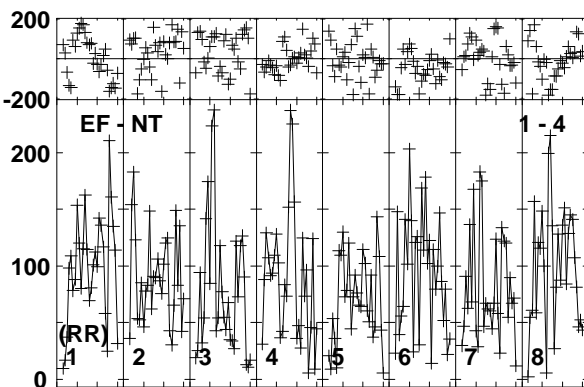
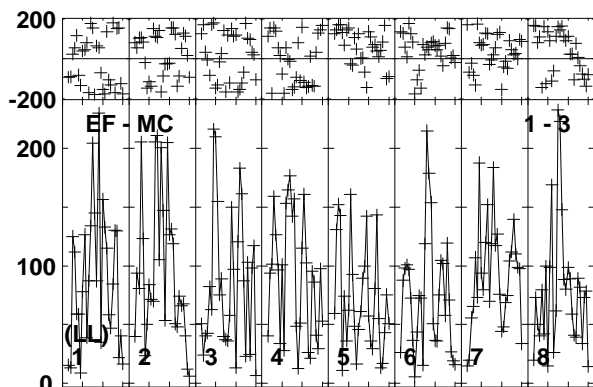
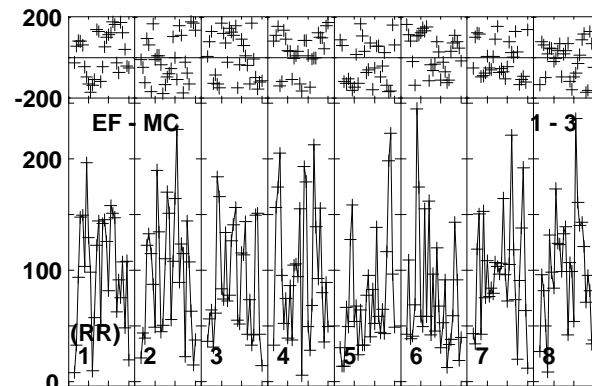
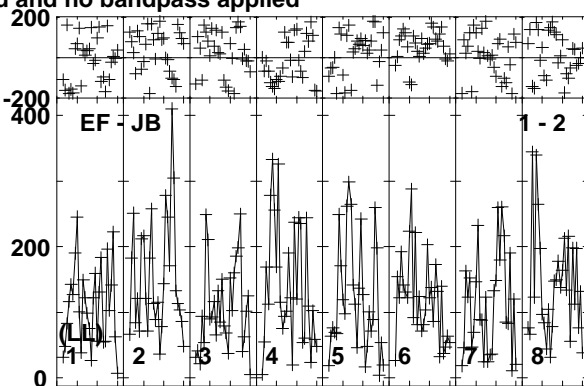
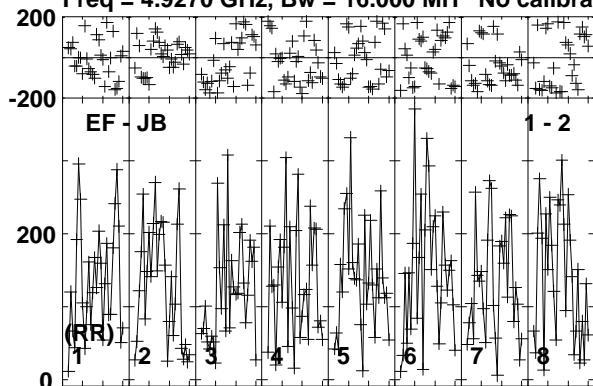

Lower frame: Micro Ampl Jy Top frame: Phas deg  
Vector averaged cross-power spectrum Baseline: EF (01) - JB (02)  
Timerange: 00:12:05:50 to 00:12:08:50

Plot file version 18 created 10-JUN-2016 15:29:16

FRB150418 RG008C.UVDATA.1

Freq = 4.9270 GHz, Bw = 16.000 MH No calibration applied and no bandpass applied

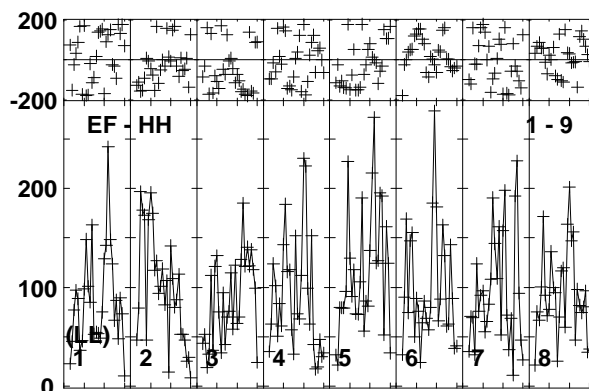
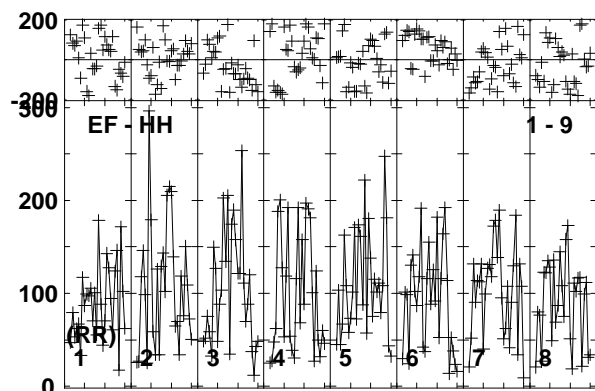
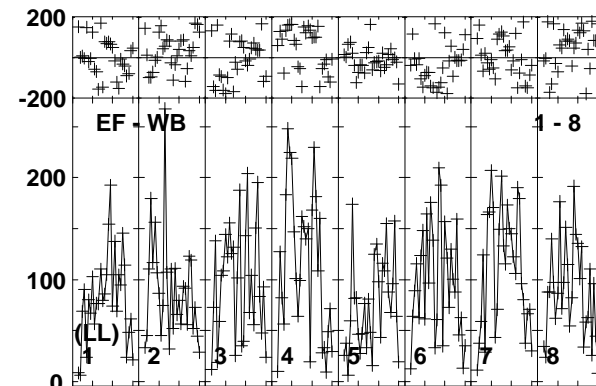
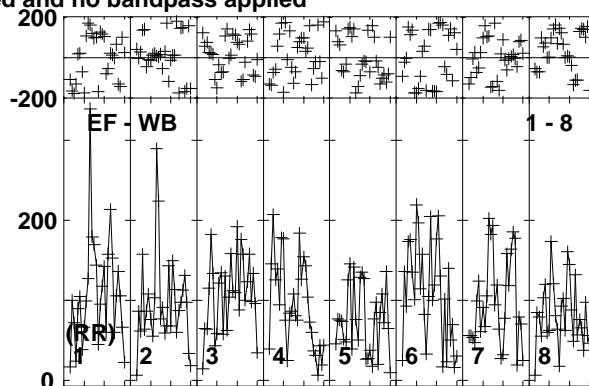
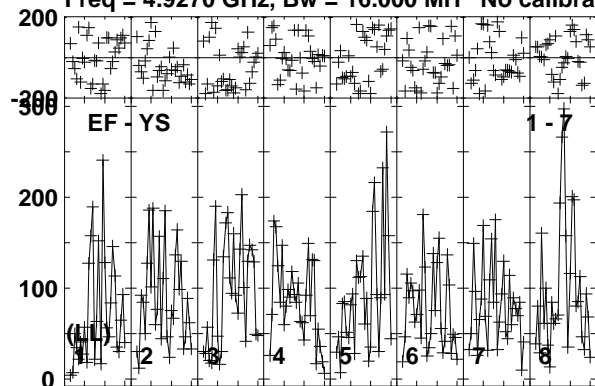

Lower frame: Micro Ampl Jy Top frame: Phas deg  
Vector averaged cross-power spectrum Baseline: EF (01) - YS (07)  
Timerange: 00/12:05:50 to 00/12:08:50

Plot file version 19 created 10-JUN-2016 15:29:17

J0718-1813 RG008C.UVDATA.1

Freq = 4.9270 GHz, Bw = 16.000 MH No calibration applied and no bandpass applied

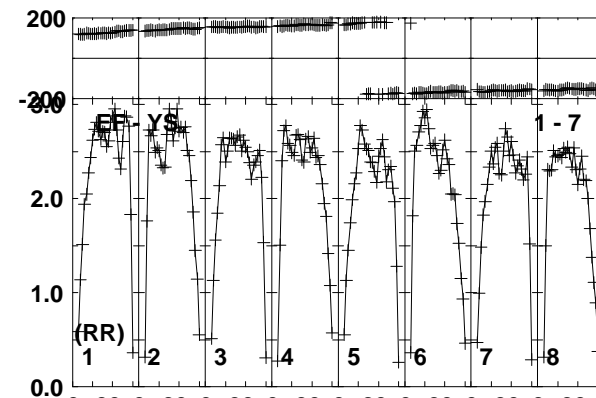
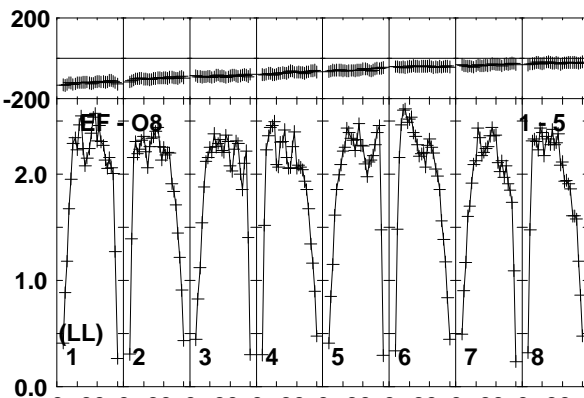
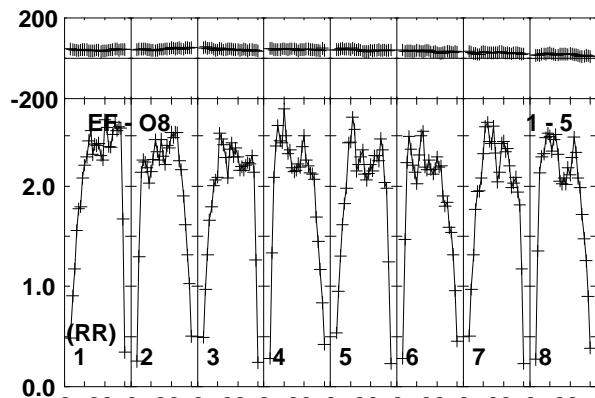
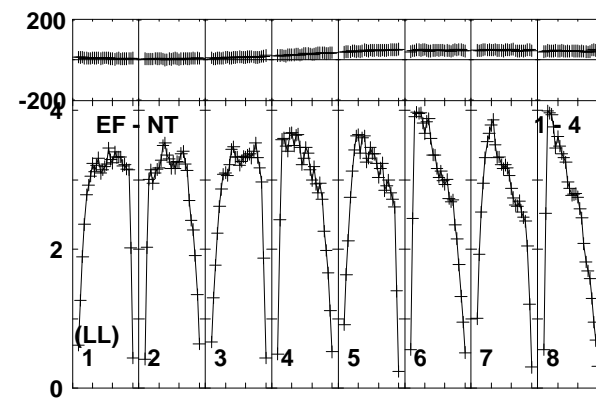
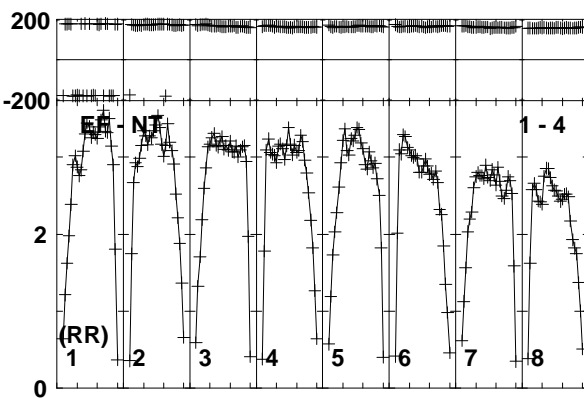
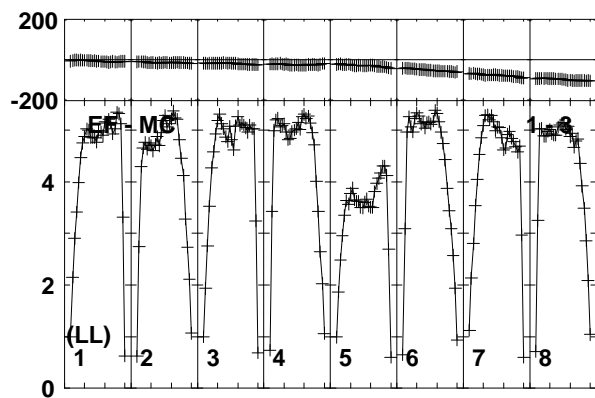
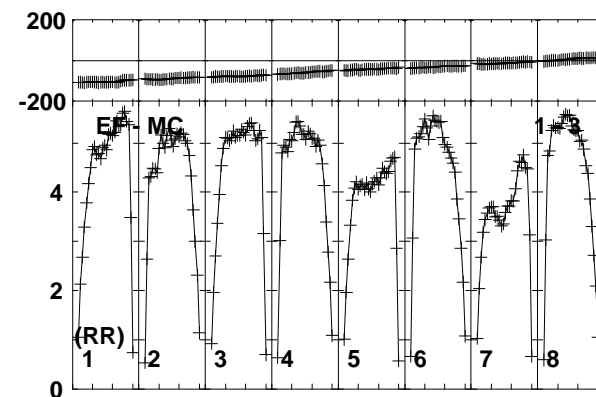
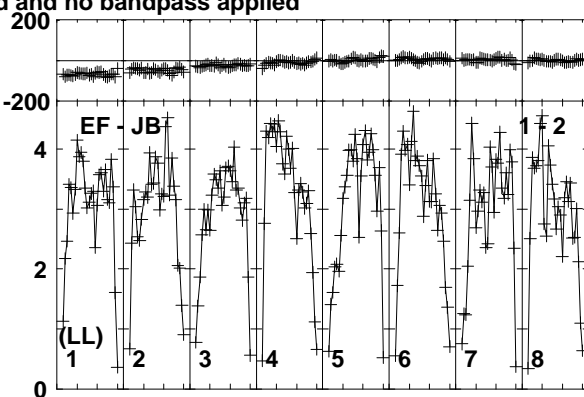
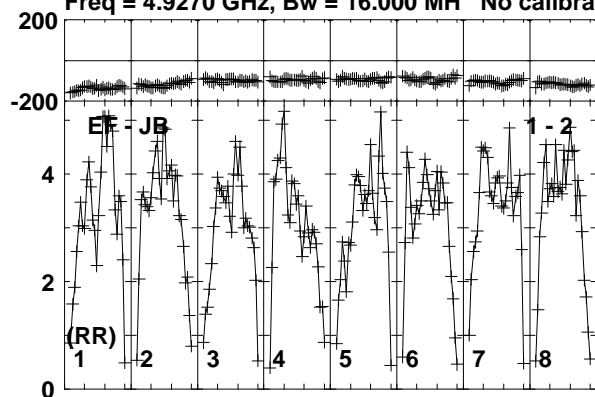

Lower frame: Milli Ampl Jy Top frame: Phas deg  
Vector averaged cross-power spectrum Baseline: EF (01) - JB (02)  
Timerange: 00:12:08:51 to 00:12:10:19

Plot file version 20 created 10-JUN-2016 15:29:17

J0718-1813 RG008C.UVDATA.1

Freq = 4.9270 GHz, Bw = 16.000 MH No calibration applied and no bandpass applied

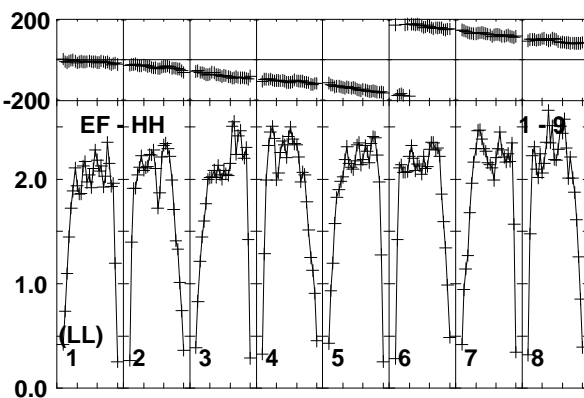
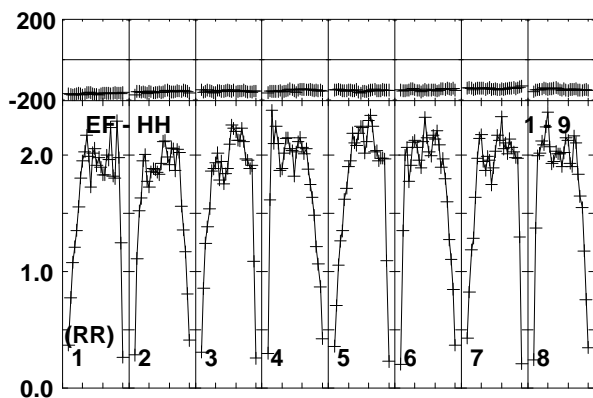
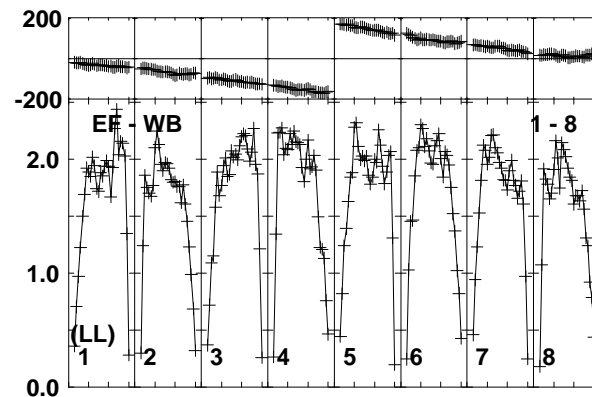
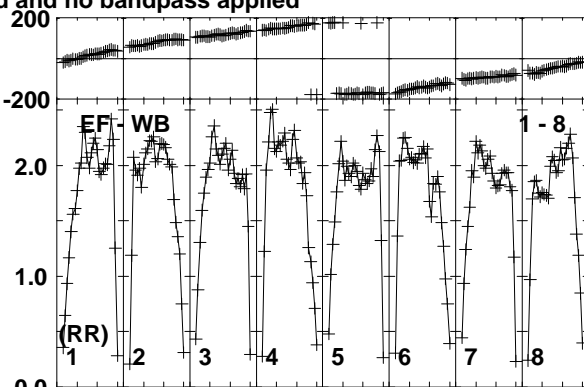
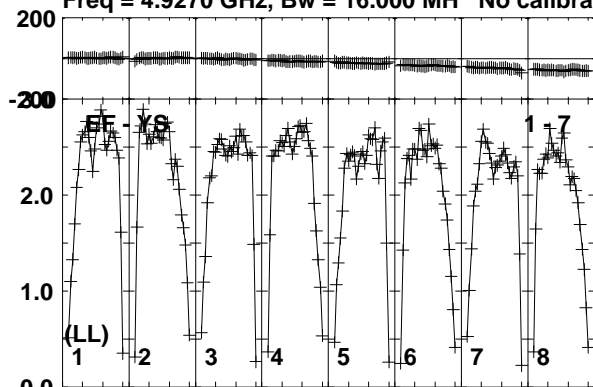

Lower frame: Milli Ampl Jy Top frame: Phas deg  
Vector averaged cross-power spectrum Baseline: EF (01) - YS (07)  
Timerange: 00/12:08:51 to 00/12:10:19

Plot file version 21 created 10-JUN-2016 15:29:17

J0716-1900 RG008C.UVDATA.1

Freq = 4.9270 GHz, Bw = 16.000 MH No calibration applied and no bandpass applied

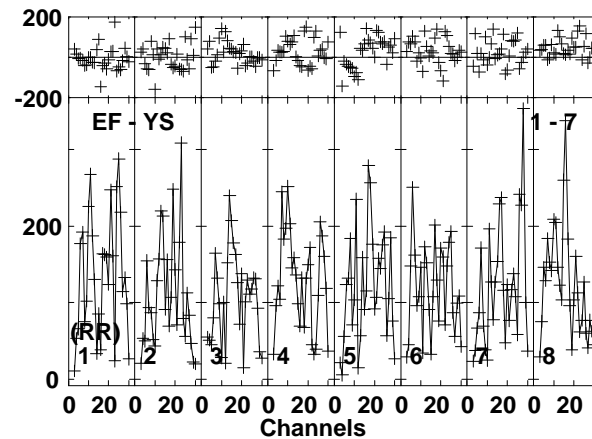
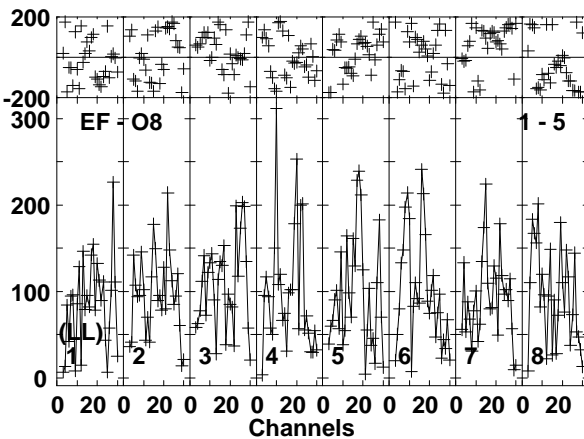
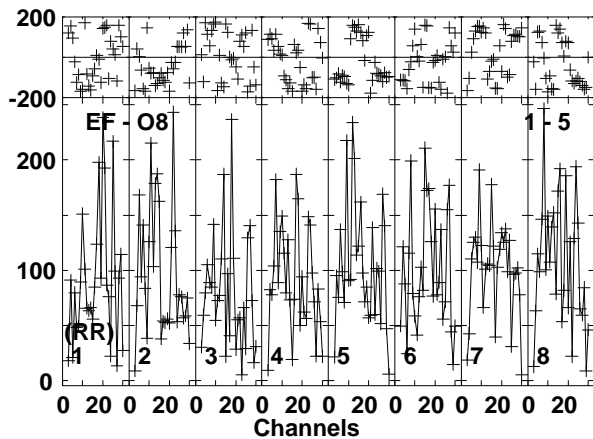
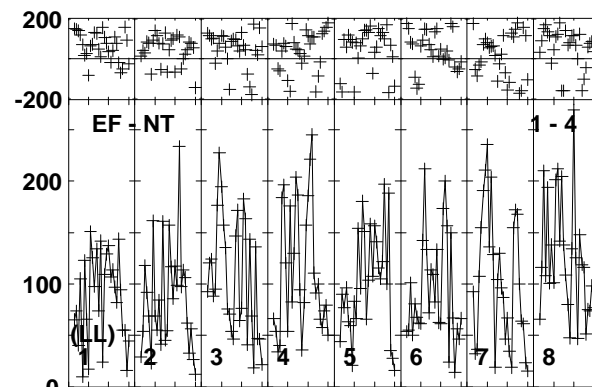
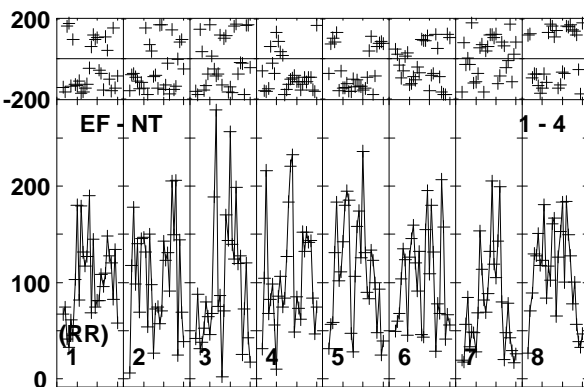
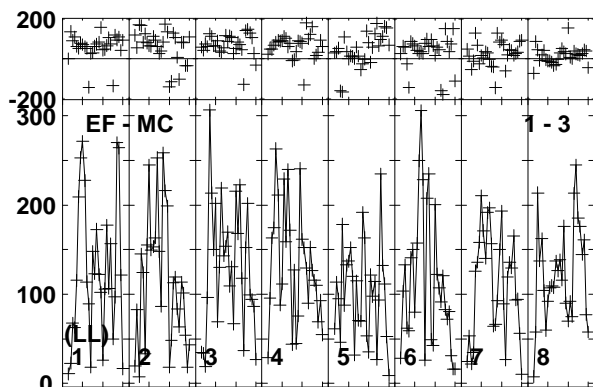
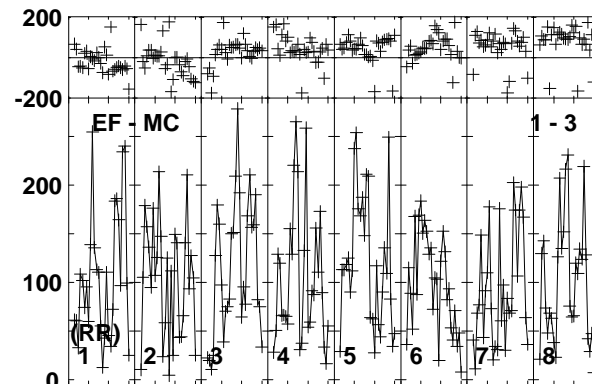
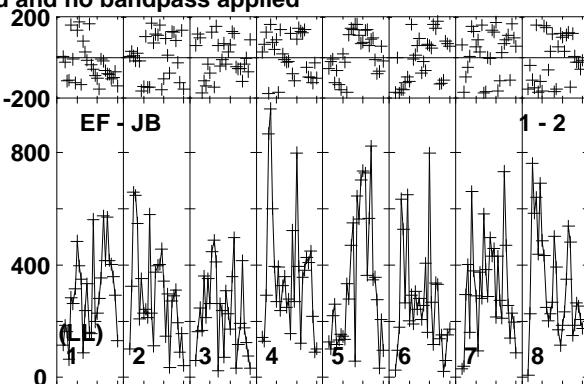
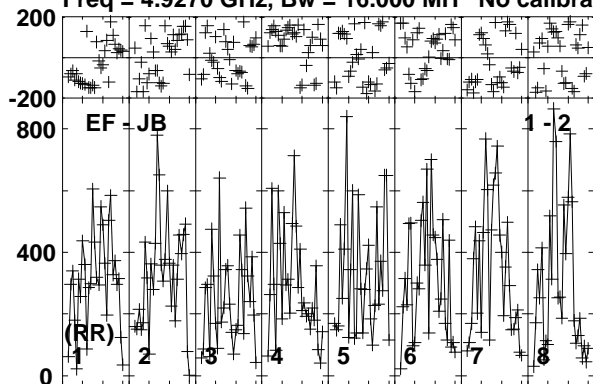

Lower frame: Micro Ampl Jy Top frame: Phas deg  
Vector averaged cross-power spectrum Baseline: EF (01) - JB (02)  
Timerange: 00:12:10:20 to 00:12:13:20

Plot file version 22 created 10-JUN-2016 15:29:17

J0716-1900 RG008C.UVDATA.1

Freq = 4.9270 GHz, Bw = 16.000 MH No calibration applied and no bandpass applied

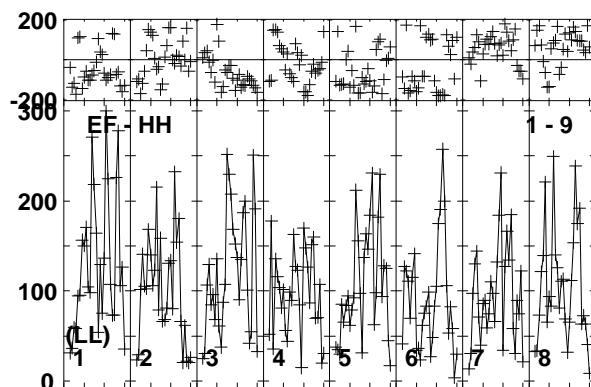
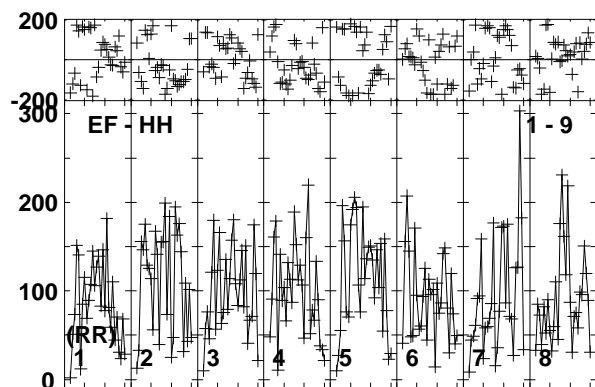
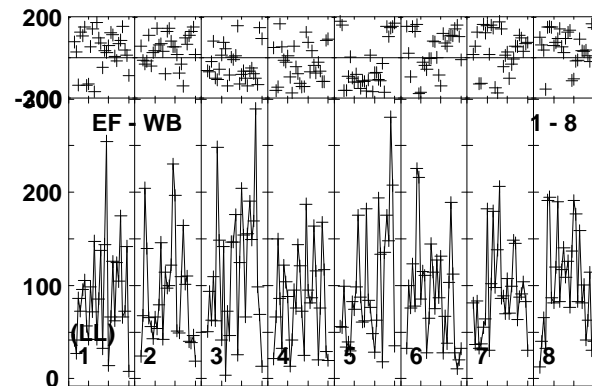
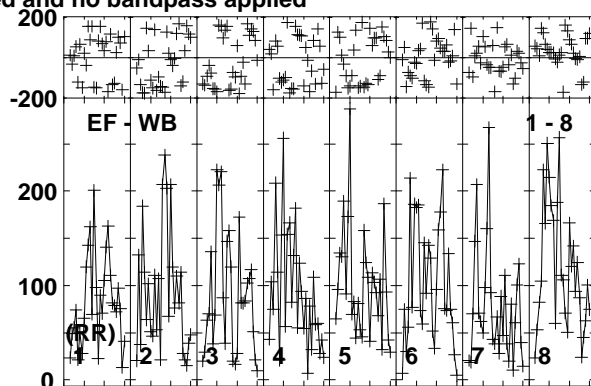
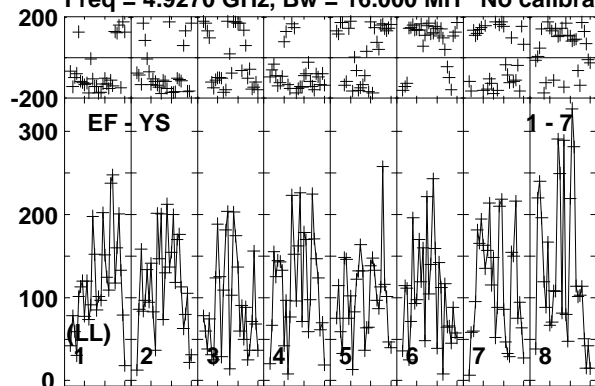

Lower frame: Micro Ampl Jy Top frame: Phas deg  
Vector averaged cross-power spectrum Baseline: EF (01) - YS (07)  
Timerange: 00:12:10:20 to 00:12:13:20

Plot file version 23 created 10-JUN-2016 15:29:17

J0718-1813 RG008C.UVDATA.1

Freq = 4.9270 GHz, Bw = 16.000 MH No calibration applied and no bandpass applied

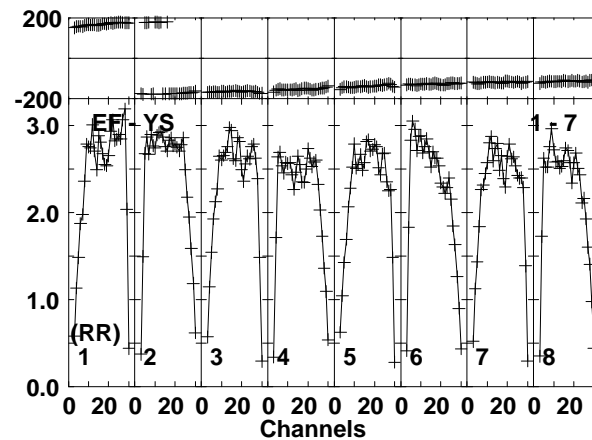
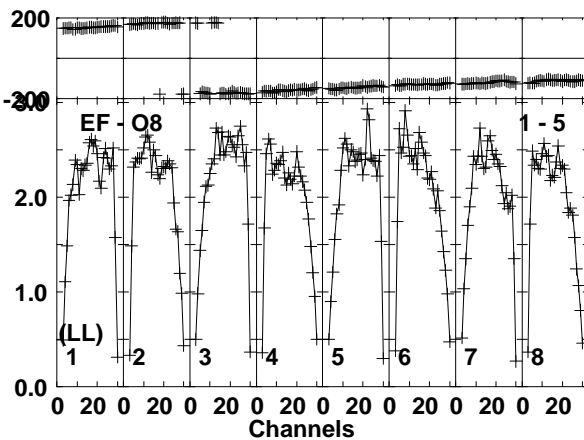
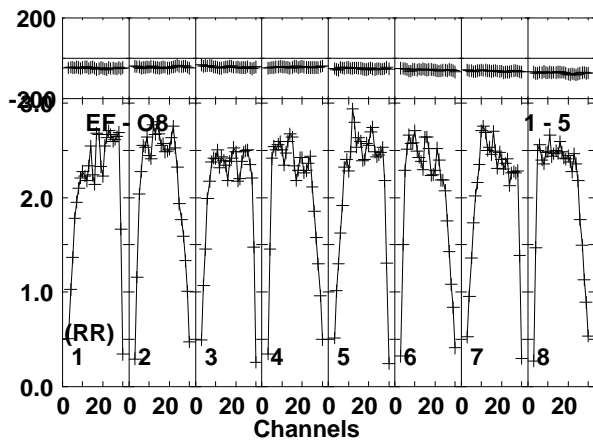
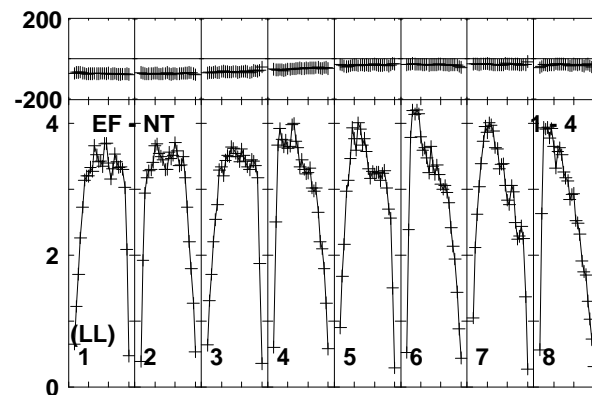
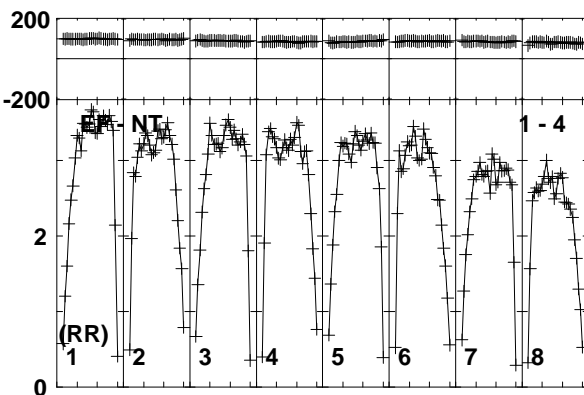
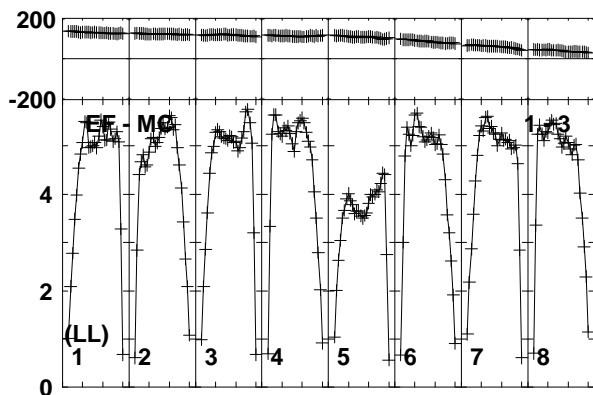
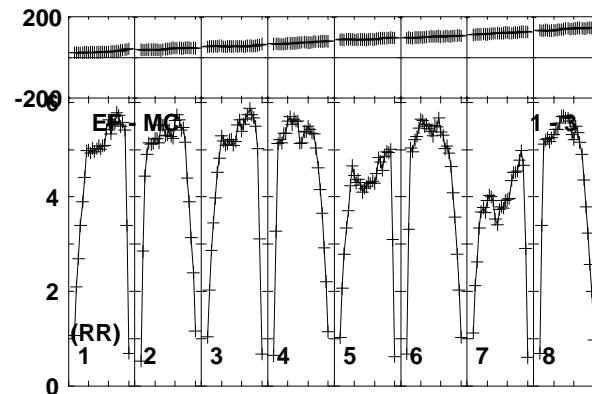
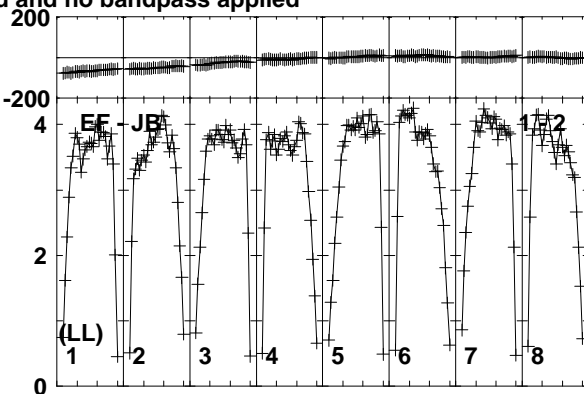
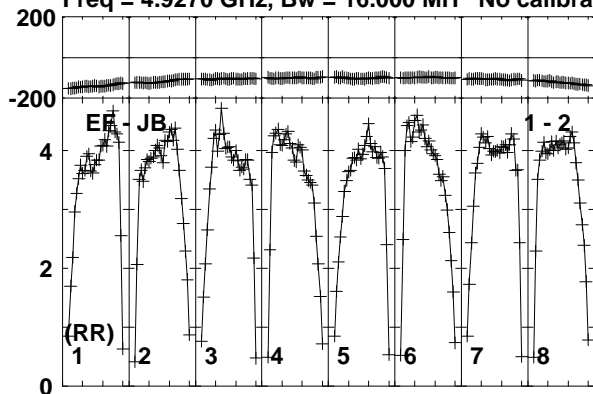

Lower frame: Milli Ampl Jy Top frame: Phas deg  
Vector averaged cross-power spectrum Baseline: EF (01) - JB (02)  
Timerange: 00:12:14:00 to 00:12:14:50

Plot file version 24 created 10-JUN-2016 15:29:17

J0718-1813 RG008C.UVDATA.1

Freq = 4.9270 GHz, Bw = 16.000 MH No calibration applied and no bandpass applied

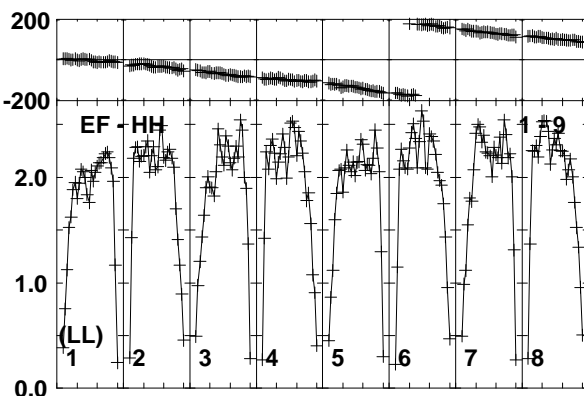
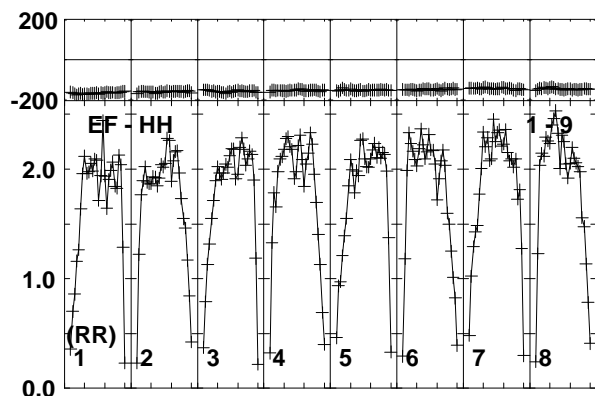
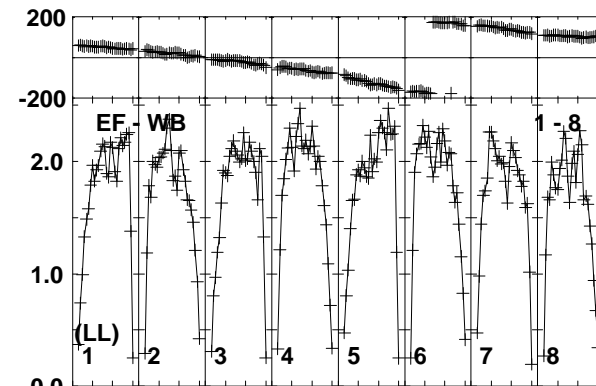
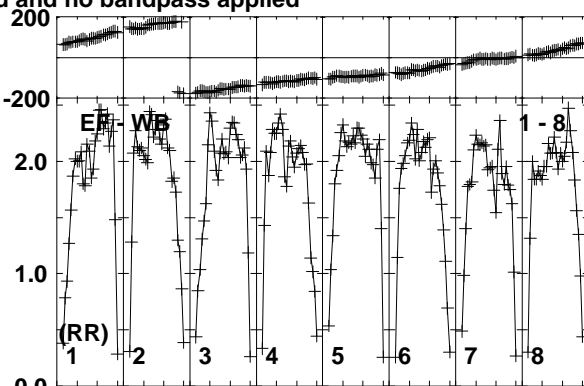
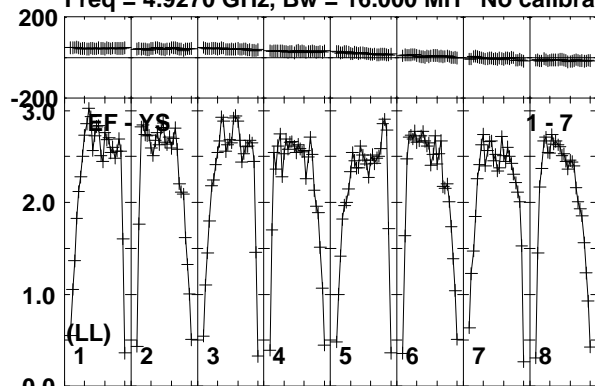

Lower frame: Milli Ampl Jy Top frame: Phas deg  
Vector averaged cross-power spectrum Baseline: EF (01) - YS (07)  
Timerange: 00:12:14:00 to 00:12:14:50



Plot file version 25 created 10-JUN-2016 15:29:17

FRB150418 RG008C.UVDATA.1

Freq = 4.9270 GHz, Bw = 16.000 MH No calibration applied and no bandpass applied

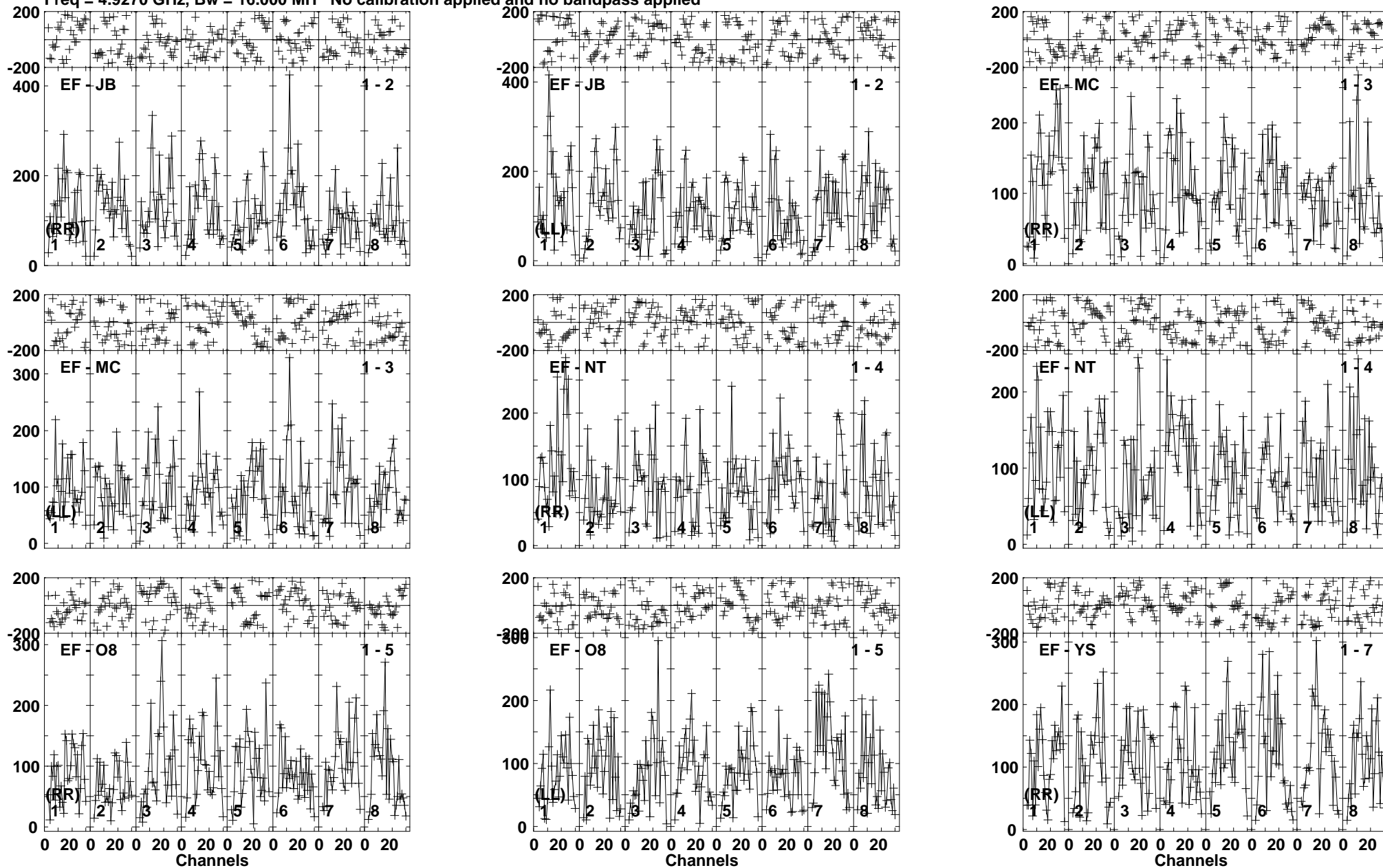

Lower frame: Micro Ampl Jy Top frame: Phas deg  
Vector averaged cross-power spectrum Baseline: EF (01) - JB (02)  
Timerange: 00/12:14:51 to 00/12:17:49

Plot file version 26 created 10-JUN-2016 15:29:17

FRB150418 RG008C.UVDATA.1

Freq = 4.9270 GHz, Bw = 16.000 MH No calibration applied and no bandpass applied

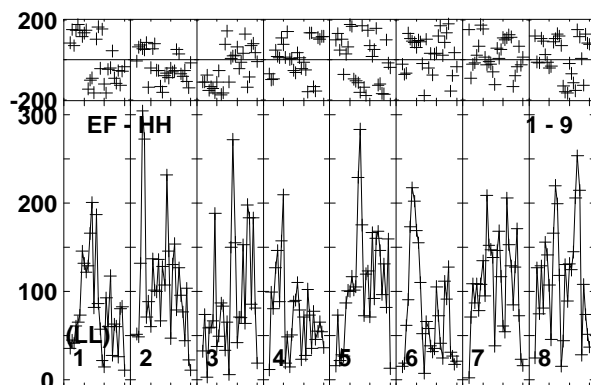
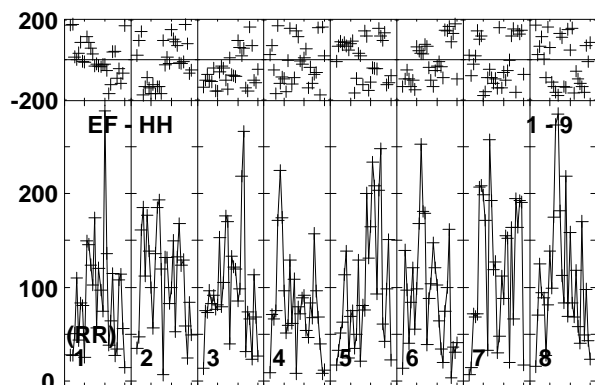
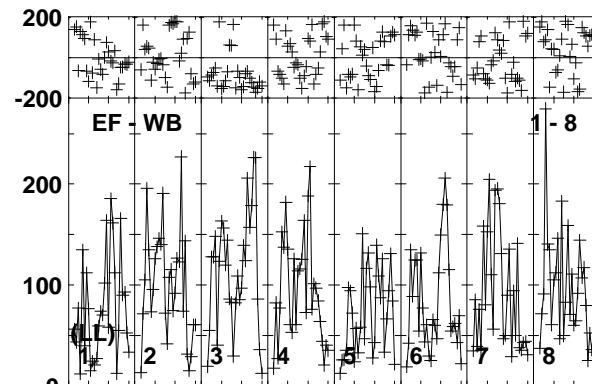
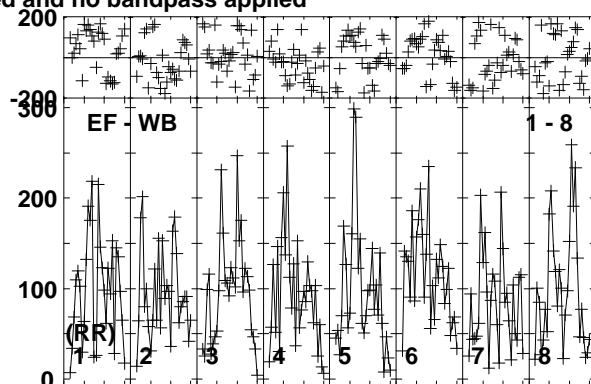
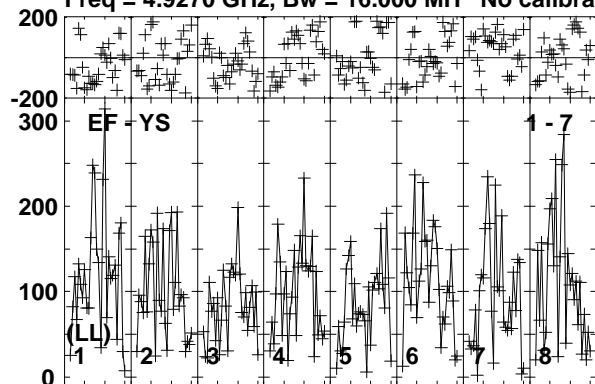

Lower frame: Micro Ampl Jy Top frame: Phas deg  
Vector averaged cross-power spectrum Baseline: EF (01) - YS (07)  
Timerange: 00/12:14:51 to 00/12:17:49

Plot file version 27 created 10-JUN-2016 15:29:17

J0718-1813 RG008C.UVDATA.1

Freq = 4.9270 GHz, Bw = 16.000 MH No calibration applied and no bandpass applied

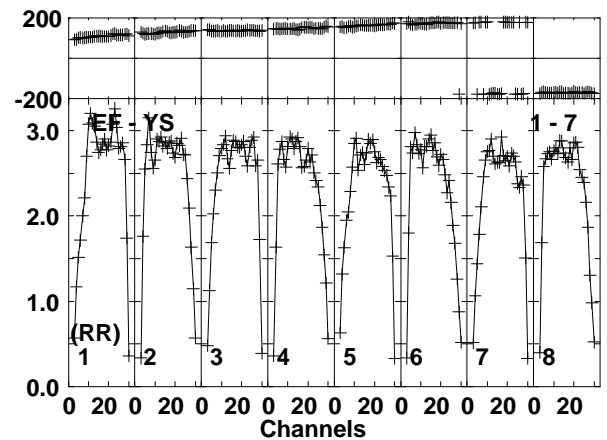
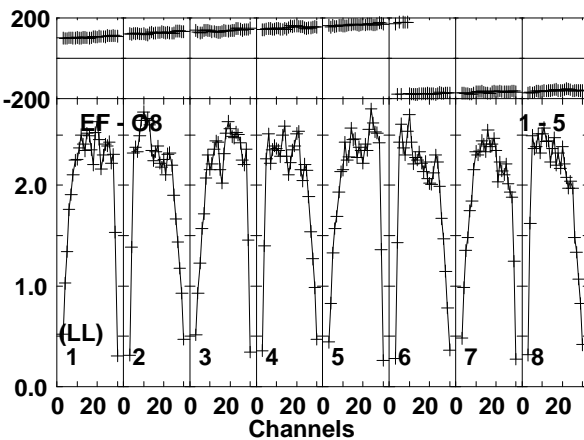
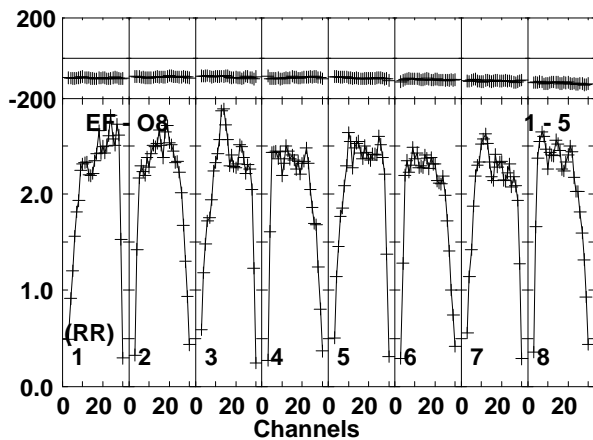
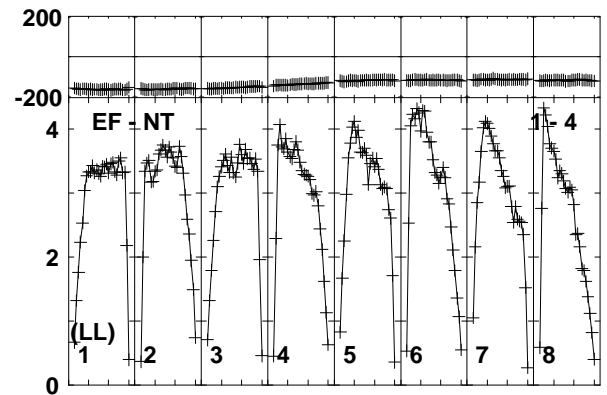
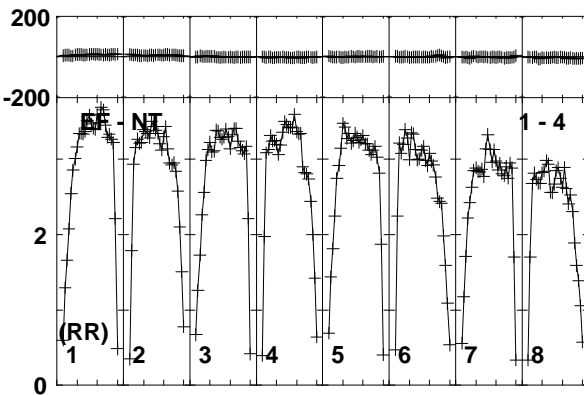
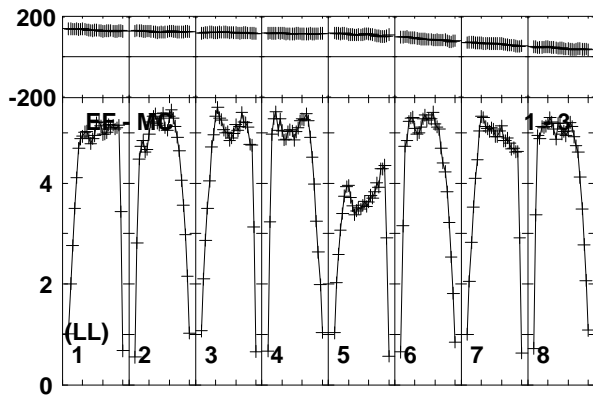
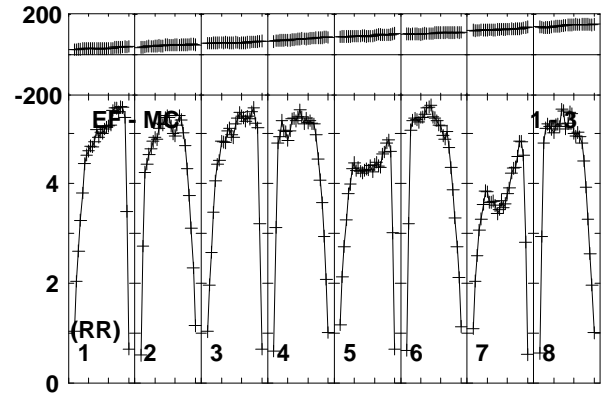
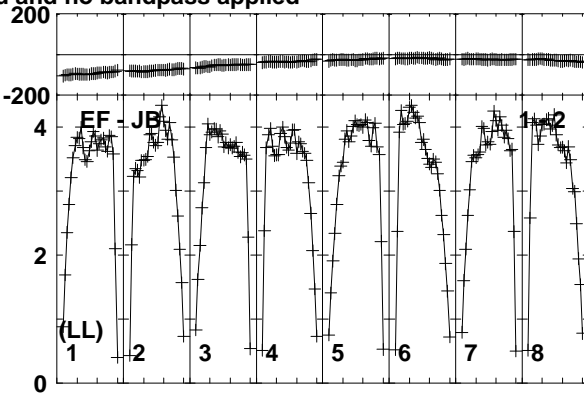
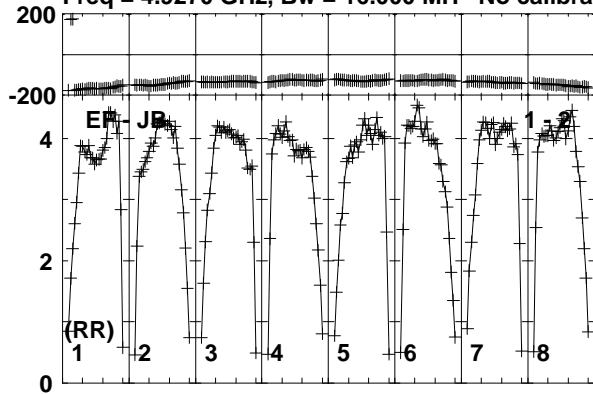

Lower frame: Milli Ampl Jy Top frame: Phas deg  
Vector averaged cross-power spectrum Baseline: EF (01) - JB (02)  
Timerange: 00:12:17:50 to 00:12:19:20

Plot file version 28 created 10-JUN-2016 15:29:17

J0718-1813 RG008C.UVDATA.1

Freq = 4.9270 GHz, Bw = 16.000 MH No calibration applied and no bandpass applied

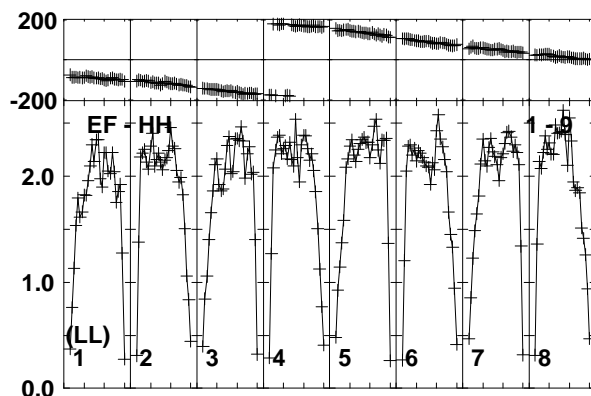
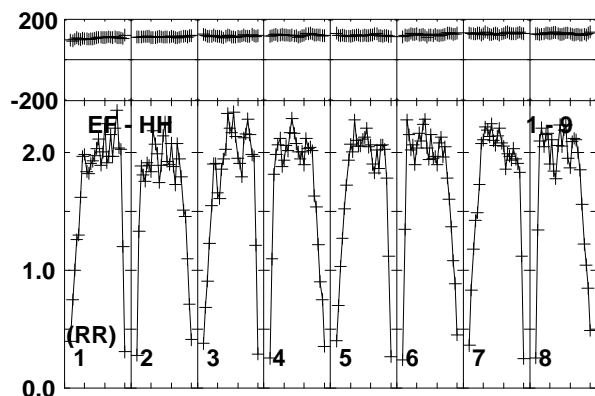
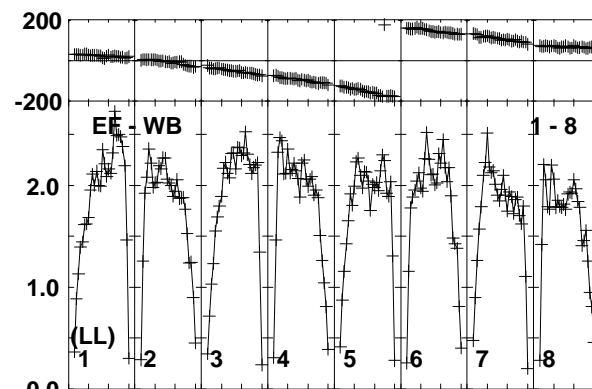
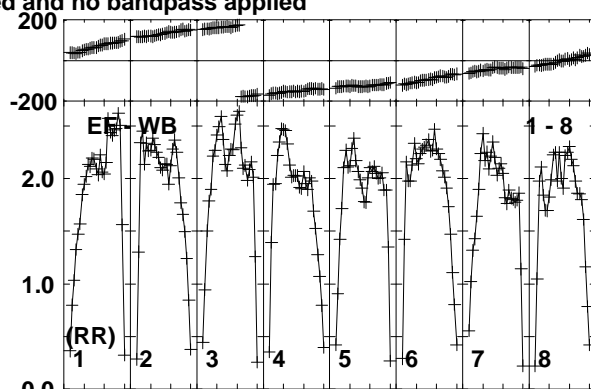
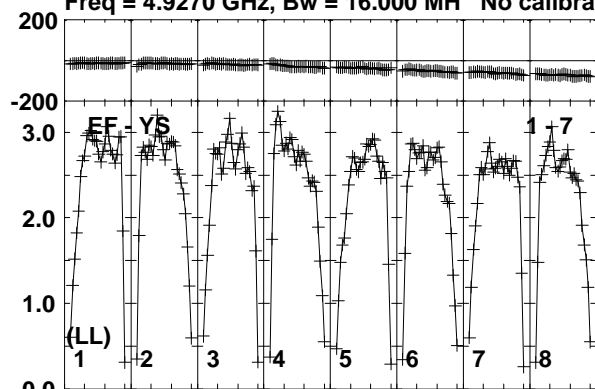

Lower frame: Milli Ampl Jy Top frame: Phas deg  
Vector averaged cross-power spectrum Baseline: EF (01) - YS (07)  
Timerange: 00:12:17:50 to 00:12:19:20

Plot file version 29 created 10-JUN-2016 15:29:17

FRB150418 RG008C.UVDATA.1

Freq = 4.9270 GHz, Bw = 16.000 MH No calibration applied and no bandpass applied

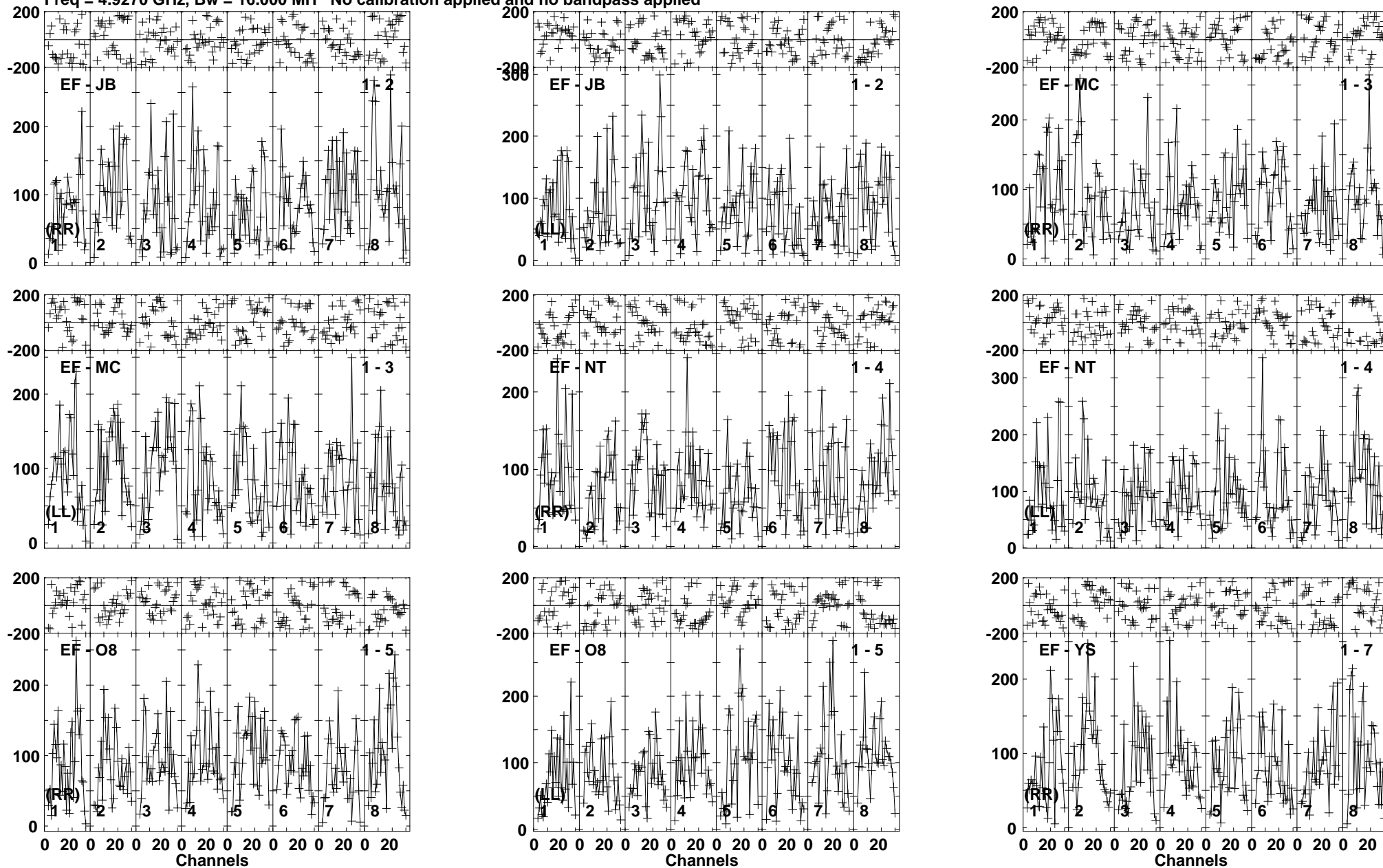

Lower frame: Micro Ampl Jy Top frame: Phas deg  
Vector averaged cross-power spectrum Baseline: EF (01) - JB (02)  
Timerange: 00/12:19:20 to 00/12:22:20

Plot file version 30 created 10-JUN-2016 15:29:18

FRB150418 RG008C.UVDATA.1

Freq = 4.9270 GHz, Bw = 16.000 MH No calibration applied and no bandpass applied

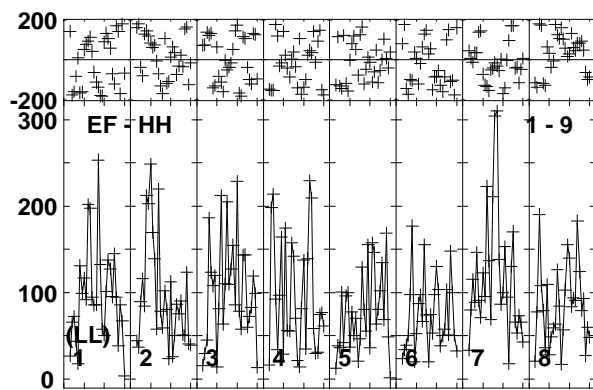
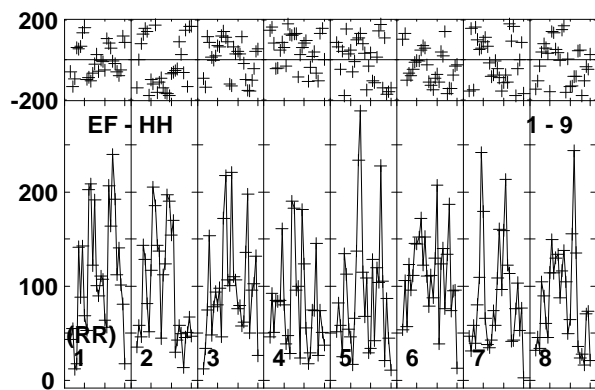
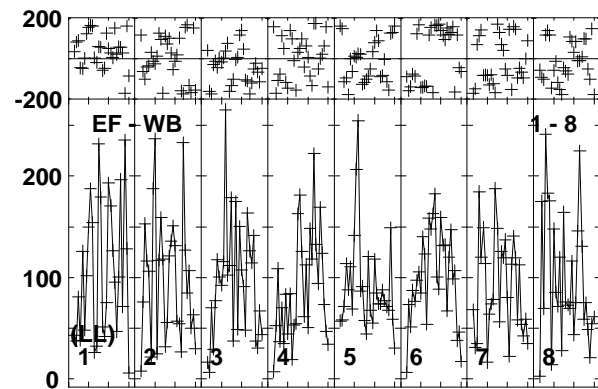
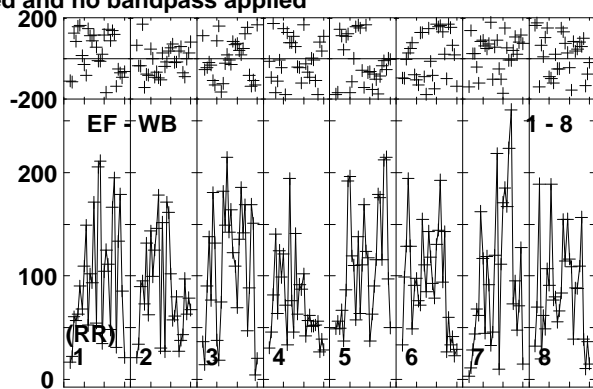
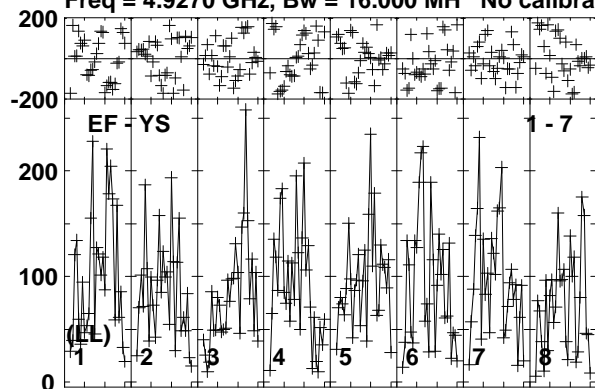

Lower frame: Micro Ampl Jy Top frame: Phas deg  
Vector averaged cross-power spectrum Baseline: EF (01) - YS (07)  
Timerange: 00/12:19:20 to 00/12:22:20

Plot file version 31 created 10-JUN-2016 15:29:18

J0718-1813 RG008C.UVDATA.1

Freq = 4.9270 GHz, Bw = 16.000 MH No calibration applied and no bandpass applied

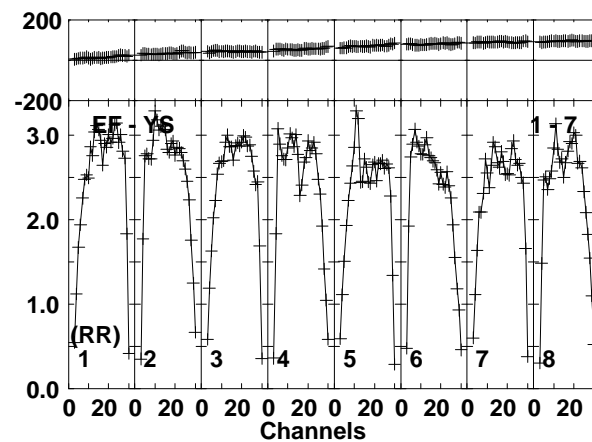
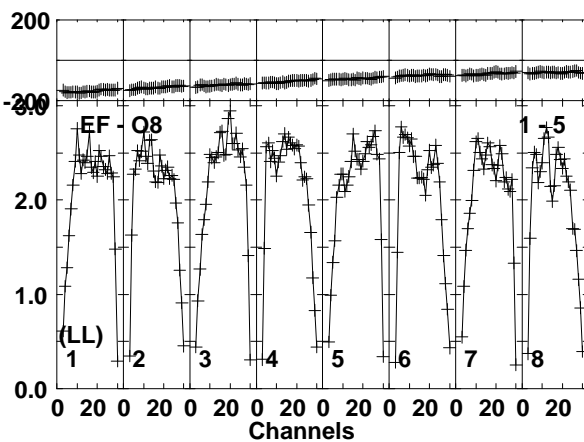
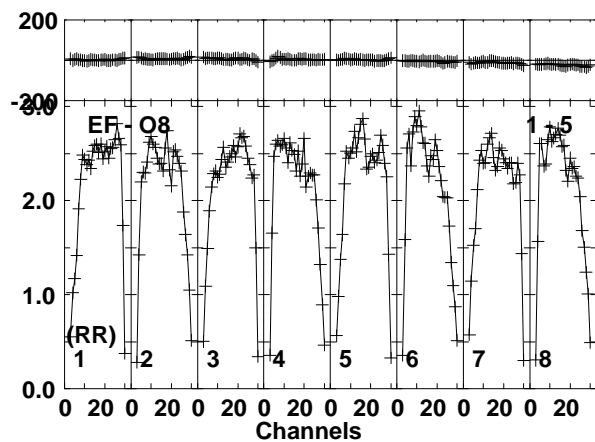
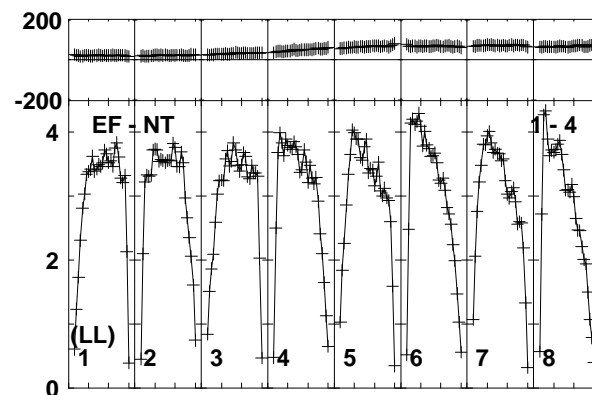
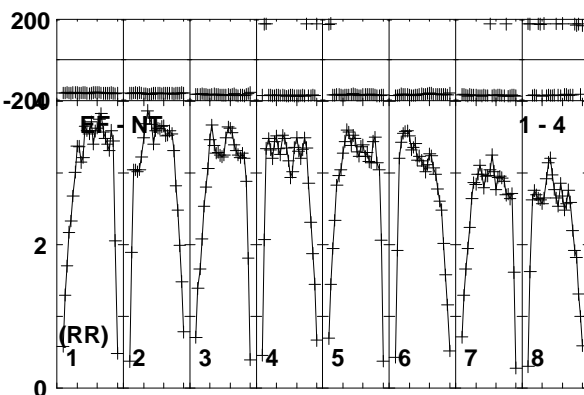
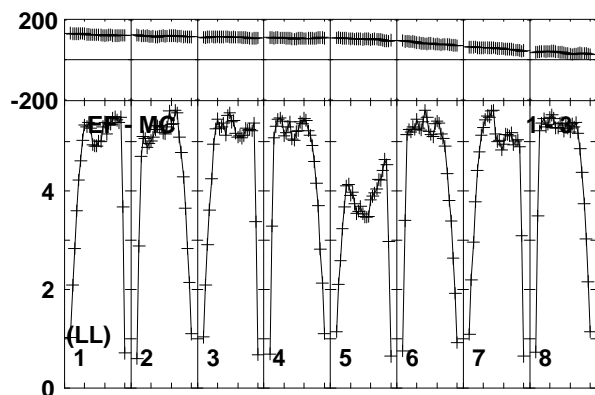
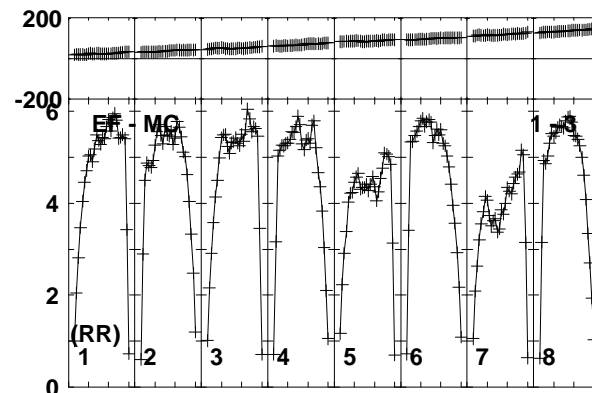
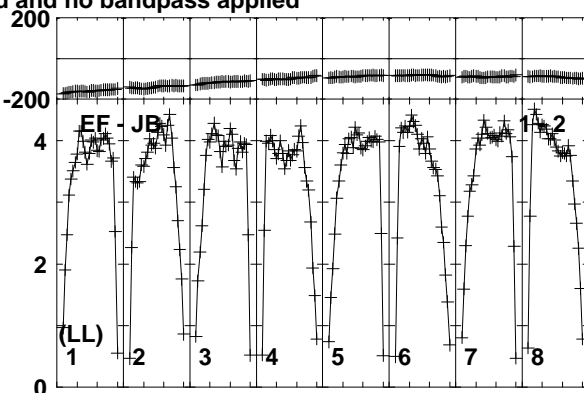
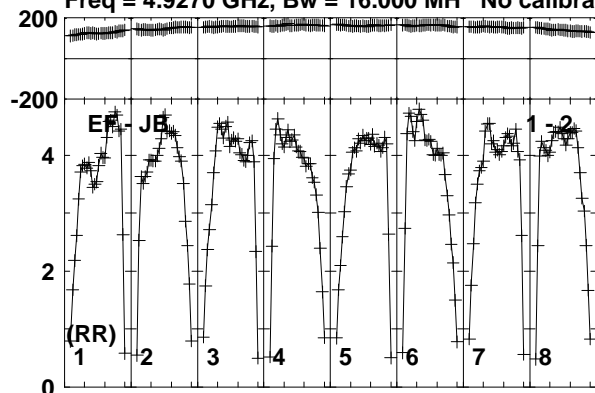

Lower frame: Milli Ampl Jy Top frame: Phas deg  
Vector averaged cross-power spectrum Baseline: EF (01) - JB (02)  
Timerange: 00:12:23:01 to 00:12:23:49

Plot file version 32 created 10-JUN-2016 15:29:18

J0718-1813 RG008C.UVDATA.1

Freq = 4.9270 GHz, Bw = 16.000 MH No calibration applied and no bandpass applied

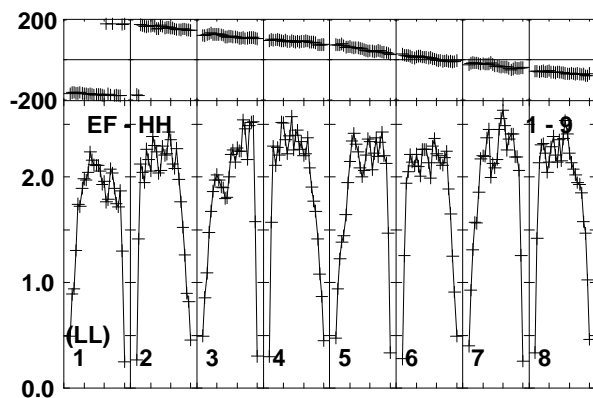
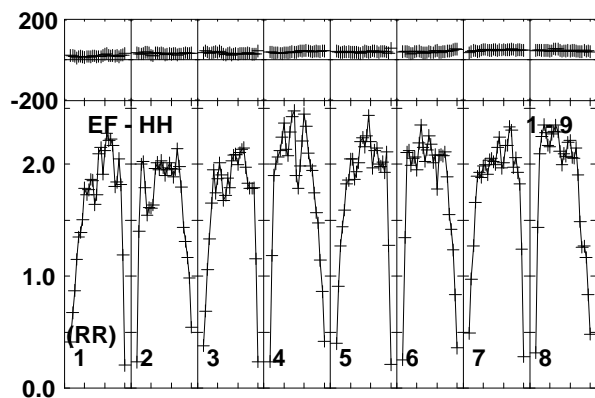
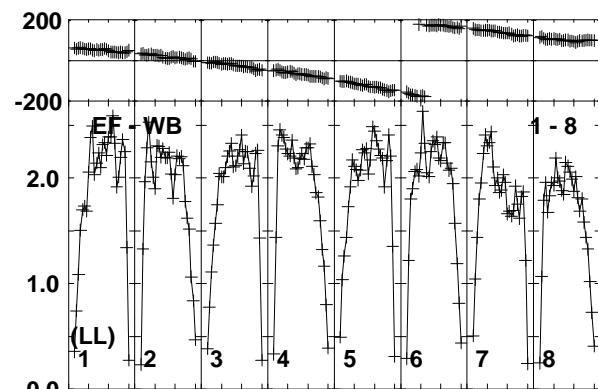
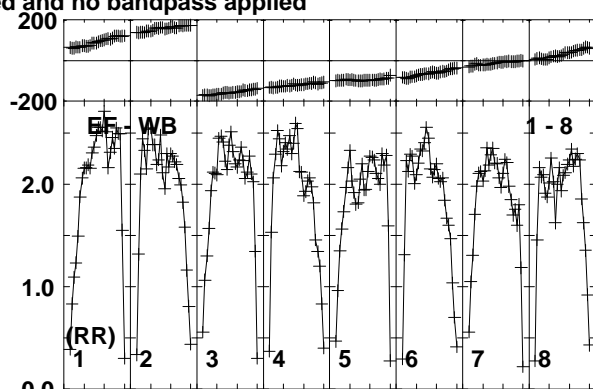
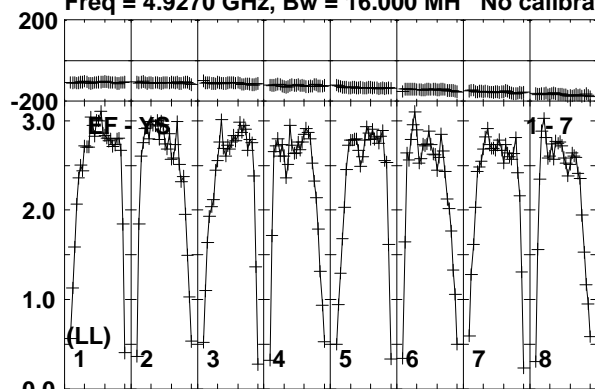

Lower frame: Milli Ampl Jy Top frame: Phas deg  
Vector averaged cross-power spectrum Baseline: EF (01) - YS (07)  
Timerange: 00:12:23:01 to 00:12:23:49



Plot file version 33 created 10-JUN-2016 15:29:18

FRB150418 RG008C.UVDATA.1

Freq = 4.9270 GHz, Bw = 16.000 MH No calibration applied and no bandpass applied

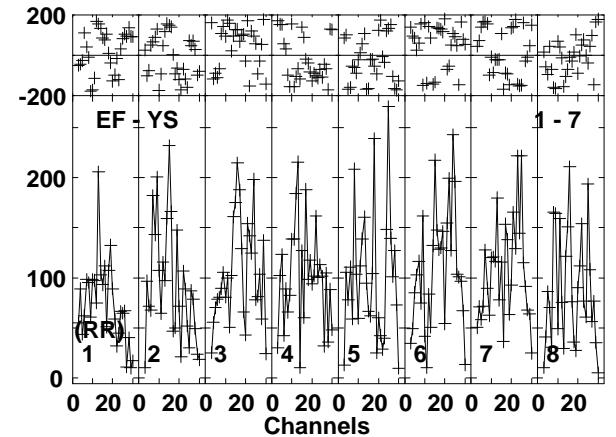
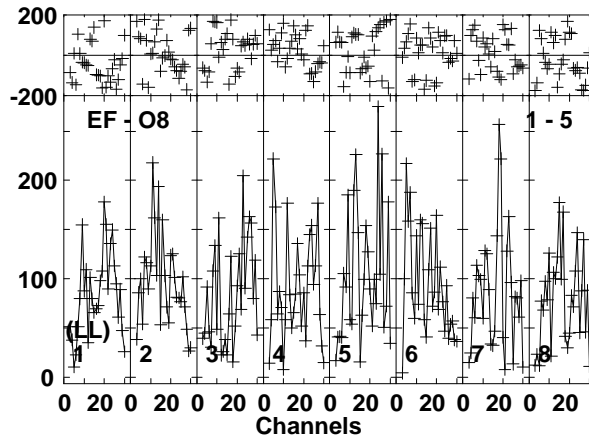
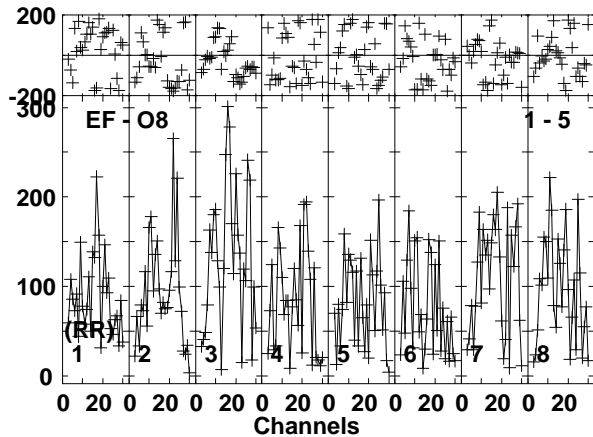
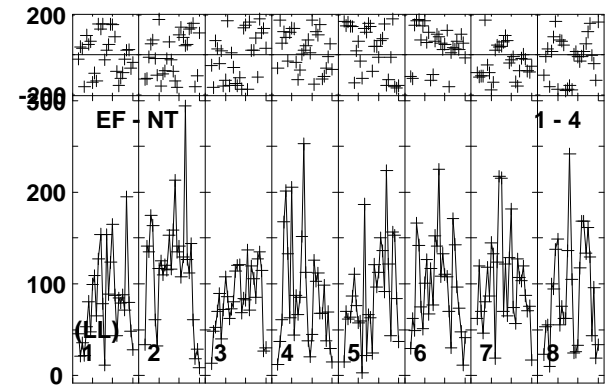
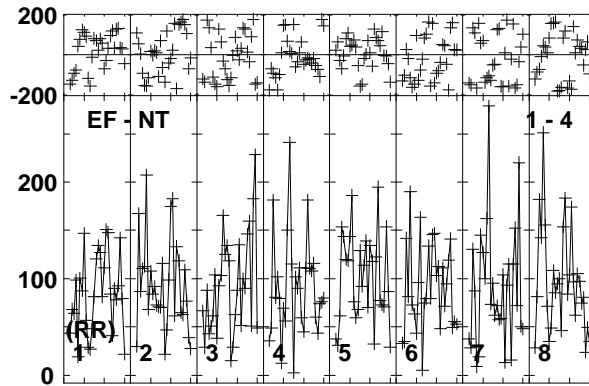
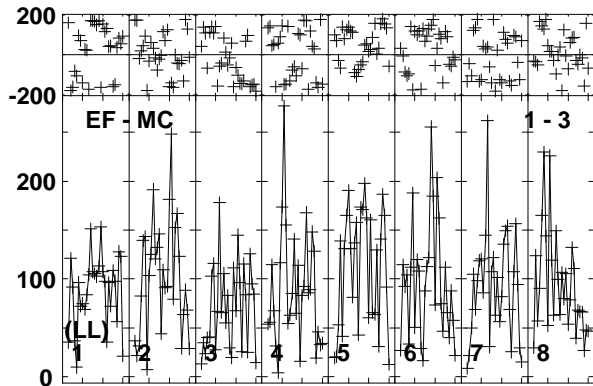
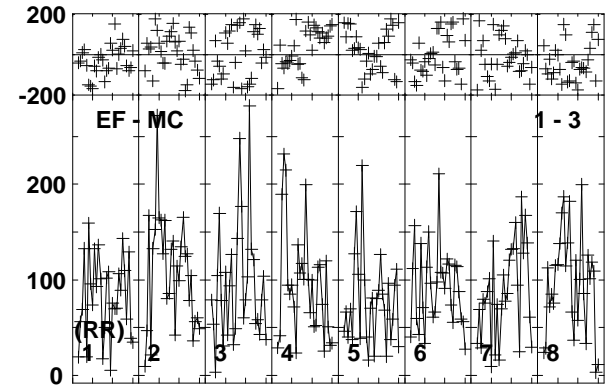
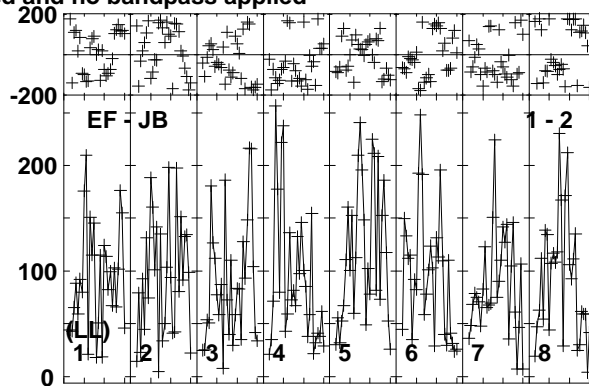
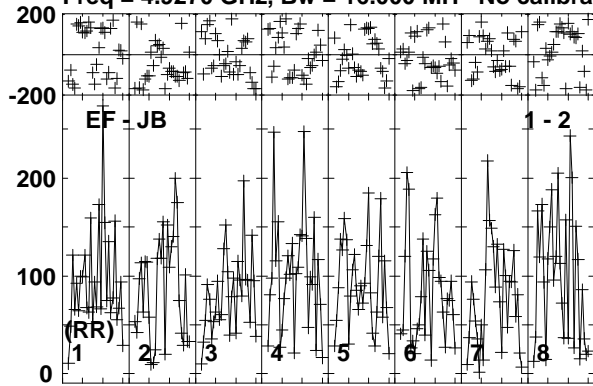

Lower frame: Micro Ampl Jy Top frame: Phas deg  
Vector averaged cross-power spectrum Baseline: EF (01) - JB (02)  
Timerange: 00:12:23:51 to 00:12:26:50

Plot file version 34 created 10-JUN-2016 15:29:18

FRB150418 RG008C.UVDATA.1

Freq = 4.9270 GHz, Bw = 16.000 MH No calibration applied and no bandpass applied

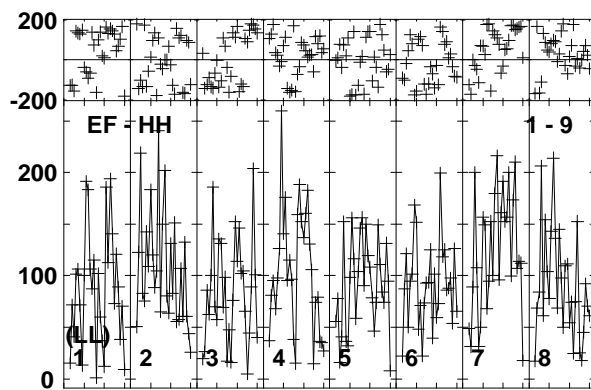
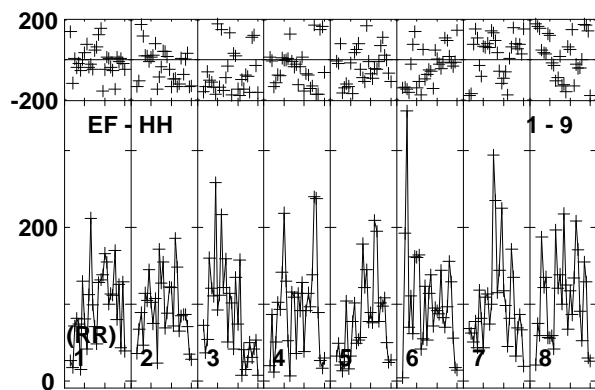
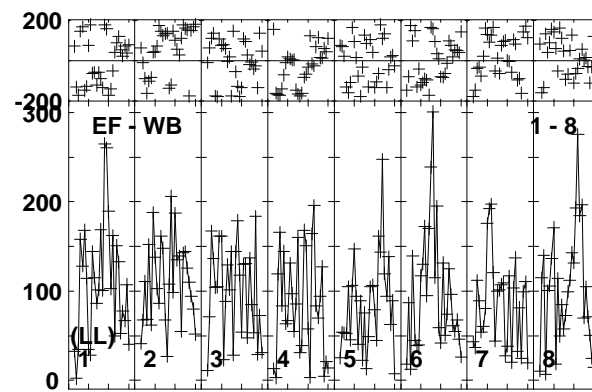
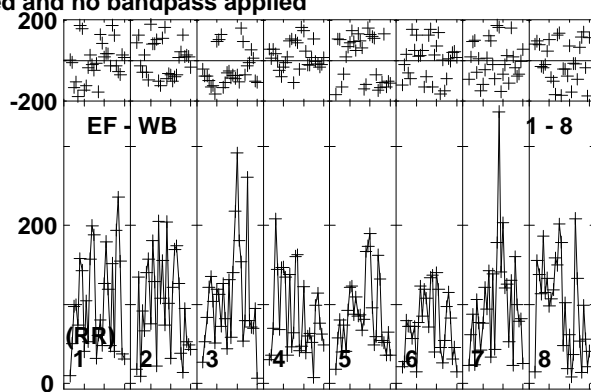
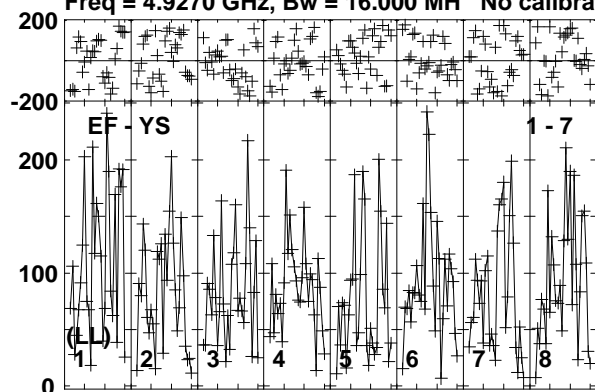

Lower frame: Micro Ampl Jy Top frame: Phas deg  
Vector averaged cross-power spectrum Baseline: EF (01) - YS (07)  
Timerange: 00/12:23:51 to 00/12:26:50

Plot file version 35 created 10-JUN-2016 15:29:18

J0718-1813 RG008C.UVDATA.1

Freq = 4.9270 GHz, Bw = 16.000 MH No calibration applied and no bandpass applied

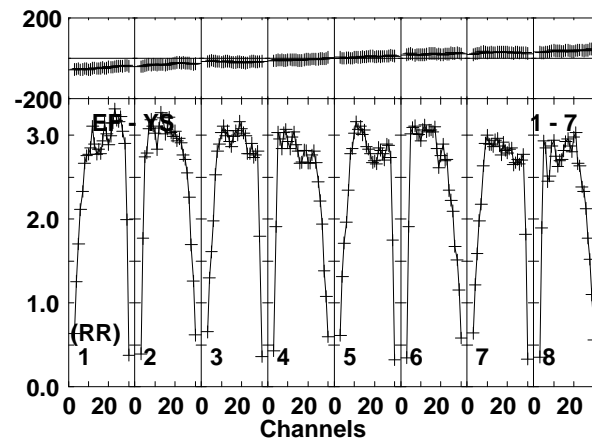
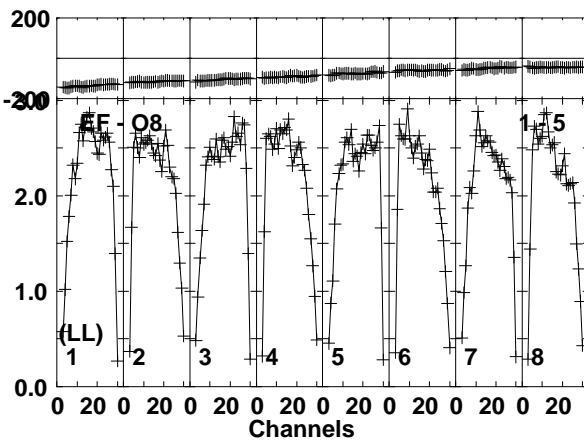
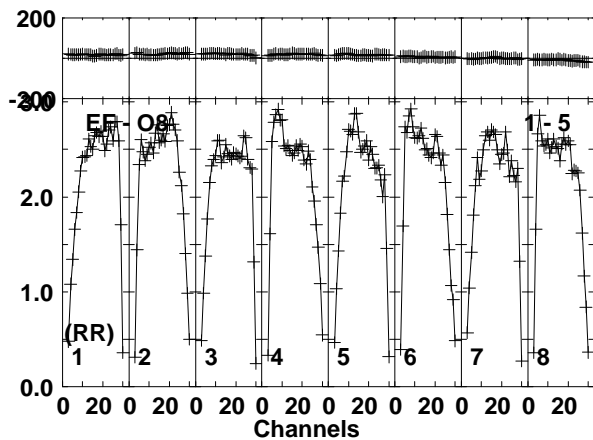
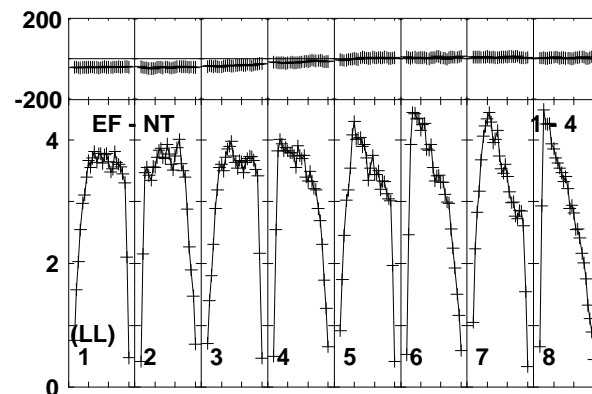
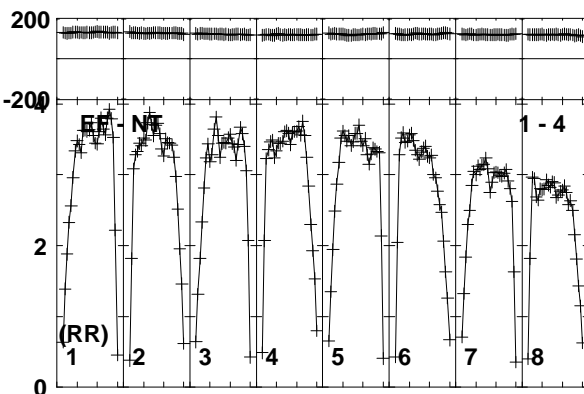
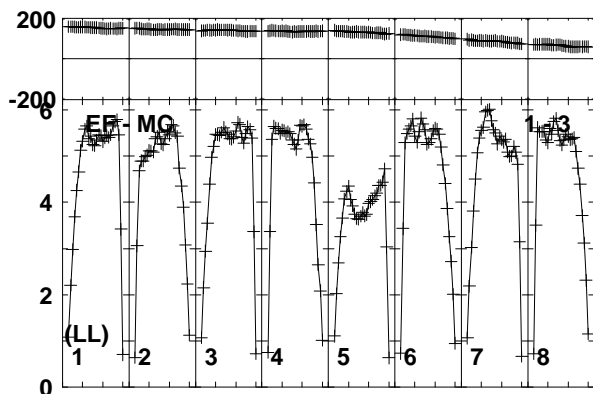
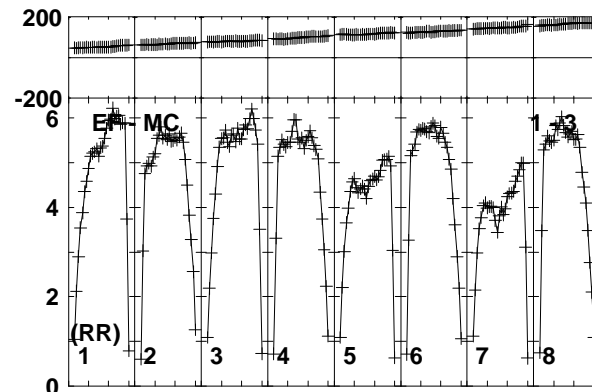
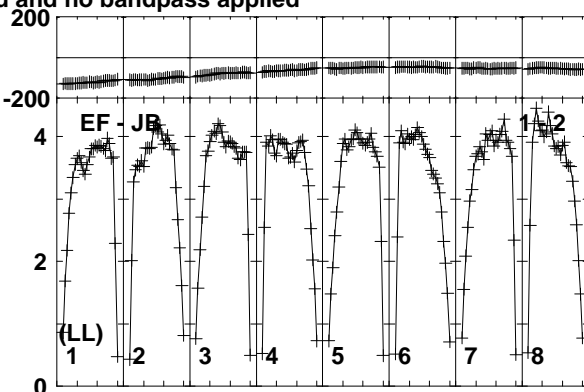
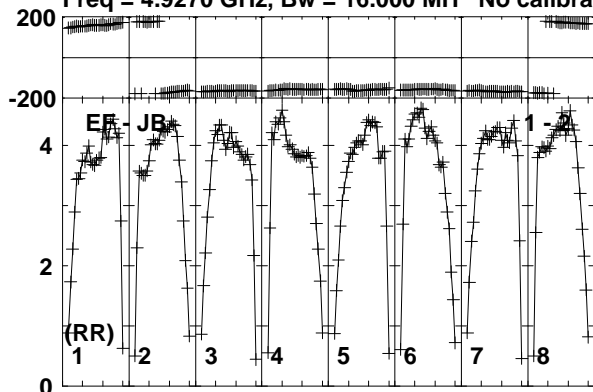

Lower frame: Milli Ampl Jy Top frame: Phas deg  
Vector averaged cross-power spectrum Baseline: EF (01) - JB (02)  
Timerange: 00:12:26:50 to 00:12:28:19

Plot file version 36 created 10-JUN-2016 15:29:18

J0718-1813 RG008C.UVDATA.1

Freq = 4.9270 GHz, Bw = 16.000 MH No calibration applied and no bandpass applied

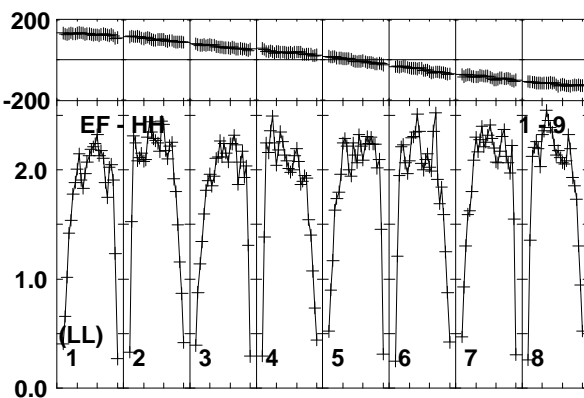
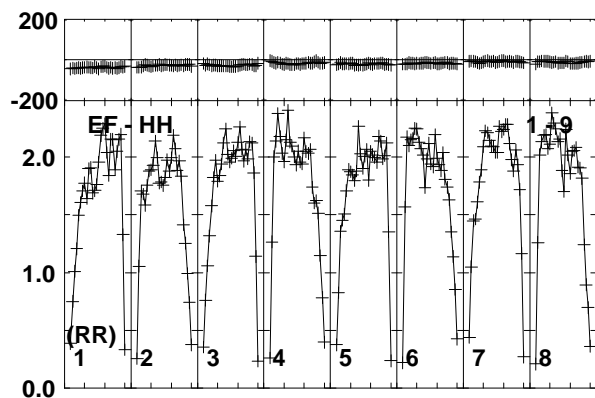
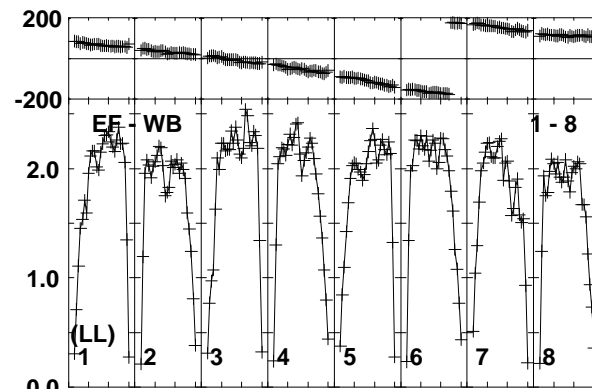
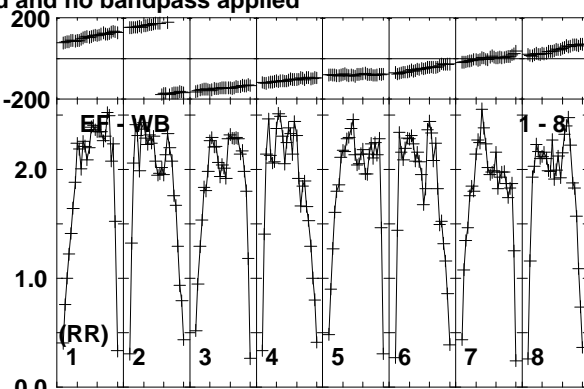
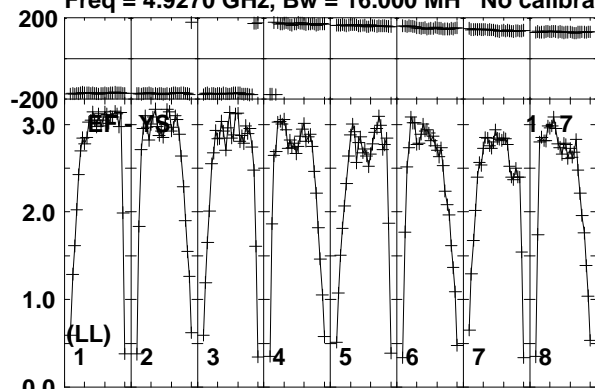

Lower frame: Milli Ampl Jy Top frame: Phas deg  
Vector averaged cross-power spectrum Baseline: EF (01) - YS (07)  
Timerange: 00:12:26:50 to 00:12:28:19

Plot file version 37 created 10-JUN-2016 15:29:18

J0712-1847 RG008C.UVDATA.1

Freq = 4.9270 GHz, Bw = 16.000 MH No calibration applied and no bandpass applied

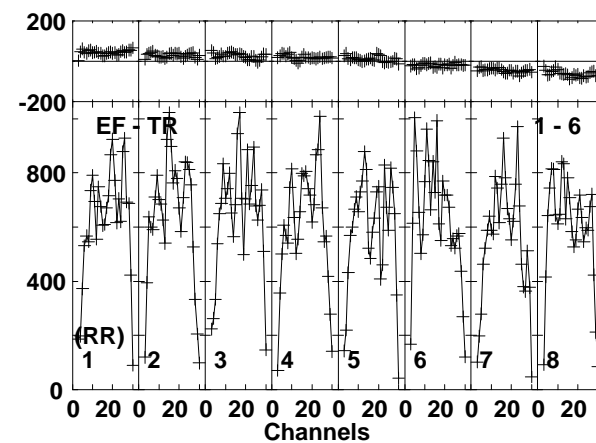
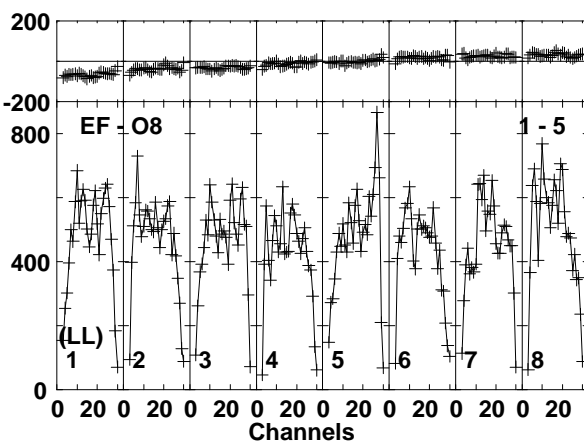
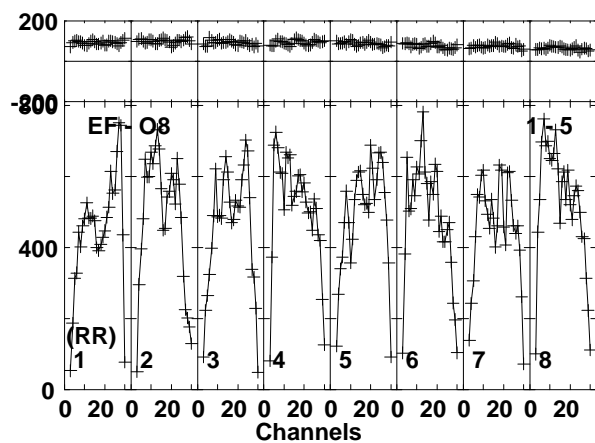
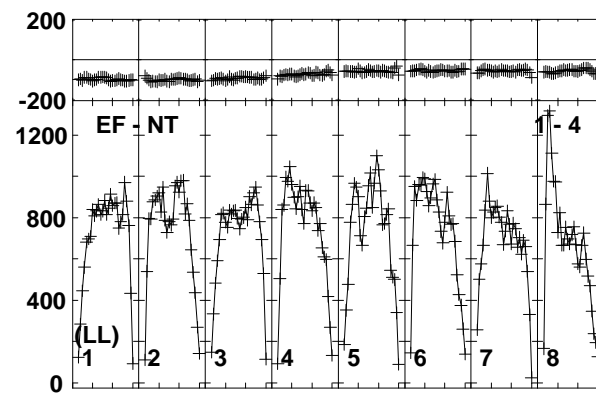
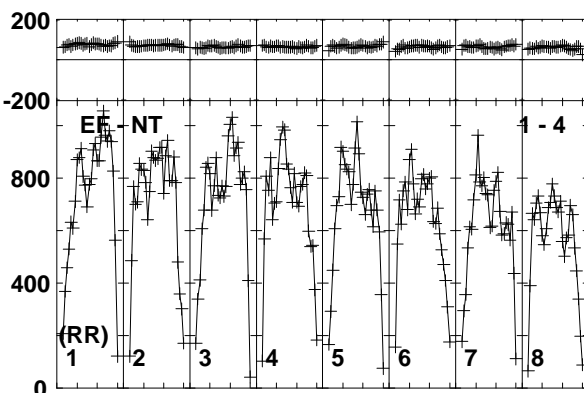
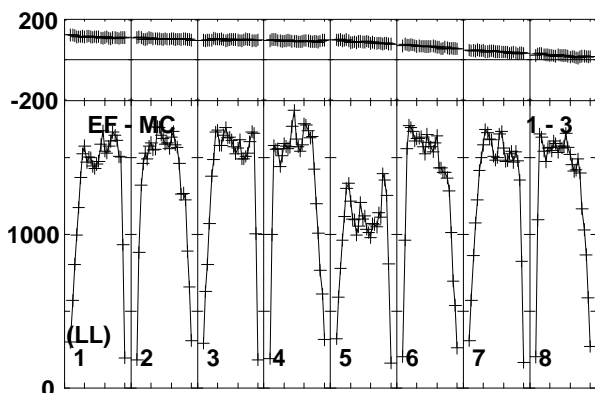
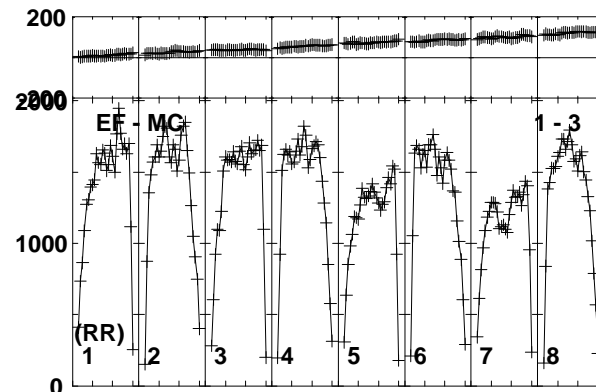
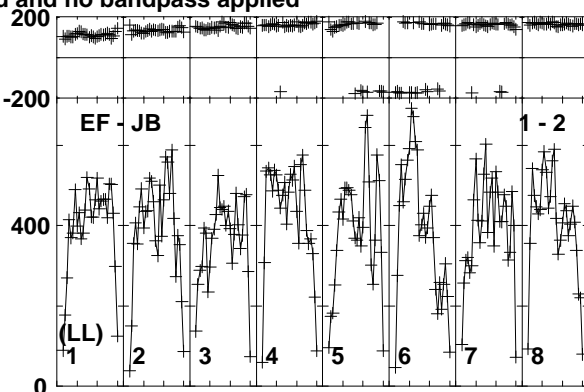
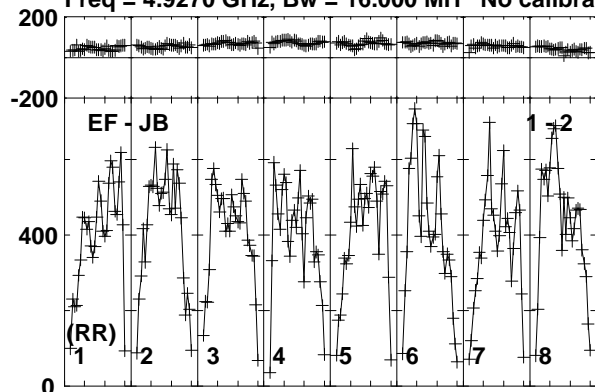

Lower frame: Micro Ampl Jy Top frame: Phas deg  
Vector averaged cross-power spectrum Baseline: EF (01) - JB (02)  
Timerange: 00/12:28:20 to 00/12:31:20

Plot file version 38 created 10-JUN-2016 15:29:18

J0712-1847 RG008C.UVDATA.1

Freq = 4.9270 GHz, Bw = 16.000 MH No calibration applied and no bandpass applied

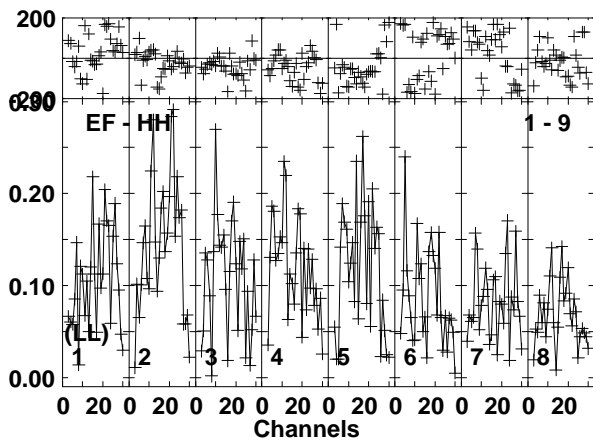
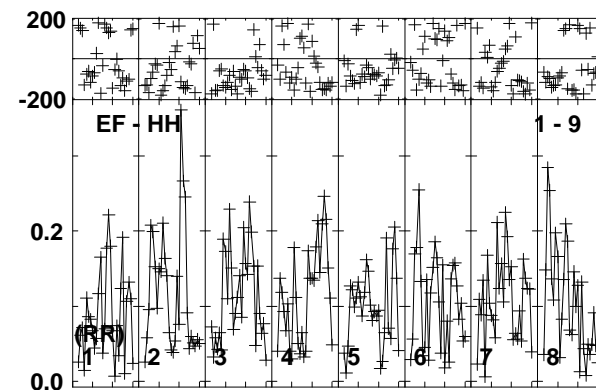
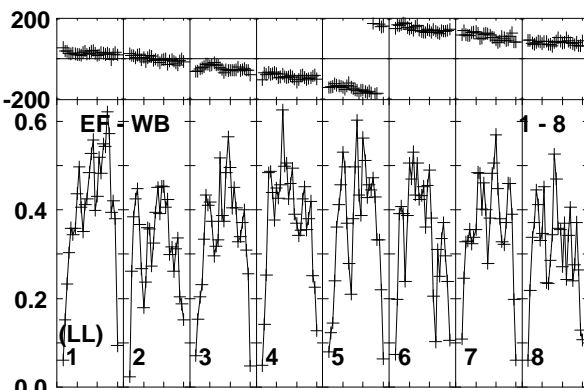
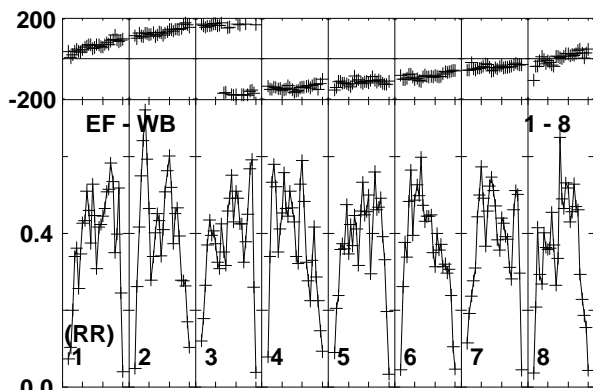
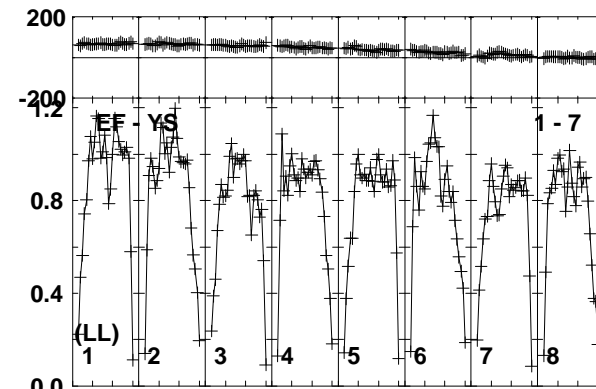
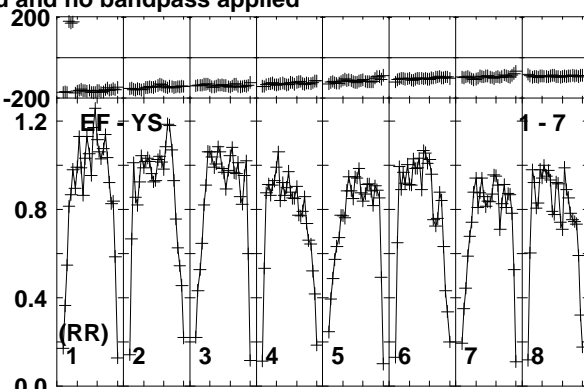
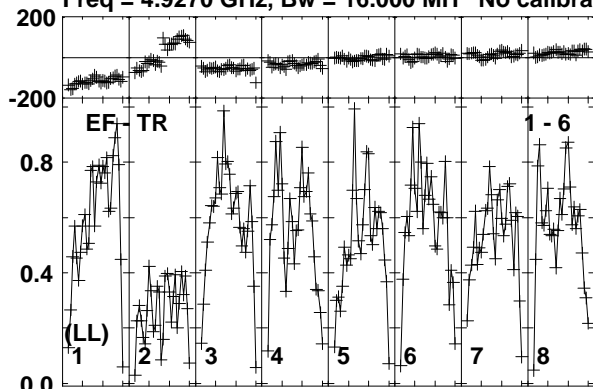

Lower frame: Milli Ampl Jy Top frame: Phas deg  
Vector averaged cross-power spectrum Baseline: EF (01) - TR (06)  
Timerange: 00/12:28:20 to 00/12:31:20

Plot file version 39 created 10-JUN-2016 15:29:18

J0718-1813 RG008C.UVDATA.1

Freq = 4.9270 GHz, Bw = 16.000 MH No calibration applied and no bandpass applied

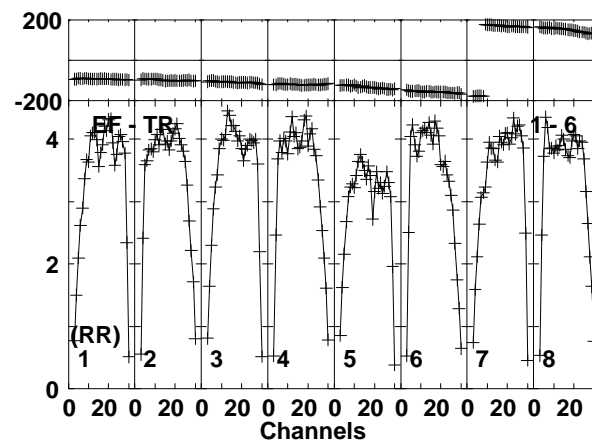
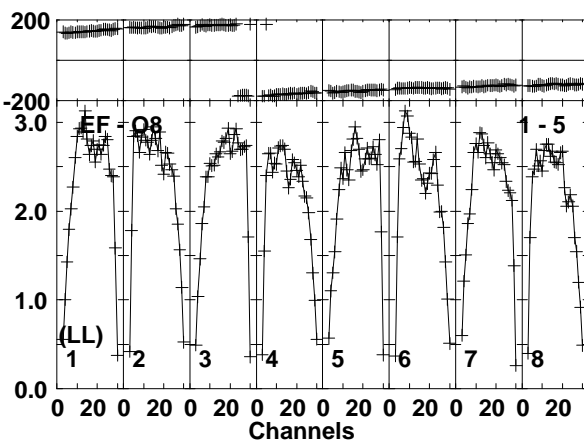
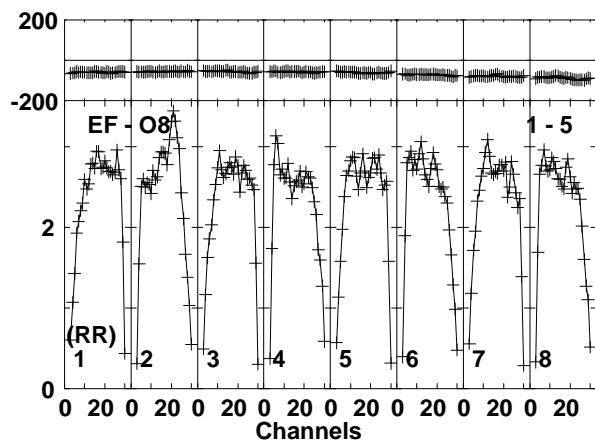
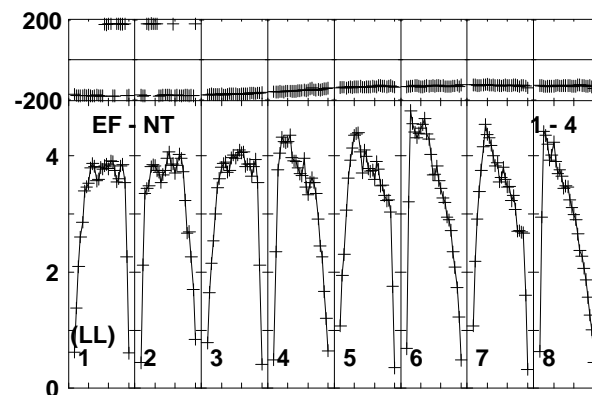
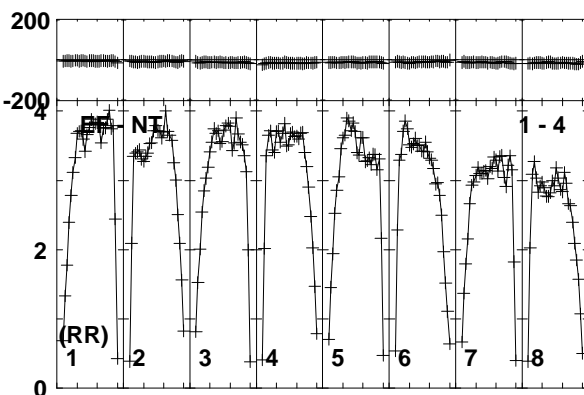
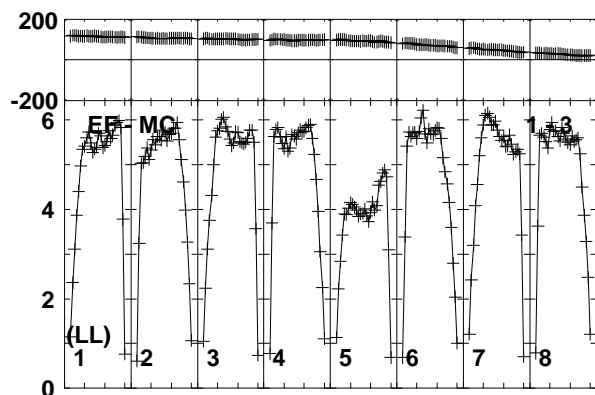
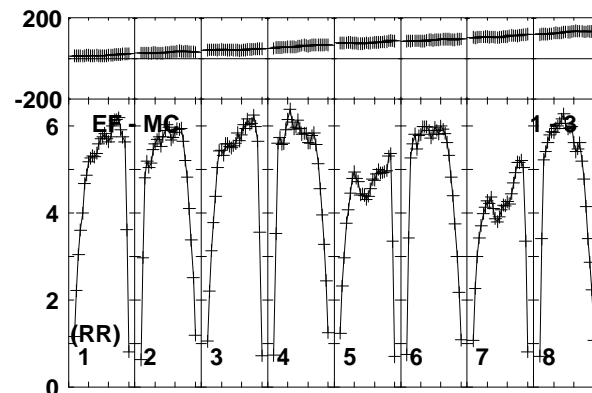
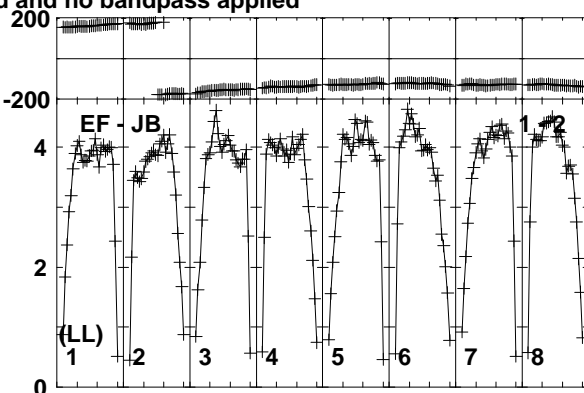
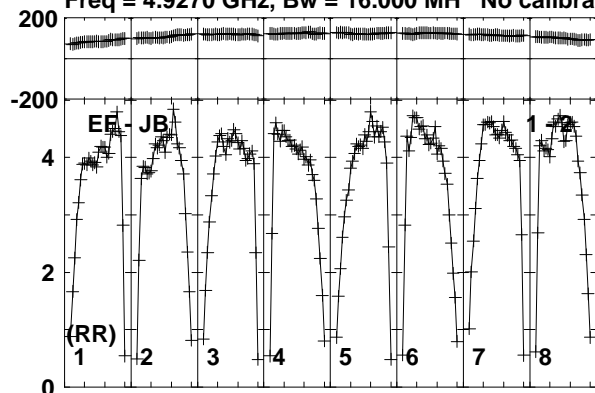

Lower frame: Milli Ampl Jy Top frame: Phas deg  
Vector averaged cross-power spectrum Baseline: EF (01) - JB (02)  
Timerange: 00:12:32:00 to 00:12:32:50

Plot file version 40 created 10-JUN-2016 15:29:18

J0718-1813 RG008C.UVDATA.1

Freq = 4.9270 GHz, Bw = 16.000 MH No calibration applied and no bandpass applied

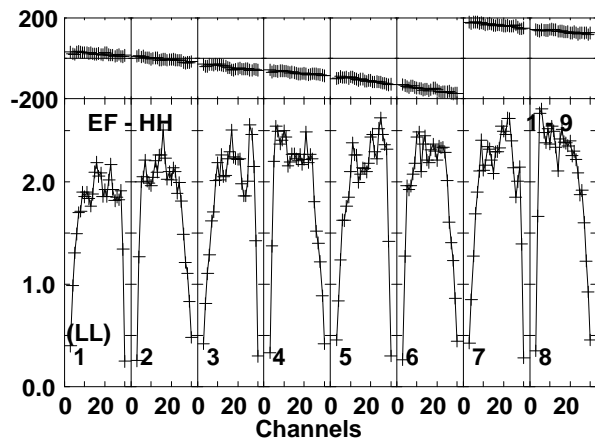
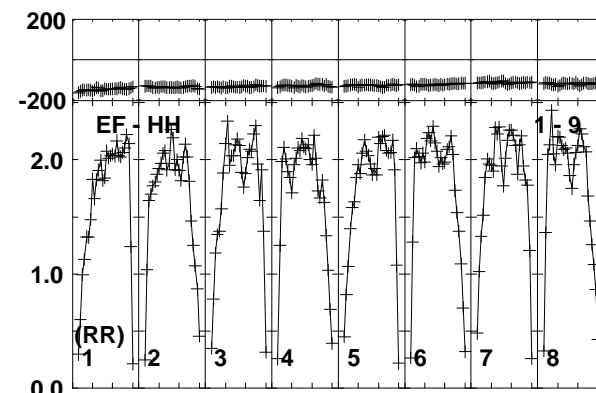
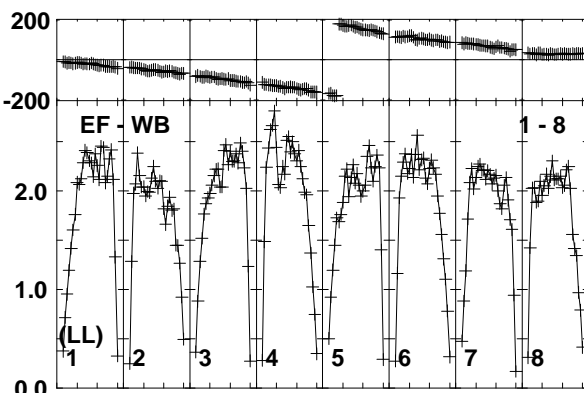
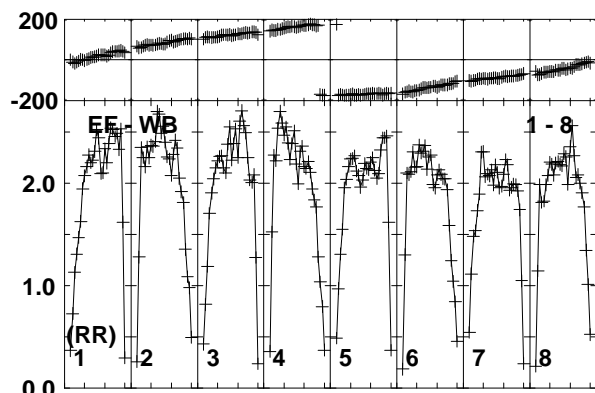
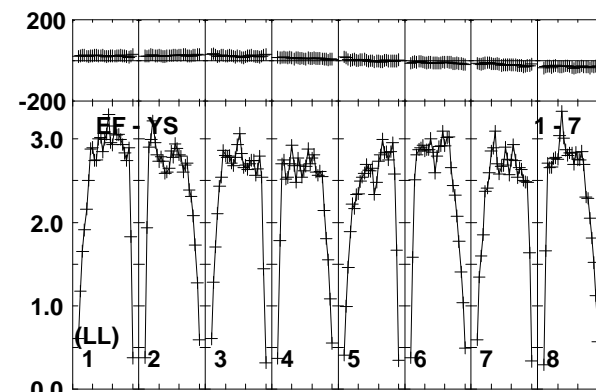
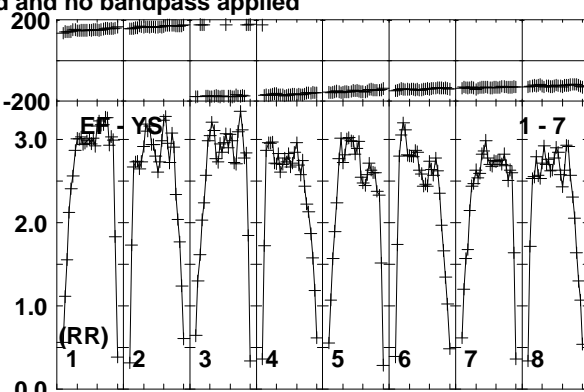
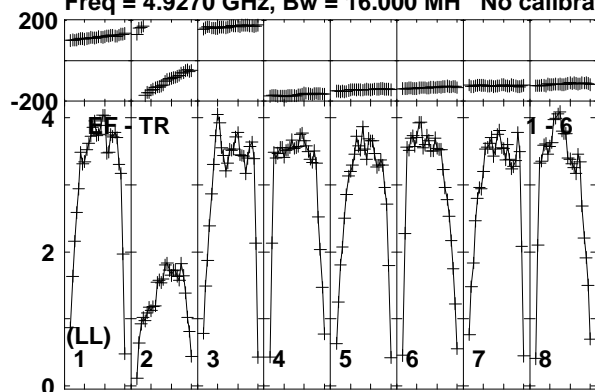

Lower frame: Milli Ampl Jy Top frame: Phas deg  
Vector averaged cross-power spectrum Baseline: EF (01) - TR (06)  
Timerange: 00:12:32:00 to 00:12:32:50



Plot file version 41 created 10-JUN-2016 15:29:19

FRB150418 RG008C.UVDATA.1

Freq = 4.9270 GHz, Bw = 16.000 MH No calibration applied and no bandpass applied

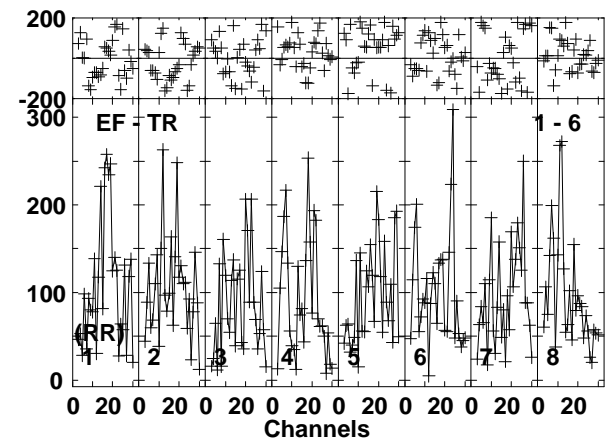
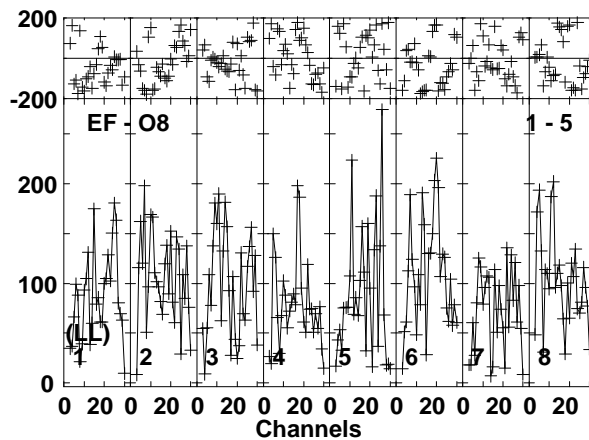
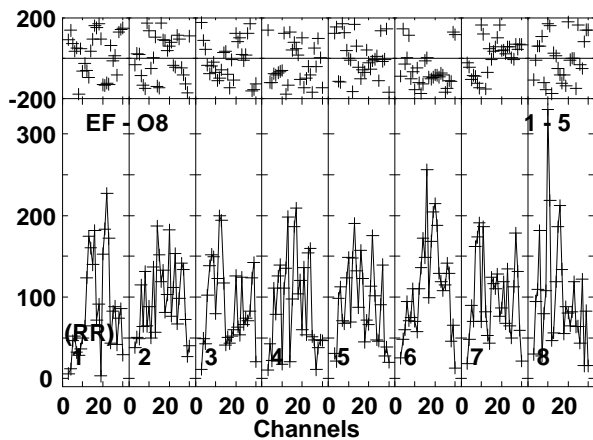
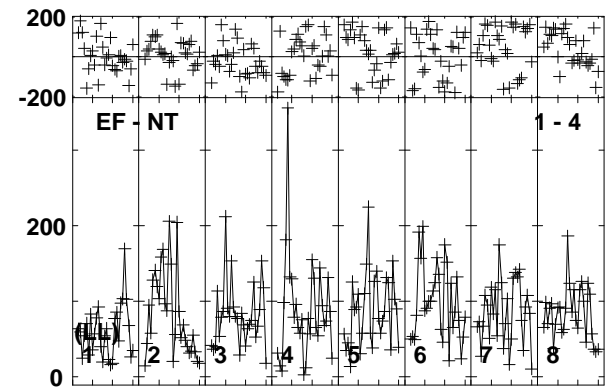
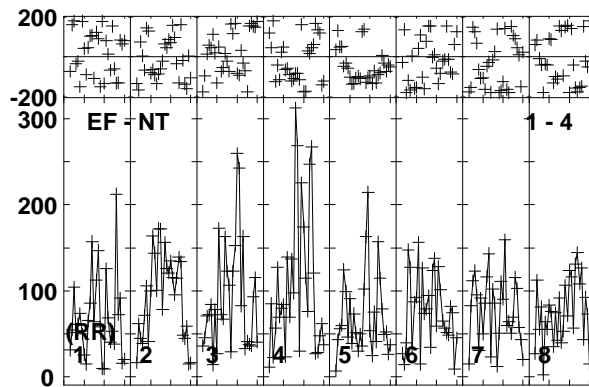
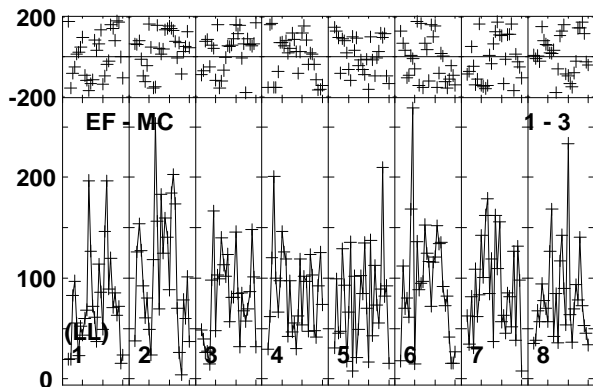
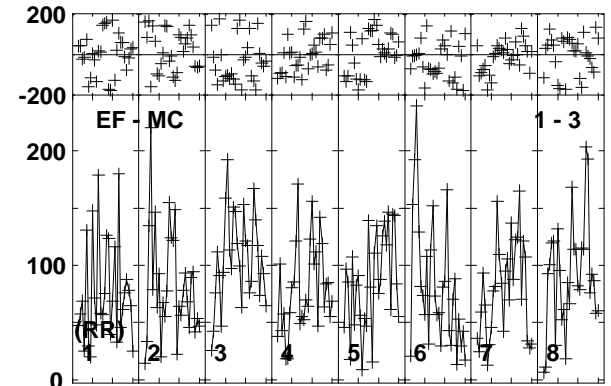
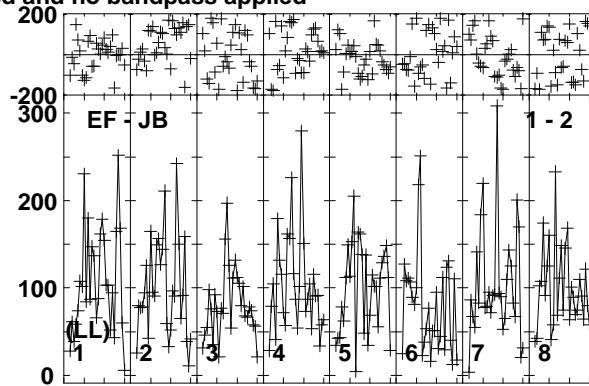
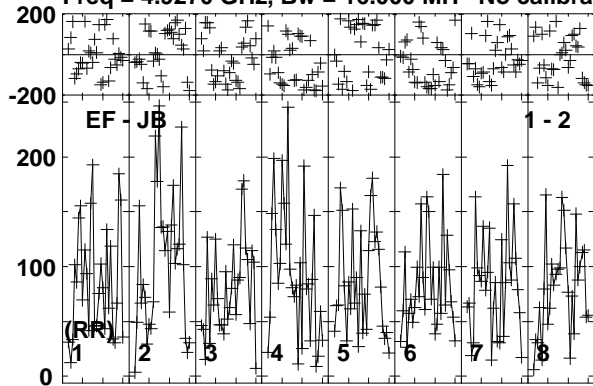

Lower frame: Micro Ampl Jy Top frame: Phas deg  
Vector averaged cross-power spectrum Baseline: EF (01) - JB (02)  
Timerange: 00/12:32:50 to 00/12:35:50

Plot file version 42 created 10-JUN-2016 15:29:19

FRB150418 RG008C.UVDATA.1

Freq = 4.9270 GHz, Bw = 16.000 MH No calibration applied and no bandpass applied

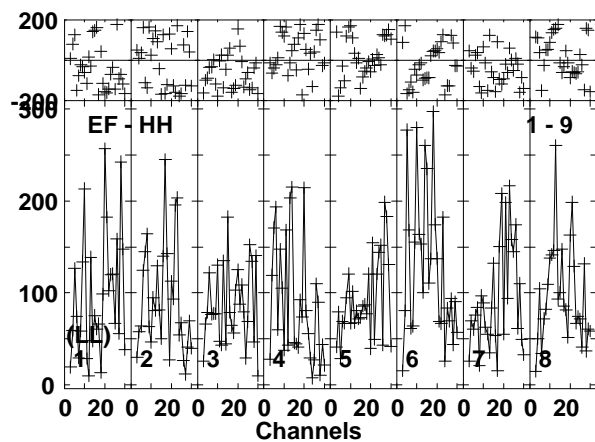
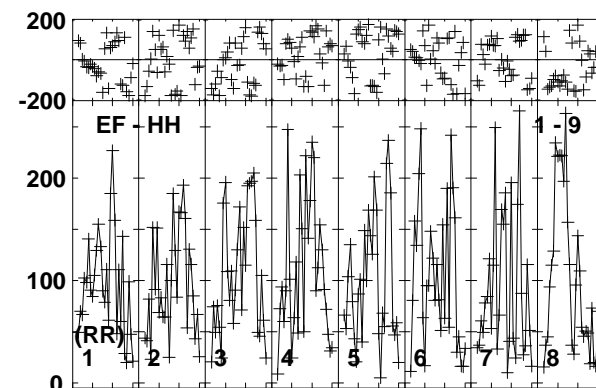
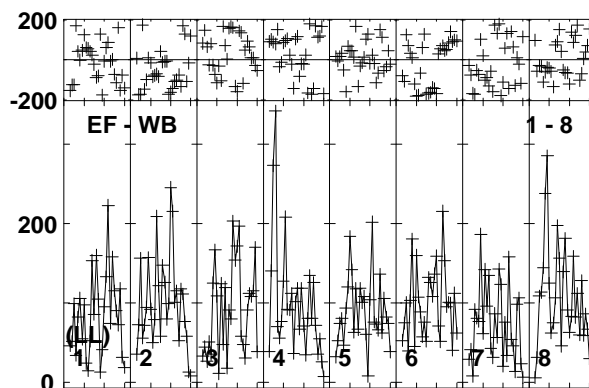
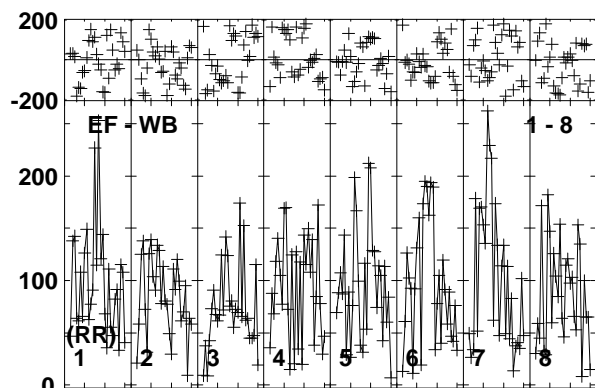
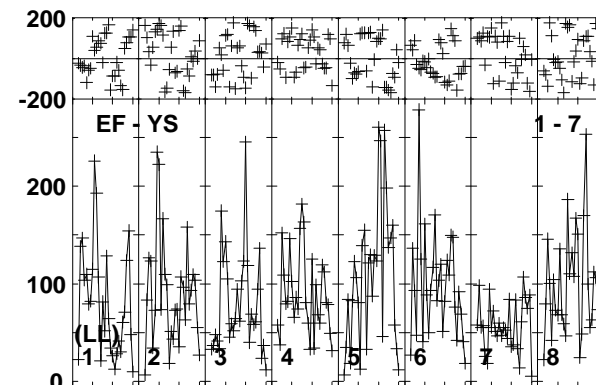
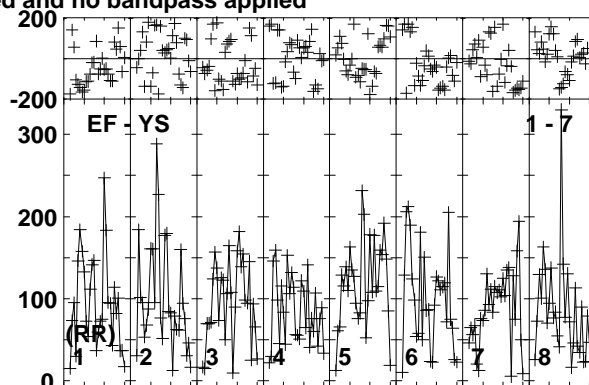
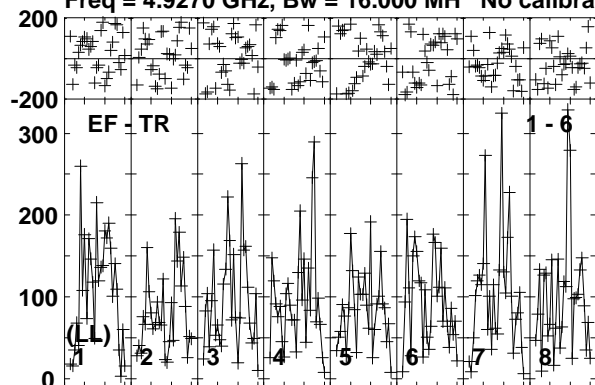

Lower frame: Micro Ampl Jy Top frame: Phas deg  
Vector averaged cross-power spectrum Baseline: EF (01) - TR (06)  
Timerange: 00/12:32:50 to 00/12:35:50

Plot file version 43 created 10-JUN-2016 15:29:19

J0718-1813 RG008C.UVDATA.1

Freq = 4.9270 GHz, Bw = 16.000 MH No calibration applied and no bandpass applied

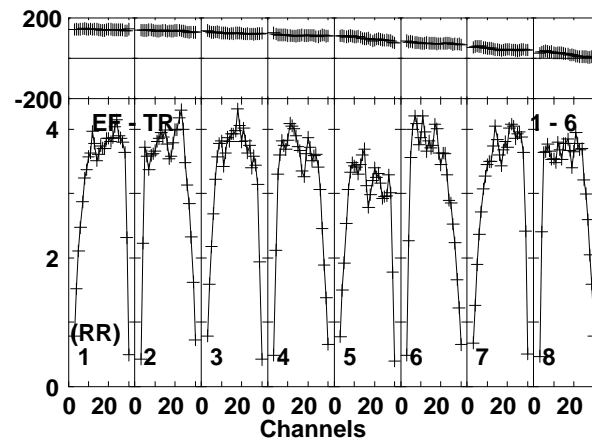
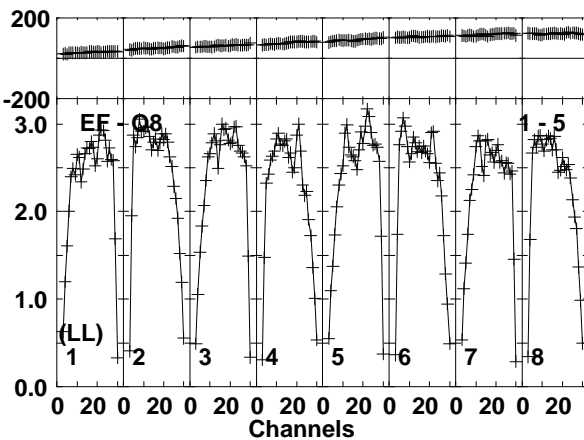
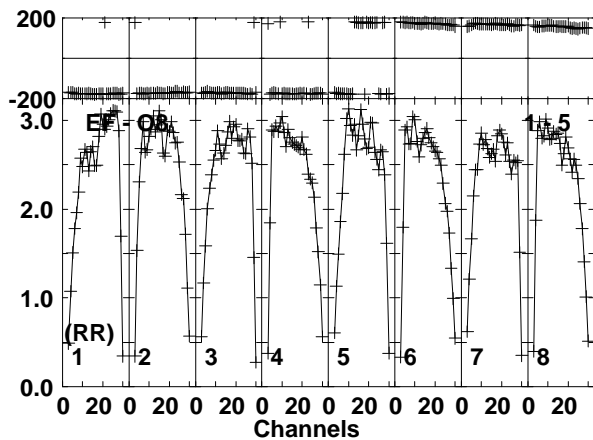
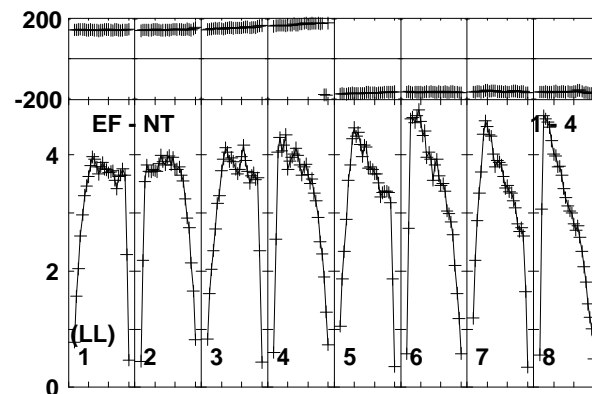
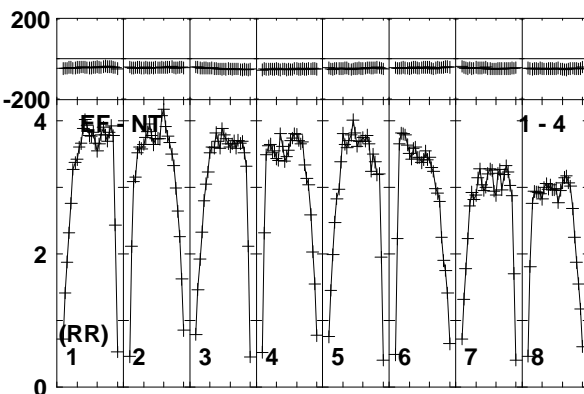
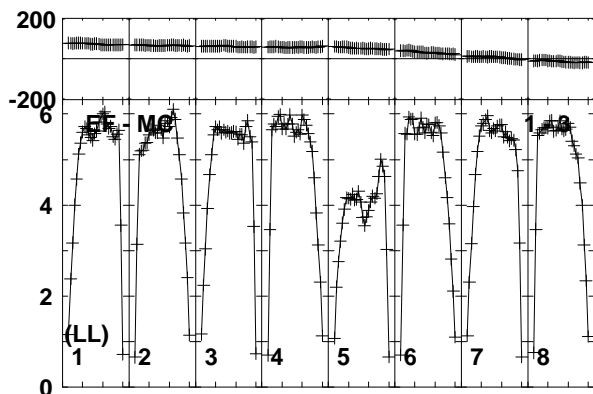
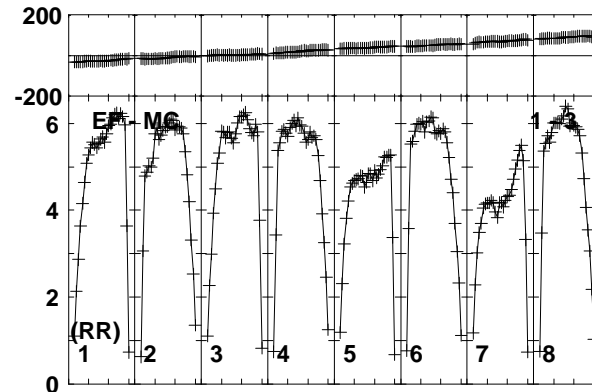
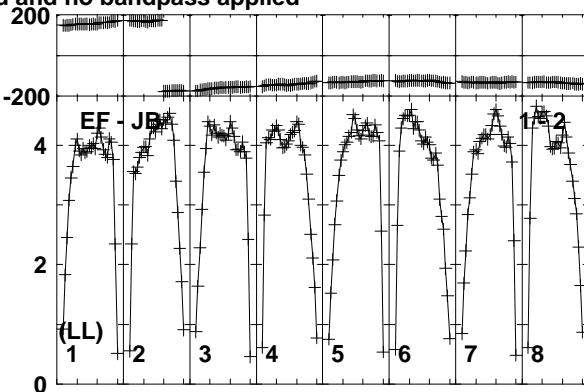
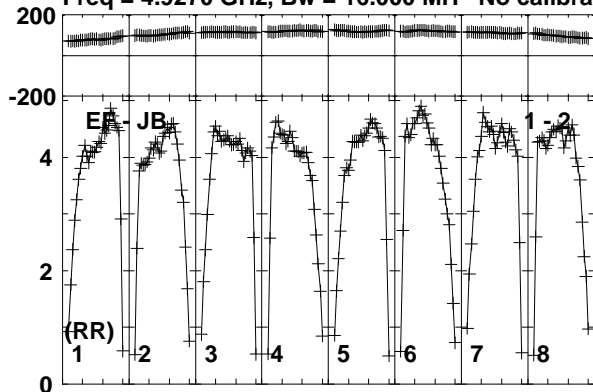

Lower frame: Milli Ampl Jy Top frame: Phas deg  
Vector averaged cross-power spectrum Baseline: EF (01) - JB (02)  
Timerange: 00:12:35:51 to 00:12:37:20

Plot file version 44 created 10-JUN-2016 15:29:19

J0718-1813 RG008C.UVDATA.1

Freq = 4.9270 GHz, Bw = 16.000 MH No calibration applied and no bandpass applied

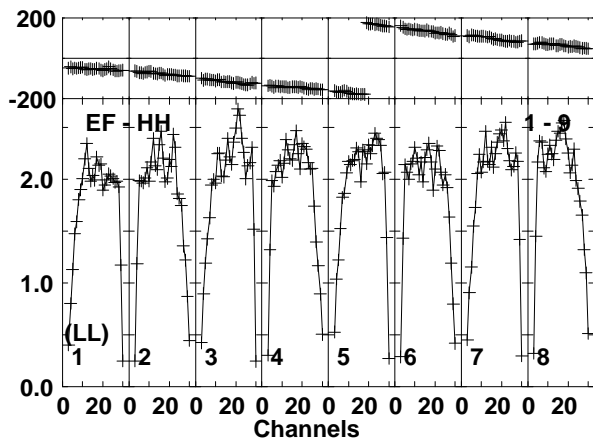
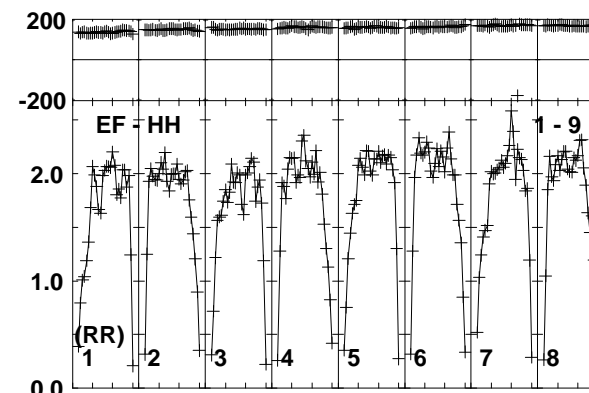
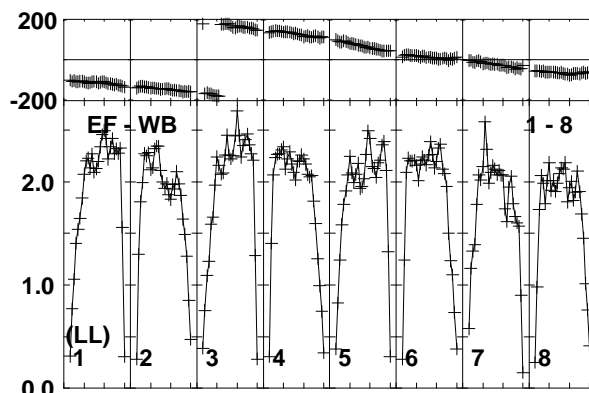
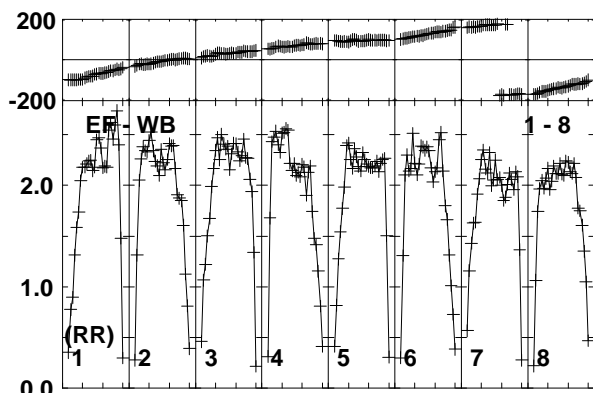
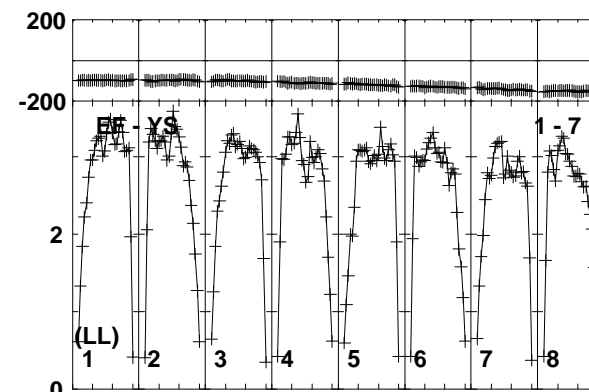
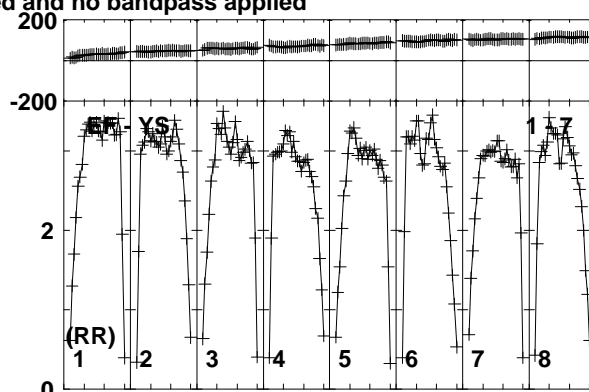
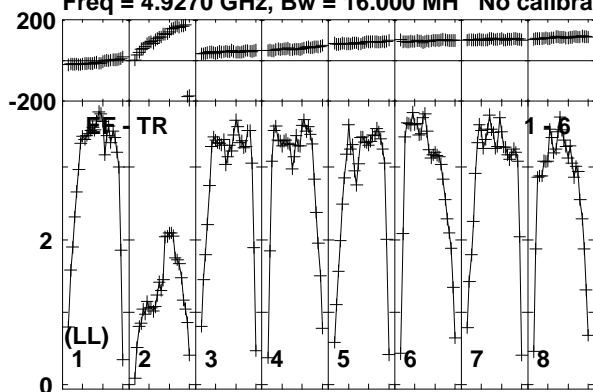

Lower frame: Milli Ampl Jy Top frame: Phas deg  
Vector averaged cross-power spectrum Baseline: EF (01) - TR (06)  
Timerange: 00:12:35:51 to 00:12:37:20

Plot file version 45 created 10-JUN-2016 15:29:19

FRB150418 RG008C.UVDATA.1

Freq = 4.9270 GHz, Bw = 16.000 MH No calibration applied and no bandpass applied

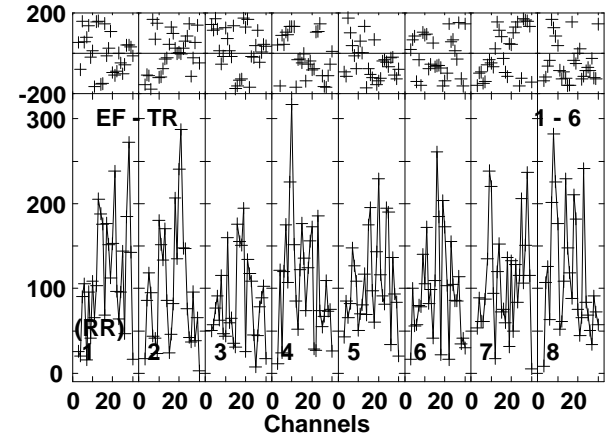
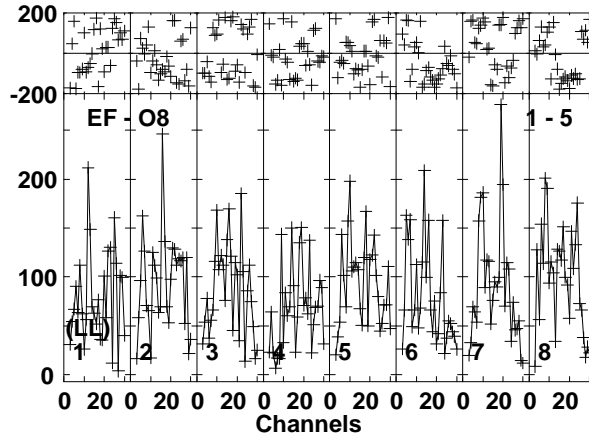
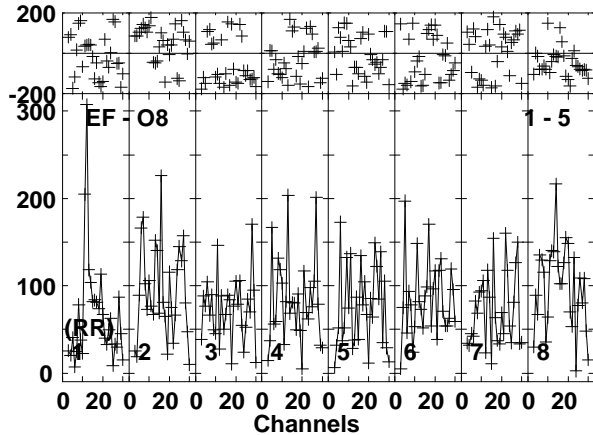
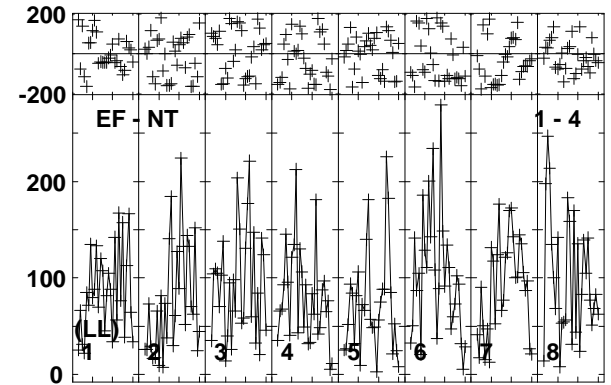
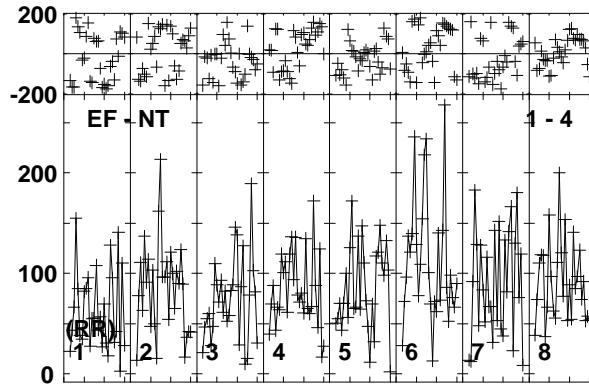
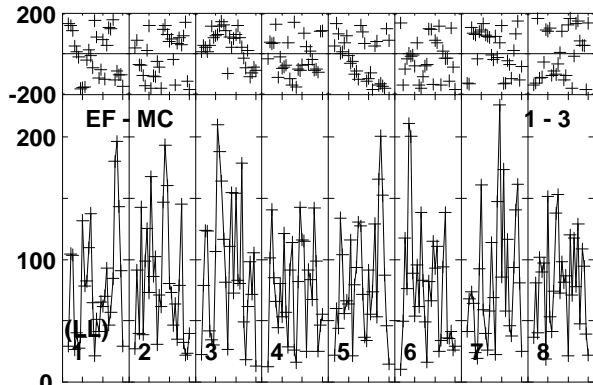
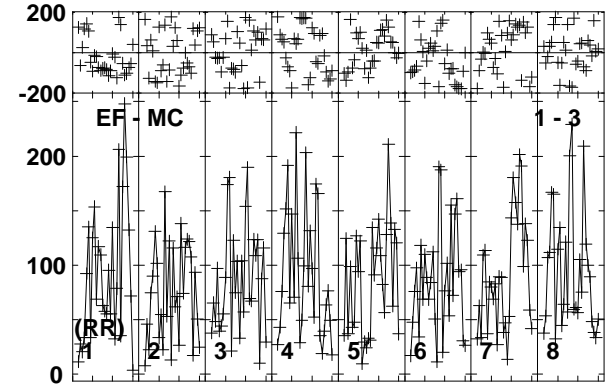
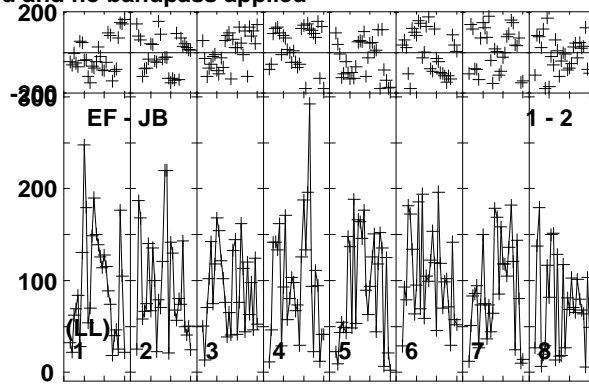
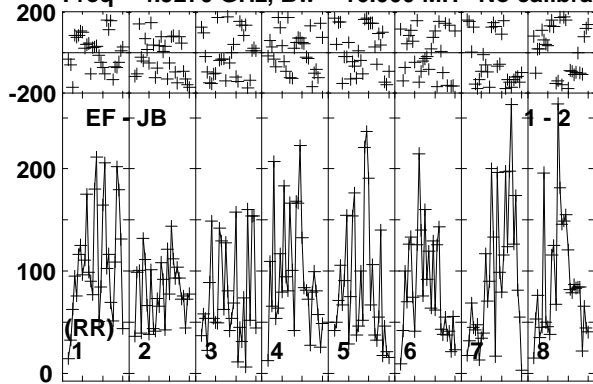

Lower frame: Micro Ampl Jy Top frame: Phas deg  
Vector averaged cross-power spectrum Baseline: EF (01) - JB (02)  
Timerange: 00:12:37:21 to 00:12:40:19

Plot file version 46 created 10-JUN-2016 15:29:19

FRB150418 RG008C.UVDATA.1

Freq = 4.9270 GHz, Bw = 16.000 MH No calibration applied and no bandpass applied

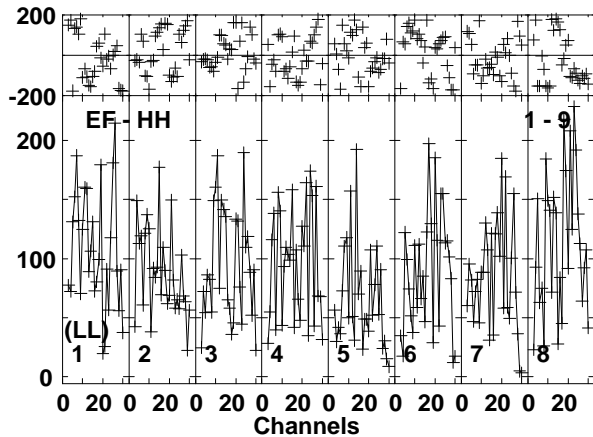
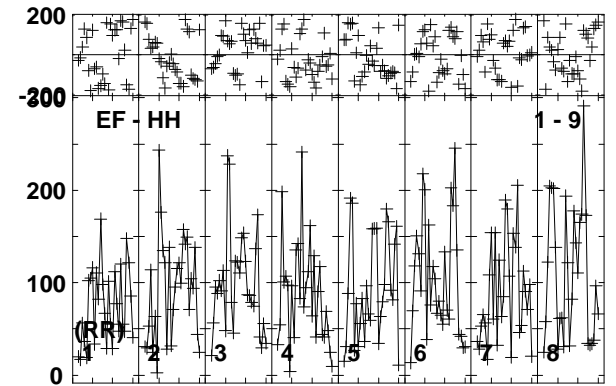
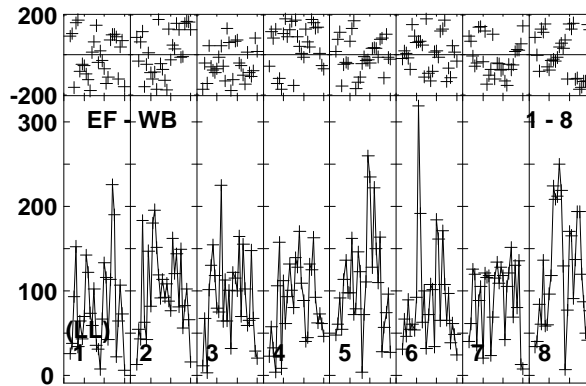
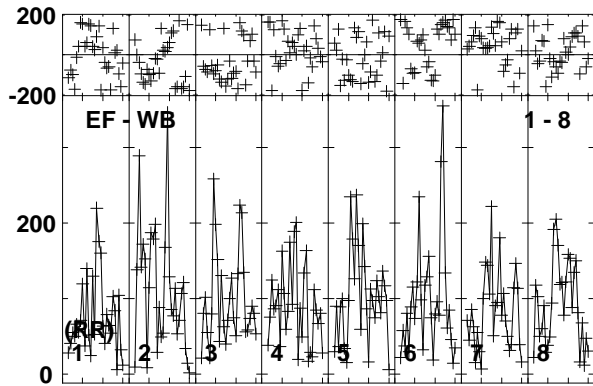
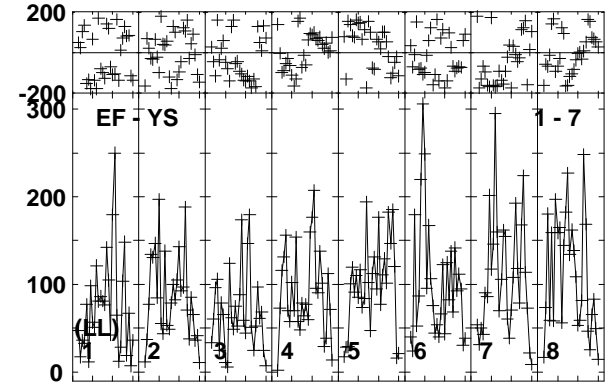
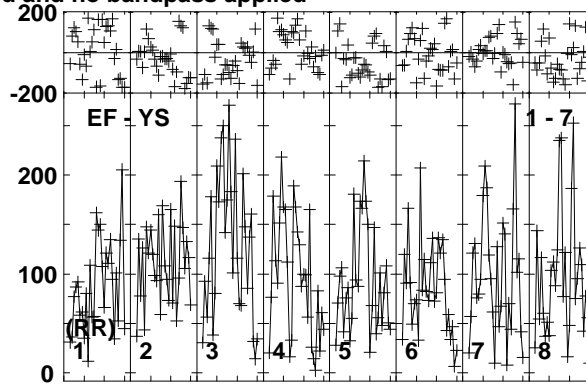
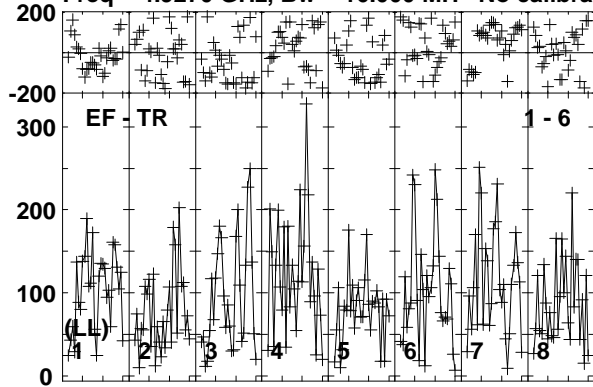

Lower frame: Micro Ampl Jy Top frame: Phas deg  
Vector averaged cross-power spectrum Baseline: EF (01) - TR (06)  
Timerange: 00:12:37:21 to 00:12:40:19

Plot file version 47 created 10-JUN-2016 15:29:19

J0718-1813 RG008C.UVDATA.1

Freq = 4.9270 GHz, Bw = 16.000 MH No calibration applied and no bandpass applied

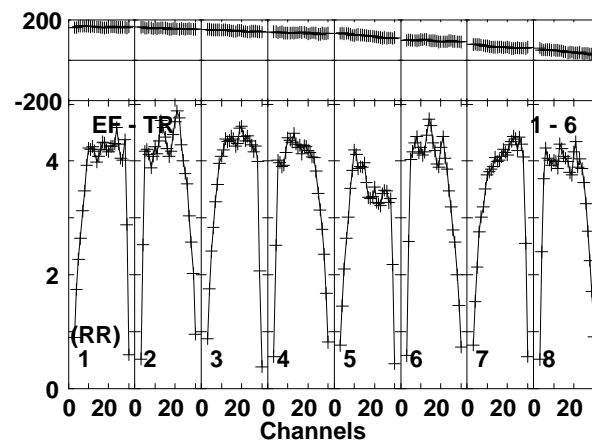
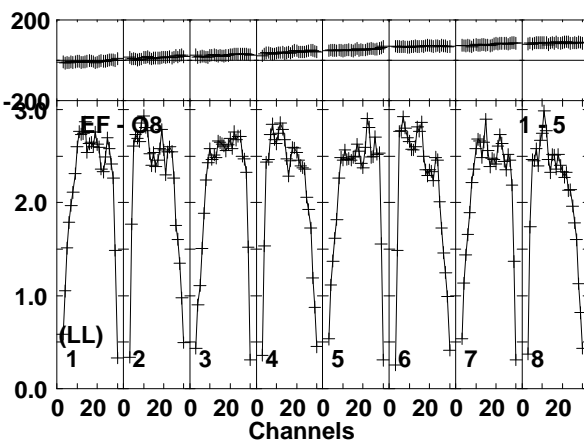
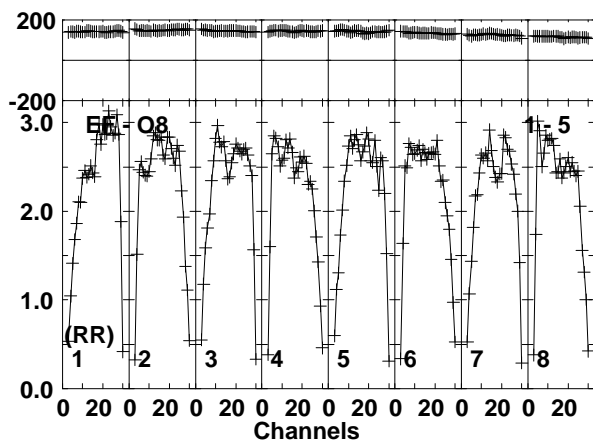
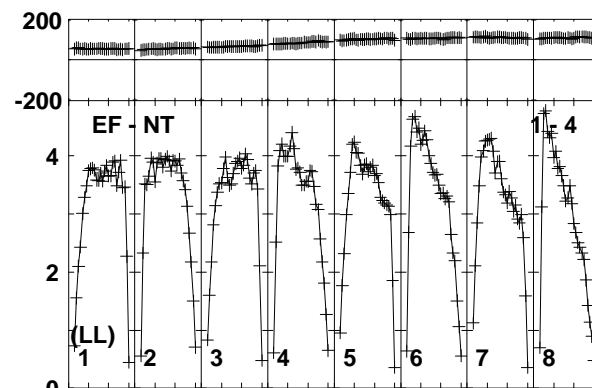
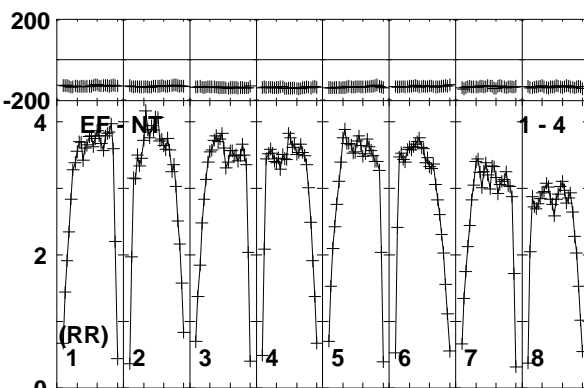
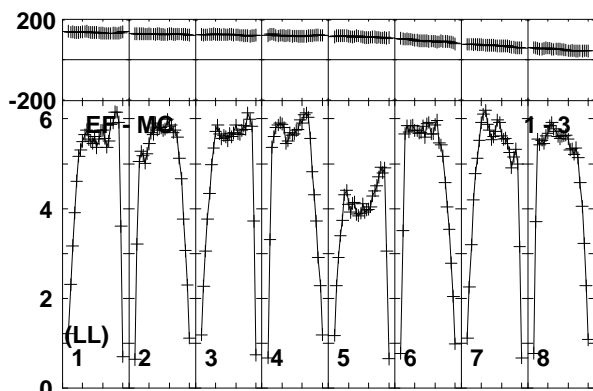
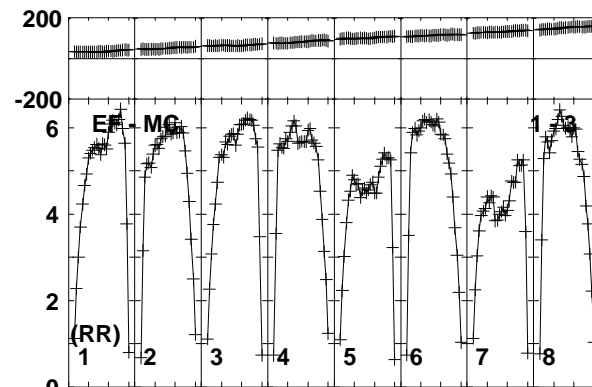
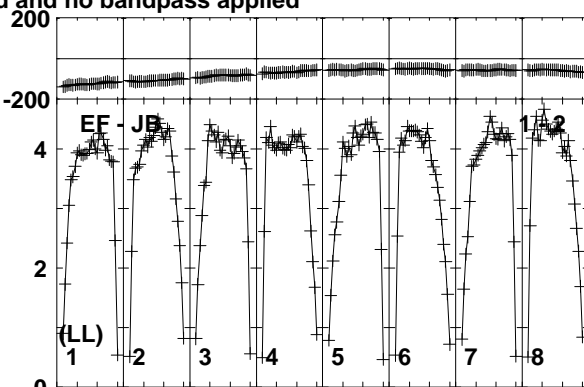
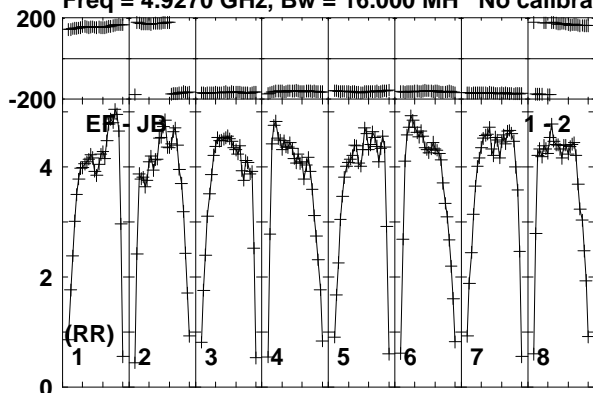

Lower frame: Milli Ampl Jy Top frame: Phas deg  
Vector averaged cross-power spectrum Baseline: EF (01) - JB (02)  
Timerange: 00:12:41:01 to 00:12:41:50

Plot file version 48 created 10-JUN-2016 15:29:19

J0718-1813 RG008C.UVDATA.1

Freq = 4.9270 GHz, Bw = 16.000 MH No calibration applied and no bandpass applied

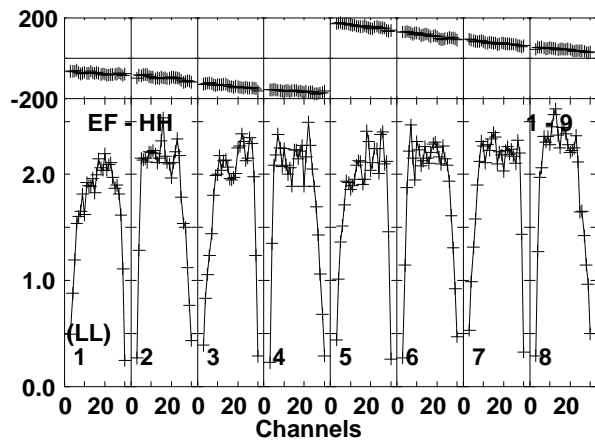
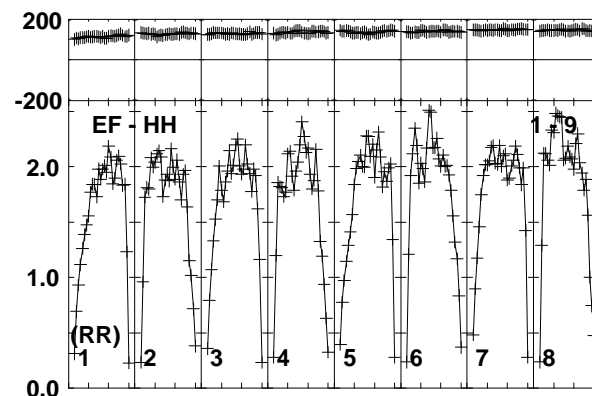
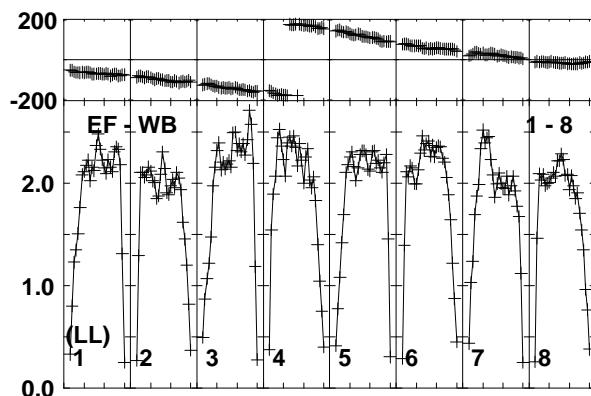
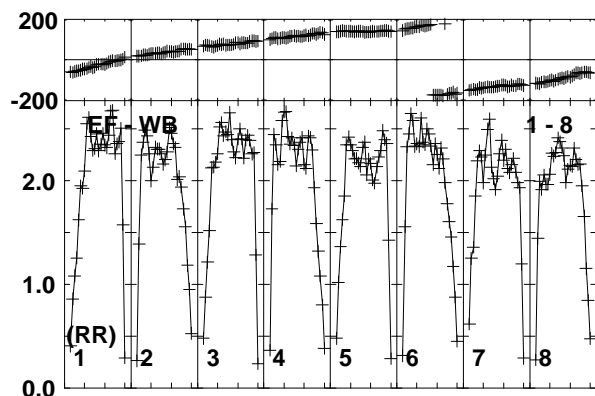
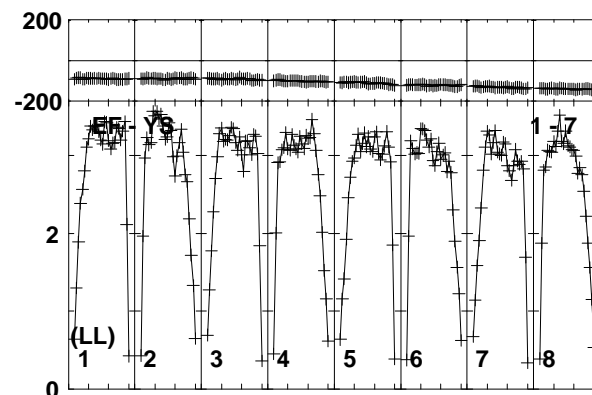
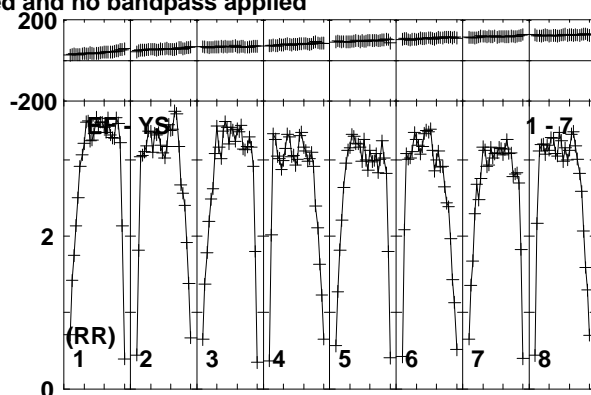
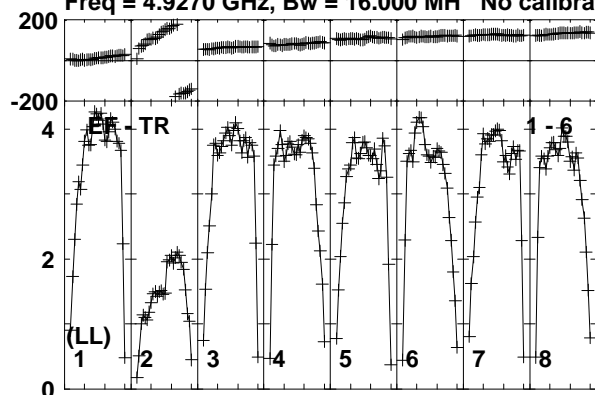

Lower frame: Milli Ampl Jy Top frame: Phas deg  
Vector averaged cross-power spectrum Baseline: EF (01) - TR (06)  
Timerange: 00:12:41:01 to 00:12:41:50



Plot file version 49 created 10-JUN-2016 15:29:20

FRB150418 RG008C.UVDATA.1

Freq = 4.9270 GHz, Bw = 16.000 MH No calibration applied and no bandpass applied

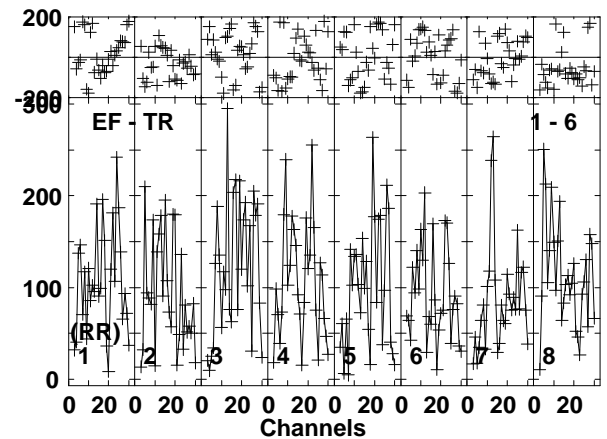
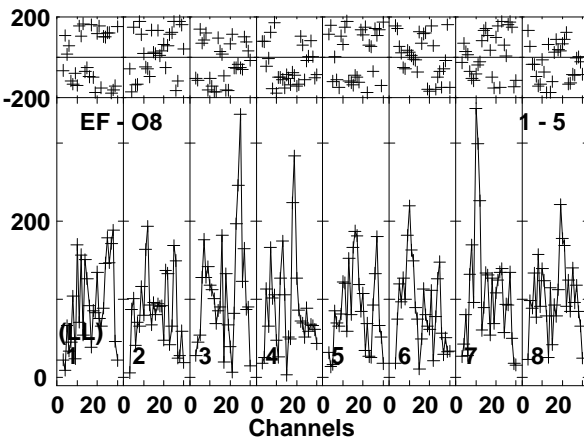
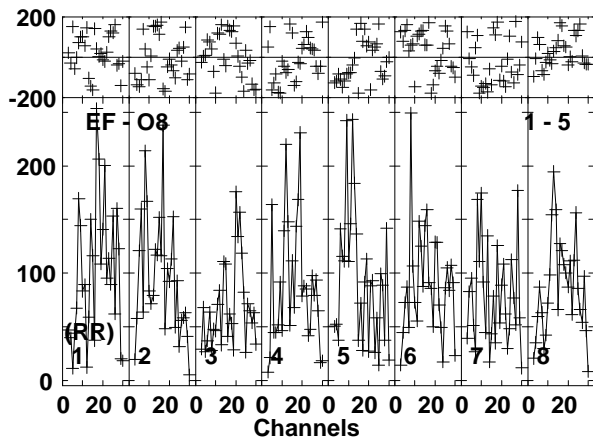
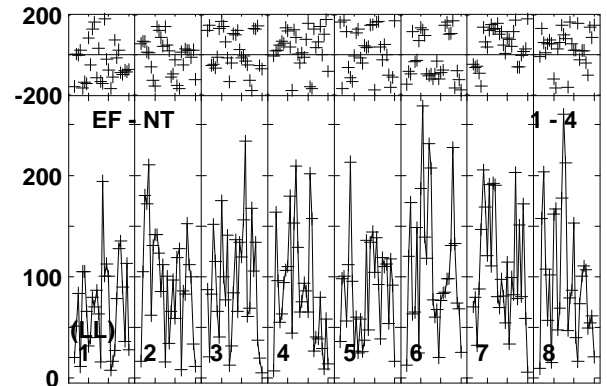
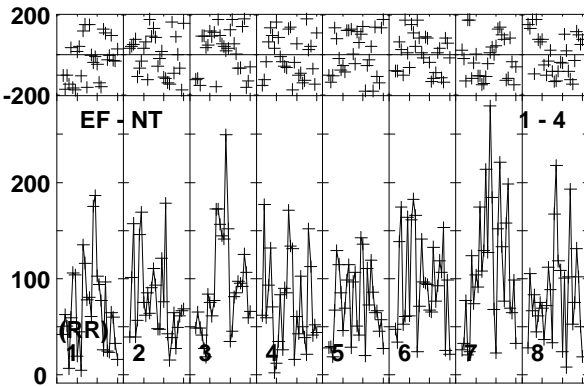
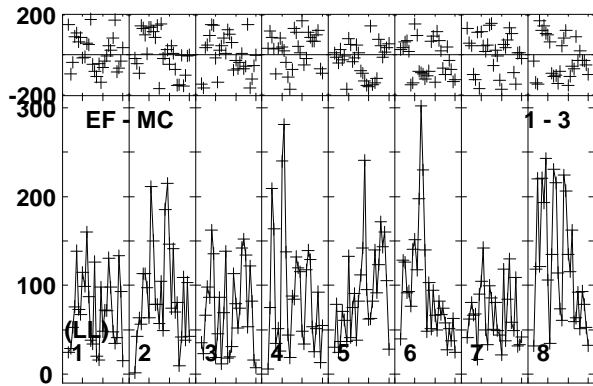
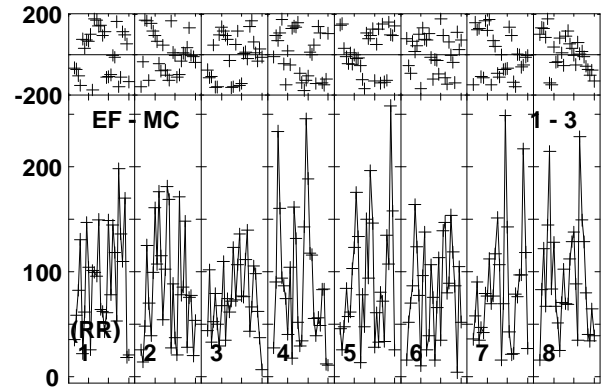
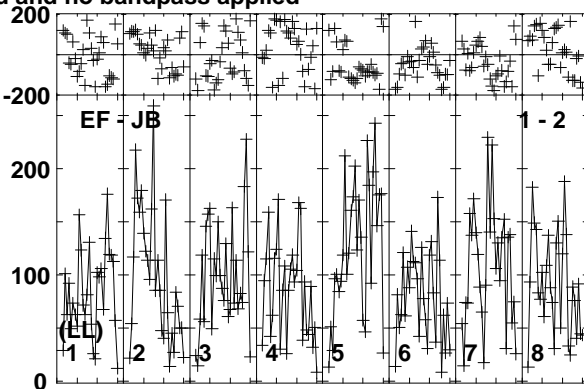
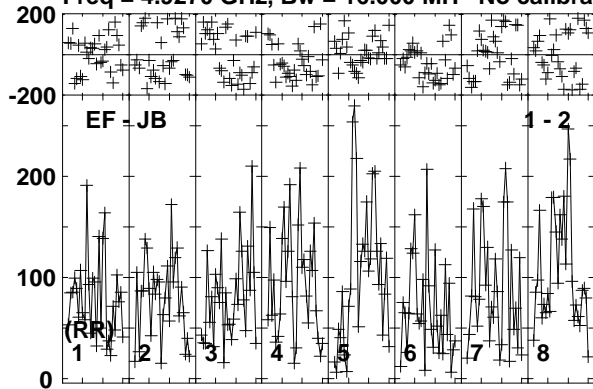

Lower frame: Micro Ampl Jy Top frame: Phas deg  
Vector averaged cross-power spectrum Baseline: EF (01) - JB (02)  
Timerange: 00/12:41:50 to 00/12:44:50

Plot file version 50 created 10-JUN-2016 15:29:20

FRB150418 RG008C.UVDATA.1

Freq = 4.9270 GHz, Bw = 16.000 MH No calibration applied and no bandpass applied

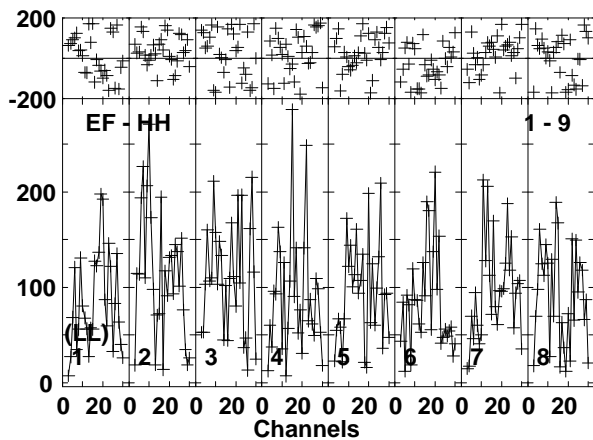
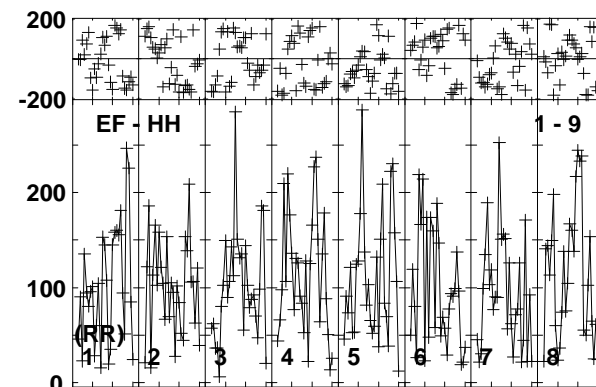
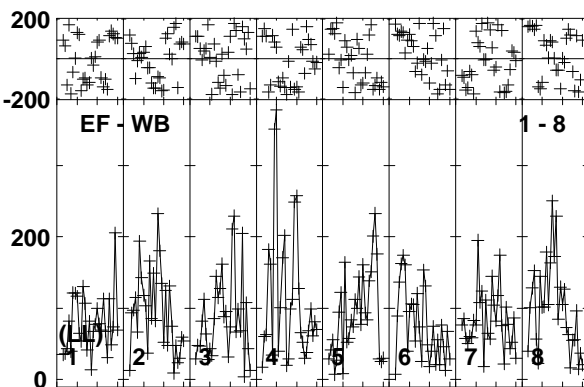
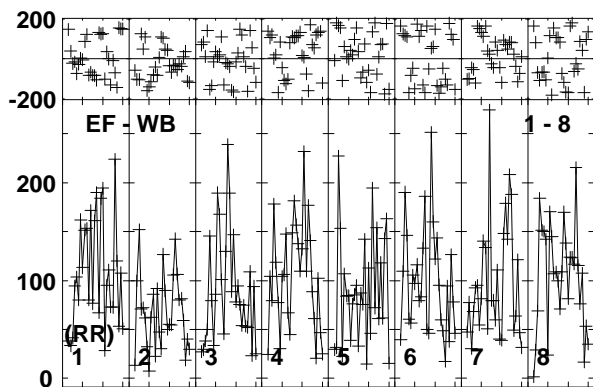
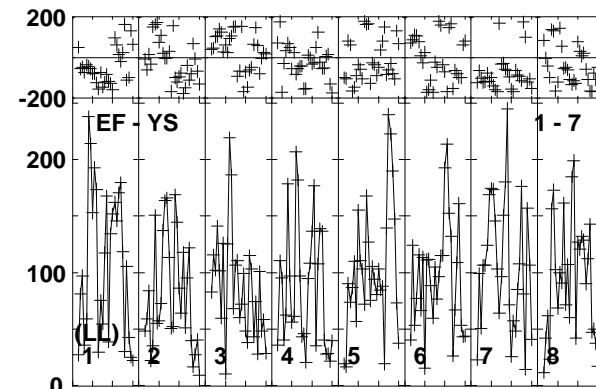
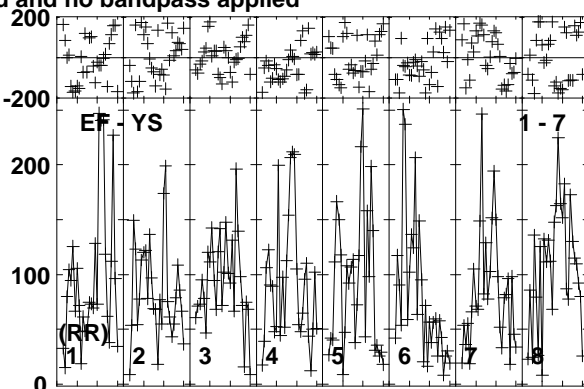
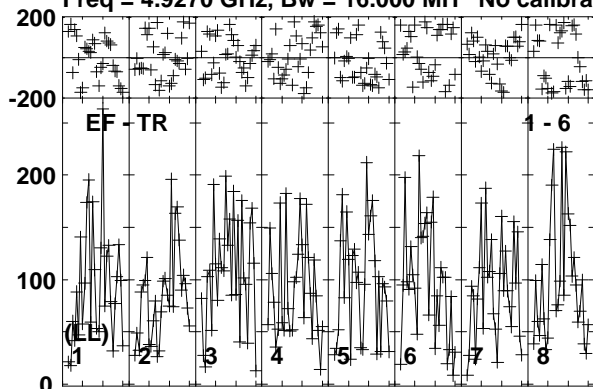

Lower frame: Micro Ampl Jy Top frame: Phas deg  
Vector averaged cross-power spectrum Baseline: EF (01) - TR (06)  
Timerange: 00/12:41:50 to 00/12:44:50

Plot file version 51 created 10-JUN-2016 15:29:20

J0718-1813 RG008C.UVDATA.1

Freq = 4.9270 GHz, Bw = 16.000 MH No calibration applied and no bandpass applied

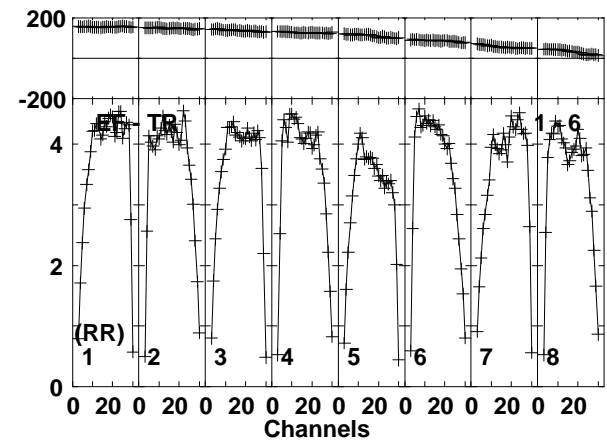
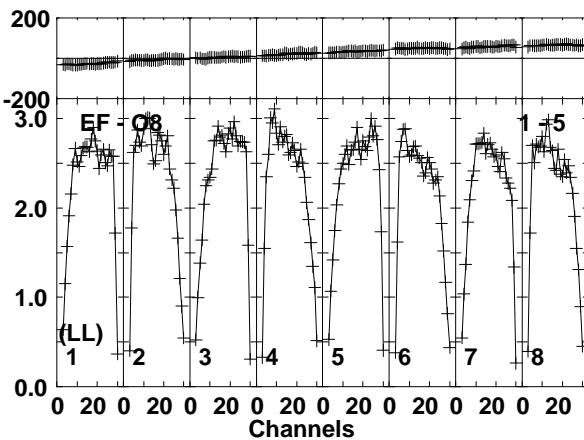
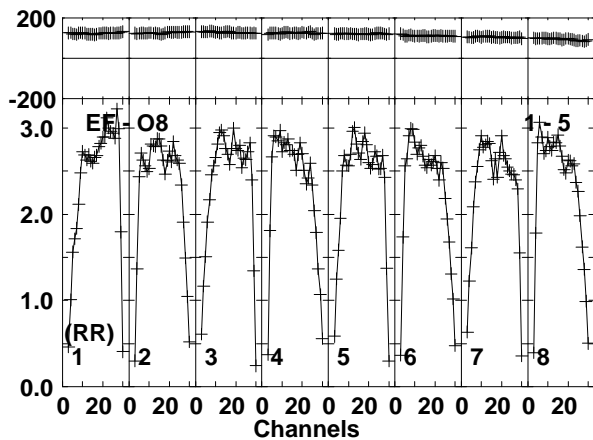
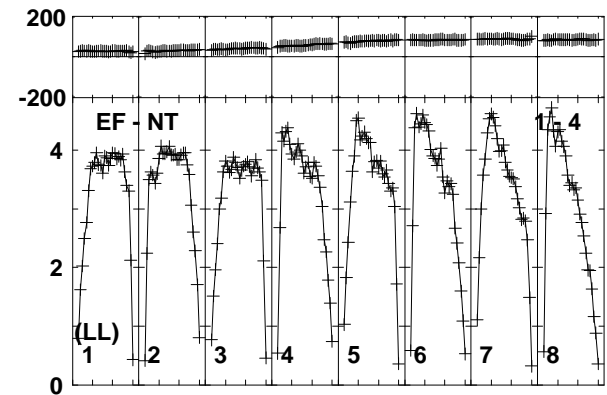
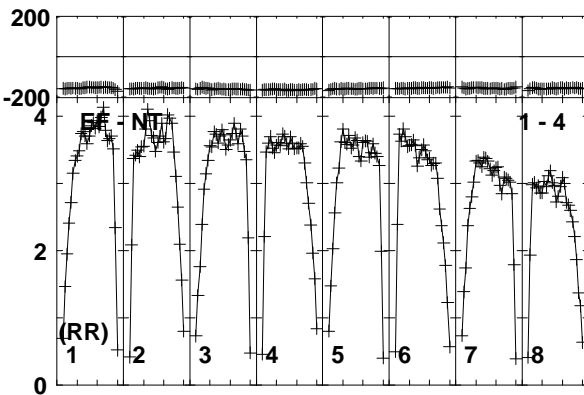
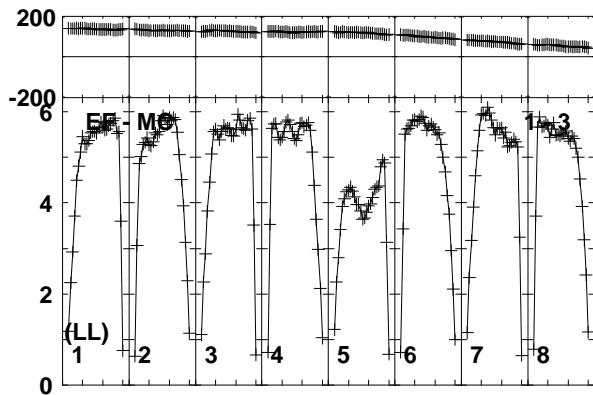
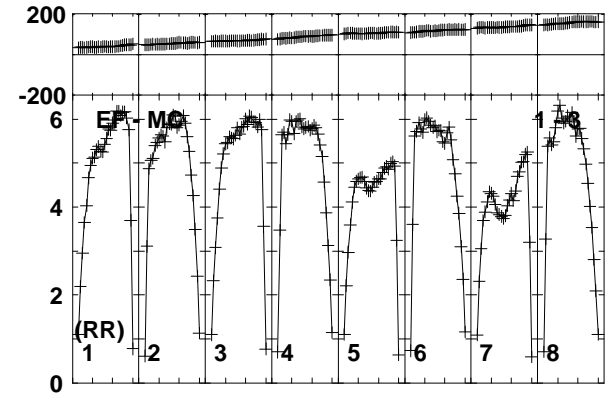
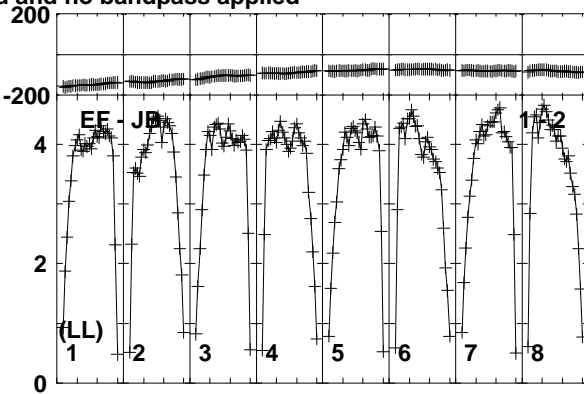
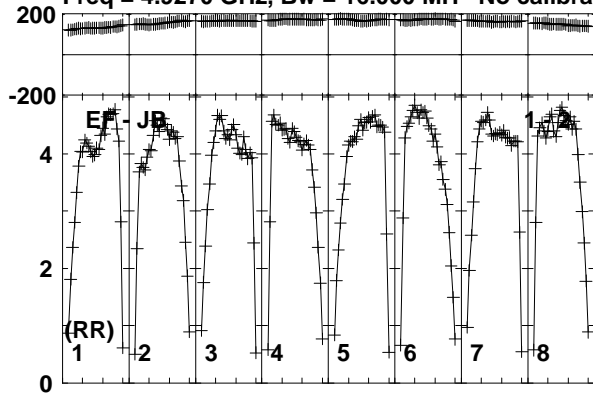

Lower frame: Milli Ampl Jy Top frame: Phas deg  
Vector averaged cross-power spectrum Baseline: EF (01) - JB (02)  
Timerange: 00:12:44:50 to 00:12:46:19

Plot file version 52 created 10-JUN-2016 15:29:20

J0718-1813 RG008C.UVDATA.1

Freq = 4.9270 GHz, Bw = 16.000 MH No calibration applied and no bandpass applied

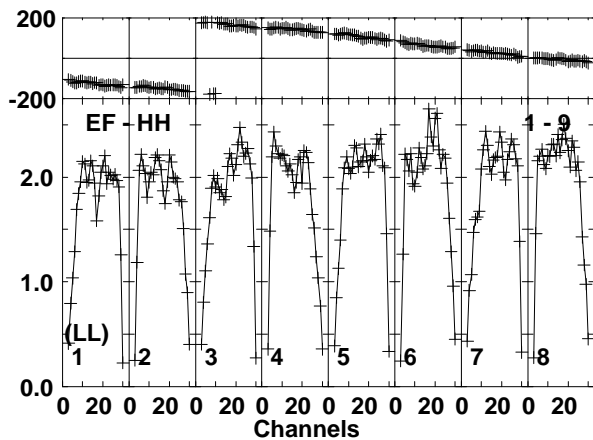
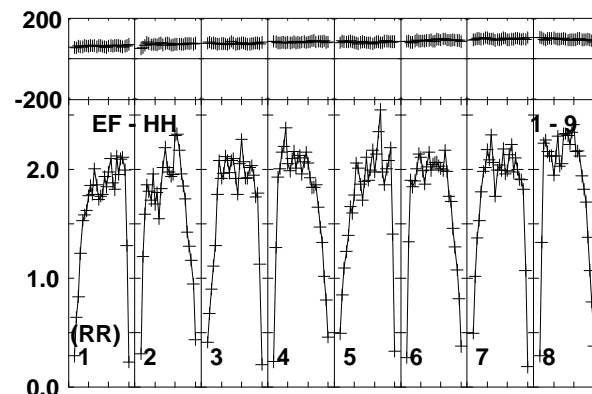
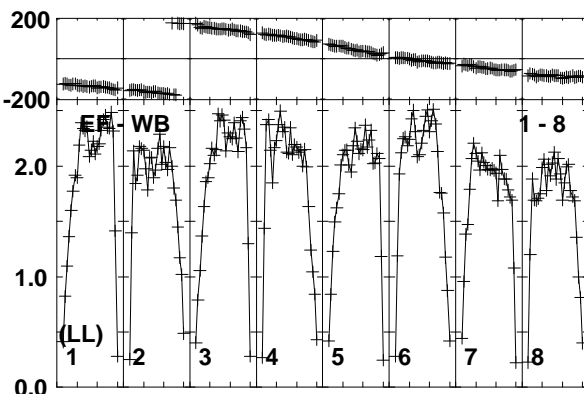
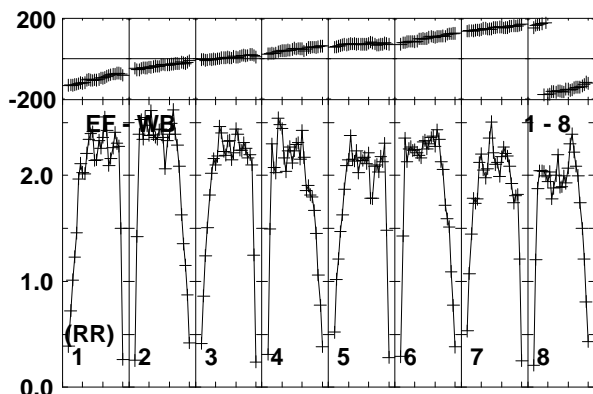
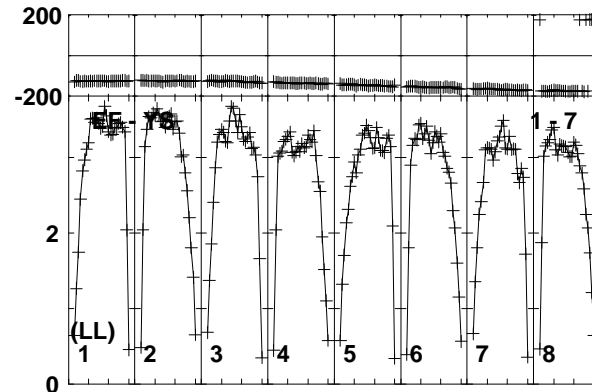
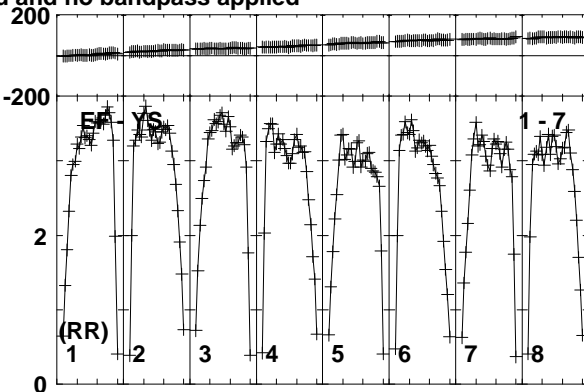
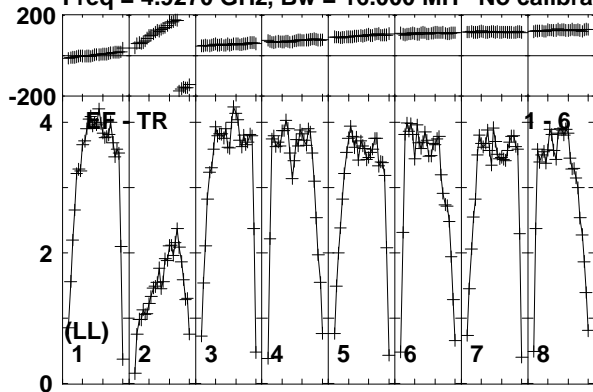

Lower frame: Milli Ampl Jy Top frame: Phas deg  
Vector averaged cross-power spectrum Baseline: EF (01) - TR (06)  
Timerange: 00:12:44:50 to 00:12:46:19

Plot file version 53 created 10-JUN-2016 15:29:20

J0712-1847 RG008C.UVDATA.1

Freq = 4.9270 GHz, Bw = 16.000 MH No calibration applied and no bandpass applied

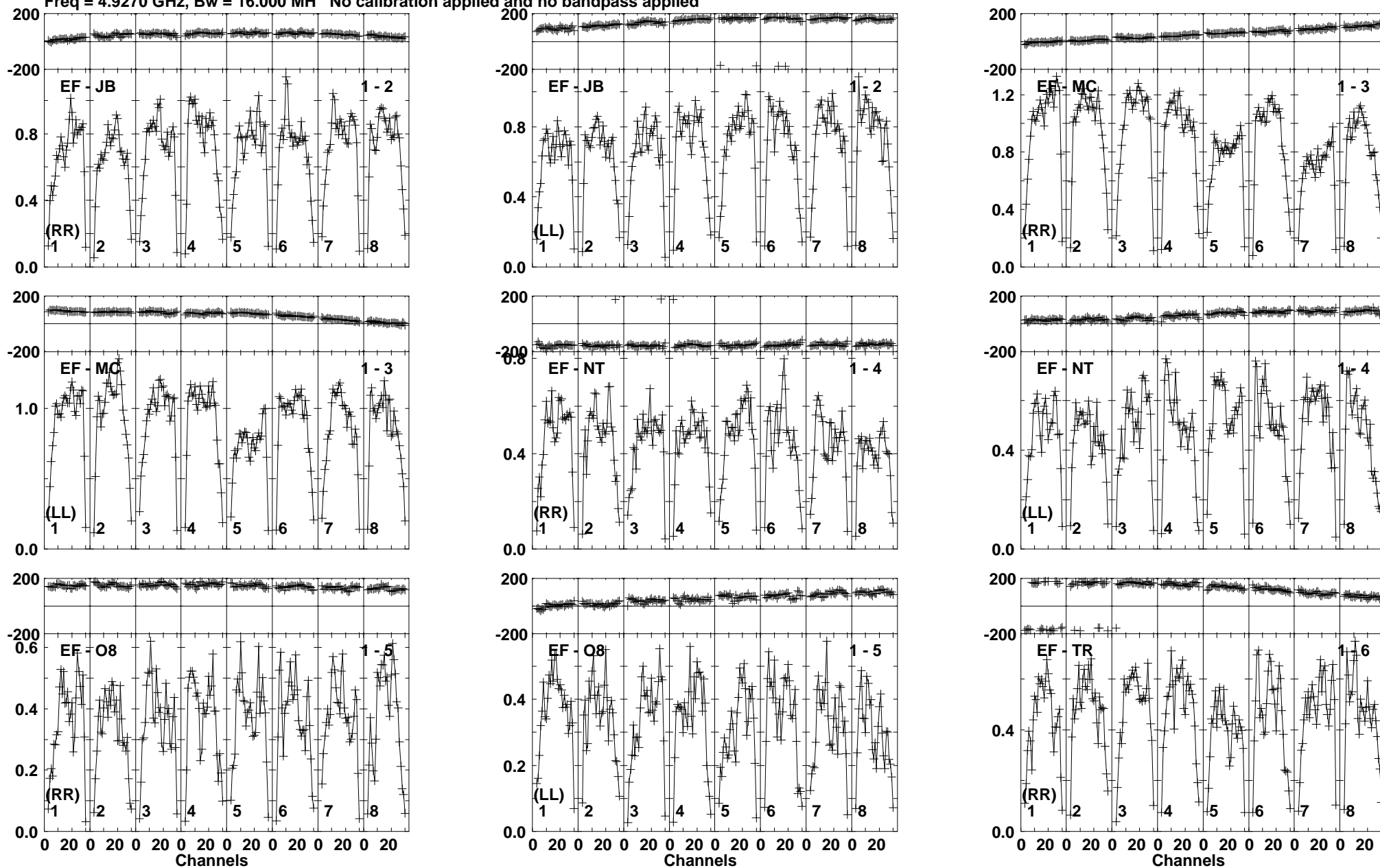

Lower frame: Milli Ampl Jy Top frame: Phas deg  
Vector averaged cross-power spectrum Baseline: EF (01) - JB (02)  
Timerange: 00:12:46:21 to 00:12:49:20

Plot file version 54 created 10-JUN-2016 15:29:20

J0712-1847 RG008C.UVDATA.1

Freq = 4.9270 GHz, Bw = 16.000 MH No calibration applied and no bandpass applied

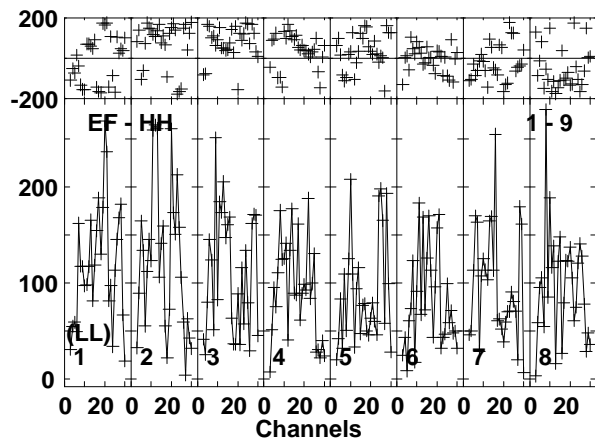
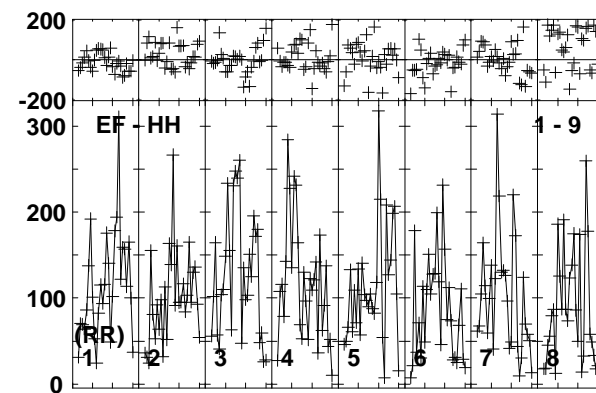
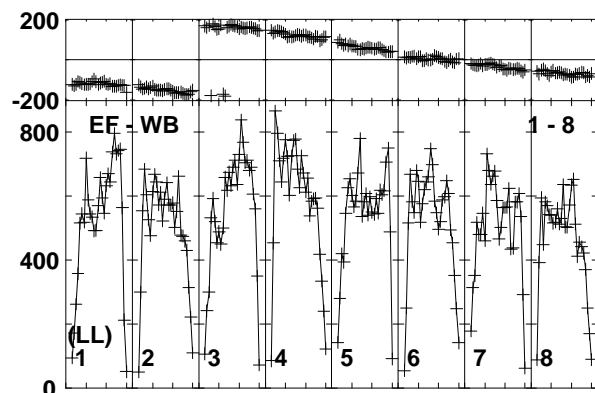
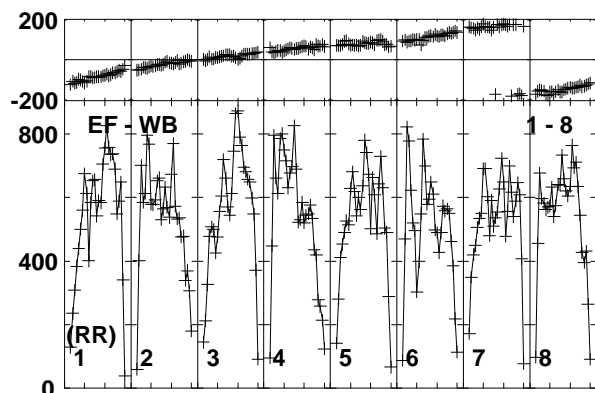
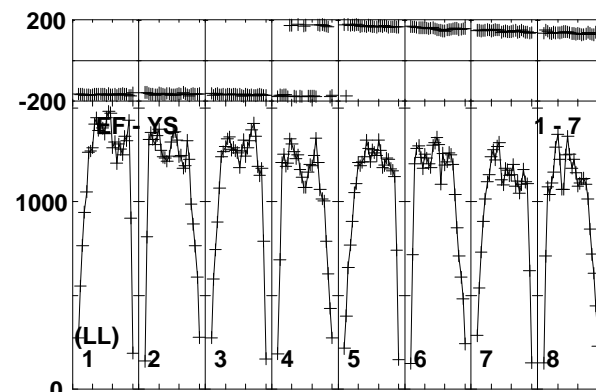
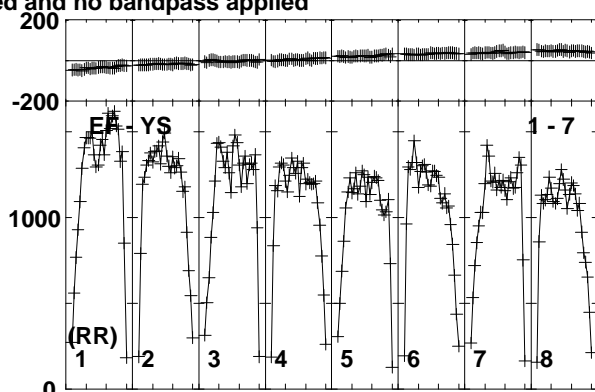
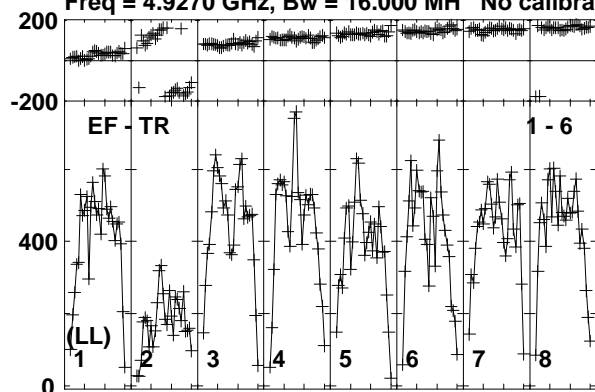

Lower frame: Micro Ampl Jy Top frame: Phas deg  
Vector averaged cross-power spectrum Baseline: EF (01) - TR (06)  
Timerange: 00:12:46:21 to 00:12:49:20

Plot file version 55 created 10-JUN-2016 15:29:20

J0718-1813 RG008C.UVDATA.1

Freq = 4.9270 GHz, Bw = 16.000 MH No calibration applied and no bandpass applied

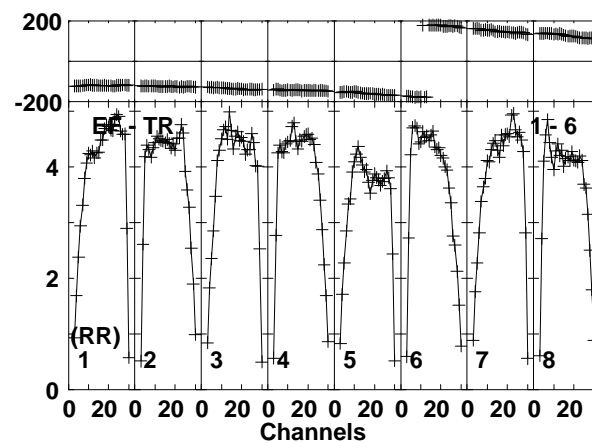
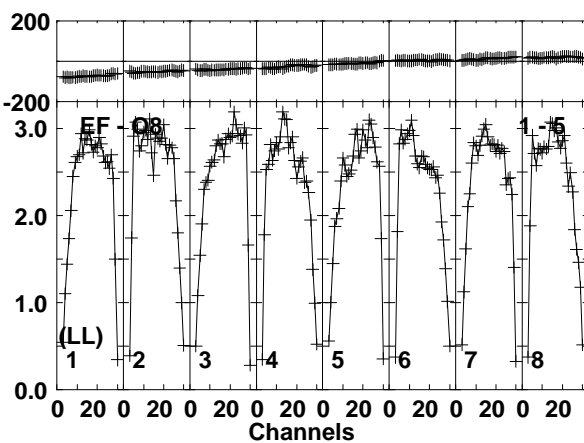
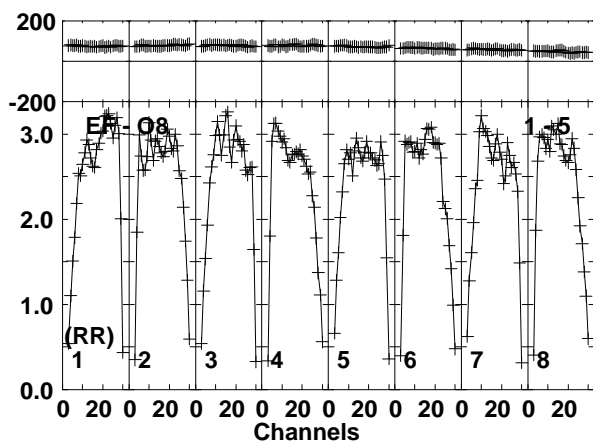
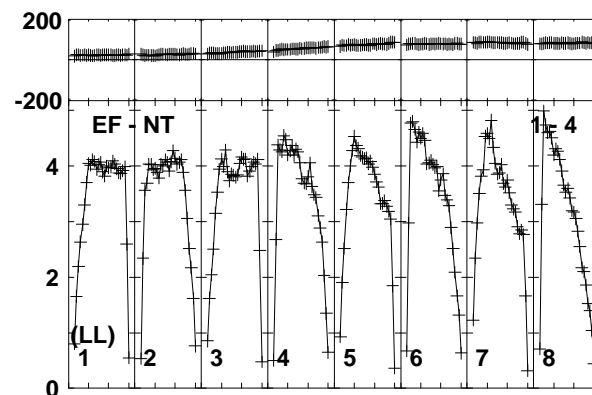
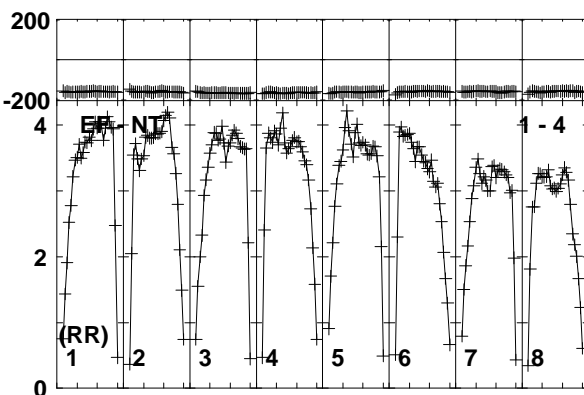
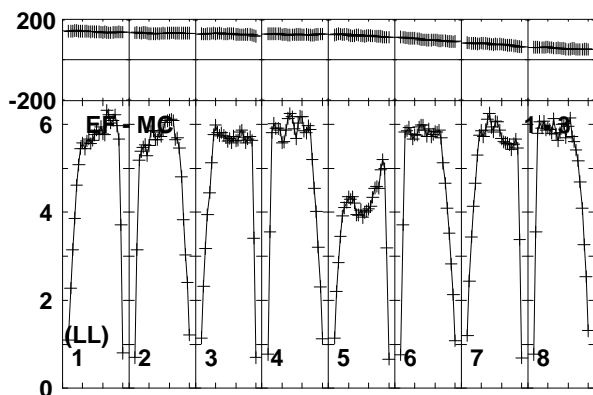
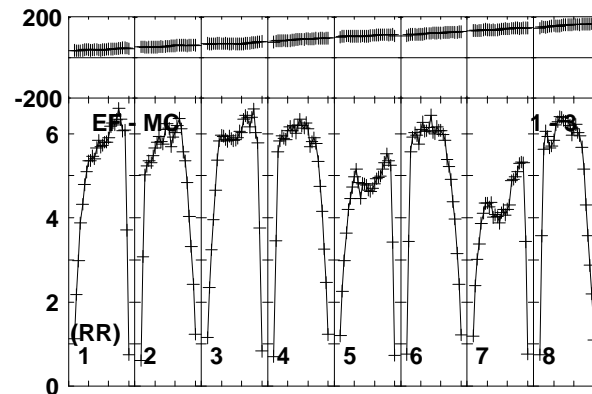
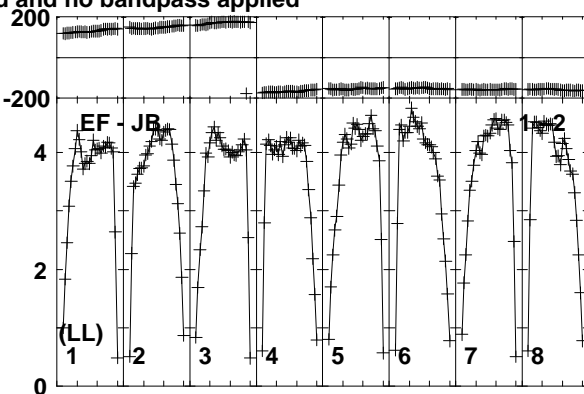
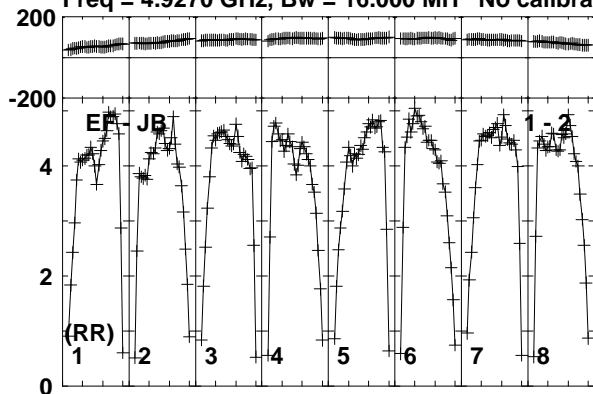

Lower frame: Milli Ampl Jy Top frame: Phas deg  
Vector averaged cross-power spectrum Baseline: EF (01) - JB (02)  
Timerange: 00:12:50:00 to 00:12:50:49

Plot file version 56 created 10-JUN-2016 15:29:20

J0718-1813 RG008C.UVDATA.1

Freq = 4.9270 GHz, Bw = 16.000 MH No calibration applied and no bandpass applied

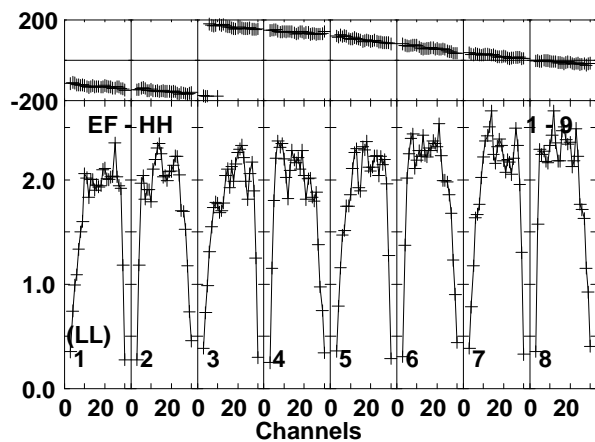
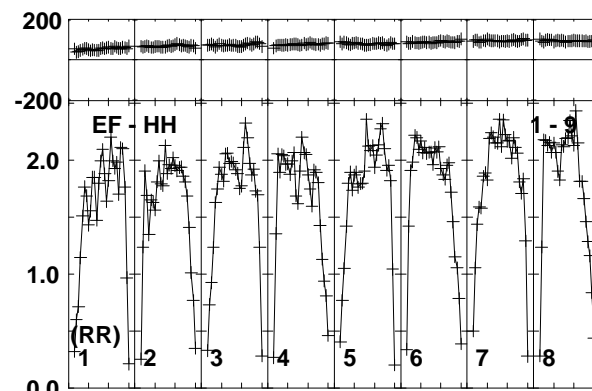
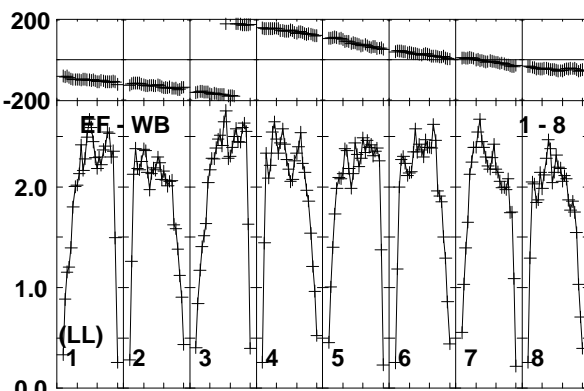
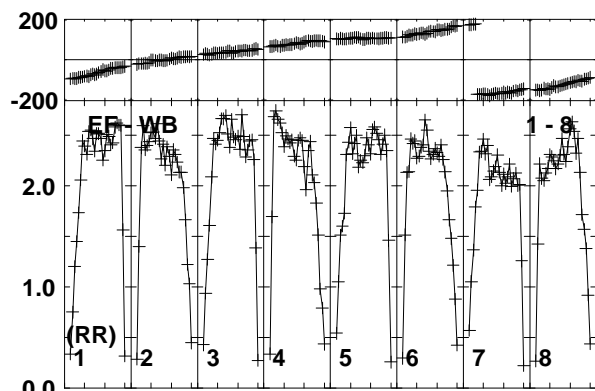
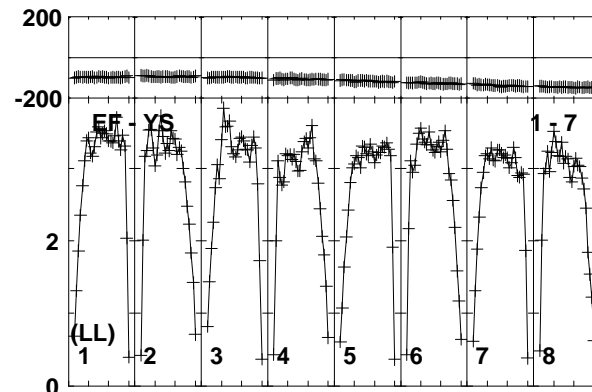
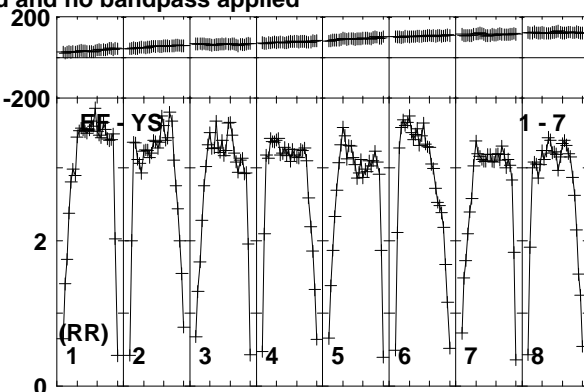
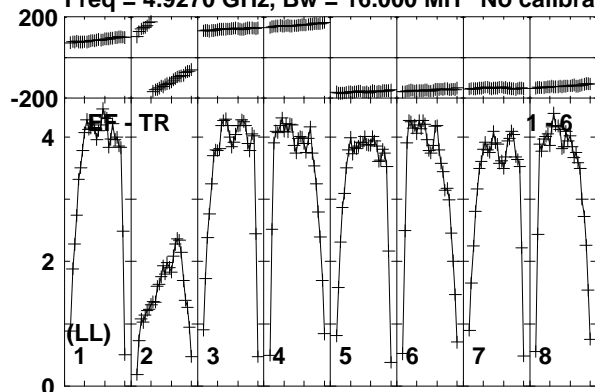

Lower frame: Milli Ampl Jy Top frame: Phas deg  
Vector averaged cross-power spectrum Baseline: EF (01) - TR (06)  
Timerange: 00/12:50:00 to 00/12:50:49



Plot file version 57 created 10-JUN-2016 15:29:21

FRB150418 RG008C.UVDATA.1

Freq = 4.9270 GHz, Bw = 16.000 MH No calibration applied and no bandpass applied

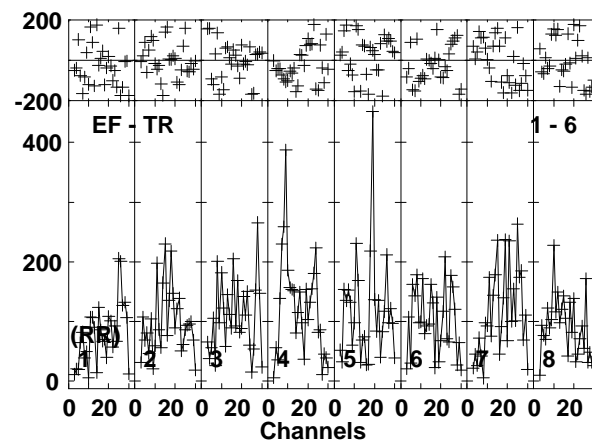
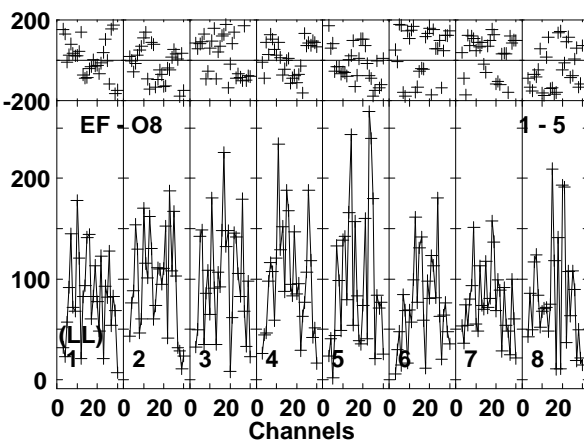
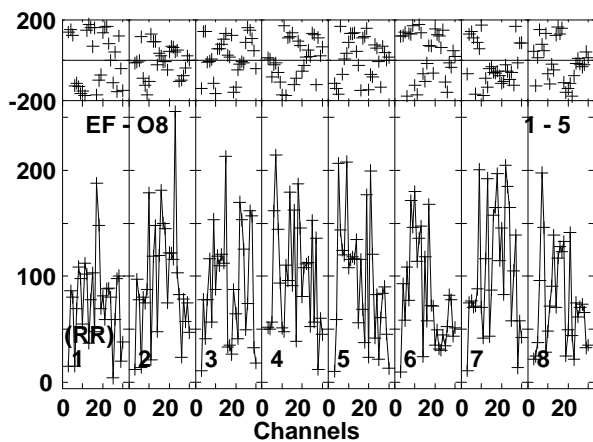
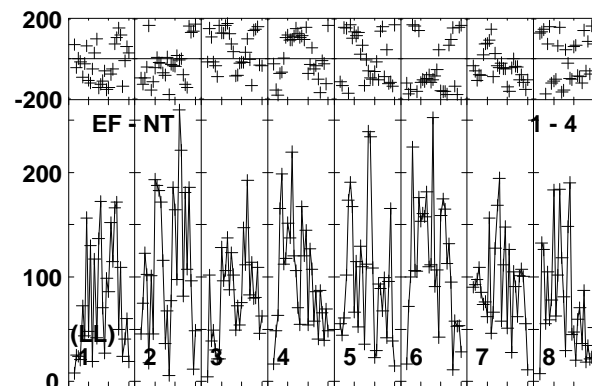
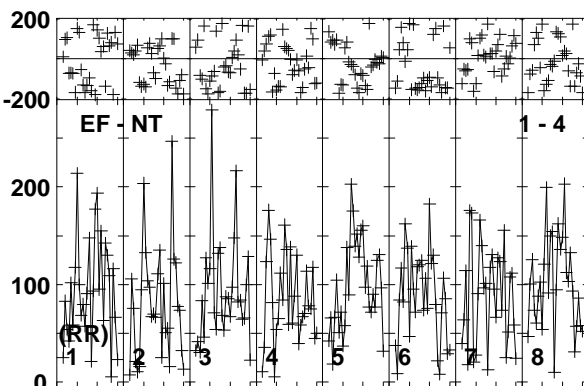
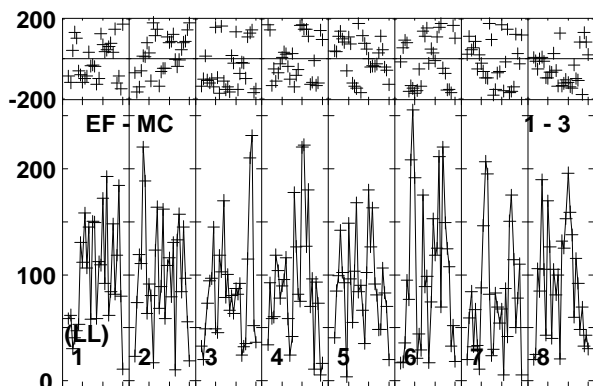
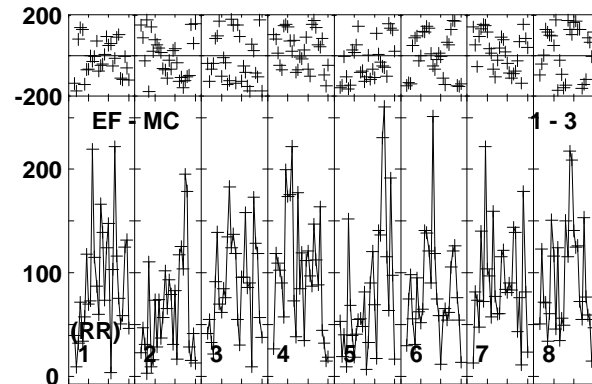
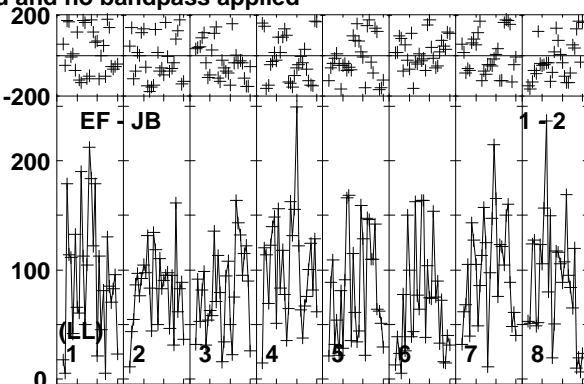
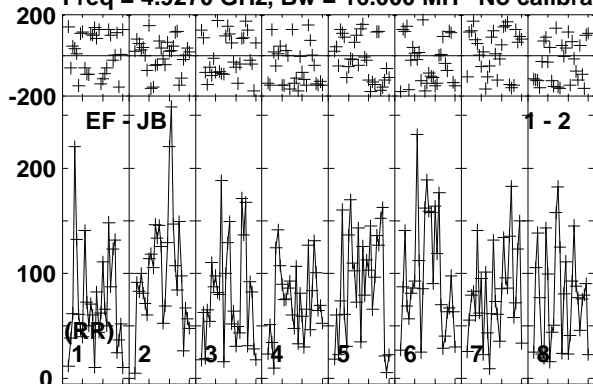

Lower frame: Micro Ampl Jy Top frame: Phas deg  
Vector averaged cross-power spectrum Baseline: EF (01) - JB (02)  
Timerange: 00/12:50:50 to 00/12:53:50

Plot file version 58 created 10-JUN-2016 15:29:21

FRB150418 RG008C.UVDATA.1

Freq = 4.9270 GHz, Bw = 16.000 MH No calibration applied and no bandpass applied

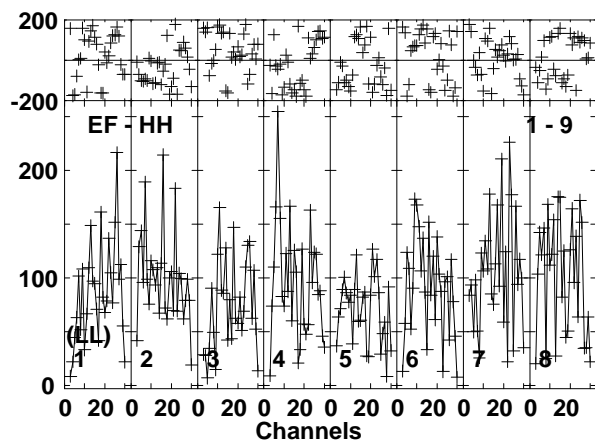
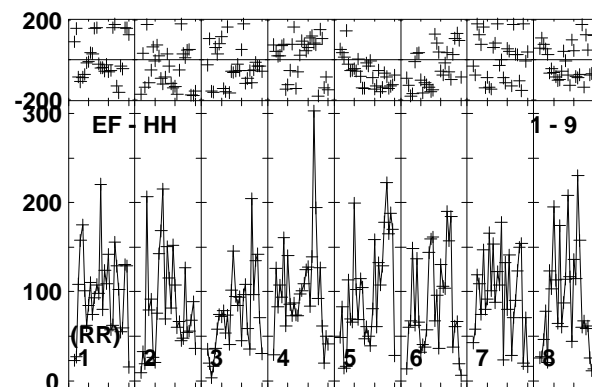
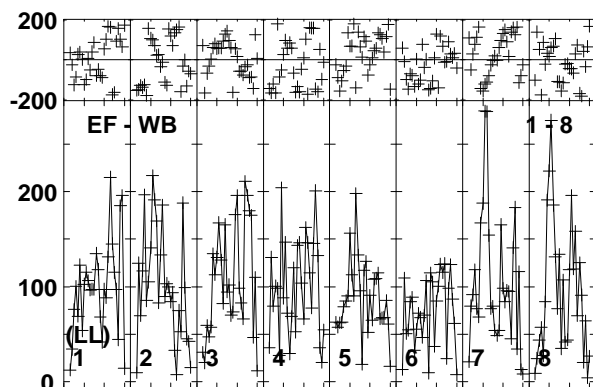
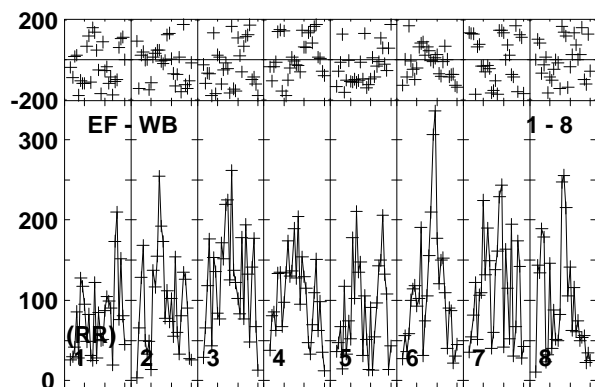
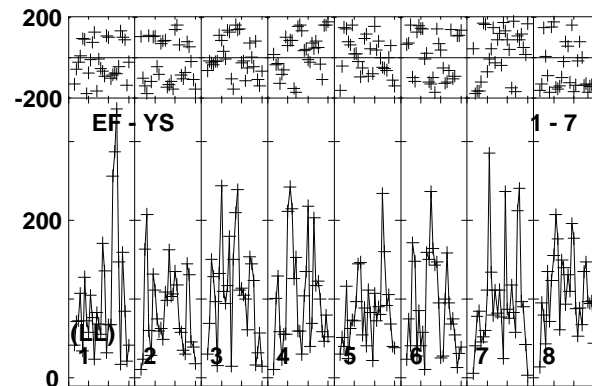
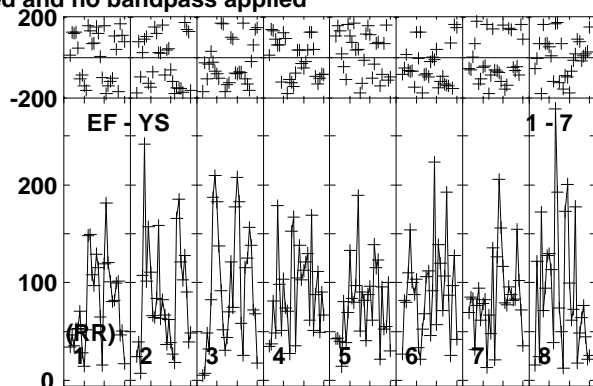
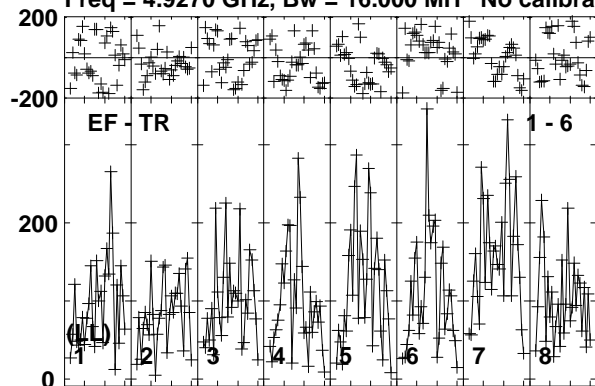

Lower frame: Micro Ampl Jy Top frame: Phas deg  
Vector averaged cross-power spectrum Baseline: EF (01) - TR (06)  
Timerange: 00:12:50:50 to 00:12:53:50

Plot file version 59 created 10-JUN-2016 15:29:21

J0718-1813 RG008C.UVDATA.1

Freq = 4.9270 GHz, Bw = 16.000 MH No calibration applied and no bandpass applied

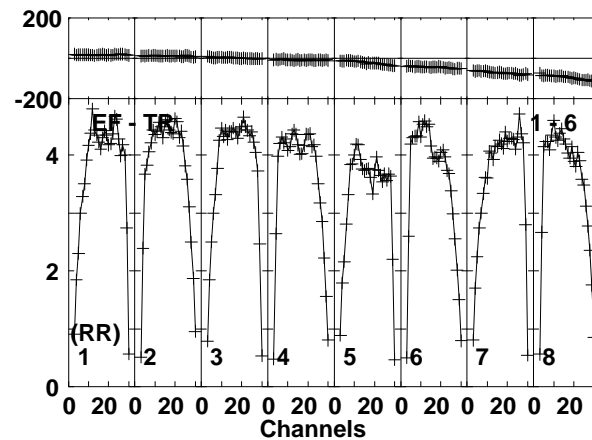
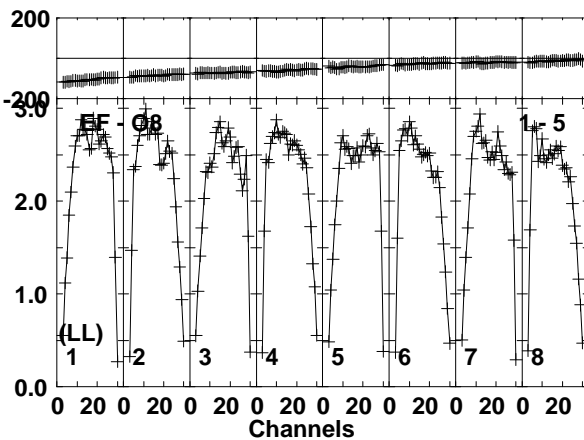
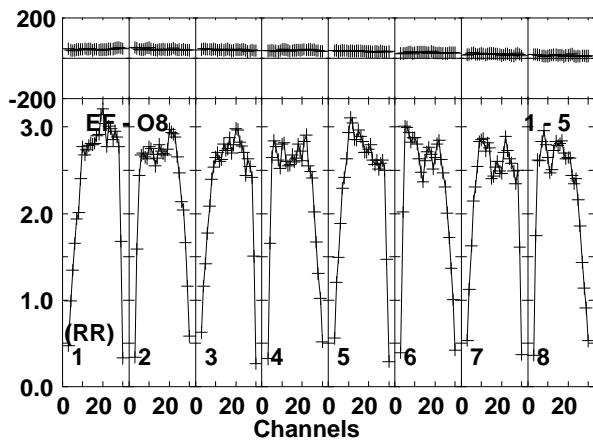
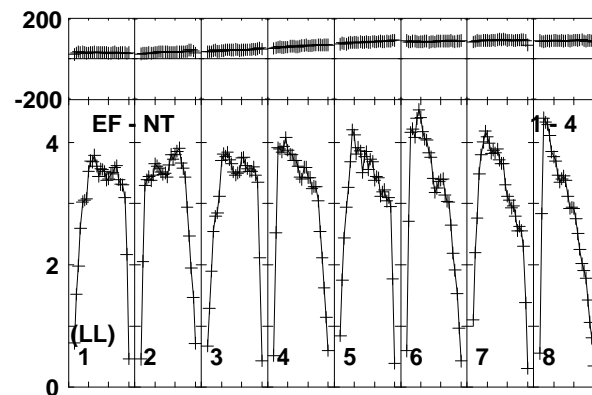
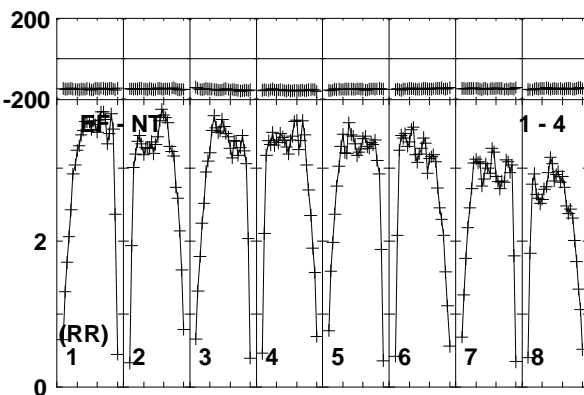
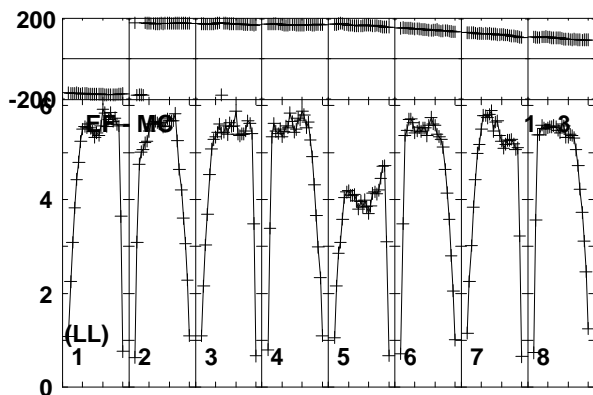
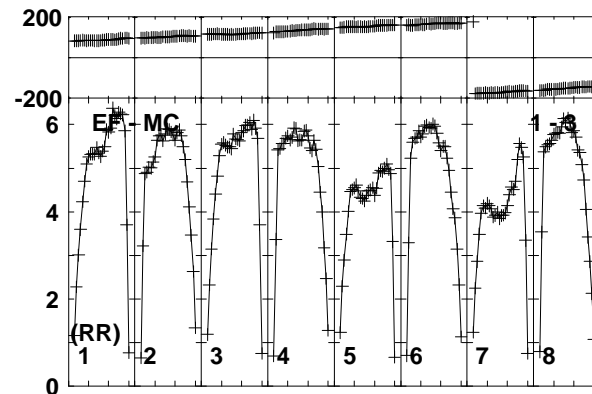
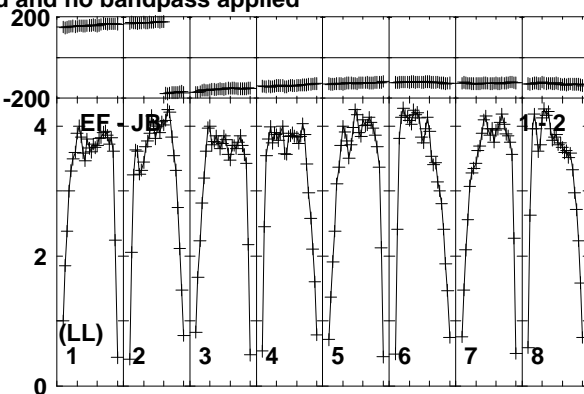
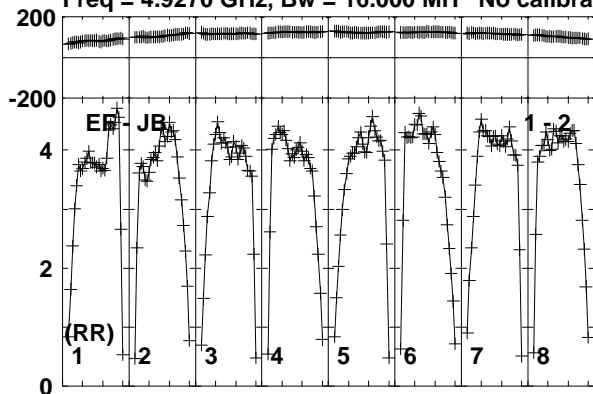

Lower frame: Milli Ampl Jy Top frame: Phas deg  
Vector averaged cross-power spectrum Baseline: EF (01) - JB (02)  
Timerange: 00:12:53:51 to 00:12:55:19

Plot file version 60 created 10-JUN-2016 15:29:21

J0718-1813 RG008C.UVDATA.1

Freq = 4.9270 GHz, Bw = 16.000 MH No calibration applied and no bandpass applied

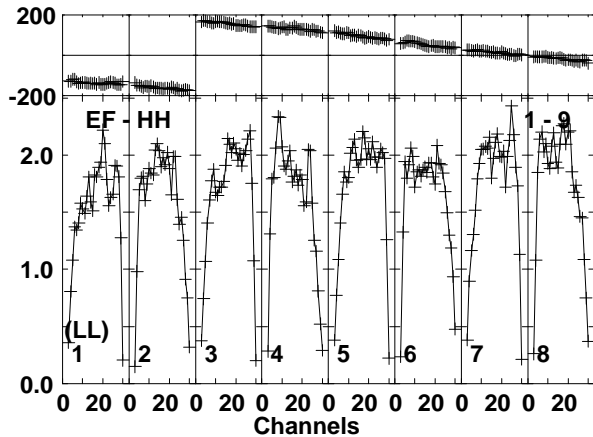
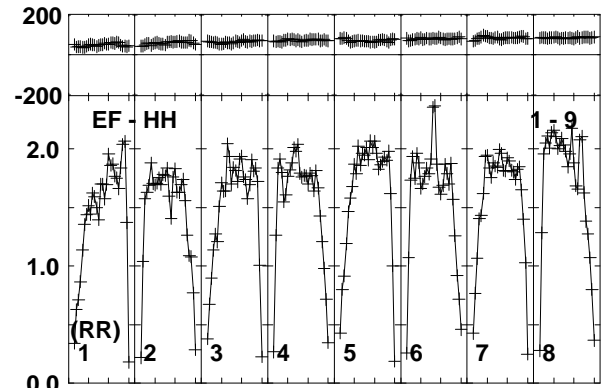
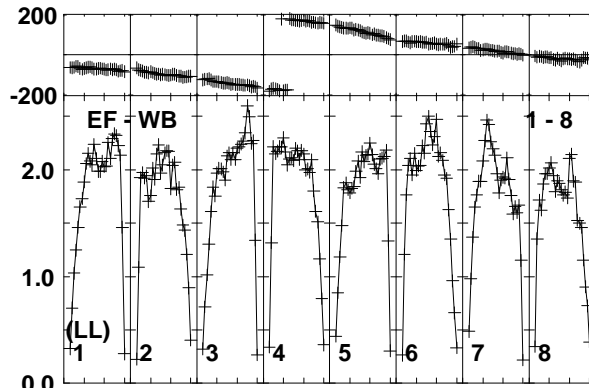
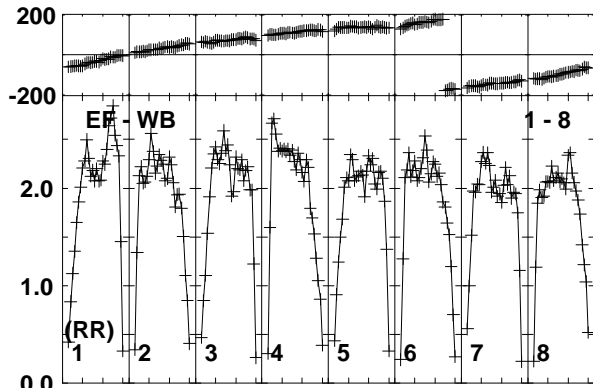
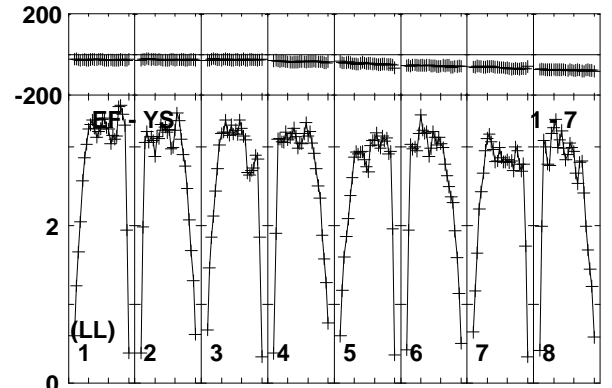
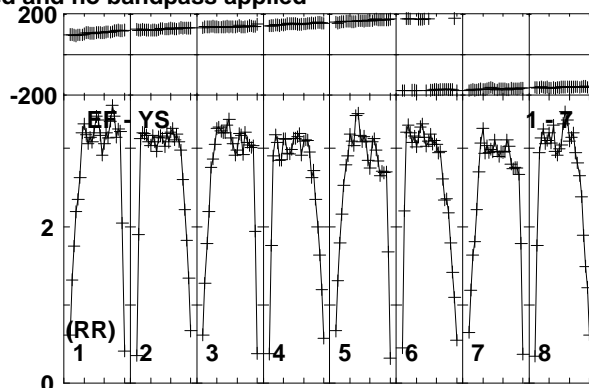
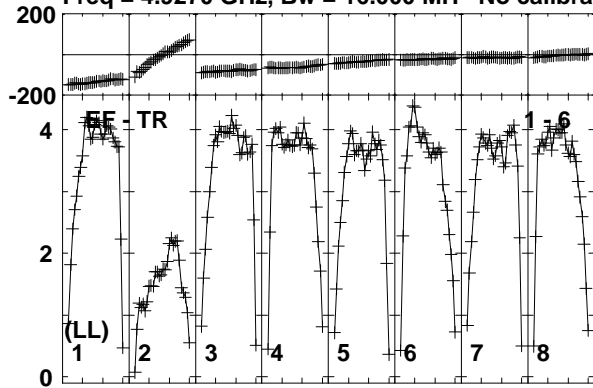

Lower frame: Milli Ampl Jy Top frame: Phas deg  
Vector averaged cross-power spectrum Baseline: EF (01) - TR (06)  
Timerange: 00/12:53:51 to 00/12:55:19

Plot file version 61 created 10-JUN-2016 15:29:21

FRB150418 RG008C.UVDATA.1

Freq = 4.9270 GHz, Bw = 16.000 MH No calibration applied and no bandpass applied

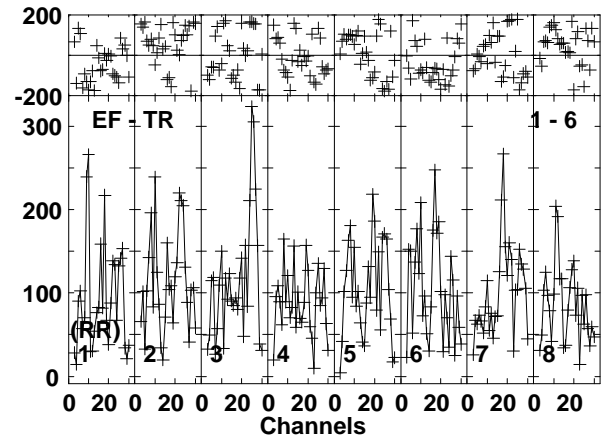
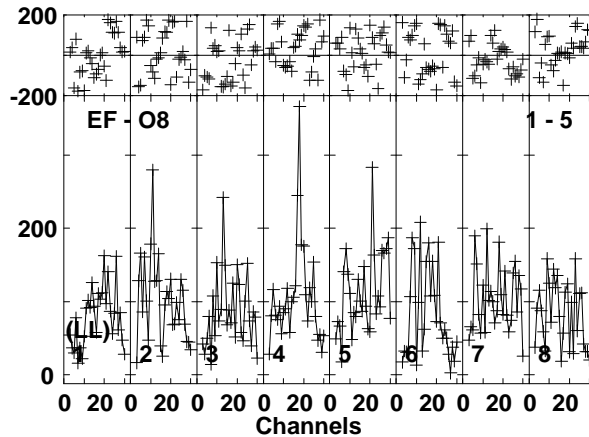
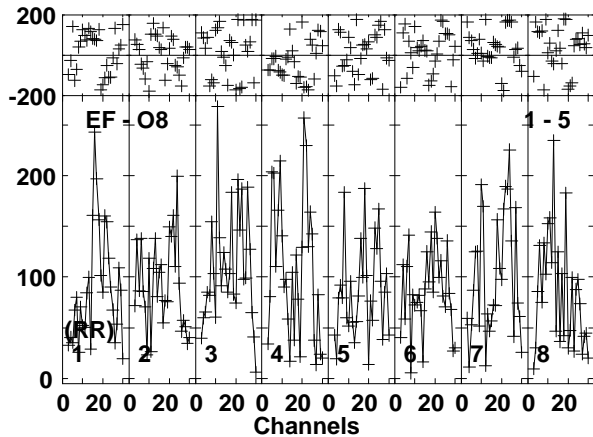
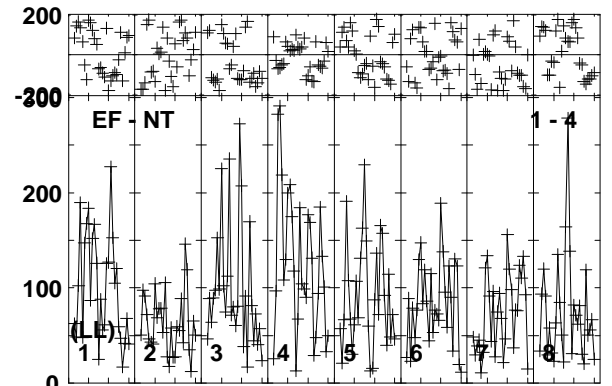
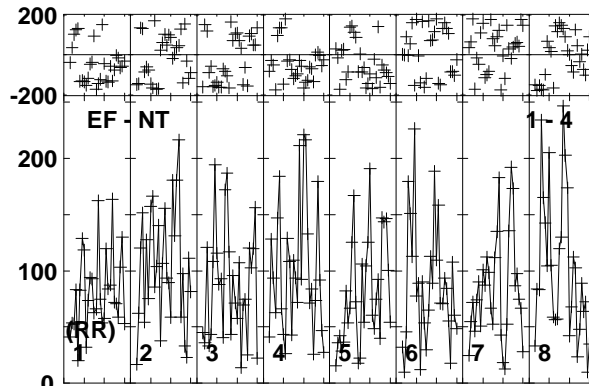
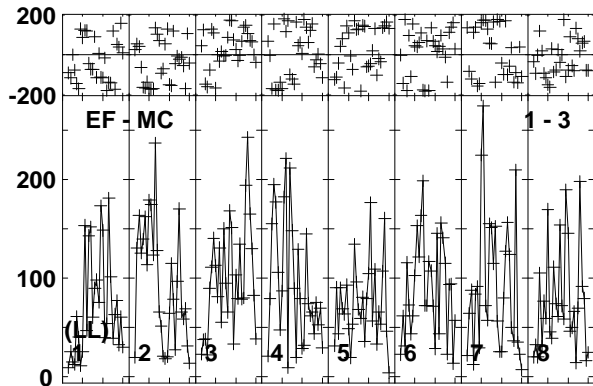
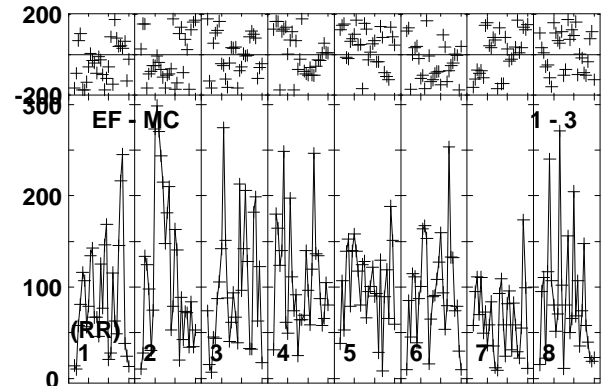
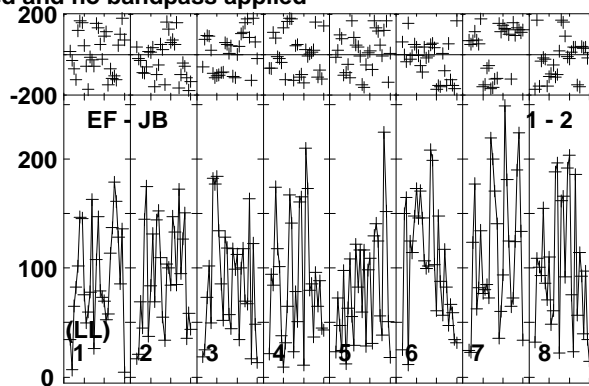
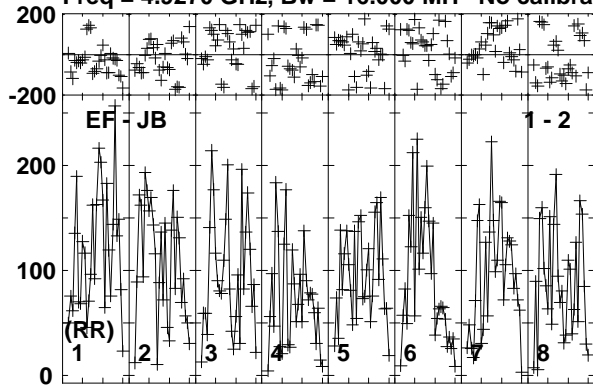

Lower frame: Micro Ampl Jy Top frame: Phas deg  
Vector averaged cross-power spectrum Baseline: EF (01) - JB (02)  
Timerange: 00/12:55:20 to 00/12:58:20

Plot file version 62 created 10-JUN-2016 15:29:21

FRB150418 RG008C.UVDATA.1

Freq = 4.9270 GHz, Bw = 16.000 MH No calibration applied and no bandpass applied

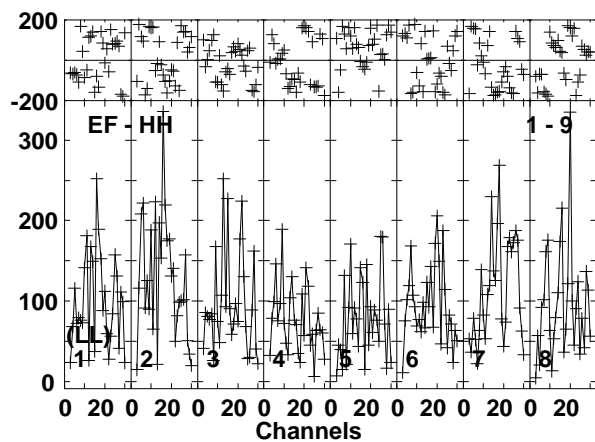
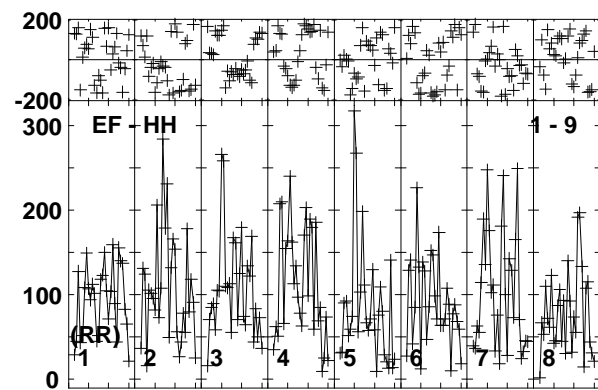
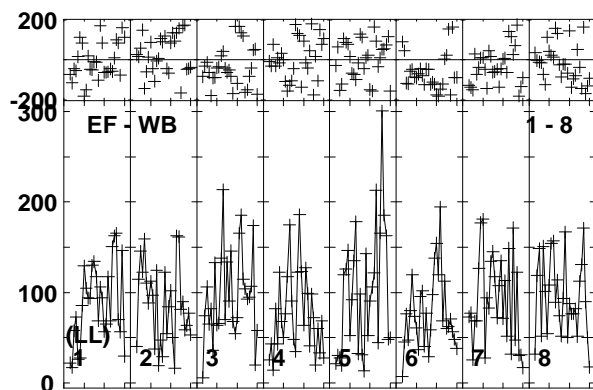
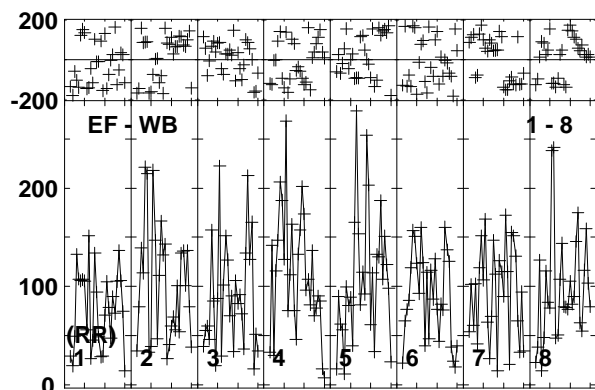
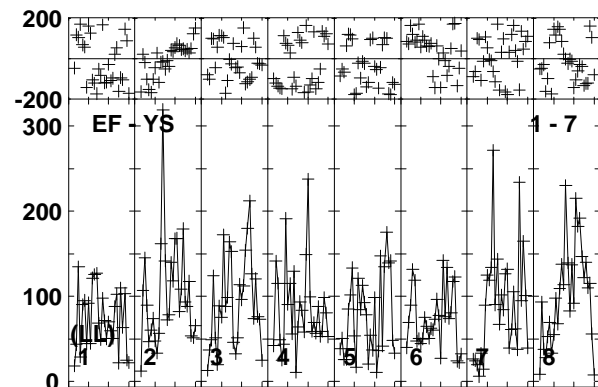
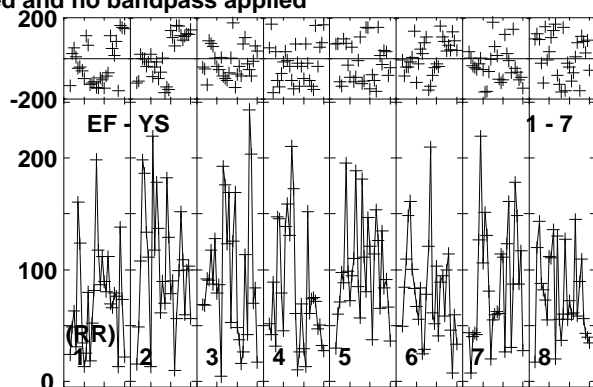
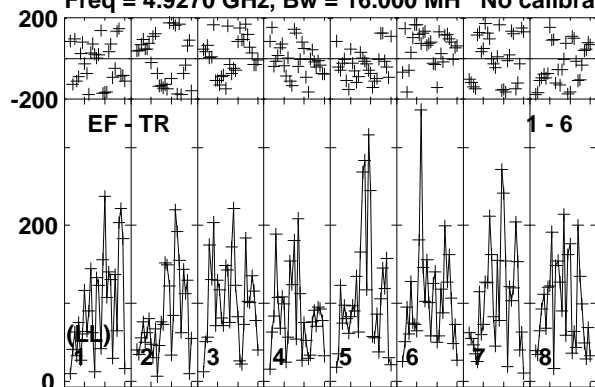

Lower frame: Micro Ampl Jy Top frame: Phas deg  
Vector averaged cross-power spectrum Baseline: EF (01) - TR (06)  
Timerange: 00/12:55:20 to 00/12:58:20

Plot file version 63 created 10-JUN-2016 15:29:21

J0718-1813 RG008C.UVDATA.1

Freq = 4.9270 GHz, Bw = 16.000 MH No calibration applied and no bandpass applied

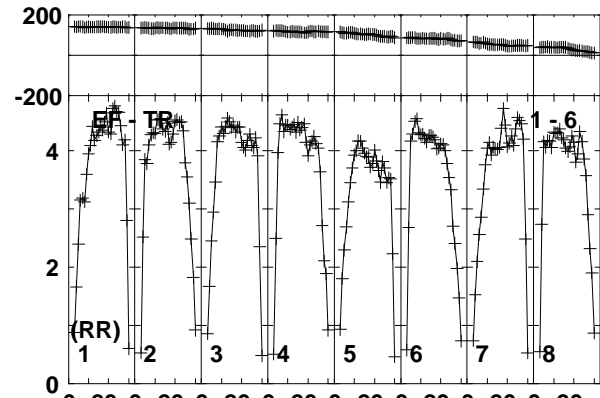
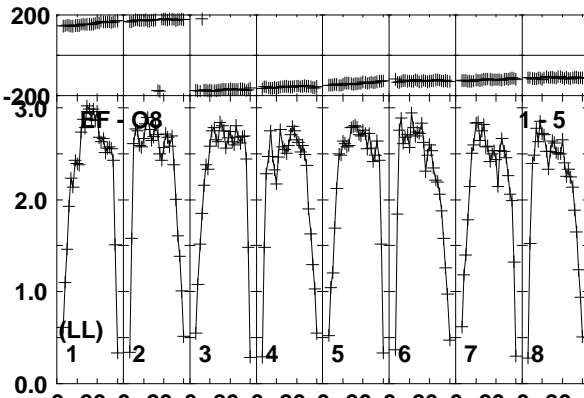
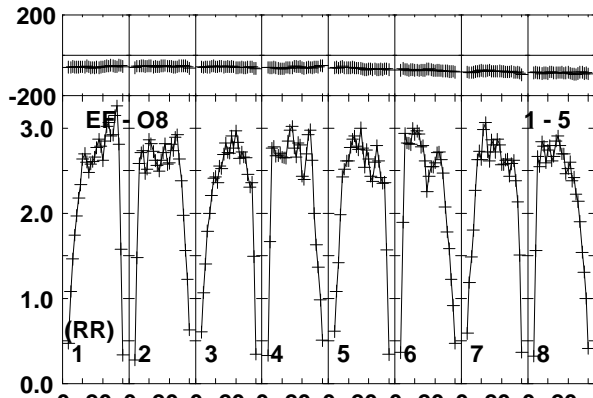
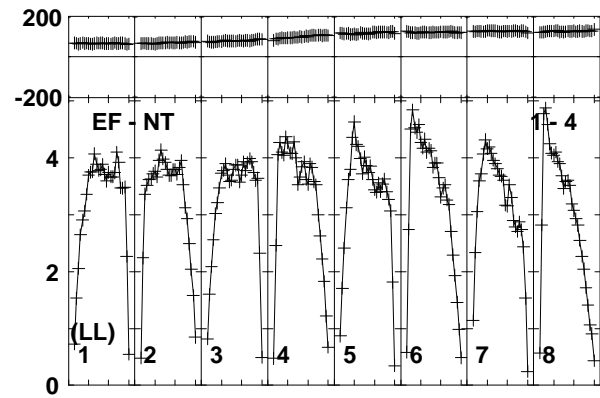
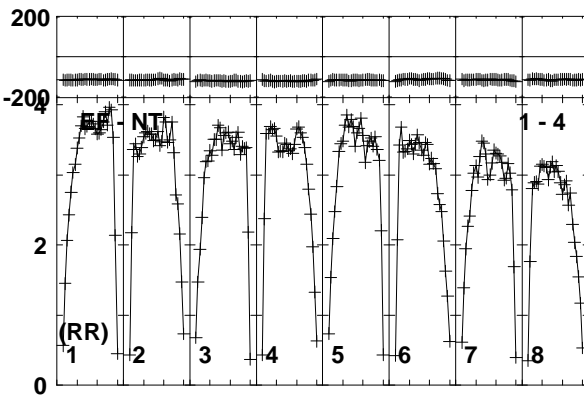
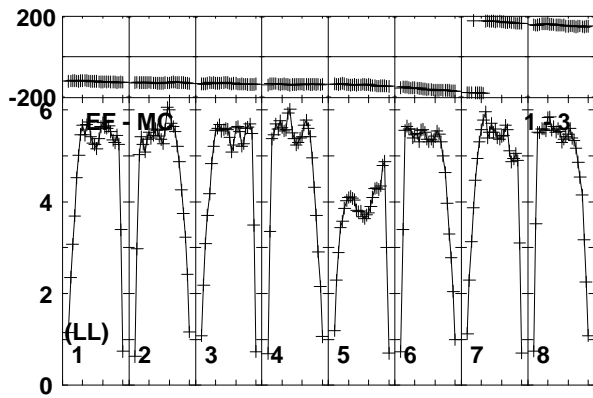
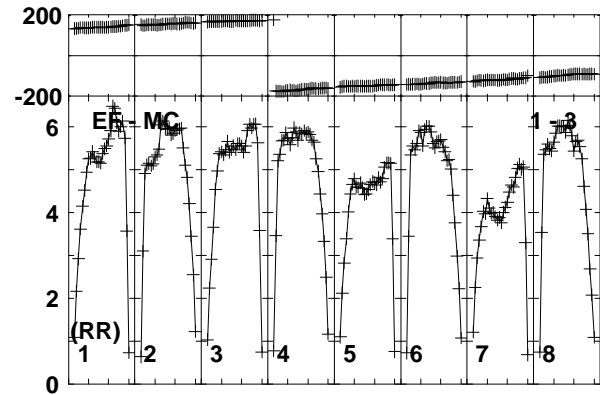
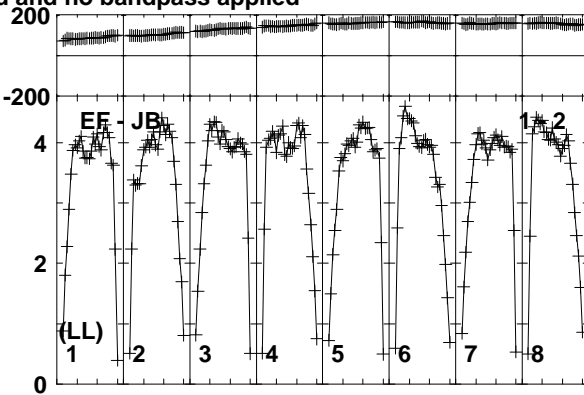
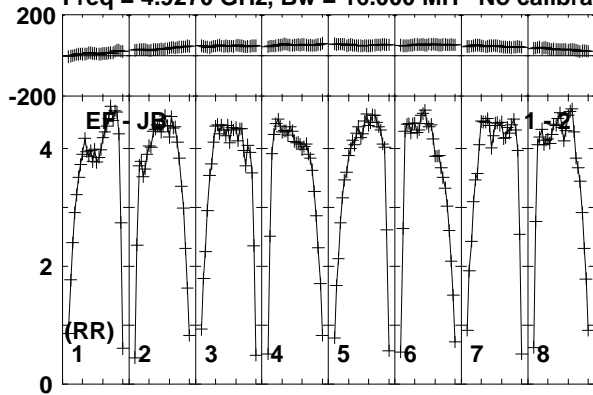

Lower frame: Milli Ampl Jy Top frame: Phas deg  
Vector averaged cross-power spectrum Baseline: EF (01) - JB (02)  
Timerange: 00:12:59:00 to 00:12:59:50

Plot file version 64 created 10-JUN-2016 15:29:21

J0718-1813 RG008C.UVDATA.1

Freq = 4.9270 GHz, Bw = 16.000 MH No calibration applied and no bandpass applied

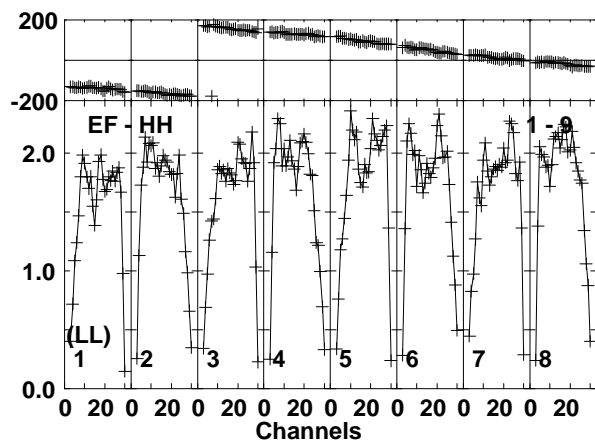
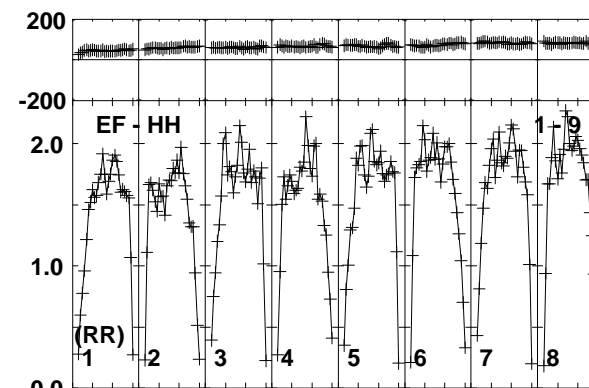
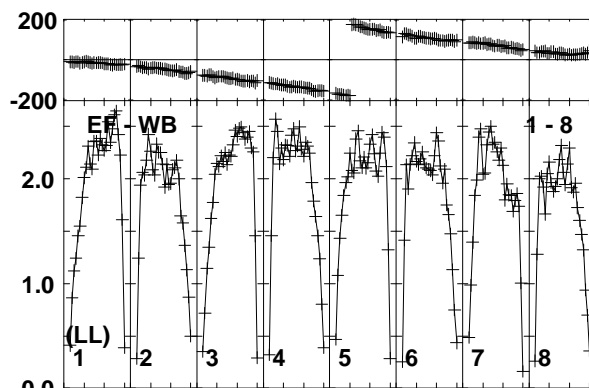
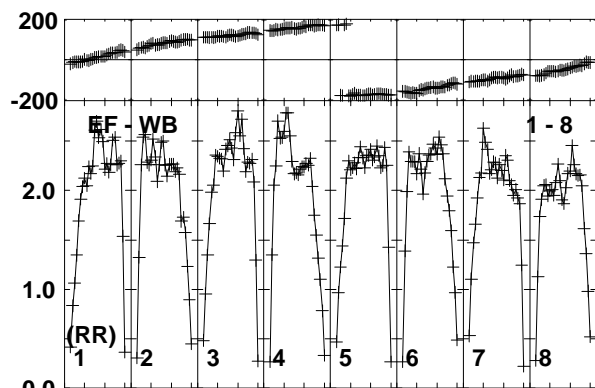
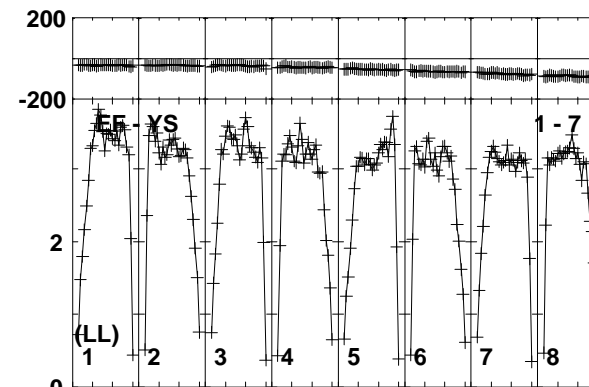
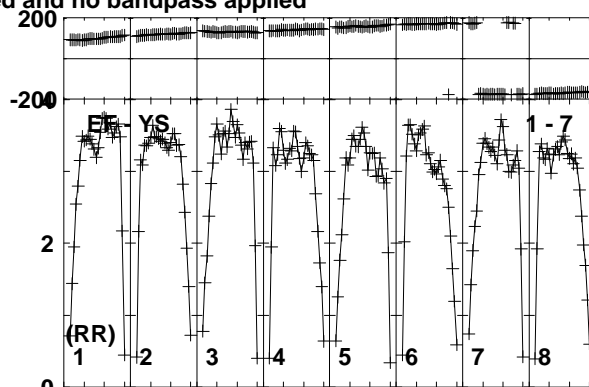
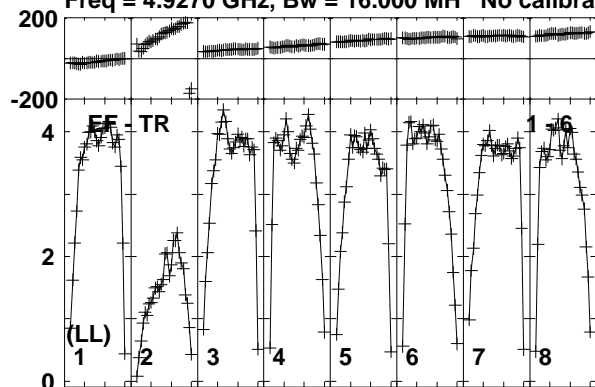

Lower frame: Milli Ampl Jy Top frame: Phas deg  
Vector averaged cross-power spectrum Baseline: EF (01) - TR (06)  
Timerange: 00:12:59:00 to 00:12:59:50



Plot file version 65 created 10-JUN-2016 15:29:22

FRB150418 RG008C.UVDATA.1

Freq = 4.9270 GHz, Bw = 16.000 MH No calibration applied and no bandpass applied

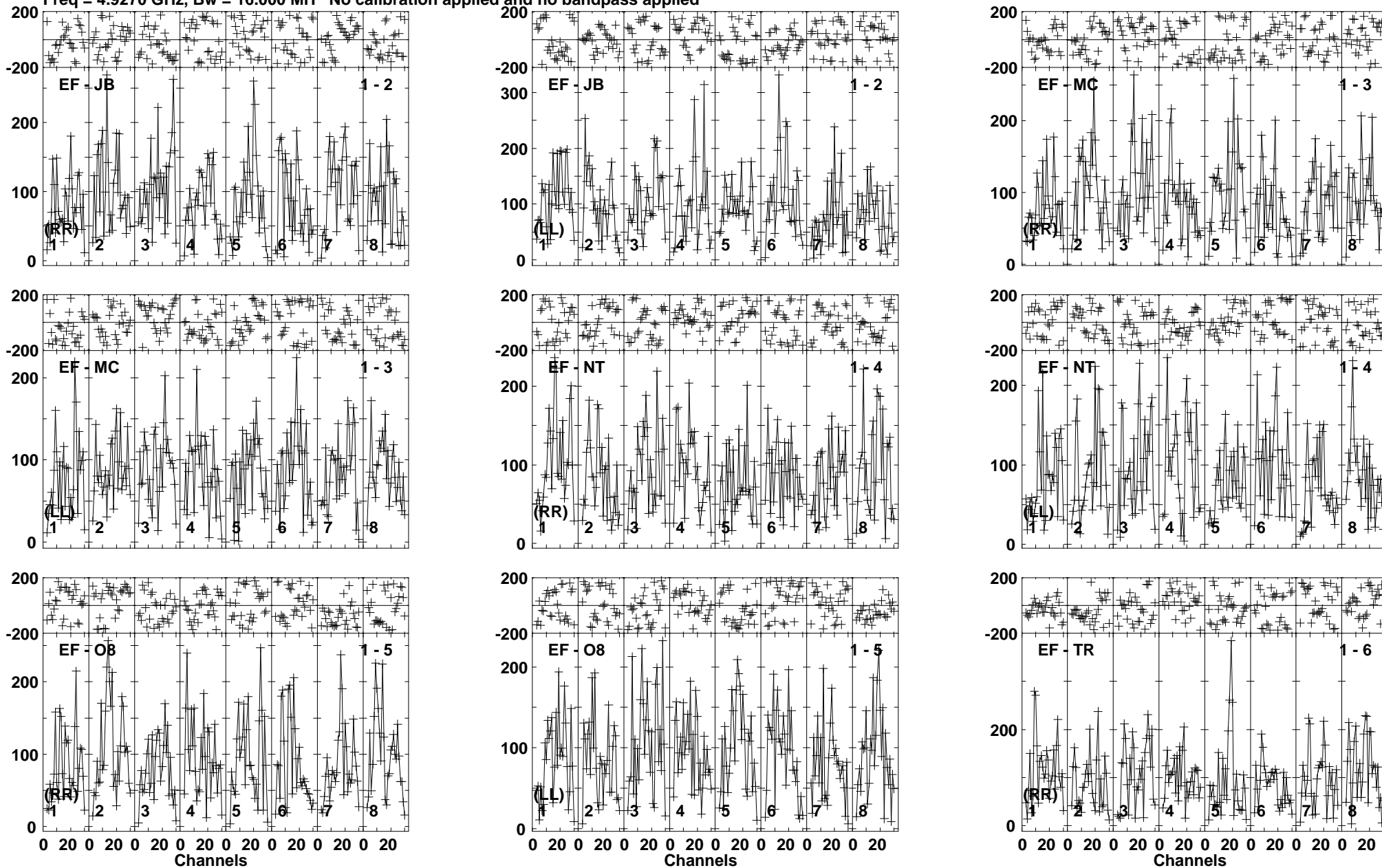

Lower frame: Micro Ampl Jy Top frame: Phas deg  
Vector averaged cross-power spectrum Baseline: EF (01) - JB (02)  
Timerange: 00/12:59:51 to 00/13:02:49

Plot file version 66 created 10-JUN-2016 15:29:22

FRB150418 RG008C.UVDATA.1

Freq = 4.9270 GHz, Bw = 16.000 MH No calibration applied and no bandpass applied

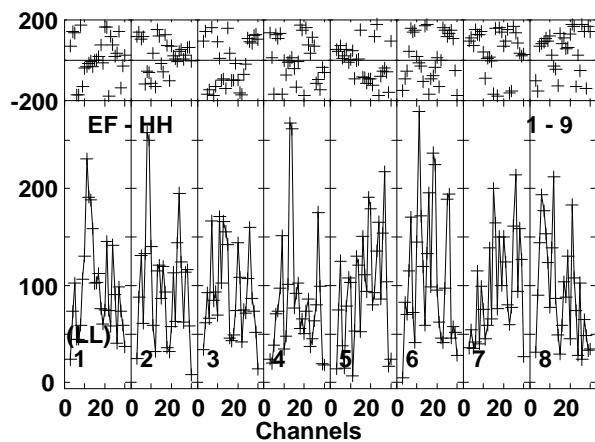
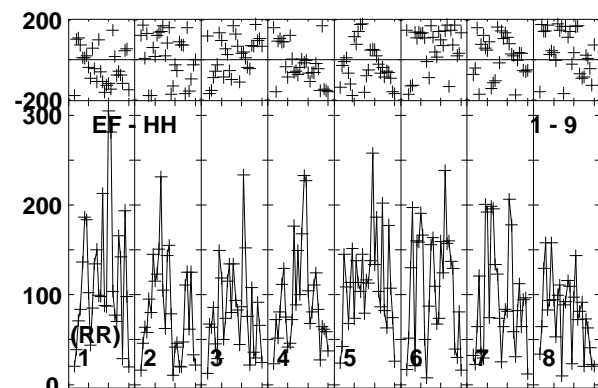
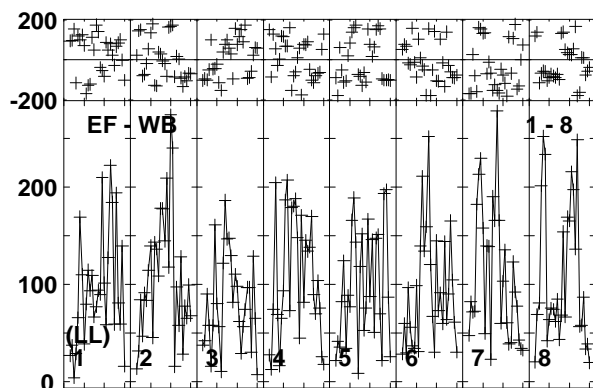
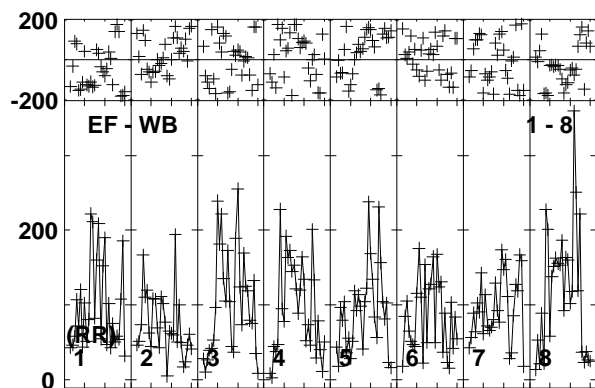
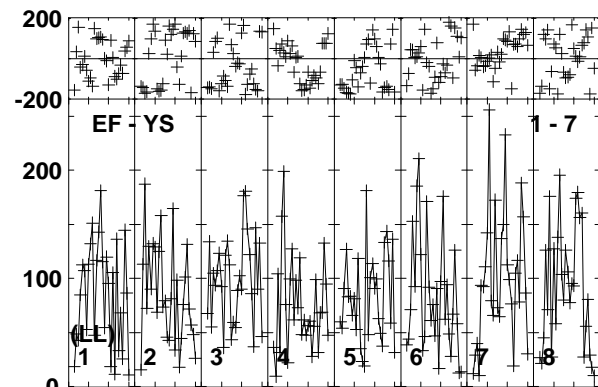
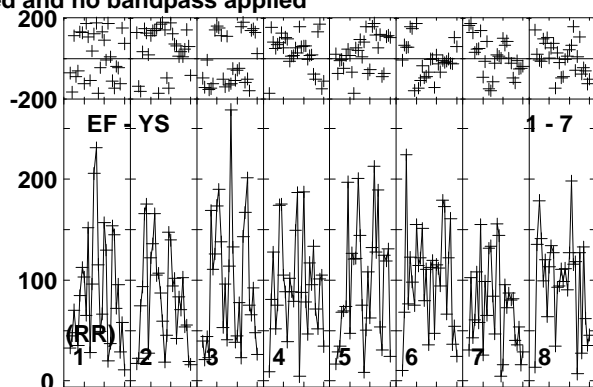
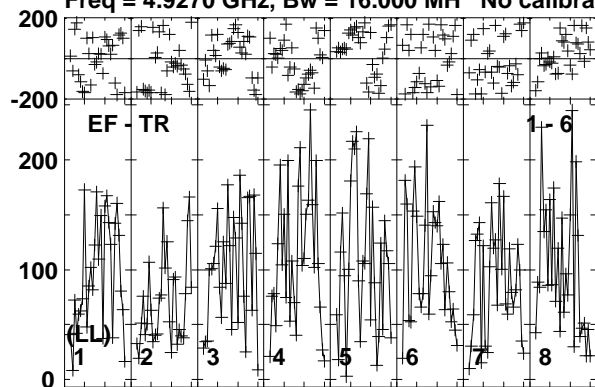

Lower frame: Micro Ampl Jy Top frame: Phas deg  
Vector averaged cross-power spectrum Baseline: EF (01) - TR (06)  
Timerange: 00/12:59:51 to 00/13:02:49

Plot file version 67 created 10-JUN-2016 15:29:22

J0718-1813 RG008C.UVDATA.1

Freq = 4.9270 GHz, Bw = 16.000 MH No calibration applied and no bandpass applied

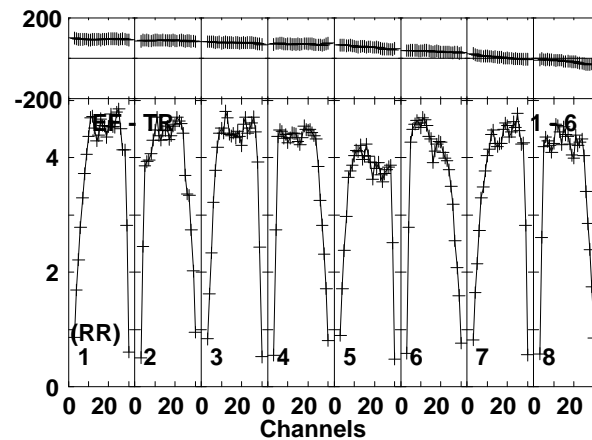
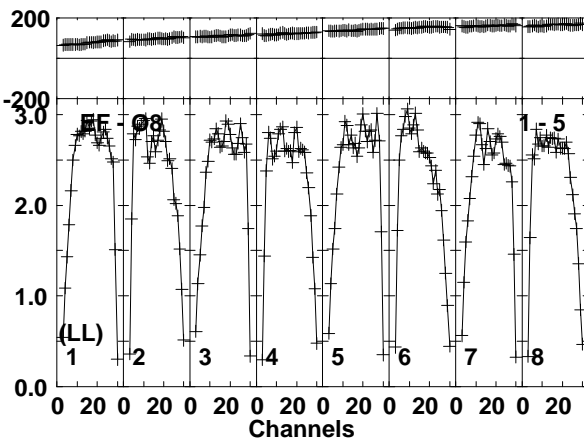
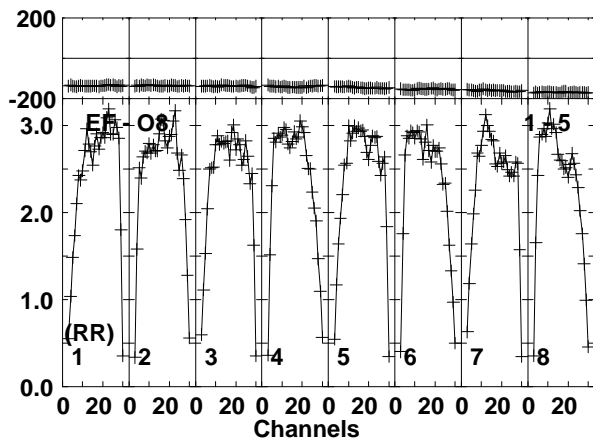
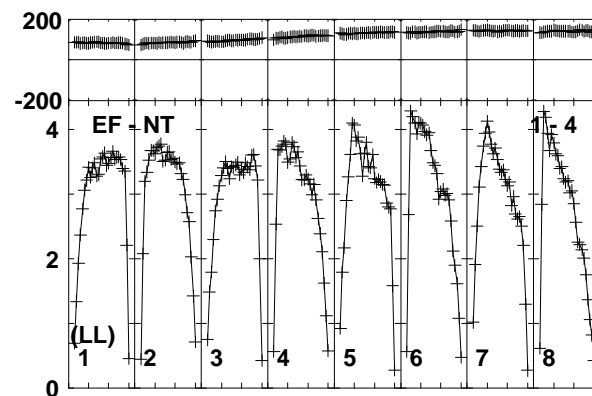
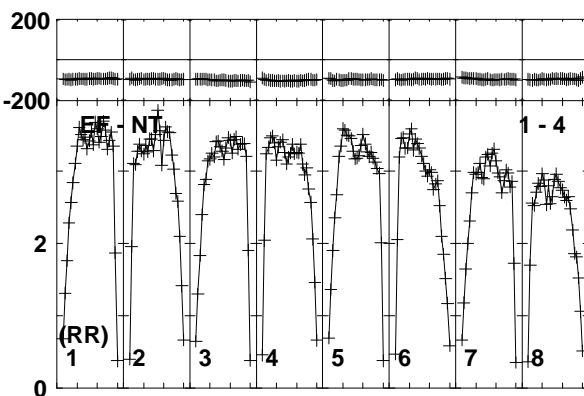
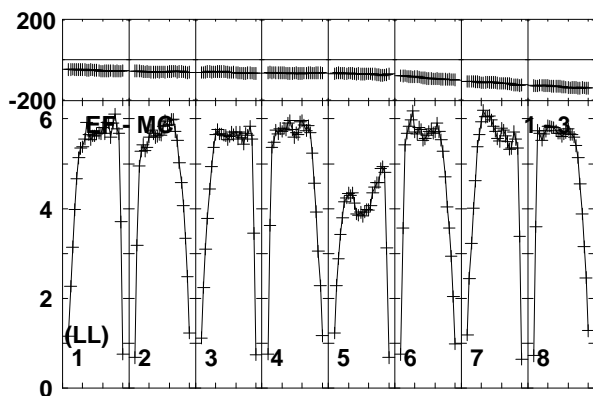
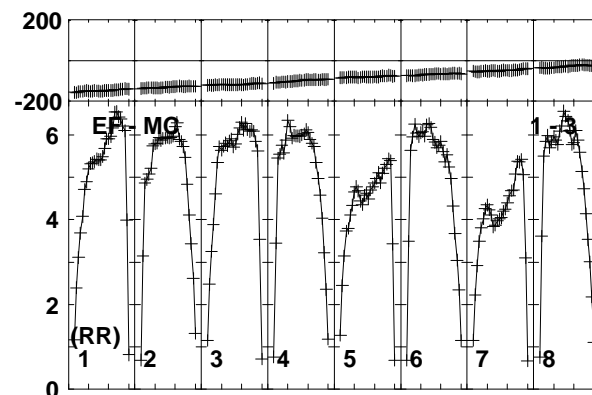
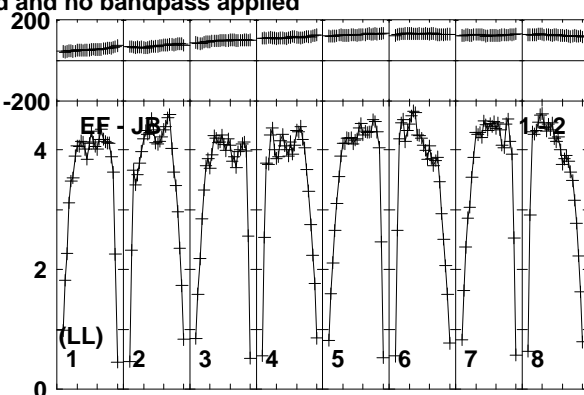
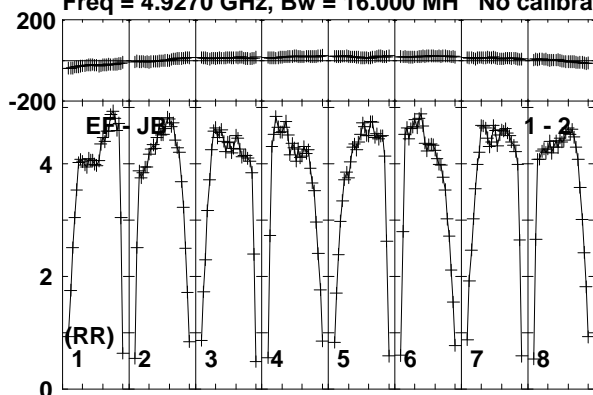

Lower frame: Milli Ampl Jy Top frame: Phas deg  
Vector averaged cross-power spectrum Baseline: EF (01) - JB (02)  
Timerange: 00/13:02:50 to 00/13:04:20

Plot file version 68 created 10-JUN-2016 15:29:22

J0718-1813 RG008C.UVDATA.1

Freq = 4.9270 GHz, Bw = 16.000 MH No calibration applied and no bandpass applied

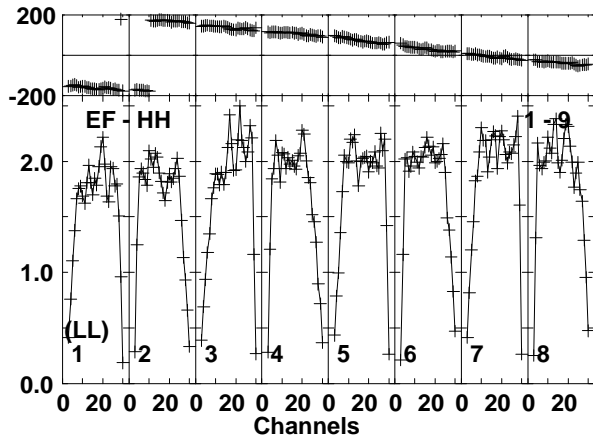
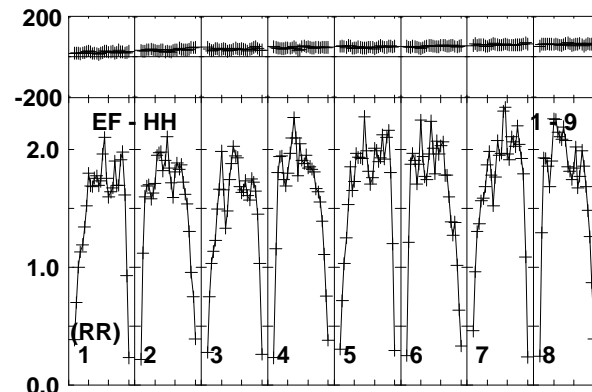
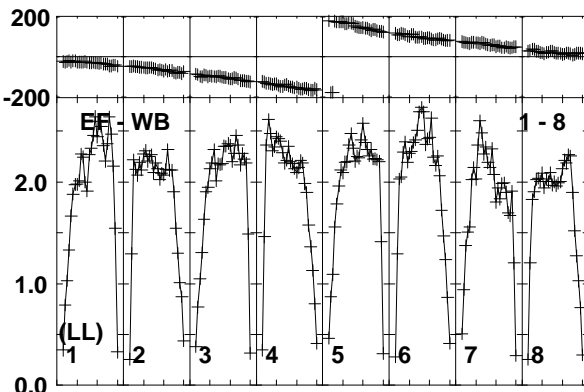
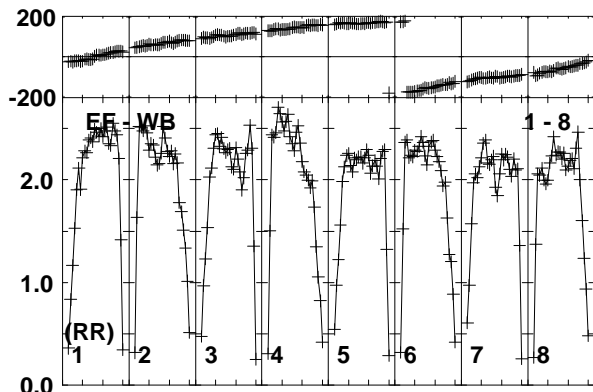
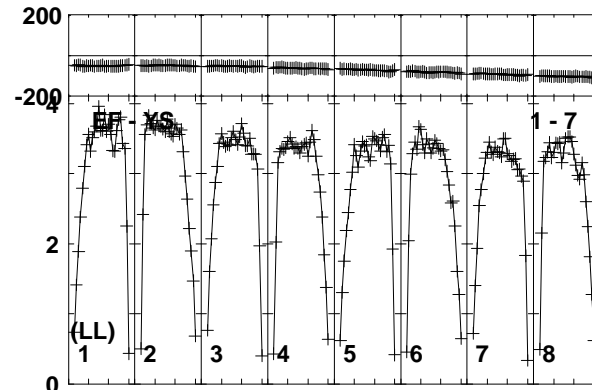
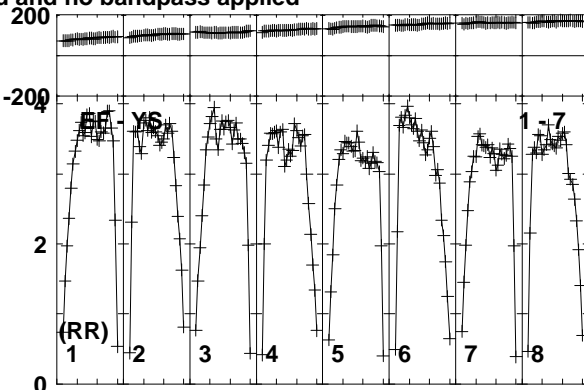
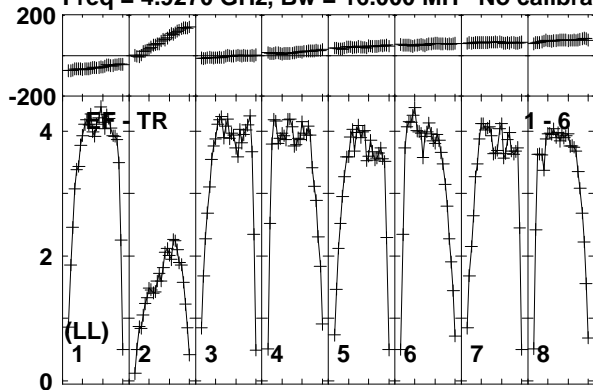

Lower frame: Milli Ampl Jy Top frame: Phas deg  
Vector averaged cross-power spectrum Baseline: EF (01) - TR (06)  
Timerange: 00/13:02:50 to 00/13:04:20

Plot file version 69 created 10-JUN-2016 15:29:22

J0712-1847 RG008C.UVDATA.1

Freq = 4.9270 GHz, Bw = 16.000 MH No calibration applied and no bandpass applied

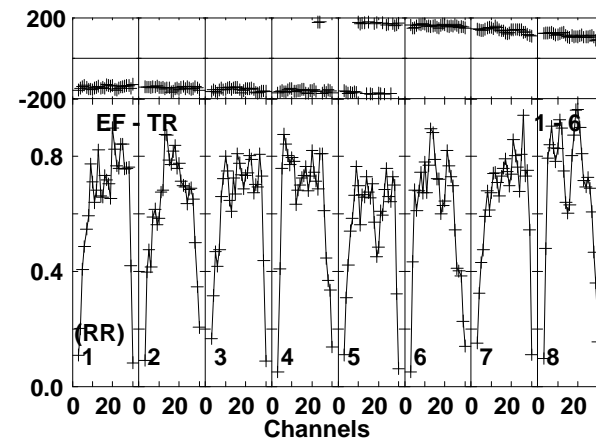
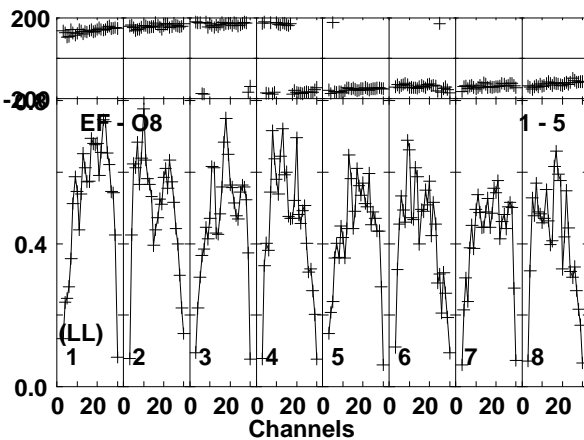
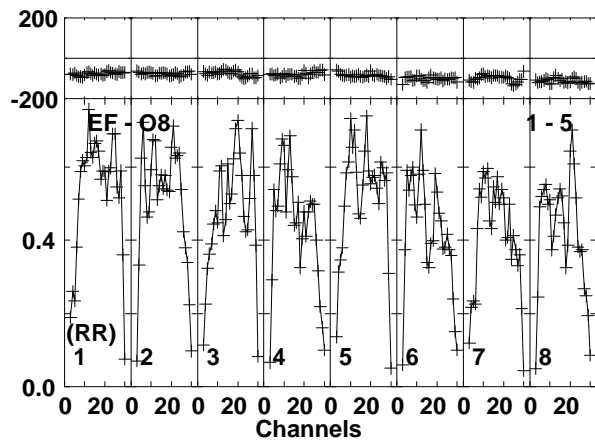
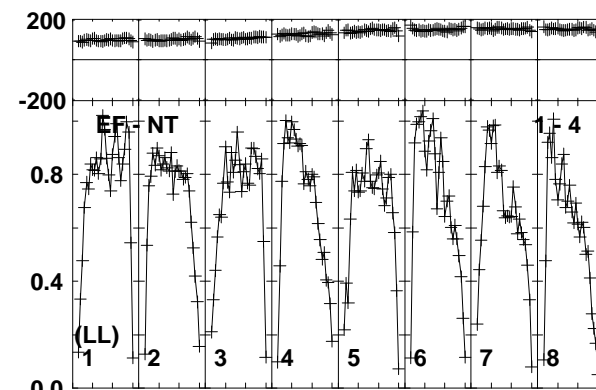
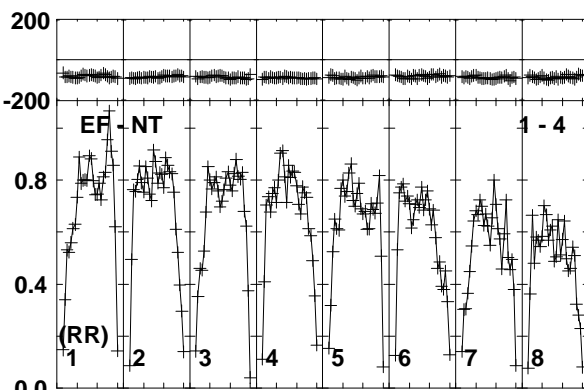
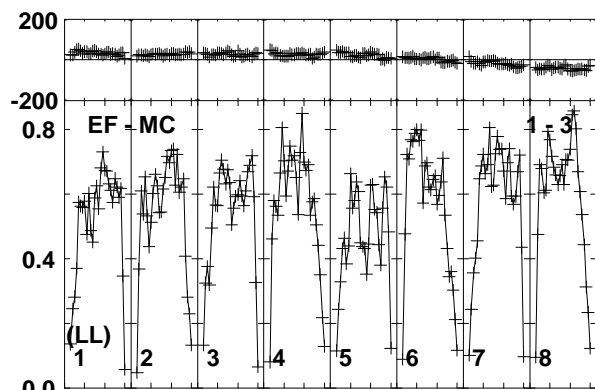
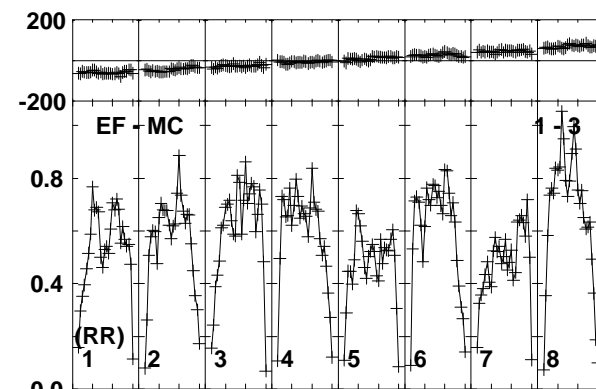
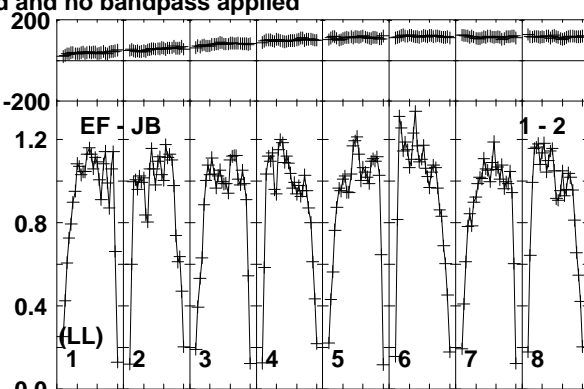
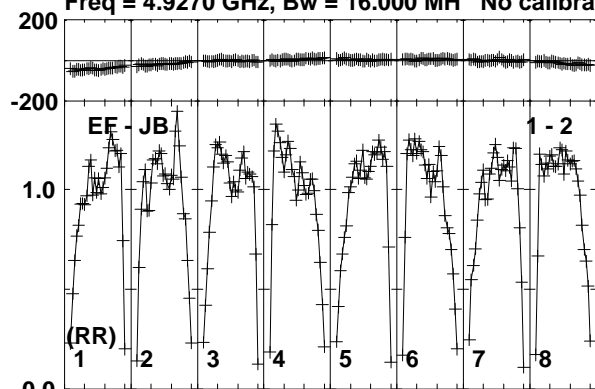

Lower frame: Milli Ampl Jy Top frame: Phas deg  
Vector averaged cross-power spectrum Baseline: EF (01) - JB (02)  
Timerange: 00/13:04:20 to 00/13:07:20

Plot file version 70 created 10-JUN-2016 15:29:22

J0712-1847 RG008C.UVDATA.1

Freq = 4.9270 GHz, Bw = 16.000 MH No calibration applied and no bandpass applied

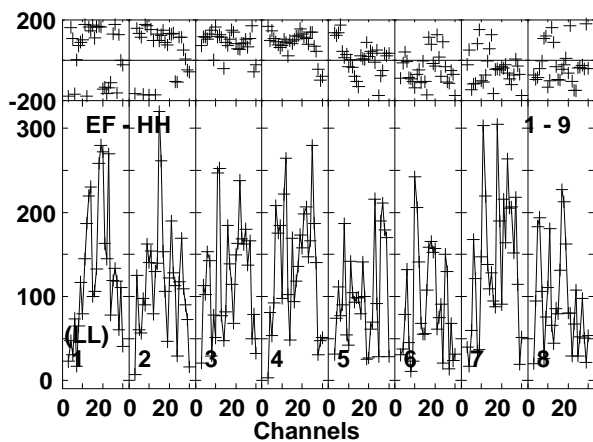
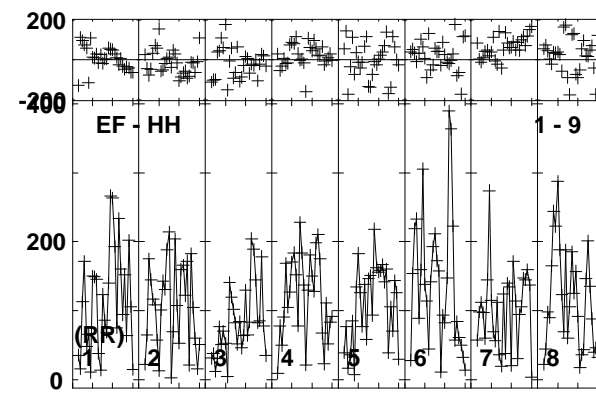
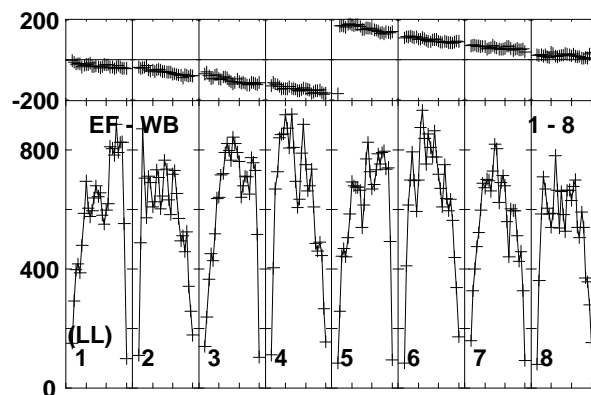
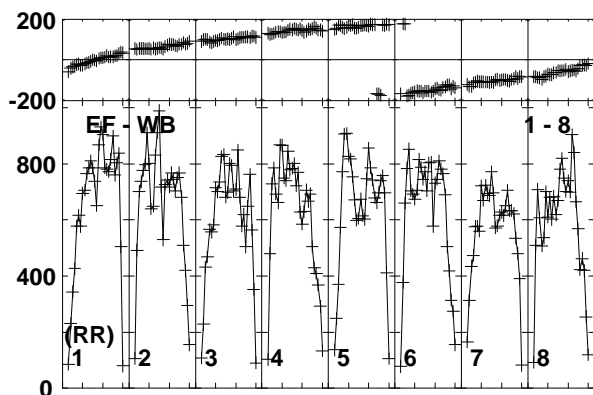
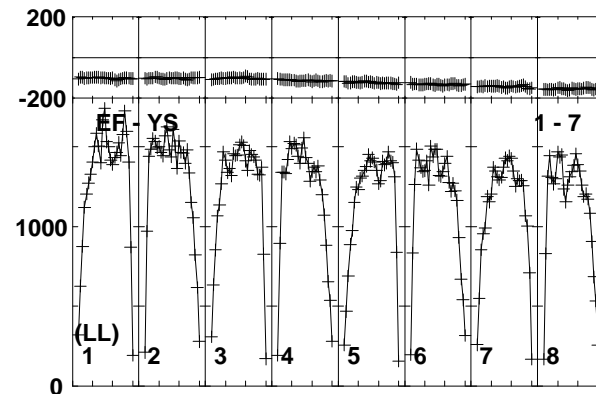
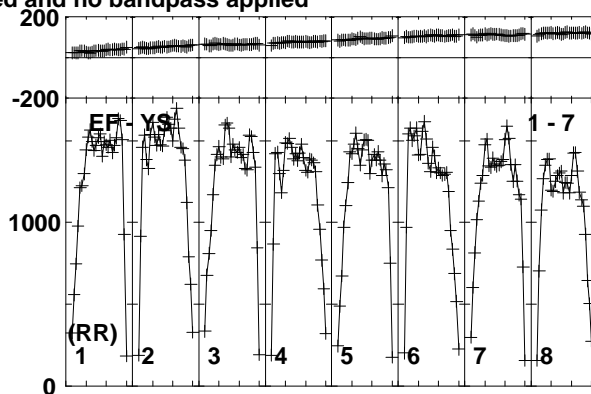
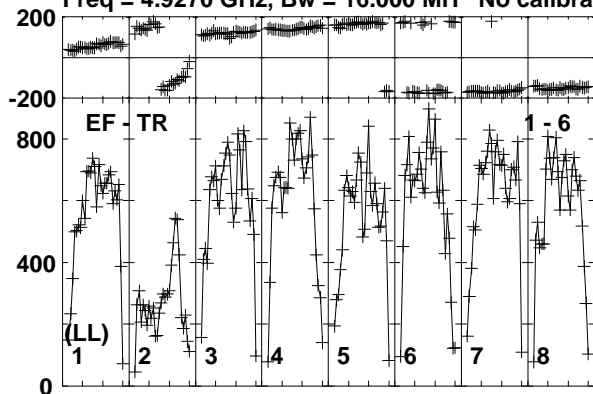

Lower frame: Micro Ampl Jy Top frame: Phas deg  
Vector averaged cross-power spectrum Baseline: EF (01) - TR (06)  
Timerange: 00/13:04:20 to 00/13:07:20

Plot file version 71 created 10-JUN-2016 15:29:22

J0718-1813 RG008C.UVDATA.1

Freq = 4.9270 GHz, Bw = 16.000 MH No calibration applied and no bandpass applied

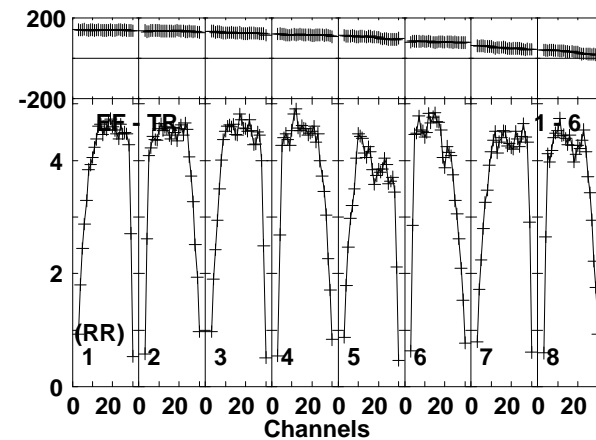
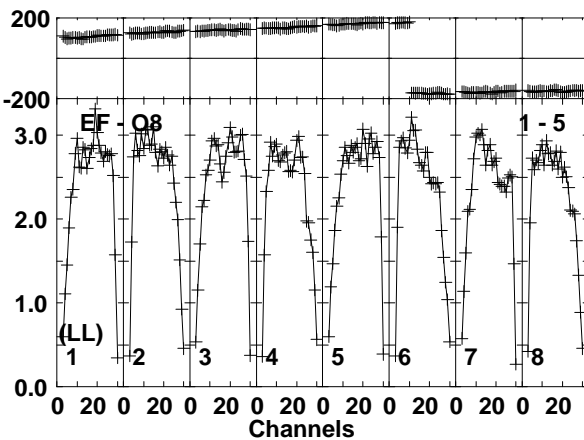
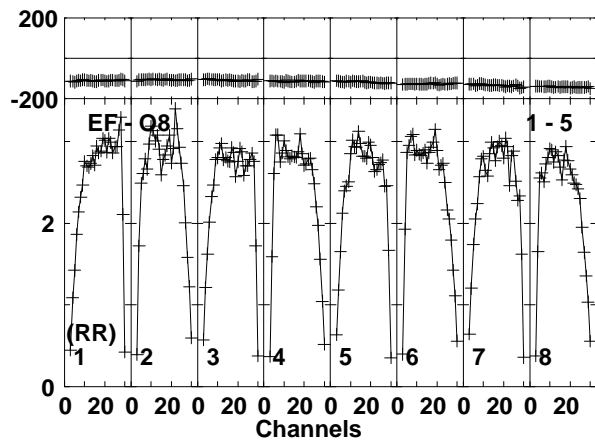
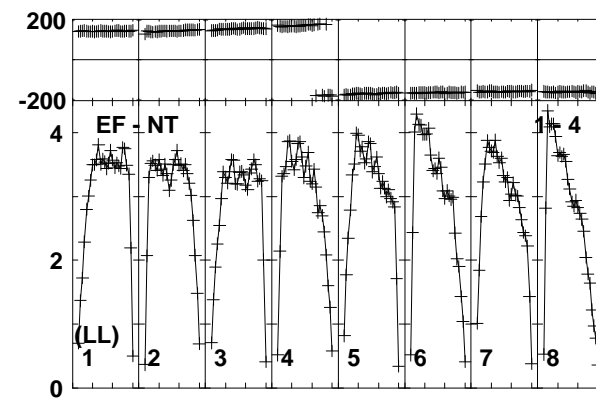
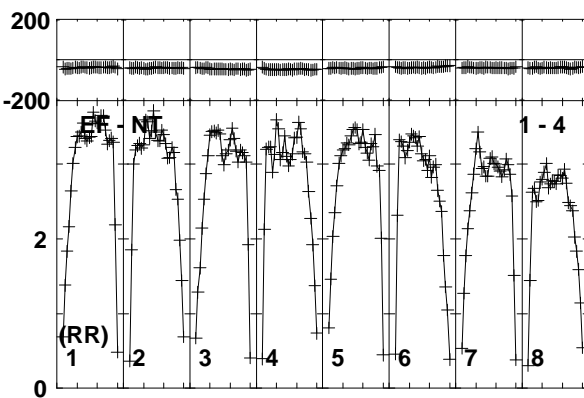
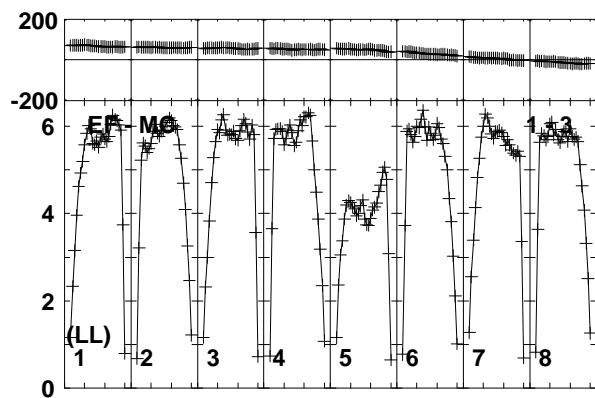
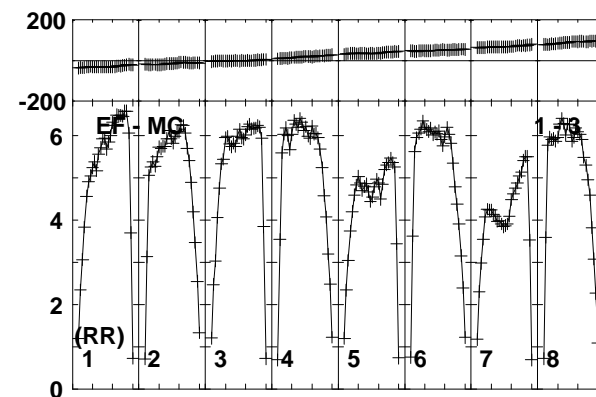
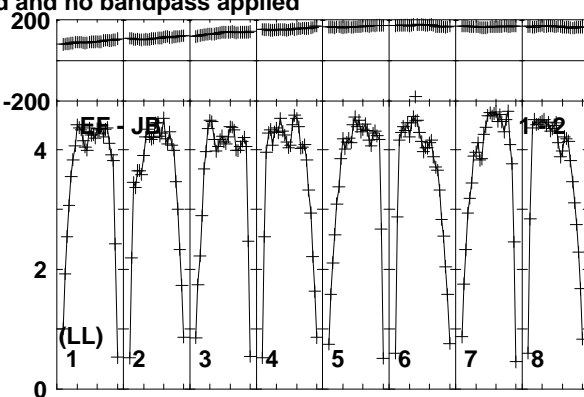
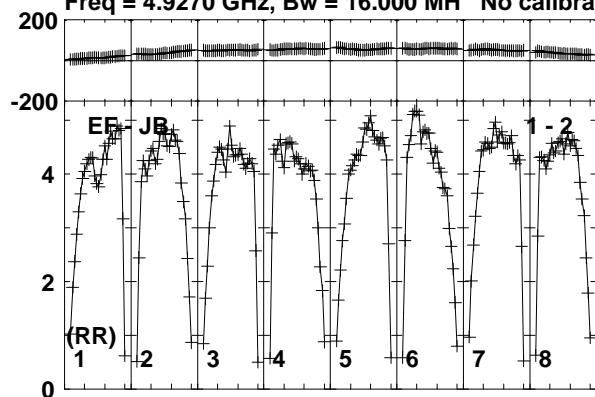

Lower frame: Milli Ampl Jy Top frame: Phas deg  
Vector averaged cross-power spectrum Baseline: EF (01) - JB (02)  
Timerange: 00/13:08:01 to 00/13:08:49

Plot file version 72 created 10-JUN-2016 15:29:22

J0718-1813 RG008C.UVDATA.1

Freq = 4.9270 GHz, Bw = 16.000 MH No calibration applied and no bandpass applied

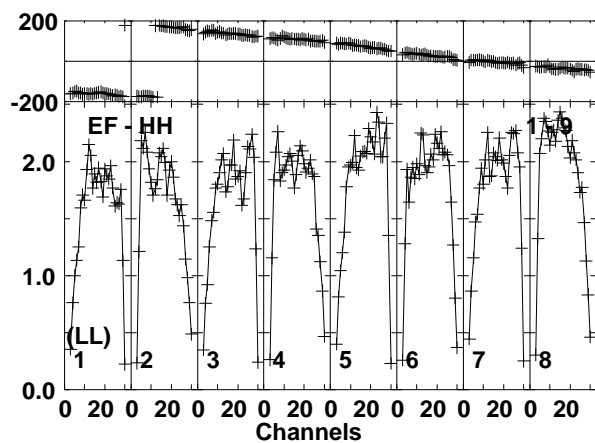
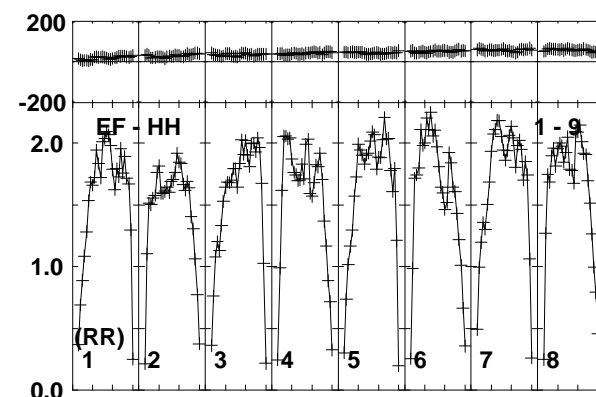
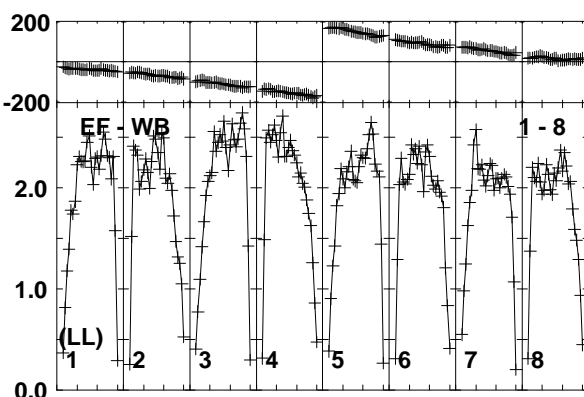
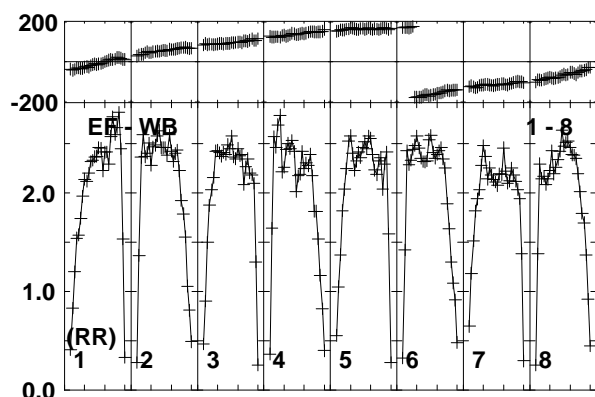
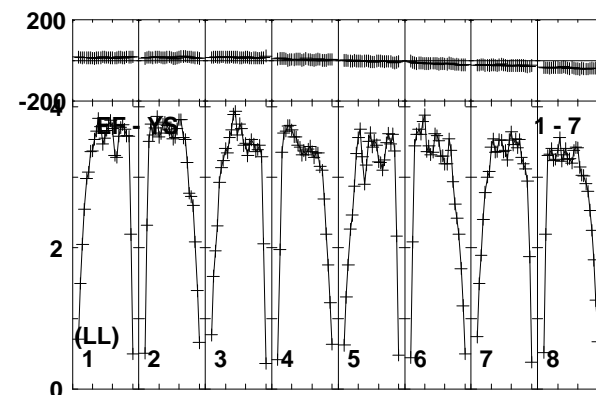
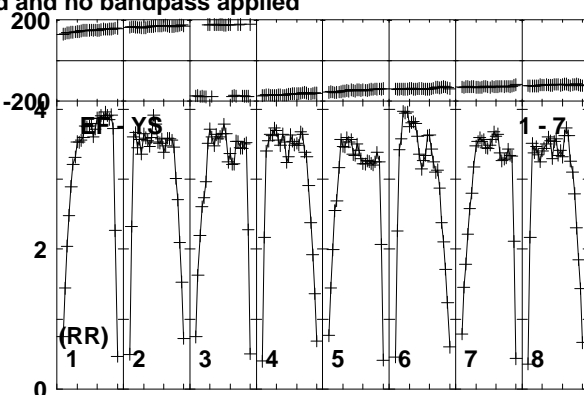
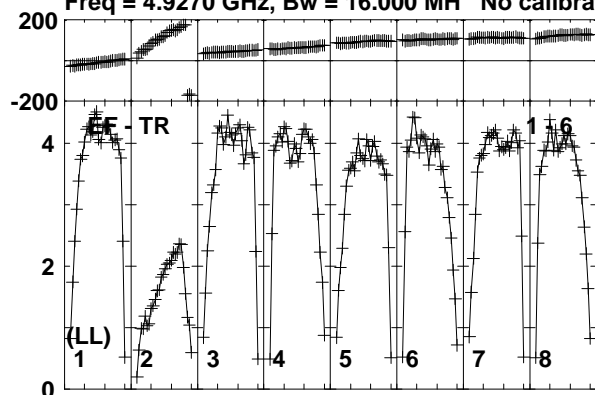

Lower frame: Milli Ampl Jy Top frame: Phas deg  
Vector averaged cross-power spectrum Baseline: EF (01) - TR (06)  
Timerange: 00/13:08:01 to 00/13:08:49



Plot file version 73 created 10-JUN-2016 15:29:23

FRB150418 RG008C.UVDATA.1

Freq = 4.9270 GHz, Bw = 16.000 MH No calibration applied and no bandpass applied

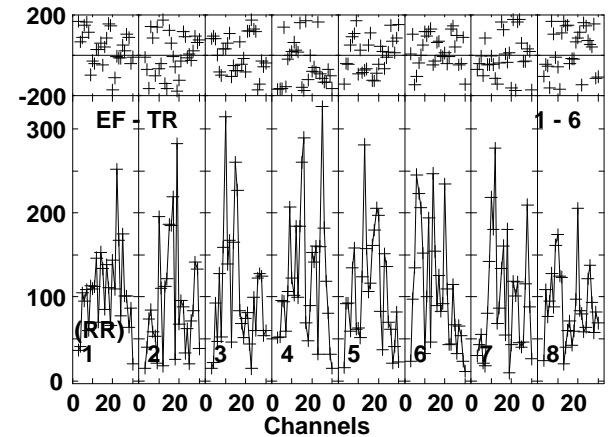
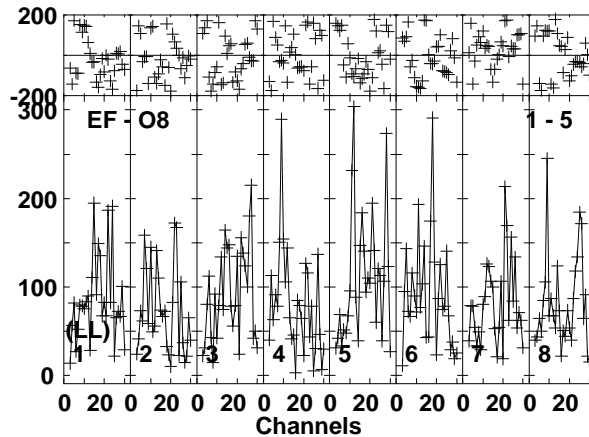
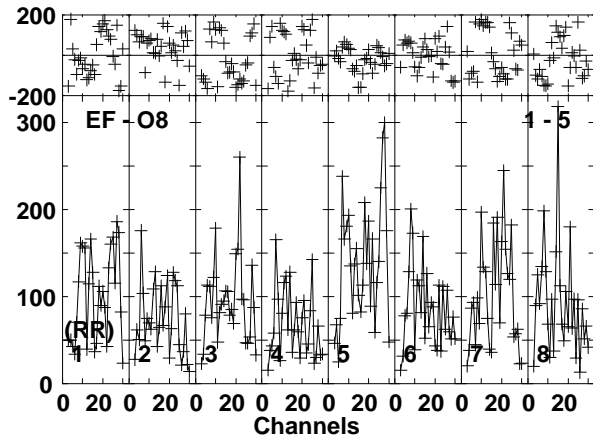
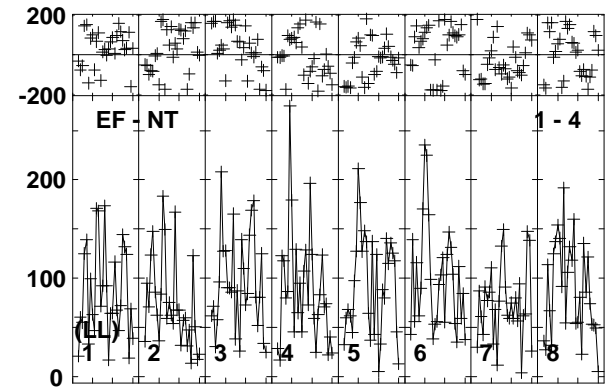
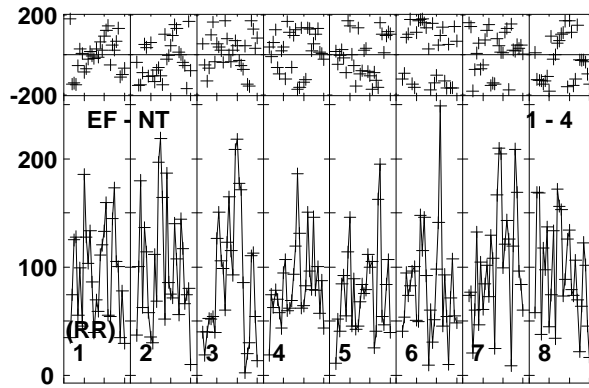
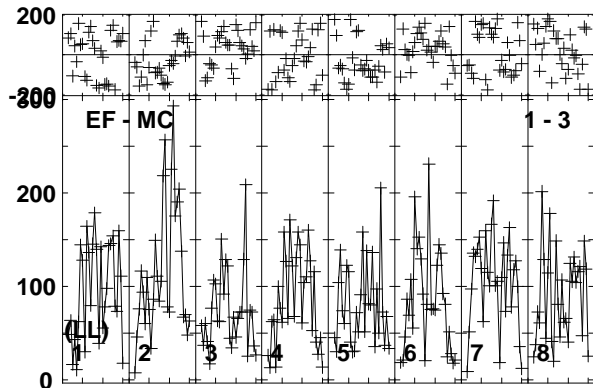
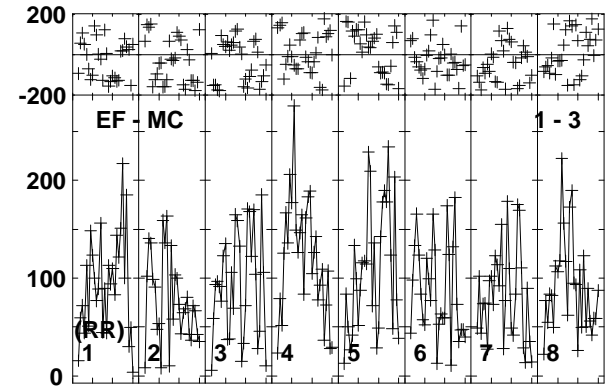
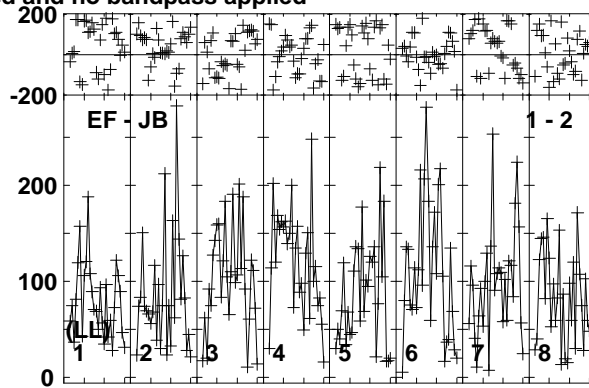
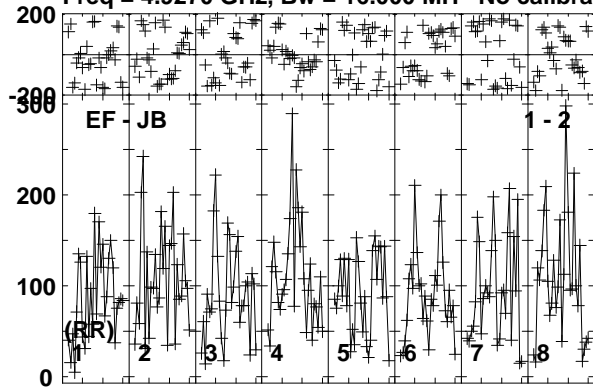

Lower frame: Micro Ampl Jy Top frame: Phas deg  
Vector averaged cross-power spectrum Baseline: EF (01) - JB (02)  
Timerange: 00/13:08:51 to 00/13:11:50

Plot file version 74 created 10-JUN-2016 15:29:23

FRB150418 RG008C.UVDATA.1

Freq = 4.9270 GHz, Bw = 16.000 MH No calibration applied and no bandpass applied

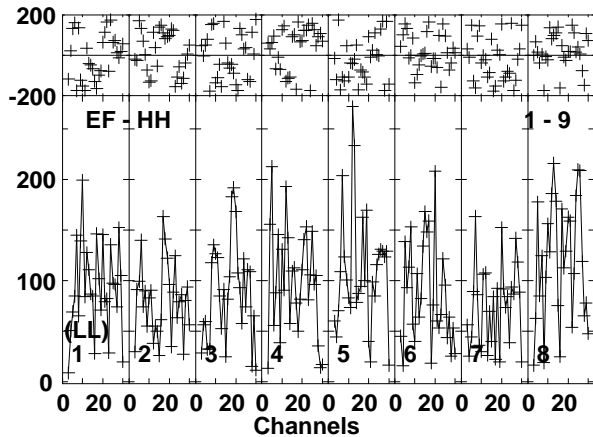
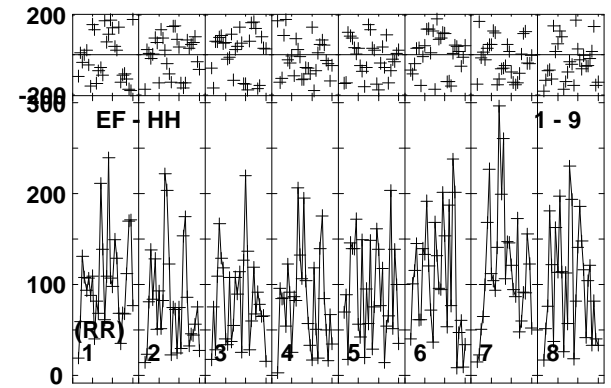
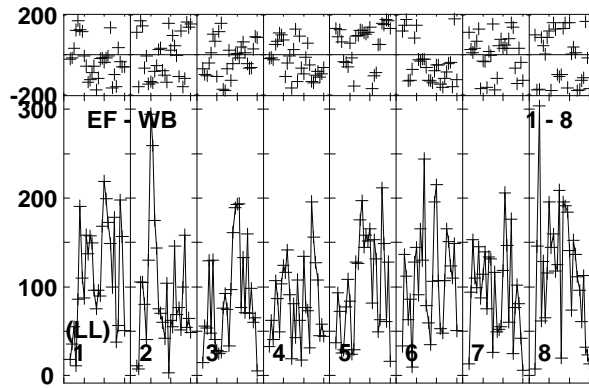
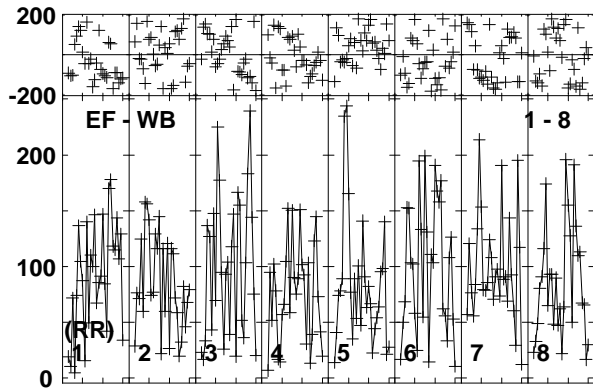
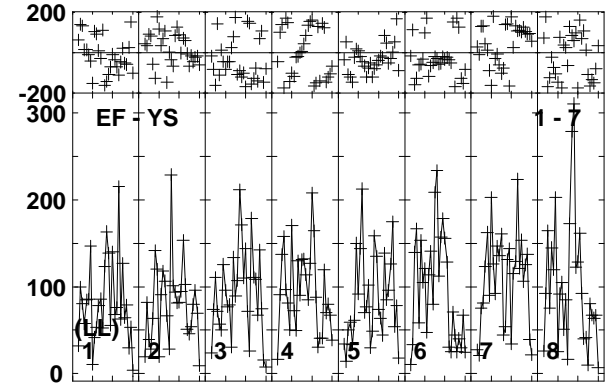
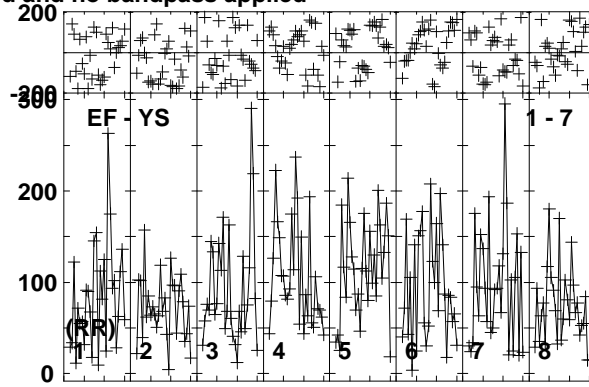
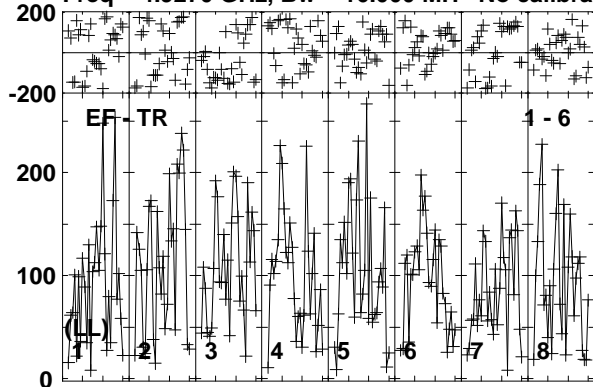

Lower frame: Micro Ampl Jy Top frame: Phas deg  
Vector averaged cross-power spectrum Baseline: EF (01) - TR (06)  
Timerange: 00/13:08:51 to 00/13:11:50

Plot file version 75 created 10-JUN-2016 15:29:23

J0718-1813 RG008C.UVDATA.1

Freq = 4.9270 GHz, Bw = 16.000 MH No calibration applied and no bandpass applied

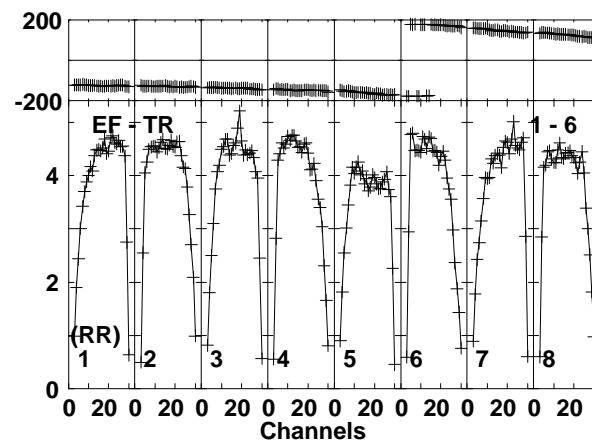
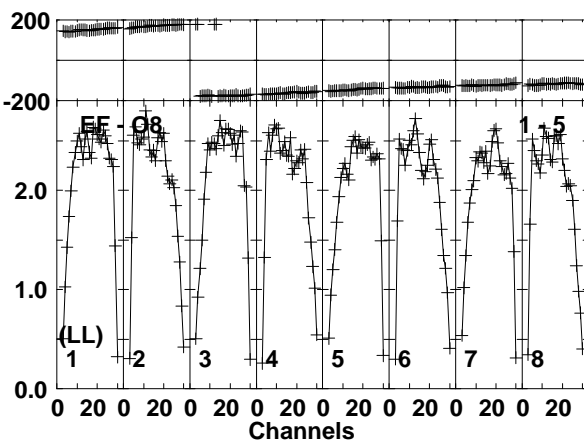
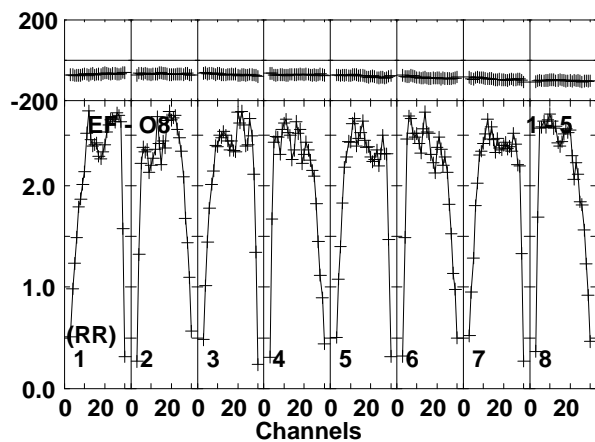
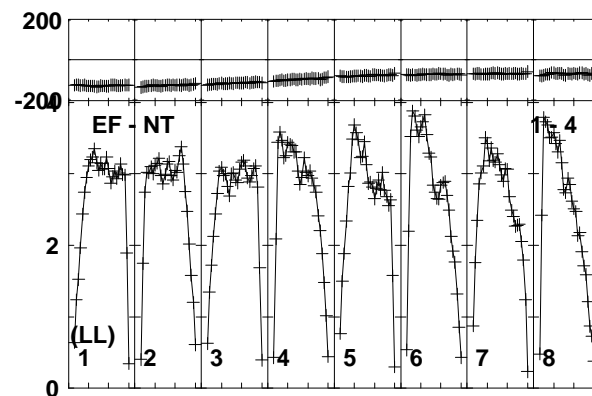
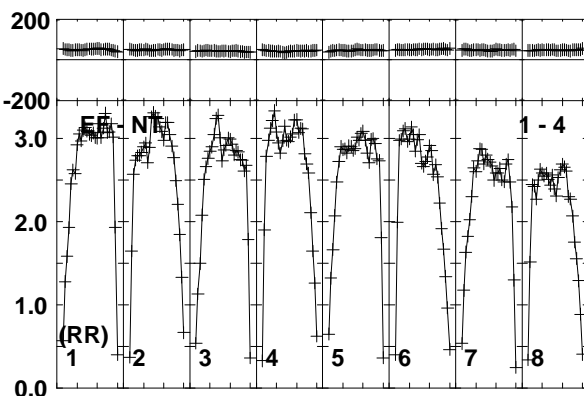
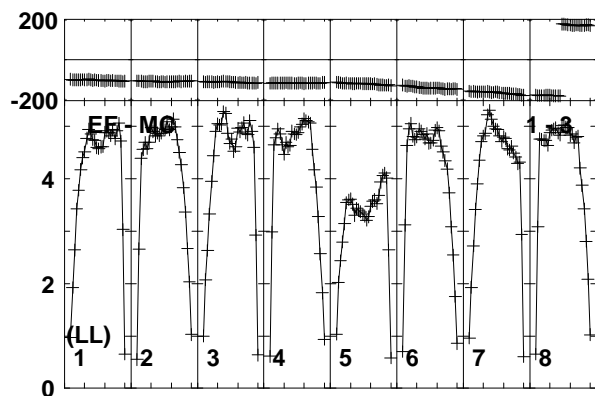
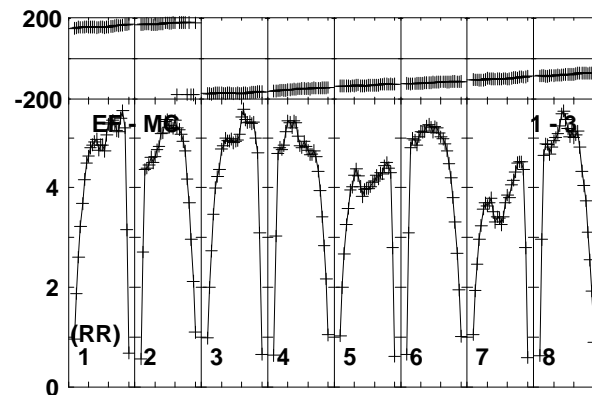
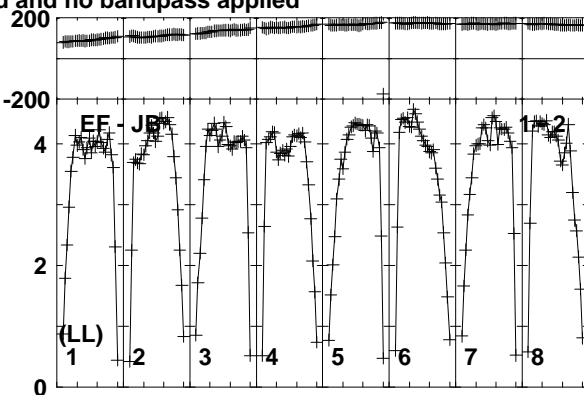
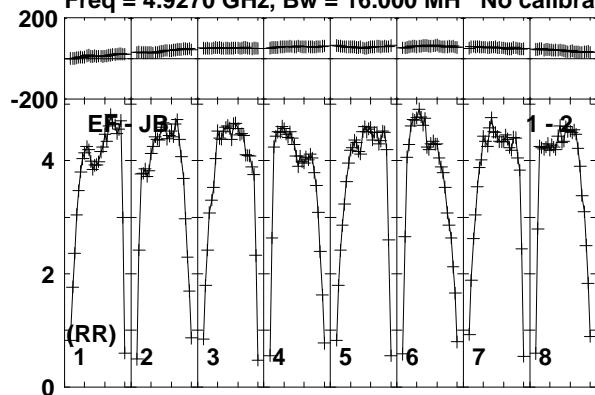

Lower frame: Milli Ampl Jy Top frame: Phas deg  
Vector averaged cross-power spectrum Baseline: EF (01) - JB (02)  
Timerange: 00/13:11:50 to 00/13:13:19

Plot file version 76 created 10-JUN-2016 15:29:23

J0718-1813 RG008C.UVDATA.1

Freq = 4.9270 GHz, Bw = 16.000 MH No calibration applied and no bandpass applied

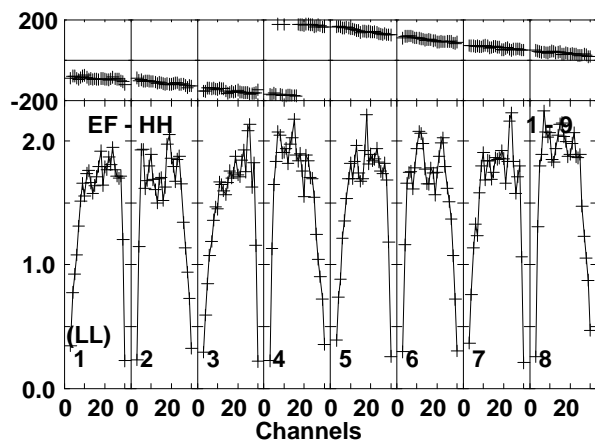
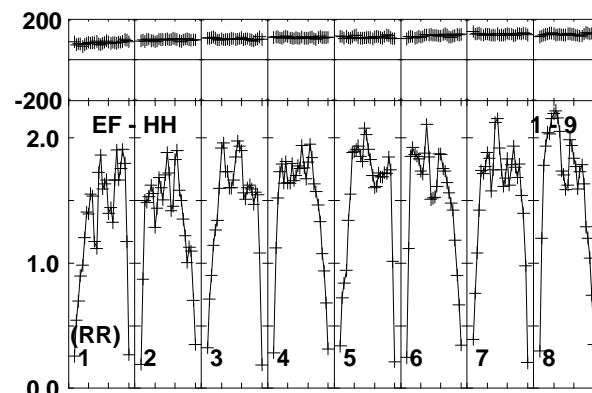
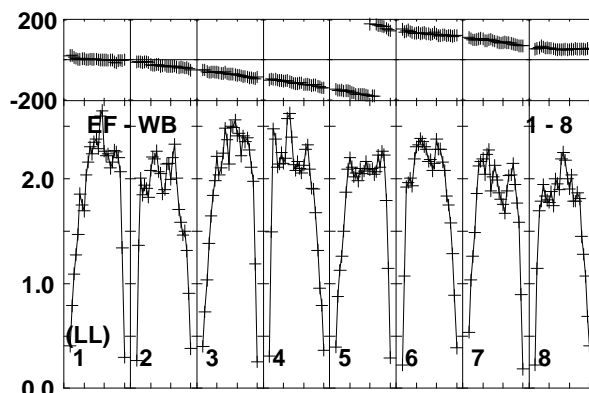
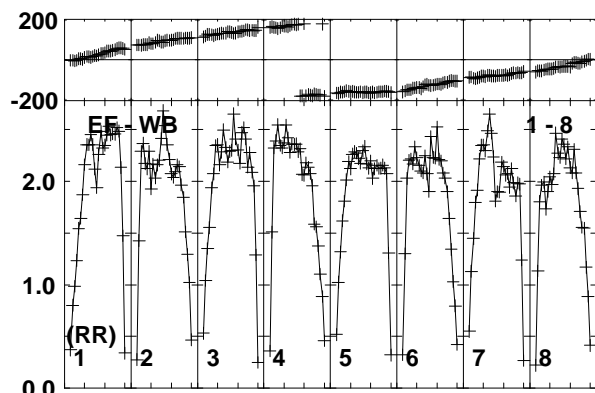
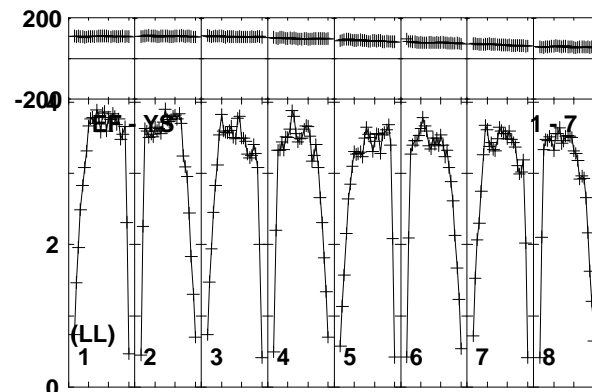
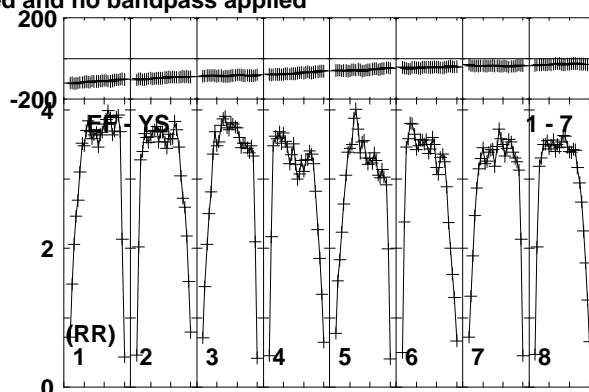
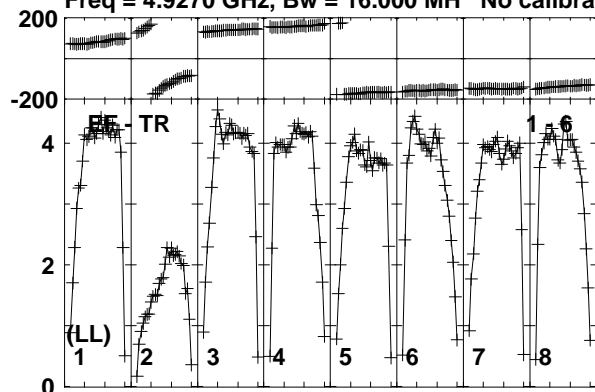

Lower frame: Milli Ampl Jy Top frame: Phas deg  
Vector averaged cross-power spectrum Baseline: EF (01) - TR (06)  
Timerange: 00:13:11:50 to 00:13:13:19

Plot file version 77 created 10-JUN-2016 15:29:23

FRB150418 RG008C.UVDATA.1

Freq = 4.9270 GHz, Bw = 16.000 MH No calibration applied and no bandpass applied

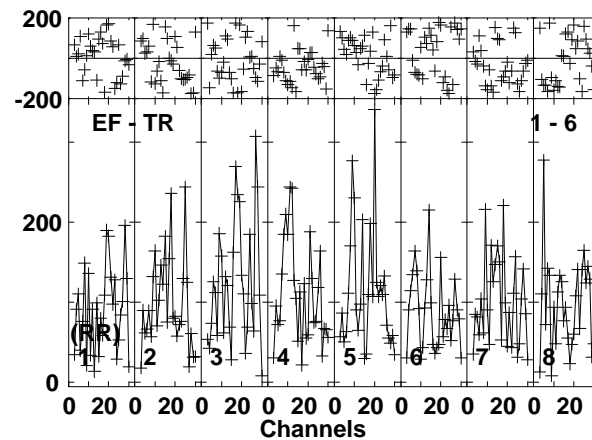
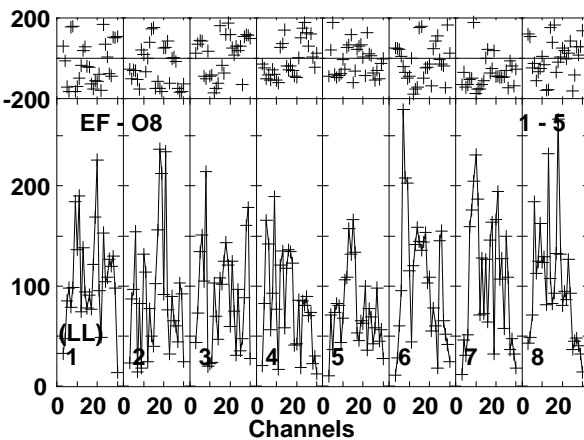
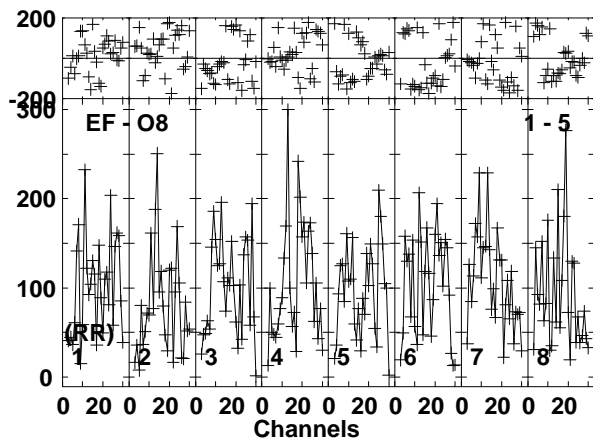
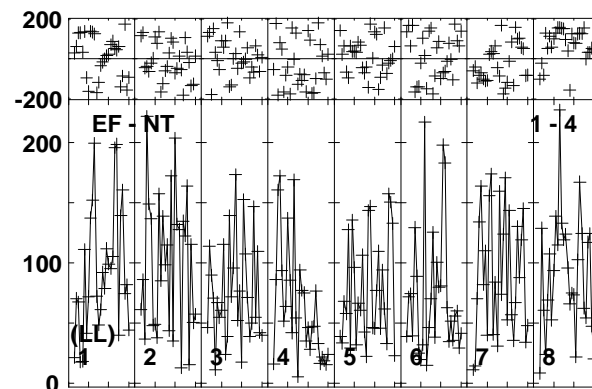
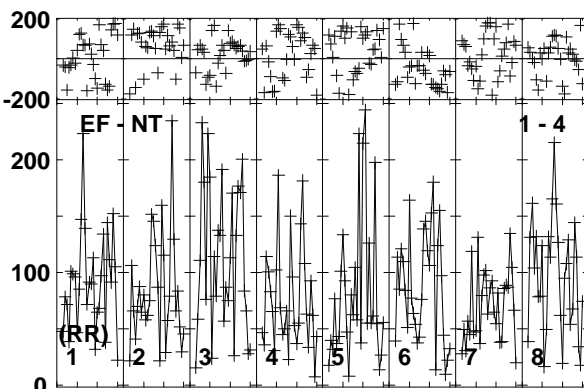
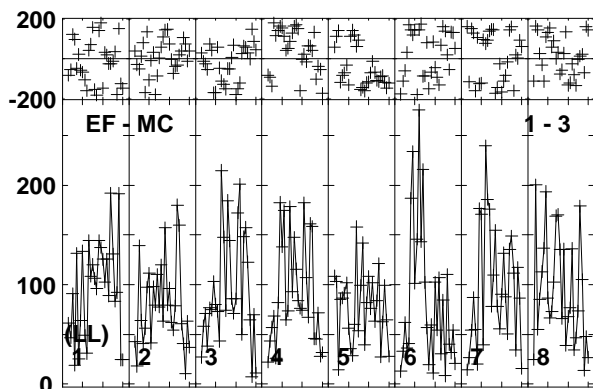
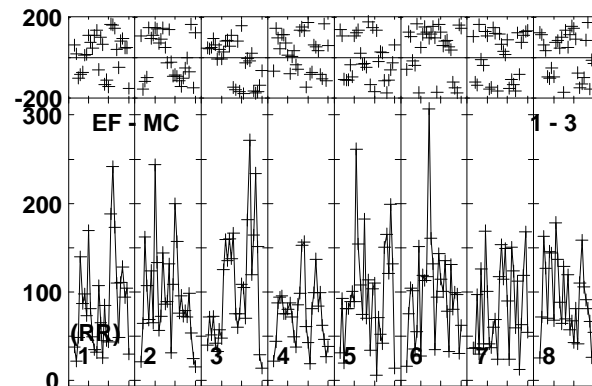
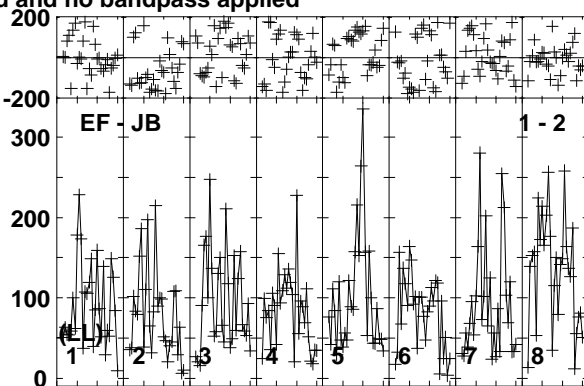
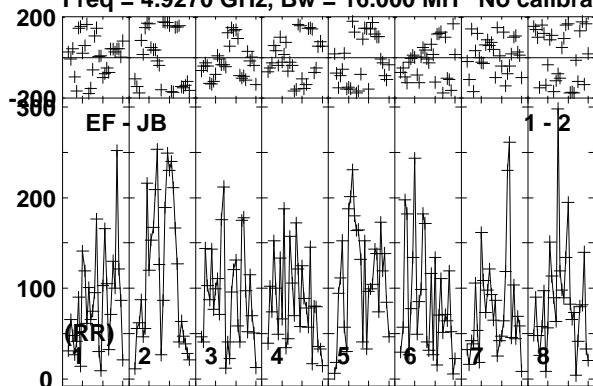

Lower frame: Micro Ampl Jy Top frame: Phas deg  
Vector averaged cross-power spectrum Baseline: EF (01) - JB (02)  
Timerange: 00/13:13:20 to 00/13:16:20

Plot file version 78 created 10-JUN-2016 15:29:23

FRB150418 RG008C.UVDATA.1

Freq = 4.9270 GHz, Bw = 16.000 MH No calibration applied and no bandpass applied

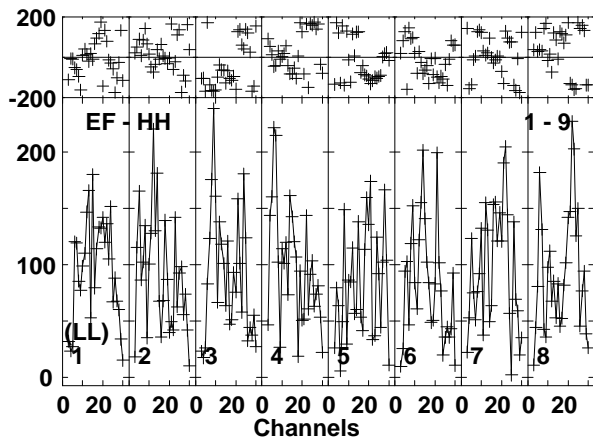
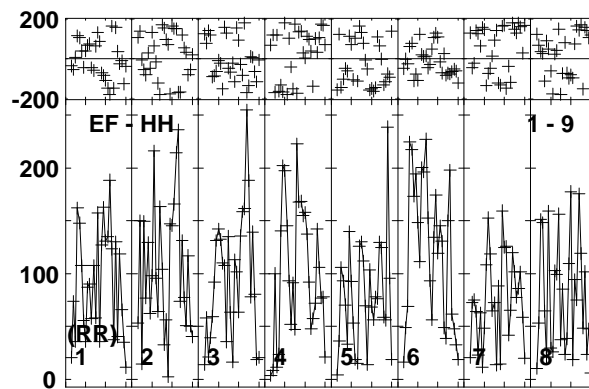
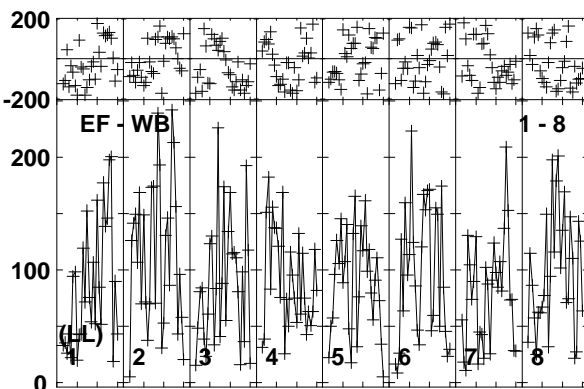
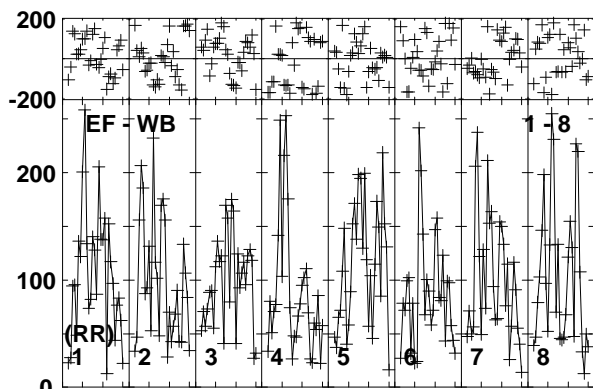
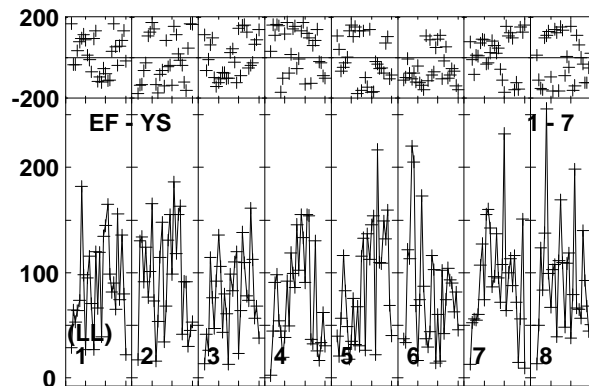
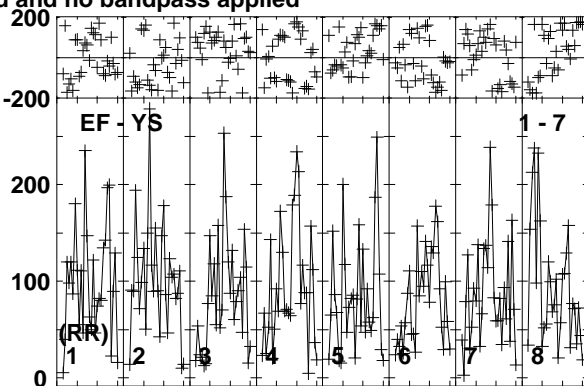
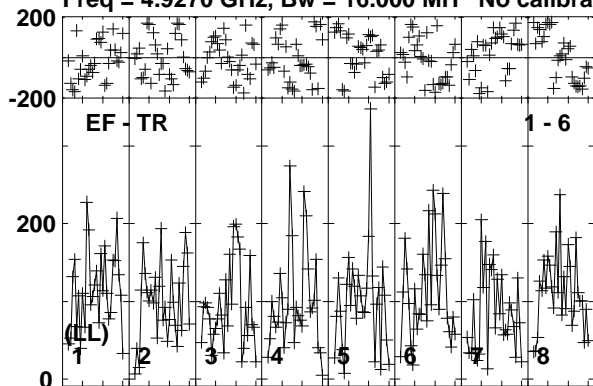

Lower frame: Micro Ampl Jy Top frame: Phas deg  
Vector averaged cross-power spectrum Baseline: EF (01) - TR (06)  
Timerange: 00/13:13:20 to 00/13:16:20

Plot file version 79 created 10-JUN-2016 15:29:23

J0718-1813 RG008C.UVDATA.1

Freq = 4.9270 GHz, Bw = 16.000 MH No calibration applied and no bandpass applied

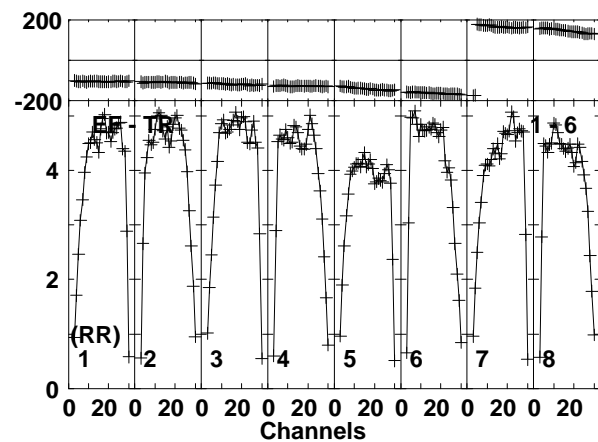
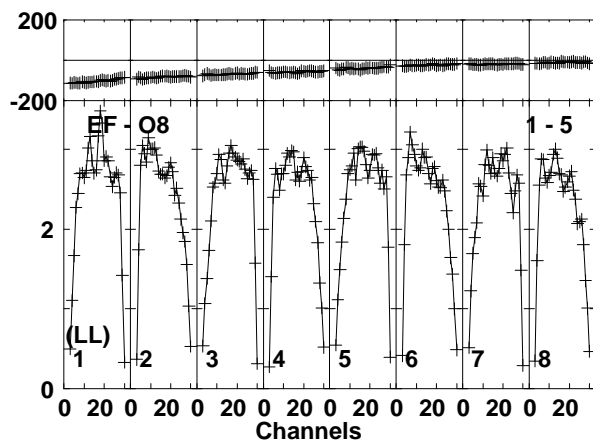
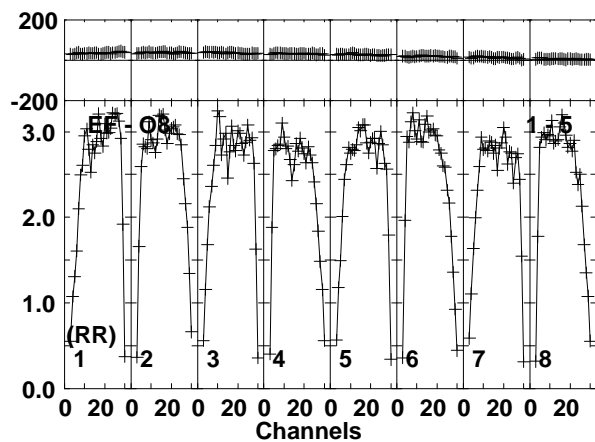
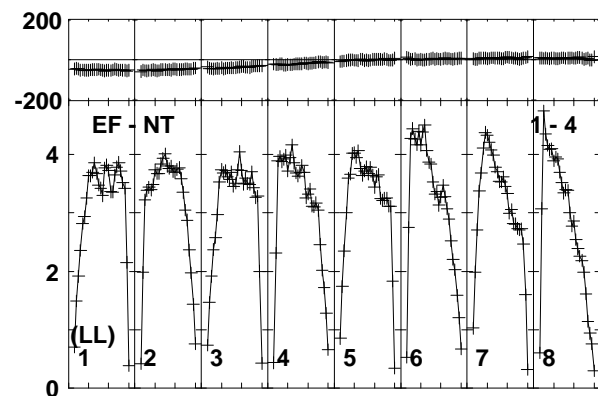
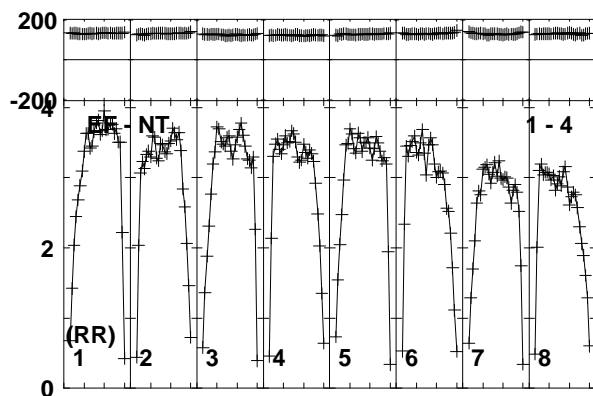
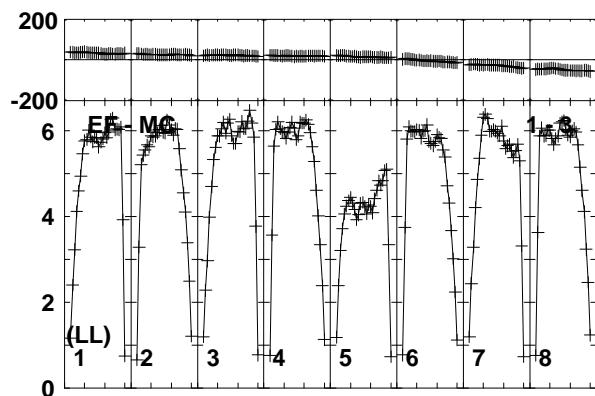
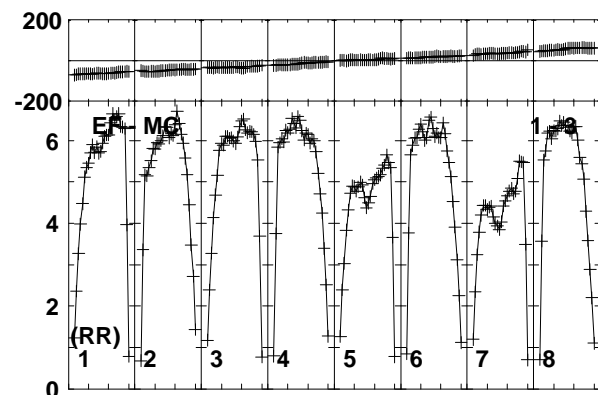
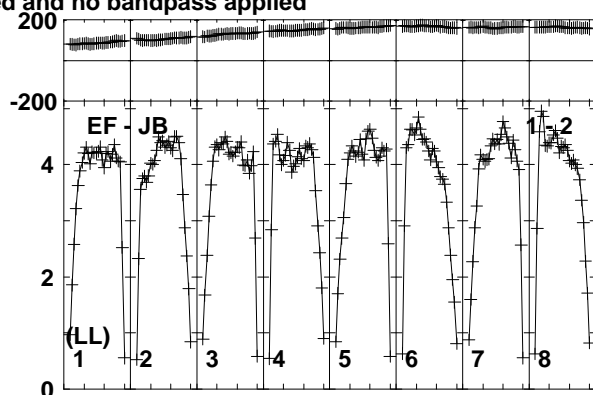
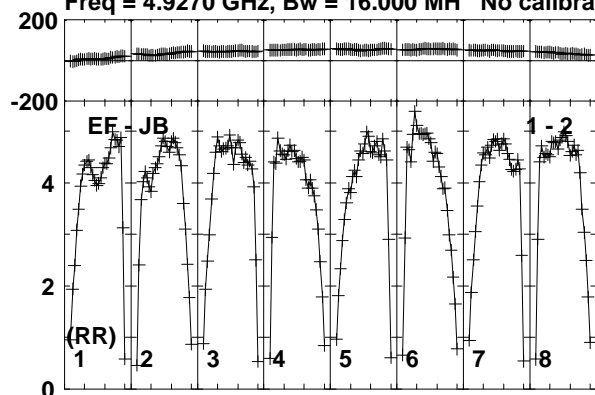

Lower frame: Milli Ampl Jy Top frame: Phas deg  
Vector averaged cross-power spectrum Baseline: EF (01) - JB (02)  
Timerange: 00/13:17:00 to 00/13:17:50

Plot file version 80 created 10-JUN-2016 15:29:23

J0718-1813 RG008C.UVDATA.1

Freq = 4.9270 GHz, Bw = 16.000 MH No calibration applied and no bandpass applied

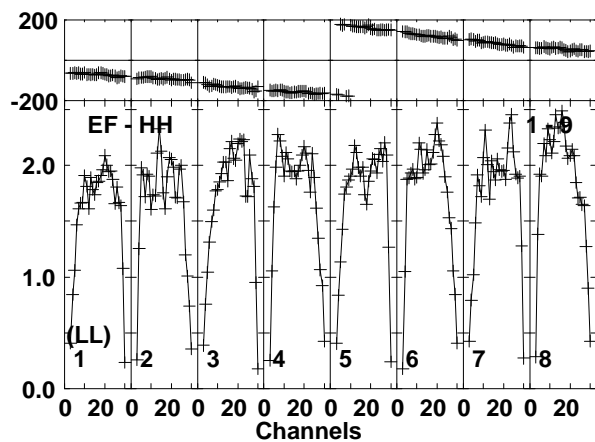
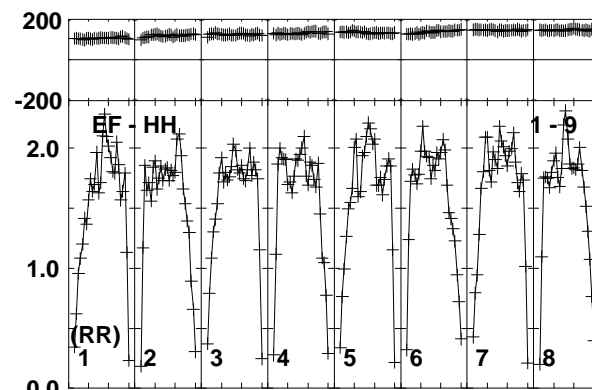
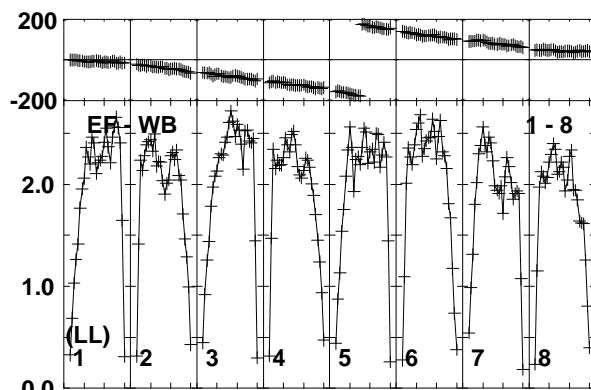
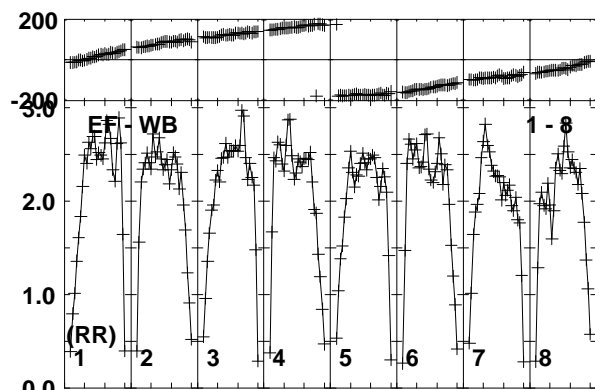
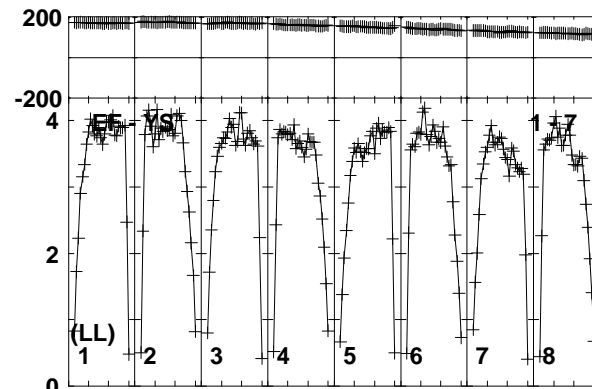
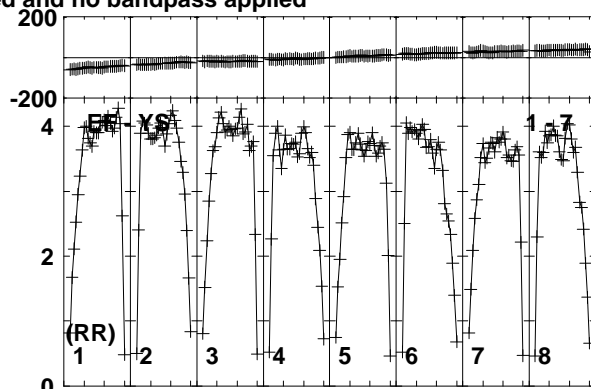
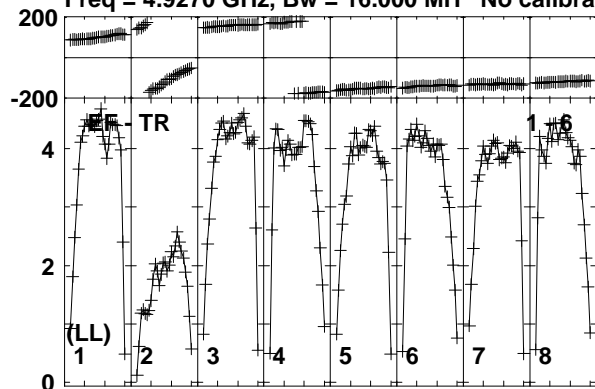

Lower frame: Milli Ampl Jy Top frame: Phas deg  
Vector averaged cross-power spectrum Baseline: EF (01) - TR (06)  
Timerange: 00/13:17:00 to 00/13:17:50



Plot file version 81 created 10-JUN-2016 15:29:23

FRB150418 RG008C.UVDATA.1

Freq = 4.9270 GHz, Bw = 16.000 MH No calibration applied and no bandpass applied

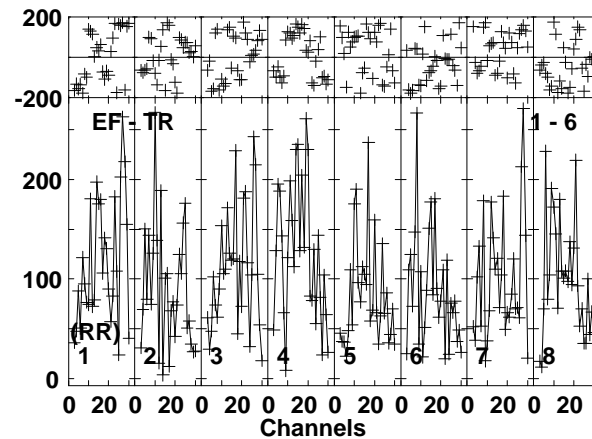
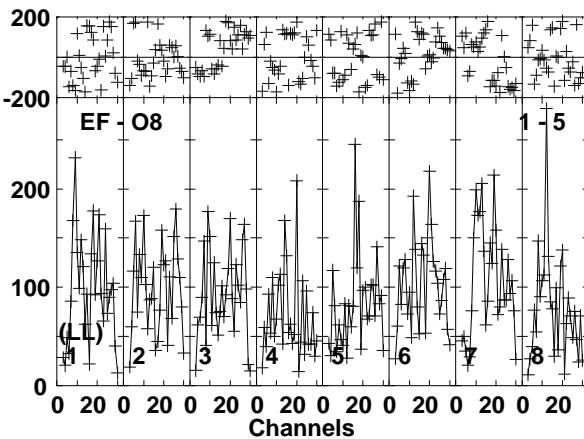
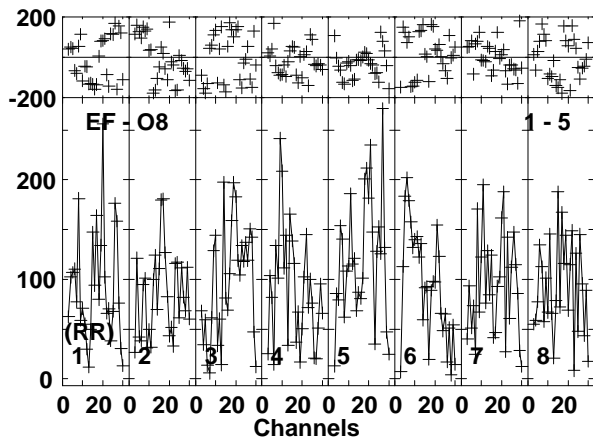
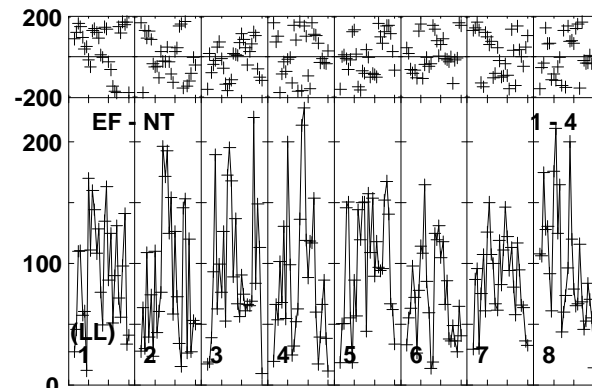
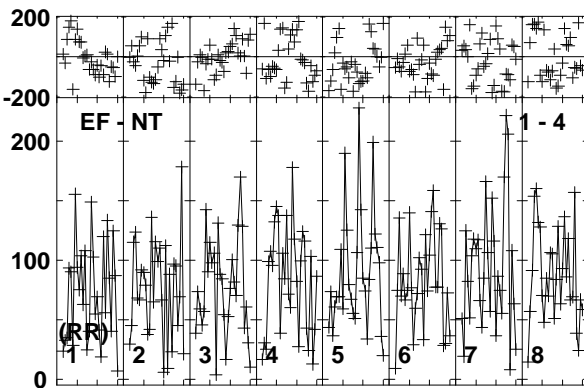
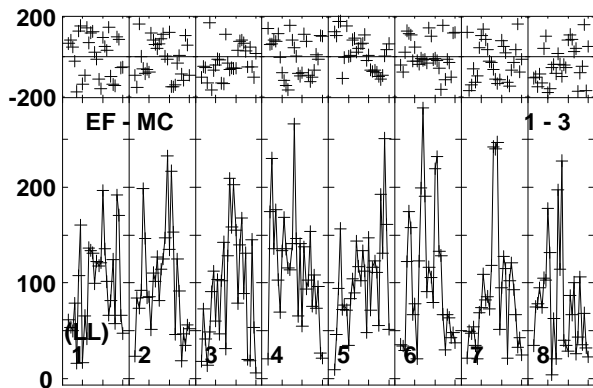
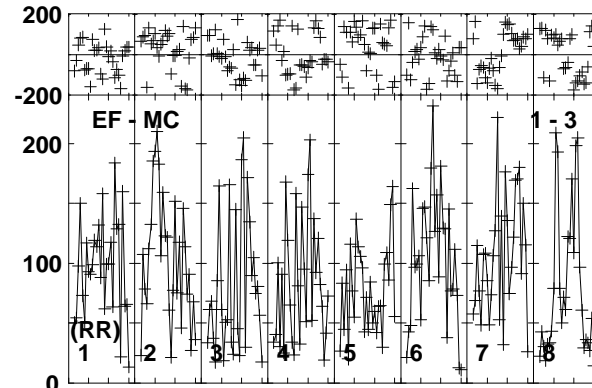
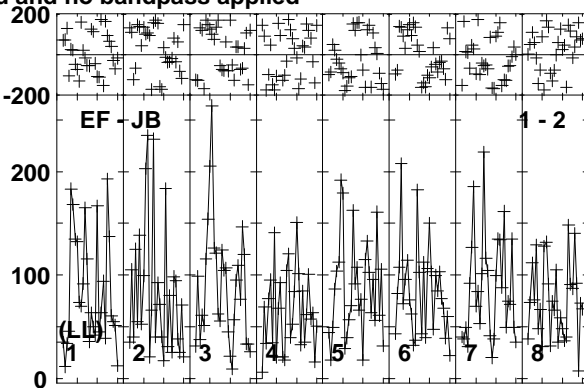
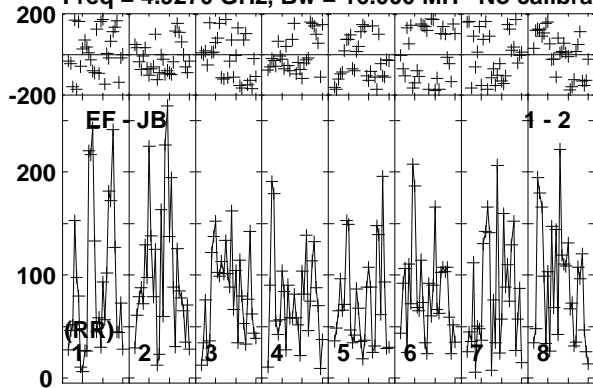

Lower frame: Micro Ampl Jy Top frame: Phas deg  
Vector averaged cross-power spectrum Baseline: EF (01) - JB (02)  
Timerange: 00/13:17:50 to 00/13:20:50

Plot file version 82 created 10-JUN-2016 15:29:24

FRB150418 RG008C.UVDATA.1

Freq = 4.9270 GHz, Bw = 16.000 MH No calibration applied and no bandpass applied

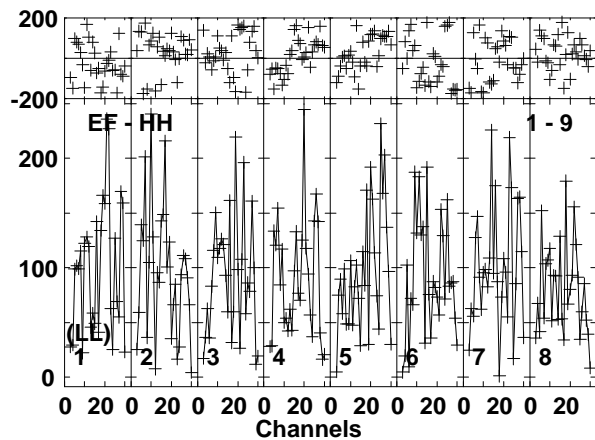
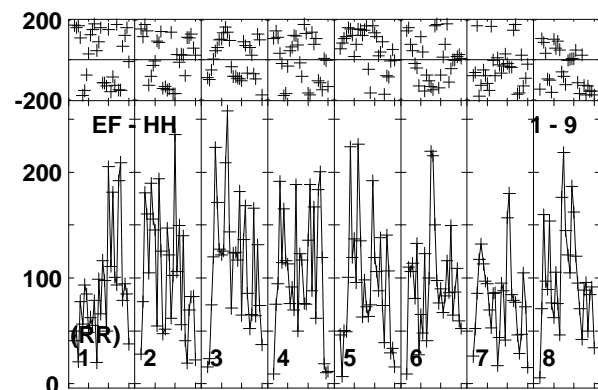
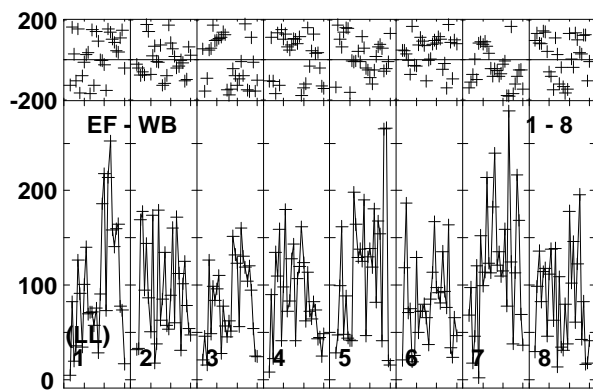
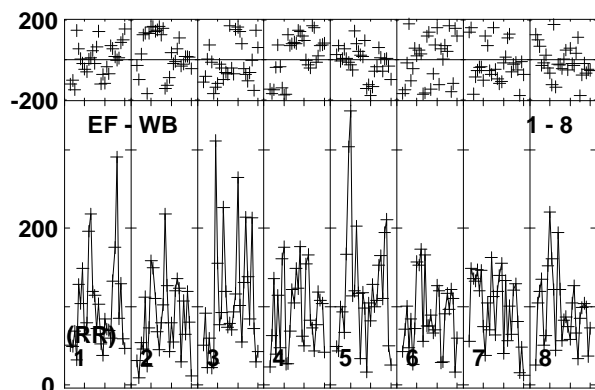
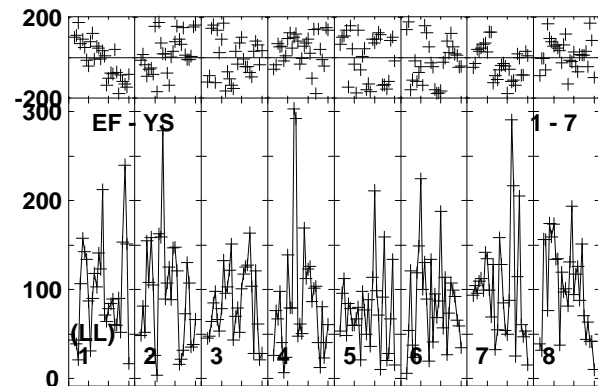
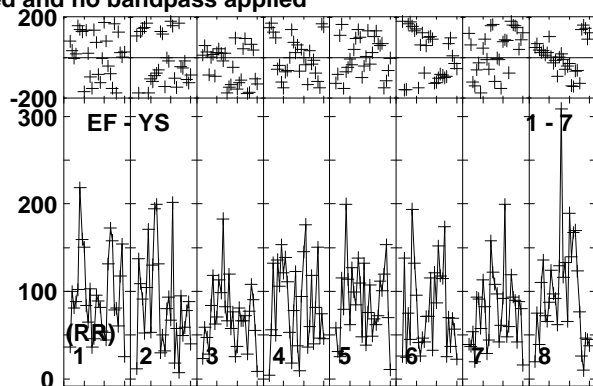
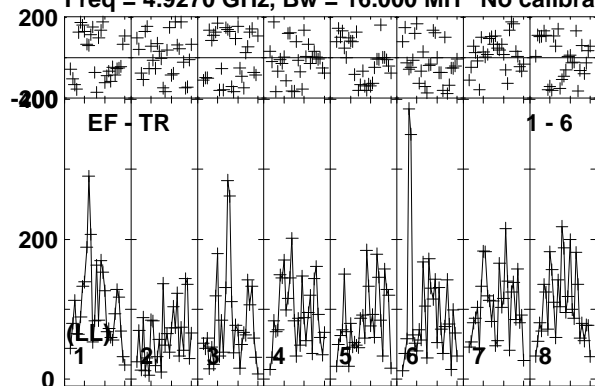

Lower frame: Micro Ampl Jy Top frame: Phas deg  
Vector averaged cross-power spectrum Baseline: EF (01) - TR (06)  
Timerange: 00/13:17:50 to 00/13:20:50

Plot file version 83 created 10-JUN-2016 15:29:24

J0718-1813 RG008C.UVDATA.1

Freq = 4.9270 GHz, Bw = 16.000 MH No calibration applied and no bandpass applied

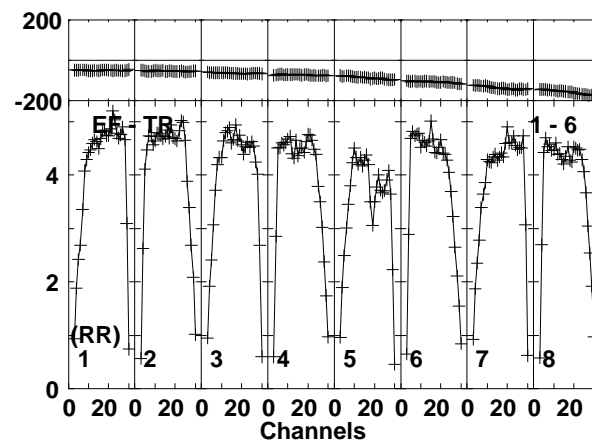
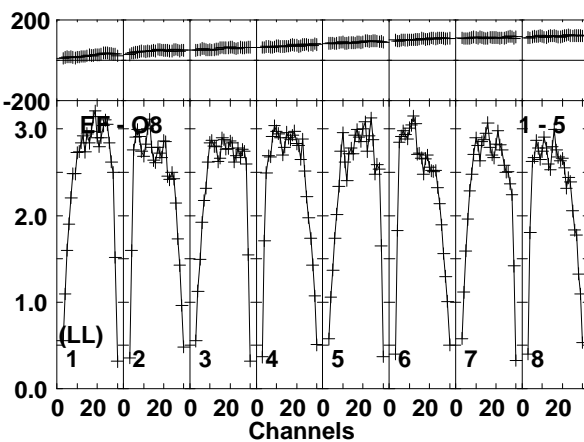
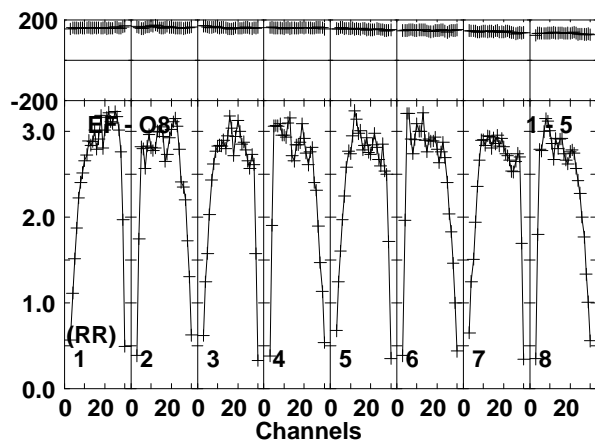
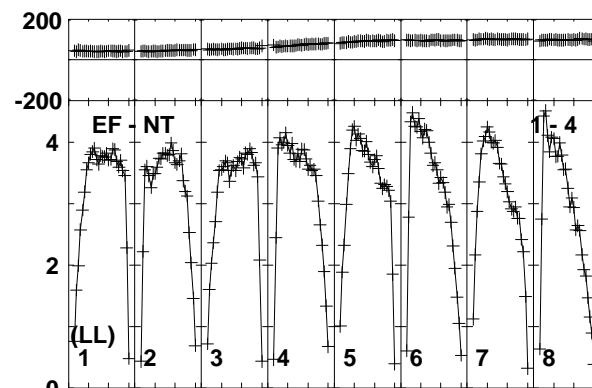
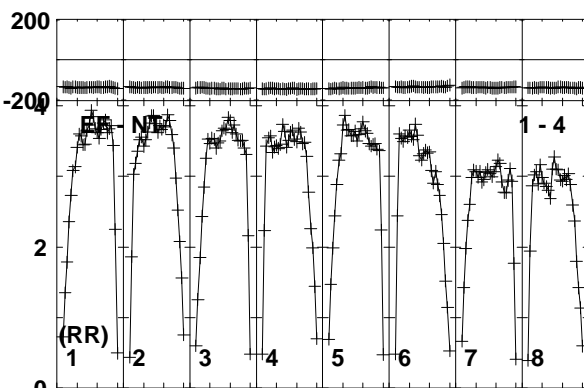
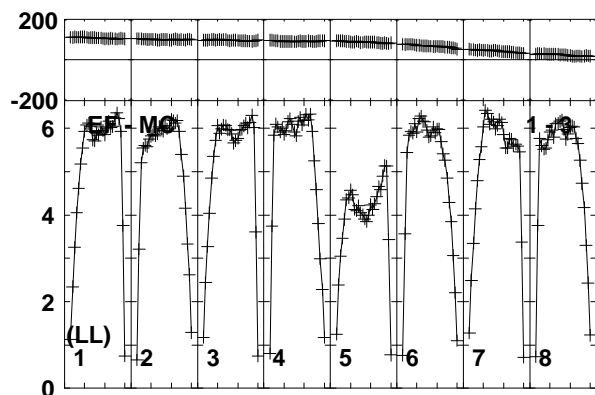
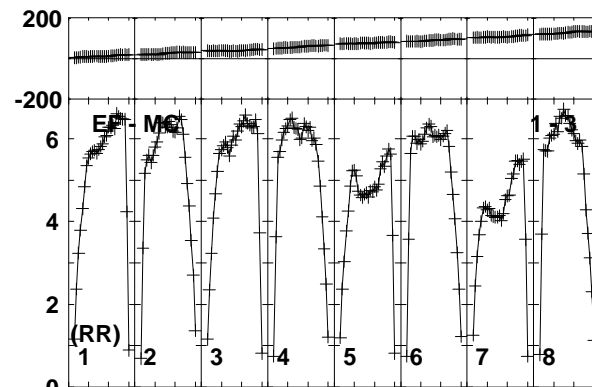
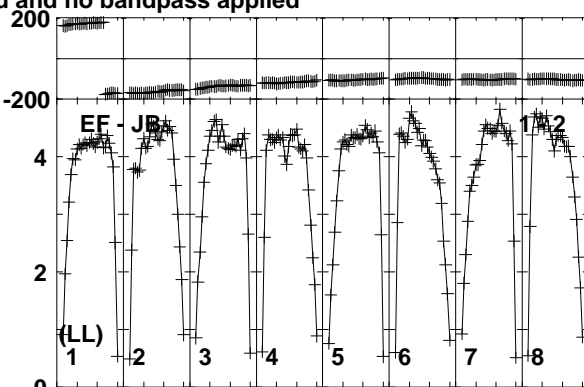
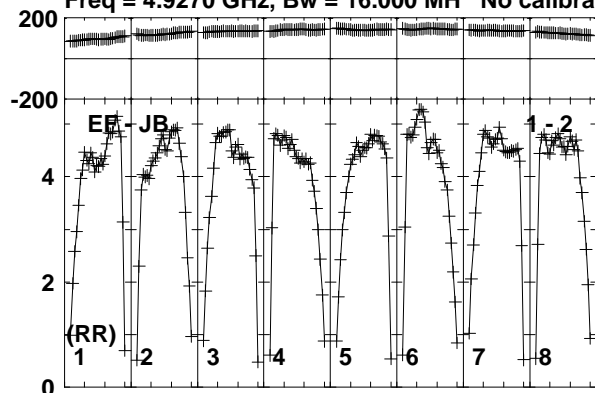

Lower frame: Milli Ampl Jy Top frame: Phas deg  
Vector averaged cross-power spectrum Baseline: EF (01) - JB (02)  
Timerange: 00/13:20:51 to 00/13:22:20

Plot file version 84 created 10-JUN-2016 15:29:24

J0718-1813 RG008C.UVDATA.1

Freq = 4.9270 GHz, Bw = 16.000 MH No calibration applied and no bandpass applied

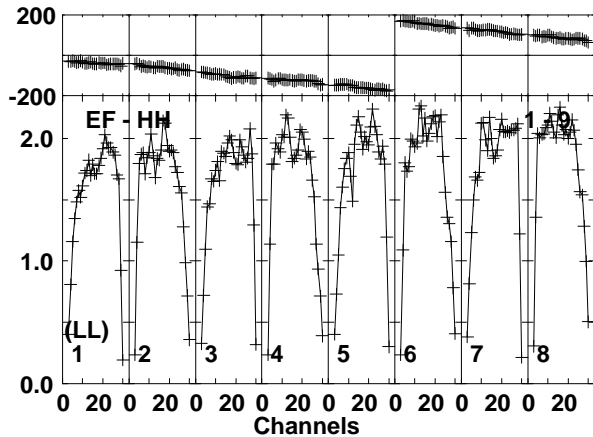
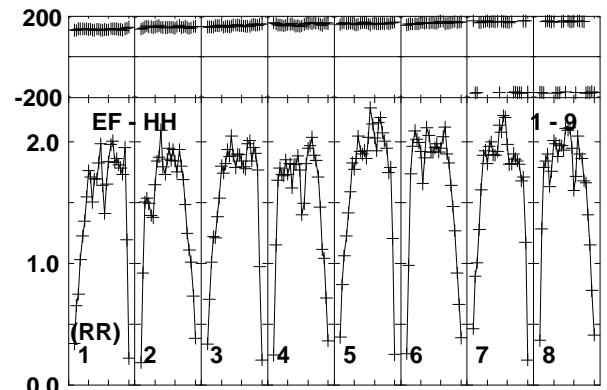
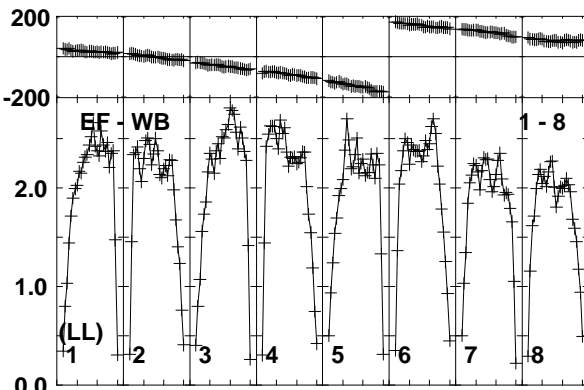
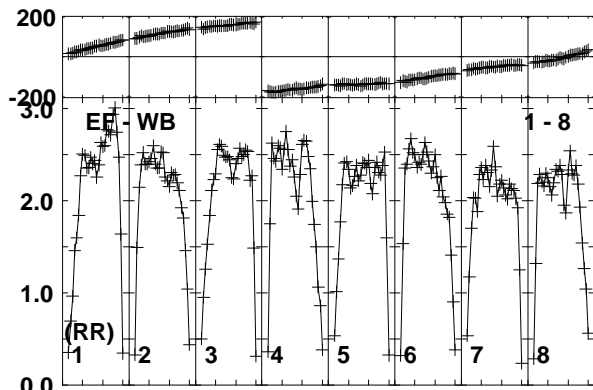
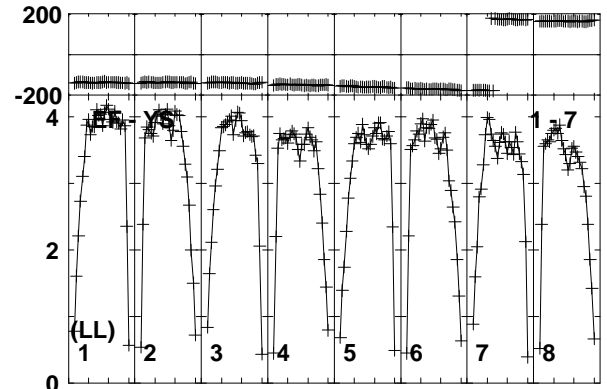
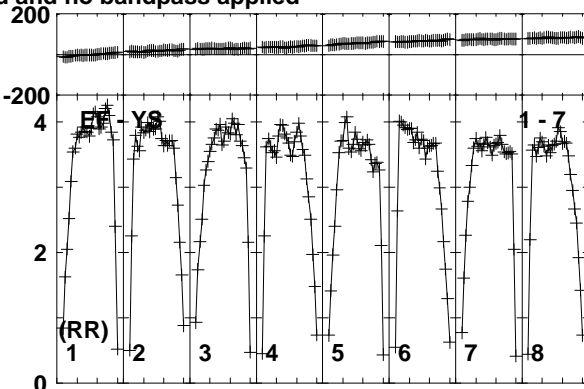
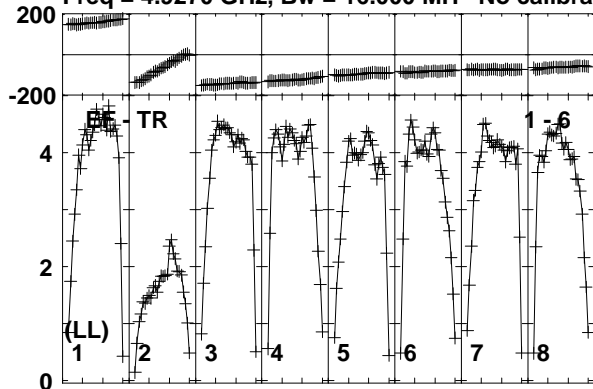

Lower frame: Milli Ampl Jy Top frame: Phas deg  
Vector averaged cross-power spectrum Baseline: EF (01) - TR (06)  
Timerange: 00/13:20:51 to 00/13:22:20

Plot file version 85 created 10-JUN-2016 15:29:24

J0712-1847 RG008C.UVDATA.1

Freq = 4.9270 GHz, Bw = 16.000 MH No calibration applied and no bandpass applied

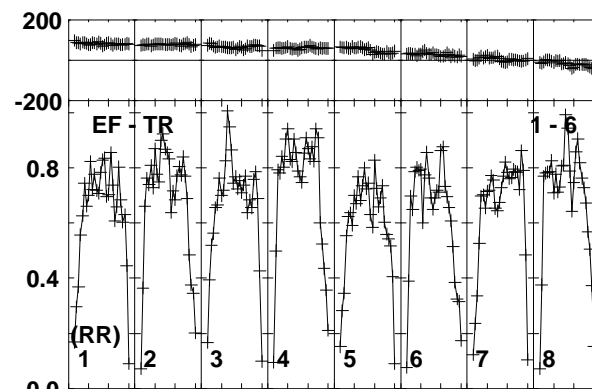
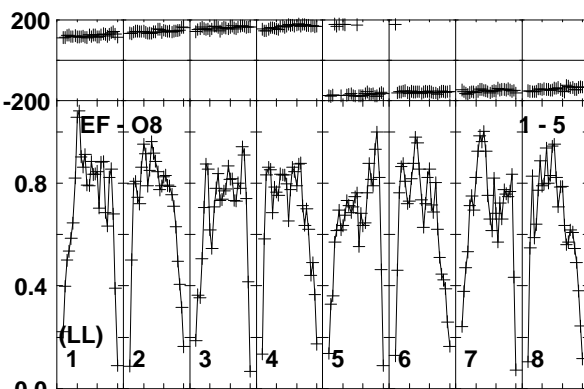
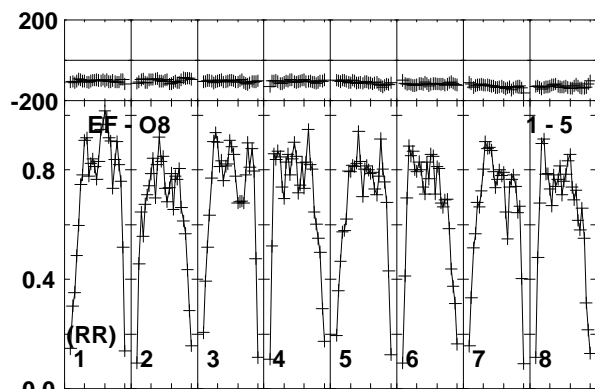
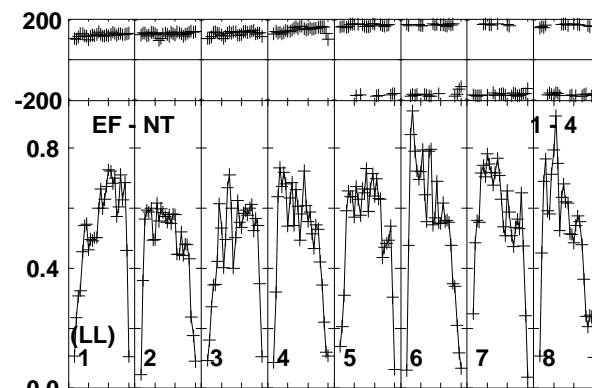
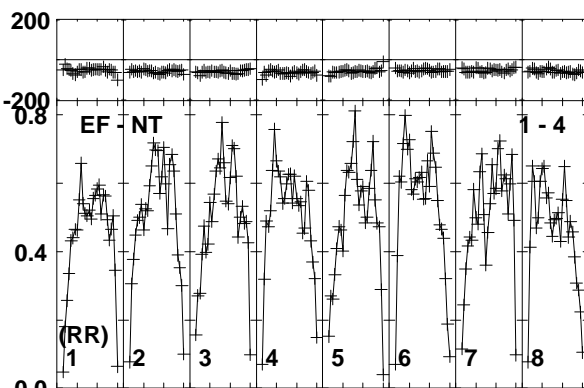
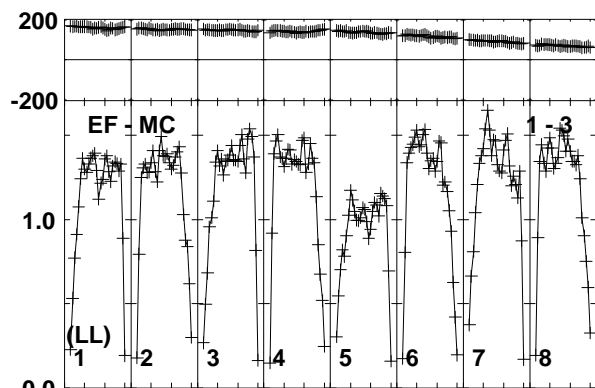
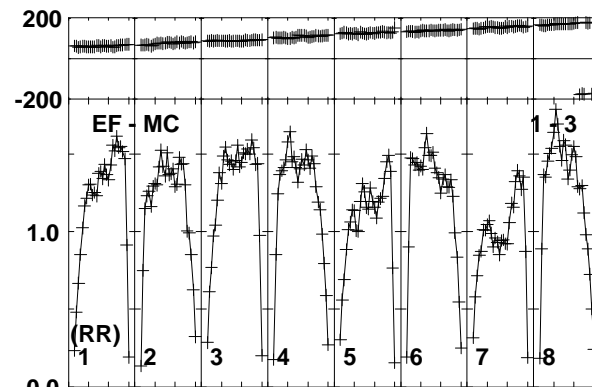
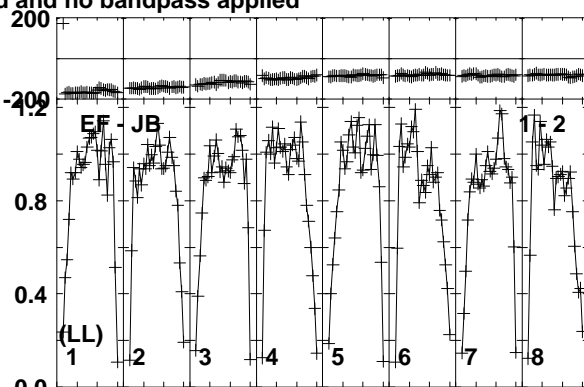
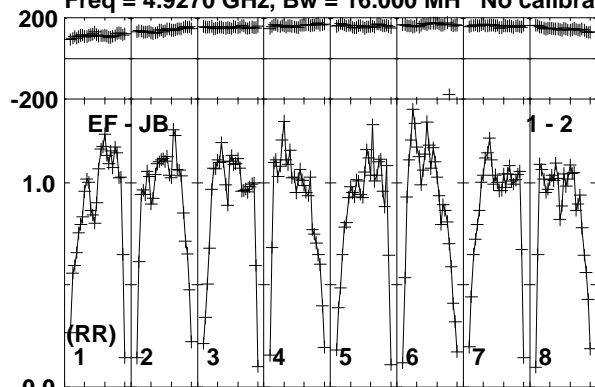

Lower frame: Milli Ampl Jy Top frame: Phas deg  
Vector averaged cross-power spectrum Baseline: EF (01) - JB (02)  
Timerange: 00/13:22:21 to 00/13:25:19

Plot file version 86 created 10-JUN-2016 15:29:24

J0712-1847 RG008C.UVDATA.1

Freq = 4.9270 GHz, Bw = 16.000 MH No calibration applied and no bandpass applied

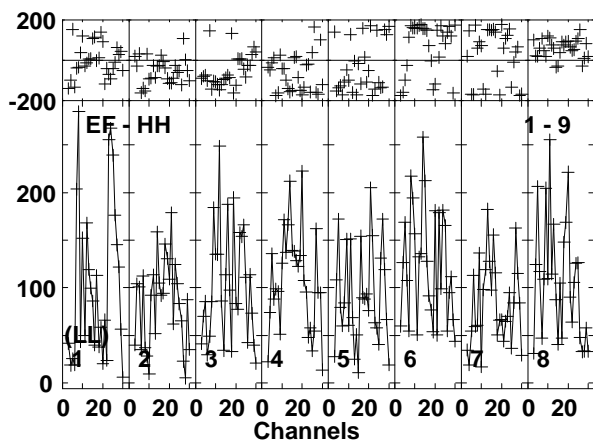
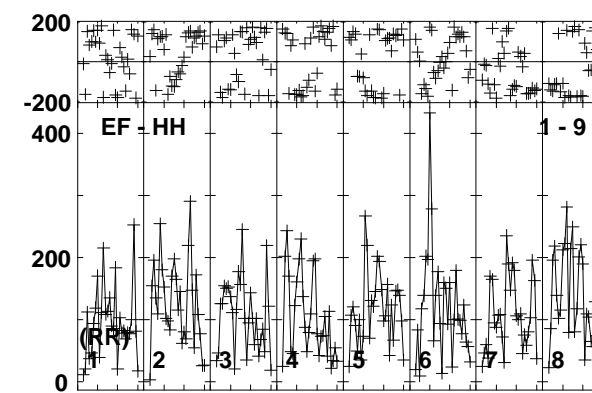
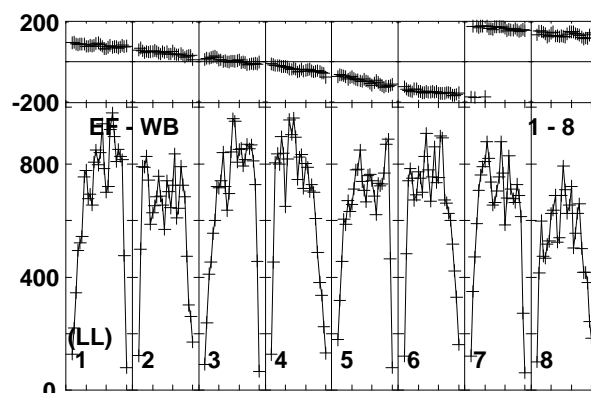
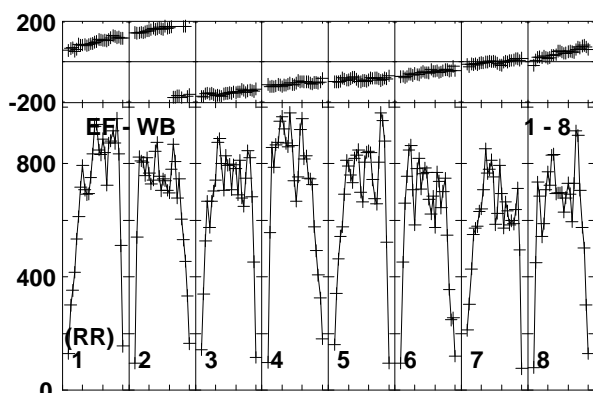
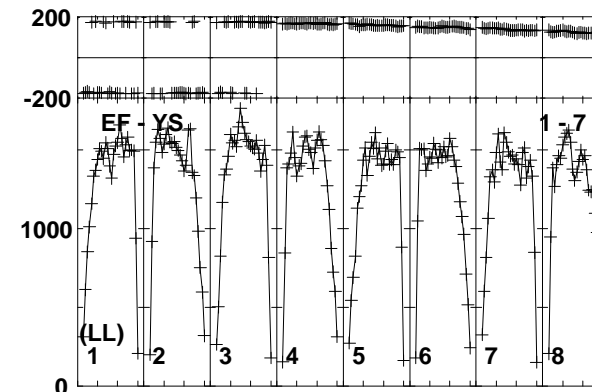
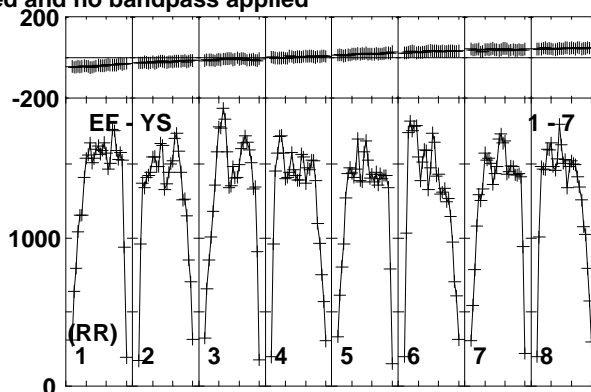
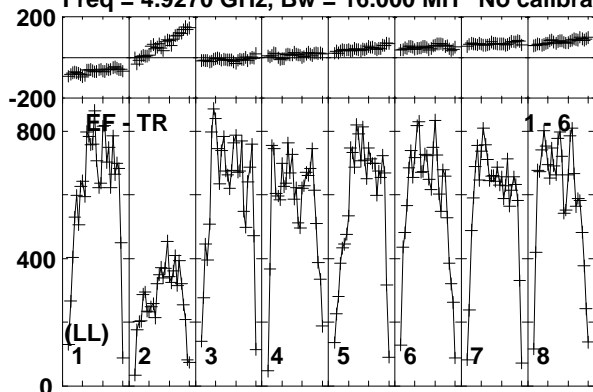

Lower frame: Micro Ampl Jy Top frame: Phas deg  
Vector averaged cross-power spectrum Baseline: EF (01) - TR (06)  
Timerange: 00/13:22:21 to 00/13:25:19

Plot file version 87 created 10-JUN-2016 15:29:24

J0718-1813 RG008C.UVDATA.1

Freq = 4.9270 GHz, Bw = 16.000 MH No calibration applied and no bandpass applied

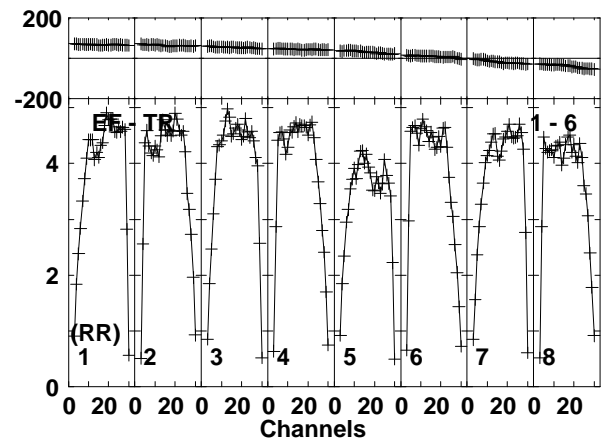
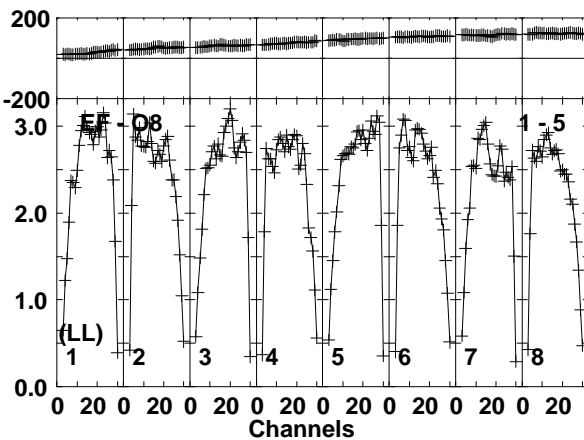
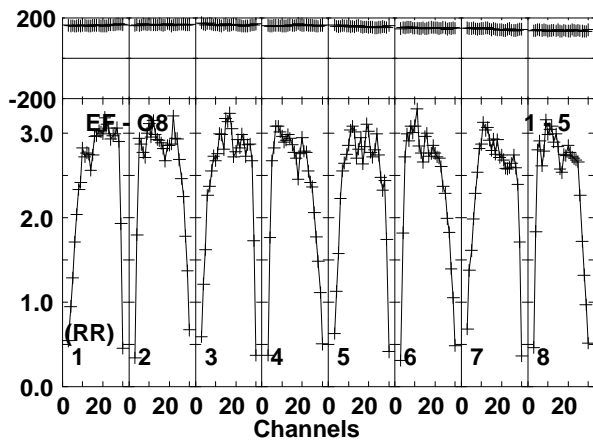
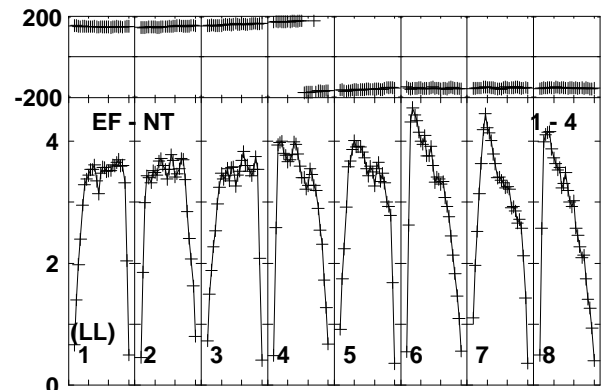
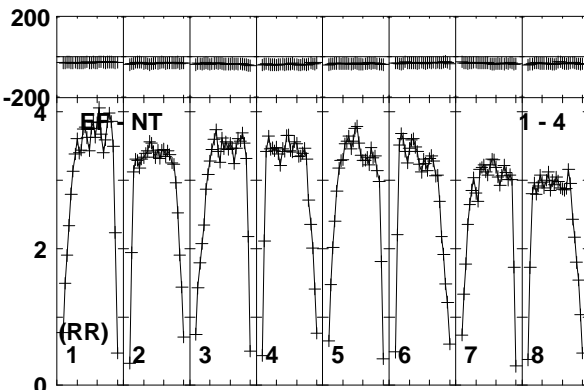
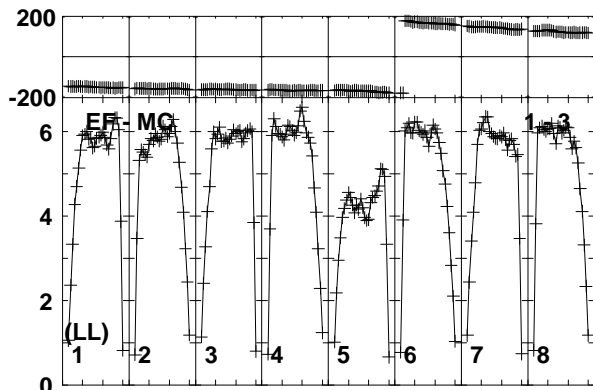
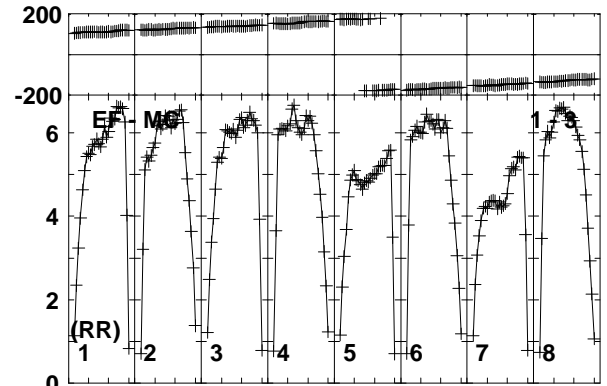
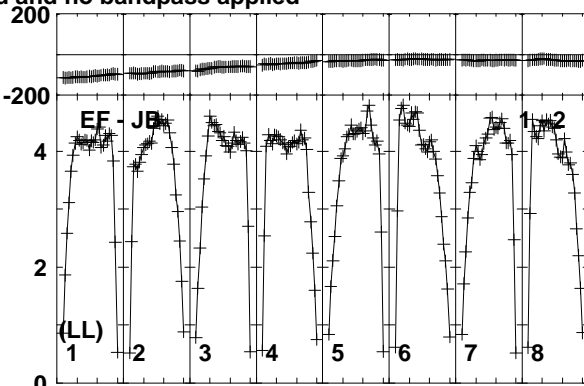
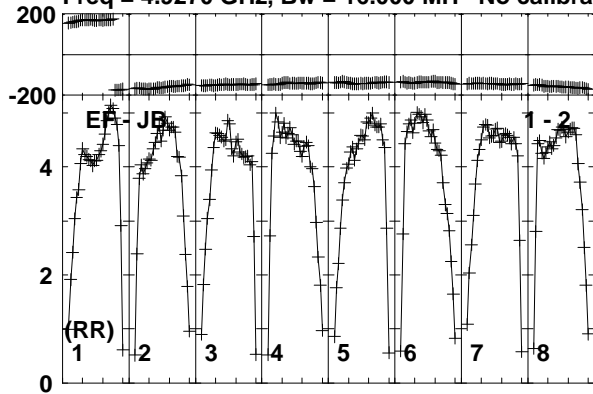

Lower frame: Milli Ampl Jy Top frame: Phas deg  
Vector averaged cross-power spectrum Baseline: EF (01) - JB (02)  
Timerange: 00/13:26:01 to 00/13:26:50

Plot file version 88 created 10-JUN-2016 15:29:24

J0718-1813 RG008C.UVDATA.1

Freq = 4.9270 GHz, Bw = 16.000 MH No calibration applied and no bandpass applied

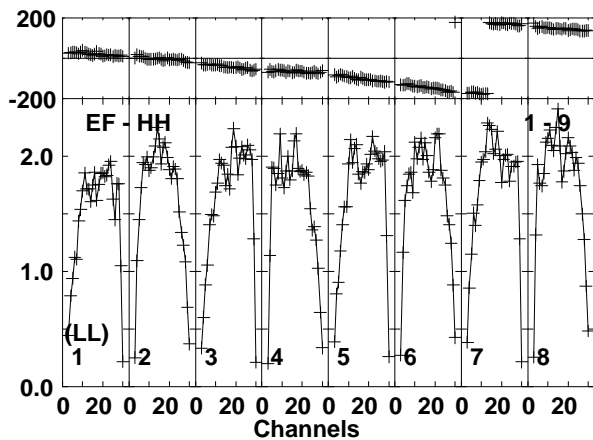
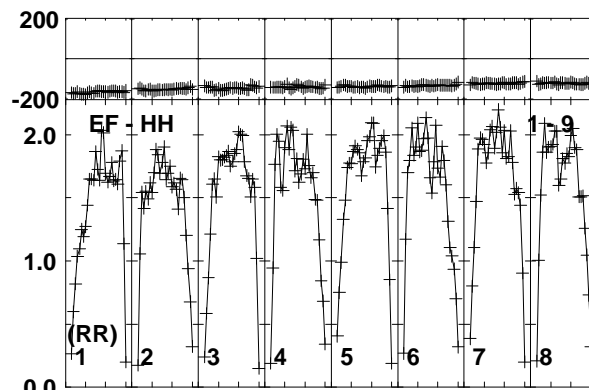
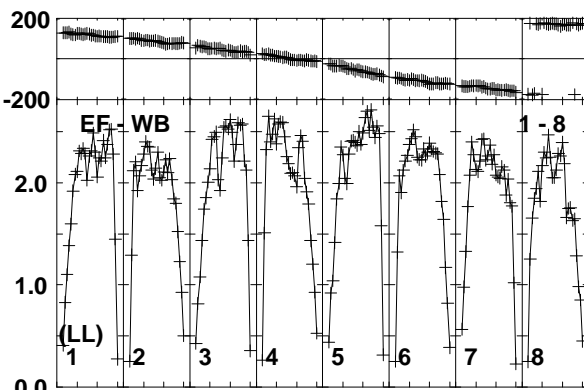
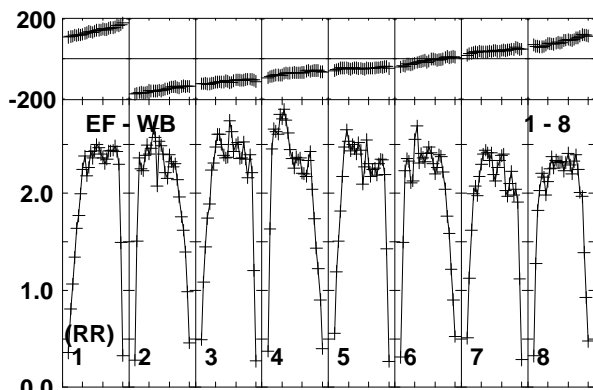
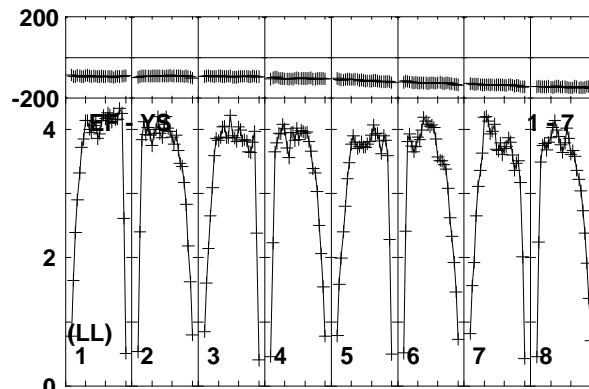
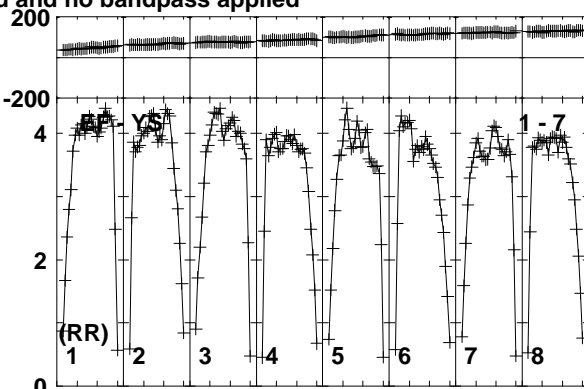
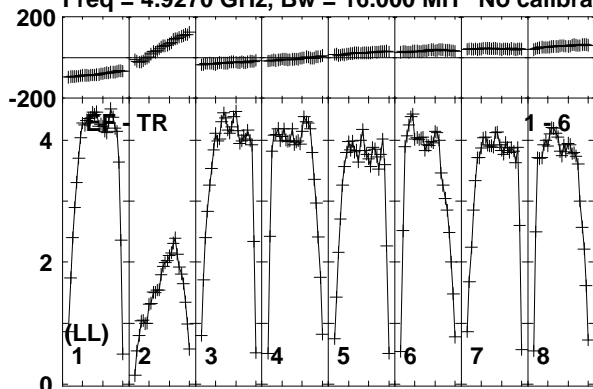

Lower frame: Milli Ampl Jy Top frame: Phas deg  
Vector averaged cross-power spectrum Baseline: EF (01) - TR (06)  
Timerange: 00/13:26:01 to 00/13:26:50



Plot file version 89 created 10-JUN-2016 15:29:24

FRB150418 RG008C.UVDATA.1

Freq = 4.9270 GHz, Bw = 16.000 MH No calibration applied and no bandpass applied

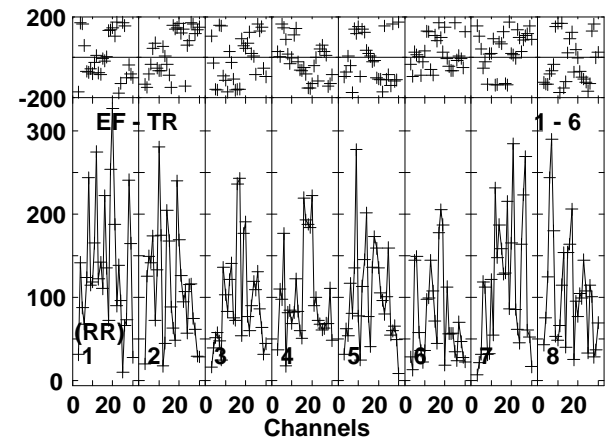
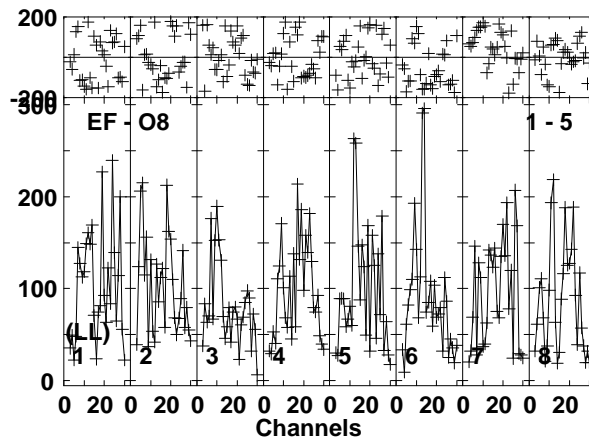
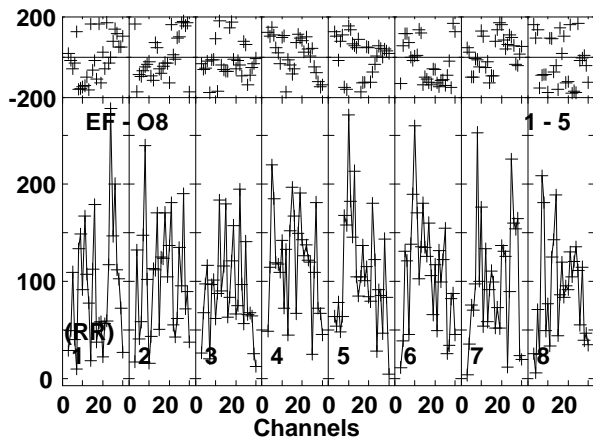
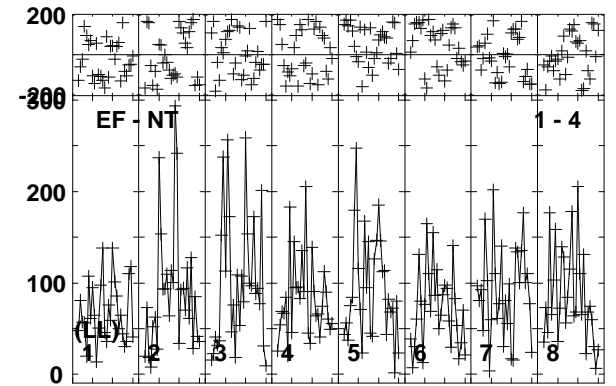
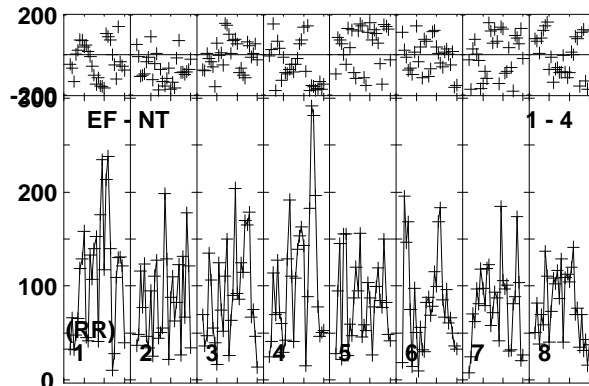
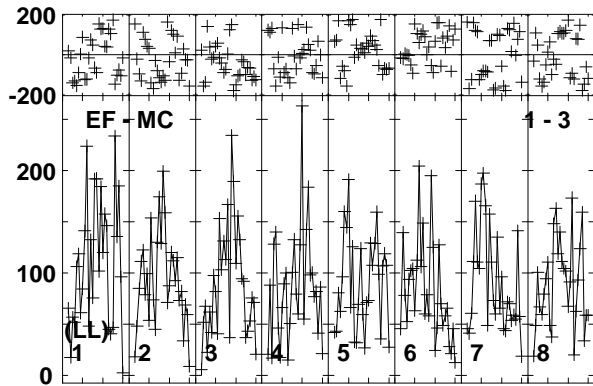
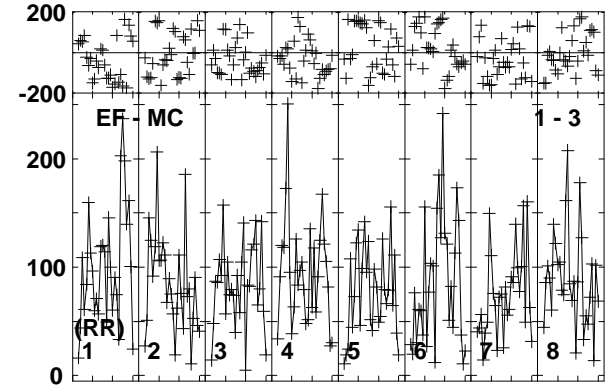
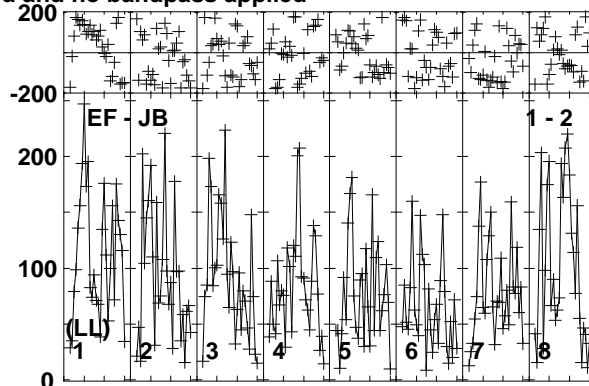
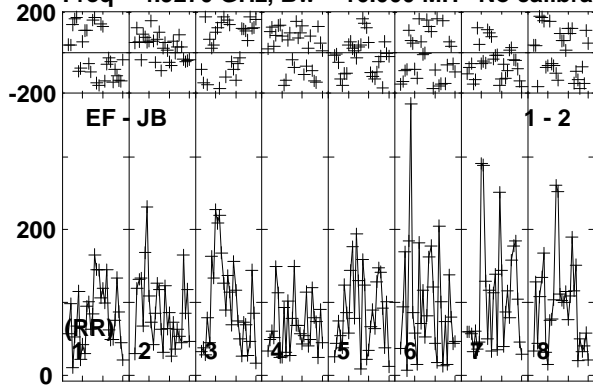

Lower frame: Micro Ampl Jy Top frame: Phas deg  
Vector averaged cross-power spectrum Baseline: EF (01) - JB (02)  
Timerange: 00/13:26:50 to 00/13:29:50

Plot file version 90 created 10-JUN-2016 15:29:24

FRB150418 RG008C.UVDATA.1

Freq = 4.9270 GHz, Bw = 16.000 MH No calibration applied and no bandpass applied

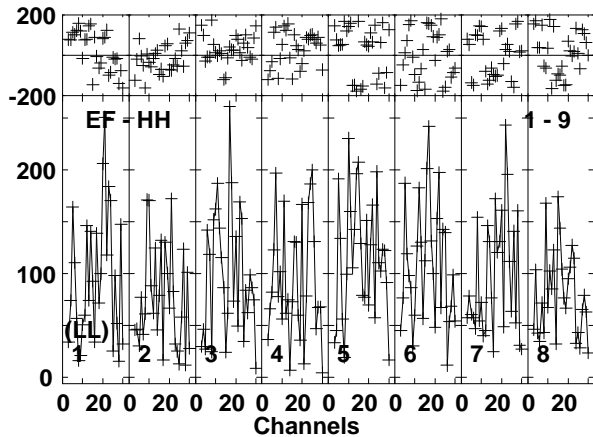
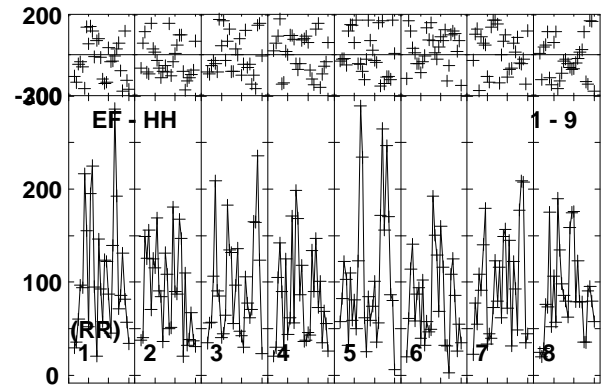
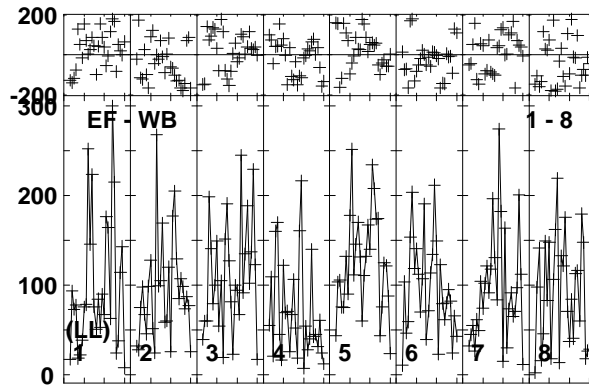
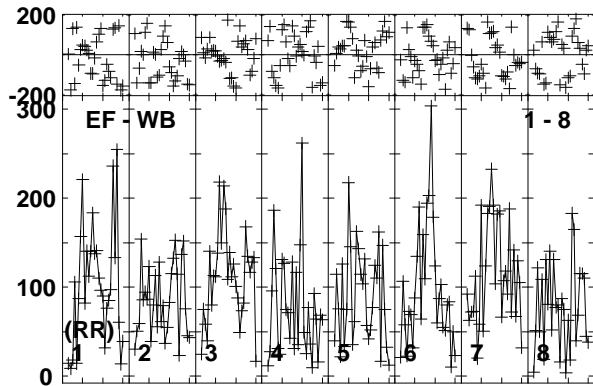
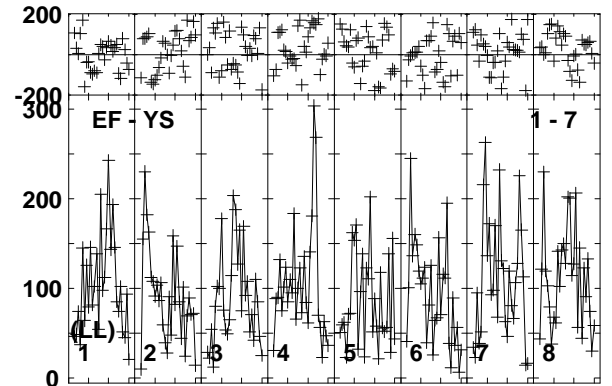
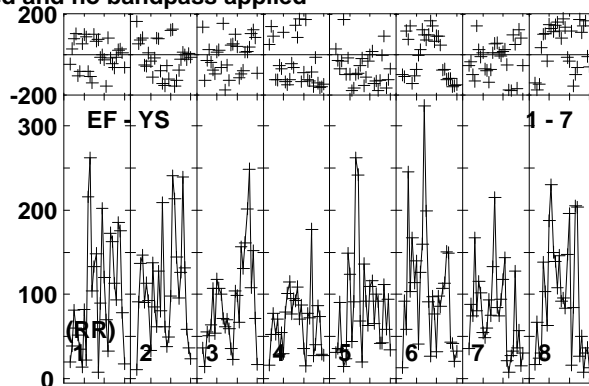
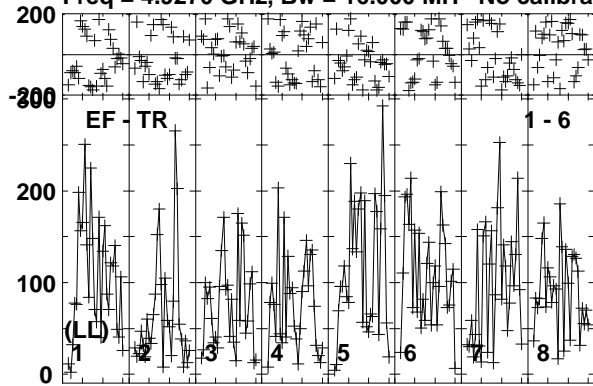

Lower frame: Micro Ampl Jy Top frame: Phas deg  
Vector averaged cross-power spectrum Baseline: EF (01) - TR (06)  
Timerange: 00/13:26:50 to 00/13:29:50

Plot file version 91 created 10-JUN-2016 15:29:25

J0718-1813 RG008C.UVDATA.1

Freq = 4.9270 GHz, Bw = 16.000 MH No calibration applied and no bandpass applied

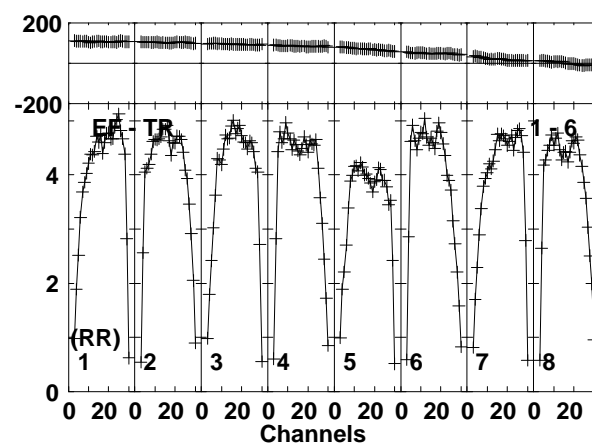
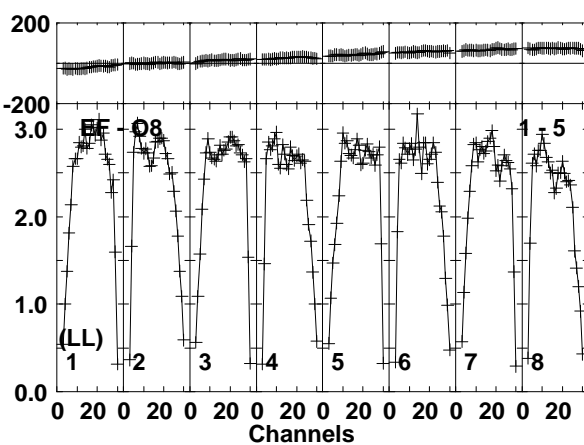
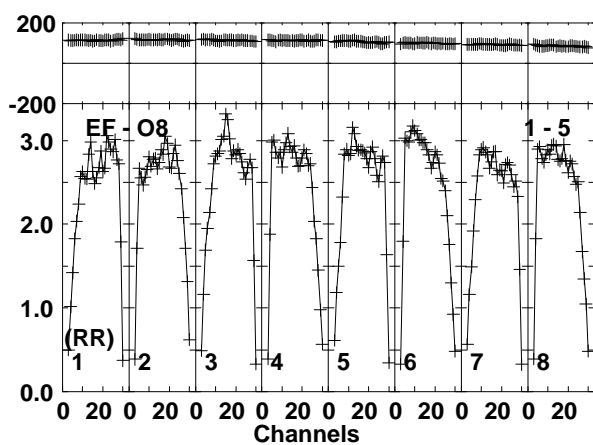
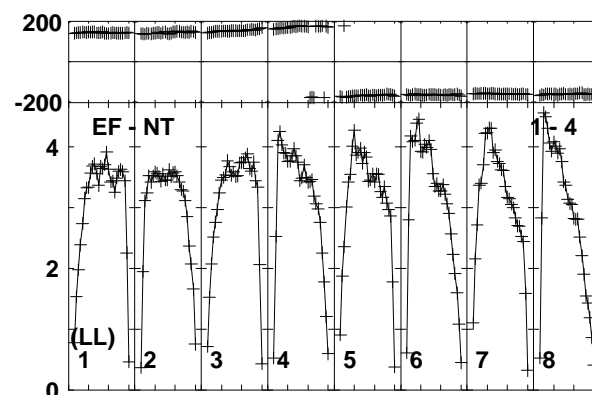
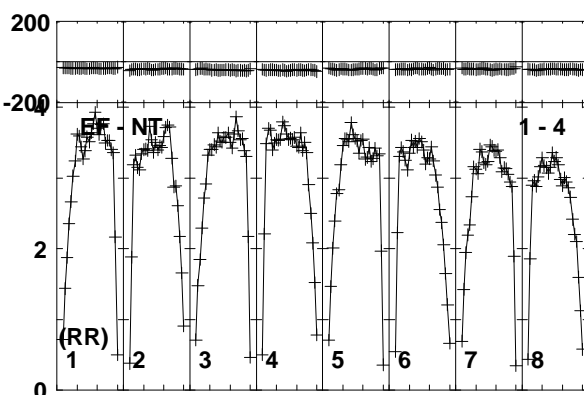
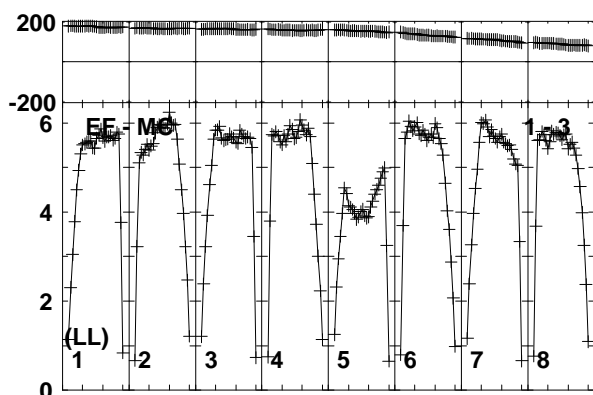
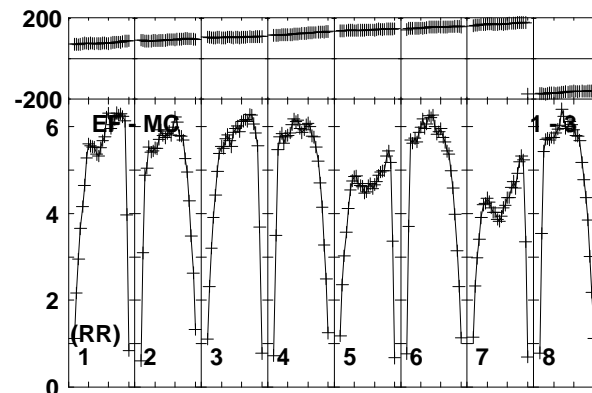
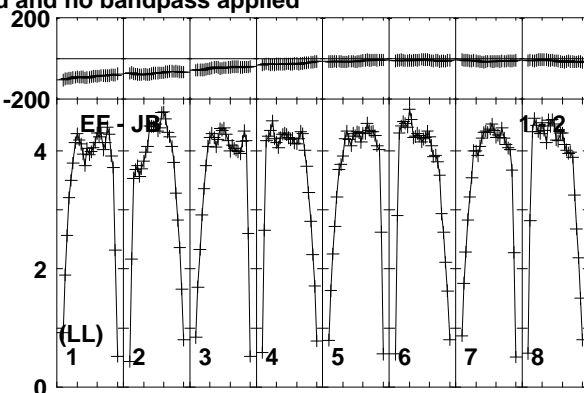
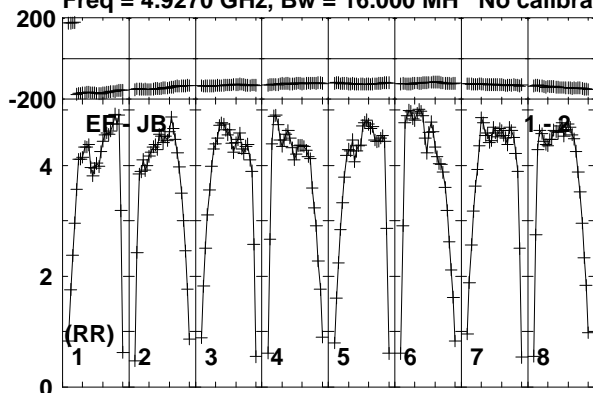

Lower frame: Milli Ampl Jy Top frame: Phas deg  
Vector averaged cross-power spectrum Baseline: EF (01) - JB (02)  
Timerange: 00/13:29:50 to 00/13:31:19

Plot file version 92 created 10-JUN-2016 15:29:25

J0718-1813 RG008C.UVDATA.1

Freq = 4.9270 GHz, Bw = 16.000 MH No calibration applied and no bandpass applied

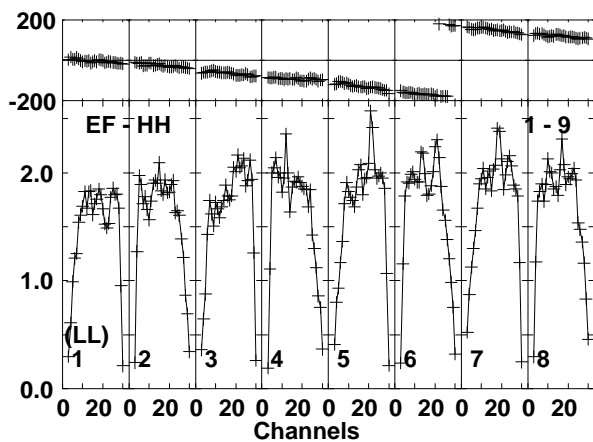
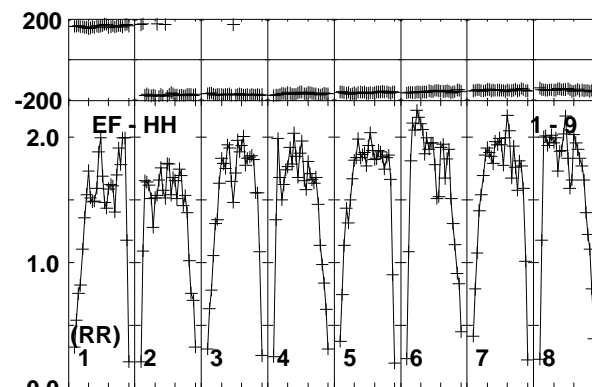
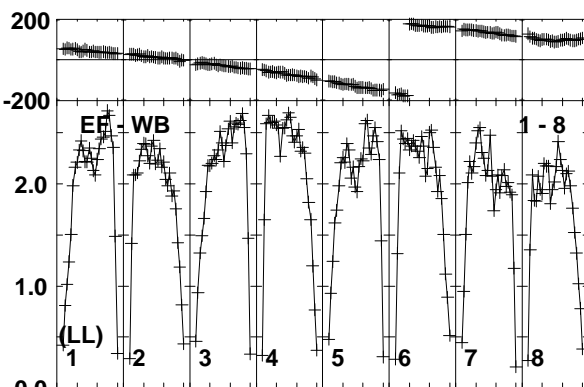
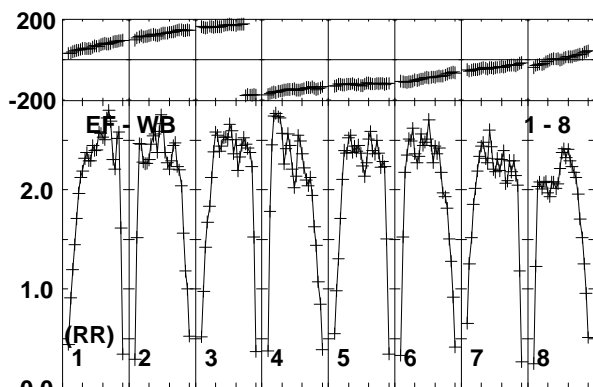
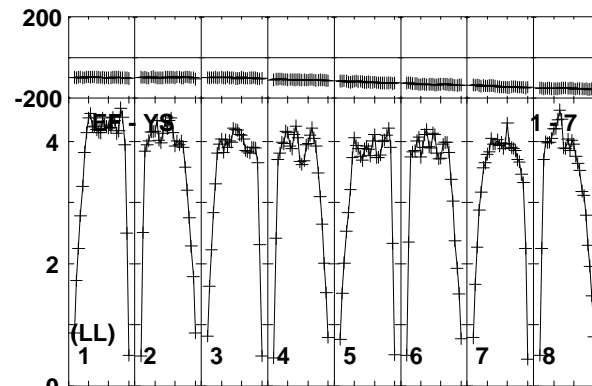
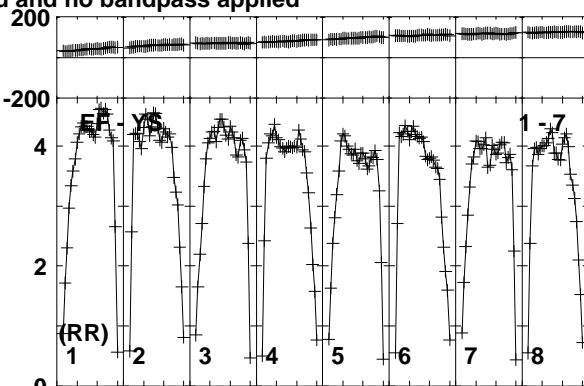
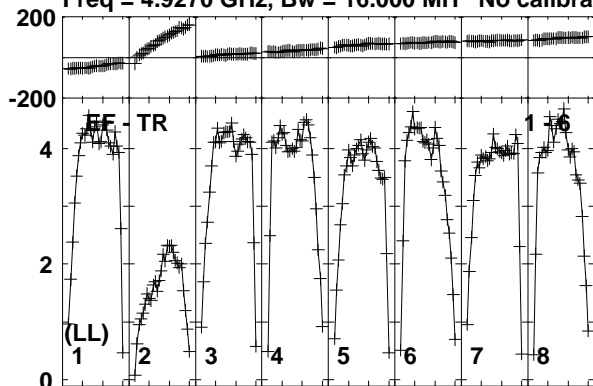

Lower frame: Milli Ampl Jy Top frame: Phas deg  
Vector averaged cross-power spectrum Baseline: EF (01) - TR (06)  
Timerange: 00/13:29:50 to 00/13:31:19

Plot file version 93 created 10-JUN-2016 15:29:25

FRB150418 RG008C.UVDATA.1

Freq = 4.9270 GHz, Bw = 16.000 MH No calibration applied and no bandpass applied

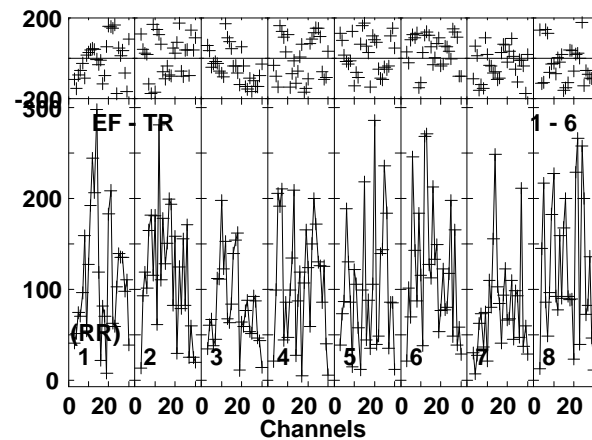
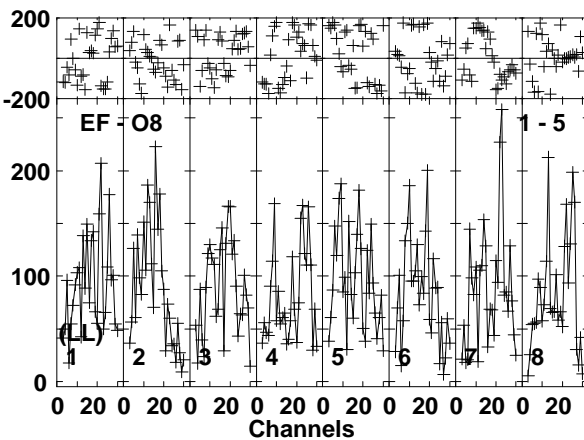
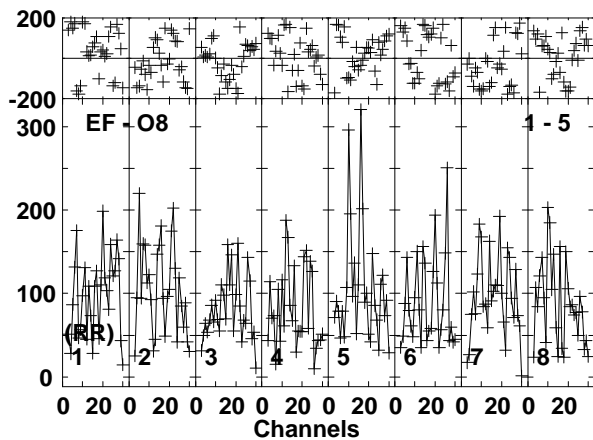
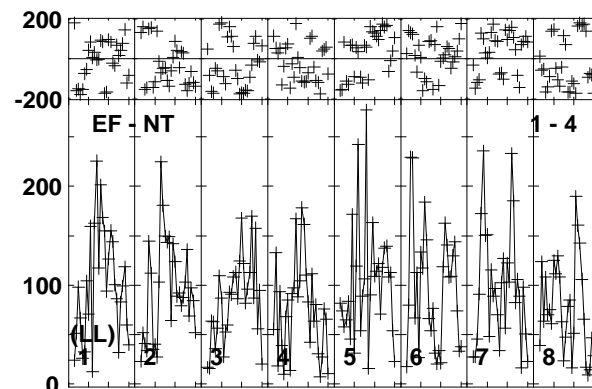
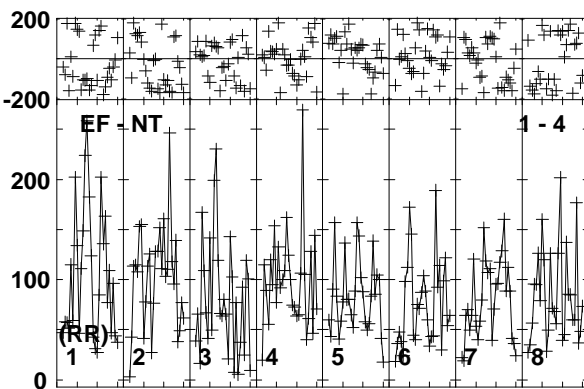
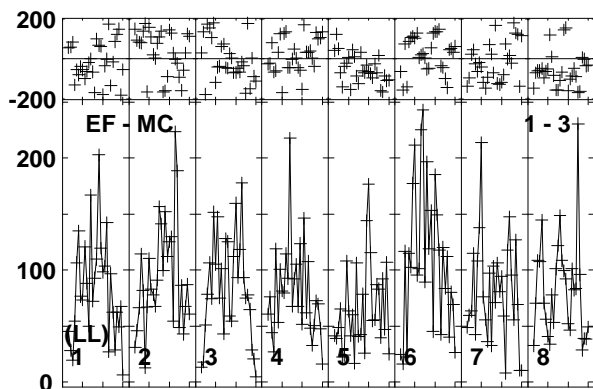
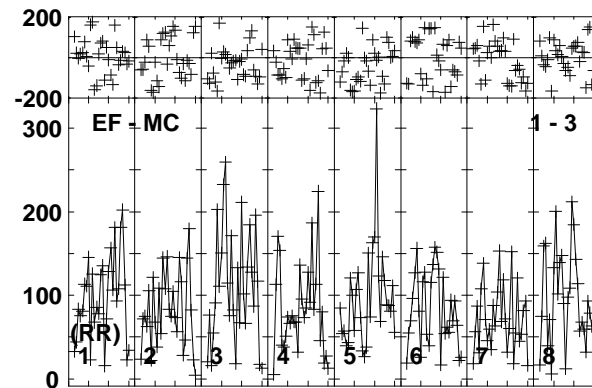
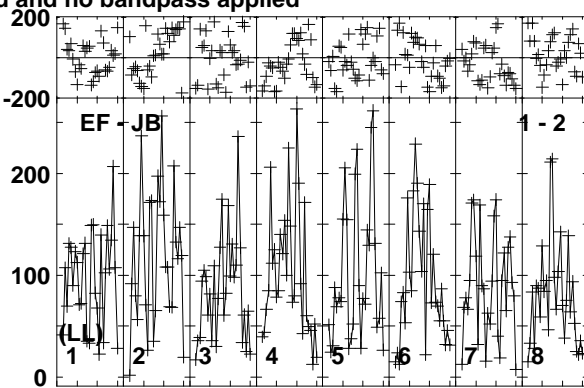
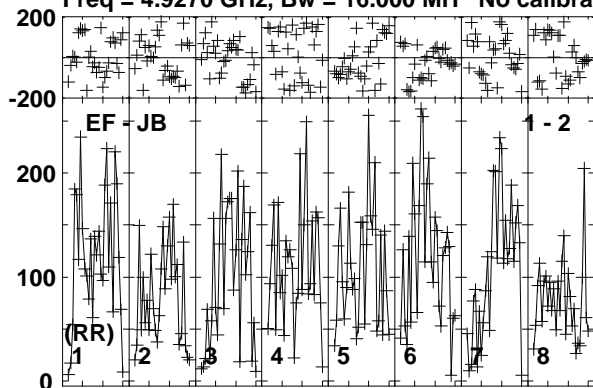

Lower frame: Micro Ampl Jy Top frame: Phas deg  
Vector averaged cross-power spectrum Baseline: EF (01) - JB (02)  
Timerange: 00/13:31:21 to 00/13:34:20

Plot file version 94 created 10-JUN-2016 15:29:25

FRB150418 RG008C.UVDATA.1

Freq = 4.9270 GHz, Bw = 16.000 MH No calibration applied and no bandpass applied

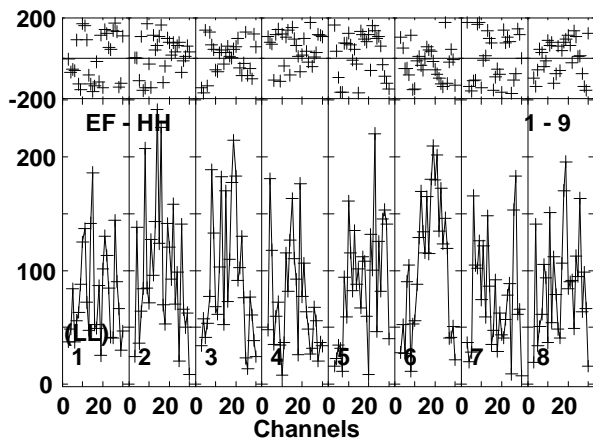
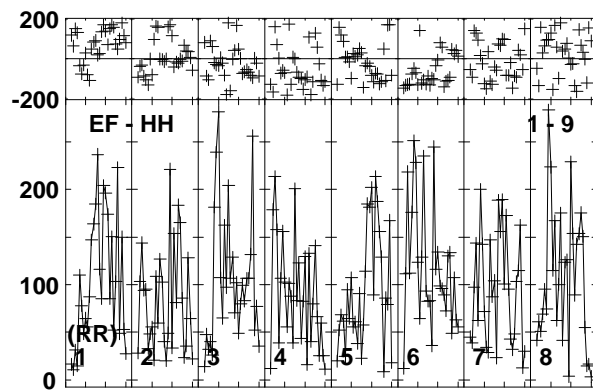
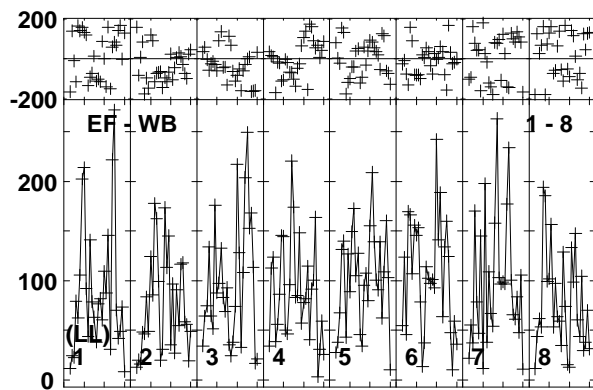
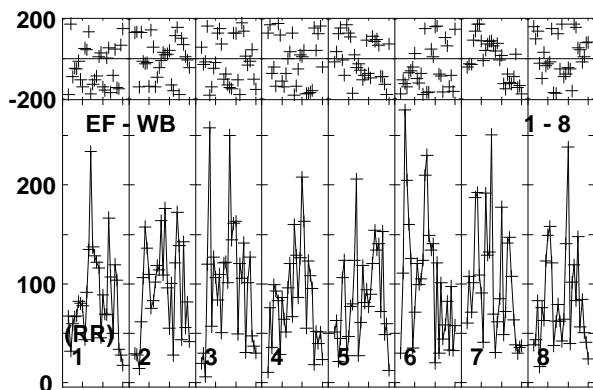
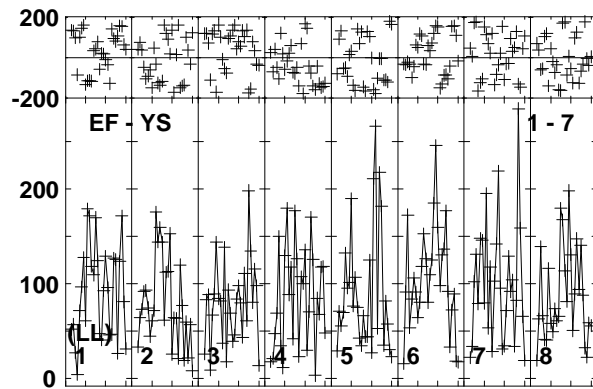
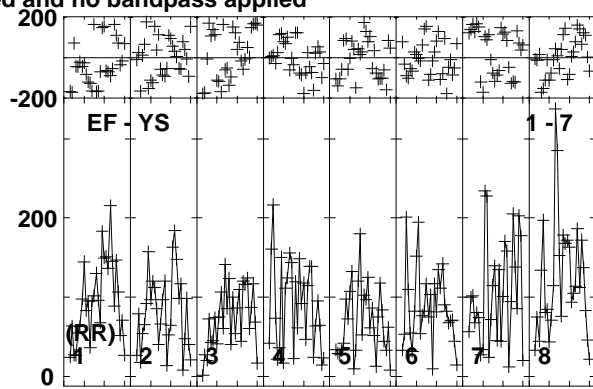
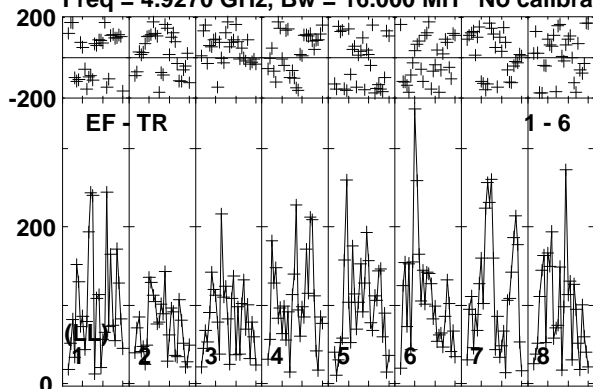

Lower frame: Micro Ampl Jy Top frame: Phas deg  
Vector averaged cross-power spectrum Baseline: EF (01) - TR (06)  
Timerange: 00/13:31:21 to 00/13:34:20

Plot file version 95 created 10-JUN-2016 15:29:25

J0718-1813 RG008C.UVDATA.1

Freq = 4.9270 GHz, Bw = 16.000 MH No calibration applied and no bandpass applied

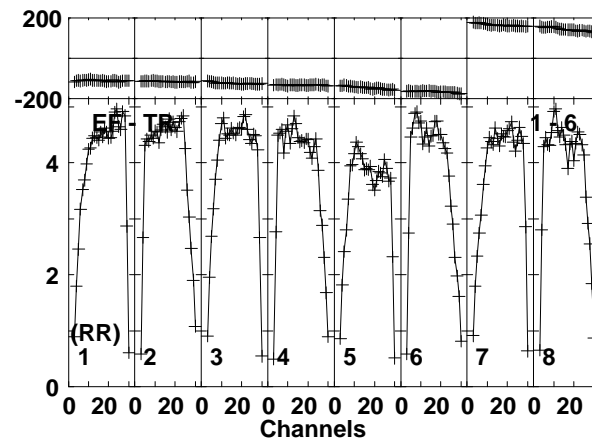
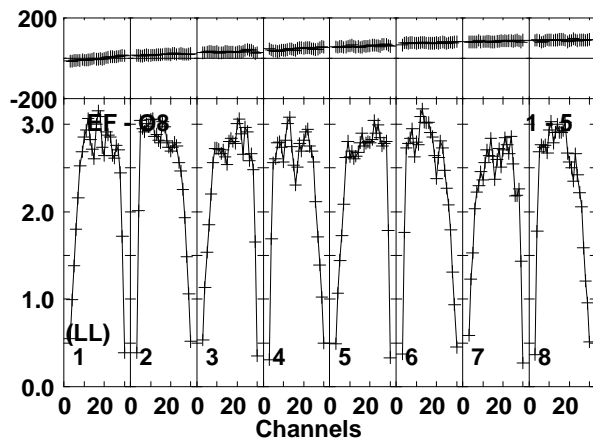
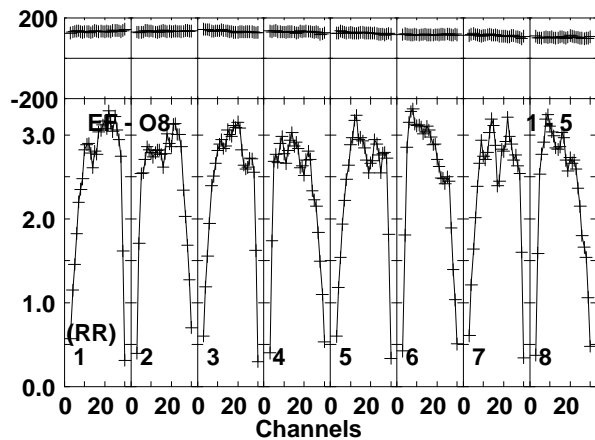
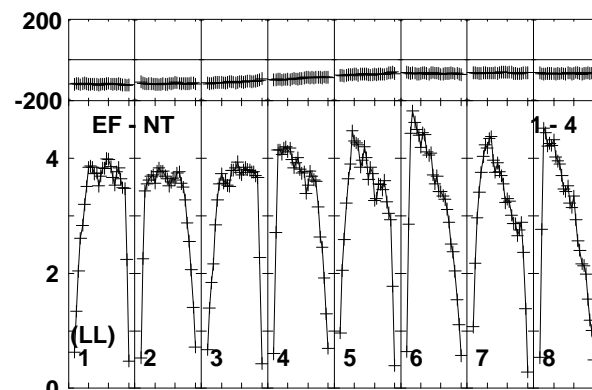
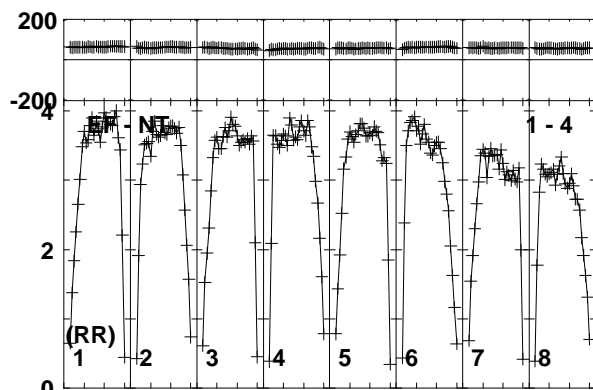
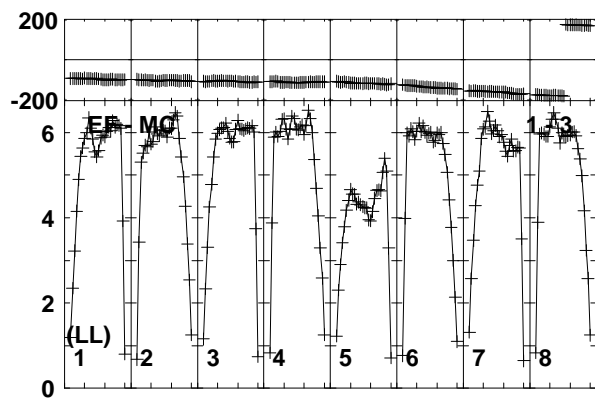
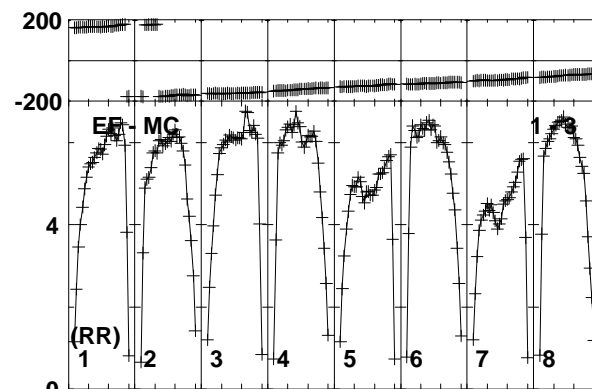
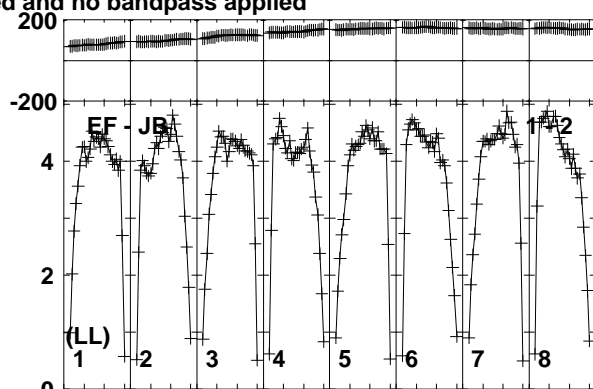
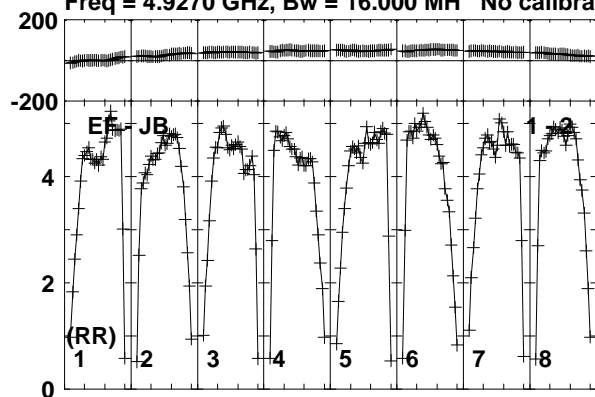

Lower frame: Milli Ampl Jy Top frame: Phas deg  
Vector averaged cross-power spectrum Baseline: EF (01) - JB (02)  
Timerange: 00/13:35:00 to 00/13:35:49

Plot file version 96 created 10-JUN-2016 15:29:25

J0718-1813 RG008C.UVDATA.1

Freq = 4.9270 GHz, Bw = 16.000 MH No calibration applied and no bandpass applied

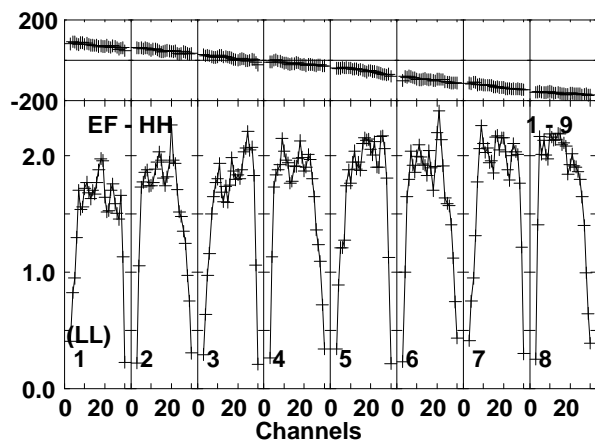
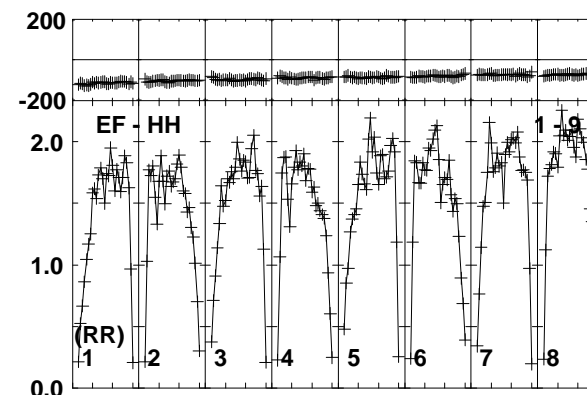
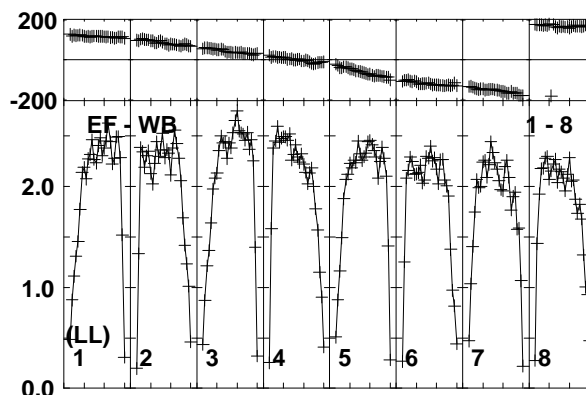
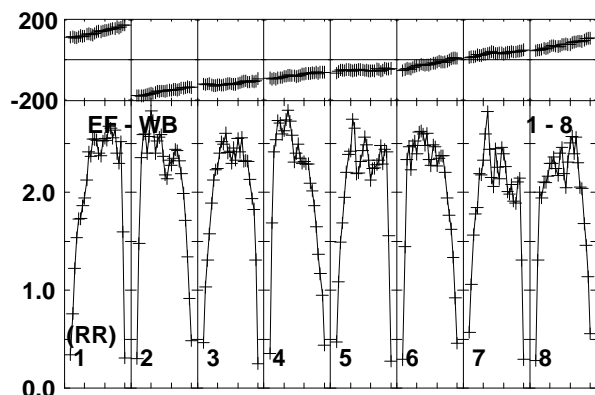
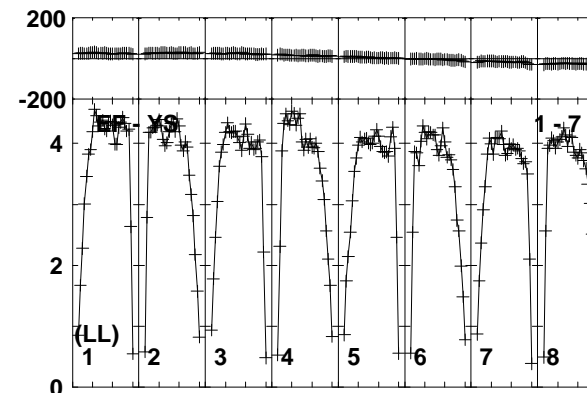
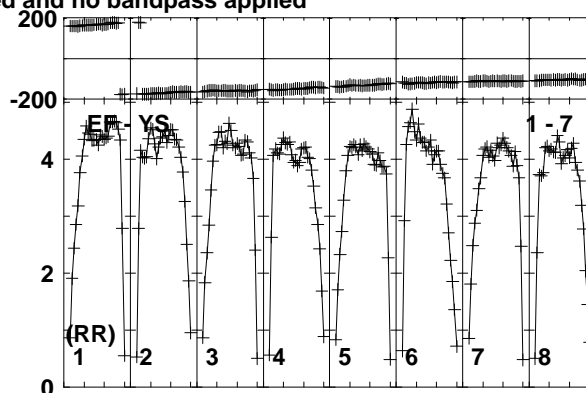
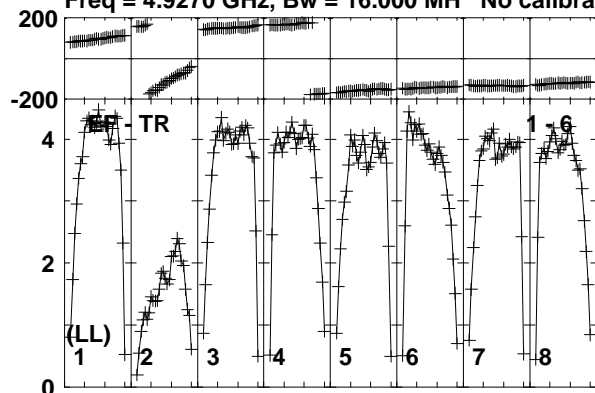

Lower frame: Milli Ampl Jy Top frame: Phas deg  
Vector averaged cross-power spectrum Baseline: EF (01) - TR (06)  
Timerange: 00/13:35:00 to 00/13:35:49



Plot file version 97 created 10-JUN-2016 15:29:25

FRB150418 RG008C.UVDATA.1

Freq = 4.9270 GHz, Bw = 16.000 MH No calibration applied and no bandpass applied

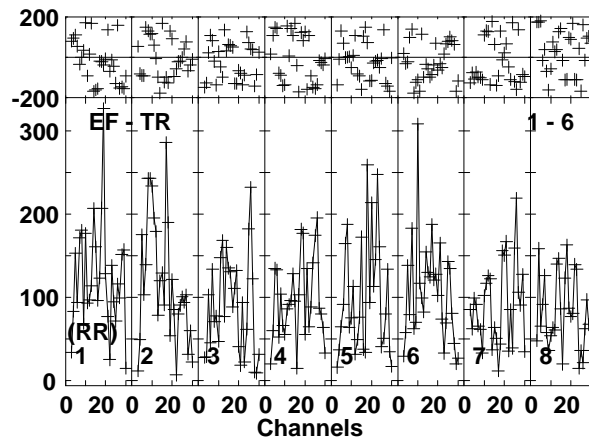
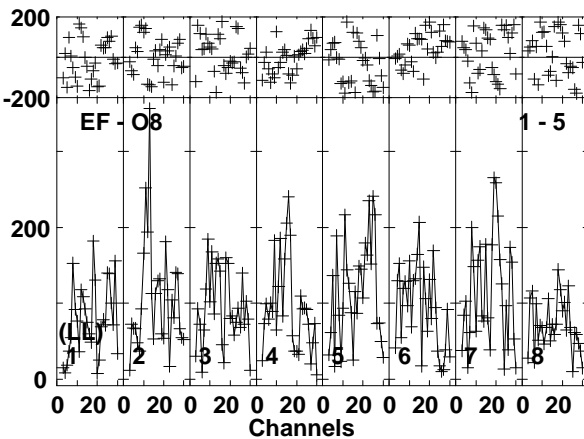
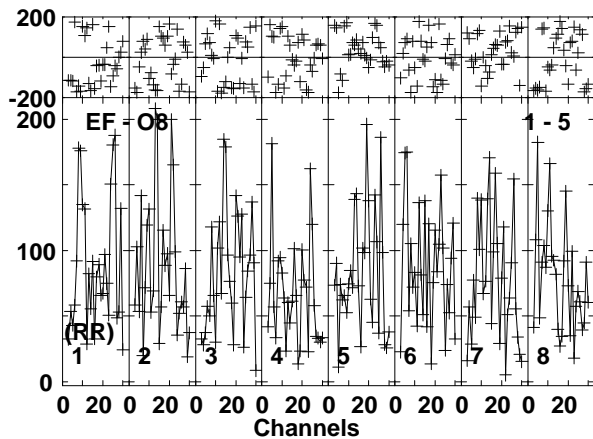
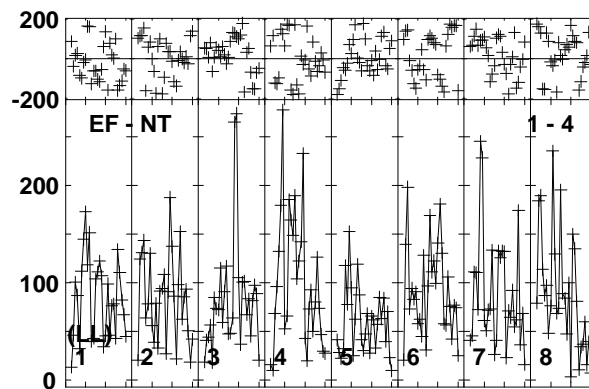
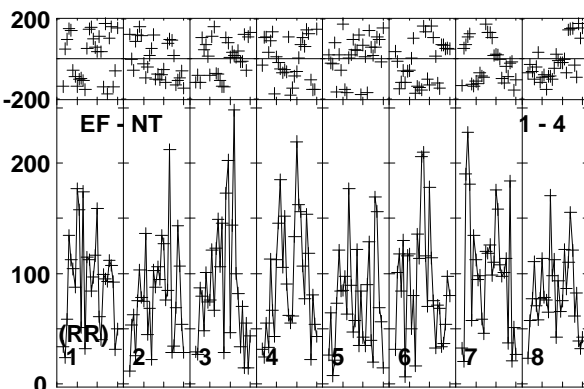
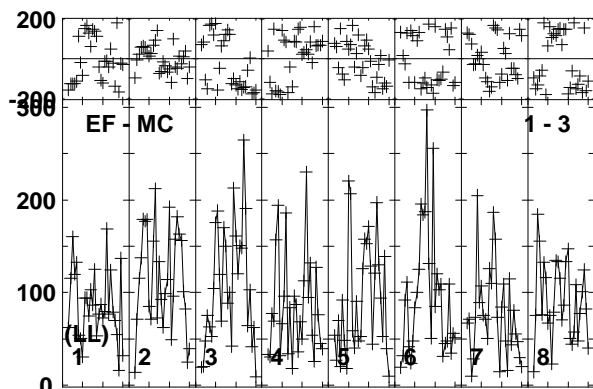
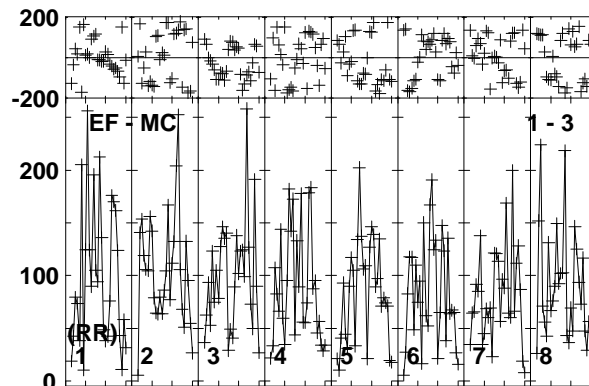
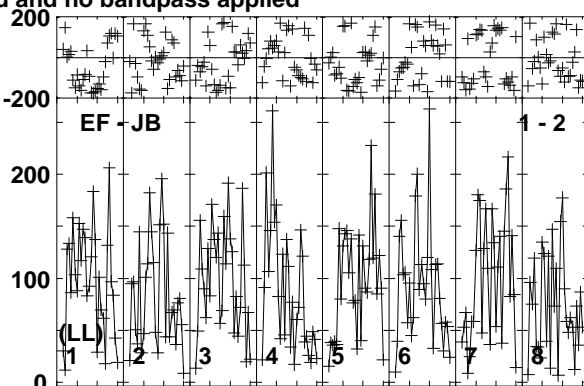
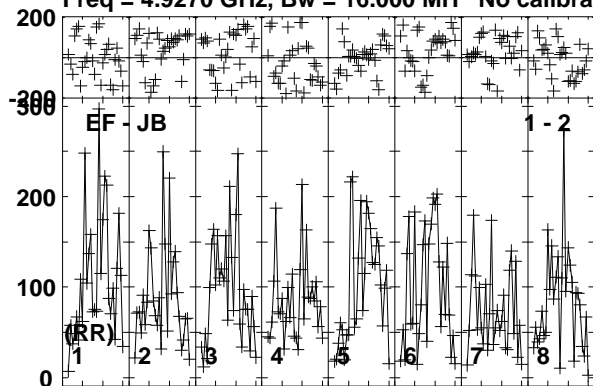

Lower frame: Micro Ampl Jy Top frame: Phas deg  
Vector averaged cross-power spectrum Baseline: EF (01) - JB (02)  
Timerange: 00:13:35:50 to 00:13:38:50

Plot file version 98 created 10-JUN-2016 15:29:25

FRB150418 RG008C.UVDATA.1

Freq = 4.9270 GHz, Bw = 16.000 MH No calibration applied and no bandpass applied

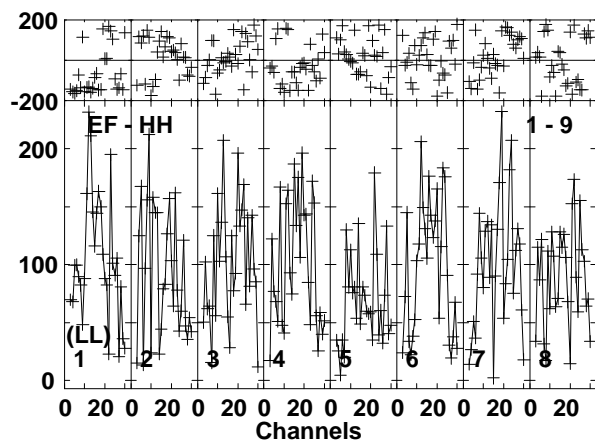
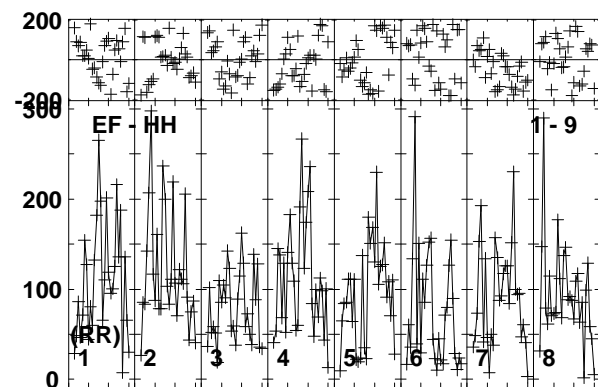
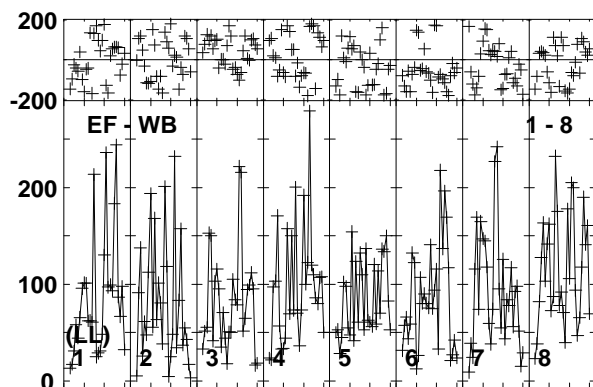
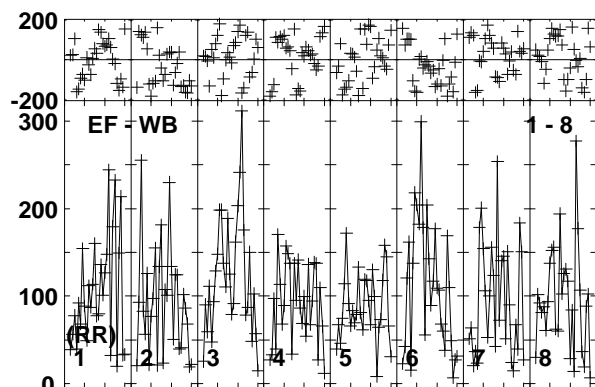
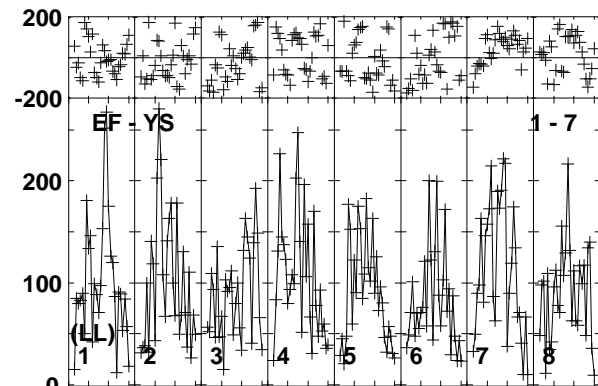
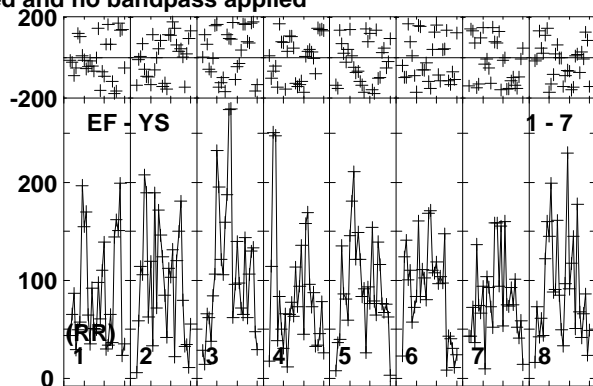
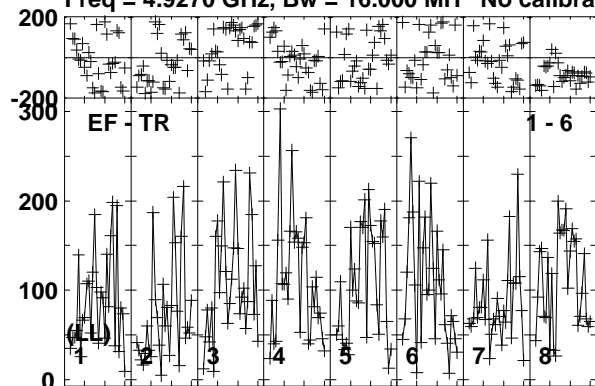

Lower frame: Micro Ampl Jy Top frame: Phas deg  
Vector averaged cross-power spectrum Baseline: EF (01) - TR (06)  
Timerange: 00/13:35:50 to 00/13:38:50

Plot file version 99 created 10-JUN-2016 15:29:26

J0718-1813 RG008C.UVDATA.1

Freq = 4.9270 GHz, Bw = 16.000 MH No calibration applied and no bandpass applied

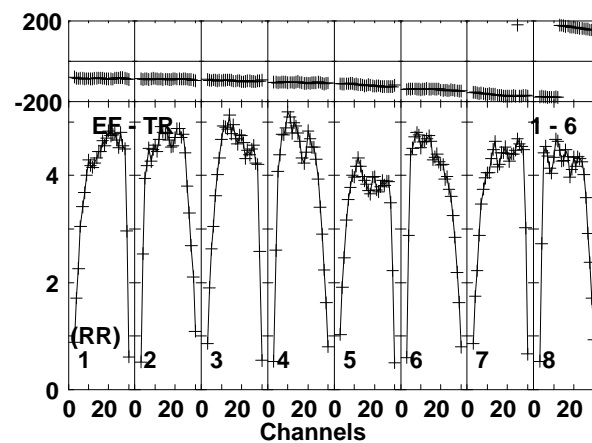
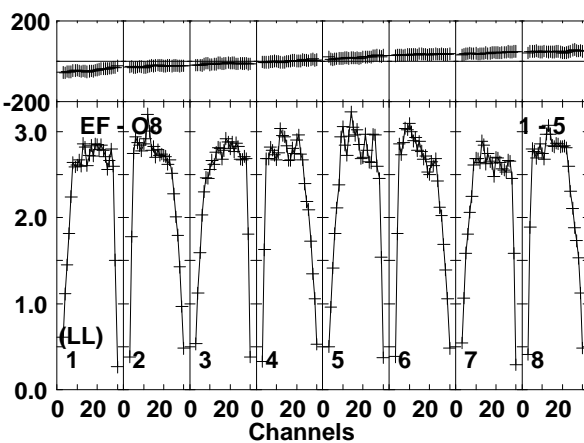
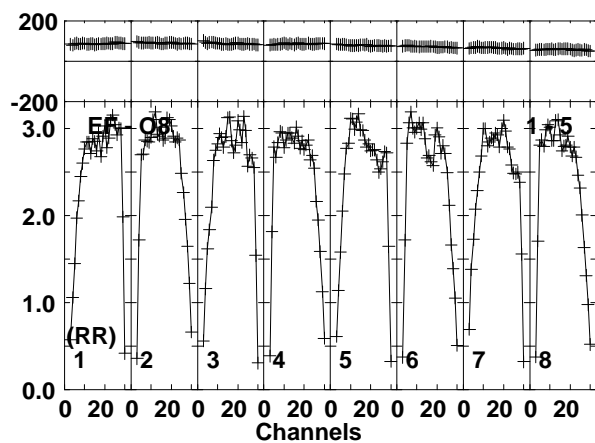
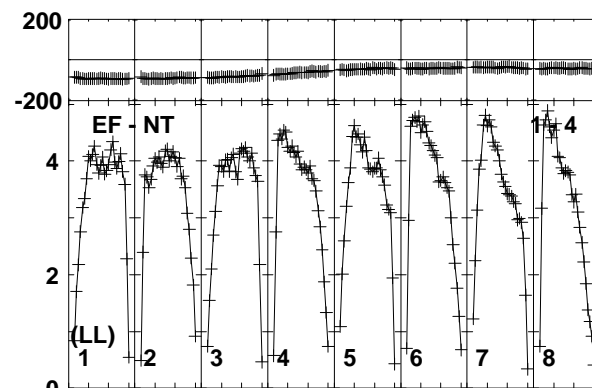
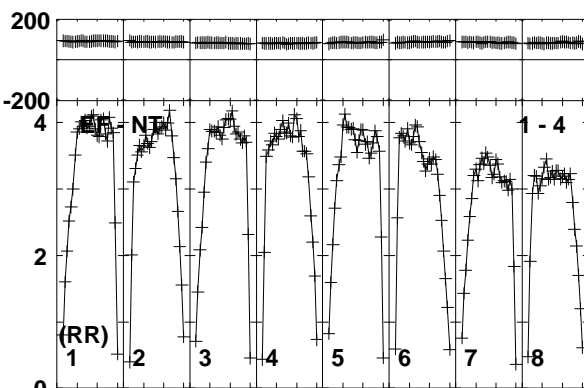
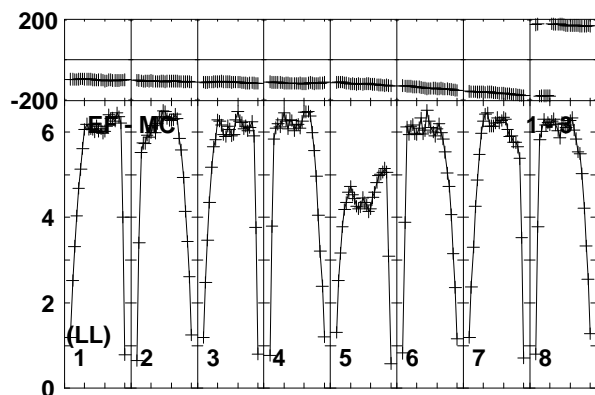
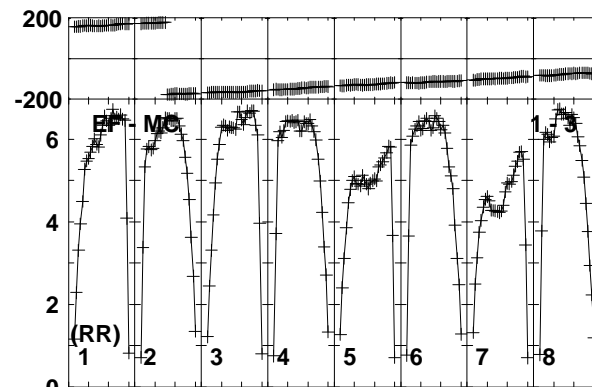
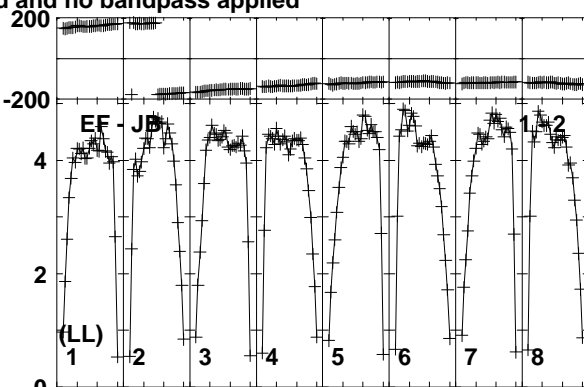
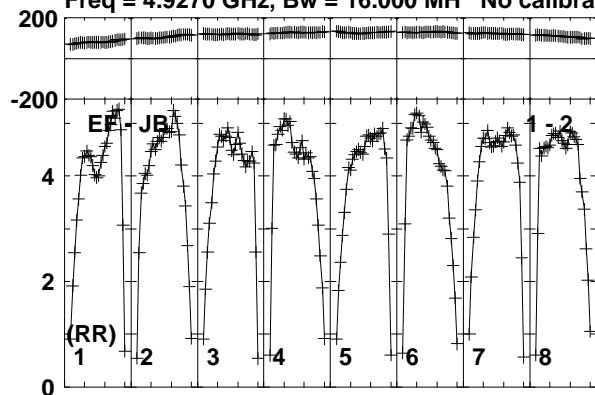

Lower frame: Milli Ampl Jy Top frame: Phas deg  
Vector averaged cross-power spectrum Baseline: EF (01) - JB (02)  
Timerange: 00/13:38:51 to 00/13:40:19

Plot file version 100 created 10-JUN-2016 15:29:26

J0718-1813 RG008C.UVDATA.1

Freq = 4.9270 GHz, Bw = 16.000 MH No calibration applied and no bandpass applied

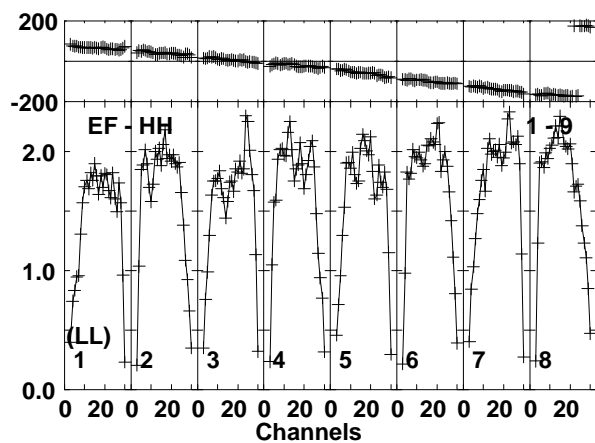
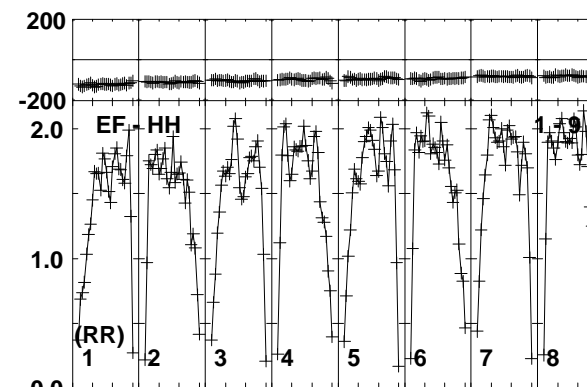
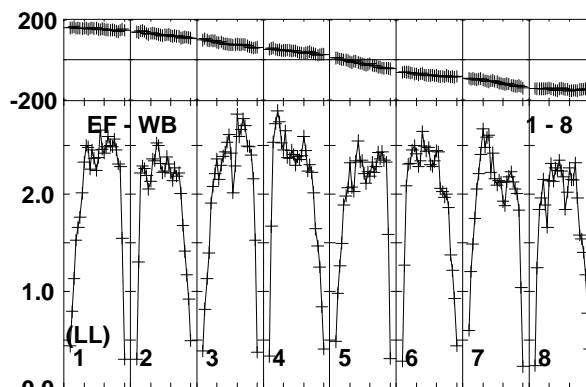
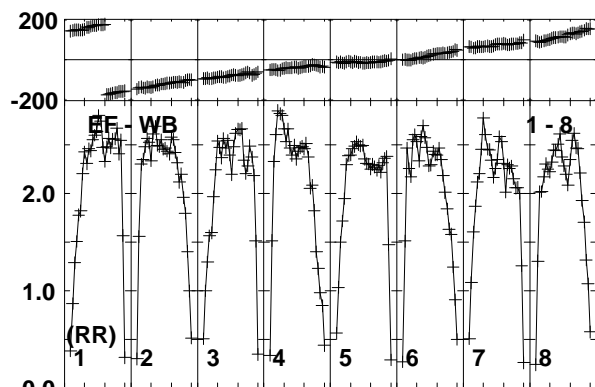
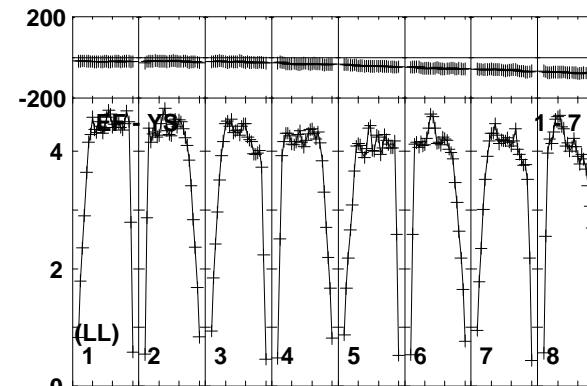
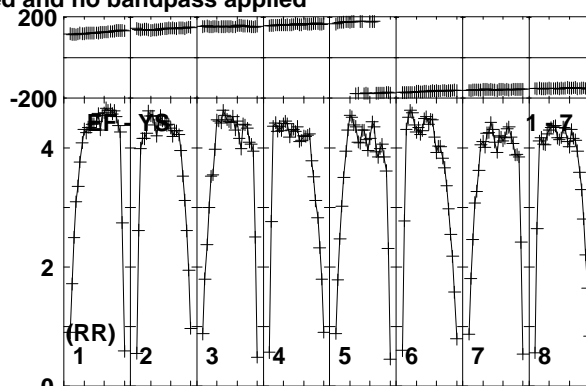
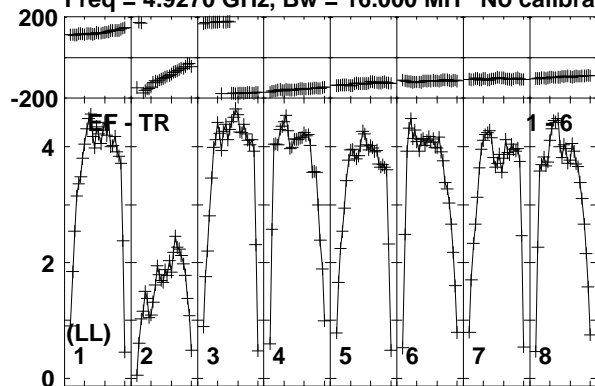

Lower frame: Milli Ampl Jy Top frame: Phas deg  
Vector averaged cross-power spectrum Baseline: EF (01) - TR (06)  
Timerange: 00/13:38:51 to 00/13:40:19

Plot file version 101 created 10-JUN-2016 15:29:26

J0712-1847 RG008C.UVDATA.1

Freq = 4.9270 GHz, Bw = 16.000 MH No calibration applied and no bandpass applied

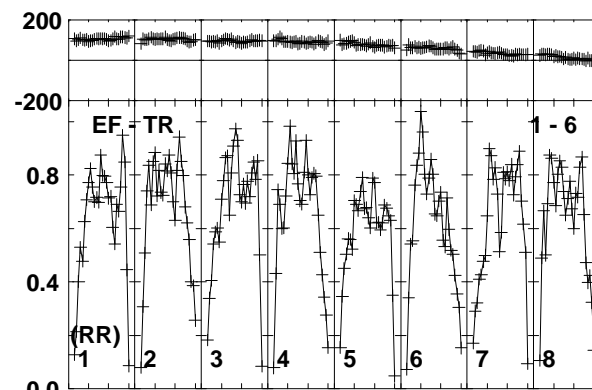
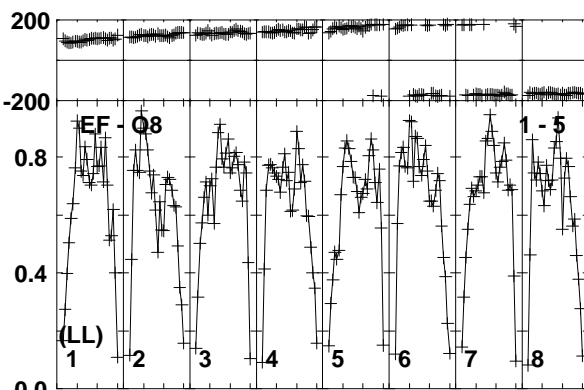
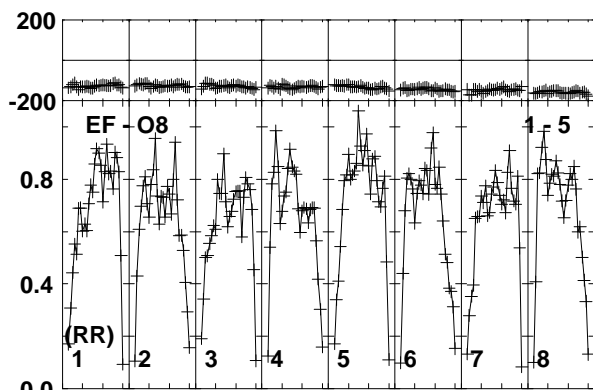
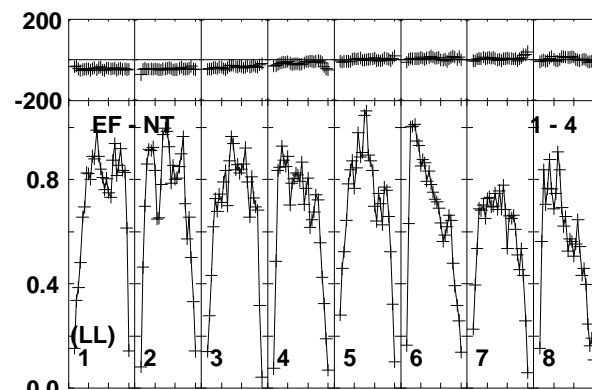
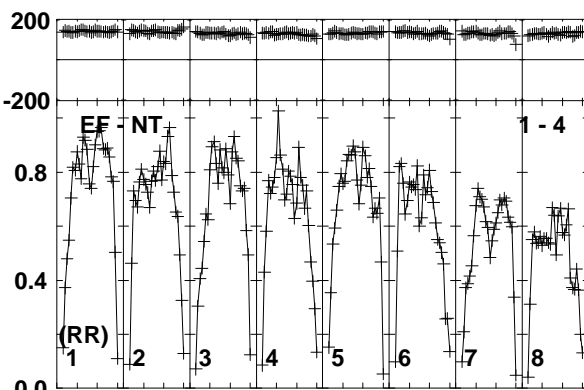
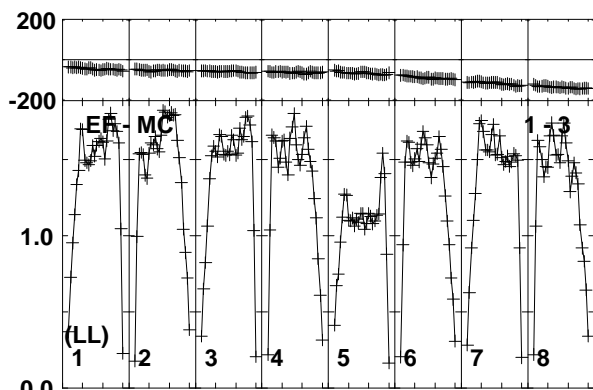
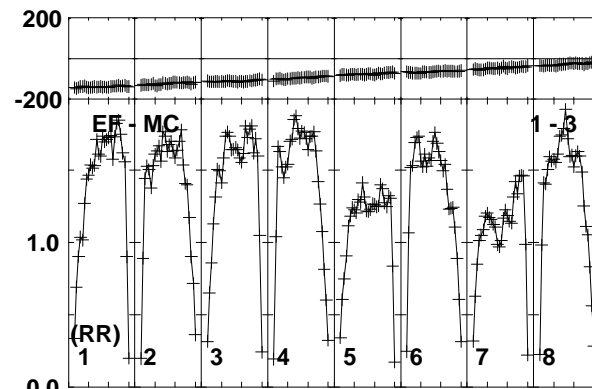
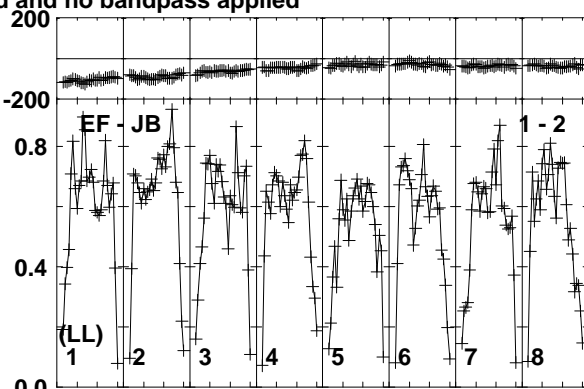
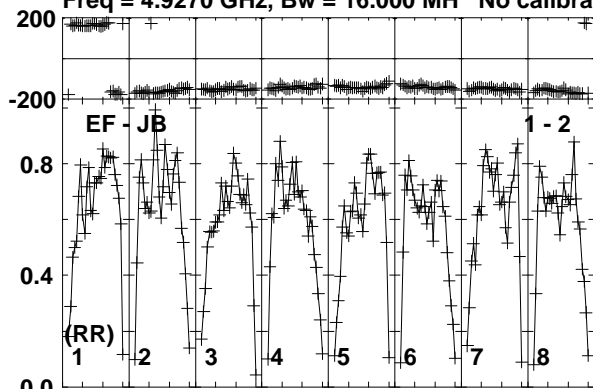

Lower frame: Milli Ampl Jy Top frame: Phas deg  
Vector averaged cross-power spectrum Baseline: EF (01) - JB (02)  
Timerange: 00/13:40:20 to 00/13:43:20

Plot file version 102 created 10-JUN-2016 15:29:26

J0712-1847 RG008C.UVDATA.1

Freq = 4.9270 GHz, Bw = 16.000 MH No calibration applied and no bandpass applied

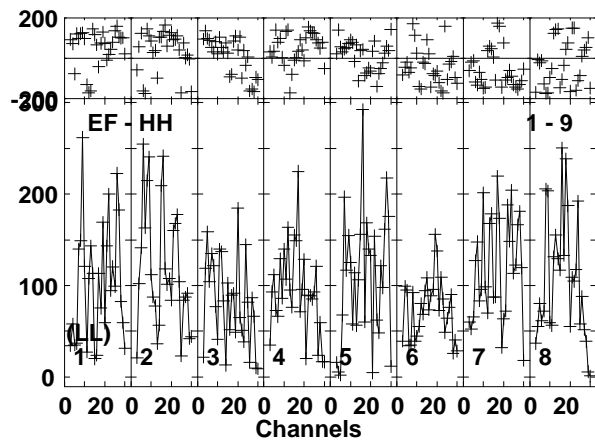
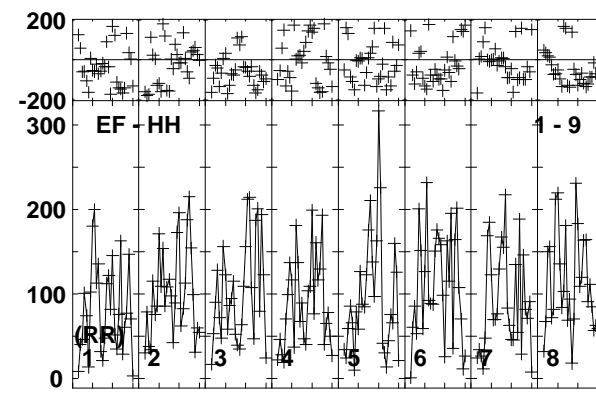
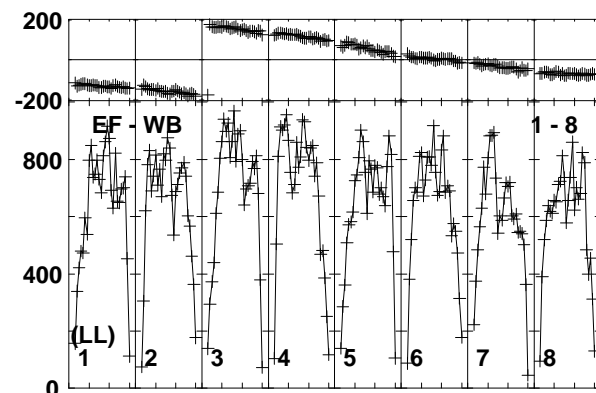
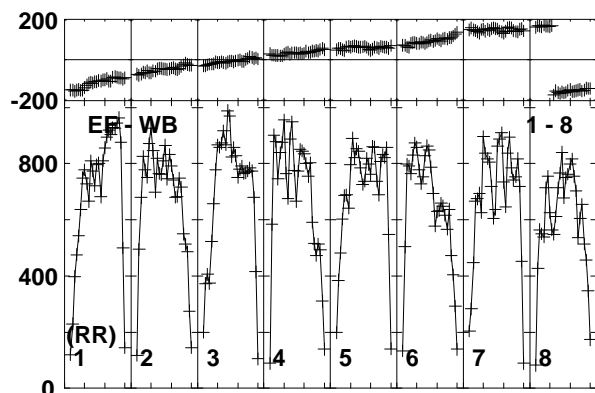
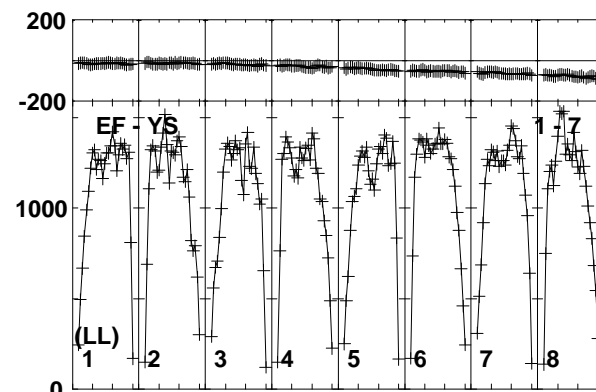
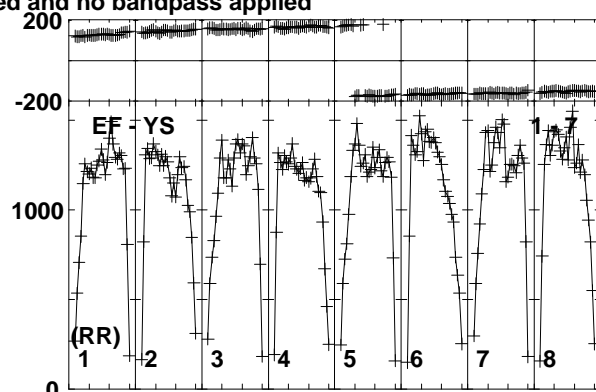
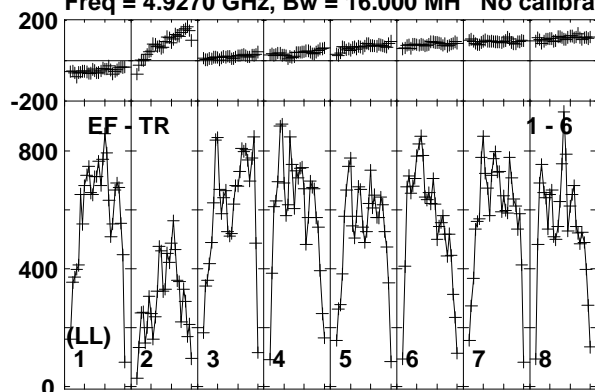

Lower frame: Micro Ampl Jy Top frame: Phas deg  
Vector averaged cross-power spectrum Baseline: EF (01) - TR (06)  
Timerange: 00/13:40:20 to 00/13:43:20

Plot file version 103 created 10-JUN-2016 15:29:26

J0718-1813 RG008C.UVDATA.1

Freq = 4.9270 GHz, Bw = 16.000 MH No calibration applied and no bandpass applied

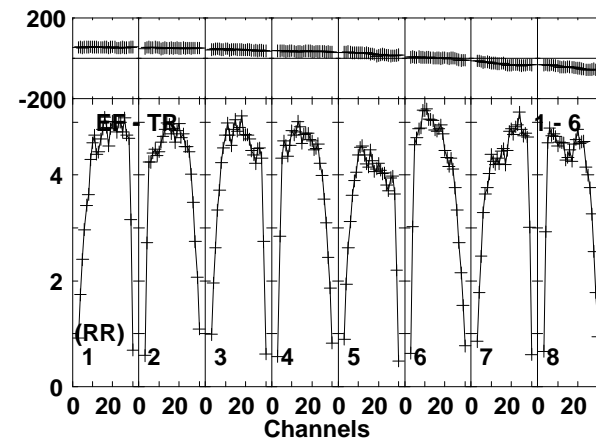
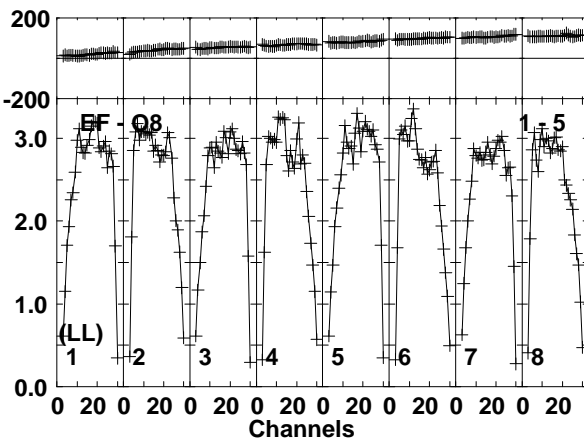
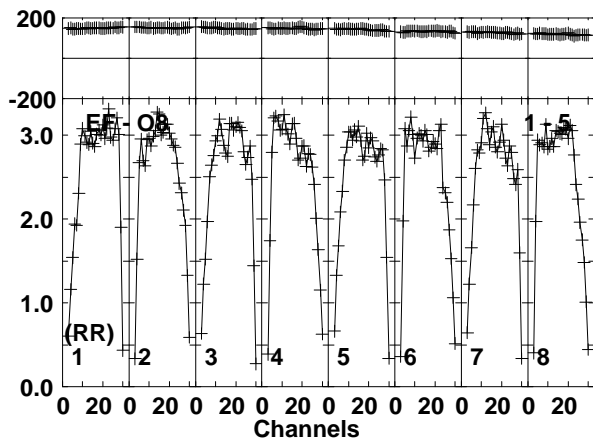
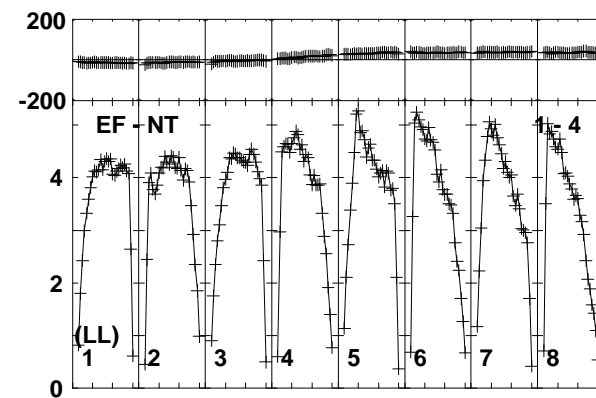
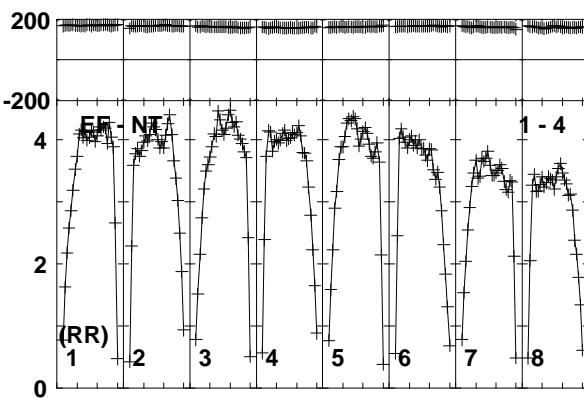
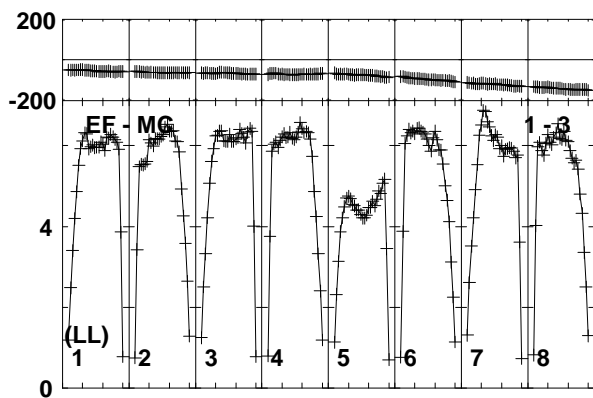
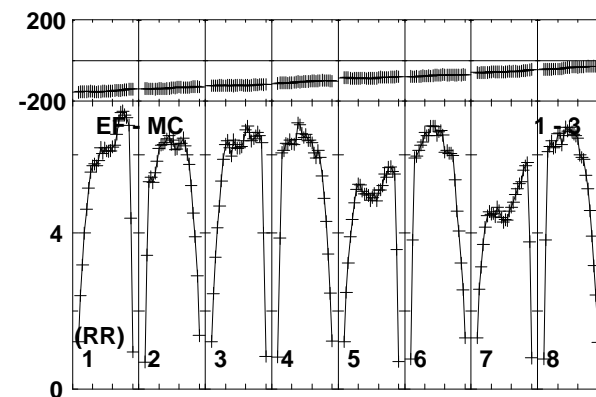
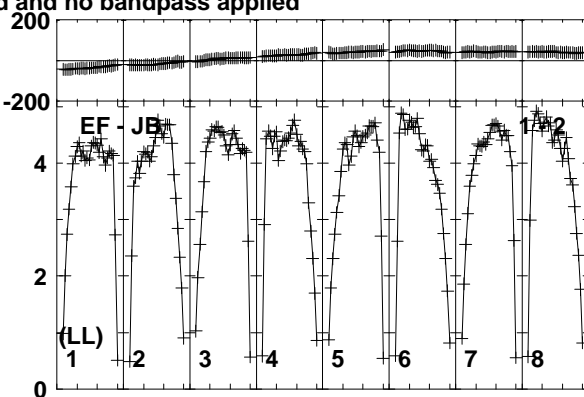
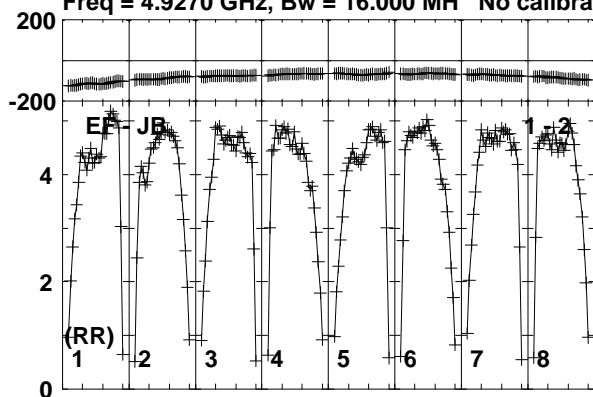

Lower frame: Milli Ampl Jy Top frame: Phas deg  
Vector averaged cross-power spectrum Baseline: EF (01) - JB (02)  
Timerange: 00/13:44:00 to 00/13:44:50

Plot file version 104 created 10-JUN-2016 15:29:26

J0718-1813 RG008C.UVDATA.1

Freq = 4.9270 GHz, Bw = 16.000 MH No calibration applied and no bandpass applied

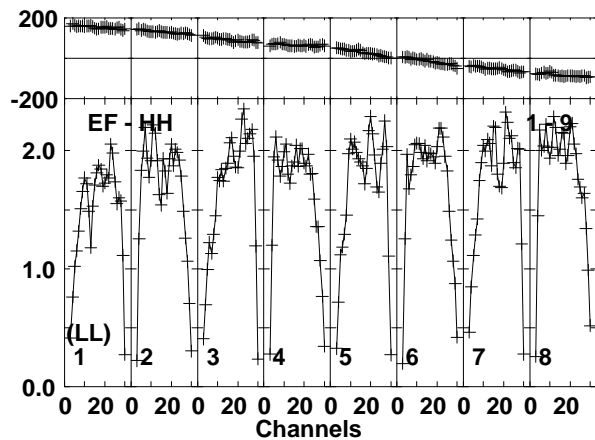
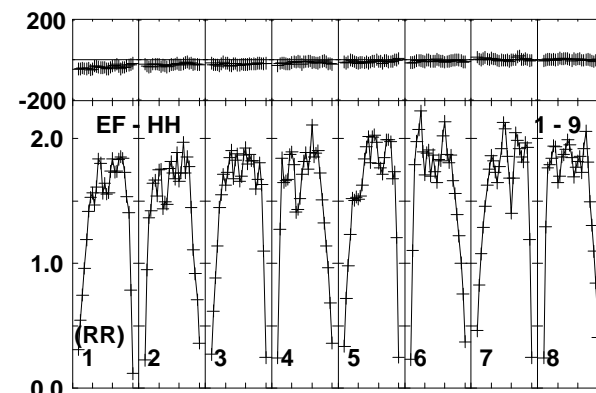
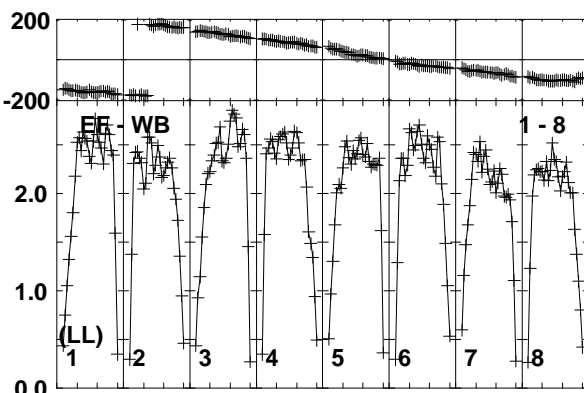
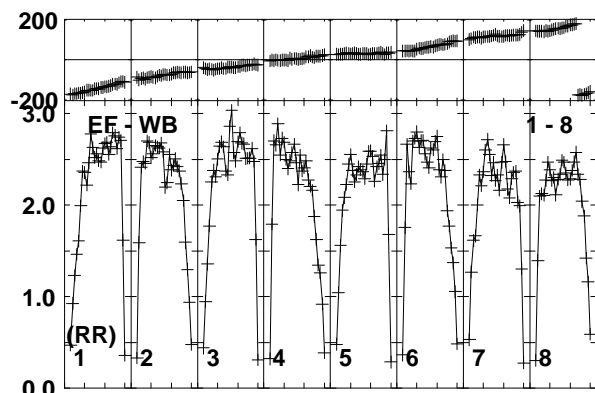
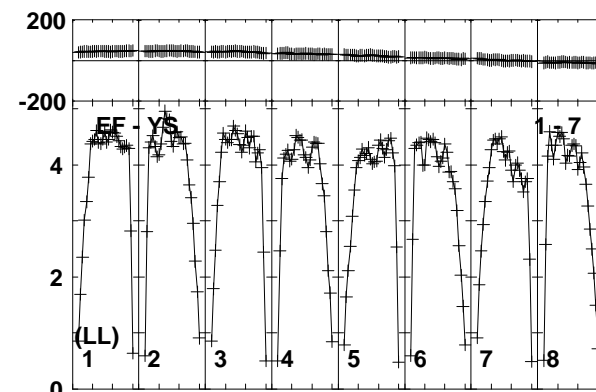
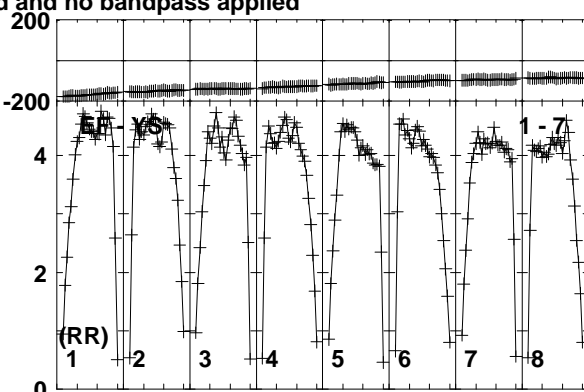
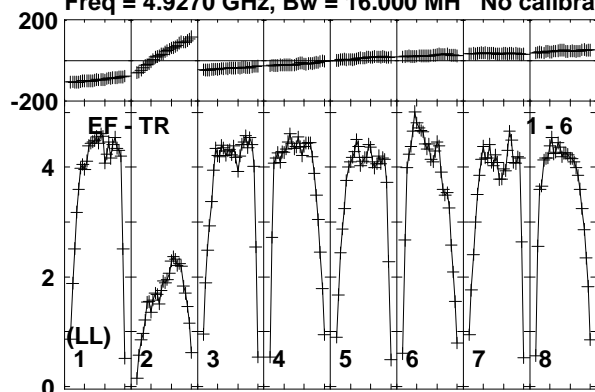

Lower frame: Milli Ampl Jy Top frame: Phas deg  
Vector averaged cross-power spectrum Baseline: EF (01) - TR (06)  
Timerange: 00/13:44:00 to 00/13:44:50



Plot file version 105 created 10-JUN-2016 15:29:26

FRB150418 RG008C.UVDATA.1

Freq = 4.9270 GHz, Bw = 16.000 MH No calibration applied and no bandpass applied

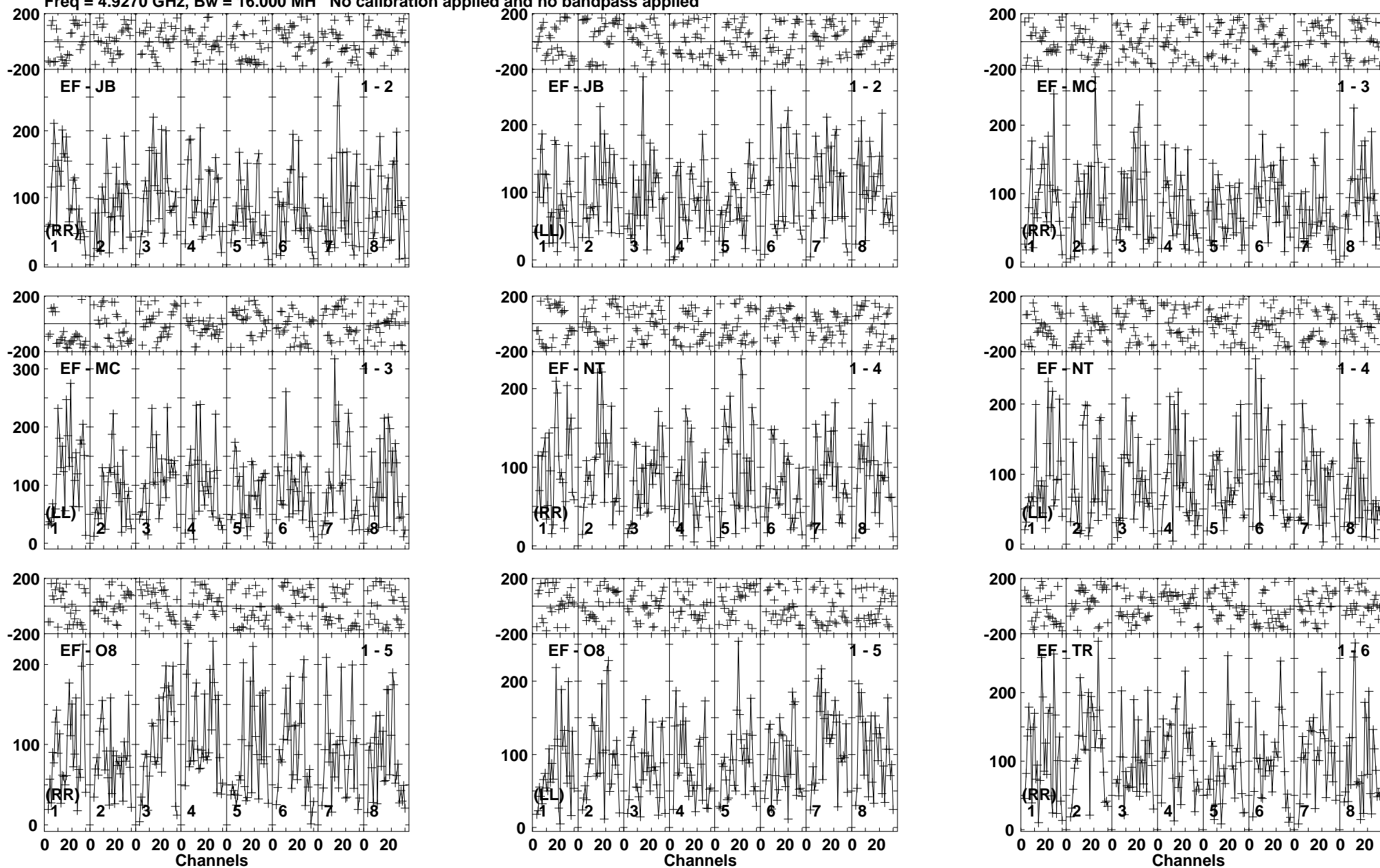

Lower frame: Micro Ampl Jy Top frame: Phas deg  
Vector averaged cross-power spectrum Baseline: EF (01) - JB (02)  
Timerange: 00/13:44:51 to 00/13:47:49

Plot file version 106 created 10-JUN-2016 15:29:26

FRB150418 RG008C.UVDATA.1

Freq = 4.9270 GHz, Bw = 16.000 MH No calibration applied and no bandpass applied

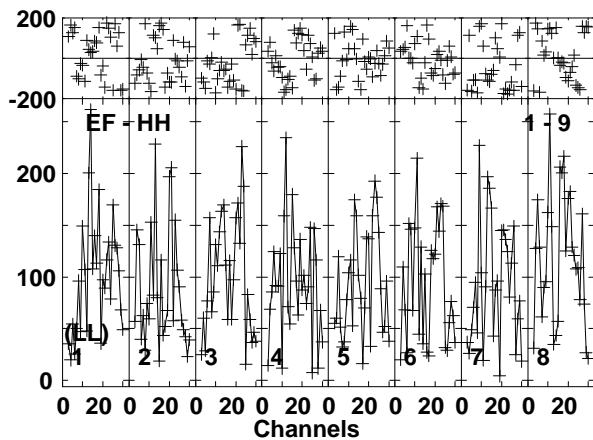
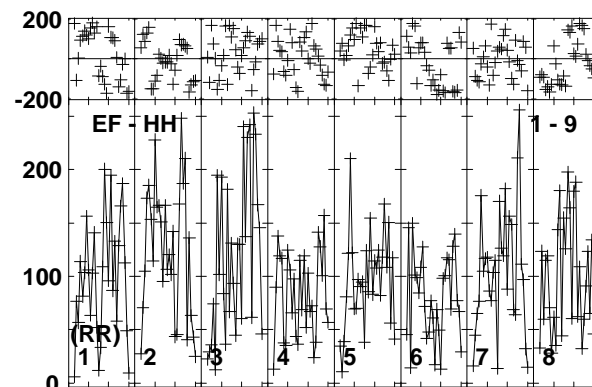
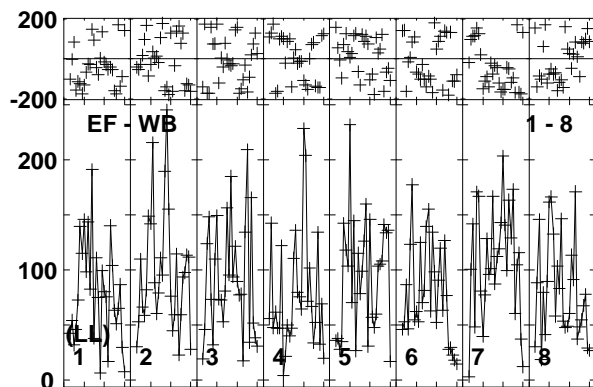
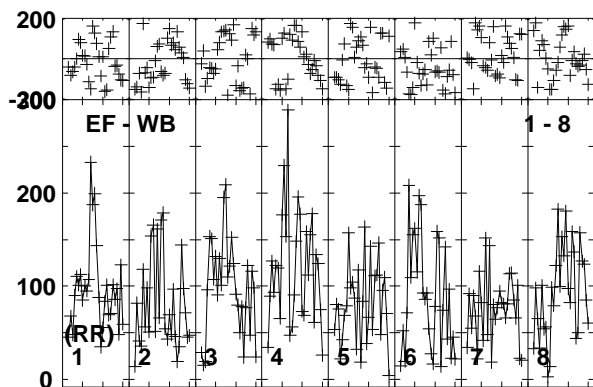
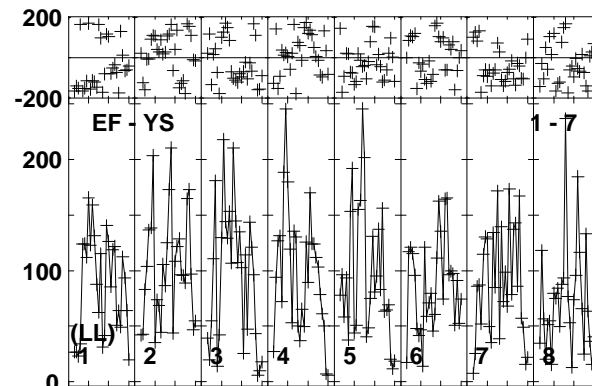
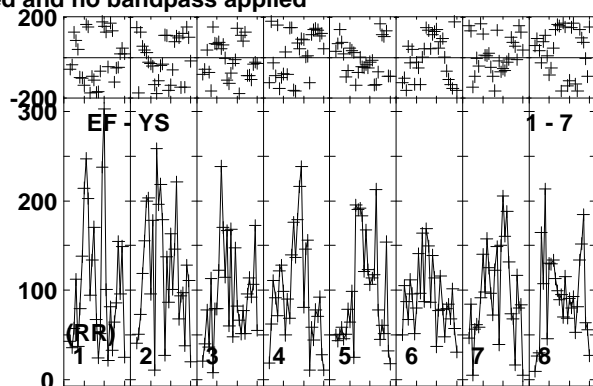
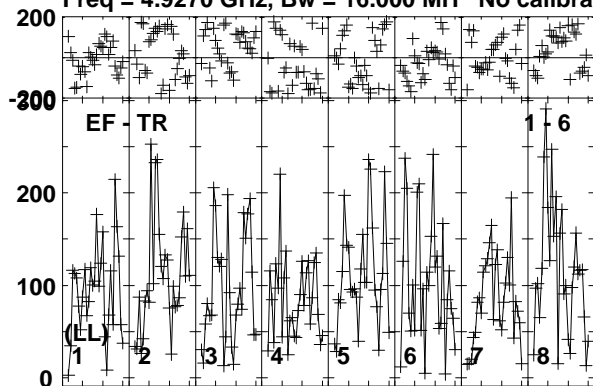

Lower frame: Micro Ampl Jy Top frame: Phas deg  
Vector averaged cross-power spectrum Baseline: EF (01) - TR (06)  
Timerange: 00/13:44:51 to 00/13:47:49

Plot file version 107 created 10-JUN-2016 15:29:26

J0718-1813 RG008C.UVDATA.1

Freq = 4.9270 GHz, Bw = 16.000 MH No calibration applied and no bandpass applied

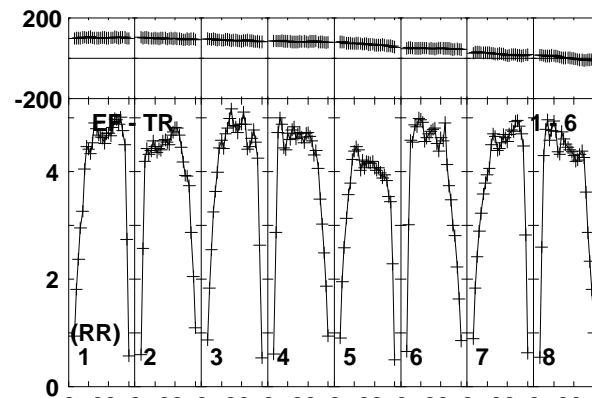
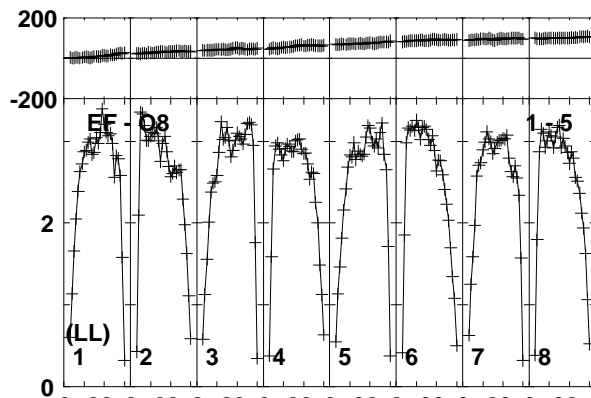
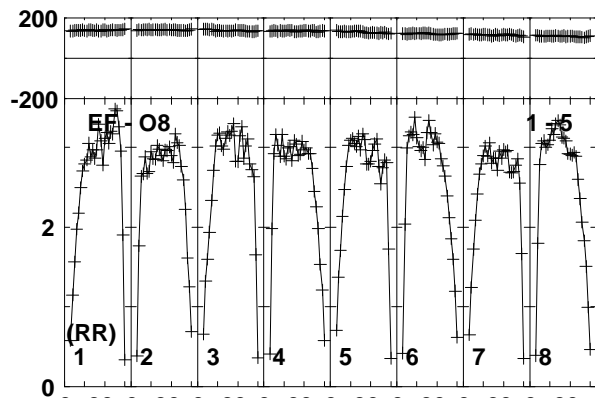
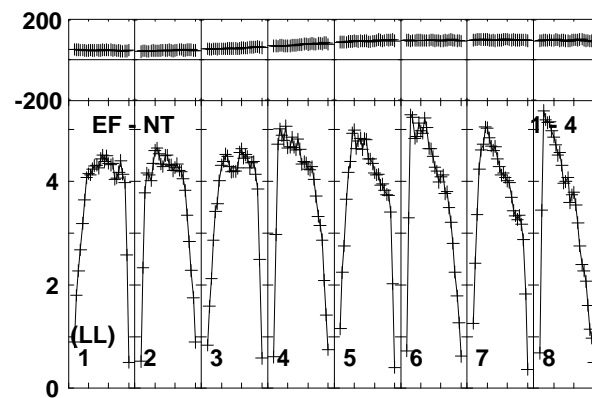
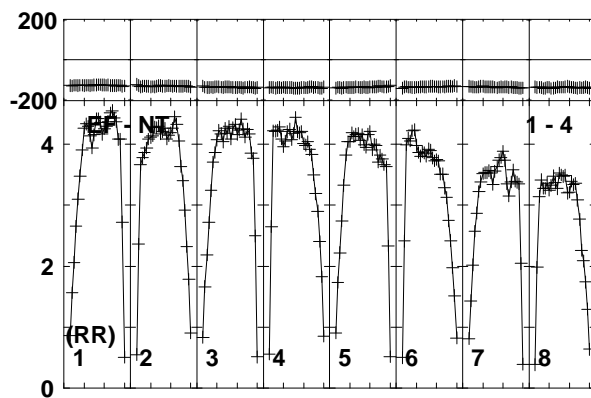
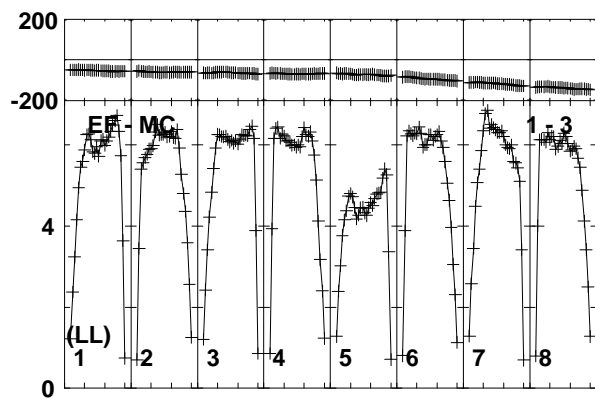
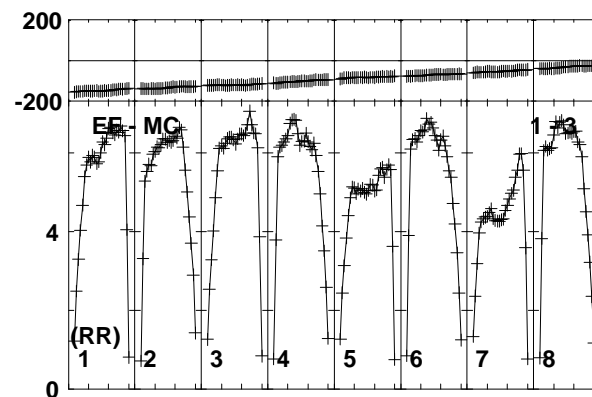
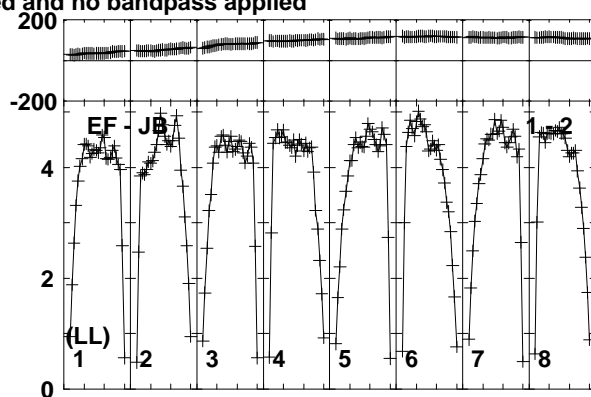
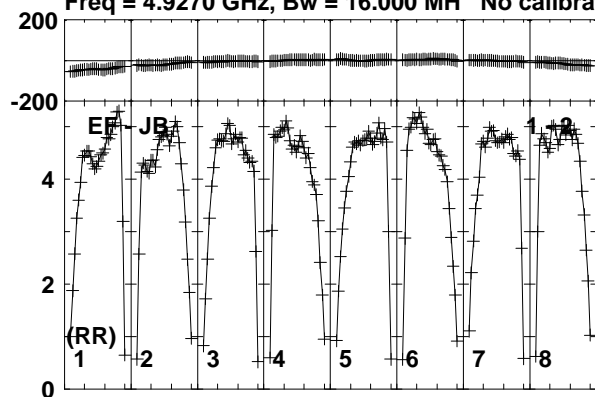

Lower frame: Milli Ampl Jy Top frame: Phas deg  
Vector averaged cross-power spectrum Baseline: EF (01) - JB (02)  
Timerange: 00:13:47:50 to 00:13:49:20

Plot file version 108 created 10-JUN-2016 15:29:27

J0718-1813 RG008C.UVDATA.1

Freq = 4.9270 GHz, Bw = 16.000 MH No calibration applied and no bandpass applied

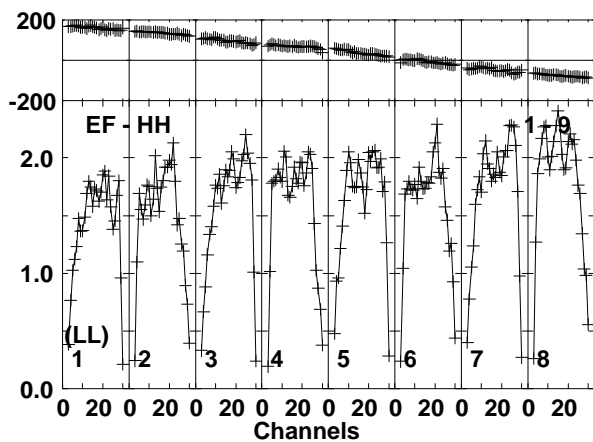
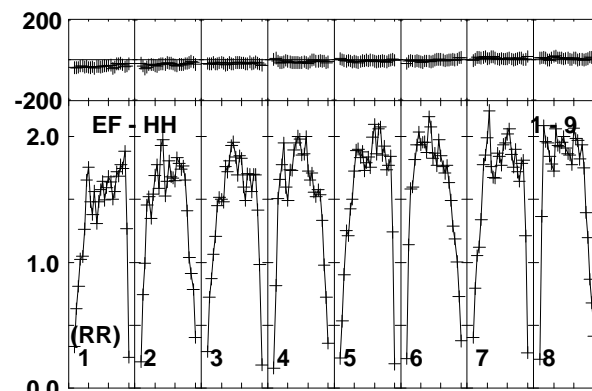
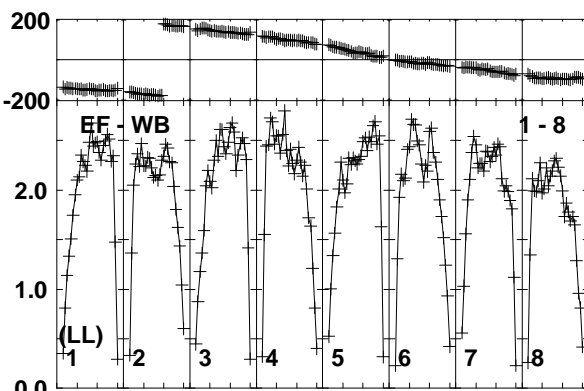
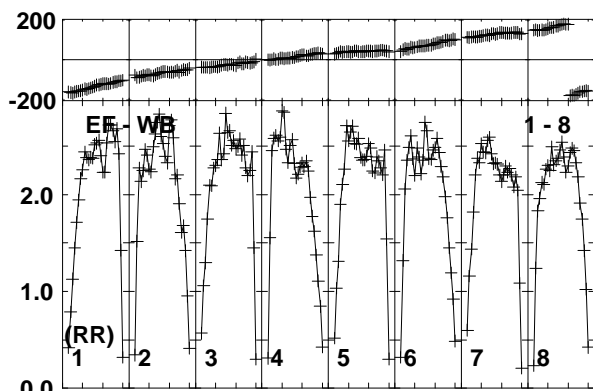
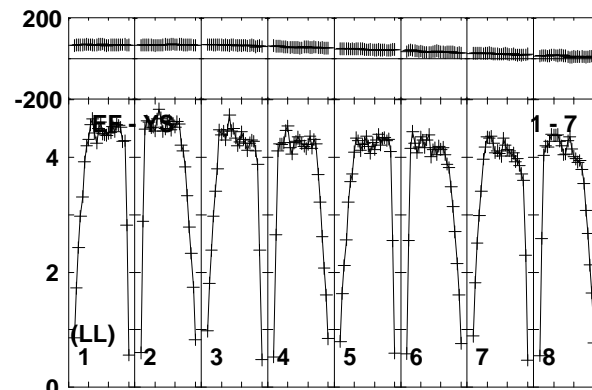
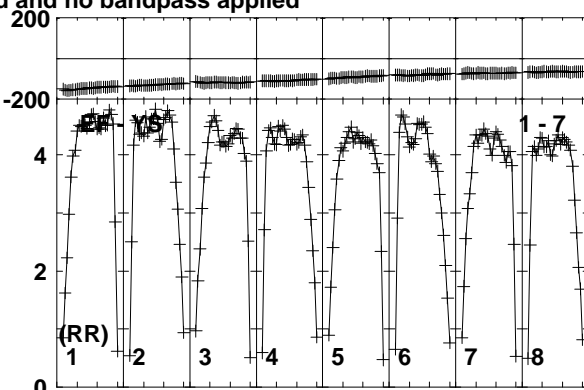
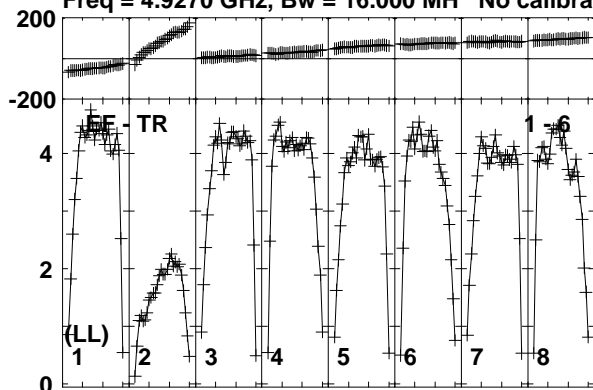

Lower frame: Milli Ampl Jy Top frame: Phas deg  
Vector averaged cross-power spectrum Baseline: EF (01) - TR (06)  
Timerange: 00:13:47:50 to 00:13:49:20

Plot file version 109 created 10-JUN-2016 15:29:27

FRB150418 RG008C.UVDATA.1

Freq = 4.9270 GHz, Bw = 16.000 MH No calibration applied and no bandpass applied

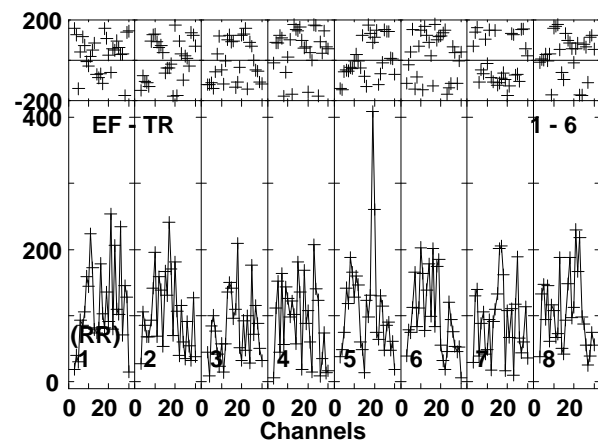
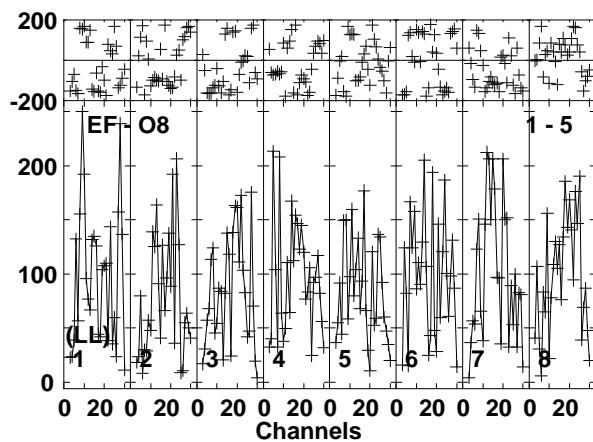
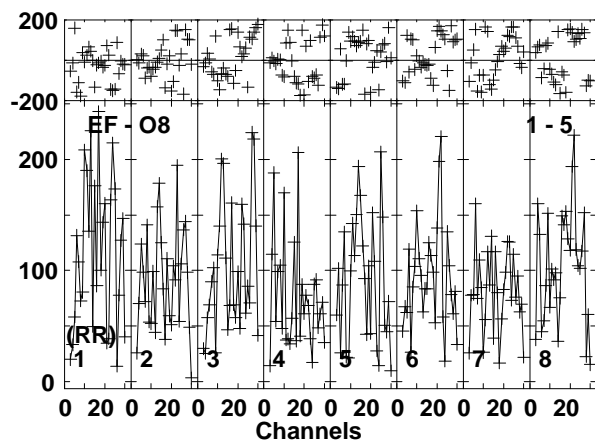
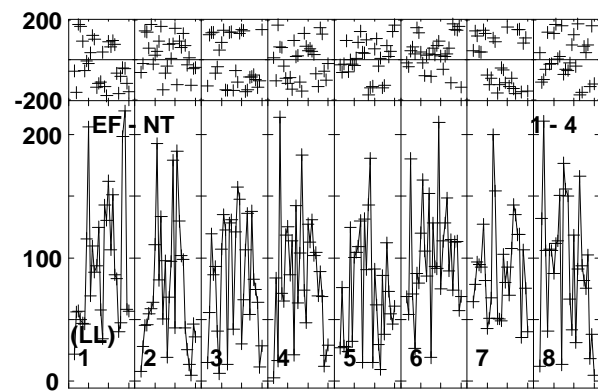
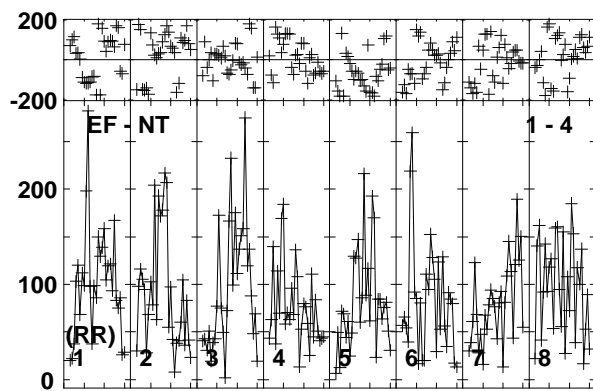
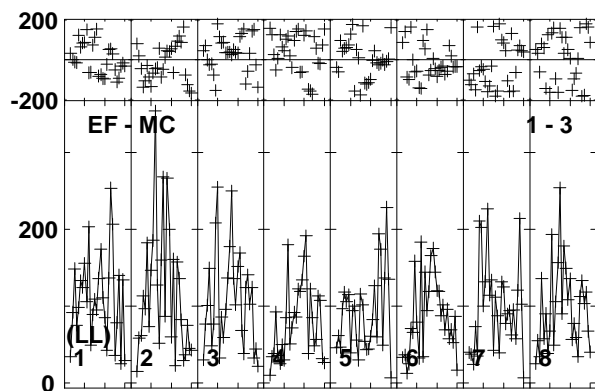
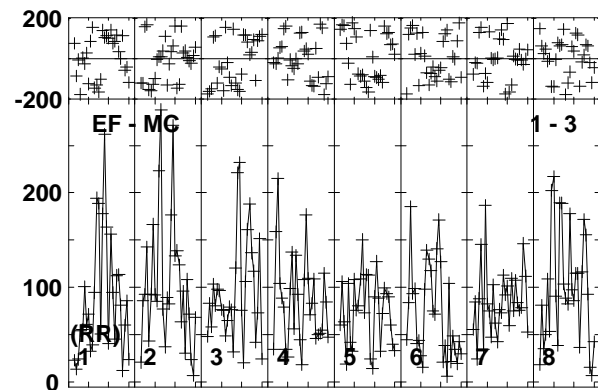
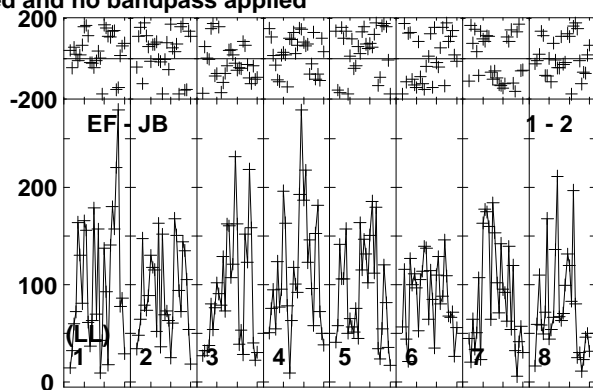
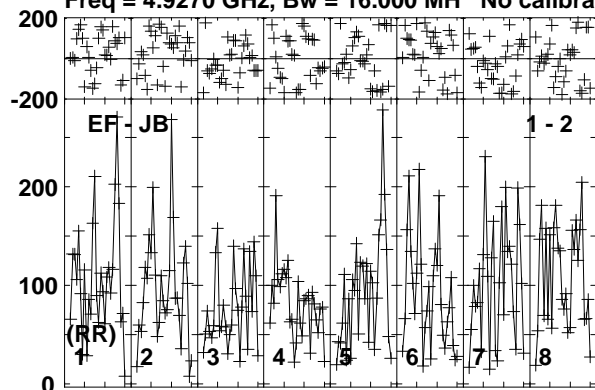

Lower frame: Micro Ampl Jy Top frame: Phas deg  
Vector averaged cross-power spectrum Baseline: EF (01) - JB (02)  
Timerange: 00/13:49:20 to 00/13:52:20

Plot file version 110 created 10-JUN-2016 15:29:27

FRB150418 RG008C.UVDATA.1

Freq = 4.9270 GHz, Bw = 16.000 MH No calibration applied and no bandpass applied

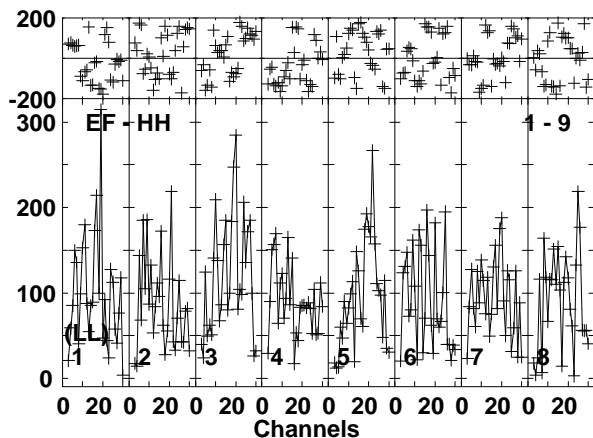
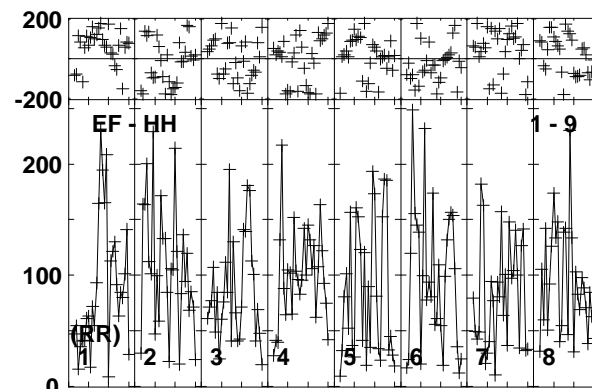
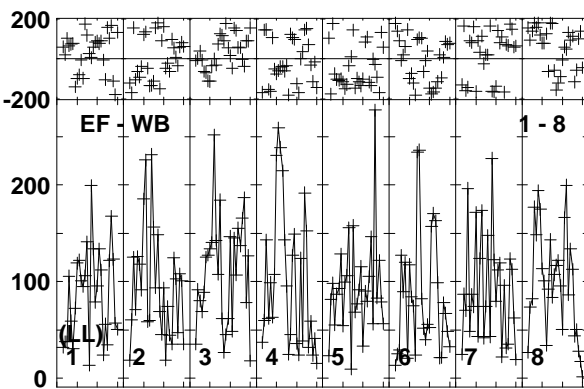
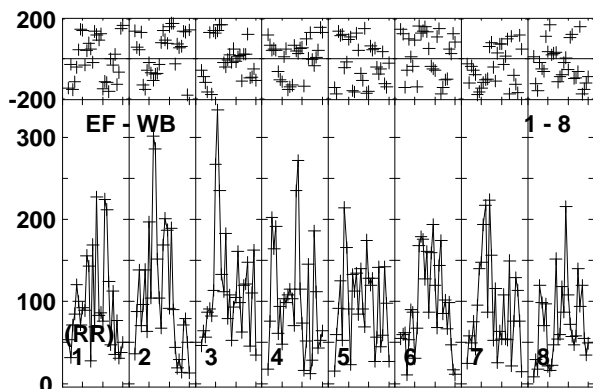
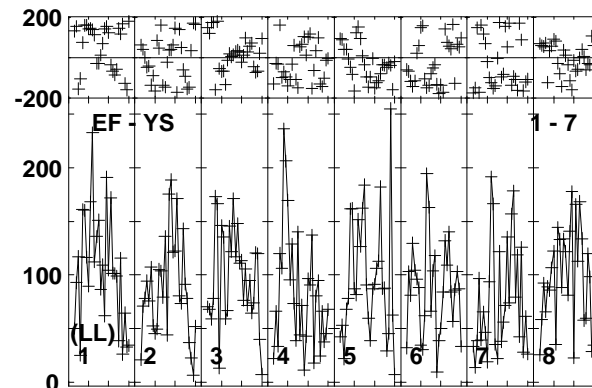
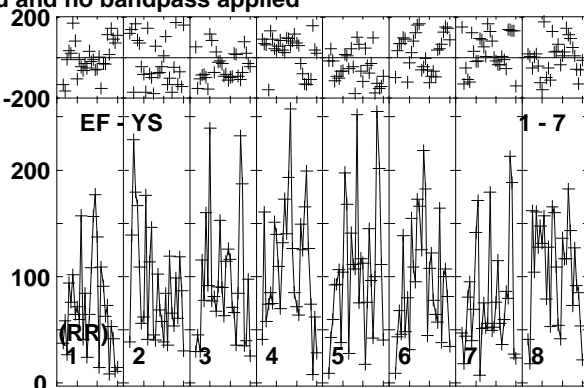
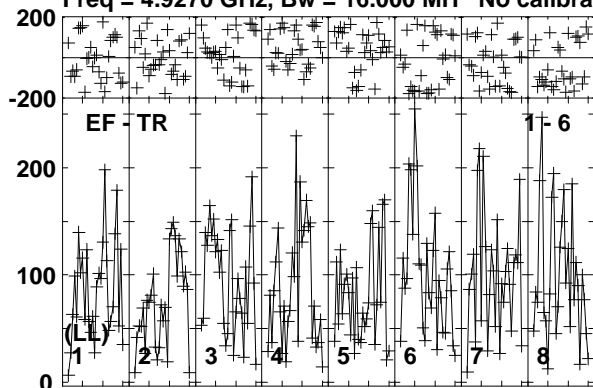

Lower frame: Micro Ampl Jy Top frame: Phas deg  
Vector averaged cross-power spectrum Baseline: EF (01) - TR (06)  
Timerange: 00/13:49:20 to 00/13:52:20

Plot file version 111 created 10-JUN-2016 15:29:27

J0718-1813 RG008C.UVDATA.1

Freq = 4.9270 GHz, Bw = 16.000 MH No calibration applied and no bandpass applied

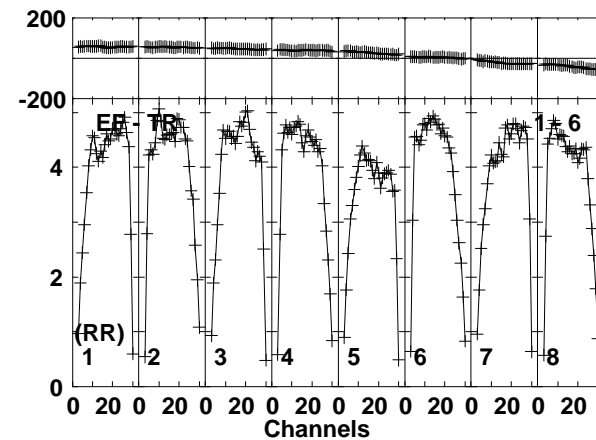
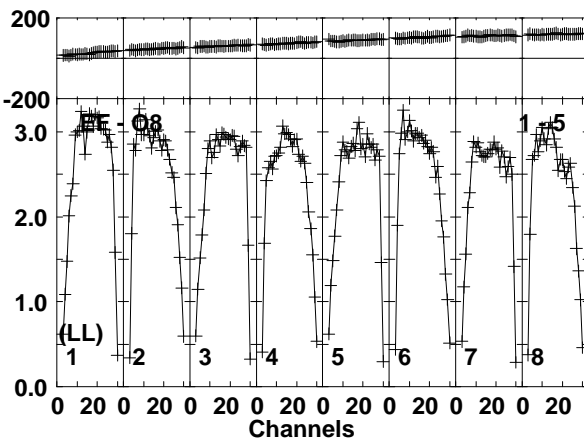
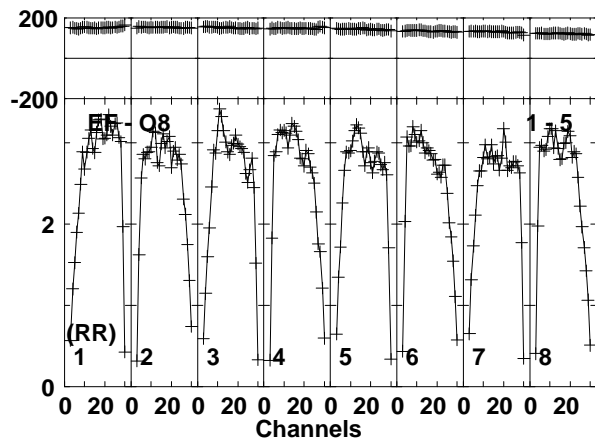
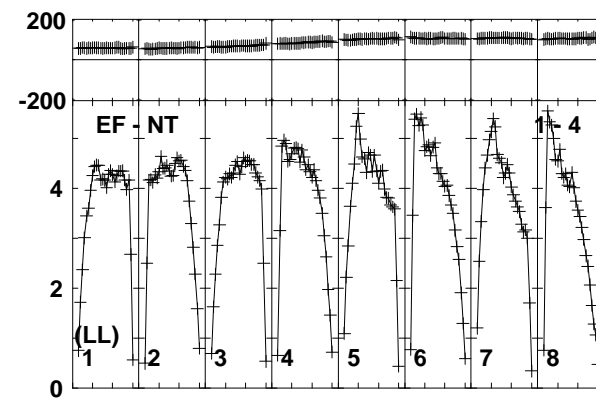
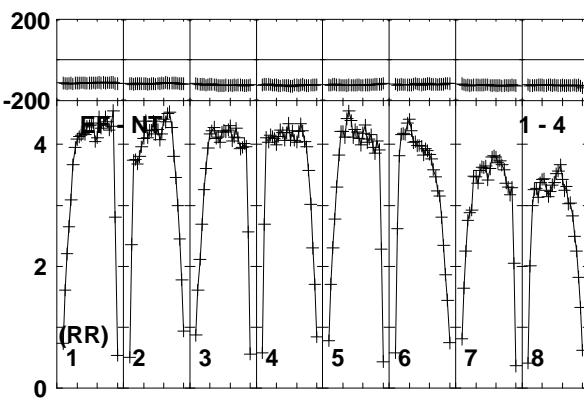
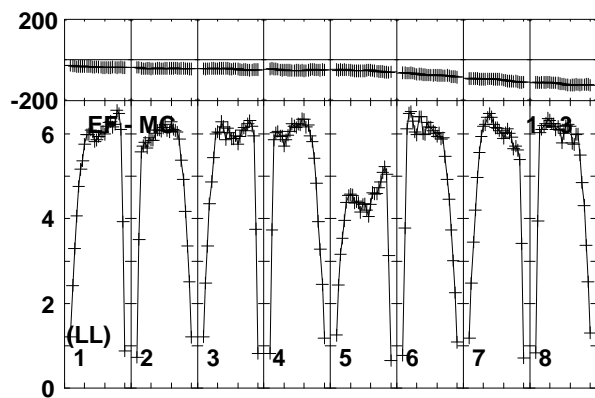
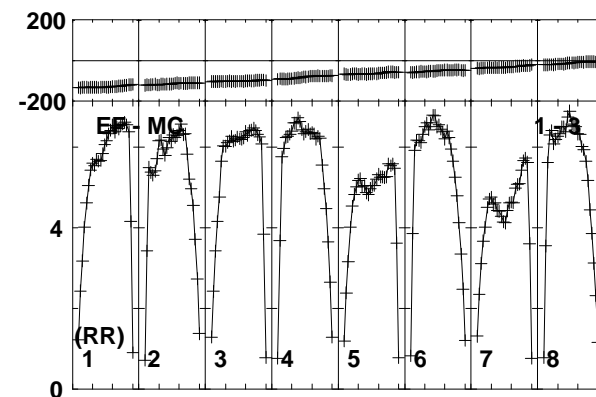
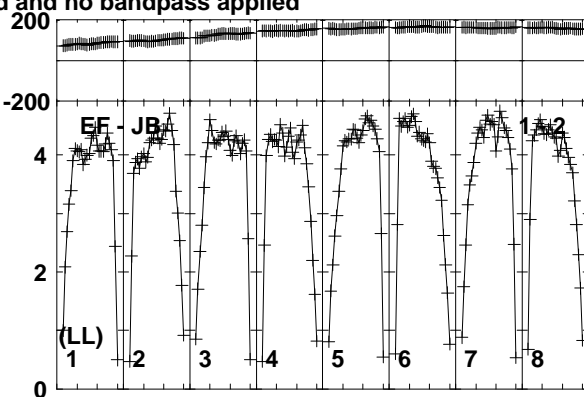
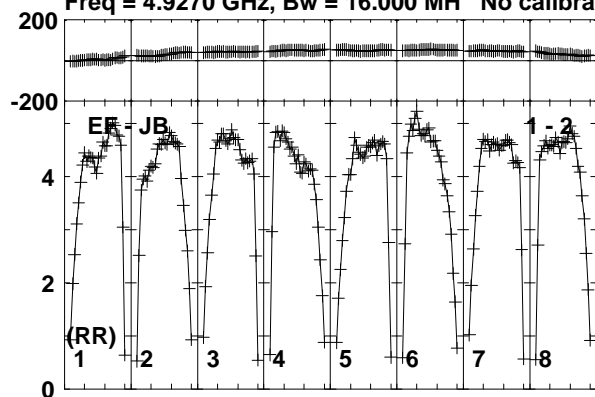

Lower frame: Milli Ampl Jy Top frame: Phas deg  
Vector averaged cross-power spectrum Baseline: EF (01) - JB (02)  
Timerange: 00/13:52:20 to 00/13:53:49

Plot file version 112 created 10-JUN-2016 15:29:27

J0718-1813 RG008C.UVDATA.1

Freq = 4.9270 GHz, Bw = 16.000 MH No calibration applied and no bandpass applied

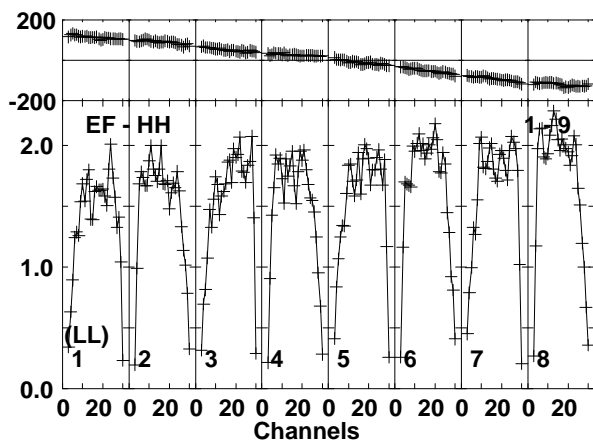
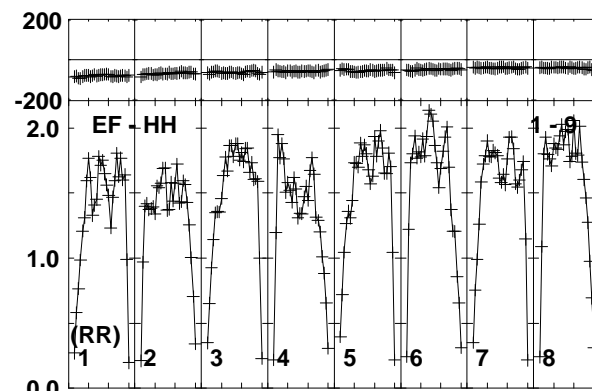
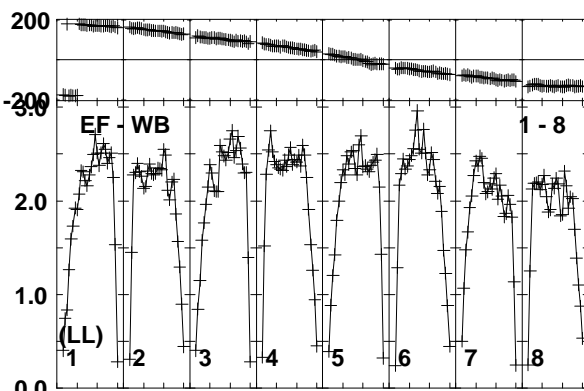
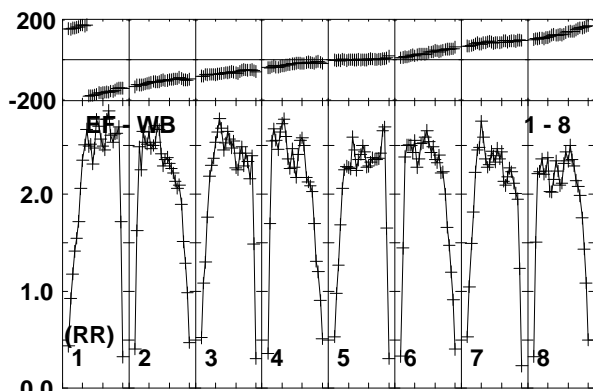
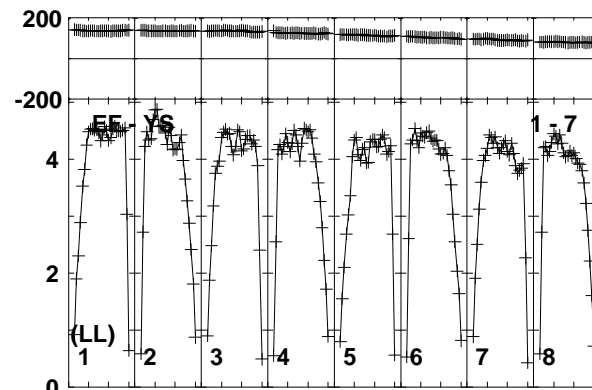
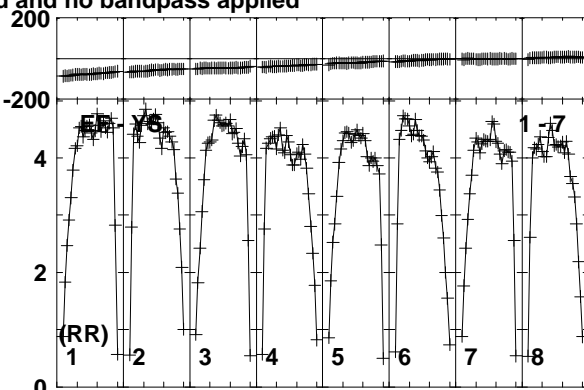
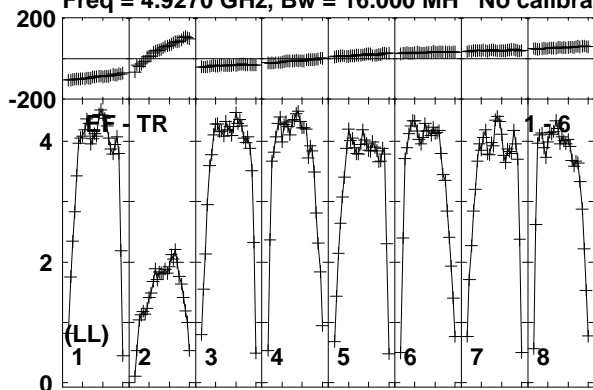

Lower frame: Milli Ampl Jy Top frame: Phas deg  
Vector averaged cross-power spectrum Baseline: EF (01) - TR (06)  
Timerange: 00/13:52:20 to 00/13:53:49



Plot file version 113 created 10-JUN-2016 15:29:27

J0716-1856 RG008C.UVDATA.1

Freq = 4.9270 GHz, Bw = 16.000 MH No calibration applied and no bandpass applied

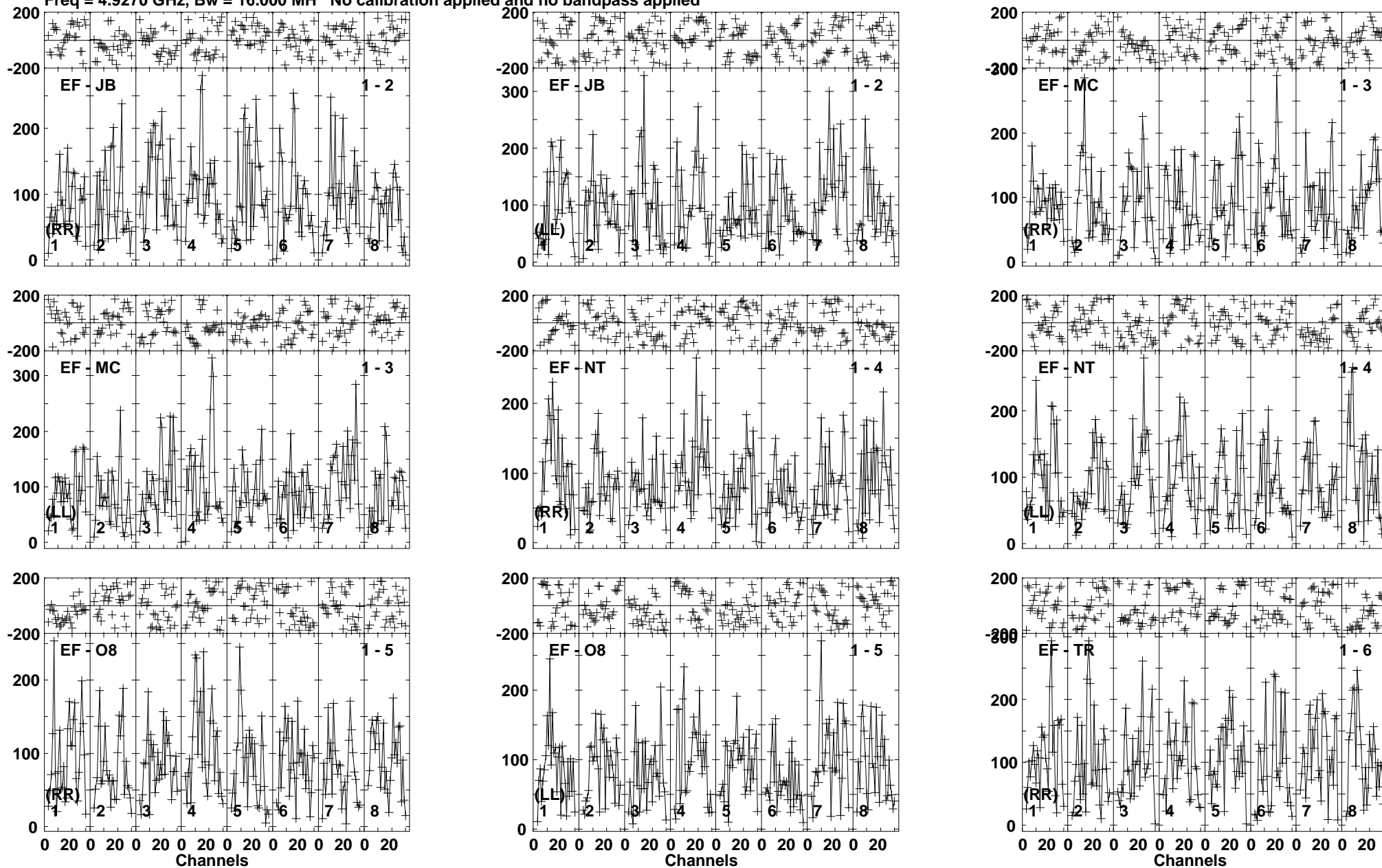

Lower frame: Micro Ampl Jy Top frame: Phas deg  
Vector averaged cross-power spectrum Baseline: EF (01) - JB (02)  
Timerange: 00/13:53:51 to 00/13:56:50

Plot file version 114 created 10-JUN-2016 15:29:27

J0716-1856 RG008C.UVDATA.1

Freq = 4.9270 GHz, Bw = 16.000 MH No calibration applied and no bandpass applied

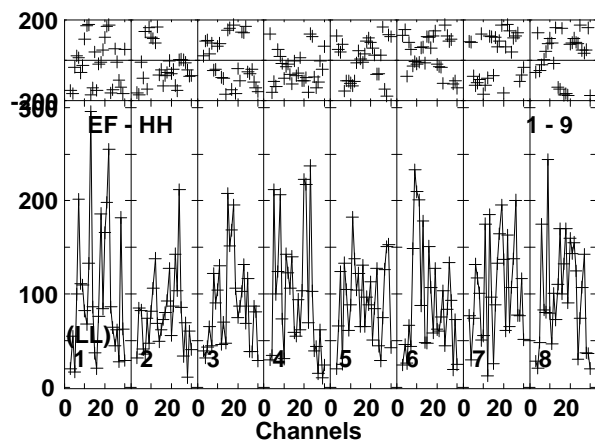
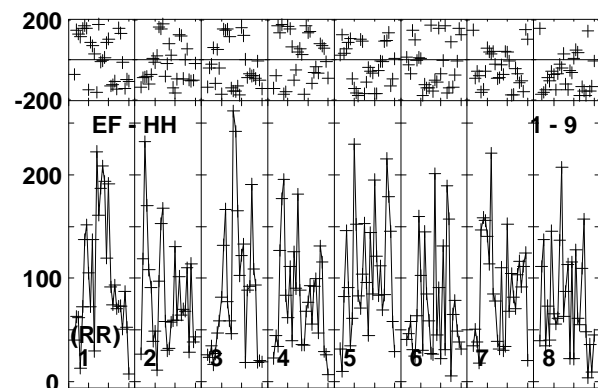
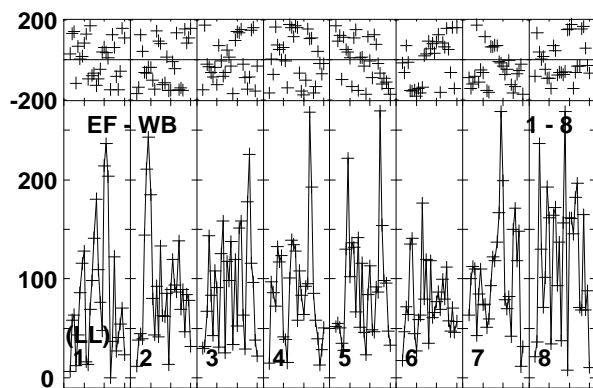
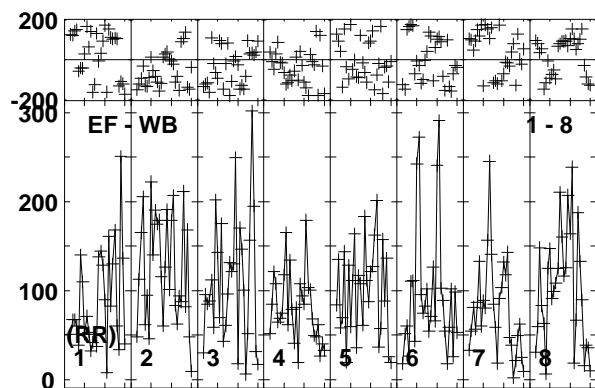
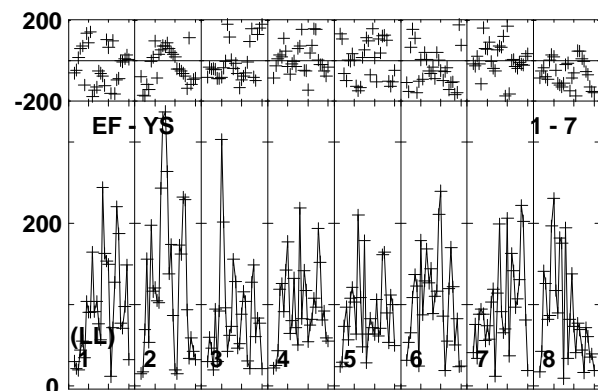
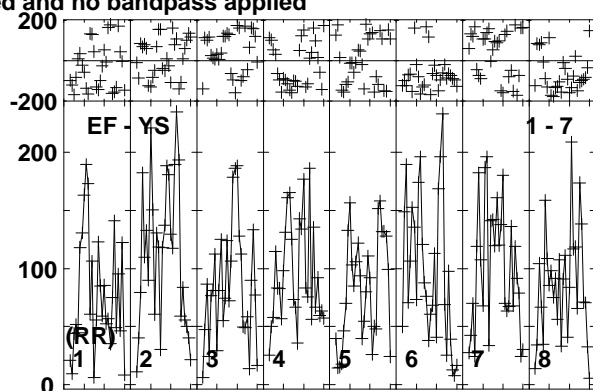
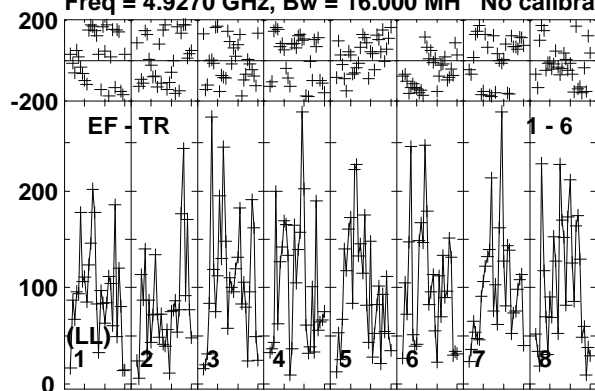

Lower frame: Micro Ampl Jy Top frame: Phas deg  
Vector averaged cross-power spectrum Baseline: EF (01) - TR (06)  
Timerange: 00/13:53:51 to 00/13:56:50

Plot file version 115 created 10-JUN-2016 15:29:27

J0718-1813 RG008C.UVDATA.1

Freq = 4.9270 GHz, Bw = 16.000 MH No calibration applied and no bandpass applied

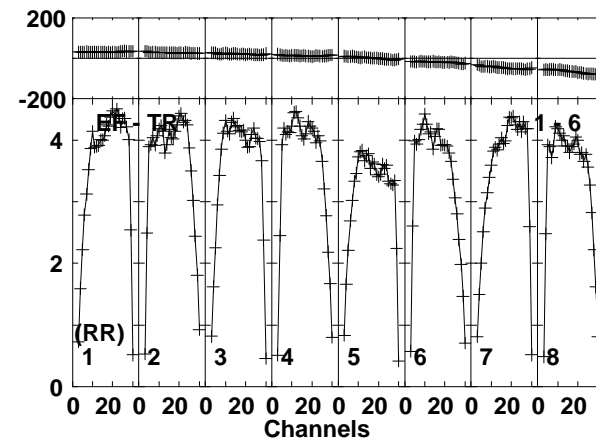
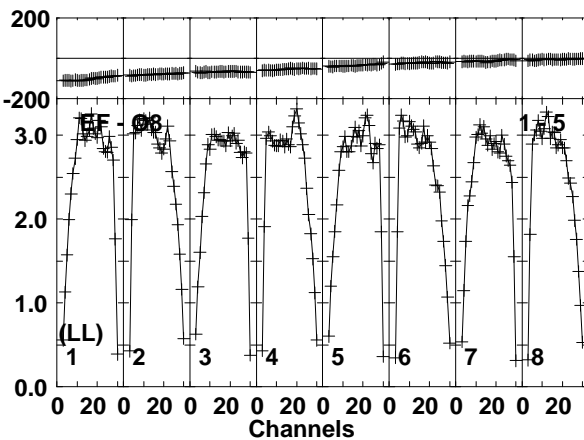
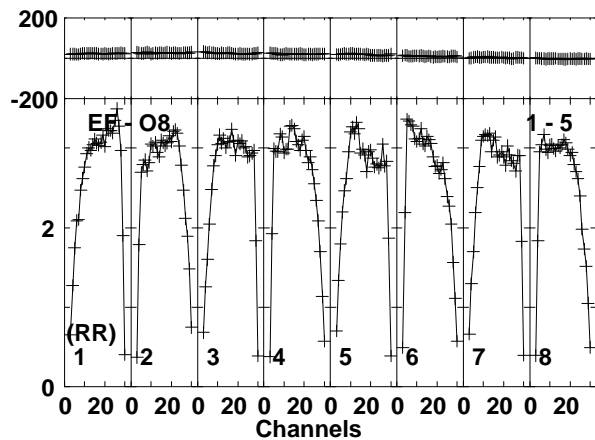
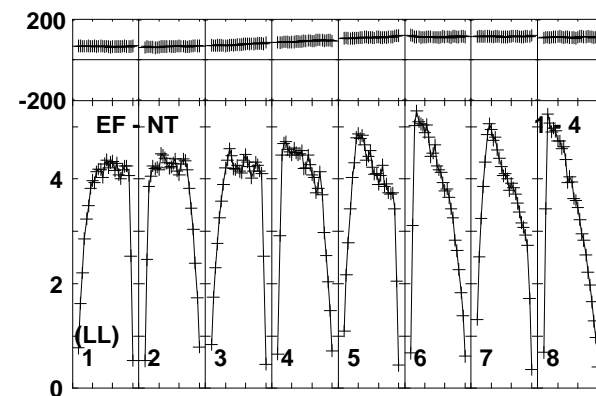
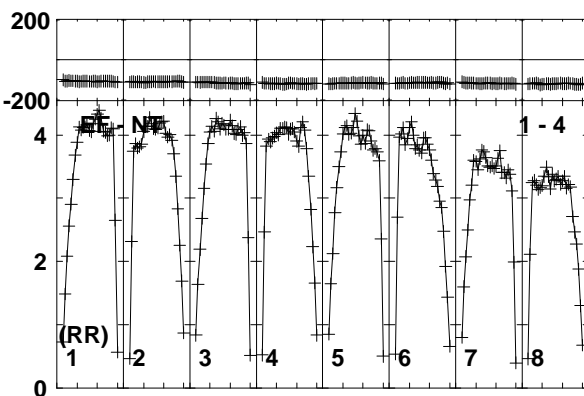
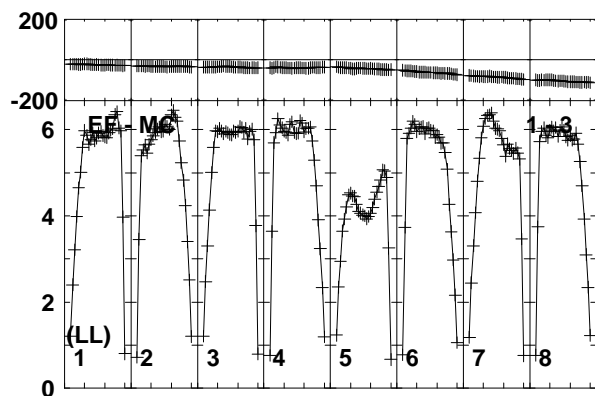
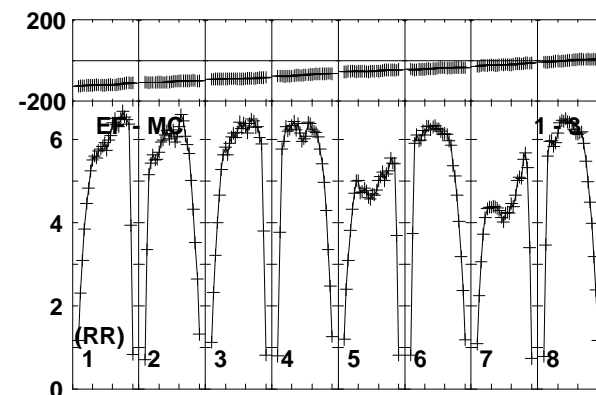
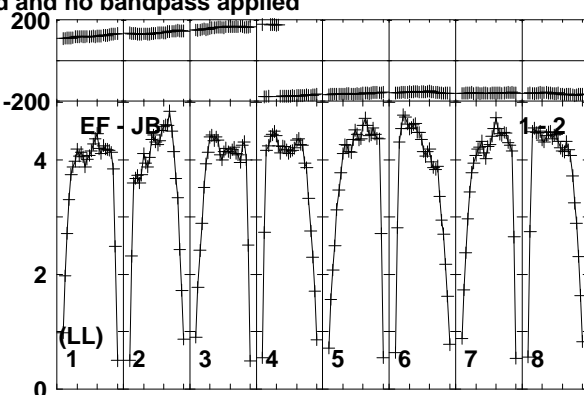
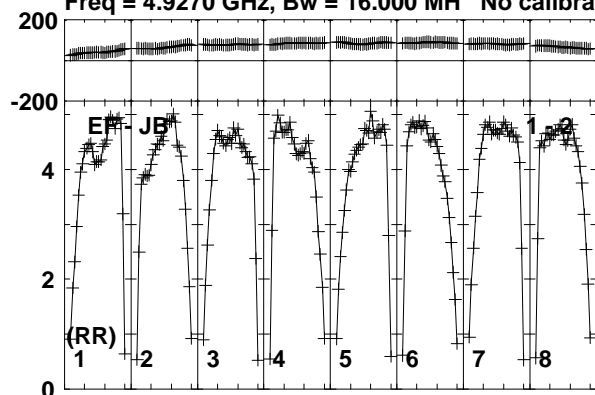

Lower frame: Milli Ampl Jy Top frame: Phas deg  
Vector averaged cross-power spectrum Baseline: EF (01) - JB (02)  
Timerange: 00/13:57:31 to 00/13:58:50

Plot file version 116 created 10-JUN-2016 15:29:28

J0718-1813 RG008C.UVDATA.1

Freq = 4.9270 GHz, Bw = 16.000 MH No calibration applied and no bandpass applied

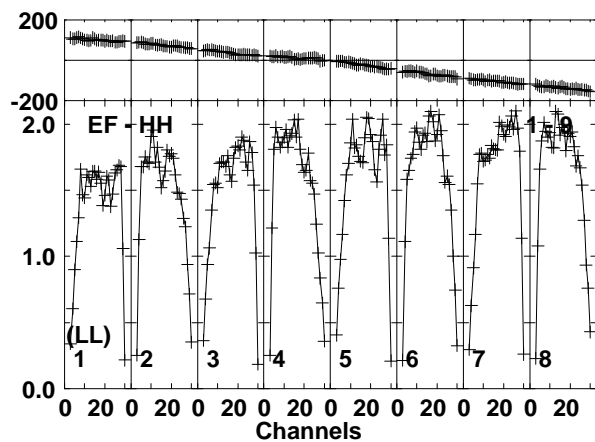
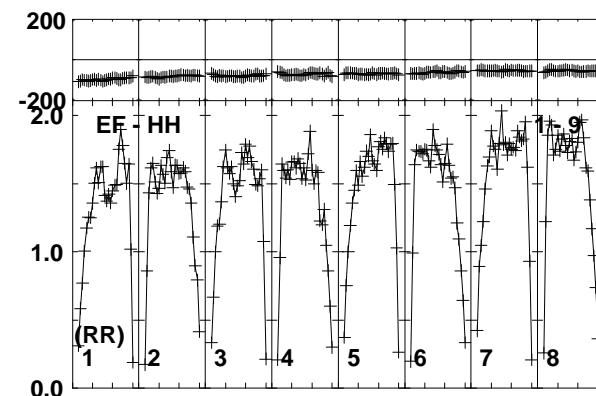
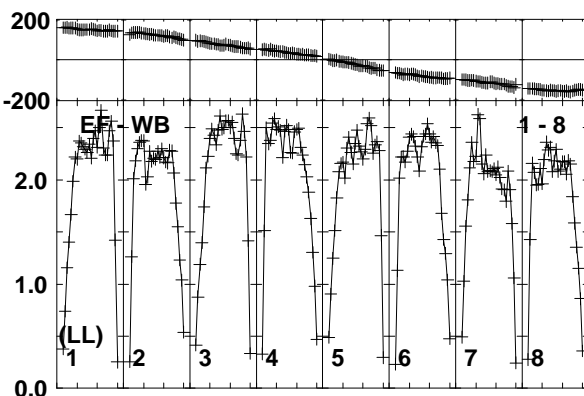
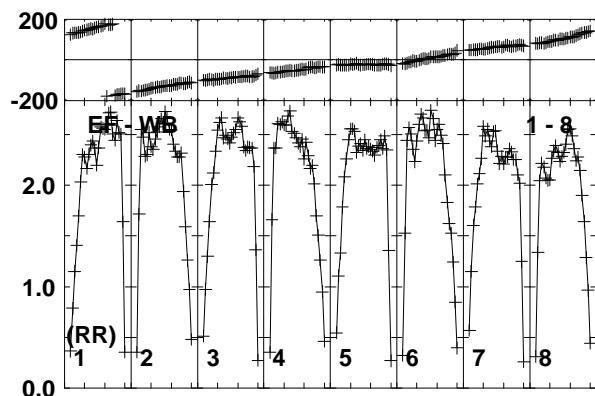
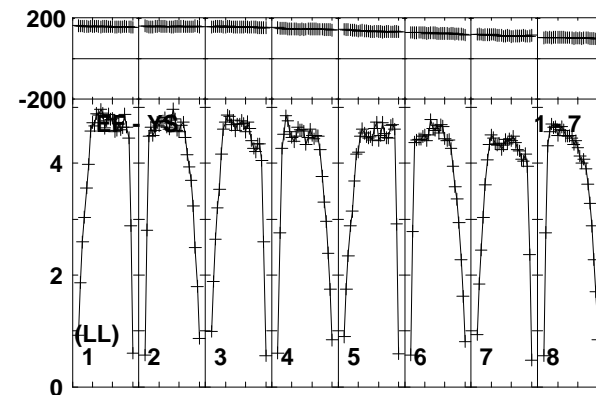
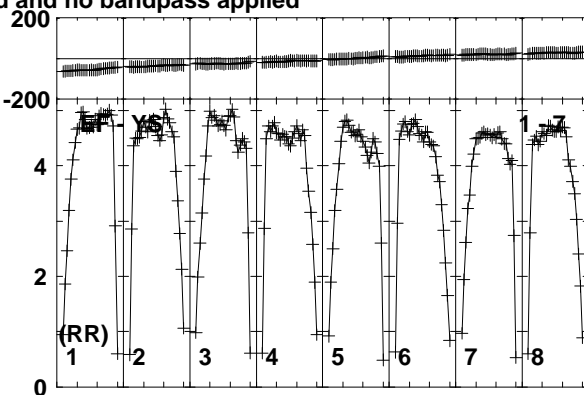
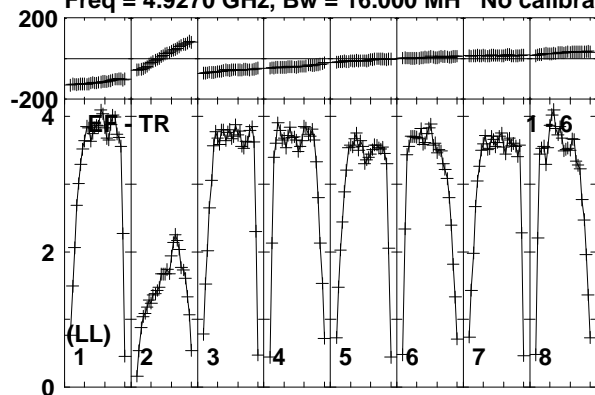

Lower frame: Milli Ampl Jy Top frame: Phas deg  
Vector averaged cross-power spectrum Baseline: EF (01) - TR (06)  
Timerange: 00/13:57:31 to 00/13:58:50

Plot file version 117 created 10-JUN-2016 15:29:28

FRB150418 RG008C.UVDATA.1

Freq = 4.9270 GHz, Bw = 16.000 MH No calibration applied and no bandpass applied

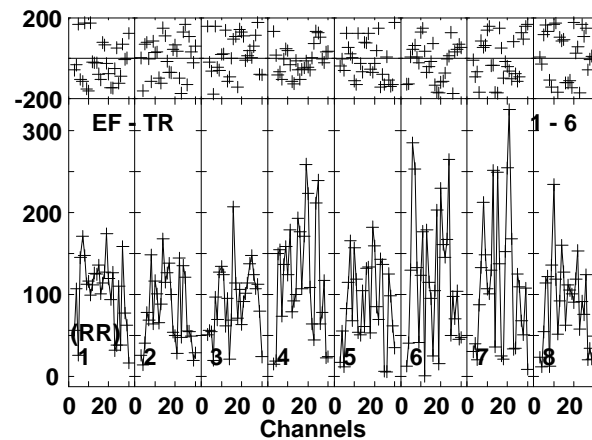
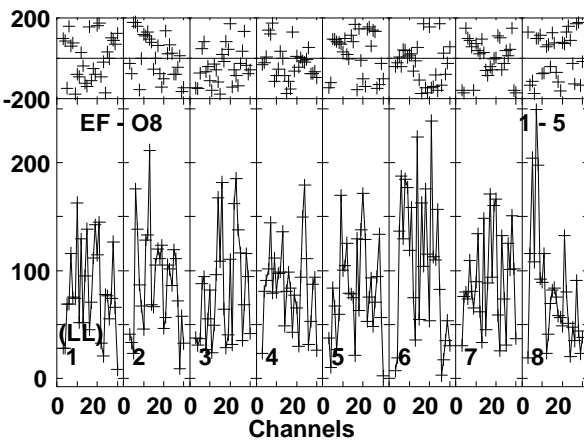
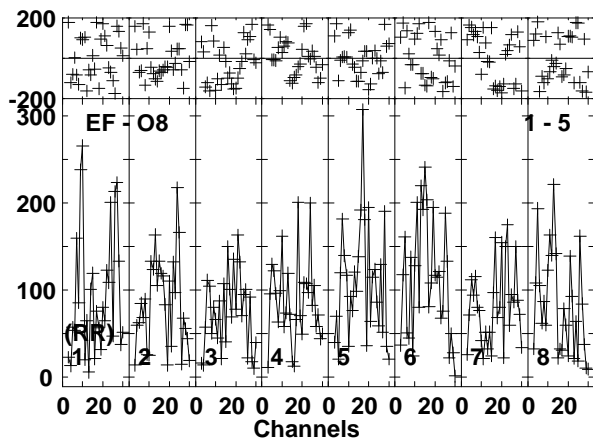
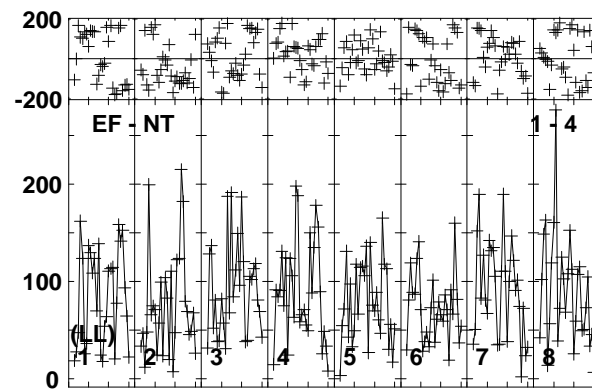
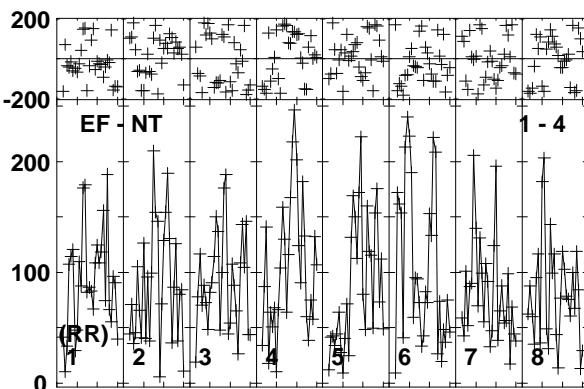
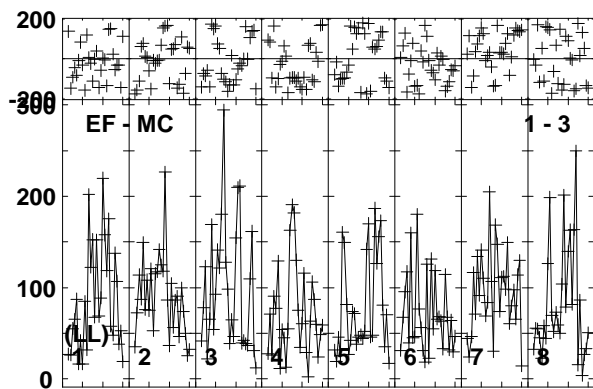
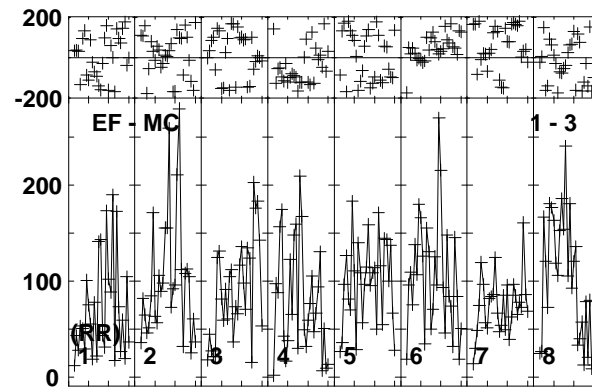
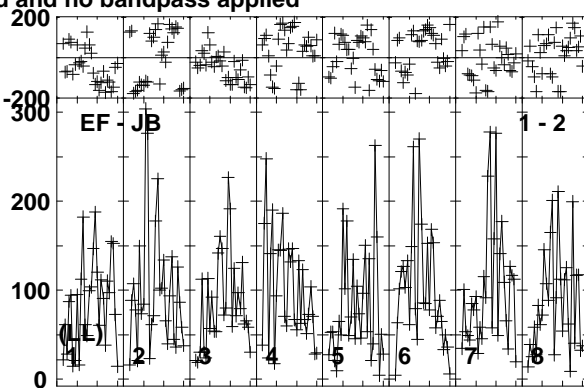
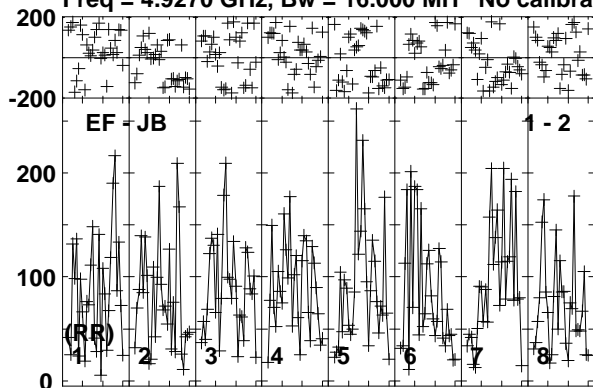

Lower frame: Micro Ampl Jy Top frame: Phas deg  
Vector averaged cross-power spectrum Baseline: EF (01) - JB (02)  
Timerange: 00/13:58:51 to 00/14:01:49

Plot file version 118 created 10-JUN-2016 15:29:28

FRB150418 RG008C.UVDATA.1

Freq = 4.9270 GHz, Bw = 16.000 MH No calibration applied and no bandpass applied

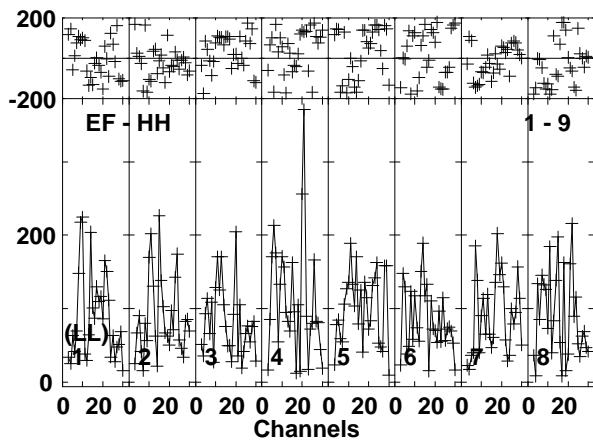
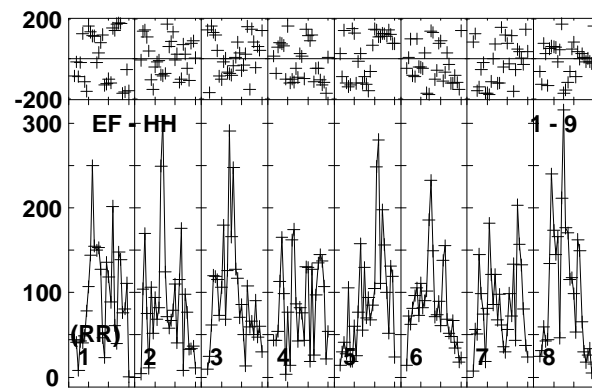
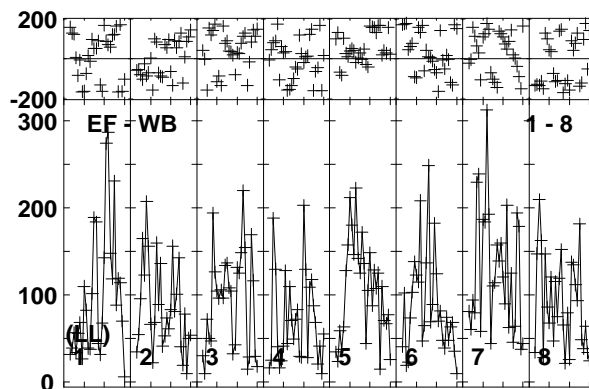
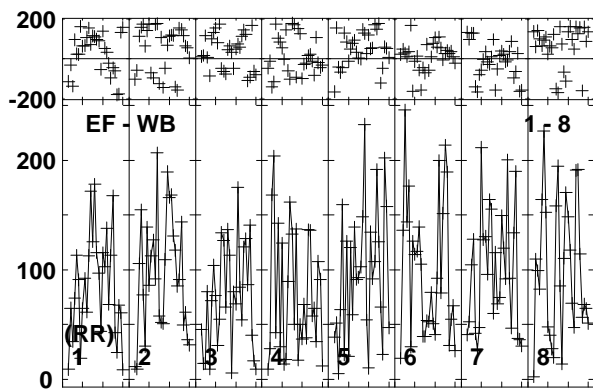
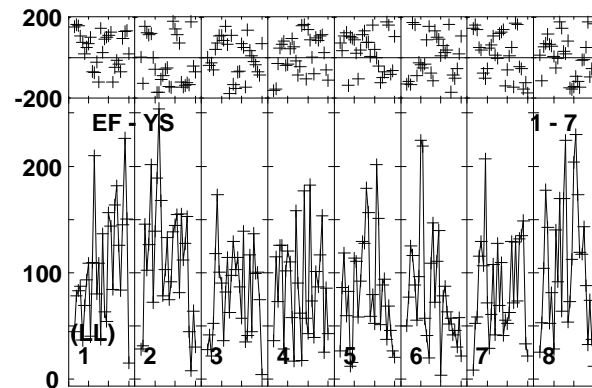
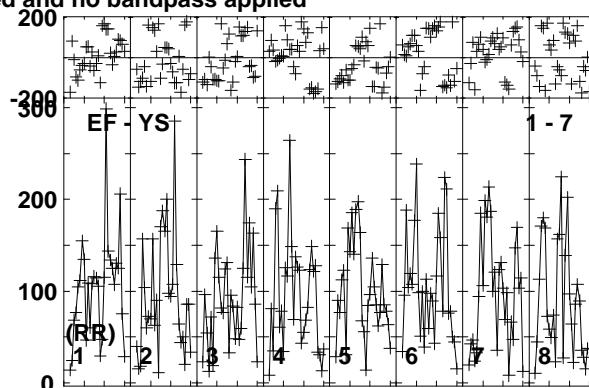
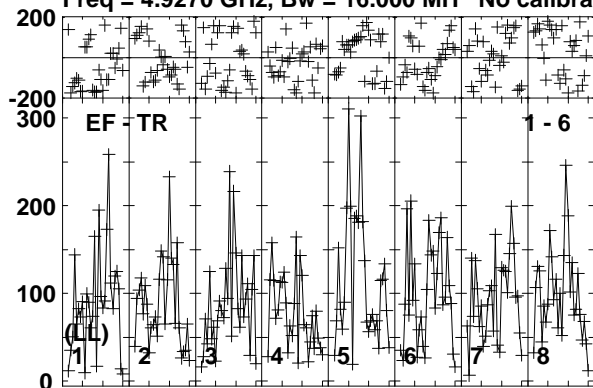

Lower frame: Micro Ampl Jy Top frame: Phas deg  
Vector averaged cross-power spectrum Baseline: EF (01) - TR (06)  
Timerange: 00/13:58:51 to 00/14:01:49

Plot file version 119 created 10-JUN-2016 15:29:28

J0718-1813 RG008C.UVDATA.1

Freq = 4.9270 GHz, Bw = 16.000 MH No calibration applied and no bandpass applied

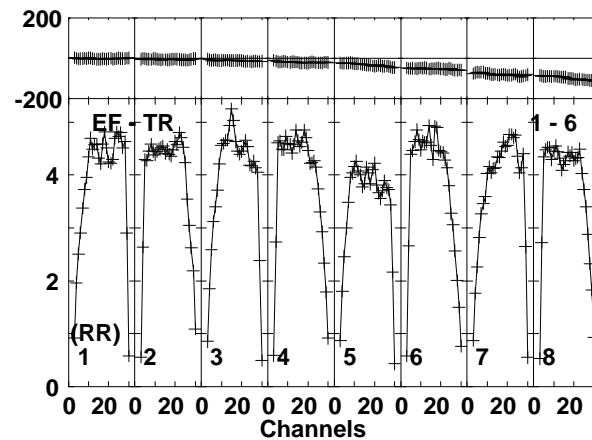
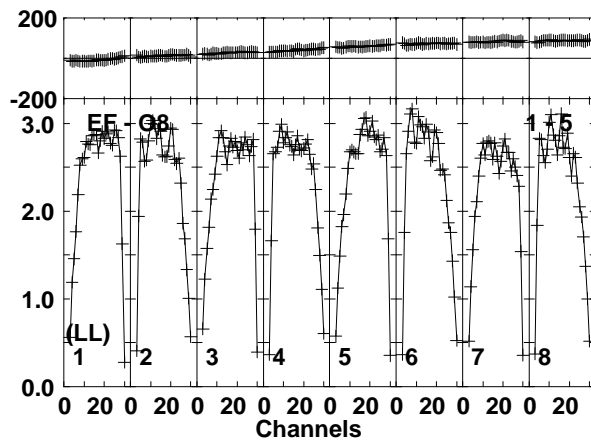
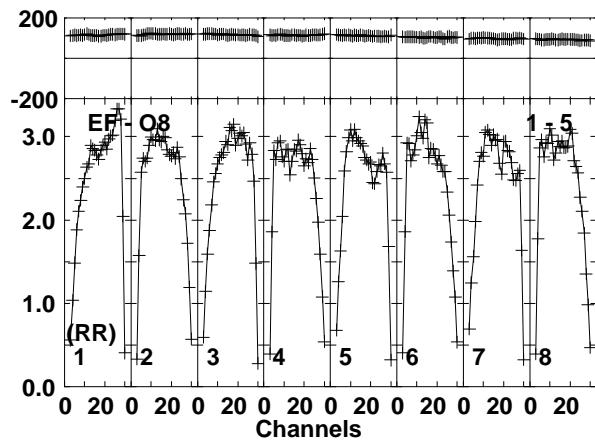
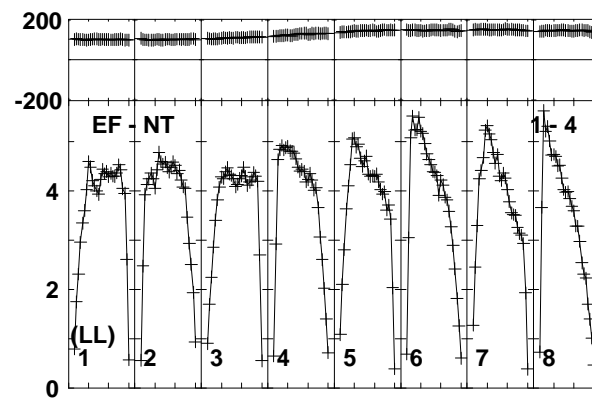
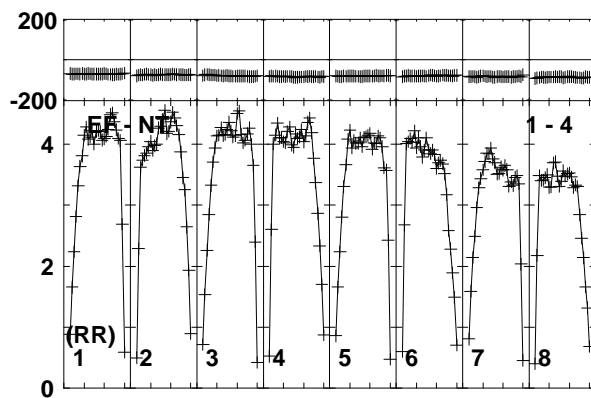
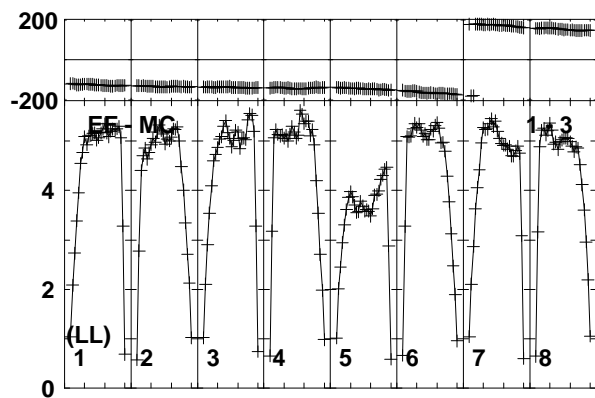
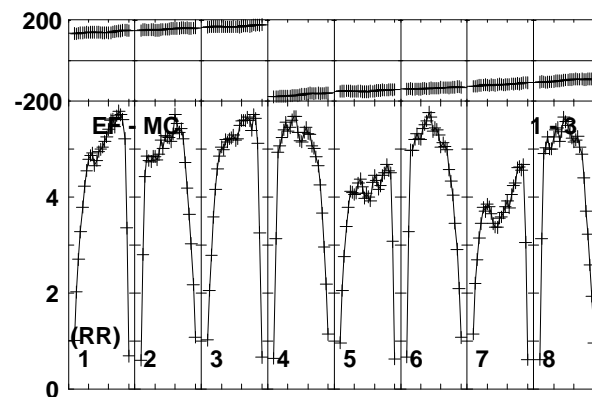
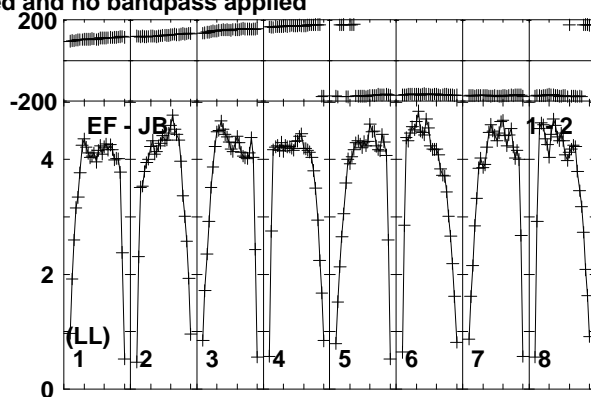
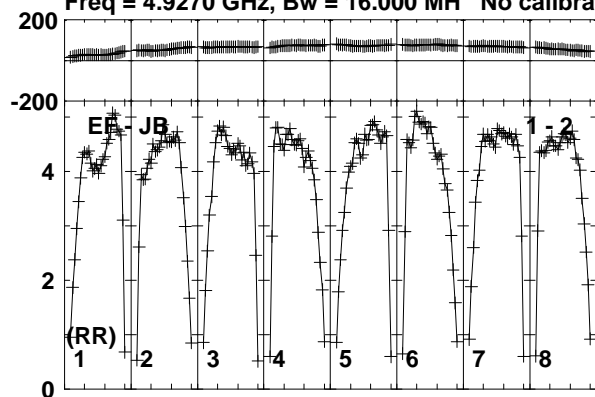

Lower frame: Milli Ampl Jy Top frame: Phas deg  
Vector averaged cross-power spectrum Baseline: EF (01) - JB (02)  
Timerange: 00/14:01:50 to 00/14:03:19

Plot file version 120 created 10-JUN-2016 15:29:28

J0718-1813 RG008C.UVDATA.1

Freq = 4.9270 GHz, Bw = 16.000 MH No calibration applied and no bandpass applied

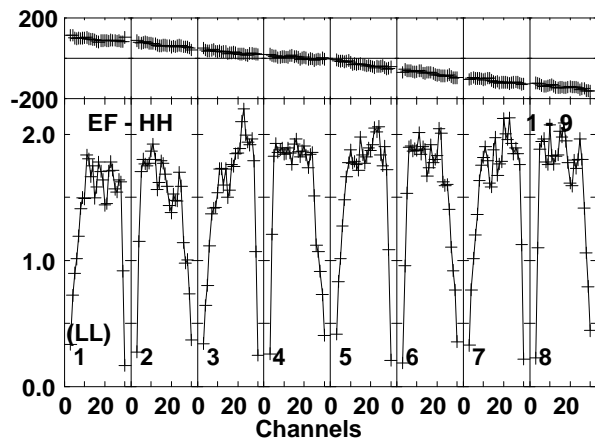
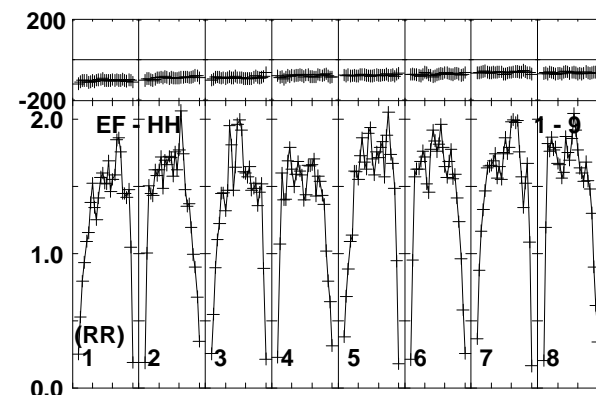
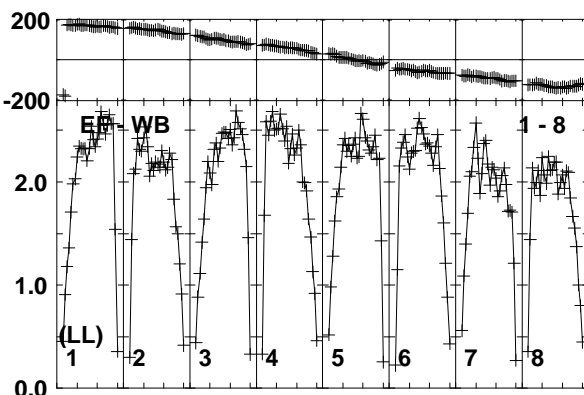
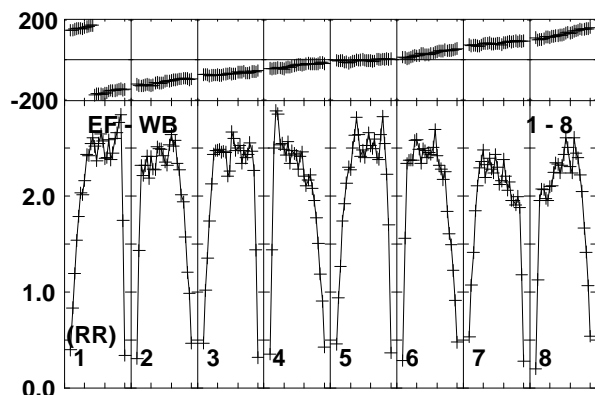
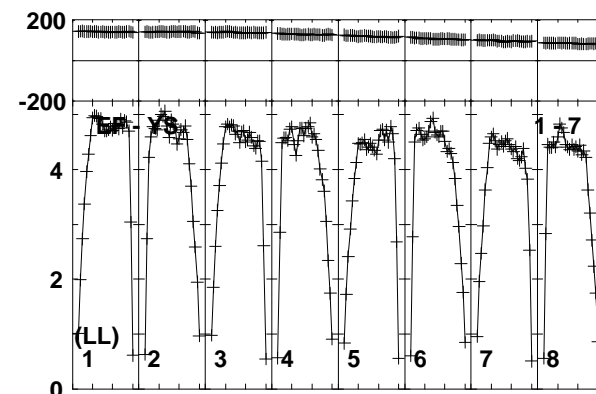
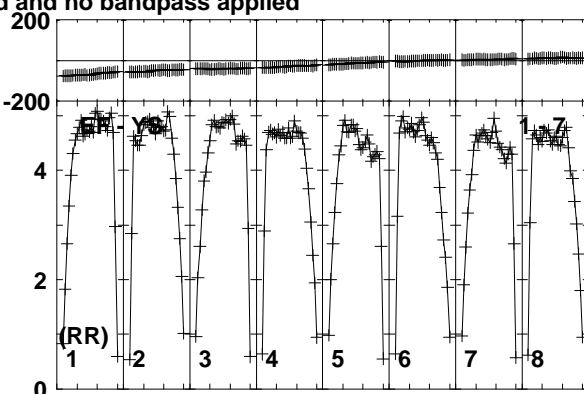
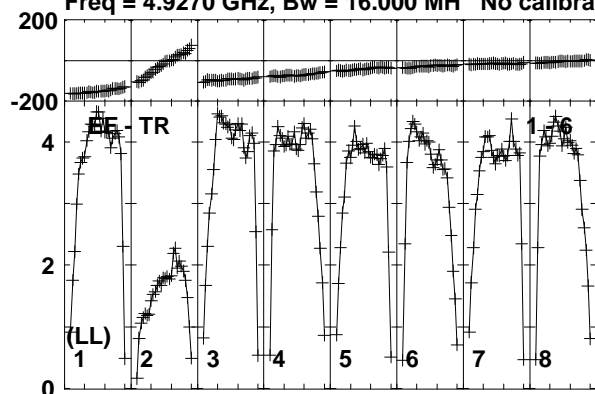

Lower frame: Milli Ampl Jy Top frame: Phas deg  
Vector averaged cross-power spectrum Baseline: EF (01) - TR (06)  
Timerange: 00/14:01:50 to 00/14:03:19



Plot file version 121 created 10-JUN-2016 15:29:28

J0716-1900 RG008C.UVDATA.1

Freq = 4.9270 GHz, Bw = 16.000 MH No calibration applied and no bandpass applied

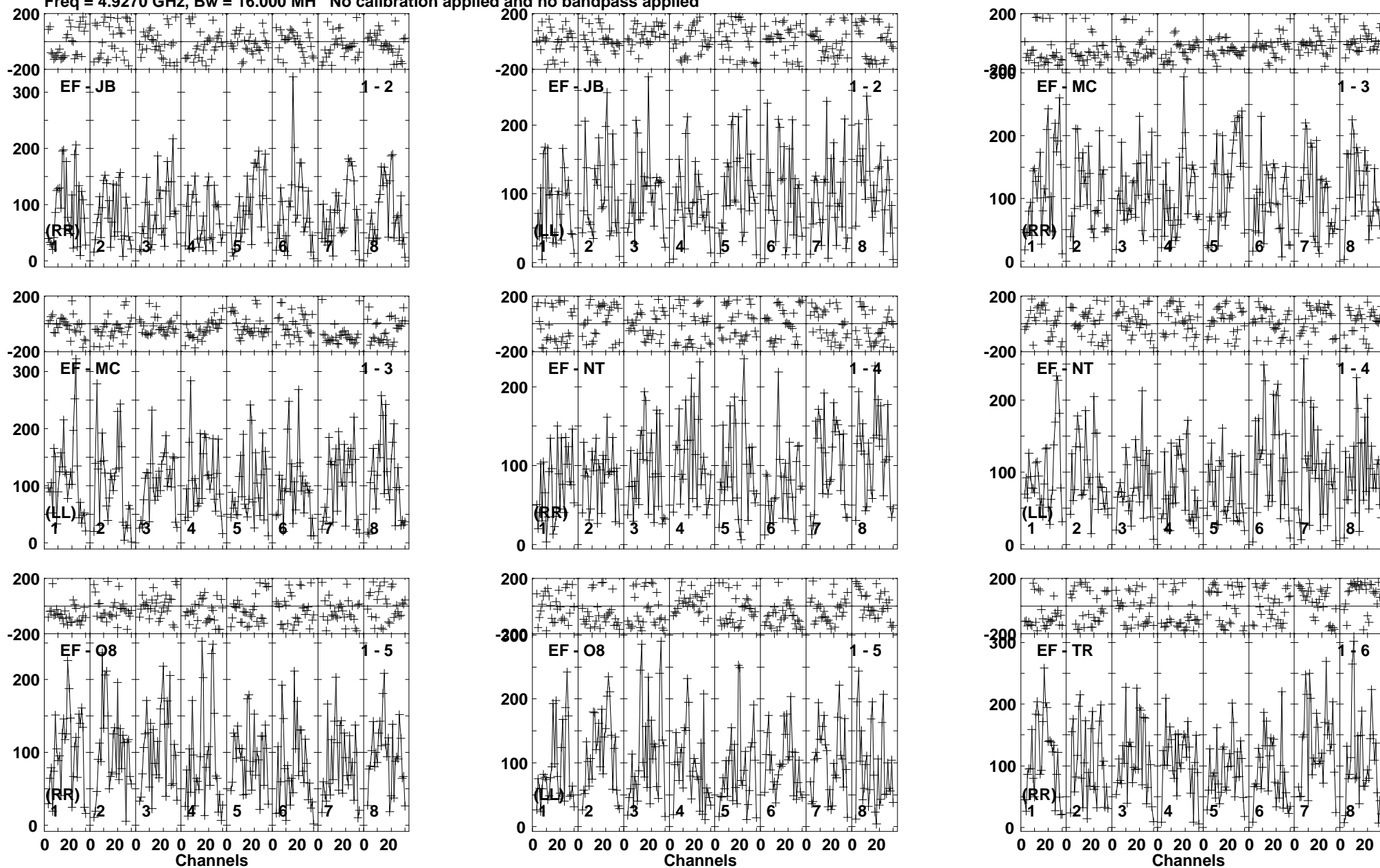

Lower frame: Micro Ampl Jy Top frame: Phas deg  
Vector averaged cross-power spectrum Baseline: EF (01) - JB (02)  
Timerange: 00/14:03:21 to 00/14:06:20

Plot file version 122 created 10-JUN-2016 15:29:28

J0716-1900 RG008C.UVDATA.1

Freq = 4.9270 GHz, Bw = 16.000 MH No calibration applied and no bandpass applied

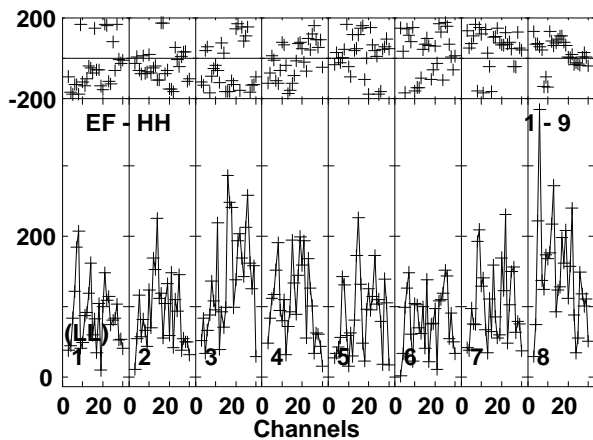
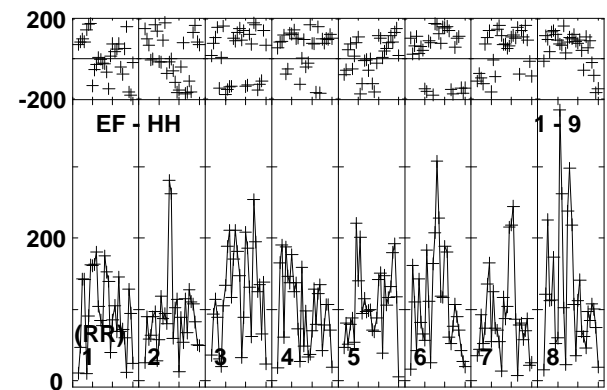
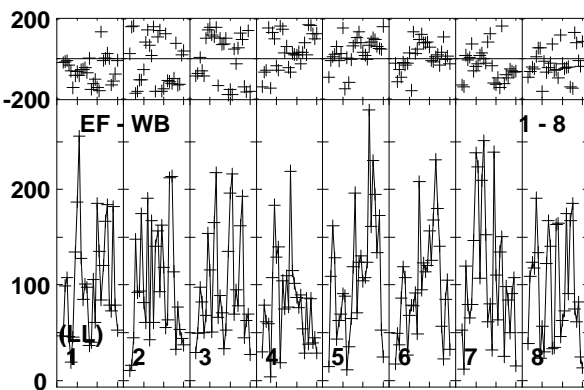
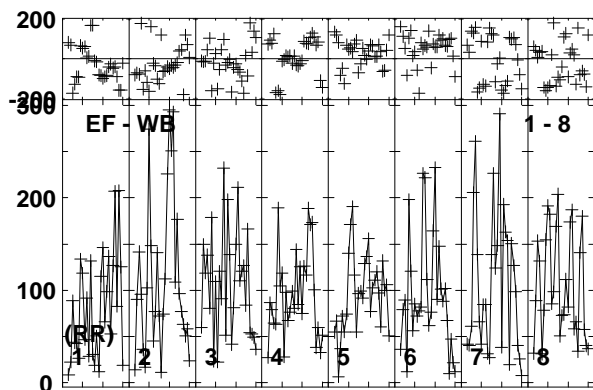
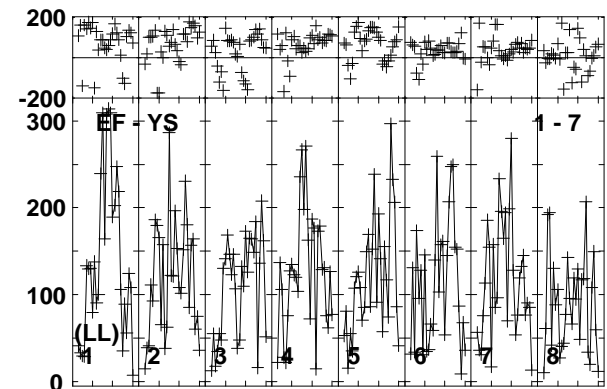
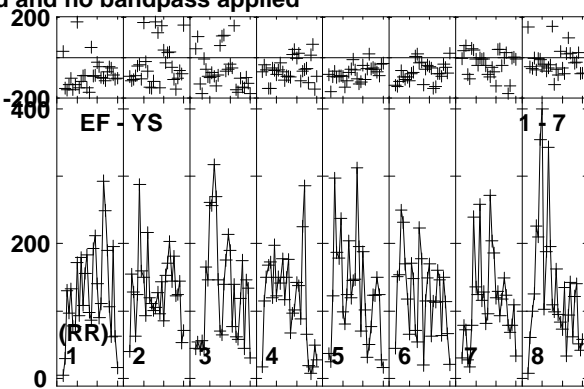
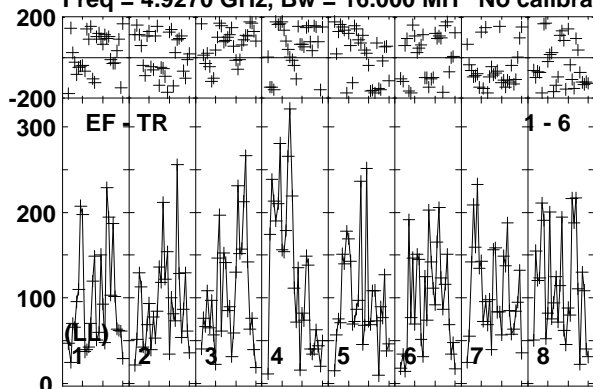

Lower frame: Micro Ampl Jy Top frame: Phas deg  
Vector averaged cross-power spectrum Baseline: EF (01) - TR (06)  
Timerange: 00/14:03:21 to 00/14:06:20

Plot file version 123 created 10-JUN-2016 15:29:28

J0718-1813 RG008C.UVDATA.1

Freq = 4.9270 GHz, Bw = 16.000 MH No calibration applied and no bandpass applied

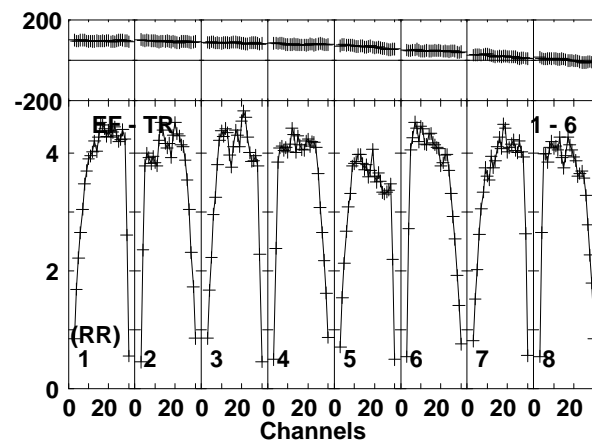
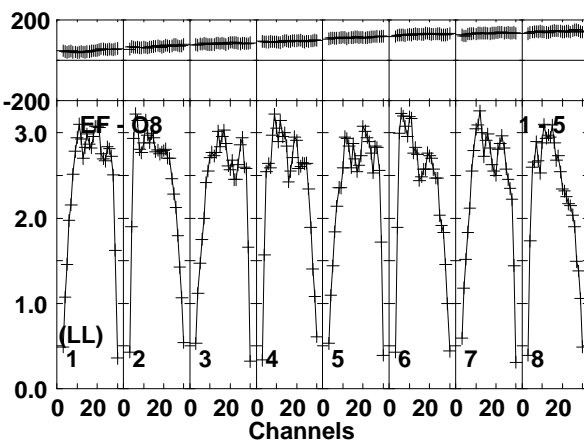
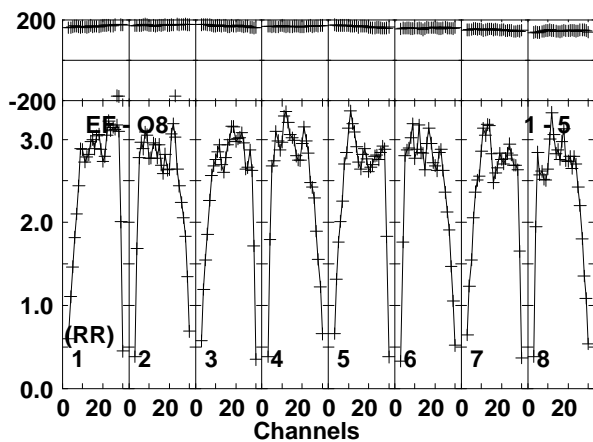
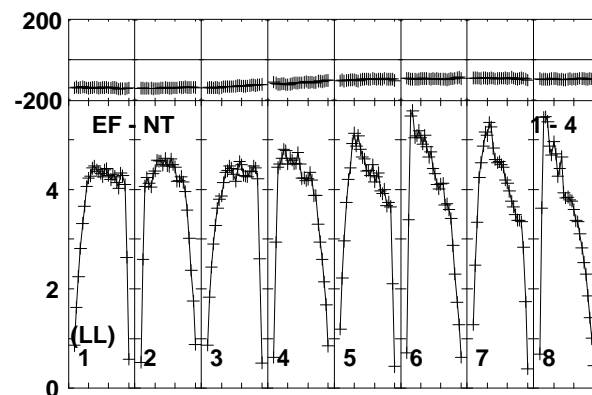
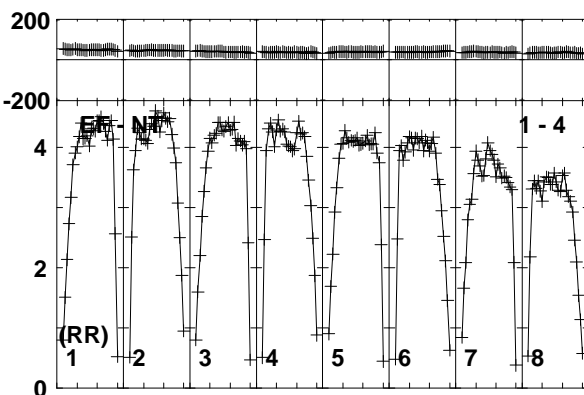
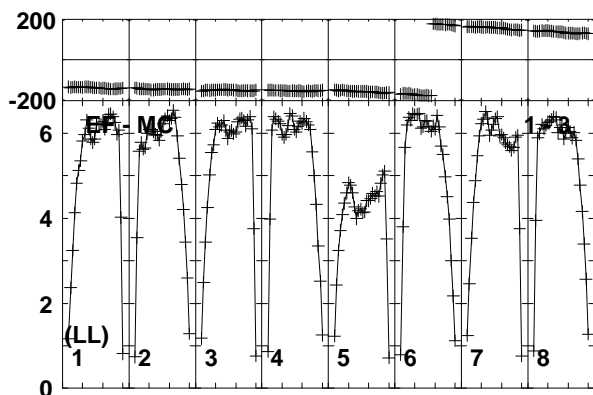
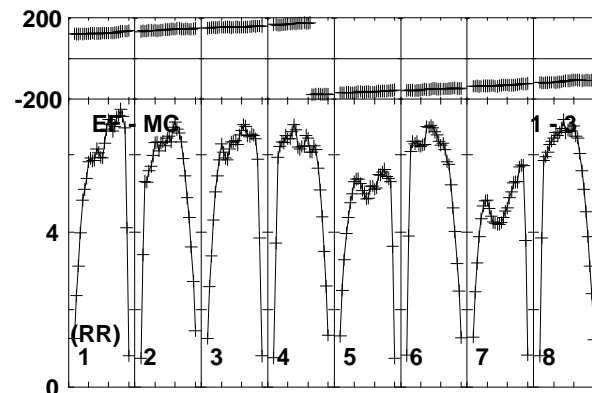
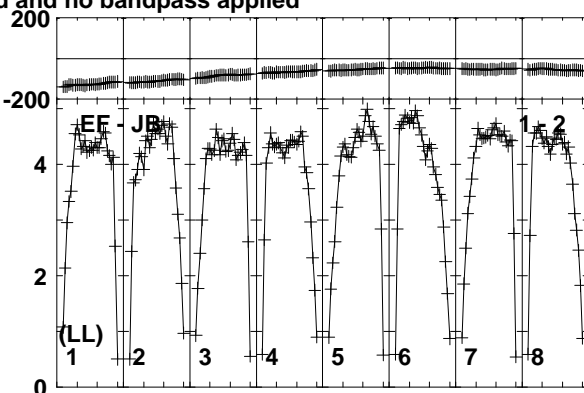
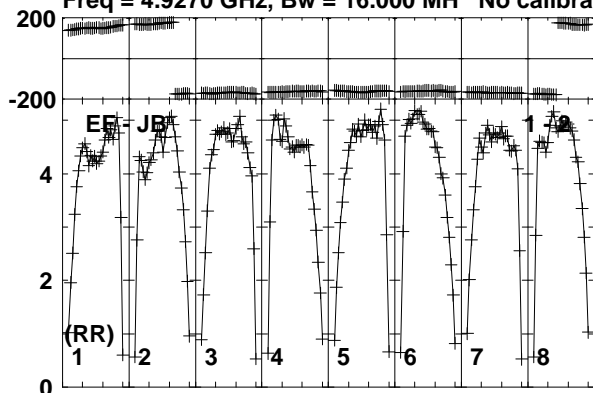

Lower frame: Milli Ampl Jy Top frame: Phas deg  
Vector averaged cross-power spectrum Baseline: EF (01) - JB (02)  
Timerange: 00/14:07:00 to 00/14:07:50

Plot file version 124 created 10-JUN-2016 15:29:29

J0718-1813 RG008C.UVDATA.1

Freq = 4.9270 GHz, Bw = 16.000 MH No calibration applied and no bandpass applied

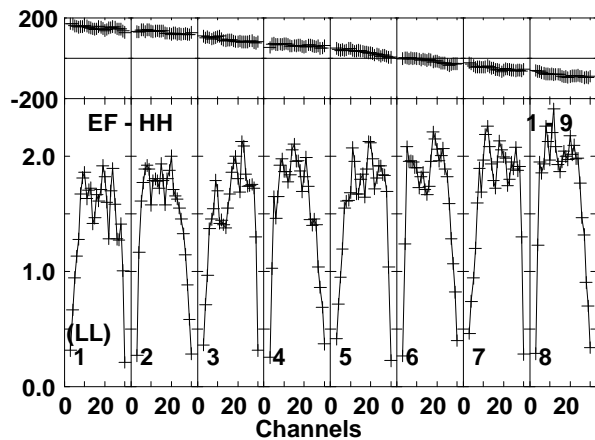
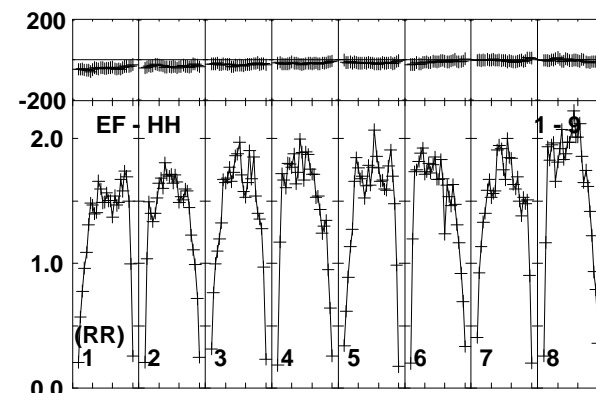
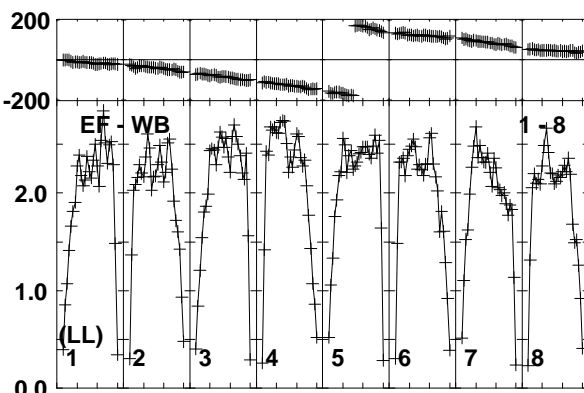
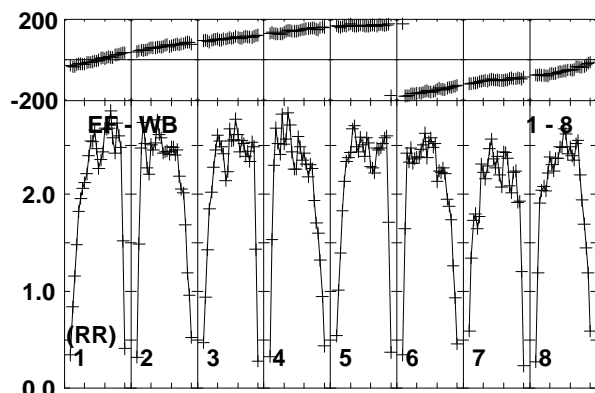
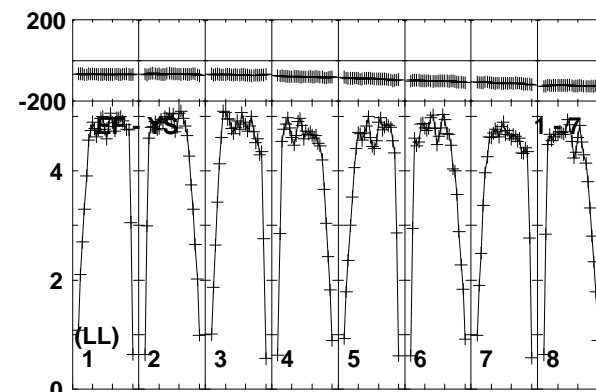
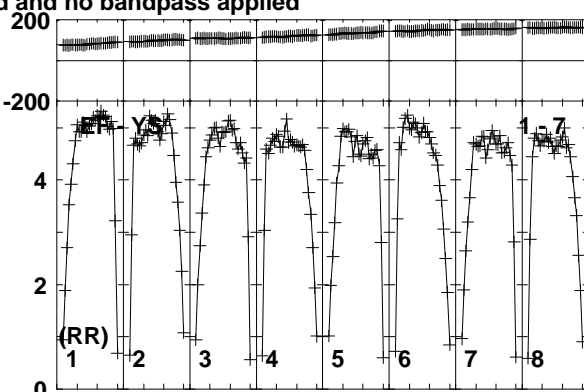
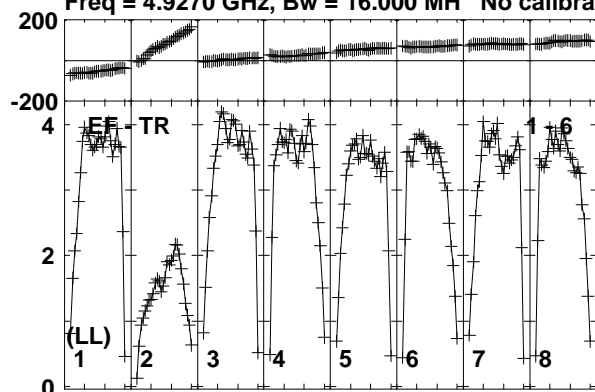

Lower frame: Milli Ampl Jy Top frame: Phas deg  
Vector averaged cross-power spectrum Baseline: EF (01) - TR (06)  
Timerange: 00/14:07:00 to 00/14:07:50

Plot file version 125 created 10-JUN-2016 15:29:29

0528+134 RG008C.UVDATA.1

Freq = 4.9270 GHz, Bw = 16.000 MH No calibration applied and no bandpass applied

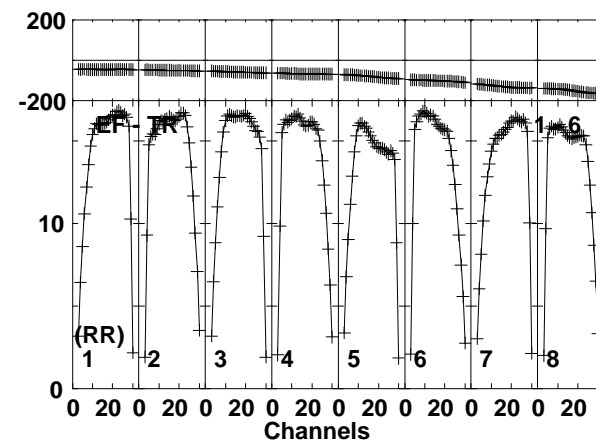
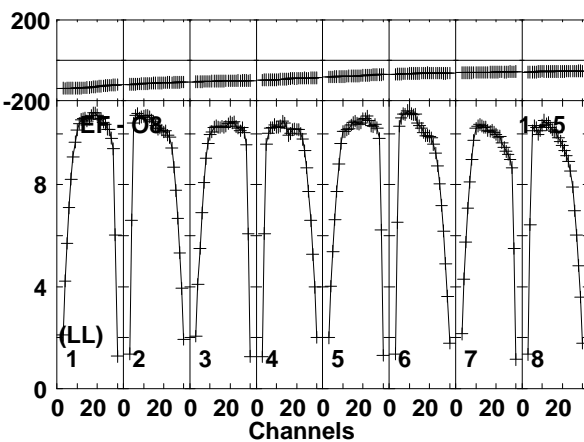
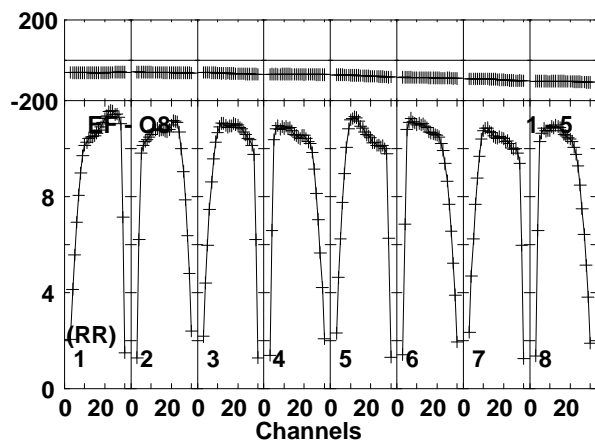
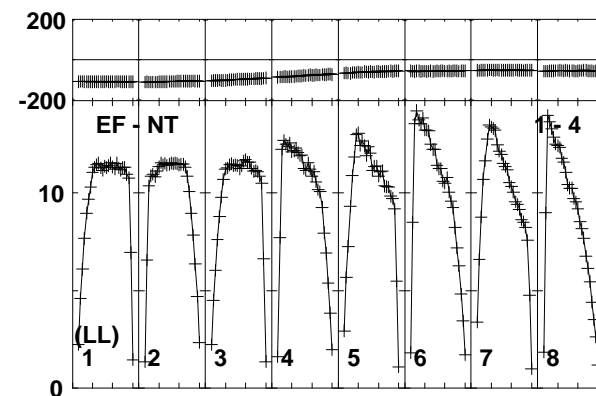
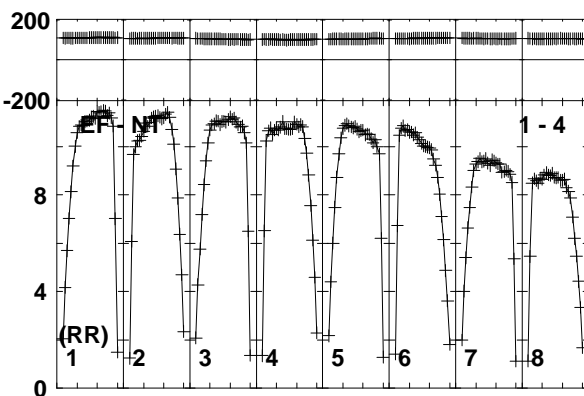
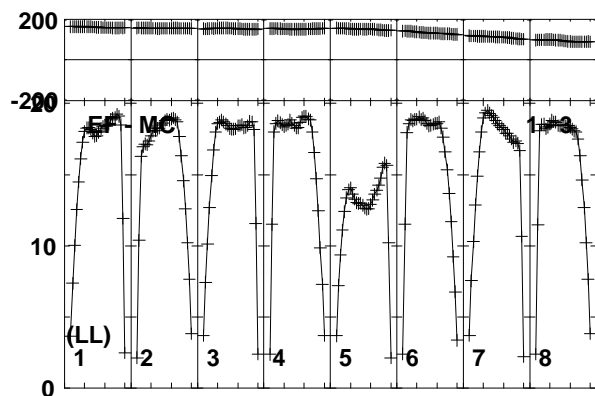
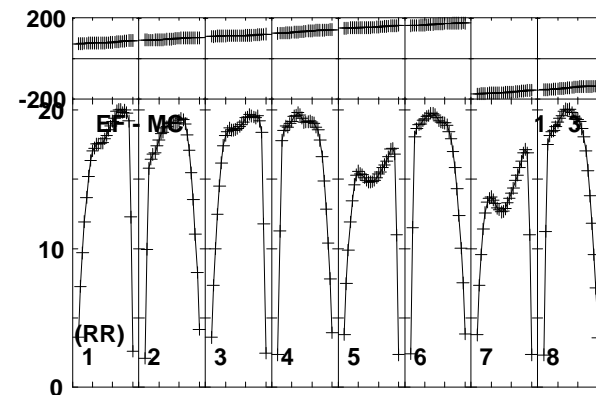
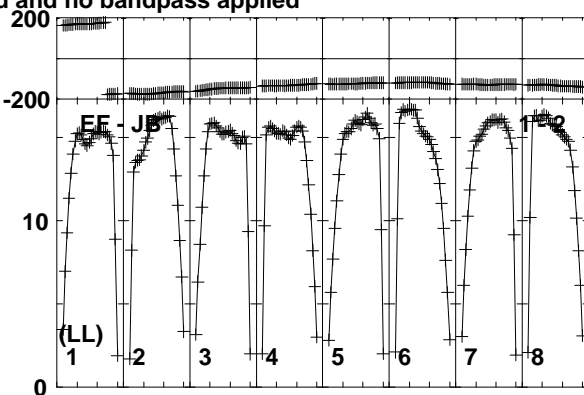
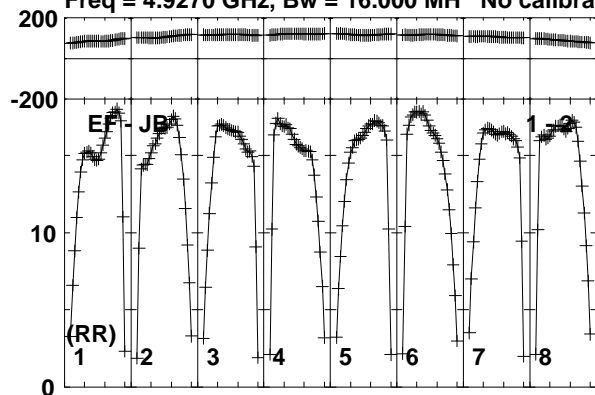

Lower frame: Milli Ampl Jy Top frame: Phas deg  
Vector averaged cross-power spectrum Baseline: EF (01) - JB (02)  
Timerange: 00/14:10:30 to 00/14:18:00

Plot file version 126 created 10-JUN-2016 15:29:29

0528+134 RG008C.UVDATA.1

Freq = 4.9270 GHz, Bw = 16.000 MH No calibration applied and no bandpass applied

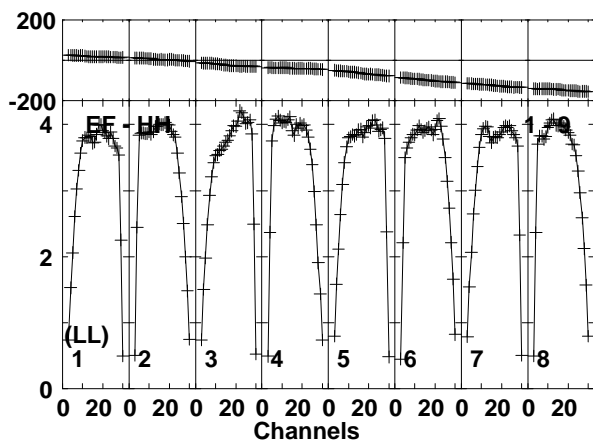
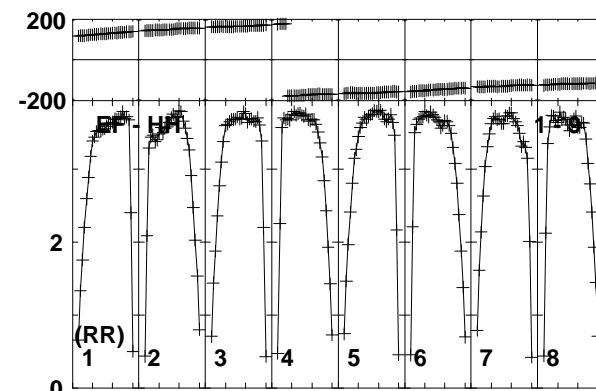
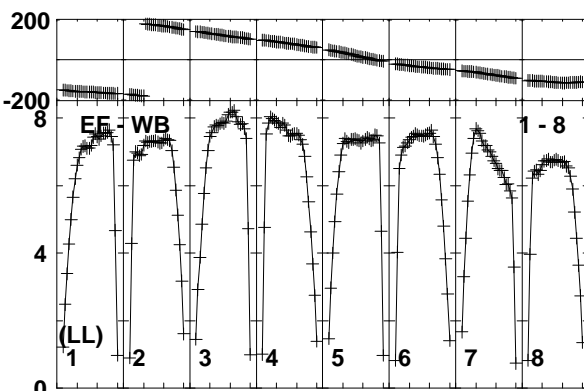
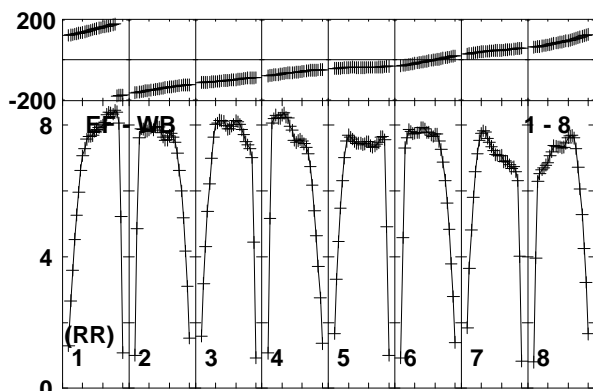
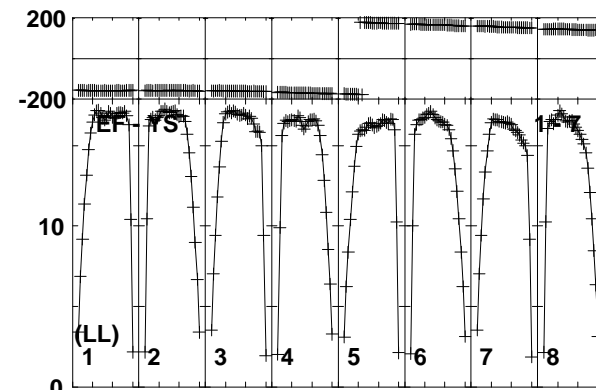
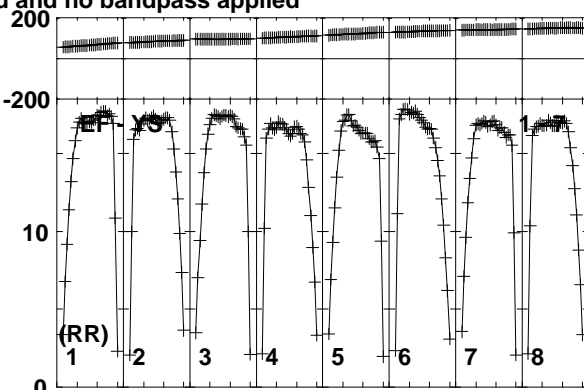
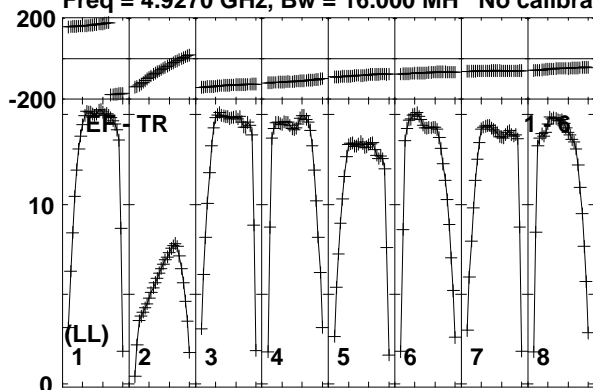

Lower frame: Milli Ampl Jy Top frame: Phas deg  
Vector averaged cross-power spectrum Baseline: EF (01) - TR (06)  
Timerange: 00/14:10:30 to 00/14:18:00

Plot file version 127 created 10-JUN-2016 15:29:29

J0718-1813 RG008C.UVDATA.1

Freq = 4.9270 GHz, Bw = 16.000 MH No calibration applied and no bandpass applied

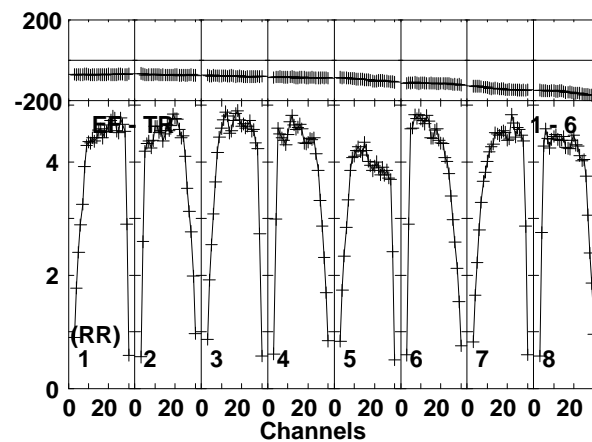
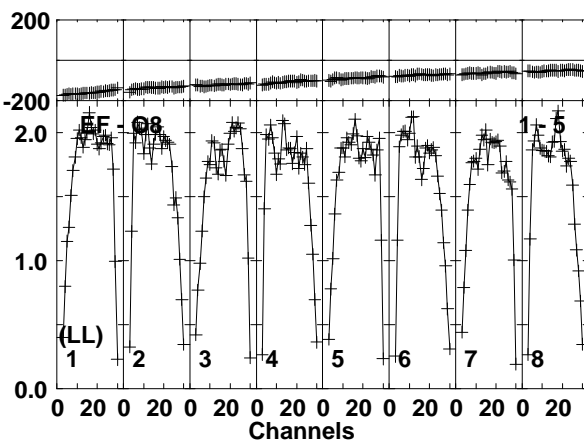
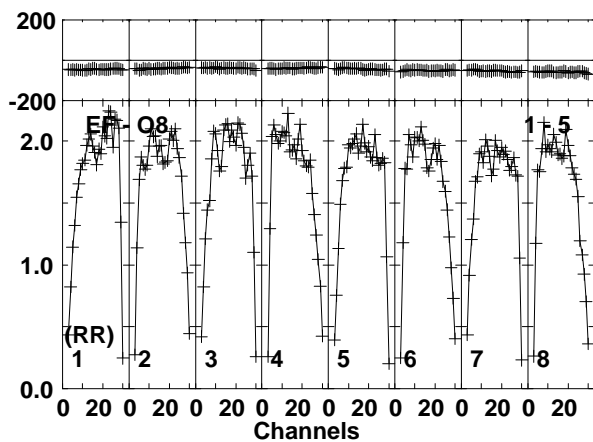
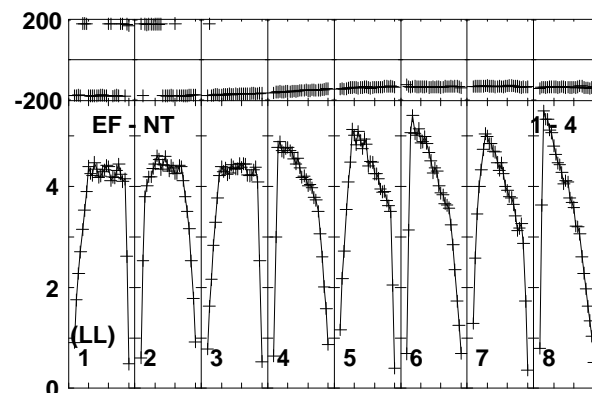
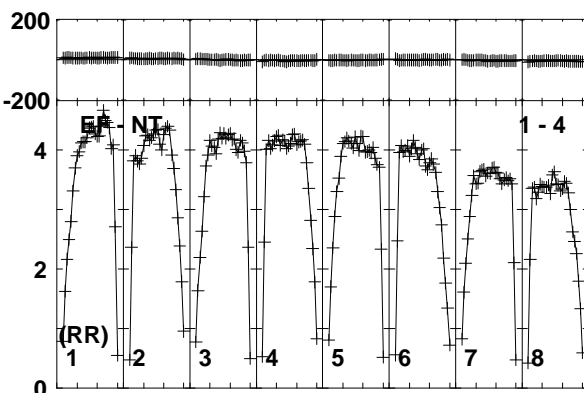
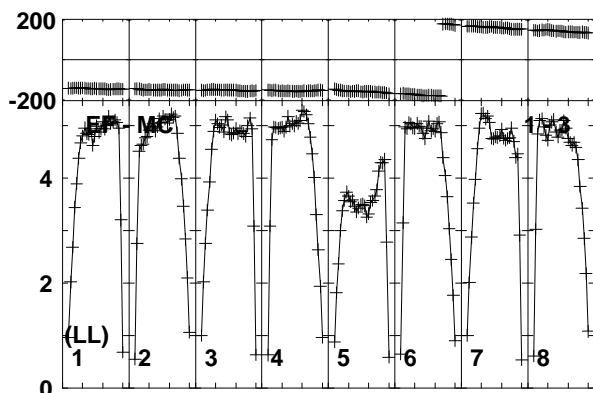
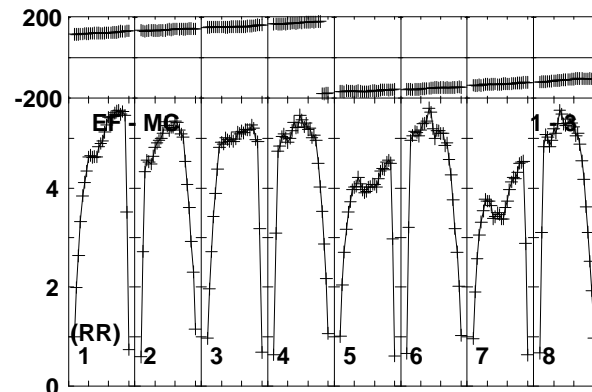
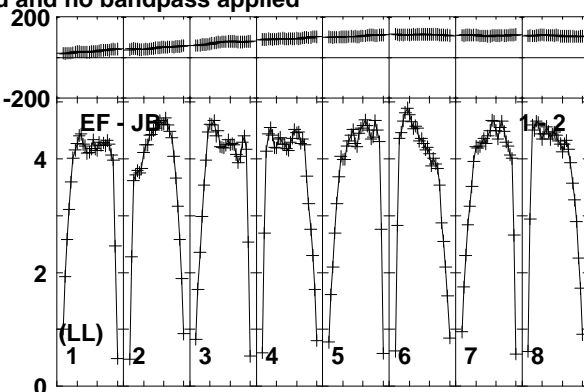
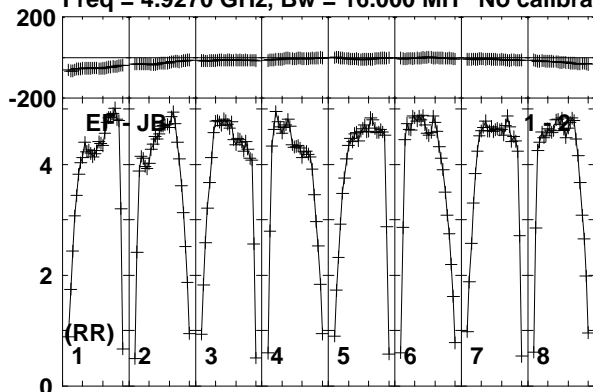

Lower frame: Milli Ampl Jy Top frame: Phas deg  
Vector averaged cross-power spectrum Baseline: EF (01) - JB (02)  
Timerange: 00/14:20:41 to 00/14:22:10

Plot file version 128 created 10-JUN-2016 15:29:29

J0718-1813 RG008C.UVDATA.1

Freq = 4.9270 GHz, Bw = 16.000 MH No calibration applied and no bandpass applied

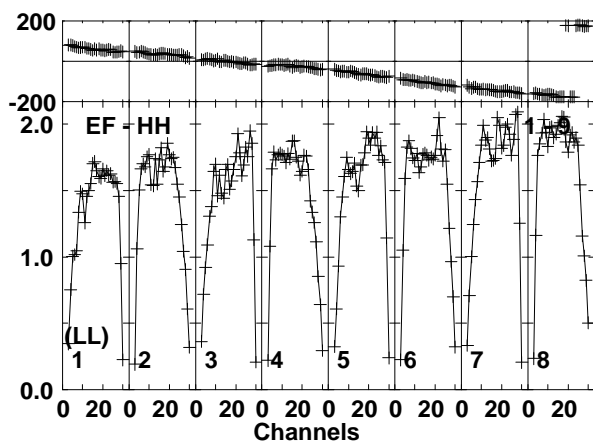
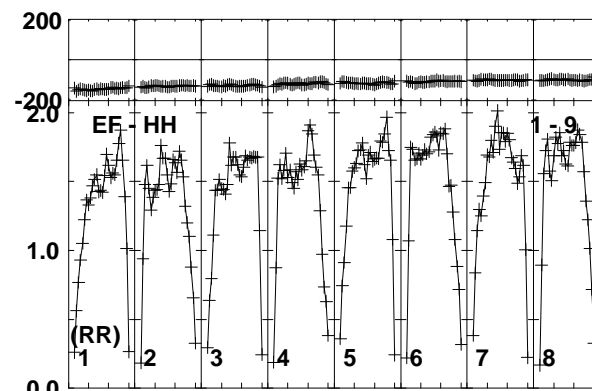
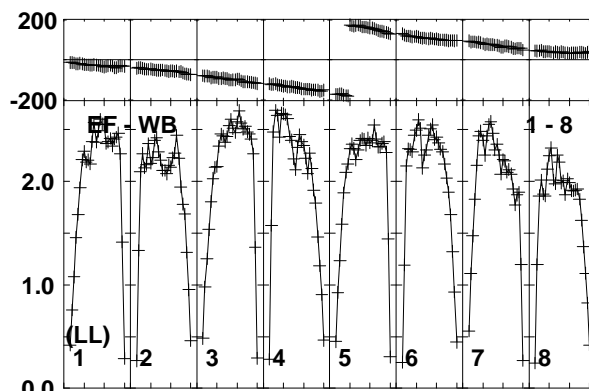
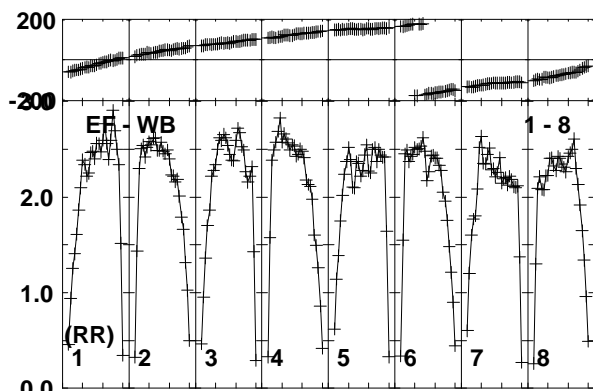
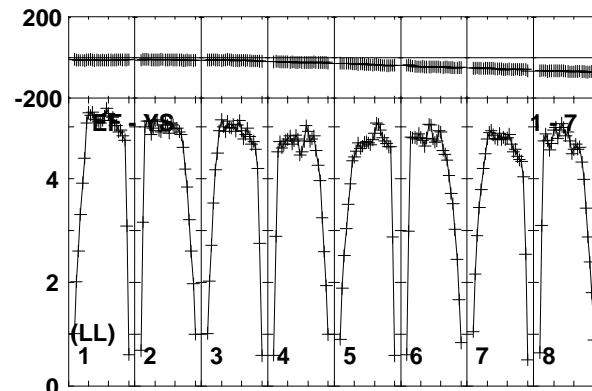
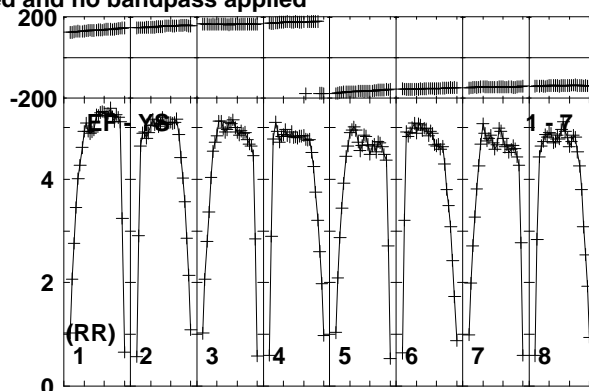
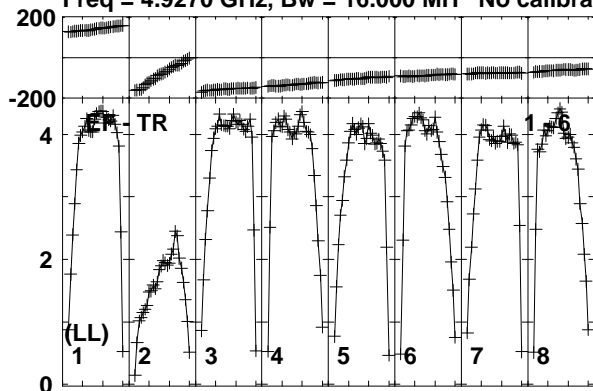

Lower frame: Milli Ampl Jy Top frame: Phas deg  
Vector averaged cross-power spectrum Baseline: EF (01) - TR (06)  
Timerange: 00/14:20:41 to 00/14:22:10



Plot file version 129 created 10-JUN-2016 15:29:30

FRB150418 RG008C.UVDATA.1

Freq = 4.9270 GHz, Bw = 16.000 MH No calibration applied and no bandpass applied

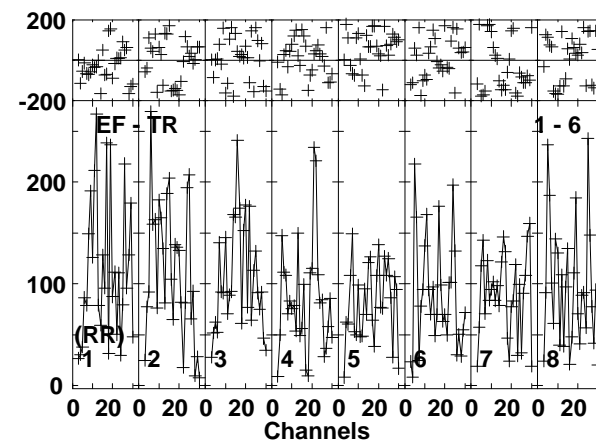
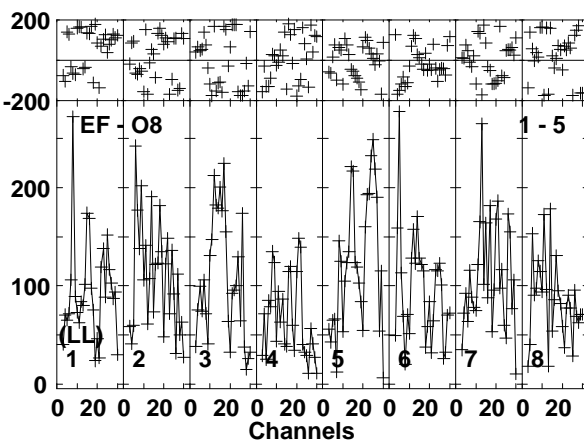
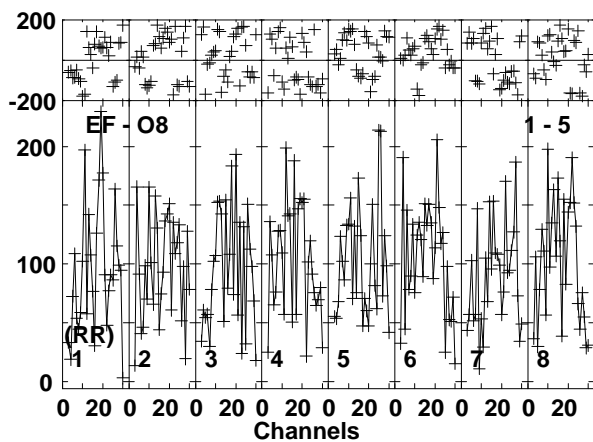
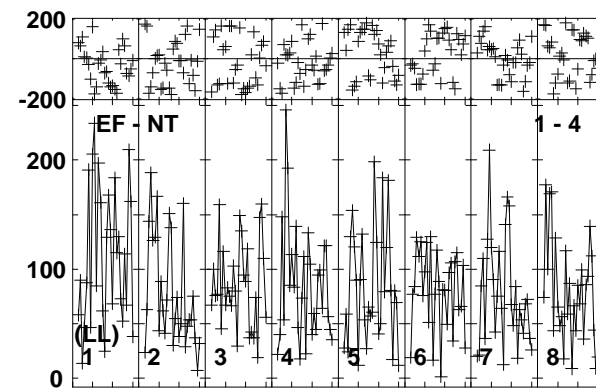
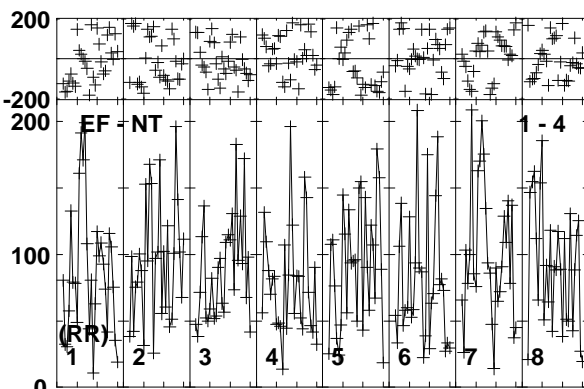
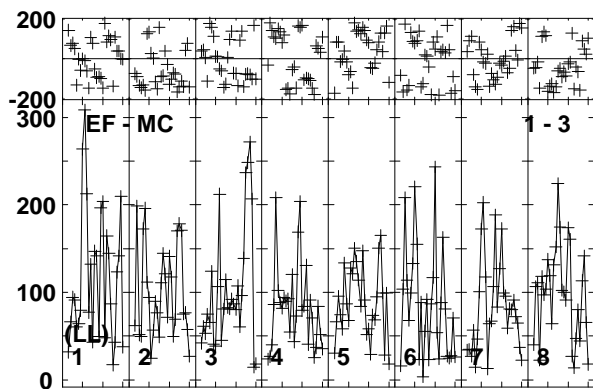
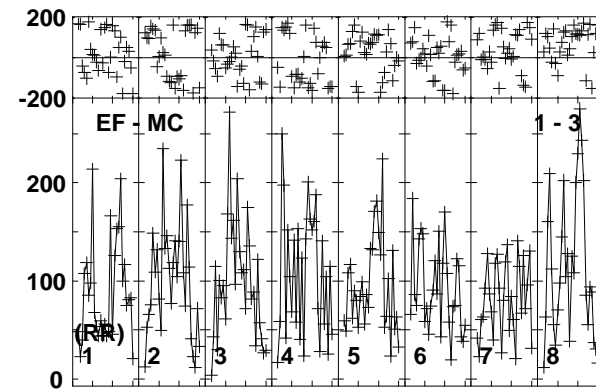
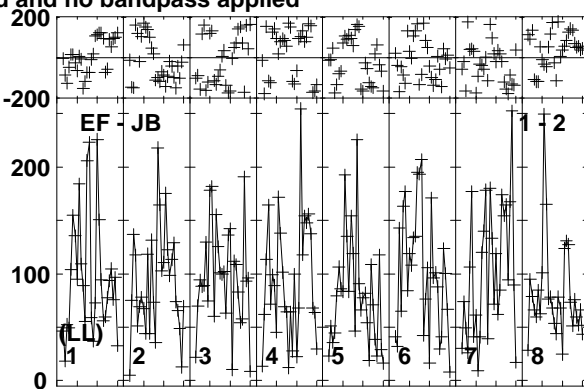
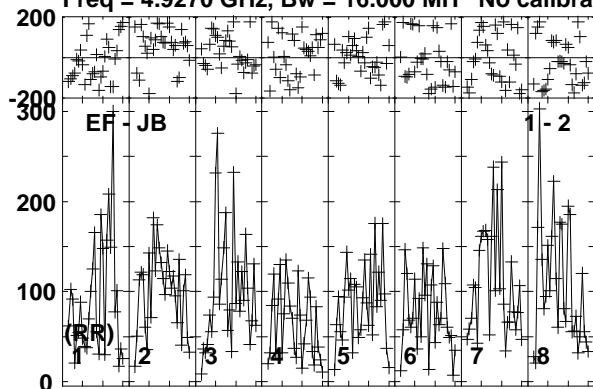

Lower frame: Micro Ampl Jy Top frame: Phas deg  
Vector averaged cross-power spectrum Baseline: EF (01) - JB (02)  
Timerange: 00/14:22:10 to 00/14:25:10

Plot file version 130 created 10-JUN-2016 15:29:30

FRB150418 RG008C.UVDATA.1

Freq = 4.9270 GHz, Bw = 16.000 MH No calibration applied and no bandpass applied

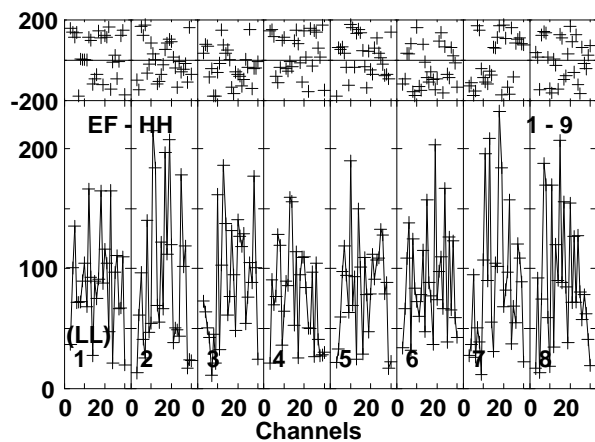
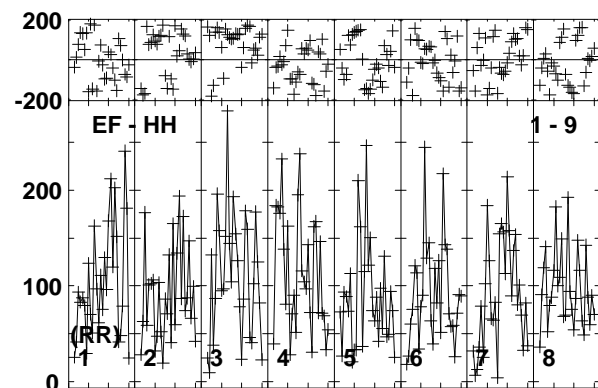
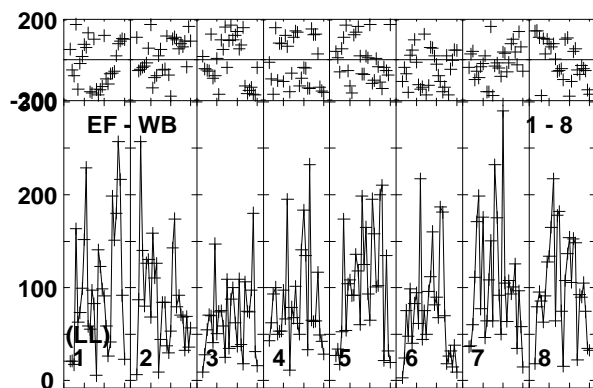
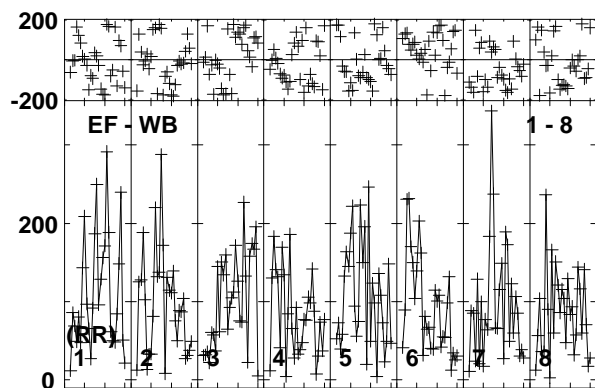
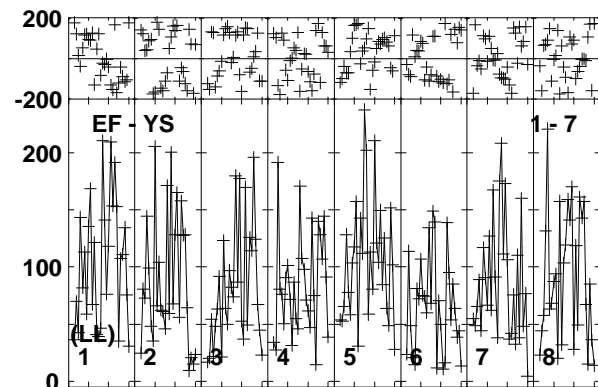
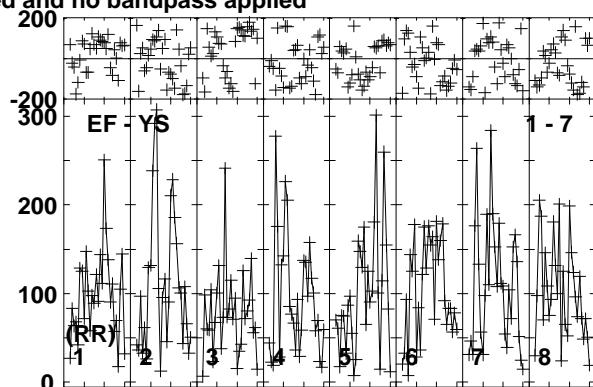
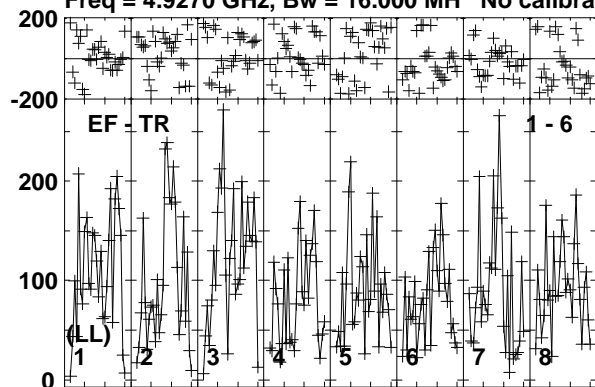

Lower frame: Micro Ampl Jy Top frame: Phas deg  
Vector averaged cross-power spectrum Baseline: EF (01) - TR (06)  
Timerange: 00/14:22:10 to 00/14:25:10

Plot file version 131 created 10-JUN-2016 15:29:30

J0718-1813 RG008C.UVDATA.1

Freq = 4.9270 GHz, Bw = 16.000 MH No calibration applied and no bandpass applied

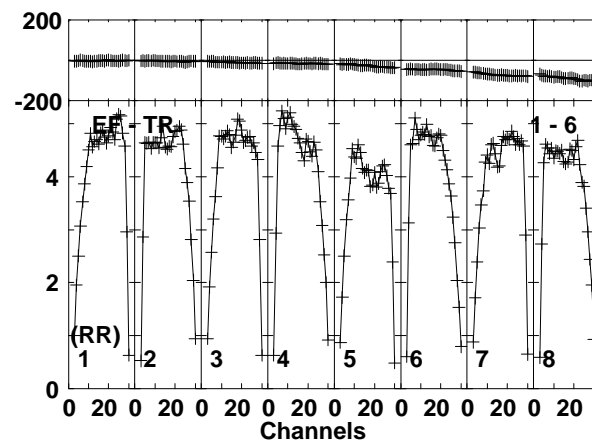
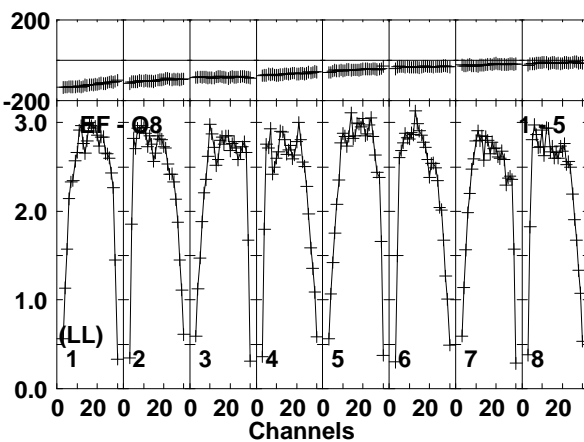
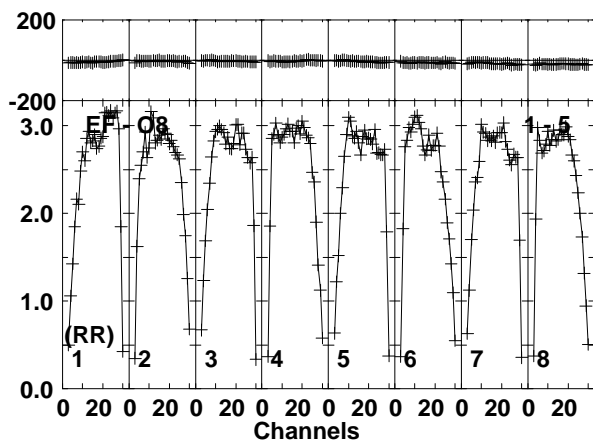
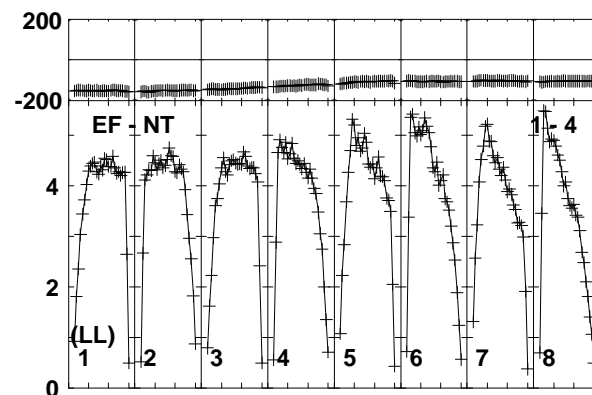
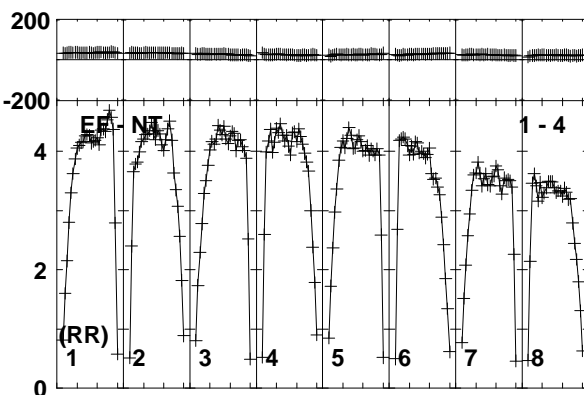
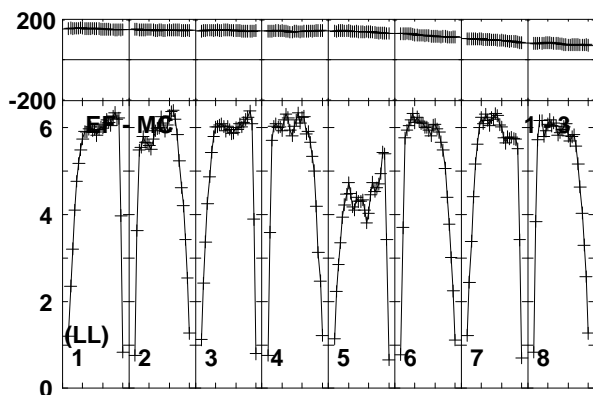
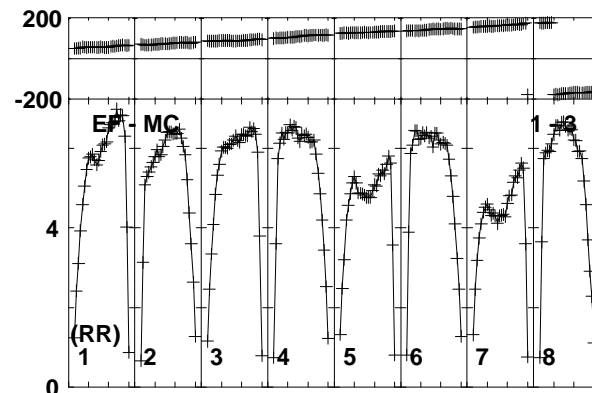
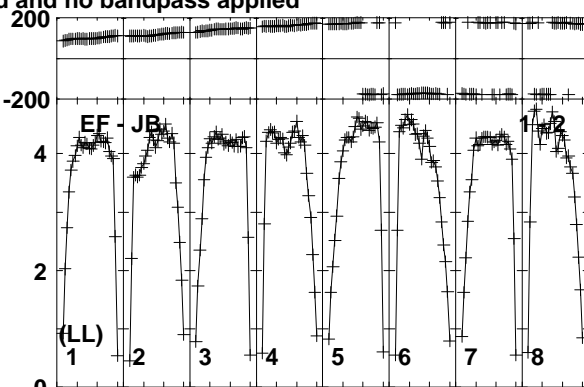
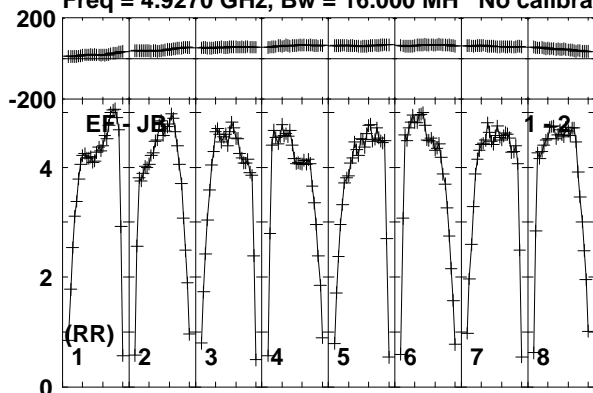

Lower frame: Milli Ampl Jy Top frame: Phas deg  
Vector averaged cross-power spectrum Baseline: EF (01) - JB (02)  
Timerange: 00/14:25:10 to 00/14:26:39

Plot file version 132 created 10-JUN-2016 15:29:30

J0718-1813 RG008C.UVDATA.1

Freq = 4.9270 GHz, Bw = 16.000 MH No calibration applied and no bandpass applied

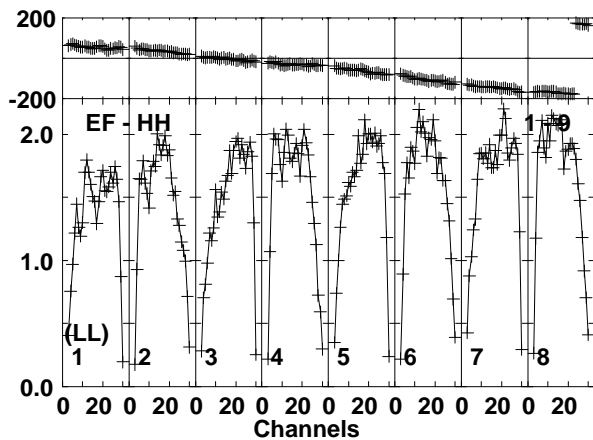
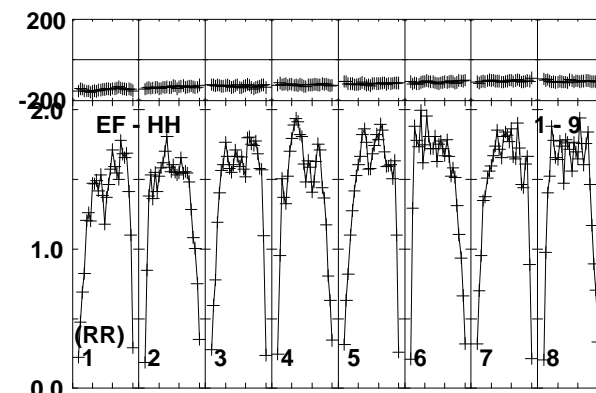
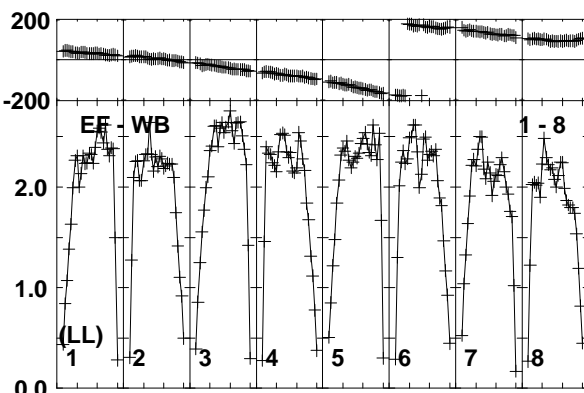
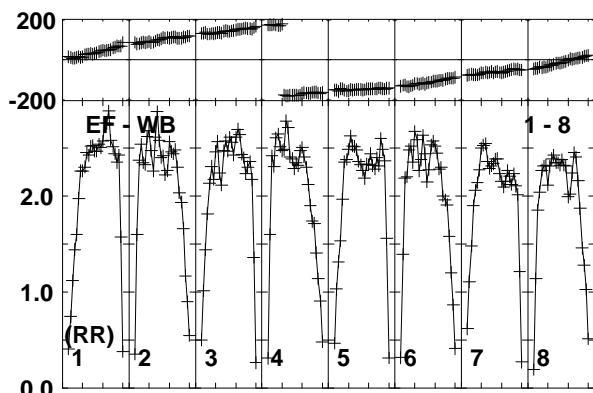
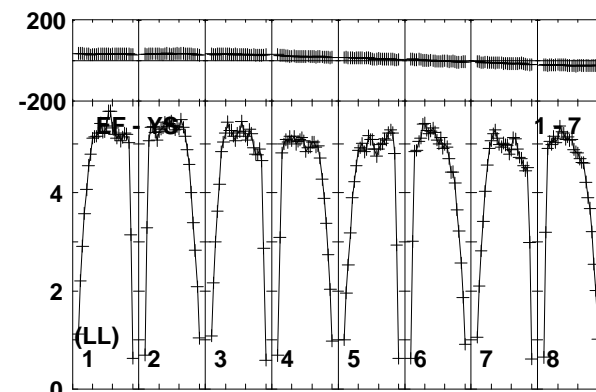
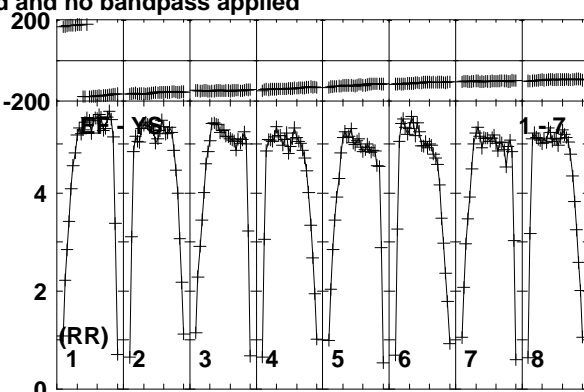
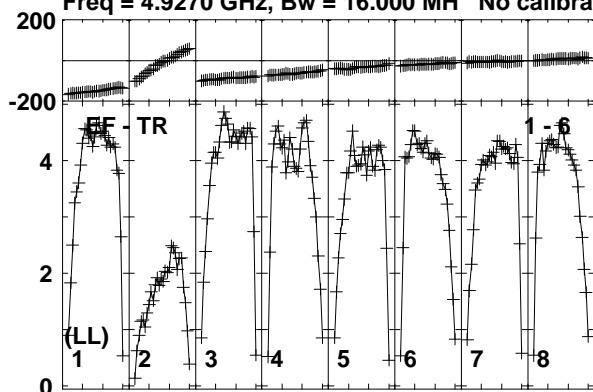

Lower frame: Milli Ampl Jy Top frame: Phas deg  
Vector averaged cross-power spectrum Baseline: EF (01) - TR (06)  
Timerange: 00/14:25:10 to 00/14:26:39

Plot file version 133 created 10-JUN-2016 15:29:30

FRB150418 RG008C.UVDATA.1

Freq = 4.9270 GHz, Bw = 16.000 MH No calibration applied and no bandpass applied

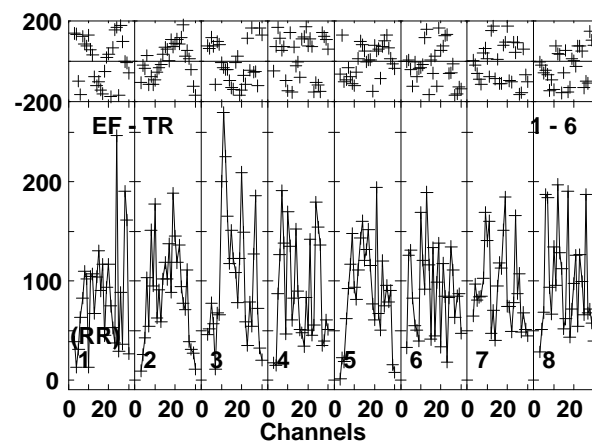
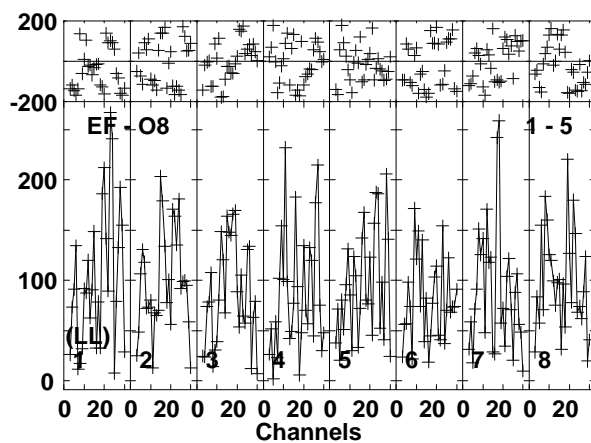
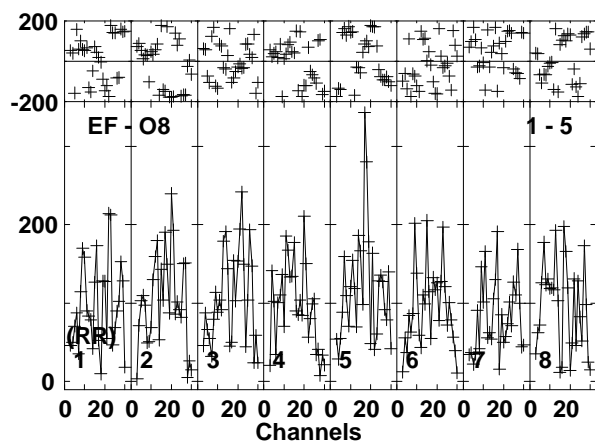
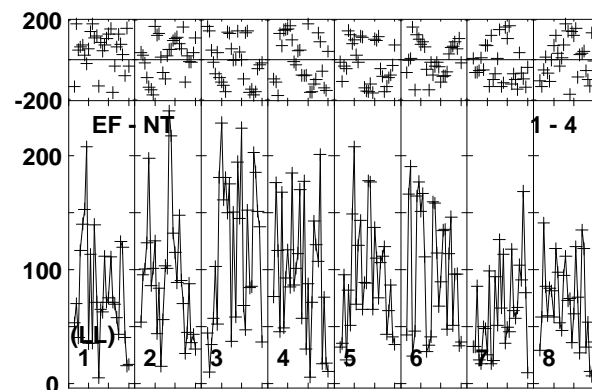
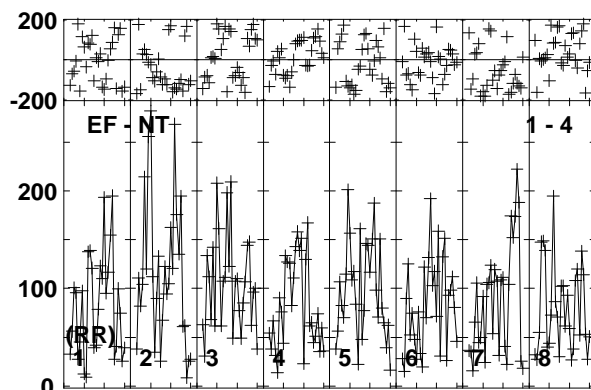
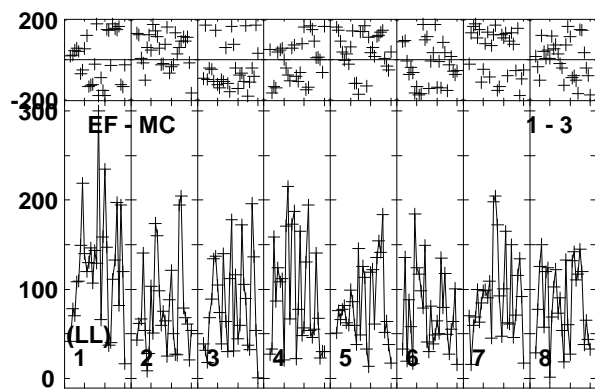
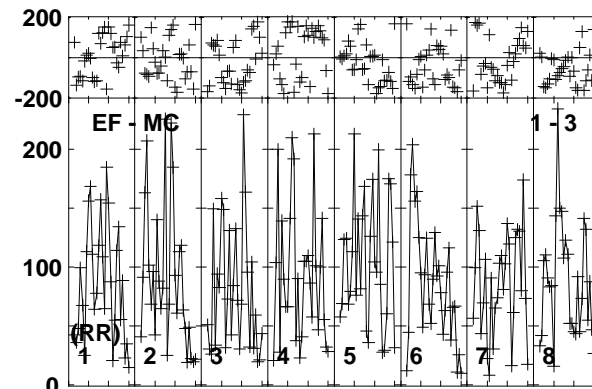
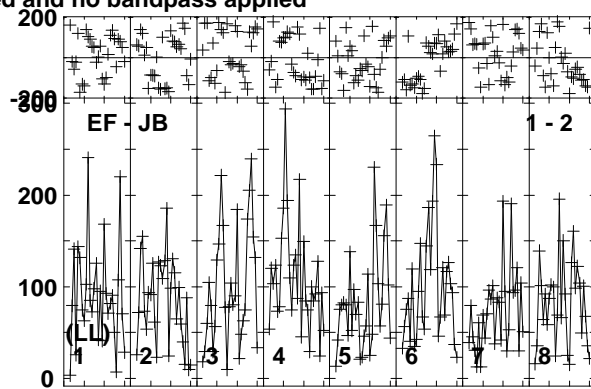
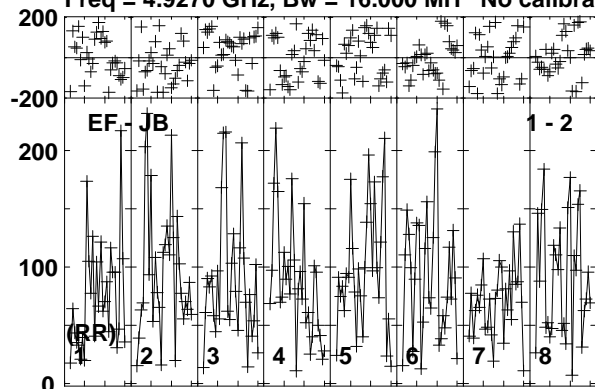

Lower frame: Micro Ampl Jy Top frame: Phas deg  
Vector averaged cross-power spectrum Baseline: EF (01) - JB (02)  
Timerange: 00/14:26:41 to 00/14:29:40

Plot file version 134 created 10-JUN-2016 15:29:30

FRB150418 RG008C.UVDATA.1

Freq = 4.9270 GHz, Bw = 16.000 MH No calibration applied and no bandpass applied

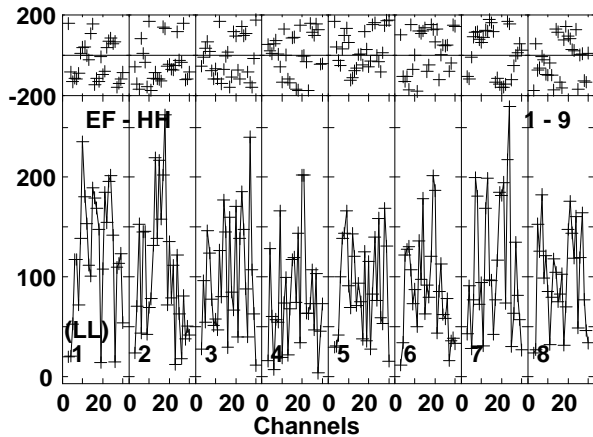
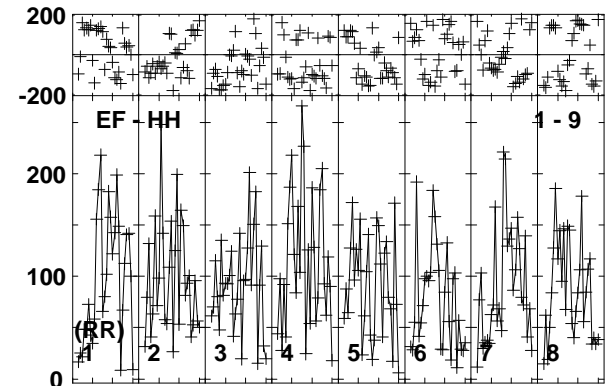
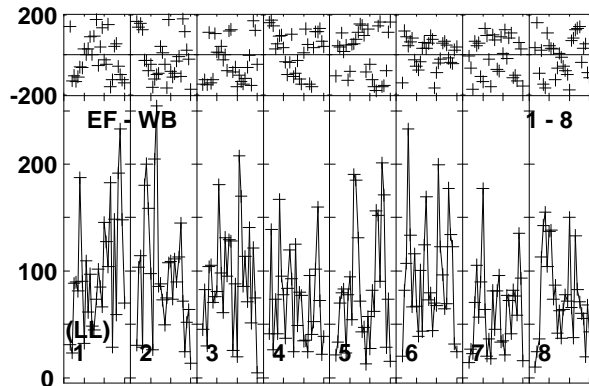
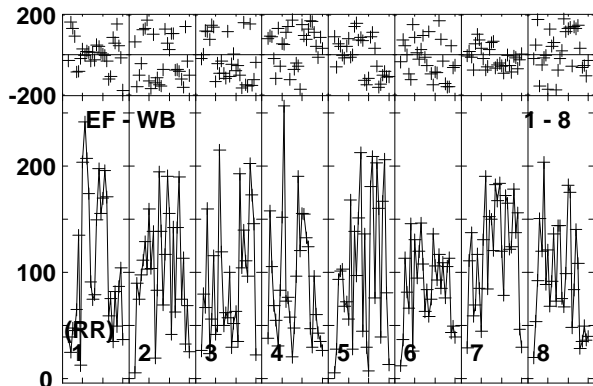
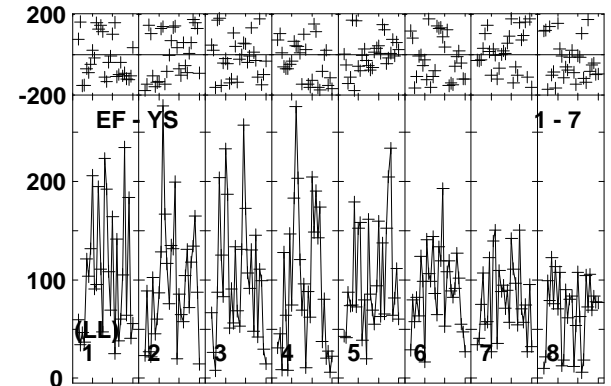
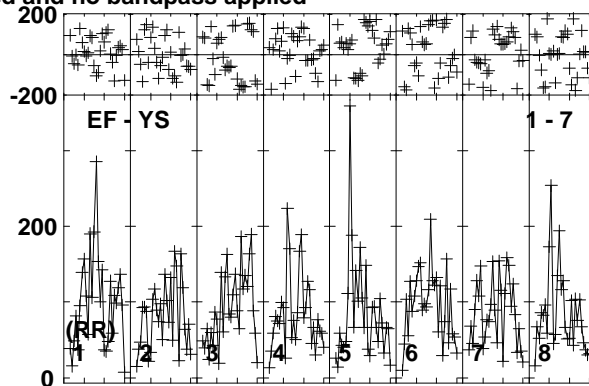
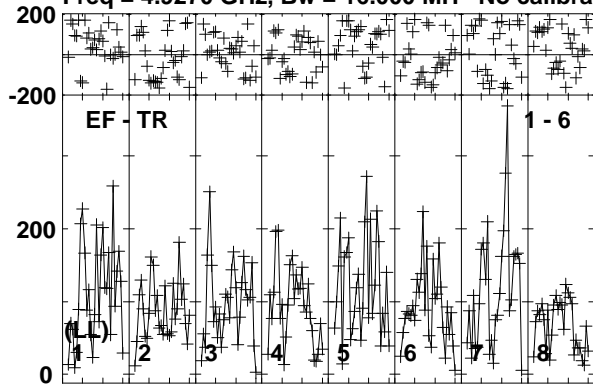

Lower frame: Micro Ampl Jy Top frame: Phas deg  
Vector averaged cross-power spectrum Baseline: EF (01) - TR (06)  
Timerange: 00/14:26:41 to 00/14:29:40

Plot file version 135 created 10-JUN-2016 15:29:30

J0718-1813 RG008C.UVDATA.1

Freq = 4.9270 GHz, Bw = 16.000 MH No calibration applied and no bandpass applied

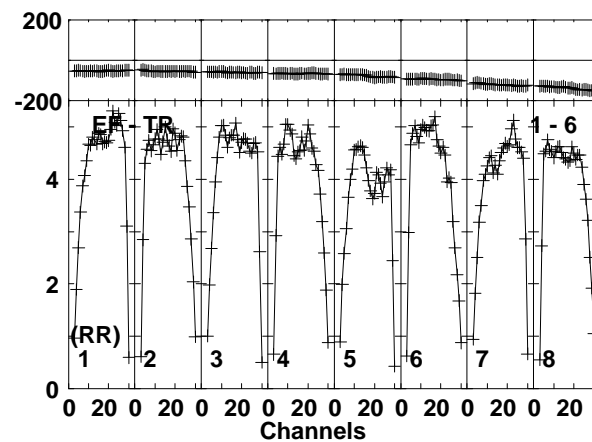
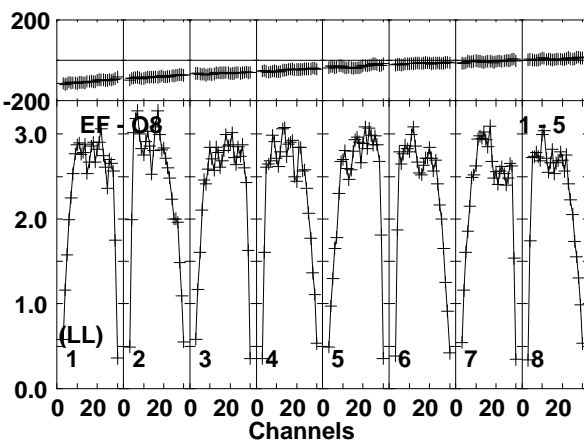
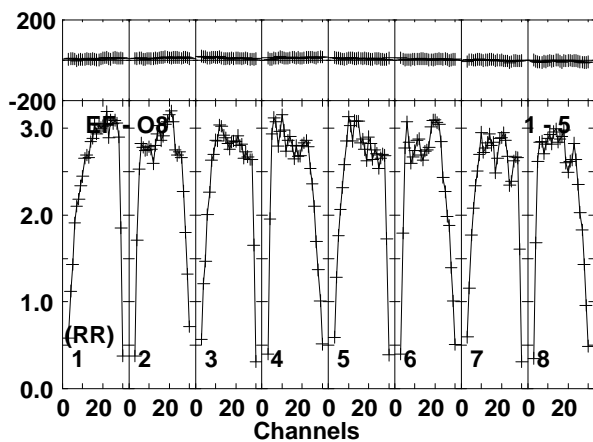
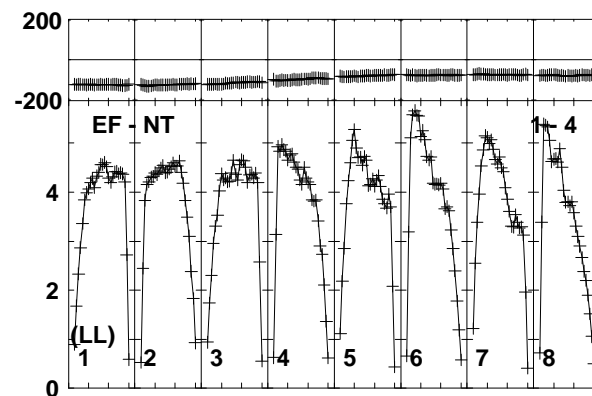
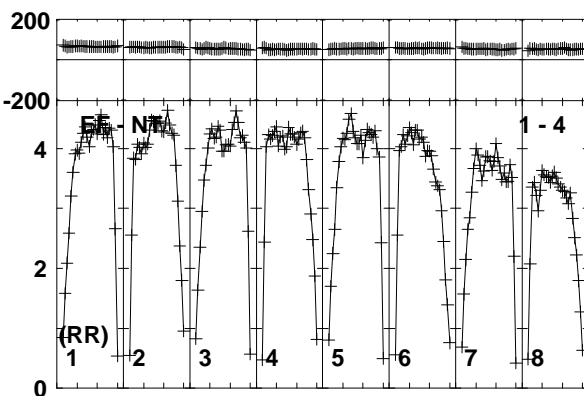
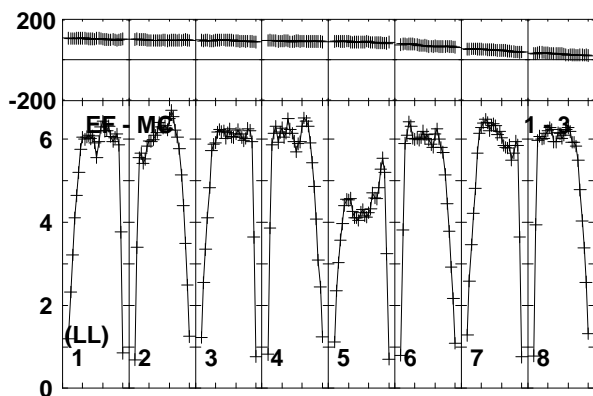
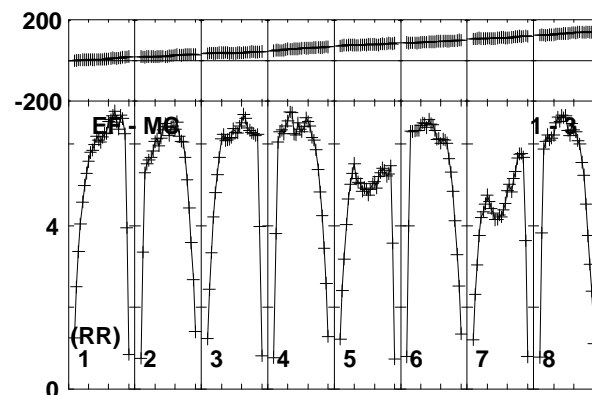
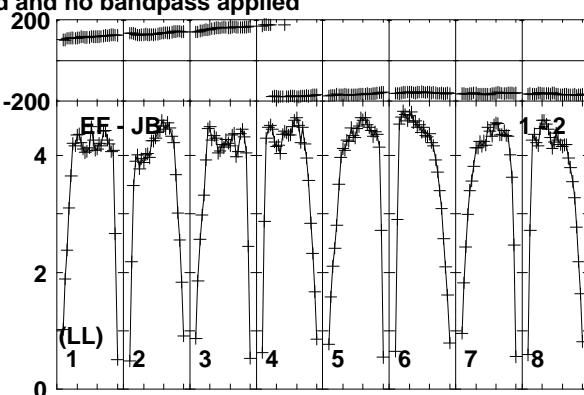
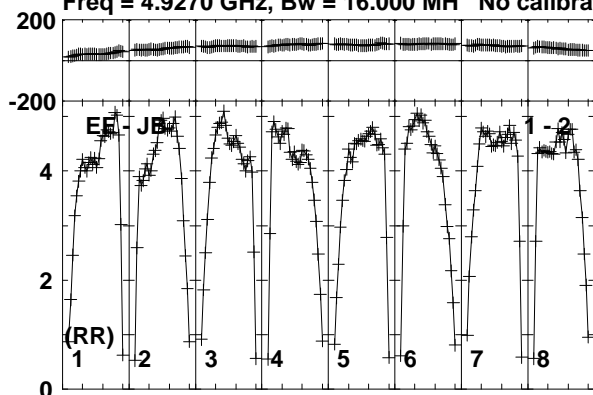

Lower frame: Milli Ampl Jy Top frame: Phas deg  
Vector averaged cross-power spectrum Baseline: EF (01) - JB (02)  
Timerange: 00/14:30:20 to 00/14:31:09

Plot file version 136 created 10-JUN-2016 15:29:30

J0718-1813 RG008C.UVDATA.1

Freq = 4.9270 GHz, Bw = 16.000 MH No calibration applied and no bandpass applied

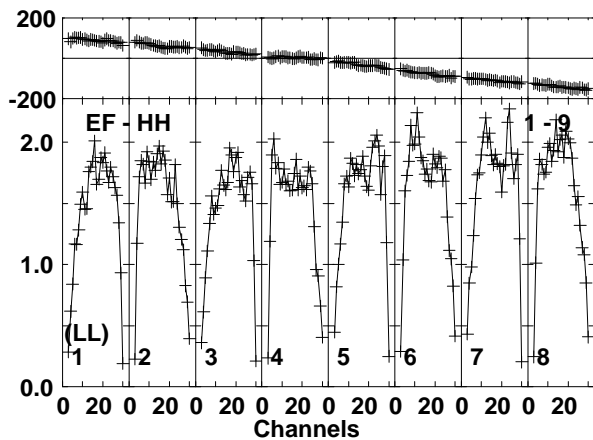
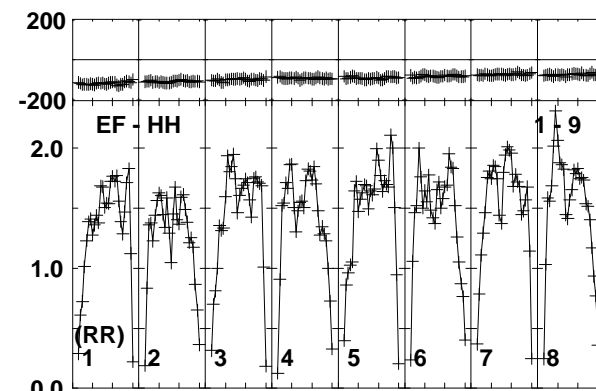
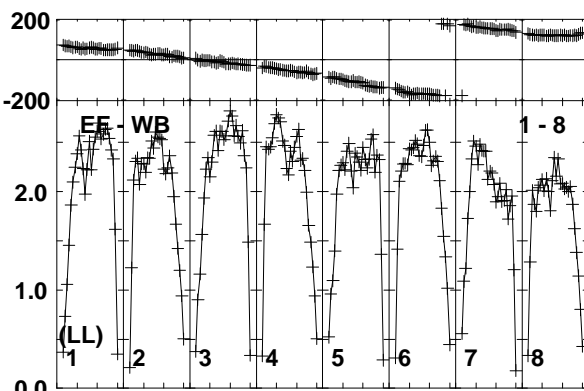
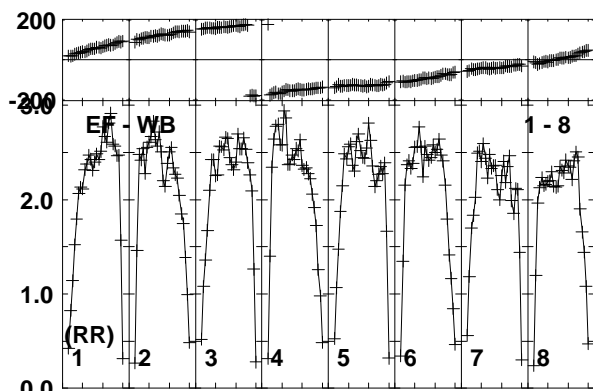
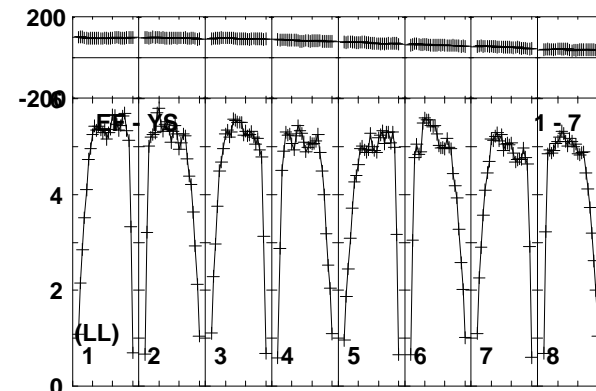
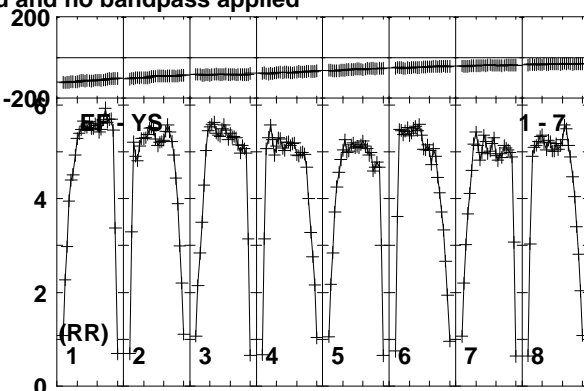
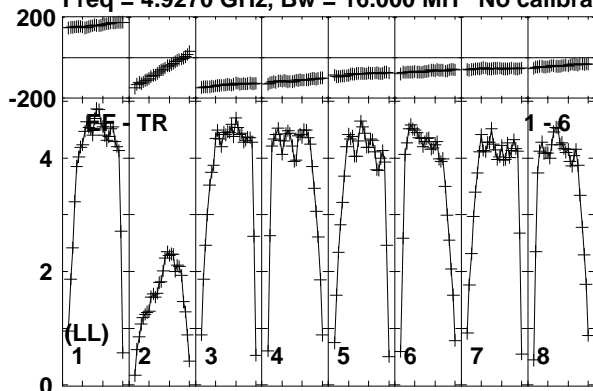

Lower frame: Milli Ampl Jy Top frame: Phas deg  
Vector averaged cross-power spectrum Baseline: EF (01) - TR (06)  
Timerange: 00/14:30:20 to 00/14:31:09



Plot file version 137 created 10-JUN-2016 15:29:31

FRB150418 RG008C.UVDATA.1

Freq = 4.9270 GHz, Bw = 16.000 MH No calibration applied and no bandpass applied

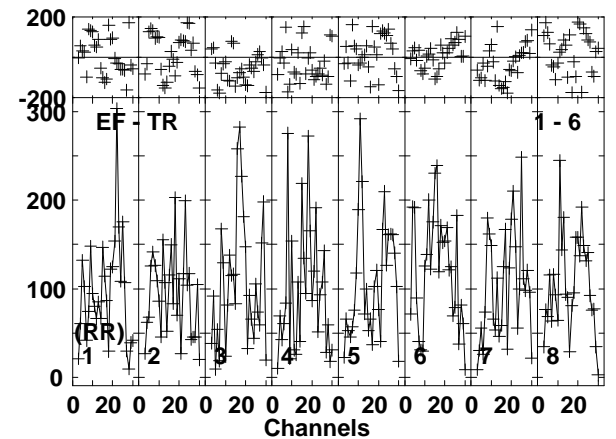
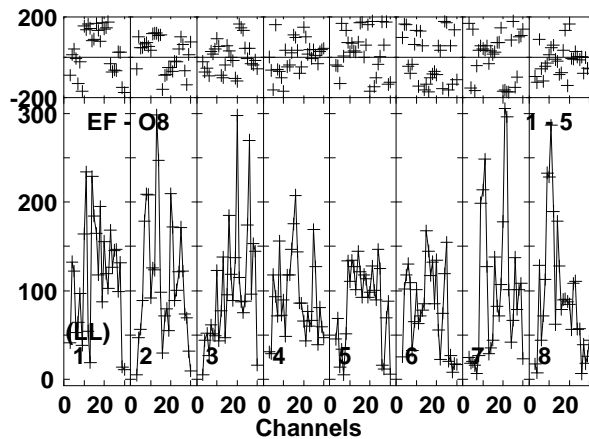
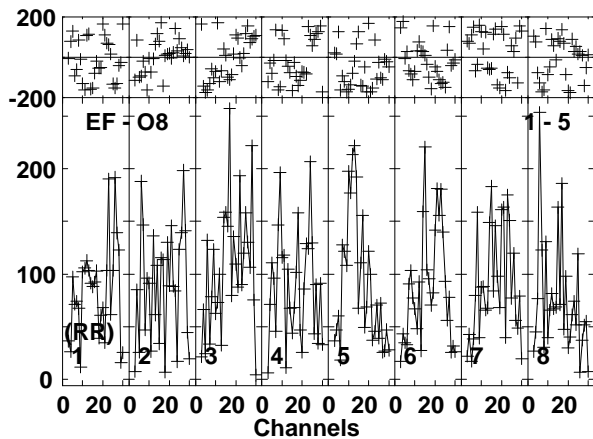
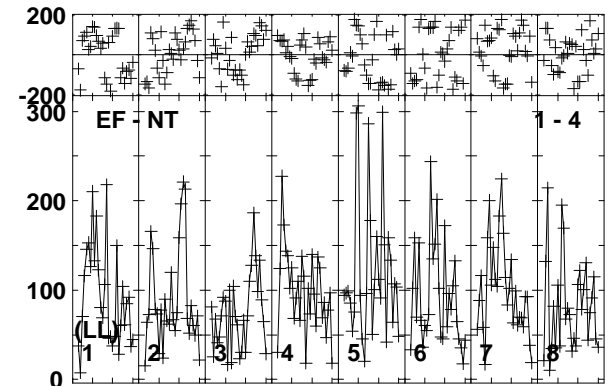
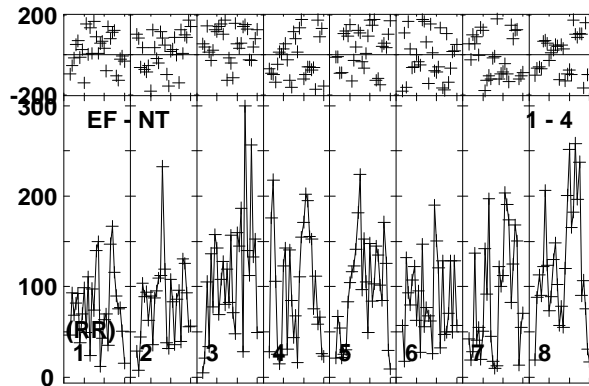
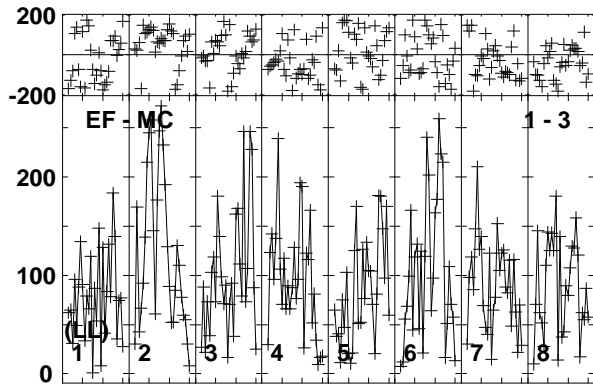
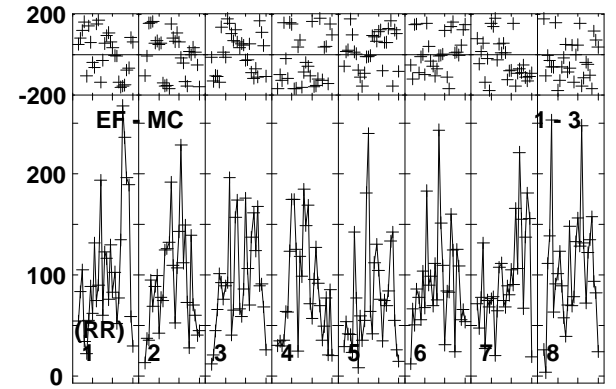
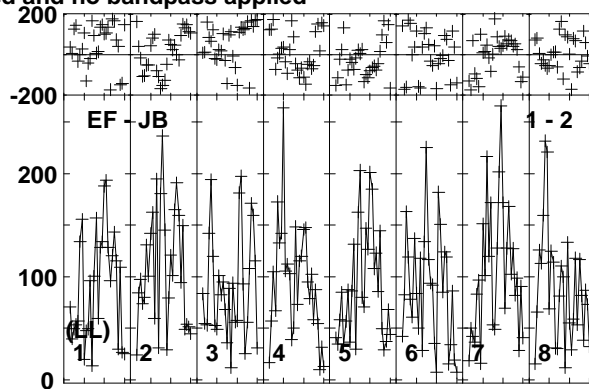
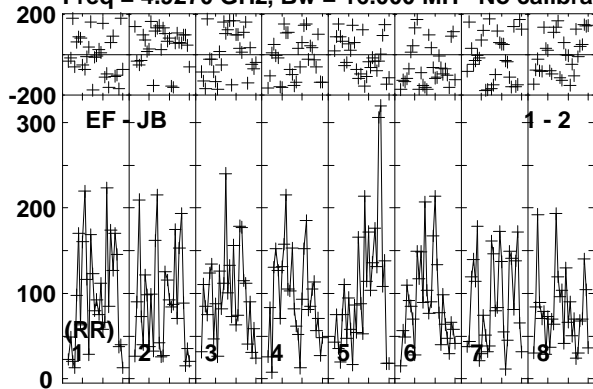

Lower frame: Micro Ampl Jy Top frame: Phas deg  
Vector averaged cross-power spectrum Baseline: EF (01) - JB (02)  
Timerange: 00/14:31:10 to 00/14:34:10

Plot file version 138 created 10-JUN-2016 15:29:31

FRB150418 RG008C.UVDATA.1

Freq = 4.9270 GHz, Bw = 16.000 MH No calibration applied and no bandpass applied

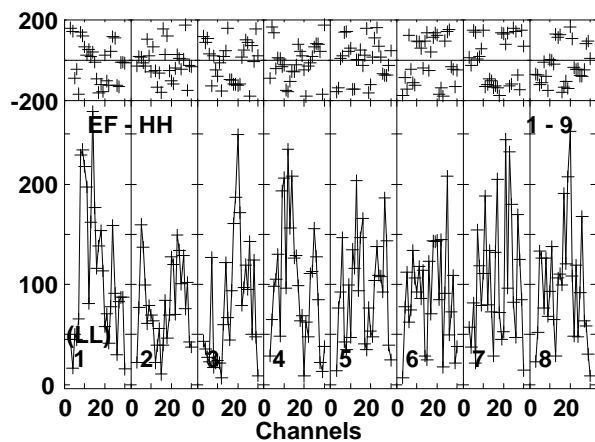
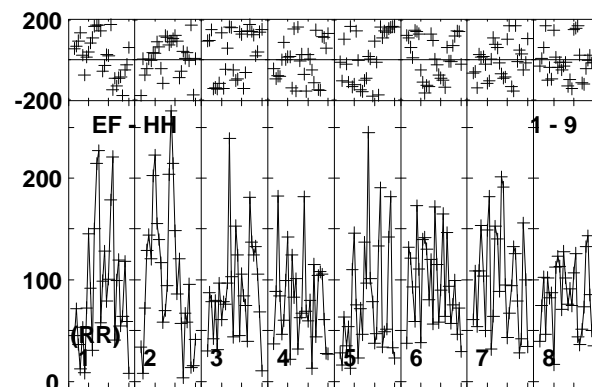
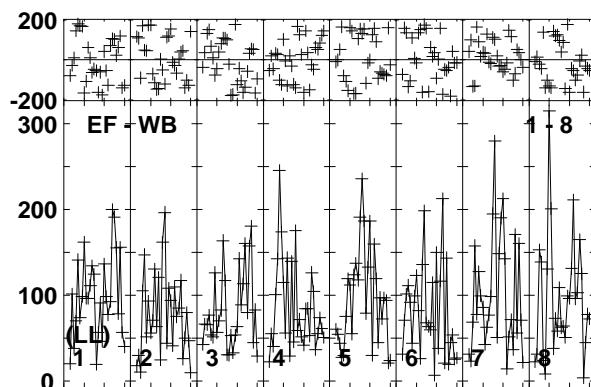
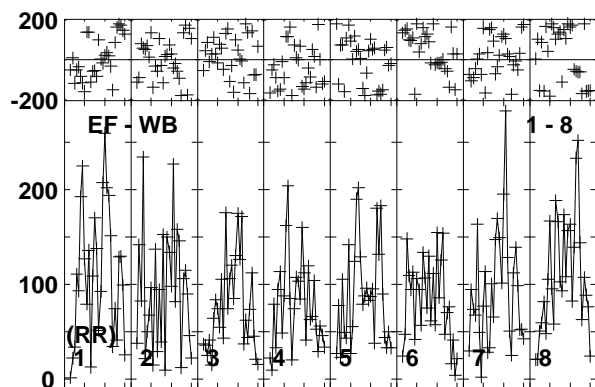
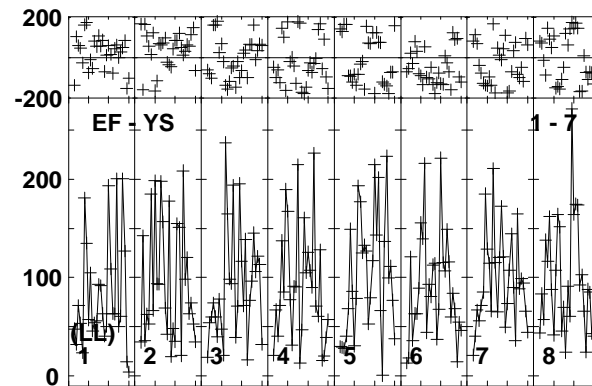
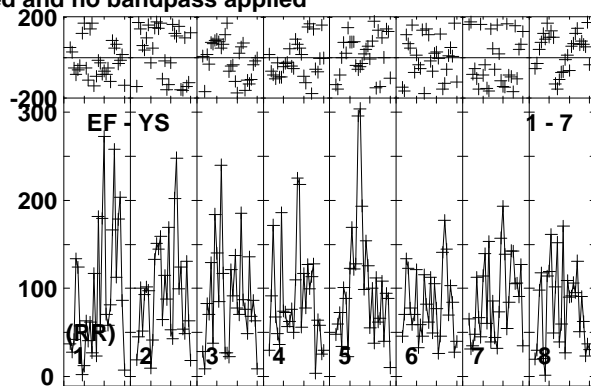
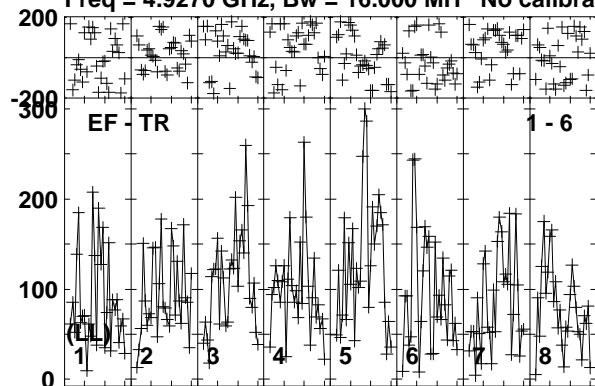

Lower frame: Micro Ampl Jy Top frame: Phas deg  
Vector averaged cross-power spectrum Baseline: EF (01) - TR (06)  
Timerange: 00/14:31:10 to 00/14:34:10

Plot file version 139 created 10-JUN-2016 15:29:31

J0718-1813 RG008C.UVDATA.1

Freq = 4.9270 GHz, Bw = 16.000 MH No calibration applied and no bandpass applied

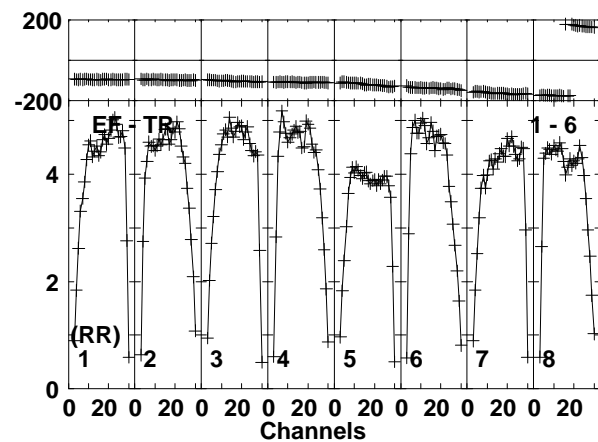
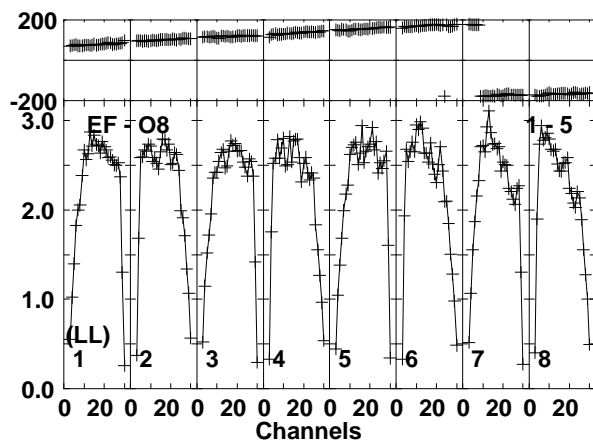
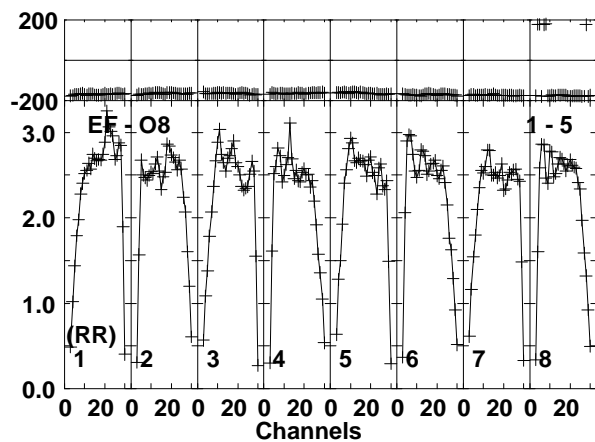
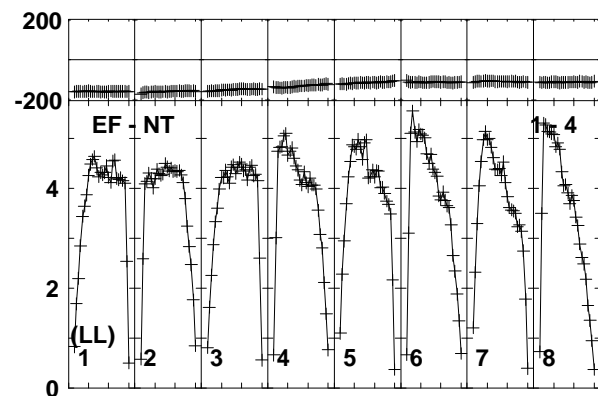
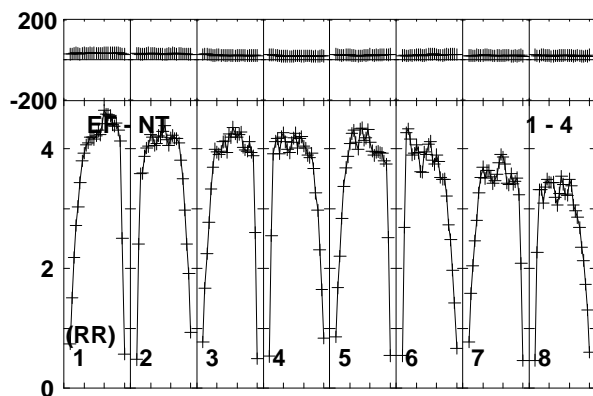
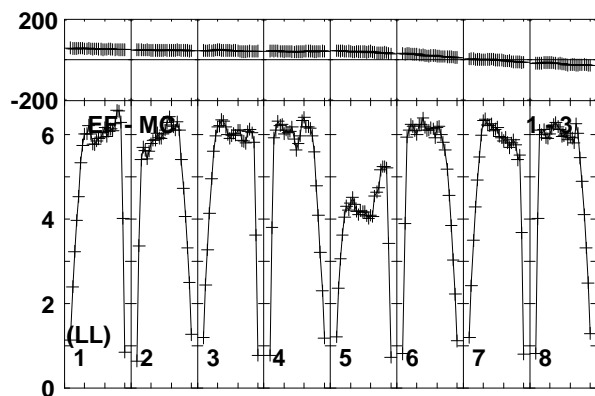
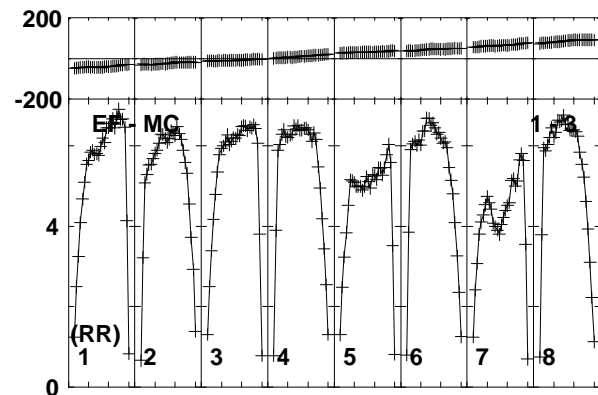
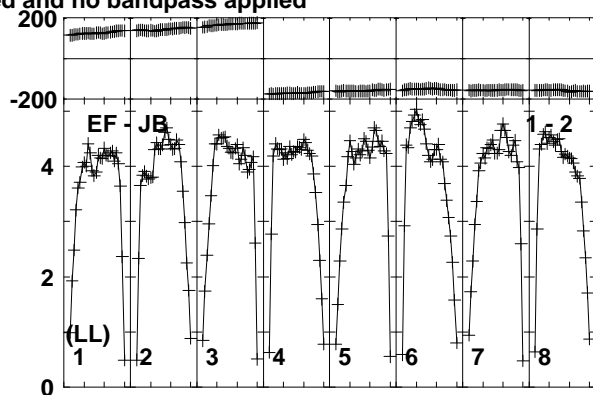
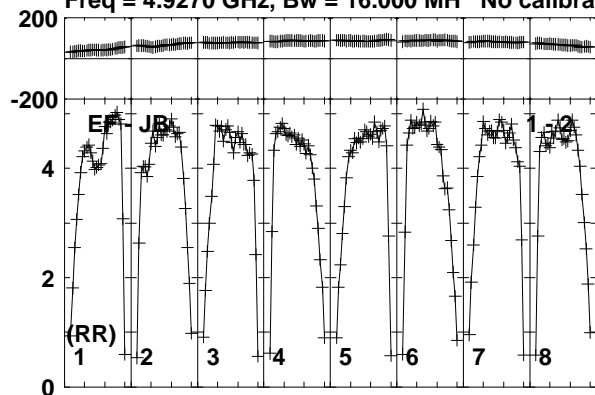

Lower frame: Milli Ampl Jy Top frame: Phas deg  
Vector averaged cross-power spectrum Baseline: EF (01) - JB (02)  
Timerange: 00/14:34:11 to 00/14:35:39

Plot file version 140 created 10-JUN-2016 15:29:31

J0718-1813 RG008C.UVDATA.1

Freq = 4.9270 GHz, Bw = 16.000 MH No calibration applied and no bandpass applied

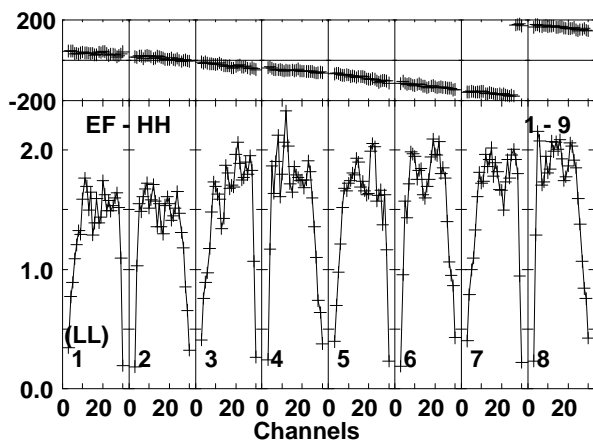
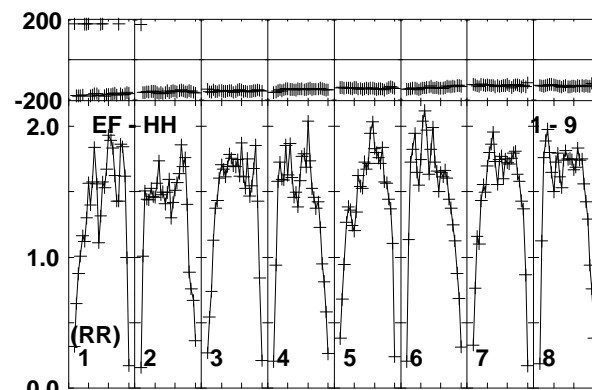
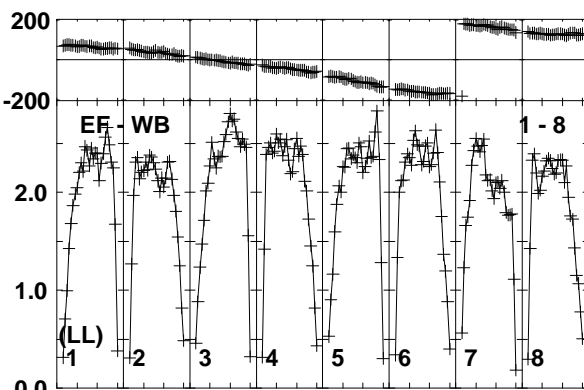
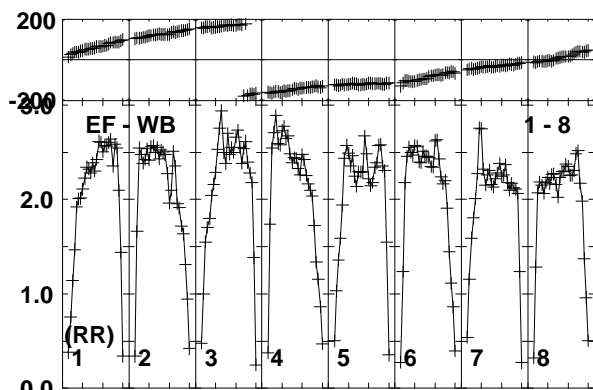
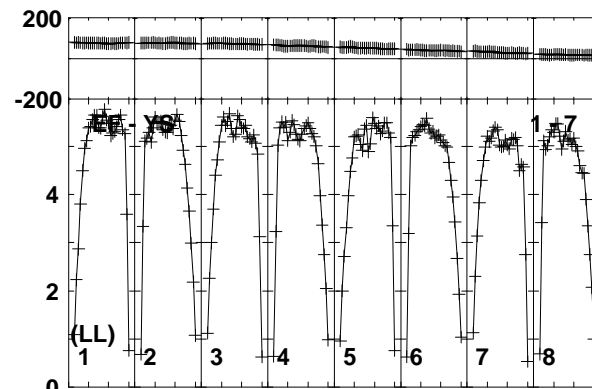
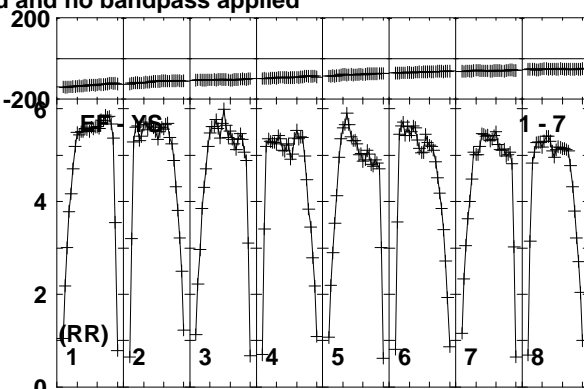
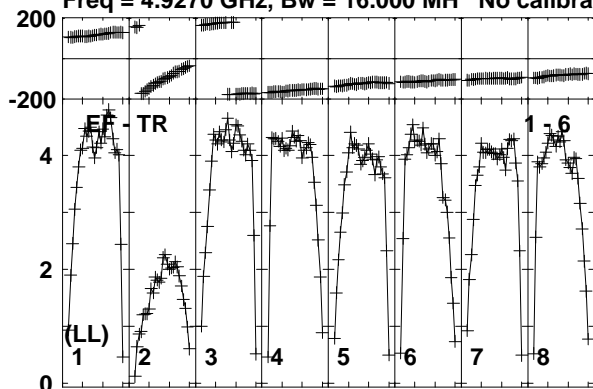

Lower frame: Milli Ampl Jy Top frame: Phas deg  
Vector averaged cross-power spectrum Baseline: EF (01) - TR (06)  
Timerange: 00/14:34:11 to 00/14:35:39

Plot file version 141 created 10-JUN-2016 15:29:31

J0712-1847 RG008C.UVDATA.1

Freq = 4.9270 GHz, Bw = 16.000 MH No calibration applied and no bandpass applied

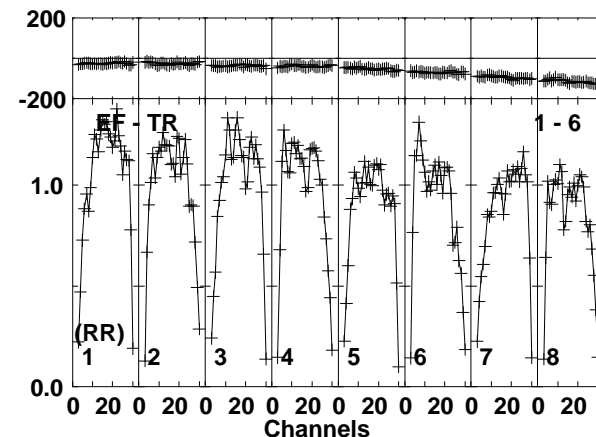
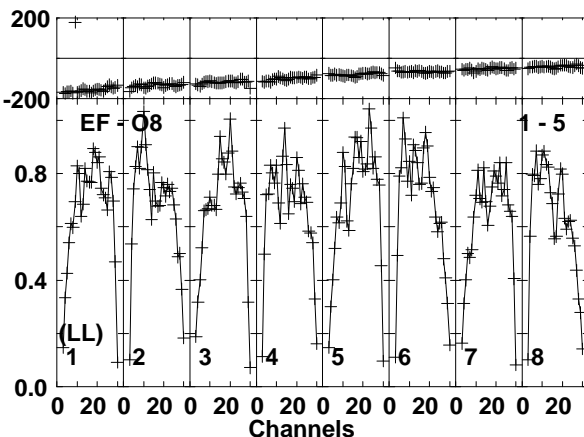
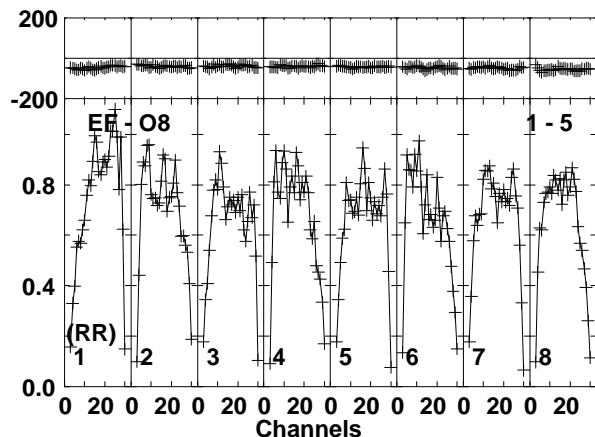
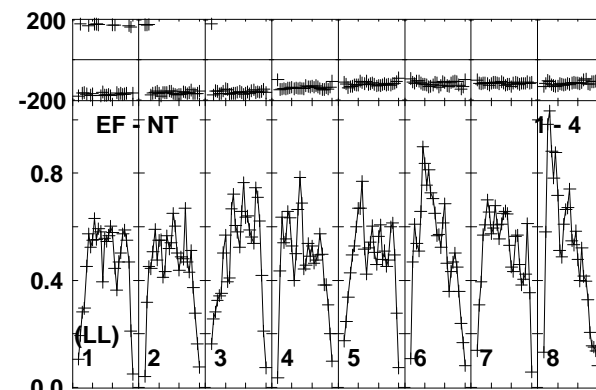
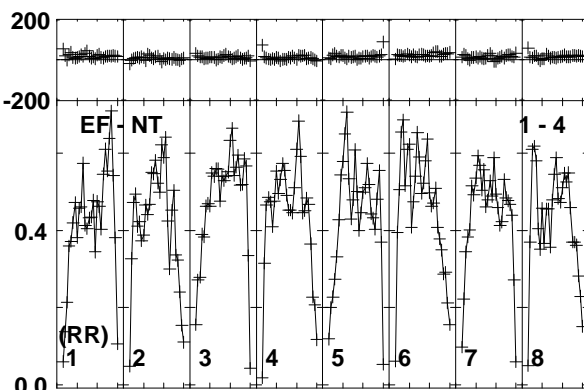
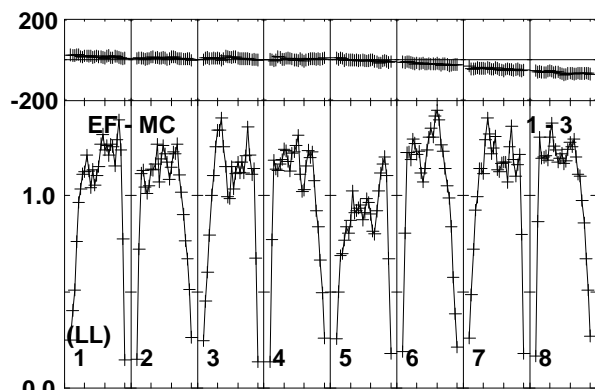
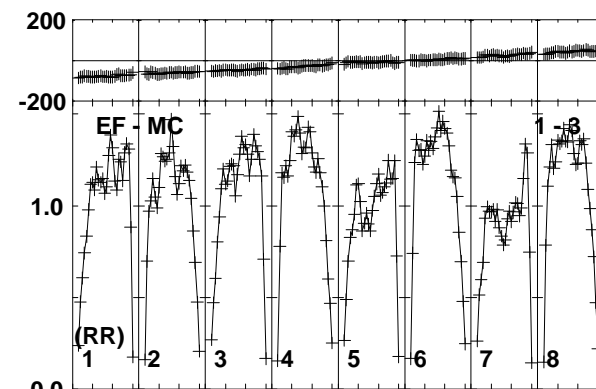
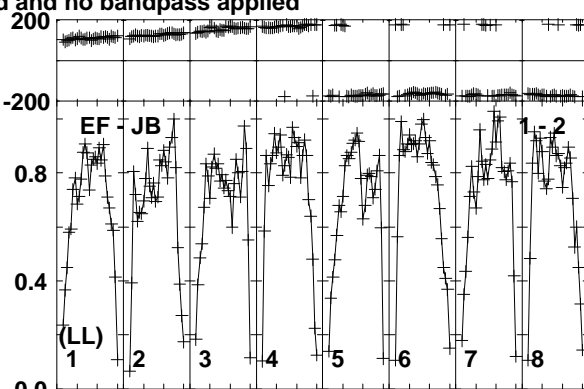
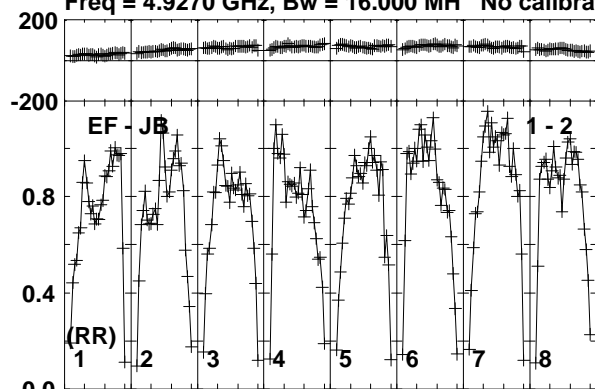

Lower frame: Milli Ampl Jy Top frame: Phas deg  
Vector averaged cross-power spectrum Baseline: EF (01) - JB (02)  
Timerange: 00/14:35:40 to 00/14:38:40

Plot file version 142 created 10-JUN-2016 15:29:31

J0712-1847 RG008C.UVDATA.1

Freq = 4.9270 GHz, Bw = 16.000 MH No calibration applied and no bandpass applied

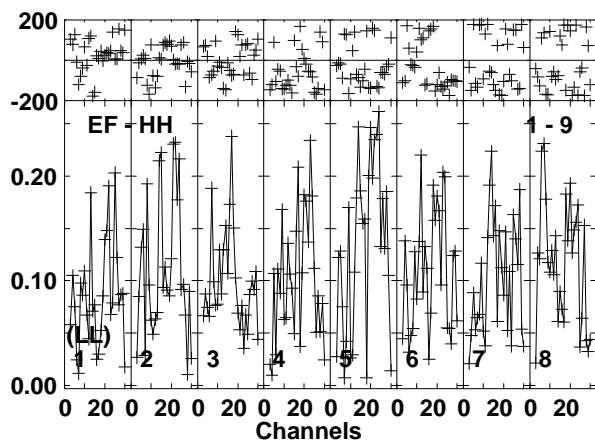
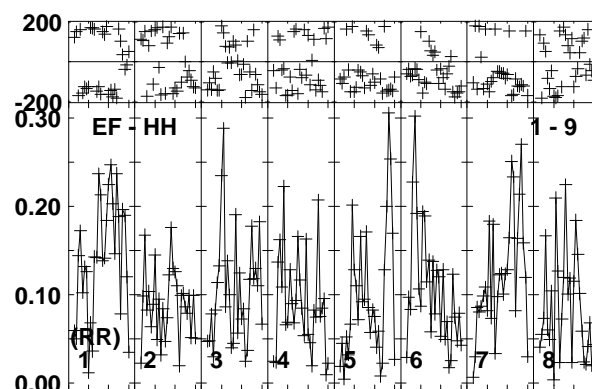
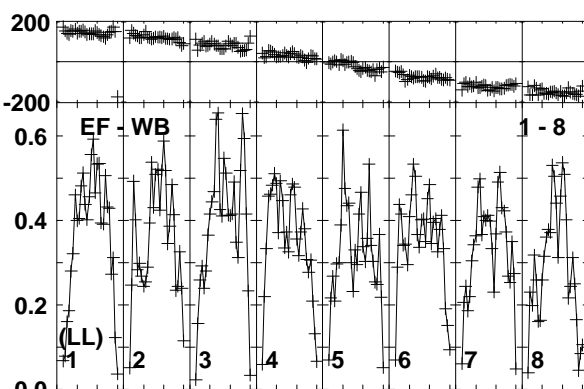
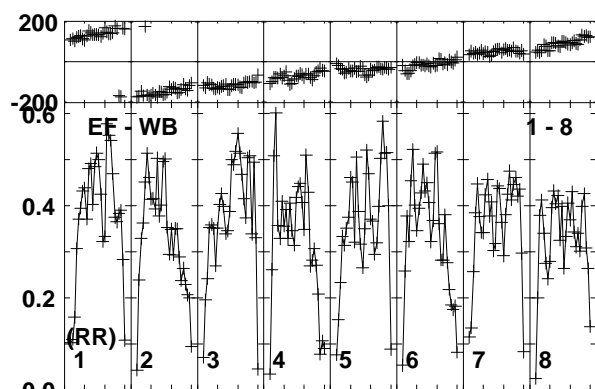
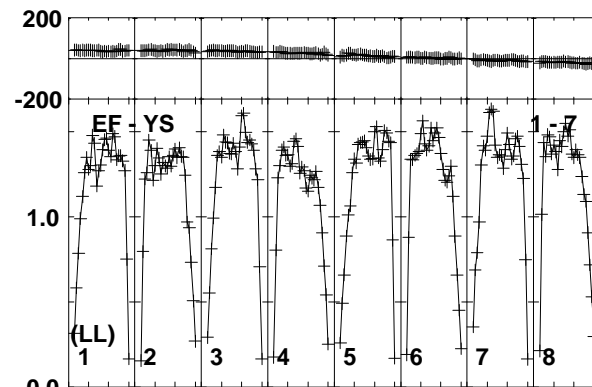
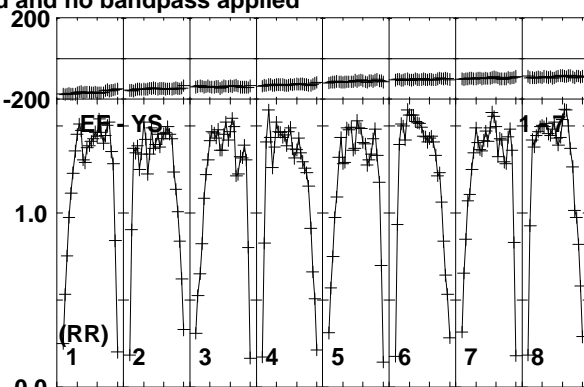
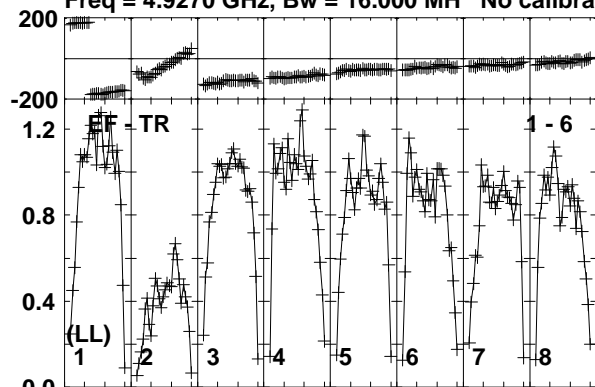

Lower frame: Milli Ampl Jy Top frame: Phas deg  
Vector averaged cross-power spectrum Baseline: EF (01) - TR (06)  
Timerange: 00/14:35:40 to 00/14:38:40

Plot file version 143 created 10-JUN-2016 15:29:31

J0718-1813 RG008C.UVDATA.1

Freq = 4.9270 GHz, Bw = 16.000 MH No calibration applied and no bandpass applied

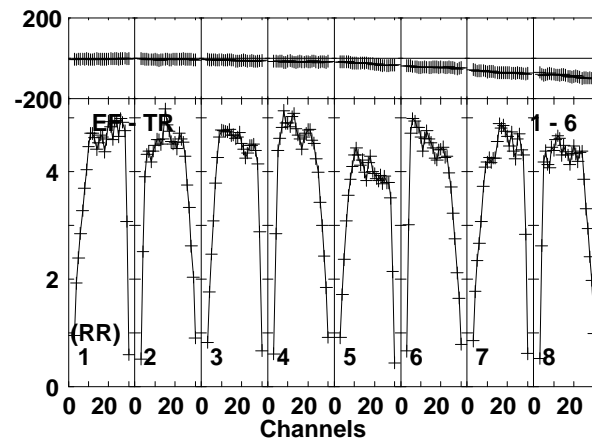
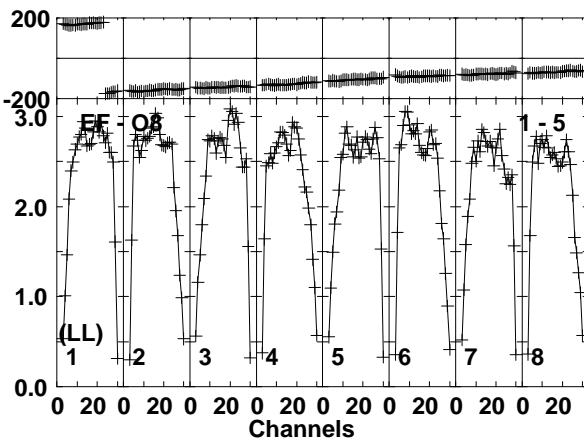
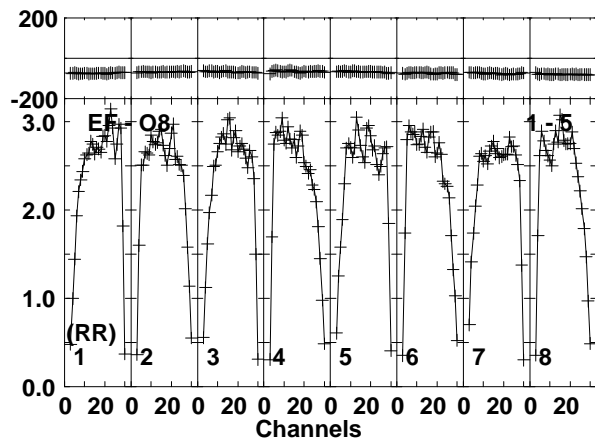
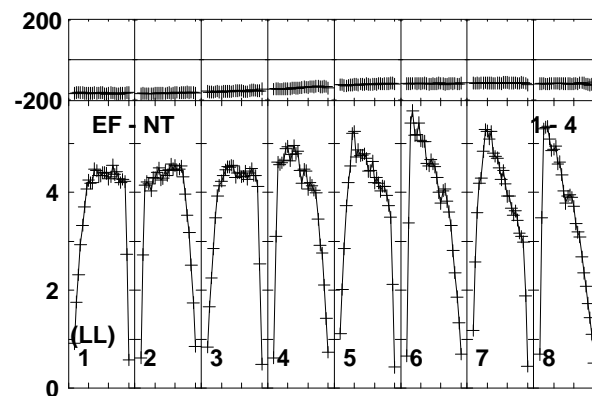
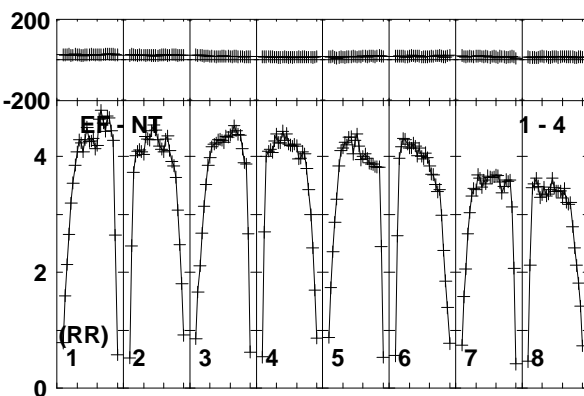
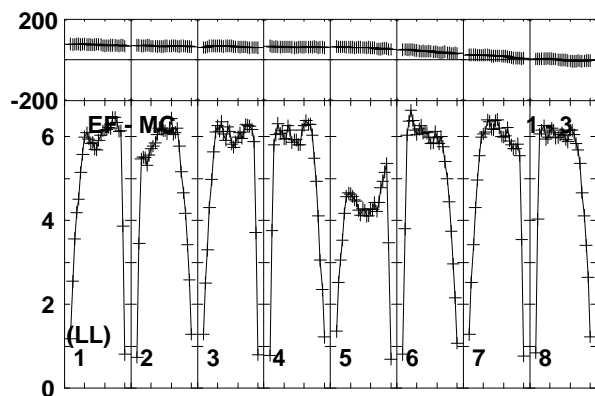
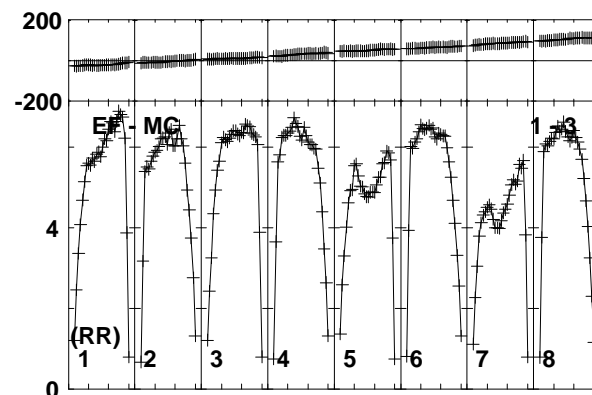
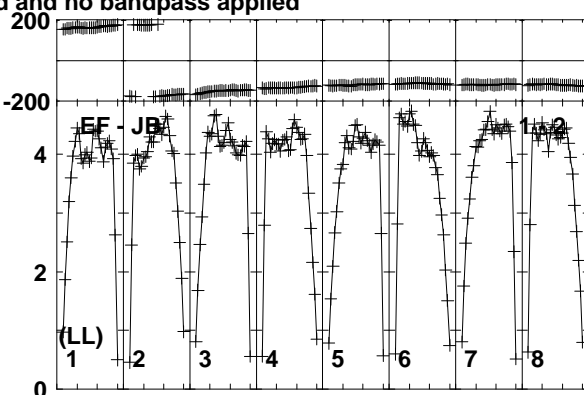
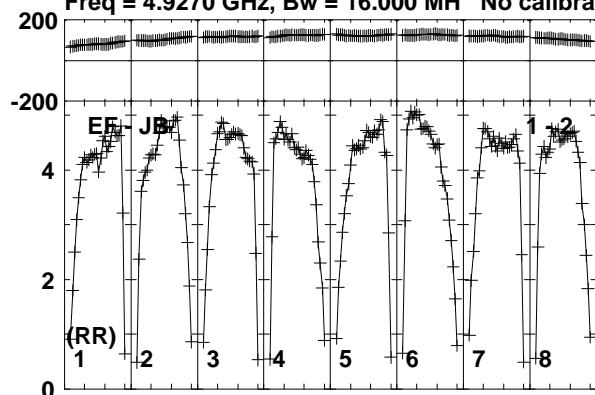

Lower frame: Milli Ampl Jy Top frame: Phas deg  
Vector averaged cross-power spectrum Baseline: EF (01) - JB (02)  
Timerange: 00:14:38:41 to 00:14:40:10

Plot file version 144 created 10-JUN-2016 15:29:31

J0718-1813 RG008C.UVDATA.1

Freq = 4.9270 GHz, Bw = 16.000 MH No calibration applied and no bandpass applied

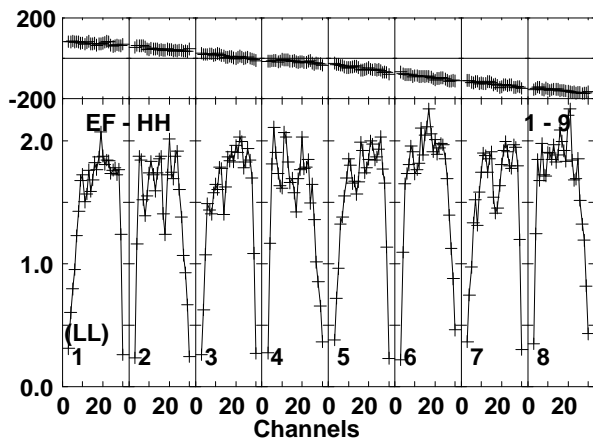
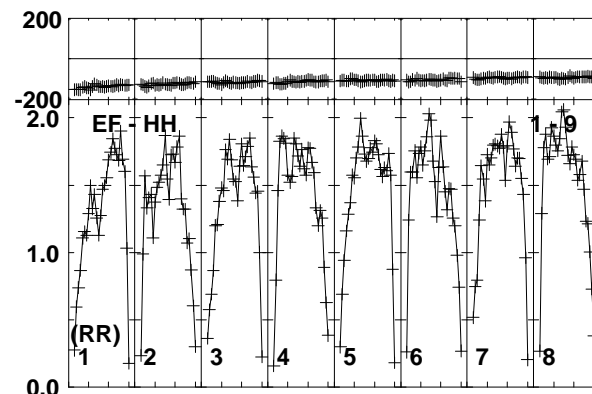
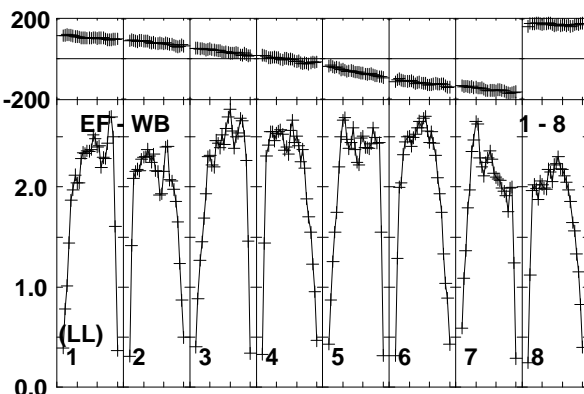
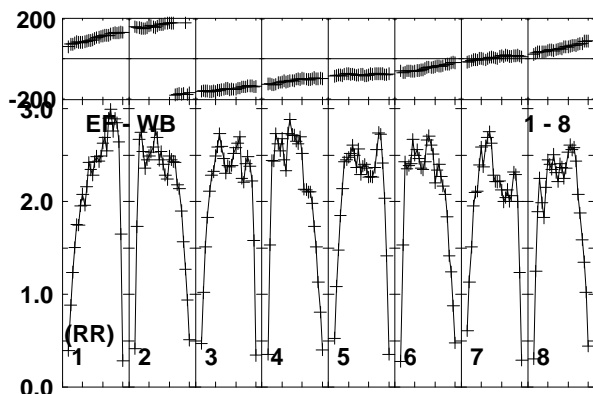
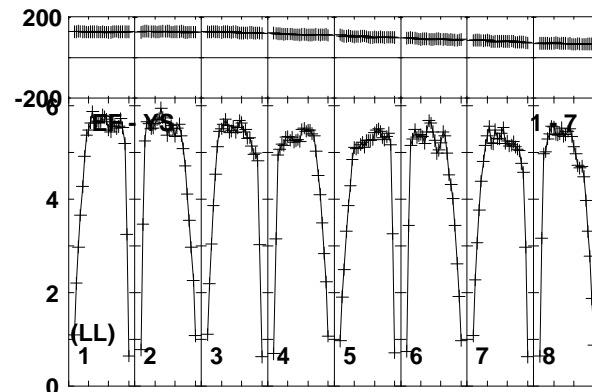
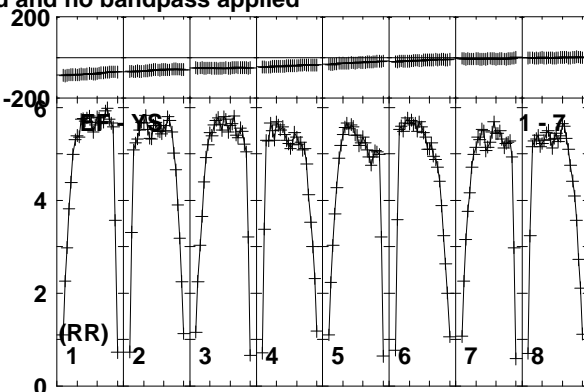
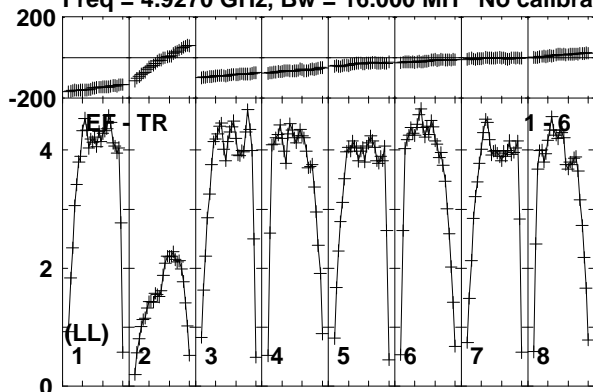

Lower frame: Milli Ampl Jy Top frame: Phas deg  
Vector averaged cross-power spectrum Baseline: EF (01) - TR (06)  
Timerange: 00/14:38:41 to 00/14:40:10



Plot file version 145 created 10-JUN-2016 15:29:31

OJ287 RG008C.UVDATA.1

Freq = 4.9270 GHz, Bw = 16.000 MH No calibration applied and no bandpass applied

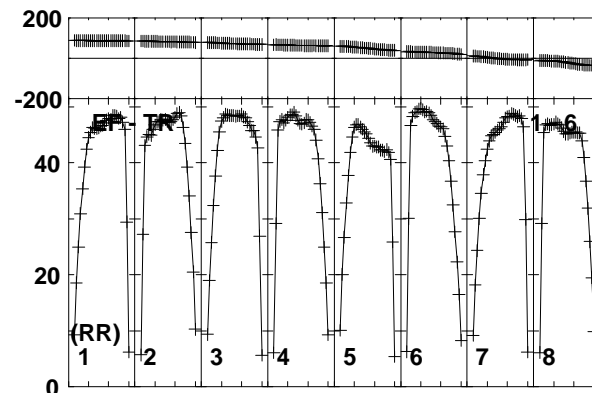
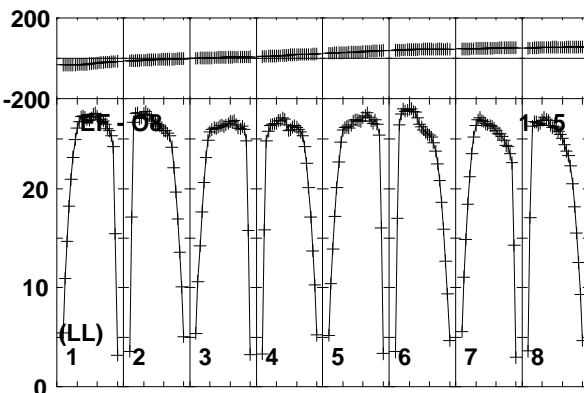
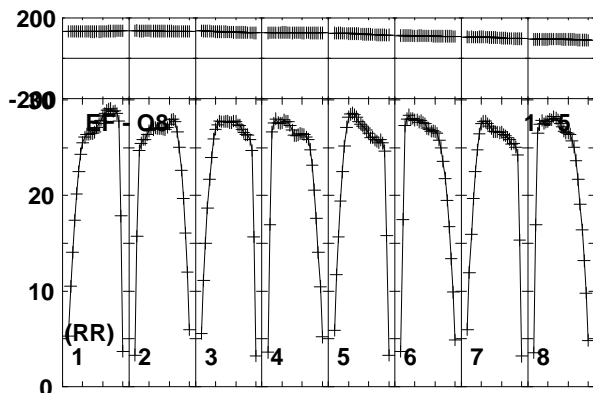
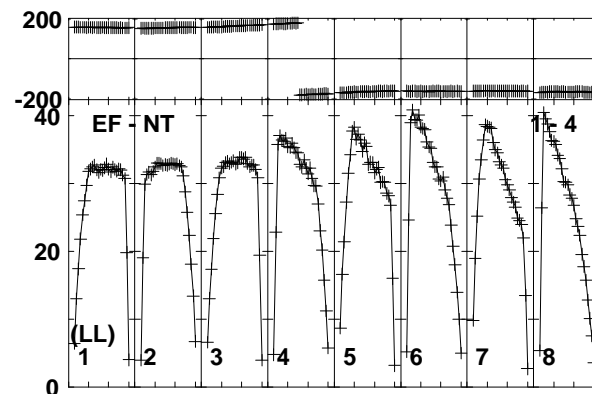
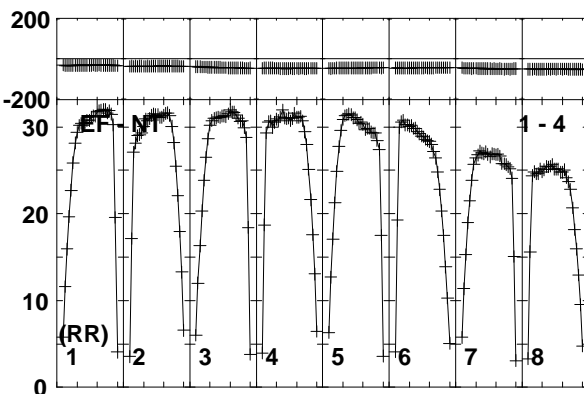
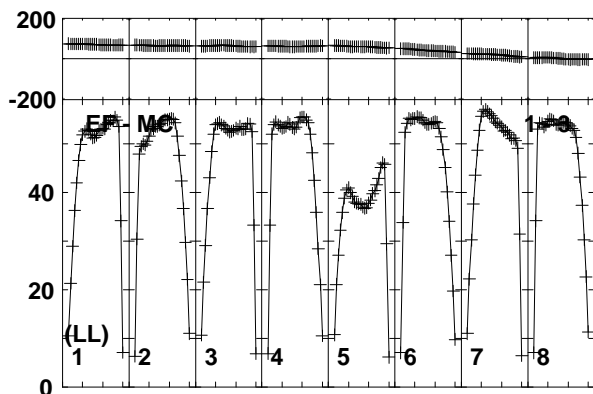
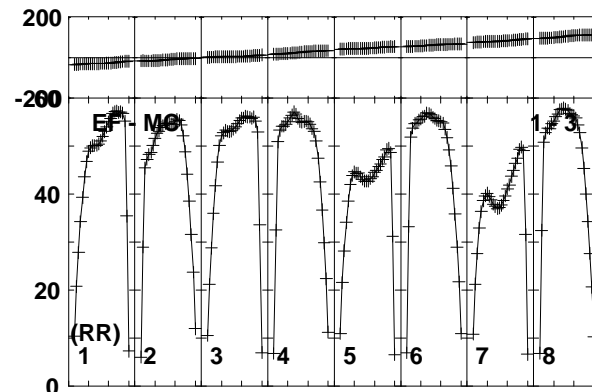
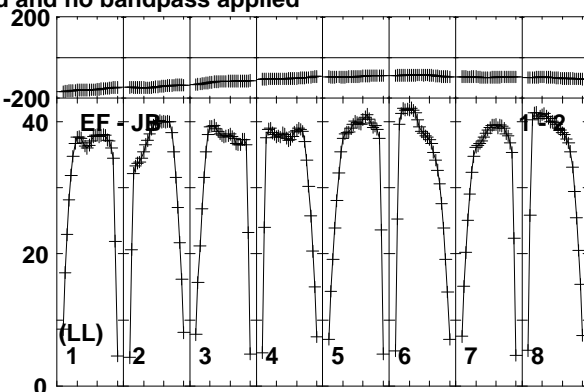
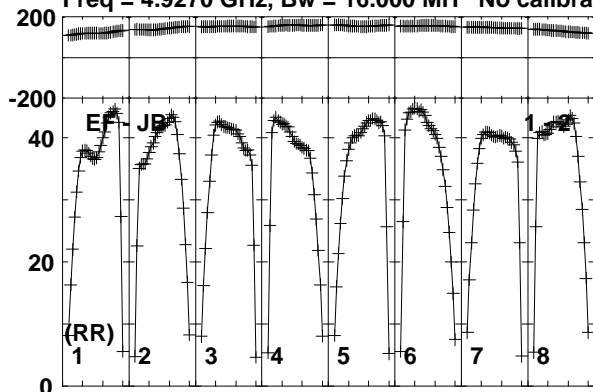

Lower frame: Milli Ampl Jy Top frame: Phas deg  
Vector averaged cross-power spectrum Baseline: EF (01) - JB (02)  
Timerange: 00/14:43:41 to 00/14:46:39

Plot file version 146 created 10-JUN-2016 15:29:32

OJ287 RG008C.UVDATA.1

Freq = 4.9270 GHz, Bw = 16.000 MH No calibration applied and no bandpass applied

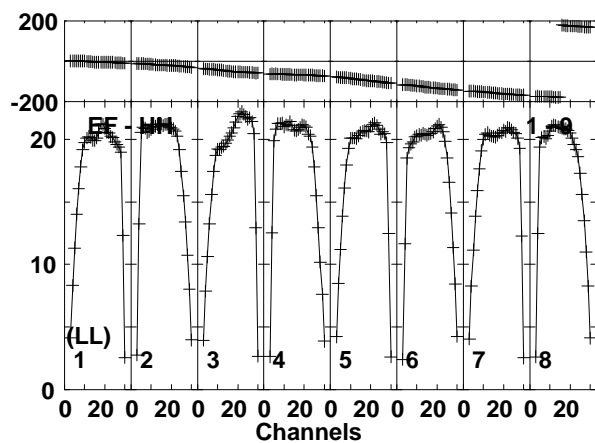
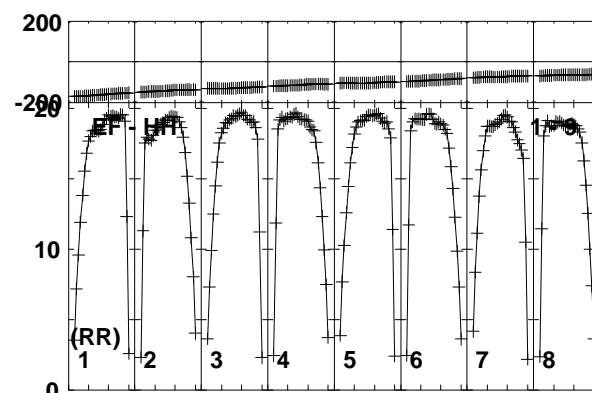
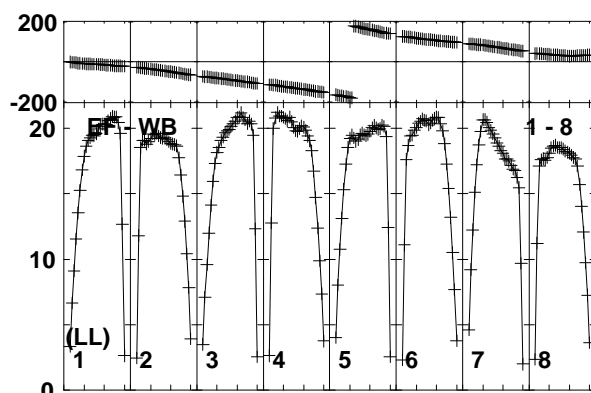
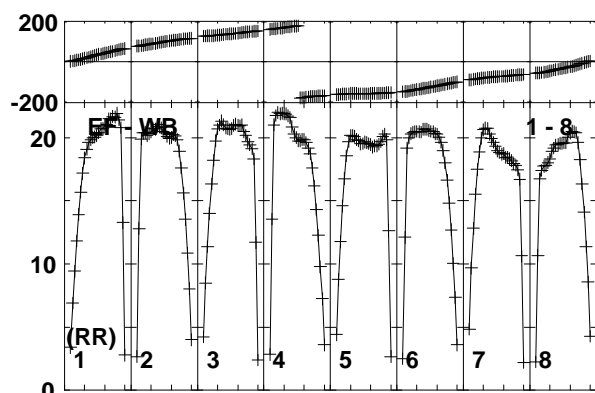
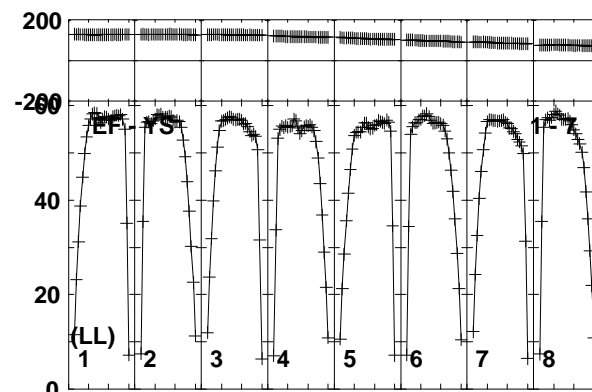
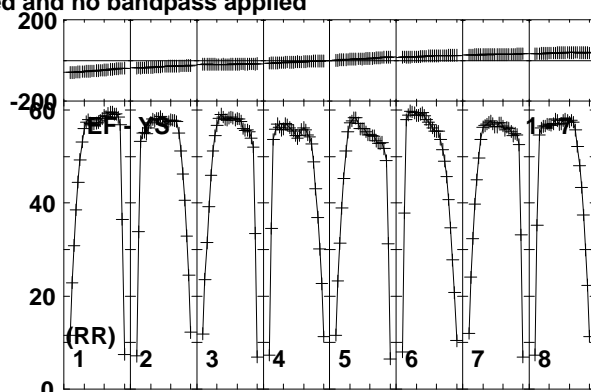
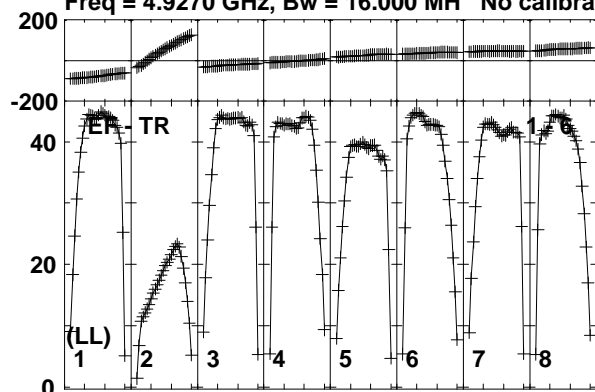

Lower frame: Milli Ampl Jy Top frame: Phas deg  
Vector averaged cross-power spectrum Baseline: EF (01) - TR (06)  
Timerange: 00/14:43:41 to 00/14:46:39

Plot file version 147 created 10-JUN-2016 15:29:32

J0718-1813 RG008C.UVDATA.1

Freq = 4.9270 GHz, Bw = 16.000 MH No calibration applied and no bandpass applied

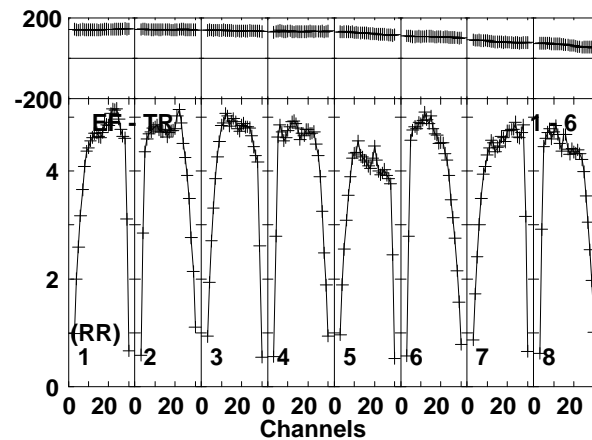
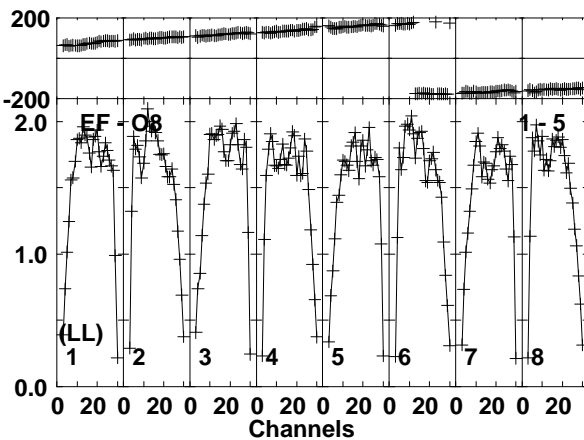
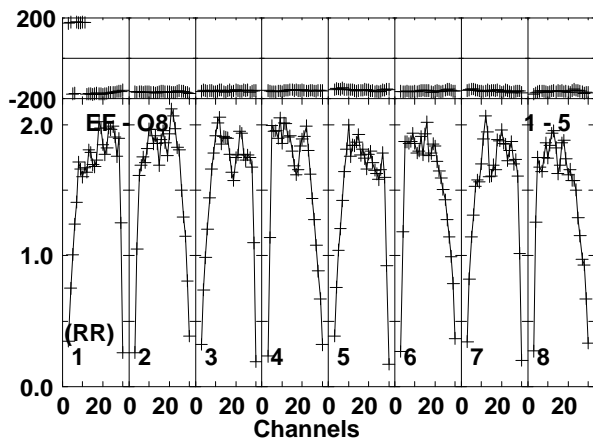
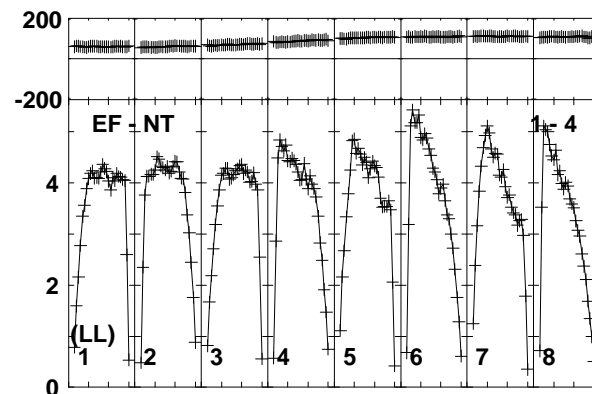
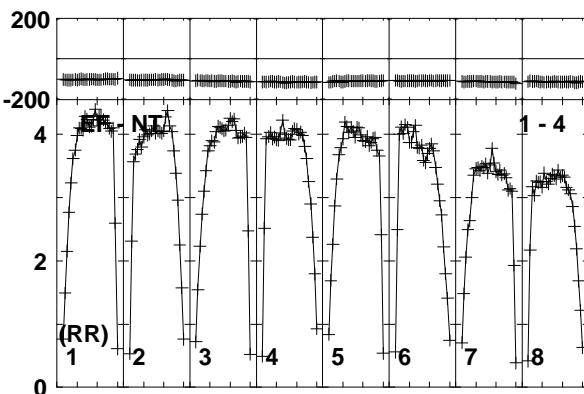
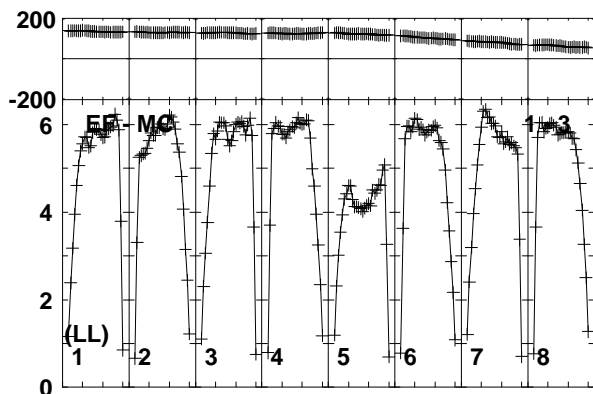
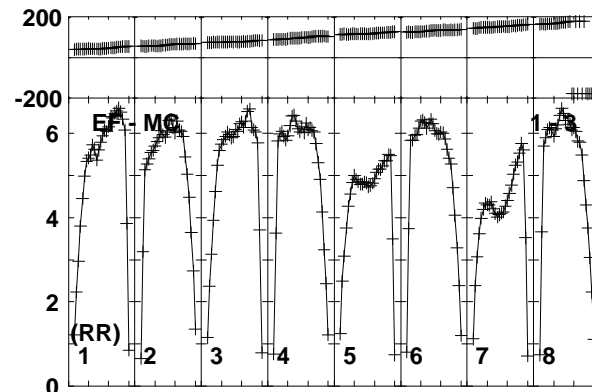
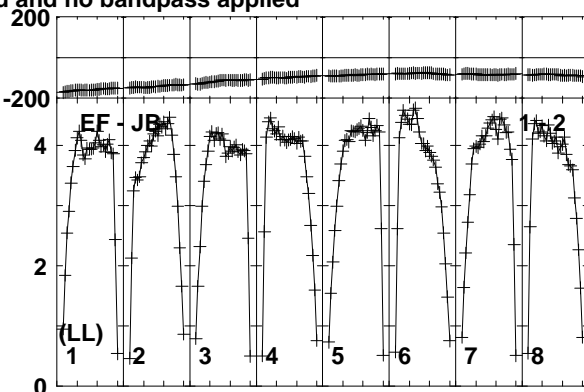
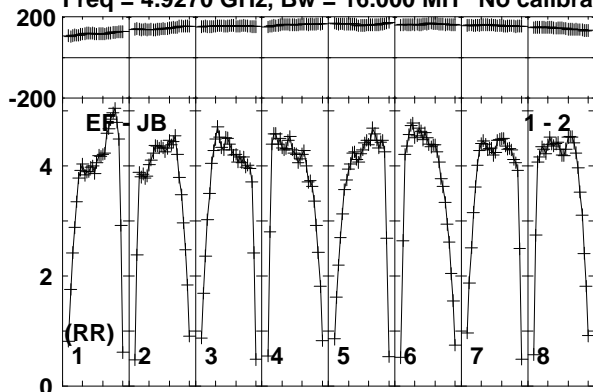

Lower frame: Milli Ampl Jy Top frame: Phas deg  
Vector averaged cross-power spectrum Baseline: EF (01) - JB (02)  
Timerange: 00/14:50:10 to 00/14:51:40

Plot file version 148 created 10-JUN-2016 15:29:32

J0718-1813 RG008C.UVDATA.1

Freq = 4.9270 GHz, Bw = 16.000 MH No calibration applied and no bandpass applied

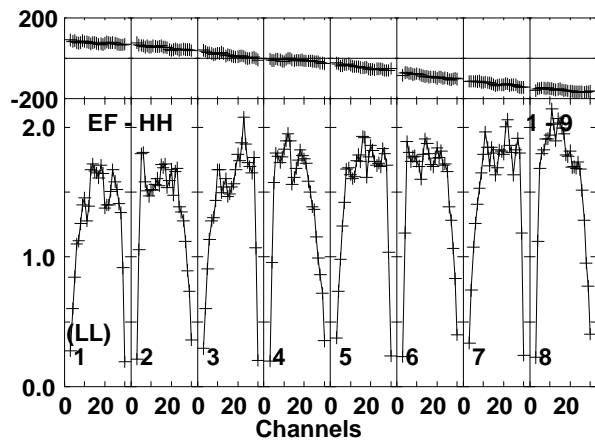
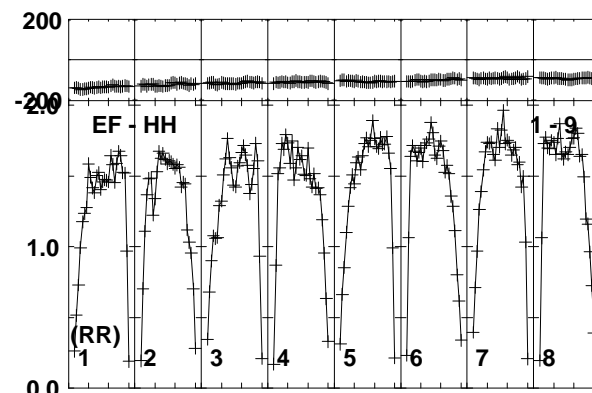
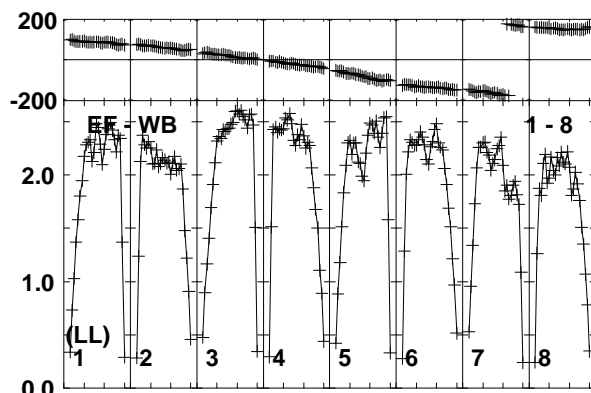
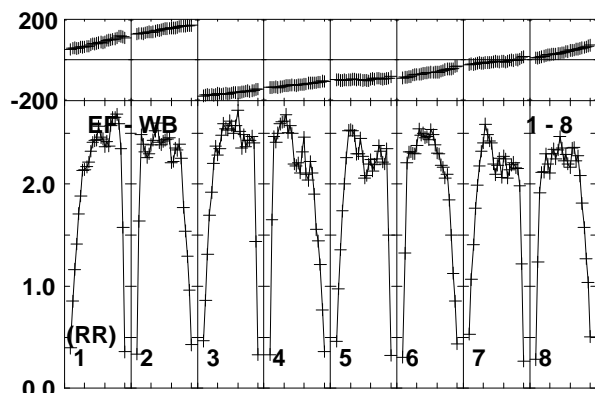
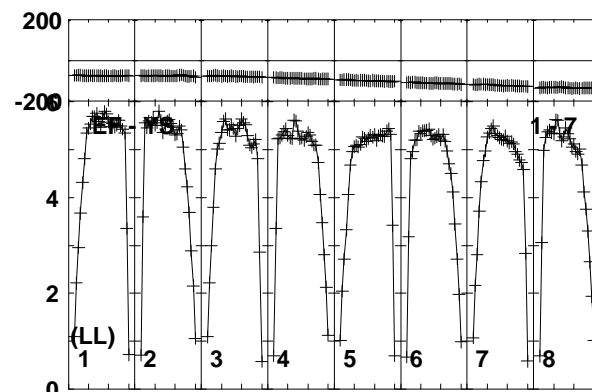
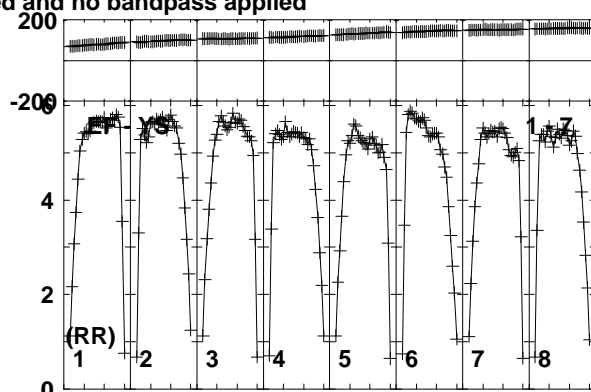
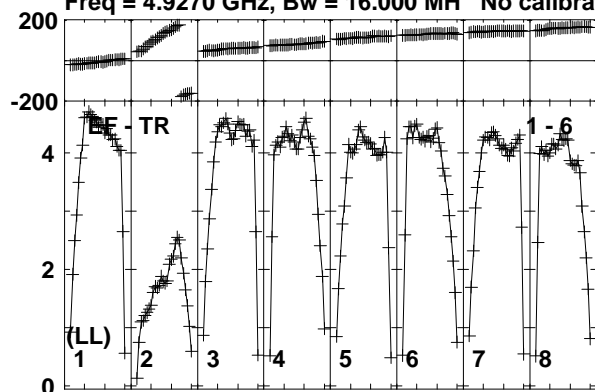

Lower frame: Milli Ampl Jy Top frame: Phas deg  
Vector averaged cross-power spectrum Baseline: EF (01) - TR (06)  
Timerange: 00/14:50:10 to 00/14:51:40

Plot file version 149 created 10-JUN-2016 15:29:32

FRB150418 RG008C.UVDATA.1

Freq = 4.9270 GHz, Bw = 16.000 MH No calibration applied and no bandpass applied

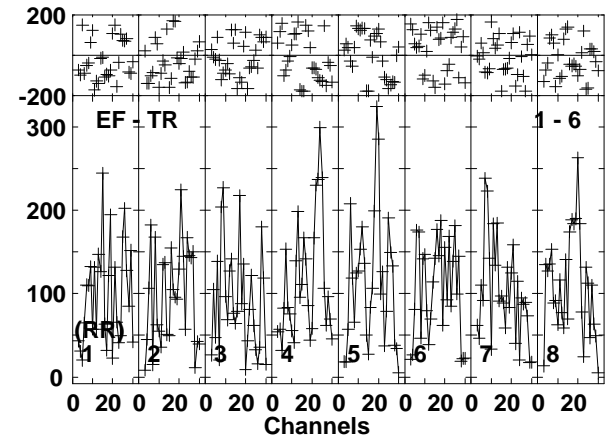
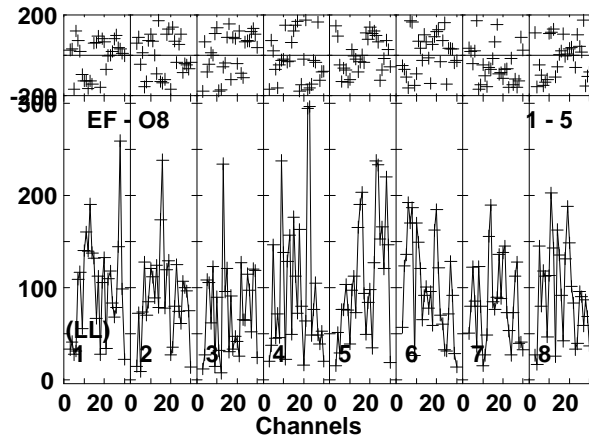
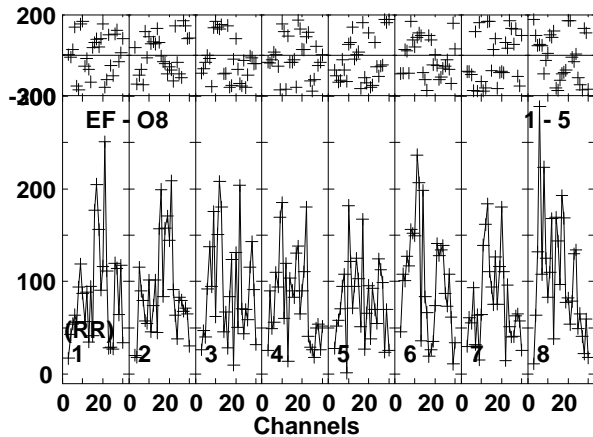
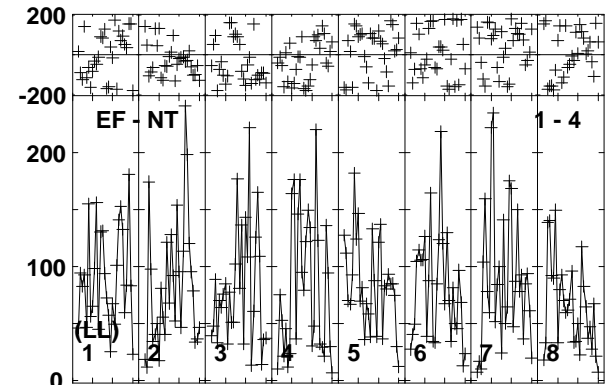
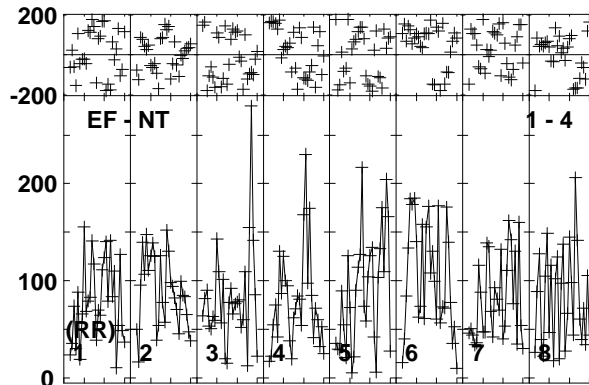
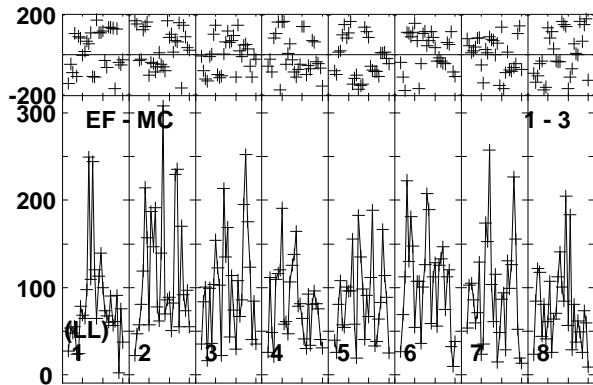
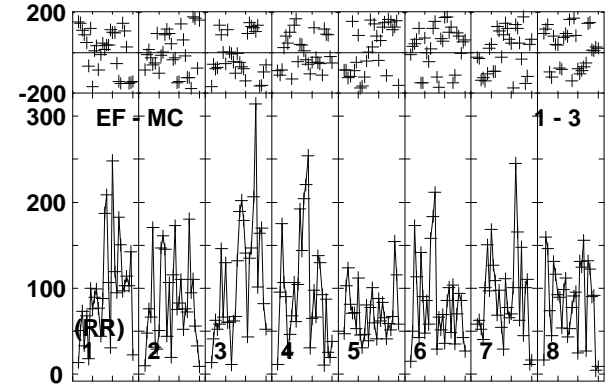
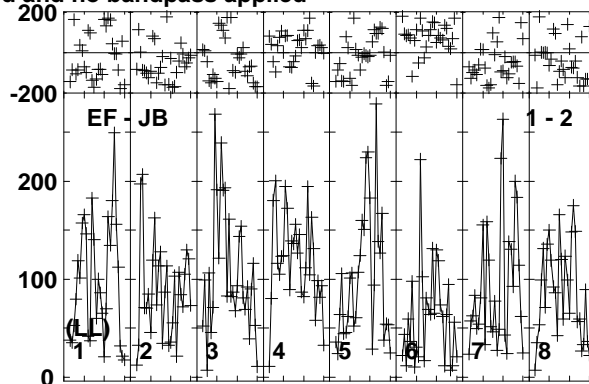
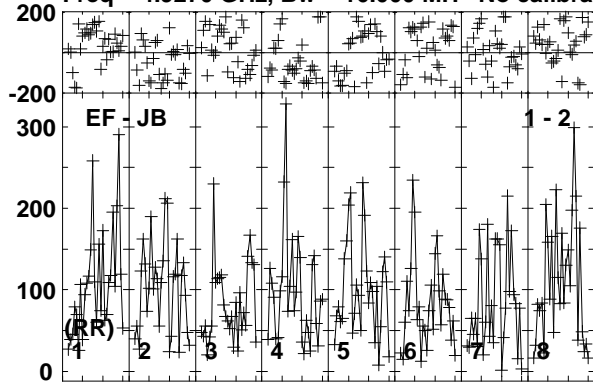

Lower frame: Micro Ampl Jy Top frame: Phas deg  
Vector averaged cross-power spectrum Baseline: EF (01) - JB (02)  
Timerange: 00/14:51:40 to 00/14:54:40

Plot file version 150 created 10-JUN-2016 15:29:32

FRB150418 RG008C.UVDATA.1

Freq = 4.9270 GHz, Bw = 16.000 MH No calibration applied and no bandpass applied

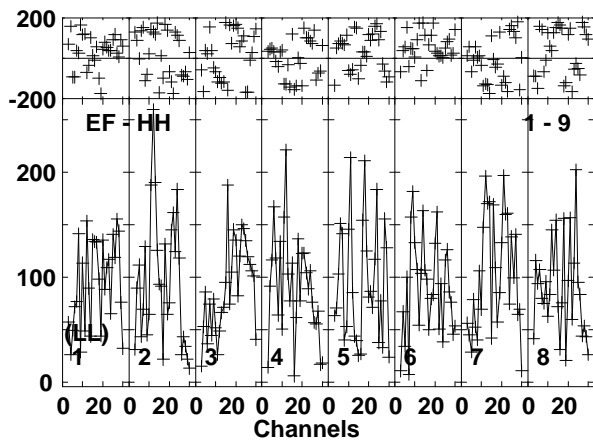
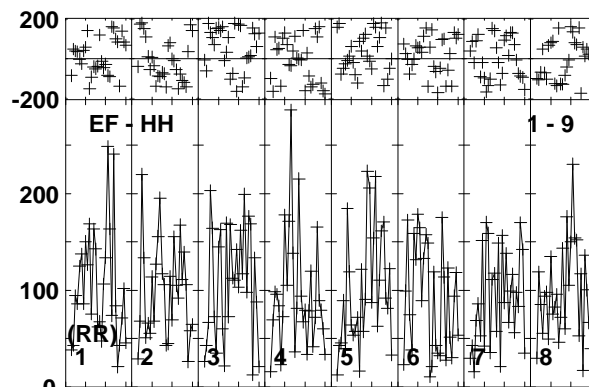
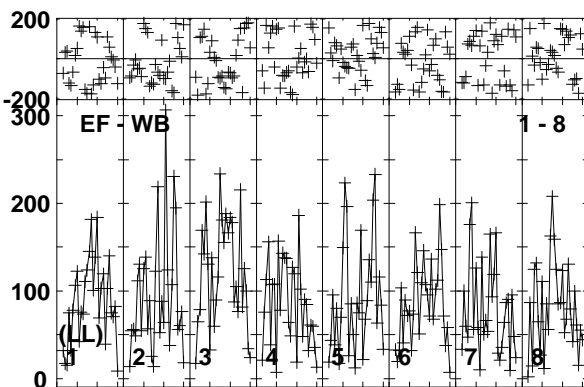
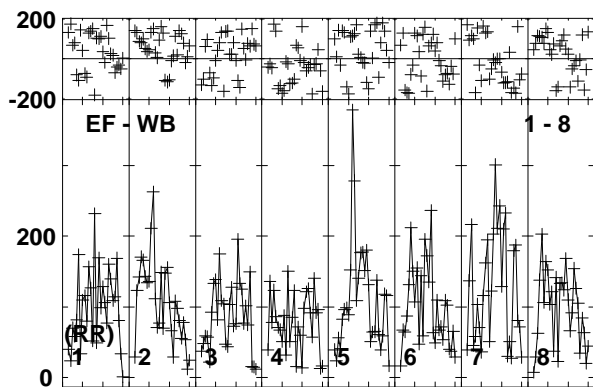
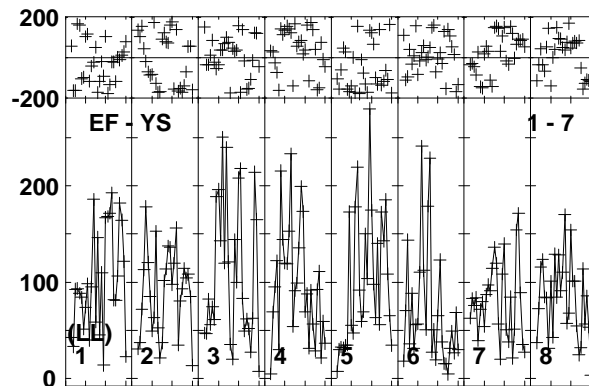
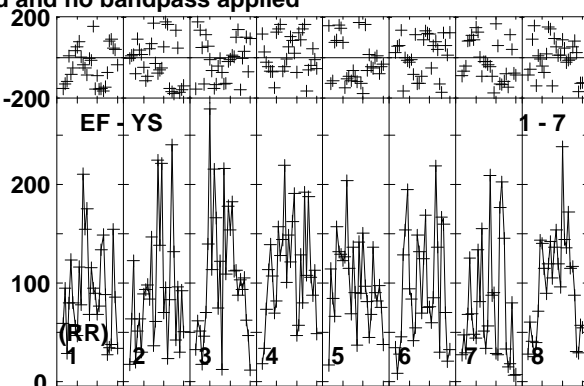
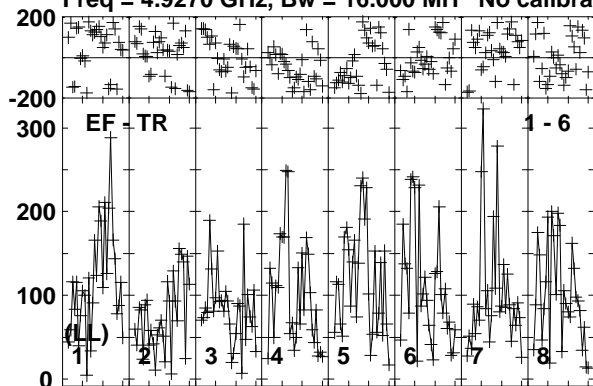

Lower frame: Micro Ampl Jy Top frame: Phas deg  
Vector averaged cross-power spectrum Baseline: EF (01) - TR (06)  
Timerange: 00/14:51:40 to 00/14:54:40

Plot file version 151 created 10-JUN-2016 15:29:32

J0718-1813 RG008C.UVDATA.1

Freq = 4.9270 GHz, Bw = 16.000 MH No calibration applied and no bandpass applied

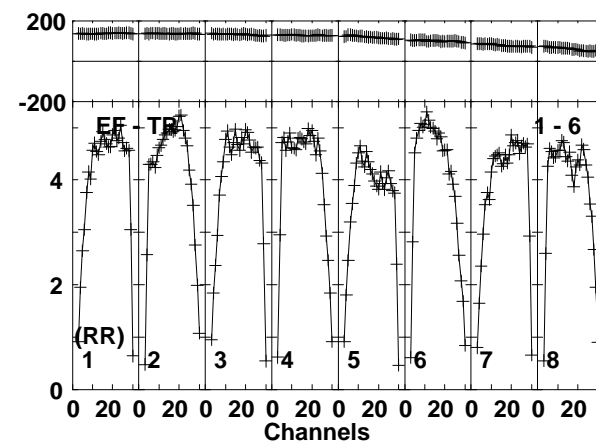
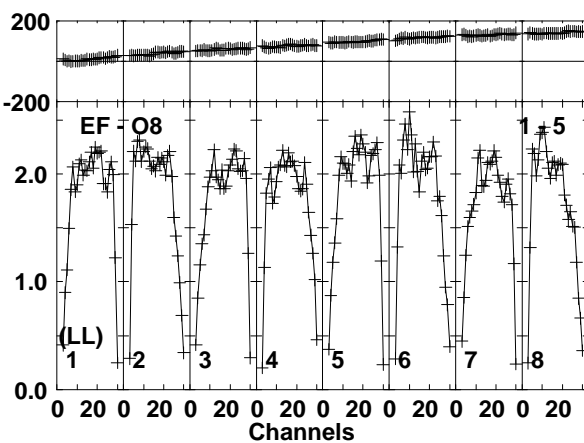
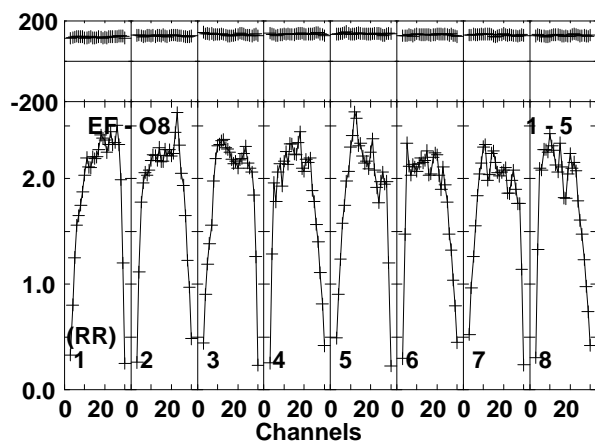
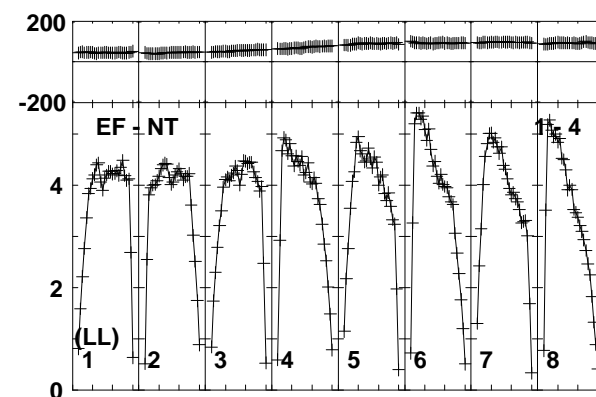
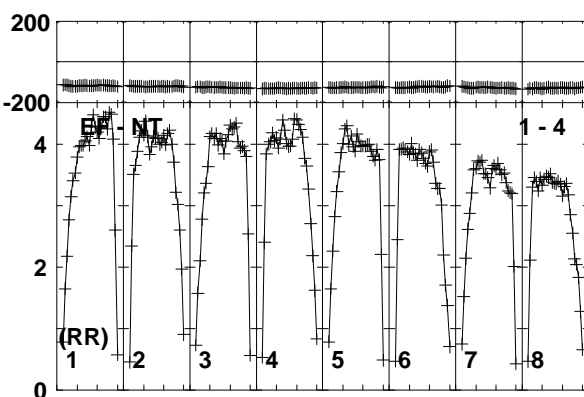
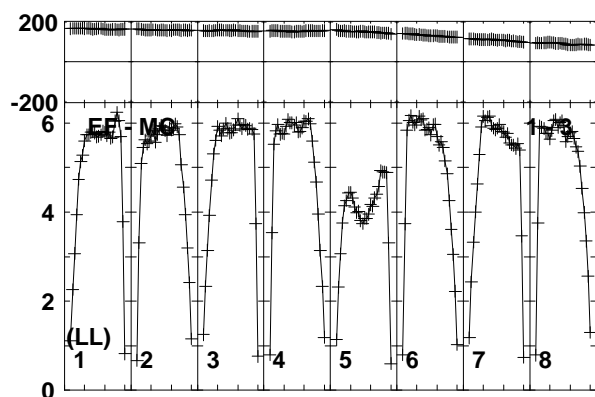
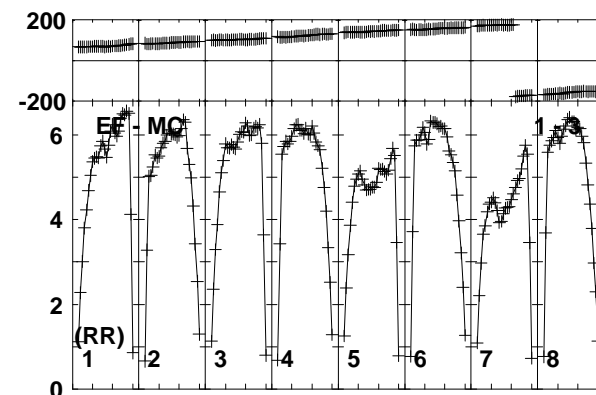
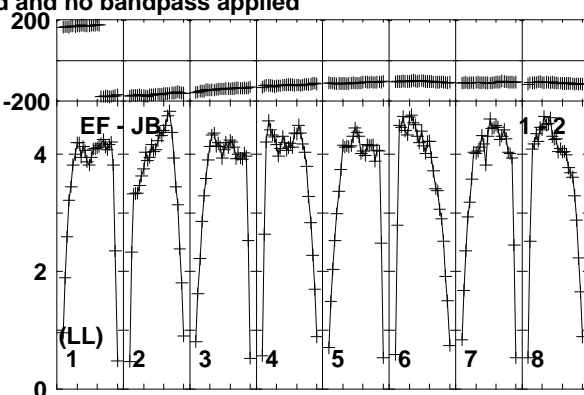
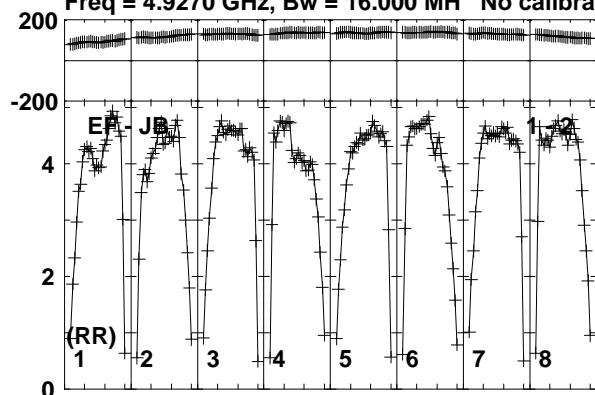

Lower frame: Milli Ampl Jy Top frame: Phas deg  
Vector averaged cross-power spectrum Baseline: EF (01) - JB (02)  
Timerange: 00/14:54:40 to 00/14:56:09

Plot file version 152 created 10-JUN-2016 15:29:32

J0718-1813 RG008C.UVDATA.1

Freq = 4.9270 GHz, Bw = 16.000 MH No calibration applied and no bandpass applied

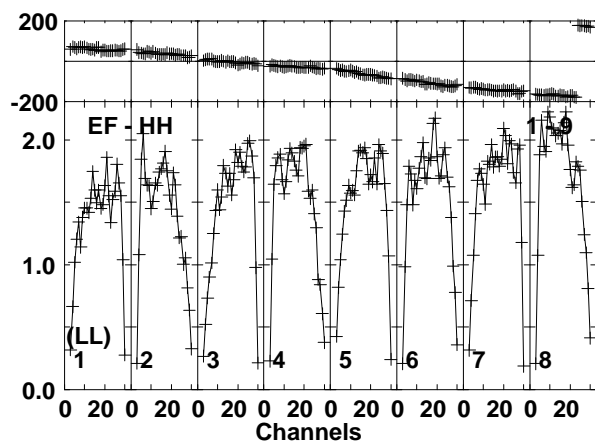
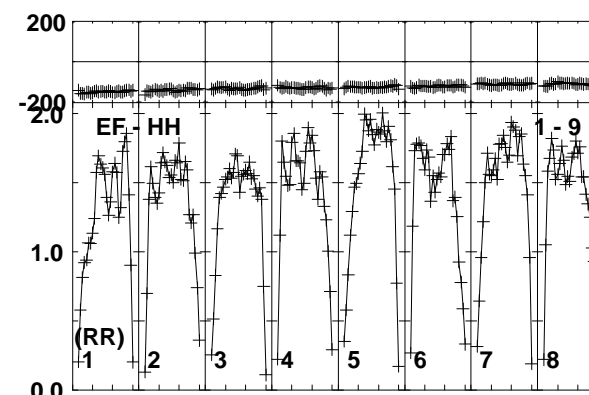
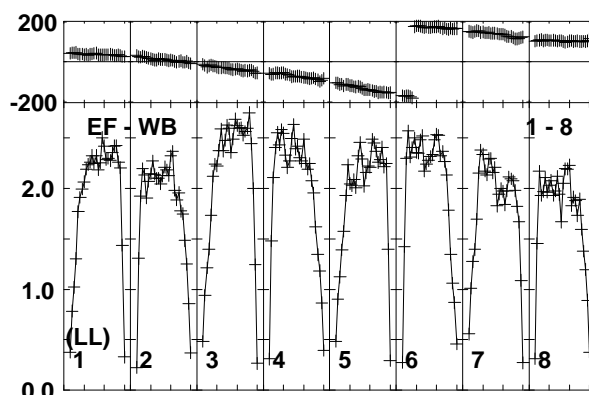
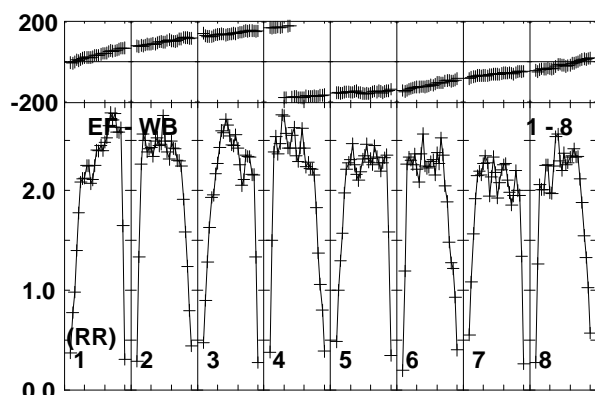
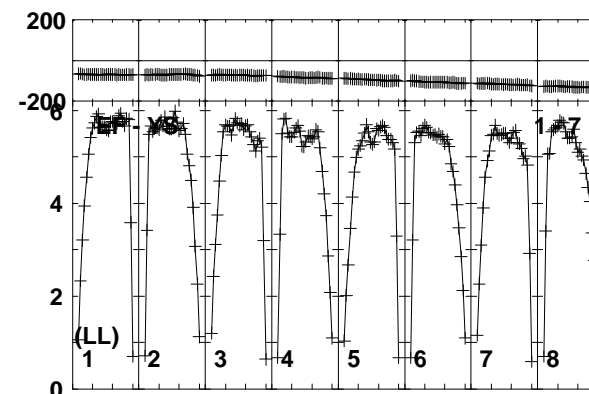
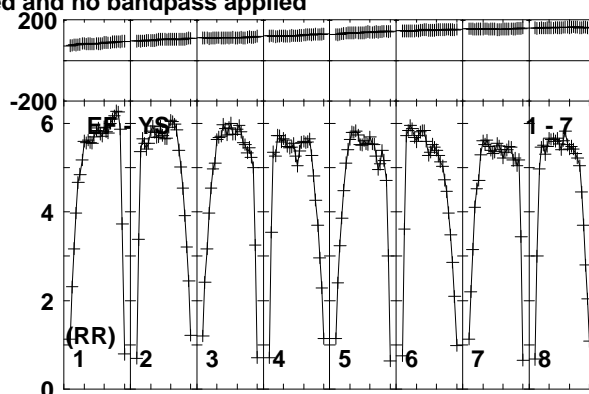
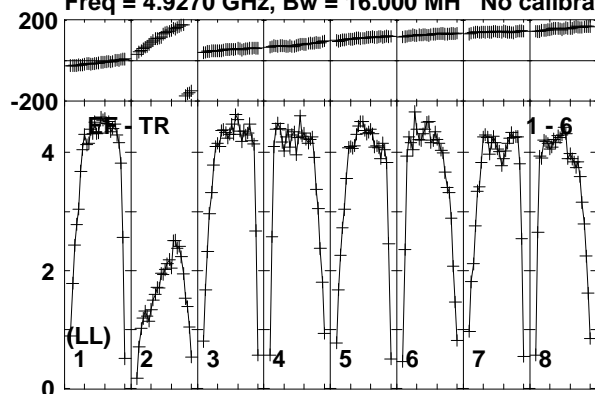

Lower frame: Milli Ampl Jy Top frame: Phas deg  
Vector averaged cross-power spectrum Baseline: EF (01) - TR (06)  
Timerange: 00/14:54:40 to 00/14:56:09



Plot file version 153 created 10-JUN-2016 15:29:32

FRB150418 RG008C.UVDATA.1

Freq = 4.9270 GHz, Bw = 16.000 MH No calibration applied and no bandpass applied

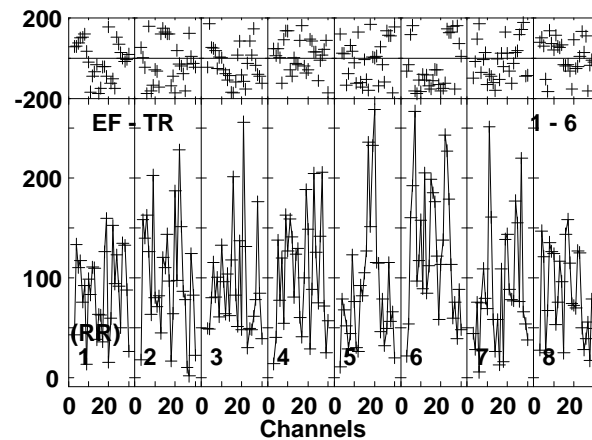
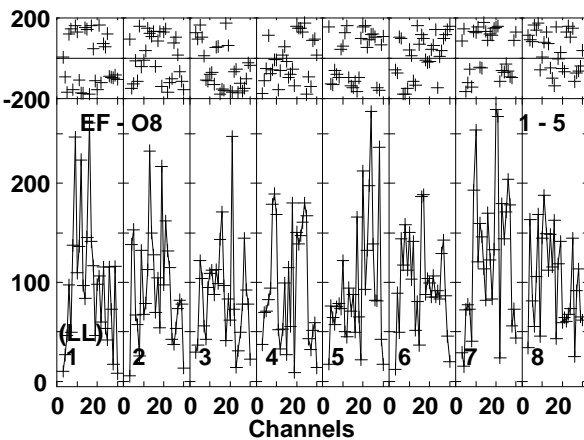
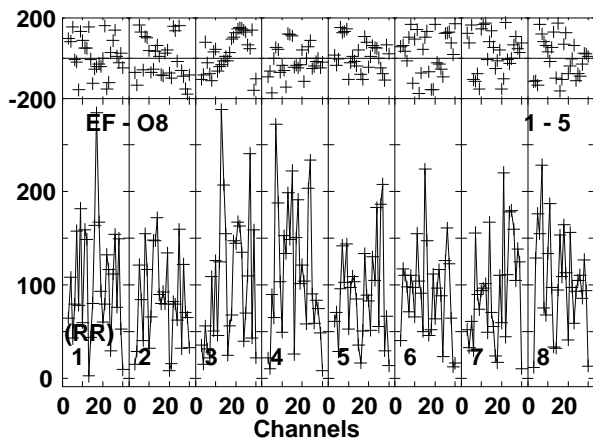
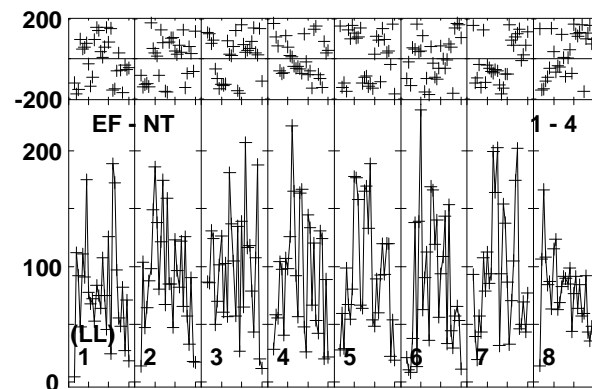
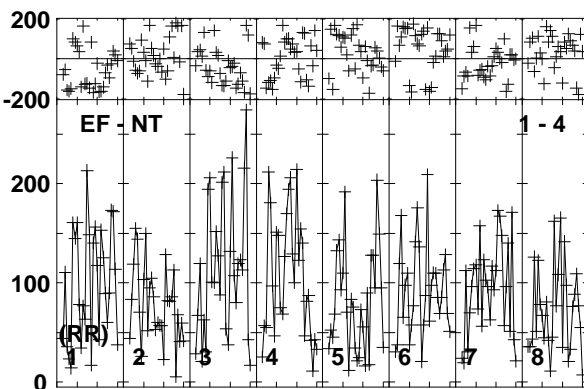
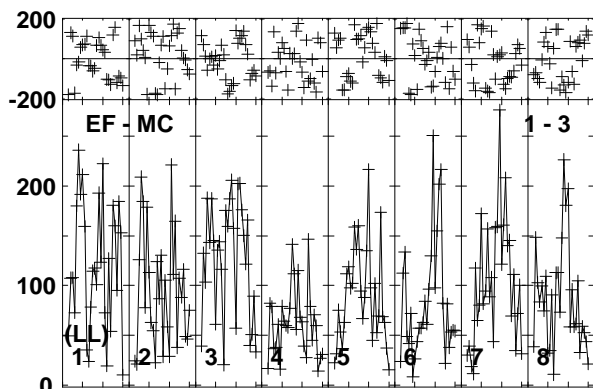
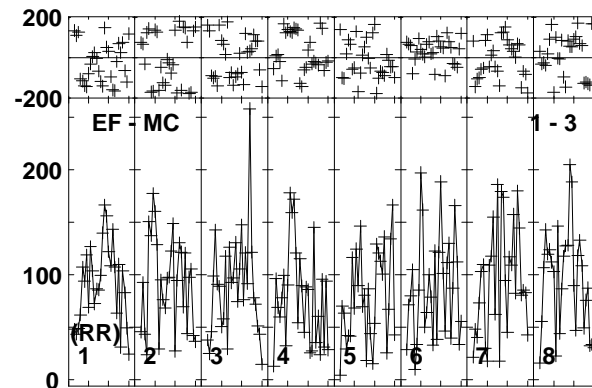
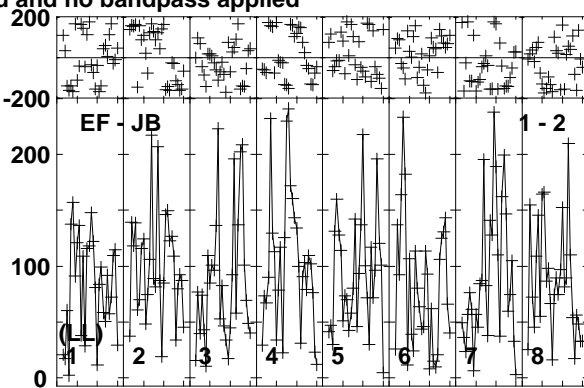
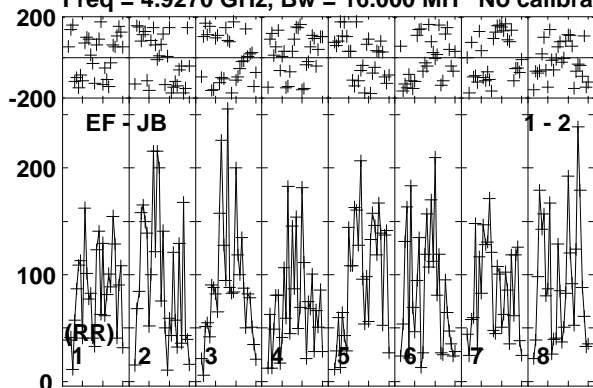

Lower frame: Micro Ampl Jy Top frame: Phas deg  
Vector averaged cross-power spectrum Baseline: EF (01) - JB (02)  
Timerange: 00/14:56:11 to 00/14:59:10

Plot file version 154 created 10-JUN-2016 15:29:33

FRB150418 RG008C.UVDATA.1

Freq = 4.9270 GHz, Bw = 16.000 MH No calibration applied and no bandpass applied

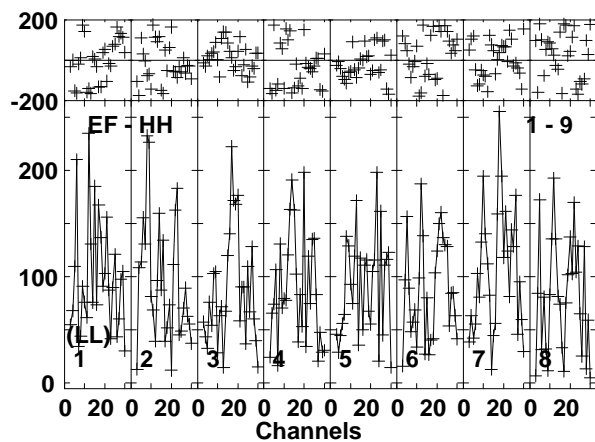
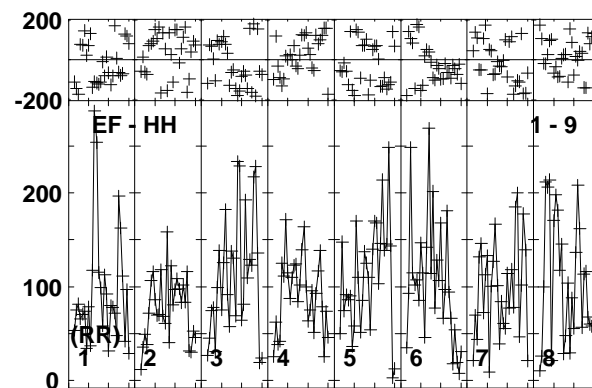
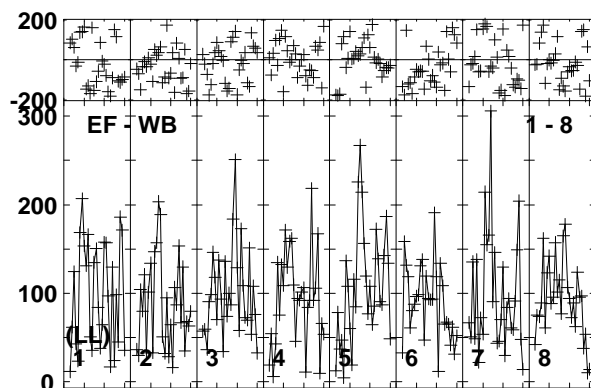
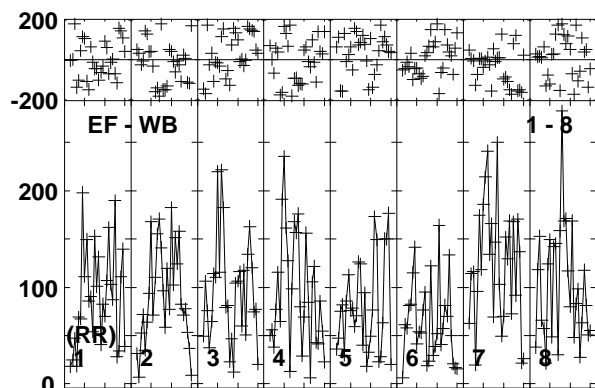
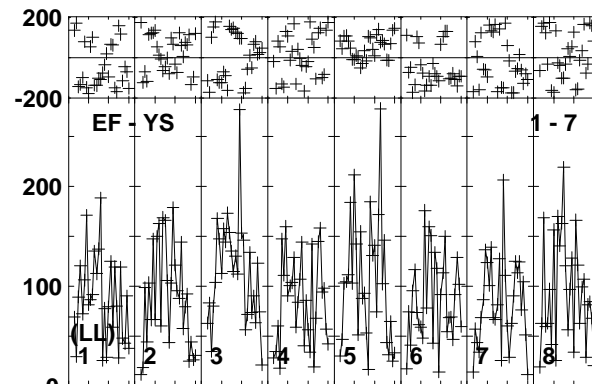
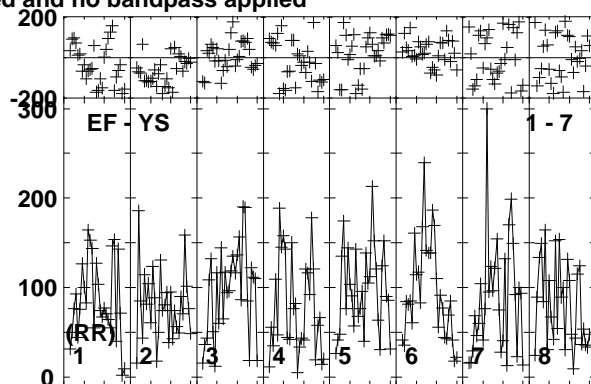
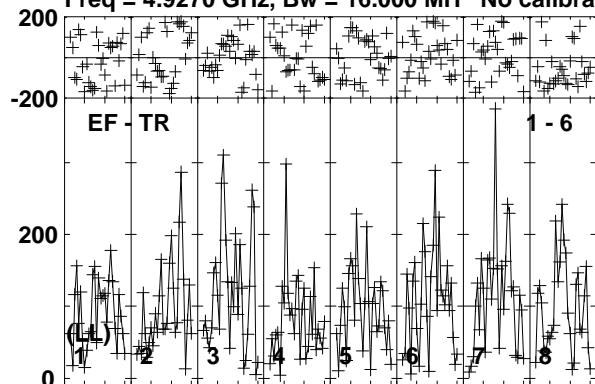

Lower frame: Micro Ampl Jy Top frame: Phas deg  
Vector averaged cross-power spectrum Baseline: EF (01) - TR (06)  
Timerange: 00/14:56:11 to 00/14:59:10

Plot file version 155 created 10-JUN-2016 15:29:33

J0718-1813 RG008C.UVDATA.1

Freq = 4.9270 GHz, Bw = 16.000 MH No calibration applied and no bandpass applied

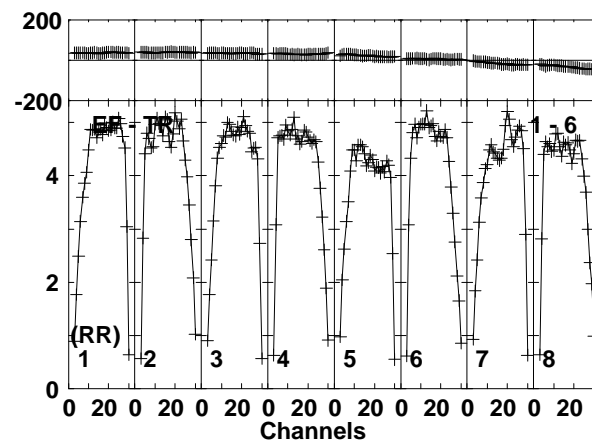
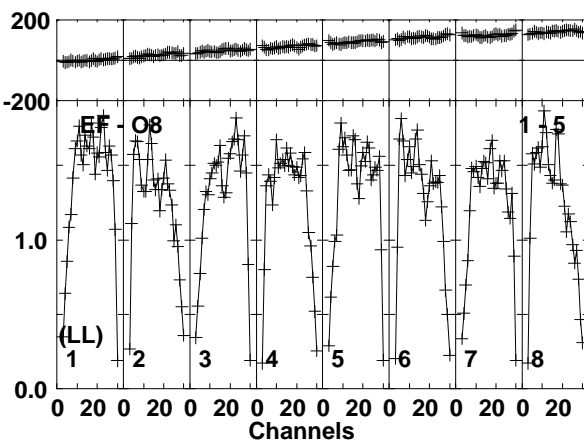
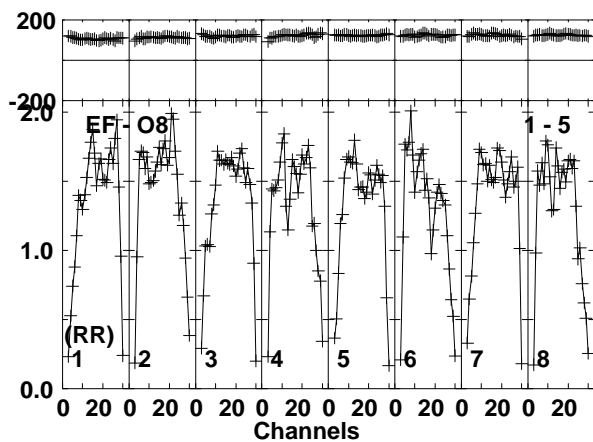
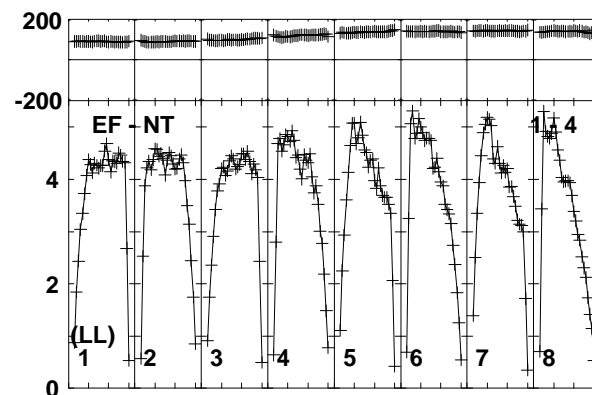
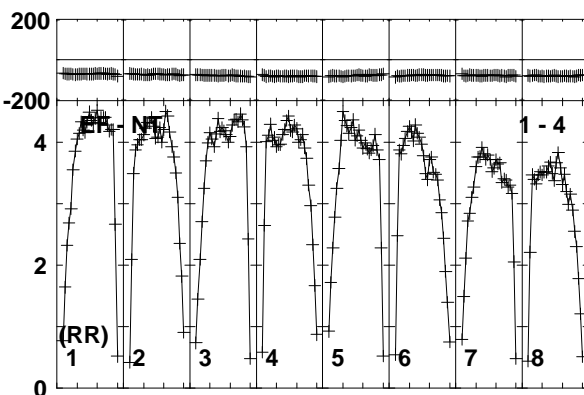
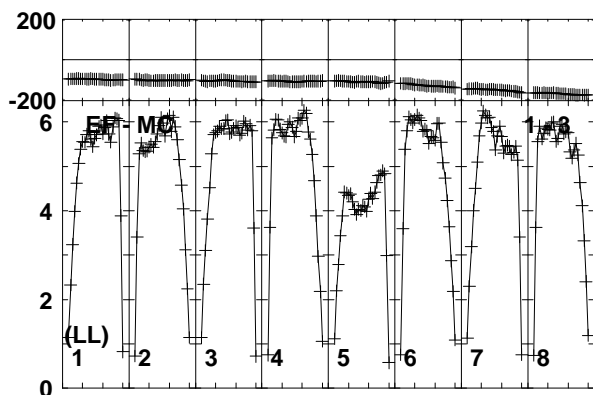
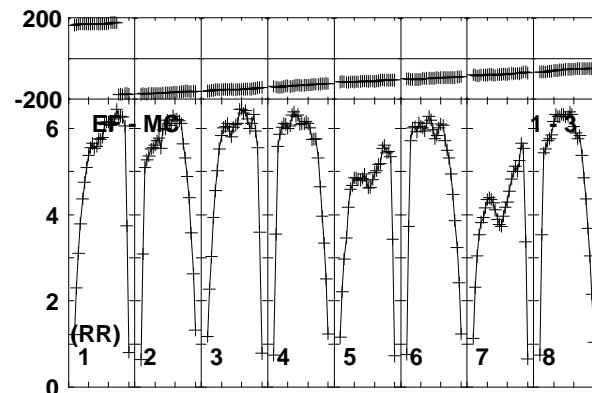
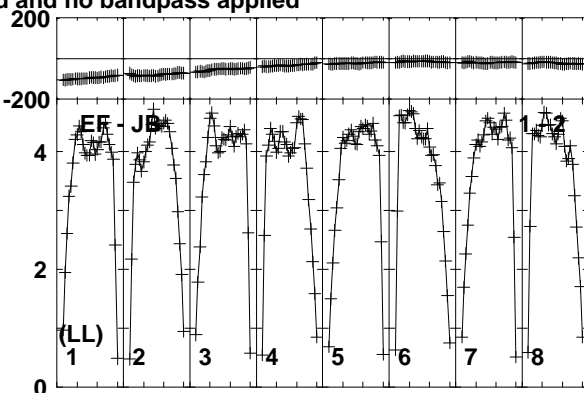
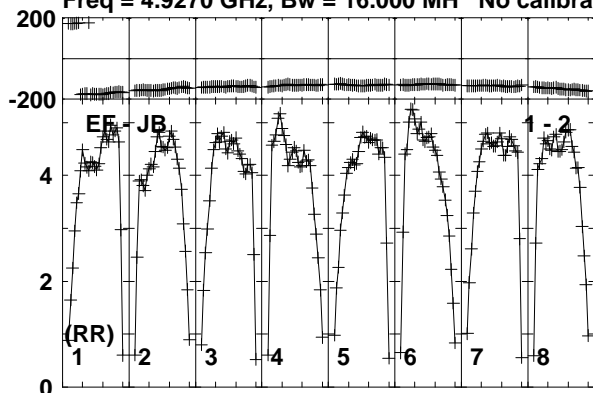

Lower frame: Milli Ampl Jy Top frame: Phas deg  
Vector averaged cross-power spectrum Baseline: EF (01) - JB (02)  
Timerange: 00/14:59:50 to 00/15:00:39

Plot file version 156 created 10-JUN-2016 15:29:33

J0718-1813 RG008C.UVDATA.1

Freq = 4.9270 GHz, Bw = 16.000 MH No calibration applied and no bandpass applied

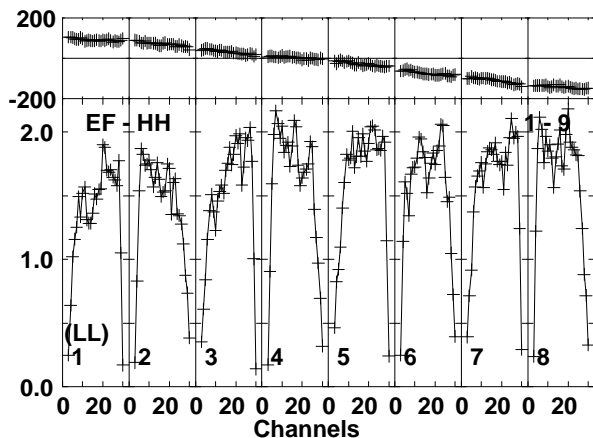
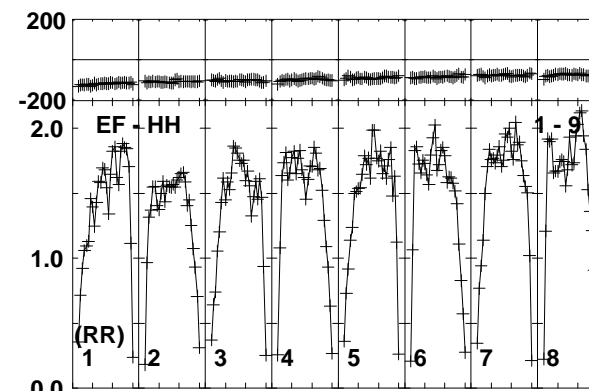
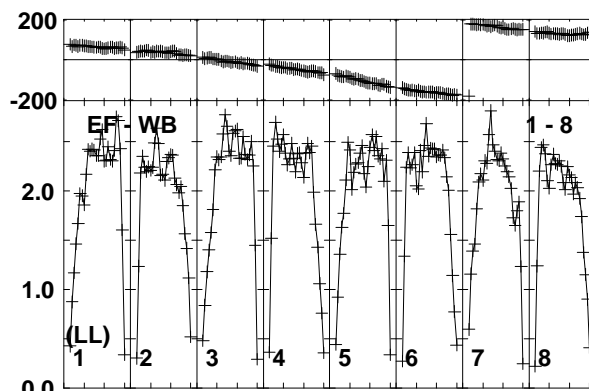
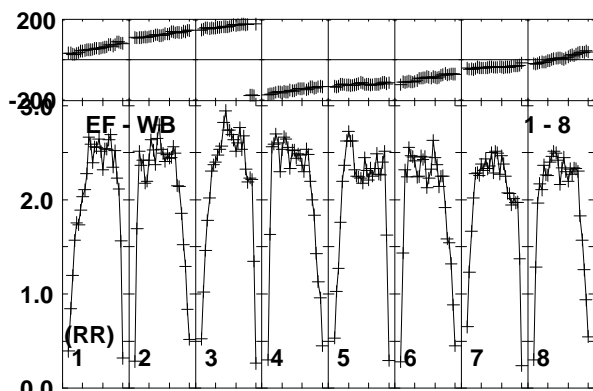
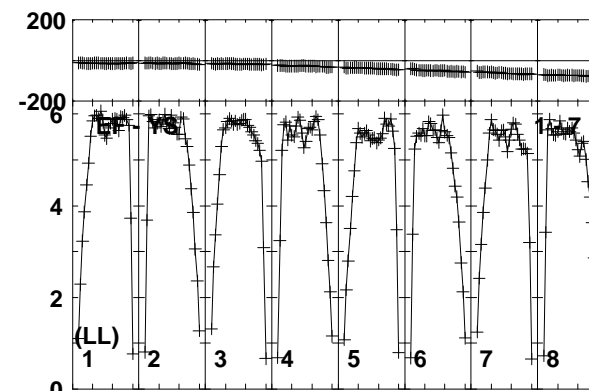
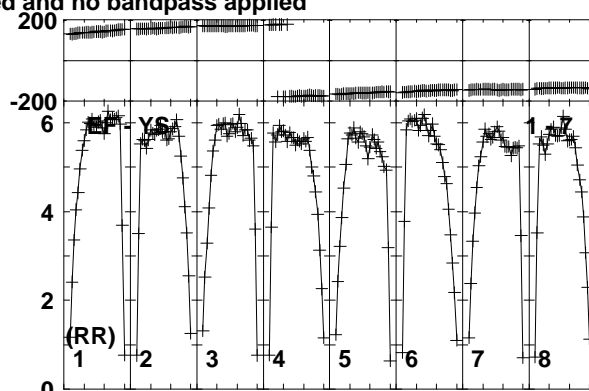
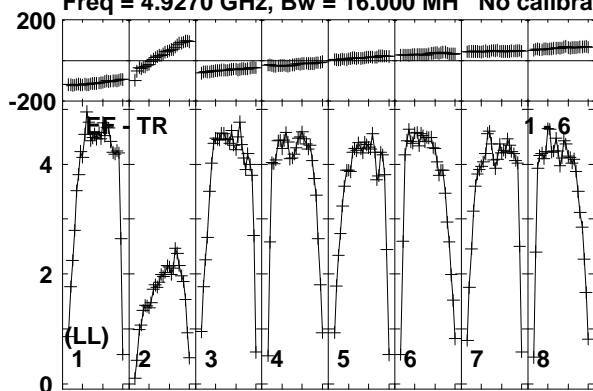

Lower frame: Milli Ampl Jy Top frame: Phas deg  
Vector averaged cross-power spectrum Baseline: EF (01) - TR (06)  
Timerange: 00/14:59:50 to 00/15:00:39

Plot file version 157 created 10-JUN-2016 15:29:33

FRB150418 RG008C.UVDATA.1

Freq = 4.9270 GHz, Bw = 16.000 MH No calibration applied and no bandpass applied

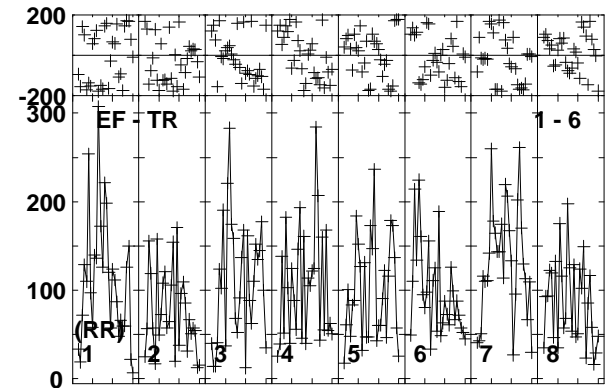
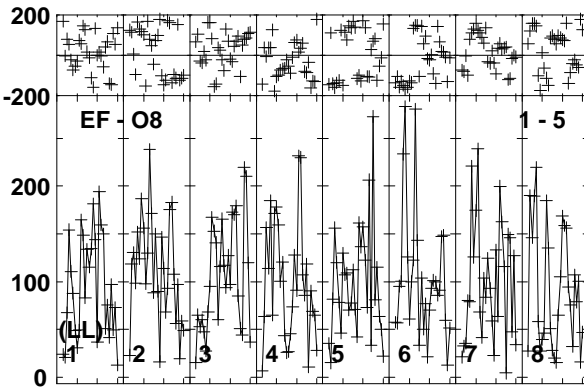
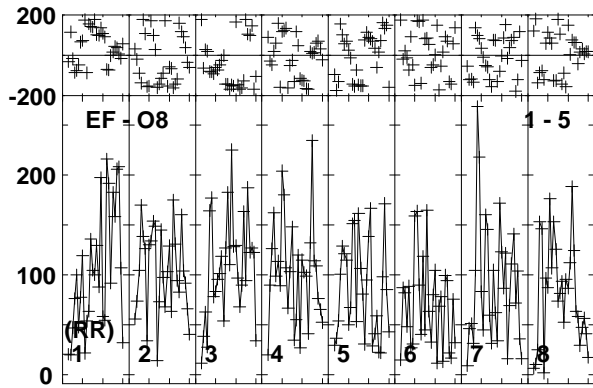
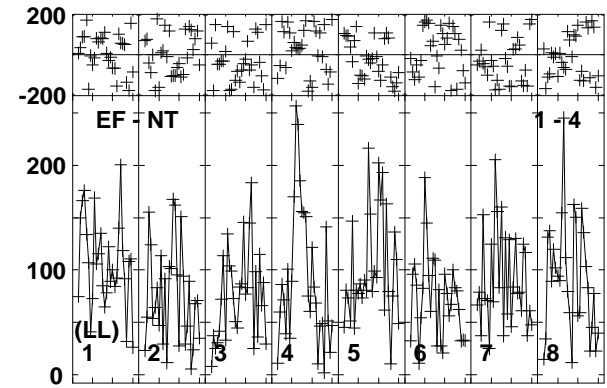
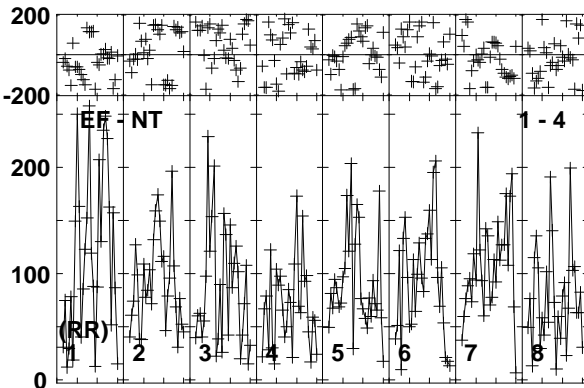
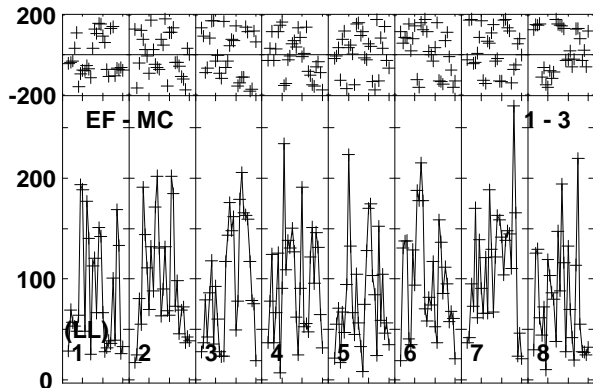
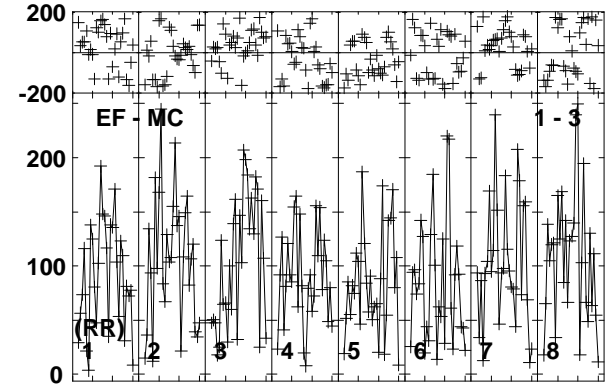
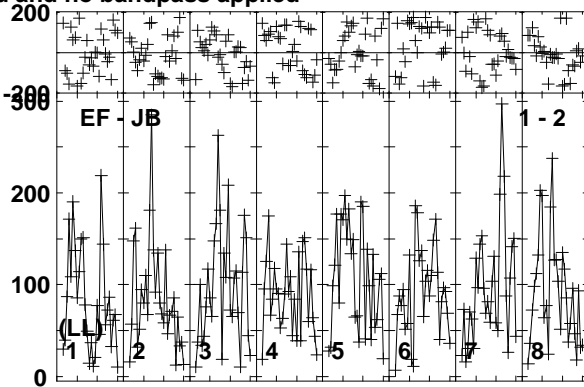
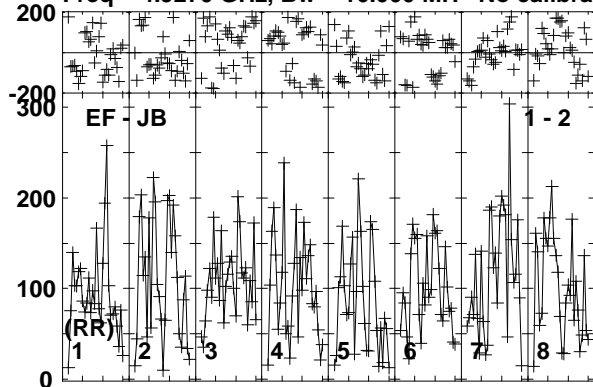

Lower frame: Micro Ampl Jy Top frame: Phas deg  
Vector averaged cross-power spectrum Baseline: EF (01) - JB (02)  
Timerange: 00/15:00:40 to 00/15:03:40

Plot file version 158 created 10-JUN-2016 15:29:33

FRB150418 RG008C.UVDATA.1

Freq = 4.9270 GHz, Bw = 16.000 MH No calibration applied and no bandpass applied

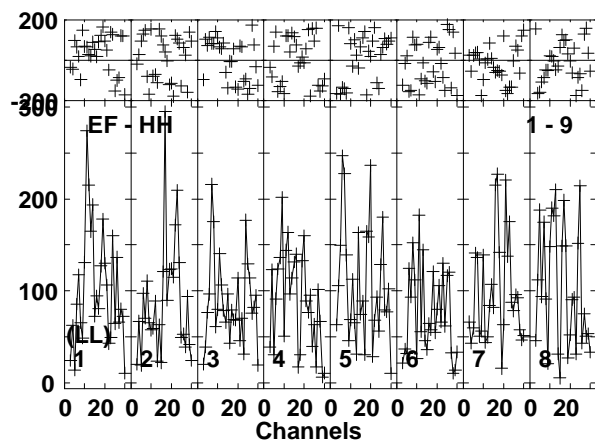
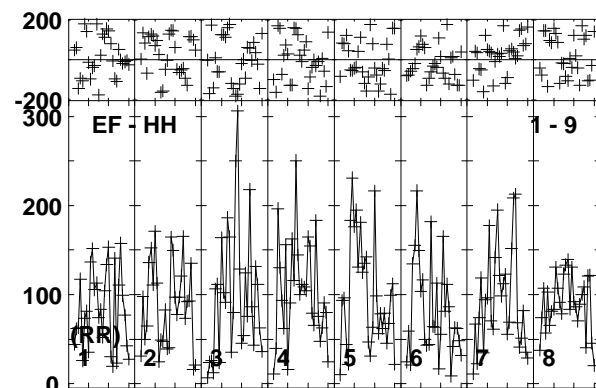
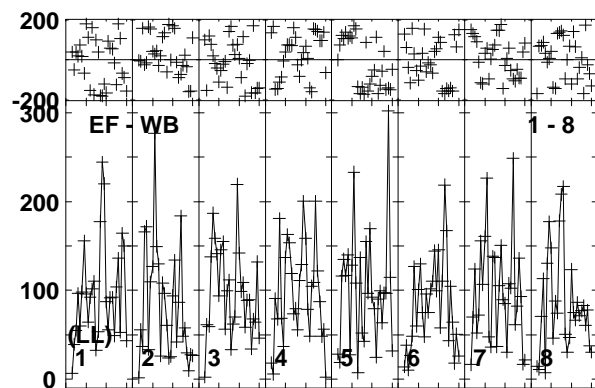
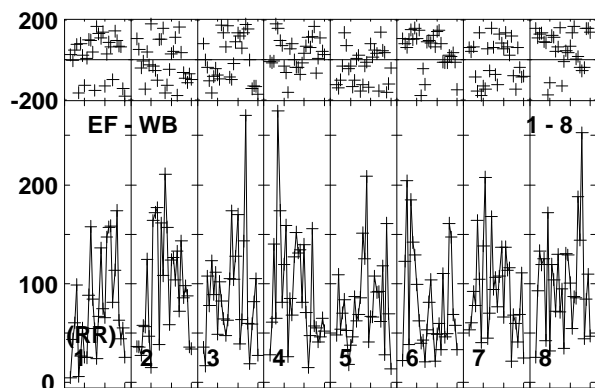
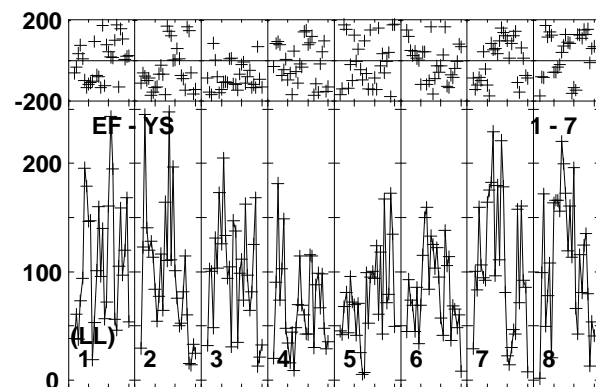
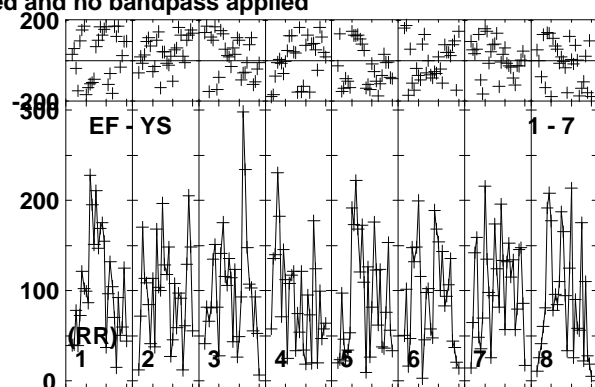
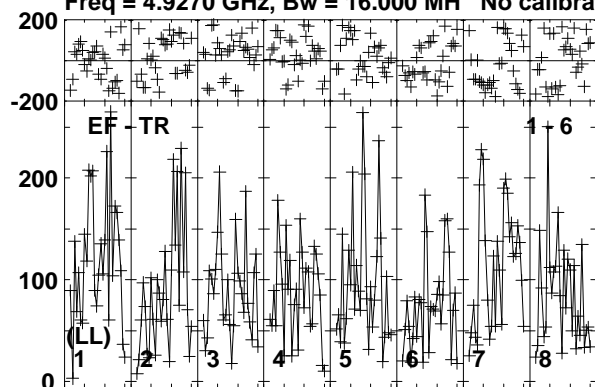

Lower frame: Micro Ampl Jy Top frame: Phas deg  
Vector averaged cross-power spectrum Baseline: EF (01) - TR (06)  
Timerange: 00/15:00:40 to 00/15:03:40

Plot file version 159 created 10-JUN-2016 15:29:33

J0718-1813 RG008C.UVDATA.1

Freq = 4.9270 GHz, Bw = 16.000 MH No calibration applied and no bandpass applied

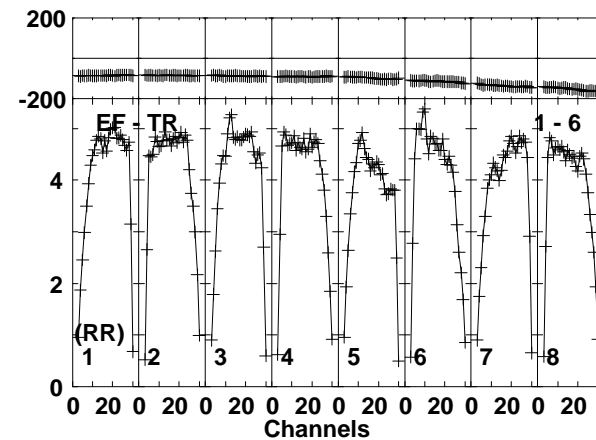
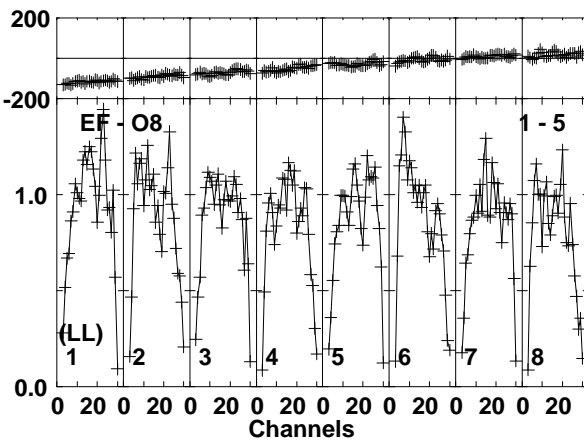
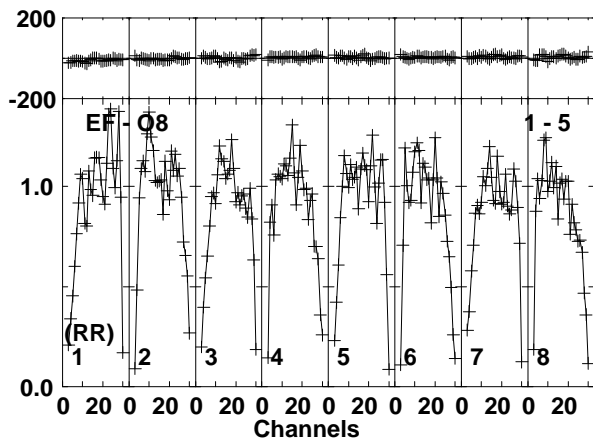
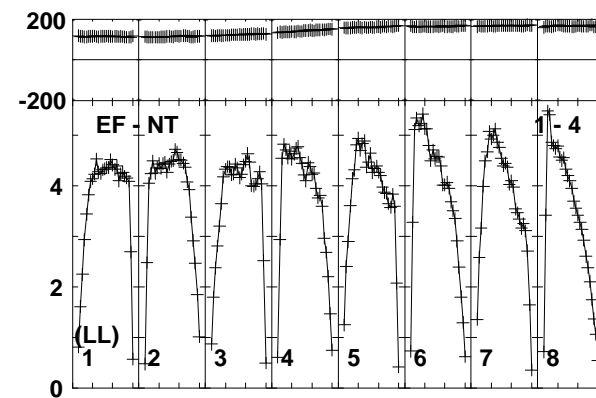
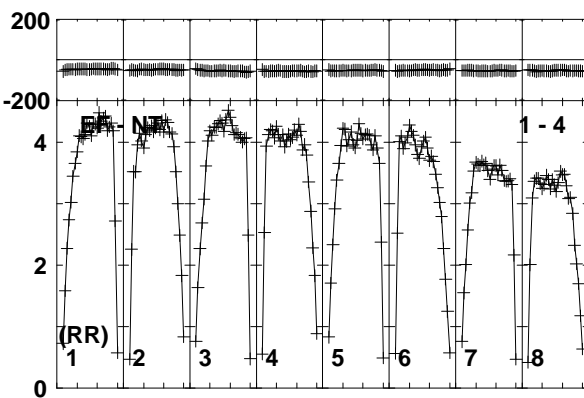
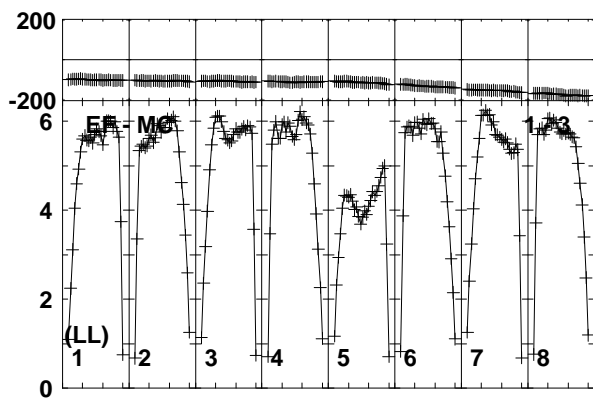
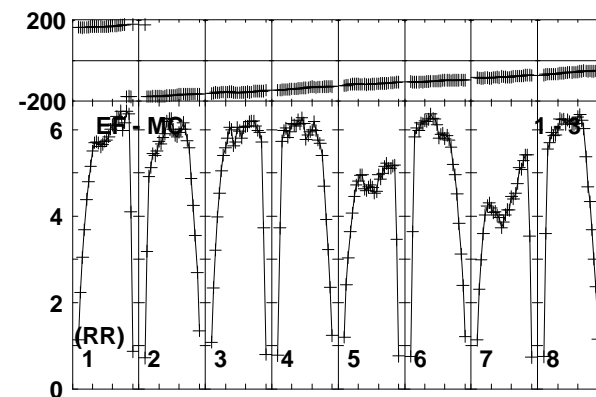
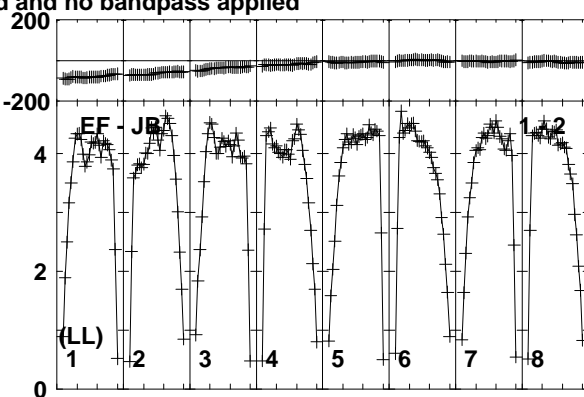
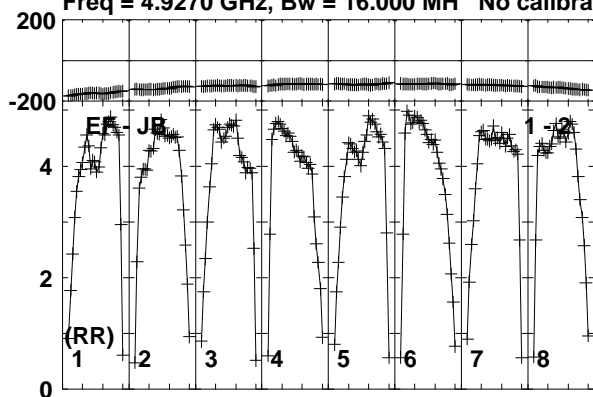

Lower frame: Milli Ampl Jy Top frame: Phas deg  
Vector averaged cross-power spectrum Baseline: EF (01) - JB (02)  
Timerange: 00/15:03:41 to 00/15:05:09

Plot file version 160 created 10-JUN-2016 15:29:33

J0718-1813 RG008C.UVDATA.1

Freq = 4.9270 GHz, Bw = 16.000 MH No calibration applied and no bandpass applied

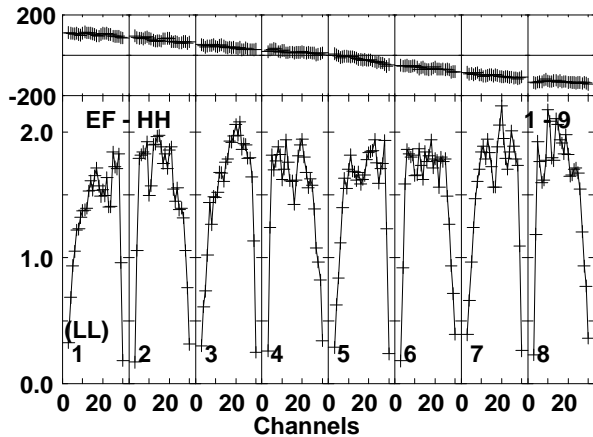
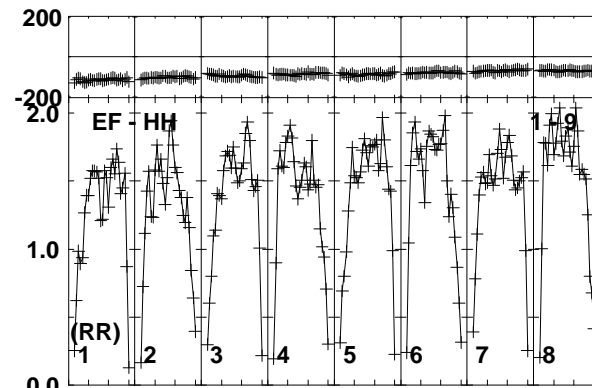
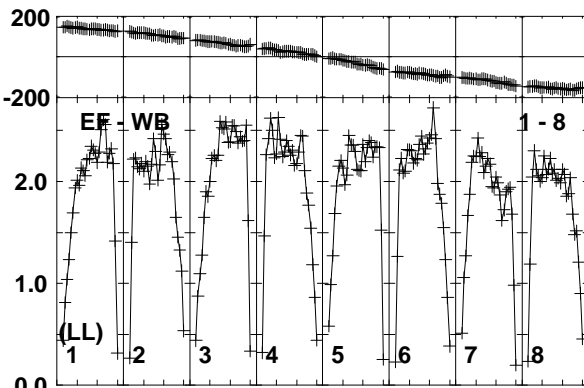
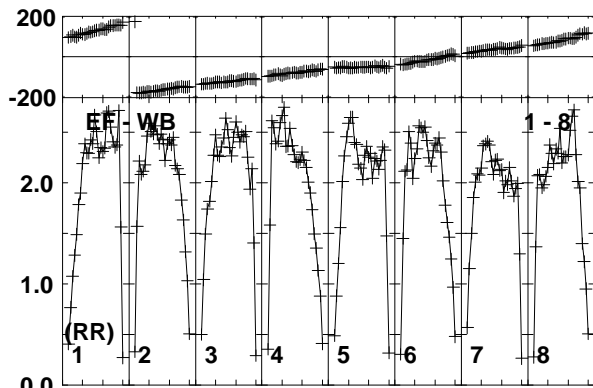
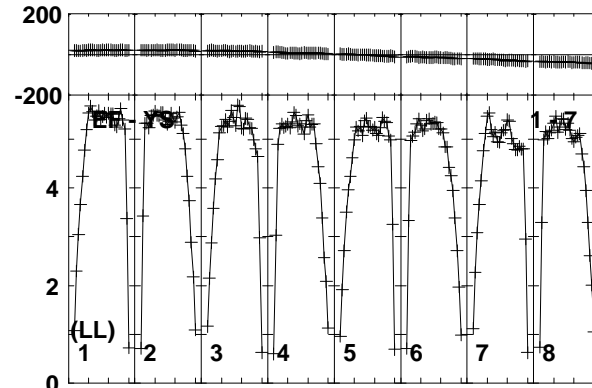
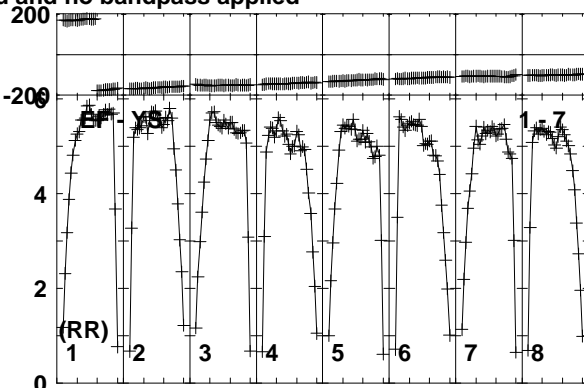
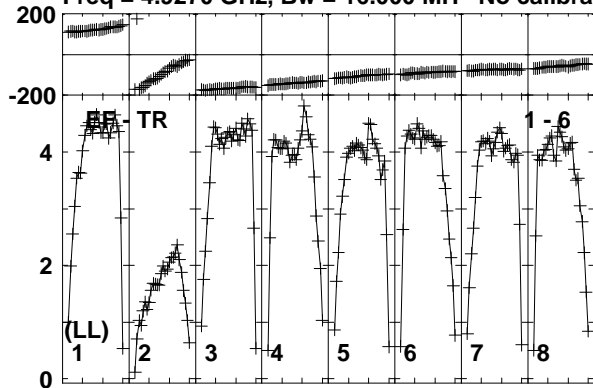

Lower frame: Milli Ampl Jy Top frame: Phas deg  
Vector averaged cross-power spectrum Baseline: EF (01) - TR (06)  
Timerange: 00/15:03:41 to 00/15:05:09



Plot file version 161 created 10-JUN-2016 15:29:33

J0712-1847 RG008C.UVDATA.1

Freq = 4.9270 GHz, Bw = 16.000 MH No calibration applied and no bandpass applied

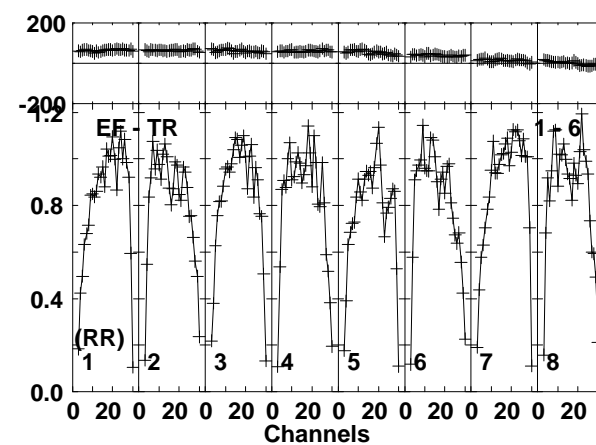
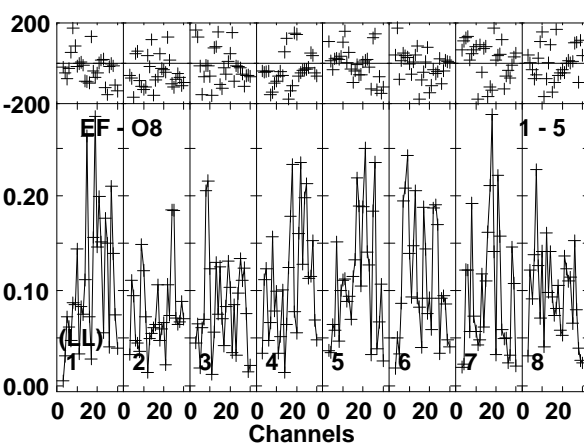
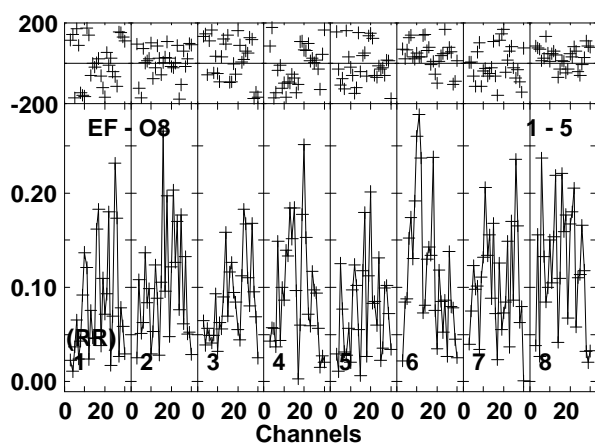
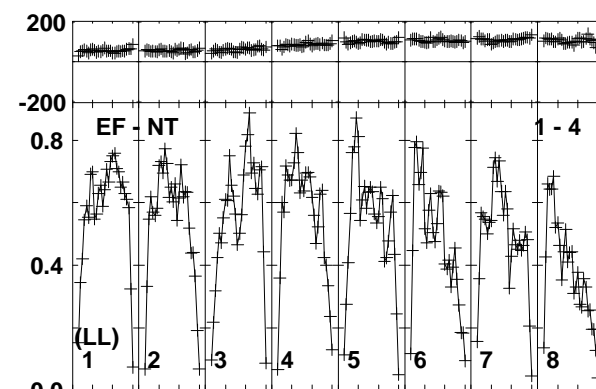
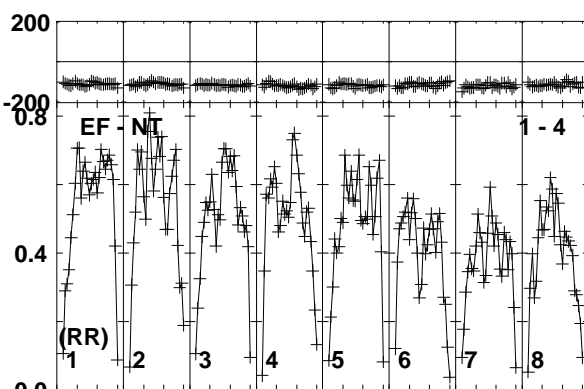
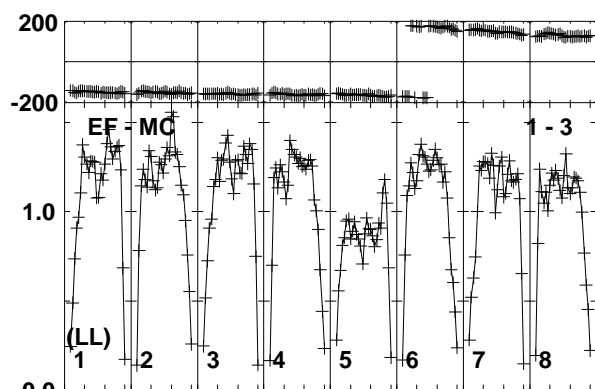
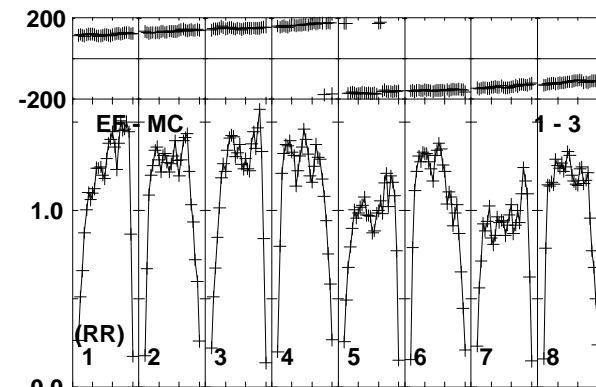
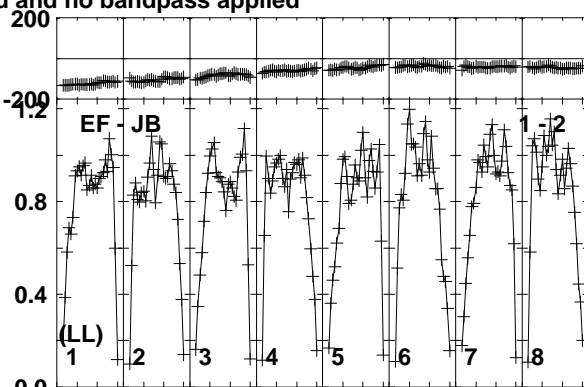
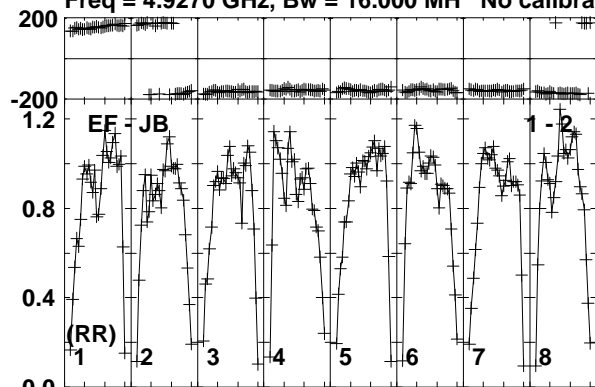

Lower frame: Milli Ampl Jy Top frame: Phas deg  
Vector averaged cross-power spectrum Baseline: EF (01) - JB (02)  
Timerange: 00/15:05:11 to 00/15:08:09

Plot file version 162 created 10-JUN-2016 15:29:34

J0712-1847 RG008C.UVDATA.1

Freq = 4.9270 GHz, Bw = 16.000 MH No calibration applied and no bandpass applied

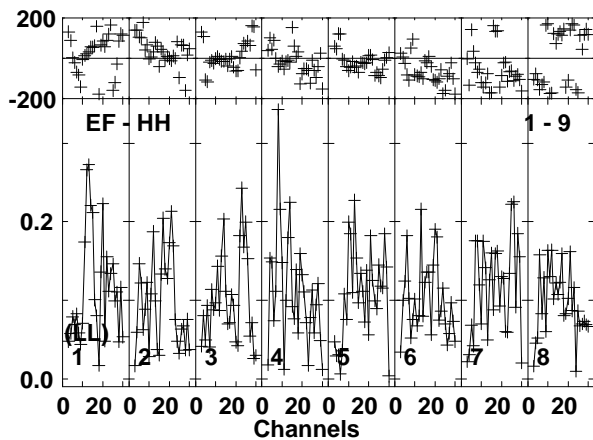
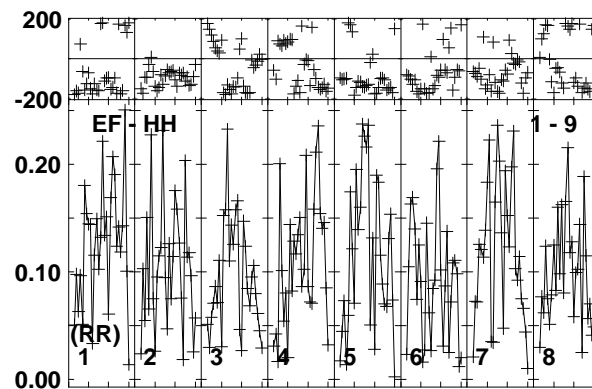
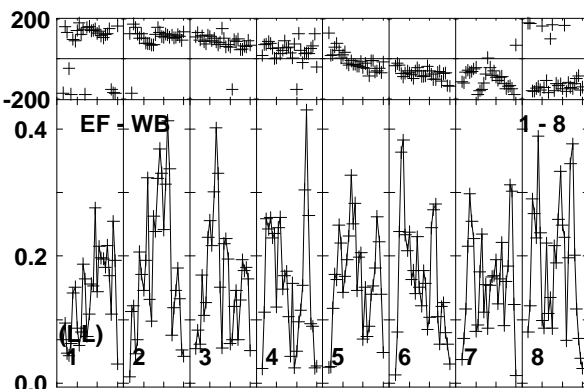
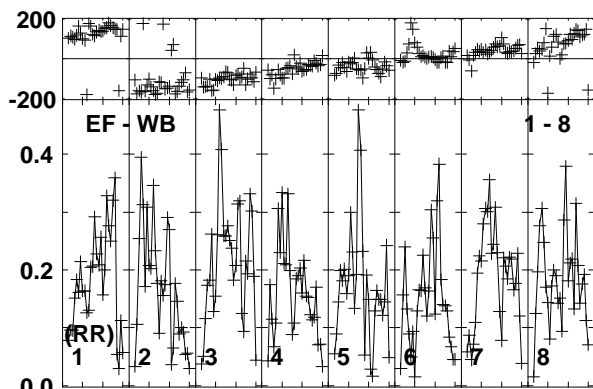
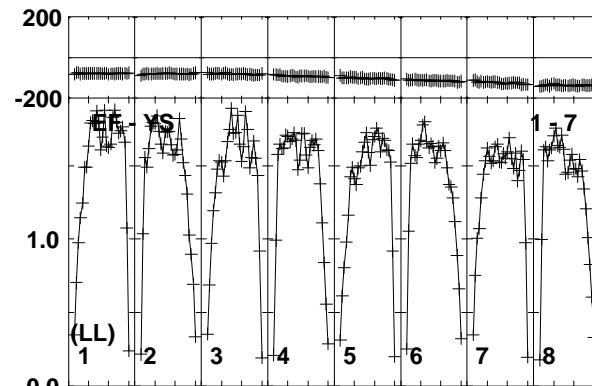
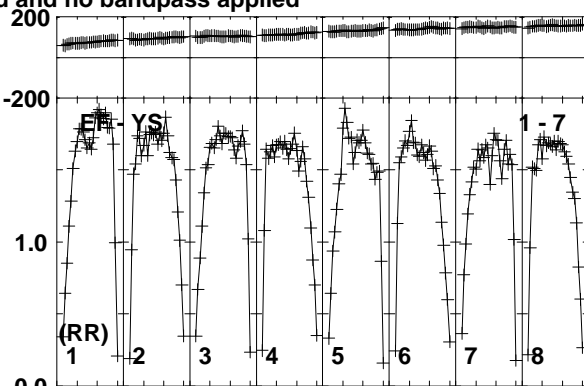
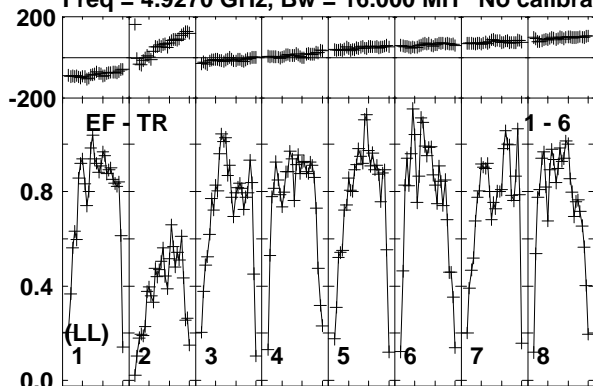

Lower frame: Milli Ampl Jy Top frame: Phas deg  
Vector averaged cross-power spectrum Baseline: EF (01) - TR (06)  
Timerange: 00/15:05:11 to 00/15:08:09

Plot file version 163 created 10-JUN-2016 15:29:34

J0718-1813 RG008C.UVDATA.1

Freq = 4.9270 GHz, Bw = 16.000 MH No calibration applied and no bandpass applied

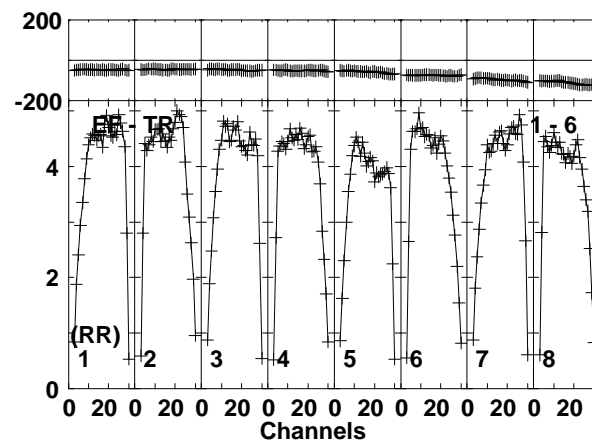
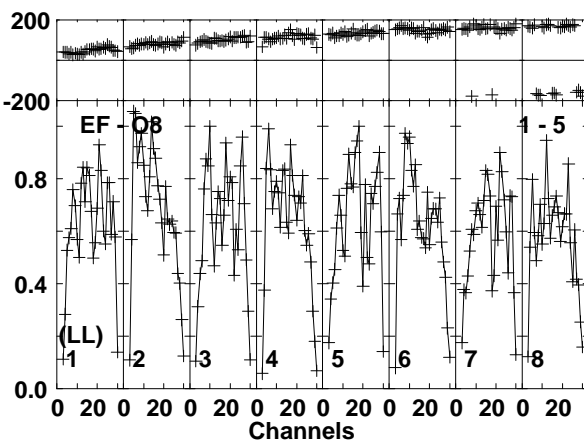
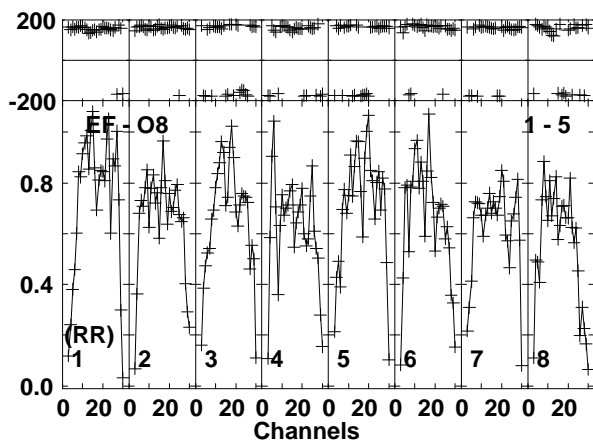
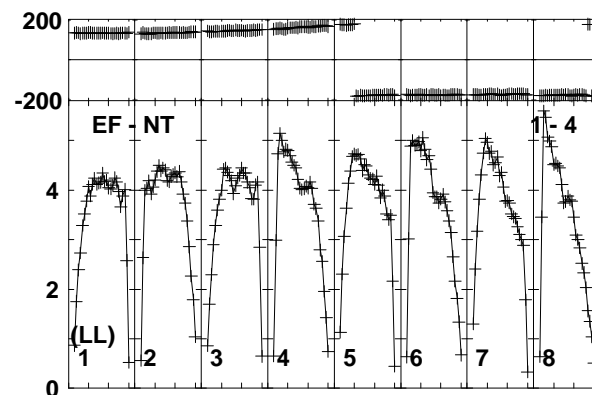
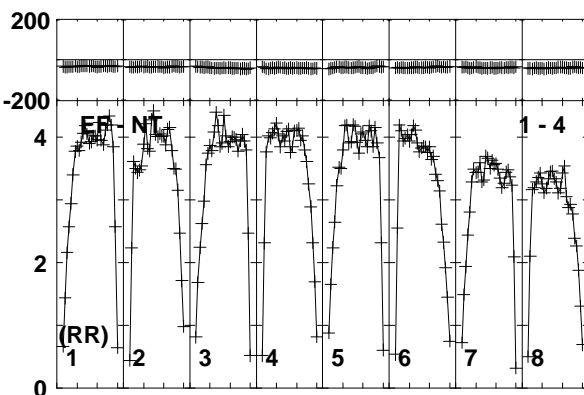
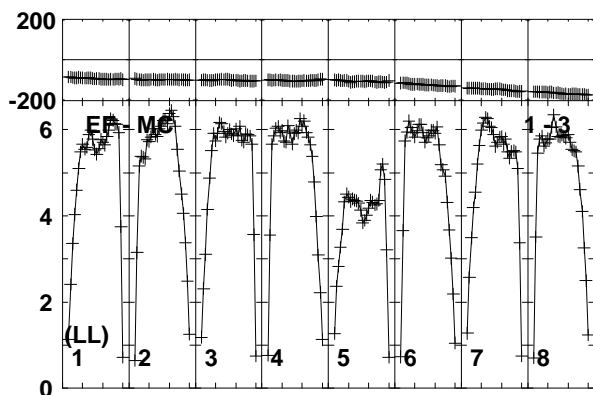
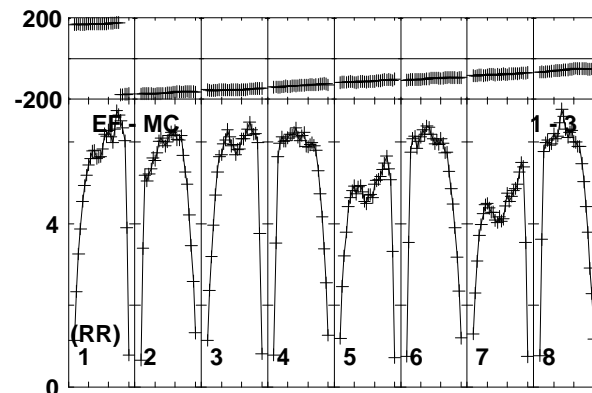
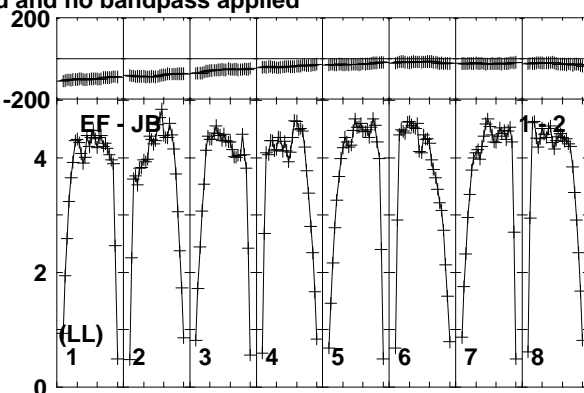
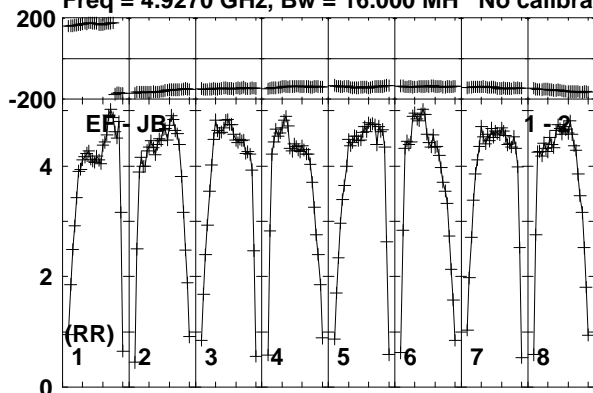

Lower frame: Milli Ampl Jy Top frame: Phas deg  
Vector averaged cross-power spectrum Baseline: EF (01) - JB (02)  
Timerange: 00/15:08:50 to 00/15:09:40

Plot file version 164 created 10-JUN-2016 15:29:34

J0718-1813 RG008C.UVDATA.1

Freq = 4.9270 GHz, Bw = 16.000 MH No calibration applied and no bandpass applied

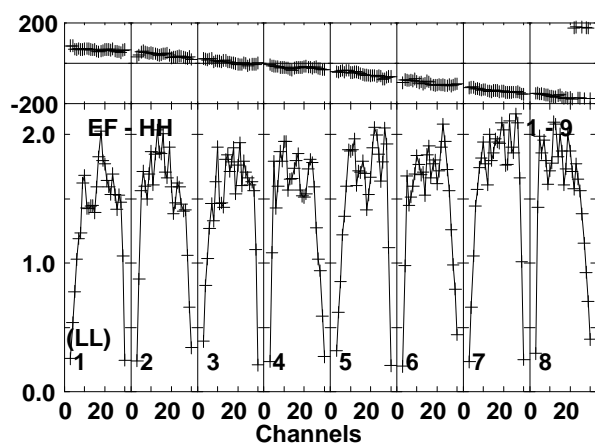
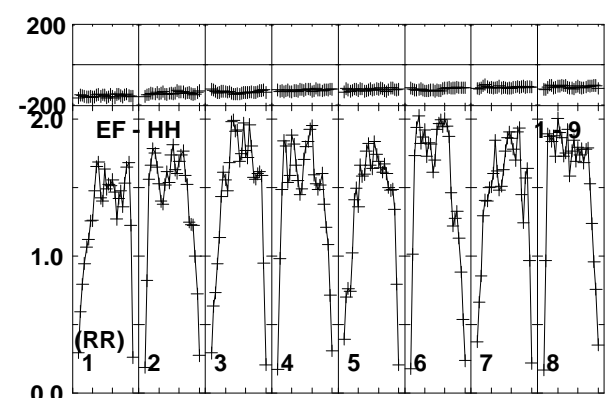
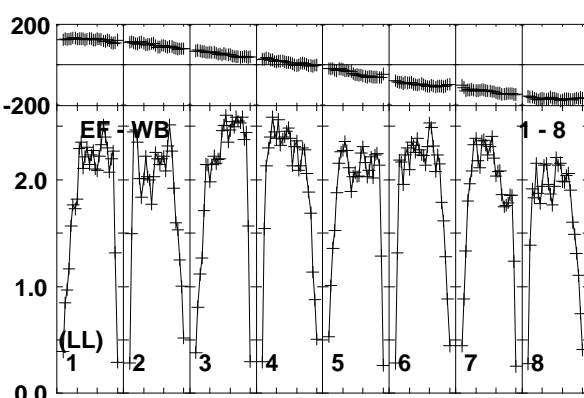
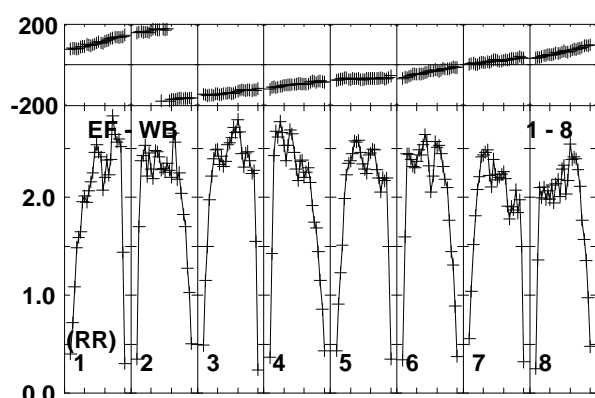
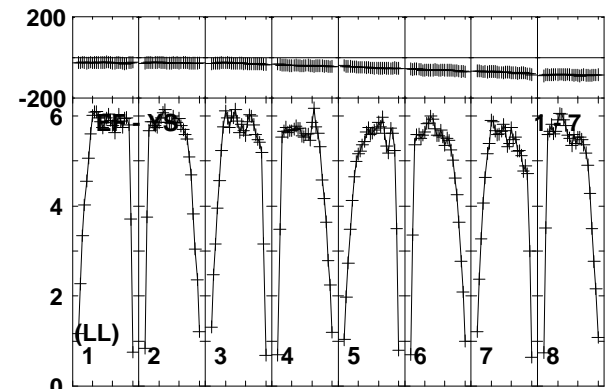
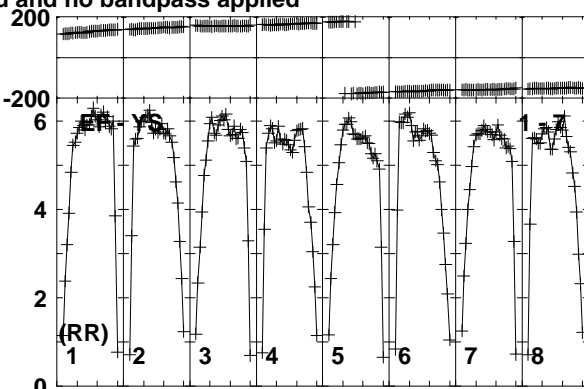
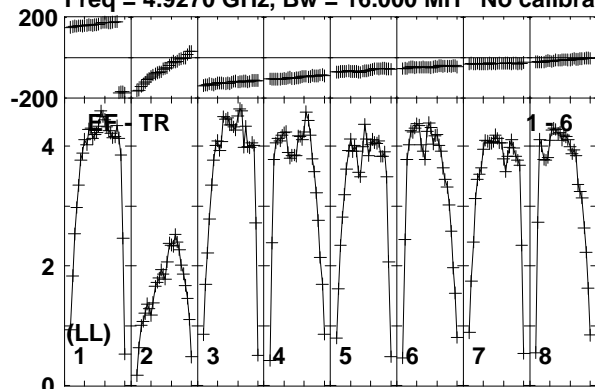

Lower frame: Milli Ampl Jy Top frame: Phas deg  
Vector averaged cross-power spectrum Baseline: EF (01) - TR (06)  
Timerange: 00/15:08:50 to 00/15:09:40

Plot file version 165 created 10-JUN-2016 15:29:34

FRB150418 RG008C.UVDATA.1

Freq = 4.9270 GHz, Bw = 16.000 MH No calibration applied and no bandpass applied

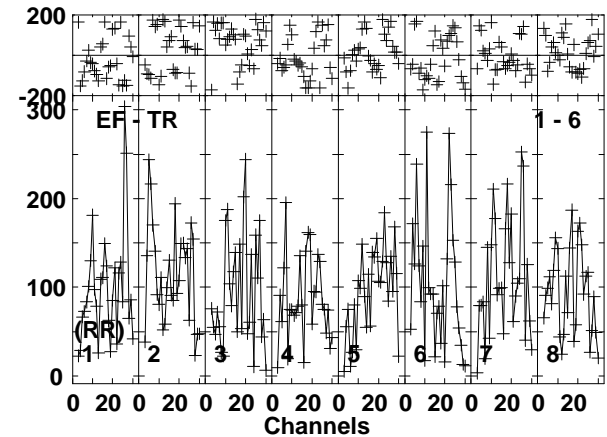
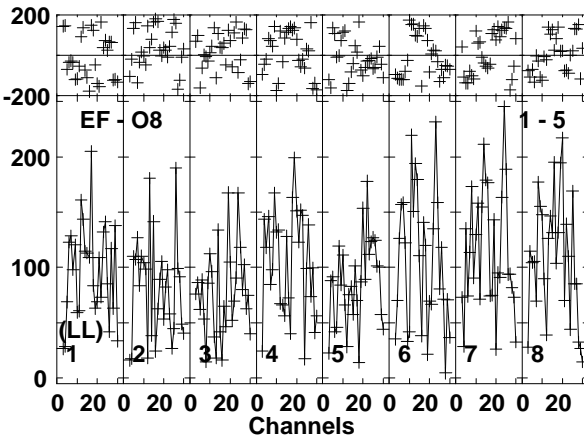
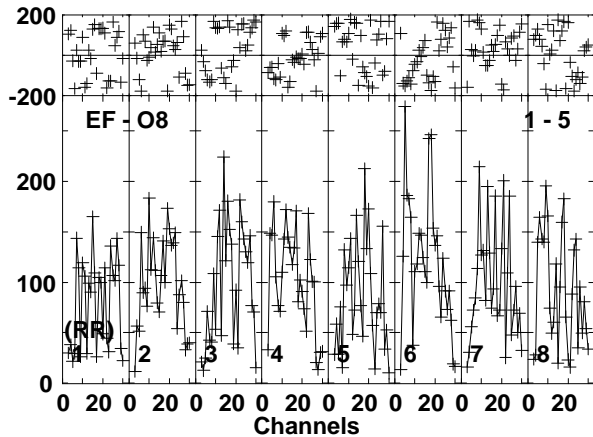
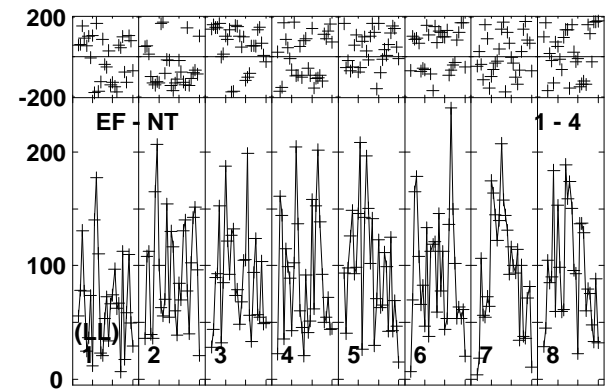
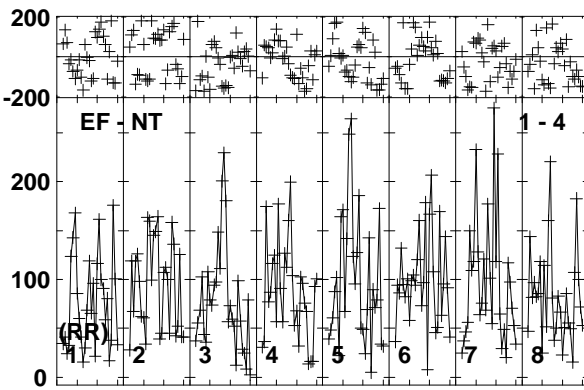
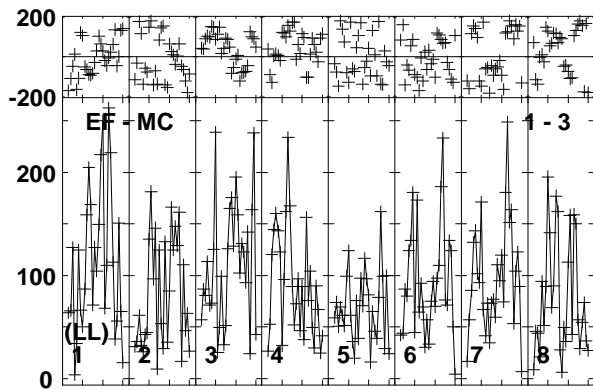
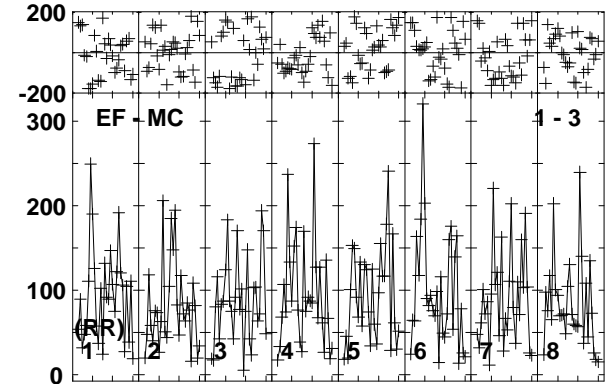
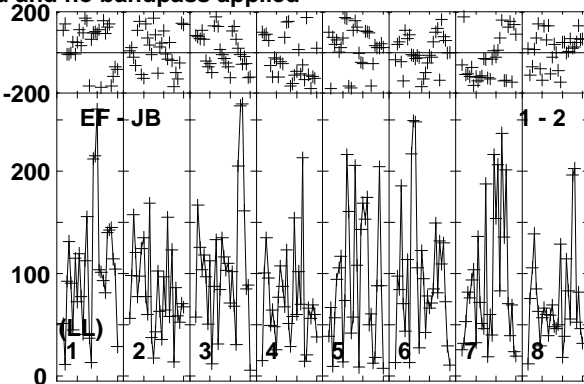
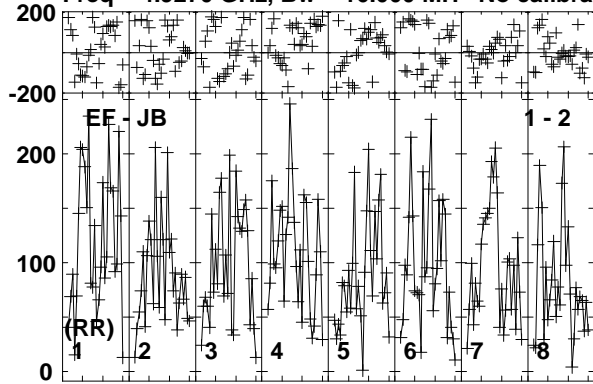

Lower frame: Micro Ampl Jy Top frame: Phas deg  
Vector averaged cross-power spectrum Baseline: EF (01) - JB (02)  
Timerange: 00/15:09:41 to 00/15:12:39

Plot file version 166 created 10-JUN-2016 15:29:34

FRB150418 RG008C.UVDATA.1

Freq = 4.9270 GHz, Bw = 16.000 MH No calibration applied and no bandpass applied

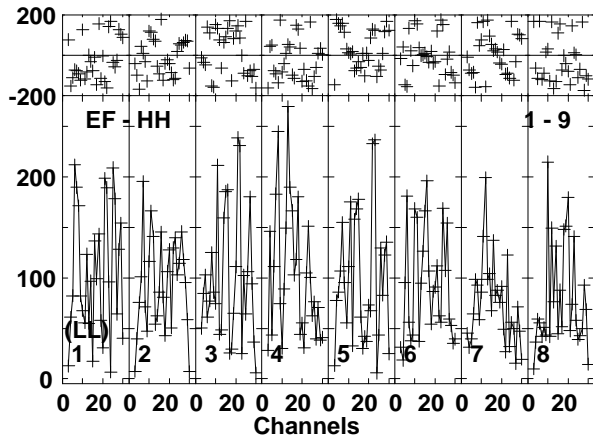
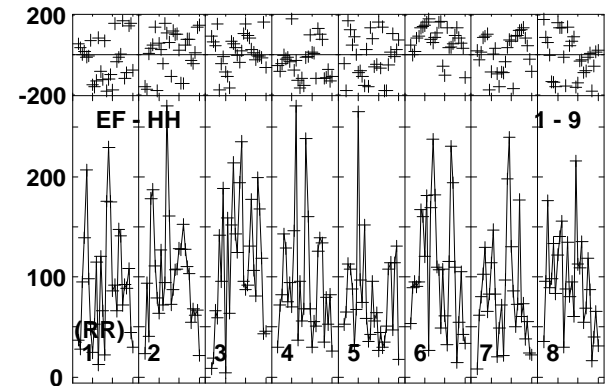
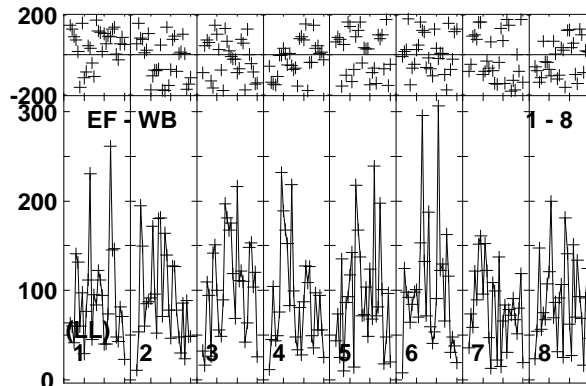
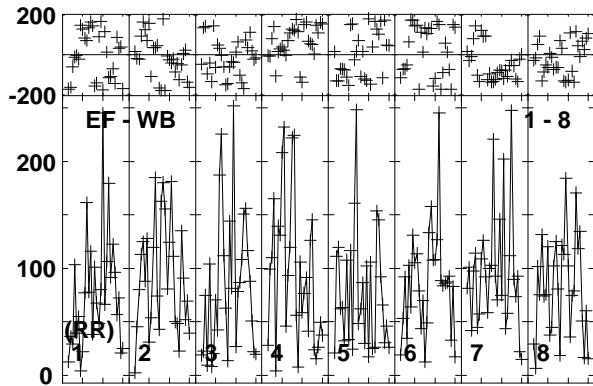
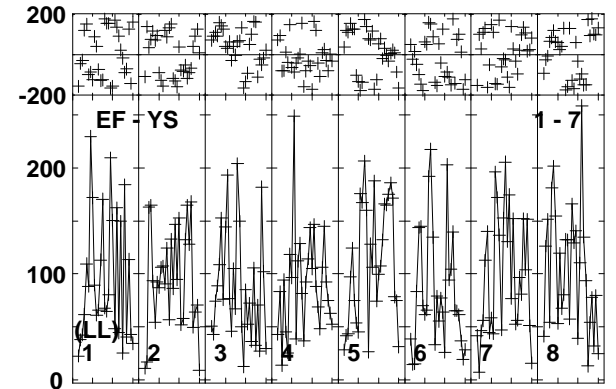
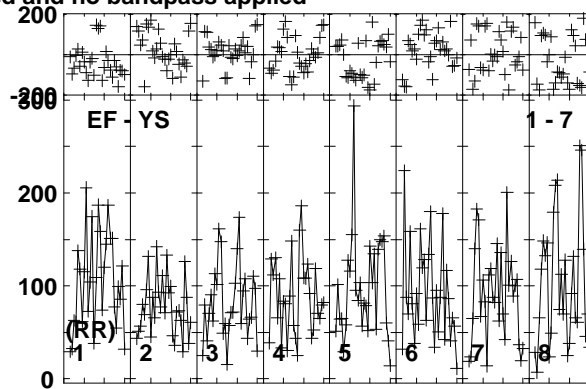
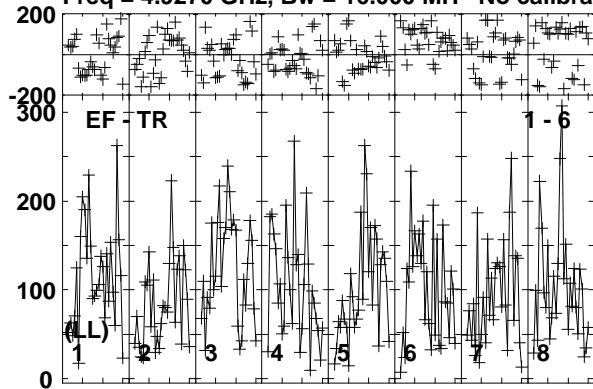

Lower frame: Micro Ampl Jy Top frame: Phas deg  
Vector averaged cross-power spectrum Baseline: EF (01) - TR (06)  
Timerange: 00/15:09:41 to 00/15:12:39

Plot file version 167 created 10-JUN-2016 15:29:34

J0718-1813 RG008C.UVDATA.1

Freq = 4.9270 GHz, Bw = 16.000 MH No calibration applied and no bandpass applied

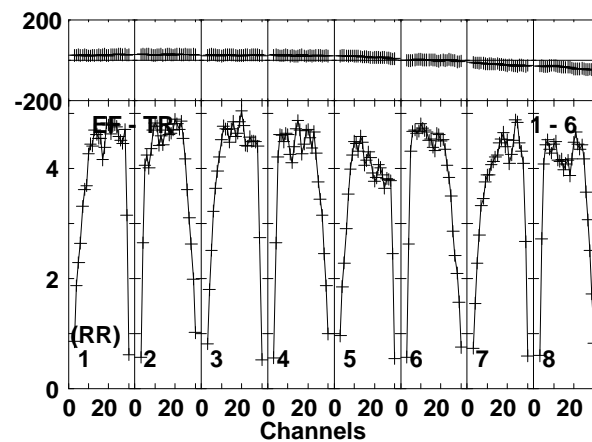
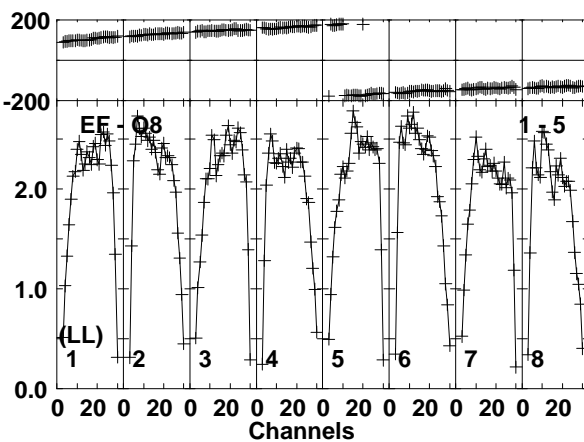
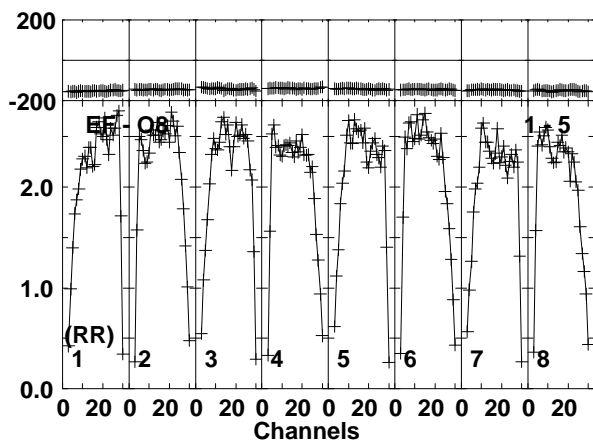
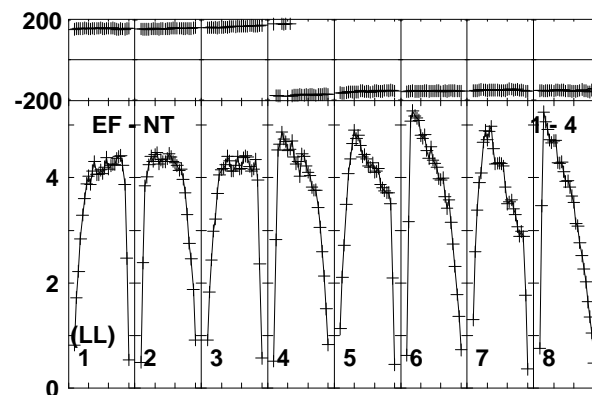
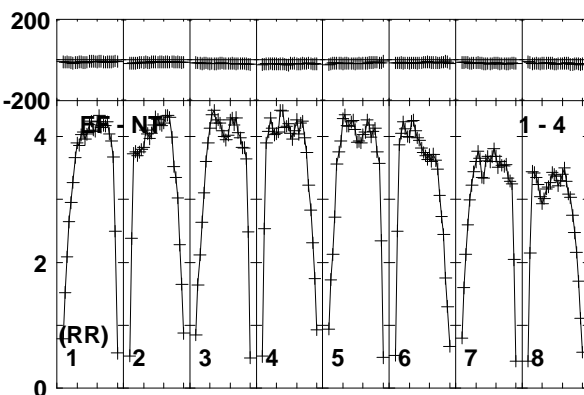
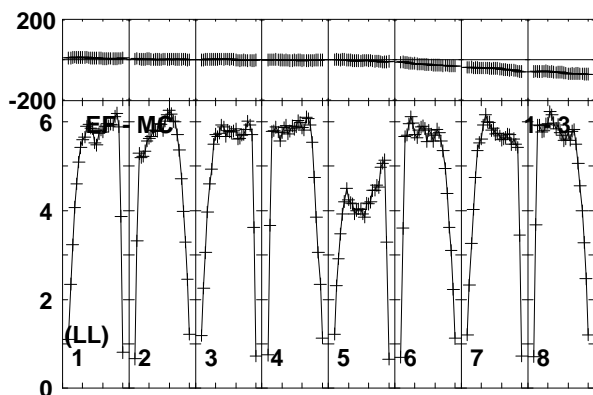
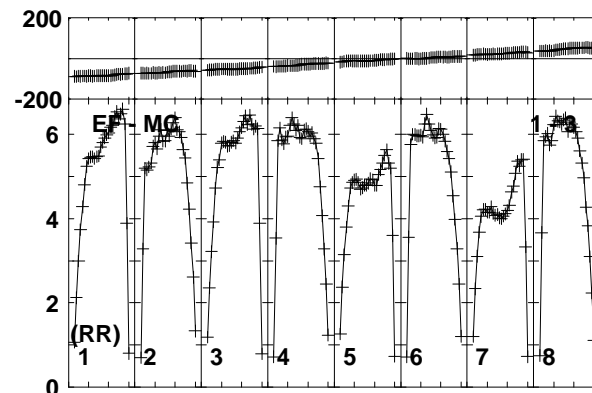
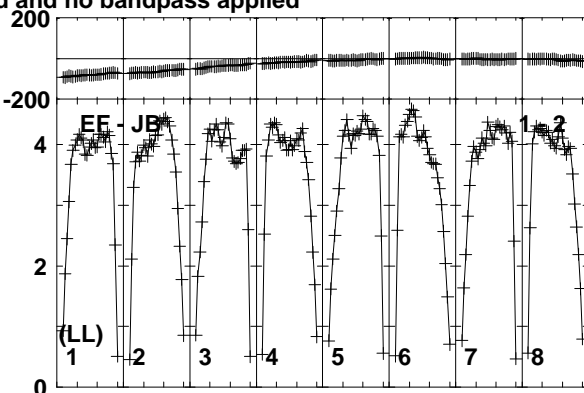
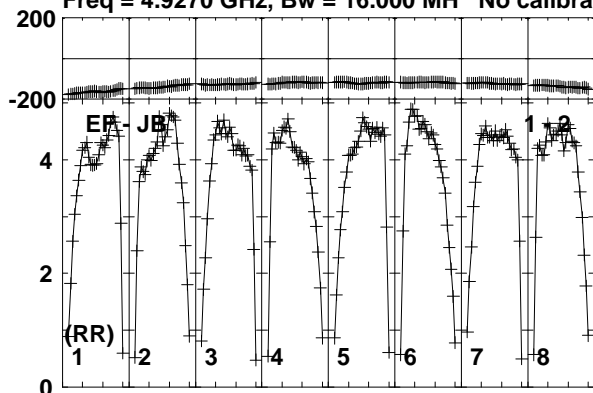

Lower frame: Milli Ampl Jy Top frame: Phas deg  
Vector averaged cross-power spectrum Baseline: EF (01) - JB (02)  
Timerange: 00/15:12:40 to 00/15:14:10

Plot file version 168 created 10-JUN-2016 15:29:34

J0718-1813 RG008C.UVDATA.1

Freq = 4.9270 GHz, Bw = 16.000 MH No calibration applied and no bandpass applied

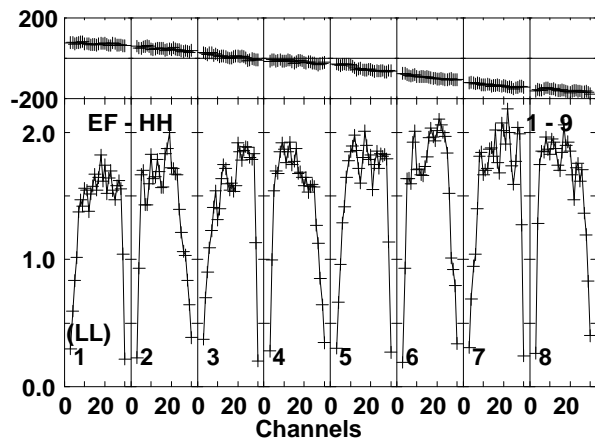
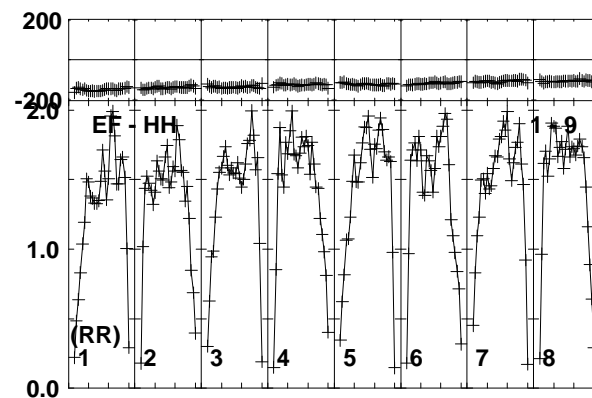
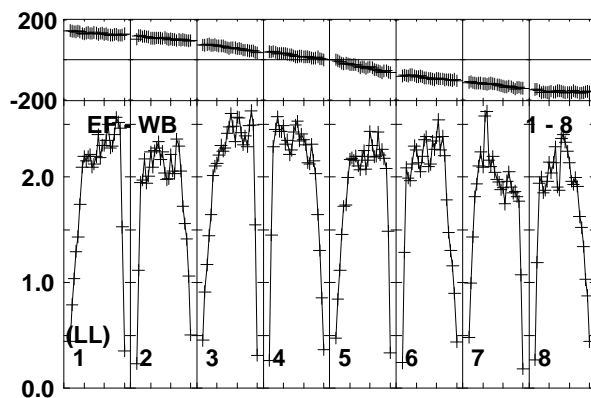
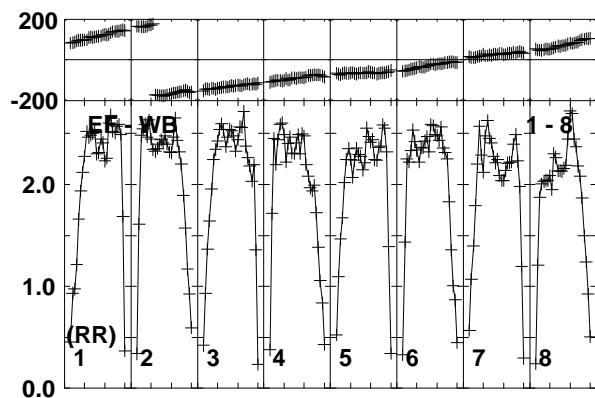
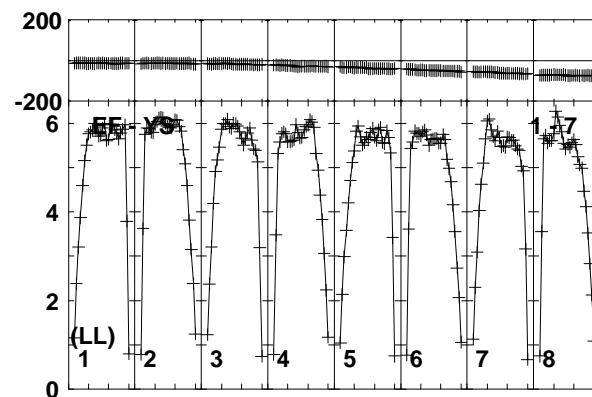
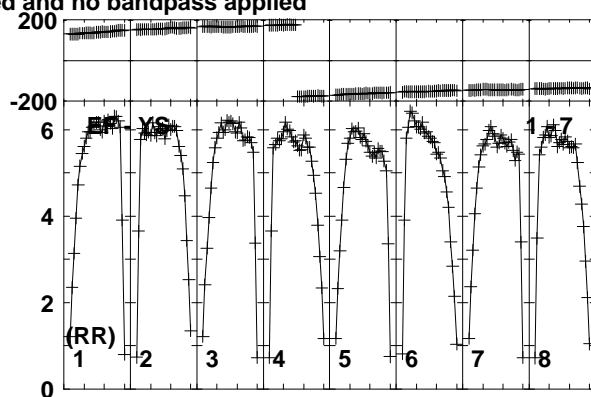
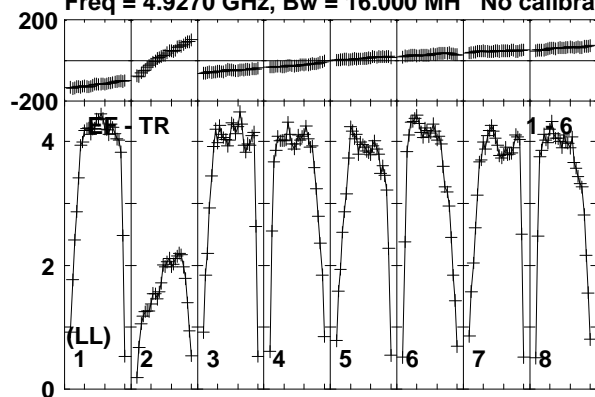

Lower frame: Milli Ampl Jy Top frame: Phas deg  
Vector averaged cross-power spectrum Baseline: EF (01) - TR (06)  
Timerange: 00/15:12:40 to 00/15:14:10



Plot file version 169 created 10-JUN-2016 15:29:34

FRB150418 RG008C.UVDATA.1

Freq = 4.9270 GHz, Bw = 16.000 MH No calibration applied and no bandpass applied

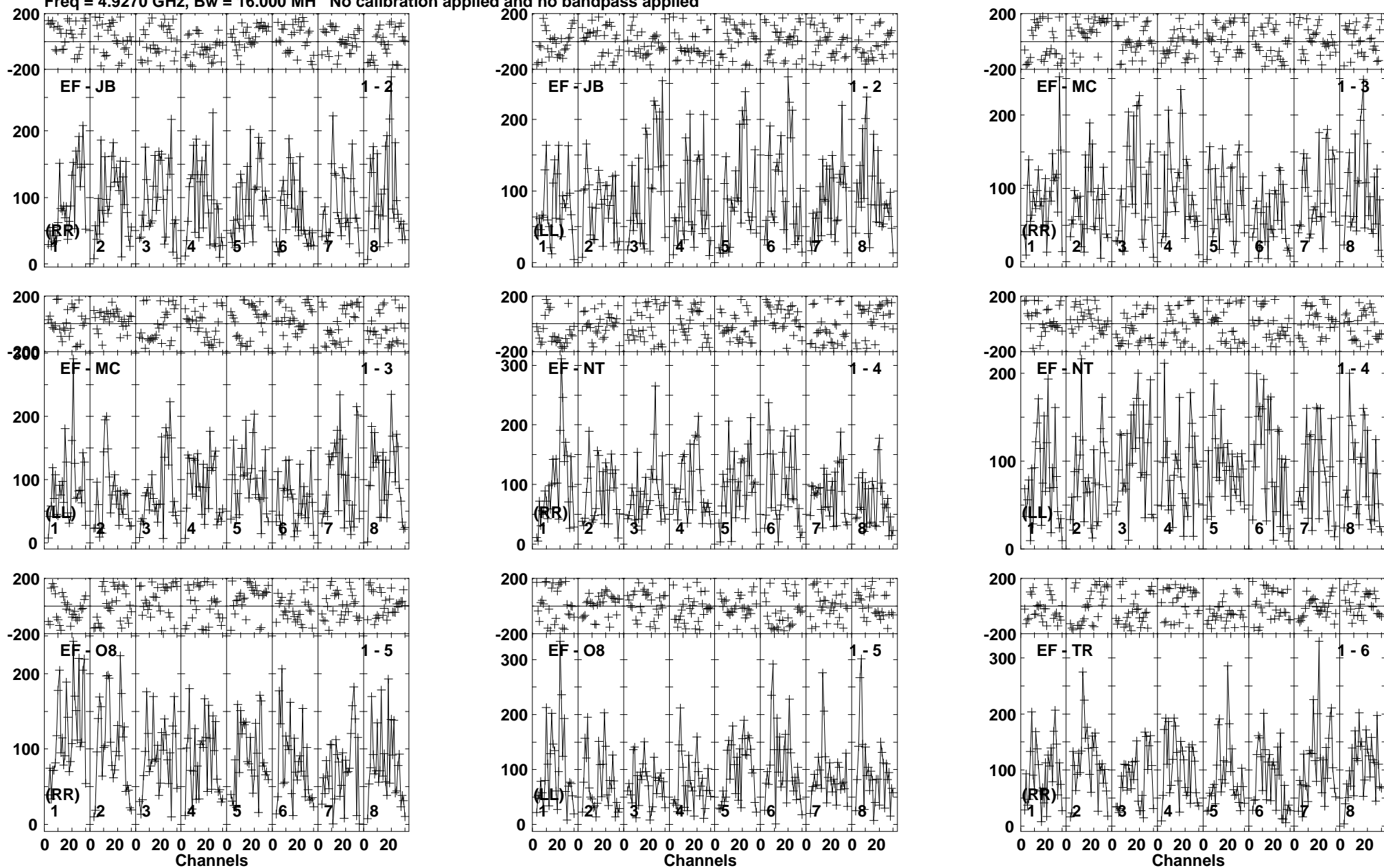

Lower frame: Micro Ampl Jy Top frame: Phas deg  
Vector averaged cross-power spectrum Baseline: EF (01) - JB (02)  
Timerange: 00/15:14:10 to 00/15:17:10

Plot file version 170 created 10-JUN-2016 15:29:34

FRB150418 RG008C.UVDATA.1

Freq = 4.9270 GHz, Bw = 16.000 MH No calibration applied and no bandpass applied

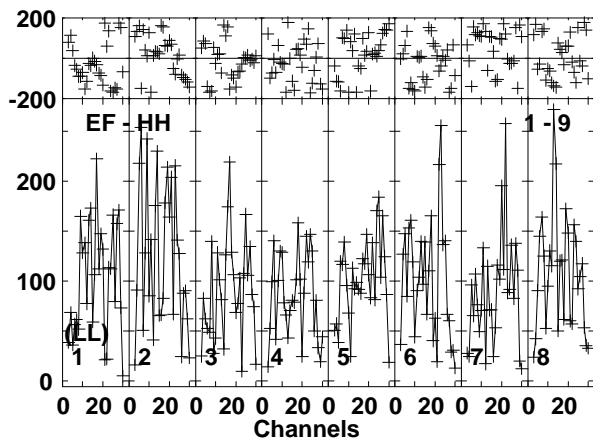
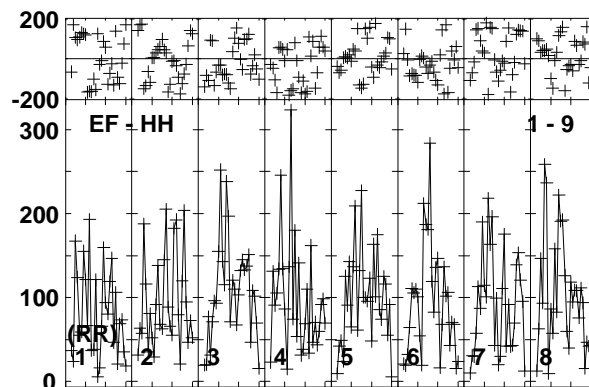
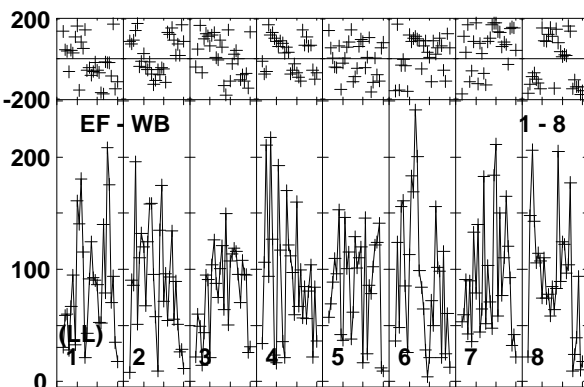
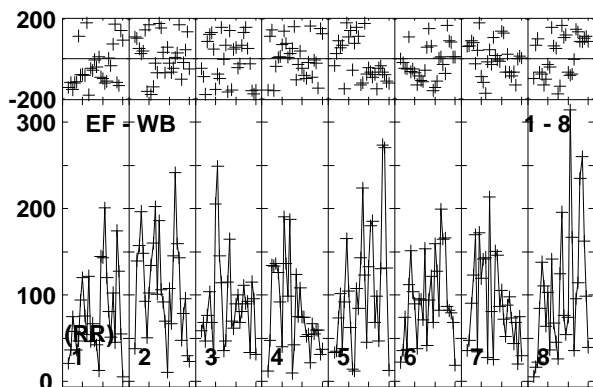
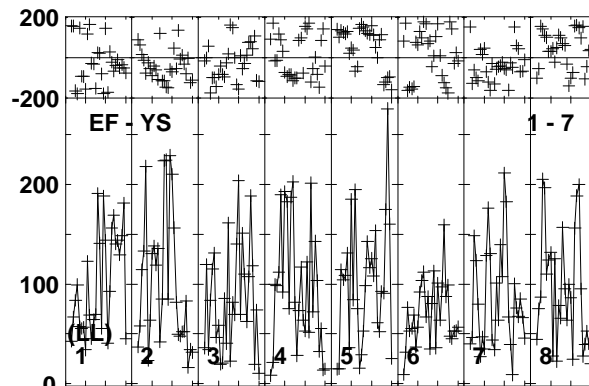
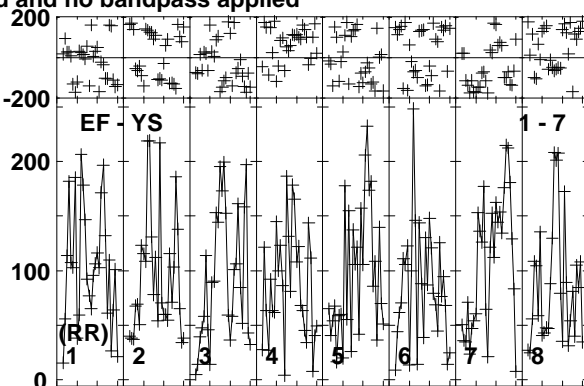
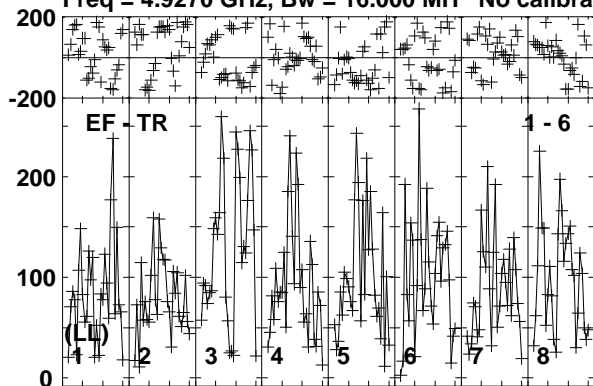

Lower frame: Micro Ampl Jy Top frame: Phas deg  
Vector averaged cross-power spectrum Baseline: EF (01) - TR (06)  
Timerange: 00/15:14:10 to 00/15:17:10

Plot file version 171 created 10-JUN-2016 15:29:35

J0718-1813 RG008C.UVDATA.1

Freq = 4.9270 GHz, Bw = 16.000 MH No calibration applied and no bandpass applied

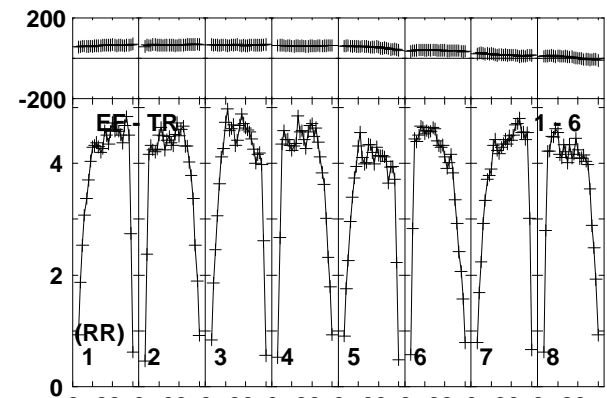
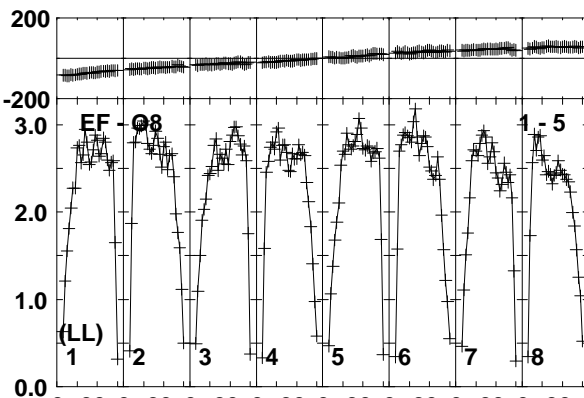
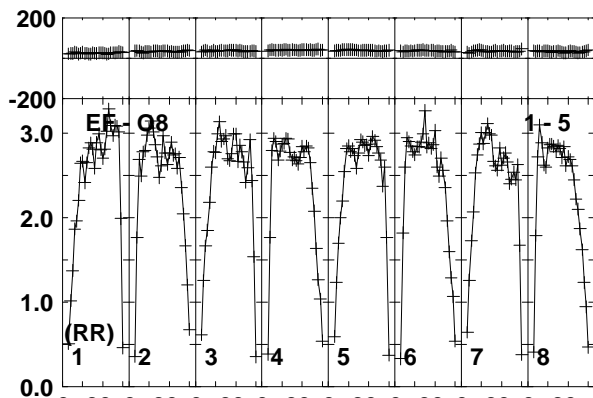
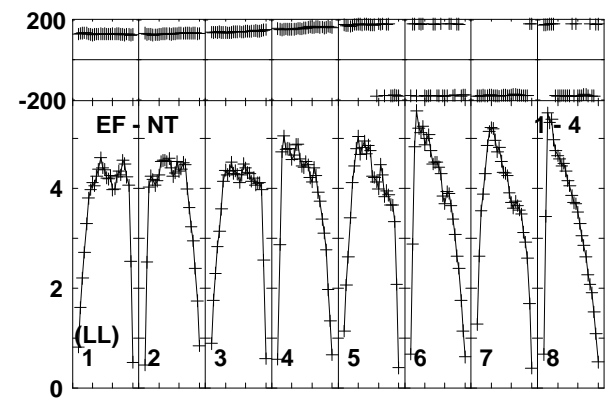
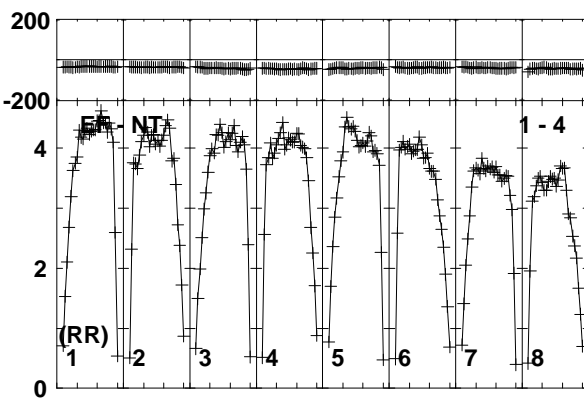
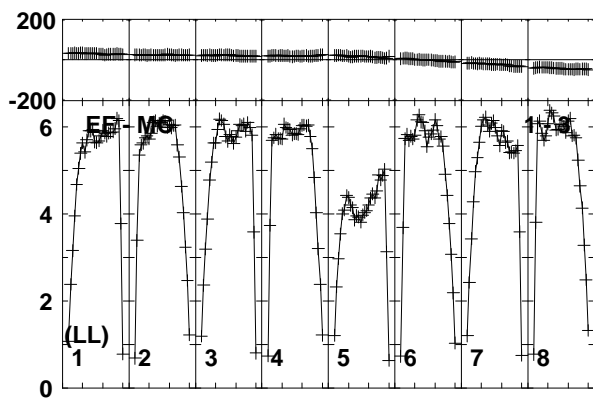
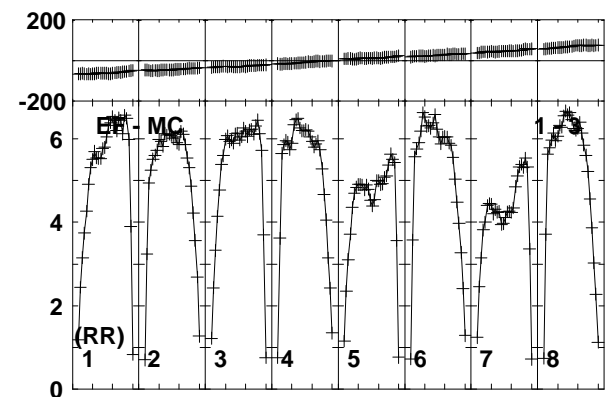
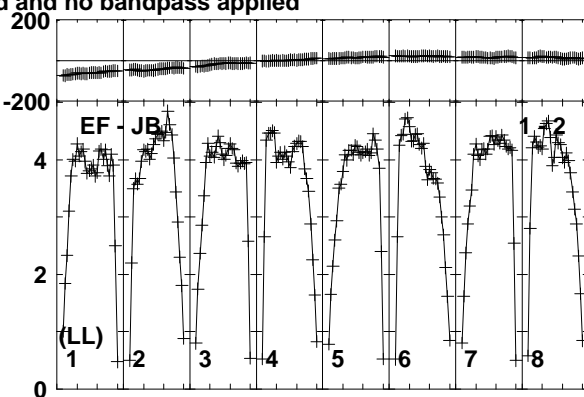
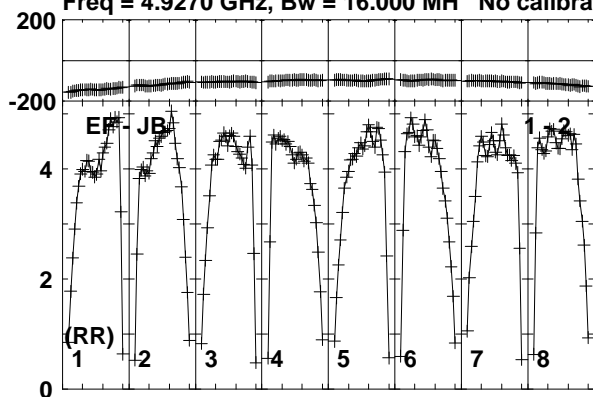

Lower frame: Milli Ampl Jy Top frame: Phas deg  
Vector averaged cross-power spectrum Baseline: EF (01) - JB (02)  
Timerange: 00/15:17:50 to 00/15:18:40

Plot file version 172 created 10-JUN-2016 15:29:35

J0718-1813 RG008C.UVDATA.1

Freq = 4.9270 GHz, Bw = 16.000 MH No calibration applied and no bandpass applied

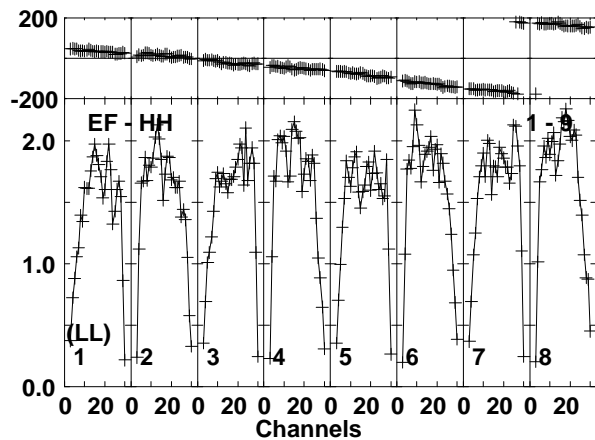
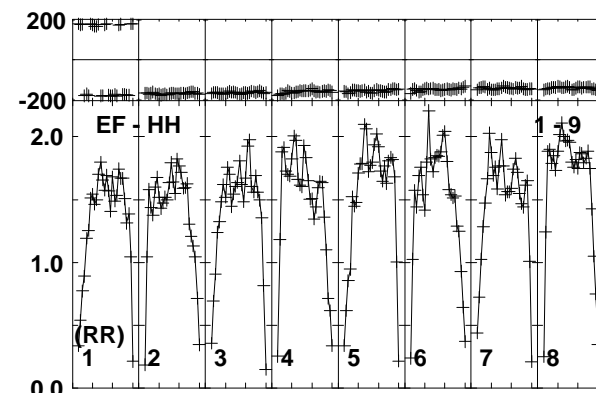
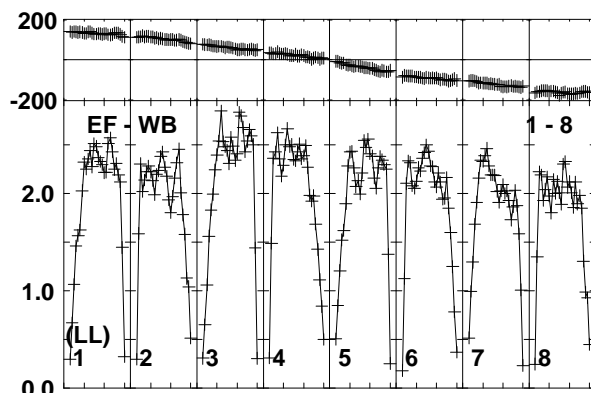
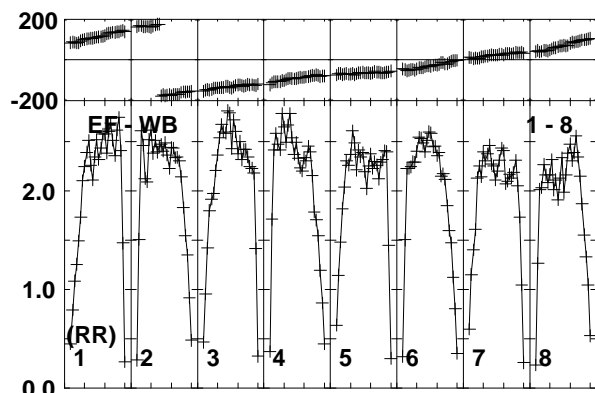
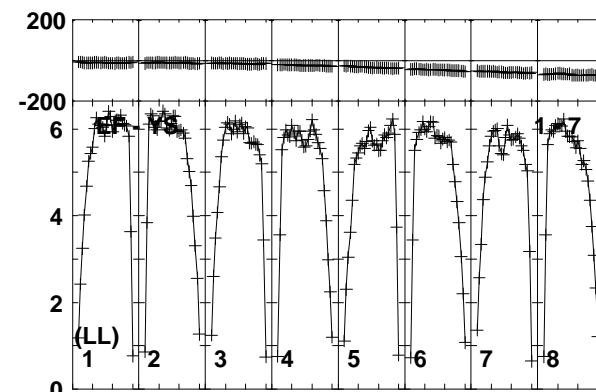
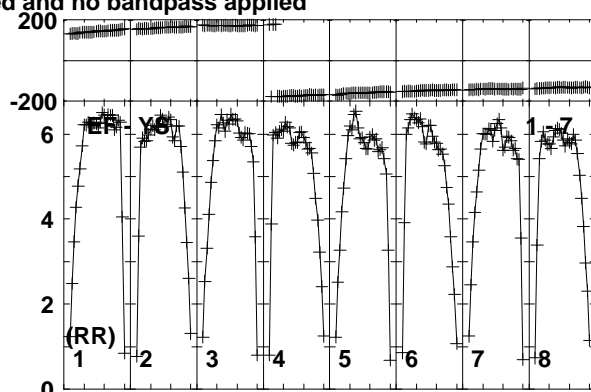
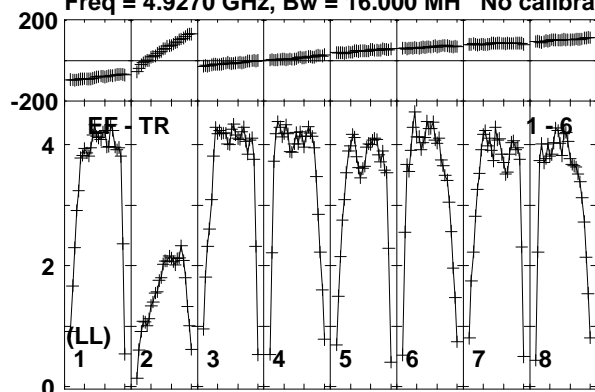

Lower frame: Milli Ampl Jy Top frame: Phas deg  
Vector averaged cross-power spectrum Baseline: EF (01) - TR (06)  
Timerange: 00:15:17:50 to 00:15:18:40

Plot file version 173 created 10-JUN-2016 15:29:35

FRB150418 RG008C.UVDATA.1

Freq = 4.9270 GHz, Bw = 16.000 MH No calibration applied and no bandpass applied

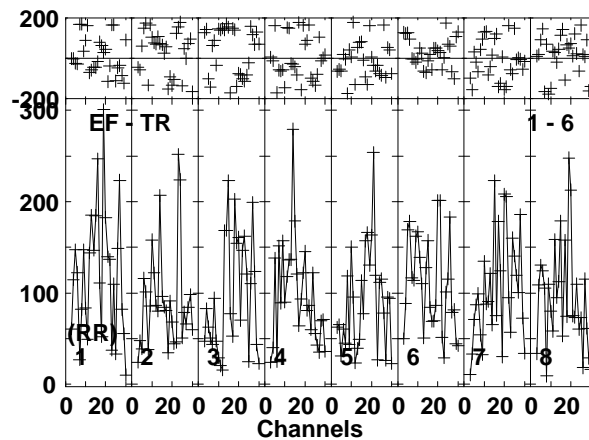
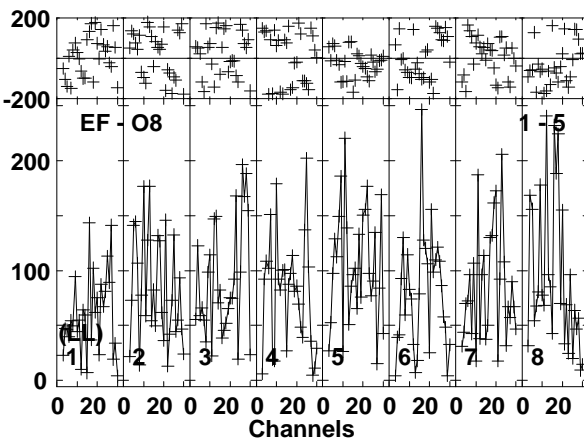
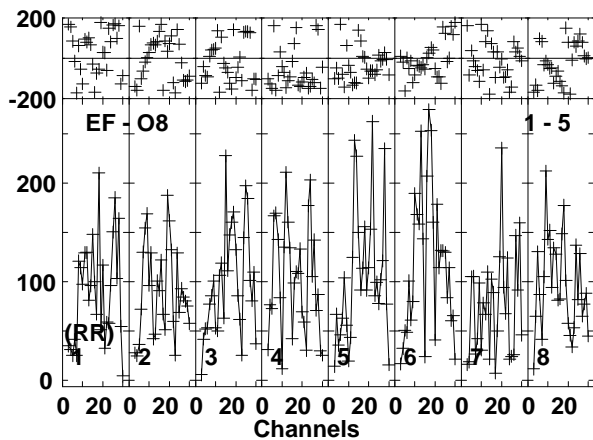
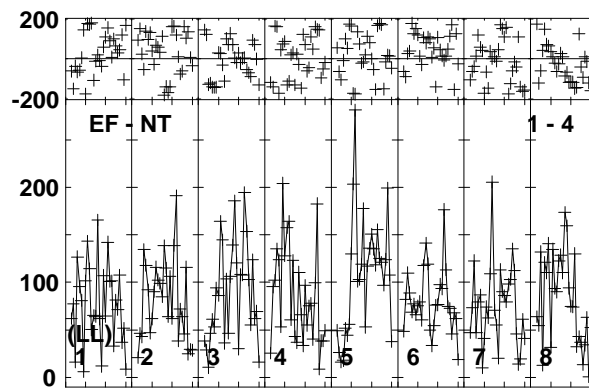
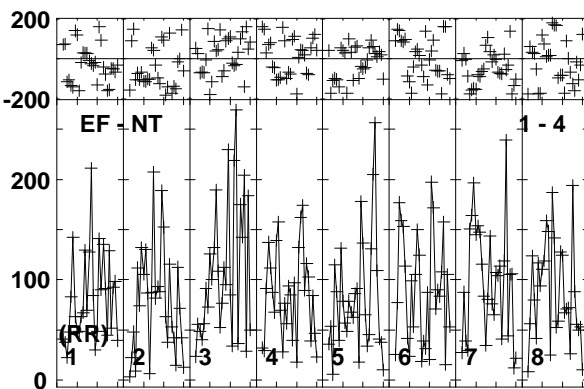
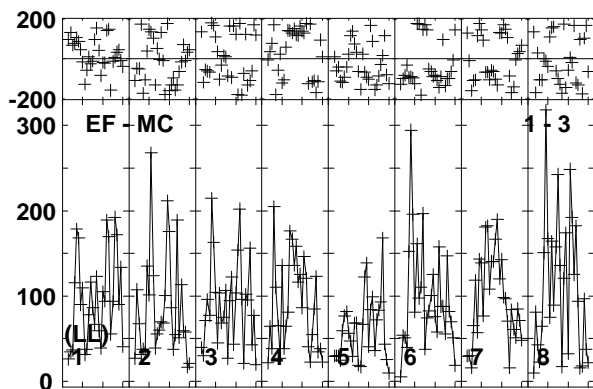
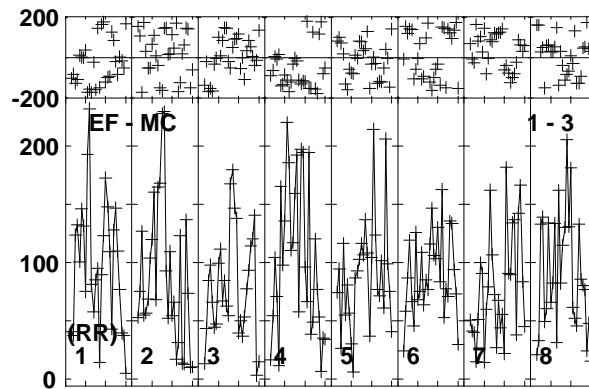
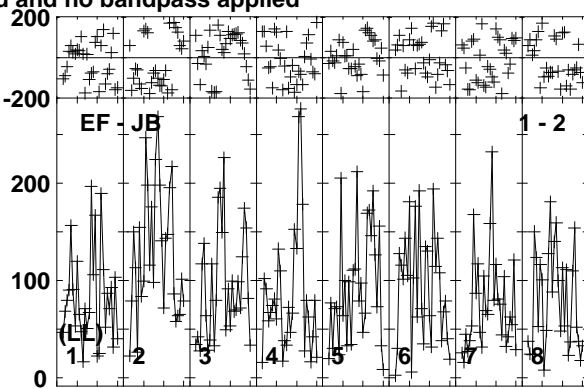
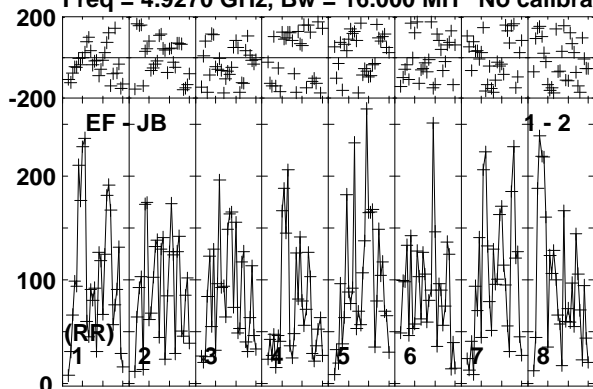

Lower frame: Micro Ampl Jy Top frame: Phas deg  
Vector averaged cross-power spectrum Baseline: EF (01) - JB (02)  
Timerange: 00/15:18:41 to 00/15:21:40

Plot file version 174 created 10-JUN-2016 15:29:35

FRB150418 RG008C.UVDATA.1

Freq = 4.9270 GHz, Bw = 16.000 MH No calibration applied and no bandpass applied

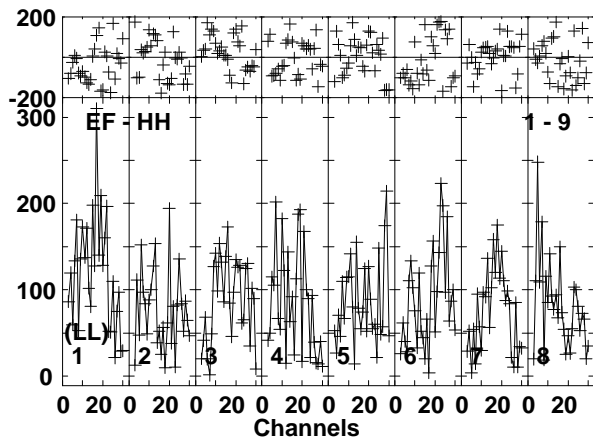
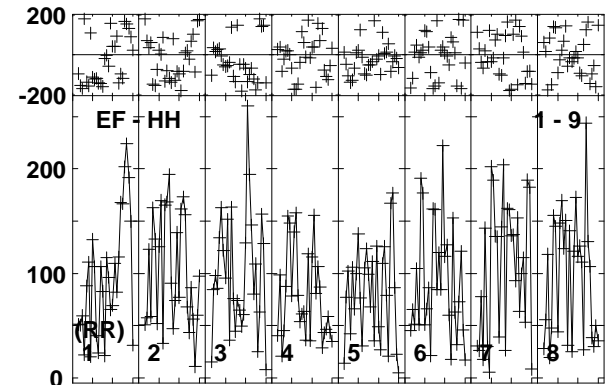
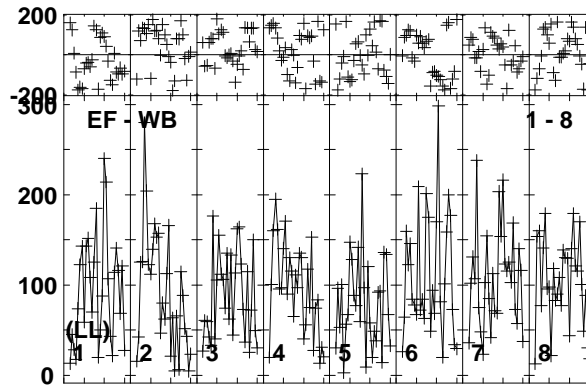
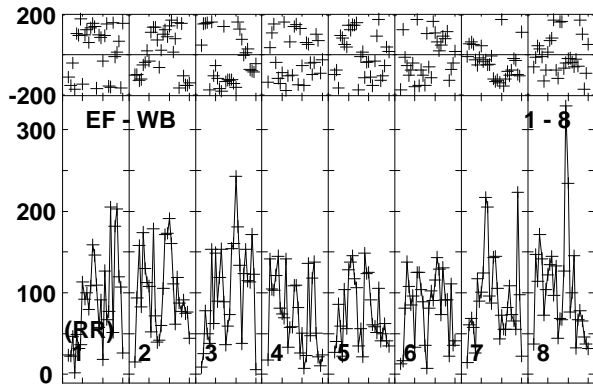
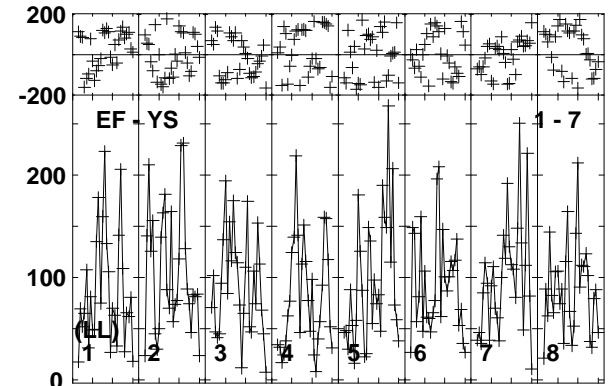
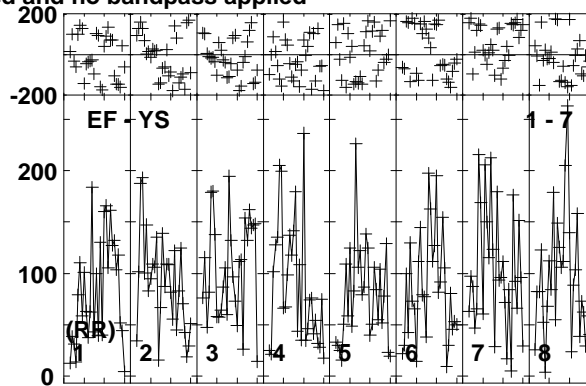
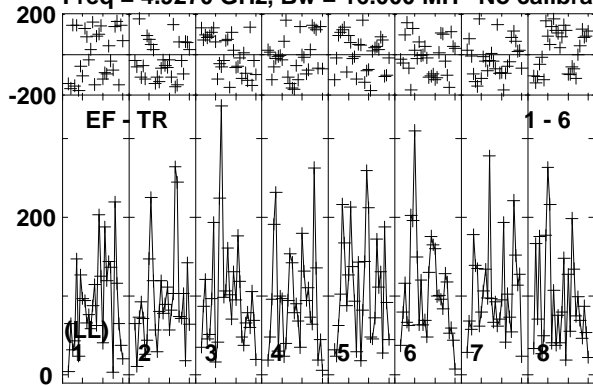

Lower frame: Micro Ampl Jy Top frame: Phas deg  
Vector averaged cross-power spectrum Baseline: EF (01) - TR (06)  
Timerange: 00/15:18:41 to 00/15:21:40

Plot file version 175 created 10-JUN-2016 15:29:35

J0718-1813 RG008C.UVDATA.1

Freq = 4.9270 GHz, Bw = 16.000 MH No calibration applied and no bandpass applied

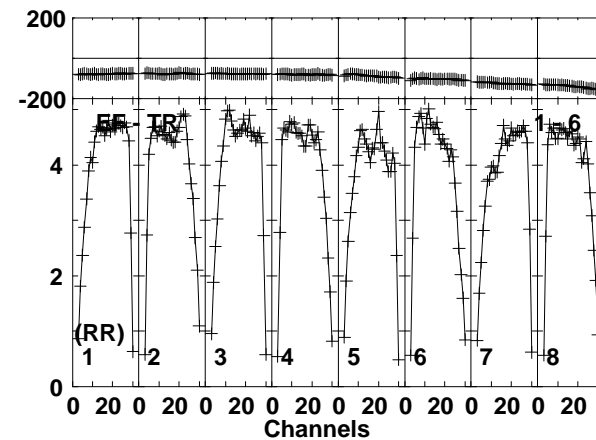
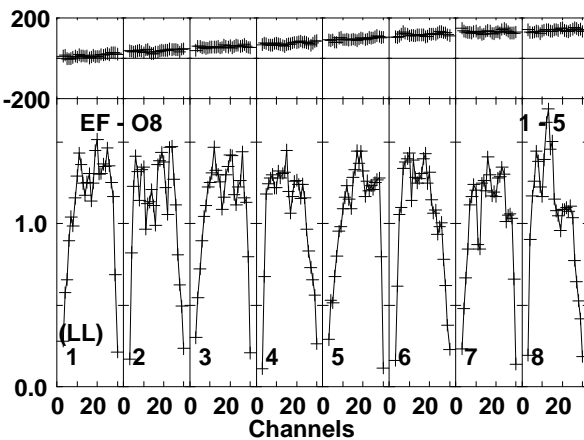
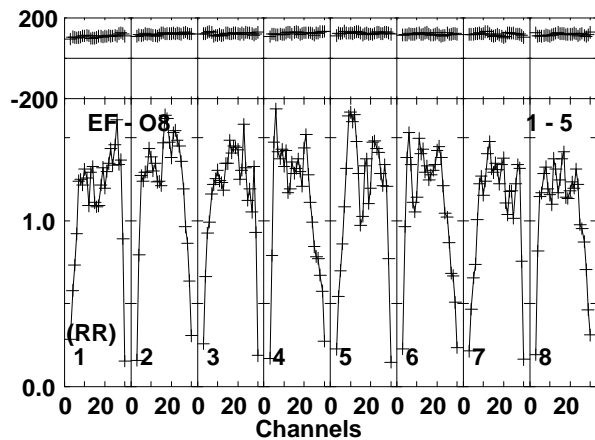
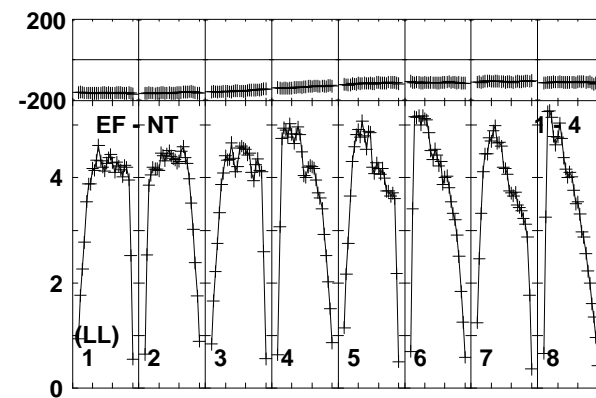
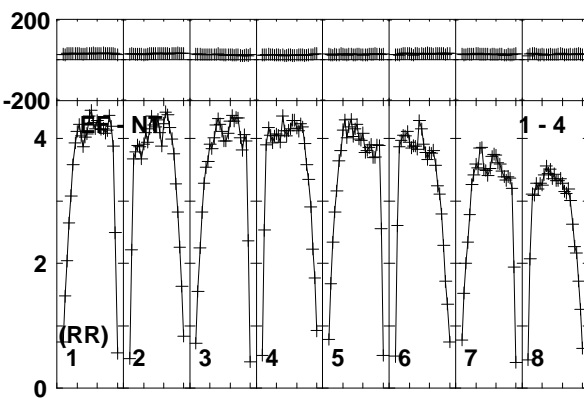
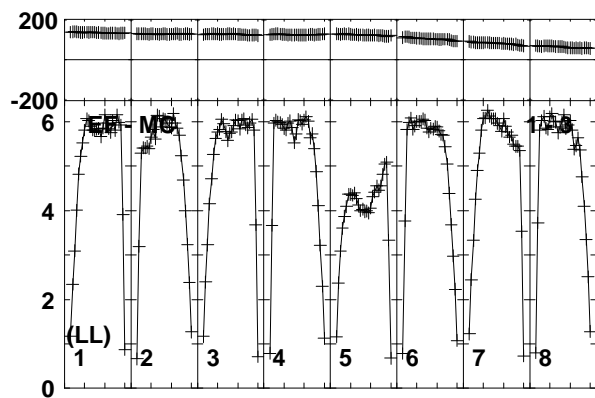
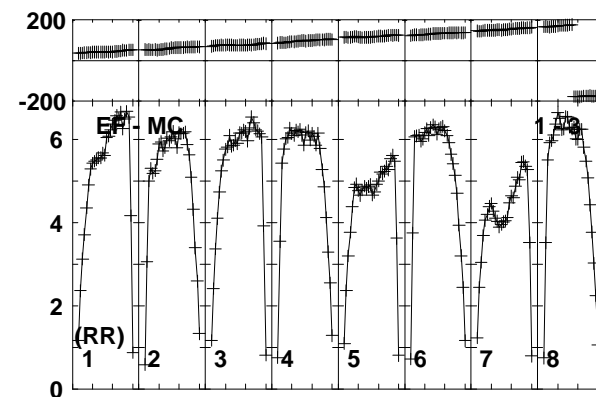
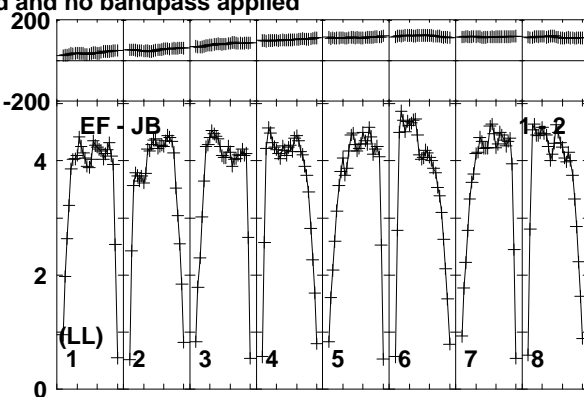
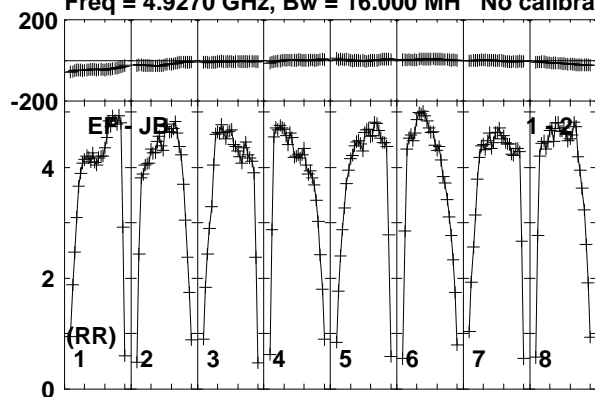

Lower frame: Milli Ampl Jy Top frame: Phas deg  
Vector averaged cross-power spectrum Baseline: EF (01) - JB (02)  
Timerange: 00/15:21:40 to 00/15:23:09

Plot file version 176 created 10-JUN-2016 15:29:35

J0718-1813 RG008C.UVDATA.1

Freq = 4.9270 GHz, Bw = 16.000 MH No calibration applied and no bandpass applied

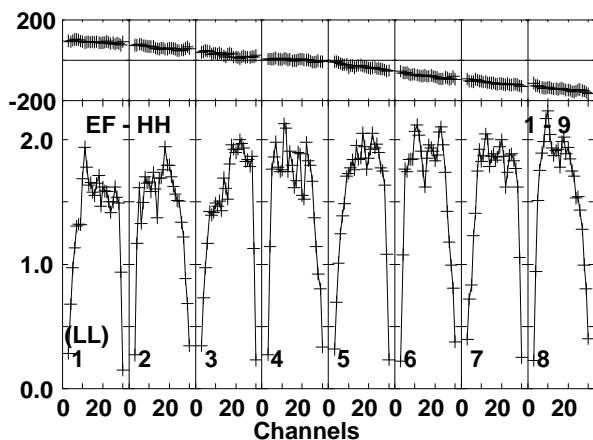
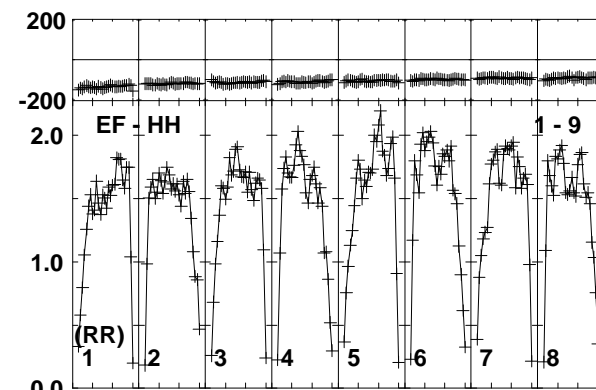
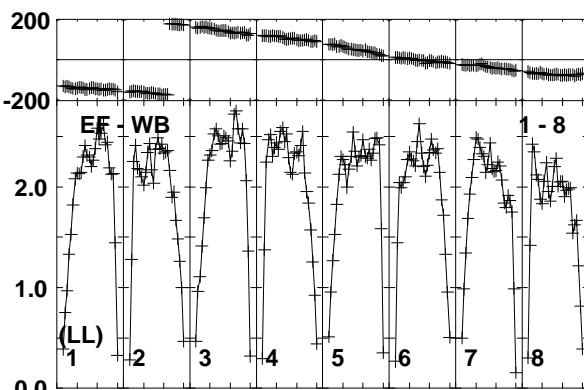
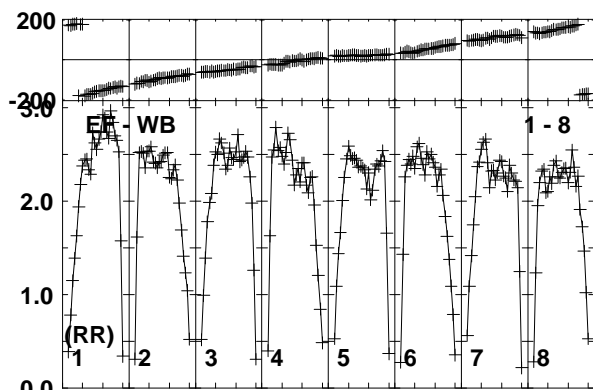
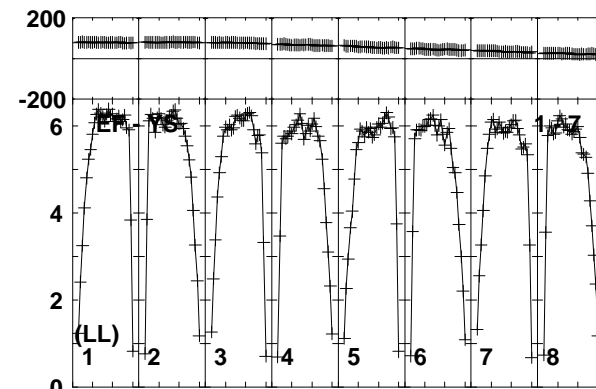
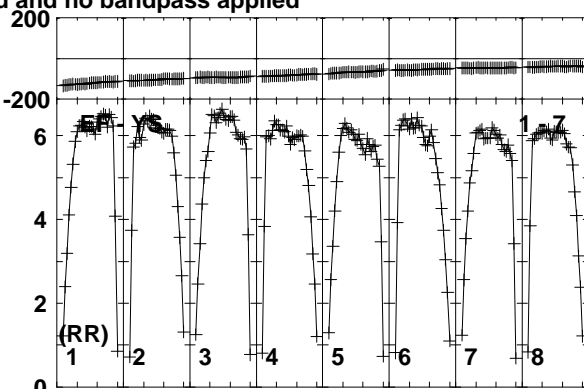
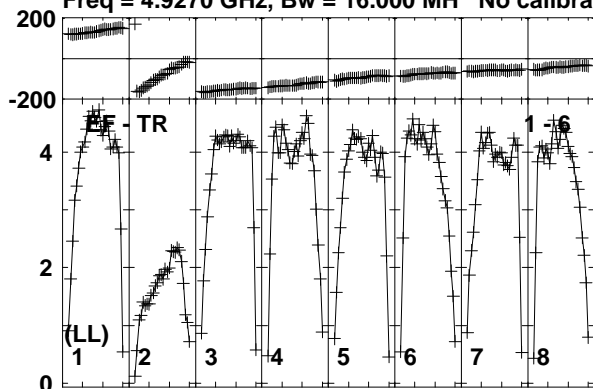

Lower frame: Milli Ampl Jy Top frame: Phas deg  
Vector averaged cross-power spectrum Baseline: EF (01) - TR (06)  
Timerange: 00/15:21:40 to 00/15:23:09



Plot file version 177 created 10-JUN-2016 15:29:35

J0712-1847 RG008C.UVDATA.1

Freq = 4.9270 GHz, Bw = 16.000 MH No calibration applied and no bandpass applied

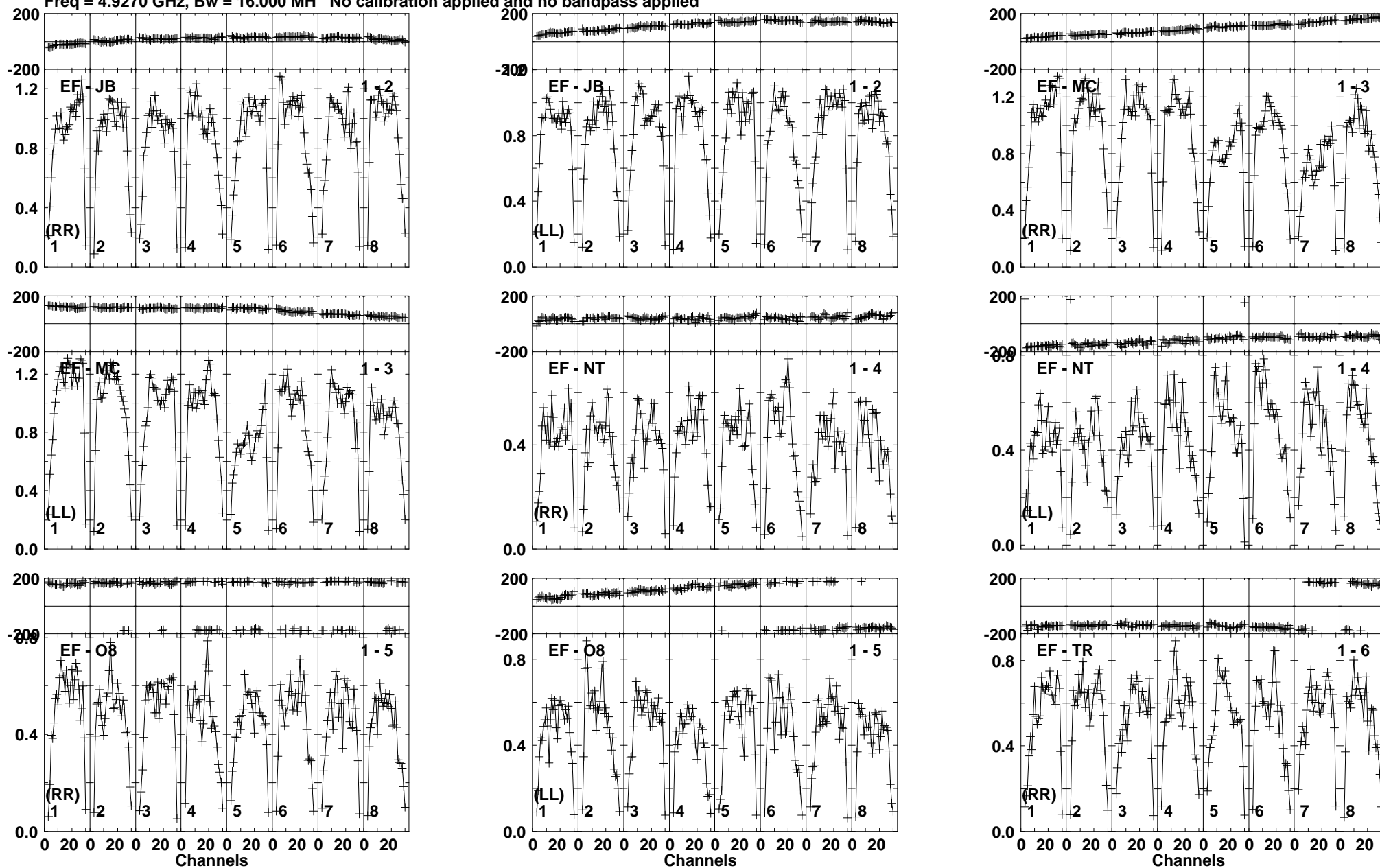

Lower frame: Milli Ampl Jy Top frame: Phas deg  
Vector averaged cross-power spectrum Baseline: EF (01) - JB (02)  
Timerange: 00/15:23:10 to 00/15:26:10

Plot file version 178 created 10-JUN-2016 15:29:35

J0712-1847 RG008C.UVDATA.1

Freq = 4.9270 GHz, Bw = 16.000 MH No calibration applied and no bandpass applied

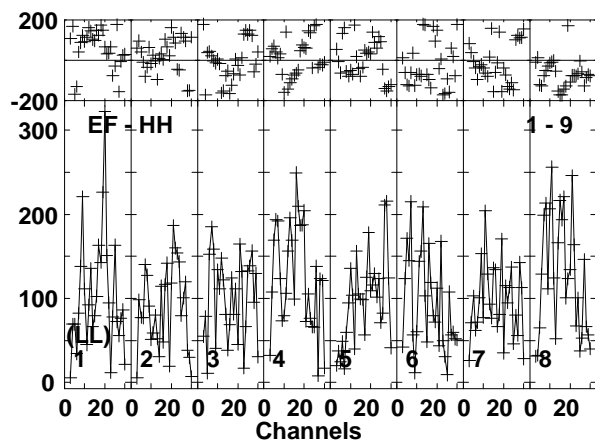
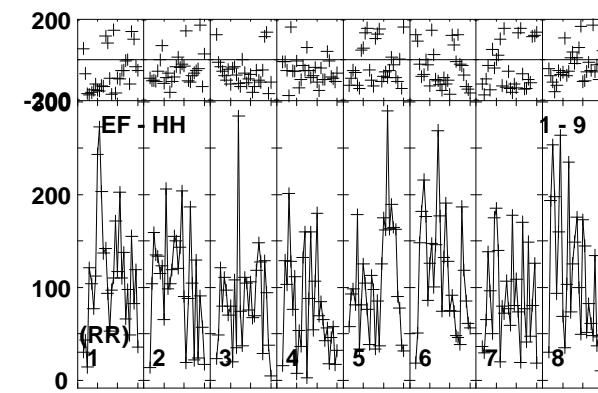
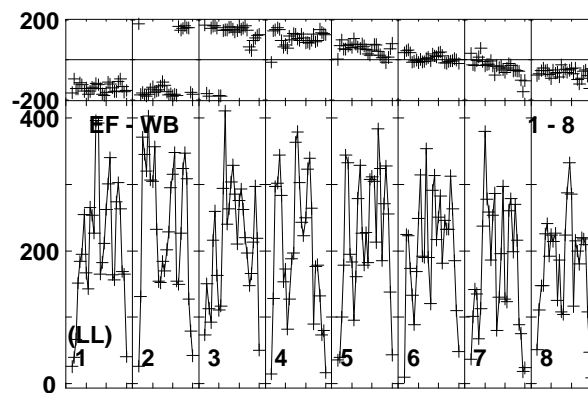
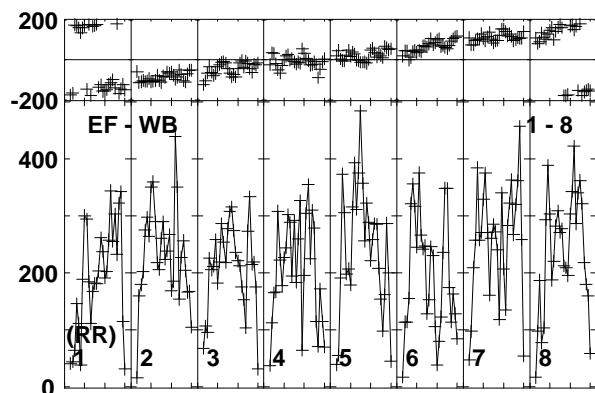
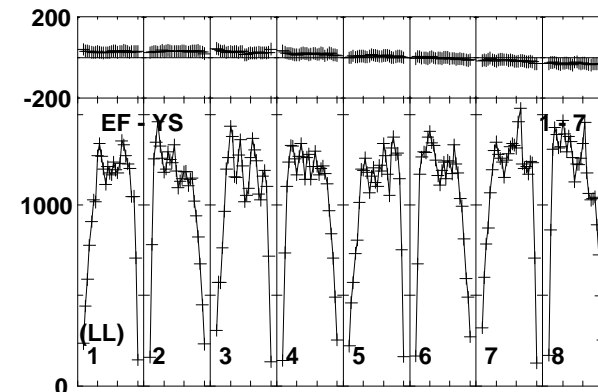
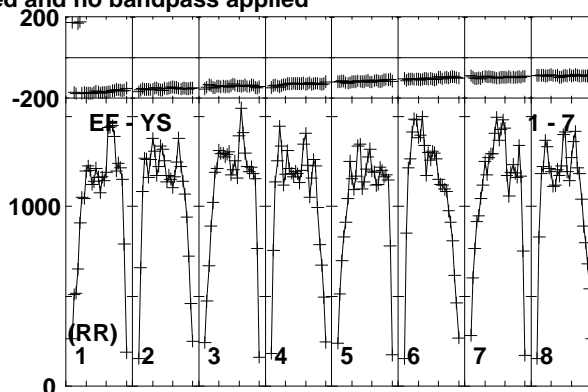
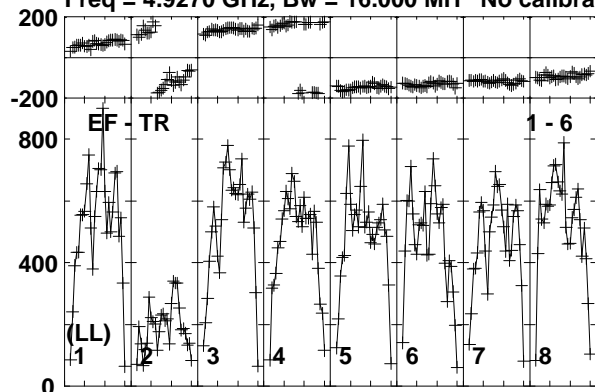

Lower frame: Micro Ampl Jy Top frame: Phas deg  
Vector averaged cross-power spectrum Baseline: EF (01) - TR (06)  
Timerange: 00/15:23:10 to 00/15:26:10

Plot file version 179 created 10-JUN-2016 15:29:35

J0718-1813 RG008C.UVDATA.1

Freq = 4.9270 GHz, Bw = 16.000 MH No calibration applied and no bandpass applied

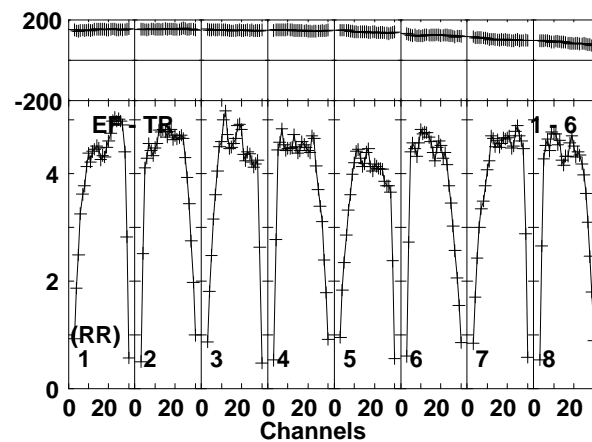
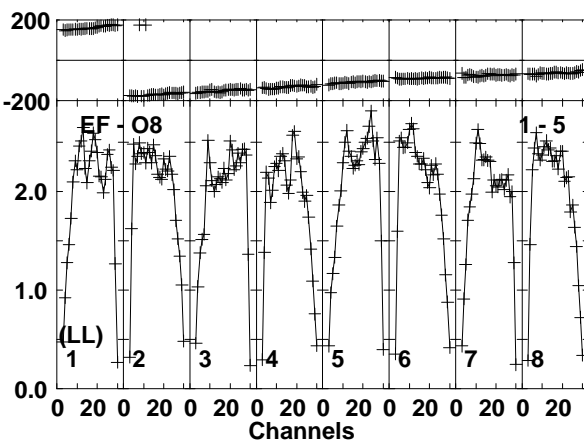
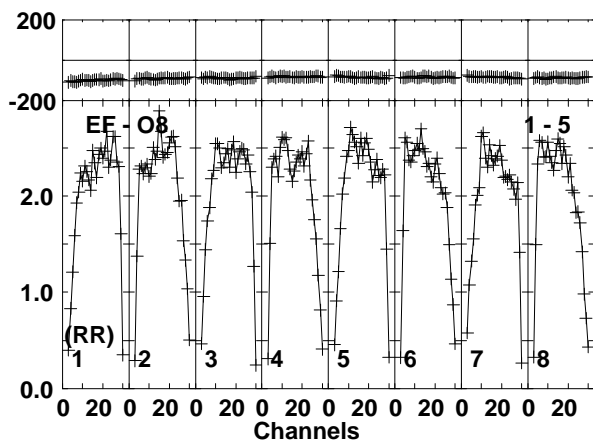
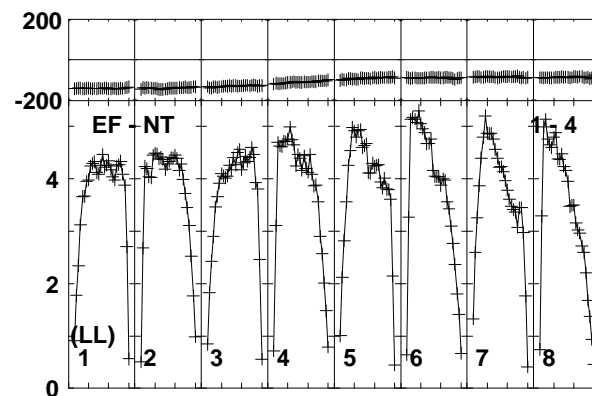
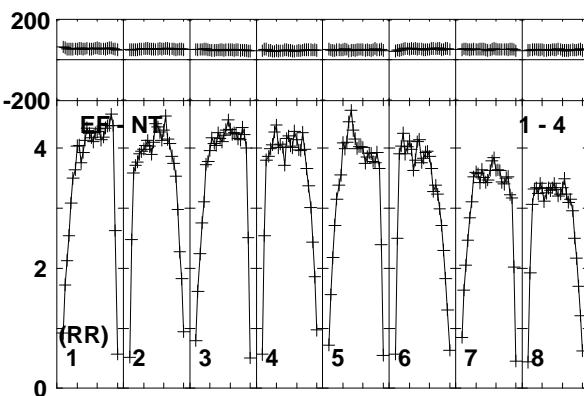
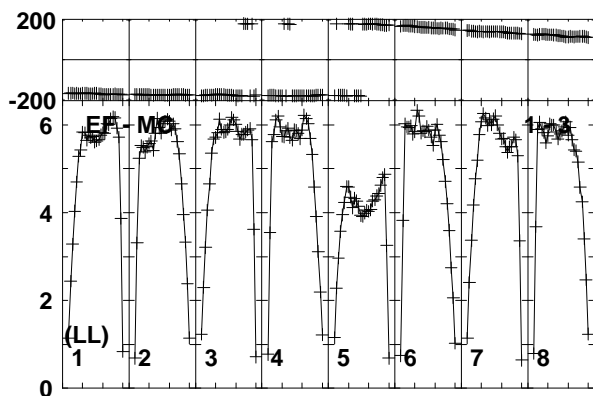
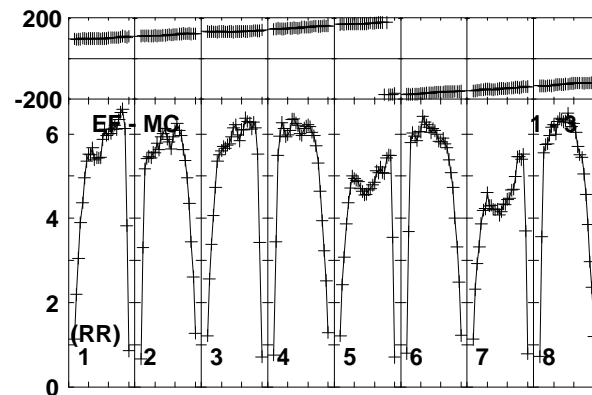
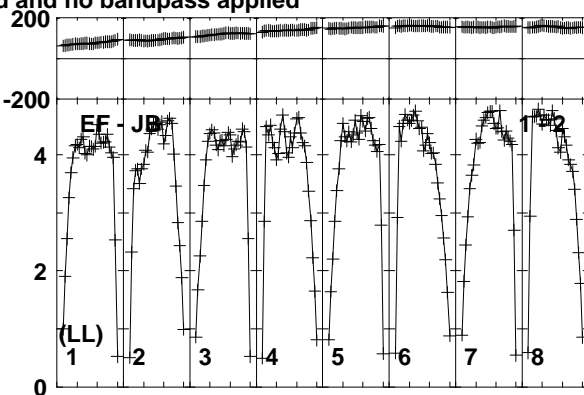
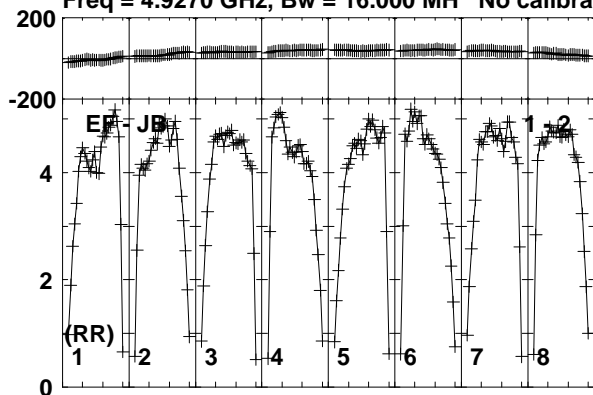

Lower frame: Milli Ampl Jy Top frame: Phas deg  
Vector averaged cross-power spectrum Baseline: EF (01) - JB (02)  
Timerange: 00/15:26:50 to 00/15:27:40

Plot file version 180 created 10-JUN-2016 15:29:36

J0718-1813 RG008C.UVDATA.1

Freq = 4.9270 GHz, Bw = 16.000 MH No calibration applied and no bandpass applied

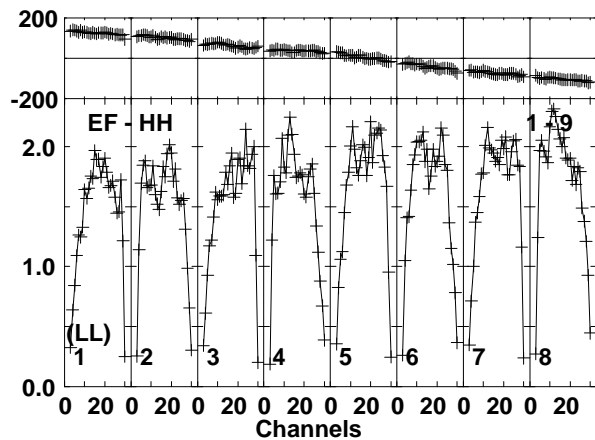
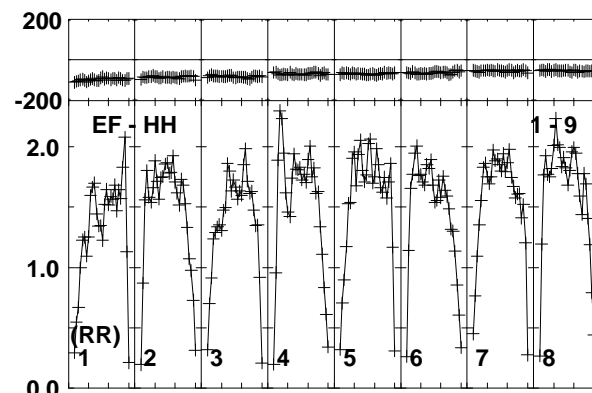
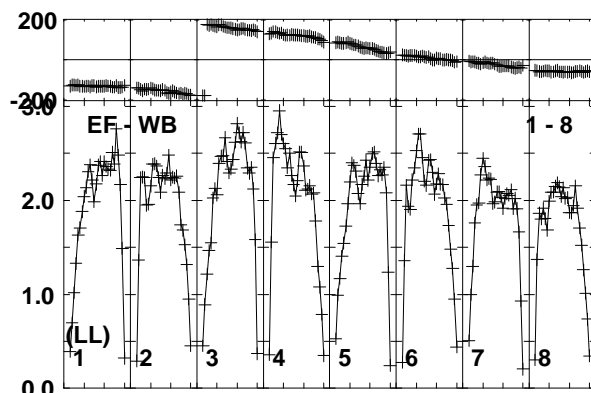
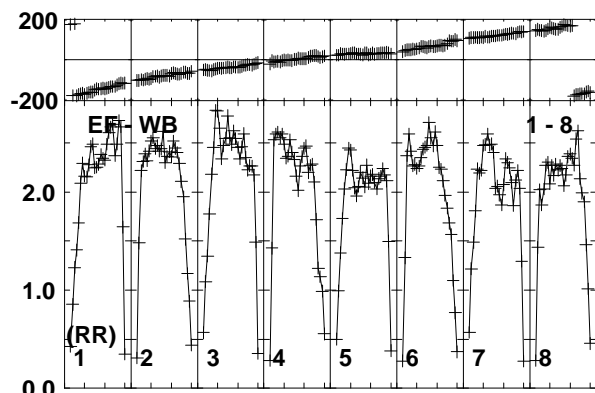
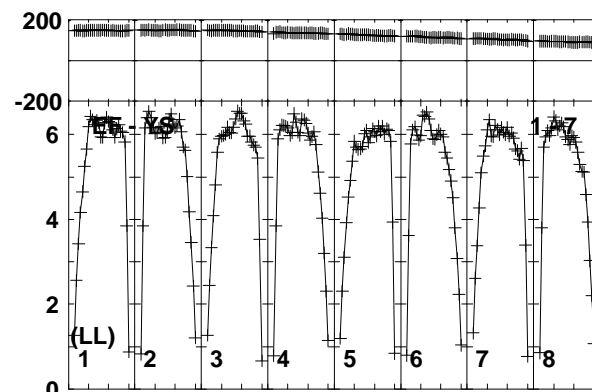
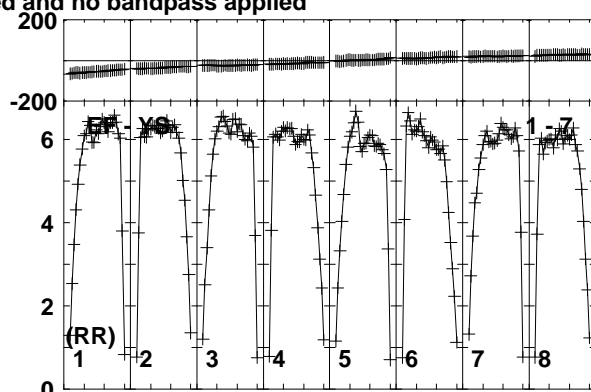
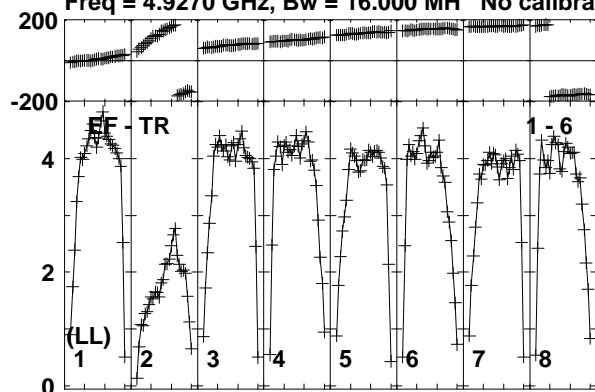

Lower frame: Milli Ampl Jy Top frame: Phas deg  
Vector averaged cross-power spectrum Baseline: EF (01) - TR (06)  
Timerange: 00/15:26:50 to 00/15:27:40

Plot file version 181 created 10-JUN-2016 15:29:36

FRB150418 RG008C.UVDATA.1

Freq = 4.9270 GHz, Bw = 16.000 MH No calibration applied and no bandpass applied

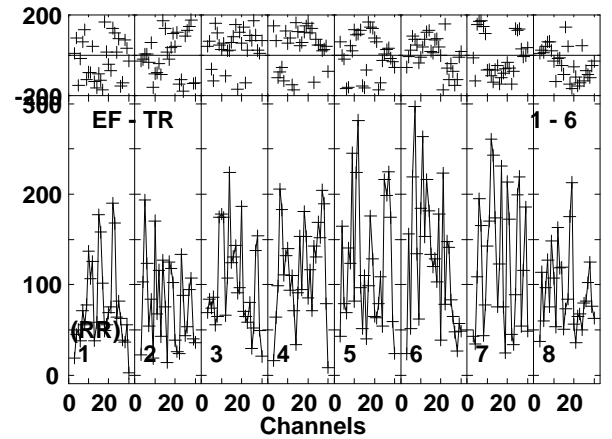
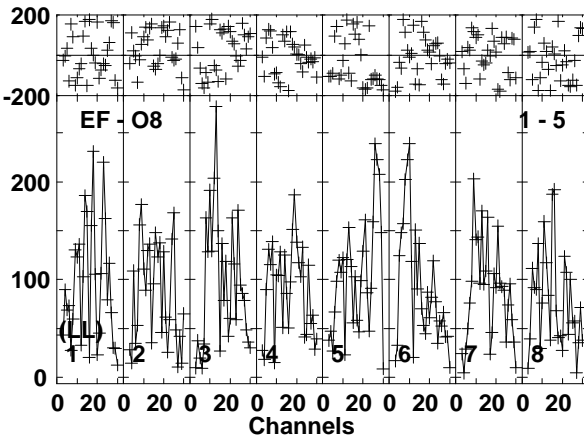
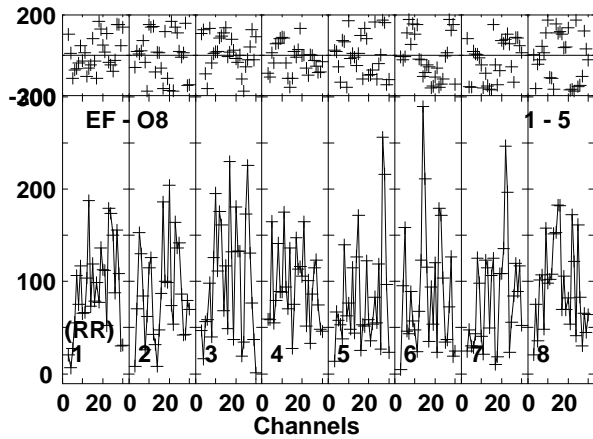
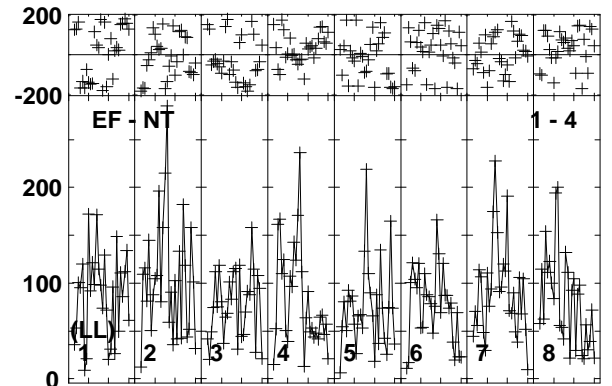
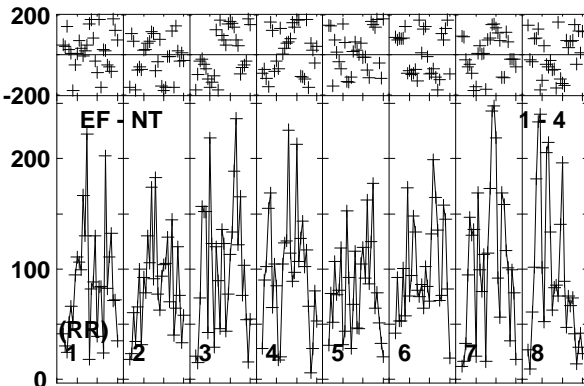
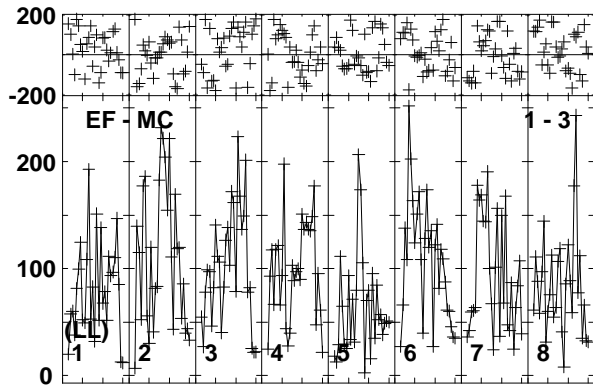
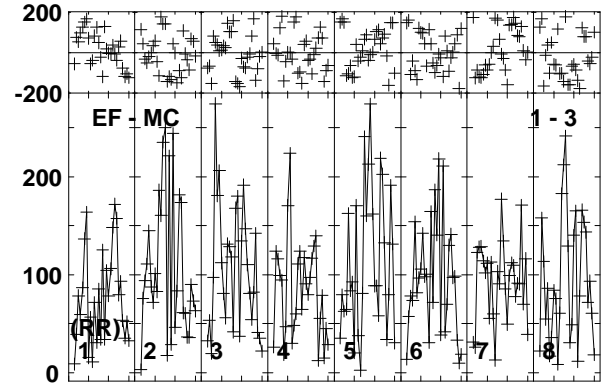
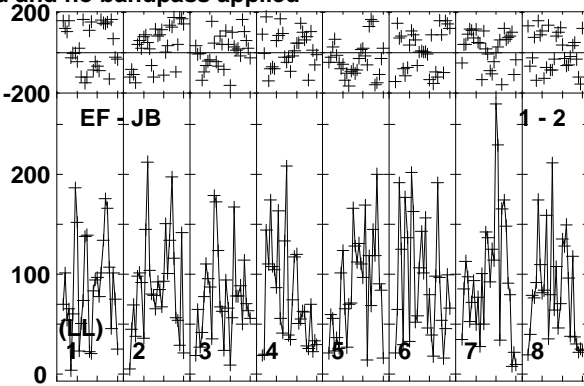
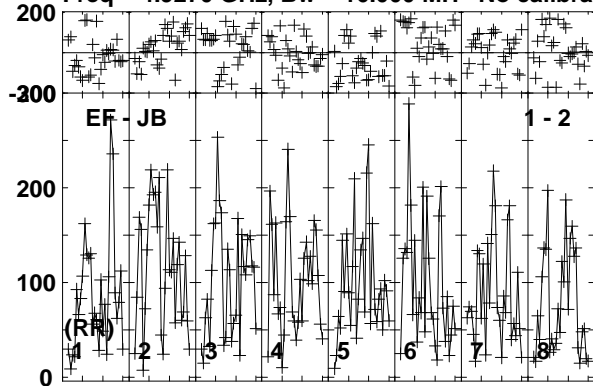

Lower frame: Micro Ampl Jy Top frame: Phas deg  
Vector averaged cross-power spectrum Baseline: EF (01) - JB (02)  
Timerange: 00/15:27:41 to 00/15:30:39

Plot file version 182 created 10-JUN-2016 15:29:36

FRB150418 RG008C.UVDATA.1

Freq = 4.9270 GHz, Bw = 16.000 MH No calibration applied and no bandpass applied

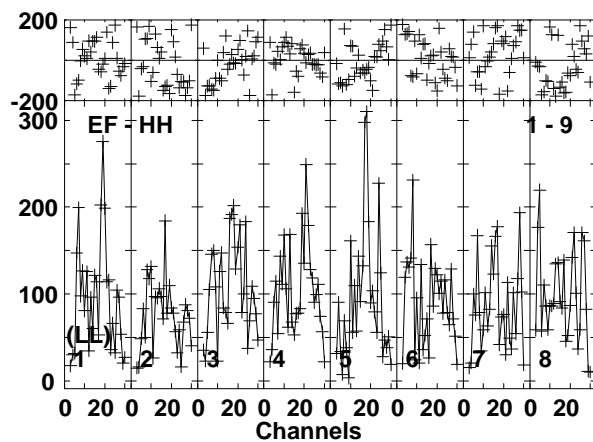
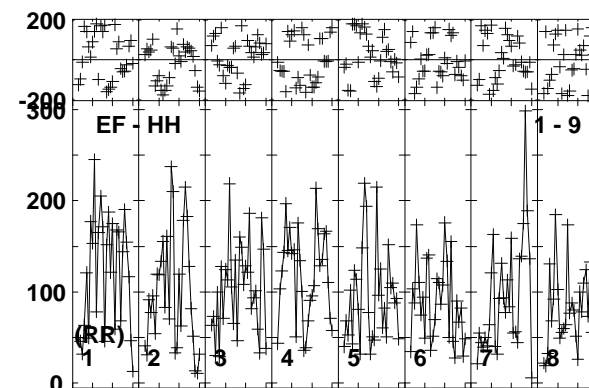
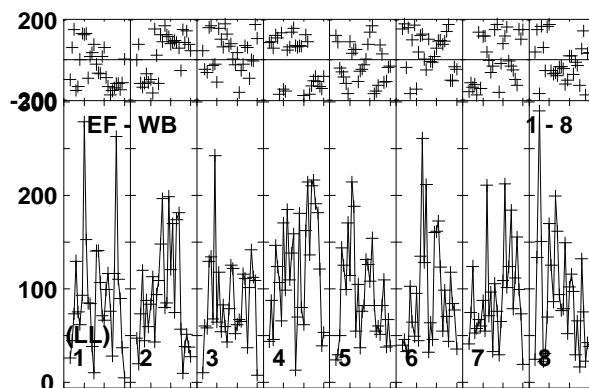
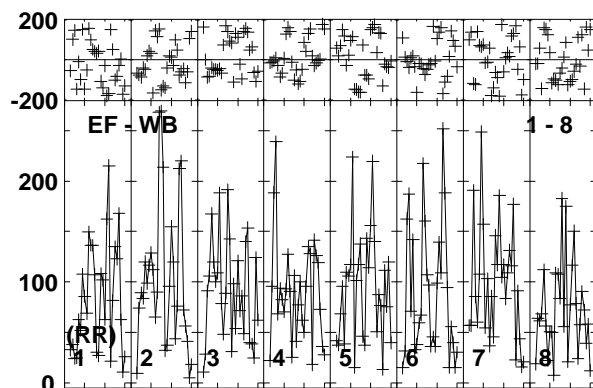
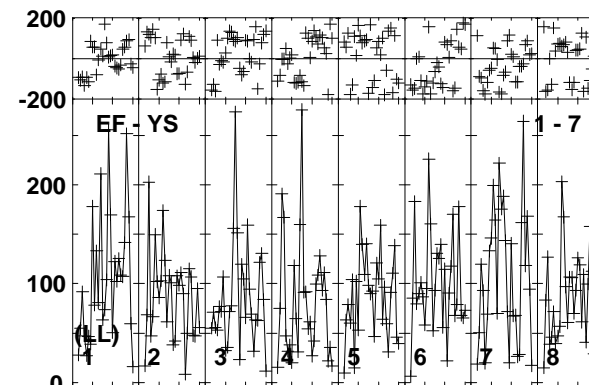
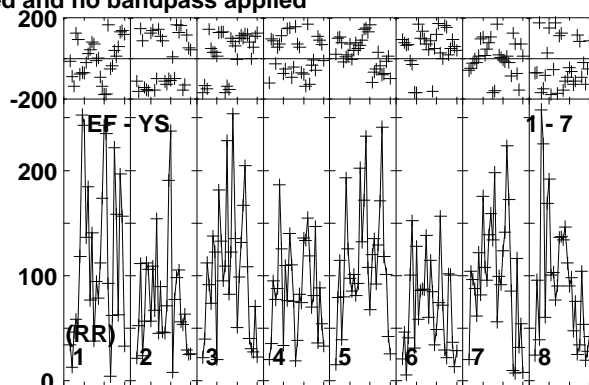
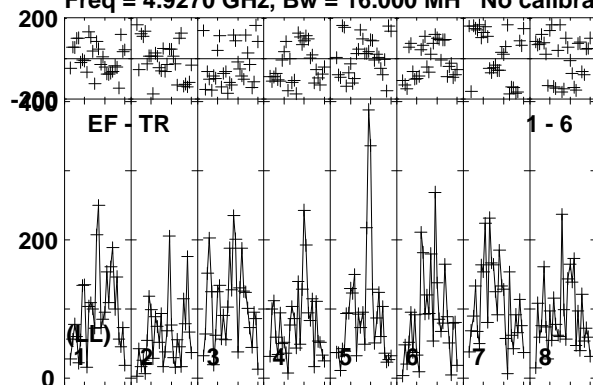

Lower frame: Micro Ampl Jy Top frame: Phas deg  
Vector averaged cross-power spectrum Baseline: EF (01) - TR (06)  
Timerange: 00/15:27:41 to 00/15:30:39

Plot file version 183 created 10-JUN-2016 15:29:36

J0718-1813 RG008C.UVDATA.1

Freq = 4.9270 GHz, Bw = 16.000 MH No calibration applied and no bandpass applied

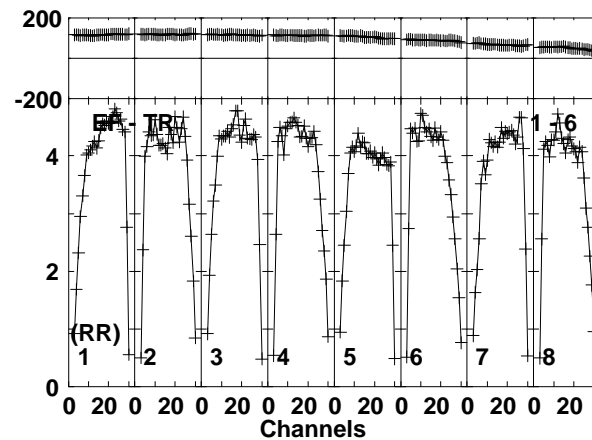
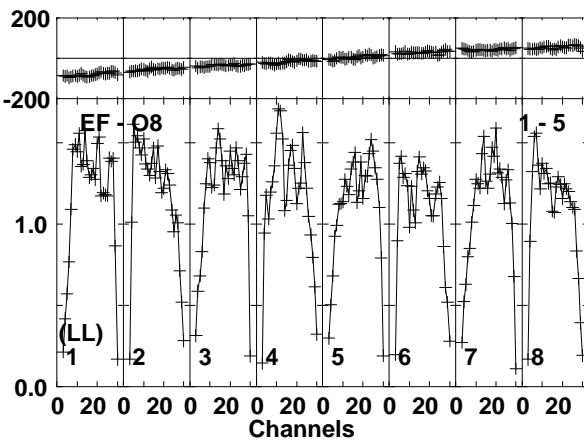
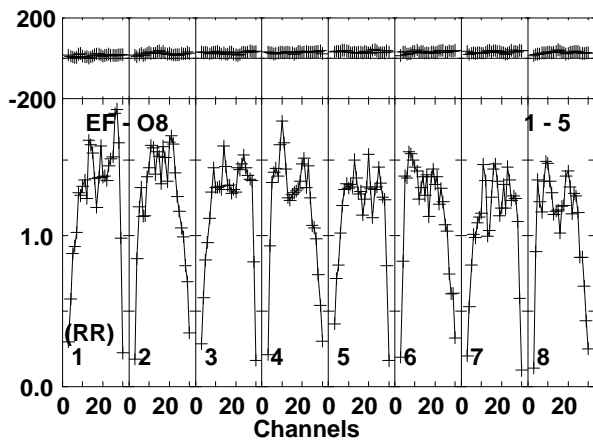
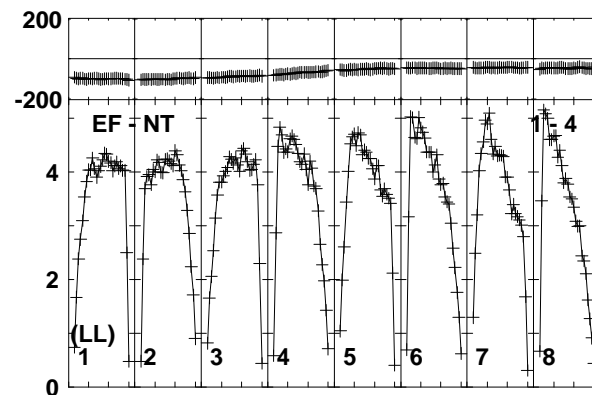
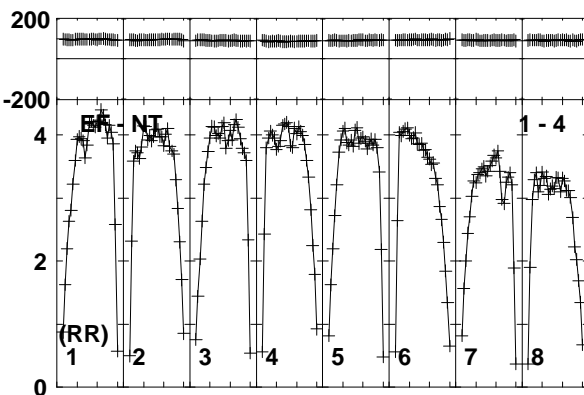
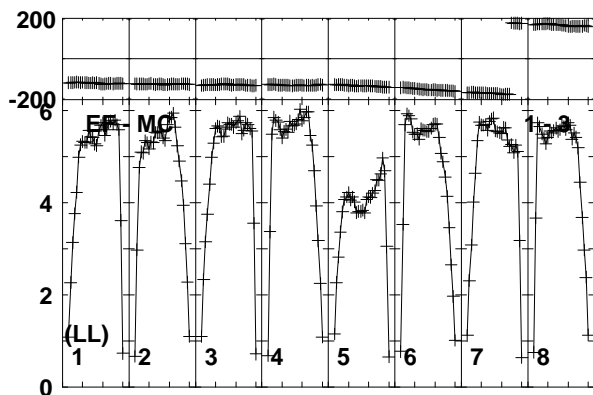
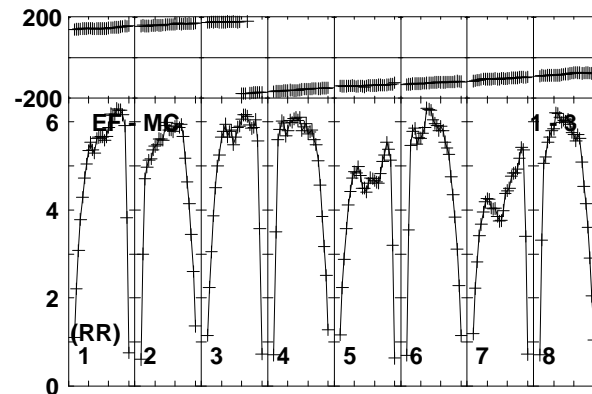
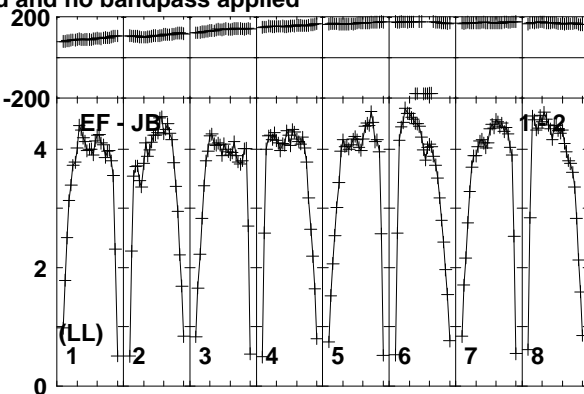
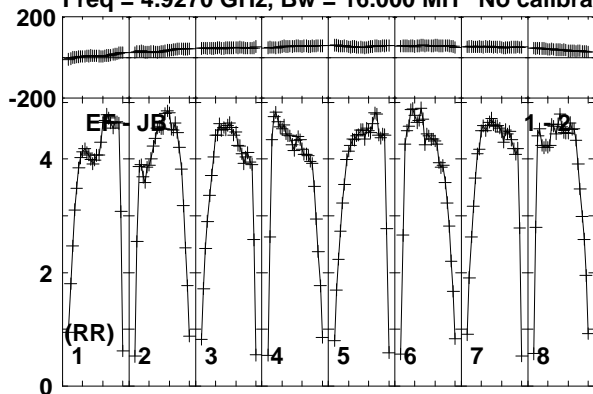

Lower frame: Milli Ampl Jy Top frame: Phas deg  
Vector averaged cross-power spectrum Baseline: EF (01) - JB (02)  
Timerange: 00/15:30:41 to 00/15:32:10

Plot file version 184 created 10-JUN-2016 15:29:36

J0718-1813 RG008C.UVDATA.1

Freq = 4.9270 GHz, Bw = 16.000 MH No calibration applied and no bandpass applied

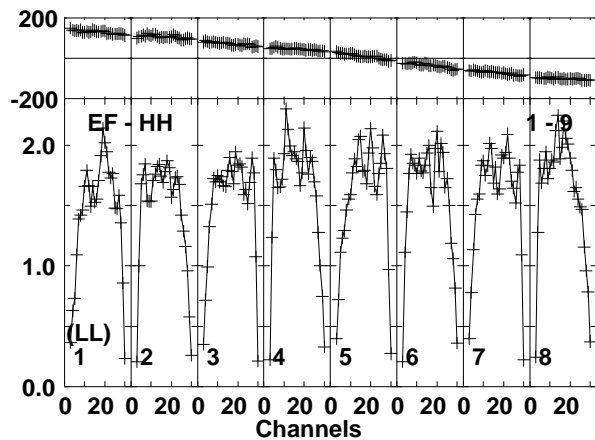
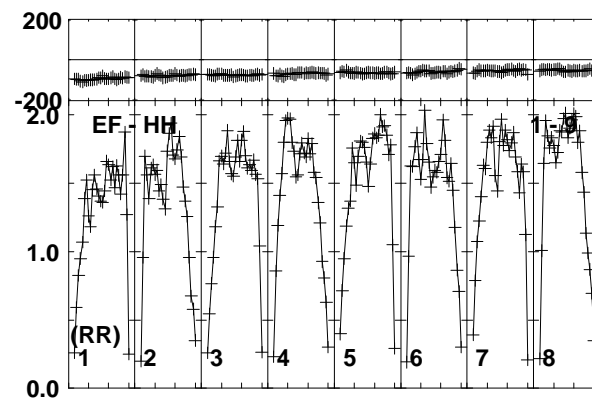
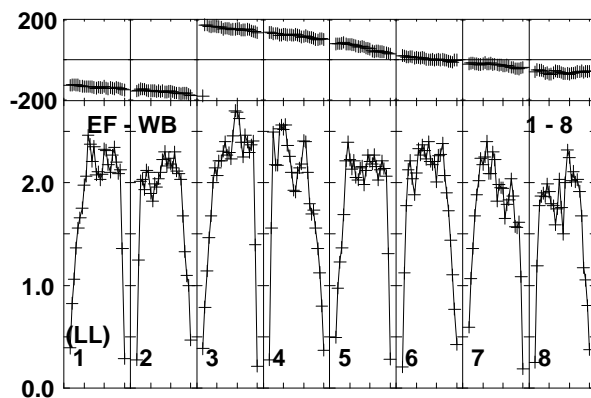
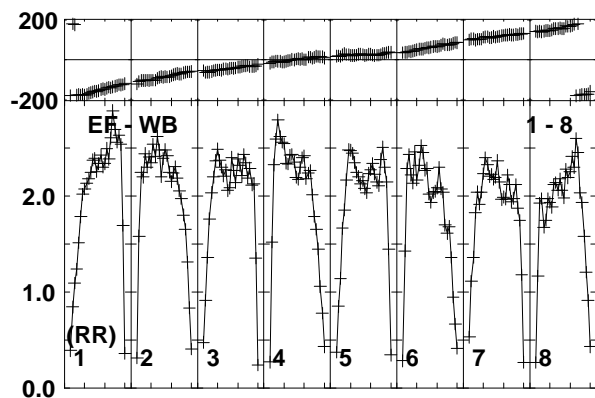
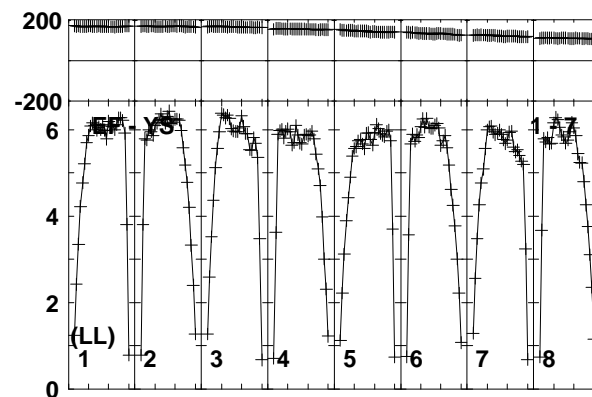
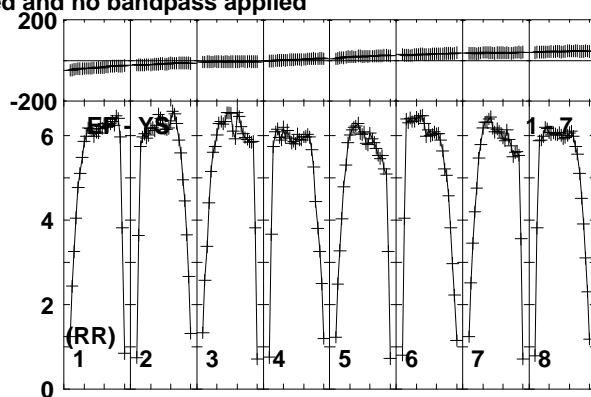
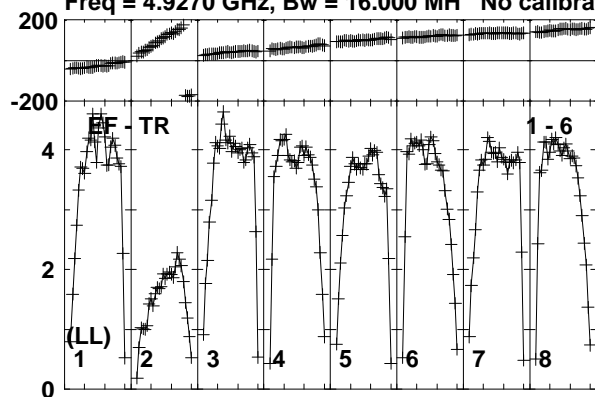

Lower frame: Milli Ampl Jy Top frame: Phas deg  
Vector averaged cross-power spectrum Baseline: EF (01) - TR (06)  
Timerange: 00/15:30:41 to 00/15:32:10



Plot file version 185 created 10-JUN-2016 15:29:36

FRB150418 RG008C.UVDATA.1

Freq = 4.9270 GHz, Bw = 16.000 MH No calibration applied and no bandpass applied

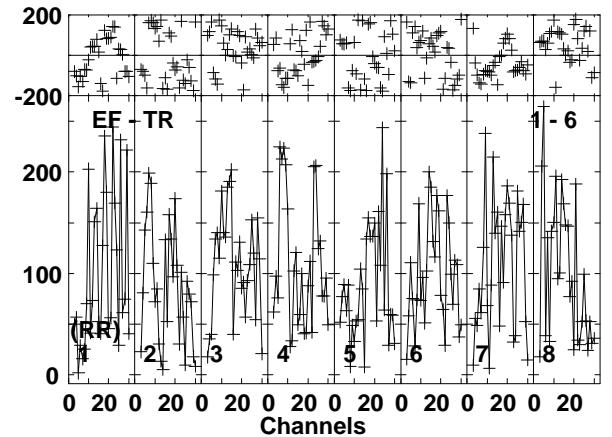
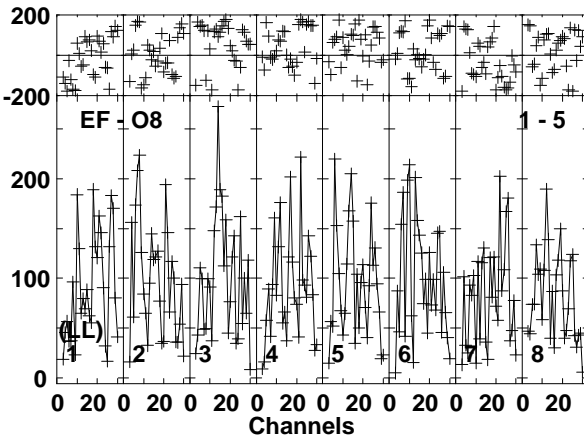
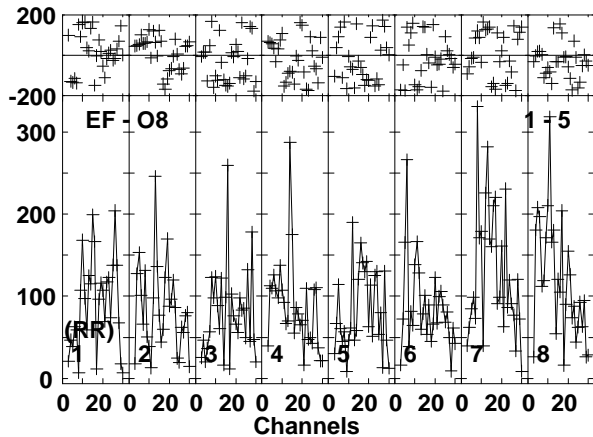
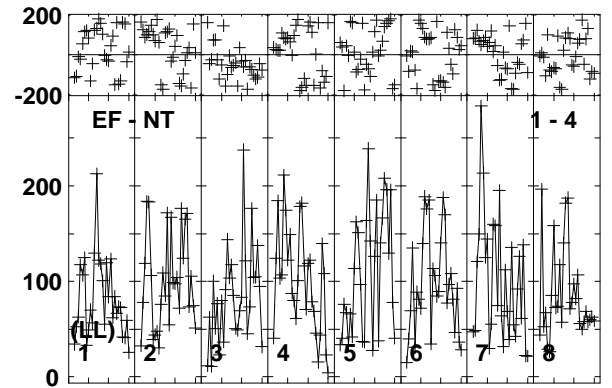
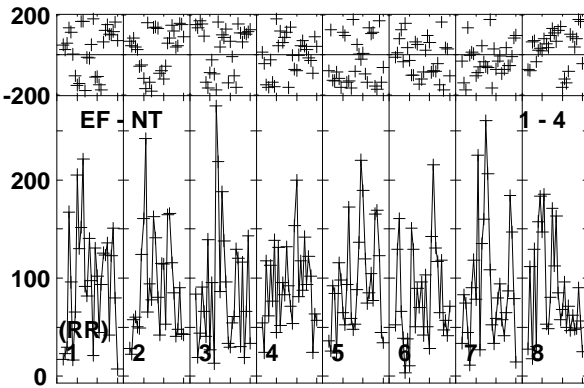
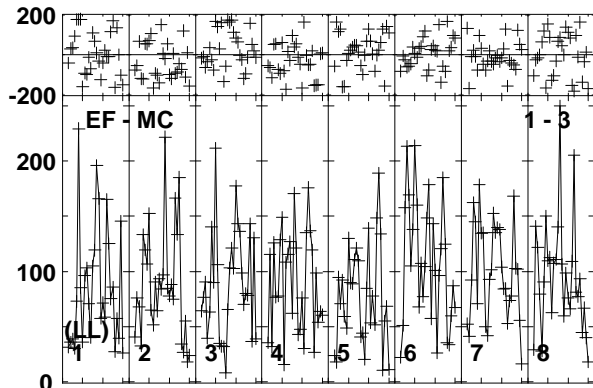
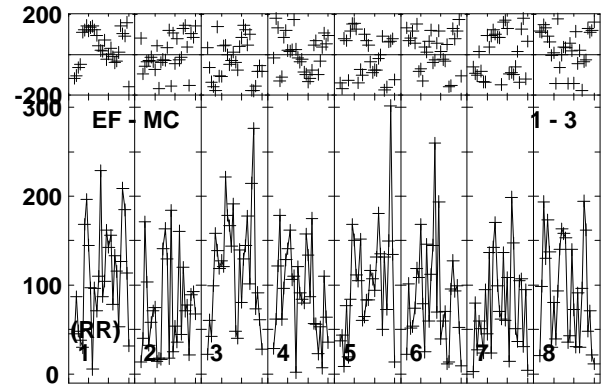
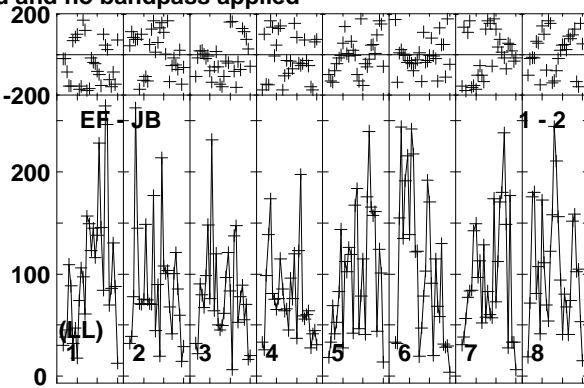
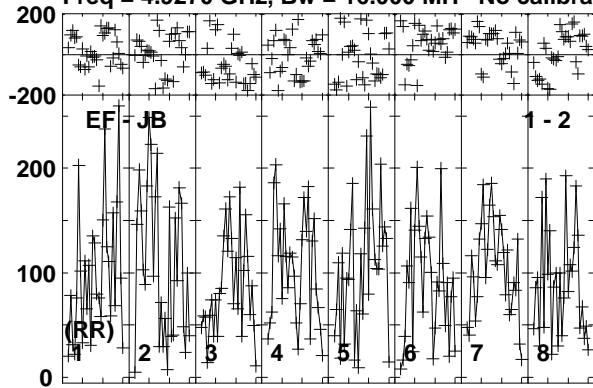

Lower frame: Micro Ampl Jy Top frame: Phas deg  
Vector averaged cross-power spectrum Baseline: EF (01) - JB (02)  
Timerange: 00/15:32:11 to 00/15:35:09

Plot file version 186 created 10-JUN-2016 15:29:36

FRB150418 RG008C.UVDATA.1

Freq = 4.9270 GHz, Bw = 16.000 MH No calibration applied and no bandpass applied

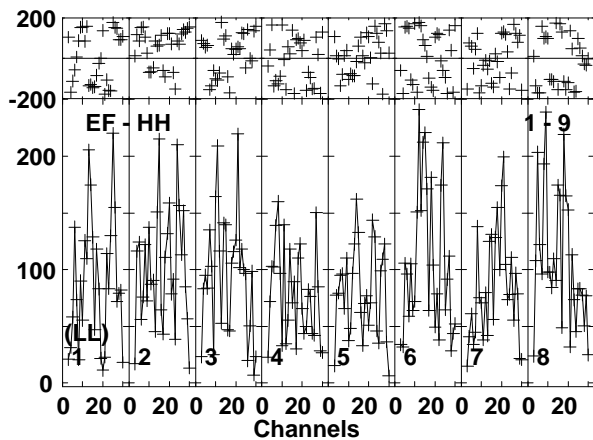
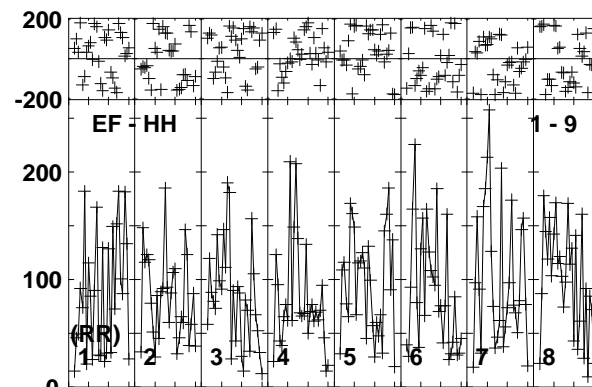
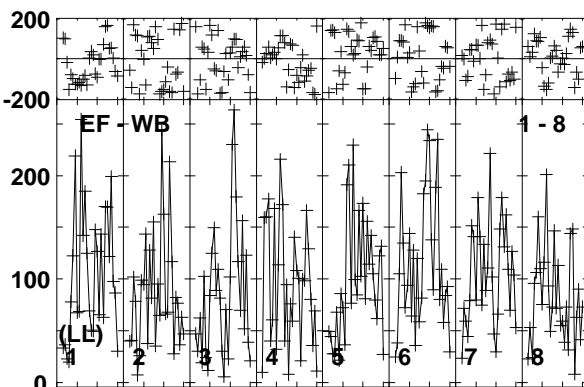
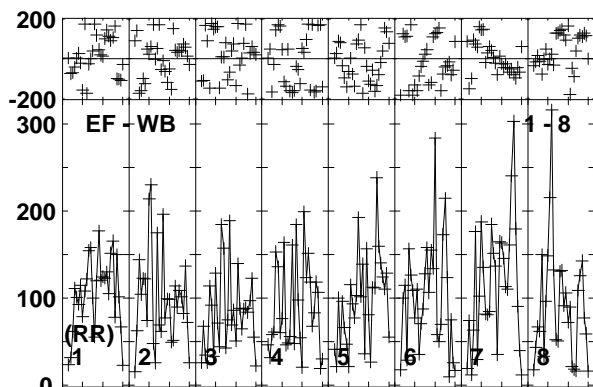
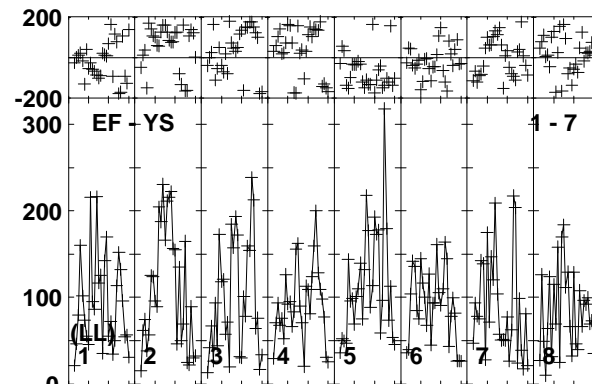
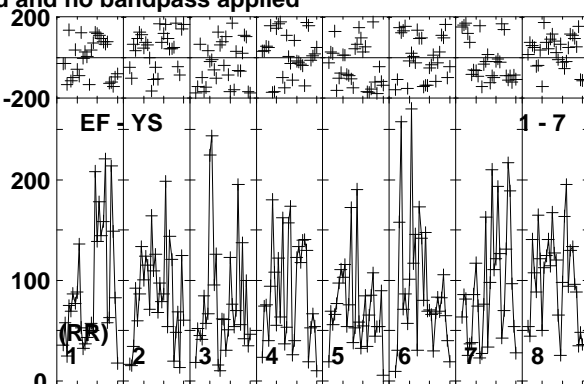
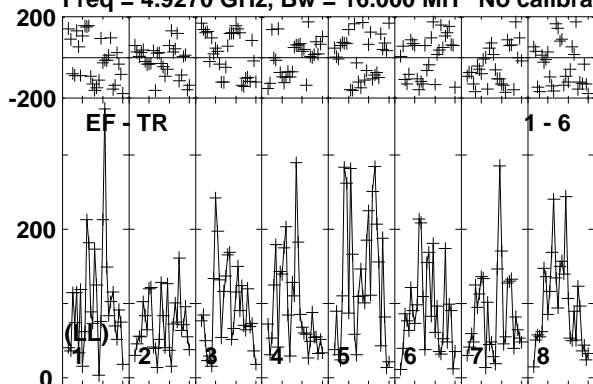

Lower frame: Micro Ampl Jy Top frame: Phas deg  
Vector averaged cross-power spectrum Baseline: EF (01) - TR (06)  
Timerange: 00/15:32:11 to 00/15:35:09

Plot file version 187 created 10-JUN-2016 15:29:36

J0718-1813 RG008C.UVDATA.1

Freq = 4.9270 GHz, Bw = 16.000 MH No calibration applied and no bandpass applied

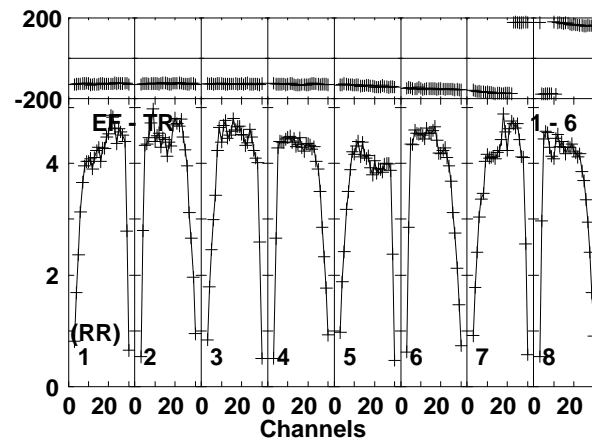
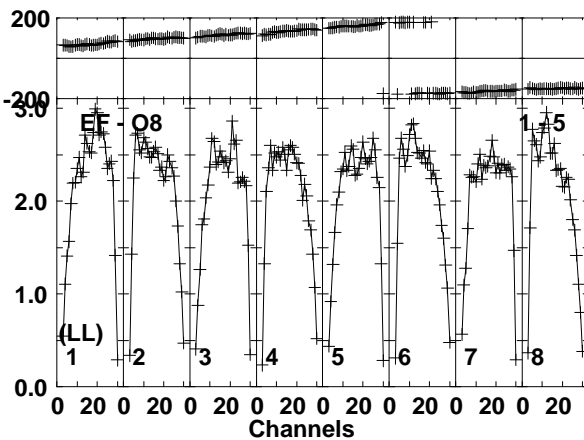
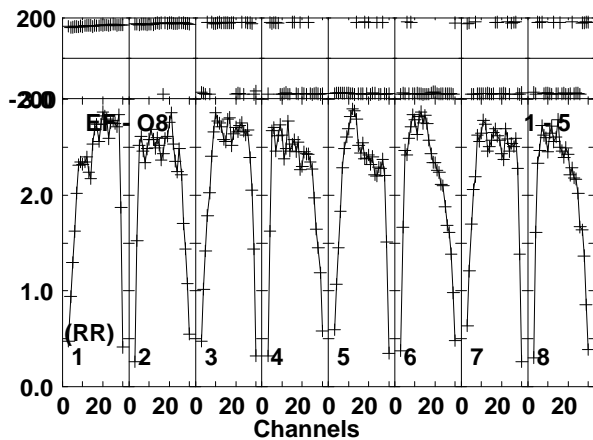
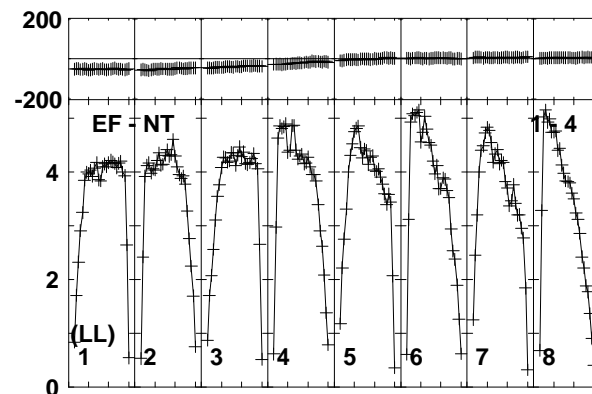
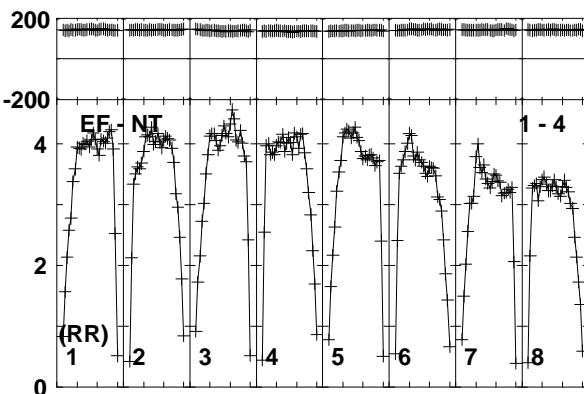
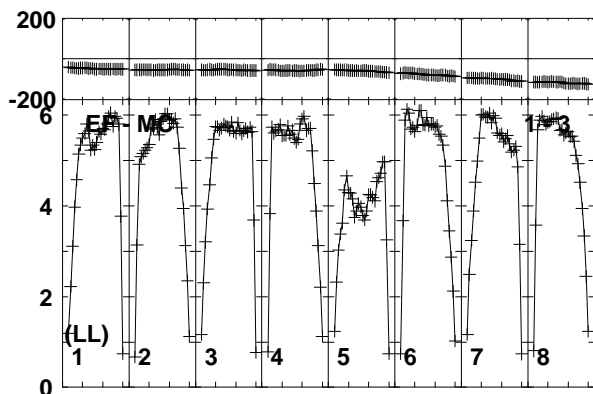
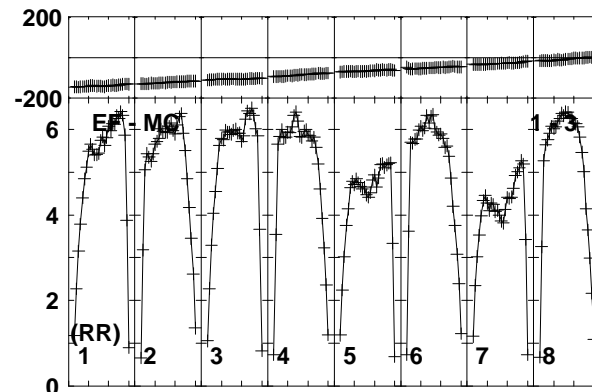
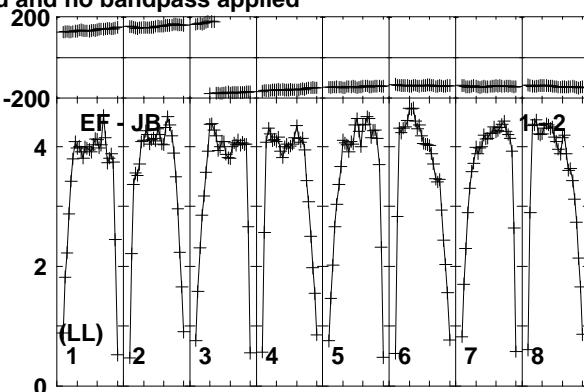
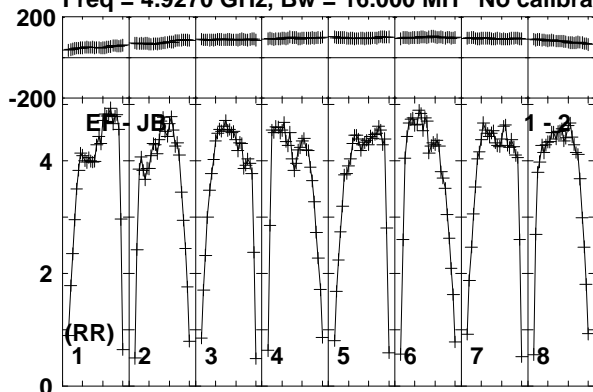

Lower frame: Milli Ampl Jy Top frame: Phas deg  
Vector averaged cross-power spectrum Baseline: EF (01) - JB (02)  
Timerange: 00/15:35:51 to 00/15:36:40

Plot file version 188 created 10-JUN-2016 15:29:36

J0718-1813 RG008C.UVDATA.1

Freq = 4.9270 GHz, Bw = 16.000 MH No calibration applied and no bandpass applied

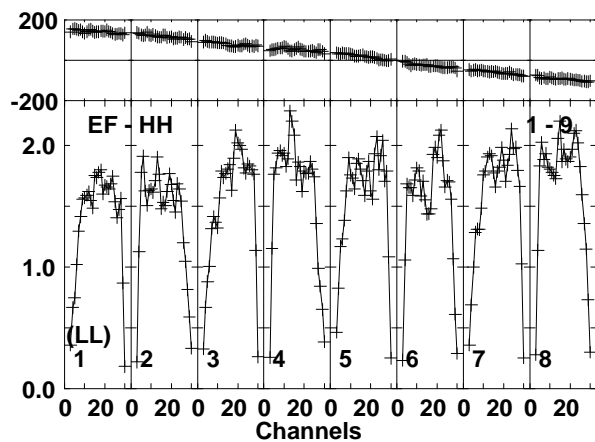
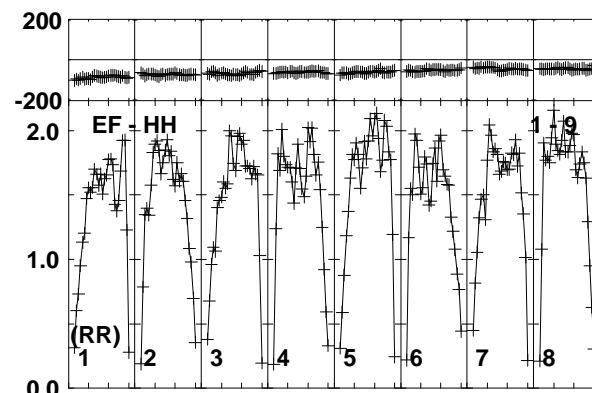
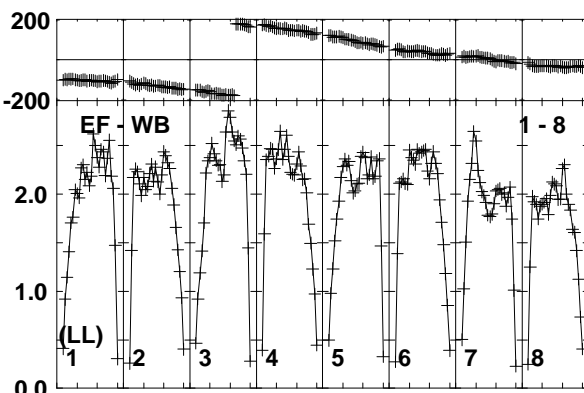
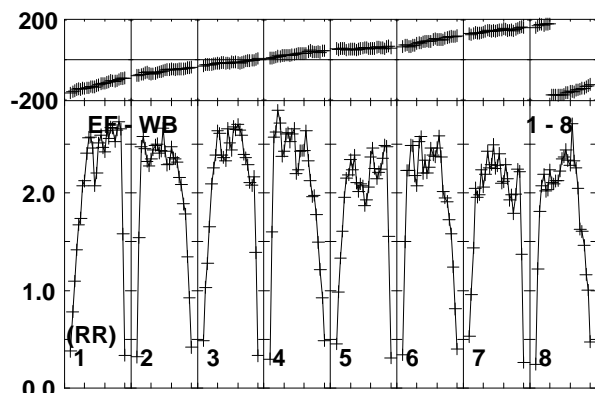
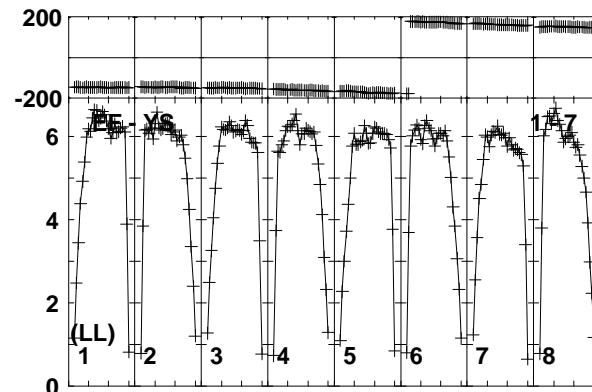
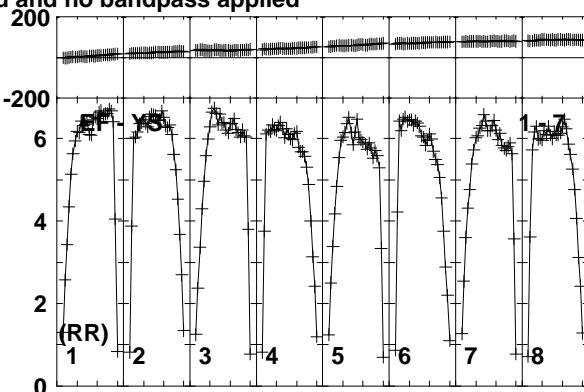
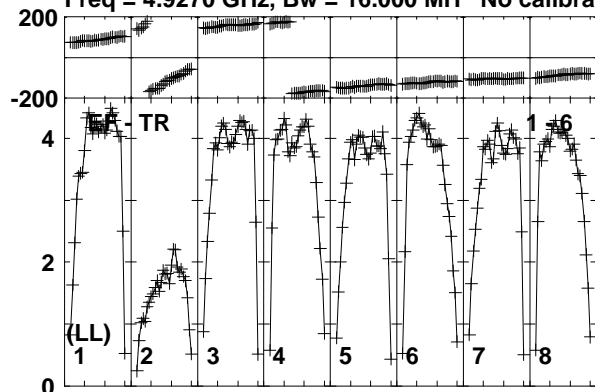

Lower frame: Milli Ampl Jy Top frame: Phas deg  
Vector averaged cross-power spectrum Baseline: EF (01) - TR (06)  
Timerange: 00/15:35:51 to 00/15:36:40

Plot file version 189 created 10-JUN-2016 15:29:37

FRB150418 RG008C.UVDATA.1

Freq = 4.9270 GHz, Bw = 16.000 MH No calibration applied and no bandpass applied

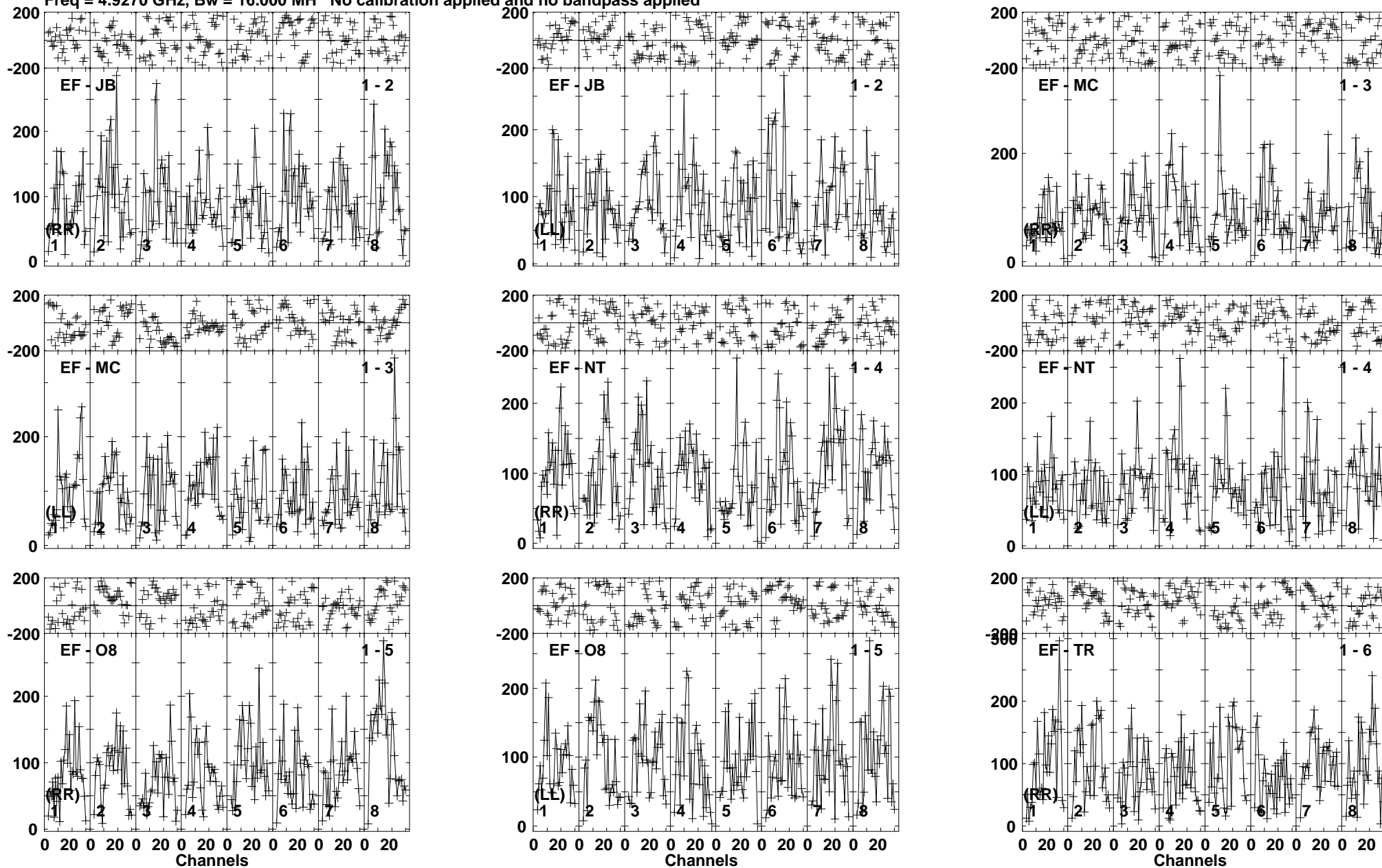

Lower frame: Micro Ampl Jy Top frame: Phas deg  
Vector averaged cross-power spectrum Baseline: EF (01) - JB (02)  
Timerange: 00/15:36:40 to 00/15:39:40

Plot file version 190 created 10-JUN-2016 15:29:37

FRB150418 RG008C.UVDATA.1

Freq = 4.9270 GHz, Bw = 16.000 MH No calibration applied and no bandpass applied

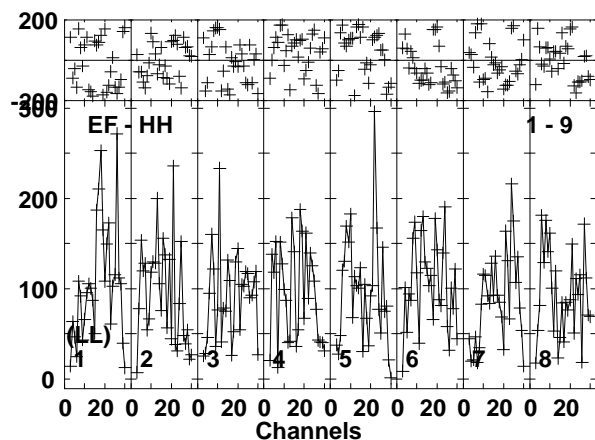
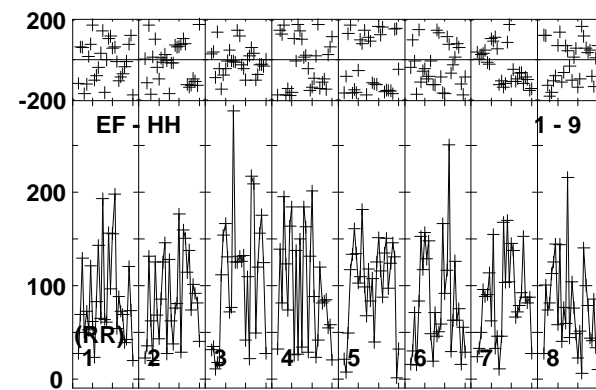
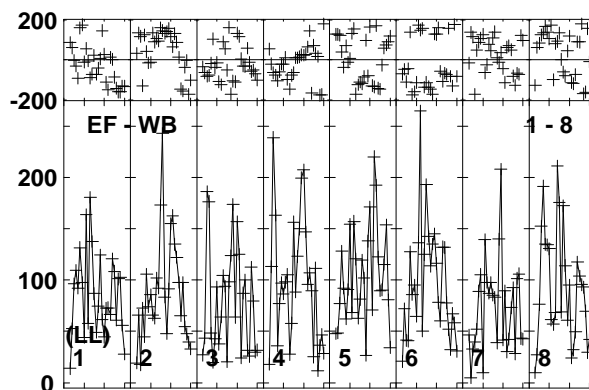
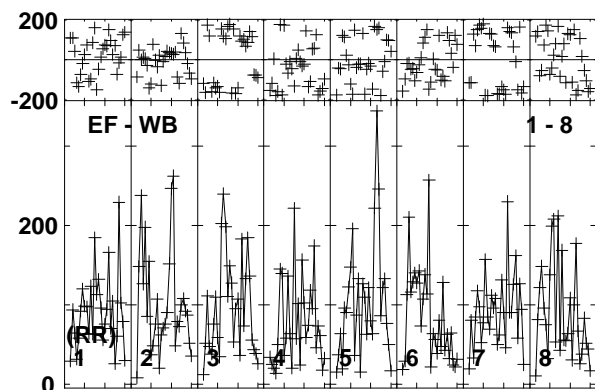
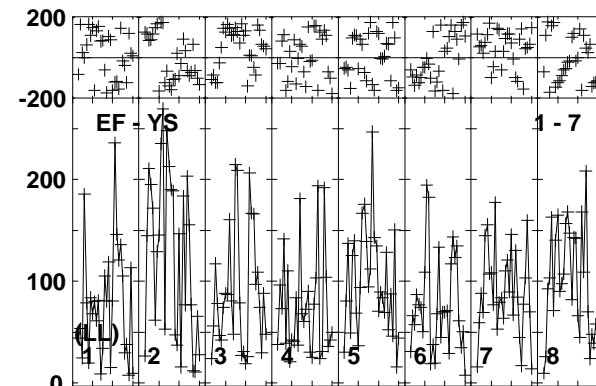
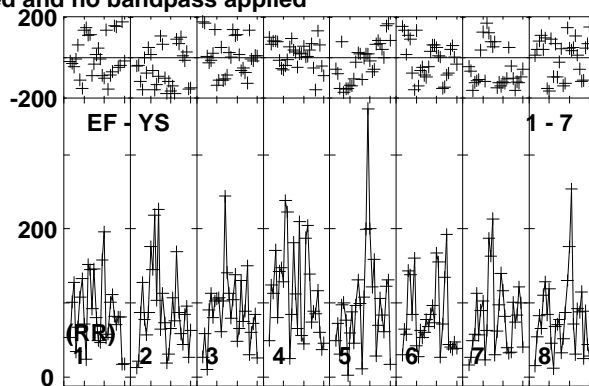
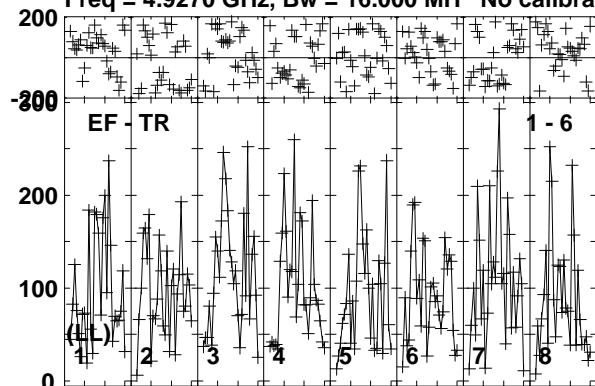

Lower frame: Micro Ampl Jy Top frame: Phas deg  
Vector averaged cross-power spectrum Baseline: EF (01) - TR (06)  
Timerange: 00/15:36:40 to 00/15:39:40

Plot file version 191 created 10-JUN-2016 15:29:37

J0718-1813 RG008C.UVDATA.1

Freq = 4.9270 GHz, Bw = 16.000 MH No calibration applied and no bandpass applied

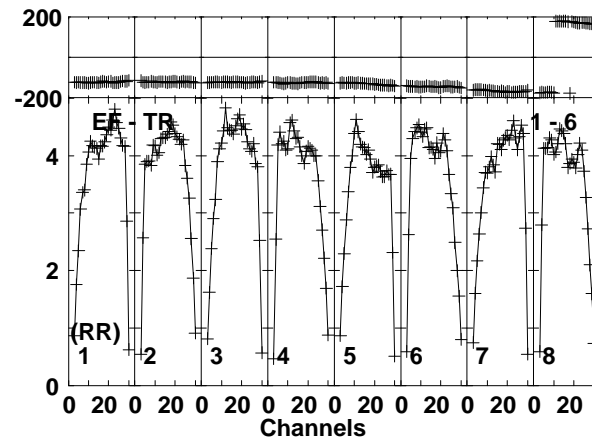
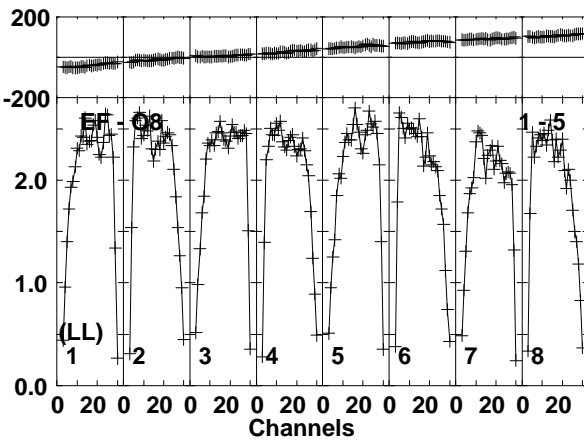
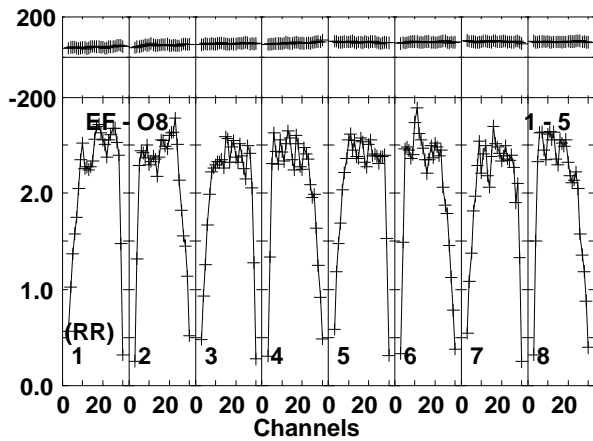
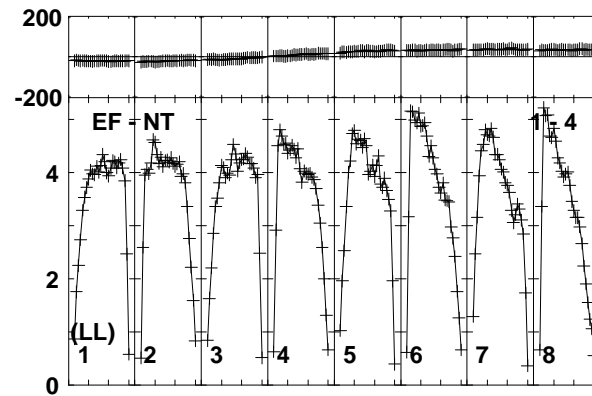
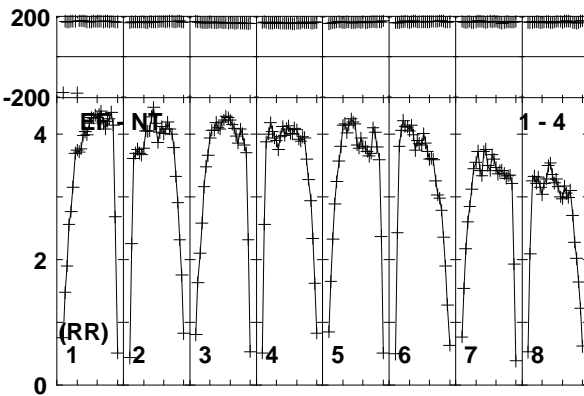
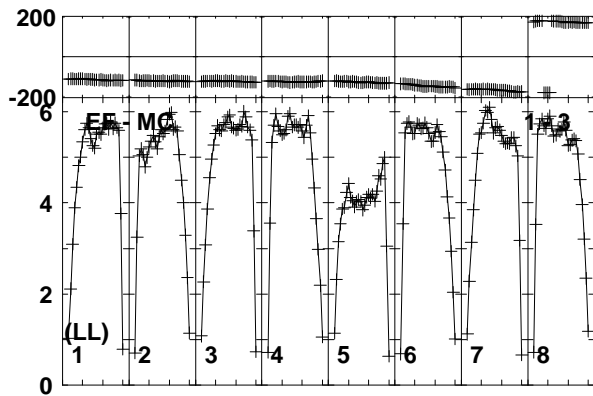
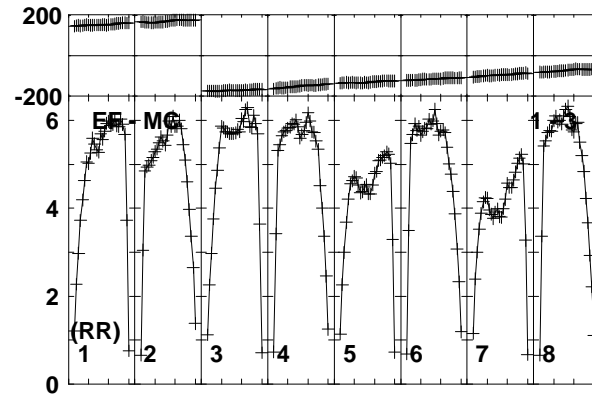
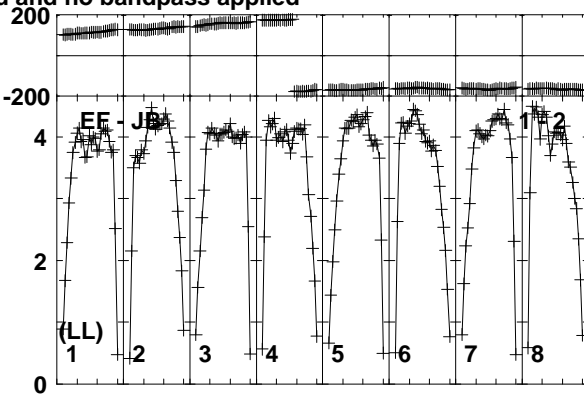
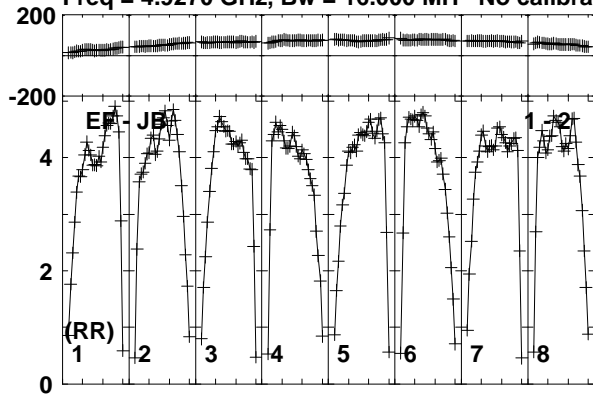

Lower frame: Milli Ampl Jy Top frame: Phas deg  
Vector averaged cross-power spectrum Baseline: EF (01) - JB (02)  
Timerange: 00/15:39:40 to 00/15:41:09

Plot file version 192 created 10-JUN-2016 15:29:37

J0718-1813 RG008C.UVDATA.1

Freq = 4.9270 GHz, Bw = 16.000 MH No calibration applied and no bandpass applied

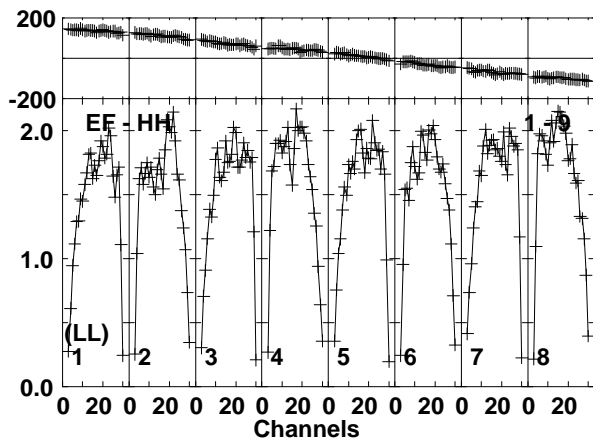
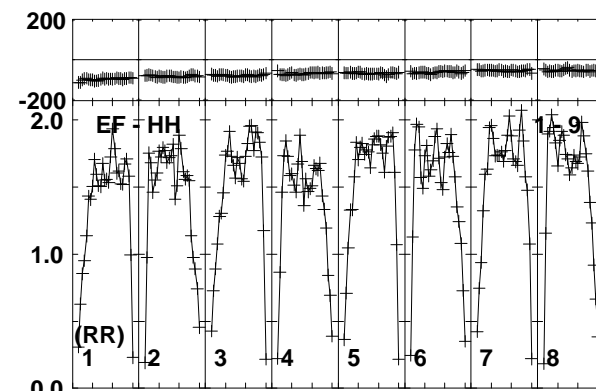
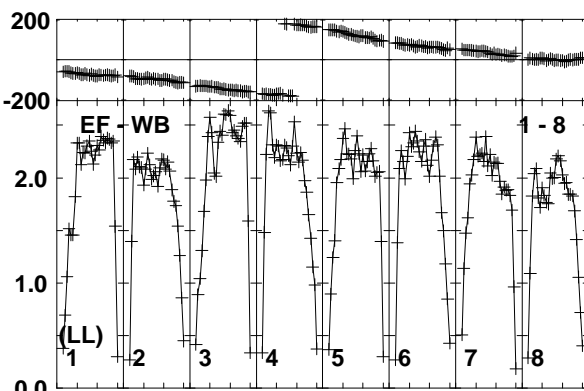
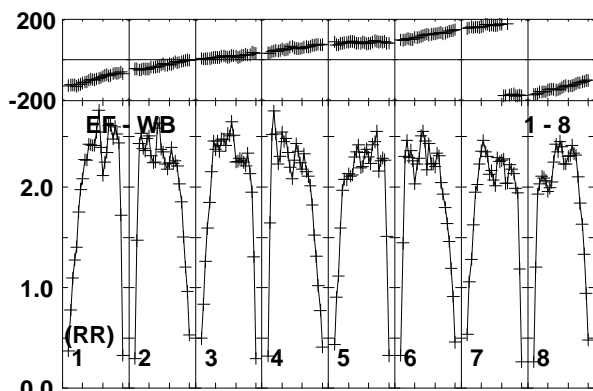
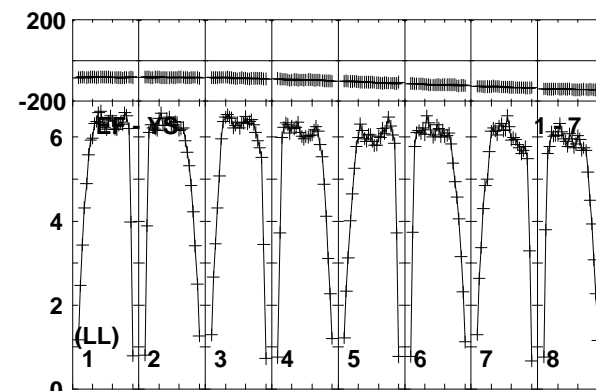
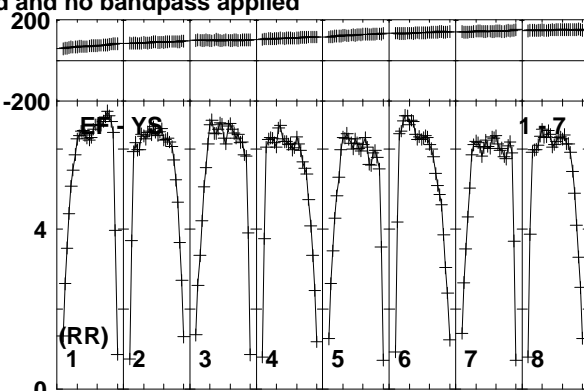
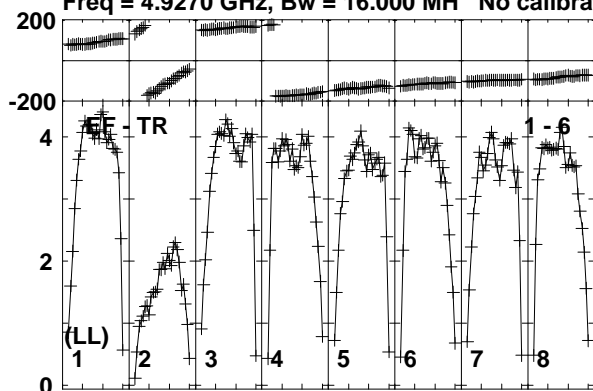

Lower frame: Milli Ampl Jy Top frame: Phas deg  
Vector averaged cross-power spectrum Baseline: EF (01) - TR (06)  
Timerange: 00/15:39:40 to 00/15:41:09



Plot file version 193 created 10-JUN-2016 15:29:37

J0712-1847 RG008C.UVDATA.1

Freq = 4.9270 GHz, Bw = 16.000 MH No calibration applied and no bandpass applied

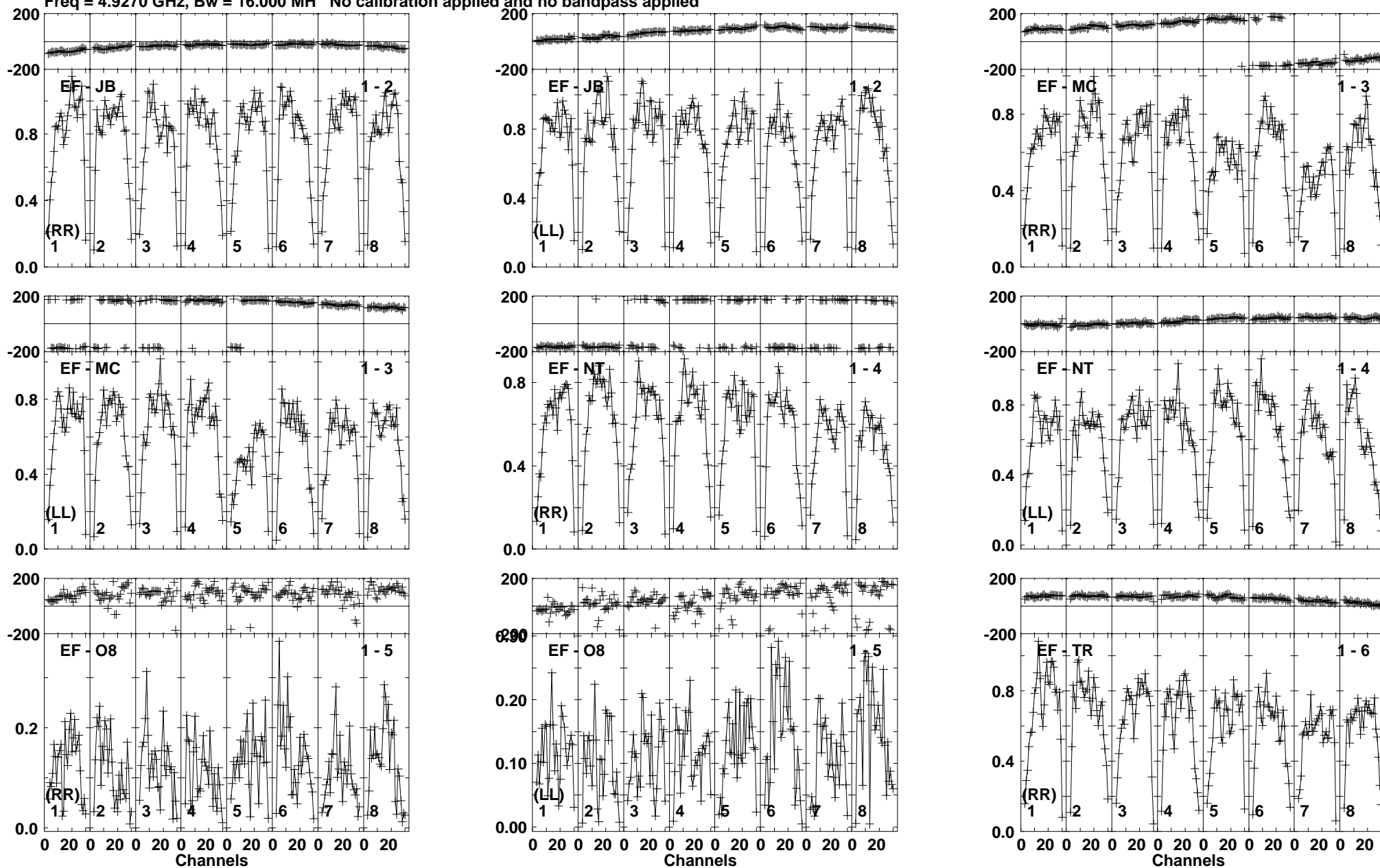

Lower frame: Milli Ampl Jy Top frame: Phas deg  
Vector averaged cross-power spectrum Baseline: EF (01) - JB (02)  
Timerange: 00/15:41:11 to 00/15:44:10

Plot file version 194 created 10-JUN-2016 15:29:37

J0712-1847 RG008C.UVDATA.1

Freq = 4.9270 GHz, Bw = 16.000 MH No calibration applied and no bandpass applied

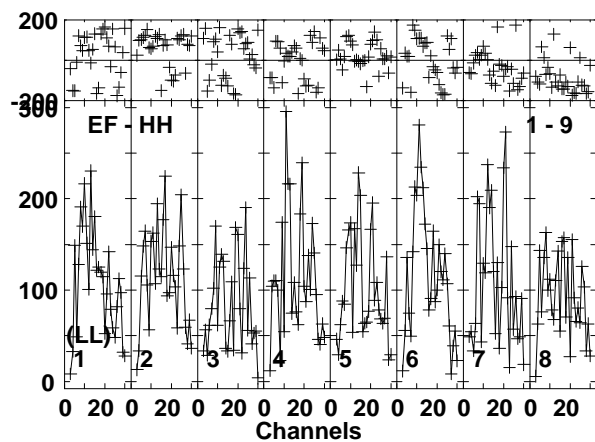
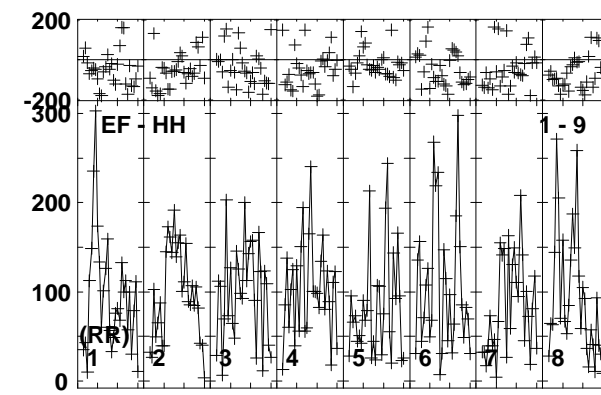
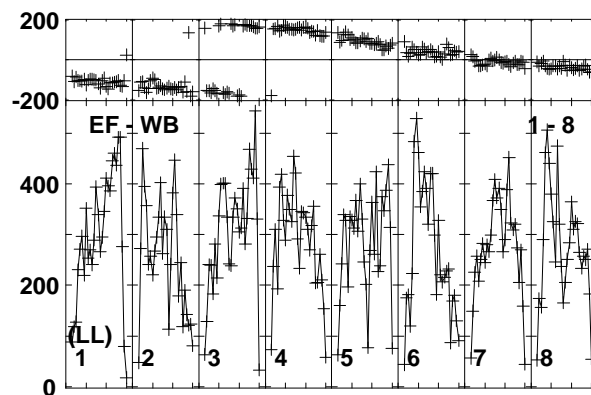
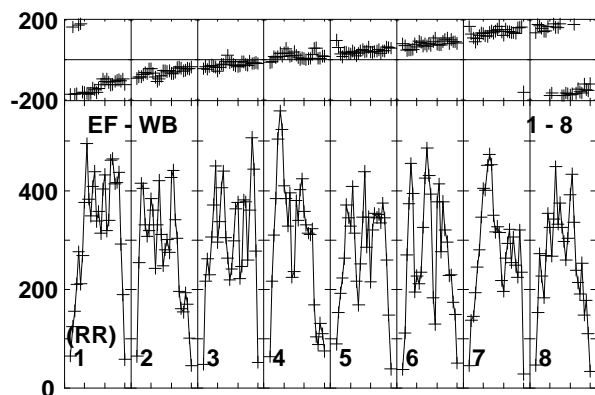
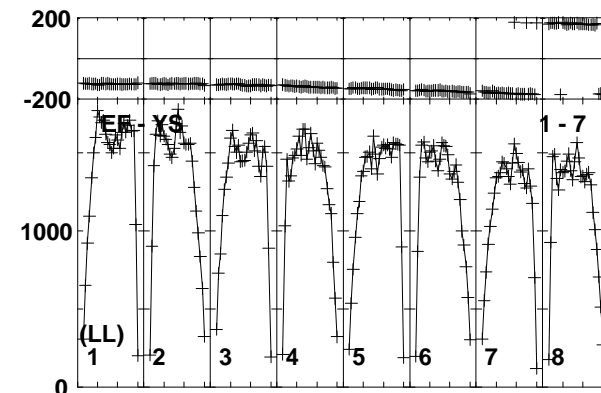
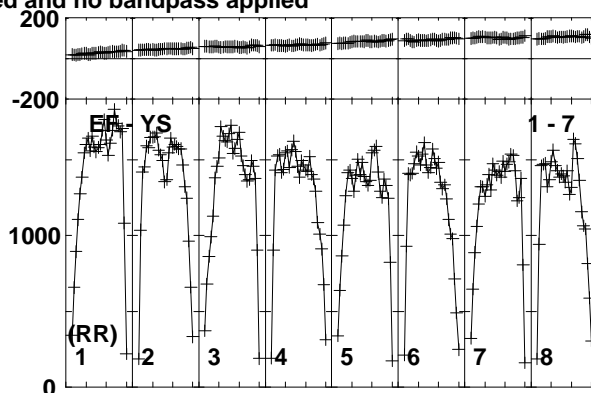
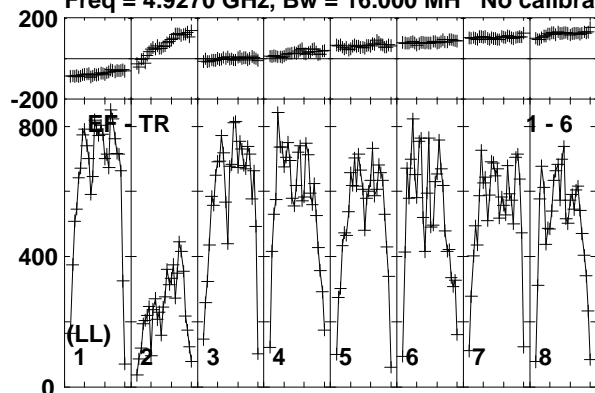

Lower frame: Micro Ampl Jy Top frame: Phas deg  
Vector averaged cross-power spectrum Baseline: EF (01) - TR (06)  
Timerange: 00/15:41:11 to 00/15:44:10

Plot file version 195 created 10-JUN-2016 15:29:37

J0718-1813 RG008C.UVDATA.1

Freq = 4.9270 GHz, Bw = 16.000 MH No calibration applied and no bandpass applied

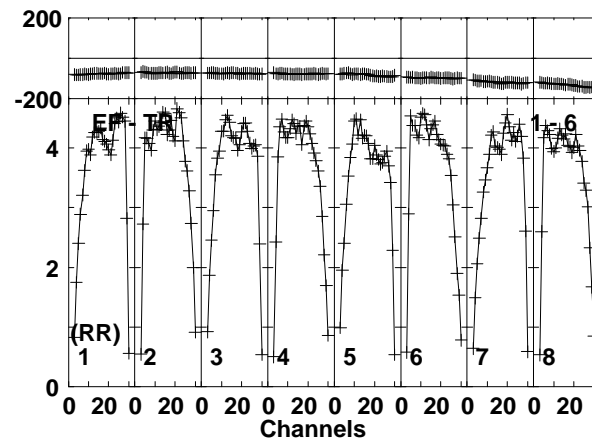
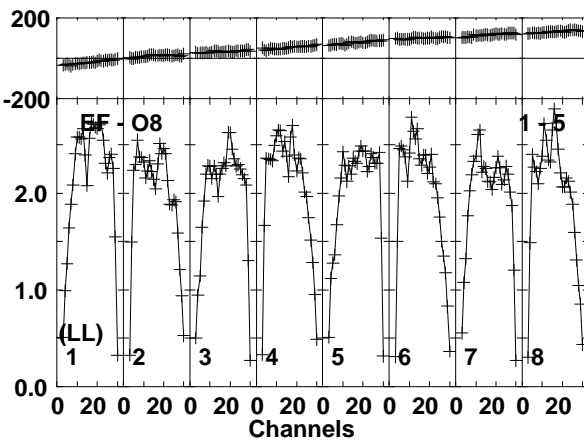
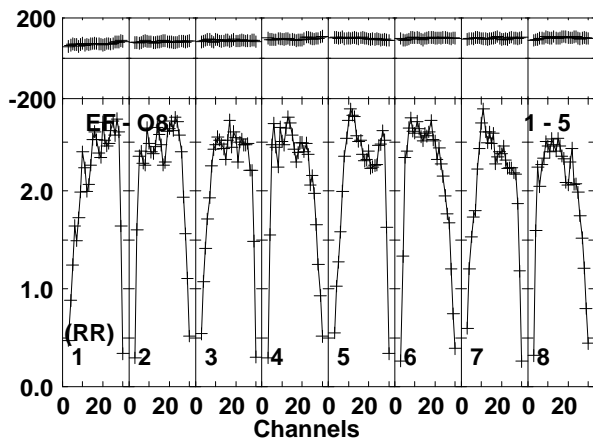
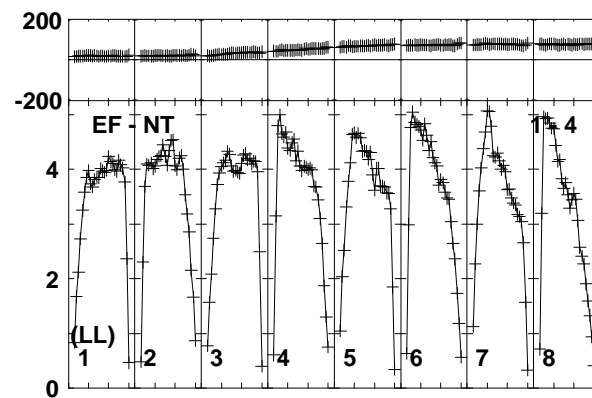
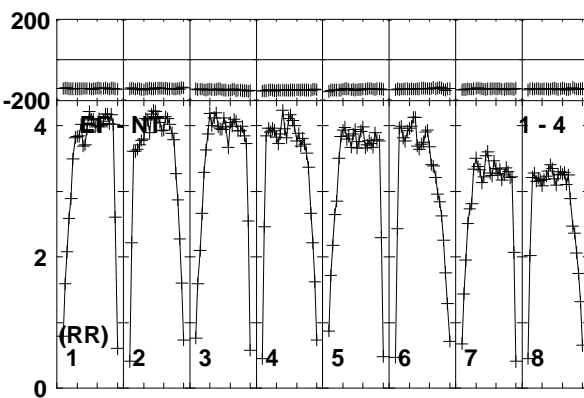
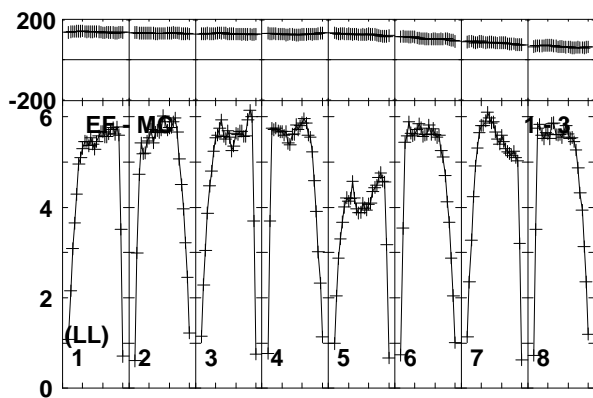
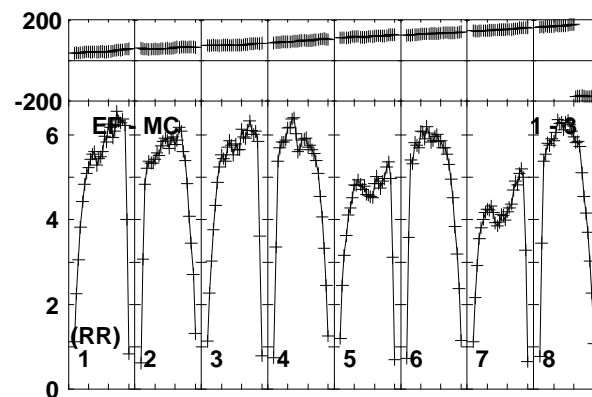
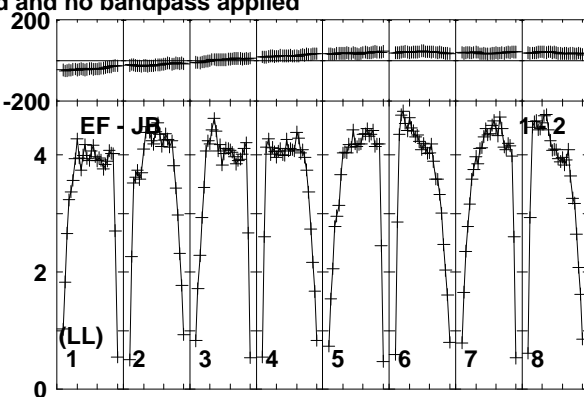
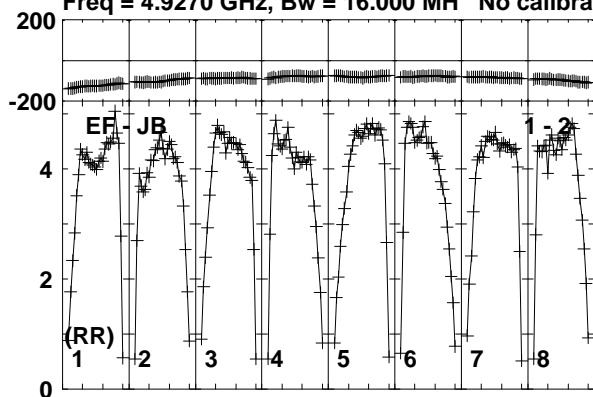

Lower frame: Milli Ampl Jy Top frame: Phas deg  
Vector averaged cross-power spectrum Baseline: EF (01) - JB (02)  
Timerange: 00/15:44:50 to 00/15:45:39

Plot file version 196 created 10-JUN-2016 15:29:37

J0718-1813 RG008C.UVDATA.1

Freq = 4.9270 GHz, Bw = 16.000 MH No calibration applied and no bandpass applied

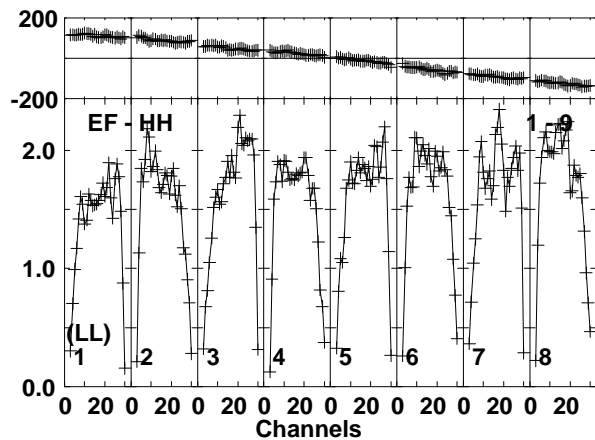
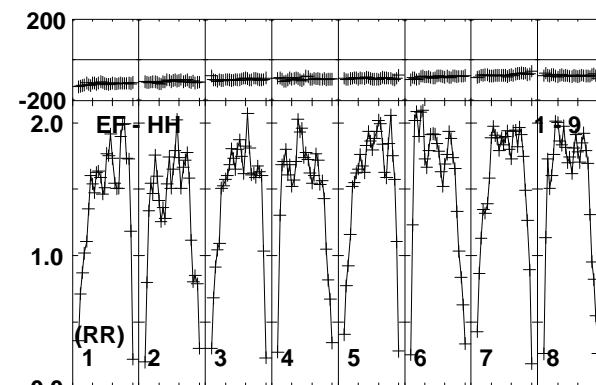
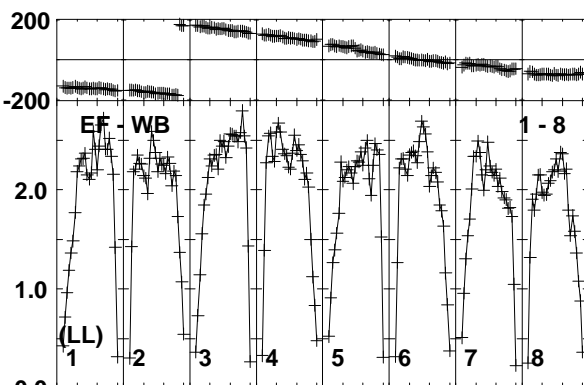
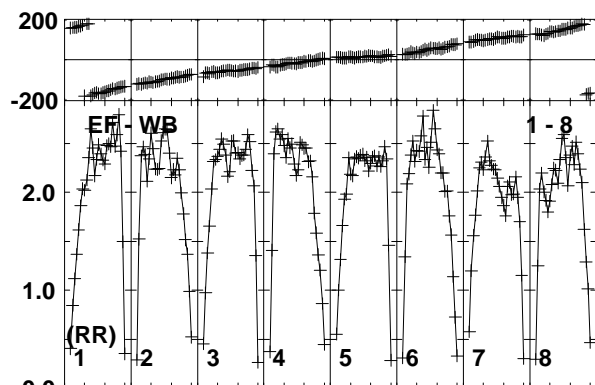
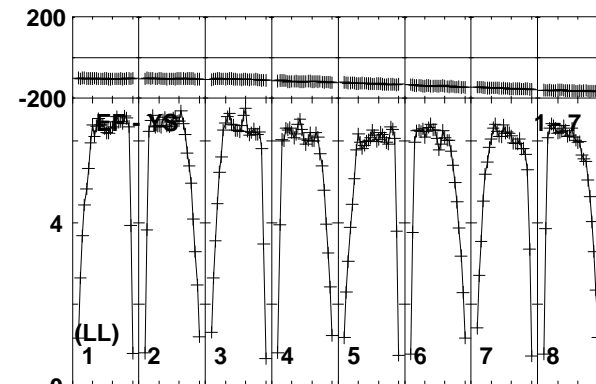
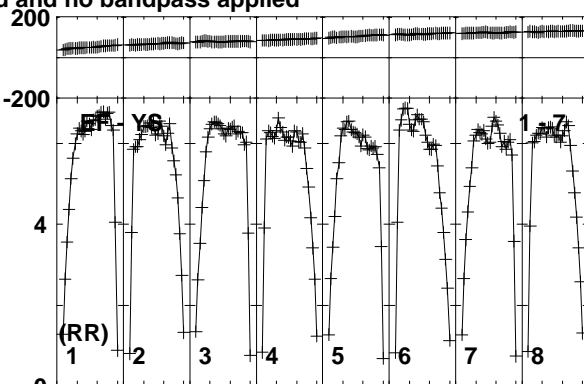
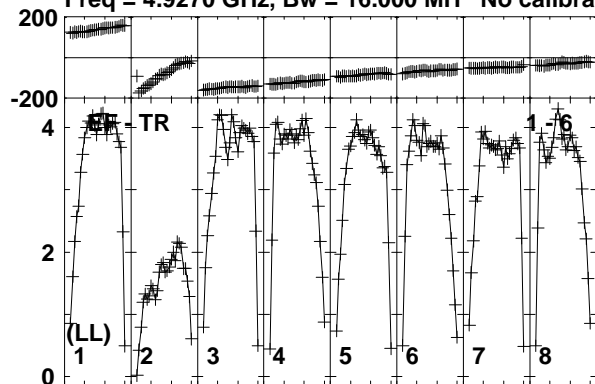

Lower frame: Milli Ampl Jy Top frame: Phas deg  
Vector averaged cross-power spectrum Baseline: EF (01) - TR (06)  
Timerange: 00/15:44:50 to 00/15:45:39

Plot file version 197 created 10-JUN-2016 15:29:38

FRB150418 RG008C.UVDATA.1

Freq = 4.9270 GHz, Bw = 16.000 MH No calibration applied and no bandpass applied

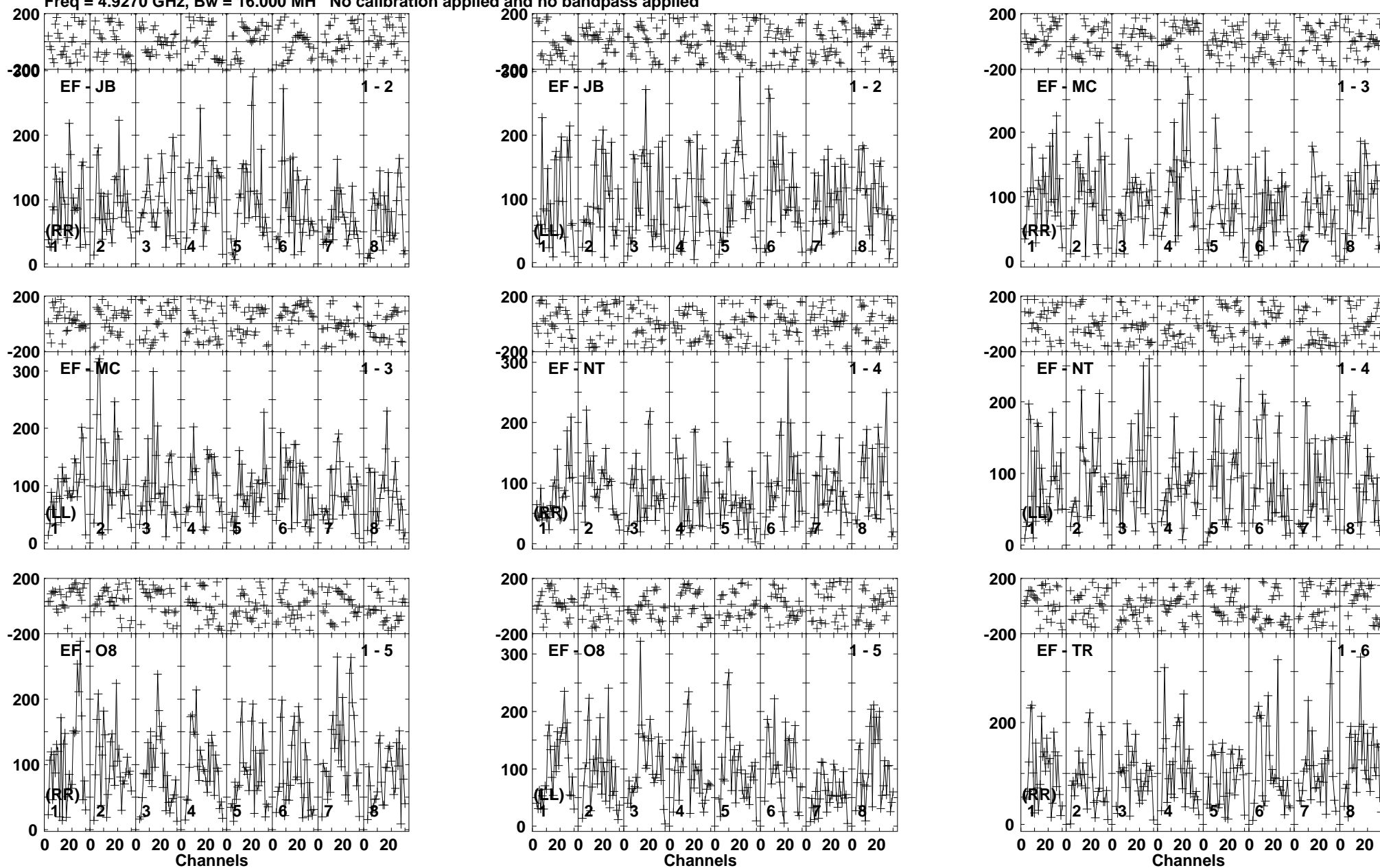

Lower frame: Micro Ampl Jy Top frame: Phas deg  
Vector averaged cross-power spectrum Baseline: EF (01) - JB (02)  
Timerange: 00/15:45:40 to 00/15:48:40

Plot file version 198 created 10-JUN-2016 15:29:38

FRB150418 RG008C.UVDATA.1

Freq = 4.9270 GHz, Bw = 16.000 MH No calibration applied and no bandpass applied

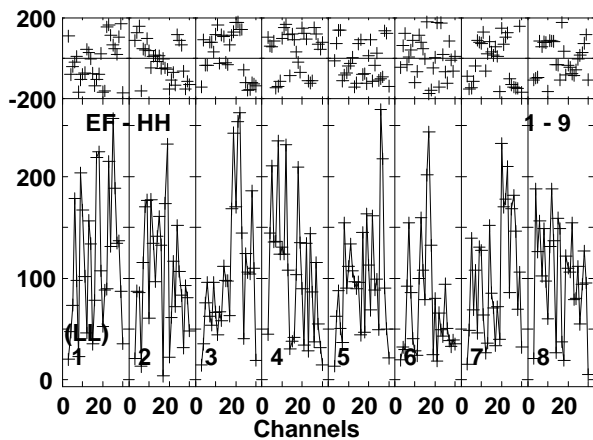
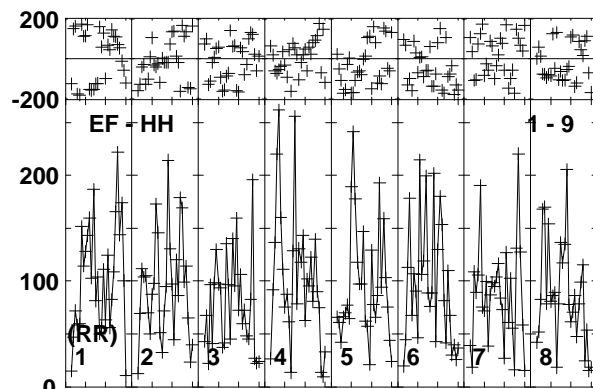
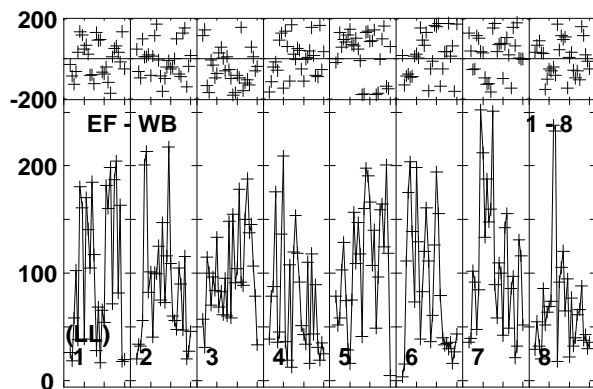
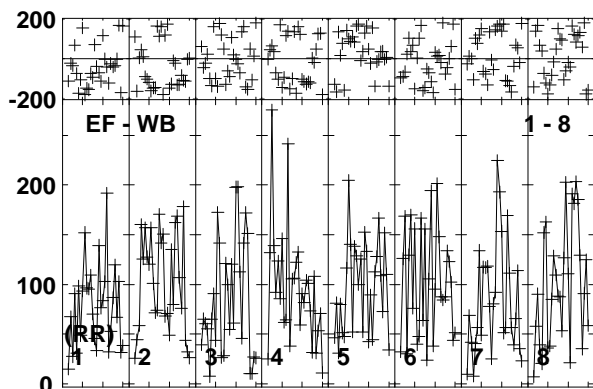
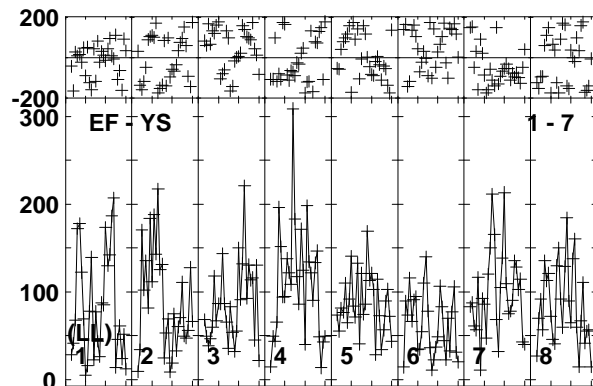
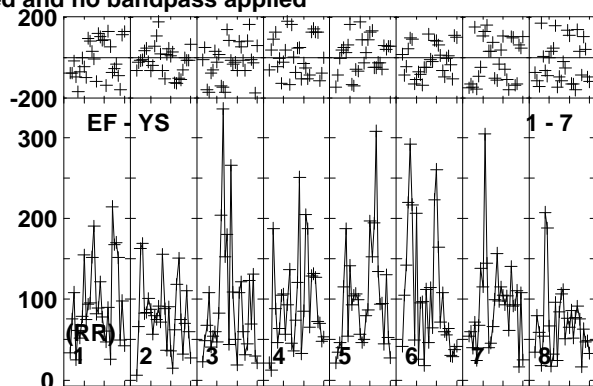
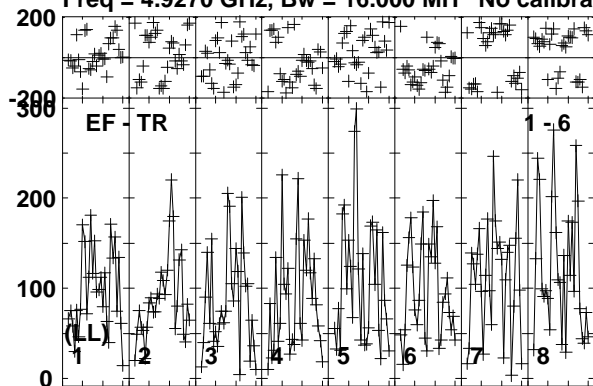

Lower frame: Micro Ampl Jy Top frame: Phas deg  
Vector averaged cross-power spectrum Baseline: EF (01) - TR (06)  
Timerange: 00/15:45:40 to 00/15:48:40

Plot file version 199 created 10-JUN-2016 15:29:38

J0718-1813 RG008C.UVDATA.1

Freq = 4.9270 GHz, Bw = 16.000 MH No calibration applied and no bandpass applied

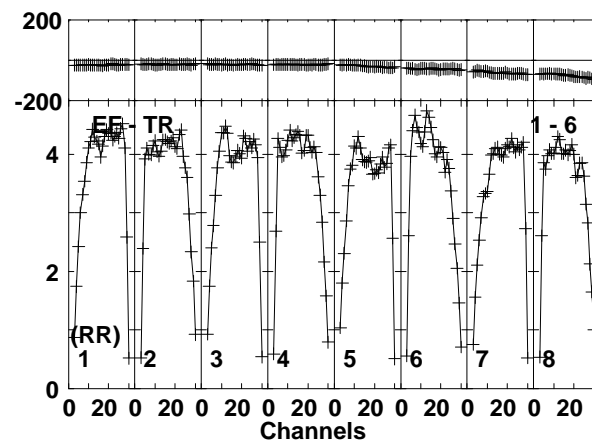
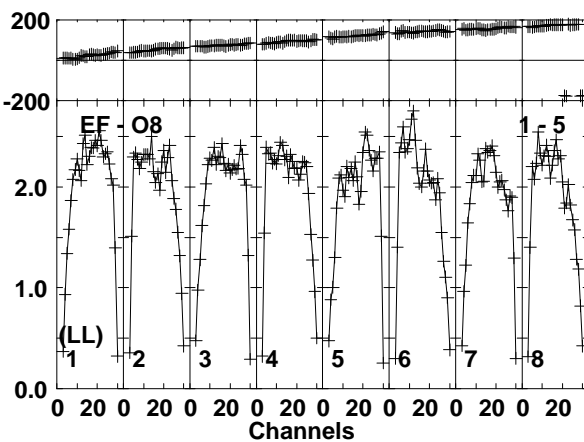
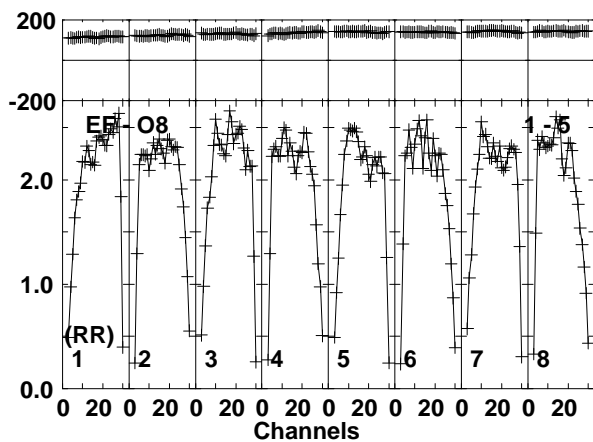
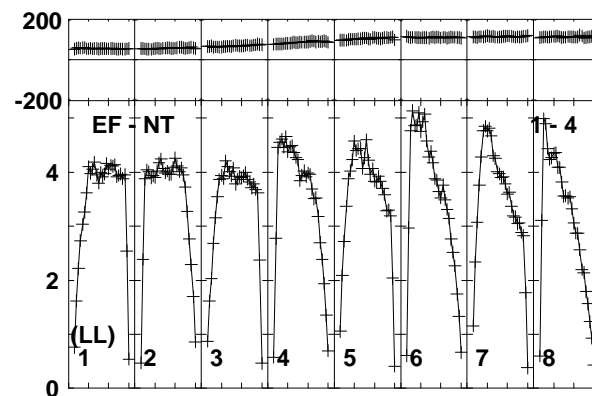
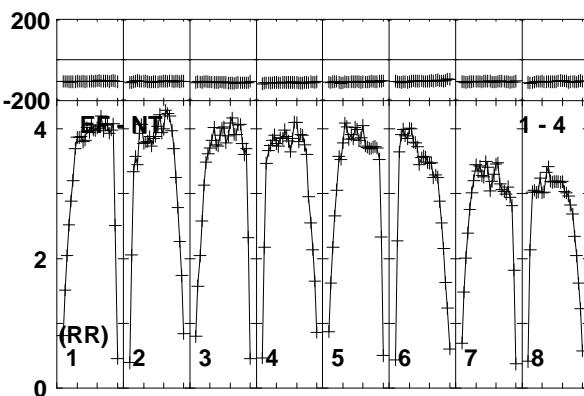
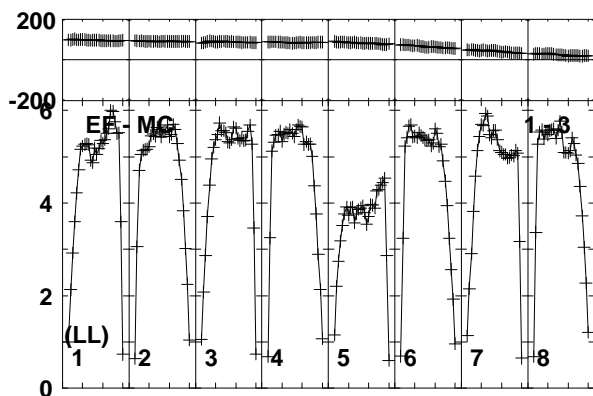
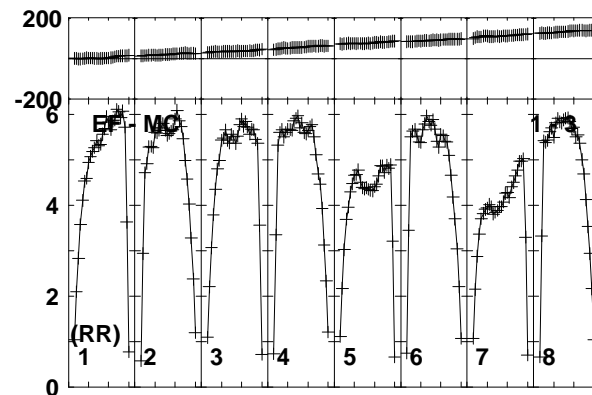
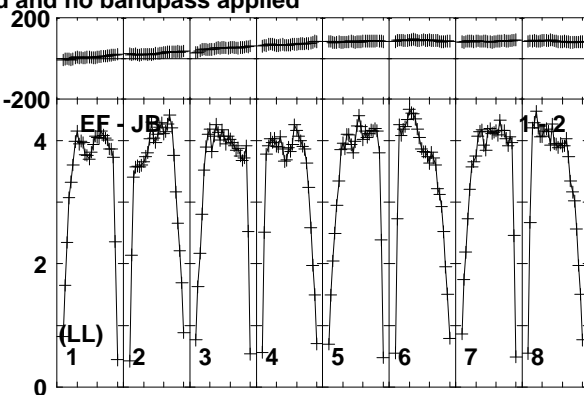
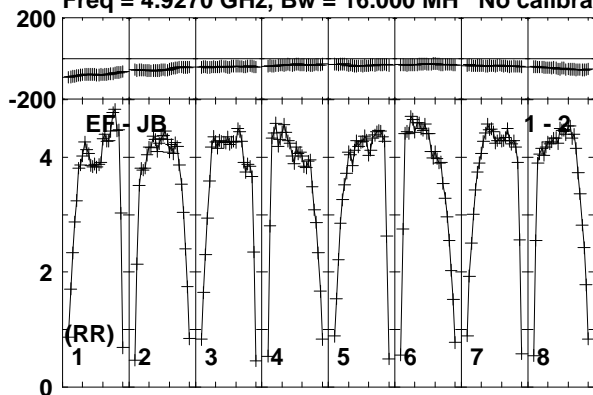

Lower frame: Milli Ampl Jy Top frame: Phas deg  
Vector averaged cross-power spectrum Baseline: EF (01) - JB (02)  
Timerange: 00/15:48:41 to 00/15:50:09

Plot file version 200 created 10-JUN-2016 15:29:38

J0718-1813 RG008C.UVDATA.1

Freq = 4.9270 GHz, Bw = 16.000 MH No calibration applied and no bandpass applied

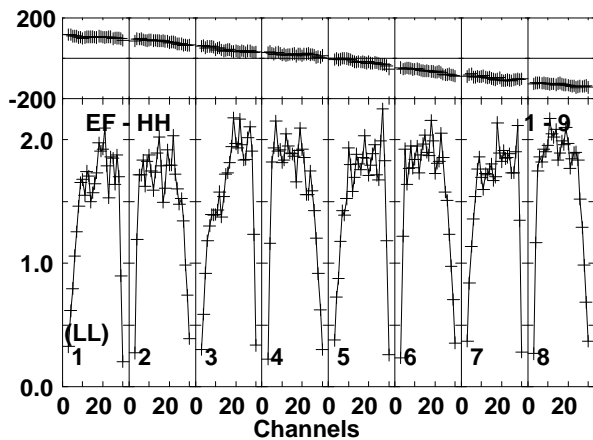
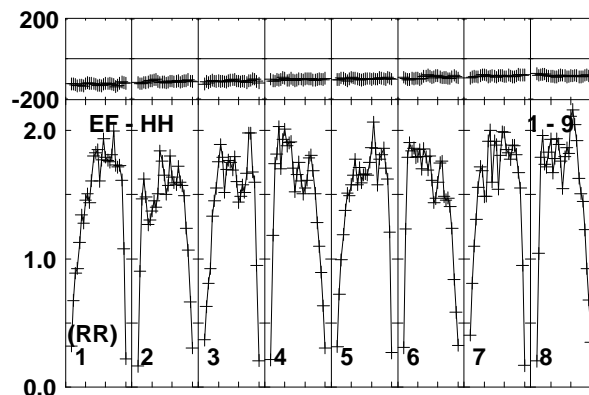
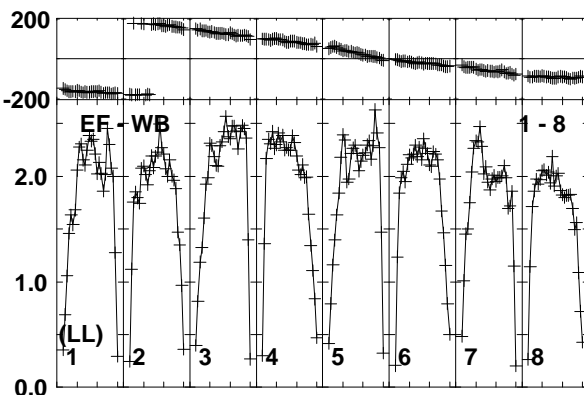
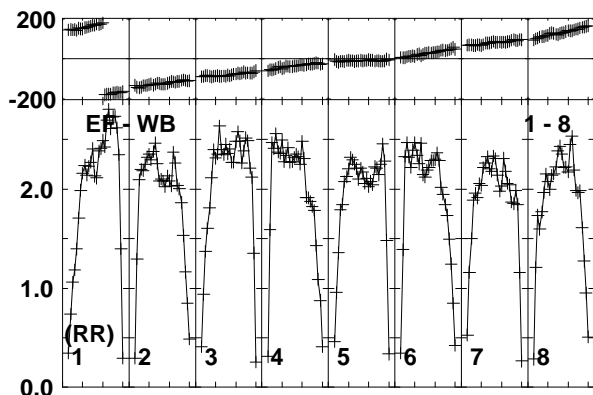
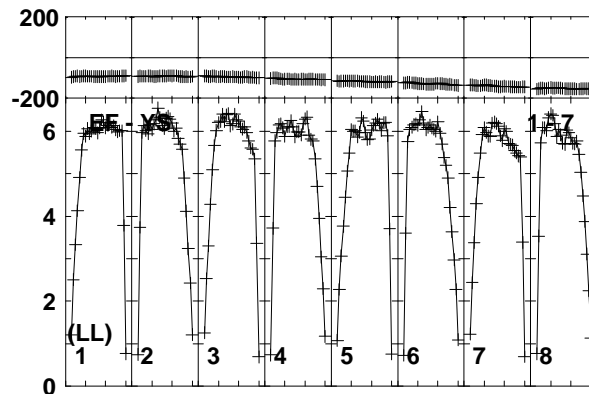
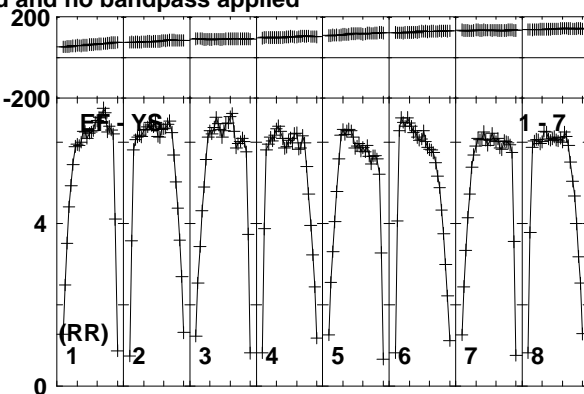
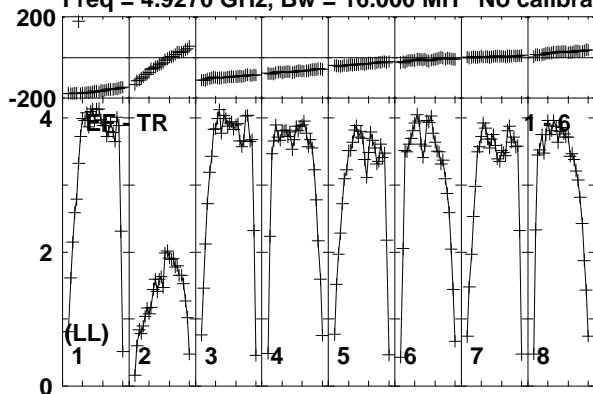

Lower frame: Milli Ampl Jy Top frame: Phas deg  
Vector averaged cross-power spectrum Baseline: EF (01) - TR (06)  
Timerange: 00/15:48:41 to 00/15:50:09



Plot file version 201 created 10-JUN-2016 15:29:38

FRB150418 RG008C.UVDATA.1

Freq = 4.9270 GHz, Bw = 16.000 MH No calibration applied and no bandpass applied

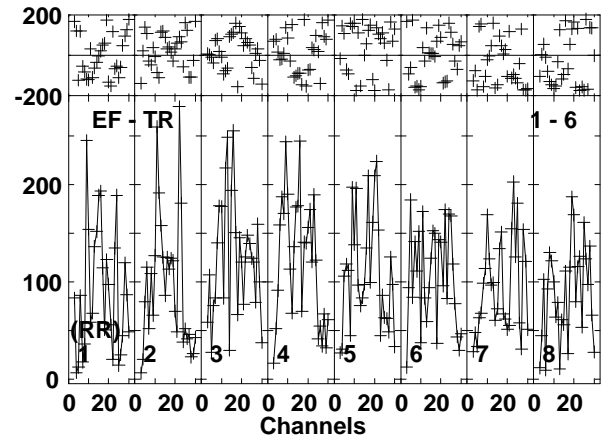
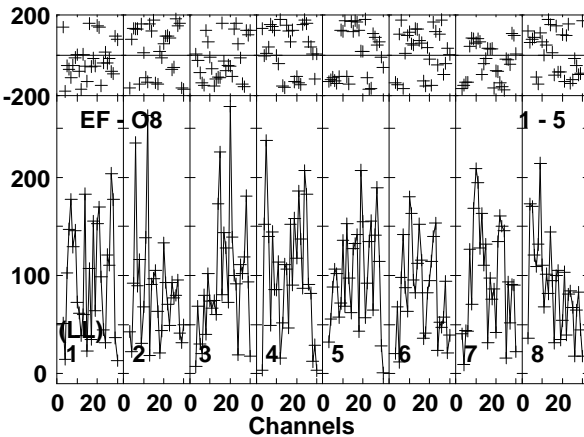
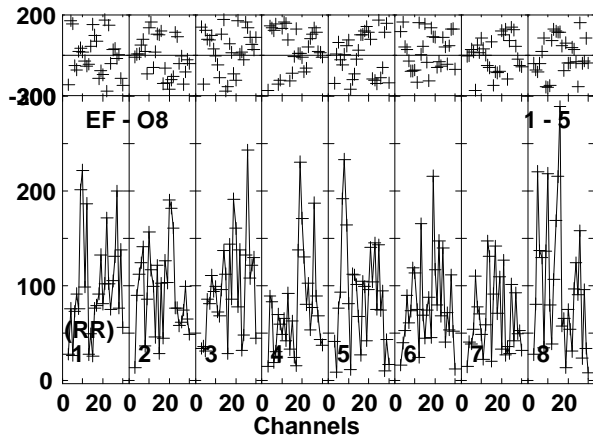
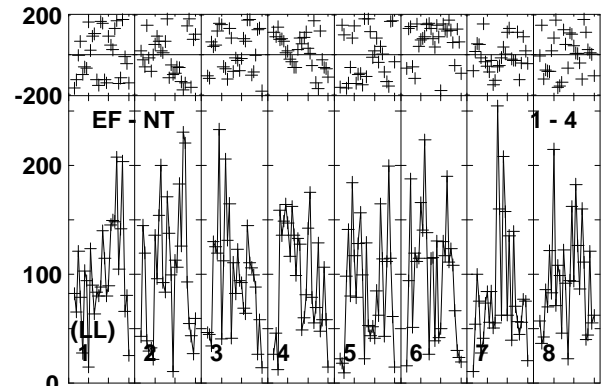
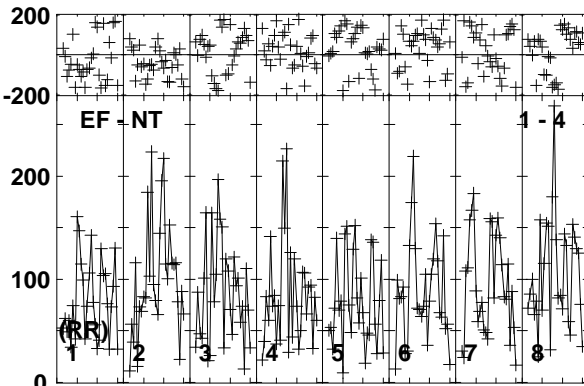
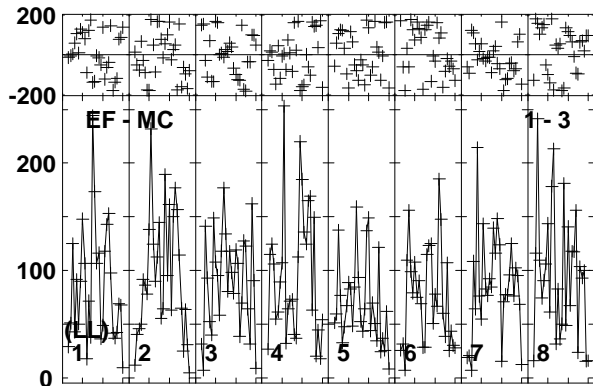
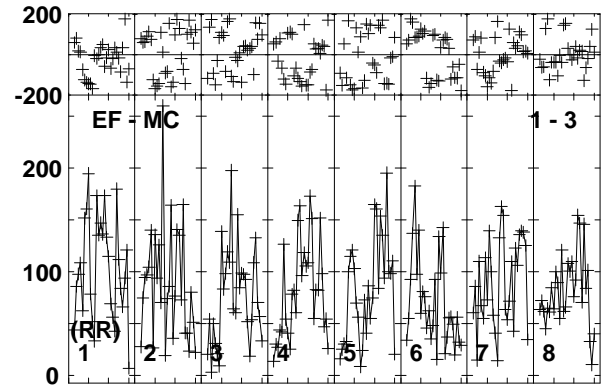
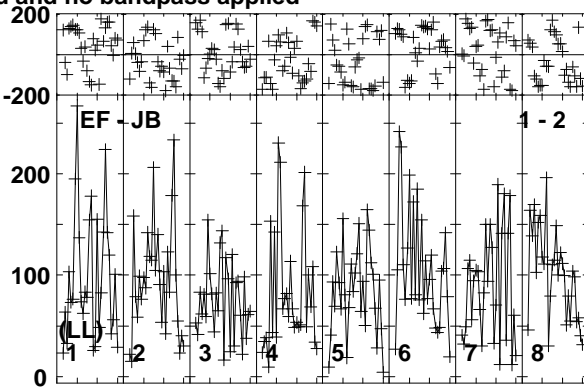
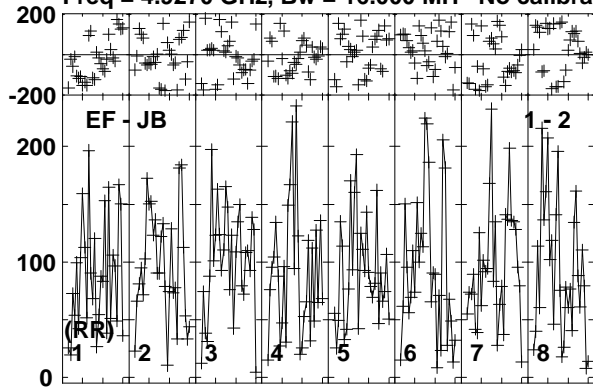

Lower frame: Micro Ampl Jy Top frame: Phas deg  
Vector averaged cross-power spectrum Baseline: EF (01) - JB (02)  
Timerange: 00/15:50:11 to 00/15:53:09

Plot file version 202 created 10-JUN-2016 15:29:38

FRB150418 RG008C.UVDATA.1

Freq = 4.9270 GHz, Bw = 16.000 MH No calibration applied and no bandpass applied

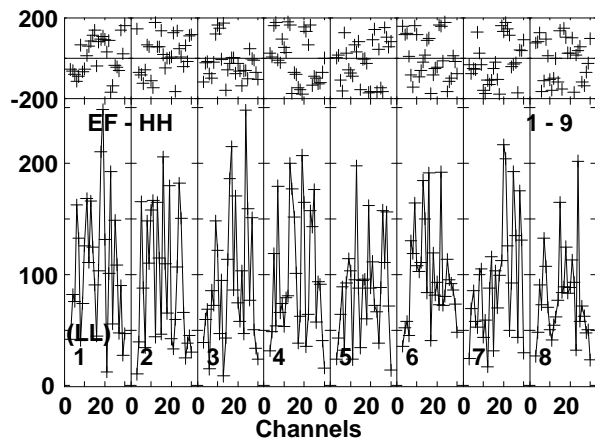
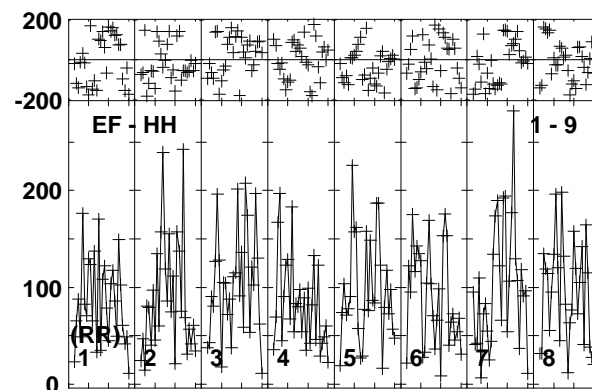
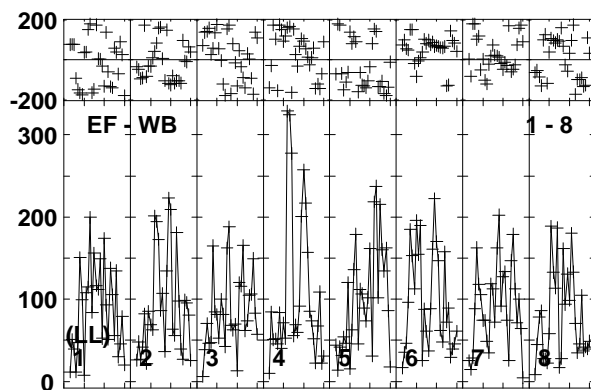
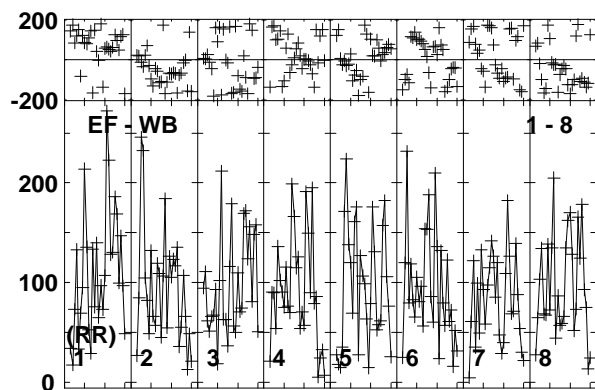
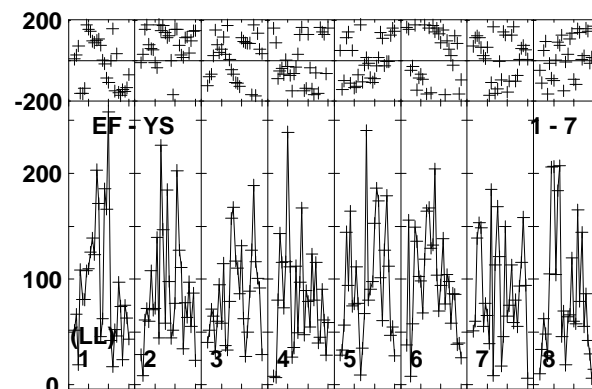
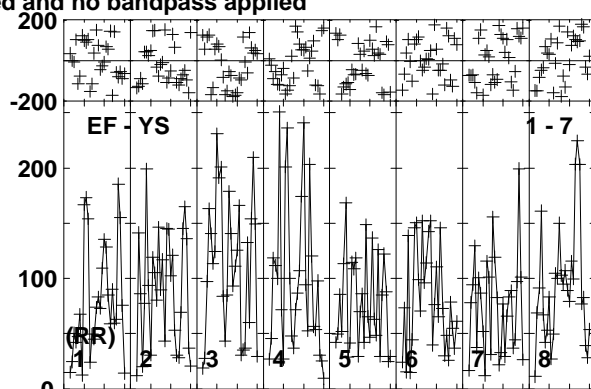
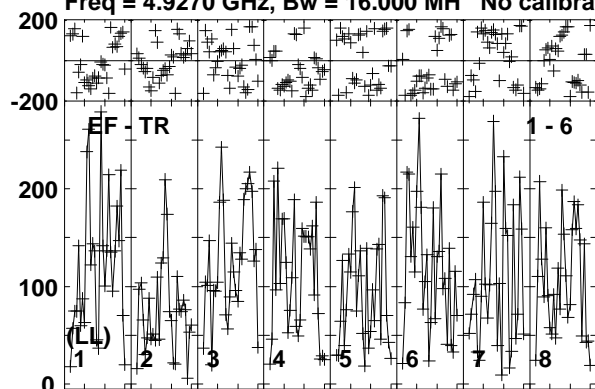

Lower frame: Micro Ampl Jy Top frame: Phas deg  
Vector averaged cross-power spectrum Baseline: EF (01) - TR (06)  
Timerange: 00/15:50:11 to 00/15:53:09

Plot file version 203 created 10-JUN-2016 15:29:38

J0718-1813 RG008C.UVDATA.1

Freq = 4.9270 GHz, Bw = 16.000 MH No calibration applied and no bandpass applied

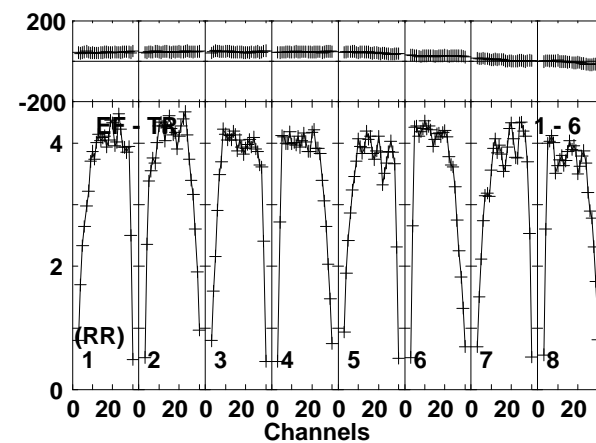
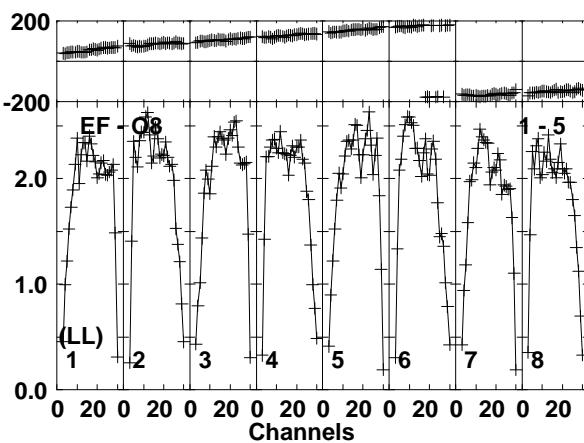
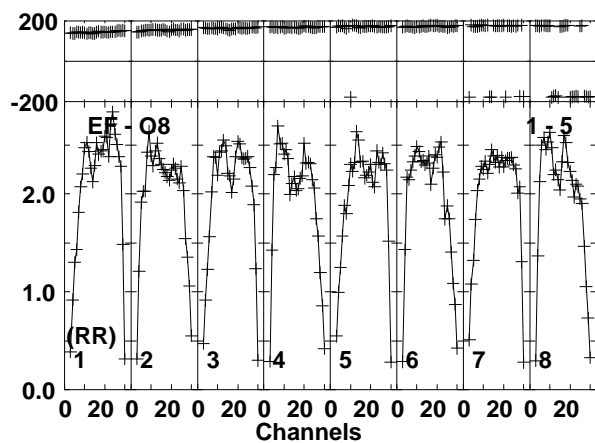
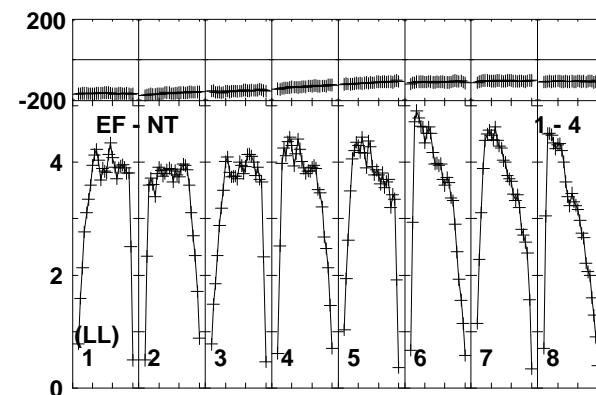
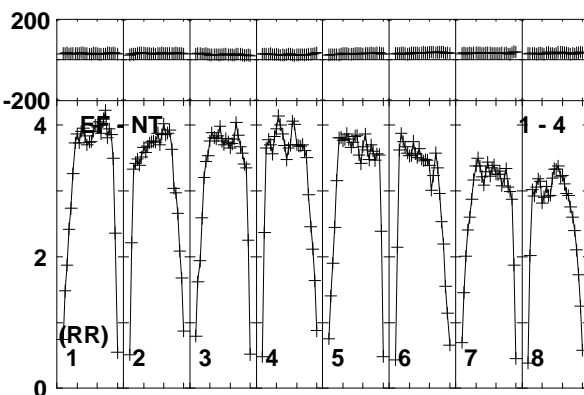
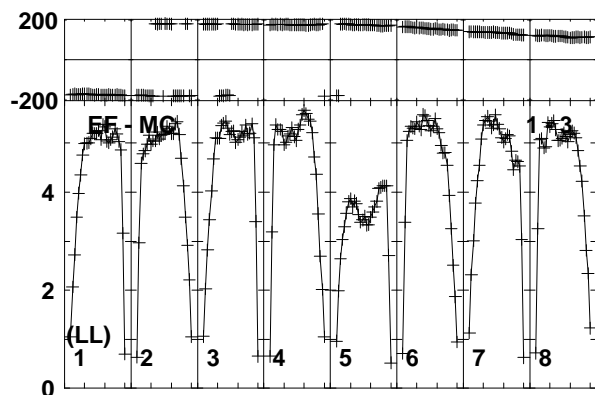
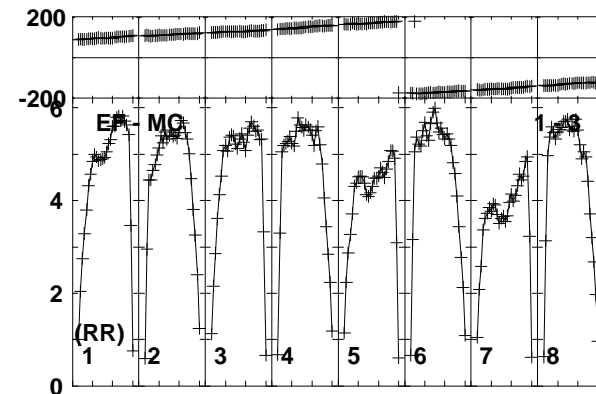
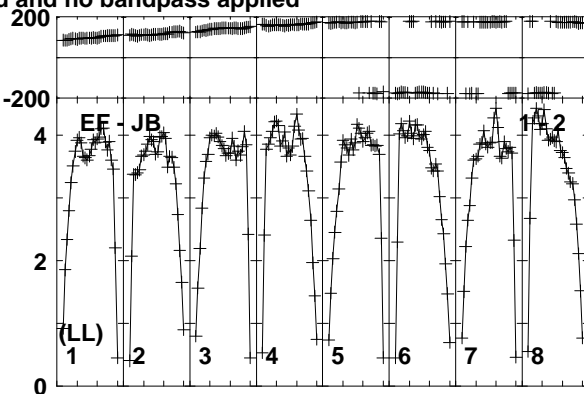
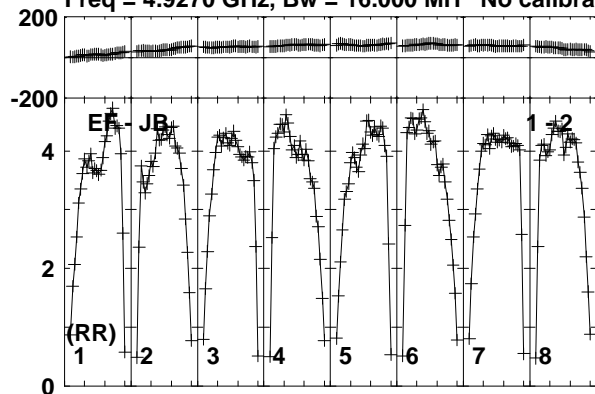

Lower frame: Milli Ampl Jy Top frame: Phas deg  
Vector averaged cross-power spectrum Baseline: EF (01) - JB (02)  
Timerange: 00/15:53:50 to 00/15:54:40

Plot file version 204 created 10-JUN-2016 15:29:38

J0718-1813 RG008C.UVDATA.1

Freq = 4.9270 GHz, Bw = 16.000 MH No calibration applied and no bandpass applied

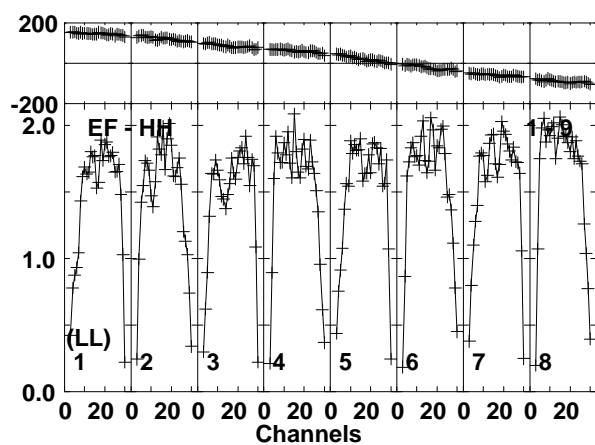
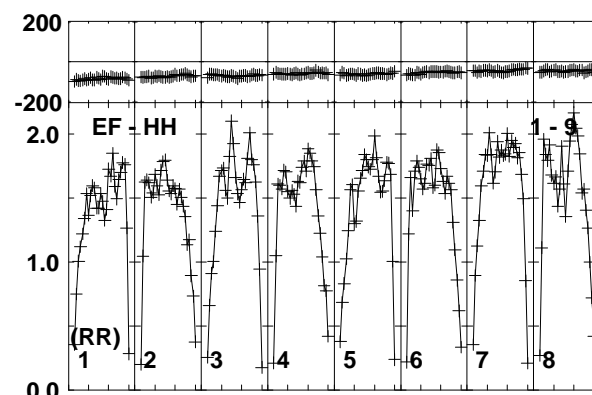
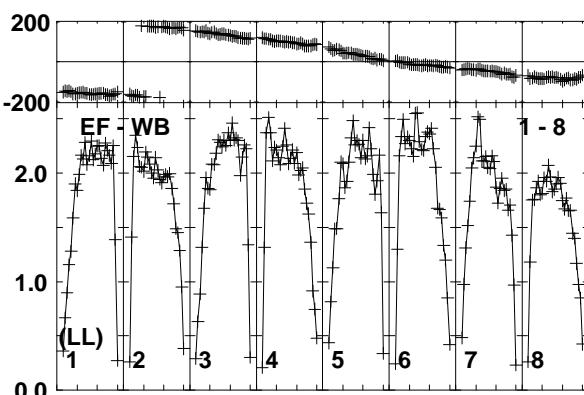
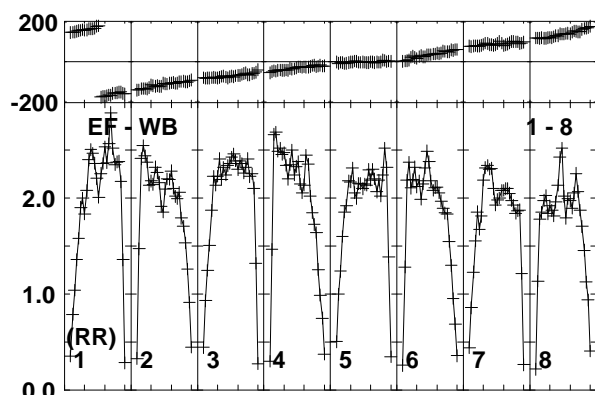
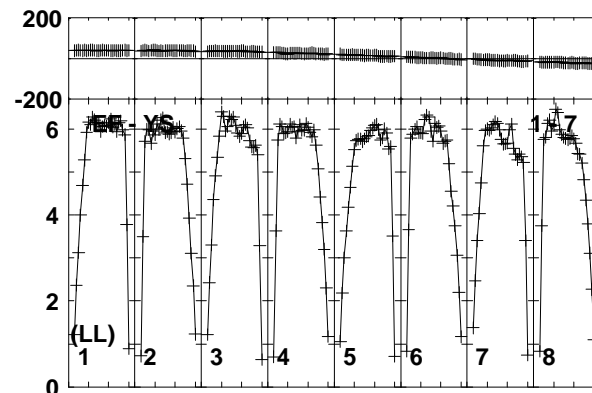
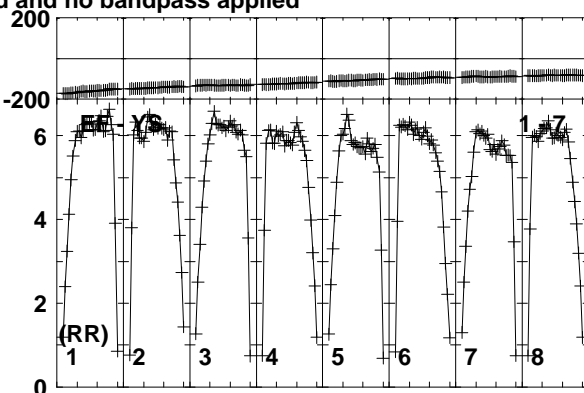
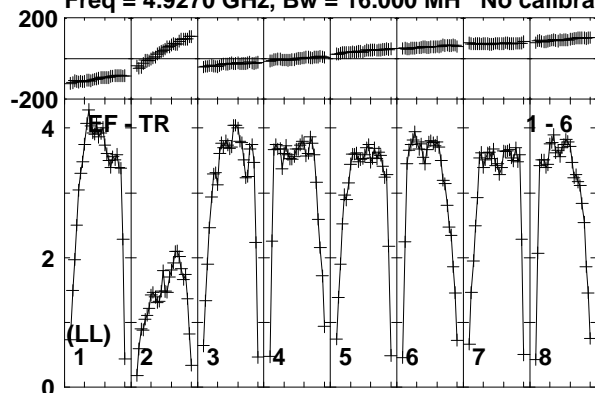

Lower frame: Milli Ampl Jy Top frame: Phas deg  
Vector averaged cross-power spectrum Baseline: EF (01) - TR (06)  
Timerange: 00/15:53:50 to 00/15:54:40

Plot file version 205 created 10-JUN-2016 15:29:39

FRB150418 RG008C.UVDATA.1

Freq = 4.9270 GHz, Bw = 16.000 MH No calibration applied and no bandpass applied

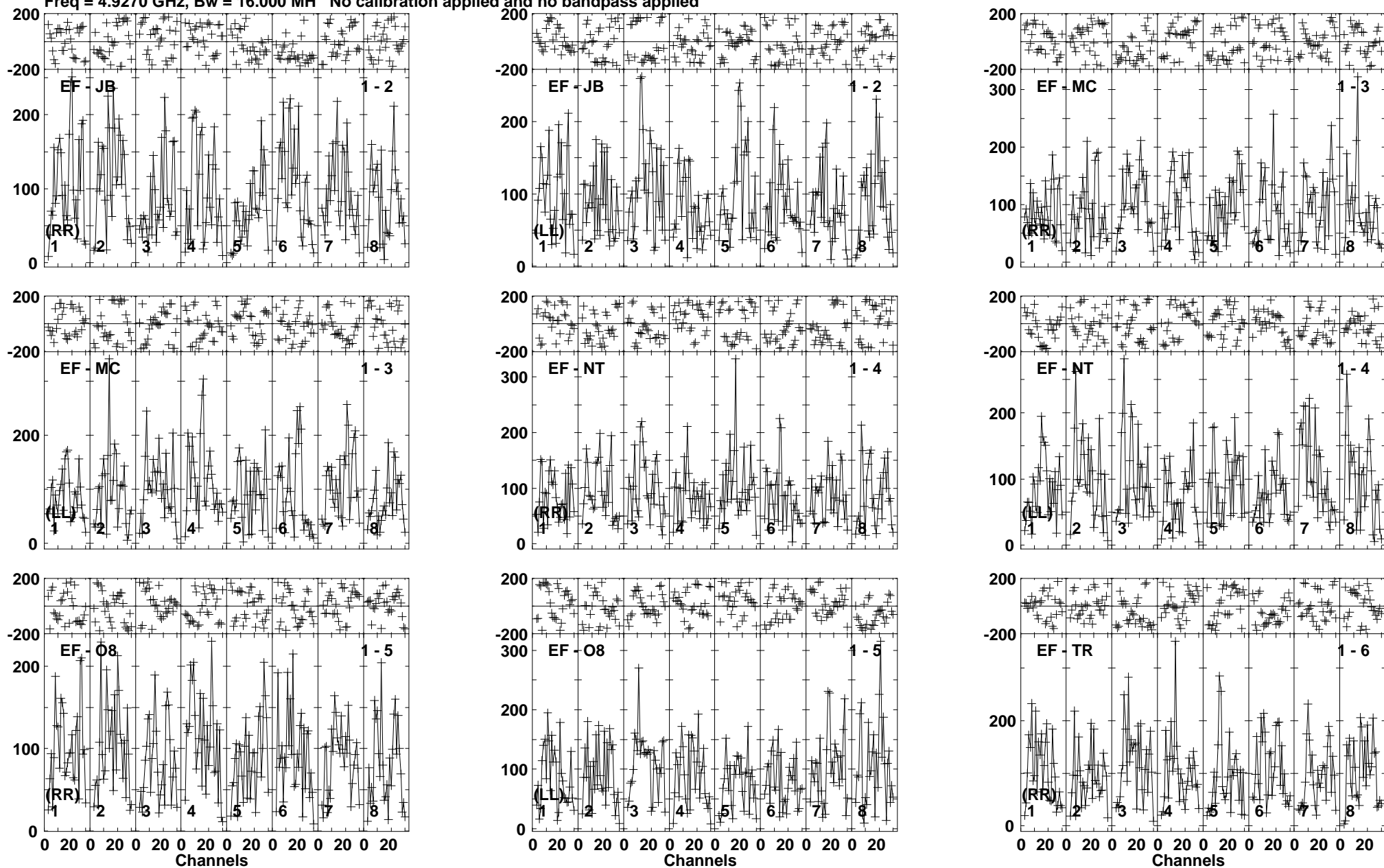

Lower frame: Micro Ampl Jy Top frame: Phas deg  
Vector averaged cross-power spectrum Baseline: EF (01) - JB (02)  
Timerange: 00/15:54:41 to 00/15:57:39

Plot file version 206 created 10-JUN-2016 15:29:39

FRB150418 RG008C.UVDATA.1

Freq = 4.9270 GHz, Bw = 16.000 MH No calibration applied and no bandpass applied

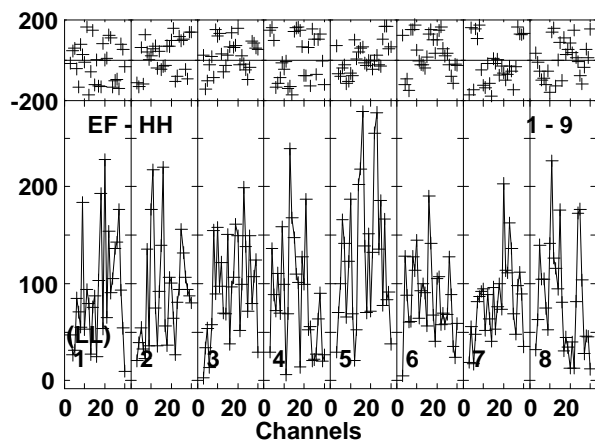
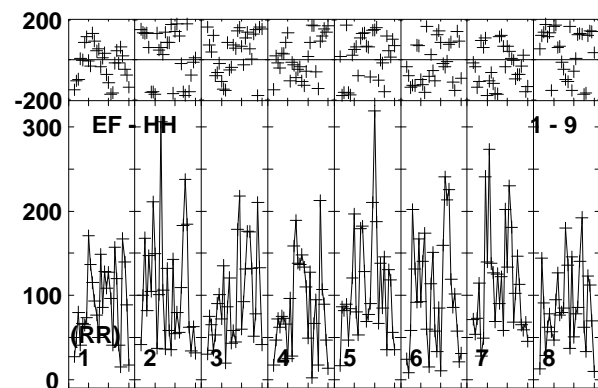
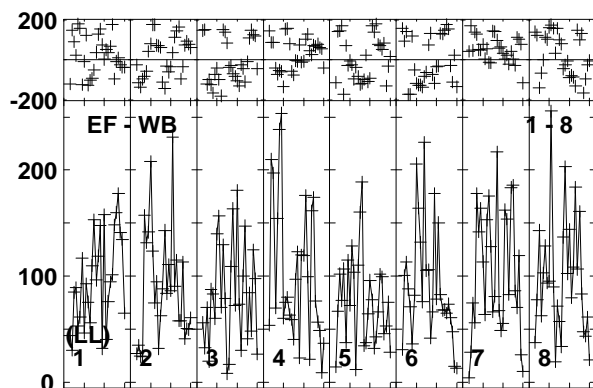
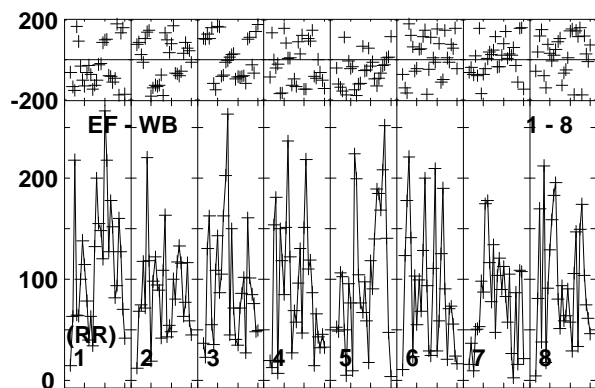
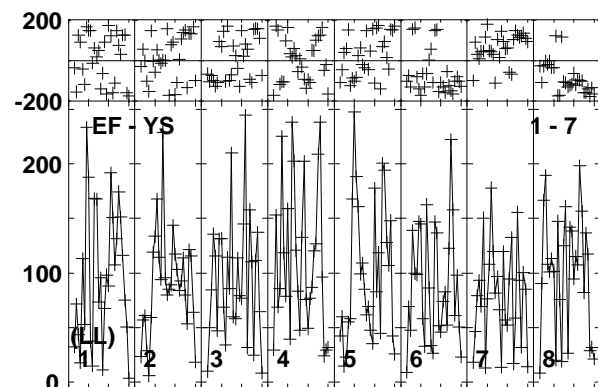
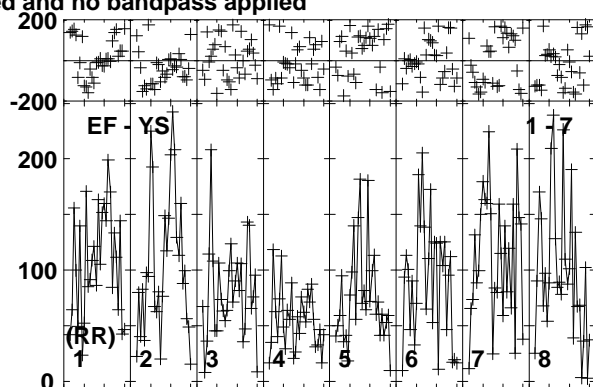
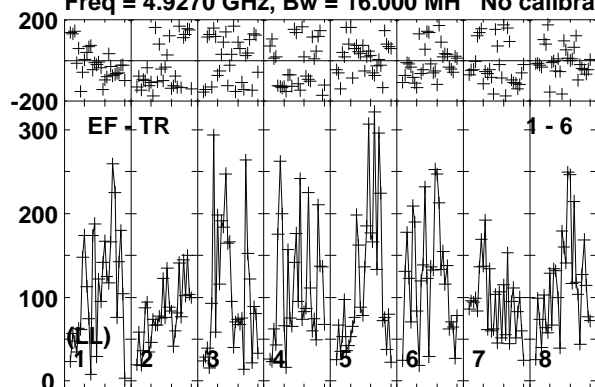

Lower frame: Micro Ampl Jy Top frame: Phas deg  
Vector averaged cross-power spectrum Baseline: EF (01) - TR (06)  
Timerange: 00/15:54:41 to 00/15:57:39

Plot file version 207 created 10-JUN-2016 15:29:39

J0718-1813 RG008C.UVDATA.1

Freq = 4.9270 GHz, Bw = 16.000 MH No calibration applied and no bandpass applied

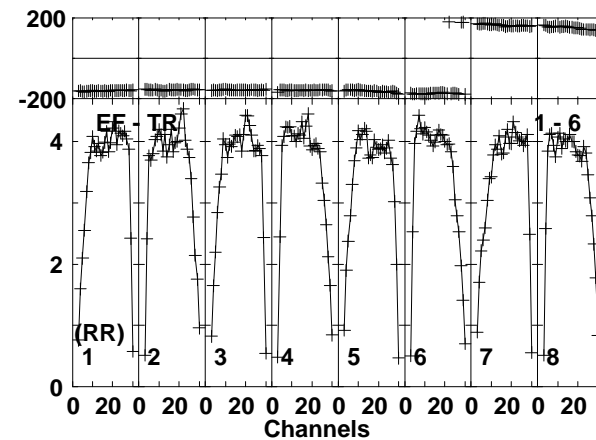
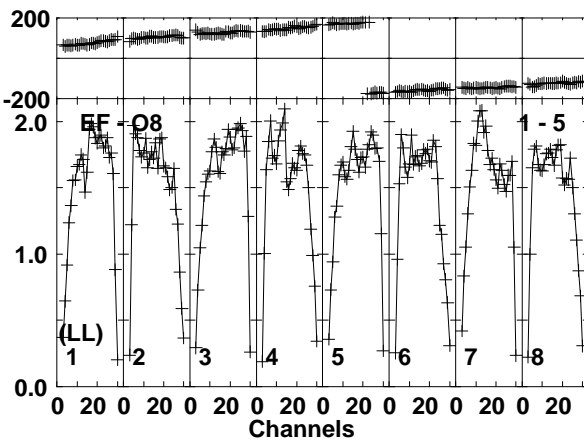
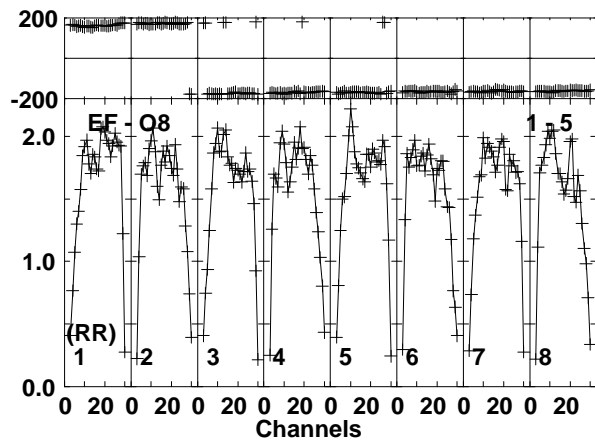
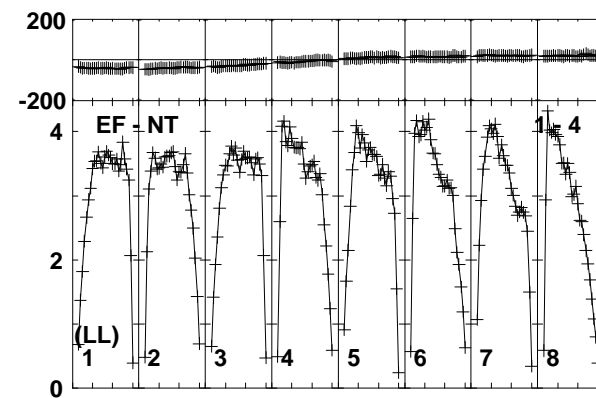
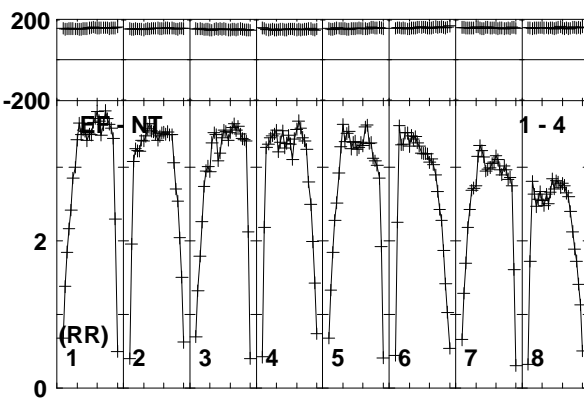
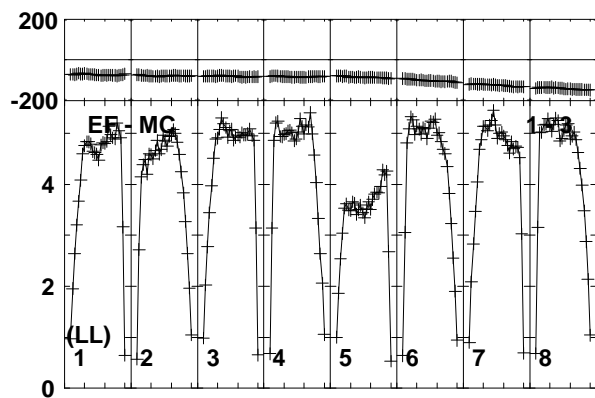
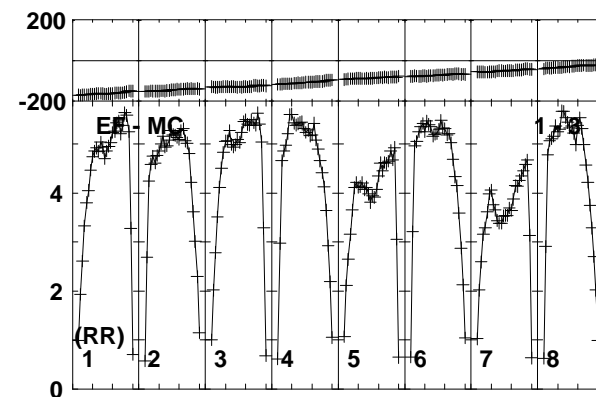
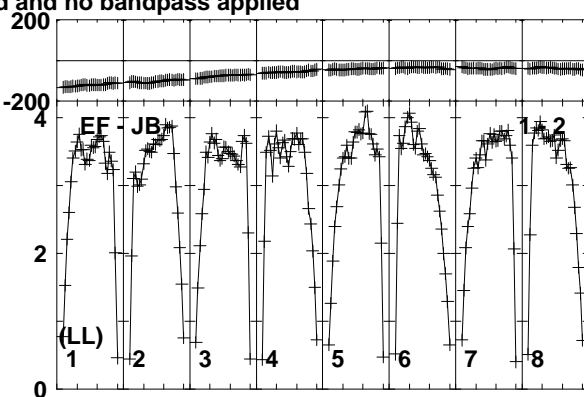
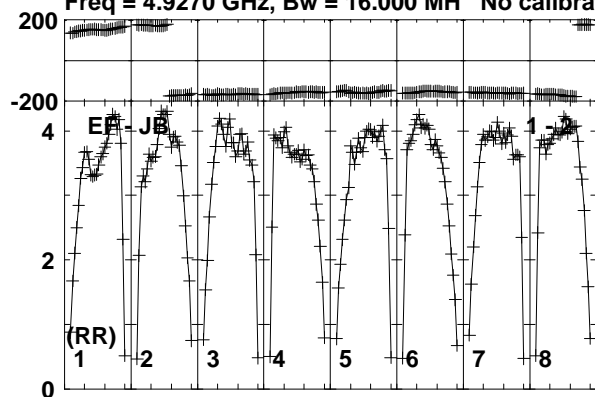

Lower frame: Milli Ampl Jy Top frame: Phas deg  
Vector averaged cross-power spectrum Baseline: EF (01) - JB (02)  
Timerange: 00:15:57:40 to 00:15:59:10

Plot file version 208 created 10-JUN-2016 15:29:39

J0718-1813 RG008C.UVDATA.1

Freq = 4.9270 GHz, Bw = 16.000 MH No calibration applied and no bandpass applied

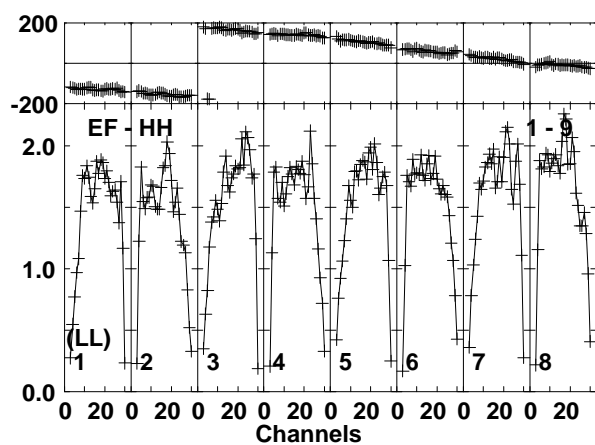
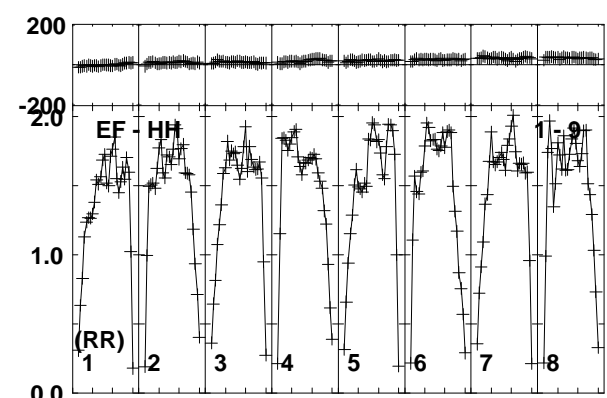
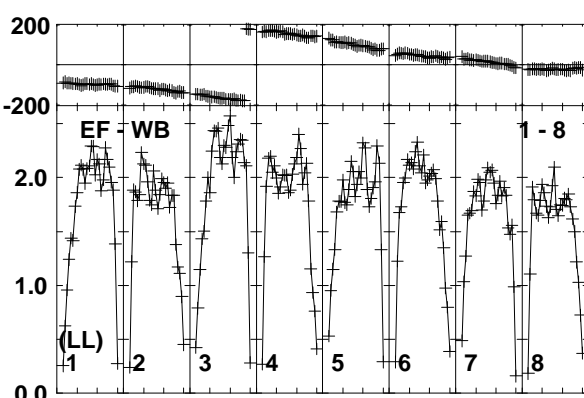
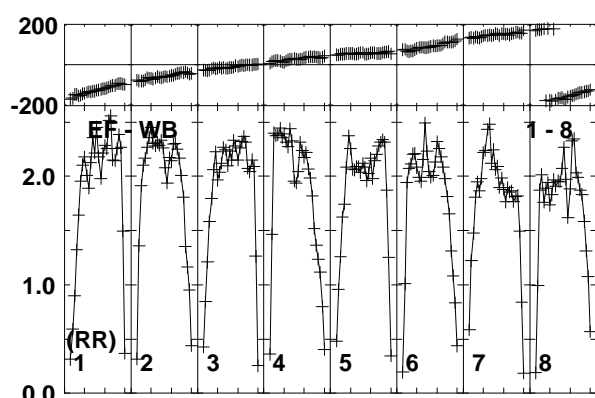
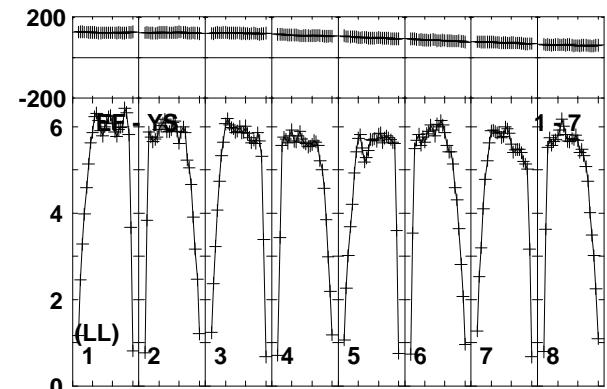
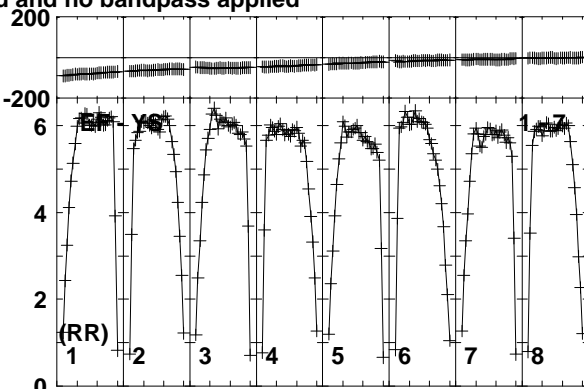
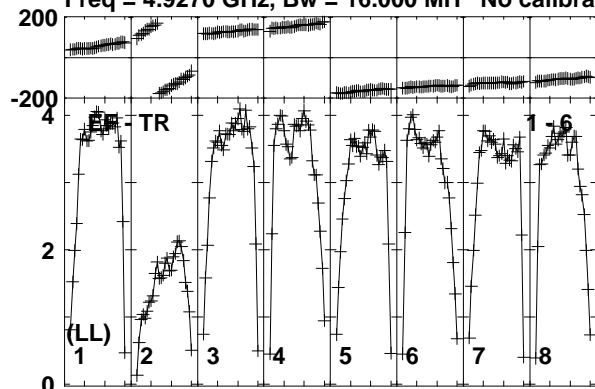

Lower frame: Milli Ampl Jy Top frame: Phas deg  
Vector averaged cross-power spectrum Baseline: EF (01) - TR (06)  
Timerange: 00/15:57:40 to 00/15:59:10



Plot file version 209 created 10-JUN-2016 15:29:39

J0712-1847 RG008C.UVDATA.1

Freq = 4.9270 GHz, Bw = 16.000 MH No calibration applied and no bandpass applied

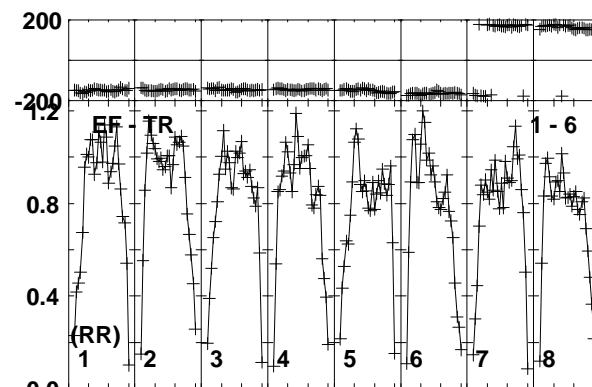
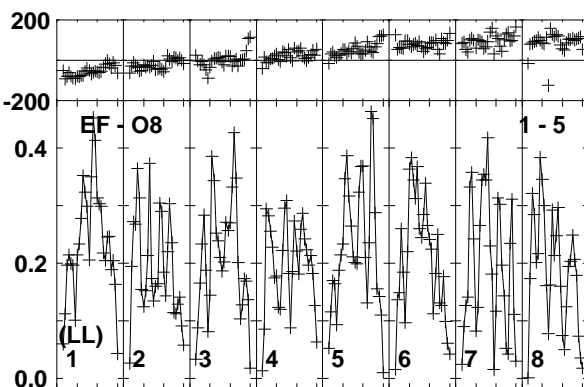
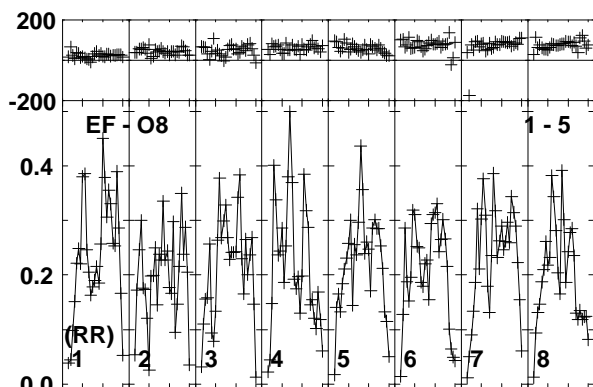
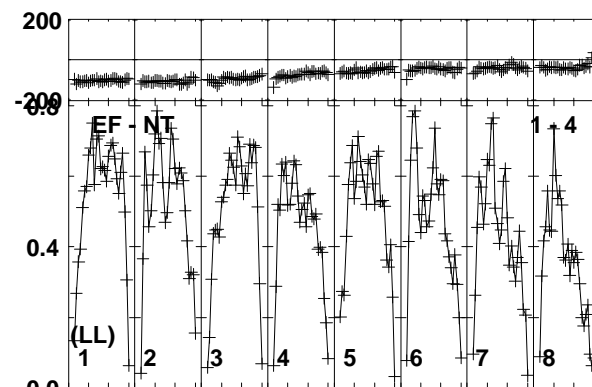
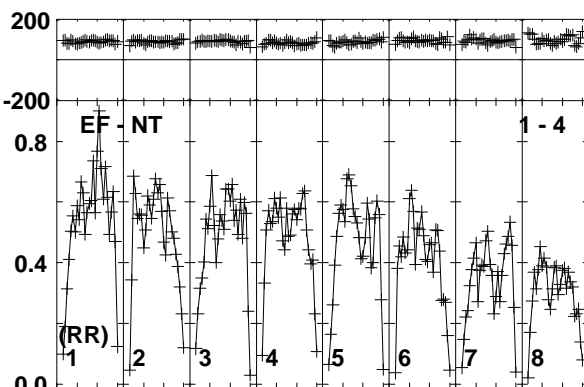
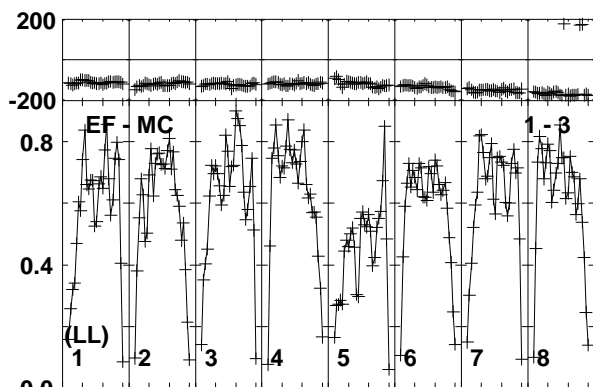
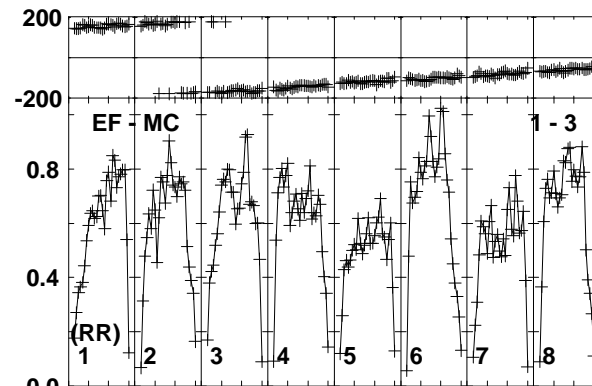
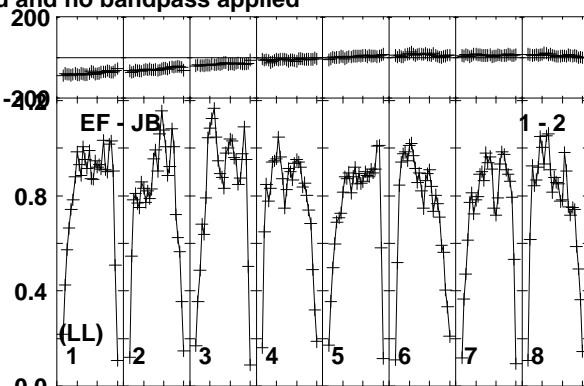
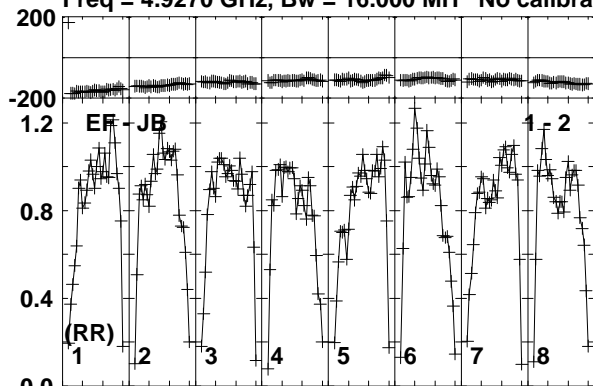

Lower frame: Milli Ampl Jy Top frame: Phas deg

Vector averaged cross-power spectrum Baseline: EF (01) - JB (02)

Timerange: 00/15:59:10 to 00/16:02:10

Plot file version 210 created 10-JUN-2016 15:29:39

J0712-1847 RG008C.UVDATA.1

Freq = 4.9270 GHz, Bw = 16.000 MH No calibration applied and no bandpass applied

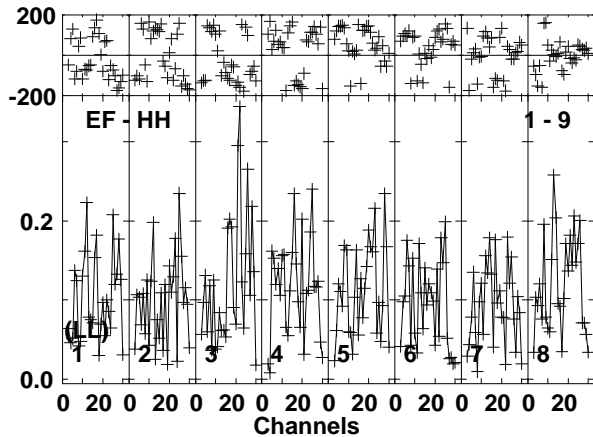
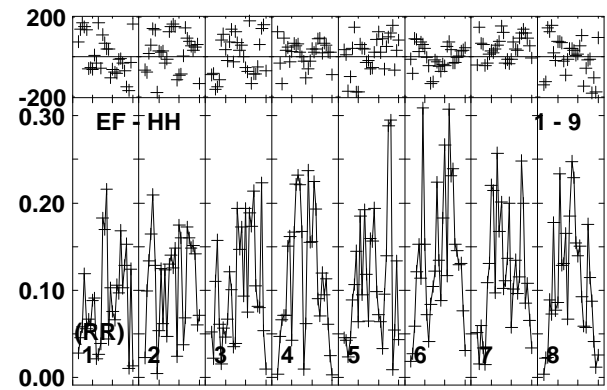
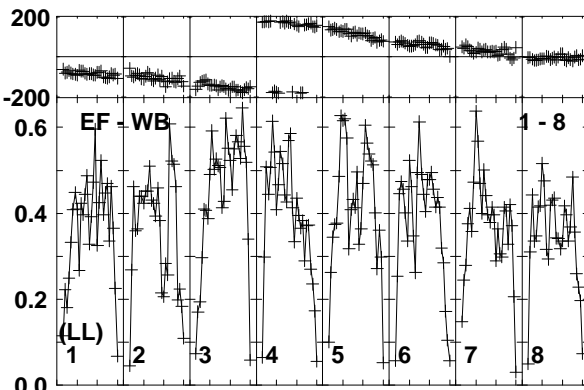
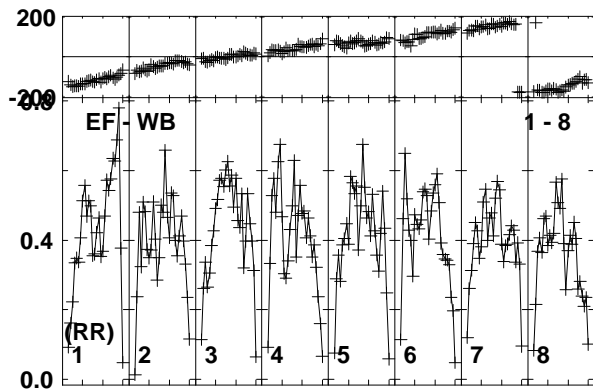
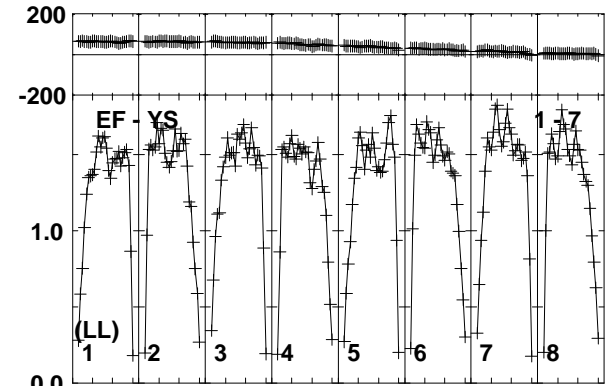
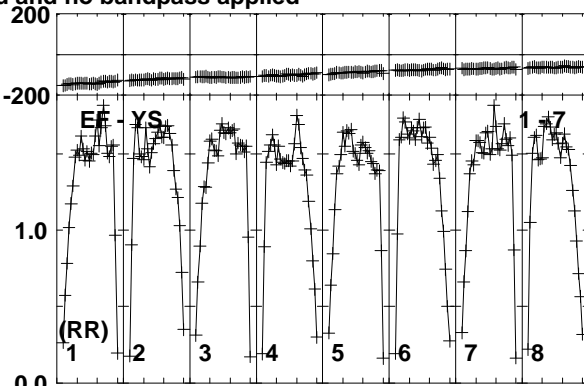
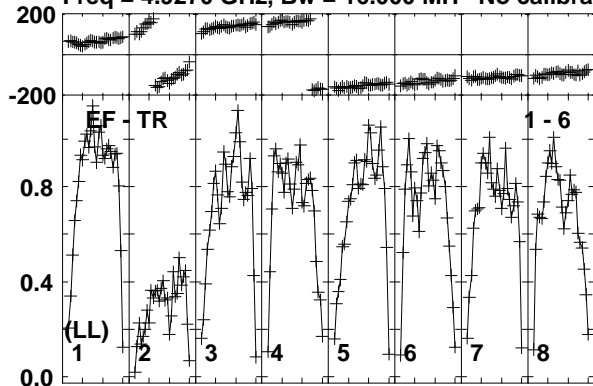

Lower frame: Milli Ampl Jy Top frame: Phas deg  
Vector averaged cross-power spectrum Baseline: EF (01) - TR (06)  
Timerange: 00/15:59:10 to 00/16:02:10

Plot file version 211 created 10-JUN-2016 15:29:39

J0718-1813 RG008C.UVDATA.1

Freq = 4.9270 GHz, Bw = 16.000 MH No calibration applied and no bandpass applied

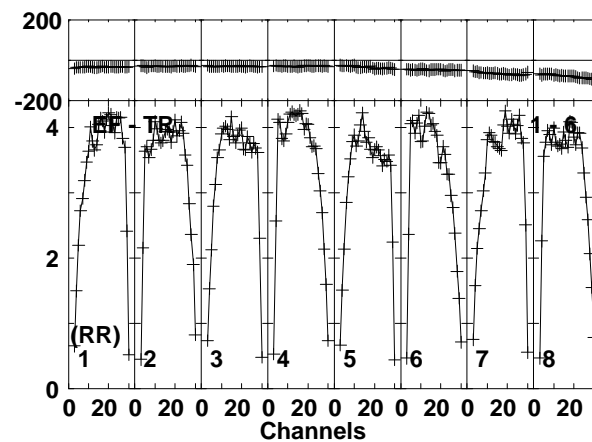
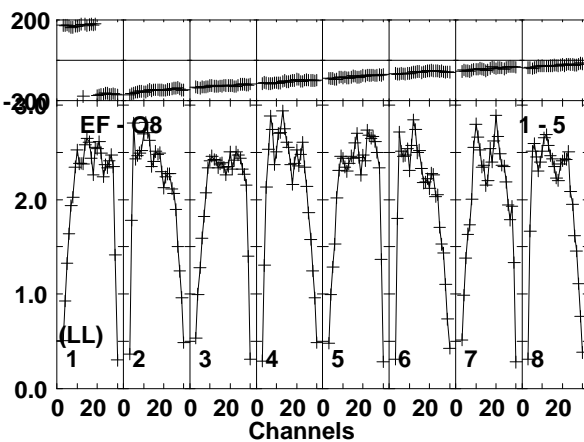
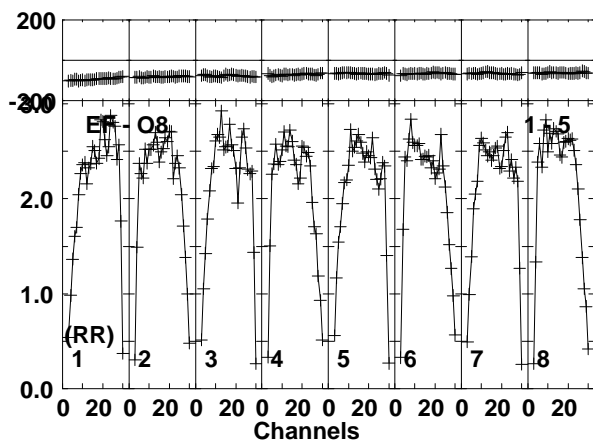
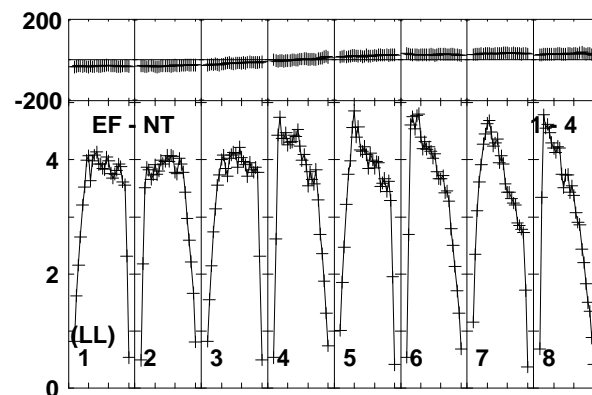
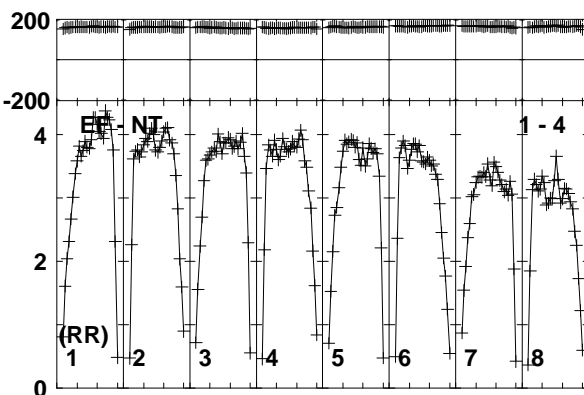
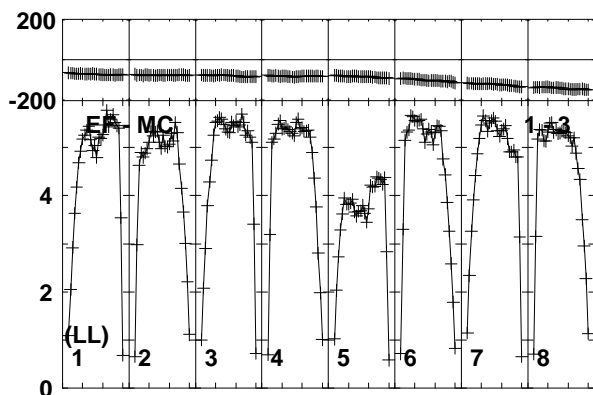
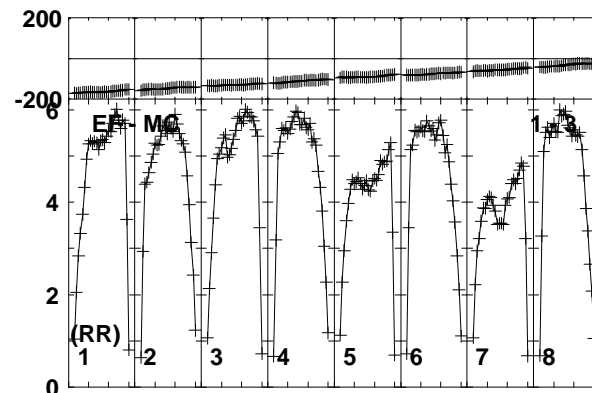
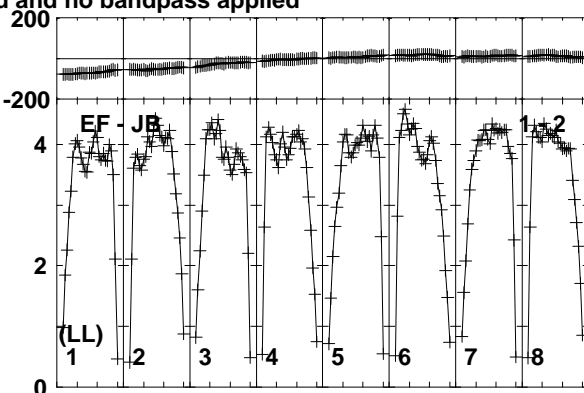
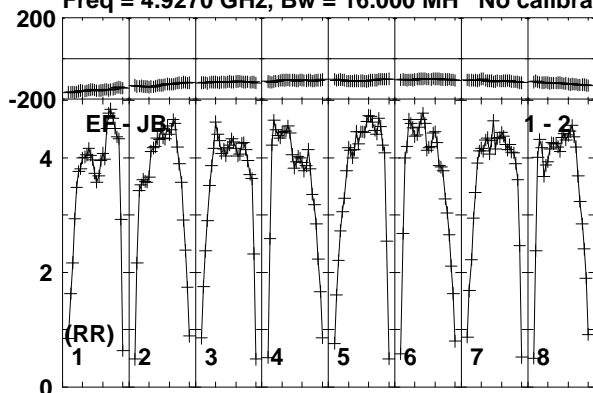

Lower frame: Milli Ampl Jy Top frame: Phas deg  
Vector averaged cross-power spectrum Baseline: EF (01) - JB (02)  
Timerange: 00/16:02:50 to 00/16:03:40

Plot file version 212 created 10-JUN-2016 15:29:39

J0718-1813 RG008C.UVDATA.1

Freq = 4.9270 GHz, Bw = 16.000 MH No calibration applied and no bandpass applied

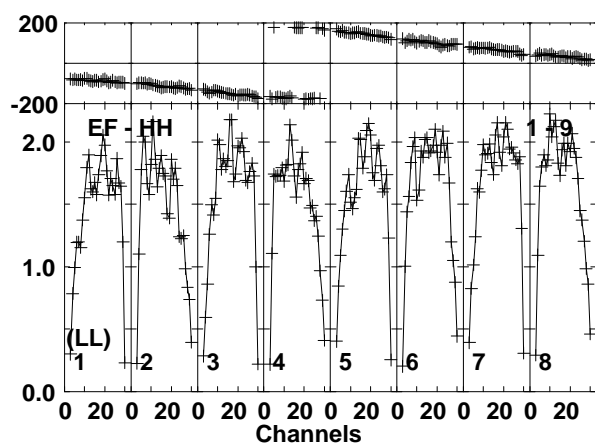
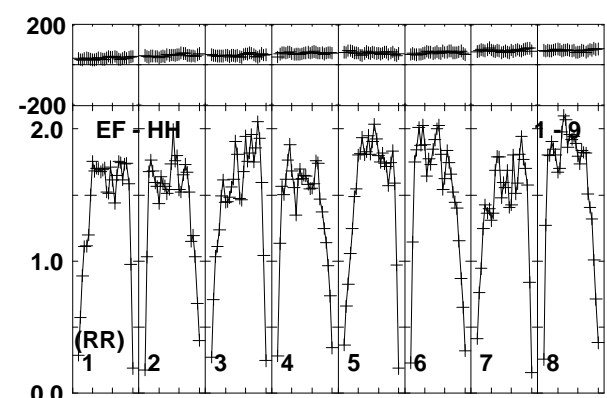
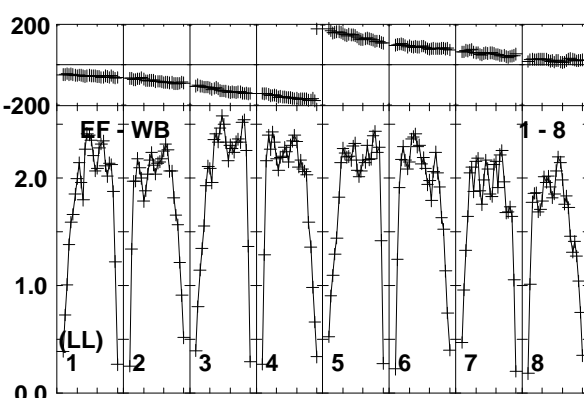
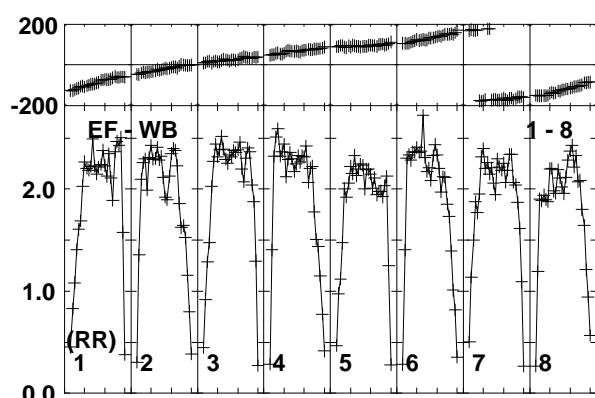
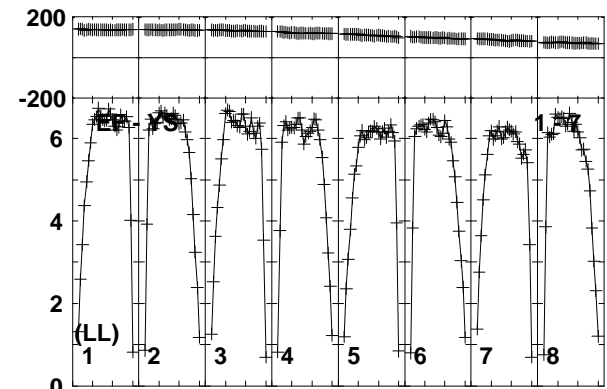
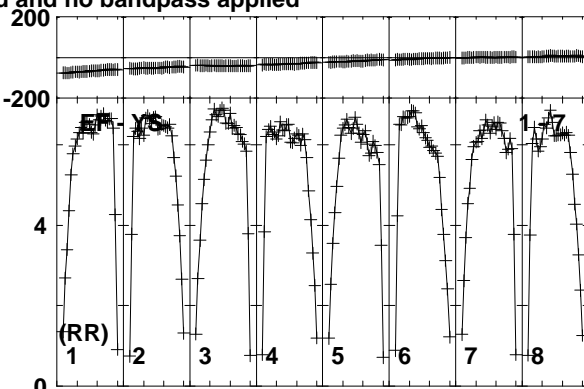
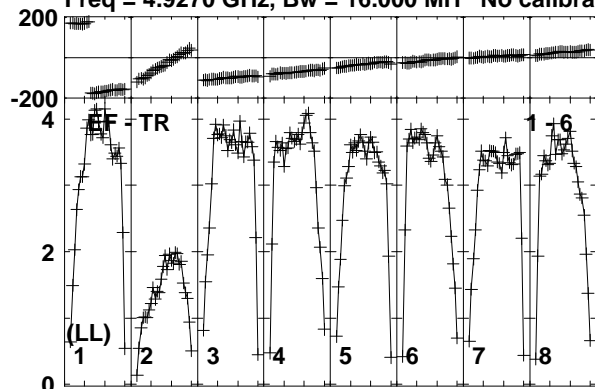

Lower frame: Milli Ampl Jy Top frame: Phas deg  
Vector averaged cross-power spectrum Baseline: EF (01) - TR (06)  
Timerange: 00/16:02:50 to 00/16:03:40

Plot file version 213 created 10-JUN-2016 15:29:40

FRB150418 RG008C.UVDATA.1

Freq = 4.9270 GHz, Bw = 16.000 MH No calibration applied and no bandpass applied

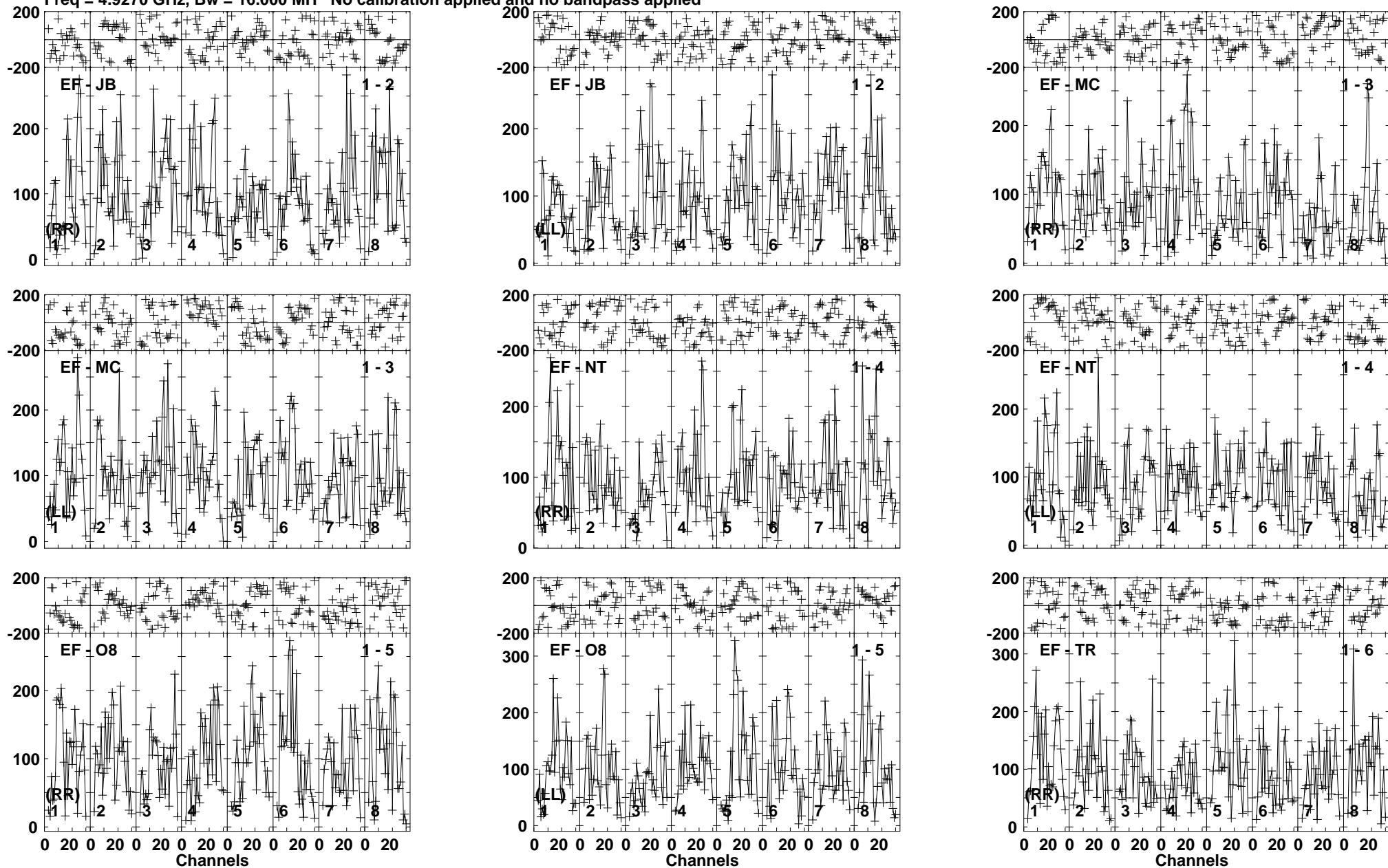

Lower frame: Micro Ampl Jy Top frame: Phas deg  
Vector averaged cross-power spectrum Baseline: EF (01) - JB (02)  
Timerange: 00/16:03:41 to 00/16:06:40

Plot file version 214 created 10-JUN-2016 15:29:40

FRB150418 RG008C.UVDATA.1

Freq = 4.9270 GHz, Bw = 16.000 MH No calibration applied and no bandpass applied

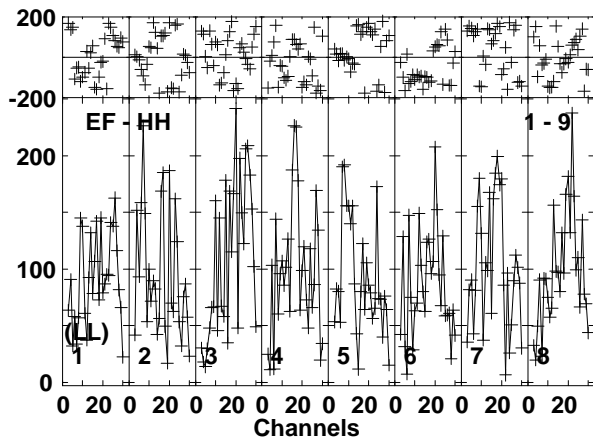
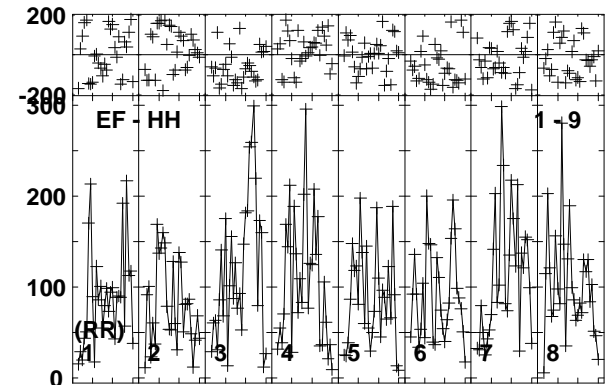
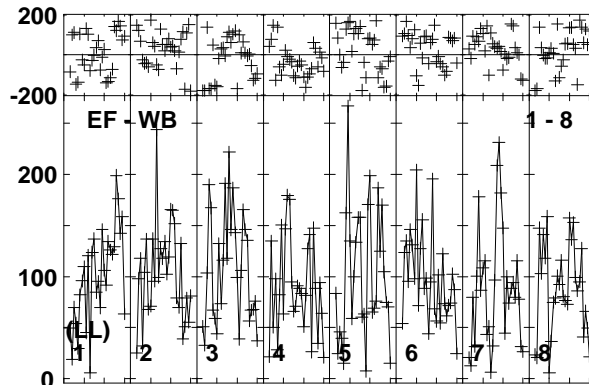
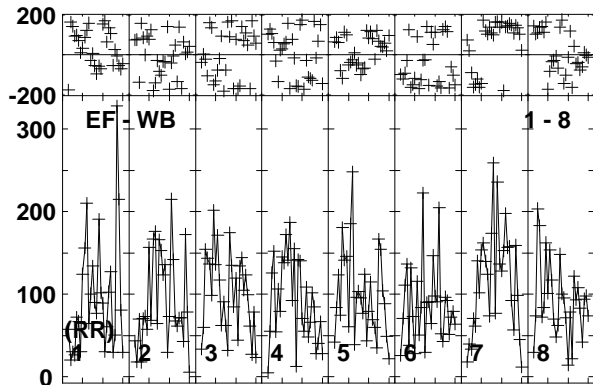
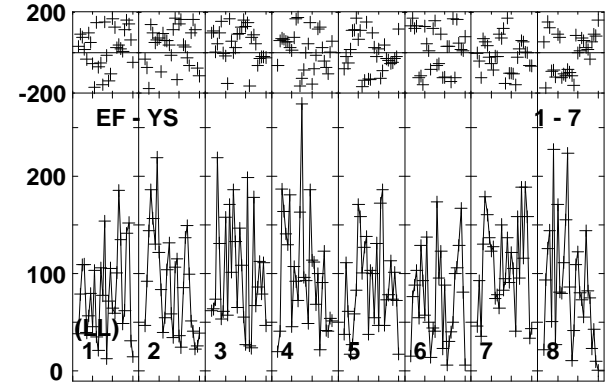
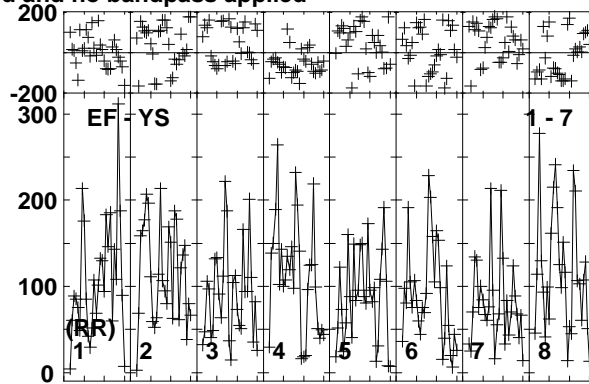
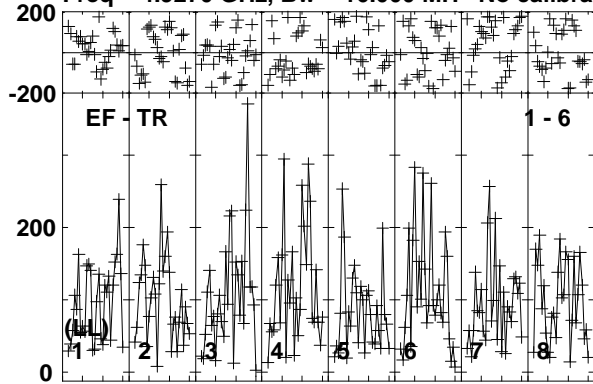

Lower frame: Micro Ampl Jy Top frame: Phas deg  
Vector averaged cross-power spectrum Baseline: EF (01) - TR (06)  
Timerange: 00/16:03:41 to 00/16:06:40

Plot file version 215 created 10-JUN-2016 15:29:40

J0718-1813 RG008C.UVDATA.1

Freq = 4.9270 GHz, Bw = 16.000 MH No calibration applied and no bandpass applied

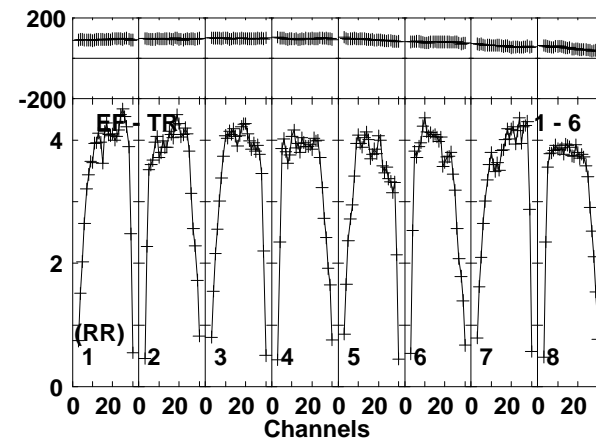
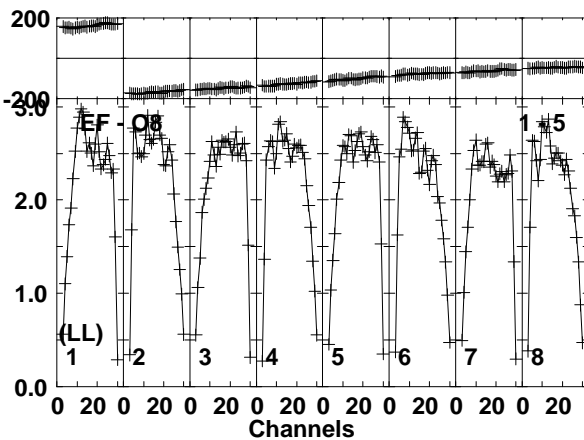
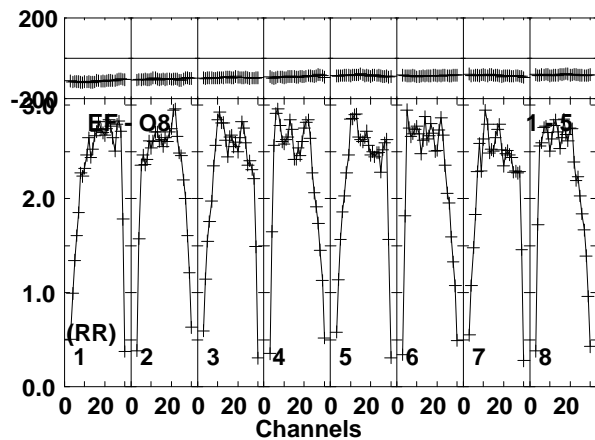
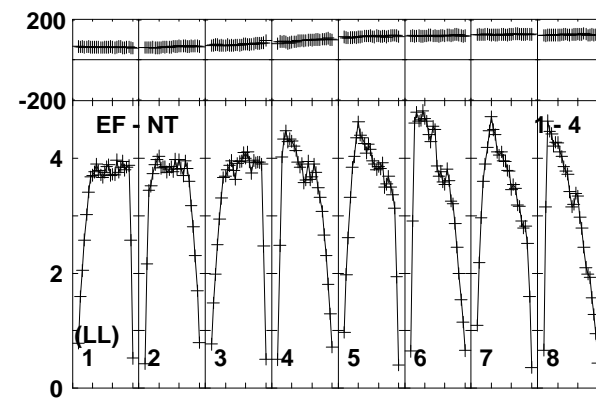
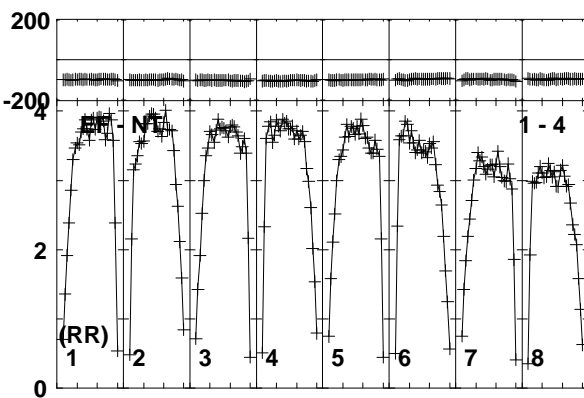
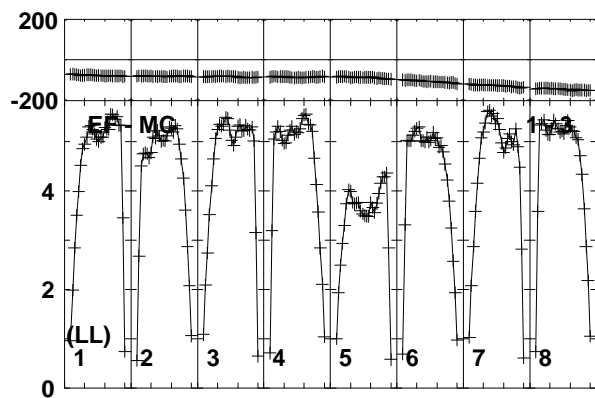
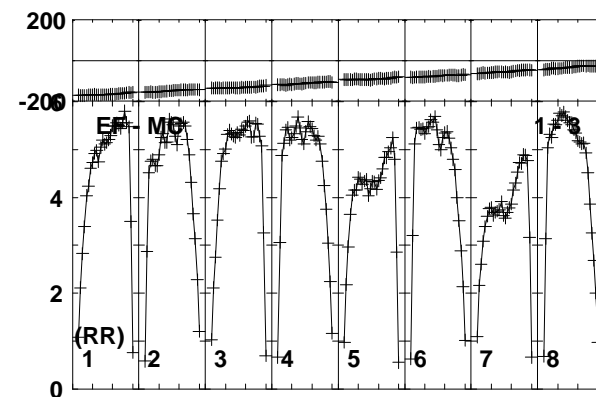
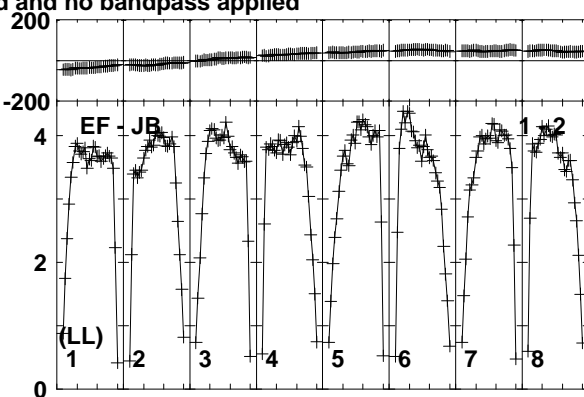
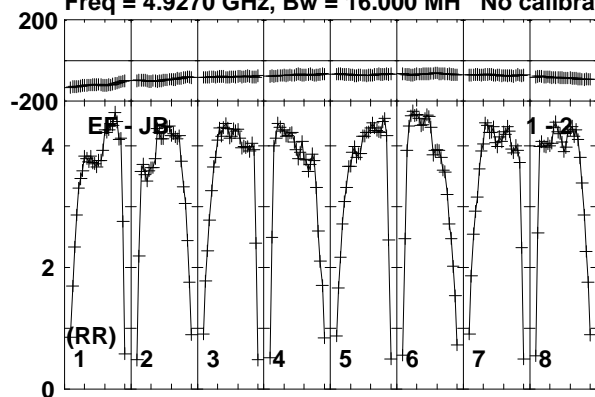

Lower frame: Milli Ampl Jy Top frame: Phas deg  
Vector averaged cross-power spectrum Baseline: EF (01) - JB (02)  
Timerange: 00/16:06:40 to 00/16:08:09

Plot file version 216 created 10-JUN-2016 15:29:40

J0718-1813 RG008C.UVDATA.1

Freq = 4.9270 GHz, Bw = 16.000 MH No calibration applied and no bandpass applied

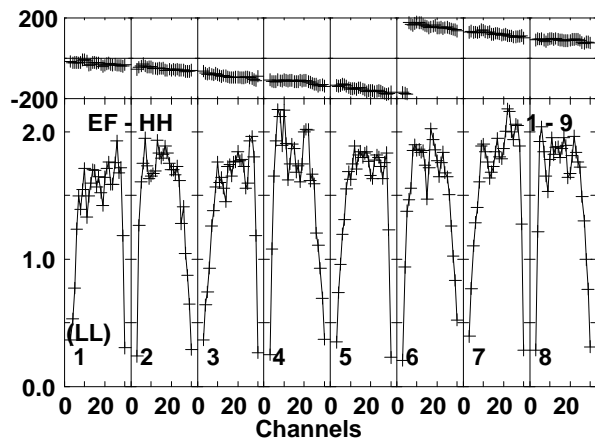
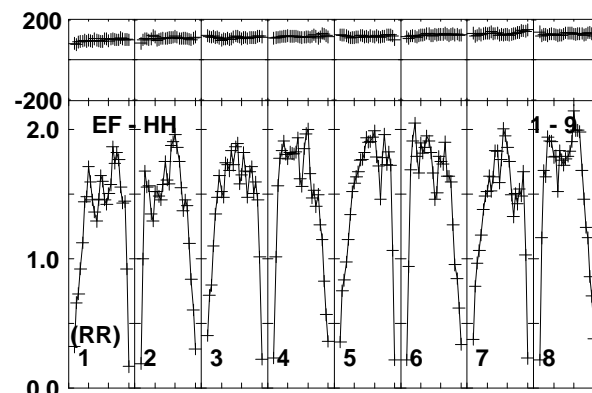
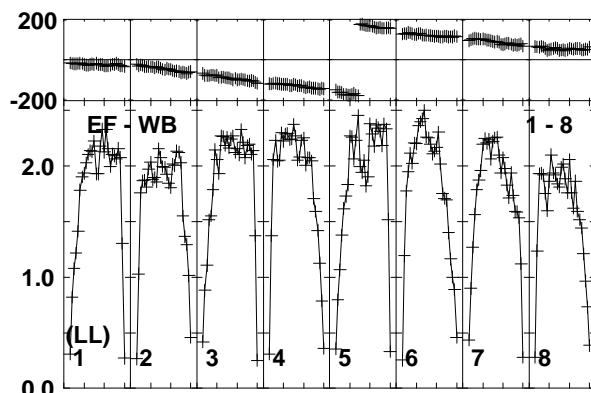
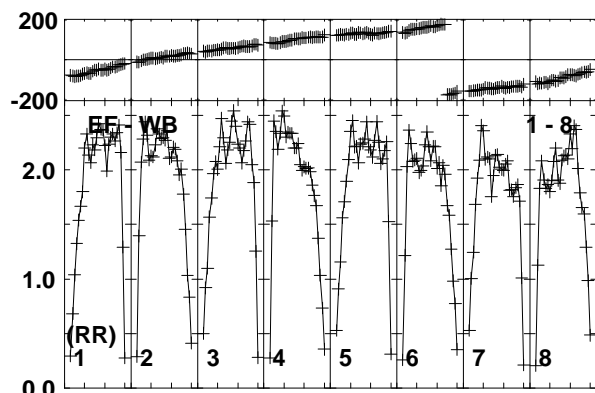
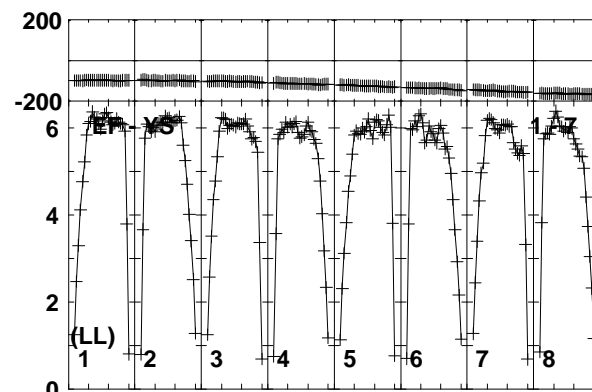
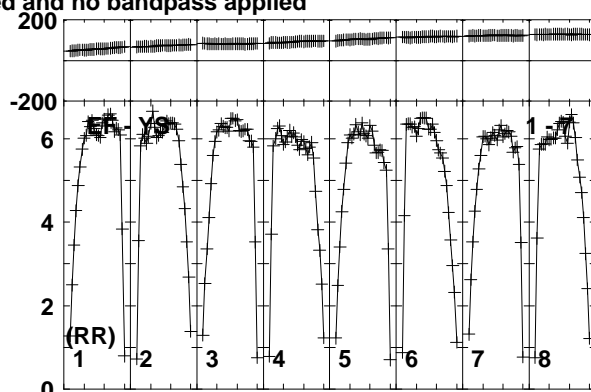
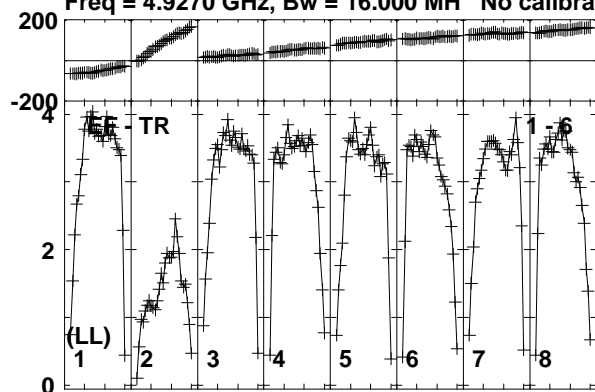

Lower frame: Milli Ampl Jy Top frame: Phas deg  
Vector averaged cross-power spectrum Baseline: EF (01) - TR (06)  
Timerange: 00/16:06:40 to 00/16:08:09



Plot file version 217 created 10-JUN-2016 15:29:40

FRB150418 RG008C.UVDATA.1

Freq = 4.9270 GHz, Bw = 16.000 MH No calibration applied and no bandpass applied

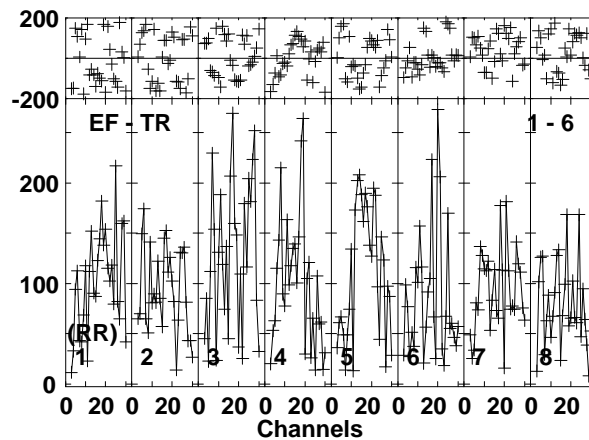
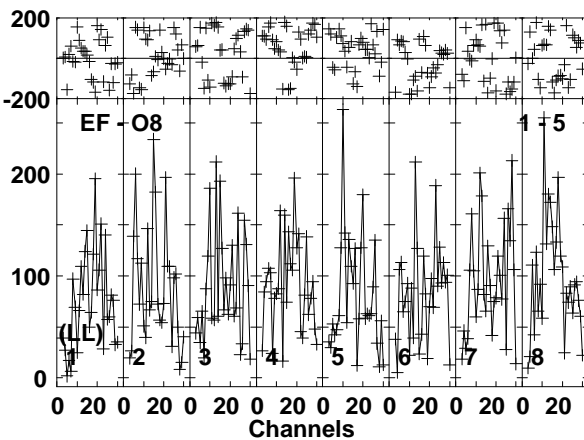
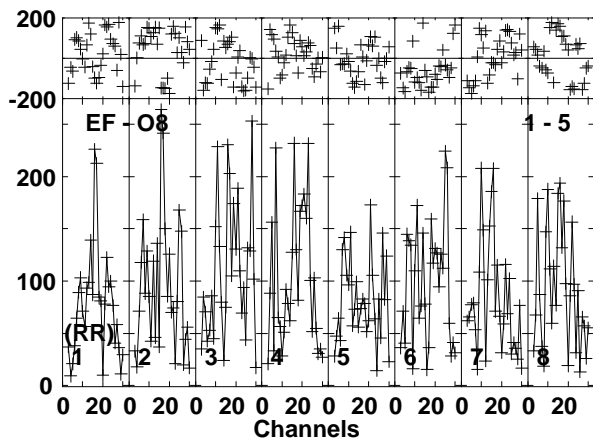
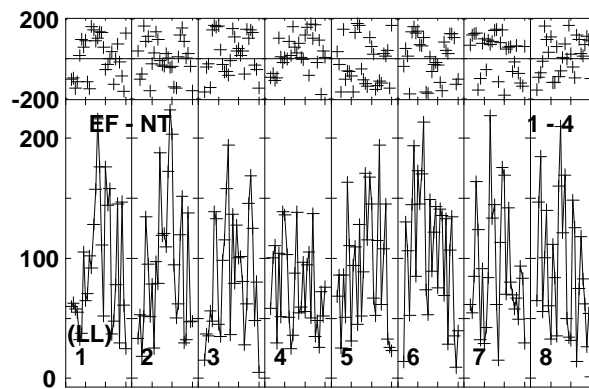
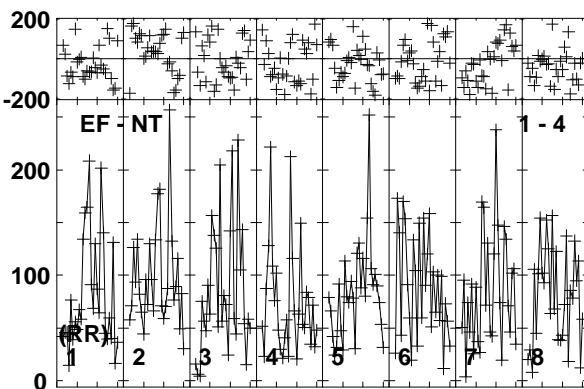
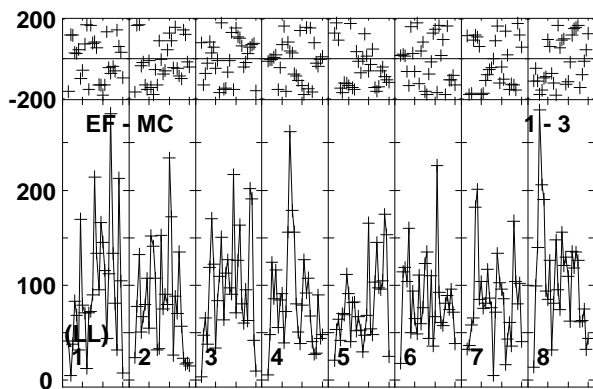
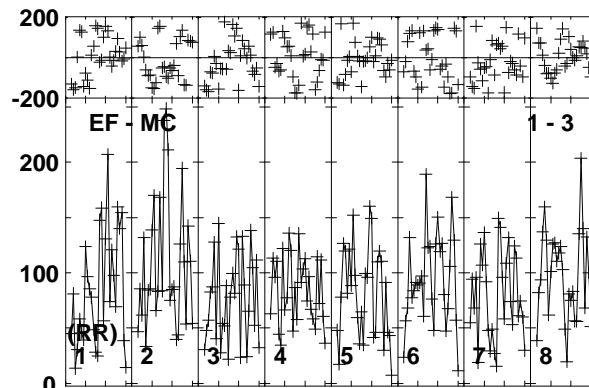
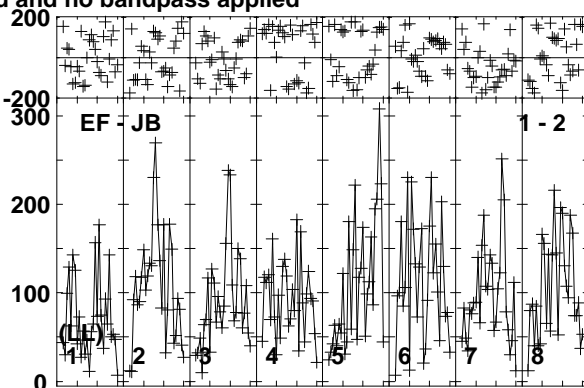
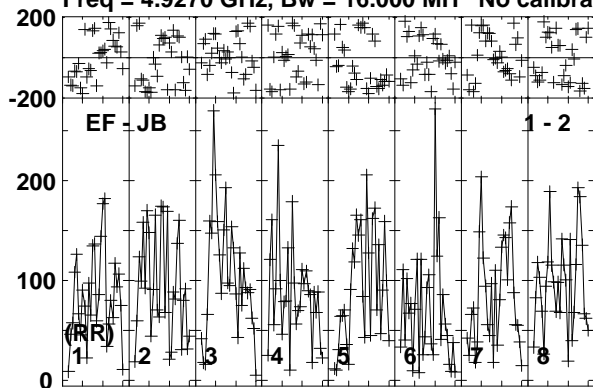

Lower frame: Micro Ampl Jy Top frame: Phas deg  
Vector averaged cross-power spectrum Baseline: EF (01) - JB (02)  
Timerange: 00/16:08:10 to 00/16:11:10

Plot file version 218 created 10-JUN-2016 15:29:40

FRB150418 RG008C.UVDATA.1

Freq = 4.9270 GHz, Bw = 16.000 MH No calibration applied and no bandpass applied

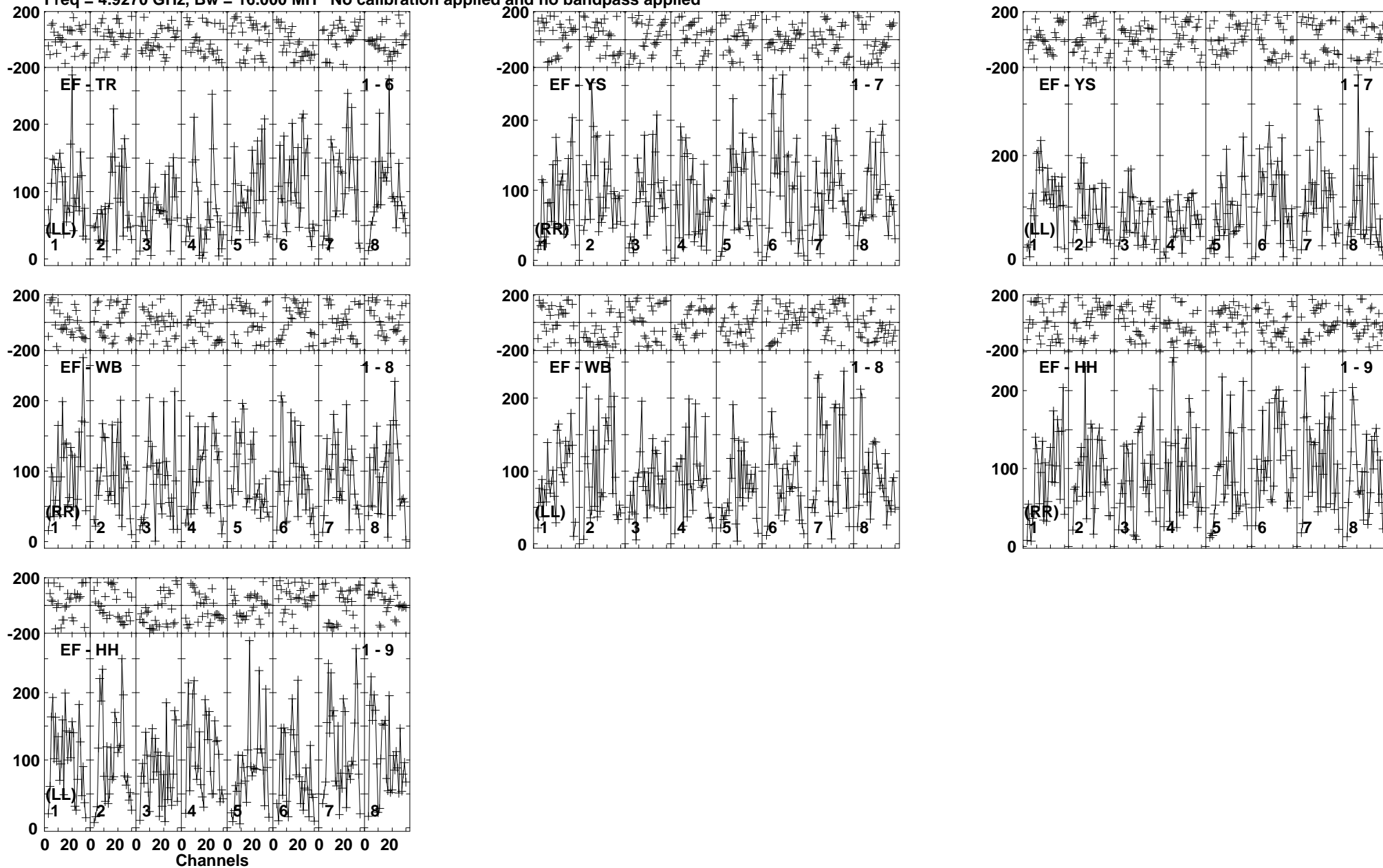

Lower frame: Micro Ampl Jy Top frame: Phas deg  
Vector averaged cross-power spectrum Baseline: EF (01) - TR (06)  
Timerange: 00/16:08:10 to 00/16:11:10

Plot file version 219 created 10-JUN-2016 15:29:40

J0718-1813 RG008C.UVDATA.1

Freq = 4.9270 GHz, Bw = 16.000 MH No calibration applied and no bandpass applied

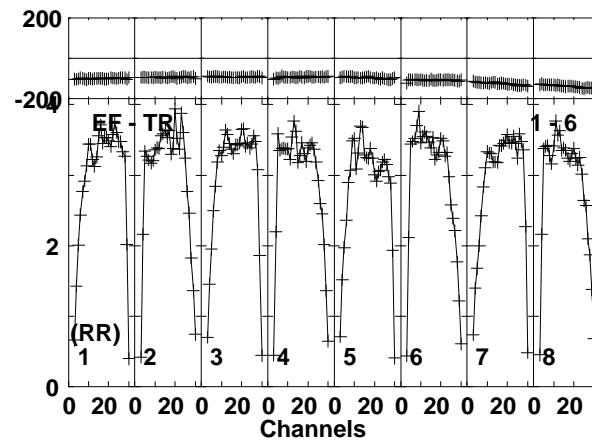
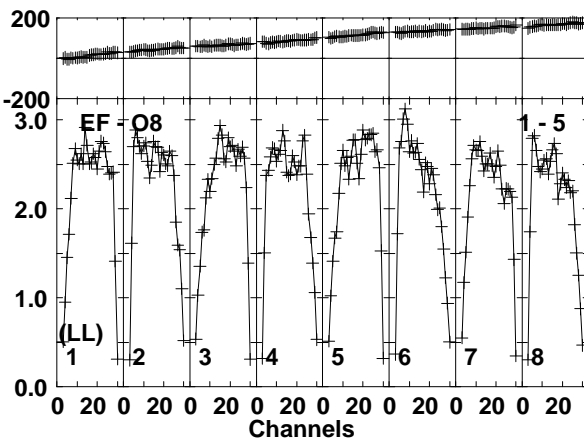
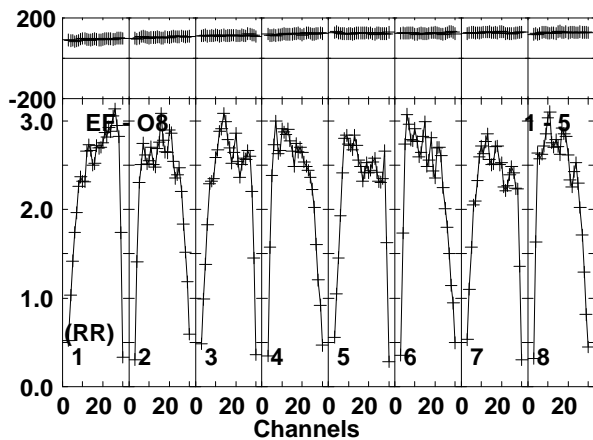
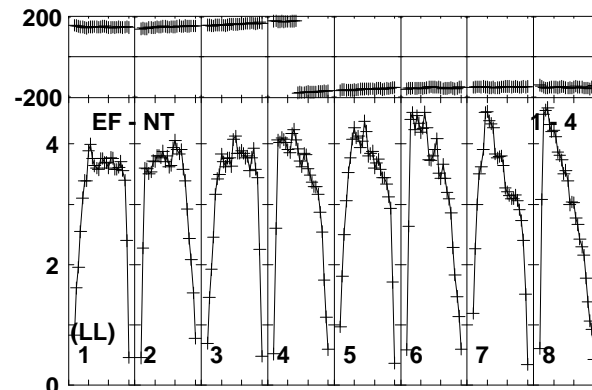
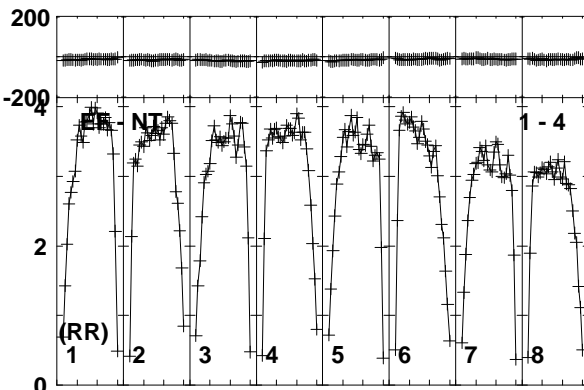
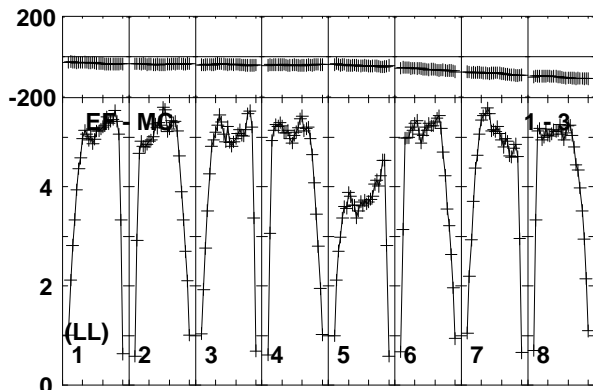
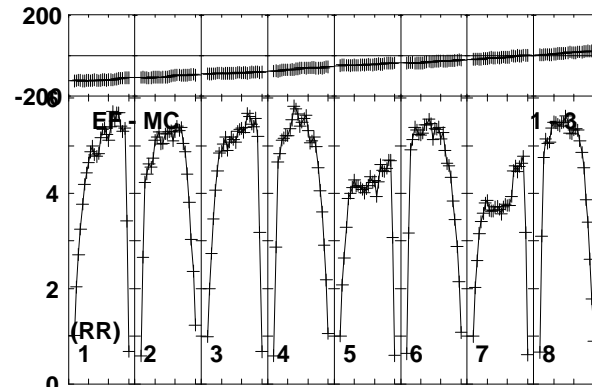
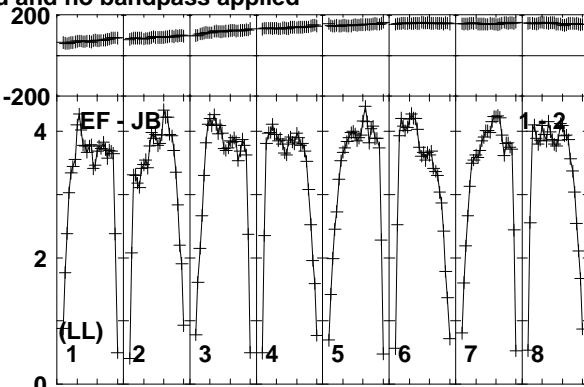
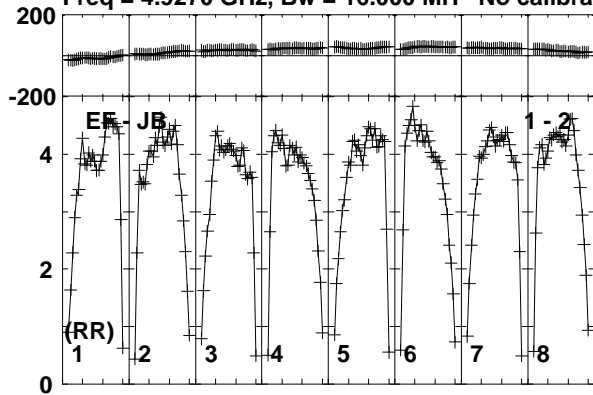

Lower frame: Milli Ampl Jy Top frame: Phas deg  
Vector averaged cross-power spectrum Baseline: EF (01) - JB (02)  
Timerange: 00/16:11:50 to 00/16:12:40

Plot file version 220 created 10-JUN-2016 15:29:40

J0718-1813 RG008C.UVDATA.1

Freq = 4.9270 GHz, Bw = 16.000 MH No calibration applied and no bandpass applied

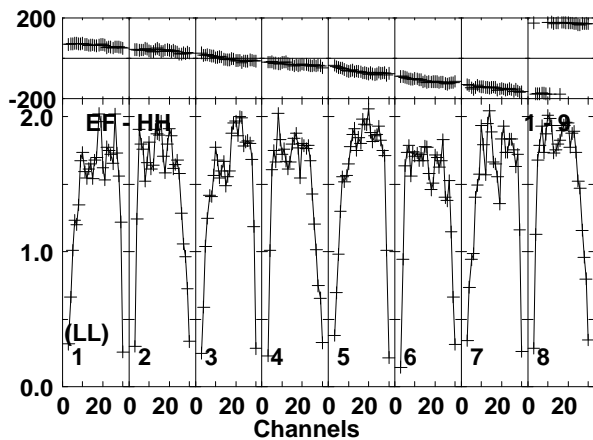
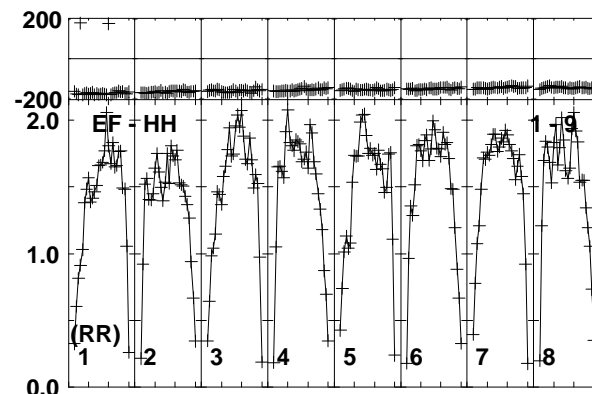
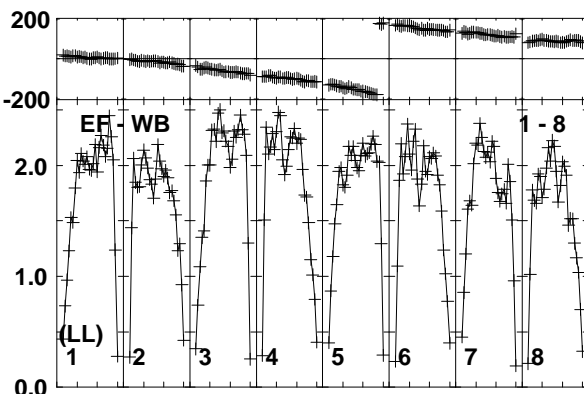
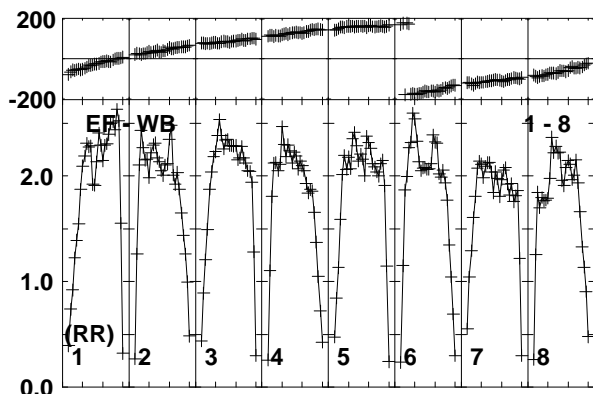
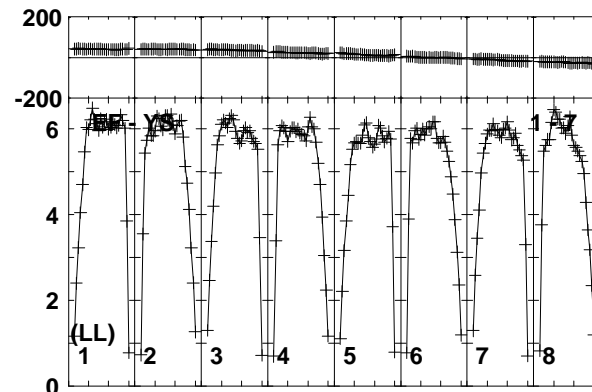
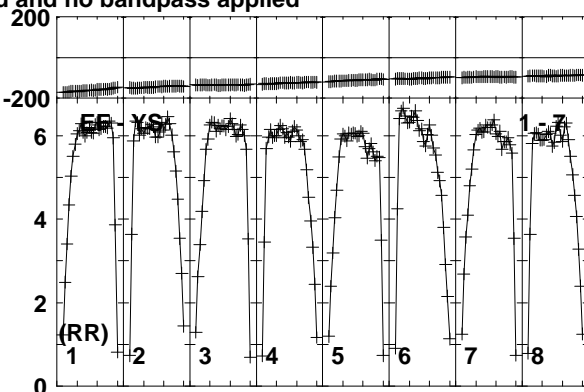
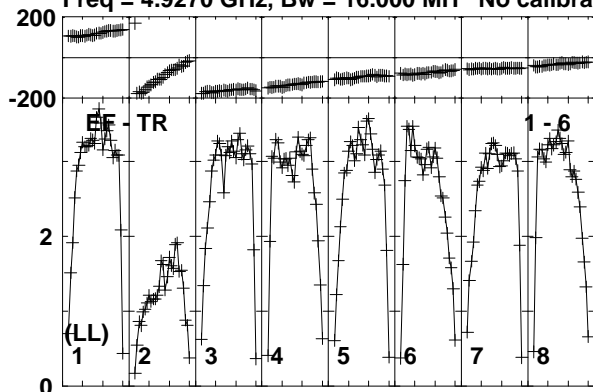

Lower frame: Milli Ampl Jy Top frame: Phas deg  
Vector averaged cross-power spectrum Baseline: EF (01) - TR (06)  
Timerange: 00/16:11:50 to 00/16:12:40

Plot file version 221 created 10-JUN-2016 15:29:41

FRB150418 RG008C.UVDATA.1

Freq = 4.9270 GHz, Bw = 16.000 MH No calibration applied and no bandpass applied

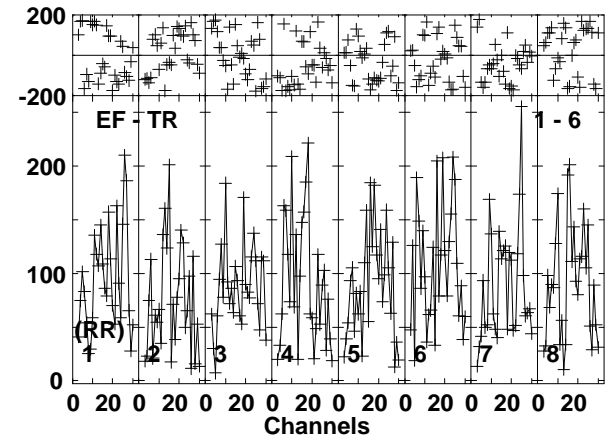
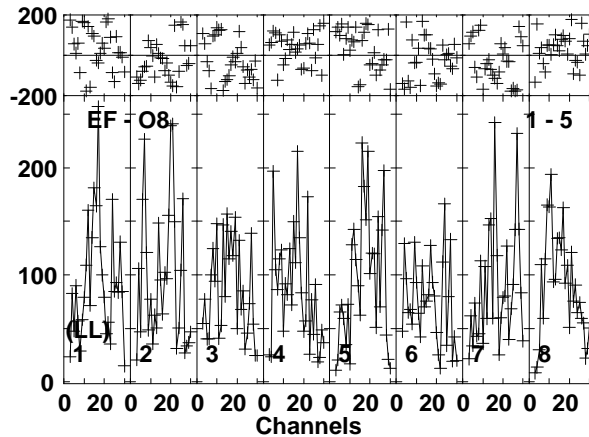
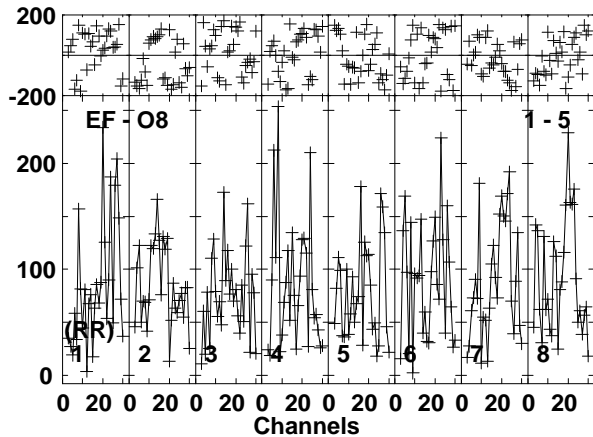
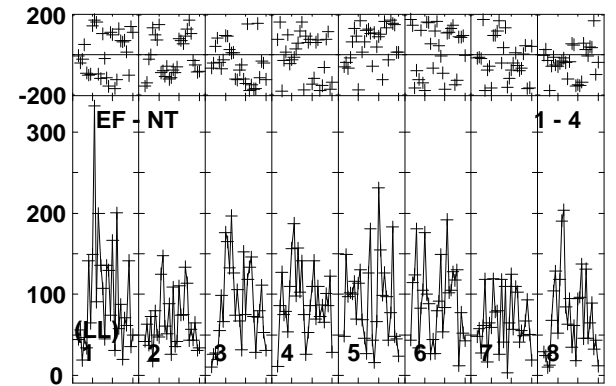
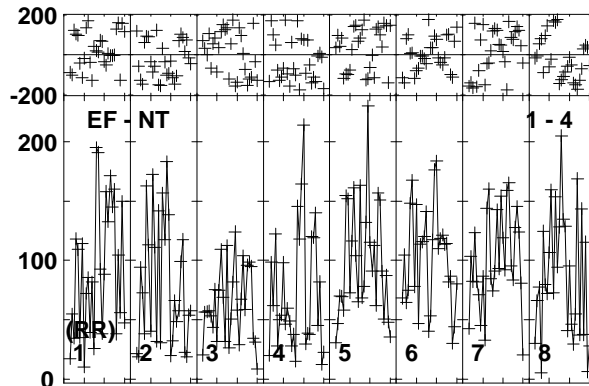
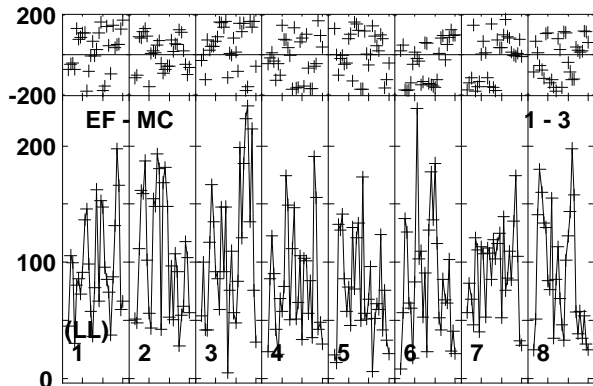
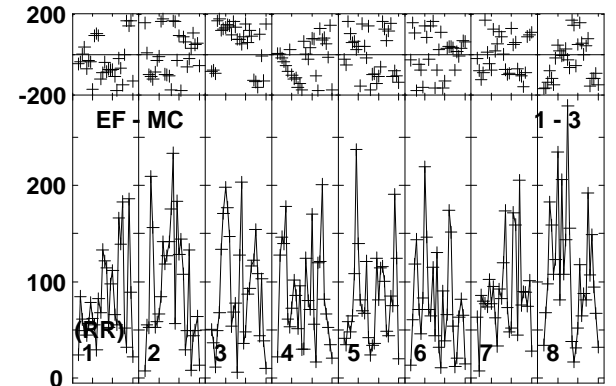
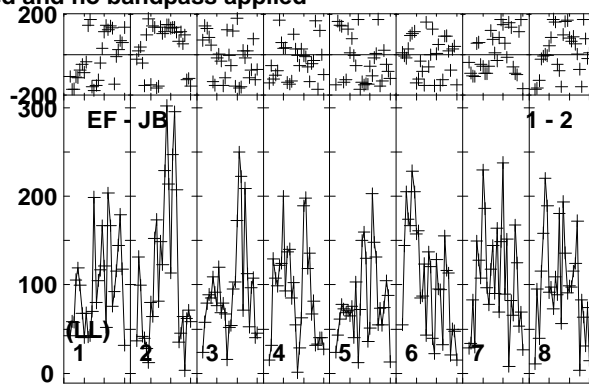
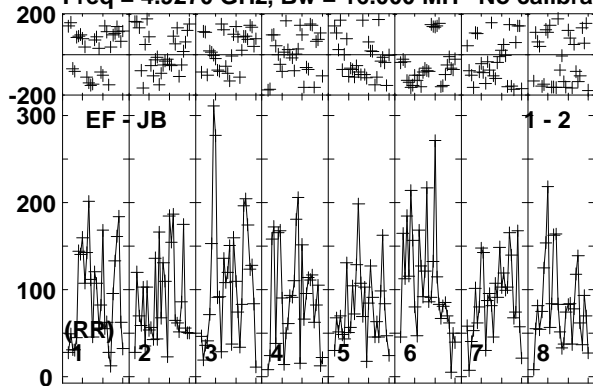

Lower frame: Micro Ampl Jy Top frame: Phas deg  
Vector averaged cross-power spectrum Baseline: EF (01) - JB (02)  
Timerange: 00/16:12:41 to 00/16:15:39

Plot file version 222 created 10-JUN-2016 15:29:41

FRB150418 RG008C.UVDATA.1

Freq = 4.9270 GHz, Bw = 16.000 MH No calibration applied and no bandpass applied

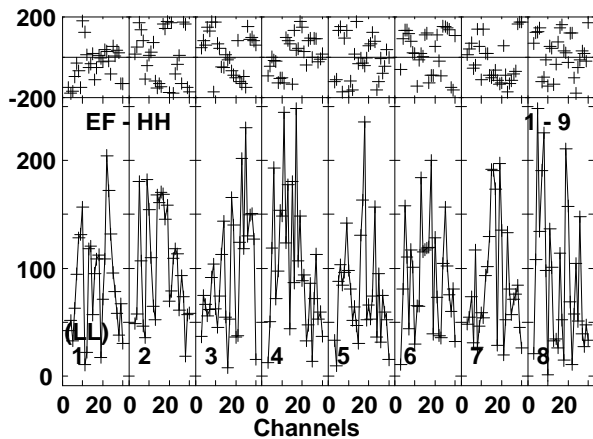
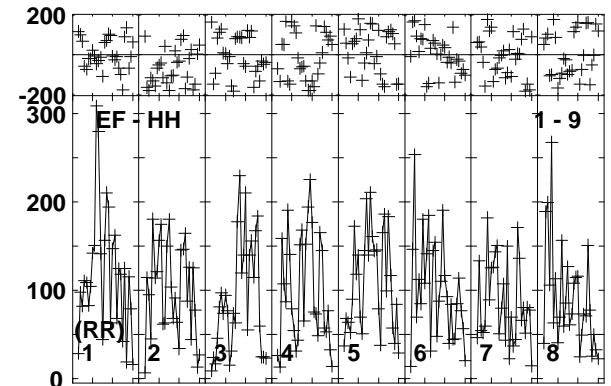
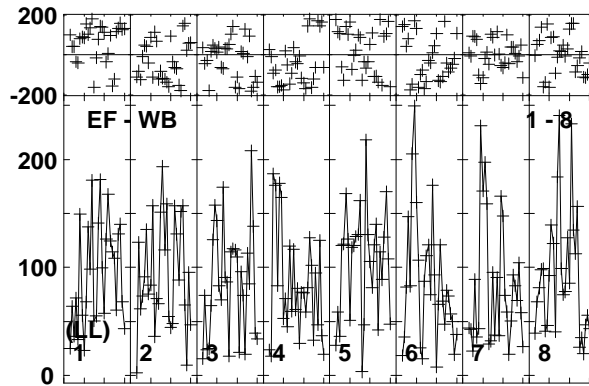
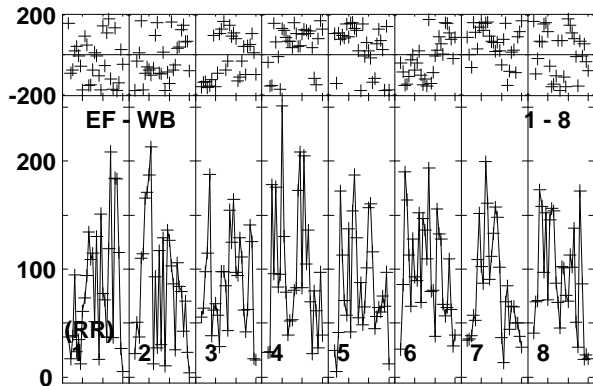
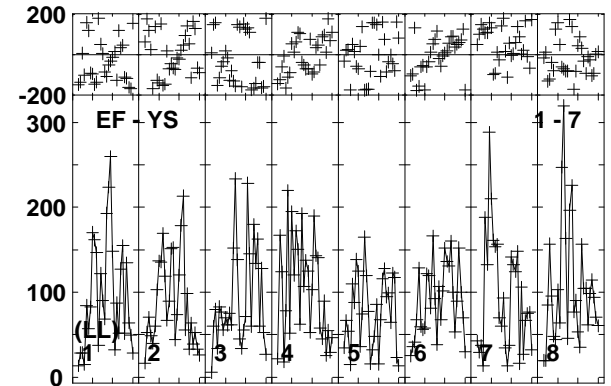
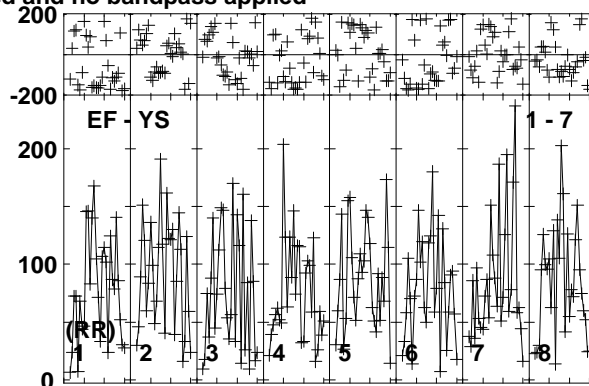
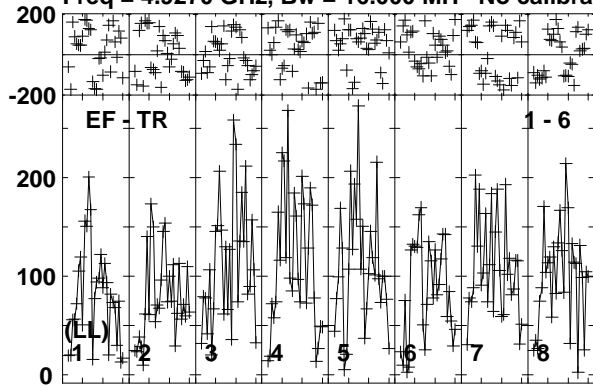

Lower frame: Micro Ampl Jy Top frame: Phas deg  
Vector averaged cross-power spectrum Baseline: EF (01) - TR (06)  
Timerange: 00/16:12:41 to 00/16:15:39

Plot file version 223 created 10-JUN-2016 15:29:41

J0718-1813 RG008C.UVDATA.1

Freq = 4.9270 GHz, Bw = 16.000 MH No calibration applied and no bandpass applied

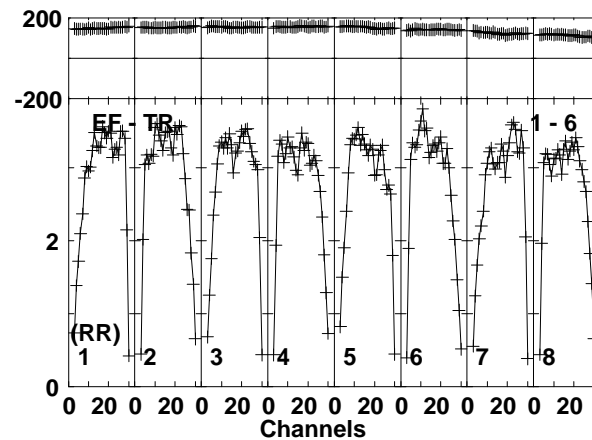
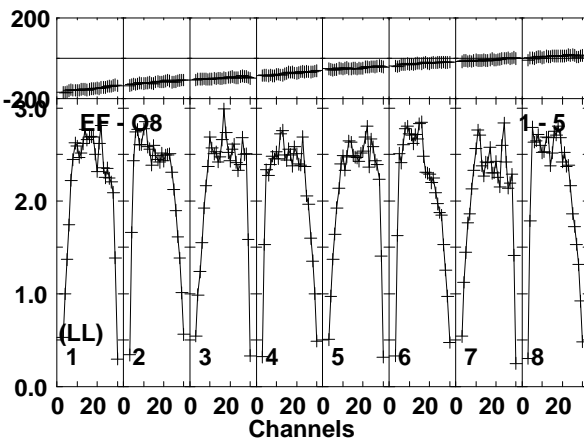
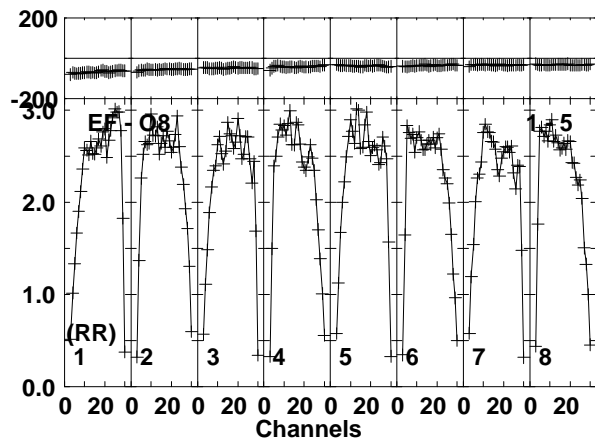
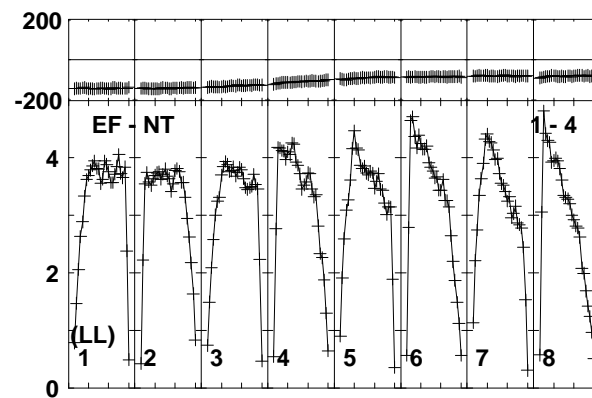
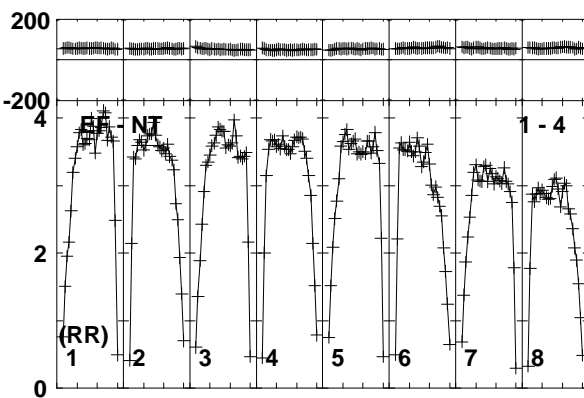
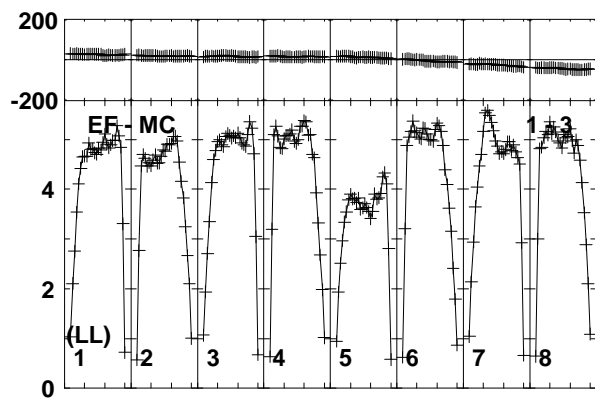
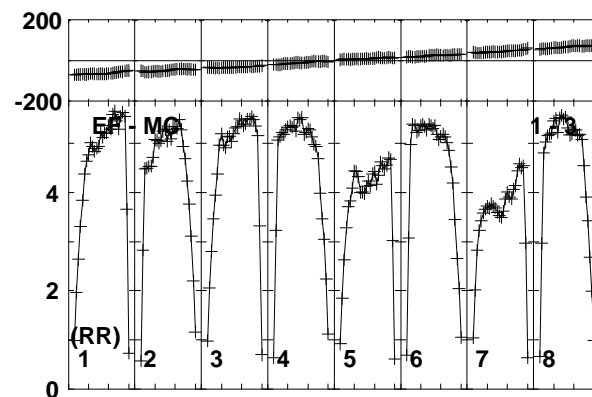
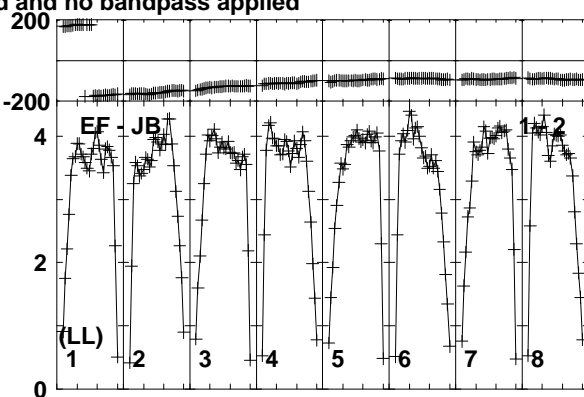
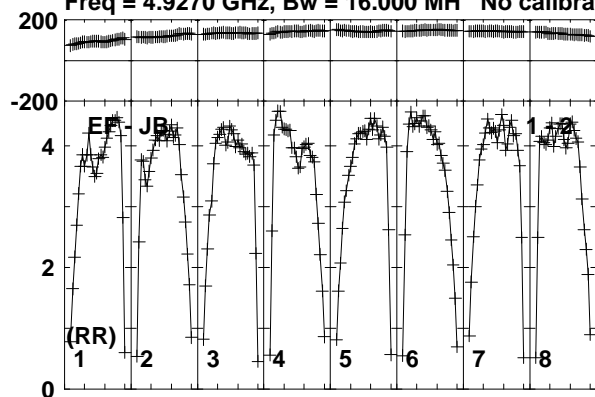

Lower frame: Milli Ampl Jy Top frame: Phas deg  
Vector averaged cross-power spectrum Baseline: EF (01) - JB (02)  
Timerange: 00:16:15:40 to 00:16:17:10

Plot file version 224 created 10-JUN-2016 15:29:41

J0718-1813 RG008C.UVDATA.1

Freq = 4.9270 GHz, Bw = 16.000 MH No calibration applied and no bandpass applied

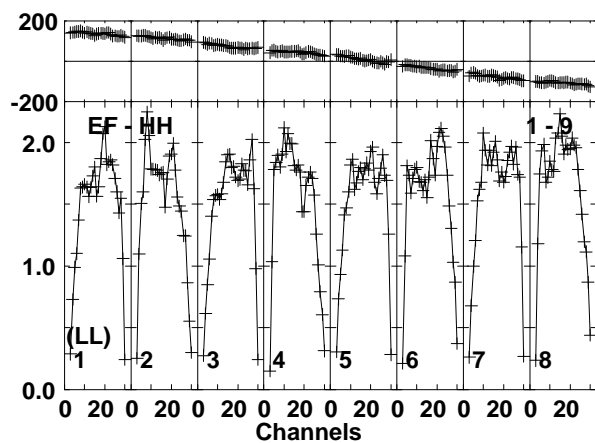
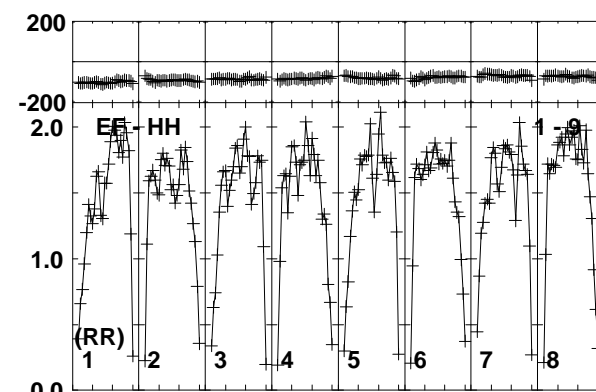
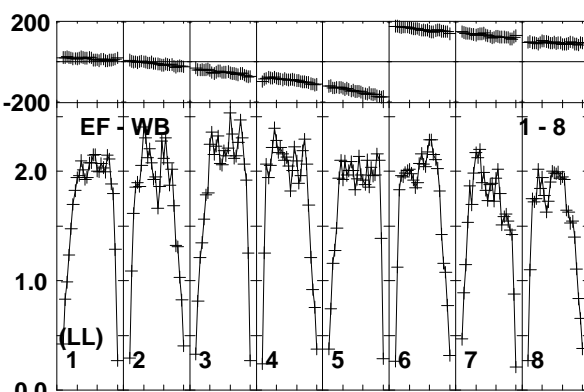
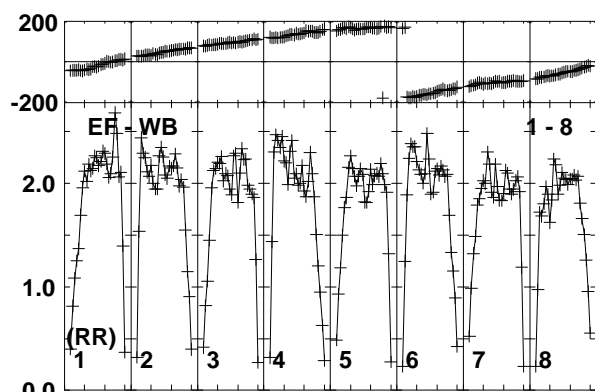
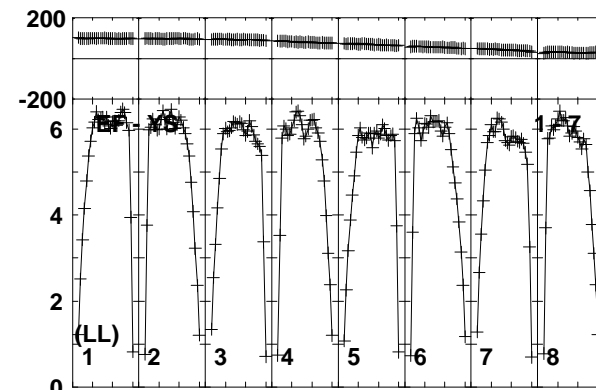
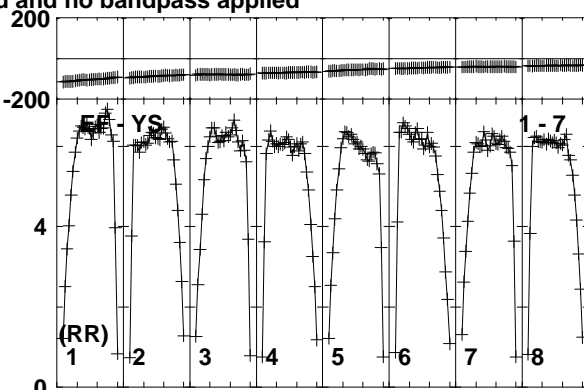
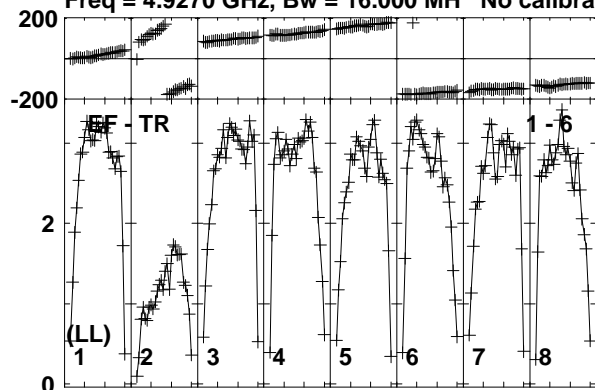

Lower frame: Milli Ampl Jy Top frame: Phas deg  
Vector averaged cross-power spectrum Baseline: EF (01) - TR (06)  
Timerange: 00/16:15:40 to 00/16:17:10



Plot file version 225 created 10-JUN-2016 15:29:41

J0712-1847 RG008C.UVDATA.1

Freq = 4.9270 GHz, Bw = 16.000 MH No calibration applied and no bandpass applied

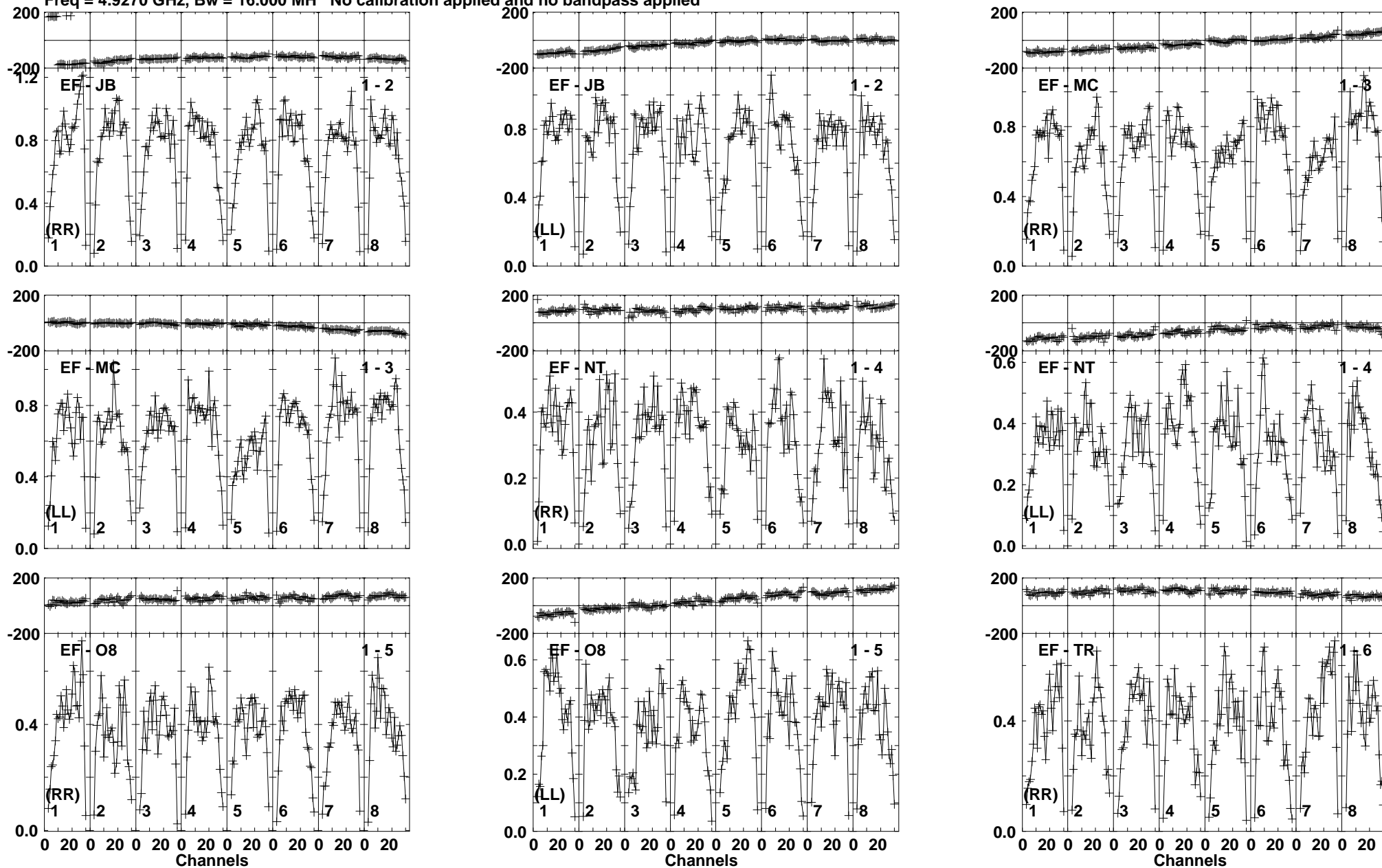

Lower frame: Milli Ampl Jy Top frame: Phas deg  
Vector averaged cross-power spectrum Baseline: EF (01) - JB (02)  
Timerange: 00/16:17:11 to 00/16:20:09

Plot file version 226 created 10-JUN-2016 15:29:41

J0712-1847 RG008C.UVDATA.1

Freq = 4.9270 GHz, Bw = 16.000 MH No calibration applied and no bandpass applied

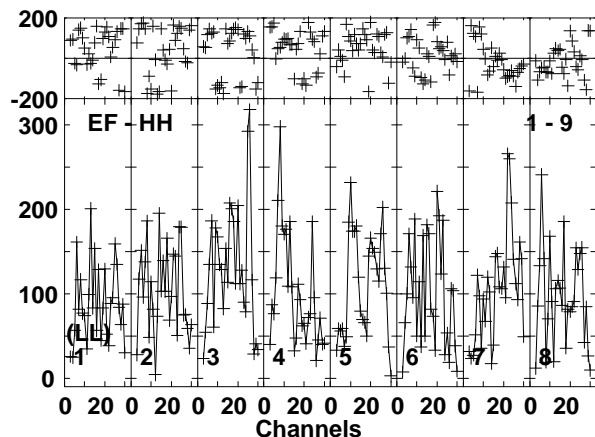
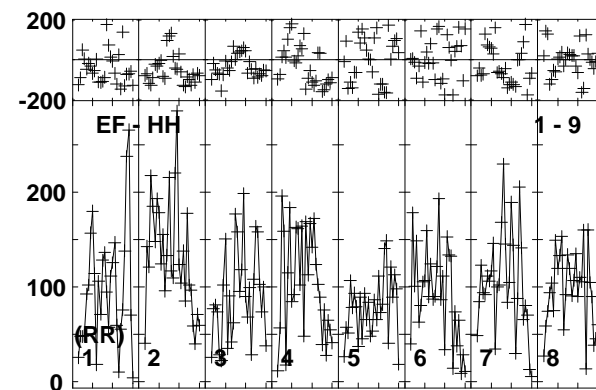
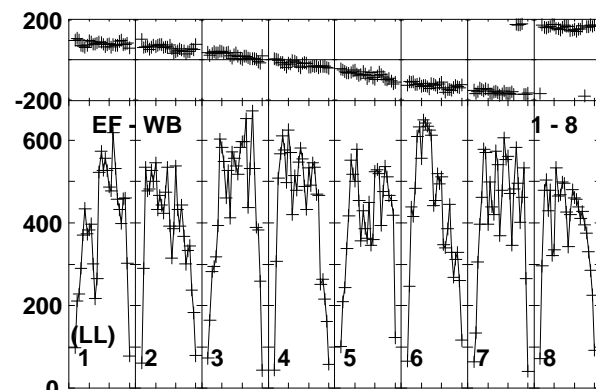
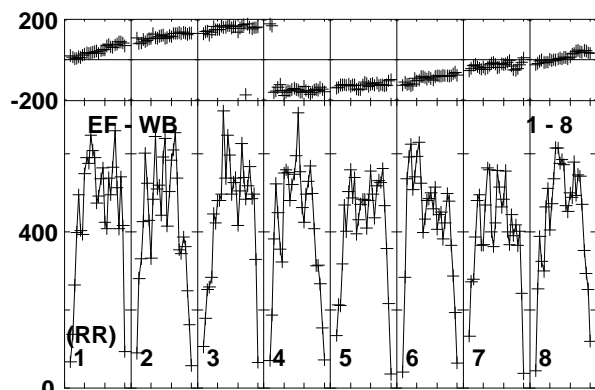
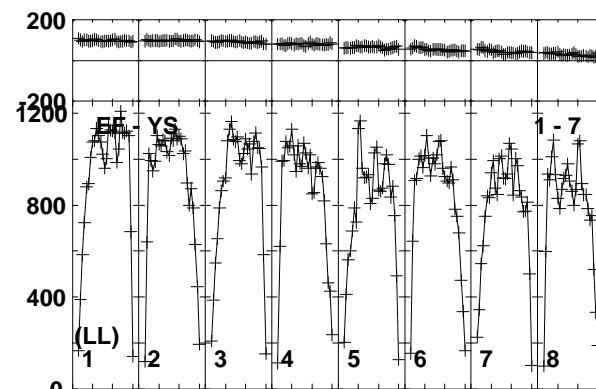
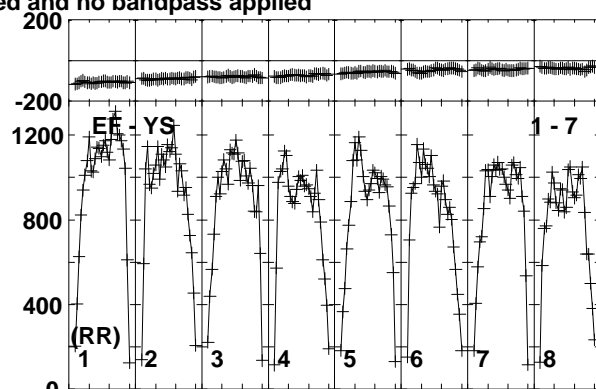
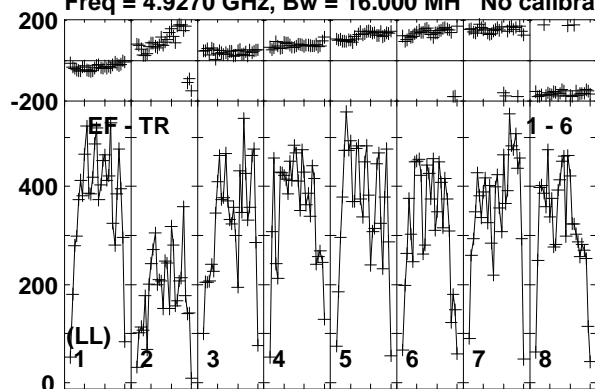

Lower frame: Micro Ampl Jy Top frame: Phas deg  
Vector averaged cross-power spectrum Baseline: EF (01) - TR (06)  
Timerange: 00/16:17:11 to 00/16:20:09

Plot file version 227 created 10-JUN-2016 15:29:41

J0718-1813 RG008C.UVDATA.1

Freq = 4.9270 GHz, Bw = 16.000 MH No calibration applied and no bandpass applied

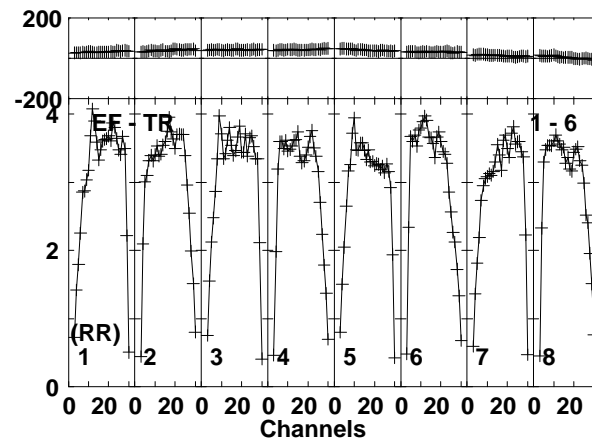
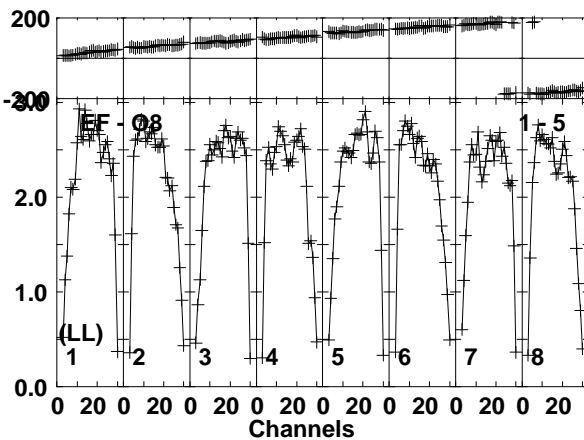
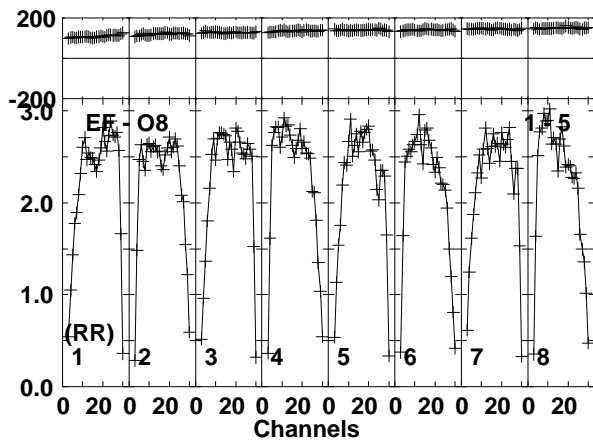
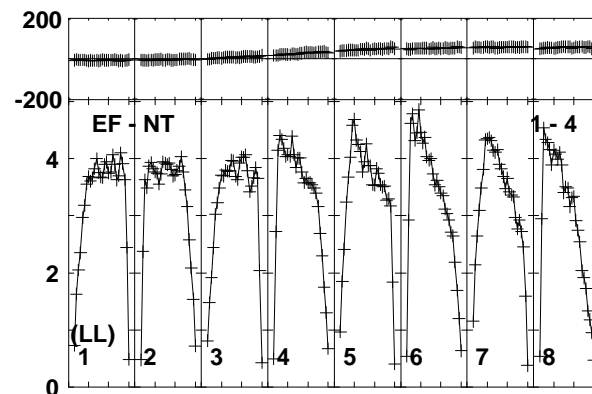
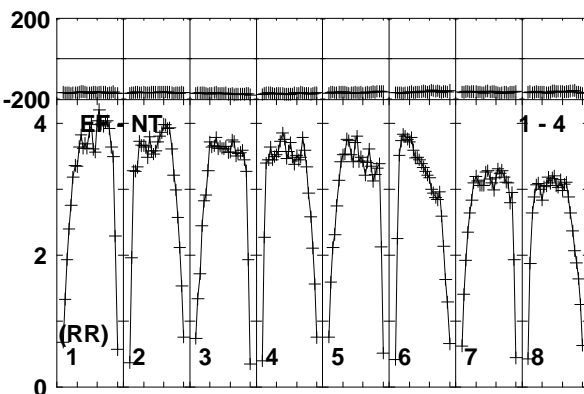
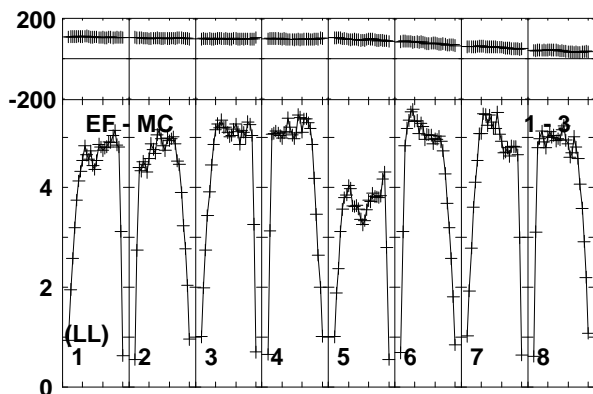
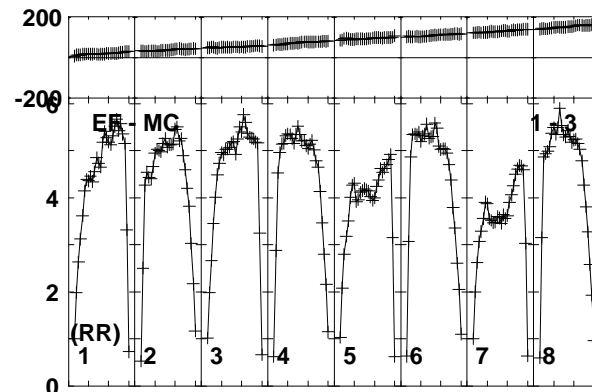
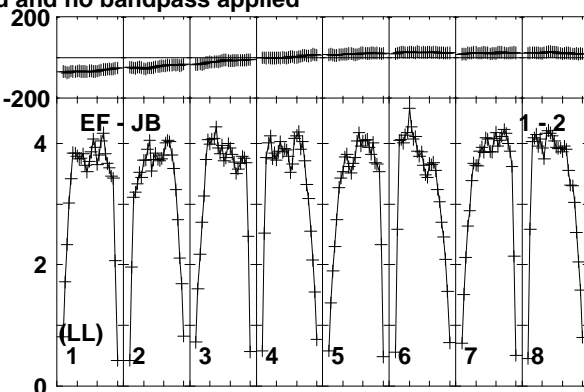
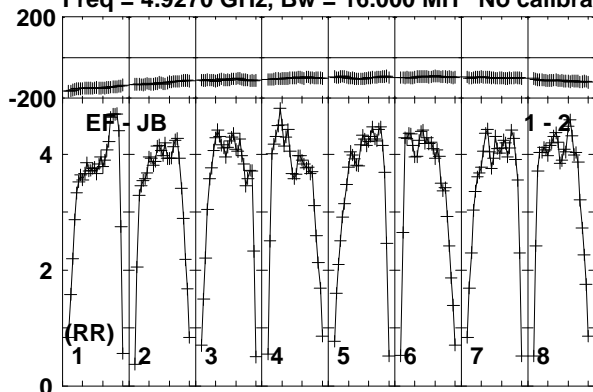

Lower frame: Milli Ampl Jy Top frame: Phas deg  
Vector averaged cross-power spectrum Baseline: EF (01) - JB (02)  
Timerange: 00/16:20:51 to 00/16:21:40

Plot file version 228 created 10-JUN-2016 15:29:41

J0718-1813 RG008C.UVDATA.1

Freq = 4.9270 GHz, Bw = 16.000 MH No calibration applied and no bandpass applied

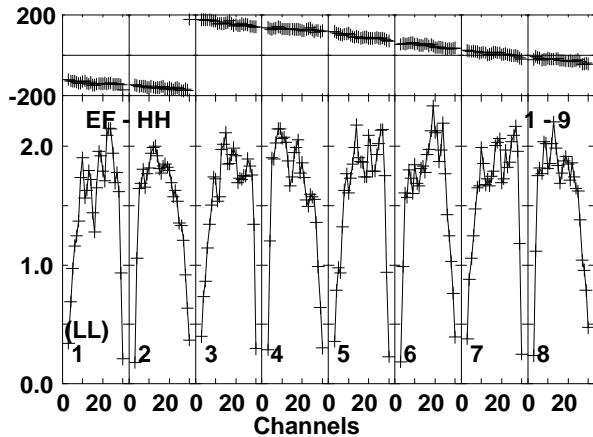
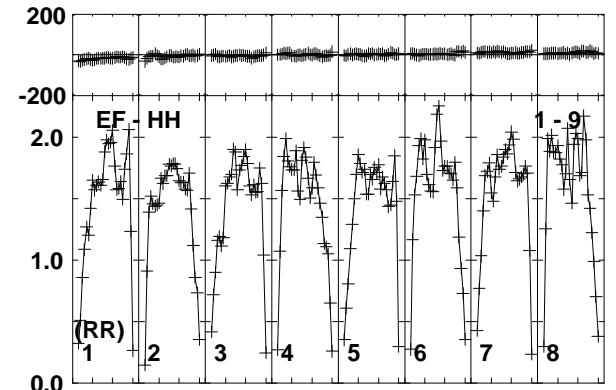
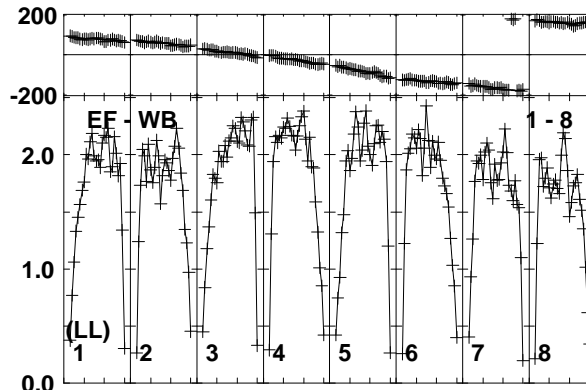
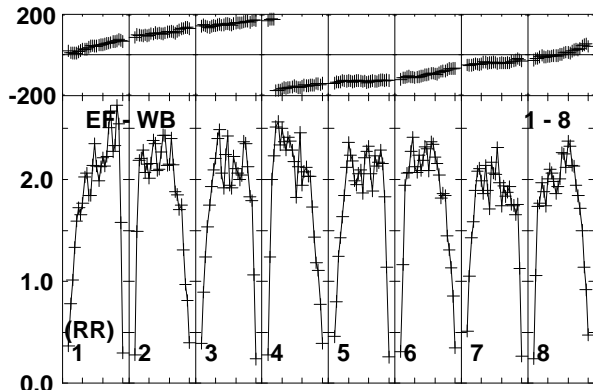
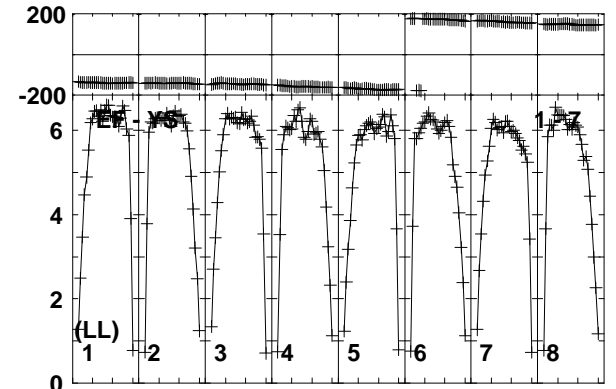
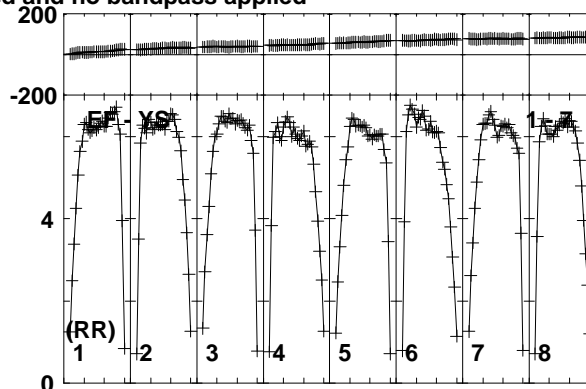
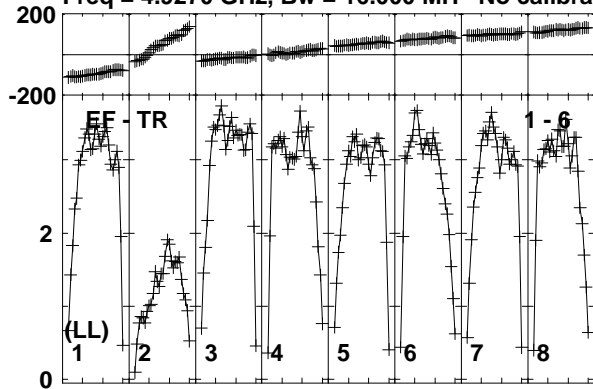

Lower frame: Milli Ampl Jy Top frame: Phas deg  
Vector averaged cross-power spectrum Baseline: EF (01) - TR (06)  
Timerange: 00/16:20:51 to 00/16:21:40

Plot file version 229 created 10-JUN-2016 15:29:41

FRB150418 RG008C.UVDATA.1

Freq = 4.9270 GHz, Bw = 16.000 MH No calibration applied and no bandpass applied

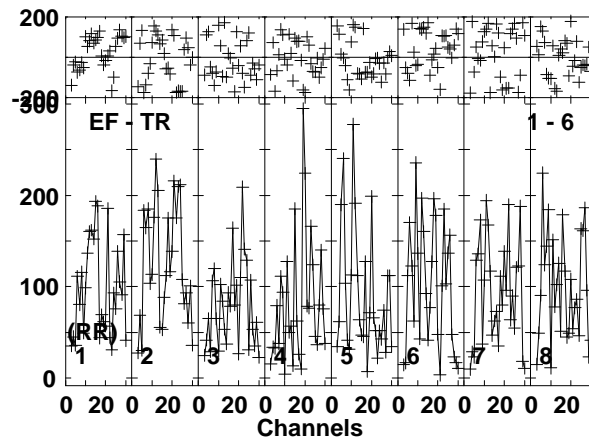
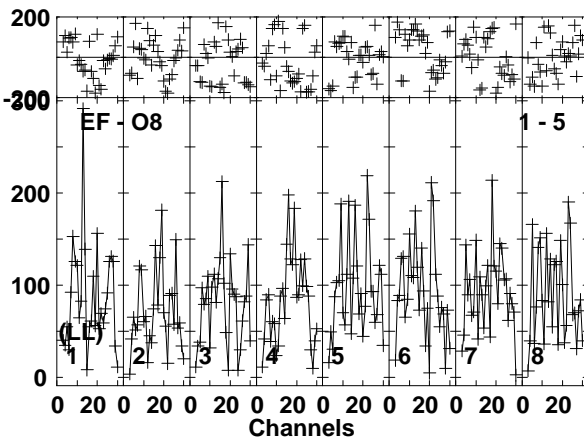
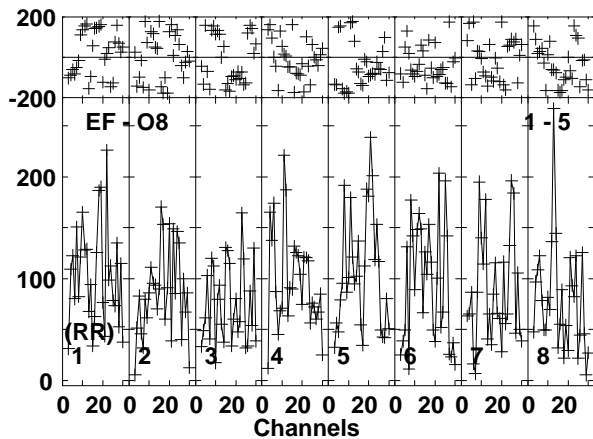
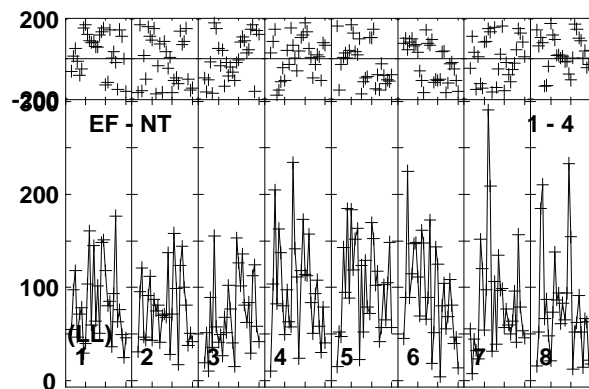
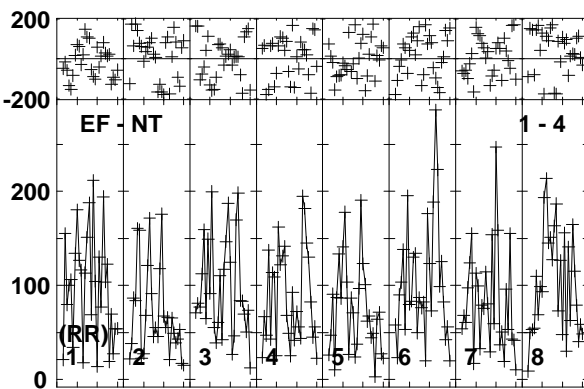
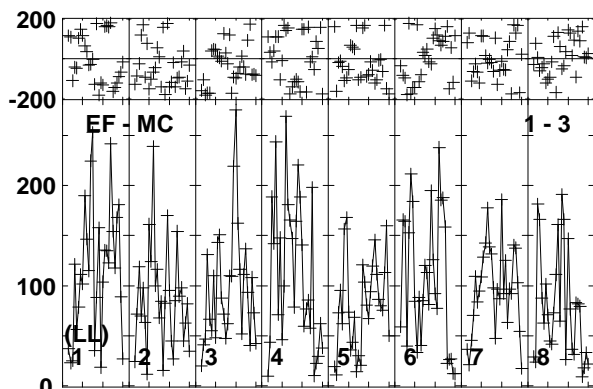
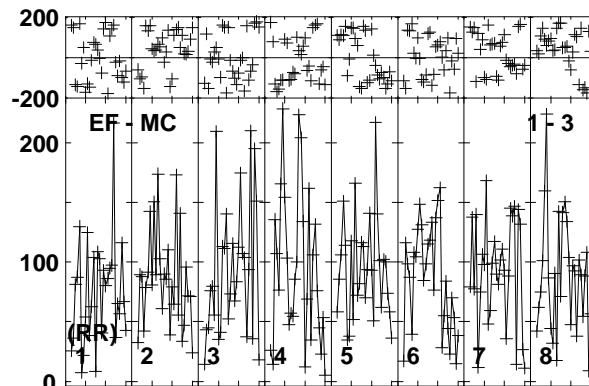
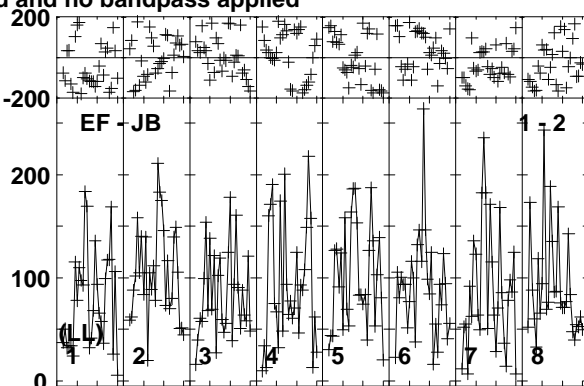
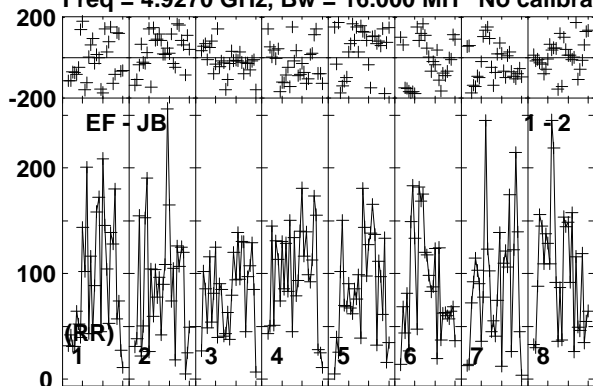

Lower frame: Micro Ampl Jy Top frame: Phas deg  
Vector averaged cross-power spectrum Baseline: EF (01) - JB (02)  
Timerange: 00/16:21:40 to 00/16:24:40

Plot file version 230 created 10-JUN-2016 15:29:42

FRB150418 RG008C.UVDATA.1

Freq = 4.9270 GHz, Bw = 16.000 MH No calibration applied and no bandpass applied

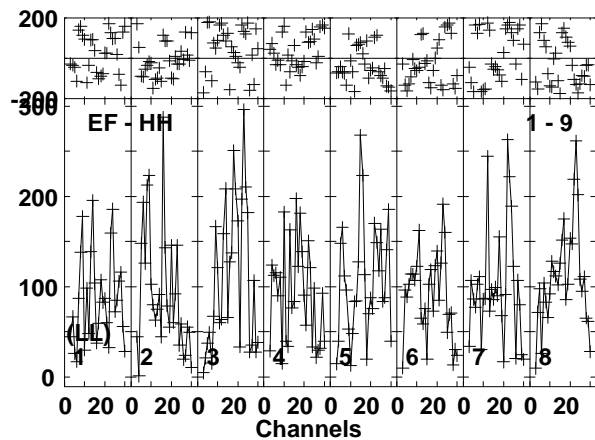
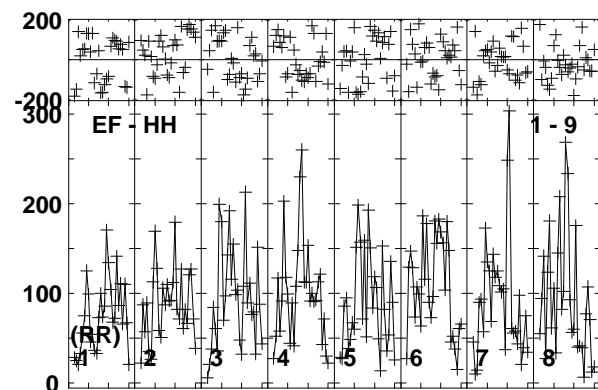
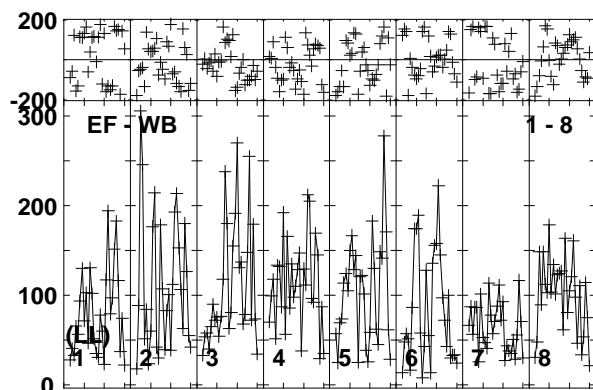
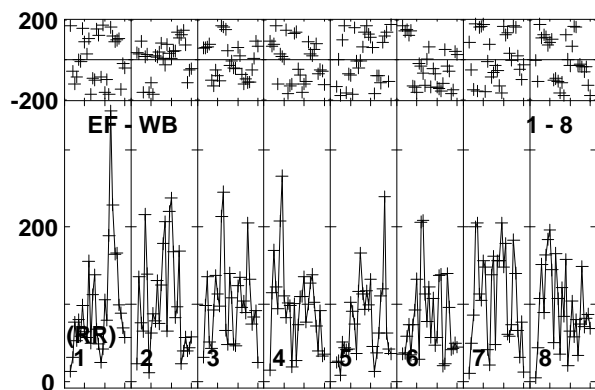
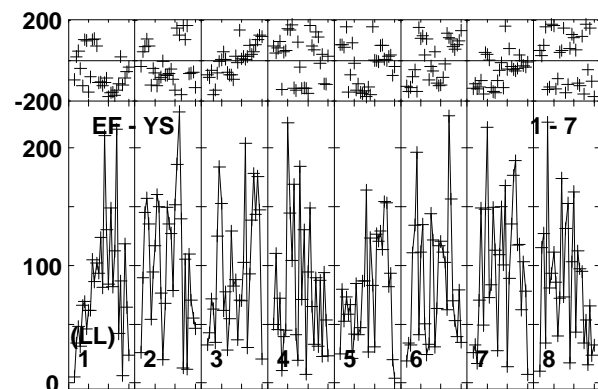
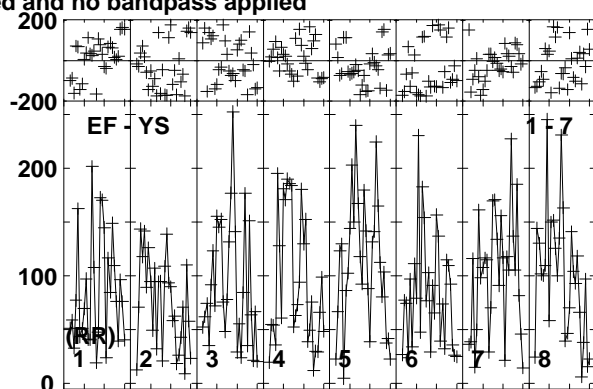
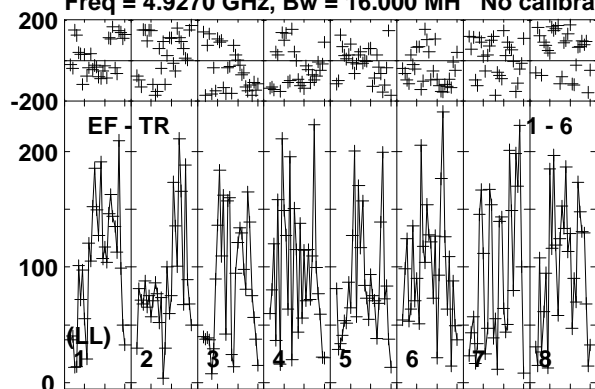

Lower frame: Micro Ampl Jy Top frame: Phas deg  
Vector averaged cross-power spectrum Baseline: EF (01) - TR (06)  
Timerange: 00/16:21:40 to 00/16:24:40

Plot file version 231 created 10-JUN-2016 15:29:42

J0718-1813 RG008C.UVDATA.1

Freq = 4.9270 GHz, Bw = 16.000 MH No calibration applied and no bandpass applied

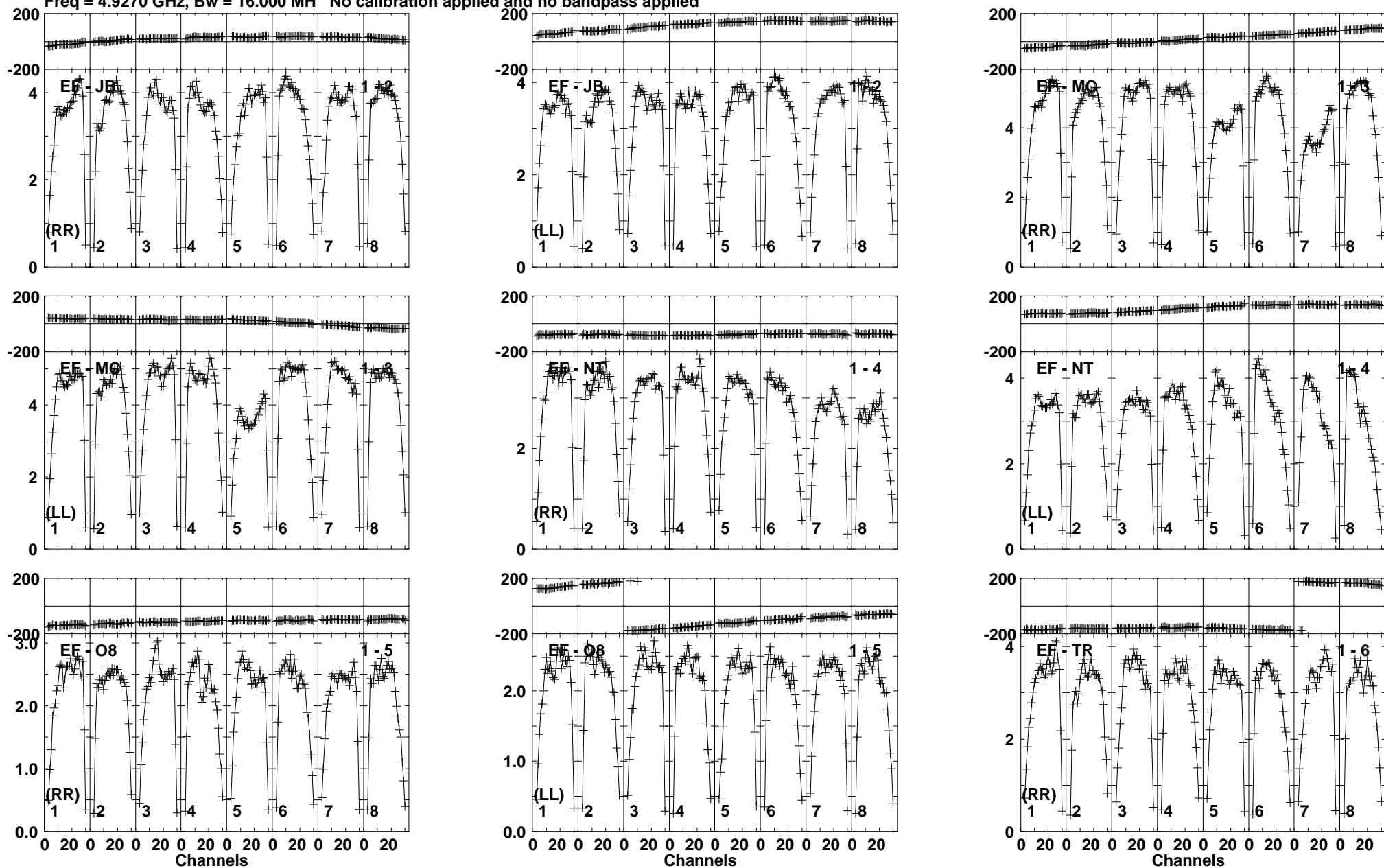

Lower frame: Milli Ampl Jy Top frame: Phas deg  
Vector averaged cross-power spectrum Baseline: EF (01) - JB (02)  
Timerange: 00/16:24:40 to 00/16:26:09

Plot file version 232 created 10-JUN-2016 15:29:42

J0718-1813 RG008C.UVDATA.1

Freq = 4.9270 GHz, Bw = 16.000 MH No calibration applied and no bandpass applied

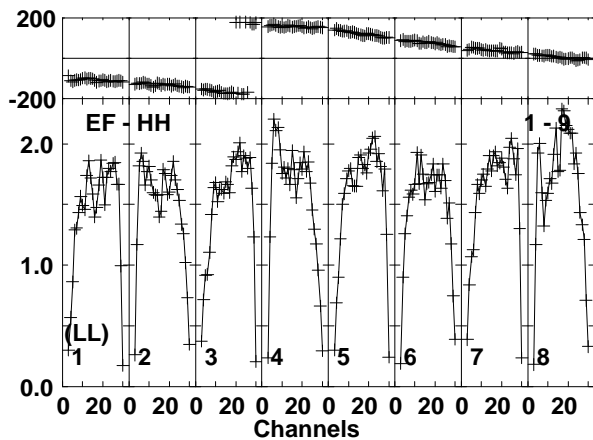
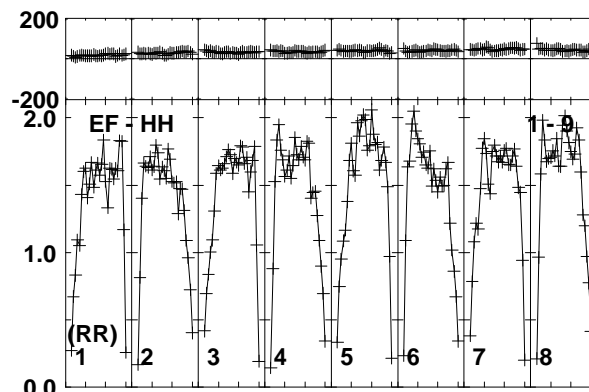
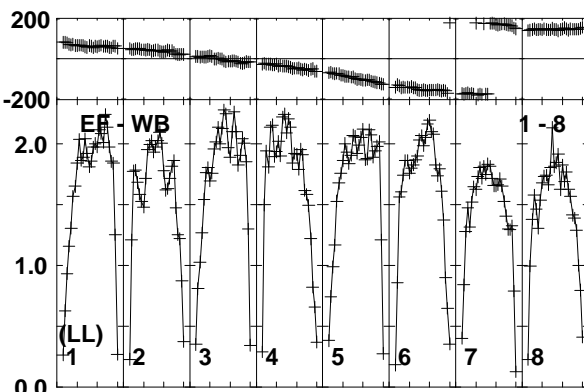
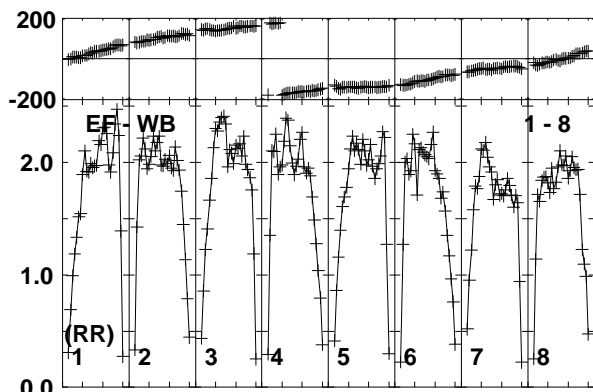
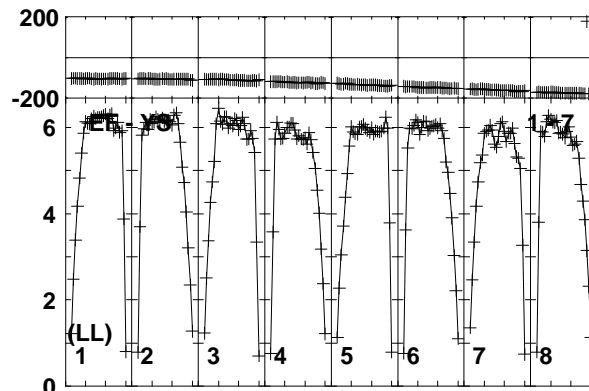
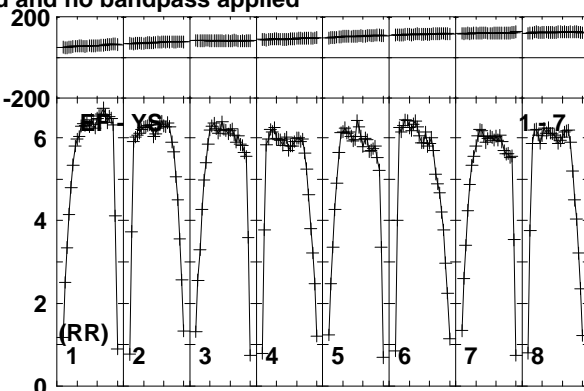
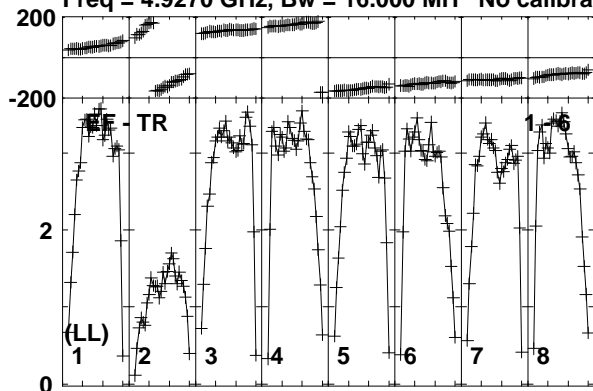

Lower frame: Milli Ampl Jy Top frame: Phas deg  
Vector averaged cross-power spectrum Baseline: EF (01) - TR (06)  
Timerange: 00/16:24:40 to 00/16:26:09



Plot file version 233 created 10-JUN-2016 15:29:42

FRB150418 RG008C.UVDATA.1

Freq = 4.9270 GHz, Bw = 16.000 MH No calibration applied and no bandpass applied

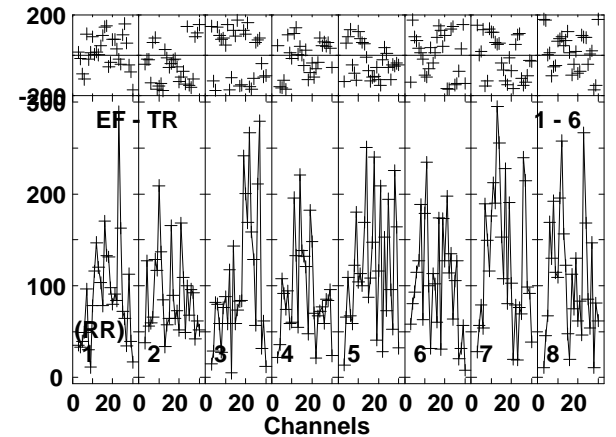
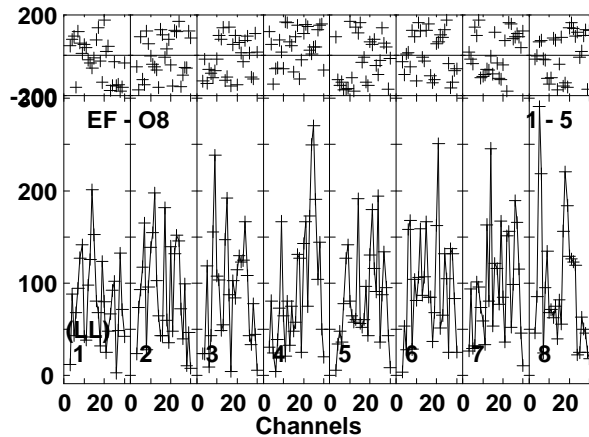
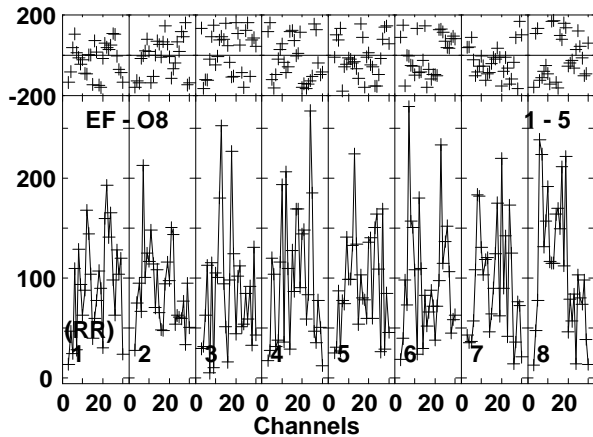
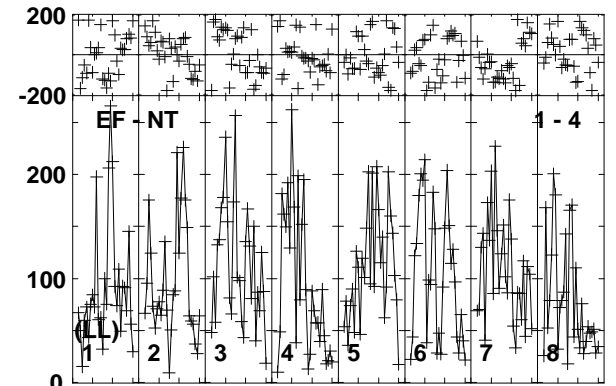
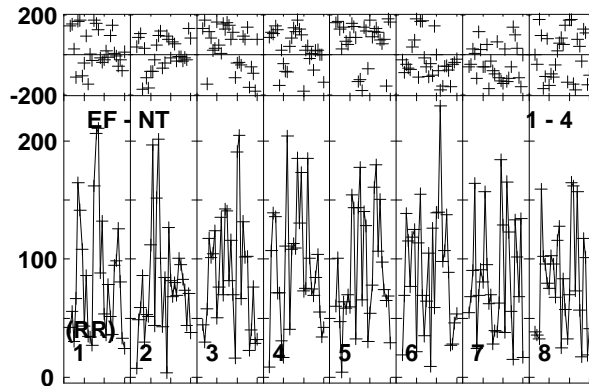
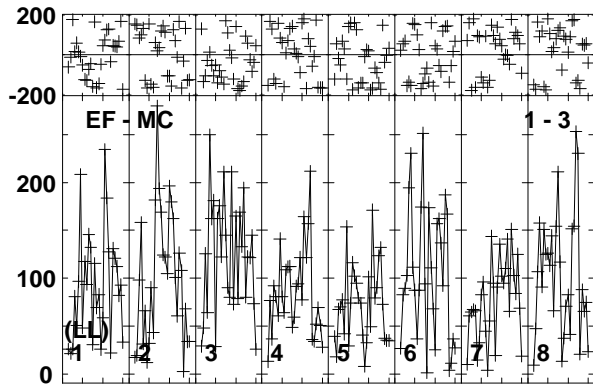
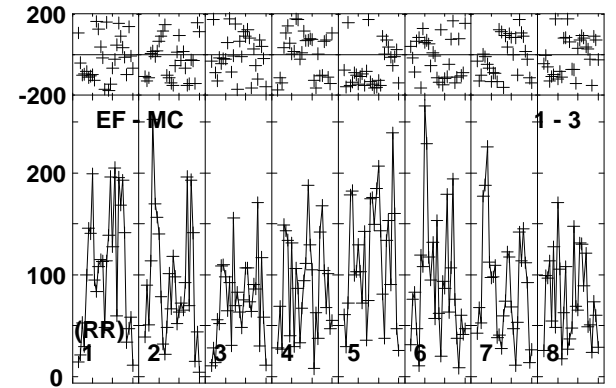
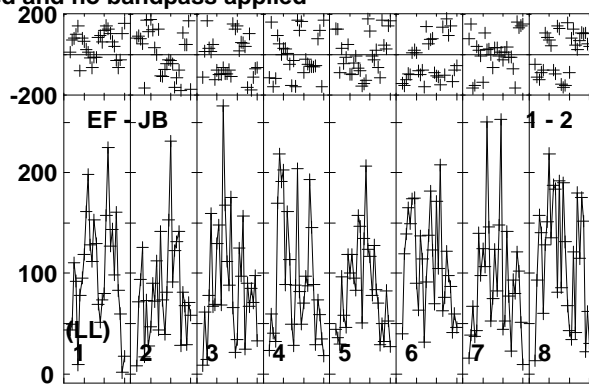
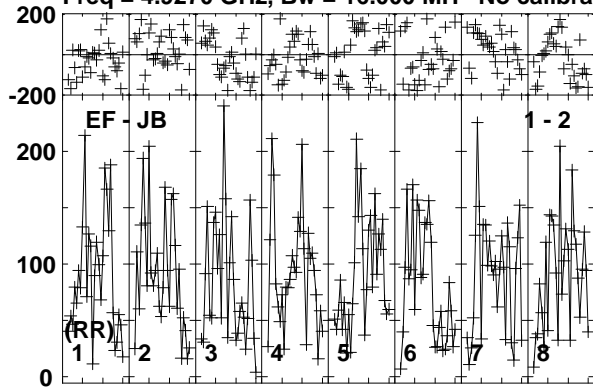

Lower frame: Micro Ampl Jy Top frame: Phas deg  
Vector averaged cross-power spectrum Baseline: EF (01) - JB (02)  
Timerange: 00/16:26:11 to 00/16:29:10

Plot file version 234 created 10-JUN-2016 15:29:42

FRB150418 RG008C.UVDATA.1

Freq = 4.9270 GHz, Bw = 16.000 MH No calibration applied and no bandpass applied

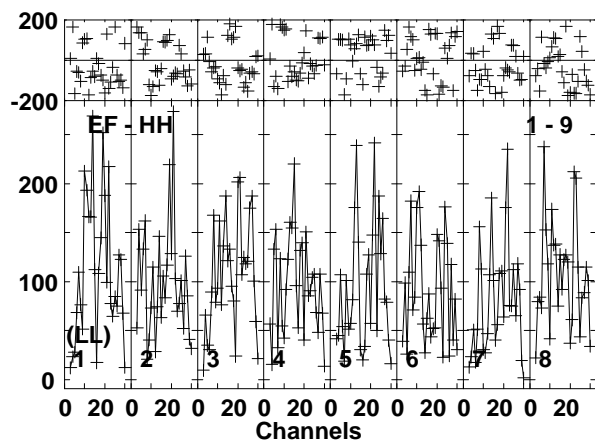
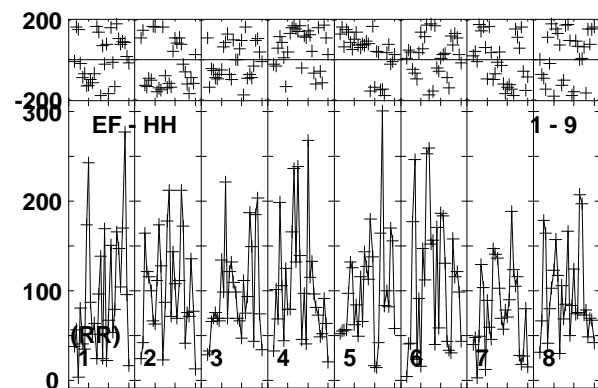
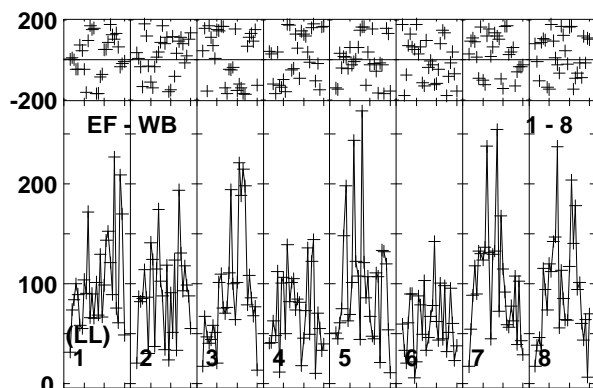
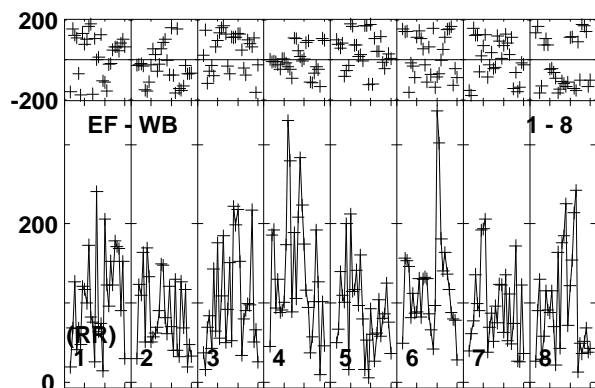
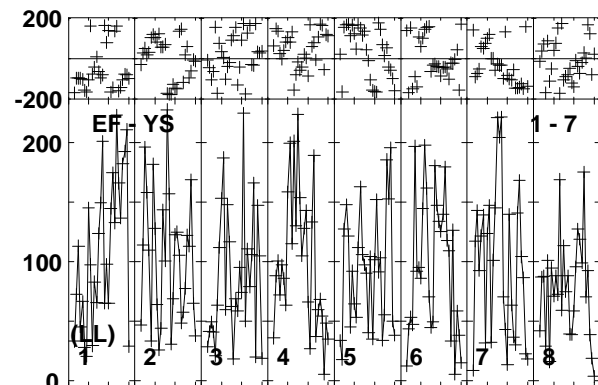
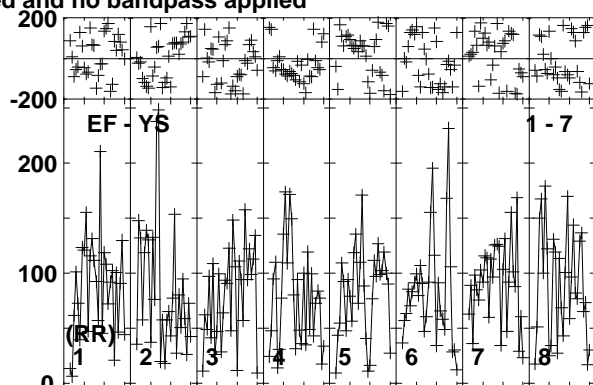
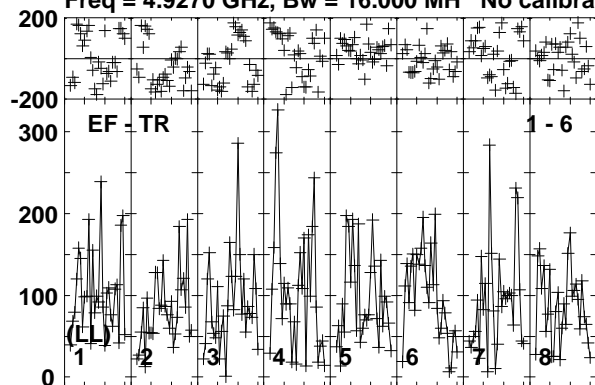

Lower frame: Micro Ampl Jy Top frame: Phas deg  
Vector averaged cross-power spectrum Baseline: EF (01) - TR (06)  
Timerange: 00/16:26:11 to 00/16:29:10

Plot file version 235 created 10-JUN-2016 15:29:42

J0718-1813 RG008C.UVDATA.1

Freq = 4.9270 GHz, Bw = 16.000 MH No calibration applied and no bandpass applied

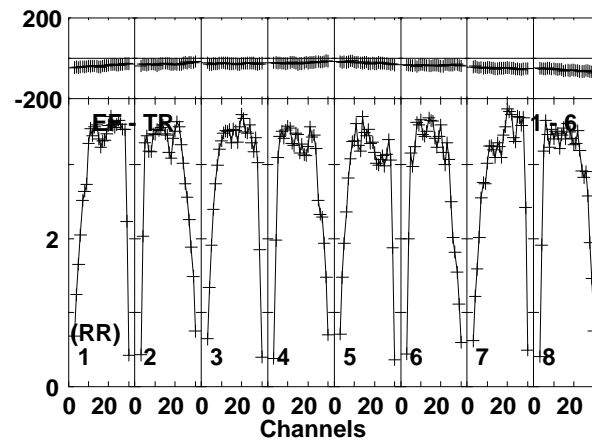
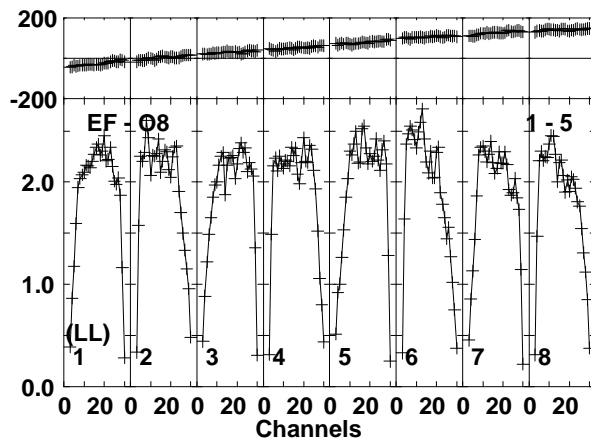
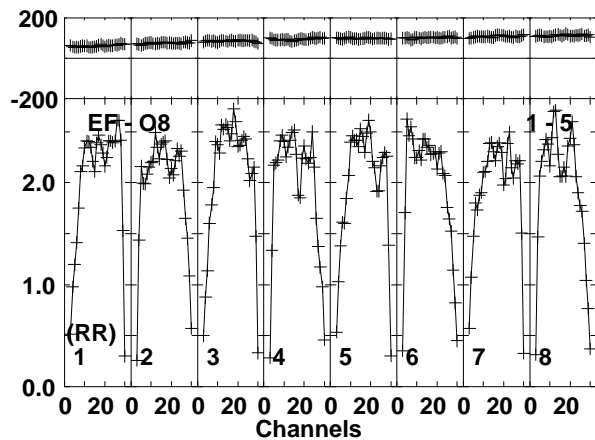
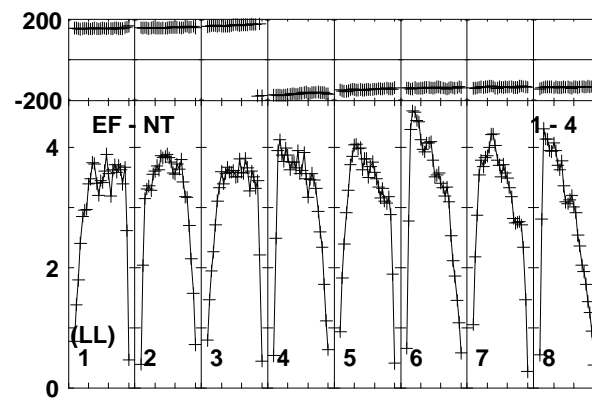
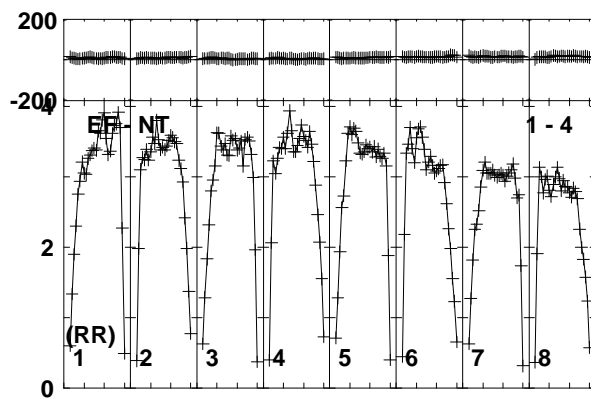
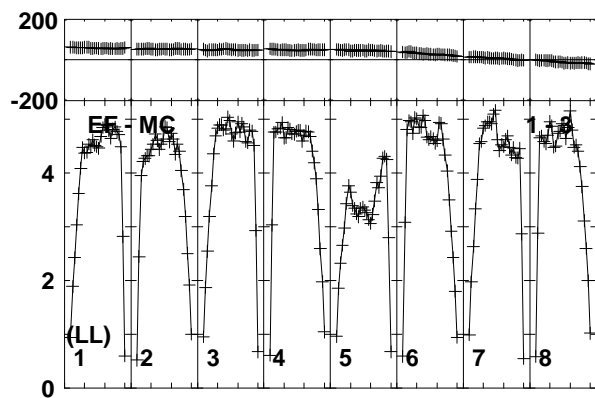
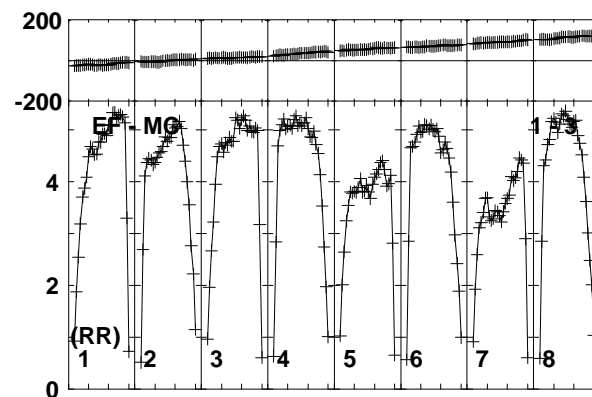
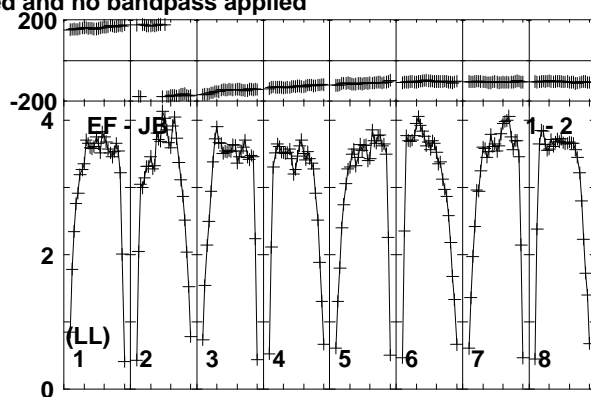
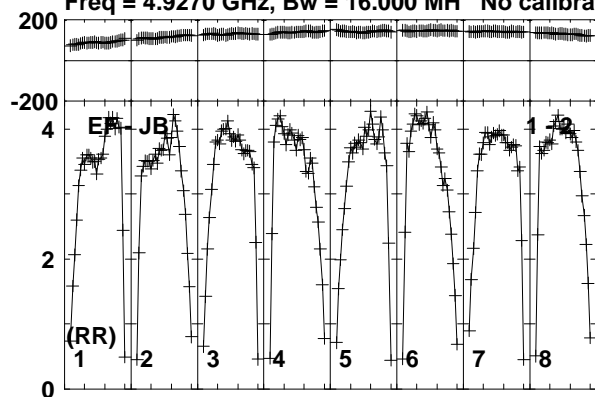

Lower frame: Milli Ampl Jy Top frame: Phas deg  
Vector averaged cross-power spectrum Baseline: EF (01) - JB (02)  
Timerange: 00/16:29:50 to 00/16:30:39

Plot file version 236 created 10-JUN-2016 15:29:42

J0718-1813 RG008C.UVDATA.1

Freq = 4.9270 GHz, Bw = 16.000 MH No calibration applied and no bandpass applied

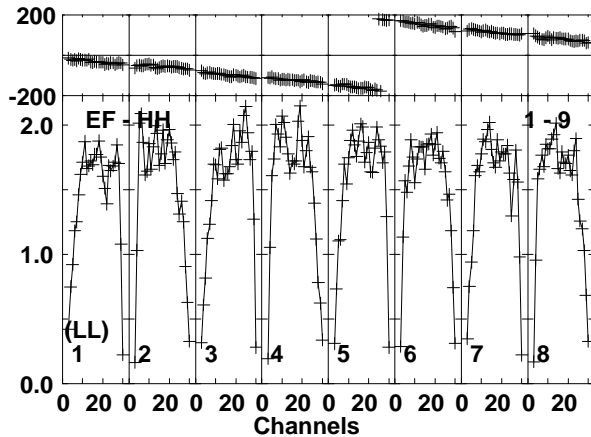
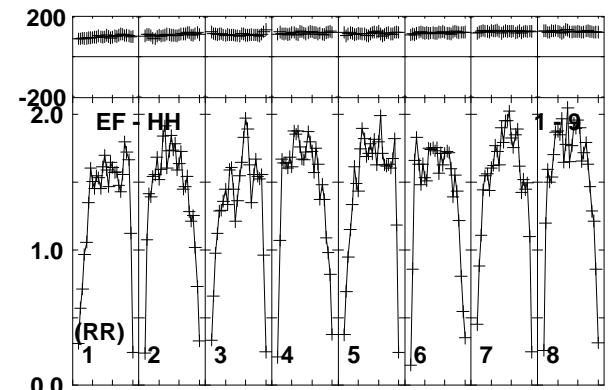
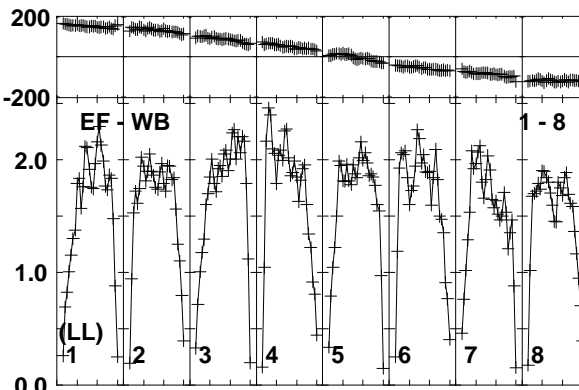
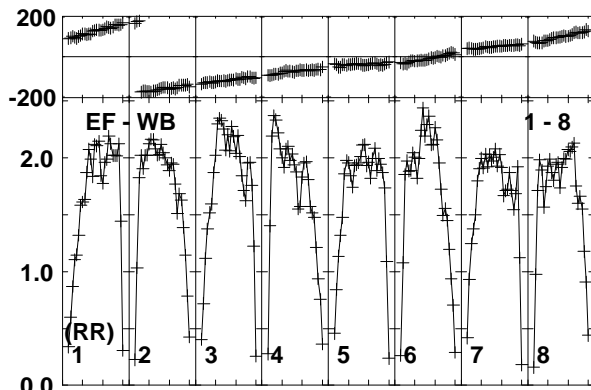
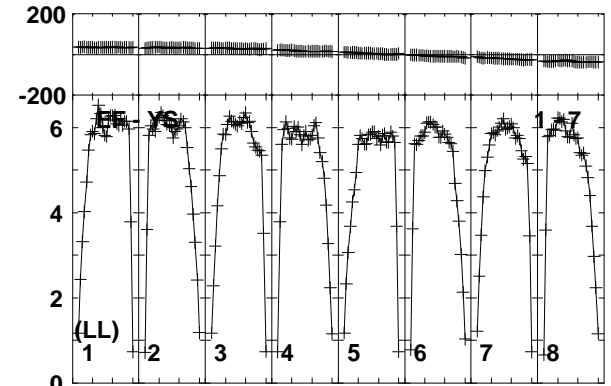
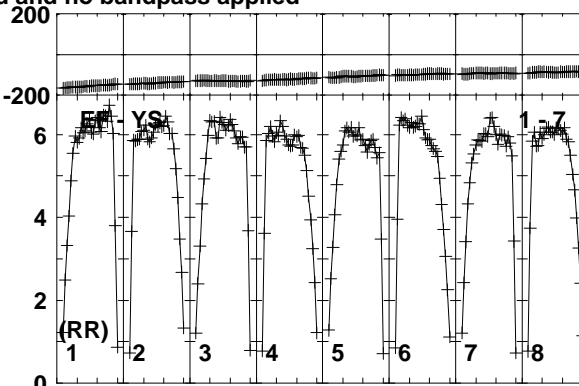
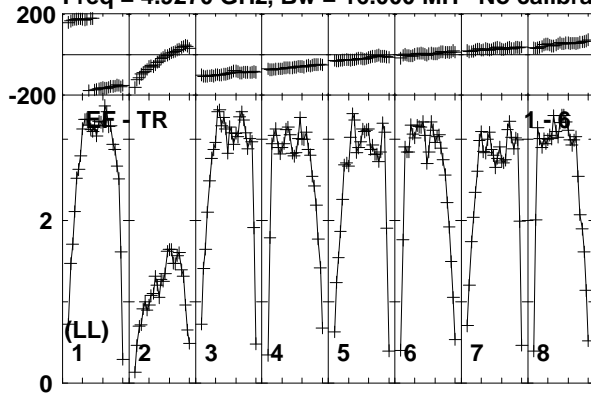

Lower frame: Milli Ampl Jy Top frame: Phas deg  
Vector averaged cross-power spectrum Baseline: EF (01) - TR (06)  
Timerange: 00/16:29:50 to 00/16:30:39

Plot file version 237 created 10-JUN-2016 15:29:42

FRB150418 RG008C.UVDATA.1

Freq = 4.9270 GHz, Bw = 16.000 MH No calibration applied and no bandpass applied

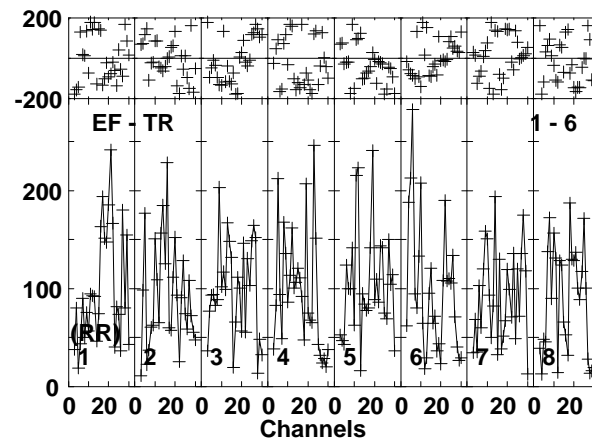
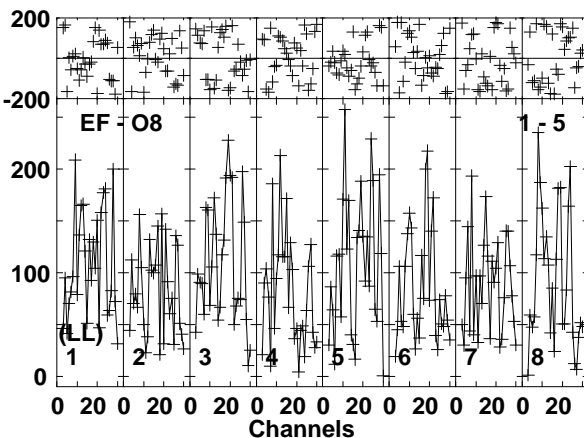
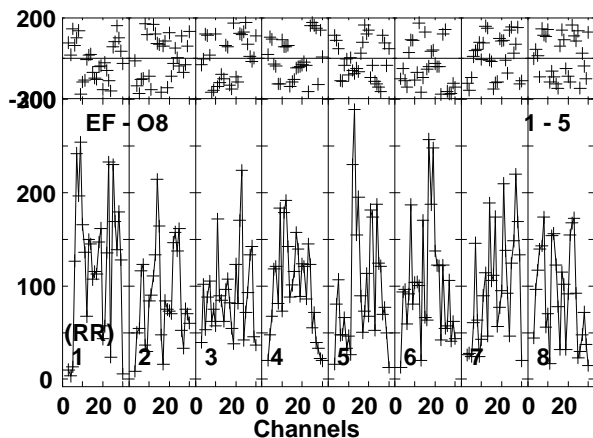
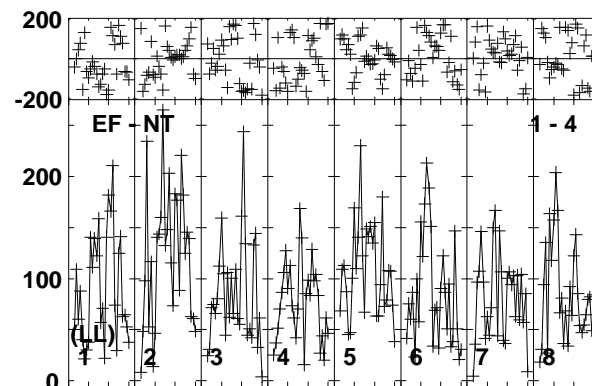
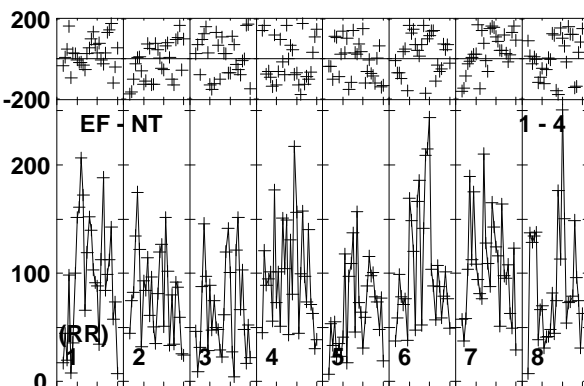
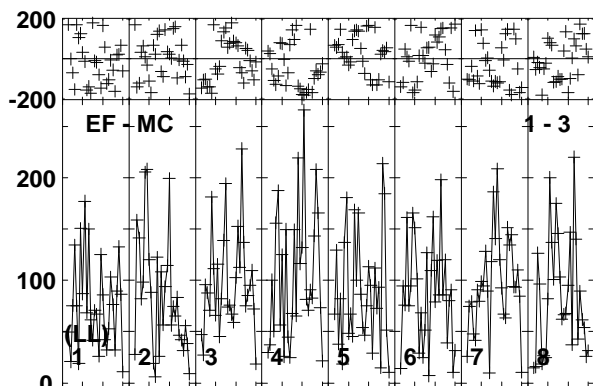
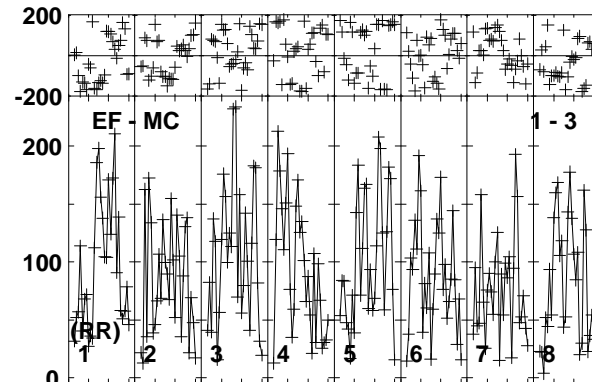
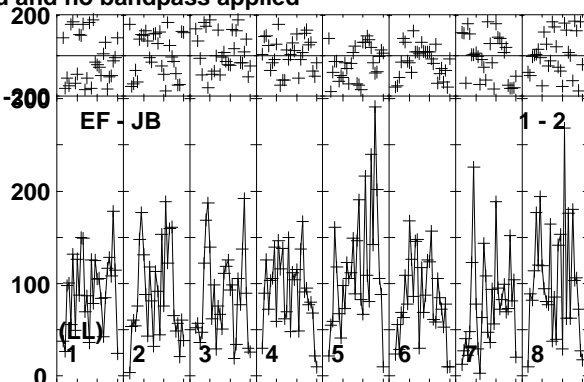
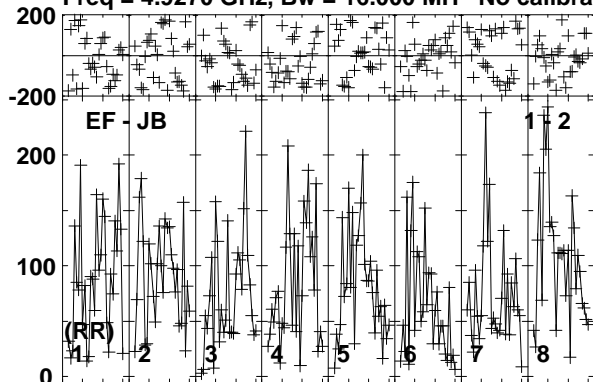

Lower frame: Micro Ampl Jy Top frame: Phas deg  
Vector averaged cross-power spectrum Baseline: EF (01) - JB (02)  
Timerange: 00/16:30:40 to 00/16:33:40

Plot file version 238 created 10-JUN-2016 15:29:43

FRB150418 RG008C.UVDATA.1

Freq = 4.9270 GHz, Bw = 16.000 MH No calibration applied and no bandpass applied

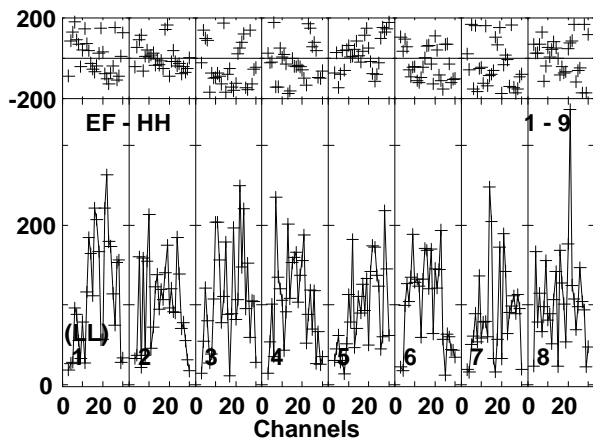
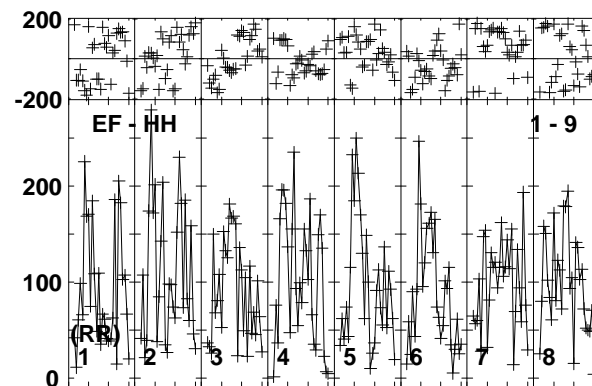
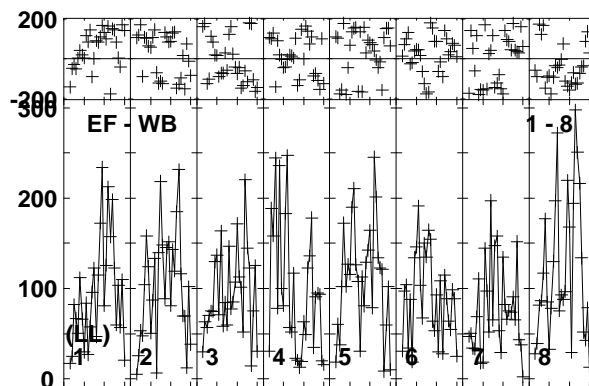
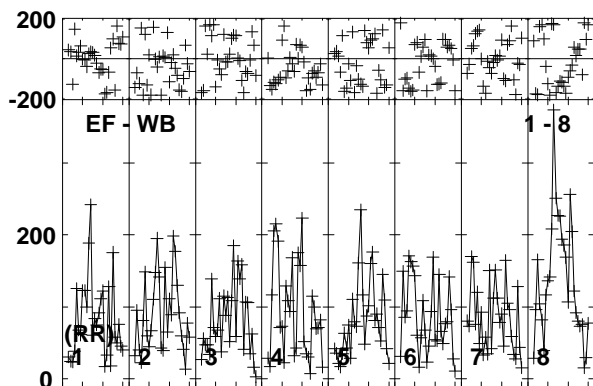
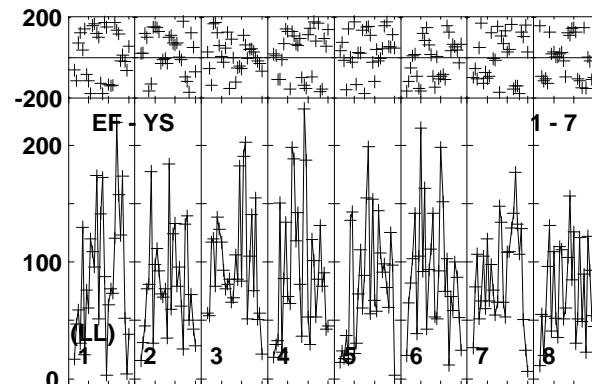
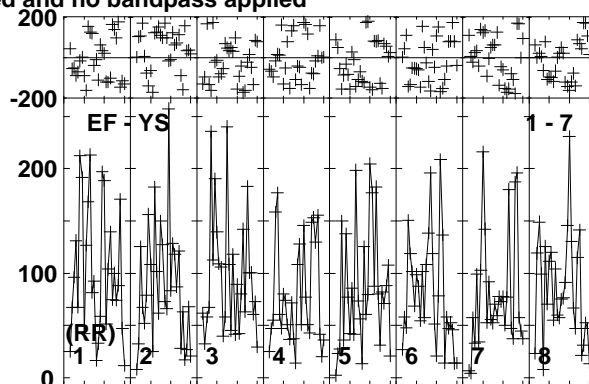
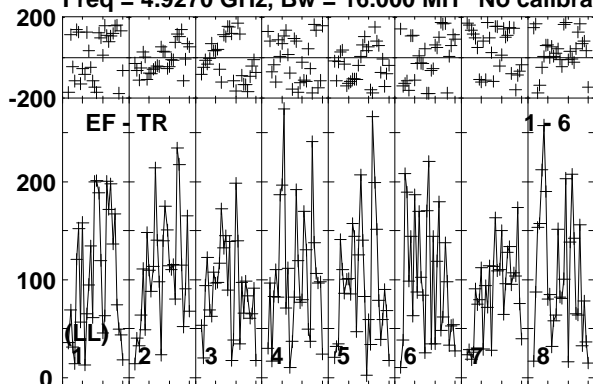

Lower frame: Micro Ampl Jy Top frame: Phas deg  
Vector averaged cross-power spectrum Baseline: EF (01) - TR (06)  
Timerange: 00/16:30:40 to 00/16:33:40

Plot file version 239 created 10-JUN-2016 15:29:43

J0718-1813 RG008C.UVDATA.1

Freq = 4.9270 GHz, Bw = 16.000 MH No calibration applied and no bandpass applied

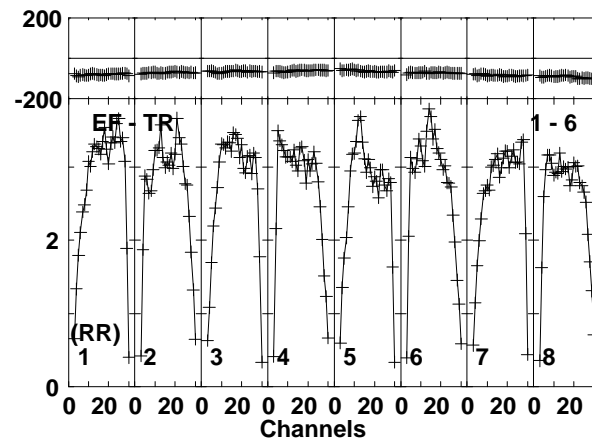
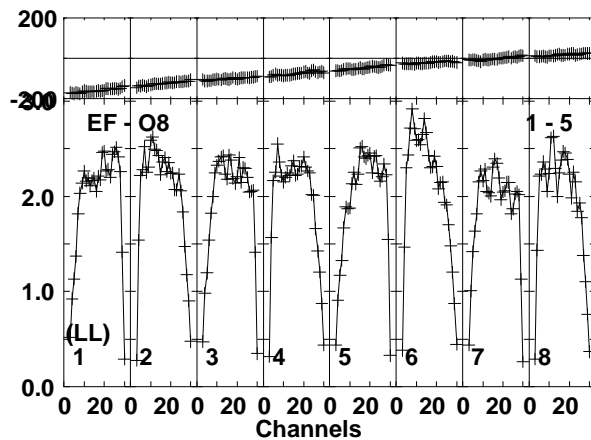
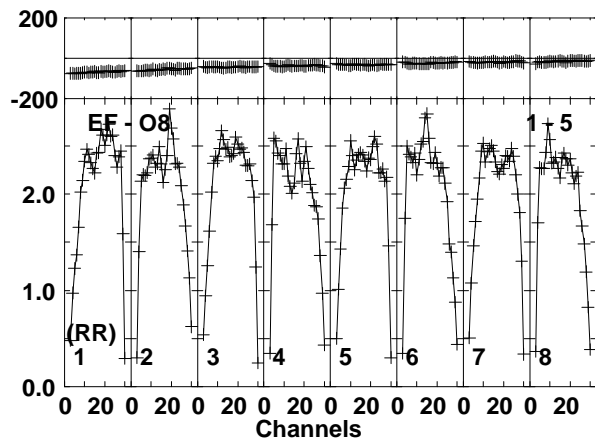
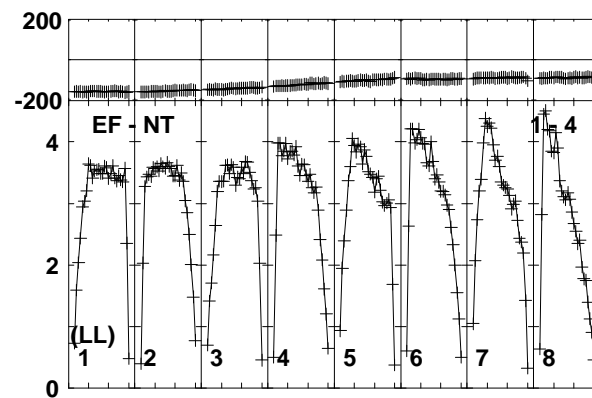
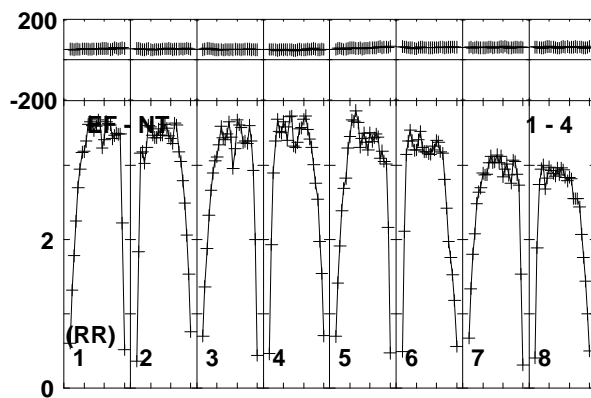
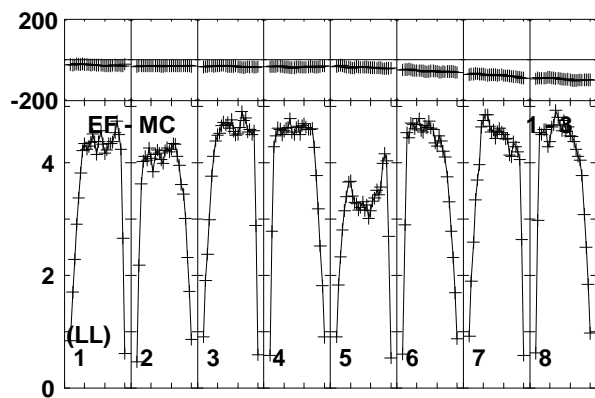
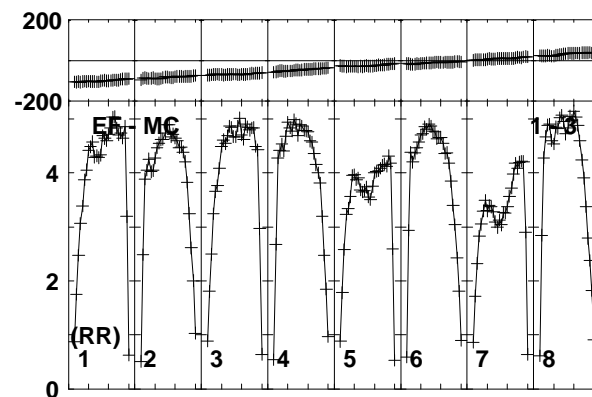
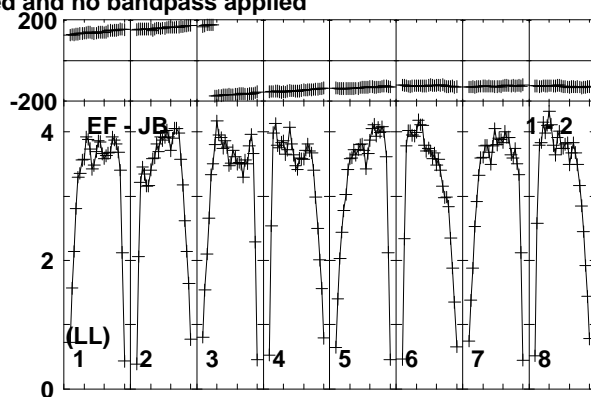
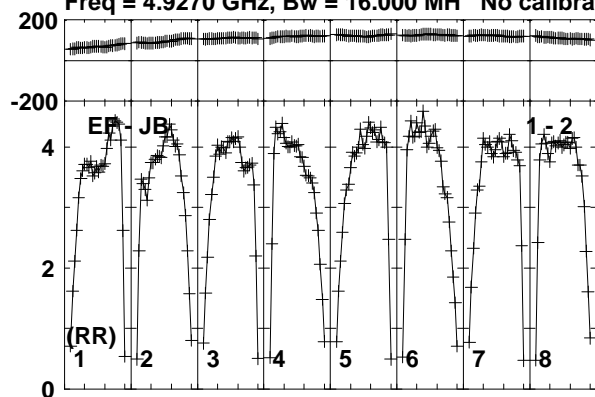

Lower frame: Milli Ampl Jy Top frame: Phas deg  
Vector averaged cross-power spectrum Baseline: EF (01) - JB (02)  
Timerange: 00/16:33:41 to 00/16:35:09

Plot file version 240 created 10-JUN-2016 15:29:43

J0718-1813 RG008C.UVDATA.1

Freq = 4.9270 GHz, Bw = 16.000 MH No calibration applied and no bandpass applied

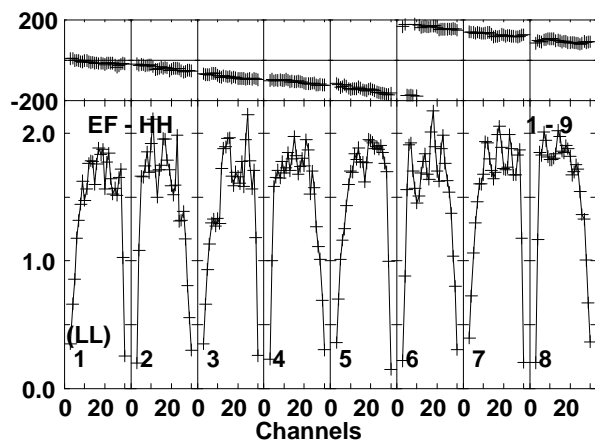
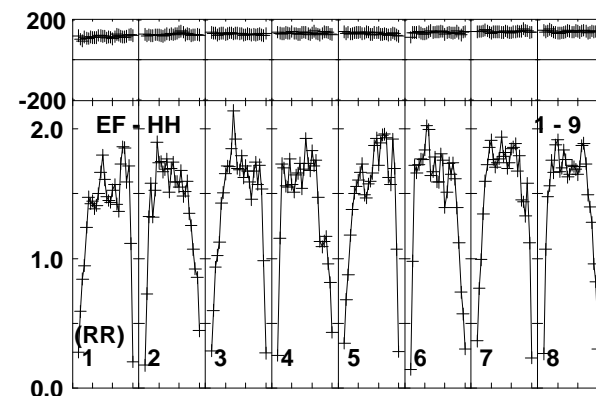
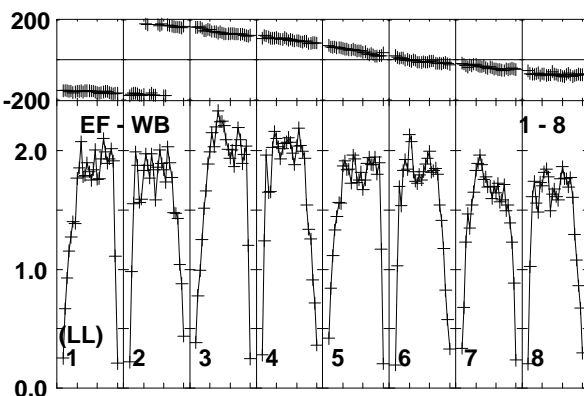
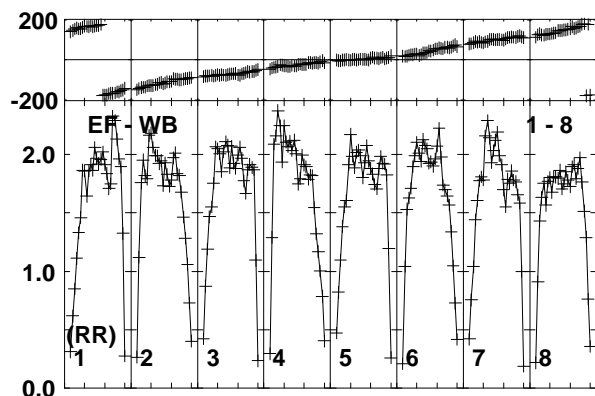
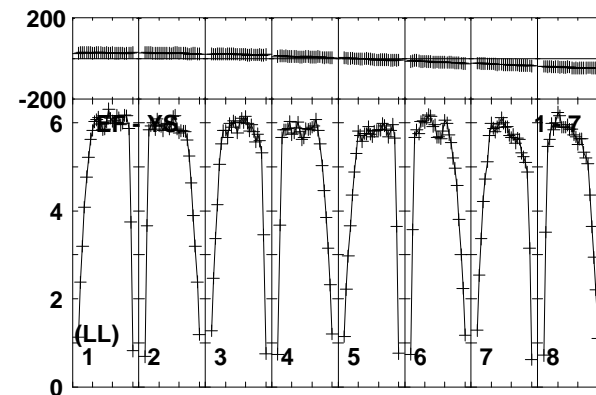
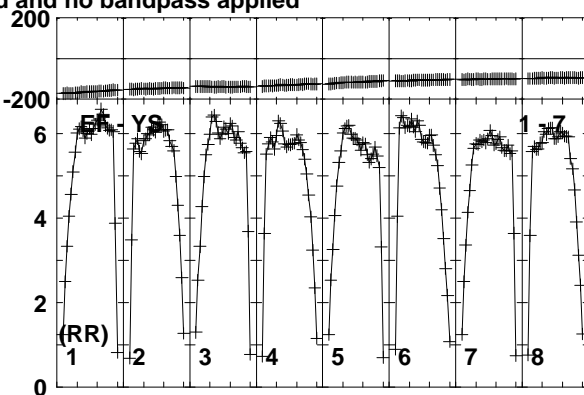
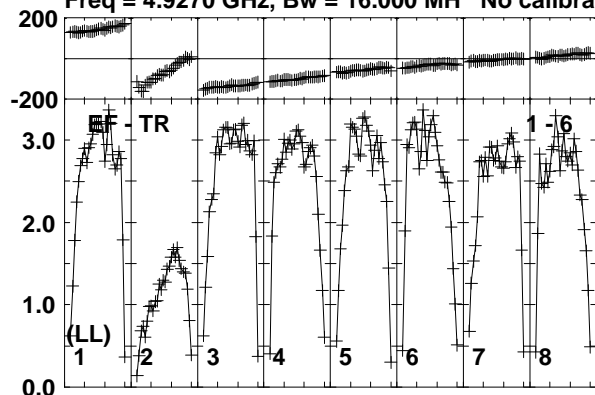

Lower frame: Milli Ampl Jy Top frame: Phas deg  
Vector averaged cross-power spectrum Baseline: EF (01) - TR (06)  
Timerange: 00/16:33:41 to 00/16:35:09



Plot file version 241 created 10-JUN-2016 15:29:43

J0712-1847 RG008C.UVDATA.1

Freq = 4.9270 GHz, Bw = 16.000 MH No calibration applied and no bandpass applied

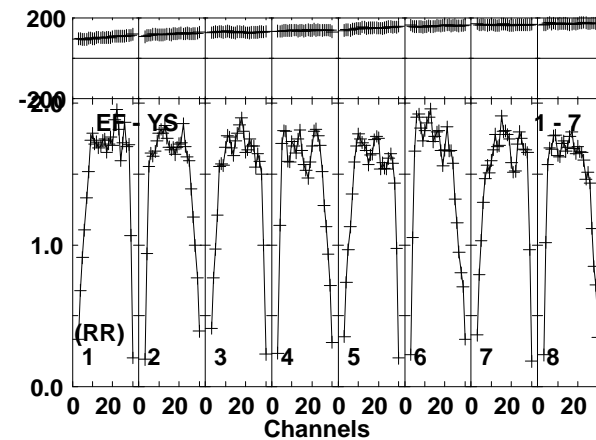
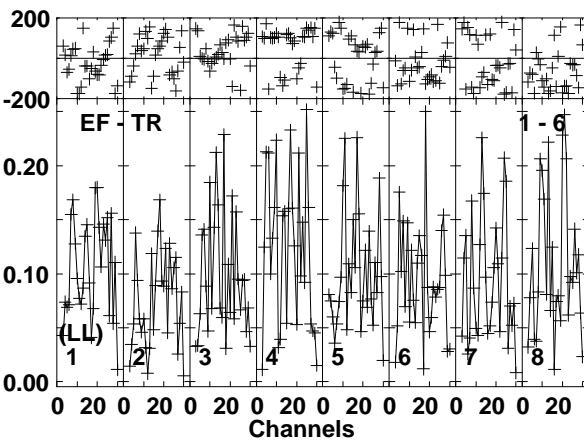
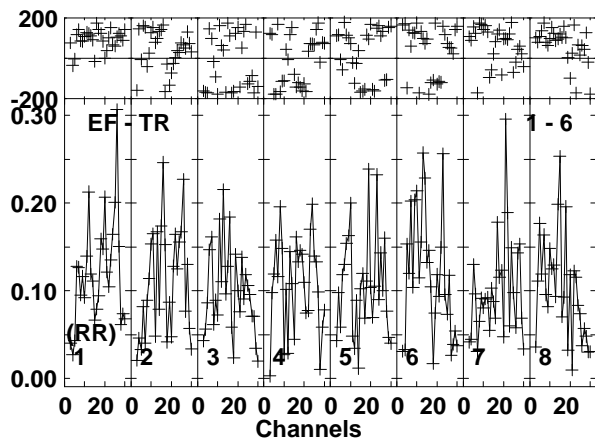
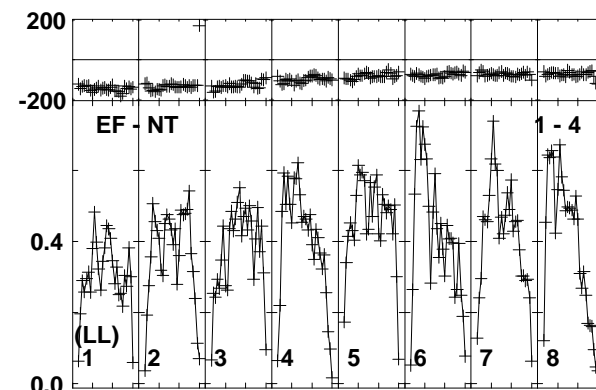
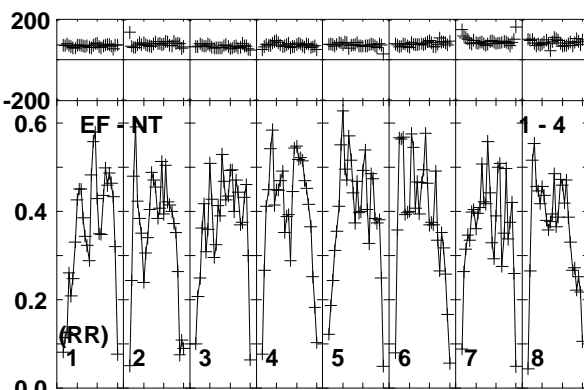
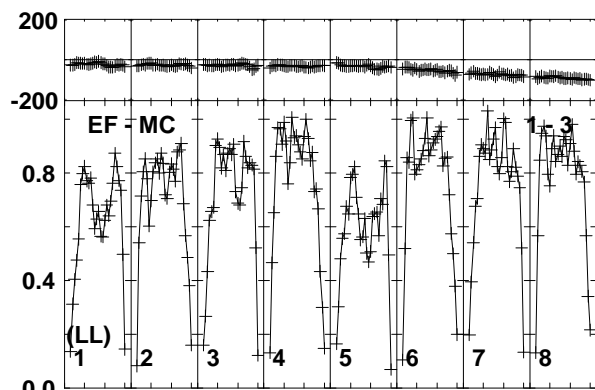
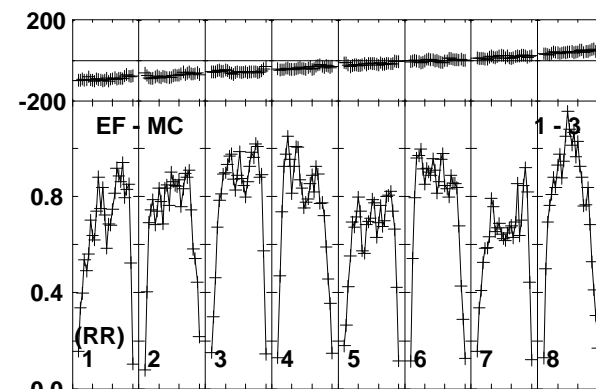
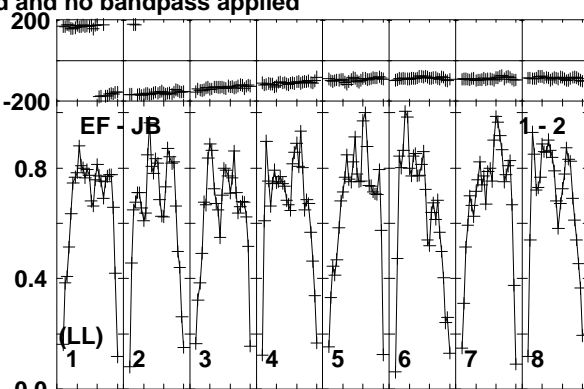
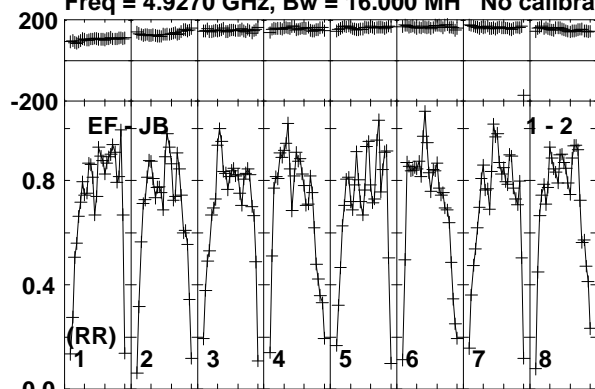

Lower frame: Milli Ampl Jy Top frame: Phas deg  
Vector averaged cross-power spectrum Baseline: EF (01) - JB (02)  
Timerange: 00/16:35:11 to 00/16:38:09

Plot file version 242 created 10-JUN-2016 15:29:43

J0712-1847 RG008C.UVDATA.1

Freq = 4.9270 GHz, Bw = 16.000 MH No calibration applied and no bandpass applied

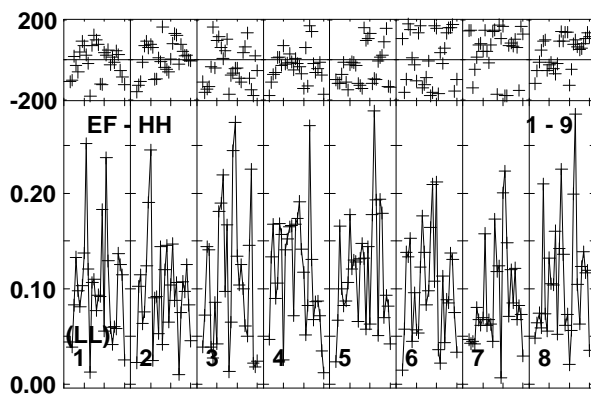
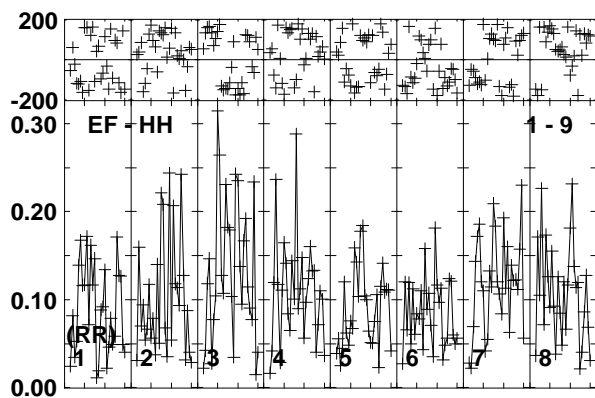
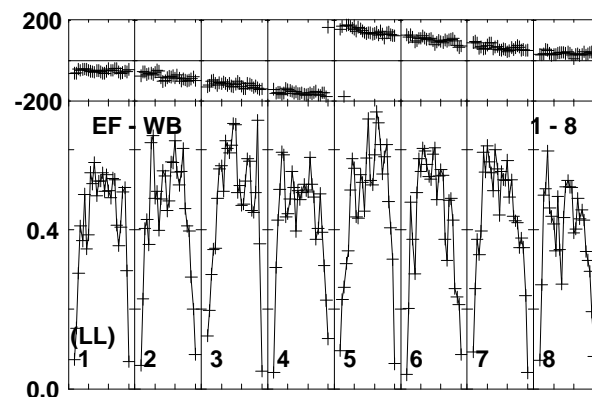
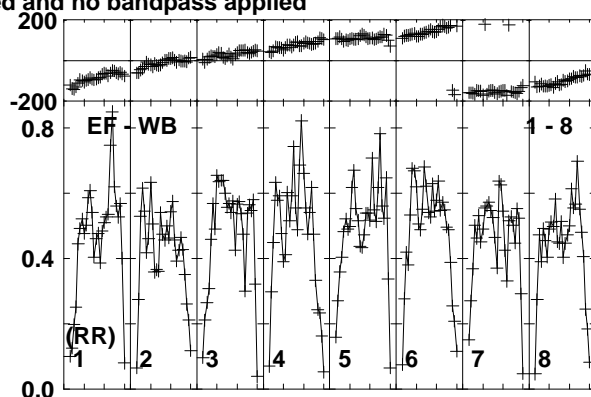
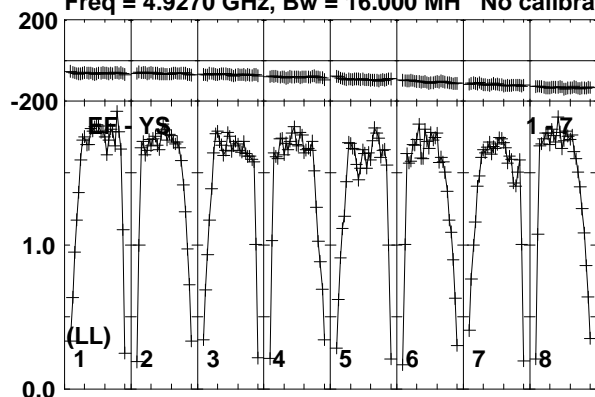

Lower frame: Milli Ampl Jy Top frame: Phas deg  
Vector averaged cross-power spectrum Baseline: EF (01) - YS (07)  
Timerange: 00/16:35:11 to 00/16:38:09

Plot file version 243 created 10-JUN-2016 15:29:43

J0718-1813 RG008C.UVDATA.1

Freq = 4.9270 GHz, Bw = 16.000 MH No calibration applied and no bandpass applied

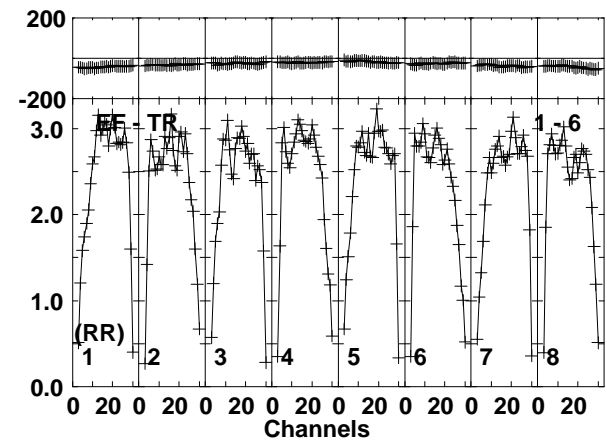
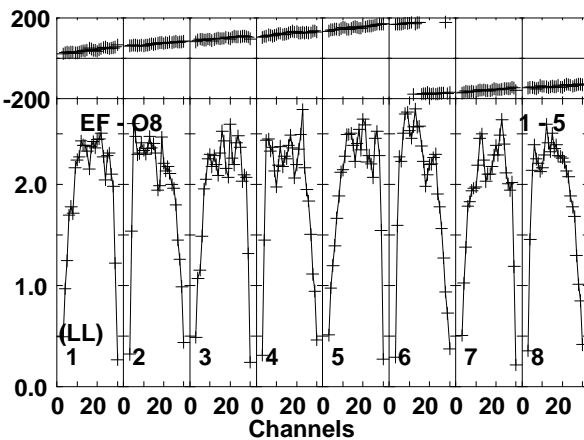
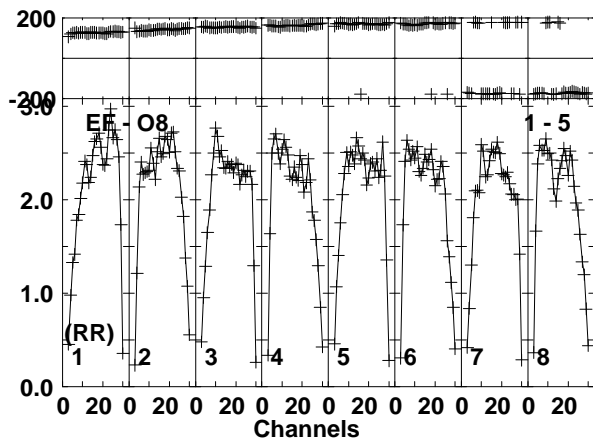
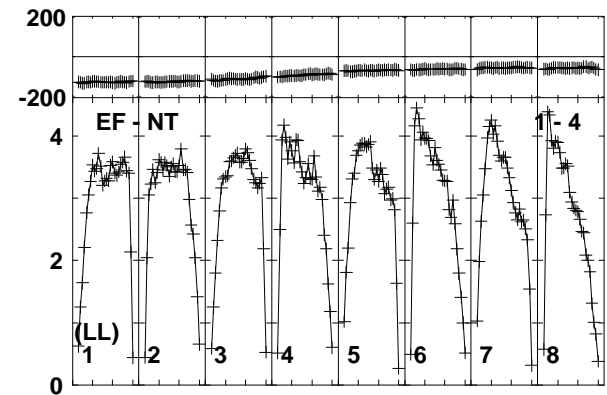
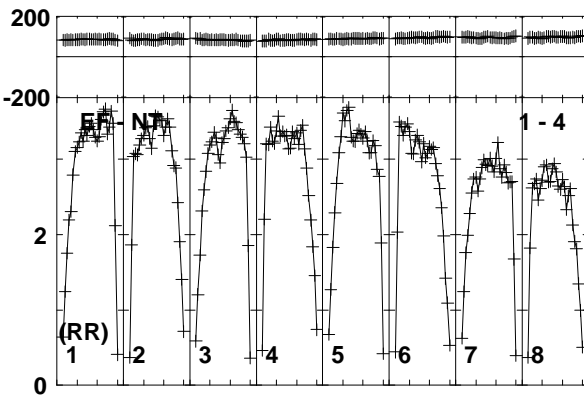
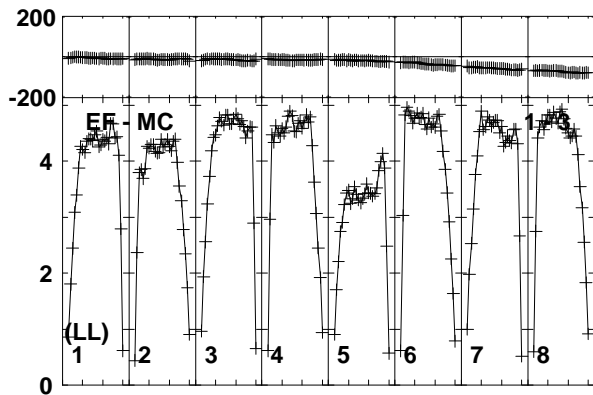
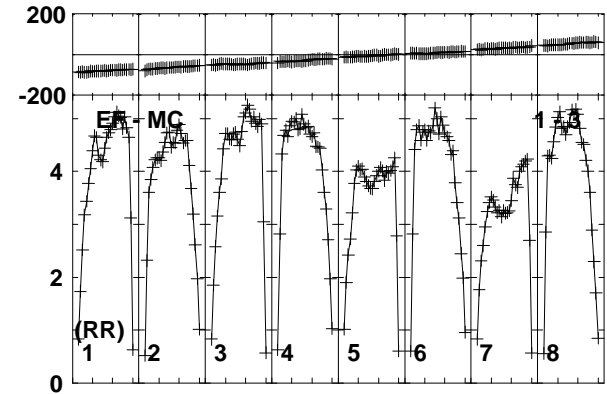
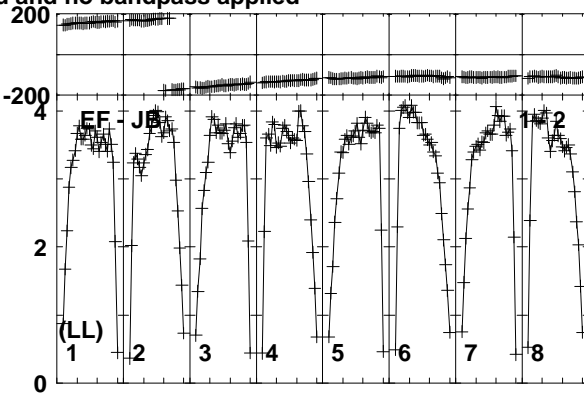
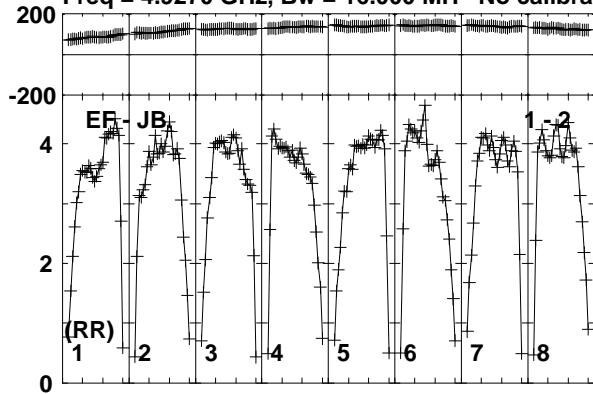

Lower frame: Milli Ampl Jy Top frame: Phas deg  
Vector averaged cross-power spectrum Baseline: EF (01) - JB (02)  
Timerange: 00/16:38:50 to 00/16:39:40

Plot file version 244 created 10-JUN-2016 15:29:43

J0718-1813 RG008C.UVDATA.1

Freq = 4.9270 GHz, Bw = 16.000 MH No calibration applied and no bandpass applied

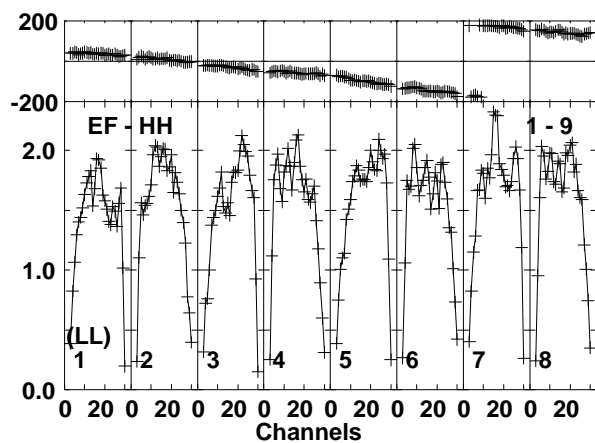
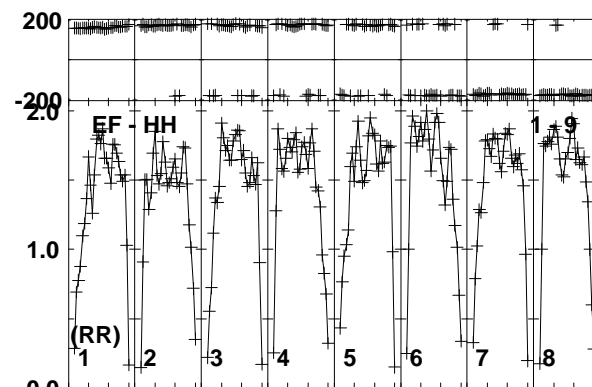
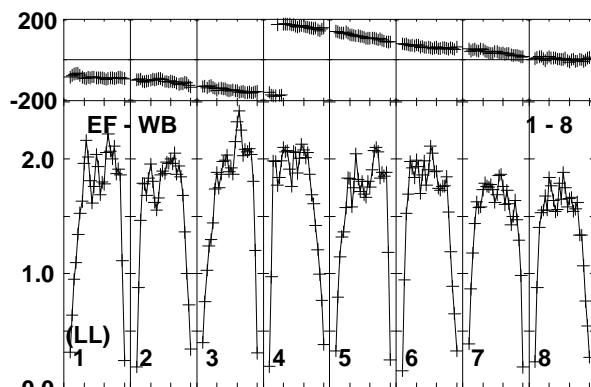
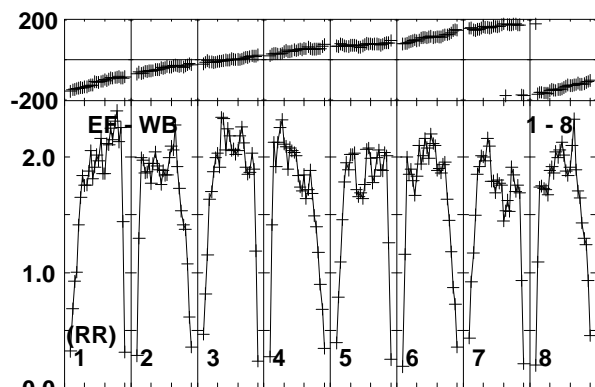
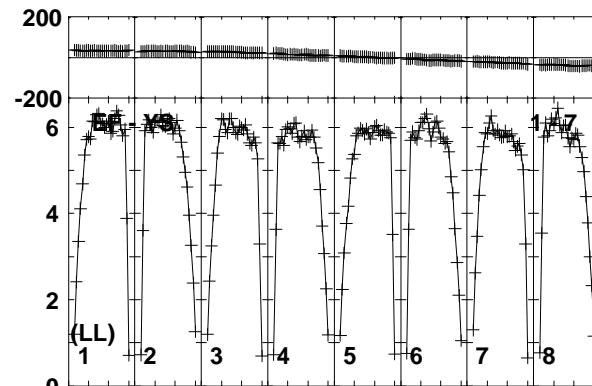
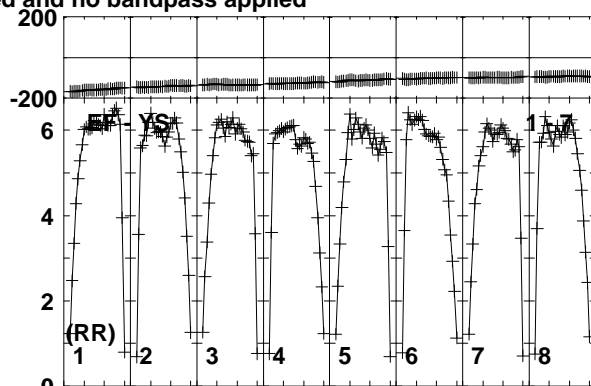
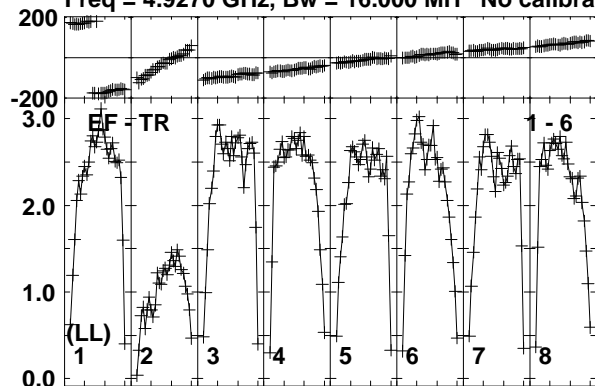

Lower frame: Milli Ampl Jy Top frame: Phas deg  
Vector averaged cross-power spectrum Baseline: EF (01) - TR (06)  
Timerange: 00/16:38:50 to 00/16:39:40

Plot file version 245 created 10-JUN-2016 15:29:43

FRB150418 RG008C.UVDATA.1

Freq = 4.9270 GHz, Bw = 16.000 MH No calibration applied and no bandpass applied

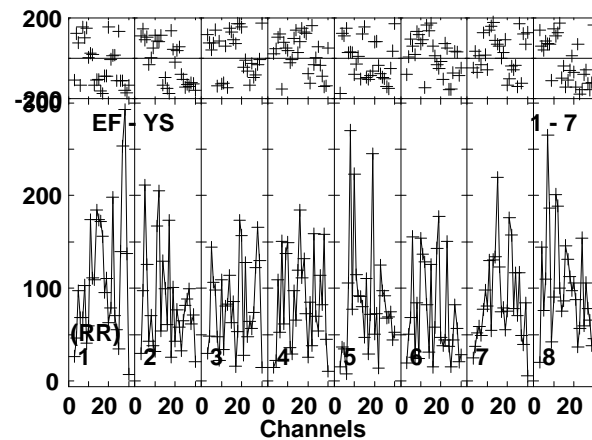
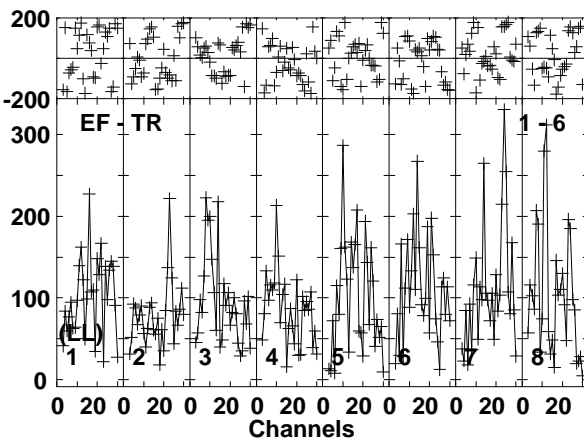
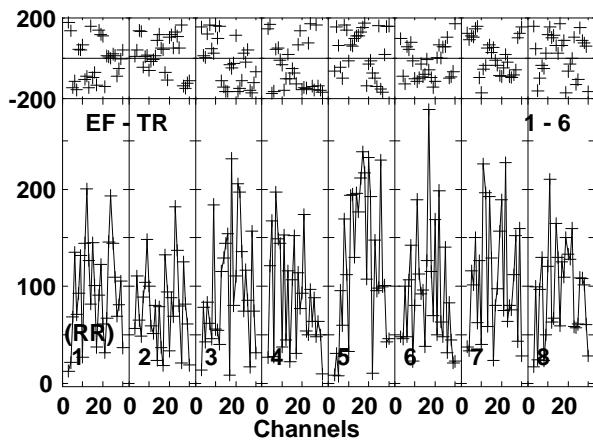
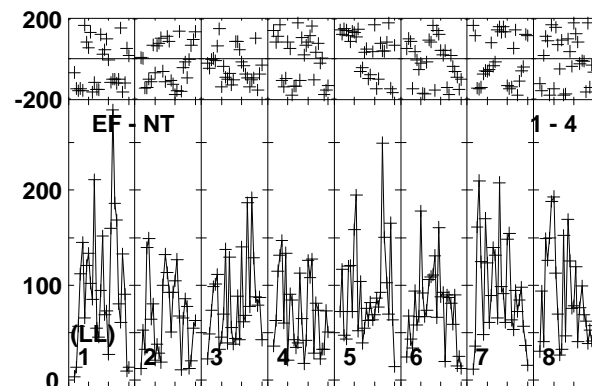
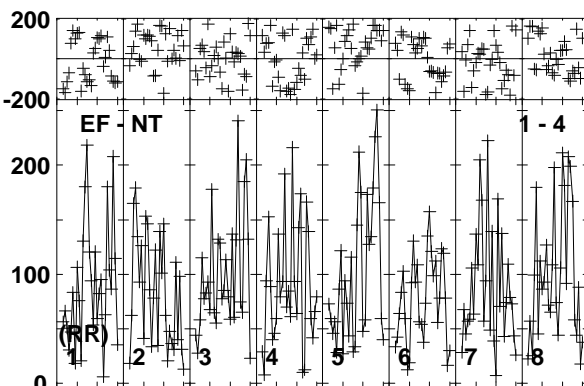
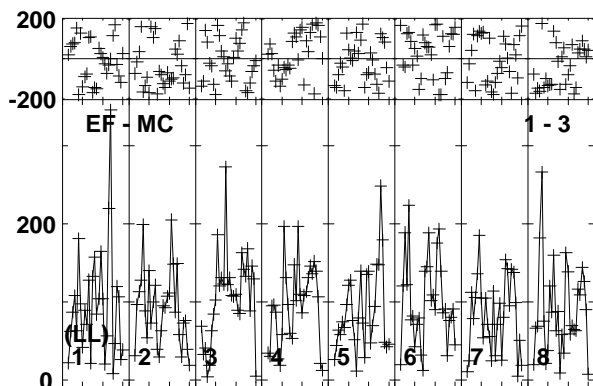
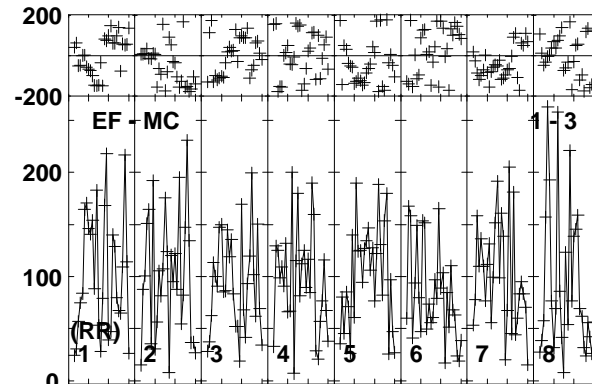
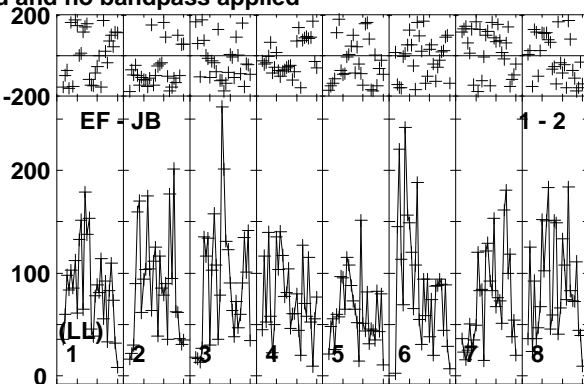
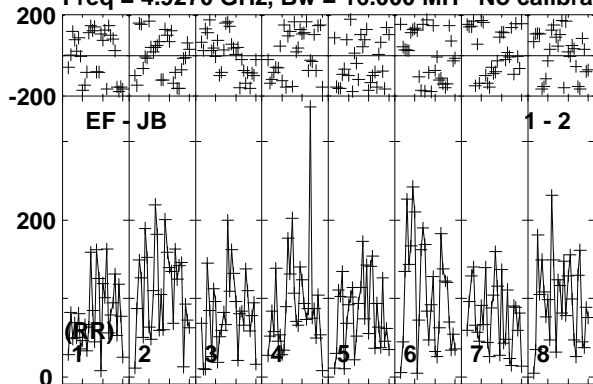

Lower frame: Micro Ampl Jy Top frame: Phas deg  
Vector averaged cross-power spectrum Baseline: EF (01) - JB (02)  
Timerange: 00/16:39:41 to 00/16:42:39

Plot file version 246 created 10-JUN-2016 15:29:44

FRB150418 RG008C.UVDATA.1

Freq = 4.9270 GHz, Bw = 16.000 MH No calibration applied and no bandpass applied

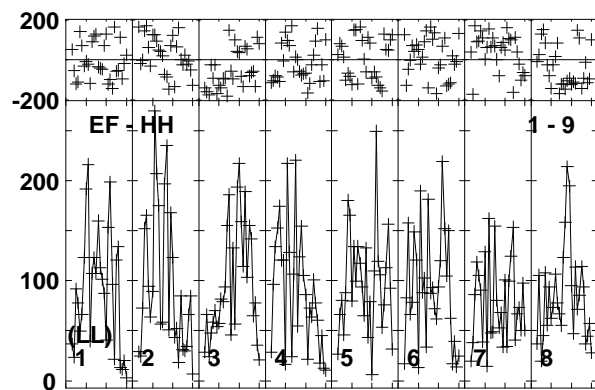
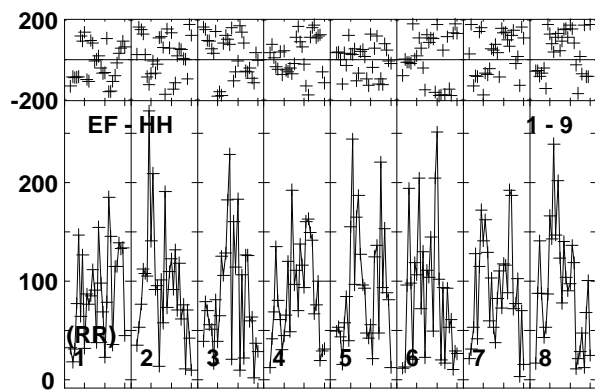
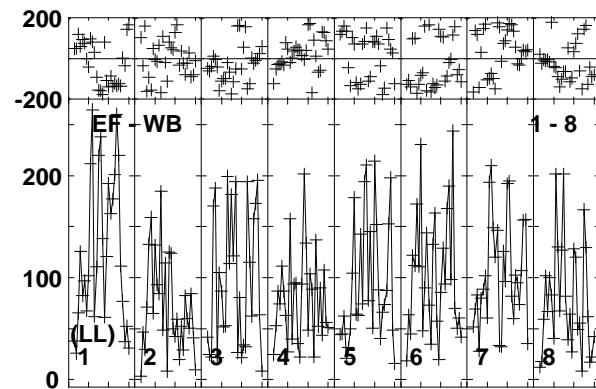
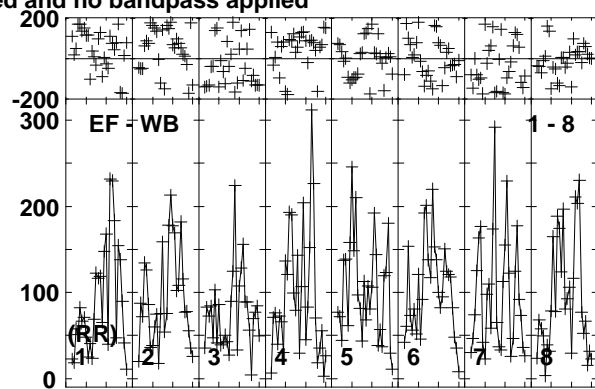
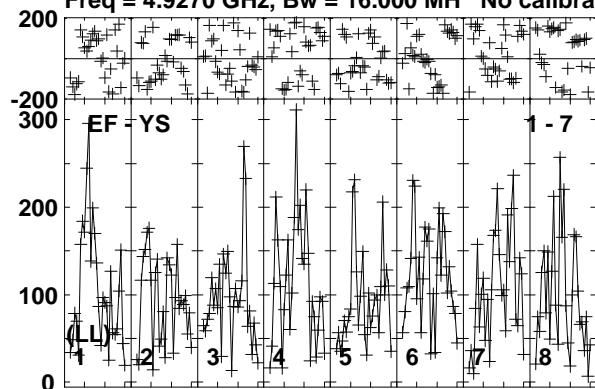

Lower frame: Micro Ampl Jy Top frame: Phas deg  
Vector averaged cross-power spectrum Baseline: EF (01) - YS (07)  
Timerange: 00/16:39:41 to 00/16:42:39

Plot file version 247 created 10-JUN-2016 15:29:44

J0718-1813 RG008C.UVDATA.1

Freq = 4.9270 GHz, Bw = 16.000 MH No calibration applied and no bandpass applied

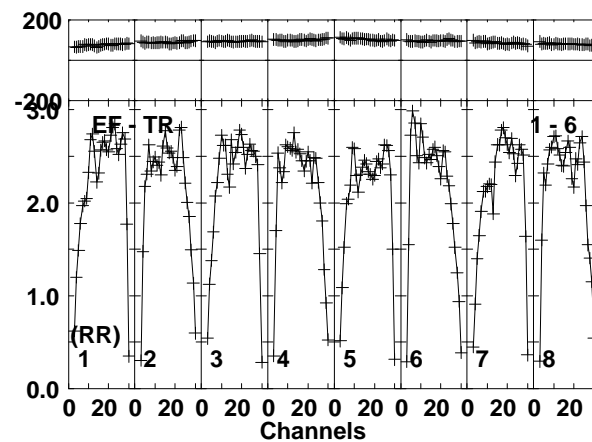
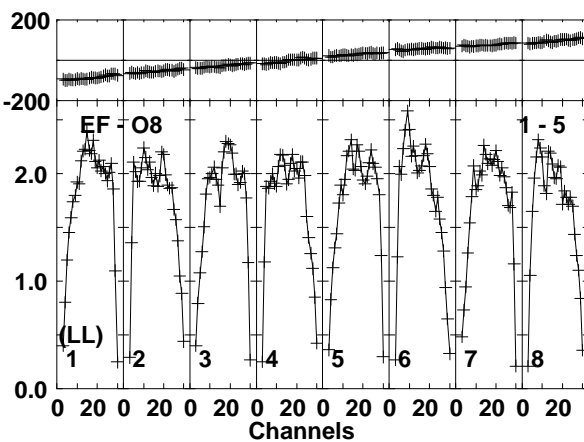
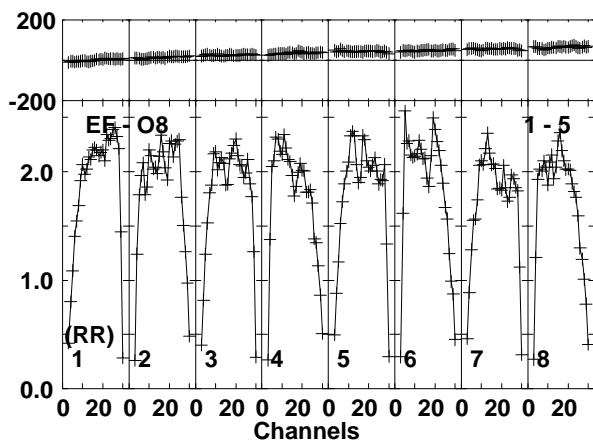
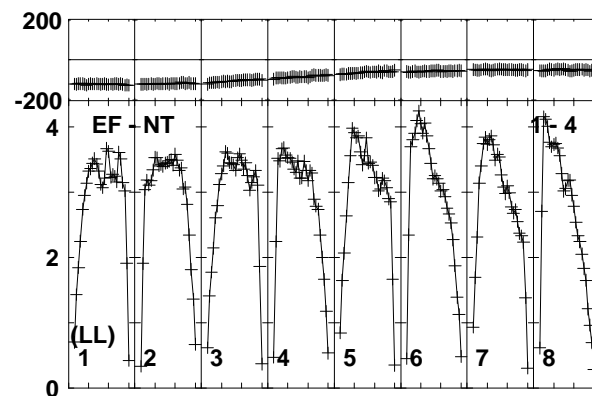
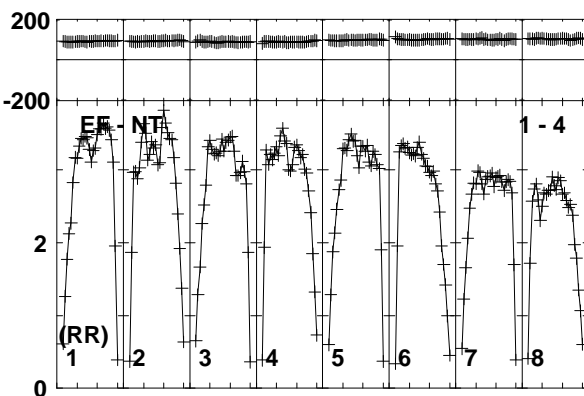
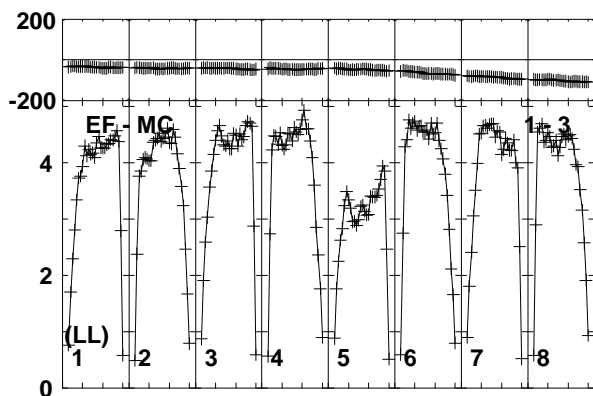
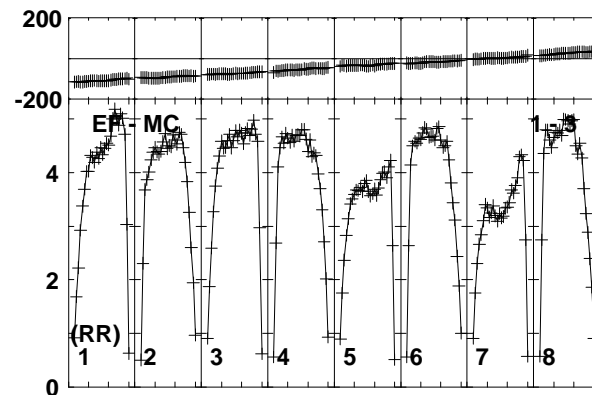
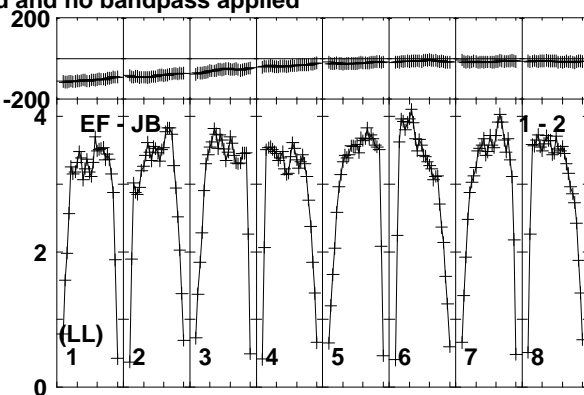
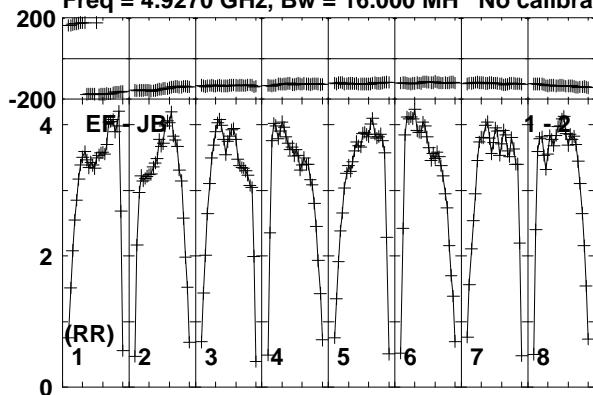

Lower frame: Milli Ampl Jy Top frame: Phas deg  
Vector averaged cross-power spectrum Baseline: EF (01) - JB (02)  
Timerange: 00:16:42:41 to 00:16:44:10

Plot file version 248 created 10-JUN-2016 15:29:44

J0718-1813 RG008C.UVDATA.1

Freq = 4.9270 GHz, Bw = 16.000 MH No calibration applied and no bandpass applied

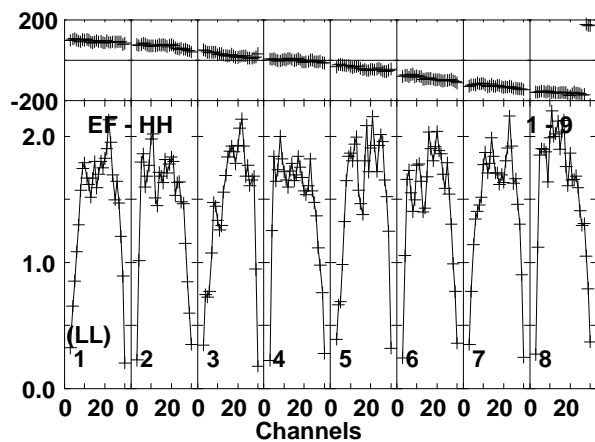
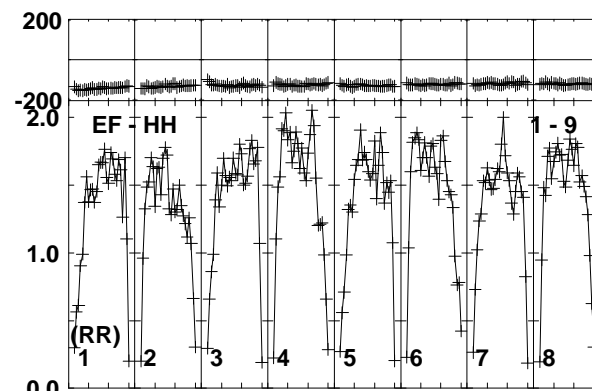
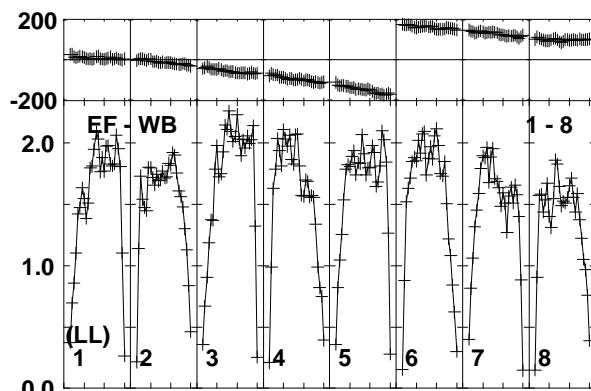
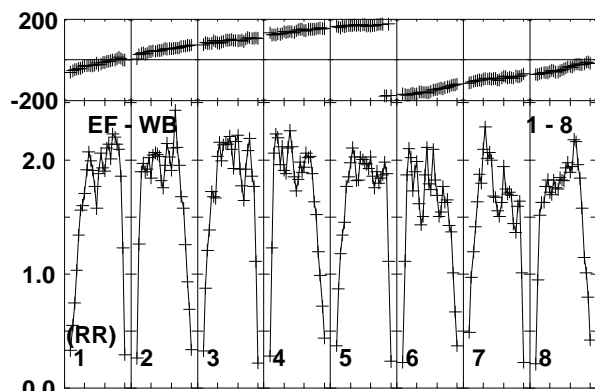
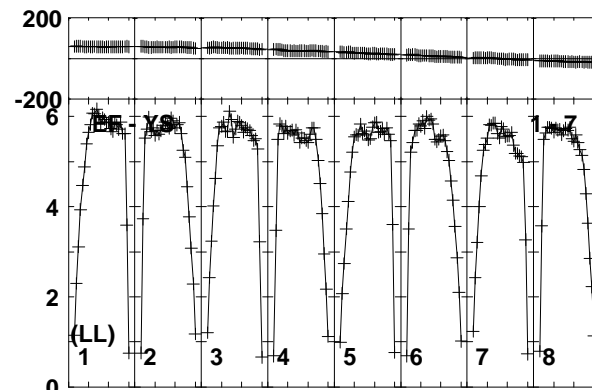
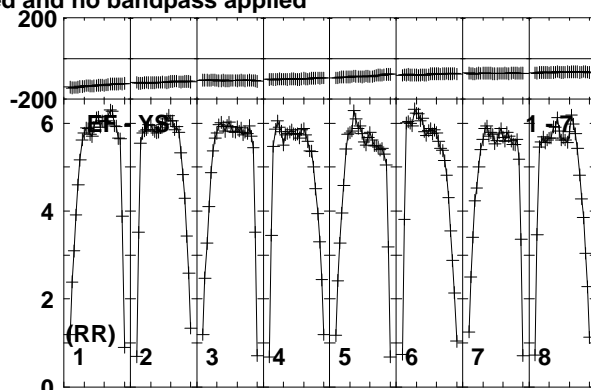
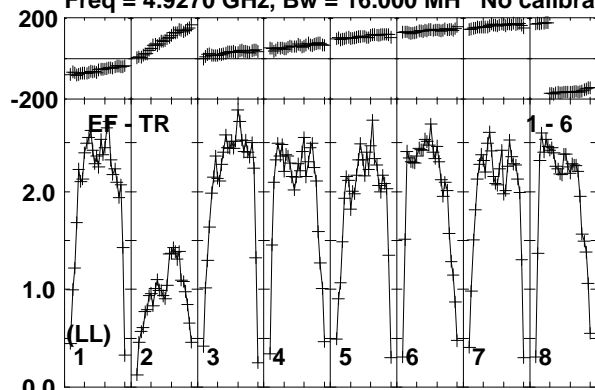

Lower frame: Milli Ampl Jy Top frame: Phas deg  
Vector averaged cross-power spectrum Baseline: EF (01) - TR (06)  
Timerange: 00/16:42:41 to 00/16:44:10



Plot file version 249 created 10-JUN-2016 15:29:44

J0716-1856 RG008C.UVDATA.1

Freq = 4.9270 GHz, Bw = 16.000 MH No calibration applied and no bandpass applied

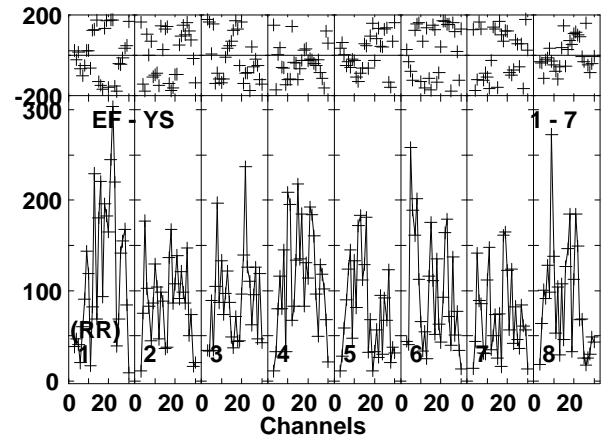
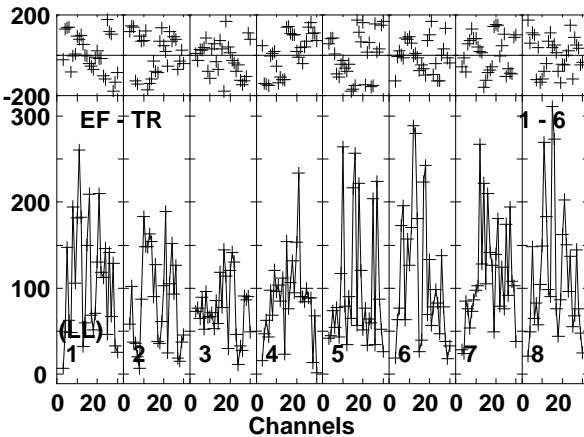
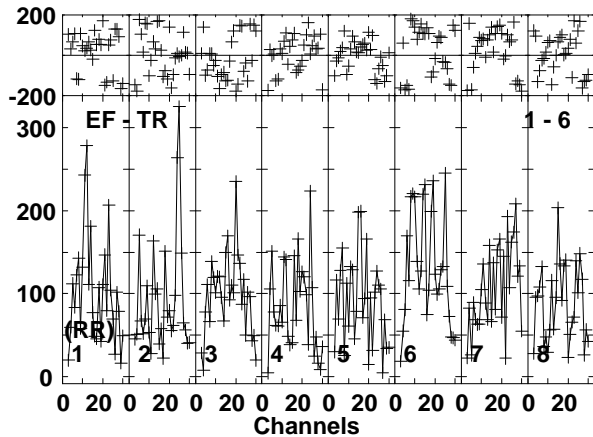
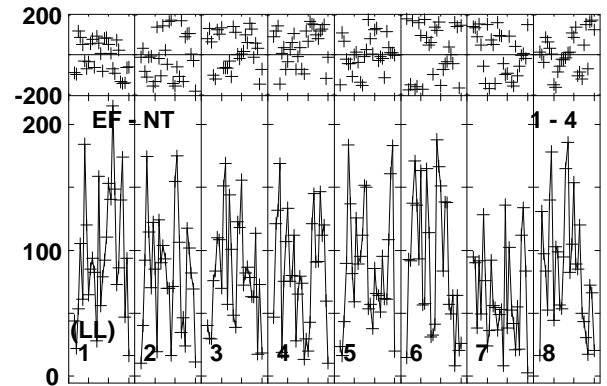
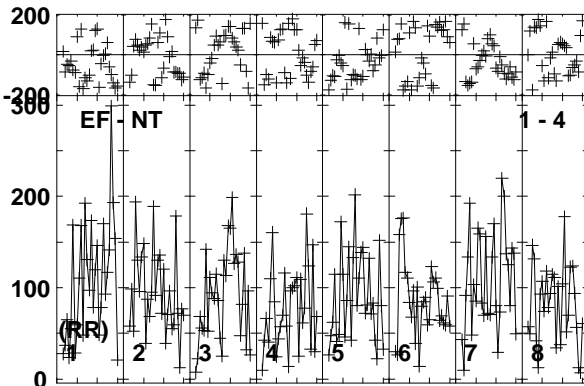
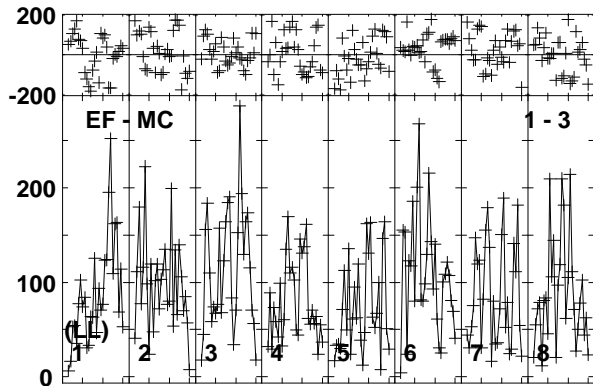
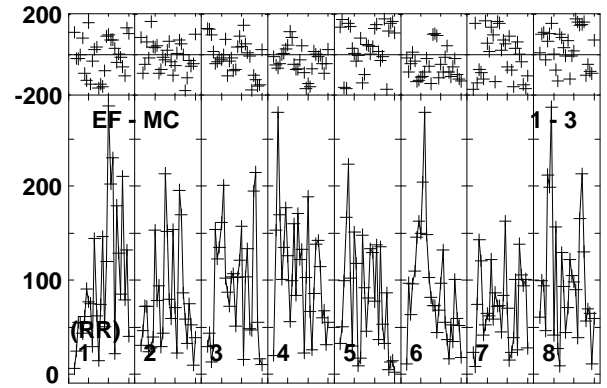
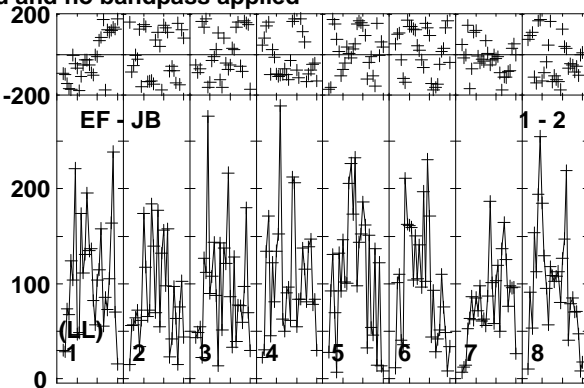
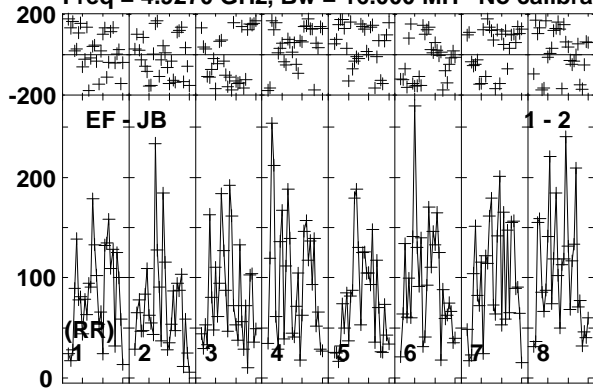

Lower frame: Micro Ampl Jy Top frame: Phas deg  
Vector averaged cross-power spectrum Baseline: EF (01) - JB (02)  
Timerange: 00/16:44:10 to 00/16:47:10

Plot file version 250 created 10-JUN-2016 15:29:44

J0716-1856 RG008C.UVDATA.1

Freq = 4.9270 GHz, Bw = 16.000 MH No calibration applied and no bandpass applied

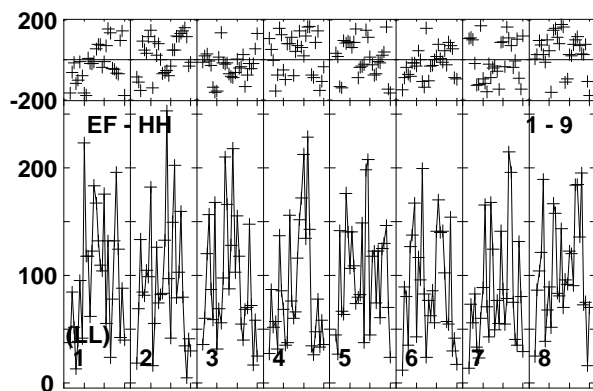
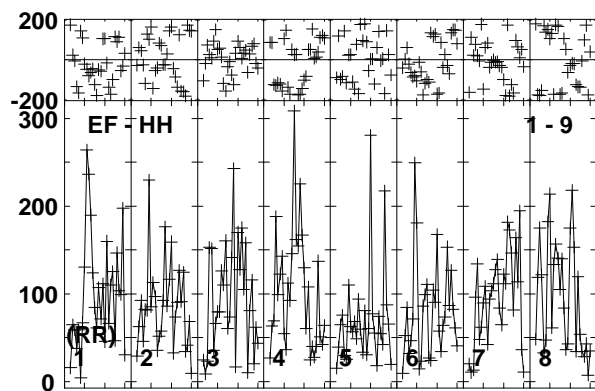
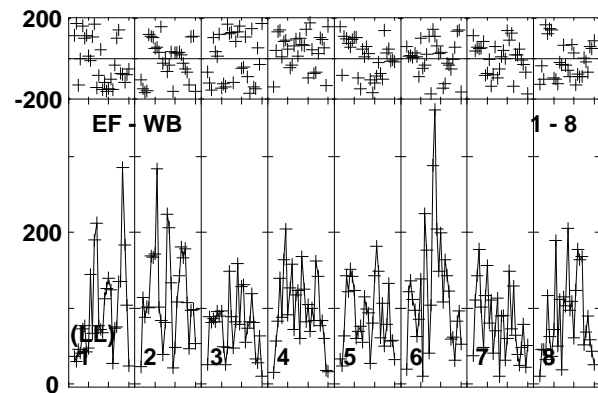
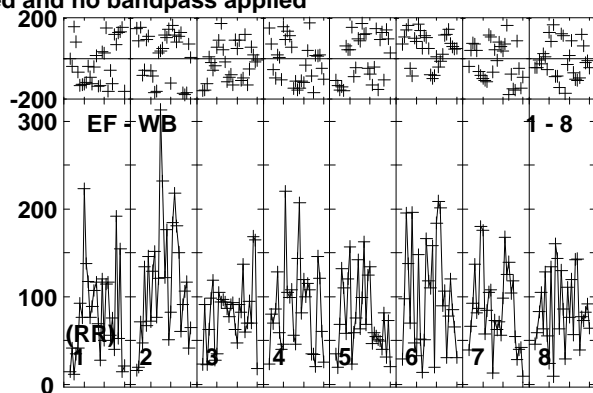
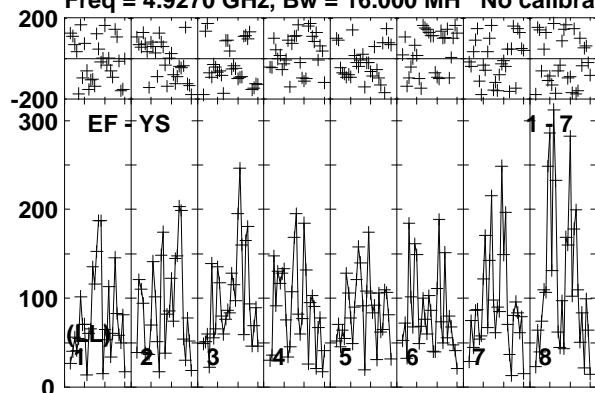

Lower frame: Micro Ampl Jy Top frame: Phas deg  
Vector averaged cross-power spectrum Baseline: EF (01) - YS (07)  
Timerange: 00/16:44:10 to 00/16:47:10

Plot file version 251 created 10-JUN-2016 15:29:44

J0718-1813 RG008C.UVDATA.1

Freq = 4.9270 GHz, Bw = 16.000 MH No calibration applied and no bandpass applied

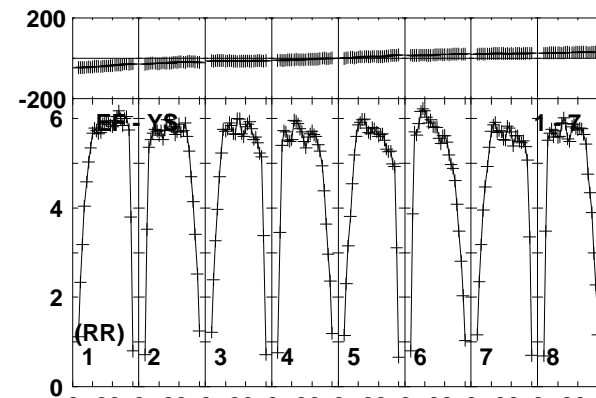
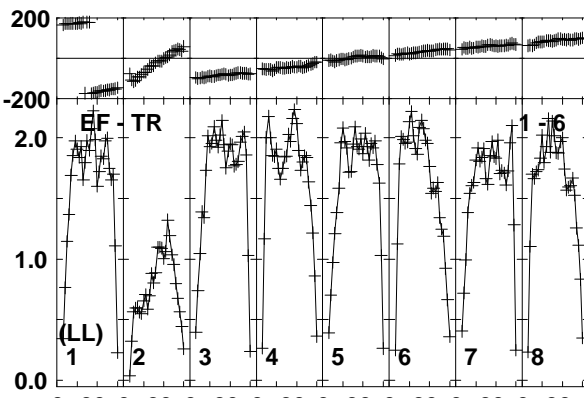
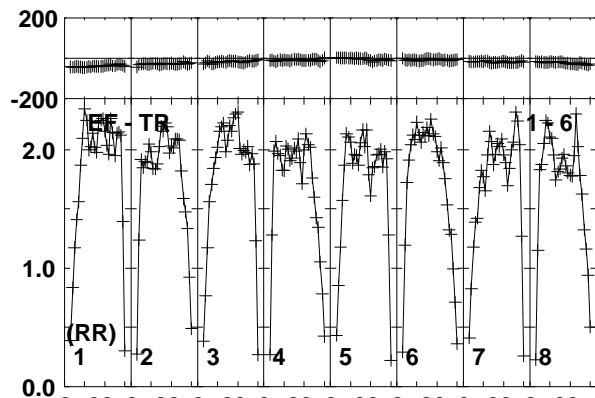
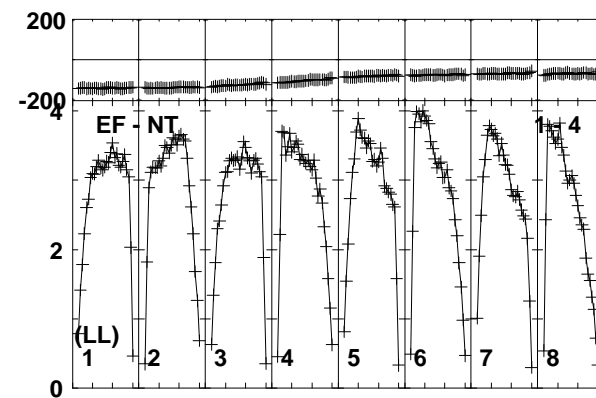
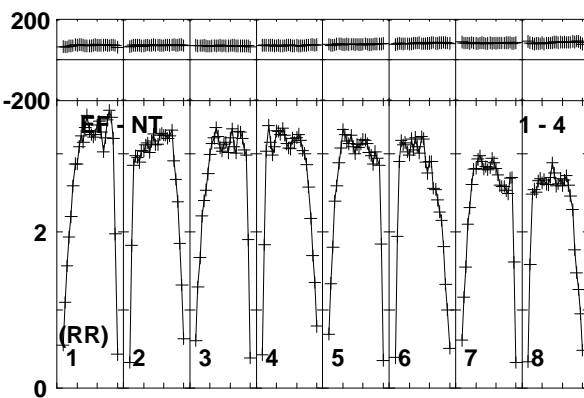
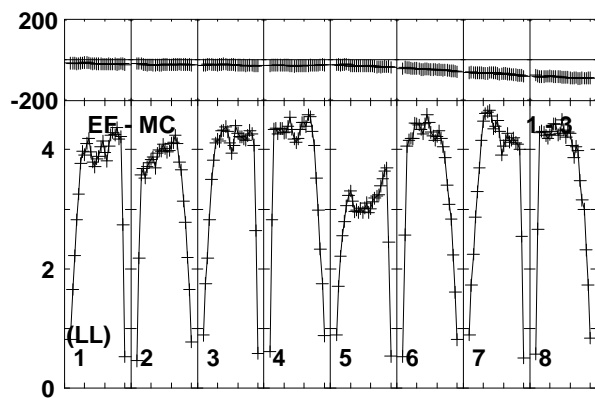
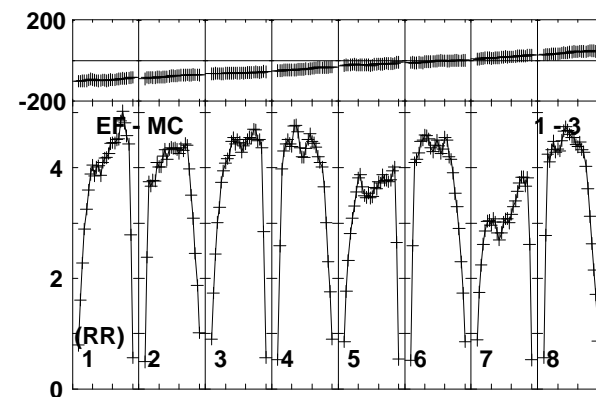
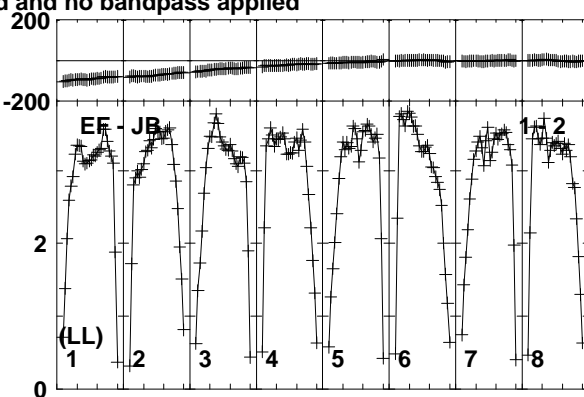
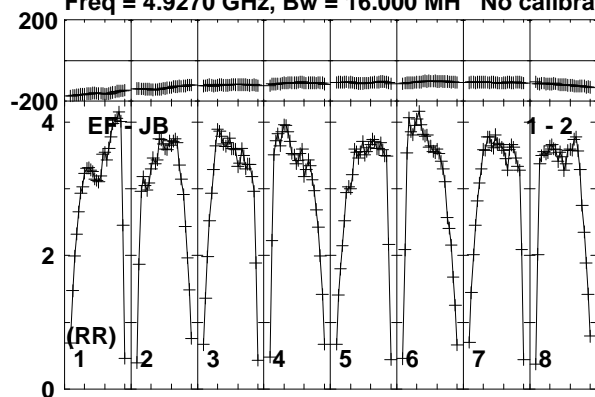

Lower frame: Milli Ampl Jy Top frame: Phas deg  
Vector averaged cross-power spectrum Baseline: EF (01) - JB (02)  
Timerange: 00/16:47:50 to 00/16:49:09

Plot file version 252 created 10-JUN-2016 15:29:44

J0718-1813 RG008C.UVDATA.1

Freq = 4.9270 GHz, Bw = 16.000 MH No calibration applied and no bandpass applied

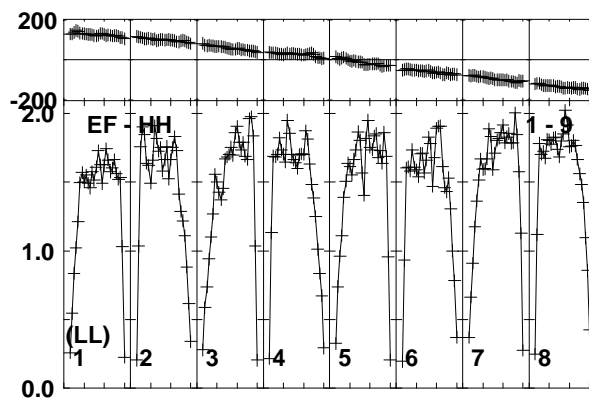
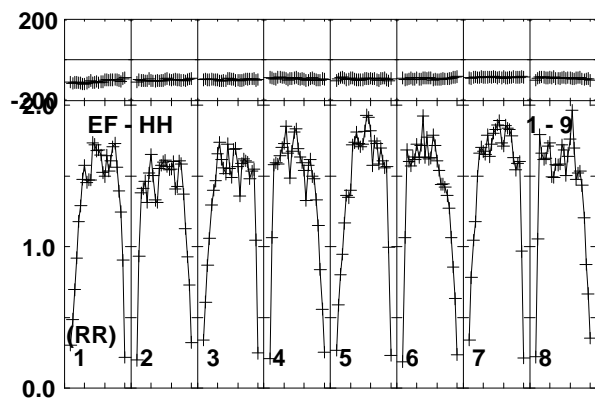
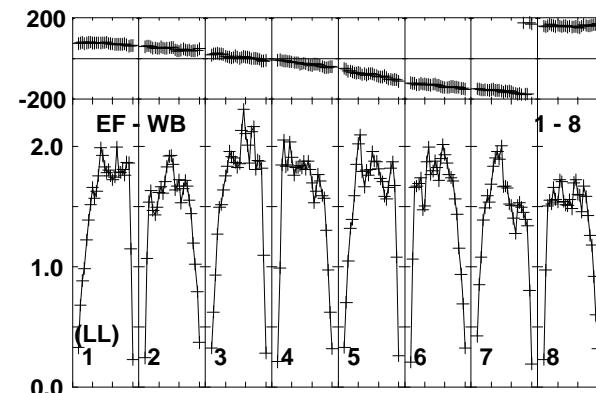
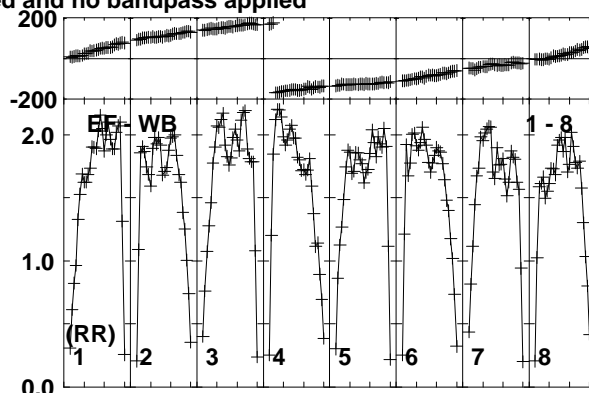
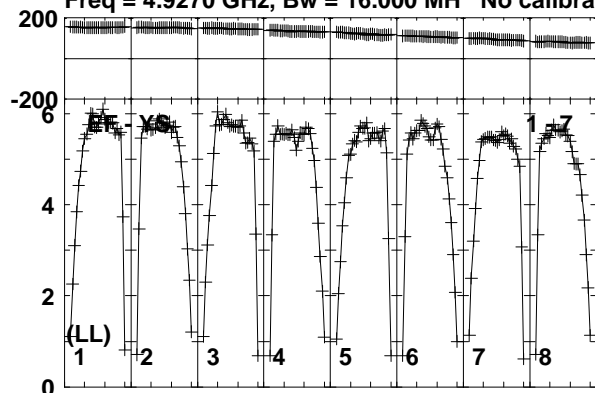

Lower frame: Milli Ampl Jy Top frame: Phas deg  
Vector averaged cross-power spectrum Baseline: EF (01) - YS (07)  
Timerange: 00/16:47:50 to 00/16:49:09

Plot file version 253 created 10-JUN-2016 15:29:44

FRB150418 RG008C.UVDATA.1

Freq = 4.9270 GHz, Bw = 16.000 MH No calibration applied and no bandpass applied

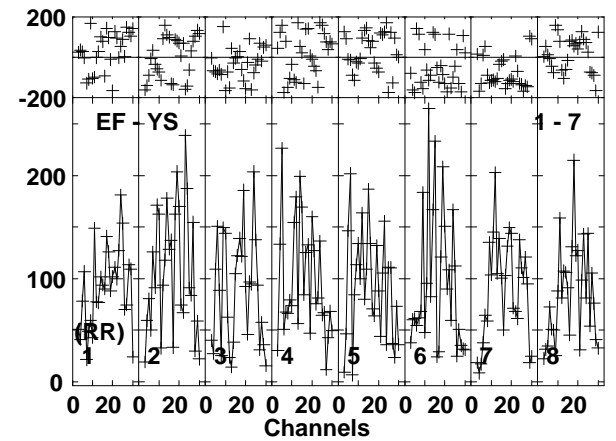
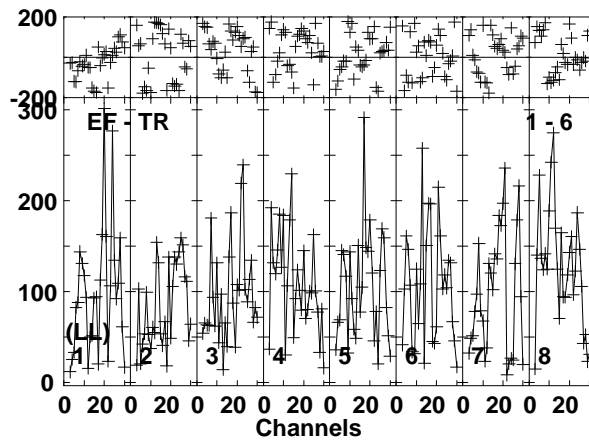
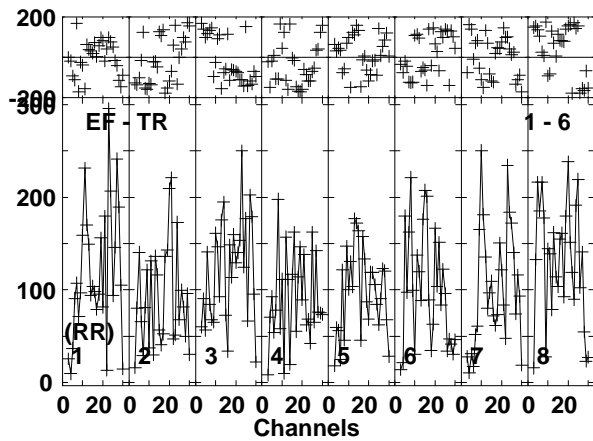
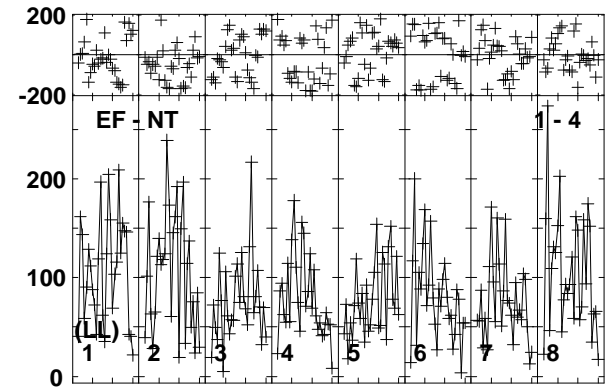
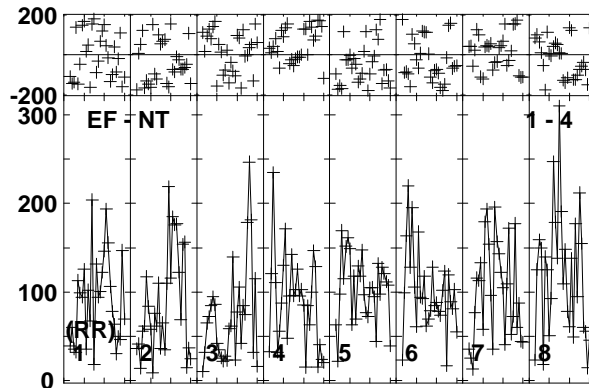
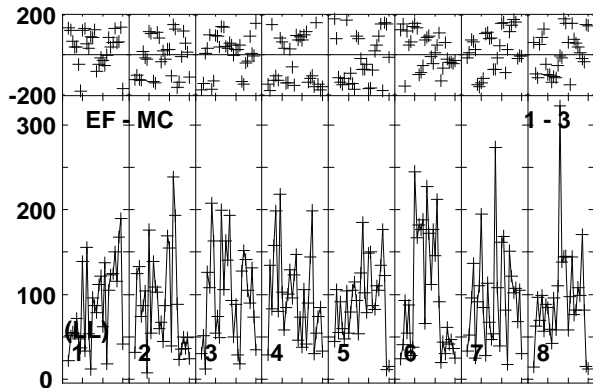
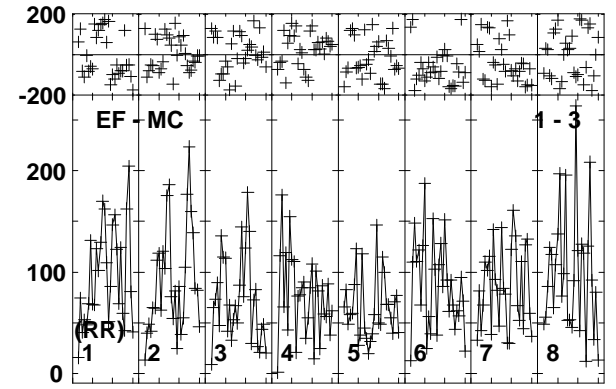
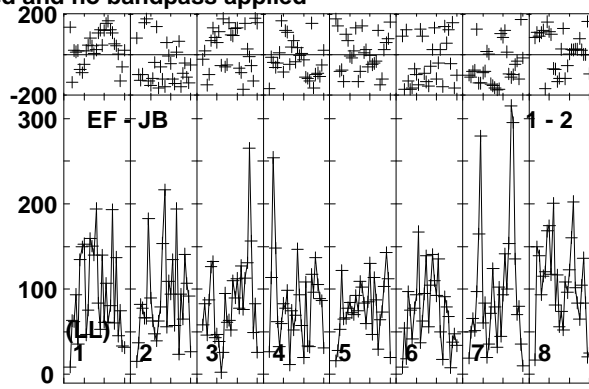
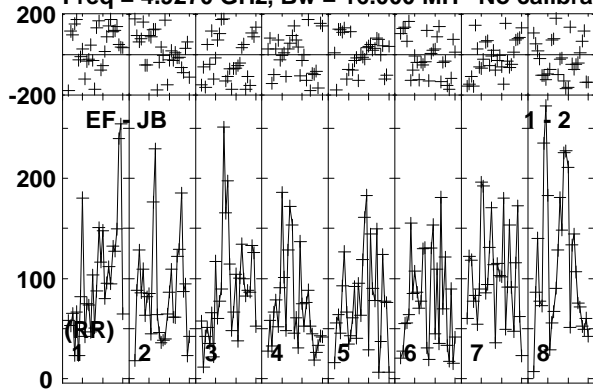

Lower frame: Micro Ampl Jy Top frame: Phas deg  
Vector averaged cross-power spectrum Baseline: EF (01) - JB (02)  
Timerange: 00/16:49:11 to 00/16:52:09

Plot file version 254 created 10-JUN-2016 15:29:45

FRB150418 RG008C.UVDATA.1

Freq = 4.9270 GHz, Bw = 16.000 MH No calibration applied and no bandpass applied

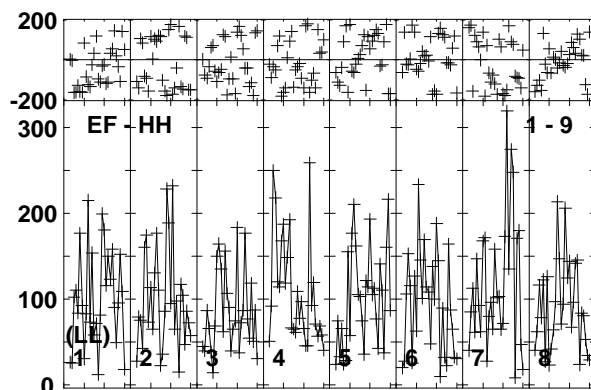
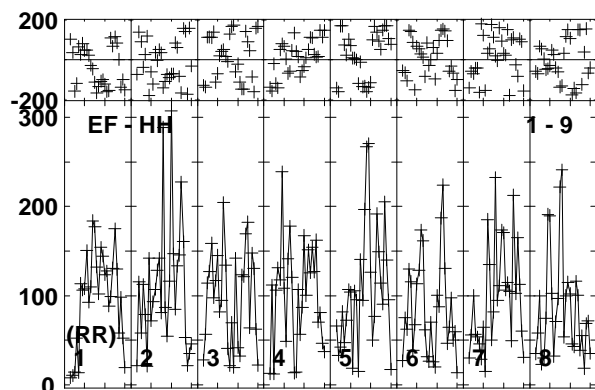
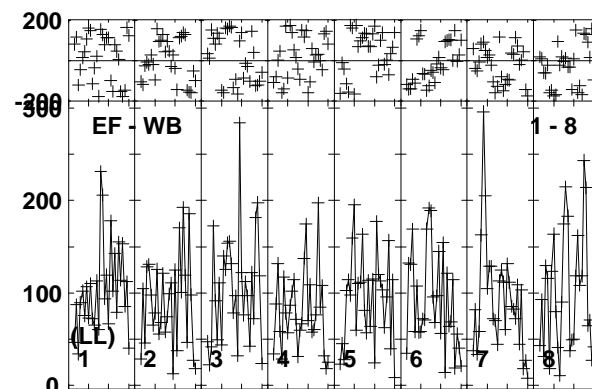
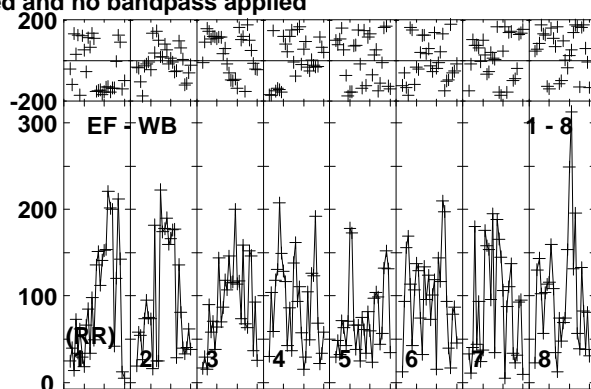
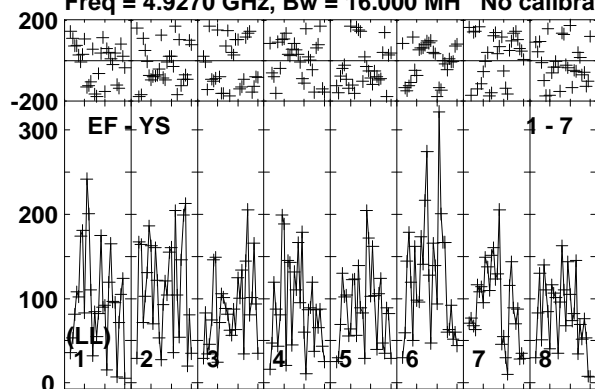

Lower frame: Micro Ampl Jy Top frame: Phas deg  
Vector averaged cross-power spectrum Baseline: EF (01) - YS (07)  
Timerange: 00/16:49:11 to 00/16:52:09

Plot file version 255 created 10-JUN-2016 15:29:45

J0718-1813 RG008C.UVDATA.1

Freq = 4.9270 GHz, Bw = 16.000 MH No calibration applied and no bandpass applied

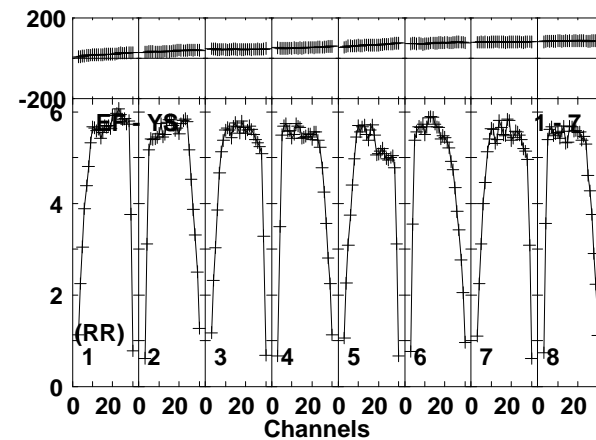
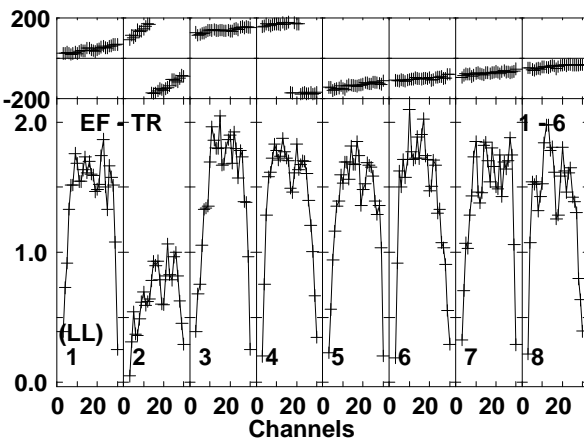
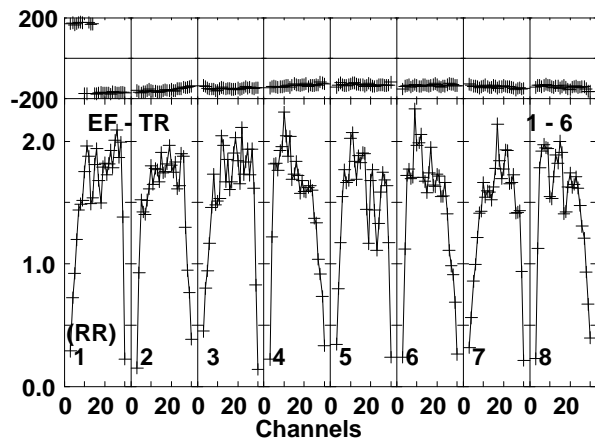
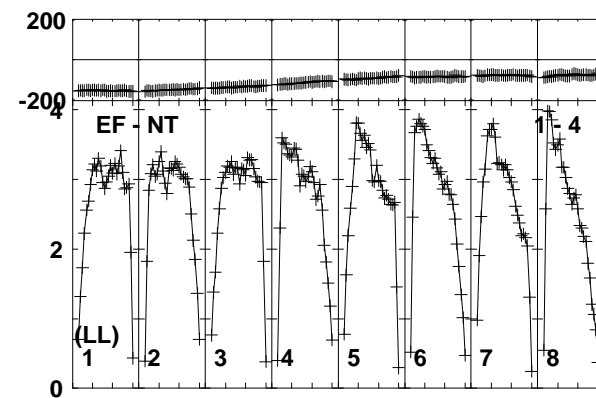
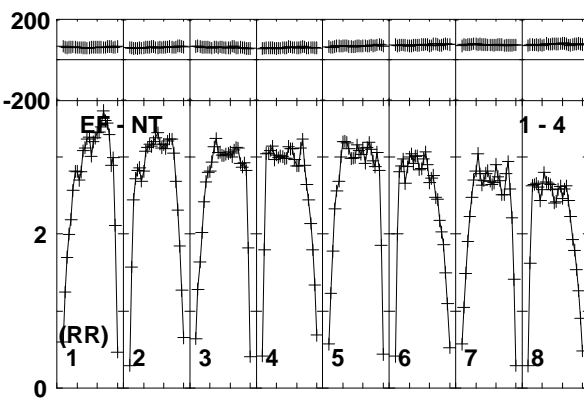
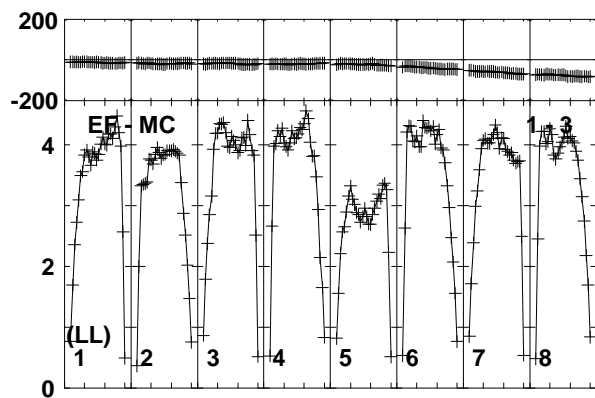
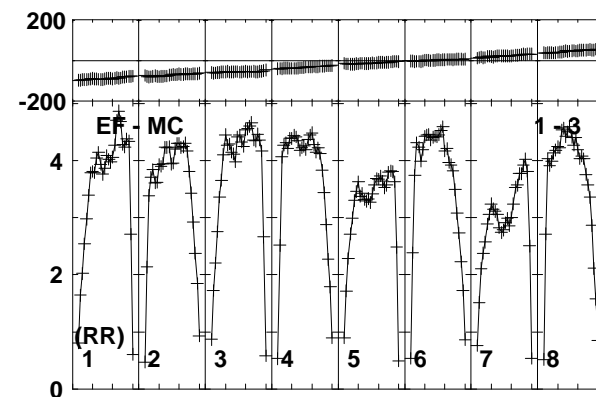
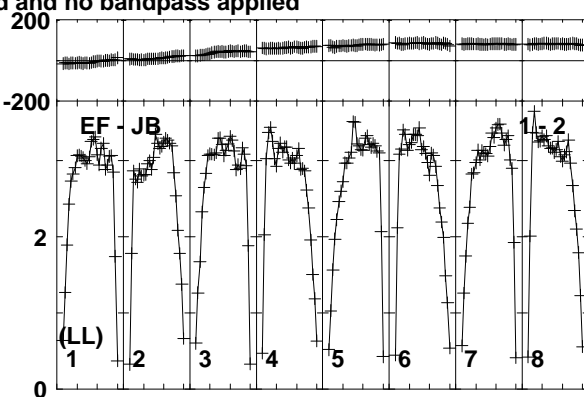
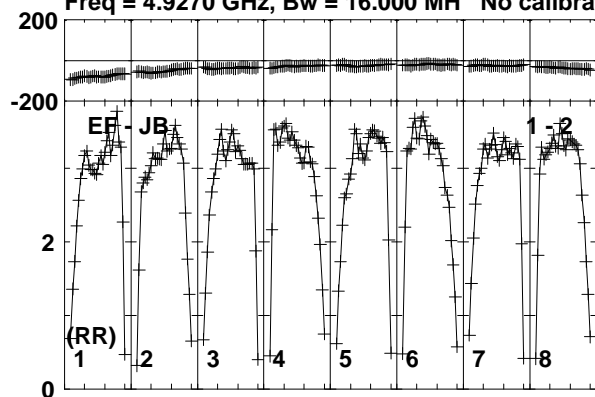

Lower frame: Milli Ampl Jy Top frame: Phas deg  
Vector averaged cross-power spectrum Baseline: EF (01) - JB (02)  
Timerange: 00/16:52:10 to 00/16:53:40

Plot file version 256 created 10-JUN-2016 15:29:45

J0718-1813 RG008C.UVDATA.1

Freq = 4.9270 GHz, Bw = 16.000 MH No calibration applied and no bandpass applied

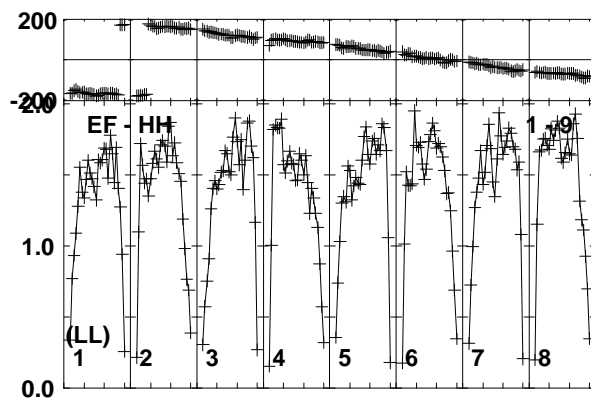
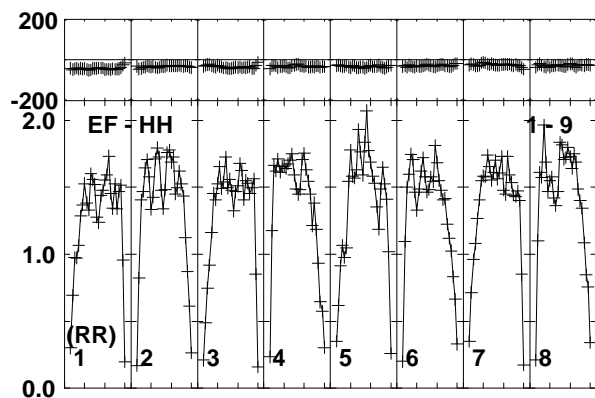
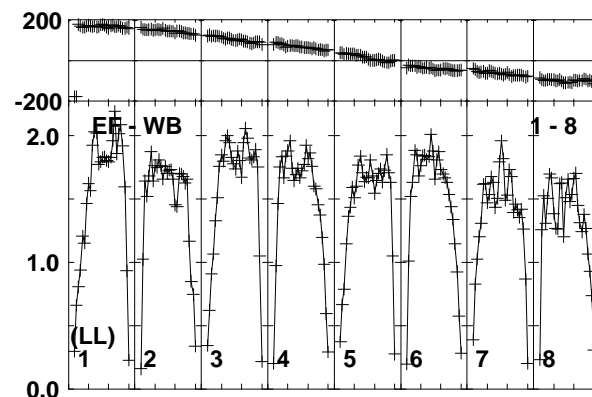
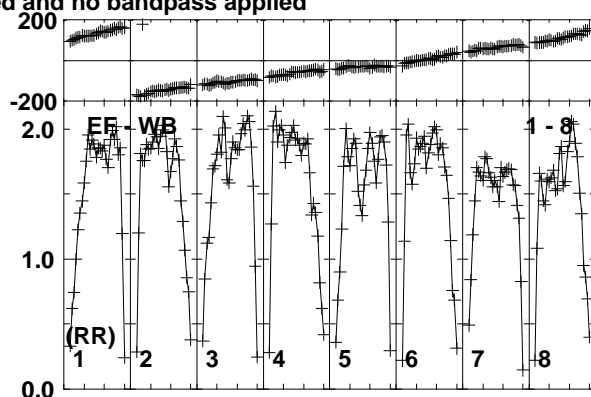
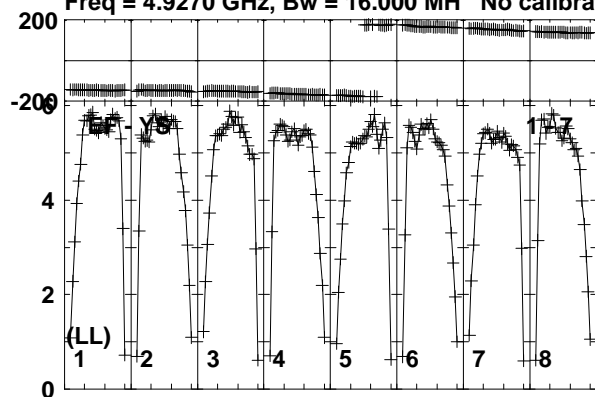

Lower frame: Milli Ampl Jy Top frame: Phas deg  
Vector averaged cross-power spectrum Baseline: EF (01) - YS (07)  
Timerange: 00/16:52:10 to 00/16:53:40



Plot file version 257 created 10-JUN-2016 15:29:45

J0716-1900 RG008C.UVDATA.1

Freq = 4.9270 GHz, Bw = 16.000 MH No calibration applied and no bandpass applied

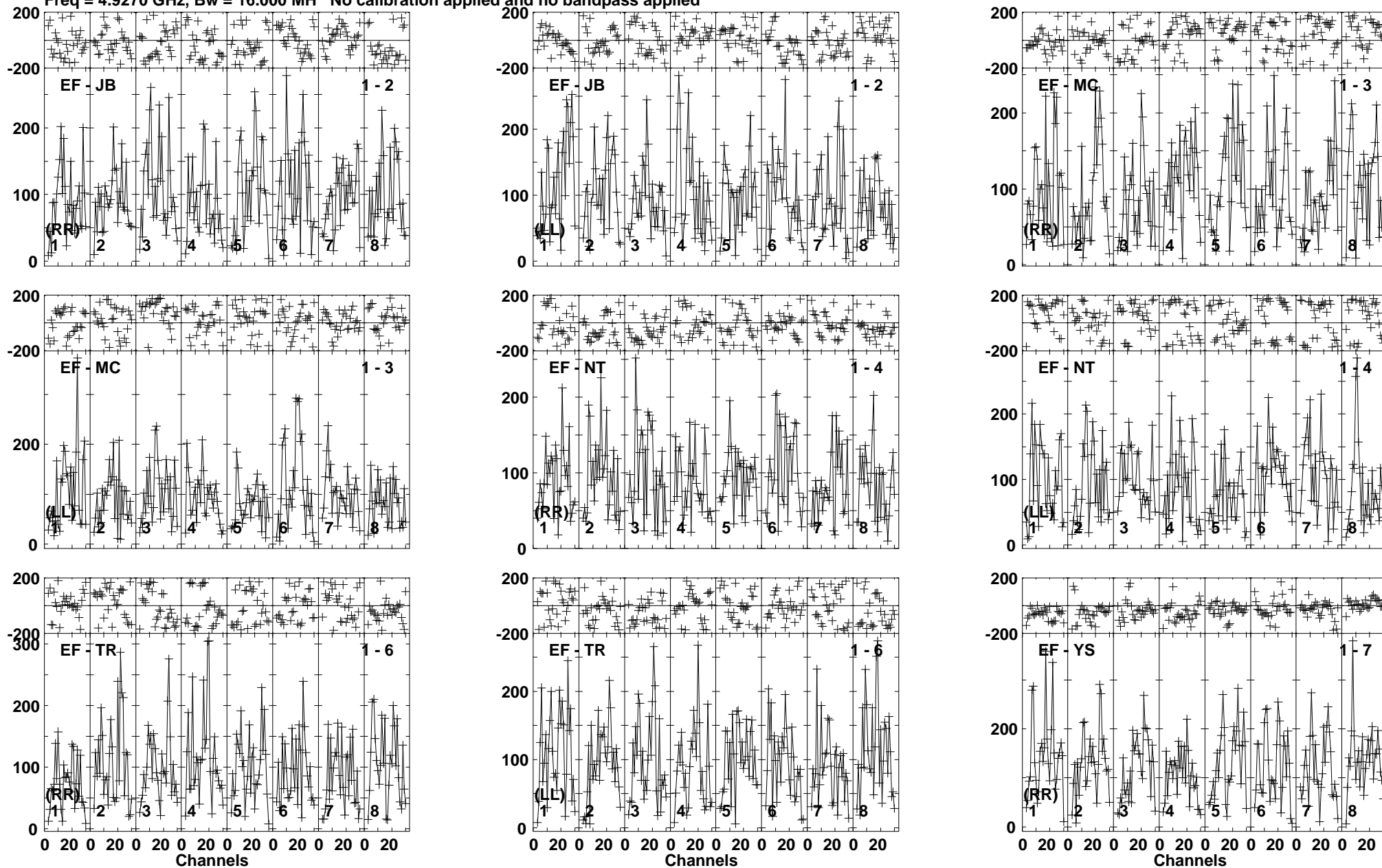

Lower frame: Micro Ampl Jy Top frame: Phas deg  
Vector averaged cross-power spectrum Baseline: EF (01) - JB (02)  
Timerange: 00/16:53:41 to 00/16:56:39

Plot file version 258 created 10-JUN-2016 15:29:45

J0716-1900 RG008C.UVDATA.1

Freq = 4.9270 GHz, Bw = 16.000 MH No calibration applied and no bandpass applied

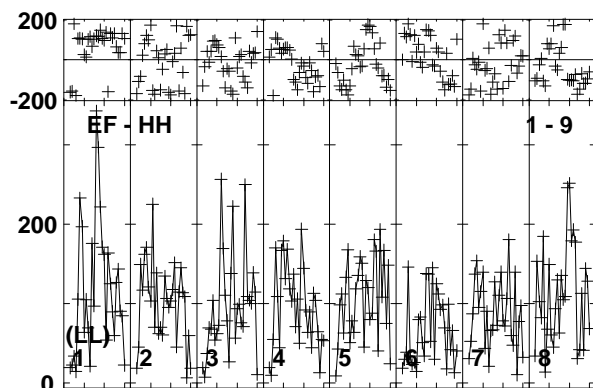
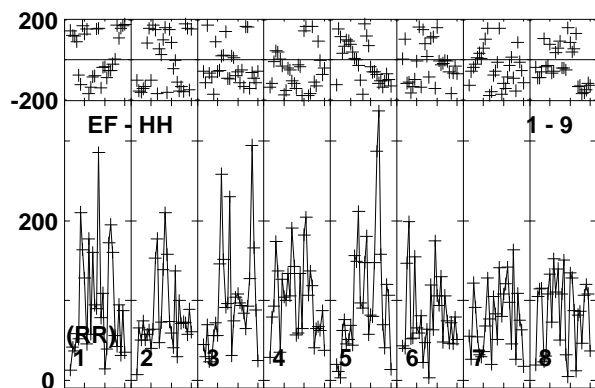
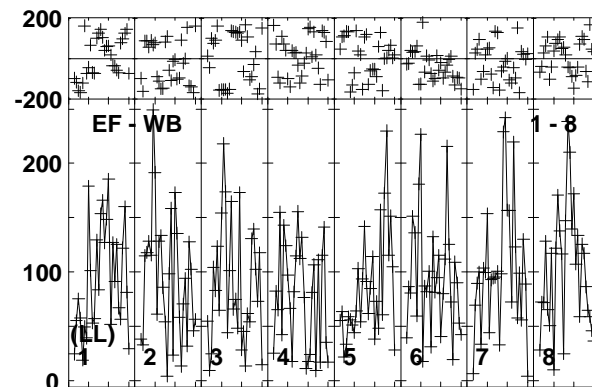
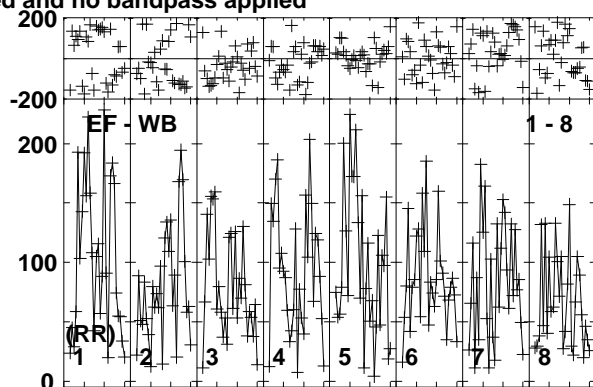
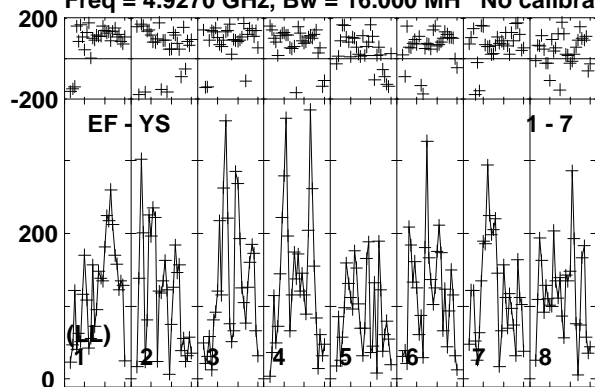

Lower frame: Micro Ampl Jy Top frame: Phas deg  
Vector averaged cross-power spectrum Baseline: EF (01) - YS (07)  
Timerange: 00/16:53:41 to 00/16:56:39

Plot file version 259 created 10-JUN-2016 15:29:45

J0718-1813 RG008C.UVDATA.1

Freq = 4.9270 GHz, Bw = 16.000 MH No calibration applied and no bandpass applied

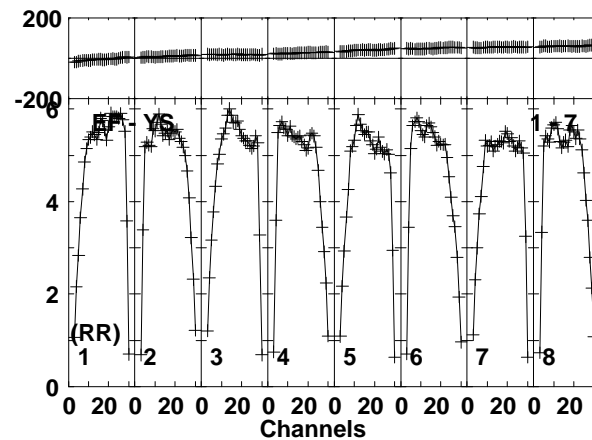
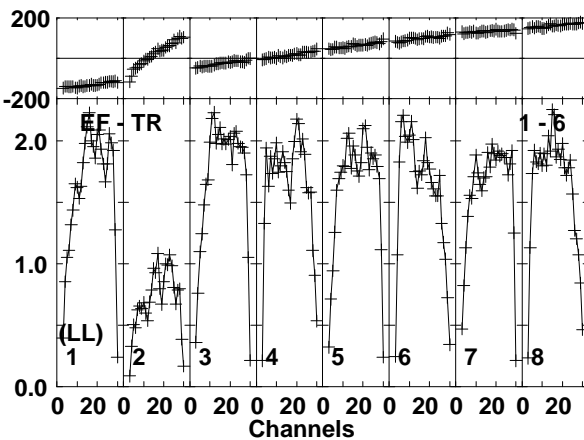
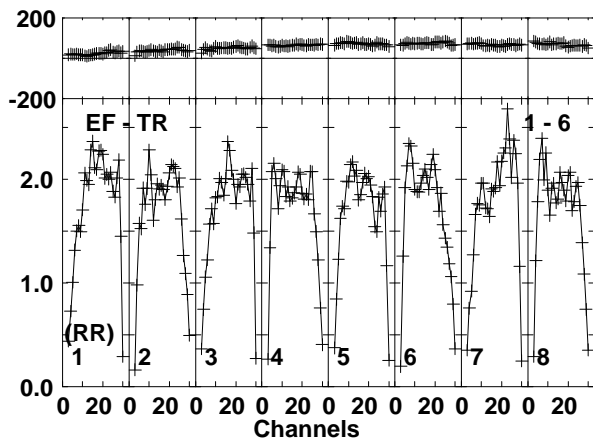
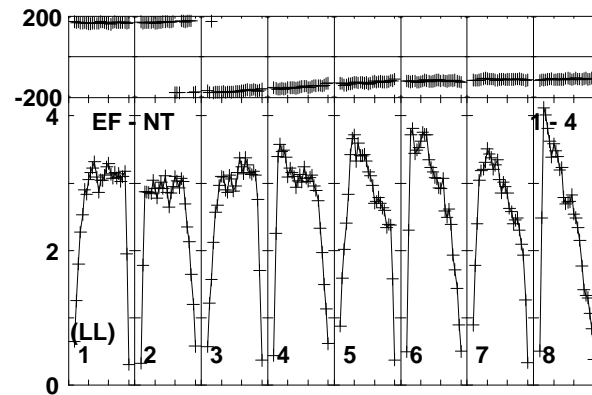
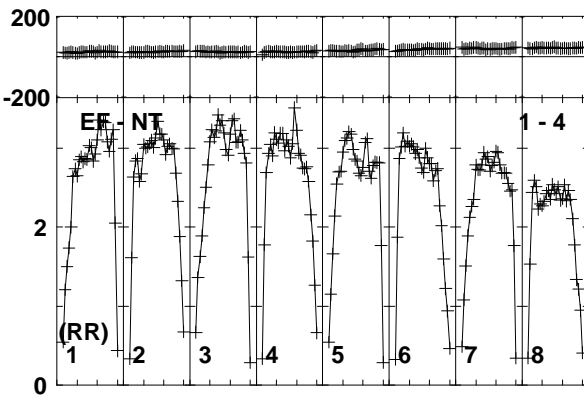
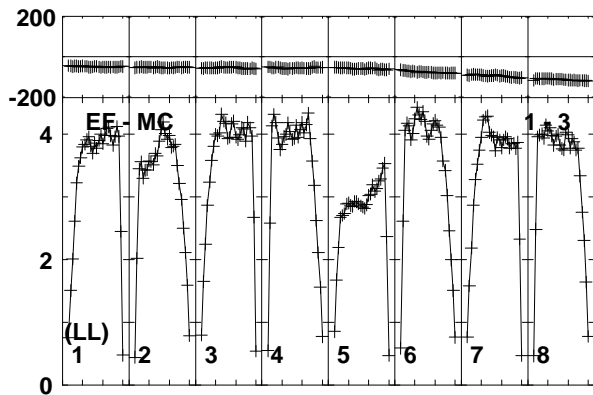
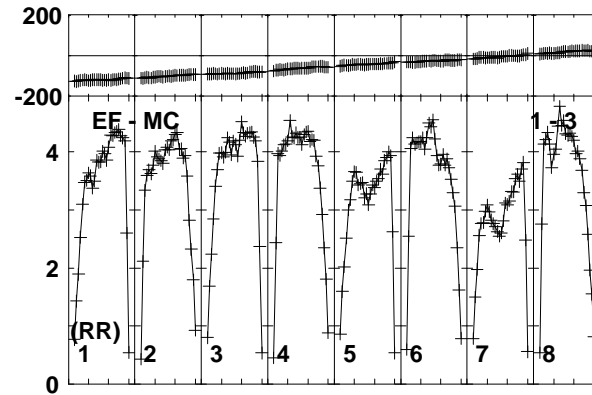
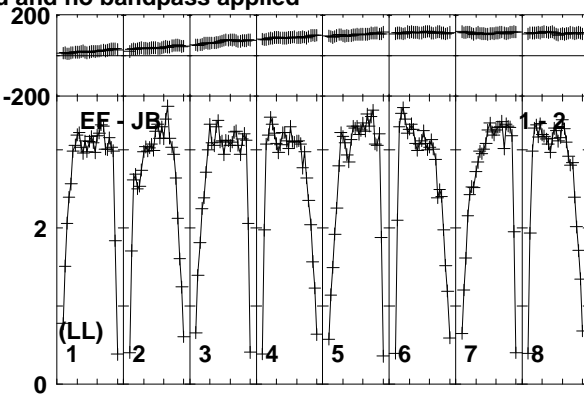
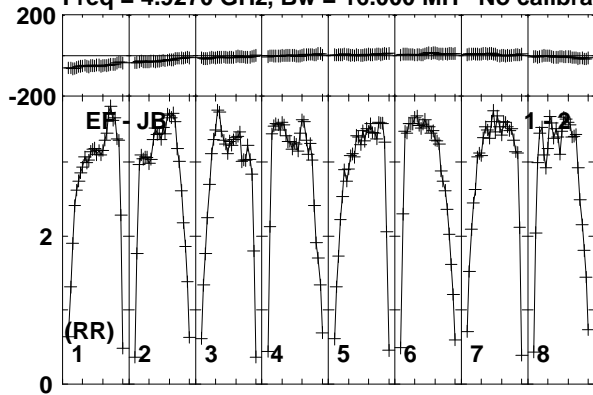

Lower frame: Milli Ampl Jy Top frame: Phas deg  
Vector averaged cross-power spectrum Baseline: EF (01) - JB (02)  
Timerange: 00/16:57:21 to 00/16:58:09

Plot file version 260 created 10-JUN-2016 15:29:45

J0718-1813 RG008C.UVDATA.1

Freq = 4.9270 GHz, Bw = 16.000 MH No calibration applied and no bandpass applied

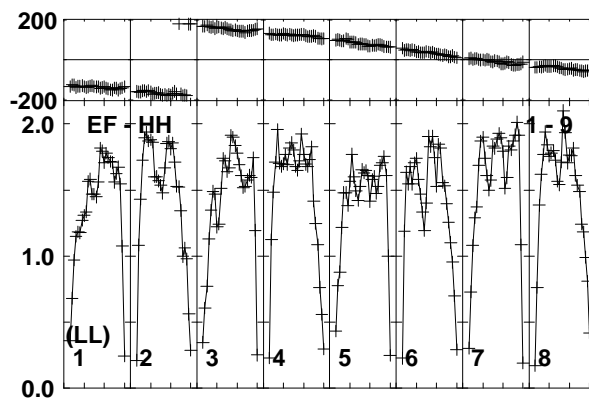
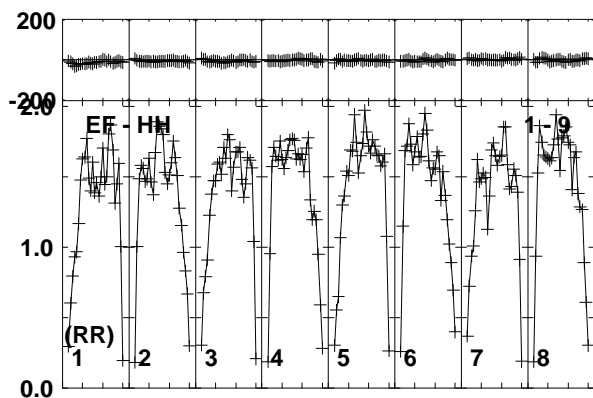
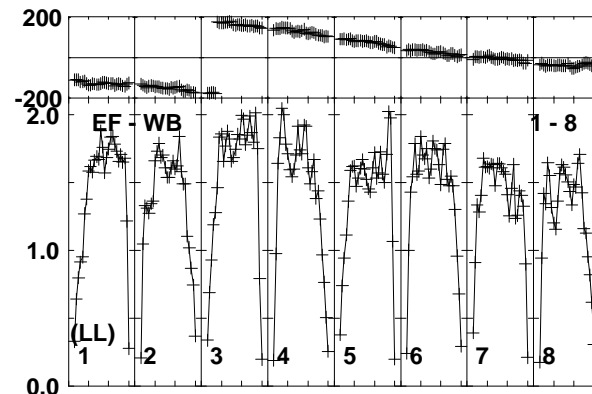
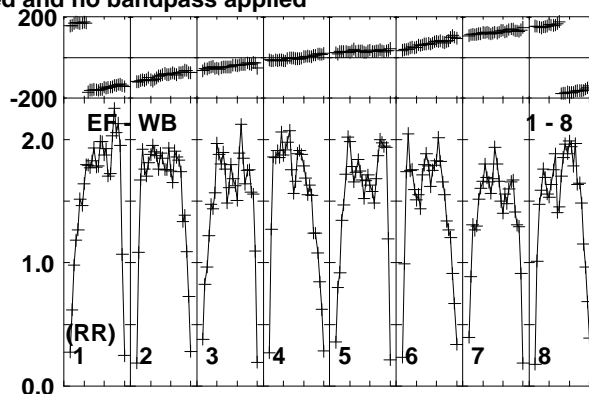
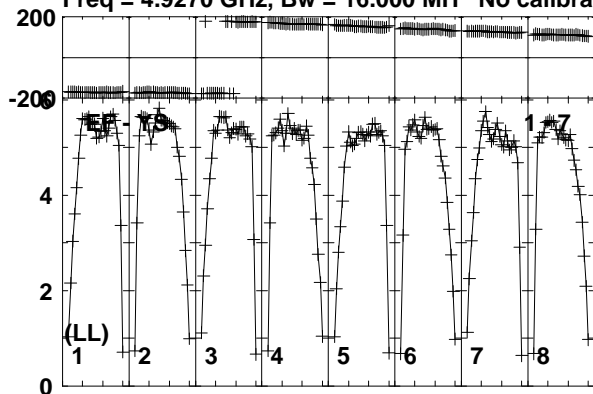

Lower frame: Milli Ampl Jy Top frame: Phas deg  
Vector averaged cross-power spectrum Baseline: EF (01) - YS (07)  
Timerange: 00/16:57:21 to 00/16:58:09

Plot file version 261 created 10-JUN-2016 15:29:46

OQ208 RG008C.UVDATA.1

Freq = 4.9270 GHz, Bw = 16.000 MH No calibration applied and no bandpass applied

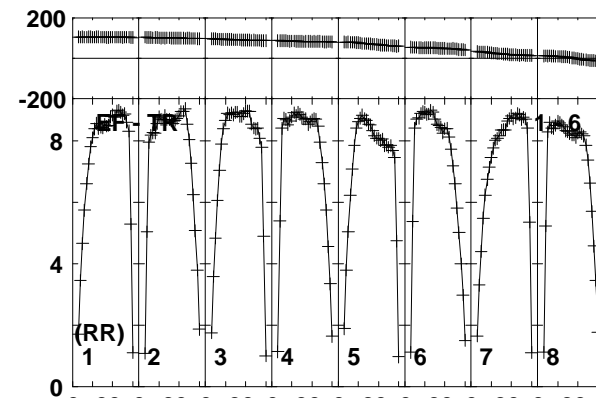
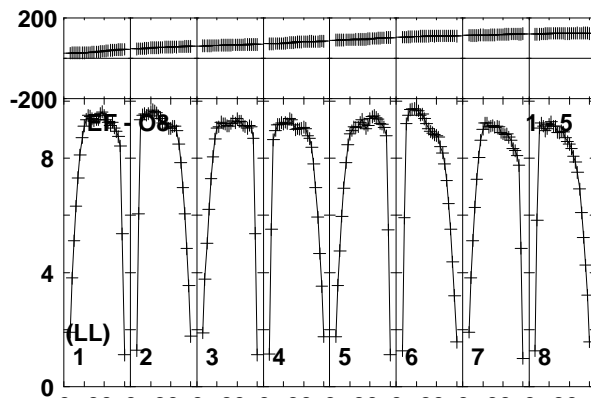
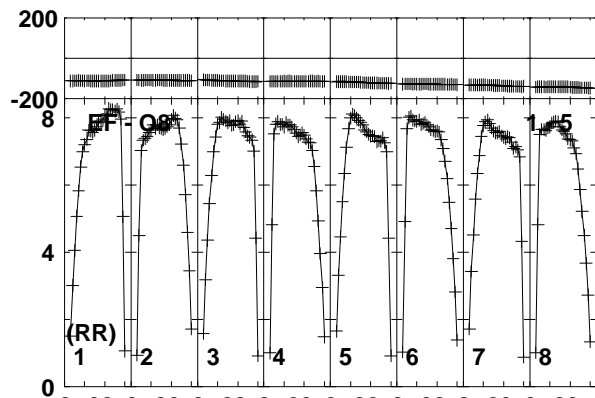
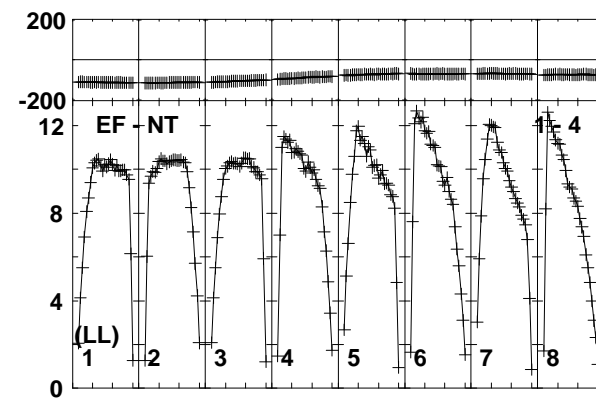
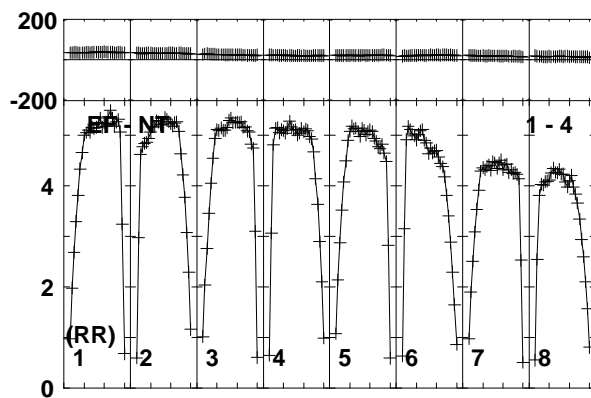
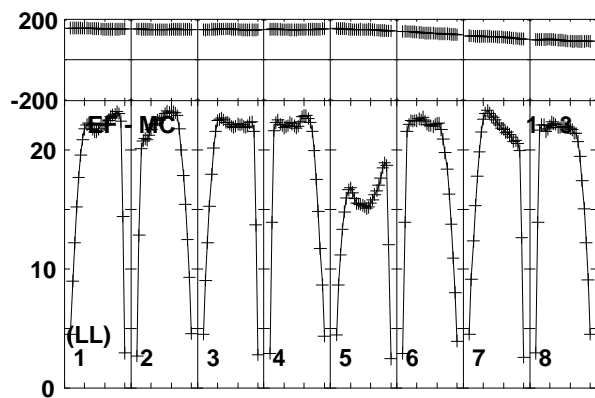
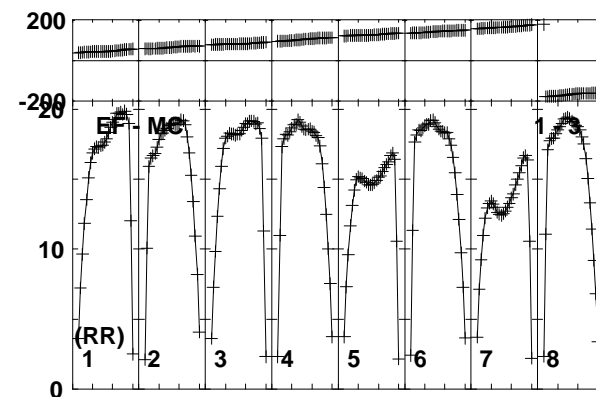
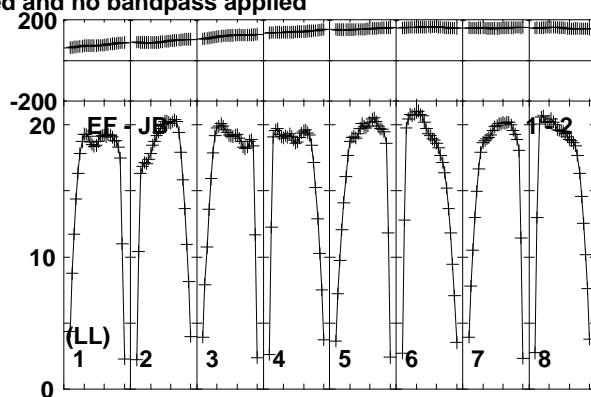
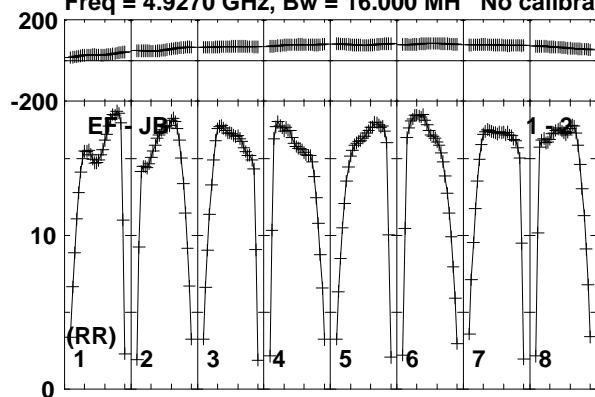

Lower frame: Milli Ampl Jy Top frame: Phas deg  
Vector averaged cross-power spectrum Baseline: EF (01) - JB (02)  
Timerange: 00/17:04:35 to 00/17:13:10

Plot file version 262 created 10-JUN-2016 15:29:46

OQ208 RG008C.UVDATA.1

Freq = 4.9270 GHz, Bw = 16.000 MH No calibration applied and no bandpass applied

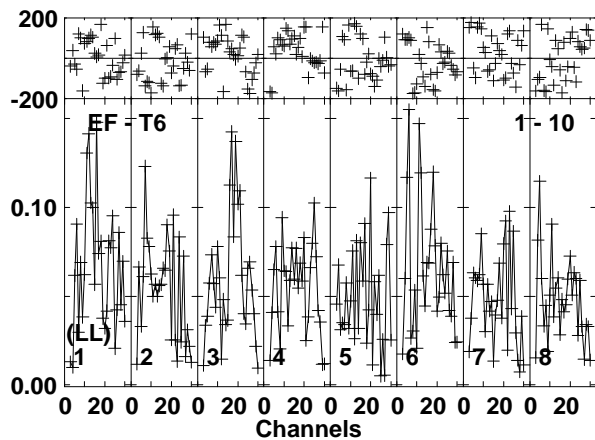
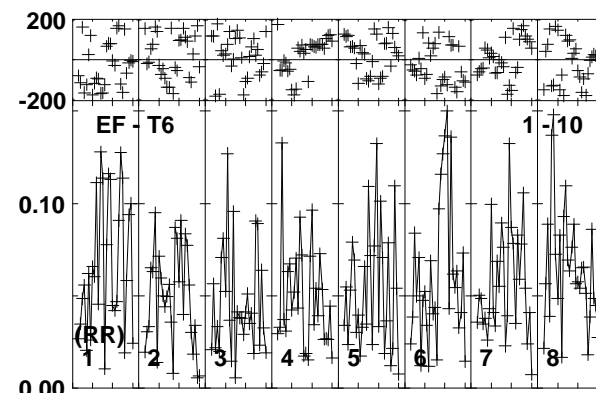
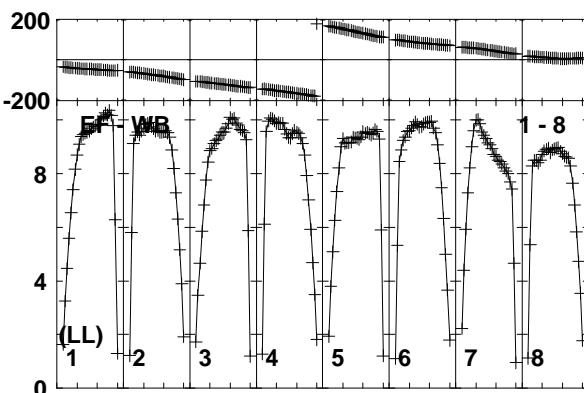
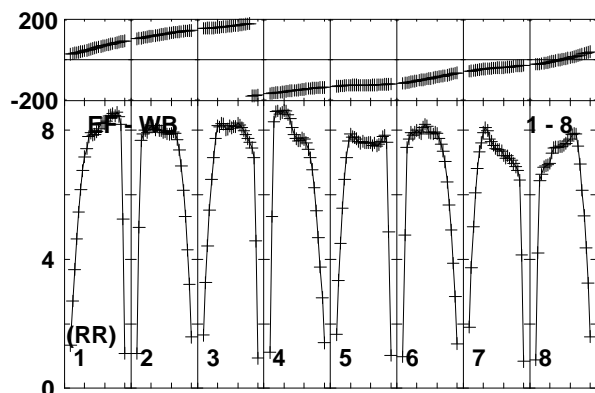
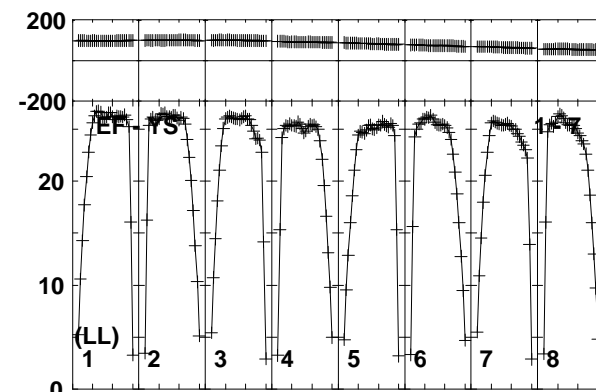
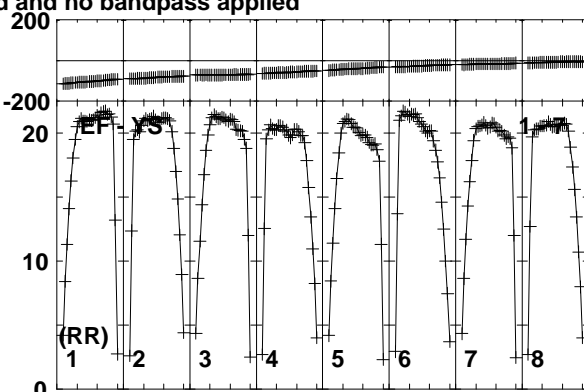
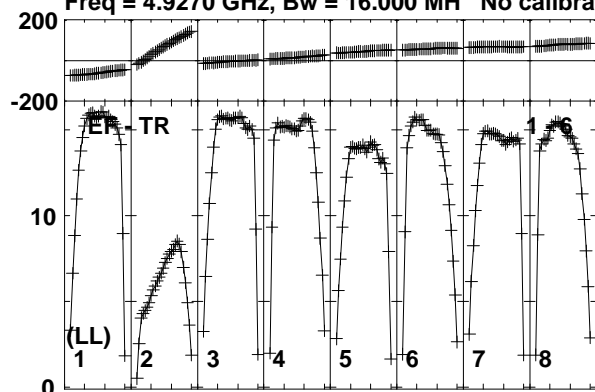

Lower frame: Milli Ampl Jy Top frame: Phas deg  
Vector averaged cross-power spectrum Baseline: EF (01) - TR (06)  
Timerange: 00/17:04:35 to 00/17:13:10

Plot file version 263 created 10-JUN-2016 15:29:46

OQ208 RG008C.UVDATA.1

Freq = 4.9270 GHz, Bw = 16.000 MH No calibration applied and no bandpass applied

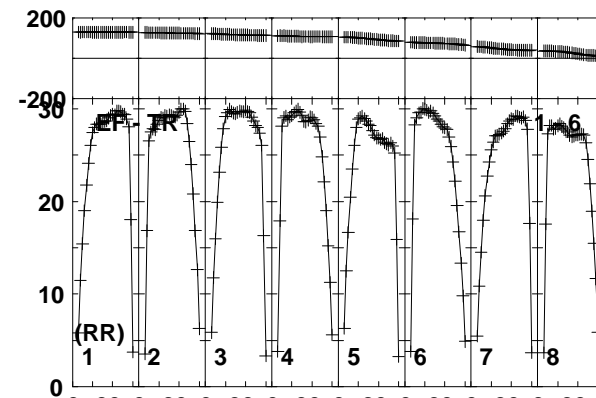
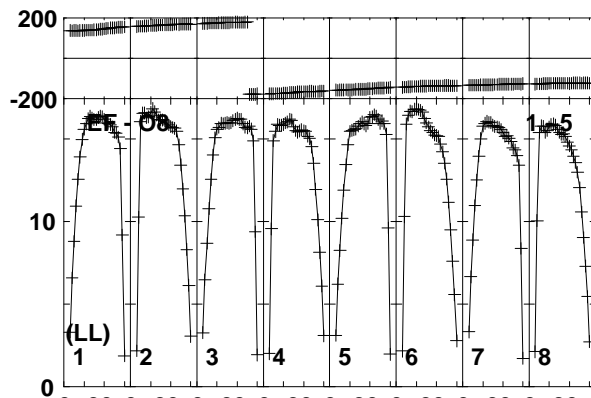
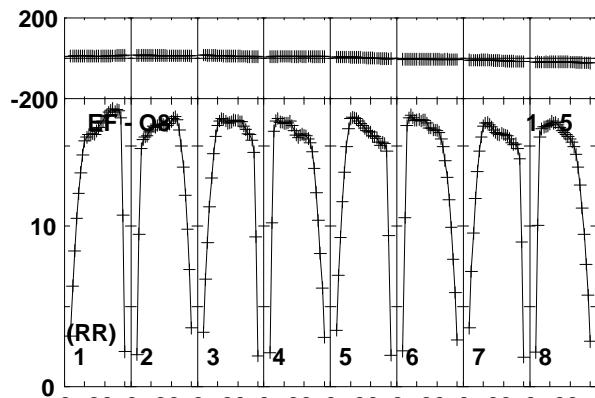
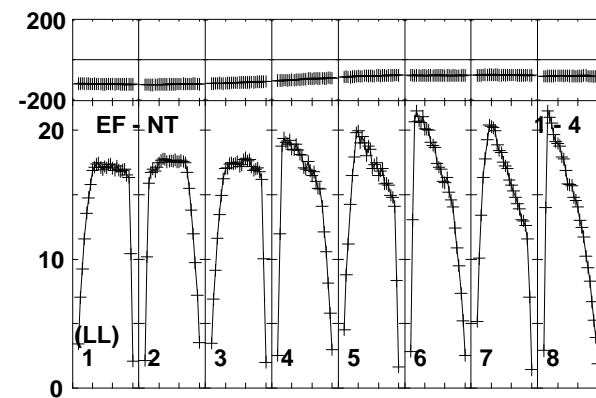
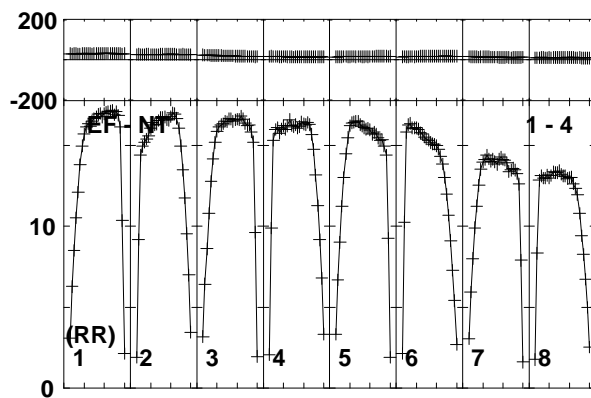
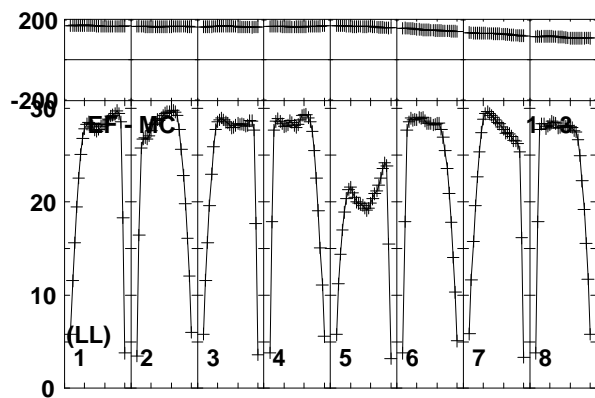
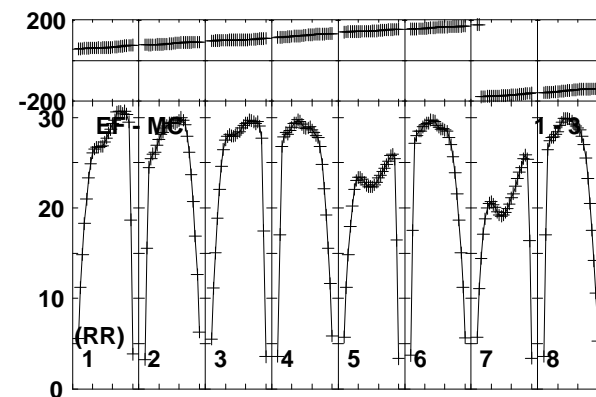
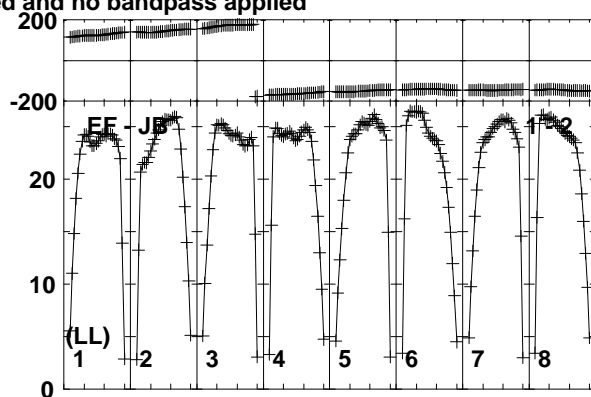
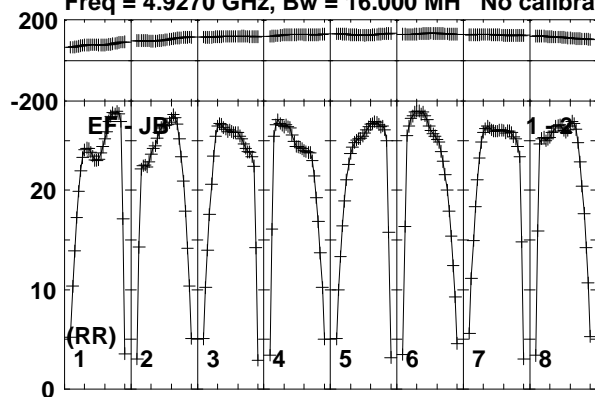

Lower frame: Milli Ampl Jy Top frame: Phas deg  
Vector averaged cross-power spectrum Baseline: EF (01) - JB (02)  
Timerange: 00/17:14:20 to 00/17:19:11

Plot file version 264 created 10-JUN-2016 15:29:46

OQ208 RG008C.UVDATA.1

Freq = 4.9270 GHz, Bw = 16.000 MH No calibration applied and no bandpass applied

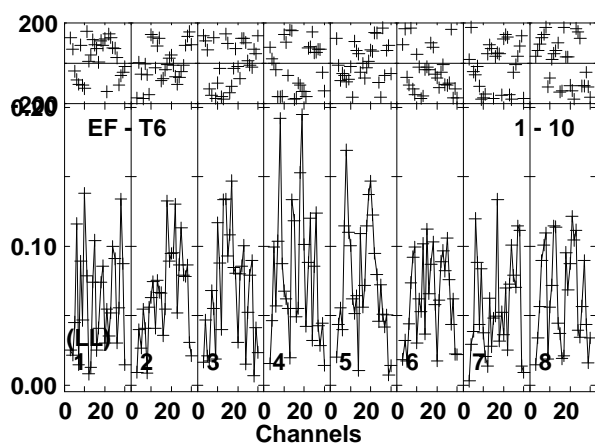
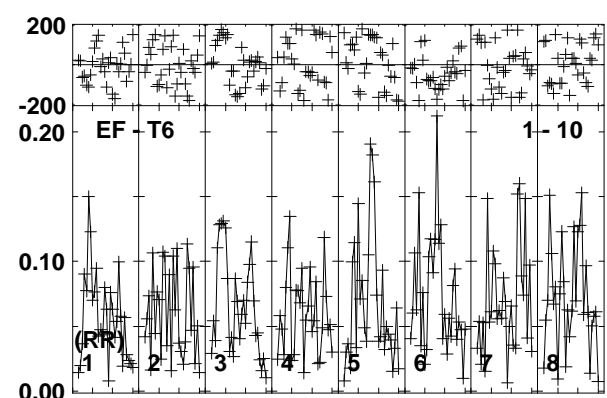
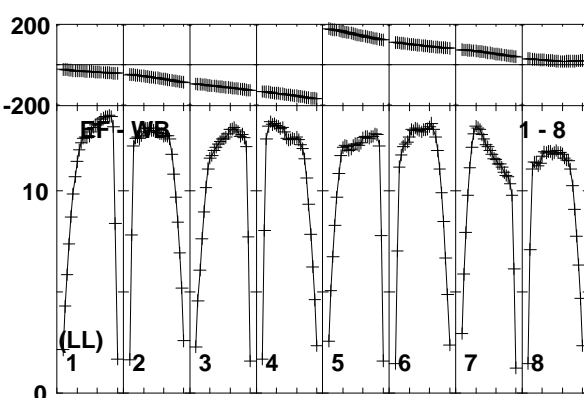
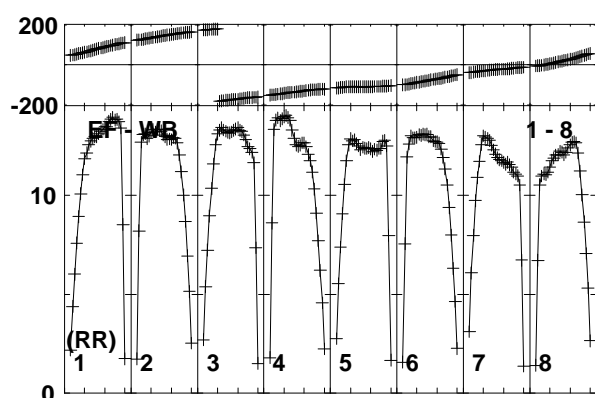
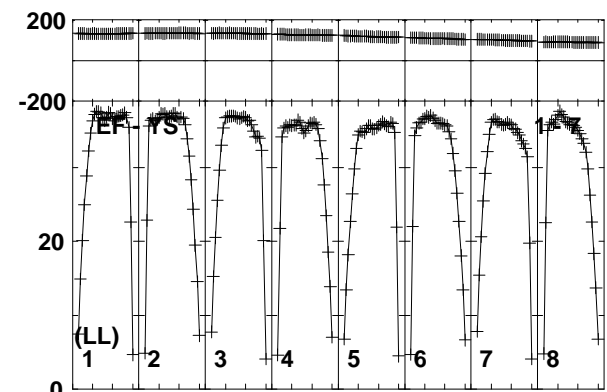
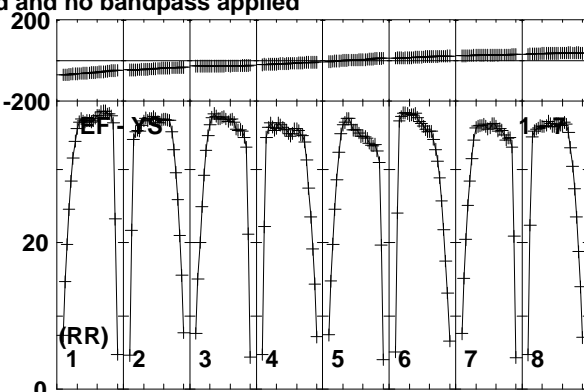
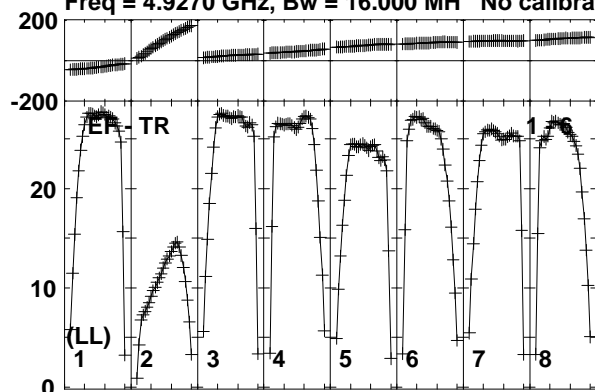

Lower frame: Milli Ampl Jy Top frame: Phas deg  
Vector averaged cross-power spectrum Baseline: EF (01) - TR (06)  
Timerange: 00/17:14:20 to 00/17:19:11