

Plot file version 1 created 10-JUN-2016 16:07:40

0528+134 RG008D.UVDATA.1

Freq = 4.9270 GHz, Bw = 16.000 MH No calibration applied and no bandpass applied

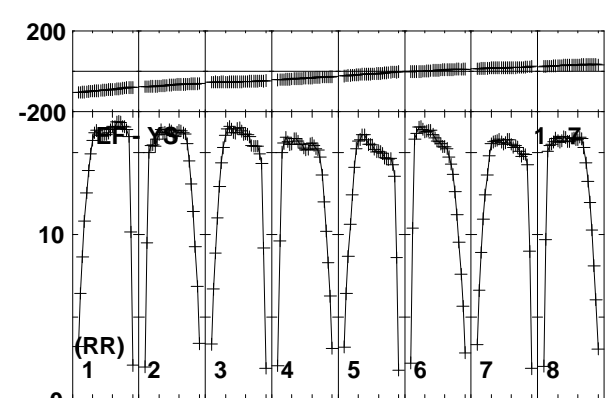
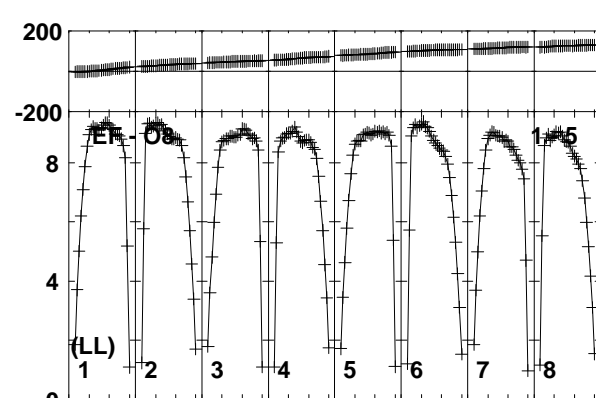
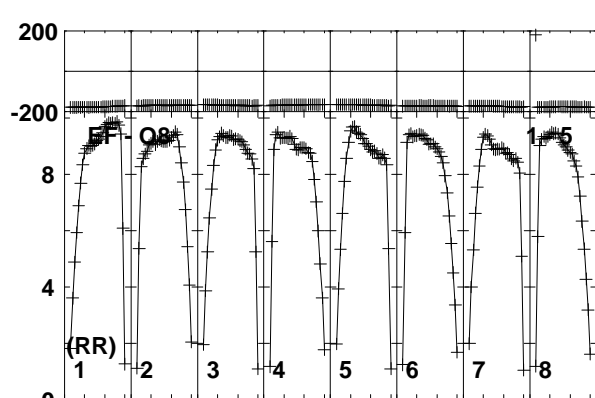
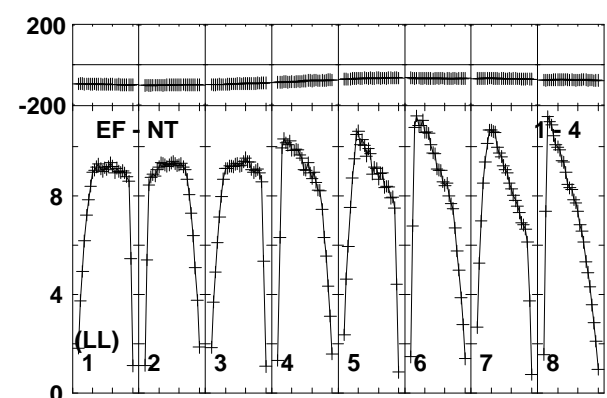
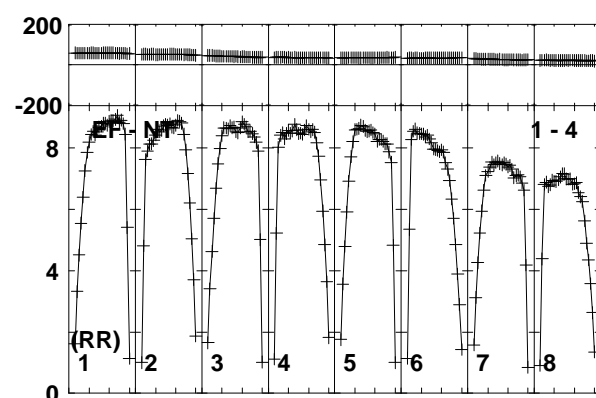
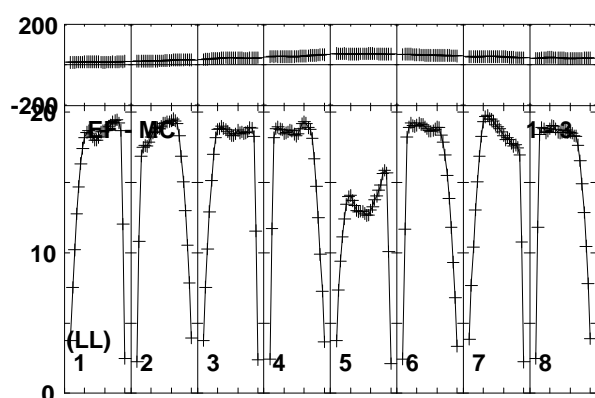
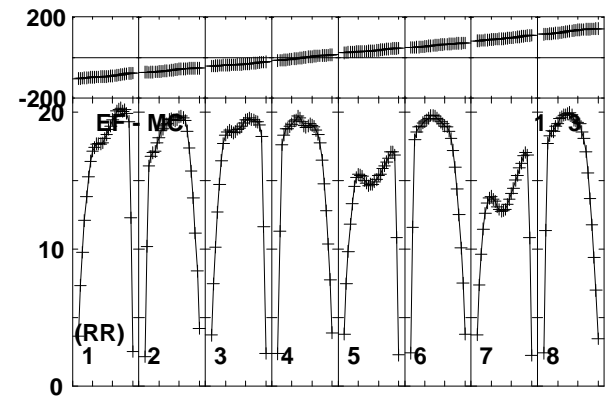
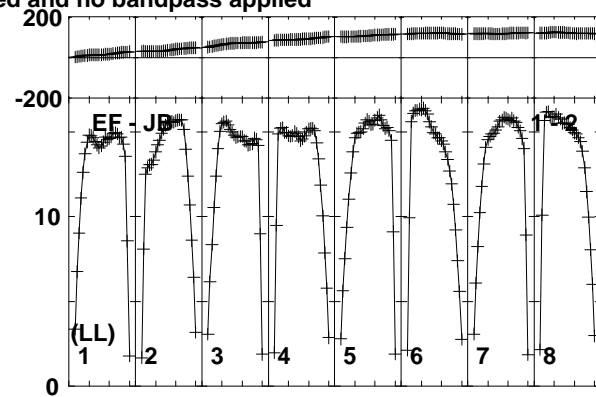
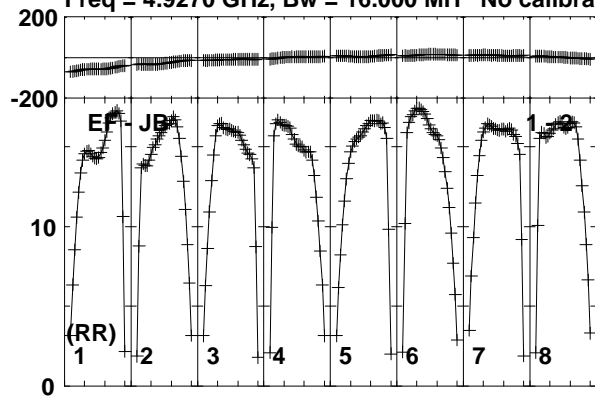

Lower frame: Milli Ampl Jy Top frame: Phas deg
Vector averaged cross-power spectrum Baseline: EF (01) - JB (02)
Timerange: 00/10/08:53 to 00/10/14:20

Plot file version 2 created 10-JUN-2016 16:07:41

0528+134 RG008D.UVDATA.1

Freq = 4.9270 GHz, Bw = 16.000 MH No calibration applied and no bandpass applied

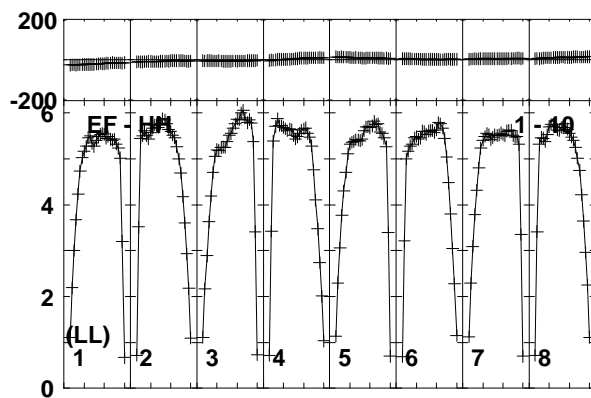
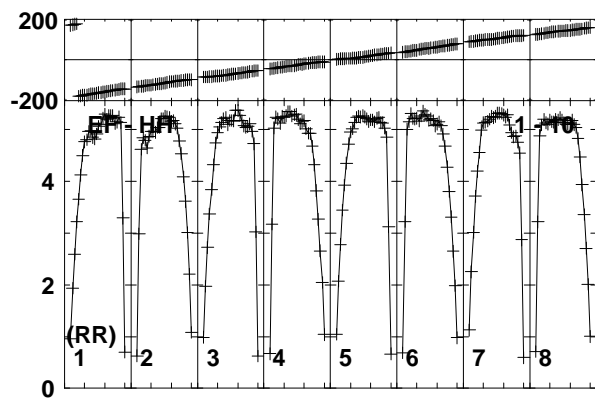
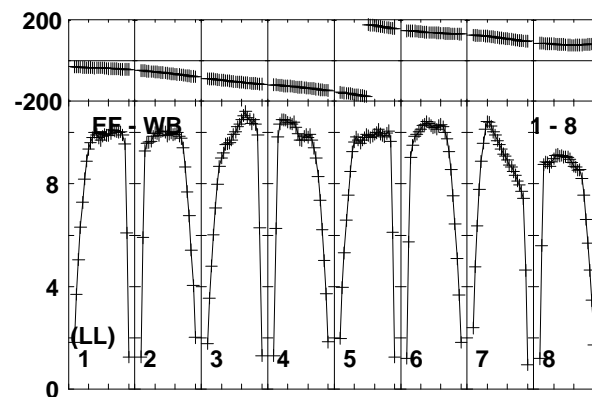
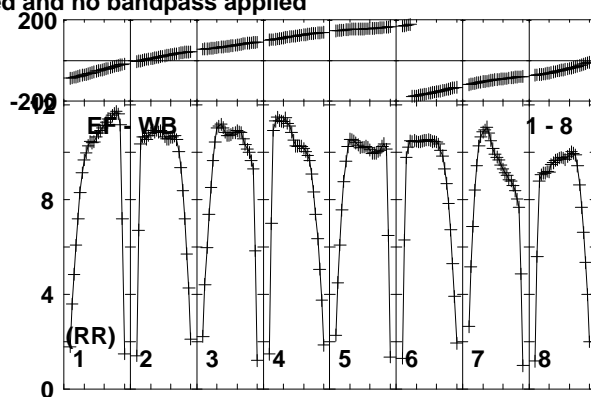
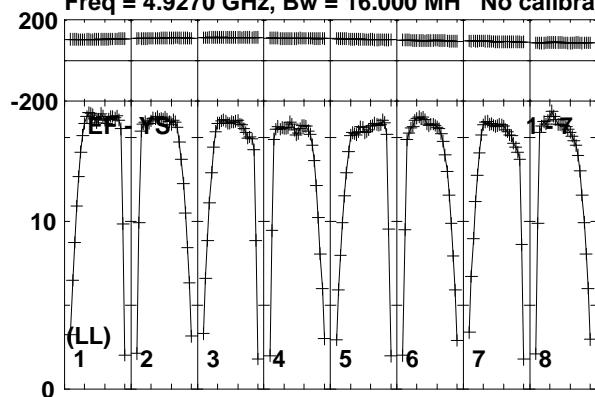

Lower frame: Milli Ampl Jy Top frame: Phas deg
Vector averaged cross-power spectrum Baseline: EF (01) - YS (07)
Timerange: 00/10:08:53 to 00/10:14:20

Plot file version 3 created 10-JUN-2016 16:07:41

0528+134 RG008D.UVDATA.1

Freq = 4.9270 GHz, Bw = 16.000 MH No calibration applied and no bandpass applied

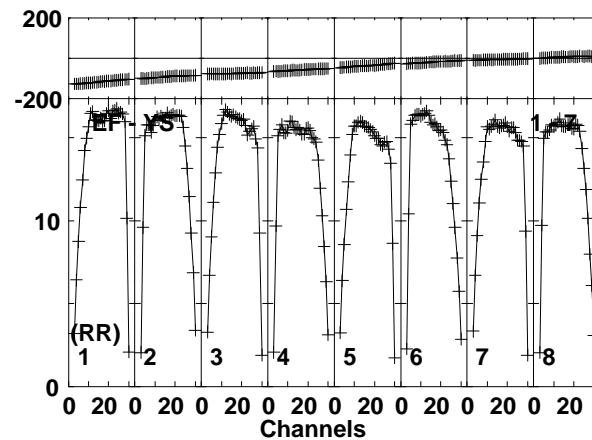
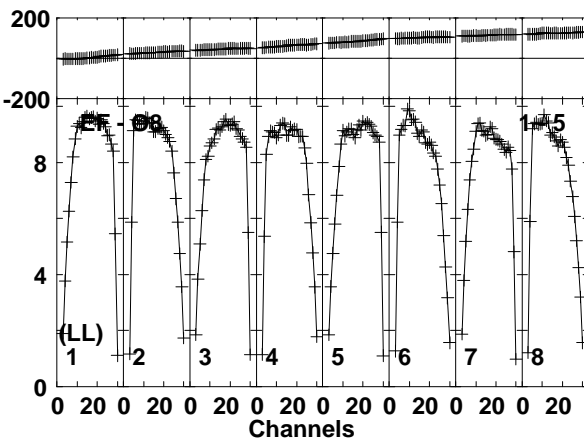
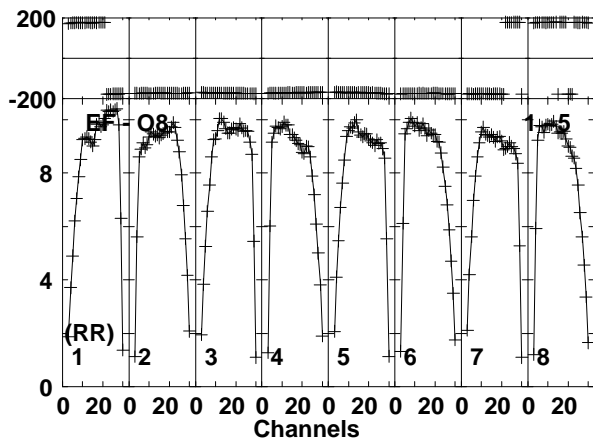
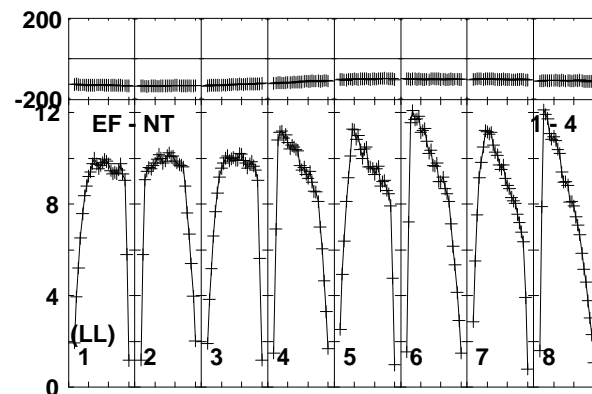
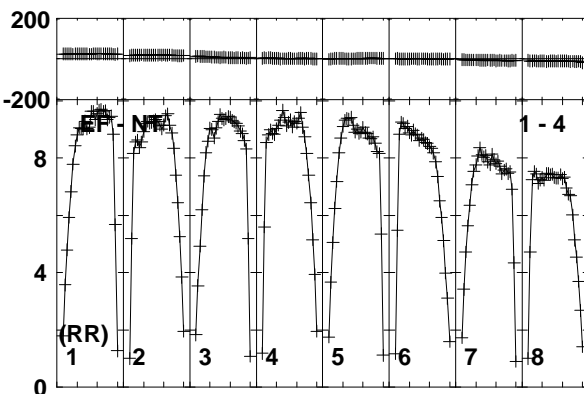
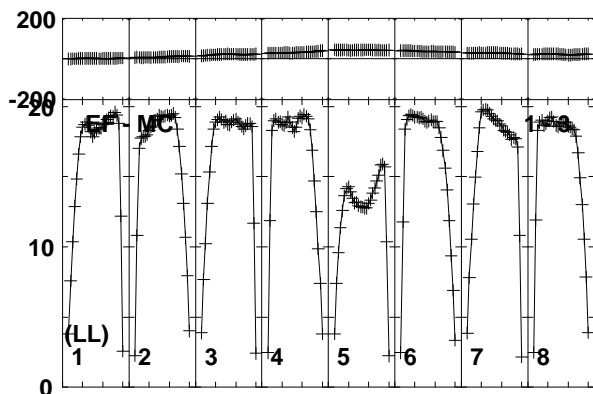
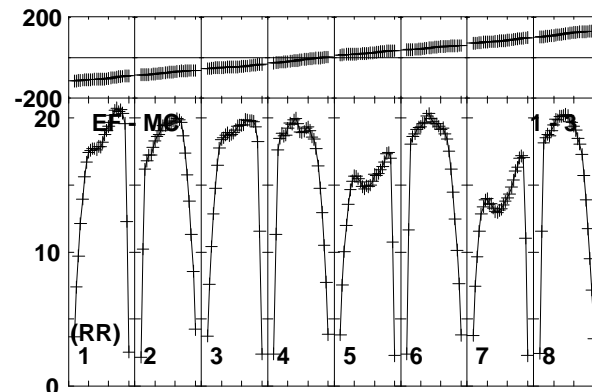
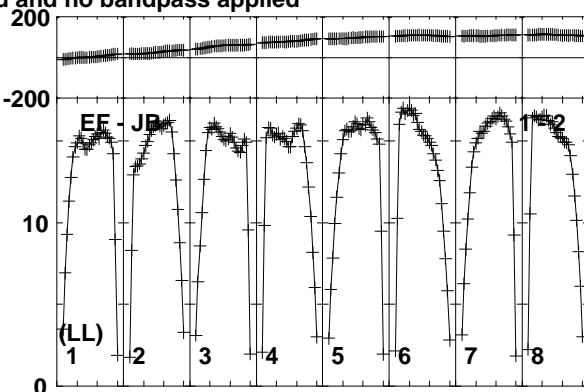
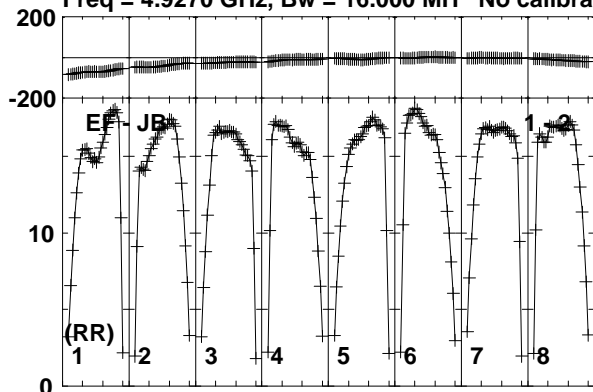

Lower frame: Milli Ampl Jy Top frame: Phas deg
Vector averaged cross-power spectrum Baseline: EF (01) - JB (02)
Timerange: 00/10:15:01 to 00/10:15:46

Plot file version 4 created 10-JUN-2016 16:07:41

0528+134 RG008D.UVDATA.1

Freq = 4.9270 GHz, Bw = 16.000 MH No calibration applied and no bandpass applied

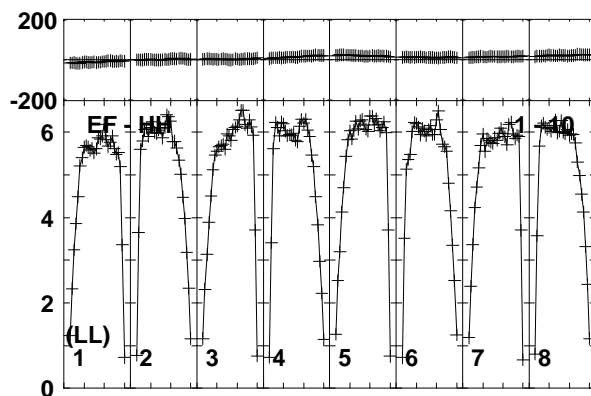
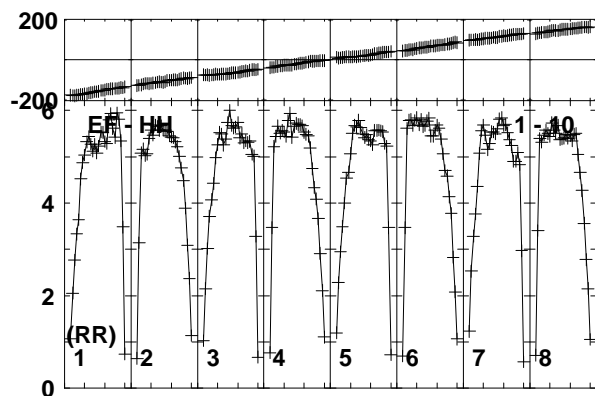
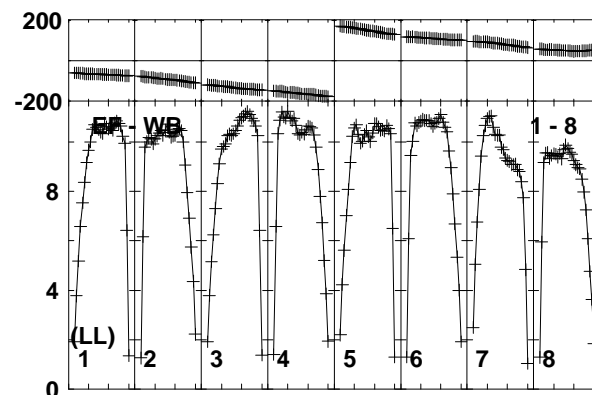
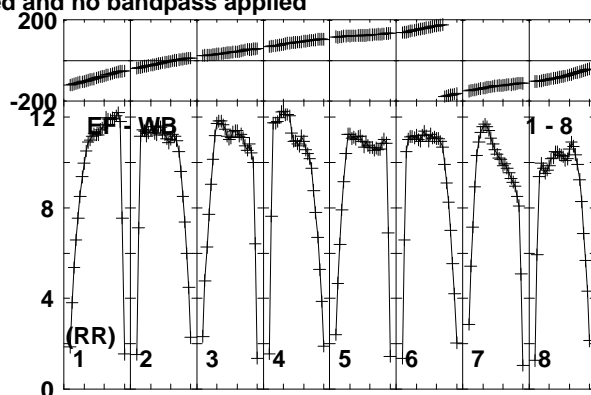
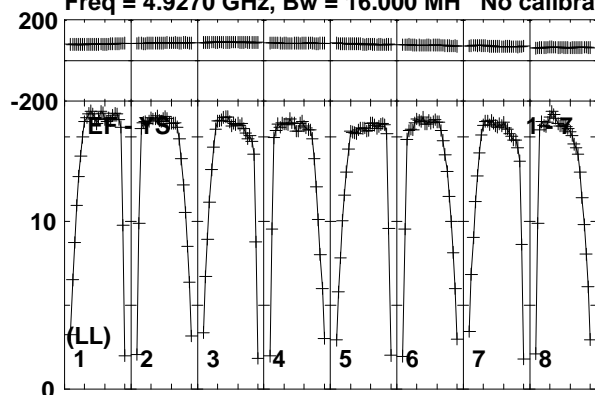

Lower frame: Milli Ampl Jy Top frame: Phas deg
Vector averaged cross-power spectrum Baseline: EF (01) - YS (07)
Timerange: 00/10:15:01 to 00/10:15:46

Plot file version 5 created 10-JUN-2016 16:07:41

0528+134 RG008D.UVDATA.1

Freq = 4.9270 GHz, Bw = 16.000 MH No calibration applied and no bandpass applied

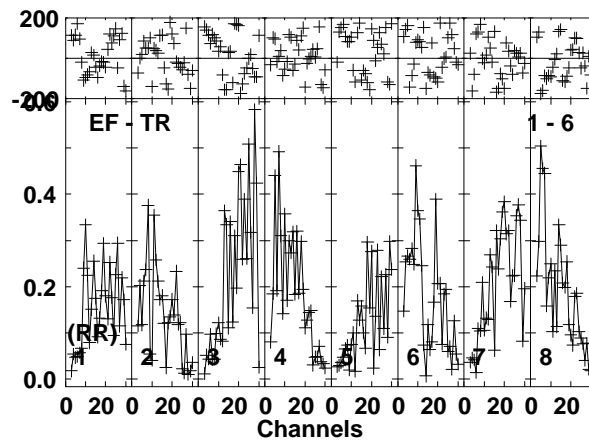
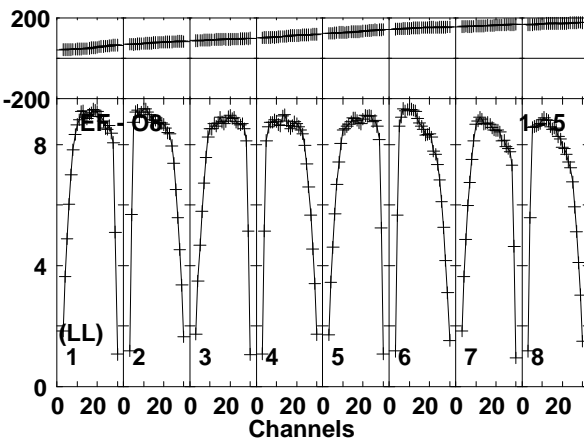
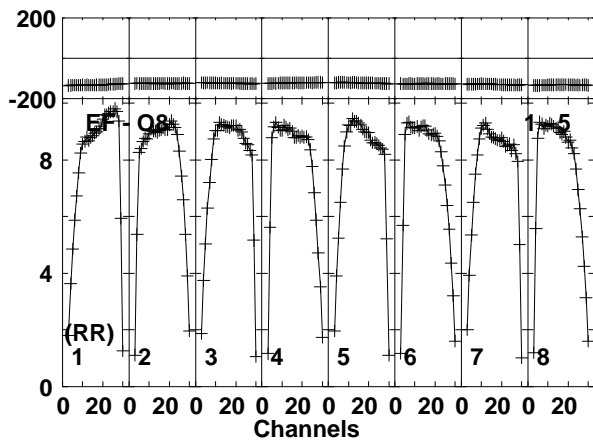
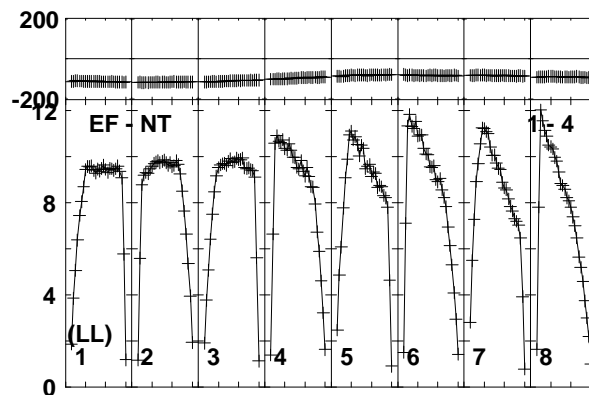
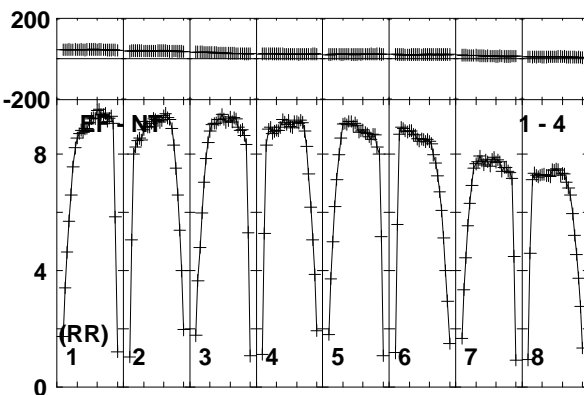
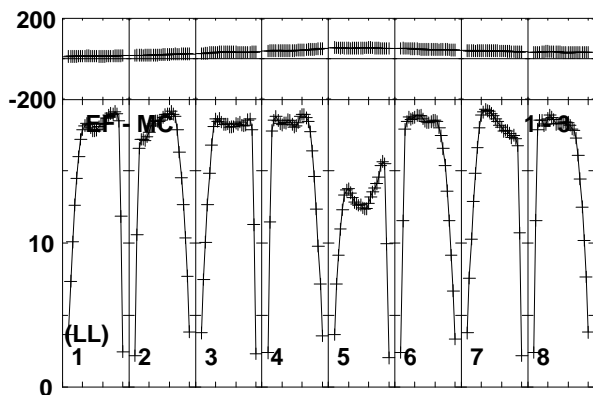
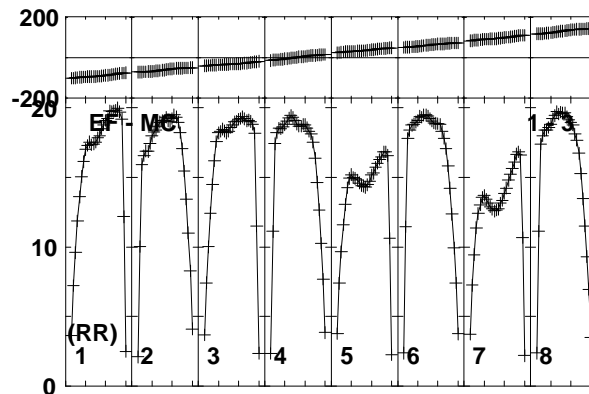
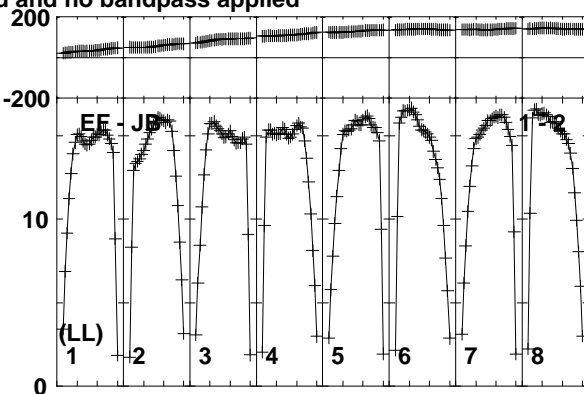
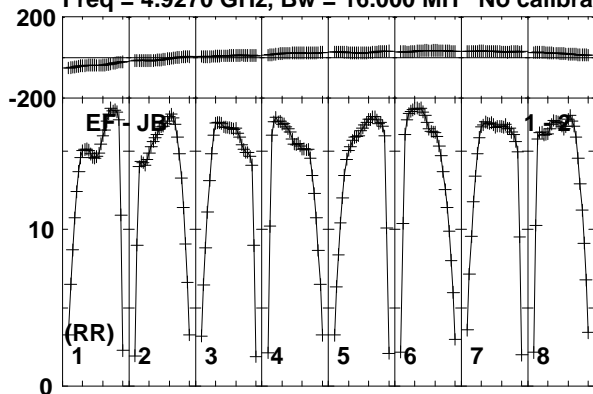

Lower frame: Milli Ampl Jy Top frame: Phas deg
Vector averaged cross-power spectrum Baseline: EF (01) - JB (02)
Timerange: 00/10:17:35 to 00/10:20:05

Plot file version 6 created 10-JUN-2016 16:07:41

0528+134 RG008D.UVDATA.1

Freq = 4.9270 GHz, Bw = 16.000 MH No calibration applied and no bandpass applied

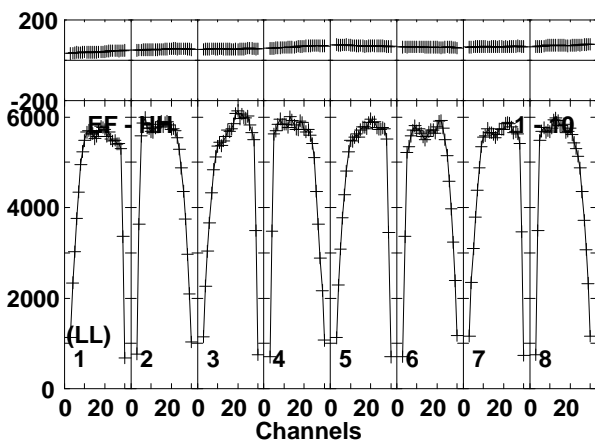
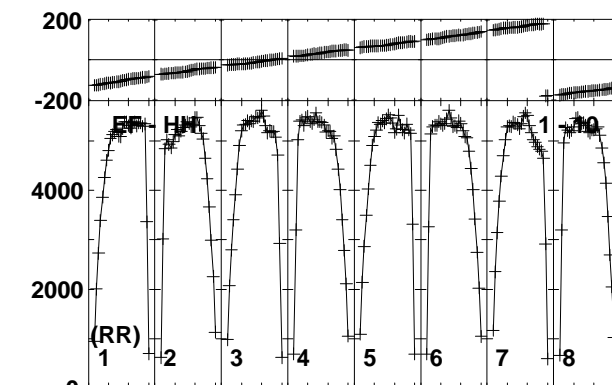
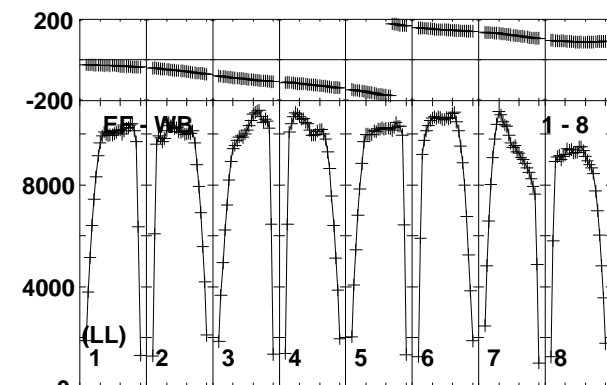
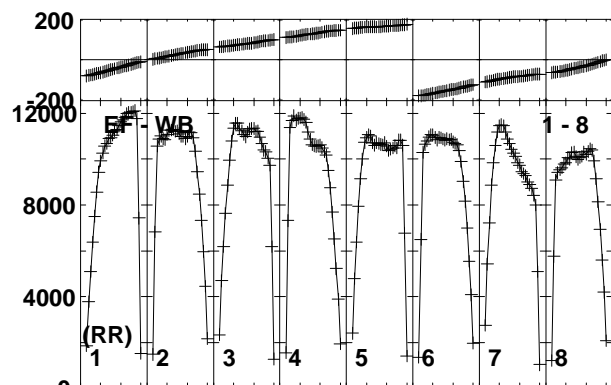
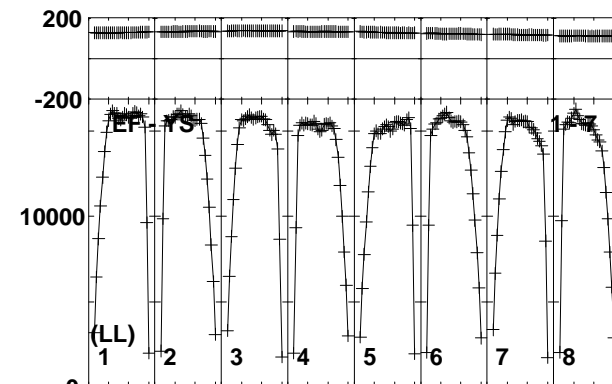
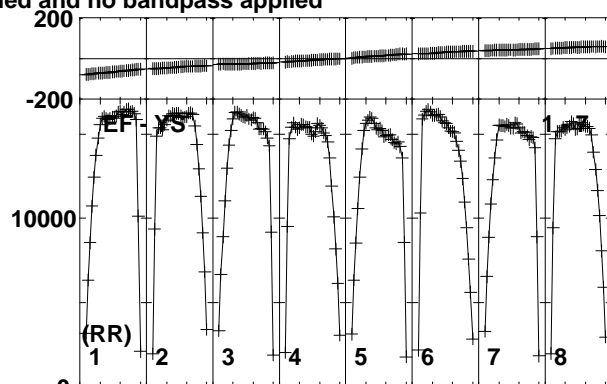
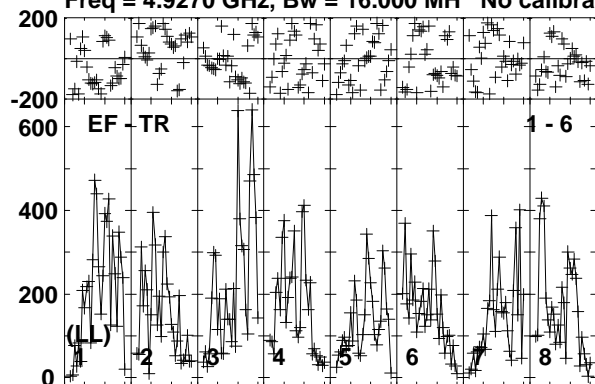

Lower frame: Micro Ampl Jy Top frame: Phas deg
Vector averaged cross-power spectrum Baseline: EF (01) - TR (06)
Timerange: 00/10:17:35 to 00/10:20:05

Plot file version 7 created 10-JUN-2016 16:07:41

0528+134 RG008D.UVDATA.1

Freq = 4.9270 GHz, Bw = 16.000 MH No calibration applied and no bandpass applied

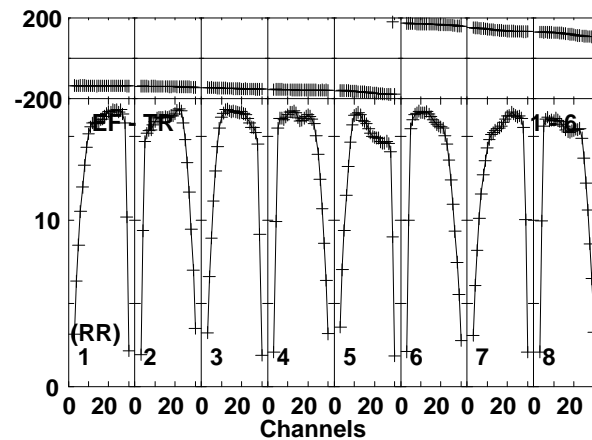
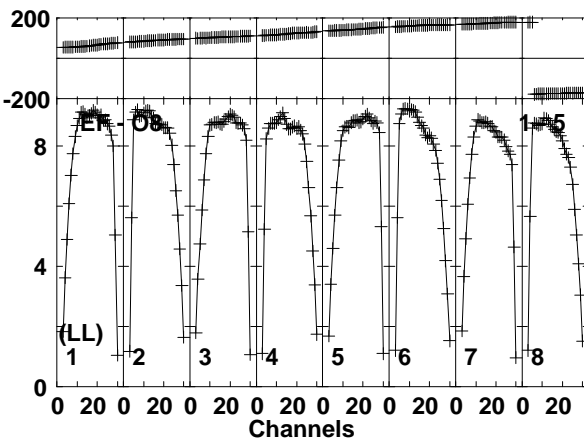
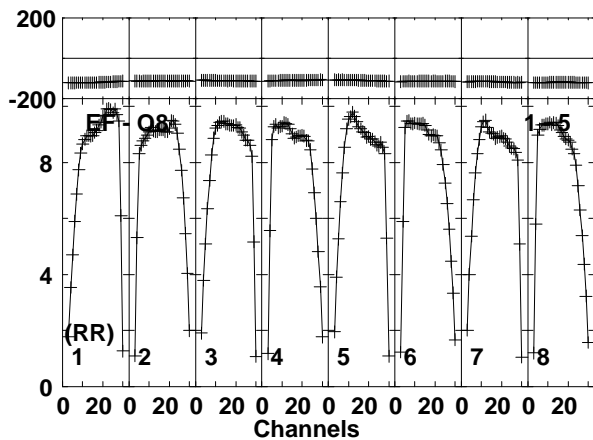
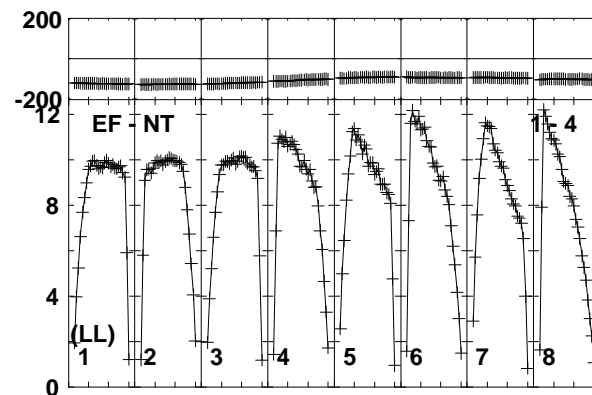
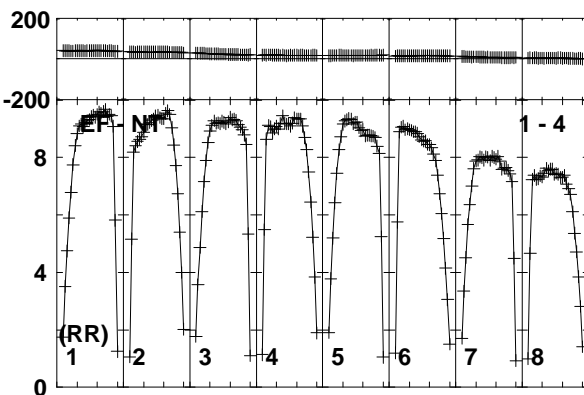
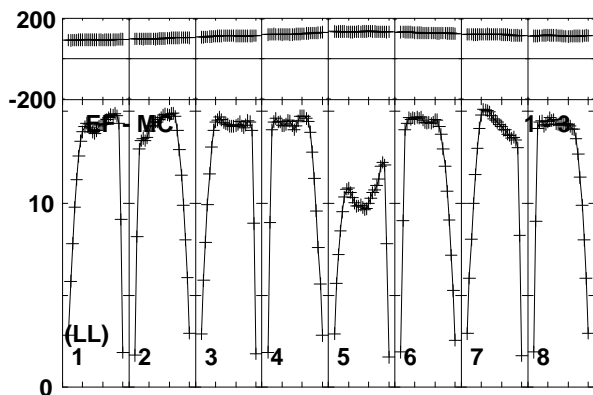
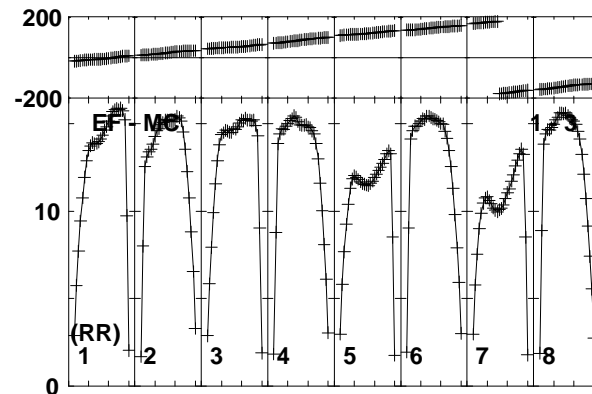
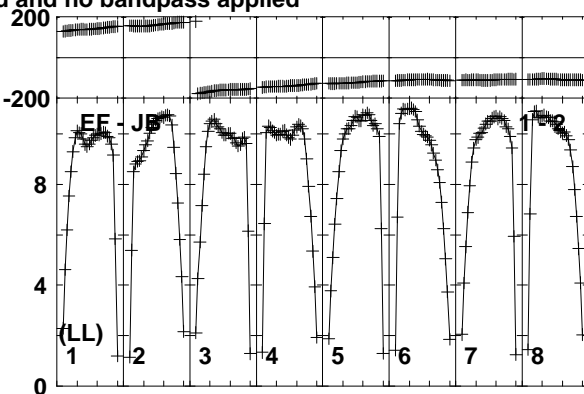
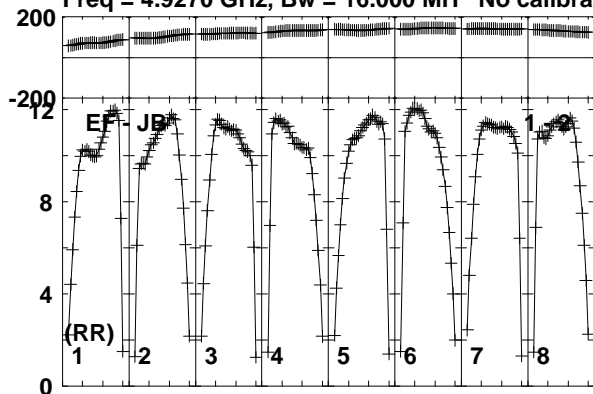

Lower frame: Milli Ampl Jy Top frame: Phas deg
Vector averaged cross-power spectrum Baseline: EF (01) - JB (02)
Timerange: 00/10:21:37 to 00/10:29:20

Plot file version 8 created 10-JUN-2016 16:07:42

0528+134 RG008D.UVDATA.1

Freq = 4.9270 GHz, Bw = 16.000 MH No calibration applied and no bandpass applied

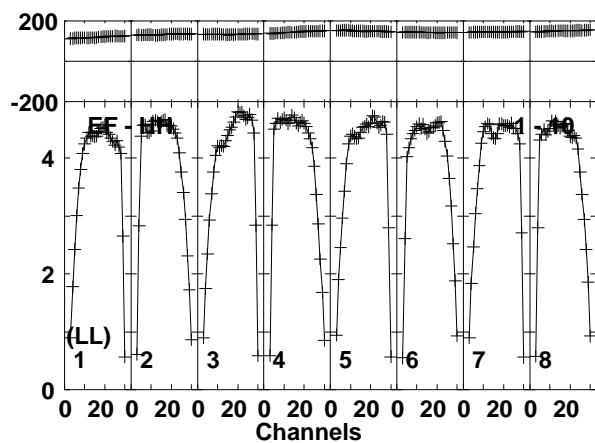
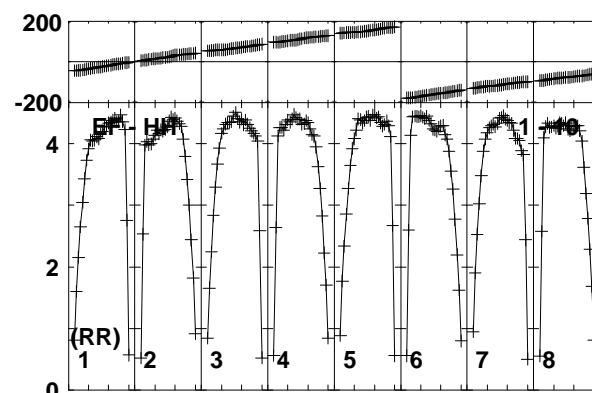
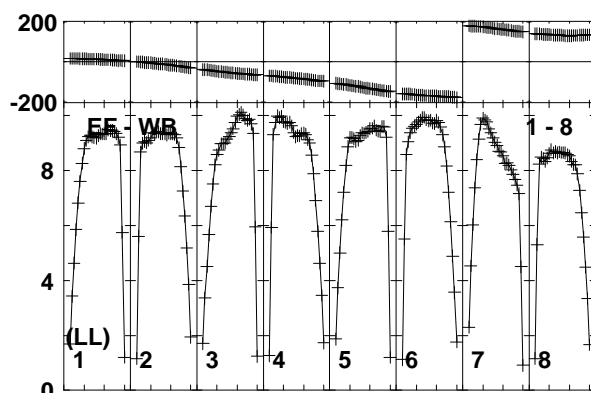
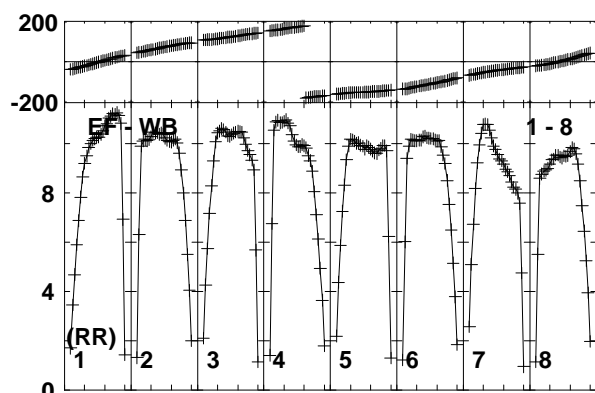
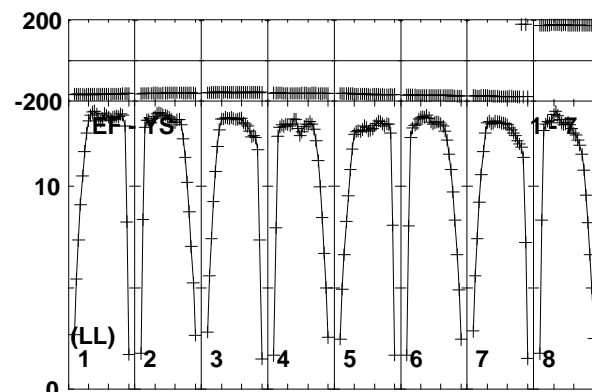
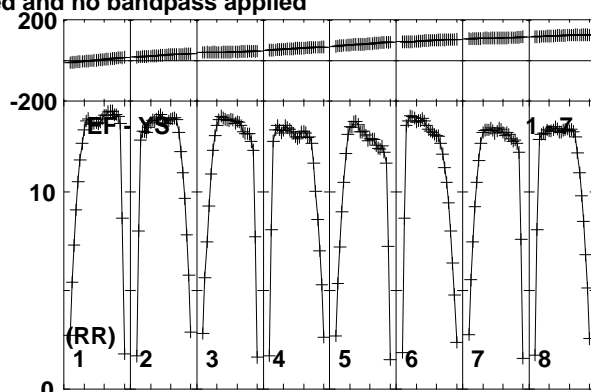
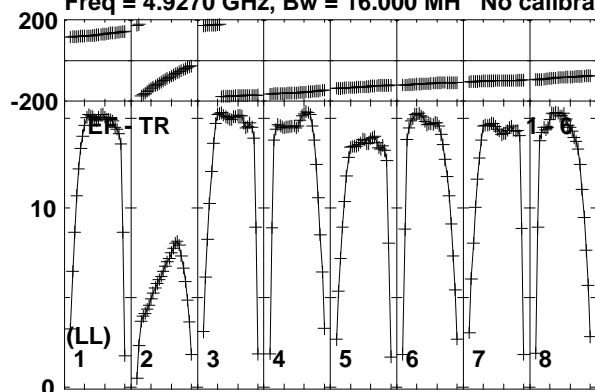

Lower frame: Milli Ampl Jy Top frame: Phas deg
Vector averaged cross-power spectrum Baseline: EF (01) - TR (06)
Timerange: 00/10:21:37 to 00/10:29:20

Plot file version 9 created 10-JUN-2016 16:07:42

0528+134 RG008D.UVDATA.1

Freq = 4.9270 GHz, Bw = 16.000 MH No calibration applied and no bandpass applied

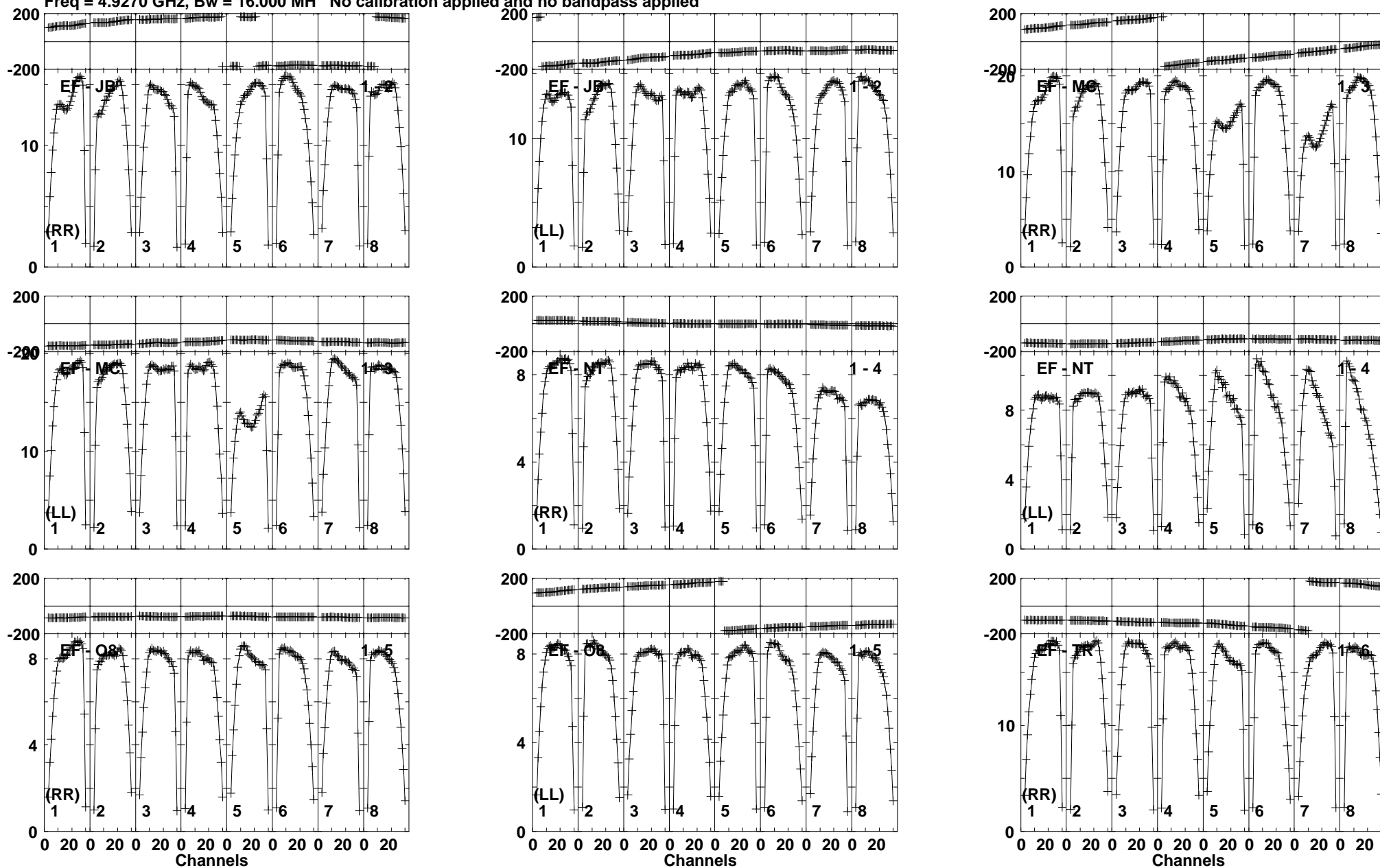

Lower frame: Milli Ampl Jy Top frame: Phas deg
Vector averaged cross-power spectrum Baseline: EF (01) - JB (02)
Timerange: 00/10:30:01 to 00/10:44:20

Plot file version 10 created 10-JUN-2016 16:07:43

0528+134 RG008D.UVDATA.1

Freq = 4.9270 GHz, Bw = 16.000 MH No calibration applied and no bandpass applied

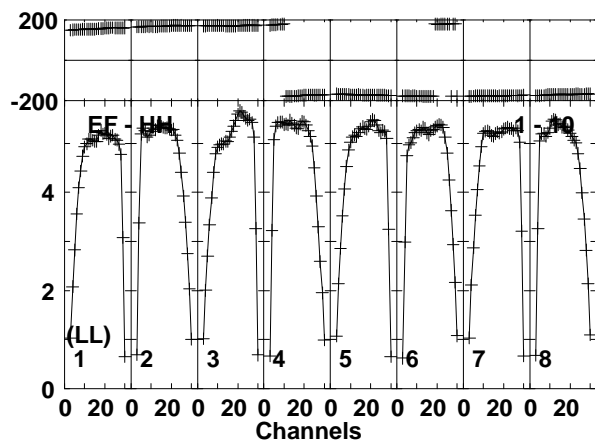
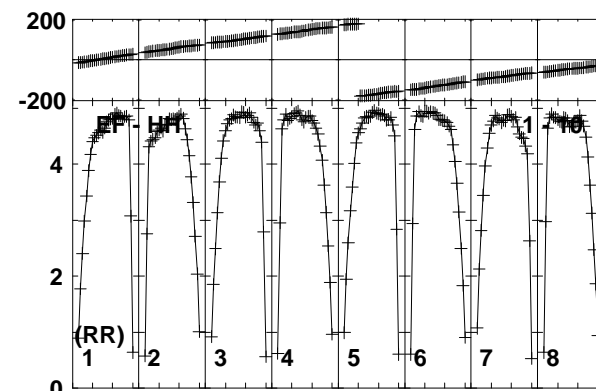
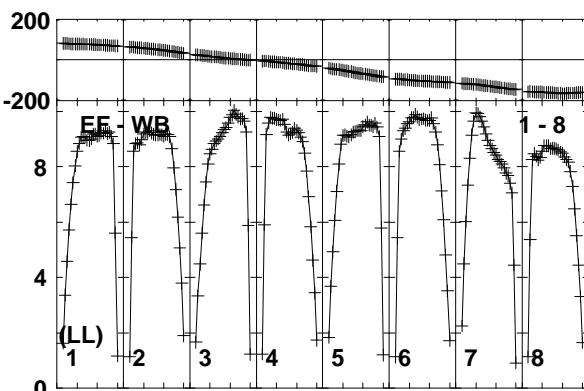
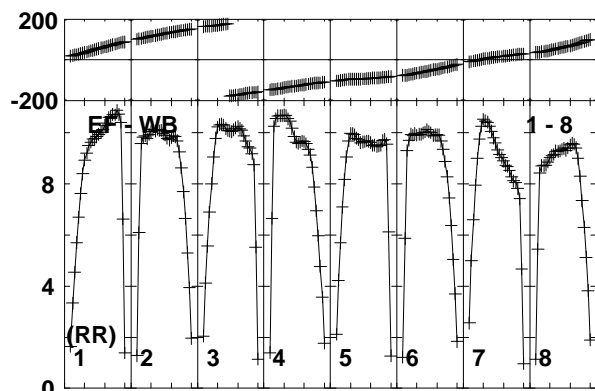
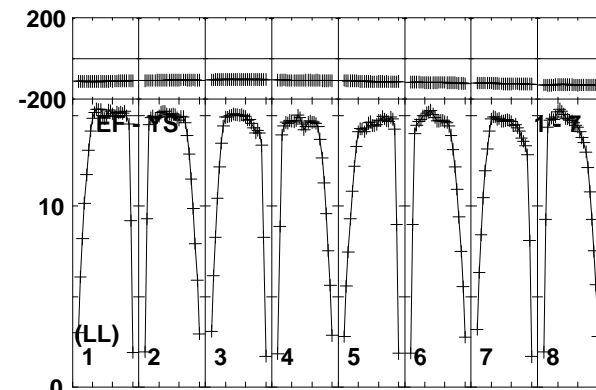
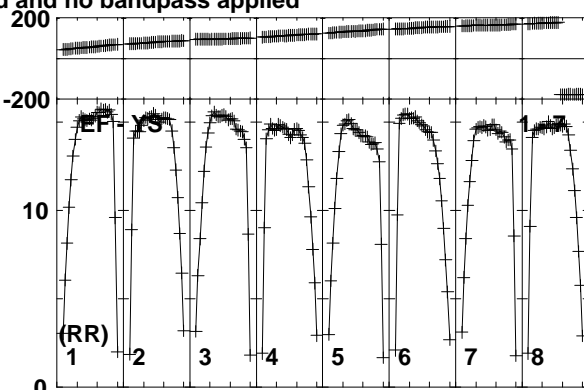
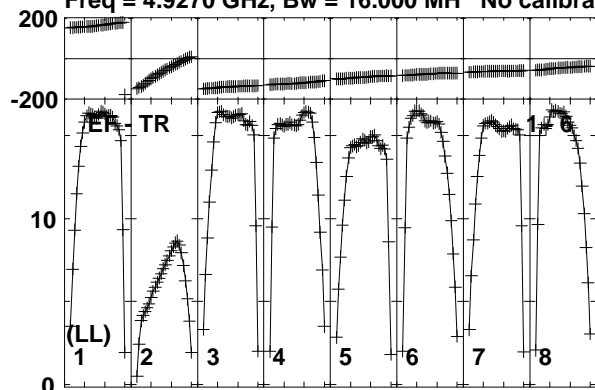

Lower frame: Milli Ampl Jy Top frame: Phas deg
Vector averaged cross-power spectrum Baseline: EF (01) - TR (06)
Timerange: 00/10:30:01 to 00/10:44:20

Plot file version 11 created 10-JUN-2016 16:07:44

DA193 RG008D.UVDATA.1

Freq = 4.9270 GHz, Bw = 16.000 MH No calibration applied and no bandpass applied

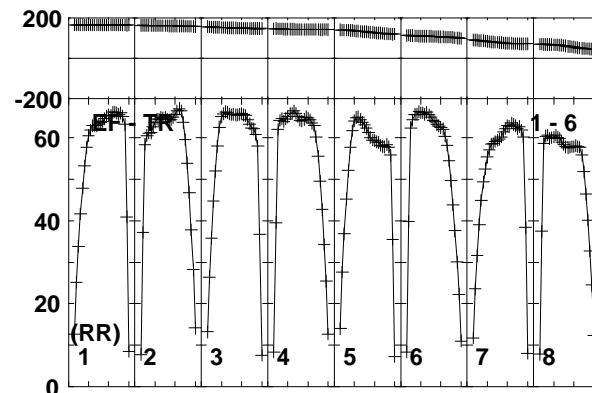
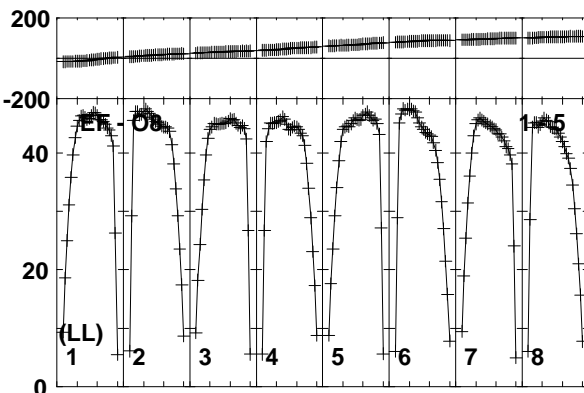
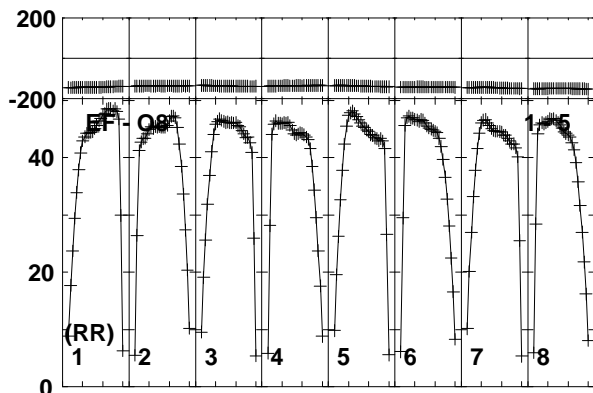
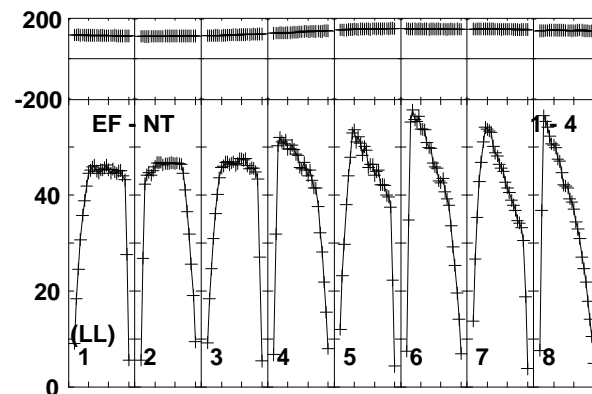
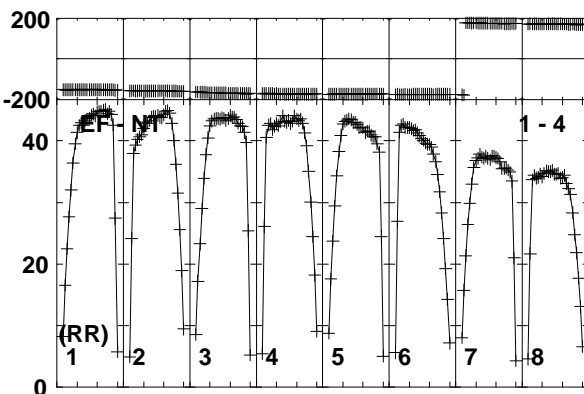
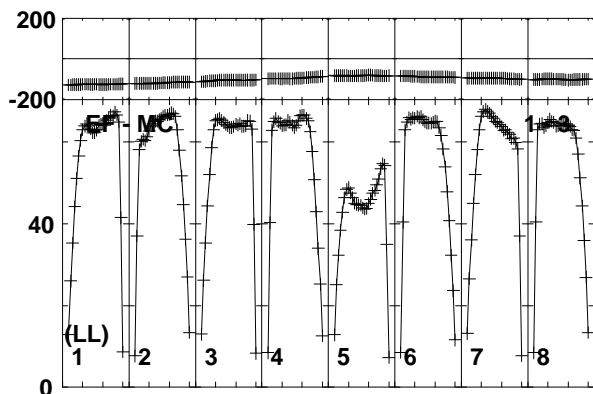
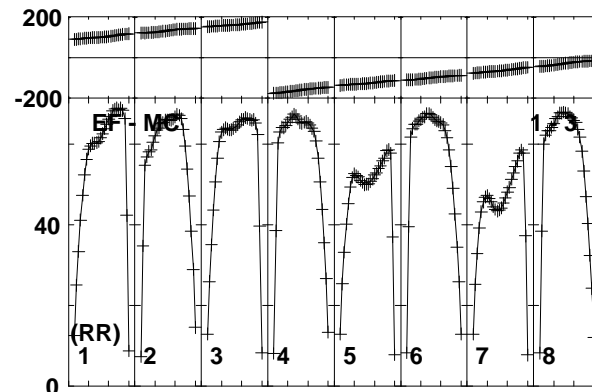
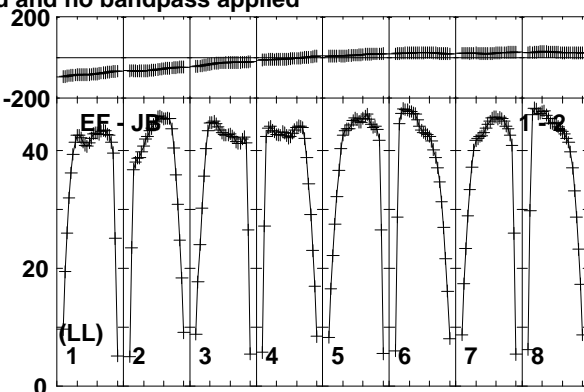
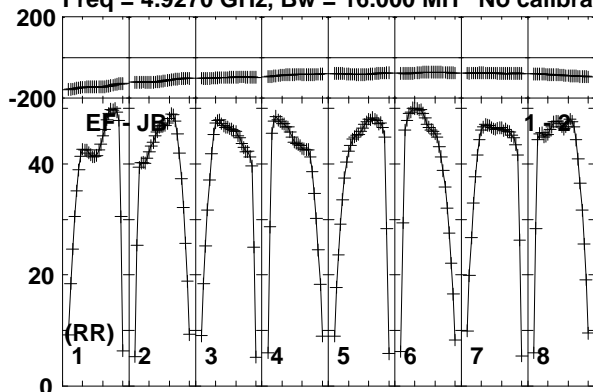

Lower frame: Milli Ampl Jy Top frame: Phas deg
Vector averaged cross-power spectrum Baseline: EF (01) - JB (02)
Timerange: 00/10:46:30 to 00/10:59:20

Plot file version 12 created 10-JUN-2016 16:07:44

DA193 RG008D.UVDATA.1

Freq = 4.9270 GHz, Bw = 16.000 MH No calibration applied and no bandpass applied

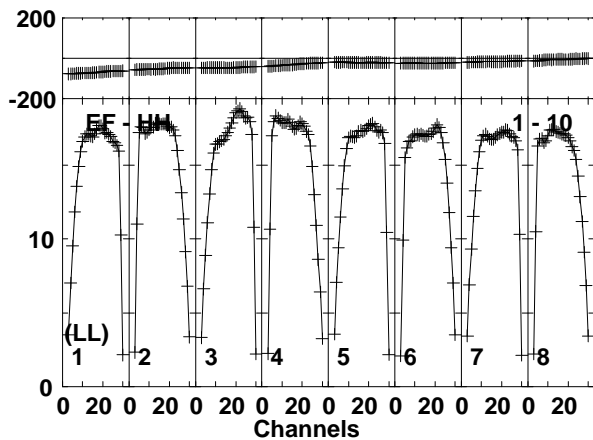
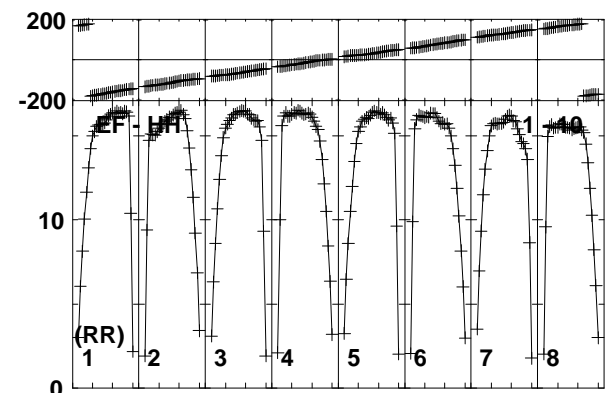
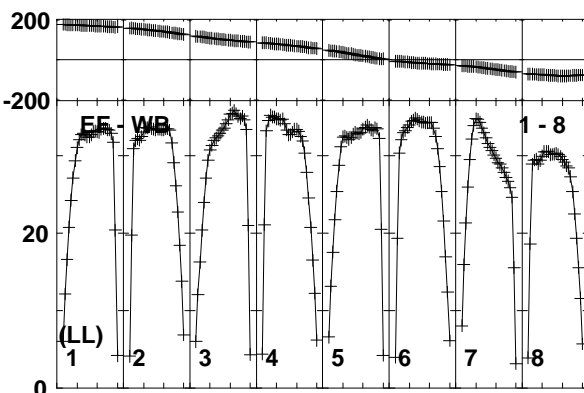
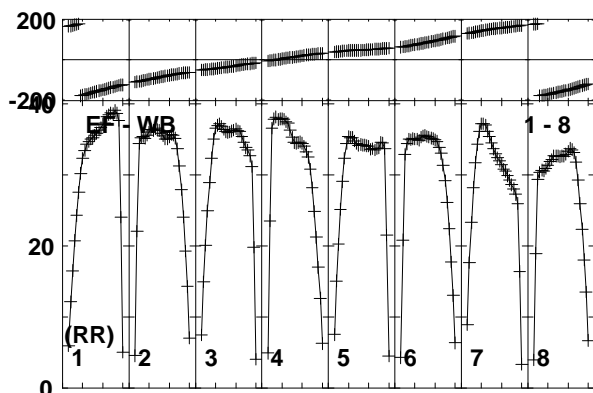
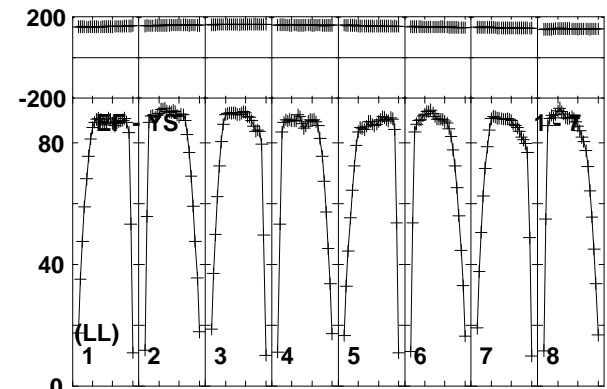
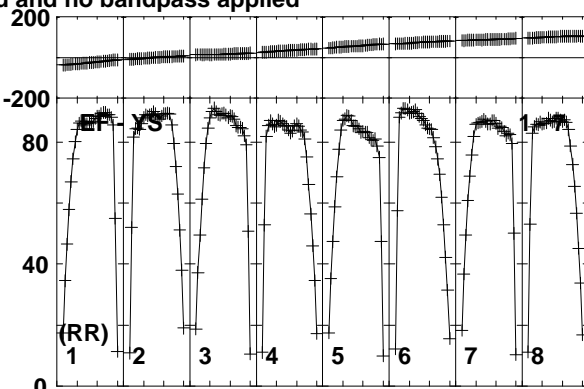
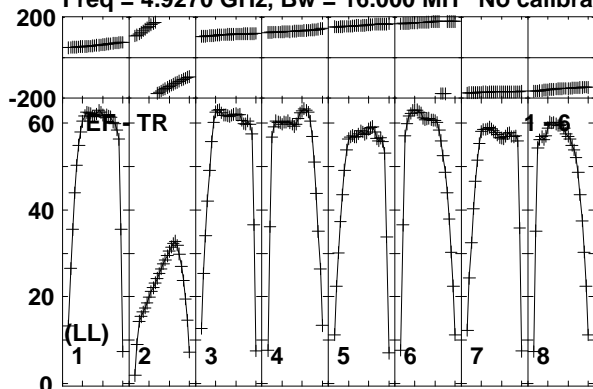

Lower frame: Milli Ampl Jy Top frame: Phas deg
Vector averaged cross-power spectrum Baseline: EF (01) - TR (06)
Timerange: 00/10:46:30 to 00/10:59:20

Plot file version 13 created 10-JUN-2016 16:07:45

DA193 RG008D.UVDATA.1

Freq = 4.9270 GHz, Bw = 16.000 MH No calibration applied and no bandpass applied

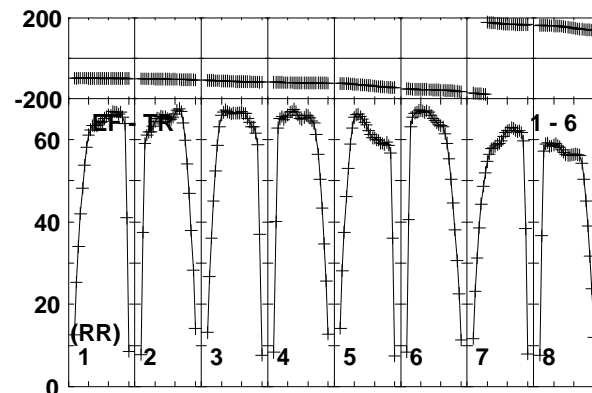
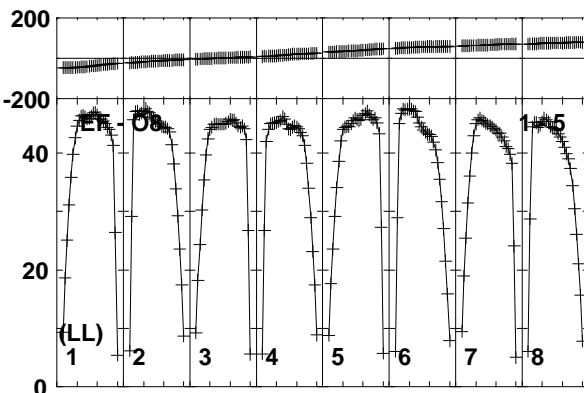
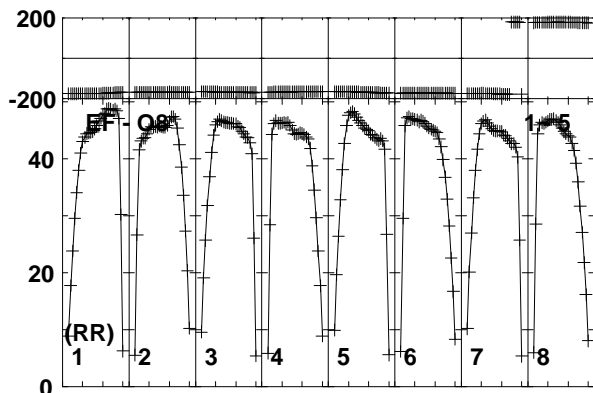
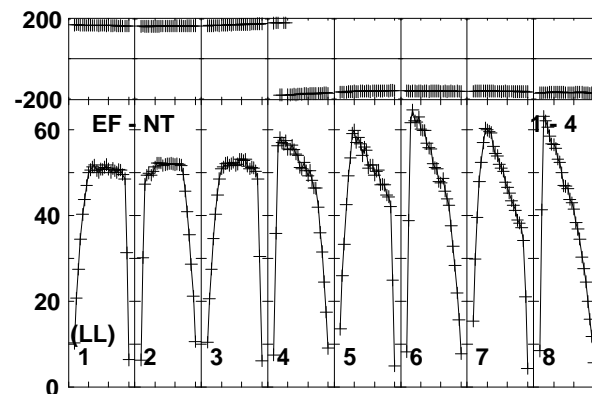
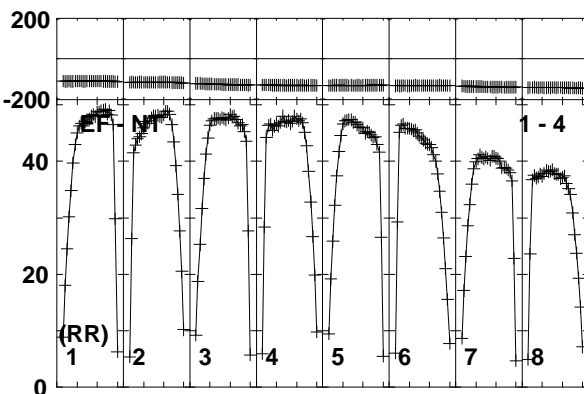
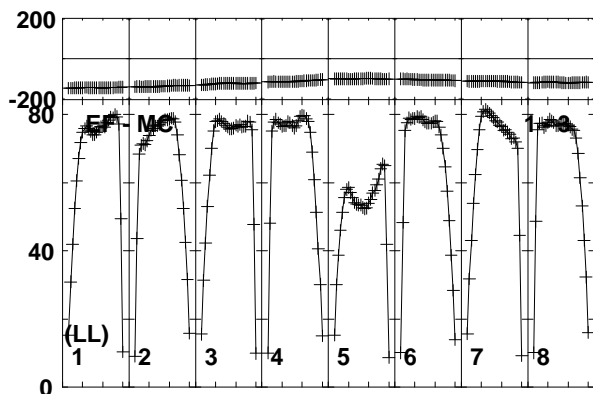
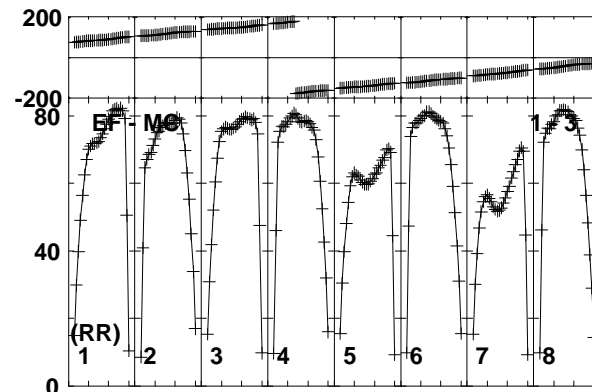
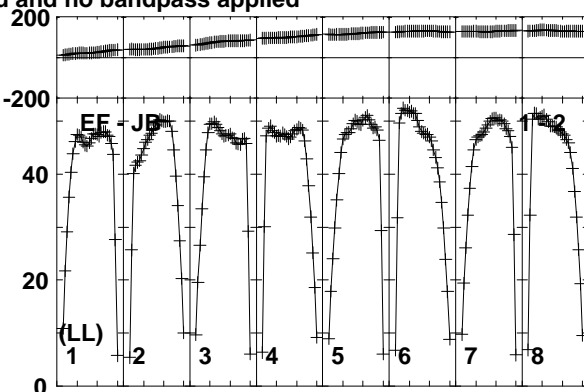
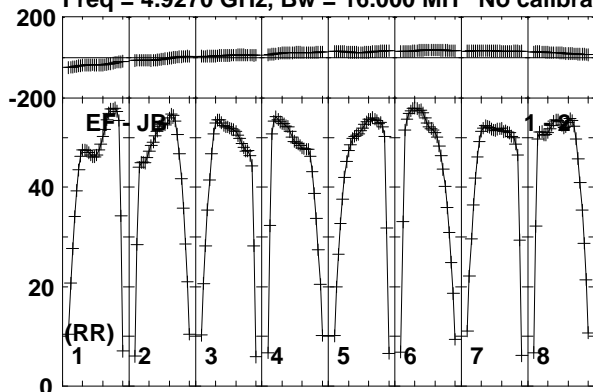

Lower frame: Milli Ampl Jy Top frame: Phas deg
Vector averaged cross-power spectrum Baseline: EF (01) - JB (02)
Timerange: 00/11:00:01 to 00/11:14:19

Plot file version 14 created 10-JUN-2016 16:07:46

DA193 RG008D.UVDATA.1

Freq = 4.9270 GHz, Bw = 16.000 MH No calibration applied and no bandpass applied

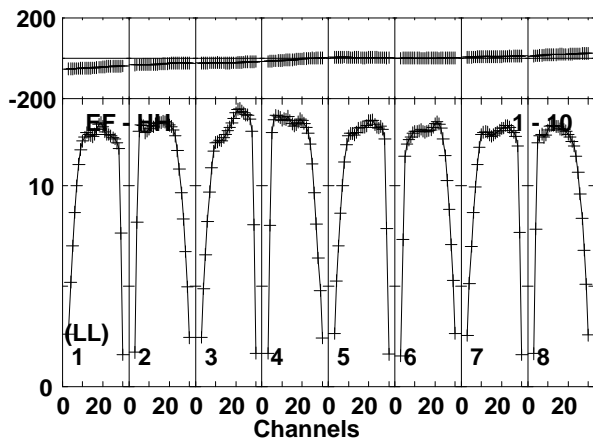
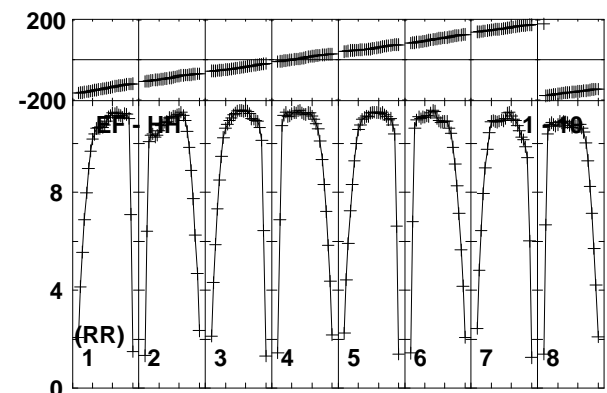
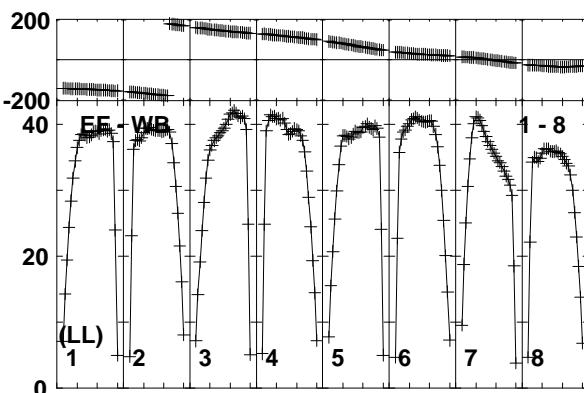
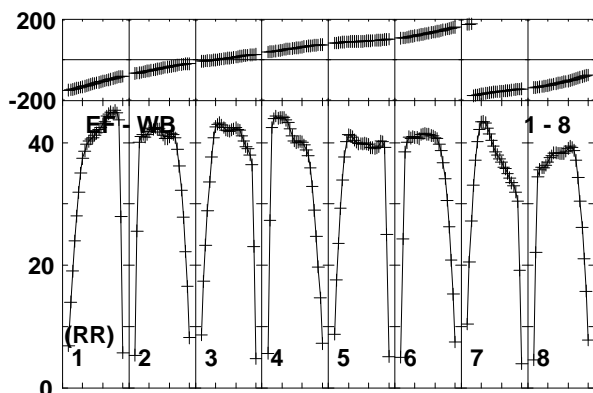
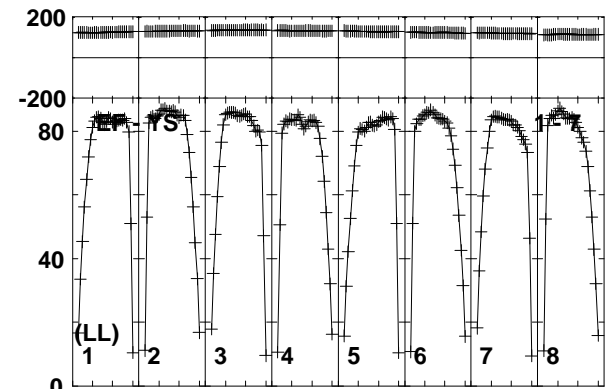
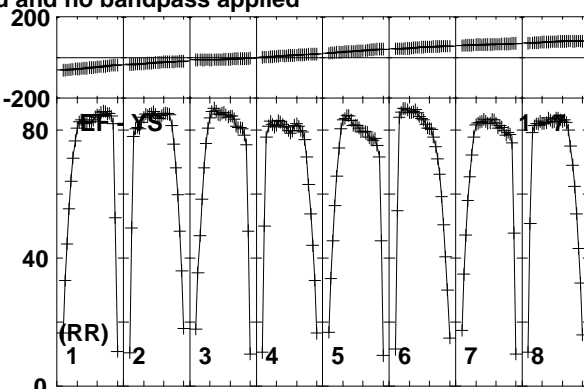
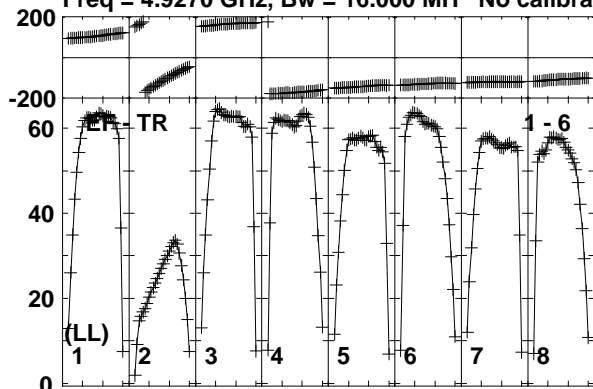

Lower frame: Milli Ampl Jy Top frame: Phas deg
Vector averaged cross-power spectrum Baseline: EF (01) - TR (06)
Timerange: 00/11:00:01 to 00/11:14:19

Plot file version 15 created 10-JUN-2016 16:07:46

DA193 RG008D.UVDATA.1

Freq = 4.9270 GHz, Bw = 16.000 MH No calibration applied and no bandpass applied

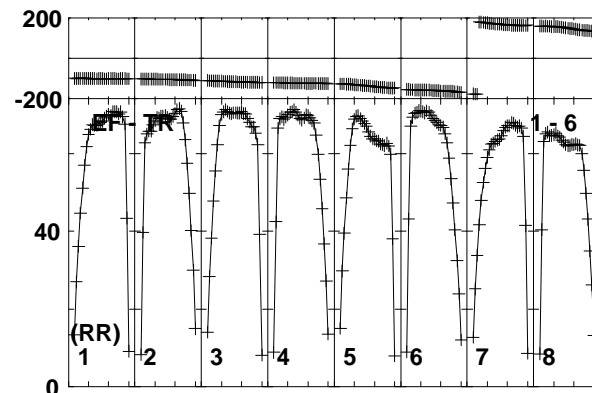
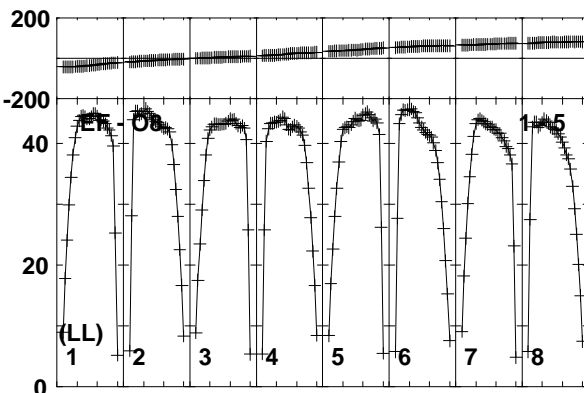
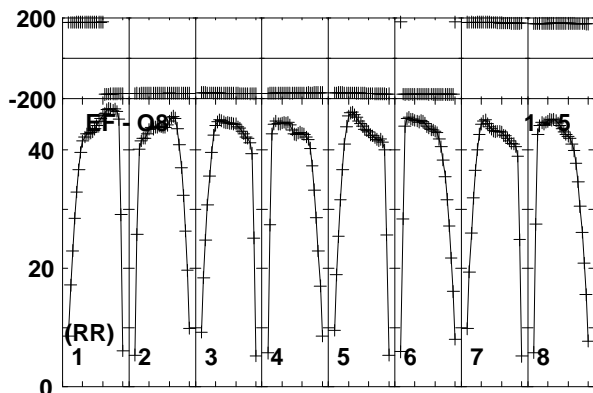
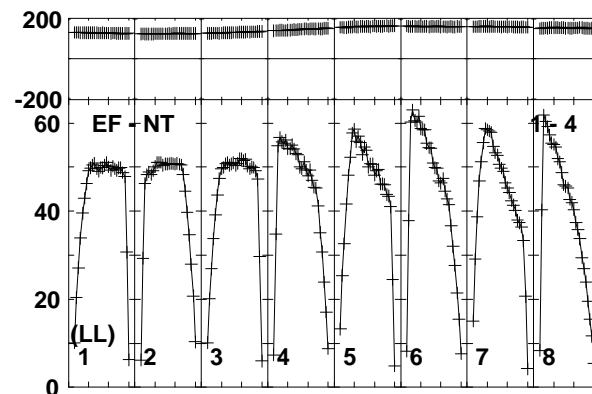
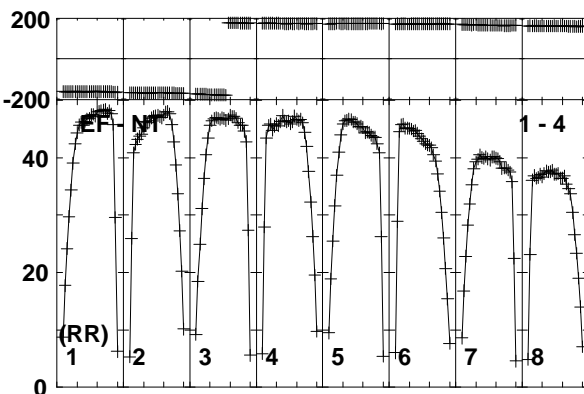
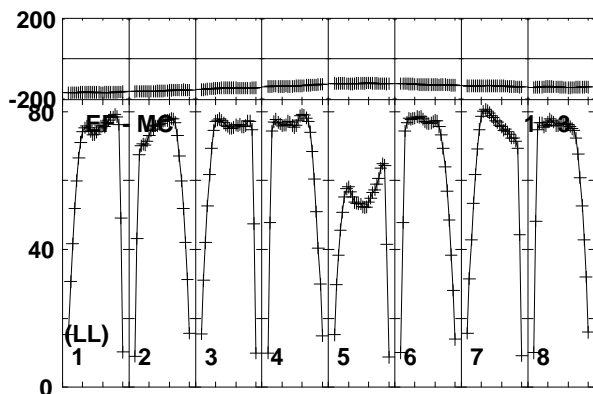
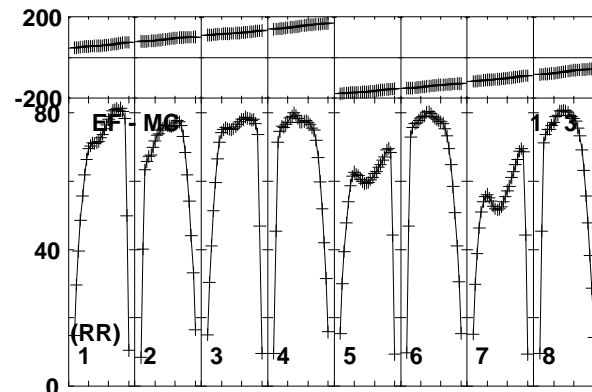
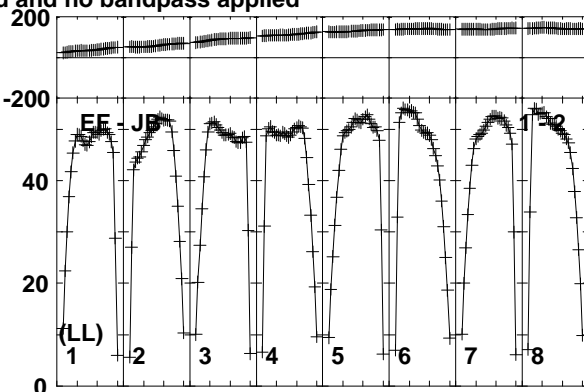
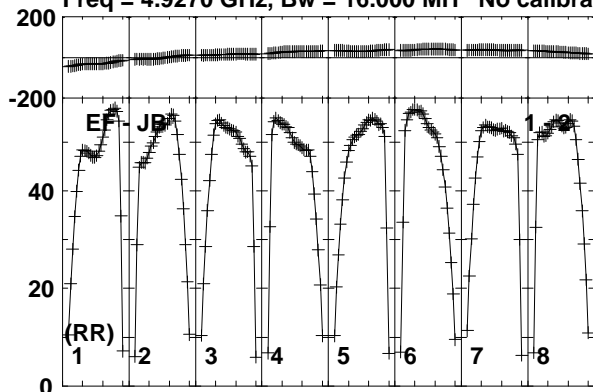

Lower frame: Milli Ampl Jy Top frame: Phas deg
Vector averaged cross-power spectrum Baseline: EF (01) - JB (02)
Timerange: 00/11:15:01 to 00/11:20:30

Plot file version 16 created 10-JUN-2016 16:07:47

DA193 RG008D.UVDATA.1

Freq = 4.9270 GHz, Bw = 16.000 MH No calibration applied and no bandpass applied

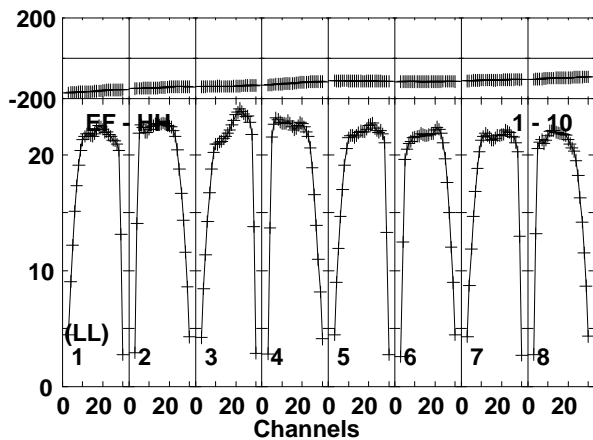
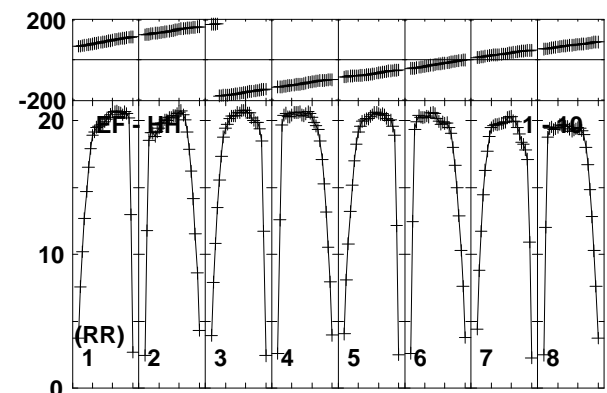
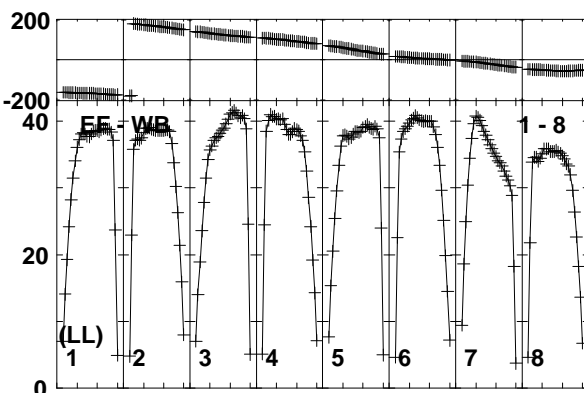
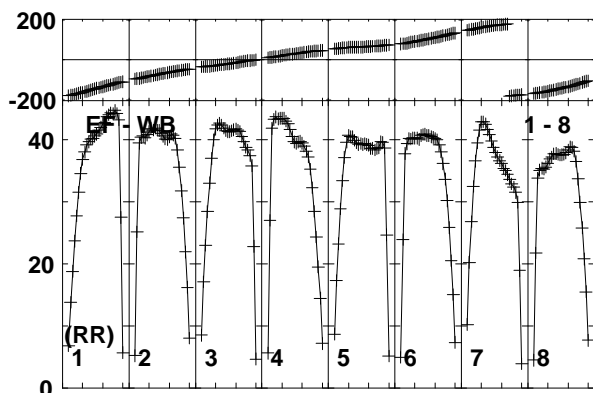
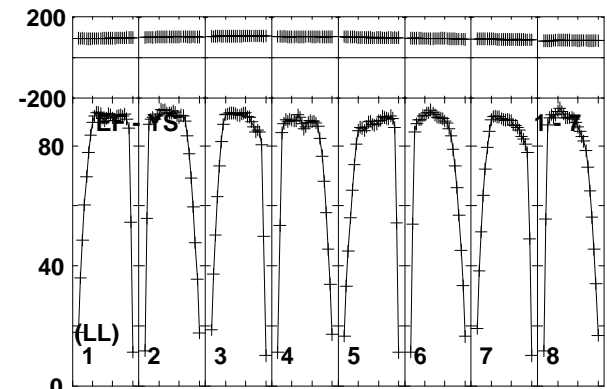
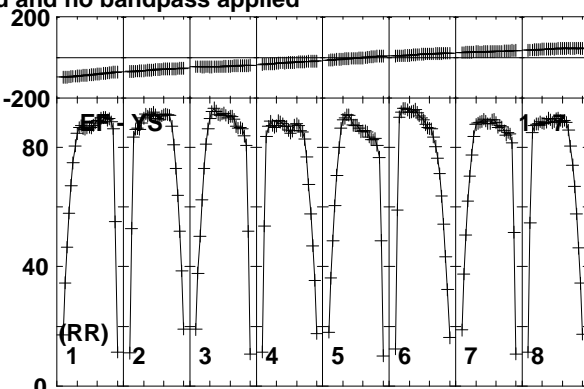
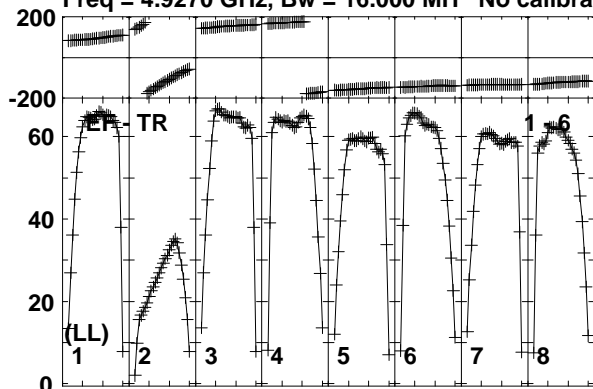

Lower frame: Milli Ampl Jy Top frame: Phas deg
Vector averaged cross-power spectrum Baseline: EF (01) - TR (06)
Timerange: 00/11:15:01 to 00/11:20:30

Plot file version 17 created 10-JUN-2016 16:07:47

J0718-1813 RG008D.UVDATA.1

Freq = 4.9270 GHz, Bw = 16.000 MH No calibration applied and no bandpass applied

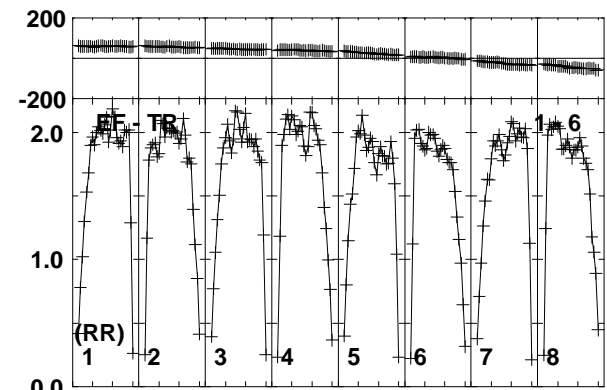
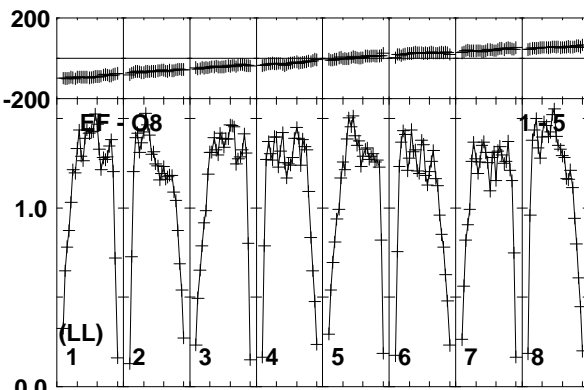
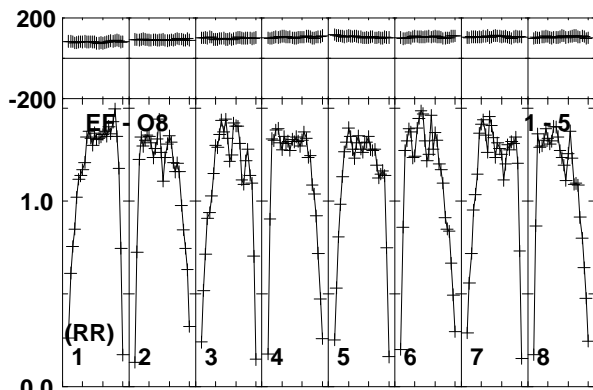
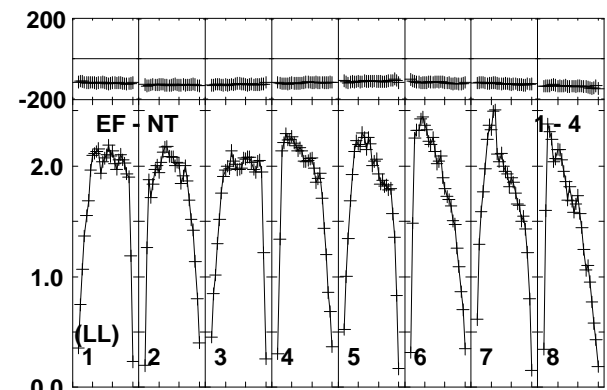
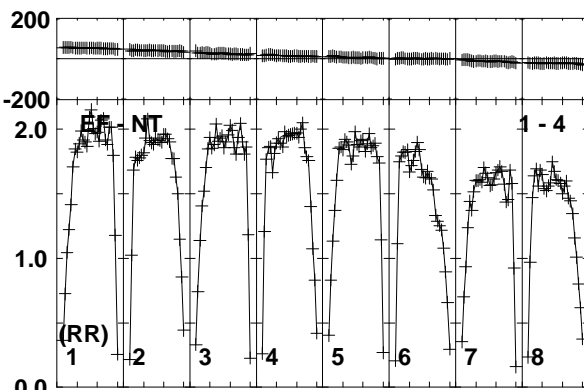
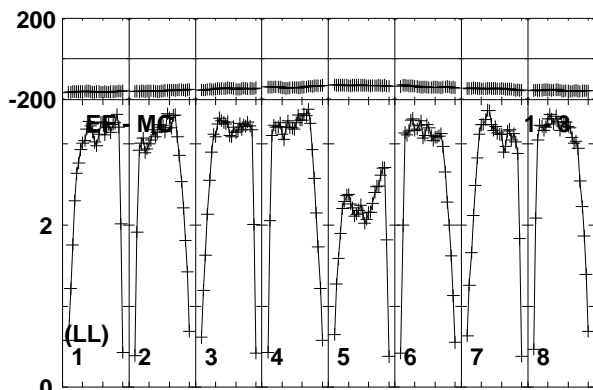
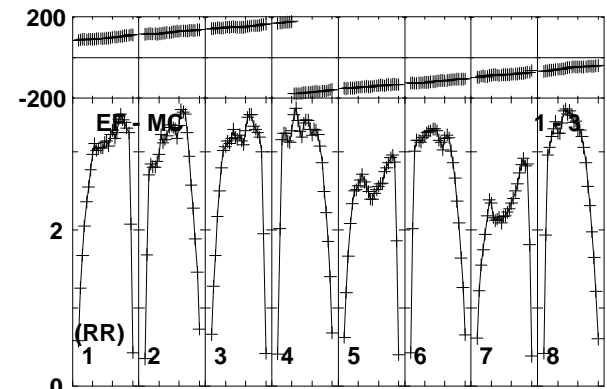
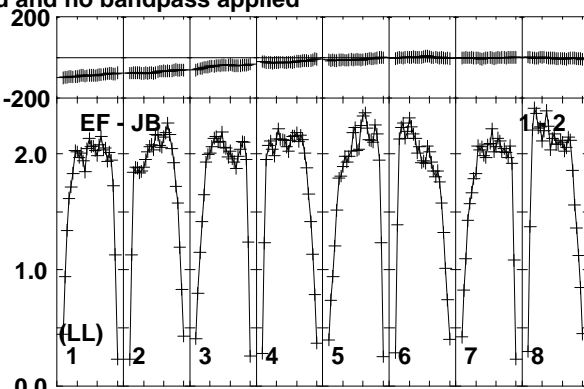
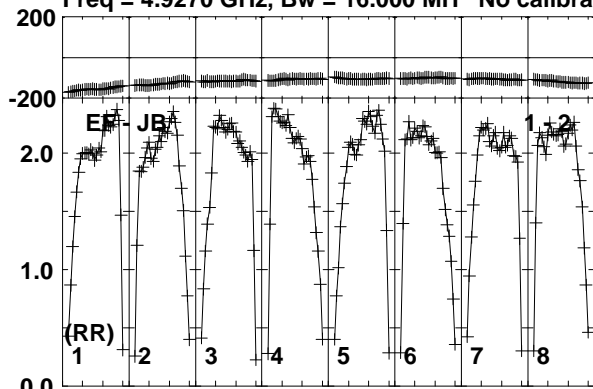

Lower frame: Milli Ampl Jy Top frame: Phas deg
Vector averaged cross-power spectrum Baseline: EF (01) - JB (02)
Timerange: 00/11:25:05 to 00/11:28:00

Plot file version 18 created 10-JUN-2016 16:07:47

J0718-1813 RG008D.UVDATA.1

Freq = 4.9270 GHz, Bw = 16.000 MH No calibration applied and no bandpass applied

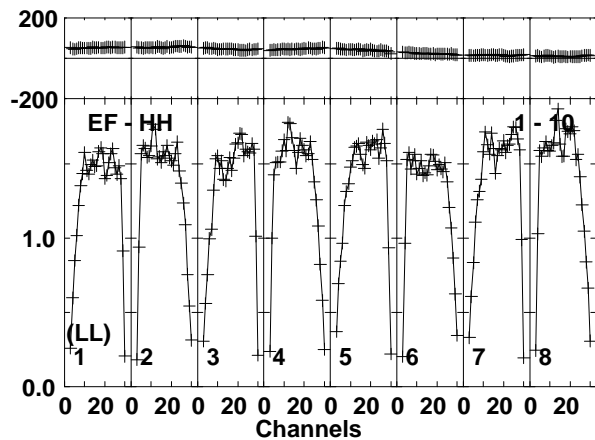
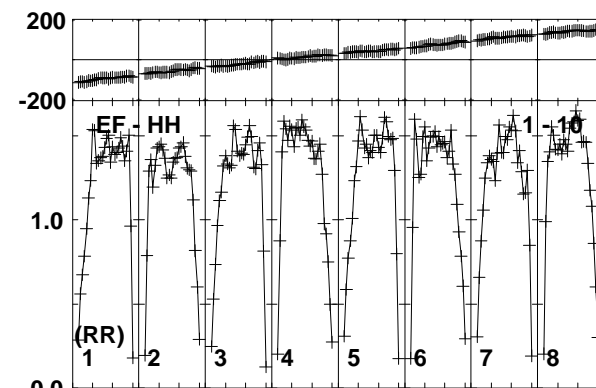
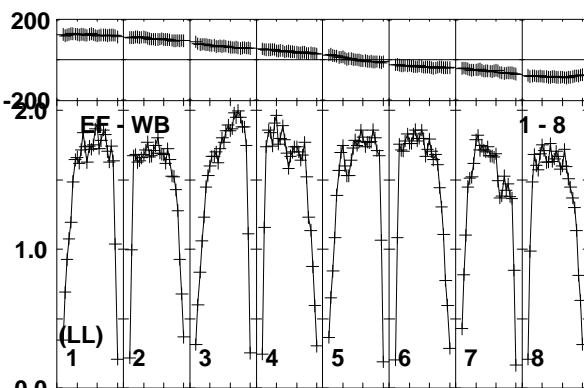
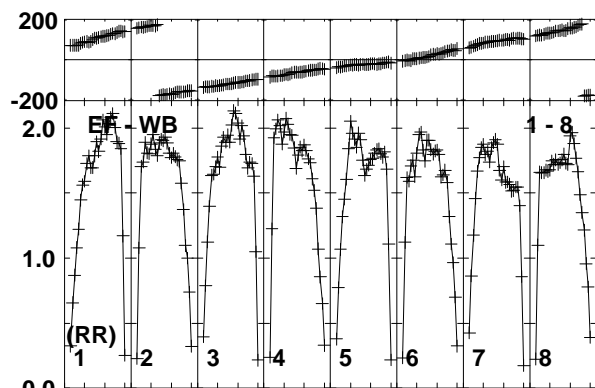
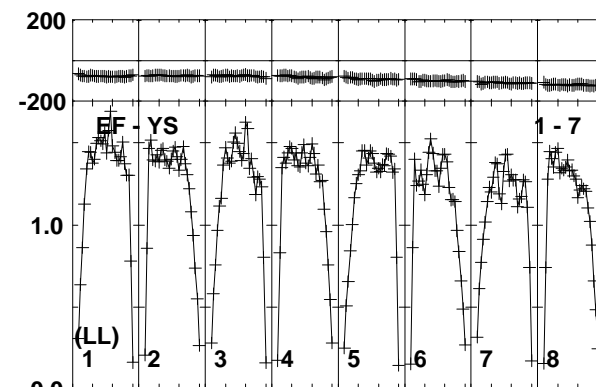
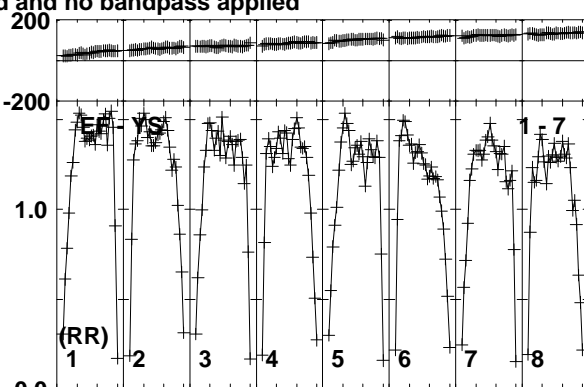
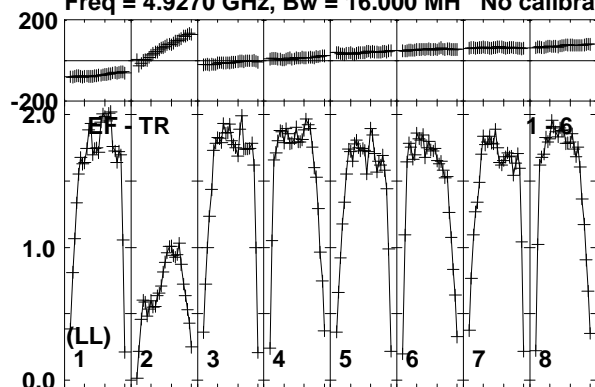

Lower frame: Milli Ampl Jy Top frame: Phas deg
Vector averaged cross-power spectrum Baseline: EF (01) - TR (06)
Timerange: 00/11:25:05 to 00/11:28:00

Plot file version 19 created 10-JUN-2016 16:07:47

FRB150418 RG008D.UVDATA.1

Freq = 4.9270 GHz, Bw = 16.000 MH No calibration applied and no bandpass applied

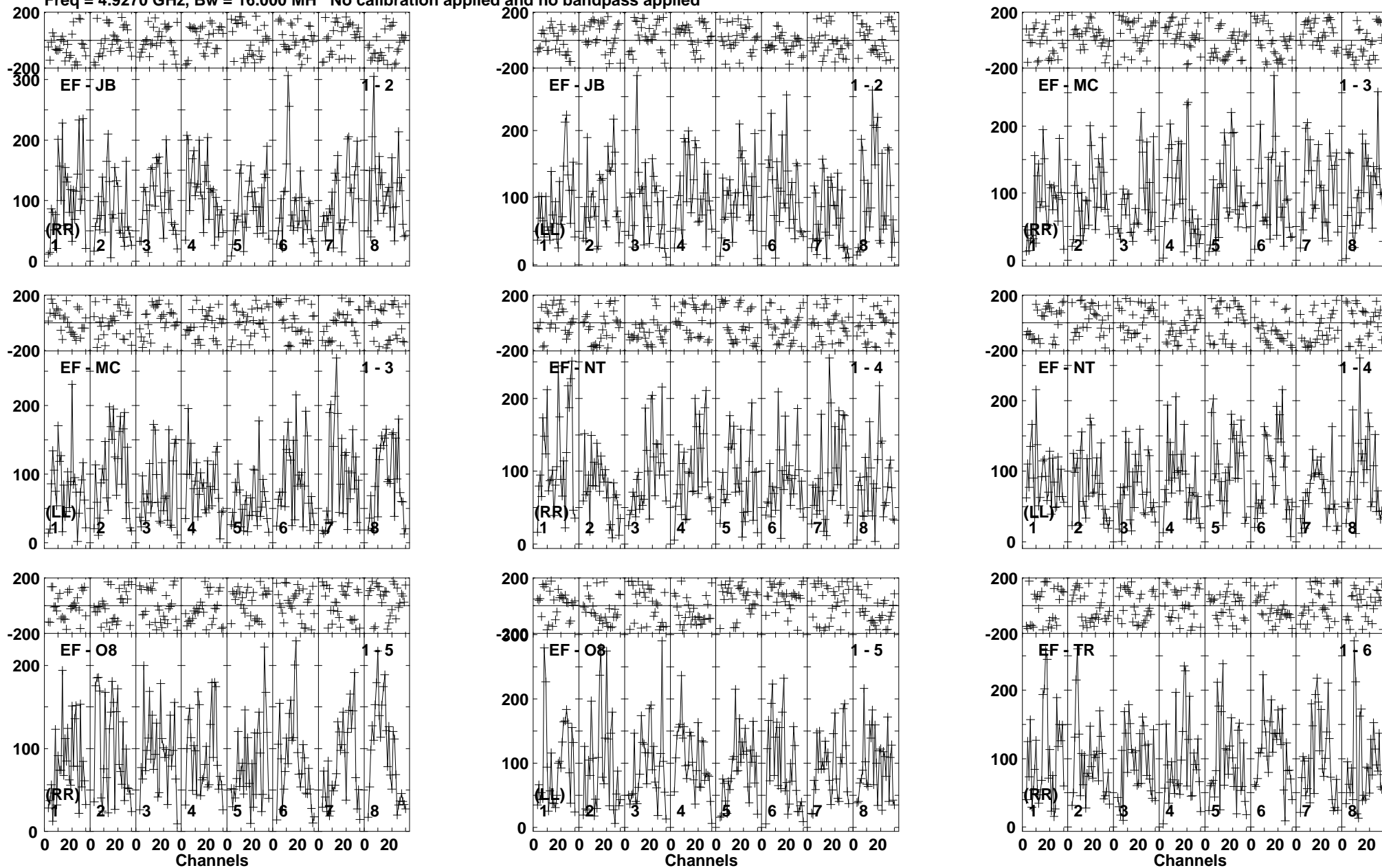

Lower frame: Micro Ampl Jy Top frame: Phas deg
Vector averaged cross-power spectrum Baseline: EF (01) - JB (02)
Timerange: 00/11:28:00 to 00/11:30:59

Plot file version 20 created 10-JUN-2016 16:07:47

FRB150418 RG008D.UVDATA.1

Freq = 4.9270 GHz, Bw = 16.000 MH No calibration applied and no bandpass applied

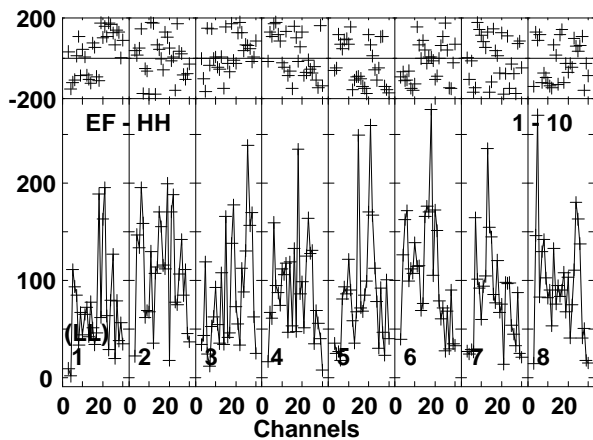
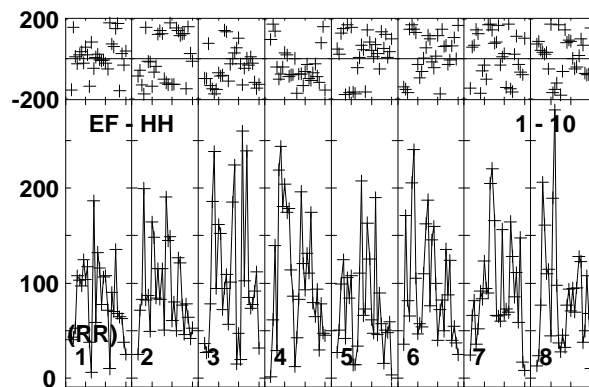
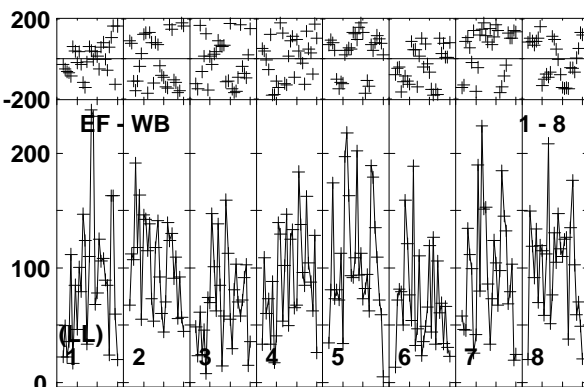
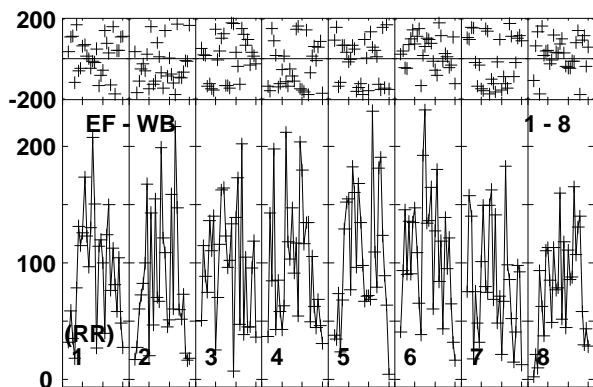
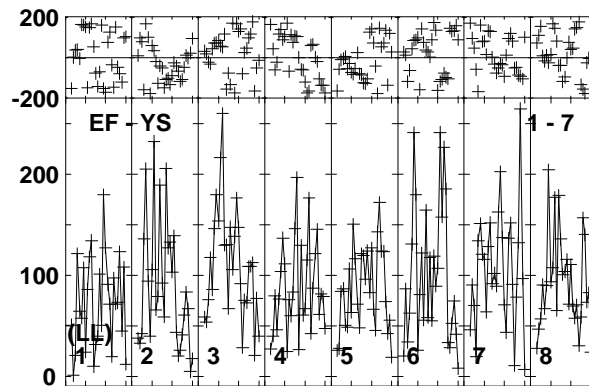
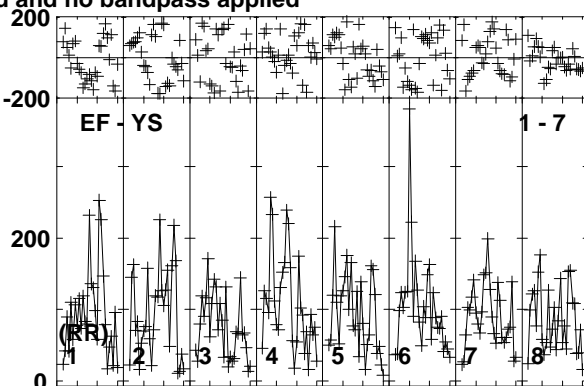
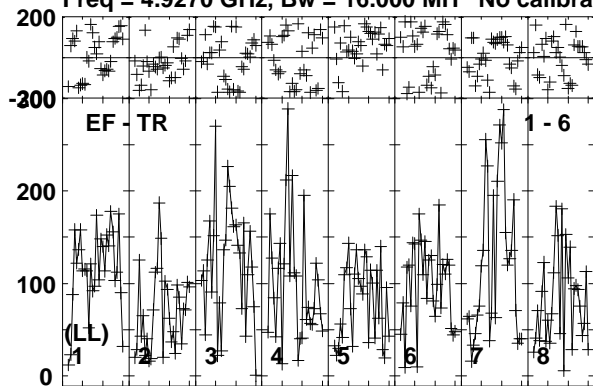

Lower frame: Micro Ampl Jy Top frame: Phas deg
Vector averaged cross-power spectrum Baseline: EF (01) - TR (06)
Timerange: 00/11:28:00 to 00/11:30:59

Plot file version 21 created 10-JUN-2016 16:07:47

J0718-1813 RG008D.UVDATA.1

Freq = 4.9270 GHz, Bw = 16.000 MH No calibration applied and no bandpass applied

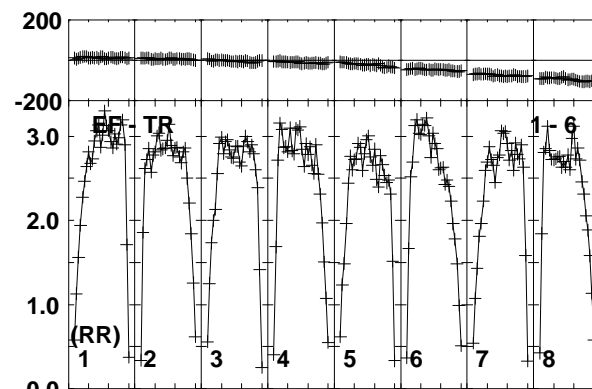
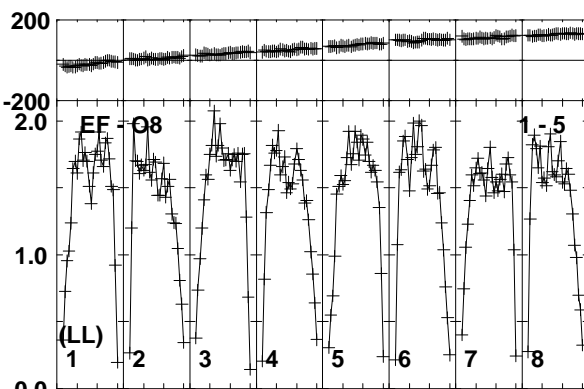
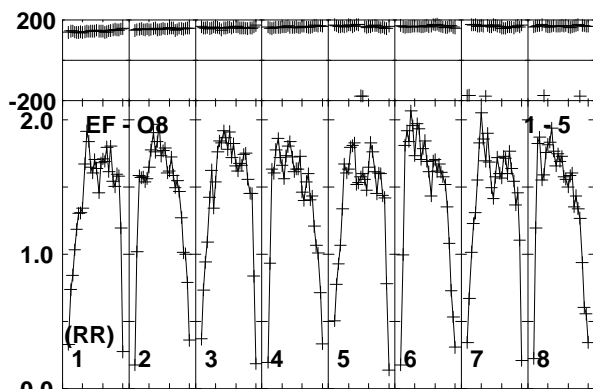
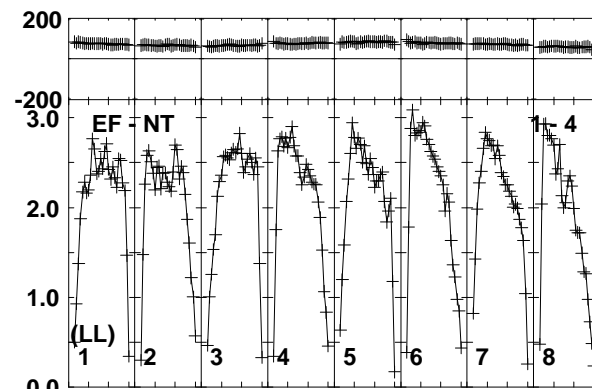
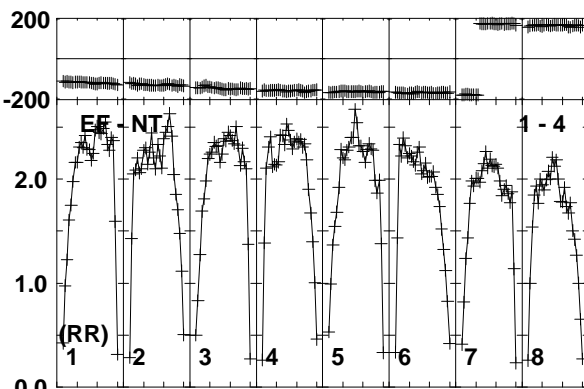
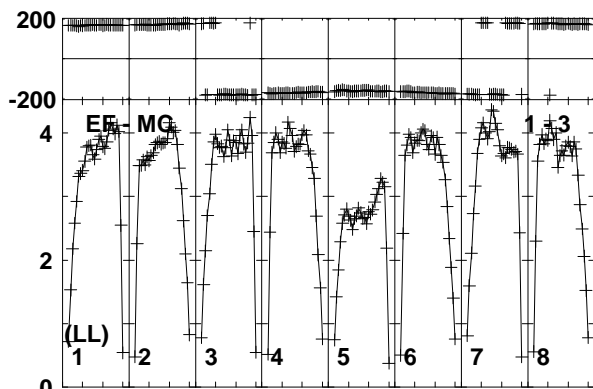
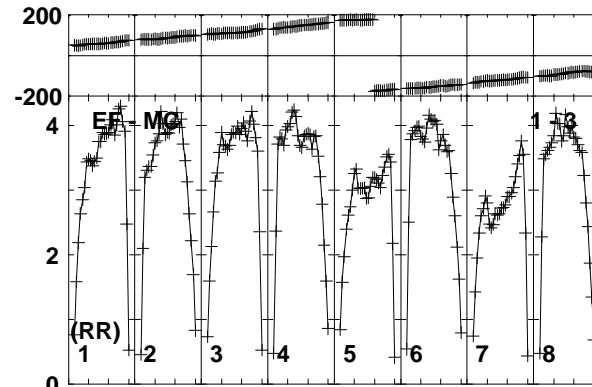
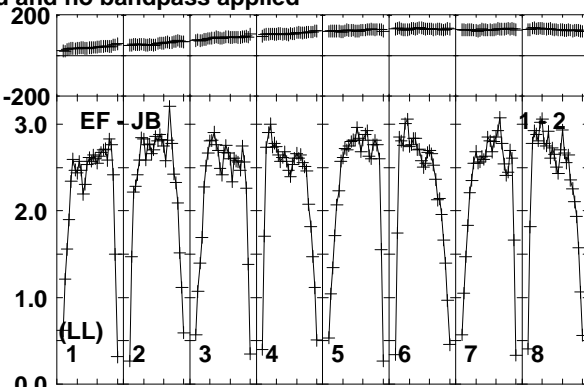
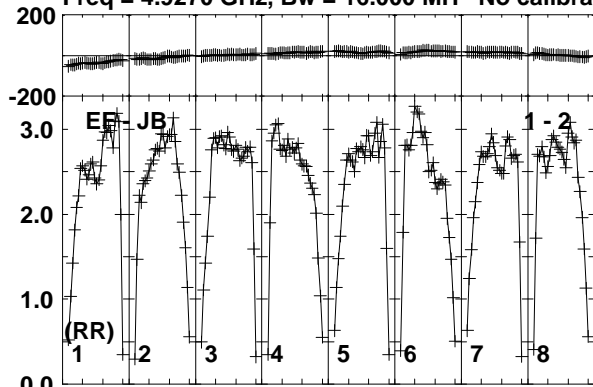

Lower frame: Milli Ampl Jy Top frame: Phas deg
Vector averaged cross-power spectrum Baseline: EF (01) - JB (02)
Timerange: 00/11:31:01 to 00/11:32:29

Plot file version 22 created 10-JUN-2016 16:07:48

J0718-1813 RG008D.UVDATA.1

Freq = 4.9270 GHz, Bw = 16.000 MH No calibration applied and no bandpass applied

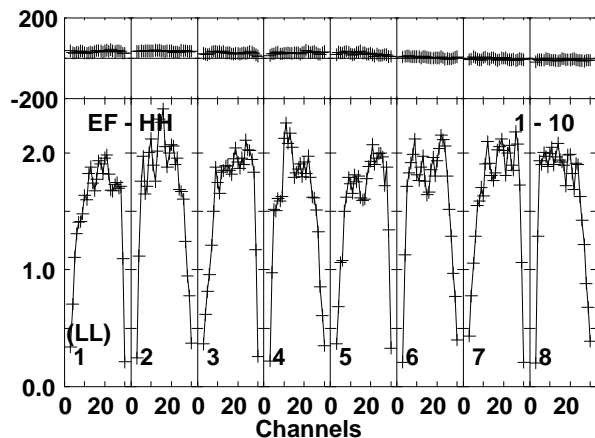
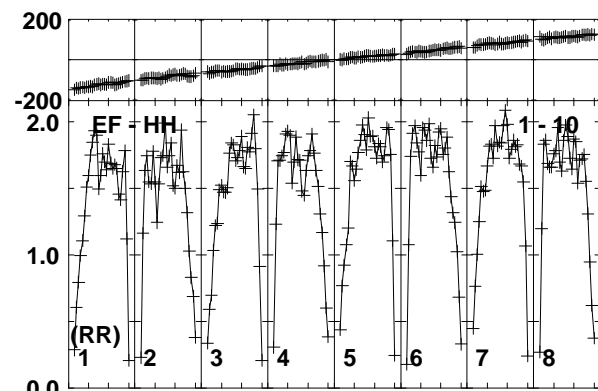
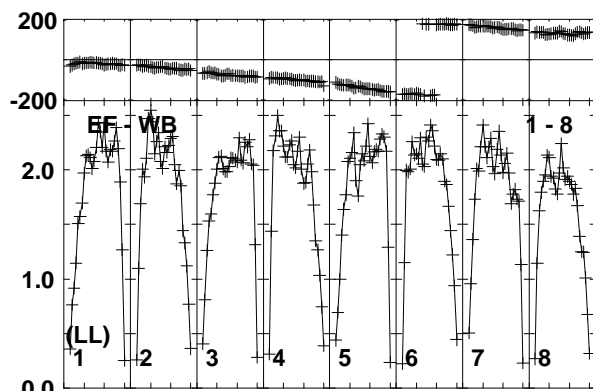
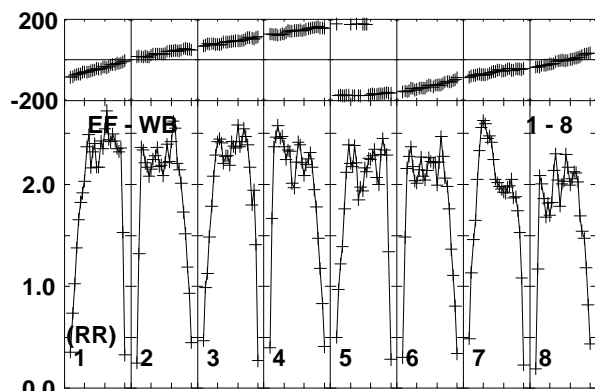
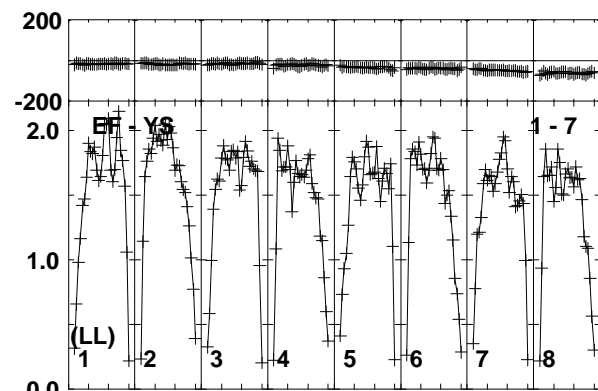
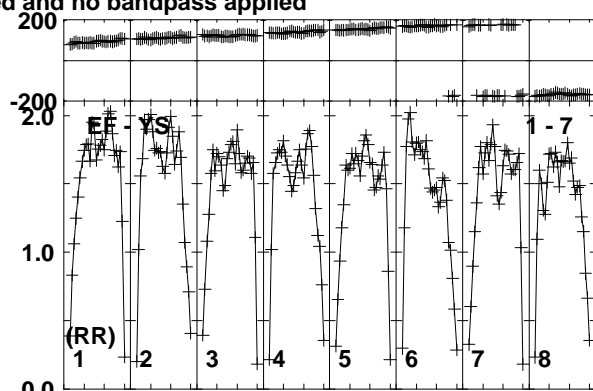
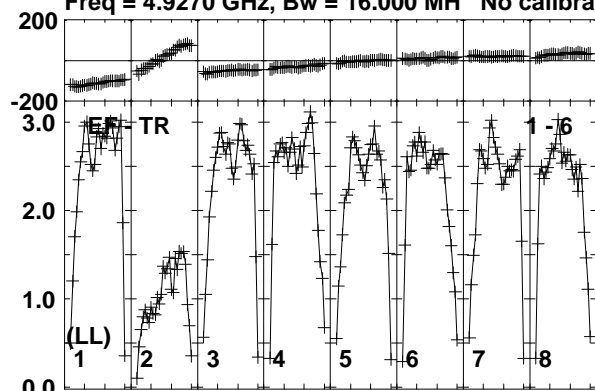

Lower frame: Milli Ampl Jy Top frame: Phas deg
Vector averaged cross-power spectrum Baseline: EF (01) - TR (06)
Timerange: 00/11:31:01 to 00/11:32:29

Plot file version 23 created 10-JUN-2016 16:07:48

FRB150418 RG008D.UVDATA.1

Freq = 4.9270 GHz, Bw = 16.000 MH No calibration applied and no bandpass applied

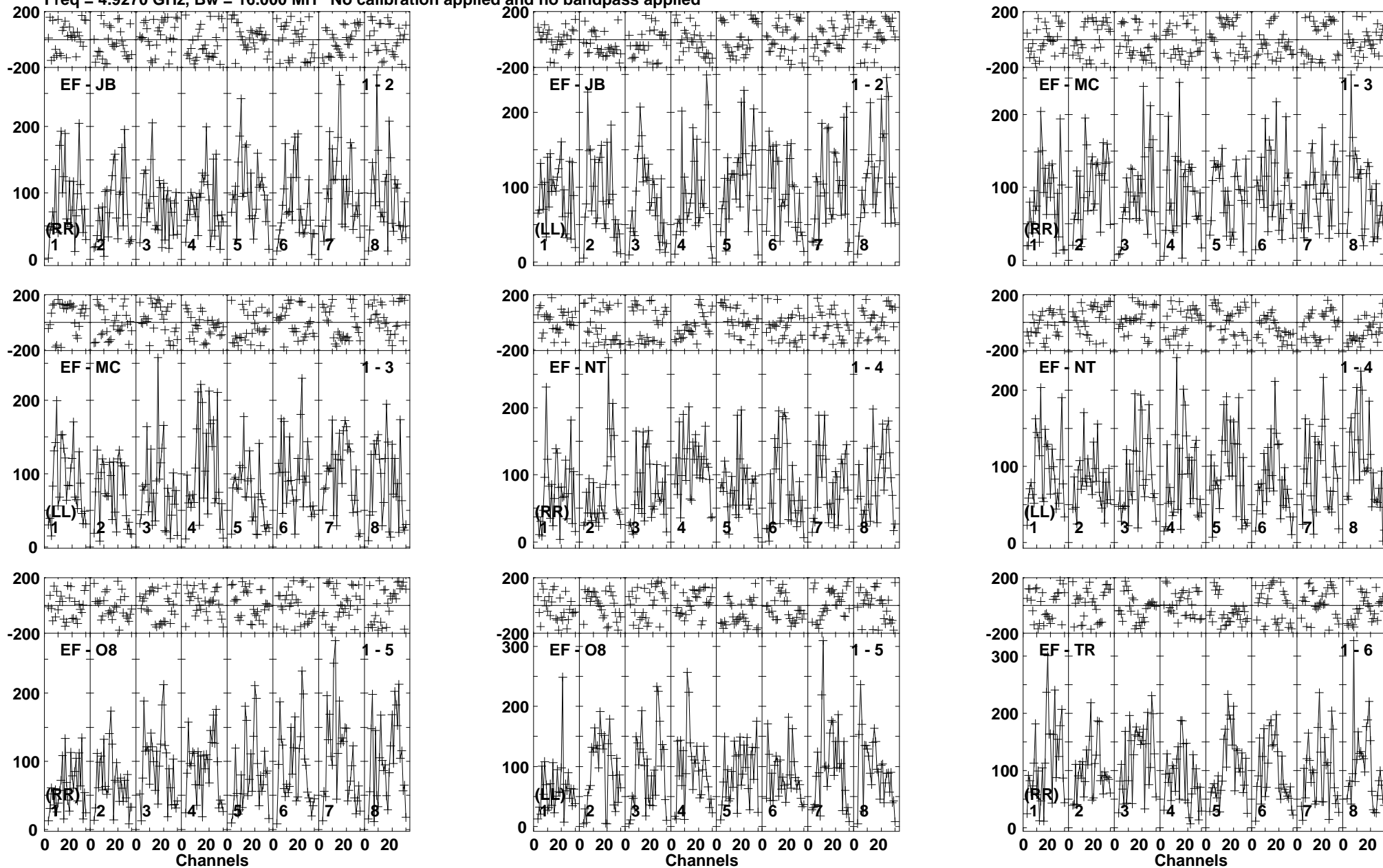

Lower frame: Micro Ampl Jy Top frame: Phas deg
Vector averaged cross-power spectrum Baseline: EF (01) - JB (02)
Timerange: 00/11:32:30 to 00/11:35:30

Plot file version 24 created 10-JUN-2016 16:07:48

FRB150418 RG008D.UVDATA.1

Freq = 4.9270 GHz, Bw = 16.000 MH No calibration applied and no bandpass applied

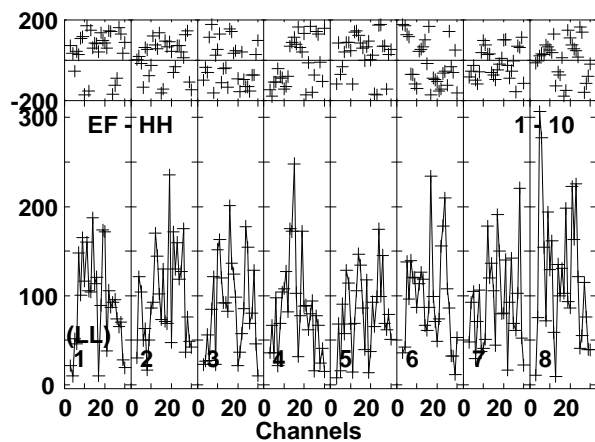
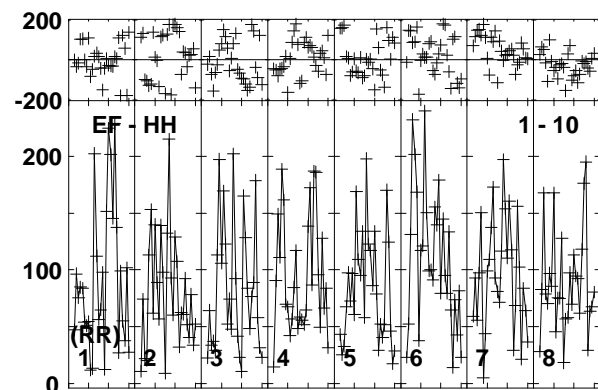
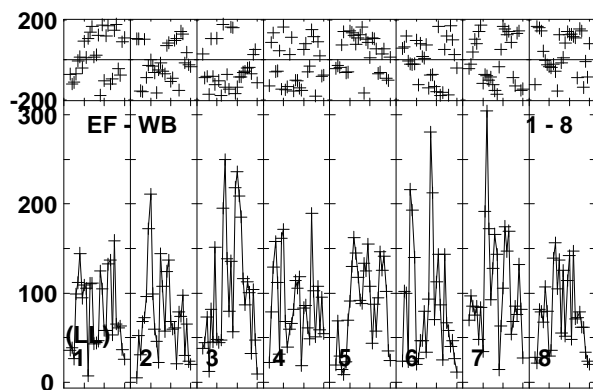
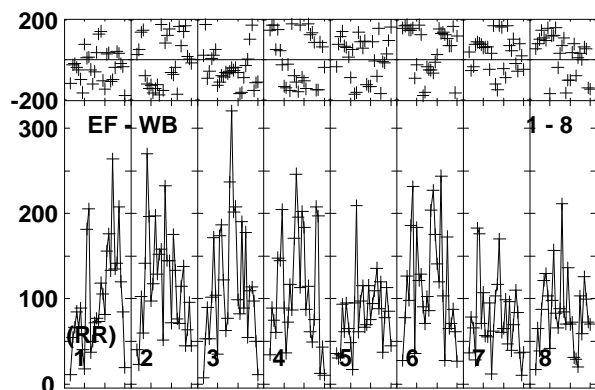
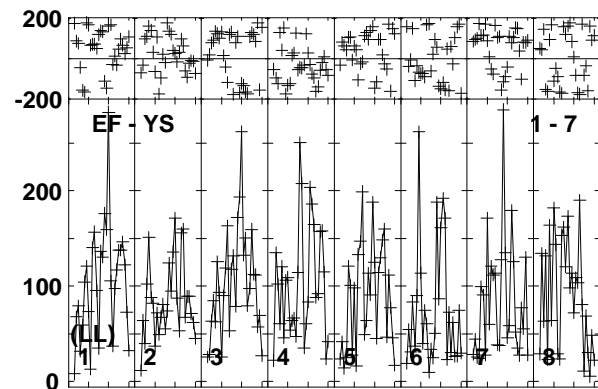
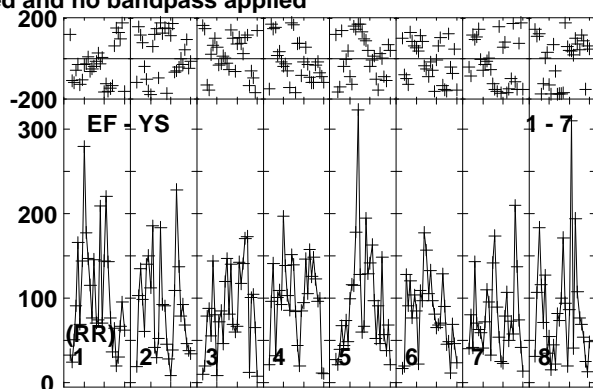
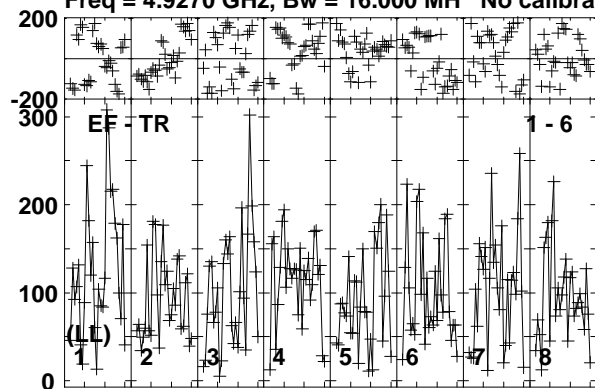

Lower frame: Micro Ampl Jy Top frame: Phas deg
Vector averaged cross-power spectrum Baseline: EF (01) - TR (06)
Timerange: 00/11:32:30 to 00/11:35:30

Plot file version 25 created 10-JUN-2016 16:07:48

J0718-1813 RG008D.UVDATA.1

Freq = 4.9270 GHz, Bw = 16.000 MH No calibration applied and no bandpass applied

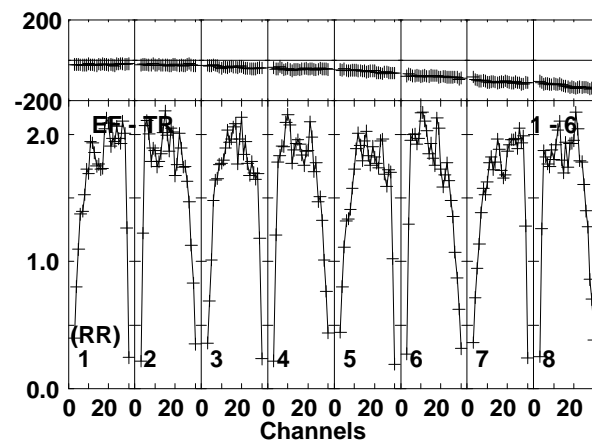
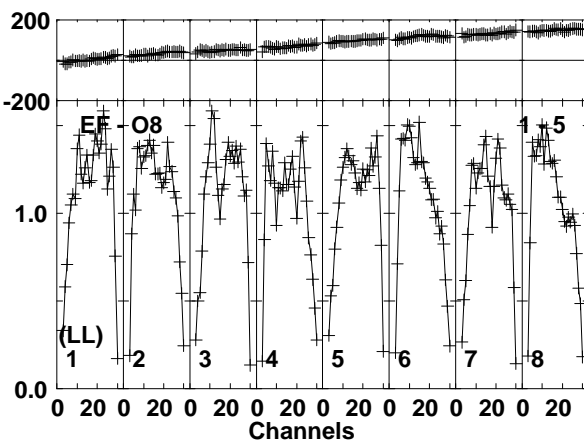
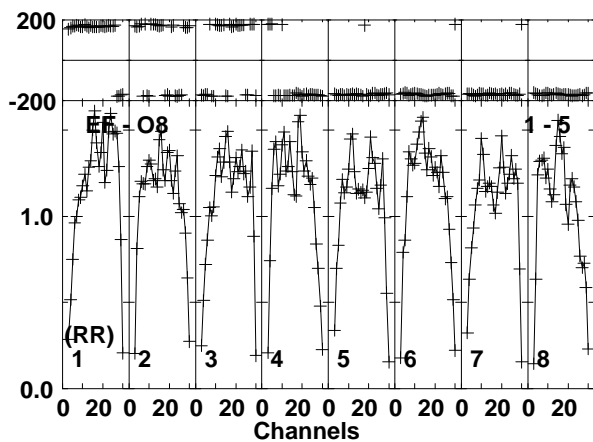
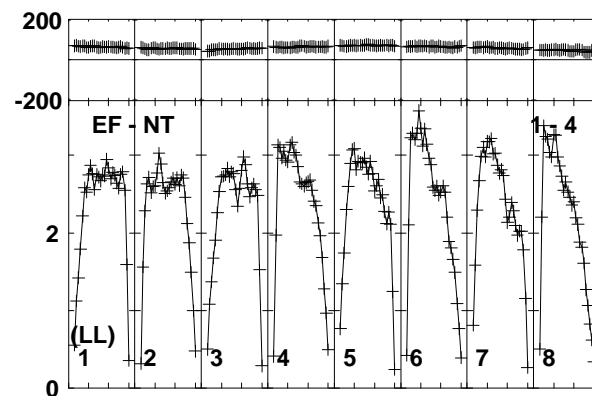
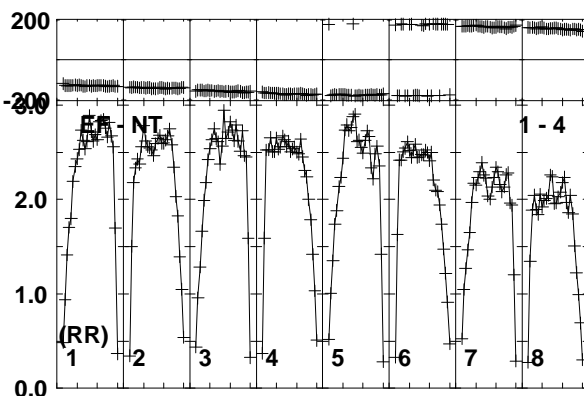
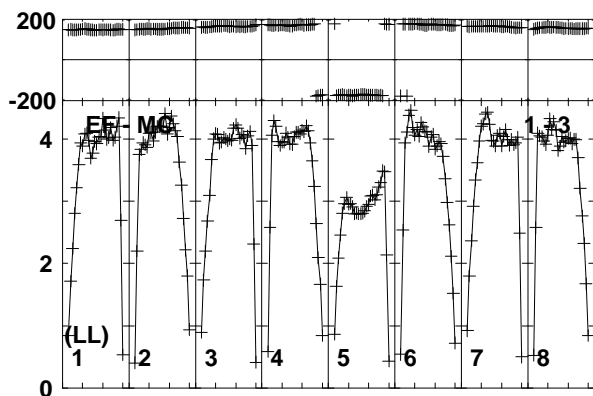
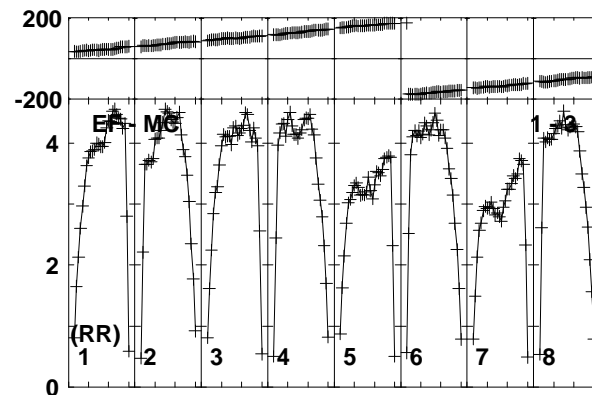
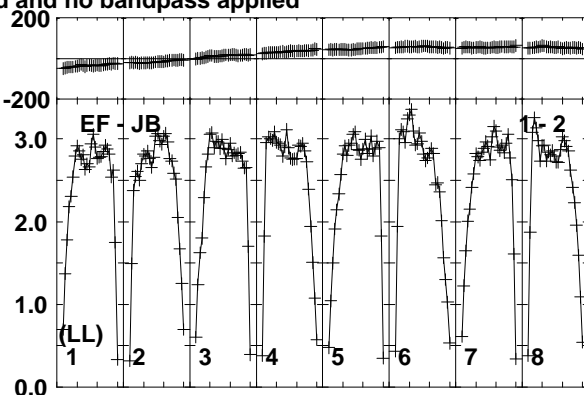
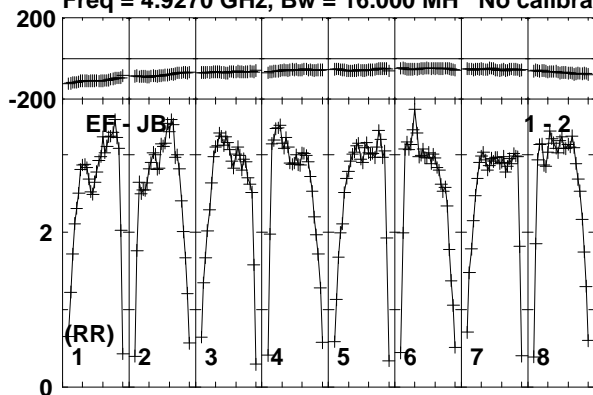

Lower frame: Milli Ampl Jy Top frame: Phas deg
Vector averaged cross-power spectrum Baseline: EF (01) - JB (02)
Timerange: 00/11:36:11 to 00/11:37:29

Plot file version 26 created 10-JUN-2016 16:07:48

J0718-1813 RG008D.UVDATA.1

Freq = 4.9270 GHz, Bw = 16.000 MH No calibration applied and no bandpass applied

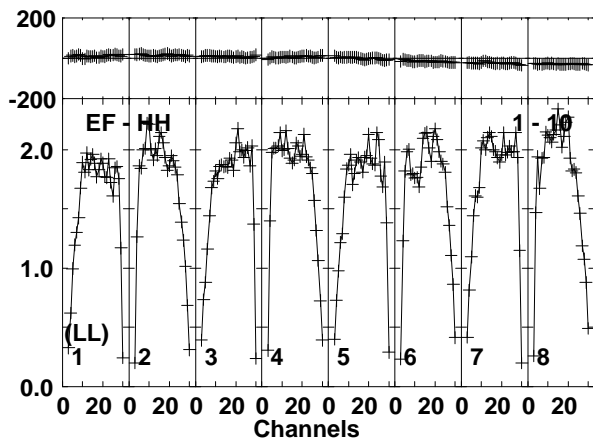
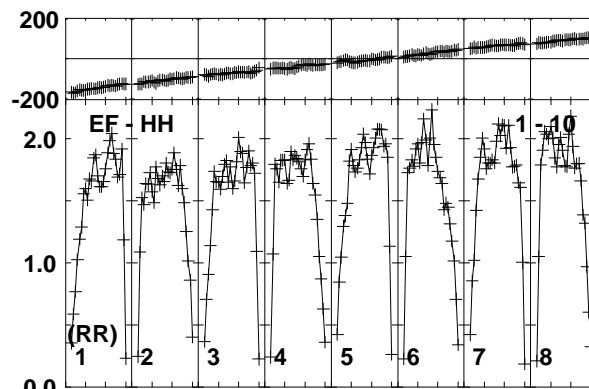
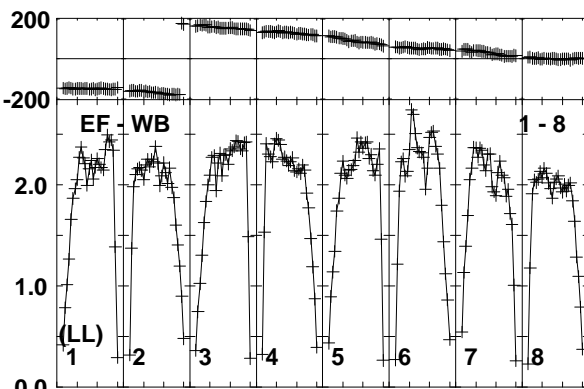
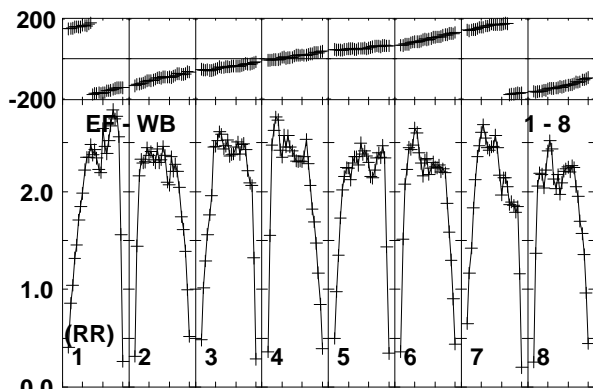
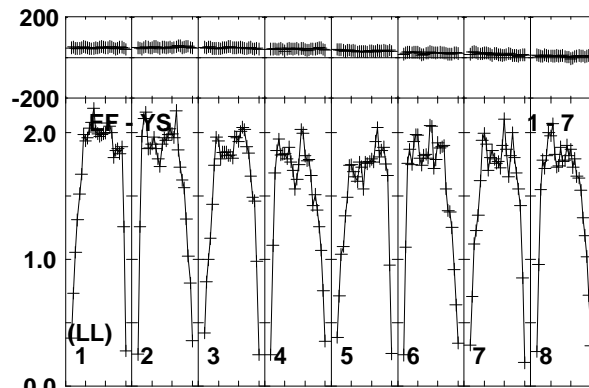
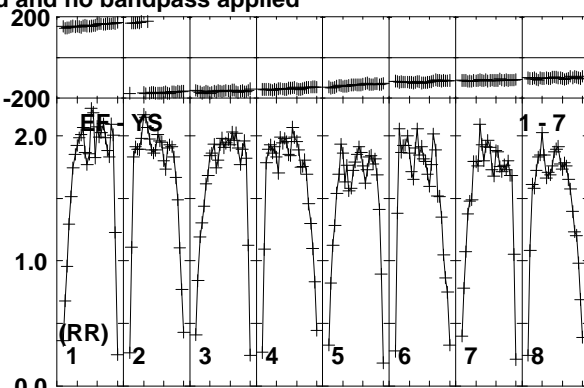
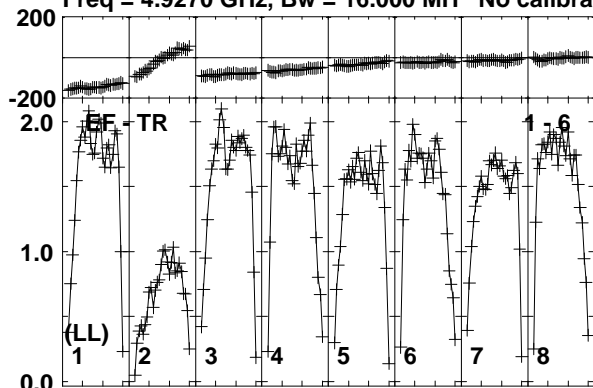

Lower frame: Milli Ampl Jy Top frame: Phas deg
Vector averaged cross-power spectrum Baseline: EF (01) - TR (06)
Timerange: 00/11:36:11 to 00/11:37:29

Plot file version 27 created 10-JUN-2016 16:07:48

J0716-1856 RG008D.UVDATA.1

Freq = 4.9270 GHz, Bw = 16.000 MH No calibration applied and no bandpass applied

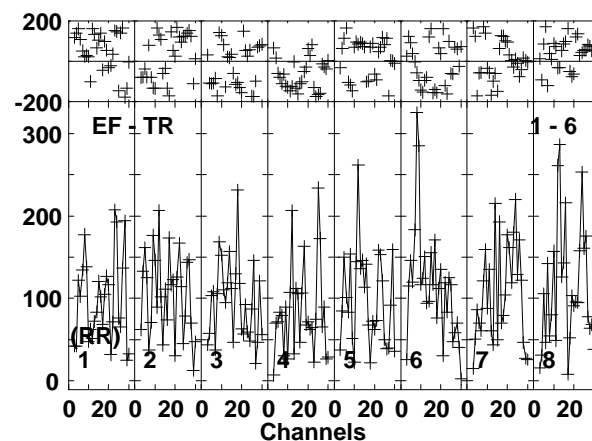
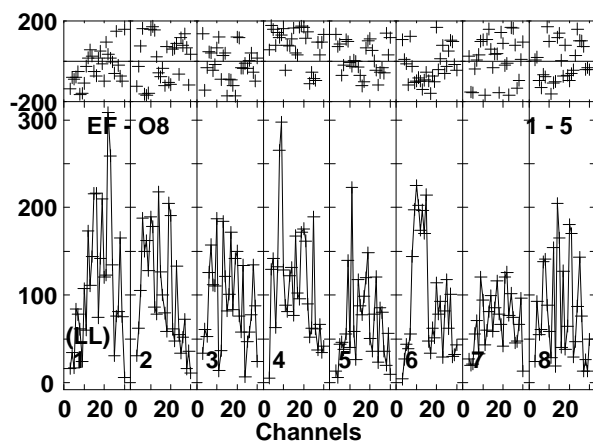
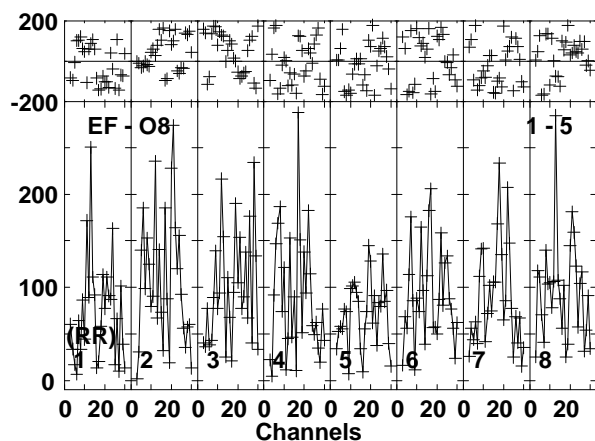
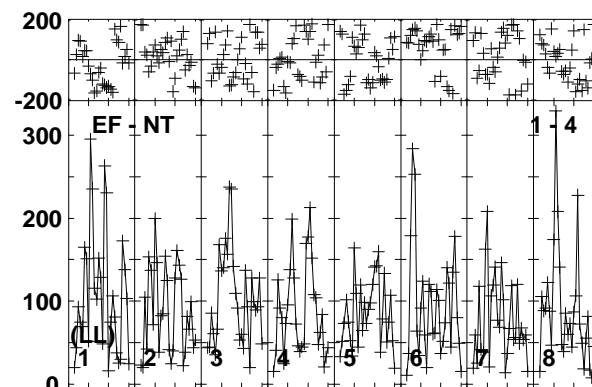
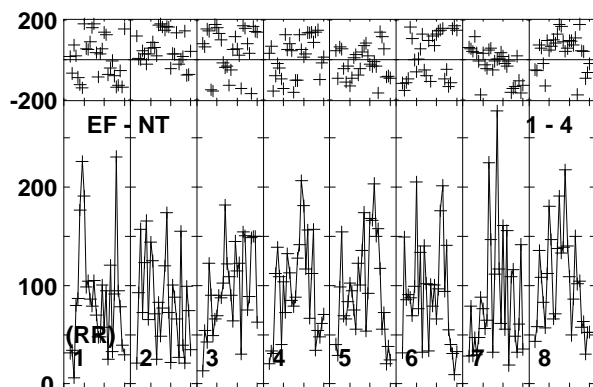
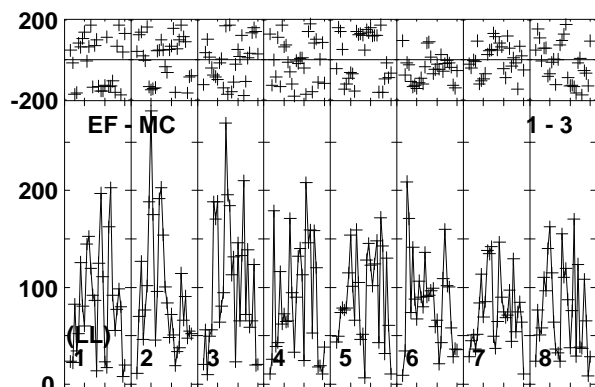
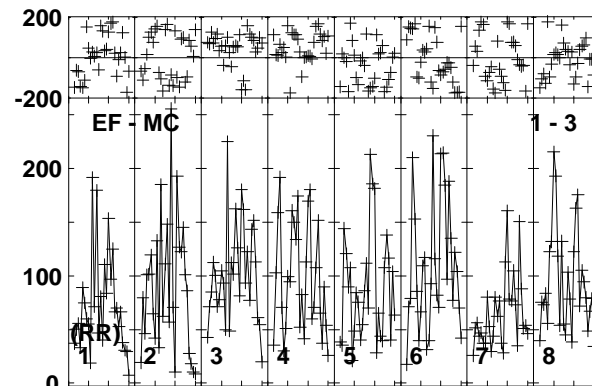
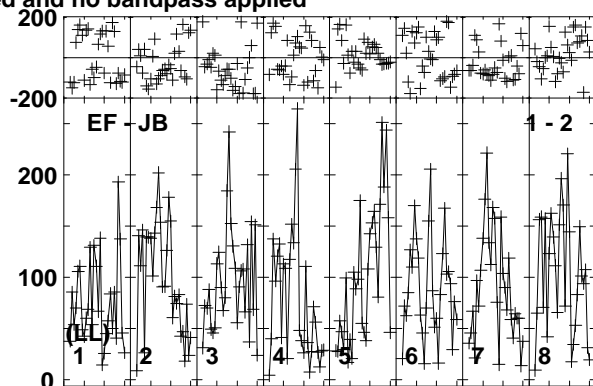
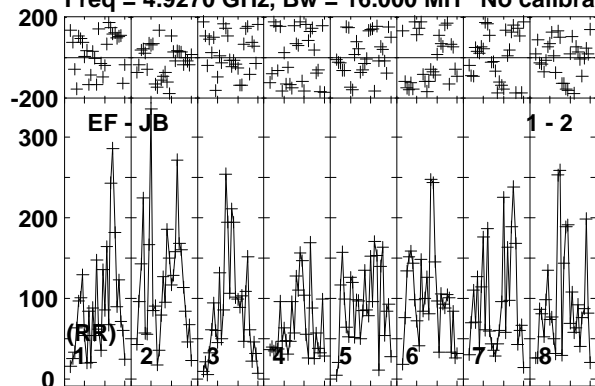

Lower frame: Micro Ampl Jy Top frame: Phas deg
Vector averaged cross-power spectrum Baseline: EF (01) - JB (02)
Timerange: 00/11:37:31 to 00/11:40:29

Plot file version 28 created 10-JUN-2016 16:07:48

J0716-1856 RG008D.UVDATA.1

Freq = 4.9270 GHz, Bw = 16.000 MH No calibration applied and no bandpass applied

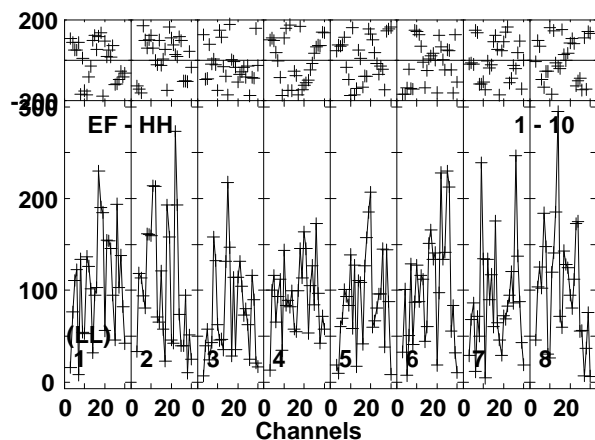
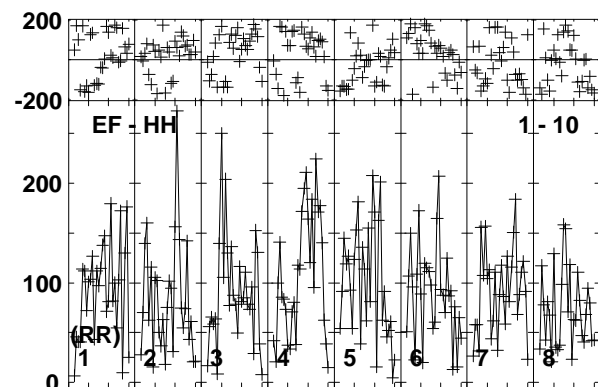
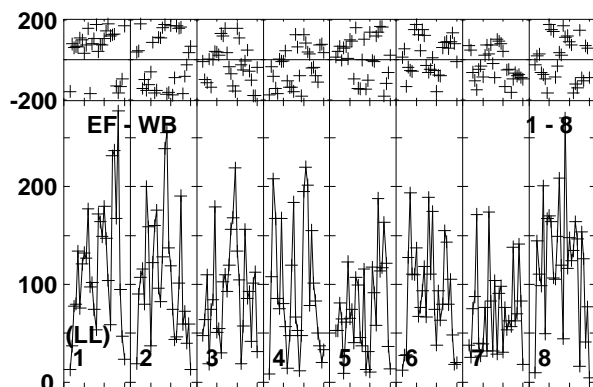
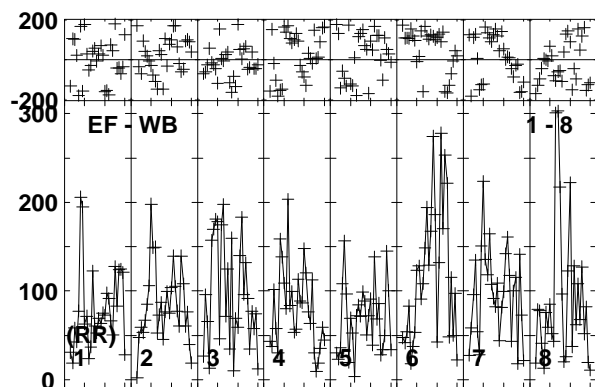
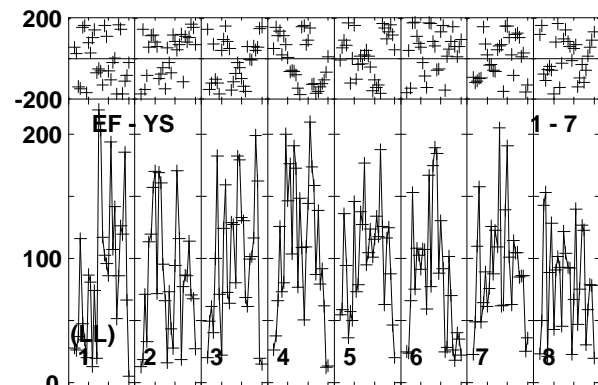
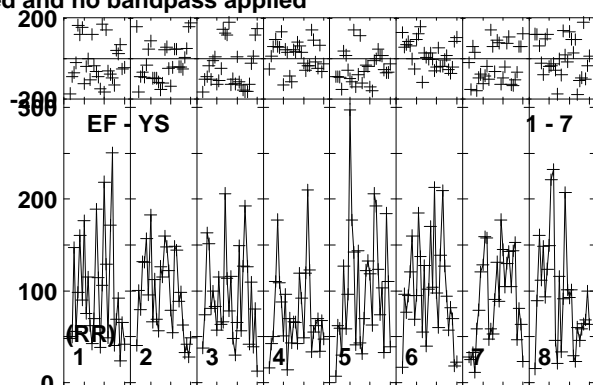
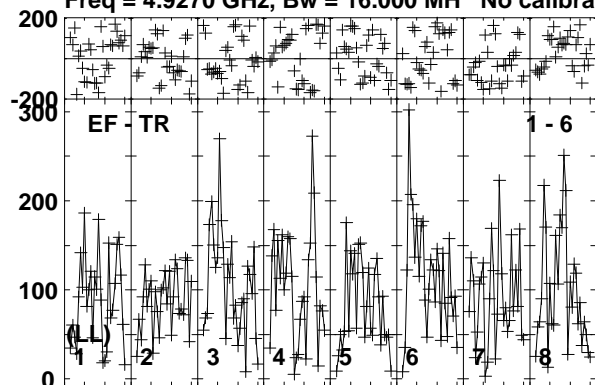

Lower frame: Micro Ampl Jy Top frame: Phas deg
Vector averaged cross-power spectrum Baseline: EF (01) - TR (06)
Timerange: 00/11:37:31 to 00/11:40:29

Plot file version 29 created 10-JUN-2016 16:07:48

J0718-1813 RG008D.UVDATA.1

Freq = 4.9270 GHz, Bw = 16.000 MH No calibration applied and no bandpass applied

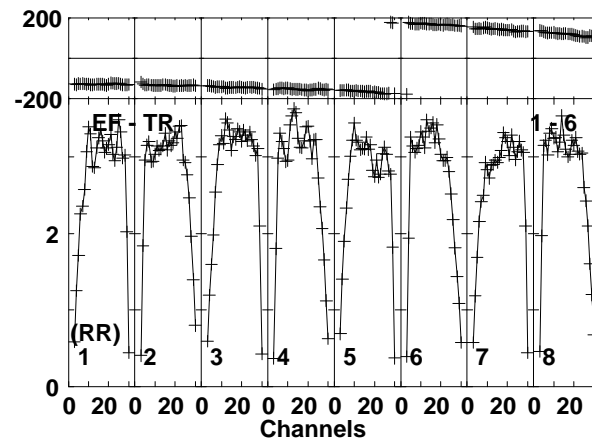
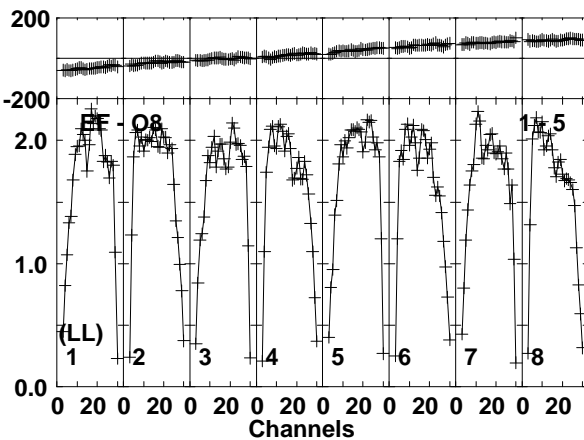
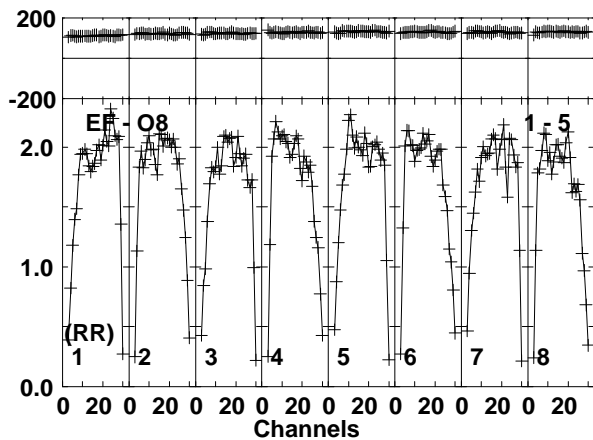
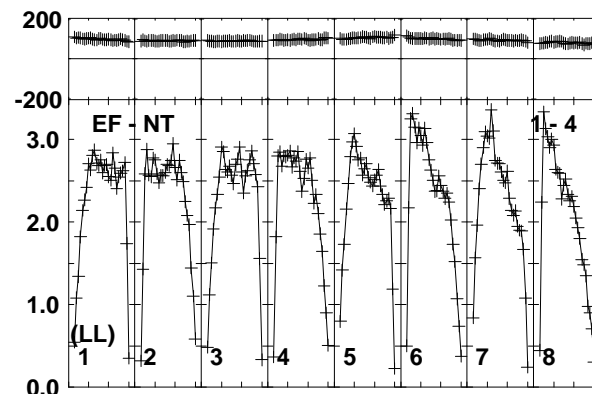
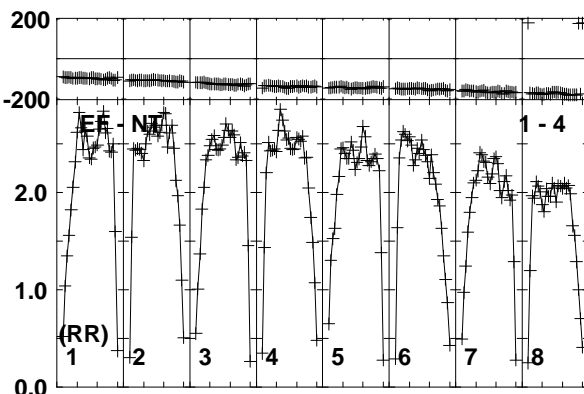
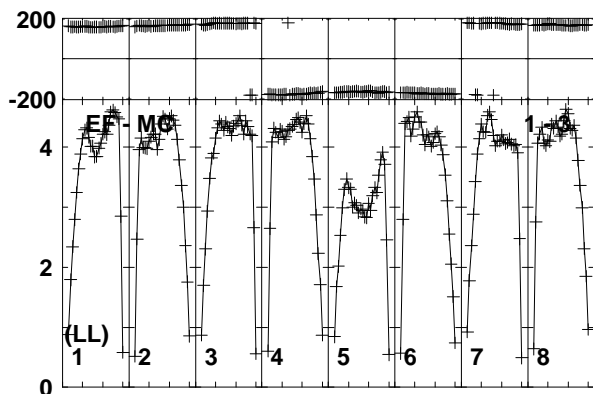
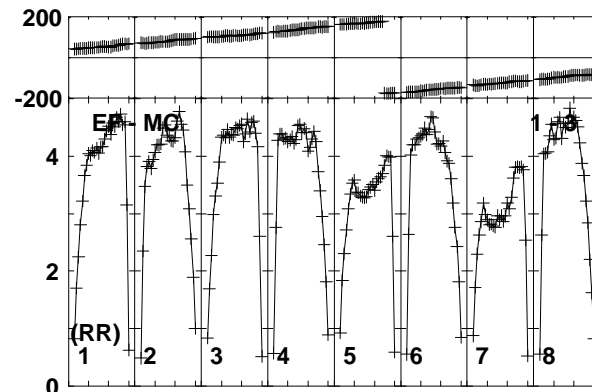
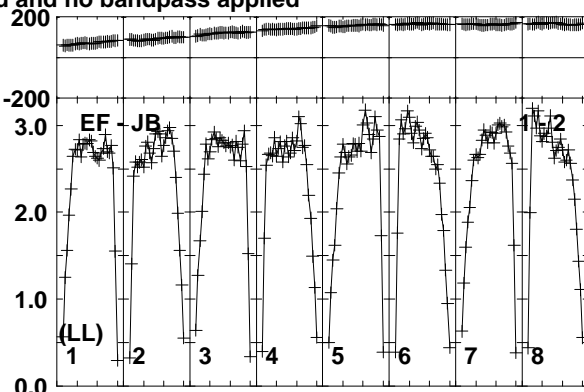
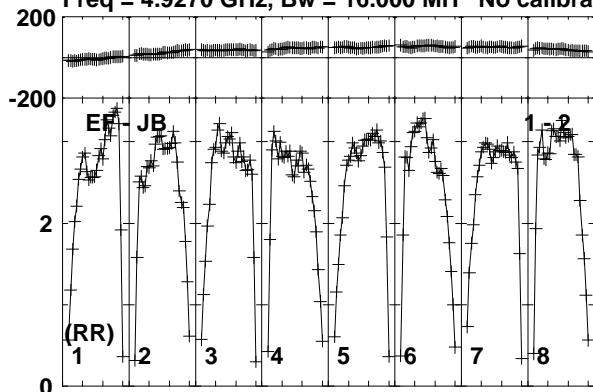

Lower frame: Milli Ampl Jy Top frame: Phas deg
Vector averaged cross-power spectrum Baseline: EF (01) - JB (02)
Timerange: 00/11:40:30 to 00/11:41:59

Plot file version 30 created 10-JUN-2016 16:07:49

J0718-1813 RG008D.UVDATA.1

Freq = 4.9270 GHz, Bw = 16.000 MH No calibration applied and no bandpass applied

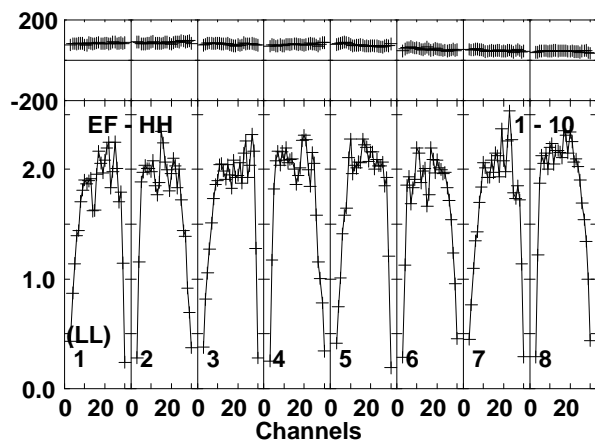
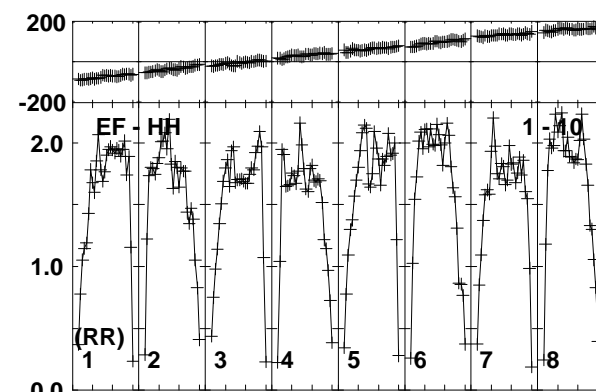
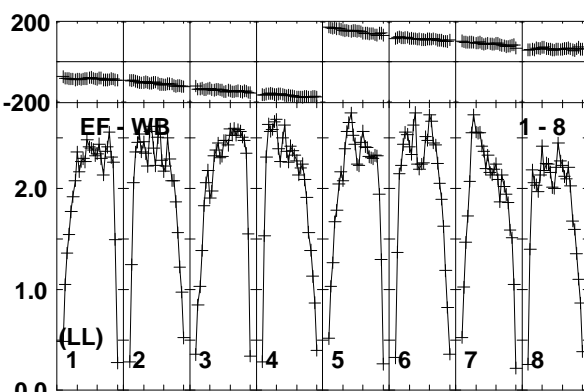
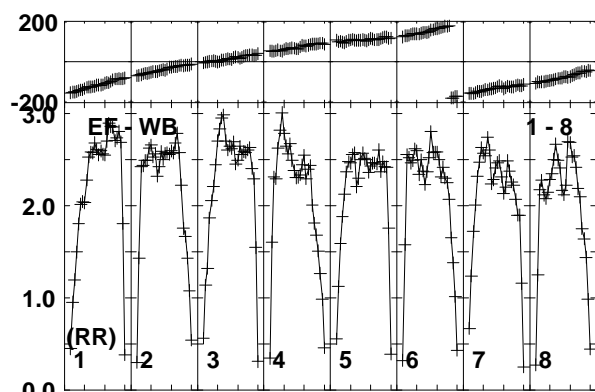
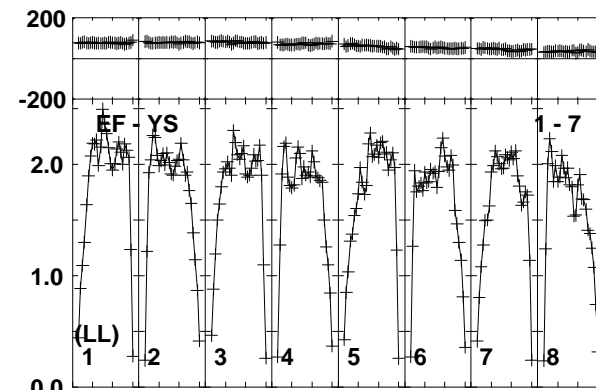
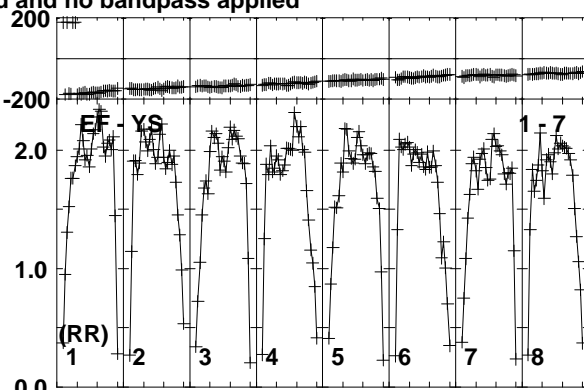
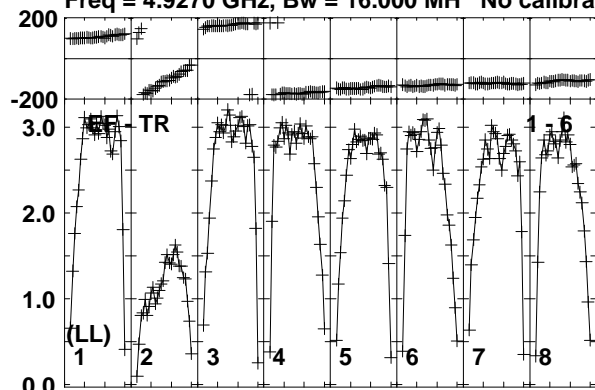

Lower frame: Milli Ampl Jy Top frame: Phas deg
Vector averaged cross-power spectrum Baseline: EF (01) - TR (06)
Timerange: 00/11:40:30 to 00/11:41:59

Plot file version 31 created 10-JUN-2016 16:07:49

FRB150418 RG008D.UVDATA.1

Freq = 4.9270 GHz, Bw = 16.000 MH No calibration applied and no bandpass applied

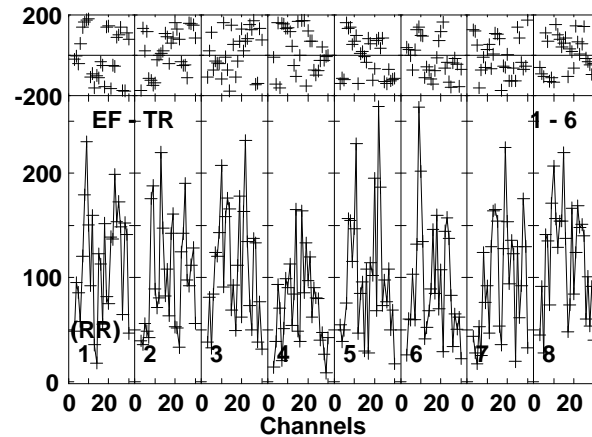
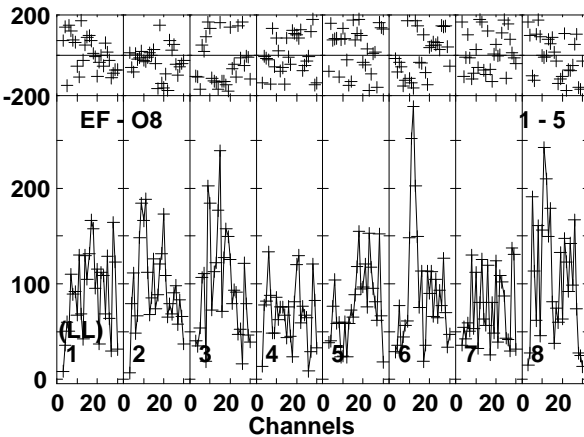
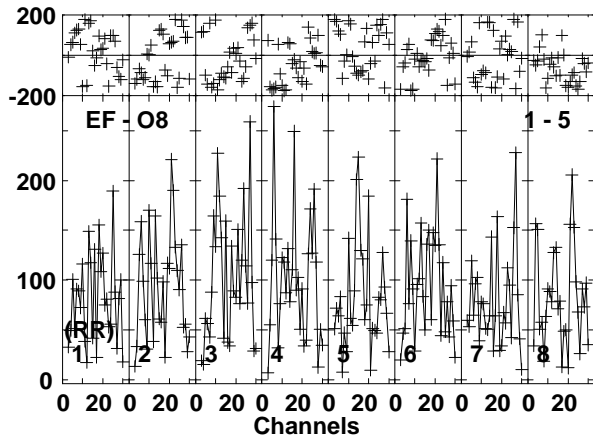
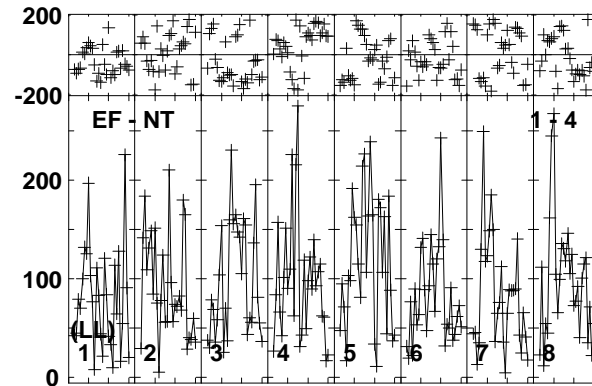
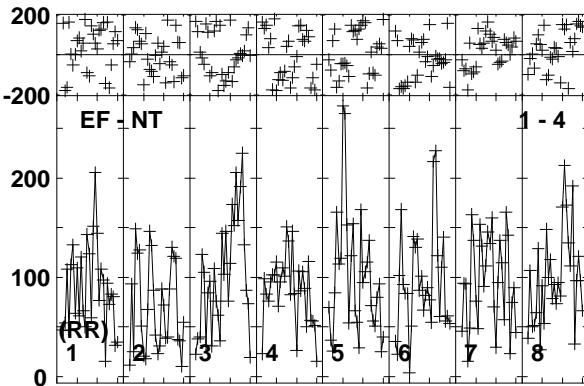
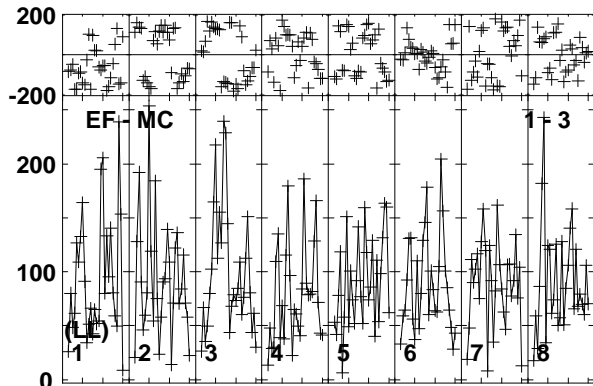
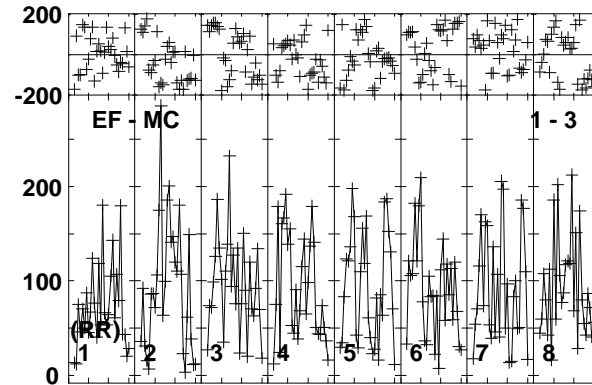
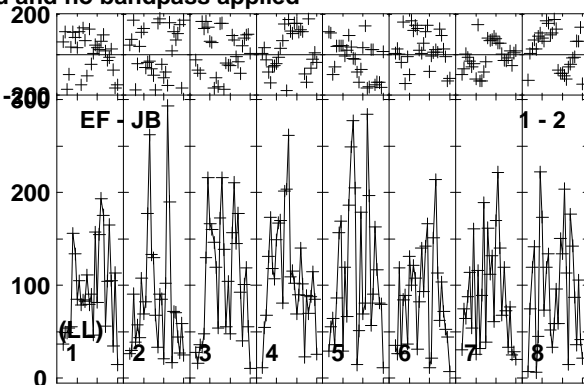
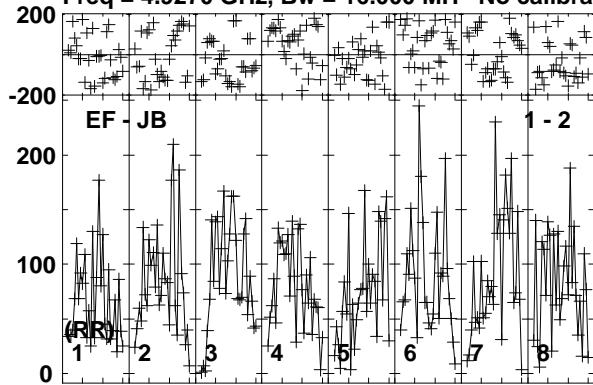

Lower frame: Micro Ampl Jy Top frame: Phas deg
Vector averaged cross-power spectrum Baseline: EF (01) - JB (02)
Timerange: 00/11:42:01 to 00/11:44:59

Plot file version 32 created 10-JUN-2016 16:07:49

FRB150418 RG008D.UVDATA.1

Freq = 4.9270 GHz, Bw = 16.000 MH No calibration applied and no bandpass applied

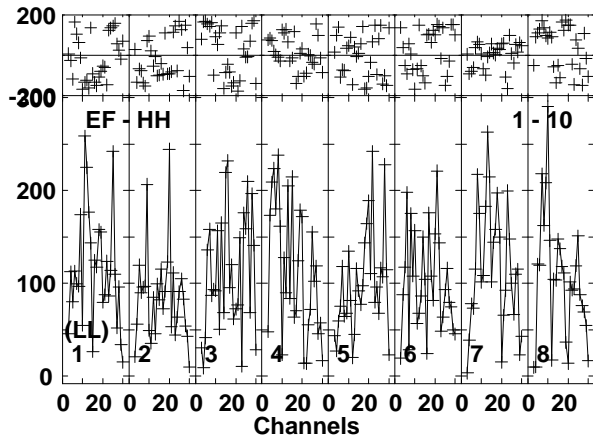
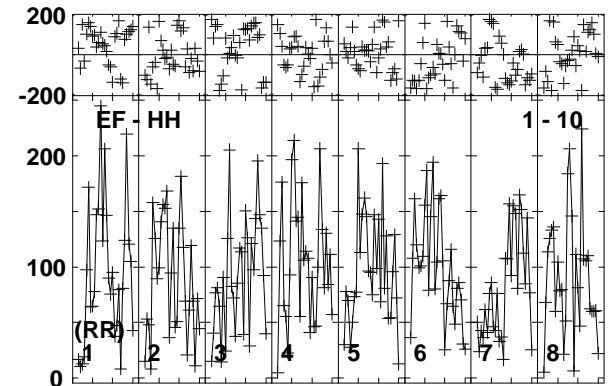
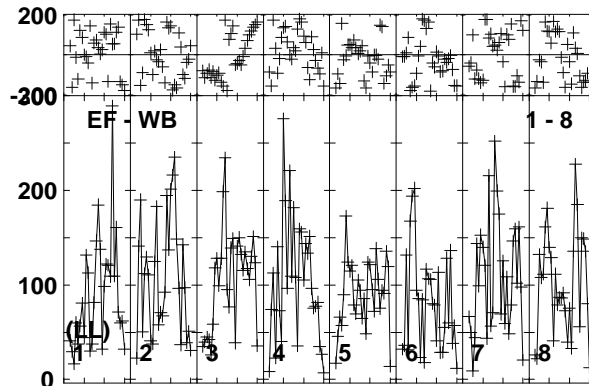
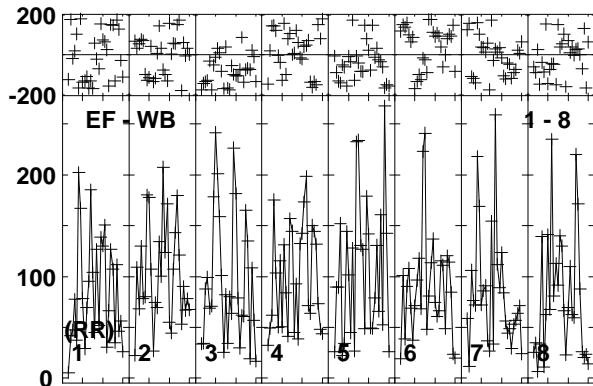
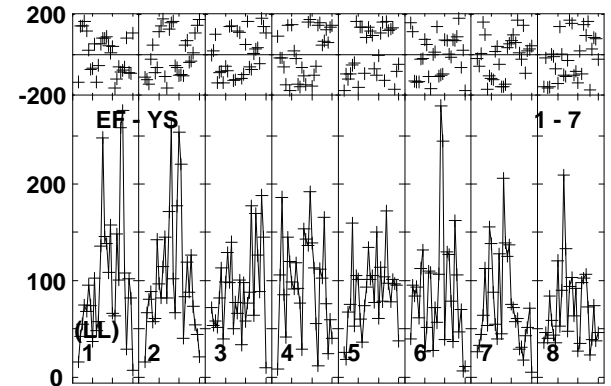
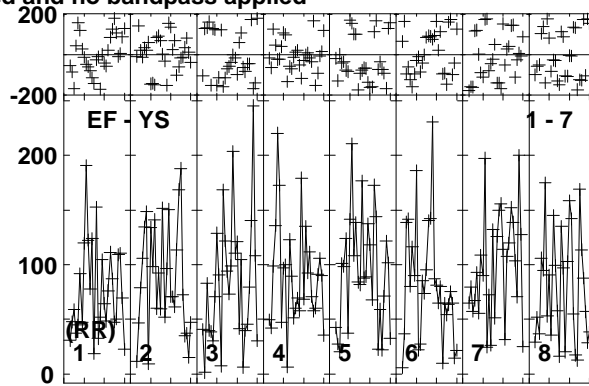
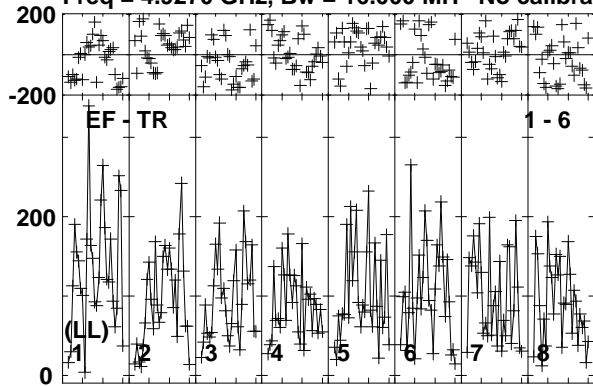

Lower frame: Micro Ampl Jy Top frame: Phas deg
Vector averaged cross-power spectrum Baseline: EF (01) - TR (06)
Timerange: 00/11:42:01 to 00/11:44:59

Plot file version 33 created 10-JUN-2016 16:07:49

J0718-1813 RG008D.UVDATA.1

Freq = 4.9270 GHz, Bw = 16.000 MH No calibration applied and no bandpass applied

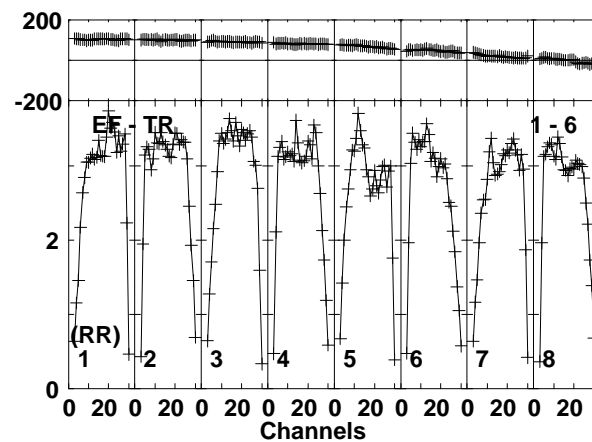
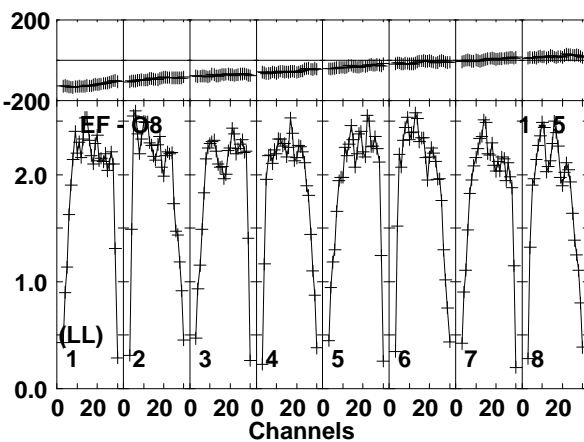
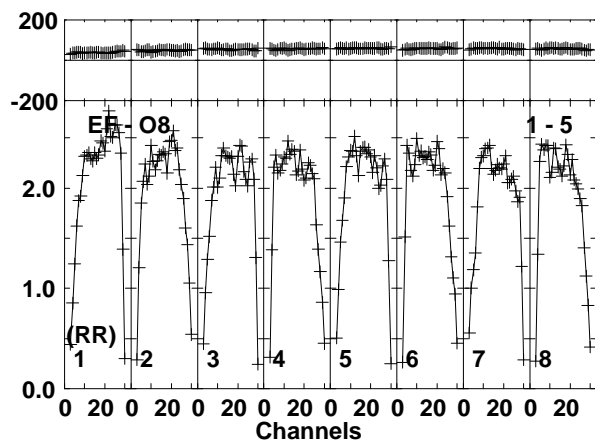
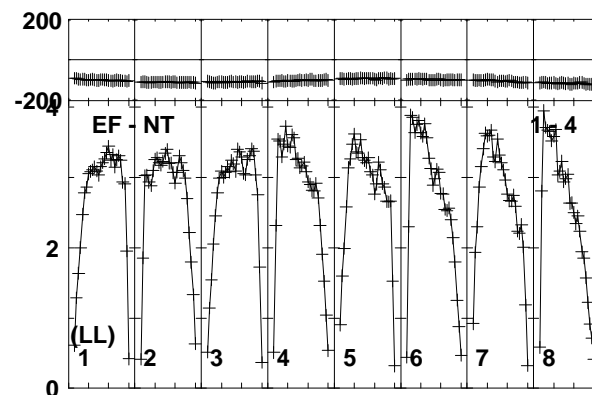
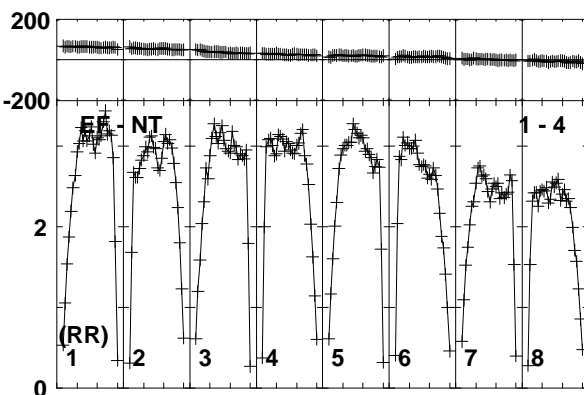
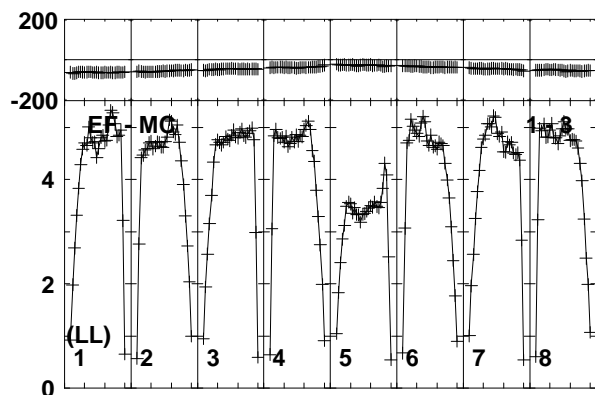
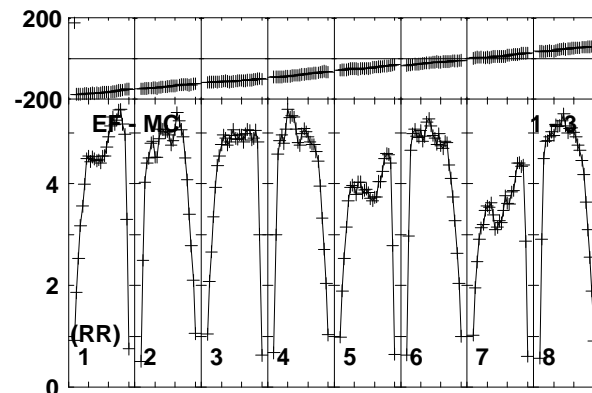
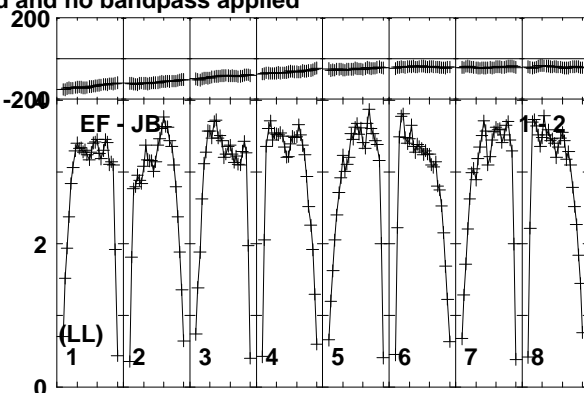
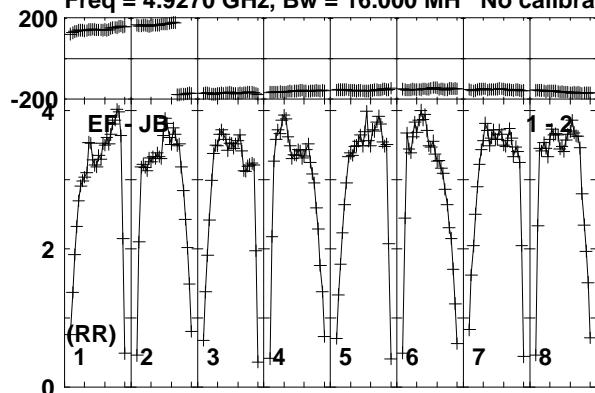

Lower frame: Milli Ampl Jy Top frame: Phas deg
Vector averaged cross-power spectrum Baseline: EF (01) - JB (02)
Timerange: 00/11:45:01 to 00/11:46:30

Plot file version 34 created 10-JUN-2016 16:07:49

J0718-1813 RG008D.UVDATA.1

Freq = 4.9270 GHz, Bw = 16.000 MH No calibration applied and no bandpass applied

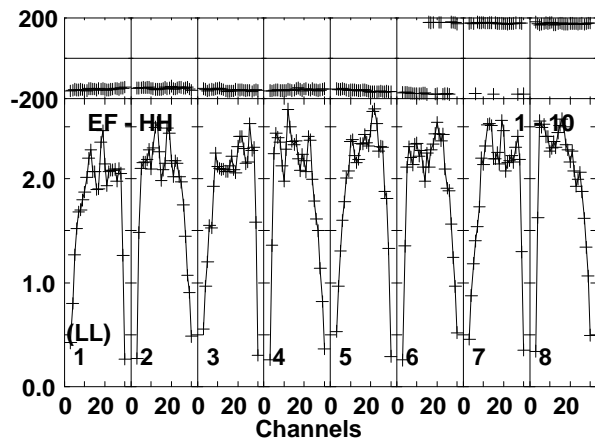
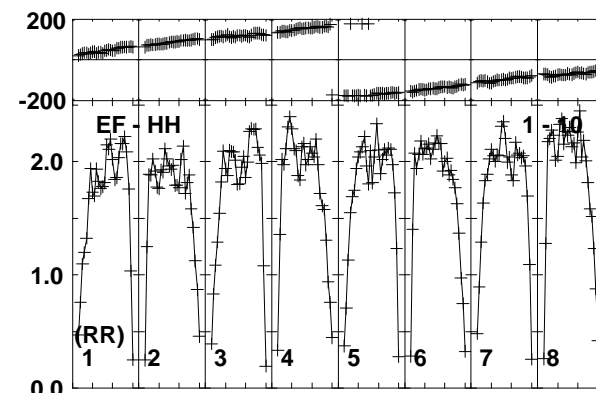
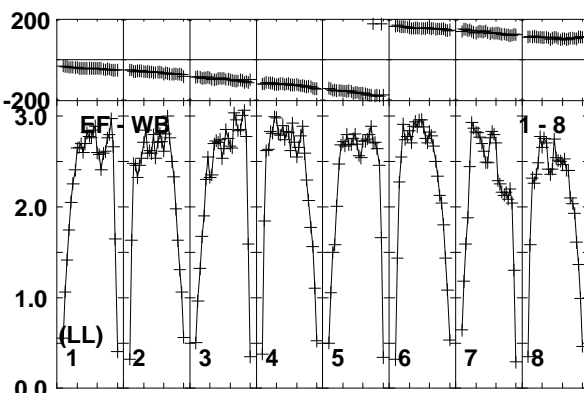
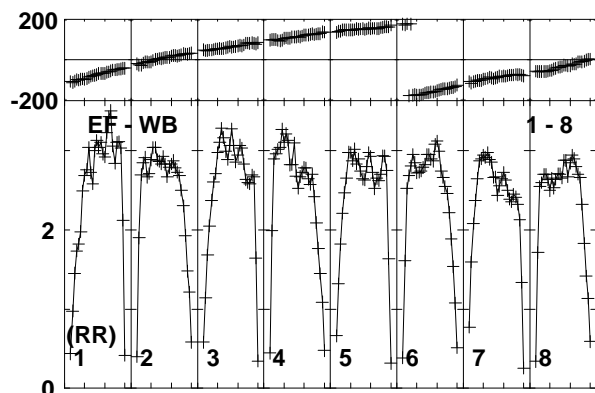
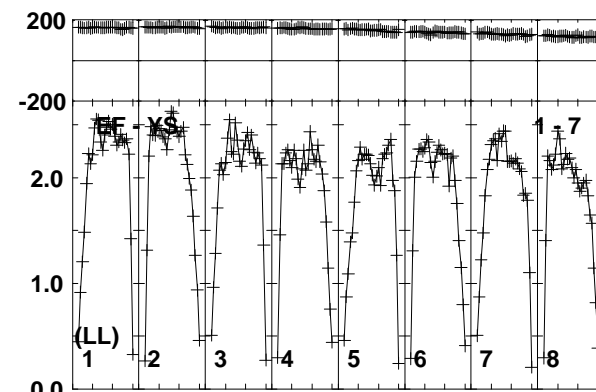
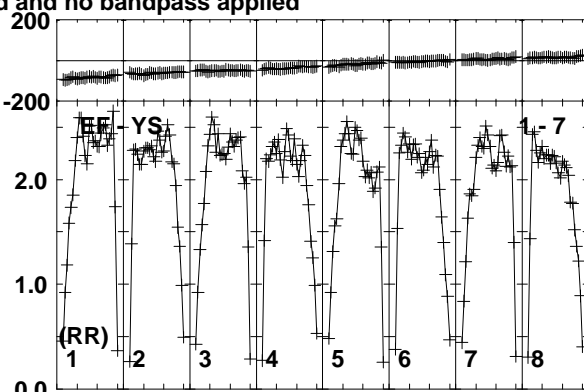
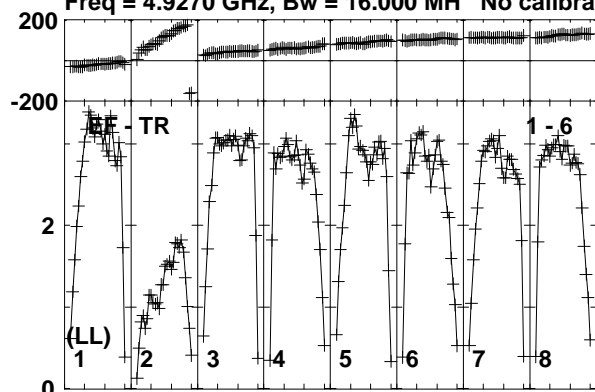

Lower frame: Milli Ampl Jy Top frame: Phas deg
Vector averaged cross-power spectrum Baseline: EF (01) - TR (06)
Timerange: 00/11:45:01 to 00/11:46:30

Plot file version 35 created 10-JUN-2016 16:07:49

J0716-1900 RG008D.UVDATA.1

Freq = 4.9270 GHz, Bw = 16.000 MH No calibration applied and no bandpass applied

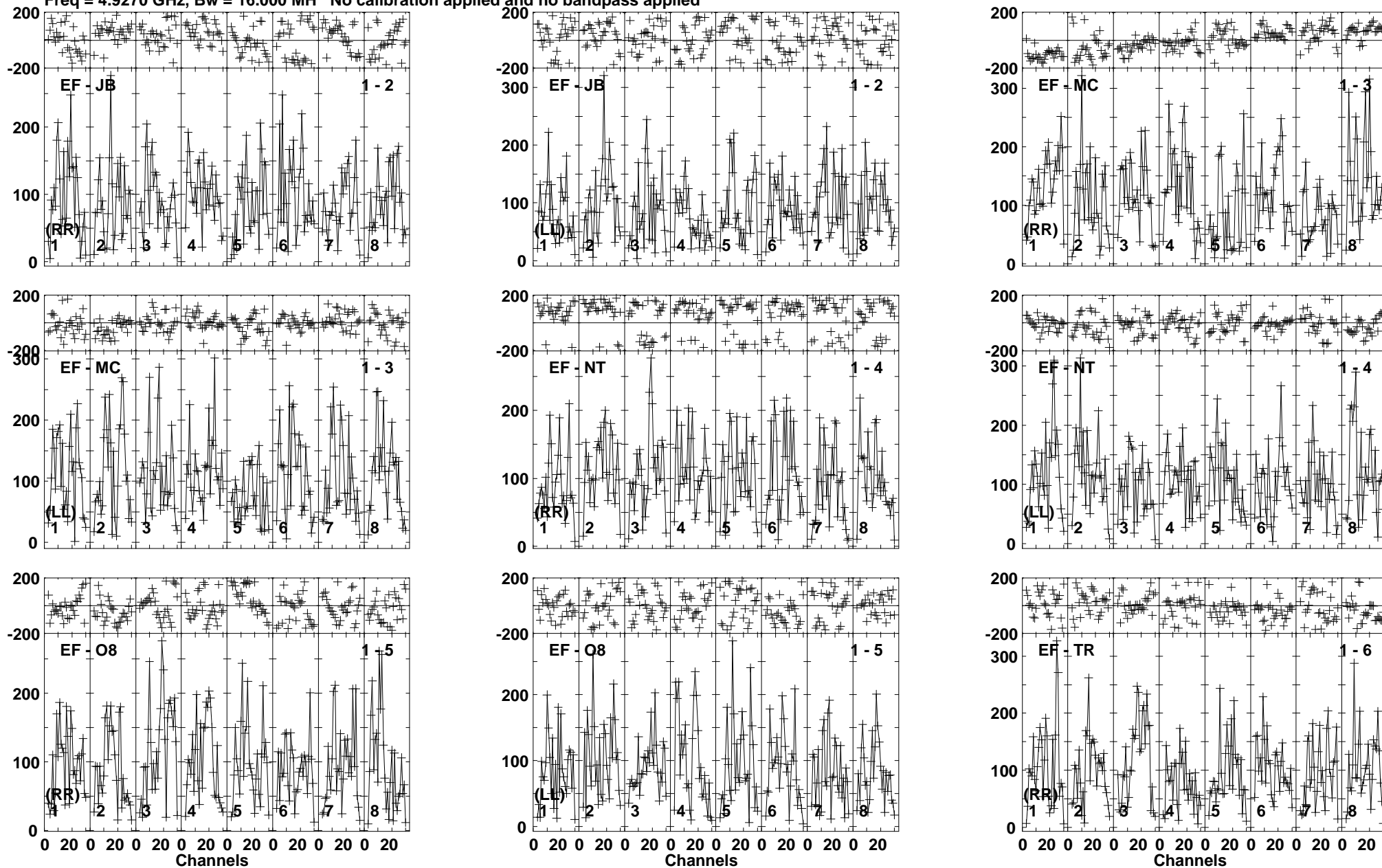

Lower frame: Micro Ampl Jy Top frame: Phas deg
Vector averaged cross-power spectrum Baseline: EF (01) - JB (02)
Timerange: 00/11:46:30 to 00/11:49:30

Plot file version 36 created 10-JUN-2016 16:07:49

J0716-1900 RG008D.UVDATA.1

Freq = 4.9270 GHz, Bw = 16.000 MH No calibration applied and no bandpass applied

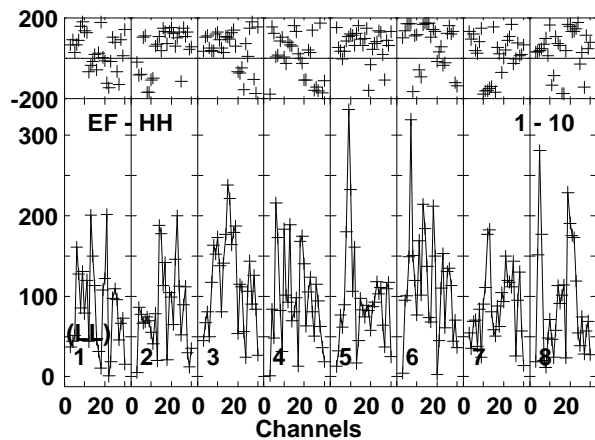
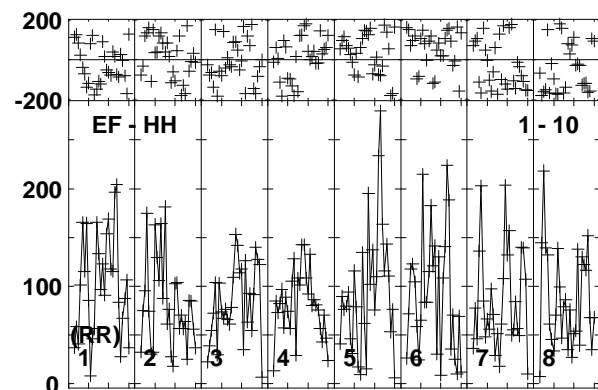
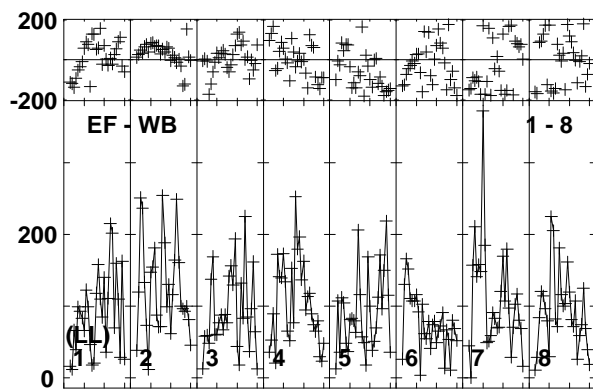
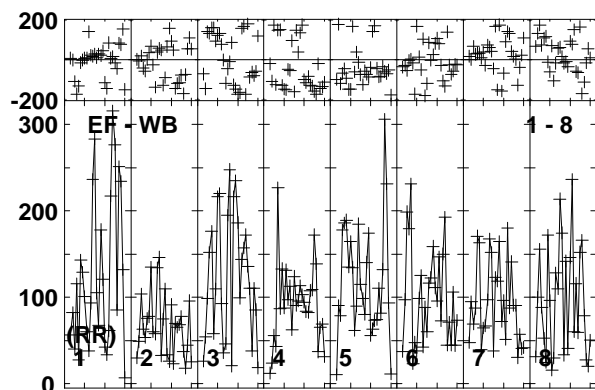
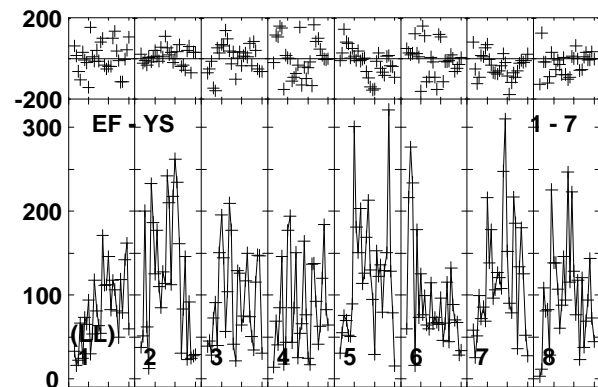
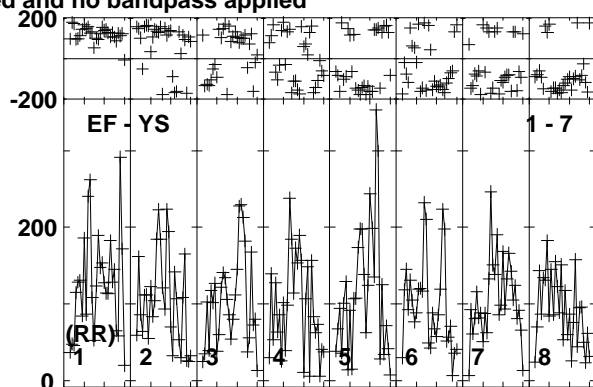
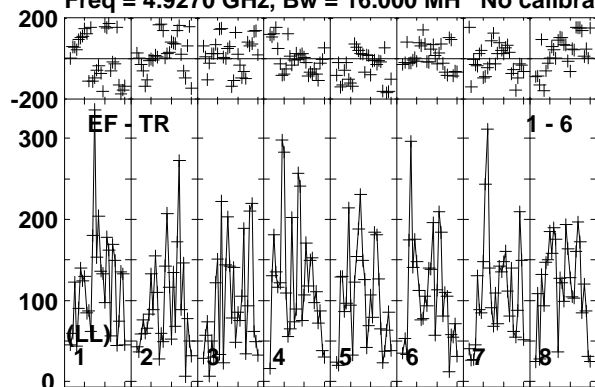

Lower frame: Micro Ampl Jy Top frame: Phas deg
Vector averaged cross-power spectrum Baseline: EF (01) - TR (06)
Timerange: 00/11:46:30 to 00/11:49:30

Plot file version 37 created 10-JUN-2016 16:07:50

J0718-1813 RG008D.UVDATA.1

Freq = 4.9270 GHz, Bw = 16.000 MH No calibration applied and no bandpass applied

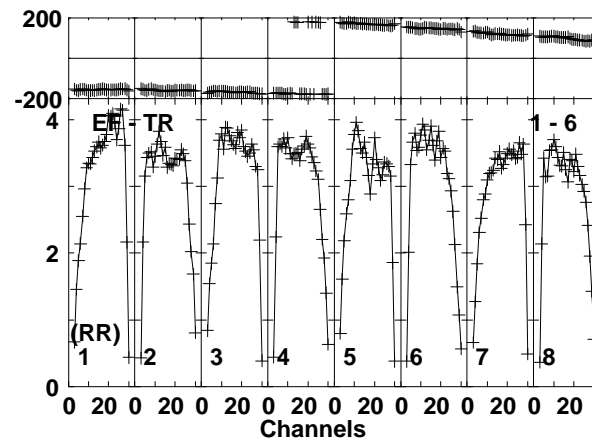
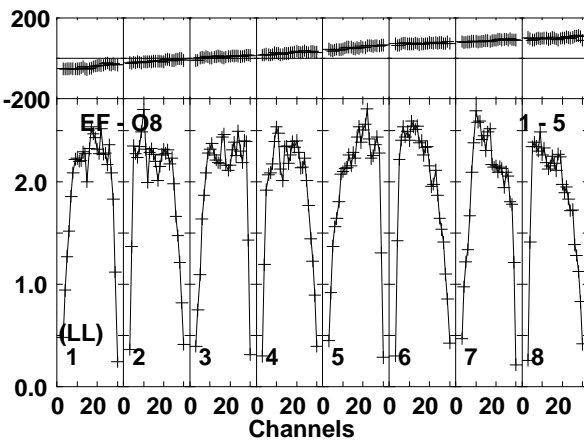
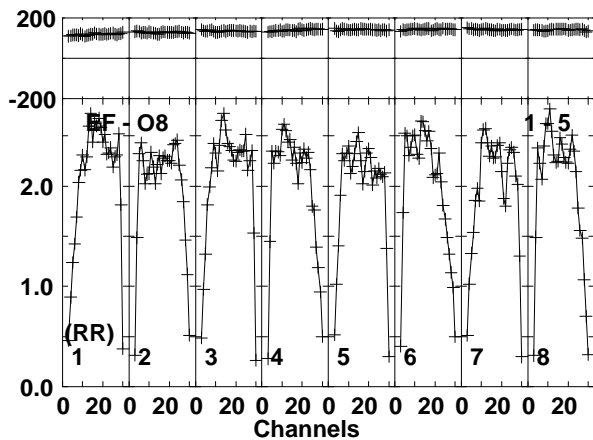
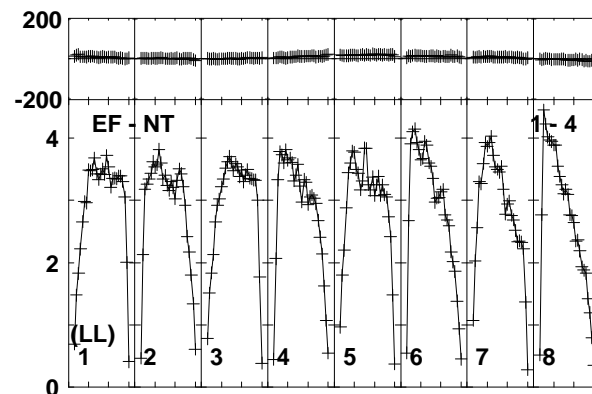
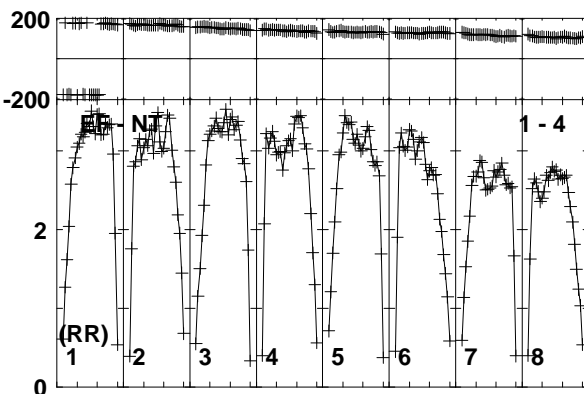
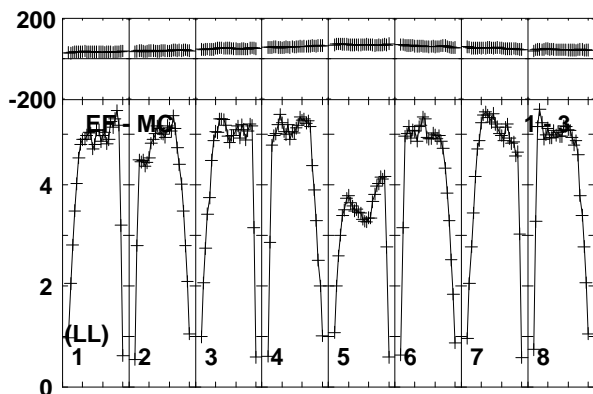
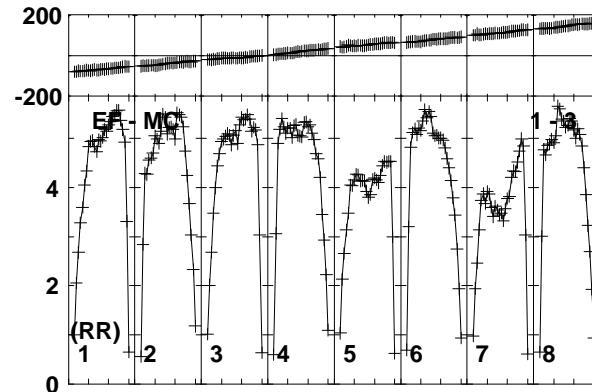
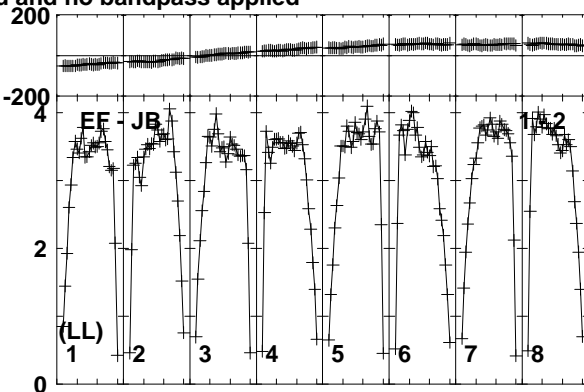
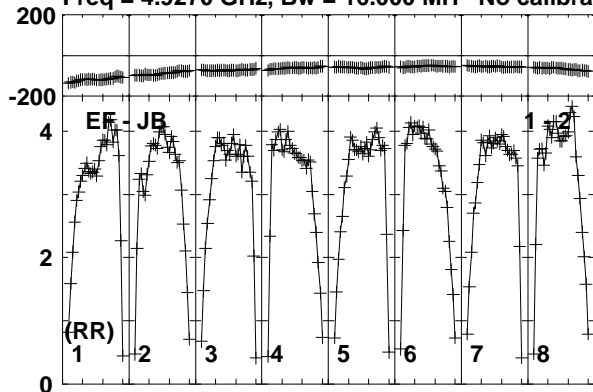

Lower frame: Milli Ampl Jy Top frame: Phas deg
Vector averaged cross-power spectrum Baseline: EF (01) - JB (02)
Timerange: 00/11:50:11 to 00/11:51:00

Plot file version 38 created 10-JUN-2016 16:07:50

J0718-1813 RG008D.UVDATA.1

Freq = 4.9270 GHz, Bw = 16.000 MH No calibration applied and no bandpass applied

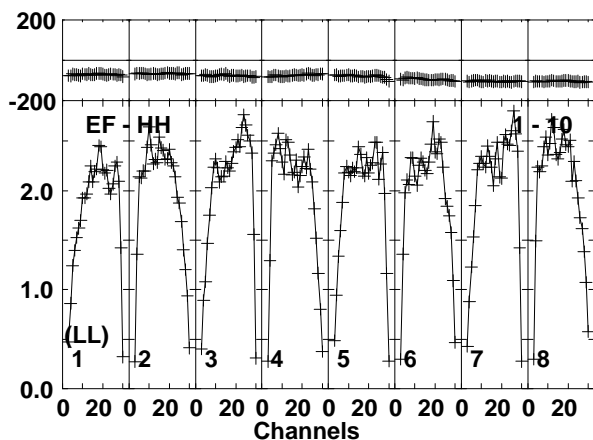
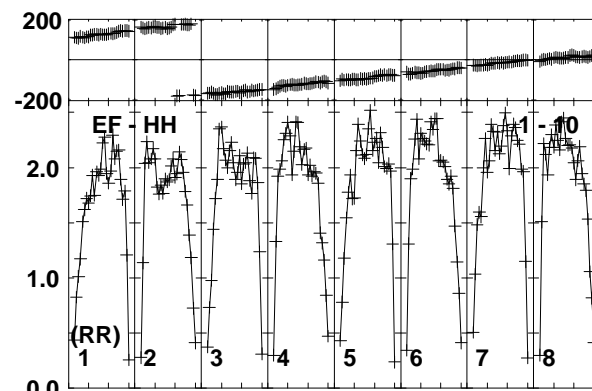
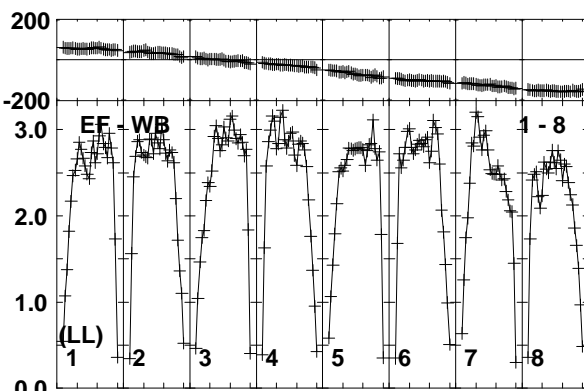
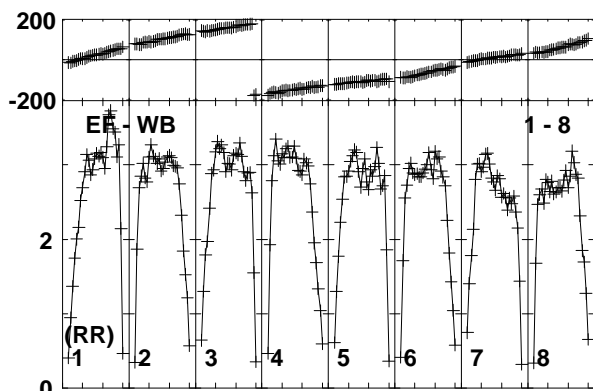
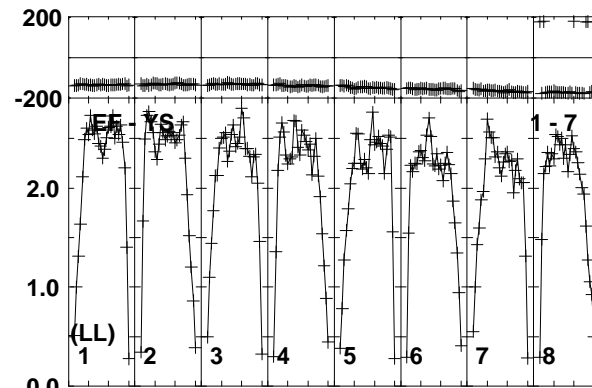
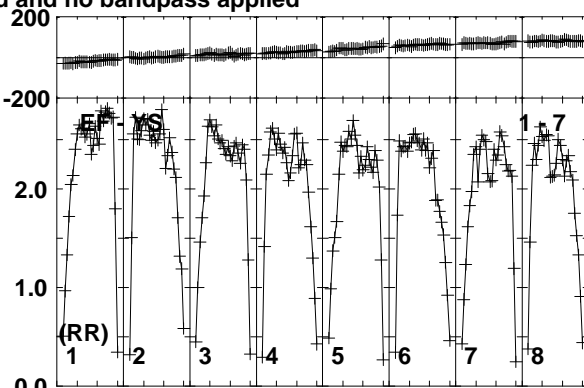
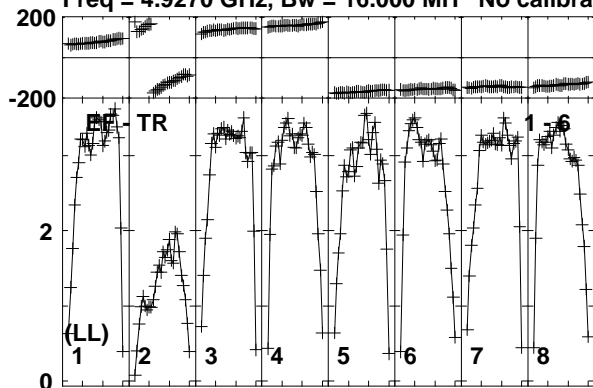

Lower frame: Milli Ampl Jy Top frame: Phas deg
Vector averaged cross-power spectrum Baseline: EF (01) - TR (06)
Timerange: 00/11:50:11 to 00/11:51:00

Plot file version 39 created 10-JUN-2016 16:07:50

FRB150418 RG008D.UVDATA.1

Freq = 4.9270 GHz, Bw = 16.000 MH No calibration applied and no bandpass applied

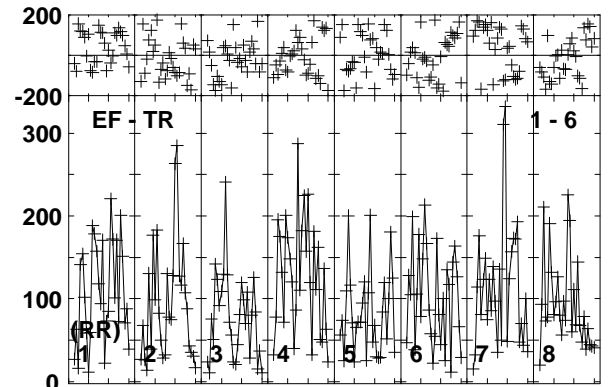
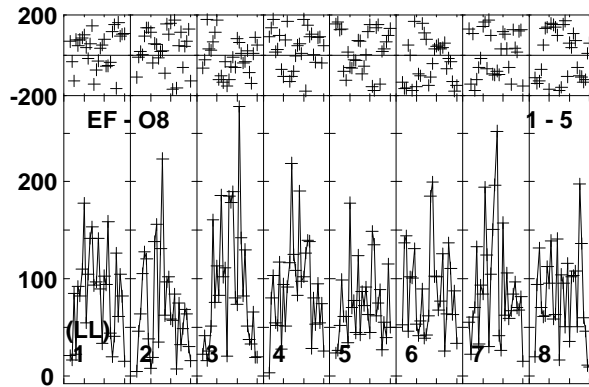
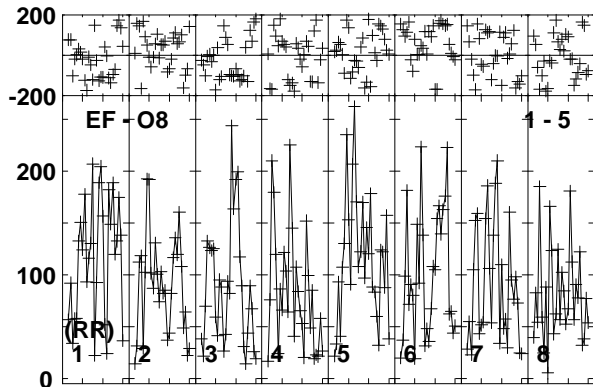
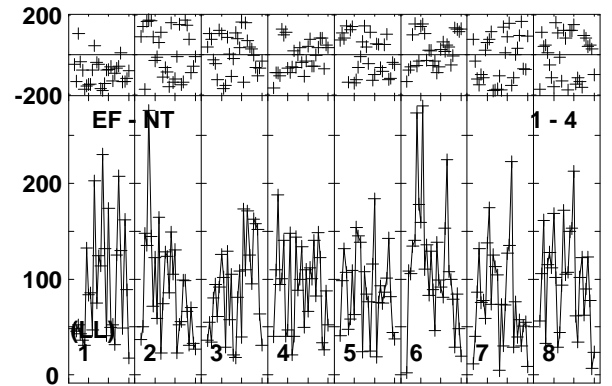
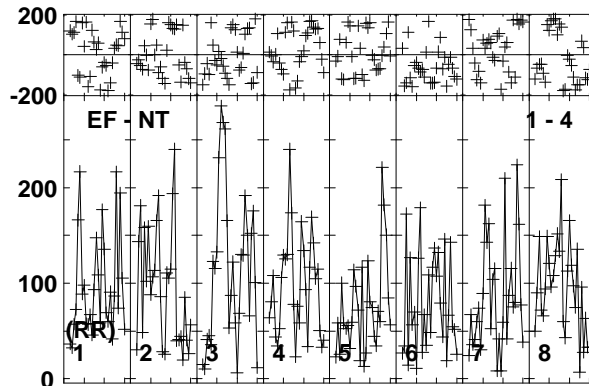
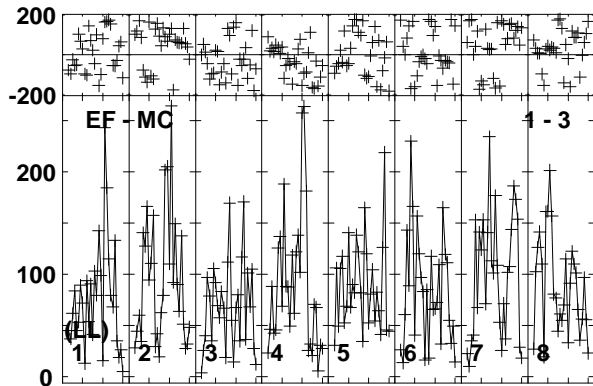
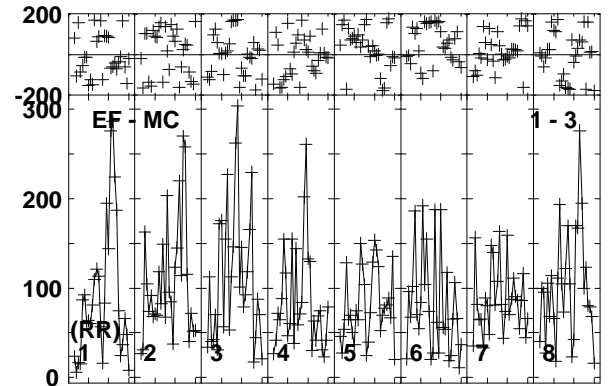
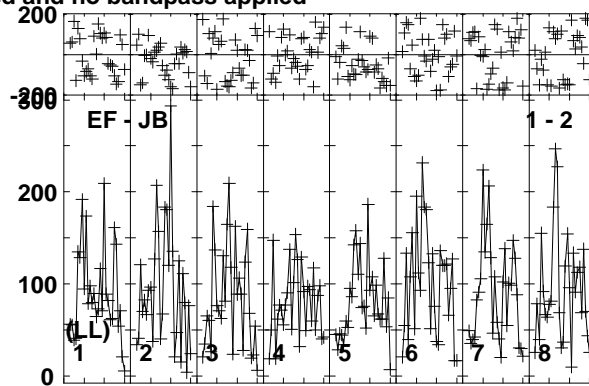
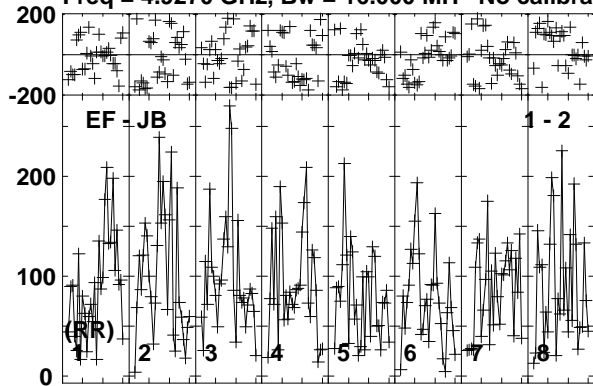

Lower frame: Micro Ampl Jy Top frame: Phas deg
Vector averaged cross-power spectrum Baseline: EF (01) - JB (02)
Timerange: 00/11:51:01 to 00/11:54:00

Plot file version 40 created 10-JUN-2016 16:07:50

FRB150418 RG008D.UVDATA.1

Freq = 4.9270 GHz, Bw = 16.000 MH No calibration applied and no bandpass applied

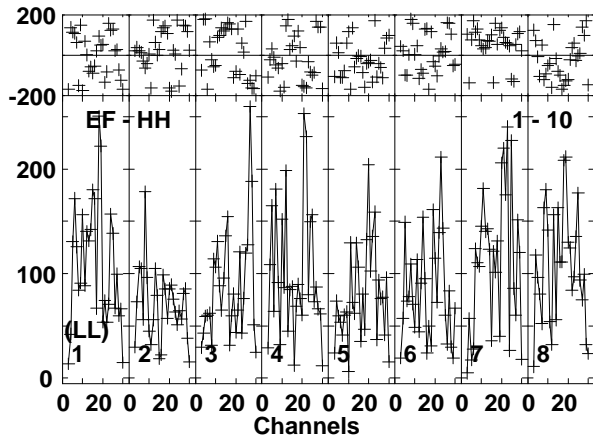
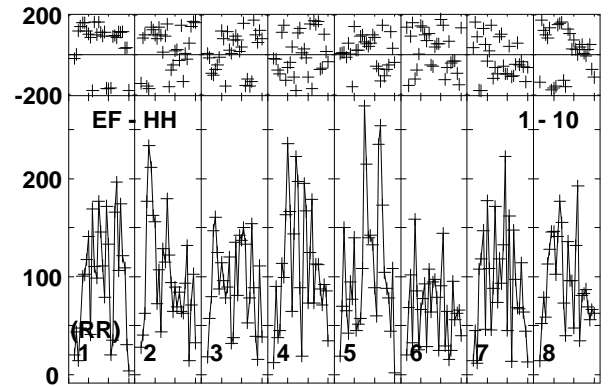
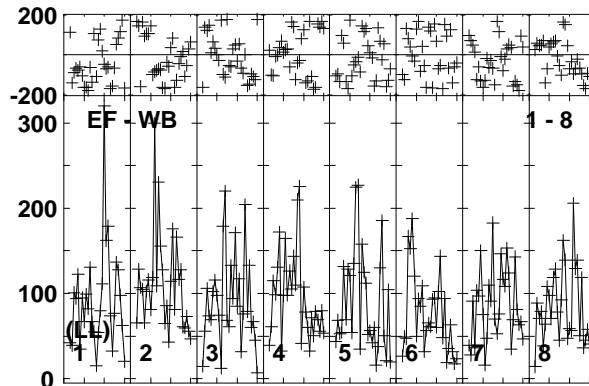
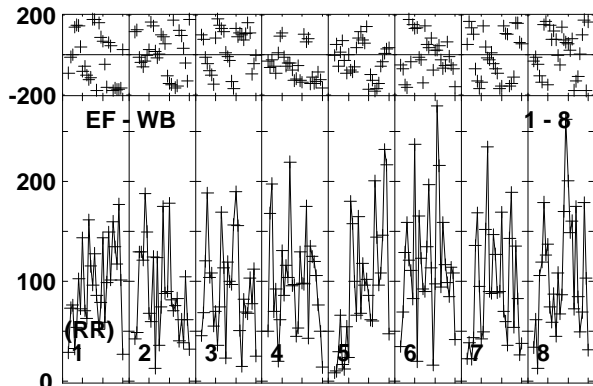
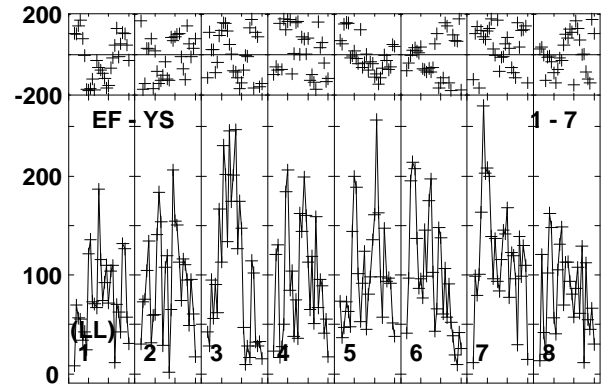
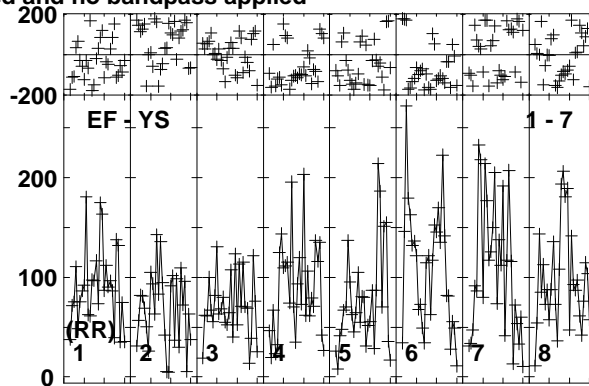
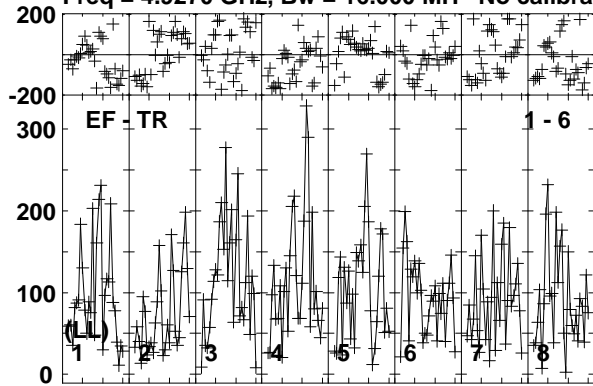

Lower frame: Micro Ampl Jy Top frame: Phas deg
Vector averaged cross-power spectrum Baseline: EF (01) - TR (06)
Timerange: 00/11:51:01 to 00/11:54:00

Plot file version 41 created 10-JUN-2016 16:07:50

J0718-1813 RG008D.UVDATA.1

Freq = 4.9270 GHz, Bw = 16.000 MH No calibration applied and no bandpass applied

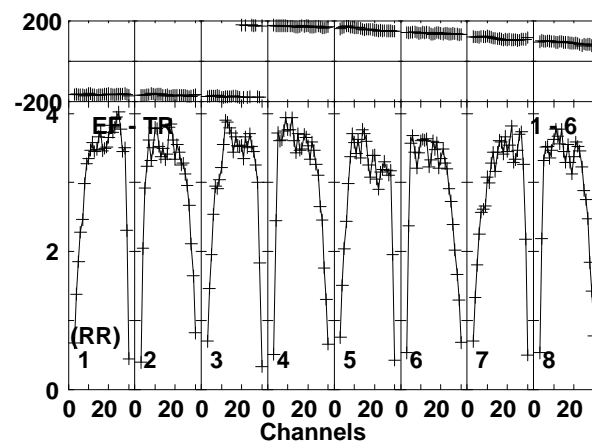
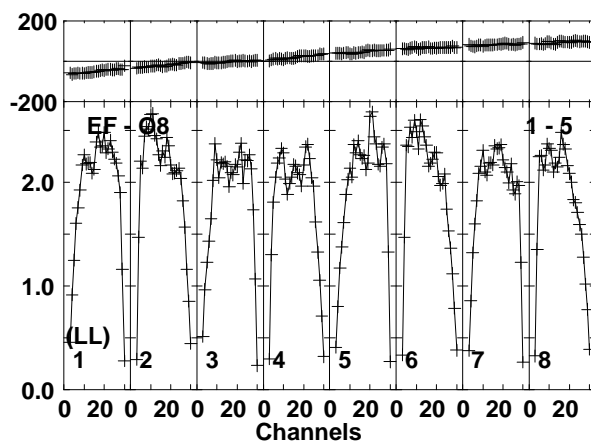
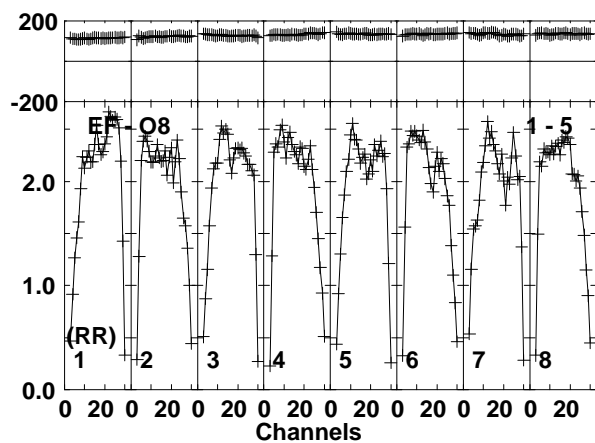
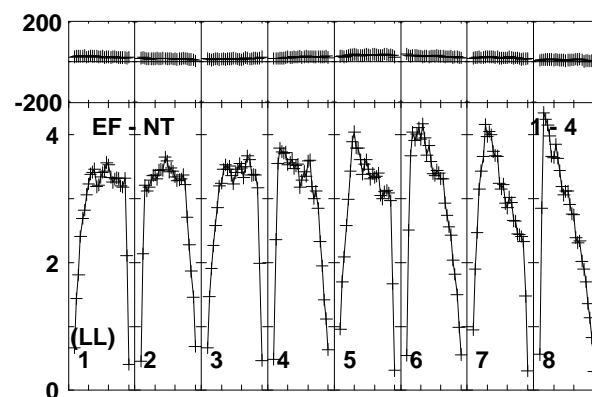
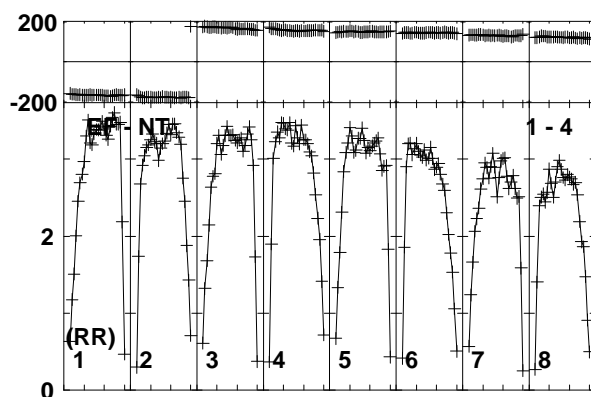
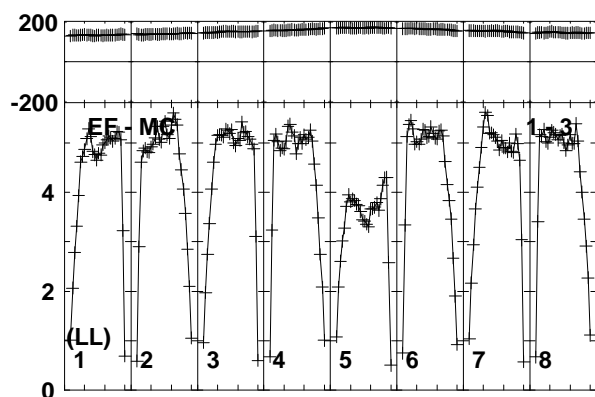
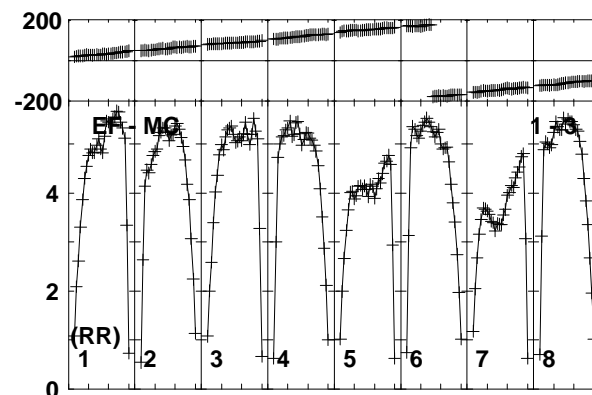
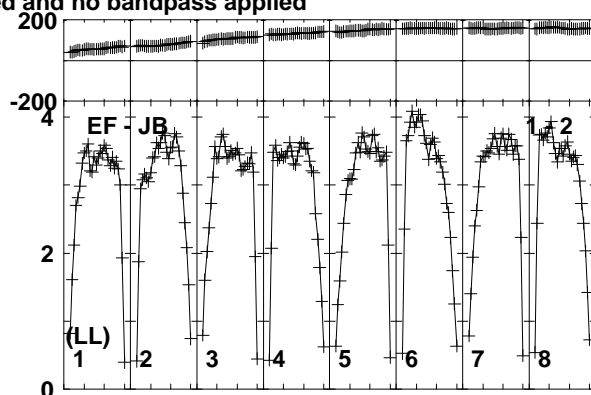
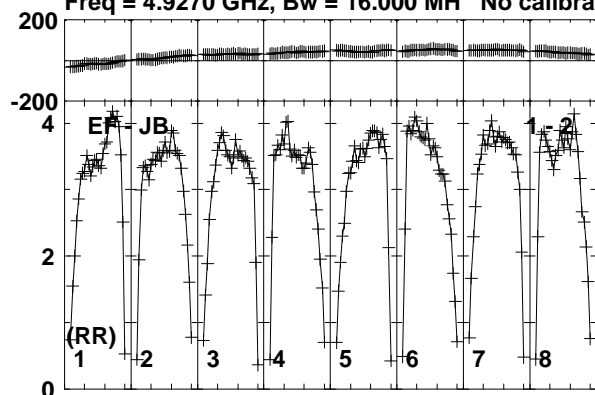

Lower frame: Milli Ampl Jy Top frame: Phas deg
Vector averaged cross-power spectrum Baseline: EF (01) - JB (02)
Timerange: 00/11:54:00 to 00/11:55:29

Plot file version 42 created 10-JUN-2016 16:07:50

J0718-1813 RG008D.UVDATA.1

Freq = 4.9270 GHz, Bw = 16.000 MH No calibration applied and no bandpass applied

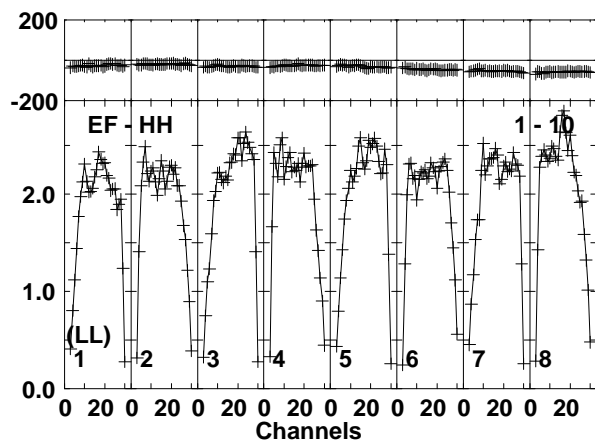
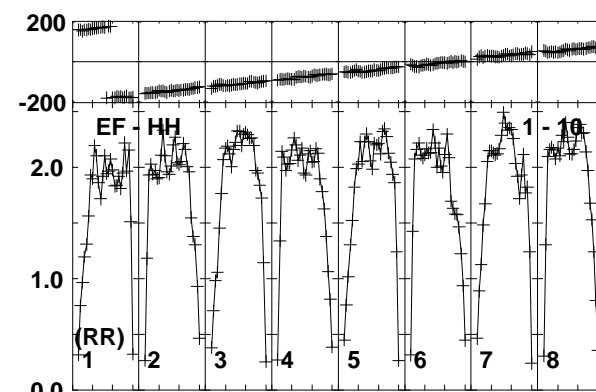
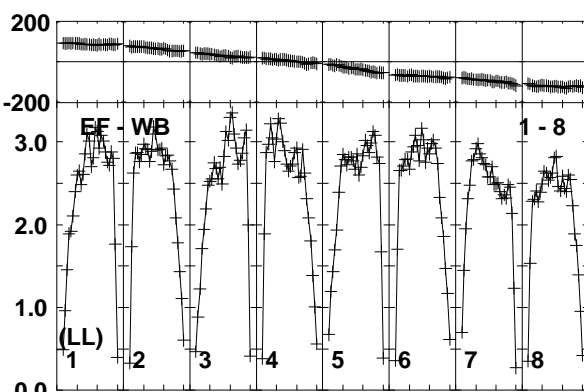
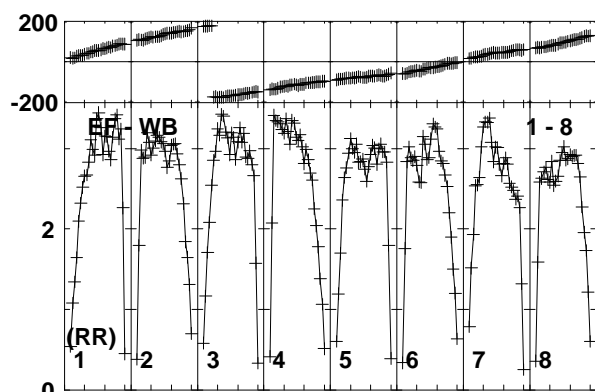
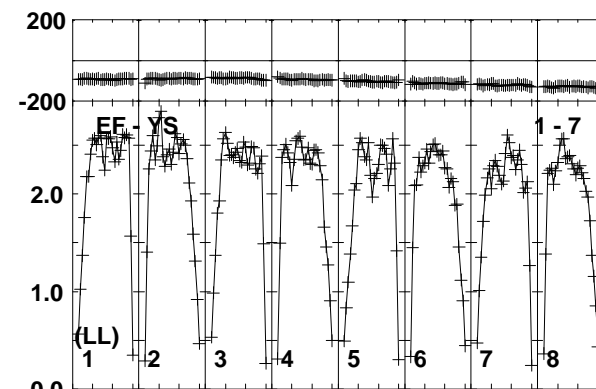
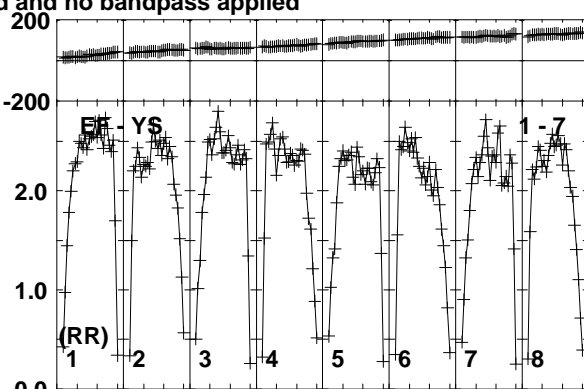
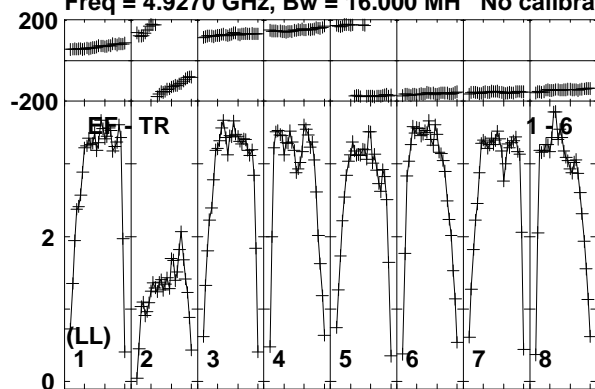

Lower frame: Milli Ampl Jy Top frame: Phas deg
Vector averaged cross-power spectrum Baseline: EF (01) - TR (06)
Timerange: 00/11:54:00 to 00/11:55:29

Plot file version 43 created 10-JUN-2016 16:07:50

FRB150418 RG008D.UVDATA.1

Freq = 4.9270 GHz, Bw = 16.000 MH No calibration applied and no bandpass applied

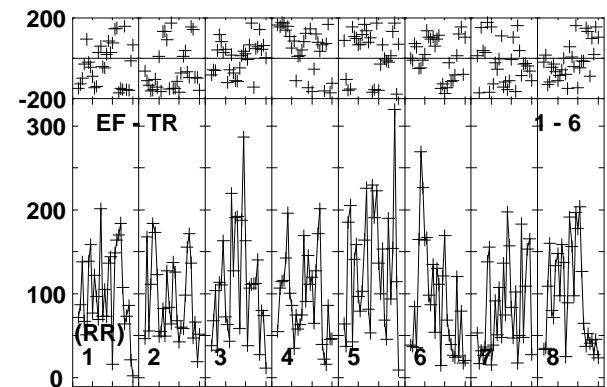
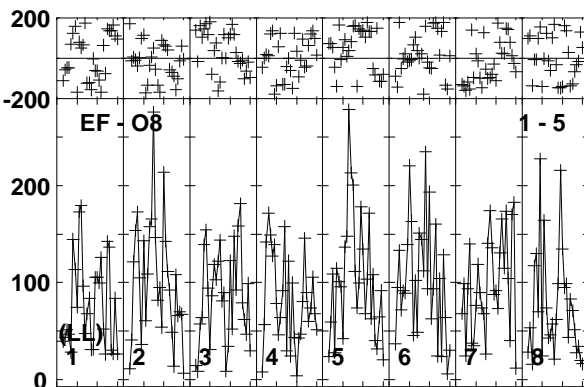
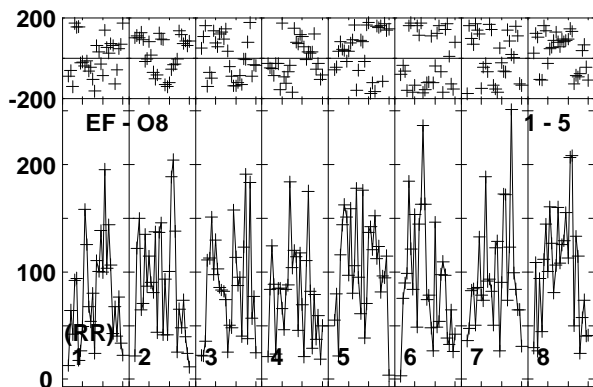
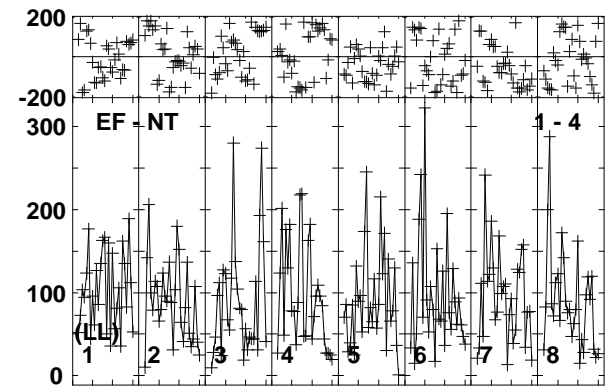
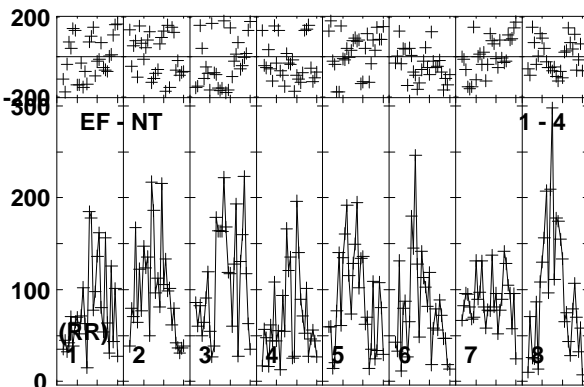
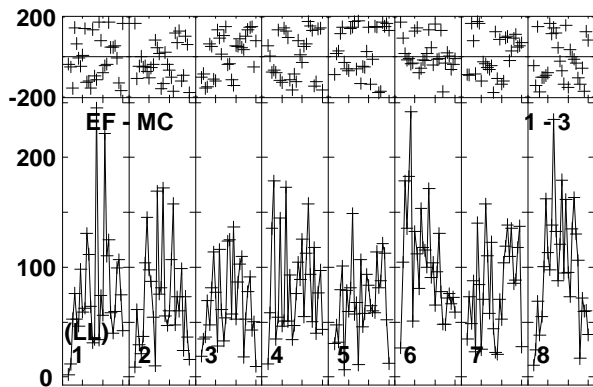
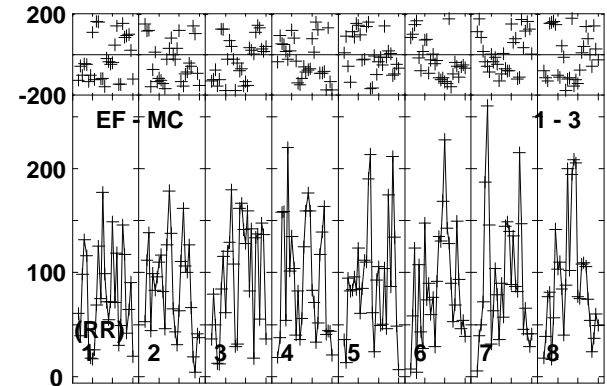
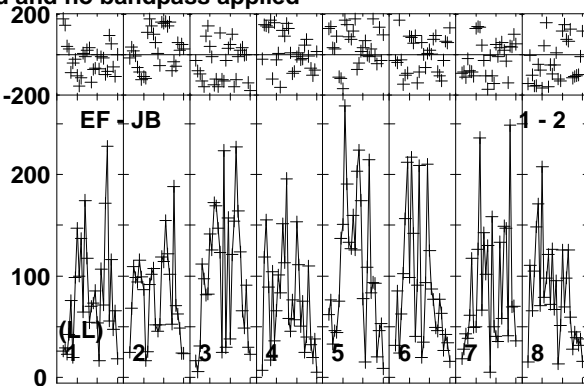
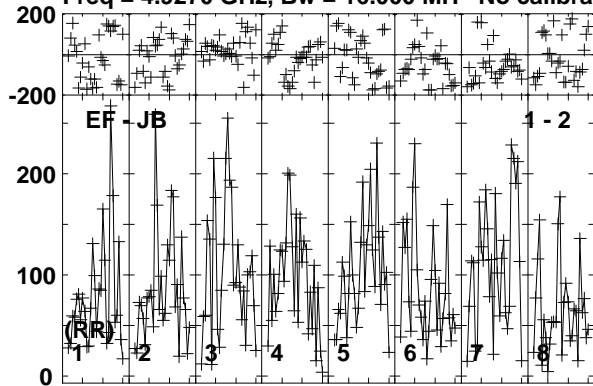

Lower frame: Micro Ampl Jy Top frame: Phas deg
Vector averaged cross-power spectrum Baseline: EF (01) - JB (02)
Timerange: 00/11:55:31 to 00/11:58:30

Plot file version 44 created 10-JUN-2016 16:07:50

FRB150418 RG008D.UVDATA.1

Freq = 4.9270 GHz, Bw = 16.000 MH No calibration applied and no bandpass applied

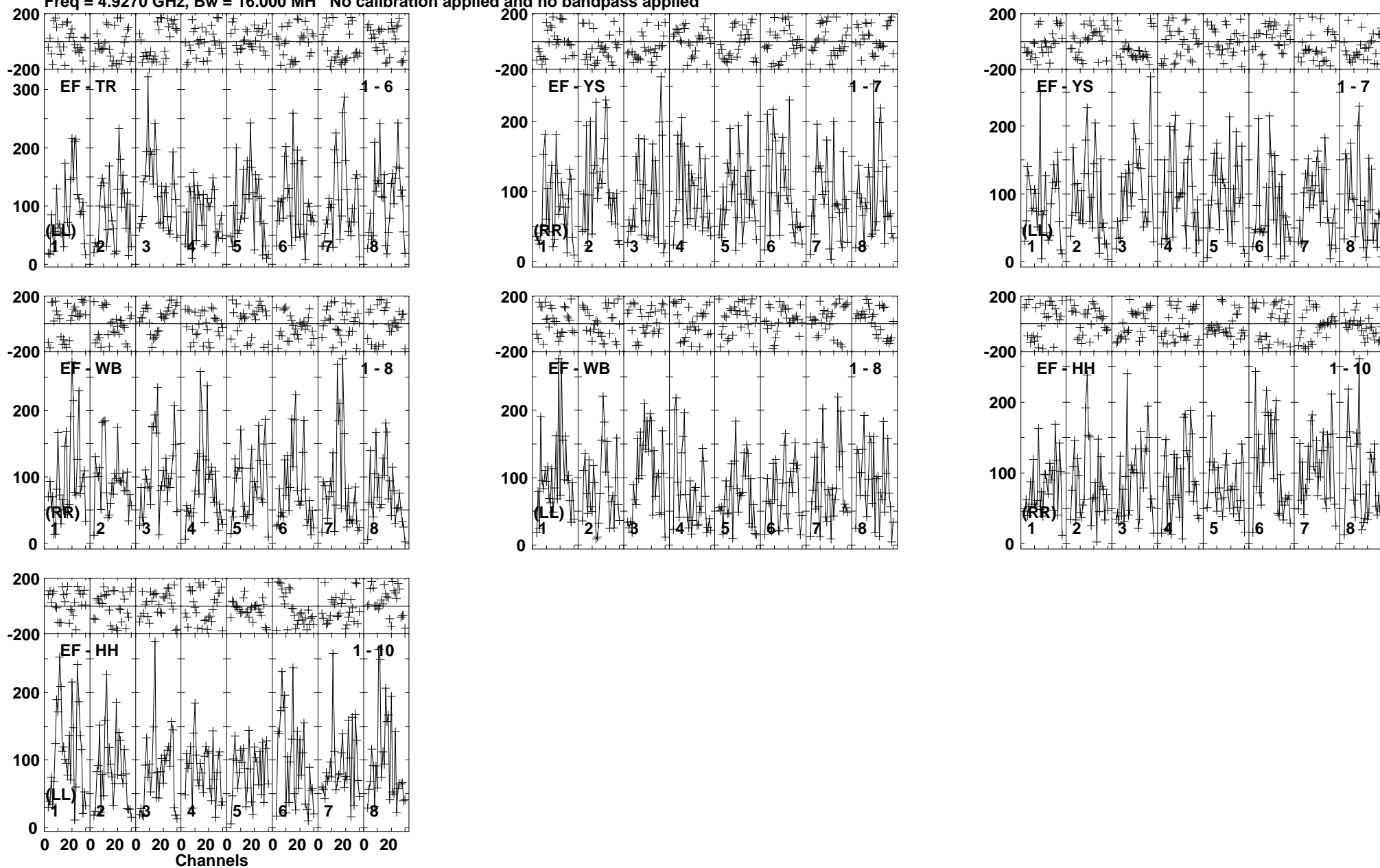

Lower frame: Micro Ampl Jy Top frame: Phas deg
Vector averaged cross-power spectrum Baseline: EF (01) - TR (06)
Timerange: 00/11:55:31 to 00/11:58:30

Plot file version 45 created 10-JUN-2016 16:07:50

J0718-1813 RG008D.UVDATA.1

Freq = 4.9270 GHz, Bw = 16.000 MH No calibration applied and no bandpass applied

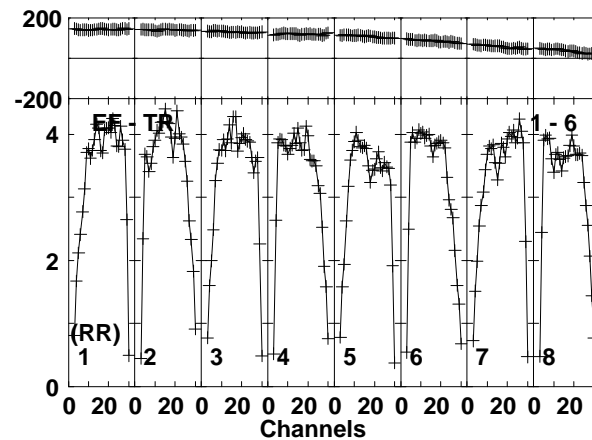
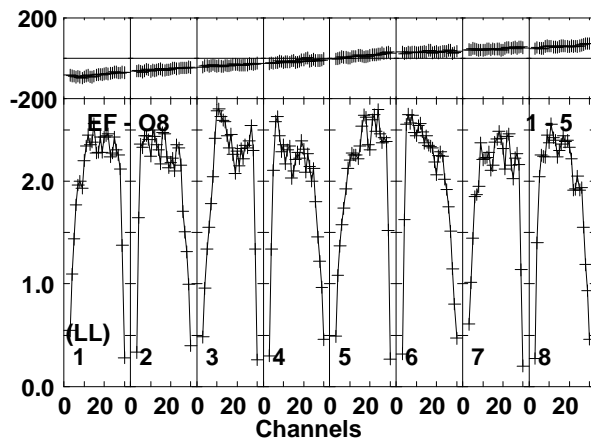
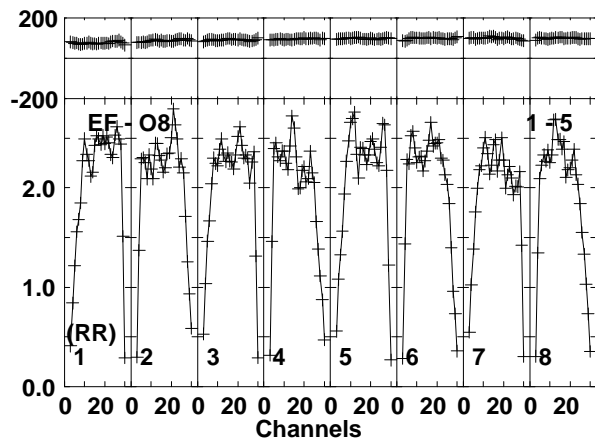
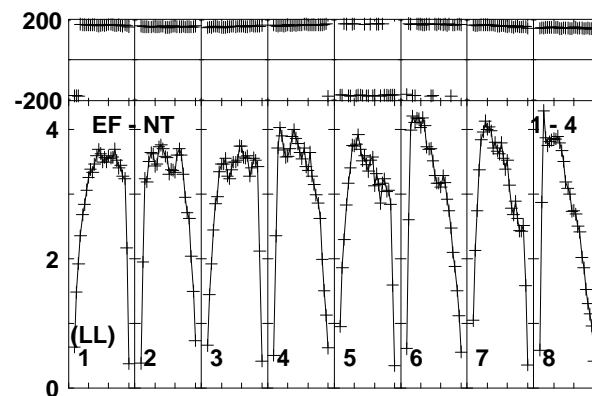
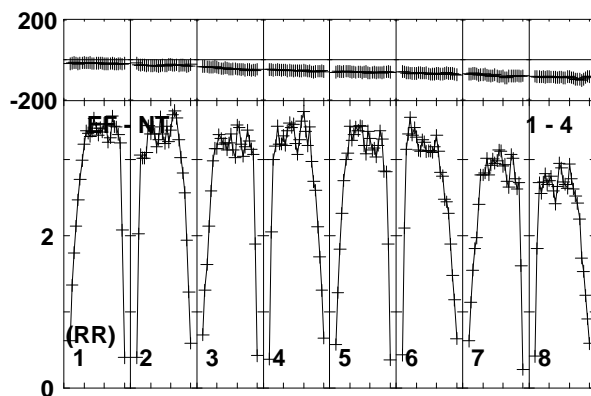
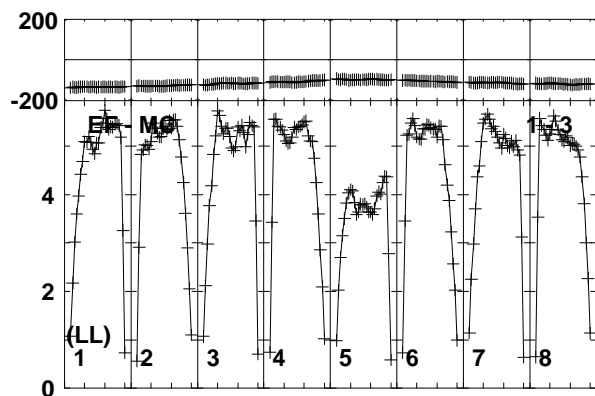
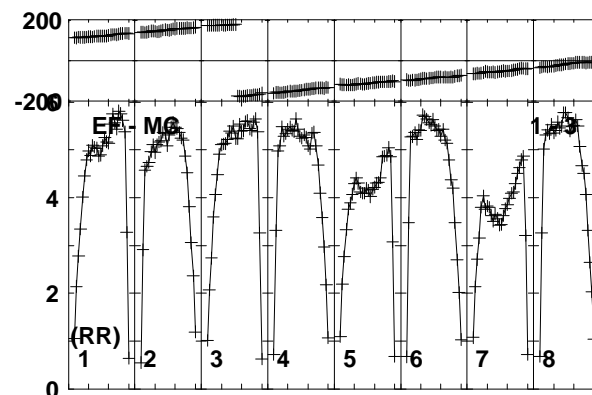
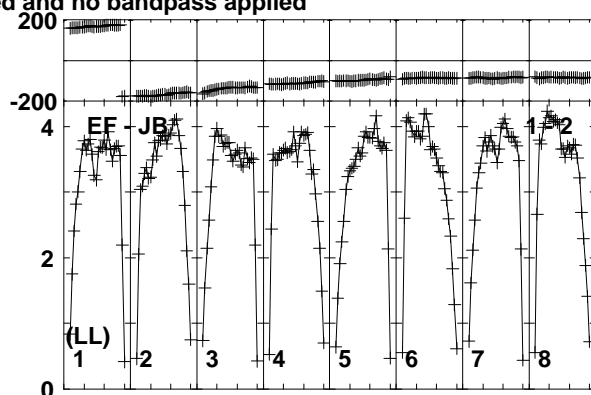
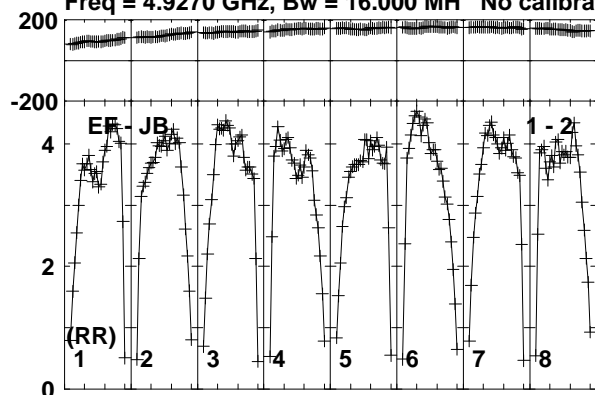

Lower frame: Milli Ampl Jy Top frame: Phas deg
Vector averaged cross-power spectrum Baseline: EF (01) - JB (02)
Timerange: 00/11:59:10 to 00/11:59:59

Plot file version 46 created 10-JUN-2016 16:07:51

J0718-1813 RG008D.UVDATA.1

Freq = 4.9270 GHz, Bw = 16.000 MH No calibration applied and no bandpass applied

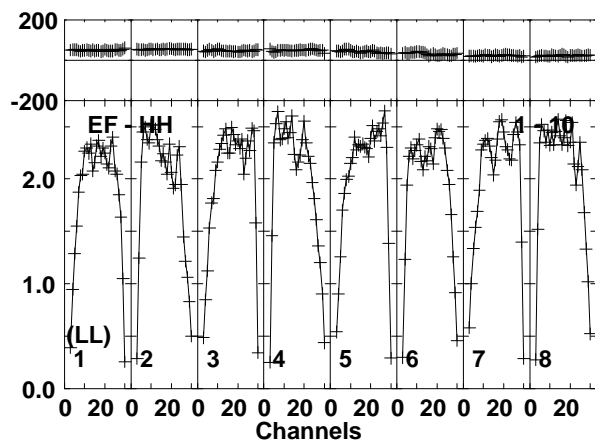
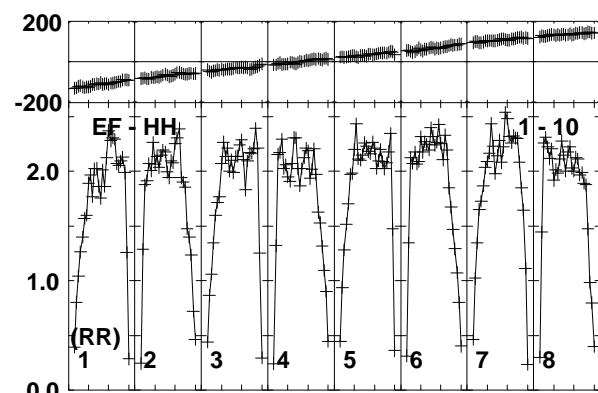
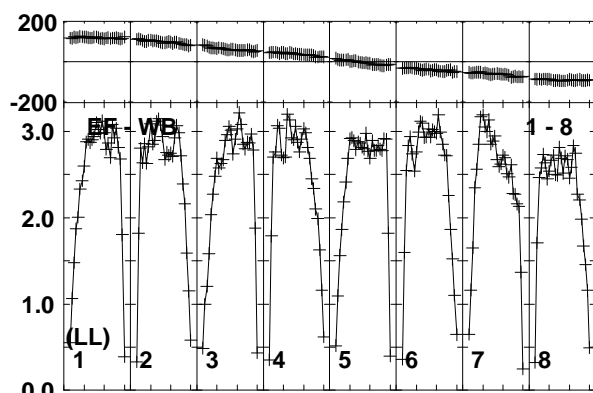
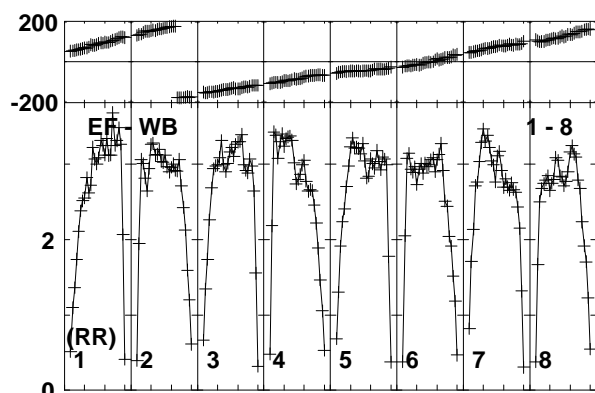
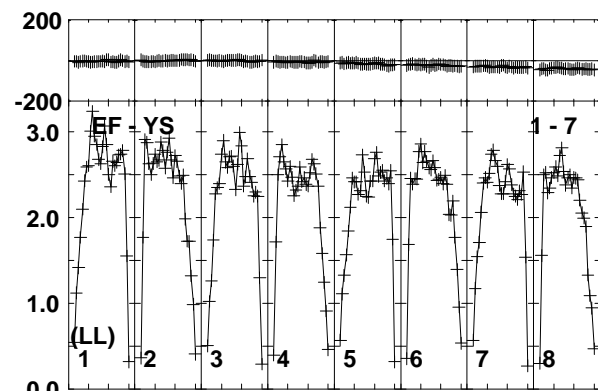
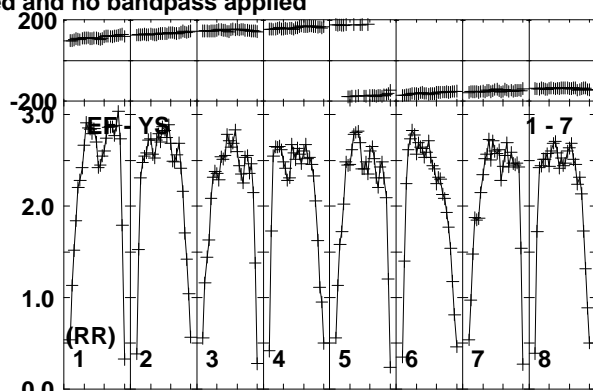
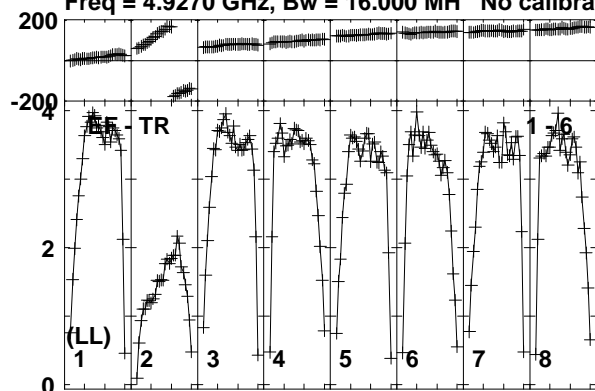

Lower frame: Milli Ampl Jy Top frame: Phas deg
Vector averaged cross-power spectrum Baseline: EF (01) - TR (06)
Timerange: 00/11:59:10 to 00/11:59:59

Plot file version 47 created 10-JUN-2016 16:07:51

FRB150418 RG008D.UVDATA.1

Freq = 4.9270 GHz, Bw = 16.000 MH No calibration applied and no bandpass applied

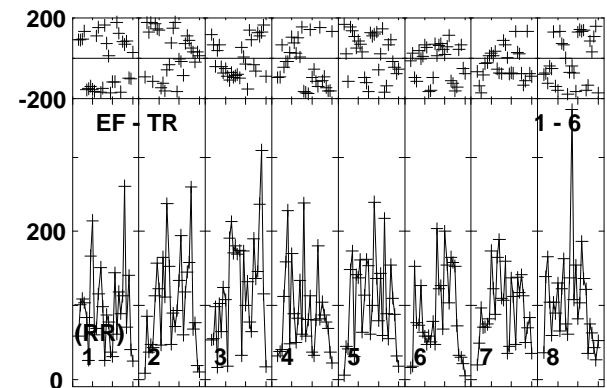
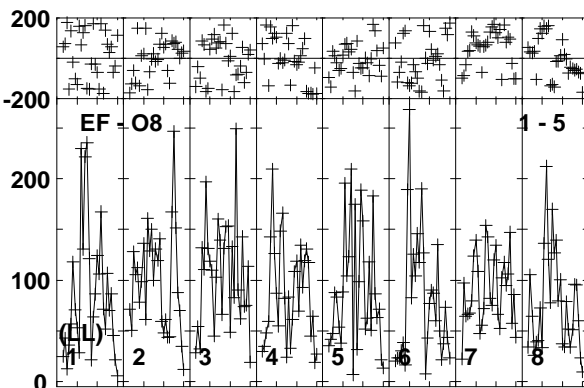
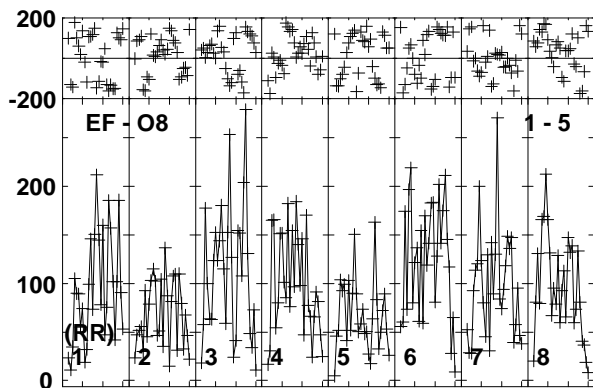
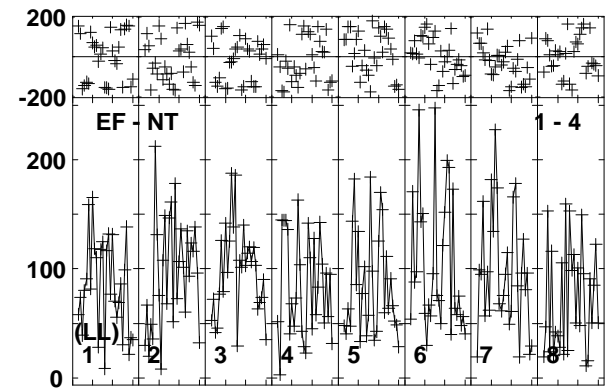
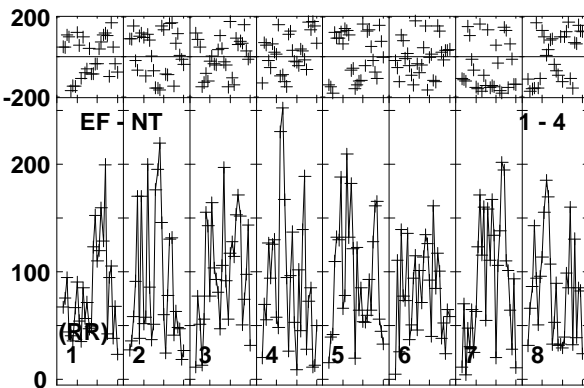
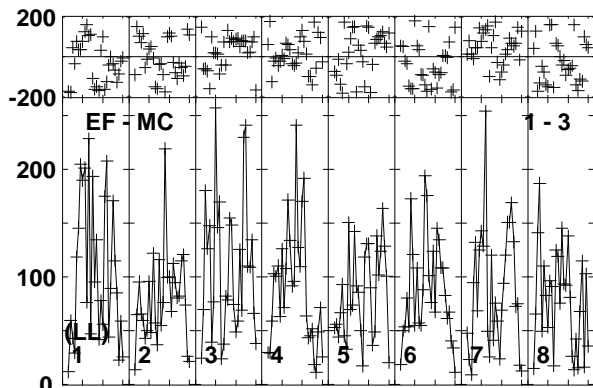
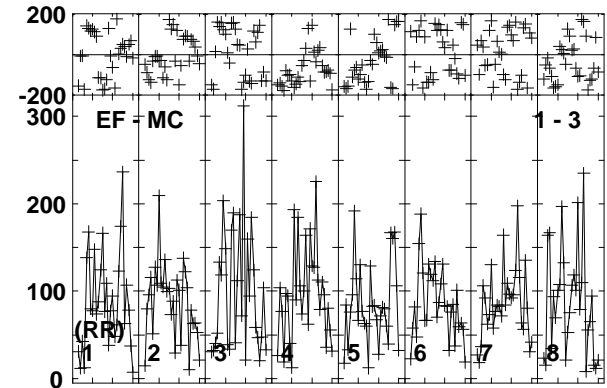
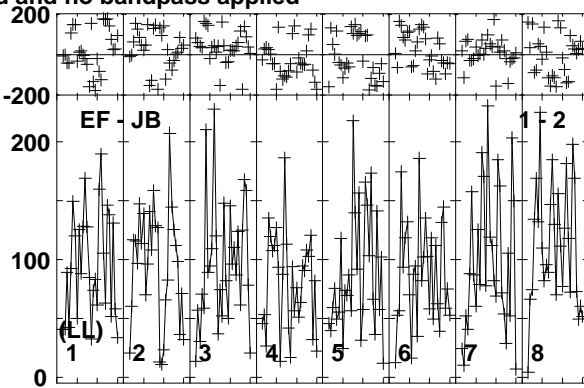
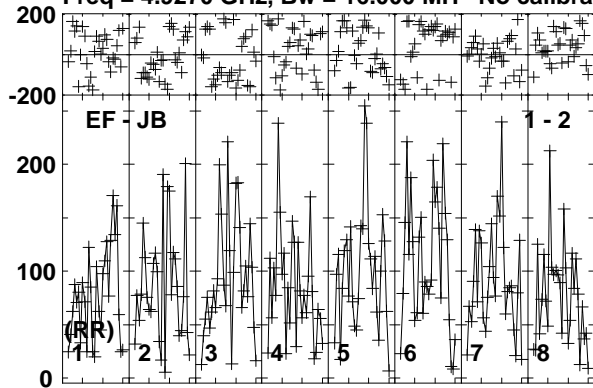

Lower frame: Micro Ampl Jy Top frame: Phas deg
Vector averaged cross-power spectrum Baseline: EF (01) - JB (02)
Timerange: 00/12:00:01 to 00/12:02:59

Plot file version 48 created 10-JUN-2016 16:07:51

FRB150418 RG008D.UVDATA.1

Freq = 4.9270 GHz, Bw = 16.000 MH No calibration applied and no bandpass applied

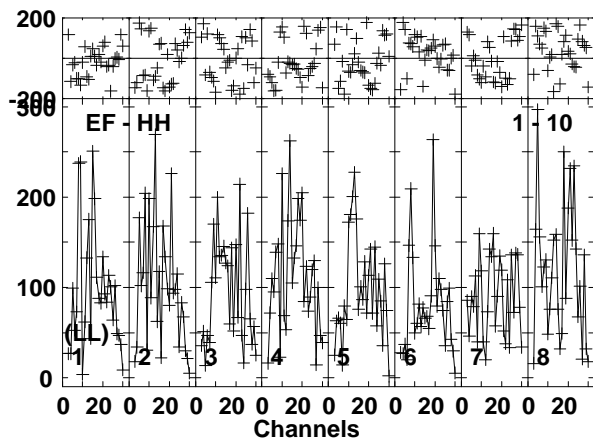
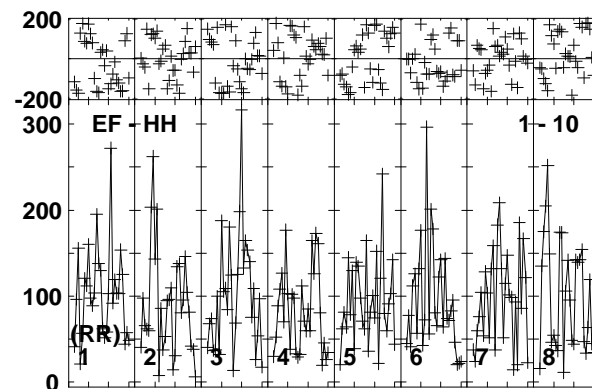
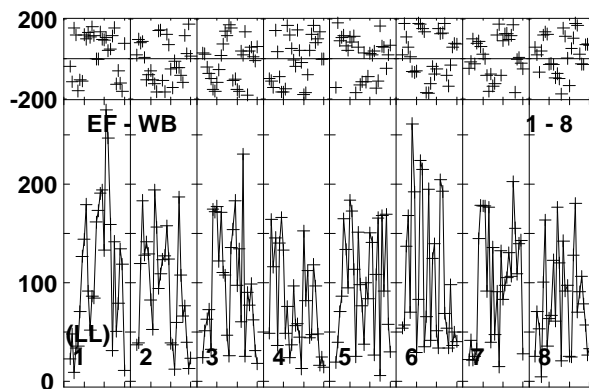
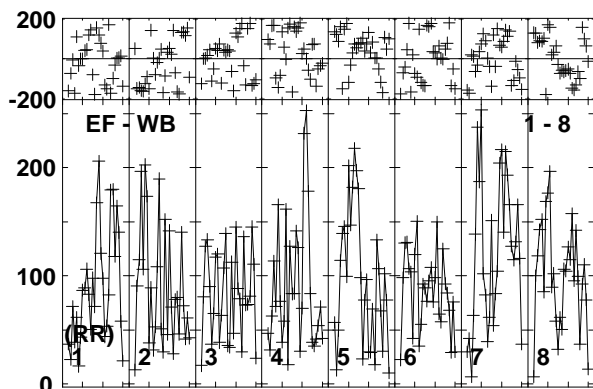
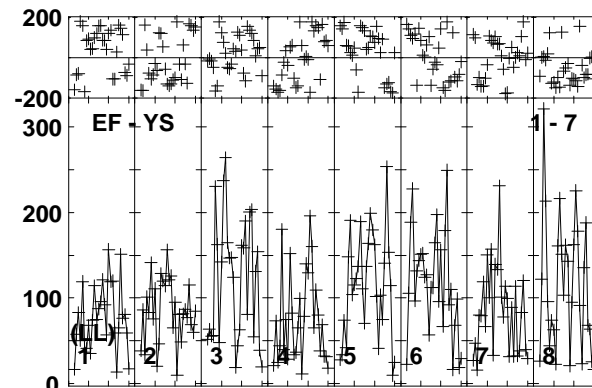
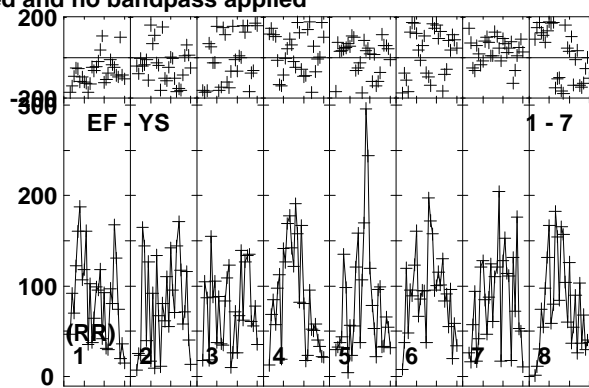
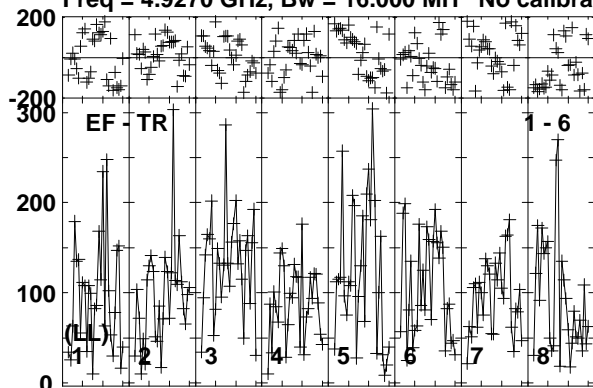

Lower frame: Micro Ampl Jy Top frame: Phas deg
Vector averaged cross-power spectrum Baseline: EF (01) - TR (06)
Timerange: 00/12:00:01 to 00/12:02:59

Plot file version 49 created 10-JUN-2016 16:07:51

J0718-1813 RG008D.UVDATA.1

Freq = 4.9270 GHz, Bw = 16.000 MH No calibration applied and no bandpass applied

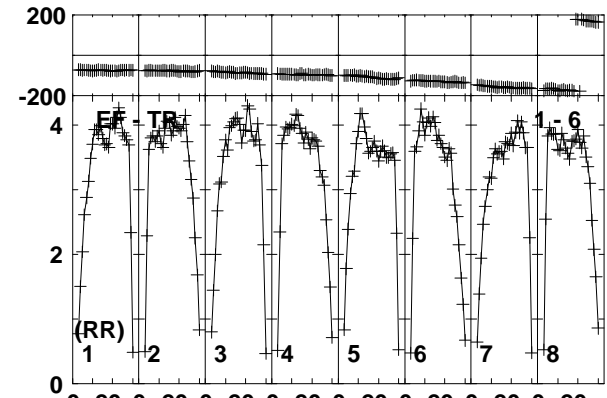
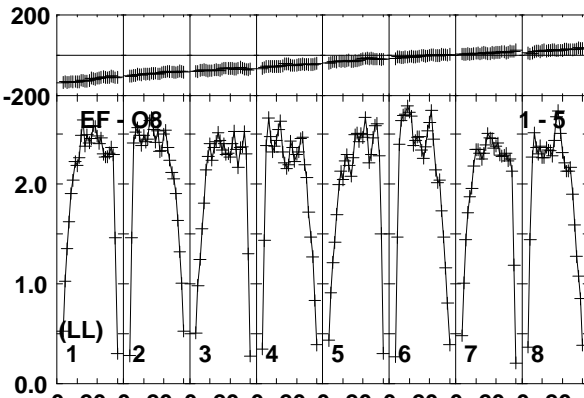
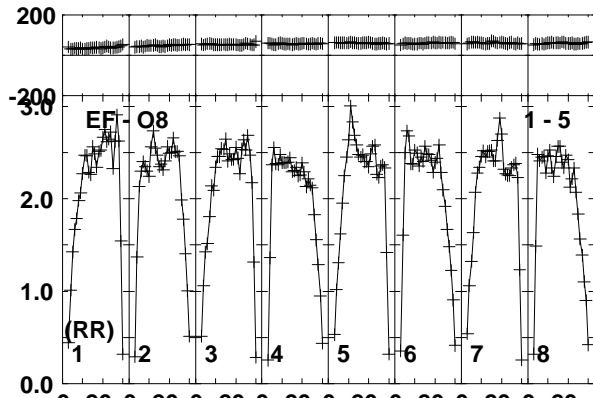
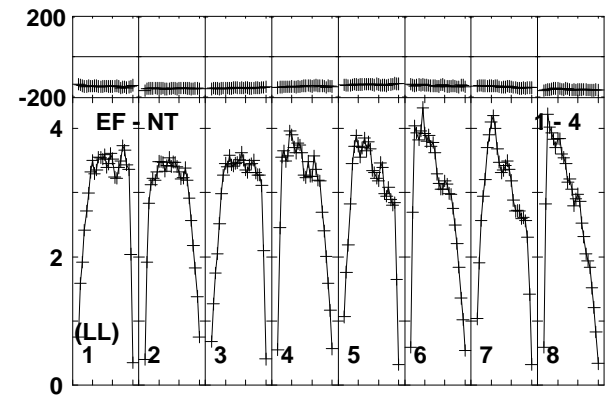
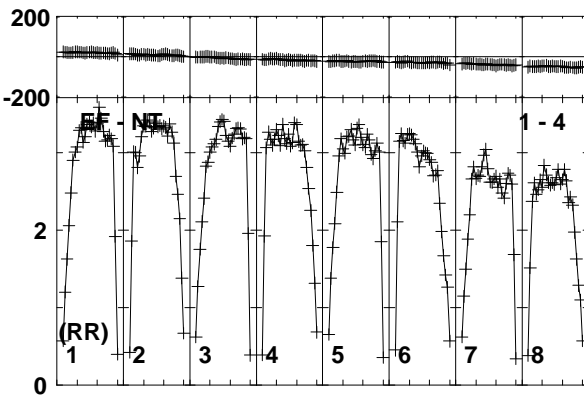
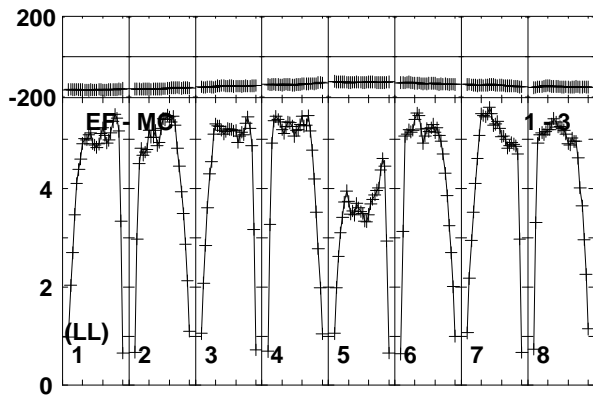
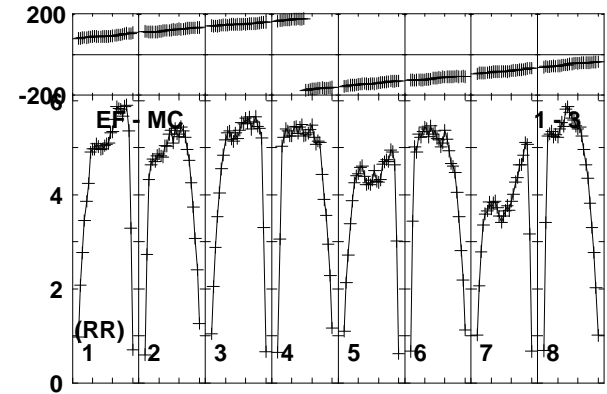
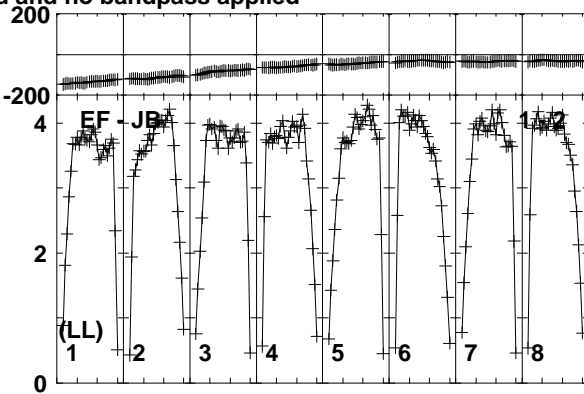
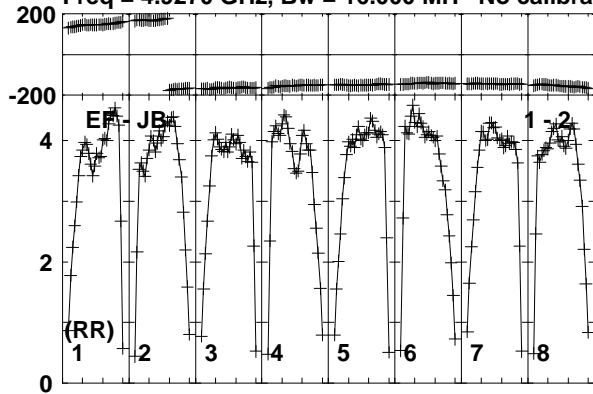

Lower frame: Milli Ampl Jy Top frame: Phas deg
Vector averaged cross-power spectrum Baseline: EF (01) - JB (02)
Timerange: 00:12:03:01 to 00:12:04:30

Plot file version 50 created 10-JUN-2016 16:07:51

J0718-1813 RG008D.UVDATA.1

Freq = 4.9270 GHz, Bw = 16.000 MH No calibration applied and no bandpass applied

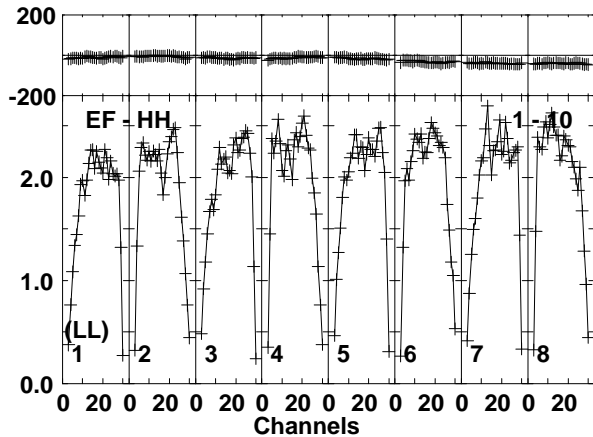
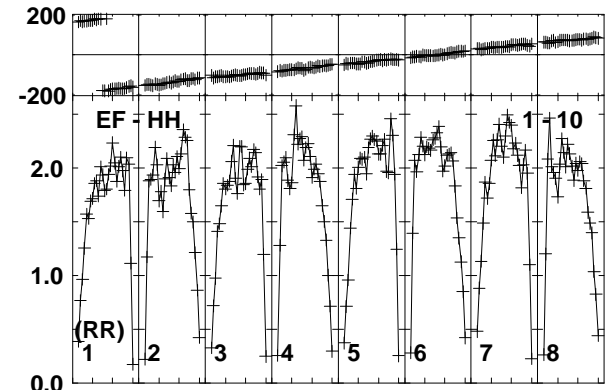
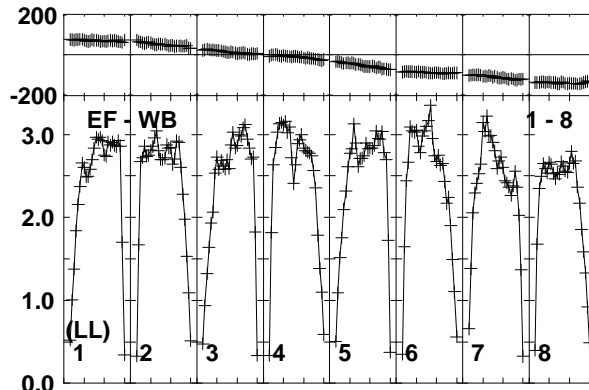
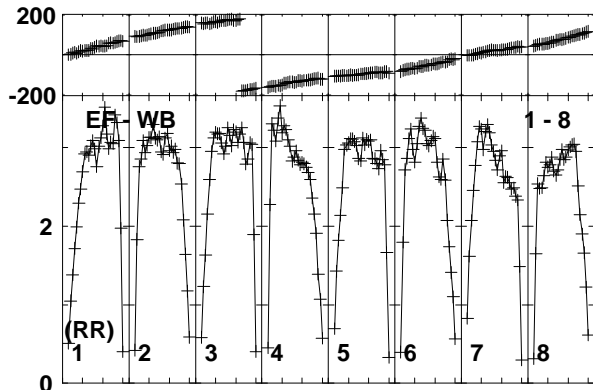
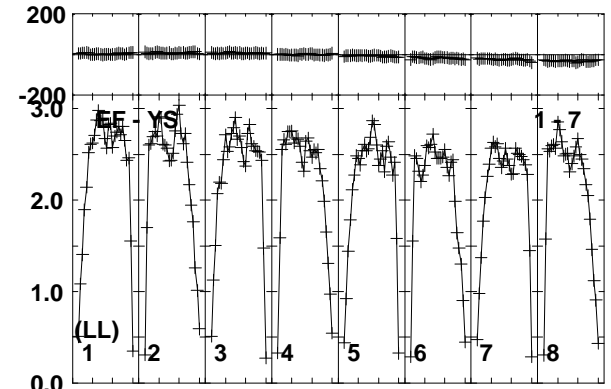
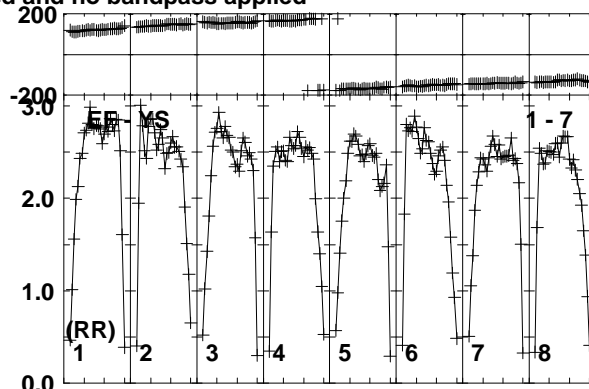
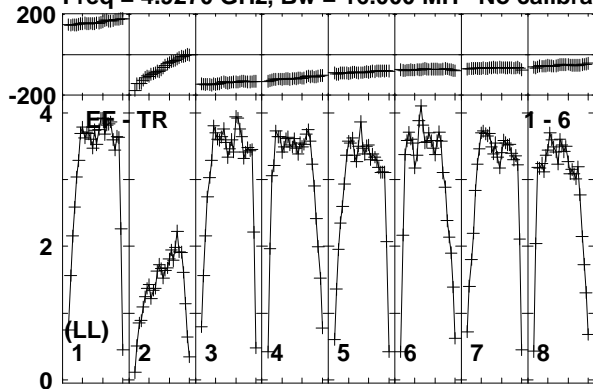

Lower frame: Milli Ampl Jy Top frame: Phas deg
Vector averaged cross-power spectrum Baseline: EF (01) - TR (06)
Timerange: 00/12:03:01 to 00/12:04:30

Plot file version 51 created 10-JUN-2016 16:07:51

J0712-1847 RG008D.UVDATA.1

Freq = 4.9270 GHz, Bw = 16.000 MH No calibration applied and no bandpass applied

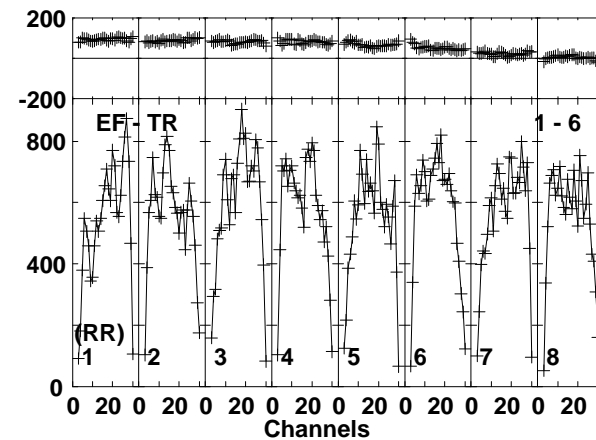
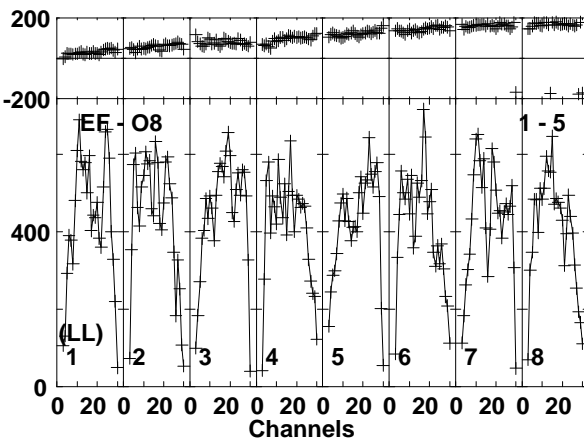
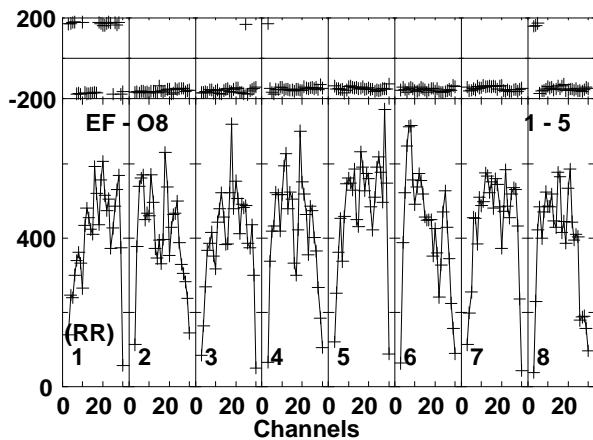
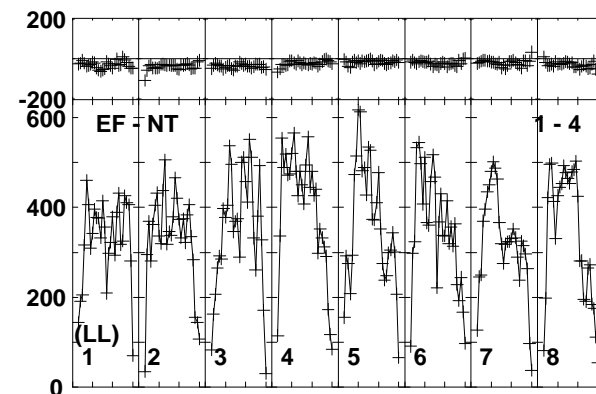
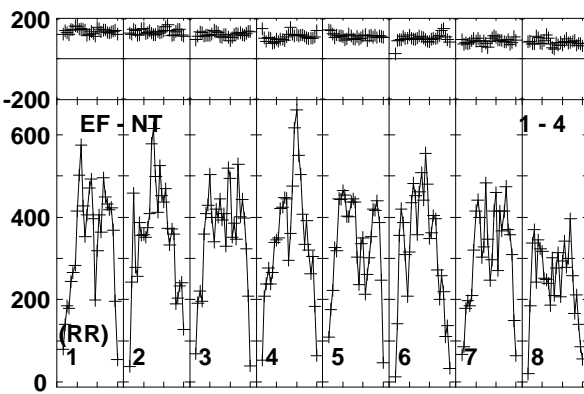
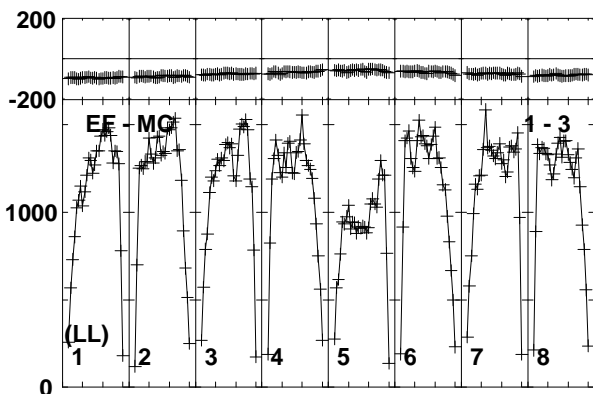
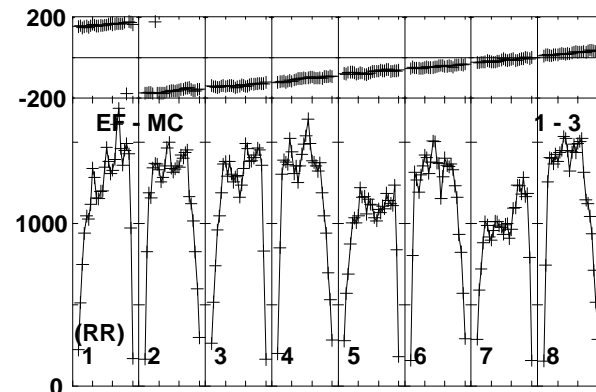
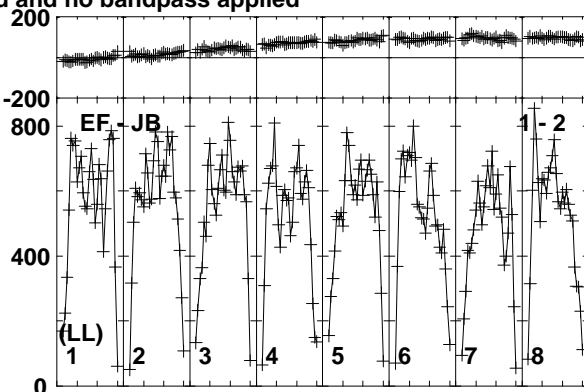
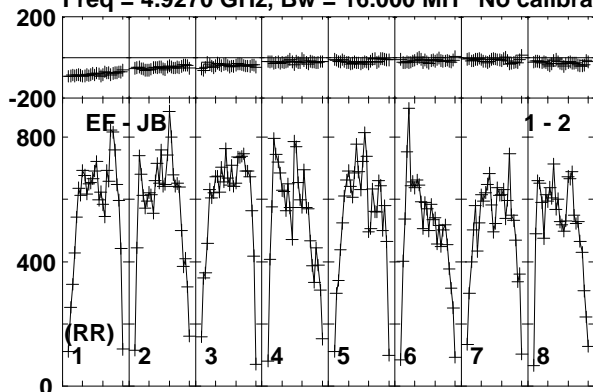

Lower frame: Micro Ampl Jy Top frame: Phas deg
Vector averaged cross-power spectrum Baseline: EF (01) - JB (02)
Timerange: 00/12:04:31 to 00/12:07:29

Plot file version 52 created 10-JUN-2016 16:07:51

J0712-1847 RG008D.UVDATA.1

Freq = 4.9270 GHz, Bw = 16.000 MH No calibration applied and no bandpass applied

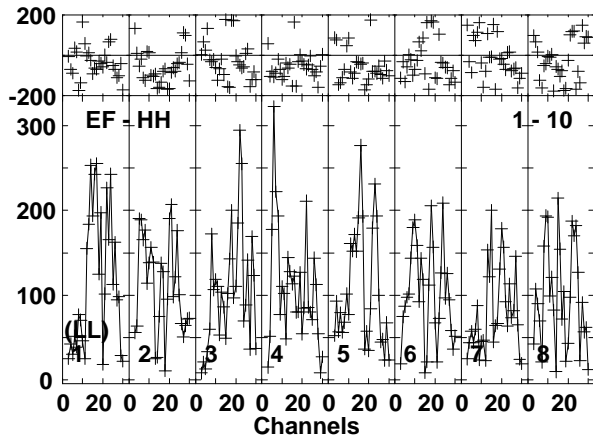
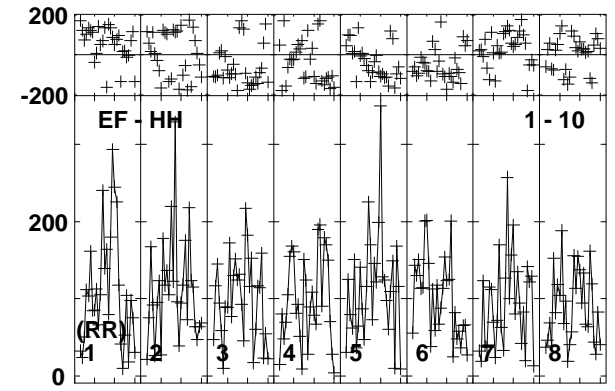
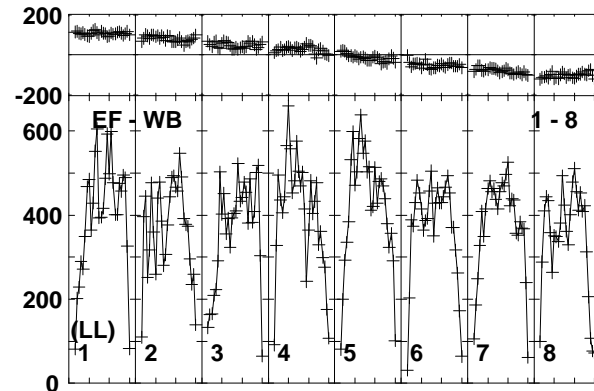
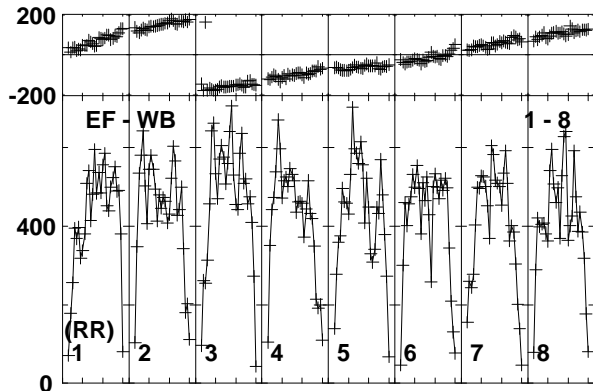
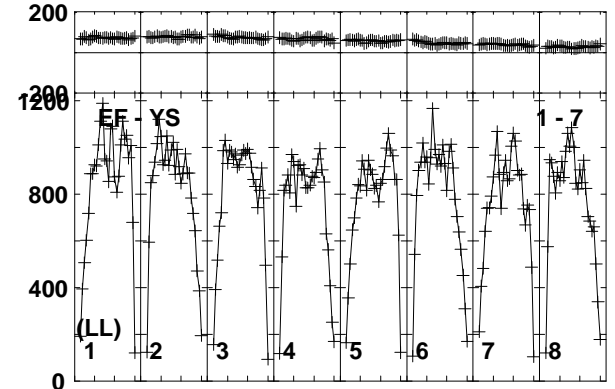
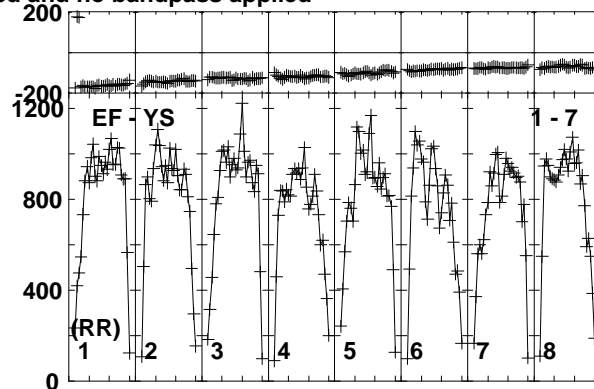
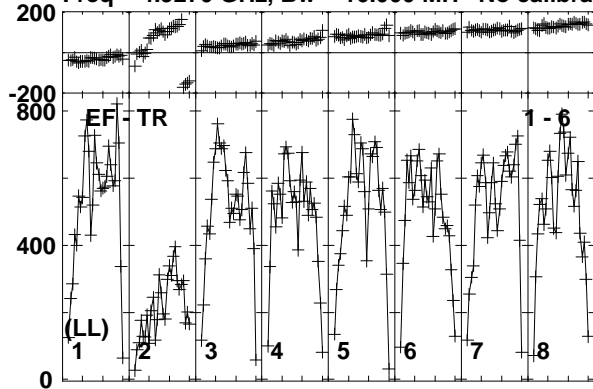

Lower frame: Micro Ampl Jy Top frame: Phas deg
Vector averaged cross-power spectrum Baseline: EF (01) - TR (06)
Timerange: 00/12:04:31 to 00/12:07:29

Plot file version 53 created 10-JUN-2016 16:07:51

J0718-1813 RG008D.UVDATA.1

Freq = 4.9270 GHz, Bw = 16.000 MH No calibration applied and no bandpass applied

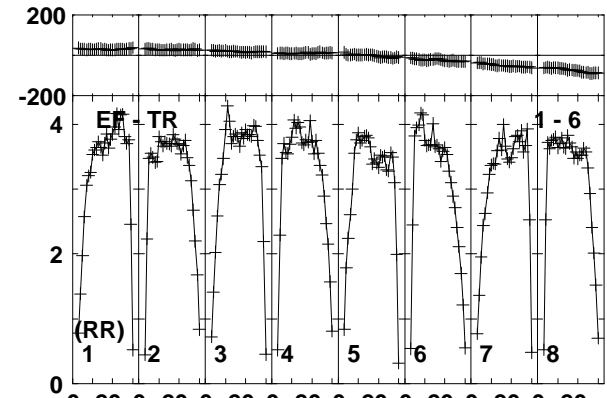
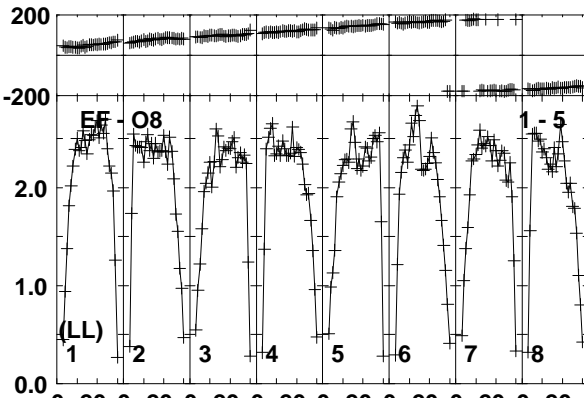
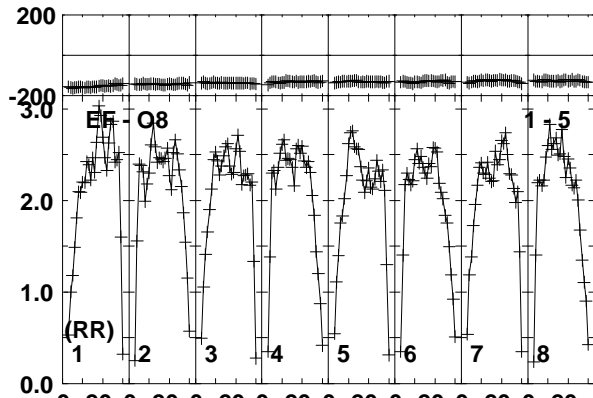
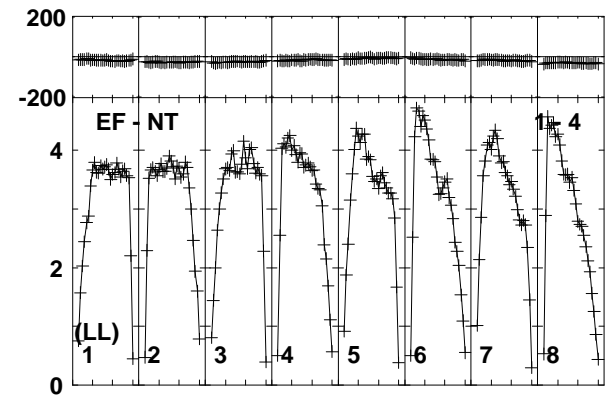
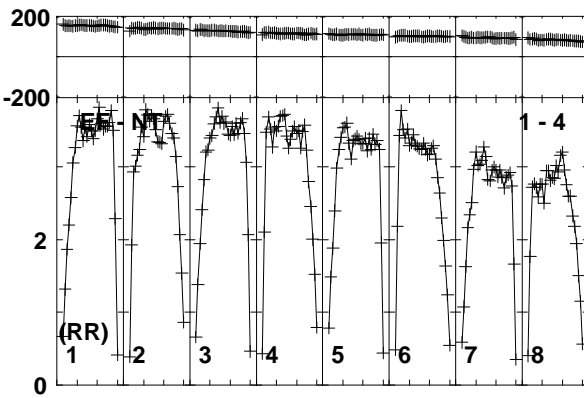
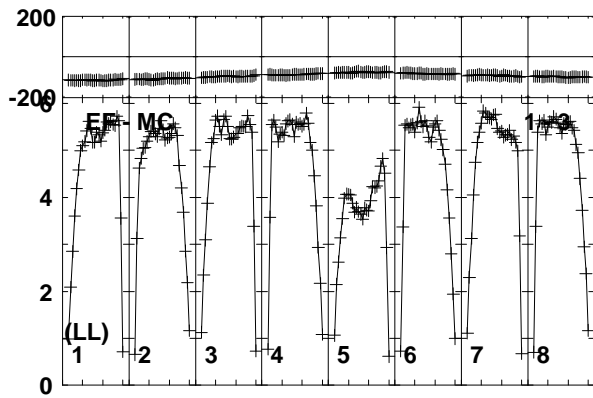
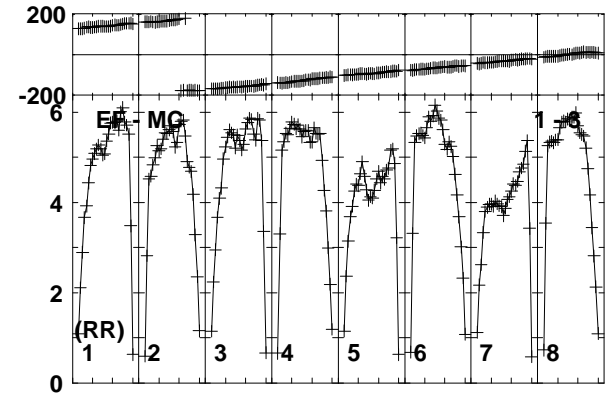
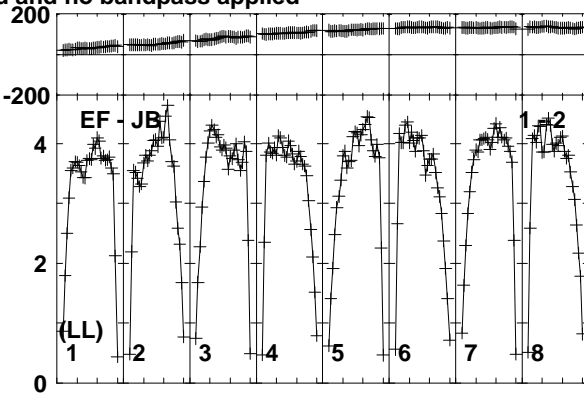
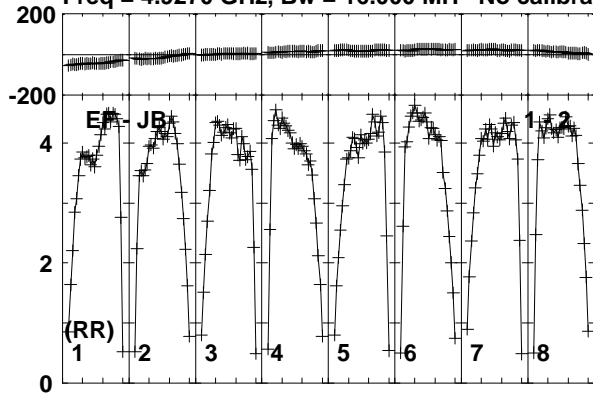

Lower frame: Milli Ampl Jy Top frame: Phas deg
Vector averaged cross-power spectrum Baseline: EF (01) - JB (02)
Timerange: 00:12:08:11 to 00:12:09:00

Plot file version 54 created 10-JUN-2016 16:07:52

J0718-1813 RG008D.UVDATA.1

Freq = 4.9270 GHz, Bw = 16.000 MH No calibration applied and no bandpass applied

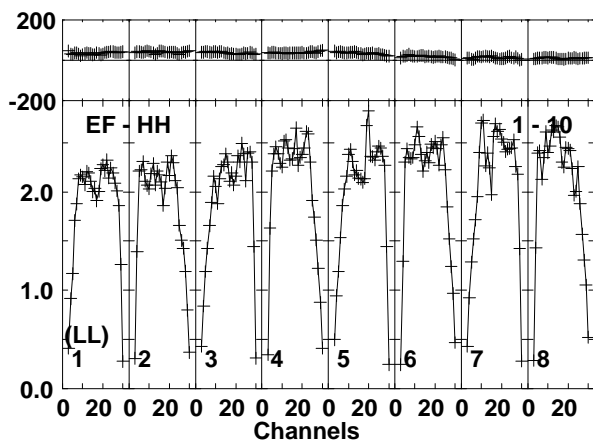
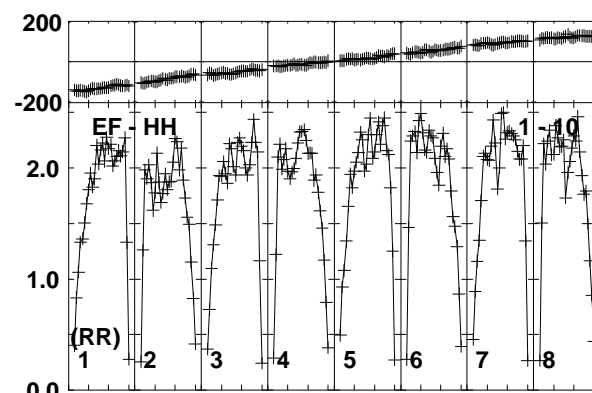
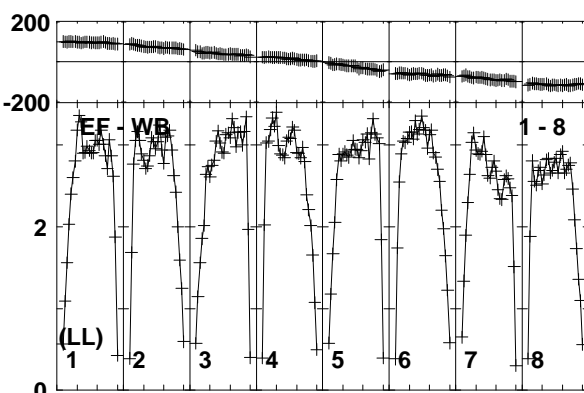
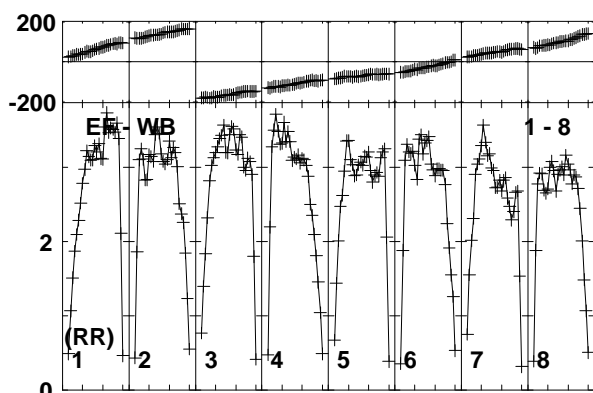
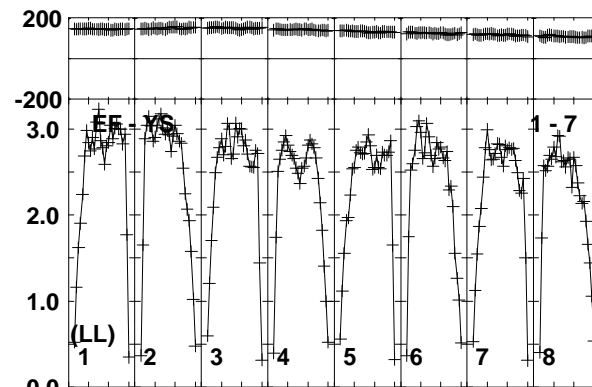
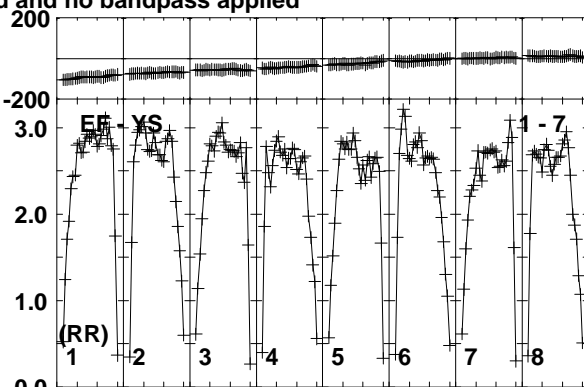
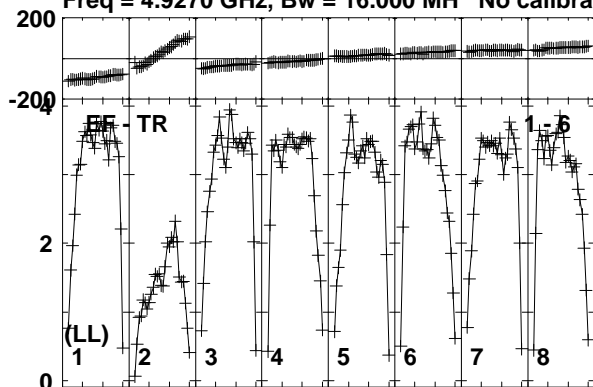

Lower frame: Milli Ampl Jy Top frame: Phas deg
Vector averaged cross-power spectrum Baseline: EF (01) - TR (06)
Timerange: 00:12:08:11 to 00:12:09:00

Plot file version 55 created 10-JUN-2016 16:07:52

FRB150418 RG008D.UVDATA.1

Freq = 4.9270 GHz, Bw = 16.000 MH No calibration applied and no bandpass applied

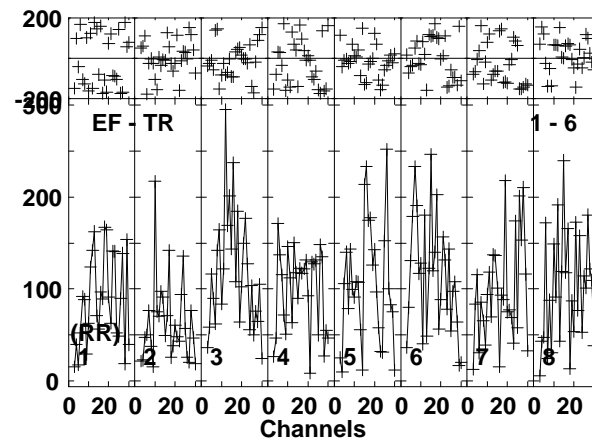
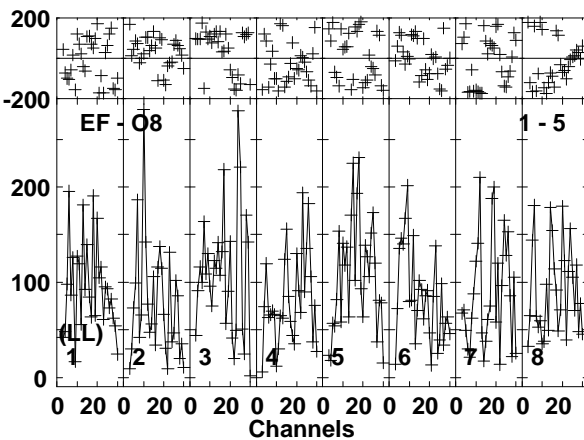
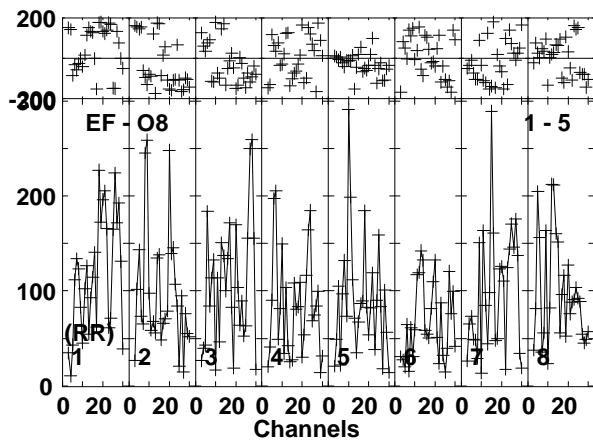
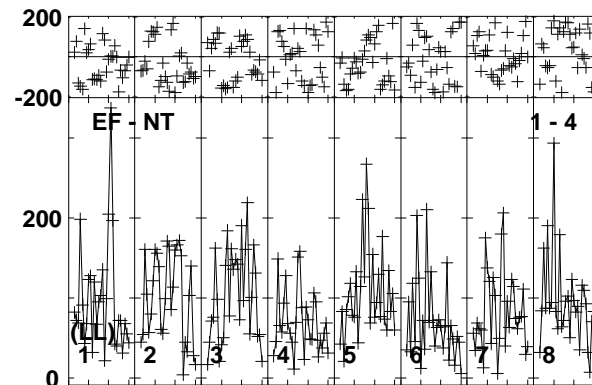
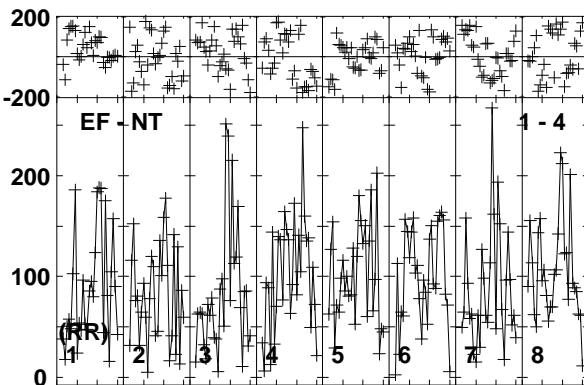
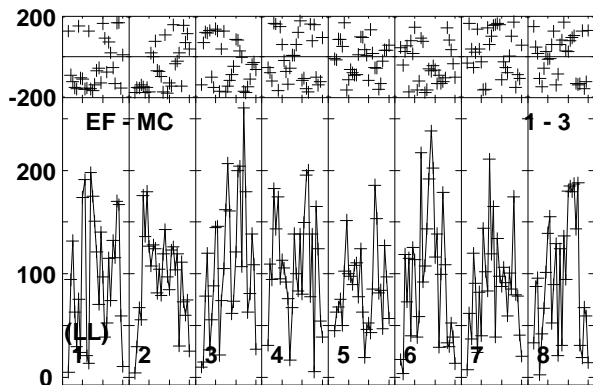
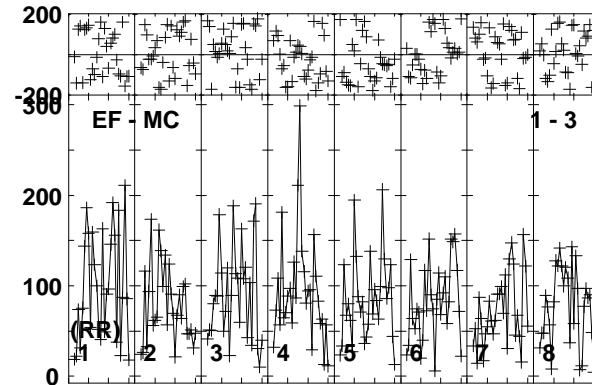
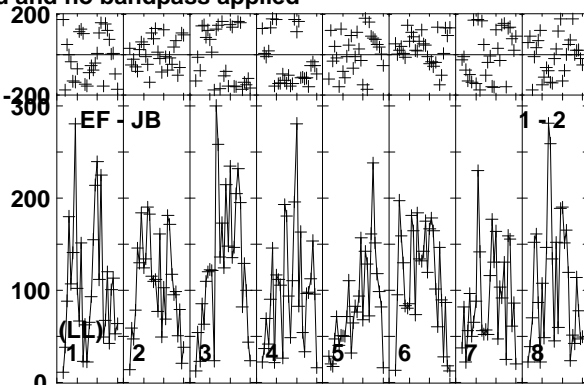
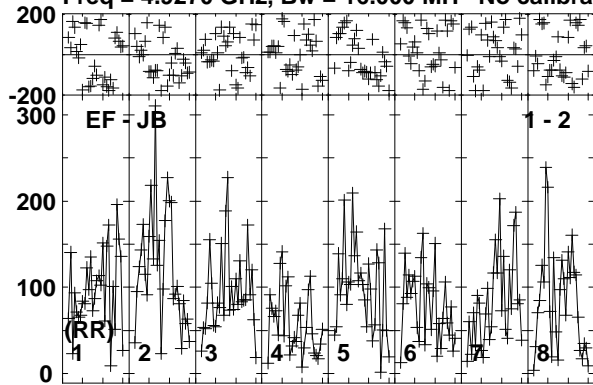

Lower frame: Micro Ampl Jy Top frame: Phas deg
Vector averaged cross-power spectrum Baseline: EF (01) - JB (02)
Timerange: 00:12:09:00 to 00:12:12:00

Plot file version 56 created 10-JUN-2016 16:07:52

FRB150418 RG008D.UVDATA.1

Freq = 4.9270 GHz, Bw = 16.000 MH No calibration applied and no bandpass applied

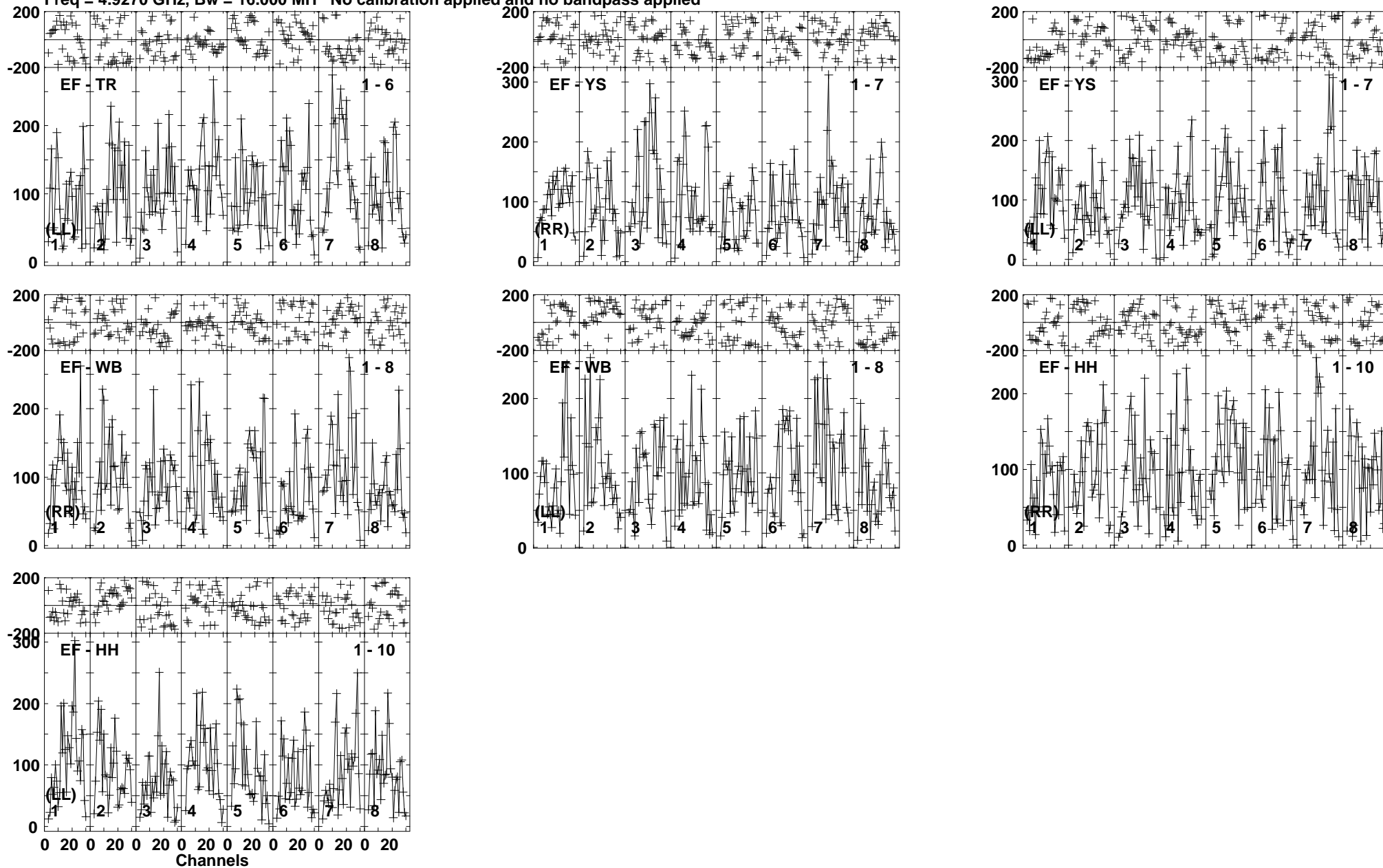

Lower frame: Micro Ampl Jy Top frame: Phas deg
Vector averaged cross-power spectrum Baseline: EF (01) - TR (06)
Timerange: 00:12:09:00 to 00:12:12:00

Plot file version 57 created 10-JUN-2016 16:07:52

J0718-1813 RG008D.UVDATA.1

Freq = 4.9270 GHz, Bw = 16.000 MH No calibration applied and no bandpass applied

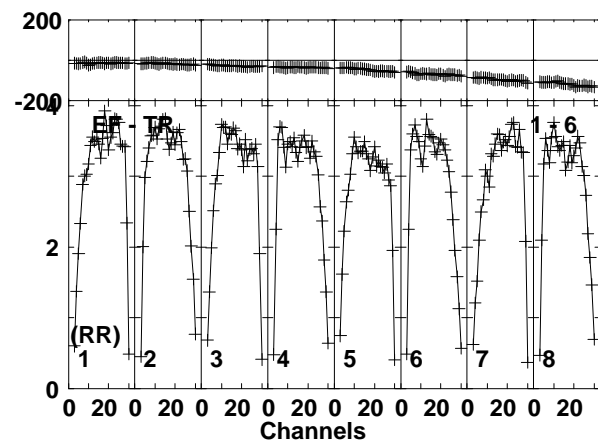
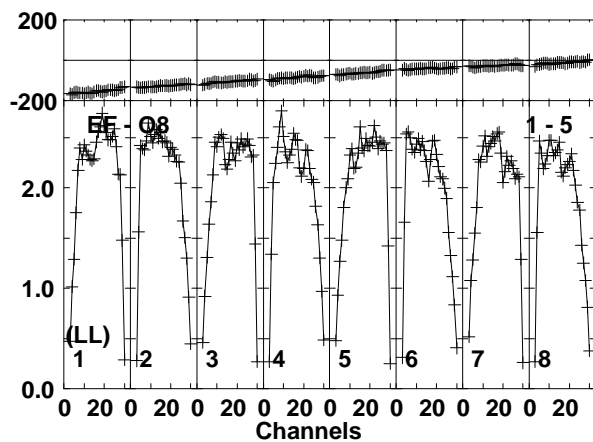
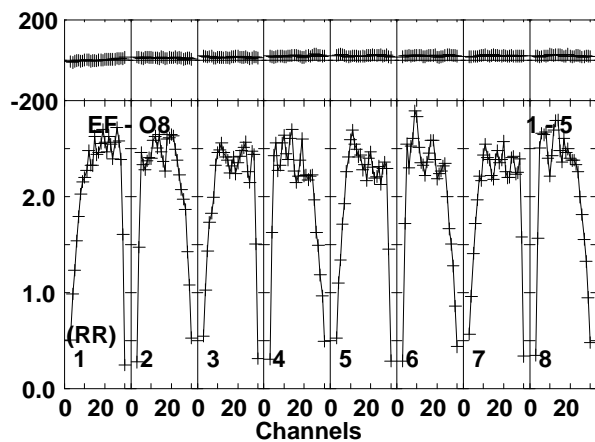
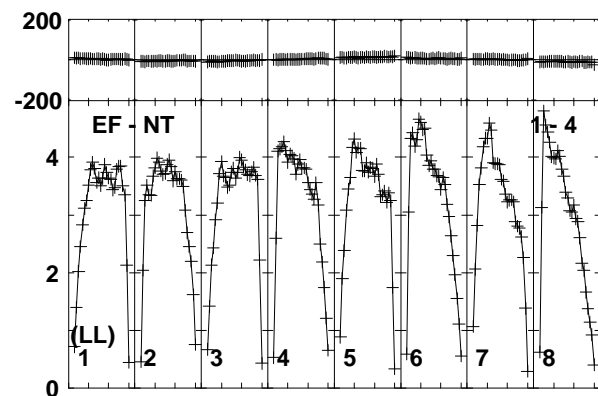
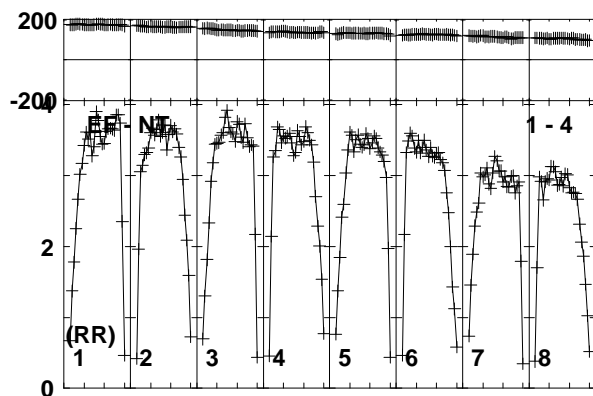
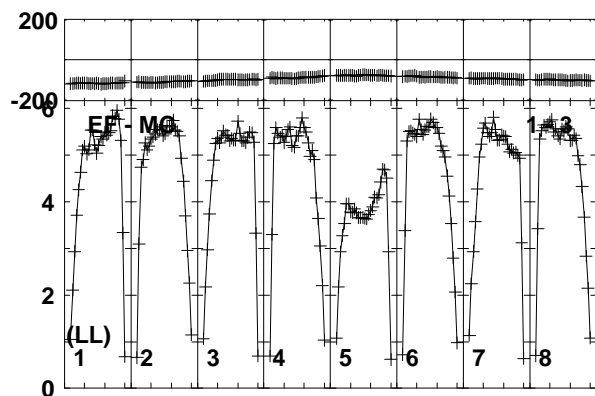
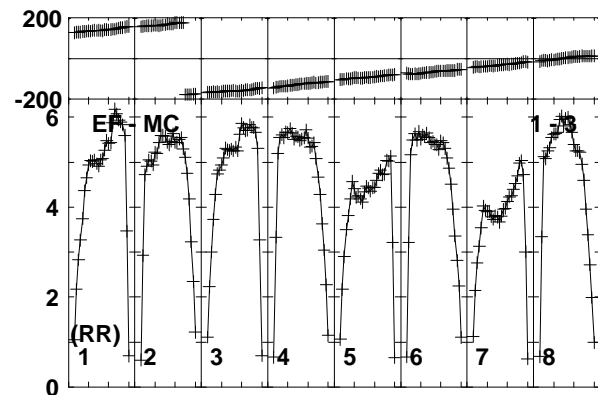
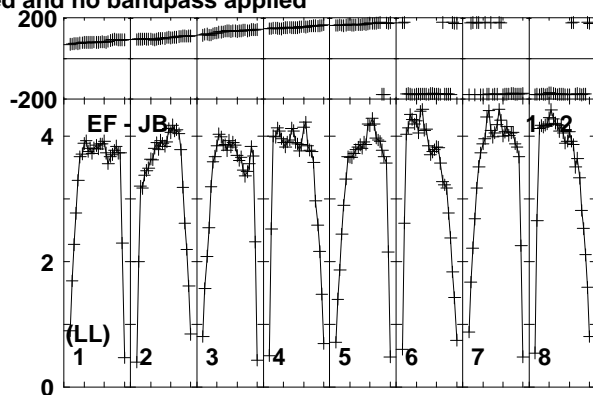
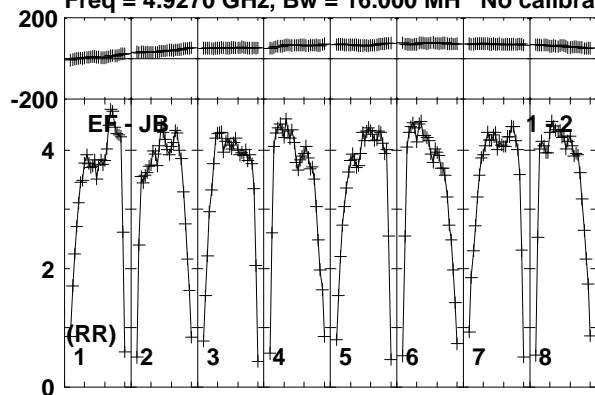

Lower frame: Milli Ampl Jy Top frame: Phas deg
Vector averaged cross-power spectrum Baseline: EF (01) - JB (02)
Timerange: 00:12:12:00 to 00:12:13:30

Plot file version 58 created 10-JUN-2016 16:07:52

J0718-1813 RG008D.UVDATA.1

Freq = 4.9270 GHz, Bw = 16.000 MH No calibration applied and no bandpass applied

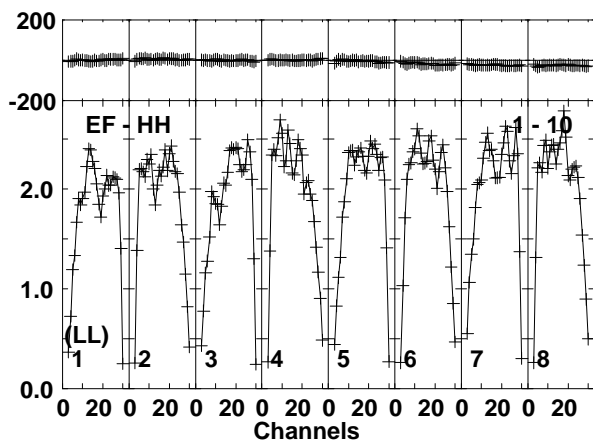
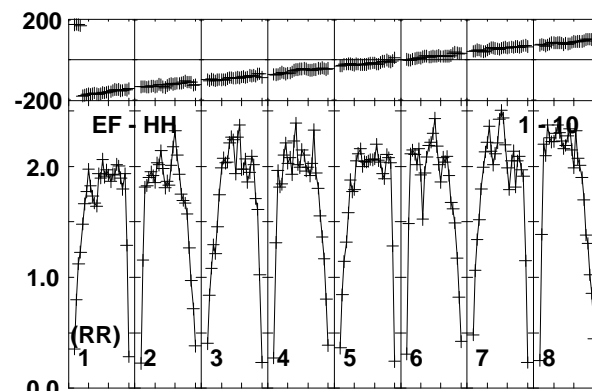
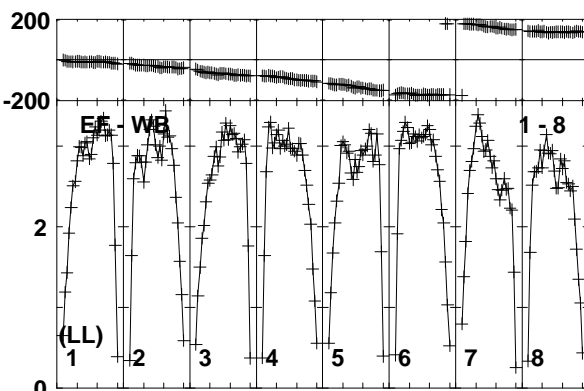
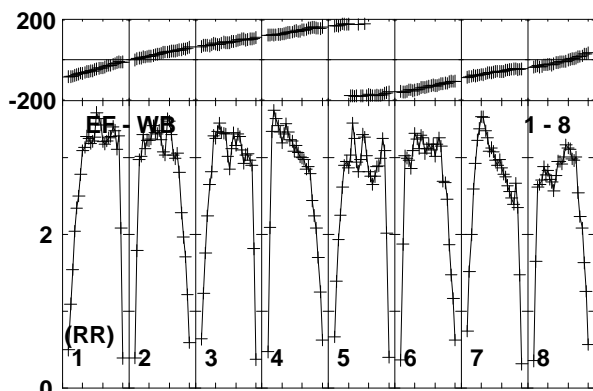
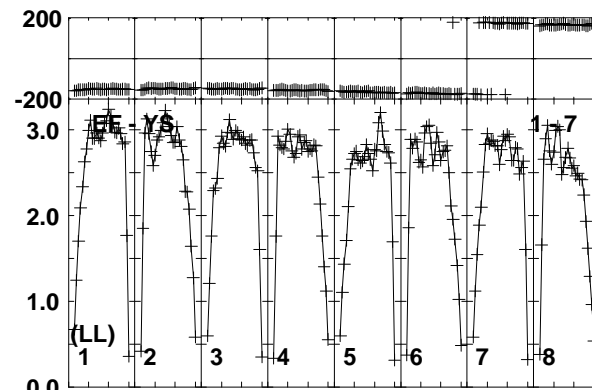
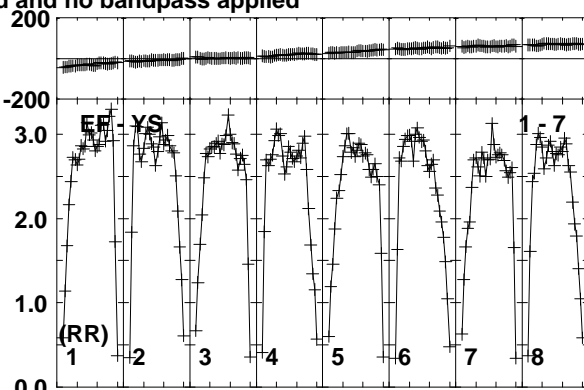
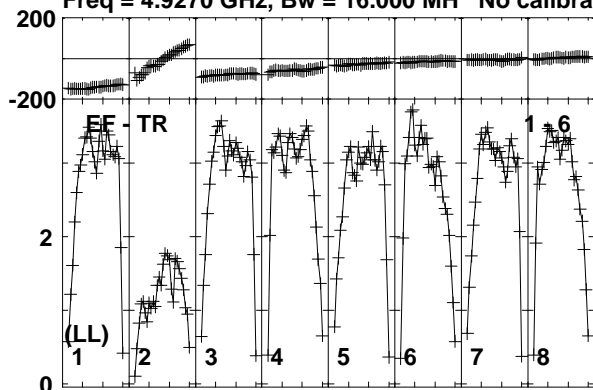

Lower frame: Milli Ampl Jy Top frame: Phas deg
Vector averaged cross-power spectrum Baseline: EF (01) - TR (06)
Timerange: 00/12:12:00 to 00/12:13:30

Plot file version 59 created 10-JUN-2016 16:07:52

FRB150418 RG008D.UVDATA.1

Freq = 4.9270 GHz, Bw = 16.000 MH No calibration applied and no bandpass applied

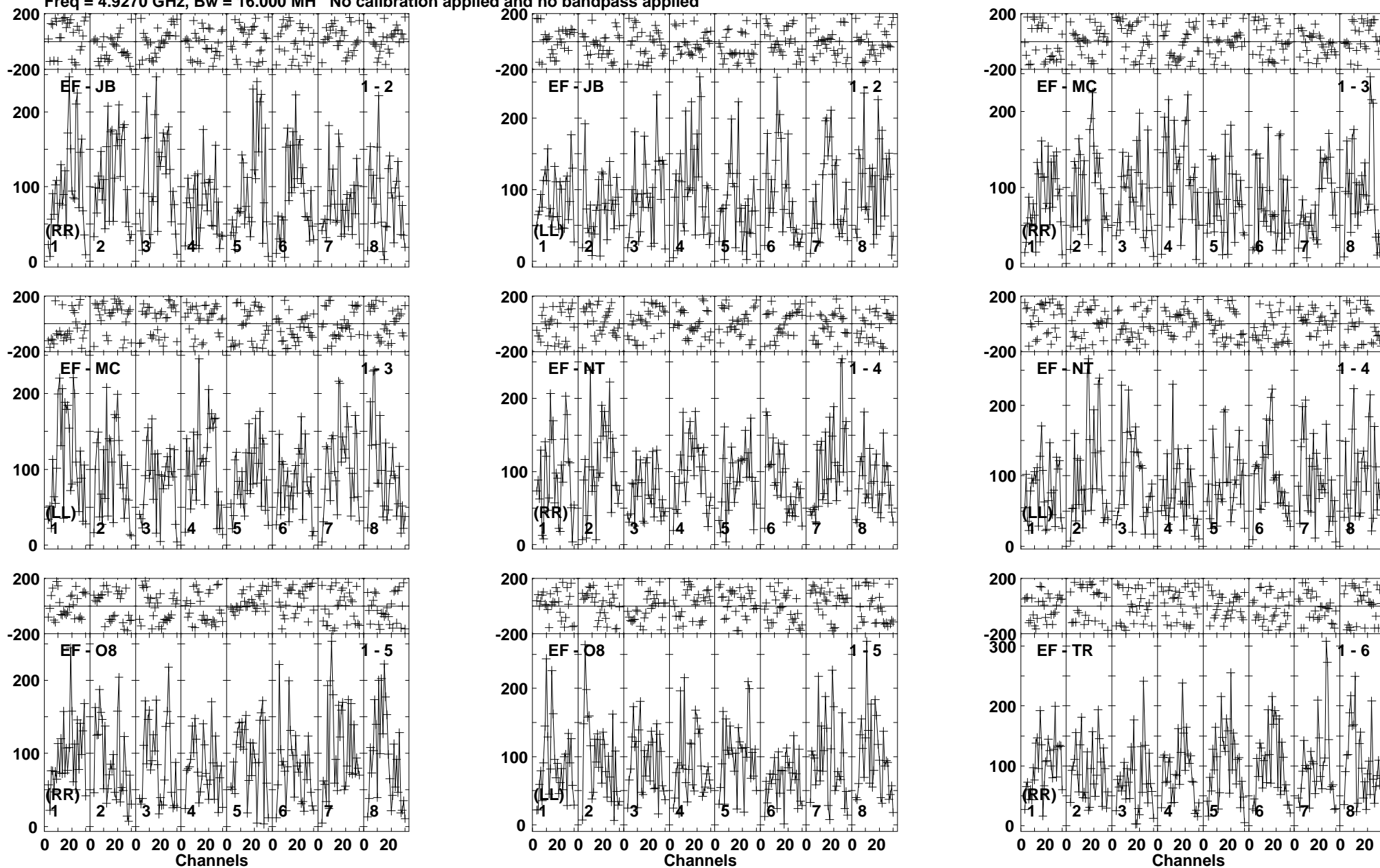

Lower frame: Micro Ampl Jy Top frame: Phas deg
Vector averaged cross-power spectrum Baseline: EF (01) - JB (02)
Timerange: 00/12:13:30 to 00/12:16:30

Plot file version 60 created 10-JUN-2016 16:07:52

FRB150418 RG008D.UVDATA.1

Freq = 4.9270 GHz, Bw = 16.000 MH No calibration applied and no bandpass applied

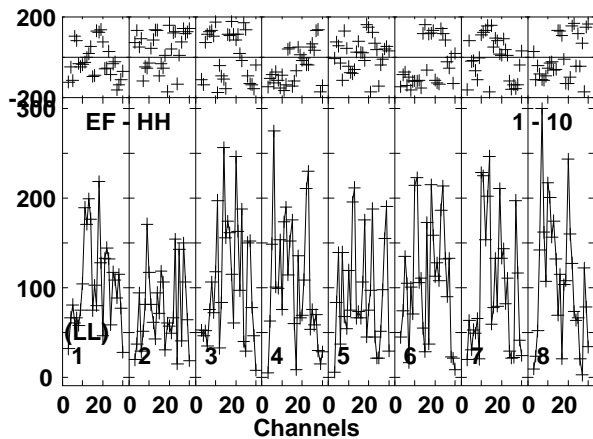
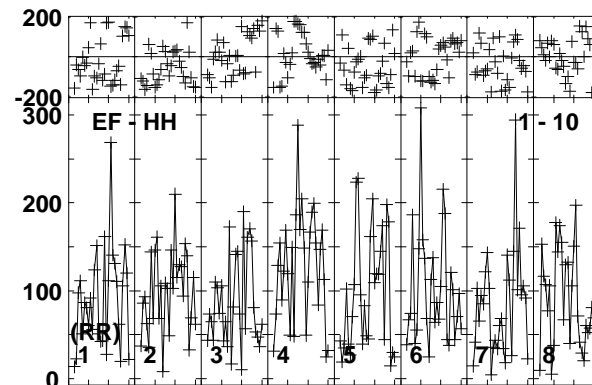
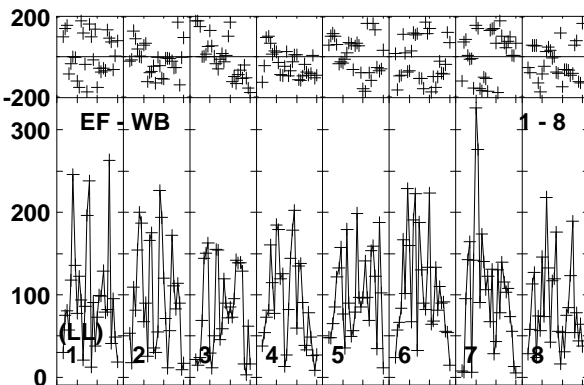
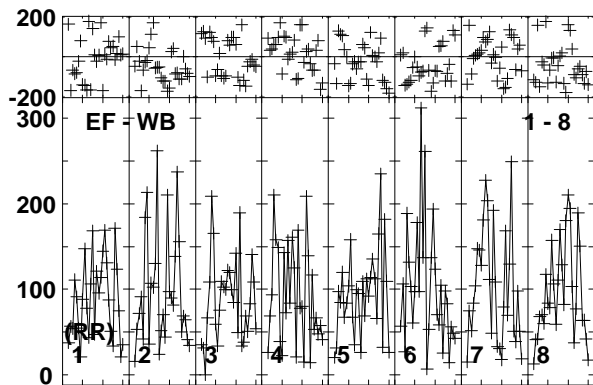
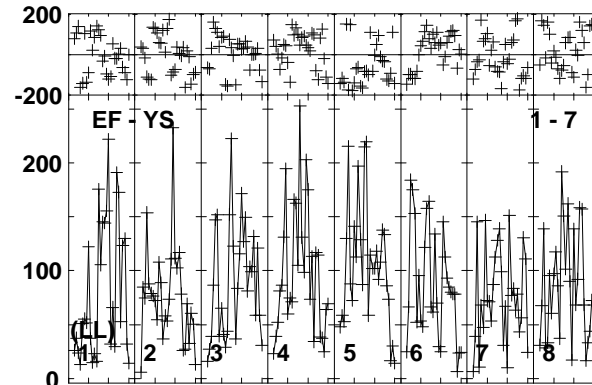
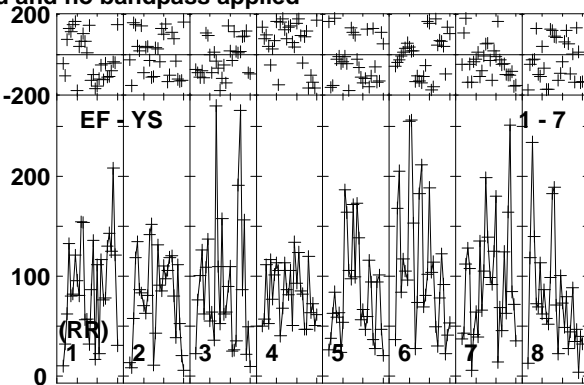
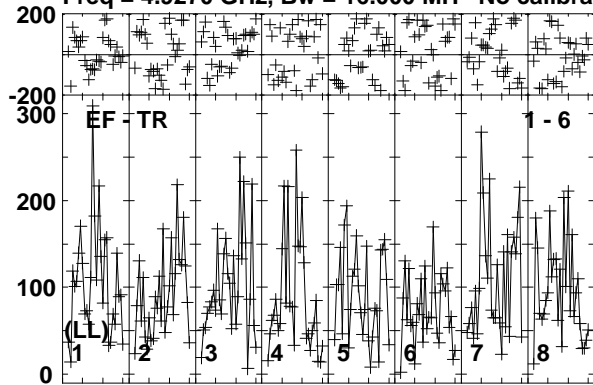

Lower frame: Micro Ampl Jy Top frame: Phas deg
Vector averaged cross-power spectrum Baseline: EF (01) - TR (06)
Timerange: 00:12:13:30 to 00:12:16:30

Plot file version 61 created 10-JUN-2016 16:07:52

J0718-1813 RG008D.UVDATA.1

Freq = 4.9270 GHz, Bw = 16.000 MH No calibration applied and no bandpass applied

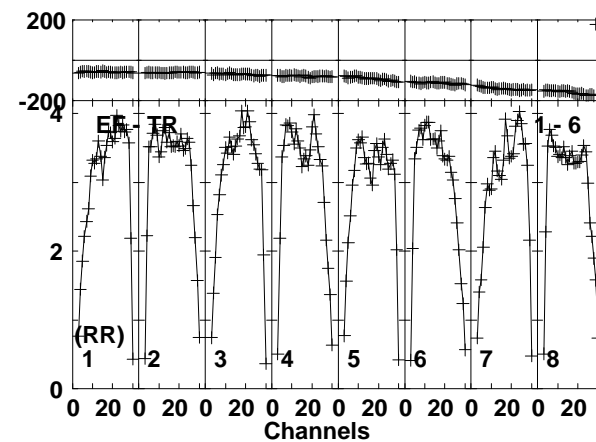
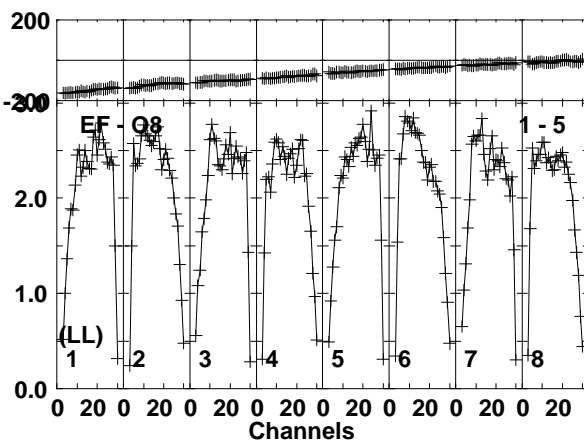
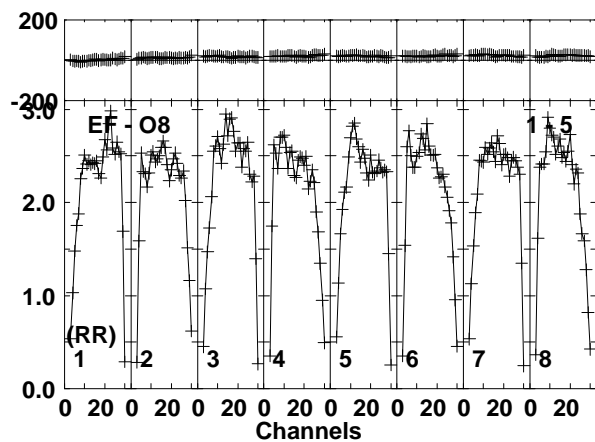
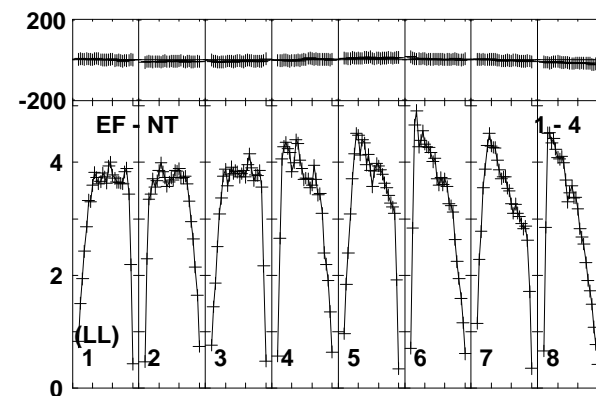
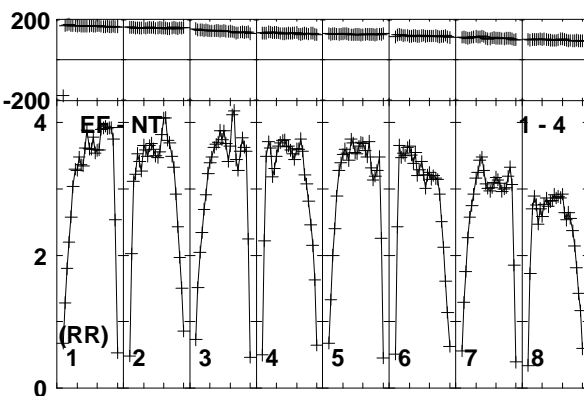
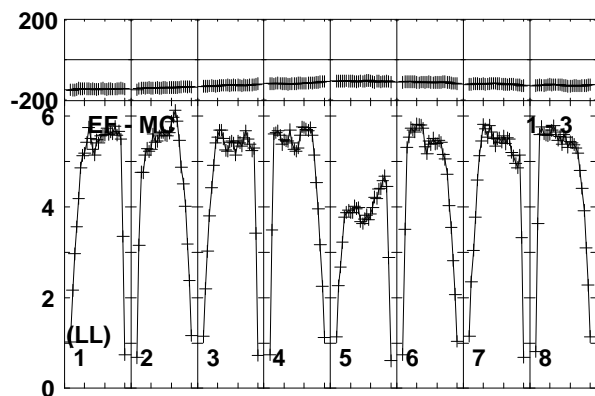
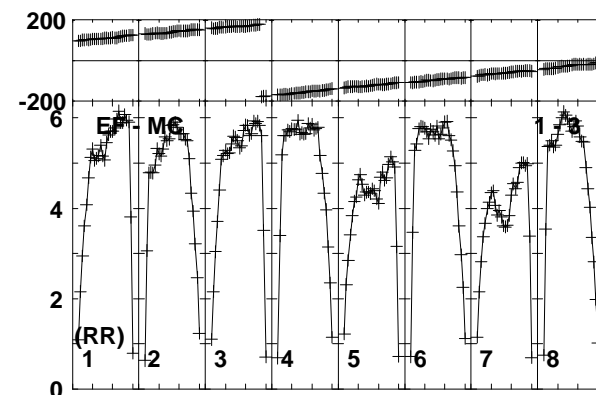
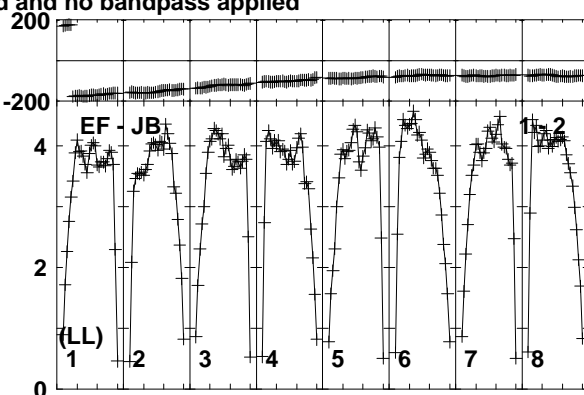
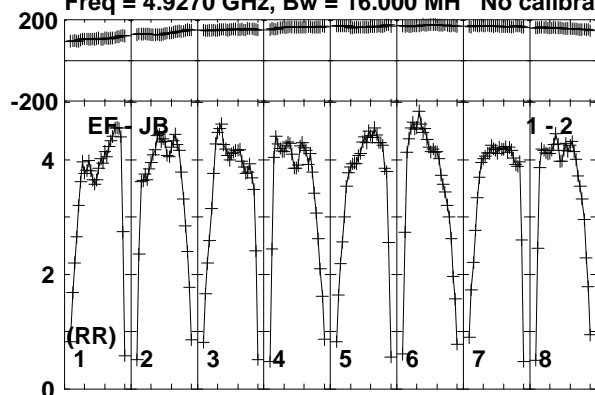

Lower frame: Milli Ampl Jy Top frame: Phas deg
Vector averaged cross-power spectrum Baseline: EF (01) - JB (02)
Timerange: 00:12:17:10 to 00:12:17:59

Plot file version 62 created 10-JUN-2016 16:07:52

J0718-1813 RG008D.UVDATA.1

Freq = 4.9270 GHz, Bw = 16.000 MH No calibration applied and no bandpass applied

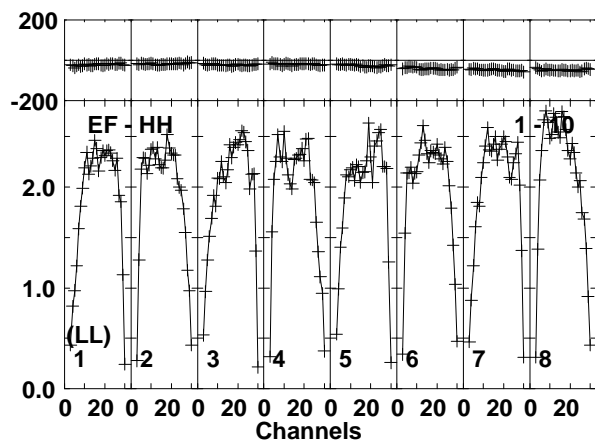
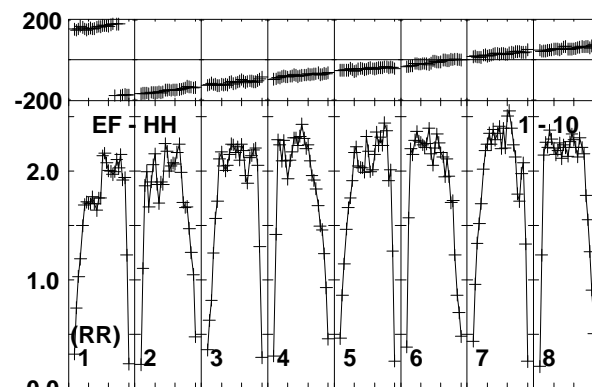
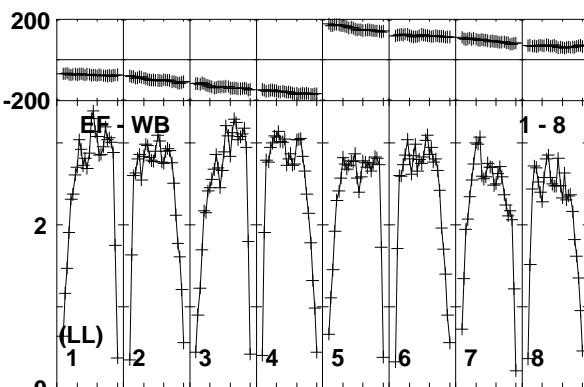
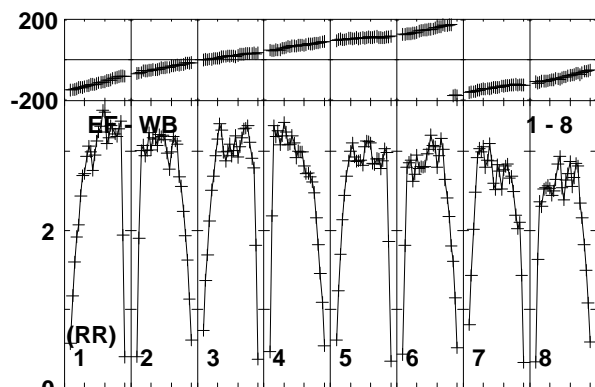
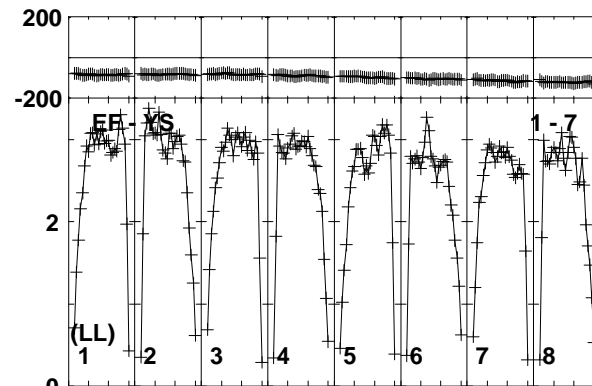
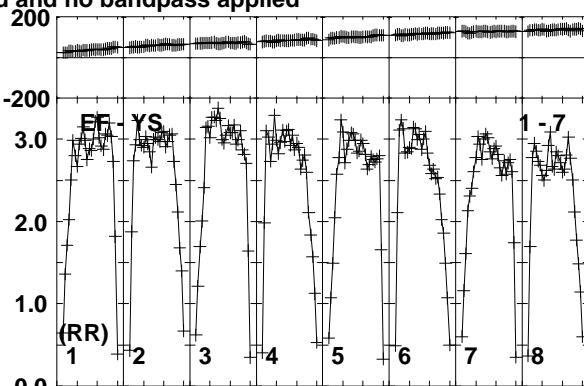
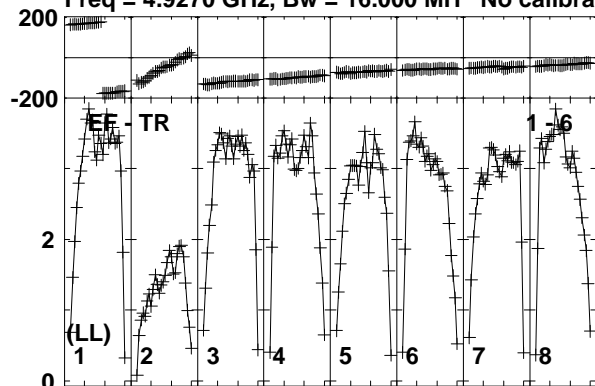

Lower frame: Milli Ampl Jy Top frame: Phas deg
Vector averaged cross-power spectrum Baseline: EF (01) - TR (06)
Timerange: 00:12:17:10 to 00:12:17:59

Plot file version 63 created 10-JUN-2016 16:07:53

FRB150418 RG008D.UVDATA.1

Freq = 4.9270 GHz, Bw = 16.000 MH No calibration applied and no bandpass applied

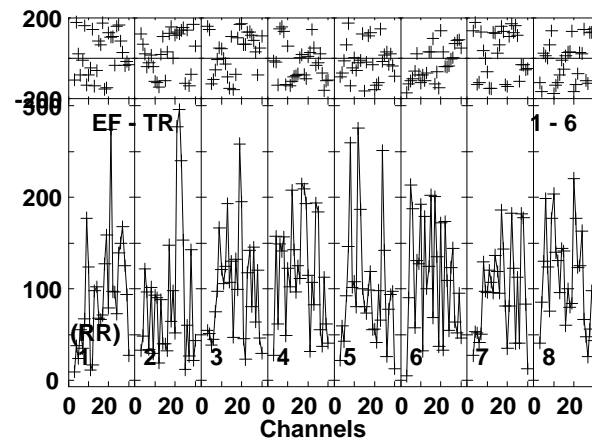
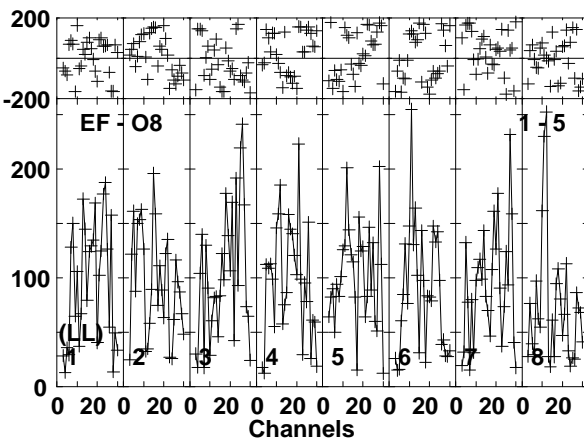
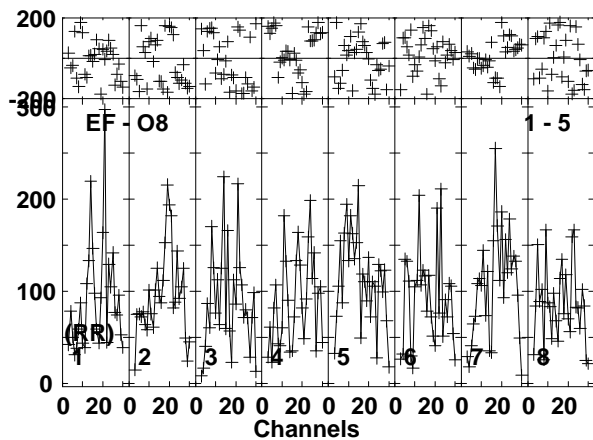
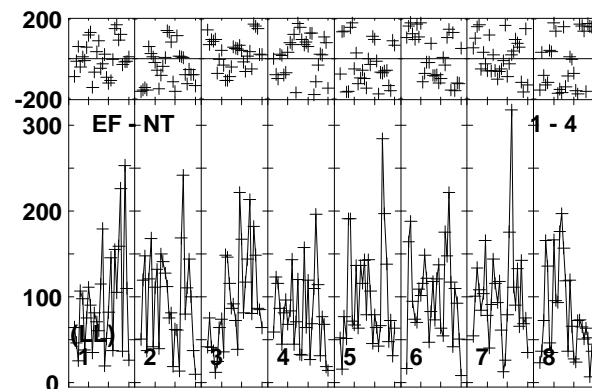
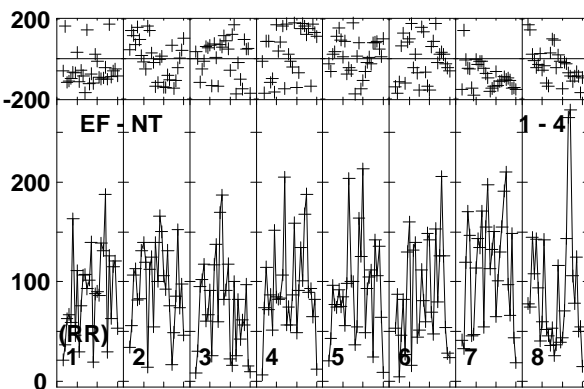
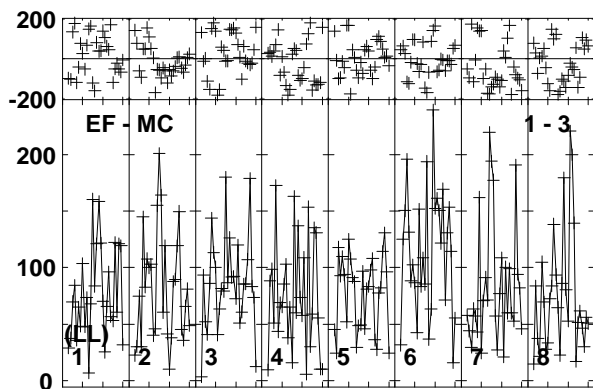
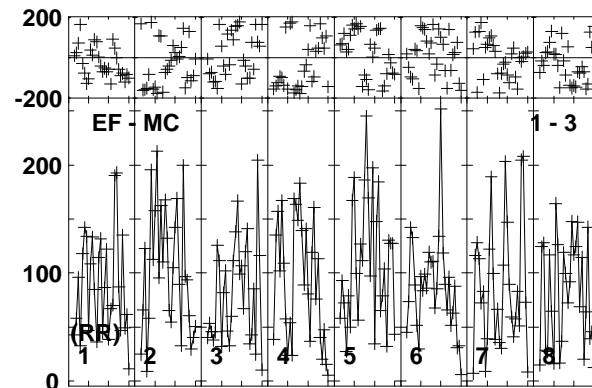
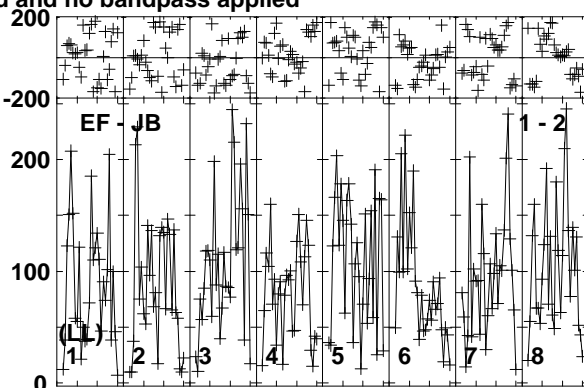
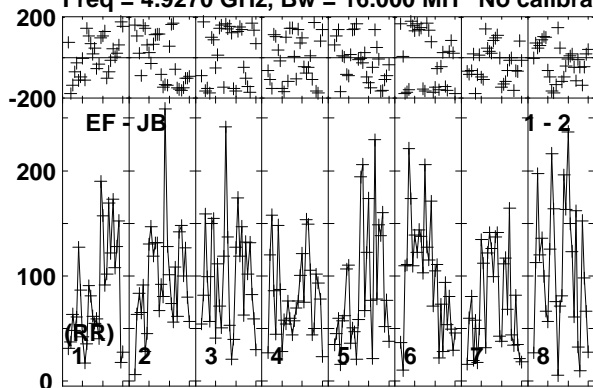

Lower frame: Micro Ampl Jy Top frame: Phas deg
Vector averaged cross-power spectrum Baseline: EF (01) - JB (02)
Timerange: 00:12:18:00 to 00:12:21:00

Plot file version 64 created 10-JUN-2016 16:07:53

FRB150418 RG008D.UVDATA.1

Freq = 4.9270 GHz, Bw = 16.000 MH No calibration applied and no bandpass applied

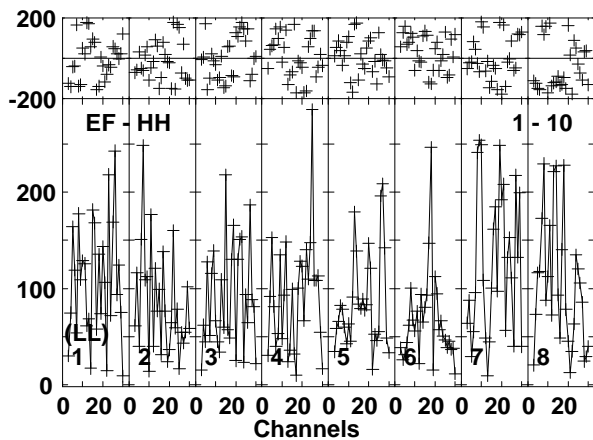
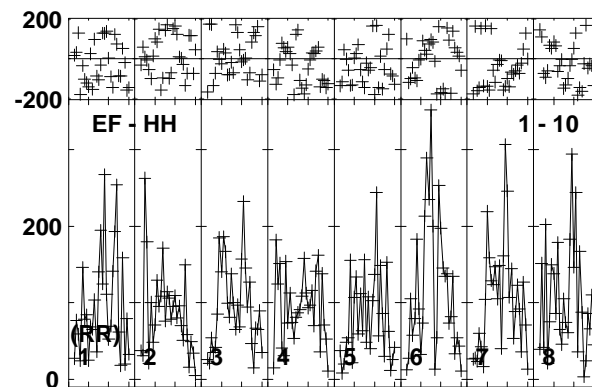
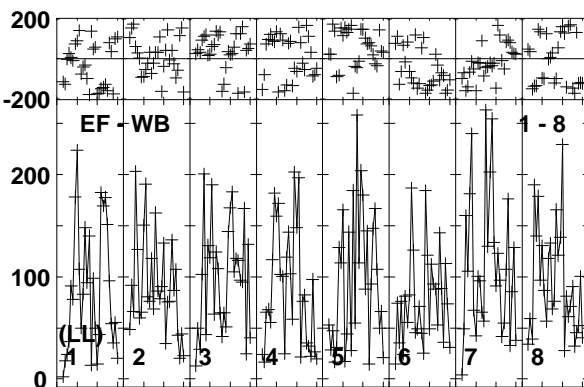
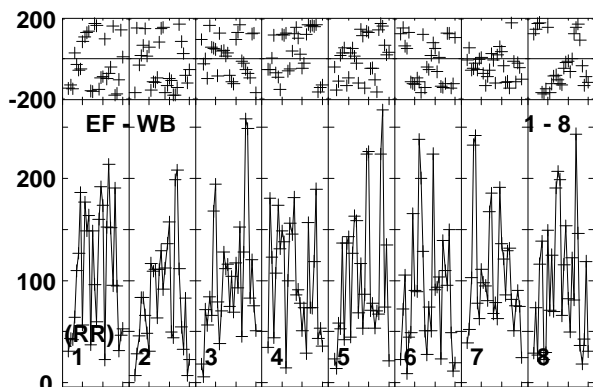
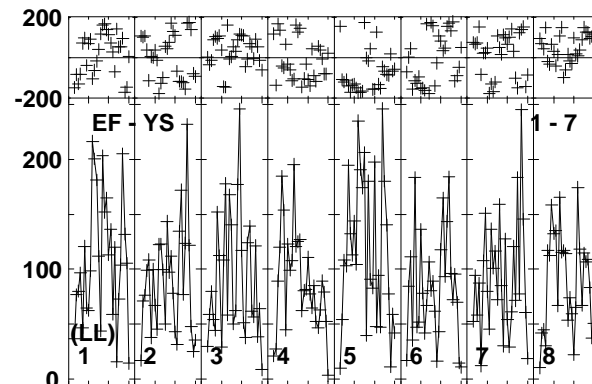
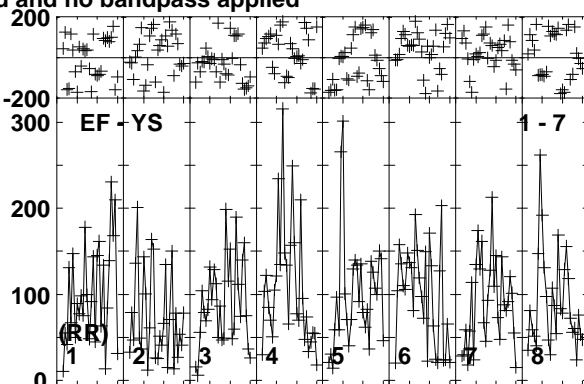
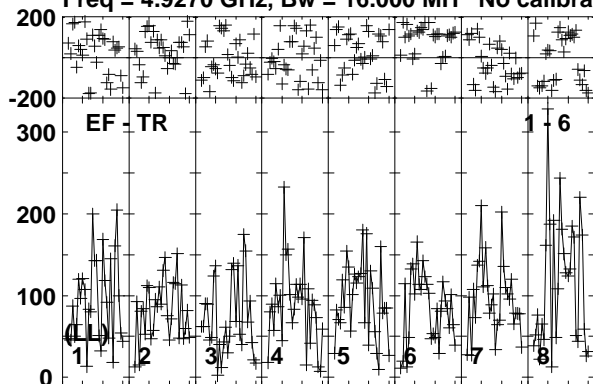

Lower frame: Micro Ampl Jy Top frame: Phas deg
Vector averaged cross-power spectrum Baseline: EF (01) - TR (06)
Timerange: 00:12:18:00 to 00:12:21:00

Plot file version 65 created 10-JUN-2016 16:07:53

J0718-1813 RG008D.UVDATA.1

Freq = 4.9270 GHz, Bw = 16.000 MH No calibration applied and no bandpass applied

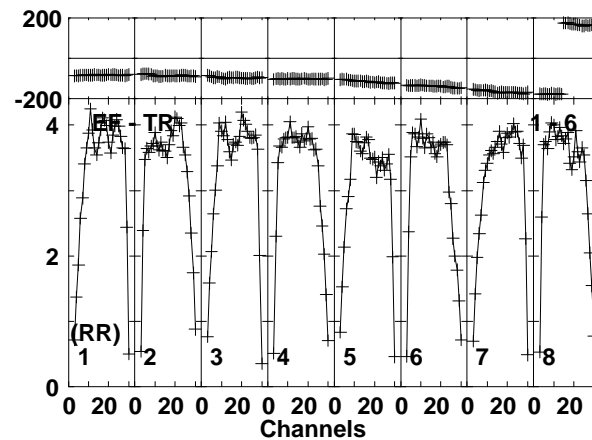
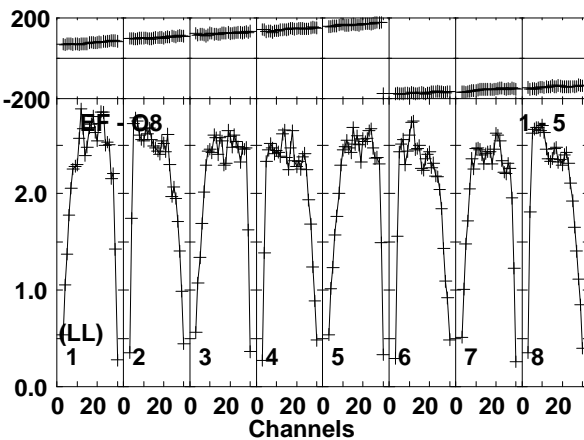
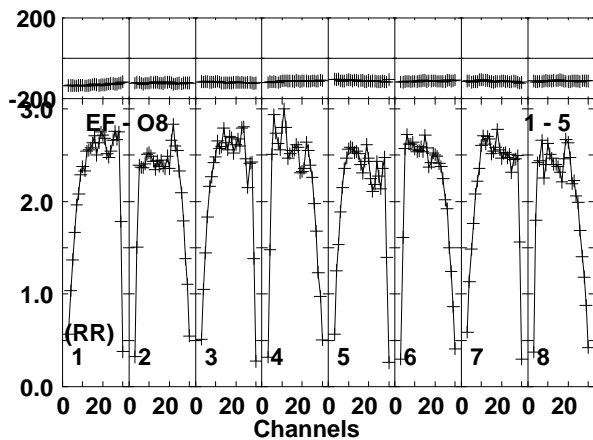
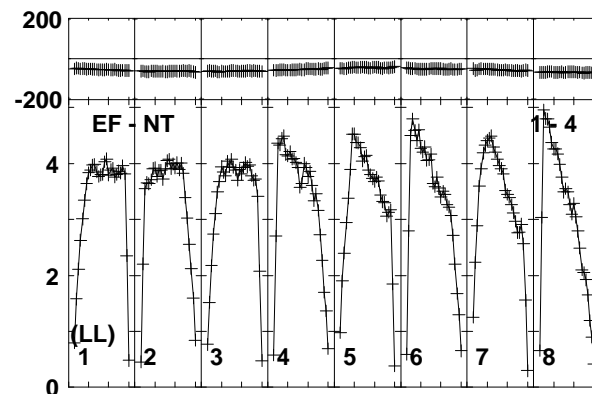
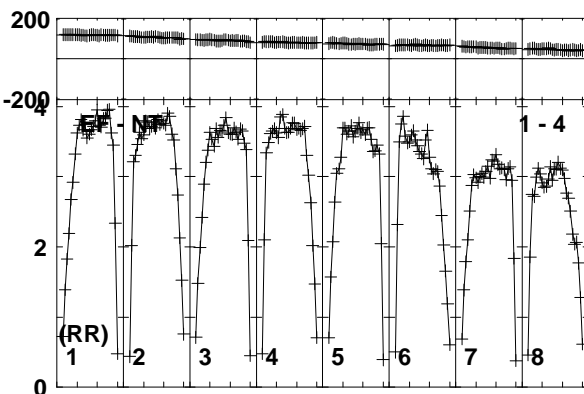
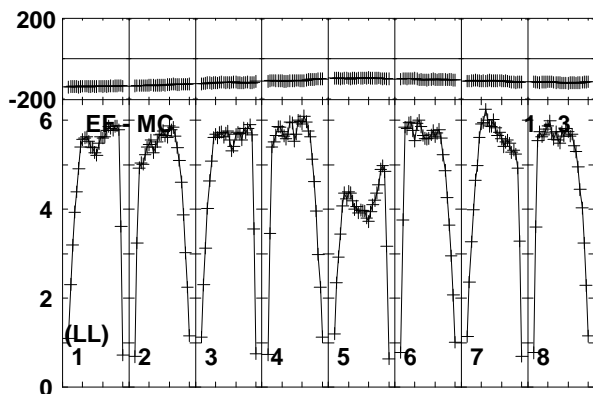
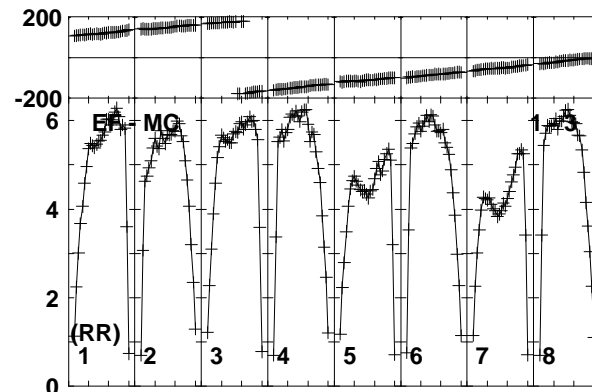
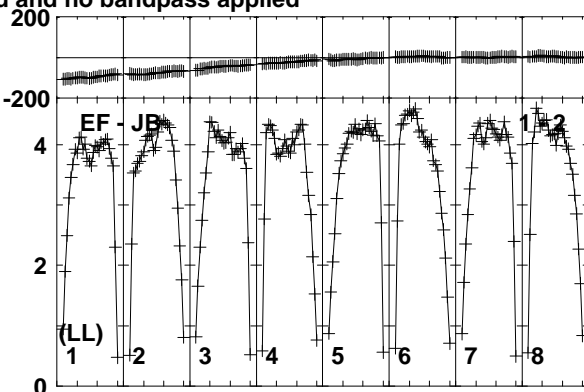
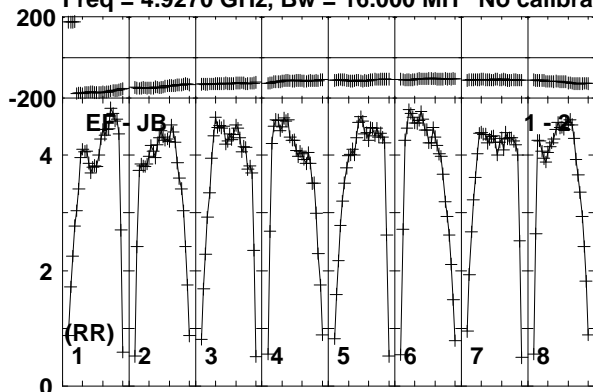

Lower frame: Milli Ampl Jy Top frame: Phas deg
Vector averaged cross-power spectrum Baseline: EF (01) - JB (02)
Timerange: 00:12:21:01 to 00:12:22:29

Plot file version 66 created 10-JUN-2016 16:07:53

J0718-1813 RG008D.UVDATA.1

Freq = 4.9270 GHz, Bw = 16.000 MH No calibration applied and no bandpass applied

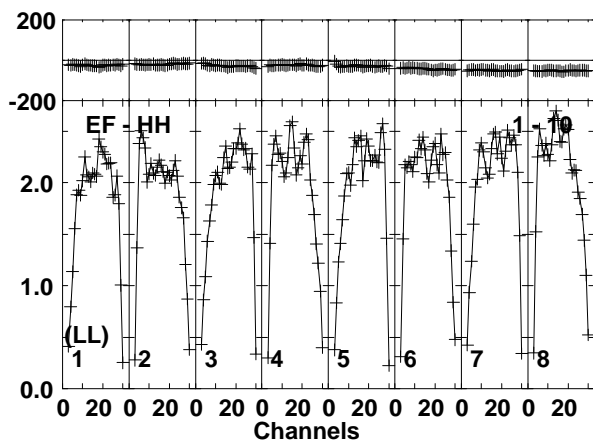
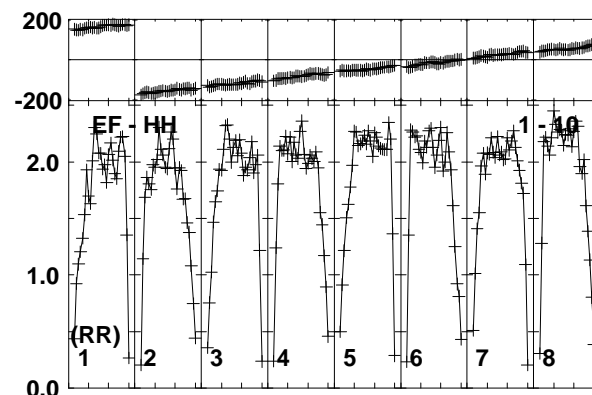
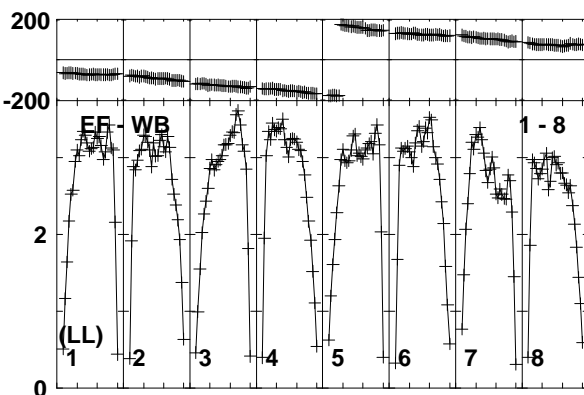
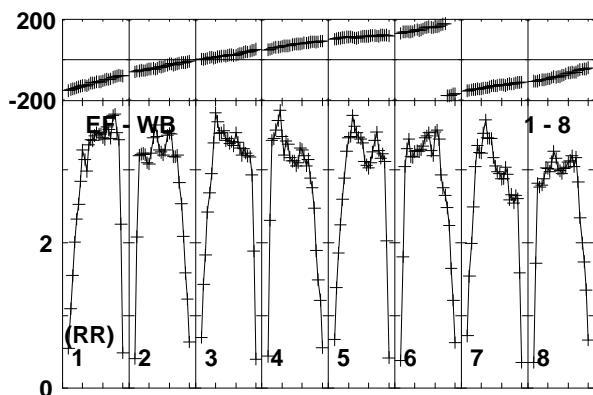
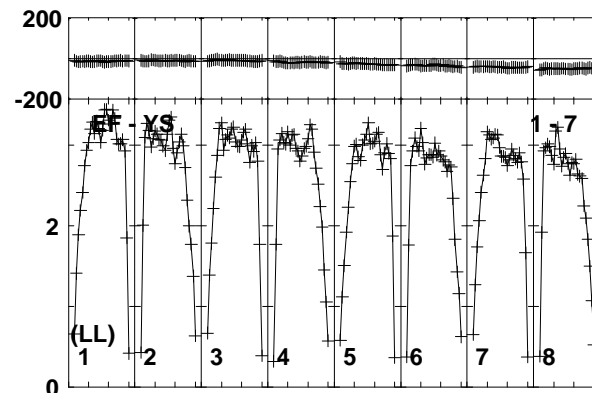
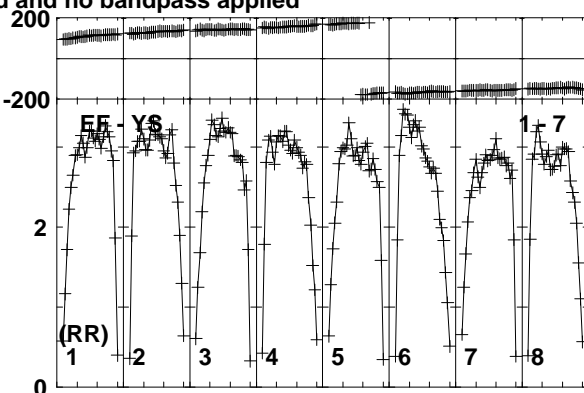
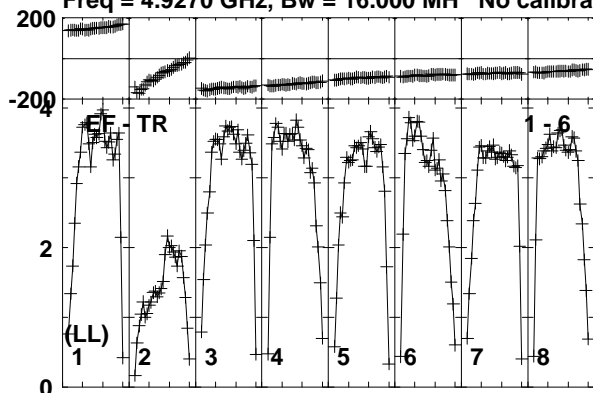

Lower frame: Milli Ampl Jy Top frame: Phas deg
Vector averaged cross-power spectrum Baseline: EF (01) - TR (06)
Timerange: 00:12:21:01 to 00:12:22:29

Plot file version 67 created 10-JUN-2016 16:07:53

J0712-1847 RG008D.UVDATA.1

Freq = 4.9270 GHz, Bw = 16.000 MH No calibration applied and no bandpass applied

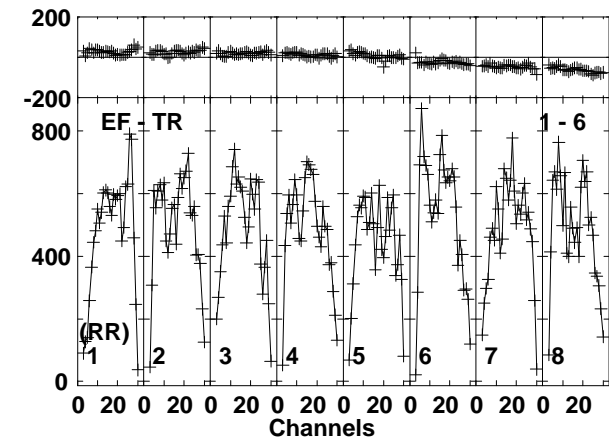
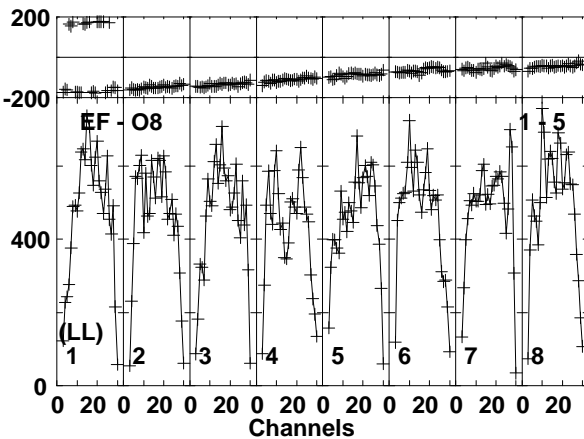
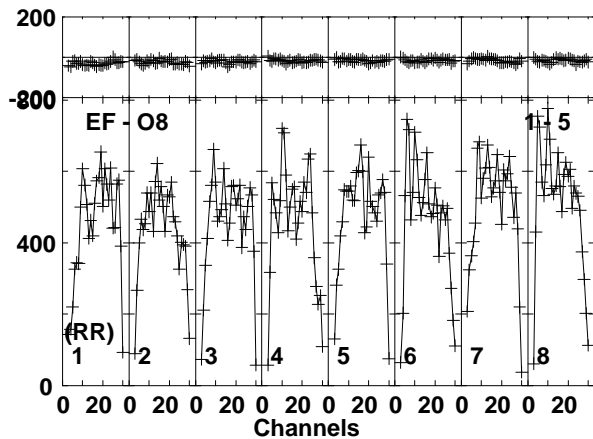
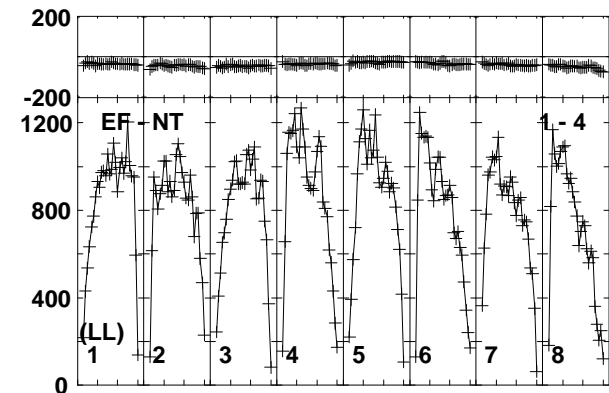
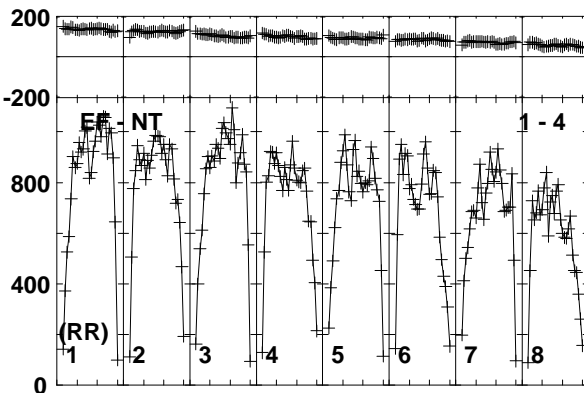
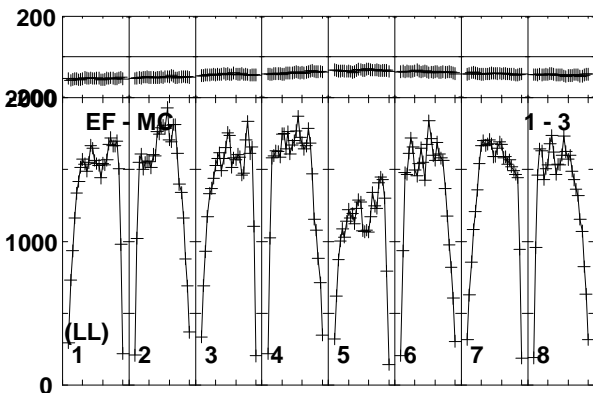
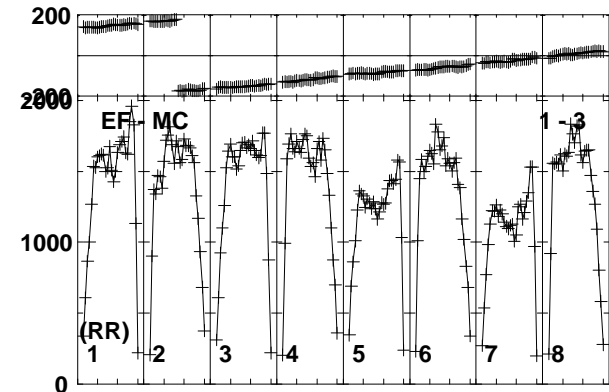
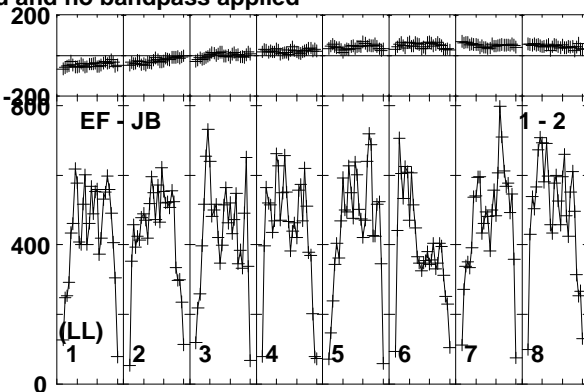
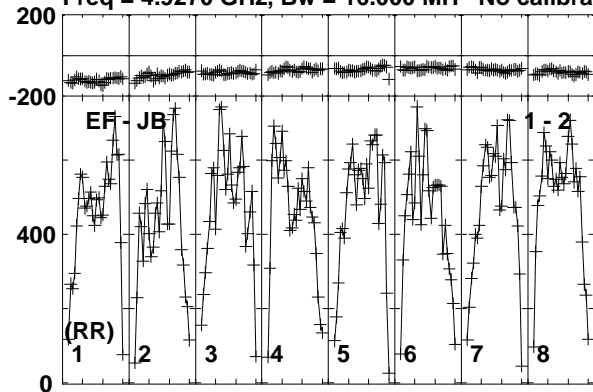

Lower frame: Micro Ampl Jy Top frame: Phas deg
Vector averaged cross-power spectrum Baseline: EF (01) - JB (02)
Timerange: 00/12:22:31 to 00/12:25:29

Plot file version 68 created 10-JUN-2016 16:07:53

J0712-1847 RG008D.UVDATA.1

Freq = 4.9270 GHz, Bw = 16.000 MH No calibration applied and no bandpass applied

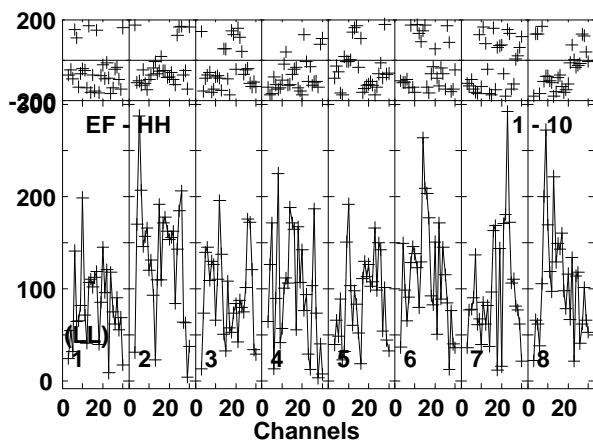
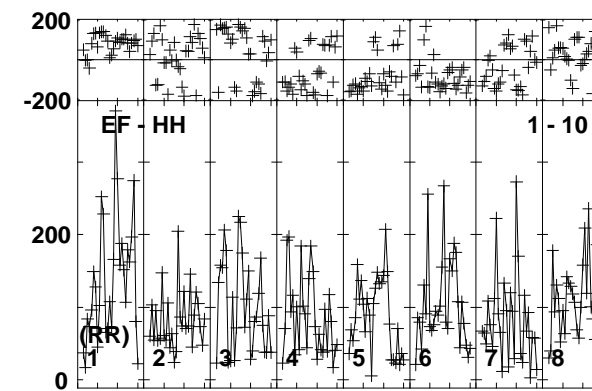
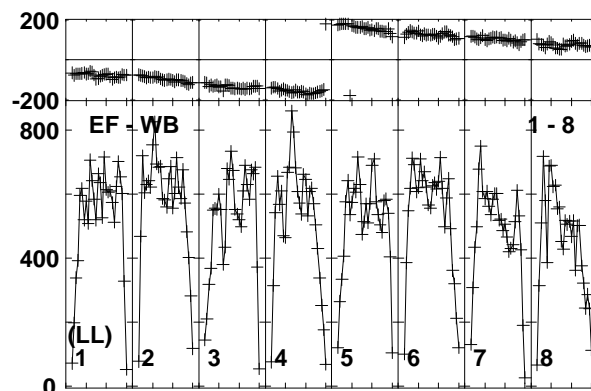
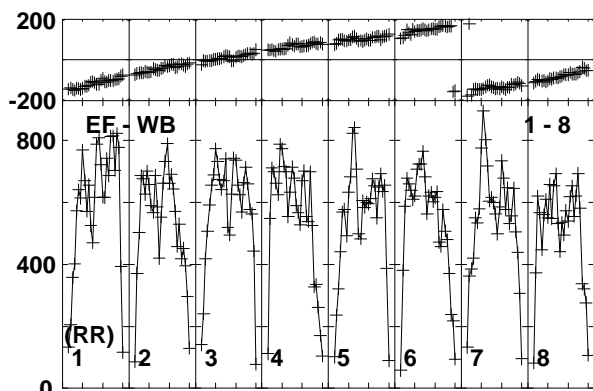
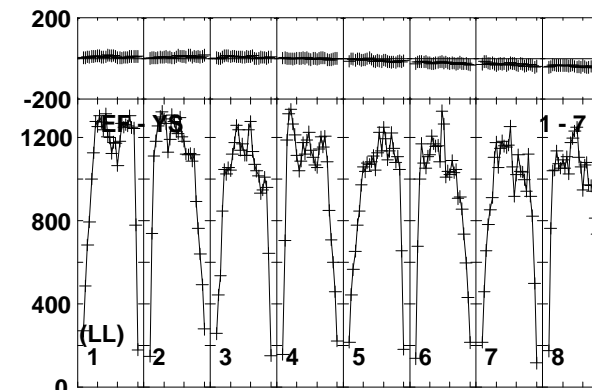
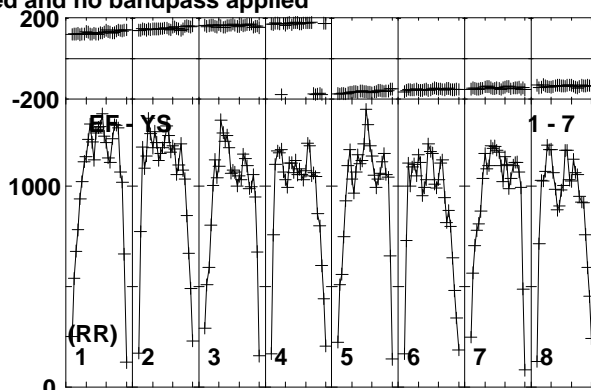
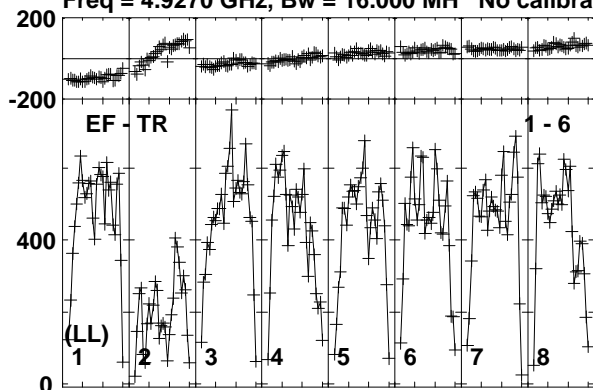

Lower frame: Micro Ampl Jy Top frame: Phas deg
Vector averaged cross-power spectrum Baseline: EF (01) - TR (06)
Timerange: 00/12:22:31 to 00/12:25:29

Plot file version 69 created 10-JUN-2016 16:07:53

J0718-1813 RG008D.UVDATA.1

Freq = 4.9270 GHz, Bw = 16.000 MH No calibration applied and no bandpass applied

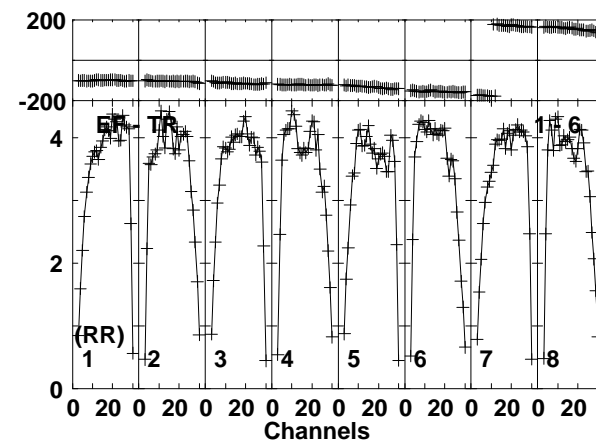
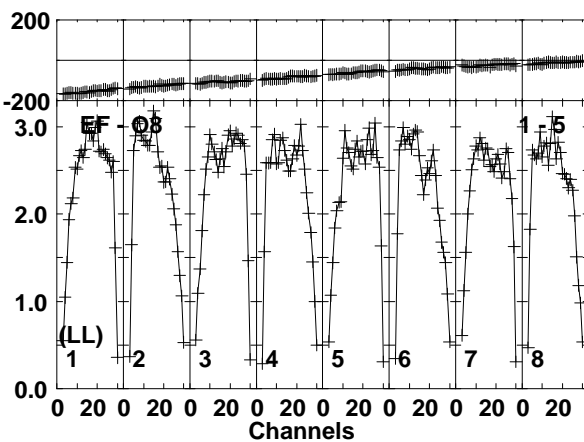
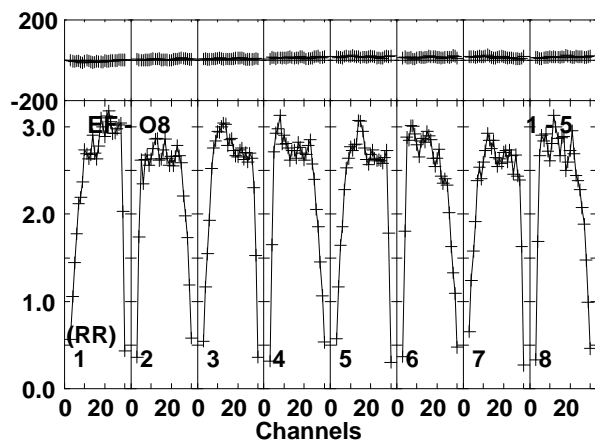
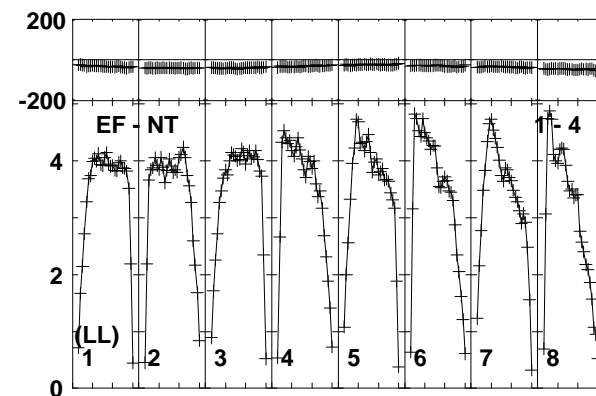
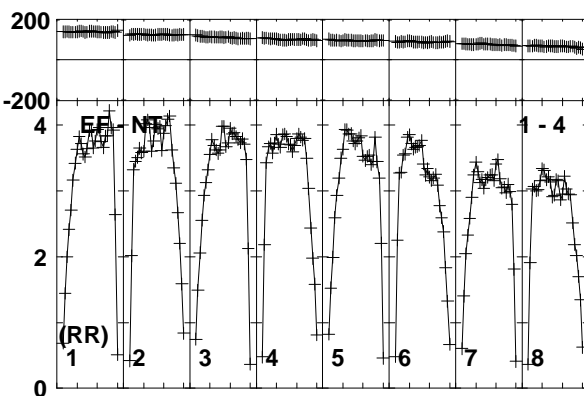
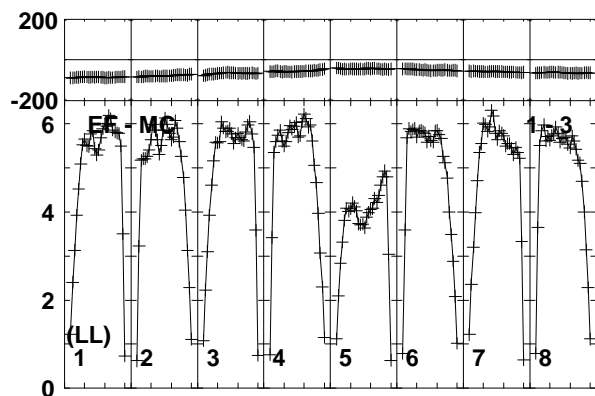
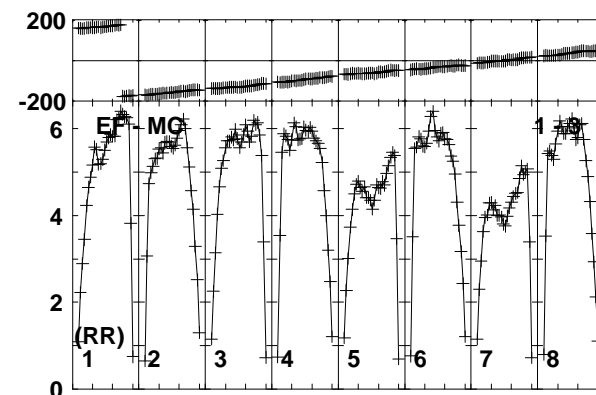
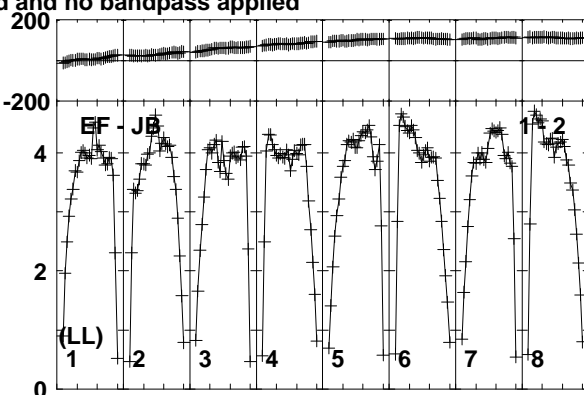
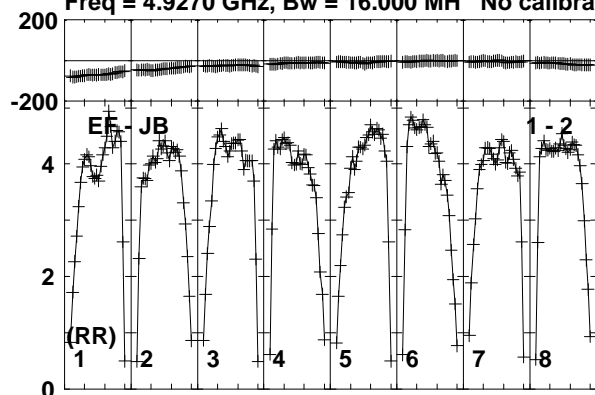

Lower frame: Milli Ampl Jy Top frame: Phas deg
Vector averaged cross-power spectrum Baseline: EF (01) - JB (02)
Timerange: 00:12:26:10 to 00:12:27:00

Plot file version 70 created 10-JUN-2016 16:07:53

J0718-1813 RG008D.UVDATA.1

Freq = 4.9270 GHz, Bw = 16.000 MH No calibration applied and no bandpass applied

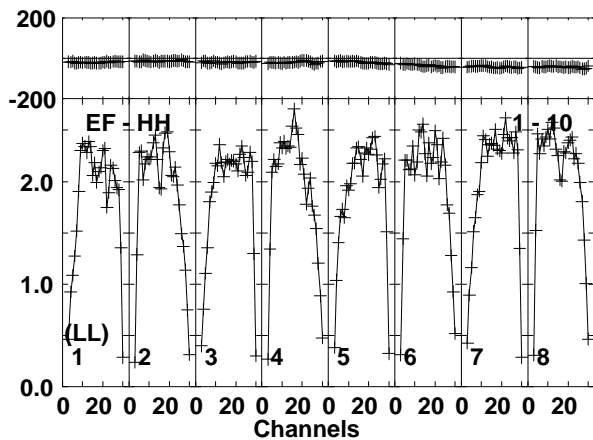
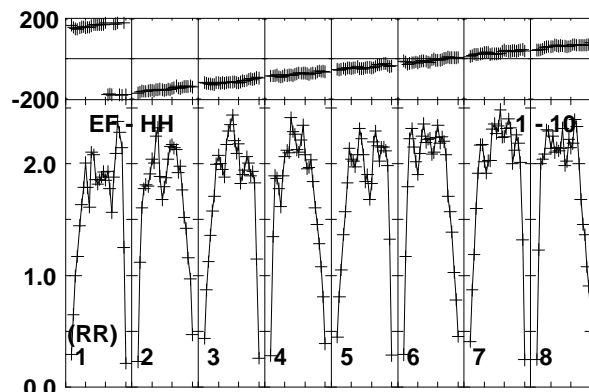
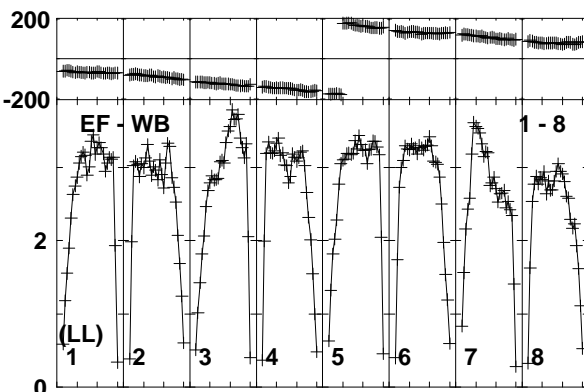
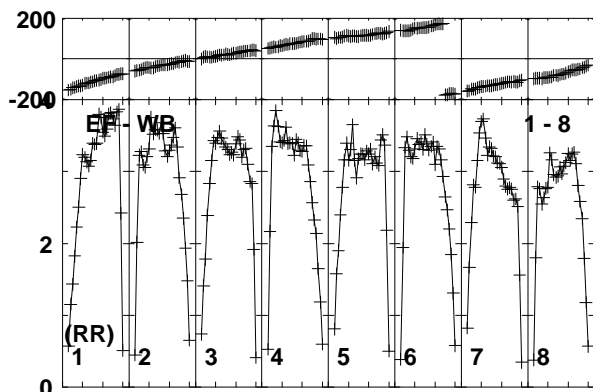
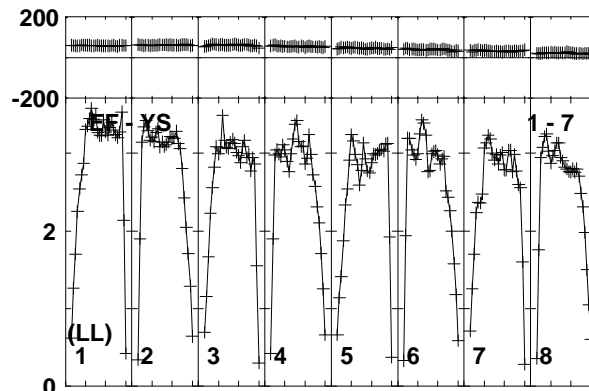
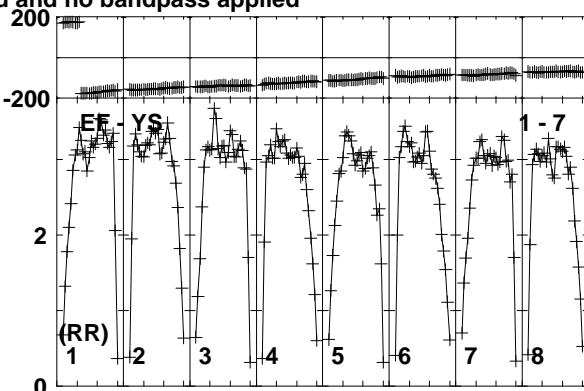
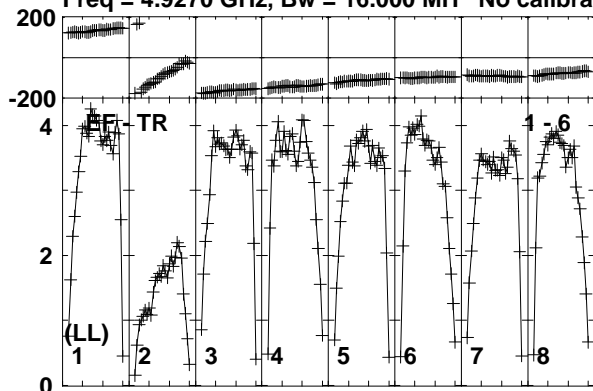

Lower frame: Milli Ampl Jy Top frame: Phas deg
Vector averaged cross-power spectrum Baseline: EF (01) - TR (06)
Timerange: 00/12:26:10 to 00/12:27:00

Plot file version 71 created 10-JUN-2016 16:07:54

FRB150418 RG008D.UVDATA.1

Freq = 4.9270 GHz, Bw = 16.000 MH No calibration applied and no bandpass applied

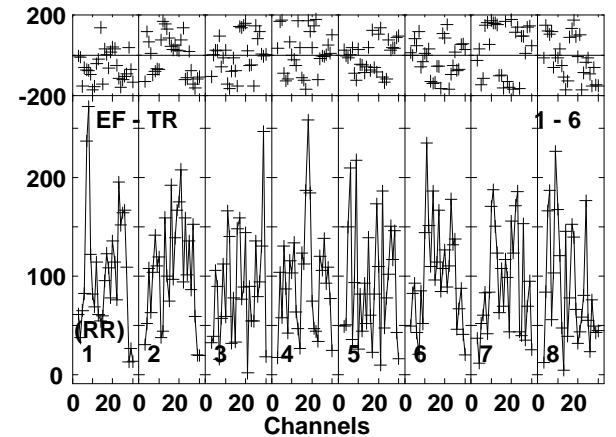
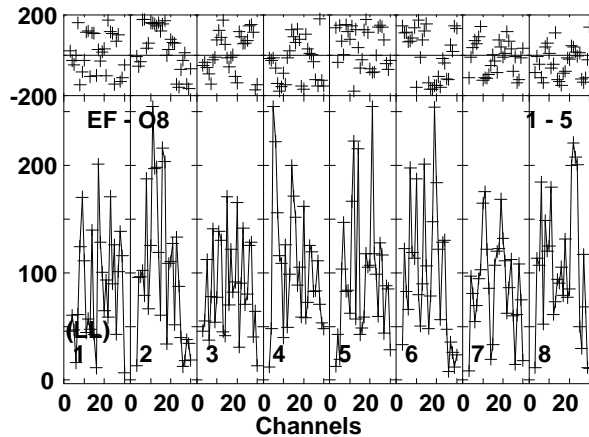
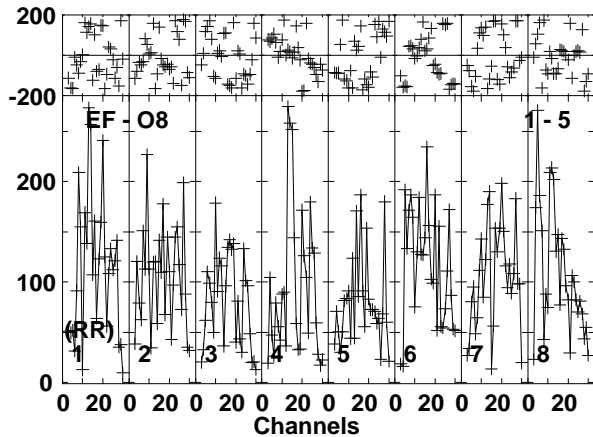
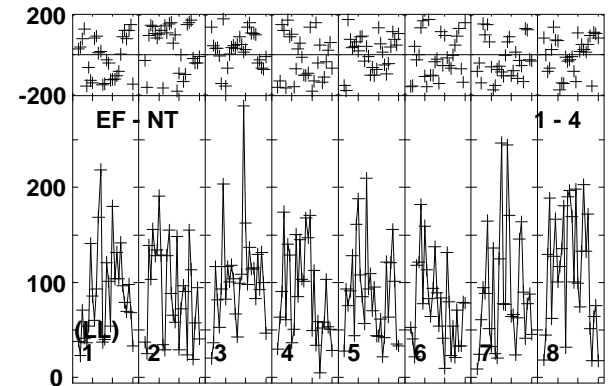
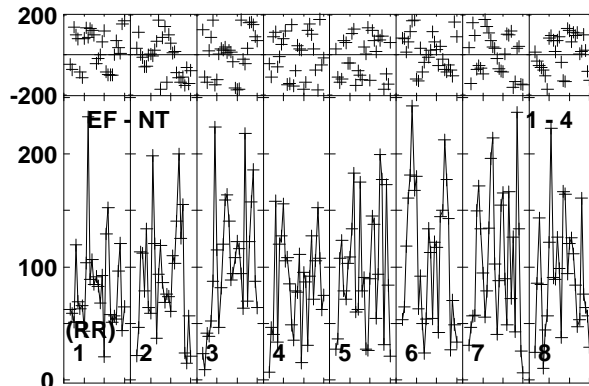
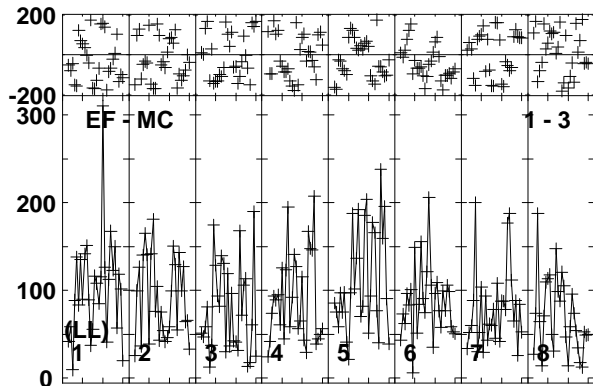
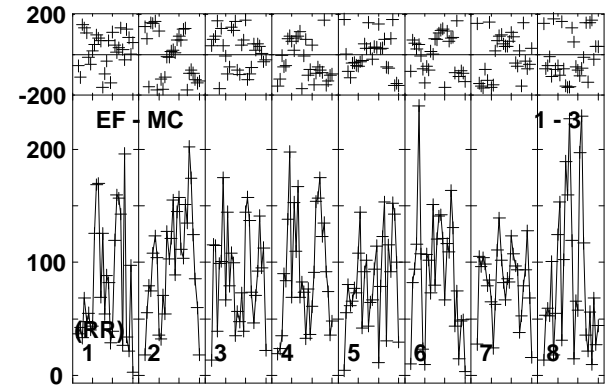
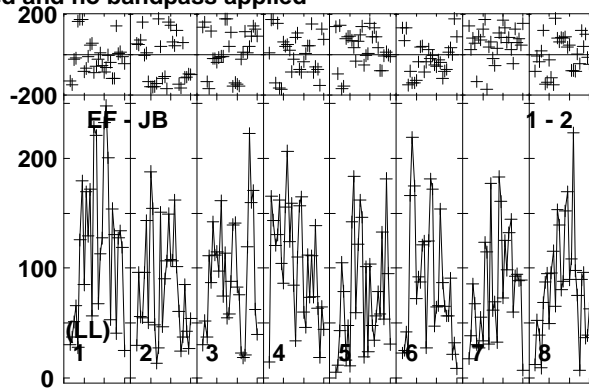
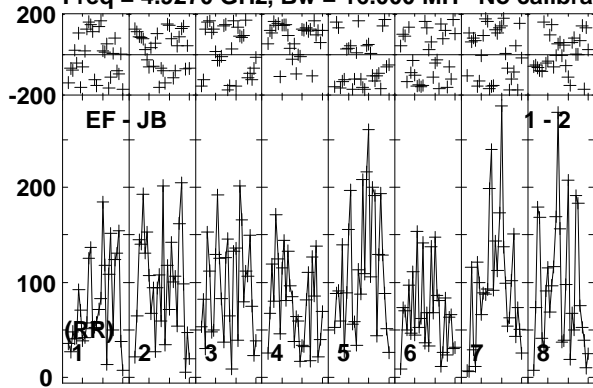

Lower frame: Micro Ampl Jy Top frame: Phas deg
Vector averaged cross-power spectrum Baseline: EF (01) - JB (02)
Timerange: 00/12:27:01 to 00/12:29:59

Plot file version 72 created 10-JUN-2016 16:07:54

FRB150418 RG008D.UVDATA.1

Freq = 4.9270 GHz, Bw = 16.000 MH No calibration applied and no bandpass applied

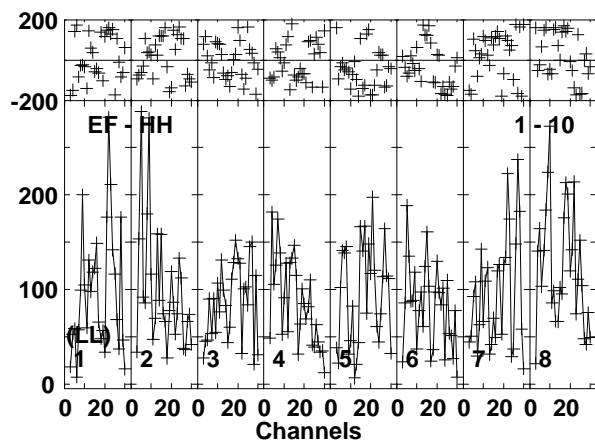
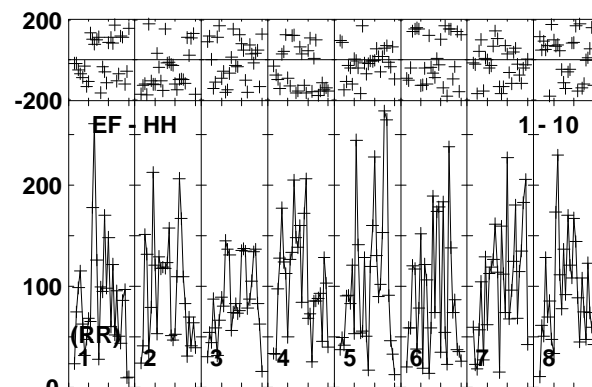
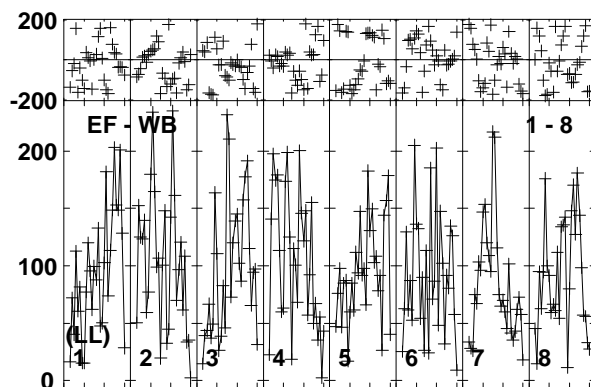
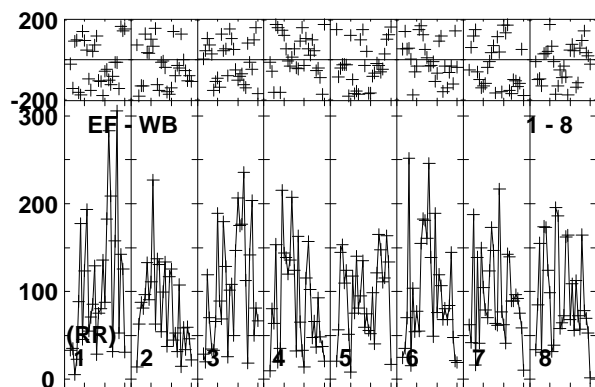
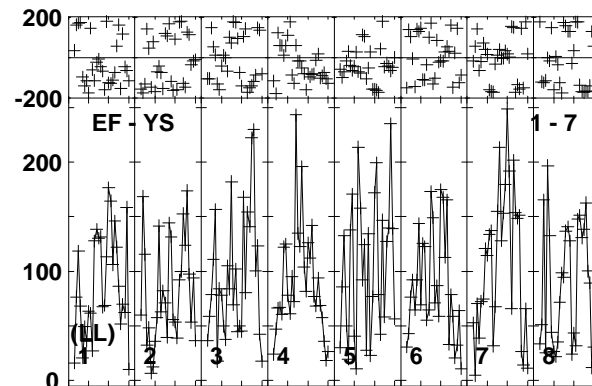
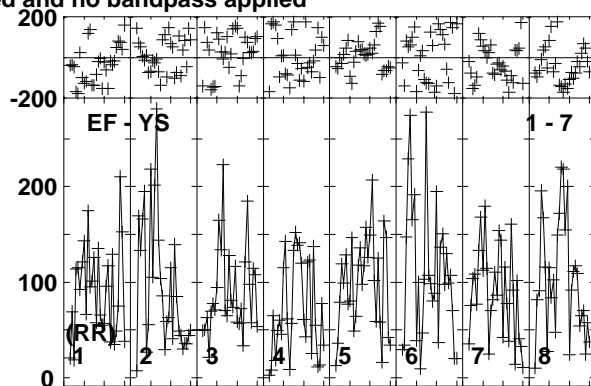
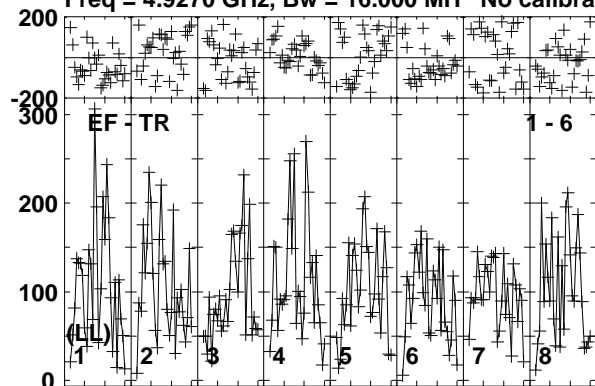

Lower frame: Micro Ampl Jy Top frame: Phas deg
Vector averaged cross-power spectrum Baseline: EF (01) - TR (06)
Timerange: 00/12:27:01 to 00/12:29:59

Plot file version 73 created 10-JUN-2016 16:07:54

J0718-1813 RG008D.UVDATA.1

Freq = 4.9270 GHz, Bw = 16.000 MH No calibration applied and no bandpass applied

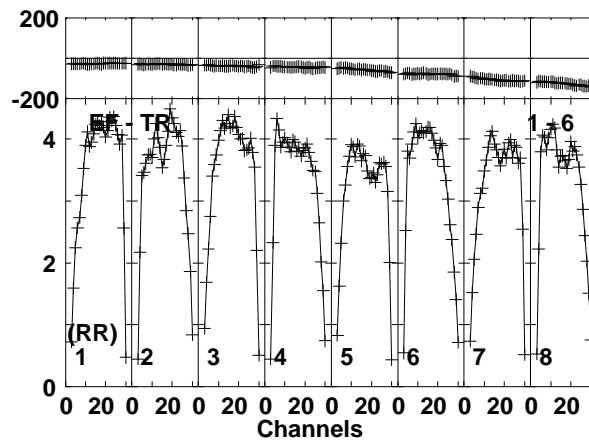
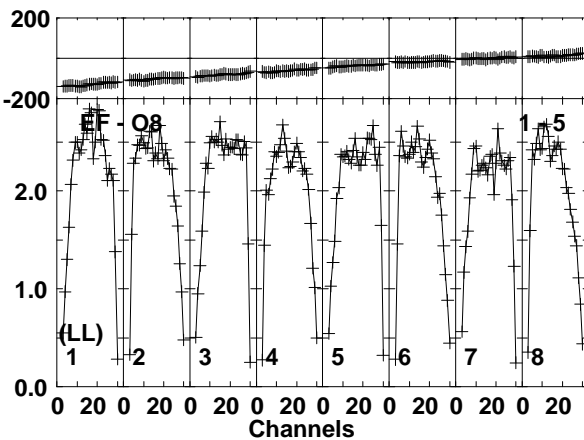
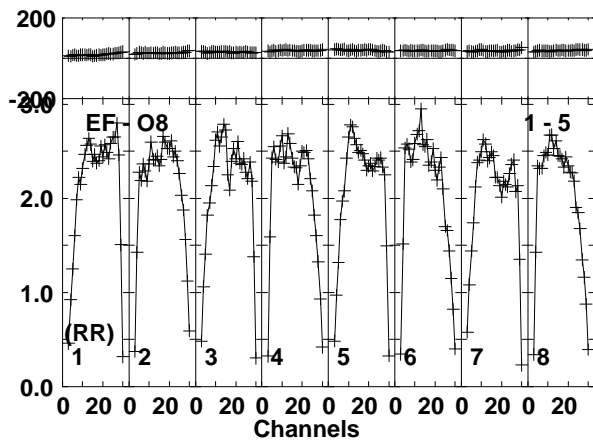
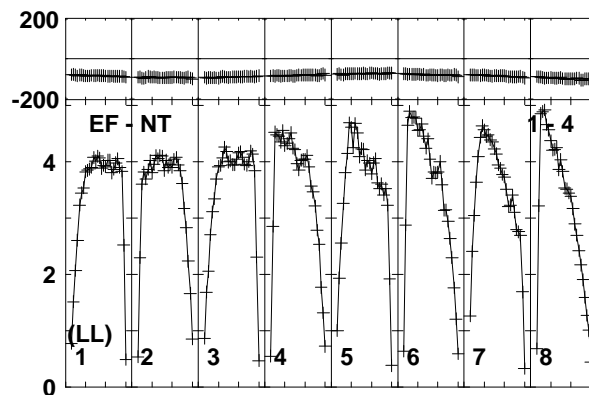
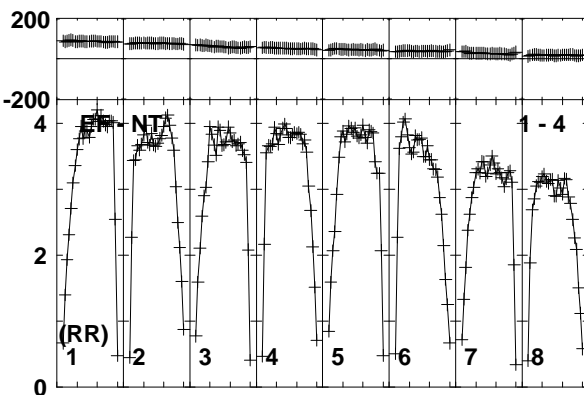
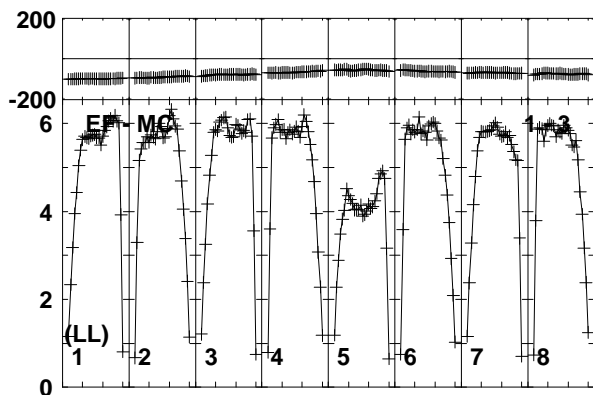
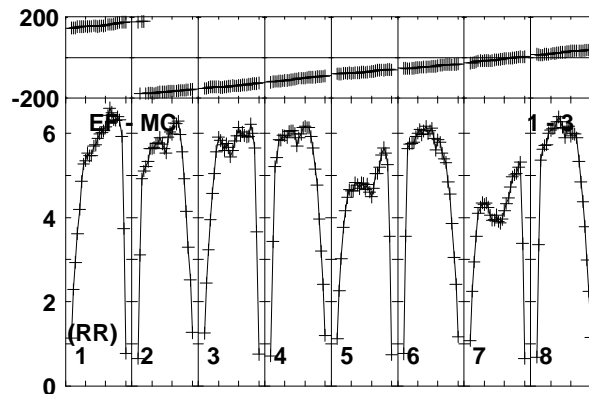
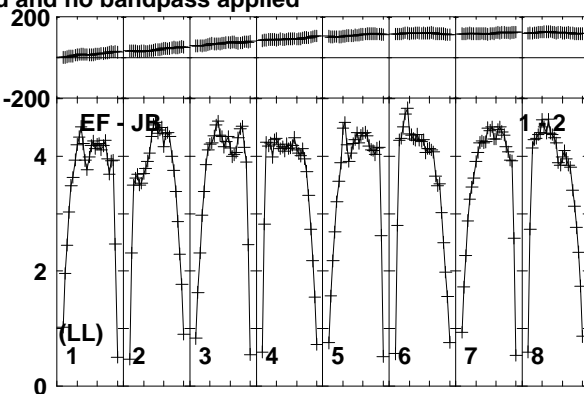
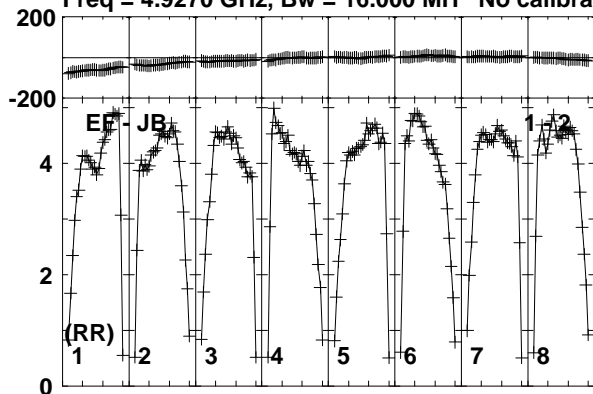

Lower frame: Milli Ampl Jy Top frame: Phas deg
Vector averaged cross-power spectrum Baseline: EF (01) - JB (02)
Timerange: 00:12:30:00 to 00:12:31:30

Plot file version 74 created 10-JUN-2016 16:07:54

J0718-1813 RG008D.UVDATA.1

Freq = 4.9270 GHz, Bw = 16.000 MH No calibration applied and no bandpass applied

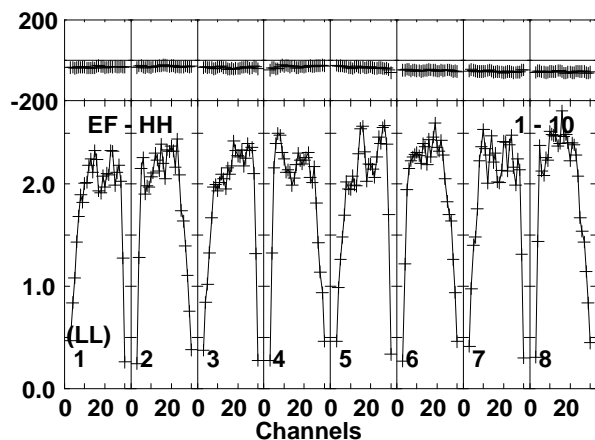
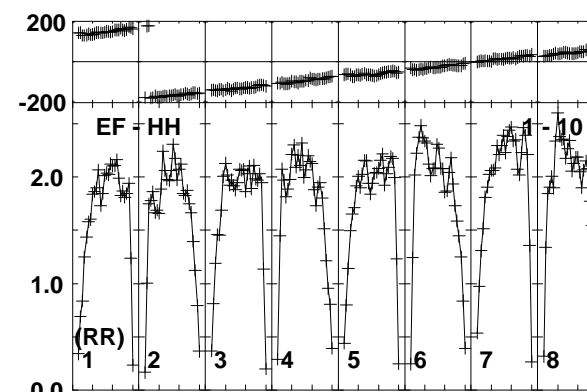
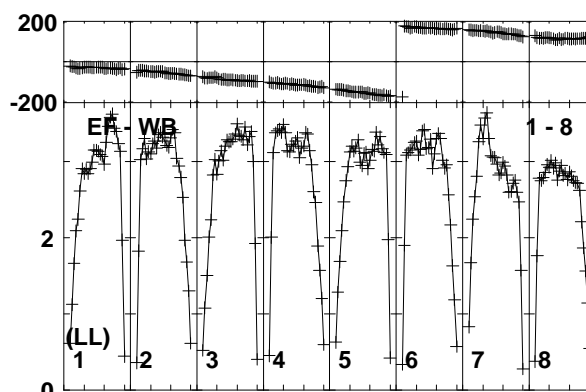
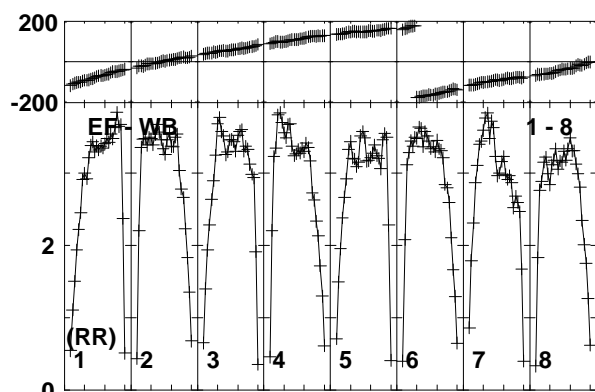
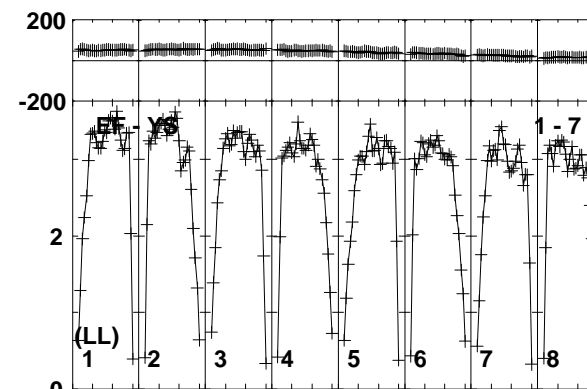
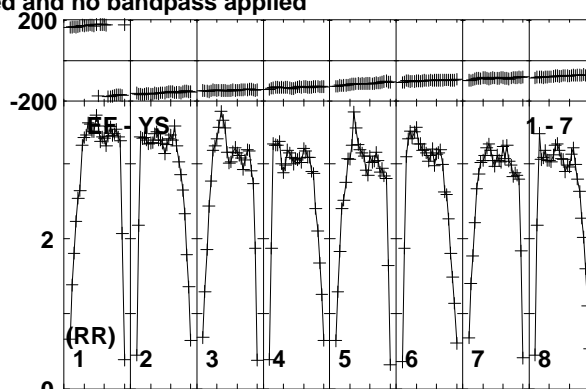
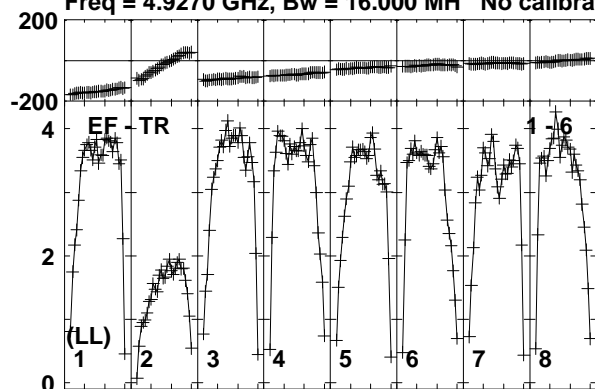

Lower frame: Milli Ampl Jy Top frame: Phas deg
Vector averaged cross-power spectrum Baseline: EF (01) - TR (06)
Timerange: 00/12:30:00 to 00/12:31:30

Plot file version 75 created 10-JUN-2016 16:07:54

FRB150418 RG008D.UVDATA.1

Freq = 4.9270 GHz, Bw = 16.000 MH No calibration applied and no bandpass applied

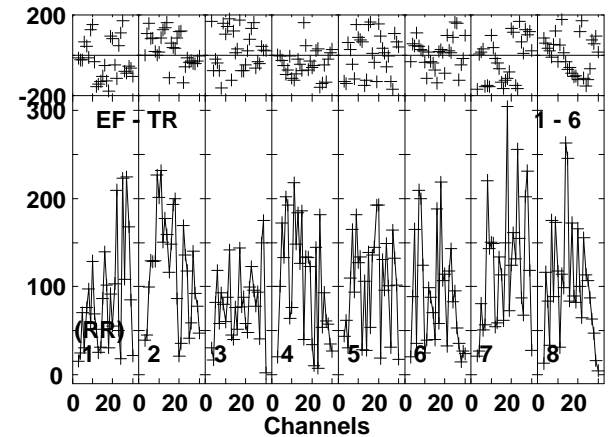
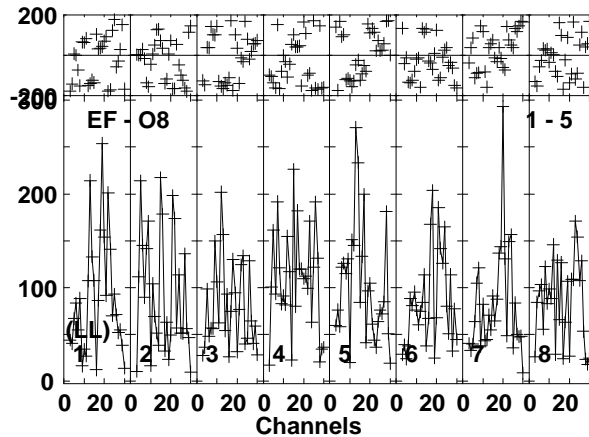
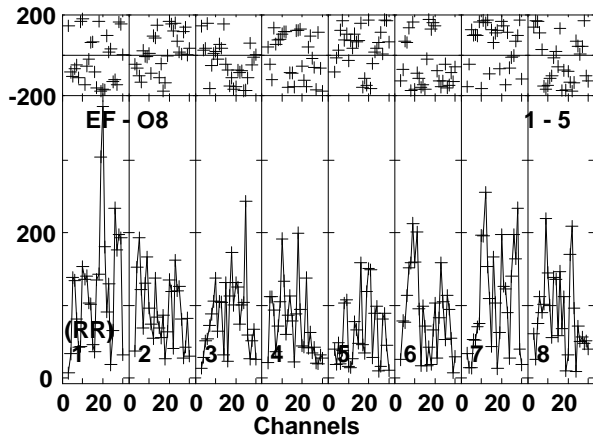
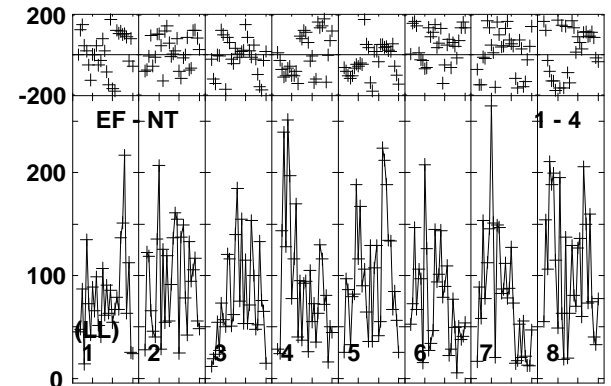
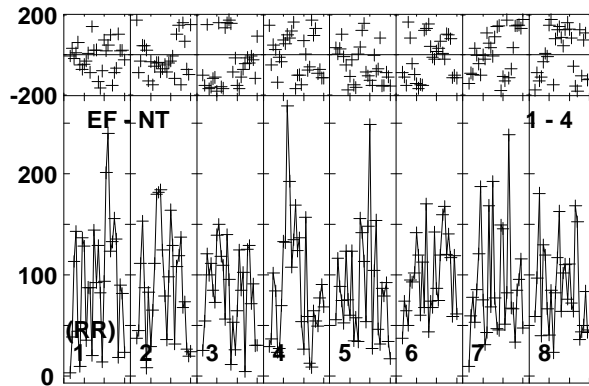
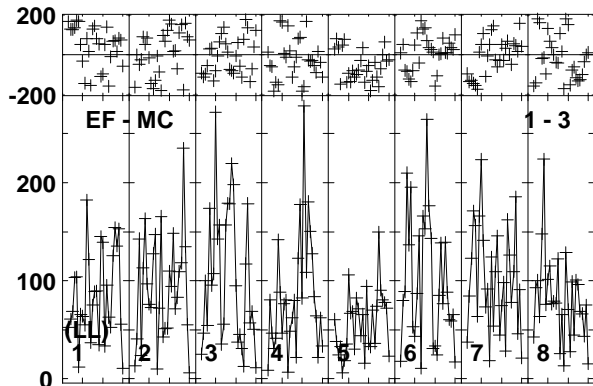
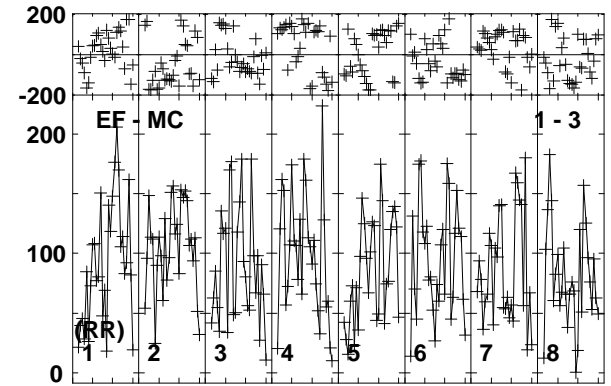
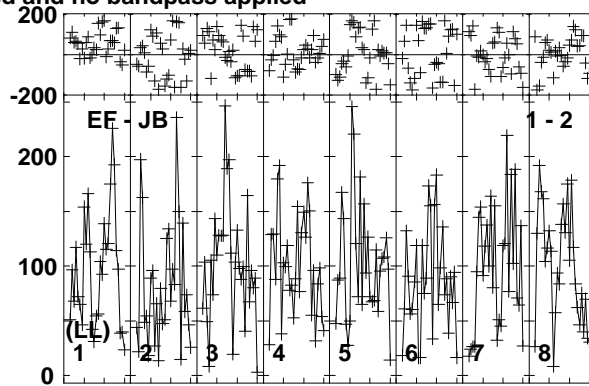
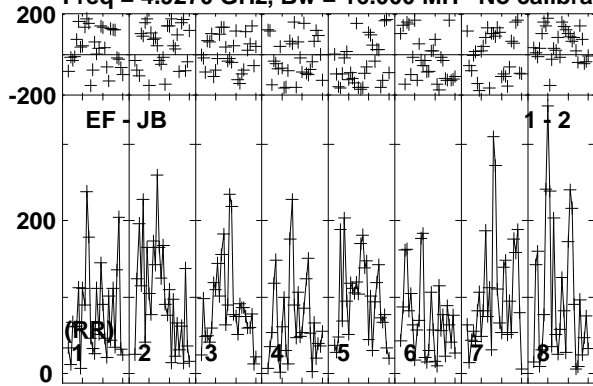

Lower frame: Micro Ampl Jy Top frame: Phas deg
Vector averaged cross-power spectrum Baseline: EF (01) - JB (02)
Timerange: 00/12:31:30 to 00/12:34:30

Plot file version 76 created 10-JUN-2016 16:07:54

FRB150418 RG008D.UVDATA.1

Freq = 4.9270 GHz, Bw = 16.000 MH No calibration applied and no bandpass applied

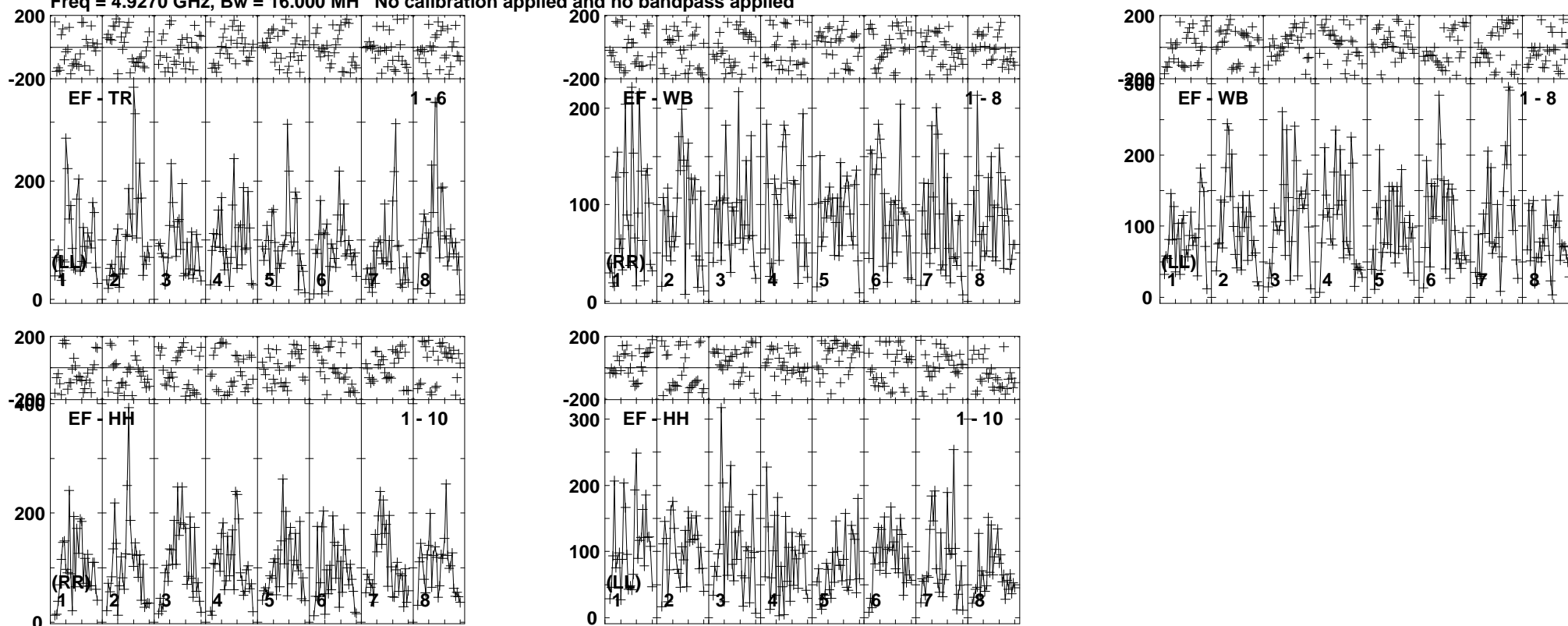

Lower frame: Micro Ampl Jy Top frame: Phas deg
Vector averaged cross-power spectrum Baseline: EF (01) - TR (06)
Timerange: 00/12:31:30 to 00/12:34:30

Plot file version 77 created 10-JUN-2016 16:07:54

J0718-1813 RG008D.UVDATA.1

Freq = 4.9270 GHz, Bw = 16.000 MH No calibration applied and no bandpass applied

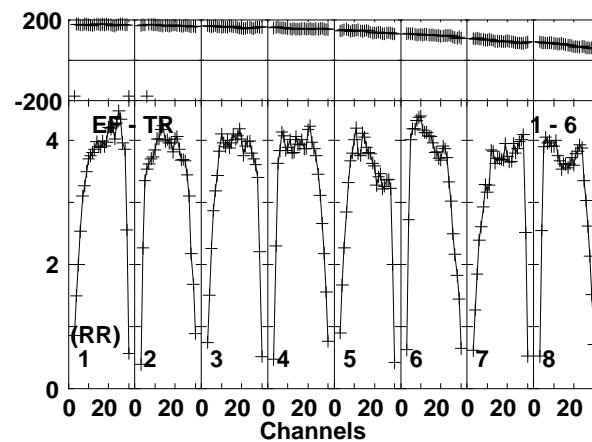
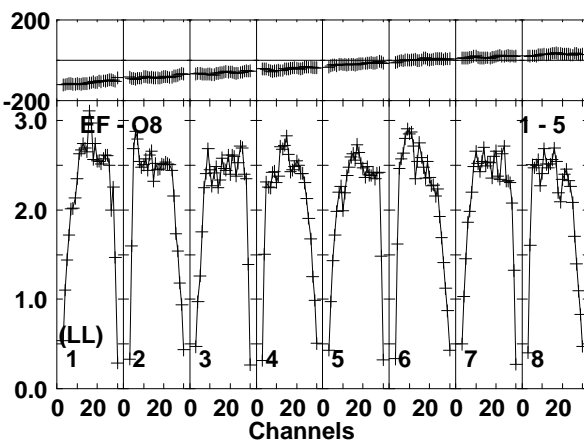
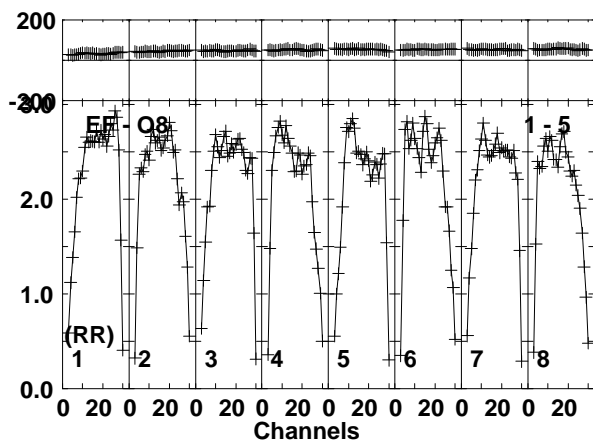
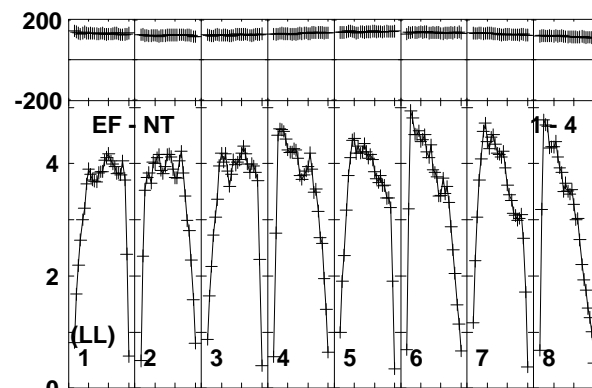
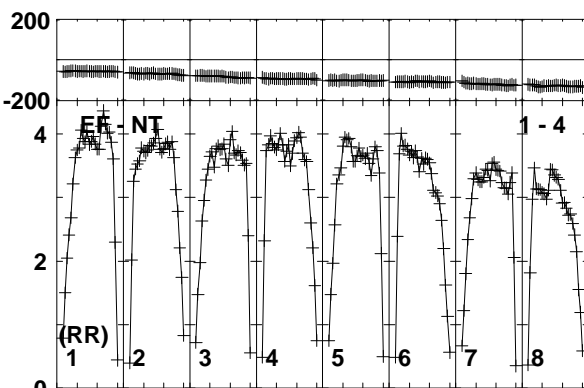
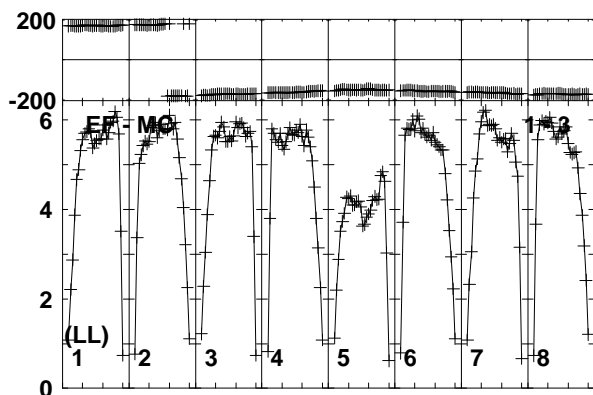
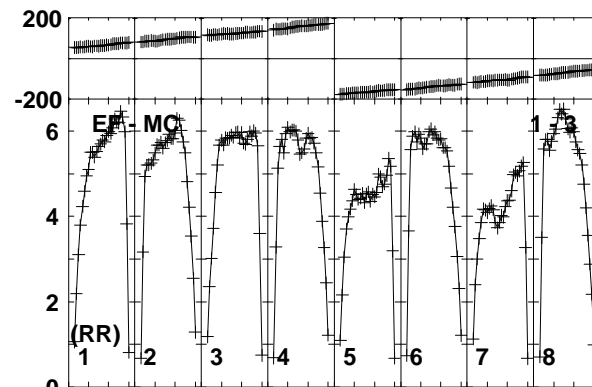
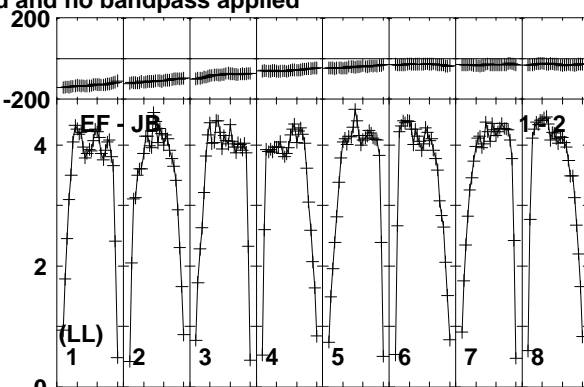
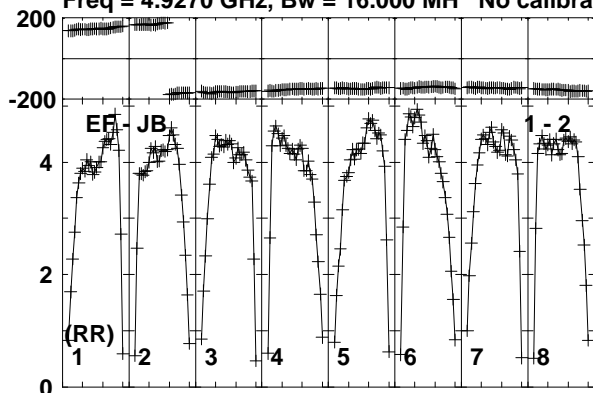

Lower frame: Milli Ampl Jy Top frame: Phas deg
Vector averaged cross-power spectrum Baseline: EF (01) - JB (02)
Timerange: 00:12:35:10 to 00:12:36:00

Plot file version 78 created 10-JUN-2016 16:07:54

J0718-1813 RG008D.UVDATA.1

Freq = 4.9270 GHz, Bw = 16.000 MH No calibration applied and no bandpass applied

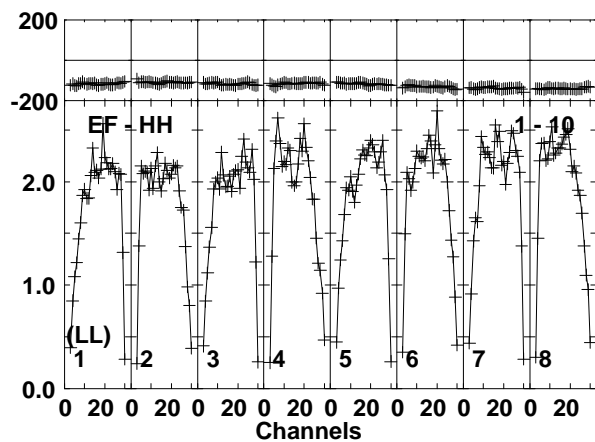
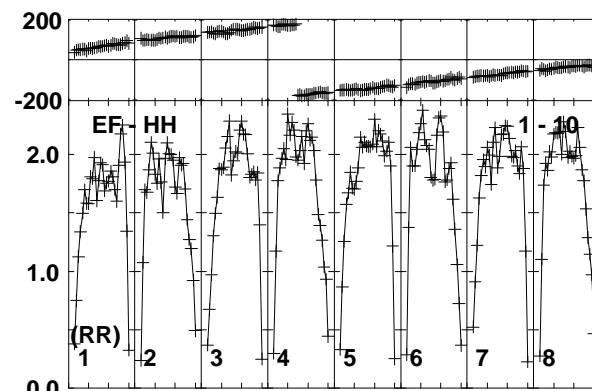
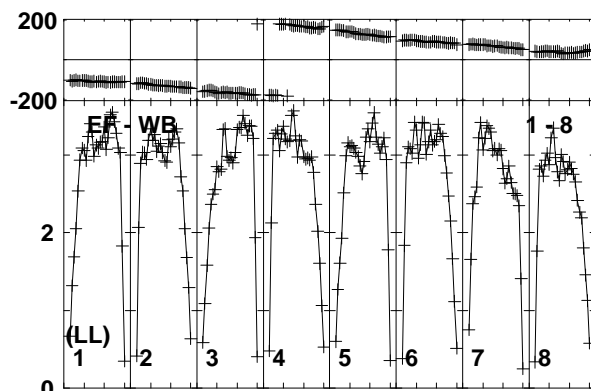
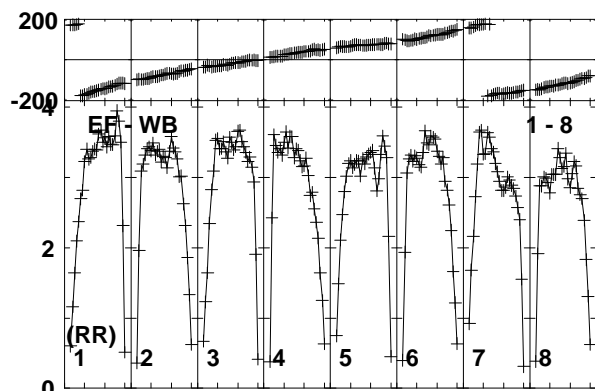
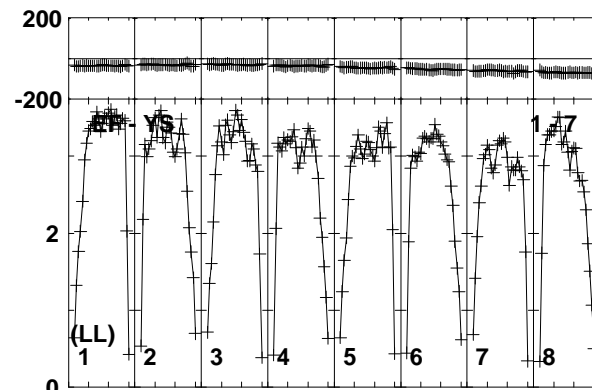
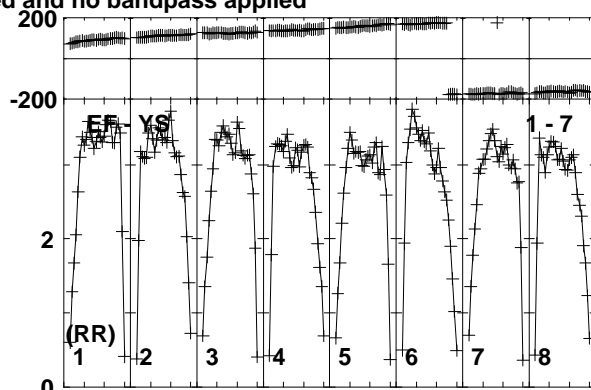
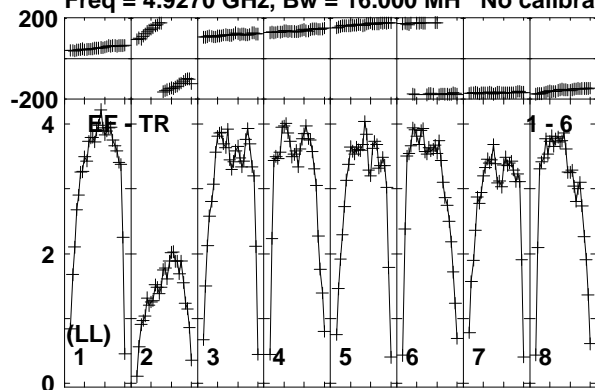

Lower frame: Milli Ampl Jy Top frame: Phas deg
Vector averaged cross-power spectrum Baseline: EF (01) - TR (06)
Timerange: 00:12:35:10 to 00:12:36:00

Plot file version 79 created 10-JUN-2016 16:07:54

FRB150418 RG008D.UVDATA.1

Freq = 4.9270 GHz, Bw = 16.000 MH No calibration applied and no bandpass applied

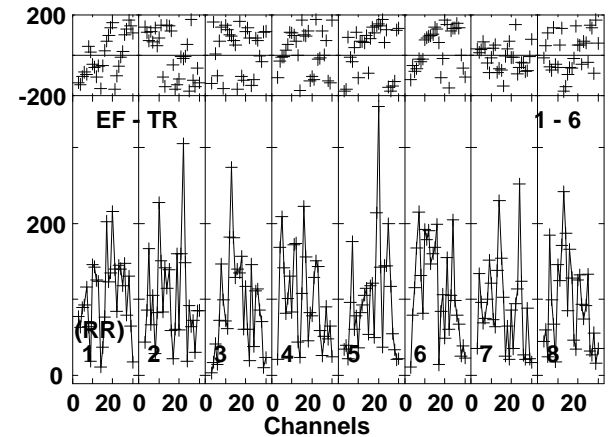
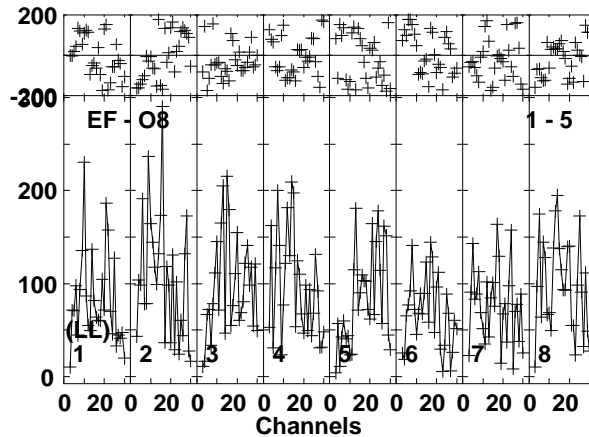
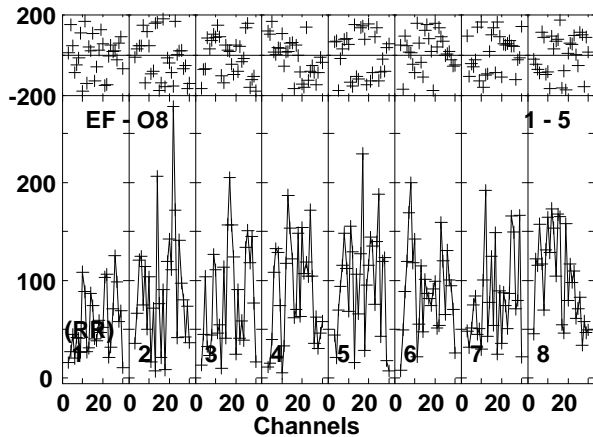
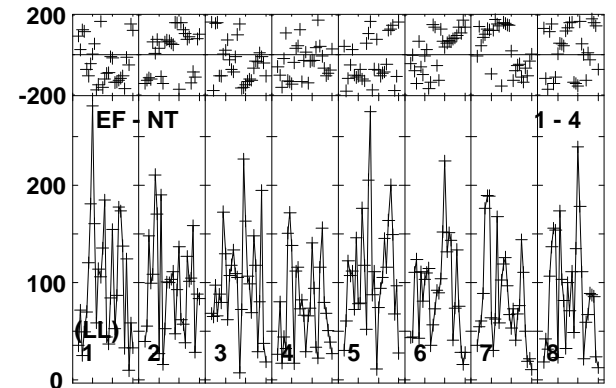
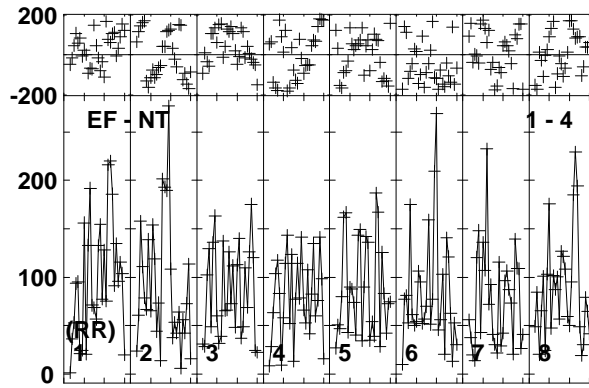
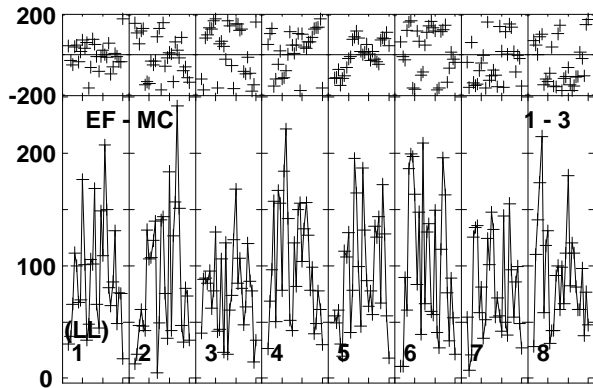
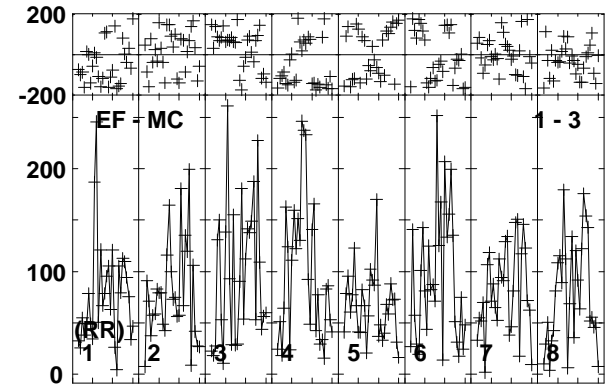
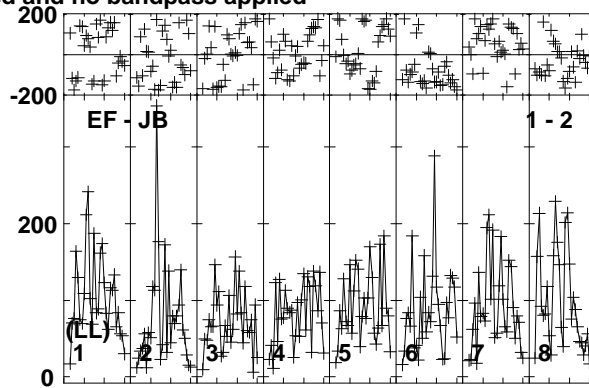
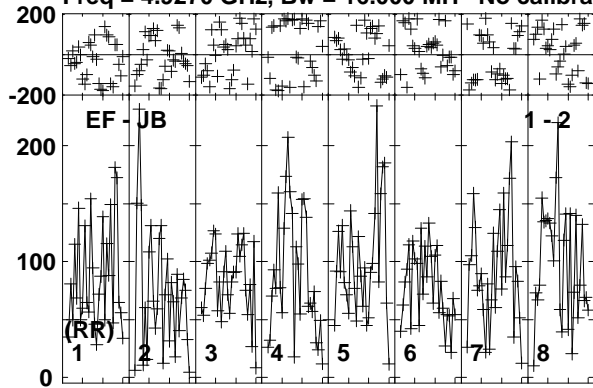

Lower frame: Micro Ampl Jy Top frame: Phas deg
Vector averaged cross-power spectrum Baseline: EF (01) - JB (02)
Timerange: 00/12:36:00 to 00/12:39:00

Plot file version 80 created 10-JUN-2016 16:07:55

FRB150418 RG008D.UVDATA.1

Freq = 4.9270 GHz, Bw = 16.000 MH No calibration applied and no bandpass applied

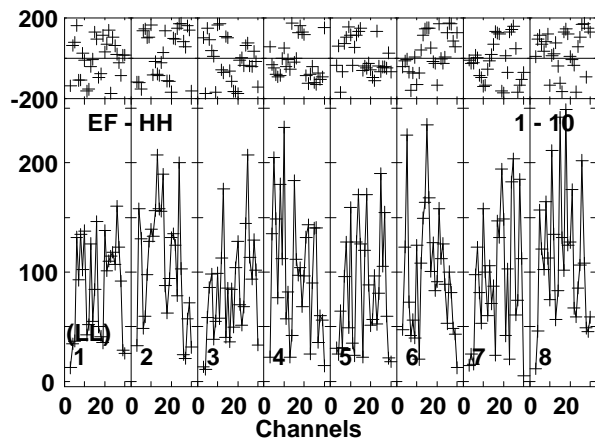
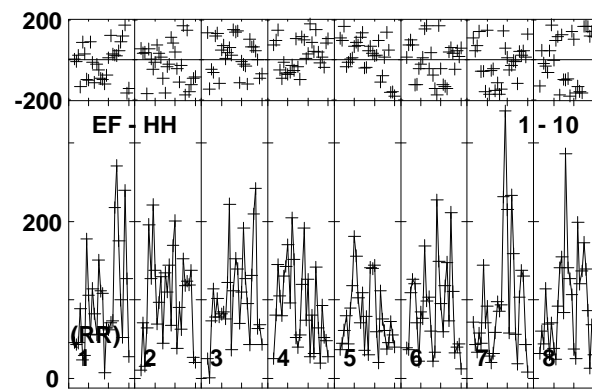
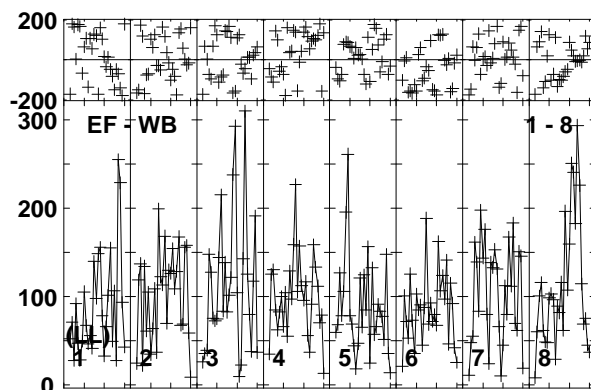
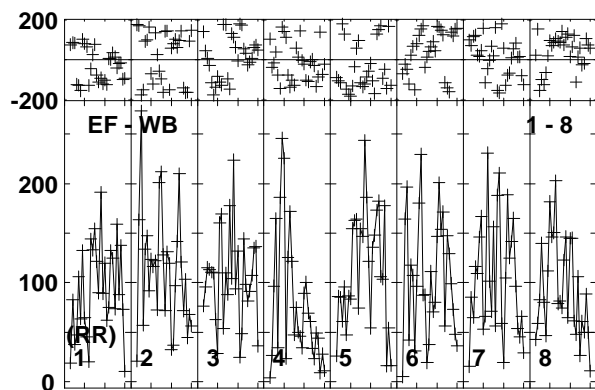
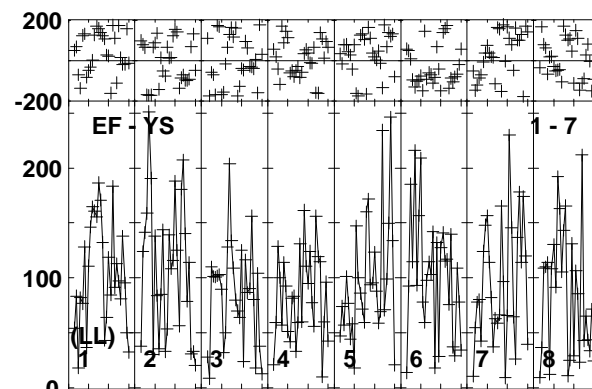
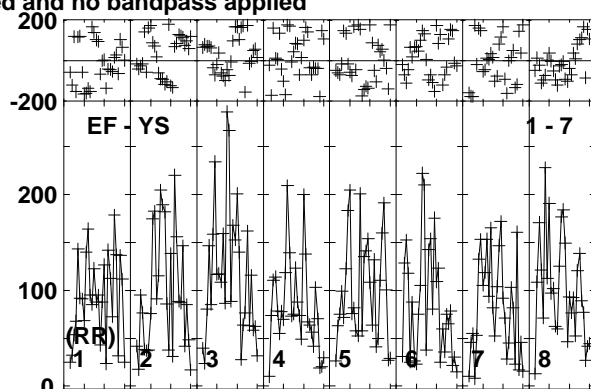
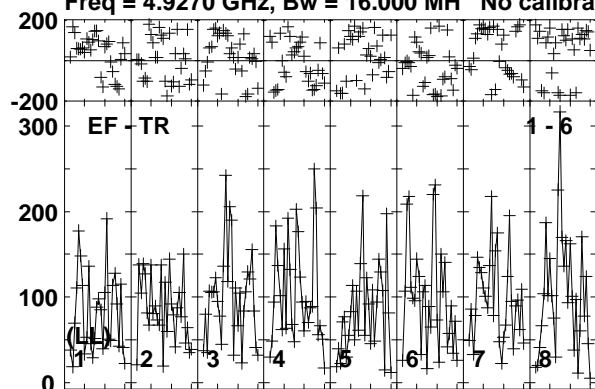

Lower frame: Micro Ampl Jy Top frame: Phas deg
Vector averaged cross-power spectrum Baseline: EF (01) - TR (06)
Timerange: 00:12:36:00 to 00:12:39:00

Plot file version 81 created 10-JUN-2016 16:07:55

J0718-1813 RG008D.UVDATA.1

Freq = 4.9270 GHz, Bw = 16.000 MH No calibration applied and no bandpass applied

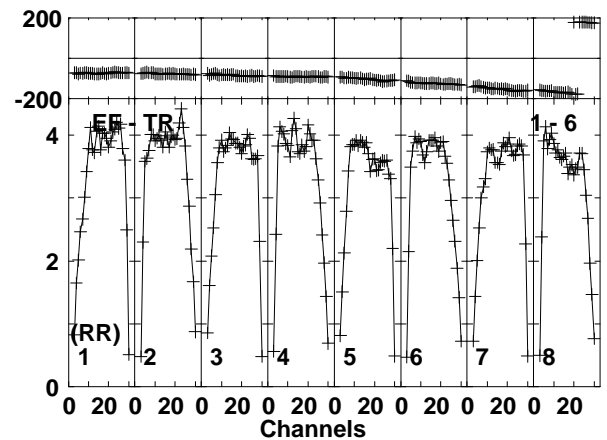
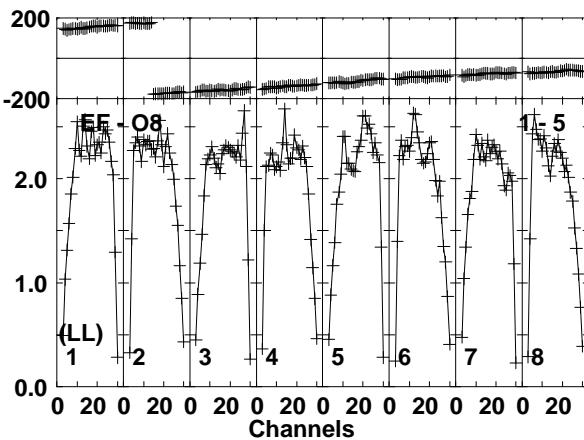
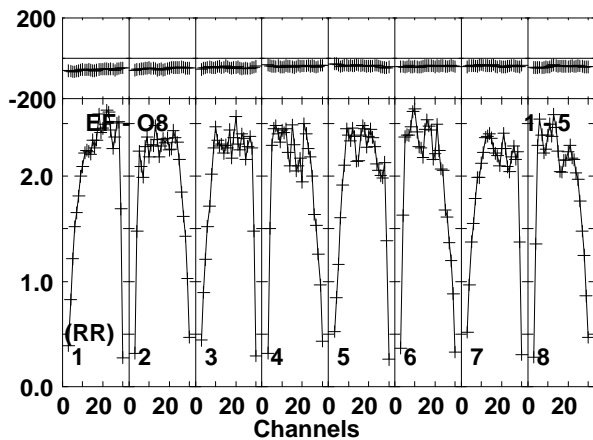
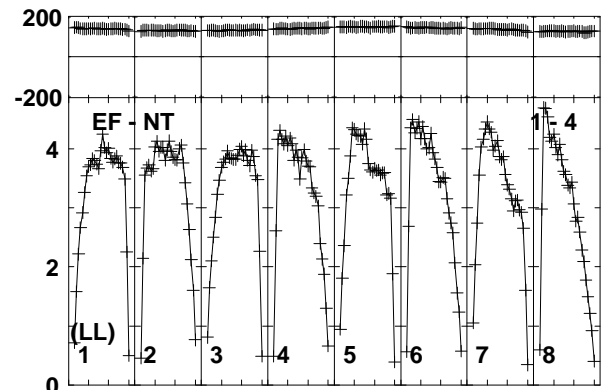
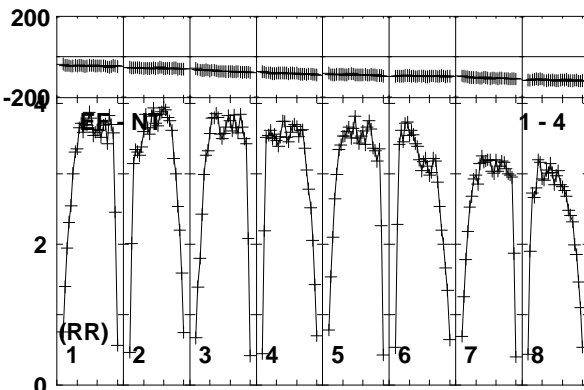
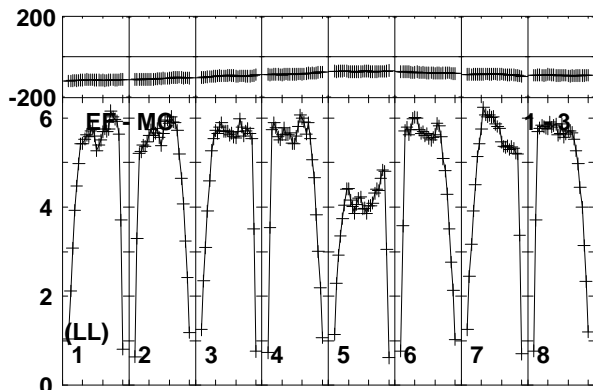
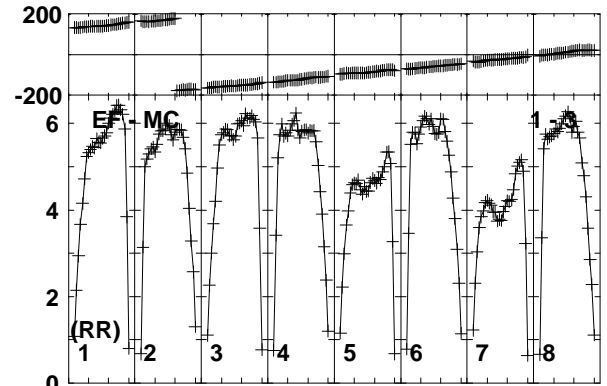
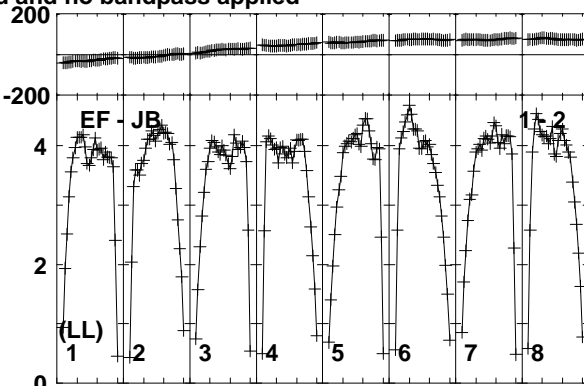
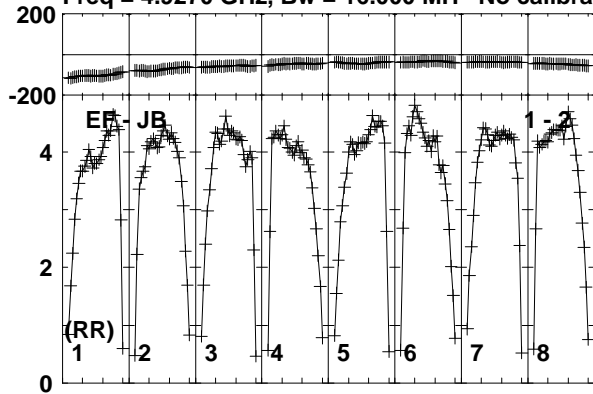

Lower frame: Milli Ampl Jy Top frame: Phas deg
Vector averaged cross-power spectrum Baseline: EF (01) - JB (02)
Timerange: 00:12:39:00 to 00:12:40:29

Plot file version 82 created 10-JUN-2016 16:07:55

J0718-1813 RG008D.UVDATA.1

Freq = 4.9270 GHz, Bw = 16.000 MH No calibration applied and no bandpass applied

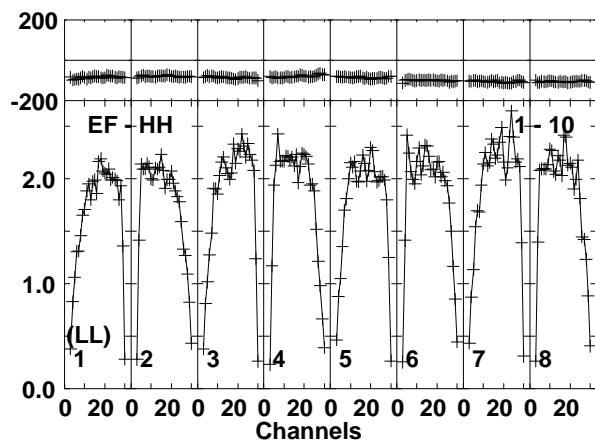
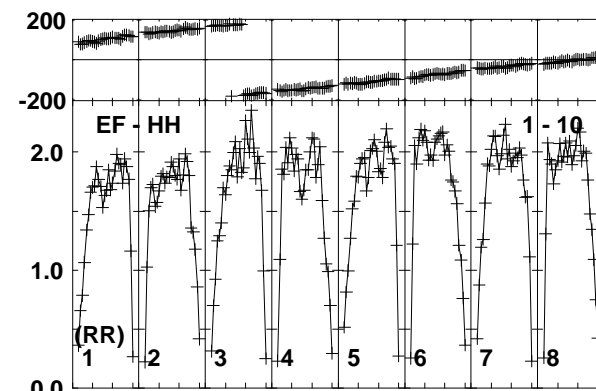
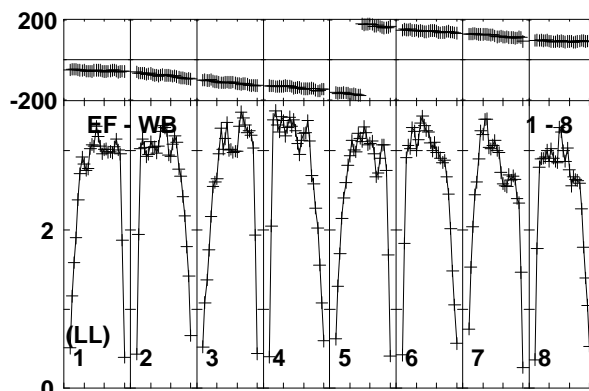
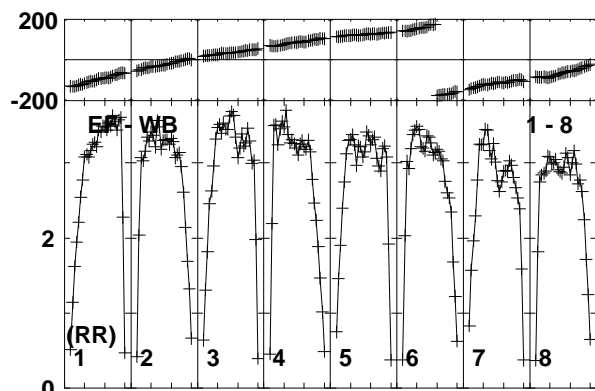
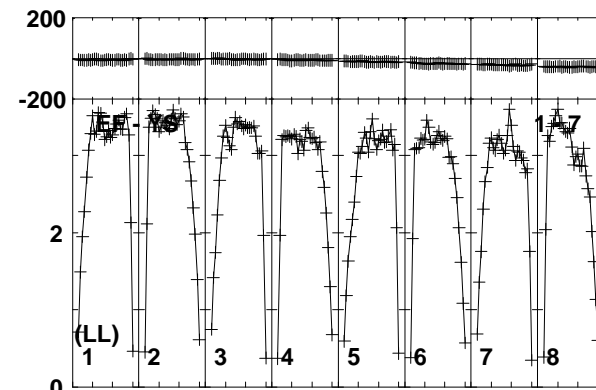
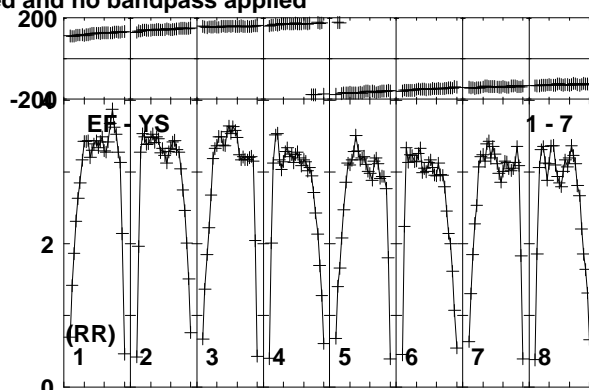
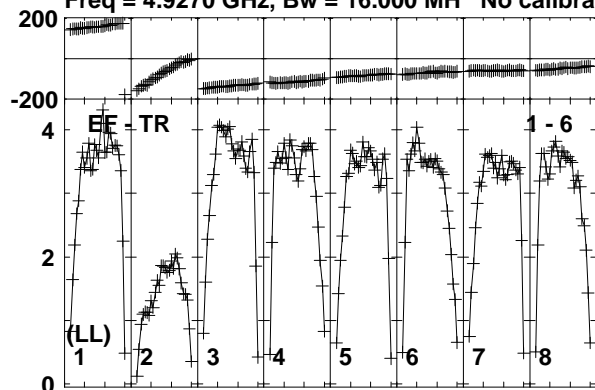

Lower frame: Milli Ampl Jy Top frame: Phas deg
Vector averaged cross-power spectrum Baseline: EF (01) - TR (06)
Timerange: 00/12:39:00 to 00/12:40:29

Plot file version 83 created 10-JUN-2016 16:07:55

J0712-1847 RG008D.UVDATA.1

Freq = 4.9270 GHz, Bw = 16.000 MH No calibration applied and no bandpass applied

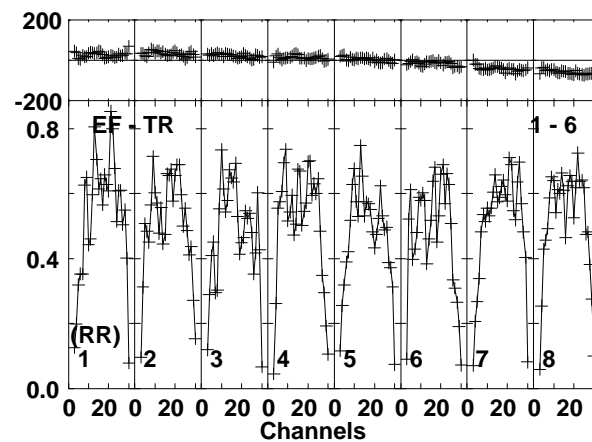
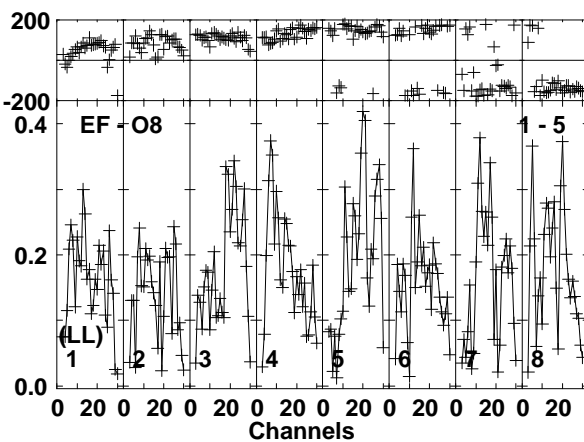
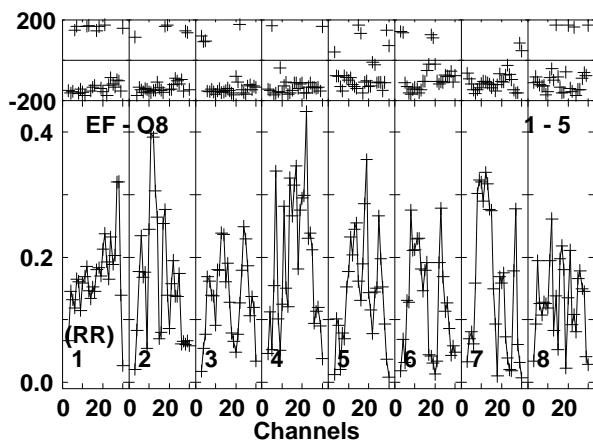
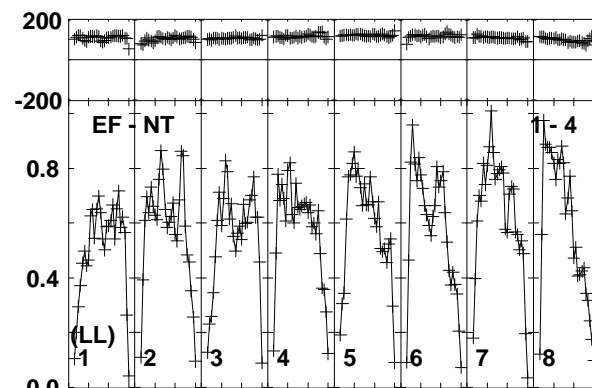
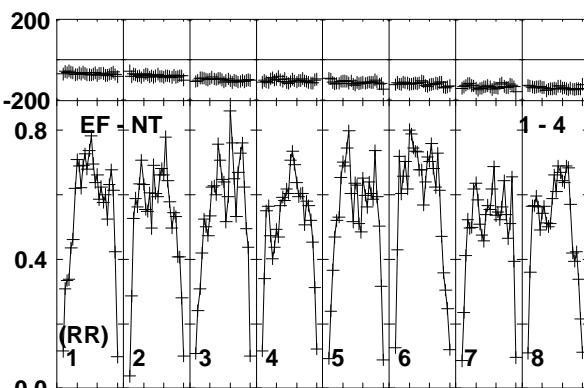
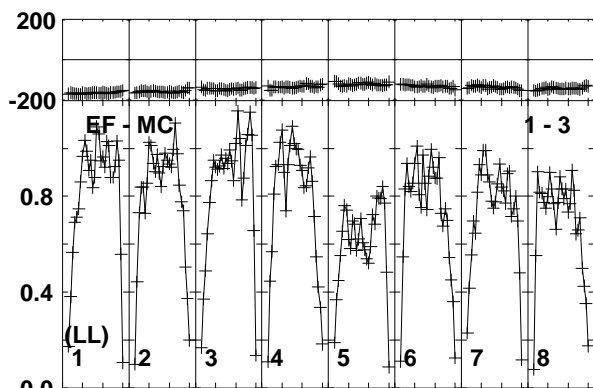
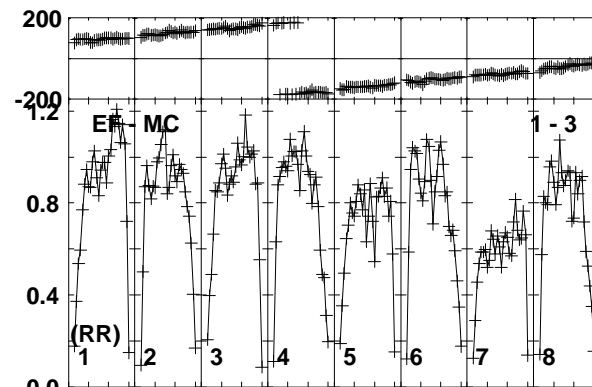
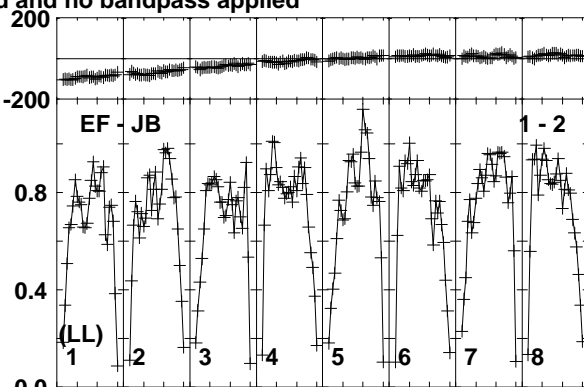
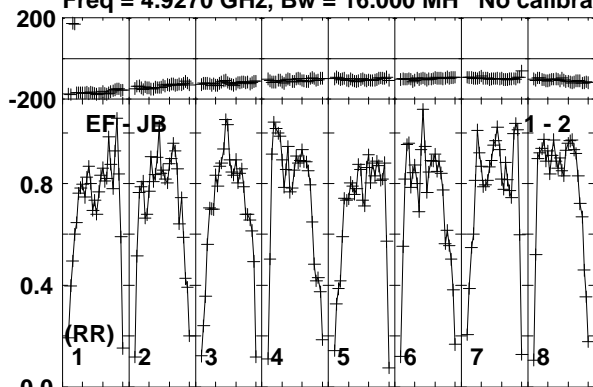

Lower frame: Milli Ampl Jy Top frame: Phas deg
Vector averaged cross-power spectrum Baseline: EF (01) - JB (02)
Timerange: 00:12:40:30 to 00:12:43:30

Plot file version 84 created 10-JUN-2016 16:07:55

J0712-1847 RG008D.UVDATA.1

Freq = 4.9270 GHz, Bw = 16.000 MH No calibration applied and no bandpass applied

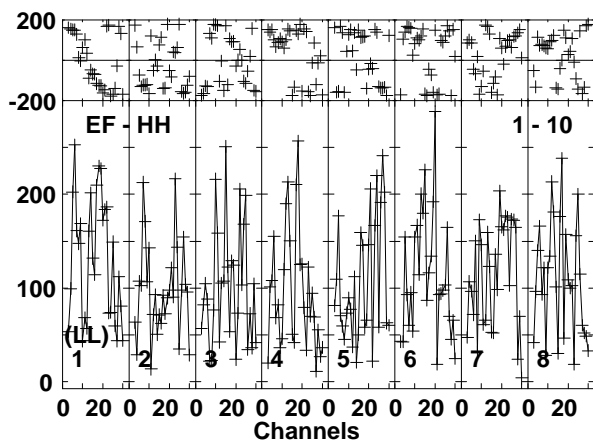
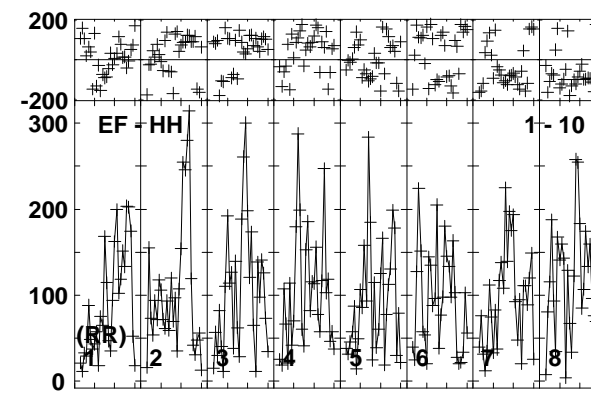
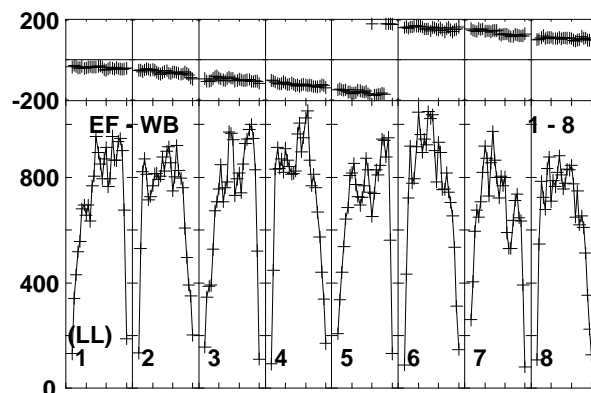
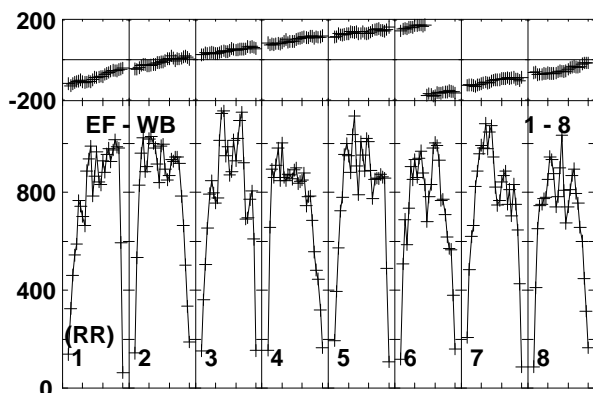
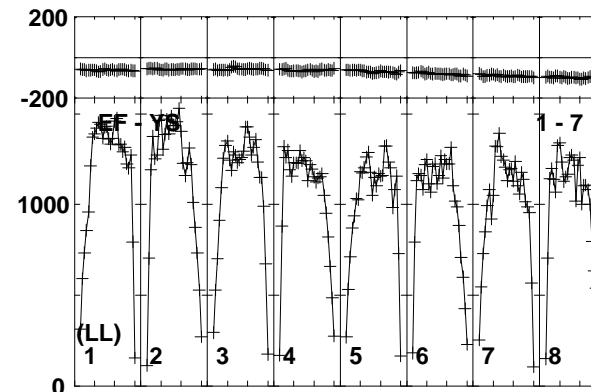
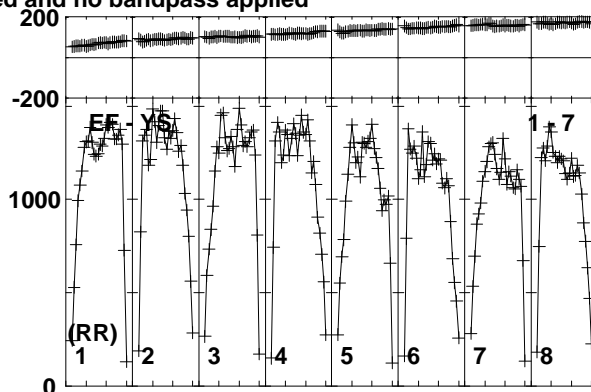
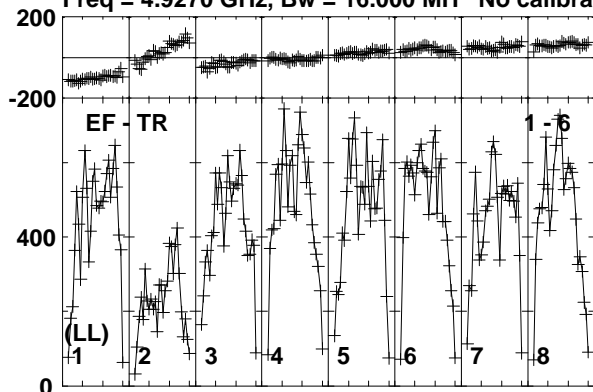

Lower frame: Micro Ampl Jy Top frame: Phas deg
Vector averaged cross-power spectrum Baseline: EF (01) - TR (06)
Timerange: 00:12:40:30 to 00:12:43:30

Plot file version 85 created 10-JUN-2016 16:07:55

J0718-1813 RG008D.UVDATA.1

Freq = 4.9270 GHz, Bw = 16.000 MH No calibration applied and no bandpass applied

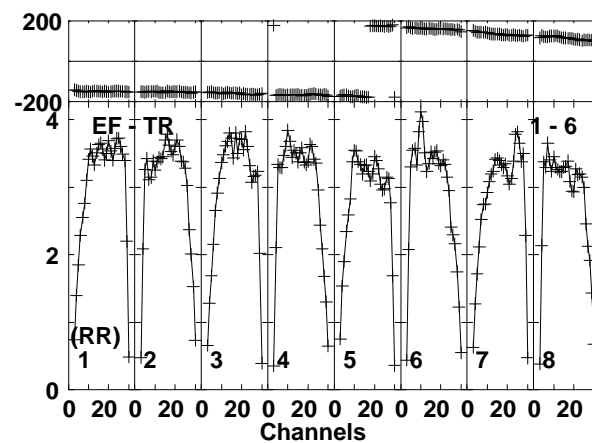
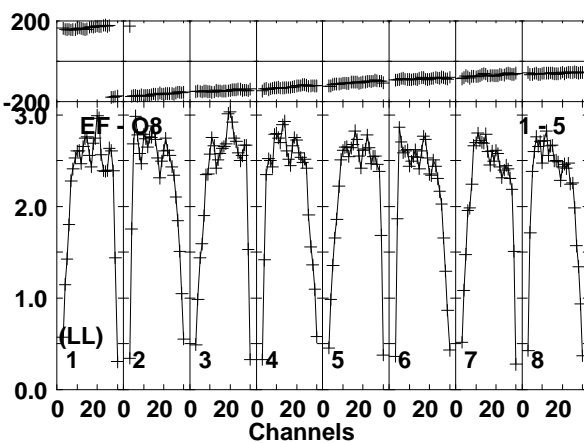
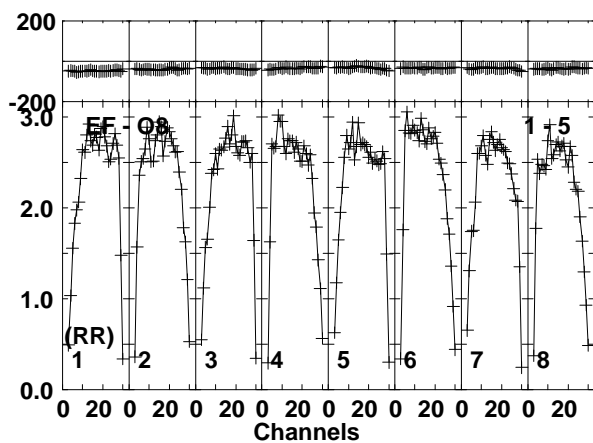
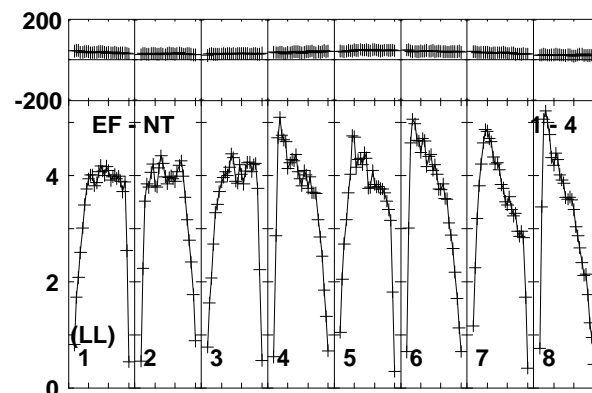
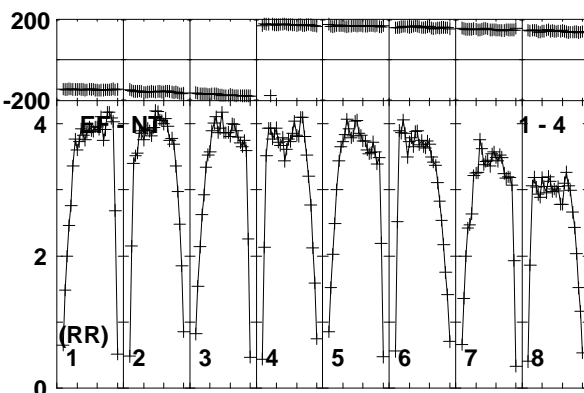
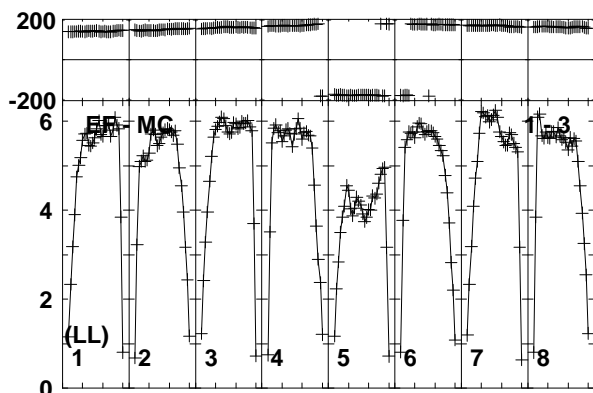
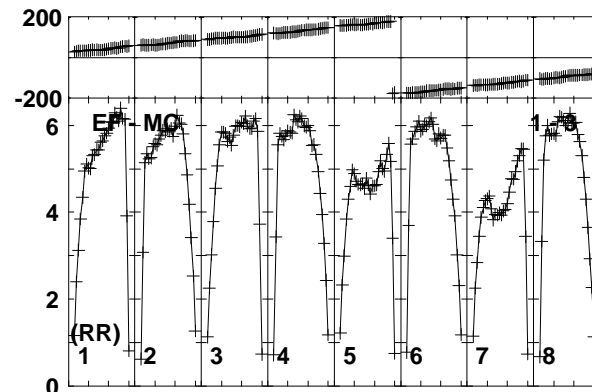
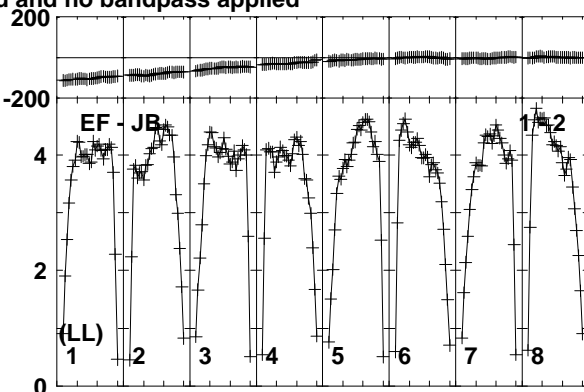
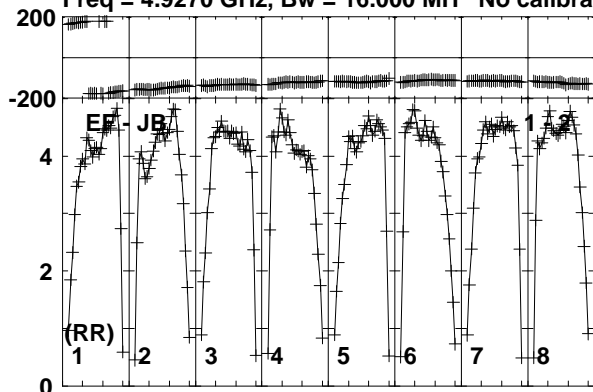

Lower frame: Milli Ampl Jy Top frame: Phas deg
Vector averaged cross-power spectrum Baseline: EF (01) - JB (02)
Timerange: 00:12:44:10 to 00:12:45:00

Plot file version 86 created 10-JUN-2016 16:07:55

J0718-1813 RG008D.UVDATA.1

Freq = 4.9270 GHz, Bw = 16.000 MH No calibration applied and no bandpass applied

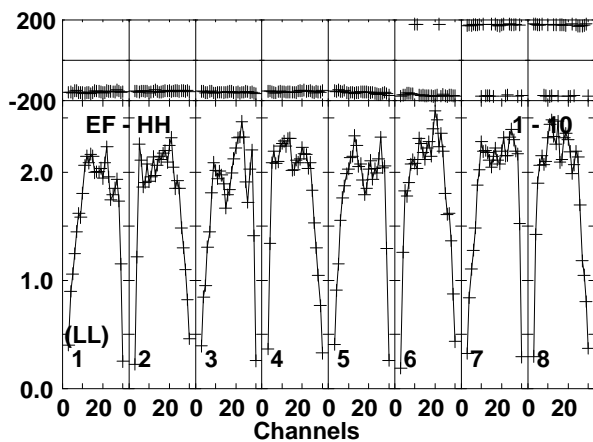
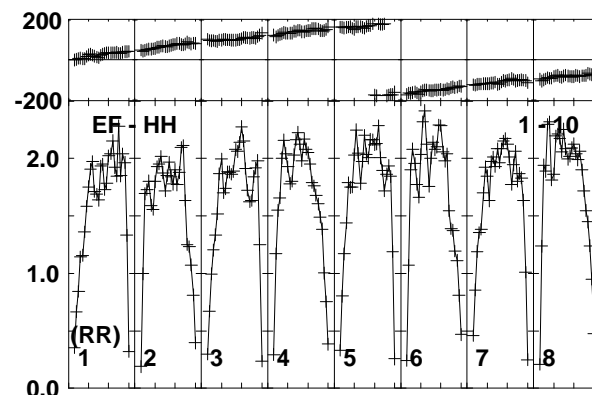
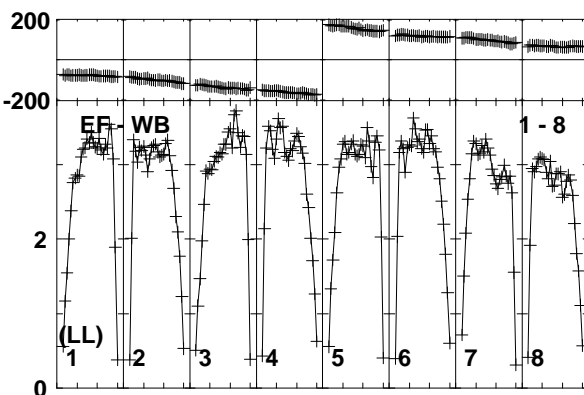
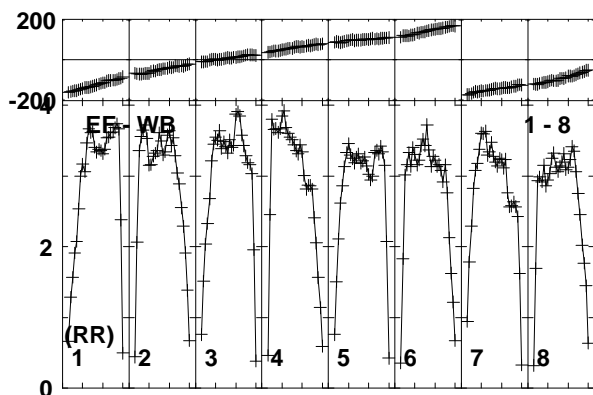
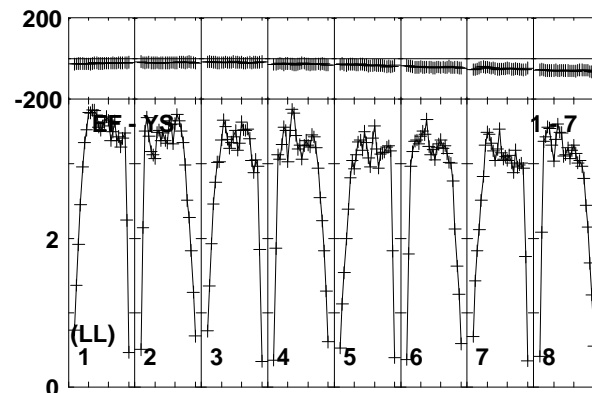
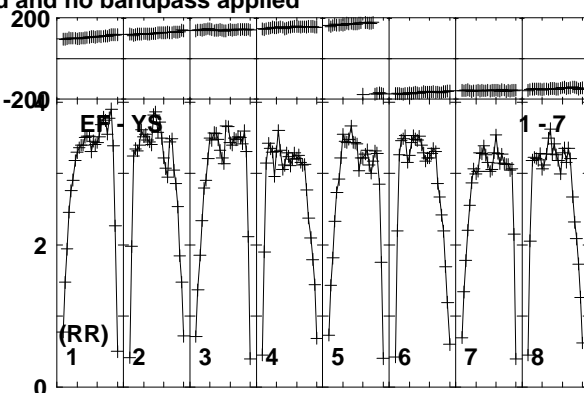
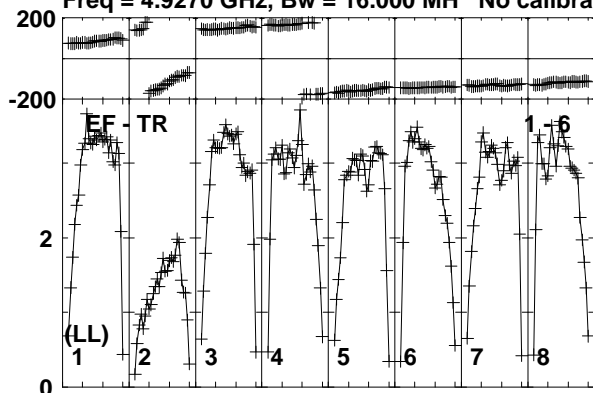

Lower frame: Milli Ampl Jy Top frame: Phas deg
Vector averaged cross-power spectrum Baseline: EF (01) - TR (06)
Timerange: 00:12:44:10 to 00:12:45:00

Plot file version 87 created 10-JUN-2016 16:07:55

FRB150418 RG008D.UVDATA.1

Freq = 4.9270 GHz, Bw = 16.000 MH No calibration applied and no bandpass applied

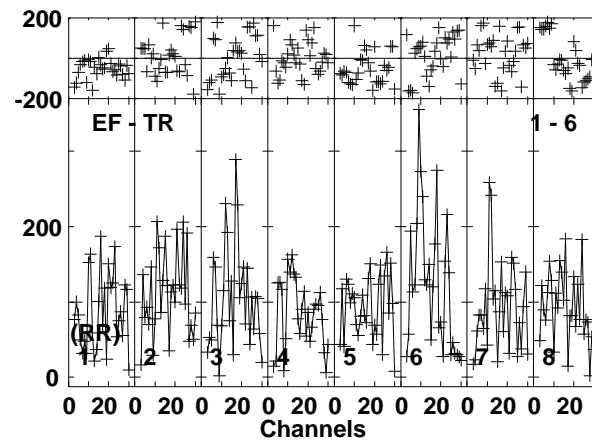
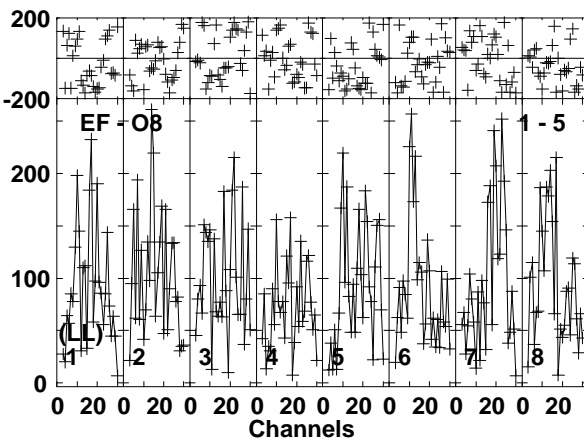
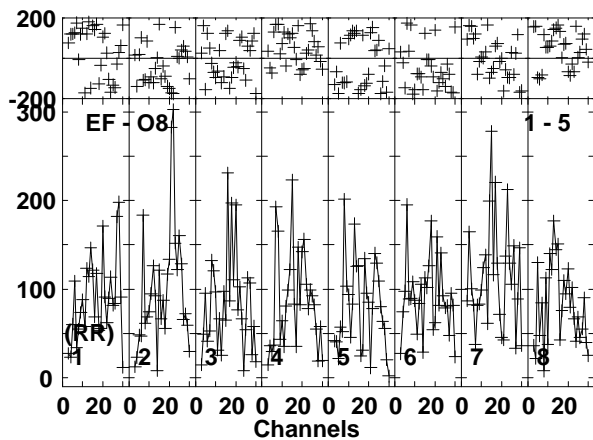
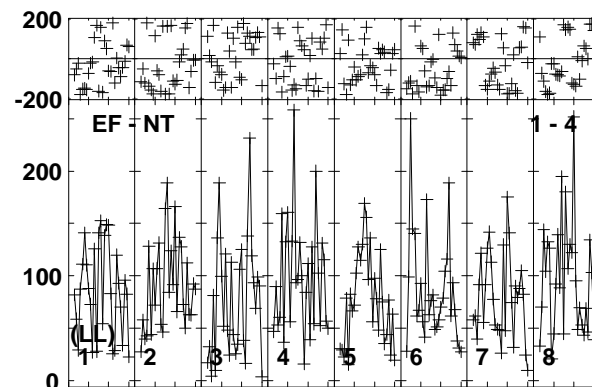
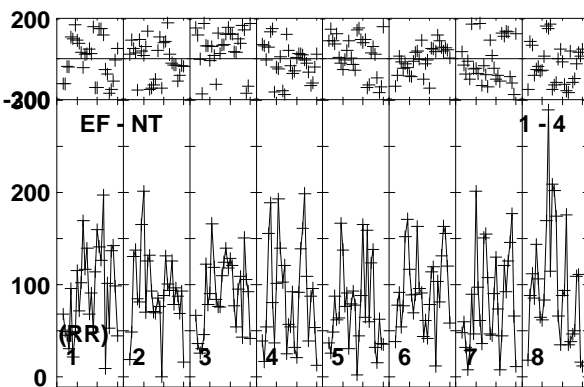
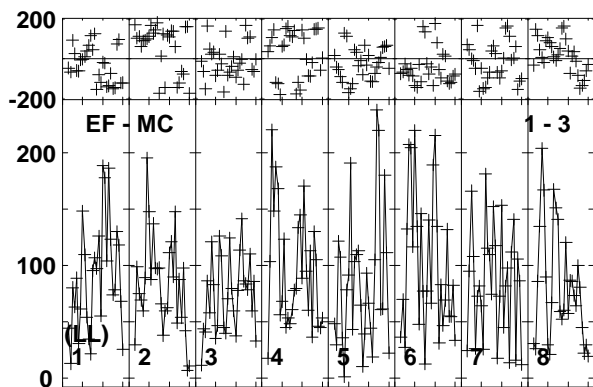
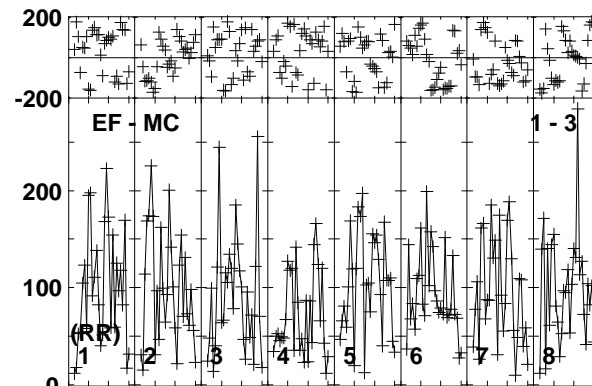
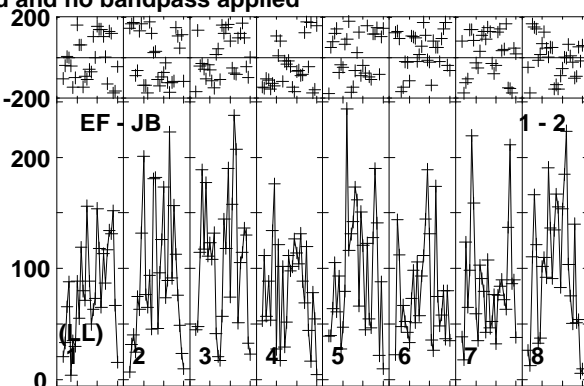
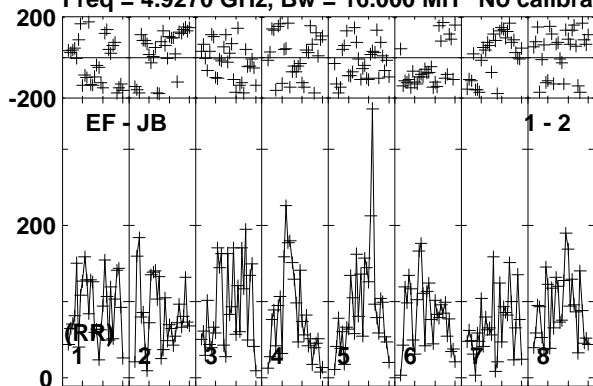

Lower frame: Micro Ampl Jy Top frame: Phas deg
Vector averaged cross-power spectrum Baseline: EF (01) - JB (02)
Timerange: 00:12:45:01 to 00:12:47:59

Plot file version 88 created 10-JUN-2016 16:07:56

FRB150418 RG008D.UVDATA.1

Freq = 4.9270 GHz, Bw = 16.000 MH No calibration applied and no bandpass applied

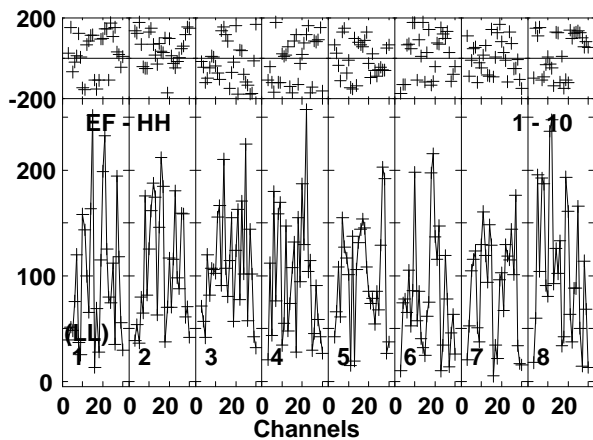
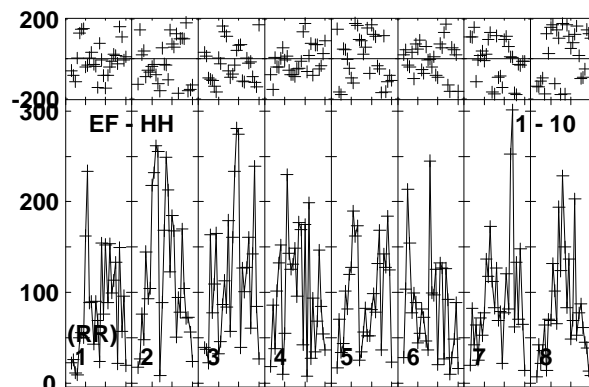
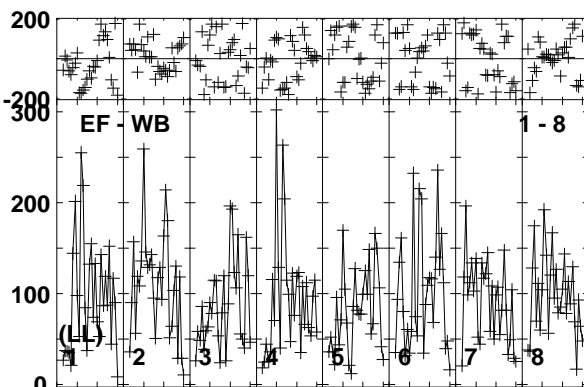
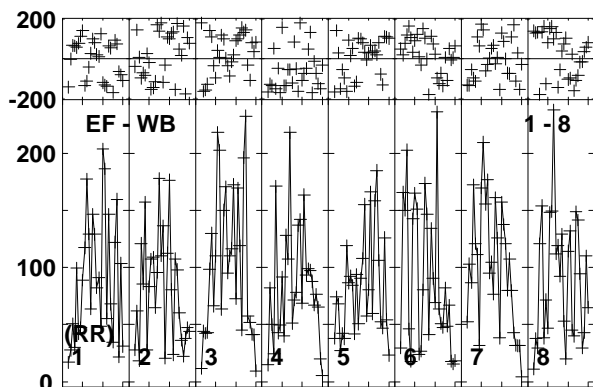
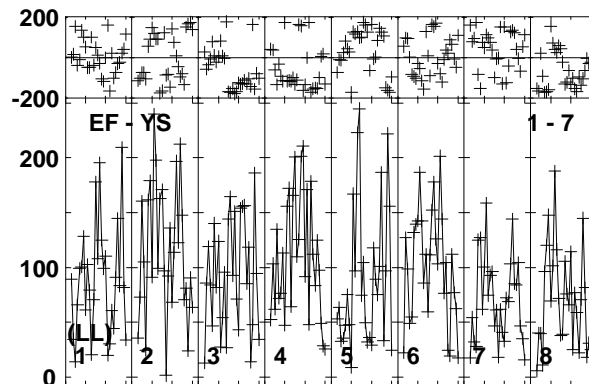
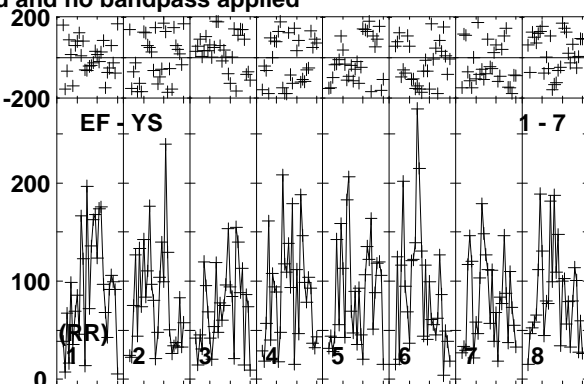
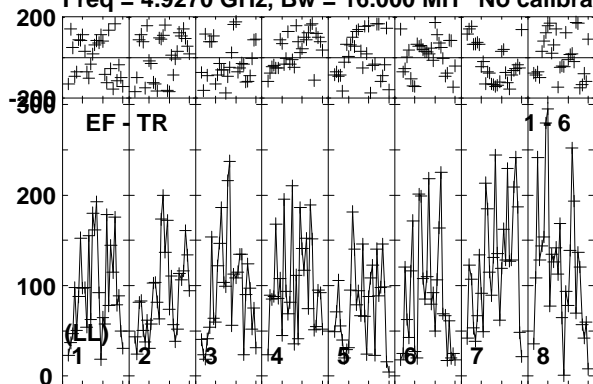

Lower frame: Micro Ampl Jy Top frame: Phas deg
Vector averaged cross-power spectrum Baseline: EF (01) - TR (06)
Timerange: 00/12:45:01 to 00/12:47:59

Plot file version 89 created 10-JUN-2016 16:07:56

J0718-1813 RG008D.UVDATA.1

Freq = 4.9270 GHz, Bw = 16.000 MH No calibration applied and no bandpass applied

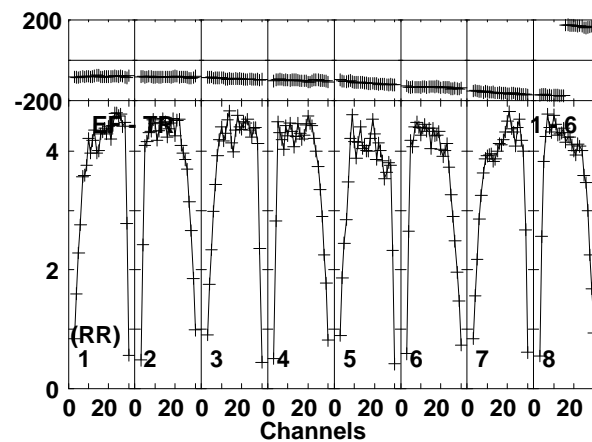
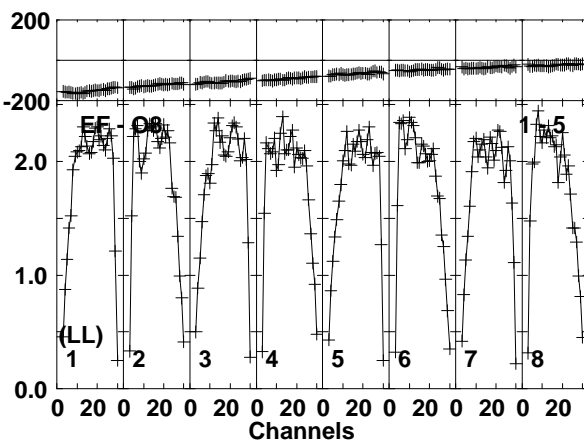
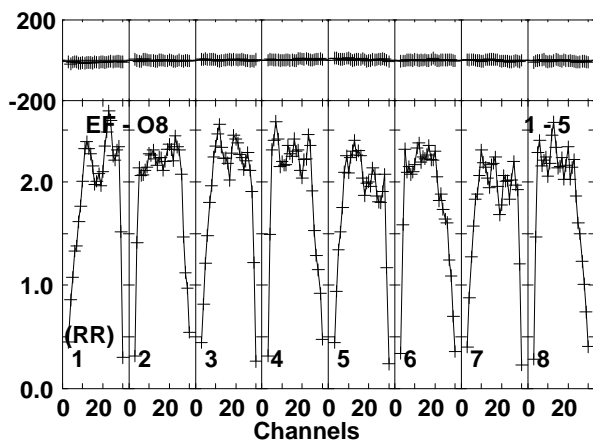
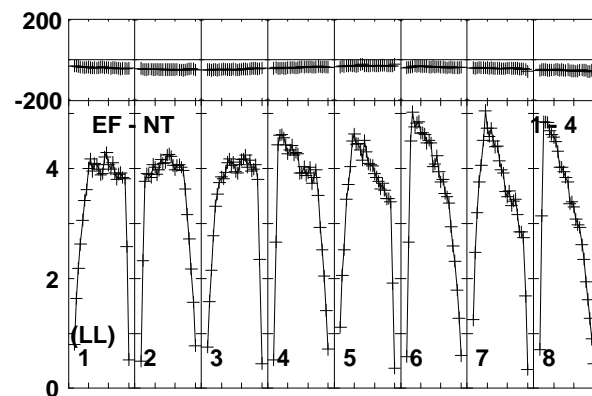
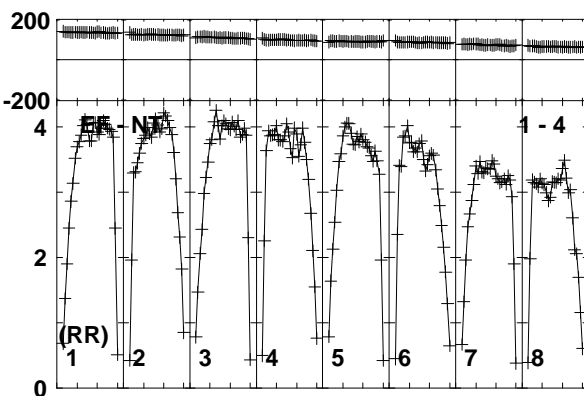
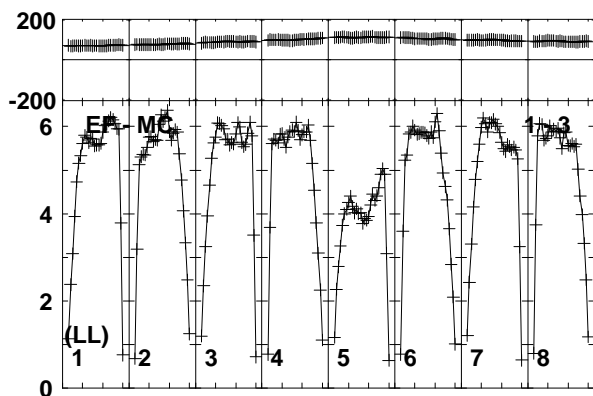
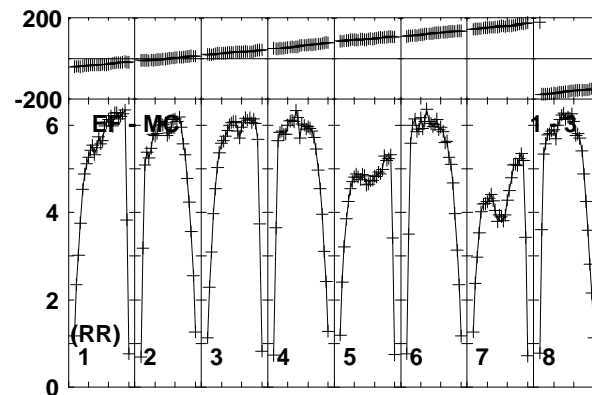
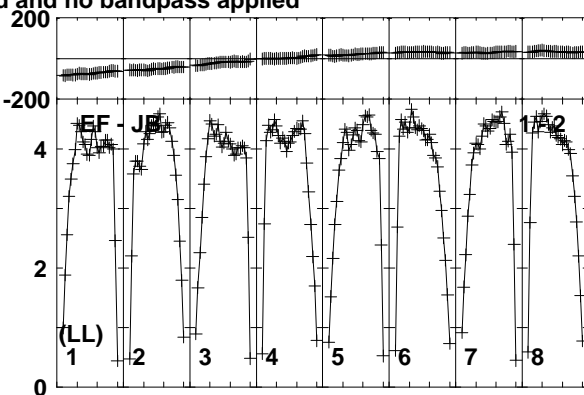
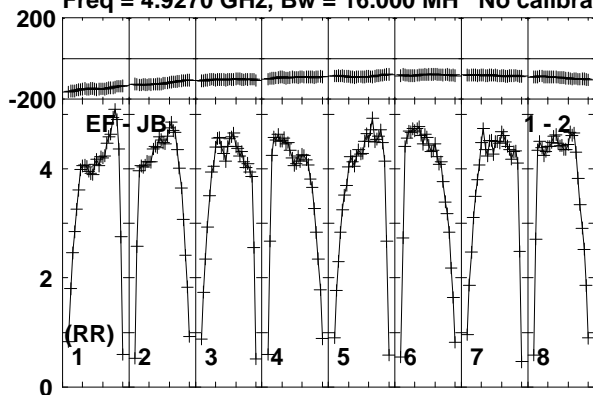

Lower frame: Milli Ampl Jy Top frame: Phas deg
Vector averaged cross-power spectrum Baseline: EF (01) - JB (02)
Timerange: 00:12:48:01 to 00:12:49:30

Plot file version 90 created 10-JUN-2016 16:07:56

J0718-1813 RG008D.UVDATA.1

Freq = 4.9270 GHz, Bw = 16.000 MH No calibration applied and no bandpass applied

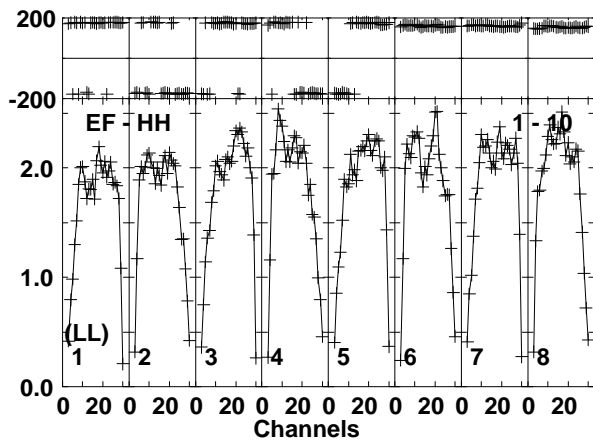
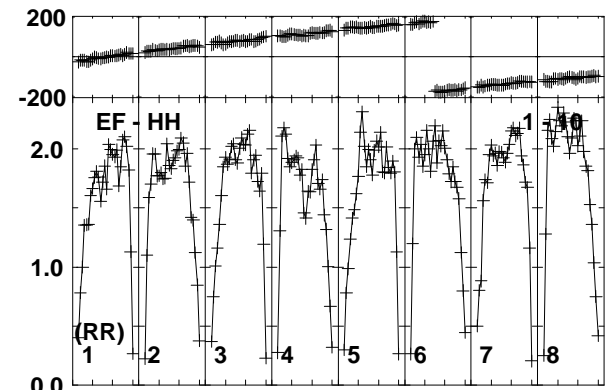
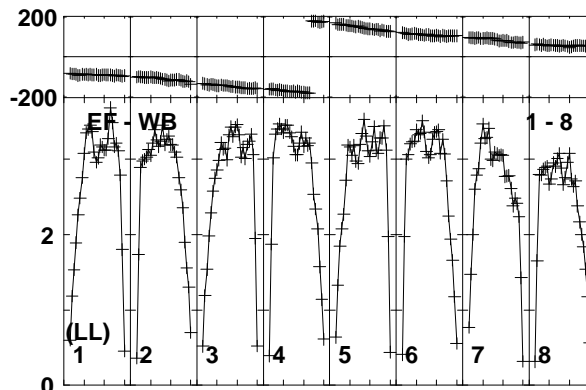
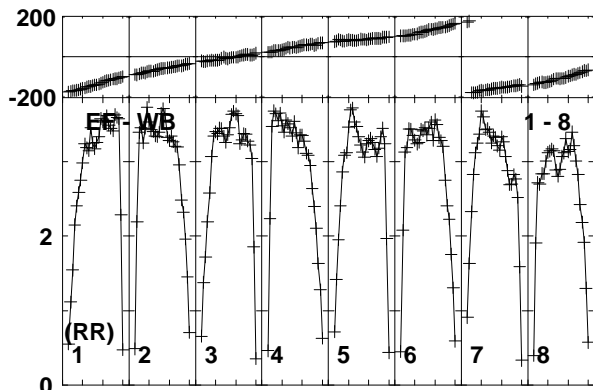
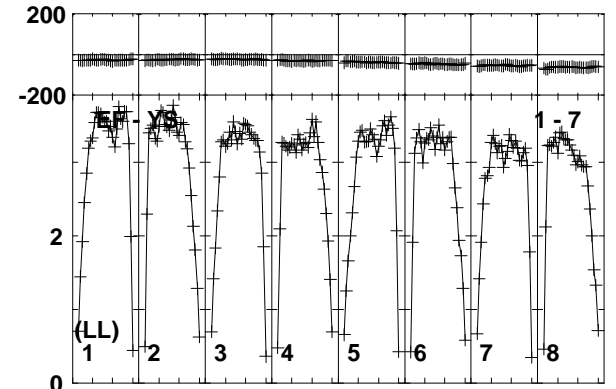
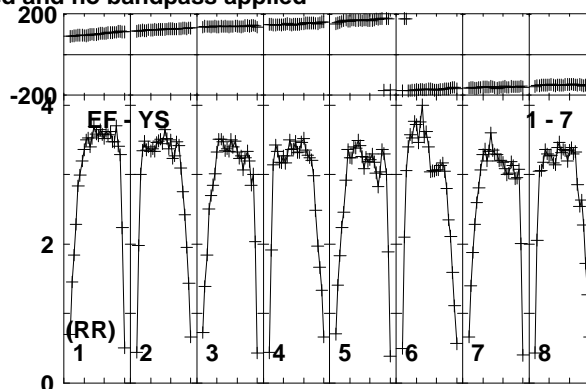
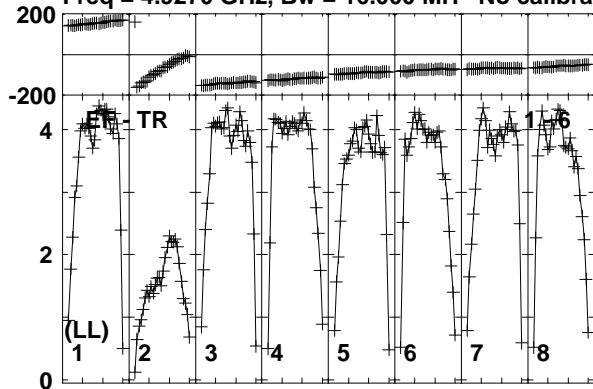

Lower frame: Milli Ampl Jy Top frame: Phas deg
Vector averaged cross-power spectrum Baseline: EF (01) - TR (06)
Timerange: 00:12:48:01 to 00:12:49:30

Plot file version 91 created 10-JUN-2016 16:07:56

FRB150418 RG008D.UVDATA.1

Freq = 4.9270 GHz, Bw = 16.000 MH No calibration applied and no bandpass applied

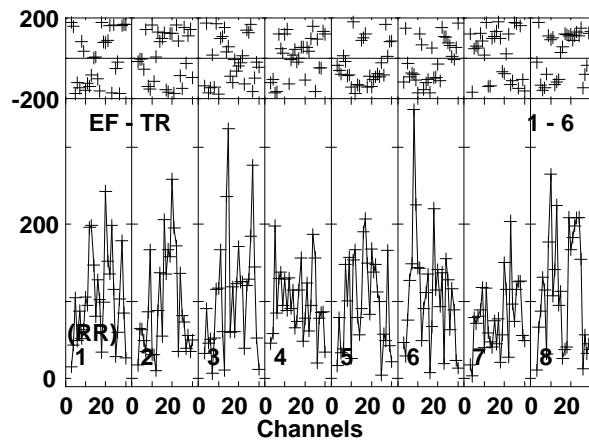
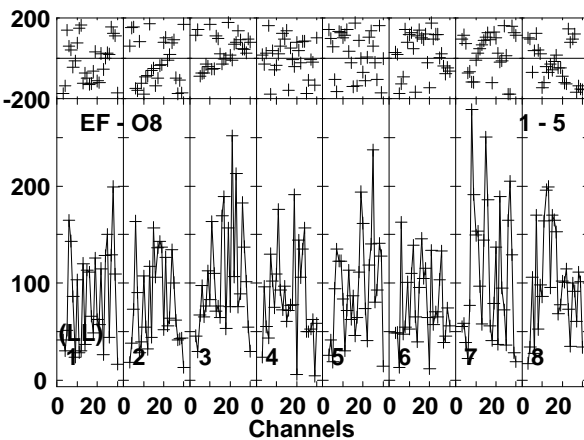
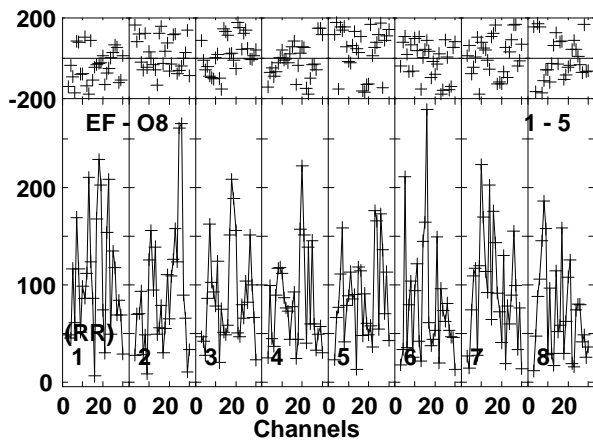
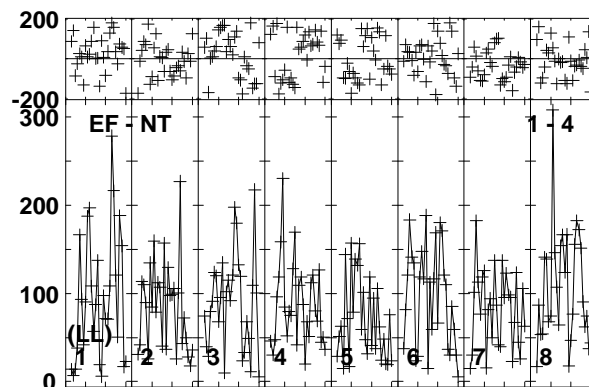
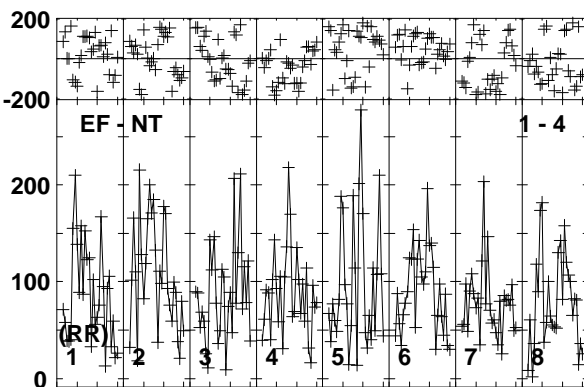
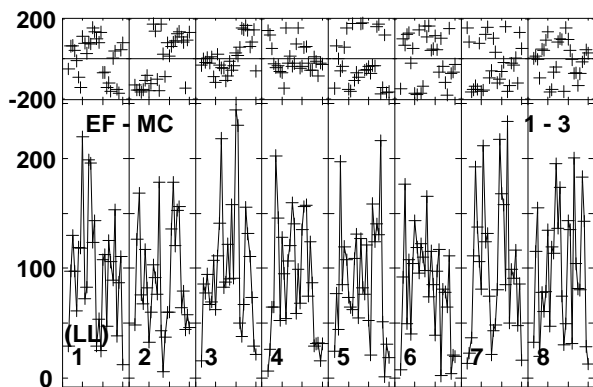
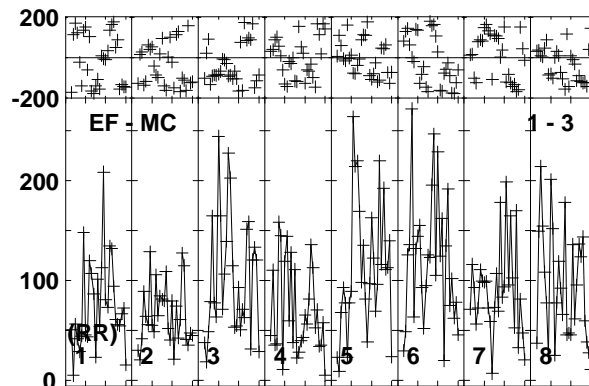
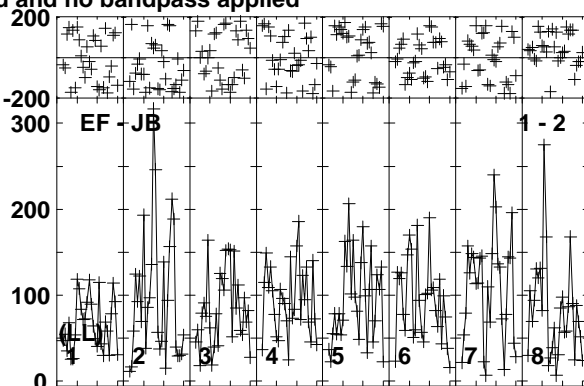
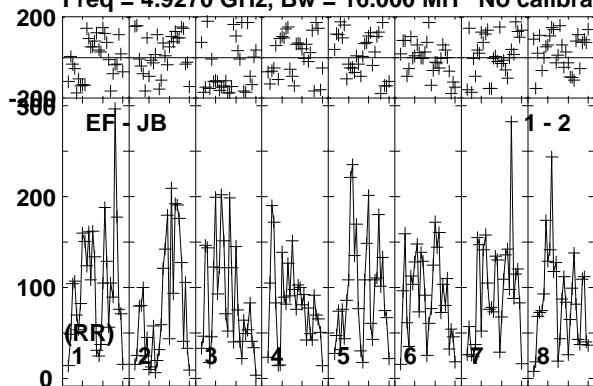

Lower frame: Micro Ampl Jy Top frame: Phas deg
Vector averaged cross-power spectrum Baseline: EF (01) - JB (02)
Timerange: 00:12:49:31 to 00:12:52:29

Plot file version 92 created 10-JUN-2016 16:07:56

FRB150418 RG008D.UVDATA.1

Freq = 4.9270 GHz, Bw = 16.000 MH No calibration applied and no bandpass applied

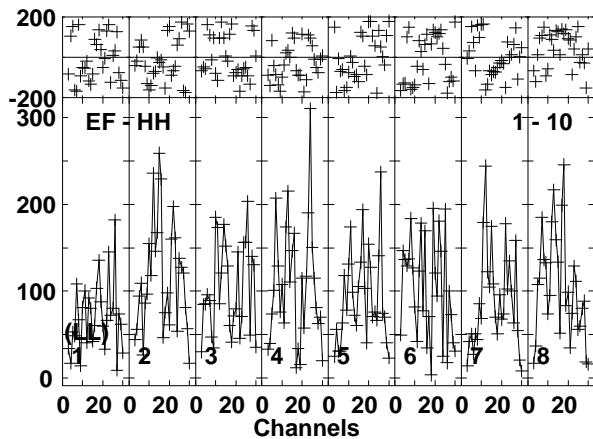
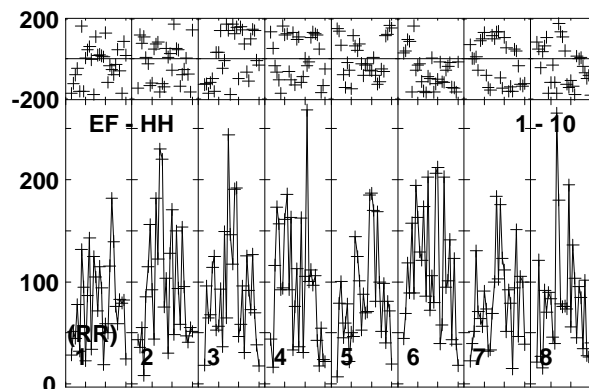
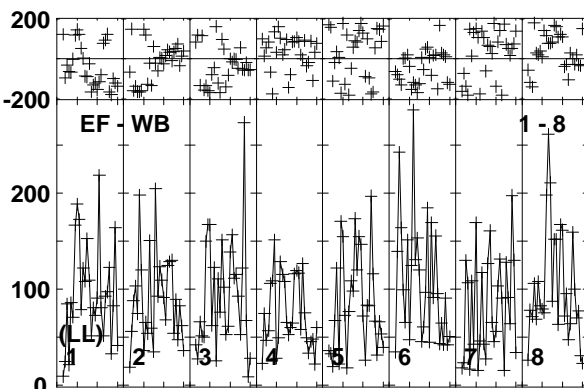
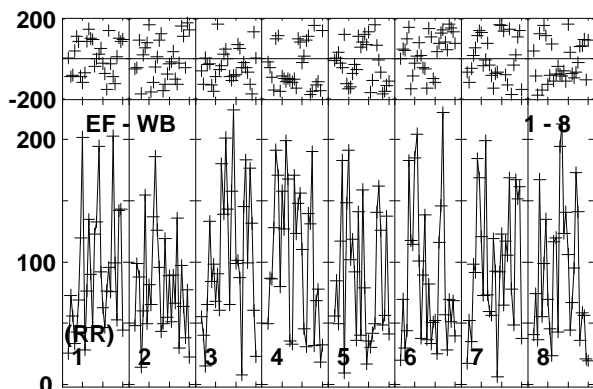
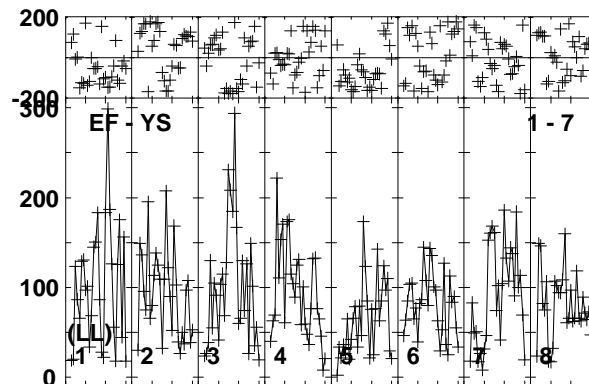
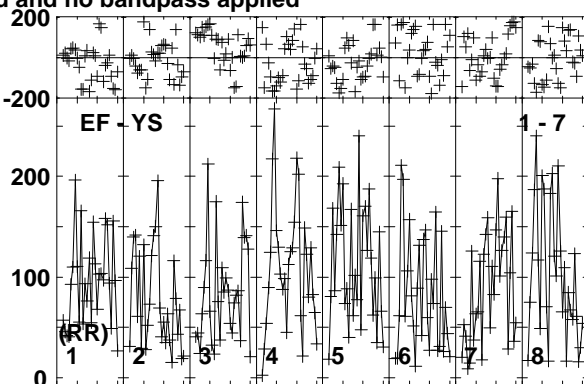
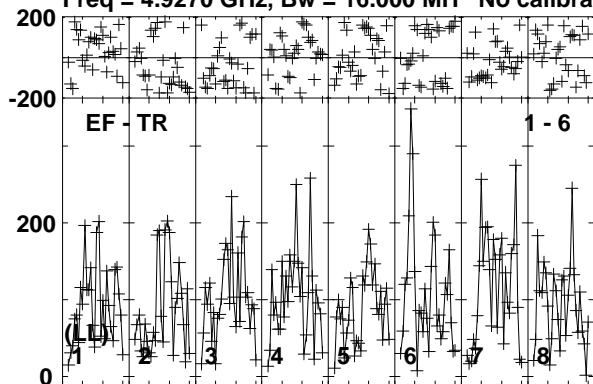

Lower frame: Micro Ampl Jy Top frame: Phas deg
Vector averaged cross-power spectrum Baseline: EF (01) - TR (06)
Timerange: 00/12:49:31 to 00/12:52:29

Plot file version 93 created 10-JUN-2016 16:07:56

J0718-1813 RG008D.UVDATA.1

Freq = 4.9270 GHz, Bw = 16.000 MH No calibration applied and no bandpass applied

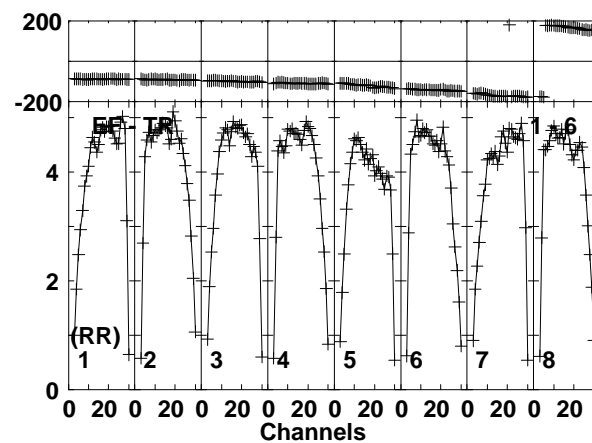
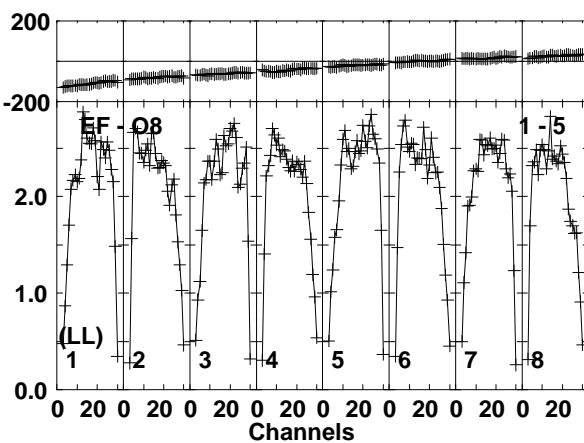
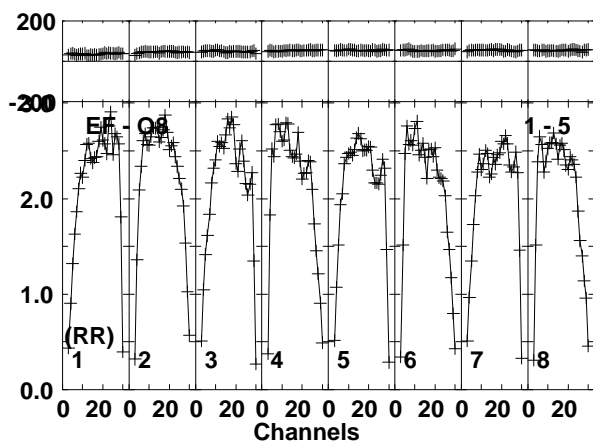
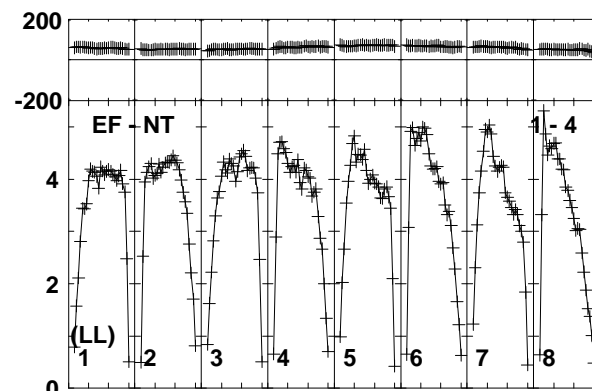
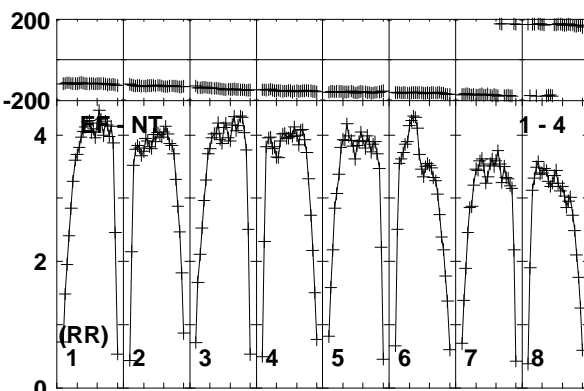
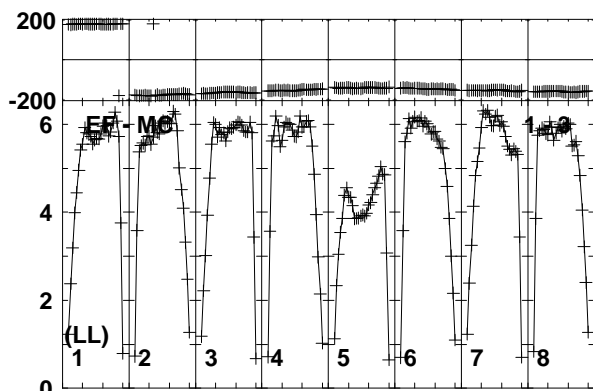
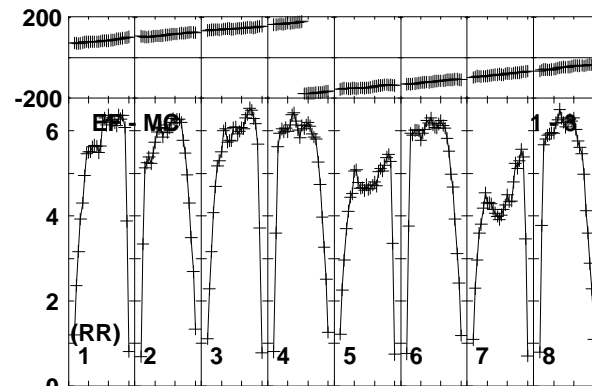
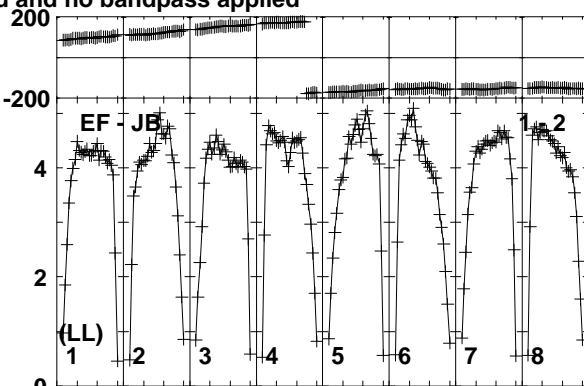
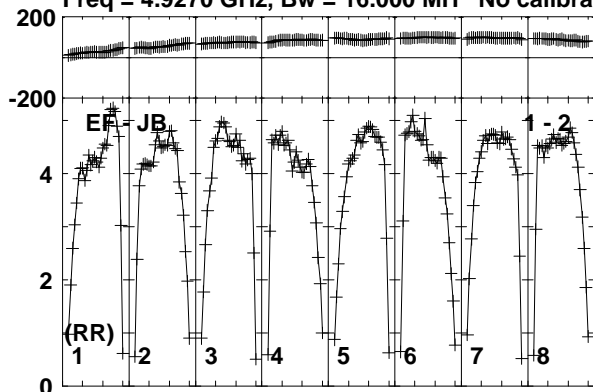

Lower frame: Milli Ampl Jy Top frame: Phas deg
Vector averaged cross-power spectrum Baseline: EF (01) - JB (02)
Timerange: 00:12:53:11 to 00:12:54:00

Plot file version 94 created 10-JUN-2016 16:07:56

J0718-1813 RG008D.UVDATA.1

Freq = 4.9270 GHz, Bw = 16.000 MH No calibration applied and no bandpass applied

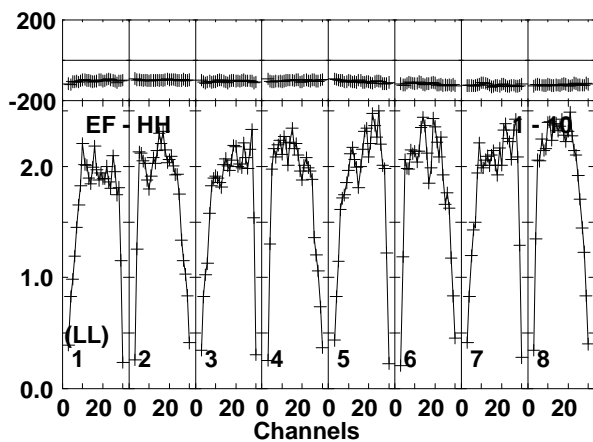
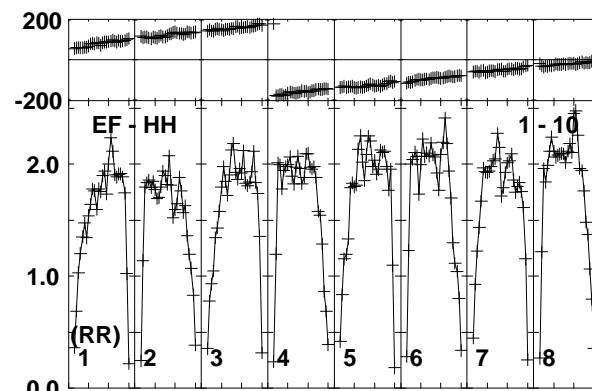
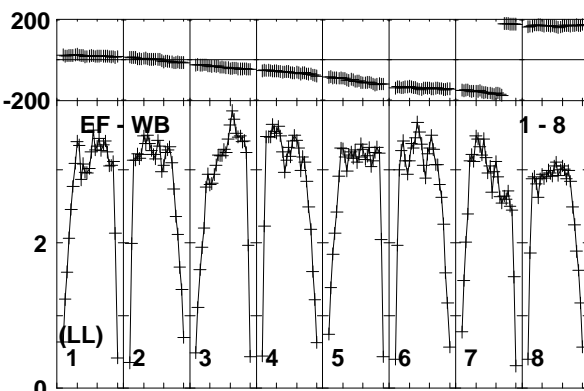
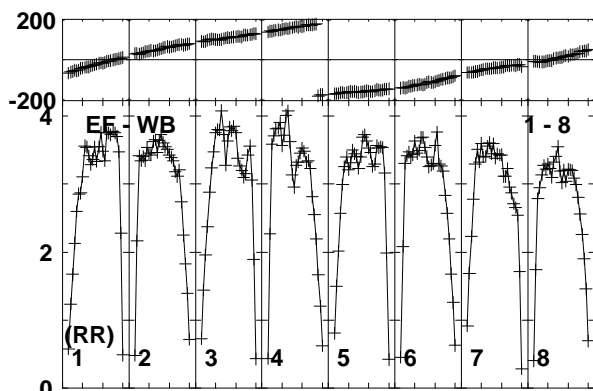
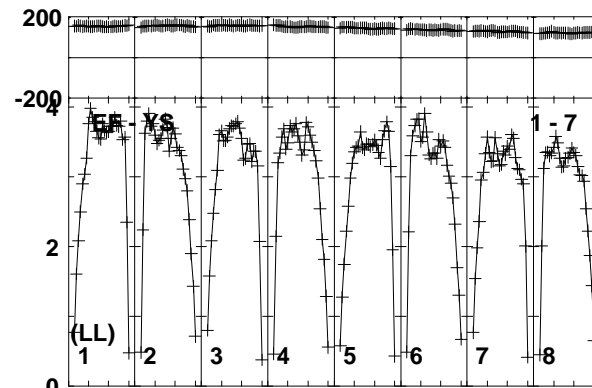
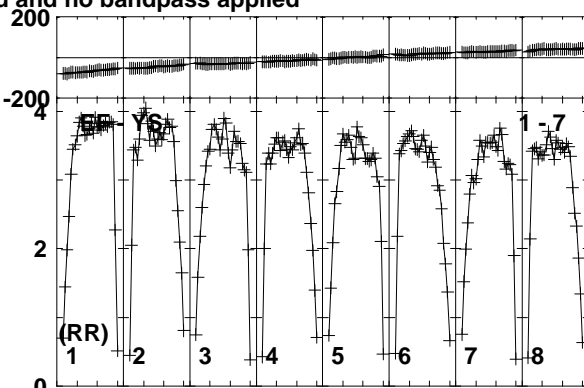
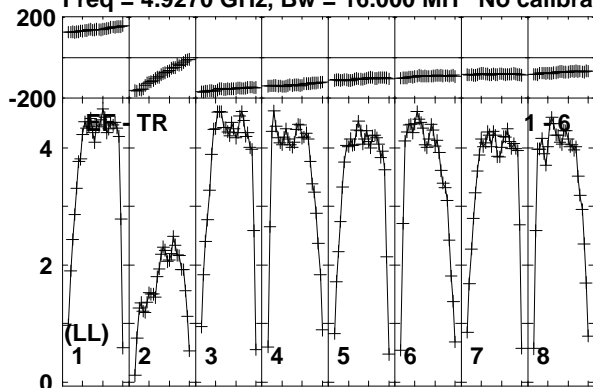

Lower frame: Milli Ampl Jy Top frame: Phas deg
Vector averaged cross-power spectrum Baseline: EF (01) - TR (06)
Timerange: 00:12:53:11 to 00:12:54:00

Plot file version 95 created 10-JUN-2016 16:07:56

FRB150418 RG008D.UVDATA.1

Freq = 4.9270 GHz, Bw = 16.000 MH No calibration applied and no bandpass applied

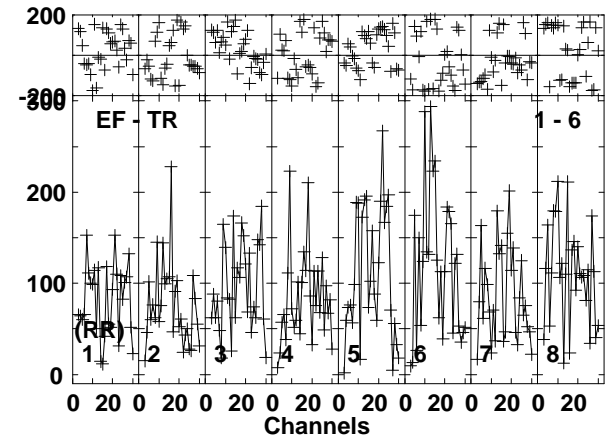
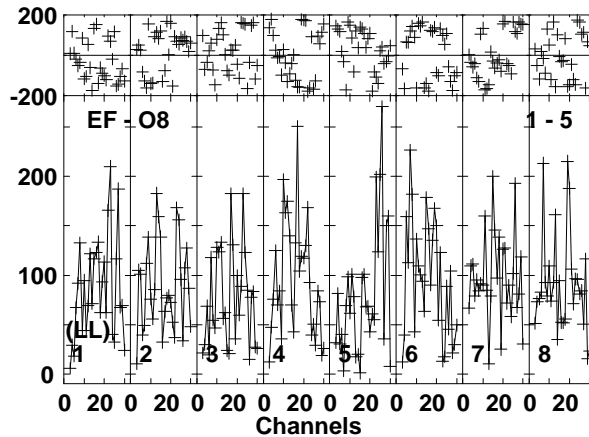
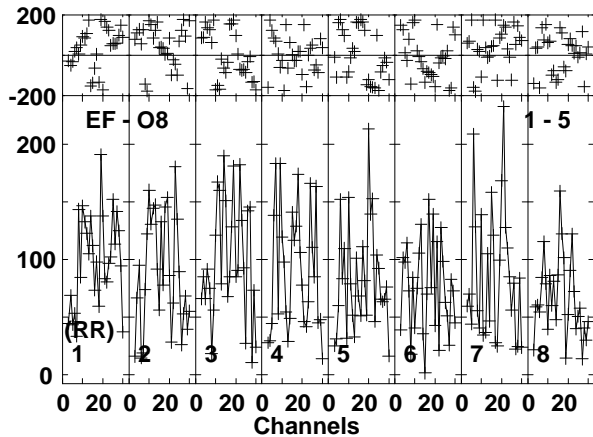
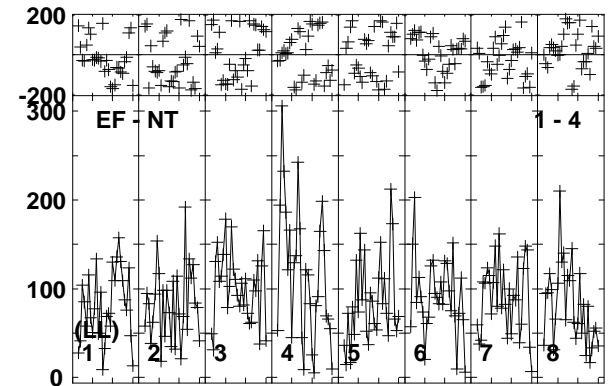
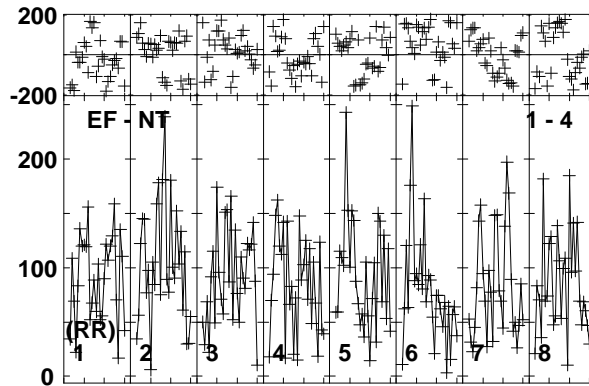
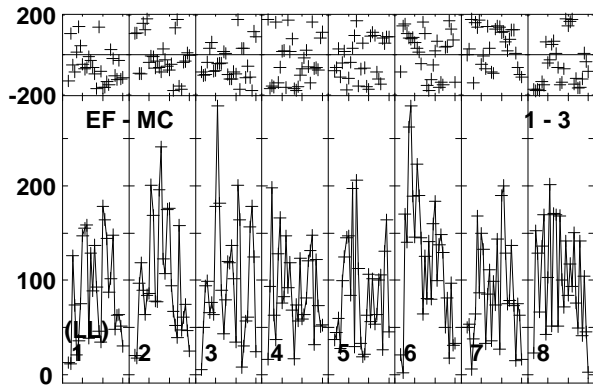
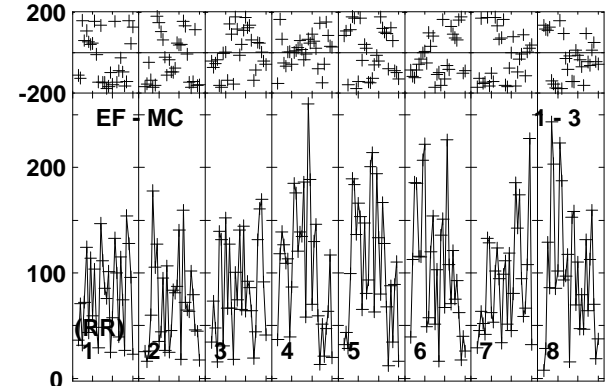
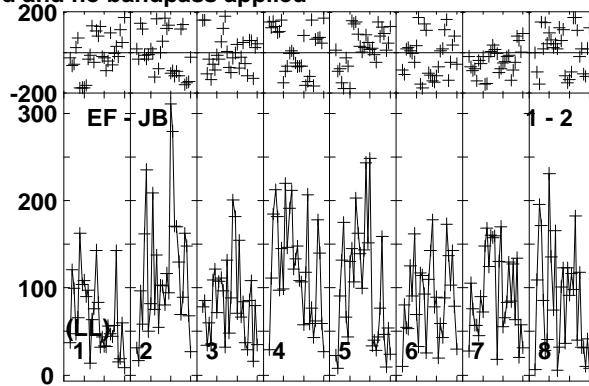
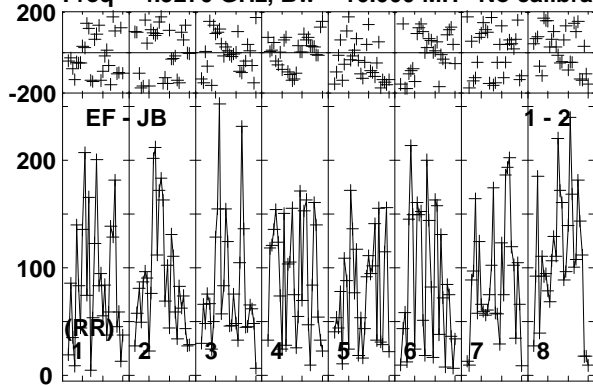

Lower frame: Micro Ampl Jy Top frame: Phas deg
Vector averaged cross-power spectrum Baseline: EF (01) - JB (02)
Timerange: 00/12:54:00 to 00/12:57:00

Plot file version 96 created 10-JUN-2016 16:07:56

FRB150418 RG008D.UVDATA.1

Freq = 4.9270 GHz, Bw = 16.000 MH No calibration applied and no bandpass applied

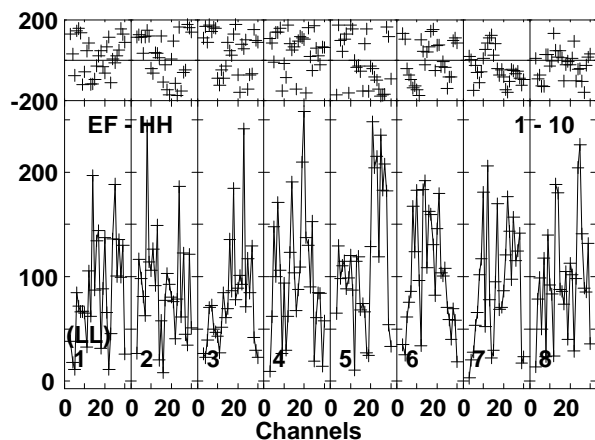
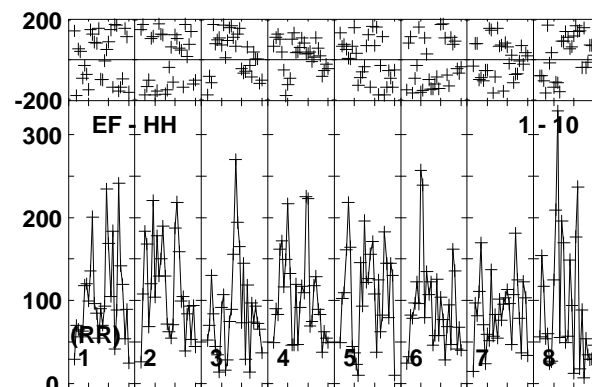
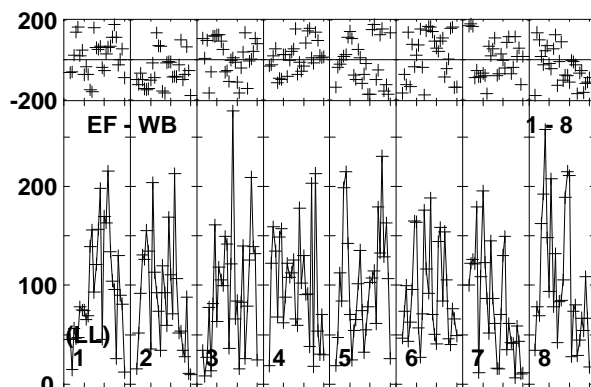
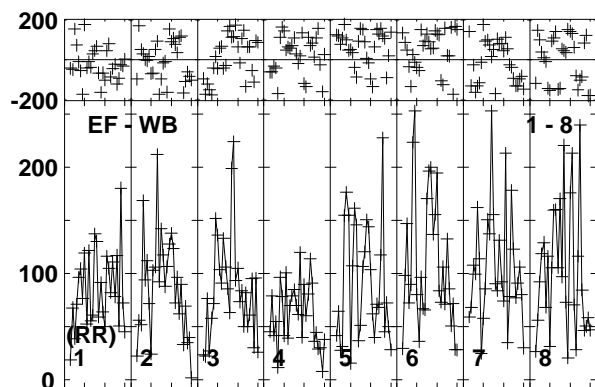
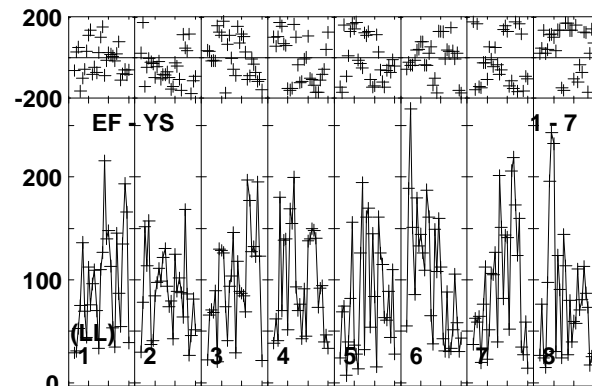
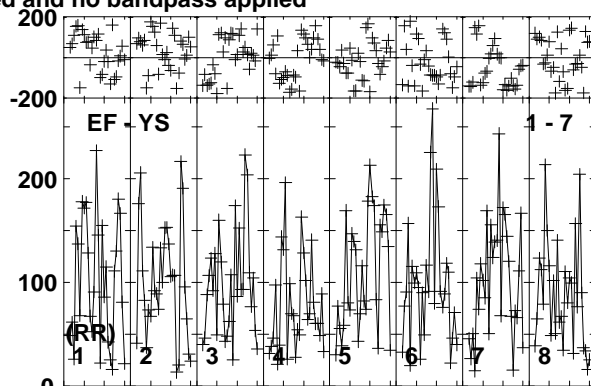
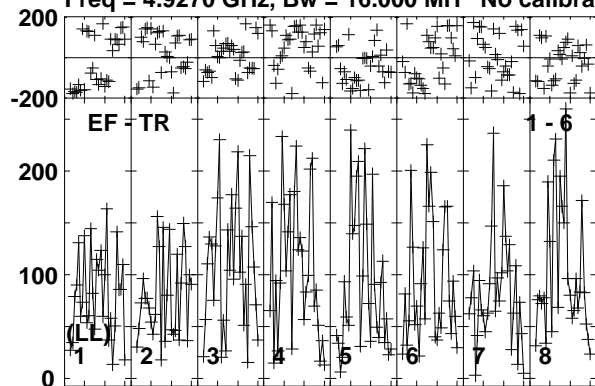

Lower frame: Micro Ampl Jy Top frame: Phas deg
Vector averaged cross-power spectrum Baseline: EF (01) - TR (06)
Timerange: 00/12:54:00 to 00/12:57:00

Plot file version 97 created 10-JUN-2016 16:07:57

J0718-1813 RG008D.UVDATA.1

Freq = 4.9270 GHz, Bw = 16.000 MH No calibration applied and no bandpass applied

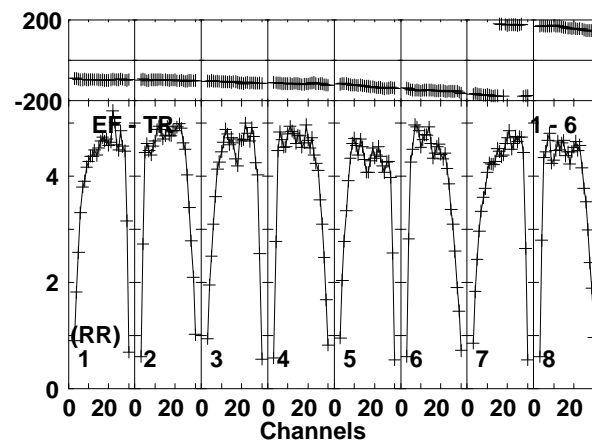
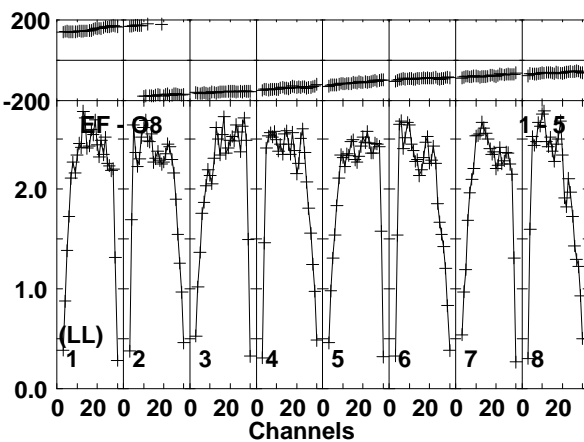
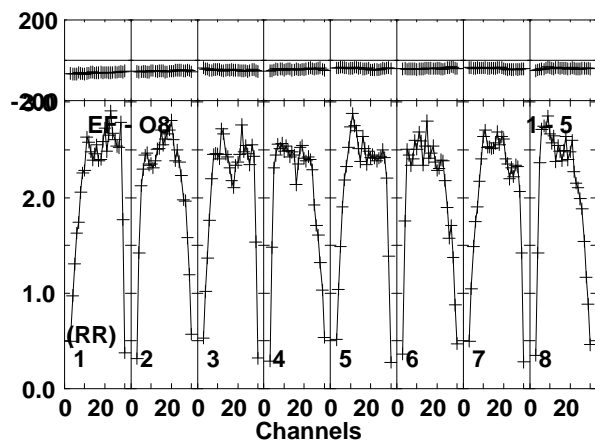
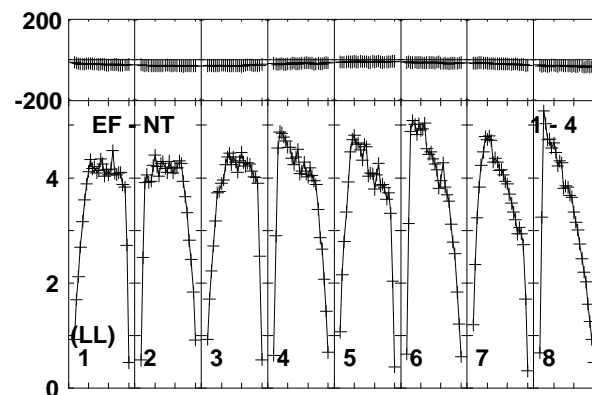
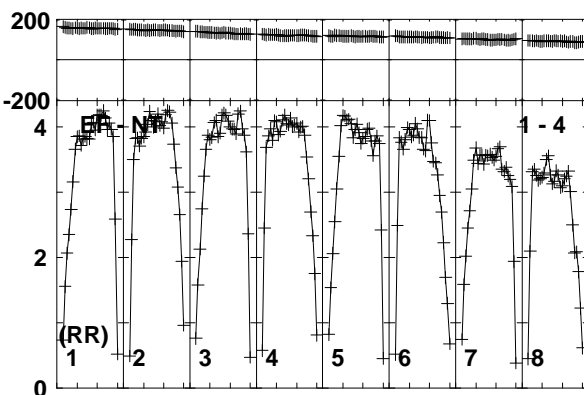
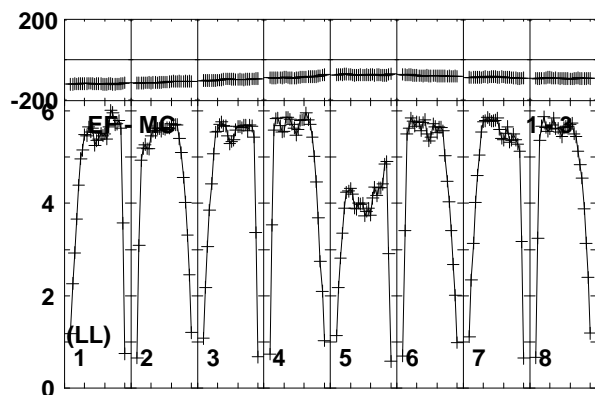
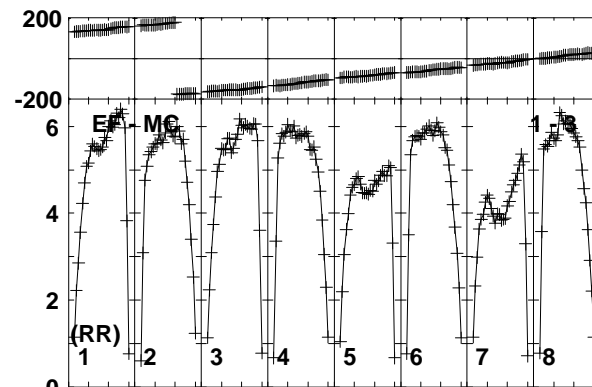
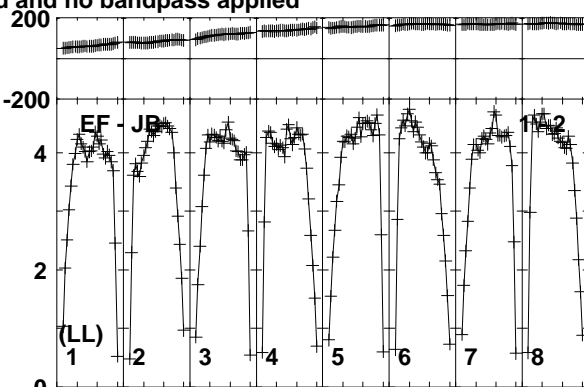
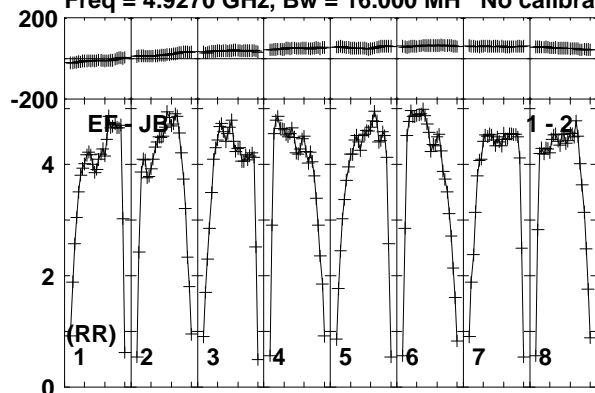

Lower frame: Milli Ampl Jy Top frame: Phas deg
Vector averaged cross-power spectrum Baseline: EF (01) - JB (02)
Timerange: 00:12:57:00 to 00:12:58:30

Plot file version 98 created 10-JUN-2016 16:07:57

J0718-1813 RG008D.UVDATA.1

Freq = 4.9270 GHz, Bw = 16.000 MH No calibration applied and no bandpass applied

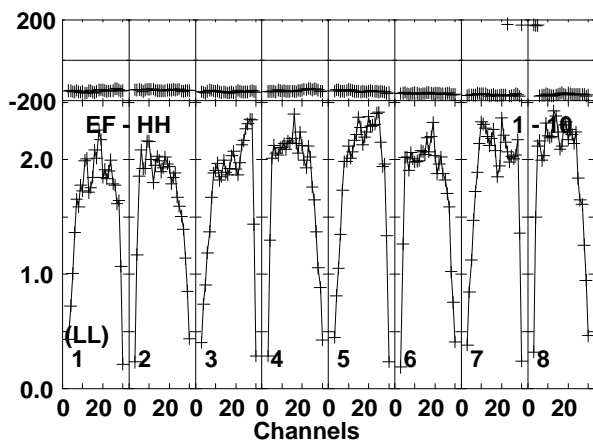
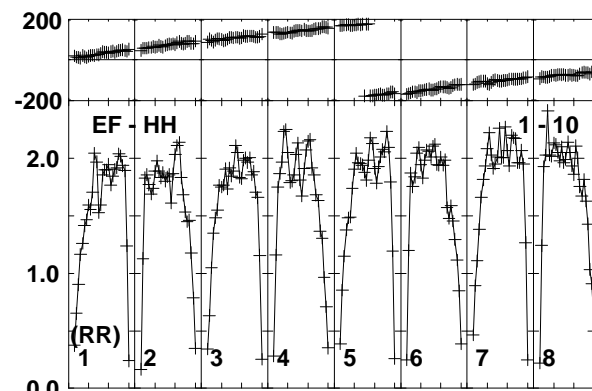
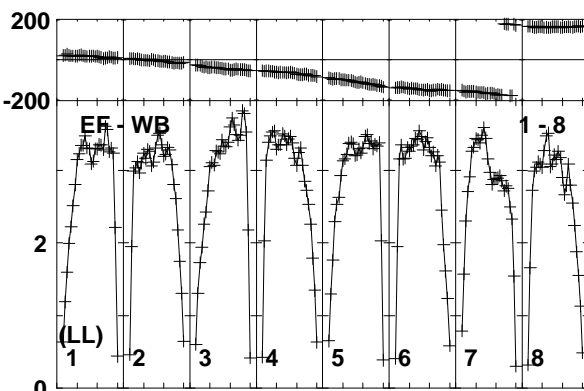
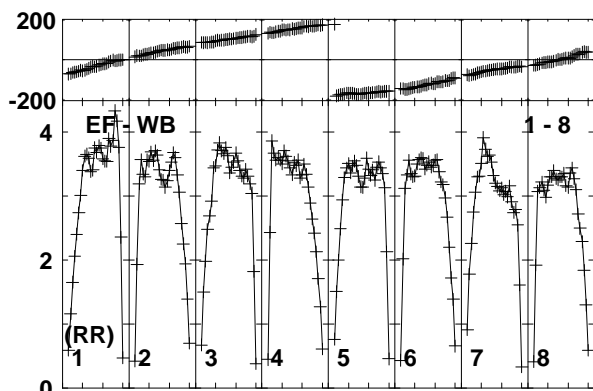
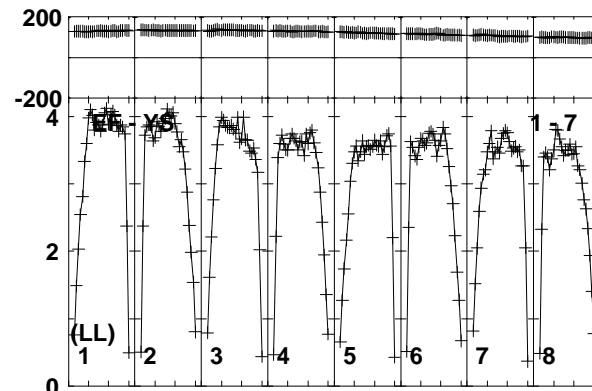
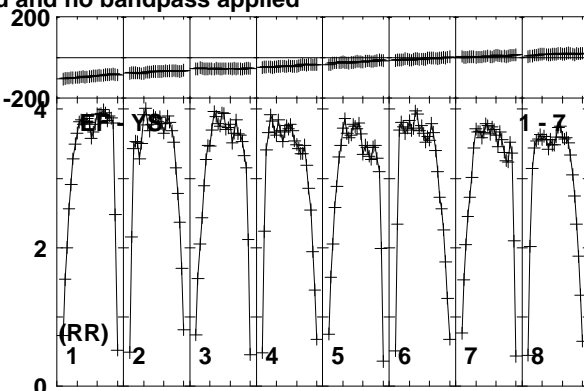
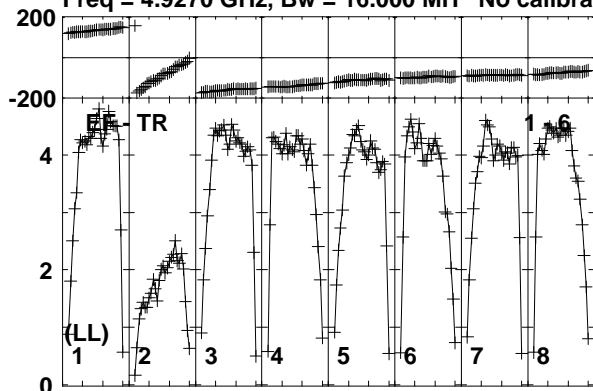

Lower frame: Milli Ampl Jy Top frame: Phas deg
Vector averaged cross-power spectrum Baseline: EF (01) - TR (06)
Timerange: 00/12:57:00 to 00/12:58:30

Plot file version 99 created 10-JUN-2016 16:07:57

J0712-1847 RG008D.UVDATA.1

Freq = 4.9270 GHz, Bw = 16.000 MH No calibration applied and no bandpass applied

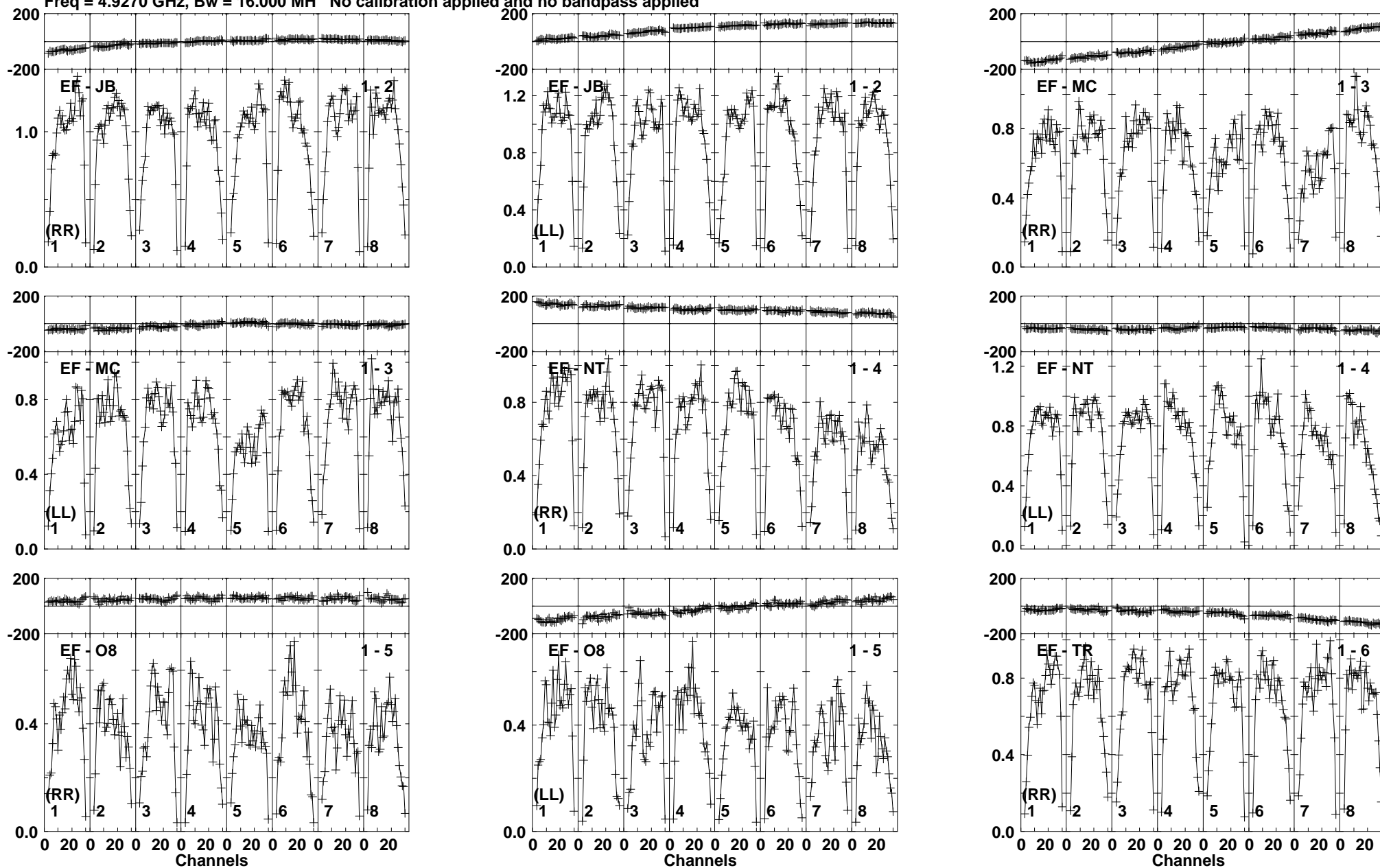

Lower frame: Milli Ampl Jy Top frame: Phas deg
Vector averaged cross-power spectrum Baseline: EF (01) - JB (02)
Timerange: 00/12:58:30 to 00/13:01:30

Plot file version 100 created 10-JUN-2016 16:07:57

J0712-1847 RG008D.UVDATA.1

Freq = 4.9270 GHz, Bw = 16.000 MH No calibration applied and no bandpass applied

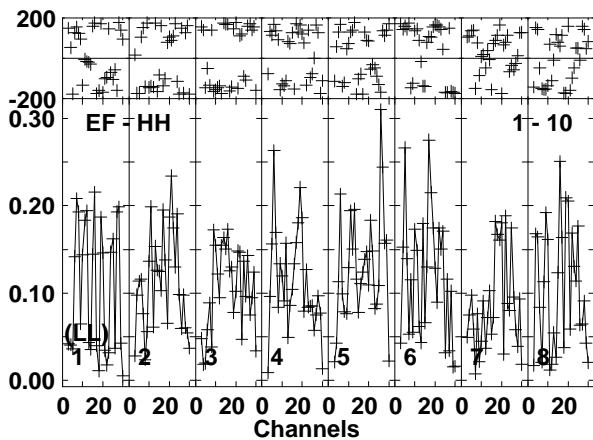
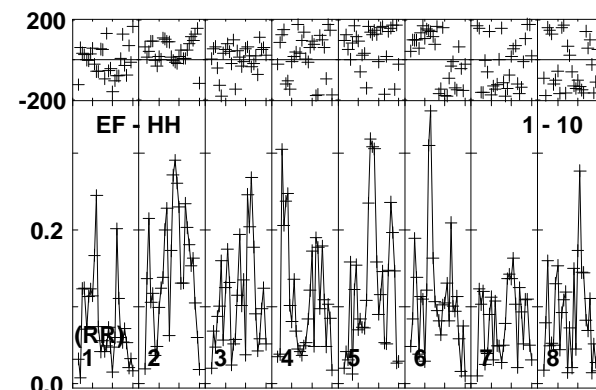
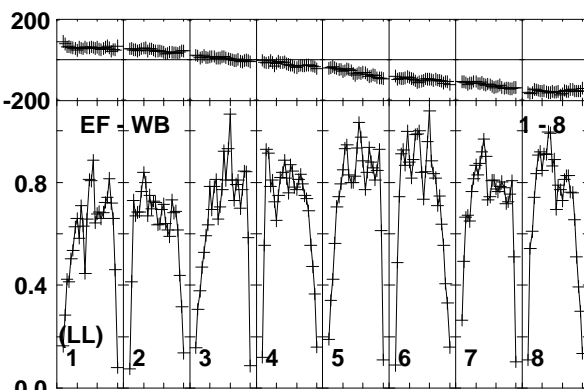
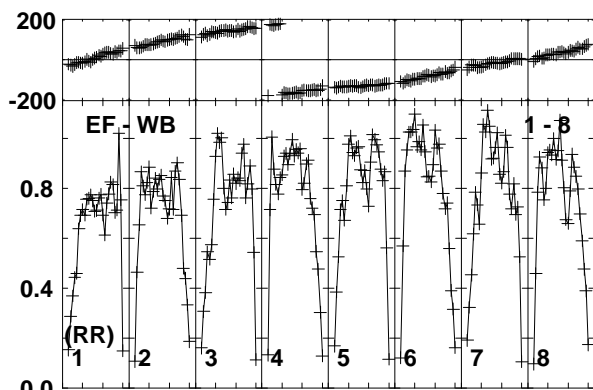
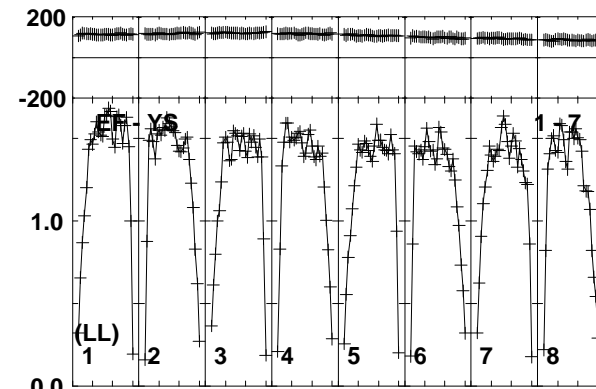
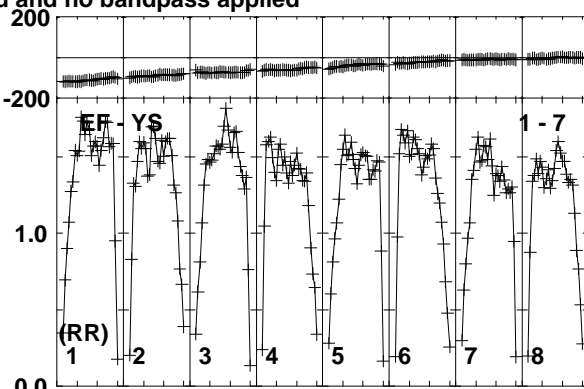
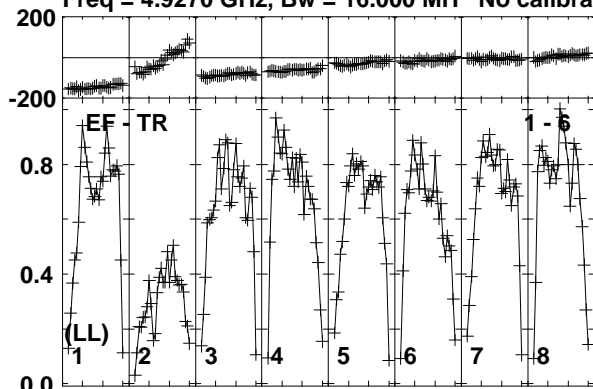

Lower frame: Milli Ampl Jy Top frame: Phas deg
Vector averaged cross-power spectrum Baseline: EF (01) - TR (06)
Timerange: 00/12:58:30 to 00/13:01:30

Plot file version 101 created 10-JUN-2016 16:07:57

J0718-1813 RG008D.UVDATA.1

Freq = 4.9270 GHz, Bw = 16.000 MH No calibration applied and no bandpass applied

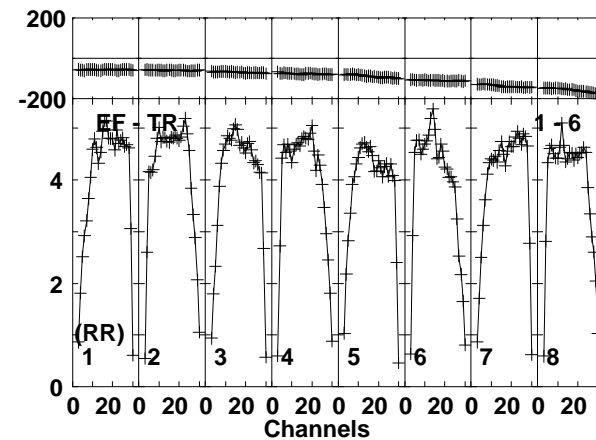
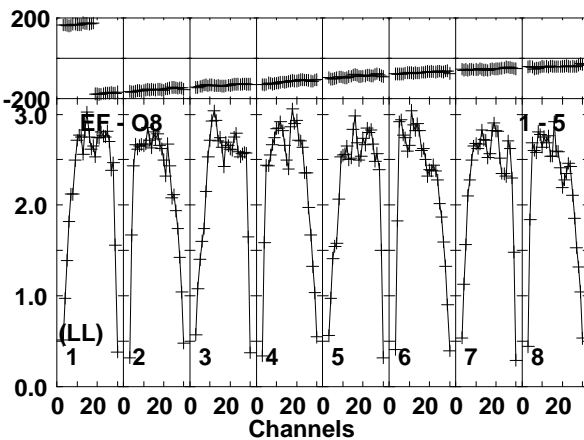
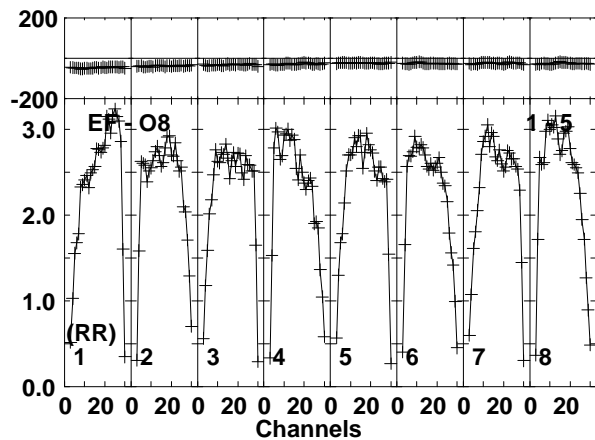
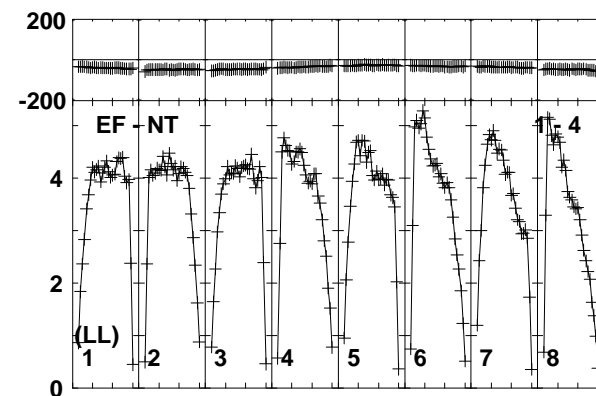
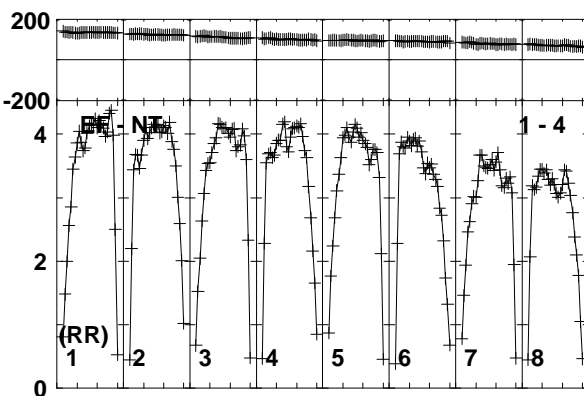
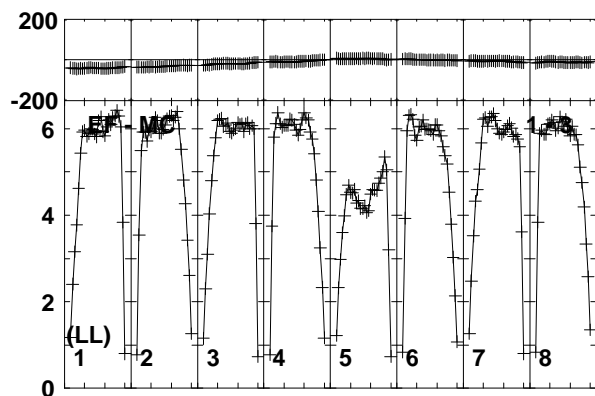
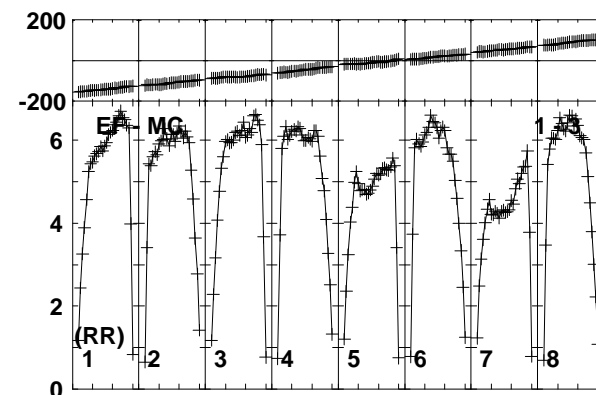
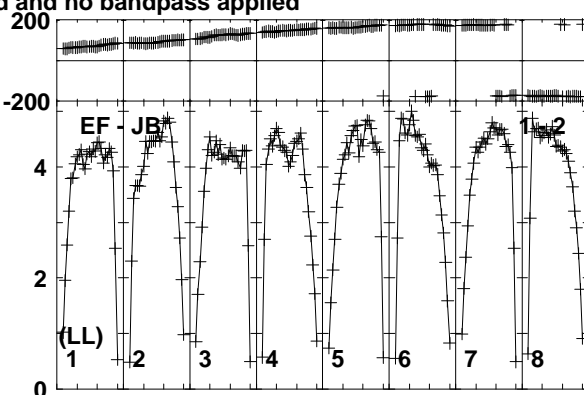
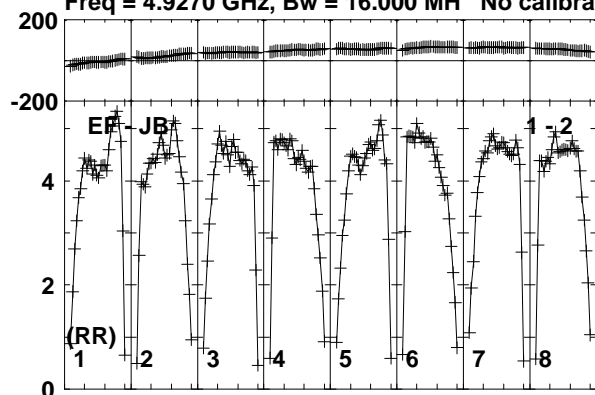

Lower frame: Milli Ampl Jy Top frame: Phas deg
Vector averaged cross-power spectrum Baseline: EF (01) - JB (02)
Timerange: 00/13:02:10 to 00/13:02:59

Plot file version 102 created 10-JUN-2016 16:07:57

J0718-1813 RG008D.UVDATA.1

Freq = 4.9270 GHz, Bw = 16.000 MH No calibration applied and no bandpass applied

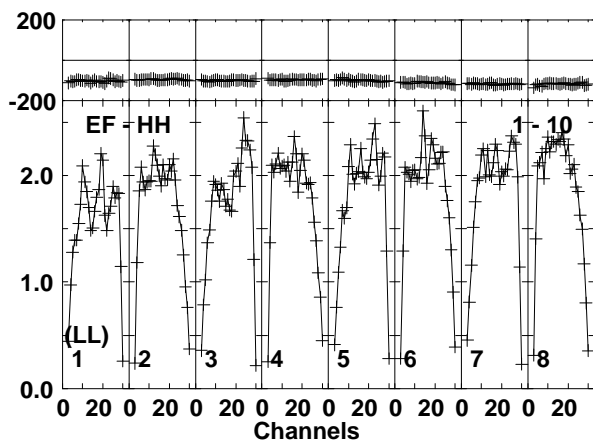
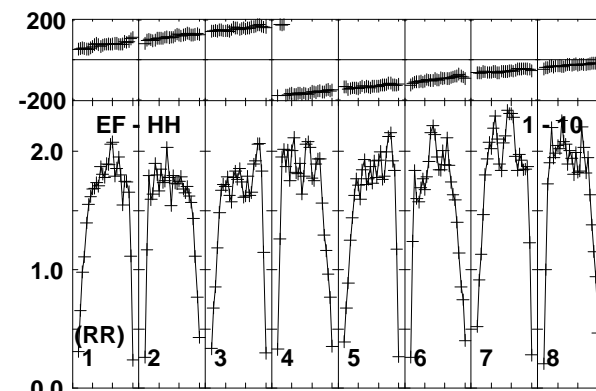
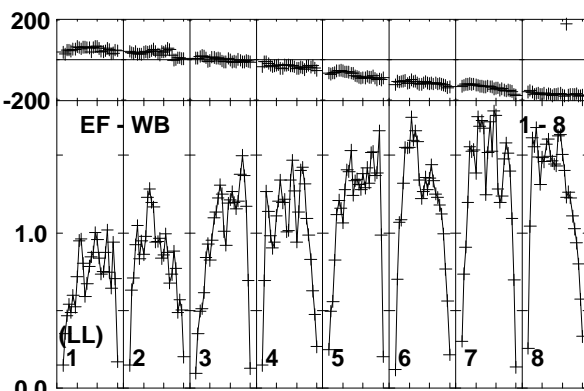
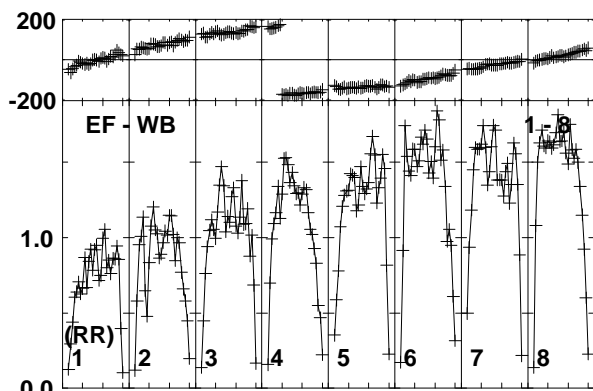
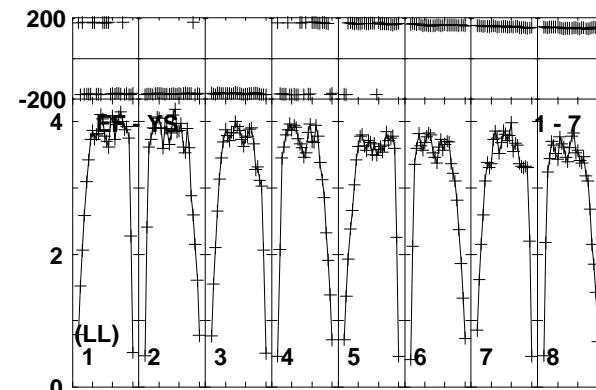
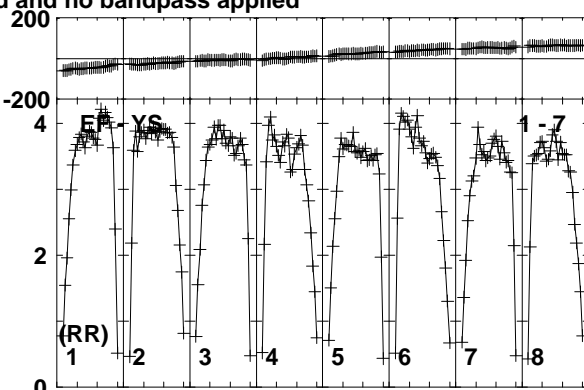
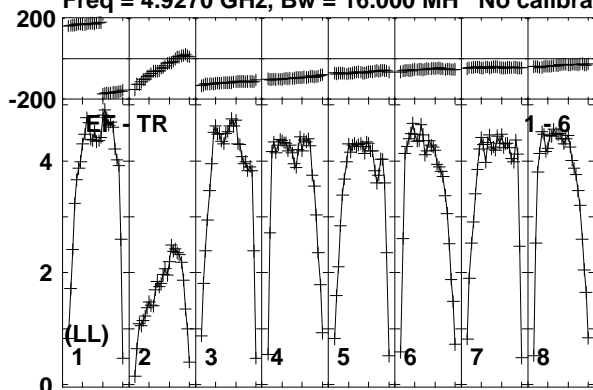

Lower frame: Milli Ampl Jy Top frame: Phas deg
Vector averaged cross-power spectrum Baseline: EF (01) - TR (06)
Timerange: 00/13:02:10 to 00/13:02:59

Plot file version 103 created 10-JUN-2016 16:07:57

FRB150418 RG008D.UVDATA.1

Freq = 4.9270 GHz, Bw = 16.000 MH No calibration applied and no bandpass applied

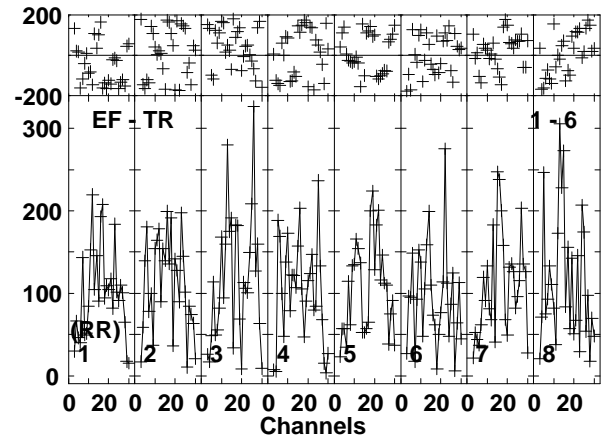
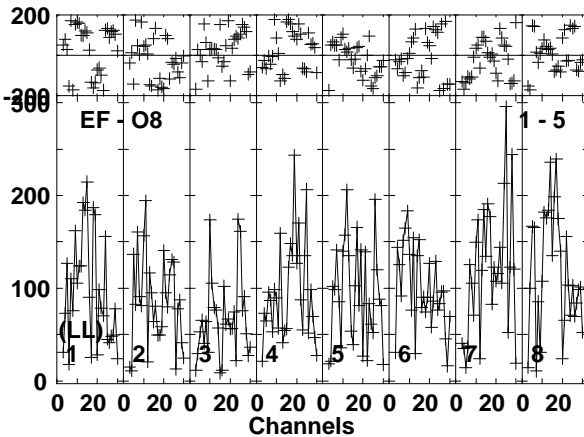
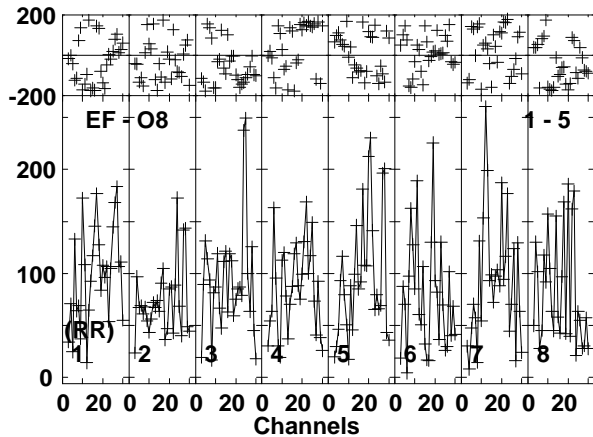
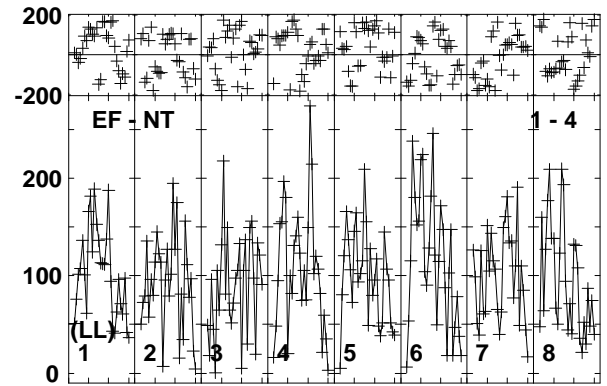
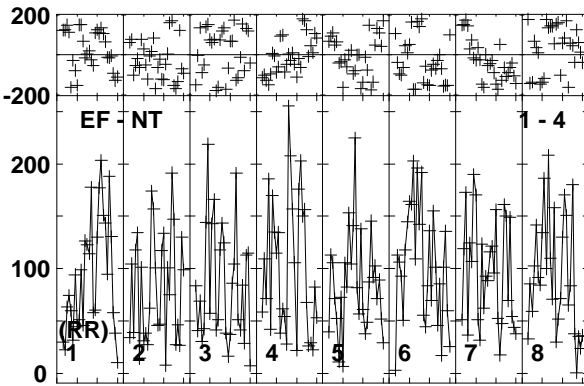
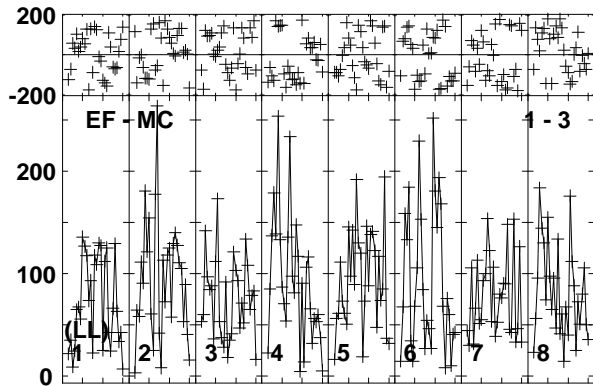
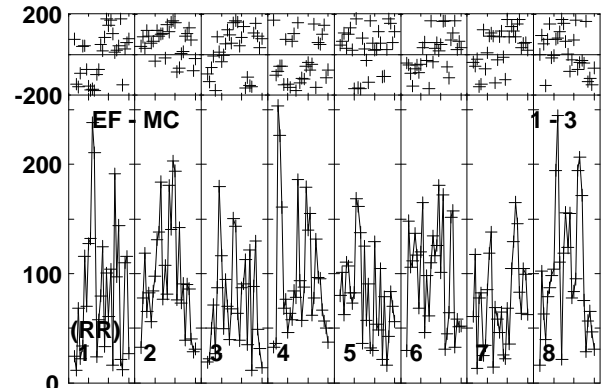
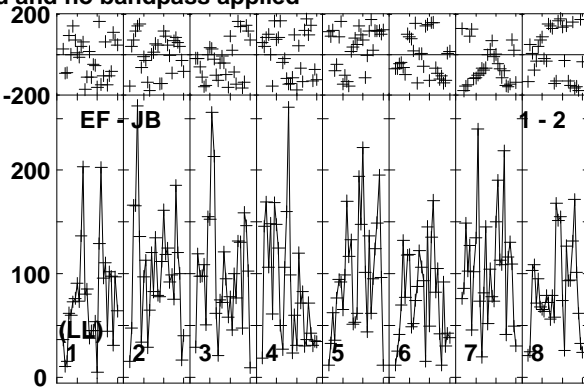
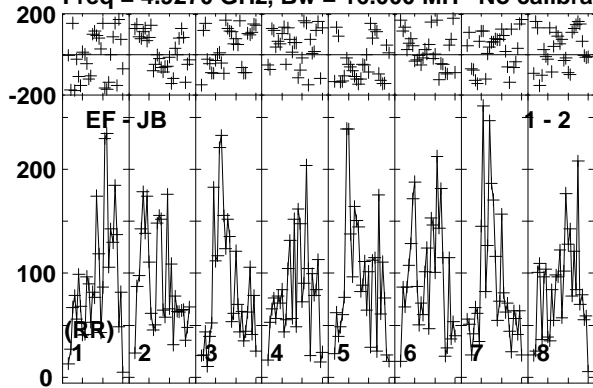

Lower frame: Micro Ampl Jy Top frame: Phas deg
Vector averaged cross-power spectrum Baseline: EF (01) - JB (02)
Timerange: 00/13:03:00 to 00/13:06:00

Plot file version 104 created 10-JUN-2016 16:07:57

FRB150418 RG008D.UVDATA.1

Freq = 4.9270 GHz, Bw = 16.000 MH No calibration applied and no bandpass applied

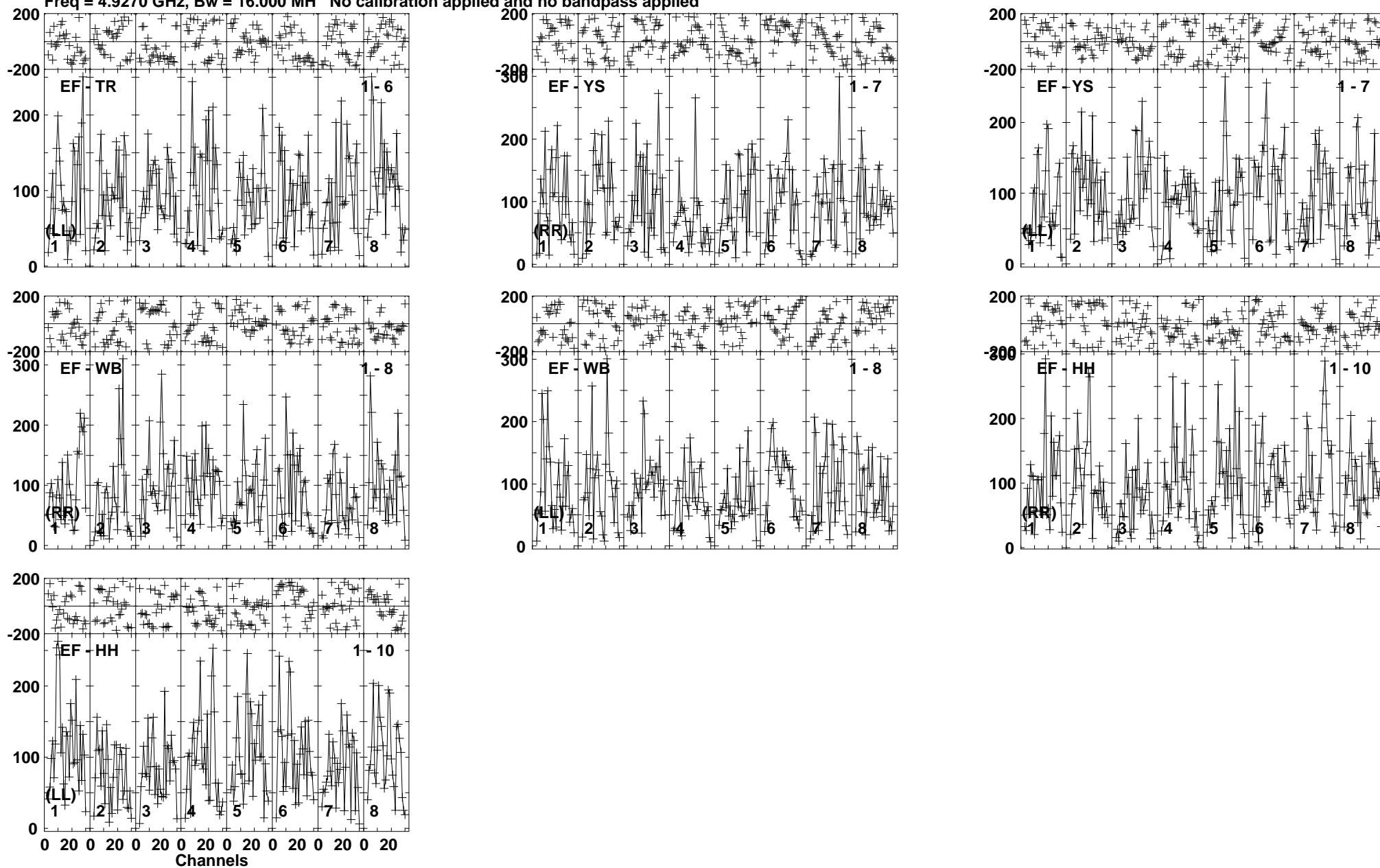

Lower frame: Micro Ampl Jy Top frame: Phas deg
Vector averaged cross-power spectrum Baseline: EF (01) - TR (06)
Timerange: 00/13:03:00 to 00/13:06:00

Plot file version 105 created 10-JUN-2016 16:07:58

J0718-1813 RG008D.UVDATA.1

Freq = 4.9270 GHz, Bw = 16.000 MH No calibration applied and no bandpass applied

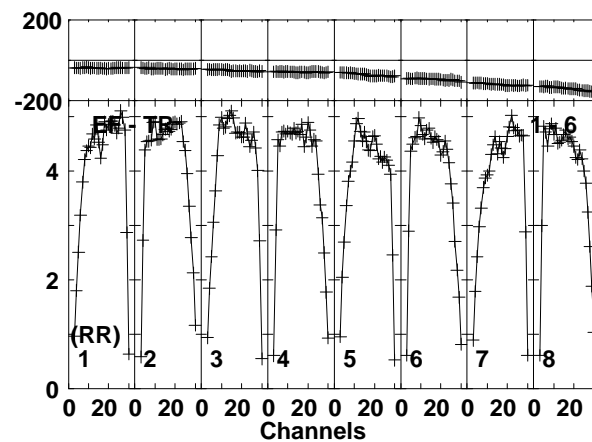
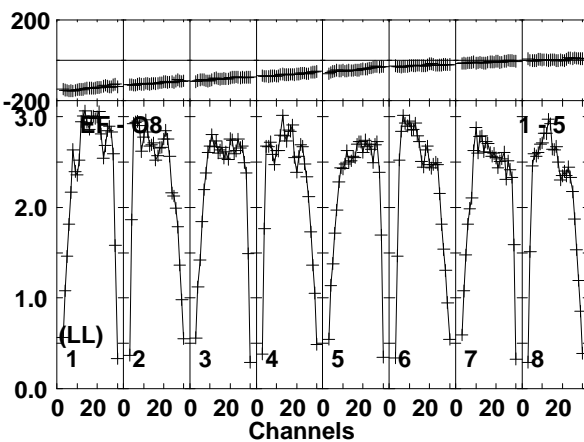
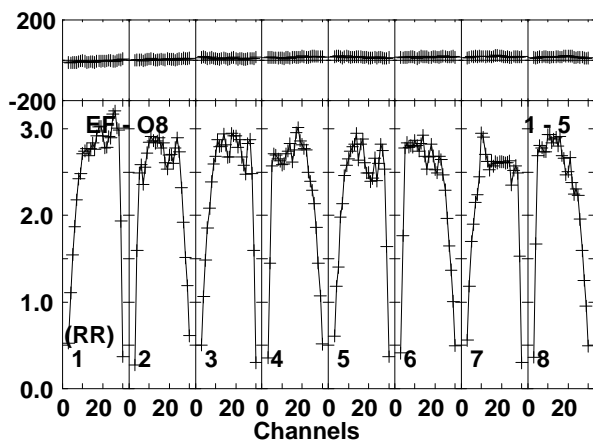
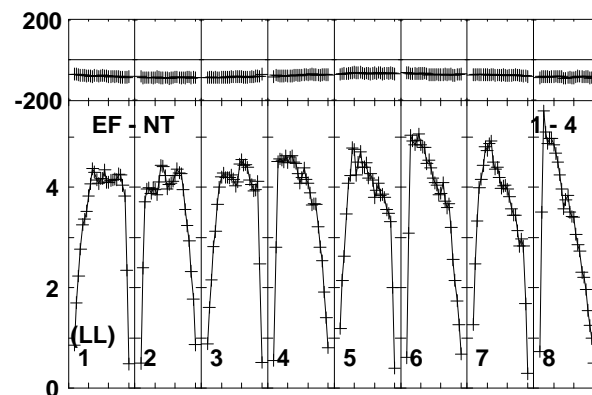
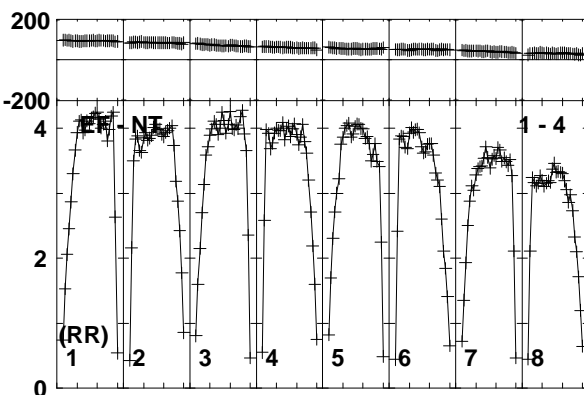
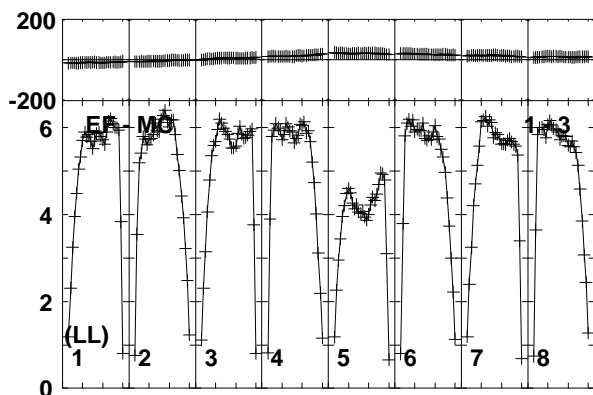
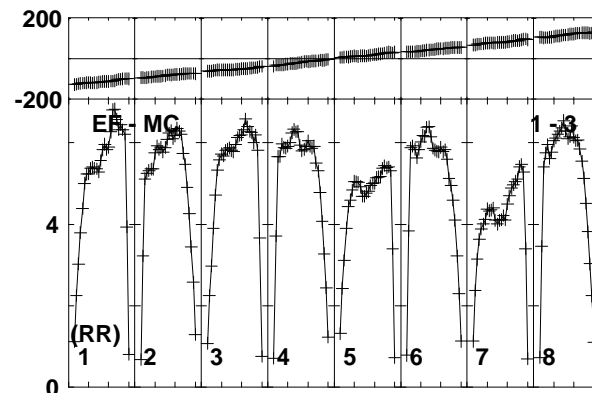
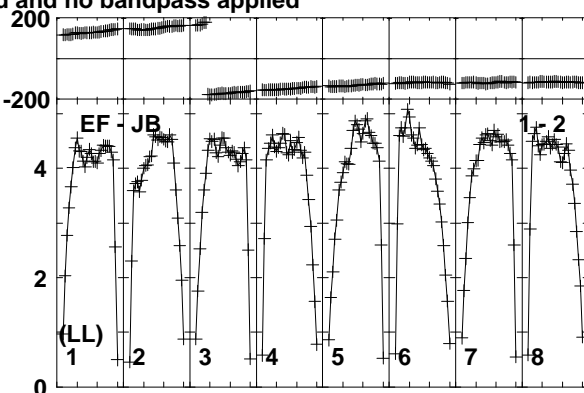
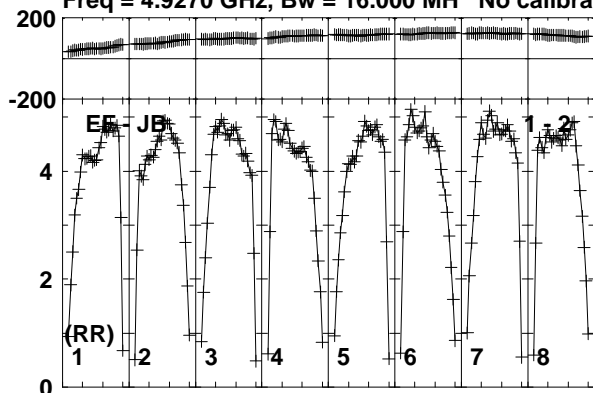

Lower frame: Milli Ampl Jy Top frame: Phas deg
Vector averaged cross-power spectrum Baseline: EF (01) - JB (02)
Timerange: 00/13:06:01 to 00/13:07:29

Plot file version 106 created 10-JUN-2016 16:07:58

J0718-1813 RG008D.UVDATA.1

Freq = 4.9270 GHz, Bw = 16.000 MH No calibration applied and no bandpass applied

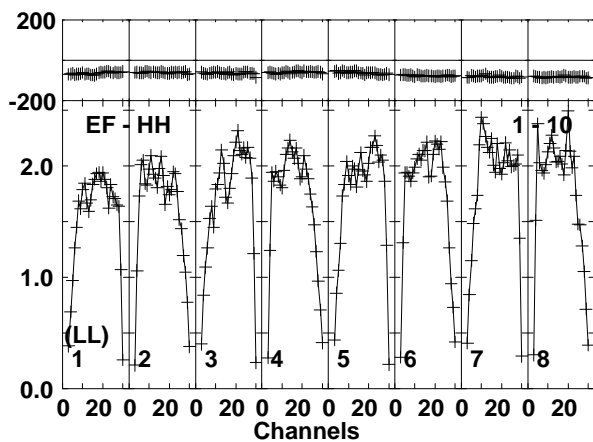
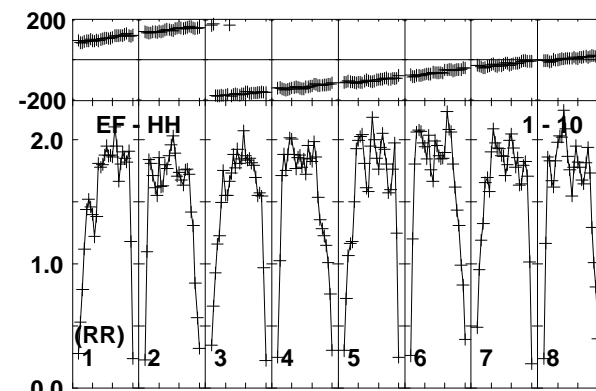
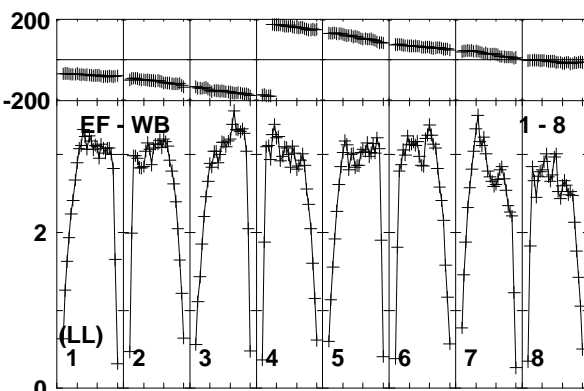
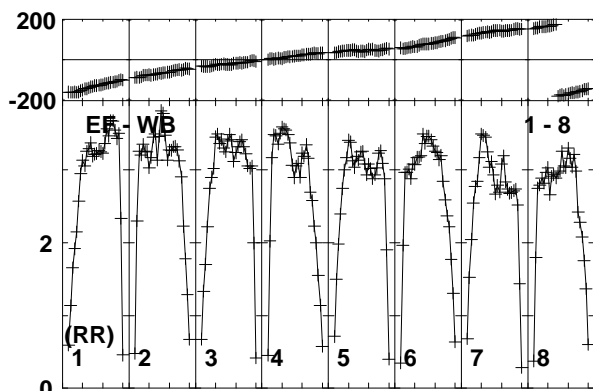
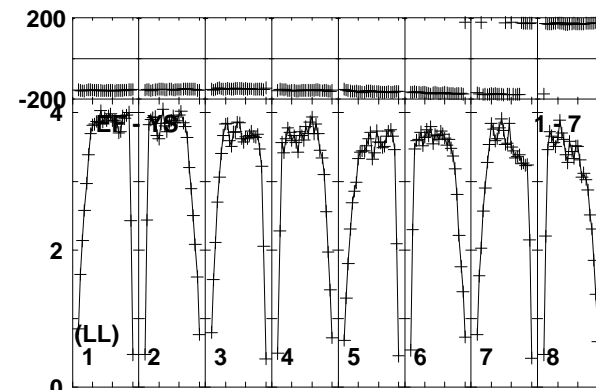
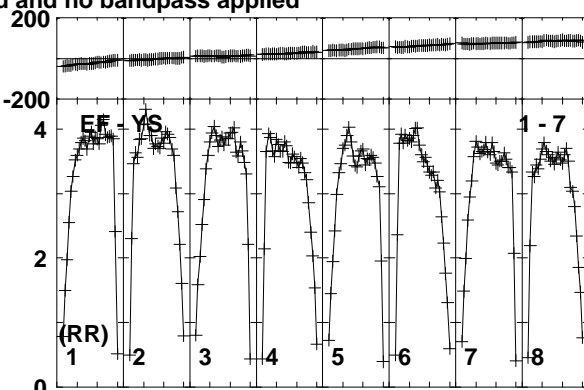
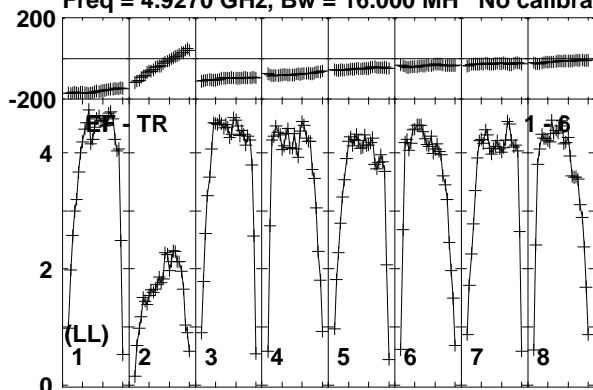

Lower frame: Milli Ampl Jy Top frame: Phas deg
Vector averaged cross-power spectrum Baseline: EF (01) - TR (06)
Timerange: 00/13:06:01 to 00/13:07:29

Plot file version 107 created 10-JUN-2016 16:07:58

FRB150418 RG008D.UVDATA.1

Freq = 4.9270 GHz, Bw = 16.000 MH No calibration applied and no bandpass applied

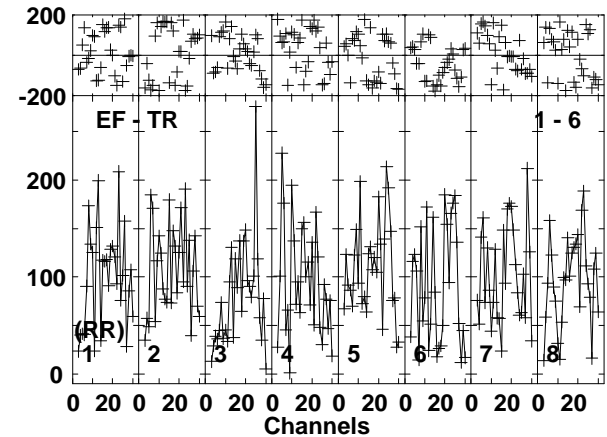
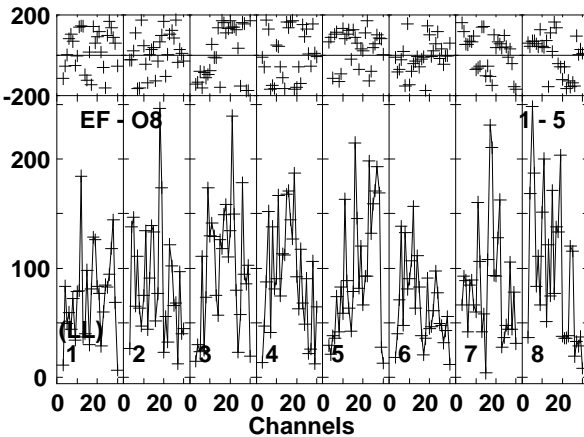
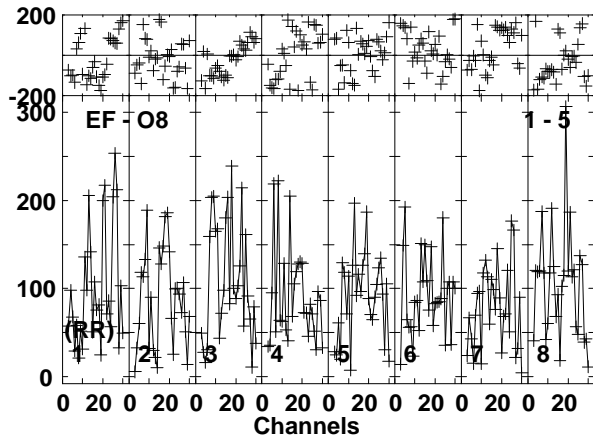
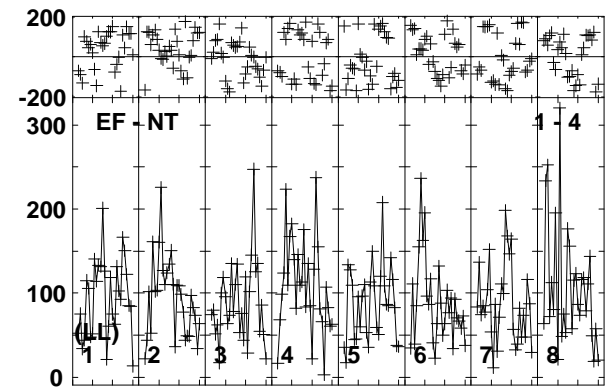
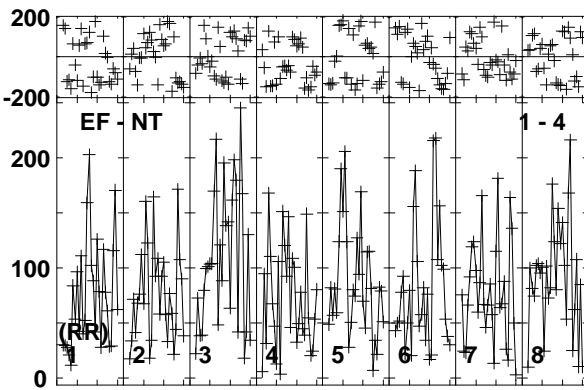
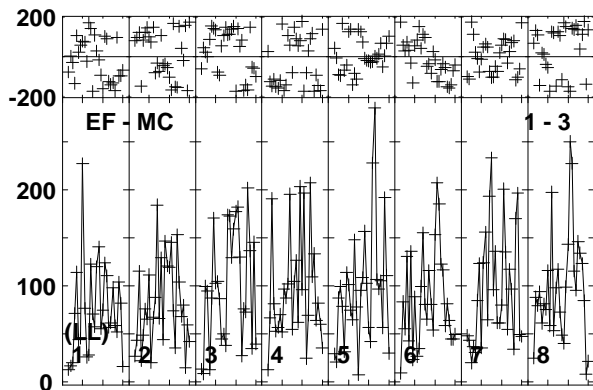
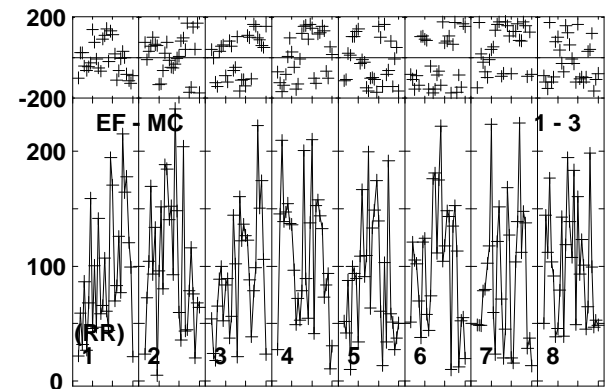
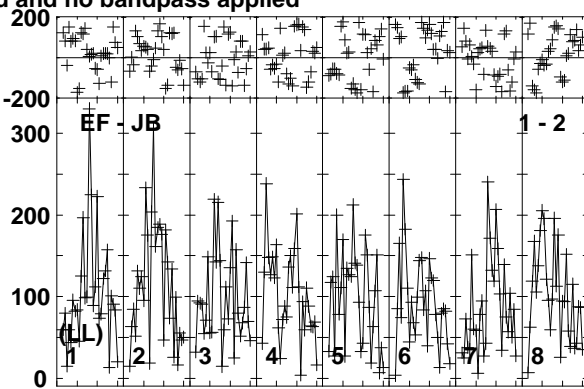
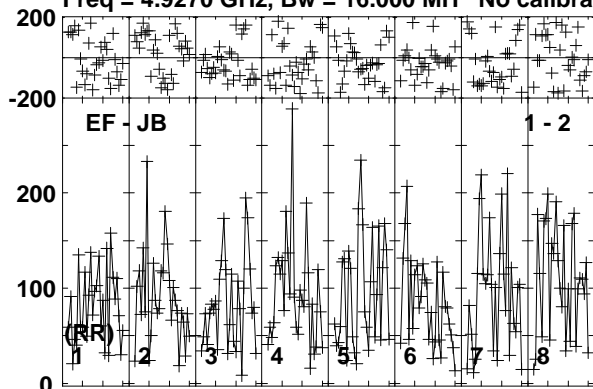

Lower frame: Micro Ampl Jy Top frame: Phas deg
Vector averaged cross-power spectrum Baseline: EF (01) - JB (02)
Timerange: 00/13:07:31 to 00/13:10:29

Plot file version 108 created 10-JUN-2016 16:07:58

FRB150418 RG008D.UVDATA.1

Freq = 4.9270 GHz, Bw = 16.000 MH No calibration applied and no bandpass applied

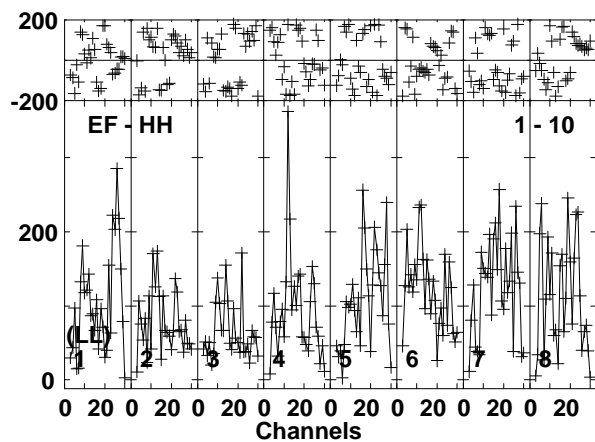
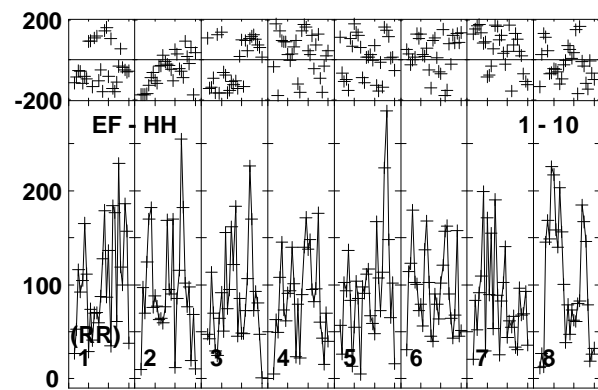
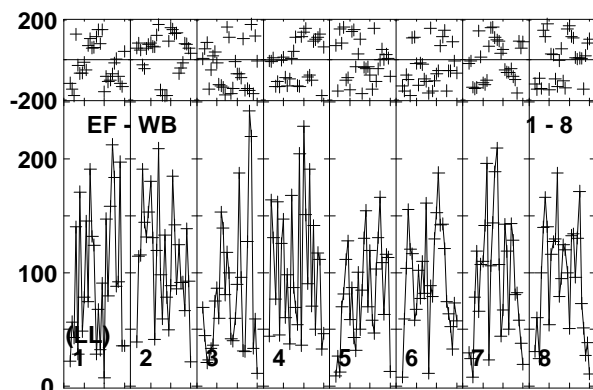
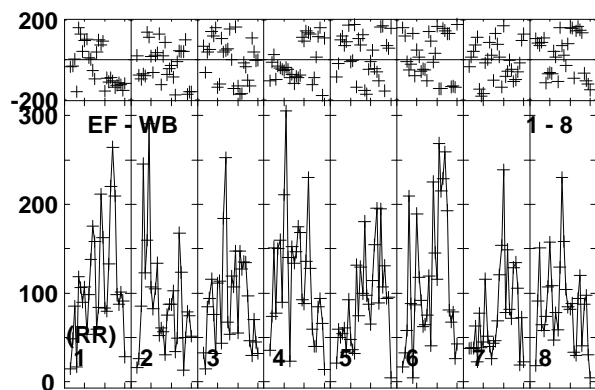
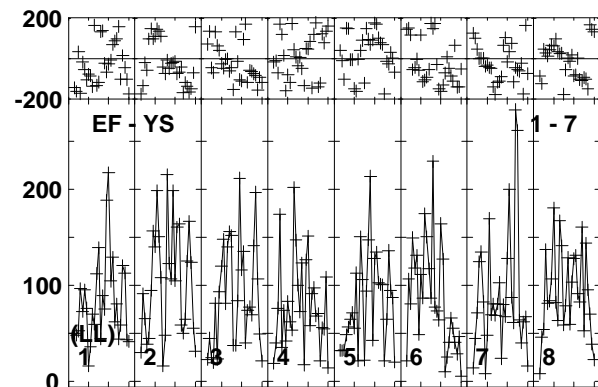
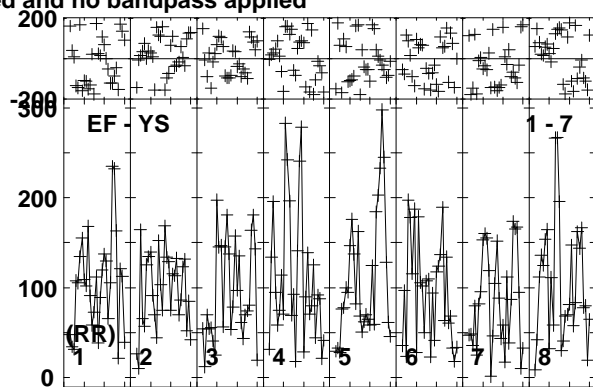
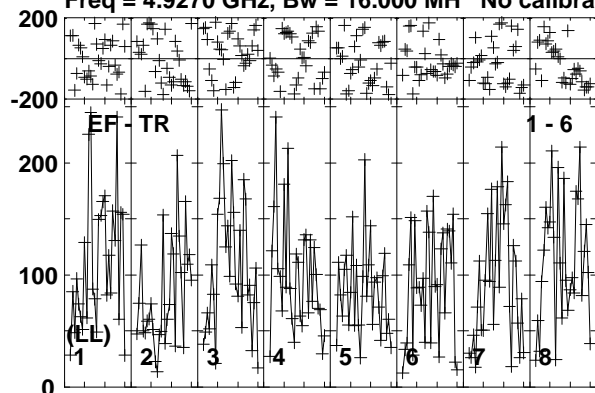

Lower frame: Micro Ampl Jy Top frame: Phas deg
Vector averaged cross-power spectrum Baseline: EF (01) - TR (06)
Timerange: 00/13:07:31 to 00/13:10:29

Plot file version 109 created 10-JUN-2016 16:07:58

J0718-1813 RG008D.UVDATA.1

Freq = 4.9270 GHz, Bw = 16.000 MH No calibration applied and no bandpass applied

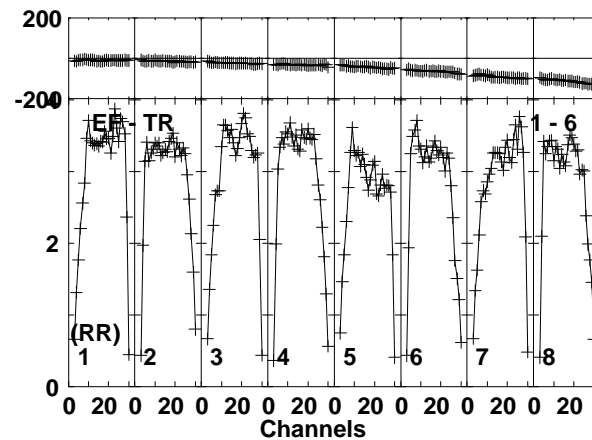
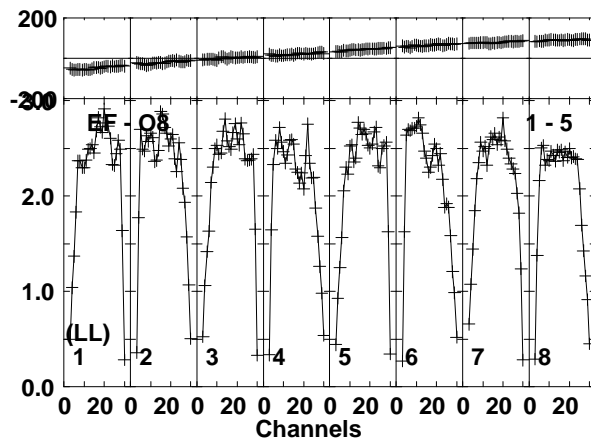
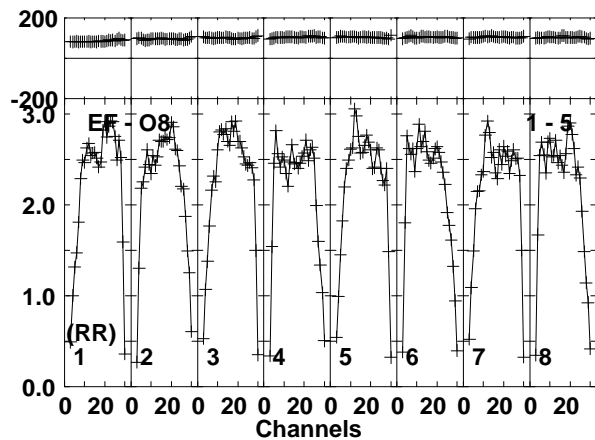
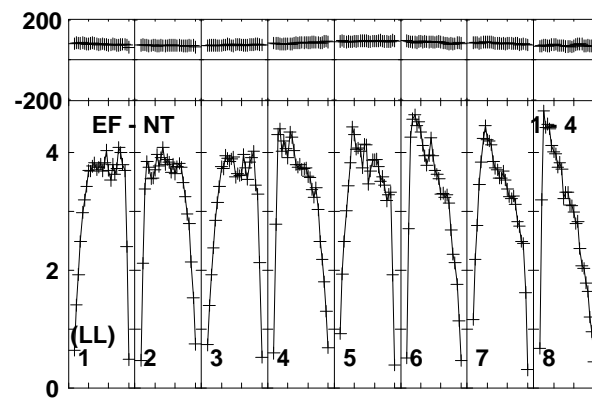
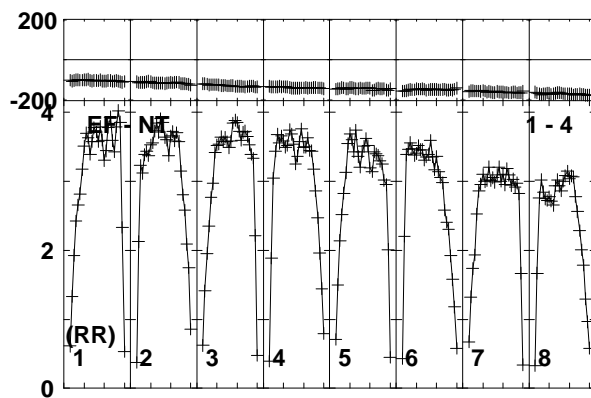
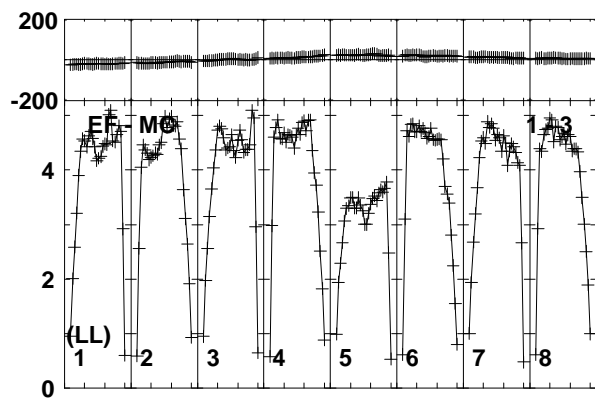
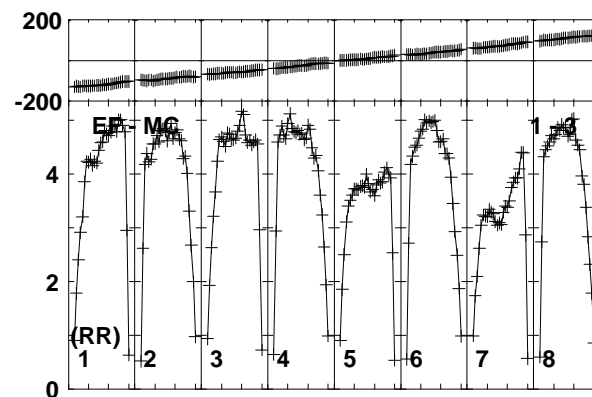
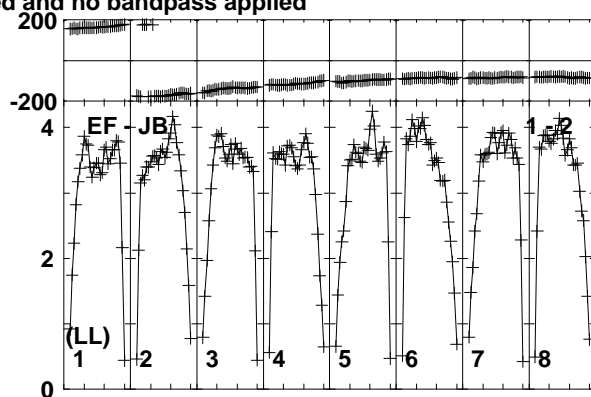
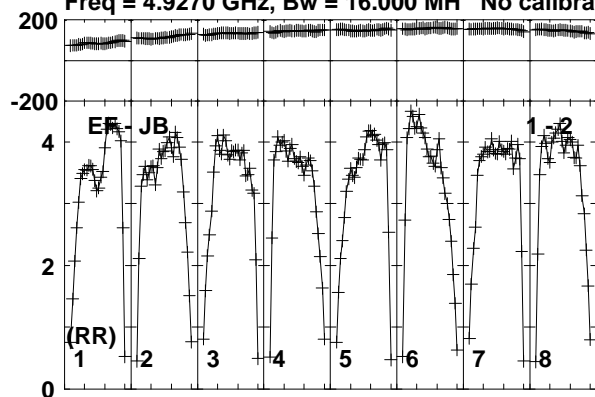

Lower frame: Milli Ampl Jy Top frame: Phas deg
Vector averaged cross-power spectrum Baseline: EF (01) - JB (02)
Timerange: 00/13:11:10 to 00/13:12:00

Plot file version 110 created 10-JUN-2016 16:07:58

J0718-1813 RG008D.UVDATA.1

Freq = 4.9270 GHz, Bw = 16.000 MH No calibration applied and no bandpass applied

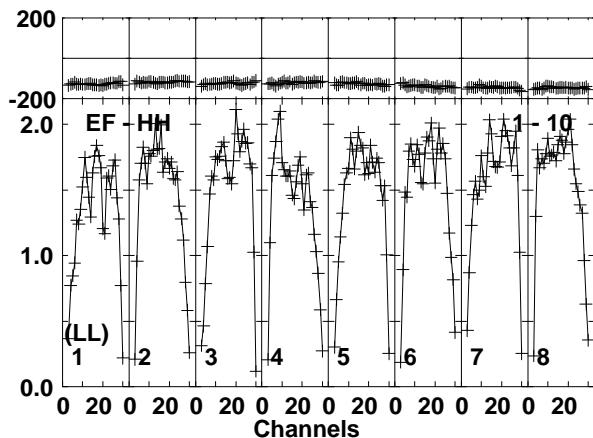
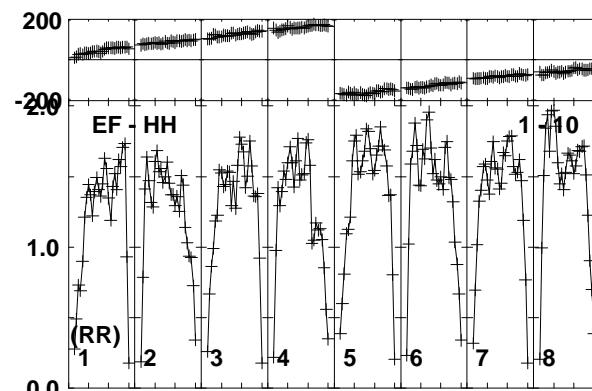
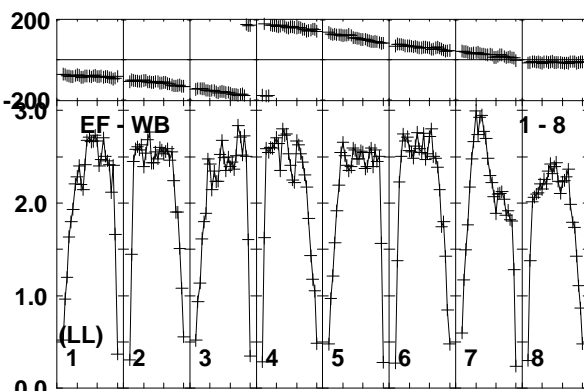
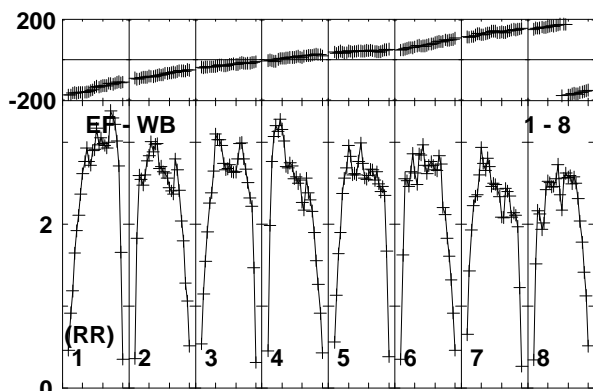
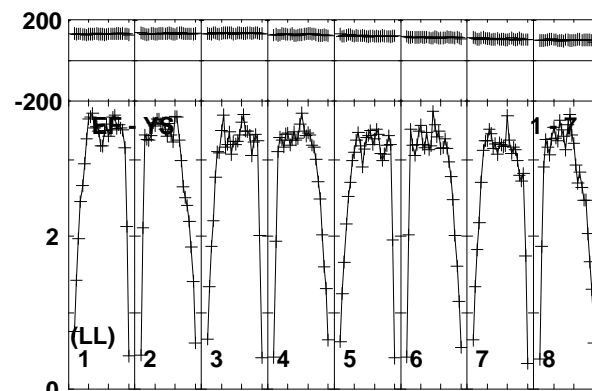
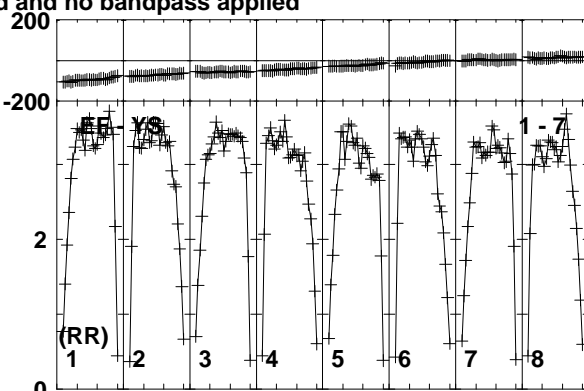
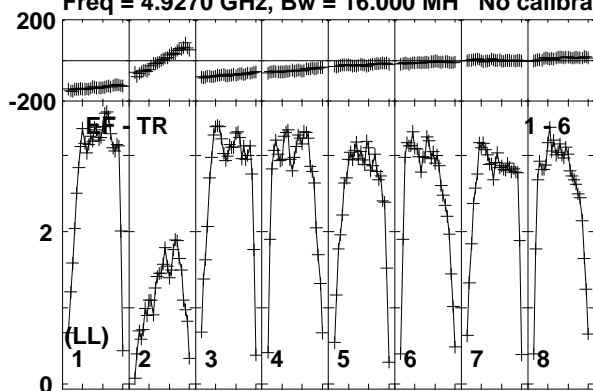

Lower frame: Milli Ampl Jy Top frame: Phas deg
Vector averaged cross-power spectrum Baseline: EF (01) - TR (06)
Timerange: 00/13:11:10 to 00/13:12:00

Plot file version 111 created 10-JUN-2016 16:07:58

FRB150418 RG008D.UVDATA.1

Freq = 4.9270 GHz, Bw = 16.000 MH No calibration applied and no bandpass applied

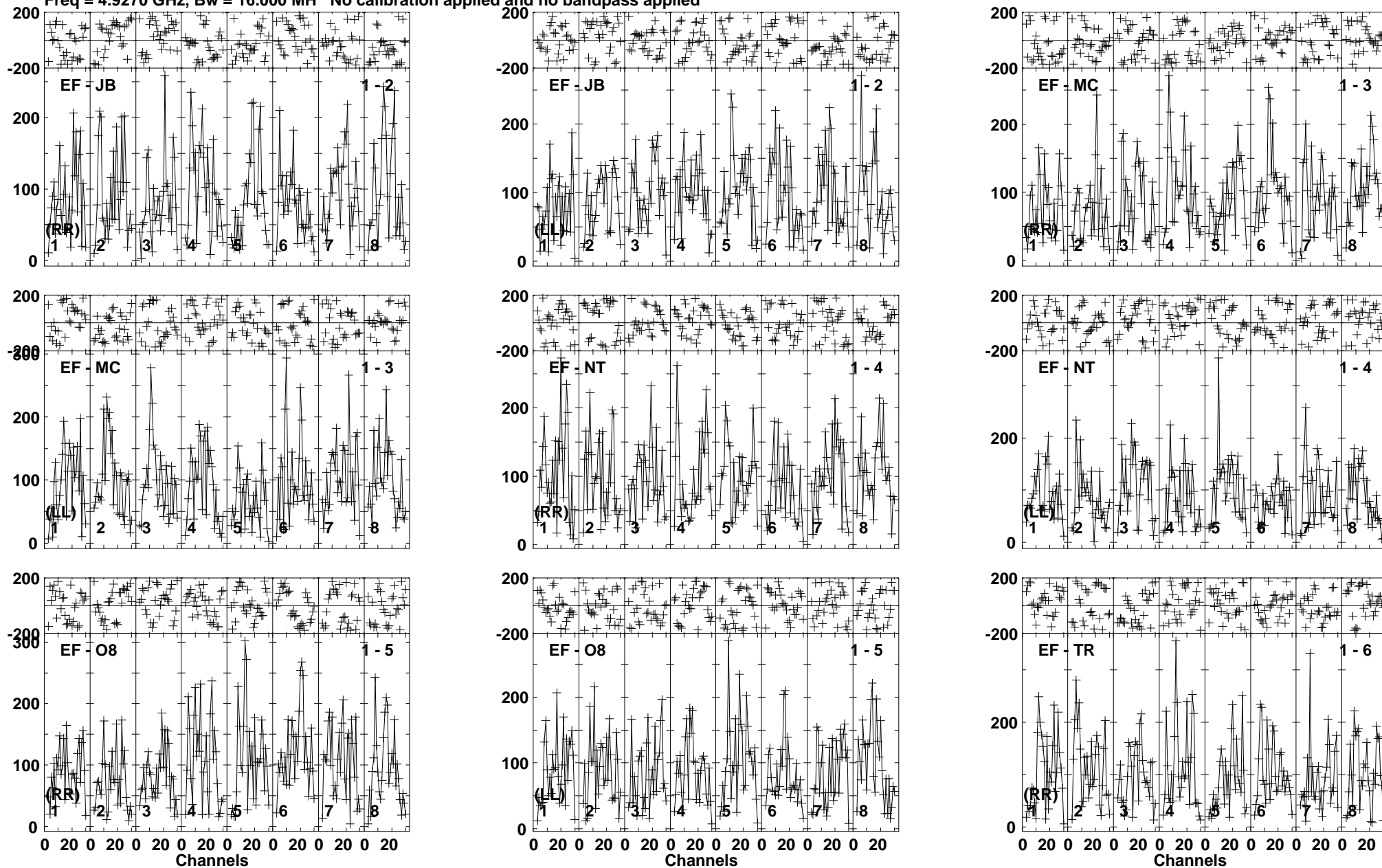

Lower frame: Micro Ampl Jy Top frame: Phas deg
Vector averaged cross-power spectrum Baseline: EF (01) - JB (02)
Timerange: 00/13:12:01 to 00/13:14:59

Plot file version 112 created 10-JUN-2016 16:07:58

FRB150418 RG008D.UVDATA.1

Freq = 4.9270 GHz, Bw = 16.000 MH No calibration applied and no bandpass applied

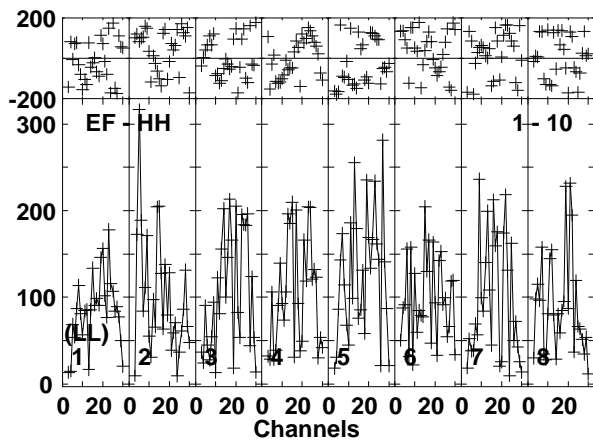
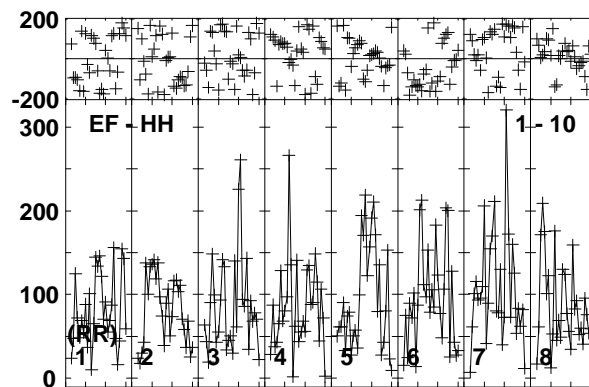
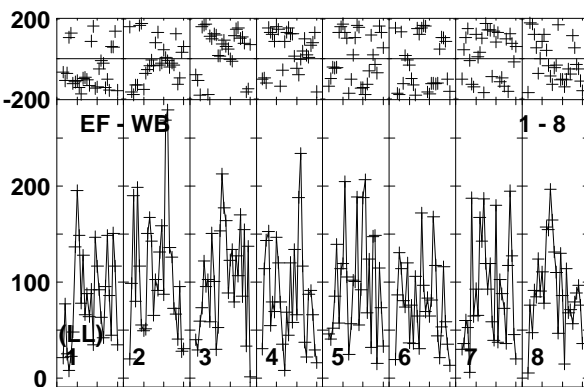
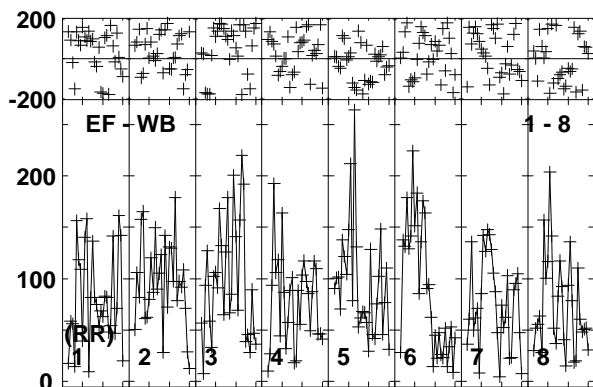
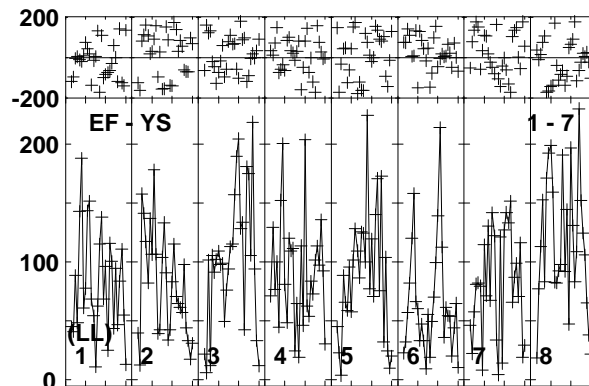
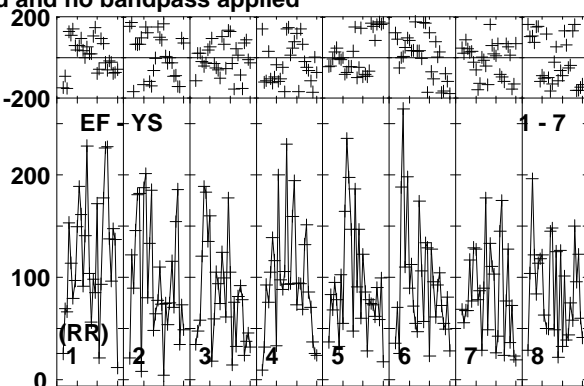
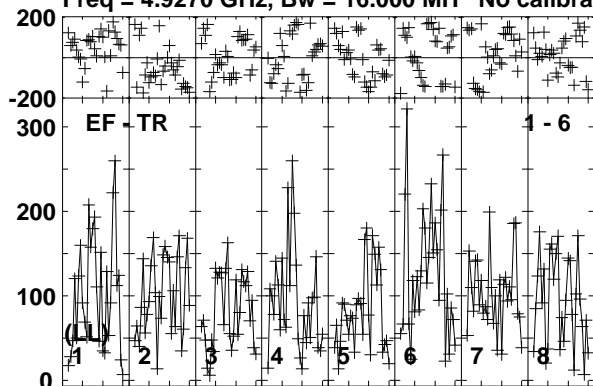

Lower frame: Micro Ampl Jy Top frame: Phas deg
Vector averaged cross-power spectrum Baseline: EF (01) - TR (06)
Timerange: 00/13:12:01 to 00/13:14:59

Plot file version 113 created 10-JUN-2016 16:07:59

J0718-1813 RG008D.UVDATA.1

Freq = 4.9270 GHz, Bw = 16.000 MH No calibration applied and no bandpass applied

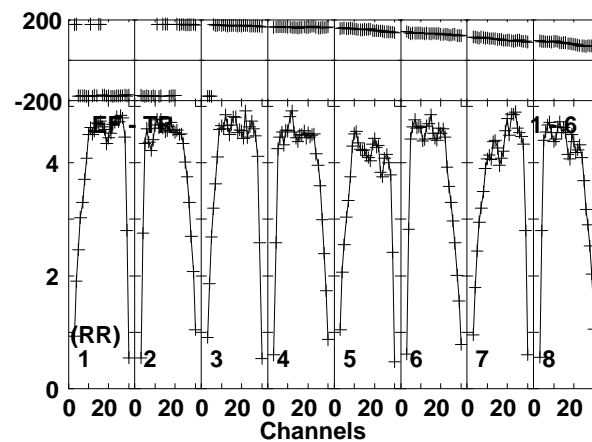
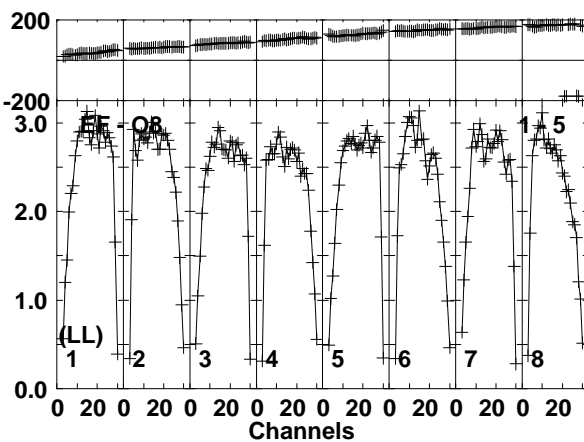
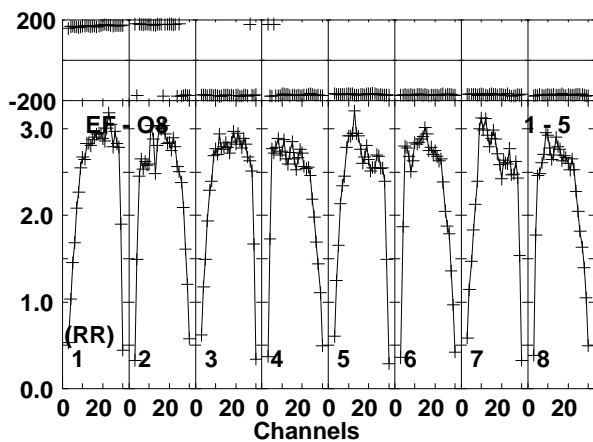
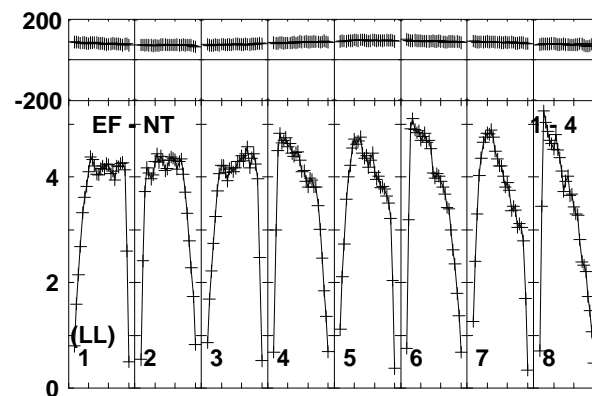
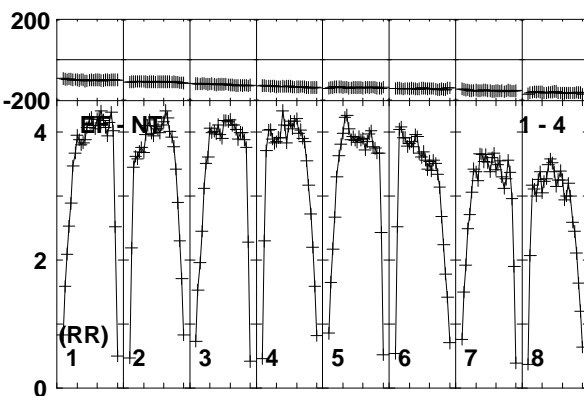
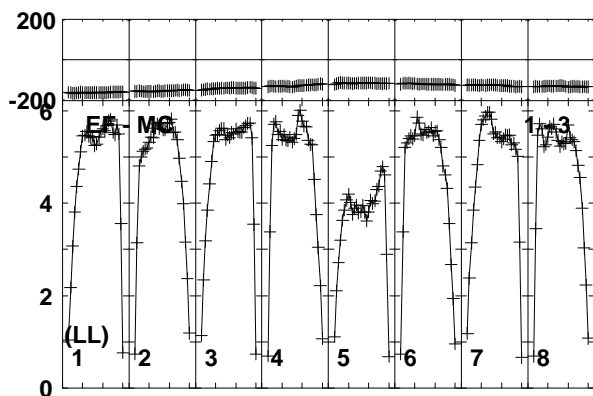
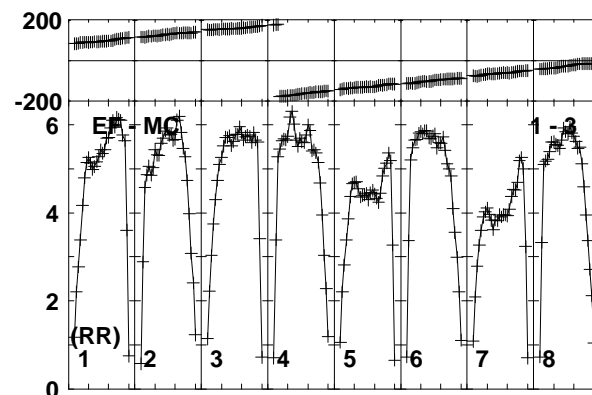
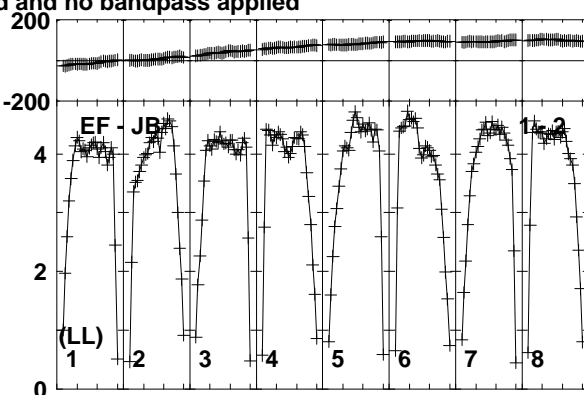
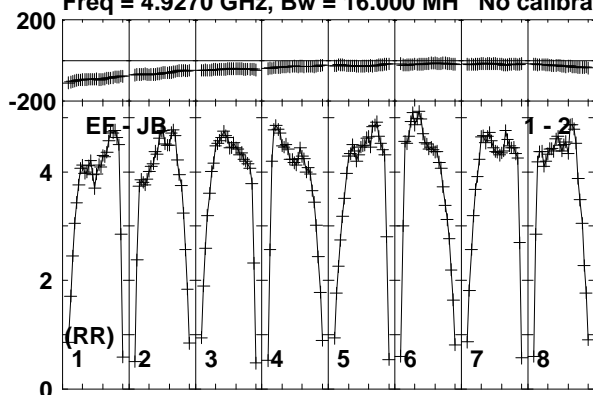

Lower frame: Milli Ampl Jy Top frame: Phas deg
Vector averaged cross-power spectrum Baseline: EF (01) - JB (02)
Timerange: 00/13:15:00 to 00/13:16:30

Plot file version 114 created 10-JUN-2016 16:07:59

J0718-1813 RG008D.UVDATA.1

Freq = 4.9270 GHz, Bw = 16.000 MH No calibration applied and no bandpass applied

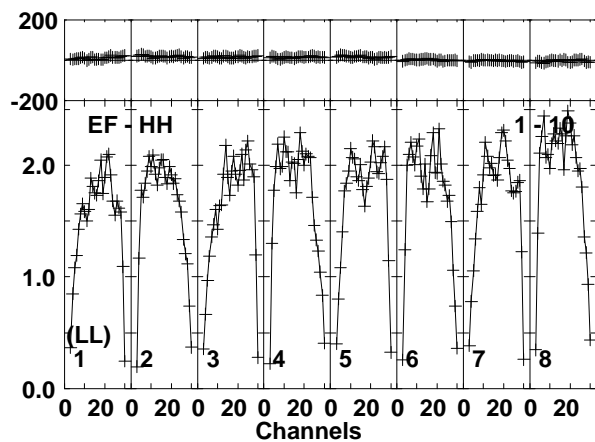
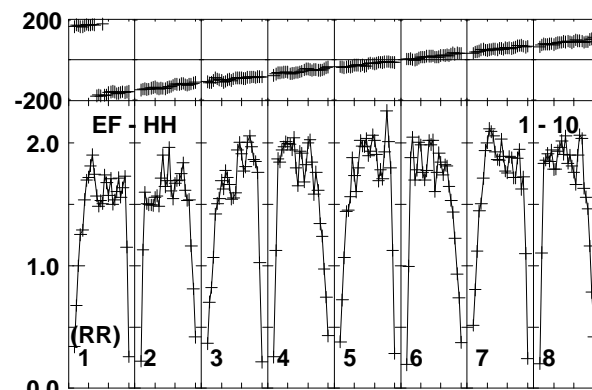
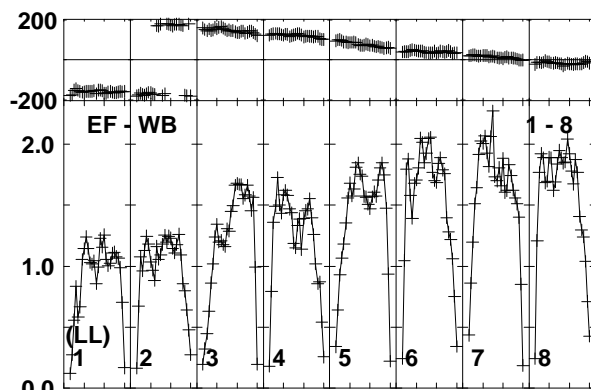
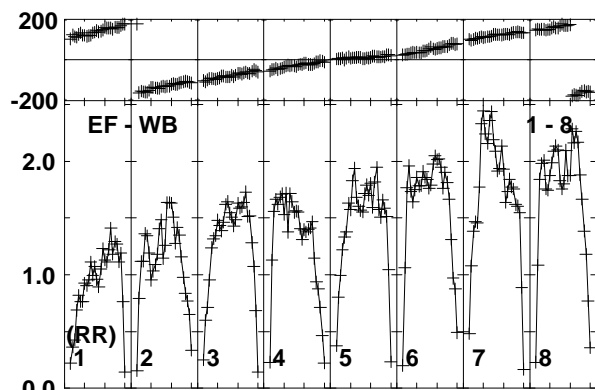
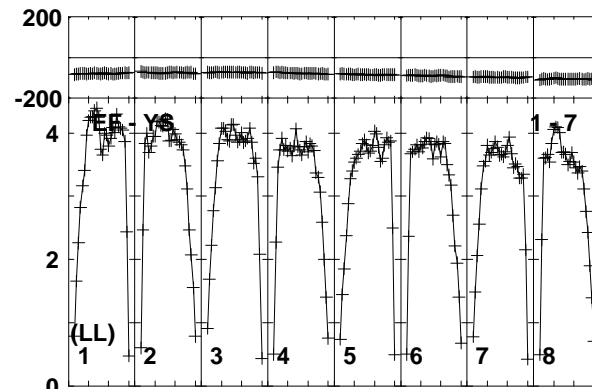
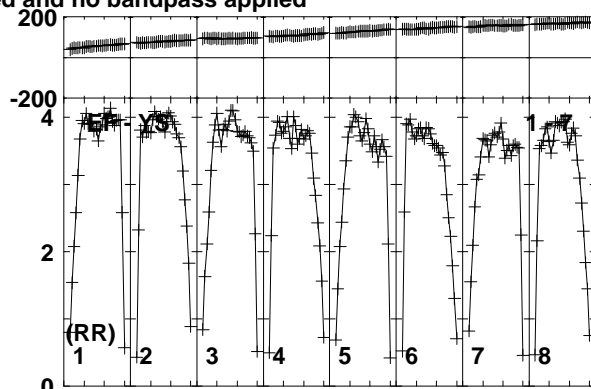
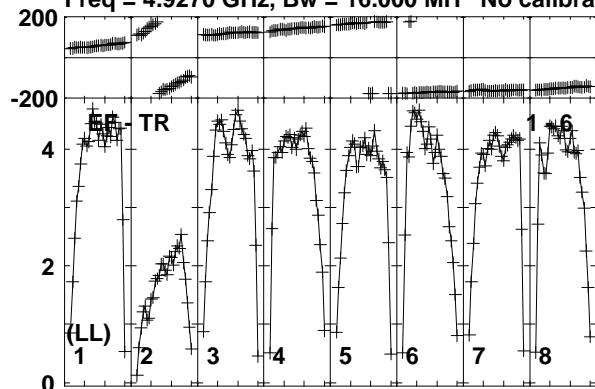

Lower frame: Milli Ampl Jy Top frame: Phas deg
Vector averaged cross-power spectrum Baseline: EF (01) - TR (06)
Timerange: 00/13:15:00 to 00/13:16:30

Plot file version 115 created 10-JUN-2016 16:07:59

J0712-1847 RG008D.UVDATA.1

Freq = 4.9270 GHz, Bw = 16.000 MH No calibration applied and no bandpass applied

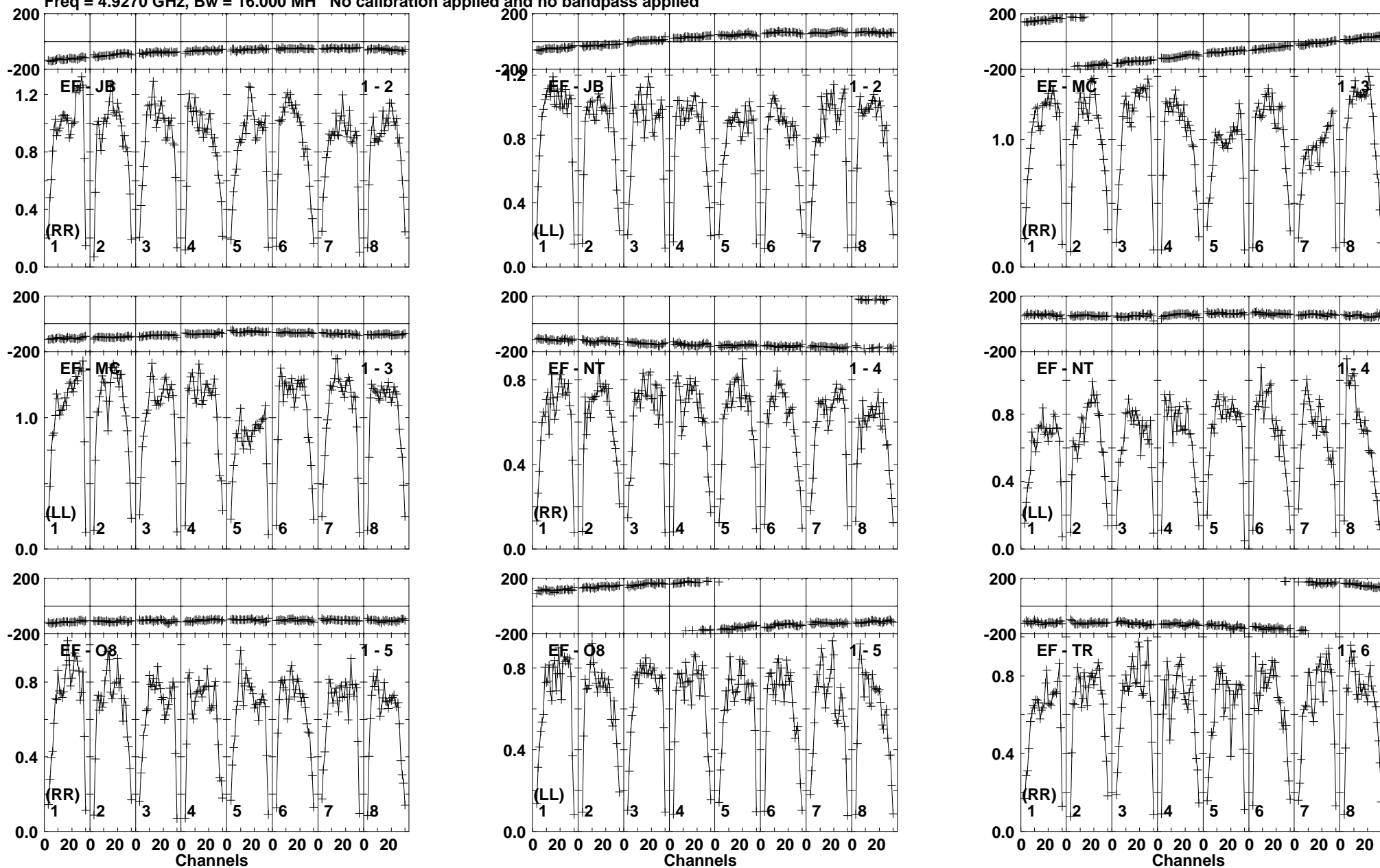

Lower frame: Milli Ampl Jy Top frame: Phas deg
Vector averaged cross-power spectrum Baseline: EF (01) - JB (02)
Timerange: 00/13:16:30 to 00/13:19:30

Plot file version 116 created 10-JUN-2016 16:07:59

J0712-1847 RG008D.UVDATA.1

Freq = 4.9270 GHz, Bw = 16.000 MH No calibration applied and no bandpass applied

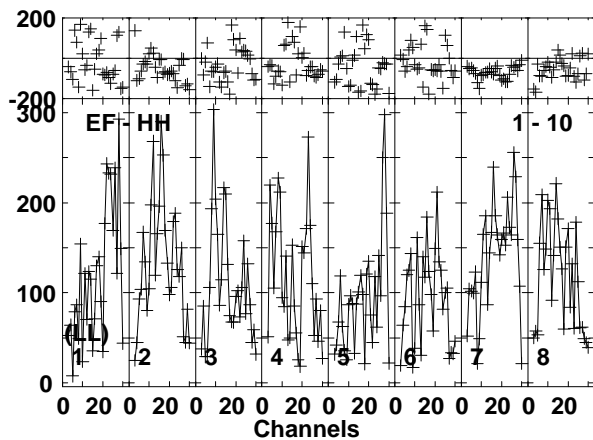
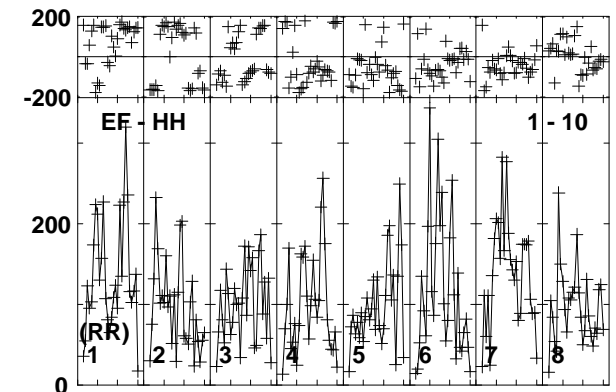
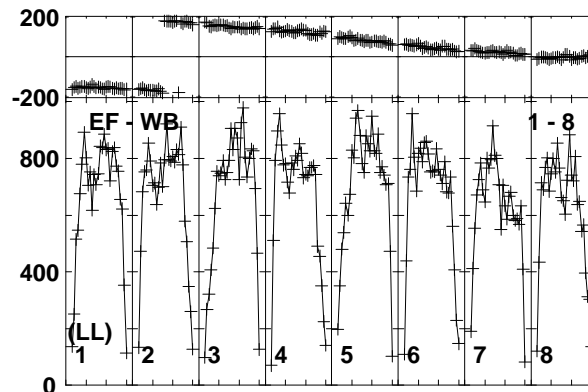
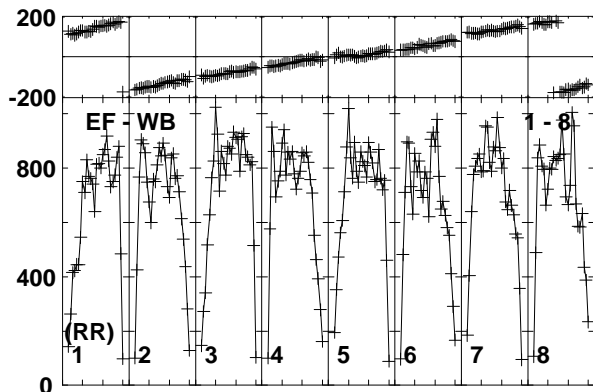
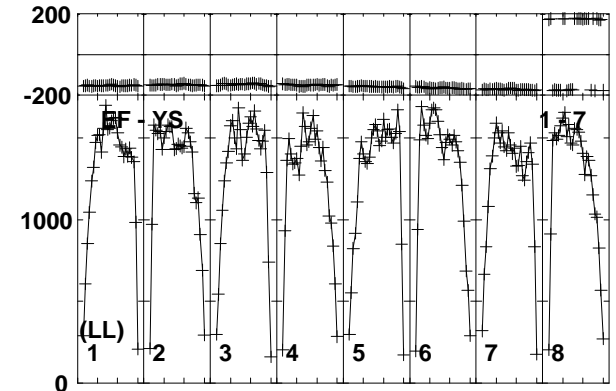
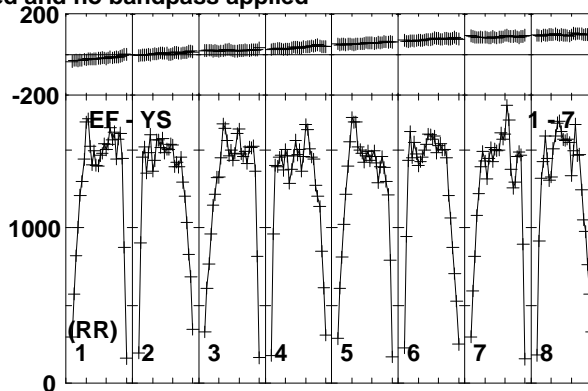
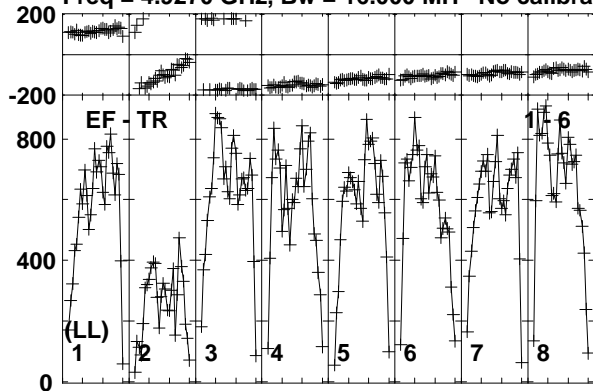

Lower frame: Micro Ampl Jy Top frame: Phas deg
Vector averaged cross-power spectrum Baseline: EF (01) - TR (06)
Timerange: 00/13:16:30 to 00/13:19:30

Plot file version 117 created 10-JUN-2016 16:07:59

J0718-1813 RG008D.UVDATA.1

Freq = 4.9270 GHz, Bw = 16.000 MH No calibration applied and no bandpass applied

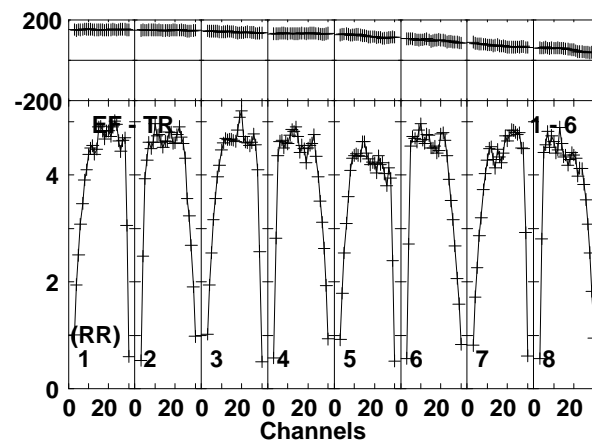
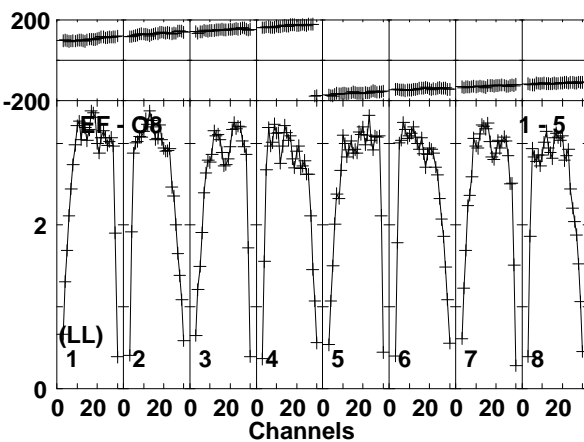
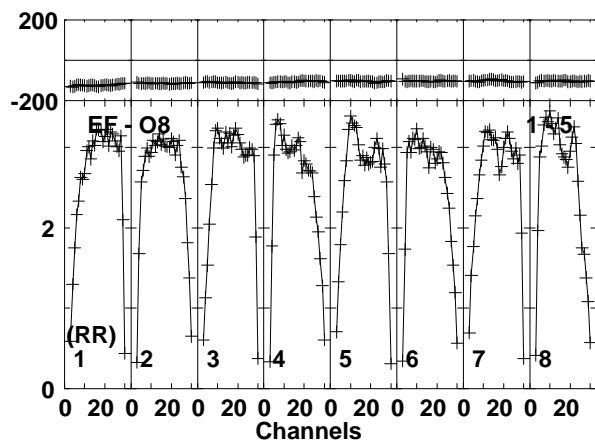
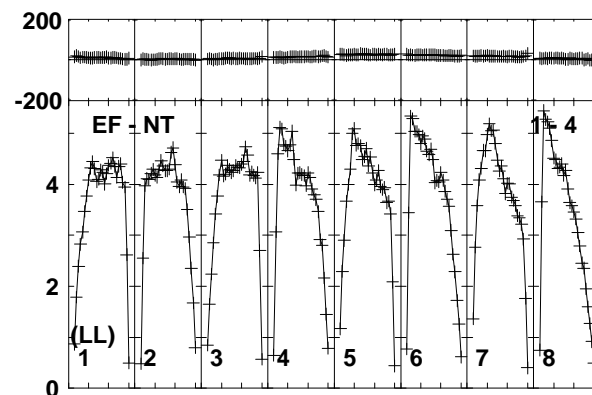
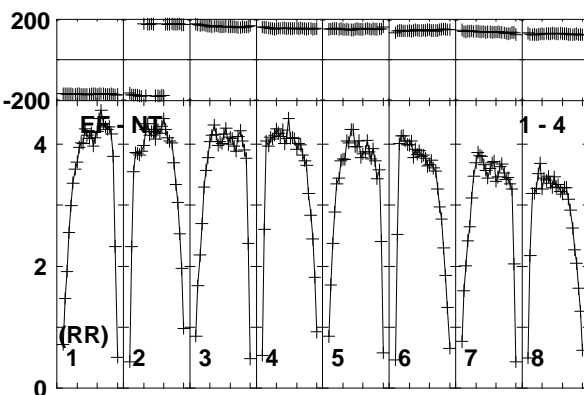
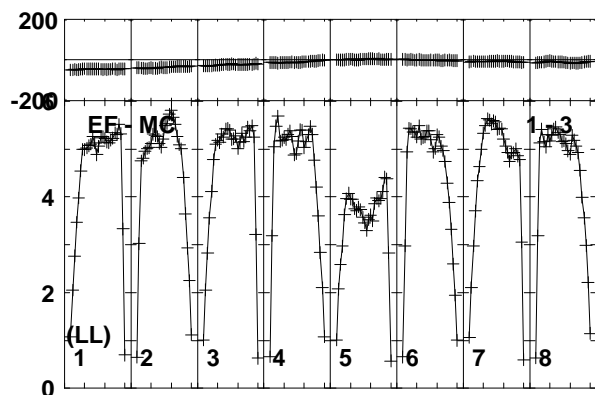
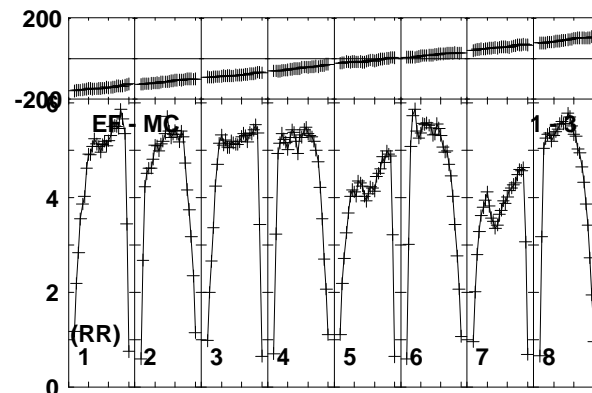
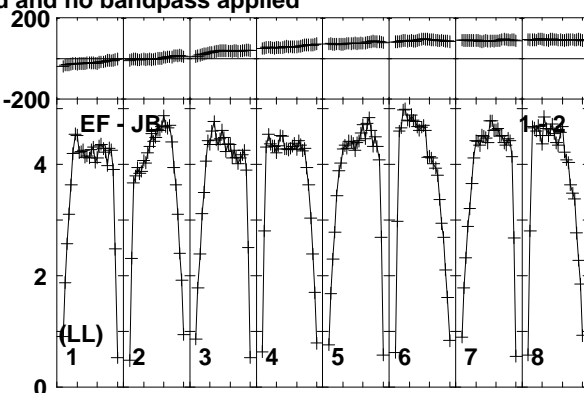
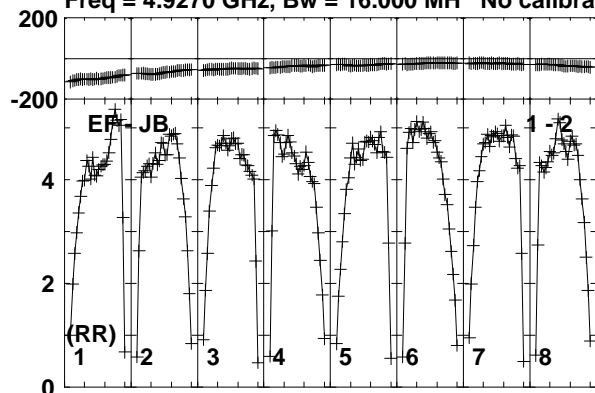

Lower frame: Milli Ampl Jy Top frame: Phas deg
Vector averaged cross-power spectrum Baseline: EF (01) - JB (02)
Timerange: 00/13:20:10 to 00/13:21:00

Plot file version 118 created 10-JUN-2016 16:07:59

J0718-1813 RG008D.UVDATA.1

Freq = 4.9270 GHz, Bw = 16.000 MH No calibration applied and no bandpass applied

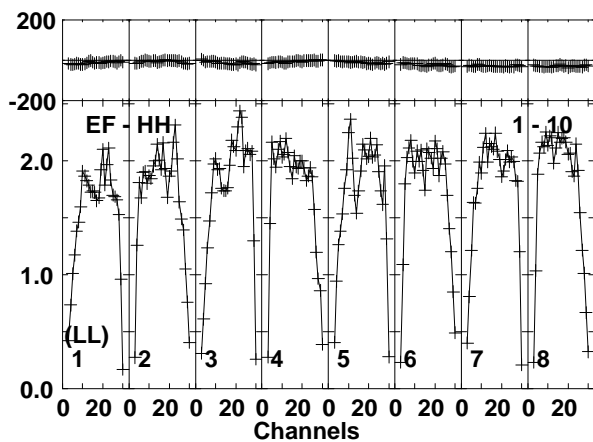
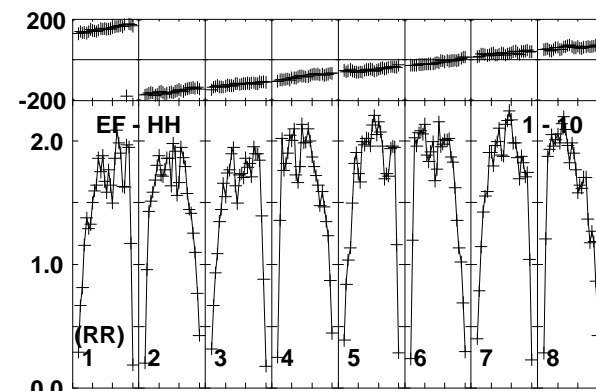
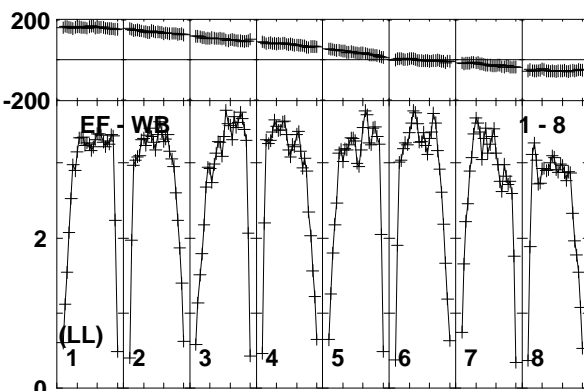
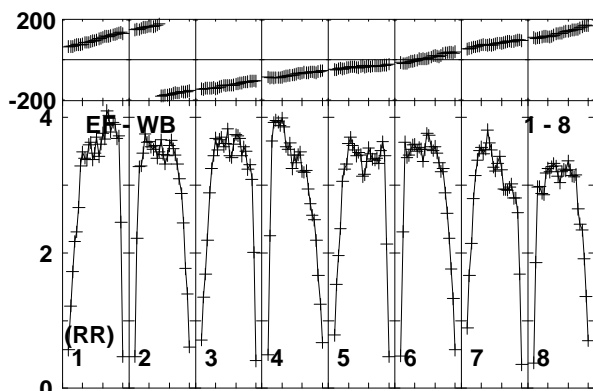
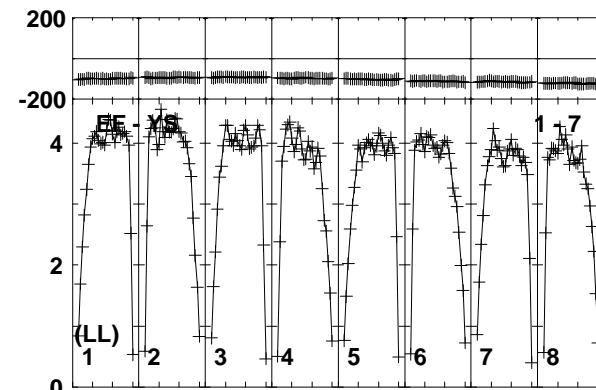
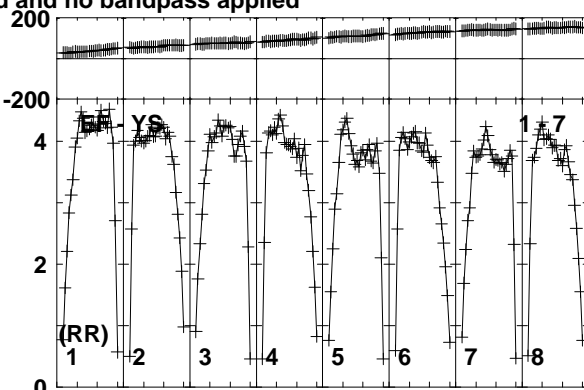
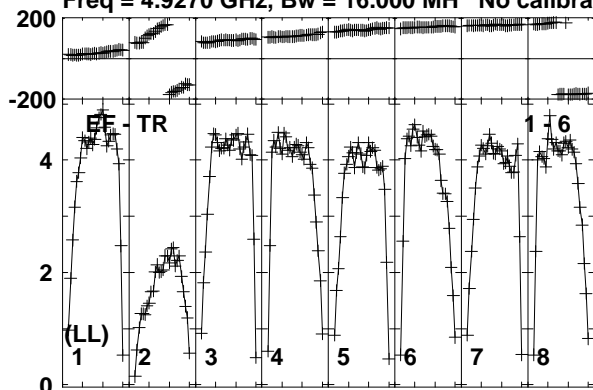

Lower frame: Milli Ampl Jy Top frame: Phas deg
Vector averaged cross-power spectrum Baseline: EF (01) - TR (06)
Timerange: 00/13:20:10 to 00/13:21:00

Plot file version 119 created 10-JUN-2016 16:07:59

FRB150418 RG008D.UVDATA.1

Freq = 4.9270 GHz, Bw = 16.000 MH No calibration applied and no bandpass applied

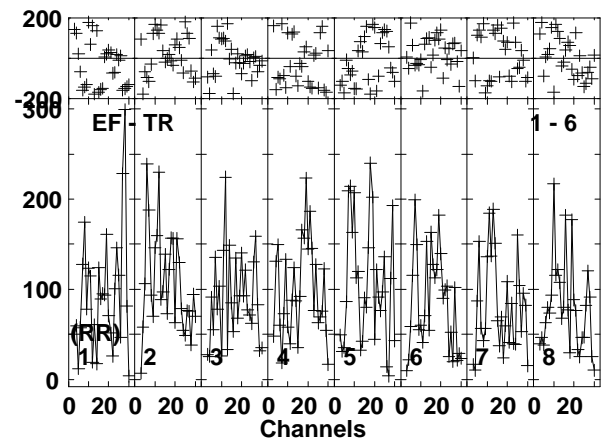
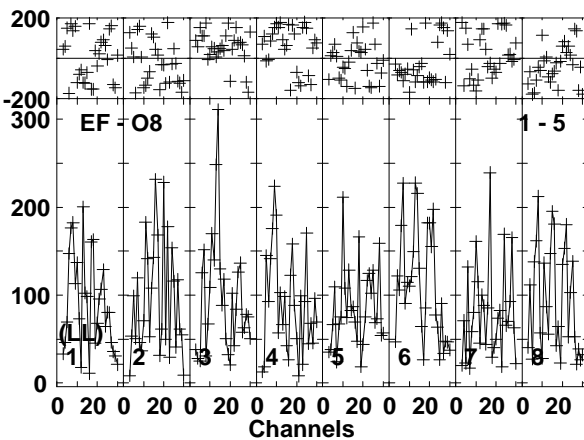
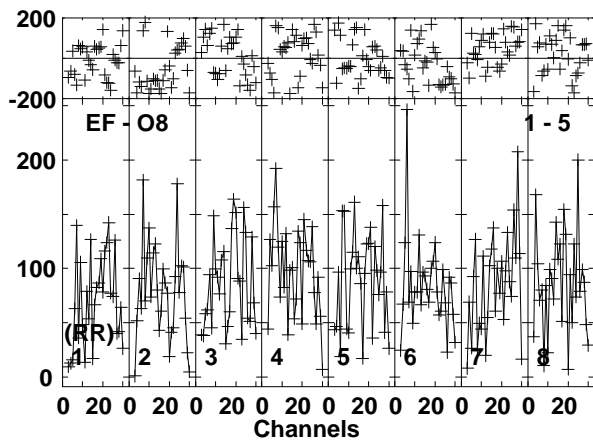
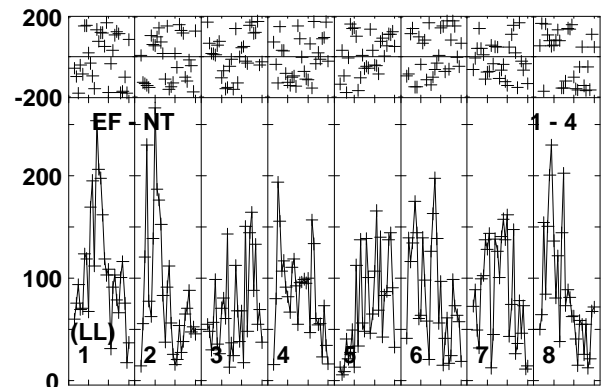
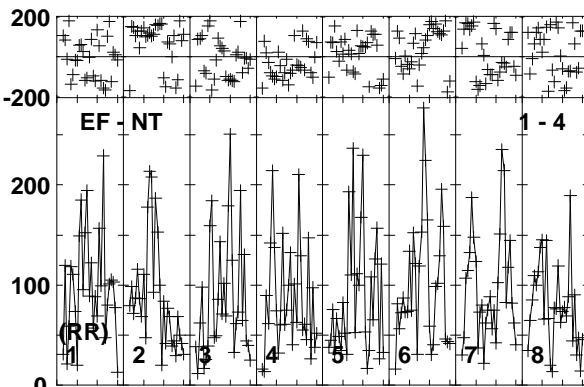
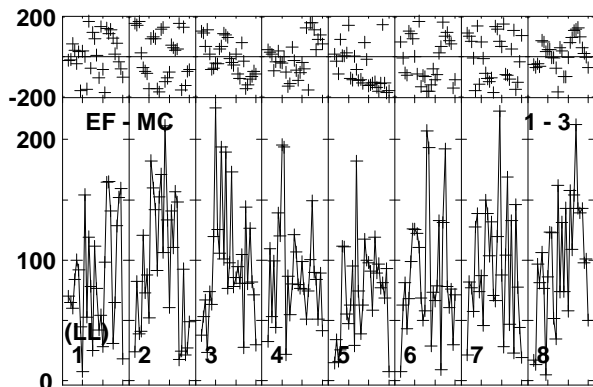
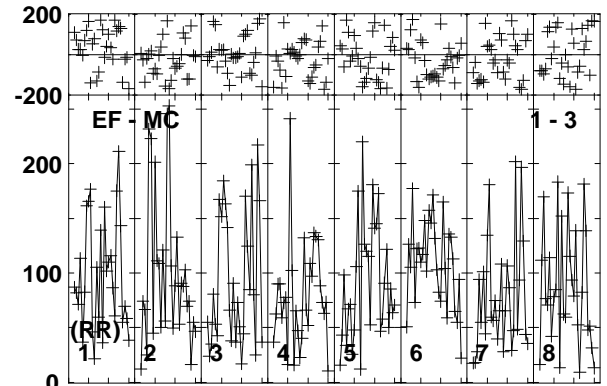
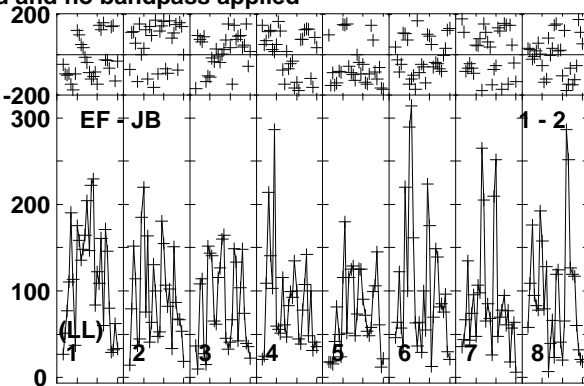
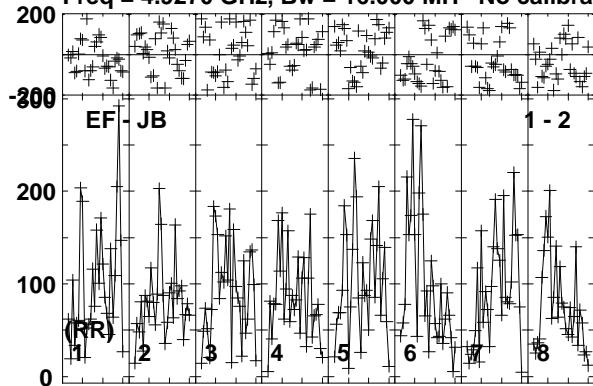

Lower frame: Micro Ampl Jy Top frame: Phas deg
Vector averaged cross-power spectrum Baseline: EF (01) - JB (02)
Timerange: 00/13:21:00 to 00/13:24:00

Plot file version 120 created 10-JUN-2016 16:07:59

FRB150418 RG008D.UVDATA.1

Freq = 4.9270 GHz, Bw = 16.000 MH No calibration applied and no bandpass applied

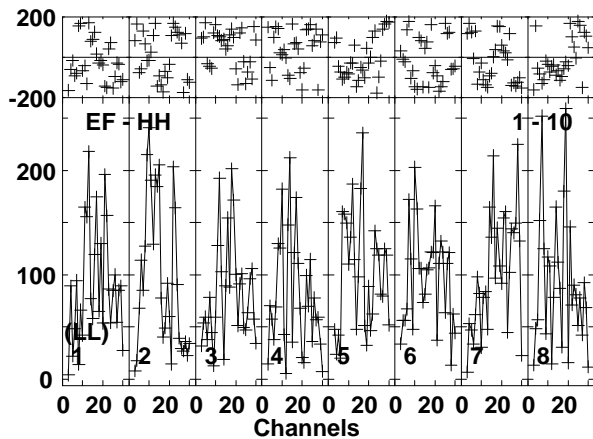
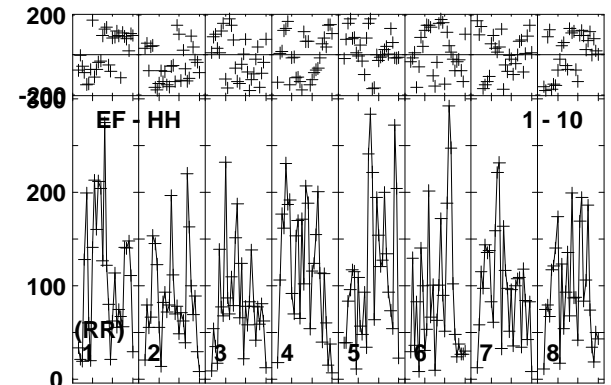
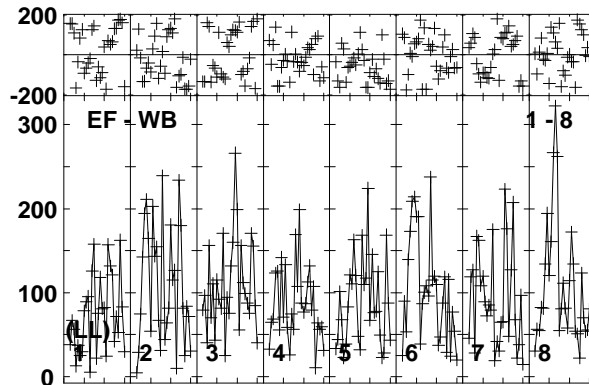
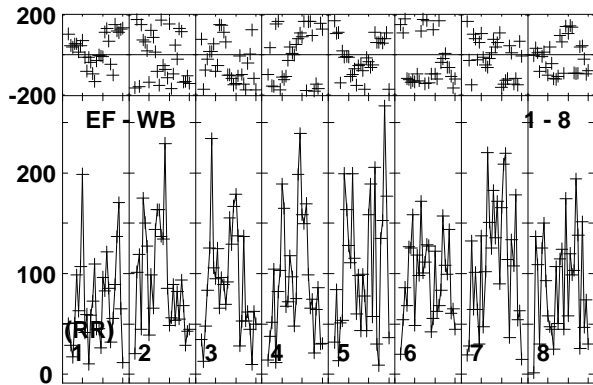
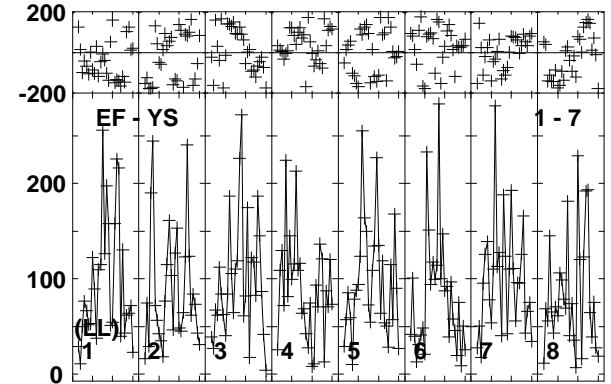
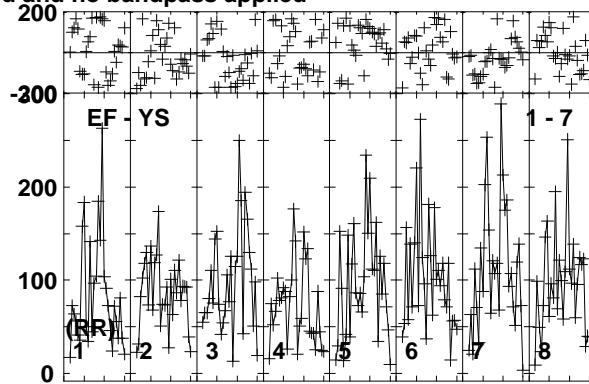
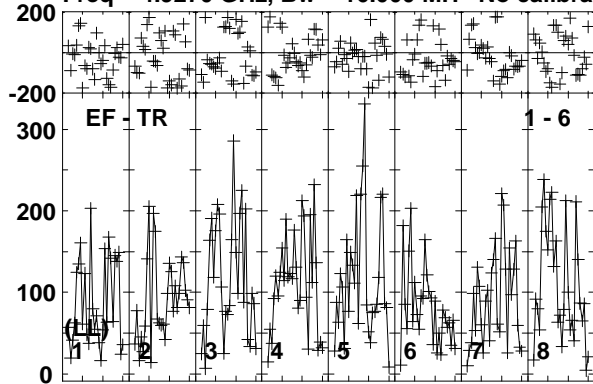

Lower frame: Micro Ampl Jy Top frame: Phas deg
Vector averaged cross-power spectrum Baseline: EF (01) - TR (06)
Timerange: 00:13:21:00 to 00:13:24:00

Plot file version 121 created 10-JUN-2016 16:07:59

J0718-1813 RG008D.UVDATA.1

Freq = 4.9270 GHz, Bw = 16.000 MH No calibration applied and no bandpass applied

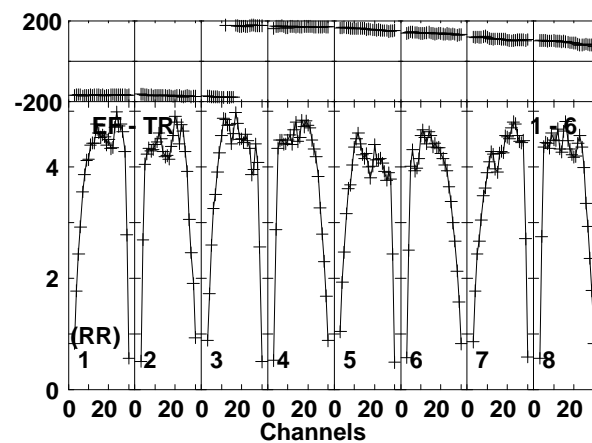
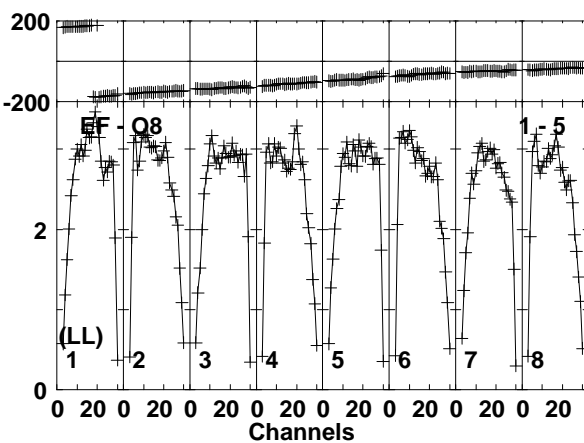
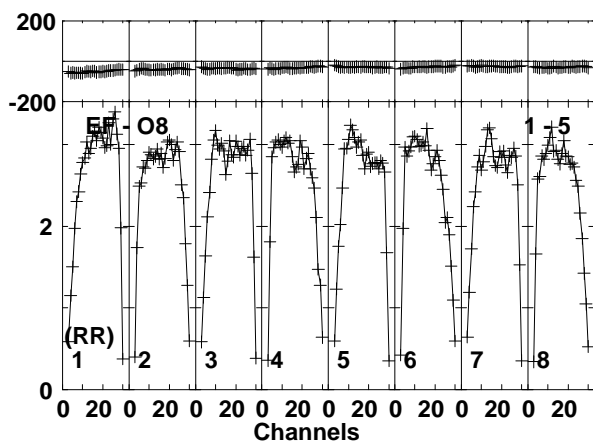
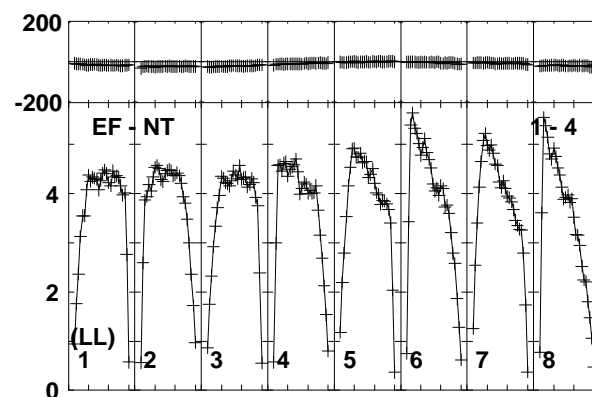
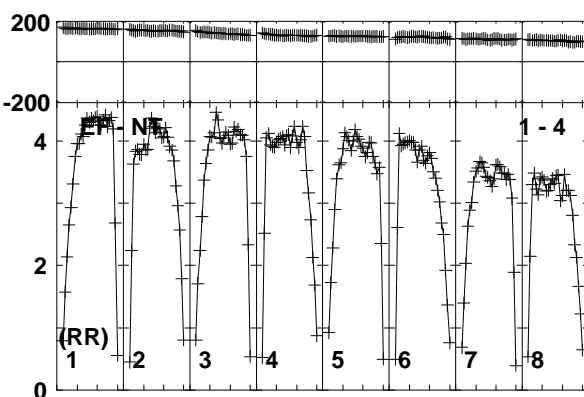
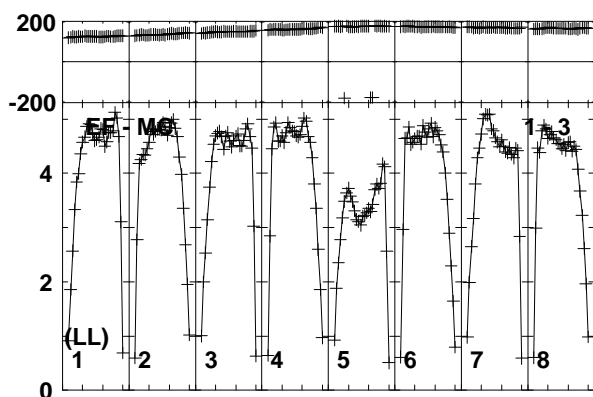
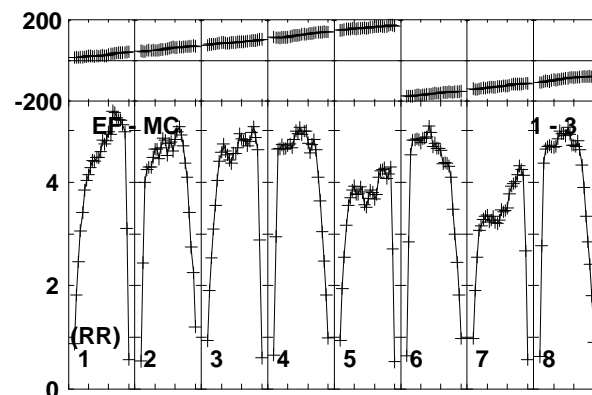
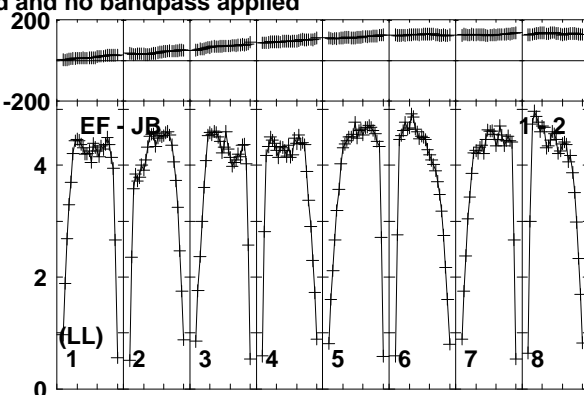
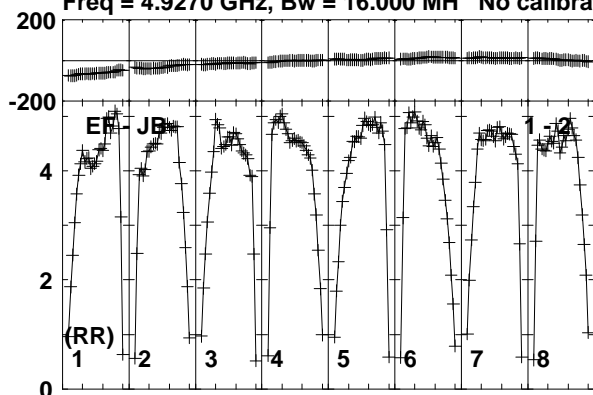

Lower frame: Milli Ampl Jy Top frame: Phas deg
Vector averaged cross-power spectrum Baseline: EF (01) - JB (02)
Timerange: 00/13:24:00 to 00/13:25:29

Plot file version 122 created 10-JUN-2016 16:08:00

J0718-1813 RG008D.UVDATA.1

Freq = 4.9270 GHz, Bw = 16.000 MH No calibration applied and no bandpass applied

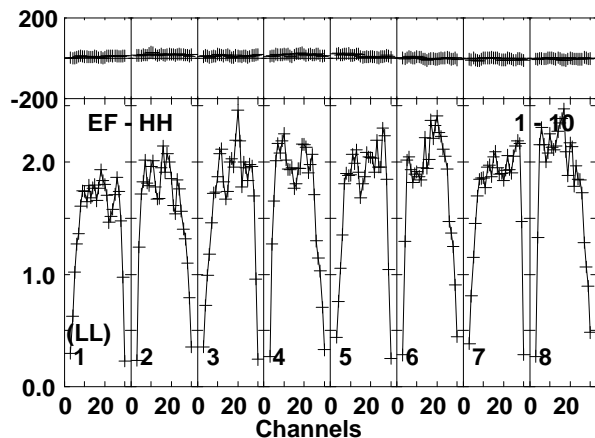
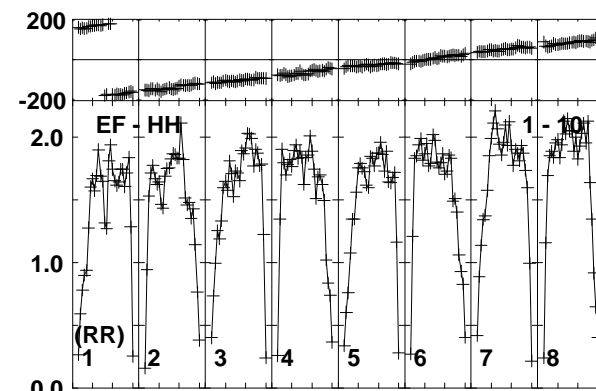
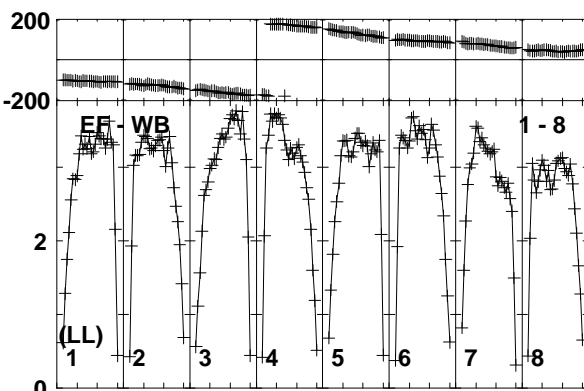
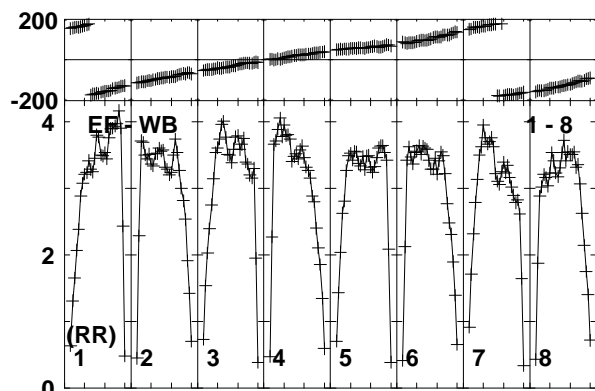
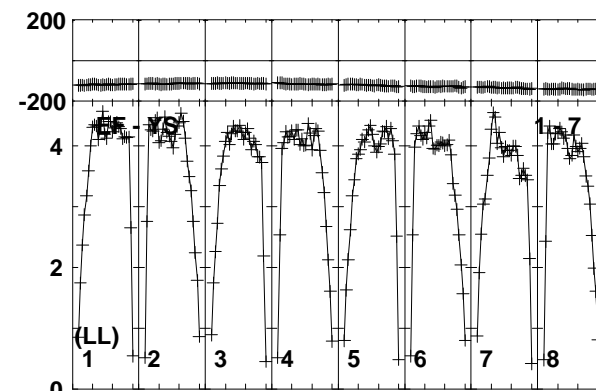
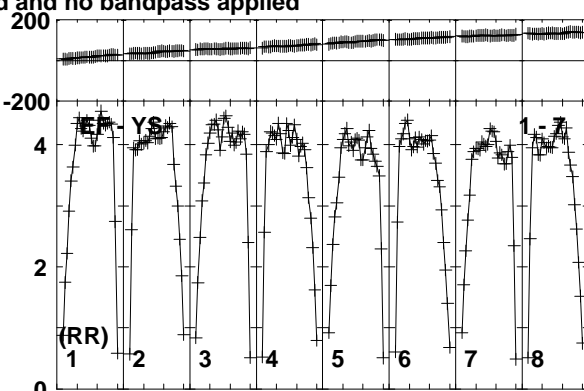
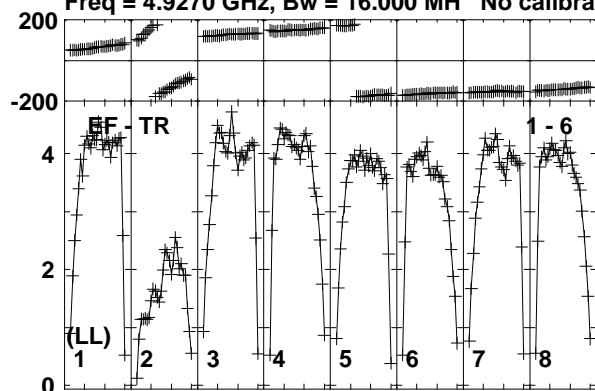

Lower frame: Milli Ampl Jy Top frame: Phas deg
Vector averaged cross-power spectrum Baseline: EF (01) - TR (06)
Timerange: 00/13:24:00 to 00/13:25:29

Plot file version 123 created 10-JUN-2016 16:08:00

FRB150418 RG008D.UVDATA.1

Freq = 4.9270 GHz, Bw = 16.000 MH No calibration applied and no bandpass applied

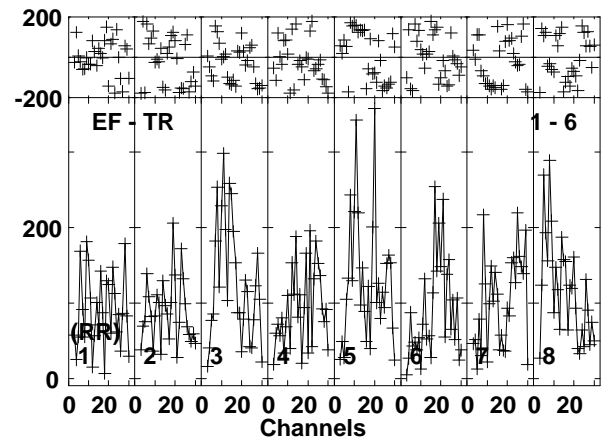
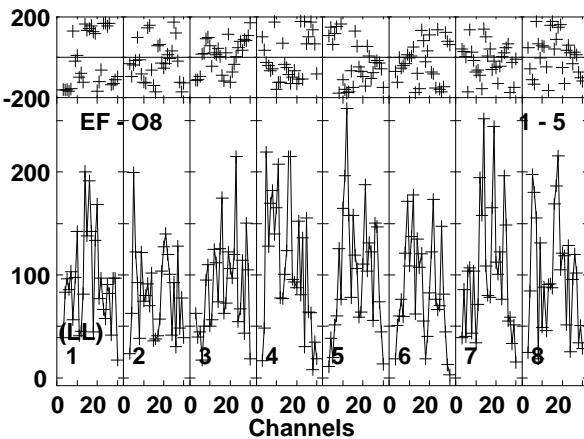
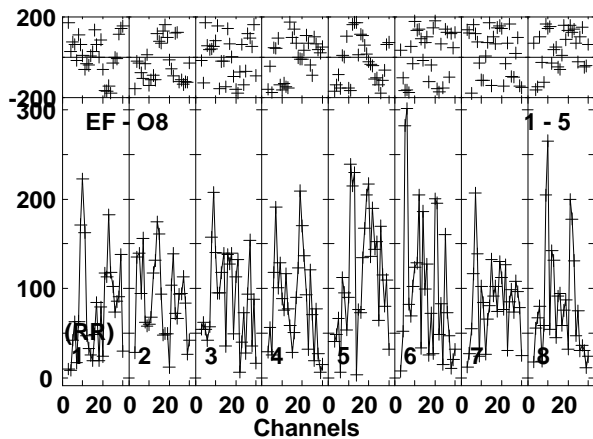
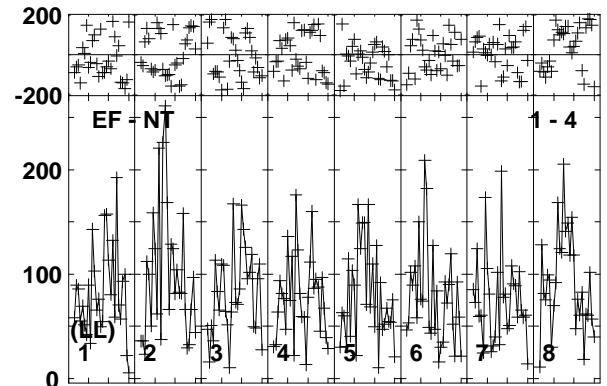
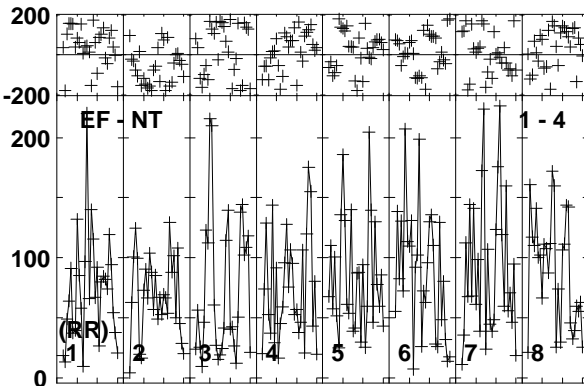
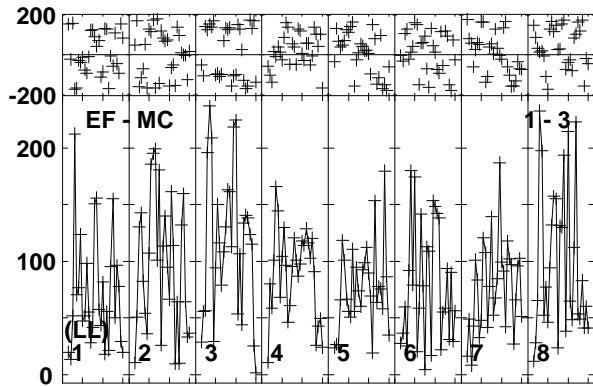
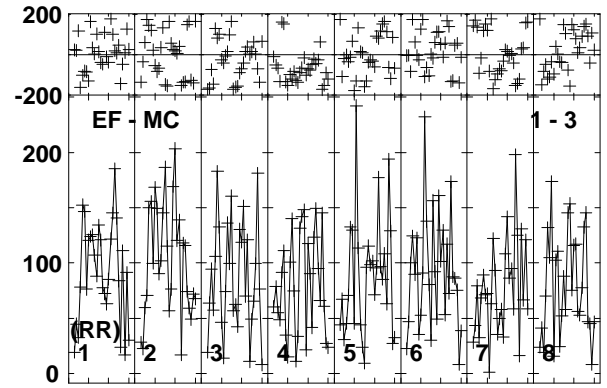
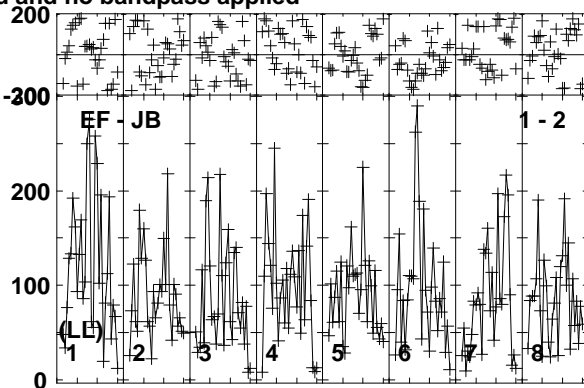
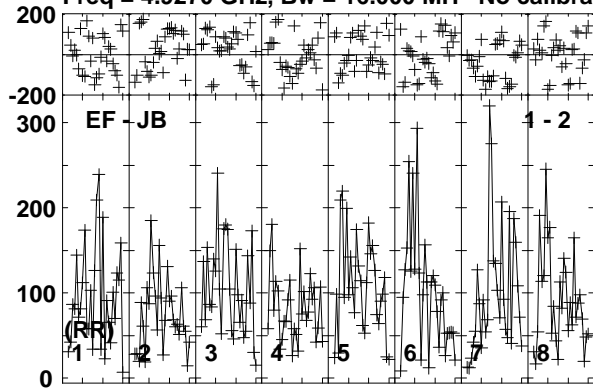

Lower frame: Micro Ampl Jy Top frame: Phas deg
Vector averaged cross-power spectrum Baseline: EF (01) - JB (02)
Timerange: 00/13:25:30 to 00/13:28:30

Plot file version 124 created 10-JUN-2016 16:08:00

FRB150418 RG008D.UVDATA.1

Freq = 4.9270 GHz, Bw = 16.000 MH No calibration applied and no bandpass applied

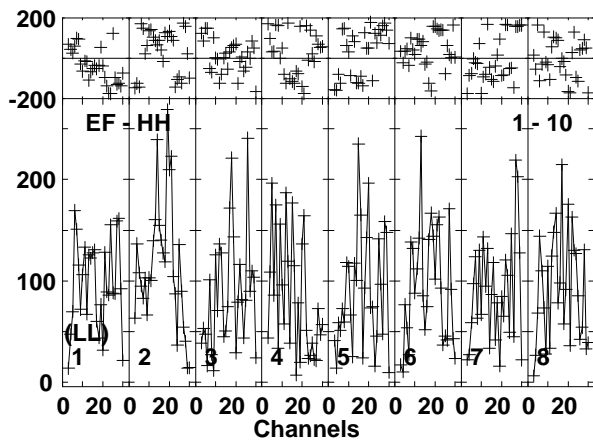
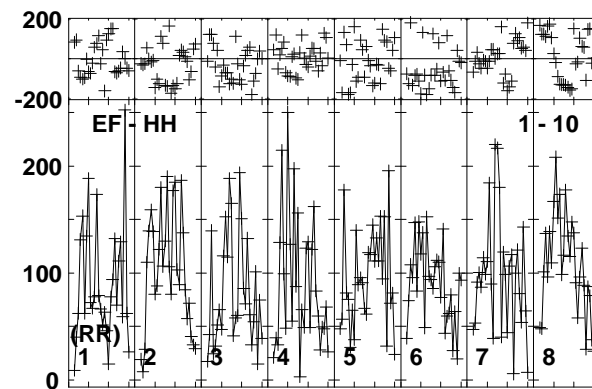
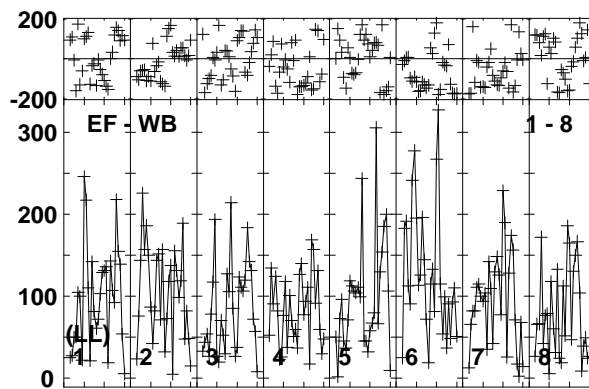
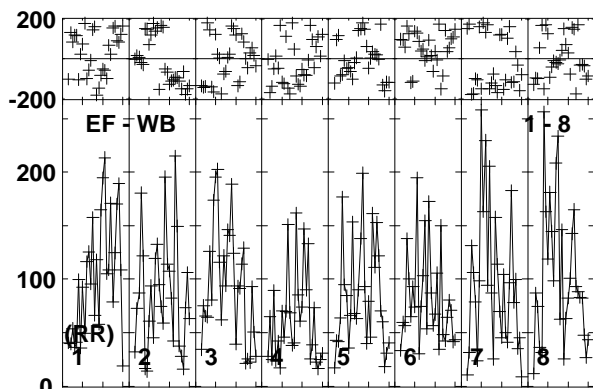
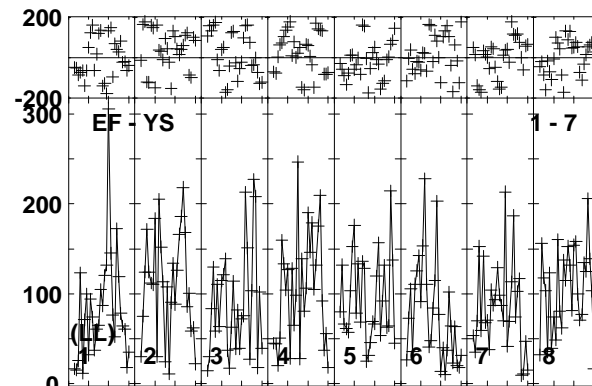
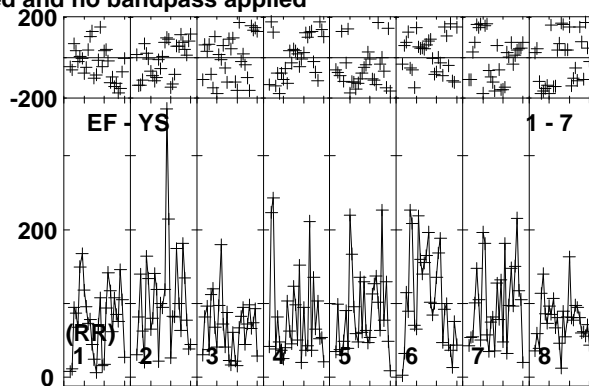
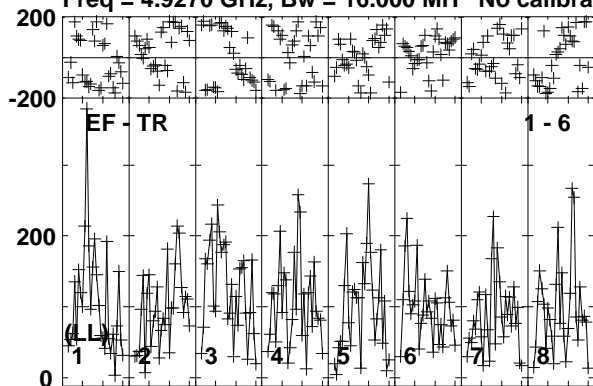

Lower frame: Micro Ampl Jy Top frame: Phas deg
Vector averaged cross-power spectrum Baseline: EF (01) - TR (06)
Timerange: 00/13:25:30 to 00/13:28:30

Plot file version 125 created 10-JUN-2016 16:08:00

J0718-1813 RG008D.UVDATA.1

Freq = 4.9270 GHz, Bw = 16.000 MH No calibration applied and no bandpass applied

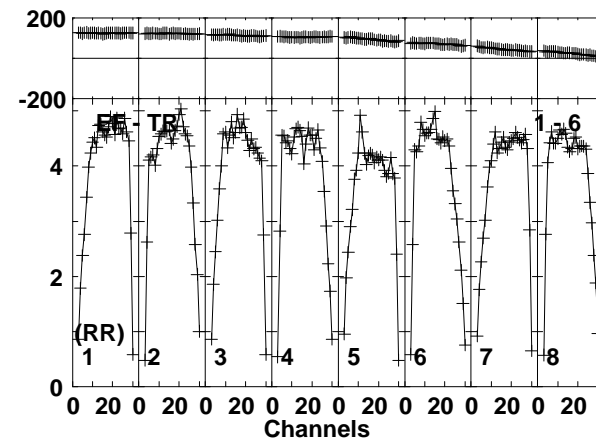
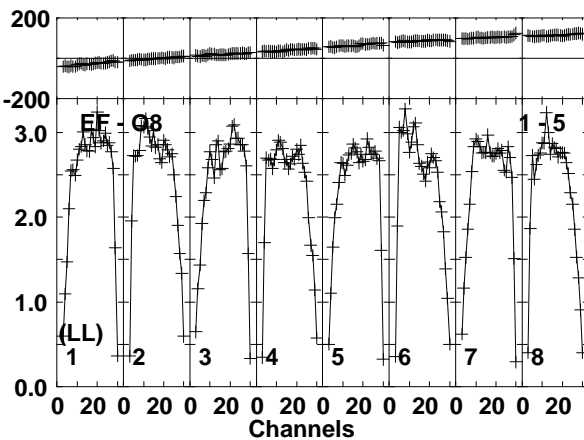
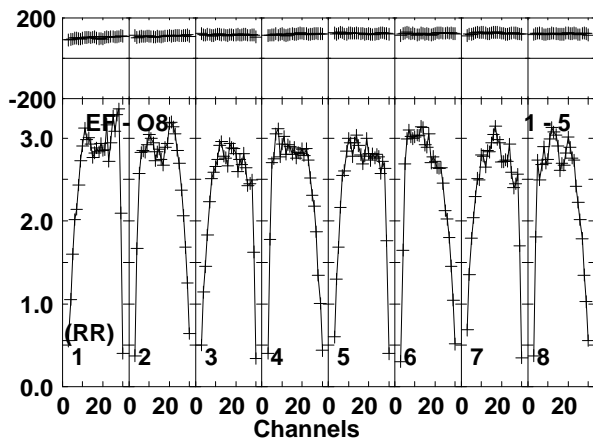
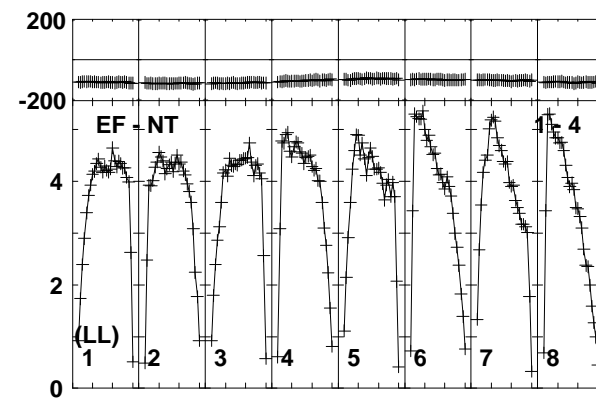
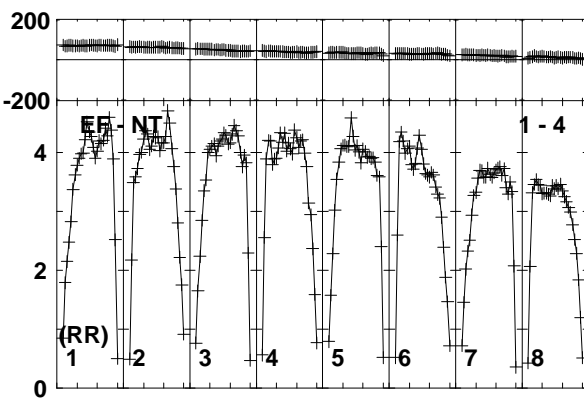
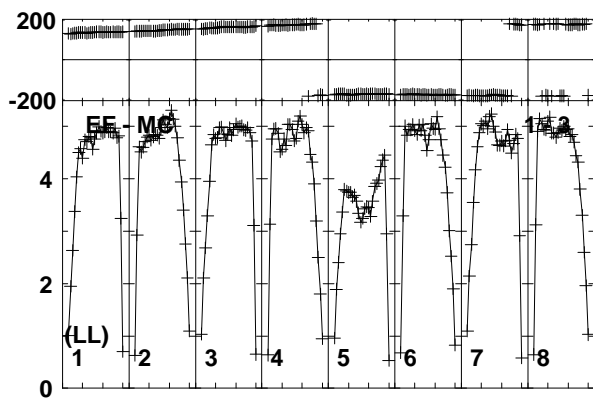
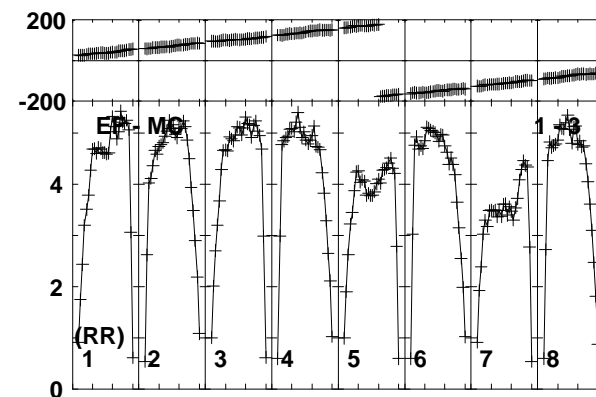
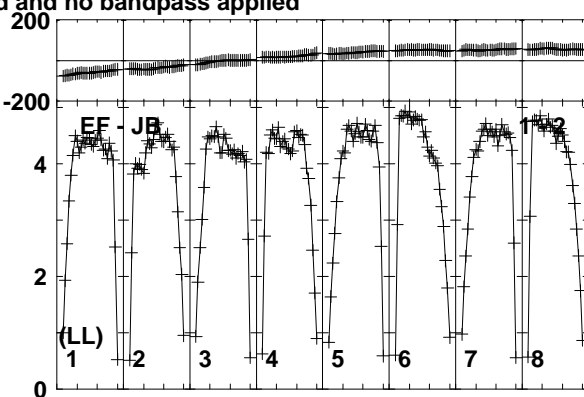
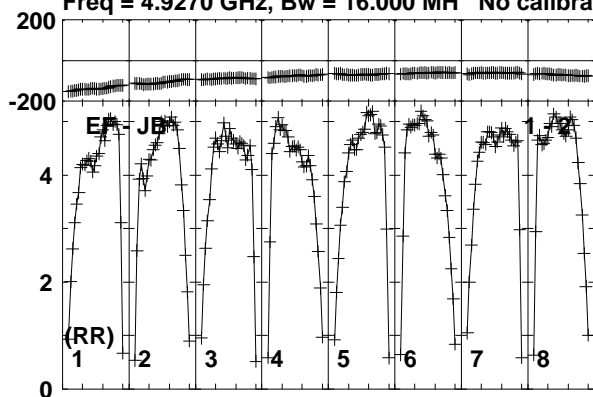

Lower frame: Milli Ampl Jy Top frame: Phas deg
Vector averaged cross-power spectrum Baseline: EF (01) - JB (02)
Timerange: 00:13:29:10 to 00:13:30:00

Plot file version 126 created 10-JUN-2016 16:08:00

J0718-1813 RG008D.UVDATA.1

Freq = 4.9270 GHz, Bw = 16.000 MH No calibration applied and no bandpass applied

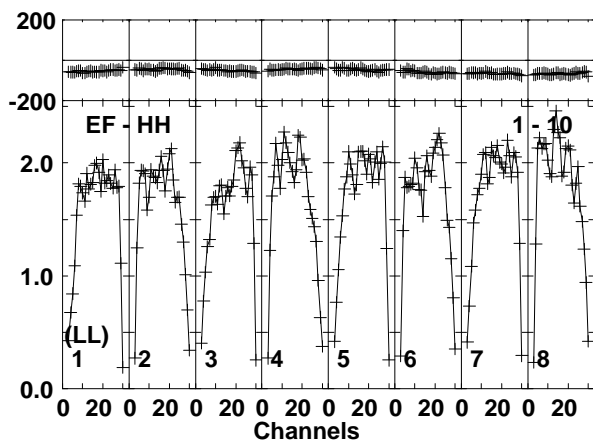
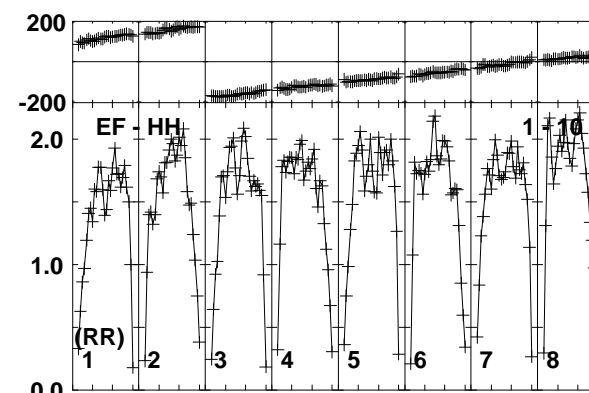
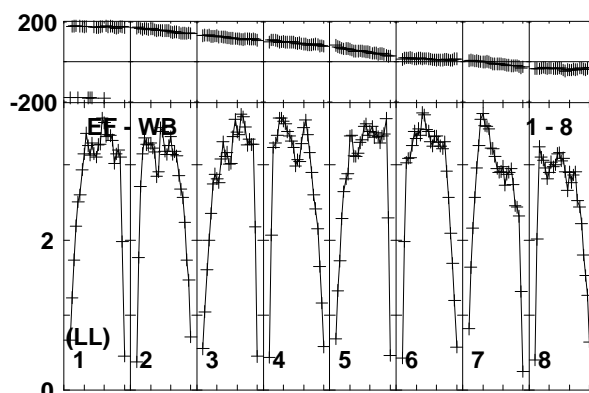
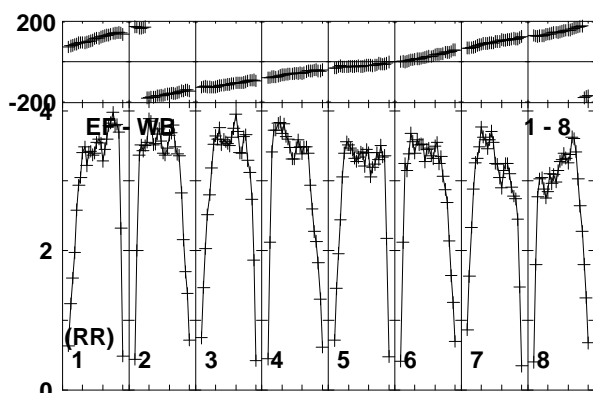
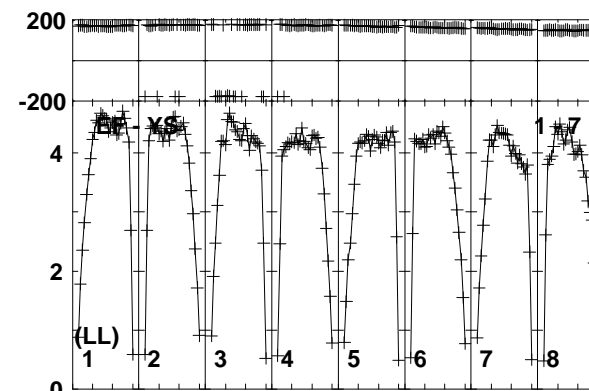
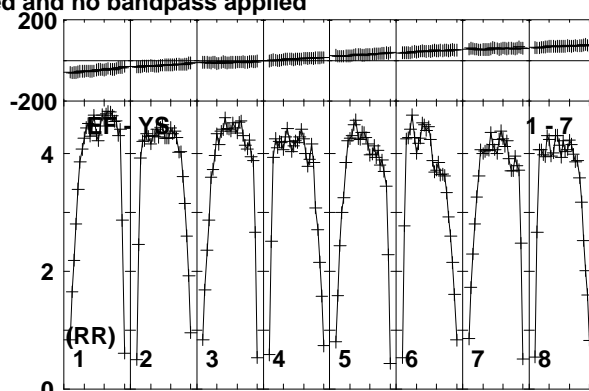
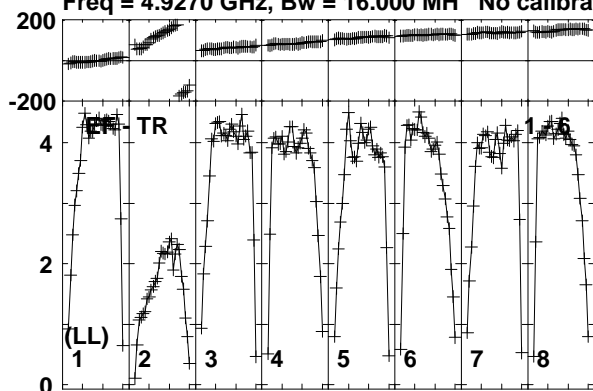

Lower frame: Milli Ampl Jy Top frame: Phas deg
Vector averaged cross-power spectrum Baseline: EF (01) - TR (06)
Timerange: 00/13:29:10 to 00/13:30:00

Plot file version 127 created 10-JUN-2016 16:08:00

FRB150418 RG008D.UVDATA.1

Freq = 4.9270 GHz, Bw = 16.000 MH No calibration applied and no bandpass applied

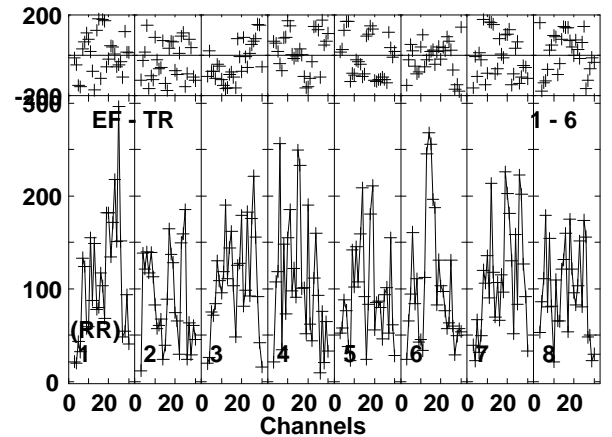
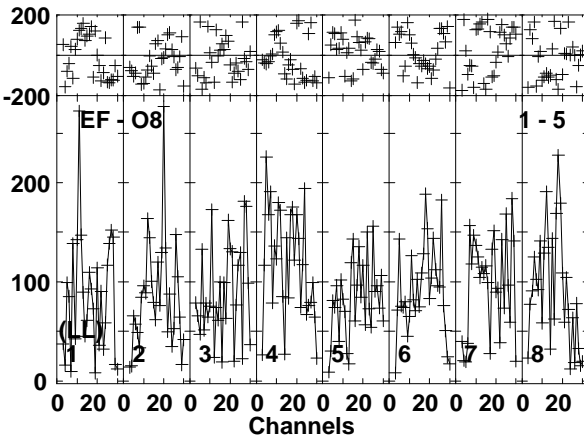
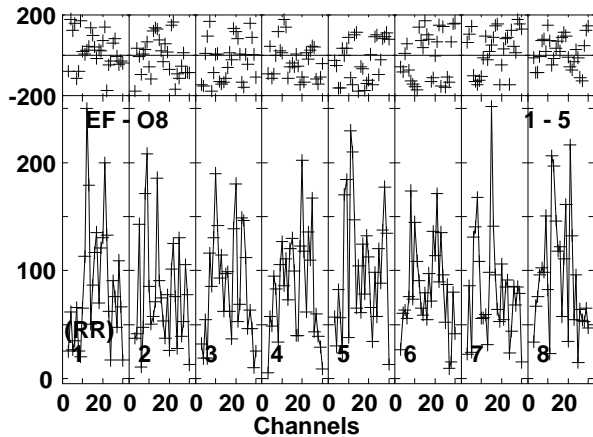
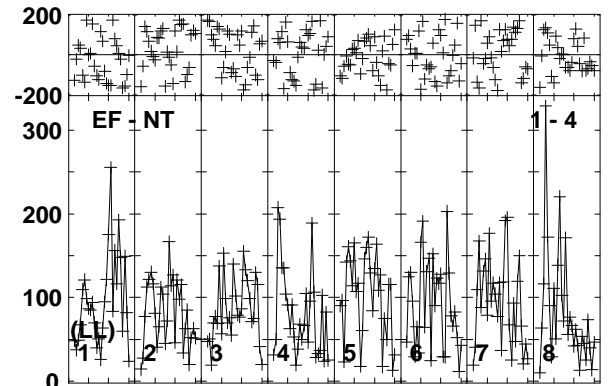
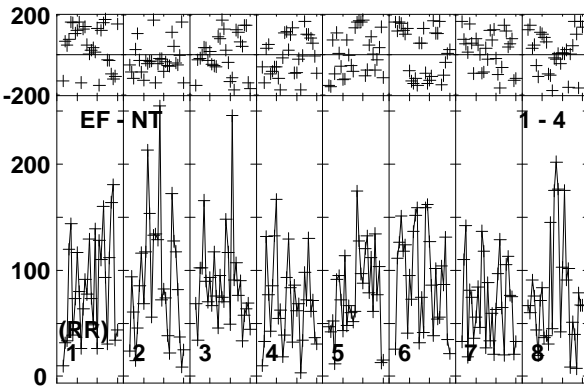
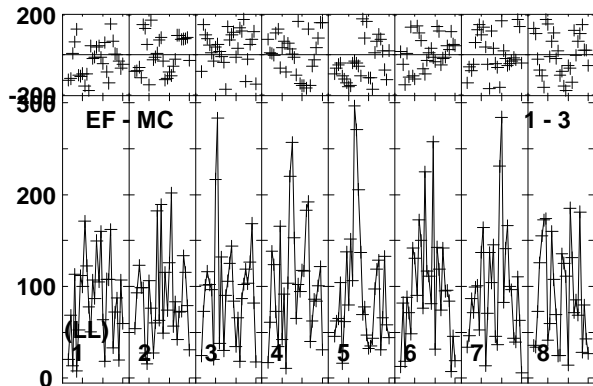
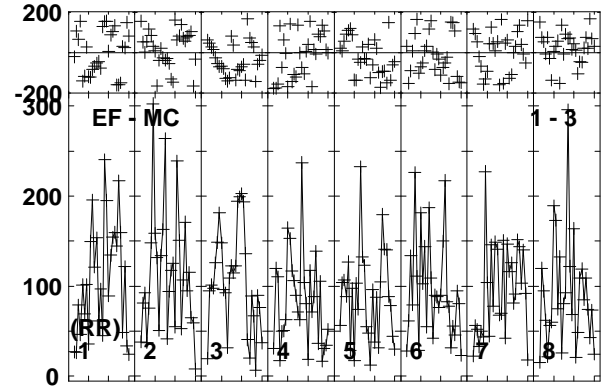
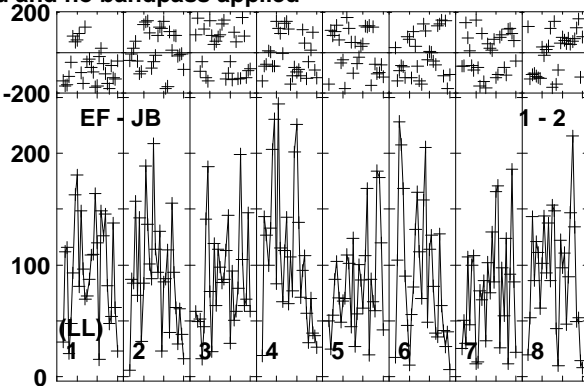
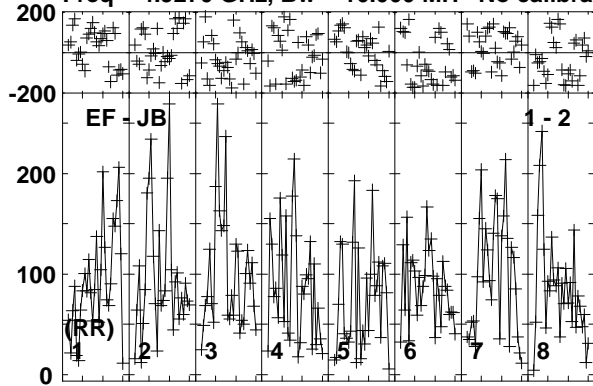

Lower frame: Micro Ampl Jy Top frame: Phas deg
Vector averaged cross-power spectrum Baseline: EF (01) - JB (02)
Timerange: 00/13:30:01 to 00/13:32:59

Plot file version 128 created 10-JUN-2016 16:08:00

FRB150418 RG008D.UVDATA.1

Freq = 4.9270 GHz, Bw = 16.000 MH No calibration applied and no bandpass applied

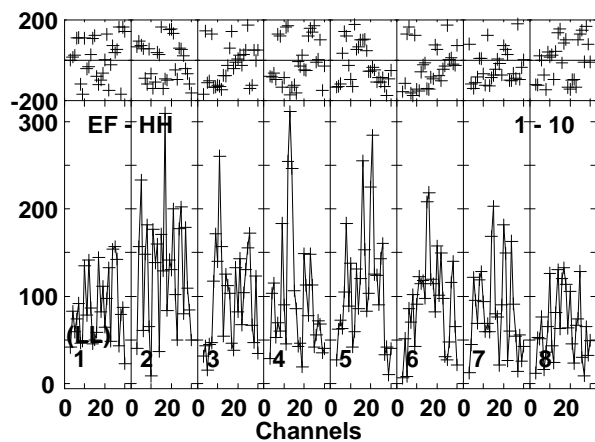
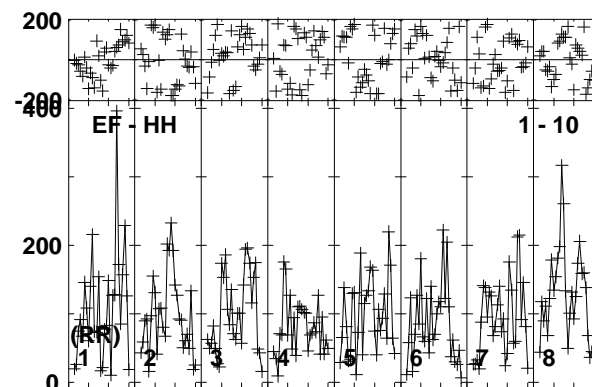
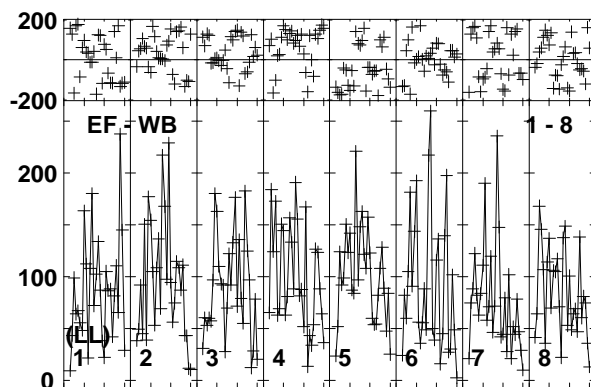
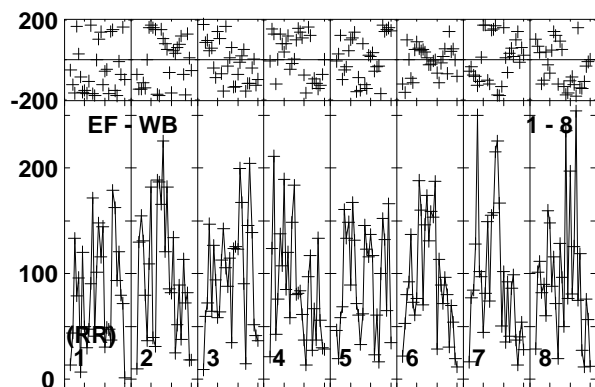
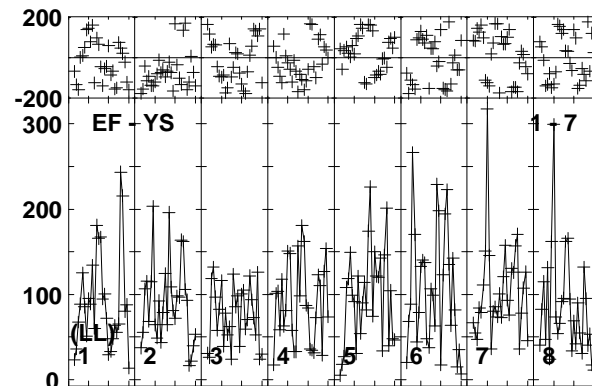
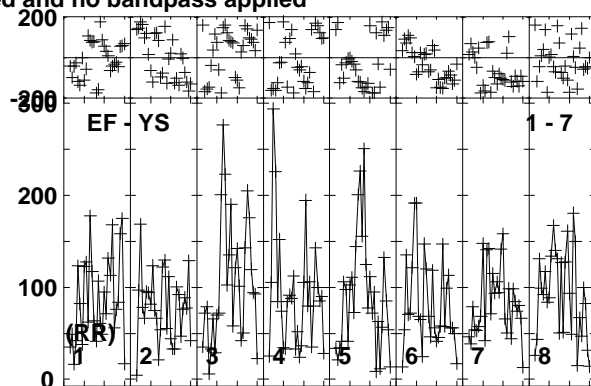
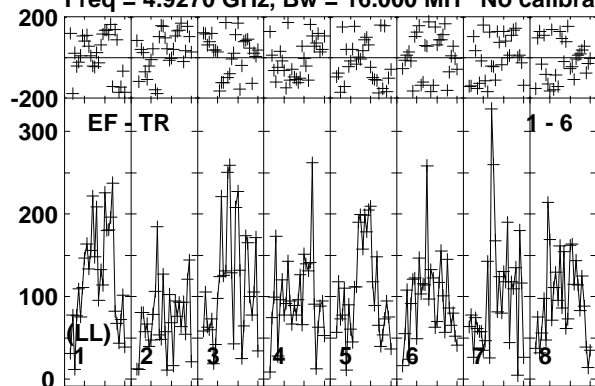

Lower frame: Micro Ampl Jy Top frame: Phas deg
Vector averaged cross-power spectrum Baseline: EF (01) - TR (06)
Timerange: 00/13:30:01 to 00/13:32:59

Plot file version 129 created 10-JUN-2016 16:08:00

J0718-1813 RG008D.UVDATA.1

Freq = 4.9270 GHz, Bw = 16.000 MH No calibration applied and no bandpass applied

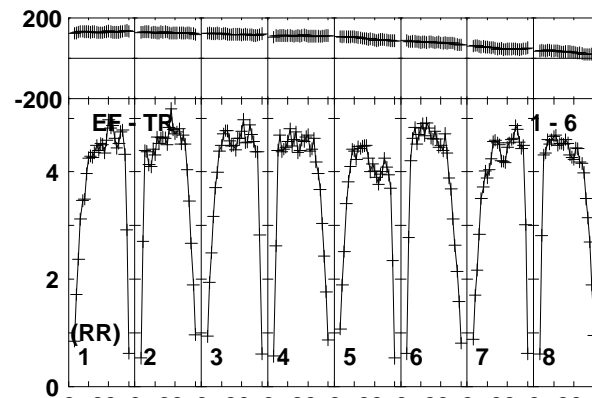
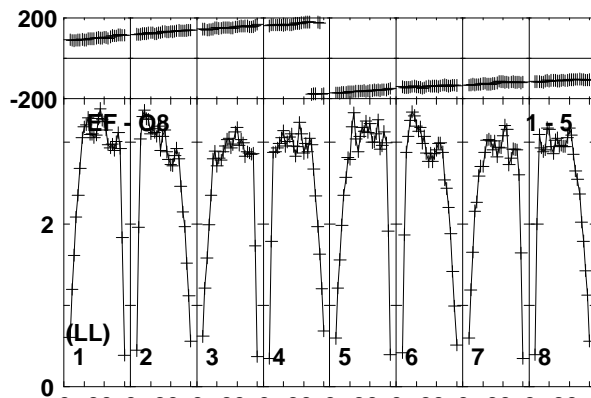
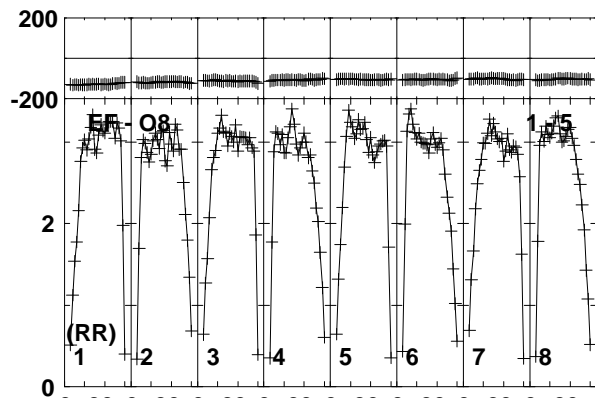
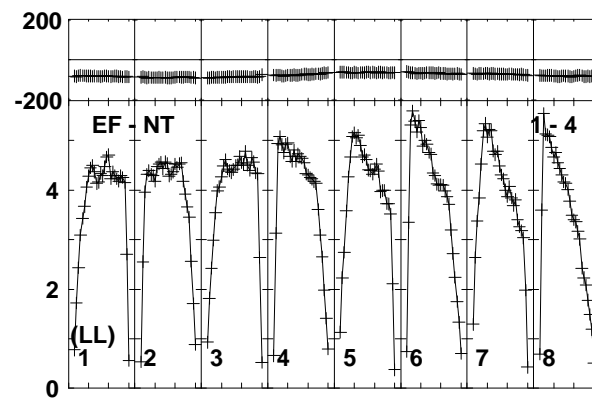
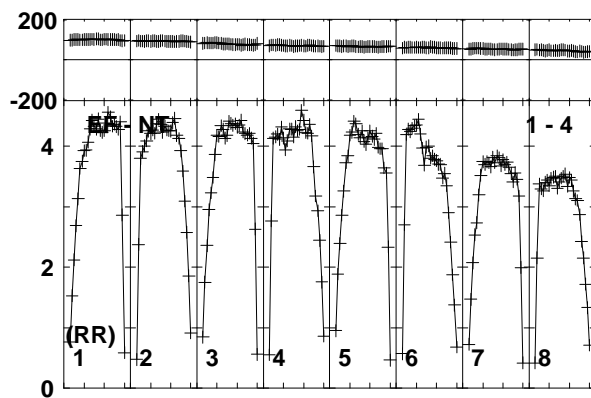
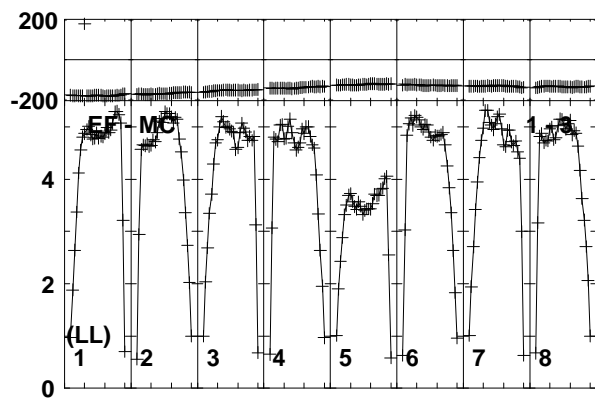
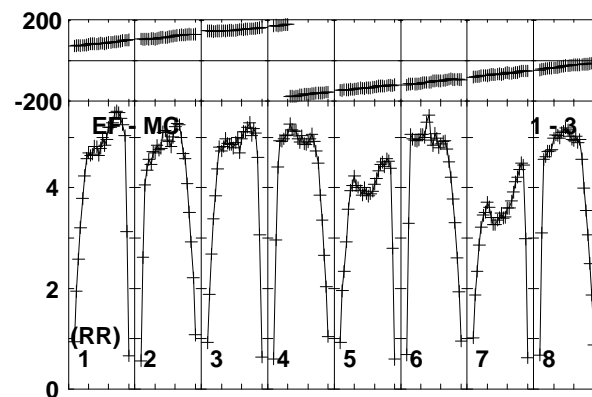
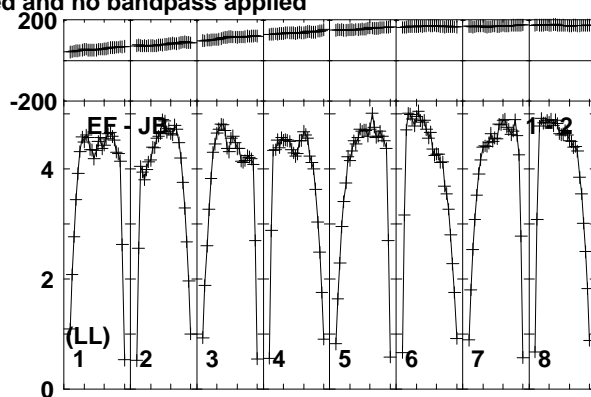
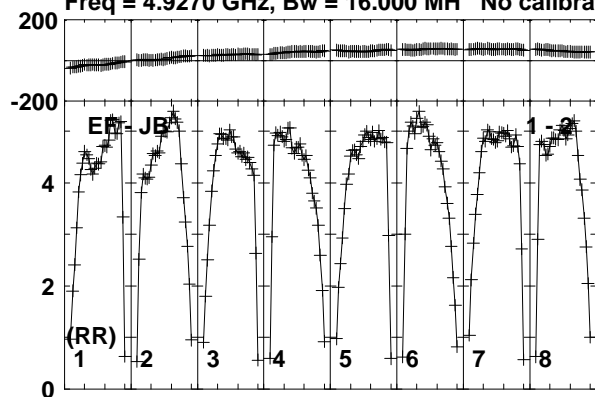

Lower frame: Milli Ampl Jy Top frame: Phas deg
Vector averaged cross-power spectrum Baseline: EF (01) - JB (02)
Timerange: 00/13:33:01 to 00/13:34:30

Plot file version 130 created 10-JUN-2016 16:08:00

J0718-1813 RG008D.UVDATA.1

Freq = 4.9270 GHz, Bw = 16.000 MH No calibration applied and no bandpass applied

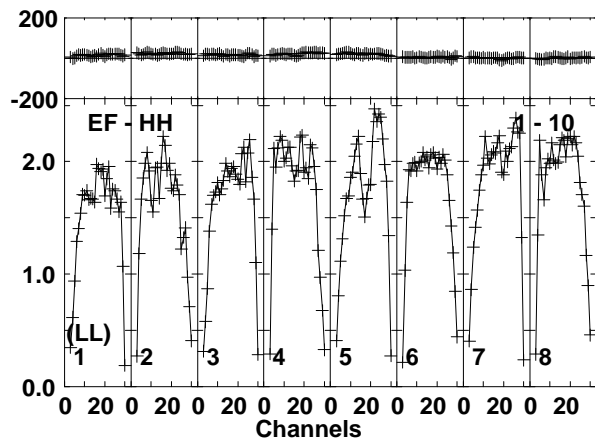
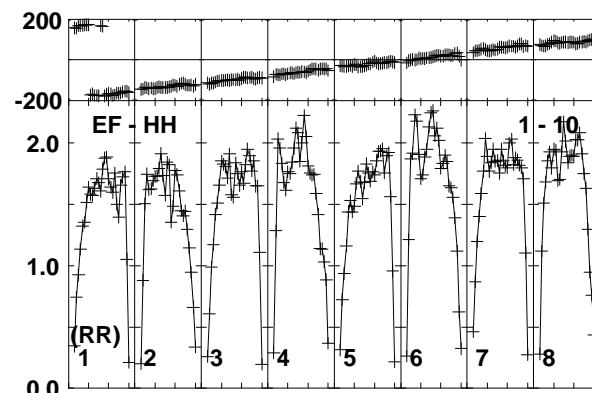
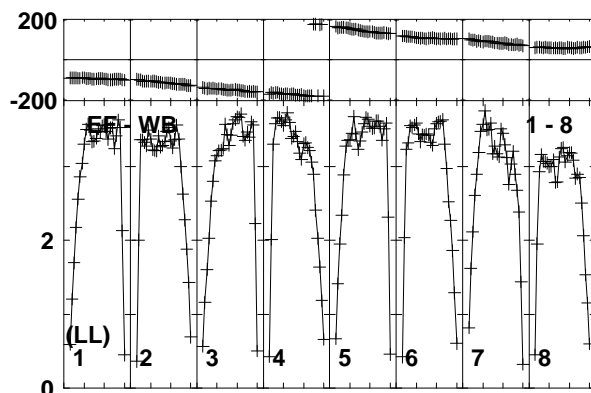
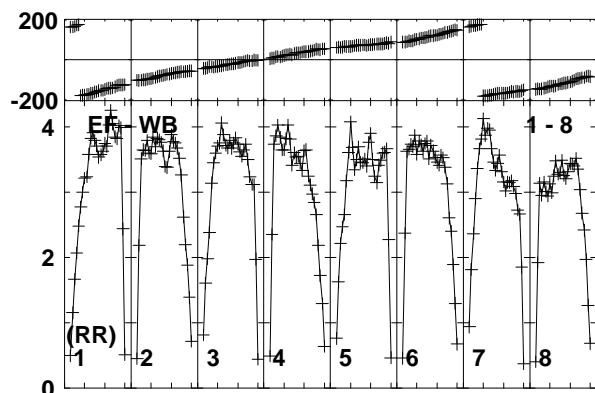
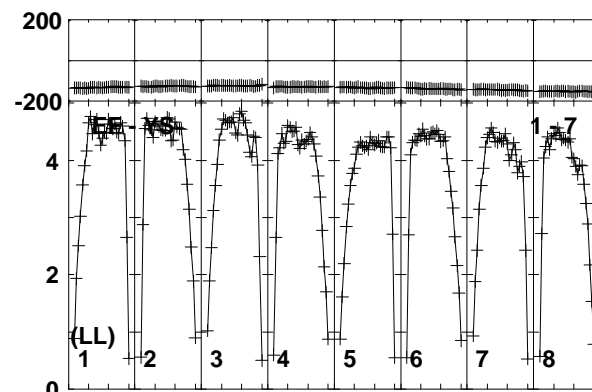
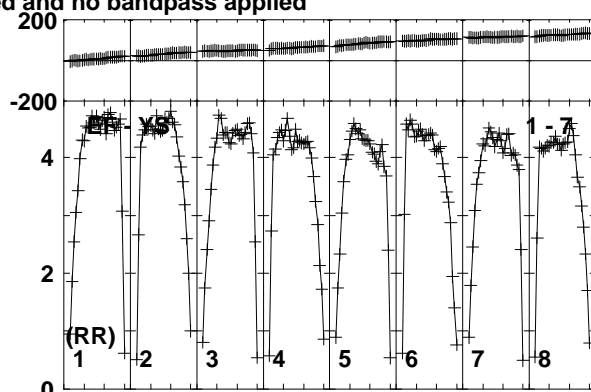
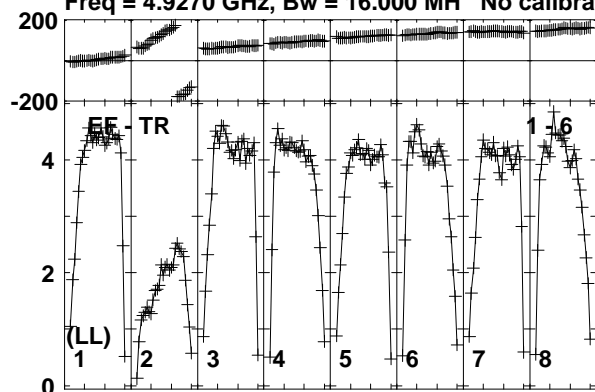

Lower frame: Milli Ampl Jy Top frame: Phas deg
Vector averaged cross-power spectrum Baseline: EF (01) - TR (06)
Timerange: 00/13:33:01 to 00/13:34:30

Plot file version 131 created 10-JUN-2016 16:08:01

J0712-1847 RG008D.UVDATA.1

Freq = 4.9270 GHz, Bw = 16.000 MH No calibration applied and no bandpass applied

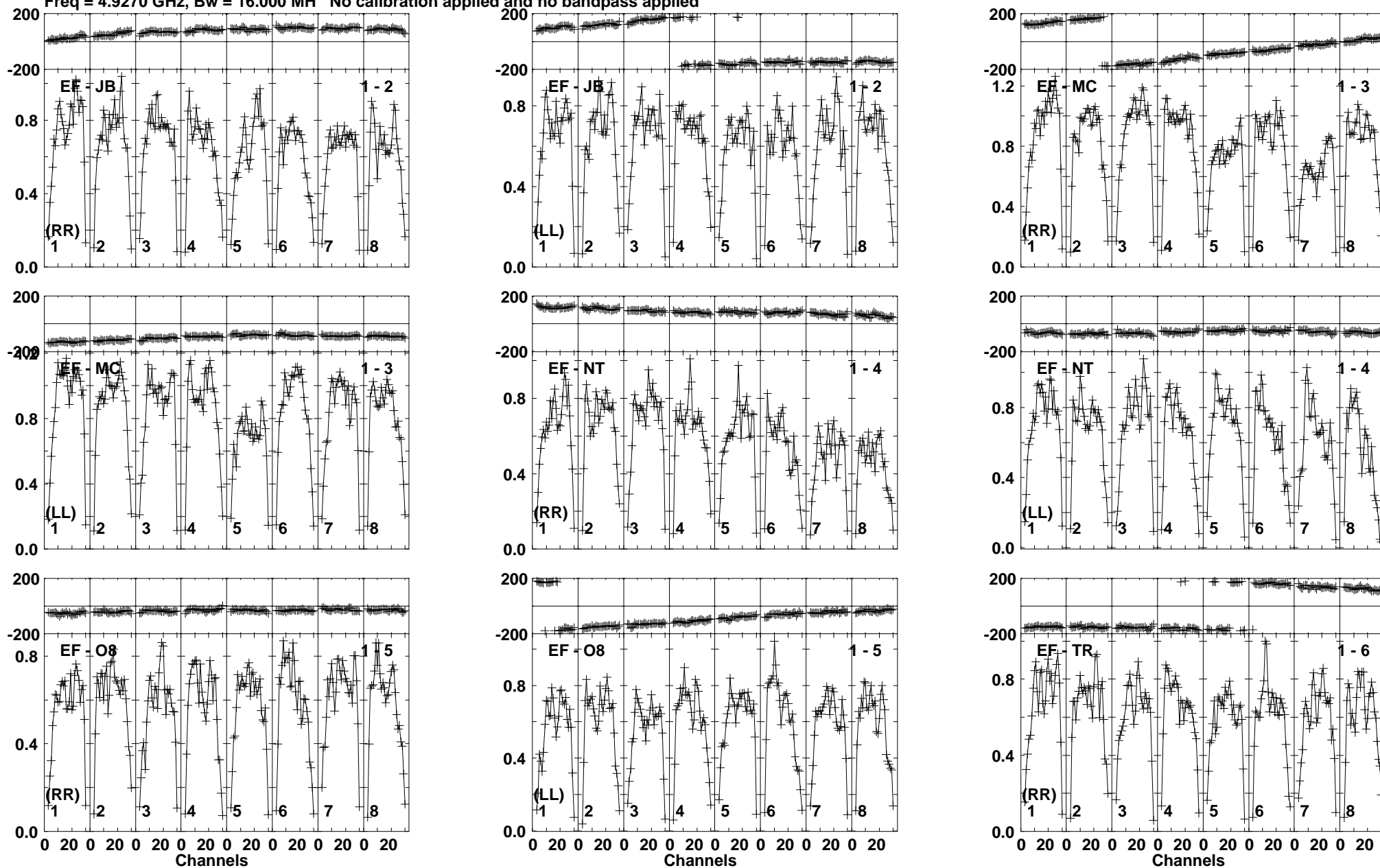

Lower frame: Milli Ampl Jy Top frame: Phas deg
Vector averaged cross-power spectrum Baseline: EF (01) - JB (02)
Timerange: 00/13:34:31 to 00/13:37:29

Plot file version 132 created 10-JUN-2016 16:08:01

J0712-1847 RG008D.UVDATA.1

Freq = 4.9270 GHz, Bw = 16.000 MH No calibration applied and no bandpass applied

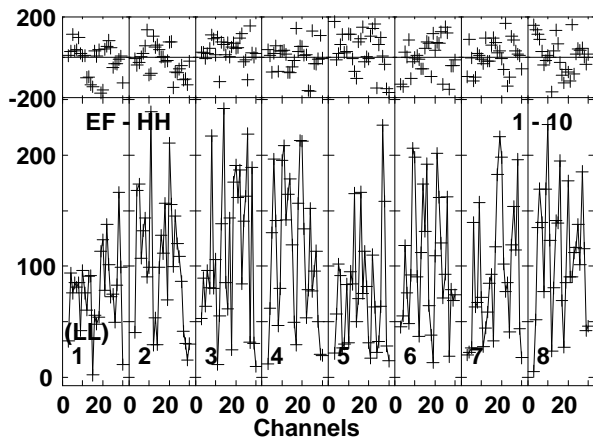
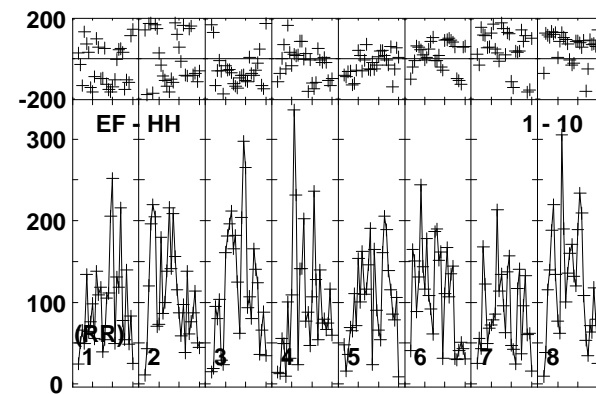
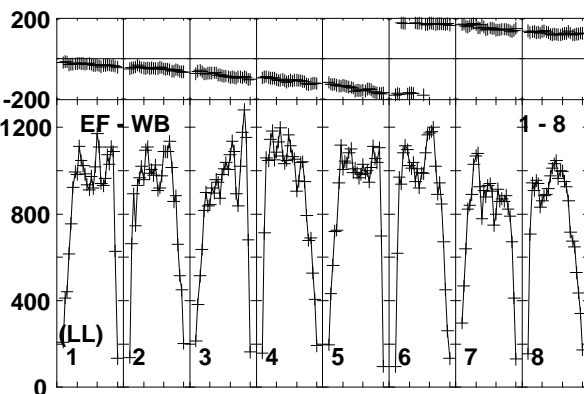
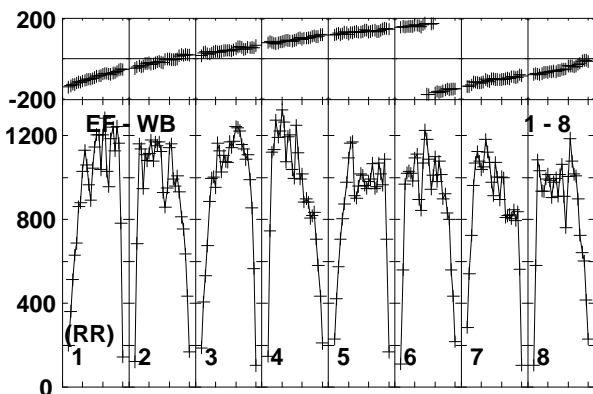
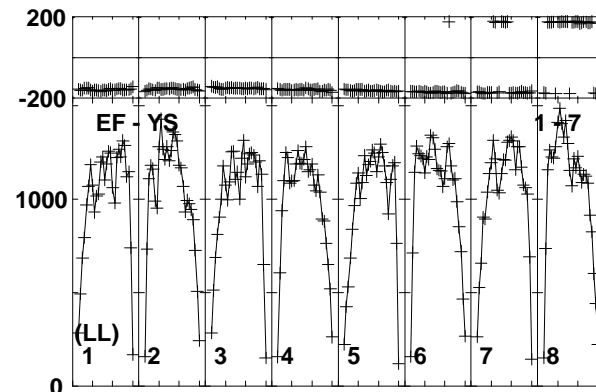
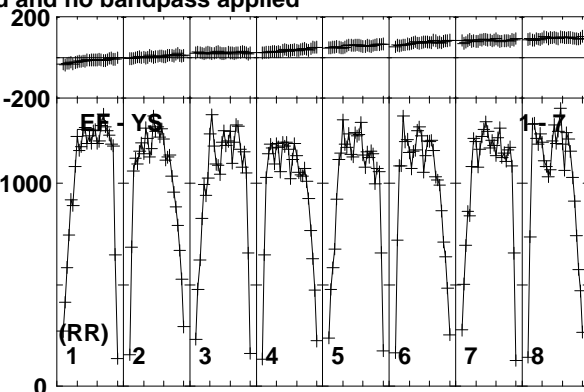
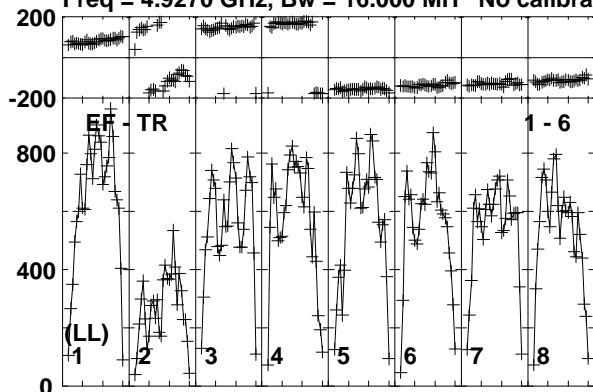

Lower frame: Micro Ampl Jy Top frame: Phas deg
Vector averaged cross-power spectrum Baseline: EF (01) - TR (06)
Timerange: 00/13:34:31 to 00/13:37:29

Plot file version 133 created 10-JUN-2016 16:08:01

J0718-1813 RG008D.UVDATA.1

Freq = 4.9270 GHz, Bw = 16.000 MH No calibration applied and no bandpass applied

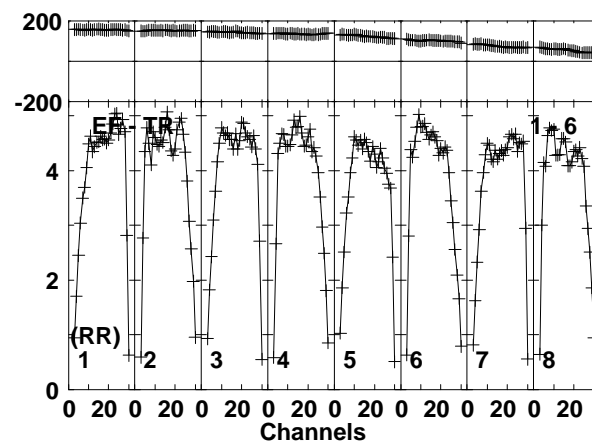
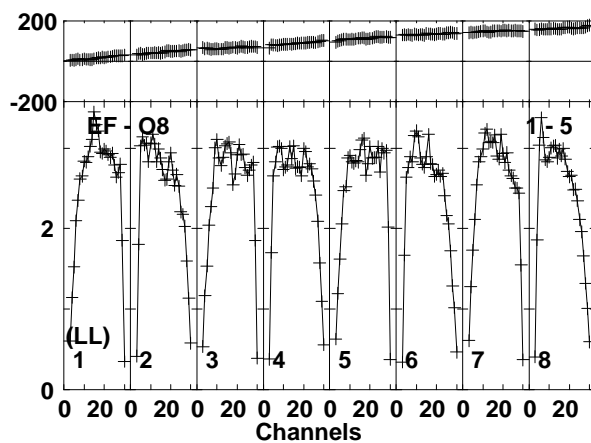
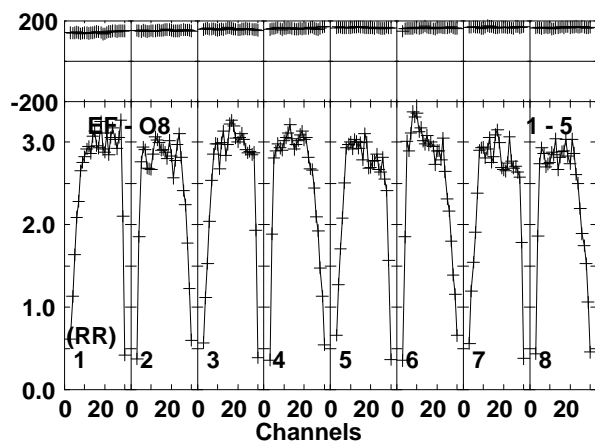
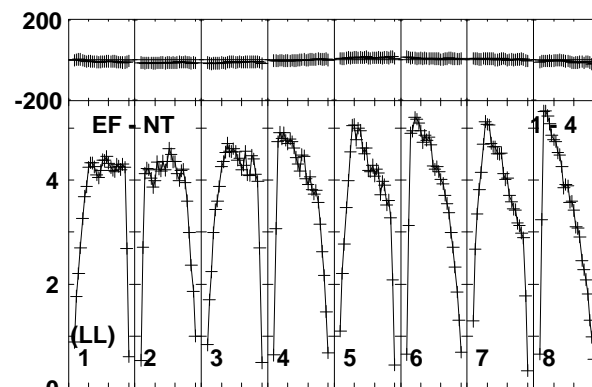
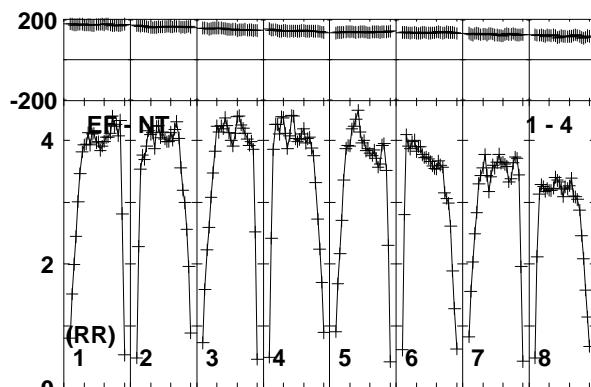
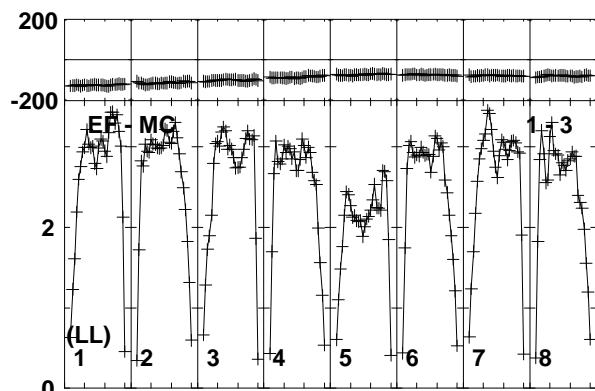
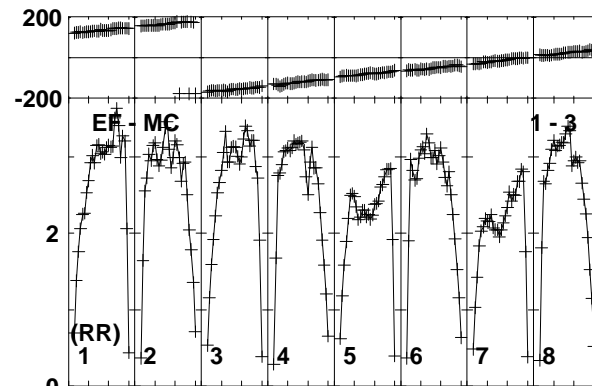
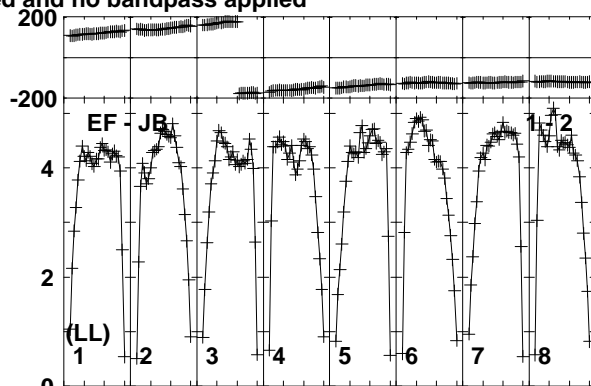
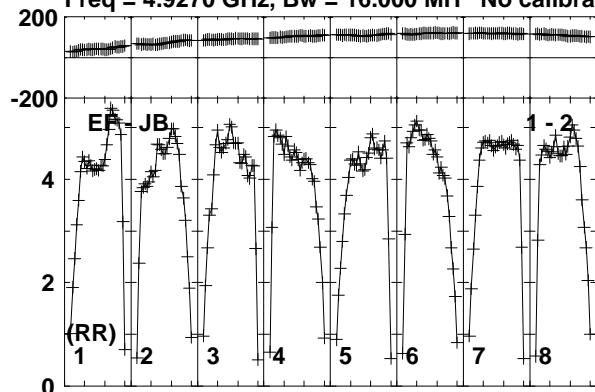

Lower frame: Milli Ampl Jy Top frame: Phas deg
Vector averaged cross-power spectrum Baseline: EF (01) - JB (02)
Timerange: 00/13:38:11 to 00/13:39:00

Plot file version 134 created 10-JUN-2016 16:08:01

J0718-1813 RG008D.UVDATA.1

Freq = 4.9270 GHz, Bw = 16.000 MH No calibration applied and no bandpass applied

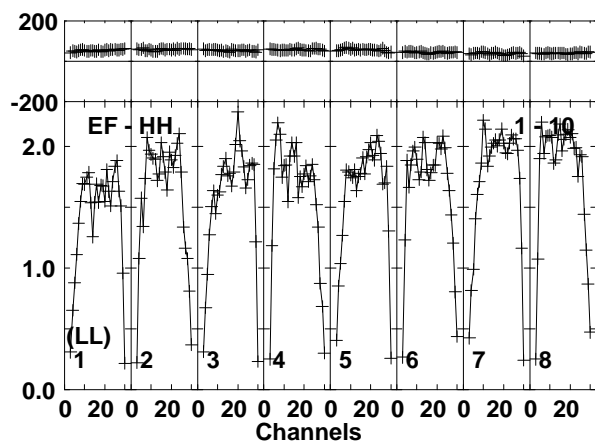
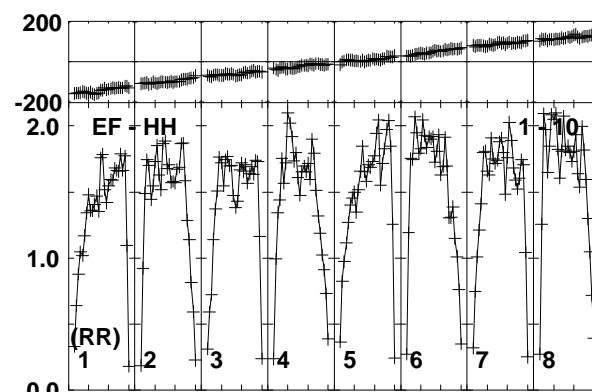
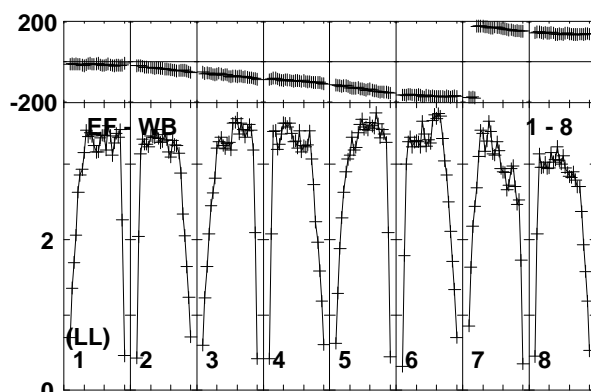
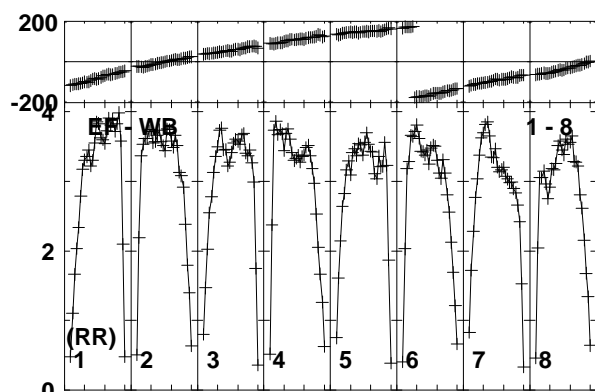
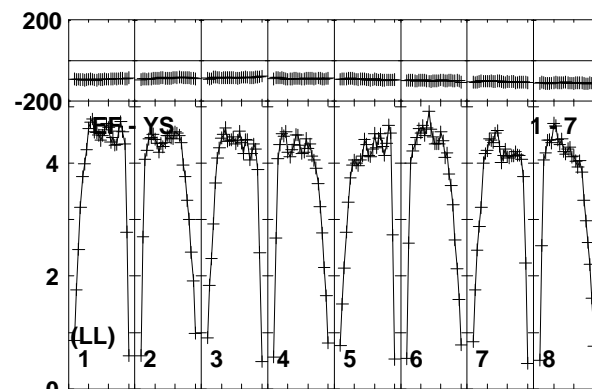
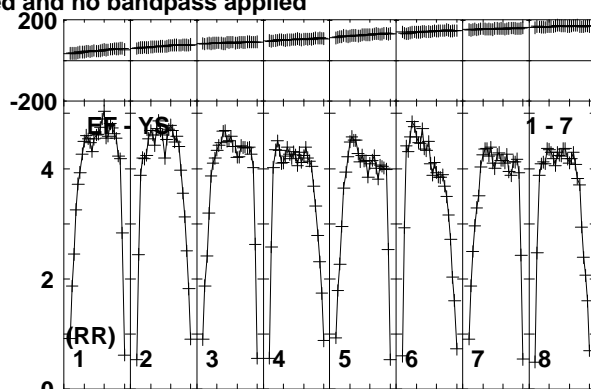
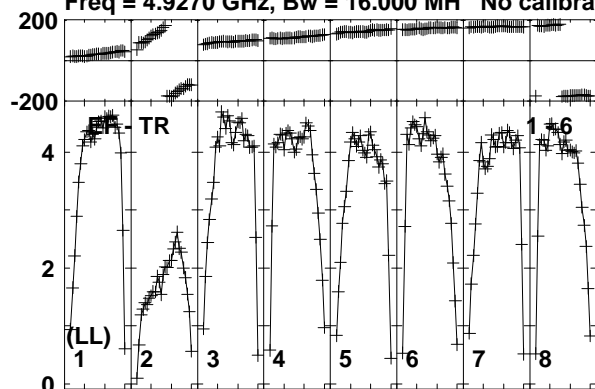

Lower frame: Milli Ampl Jy Top frame: Phas deg
Vector averaged cross-power spectrum Baseline: EF (01) - TR (06)
Timerange: 00/13:38:11 to 00/13:39:00

Plot file version 135 created 10-JUN-2016 16:08:01

FRB150418 RG008D.UVDATA.1

Freq = 4.9270 GHz, Bw = 16.000 MH No calibration applied and no bandpass applied

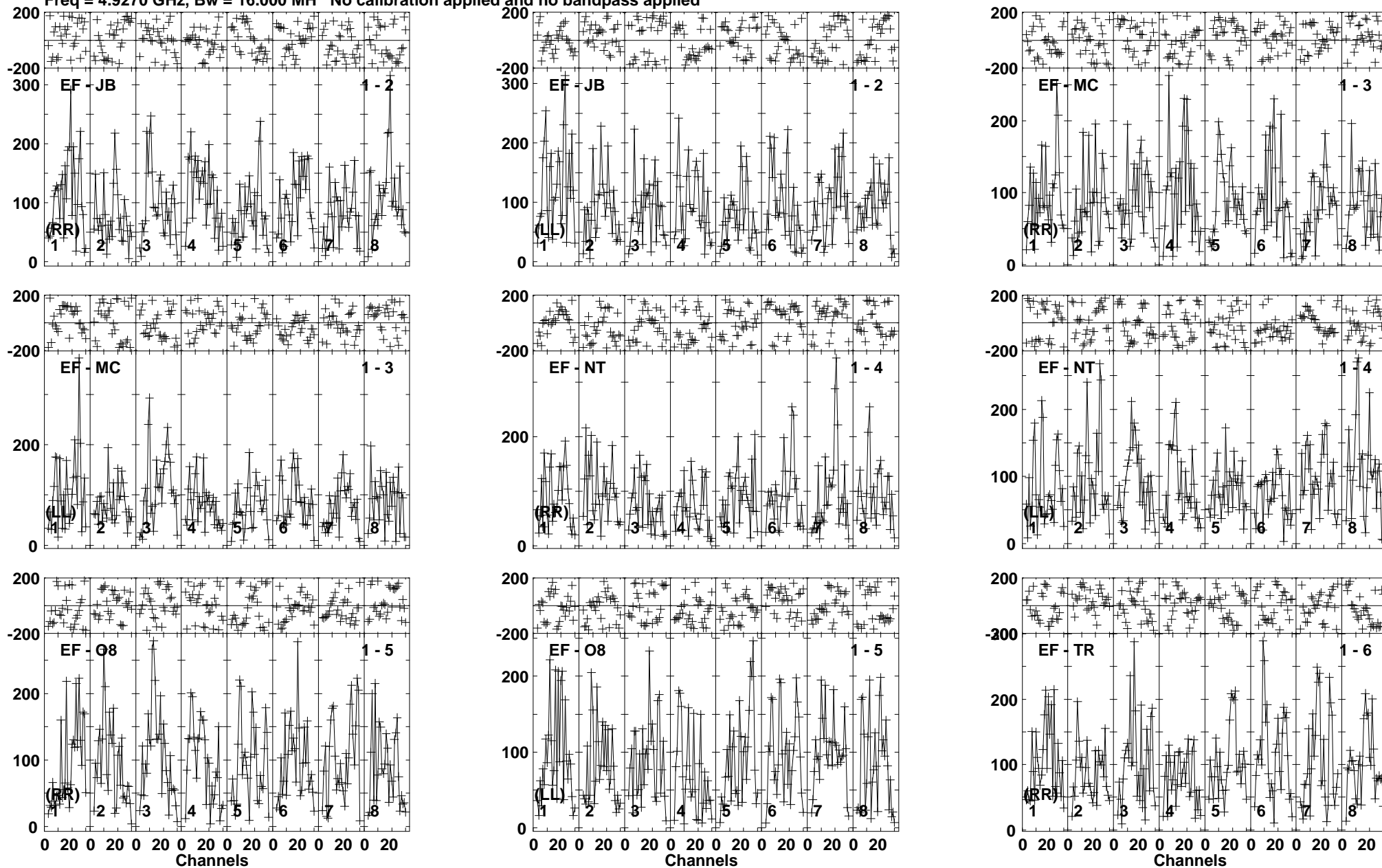

Lower frame: Micro Ampl Jy Top frame: Phas deg
Vector averaged cross-power spectrum Baseline: EF (01) - JB (02)
Timerange: 00/13:39:00 to 00/13:42:00

Plot file version 136 created 10-JUN-2016 16:08:01

FRB150418 RG008D.UVDATA.1

Freq = 4.9270 GHz, Bw = 16.000 MH No calibration applied and no bandpass applied

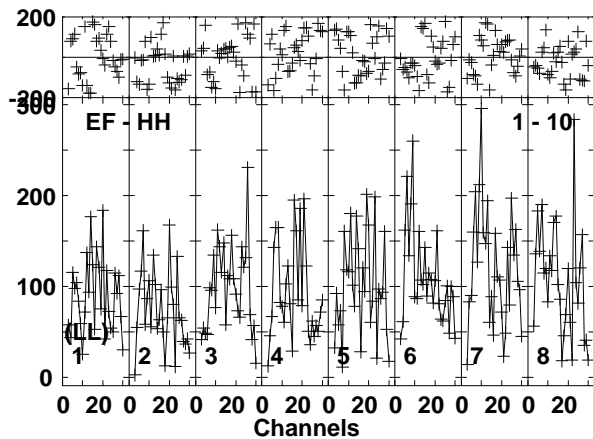
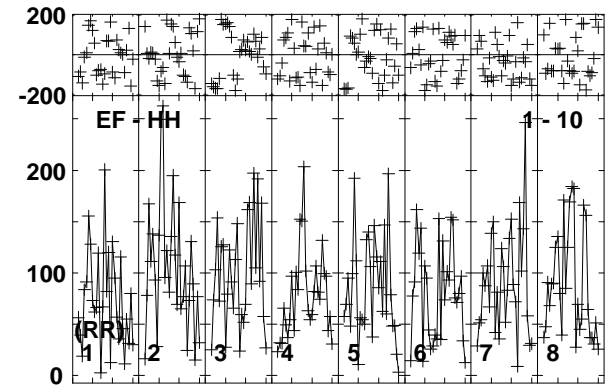
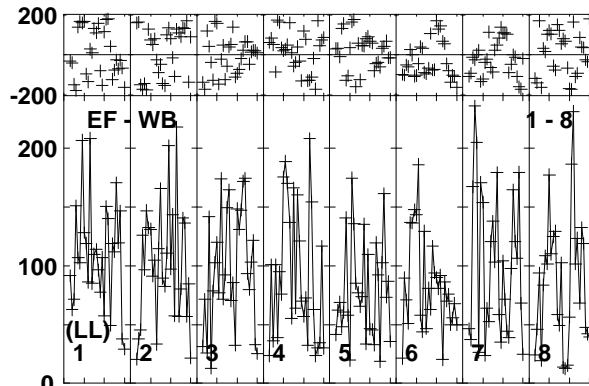
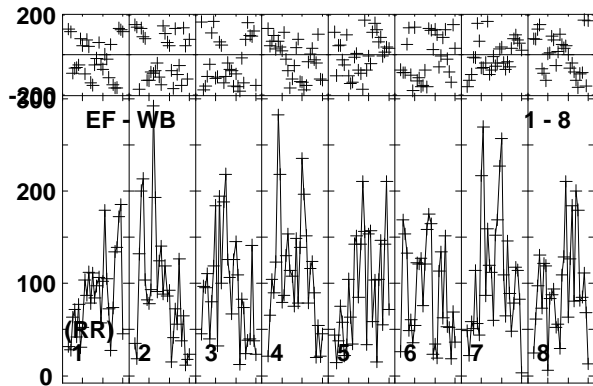
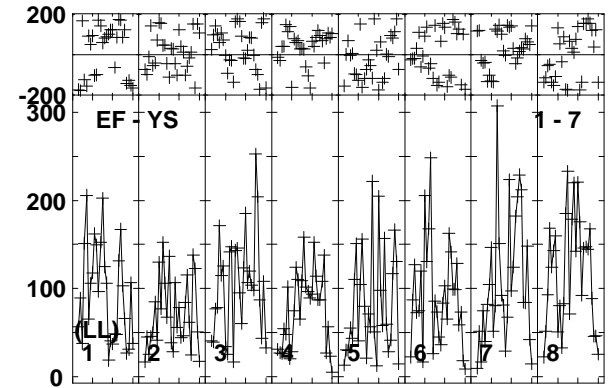
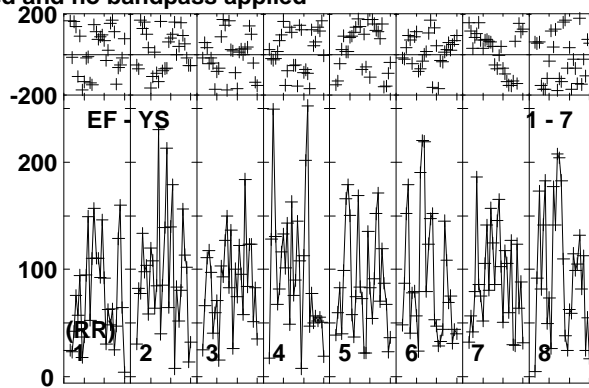
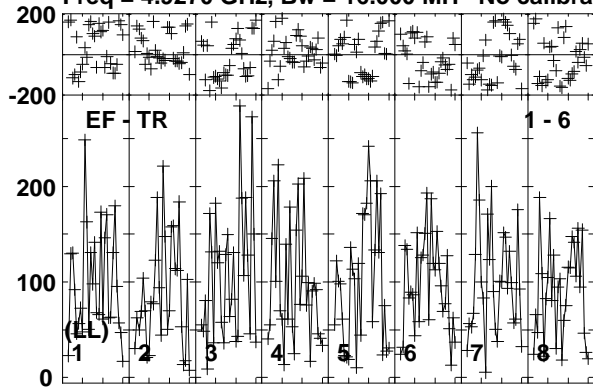

Lower frame: Micro Ampl Jy Top frame: Phas deg
Vector averaged cross-power spectrum Baseline: EF (01) - TR (06)
Timerange: 00/13:39:00 to 00/13:42:00

Plot file version 137 created 10-JUN-2016 16:08:01

J0718-1813 RG008D.UVDATA.1

Freq = 4.9270 GHz, Bw = 16.000 MH No calibration applied and no bandpass applied

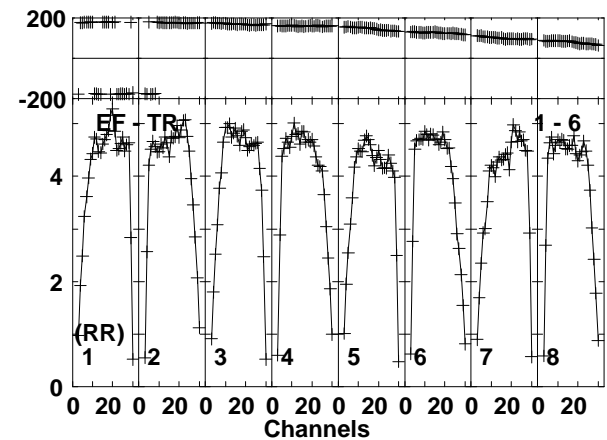
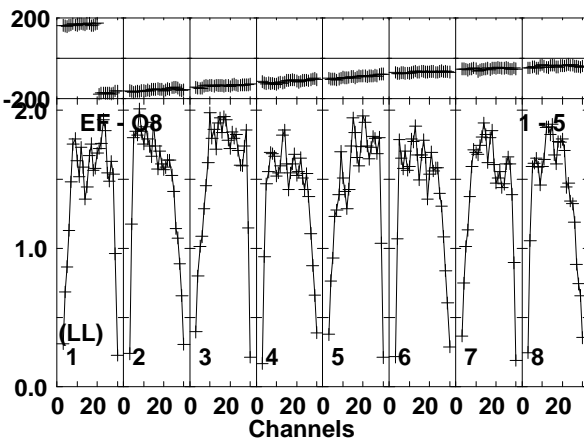
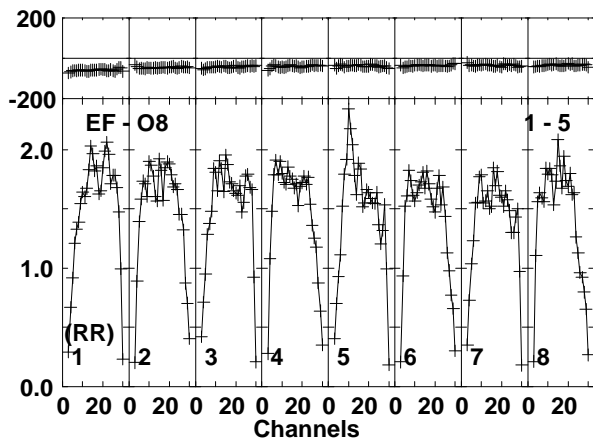
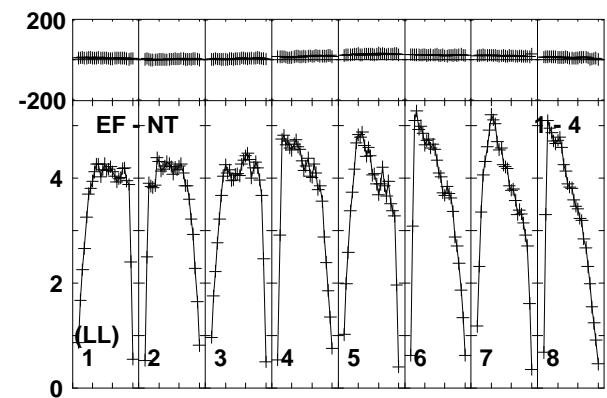
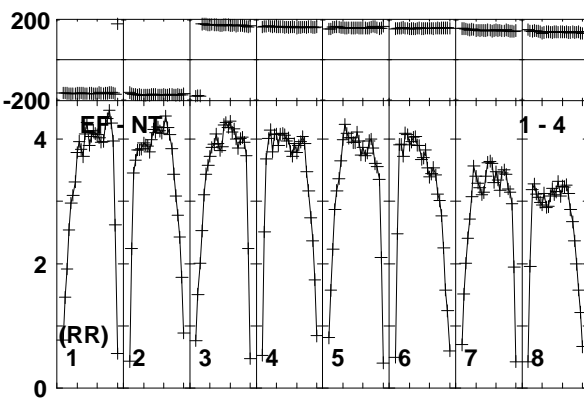
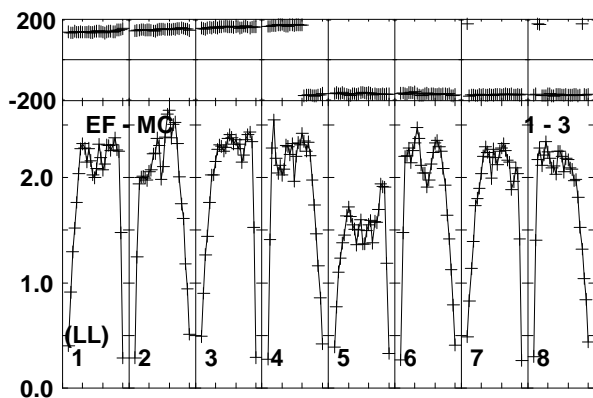
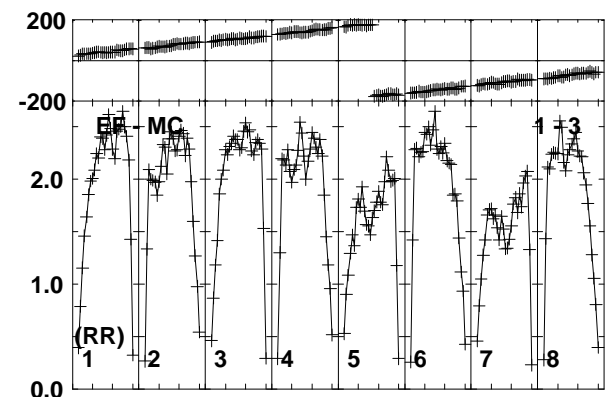
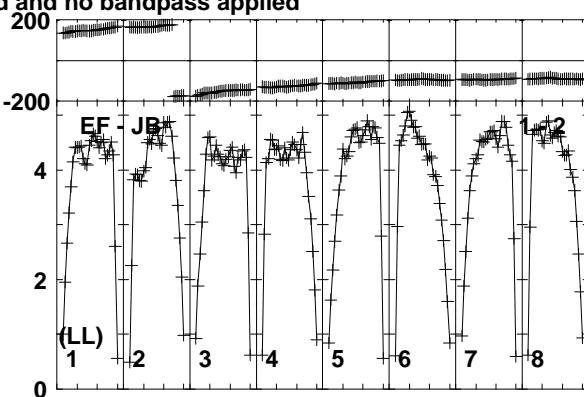
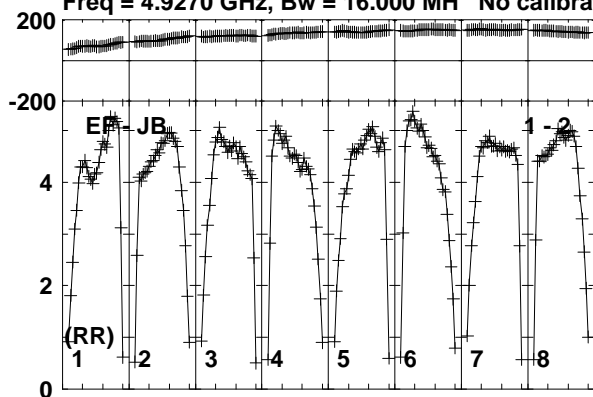

Lower frame: Milli Ampl Jy Top frame: Phas deg
Vector averaged cross-power spectrum Baseline: EF (01) - JB (02)
Timerange: 00:13:42:00 to 00:13:43:30

Plot file version 138 created 10-JUN-2016 16:08:01

J0718-1813 RG008D.UVDATA.1

Freq = 4.9270 GHz, Bw = 16.000 MH No calibration applied and no bandpass applied

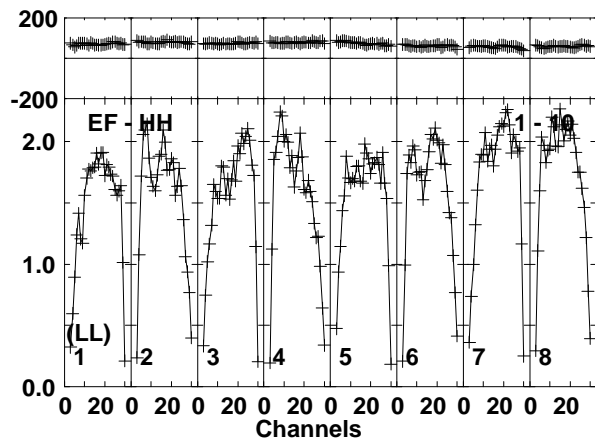
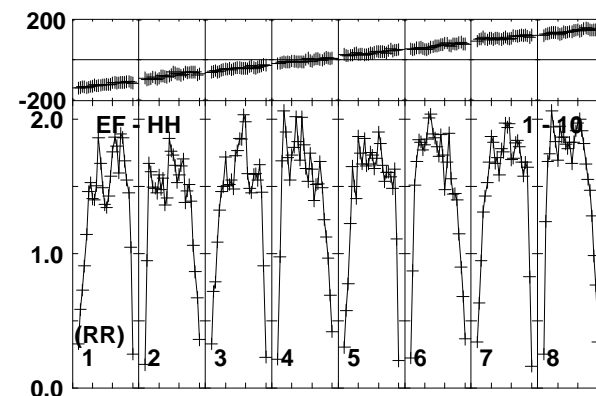
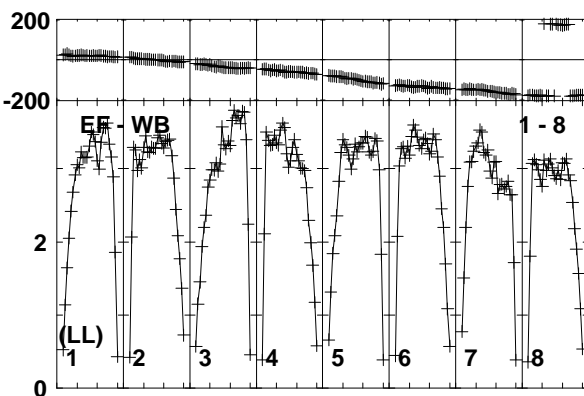
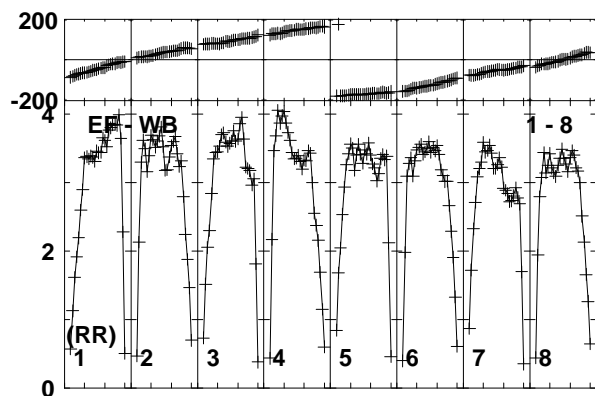
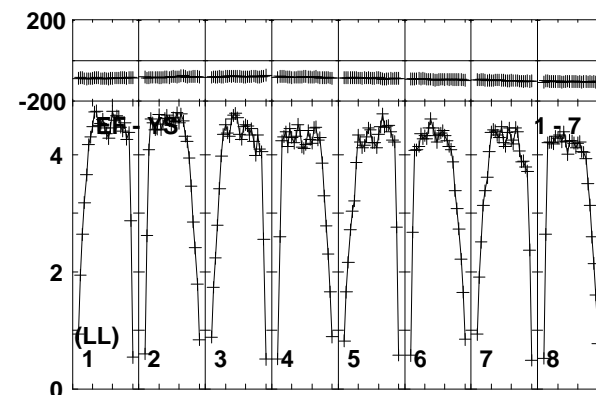
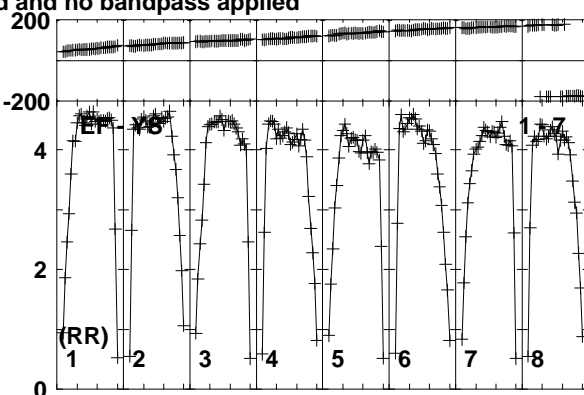
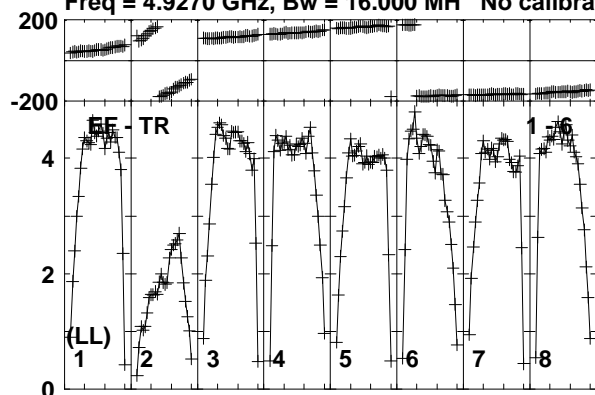

Lower frame: Milli Ampl Jy Top frame: Phas deg
Vector averaged cross-power spectrum Baseline: EF (01) - TR (06)
Timerange: 00/13:42:00 to 00/13:43:30

Plot file version 139 created 10-JUN-2016 16:08:02

FRB150418 RG008D.UVDATA.1

Freq = 4.9270 GHz, Bw = 16.000 MH No calibration applied and no bandpass applied

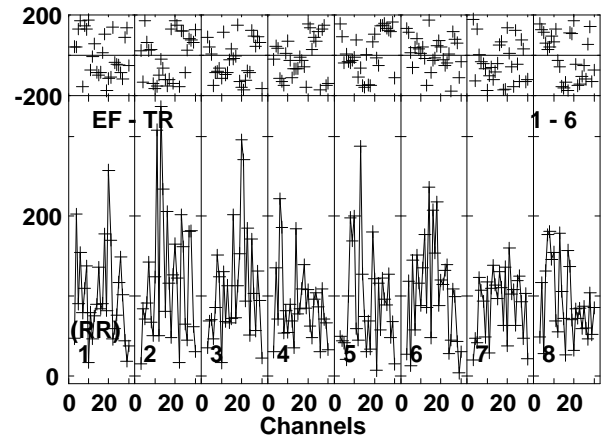
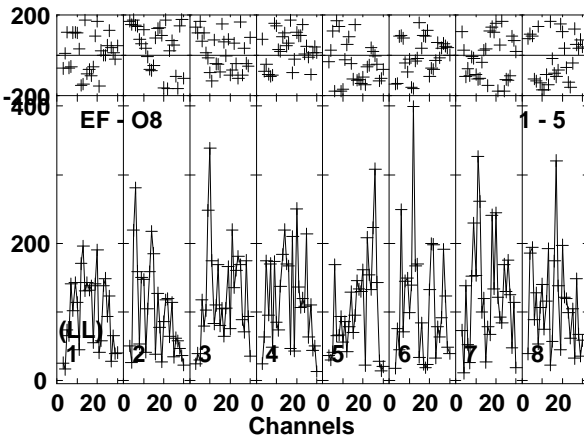
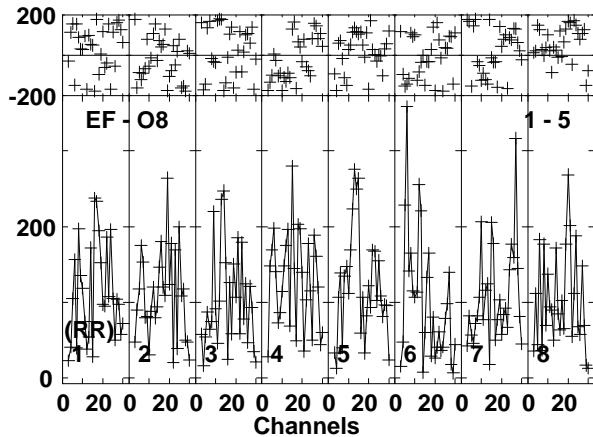
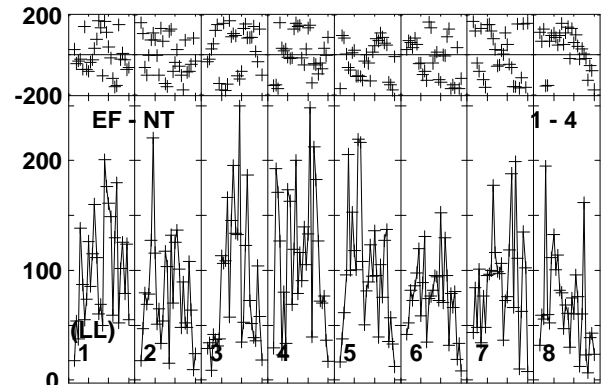
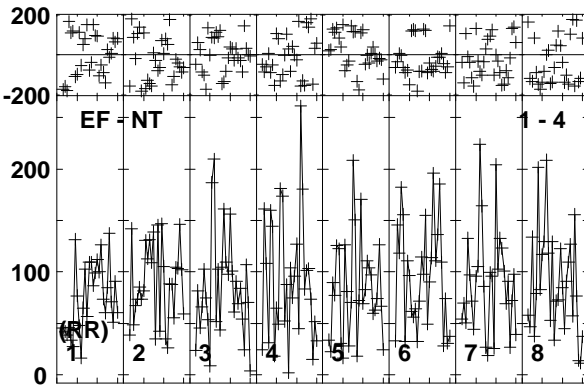
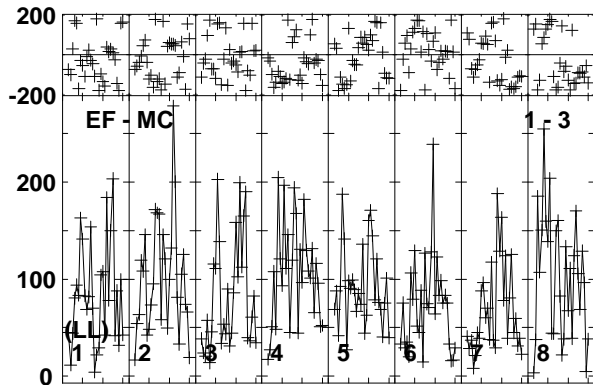
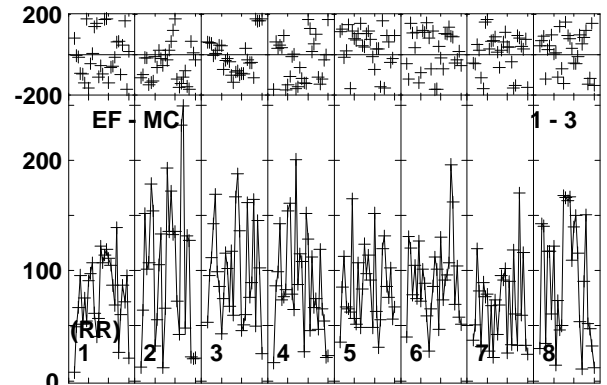
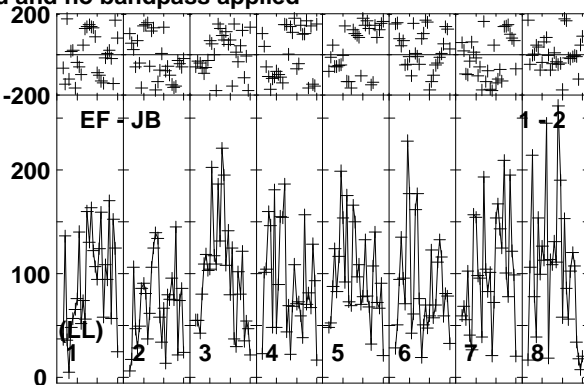
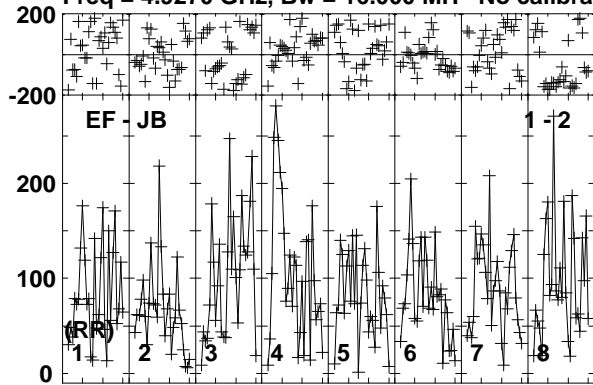

Lower frame: Micro Ampl Jy Top frame: Phas deg
Vector averaged cross-power spectrum Baseline: EF (01) - JB (02)
Timerange: 00/13:43:30 to 00/13:46:30

Plot file version 140 created 10-JUN-2016 16:08:02

FRB150418 RG008D.UVDATA.1

Freq = 4.9270 GHz, Bw = 16.000 MH No calibration applied and no bandpass applied

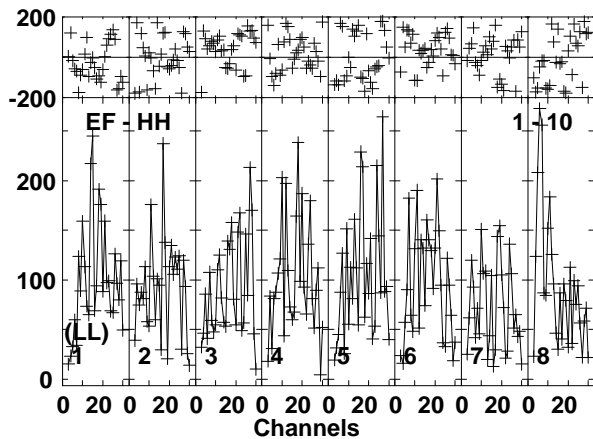
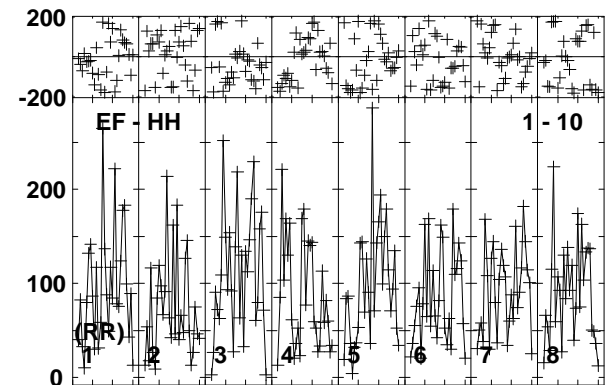
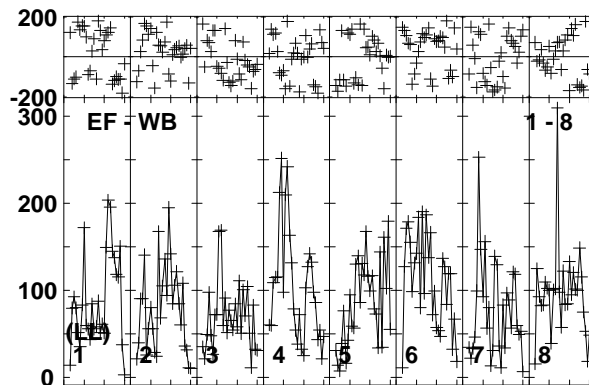
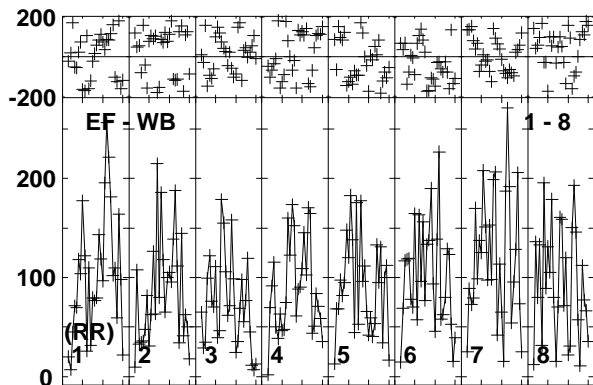
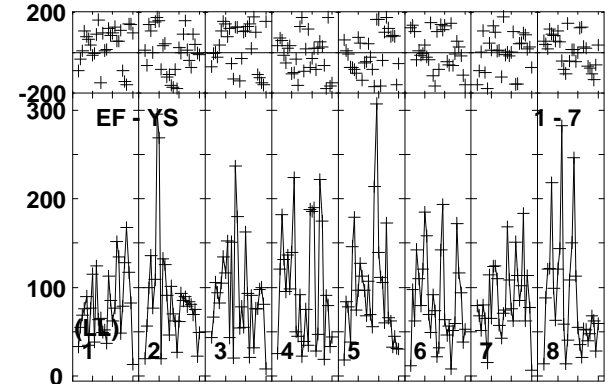
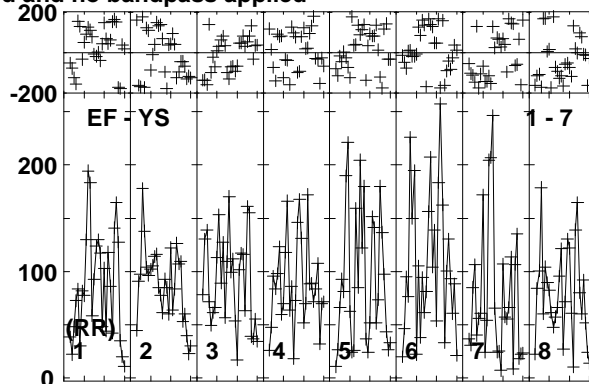
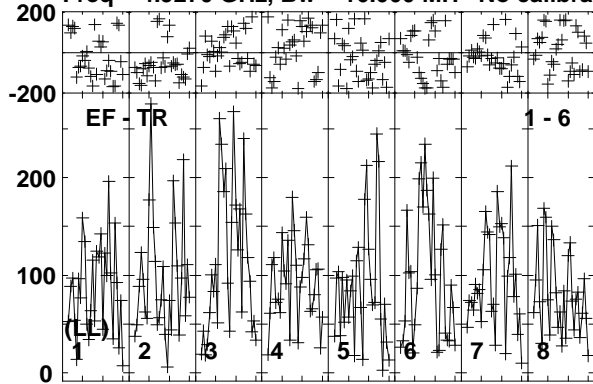

Lower frame: Micro Ampl Jy Top frame: Phas deg
Vector averaged cross-power spectrum Baseline: EF (01) - TR (06)
Timerange: 00/13:43:30 to 00/13:46:30

Plot file version 141 created 10-JUN-2016 16:08:02

J0718-1813 RG008D.UVDATA.1

Freq = 4.9270 GHz, Bw = 16.000 MH No calibration applied and no bandpass applied

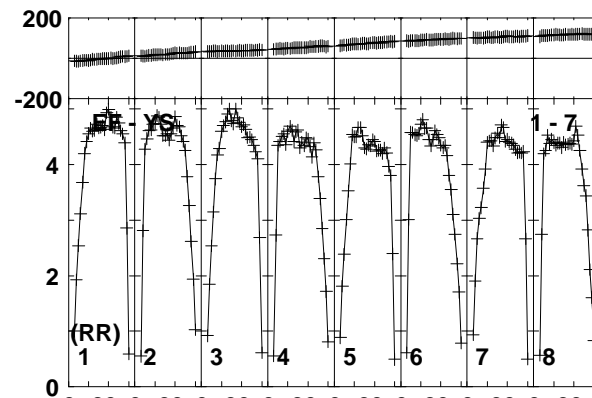
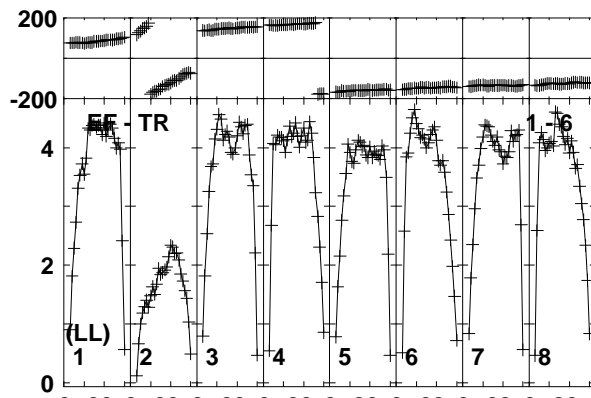
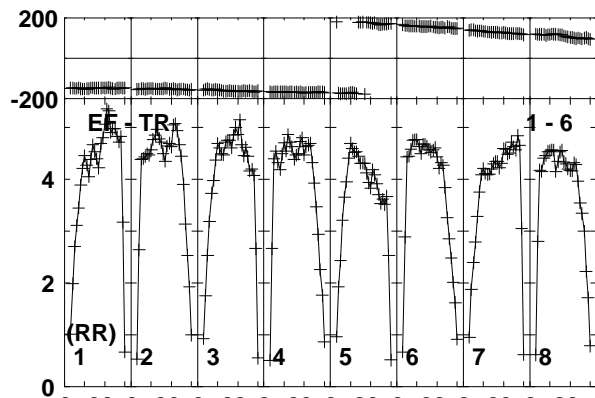
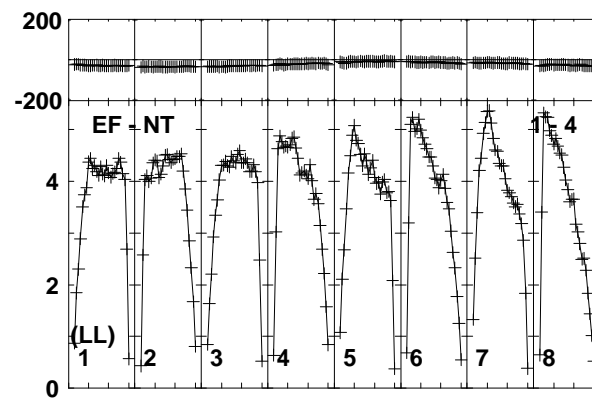
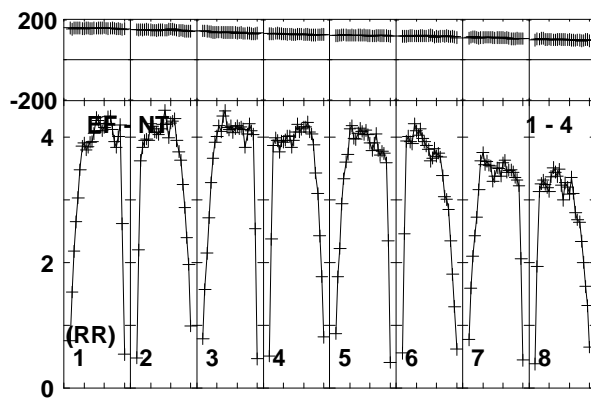
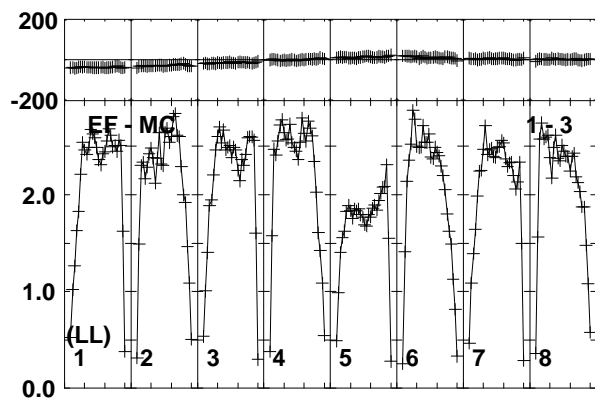
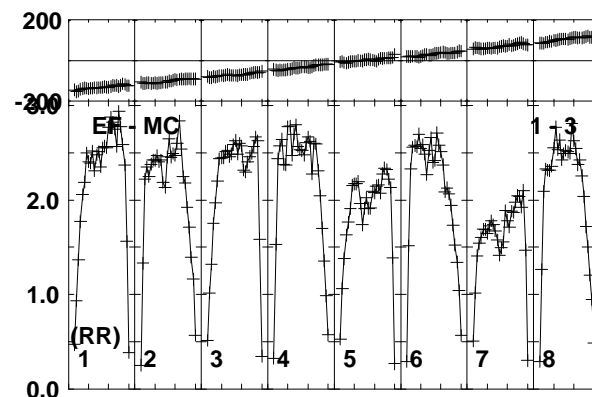
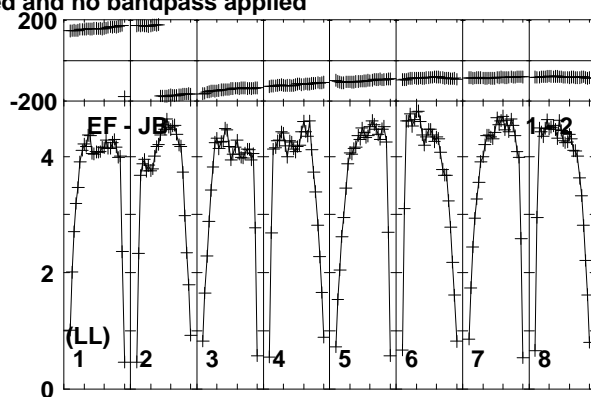
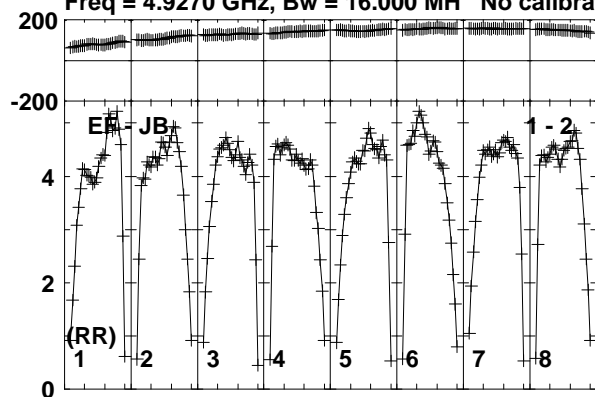

Lower frame: Milli Ampl Jy Top frame: Phas deg
Vector averaged cross-power spectrum Baseline: EF (01) - JB (02)
Timerange: 00/13:46:30 to 00/13:47:59

Plot file version 142 created 10-JUN-2016 16:08:02

J0718-1813 RG008D.UVDATA.1

Freq = 4.9270 GHz, Bw = 16.000 MH No calibration applied and no bandpass applied

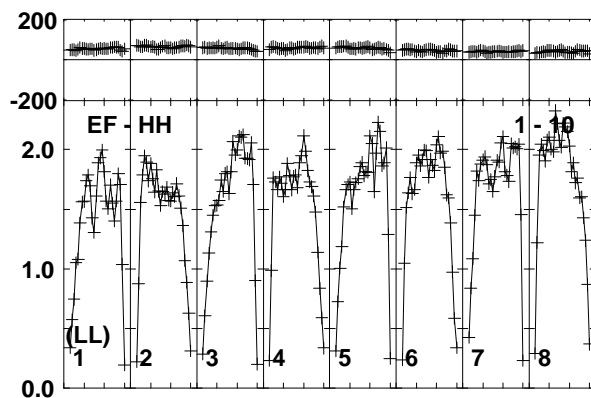
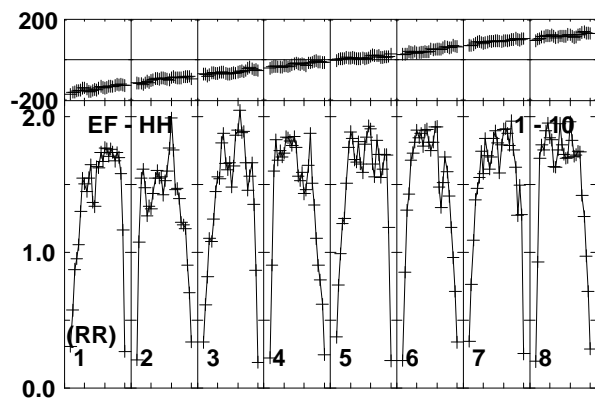
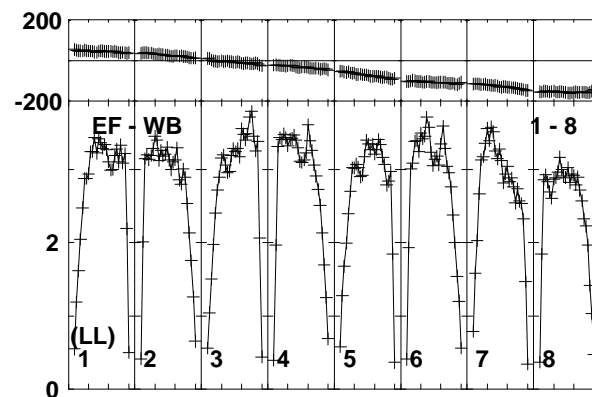
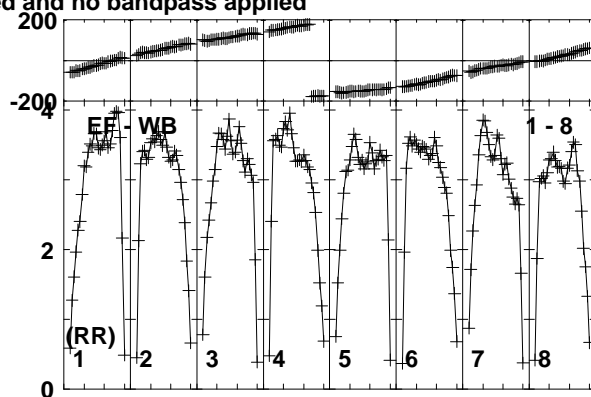
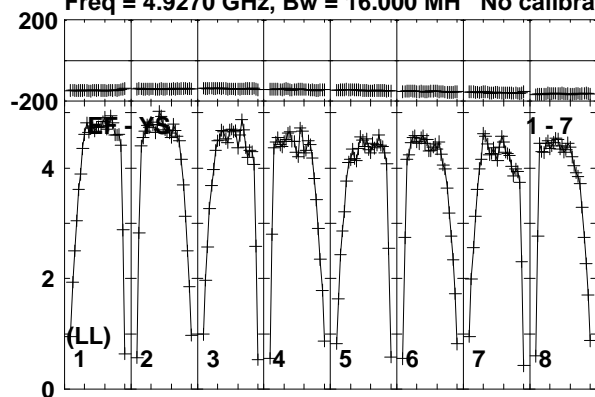

Lower frame: Milli Ampl Jy Top frame: Phas deg
Vector averaged cross-power spectrum Baseline: EF (01) - YS (07)
Timerange: 00/13:46:30 to 00/13:47:59

Plot file version 143 created 10-JUN-2016 16:08:02

J0716-1856 RG008D.UVDATA.1

Freq = 4.9270 GHz, Bw = 16.000 MH No calibration applied and no bandpass applied

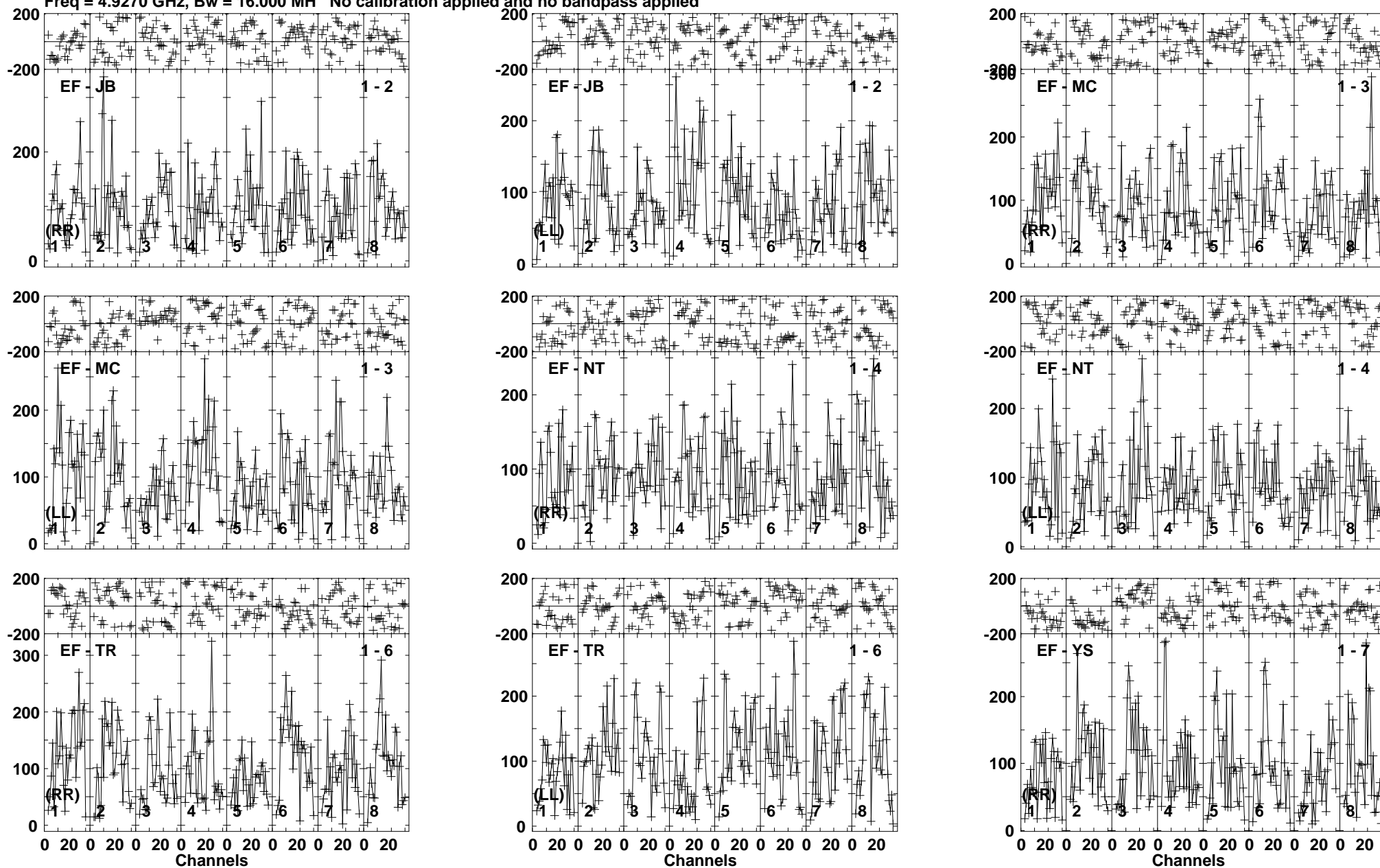

Lower frame: Micro Ampl Jy Top frame: Phas deg
Vector averaged cross-power spectrum Baseline: EF (01) - JB (02)
Timerange: 00/13:48:00 to 00/13:51:00

Plot file version 144 created 10-JUN-2016 16:08:02

J0716-1856 RG008D.UVDATA.1

Freq = 4.9270 GHz, Bw = 16.000 MH No calibration applied and no bandpass applied

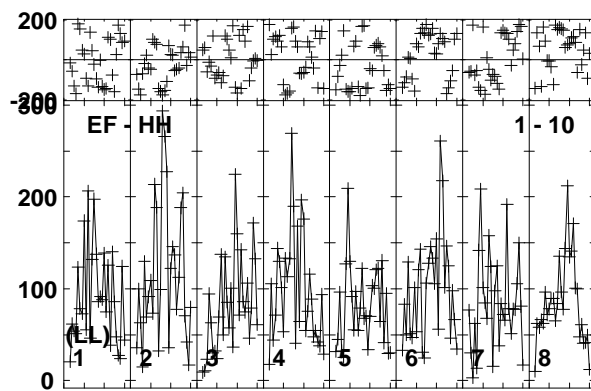
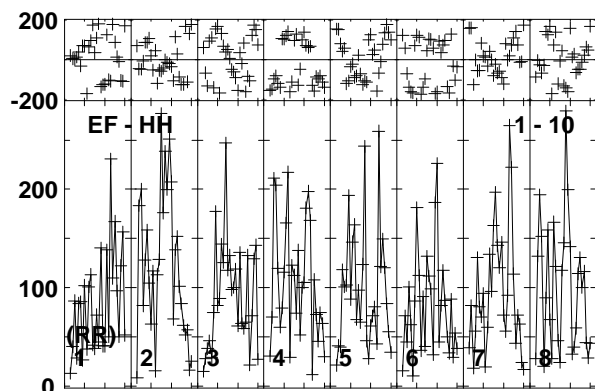
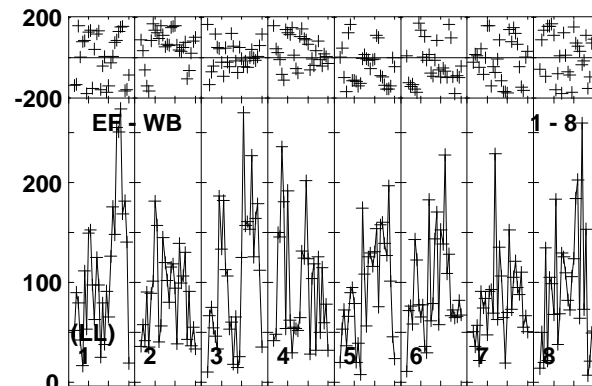
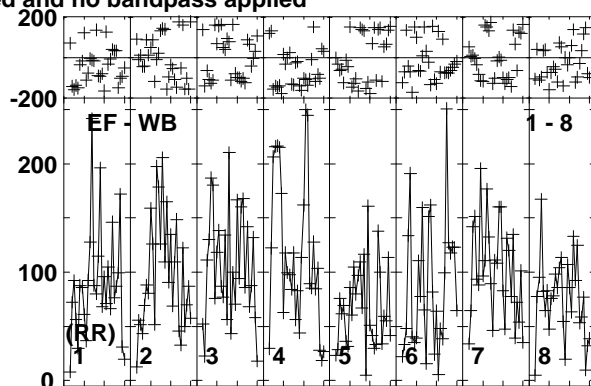
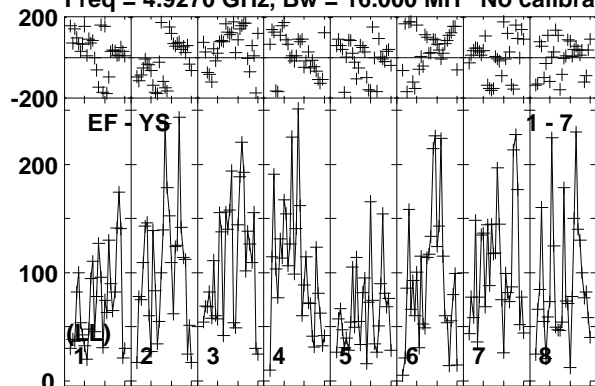

Lower frame: Micro Ampl Jy Top frame: Phas deg
Vector averaged cross-power spectrum Baseline: EF (01) - YS (07)
Timerange: 00/13:48:00 to 00/13:51:00

Plot file version 145 created 10-JUN-2016 16:08:02

J0718-1813 RG008D.UVDATA.1

Freq = 4.9270 GHz, Bw = 16.000 MH No calibration applied and no bandpass applied

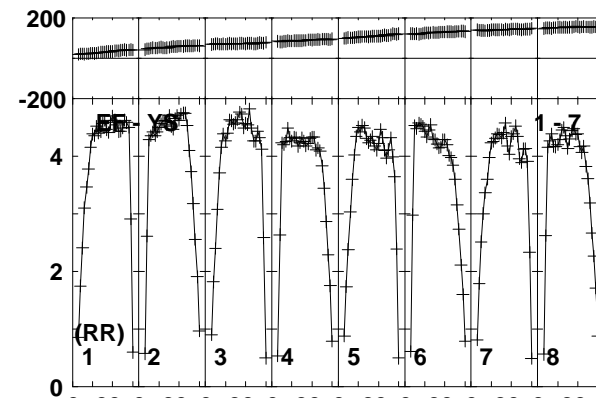
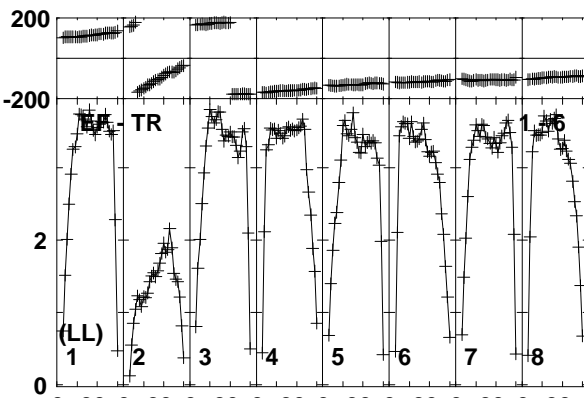
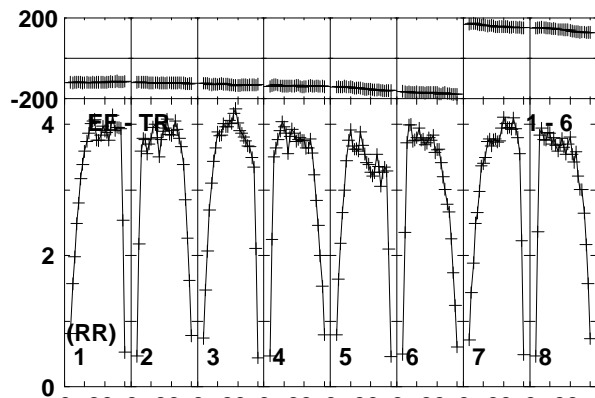
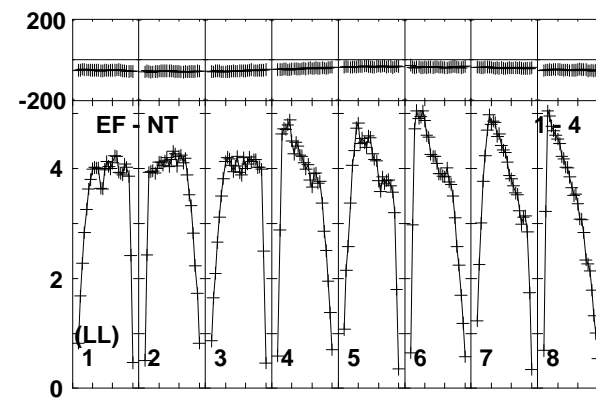
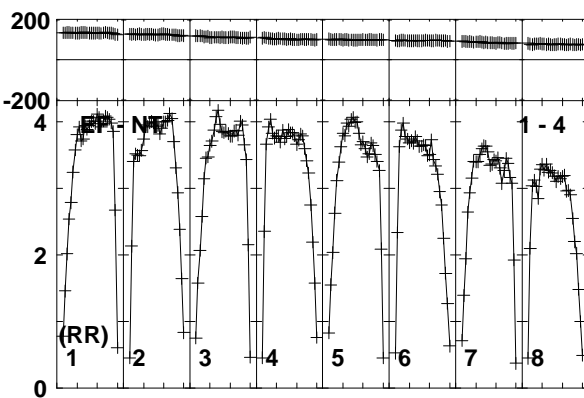
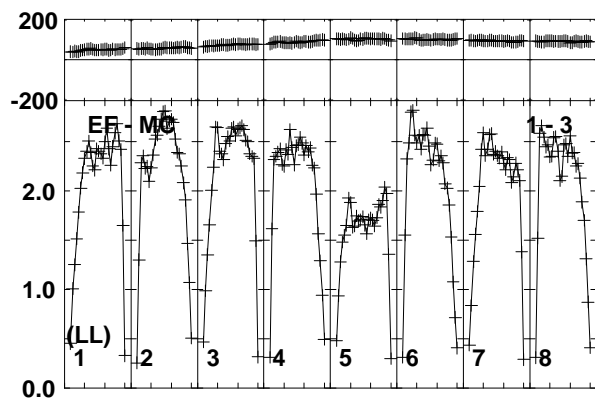
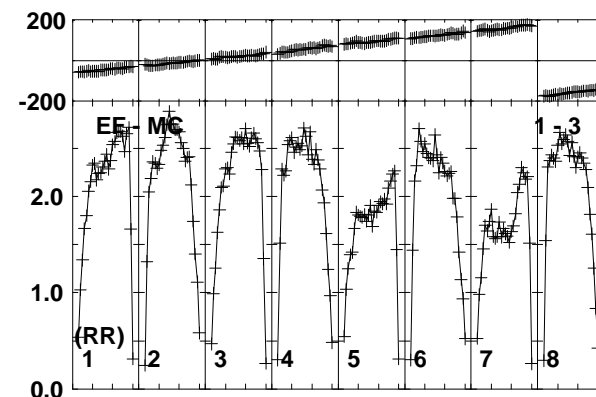
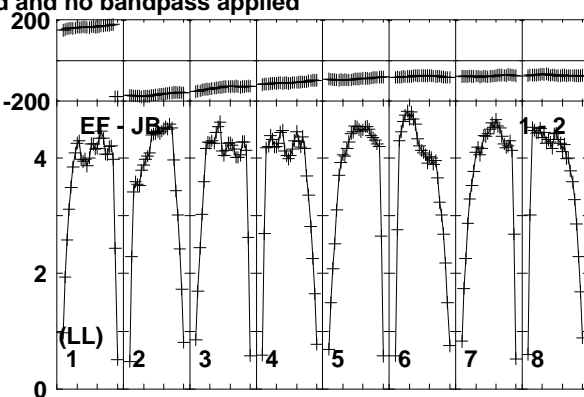
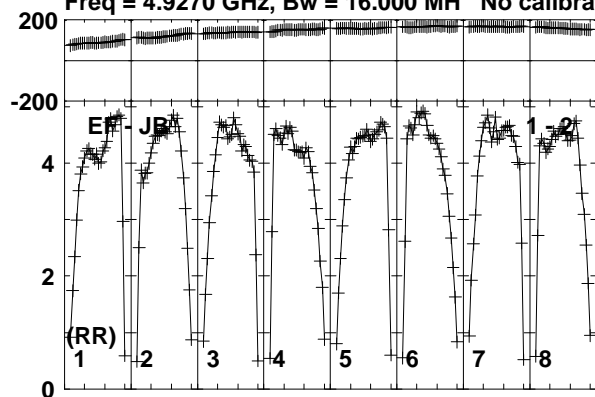

Lower frame: Milli Ampl Jy Top frame: Phas deg
Vector averaged cross-power spectrum Baseline: EF (01) - JB (02)
Timerange: 00/13:51:40 to 00/13:52:59

Plot file version 146 created 10-JUN-2016 16:08:02

J0718-1813 RG008D.UVDATA.1

Freq = 4.9270 GHz, Bw = 16.000 MH No calibration applied and no bandpass applied

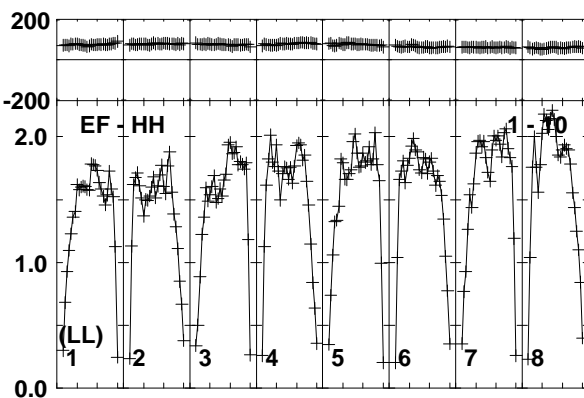
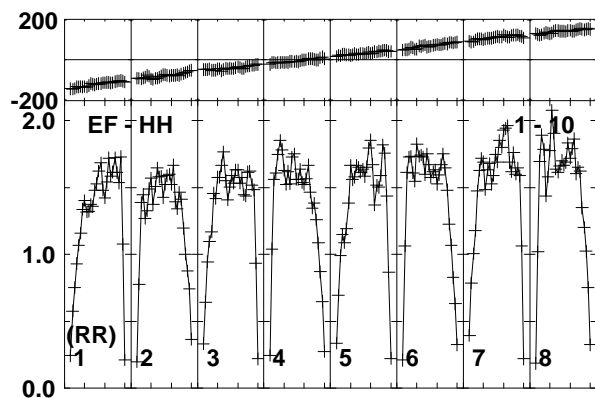
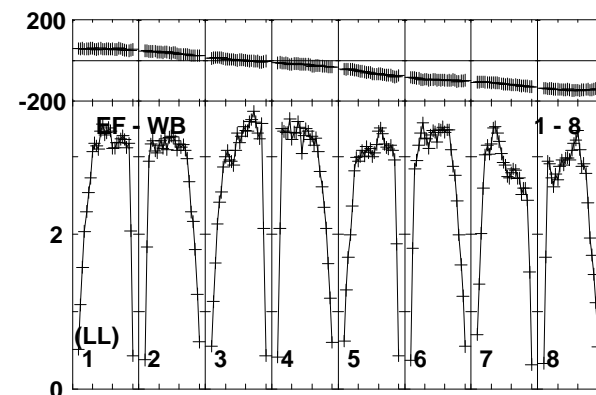
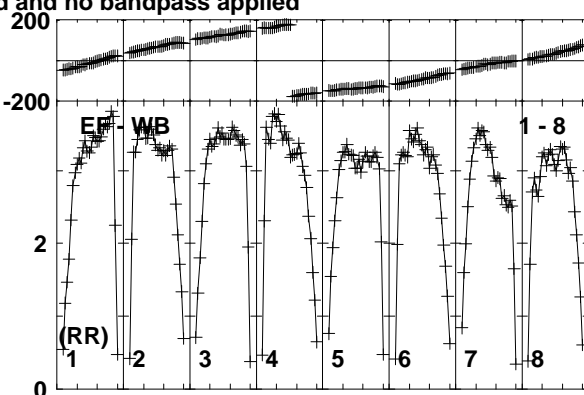
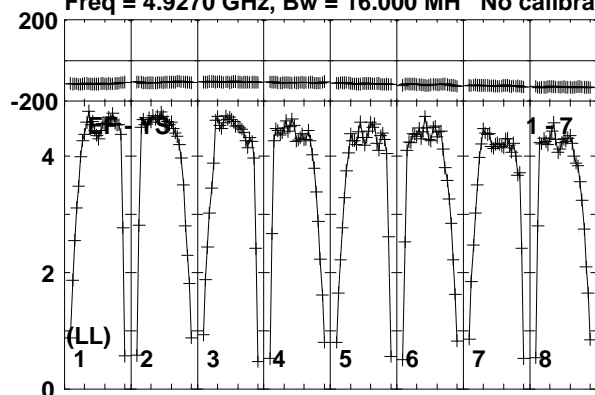

Lower frame: Milli Ampl Jy Top frame: Phas deg
Vector averaged cross-power spectrum Baseline: EF (01) - YS (07)
Timerange: 00/13:51:40 to 00/13:52:59

Plot file version 147 created 10-JUN-2016 16:08:03

FRB150418 RG008D.UVDATA.1

Freq = 4.9270 GHz, Bw = 16.000 MH No calibration applied and no bandpass applied

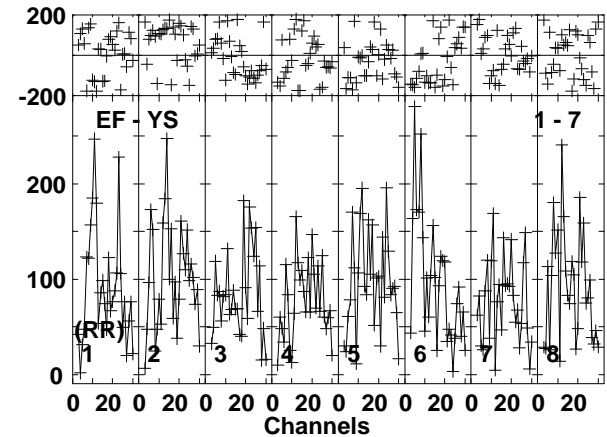
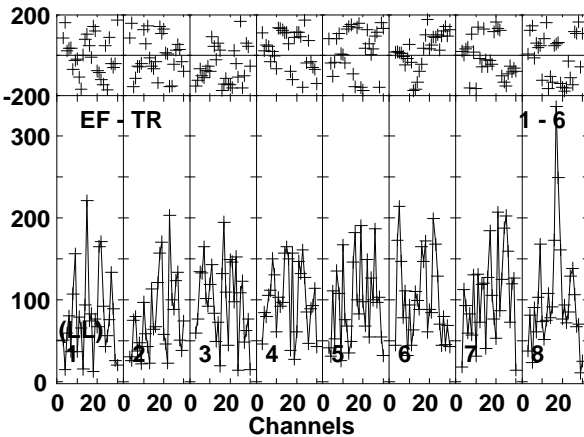
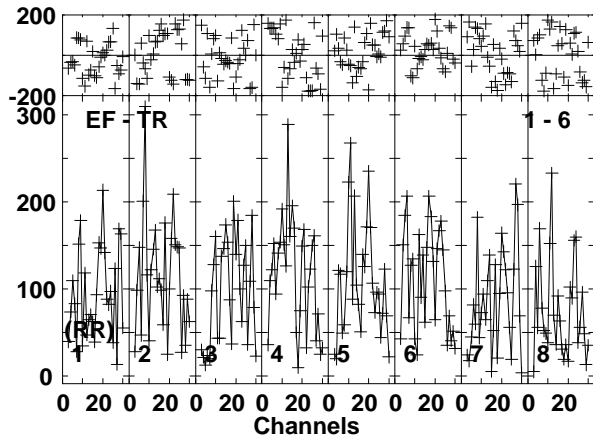
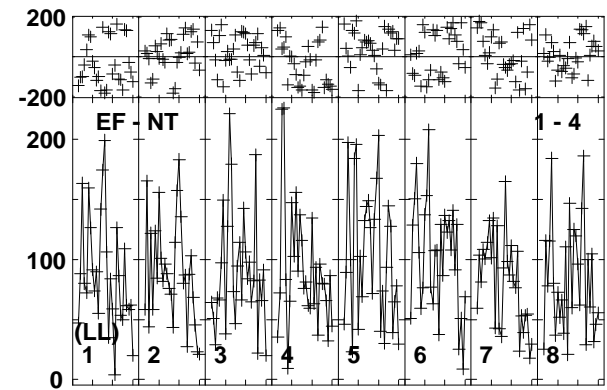
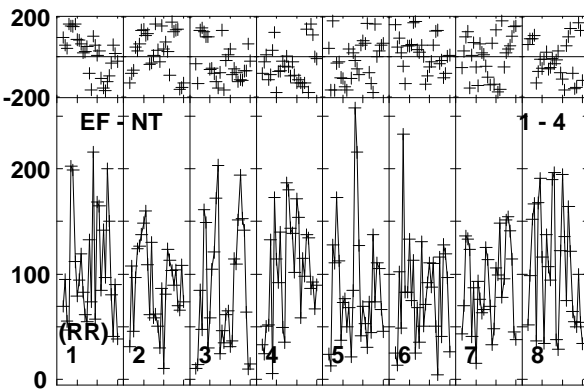
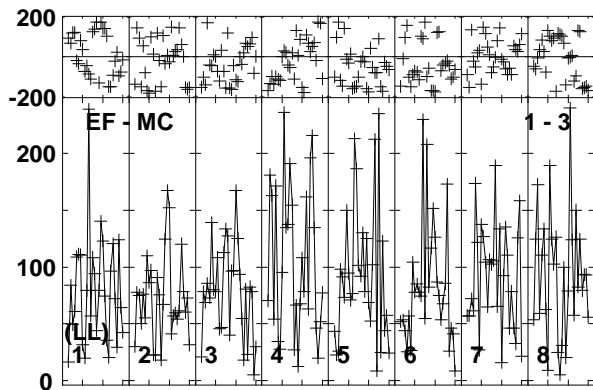
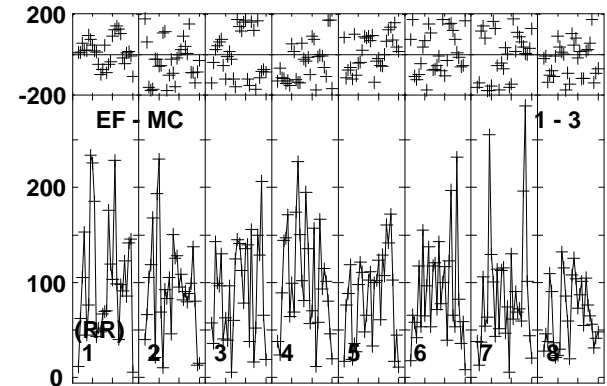
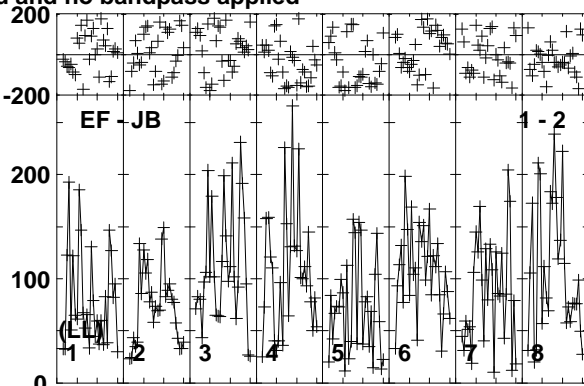
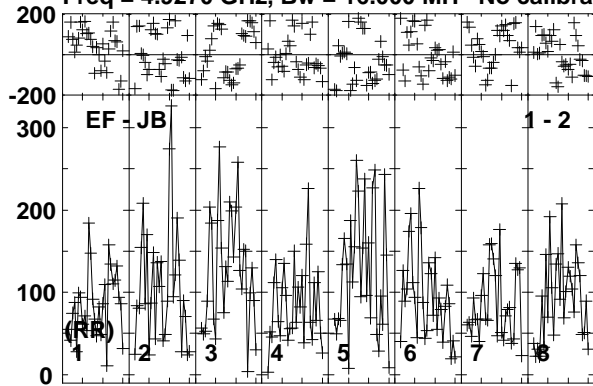

Lower frame: Micro Ampl Jy Top frame: Phas deg
Vector averaged cross-power spectrum Baseline: EF (01) - JB (02)
Timerange: 00/13:53:01 to 00/13:56:00

Plot file version 148 created 10-JUN-2016 16:08:03

FRB150418 RG008D.UVDATA.1

Freq = 4.9270 GHz, Bw = 16.000 MH No calibration applied and no bandpass applied

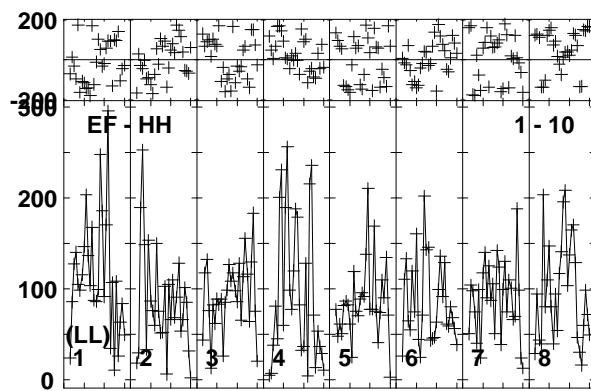
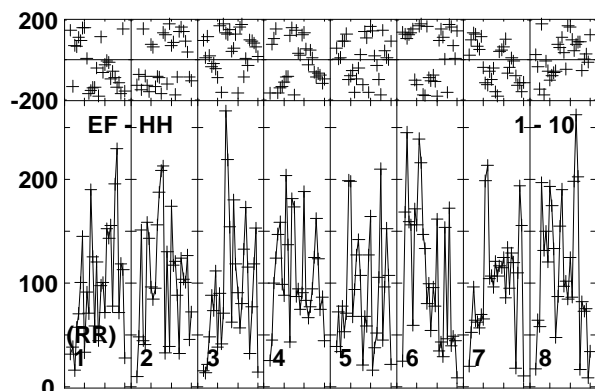
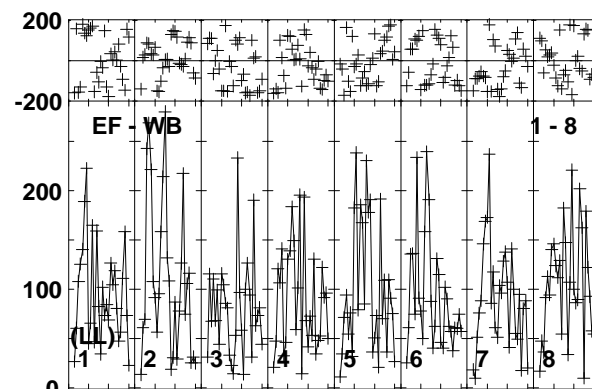
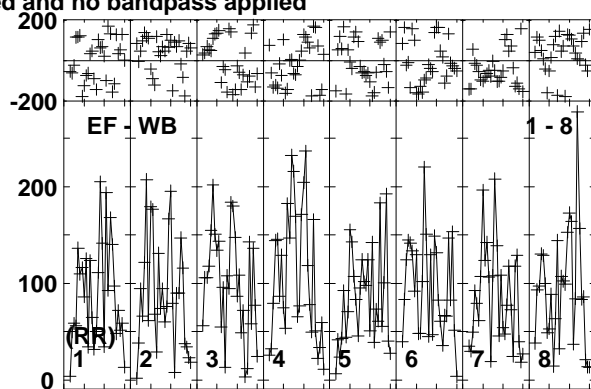
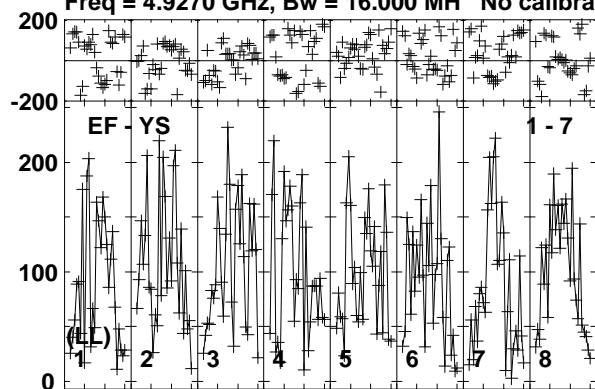

Lower frame: Micro Ampl Jy Top frame: Phas deg
Vector averaged cross-power spectrum Baseline: EF (01) - YS (07)
Timerange: 00/13:53:01 to 00/13:56:00

Plot file version 149 created 10-JUN-2016 16:08:03

J0718-1813 RG008D.UVDATA.1

Freq = 4.9270 GHz, Bw = 16.000 MH No calibration applied and no bandpass applied

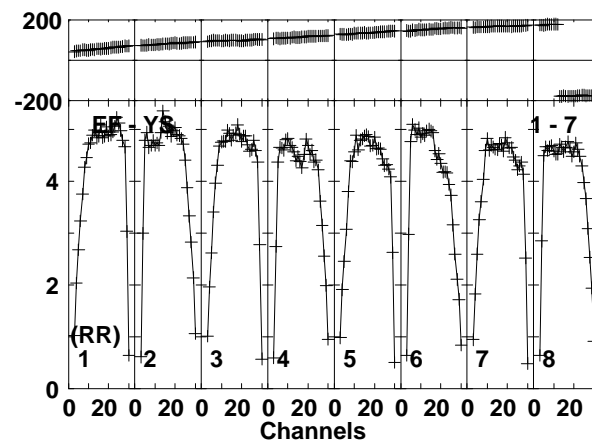
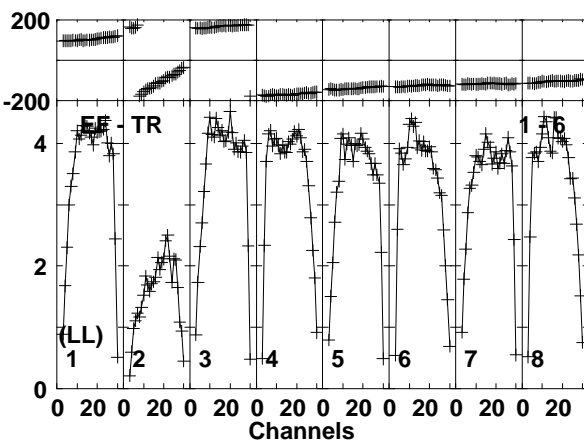
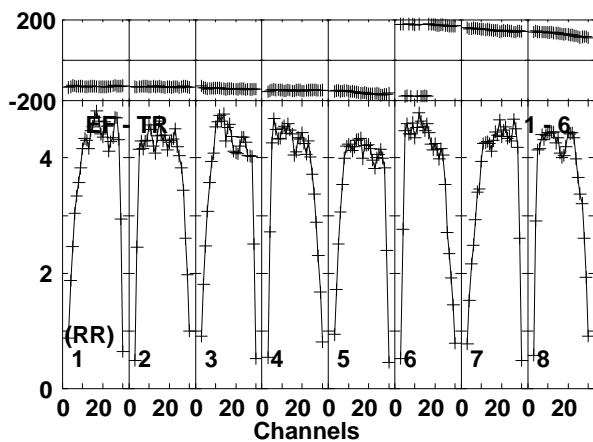
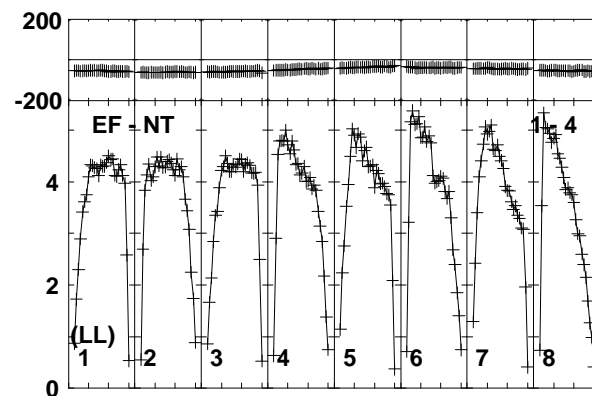
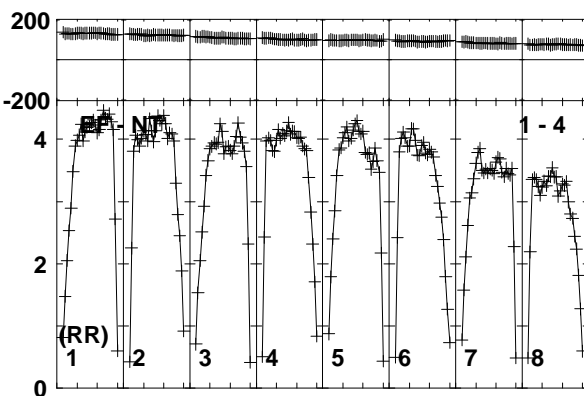
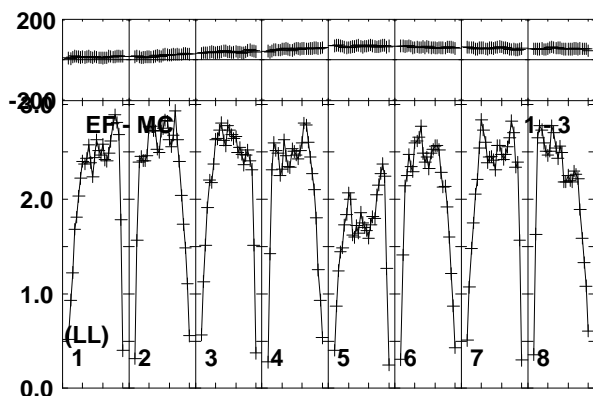
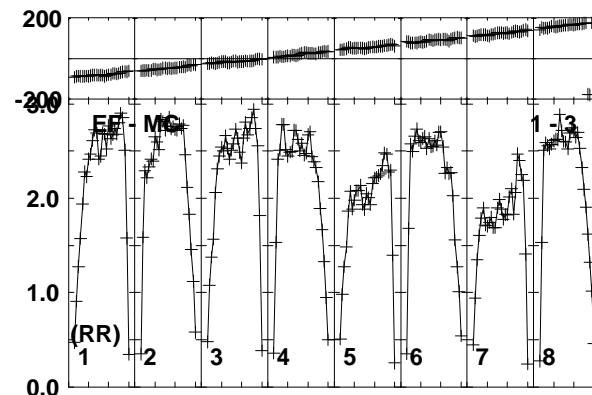
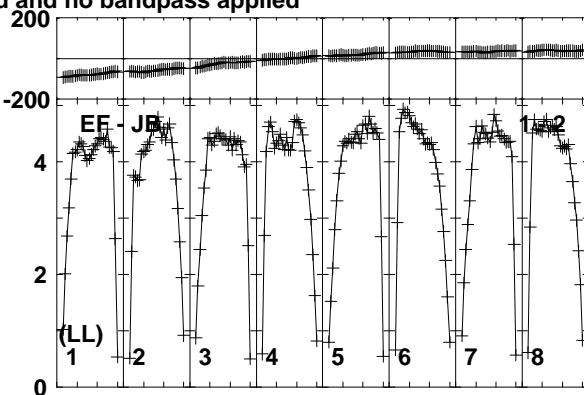
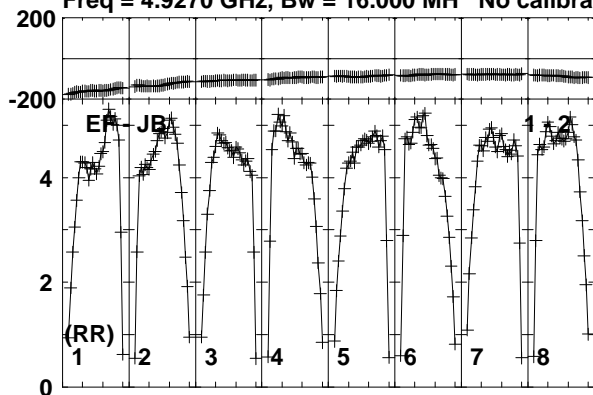

Lower frame: Milli Ampl Jy Top frame: Phas deg
Vector averaged cross-power spectrum Baseline: EF (01) - JB (02)
Timerange: 00/13:56:00 to 00/13:57:30

Plot file version 150 created 10-JUN-2016 16:08:03

J0718-1813 RG008D.UVDATA.1

Freq = 4.9270 GHz, Bw = 16.000 MH No calibration applied and no bandpass applied

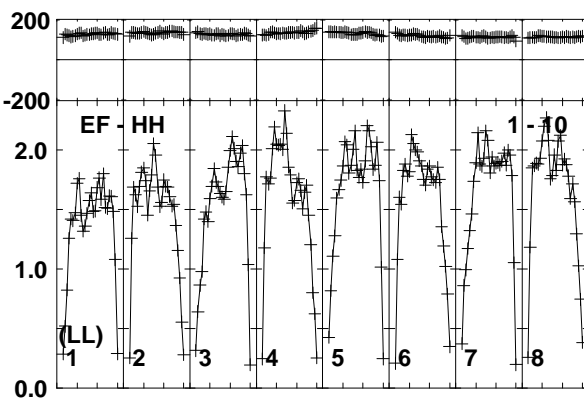
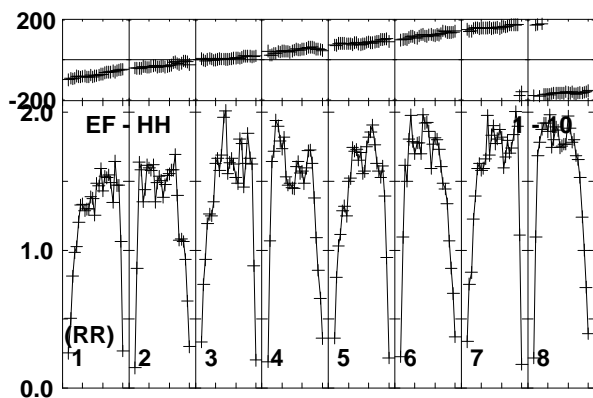
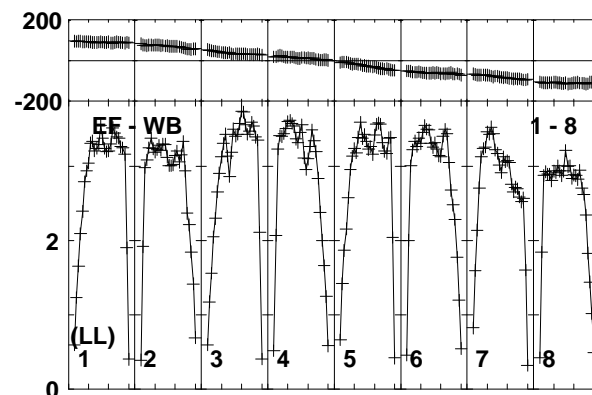
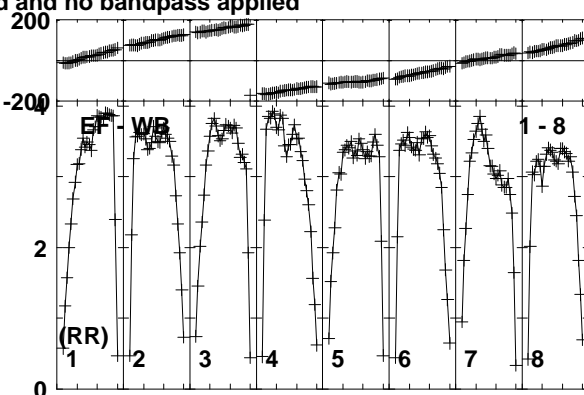
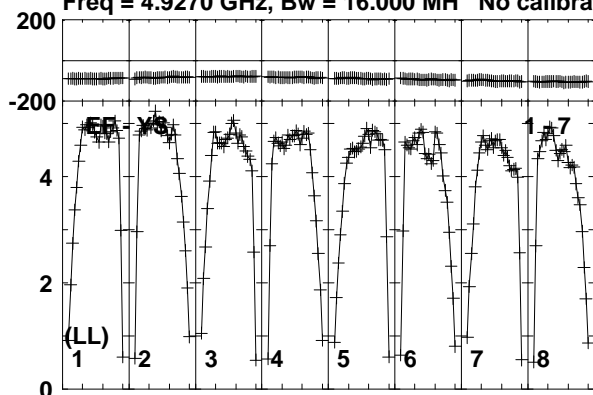

Lower frame: Milli Ampl Jy Top frame: Phas deg
Vector averaged cross-power spectrum Baseline: EF (01) - YS (07)
Timerange: 00/13:56:00 to 00/13:57:30

Plot file version 151 created 10-JUN-2016 16:08:03

J0716-1900 RG008D.UVDATA.1

Freq = 4.9270 GHz, Bw = 16.000 MH No calibration applied and no bandpass applied

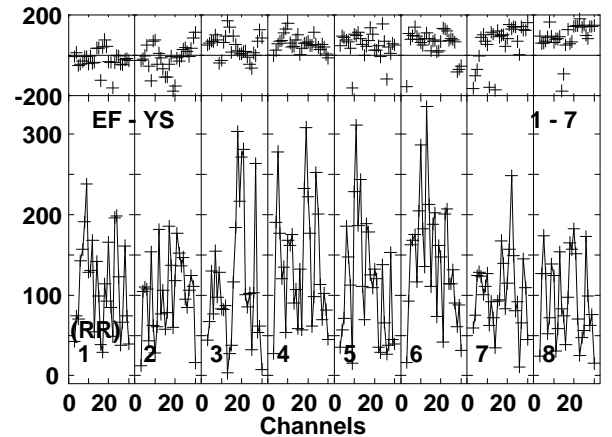
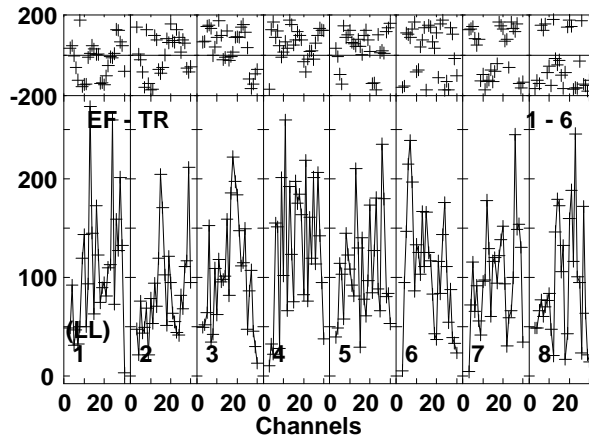
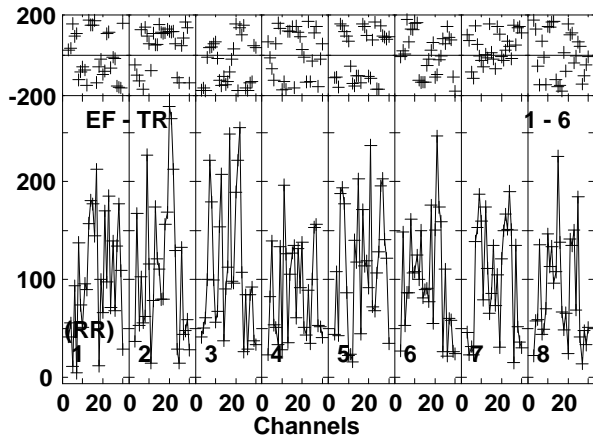
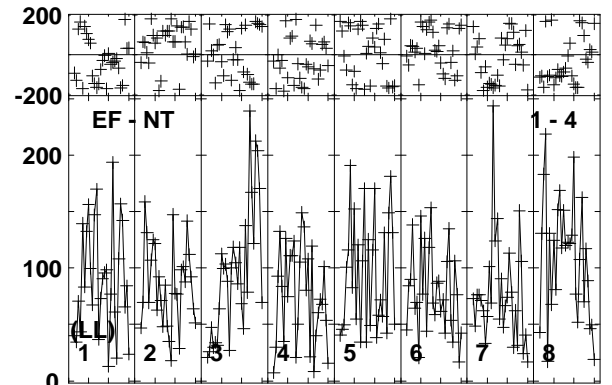
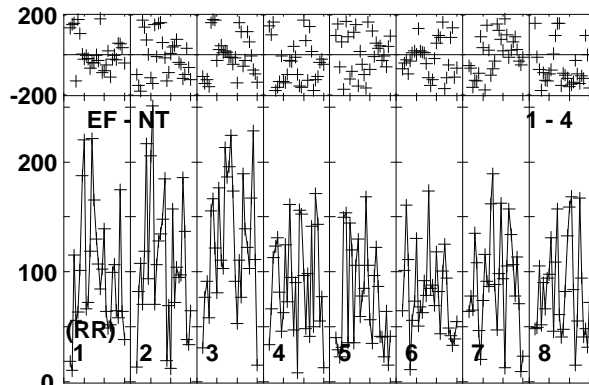
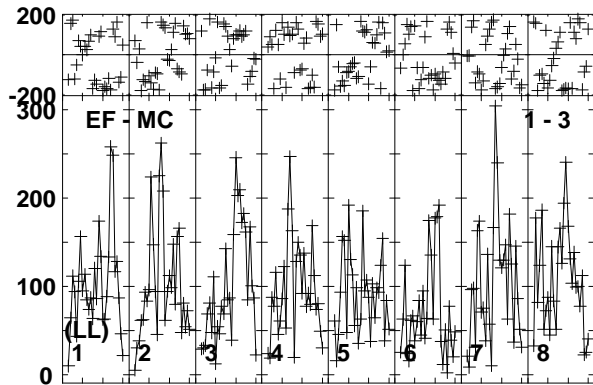
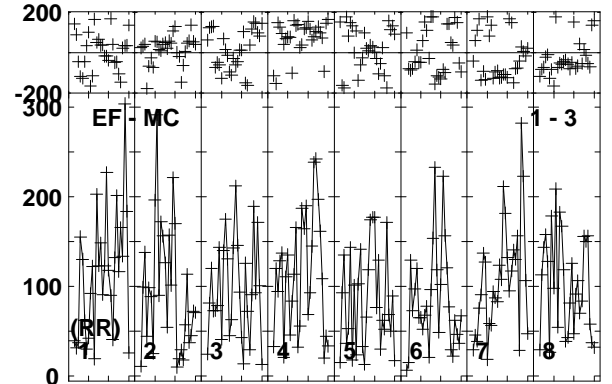
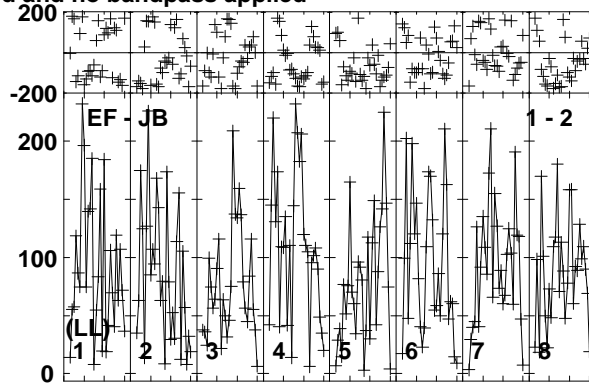
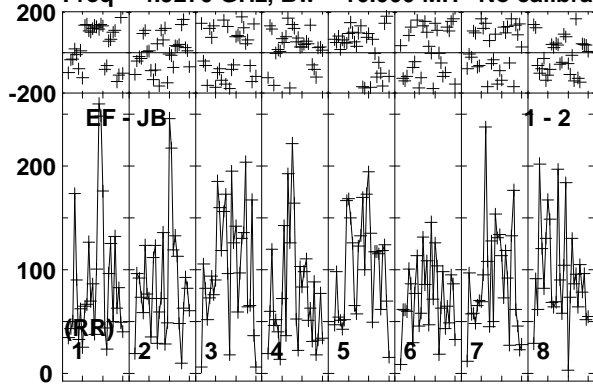

Lower frame: Micro Ampl Jy Top frame: Phas deg
Vector averaged cross-power spectrum Baseline: EF (01) - JB (02)
Timerange: 00/13:57:30 to 00/14:00:30

Plot file version 152 created 10-JUN-2016 16:08:03

J0716-1900 RG008D.UVDATA.1

Freq = 4.9270 GHz, Bw = 16.000 MH No calibration applied and no bandpass applied

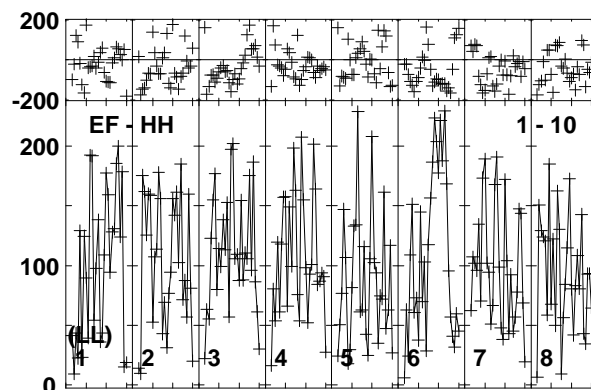
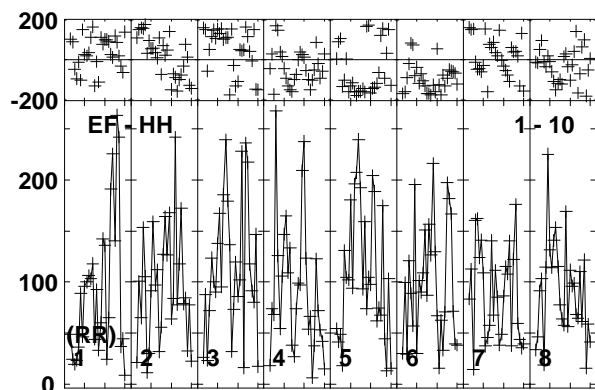
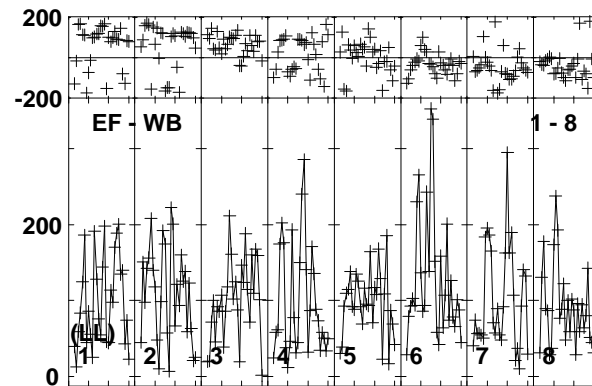
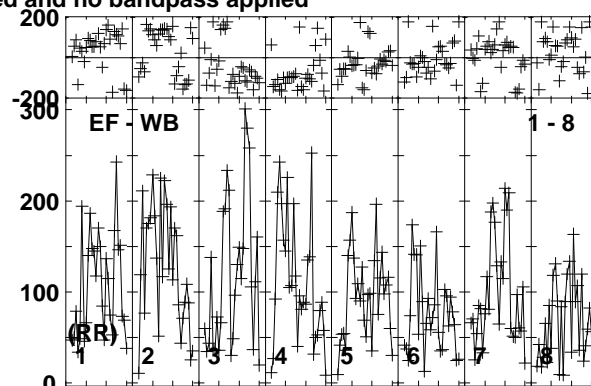
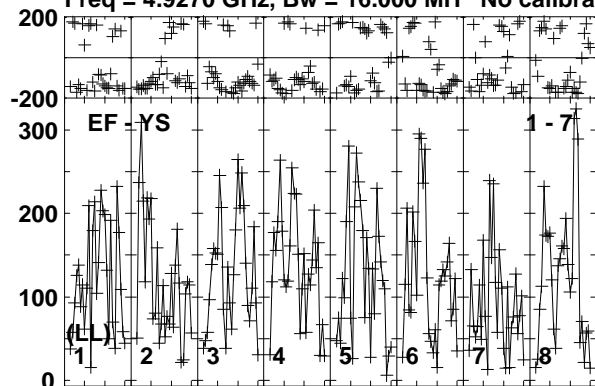

Lower frame: Micro Ampl Jy Top frame: Phas deg
Vector averaged cross-power spectrum Baseline: EF (01) - YS (07)
Timerange: 00/13:57:30 to 00/14:00:30

Plot file version 153 created 10-JUN-2016 16:08:03

J0718-1813 RG008D.UVDATA.1

Freq = 4.9270 GHz, Bw = 16.000 MH No calibration applied and no bandpass applied

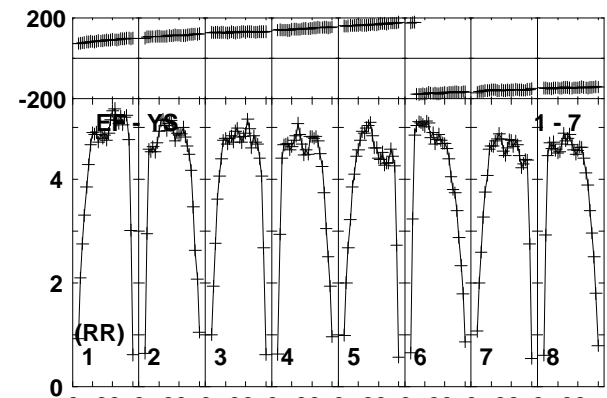
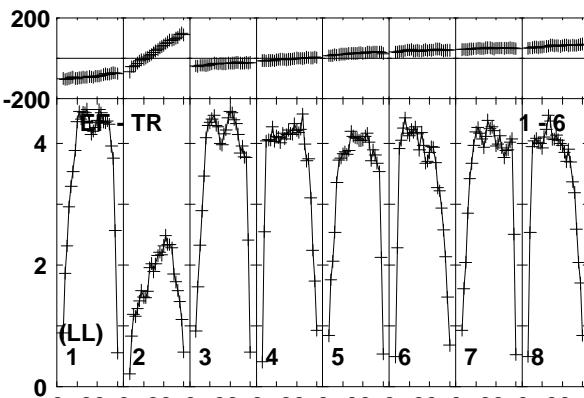
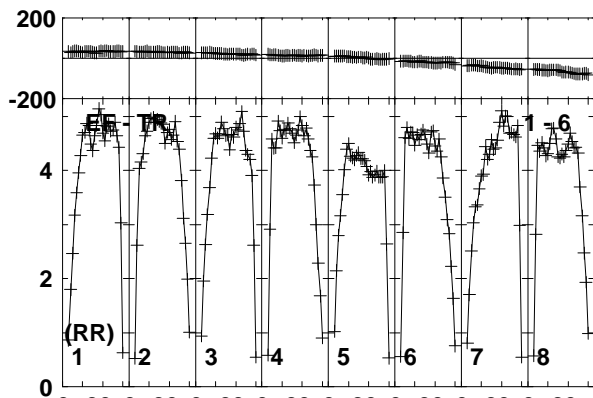
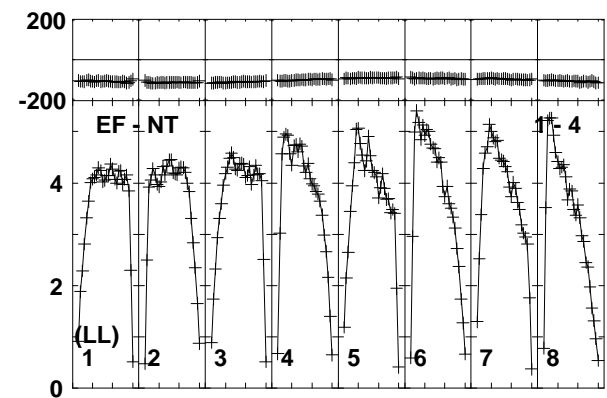
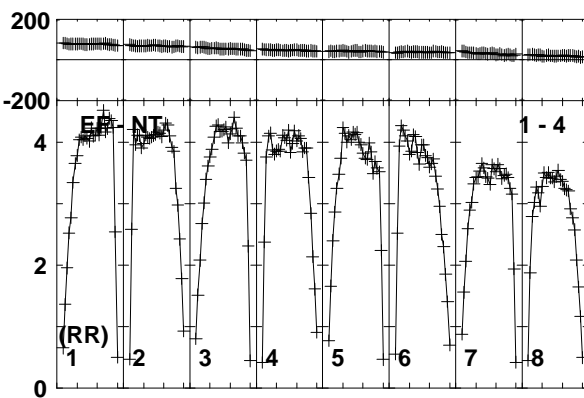
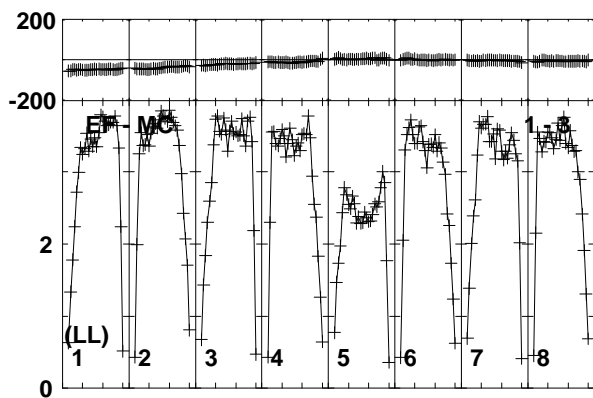
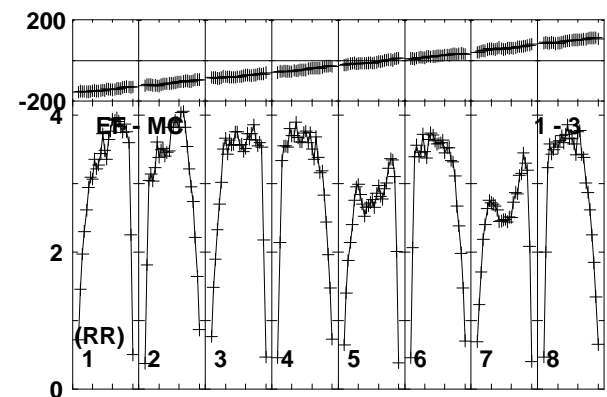
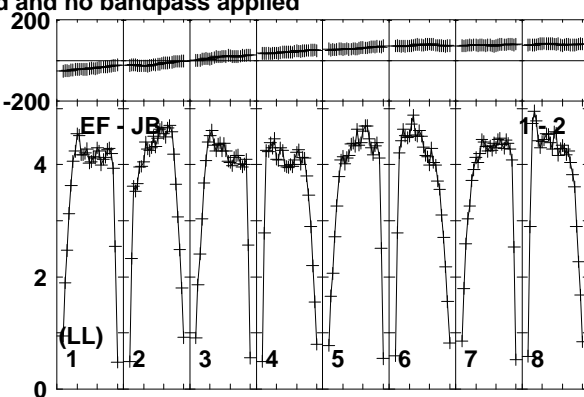
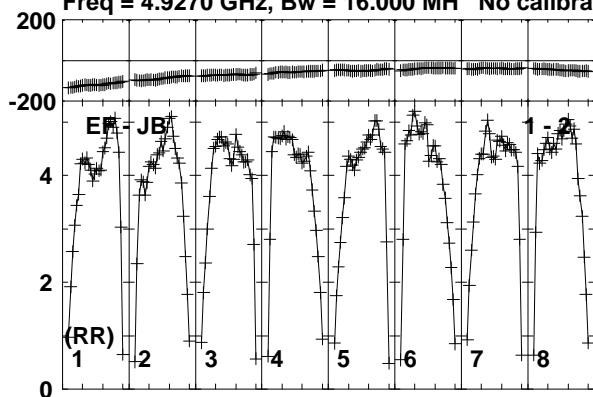

Lower frame: Milli Ampl Jy Top frame: Phas deg
Vector averaged cross-power spectrum Baseline: EF (01) - JB (02)
Timerange: 00/14:01:10 to 00/14:02:00

Plot file version 154 created 10-JUN-2016 16:08:04

J0718-1813 RG008D.UVDATA.1

Freq = 4.9270 GHz, Bw = 16.000 MH No calibration applied and no bandpass applied

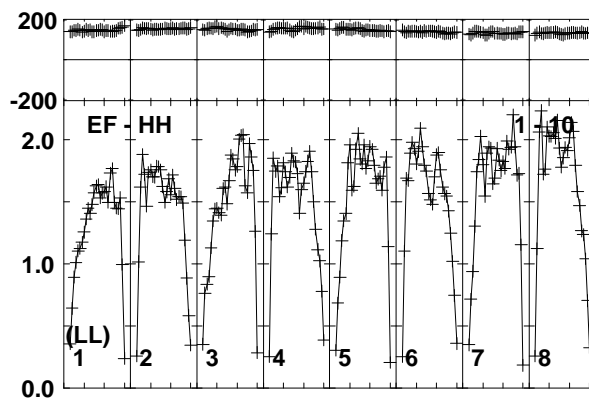
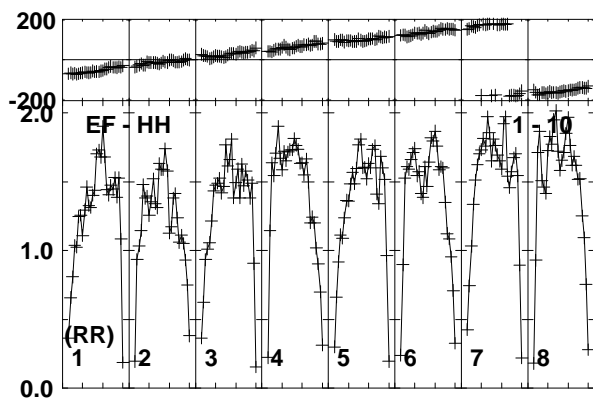
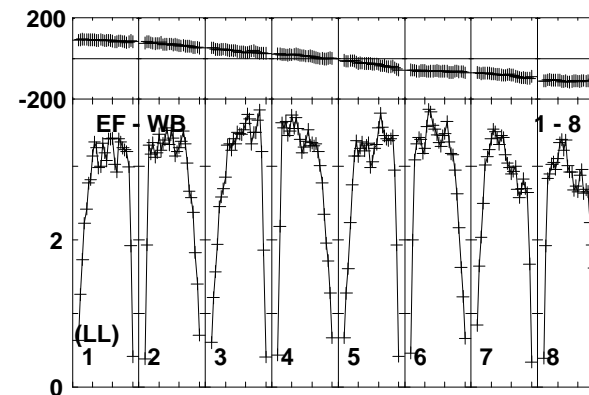
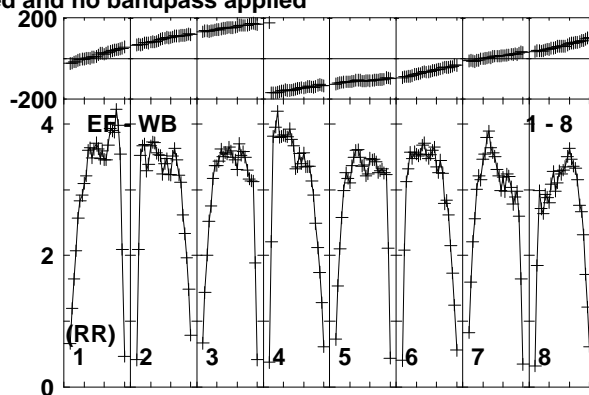
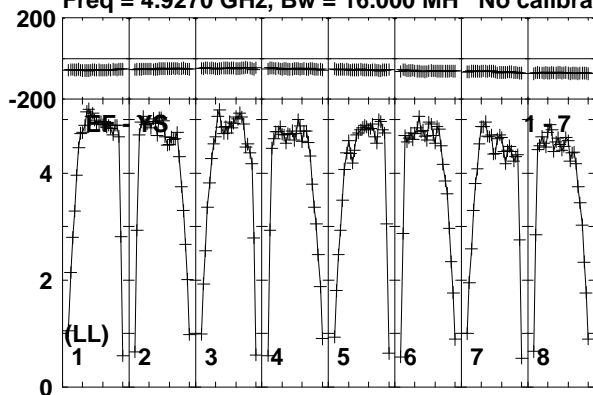

Lower frame: Milli Ampl Jy Top frame: Phas deg
Vector averaged cross-power spectrum Baseline: EF (01) - YS (07)
Timerange: 00/14:01:10 to 00/14:02:00

Plot file version 155 created 10-JUN-2016 16:08:04
 0528+134 RG008D.UVDATA.1

Freq = 4.9270 GHz, Bw = 16.000 MH No calibration applied and no bandpass applied

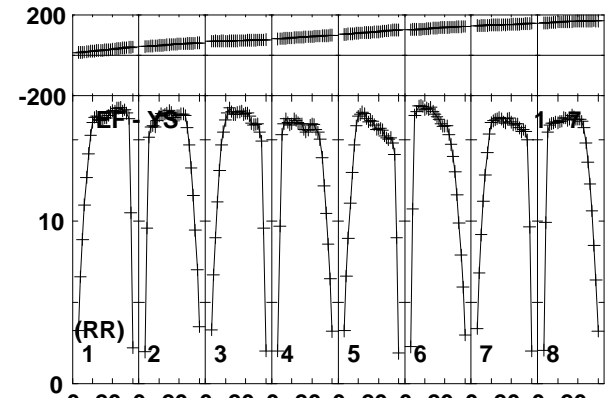
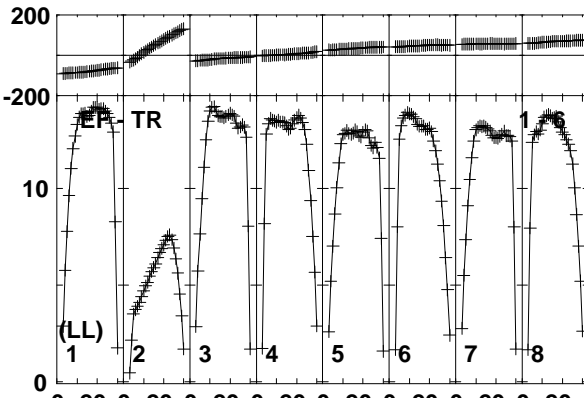
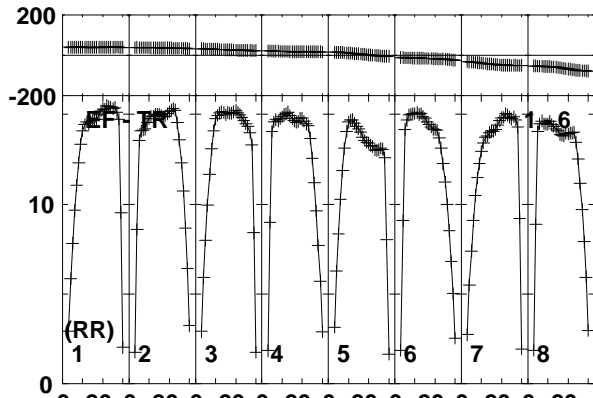
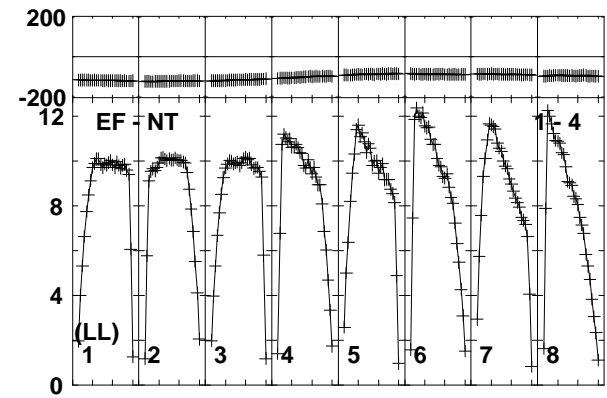
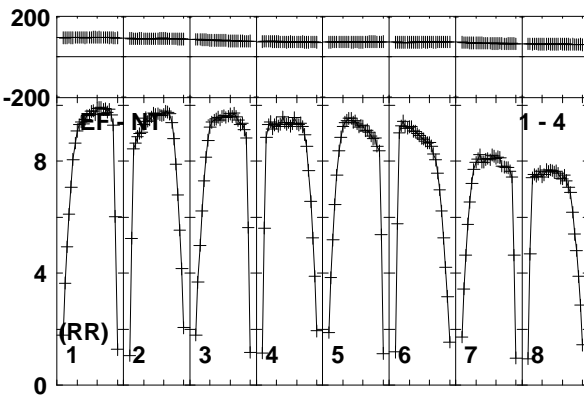
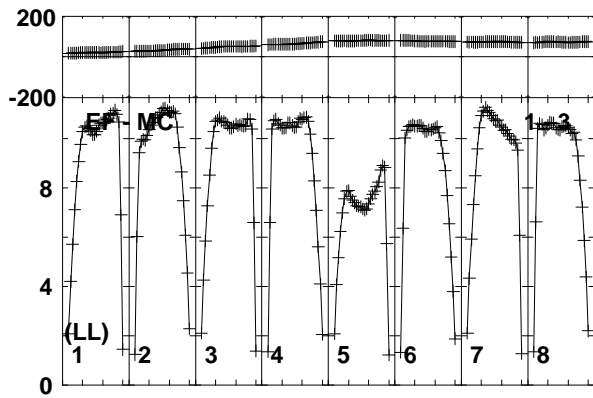
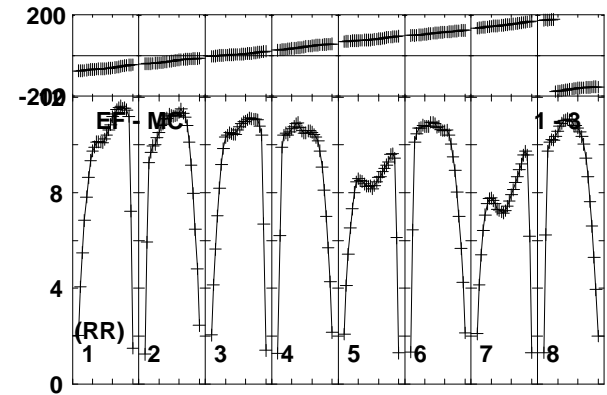
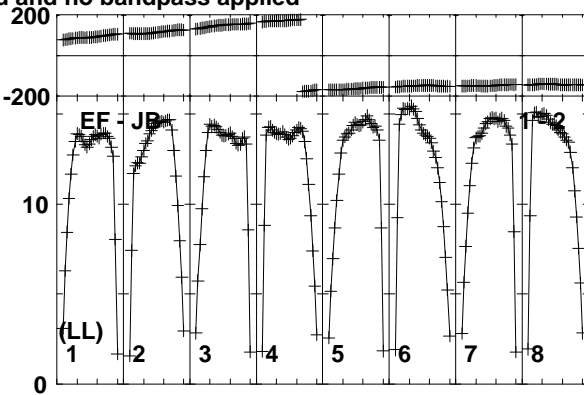
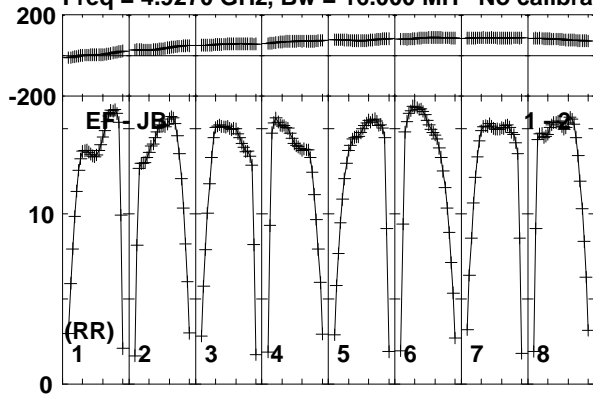

Lower frame: Milli Ampl Jy Top frame: Phas deg
 Vector averaged cross-power spectrum Baseline: EF (01) - JB (02)
 Timerange: 00/14:04:40 to 00/14:12:09

Plot file version 156 created 10-JUN-2016 16:08:04

0528+134 RG008D.UVDATA.1

Freq = 4.9270 GHz, Bw = 16.000 MH No calibration applied and no bandpass applied

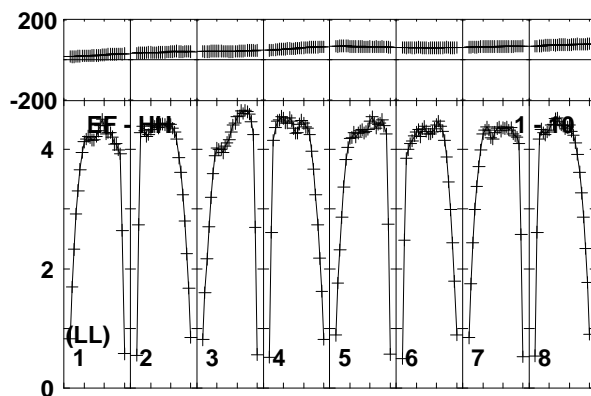
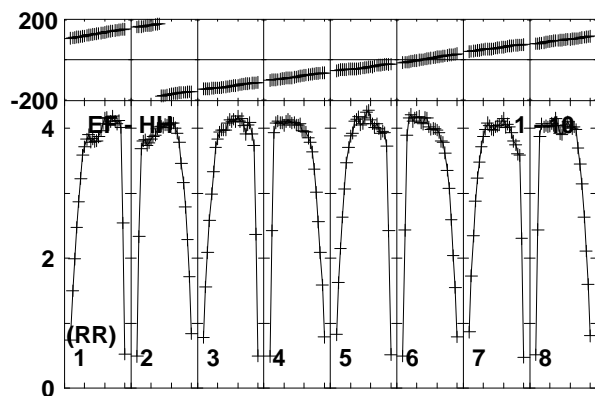
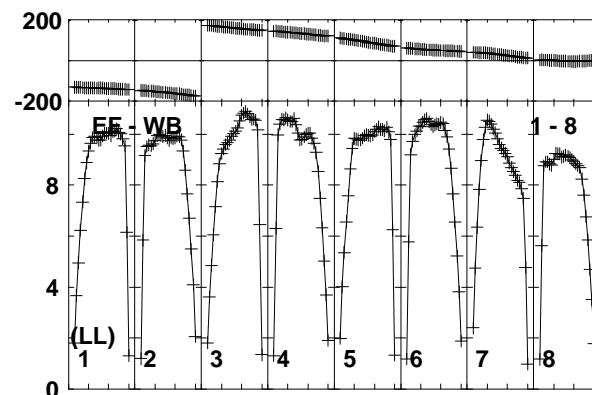
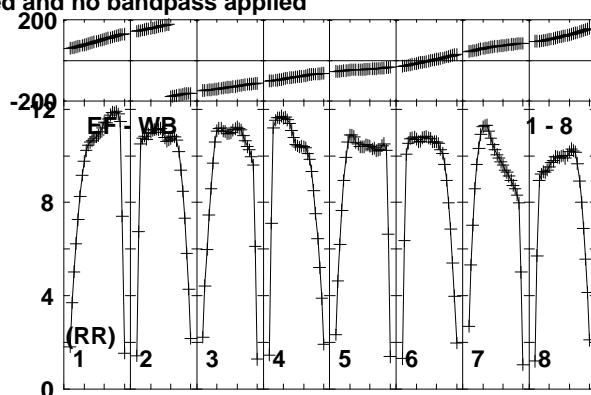
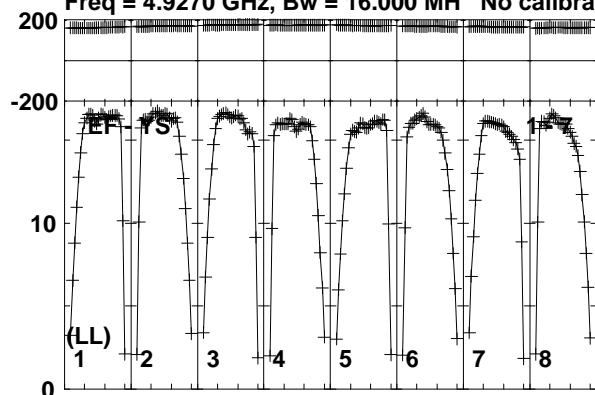

Lower frame: Milli Ampl Jy Top frame: Phas deg
Vector averaged cross-power spectrum Baseline: EF (01) - YS (07)
Timerange: 00/14:04:40 to 00/14:12:09

Plot file version 157 created 10-JUN-2016 16:08:04

FRB150418 RG008D.UVDATA.1

Freq = 4.9270 GHz, Bw = 16.000 MH No calibration applied and no bandpass applied

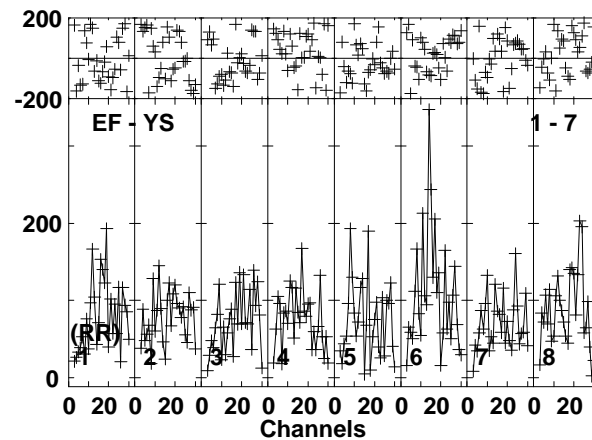
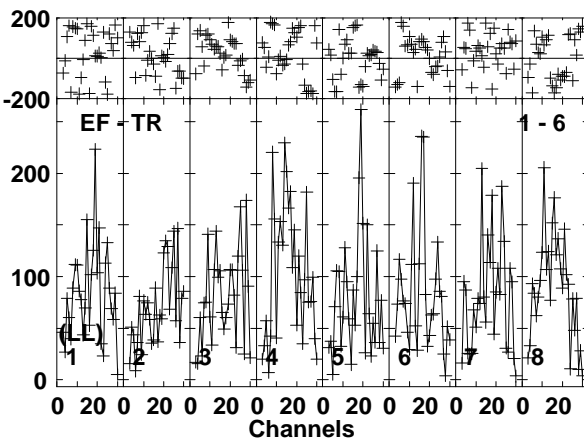
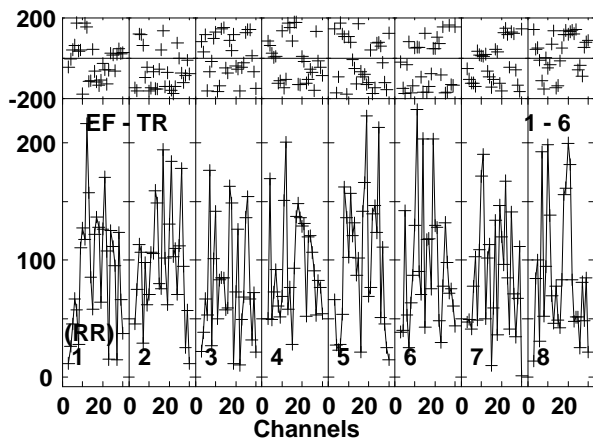
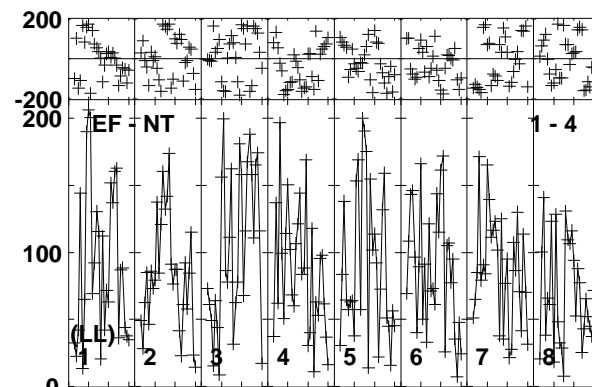
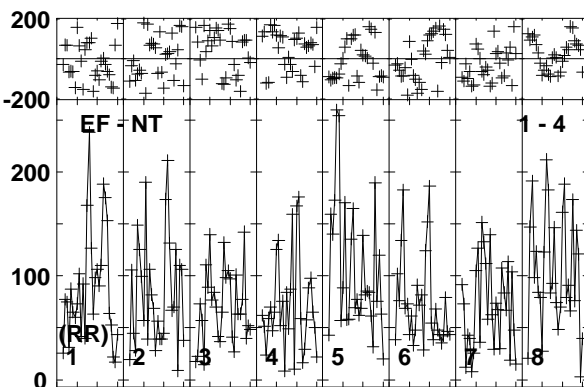
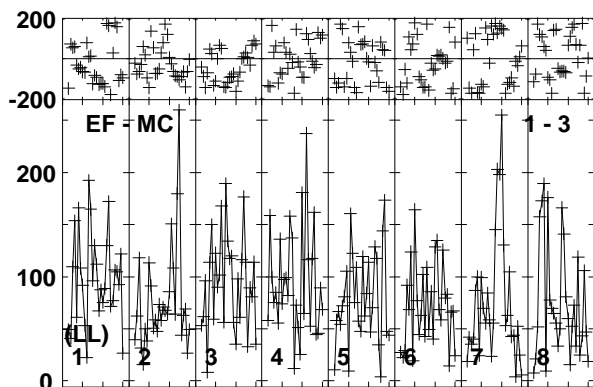
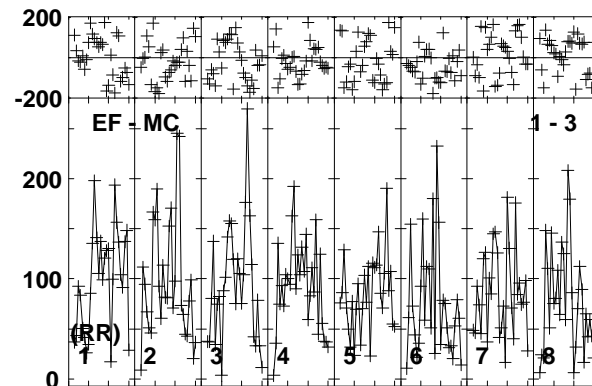
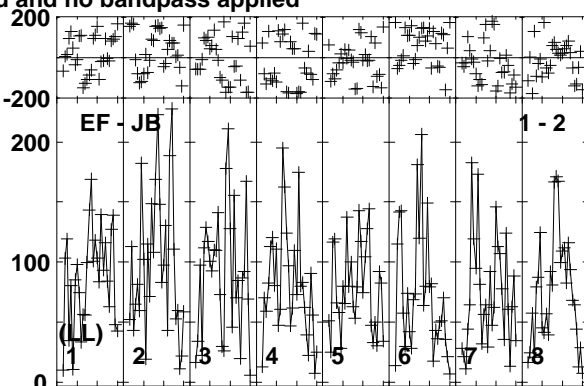
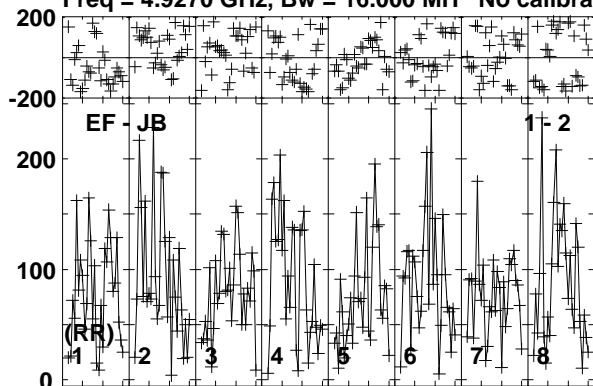

Lower frame: Micro Ampl Jy Top frame: Phas deg
Vector averaged cross-power spectrum Baseline: EF (01) - JB (02)
Timerange: 00/14:14:50 to 00/14:17:50

Plot file version 158 created 10-JUN-2016 16:08:05

FRB150418 RG008D.UVDATA.1

Freq = 4.9270 GHz, Bw = 16.000 MH No calibration applied and no bandpass applied

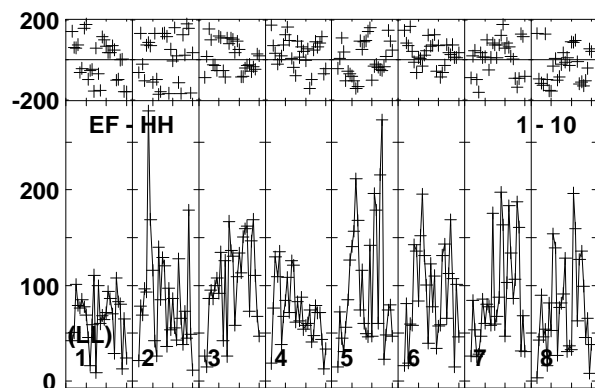
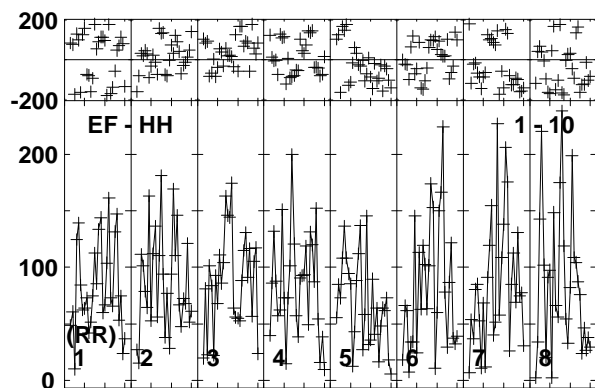
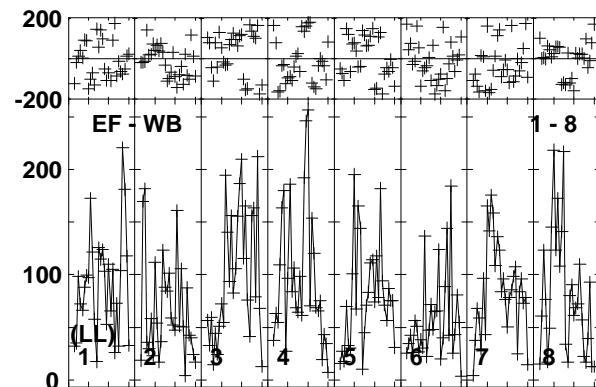
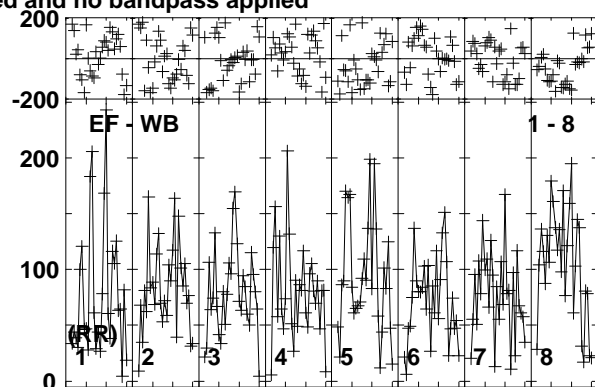
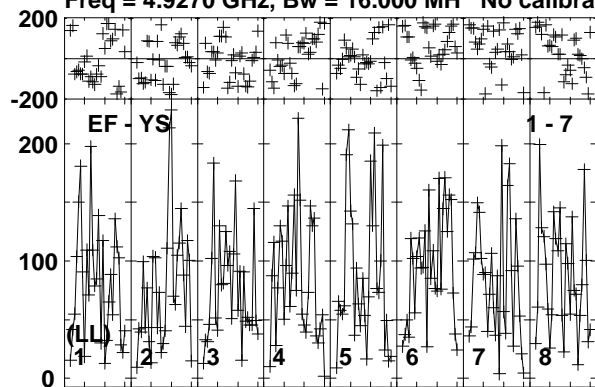

Lower frame: Micro Ampl Jy Top frame: Phas deg
Vector averaged cross-power spectrum Baseline: EF (01) - YS (07)
Timerange: 00/14:14:50 to 00/14:17:50

Plot file version 159 created 10-JUN-2016 16:08:05

J0718-1813 RG008D.UVDATA.1

Freq = 4.9270 GHz, Bw = 16.000 MH No calibration applied and no bandpass applied

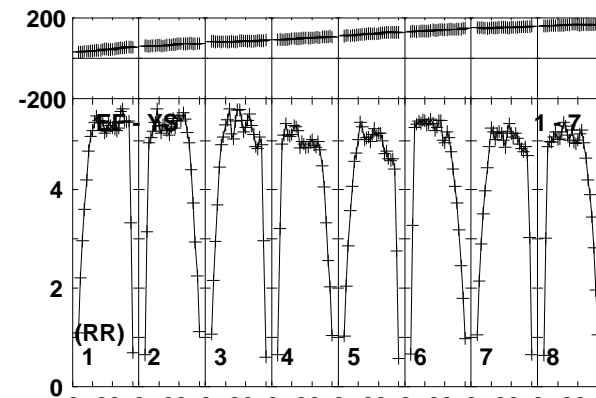
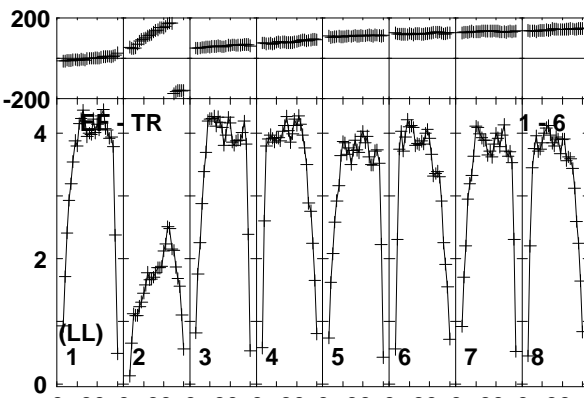
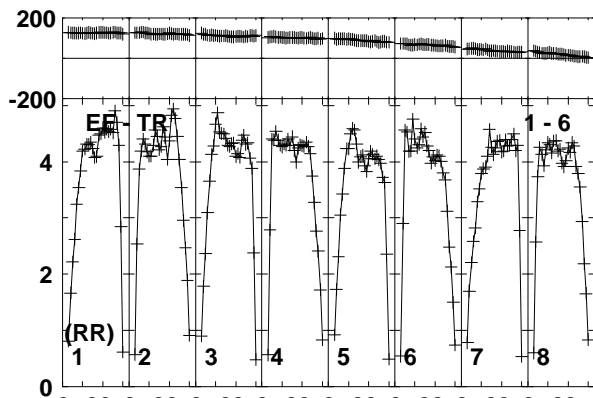
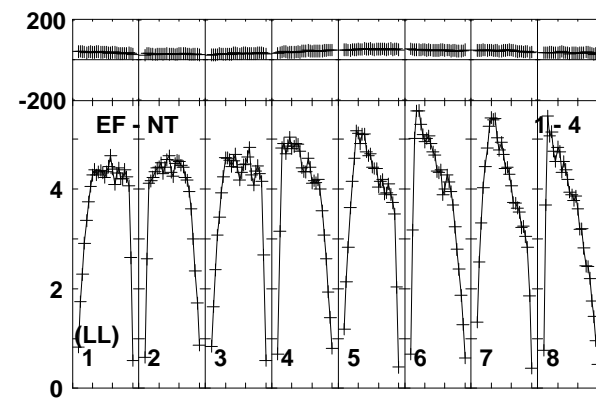
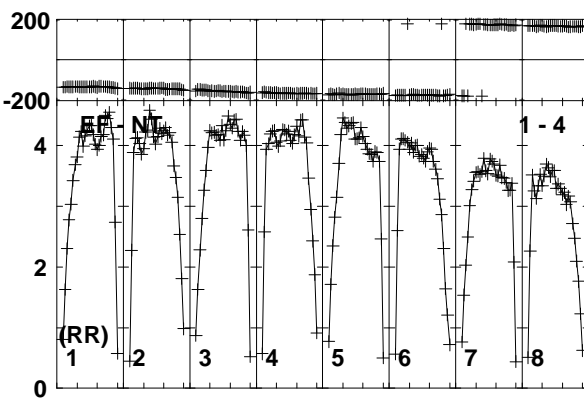
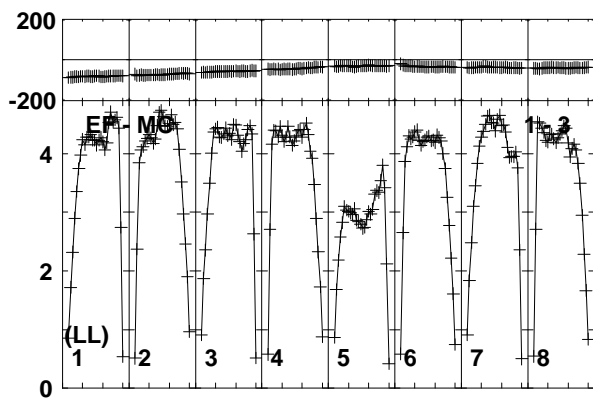
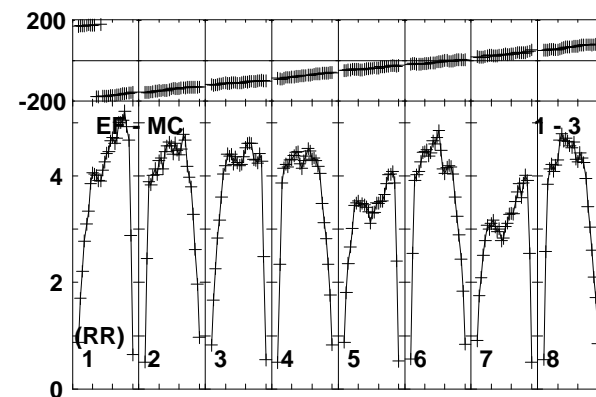
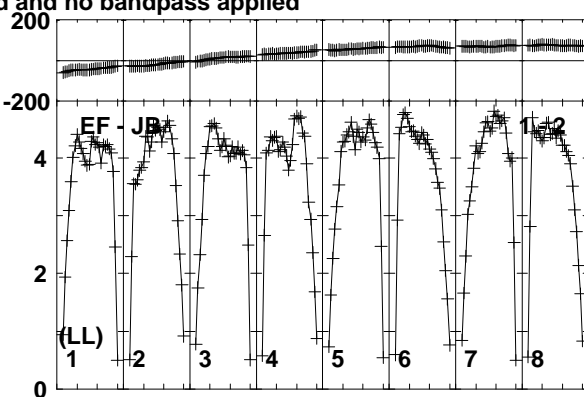
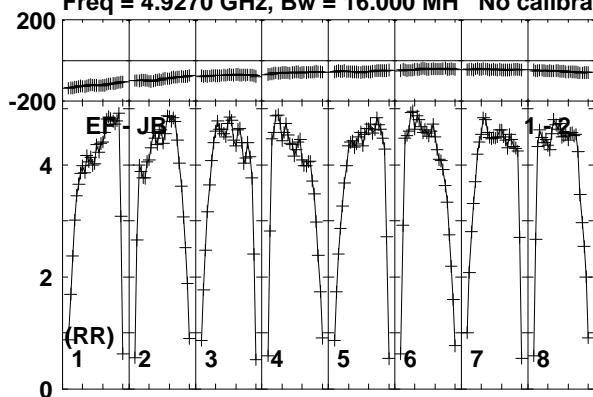

Lower frame: Milli Ampl Jy Top frame: Phas deg
Vector averaged cross-power spectrum Baseline: EF (01) - JB (02)
Timerange: 00/14:17:51 to 00/14:19:20

Plot file version 160 created 10-JUN-2016 16:08:05

J0718-1813 RG008D.UVDATA.1

Freq = 4.9270 GHz, Bw = 16.000 MH No calibration applied and no bandpass applied

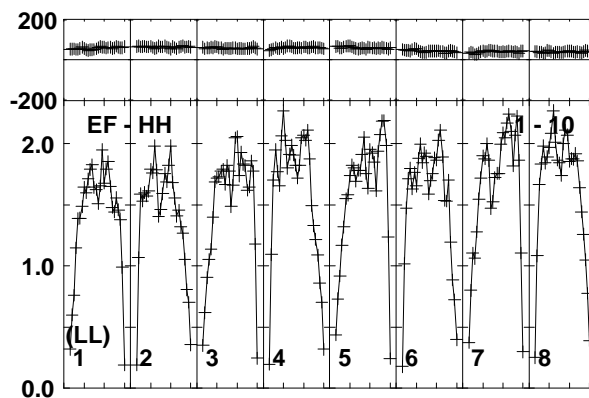
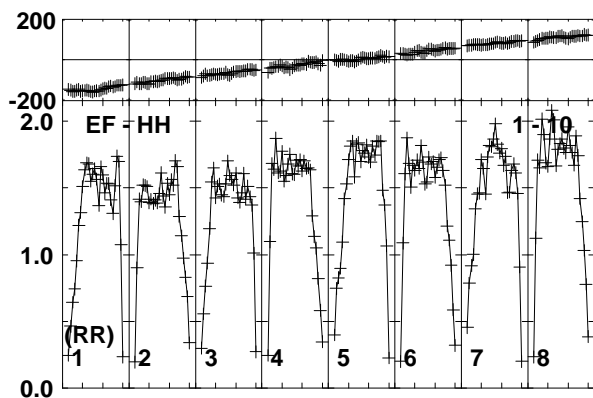
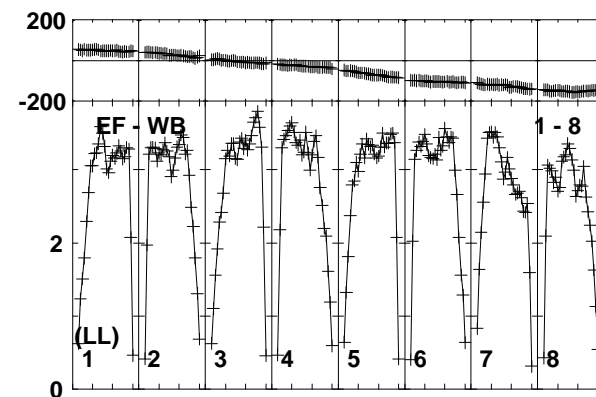
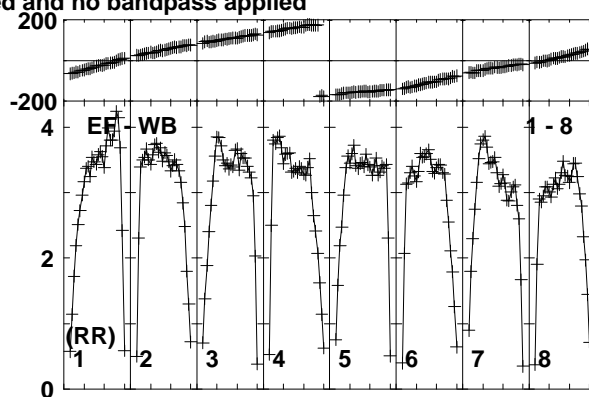
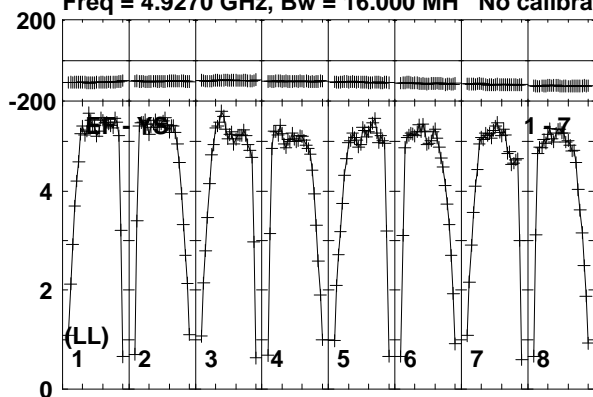

Lower frame: Milli Ampl Jy Top frame: Phas deg
Vector averaged cross-power spectrum Baseline: EF (01) - YS (07)
Timerange: 00/14:17:51 to 00/14:19:20

Plot file version 161 created 10-JUN-2016 16:08:05

FRB150418 RG008D.UVDATA.1

Freq = 4.9270 GHz, Bw = 16.000 MH No calibration applied and no bandpass applied

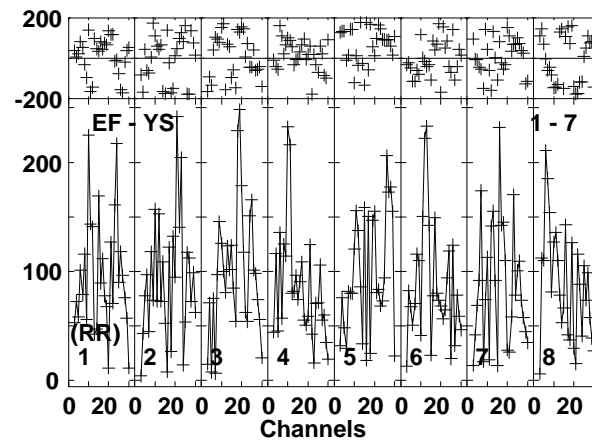
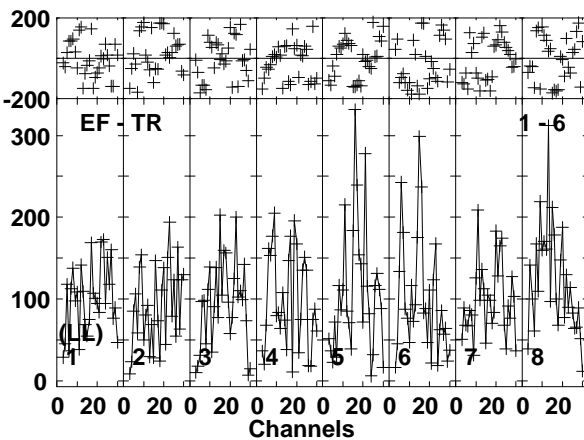
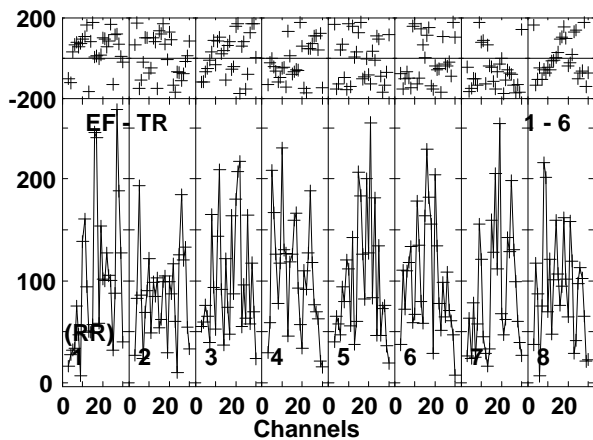
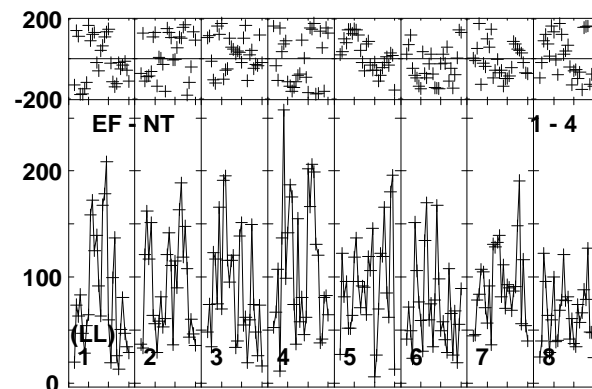
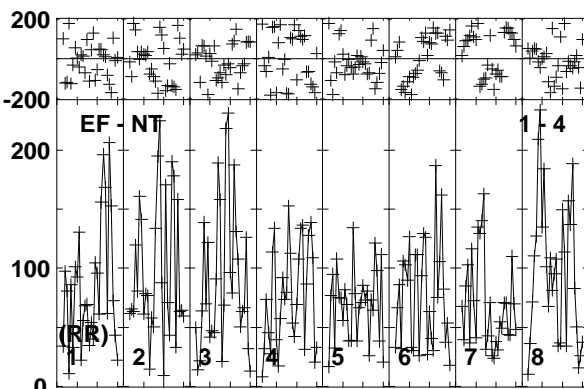
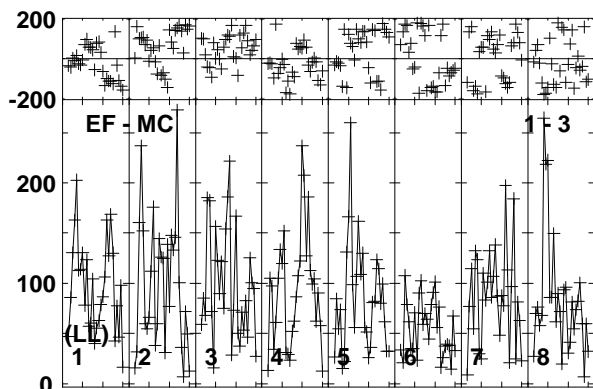
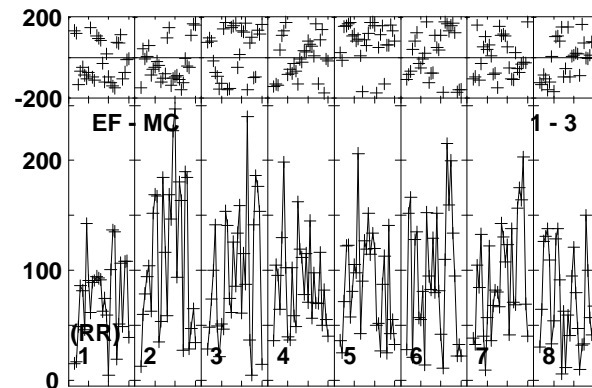
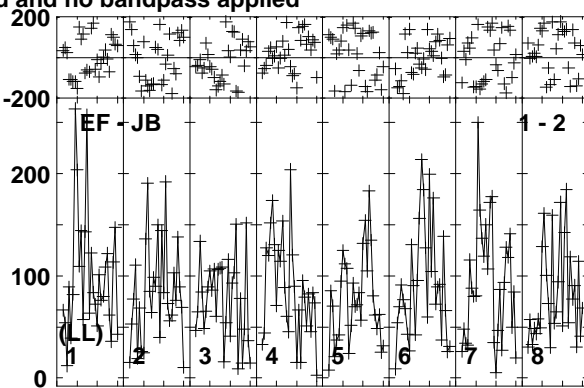
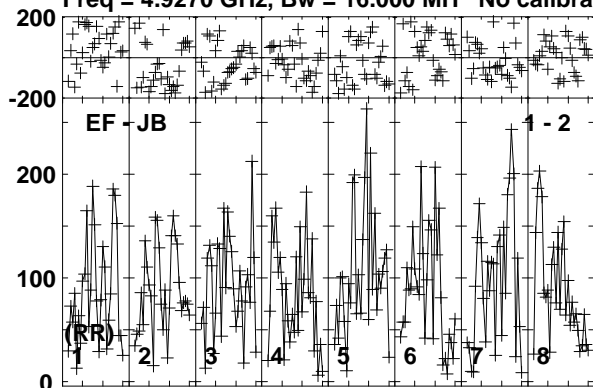

Lower frame: Micro Ampl Jy Top frame: Phas deg
Vector averaged cross-power spectrum Baseline: EF (01) - JB (02)
Timerange: 00/14:19:20 to 00/14:22:19

Plot file version 162 created 10-JUN-2016 16:08:05

FRB150418 RG008D.UVDATA.1

Freq = 4.9270 GHz, Bw = 16.000 MH No calibration applied and no bandpass applied

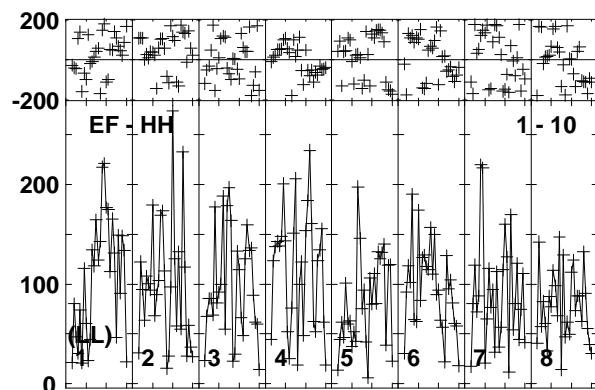
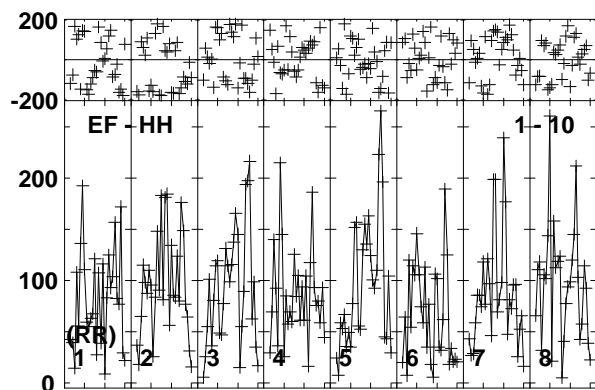
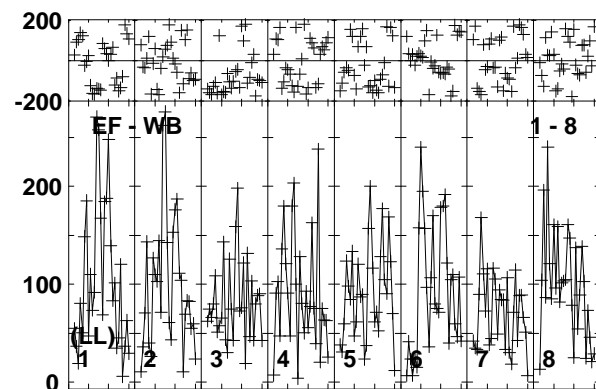
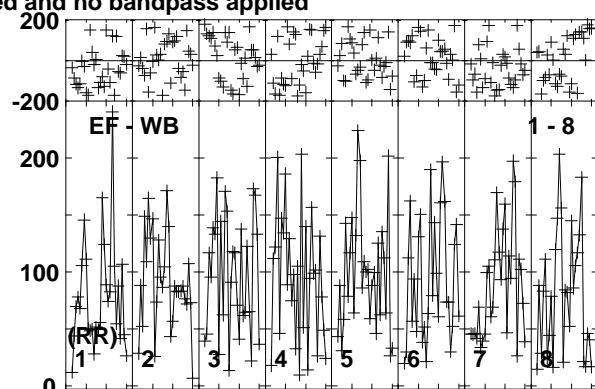
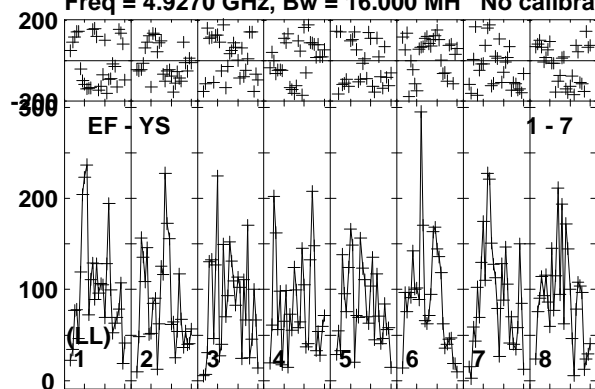

Lower frame: Micro Ampl Jy Top frame: Phas deg
Vector averaged cross-power spectrum Baseline: EF (01) - YS (07)
Timerange: 00/14:19:20 to 00/14:22:19

Plot file version 163 created 10-JUN-2016 16:08:05

J0718-1813 RG008D.UVDATA.1

Freq = 4.9270 GHz, Bw = 16.000 MH No calibration applied and no bandpass applied

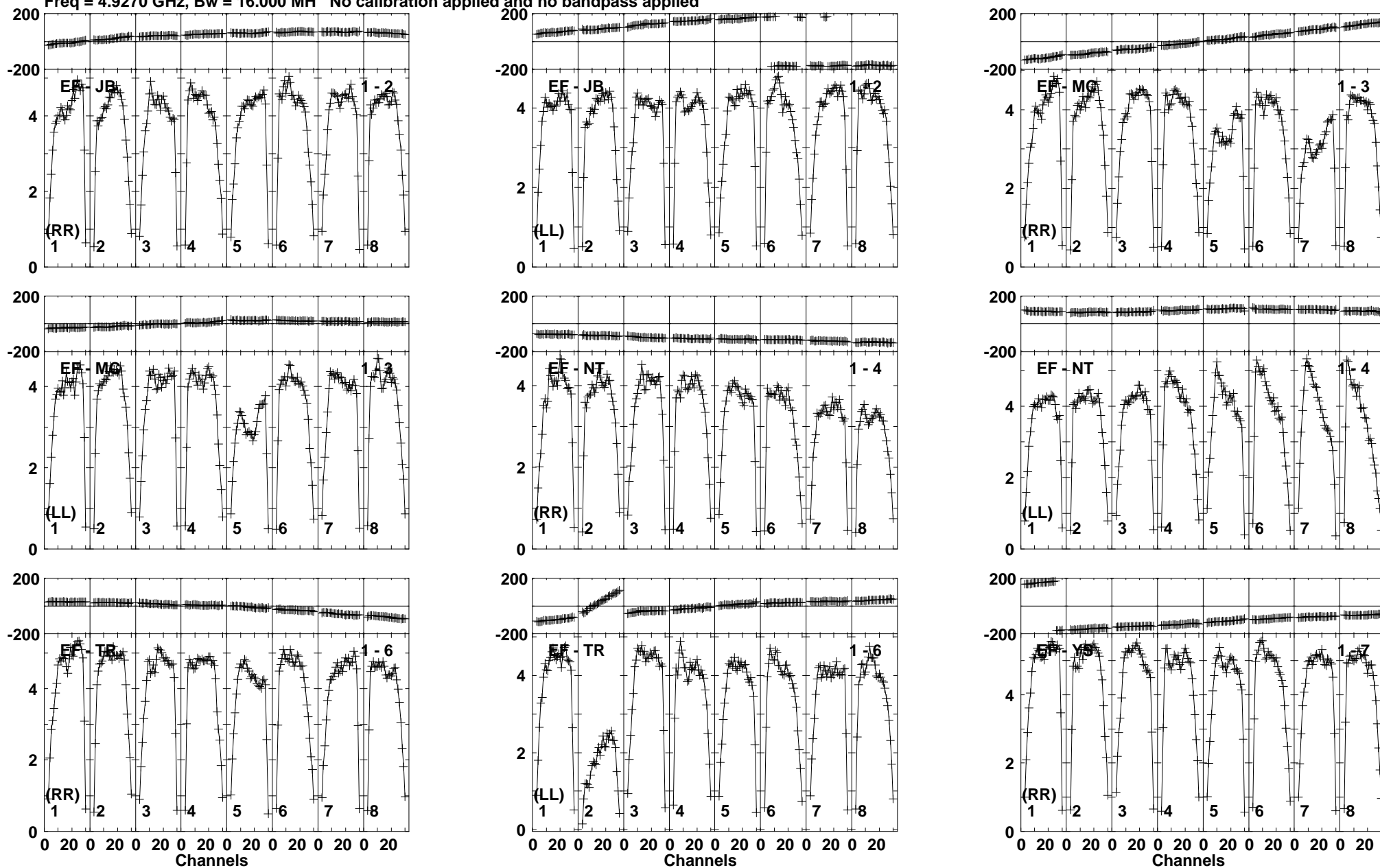

Lower frame: Milli Ampl Jy Top frame: Phas deg
Vector averaged cross-power spectrum Baseline: EF (01) - JB (02)
Timerange: 00/14:23:01 to 00/14:23:50

Plot file version 164 created 10-JUN-2016 16:08:05

J0718-1813 RG008D.UVDATA.1

Freq = 4.9270 GHz, Bw = 16.000 MH No calibration applied and no bandpass applied

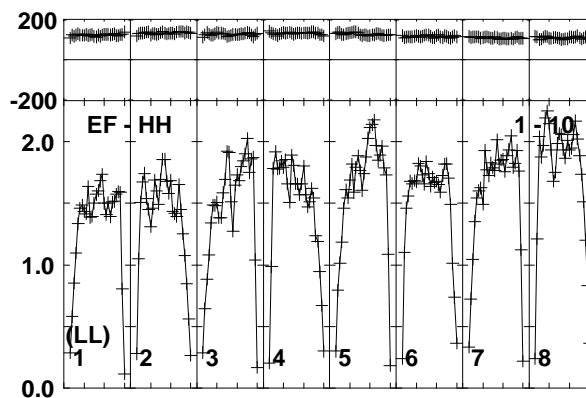
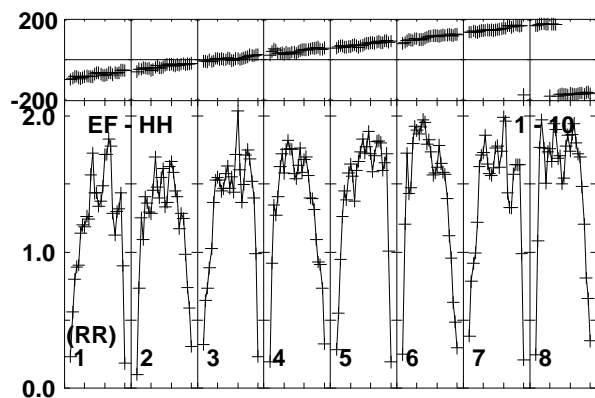
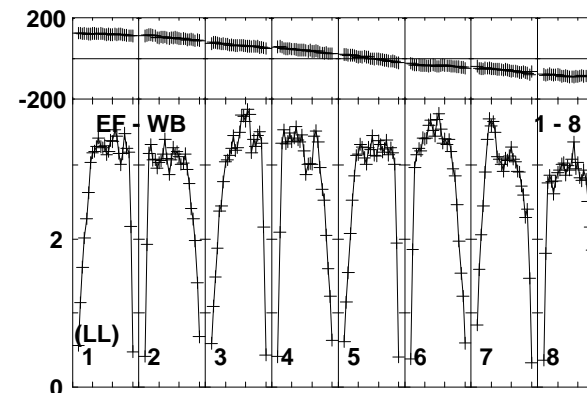
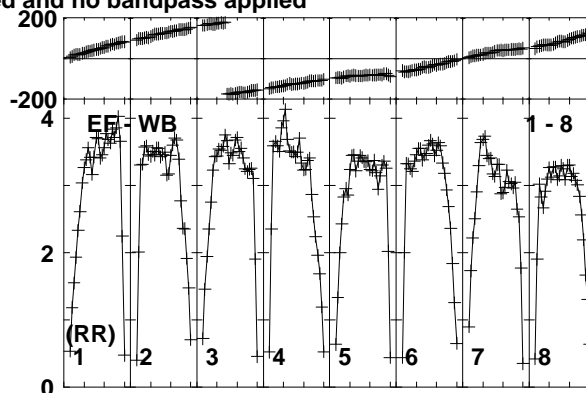
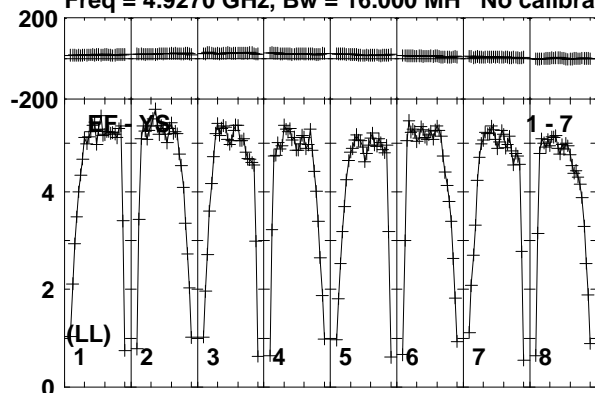

Lower frame: Milli Ampl Jy Top frame: Phas deg
Vector averaged cross-power spectrum Baseline: EF (01) - YS (07)
Timerange: 00/14:23:01 to 00/14:23:50

Plot file version 165 created 10-JUN-2016 16:08:05

FRB150418 RG008D.UVDATA.1

Freq = 4.9270 GHz, Bw = 16.000 MH No calibration applied and no bandpass applied

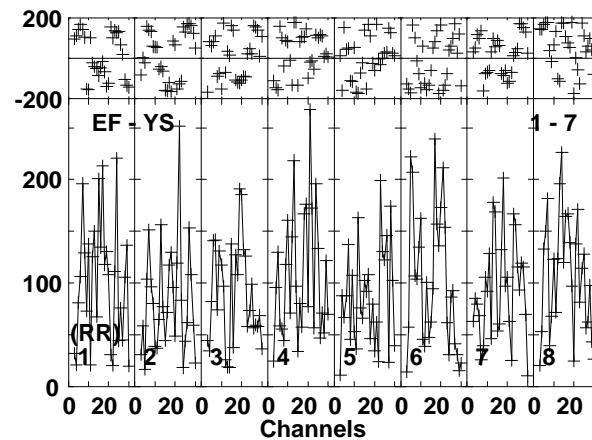
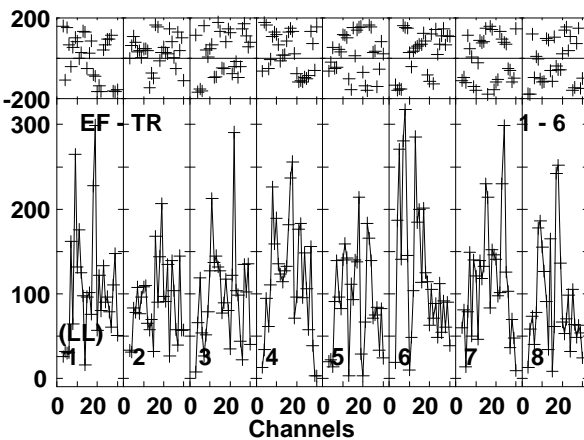
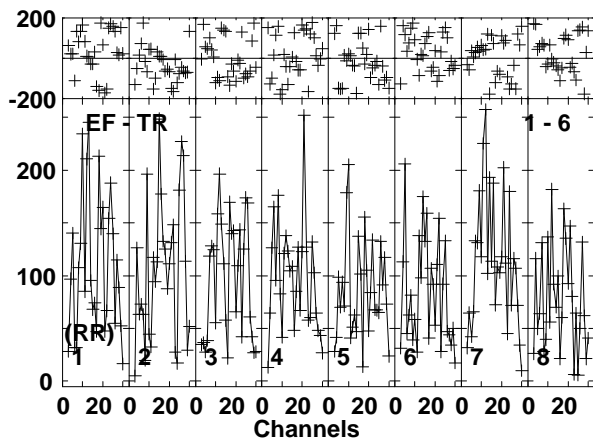
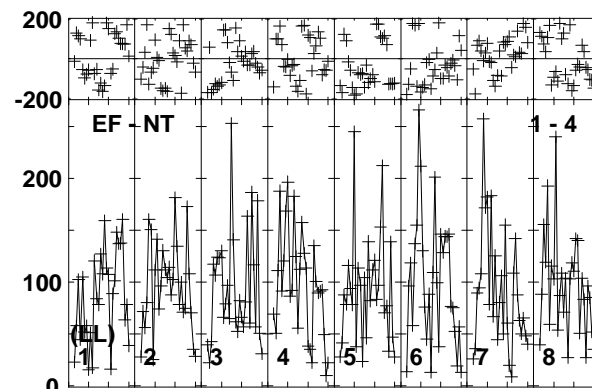
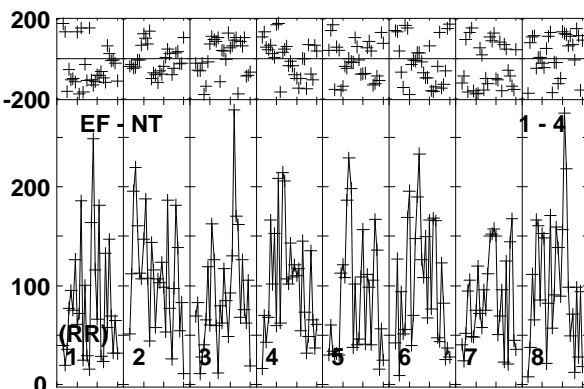
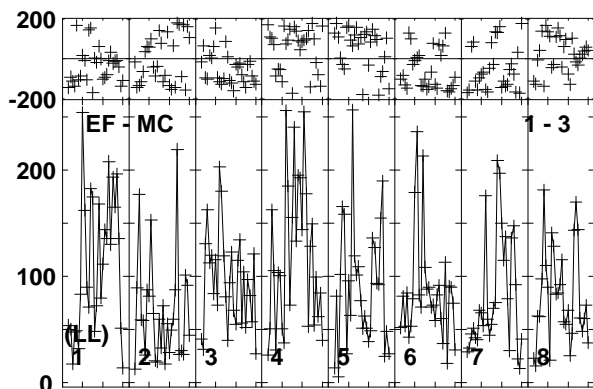
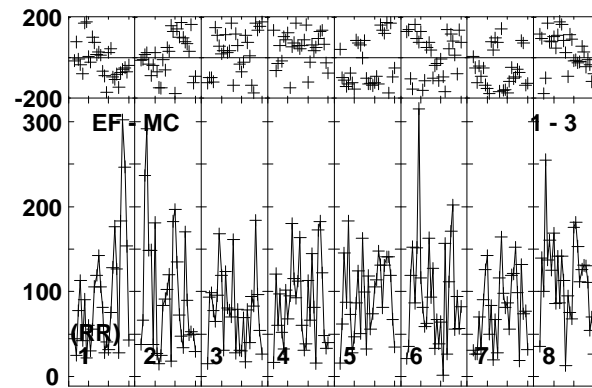
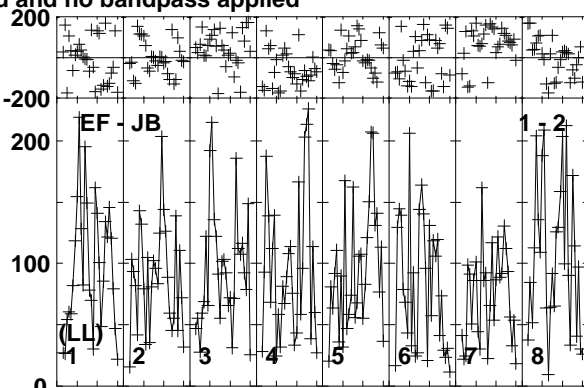
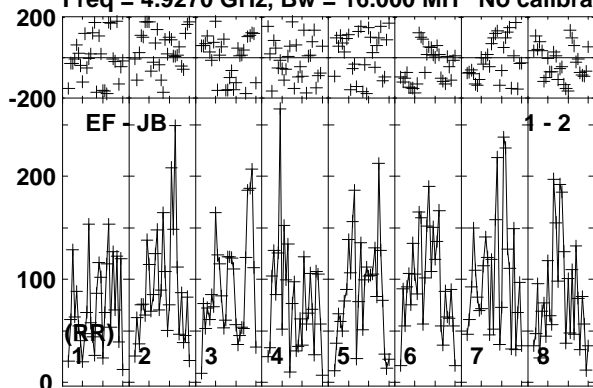

Lower frame: Micro Ampl Jy Top frame: Phas deg
Vector averaged cross-power spectrum Baseline: EF (01) - JB (02)
Timerange: 00/14:23:51 to 00/14:26:49

Plot file version 166 created 10-JUN-2016 16:08:06

FRB150418 RG008D.UVDATA.1

Freq = 4.9270 GHz, Bw = 16.000 MH No calibration applied and no bandpass applied

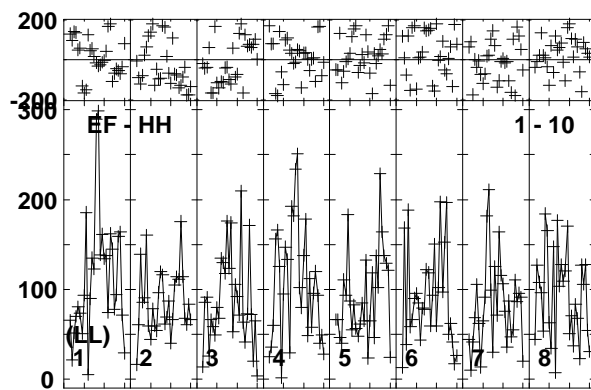
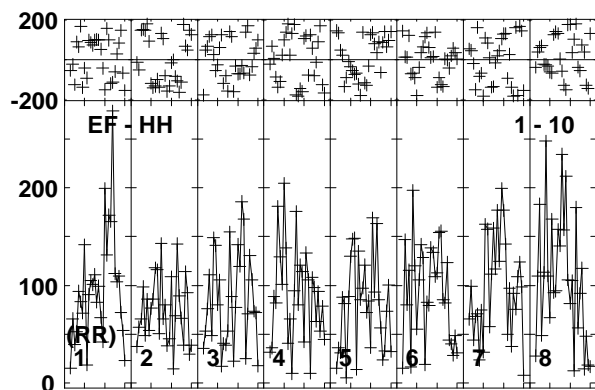
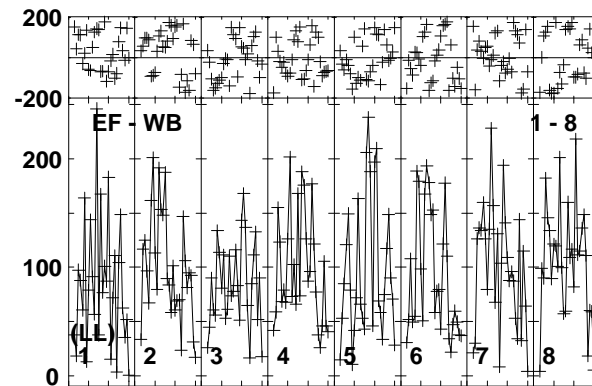
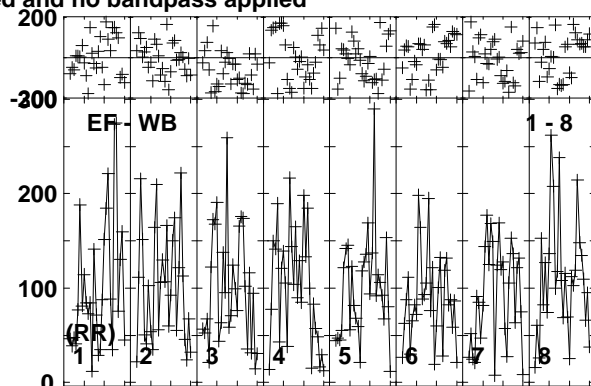
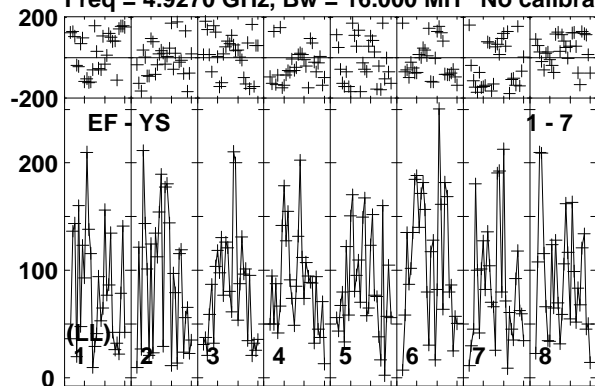

Lower frame: Micro Ampl Jy Top frame: Phas deg
Vector averaged cross-power spectrum Baseline: EF (01) - YS (07)
Timerange: 00/14:23:51 to 00/14:26:49

Plot file version 167 created 10-JUN-2016 16:08:06

J0718-1813 RG008D.UVDATA.1

Freq = 4.9270 GHz, Bw = 16.000 MH No calibration applied and no bandpass applied

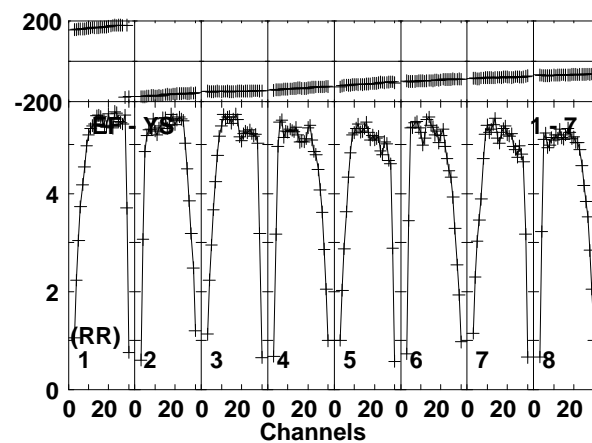
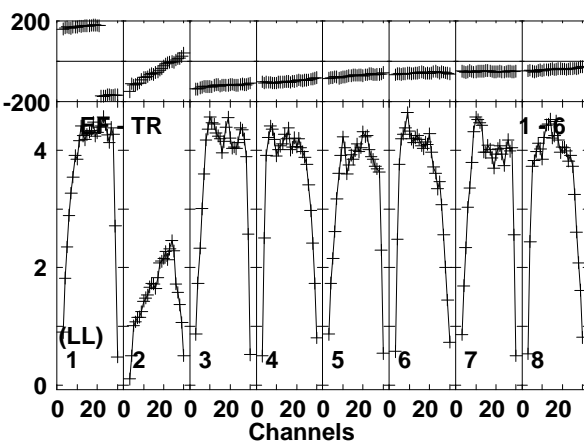
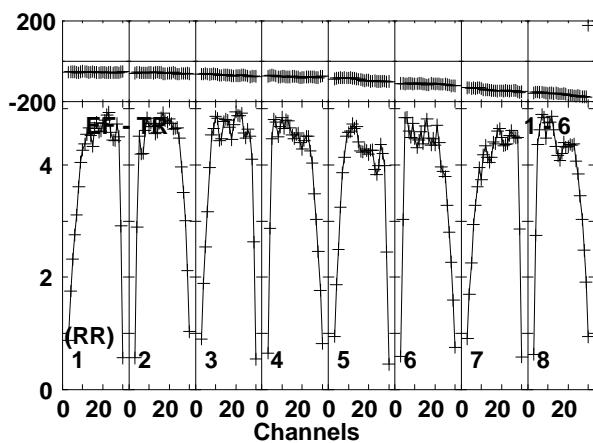
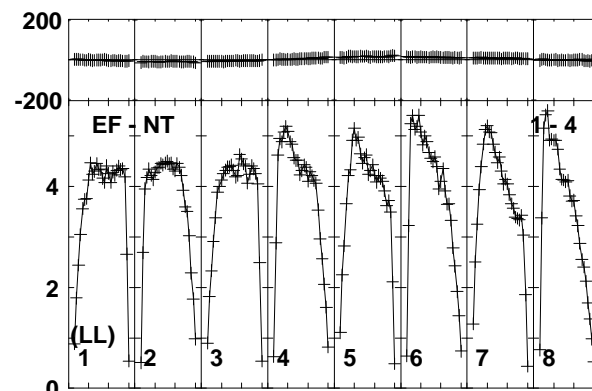
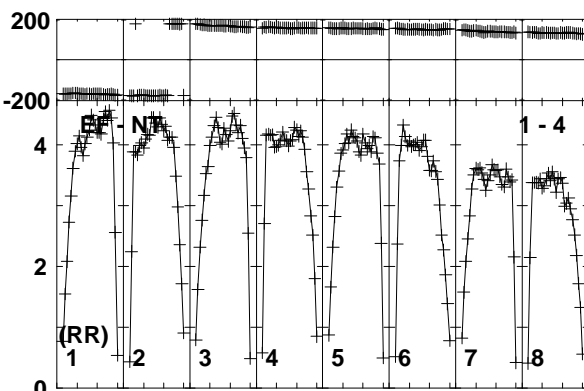
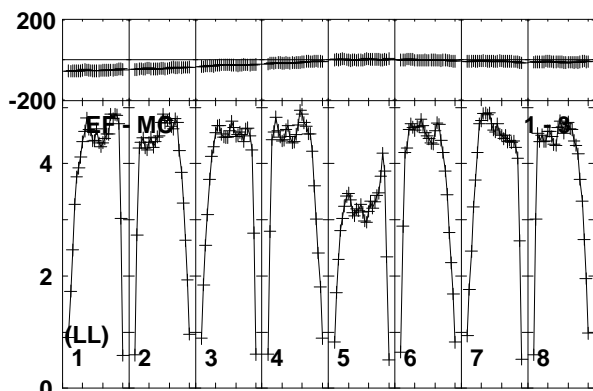
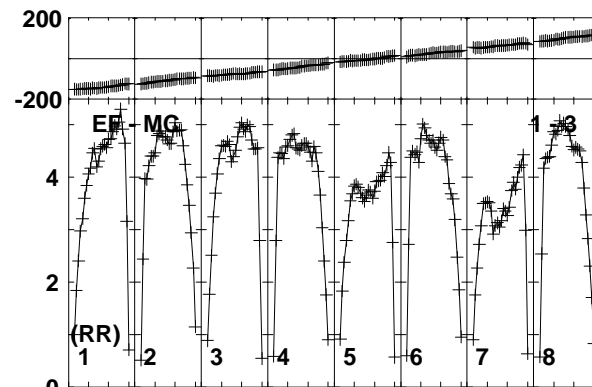
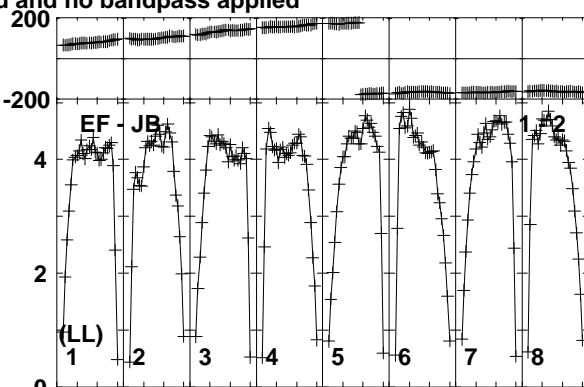
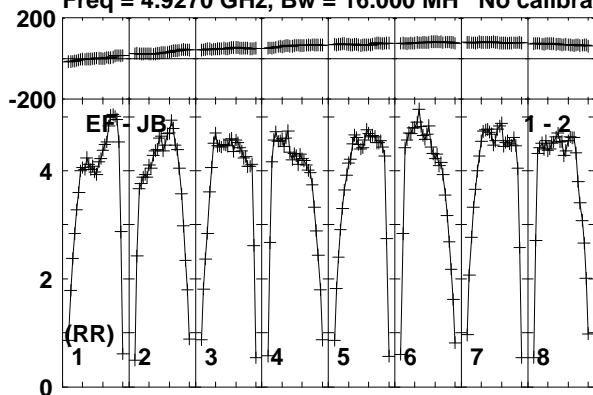

Lower frame: Milli Ampl Jy Top frame: Phas deg
Vector averaged cross-power spectrum Baseline: EF (01) - JB (02)
Timerange: 00/14:26:50 to 00/14:28:20

Plot file version 168 created 10-JUN-2016 16:08:06

J0718-1813 RG008D.UVDATA.1

Freq = 4.9270 GHz, Bw = 16.000 MH No calibration applied and no bandpass applied

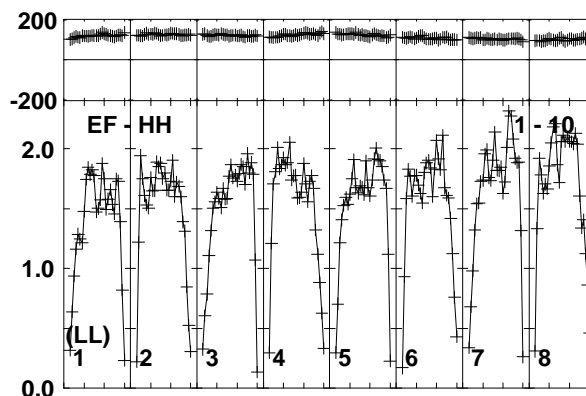
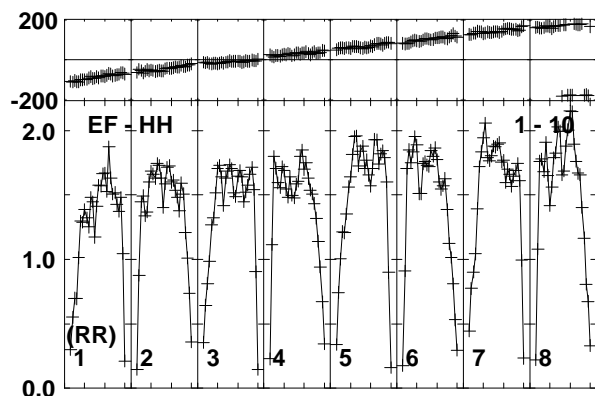
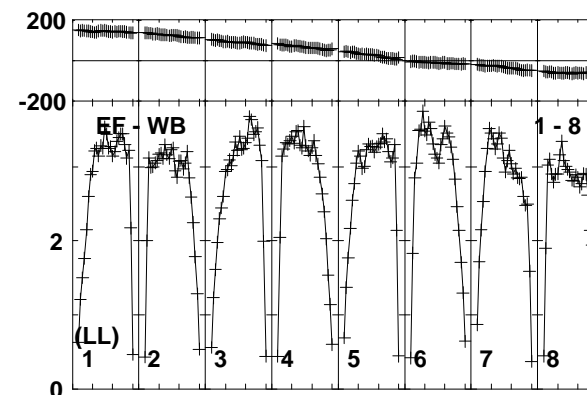
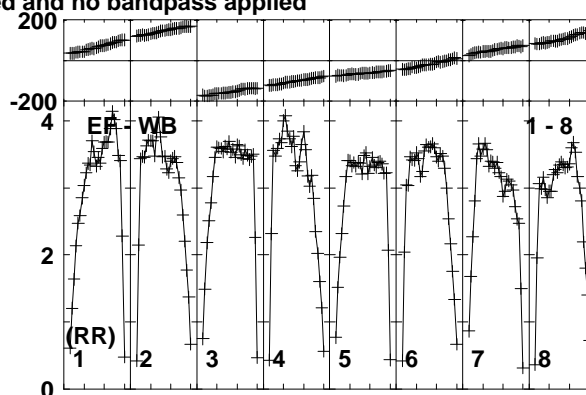
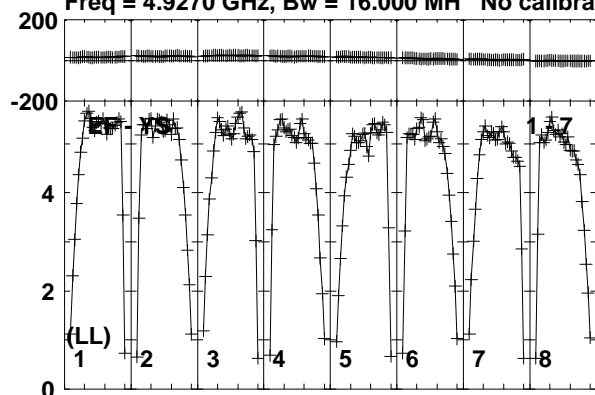

Lower frame: Milli Ampl Jy Top frame: Phas deg
Vector averaged cross-power spectrum Baseline: EF (01) - YS (07)
Timerange: 00/14:26:50 to 00/14:28:20

Plot file version 169 created 10-JUN-2016 16:08:06

J0712-1847 RG008D.UVDATA.1

Freq = 4.9270 GHz, Bw = 16.000 MH No calibration applied and no bandpass applied

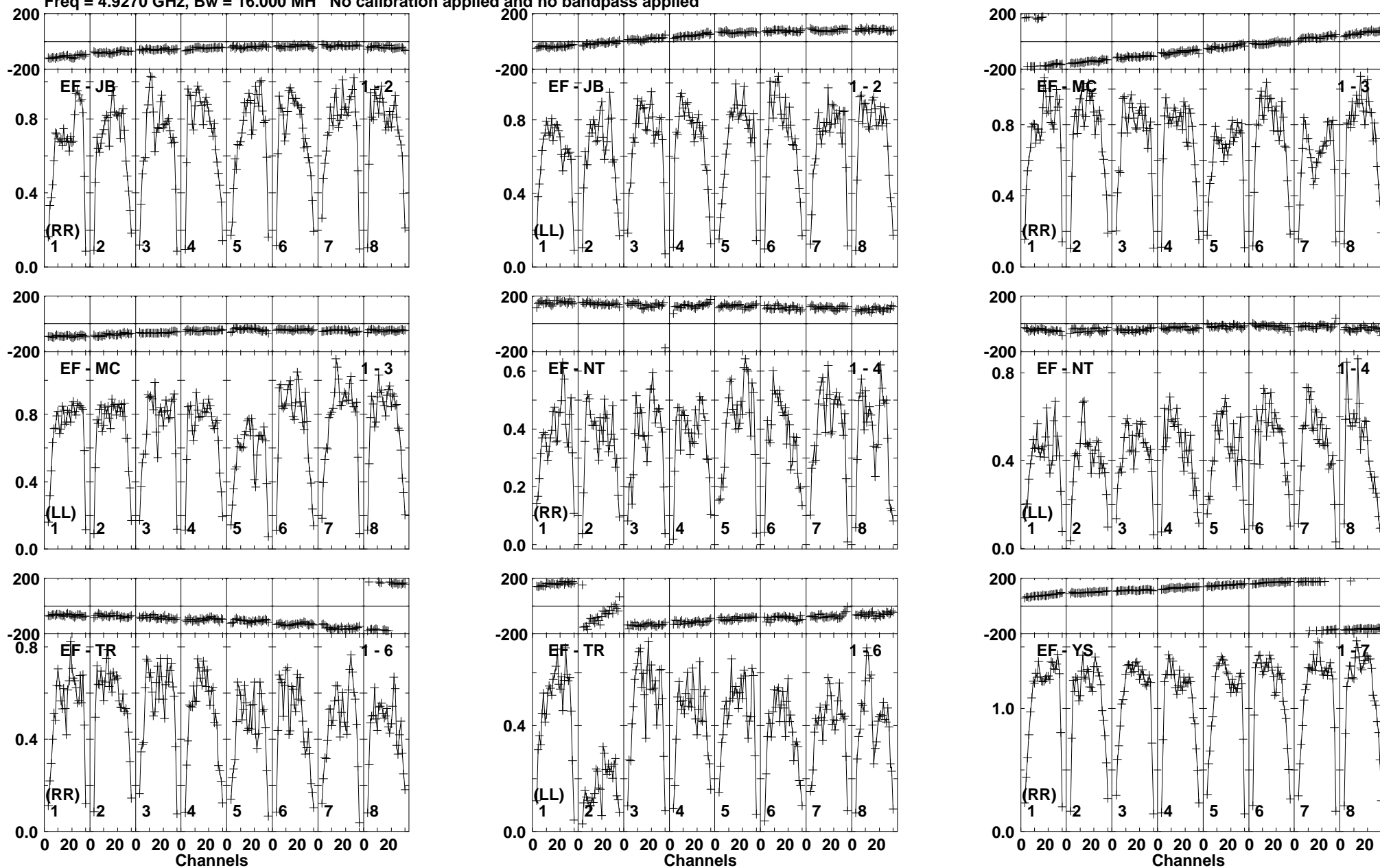

Lower frame: Milli Ampl Jy Top frame: Phas deg
Vector averaged cross-power spectrum Baseline: EF (01) - JB (02)
Timerange: 00/14:28:21 to 00/14:31:19

Plot file version 170 created 10-JUN-2016 16:08:06

J0712-1847 RG008D.UVDATA.1

Freq = 4.9270 GHz, Bw = 16.000 MH No calibration applied and no bandpass applied

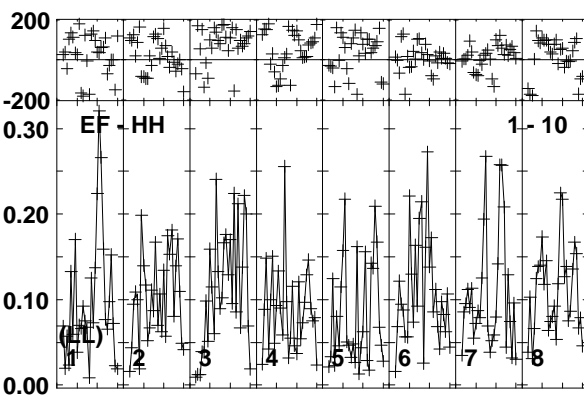
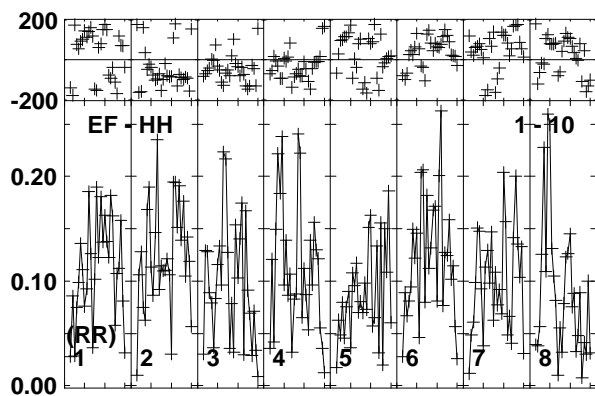
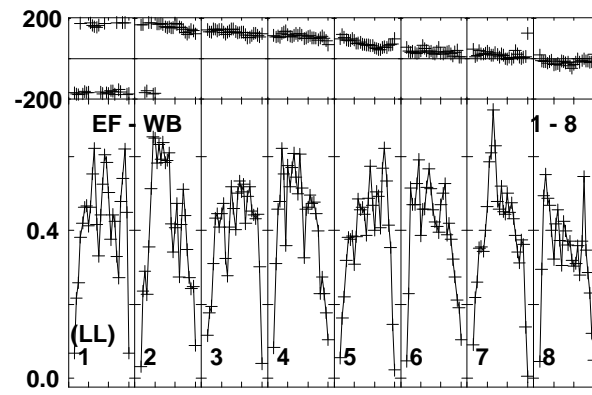
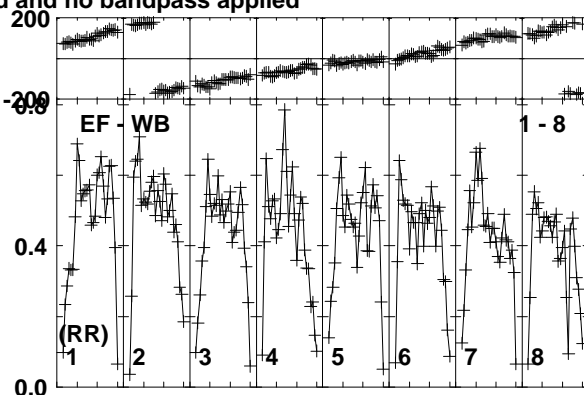
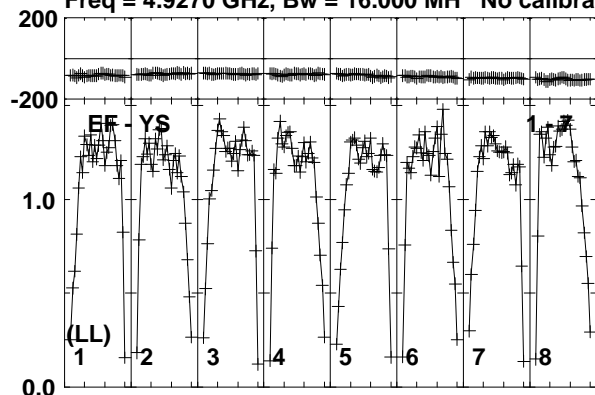

Lower frame: Milli Ampl Jy Top frame: Phas deg
Vector averaged cross-power spectrum Baseline: EF (01) - YS (07)
Timerange: 00/14:28:21 to 00/14:31:19

Plot file version 171 created 10-JUN-2016 16:08:06

J0718-1813 RG008D.UVDATA.1

Freq = 4.9270 GHz, Bw = 16.000 MH No calibration applied and no bandpass applied

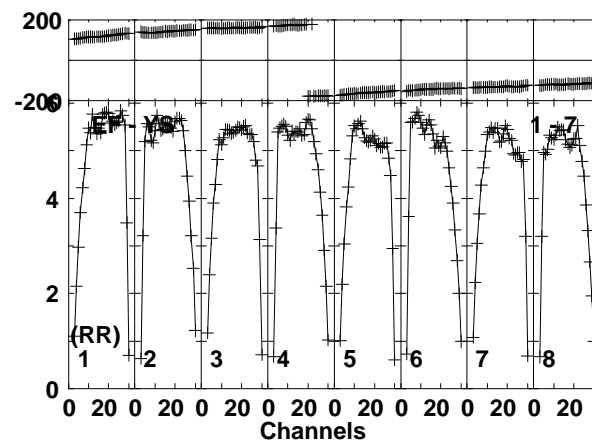
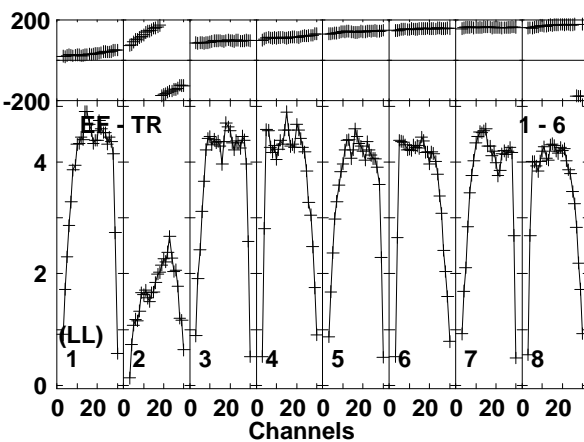
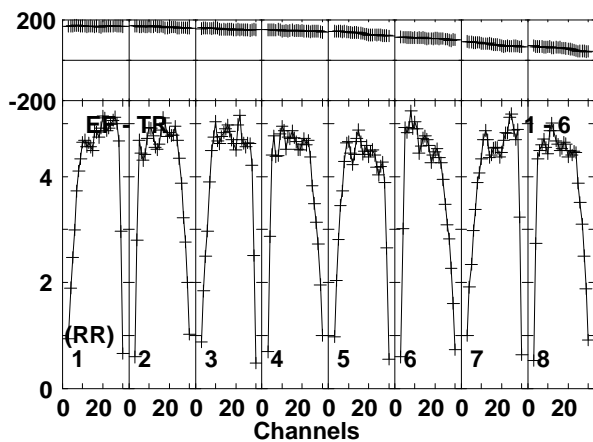
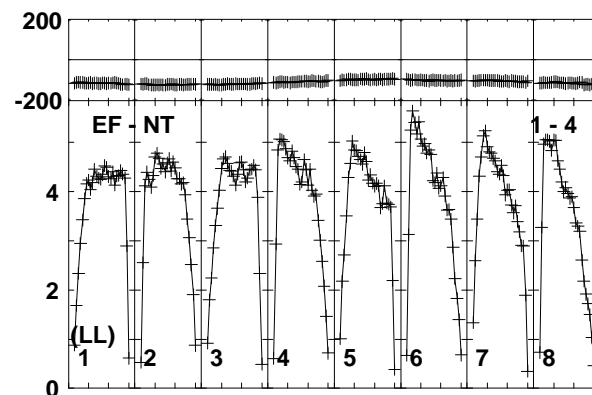
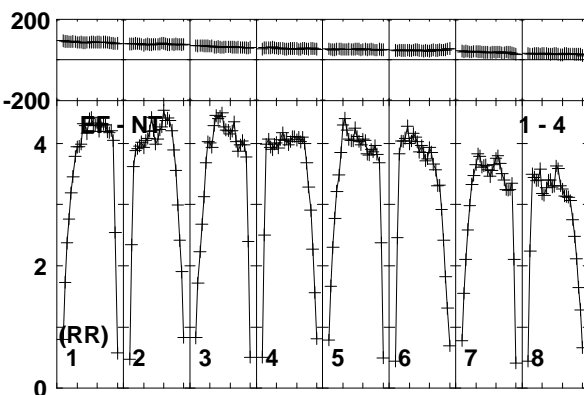
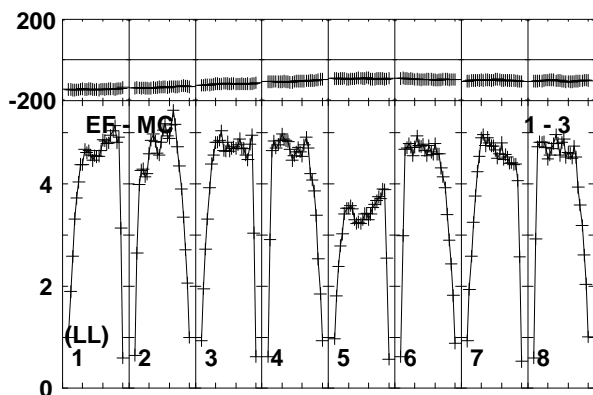
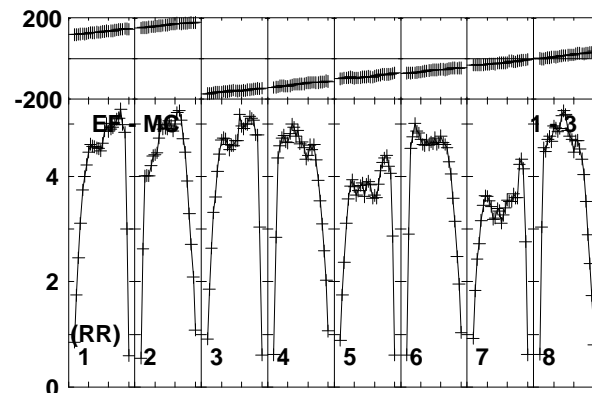
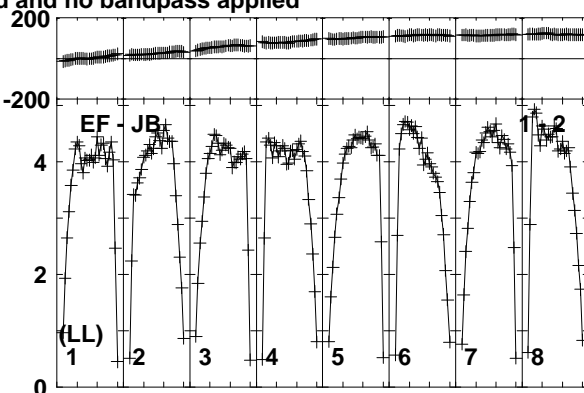
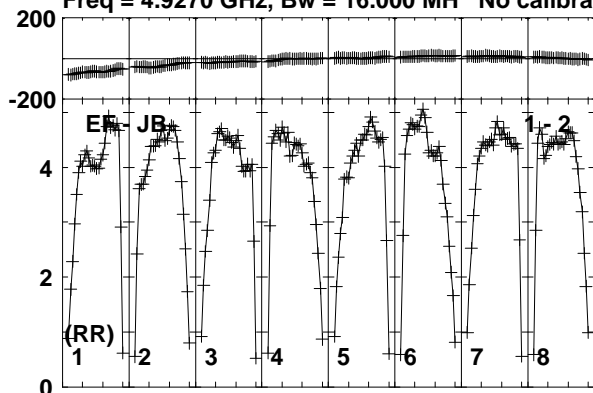

Lower frame: Milli Ampl Jy Top frame: Phas deg
Vector averaged cross-power spectrum Baseline: EF (01) - JB (02)
Timerange: 00/14:31:20 to 00/14:32:49

Plot file version 172 created 10-JUN-2016 16:08:06

J0718-1813 RG008D.UVDATA.1

Freq = 4.9270 GHz, Bw = 16.000 MH No calibration applied and no bandpass applied

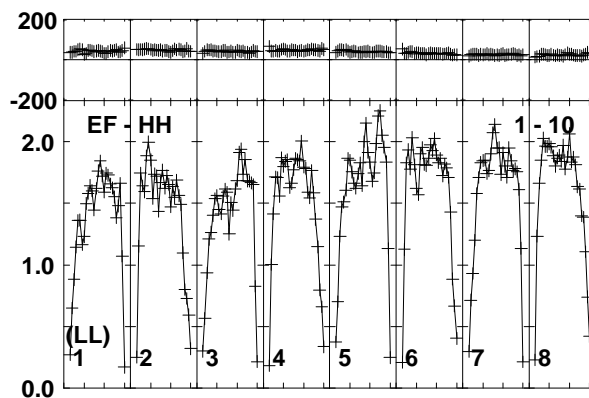
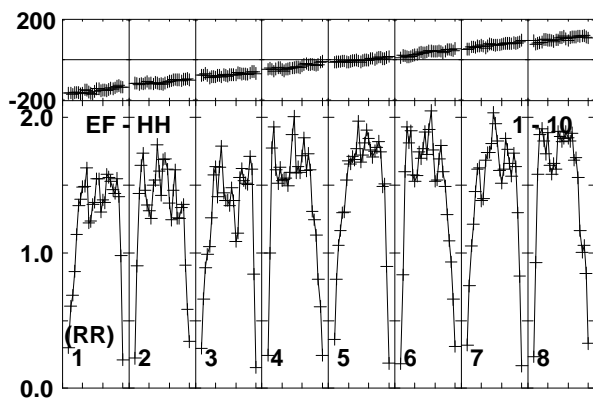
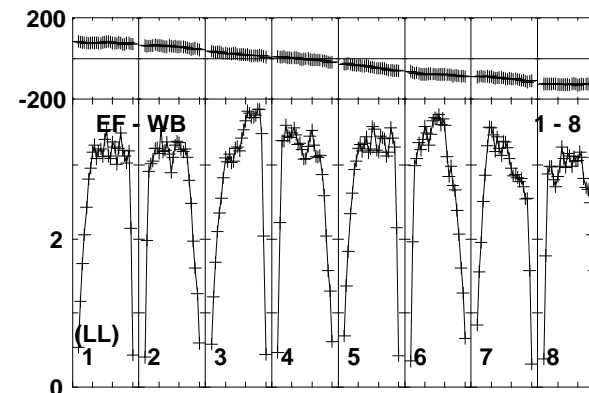
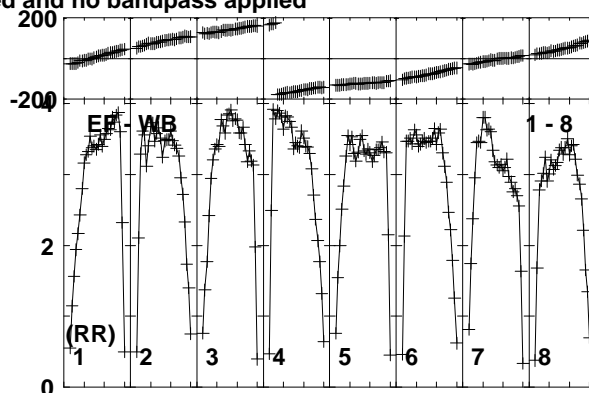
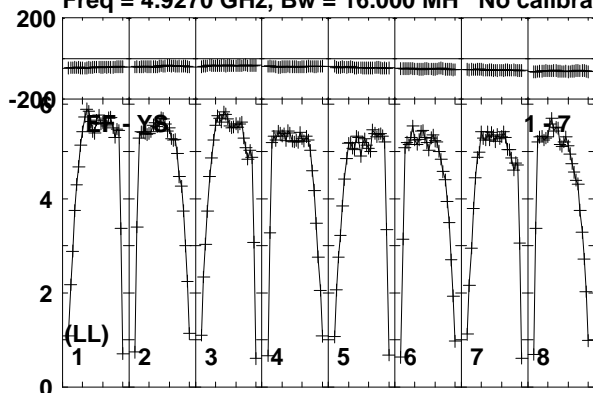

Lower frame: Milli Ampl Jy Top frame: Phas deg
Vector averaged cross-power spectrum Baseline: EF (01) - YS (07)
Timerange: 00/14:31:20 to 00/14:32:49

Plot file version 173 created 10-JUN-2016 16:08:06

OJ287 RG008D.UVDATA.1

Freq = 4.9270 GHz, Bw = 16.000 MH No calibration applied and no bandpass applied

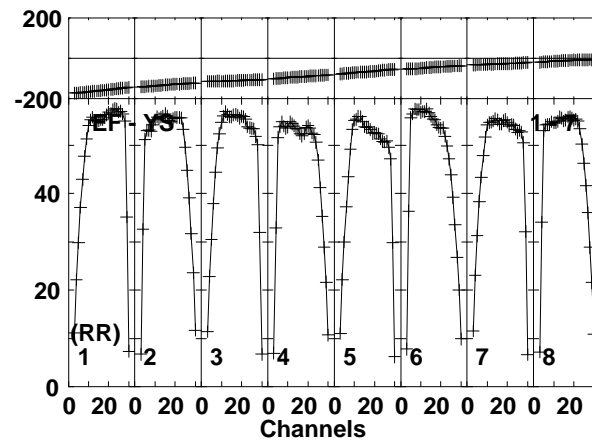
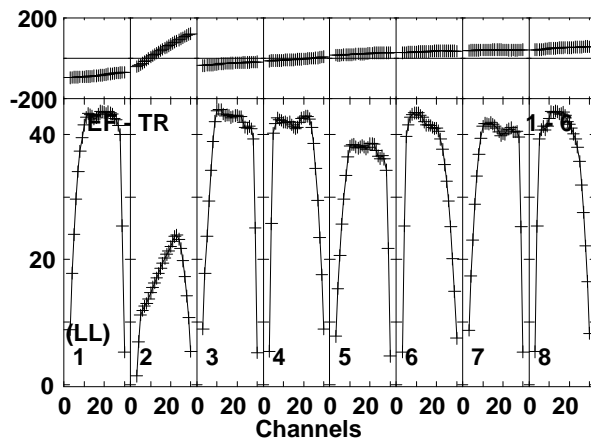
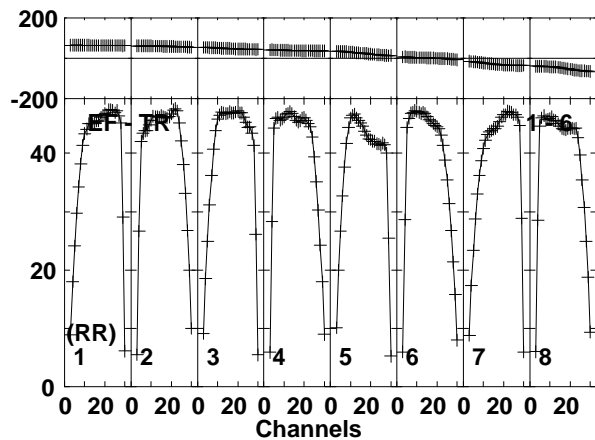
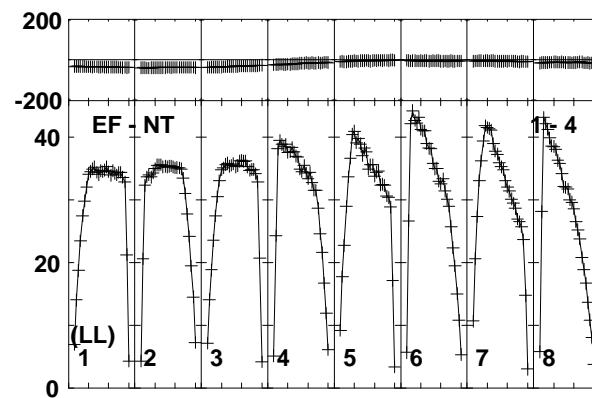
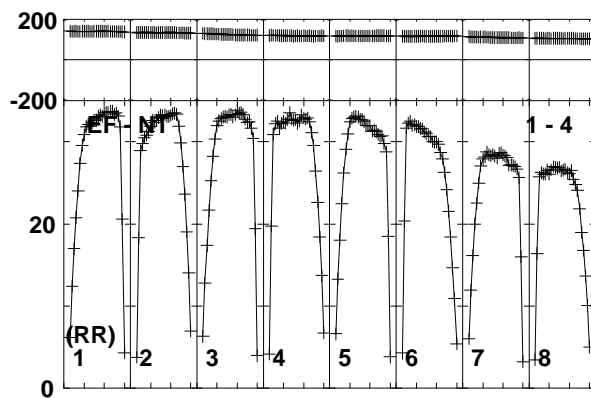
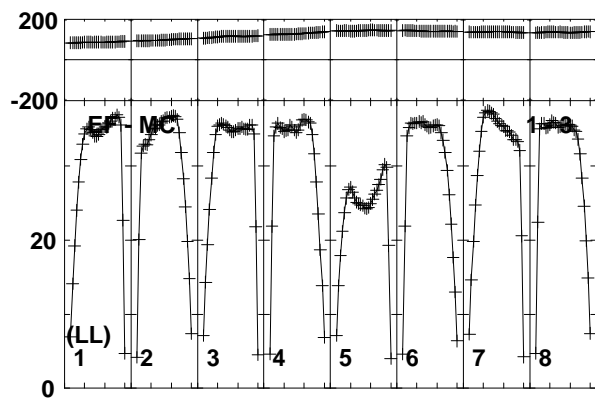
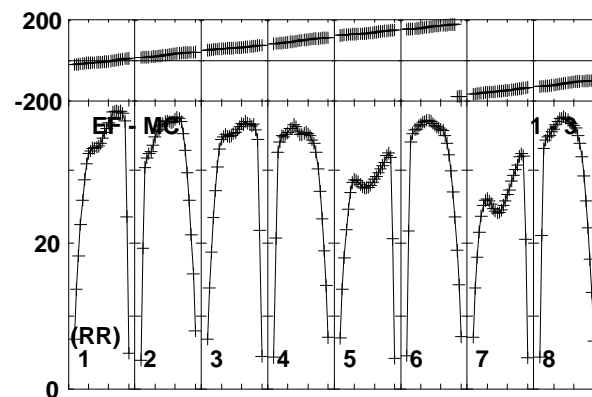
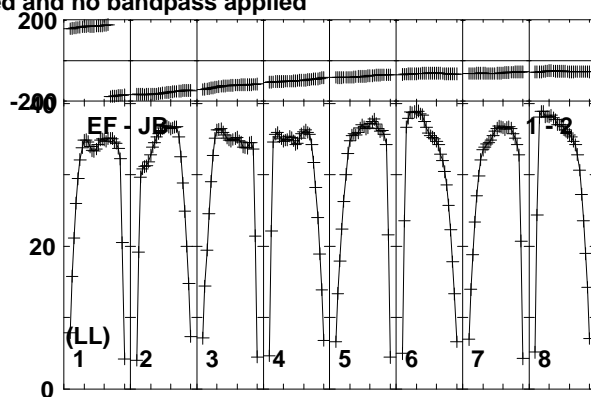
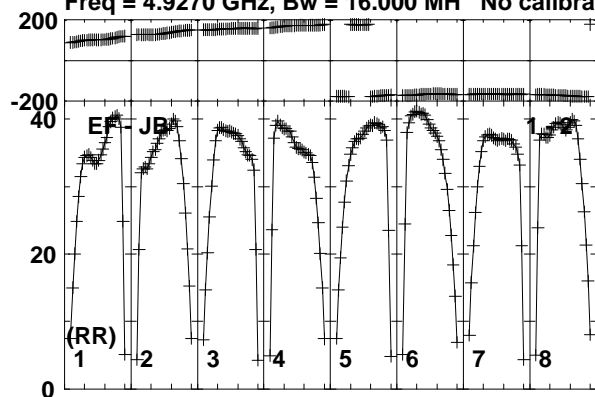

Lower frame: Milli Ampl Jy Top frame: Phas deg
Vector averaged cross-power spectrum Baseline: EF (01) - JB (02)
Timerange: 00/14:35:50 to 00/14:38:49

Plot file version 174 created 10-JUN-2016 16:08:07

OJ287 RG008D.UVDATA.1

Freq = 4.9270 GHz, Bw = 16.000 MH No calibration applied and no bandpass applied

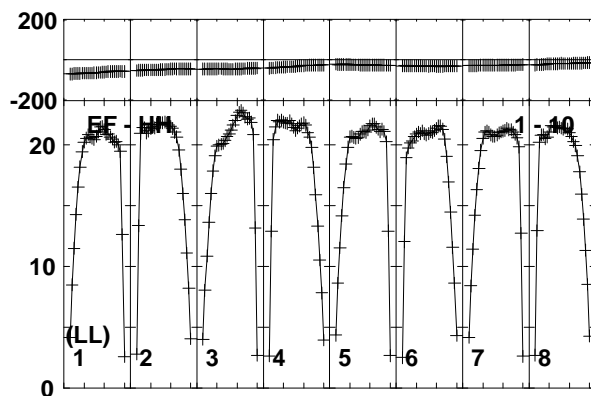
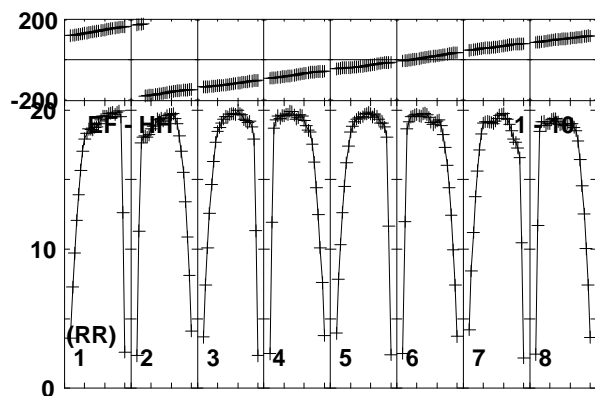
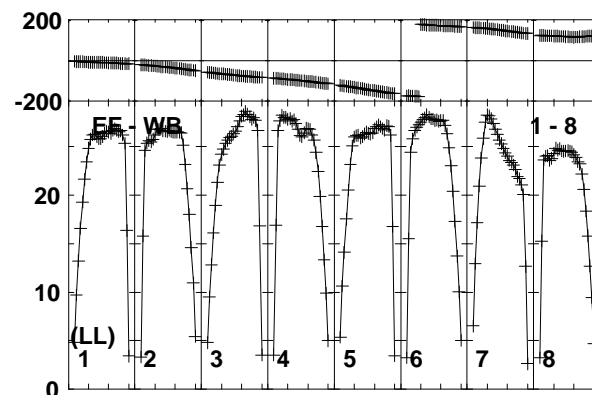
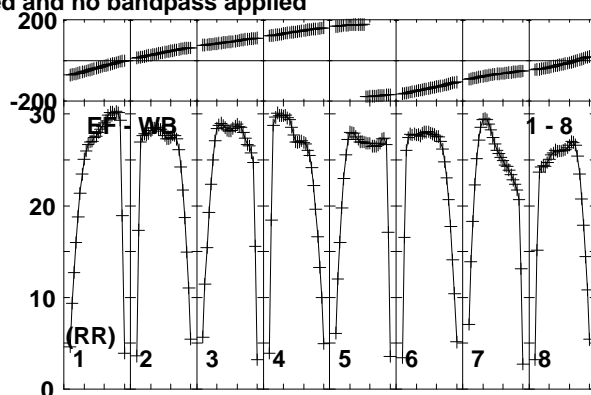
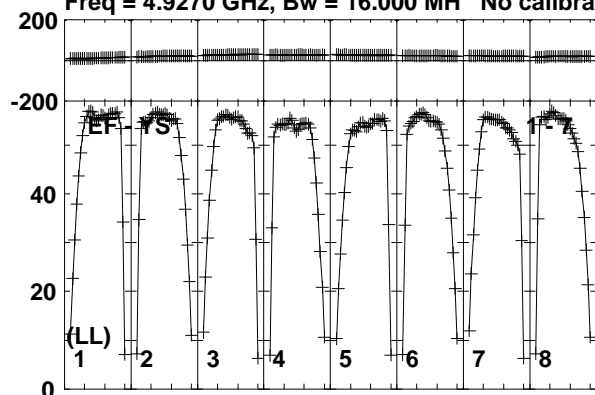

Lower frame: Milli Ampl Jy Top frame: Phas deg
Vector averaged cross-power spectrum Baseline: EF (01) - YS (07)
Timerange: 00/14:35:50 to 00/14:38:49

Plot file version 175 created 10-JUN-2016 16:08:07

J0718-1813 RG008D.UVDATA.1

Freq = 4.9270 GHz, Bw = 16.000 MH No calibration applied and no bandpass applied

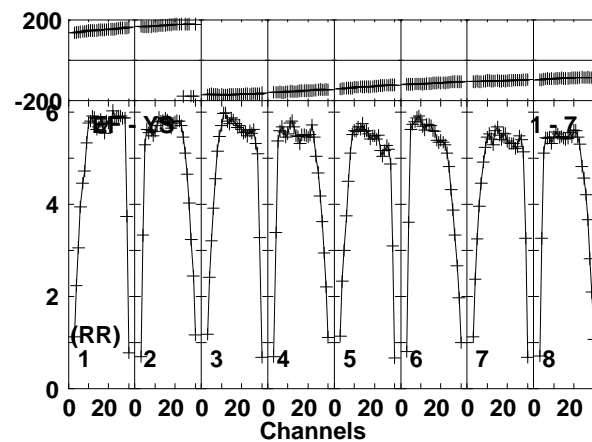
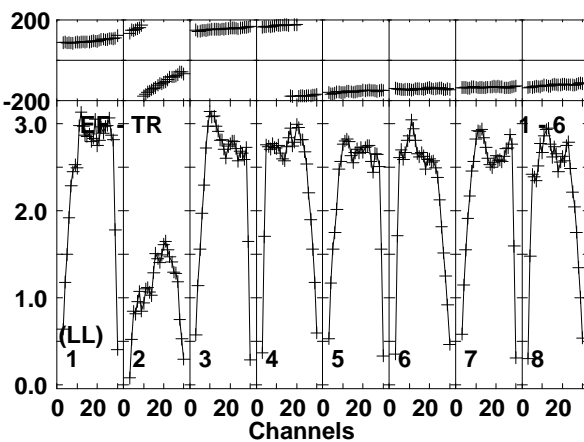
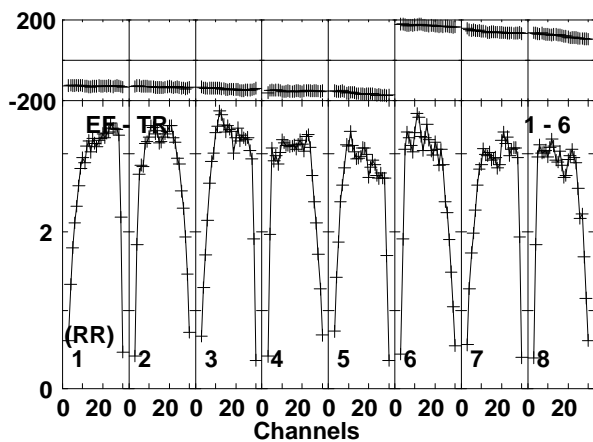
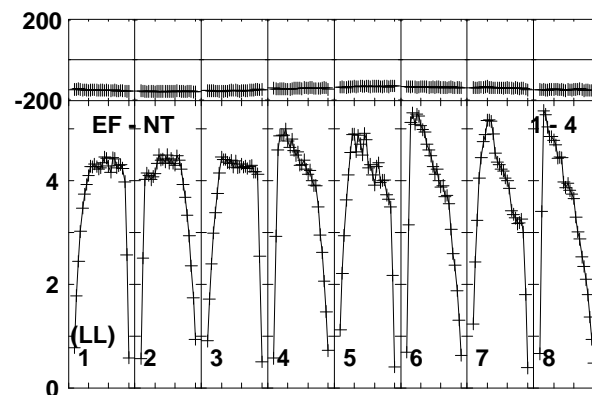
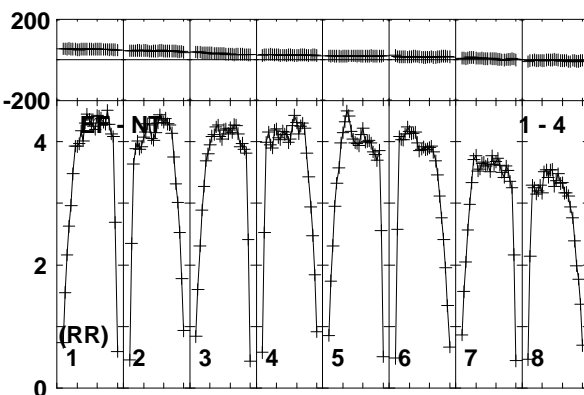
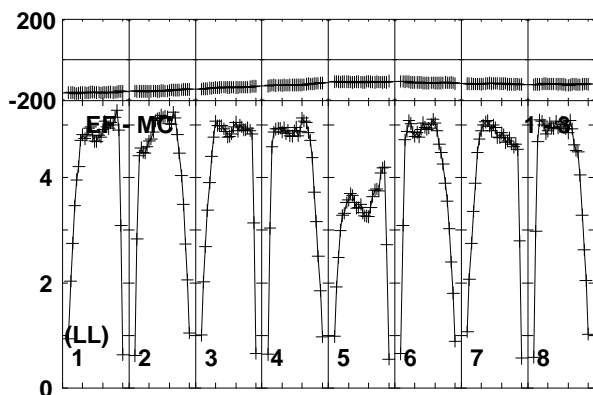
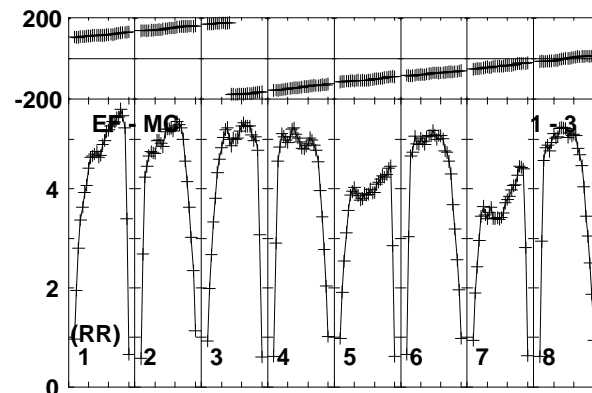
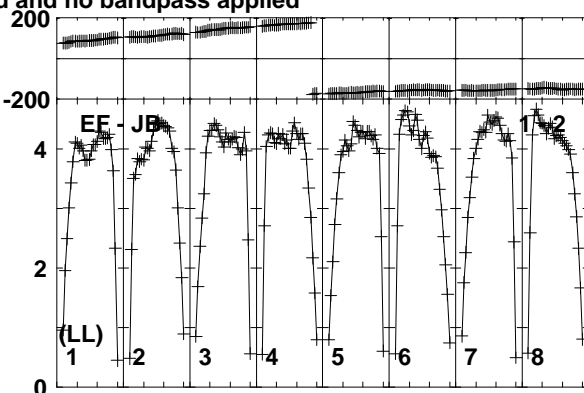
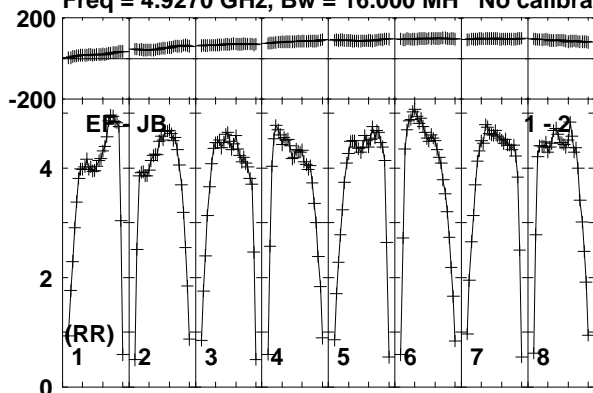

Lower frame: Milli Ampl Jy Top frame: Phas deg
Vector averaged cross-power spectrum Baseline: EF (01) - JB (02)
Timerange: 00/14:41:50 to 00/14:43:19

Plot file version 176 created 10-JUN-2016 16:08:07

J0718-1813 RG008D.UVDATA.1

Freq = 4.9270 GHz, Bw = 16.000 MH No calibration applied and no bandpass applied

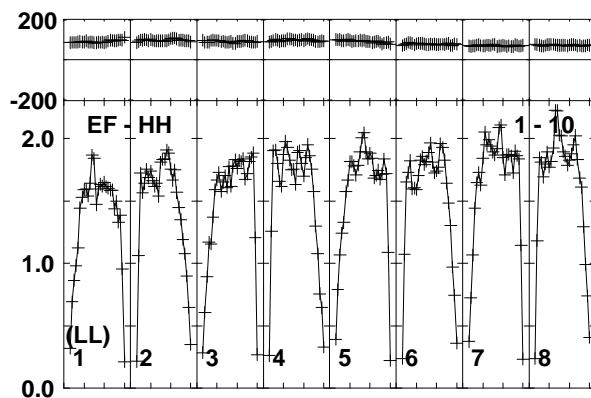
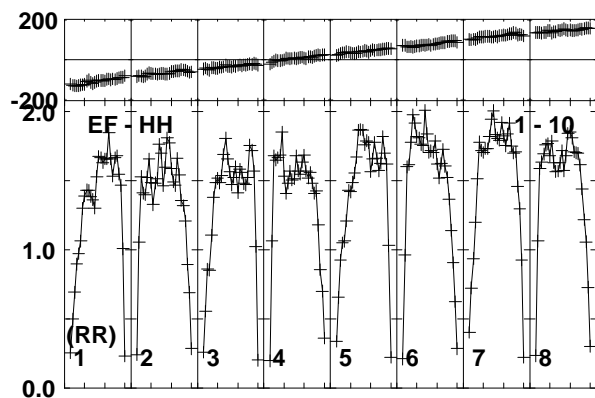
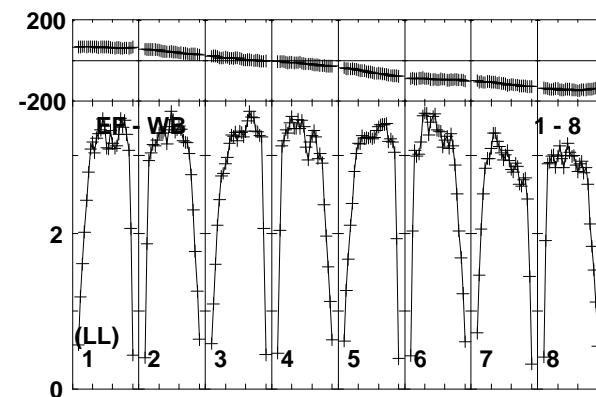
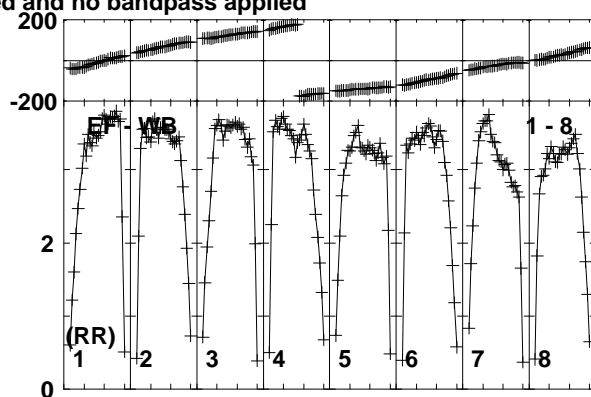
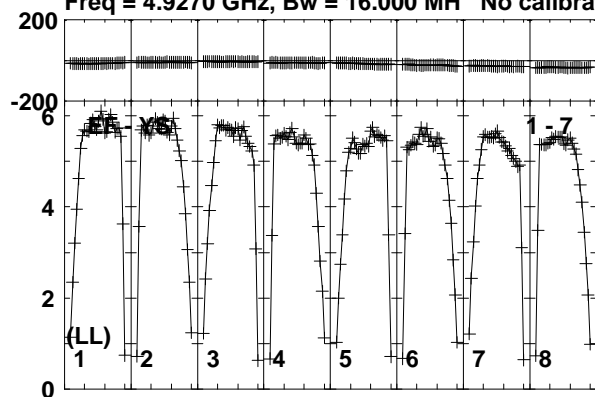

Lower frame: Milli Ampl Jy Top frame: Phas deg
Vector averaged cross-power spectrum Baseline: EF (01) - YS (07)
Timerange: 00/14:41:50 to 00/14:43:19

Plot file version 177 created 10-JUN-2016 16:08:07

FRB150418 RG008D.UVDATA.1

Freq = 4.9270 GHz, Bw = 16.000 MH No calibration applied and no bandpass applied

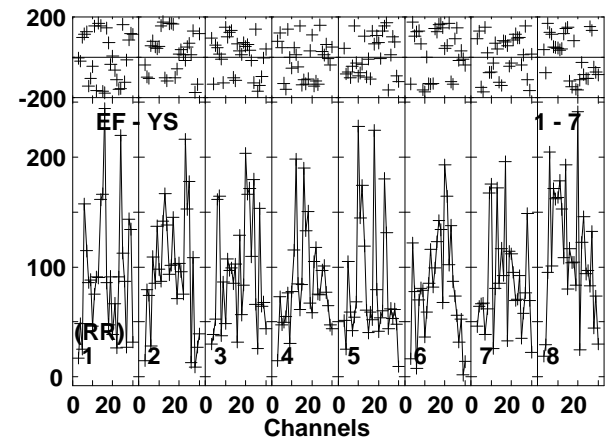
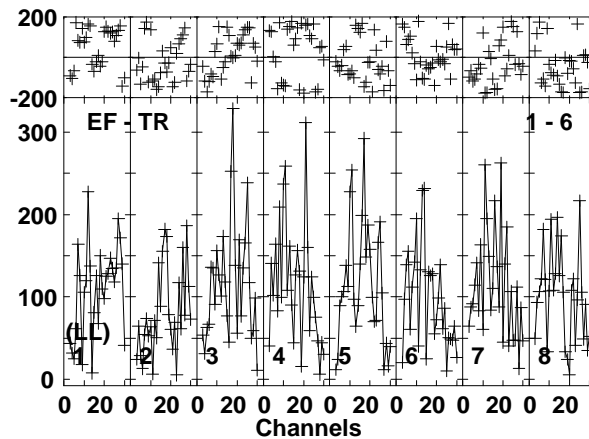
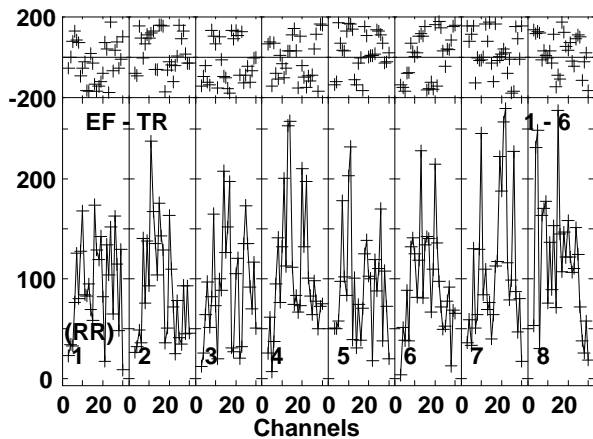
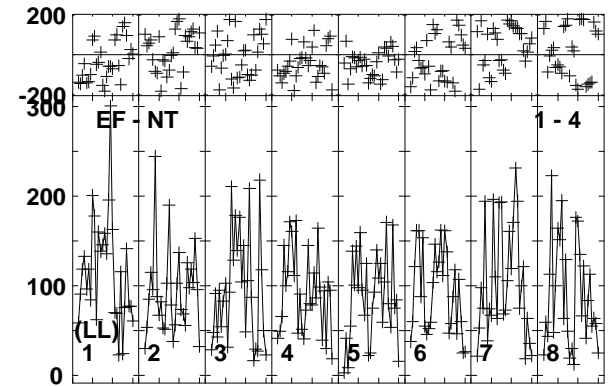
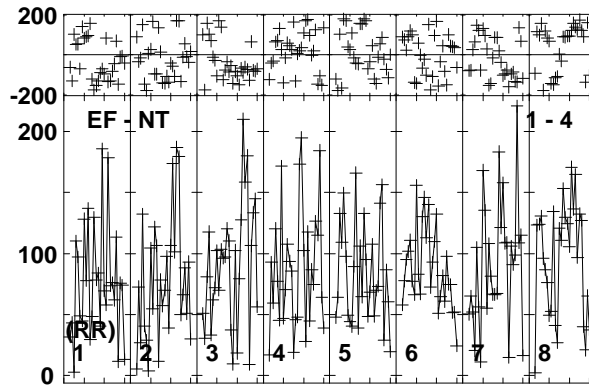
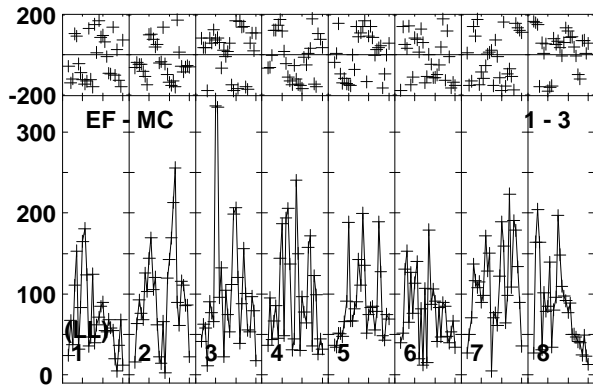
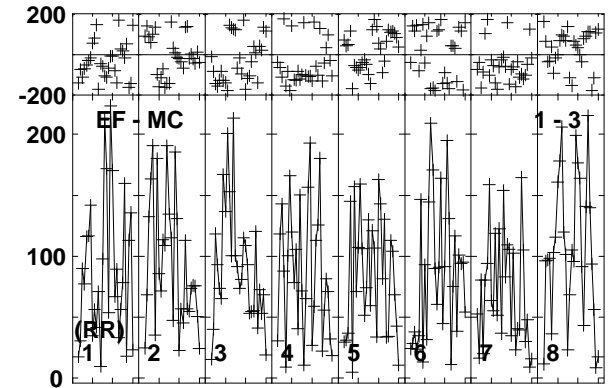
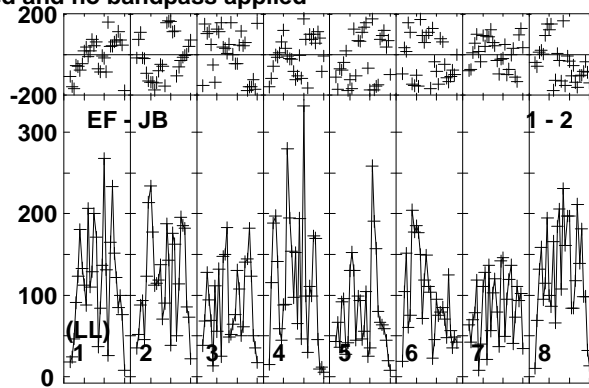
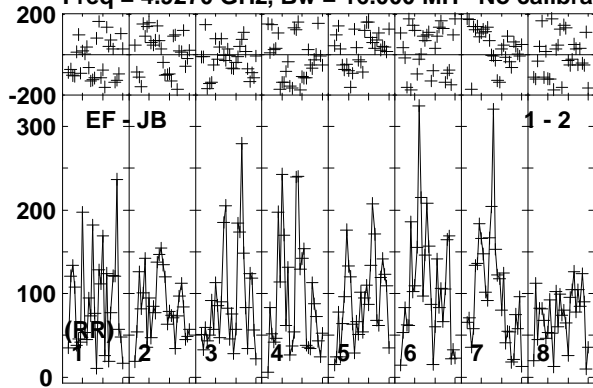

Lower frame: Micro Ampl Jy Top frame: Phas deg
Vector averaged cross-power spectrum Baseline: EF (01) - JB (02)
Timerange: 00/14:43:20 to 00/14:46:20

Plot file version 178 created 10-JUN-2016 16:08:07

FRB150418 RG008D.UVDATA.1

Freq = 4.9270 GHz, Bw = 16.000 MH No calibration applied and no bandpass applied

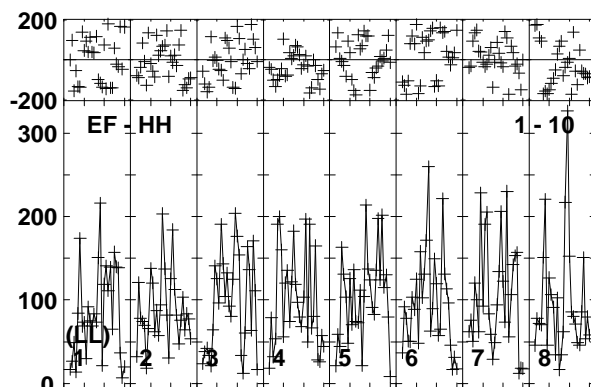
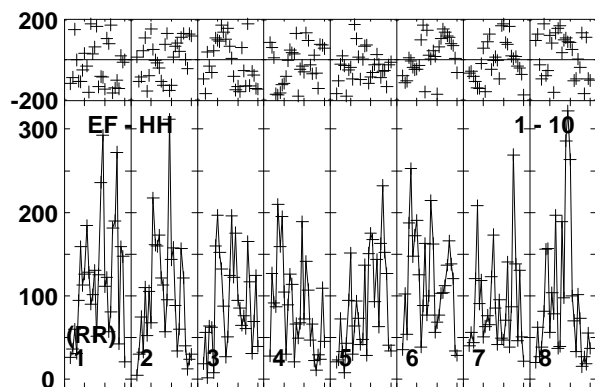
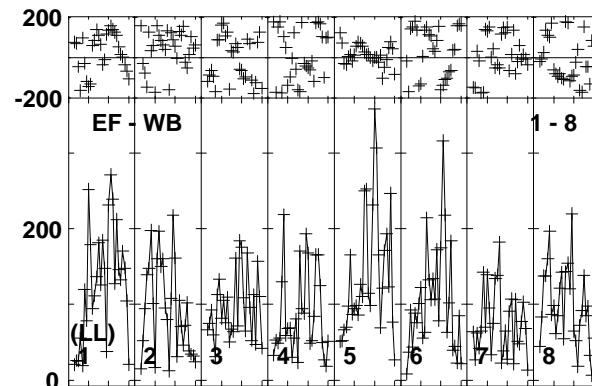
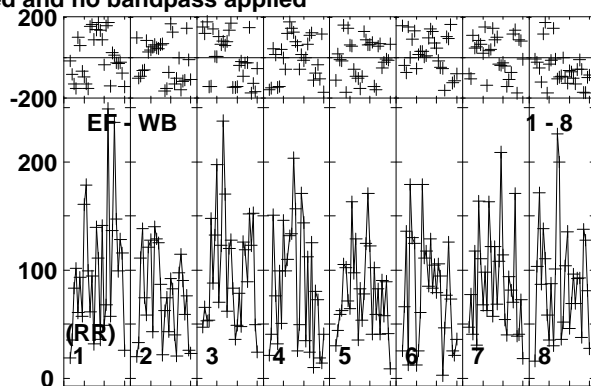
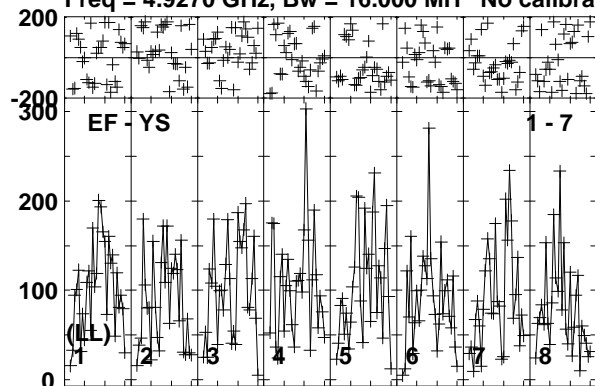

Lower frame: Micro Ampl Jy Top frame: Phas deg
Vector averaged cross-power spectrum Baseline: EF (01) - YS (07)
Timerange: 00/14:43:20 to 00/14:46:20

Plot file version 179 created 10-JUN-2016 16:08:07

J0718-1813 RG008D.UVDATA.1

Freq = 4.9270 GHz, Bw = 16.000 MH No calibration applied and no bandpass applied

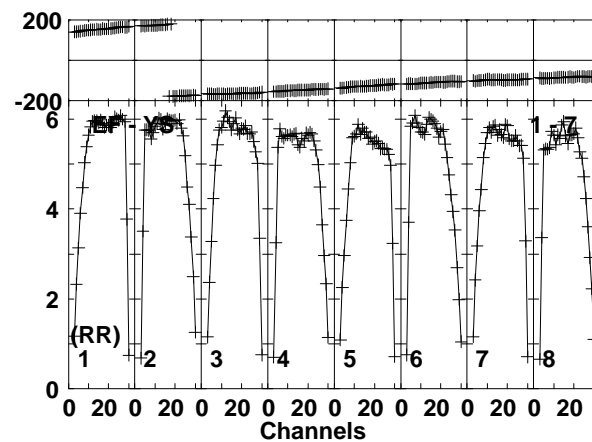
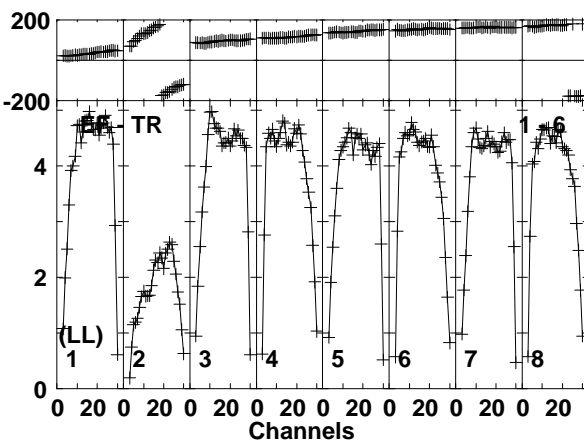
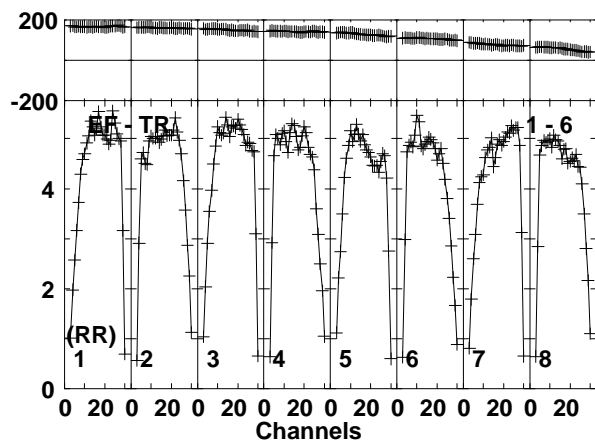
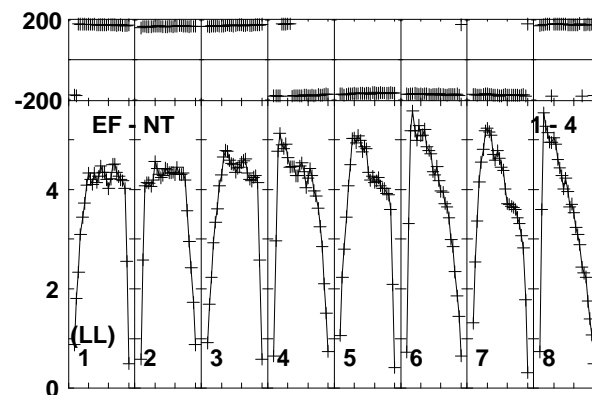
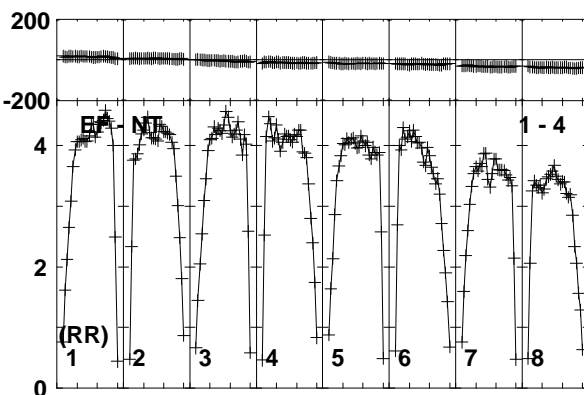
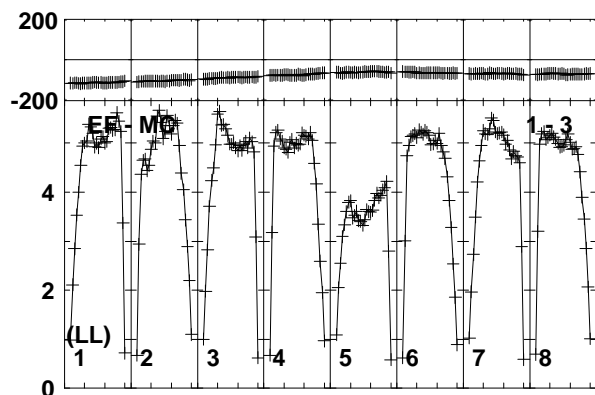
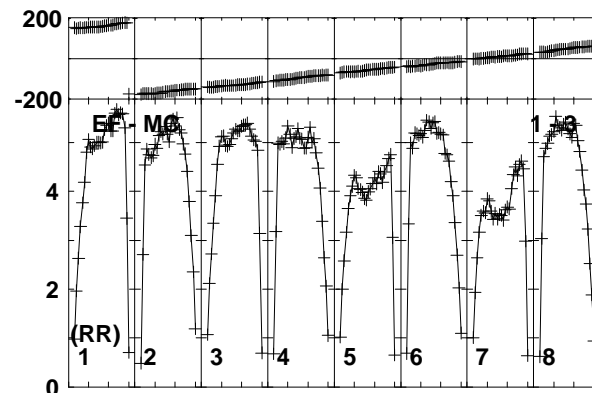
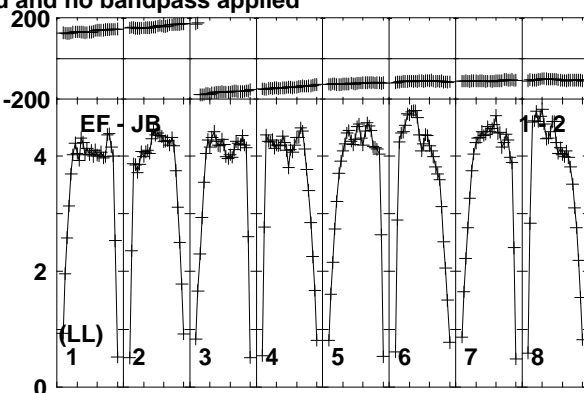
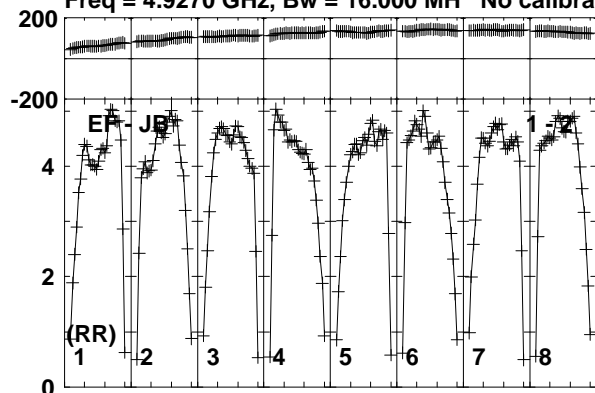

Lower frame: Milli Ampl Jy Top frame: Phas deg
Vector averaged cross-power spectrum Baseline: EF (01) - JB (02)
Timerange: 00/14:46:21 to 00/14:47:49

Plot file version 180 created 10-JUN-2016 16:08:07

J0718-1813 RG008D.UVDATA.1

Freq = 4.9270 GHz, Bw = 16.000 MH No calibration applied and no bandpass applied

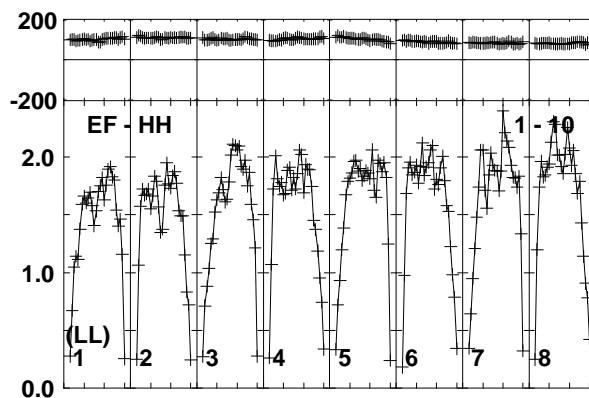
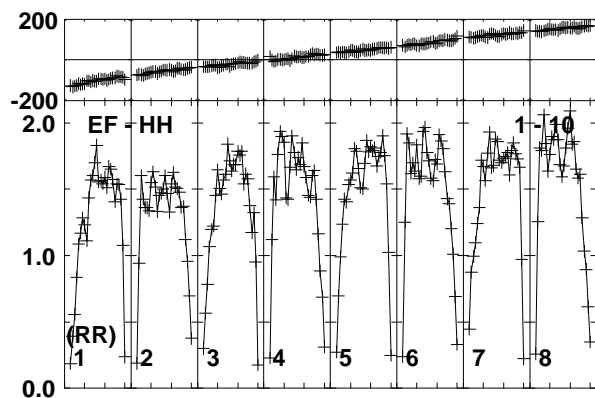
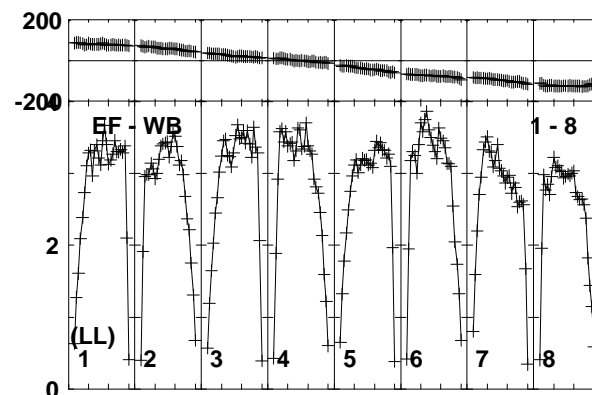
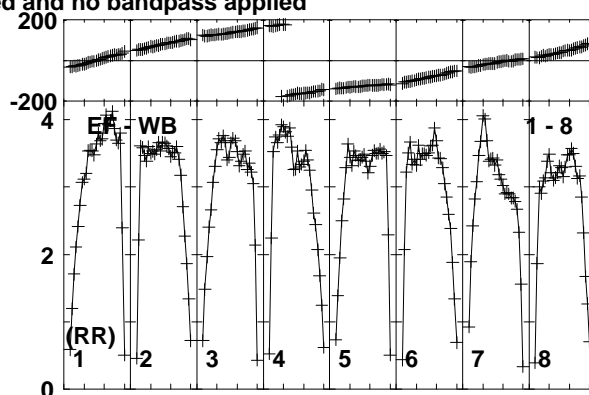
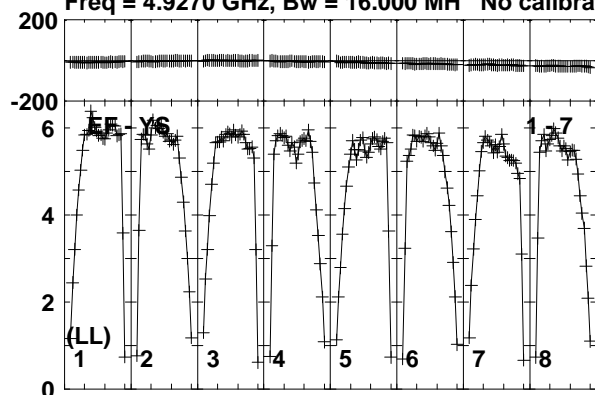

Lower frame: Milli Ampl Jy Top frame: Phas deg
Vector averaged cross-power spectrum Baseline: EF (01) - YS (07)
Timerange: 00/14:46:21 to 00/14:47:49

Plot file version 181 created 10-JUN-2016 16:08:07

FRB150418 RG008D.UVDATA.1

Freq = 4.9270 GHz, Bw = 16.000 MH No calibration applied and no bandpass applied

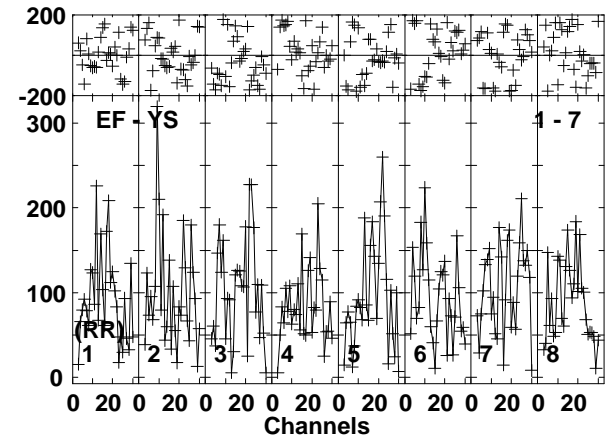
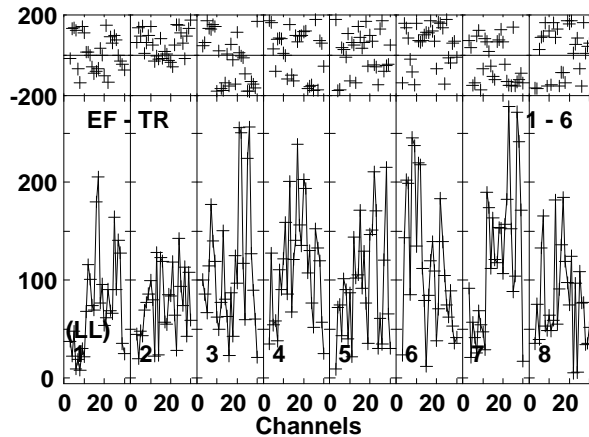
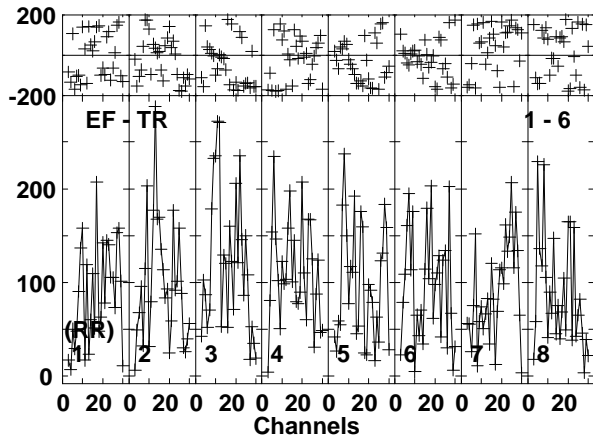
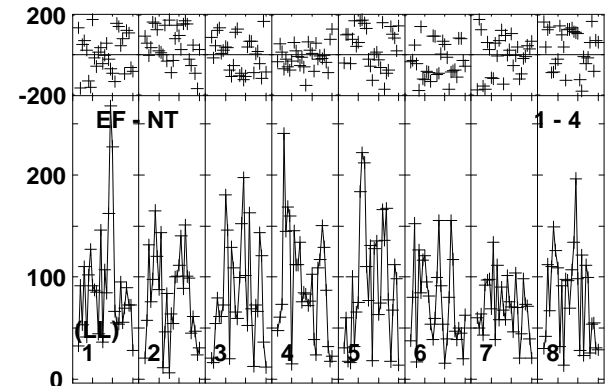
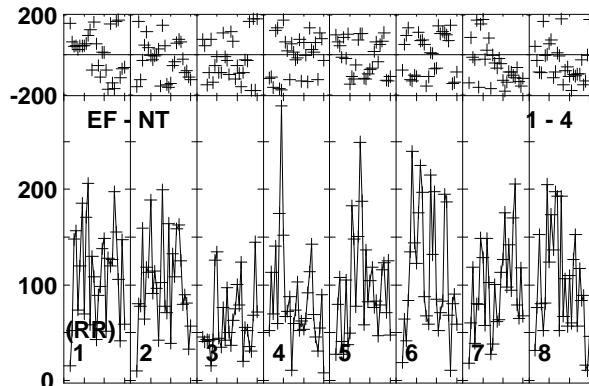
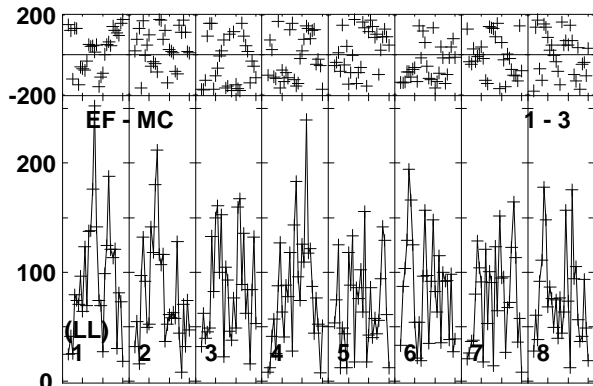
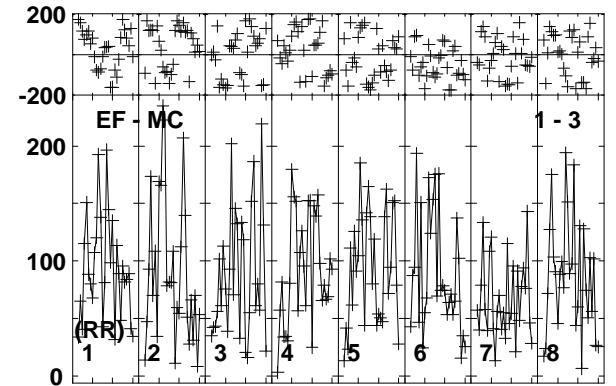
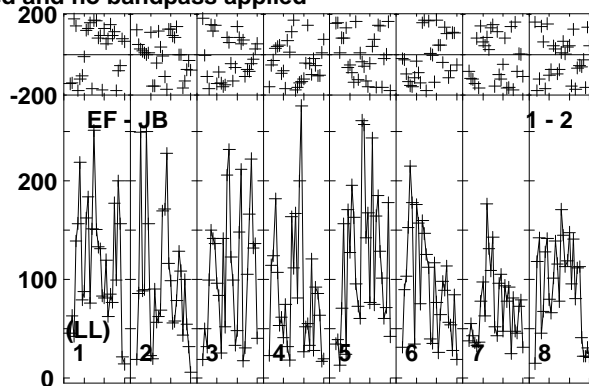
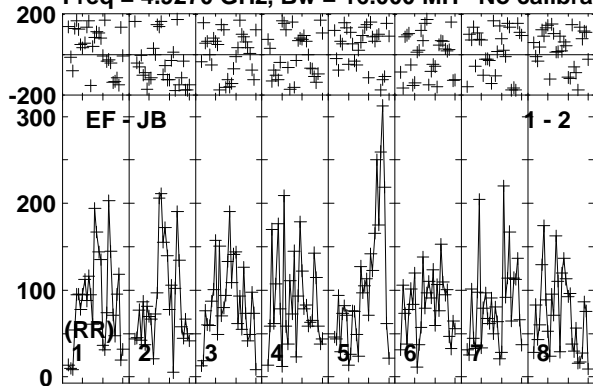

Lower frame: Micro Ampl Jy Top frame: Phas deg
Vector averaged cross-power spectrum Baseline: EF (01) - JB (02)
Timerange: 00/14:47:50 to 00/14:50:50

Plot file version 182 created 10-JUN-2016 16:08:08

FRB150418 RG008D.UVDATA.1

Freq = 4.9270 GHz, Bw = 16.000 MH No calibration applied and no bandpass applied

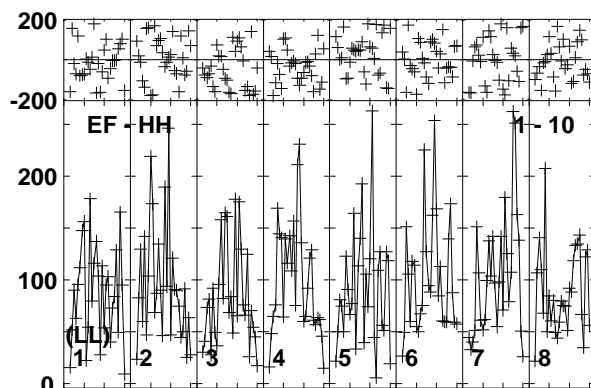
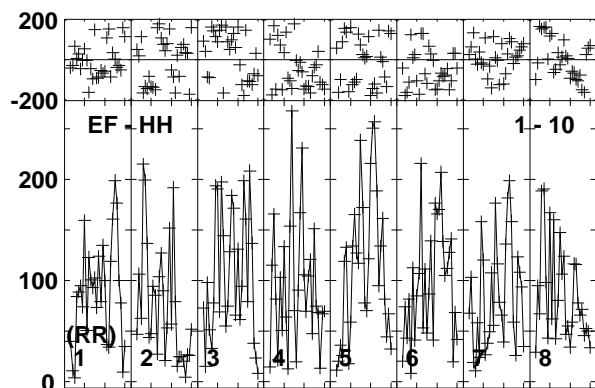
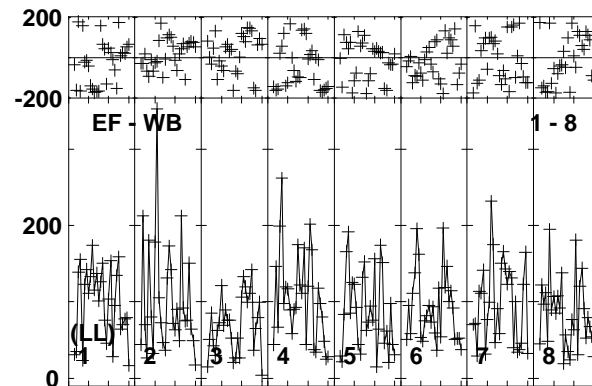
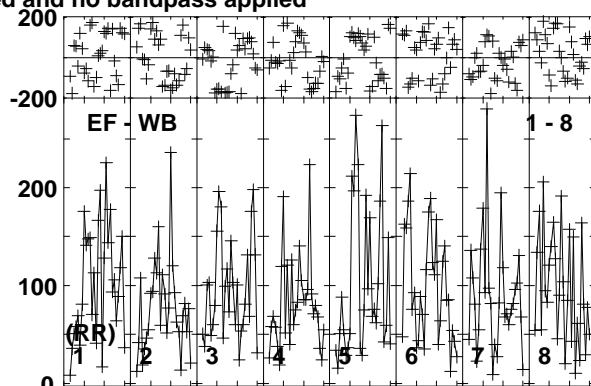
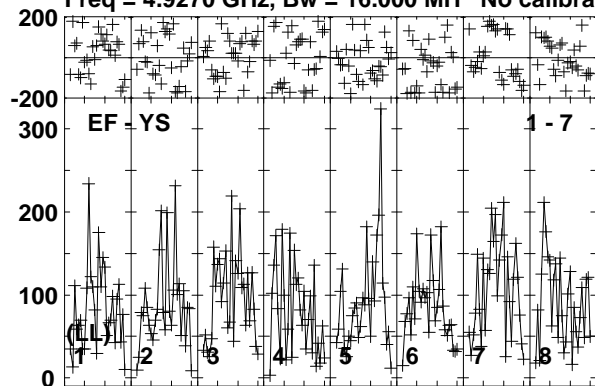

Lower frame: Micro Ampl Jy Top frame: Phas deg
Vector averaged cross-power spectrum Baseline: EF (01) - YS (07)
Timerange: 00/14:47:50 to 00/14:50:50

Plot file version 183 created 10-JUN-2016 16:08:08

J0718-1813 RG008D.UVDATA.1

Freq = 4.9270 GHz, Bw = 16.000 MH No calibration applied and no bandpass applied

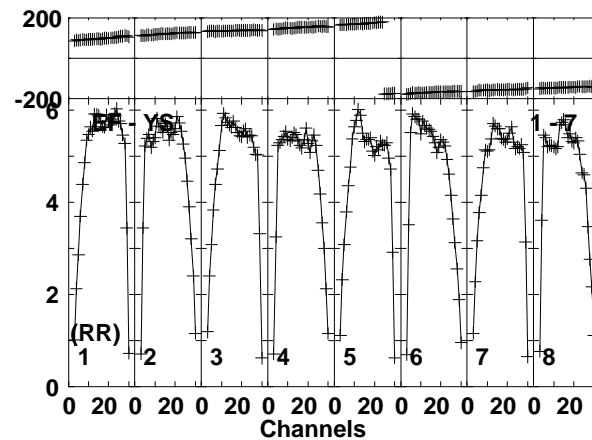
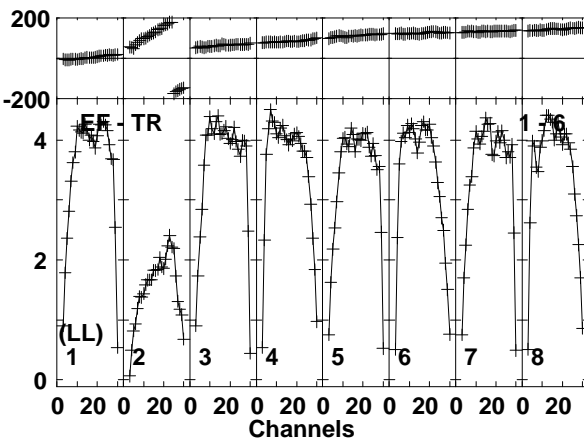
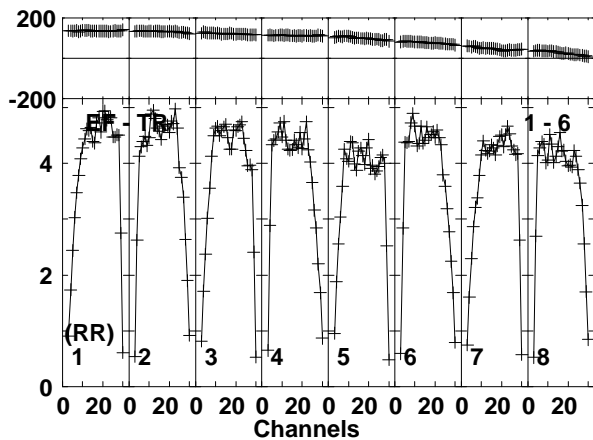
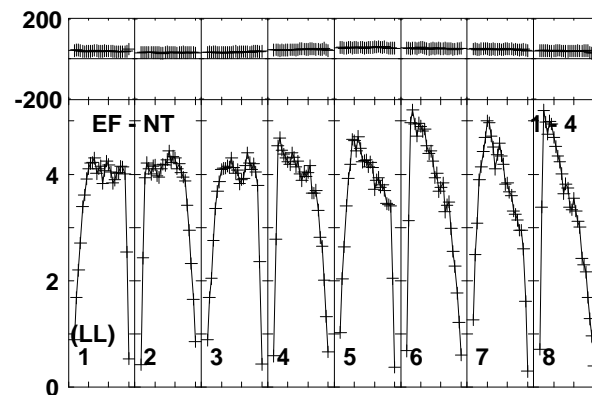
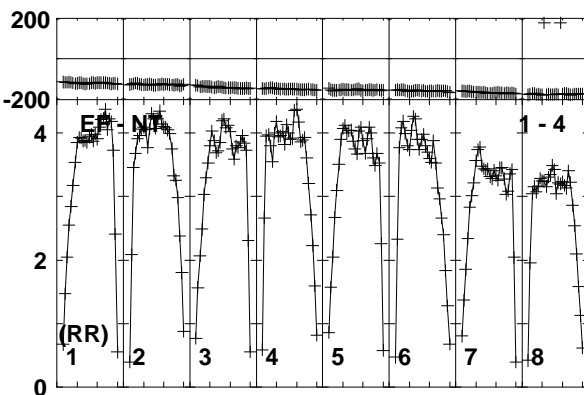
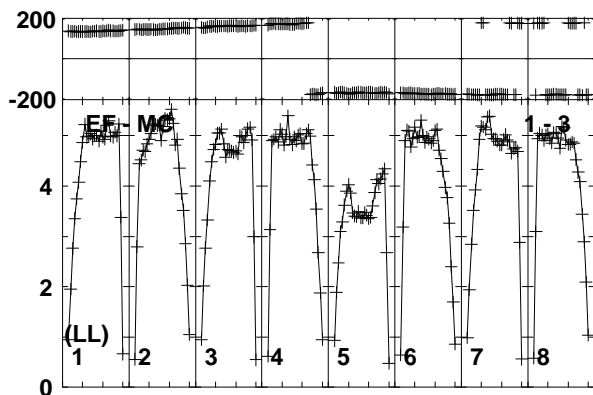
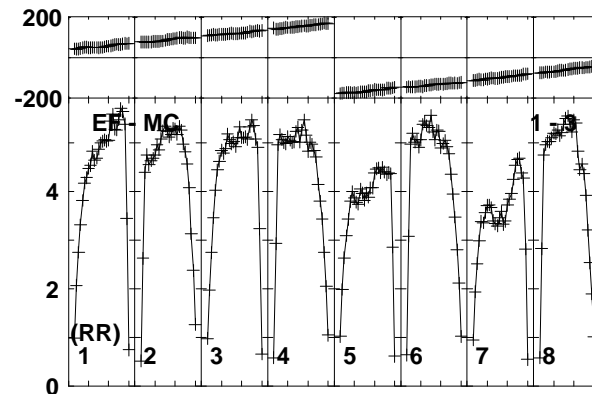
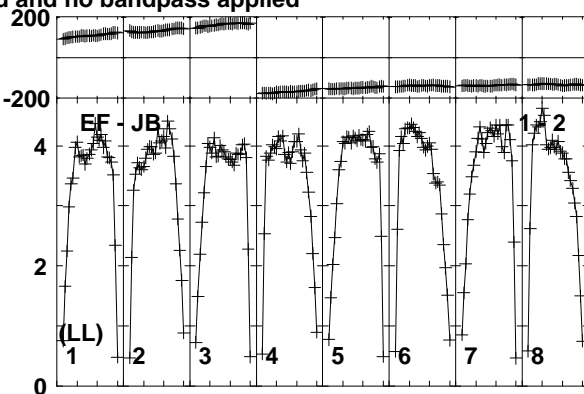
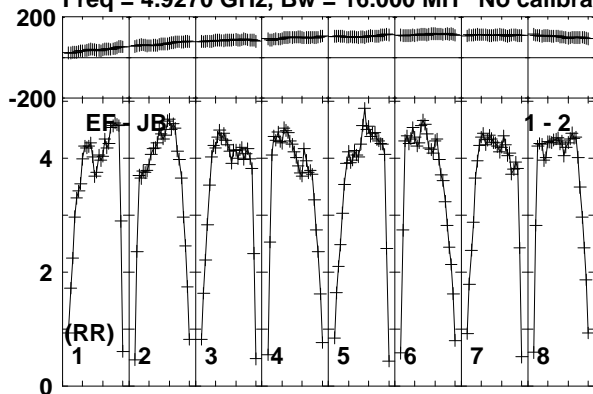

Lower frame: Milli Ampl Jy Top frame: Phas deg
Vector averaged cross-power spectrum Baseline: EF (01) - JB (02)
Timerange: 00/14:51:30 to 00/14:52:20

Plot file version 184 created 10-JUN-2016 16:08:08

J0718-1813 RG008D.UVDATA.1

Freq = 4.9270 GHz, Bw = 16.000 MH No calibration applied and no bandpass applied

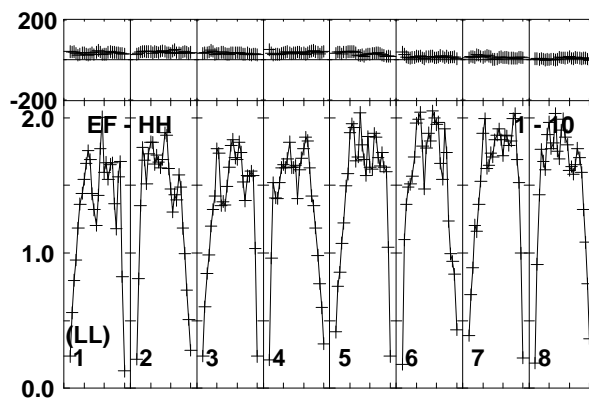
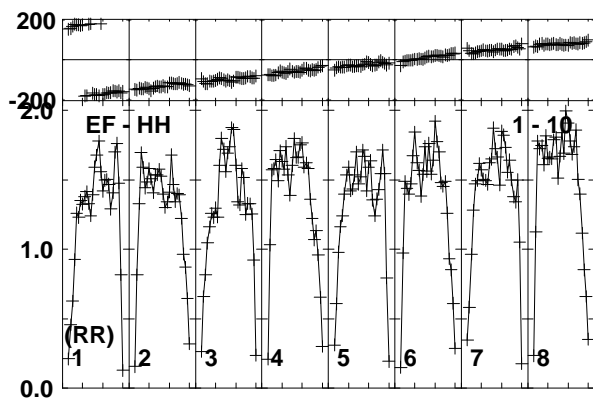
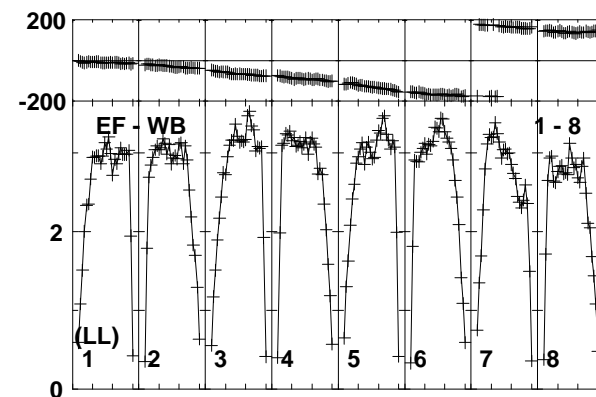
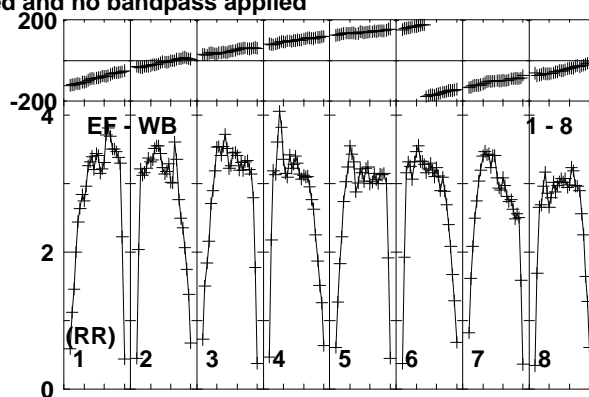
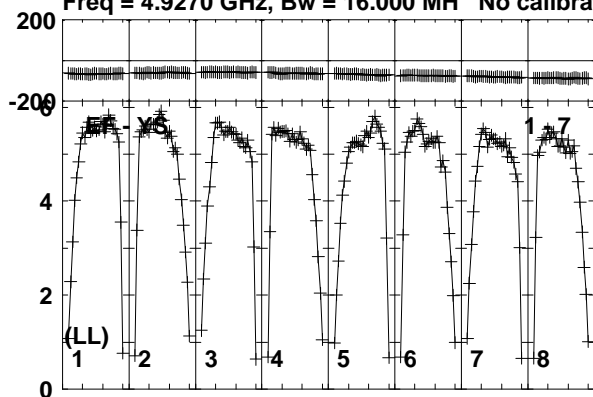

Lower frame: Milli Ampl Jy Top frame: Phas deg
Vector averaged cross-power spectrum Baseline: EF (01) - YS (07)
Timerange: 00/14:51:30 to 00/14:52:20

Plot file version 185 created 10-JUN-2016 16:08:08

FRB150418 RG008D.UVDATA.1

Freq = 4.9270 GHz, Bw = 16.000 MH No calibration applied and no bandpass applied

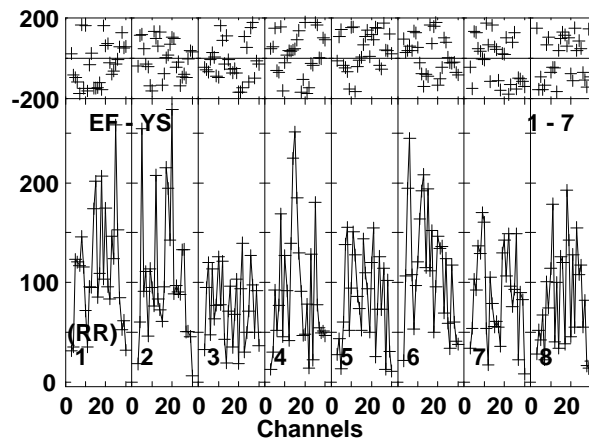
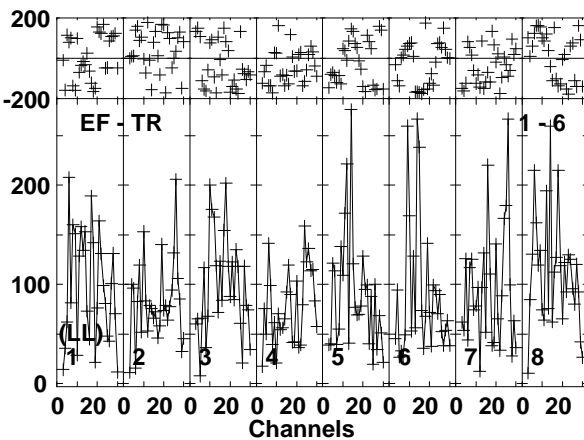
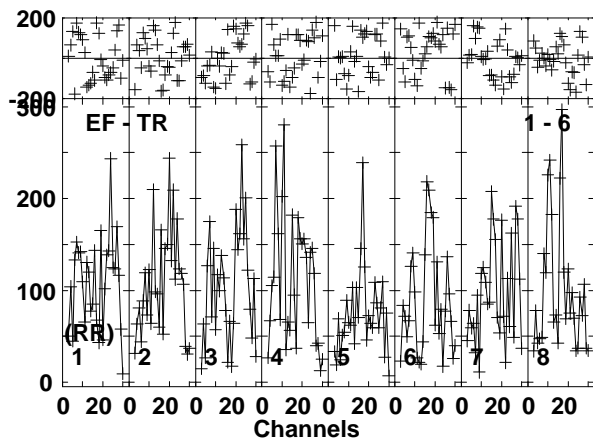
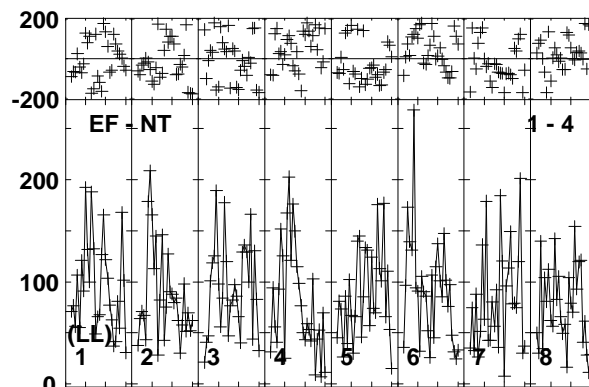
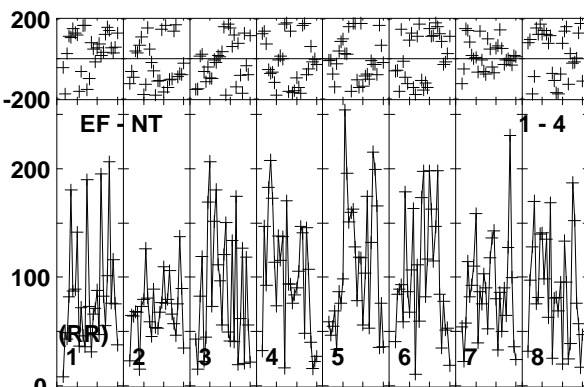
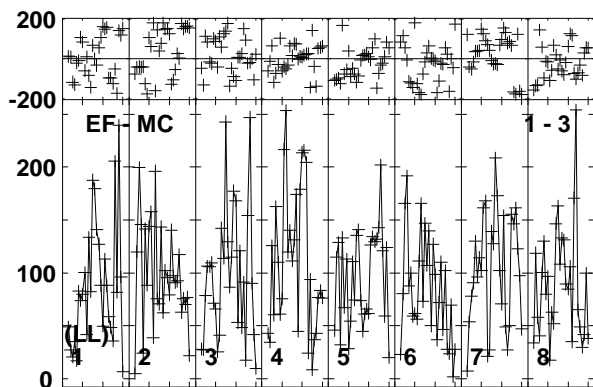
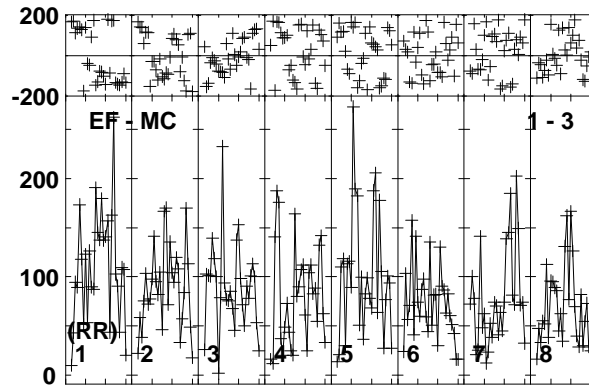
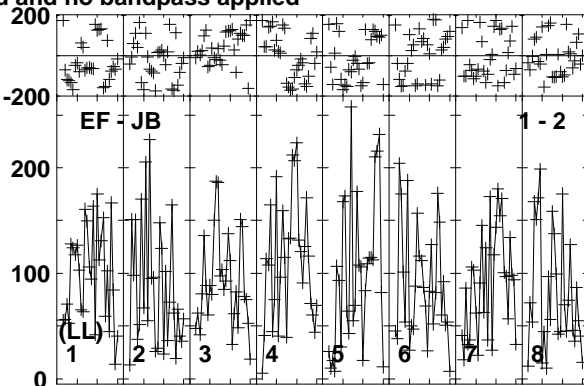
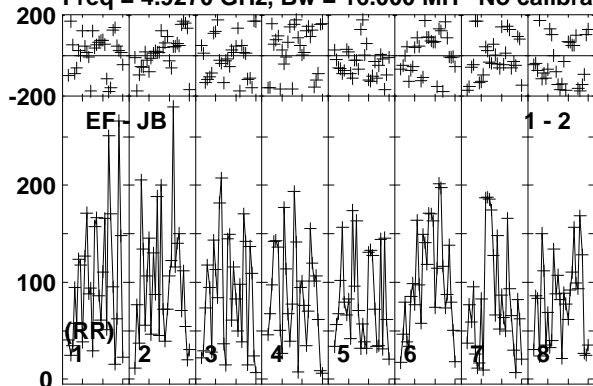

Lower frame: Micro Ampl Jy Top frame: Phas deg
Vector averaged cross-power spectrum Baseline: EF (01) - JB (02)
Timerange: 00/14:52:21 to 00/14:55:19

Plot file version 186 created 10-JUN-2016 16:08:08

FRB150418 RG008D.UVDATA.1

Freq = 4.9270 GHz, Bw = 16.000 MH No calibration applied and no bandpass applied

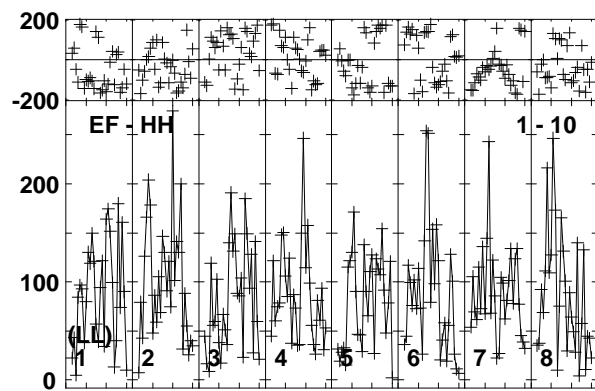
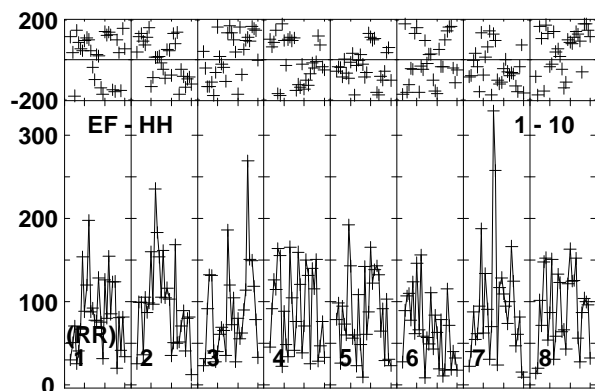
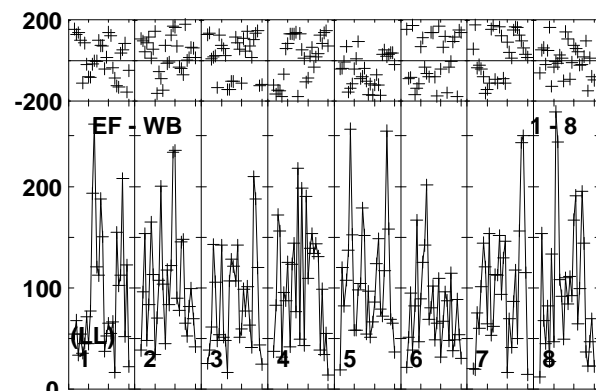
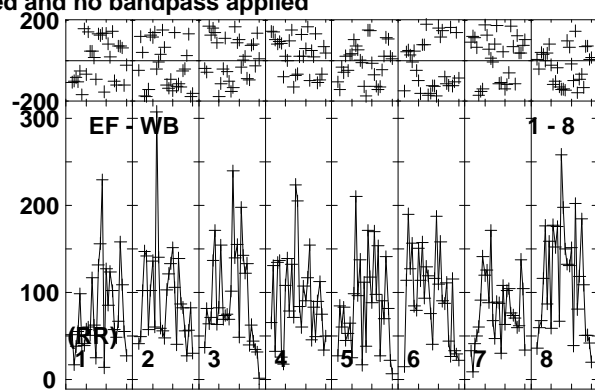
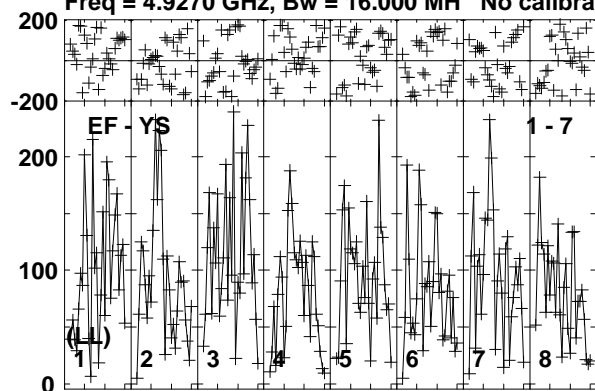

Lower frame: Micro Ampl Jy Top frame: Phas deg
Vector averaged cross-power spectrum Baseline: EF (01) - YS (07)
Timerange: 00/14:52:21 to 00/14:55:19

Plot file version 187 created 10-JUN-2016 16:08:08

J0718-1813 RG008D.UVDATA.1

Freq = 4.9270 GHz, Bw = 16.000 MH No calibration applied and no bandpass applied

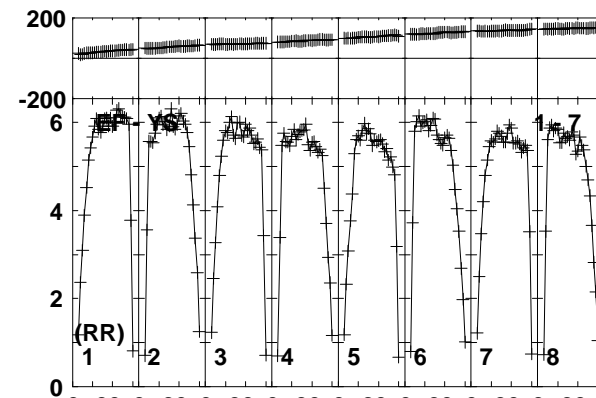
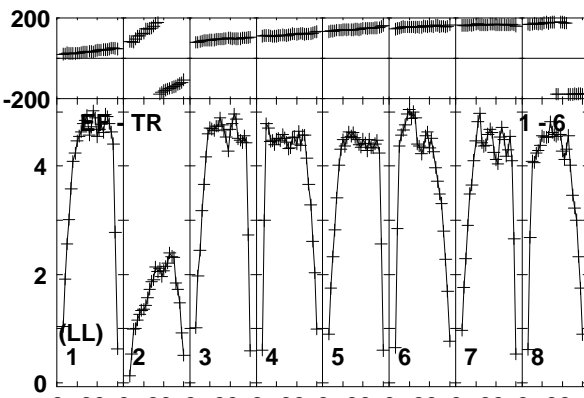
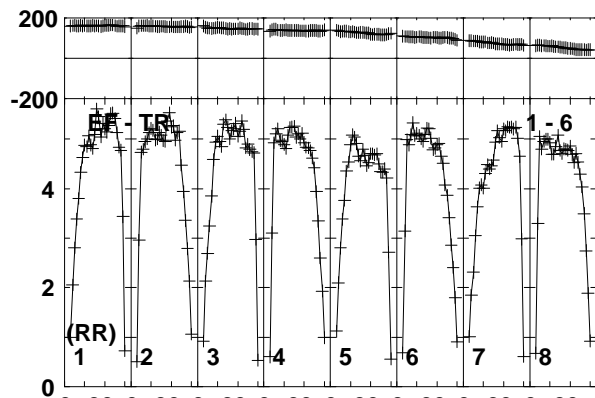
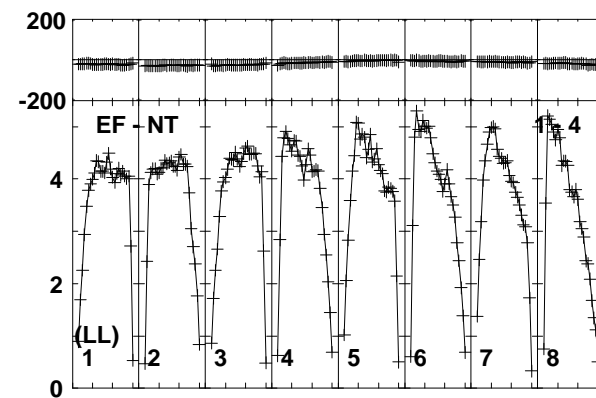
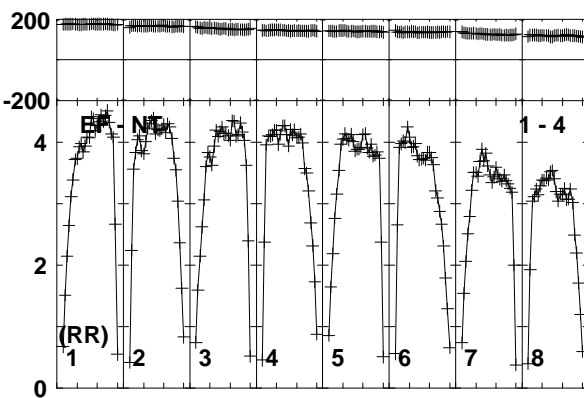
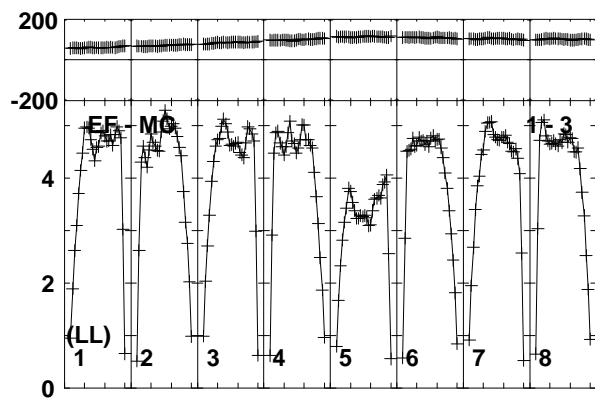
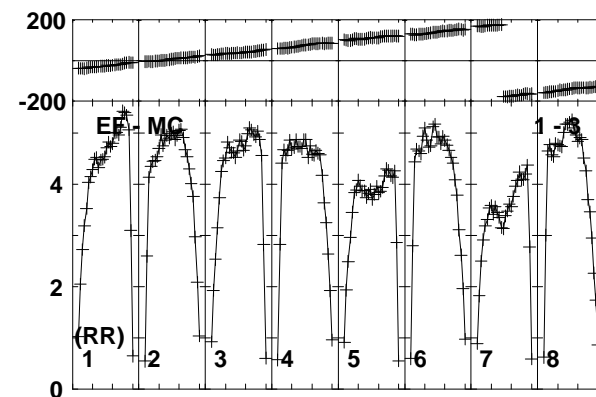
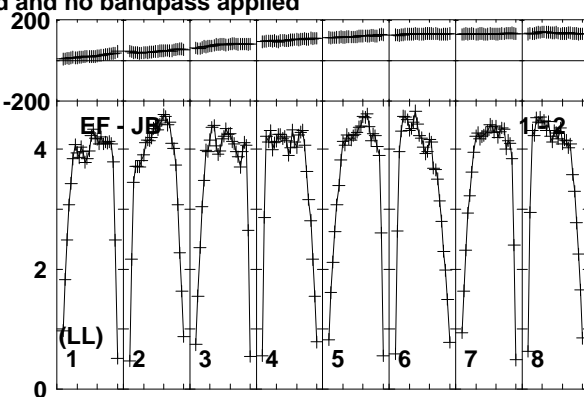
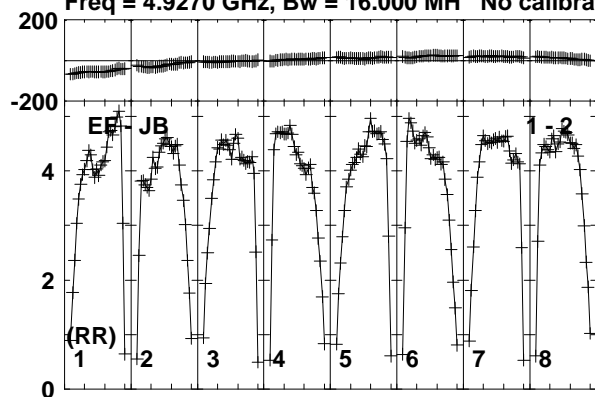

Lower frame: Milli Ampl Jy Top frame: Phas deg
Vector averaged cross-power spectrum Baseline: EF (01) - JB (02)
Timerange: 00/14:55:20 to 00/14:56:50

Plot file version 188 created 10-JUN-2016 16:08:08

J0718-1813 RG008D.UVDATA.1

Freq = 4.9270 GHz, Bw = 16.000 MH No calibration applied and no bandpass applied

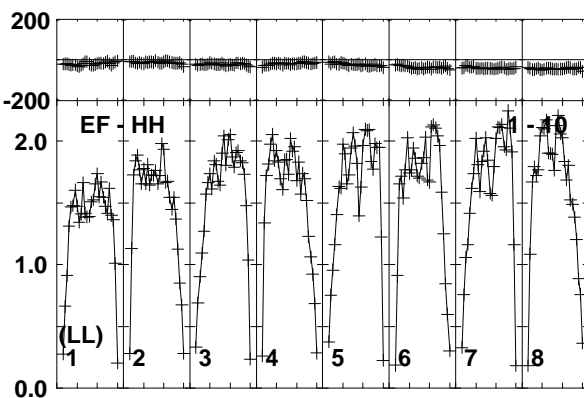
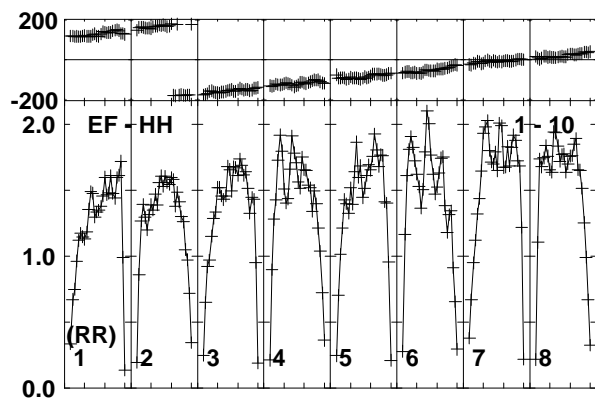
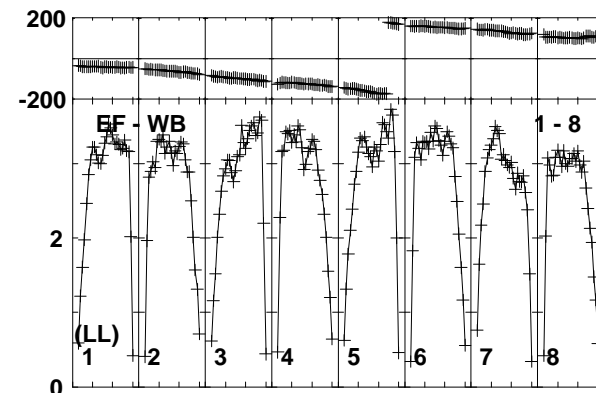
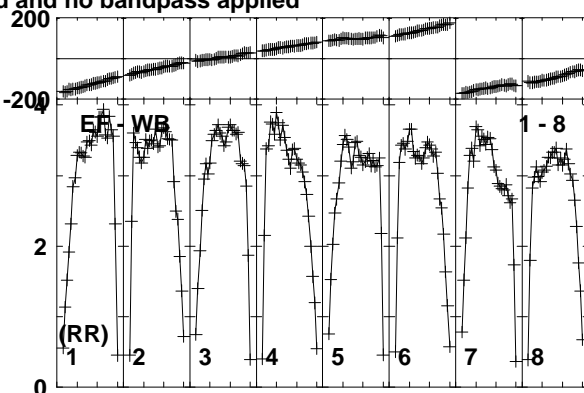
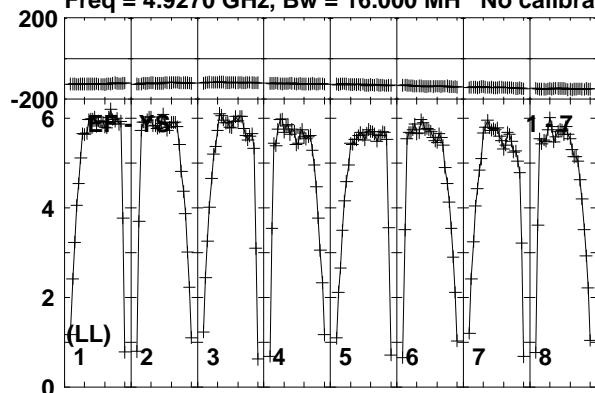

Lower frame: Milli Ampl Jy Top frame: Phas deg
Vector averaged cross-power spectrum Baseline: EF (01) - YS (07)
Timerange: 00/14:55:20 to 00/14:56:50

Plot file version 189 created 10-JUN-2016 16:08:08

J0712-1847 RG008D.UVDATA.1

Freq = 4.9270 GHz, Bw = 16.000 MH No calibration applied and no bandpass applied

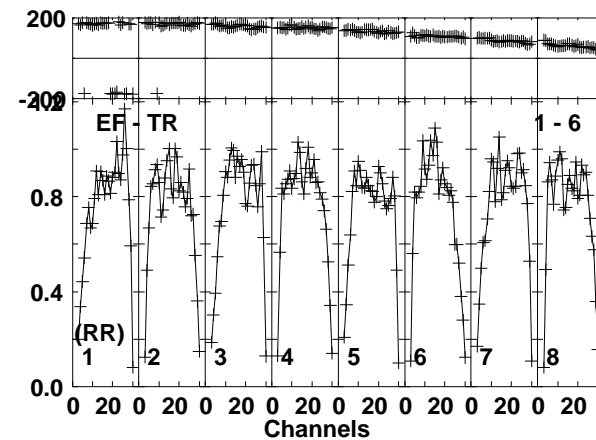
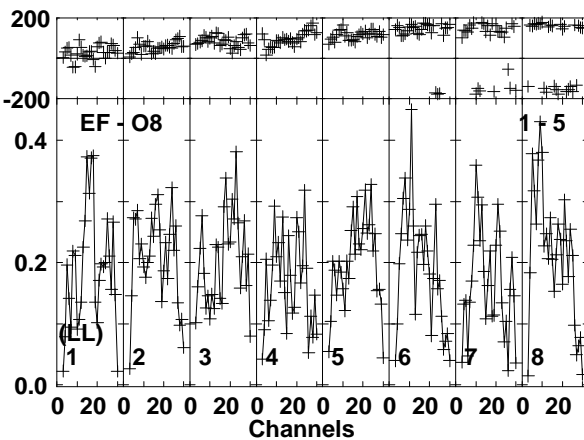
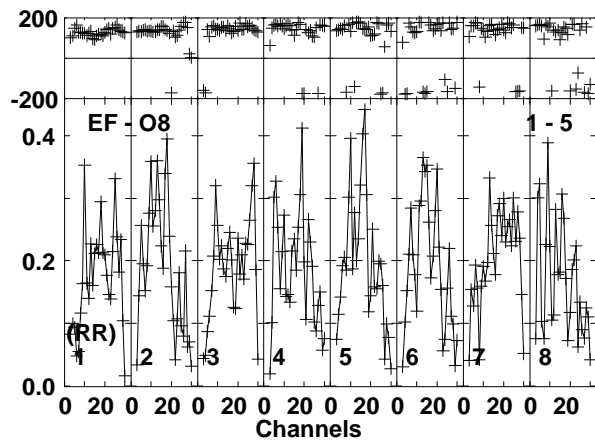
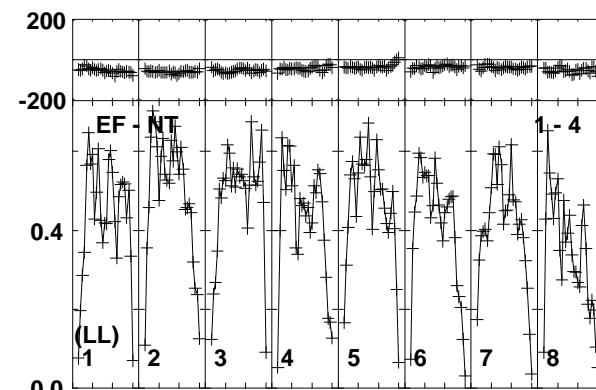
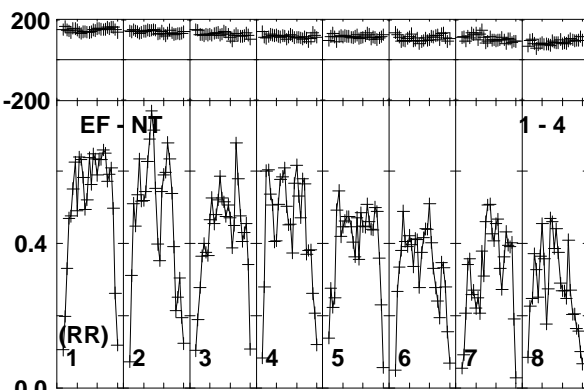
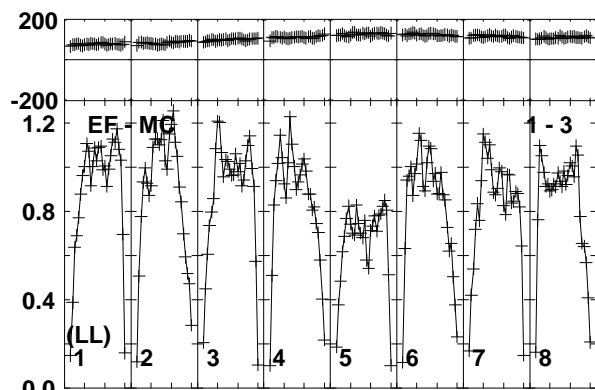
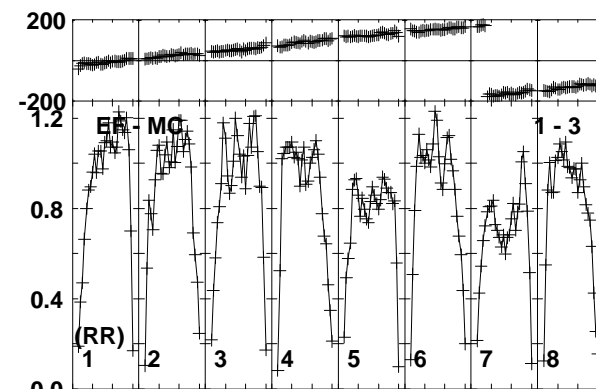
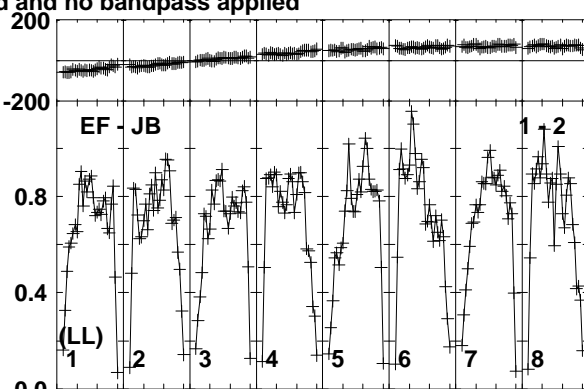
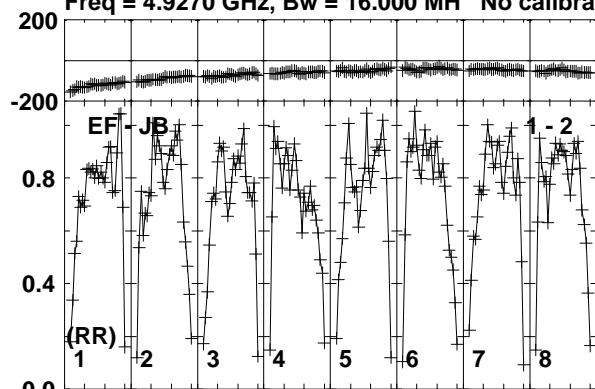

Lower frame: Milli Ampl Jy Top frame: Phas deg
Vector averaged cross-power spectrum Baseline: EF (01) - JB (02)
Timerange: 00/14:56:50 to 00/14:59:50

Plot file version 190 created 10-JUN-2016 16:08:08

J0712-1847 RG008D.UVDATA.1

Freq = 4.9270 GHz, Bw = 16.000 MH No calibration applied and no bandpass applied

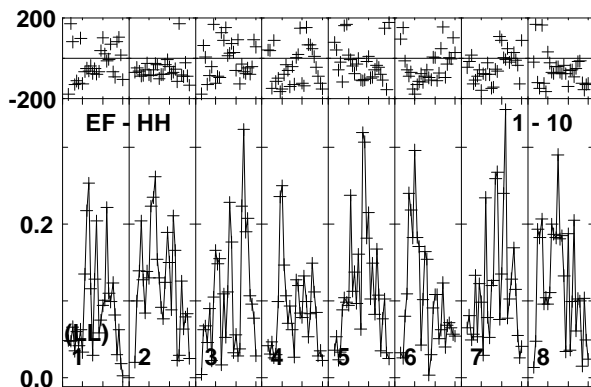
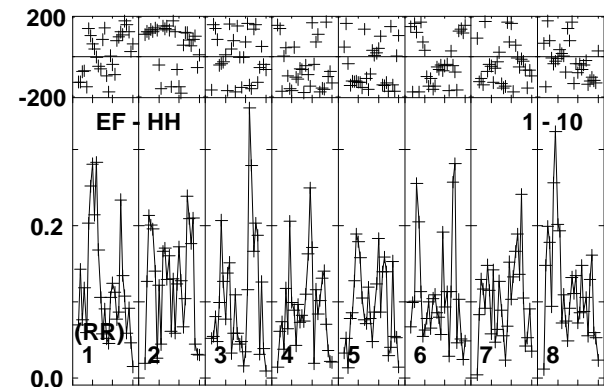
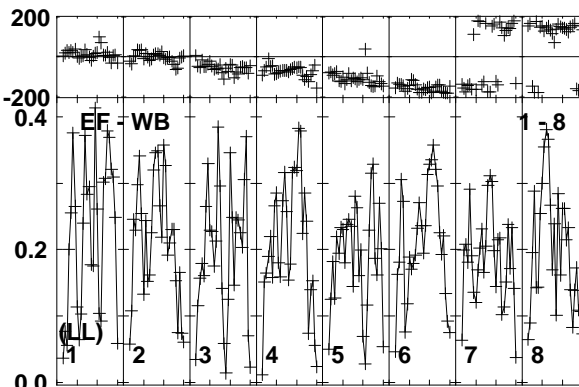
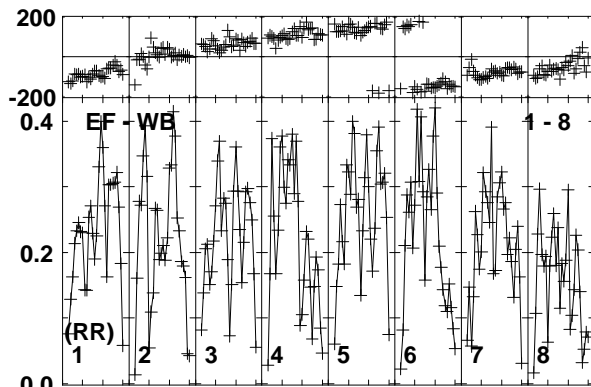
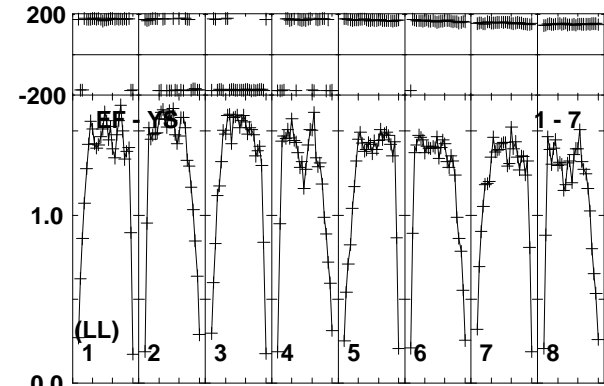
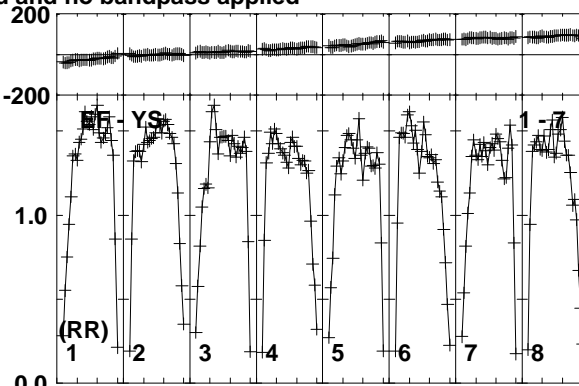
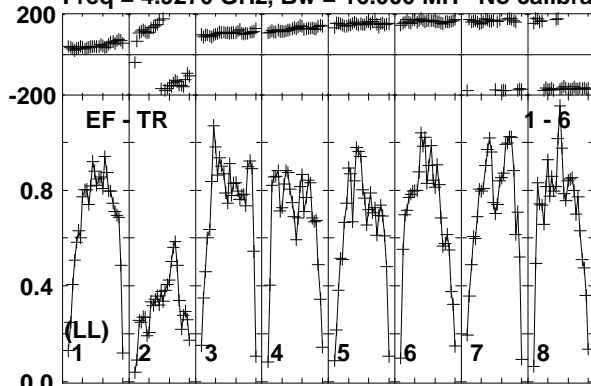

Lower frame: Milli Ampl Jy Top frame: Phas deg
Vector averaged cross-power spectrum Baseline: EF (01) - TR (06)
Timerange: 00/14:56:50 to 00/14:59:50

Plot file version 191 created 10-JUN-2016 16:08:09

J0718-1813 RG008D.UVDATA.1

Freq = 4.9270 GHz, Bw = 16.000 MH No calibration applied and no bandpass applied

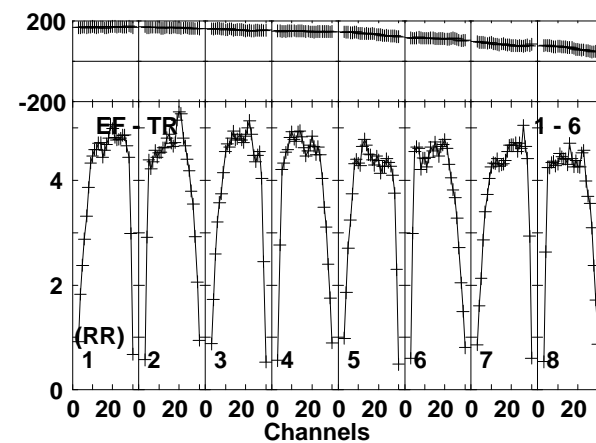
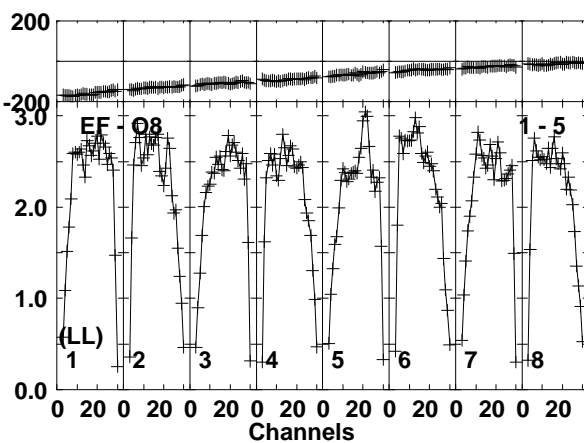
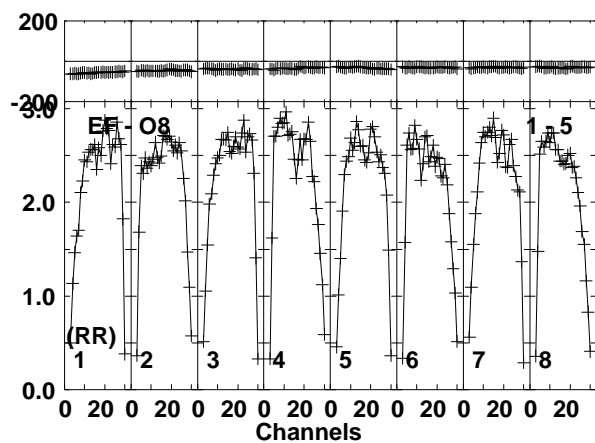
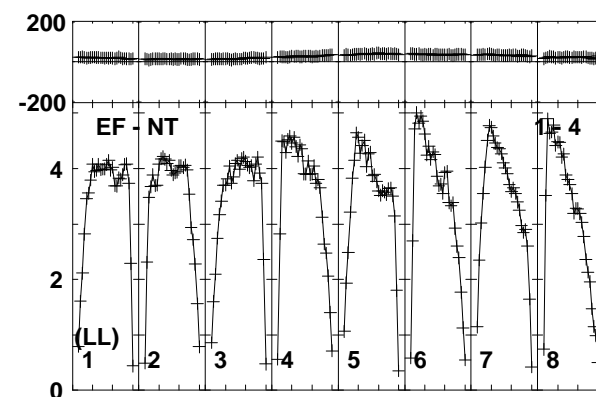
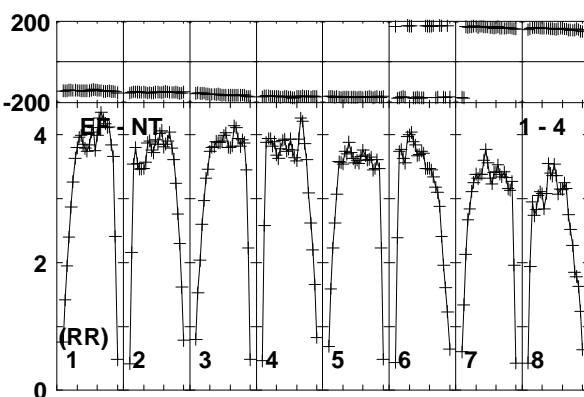
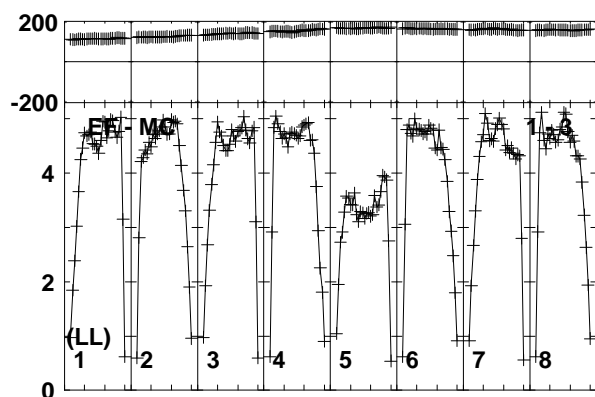
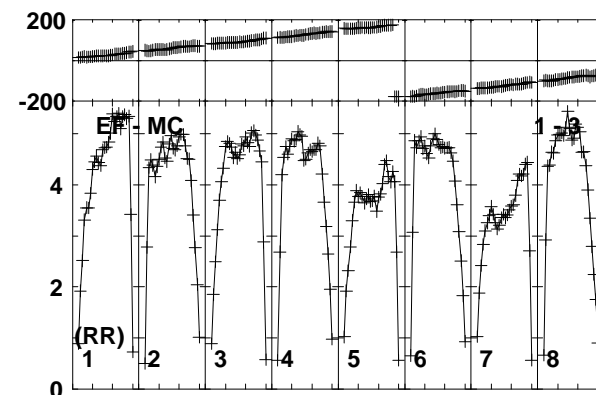
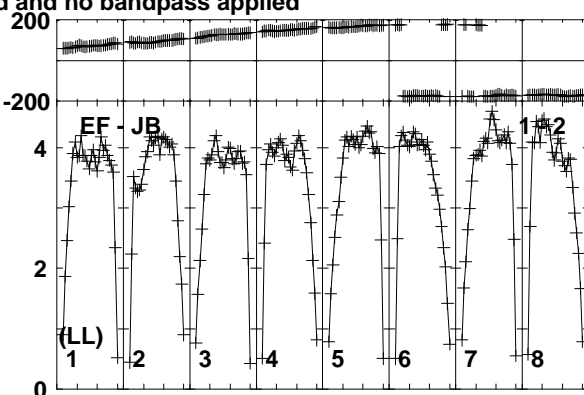
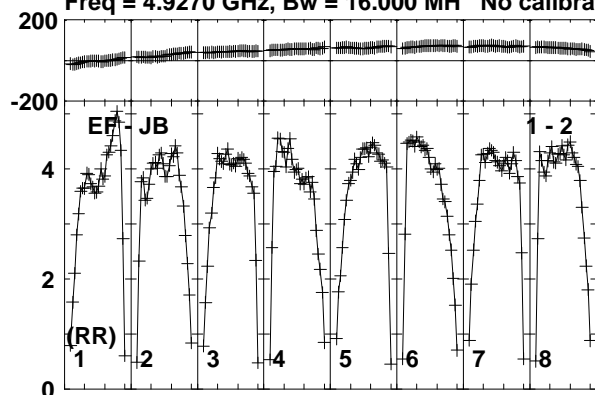

Lower frame: Milli Ampl Jy Top frame: Phas deg
Vector averaged cross-power spectrum Baseline: EF (01) - JB (02)
Timerange: 00/15:00:31 to 00/15:01:19

Plot file version 192 created 10-JUN-2016 16:08:09

J0718-1813 RG008D.UVDATA.1

Freq = 4.9270 GHz, Bw = 16.000 MH No calibration applied and no bandpass applied

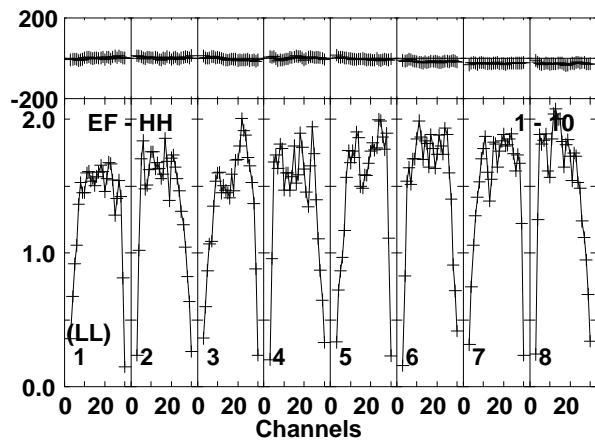
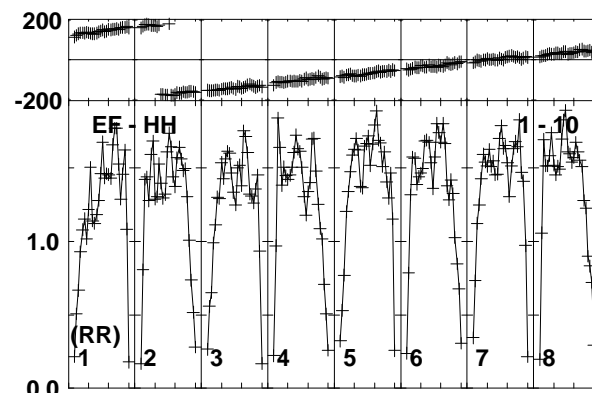
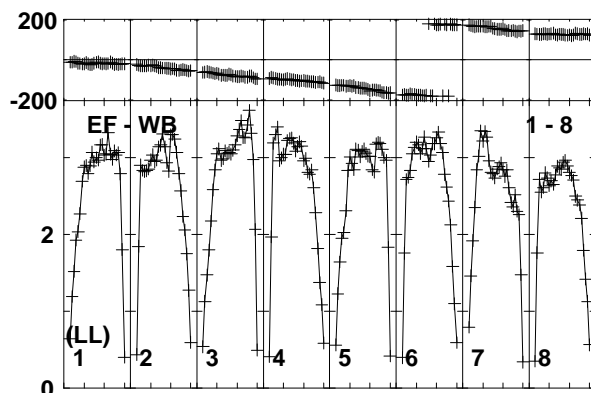
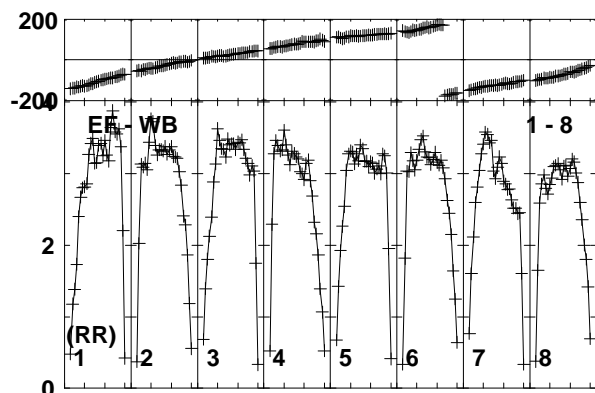
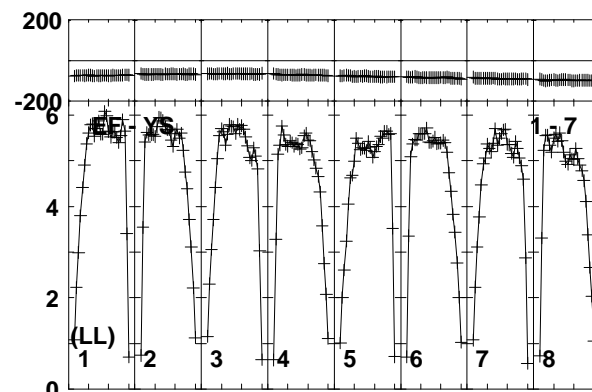
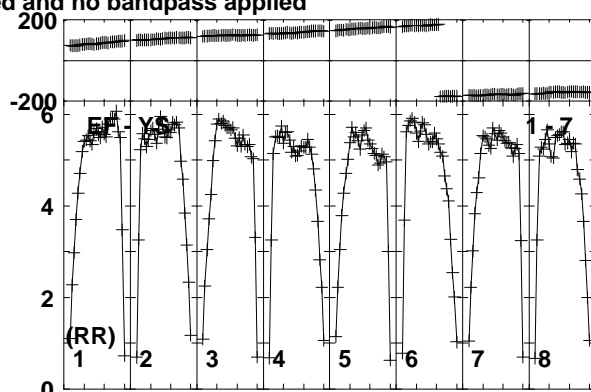
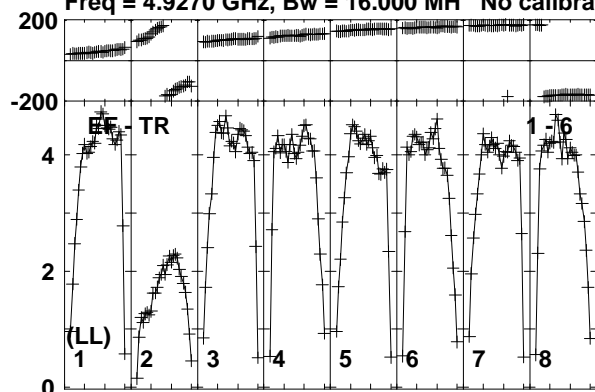

Lower frame: Milli Ampl Jy Top frame: Phas deg
Vector averaged cross-power spectrum Baseline: EF (01) - TR (06)
Timerange: 00/15:00:31 to 00/15:01:19

Plot file version 193 created 10-JUN-2016 16:08:09

FRB150418 RG008D.UVDATA.1

Freq = 4.9270 GHz, Bw = 16.000 MH No calibration applied and no bandpass applied

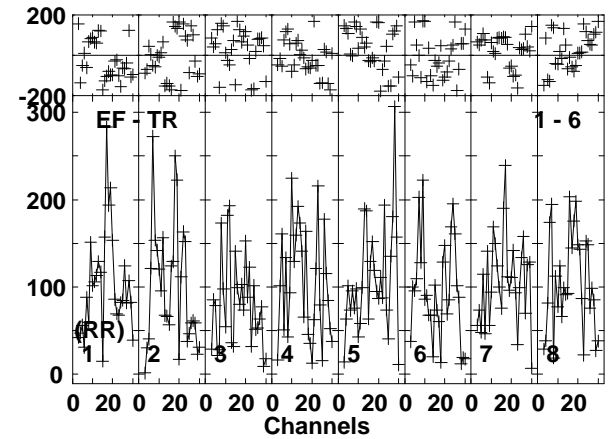
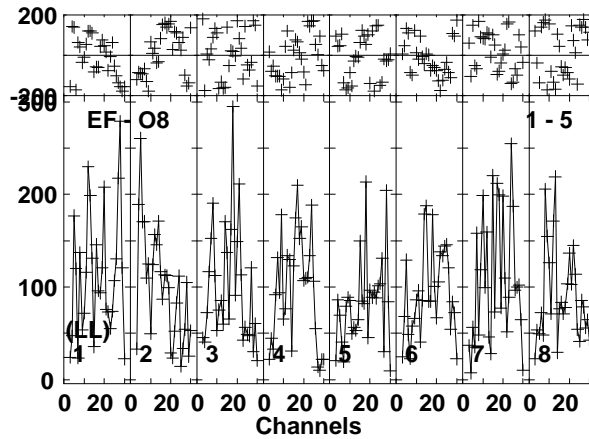
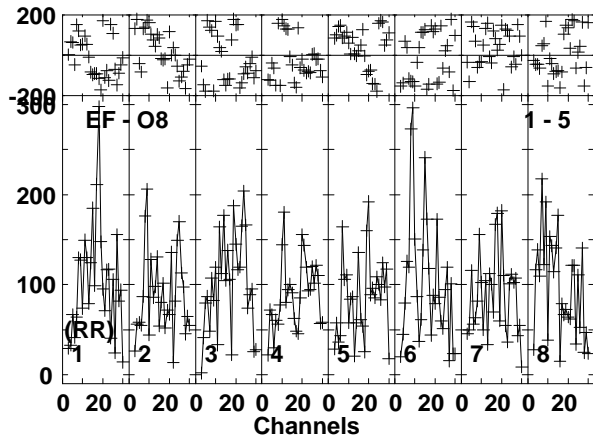
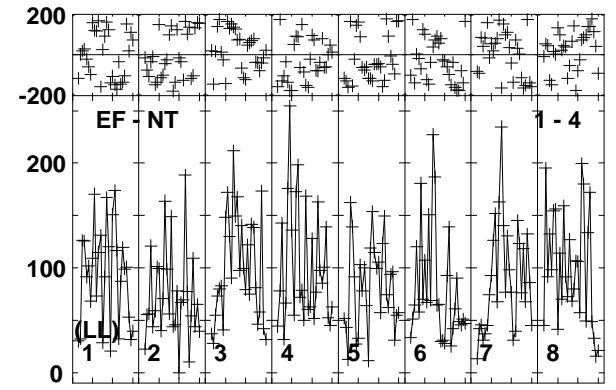
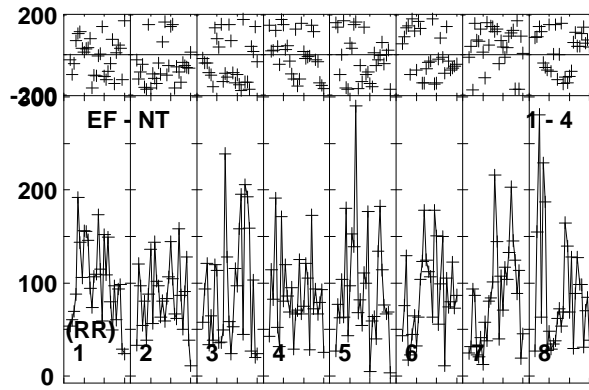
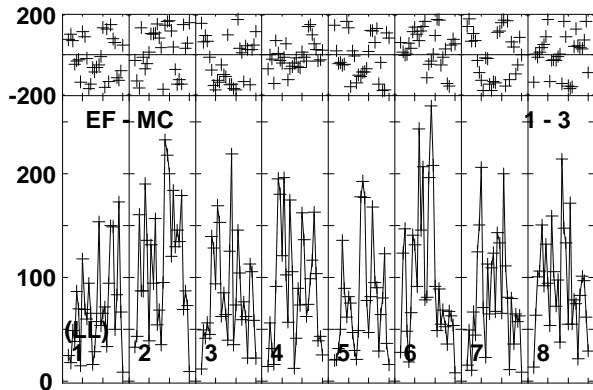
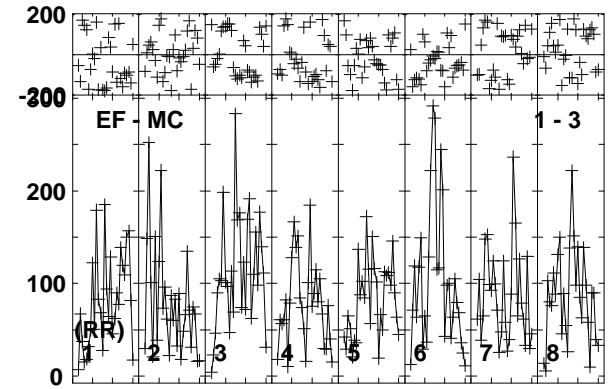
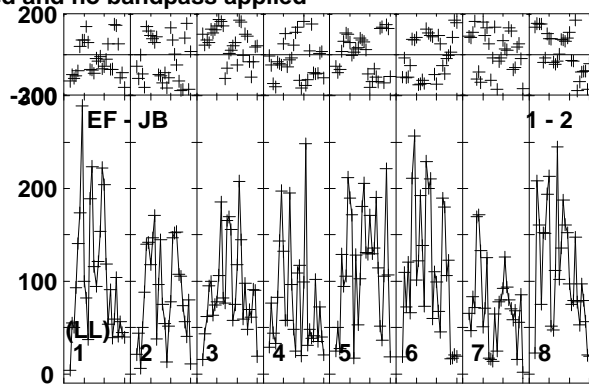
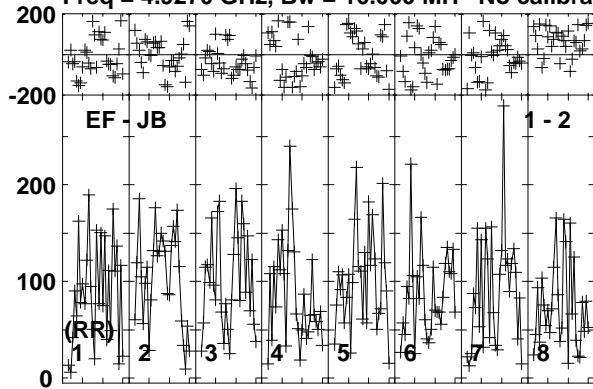

Lower frame: Micro Ampl Jy Top frame: Phas deg
Vector averaged cross-power spectrum Baseline: EF (01) - JB (02)
Timerange: 00/15:01:21 to 00/15:04:20

Plot file version 194 created 10-JUN-2016 16:08:09

FRB150418 RG008D.UVDATA.1

Freq = 4.9270 GHz, Bw = 16.000 MH No calibration applied and no bandpass applied

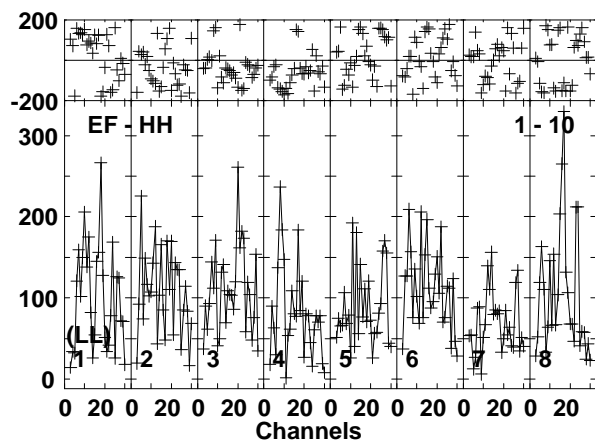
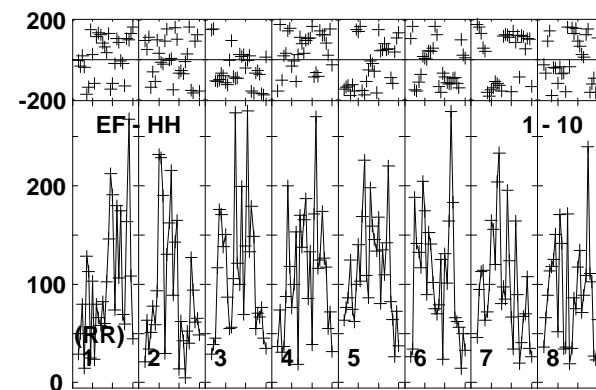
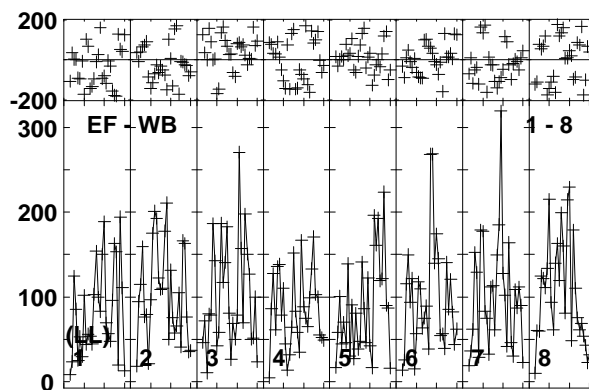
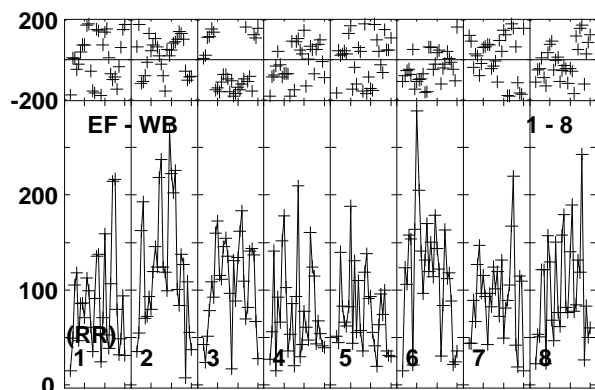
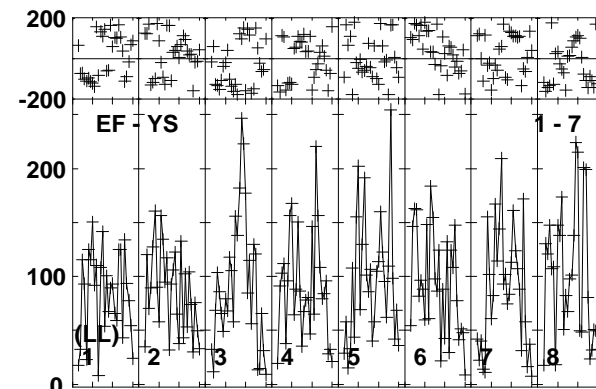
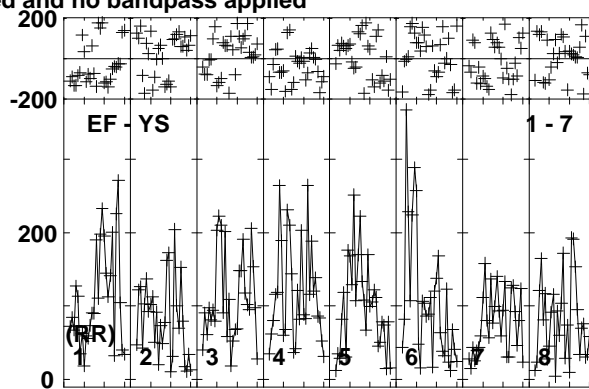
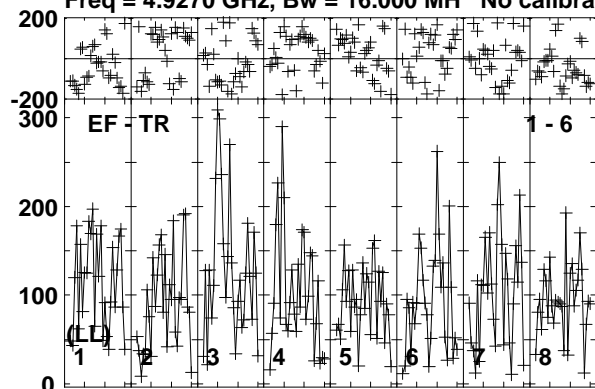

Lower frame: Micro Ampl Jy Top frame: Phas deg
Vector averaged cross-power spectrum Baseline: EF (01) - TR (06)
Timerange: 00/15:01:21 to 00/15:04:20

Plot file version 195 created 10-JUN-2016 16:08:09

J0718-1813 RG008D.UVDATA.1

Freq = 4.9270 GHz, Bw = 16.000 MH No calibration applied and no bandpass applied

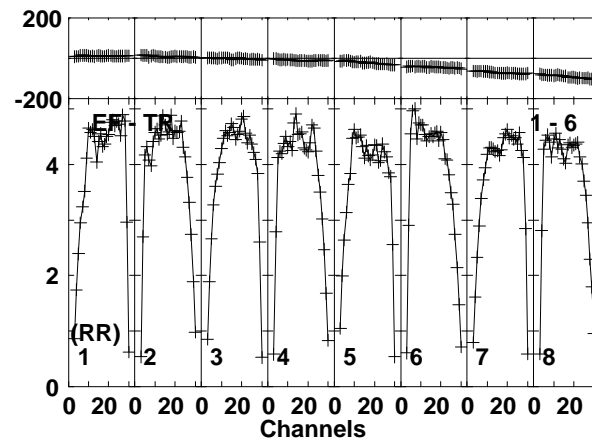
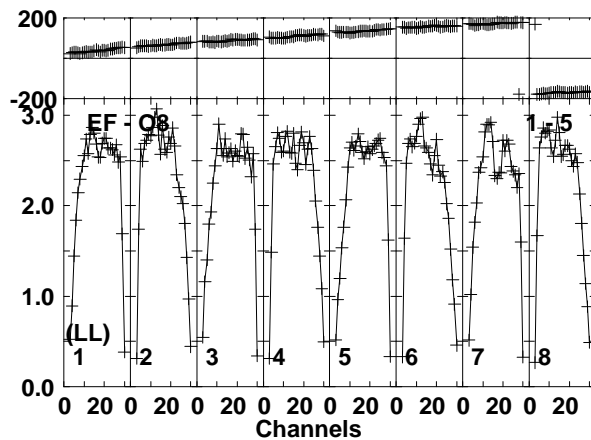
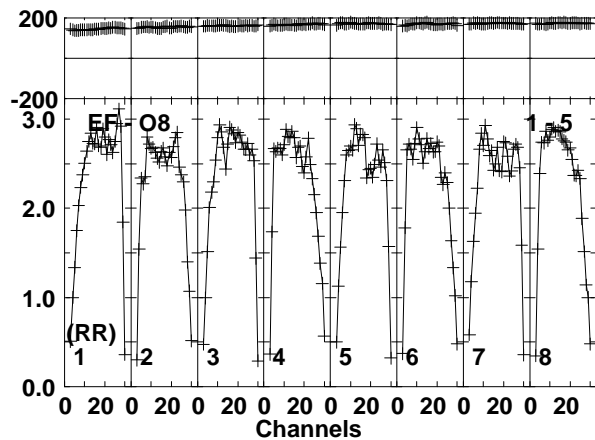
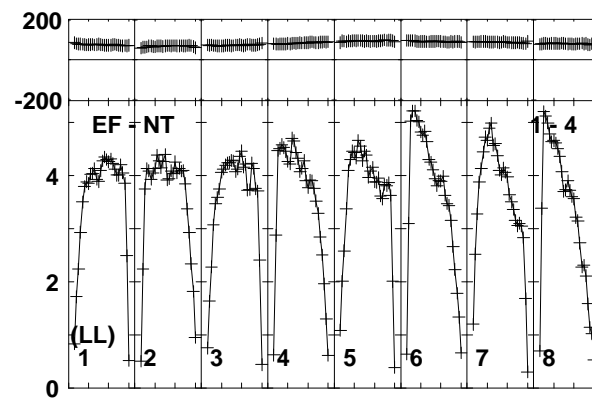
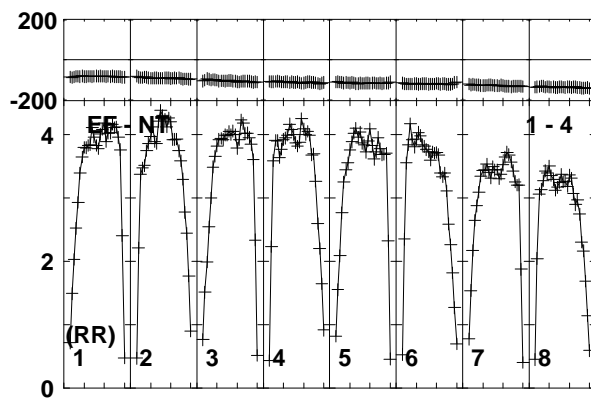
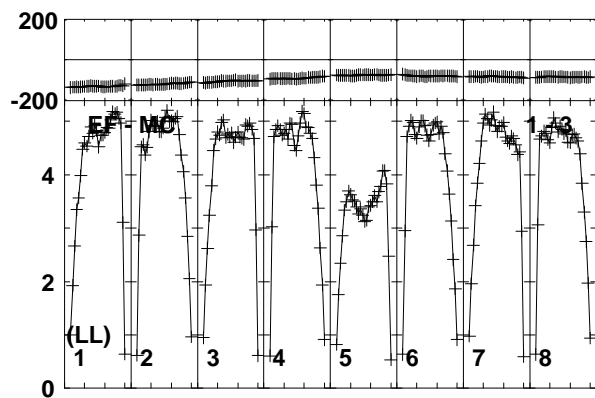
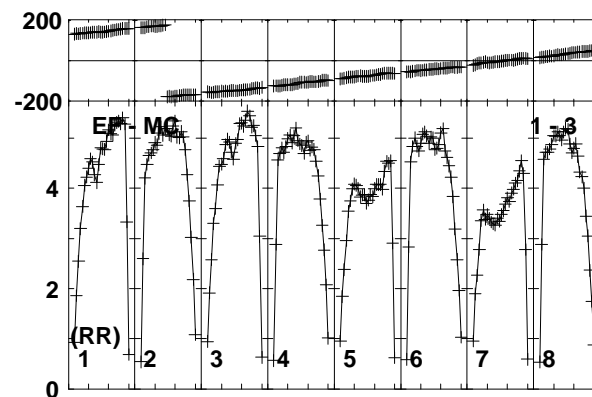
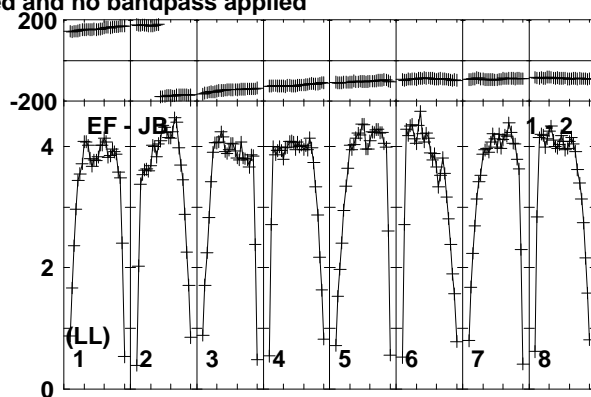
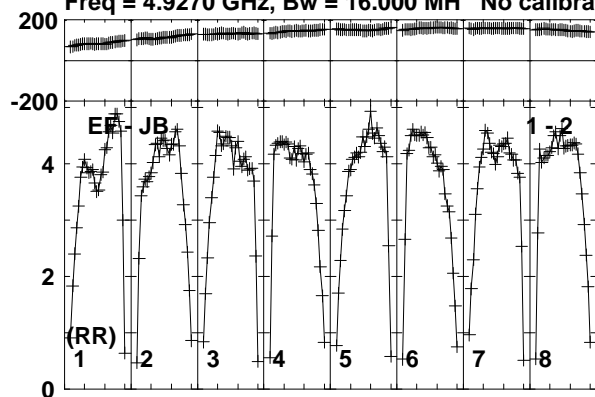

Lower frame: Milli Ampl Jy Top frame: Phas deg
Vector averaged cross-power spectrum Baseline: EF (01) - JB (02)
Timerange: 00/15:04:20 to 00/15:05:49

Plot file version 196 created 10-JUN-2016 16:08:09

J0718-1813 RG008D.UVDATA.1

Freq = 4.9270 GHz, Bw = 16.000 MH No calibration applied and no bandpass applied

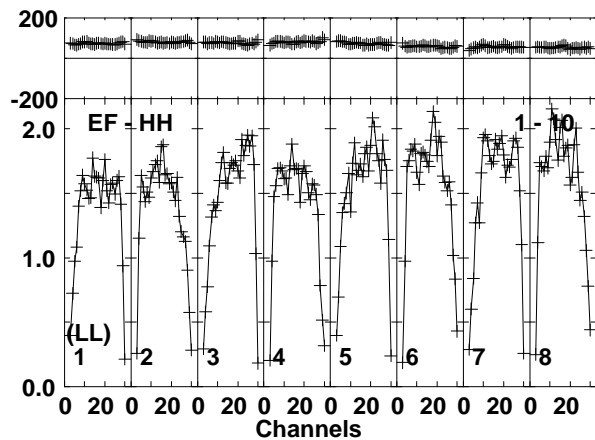
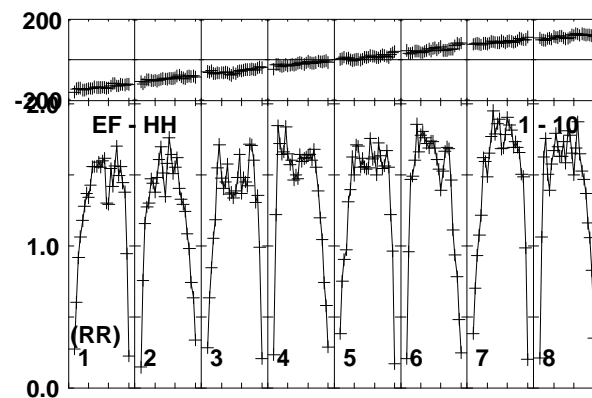
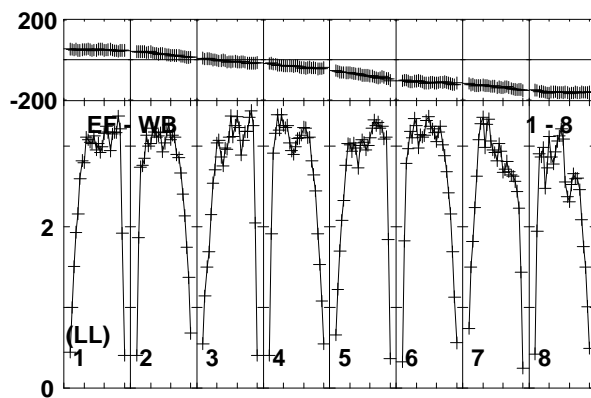
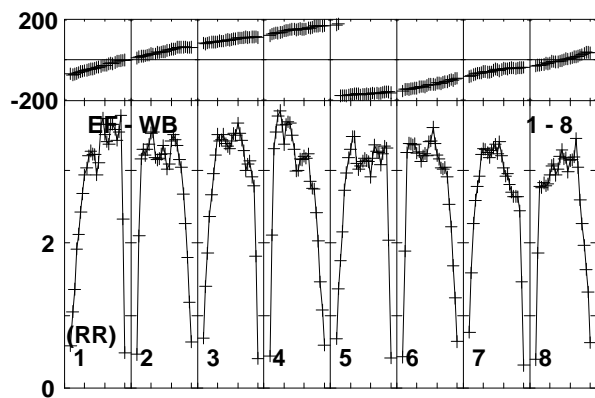
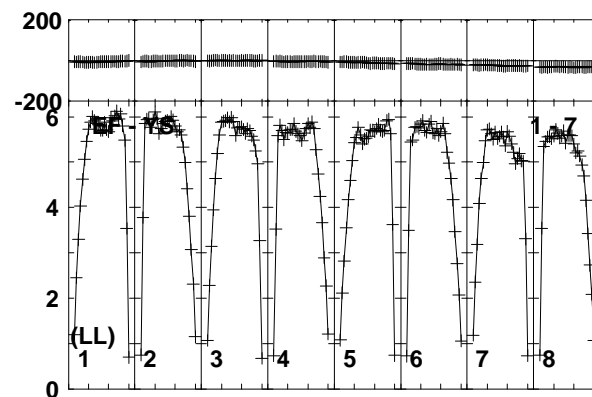
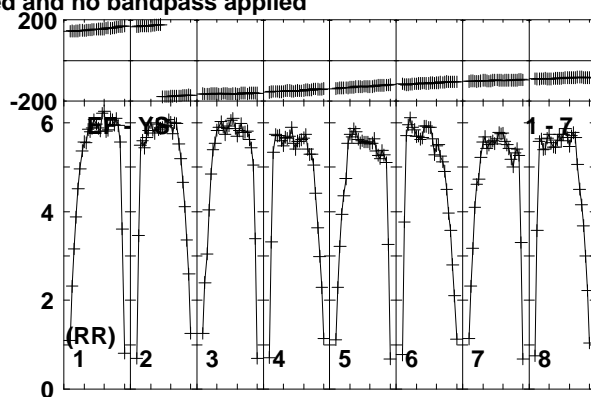
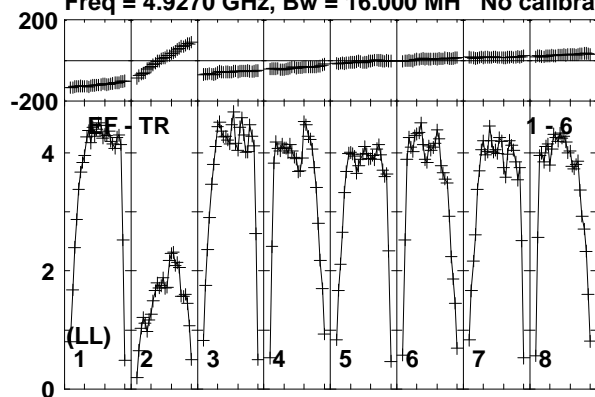

Lower frame: Milli Ampl Jy Top frame: Phas deg
Vector averaged cross-power spectrum Baseline: EF (01) - TR (06)
Timerange: 00/15:04:20 to 00/15:05:49

Plot file version 197 created 10-JUN-2016 16:08:09

FRB150418 RG008D.UVDATA.1

Freq = 4.9270 GHz, Bw = 16.000 MH No calibration applied and no bandpass applied

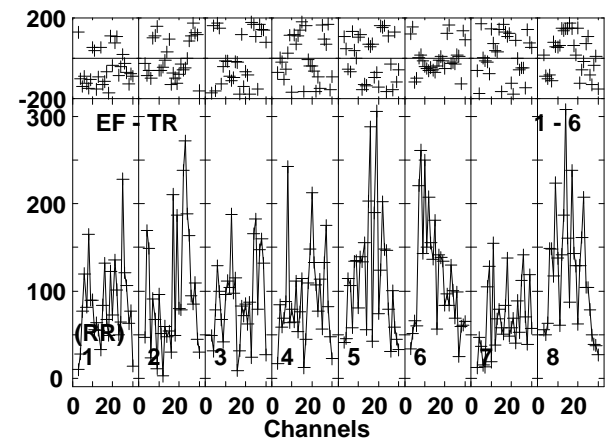
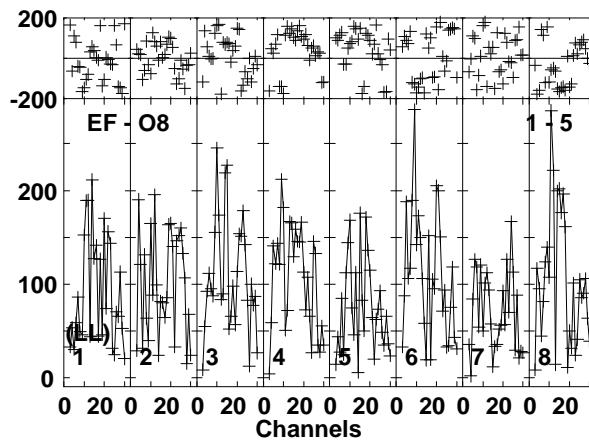
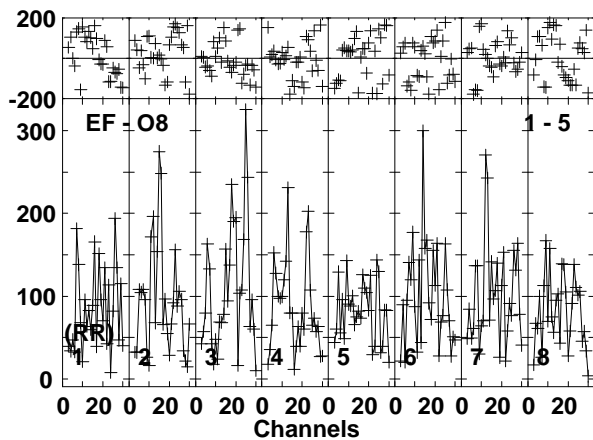
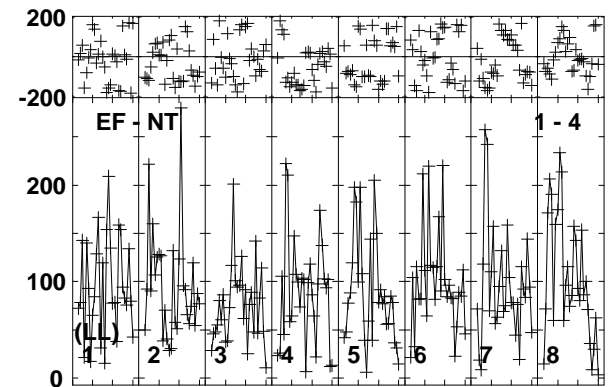
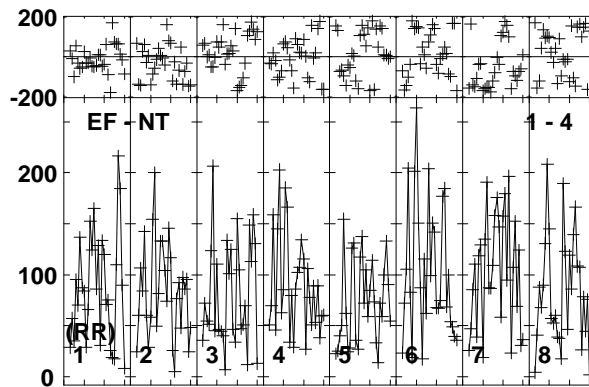
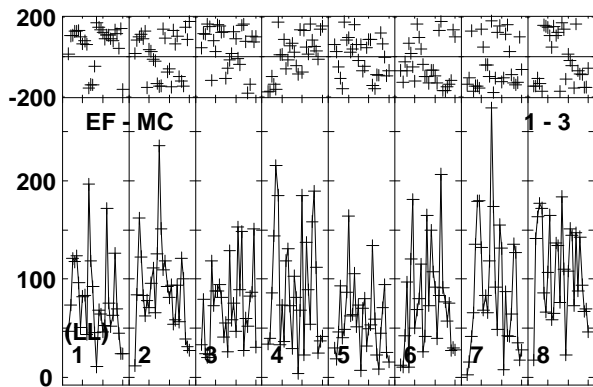
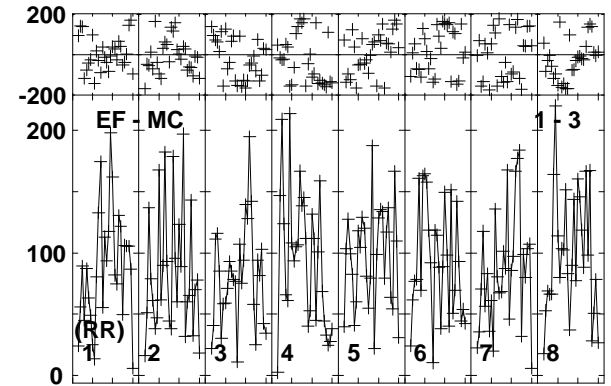
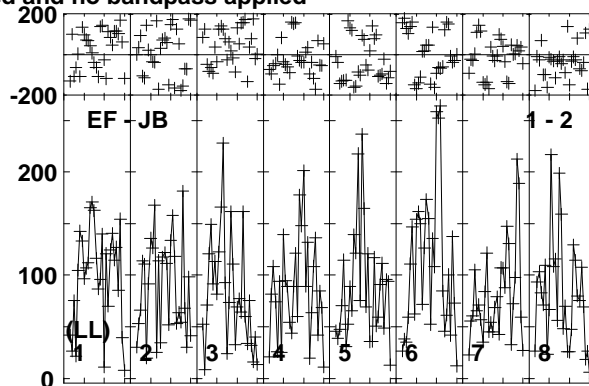
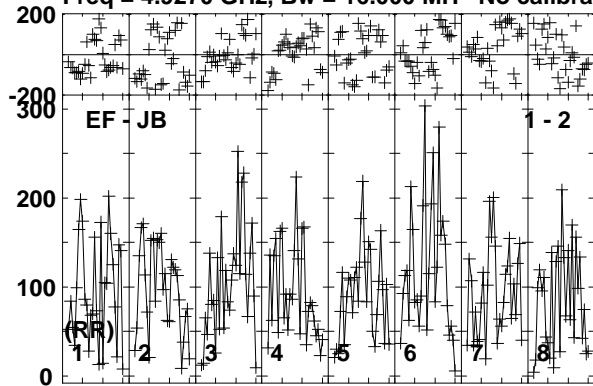

Lower frame: Micro Ampl Jy Top frame: Phas deg
Vector averaged cross-power spectrum Baseline: EF (01) - JB (02)
Timerange: 00/15:05:50 to 00/15:08:50

Plot file version 198 created 10-JUN-2016 16:08:09

FRB150418 RG008D.UVDATA.1

Freq = 4.9270 GHz, Bw = 16.000 MH No calibration applied and no bandpass applied

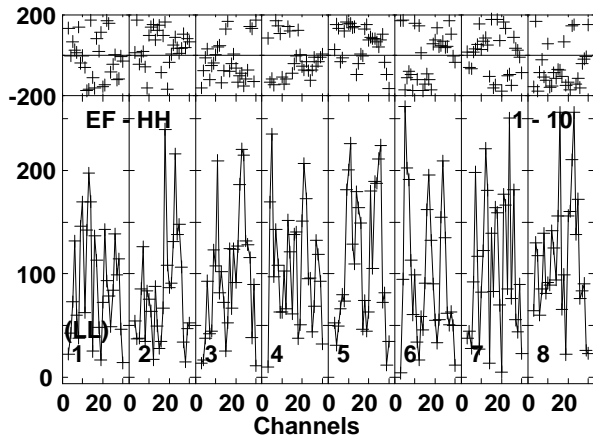
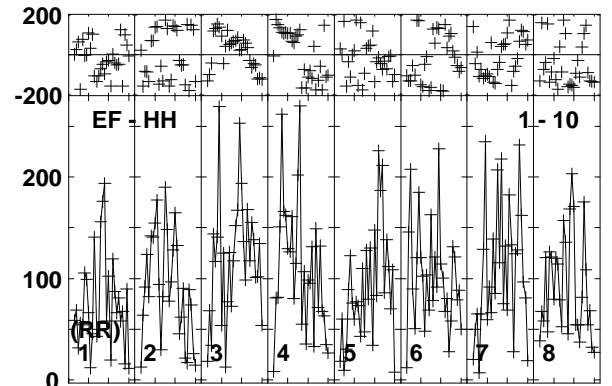
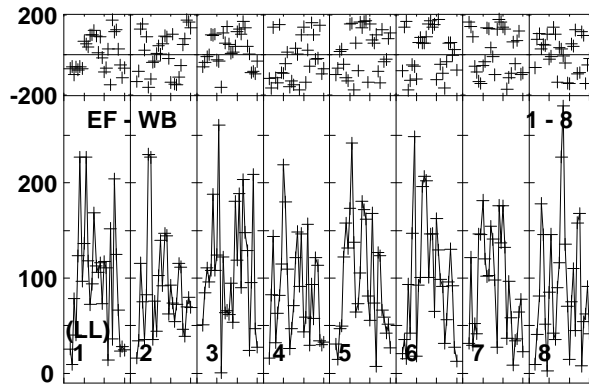
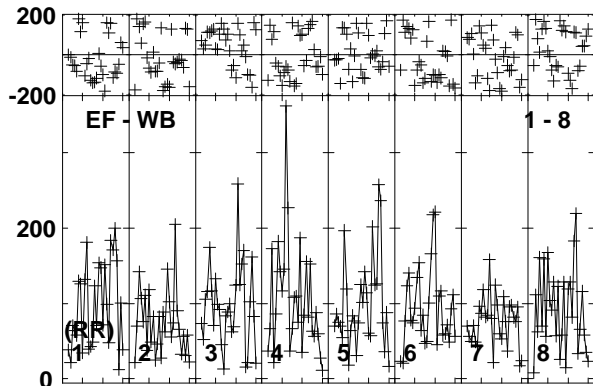
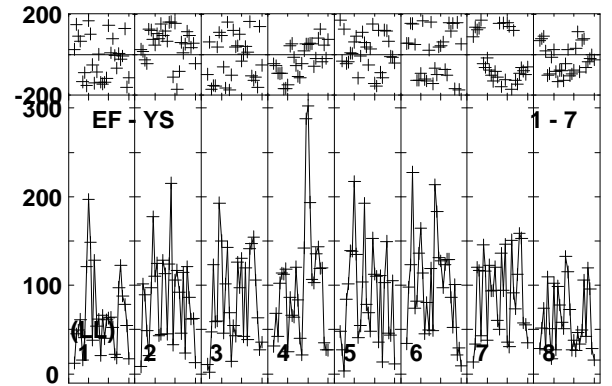
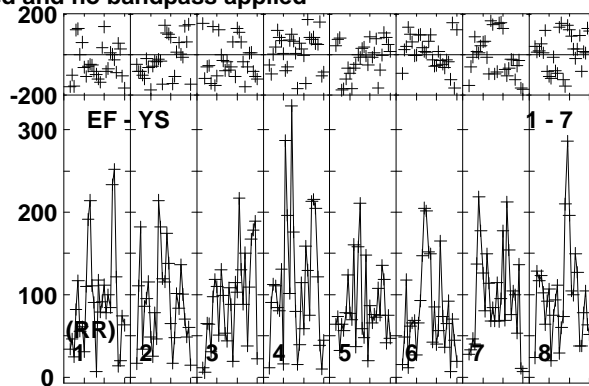
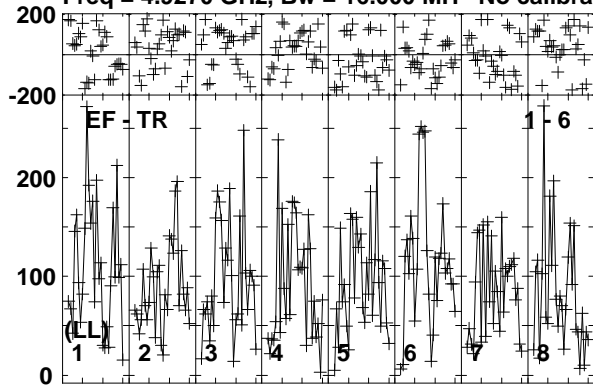

Lower frame: Micro Ampl Jy Top frame: Phas deg
Vector averaged cross-power spectrum Baseline: EF (01) - TR (06)
Timerange: 00/15:05:50 to 00/15:08:50

Plot file version 199 created 10-JUN-2016 16:08:09

J0718-1813 RG008D.UVDATA.1

Freq = 4.9270 GHz, Bw = 16.000 MH No calibration applied and no bandpass applied

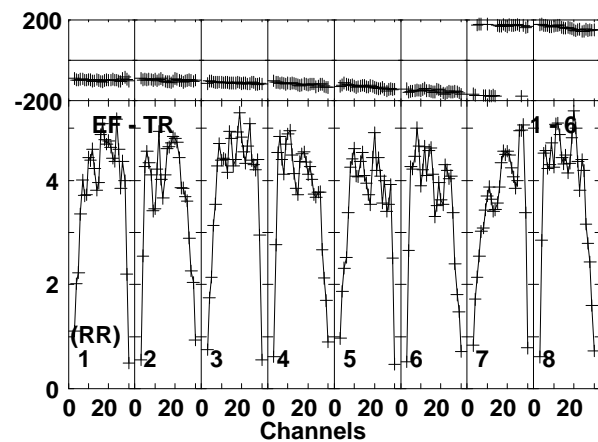
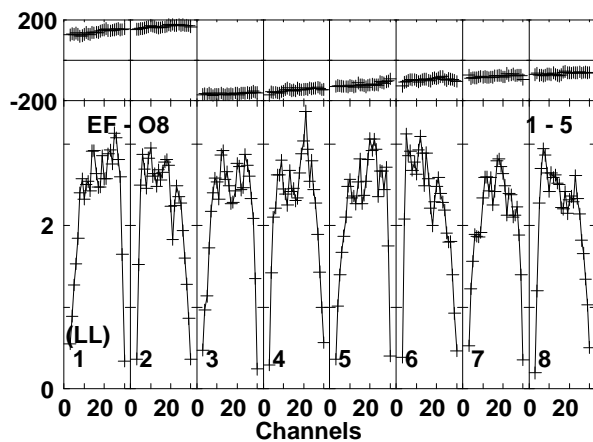
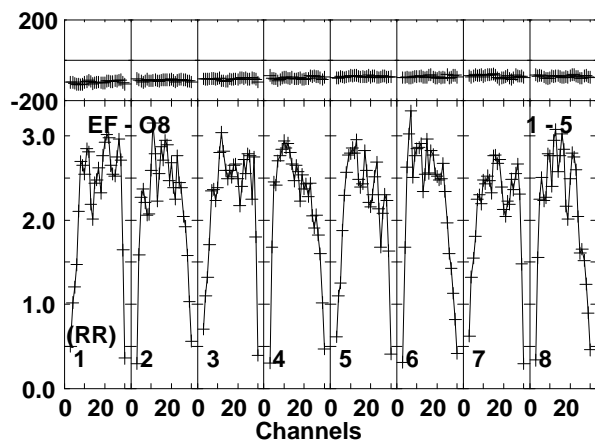
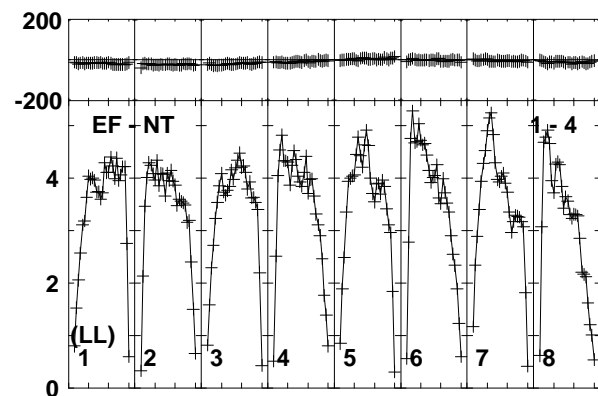
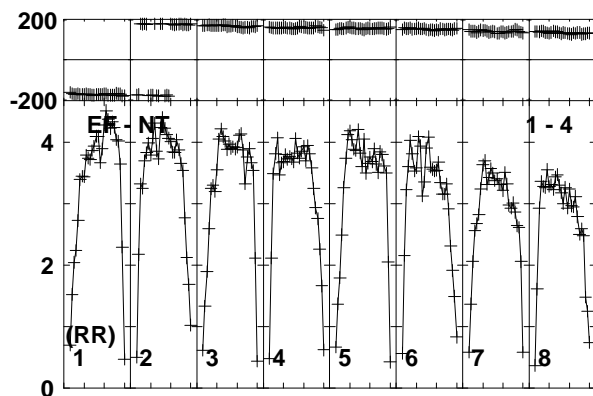
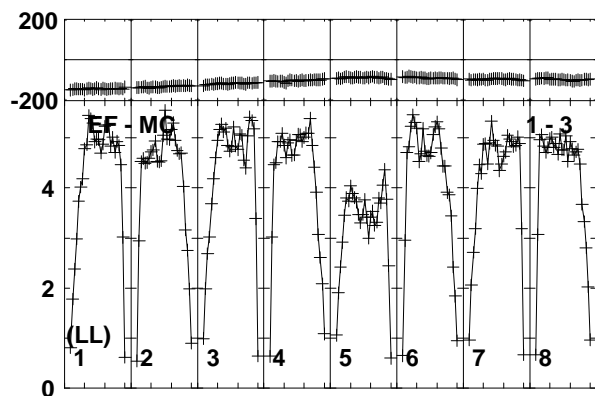
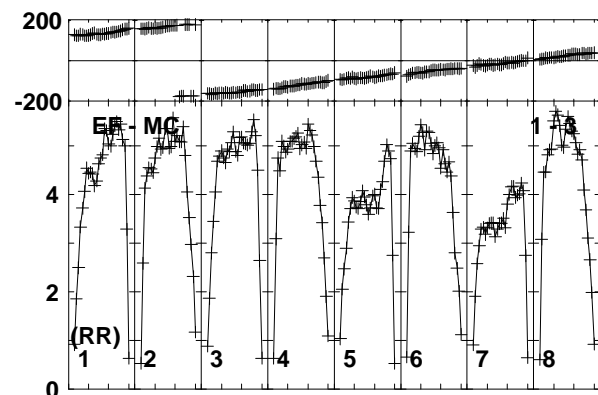
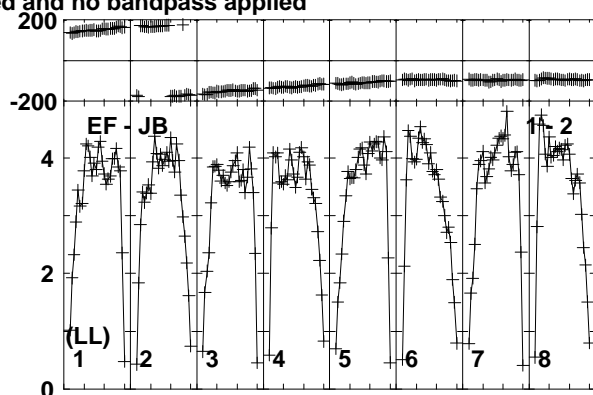
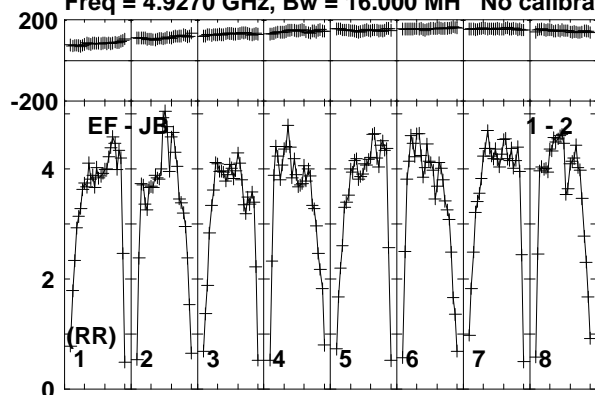

Lower frame: Milli Ampl Jy Top frame: Phas deg
Vector averaged cross-power spectrum Baseline: EF (01) - JB (02)
Timerange: 00/15:09:30 to 00/15:10:20

Plot file version 200 created 10-JUN-2016 16:08:10

J0718-1813 RG008D.UVDATA.1

Freq = 4.9270 GHz, Bw = 16.000 MH No calibration applied and no bandpass applied

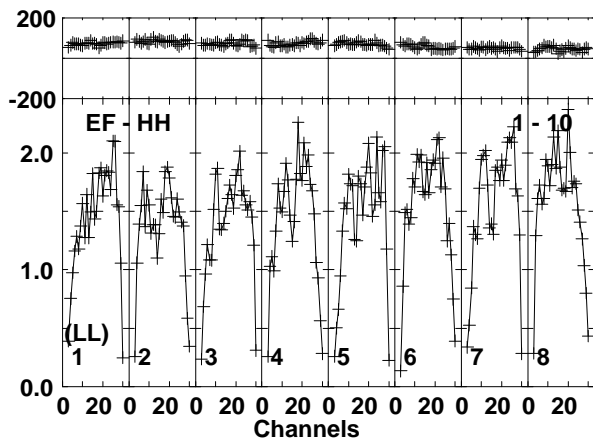
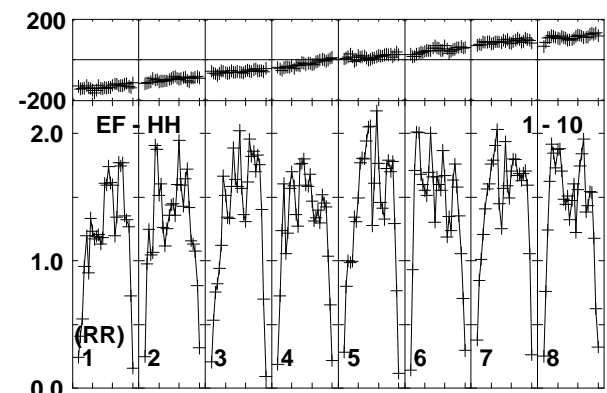
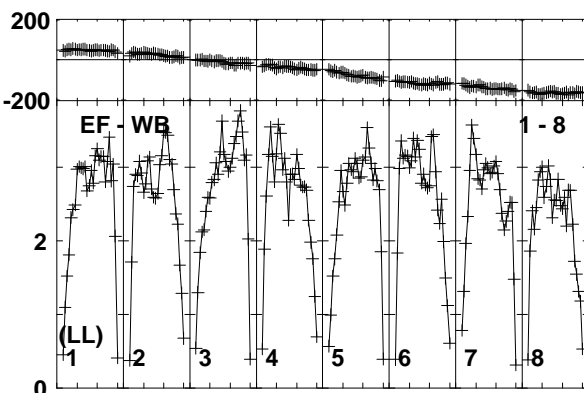
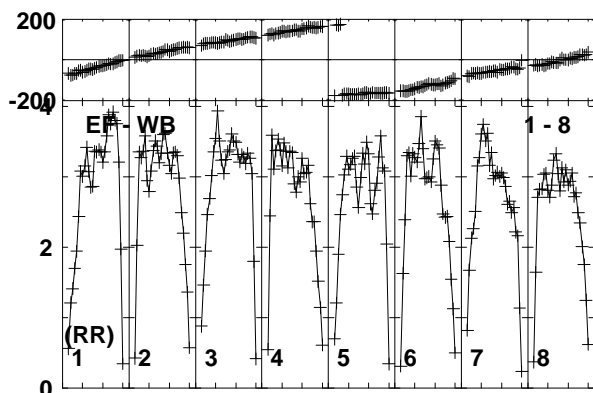
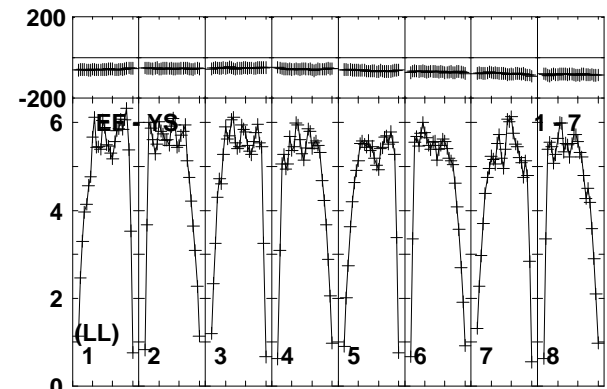
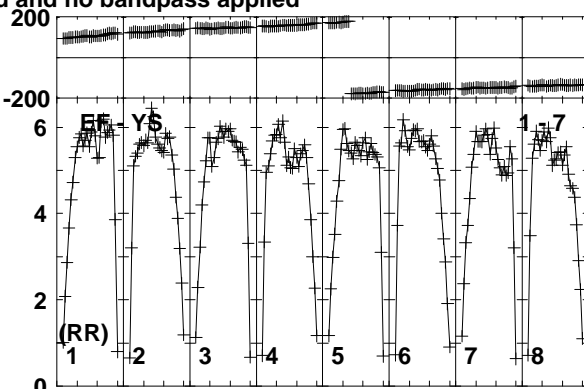
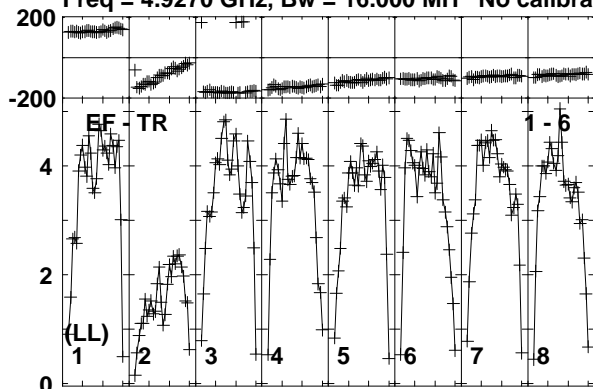

Lower frame: Milli Ampl Jy Top frame: Phas deg
Vector averaged cross-power spectrum Baseline: EF (01) - TR (06)
Timerange: 00/15:09:30 to 00/15:10:20

Plot file version 201 created 10-JUN-2016 16:08:19

J0718-1813 RG008D.UVDATA.1

Freq = 4.9270 GHz, Bw = 16.000 MH No calibration applied and no bandpass applied

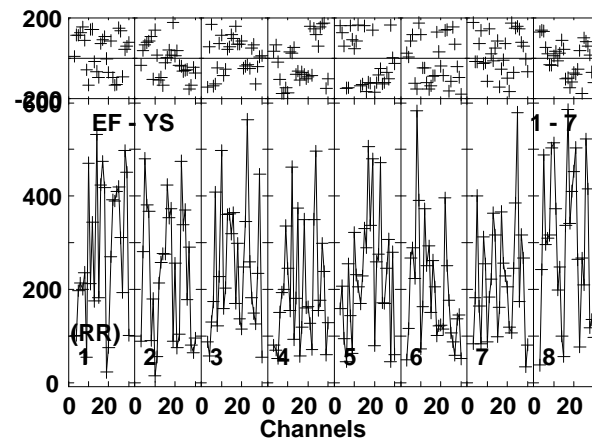
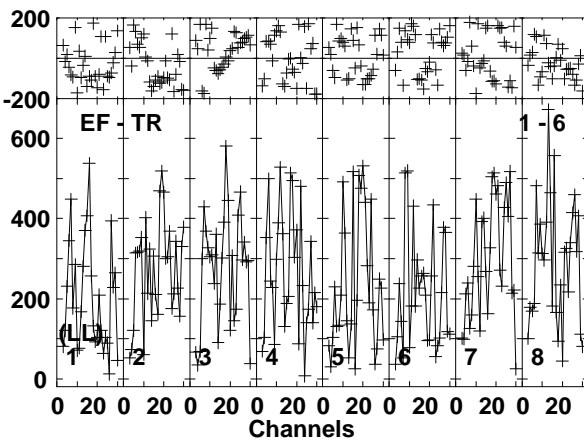
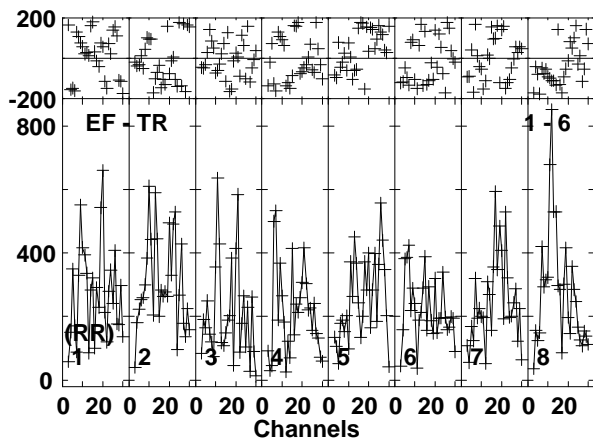
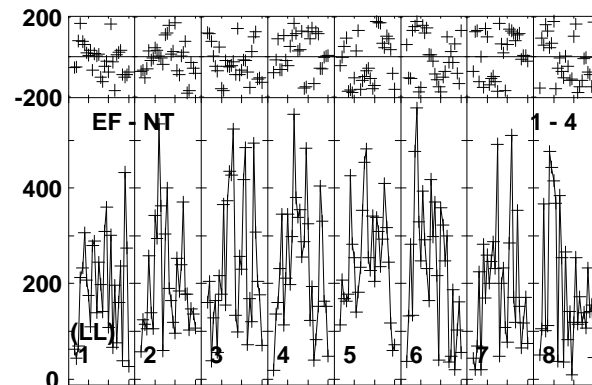
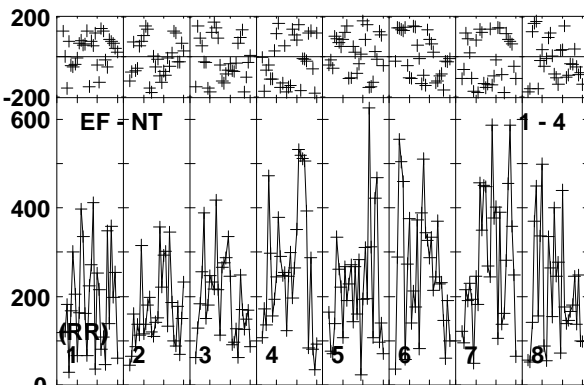
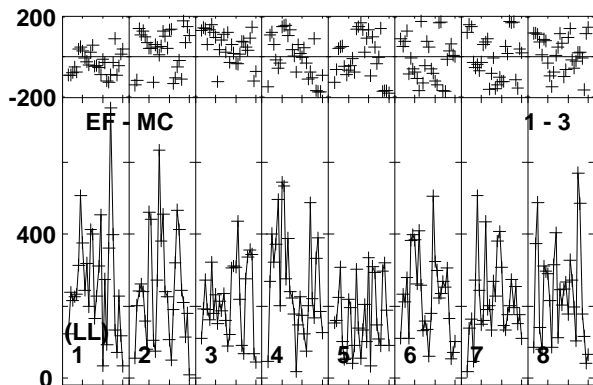
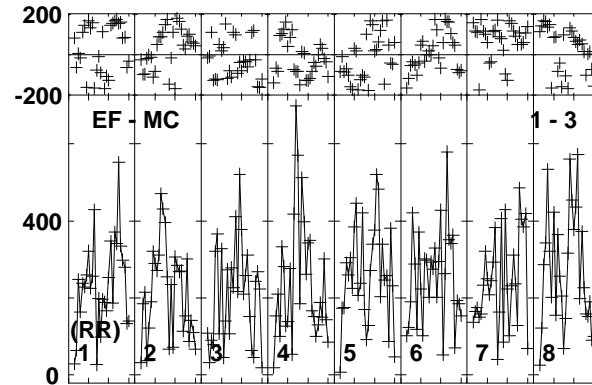
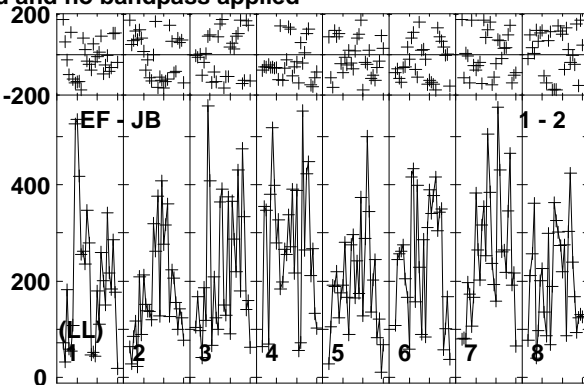
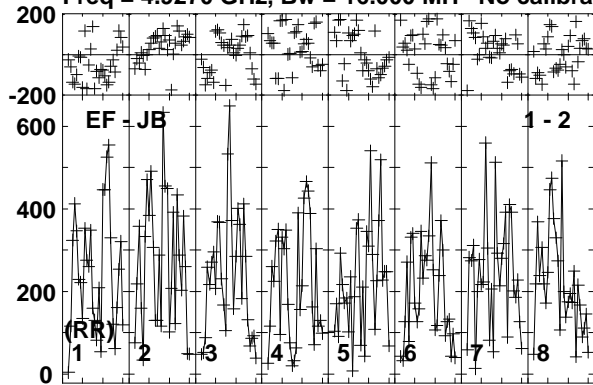

Lower frame: Micro Ampl Jy Top frame: Phas deg
Vector averaged cross-power spectrum Baseline: EF (01) - JB (02)
Timerange: 00/16:56:00 to 00/16:56:49

Plot file version 202 created 10-JUN-2016 16:08:19

J0718-1813 RG008D.UVDATA.1

Freq = 4.9270 GHz, Bw = 16.000 MH No calibration applied and no bandpass applied

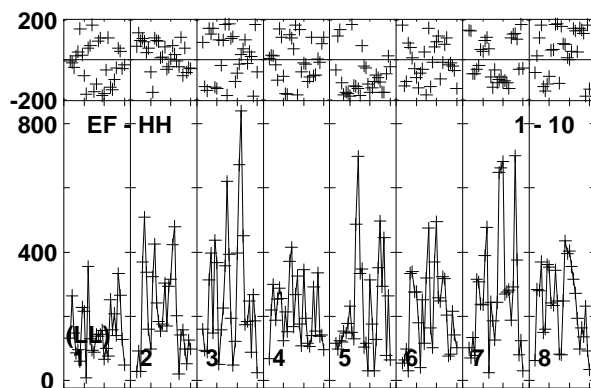
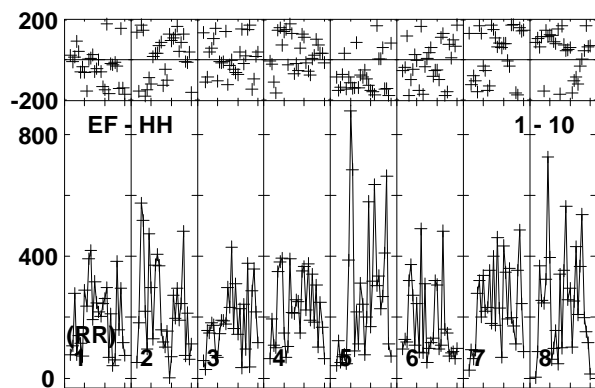
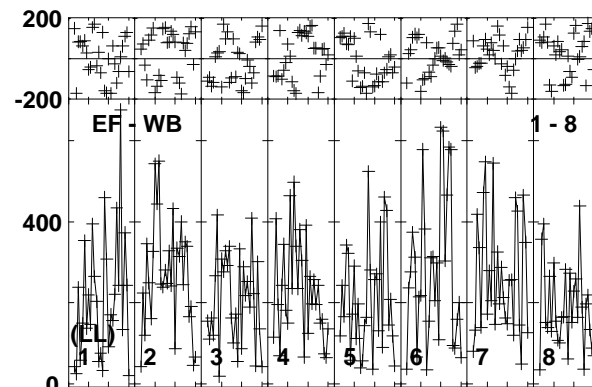
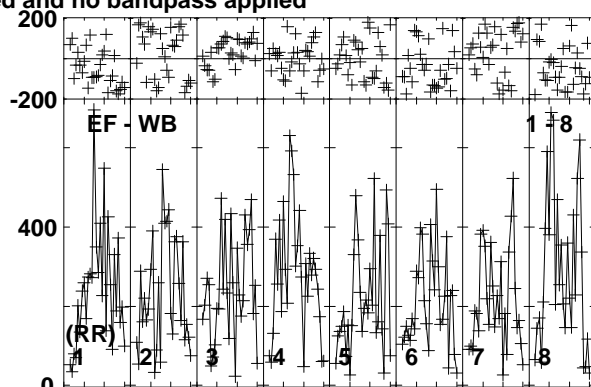
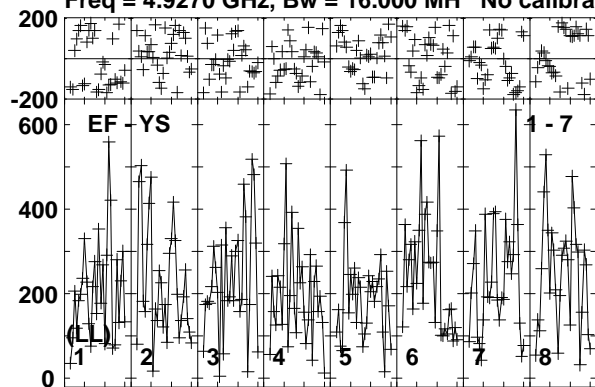

Lower frame: Micro Ampl Jy Top frame: Phas deg
Vector averaged cross-power spectrum Baseline: EF (01) - YS (07)
Timerange: 00/16:56:00 to 00/16:56:49

Plot file version 203 created 10-JUN-2016 16:08:20
 OQ208 RG008D.UVDATA.1

Freq = 4.9270 GHz, Bw = 16.000 MH No calibration applied and no bandpass applied

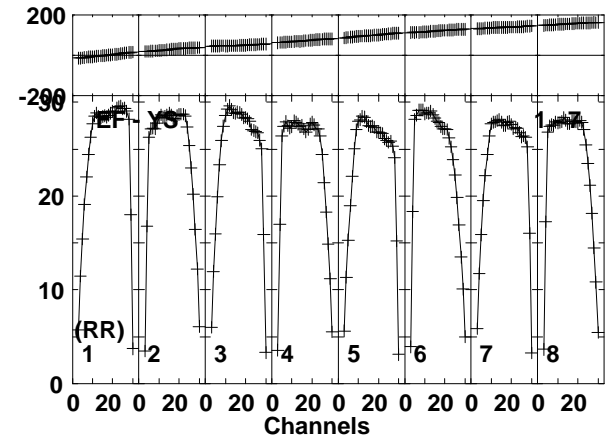
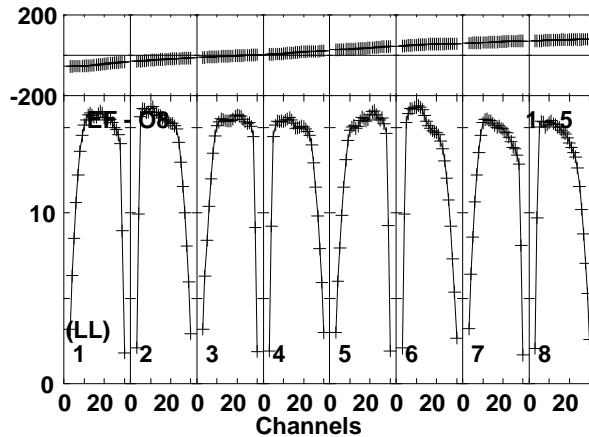
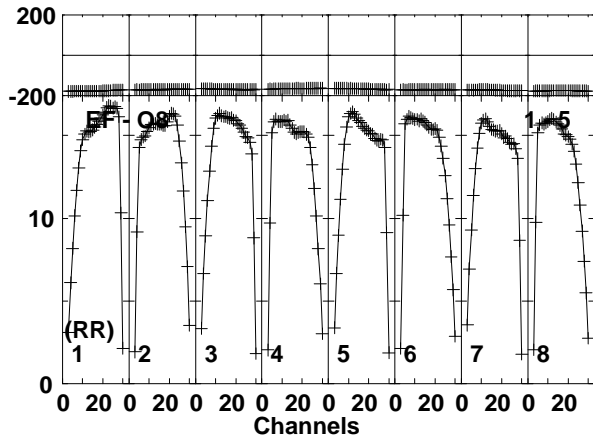
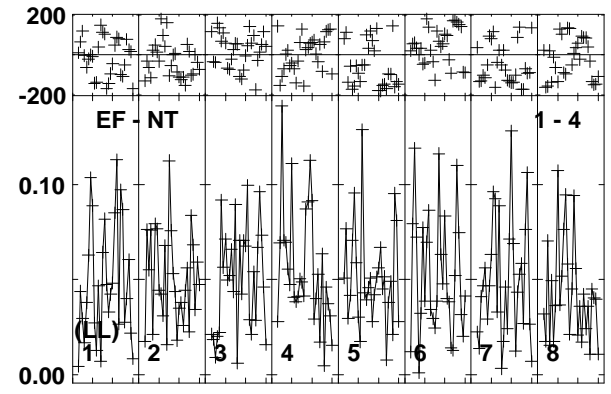
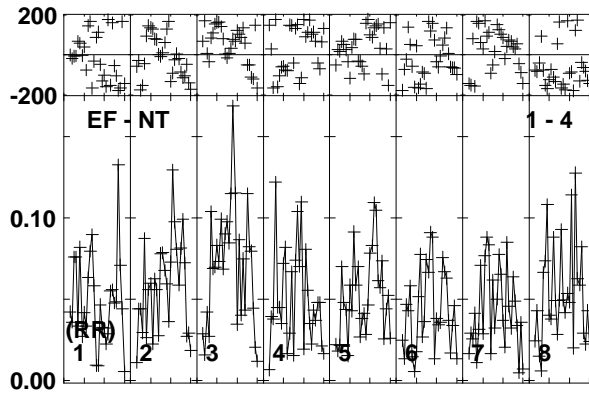
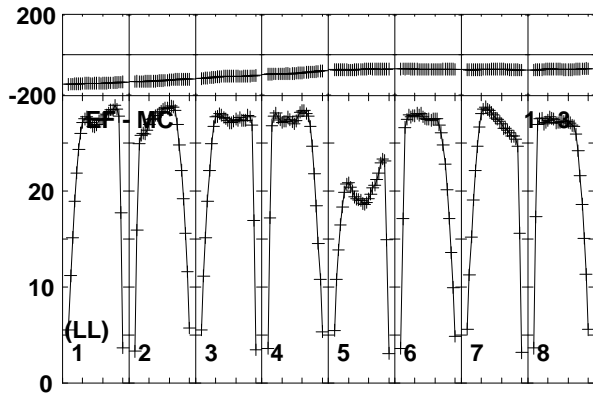
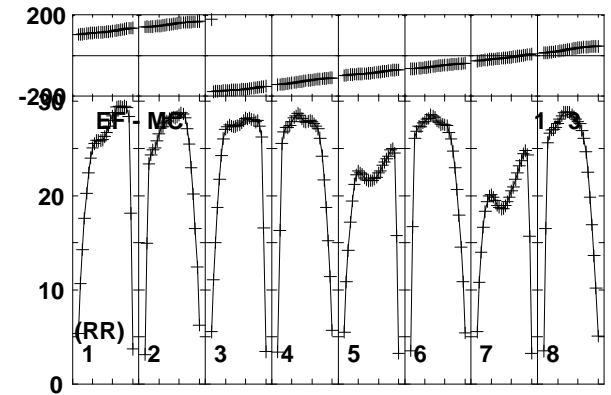
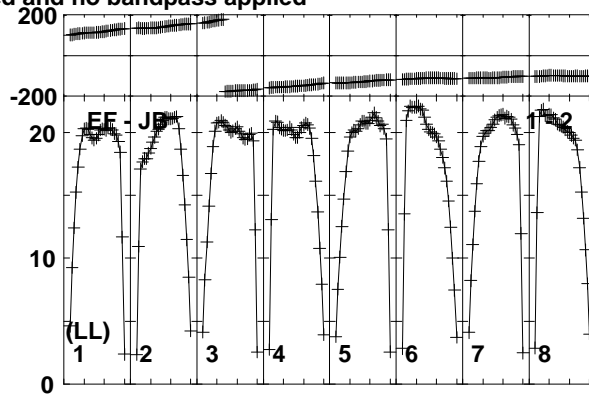
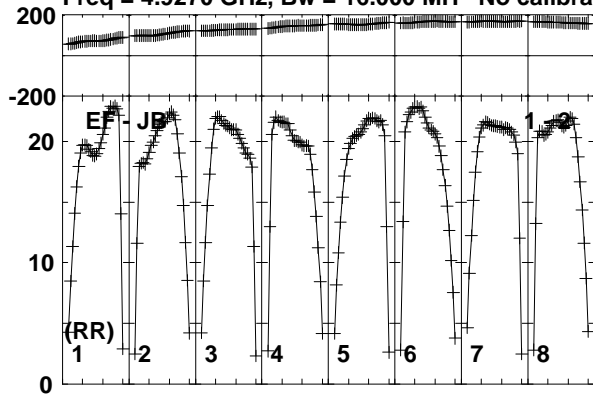

Lower frame: Milli Ampl Jy Top frame: Phas deg
 Vector averaged cross-power spectrum Baseline: EF (01) - JB (02)
 Timerange: 00/17:03:30 to 00/17:11:49

Plot file version 204 created 10-JUN-2016 16:08:20

OQ208 RG008D.UVDATA.1

Freq = 4.9270 GHz, Bw = 16.000 MH No calibration applied and no bandpass applied

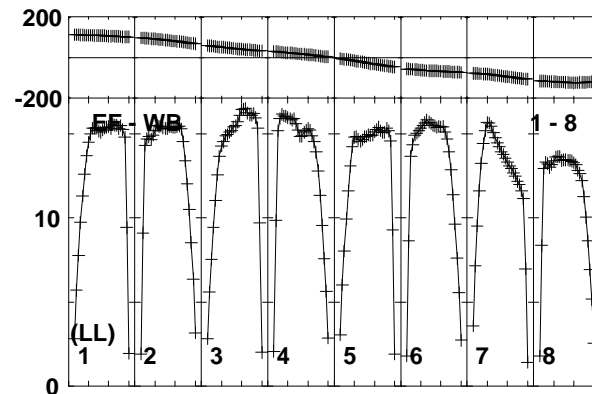
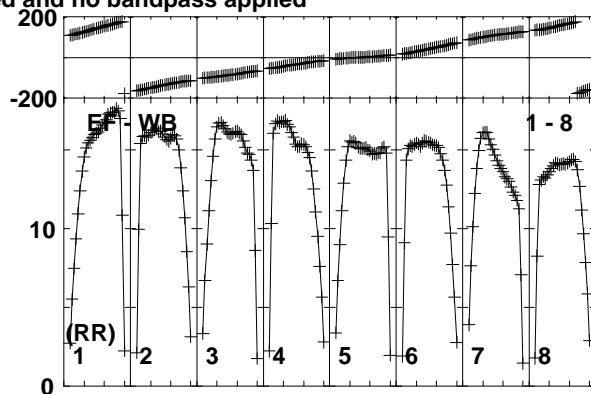
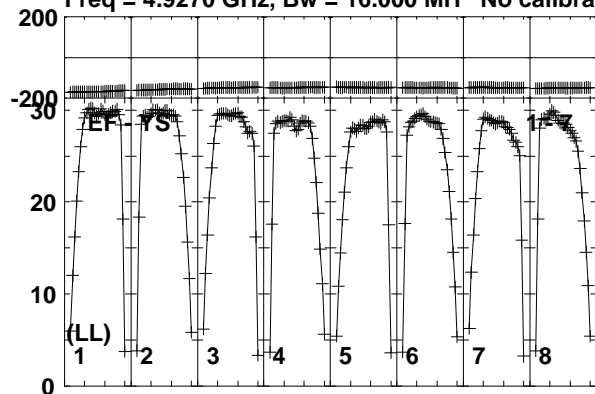

Lower frame: Milli Ampl Jy Top frame: Phas deg
Vector averaged cross-power spectrum Baseline: EF (01) - YS (07)
Timerange: 00/17:03:30 to 00/17:11:49

Plot file version 205 created 10-JUN-2016 16:08:21

OQ208 RG008D.UVDATA.1

Freq = 4.9270 GHz, Bw = 16.000 MH No calibration applied and no bandpass applied

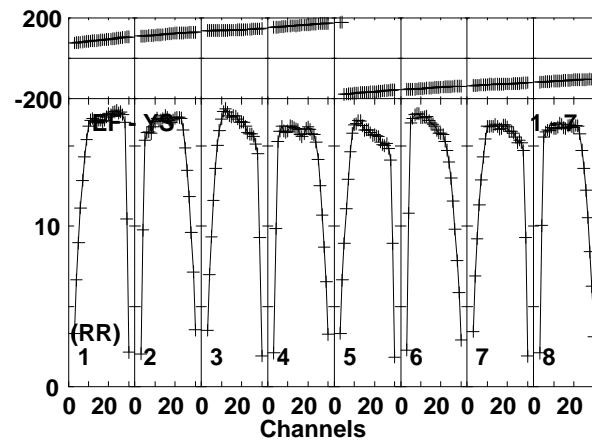
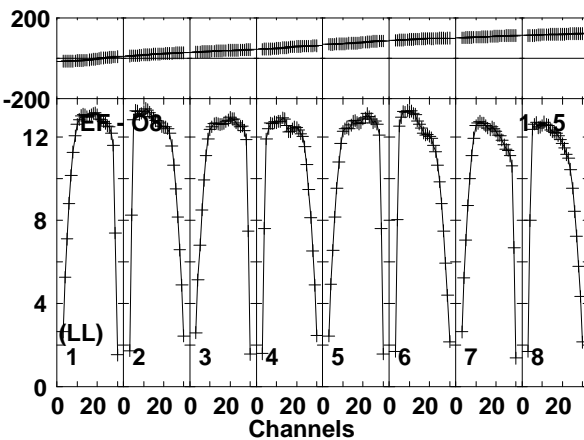
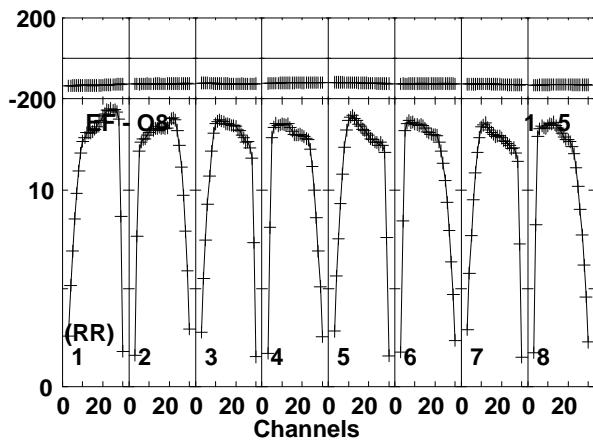
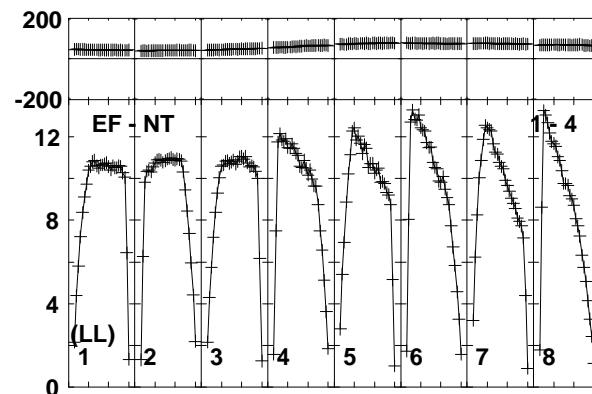
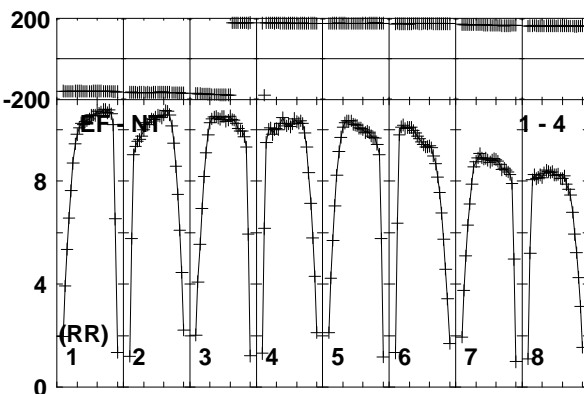
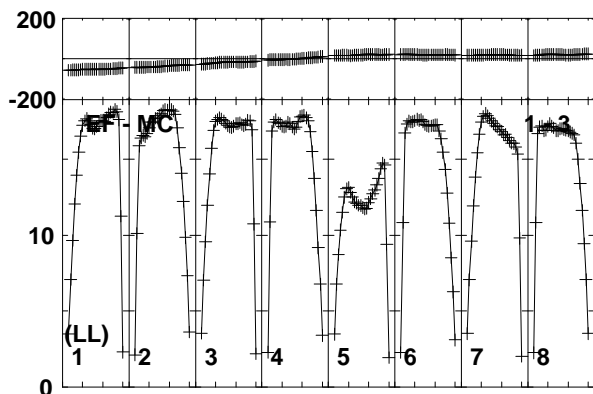
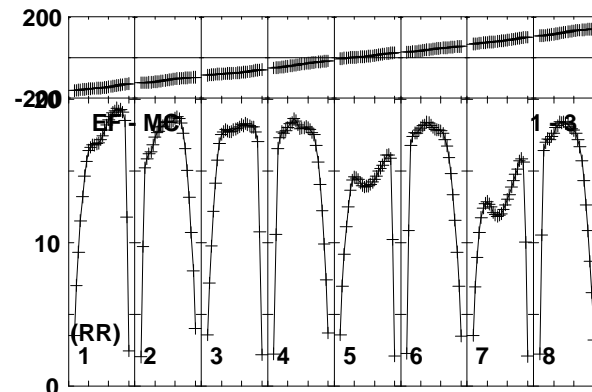
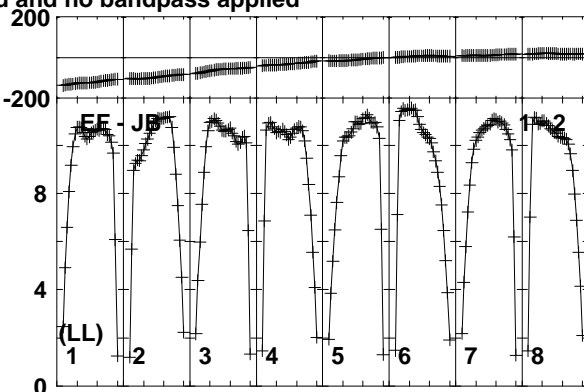
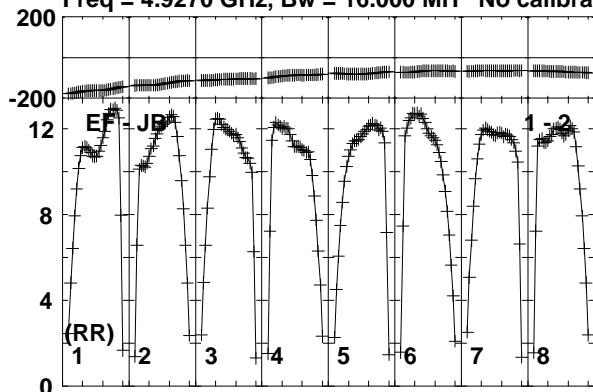

Lower frame: Milli Amply Jy Top frame: Phas deg
Vector averaged cross-power spectrum Baseline: EF (01) - JB (02)
Timerange: 00/17:13:42 to 00/17:26:49

Plot file version 206 created 10-JUN-2016 16:08:22

OQ208 RG008D.UVDATA.1

Freq = 4.9270 GHz, Bw = 16.000 MH No calibration applied and no bandpass applied

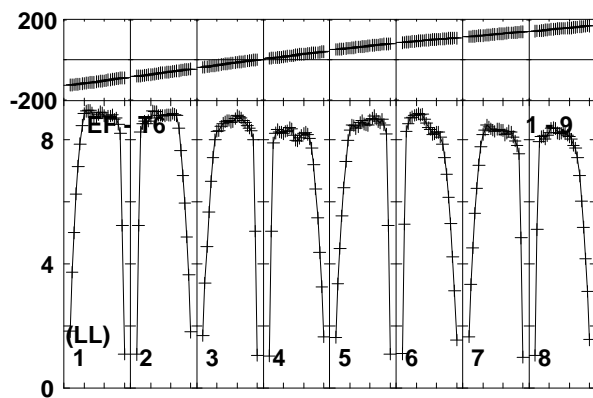
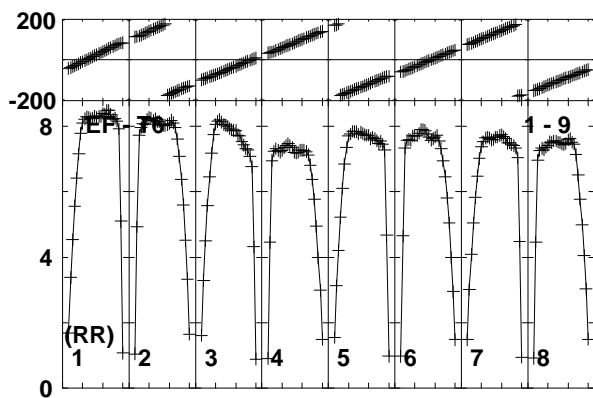
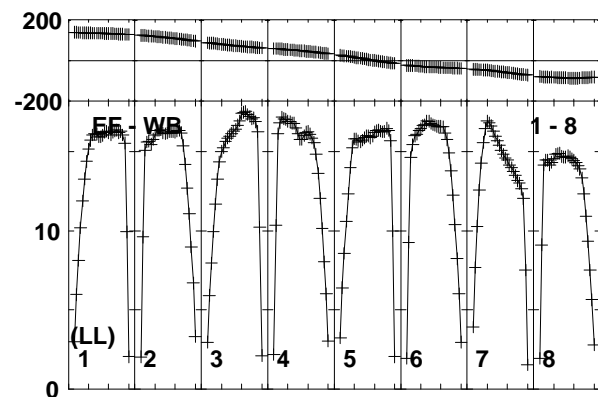
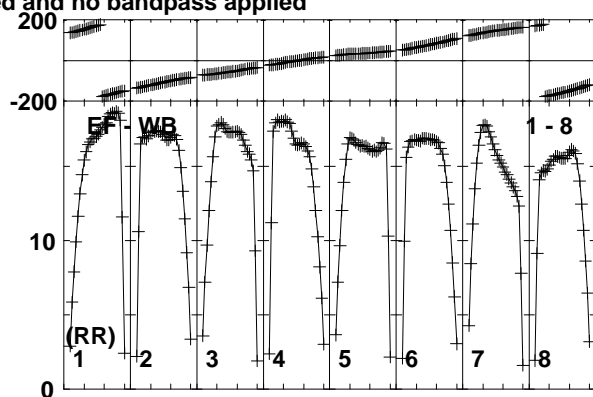
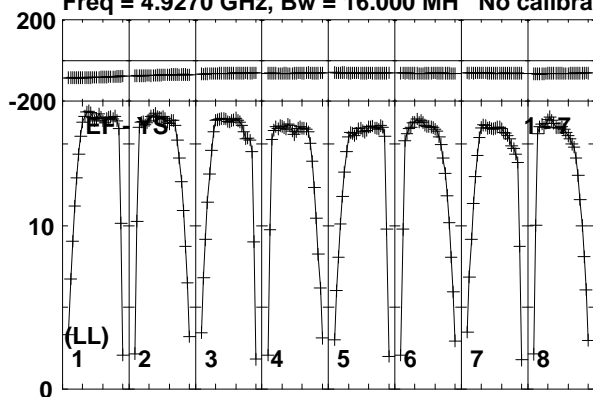

Lower frame: Milli Ampl Jy Top frame: Phas deg
Vector averaged cross-power spectrum Baseline: EF (01) - YS (07)
Timerange: 00/17:13:42 to 00/17:26:49

Plot file version 207 created 10-JUN-2016 16:08:22

OQ208 RG008D.UVDATA.1

Freq = 4.9270 GHz, Bw = 16.000 MH No calibration applied and no bandpass applied

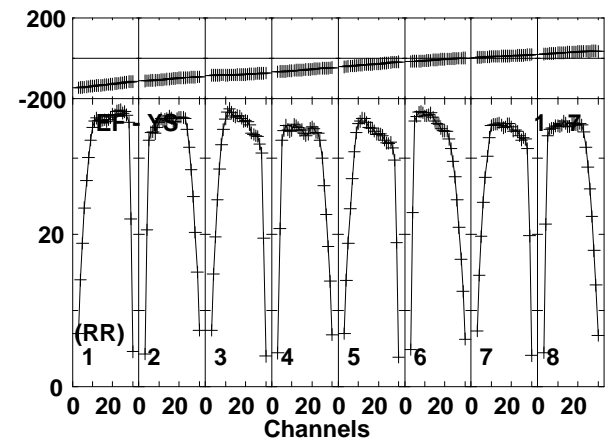
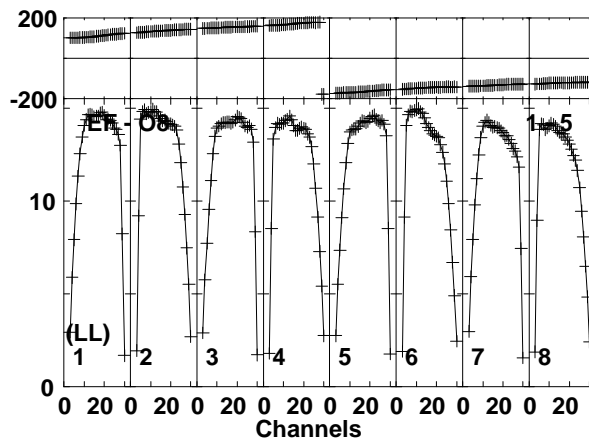
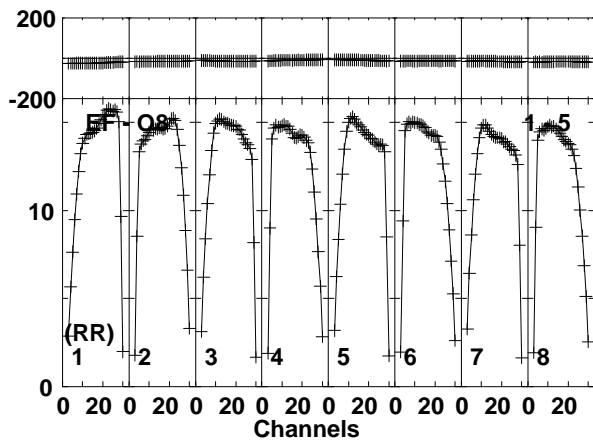
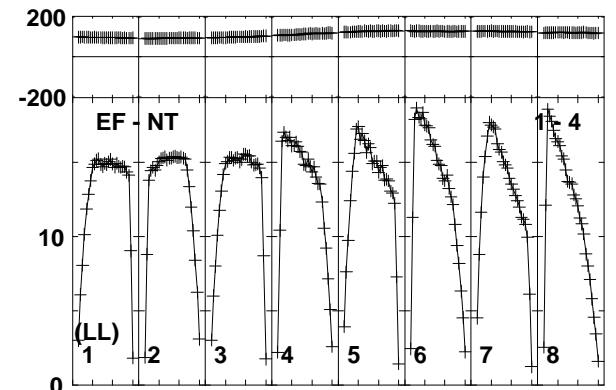
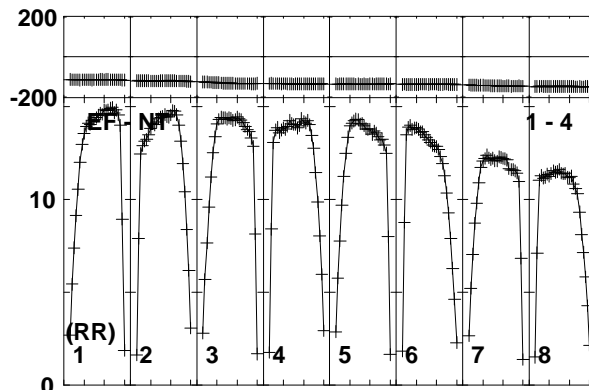
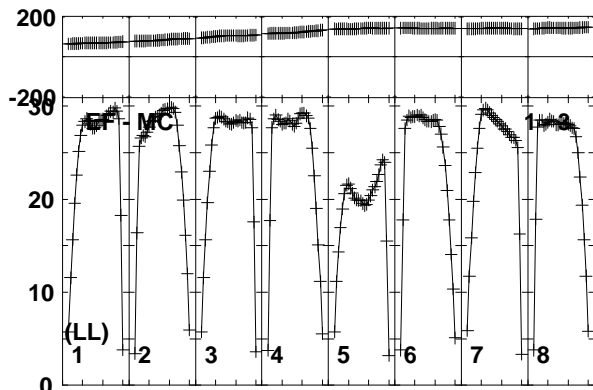
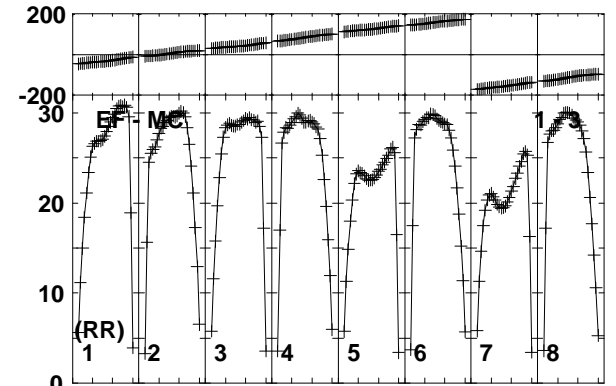
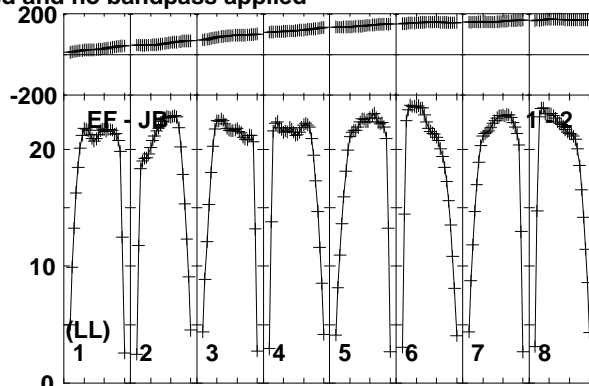
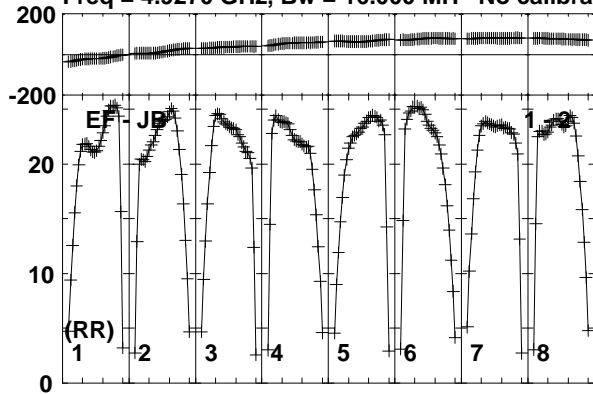

Lower frame: Milli Ampl Jy Top frame: Phas deg
Vector averaged cross-power spectrum Baseline: EF (01) - JB (02)
Timerange: 00/17:27:31 to 00/17:41:49

Plot file version 208 created 10-JUN-2016 16:08:23

OQ208 RG008D.UVDATA.1

Freq = 4.9270 GHz, Bw = 16.000 MH No calibration applied and no bandpass applied

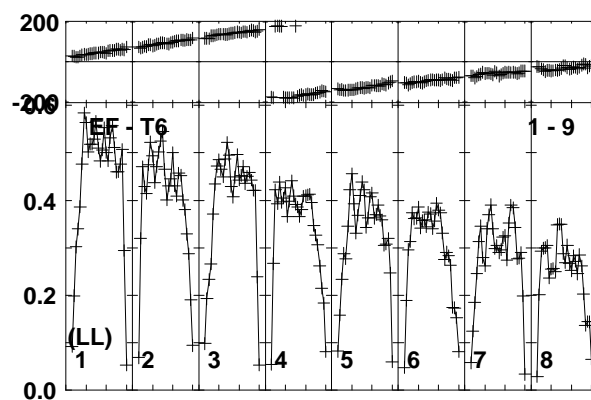
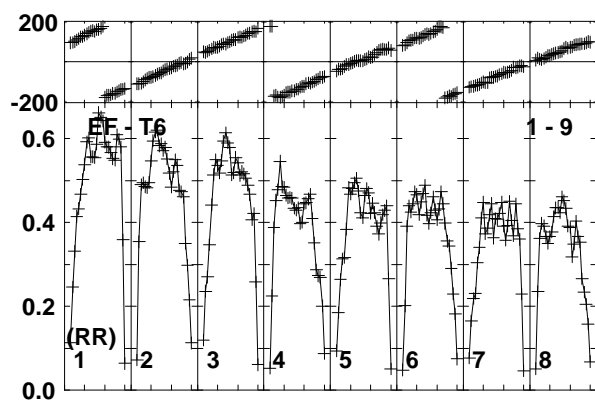
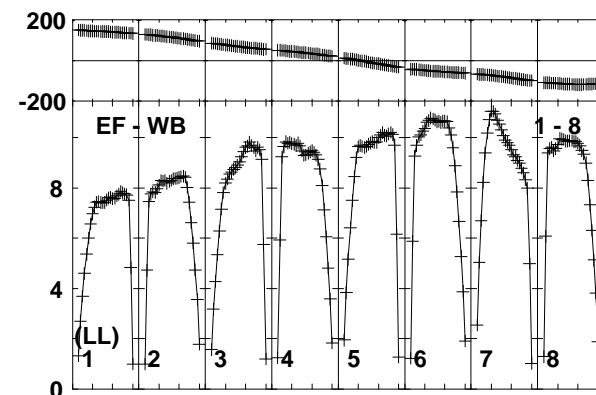
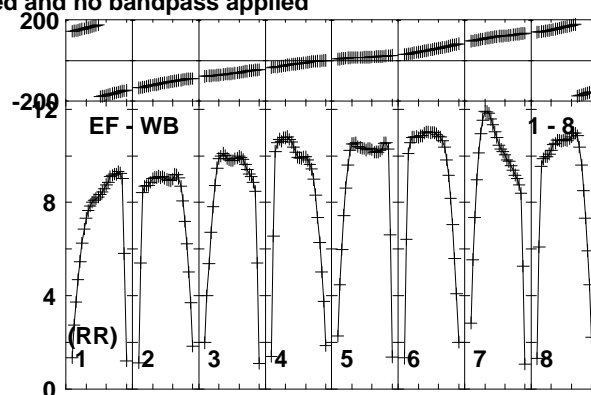
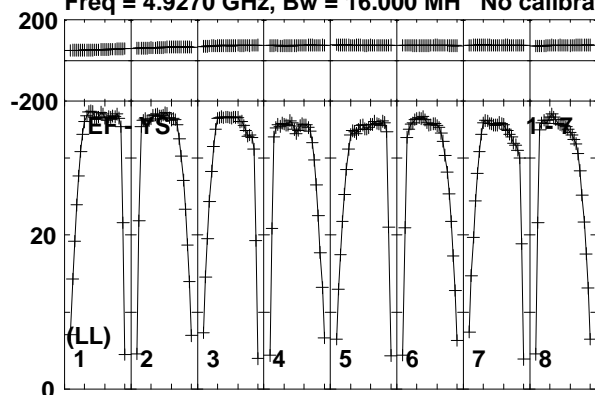

Lower frame: Milli Ampl Jy Top frame: Phas deg
Vector averaged cross-power spectrum Baseline: EF (01) - YS (07)
Timerange: 00/17:27:31 to 00/17:41:49

Plot file version 209 created 10-JUN-2016 16:08:24

OQ208 RG008D.UVDATA.1

Freq = 4.9270 GHz, Bw = 16.000 MH No calibration applied and no bandpass applied

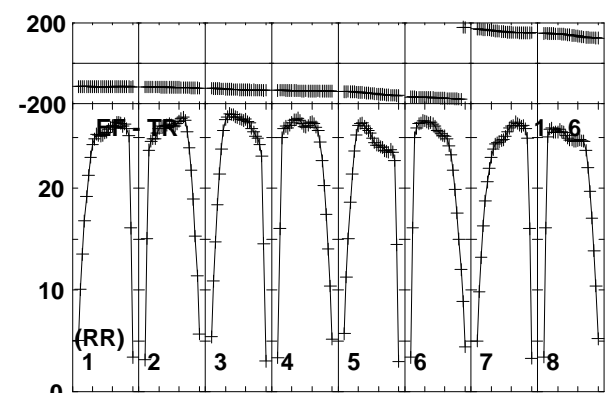
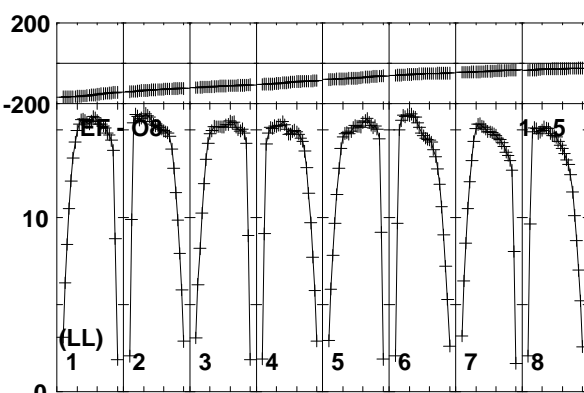
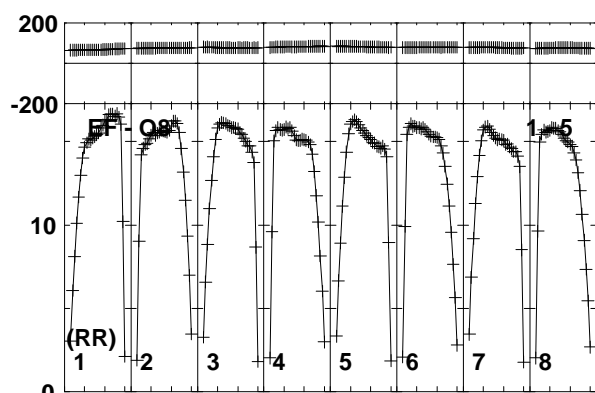
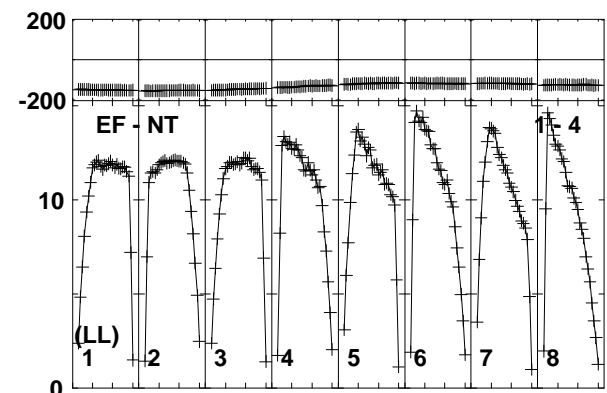
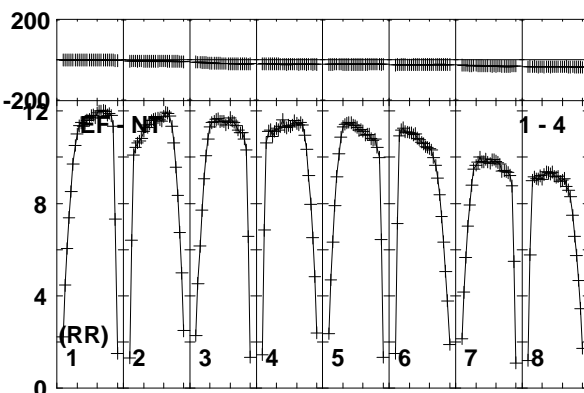
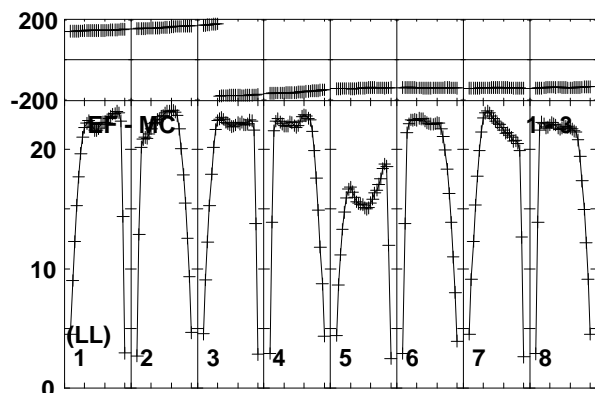
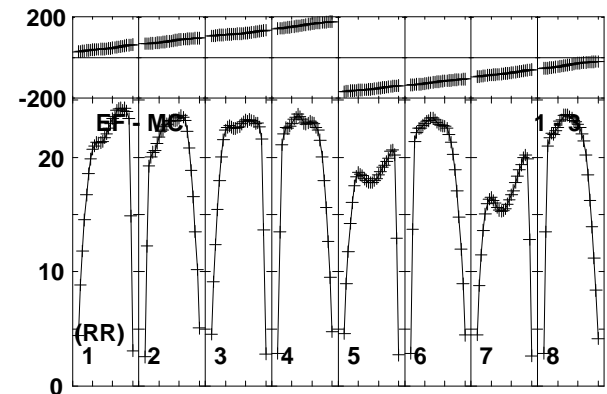
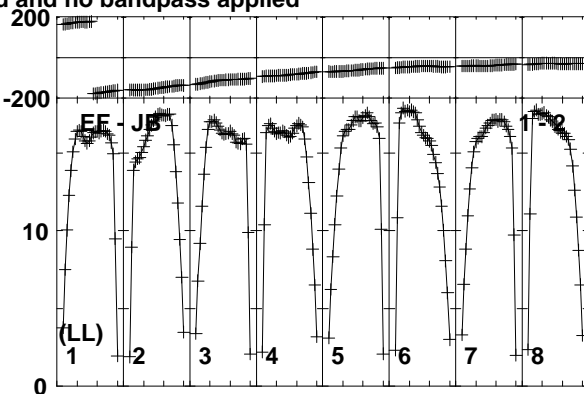
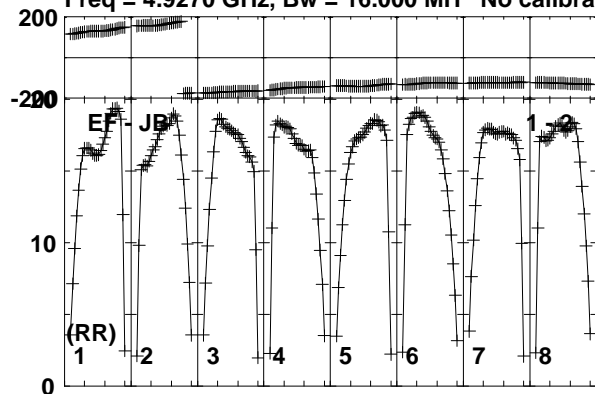

Lower frame: Milli Ampl Jy Top frame: Phas deg
Vector averaged cross-power spectrum Baseline: EF (01) - JB (02)
Timerange: 00/17:42:30 to 00/17:56:50

Plot file version 210 created 10-JUN-2016 16:08:24

OQ208 RG008D.UVDATA.1

Freq = 4.9270 GHz, Bw = 16.000 MH No calibration applied and no bandpass applied

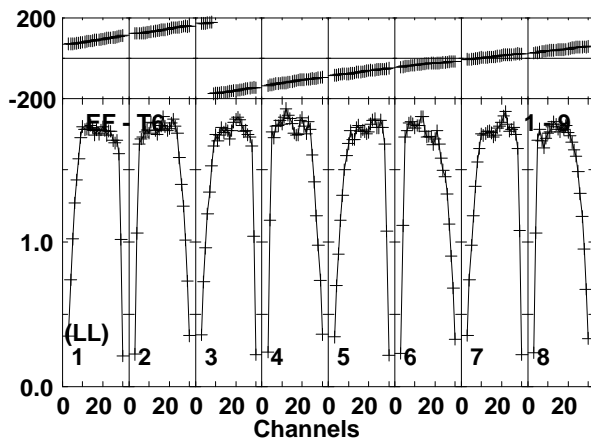
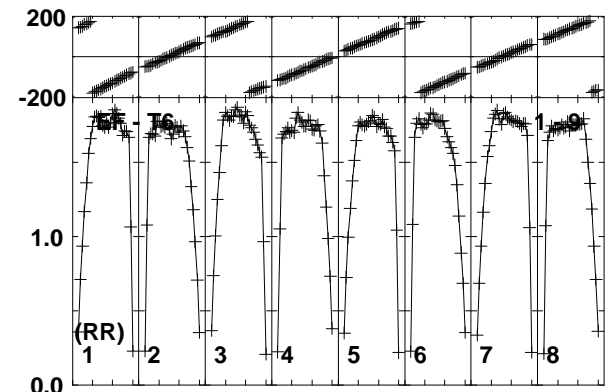
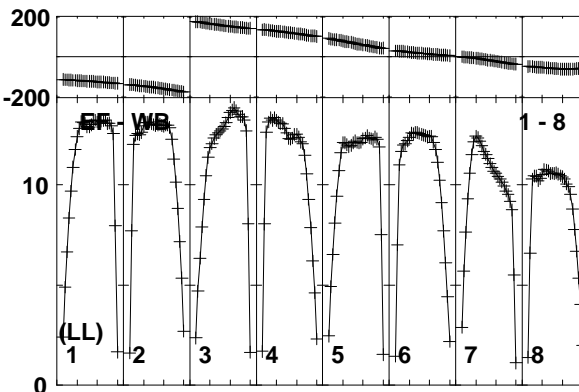
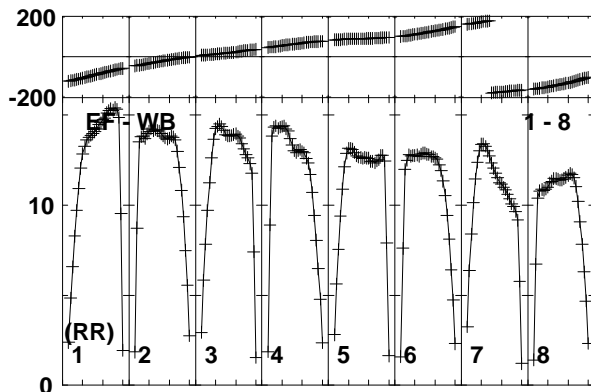
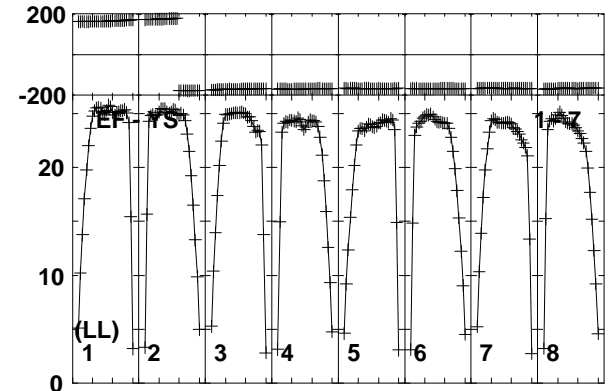
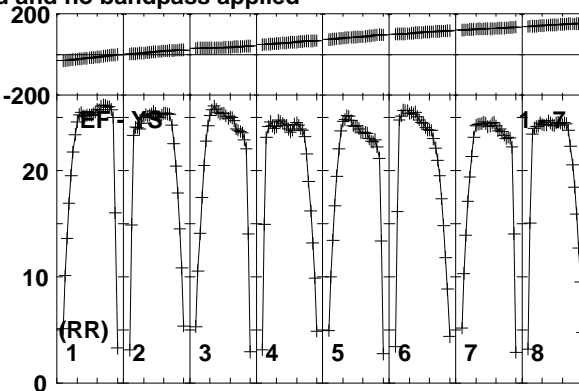
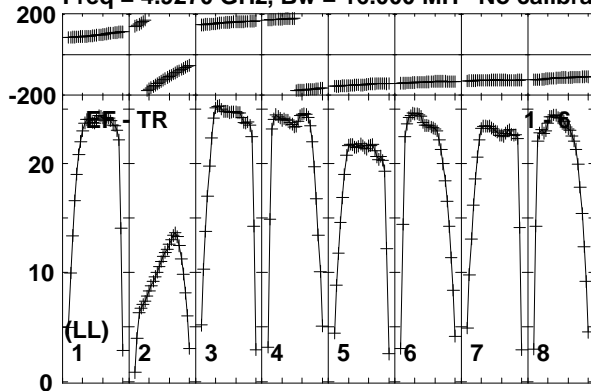

Lower frame: Milli Ampl Jy Top frame: Phas deg
Vector averaged cross-power spectrum Baseline: EF (01) - TR (06)
Timerange: 00/17:42:30 to 00/17:56:50

Plot file version 211 created 10-JUN-2016 16:08:25

OQ208 RG008D.UVDATA.1

Freq = 4.9270 GHz, Bw = 16.000 MH No calibration applied and no bandpass applied

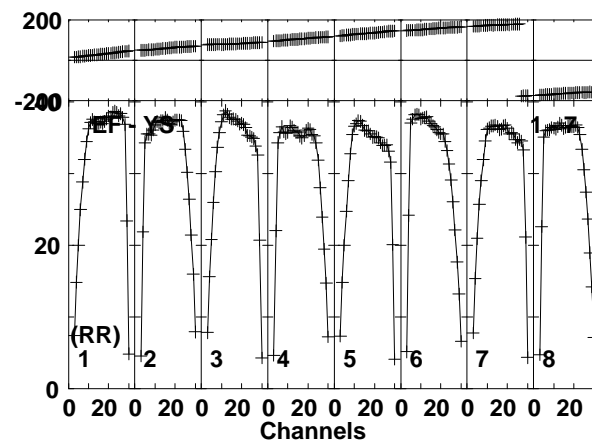
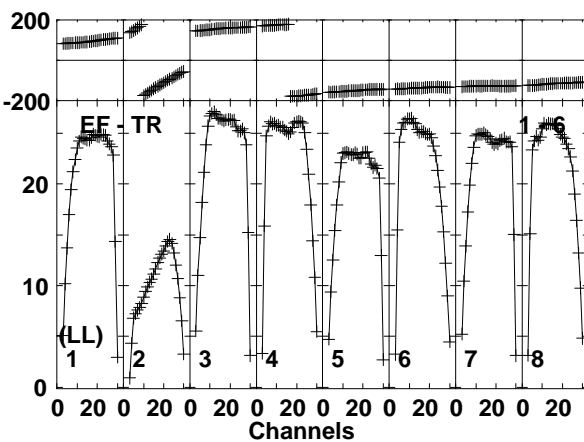
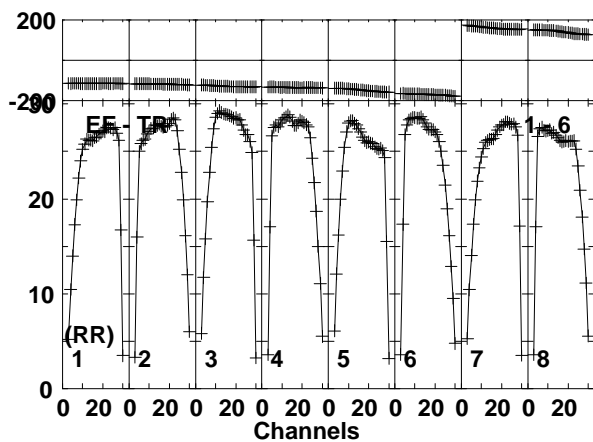
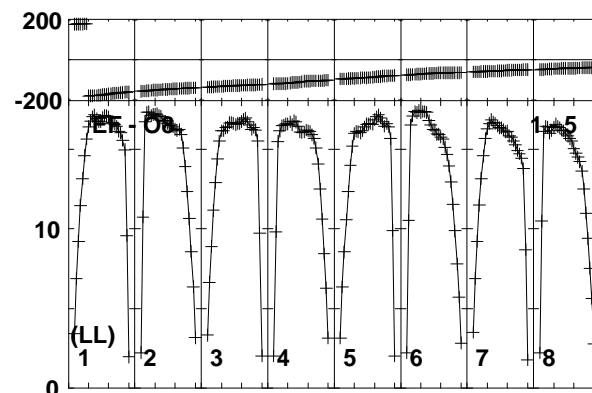
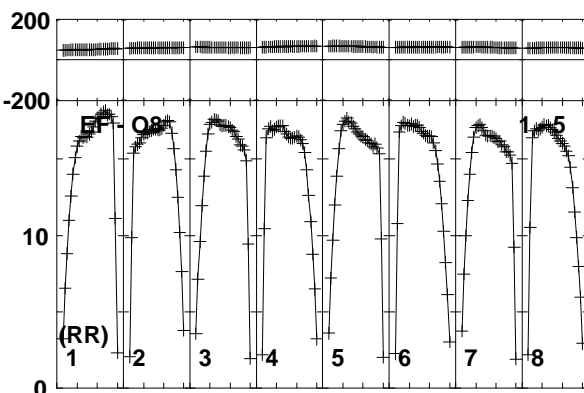
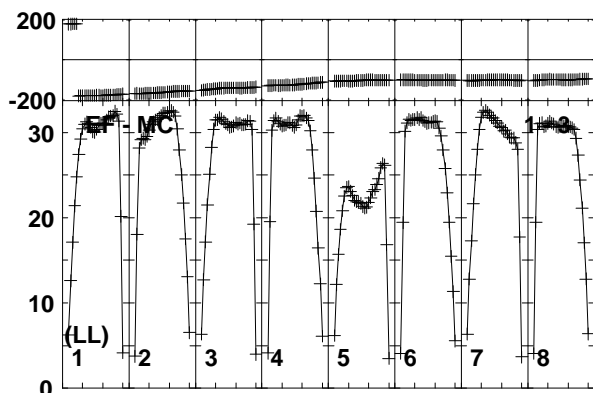
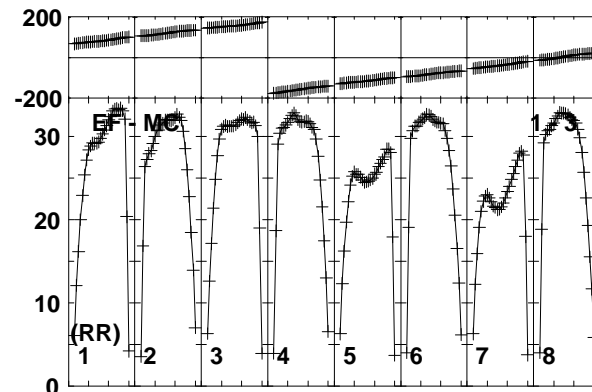
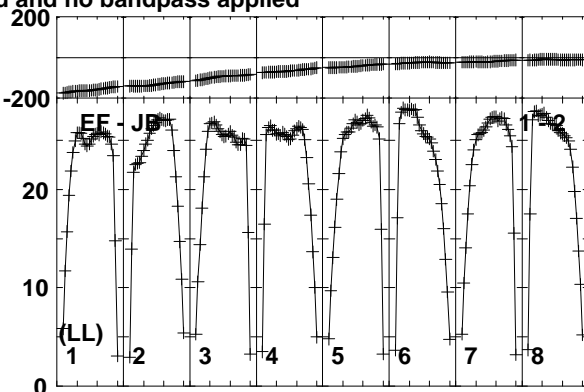
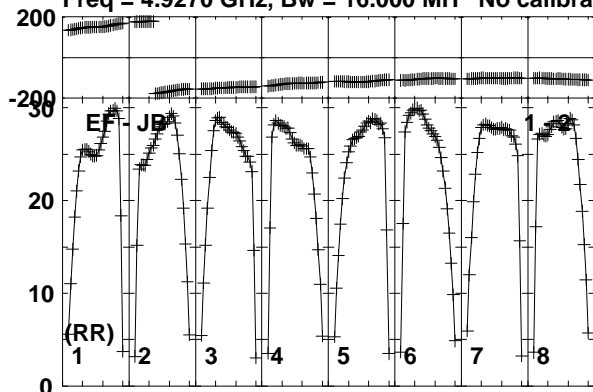

Lower frame: Milli Ampl Jy Top frame: Phas deg
Vector averaged cross-power spectrum Baseline: EF (01) - JB (02)
Timerange: 00/17:57:31 to 00/18:00:48

Plot file version 212 created 10-JUN-2016 16:08:25

OQ208 RG008D.UVDATA.1

Freq = 4.9270 GHz, Bw = 16.000 MH No calibration applied and no bandpass applied

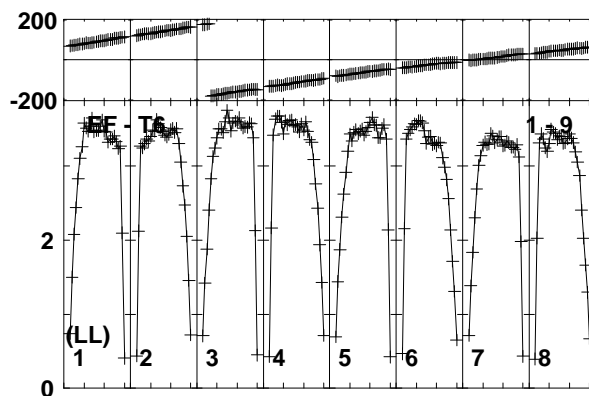
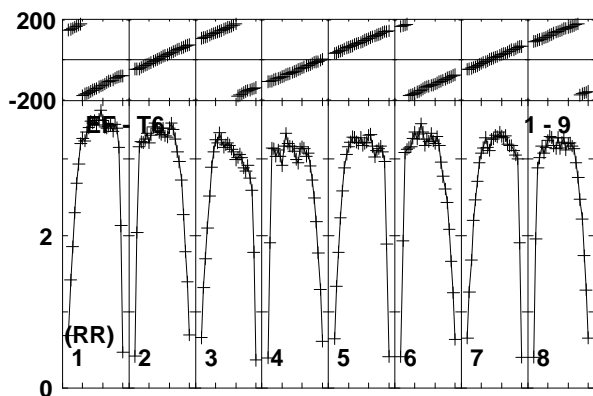
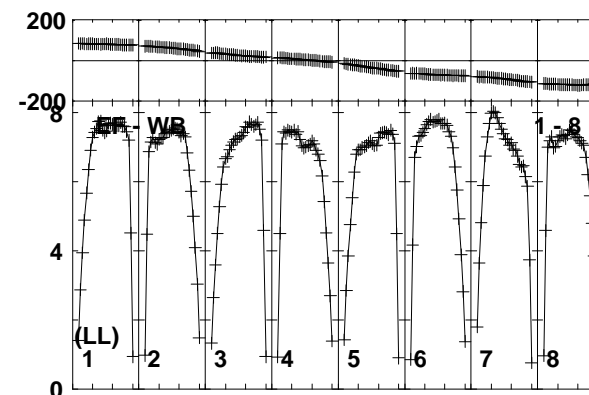
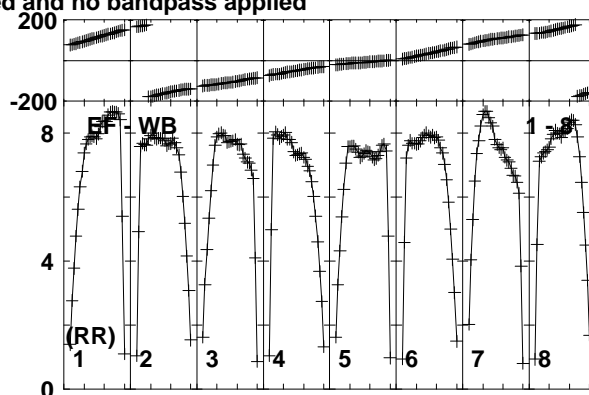
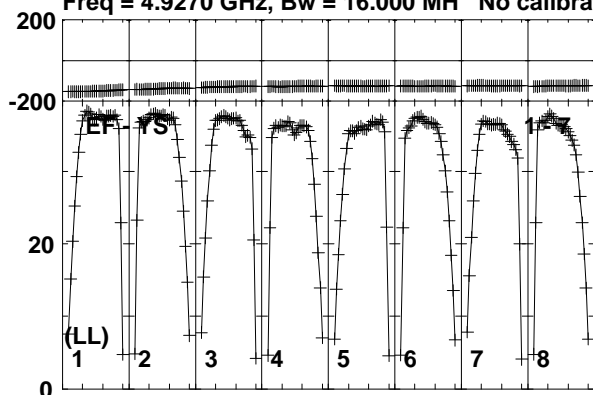

Lower frame: Milli Ampl Jy Top frame: Phas deg
Vector averaged cross-power spectrum Baseline: EF (01) - YS (07)
Timerange: 00/17:57:31 to 00/18:00:48