

Plot file version 1 created 20-APR-2018 18:07:51

J1310+3220 RG009B.UVDATA.1

Freq = 4.7995 GHz, Bw = 32.000 MH No calibration applied and no bandpass applied

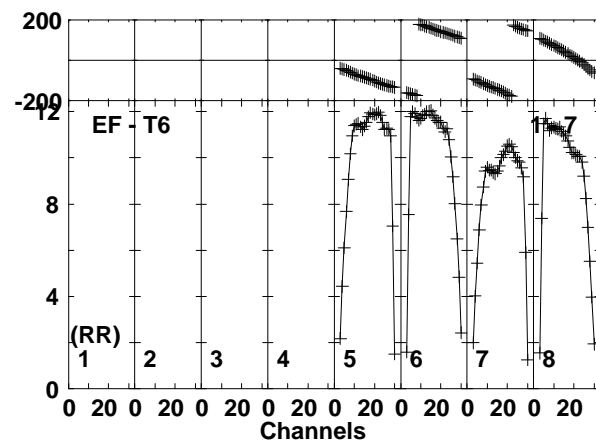
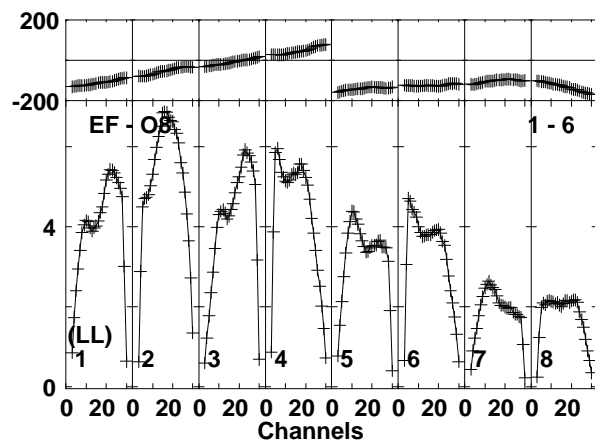
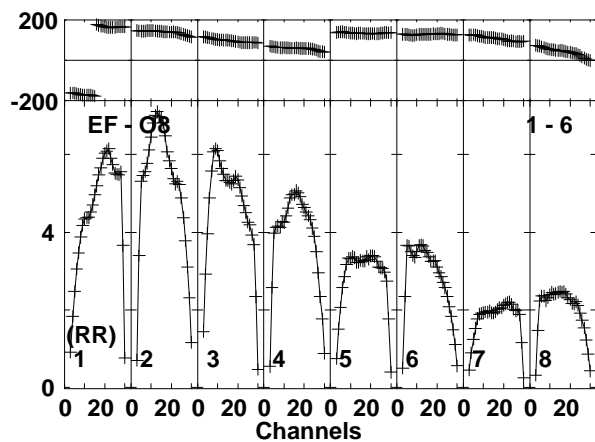
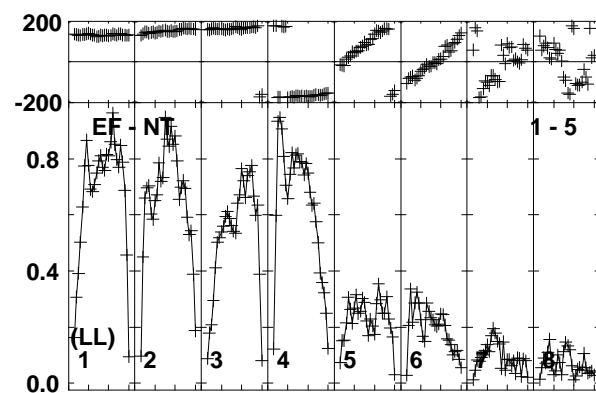
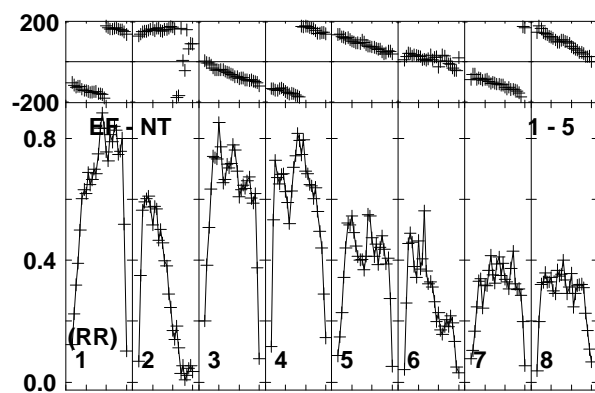
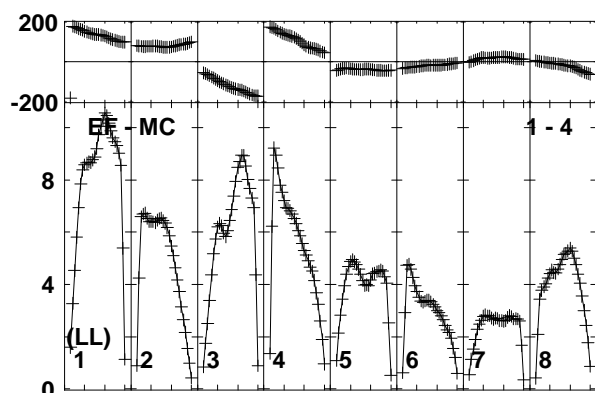
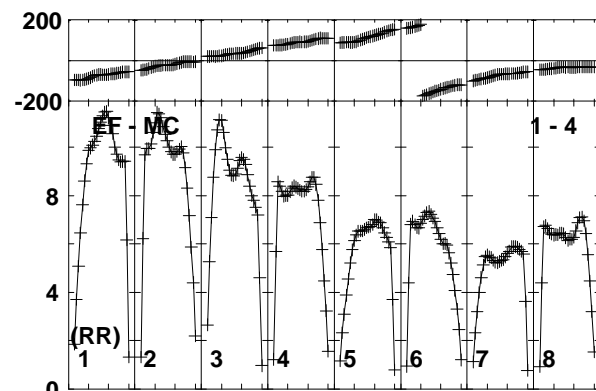
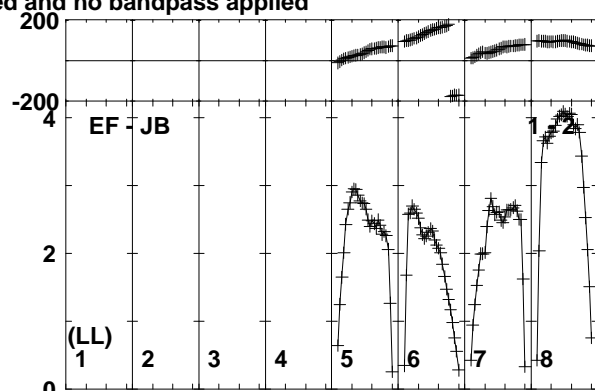
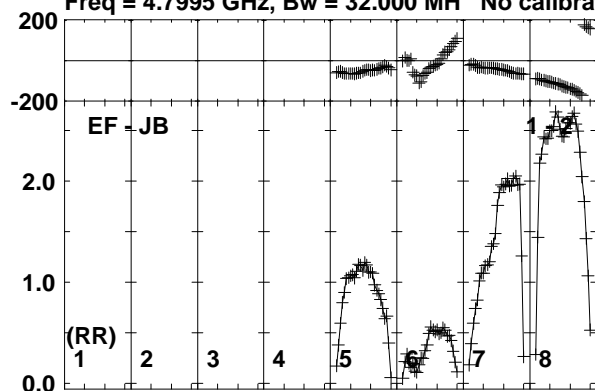

Lower frame: Milli Ampl Jy Top frame: Phas deg
Vector averaged cross-power spectrum Baseline: EF (01) - JB (02)
Timerange: 00/21:07:07 to 00/21:09:59

Plot file version 2 created 20-APR-2018 18:07:51
 J1310+3220 RG009B.UVDATA.1
 Freq = 4.7995 GHz, Bw = 32.000 MH No calibration applied and no bandpass applied

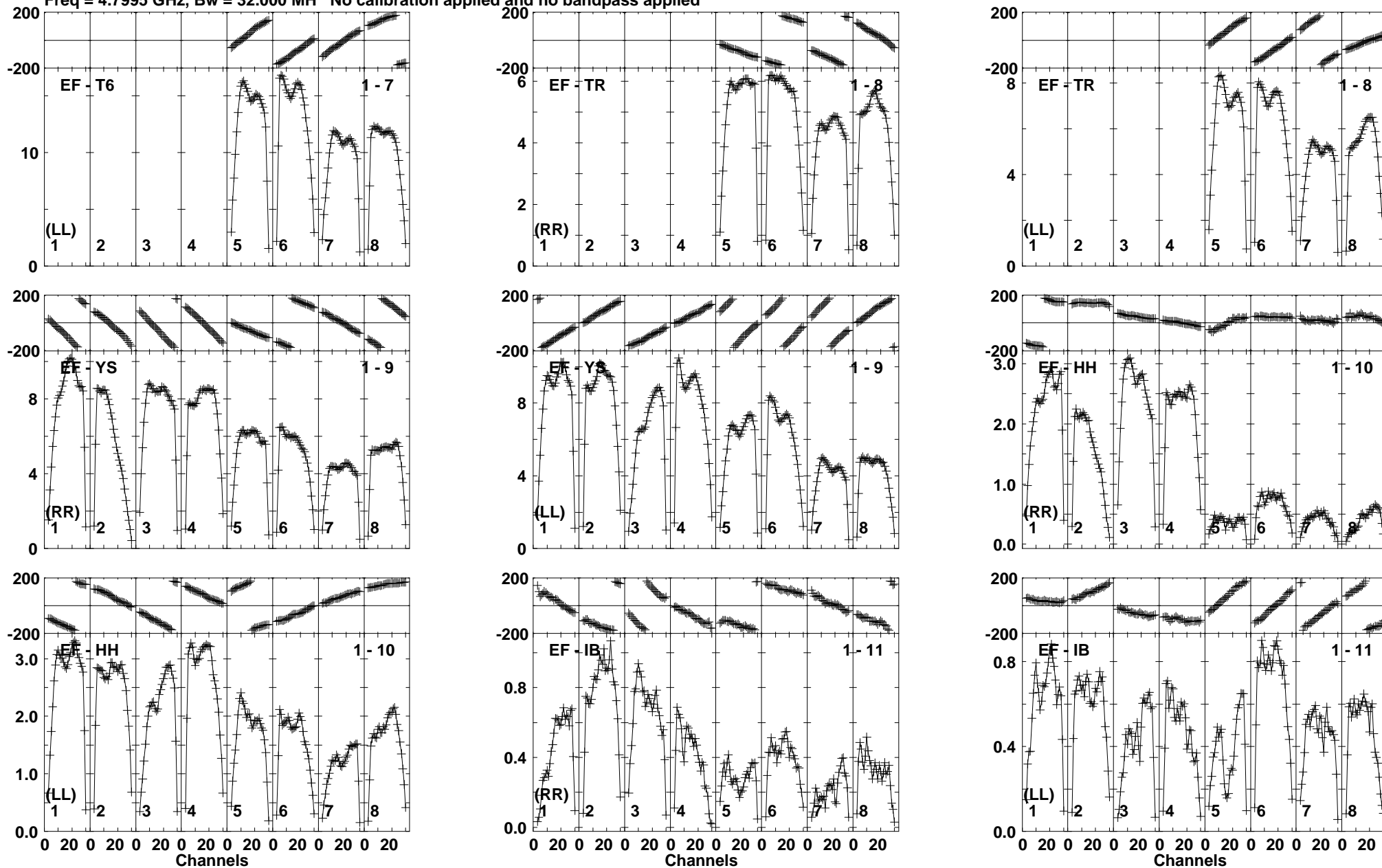

Lower frame: Milli Ampl Jy Top frame: Phas deg
 Vector averaged cross-power spectrum Baseline: EF (01) - T6 (07)
 Timerange: 00/21:07:07 to 00/21:09:59

Plot file version 3 created 20-APR-2018 18:07:51

J1311-2329 RG009B.UVDATA.1

Freq = 4.7995 GHz, Bw = 32.000 MH No calibration applied and no bandpass applied

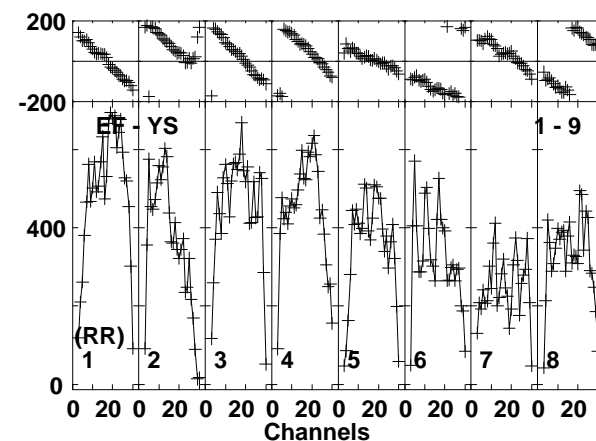
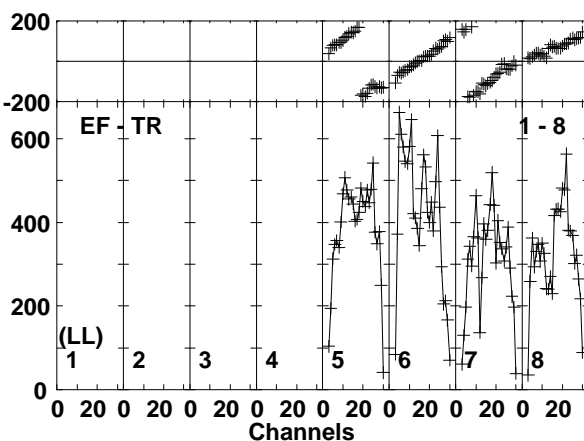
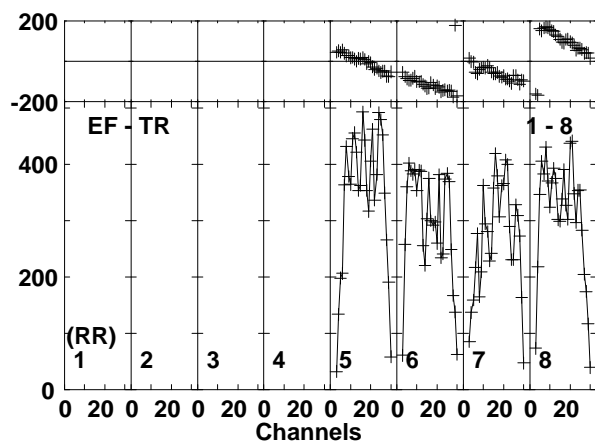
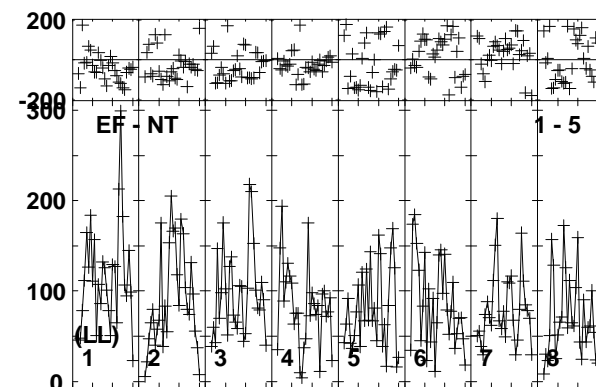
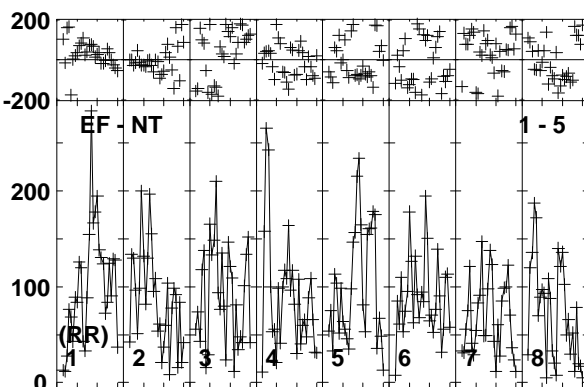
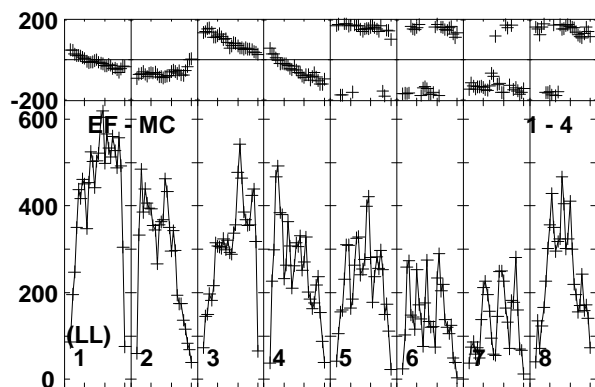
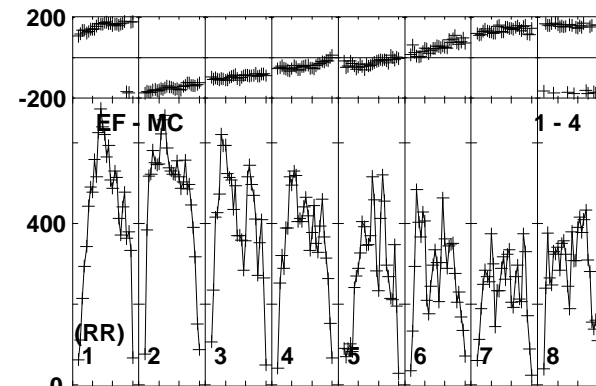
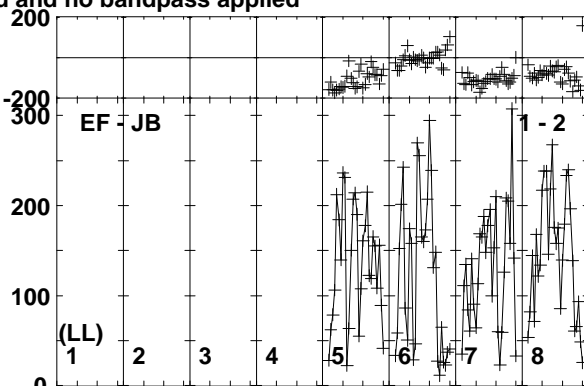
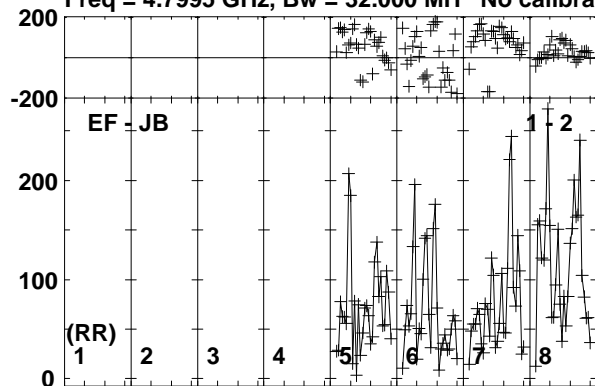

Lower frame: Micro Ampl Jy Top frame: Phas deg
Vector averaged cross-power spectrum Baseline: EF (01) - JB (02)
Timerange: 00/21:13:41 to 00/21:15:39

Plot file version 4 created 20-APR-2018 18:07:51

J1311-2329 RG009B.UVDATA.1

Freq = 4.7995 GHz, Bw = 32.000 MH No calibration applied and no bandpass applied

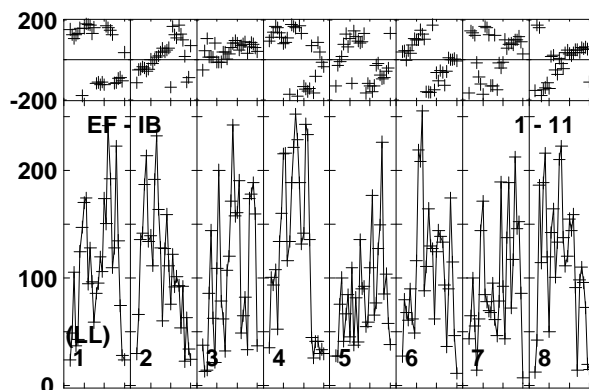
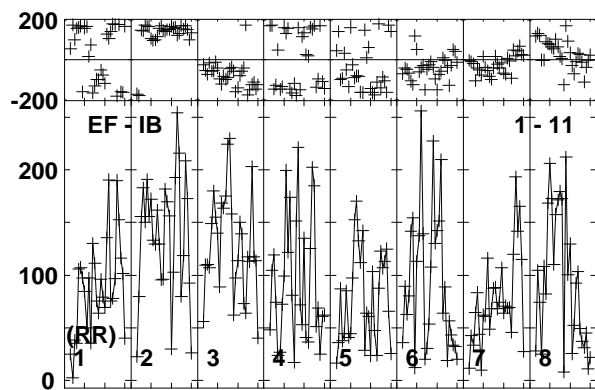
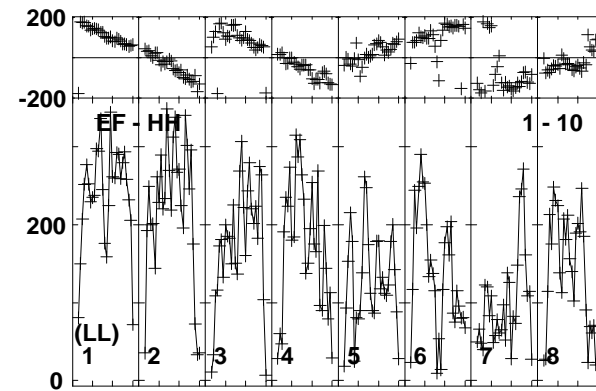
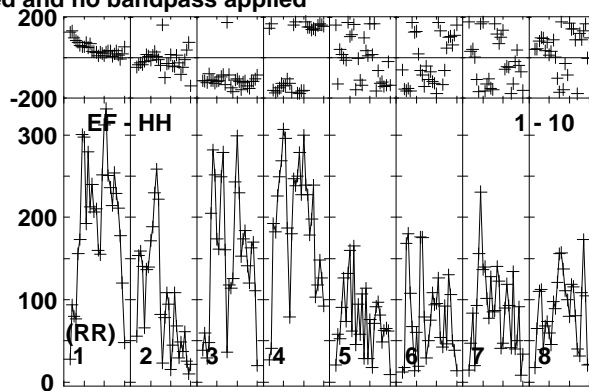
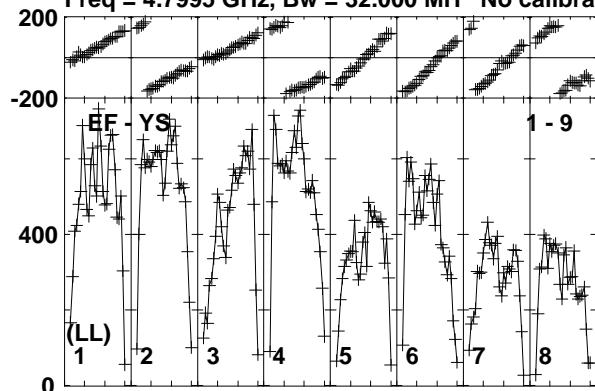

Lower frame: Micro Ampl Jy Top frame: Phas deg
Vector averaged cross-power spectrum Baseline: EF (01) - YS (09)
Timerange: 00/21:13:41 to 00/21:15:39

Plot file version 5 created 20-APR-2018 18:07:51
EM170817 RG009B.UVDATA.1

Freq = 4.7995 GHz, Bw = 32.000 MH No calibration applied and no bandpass applied

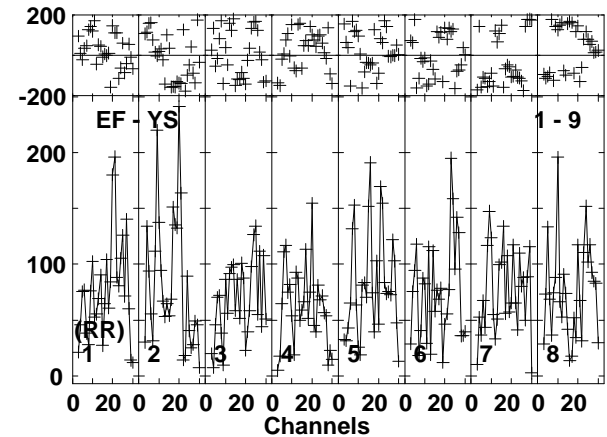
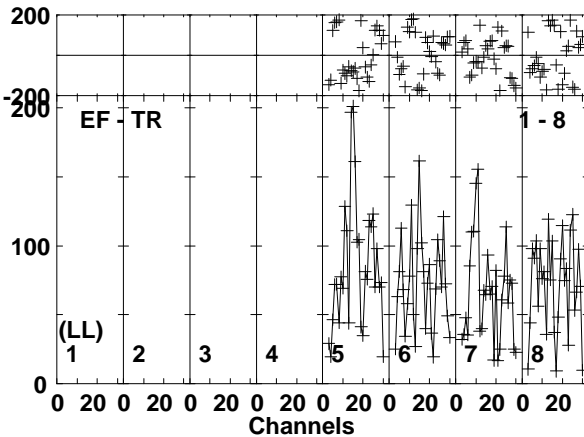
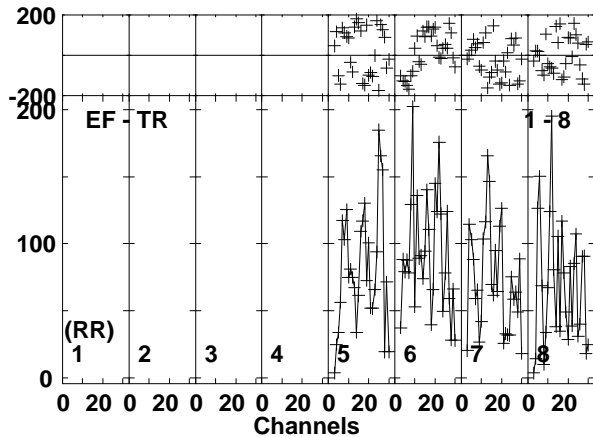
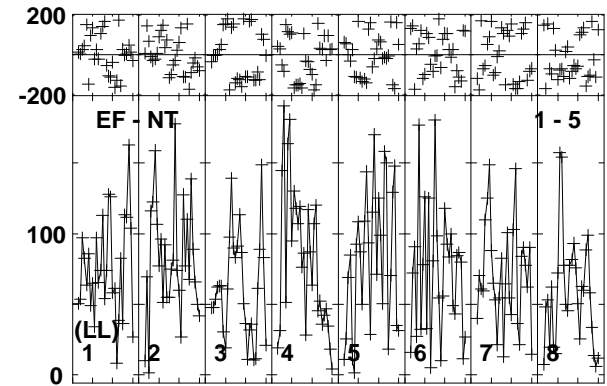
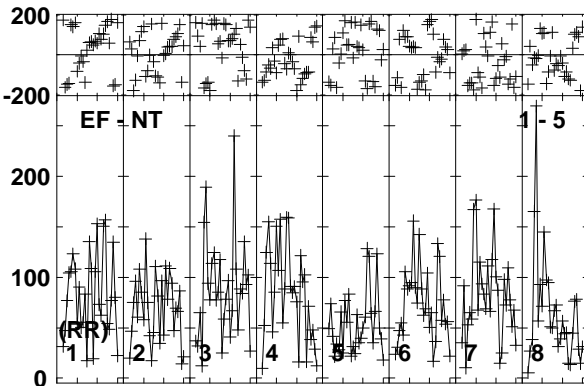
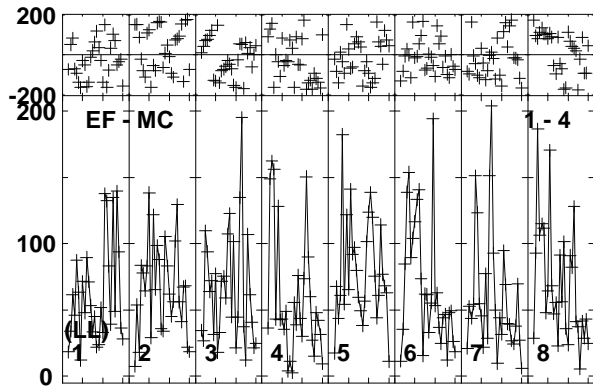
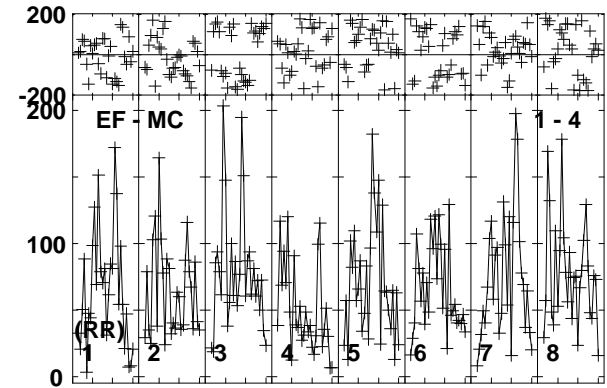
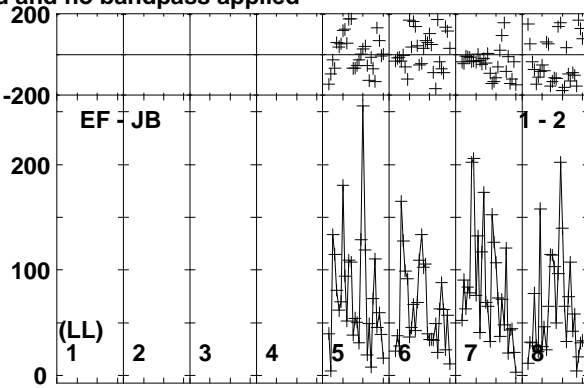
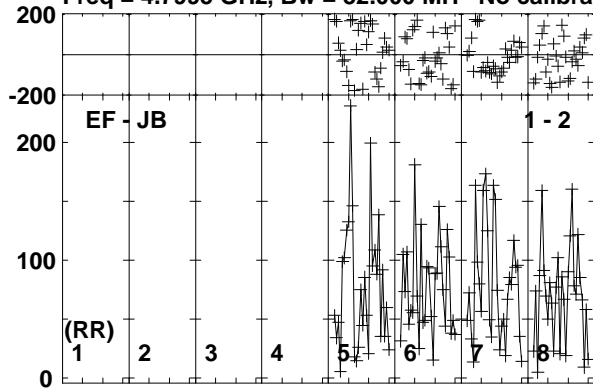

Lower frame: Micro Ampl Jy Top frame: Phas deg
Vector averaged cross-power spectrum Baseline: EF (01) - JB (02)
Timerange: 00/21:15:41 to 00/21:18:09

Plot file version 6 created 20-APR-2018 18:07:52

EM170817 RG009B.UVDATA.1

Freq = 4.7995 GHz, Bw = 32.000 MH No calibration applied and no bandpass applied

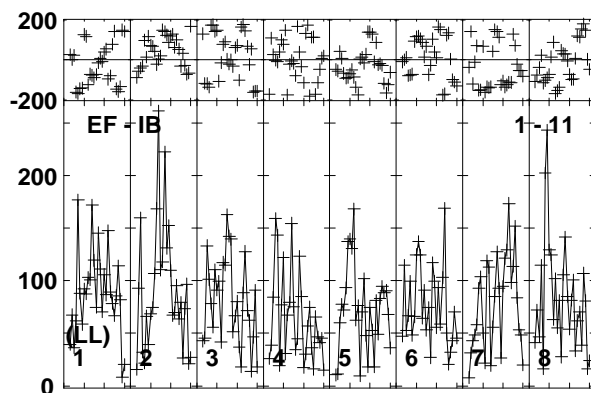
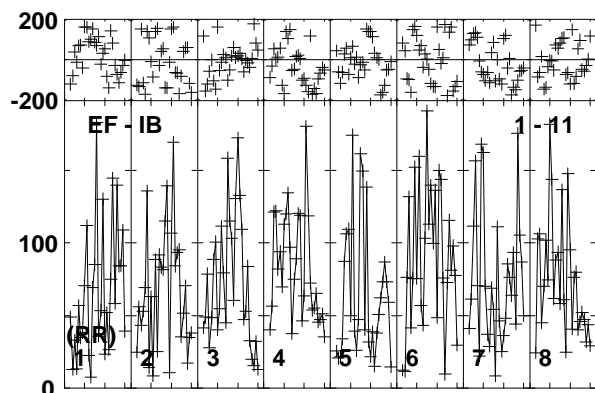
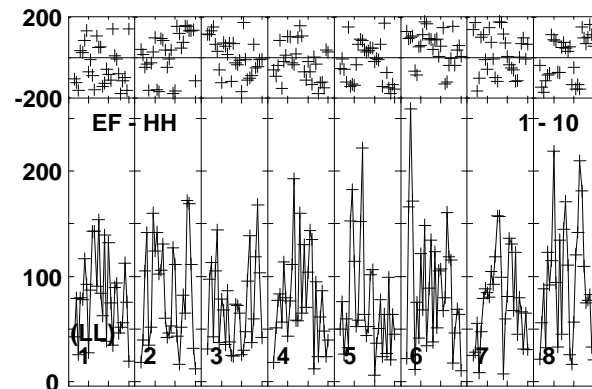
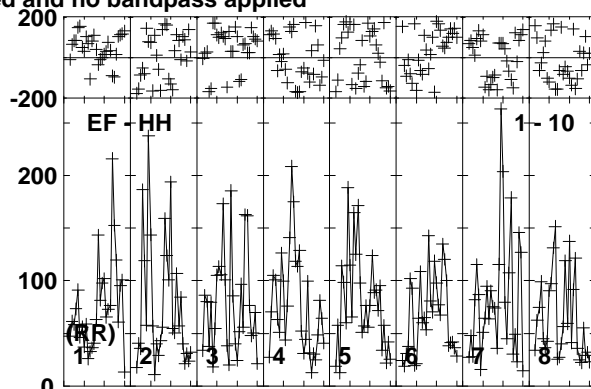
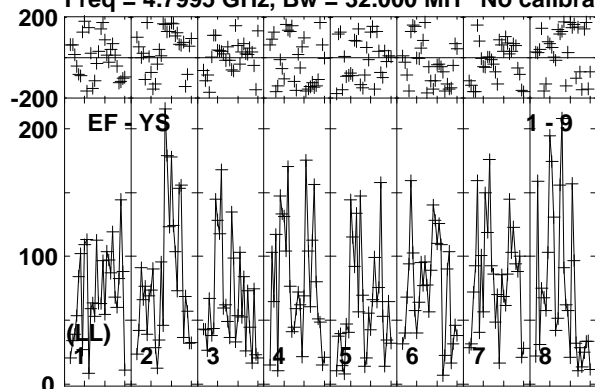

Lower frame: Micro Ampl Jy Top frame: Phas deg
Vector averaged cross-power spectrum Baseline: EF (01) - YS (09)
Timerange: 00/21:15:41 to 00/21:18:09

Plot file version 7 created 20-APR-2018 18:07:52

J1311-2329 RG009B.UVDATA.1

Freq = 4.7995 GHz, Bw = 32.000 MH No calibration applied and no bandpass applied

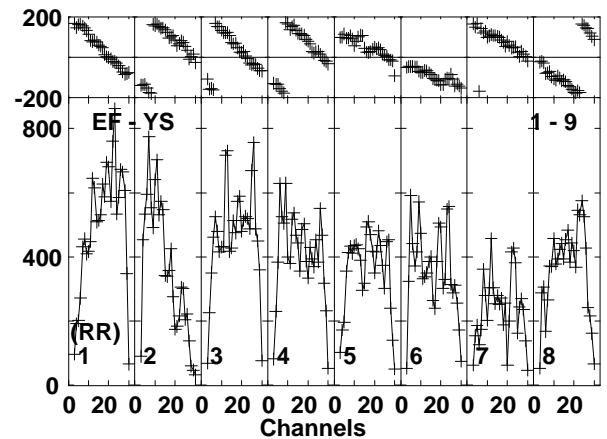
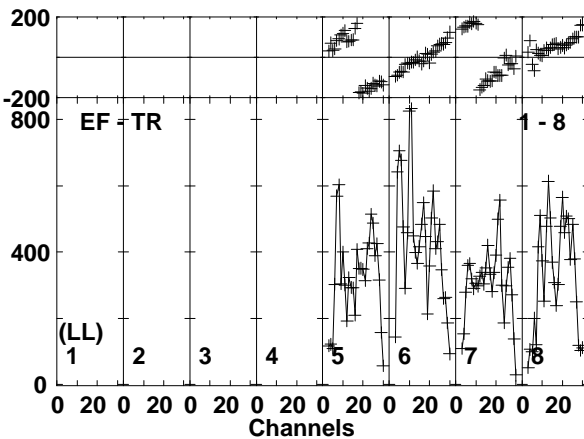
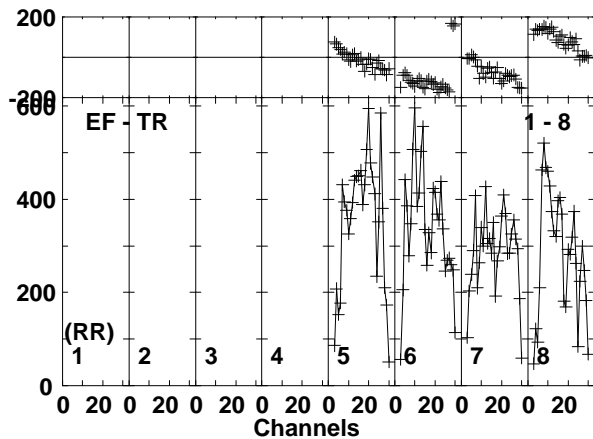
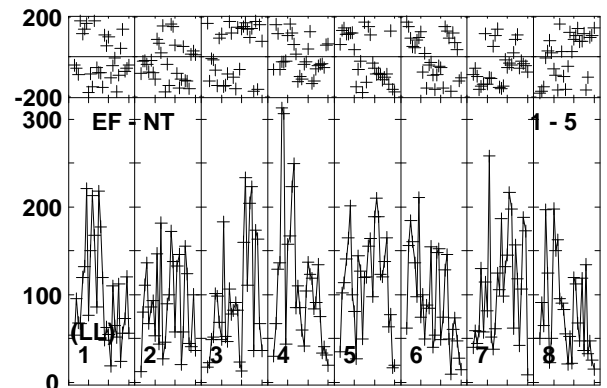
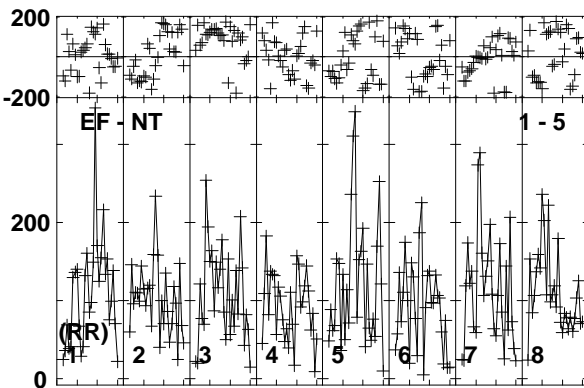
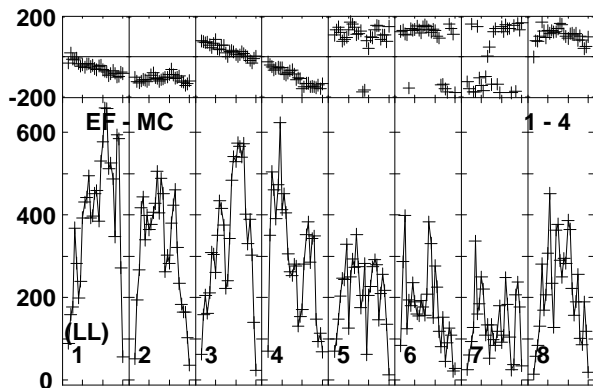
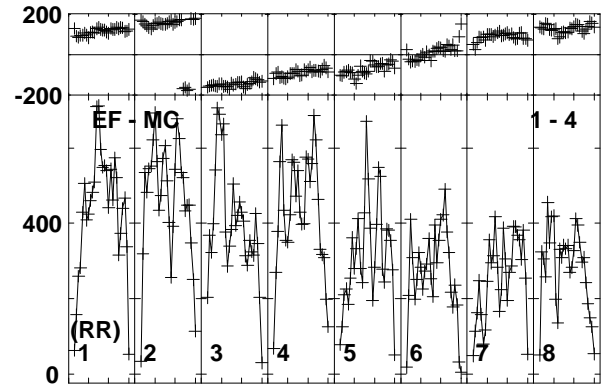
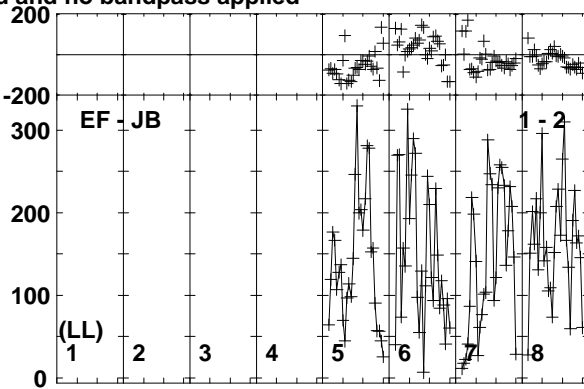
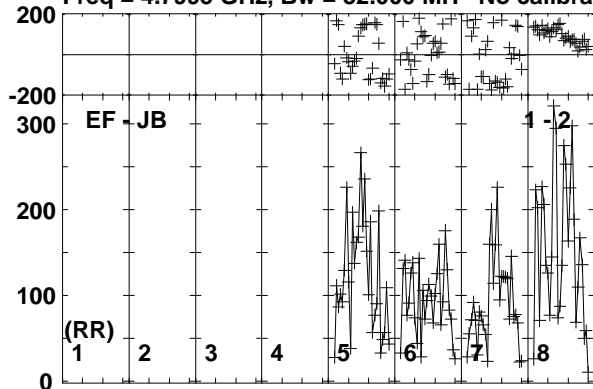

Lower frame: Micro Ampl Jy Top frame: Phas deg
Vector averaged cross-power spectrum Baseline: EF (01) - JB (02)
Timerange: 00/21:18:11 to 00/21:19:39

Plot file version 8 created 20-APR-2018 18:07:52

J1311-2329 RG009B.UVDATA.1

Freq = 4.7995 GHz, Bw = 32.000 MH No calibration applied and no bandpass applied

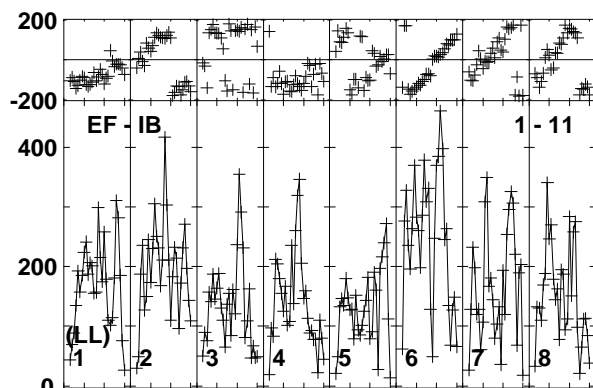
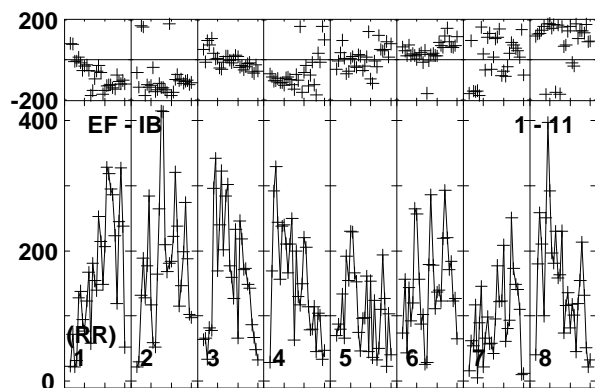
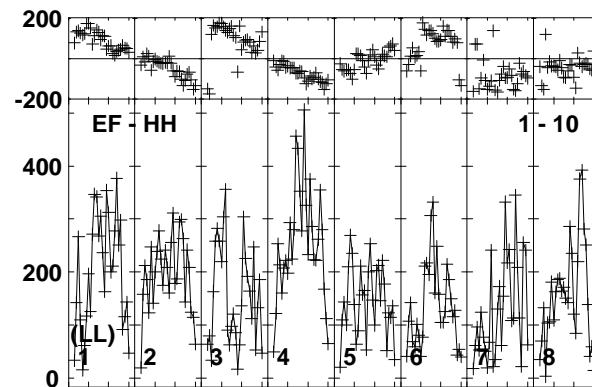
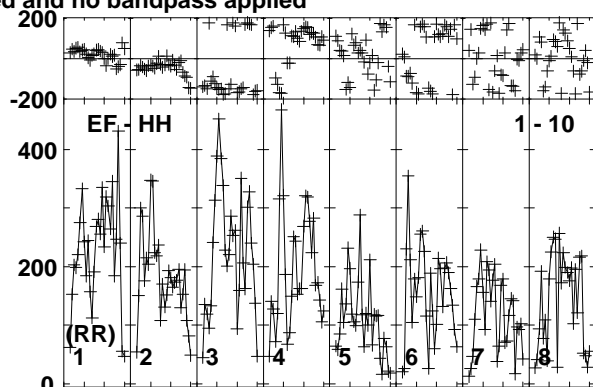
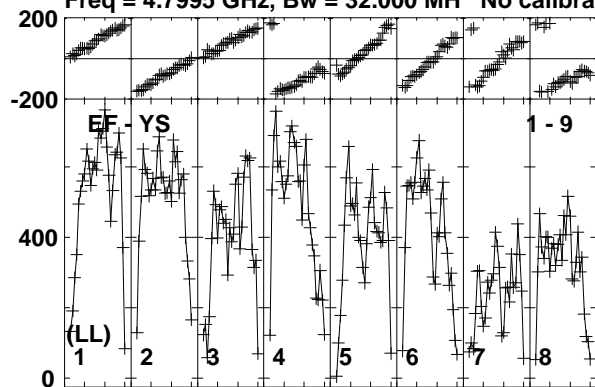

Lower frame: Micro Ampl Jy Top frame: Phas deg
Vector averaged cross-power spectrum Baseline: EF (01) - YS (09)
Timerange: 00/21:18:11 to 00/21:19:39

Plot file version 9 created 20-APR-2018 18:07:52

EM170817 RG009B.UVDATA.1

Freq = 4.7995 GHz, Bw = 32.000 MH No calibration applied and no bandpass applied

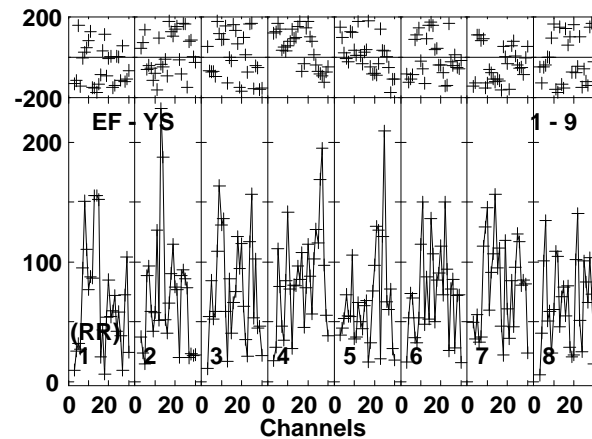
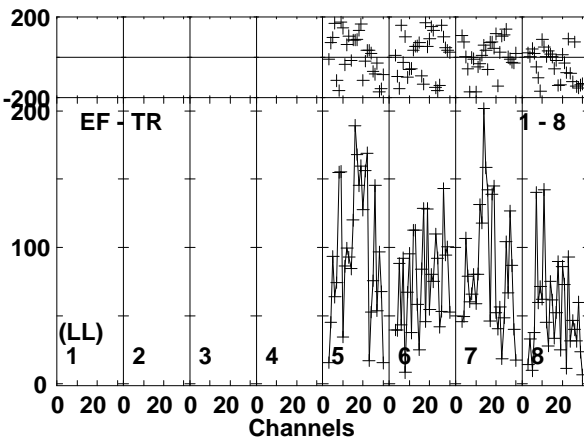
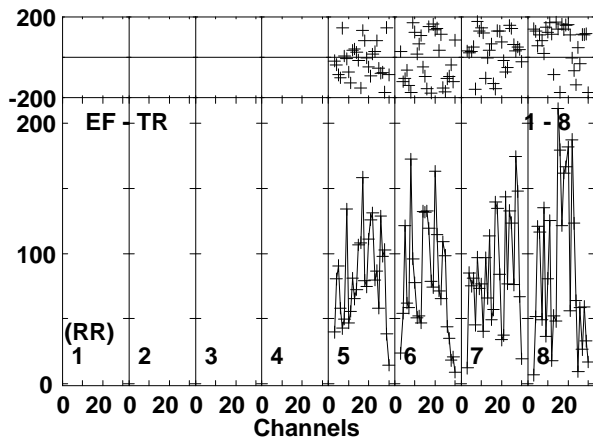
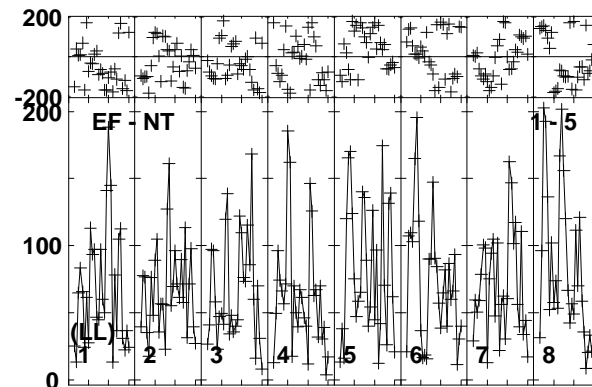
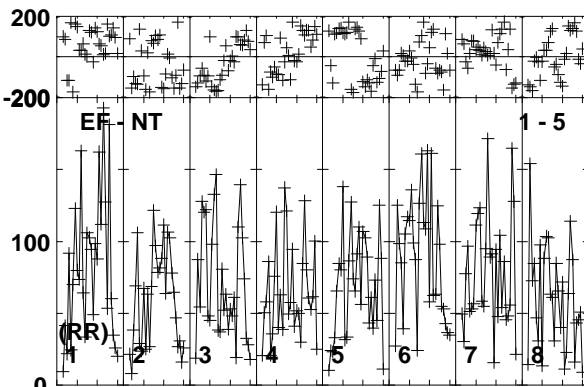
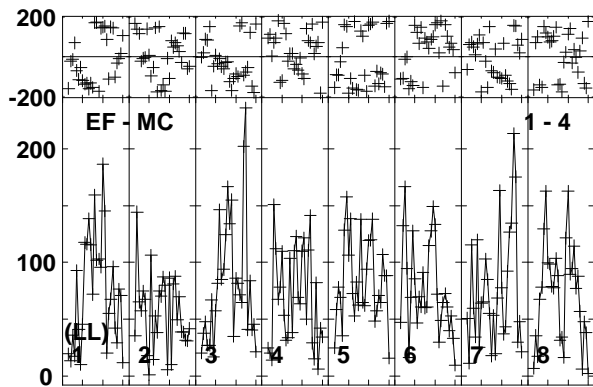
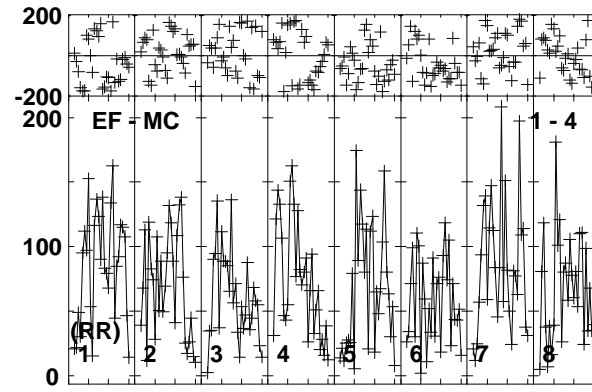
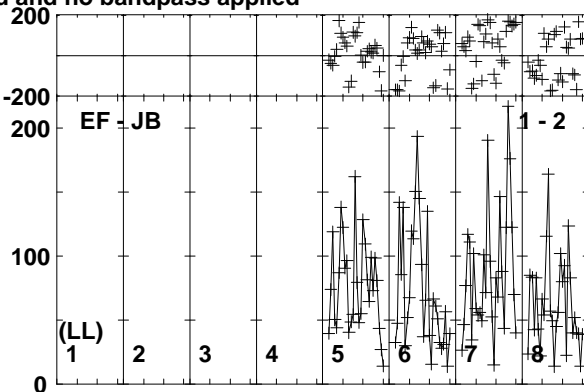
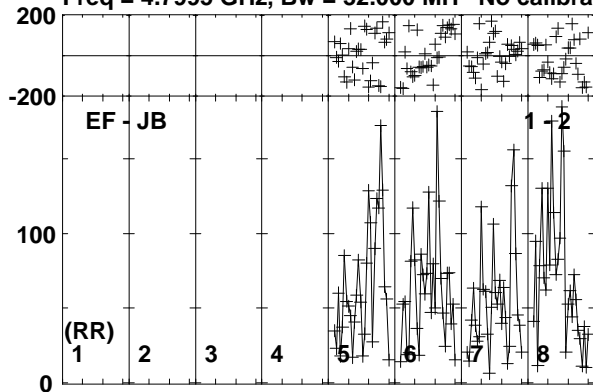

Lower frame: Micro Ampl Jy Top frame: Phas deg
Vector averaged cross-power spectrum Baseline: EF (01) - JB (02)
Timerange: 00/21:19:41 to 00/21:22:09

Plot file version 10 created 20-APR-2018 18:07:52

EM170817 RG009B.UVDATA.1

Freq = 4.7995 GHz, Bw = 32.000 MH No calibration applied and no bandpass applied

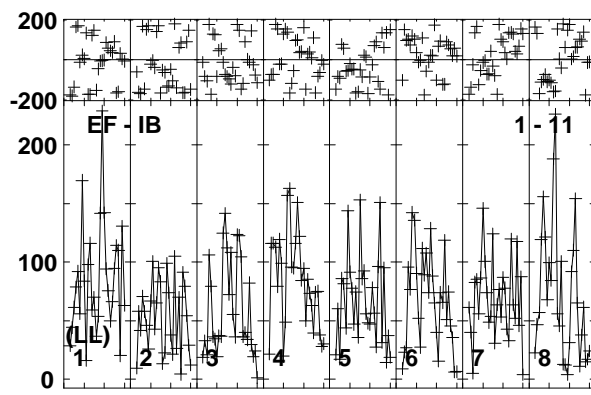
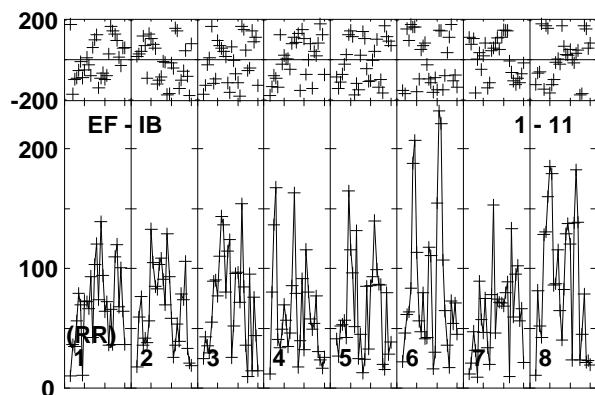
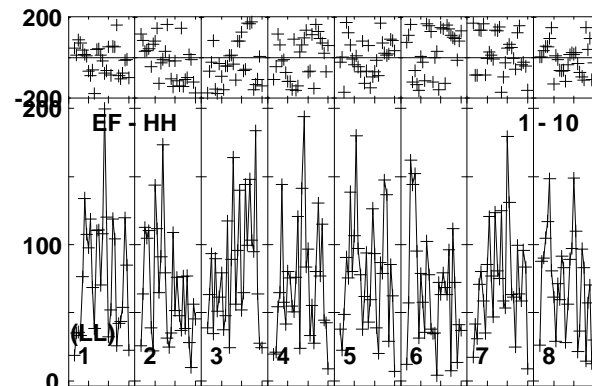
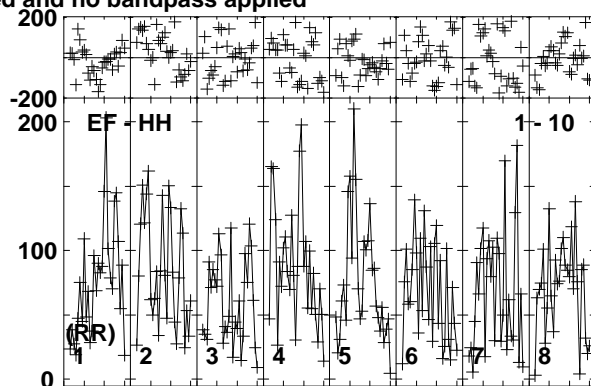
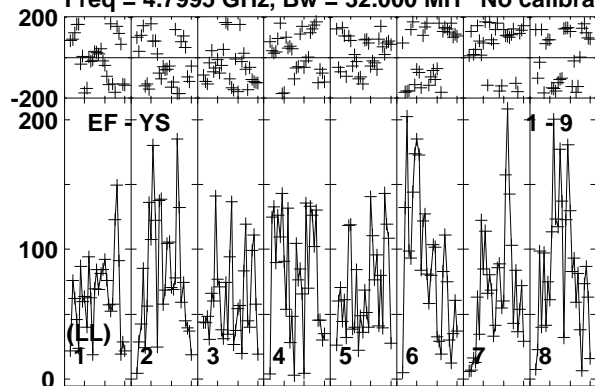

Lower frame: Micro Ampl Jy Top frame: Phas deg
Vector averaged cross-power spectrum Baseline: EF (01) - YS (09)
Timerange: 00/21:19:41 to 00/21:22:09

Plot file version 11 created 20-APR-2018 18:07:52

J1311-2329 RG009B.UVDATA.1

Freq = 4.7995 GHz, Bw = 32.000 MH No calibration applied and no bandpass applied

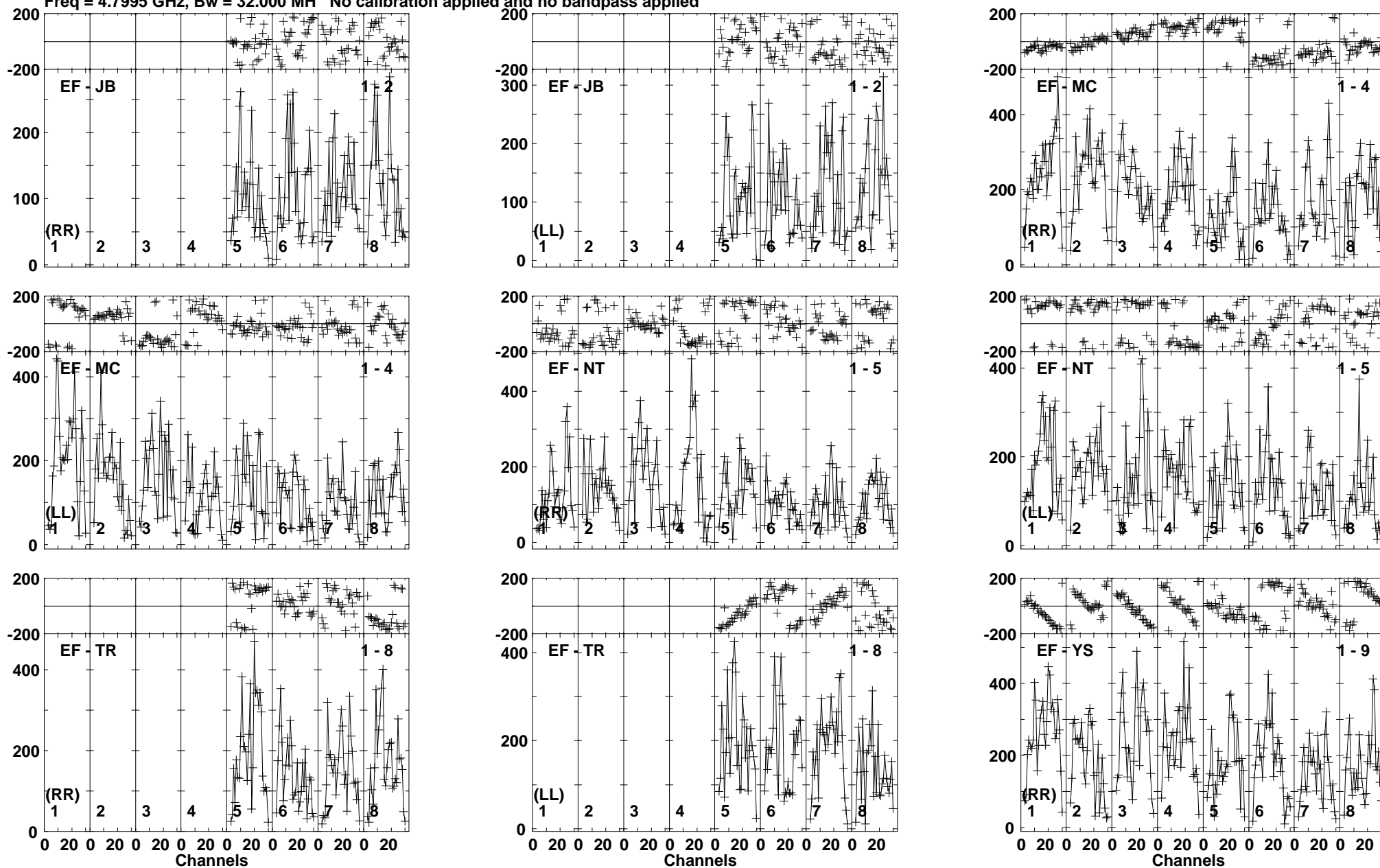

Lower frame: Micro Ampl Jy Top frame: Phas deg
Vector averaged cross-power spectrum Baseline: EF (01) - JB (02)
Timerange: 00/21:22:41 to 00/21:23:39

Plot file version 12 created 20-APR-2018 18:07:52

J1311-2329 RG009B.UVDATA.1

Freq = 4.7995 GHz, Bw = 32.000 MH No calibration applied and no bandpass applied

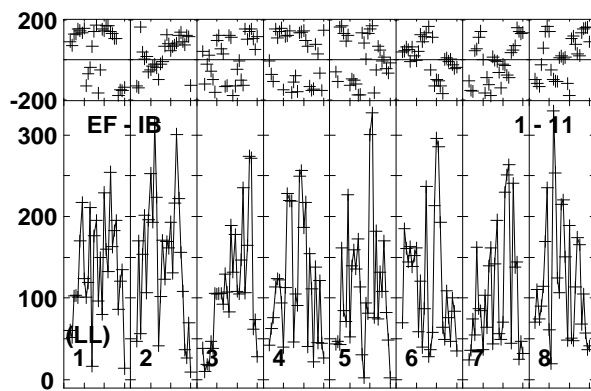
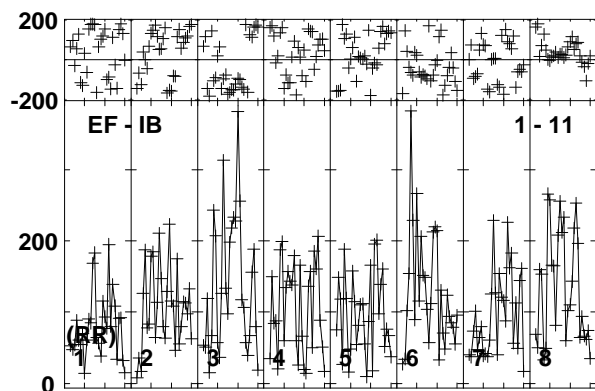
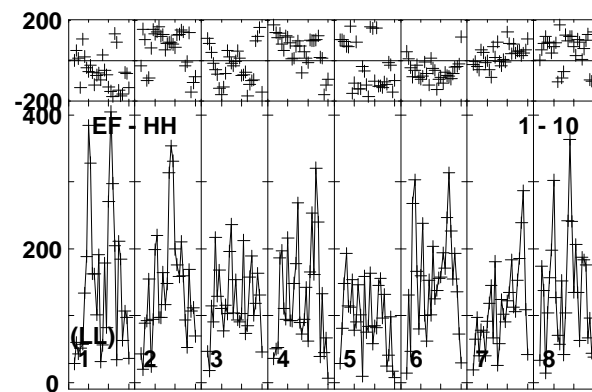
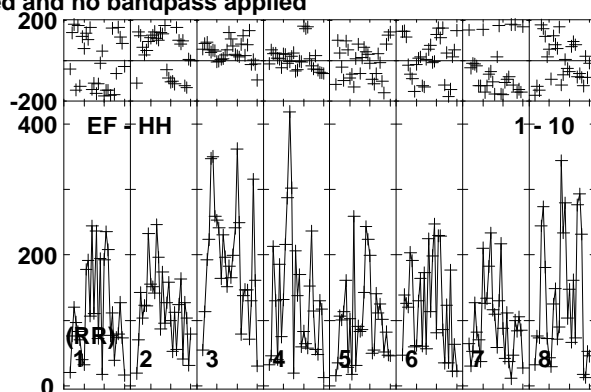
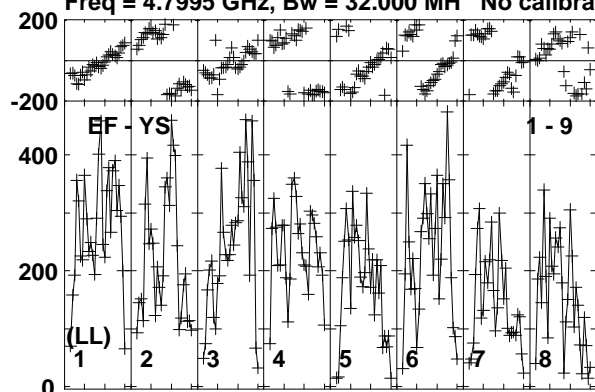

Lower frame: Micro Ampl Jy Top frame: Phas deg
Vector averaged cross-power spectrum Baseline: EF (01) - YS (09)
Timerange: 00/21:22:41 to 00/21:23:39

Plot file version 13 created 20-APR-2018 18:07:52
 EM170817 RG009B.UVDATA.1
 Freq = 4.7995 GHz, Bw = 32.000 MH No calibration applied and no bandpass applied

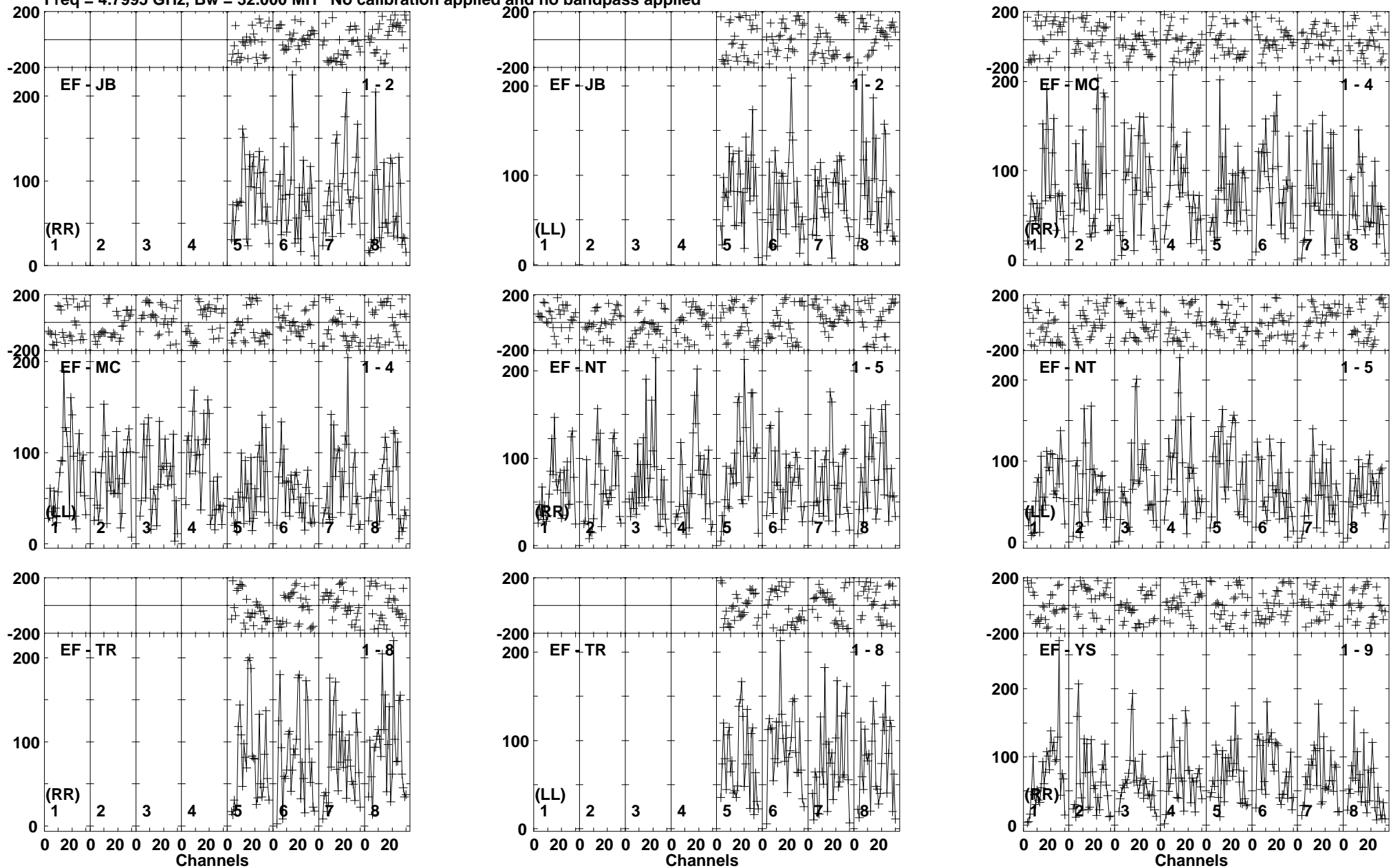

Lower frame: Micro Ampl Jy Top frame: Phas deg
 Vector averaged cross-power spectrum Baseline: EF (01) - JB (02)
 Timerange: 00/21:23:41 to 00/21:26:09

Plot file version 14 created 20-APR-2018 18:07:52

EM170817 RG009B.UVDATA.1

Freq = 4.7995 GHz, Bw = 32.000 MH No calibration applied and no bandpass applied

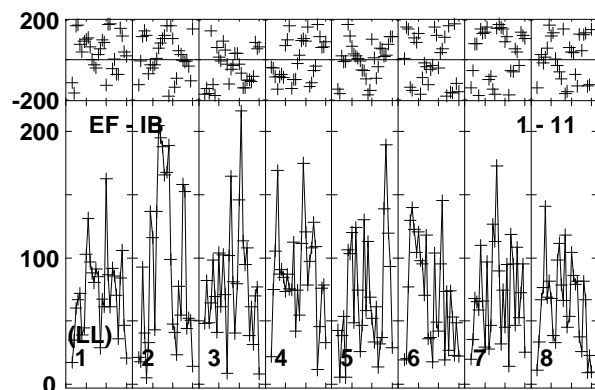
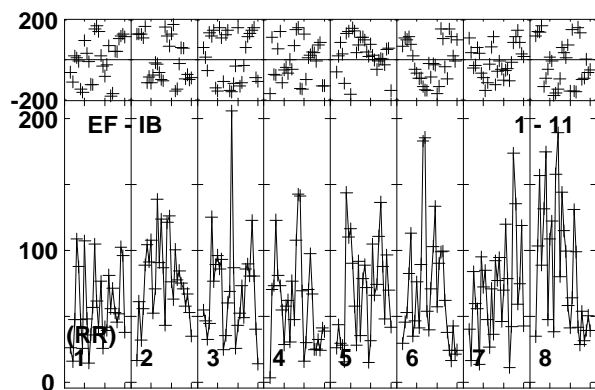
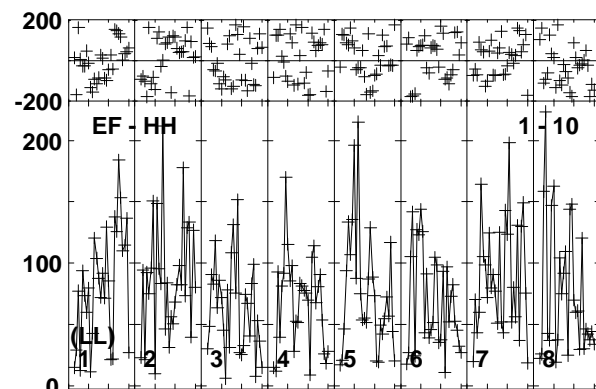
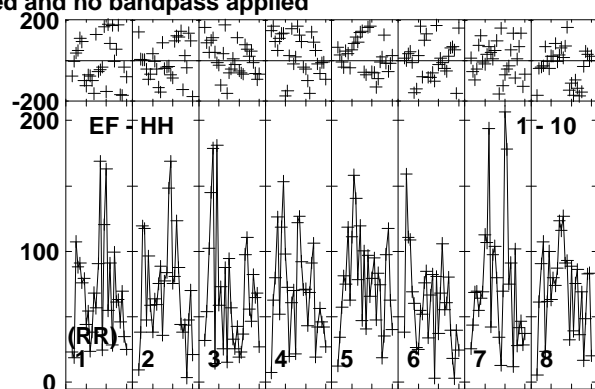
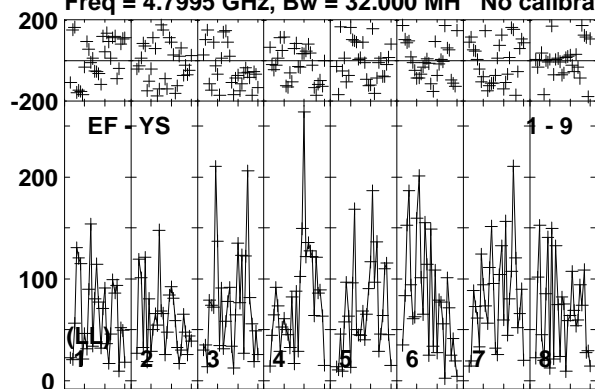

Lower frame: Micro Ampl Jy Top frame: Phas deg
Vector averaged cross-power spectrum Baseline: EF (01) - YS (09)
Timerange: 00/21:23:41 to 00/21:26:09

Plot file version 15 created 20-APR-2018 18:07:52

J1311-2329 RG009B.UVDATA.1

Freq = 4.7995 GHz, Bw = 32.000 MH No calibration applied and no bandpass applied

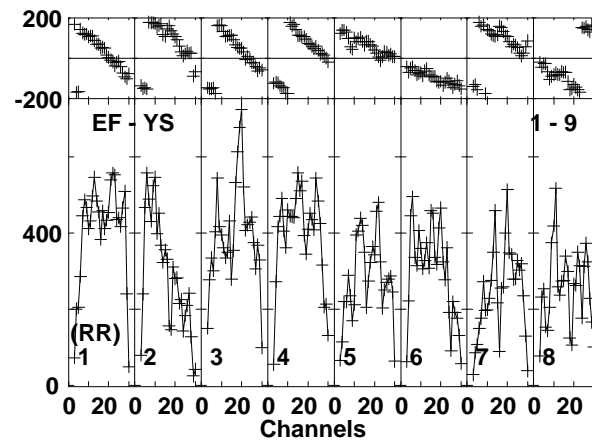
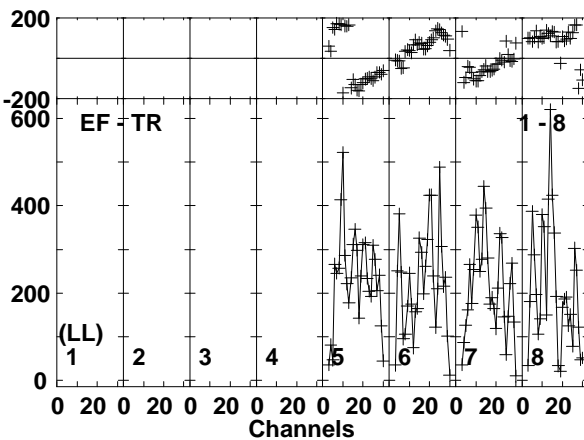
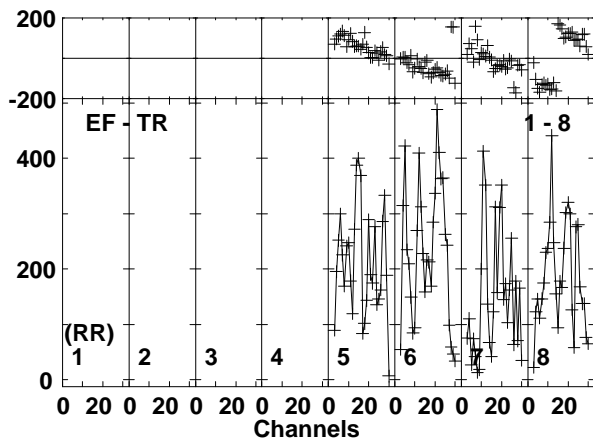
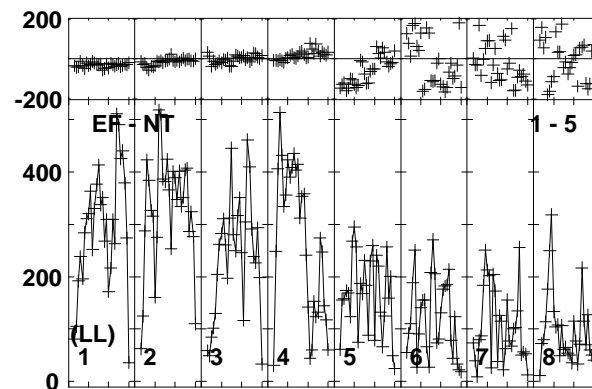
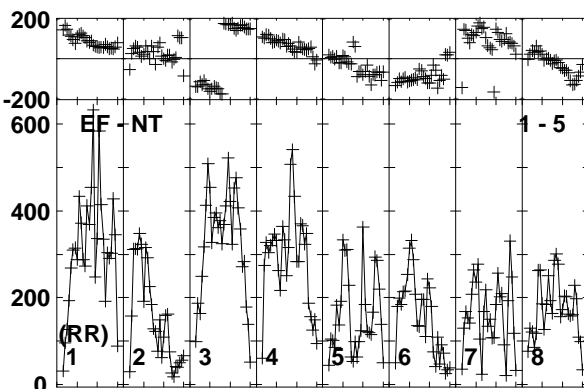
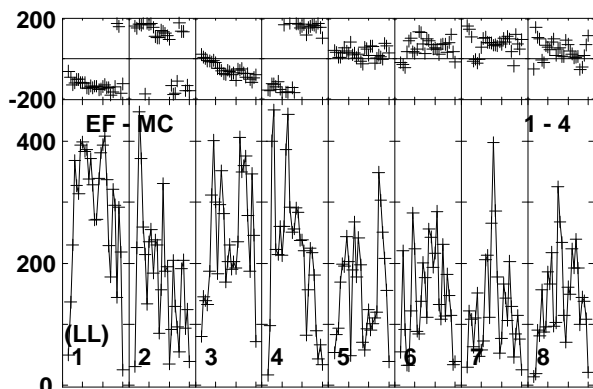
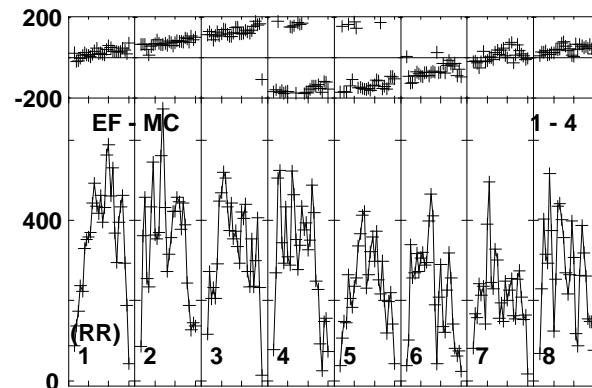
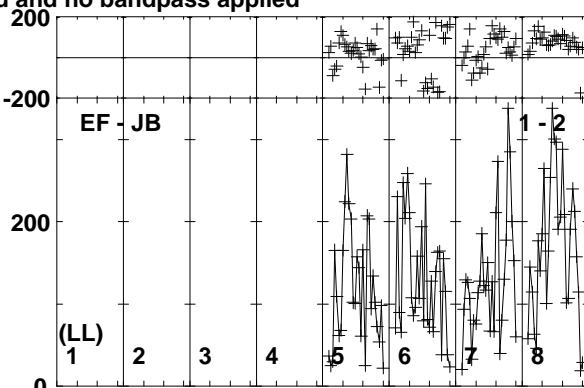
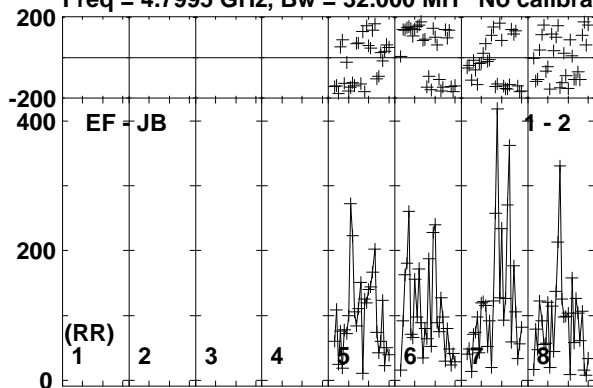

Lower frame: Micro Ampl Jy Top frame: Phas deg
Vector averaged cross-power spectrum Baseline: EF (01) - JB (02)
Timerange: 00/21:26:11 to 00/21:27:39

Plot file version 16 created 20-APR-2018 18:07:53

J1311-2329 RG009B.UVDATA.1

Freq = 4.7995 GHz, Bw = 32.000 MH No calibration applied and no bandpass applied

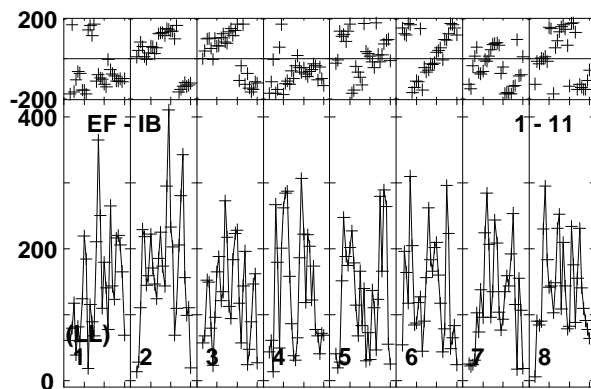
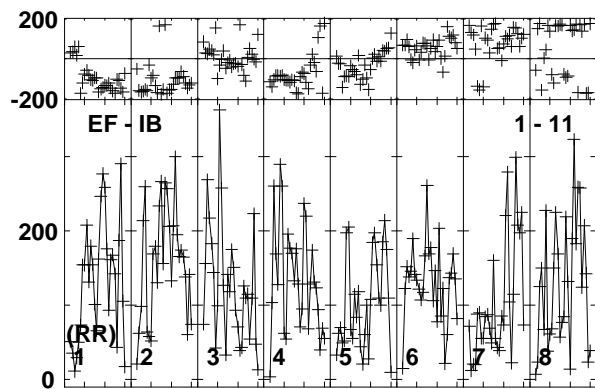
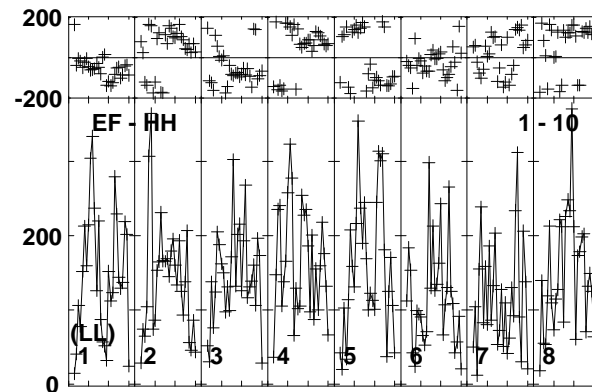
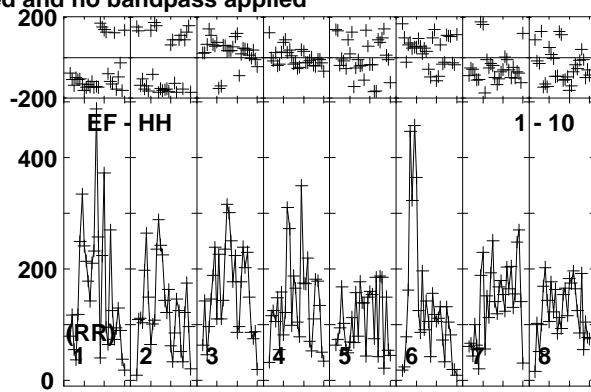
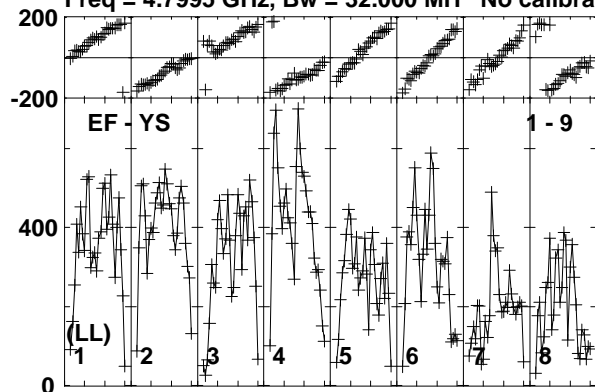

Lower frame: Micro Ampl Jy Top frame: Phas deg
Vector averaged cross-power spectrum Baseline: EF (01) - YS (09)
Timerange: 00/21:26:11 to 00/21:27:39

Plot file version 17 created 20-APR-2018 18:07:53

J1312-2350 RG009B.UVDATA.1

Freq = 4.7995 GHz, Bw = 32.000 MH No calibration applied and no bandpass applied

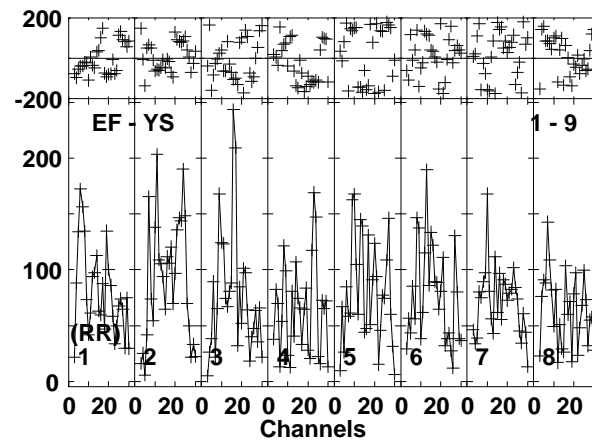
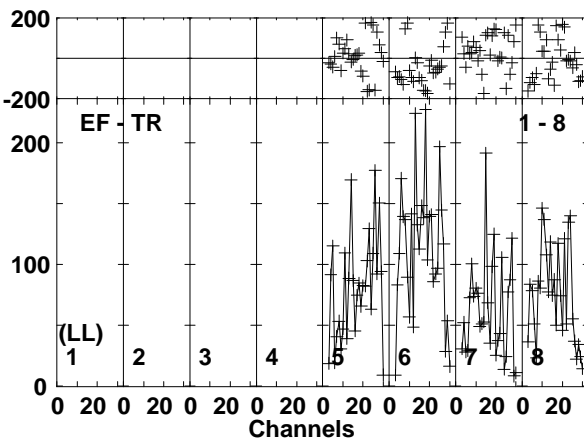
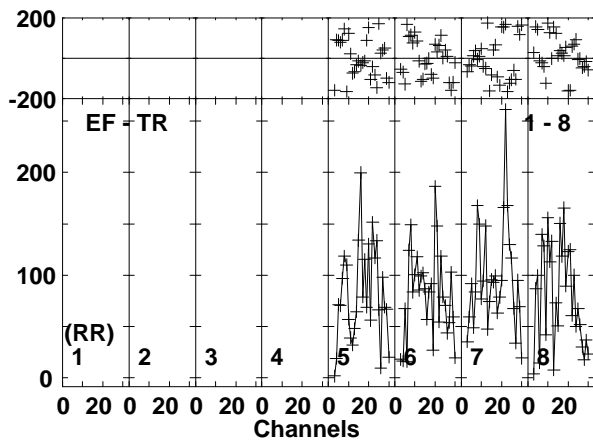
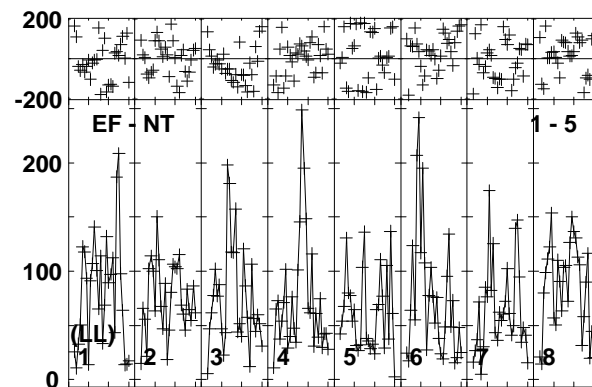
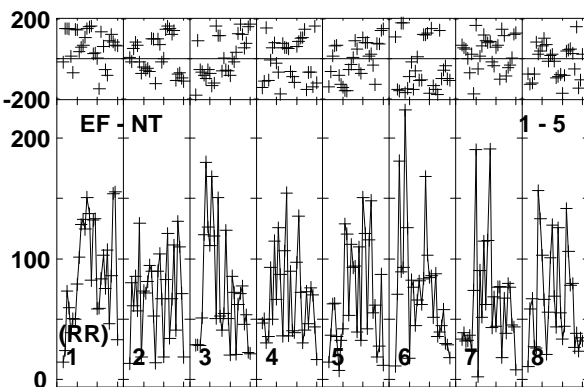
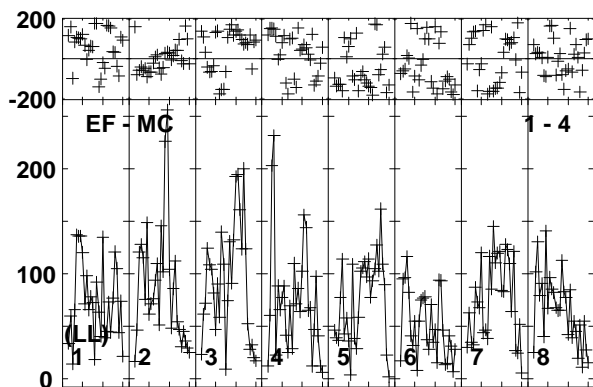
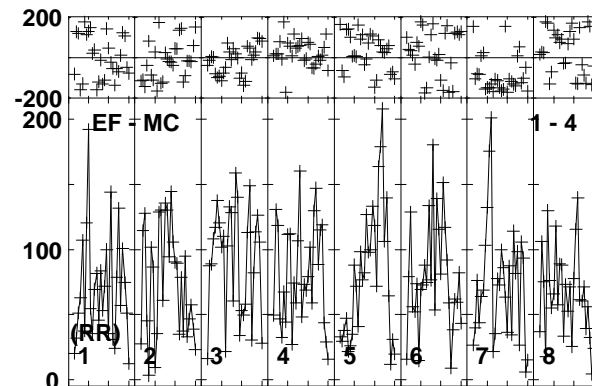
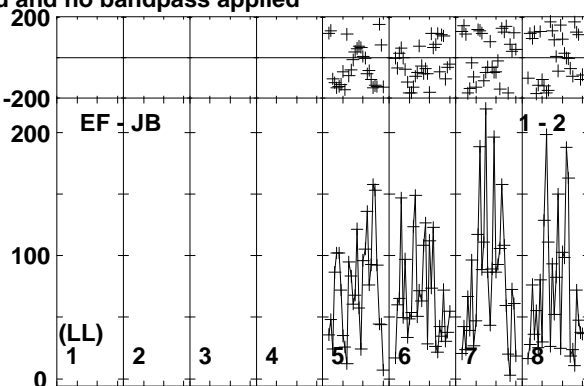
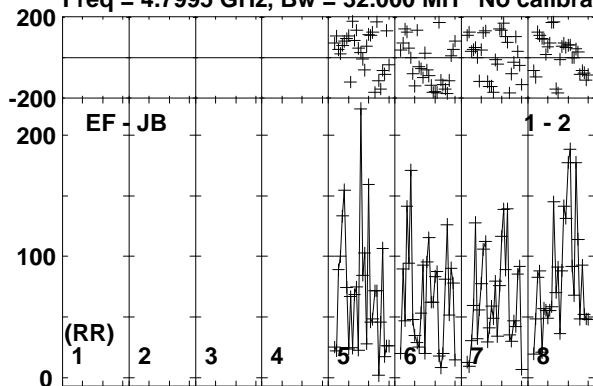

Lower frame: Micro Ampl Jy Top frame: Phas deg
Vector averaged cross-power spectrum Baseline: EF (01) - JB (02)
Timerange: 00/21:27:41 to 00/21:30:09

Plot file version 18 created 20-APR-2018 18:07:53

J1312-2350 RG009B.UVDATA.1

Freq = 4.7995 GHz, Bw = 32.000 MH No calibration applied and no bandpass applied

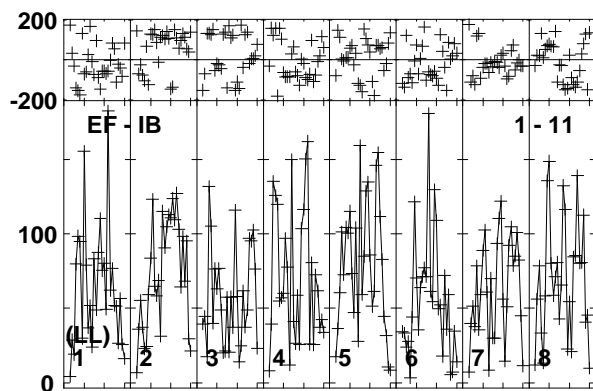
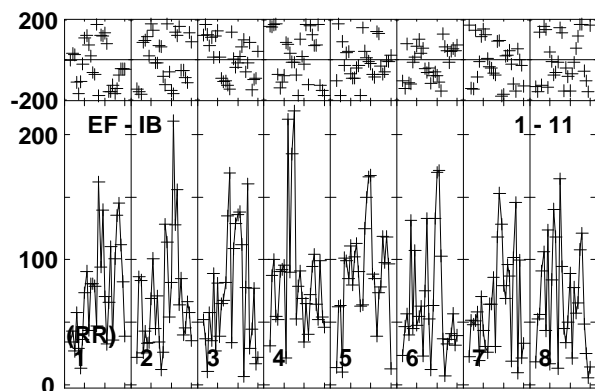
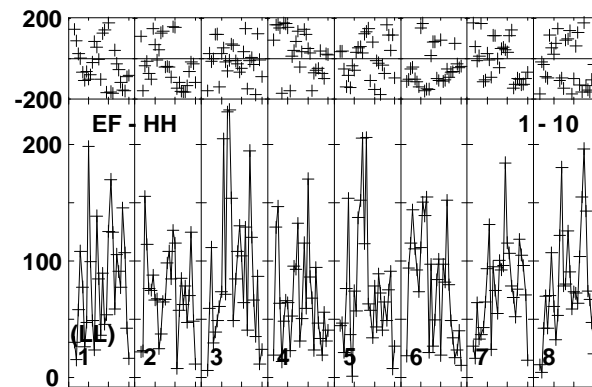
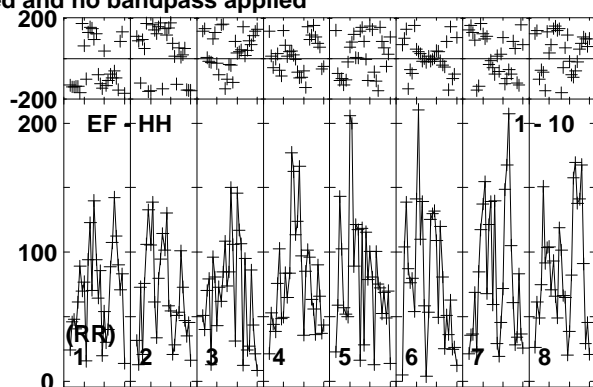
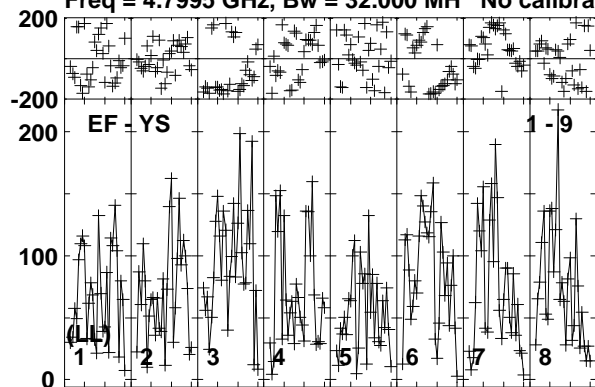

Lower frame: Micro Ampl Jy Top frame: Phas deg
Vector averaged cross-power spectrum Baseline: EF (01) - YS (09)
Timerange: 00/21:27:41 to 00/21:30:09

Plot file version 19 created 20-APR-2018 18:07:53

J1311-2329 RG009B.UVDATA.1

Freq = 4.7995 GHz, Bw = 32.000 MH No calibration applied and no bandpass applied

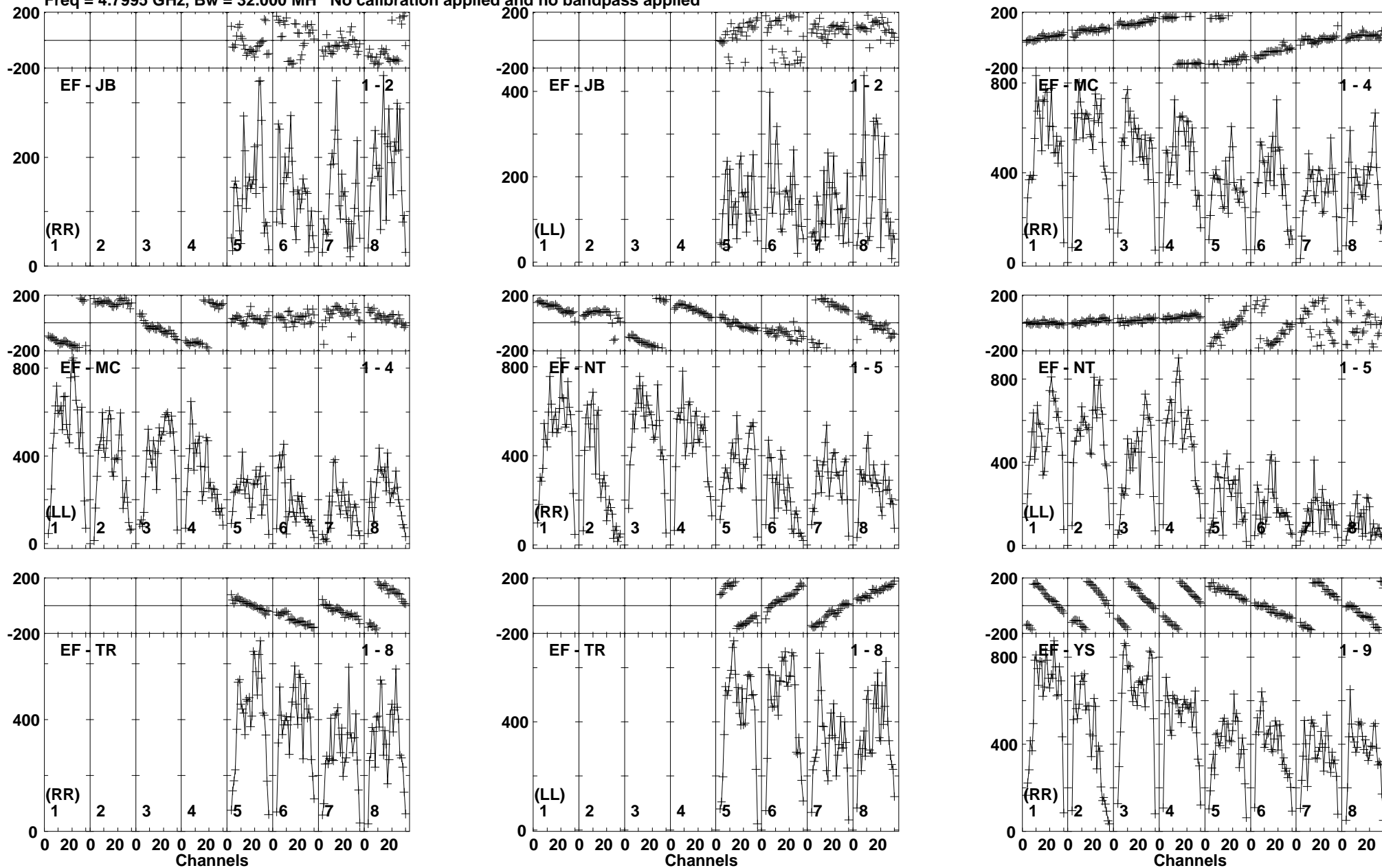

Lower frame: Micro Ampl Jy Top frame: Phas deg
Vector averaged cross-power spectrum Baseline: EF (01) - JB (02)
Timerange: 00/21:30:51 to 00/21:31:49

Plot file version 20 created 20-APR-2018 18:07:53

J1311-2329 RG009B.UVDATA.1

Freq = 4.7995 GHz, Bw = 32.000 MH No calibration applied and no bandpass applied

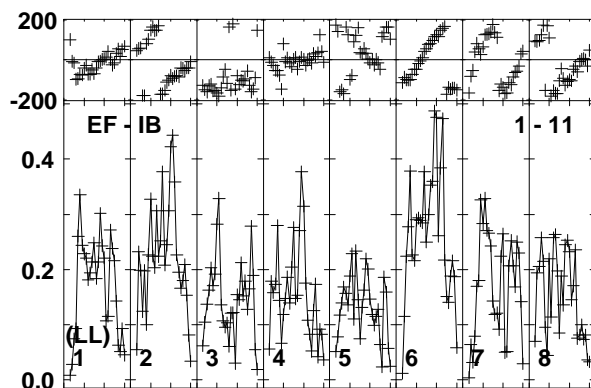
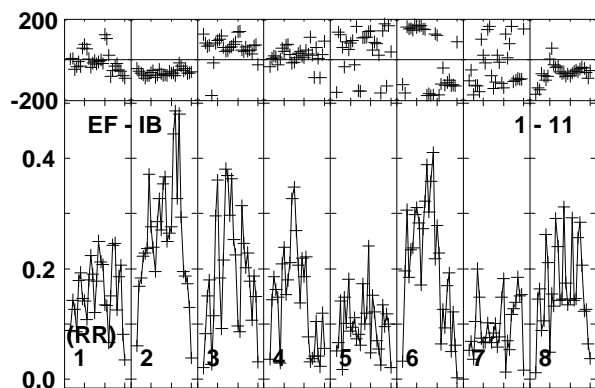
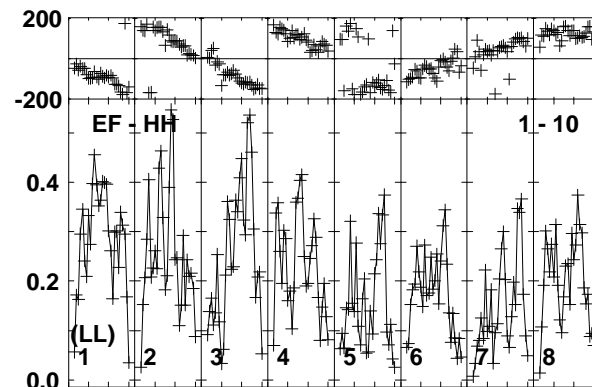
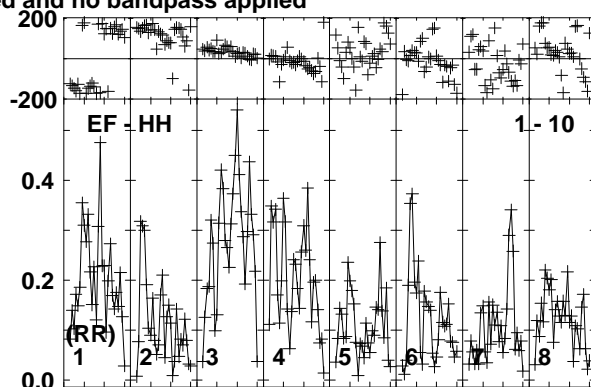
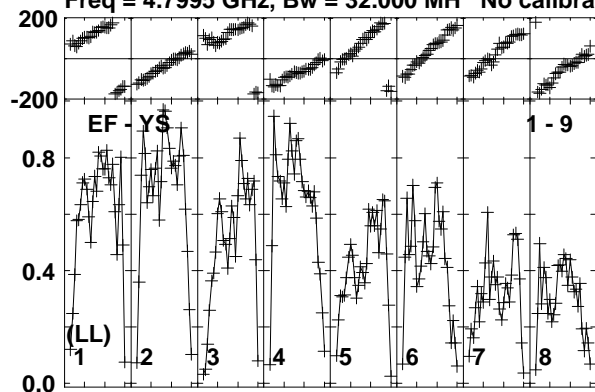

Lower frame: Milli Ampl Jy Top frame: Phas deg
Vector averaged cross-power spectrum Baseline: EF (01) - YS (09)
Timerange: 00/21:30:51 to 00/21:31:49

Plot file version 21 created 20-APR-2018 18:07:53

EM170817 RG009B.UVDATA.1

Freq = 4.7995 GHz, Bw = 32.000 MH No calibration applied and no bandpass applied

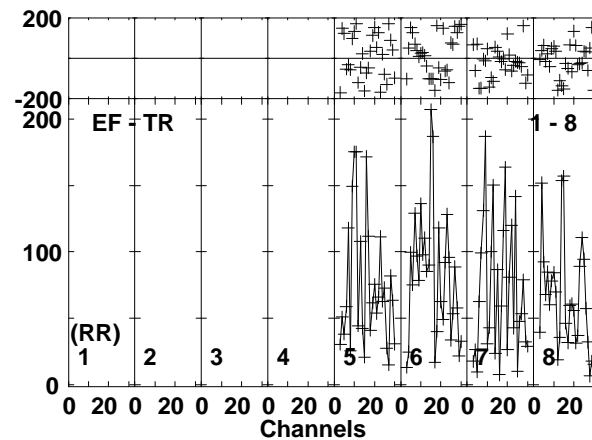
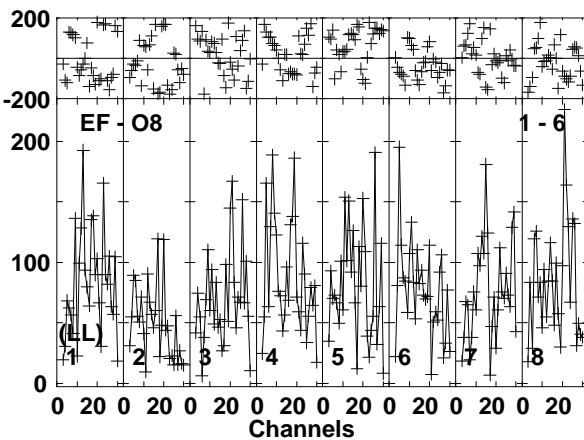
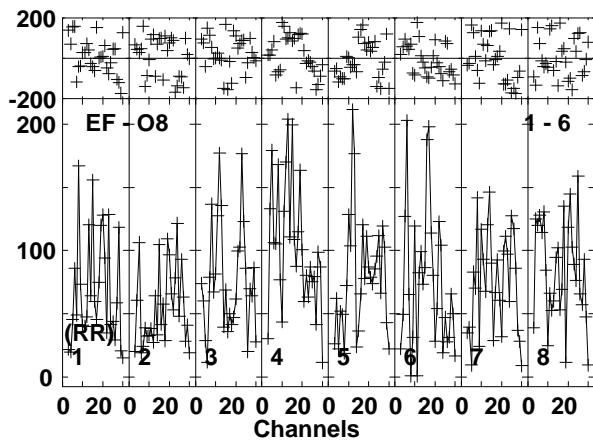
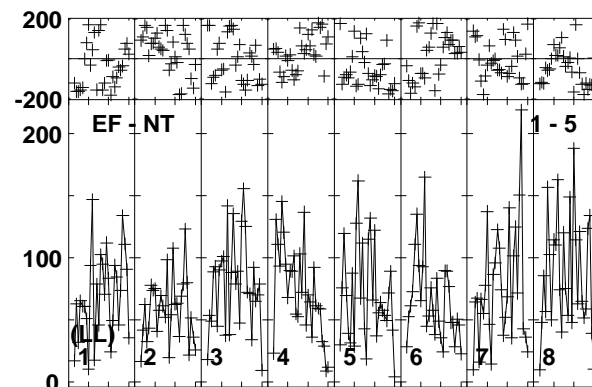
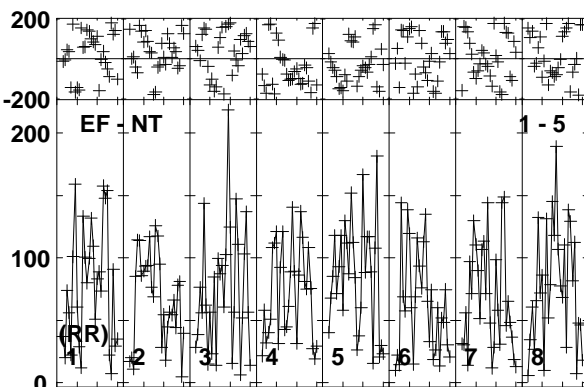
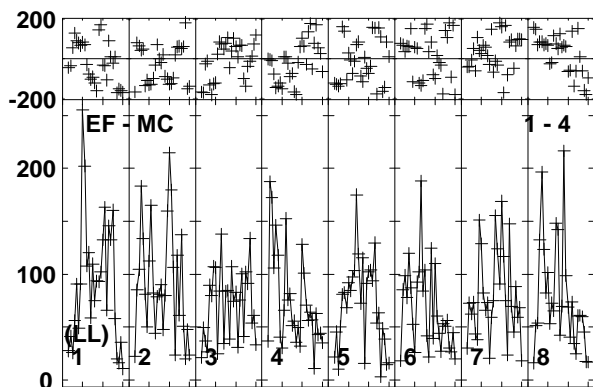
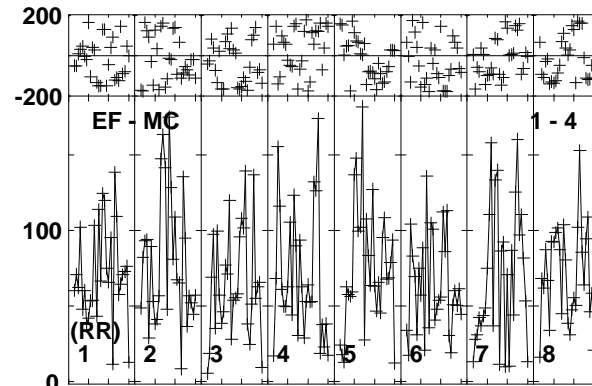
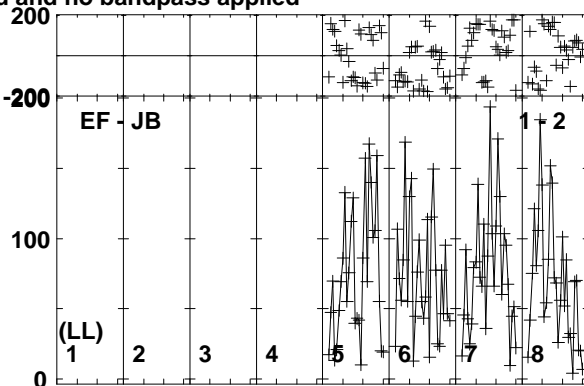
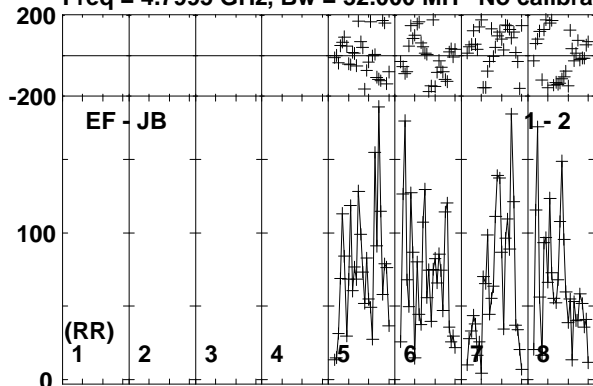

Lower frame: Micro Ampl Jy Top frame: Phas deg
Vector averaged cross-power spectrum Baseline: EF (01) - JB (02)
Timerange: 00/21:31:51 to 00/21:34:19

Plot file version 22 created 20-APR-2018 18:07:53

EM170817 RG009B.UVDATA.1

Freq = 4.7995 GHz, Bw = 32.000 MH No calibration applied and no bandpass applied

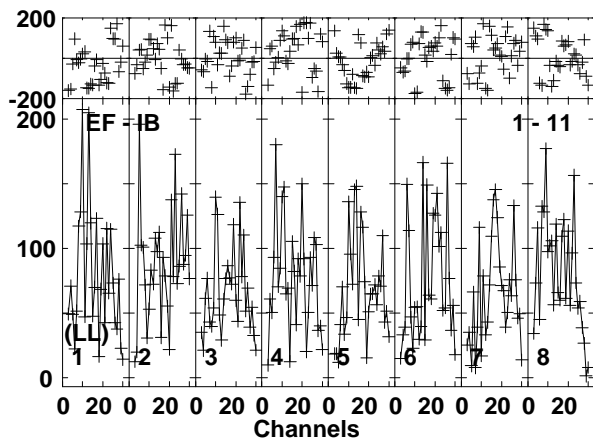
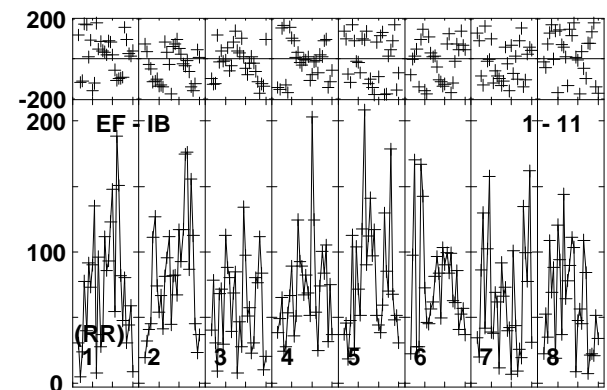
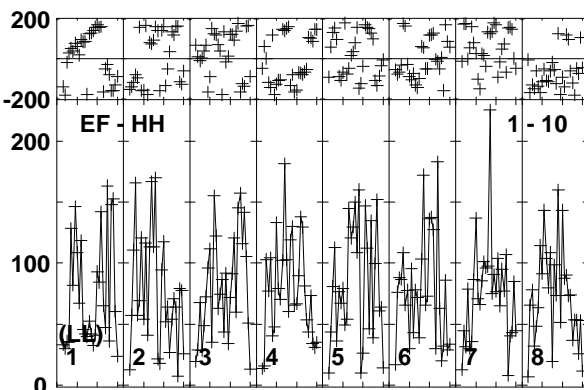
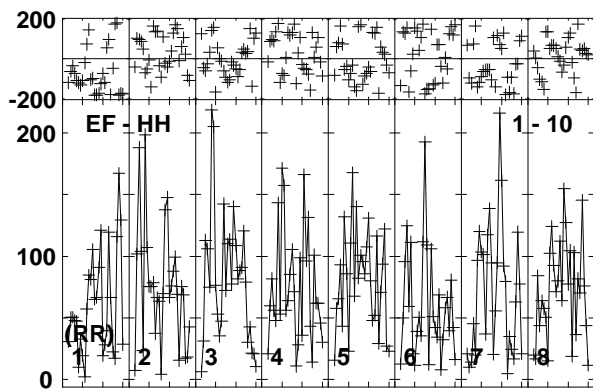
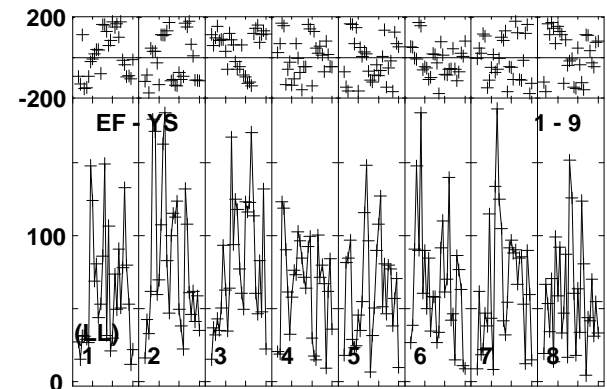
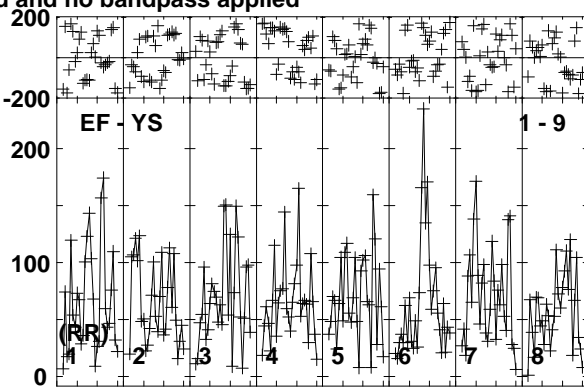
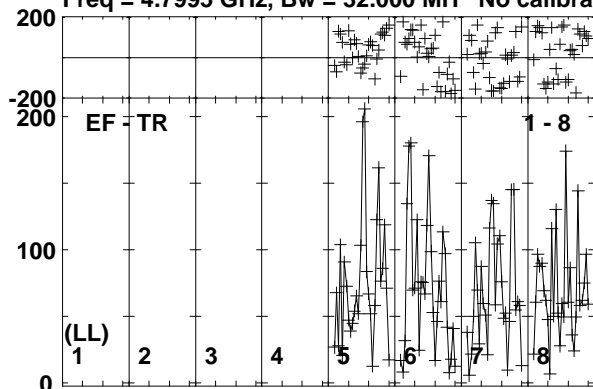

Lower frame: Micro Ampl Jy Top frame: Phas deg
Vector averaged cross-power spectrum Baseline: EF (01) - TR (08)
Timerange: 00/21:31:51 to 00/21:34:19

Plot file version 23 created 20-APR-2018 18:07:53

J1311-2329 RG009B.UVDATA.1

Freq = 4.7995 GHz, Bw = 32.000 MH No calibration applied and no bandpass applied

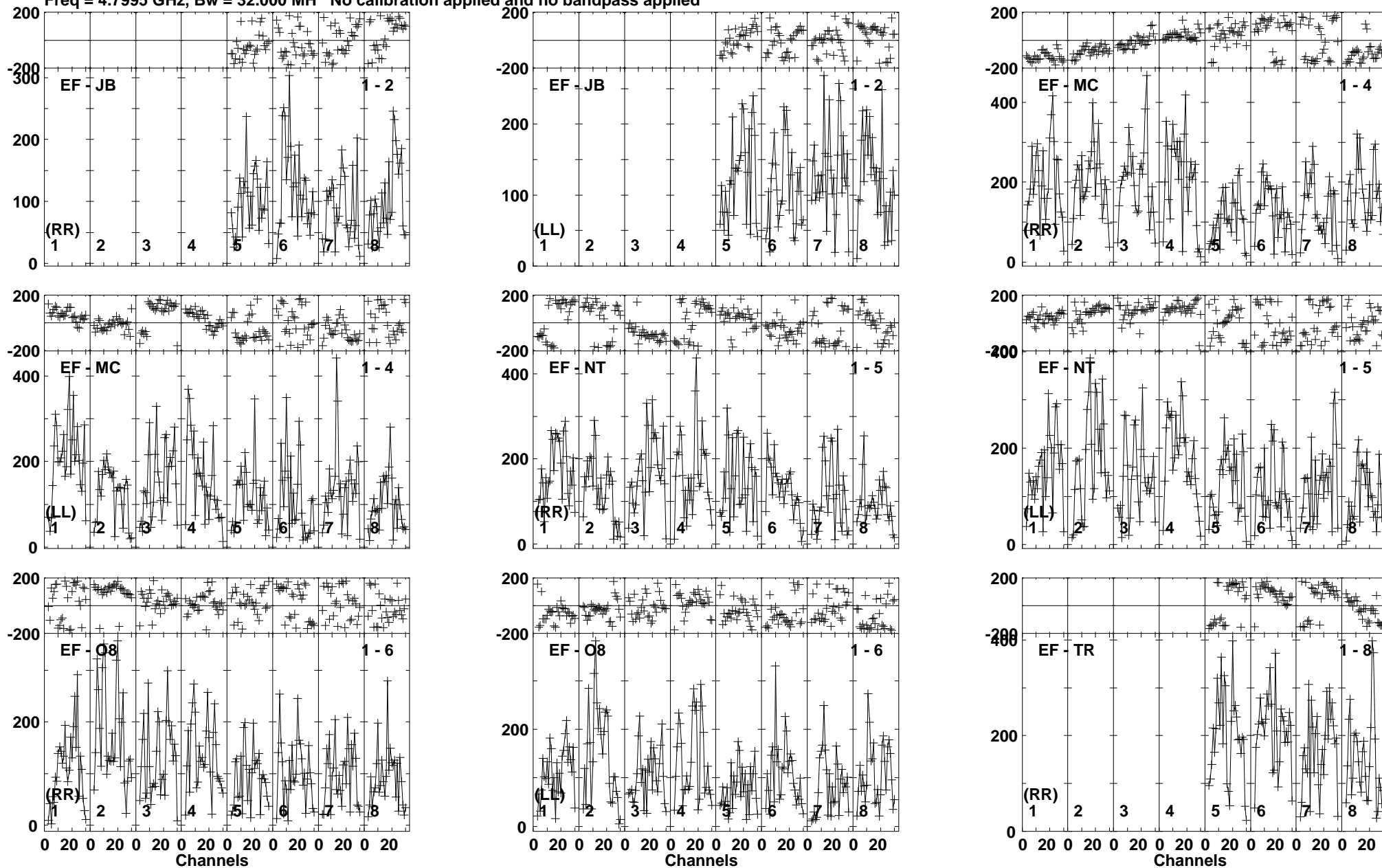

Lower frame: Micro Ampl Jy Top frame: Phas deg
Vector averaged cross-power spectrum Baseline: EF (01) - JB (02)
Timerange: 00/21:34:21 to 00/21:35:49

Plot file version 24 created 20-APR-2018 18:07:53

J1311-2329 RG009B.UVDATA.1

Freq = 4.7995 GHz, Bw = 32.000 MH No calibration applied and no bandpass applied

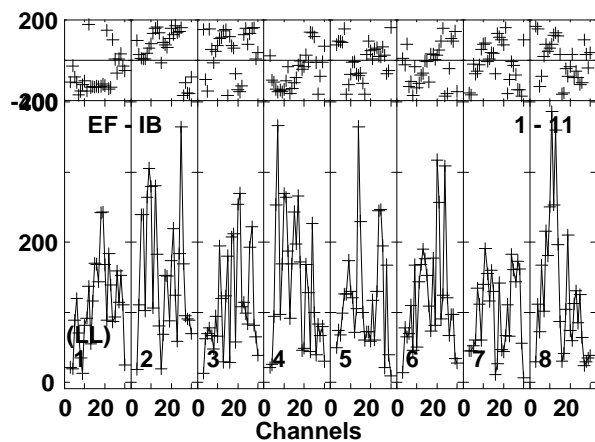
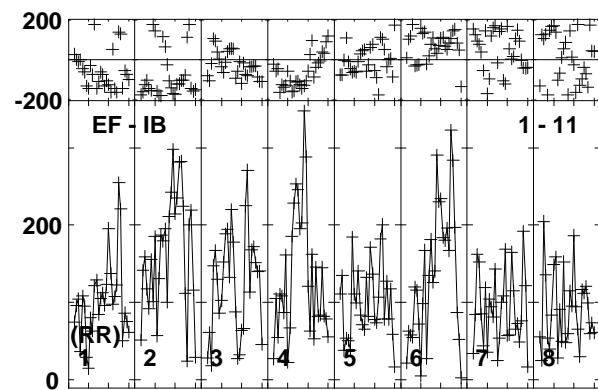
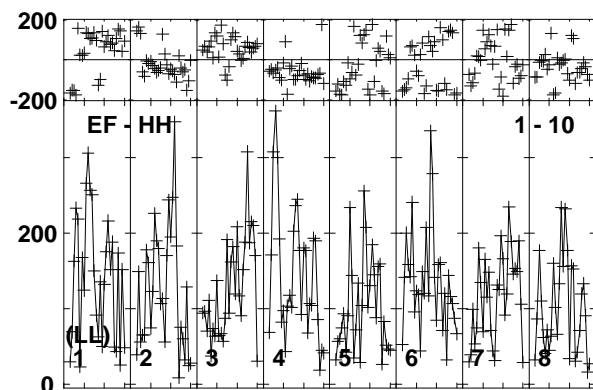
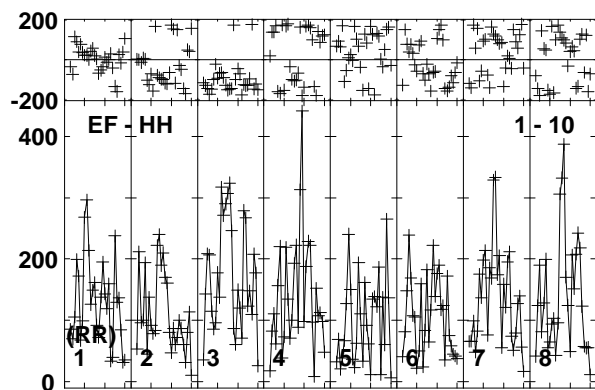
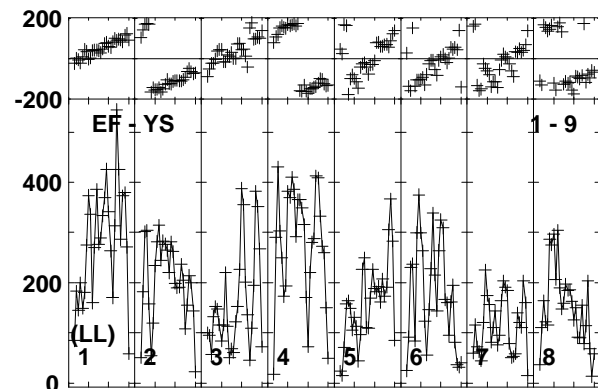
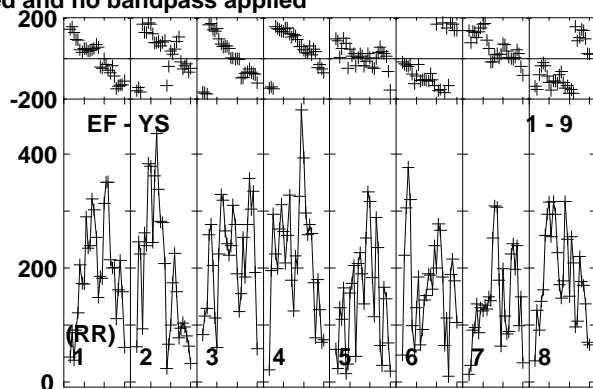
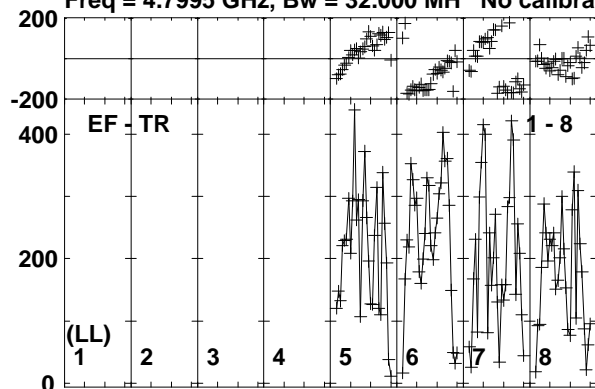

Lower frame: Micro Ampl Jy Top frame: Phas deg
Vector averaged cross-power spectrum Baseline: EF (01) - TR (08)
Timerange: 00/21:34:21 to 00/21:35:49

Plot file version 25 created 20-APR-2018 18:07:53

EM170817 RG009B.UVDATA.1

Freq = 4.7995 GHz, Bw = 32.000 MH No calibration applied and no bandpass applied

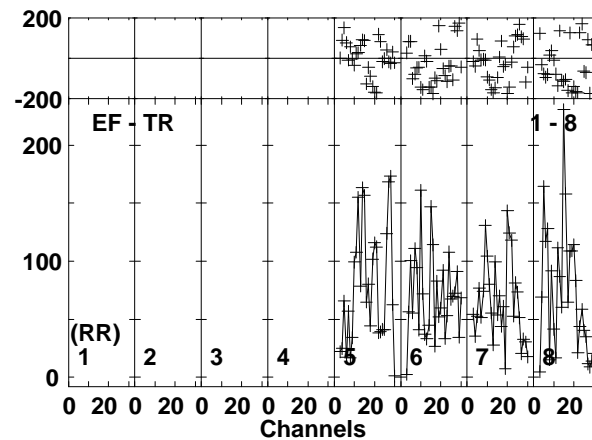
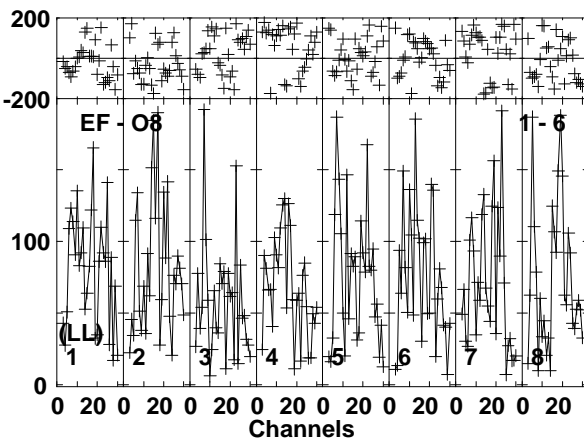
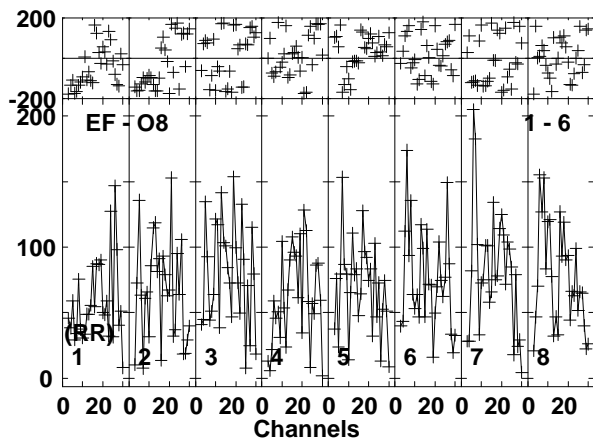
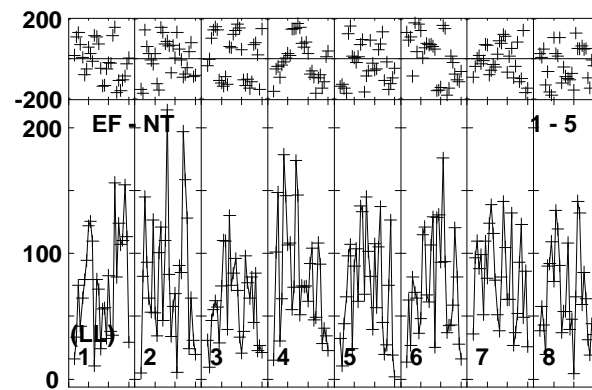
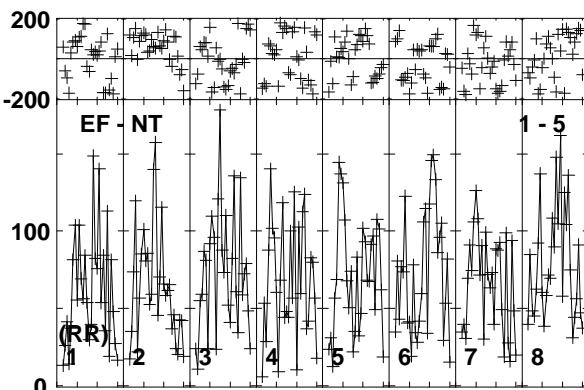
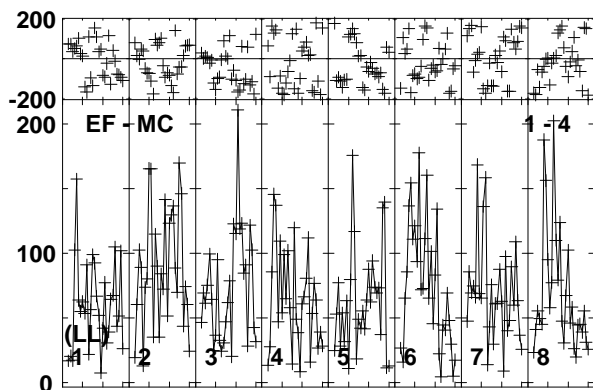
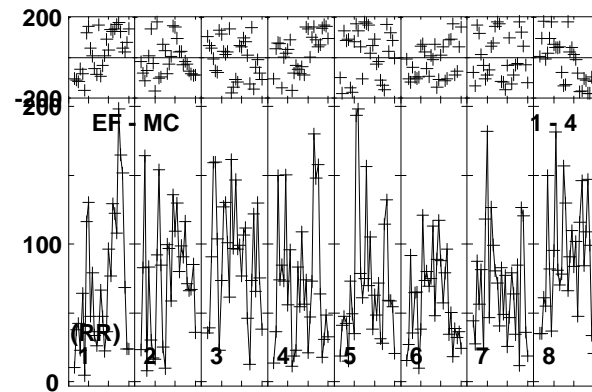
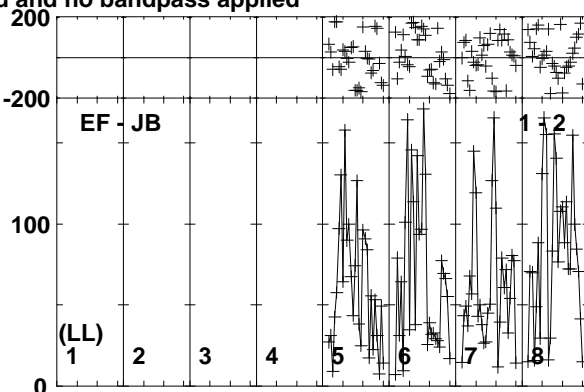
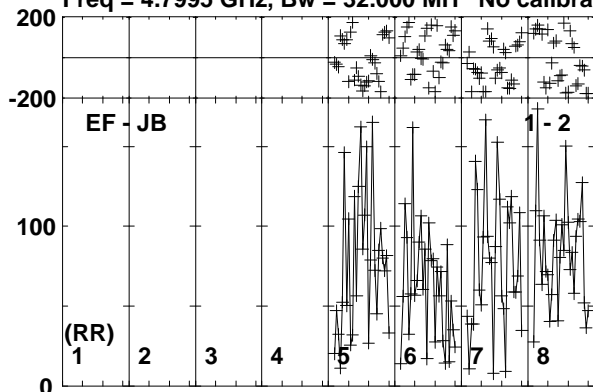

Lower frame: Micro Ampl Jy Top frame: Phas deg
Vector averaged cross-power spectrum Baseline: EF (01) - JB (02)
Timerange: 00/21:35:51 to 00/21:38:19

Plot file version 26 created 20-APR-2018 18:07:53

EM170817 RG009B.UVDATA.1

Freq = 4.7995 GHz, Bw = 32.000 MH No calibration applied and no bandpass applied

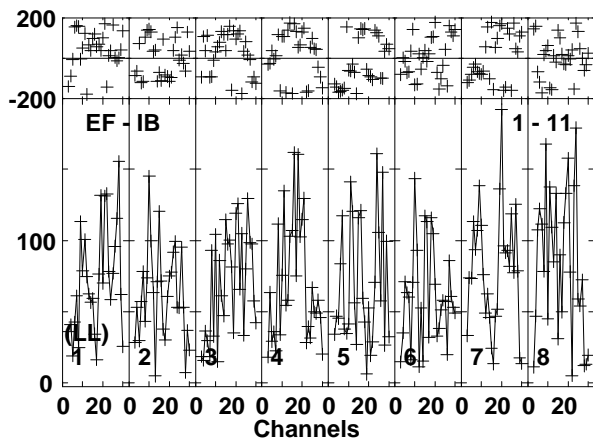
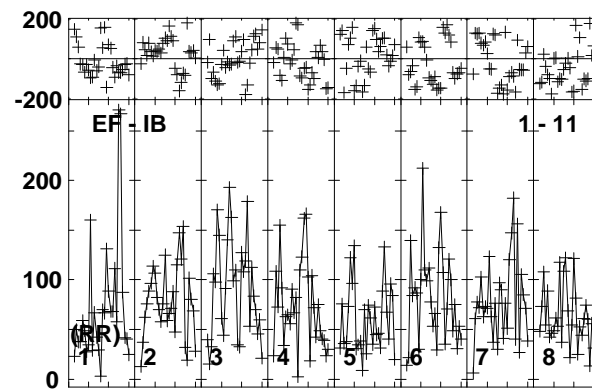
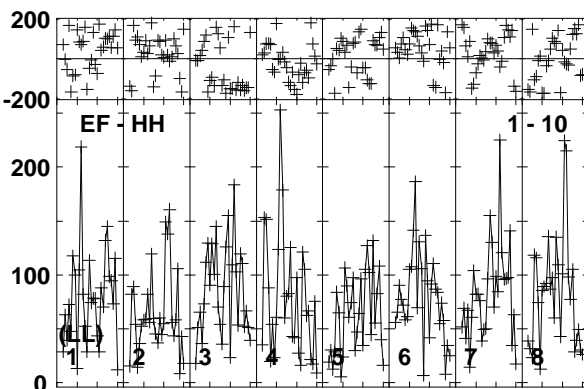
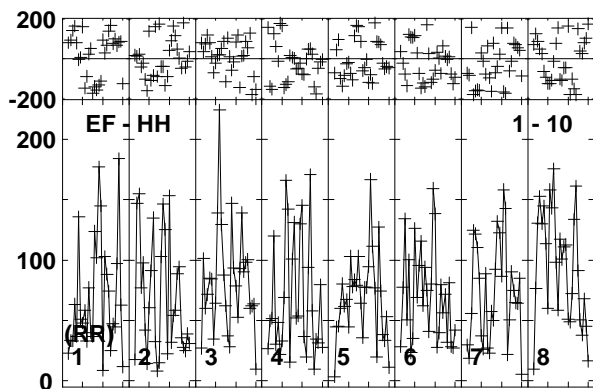
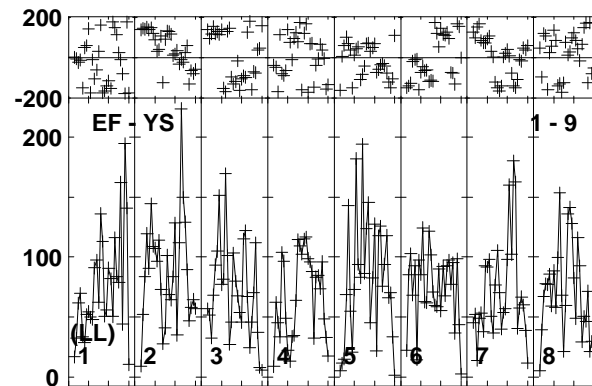
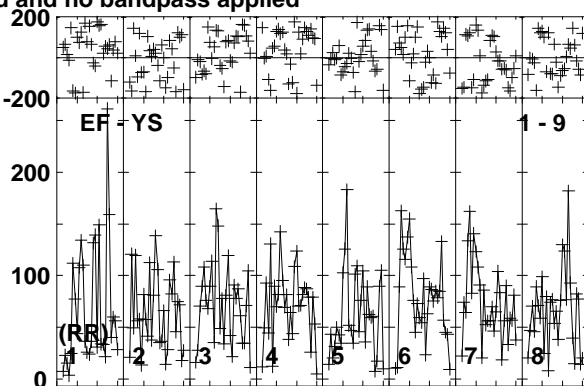
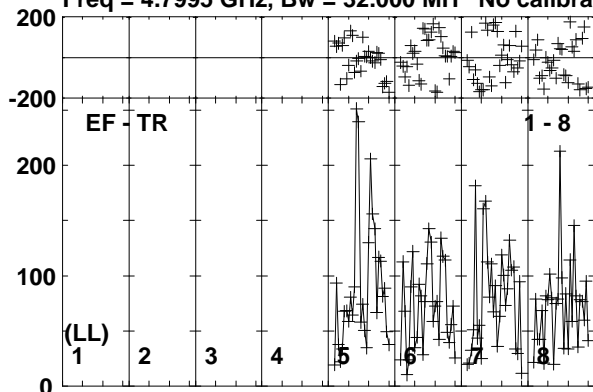

Lower frame: Micro Ampl Jy Top frame: Phas deg
Vector averaged cross-power spectrum Baseline: EF (01) - TR (08)
Timerange: 00/21:35:51 to 00/21:38:19

Plot file version 27 created 20-APR-2018 18:07:53

J1311-2329 RG009B.UVDATA.1

Freq = 4.7995 GHz, Bw = 32.000 MH No calibration applied and no bandpass applied

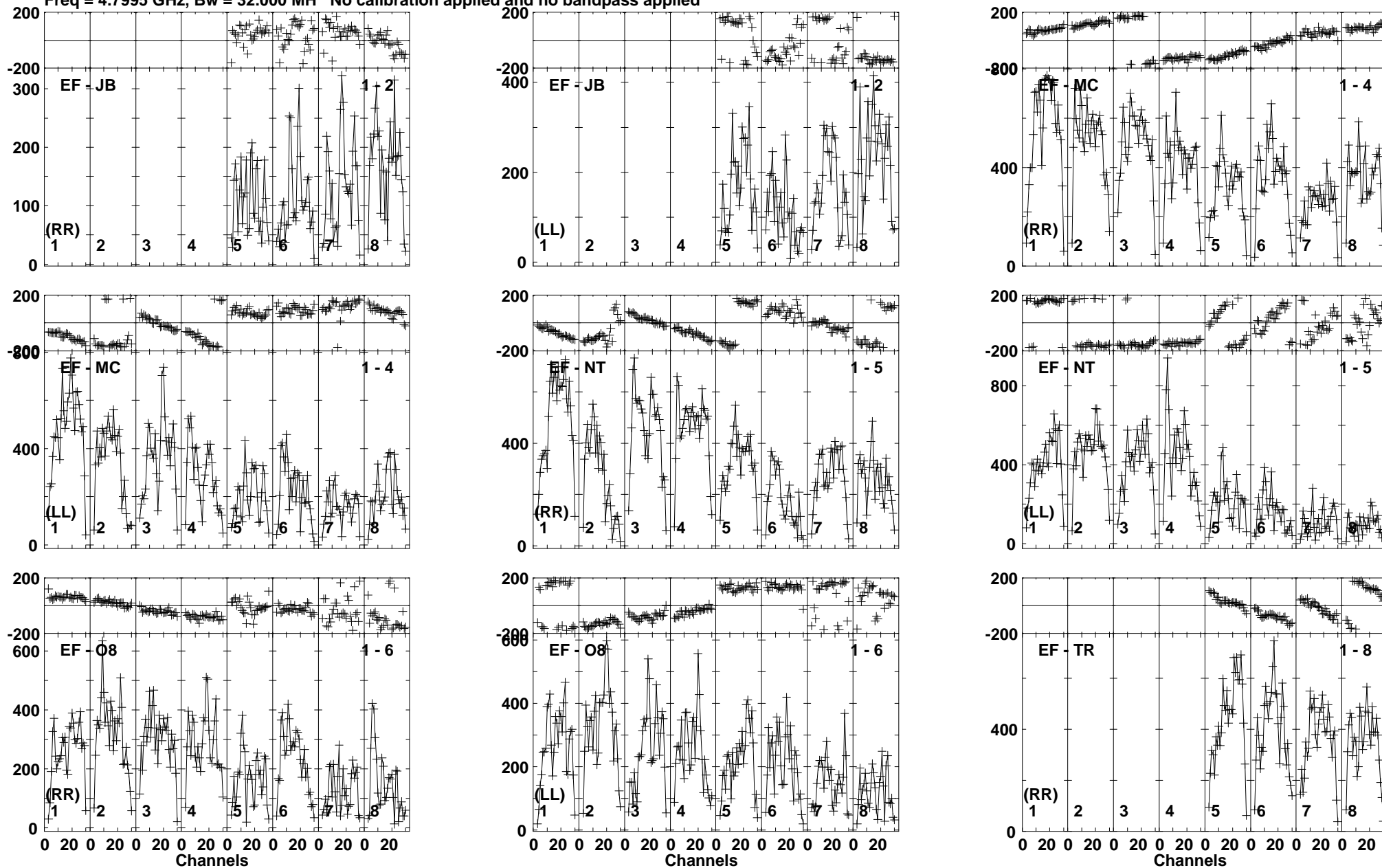

Lower frame: Micro Ampl Jy Top frame: Phas deg
Vector averaged cross-power spectrum Baseline: EF (01) - JB (02)
Timerange: 00/21:38:51 to 00/21:39:49

Plot file version 28 created 20-APR-2018 18:07:54

J1311-2329 RG009B.UVDATA.1

Freq = 4.7995 GHz, Bw = 32.000 MH No calibration applied and no bandpass applied

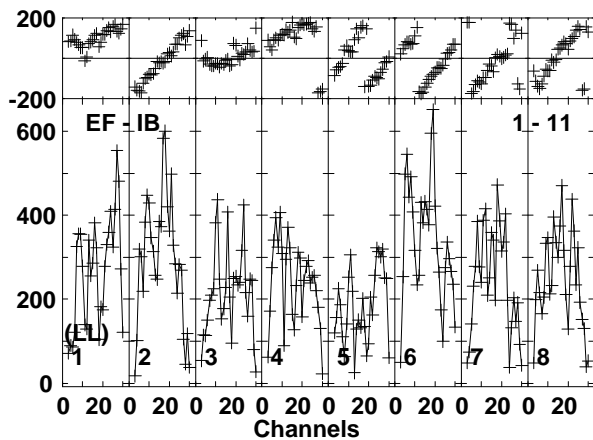
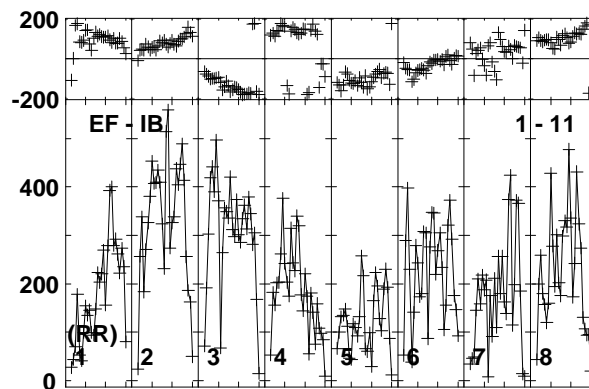
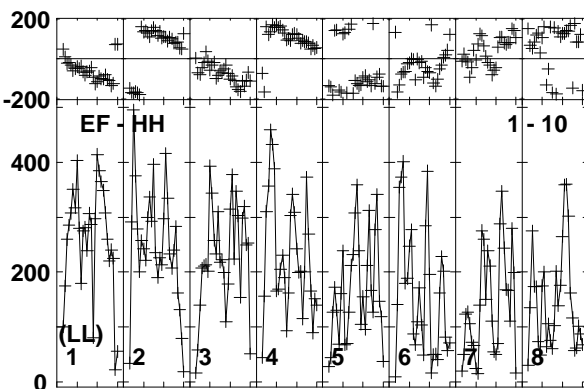
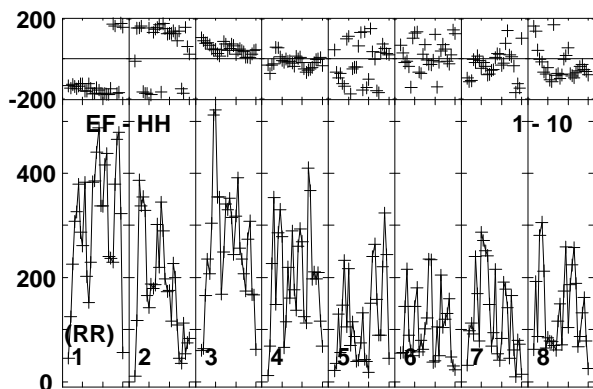
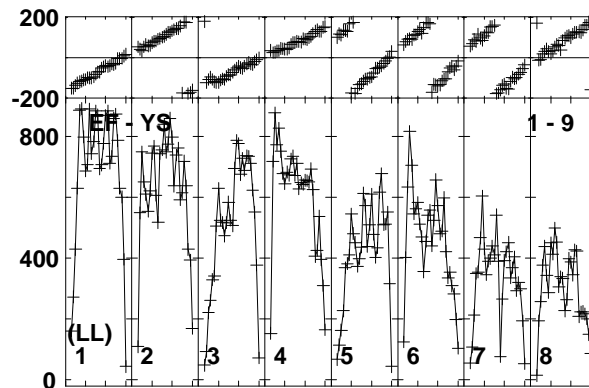
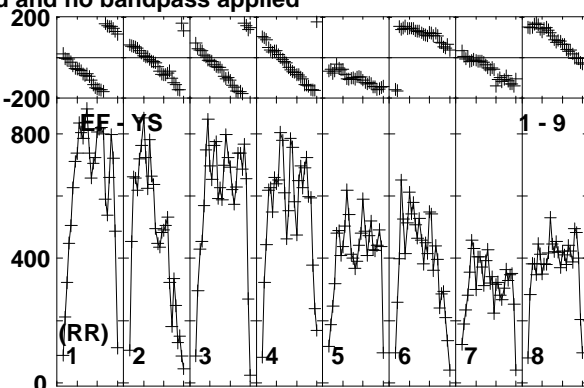
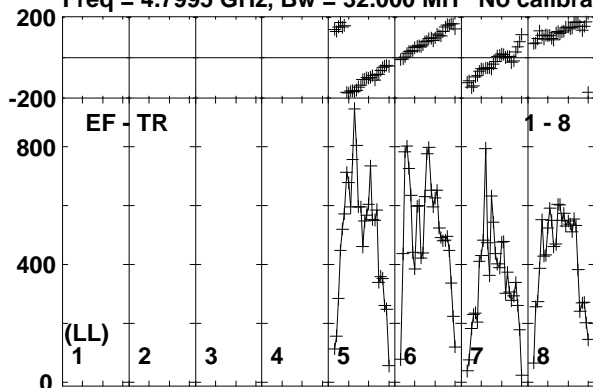

Lower frame: Micro Ampl Jy Top frame: Phas deg
Vector averaged cross-power spectrum Baseline: EF (01) - TR (08)
Timerange: 00/21:38:51 to 00/21:39:49

Plot file version 29 created 20-APR-2018 18:07:54

EM170817 RG009B.UVDATA.1

Freq = 4.7995 GHz, Bw = 32.000 MH No calibration applied and no bandpass applied

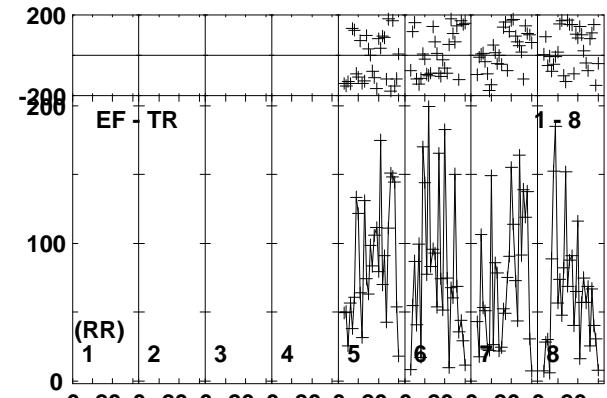
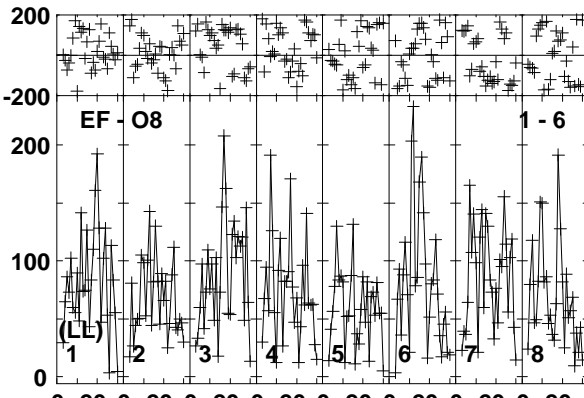
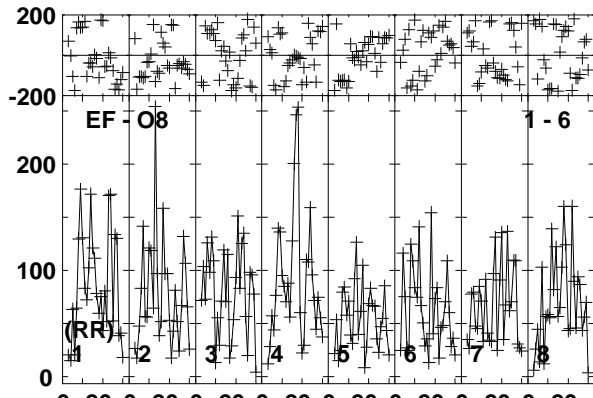
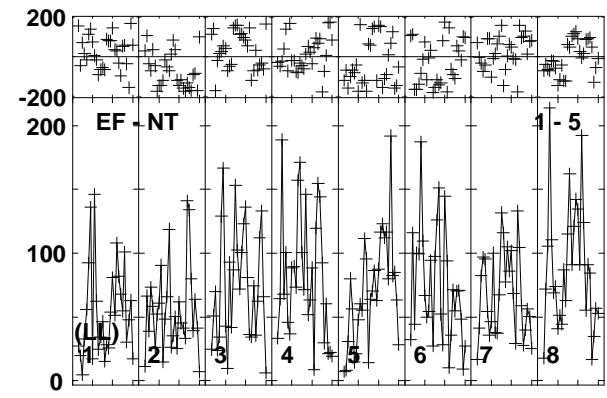
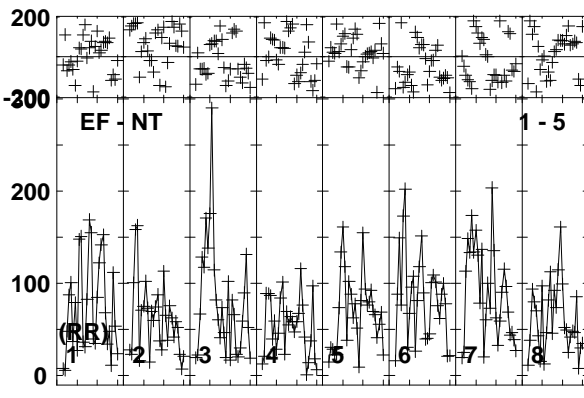
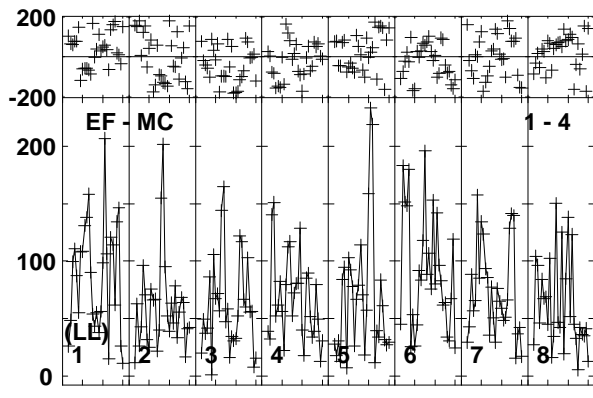
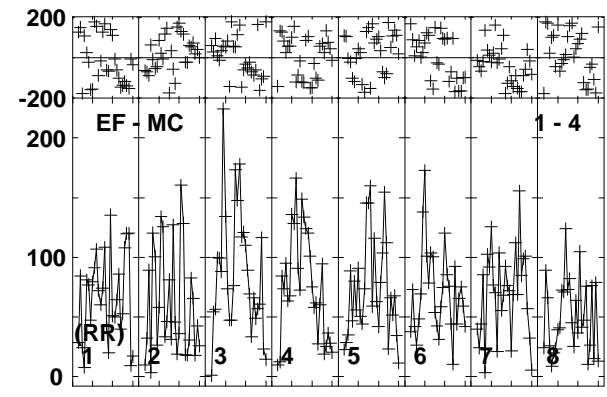
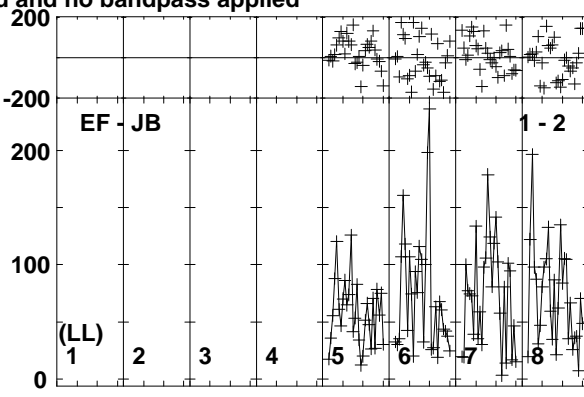
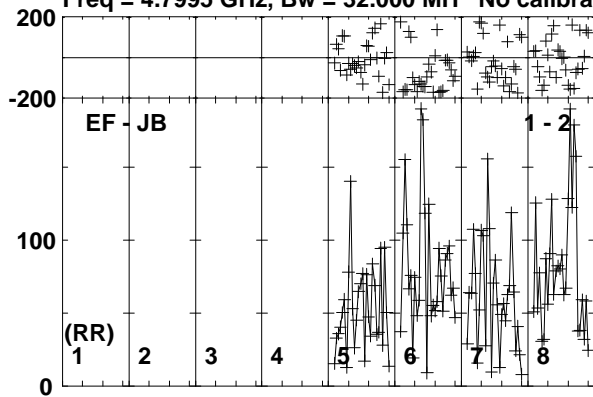

Lower frame: Micro Ampl Jy Top frame: Phas deg
Vector averaged cross-power spectrum Baseline: EF (01) - JB (02)
Timerange: 00/21:39:51 to 00/21:42:19

Plot file version 30 created 20-APR-2018 18:07:54

EM170817 RG009B.UVDATA.1

Freq = 4.7995 GHz, Bw = 32.000 MH No calibration applied and no bandpass applied

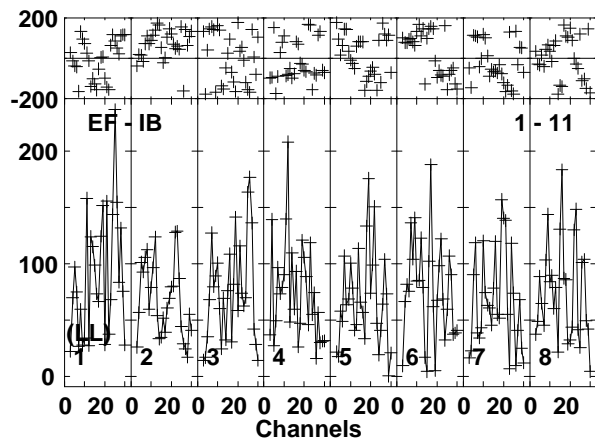
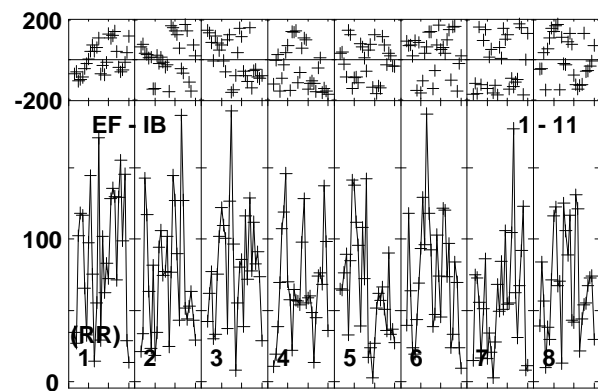
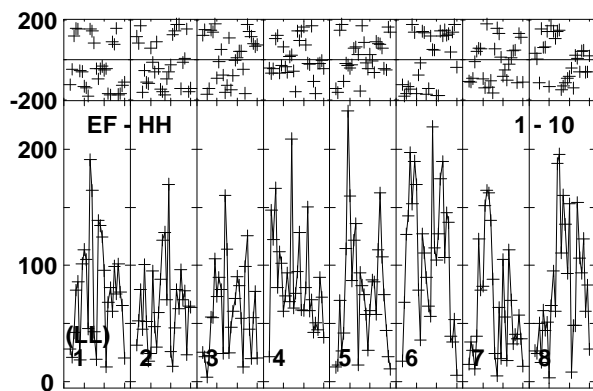
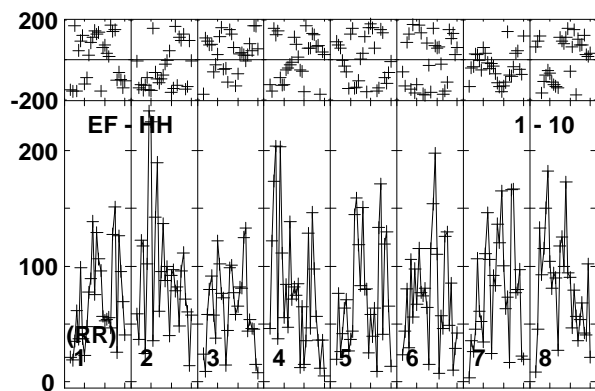
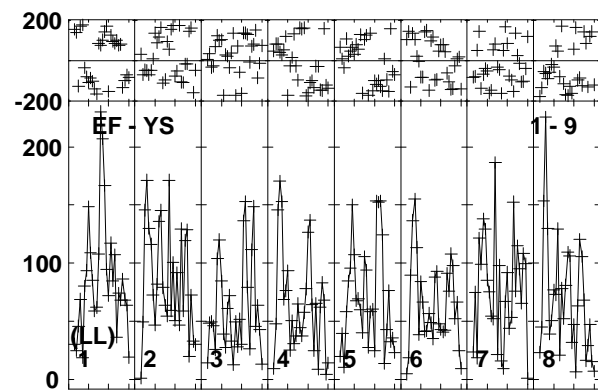
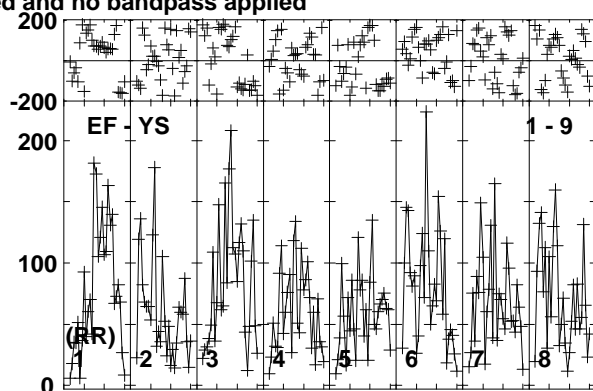
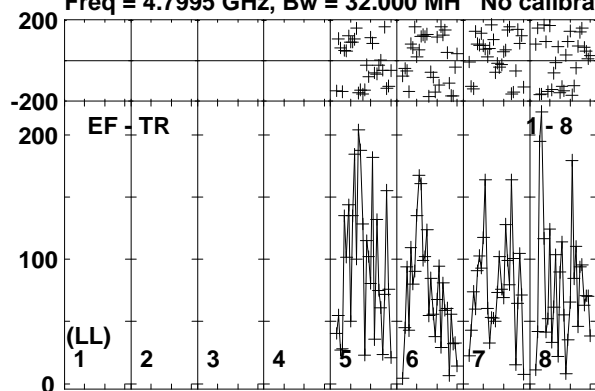

Lower frame: Micro Ampl Jy Top frame: Phas deg
Vector averaged cross-power spectrum Baseline: EF (01) - TR (08)
Timerange: 00/21:39:51 to 00/21:42:19

Plot file version 31 created 20-APR-2018 18:07:54

J1311-2329 RG009B.UVDATA.1

Freq = 4.7995 GHz, Bw = 32.000 MH No calibration applied and no bandpass applied

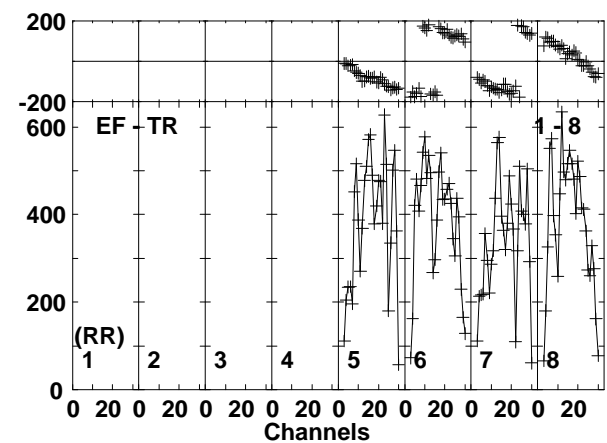
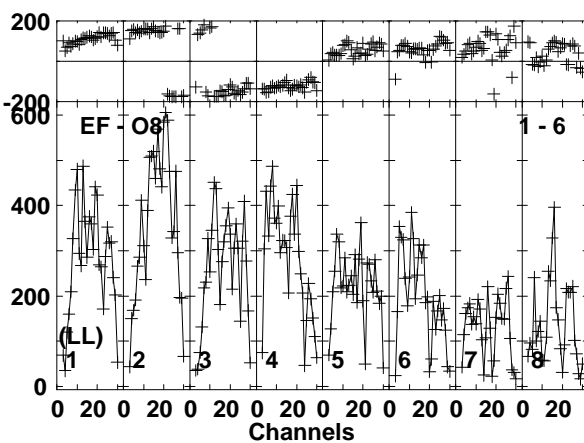
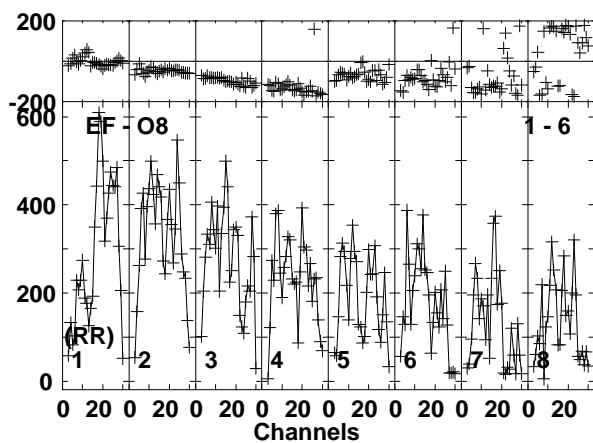
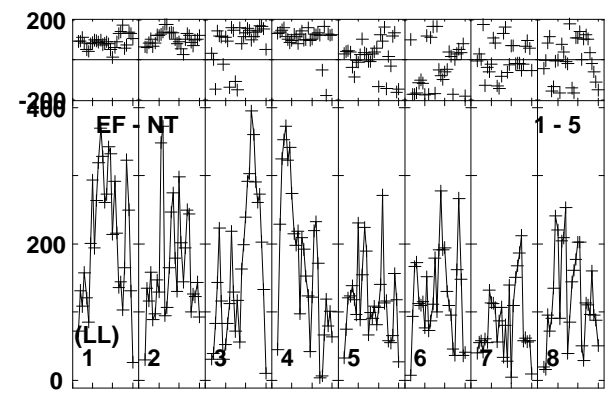
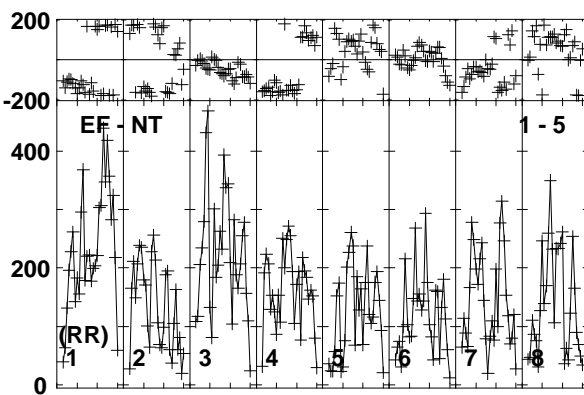
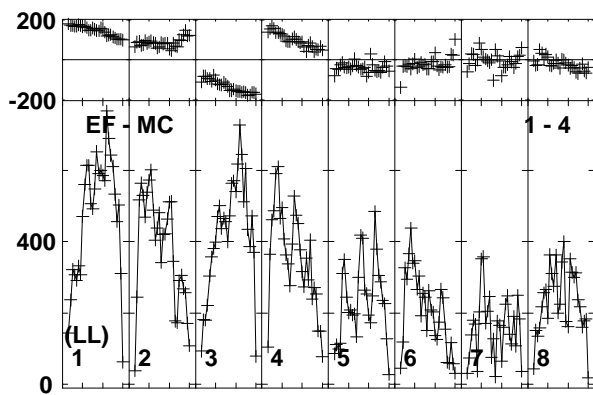
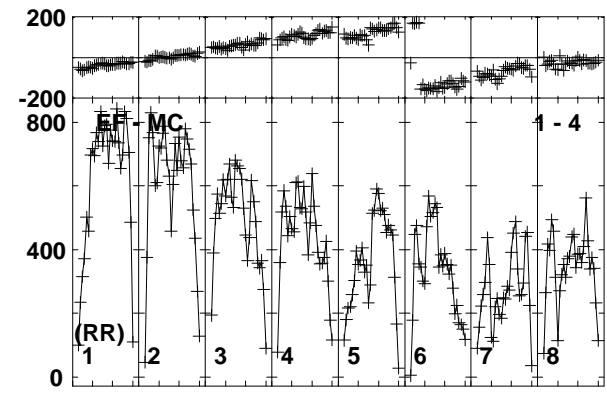
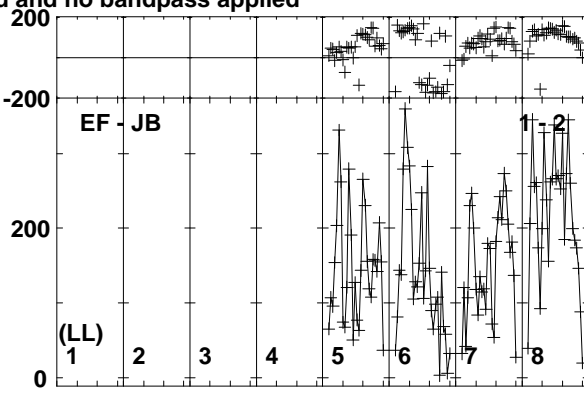
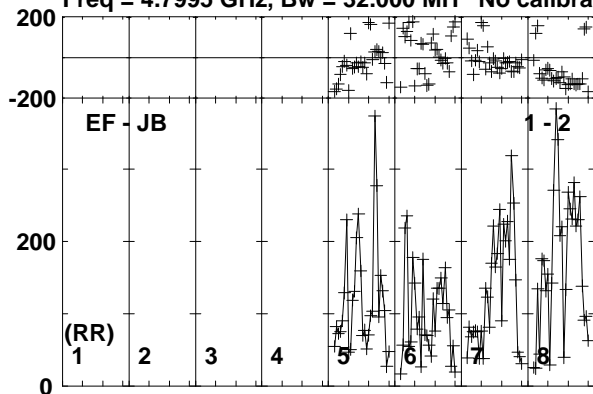

Lower frame: Micro Ampl Jy Top frame: Phas deg
Vector averaged cross-power spectrum Baseline: EF (01) - JB (02)
Timerange: 00/21:42:21 to 00/21:43:49

Plot file version 32 created 20-APR-2018 18:07:54

J1311-2329 RG009B.UVDATA.1

Freq = 4.7995 GHz, Bw = 32.000 MH No calibration applied and no bandpass applied

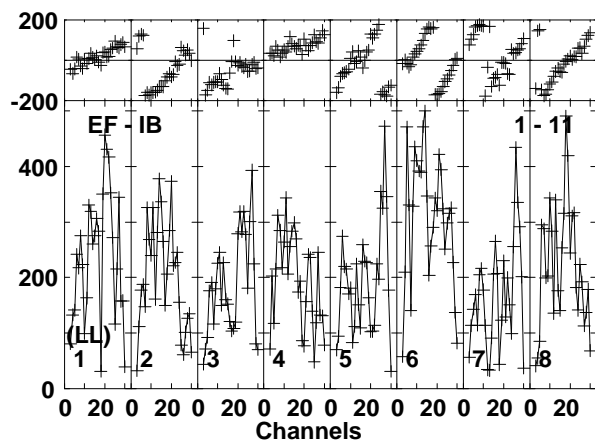
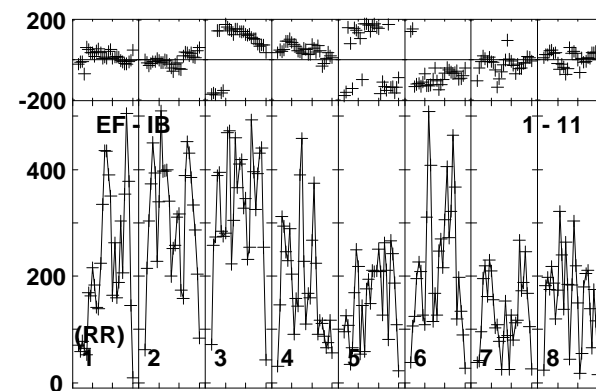
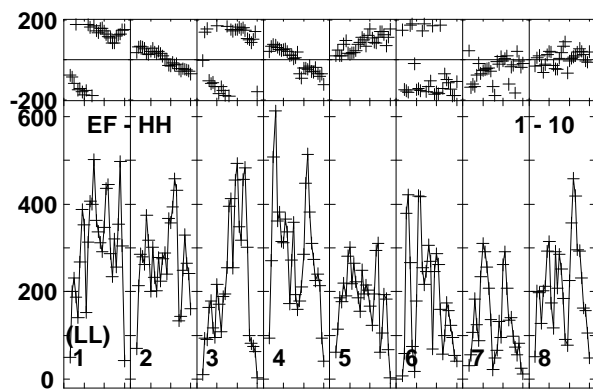
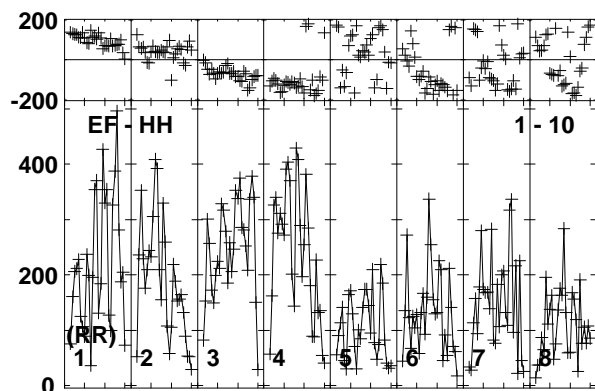
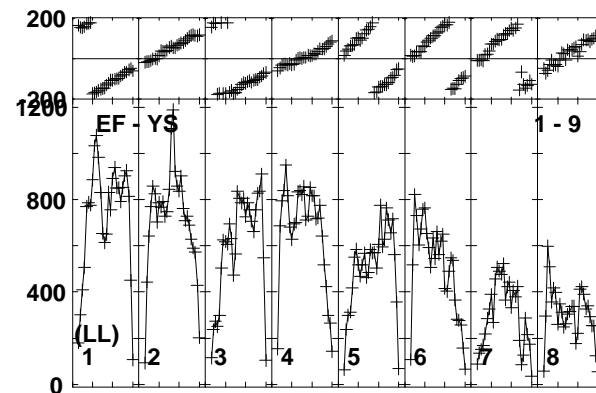
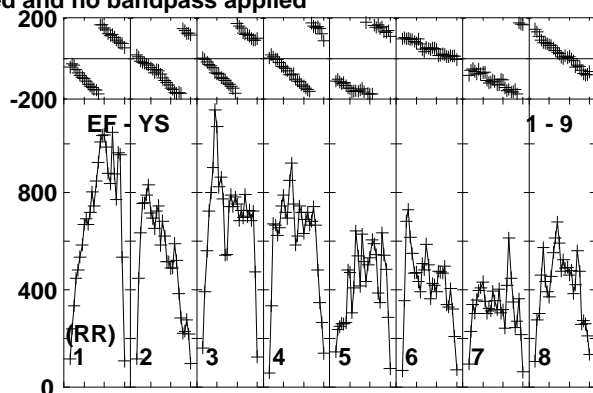
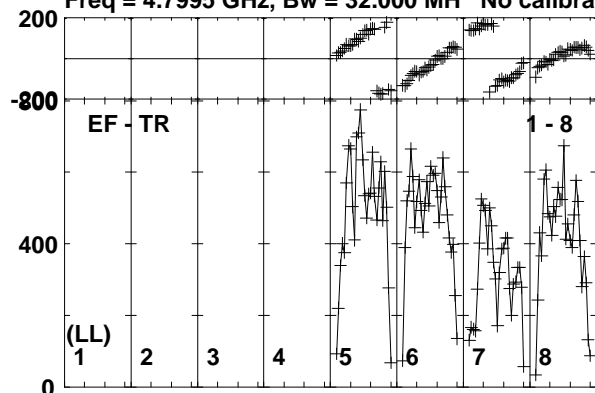

Lower frame: Micro Ampl Jy Top frame: Phas deg
Vector averaged cross-power spectrum Baseline: EF (01) - TR (08)
Timerange: 00/21:42:21 to 00/21:43:49

Plot file version 33 created 20-APR-2018 18:07:54

J1312-2350 RG009B.UVDATA.1

Freq = 4.7995 GHz, Bw = 32.000 MH No calibration applied and no bandpass applied

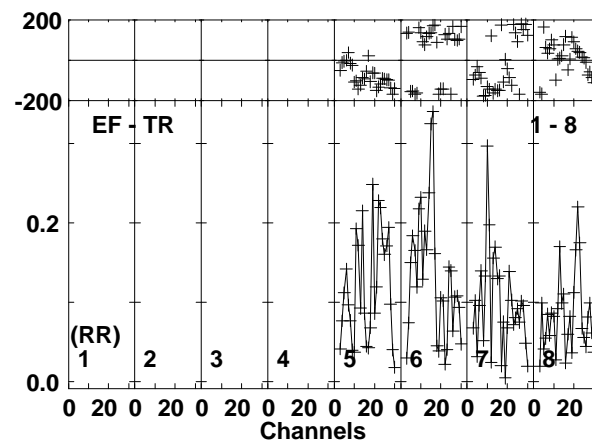
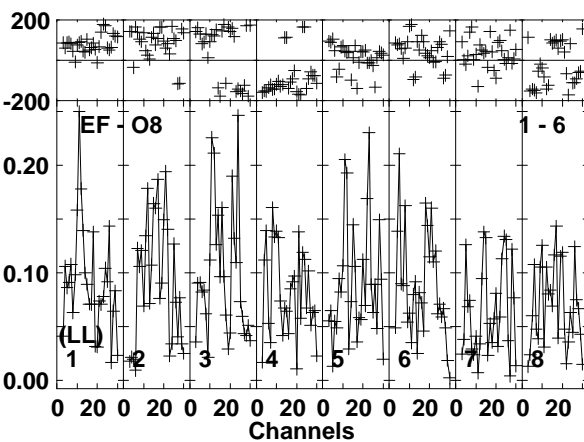
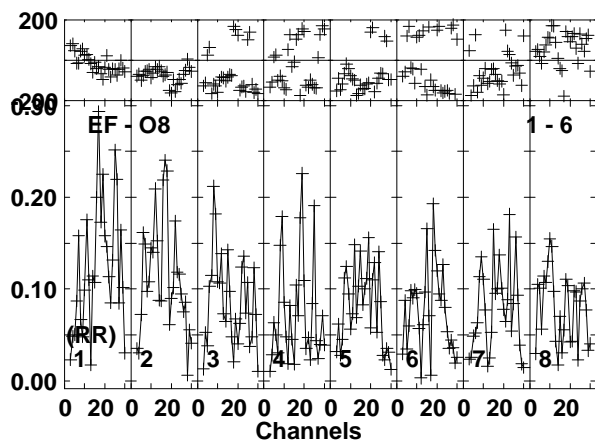
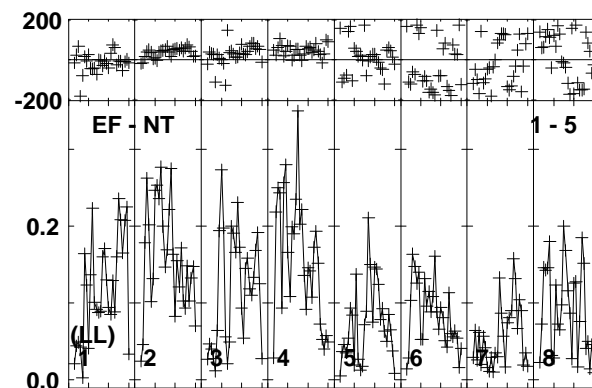
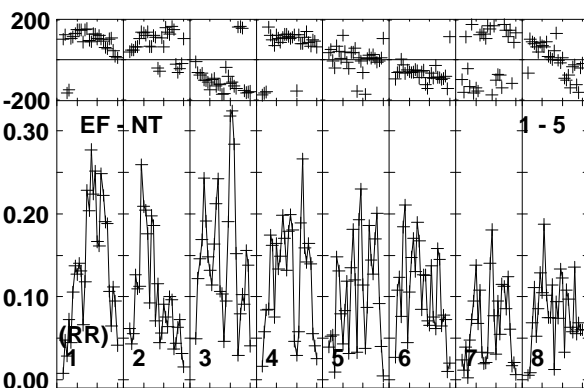
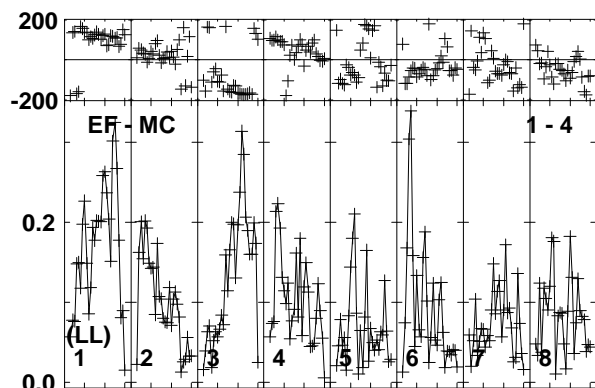
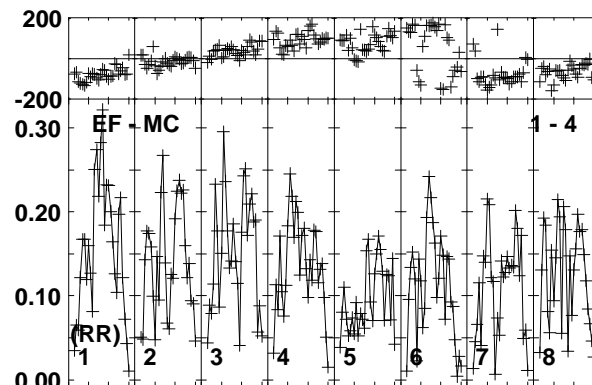
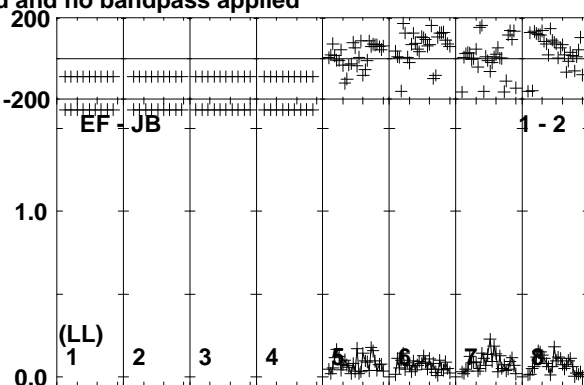
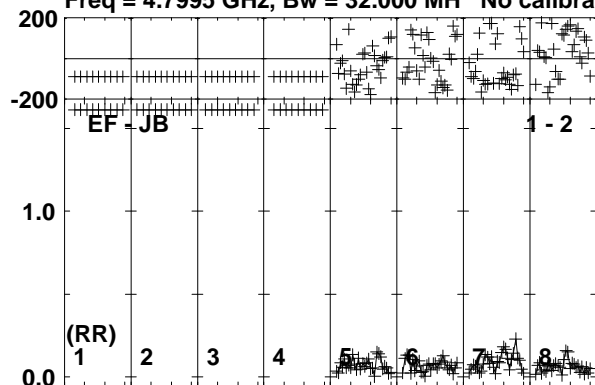

Lower frame: Milli Ampl Jy Top frame: Phas deg
Vector averaged cross-power spectrum Baseline: EF (01) - JB (02)
Timerange: 00/21:43:51 to 00/21:46:19

Plot file version 34 created 20-APR-2018 18:07:54

J1312-2350 RG009B.UVDATA.1

Freq = 4.7995 GHz, Bw = 32.000 MH No calibration applied and no bandpass applied

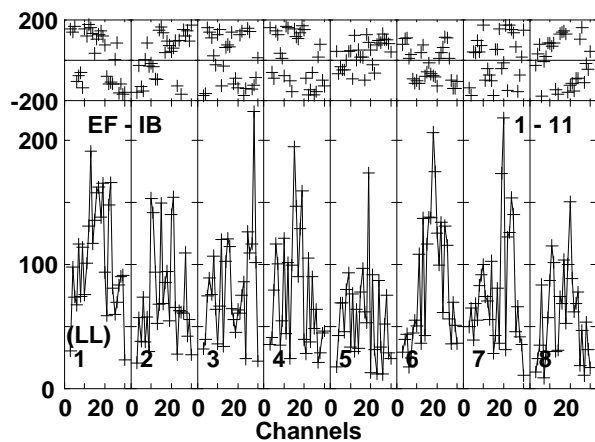
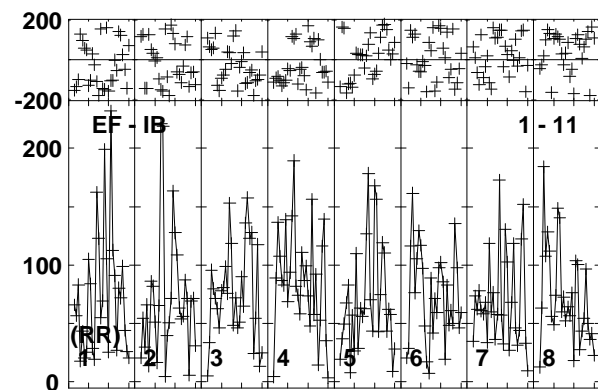
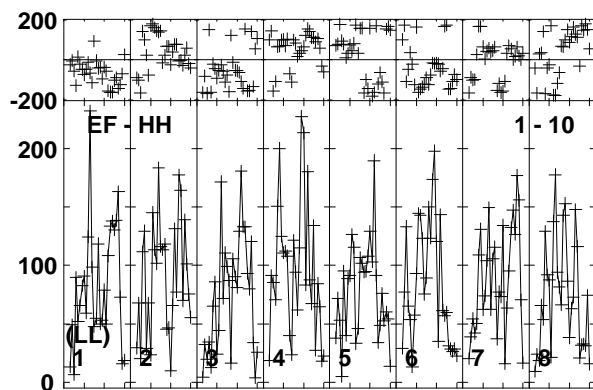
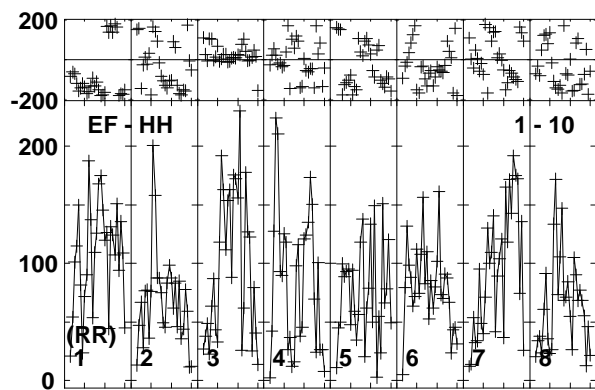
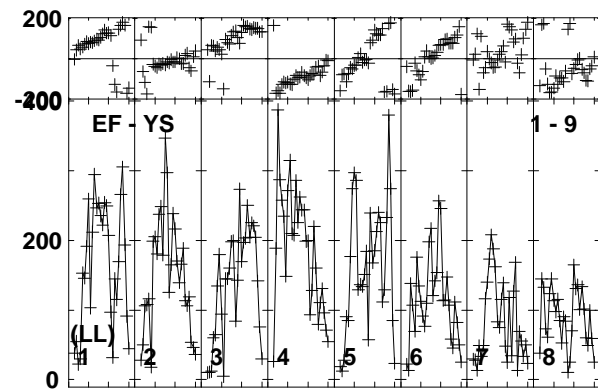
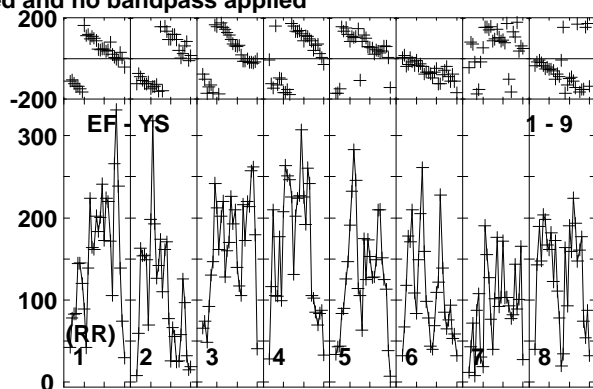
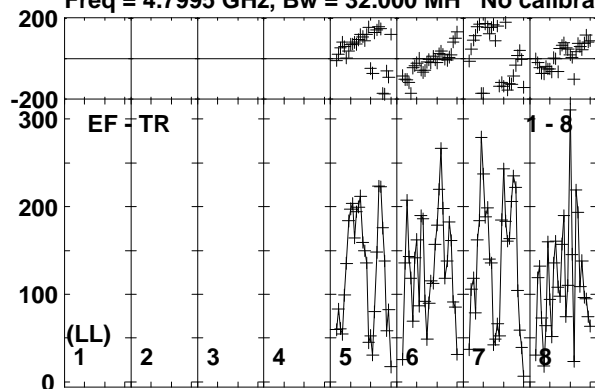

Lower frame: Micro Ampl Jy Top frame: Phas deg
Vector averaged cross-power spectrum Baseline: EF (01) - TR (08)
Timerange: 00/21:43:51 to 00/21:46:19

Plot file version 35 created 20-APR-2018 18:07:54

J1311-2329 RG009B.UVDATA.1

Freq = 4.7995 GHz, Bw = 32.000 MH No calibration applied and no bandpass applied

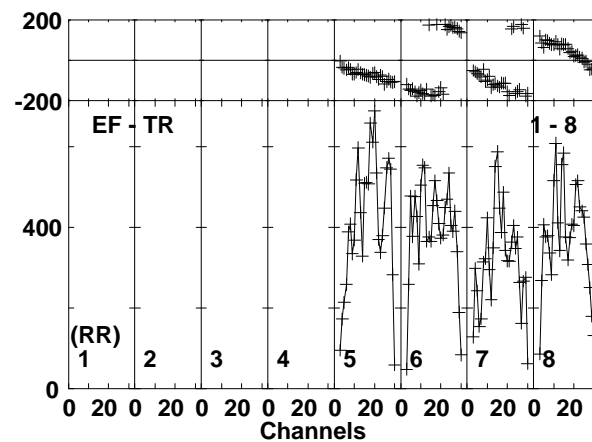
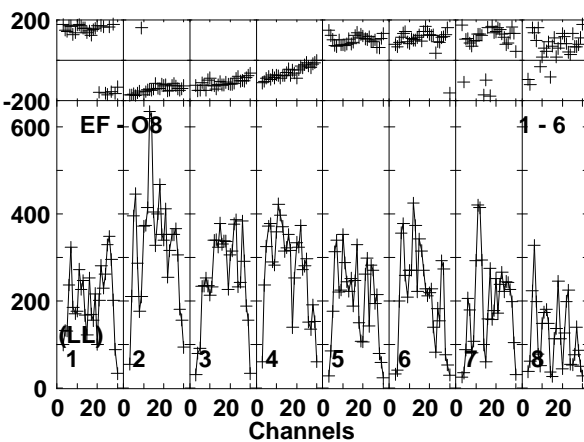
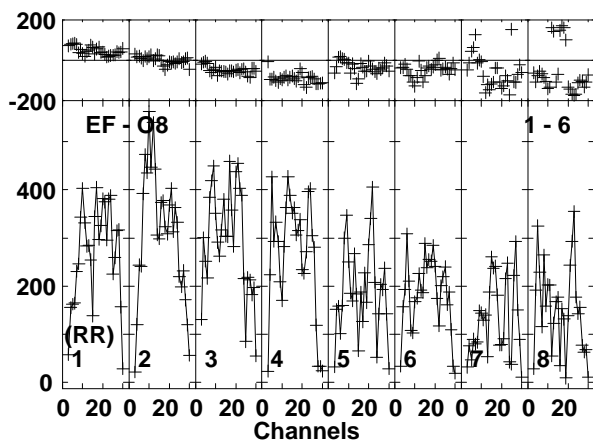
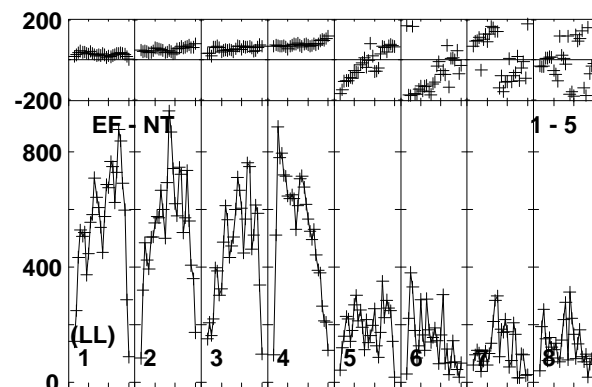
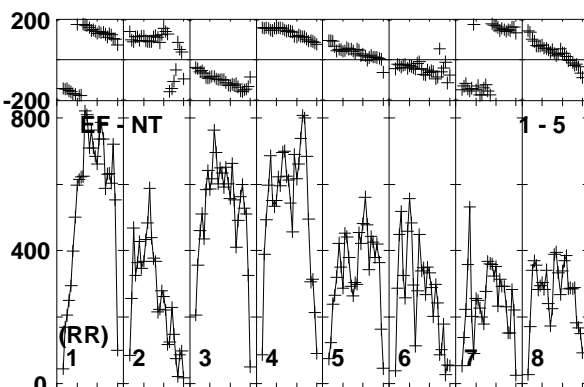
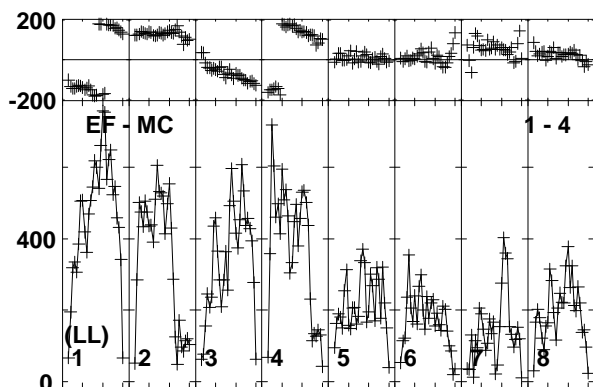
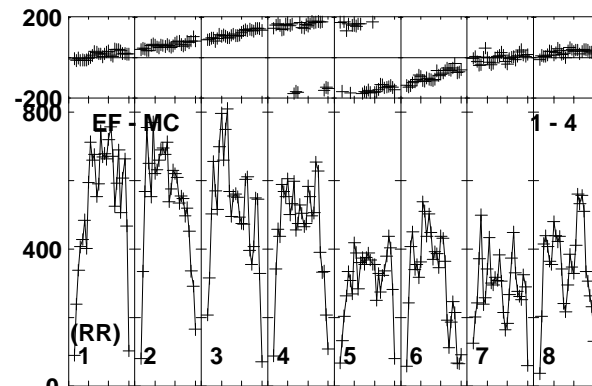
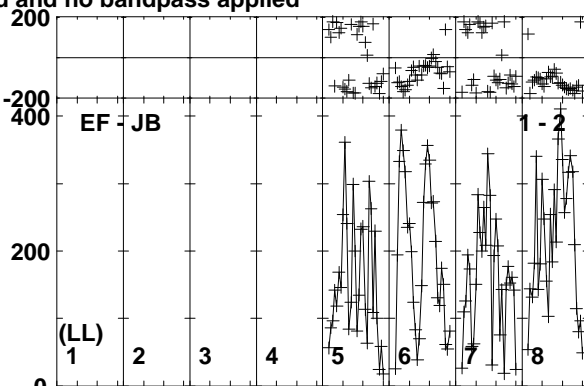
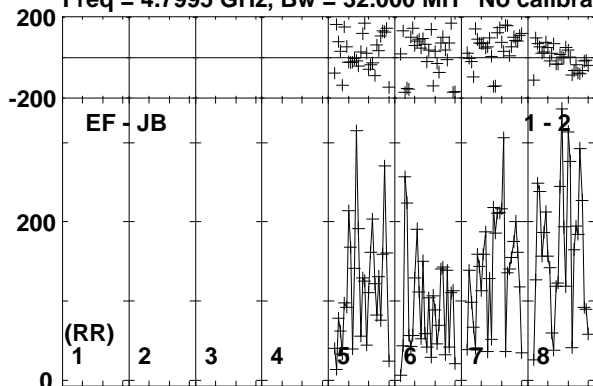

Lower frame: Micro Ampl Jy Top frame: Phas deg
Vector averaged cross-power spectrum Baseline: EF (01) - JB (02)
Timerange: 00/21:46:21 to 00/21:47:49

Plot file version 36 created 20-APR-2018 18:07:54

J1311-2329 RG009B.UVDATA.1

Freq = 4.7995 GHz, Bw = 32.000 MH No calibration applied and no bandpass applied

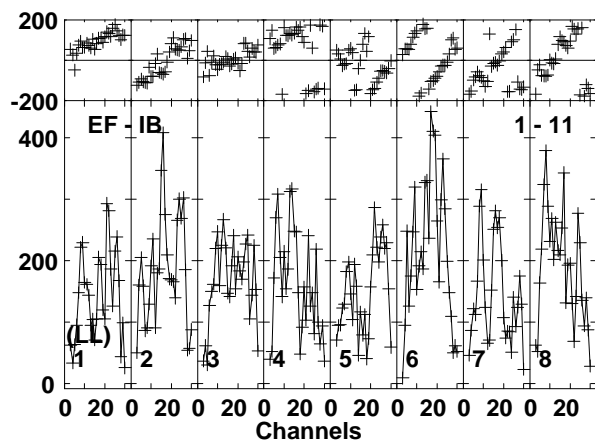
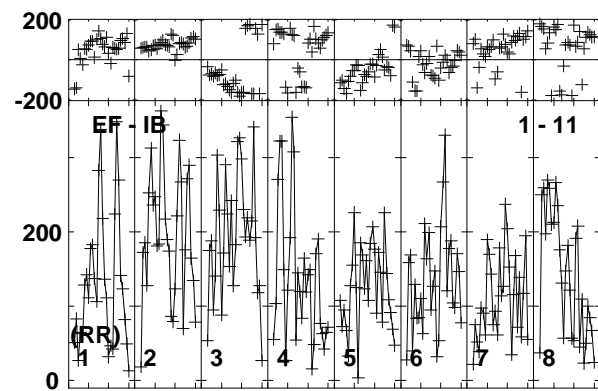
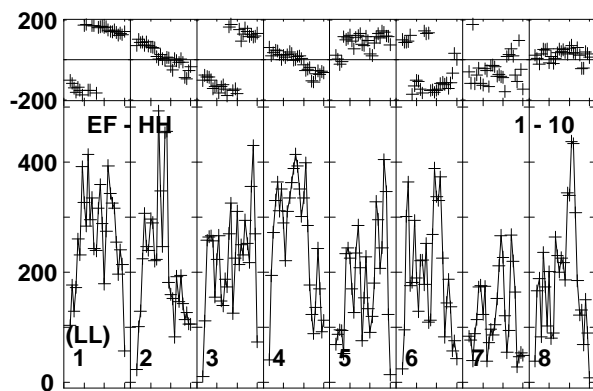
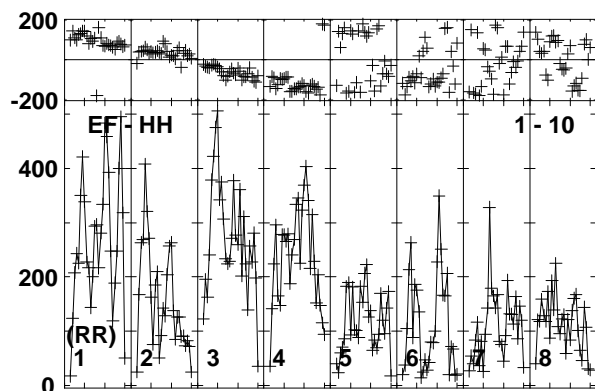
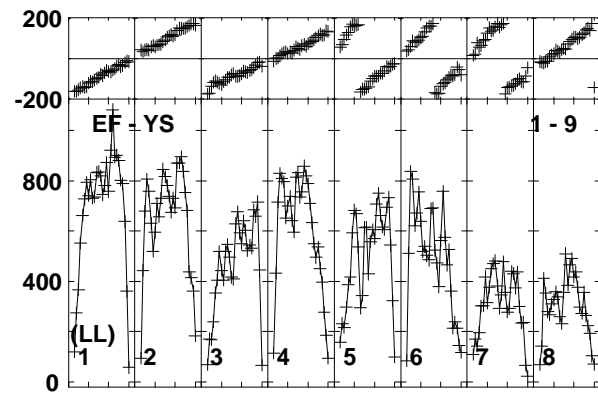
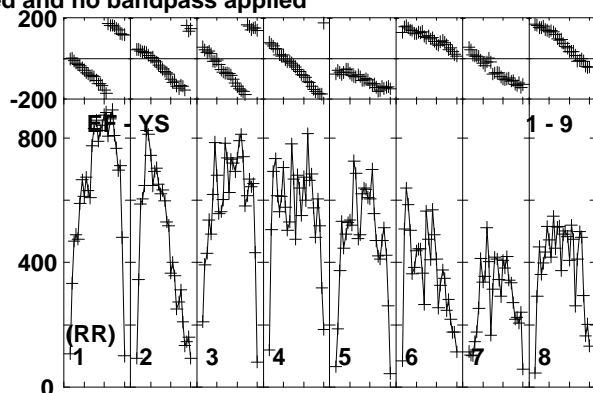
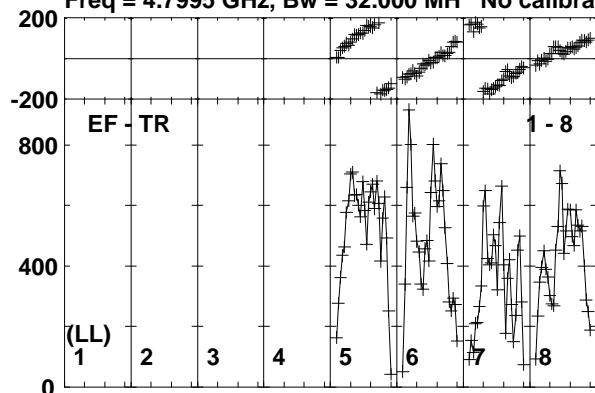

Lower frame: Micro Ampl Jy Top frame: Phas deg
Vector averaged cross-power spectrum Baseline: EF (01) - TR (08)
Timerange: 00/21:46:21 to 00/21:47:49

Plot file version 37 created 20-APR-2018 18:07:54

J1303-2405 RG009B.UVDATA.1

Freq = 4.7995 GHz, Bw = 32.000 MH No calibration applied and no bandpass applied

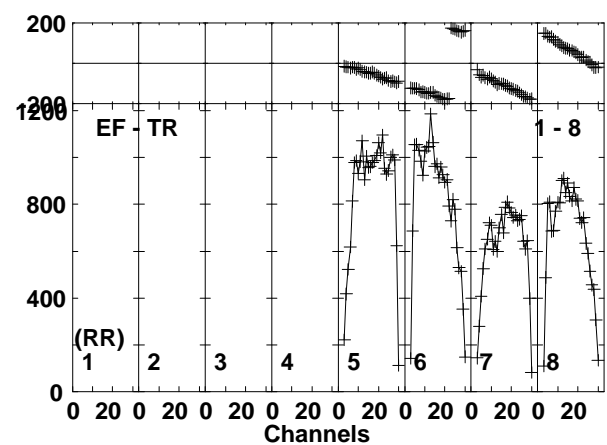
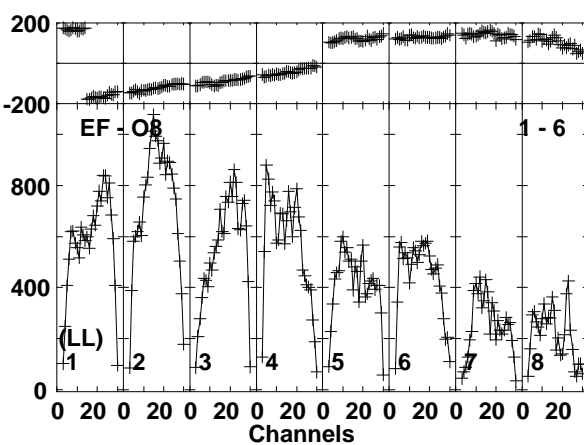
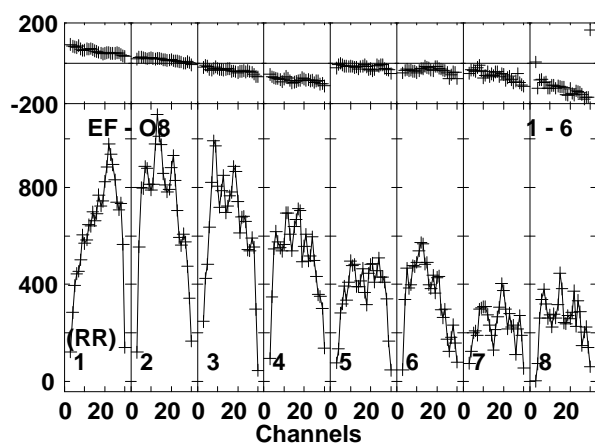
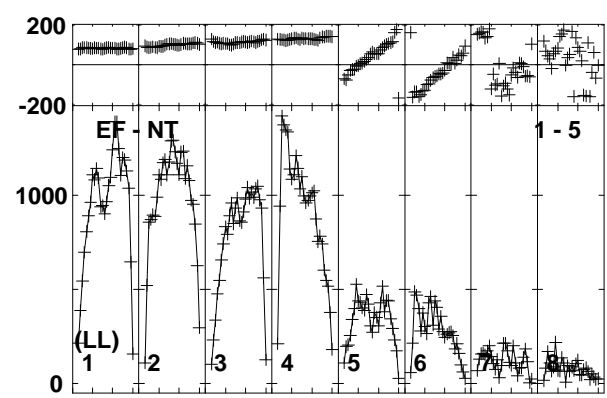
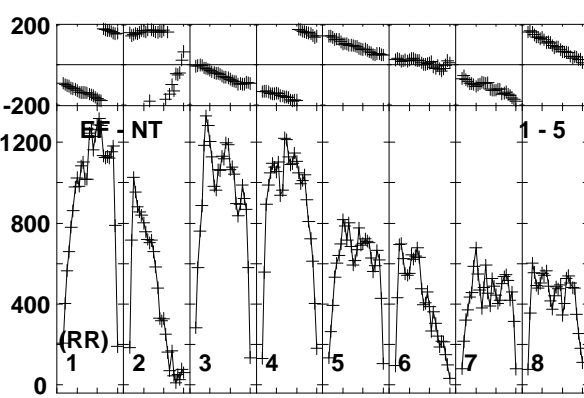
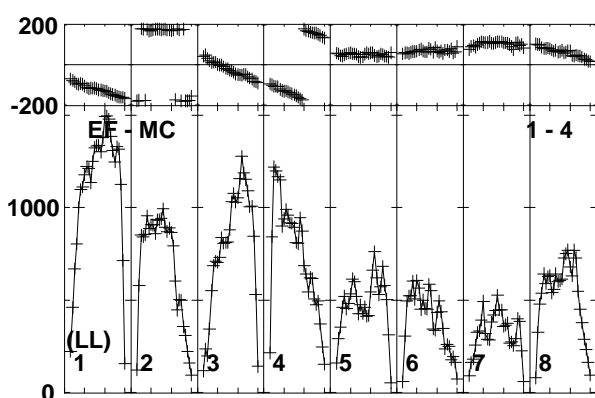
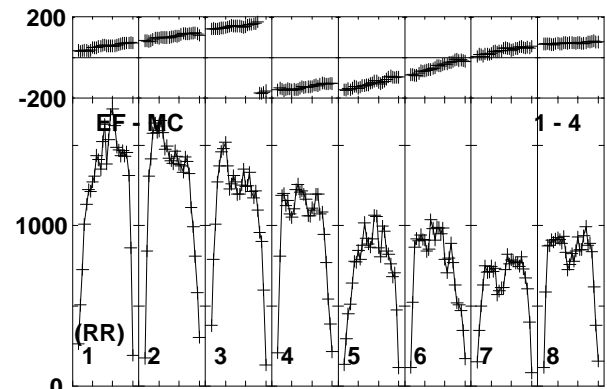
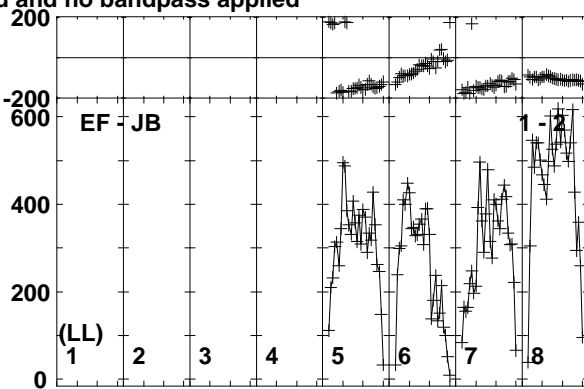
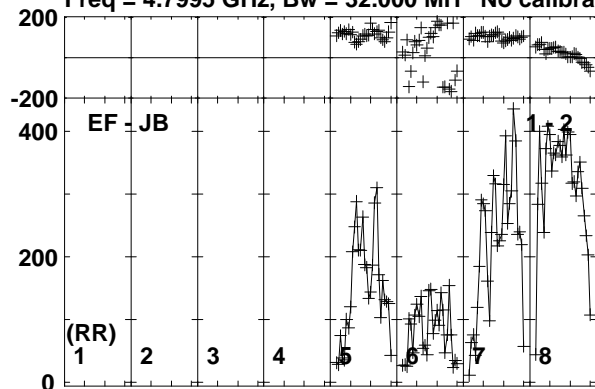

Lower frame: Micro Ampl Jy Top frame: Phas deg
Vector averaged cross-power spectrum Baseline: EF (01) - JB (02)
Timerange: 00/21:47:51 to 00/21:50:19

Plot file version 38 created 20-APR-2018 18:07:54

J1303-2405 RG009B.UVDATA.1

Freq = 4.7995 GHz, Bw = 32.000 MH No calibration applied and no bandpass applied

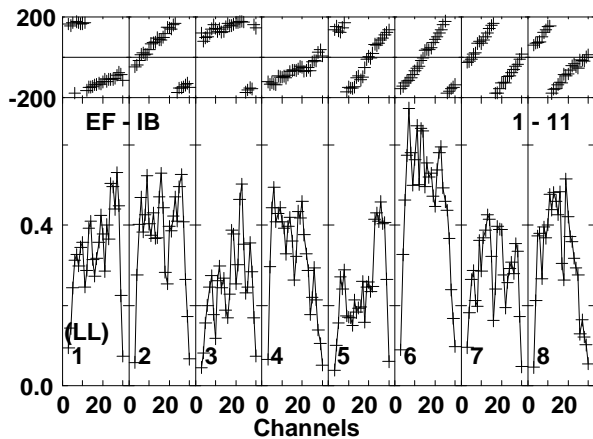
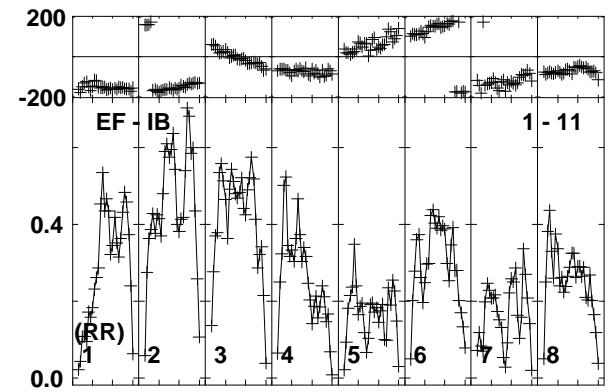
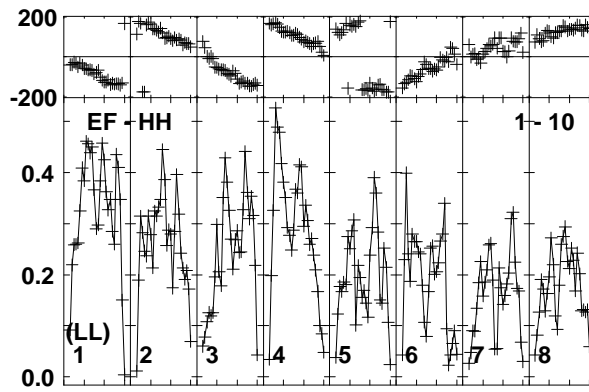
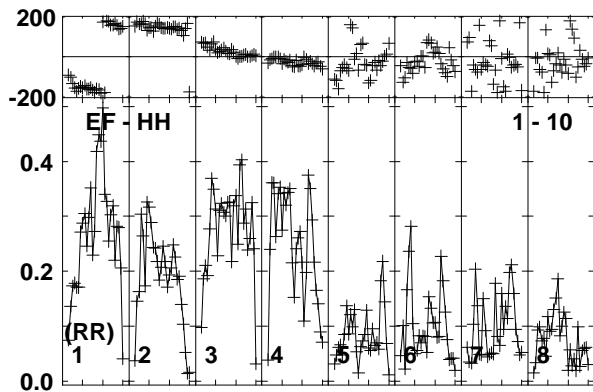
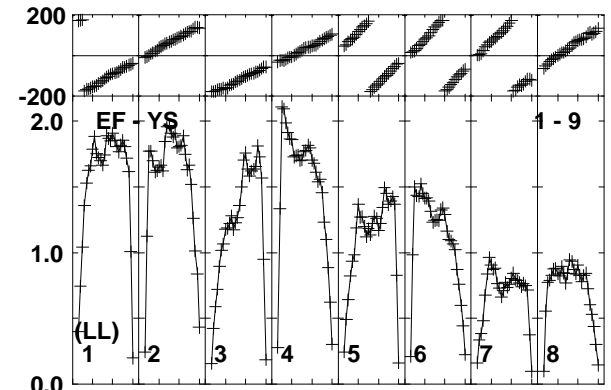
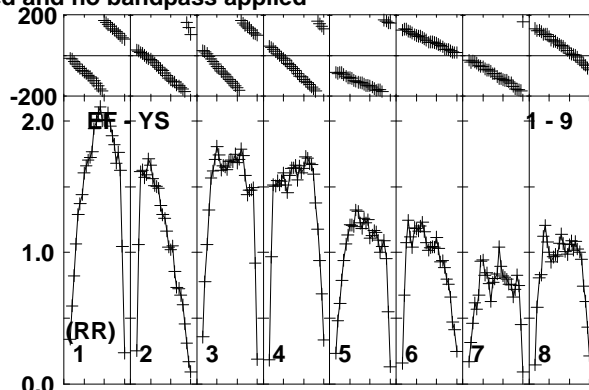
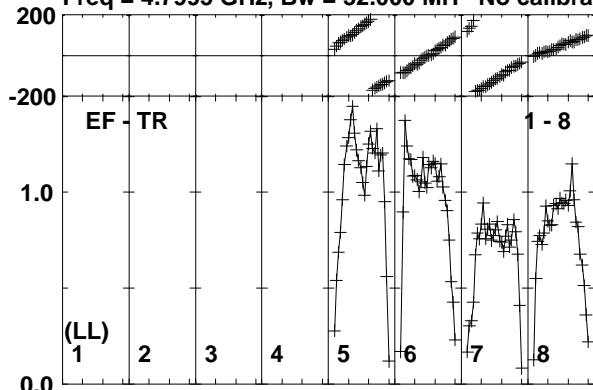

Lower frame: Milli Ampl Jy Top frame: Phas deg
Vector averaged cross-power spectrum Baseline: EF (01) - TR (08)
Timerange: 00:21:47:51 to 00:21:50:19

Plot file version 39 created 20-APR-2018 18:07:54
 J1311-2329 RG009B.UVDATA.1

Freq = 4.7995 GHz, Bw = 32.000 MH No calibration applied and no bandpass applied

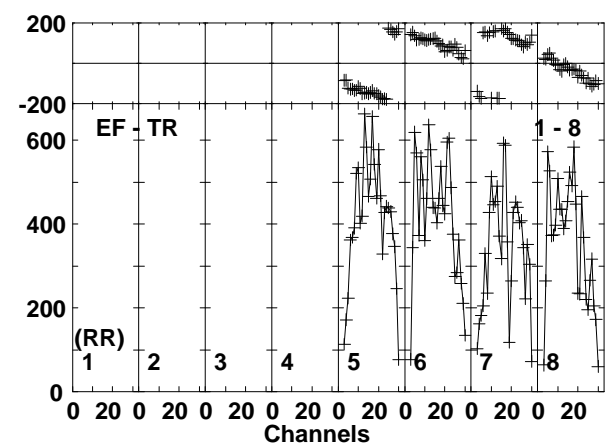
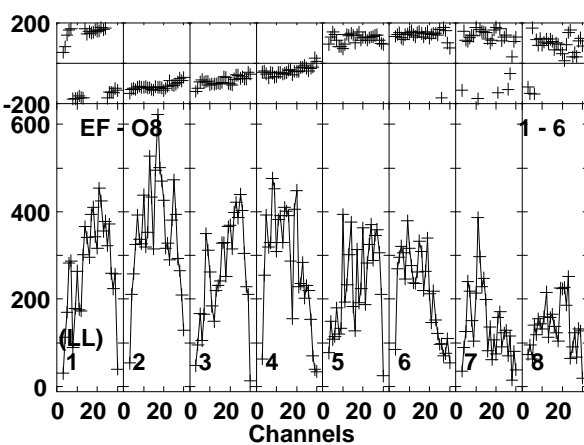
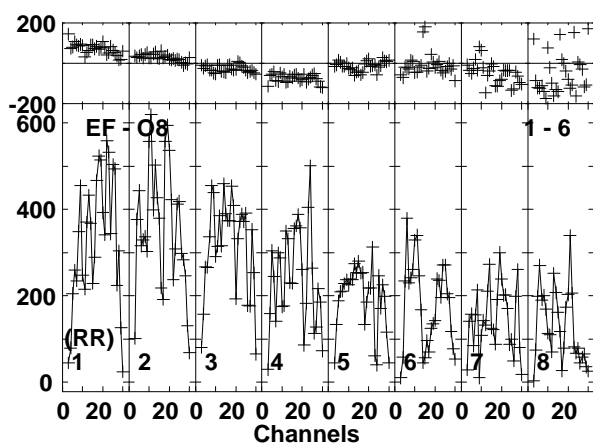
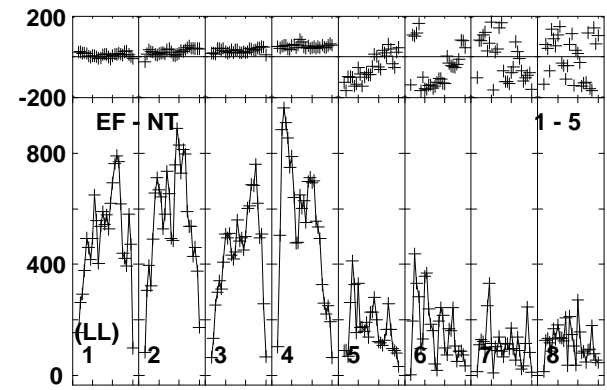
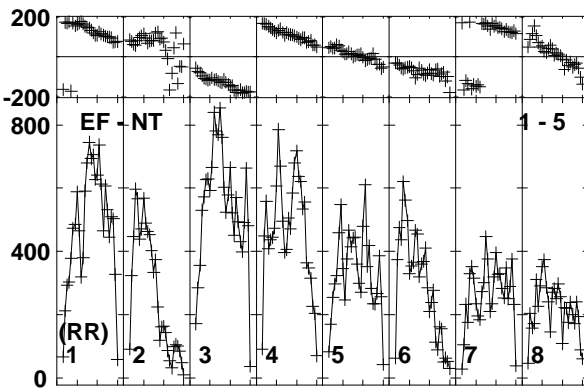
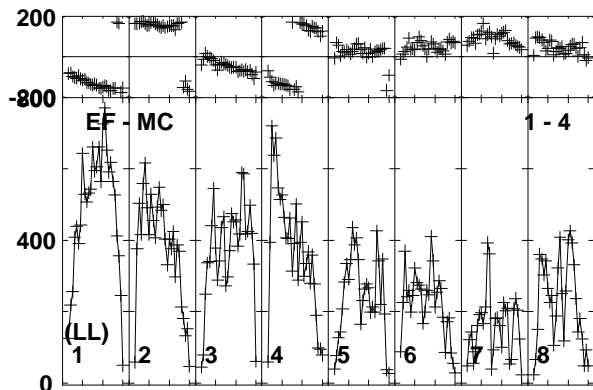
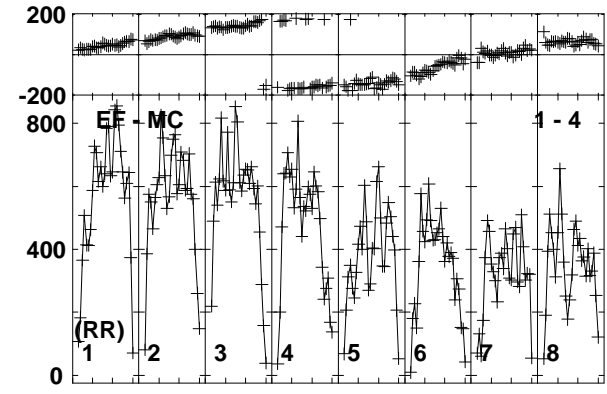
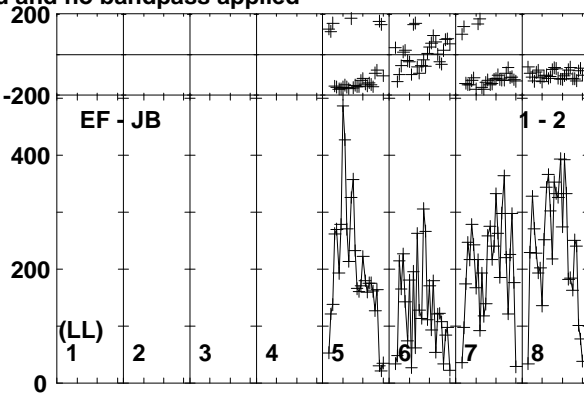
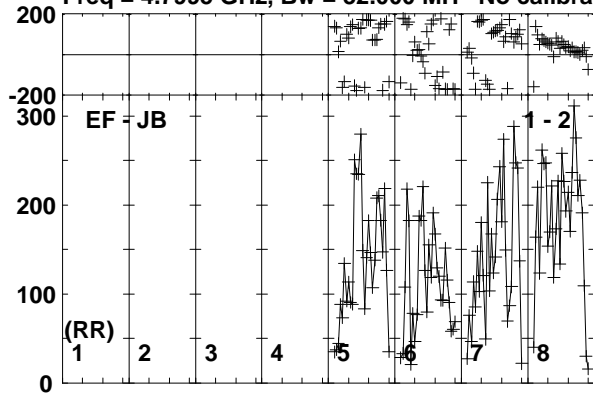

Lower frame: Micro Ampl Jy Top frame: Phas deg
 Vector averaged cross-power spectrum Baseline: EF (01) - JB (02)
 Timerange: 00:21:51:01 to 00:21:51:59

Plot file version 40 created 20-APR-2018 18:07:54

J1311-2329 RG009B.UVDATA.1

Freq = 4.7995 GHz, Bw = 32.000 MH No calibration applied and no bandpass applied

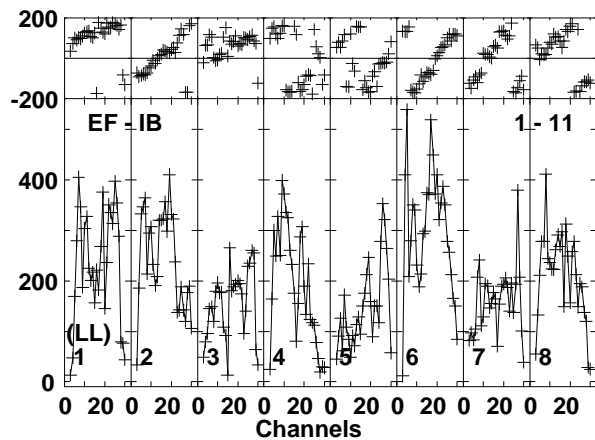
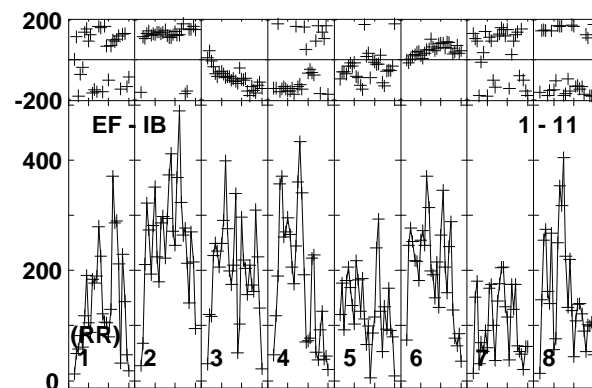
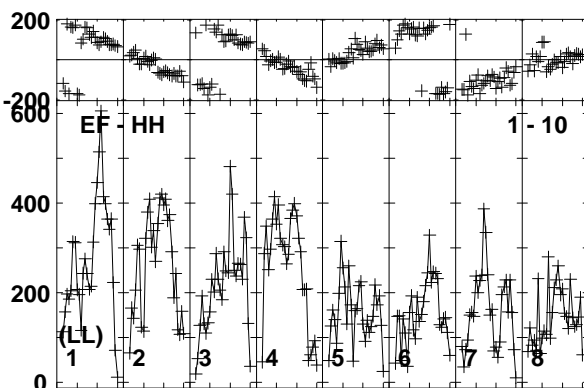
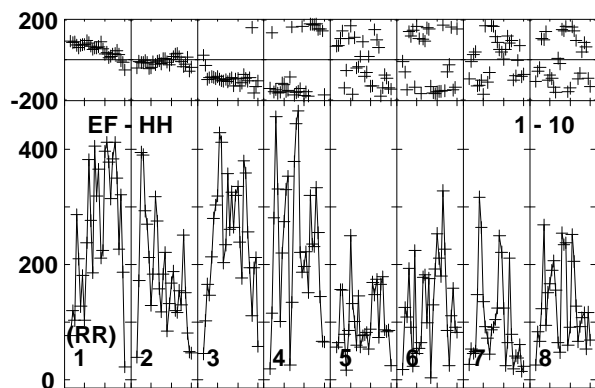
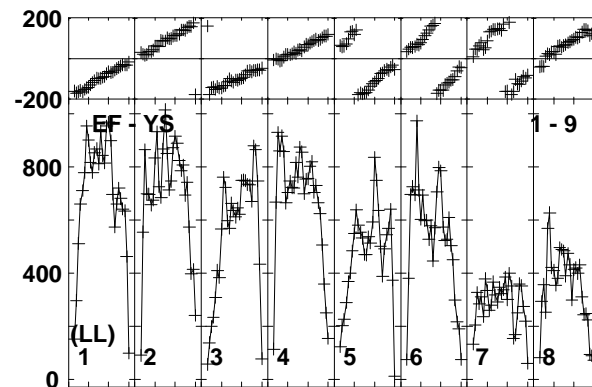
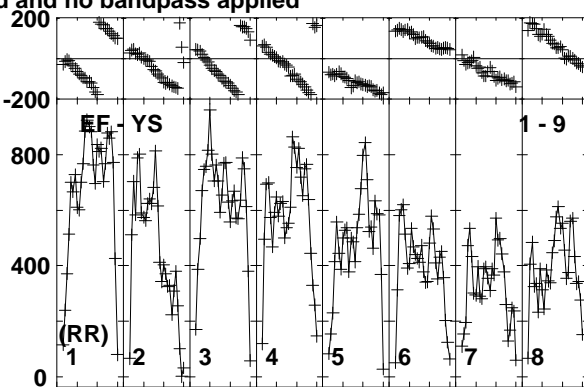
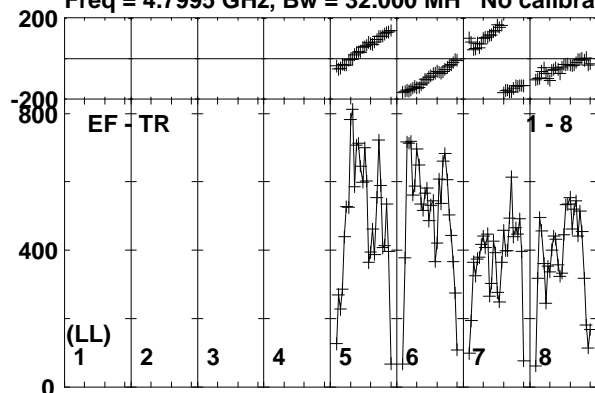

Lower frame: Micro Ampl Jy Top frame: Phas deg
Vector averaged cross-power spectrum Baseline: EF (01) - TR (08)
Timerange: 00/21:51:01 to 00/21:51:59

Plot file version 41 created 20-APR-2018 18:07:55

EM170817 RG009B.UVDATA.1

Freq = 4.7995 GHz, Bw = 32.000 MH No calibration applied and no bandpass applied

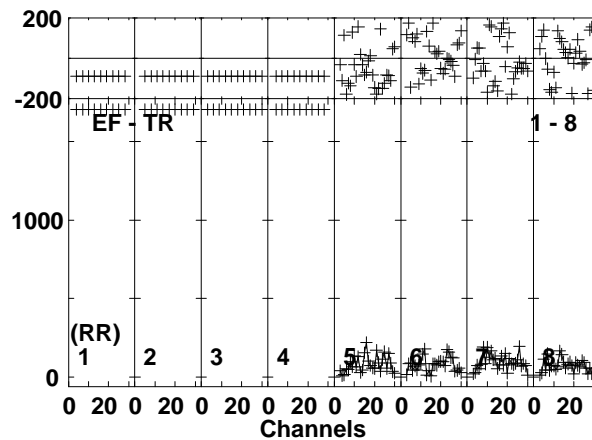
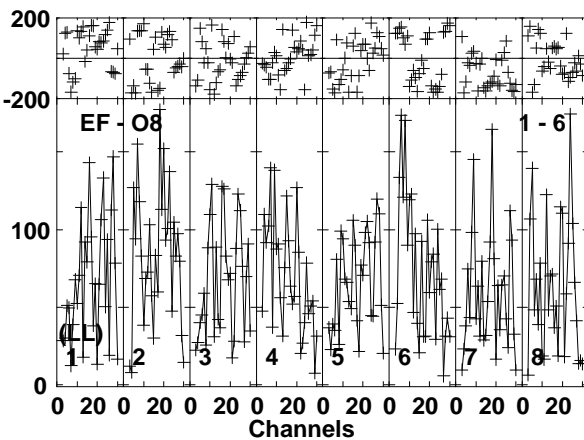
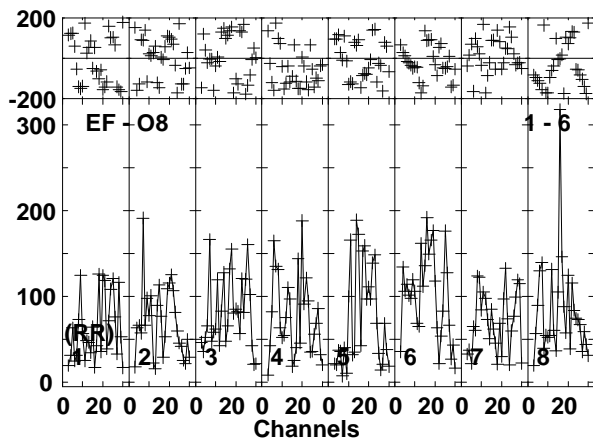
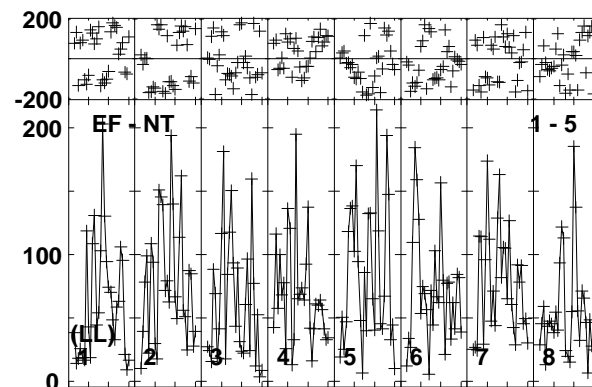
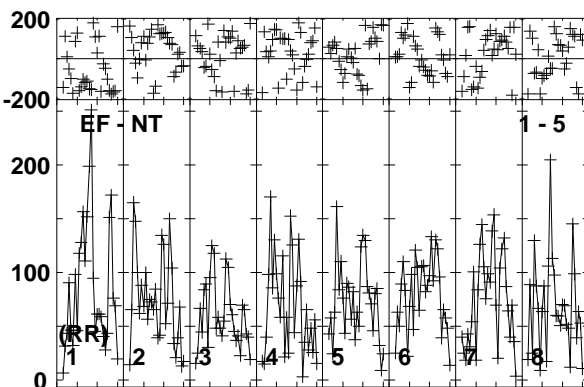
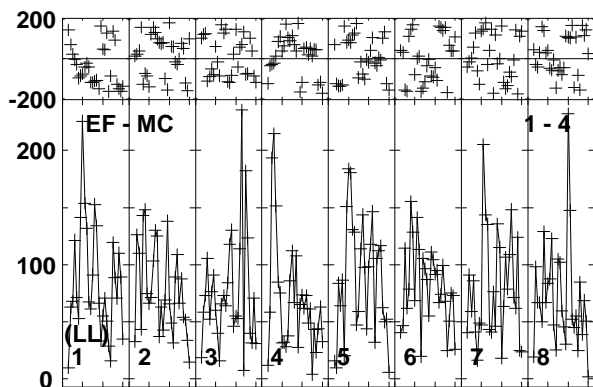
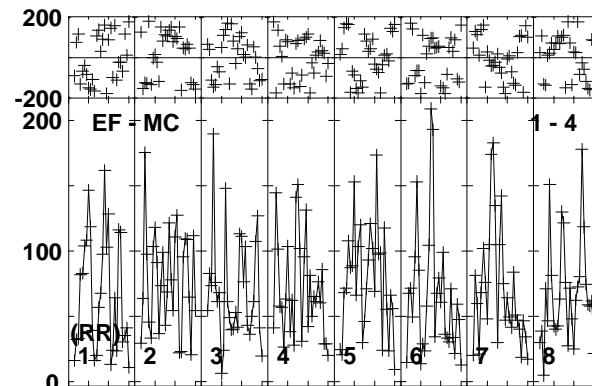
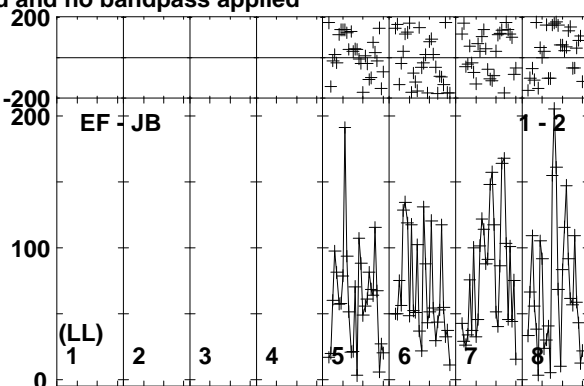
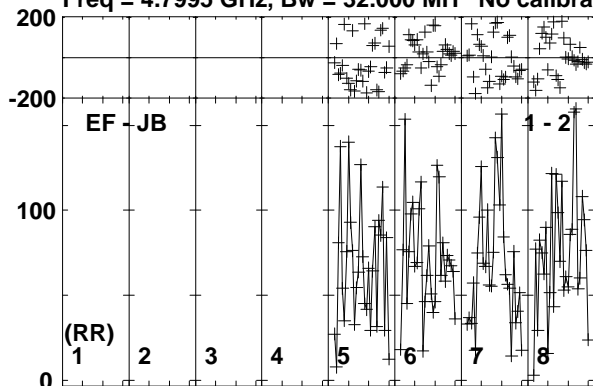

Lower frame: Micro Ampl Jy Top frame: Phas deg
Vector averaged cross-power spectrum Baseline: EF (01) - JB (02)
Timerange: 00:21:52:01 to 00:21:54:29

Plot file version 42 created 20-APR-2018 18:07:55

EM170817 RG009B.UVDATA.1

Freq = 4.7995 GHz, Bw = 32.000 MH No calibration applied and no bandpass applied

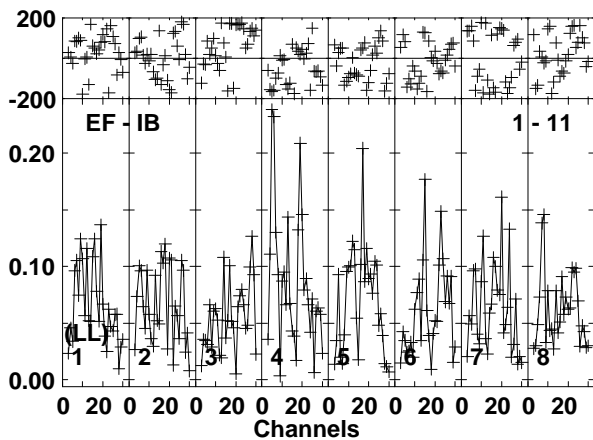
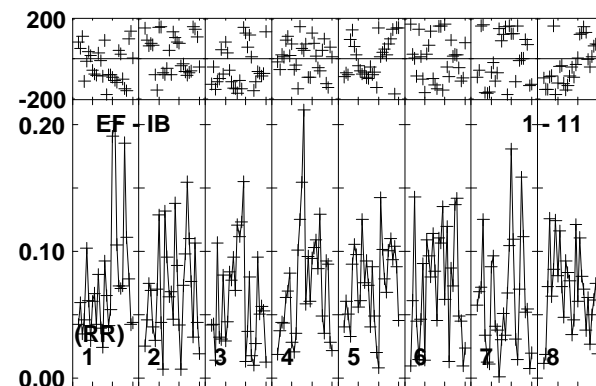
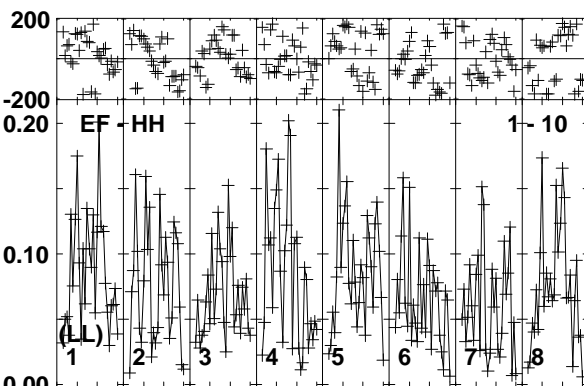
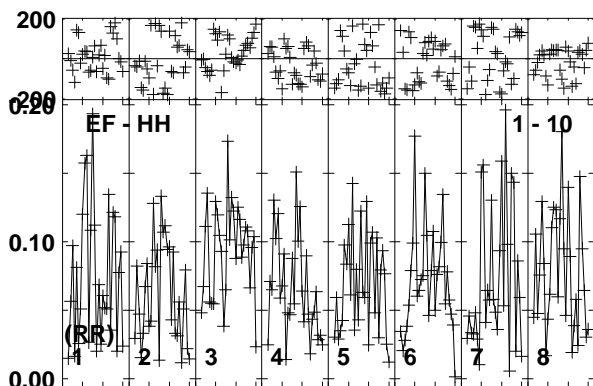
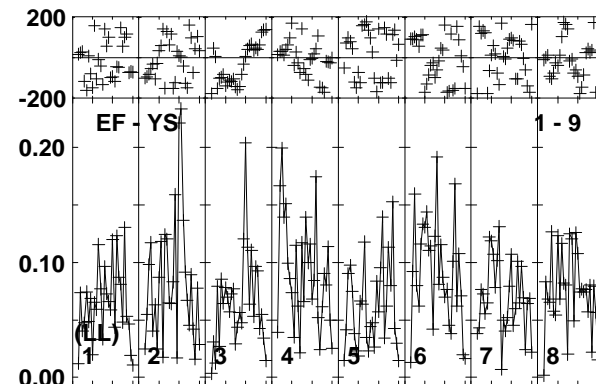
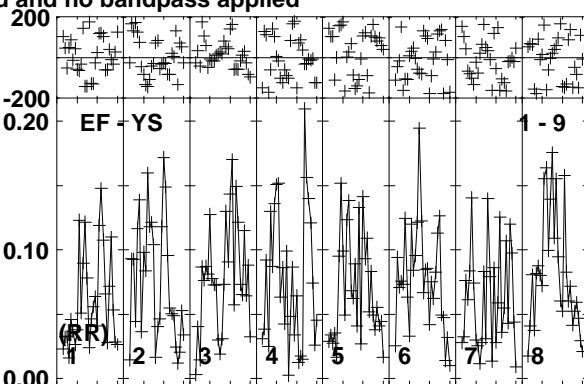
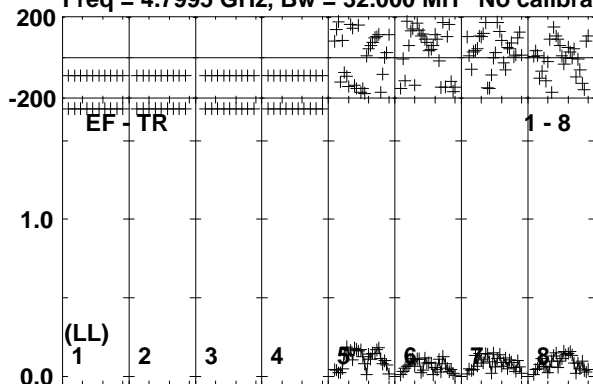

Lower frame: Milli Ampl Jy Top frame: Phas deg
Vector averaged cross-power spectrum Baseline: EF (01) - TR (08)
Timerange: 00/21:52:01 to 00/21:54:29

Plot file version 43 created 20-APR-2018 18:07:55

J1311-2329 RG009B.UVDATA.1

Freq = 4.7995 GHz, Bw = 32.000 MH No calibration applied and no bandpass applied

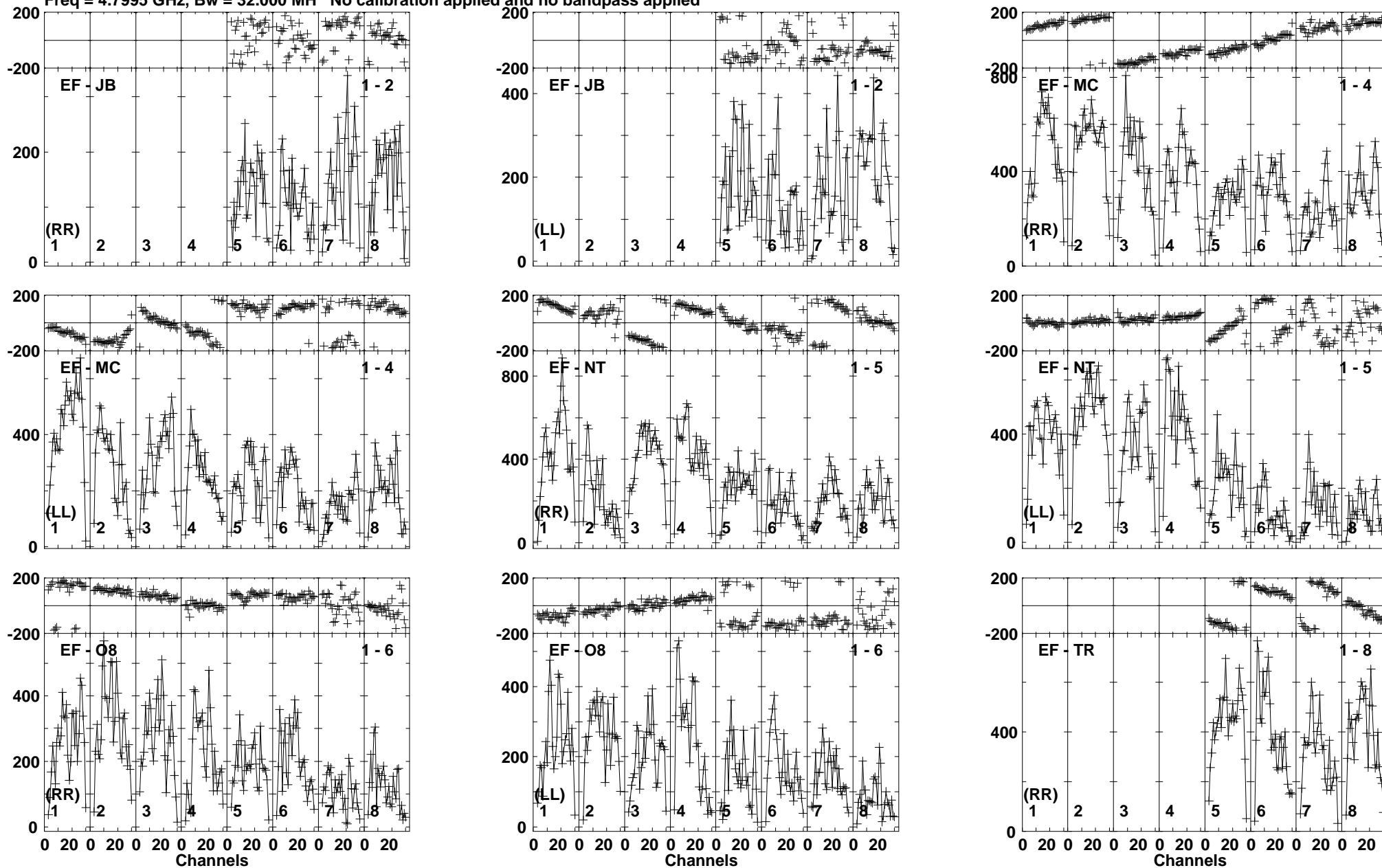

Lower frame: Micro Ampl Jy Top frame: Phas deg
Vector averaged cross-power spectrum Baseline: EF (01) - JB (02)
Timerange: 00/21:54:31 to 00/21:55:59

Plot file version 44 created 20-APR-2018 18:07:55

J1311-2329 RG009B.UVDATA.1

Freq = 4.7995 GHz, Bw = 32.000 MH No calibration applied and no bandpass applied

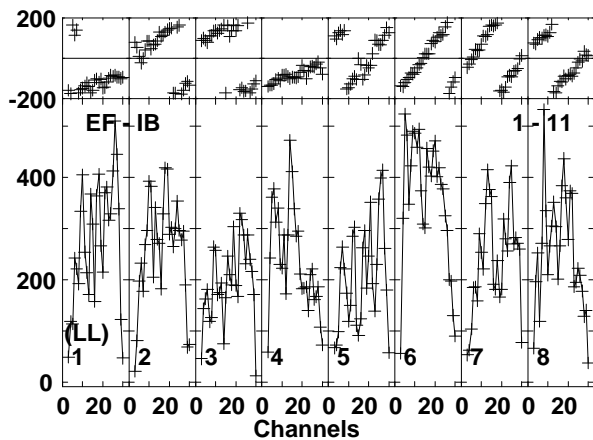
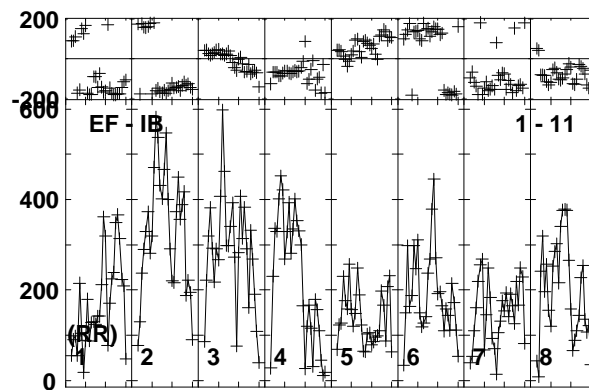
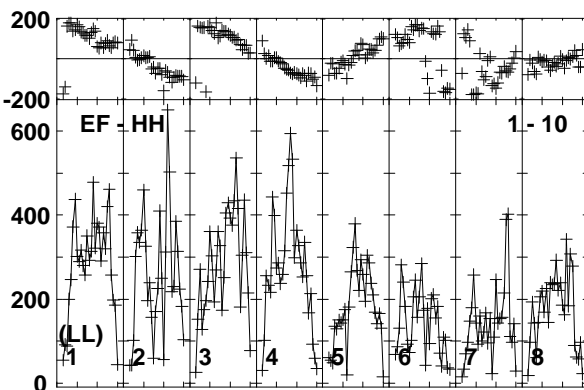
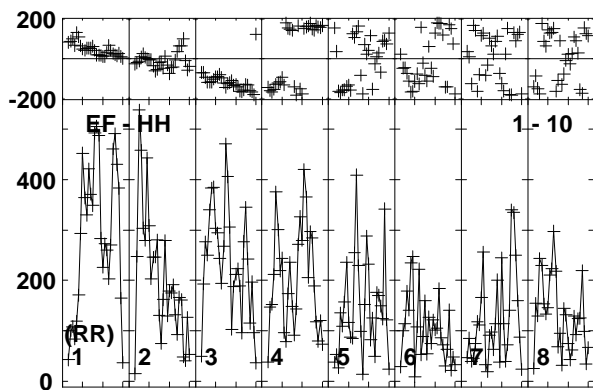
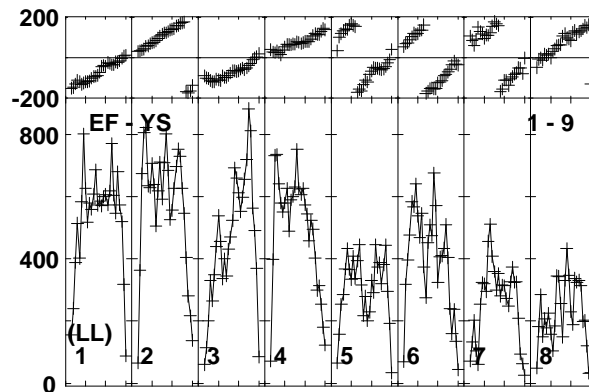
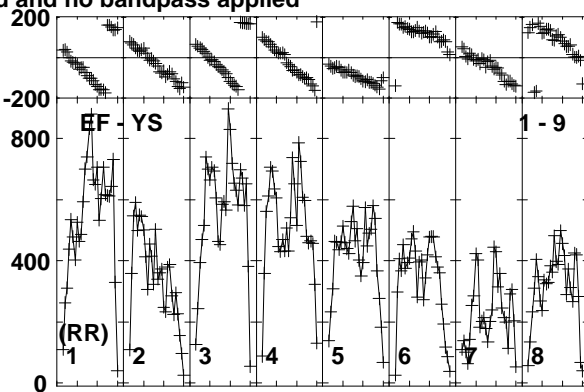
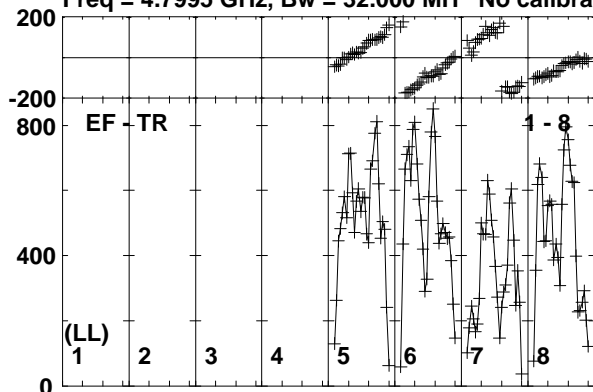

Lower frame: Micro Ampl Jy Top frame: Phas deg
Vector averaged cross-power spectrum Baseline: EF (01) - TR (08)
Timerange: 00/21:54:31 to 00/21:55:59

Plot file version 45 created 20-APR-2018 18:07:55

EM170817 RG009B.UVDATA.1

Freq = 4.7995 GHz, Bw = 32.000 MH No calibration applied and no bandpass applied

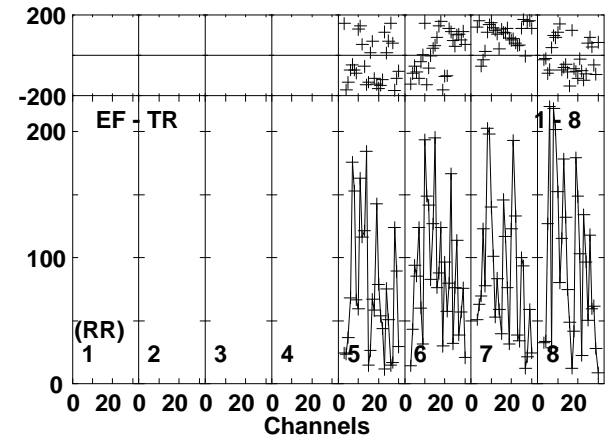
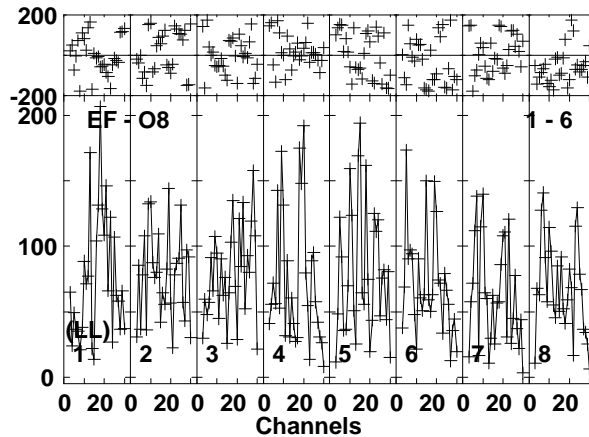
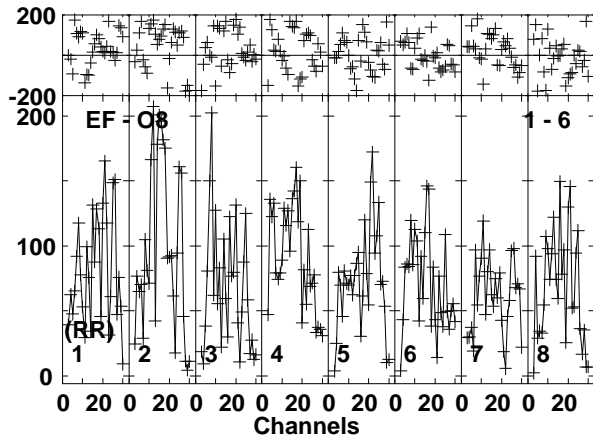
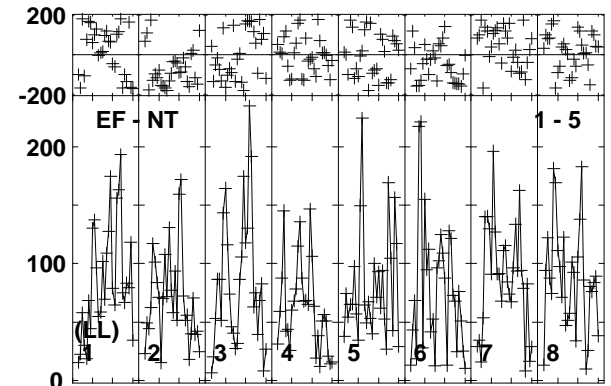
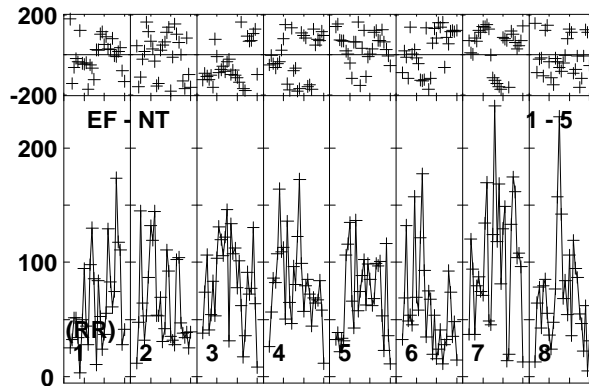
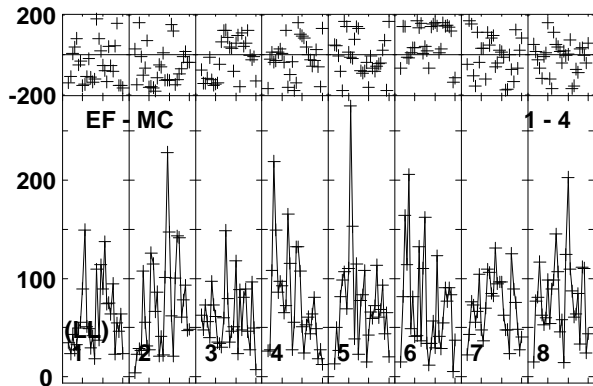
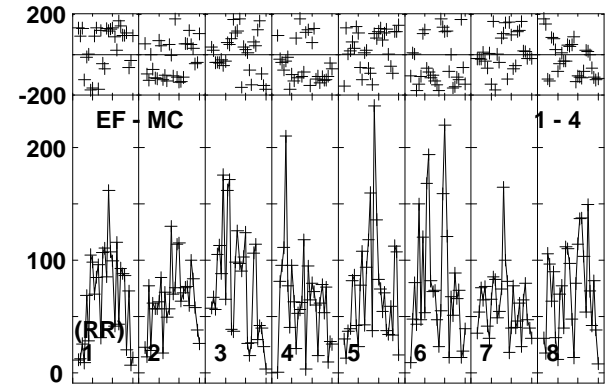
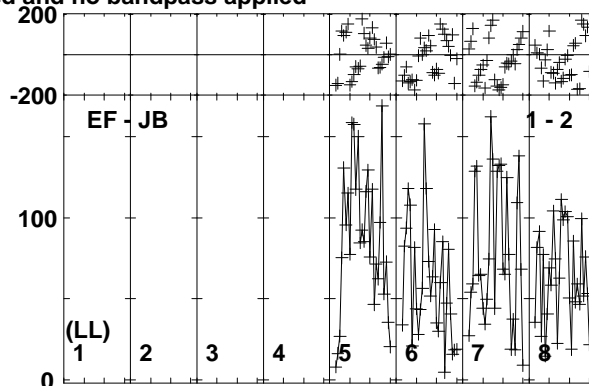
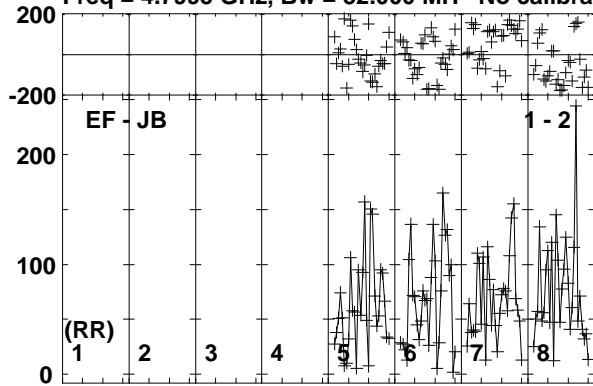

Lower frame: Micro Ampl Jy Top frame: Phas deg
Vector averaged cross-power spectrum Baseline: EF (01) - JB (02)
Timerange: 00/21:56:01 to 00/21:58:29

Plot file version 46 created 20-APR-2018 18:07:55

EM170817 RG009B.UVDATA.1

Freq = 4.7995 GHz, Bw = 32.000 MH No calibration applied and no bandpass applied

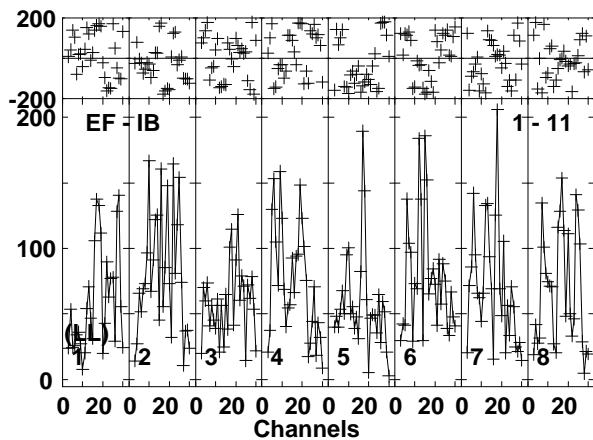
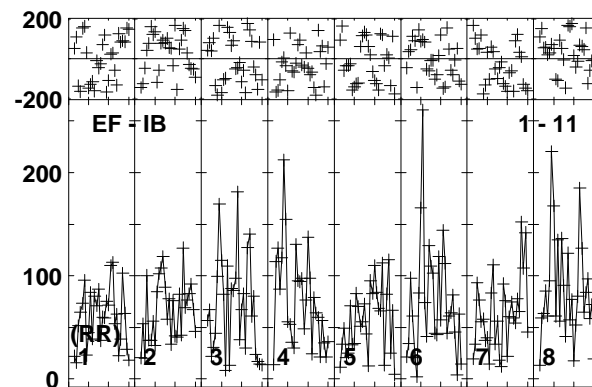
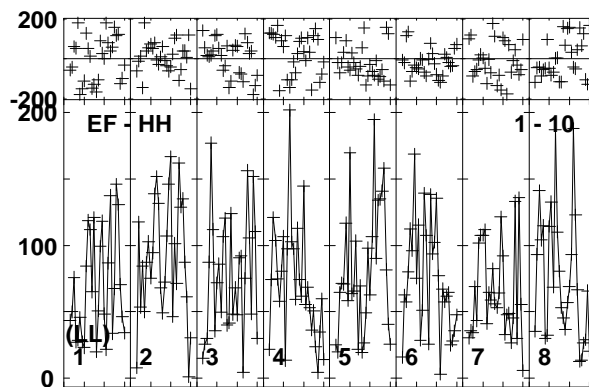
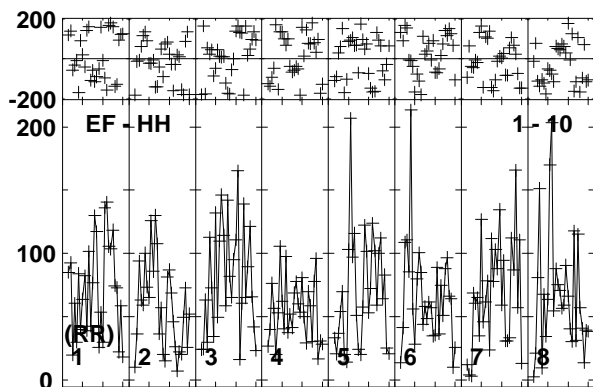
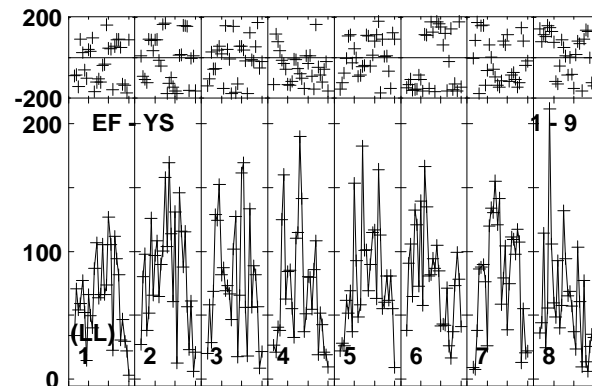
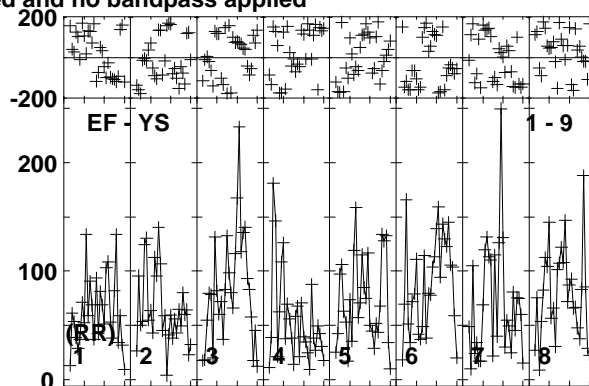
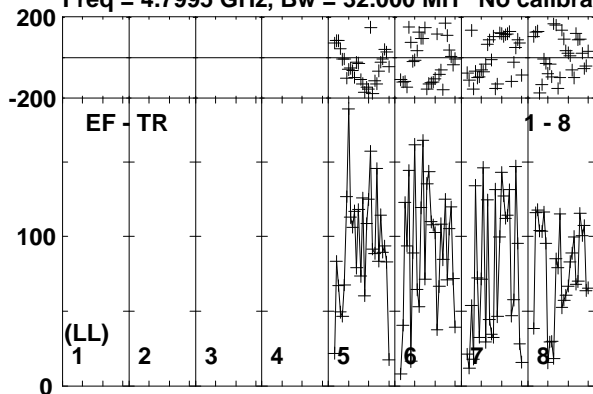

Lower frame: Micro Ampl Jy Top frame: Phas deg
Vector averaged cross-power spectrum Baseline: EF (01) - TR (08)
Timerange: 00/21:56:01 to 00/21:58:29

Plot file version 47 created 20-APR-2018 18:07:55

J1311-2329 RG009B.UVDATA.1

Freq = 4.7995 GHz, Bw = 32.000 MH No calibration applied and no bandpass applied

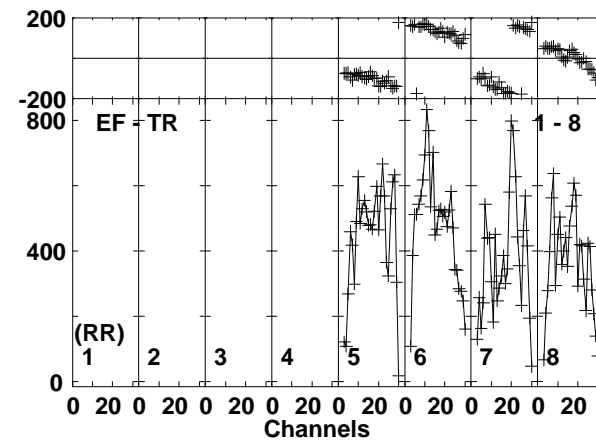
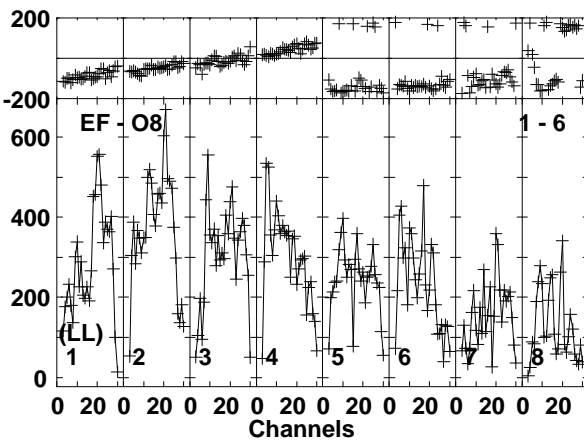
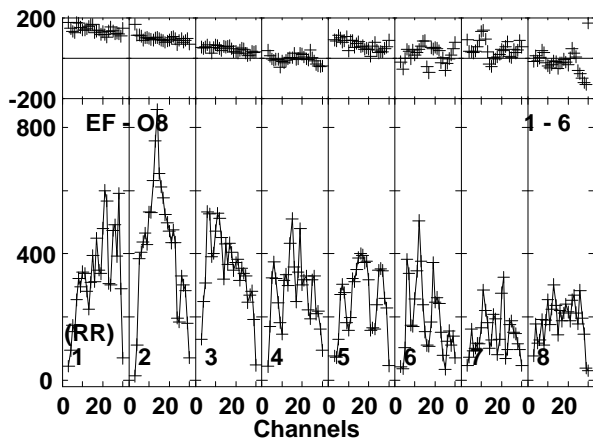
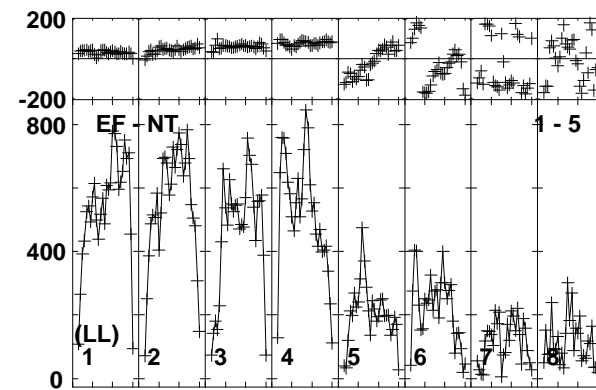
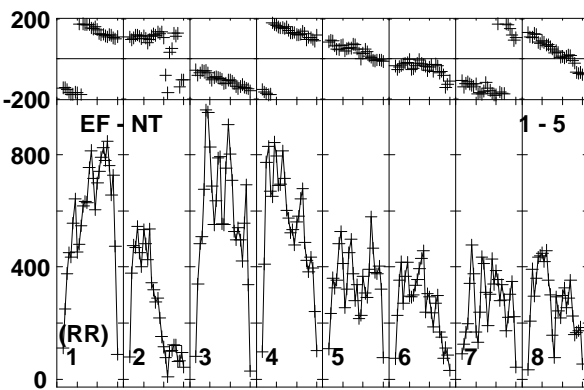
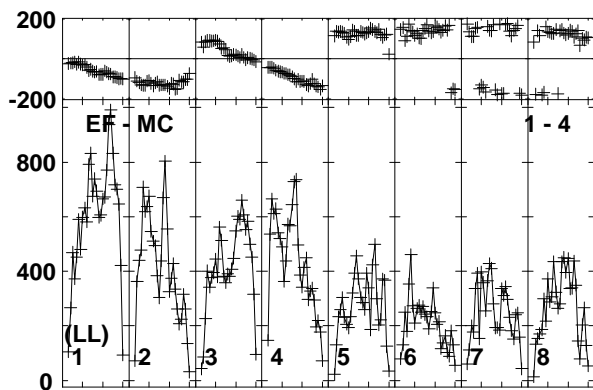
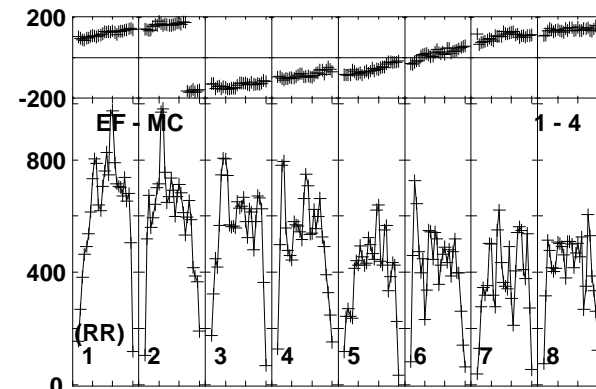
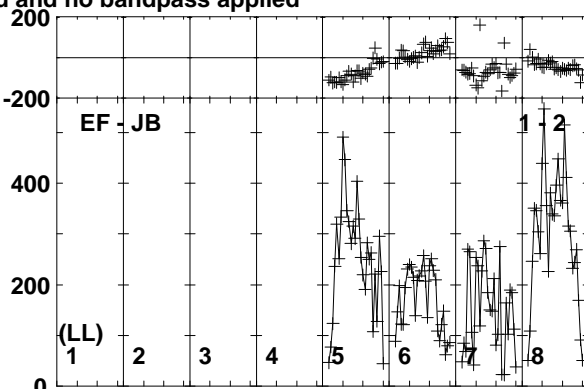
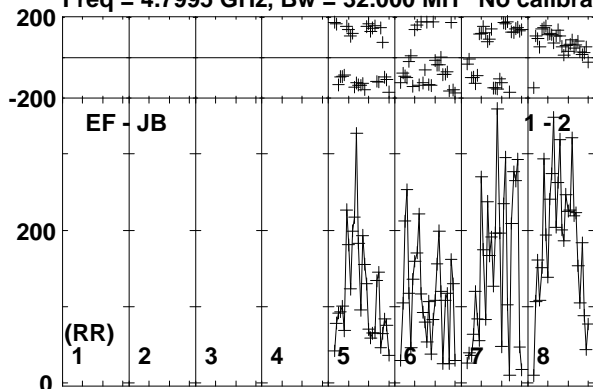

Lower frame: Micro Ampl Jy Top frame: Phas deg
Vector averaged cross-power spectrum Baseline: EF (01) - JB (02)
Timerange: 00/21:59:01 to 00/21:59:59

Plot file version 48 created 20-APR-2018 18:07:55

J1311-2329 RG009B.UVDATA.1

Freq = 4.7995 GHz, Bw = 32.000 MH No calibration applied and no bandpass applied

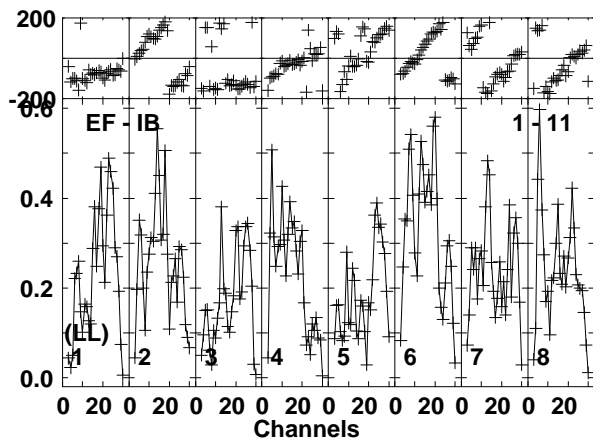
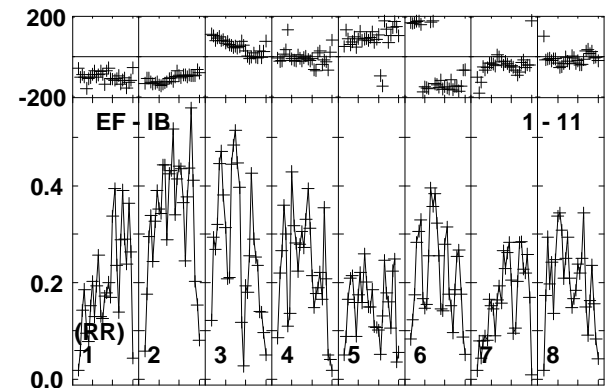
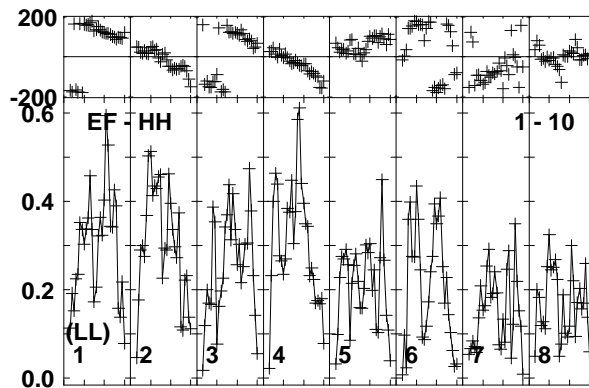
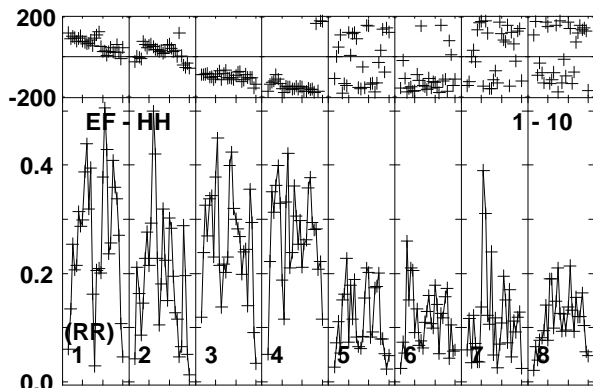
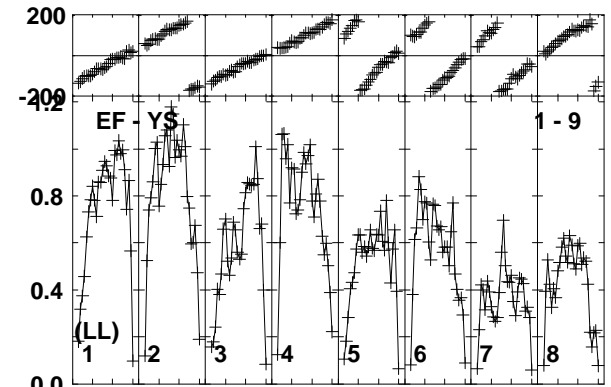
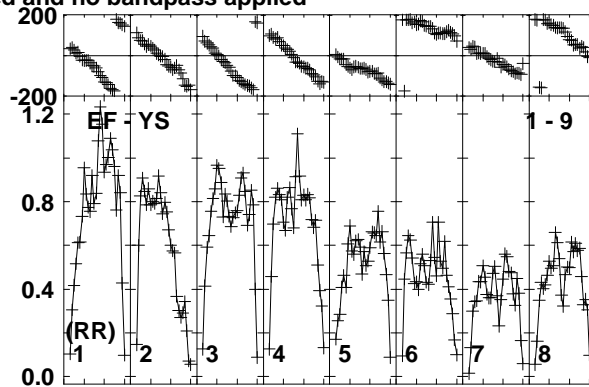
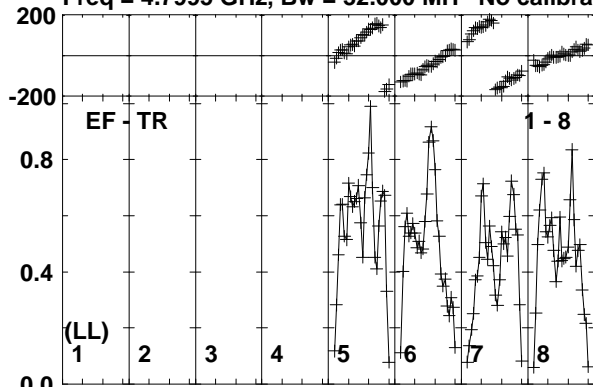

Lower frame: Milli Ampl Jy Top frame: Phas deg
Vector averaged cross-power spectrum Baseline: EF (01) - TR (08)
Timerange: 00:21:59:01 to 00:21:59:59

Plot file version 49 created 20-APR-2018 18:07:55

EM170817 RG009B.UVDATA.1

Freq = 4.7995 GHz, Bw = 32.000 MH No calibration applied and no bandpass applied

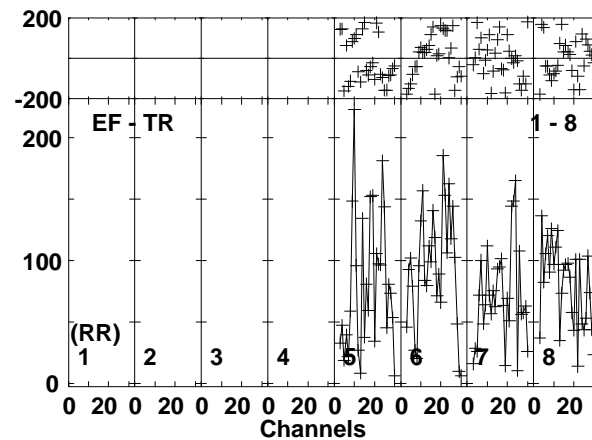
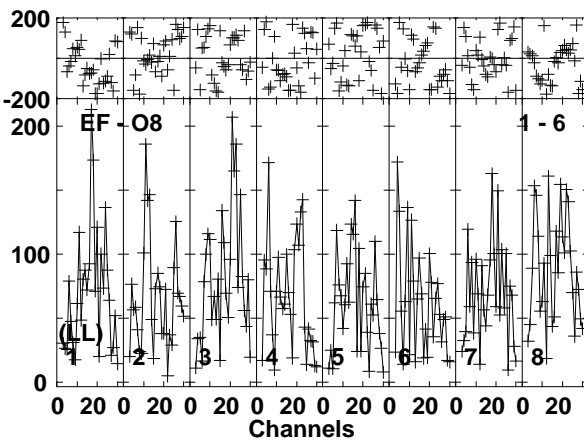
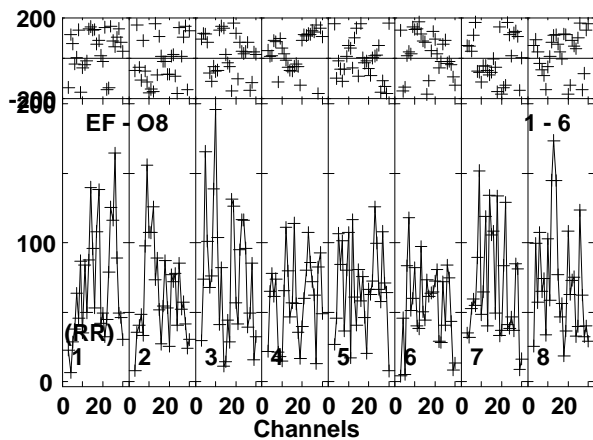
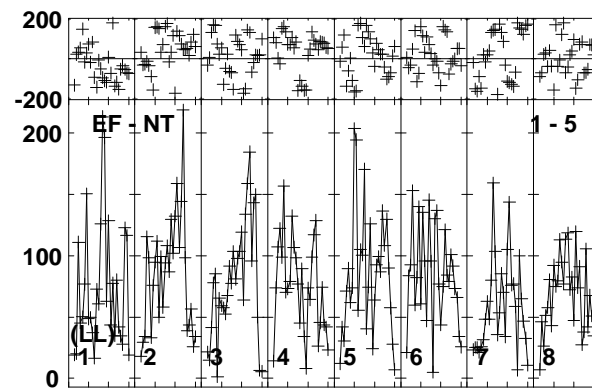
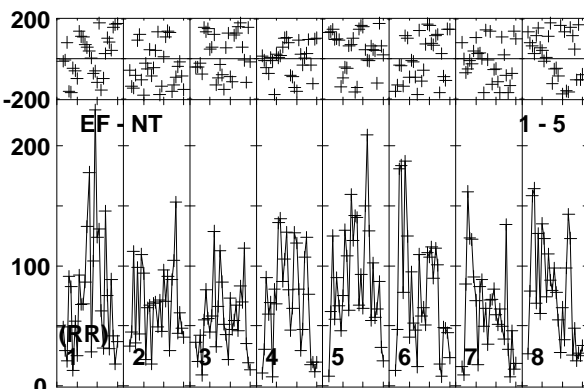
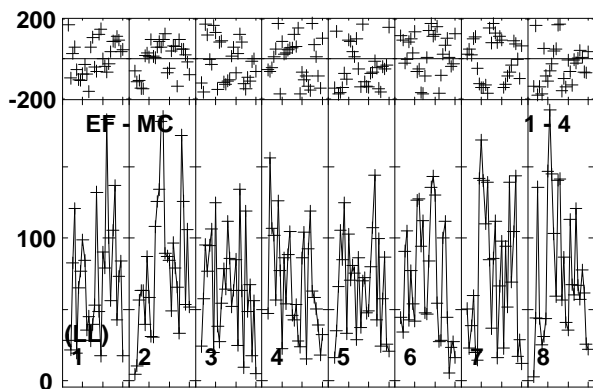
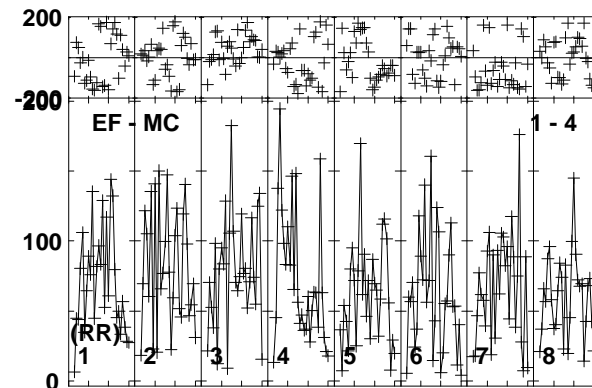
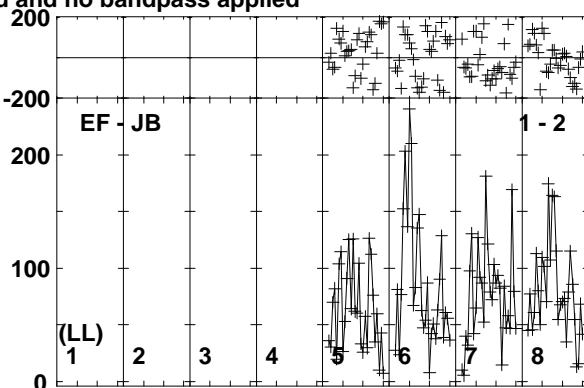
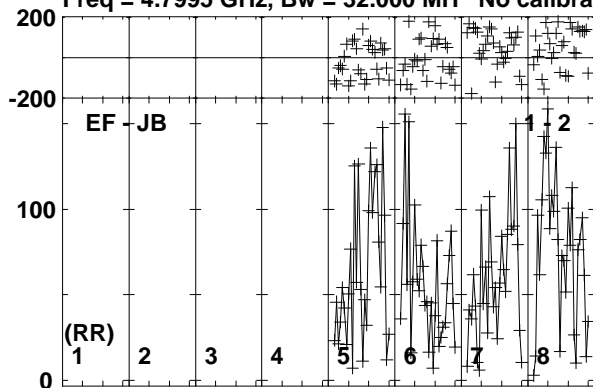

Lower frame: Micro Ampl Jy Top frame: Phas deg
Vector averaged cross-power spectrum Baseline: EF (01) - JB (02)
Timerange: 00:22:00:01 to 00:22:02:29

Plot file version 50 created 20-APR-2018 18:07:55

EM170817 RG009B.UVDATA.1

Freq = 4.7995 GHz, Bw = 32.000 MH No calibration applied and no bandpass applied

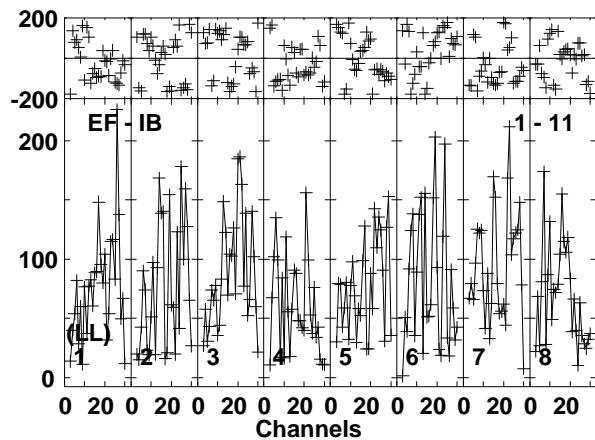
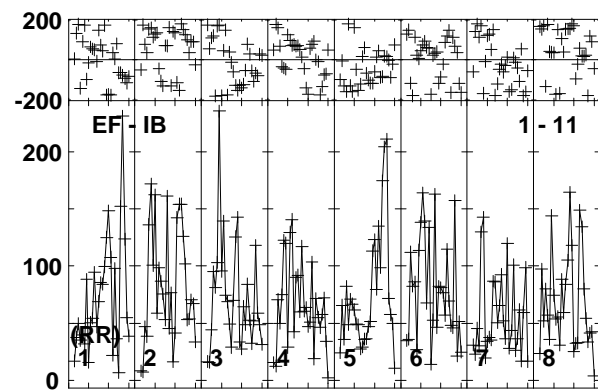
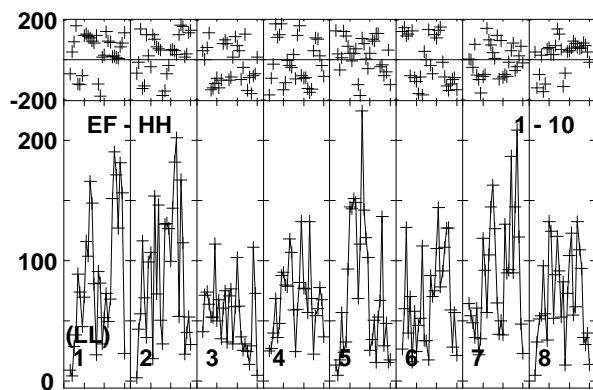
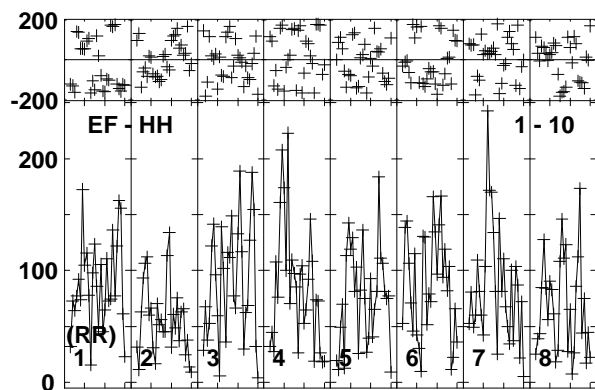
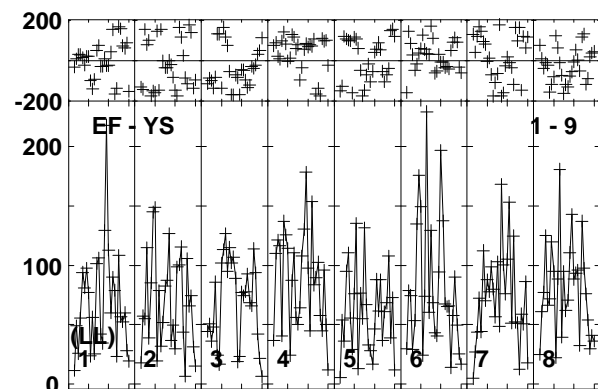
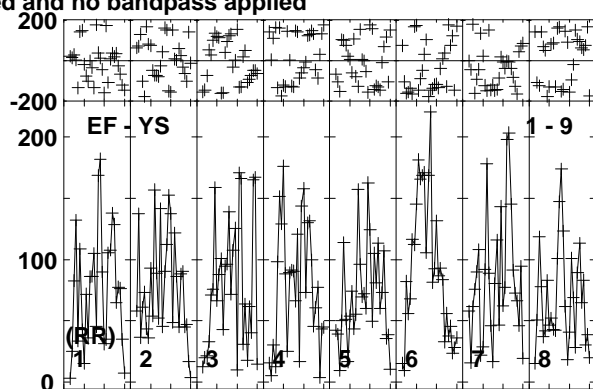
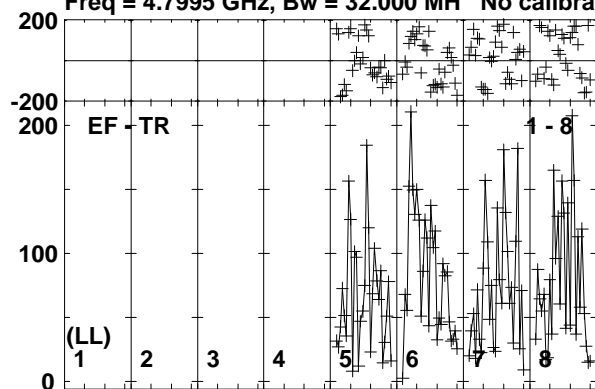

Lower frame: Micro Ampl Jy Top frame: Phas deg
Vector averaged cross-power spectrum Baseline: EF (01) - TR (08)
Timerange: 00:22:00:01 to 00:22:02:29

Plot file version 51 created 20-APR-2018 18:07:55

J1311-2329 RG009B.UVDATA.1

Freq = 4.7995 GHz, Bw = 32.000 MH No calibration applied and no bandpass applied

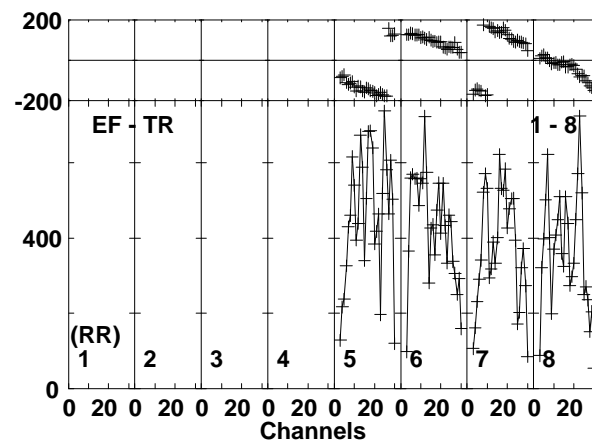
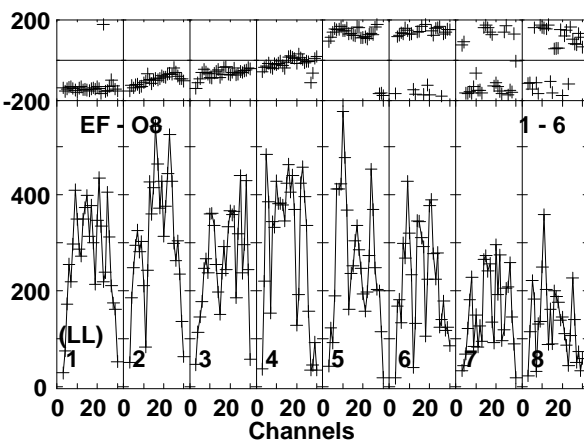
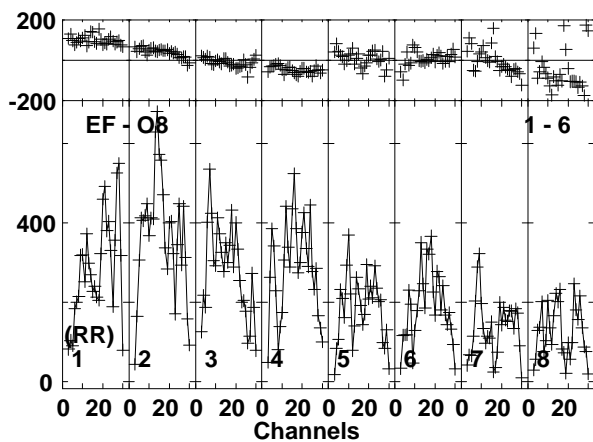
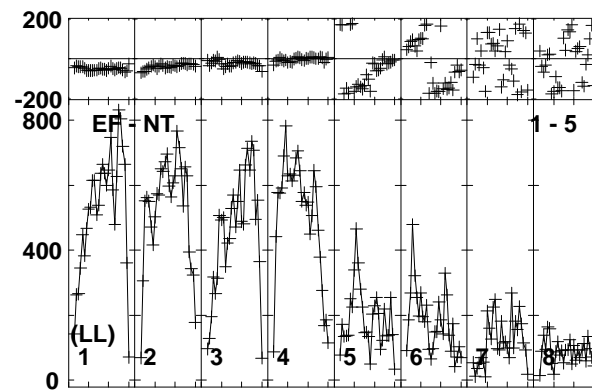
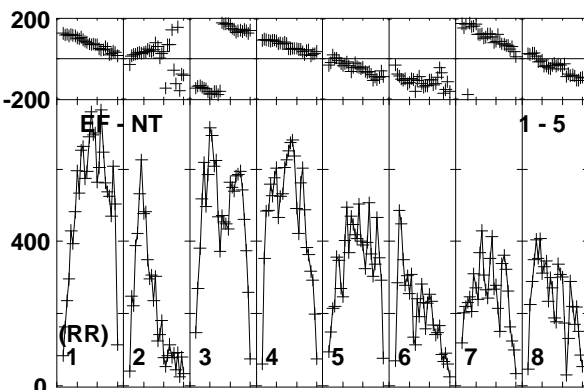
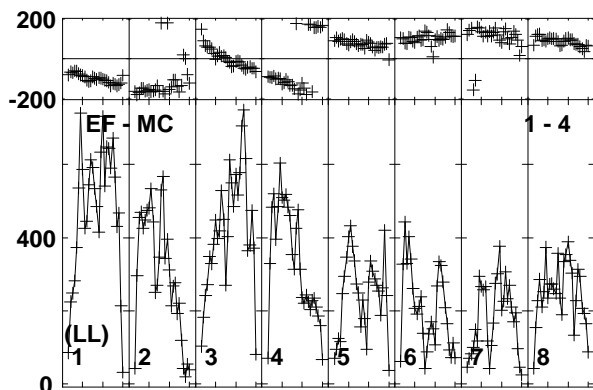
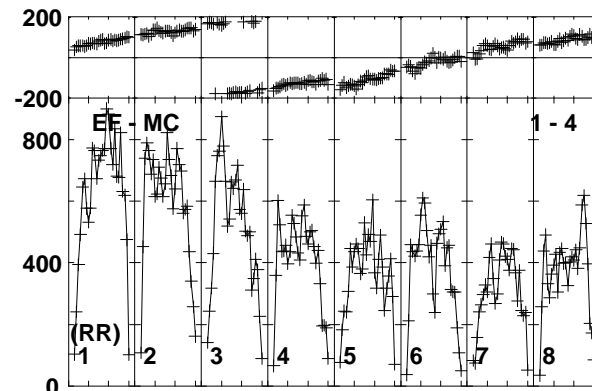
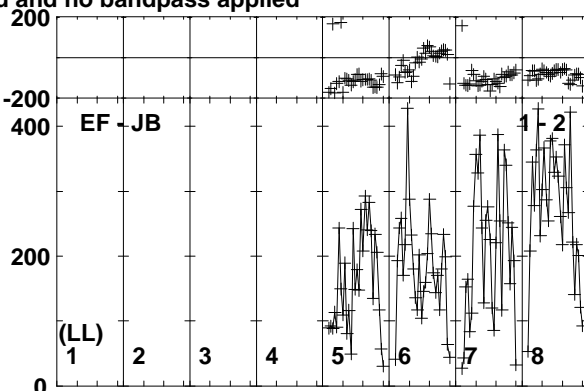
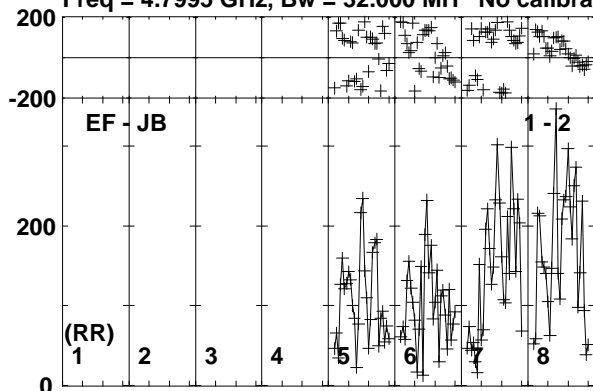

Lower frame: Micro Ampl Jy Top frame: Phas deg
Vector averaged cross-power spectrum Baseline: EF (01) - JB (02)
Timerange: 00/22:02:31 to 00/22:03:59

Plot file version 52 created 20-APR-2018 18:07:56

J1311-2329 RG009B.UVDATA.1

Freq = 4.7995 GHz, Bw = 32.000 MH No calibration applied and no bandpass applied

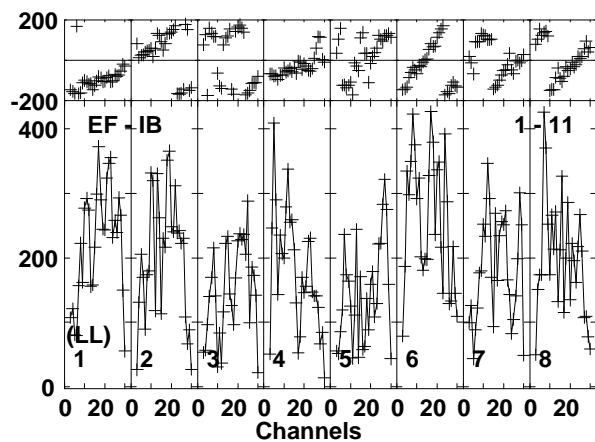
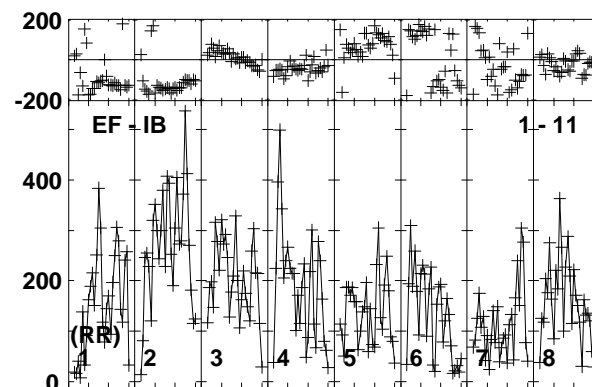
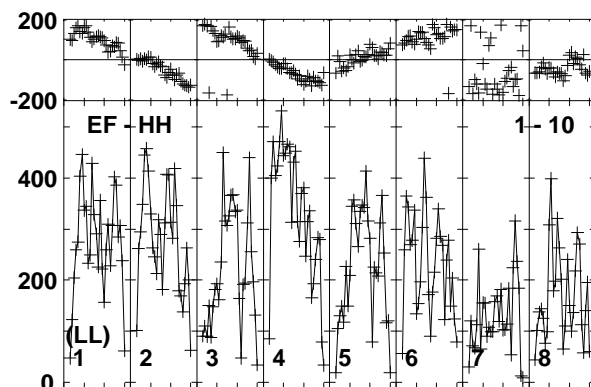
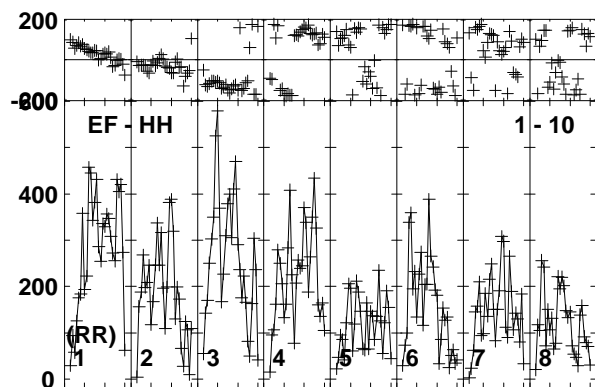
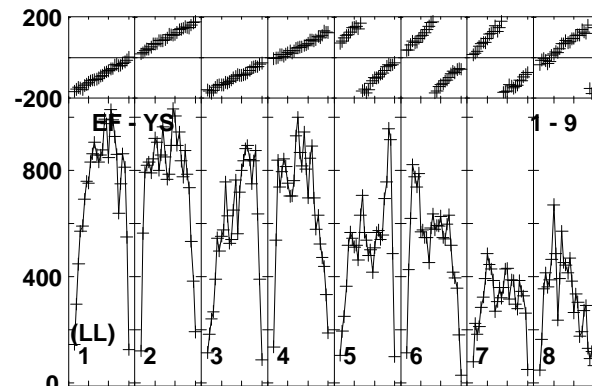
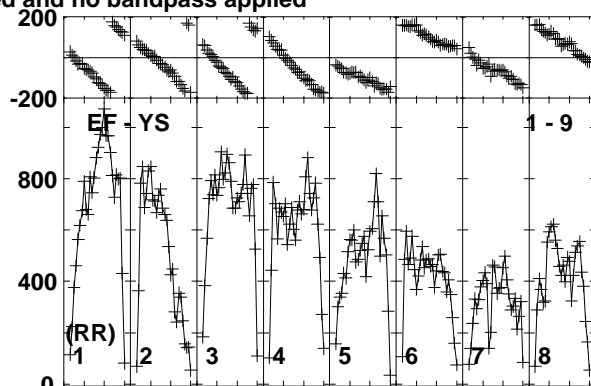
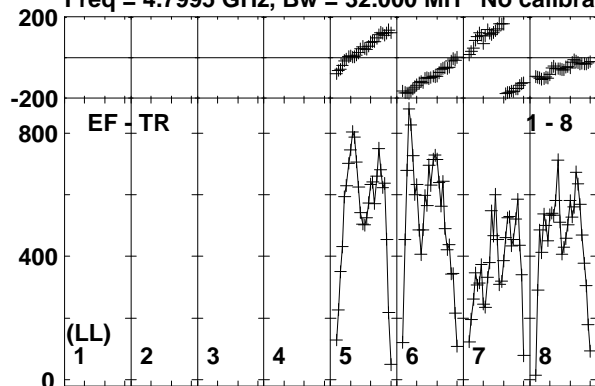

Lower frame: Micro Ampl Jy Top frame: Phas deg
Vector averaged cross-power spectrum Baseline: EF (01) - TR (08)
Timerange: 00/22:02:31 to 00/22:03:59

Plot file version 53 created 20-APR-2018 18:07:56

J1312-2350 RG009B.UVDATA.1

Freq = 4.7995 GHz, Bw = 32.000 MH No calibration applied and no bandpass applied

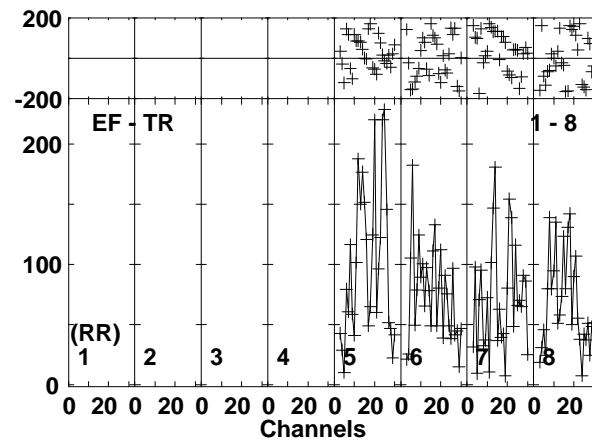
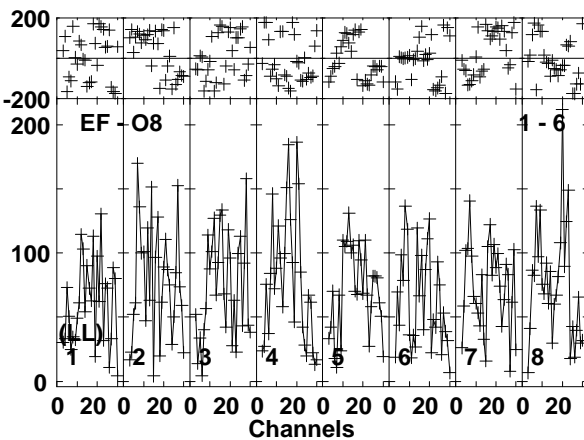
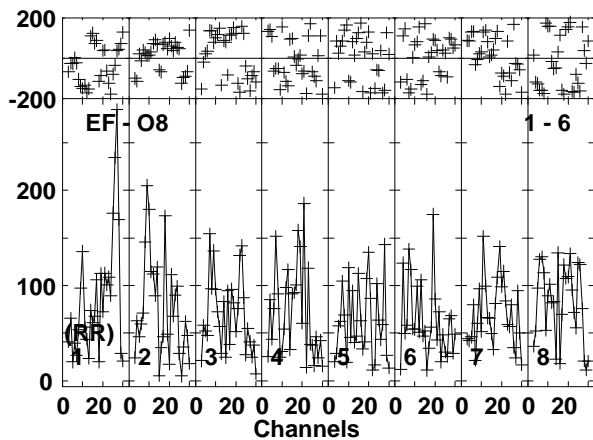
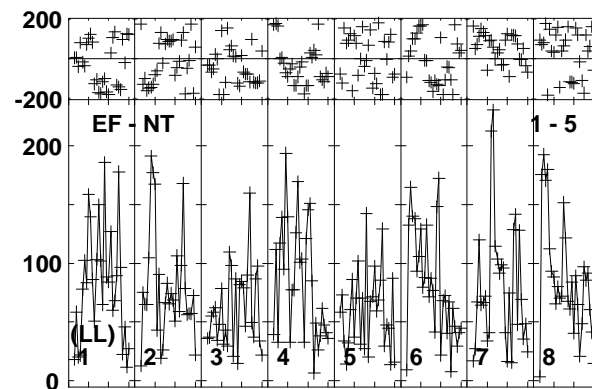
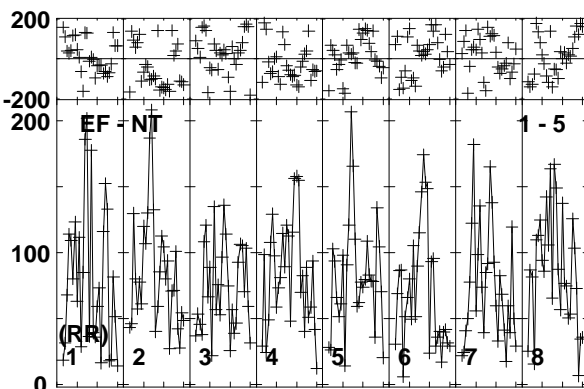
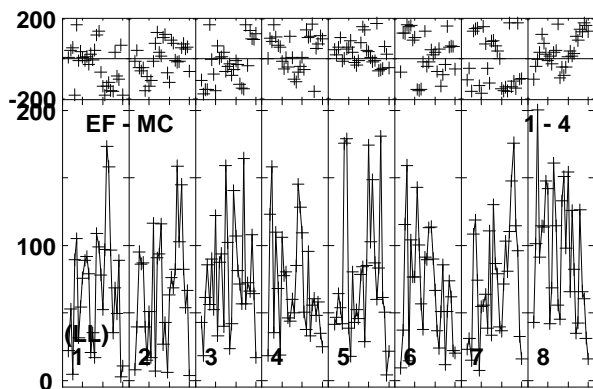
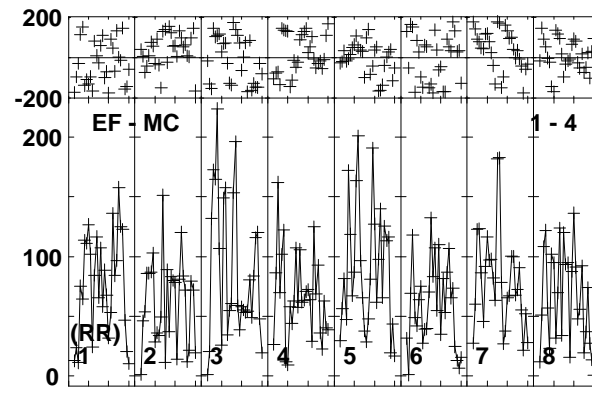
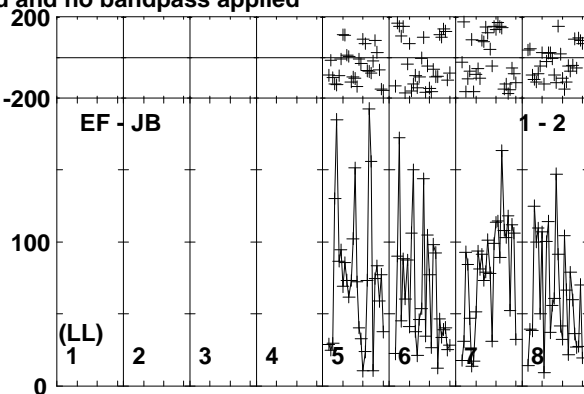
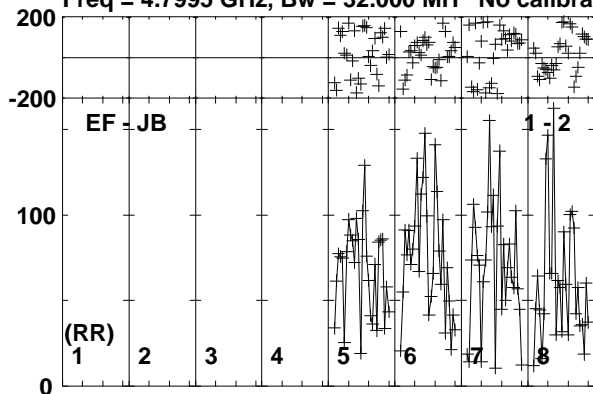

Lower frame: Micro Ampl Jy Top frame: Phas deg
Vector averaged cross-power spectrum Baseline: EF (01) - JB (02)
Timerange: 00/22:04:01 to 00/22:06:29

Plot file version 54 created 20-APR-2018 18:07:56

J1312-2350 RG009B.UVDATA.1

Freq = 4.7995 GHz, Bw = 32.000 MH No calibration applied and no bandpass applied

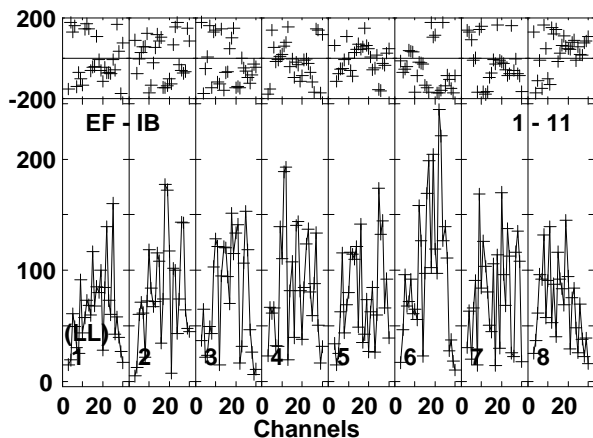
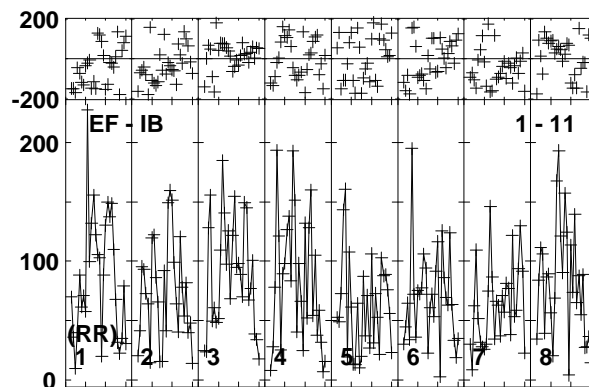
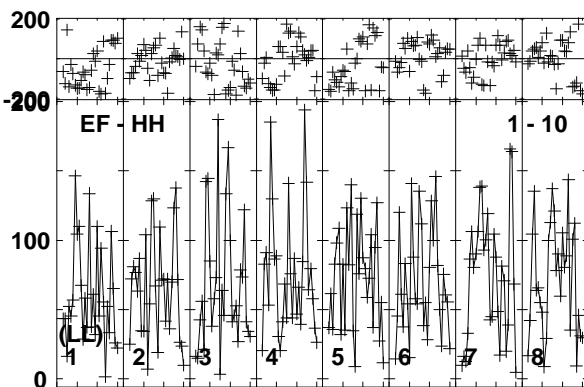
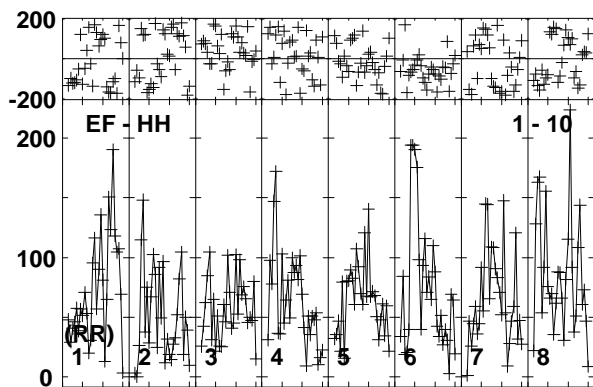
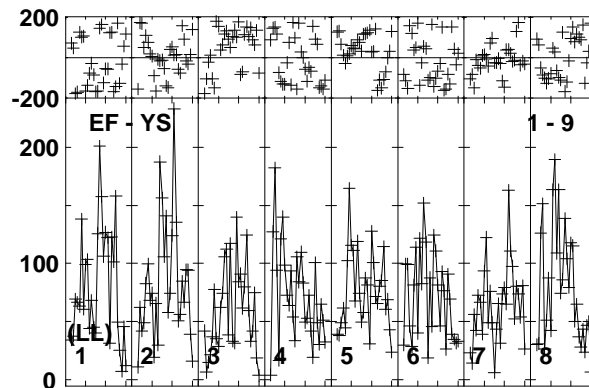
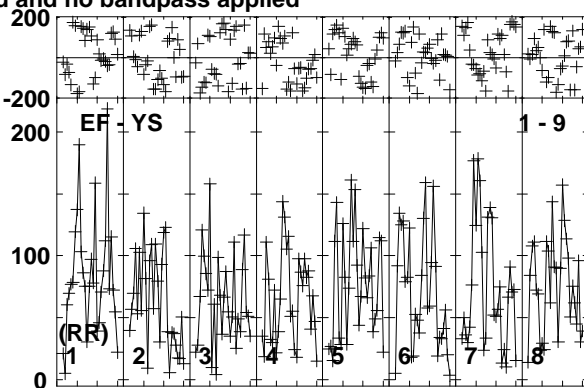
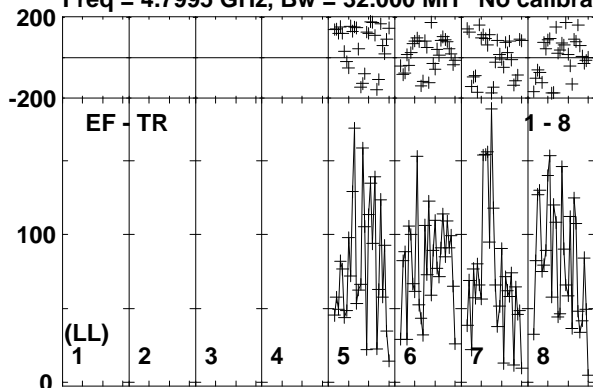

Lower frame: Micro Ampl Jy Top frame: Phas deg
Vector averaged cross-power spectrum Baseline: EF (01) - TR (08)
Timerange: 00/22:04:01 to 00/22:06:29

Plot file version 55 created 20-APR-2018 18:07:56

J1311-2329 RG009B.UVDATA.1

Freq = 4.7995 GHz, Bw = 32.000 MH No calibration applied and no bandpass applied

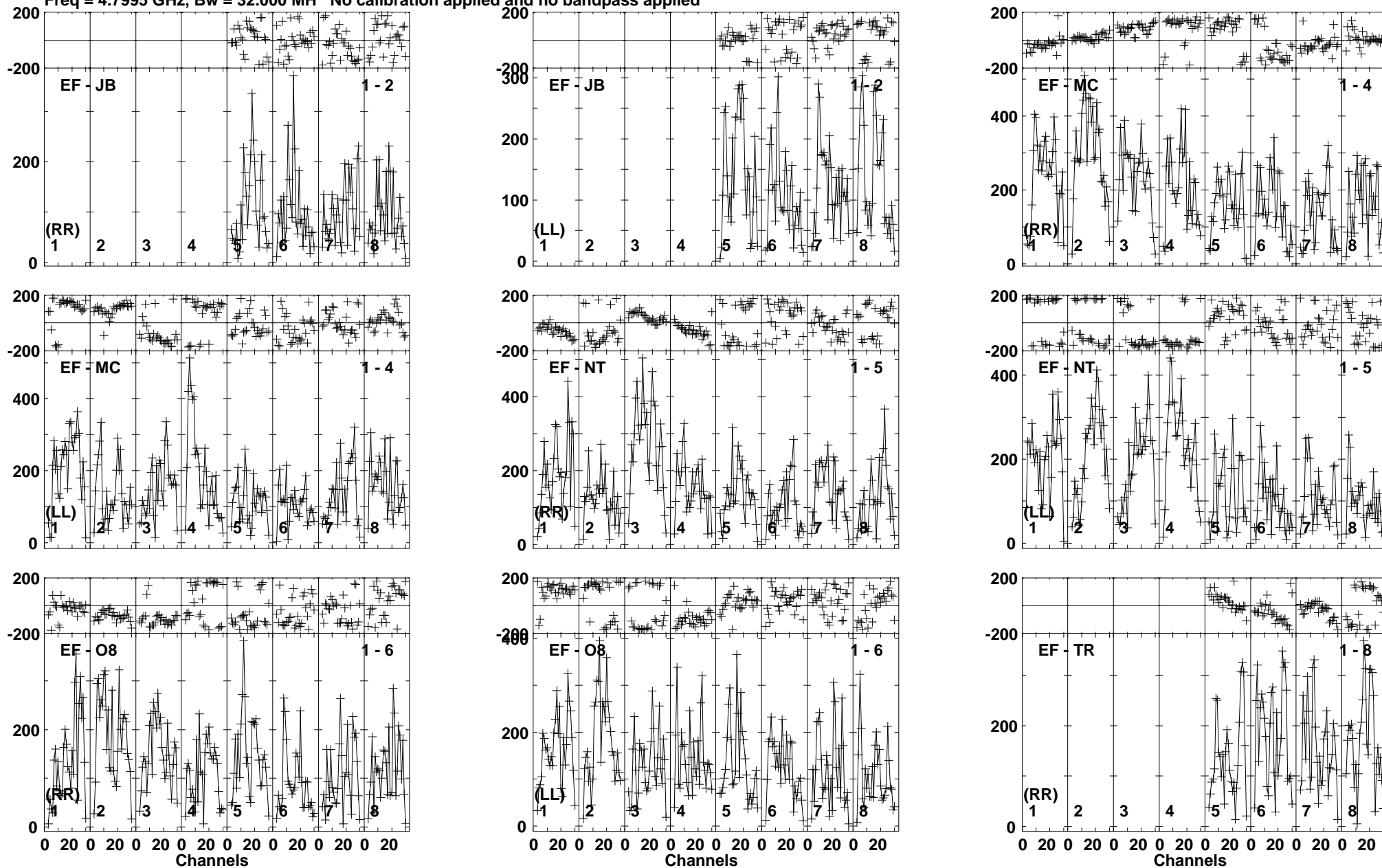

Lower frame: Micro Ampl Jy Top frame: Phas deg
Vector averaged cross-power spectrum Baseline: EF (01) - JB (02)
Timerange: 00/22:07:11 to 00/22:08:09

Plot file version 56 created 20-APR-2018 18:07:56

J1311-2329 RG009B.UVDATA.1

Freq = 4.7995 GHz, Bw = 32.000 MH No calibration applied and no bandpass applied

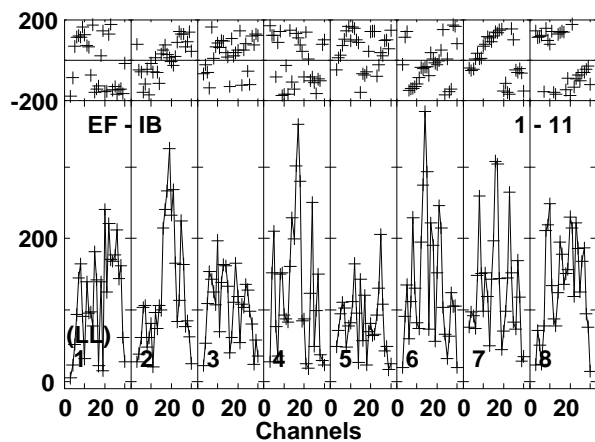
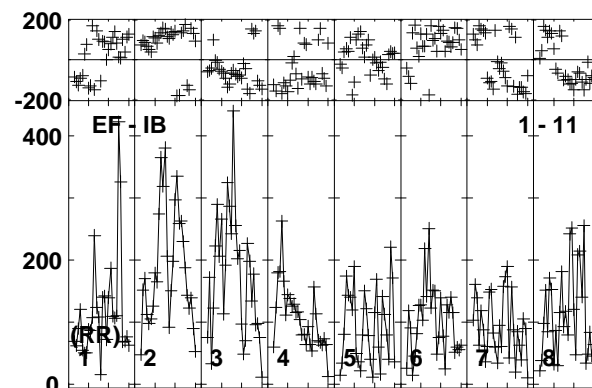
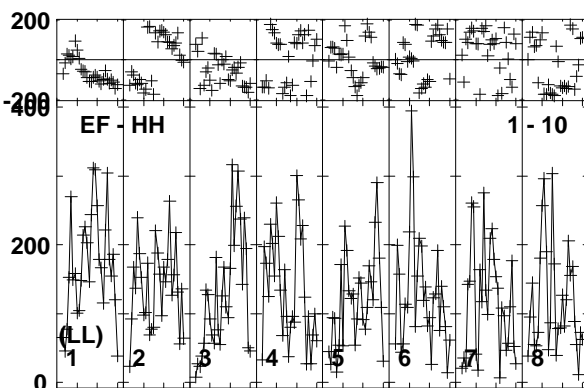
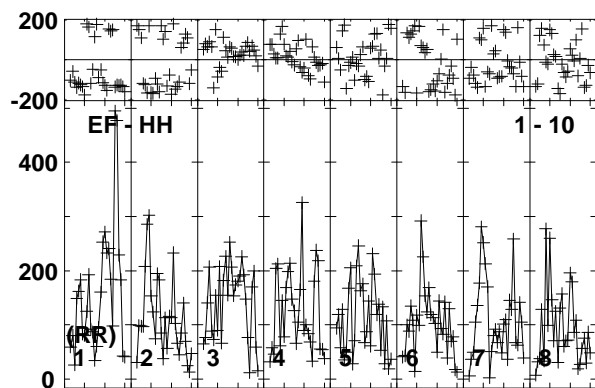
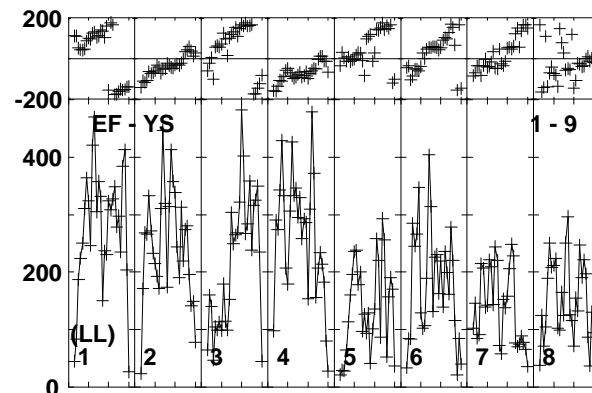
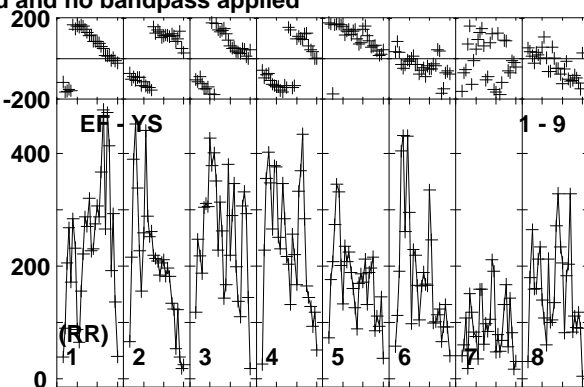
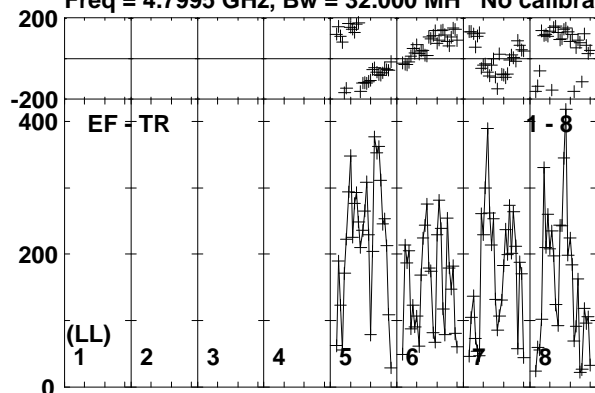

Lower frame: Micro Ampl Jy Top frame: Phas deg
Vector averaged cross-power spectrum Baseline: EF (01) - TR (08)
Timerange: 00/22:07:11 to 00/22:08:09

Plot file version 57 created 20-APR-2018 18:07:56

EM170817 RG009B.UVDATA.1

Freq = 4.7995 GHz, Bw = 32.000 MH No calibration applied and no bandpass applied

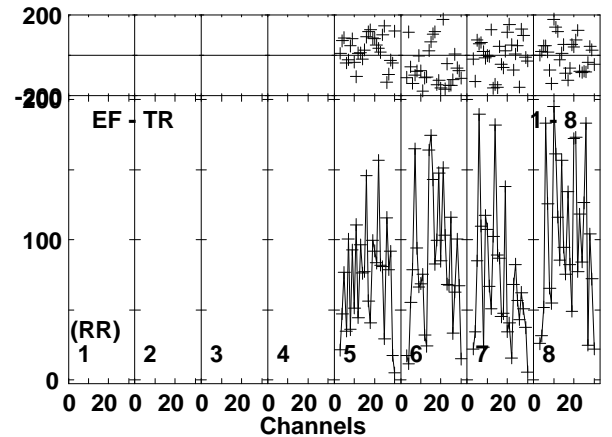
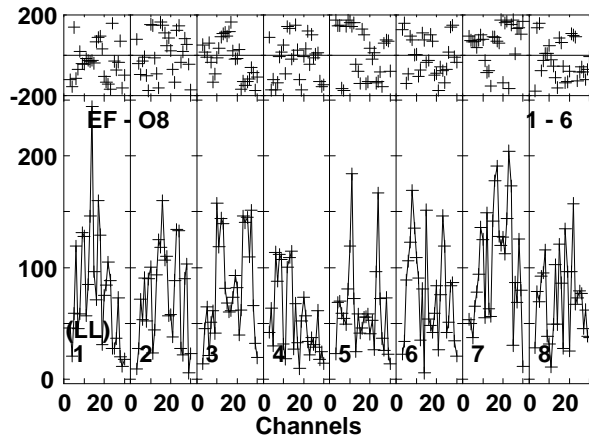
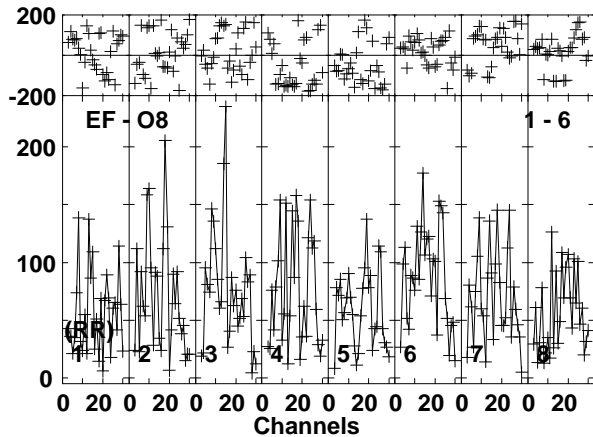
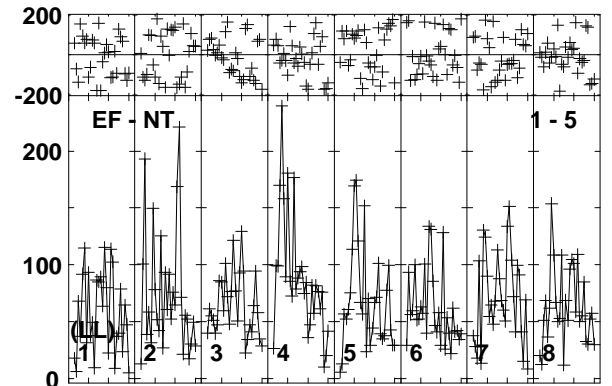
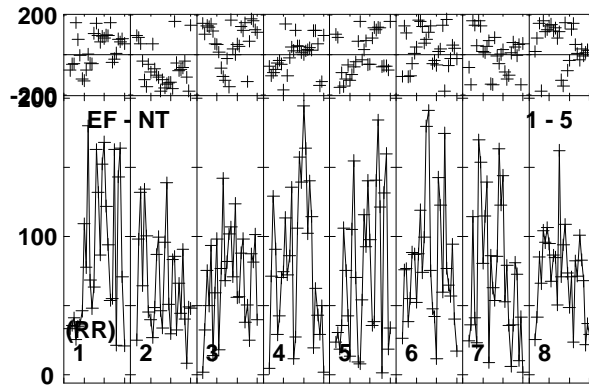
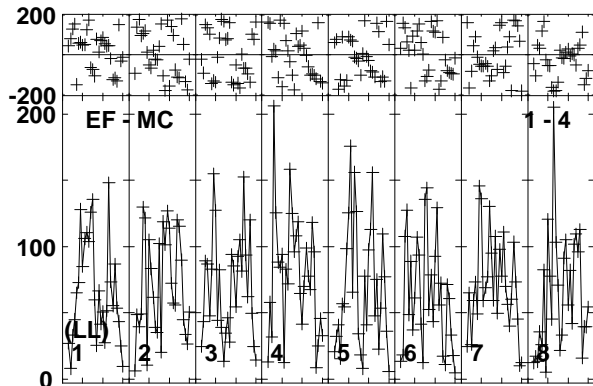
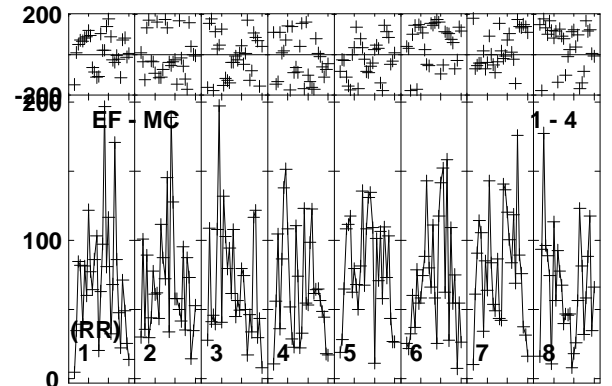
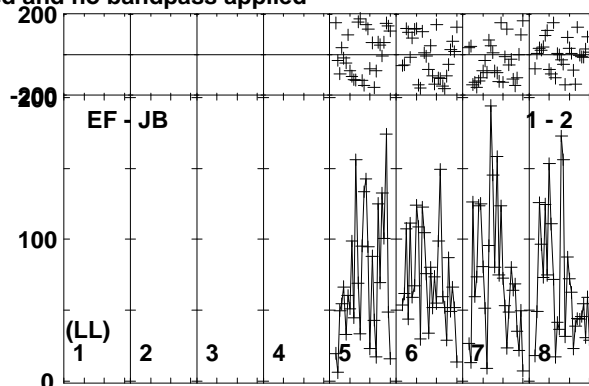
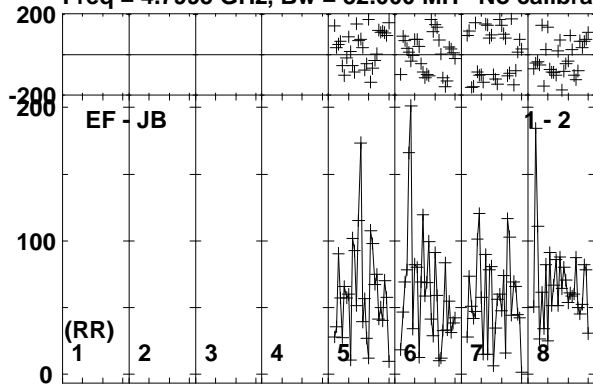

Lower frame: Micro Ampl Jy Top frame: Phas deg
Vector averaged cross-power spectrum Baseline: EF (01) - JB (02)
Timerange: 00:22:08:11 to 00:22:10:39

Plot file version 58 created 20-APR-2018 18:07:56

EM170817 RG009B.UVDATA.1

Freq = 4.7995 GHz, Bw = 32.000 MH No calibration applied and no bandpass applied

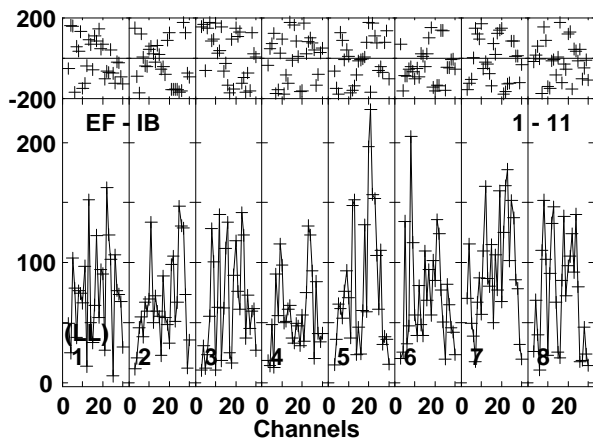
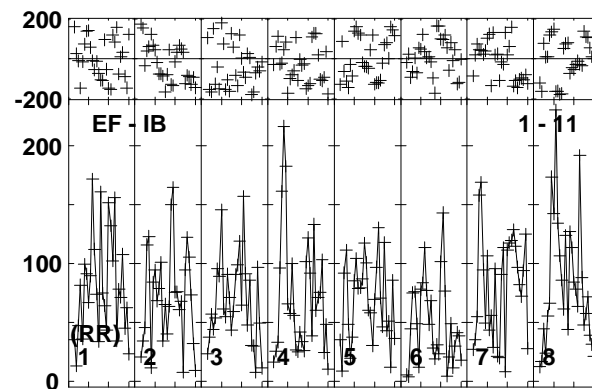
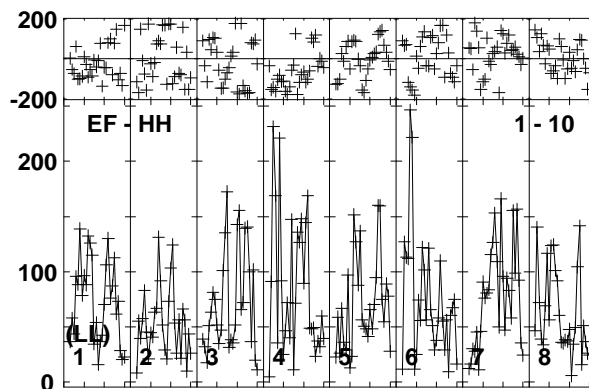
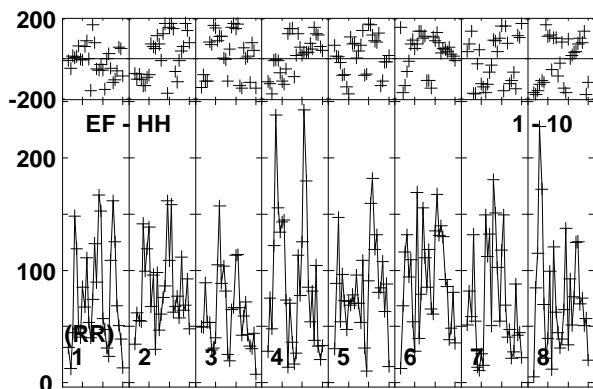
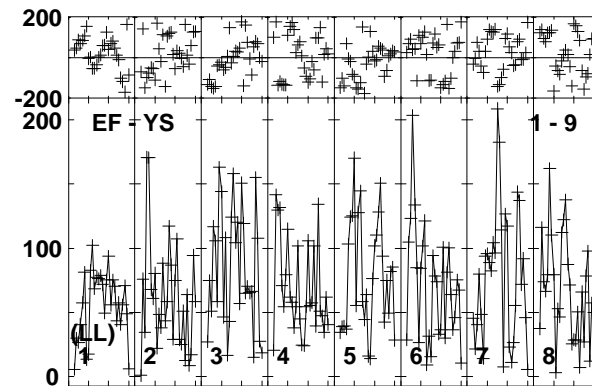
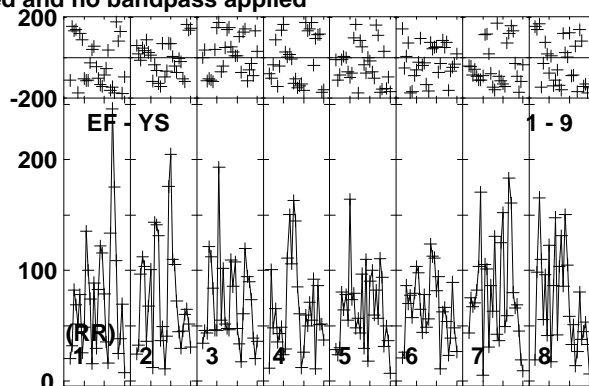
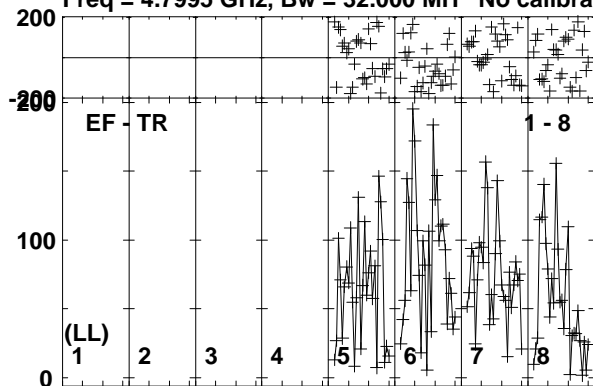

Lower frame: Micro Ampl Jy Top frame: Phas deg
Vector averaged cross-power spectrum Baseline: EF (01) - TR (08)
Timerange: 00/22:08:11 to 00/22:10:39

Plot file version 59 created 20-APR-2018 18:07:56

J1311-2329 RG009B.UVDATA.1

Freq = 4.7995 GHz, Bw = 32.000 MH No calibration applied and no bandpass applied

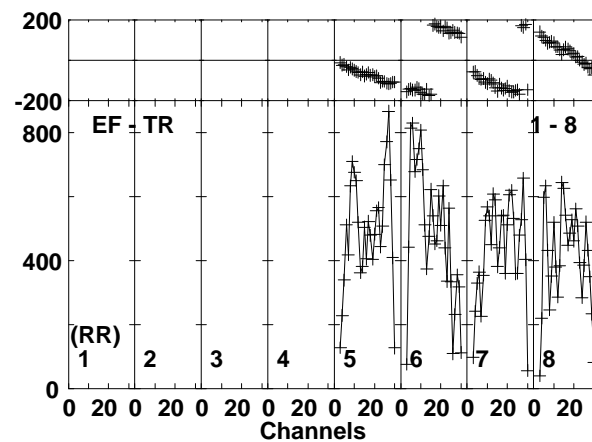
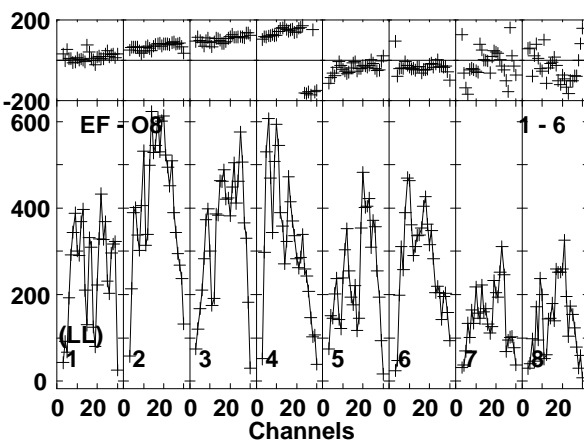
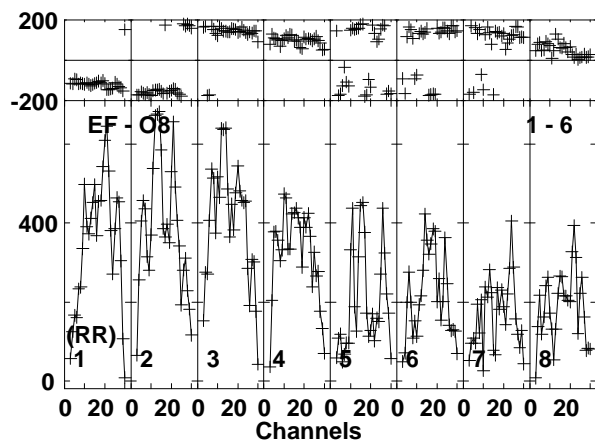
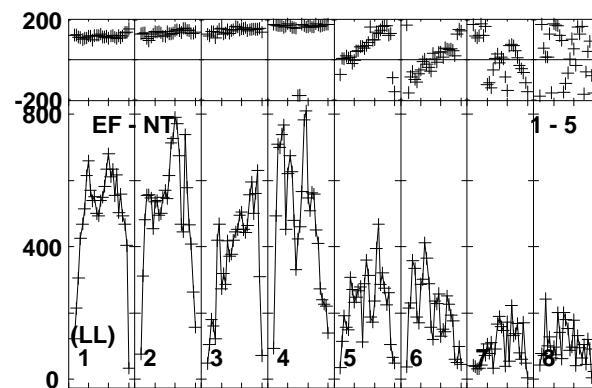
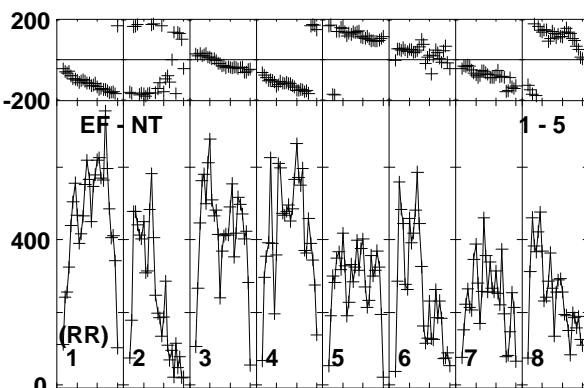
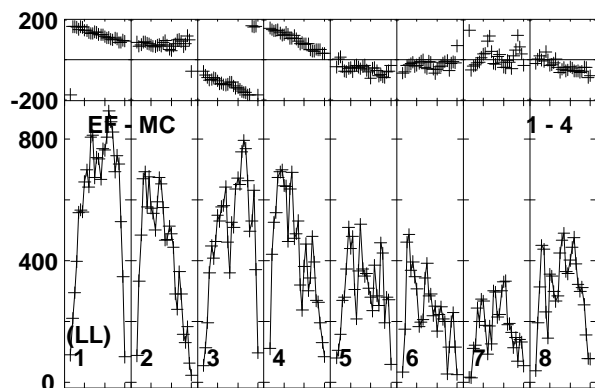
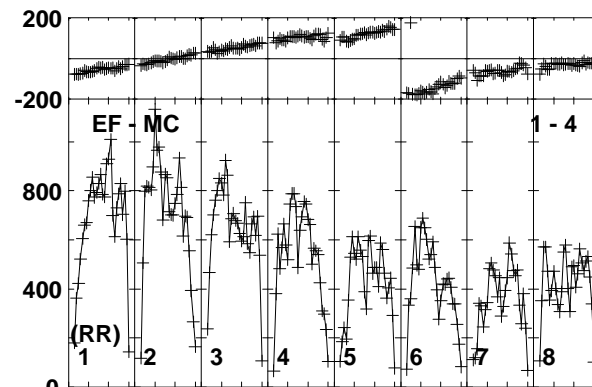
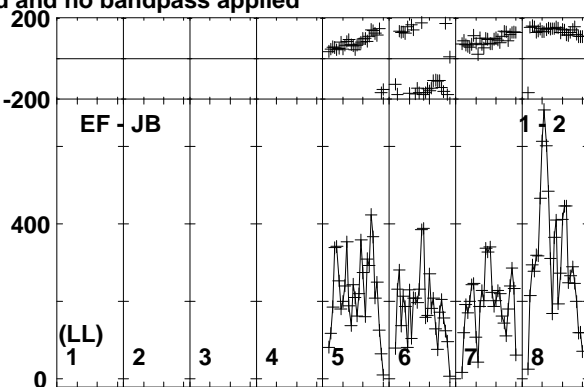
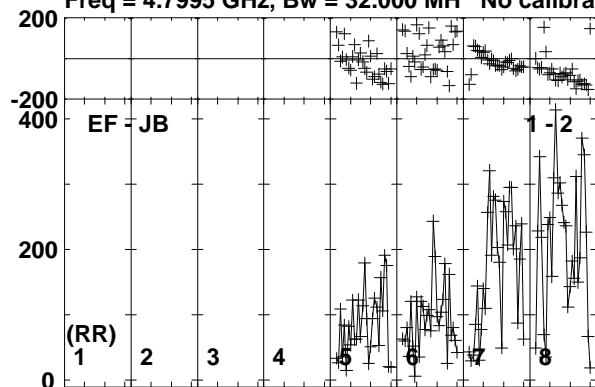

Lower frame: Micro Ampl Jy Top frame: Phas deg
Vector averaged cross-power spectrum Baseline: EF (01) - JB (02)
Timerange: 00:22:10:41 to 00:22:12:09

Plot file version 60 created 20-APR-2018 18:07:56

J1311-2329 RG009B.UVDATA.1

Freq = 4.7995 GHz, Bw = 32.000 MH No calibration applied and no bandpass applied

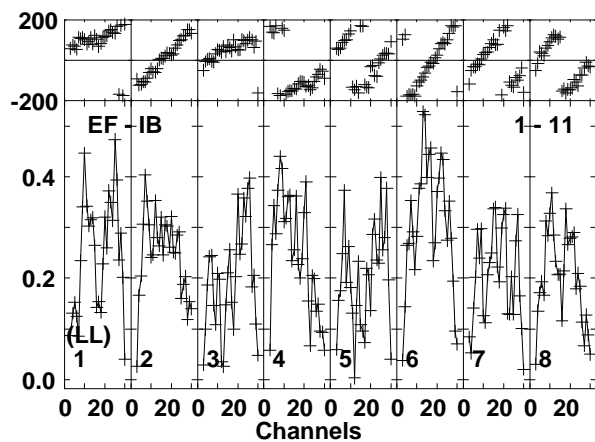
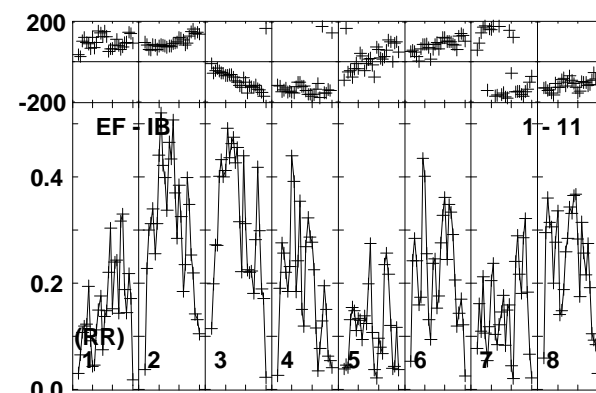
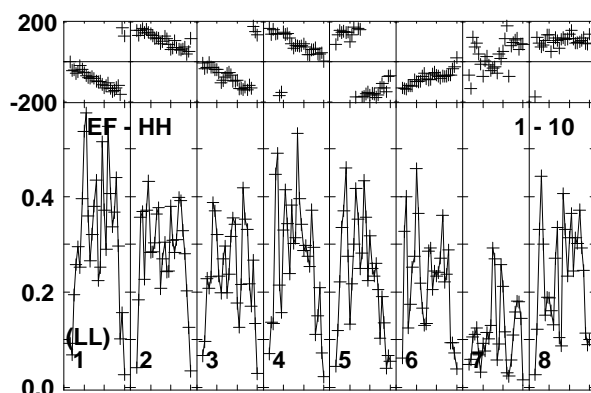
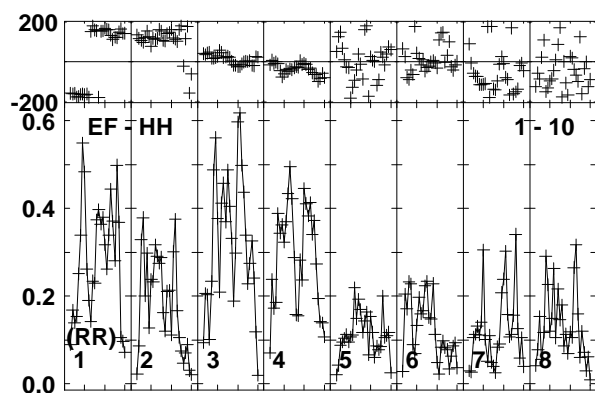
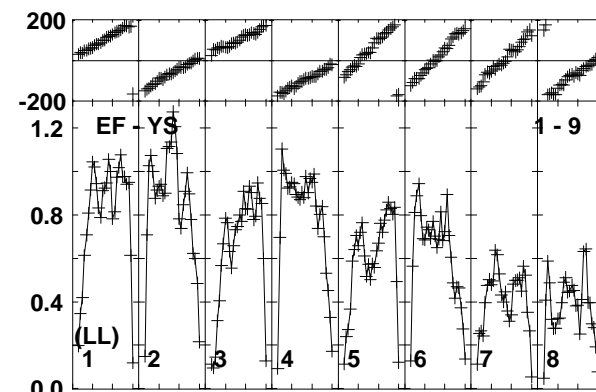
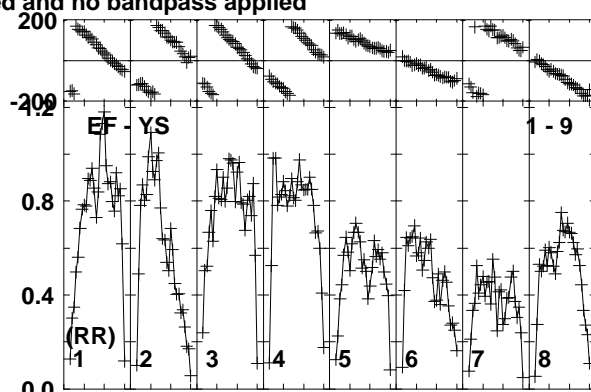
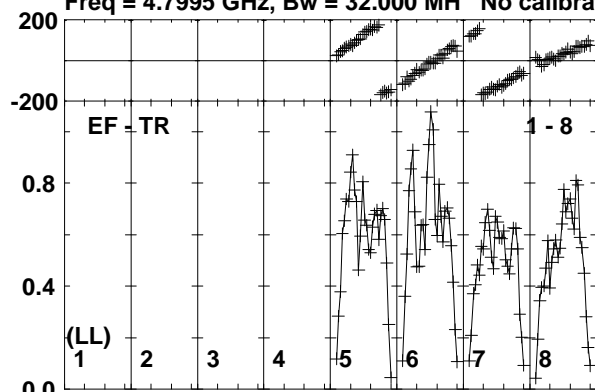

Lower frame: Milli Ampl Jy Top frame: Phas deg
Vector averaged cross-power spectrum Baseline: EF (01) - TR (08)
Timerange: 00:22:10:41 to 00:22:12:09

Plot file version 61 created 20-APR-2018 18:07:56

EM170817 RG009B.UVDATA.1

Freq = 4.7995 GHz, Bw = 32.000 MH No calibration applied and no bandpass applied

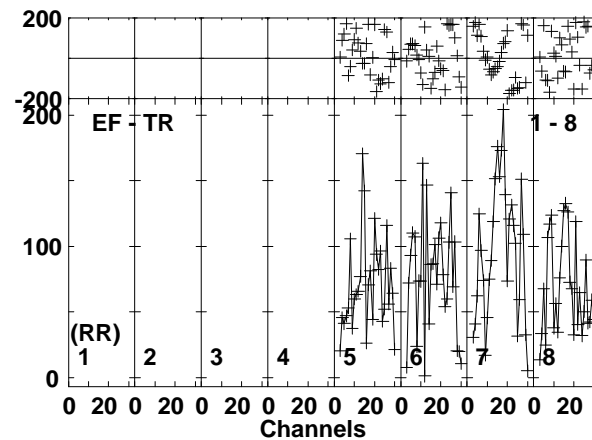
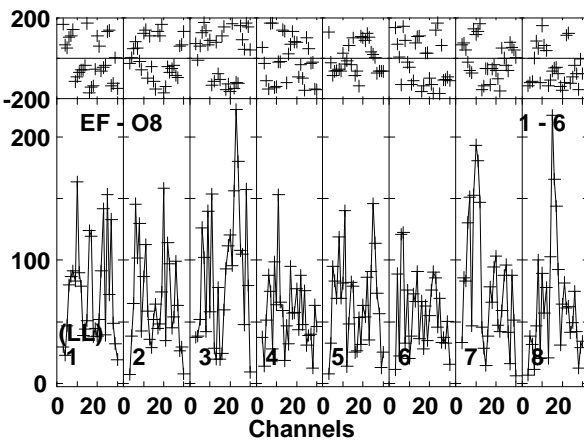
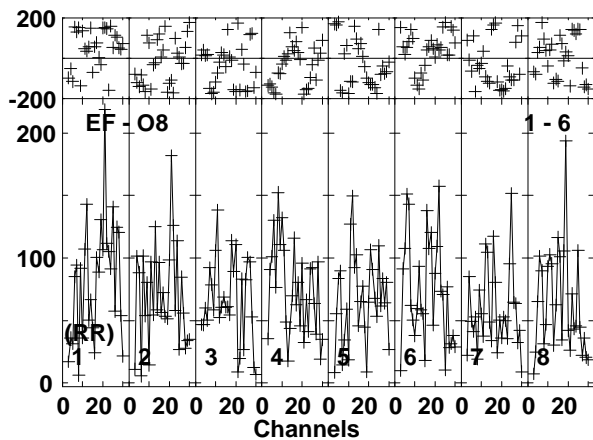
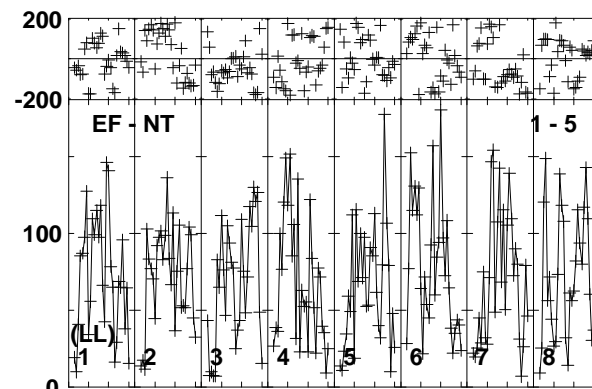
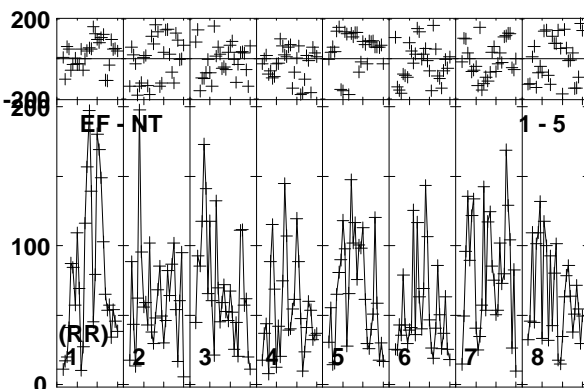
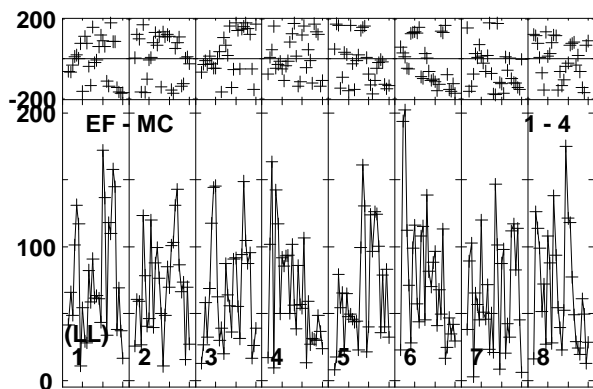
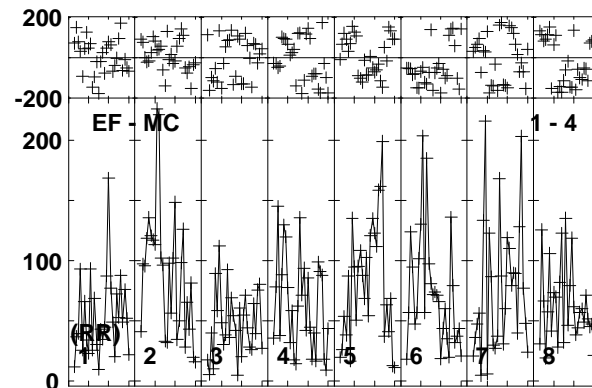
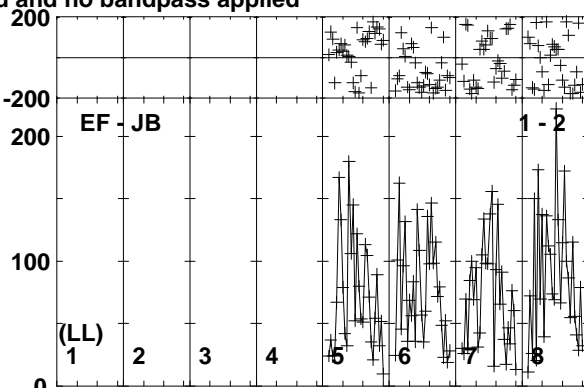
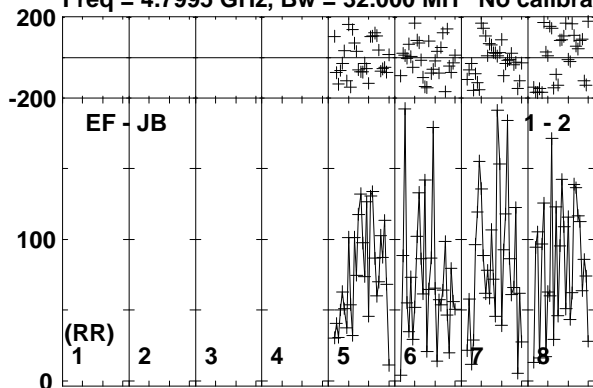

Lower frame: Micro Ampl Jy Top frame: Phas deg
Vector averaged cross-power spectrum Baseline: EF (01) - JB (02)
Timerange: 00/22:12:11 to 00/22:14:39

Plot file version 62 created 20-APR-2018 18:07:56

EM170817 RG009B.UVDATA.1

Freq = 4.7995 GHz, Bw = 32.000 MH No calibration applied and no bandpass applied

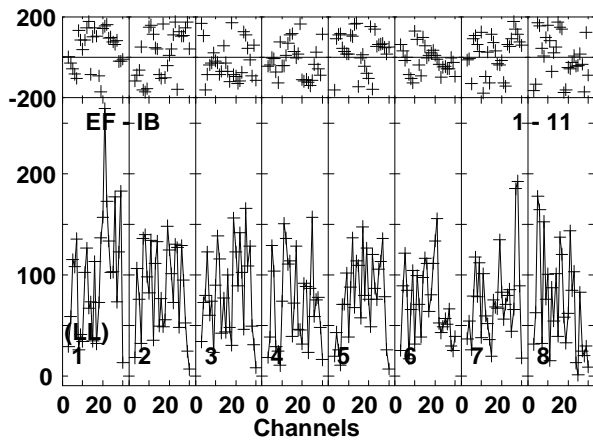
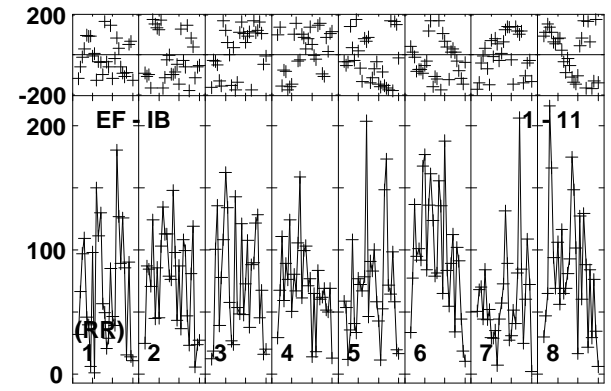
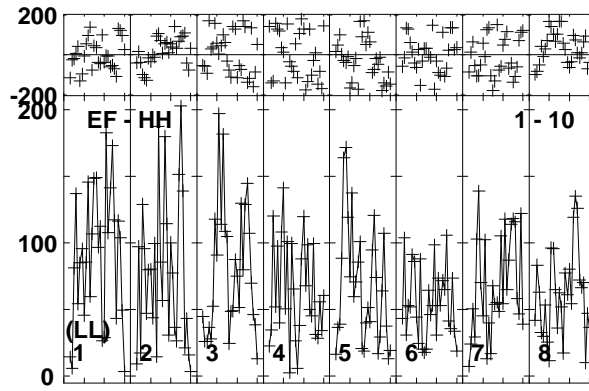
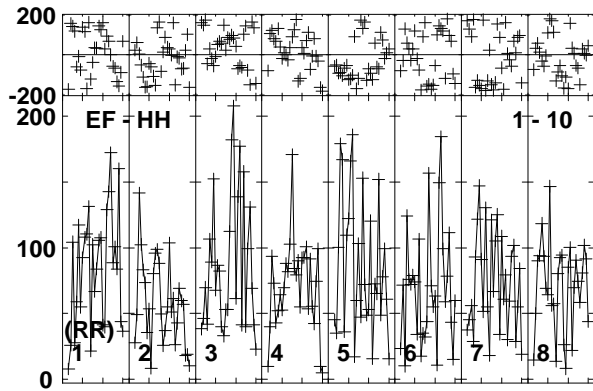
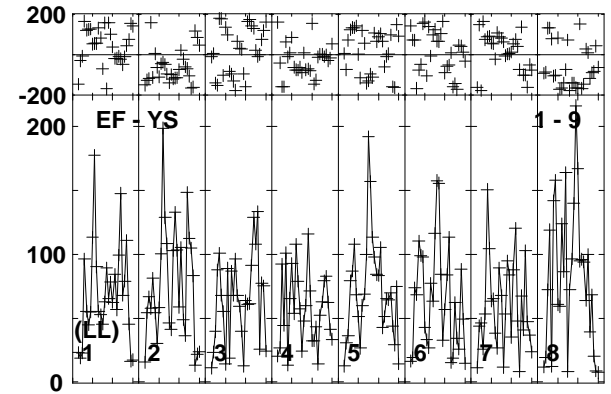
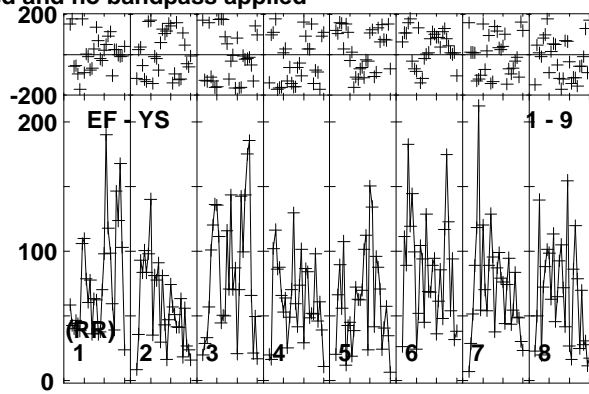
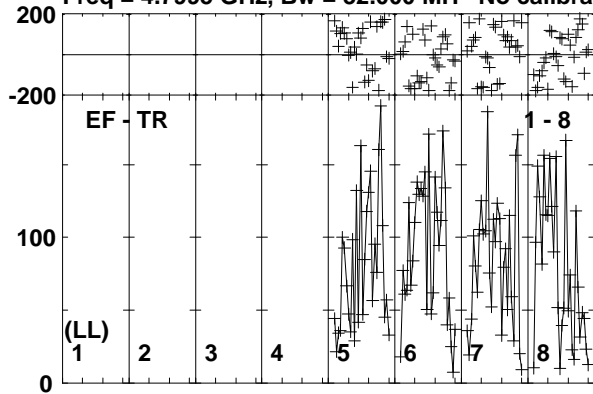

Lower frame: Micro Ampl Jy Top frame: Phas deg
Vector averaged cross-power spectrum Baseline: EF (01) - TR (08)
Timerange: 00:22:12:11 to 00:22:14:39

Plot file version 63 created 20-APR-2018 18:07:56

J1311-2329 RG009B.UVDATA.1

Freq = 4.7995 GHz, Bw = 32.000 MH No calibration applied and no bandpass applied

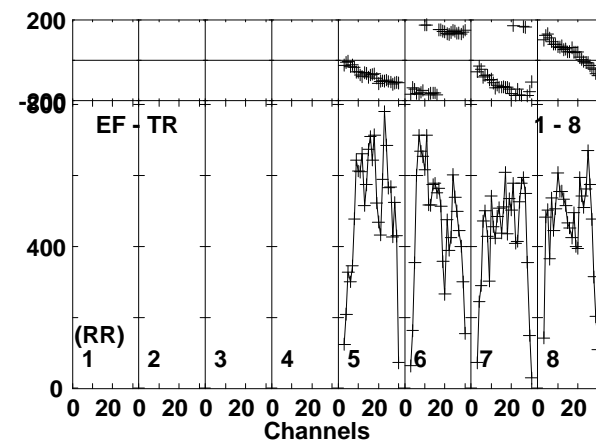
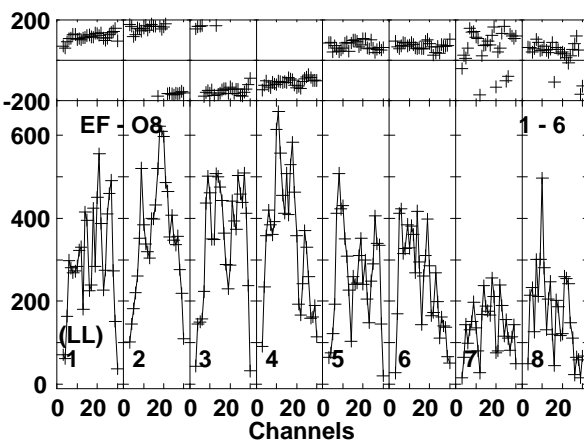
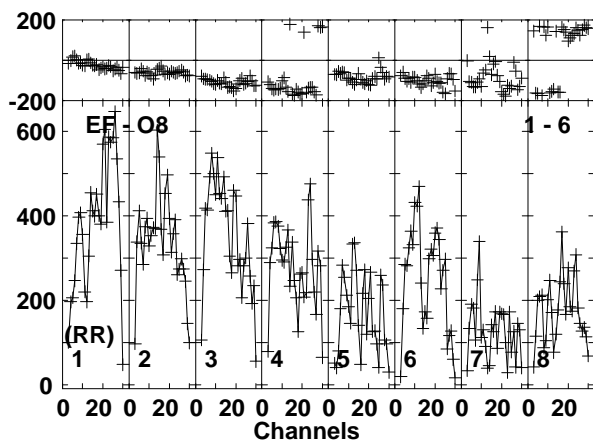
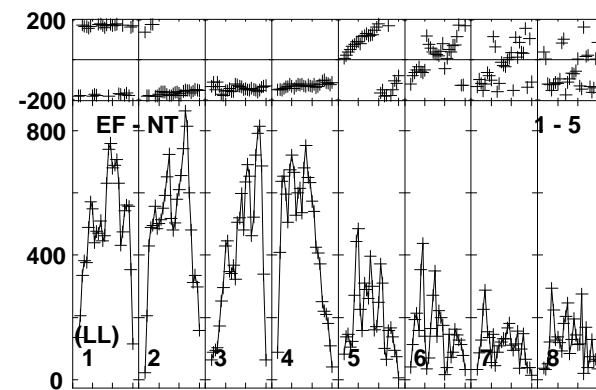
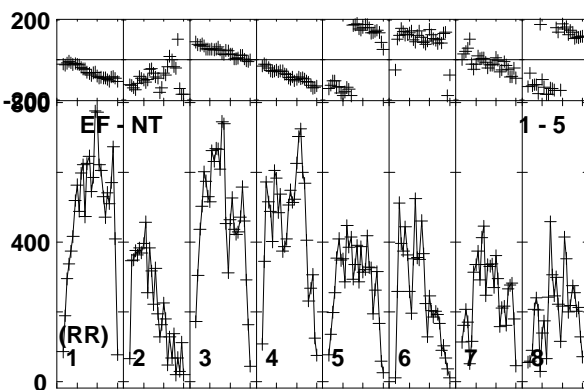
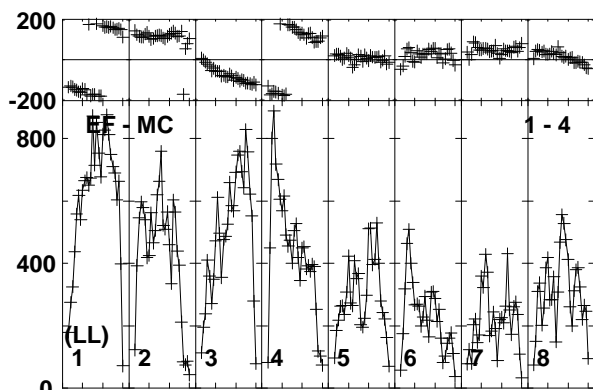
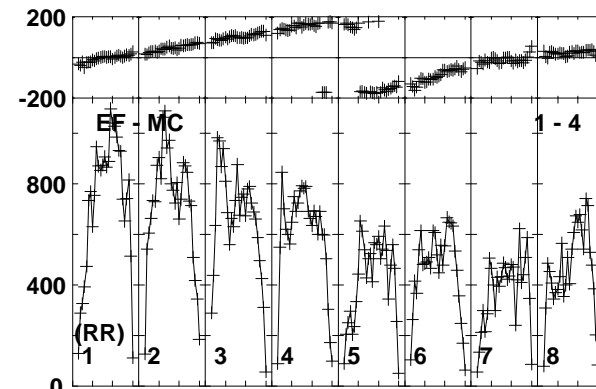
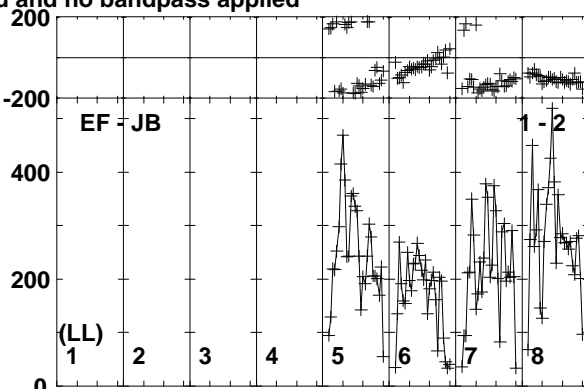
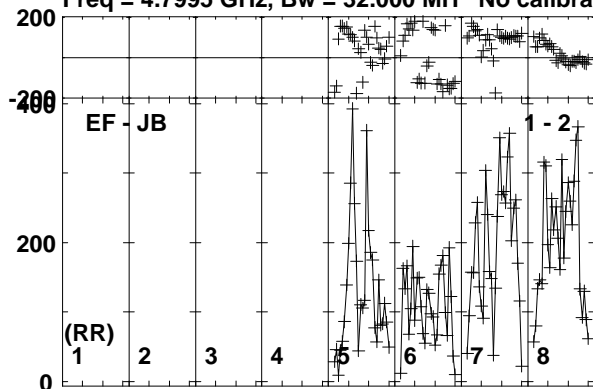

Lower frame: Micro Ampl Jy Top frame: Phas deg
Vector averaged cross-power spectrum Baseline: EF (01) - JB (02)
Timerange: 00:22:15:11 to 00:22:16:09

Plot file version 64 created 20-APR-2018 18:07:56

J1311-2329 RG009B.UVDATA.1

Freq = 4.7995 GHz, Bw = 32.000 MH No calibration applied and no bandpass applied

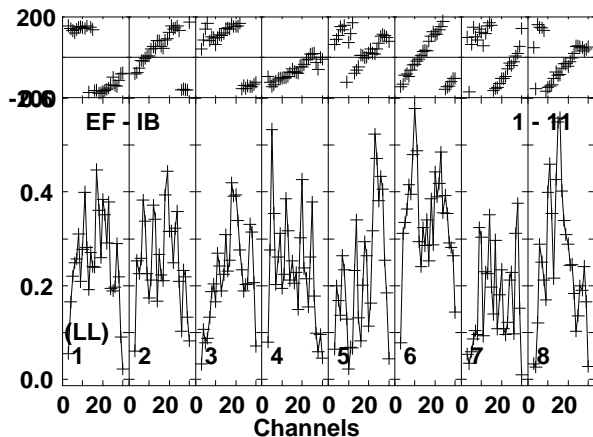
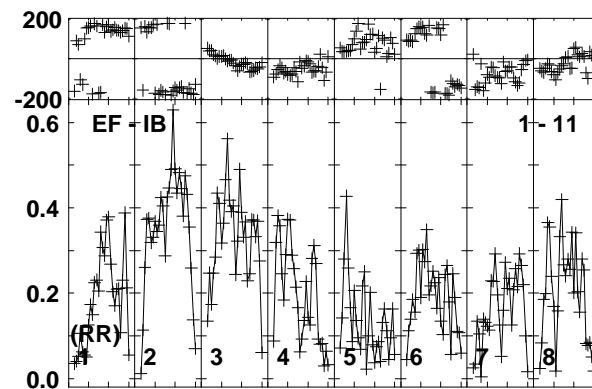
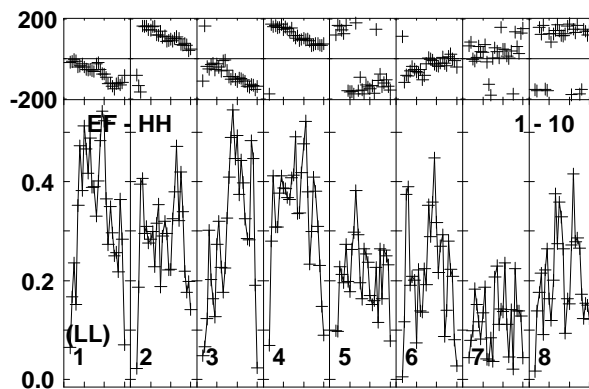
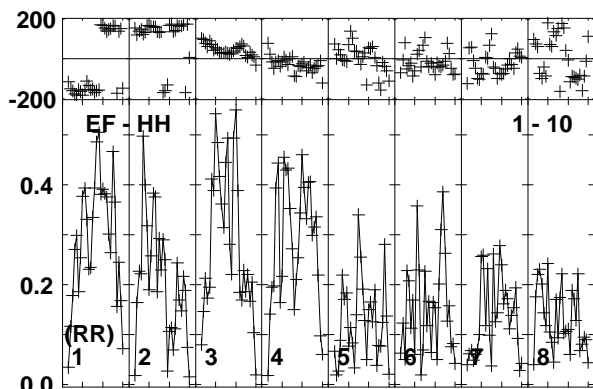
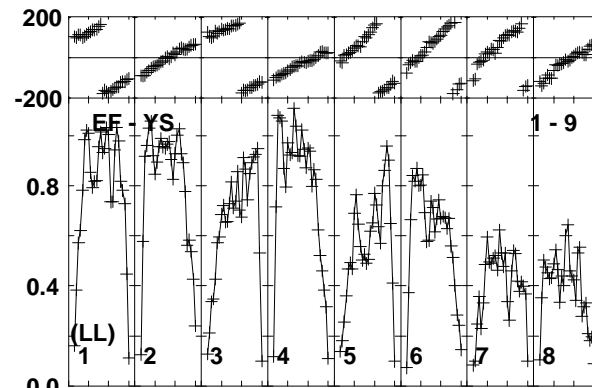
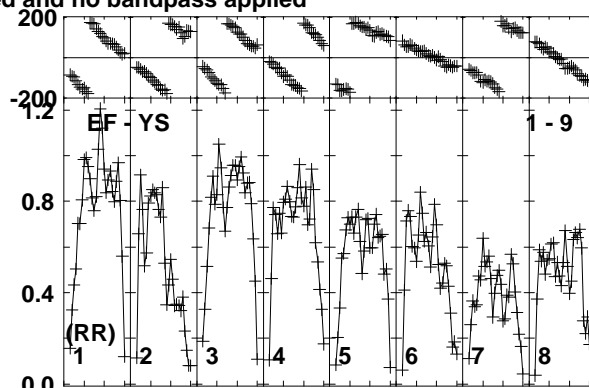
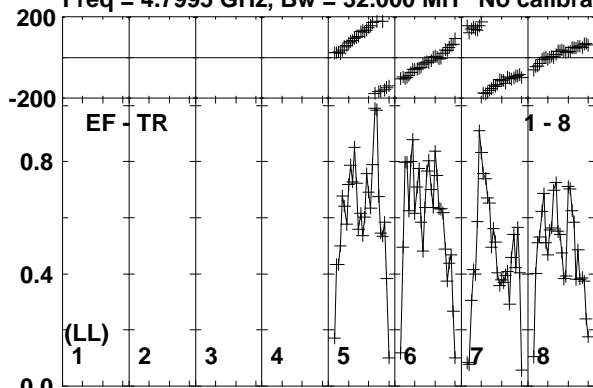

0 20 0 20 0 20 0 20 0 20 0 20 0 20 0 20 0 20
Channels
Lower frame: Milli Ampl Jy Top frame: Phas deg
Vector averaged cross-power spectrum Baseline: EF (01) - TR (08)
Timerange: 00/22:15:11 to 00/22:16:09

Plot file version 65 created 20-APR-2018 18:07:56

EM170817 RG009B.UVDATA.1

Freq = 4.7995 GHz, Bw = 32.000 MH No calibration applied and no bandpass applied

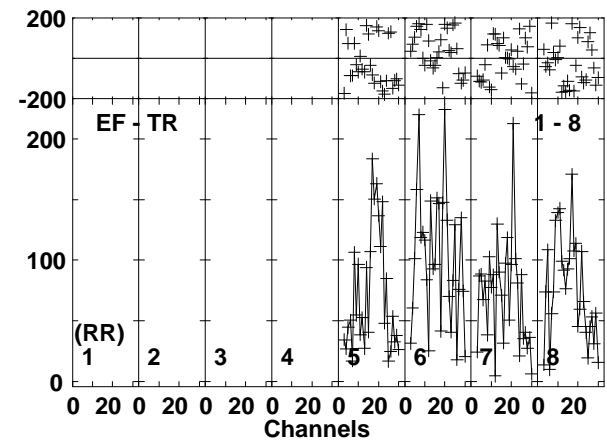
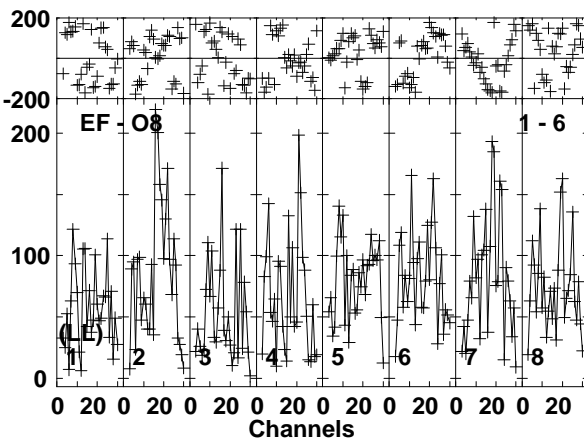
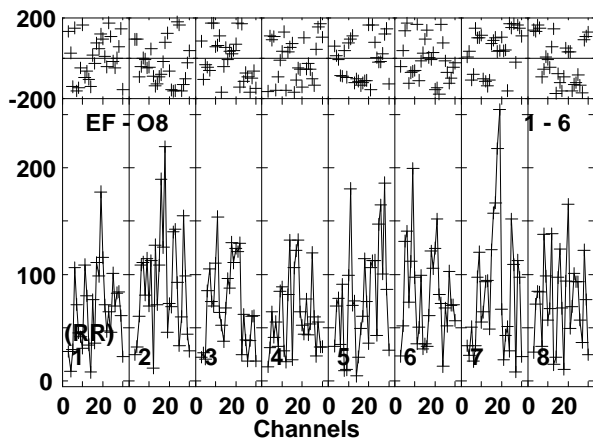
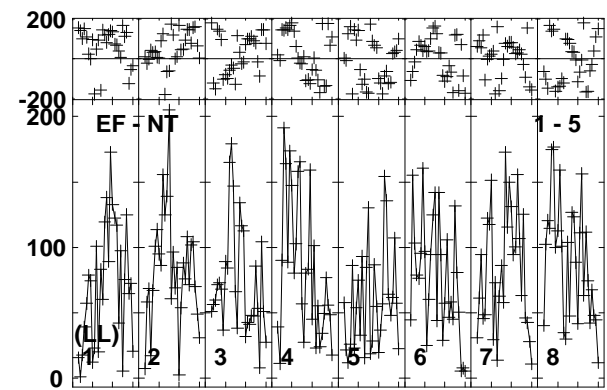
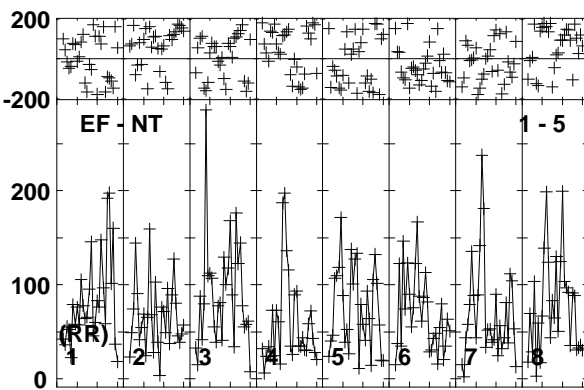
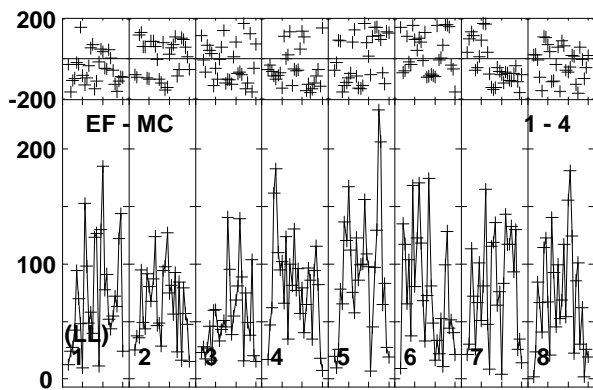
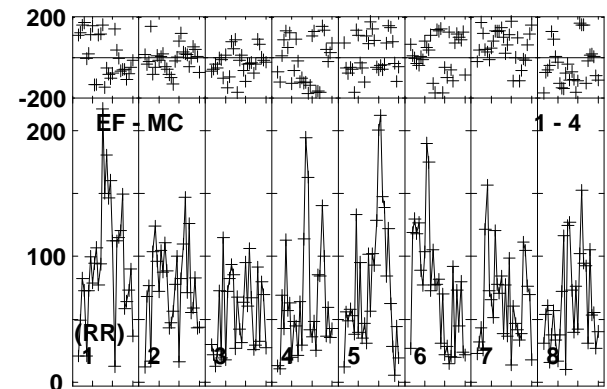
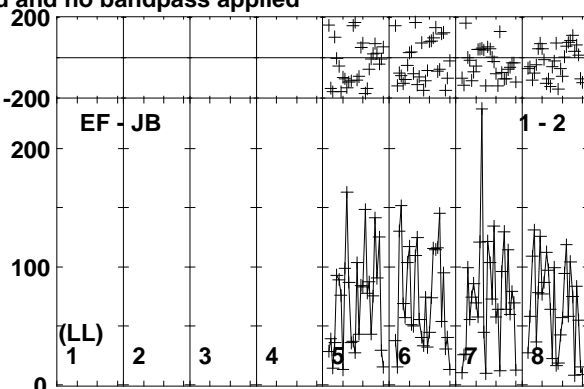
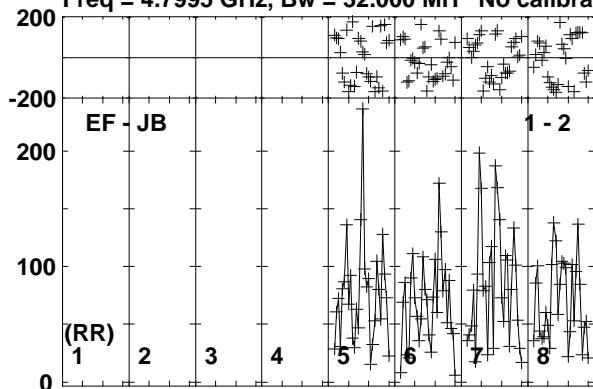

Lower frame: Micro Ampl Jy Top frame: Phas deg
Vector averaged cross-power spectrum Baseline: EF (01) - JB (02)
Timerange: 00/22:16:11 to 00/22:18:39

Plot file version 66 created 20-APR-2018 18:07:57

EM170817 RG009B.UVDATA.1

Freq = 4.7995 GHz, Bw = 32.000 MH No calibration applied and no bandpass applied

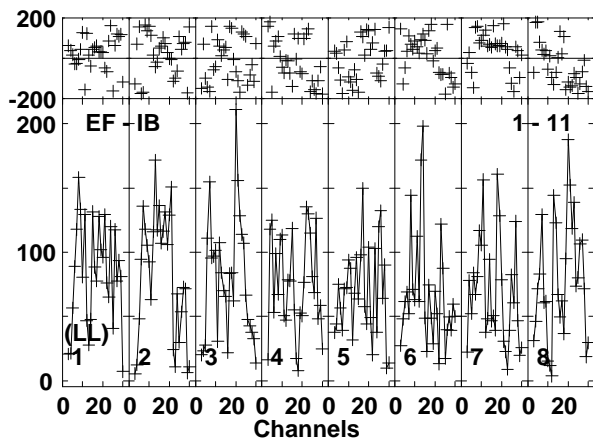
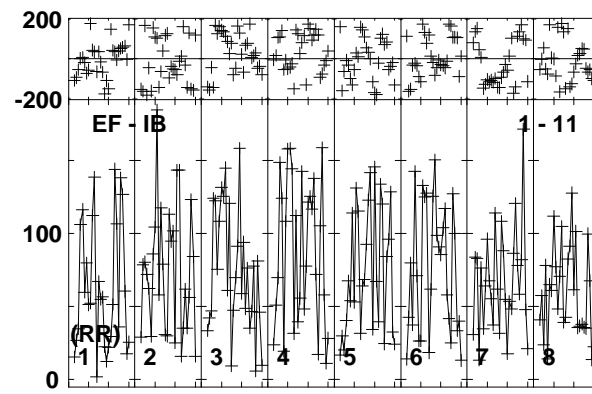
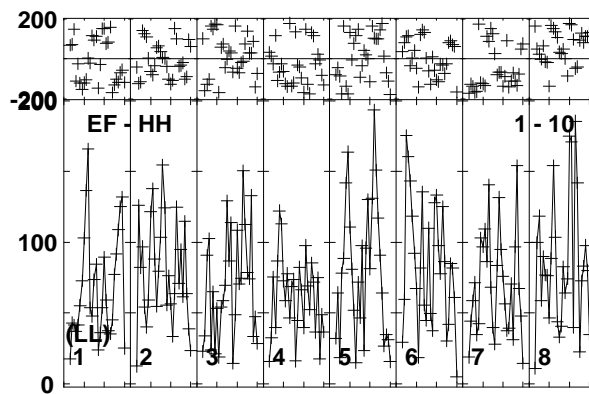
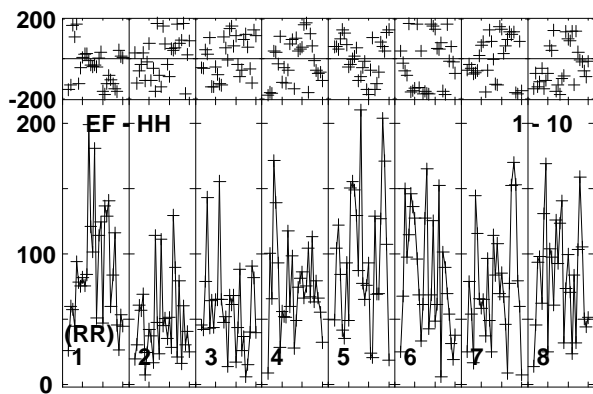
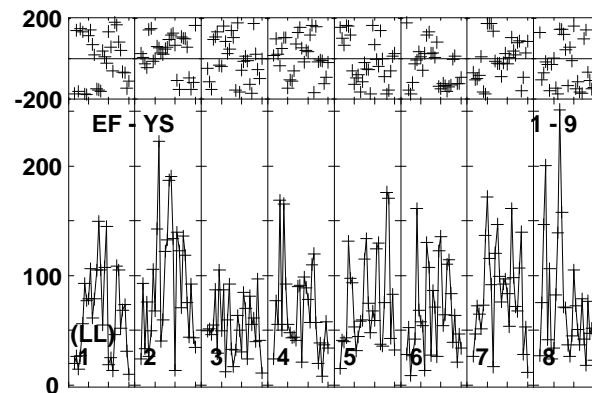
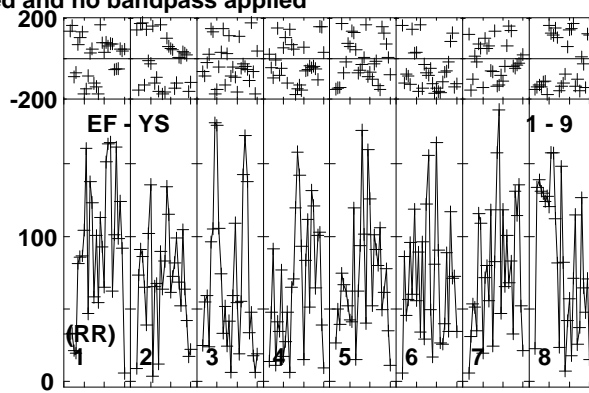
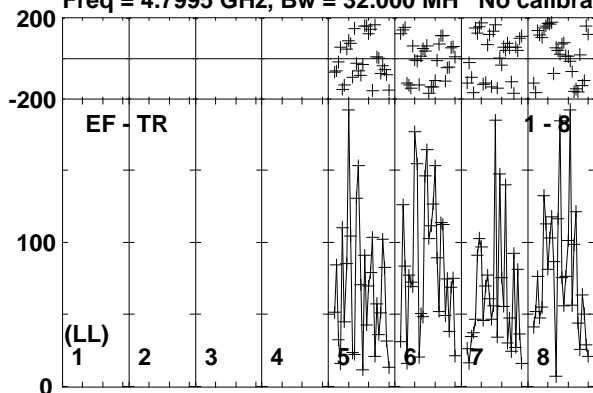

Lower frame: Micro Ampl Jy Top frame: Phas deg
Vector averaged cross-power spectrum Baseline: EF (01) - TR (08)
Timerange: 00/22:16:11 to 00/22:18:39

Plot file version 67 created 20-APR-2018 18:07:57

J1311-2329 RG009B.UVDATA.1

Freq = 4.7995 GHz, Bw = 32.000 MH No calibration applied and no bandpass applied

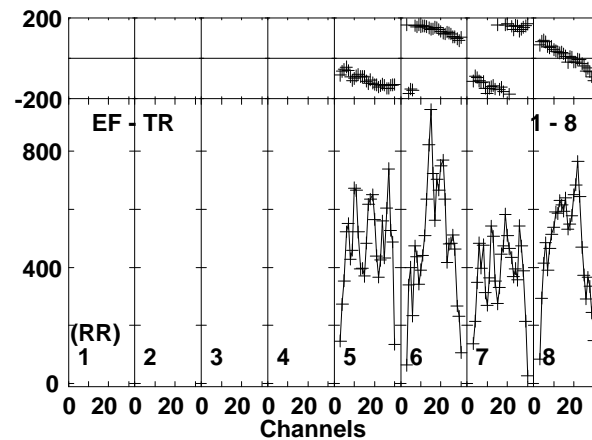
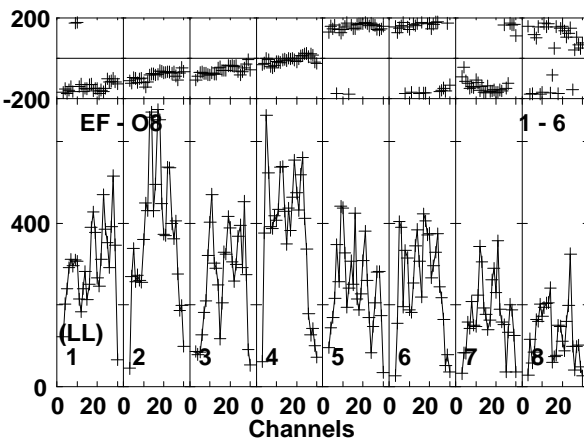
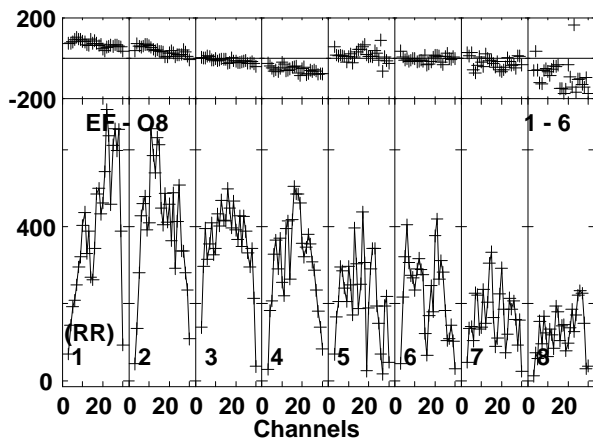
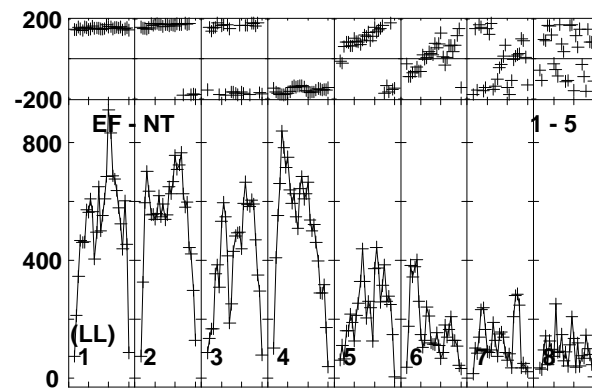
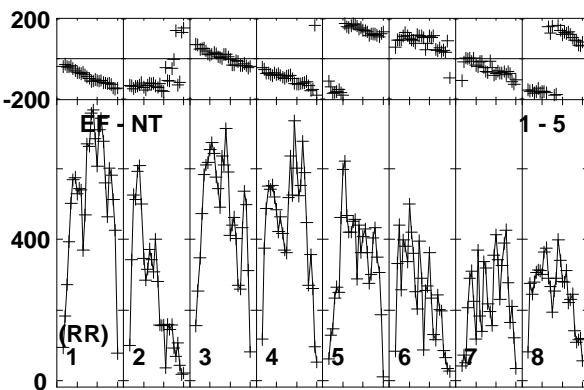
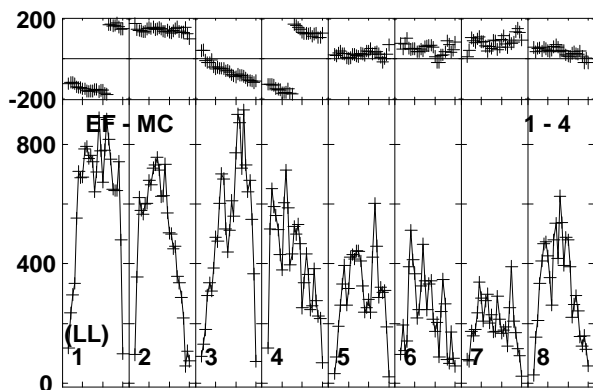
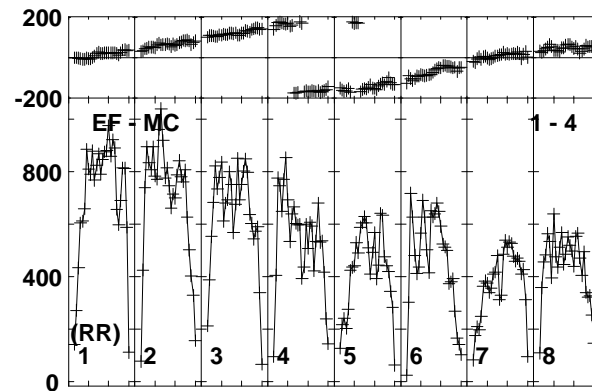
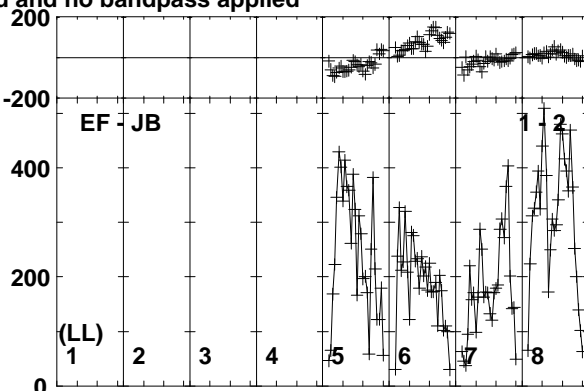
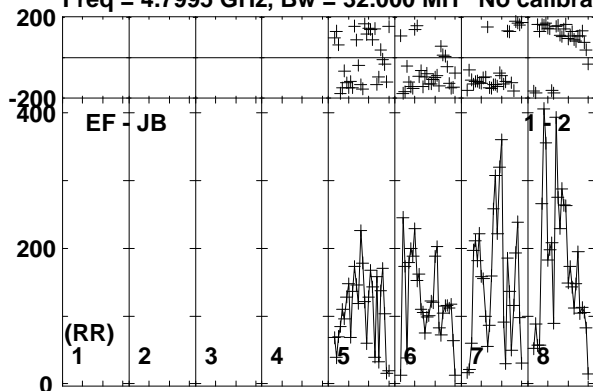

Lower frame: Micro Ampl Jy Top frame: Phas deg
Vector averaged cross-power spectrum Baseline: EF (01) - JB (02)
Timerange: 00/22:18:41 to 00/22:20:09

Plot file version 68 created 20-APR-2018 18:07:57

J1311-2329 RG009B.UVDATA.1

Freq = 4.7995 GHz, Bw = 32.000 MH No calibration applied and no bandpass applied

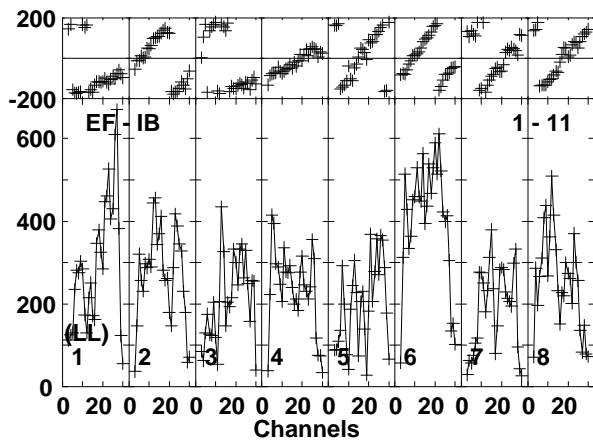
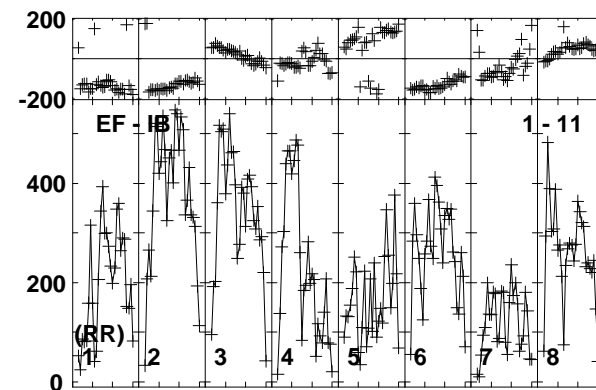
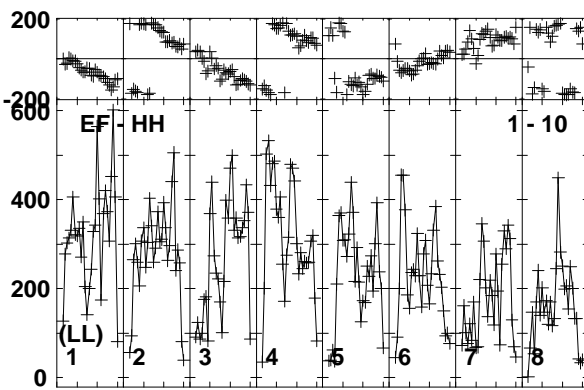
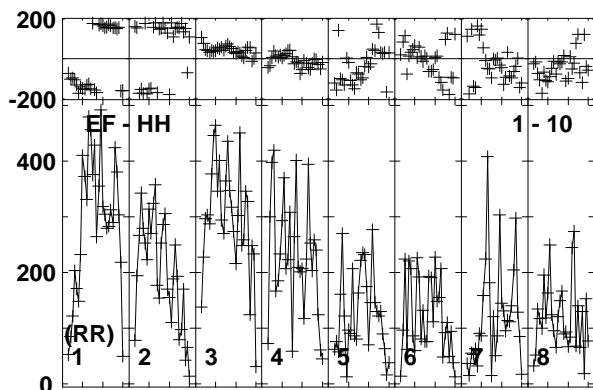
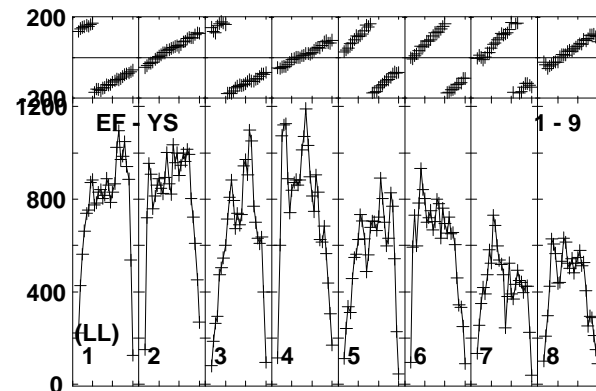
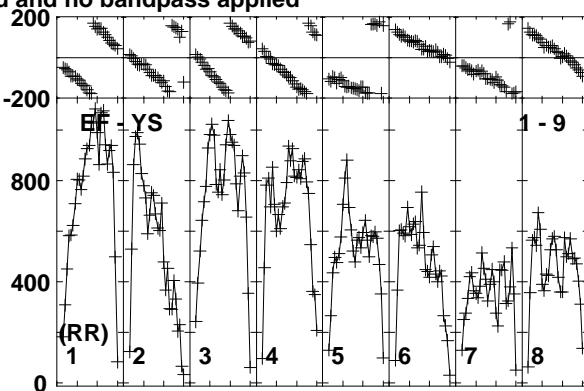
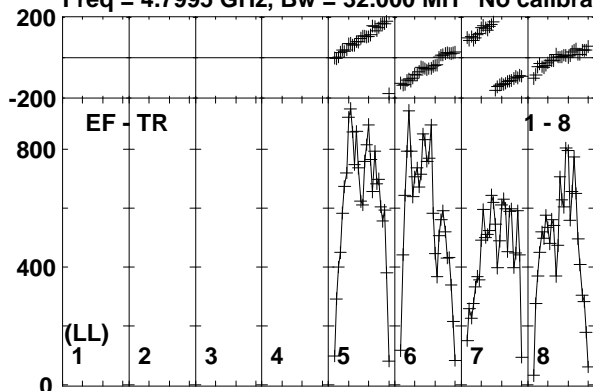

Lower frame: Micro Ampl Jy Top frame: Phas deg
Vector averaged cross-power spectrum Baseline: EF (01) - TR (08)
Timerange: 00/22:18:41 to 00/22:20:09

Plot file version 69 created 20-APR-2018 18:07:57

J1312-2350 RG009B.UVDATA.1

Freq = 4.7995 GHz, Bw = 32.000 MH No calibration applied and no bandpass applied

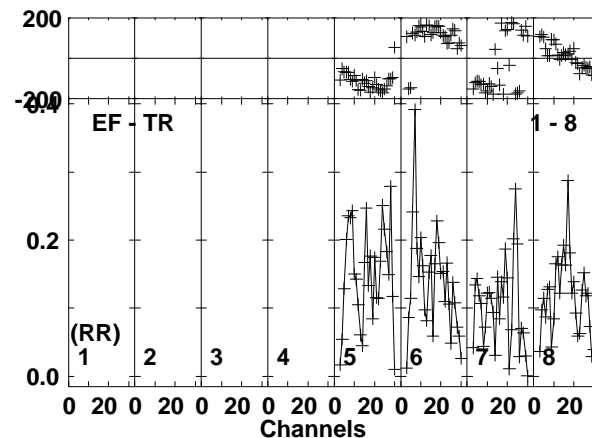
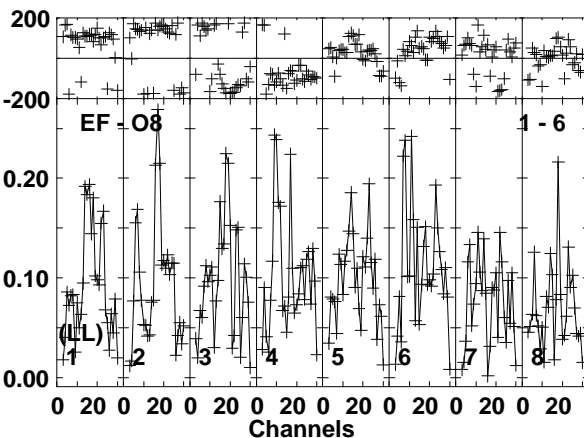
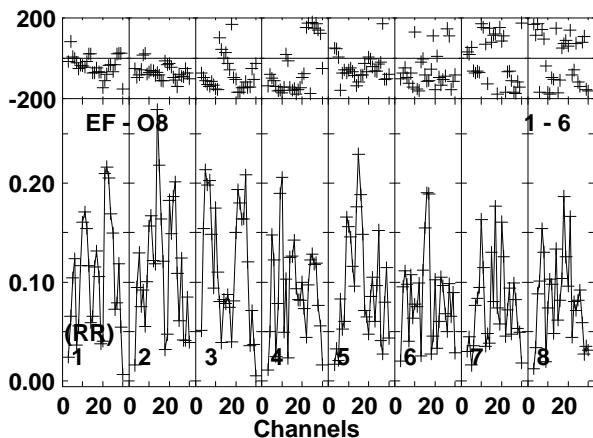
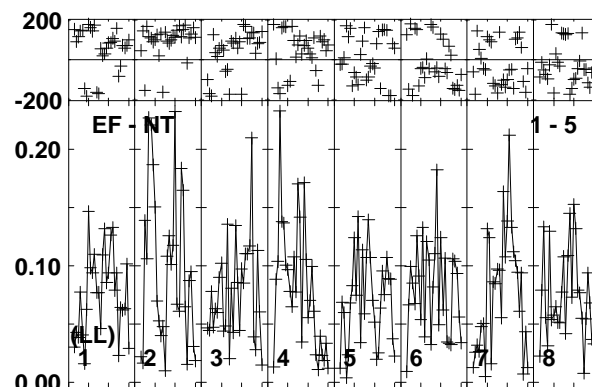
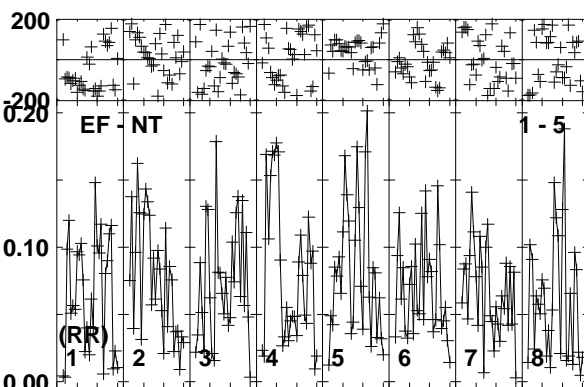
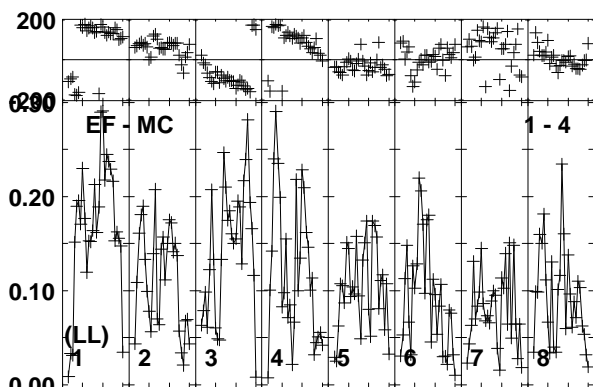
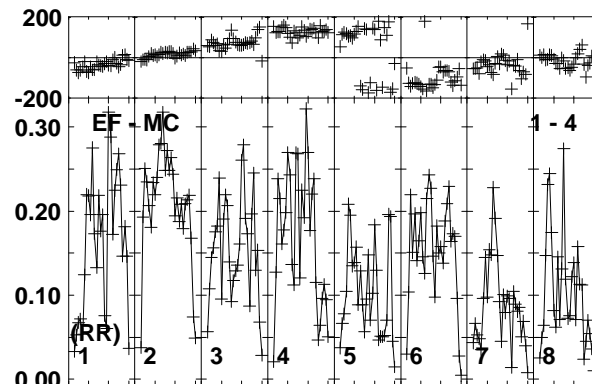
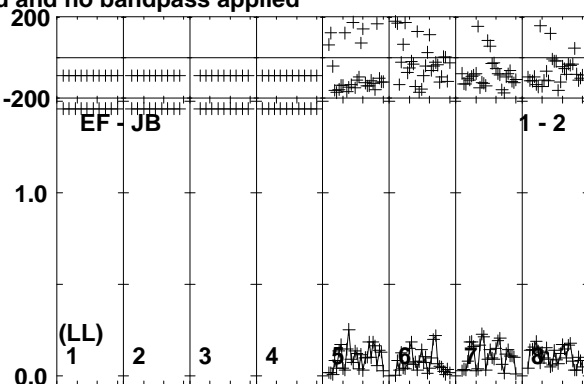
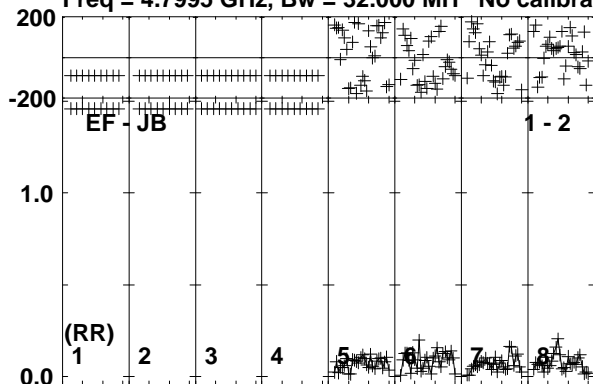

Lower frame: Milli Ampl Jy Top frame: Phas deg
Vector averaged cross-power spectrum Baseline: EF (01) - JB (02)
Timerange: 00/22:20:11 to 00/22:22:39

Plot file version 70 created 20-APR-2018 18:07:57

J1312-2350 RG009B.UVDATA.1

Freq = 4.7995 GHz, Bw = 32.000 MH No calibration applied and no bandpass applied

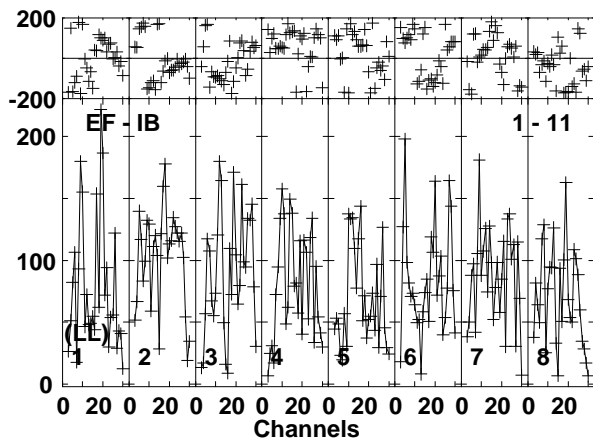
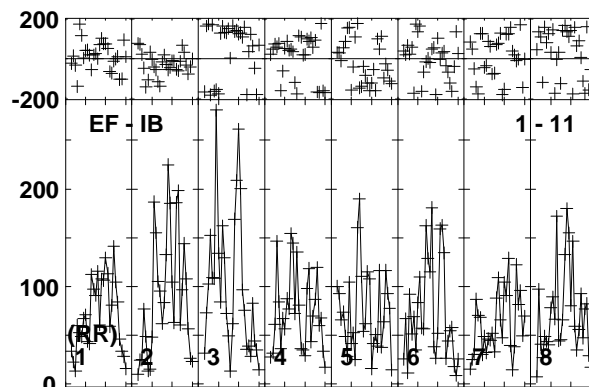
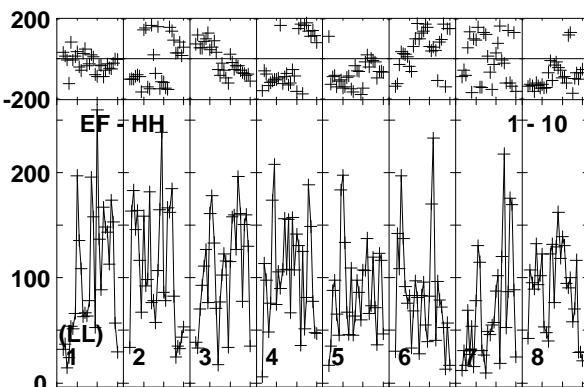
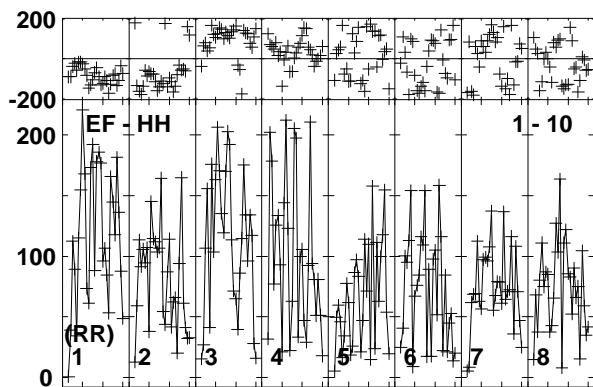
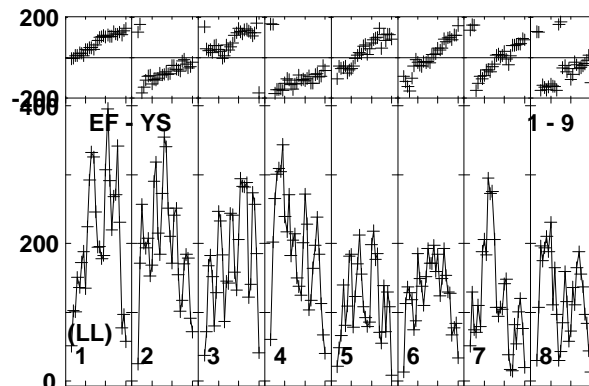
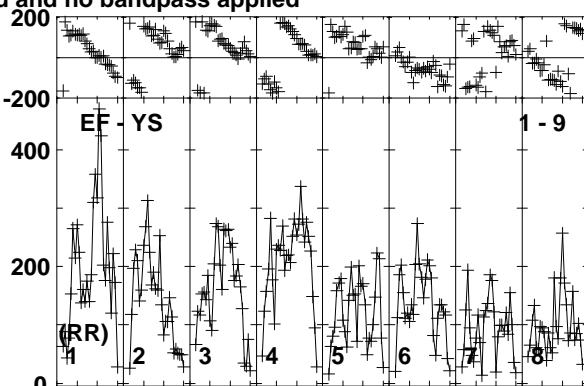
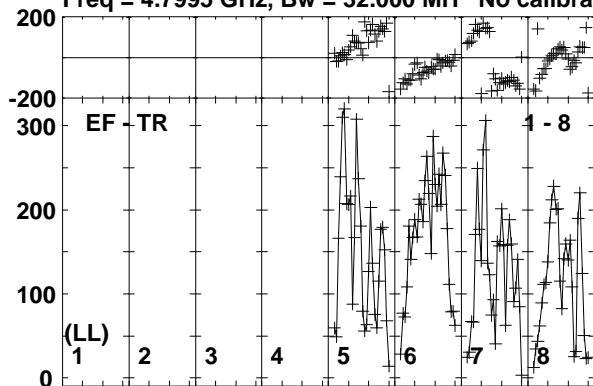

Lower frame: Micro Ampl Jy Top frame: Phas deg
Vector averaged cross-power spectrum Baseline: EF (01) - TR (08)
Timerange: 00/22:20:11 to 00/22:22:39

Plot file version 71 created 20-APR-2018 18:07:57

J1311-2329 RG009B.UVDATA.1

Freq = 4.7995 GHz, Bw = 32.000 MH No calibration applied and no bandpass applied

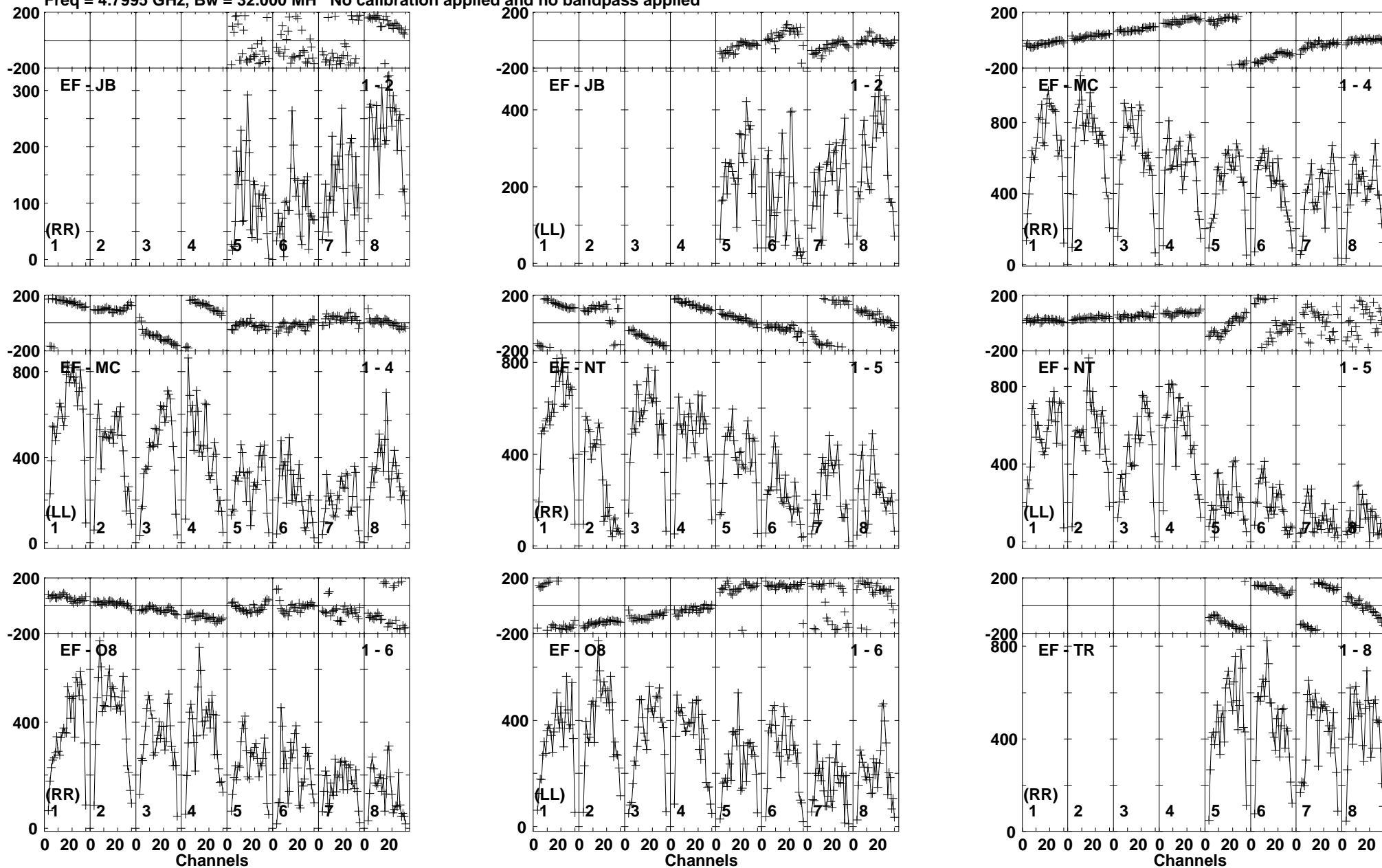

Lower frame: Micro Ampl Jy Top frame: Phas deg
Vector averaged cross-power spectrum Baseline: EF (01) - JB (02)
Timerange: 00/22:22:41 to 00/22:24:09

Plot file version 72 created 20-APR-2018 18:07:57

J1311-2329 RG009B.UVDATA.1

Freq = 4.7995 GHz, Bw = 32.000 MH No calibration applied and no bandpass applied

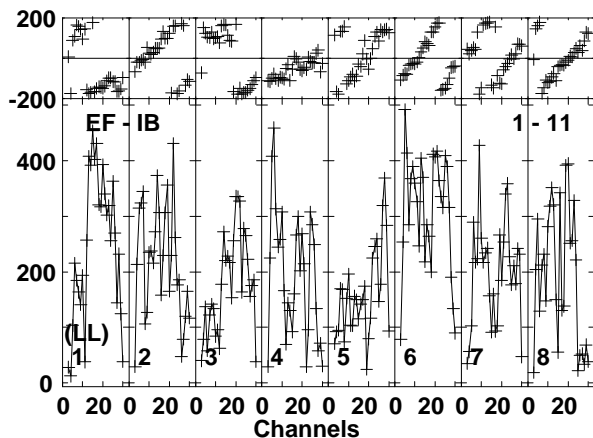
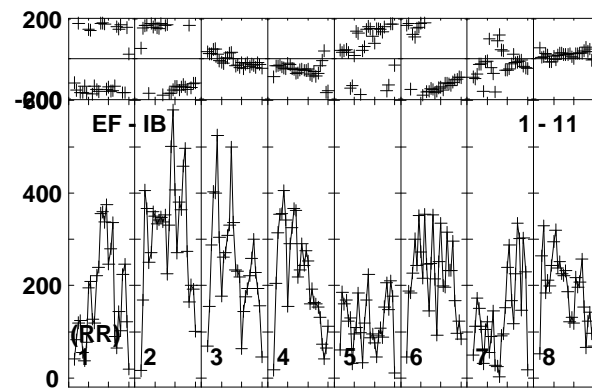
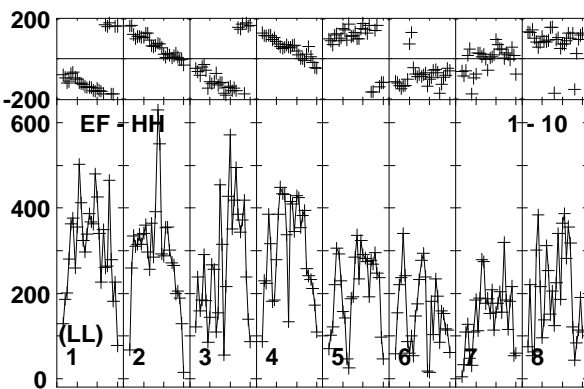
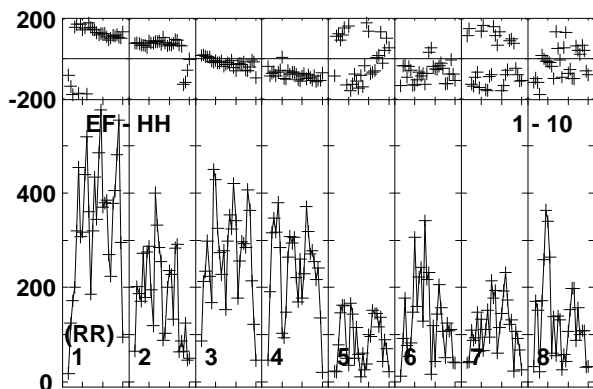
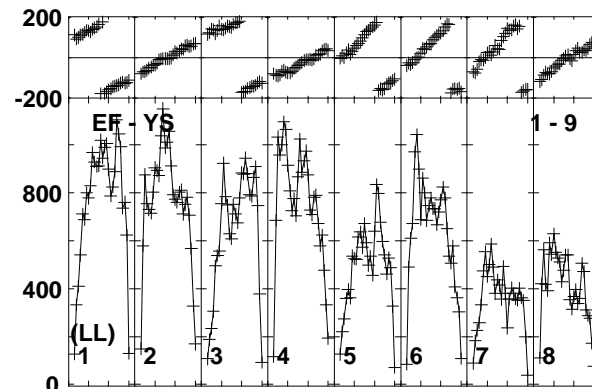
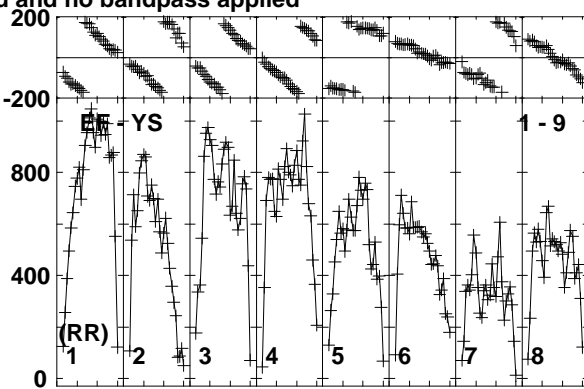
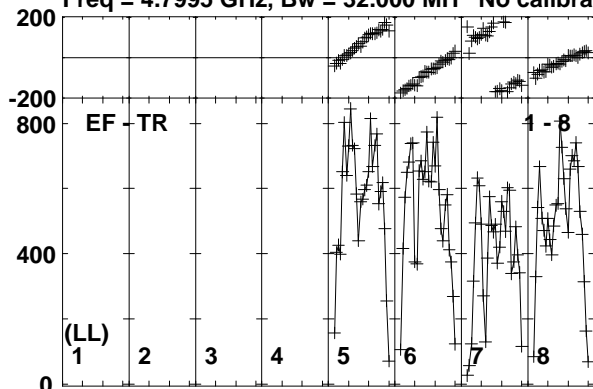

Lower frame: Micro Ampl Jy Top frame: Phas deg
Vector averaged cross-power spectrum Baseline: EF (01) - TR (08)
Timerange: 00/22:22:41 to 00/22:24:09

Plot file version 73 created 20-APR-2018 18:07:57

J1303-2405 RG009B.UVDATA.1

Freq = 4.7995 GHz, Bw = 32.000 MH No calibration applied and no bandpass applied

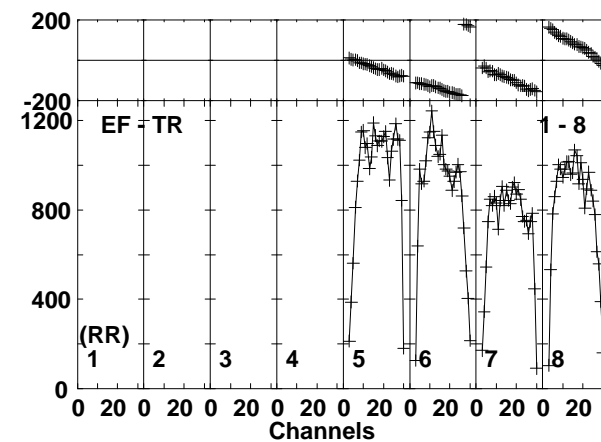
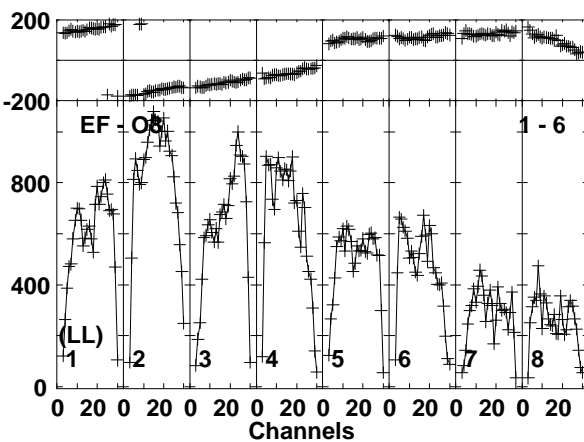
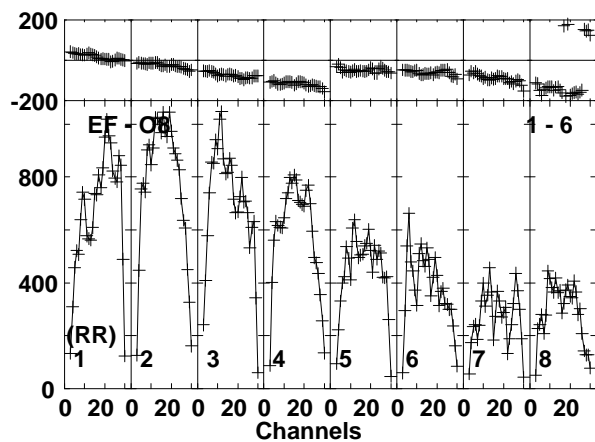
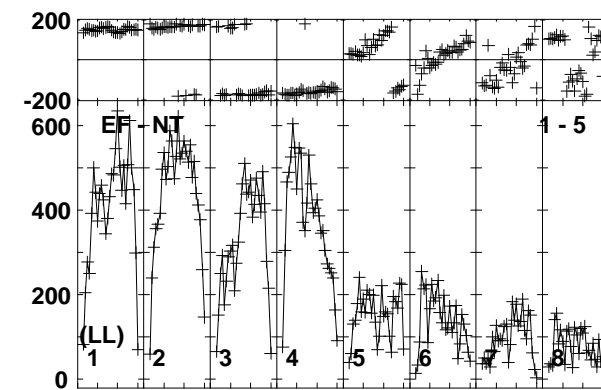
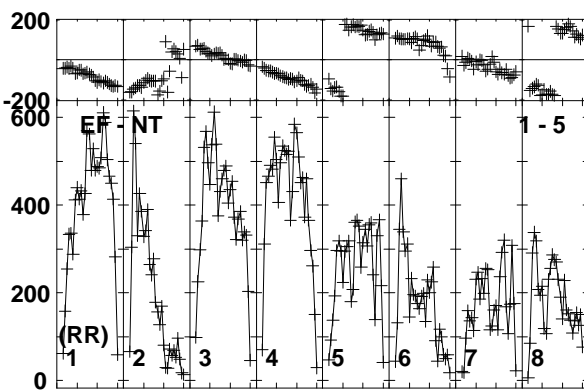
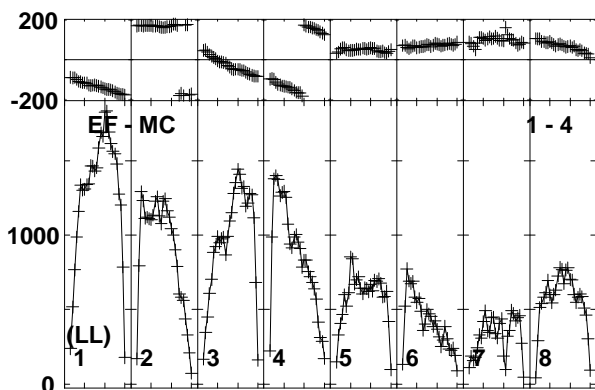
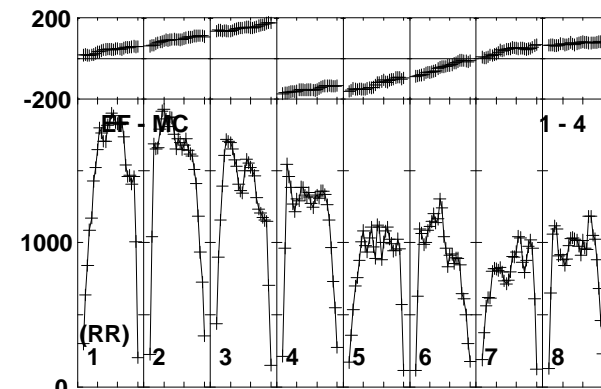
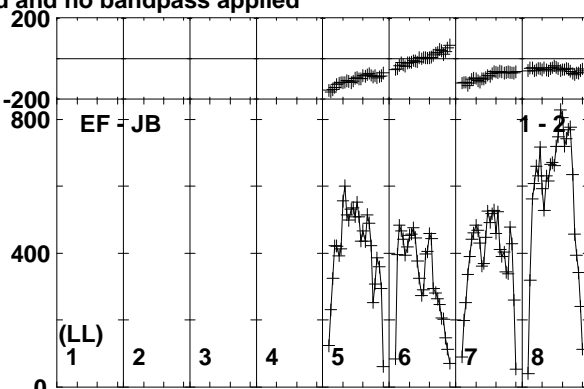
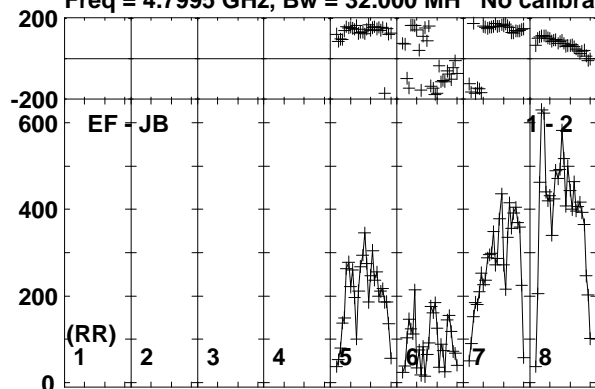

Lower frame: Micro Ampl Jy Top frame: Phas deg
Vector averaged cross-power spectrum Baseline: EF (01) - JB (02)
Timerange: 00/22:24:11 to 00/22:26:39

Plot file version 74 created 20-APR-2018 18:07:57

J1303-2405 RG009B.UVDATA.1

Freq = 4.7995 GHz, Bw = 32.000 MH No calibration applied and no bandpass applied

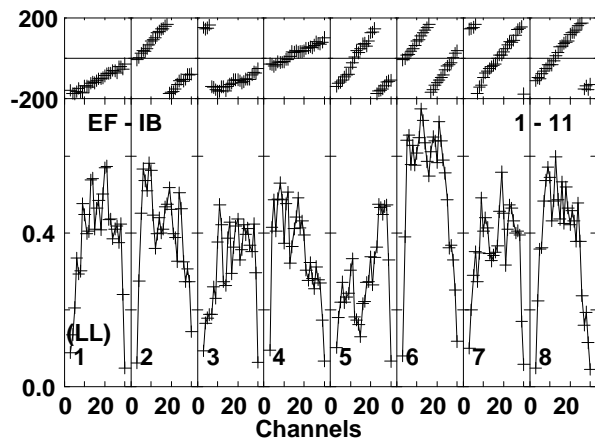
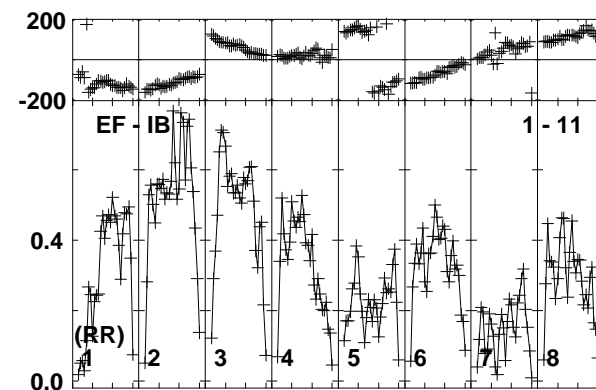
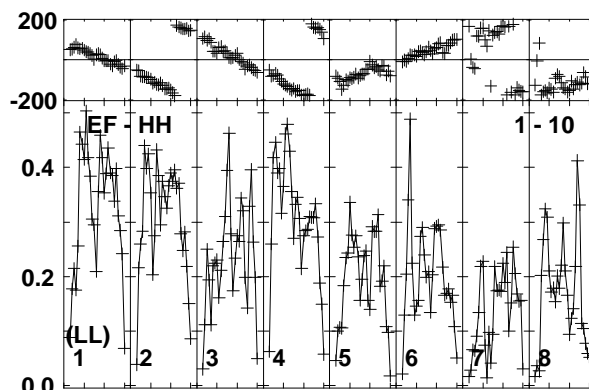
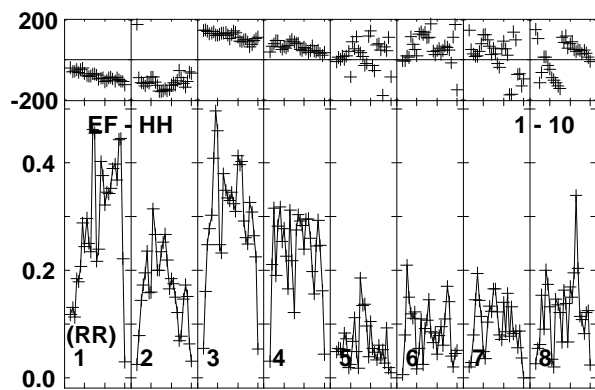
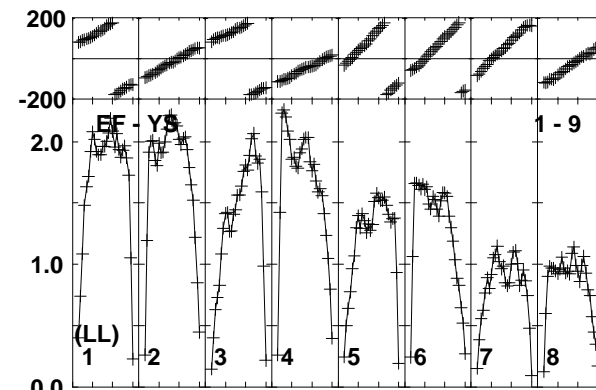
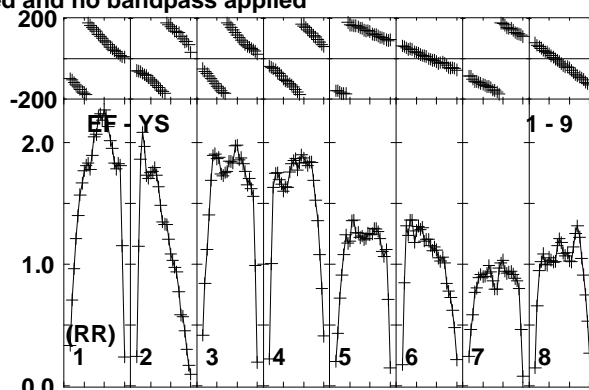
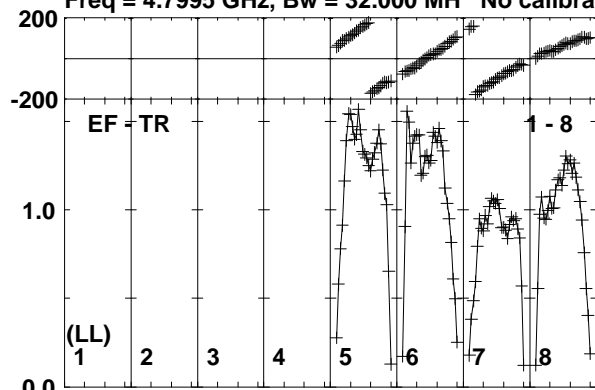

Lower frame: Milli Ampl Jy Top frame: Phas deg
Vector averaged cross-power spectrum Baseline: EF (01) - TR (08)
Timerange: 00/22:24:11 to 00/22:26:39

Plot file version 75 created 20-APR-2018 18:07:57

J1311-2329 RG009B.UVDATA.1

Freq = 4.7995 GHz, Bw = 32.000 MH No calibration applied and no bandpass applied

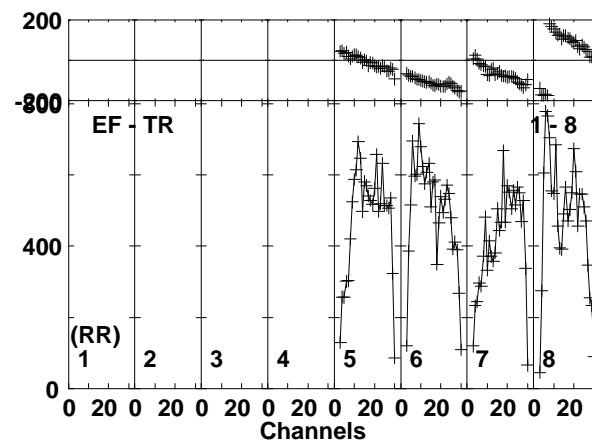
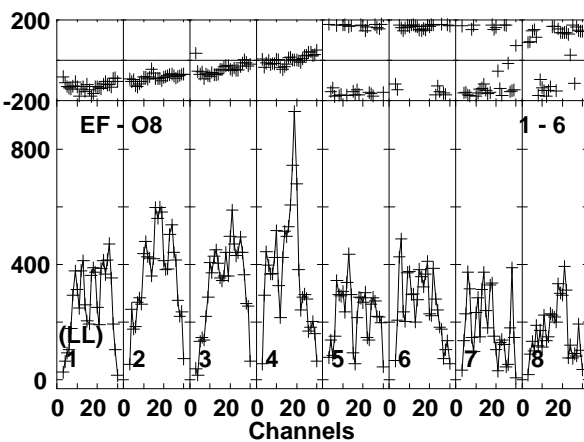
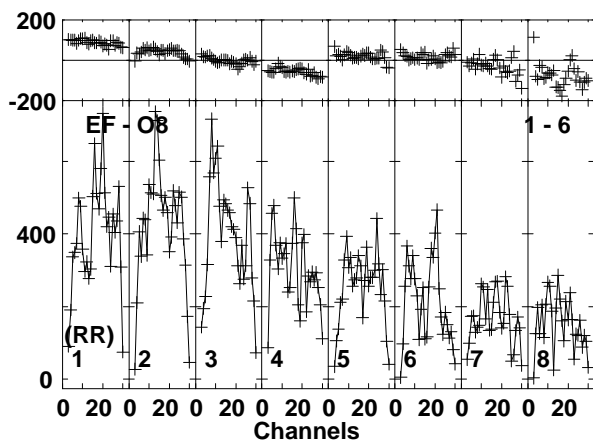
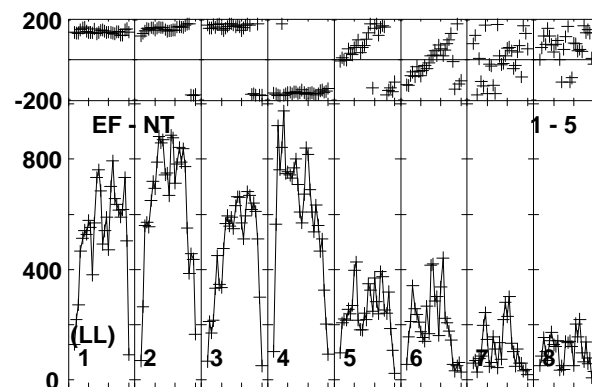
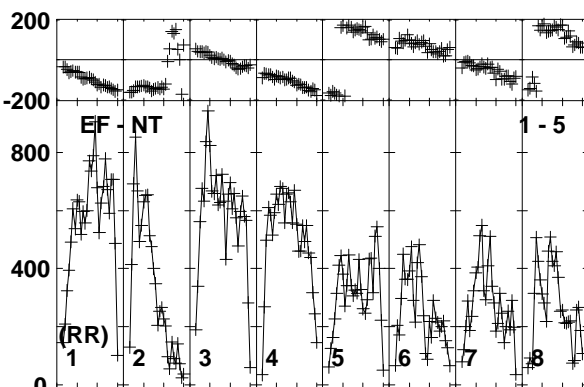
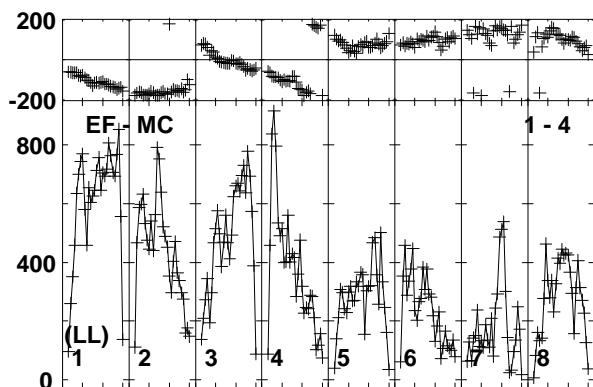
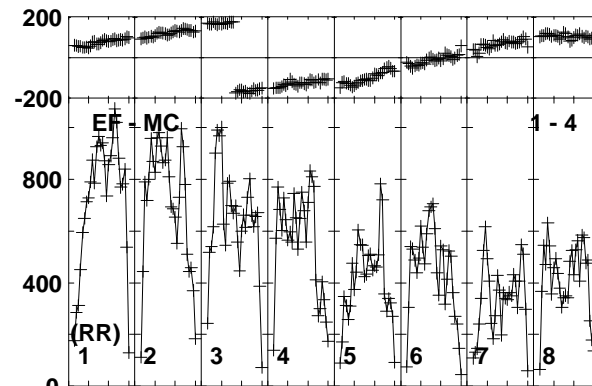
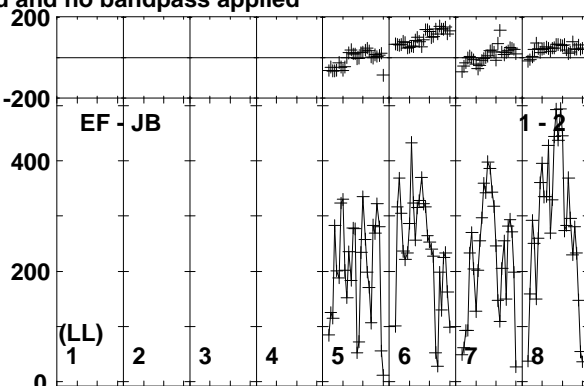
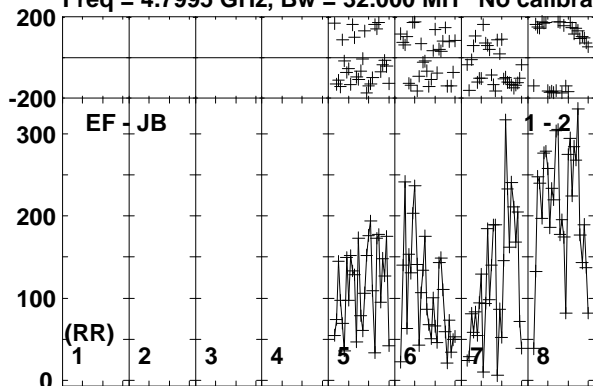

Lower frame: Micro Ampl Jy Top frame: Phas deg
Vector averaged cross-power spectrum Baseline: EF (01) - JB (02)
Timerange: 00/22:27:21 to 00/22:28:19

Plot file version 76 created 20-APR-2018 18:07:57

J1311-2329 RG009B.UVDATA.1

Freq = 4.7995 GHz, Bw = 32.000 MH No calibration applied and no bandpass applied

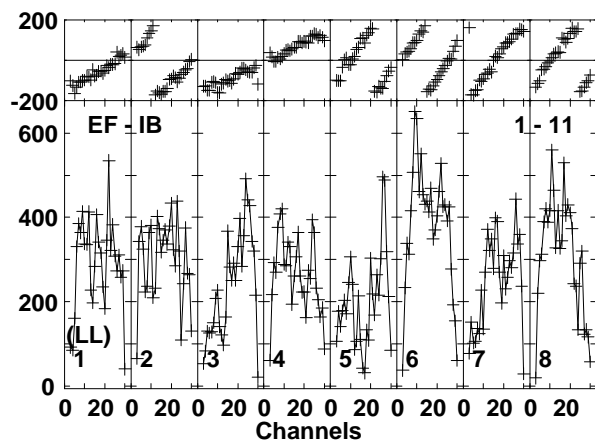
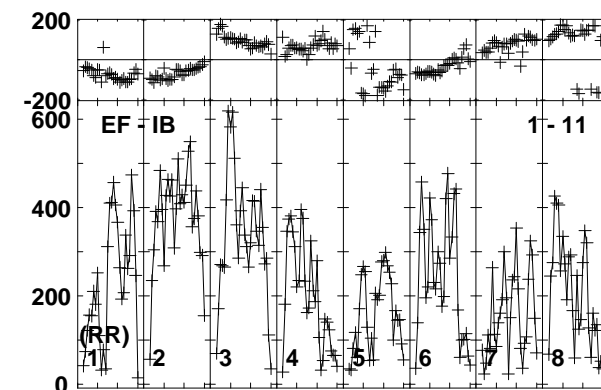
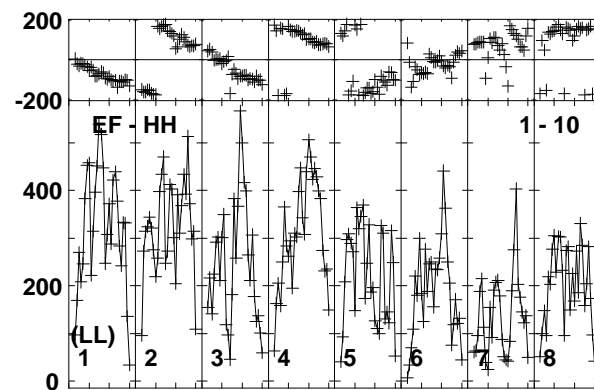
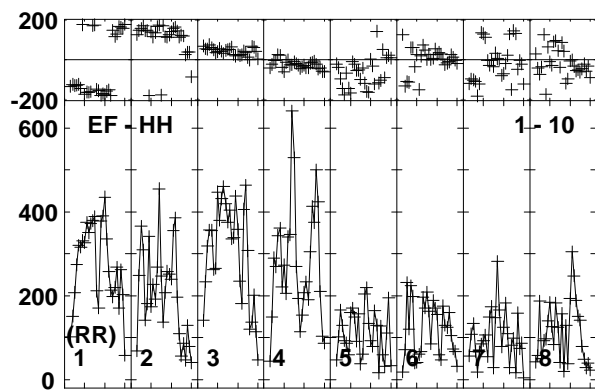
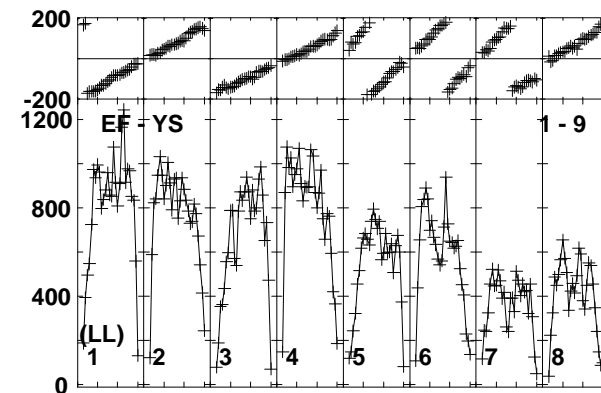
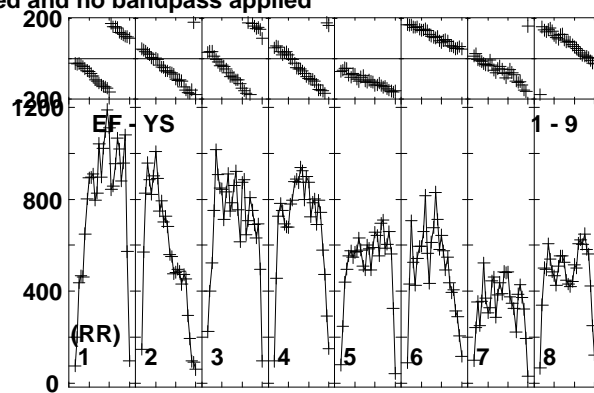
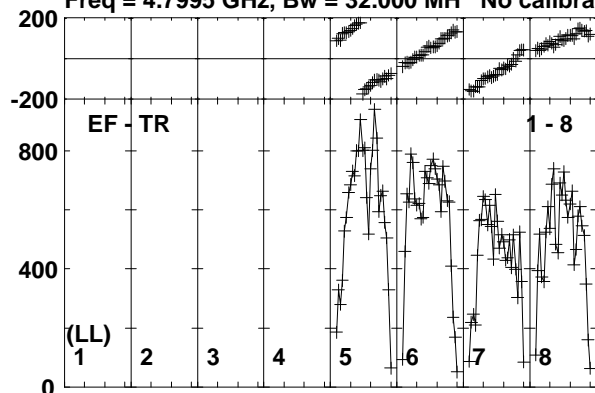

Lower frame: Micro Ampl Jy Top frame: Phas deg
Vector averaged cross-power spectrum Baseline: EF (01) - TR (08)
Timerange: 00/22:27:21 to 00/22:28:19

Plot file version 77 created 20-APR-2018 18:07:57

EM170817 RG009B.UVDATA.1

Freq = 4.7995 GHz, Bw = 32.000 MH No calibration applied and no bandpass applied

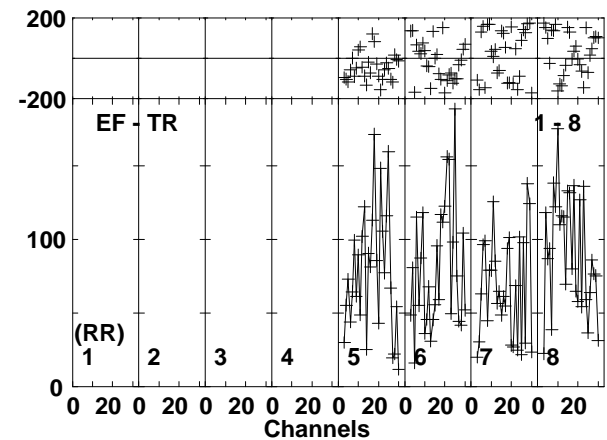
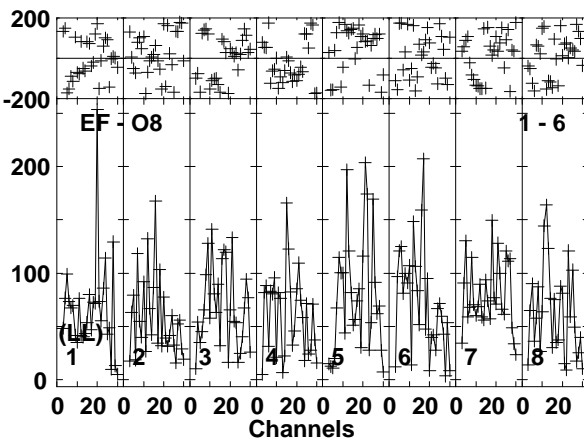
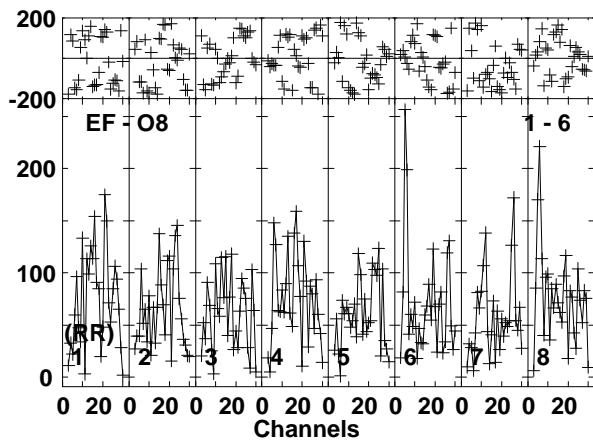
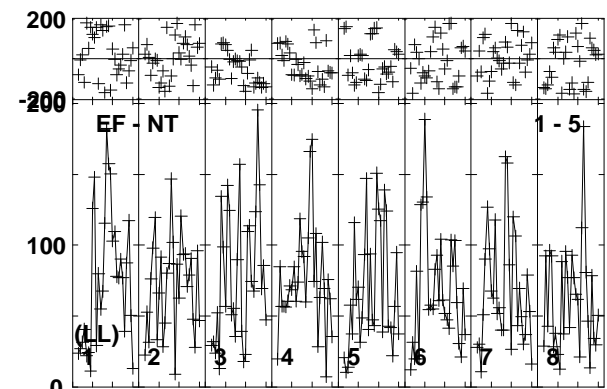
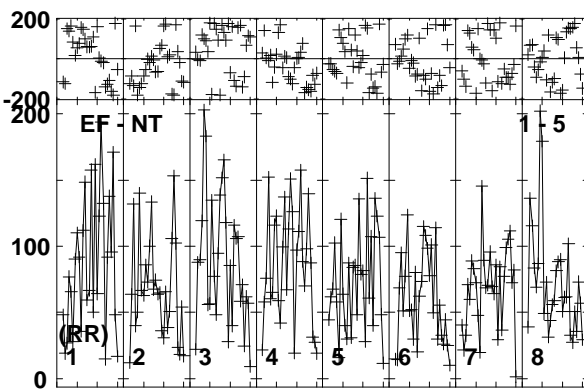
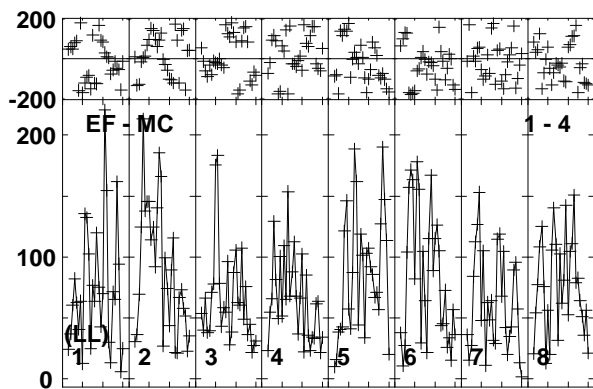
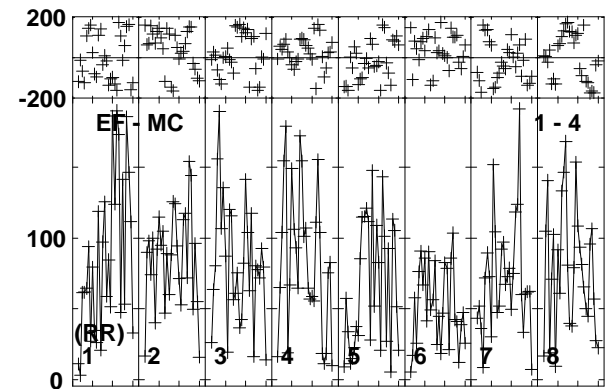
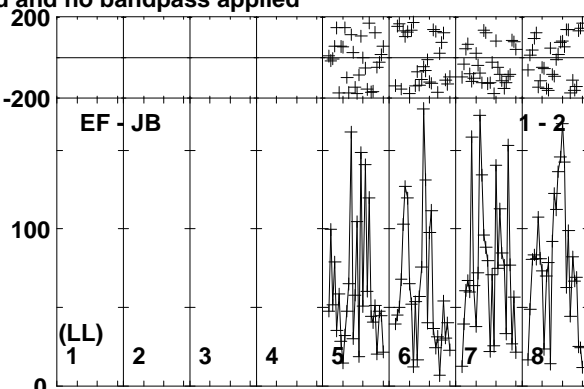
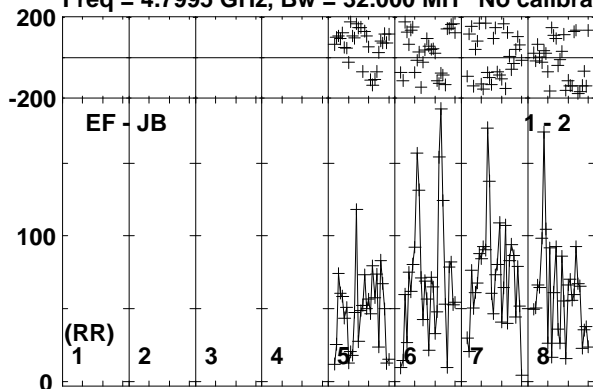

Lower frame: Micro Ampl Jy Top frame: Phas deg
Vector averaged cross-power spectrum Baseline: EF (01) - JB (02)
Timerange: 00/22:28:21 to 00/22:30:49

Plot file version 79 created 20-APR-2018 18:07:58

J1311-2329 RG009B.UVDATA.1

Freq = 4.7995 GHz, Bw = 32.000 MH No calibration applied and no bandpass applied

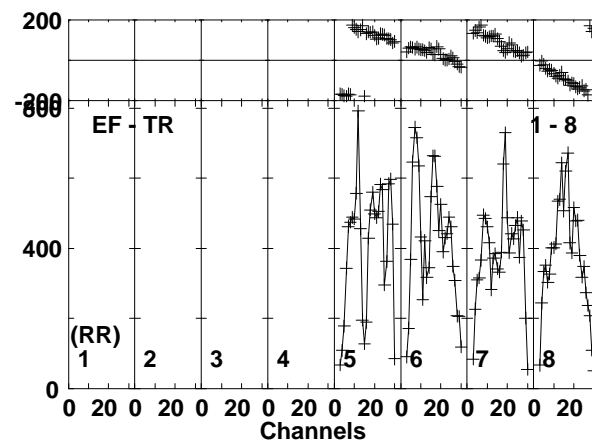
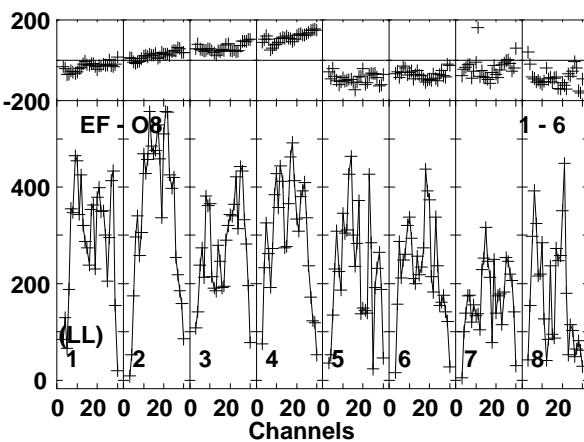
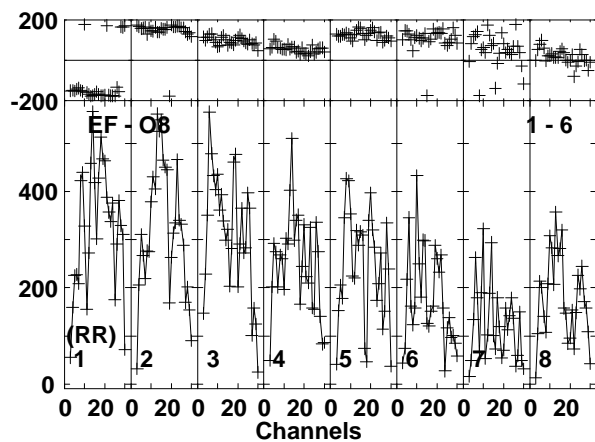
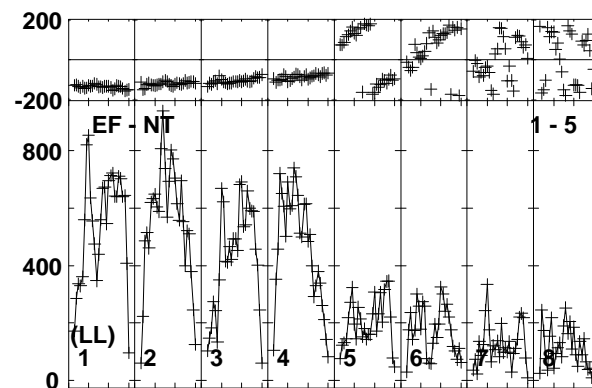
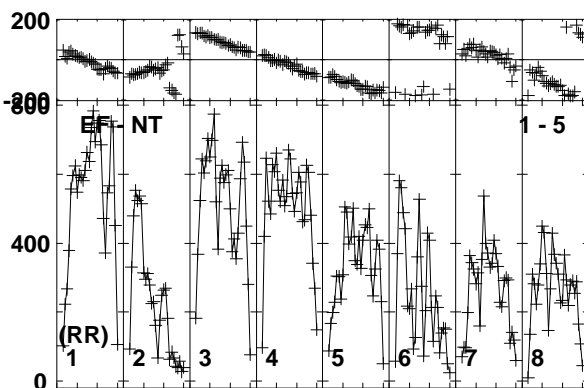
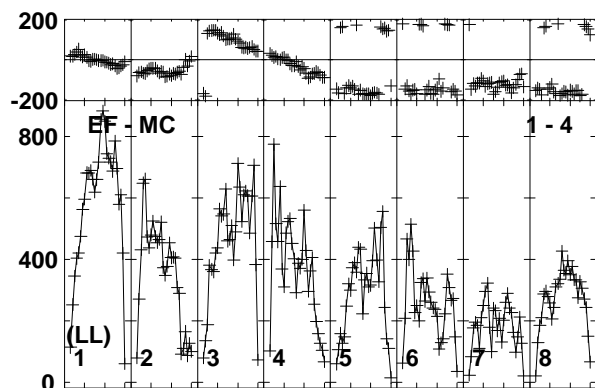
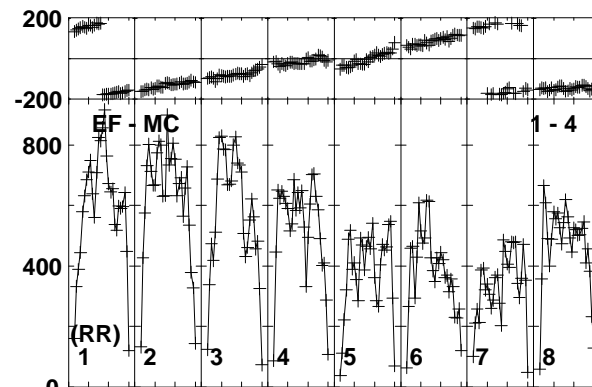
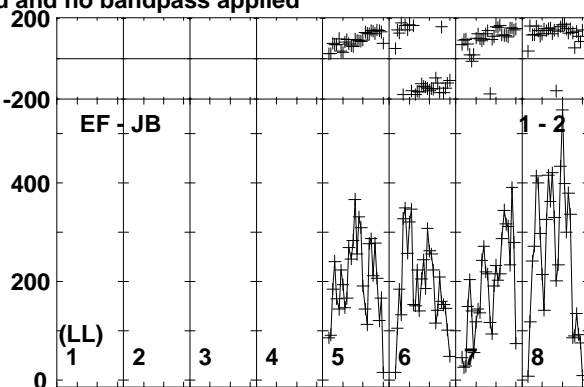
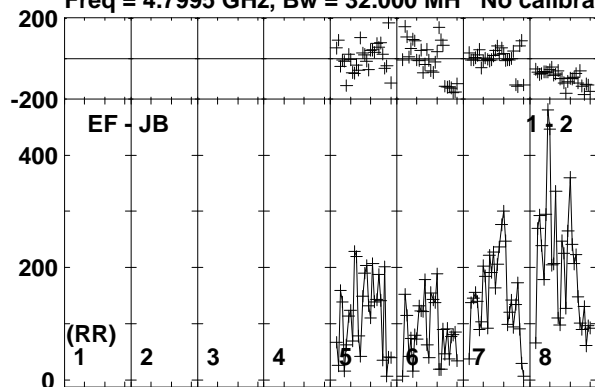

Lower frame: Micro Ampl Jy Top frame: Phas deg
Vector averaged cross-power spectrum Baseline: EF (01) - JB (02)
Timerange: 00:22:30:51 to 00:22:32:19

Plot file version 80 created 20-APR-2018 18:07:58

J1311-2329 RG009B.UVDATA.1

Freq = 4.7995 GHz, Bw = 32.000 MH No calibration applied and no bandpass applied

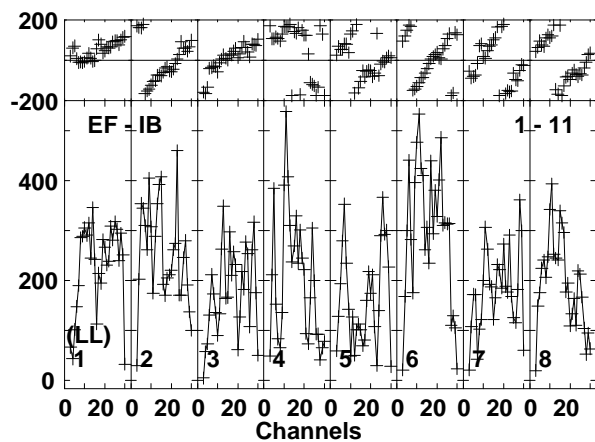
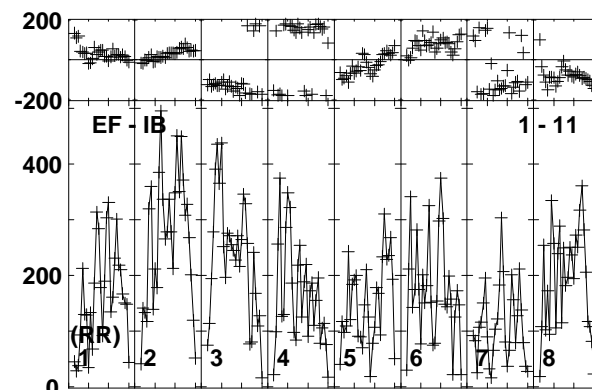
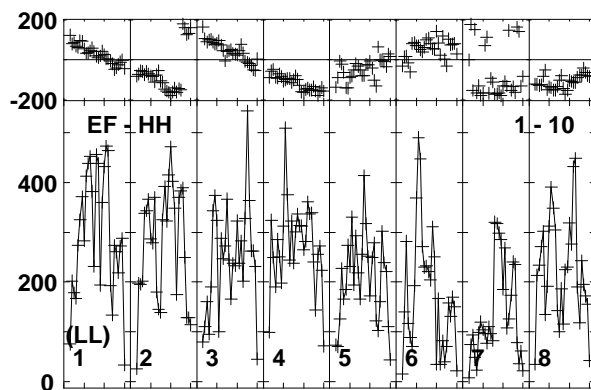
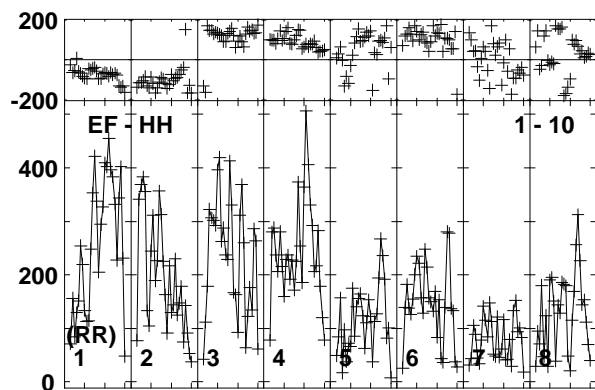
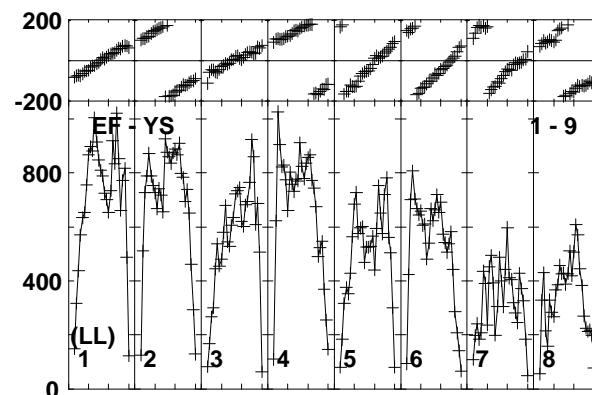
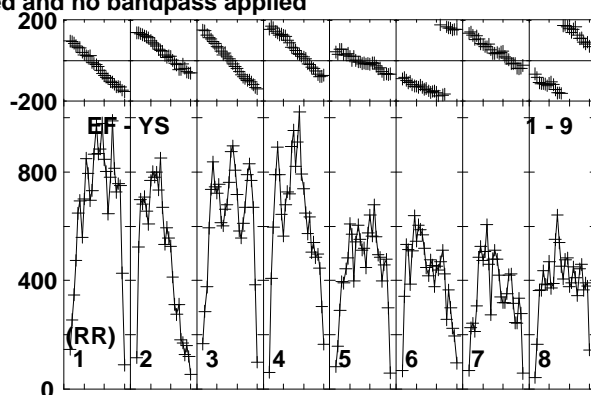
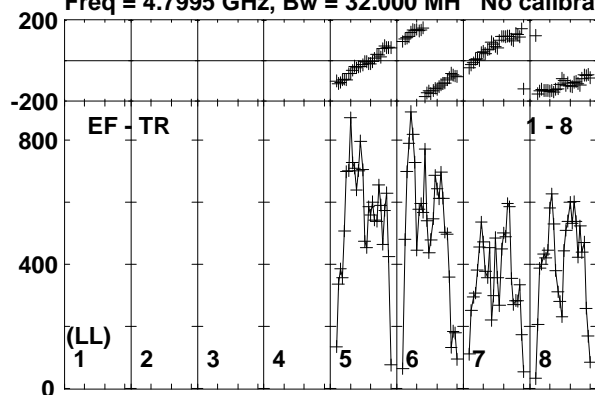

Lower frame: Micro Ampl Jy Top frame: Phas deg
Vector averaged cross-power spectrum Baseline: EF (01) - TR (08)
Timerange: 00/22:30:51 to 00/22:32:19

Plot file version 81 created 20-APR-2018 18:07:58

EM170817 RG009B.UVDATA.1

Freq = 4.7995 GHz, Bw = 32.000 MH No calibration applied and no bandpass applied

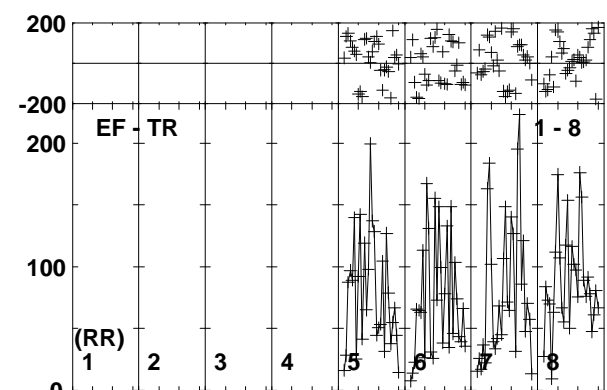
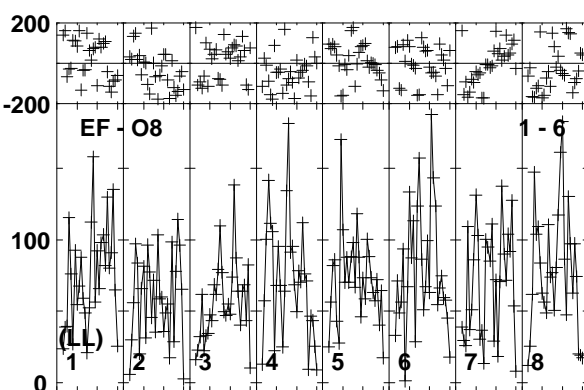
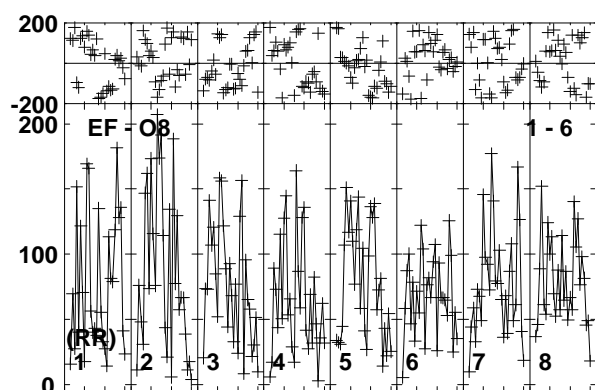
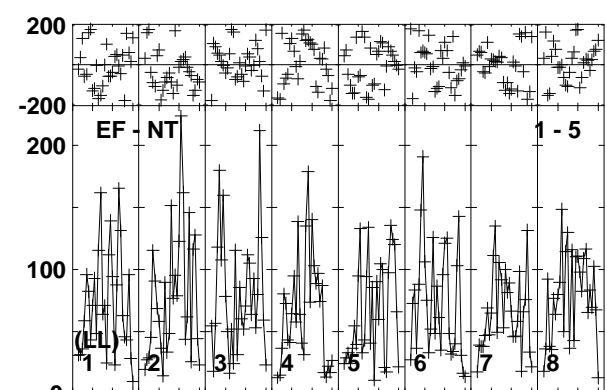
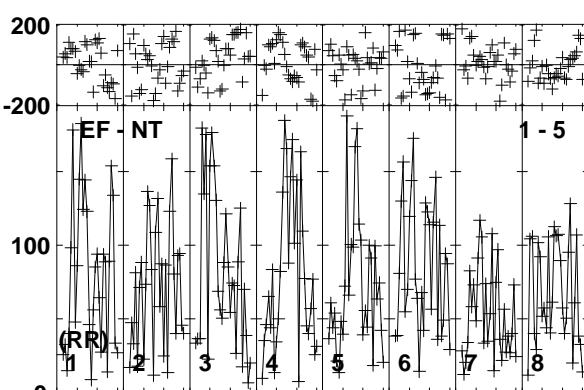
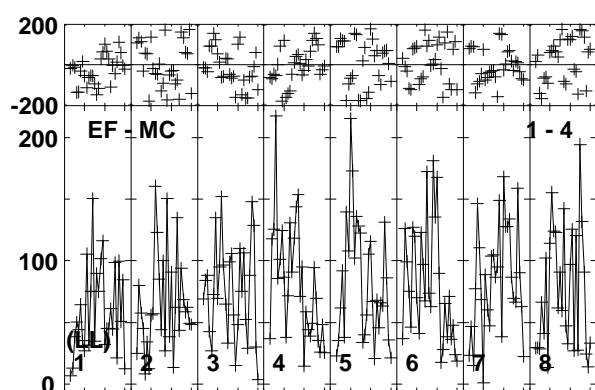
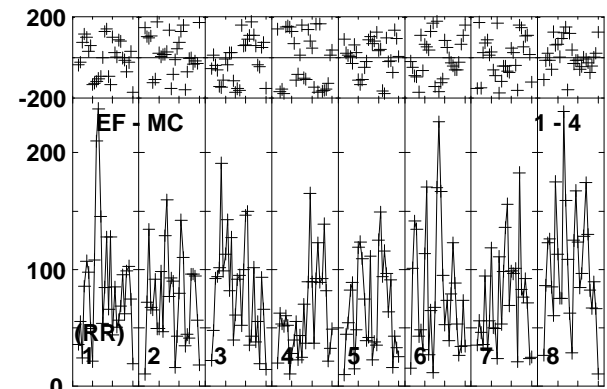
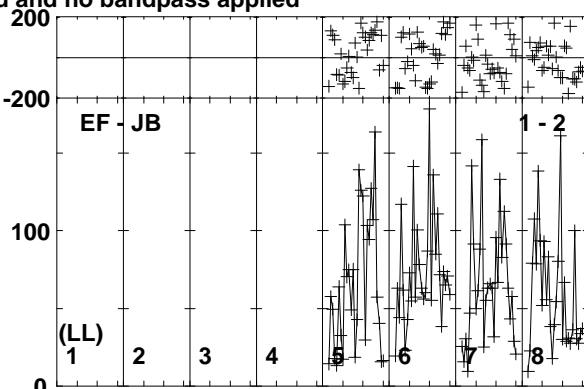
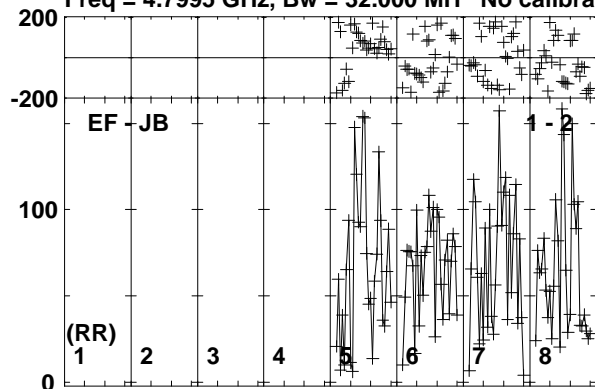

Lower frame: Micro Ampl Jy Top frame: Phas deg
Vector averaged cross-power spectrum Baseline: EF (01) - JB (02)
Timerange: 00:22:32:21 to 00:22:34:49

Plot file version 82 created 20-APR-2018 18:07:58

EM170817 RG009B.UVDATA.1

Freq = 4.7995 GHz, Bw = 32.000 MH No calibration applied and no bandpass applied

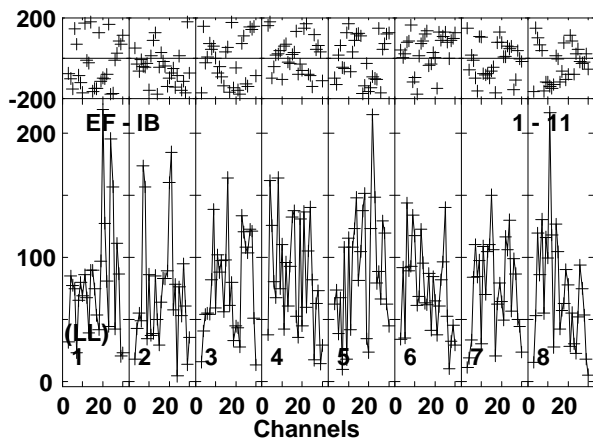
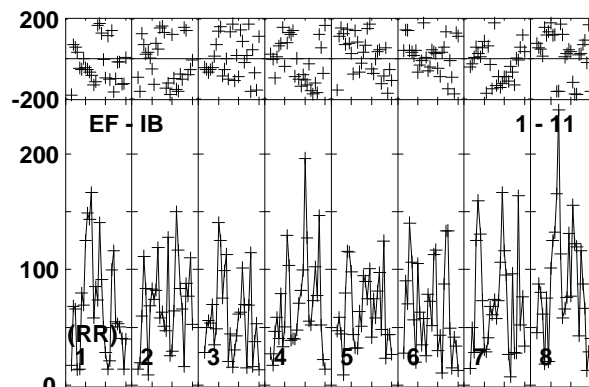
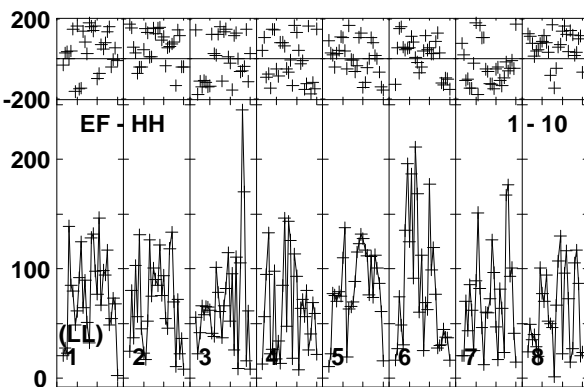
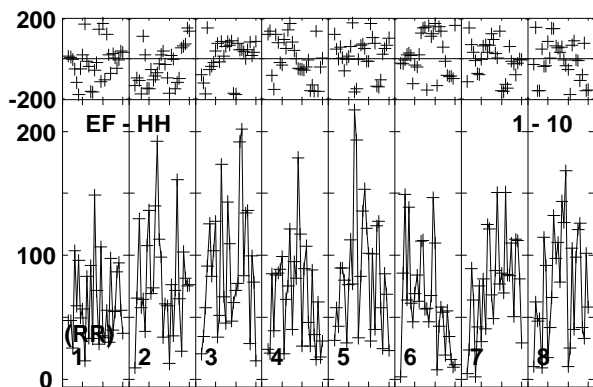
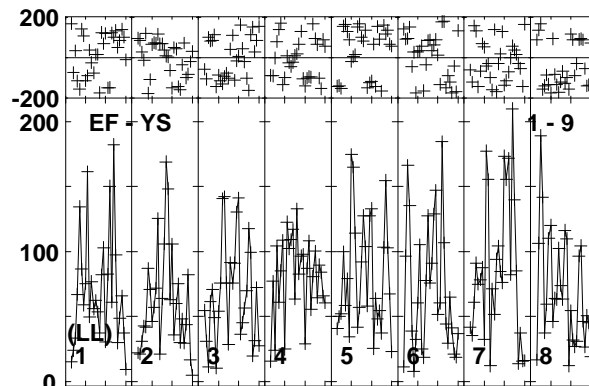
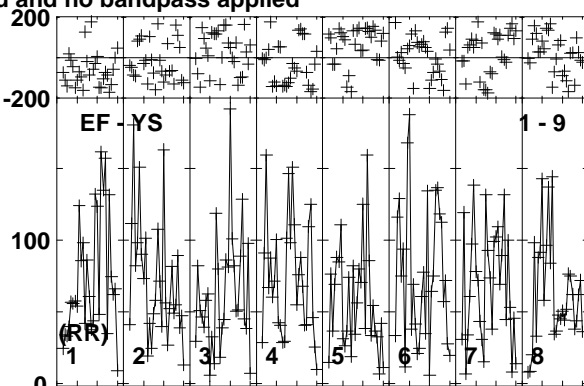
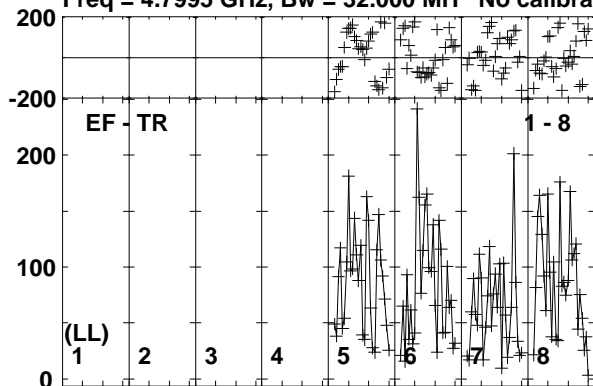

Lower frame: Micro Ampl Jy Top frame: Phas deg
Vector averaged cross-power spectrum Baseline: EF (01) - TR (08)
Timerange: 00:22:32:21 to 00:22:34:49

Plot file version 83 created 20-APR-2018 18:07:58

J1311-2329 RG009B.UVDATA.1

Freq = 4.7995 GHz, Bw = 32.000 MH No calibration applied and no bandpass applied

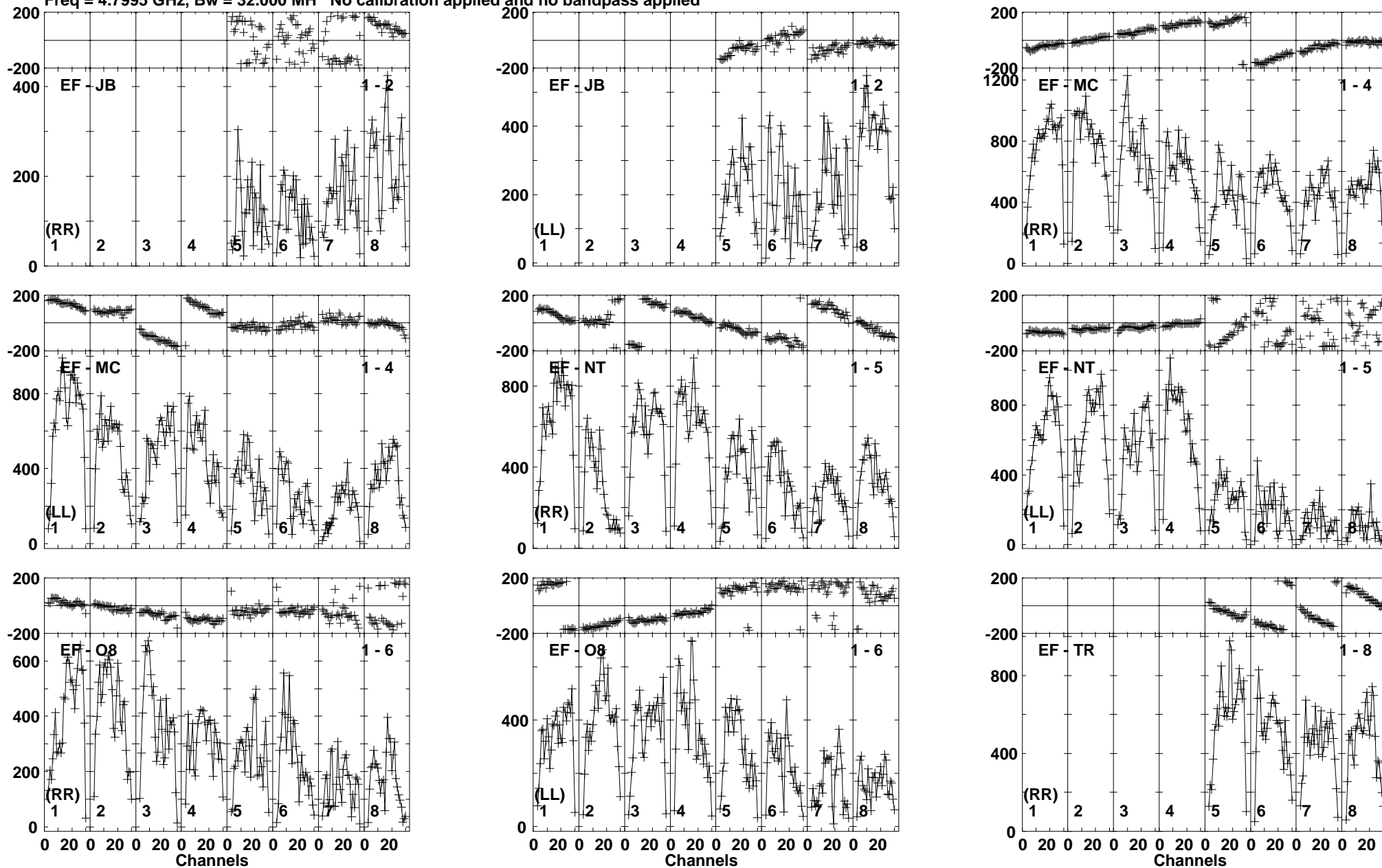

Lower frame: Micro Ampl Jy Top frame: Phas deg
Vector averaged cross-power spectrum Baseline: EF (01) - JB (02)
Timerange: 00/22:35:21 to 00/22:36:19

Plot file version 84 created 20-APR-2018 18:07:58

J1311-2329 RG009B.UVDATA.1

Freq = 4.7995 GHz, Bw = 32.000 MH No calibration applied and no bandpass applied

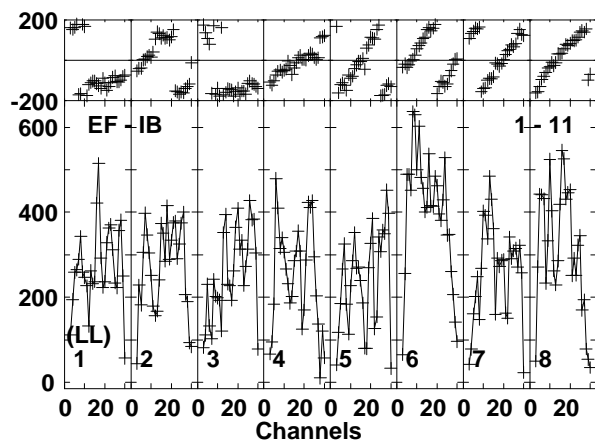
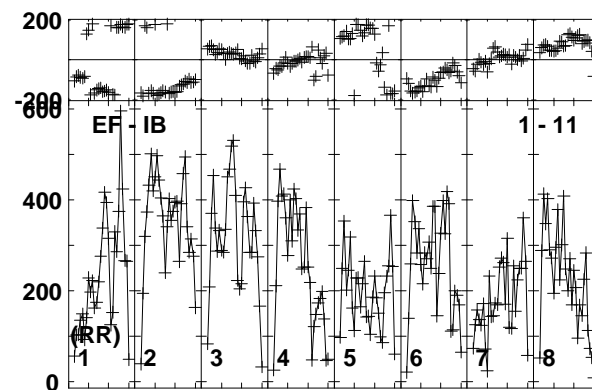
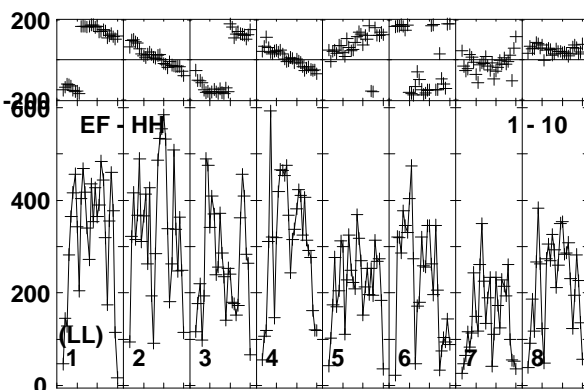
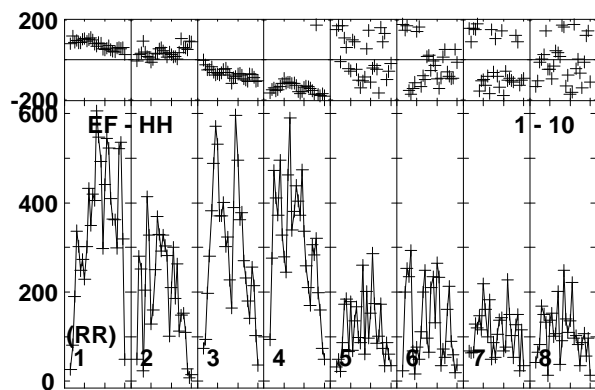
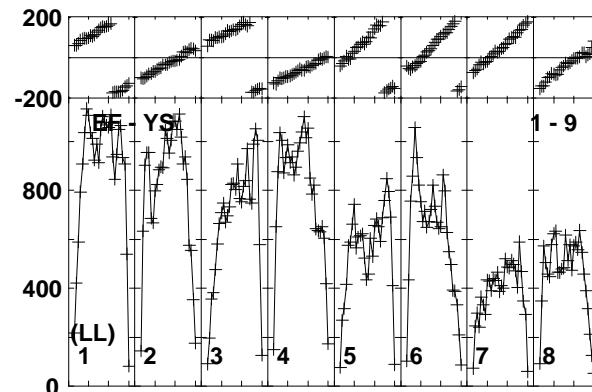
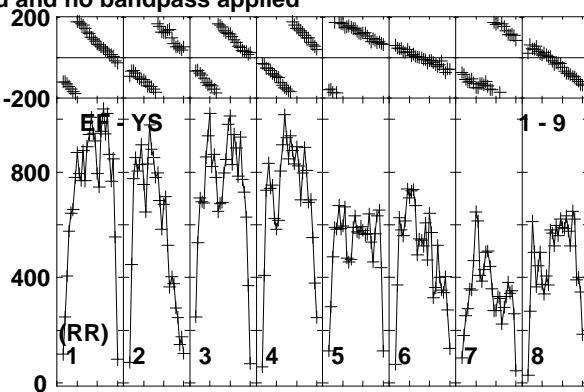
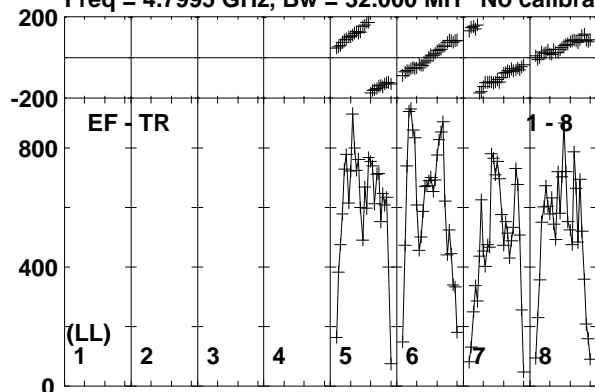

Lower frame: Micro Ampl Jy Top frame: Phas deg
Vector averaged cross-power spectrum Baseline: EF (01) - TR (08)
Timerange: 00:22:35:21 to 00:22:36:19

Plot file version 85 created 20-APR-2018 18:07:58

EM170817 RG009B.UVDATA.1

Freq = 4.7995 GHz, Bw = 32.000 MH No calibration applied and no bandpass applied

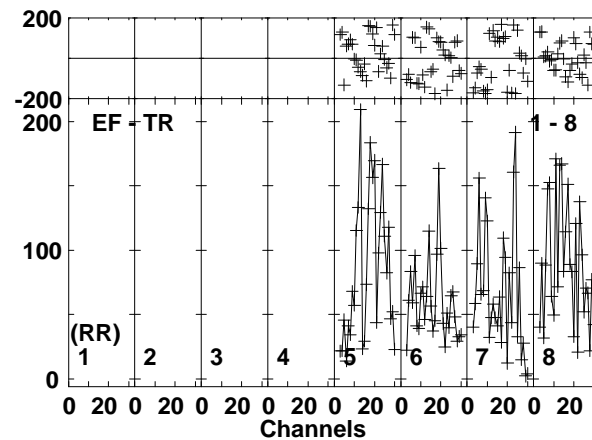
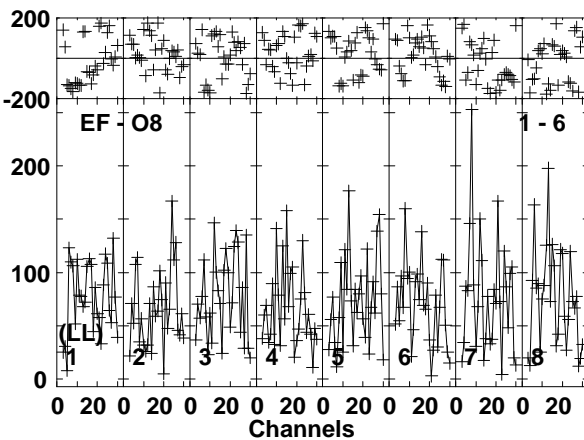
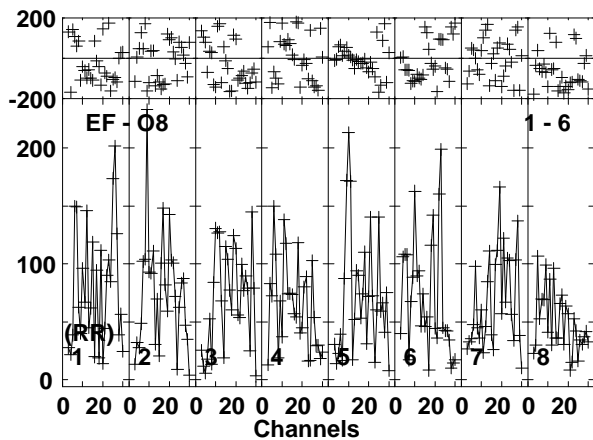
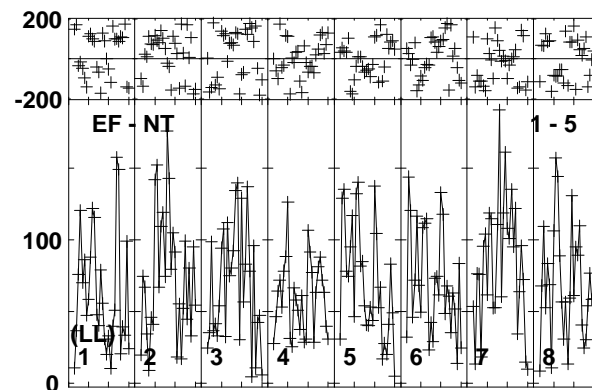
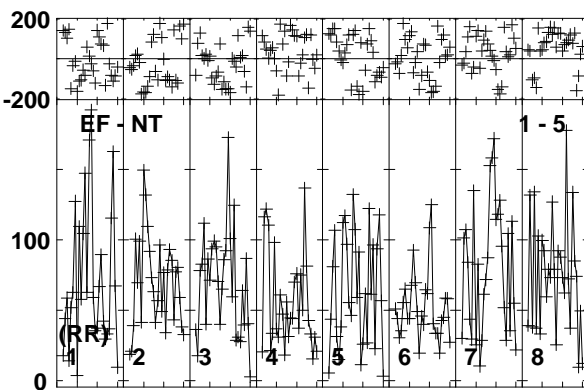
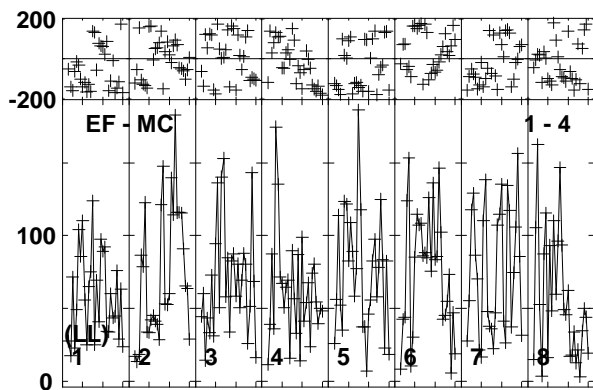
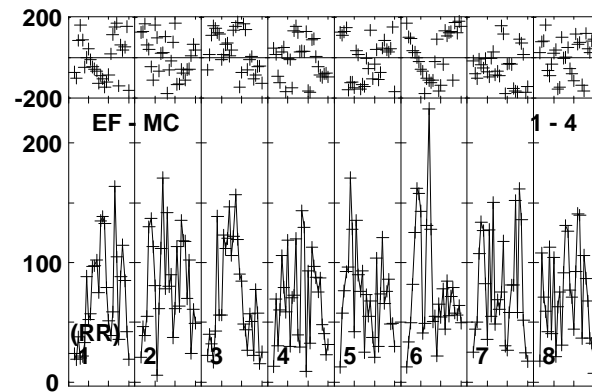
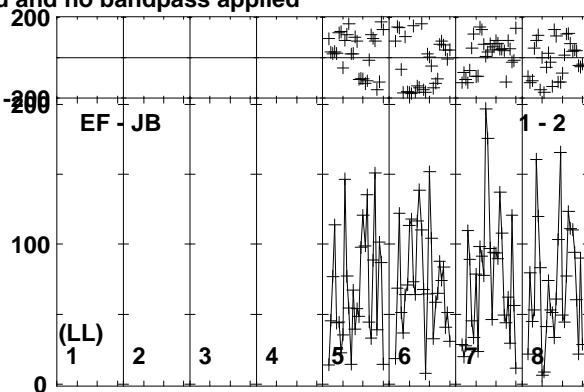
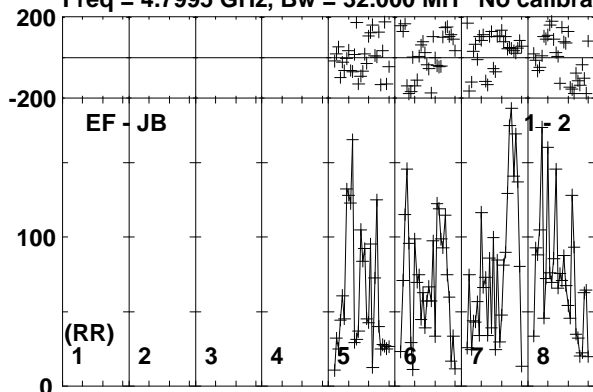

Lower frame: Micro Ampl Jy Top frame: Phas deg
Vector averaged cross-power spectrum Baseline: EF (01) - JB (02)
Timerange: 00/22:36:21 to 00/22:38:49

Plot file version 86 created 20-APR-2018 18:07:58

EM170817 RG009B.UVDATA.1

Freq = 4.7995 GHz, Bw = 32.000 MH No calibration applied and no bandpass applied

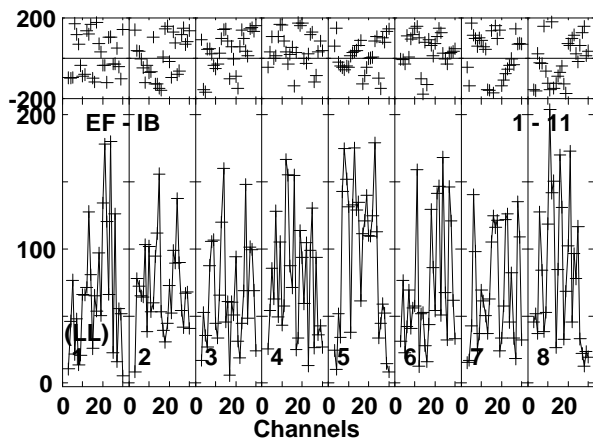
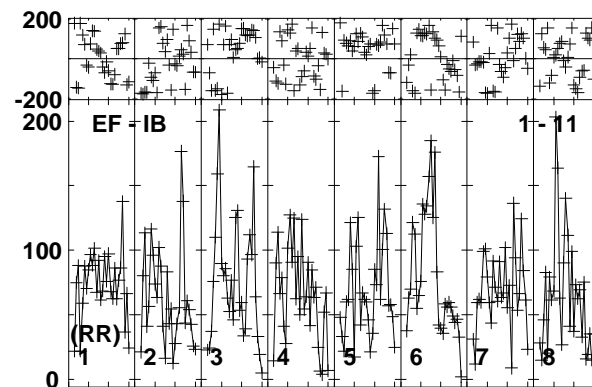
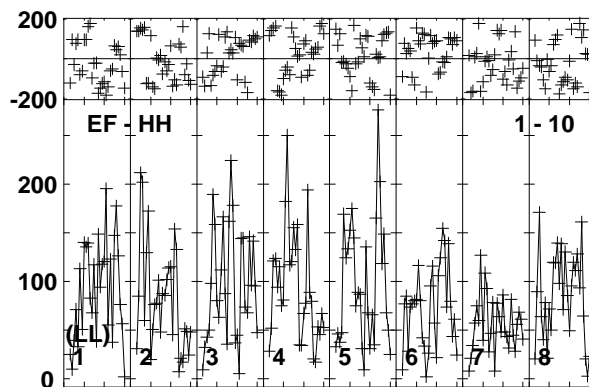
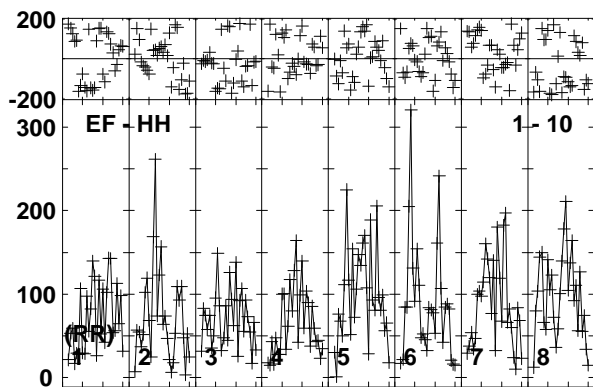
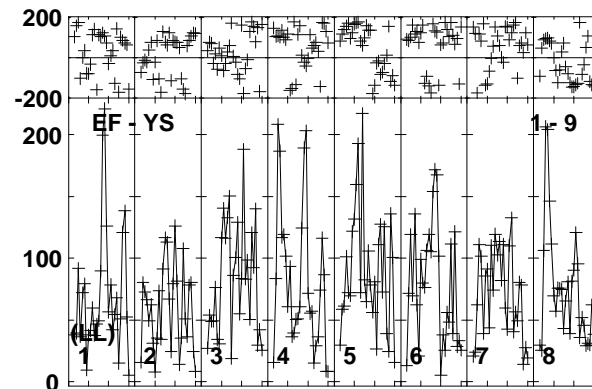
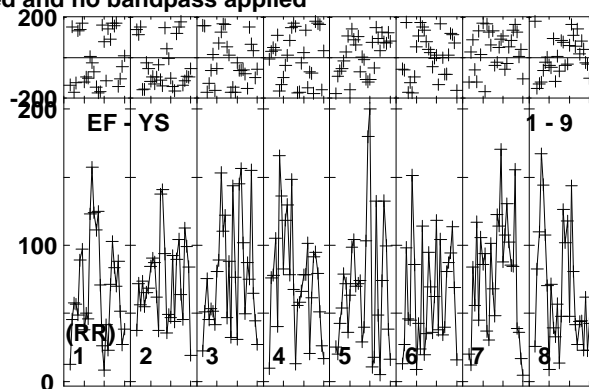
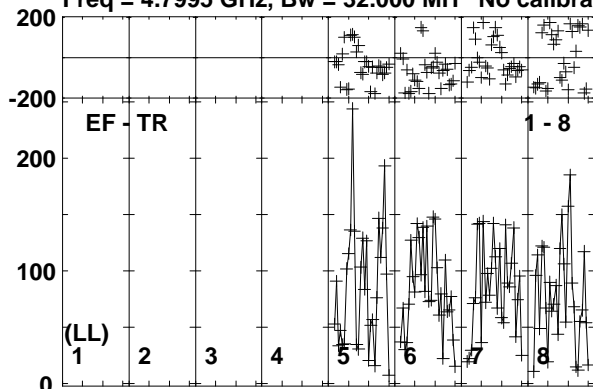

Lower frame: Micro Ampl Jy Top frame: Phas deg
Vector averaged cross-power spectrum Baseline: EF (01) - TR (08)
Timerange: 00:22:36:21 to 00:22:38:49

Plot file version 87 created 20-APR-2018 18:07:58

J1311-2329 RG009B.UVDATA.1

Freq = 4.7995 GHz, Bw = 32.000 MH No calibration applied and no bandpass applied

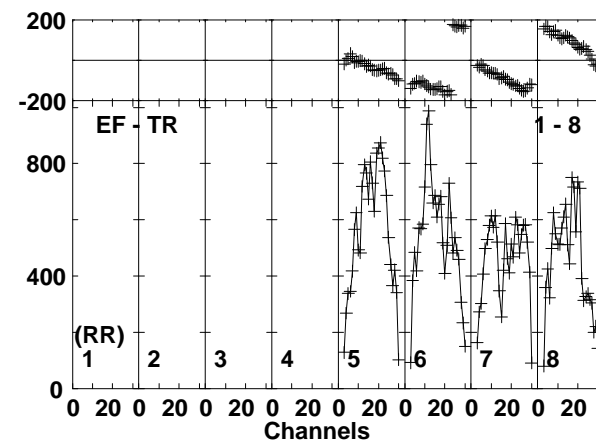
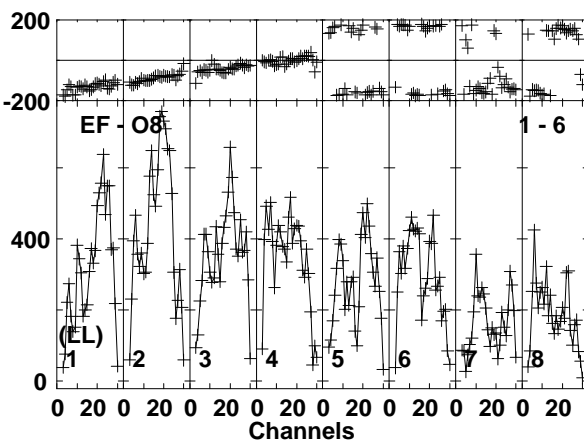
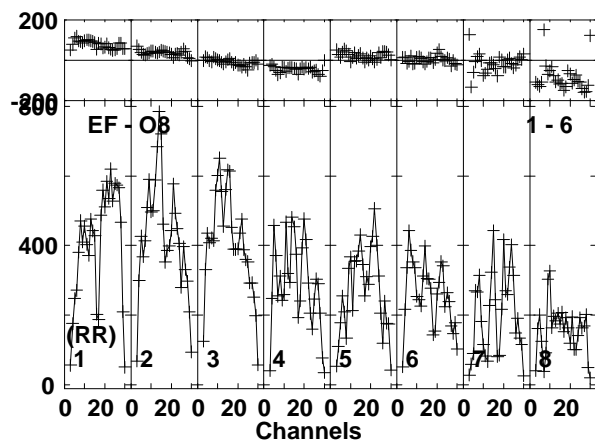
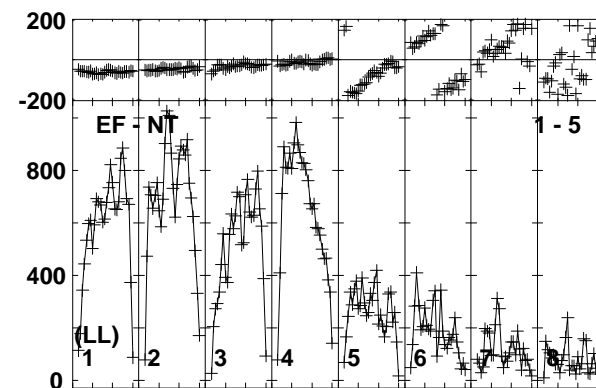
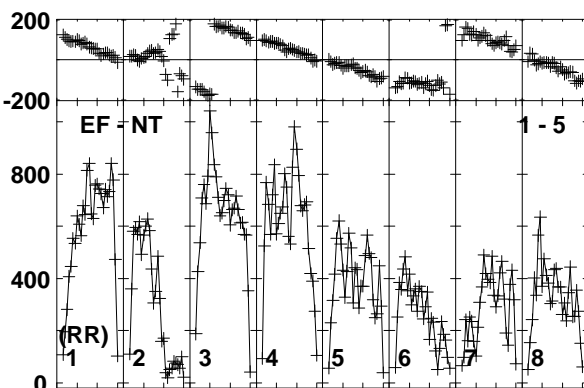
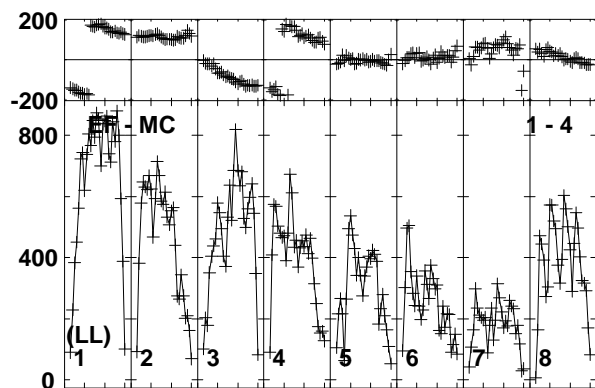
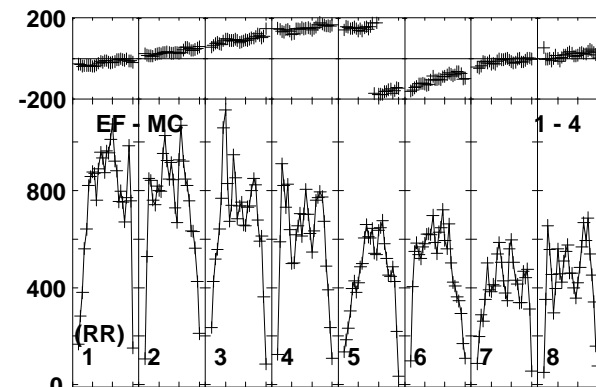
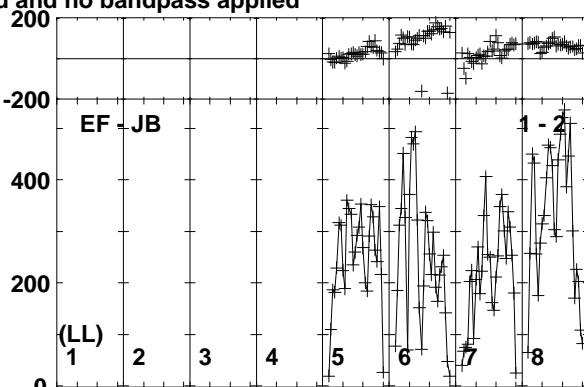
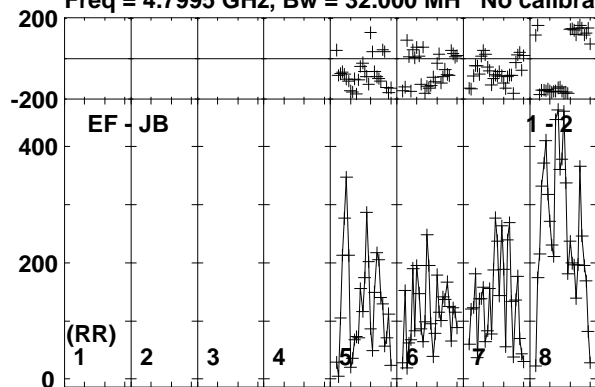

Lower frame: Micro Ampl Jy Top frame: Phas deg
Vector averaged cross-power spectrum Baseline: EF (01) - JB (02)
Timerange: 00/22:38:51 to 00/22:40:19

Plot file version 88 created 20-APR-2018 18:07:58

J1311-2329 RG009B.UVDATA.1

Freq = 4.7995 GHz, Bw = 32.000 MH No calibration applied and no bandpass applied

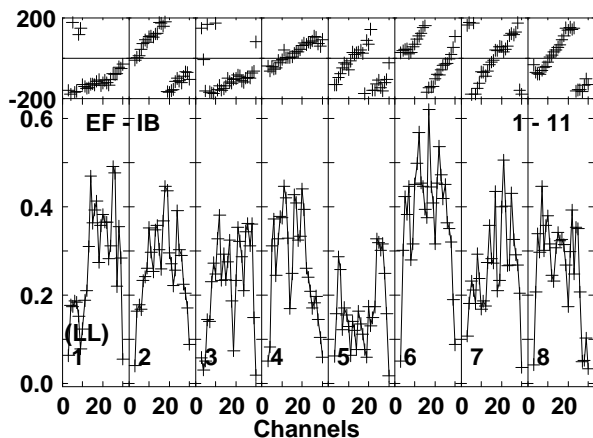
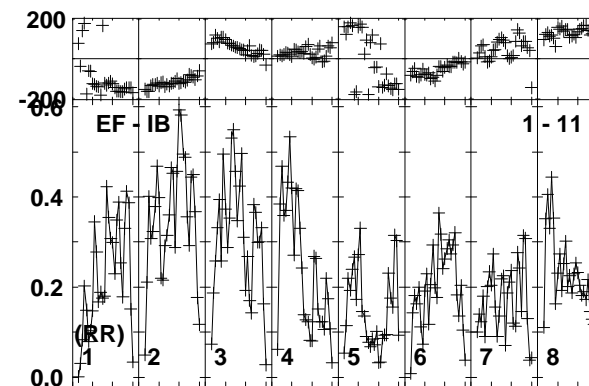
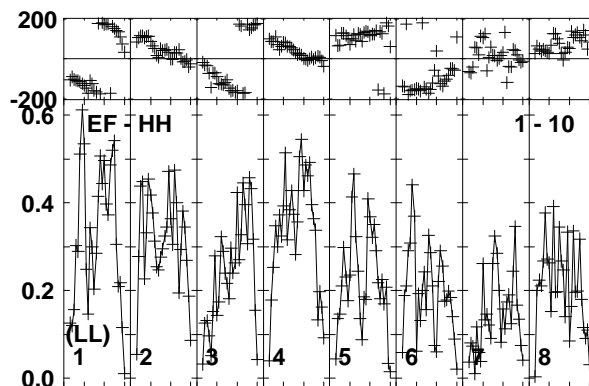
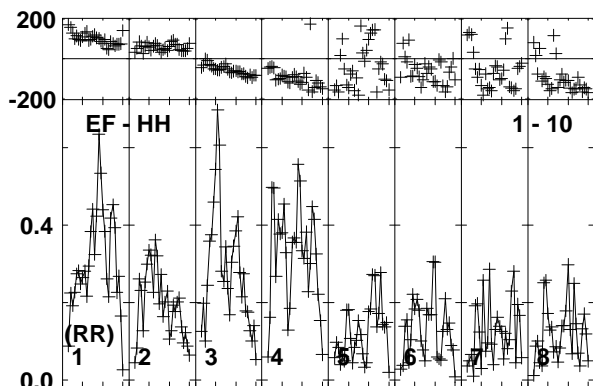
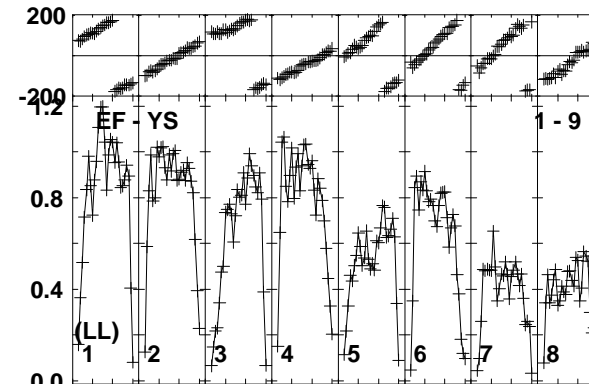
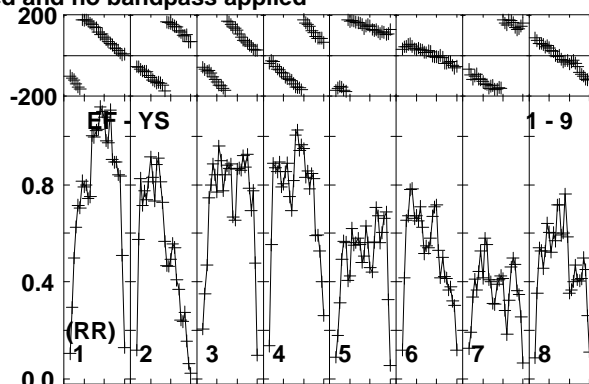
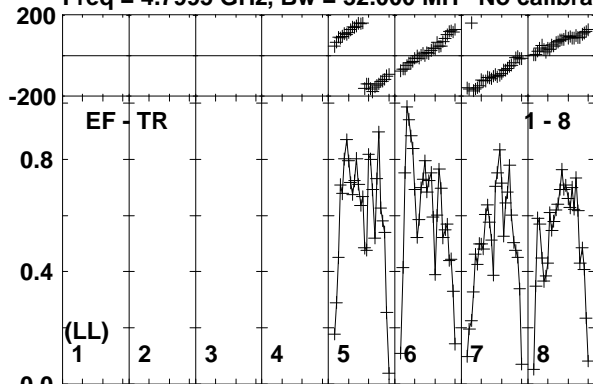

Lower frame: Milli Ampl Jy Top frame: Phas deg
Vector averaged cross-power spectrum Baseline: EF (01) - TR (08)
Timerange: 00:22:38:51 to 00:22:40:19

Plot file version 89 created 20-APR-2018 18:07:58

J1312-2350 RG009B.UVDATA.1

Freq = 4.7995 GHz, Bw = 32.000 MH No calibration applied and no bandpass applied

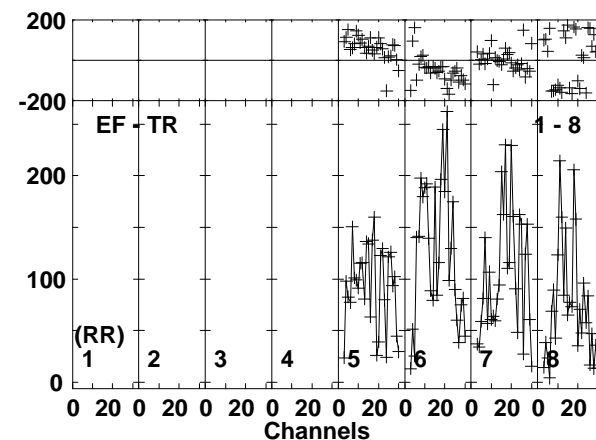
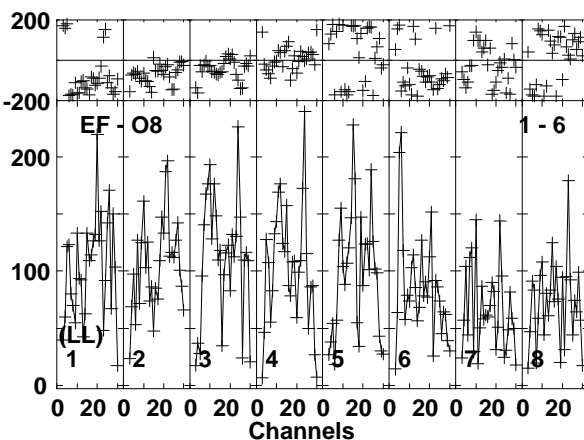
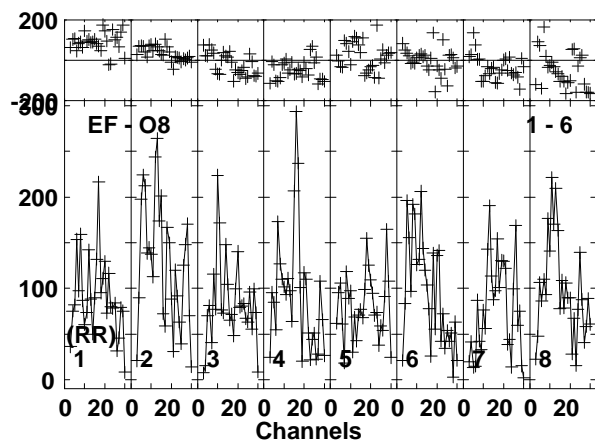
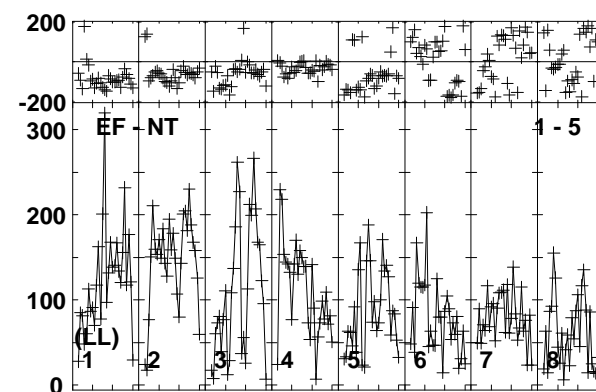
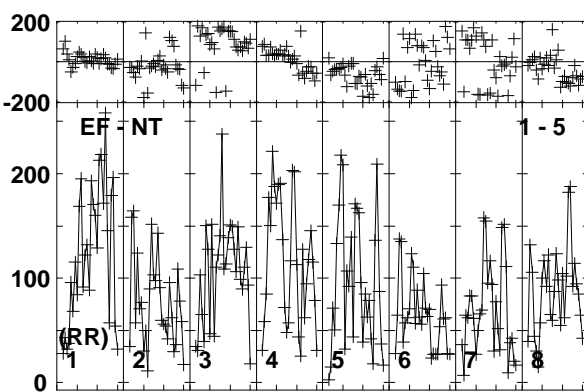
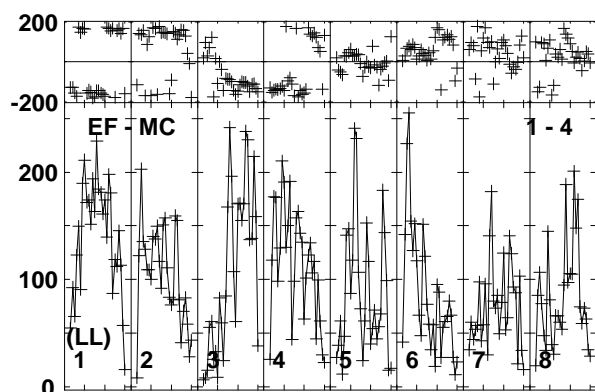
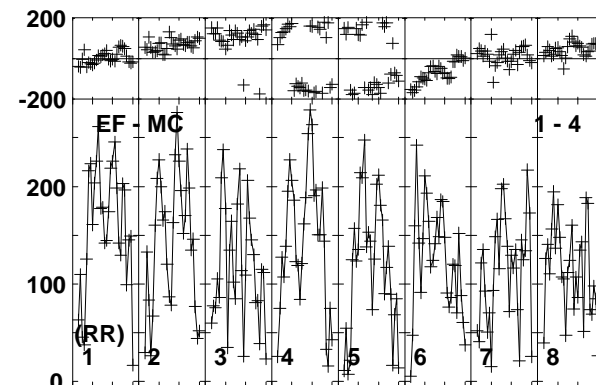
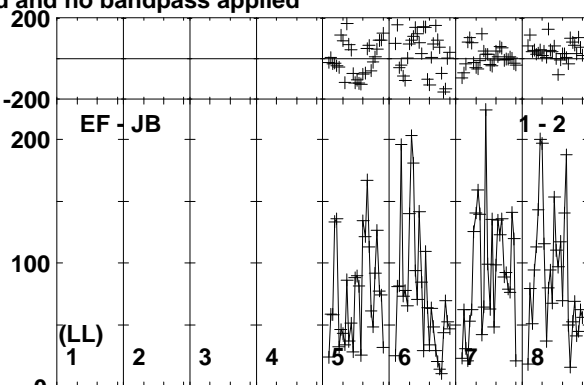
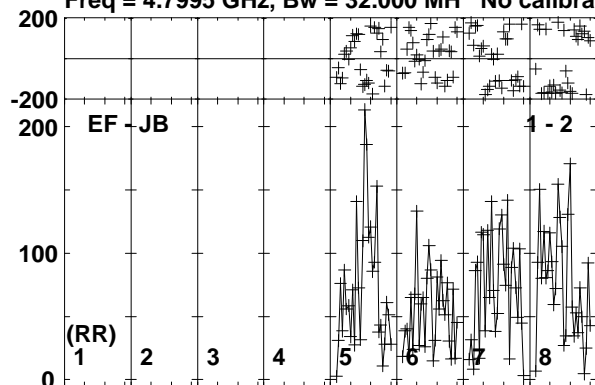

Lower frame: Micro Ampl Jy Top frame: Phas deg
Vector averaged cross-power spectrum Baseline: EF (01) - JB (02)
Timerange: 00:22:40:21 to 00:22:42:49

Plot file version 90 created 20-APR-2018 18:07:58

J1312-2350 RG009B.UVDATA.1

Freq = 4.7995 GHz, Bw = 32.000 MH No calibration applied and no bandpass applied

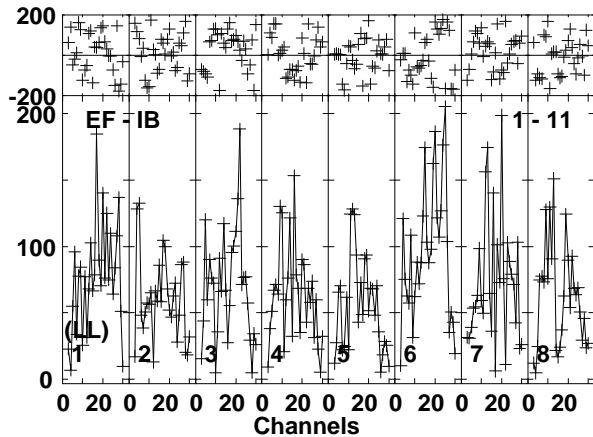
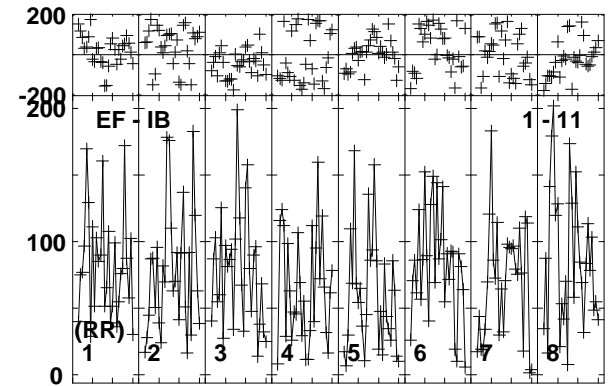
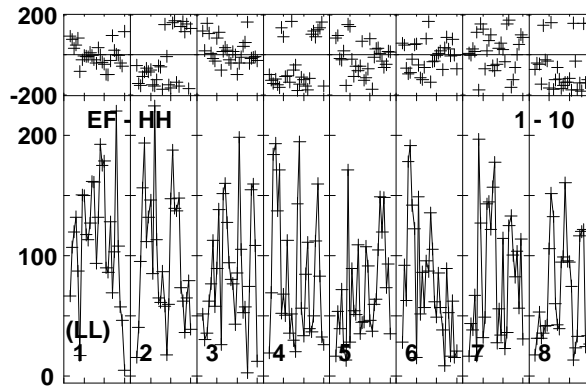
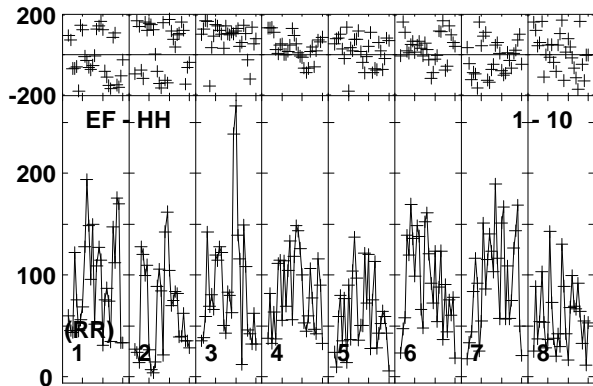
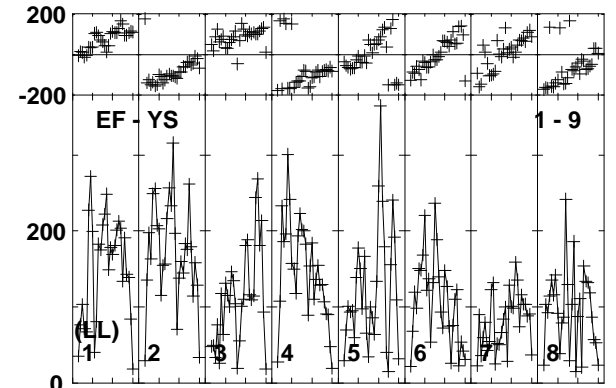
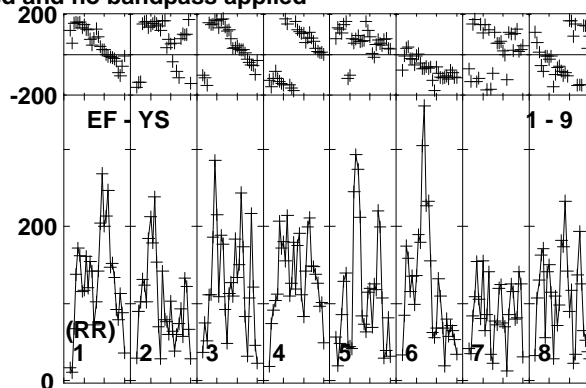
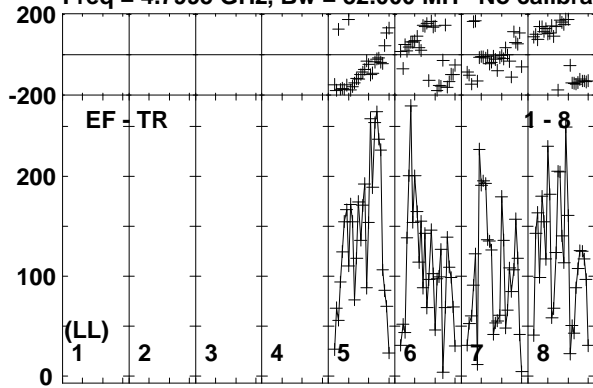

Lower frame: Micro Ampl Jy Top frame: Phas deg
Vector averaged cross-power spectrum Baseline: EF (01) - TR (08)
Timerange: 00/22:40:21 to 00/22:42:49

Plot file version 91 created 20-APR-2018 18:07:59

J1311-2329 RG009B.UVDATA.1

Freq = 4.7995 GHz, Bw = 32.000 MH No calibration applied and no bandpass applied

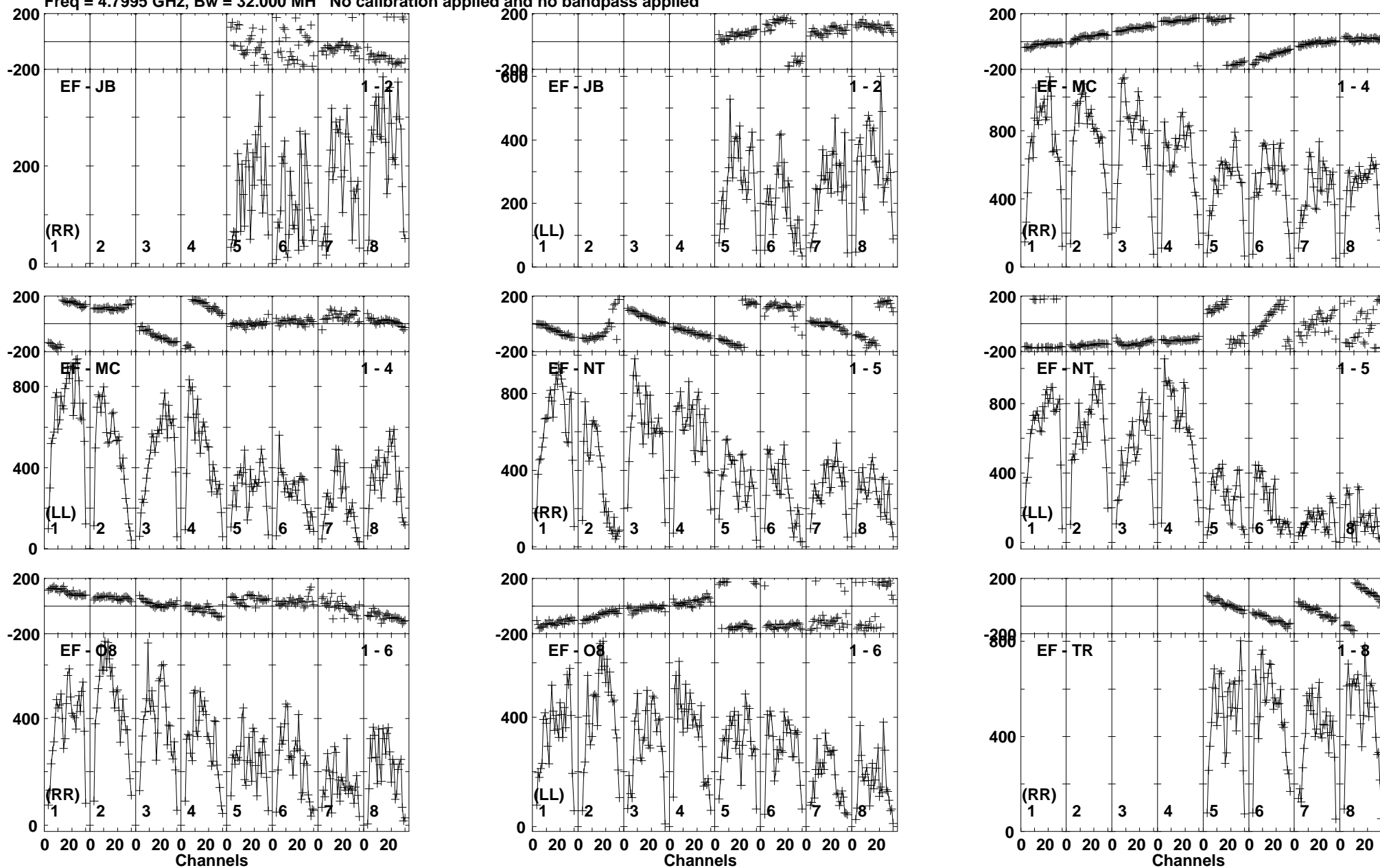

Lower frame: Micro Ampl Jy Top frame: Phas deg
Vector averaged cross-power spectrum Baseline: EF (01) - JB (02)
Timerange: 00:22:43:31 to 00:22:44:29

Plot file version 92 created 20-APR-2018 18:07:59

J1311-2329 RG009B.UVDATA.1

Freq = 4.7995 GHz, Bw = 32.000 MH No calibration applied and no bandpass applied

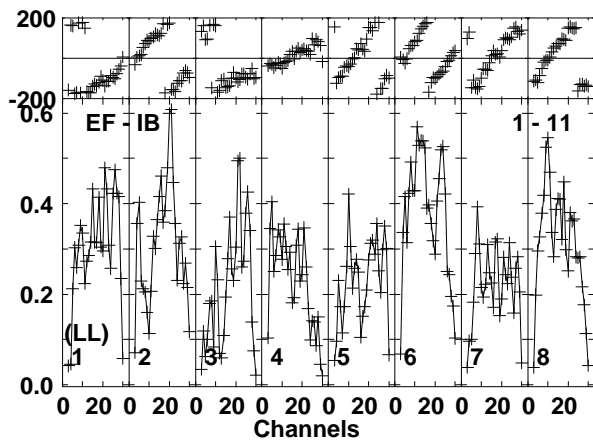
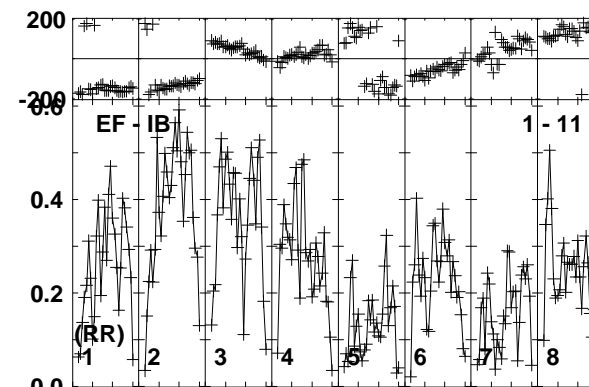
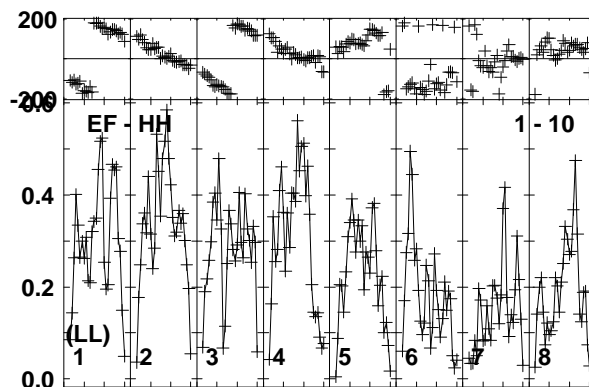
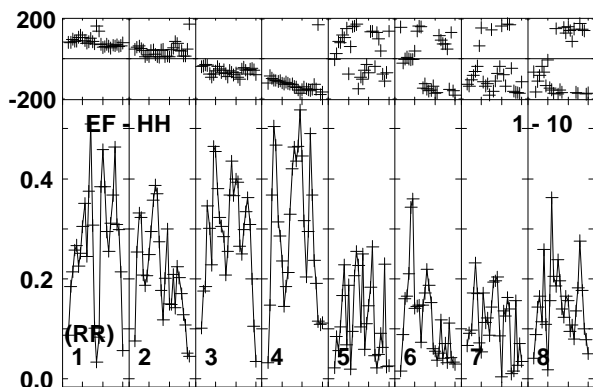
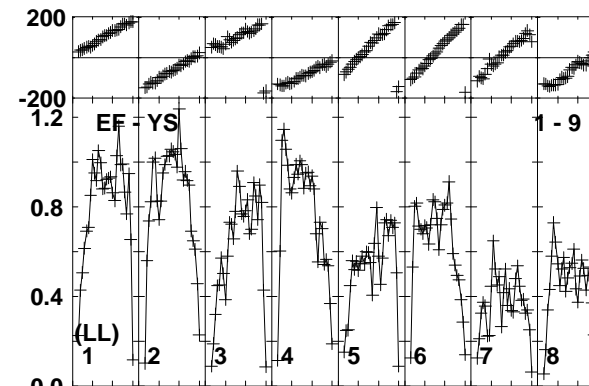
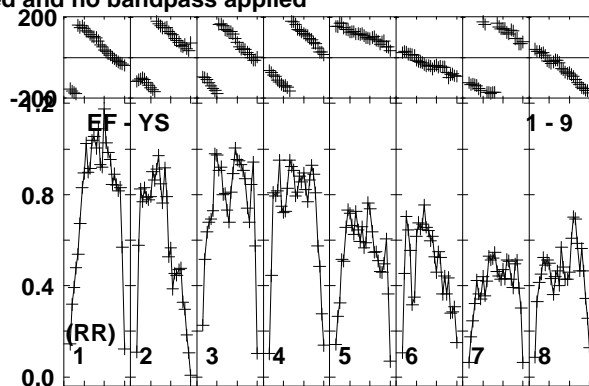
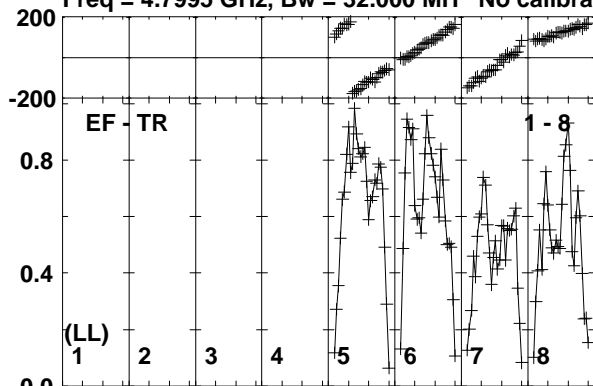

Lower frame: Milli Ampl Jy Top frame: Phas deg
Vector averaged cross-power spectrum Baseline: EF (01) - TR (08)
Timerange: 00/22:43:31 to 00/22:44:29

Plot file version 93 created 20-APR-2018 18:07:59

EM170817 RG009B.UVDATA.1

Freq = 4.7995 GHz, Bw = 32.000 MH No calibration applied and no bandpass applied

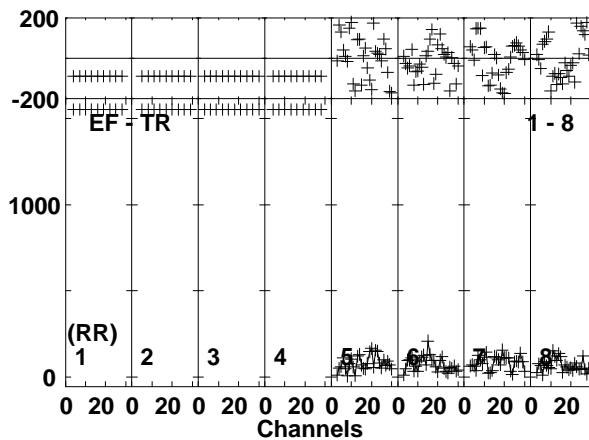
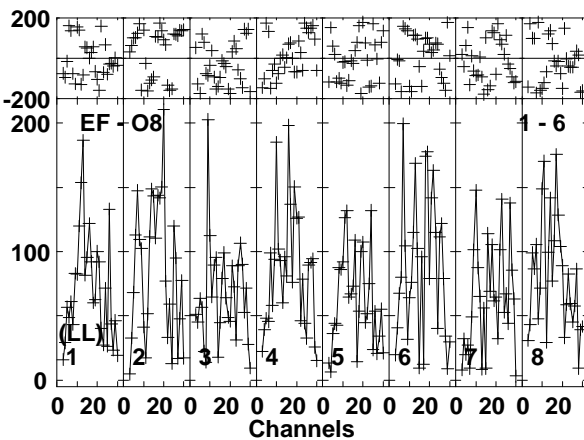
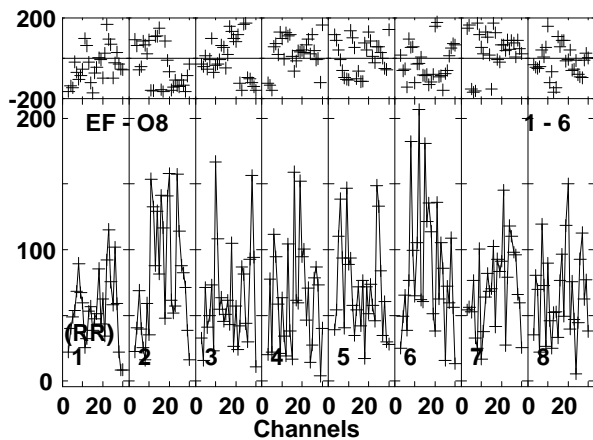
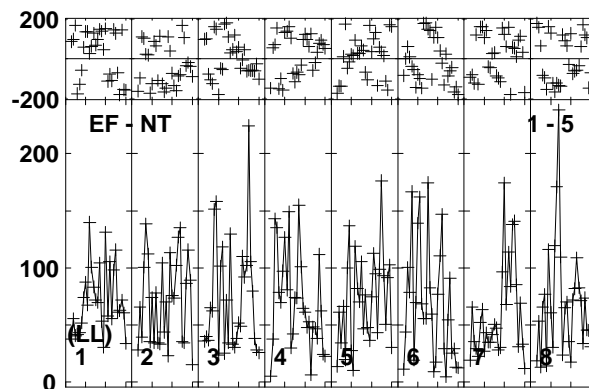
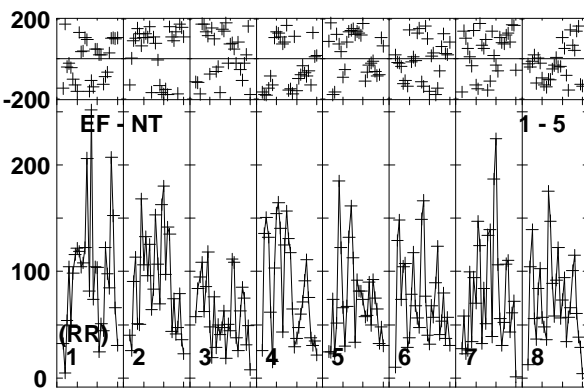
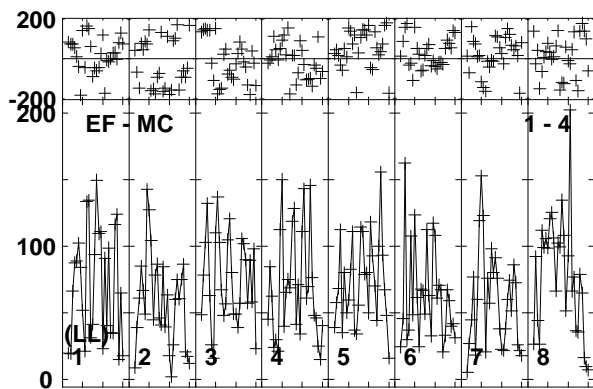
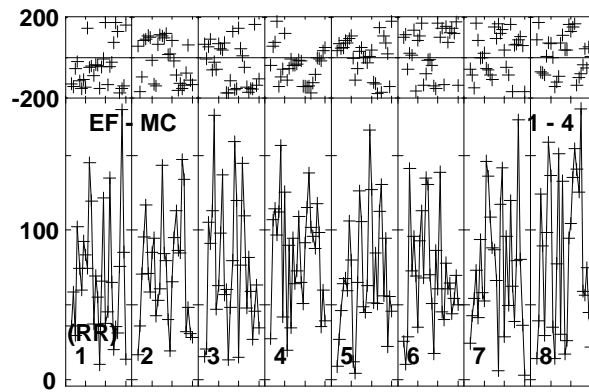
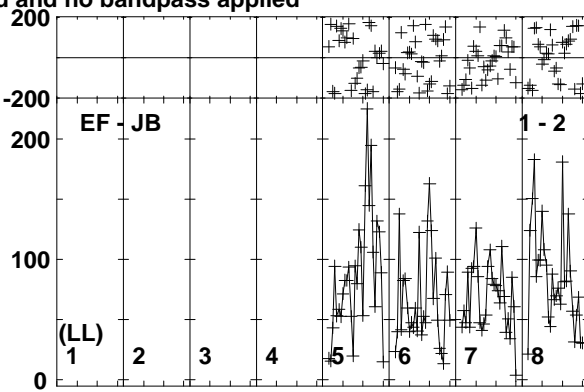
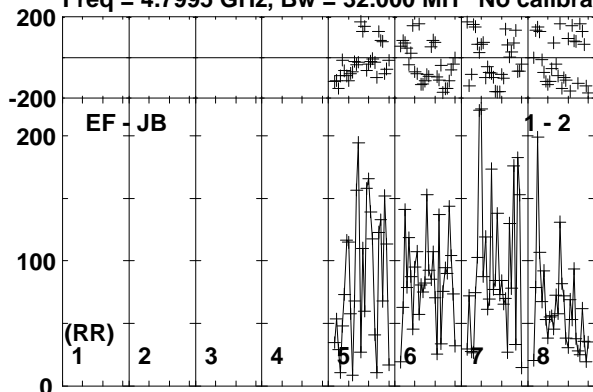

Lower frame: Micro Ampl Jy Top frame: Phas deg
Vector averaged cross-power spectrum Baseline: EF (01) - JB (02)
Timerange: 00:22:44:31 to 00:22:46:59

Plot file version 94 created 20-APR-2018 18:07:59

EM170817 RG009B.UVDATA.1

Freq = 4.7995 GHz, Bw = 32.000 MH No calibration applied and no bandpass applied

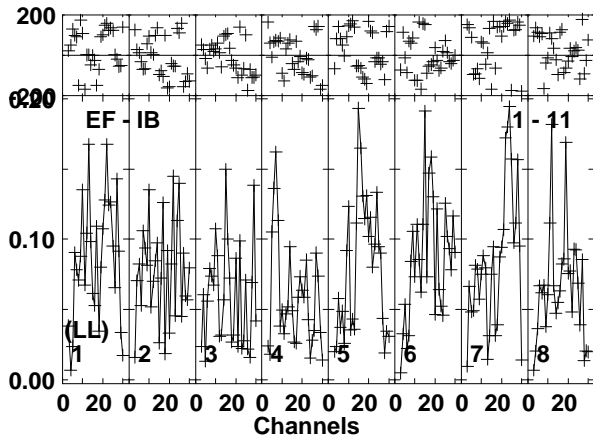
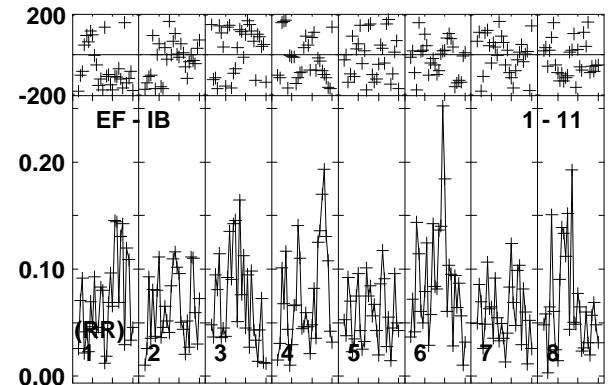
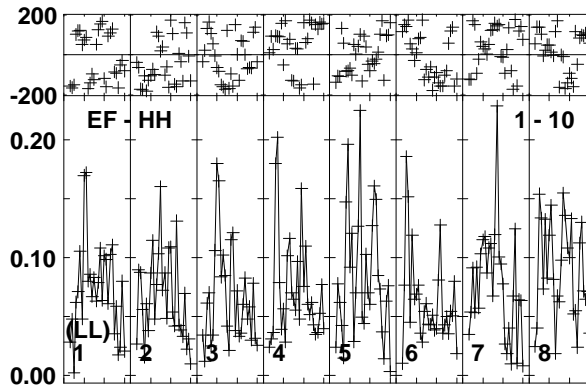
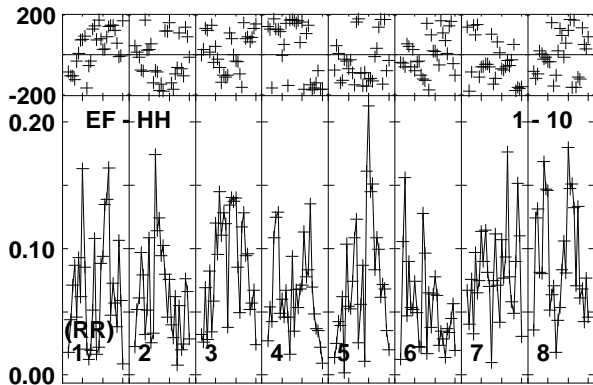
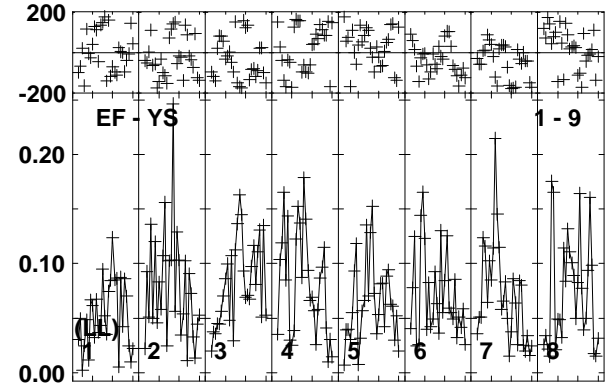
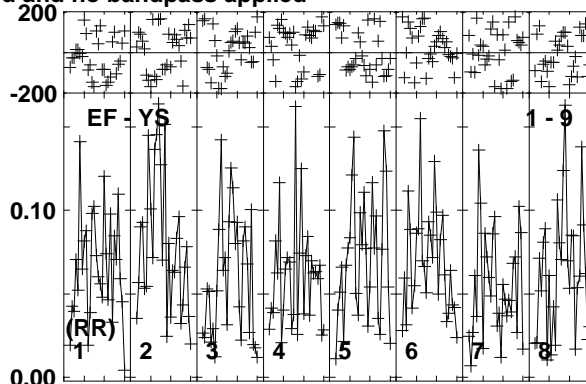
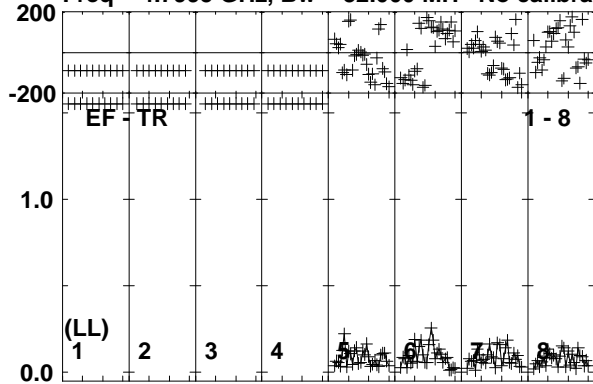

Lower frame: Milli Ampl Jy Top frame: Phas deg
Vector averaged cross-power spectrum Baseline: EF (01) - TR (08)
Timerange: 00/22:44:31 to 00/22:46:59

Plot file version 95 created 20-APR-2018 18:07:59

J1311-2329 RG009B.UVDATA.1

Freq = 4.7995 GHz, Bw = 32.000 MH No calibration applied and no bandpass applied

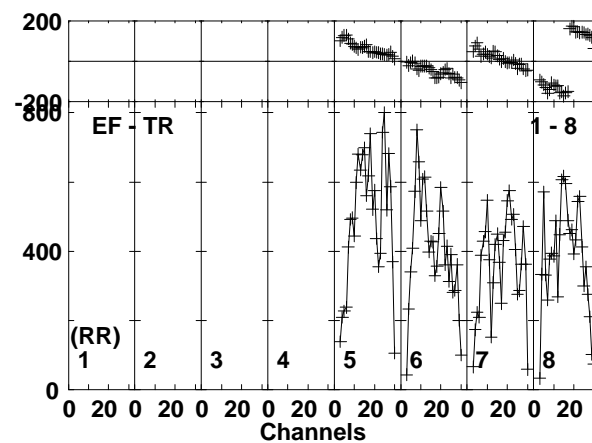
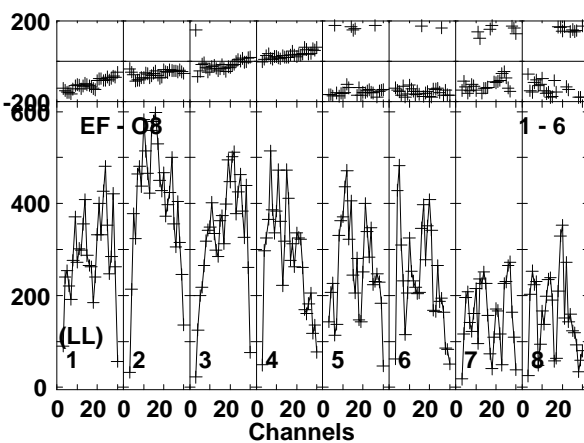
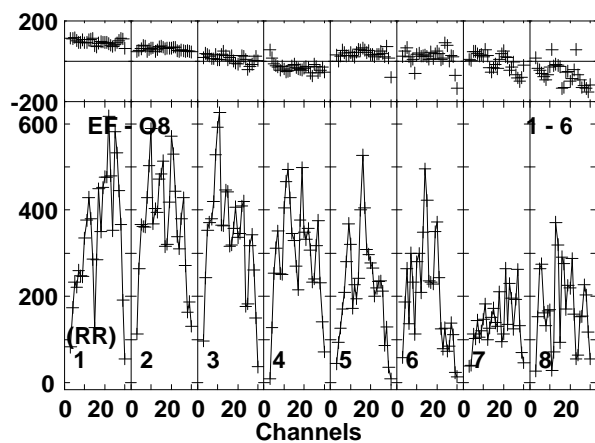
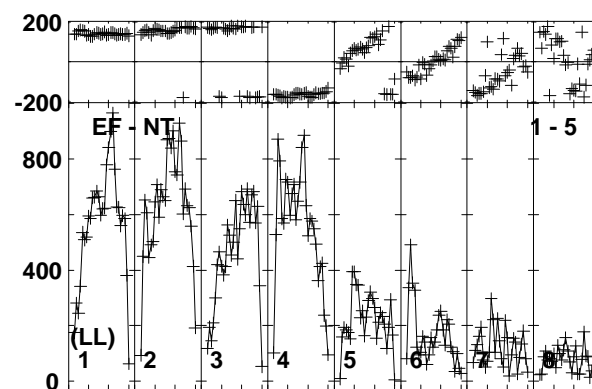
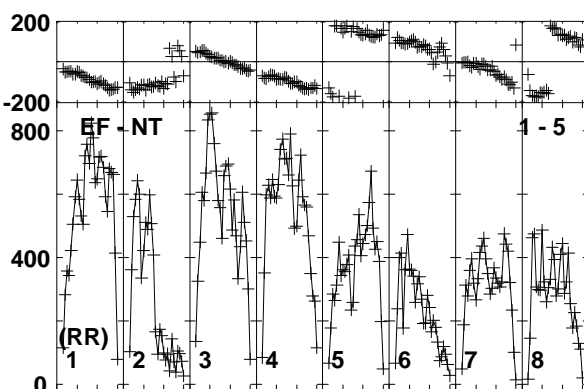
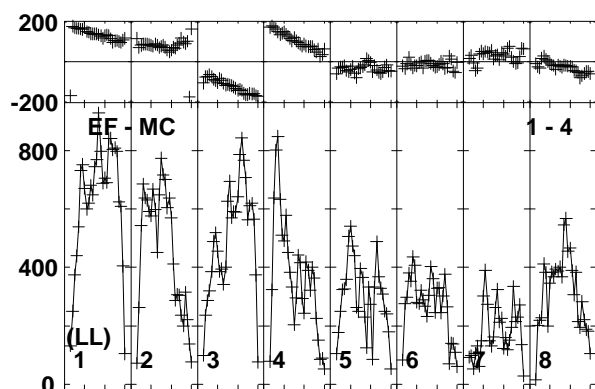
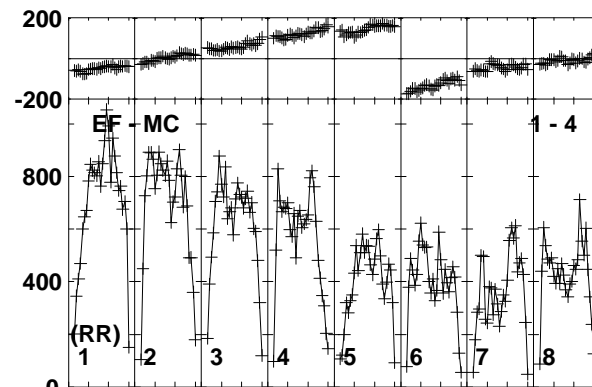
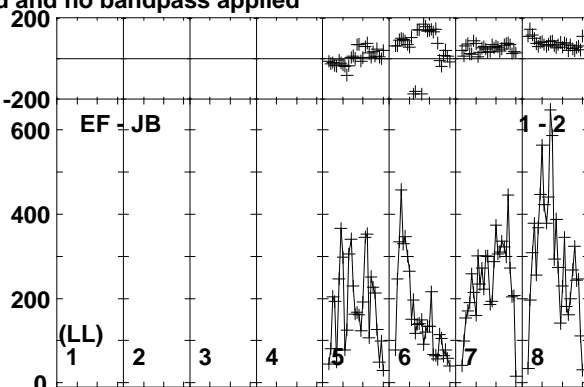
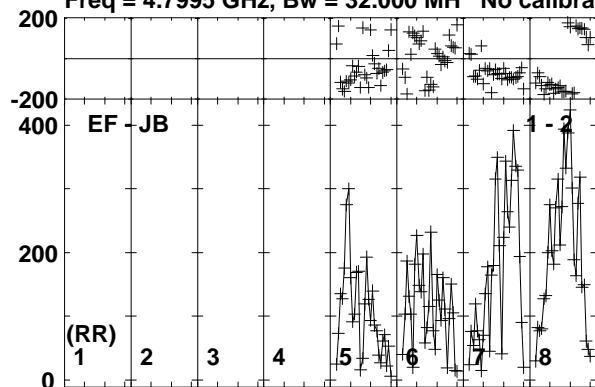

Lower frame: Micro Ampl Jy Top frame: Phas deg
Vector averaged cross-power spectrum Baseline: EF (01) - JB (02)
Timerange: 00:22:47:01 to 00:22:48:29

Plot file version 96 created 20-APR-2018 18:07:59

J1311-2329 RG009B.UVDATA.1

Freq = 4.7995 GHz, Bw = 32.000 MH No calibration applied and no bandpass applied

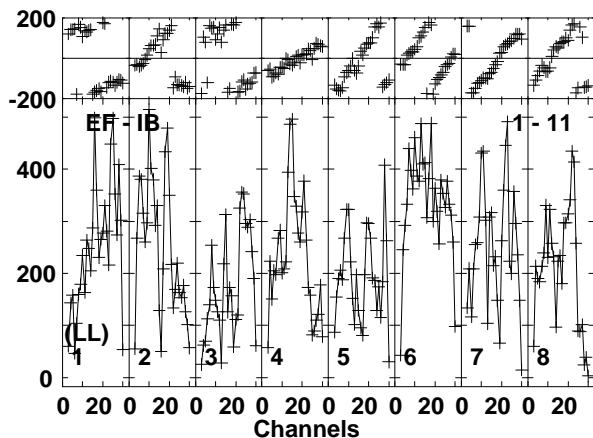
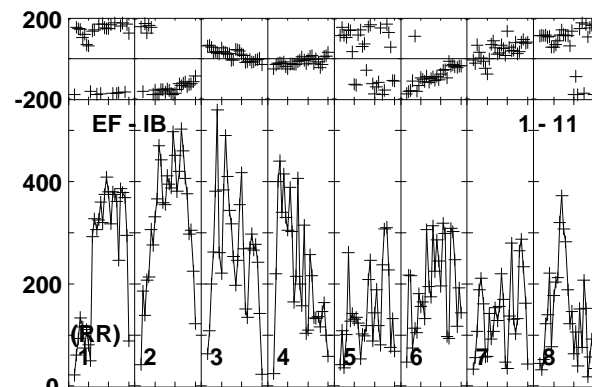
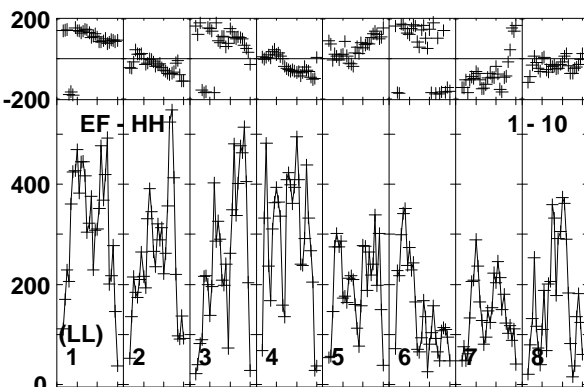
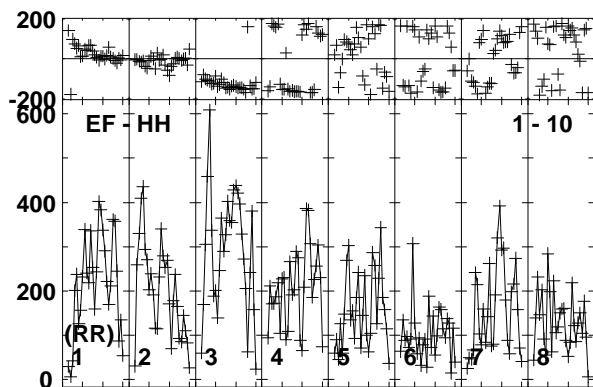
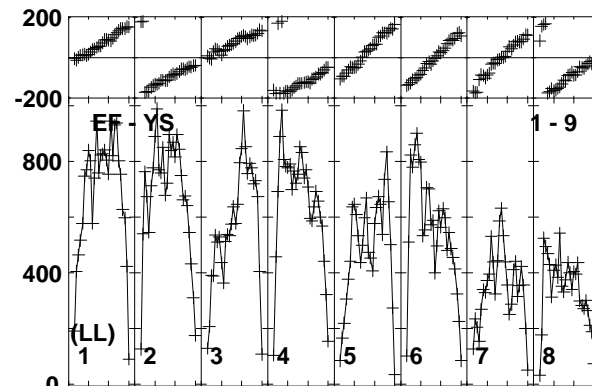
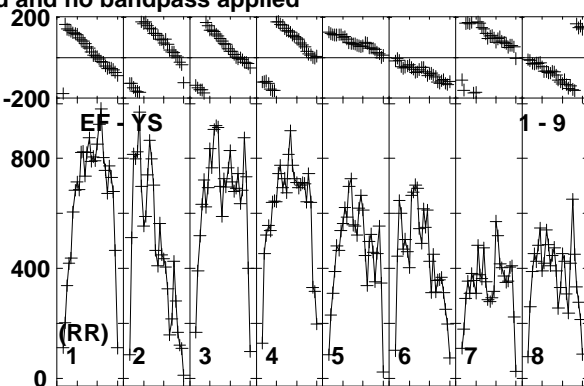
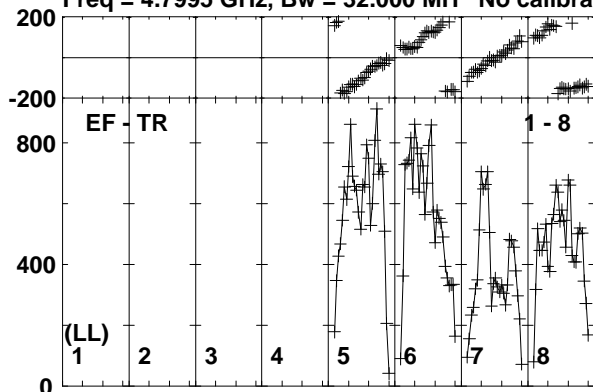

Lower frame: Micro Ampl Jy Top frame: Phas deg
Vector averaged cross-power spectrum Baseline: EF (01) - TR (08)
Timerange: 00/22:47:01 to 00/22:48:29

Plot file version 97 created 20-APR-2018 18:07:59

EM170817 RG009B.UVDATA.1

Freq = 4.7995 GHz, Bw = 32.000 MH No calibration applied and no bandpass applied

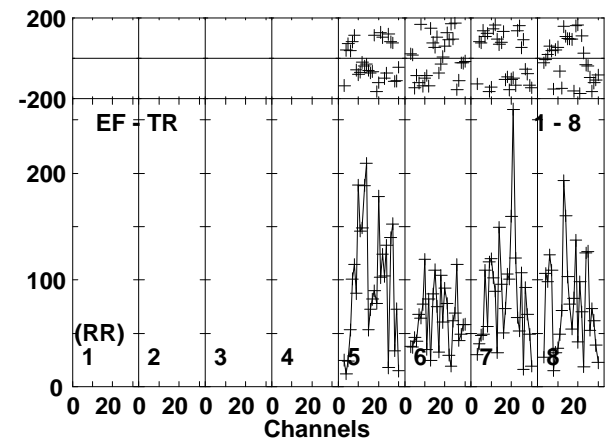
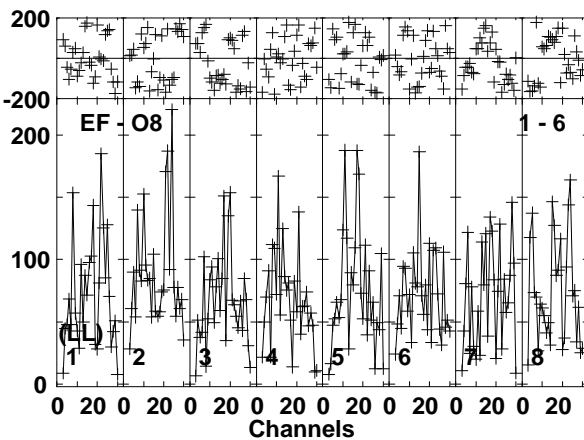
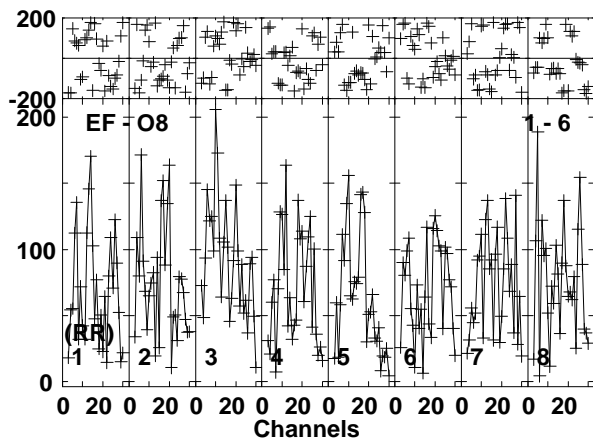
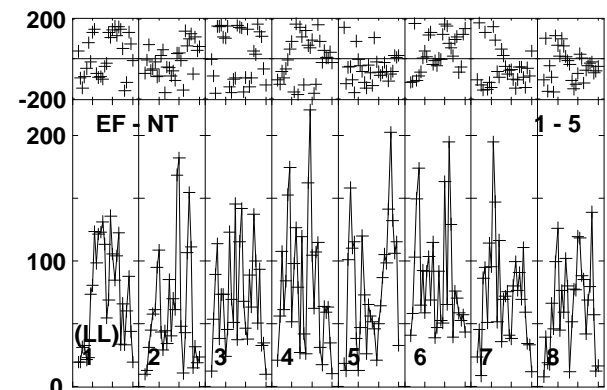
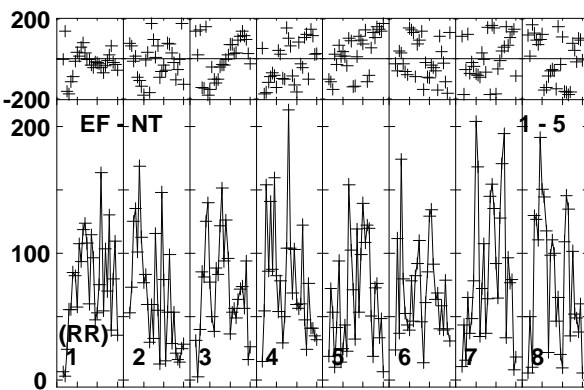
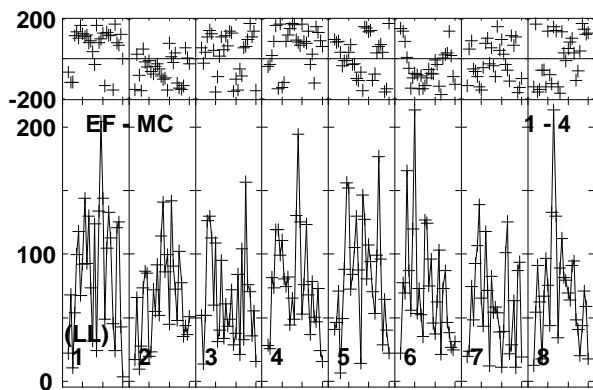
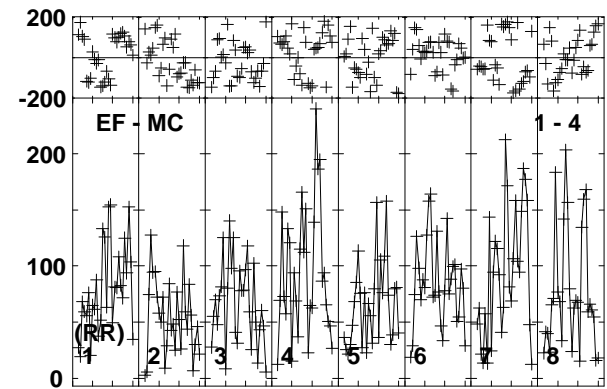
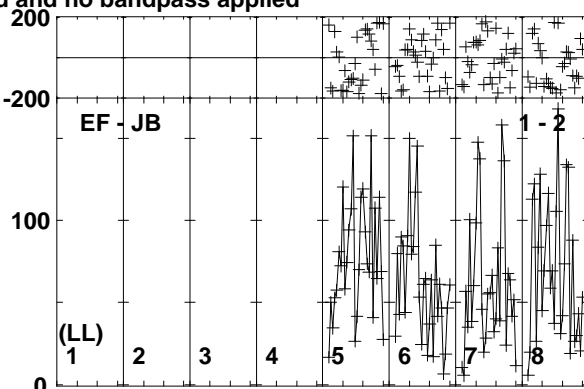
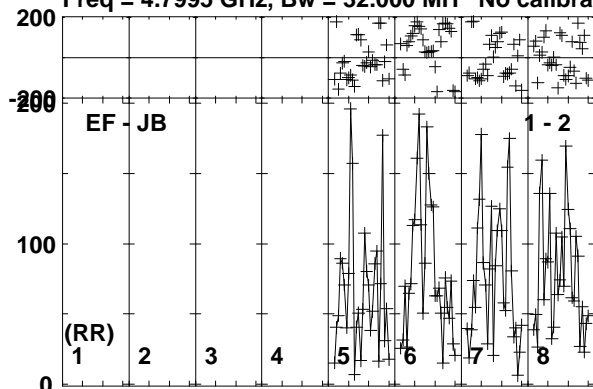

Lower frame: Micro Ampl Jy Top frame: Phas deg
Vector averaged cross-power spectrum Baseline: EF (01) - JB (02)
Timerange: 00/22:48:31 to 00/22:50:59

Plot file version 98 created 20-APR-2018 18:07:59

EM170817 RG009B.UVDATA.1

Freq = 4.7995 GHz, Bw = 32.000 MH No calibration applied and no bandpass applied

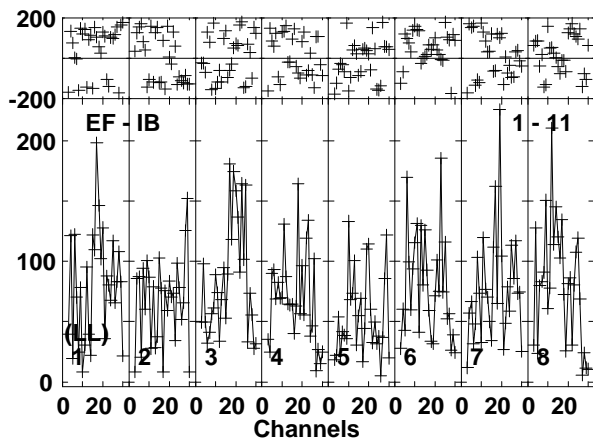
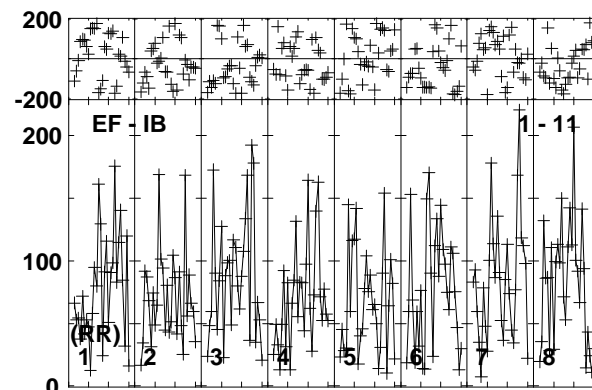
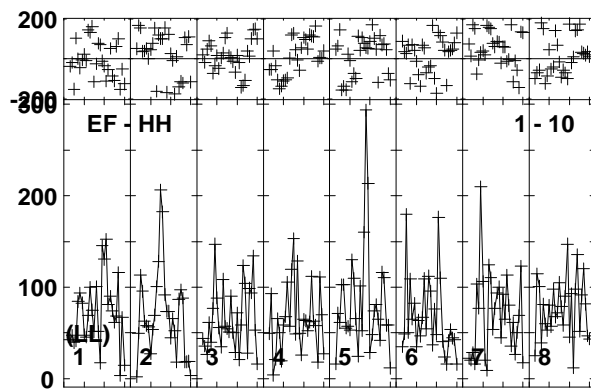
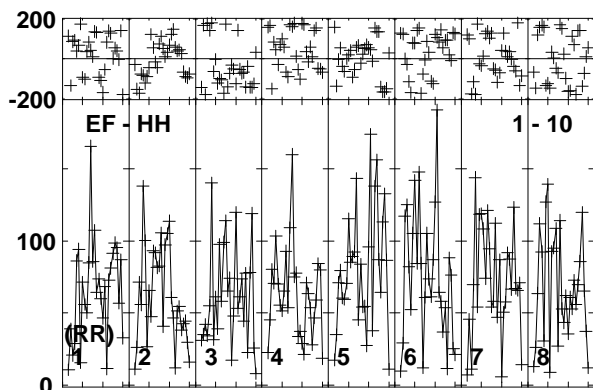
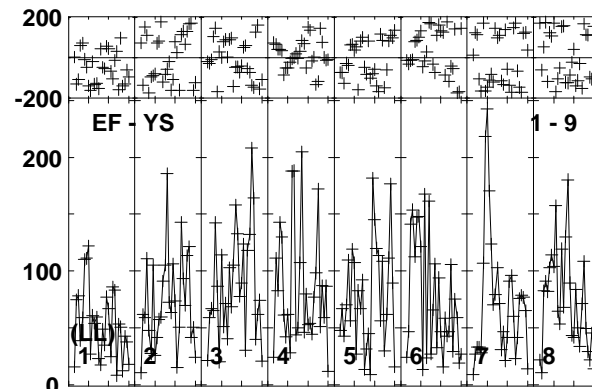
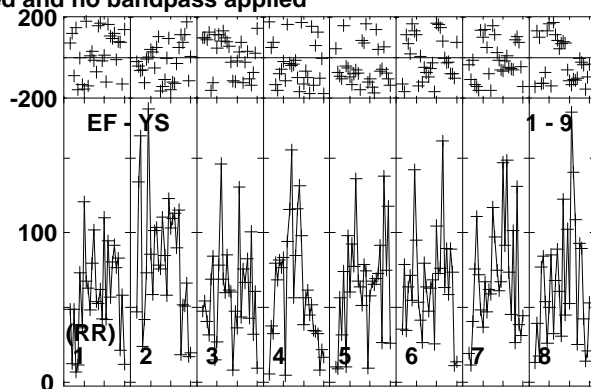
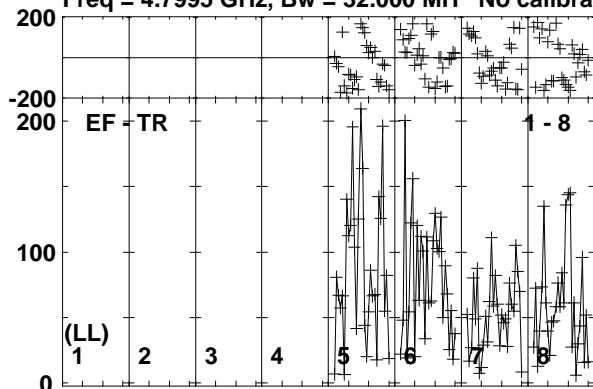

Lower frame: Micro Ampl Jy Top frame: Phas deg
Vector averaged cross-power spectrum Baseline: EF (01) - TR (08)
Timerange: 00:22:48:31 to 00:22:50:59

Plot file version 99 created 20-APR-2018 18:07:59

J1311-2329 RG009B.UVDATA.1

Freq = 4.7995 GHz, Bw = 32.000 MH No calibration applied and no bandpass applied

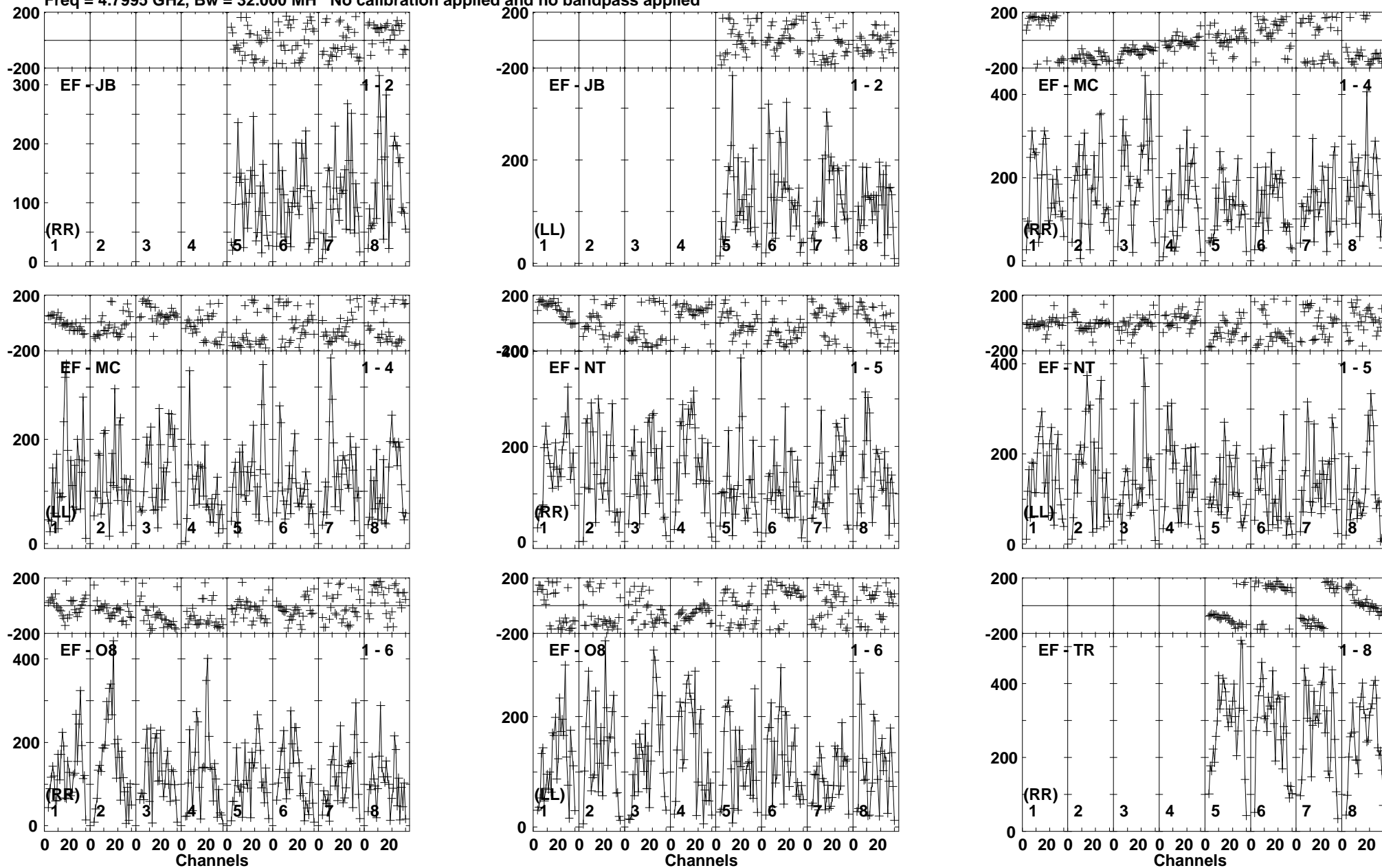

Lower frame: Micro Ampl Jy Top frame: Phas deg
Vector averaged cross-power spectrum Baseline: EF (01) - JB (02)
Timerange: 00:22:51:31 to 00:22:52:29

Plot file version 100 created 20-APR-2018 18:07:59

J1311-2329 RG009B.UVDATA.1

Freq = 4.7995 GHz, Bw = 32.000 MH No calibration applied and no bandpass applied

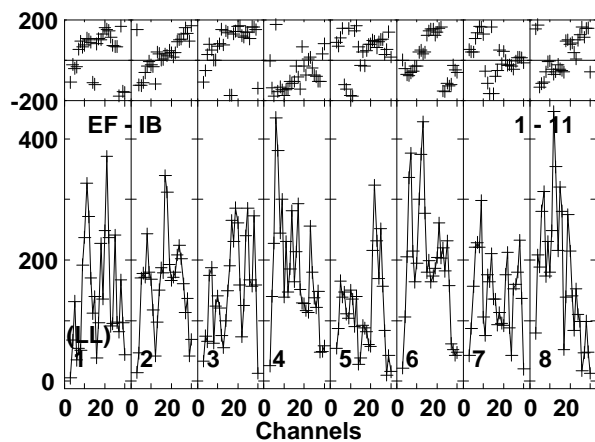
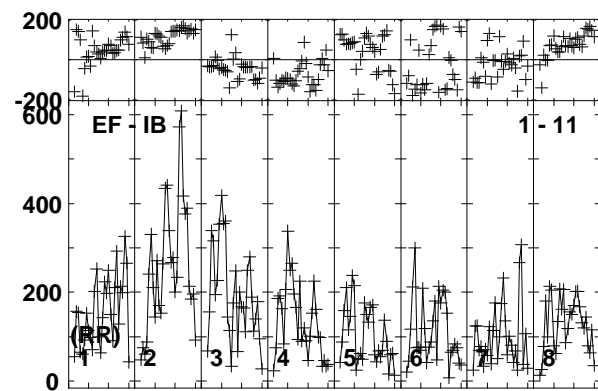
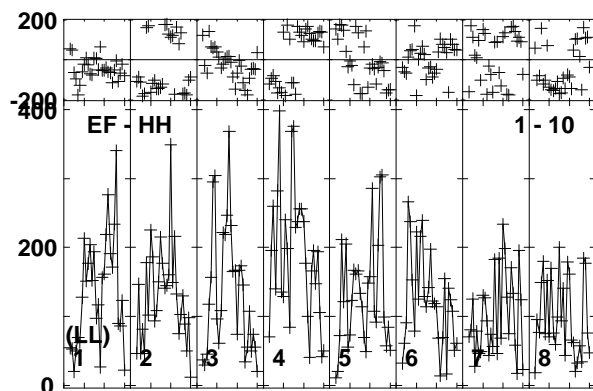
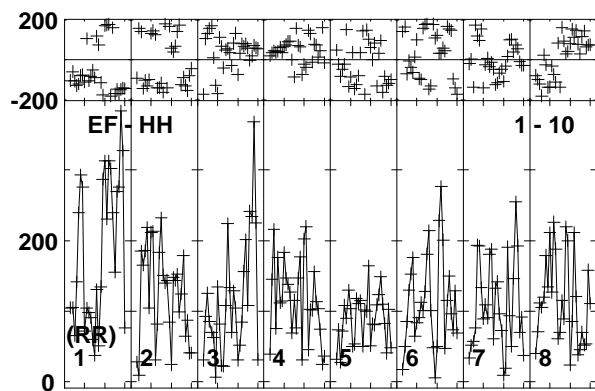
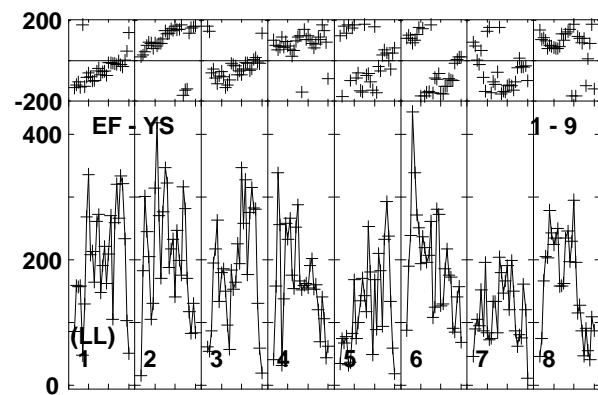
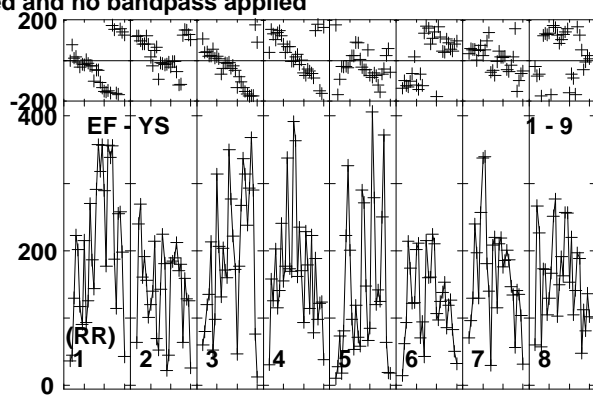
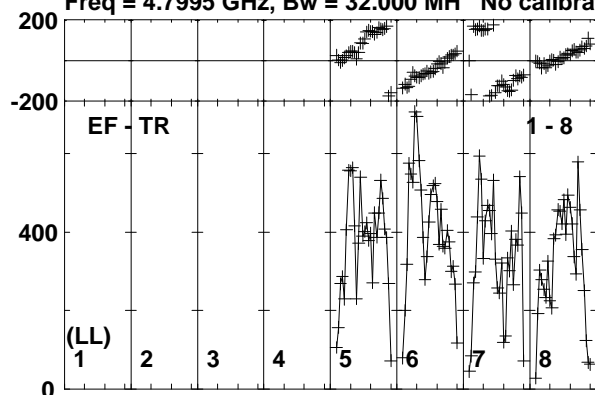

Lower frame: Micro Ampl Jy Top frame: Phas deg
Vector averaged cross-power spectrum Baseline: EF (01) - TR (08)
Timerange: 00:22:51:31 to 00:22:52:29

Plot file version 102 created 20-APR-2018 18:07:59

EM170817 RG009B.UVDATA.1

Freq = 4.7995 GHz, Bw = 32.000 MH No calibration applied and no bandpass applied

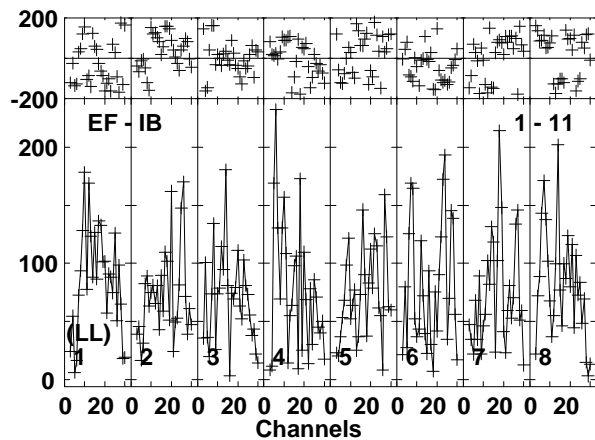
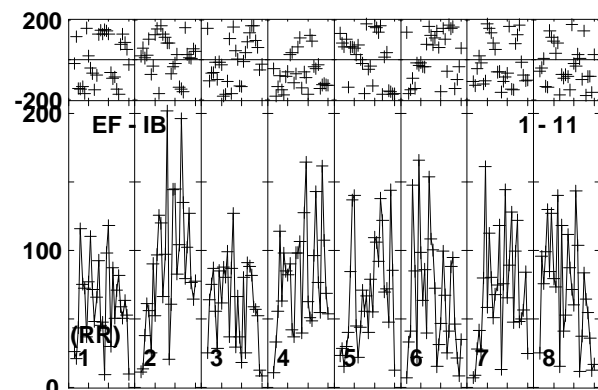
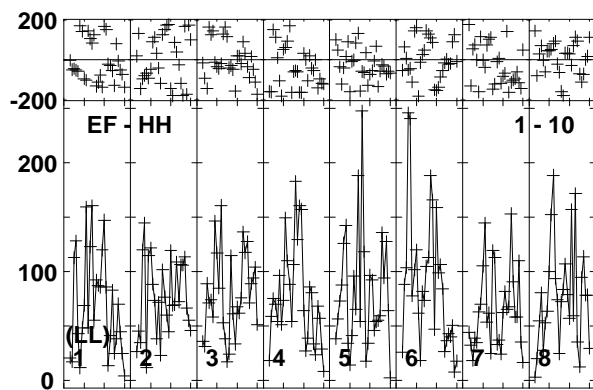
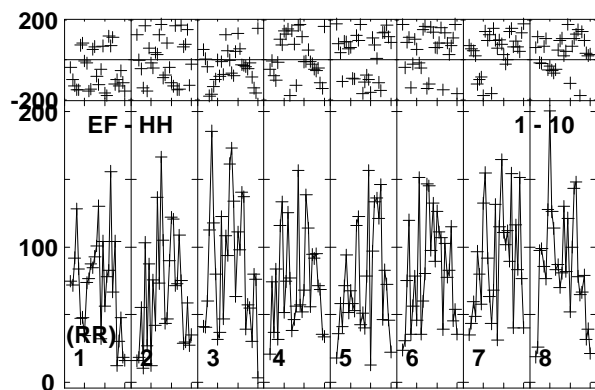
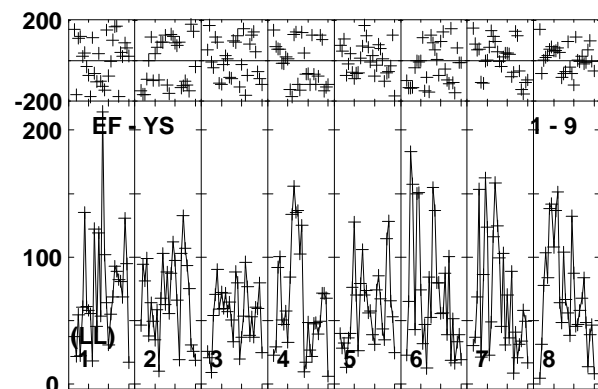
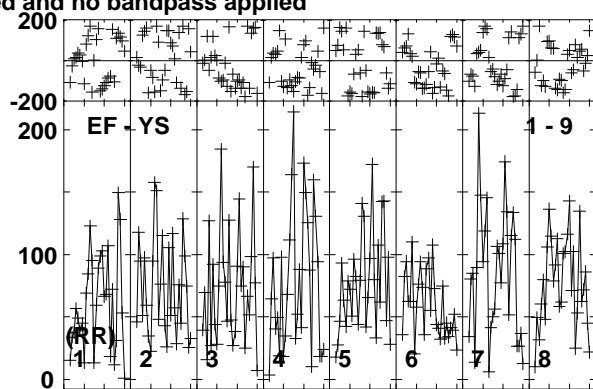
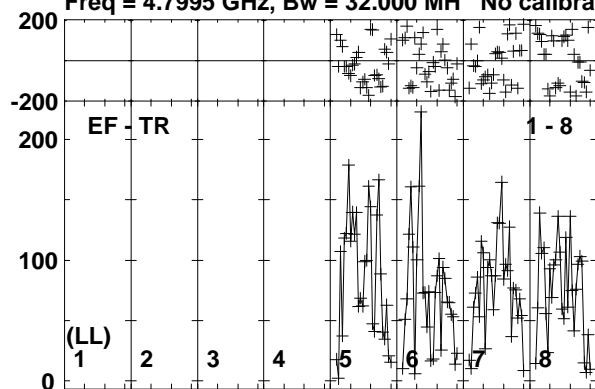

Lower frame: Micro Ampl Jy Top frame: Phas deg
Vector averaged cross-power spectrum Baseline: EF (01) - TR (08)
Timerange: 00:22:52:31 to 00:22:54:59

Plot file version 103 created 20-APR-2018 18:07:59

J1311-2329 RG009B.UVDATA.1

Freq = 4.7995 GHz, Bw = 32.000 MH No calibration applied and no bandpass applied

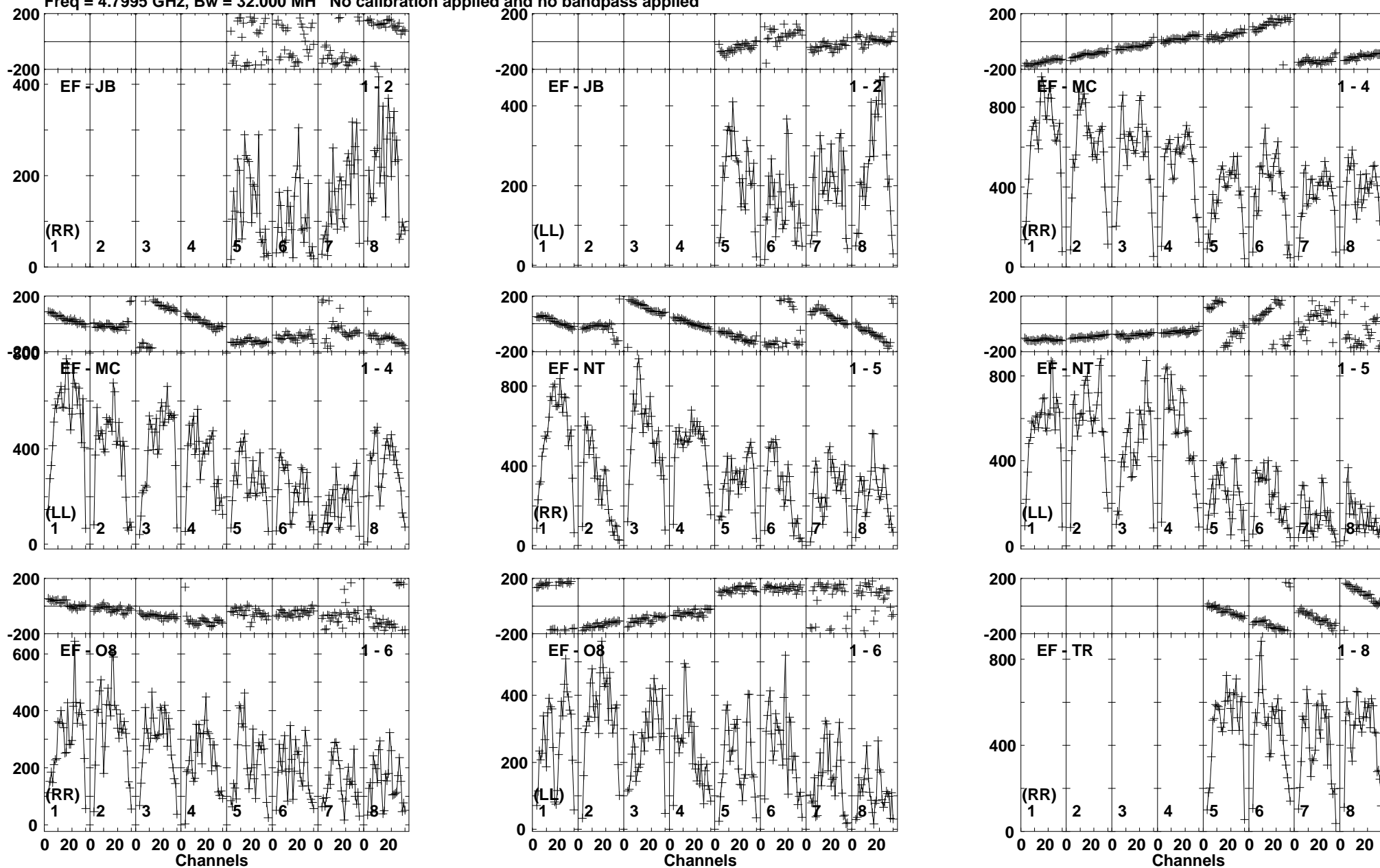

Lower frame: Micro Ampl Jy Top frame: Phas deg
Vector averaged cross-power spectrum Baseline: EF (01) - JB (02)
Timerange: 00:22:55:01 to 00:22:56:29

Plot file version 104 created 20-APR-2018 18:07:59

J1311-2329 RG009B.UVDATA.1

Freq = 4.7995 GHz, Bw = 32.000 MH No calibration applied and no bandpass applied

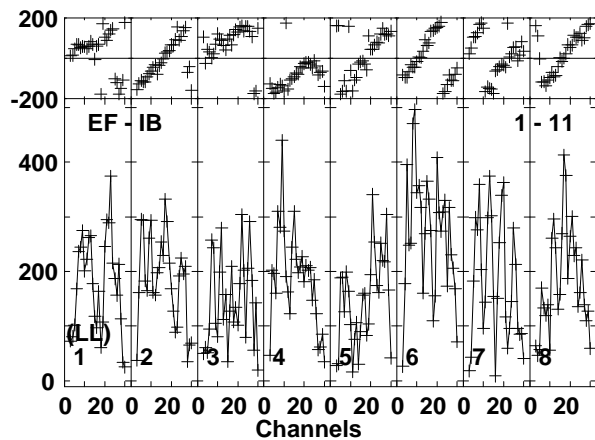
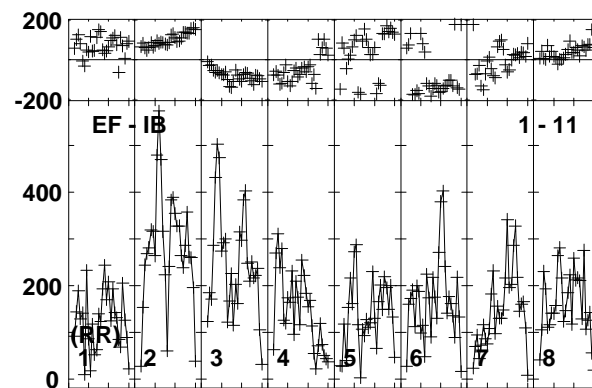
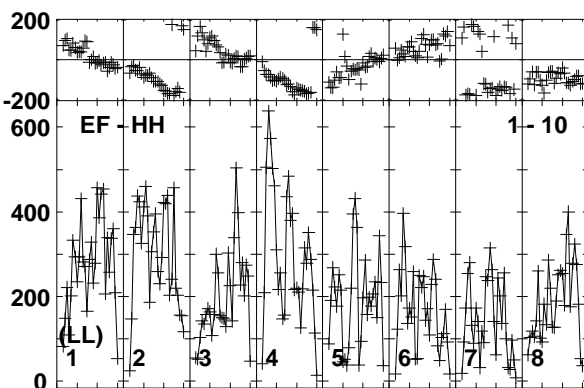
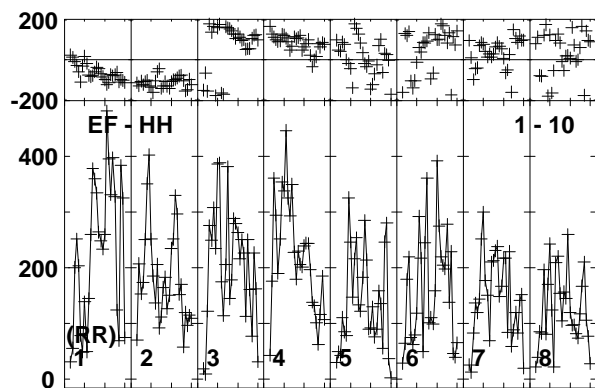
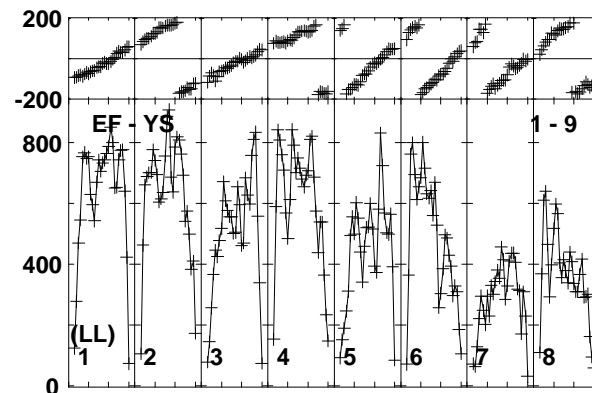
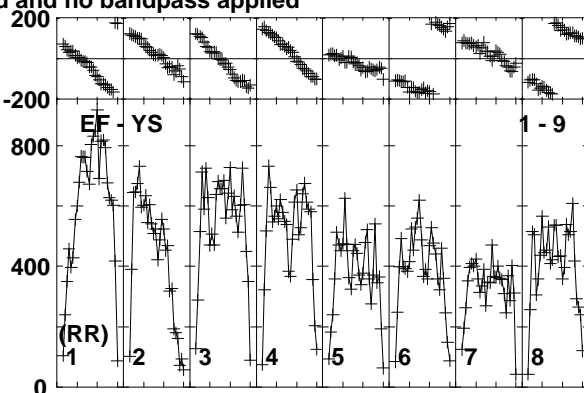
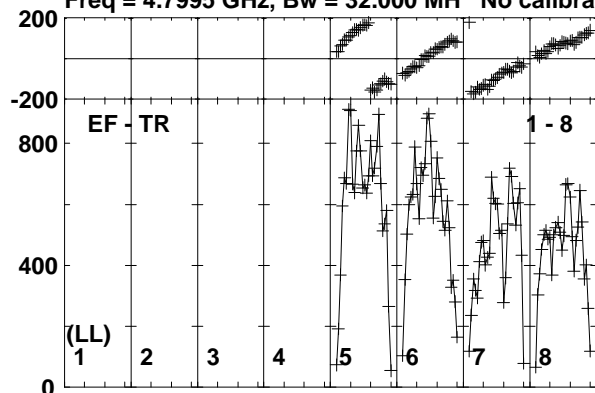

Lower frame: Micro Ampl Jy Top frame: Phas deg
Vector averaged cross-power spectrum Baseline: EF (01) - TR (08)
Timerange: 00:22:55:01 to 00:22:56:29

Plot file version 105 created 20-APR-2018 18:08:00

J1312-2350 RG009B.UVDATA.1

Freq = 4.7995 GHz, Bw = 32.000 MH No calibration applied and no bandpass applied

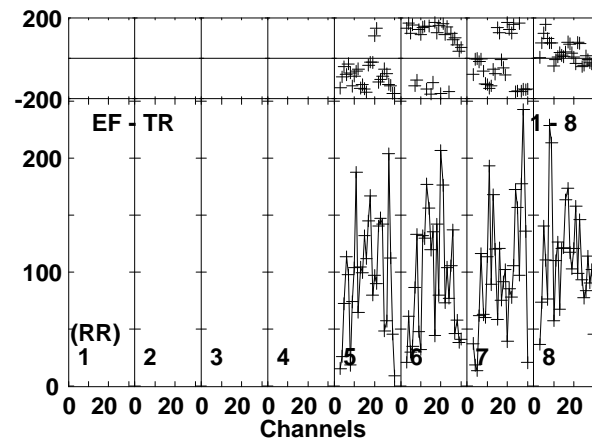
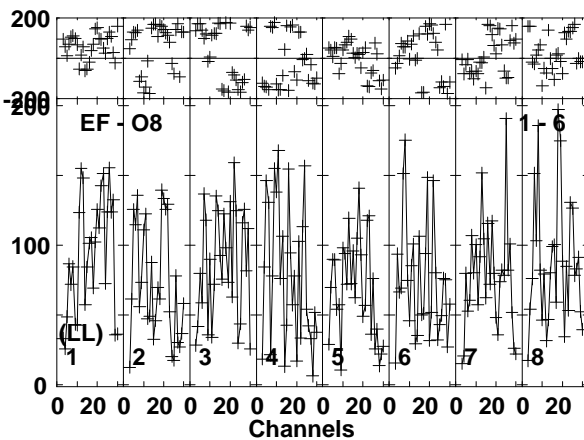
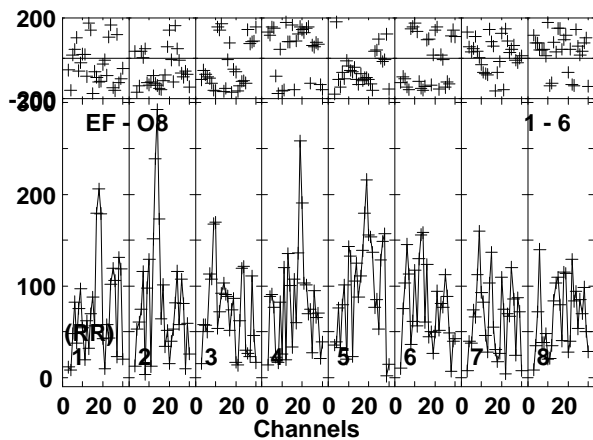
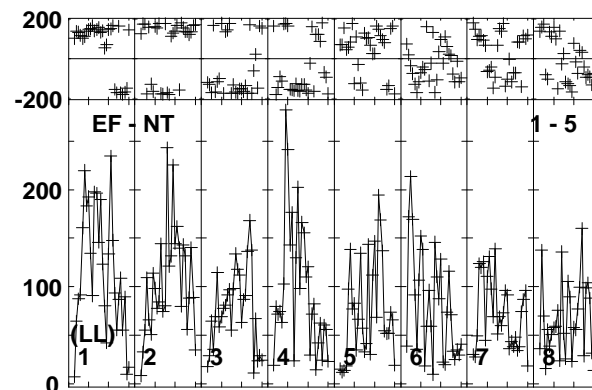
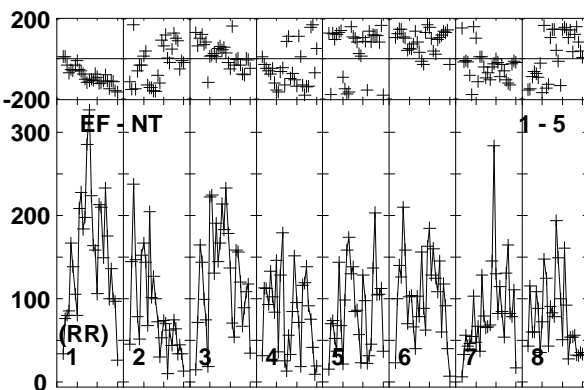
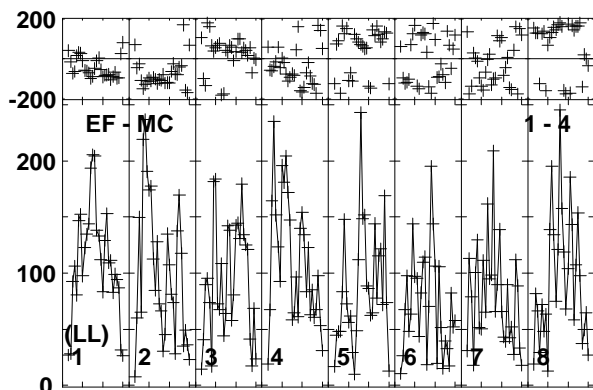
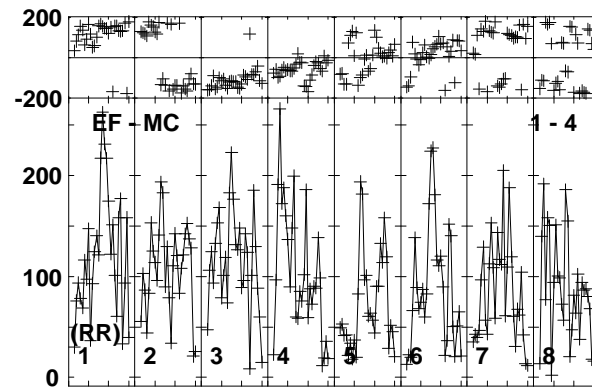
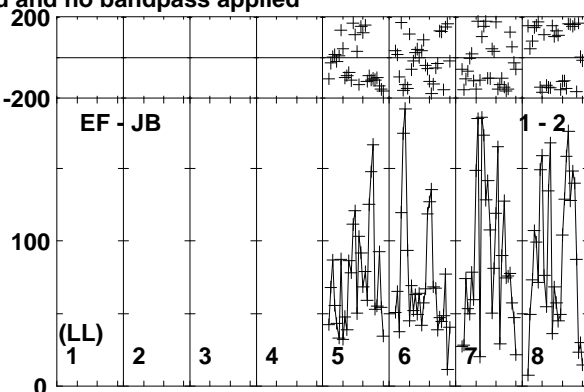
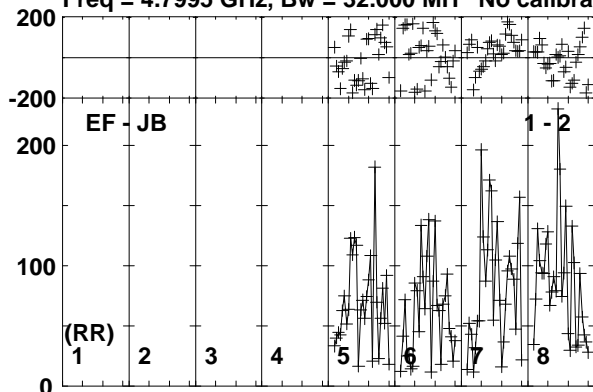

Lower frame: Micro Ampl Jy Top frame: Phas deg
Vector averaged cross-power spectrum Baseline: EF (01) - JB (02)
Timerange: 00:22:56:31 to 00:22:58:59

Plot file version 106 created 20-APR-2018 18:08:00

J1312-2350 RG009B.UVDATA.1

Freq = 4.7995 GHz, Bw = 32.000 MH No calibration applied and no bandpass applied

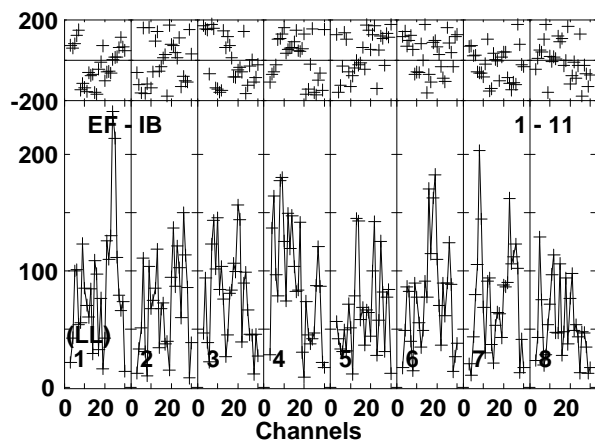
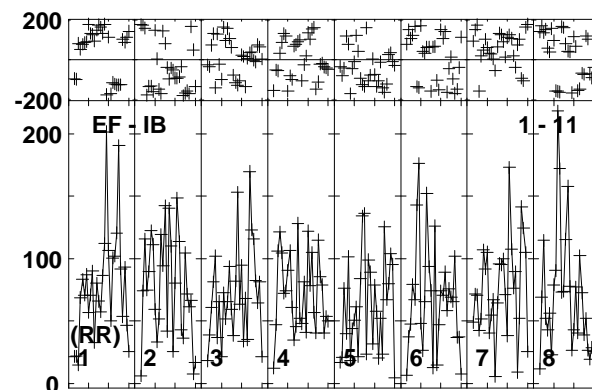
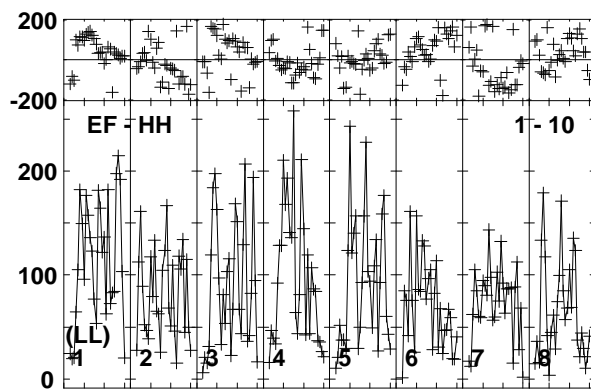
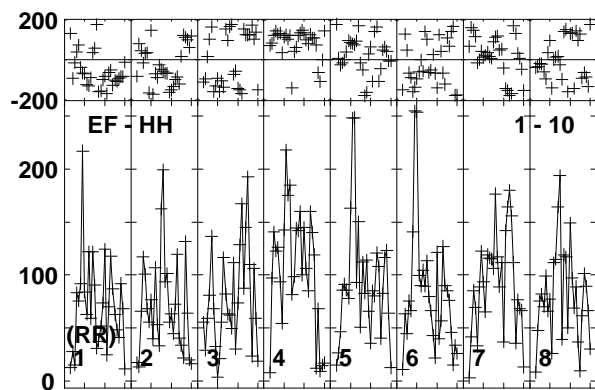
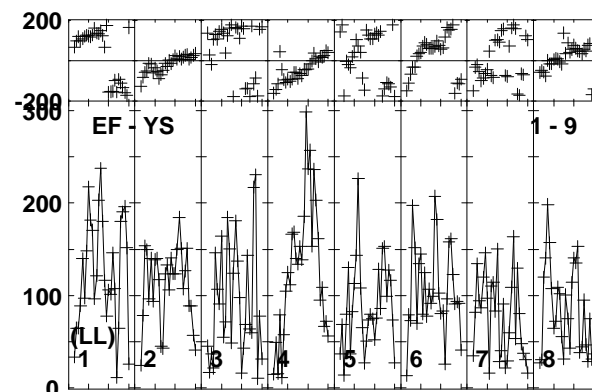
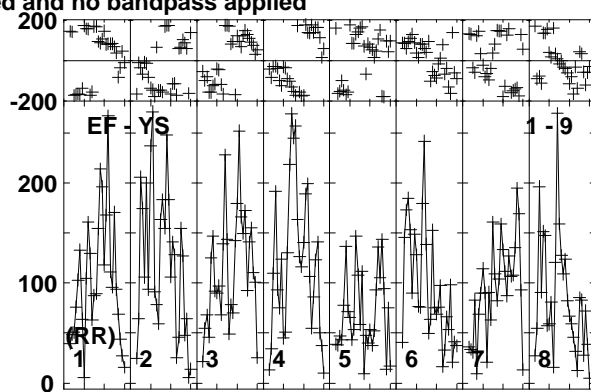
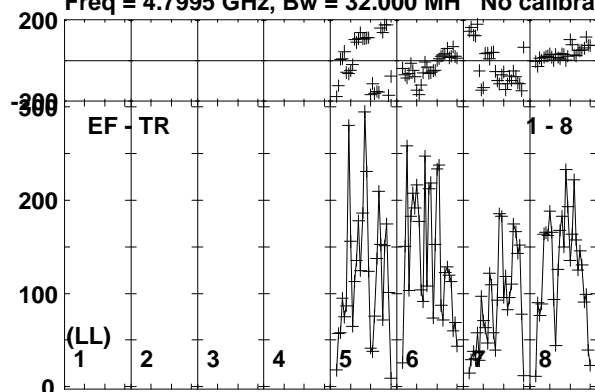

Lower frame: Micro Ampl Jy Top frame: Phas deg
Vector averaged cross-power spectrum Baseline: EF (01) - TR (08)
Timerange: 00/22:56:31 to 00/22:58:59

Plot file version 107 created 20-APR-2018 18:08:00

J1311-2329 RG009B.UVDATA.1

Freq = 4.7995 GHz, Bw = 32.000 MH No calibration applied and no bandpass applied

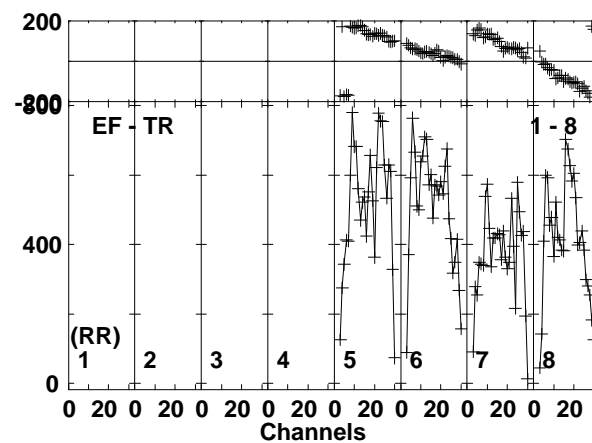
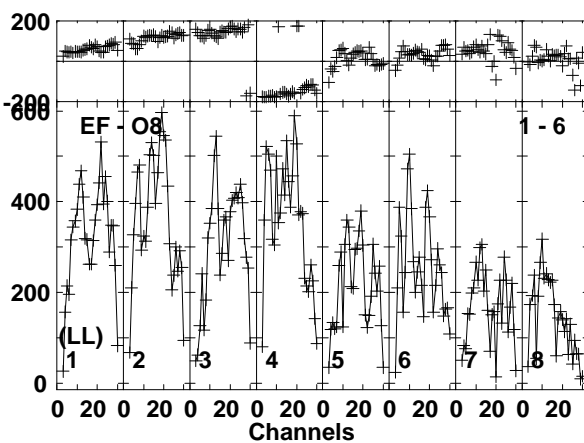
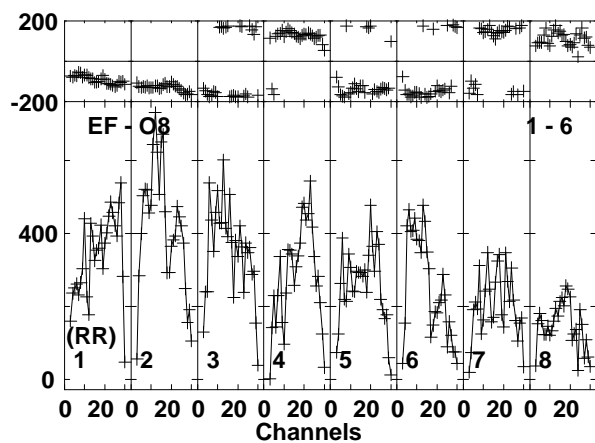
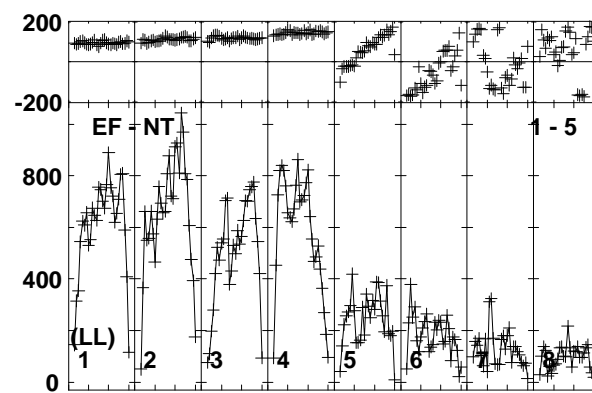
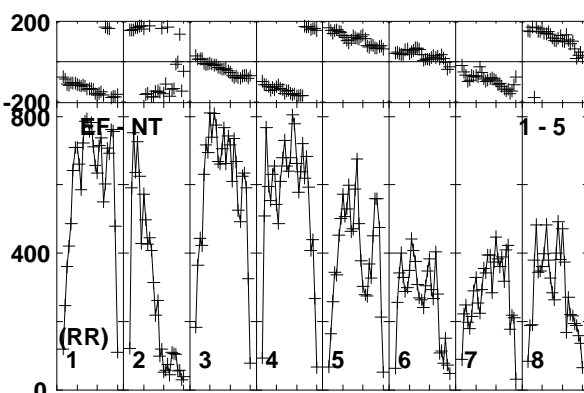
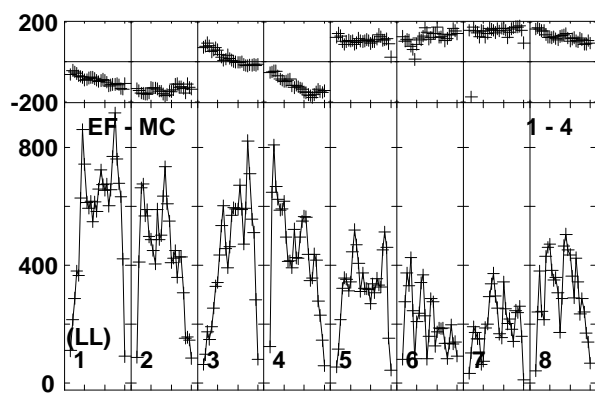
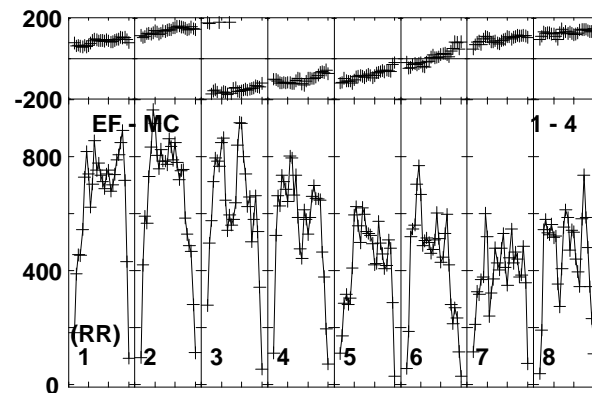
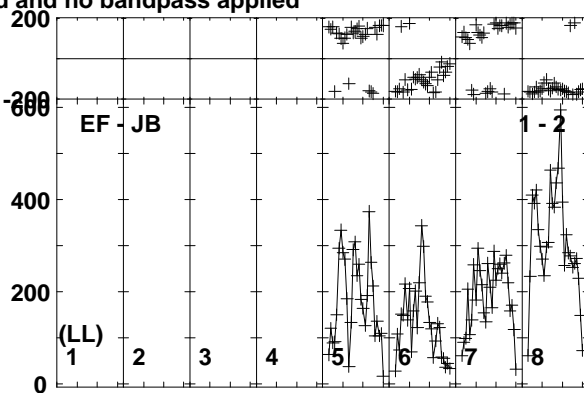
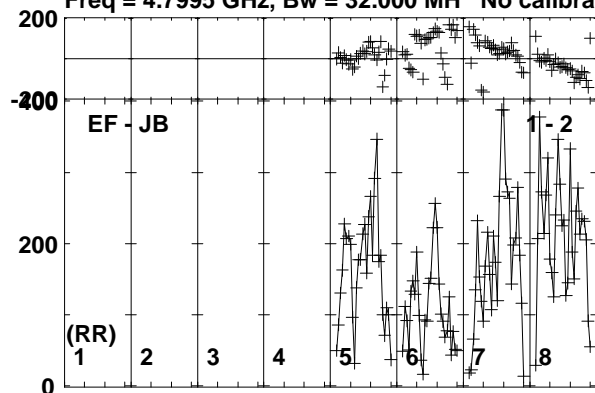

Lower frame: Micro Ampl Jy Top frame: Phas deg
Vector averaged cross-power spectrum Baseline: EF (01) - JB (02)
Timerange: 00/22:59:01 to 00/23:00:29

Plot file version 108 created 20-APR-2018 18:08:00

J1311-2329 RG009B.UVDATA.1

Freq = 4.7995 GHz, Bw = 32.000 MH No calibration applied and no bandpass applied

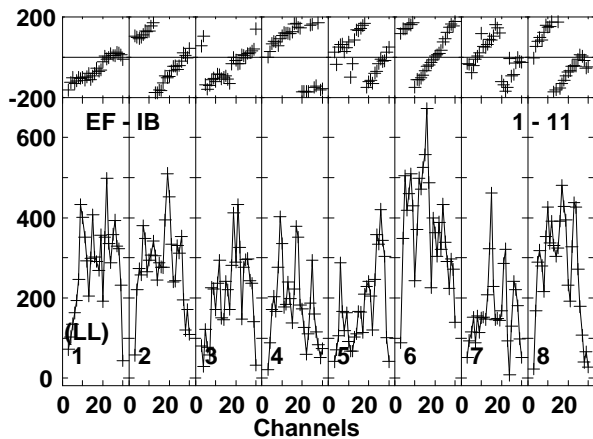
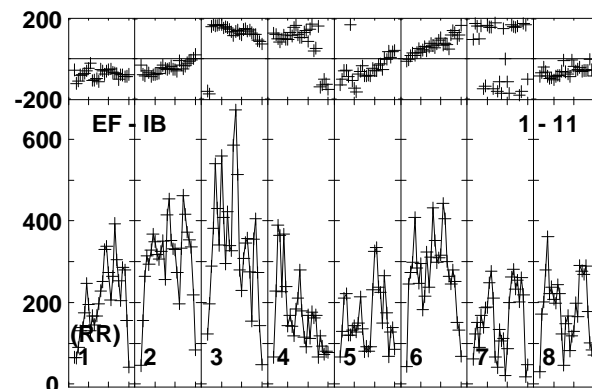
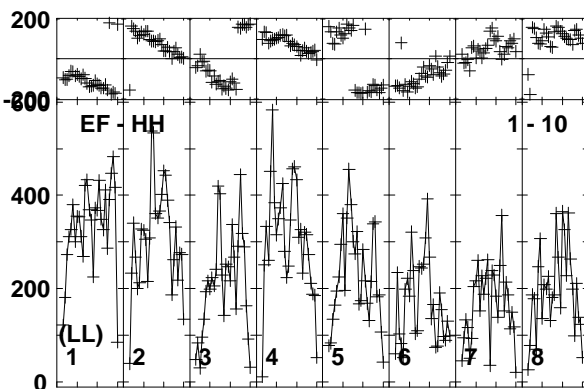
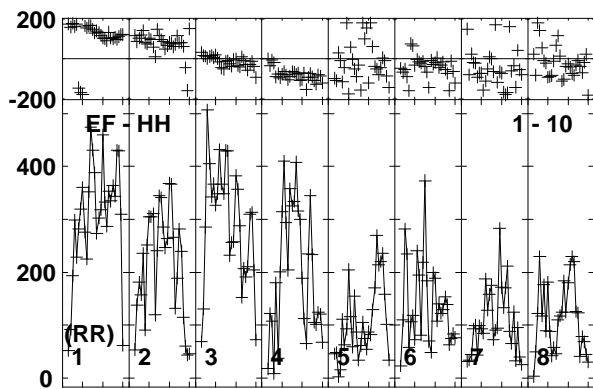
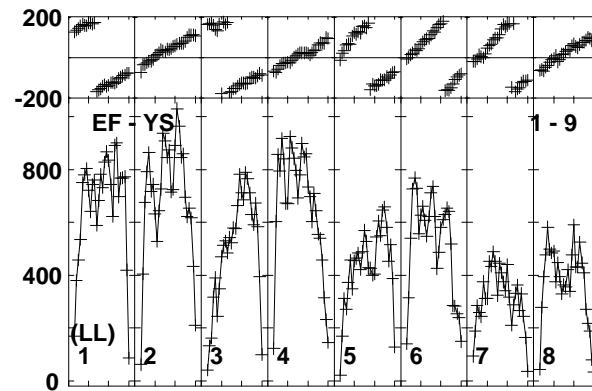
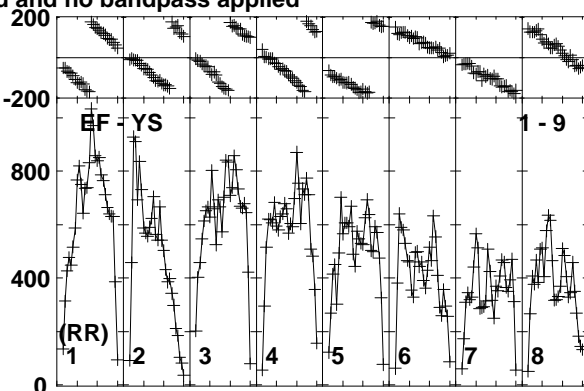
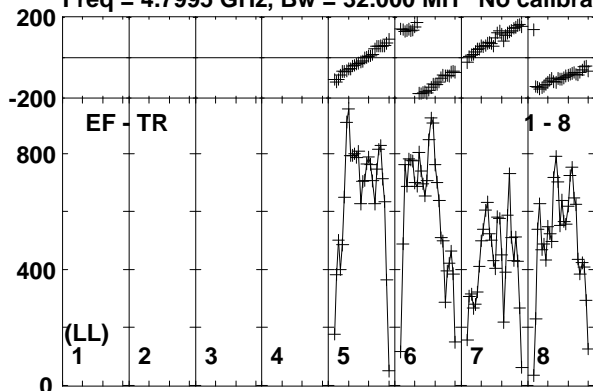

Lower frame: Micro Ampl Jy Top frame: Phas deg
Vector averaged cross-power spectrum Baseline: EF (01) - TR (08)
Timerange: 00/22:59:01 to 00/23:00:29

Plot file version 109 created 20-APR-2018 18:08:00

J1303-2405 RG009B.UVDATA.1

Freq = 4.7995 GHz, Bw = 32.000 MH No calibration applied and no bandpass applied

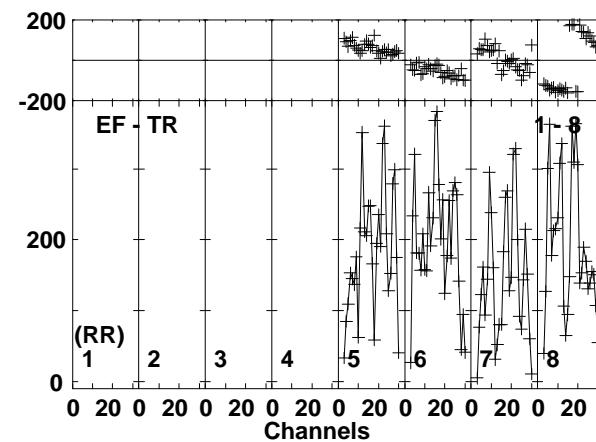
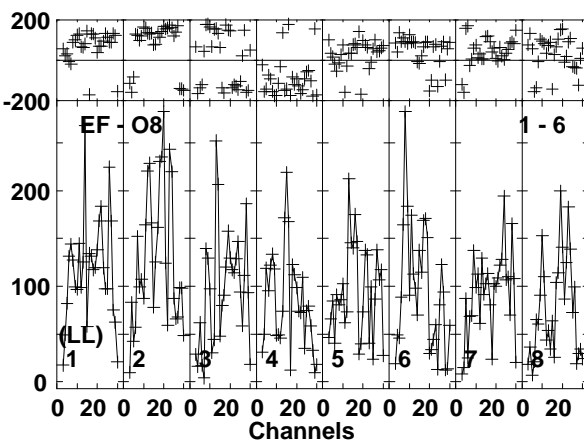
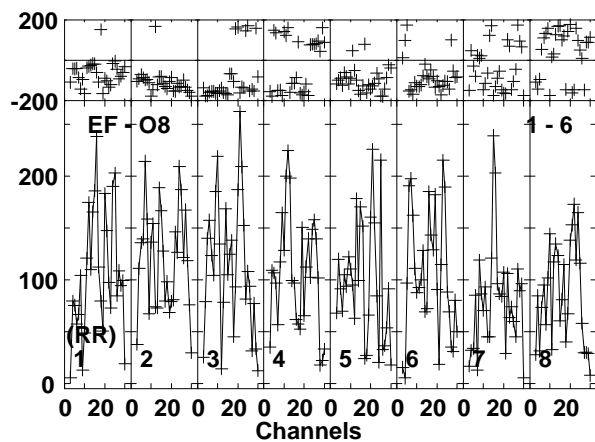
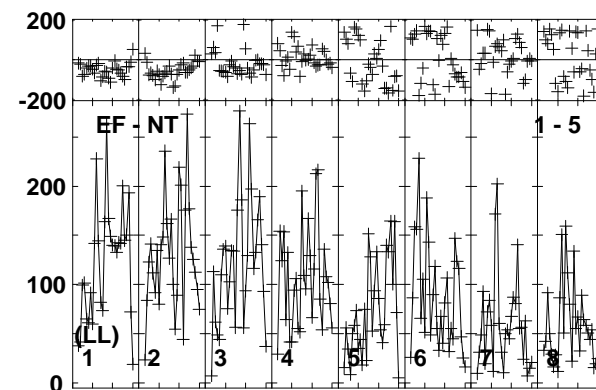
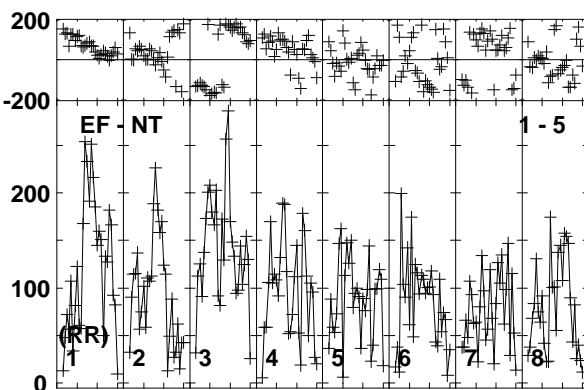
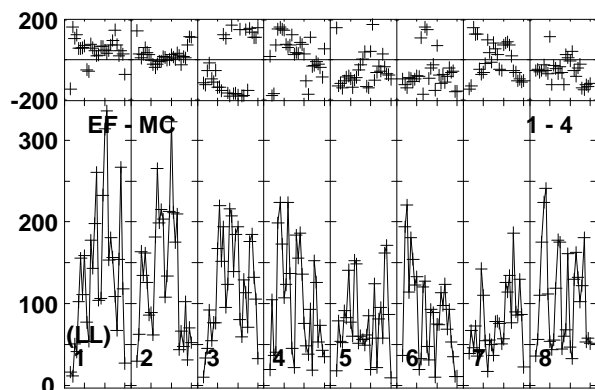
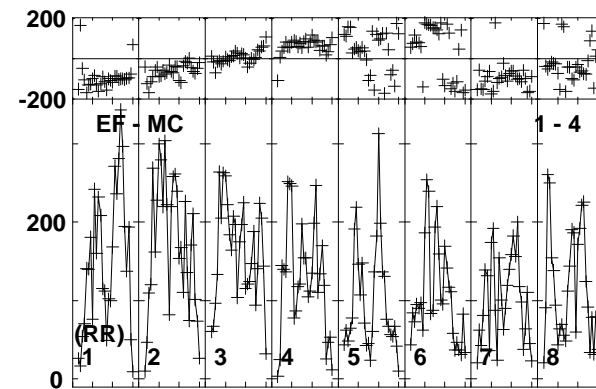
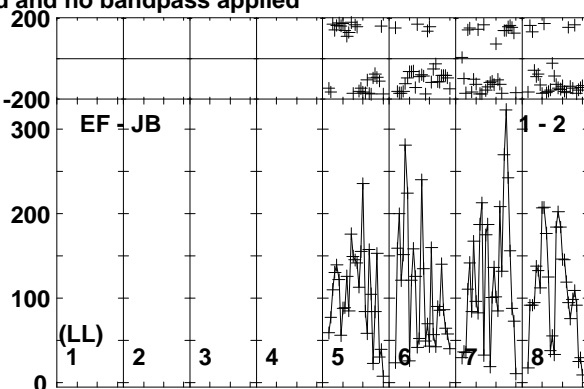
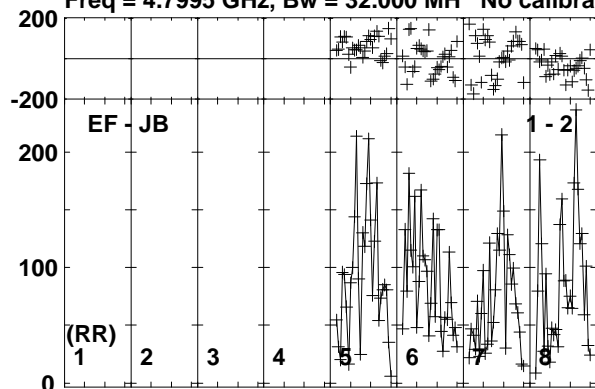

Lower frame: Micro Ampl Jy Top frame: Phas deg
Vector averaged cross-power spectrum Baseline: EF (01) - JB (02)
Timerange: 00/23:00:31 to 00/23:02:59

Plot file version 110 created 20-APR-2018 18:08:00

J1303-2405 RG009B.UVDATA.1

Freq = 4.7995 GHz, Bw = 32.000 MH No calibration applied and no bandpass applied

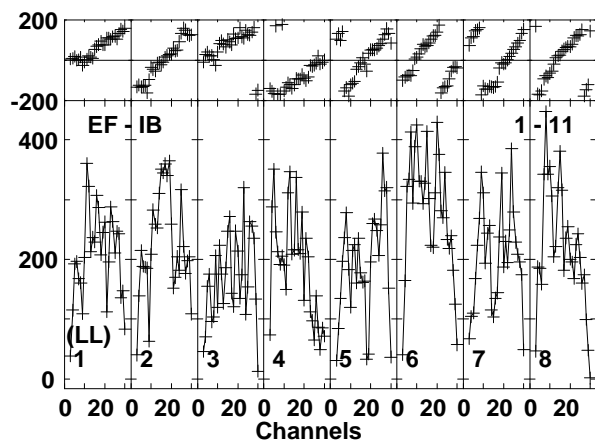
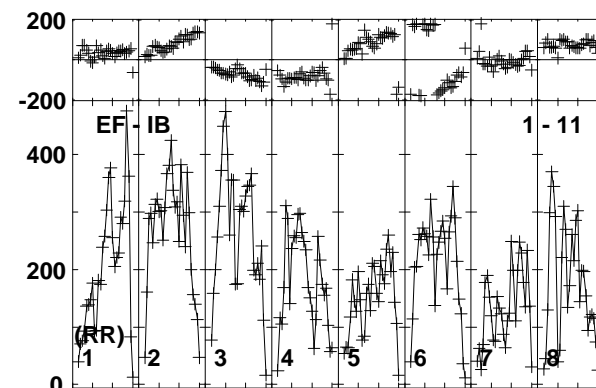
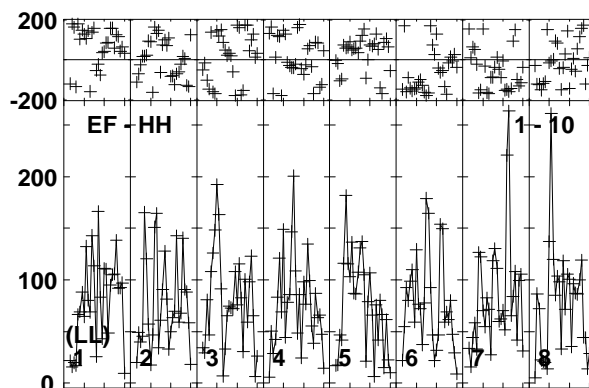
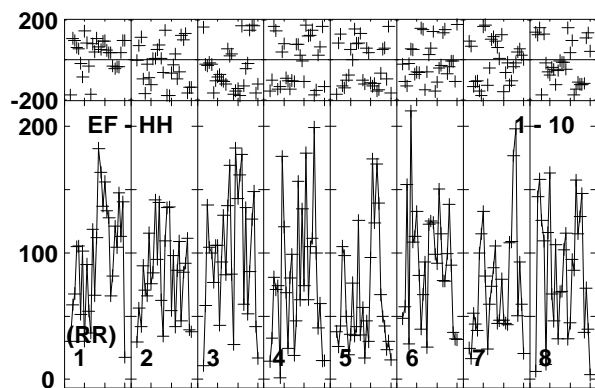
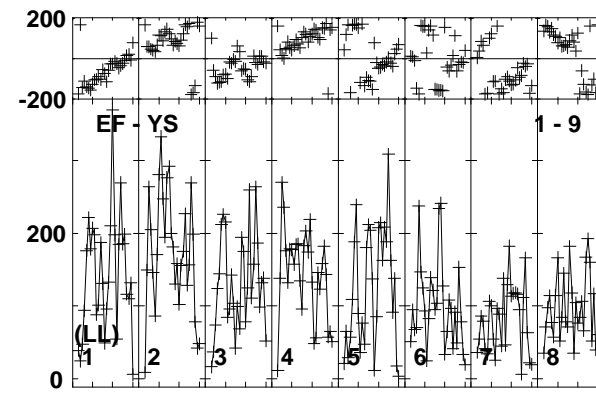
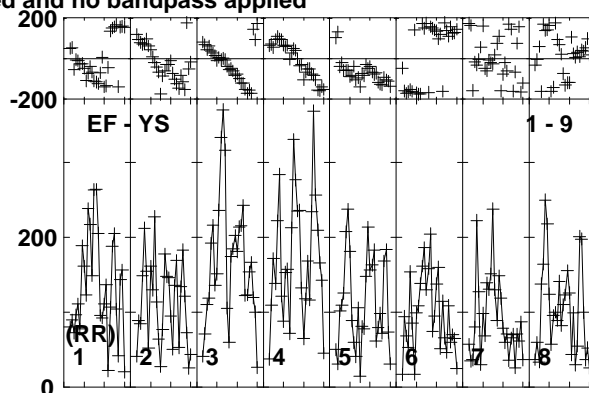
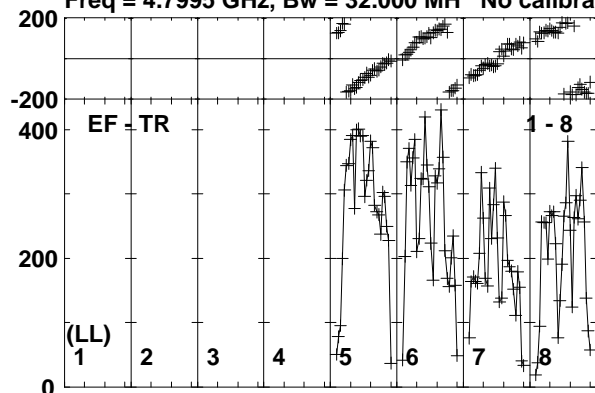

Lower frame: Micro Ampl Jy Top frame: Phas deg
Vector averaged cross-power spectrum Baseline: EF (01) - TR (08)
Timerange: 00/23:00:31 to 00/23:02:59

Plot file version 111 created 20-APR-2018 18:08:00

J1311-2329 RG009B.UVDATA.1

Freq = 4.7995 GHz, Bw = 32.000 MH No calibration applied and no bandpass applied

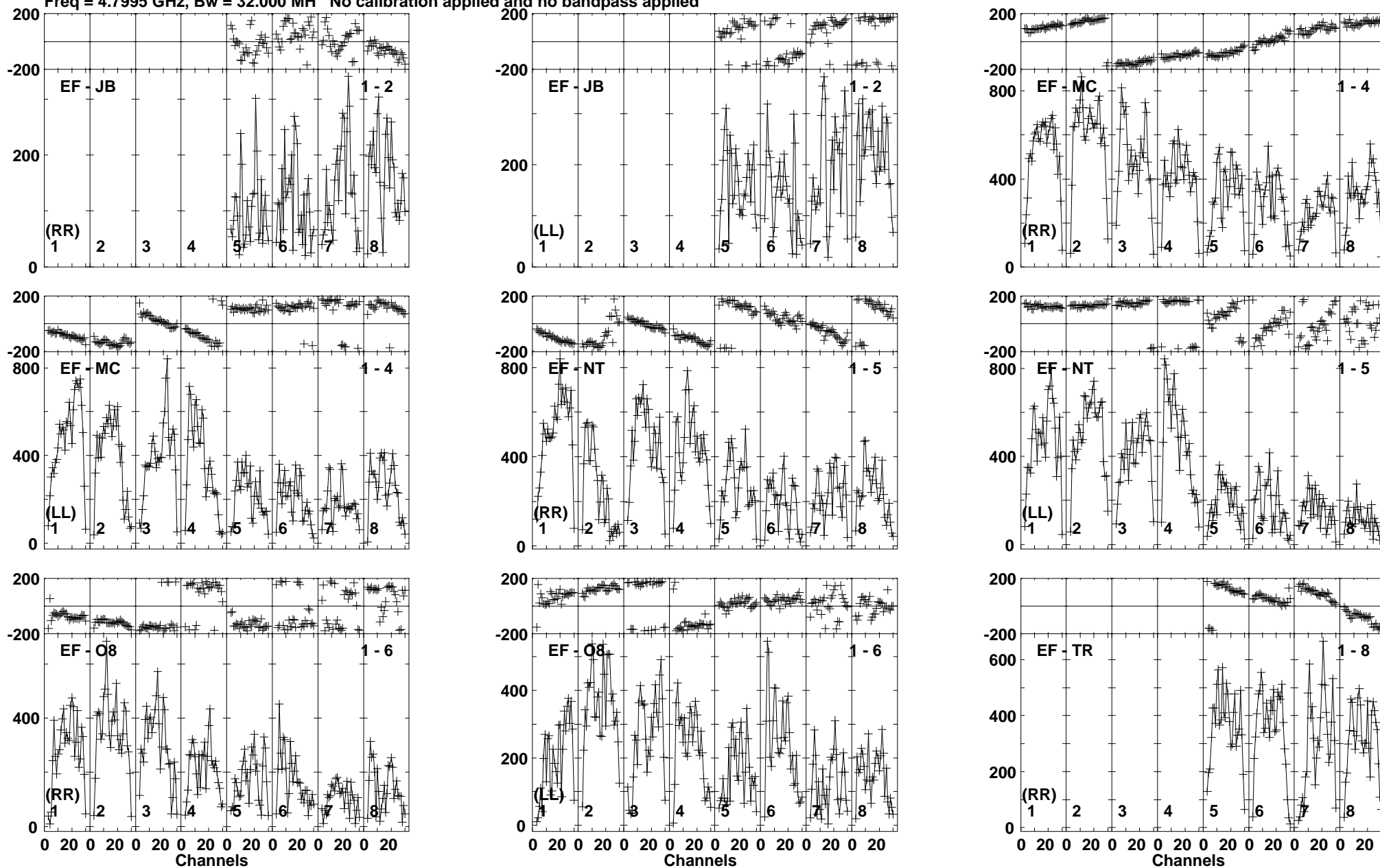

Lower frame: Micro Ampl Jy Top frame: Phas deg
Vector averaged cross-power spectrum Baseline: EF (01) - JB (02)
Timerange: 00/23:03:41 to 00/23:04:39

Plot file version 112 created 20-APR-2018 18:08:00

J1311-2329 RG009B.UVDATA.1

Freq = 4.7995 GHz, Bw = 32.000 MH No calibration applied and no bandpass applied

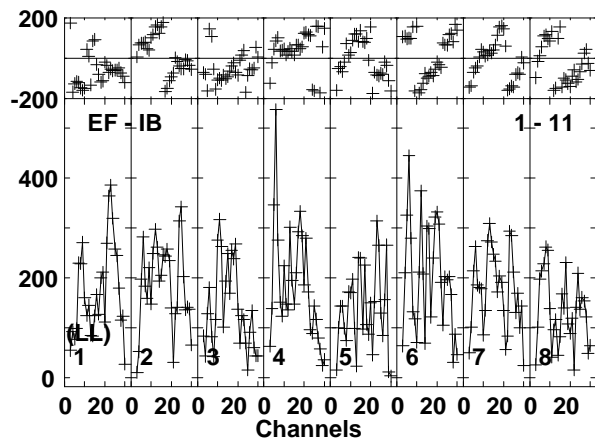
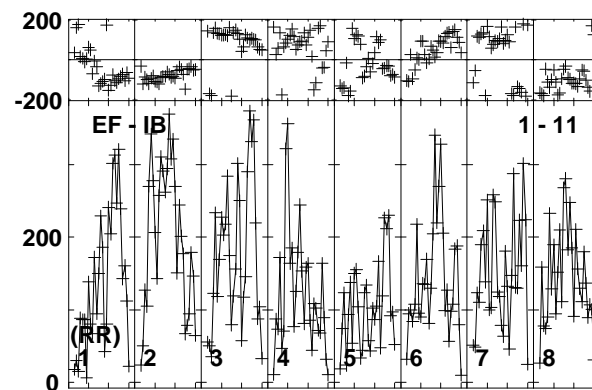
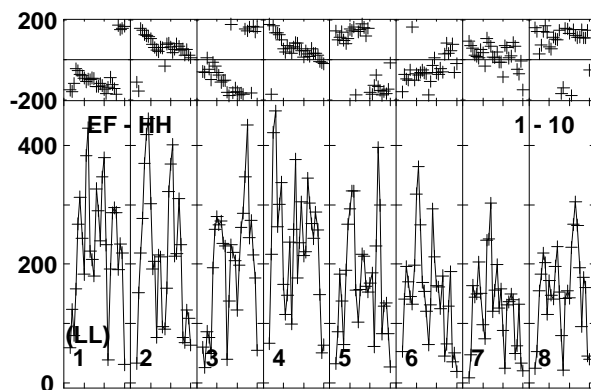
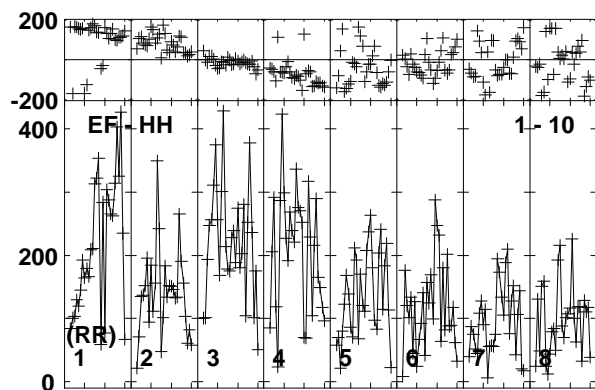
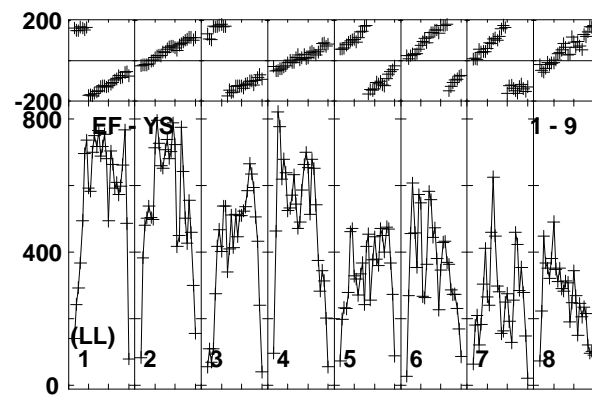
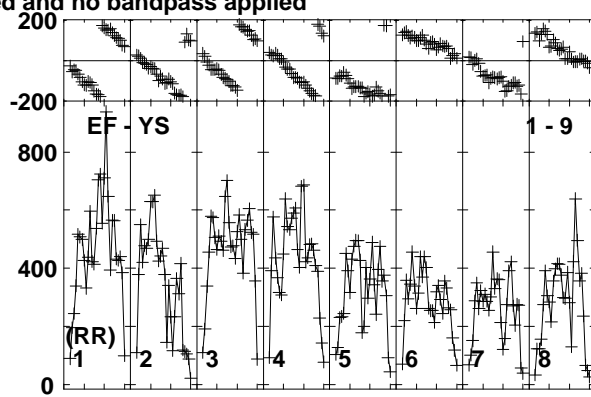
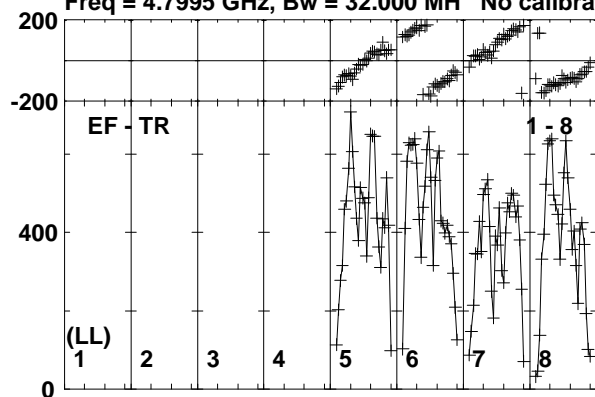

Lower frame: Micro Ampl Jy Top frame: Phas deg
Vector averaged cross-power spectrum Baseline: EF (01) - TR (08)
Timerange: 00/23:03:41 to 00/23:04:39

Plot file version 113 created 20-APR-2018 18:08:00

J1337-1257 RG009B.UVDATA.1

Freq = 4.7995 GHz, Bw = 32.000 MH No calibration applied and no bandpass applied

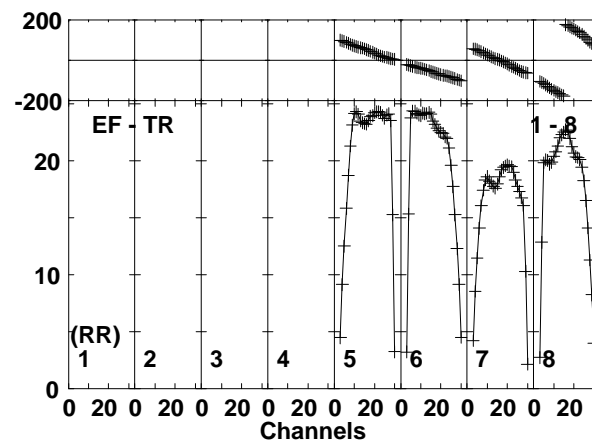
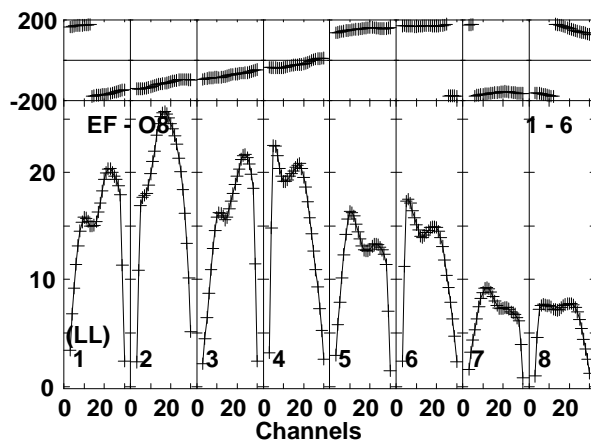
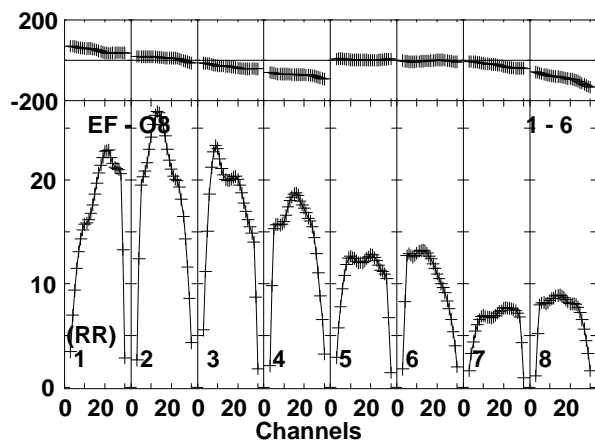
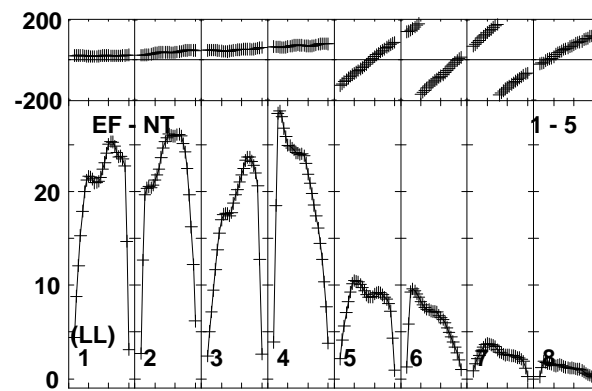
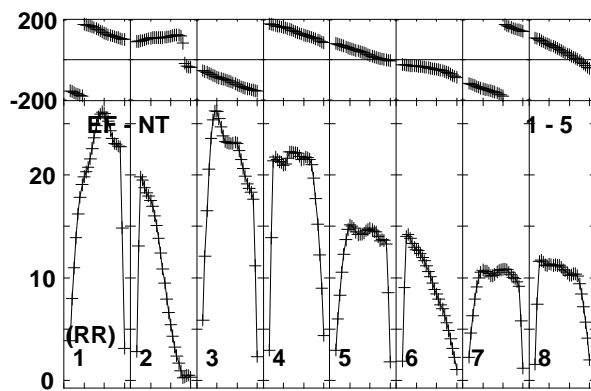
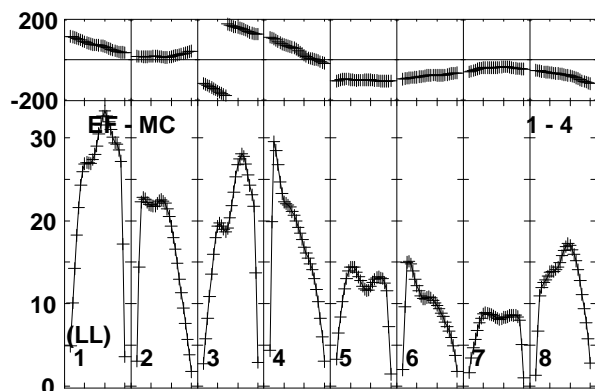
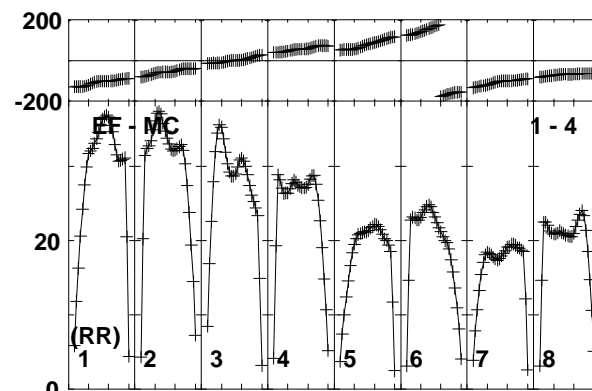
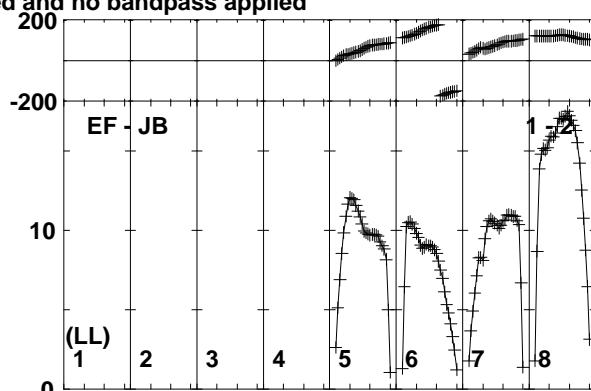
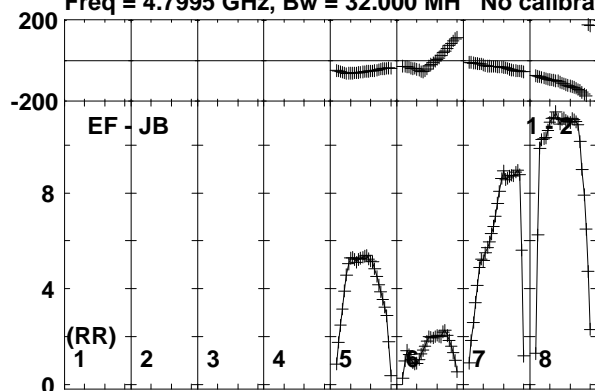

Lower frame: Milli Ampl Jy Top frame: Phas deg
Vector averaged cross-power spectrum Baseline: EF (01) - JB (02)
Timerange: 00/23:05:51 to 00/23:08:49

Plot file version 114 created 20-APR-2018 18:08:00

J1337-1257 RG009B.UVDATA.1

Freq = 4.7995 GHz, Bw = 32.000 MH No calibration applied and no bandpass applied

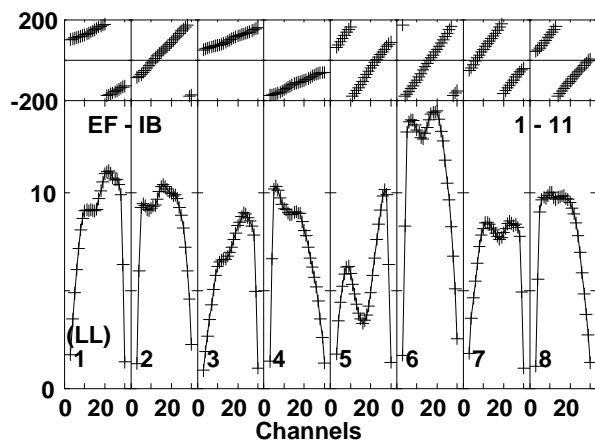
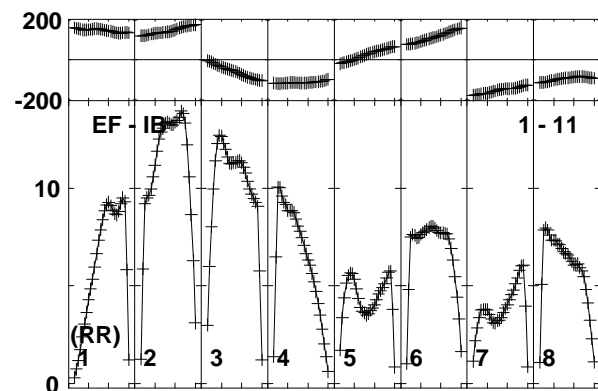
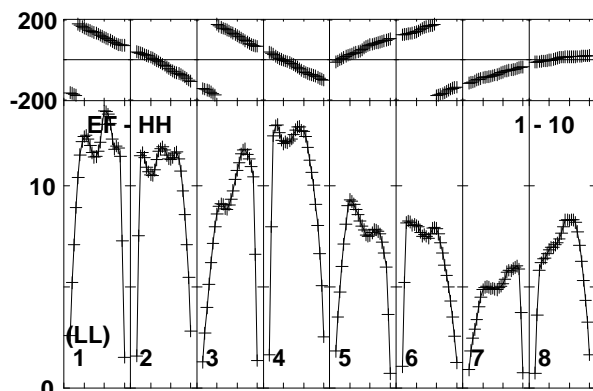
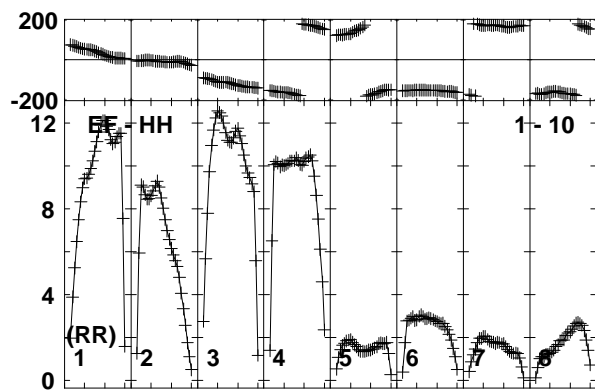
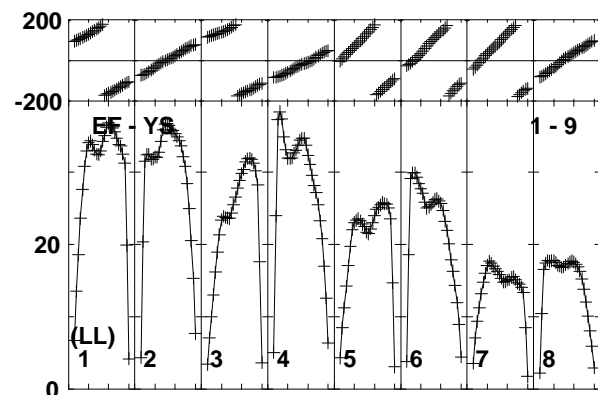
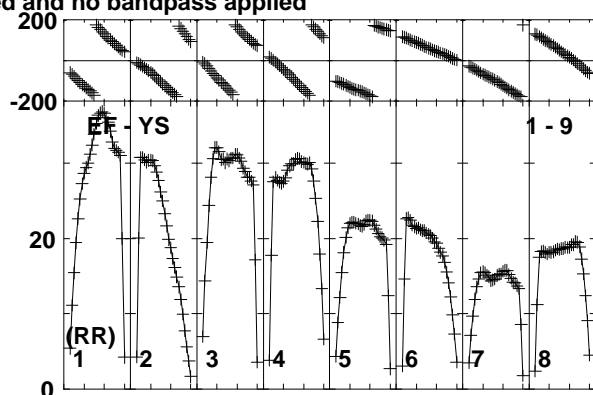
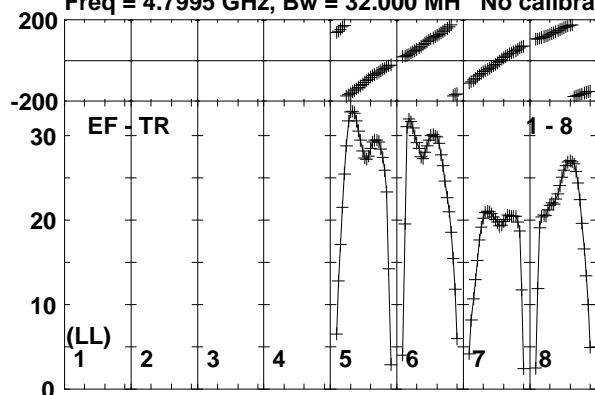

Lower frame: Milli Ampl Jy Top frame: Phas deg
Vector averaged cross-power spectrum Baseline: EF (01) - TR (08)
Timerange: 00/23:05:51 to 00/23:08:49

Plot file version 115 created 20-APR-2018 18:08:00

J1311-2329 RG009B.UVDATA.1

Freq = 4.7995 GHz, Bw = 32.000 MH No calibration applied and no bandpass applied

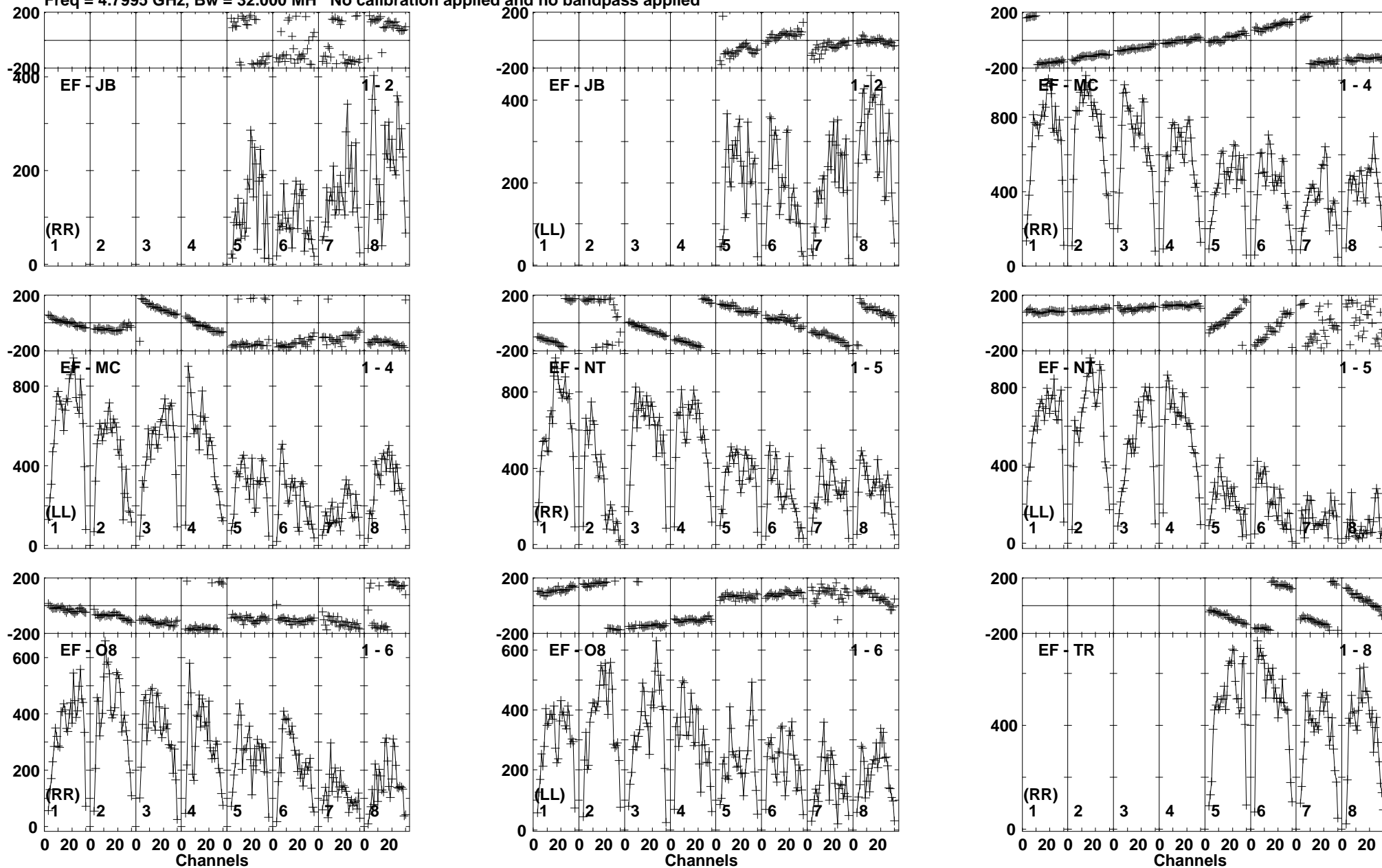

Lower frame: Micro Ampl Jy Top frame: Phas deg
Vector averaged cross-power spectrum Baseline: EF (01) - JB (02)
Timerange: 00/23:10:01 to 00/23:11:59

Plot file version 116 created 20-APR-2018 18:08:00

J1311-2329 RG009B.UVDATA.1

Freq = 4.7995 GHz, Bw = 32.000 MH No calibration applied and no bandpass applied

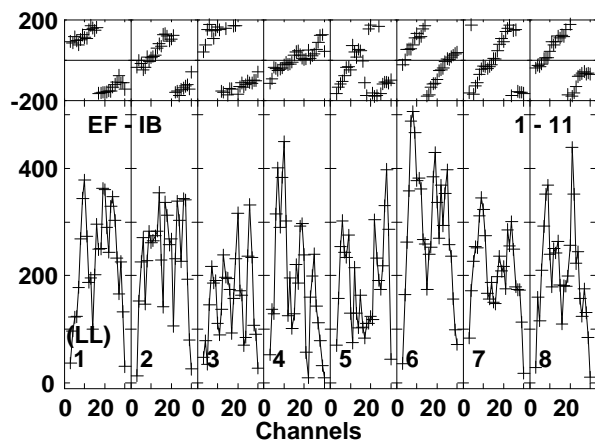
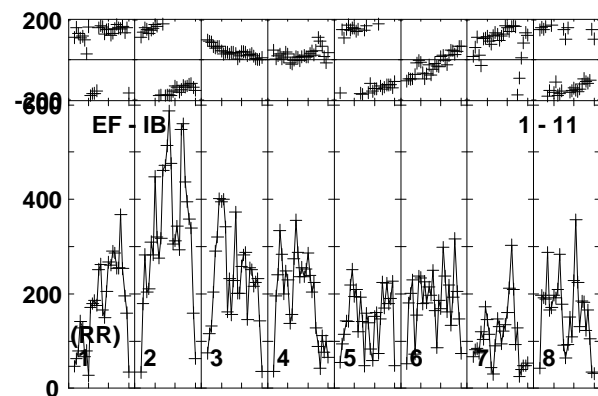
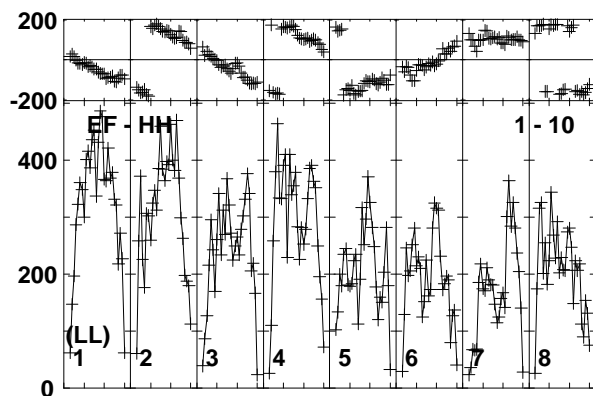
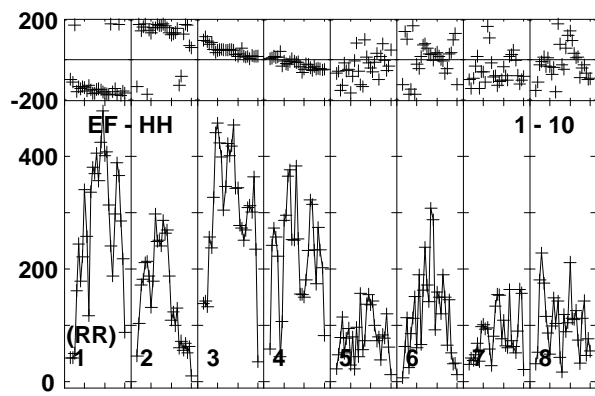
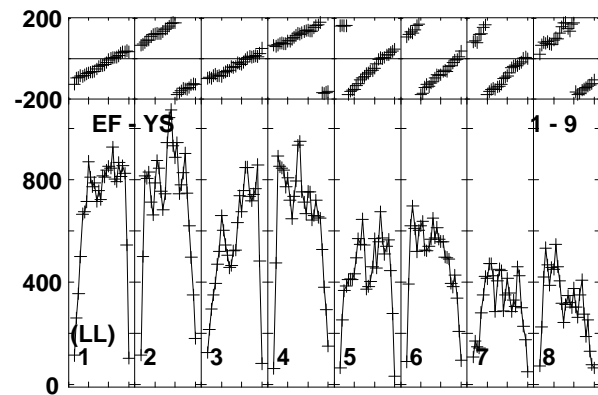
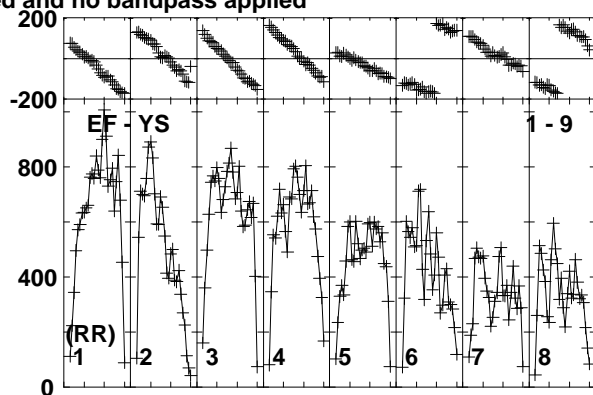
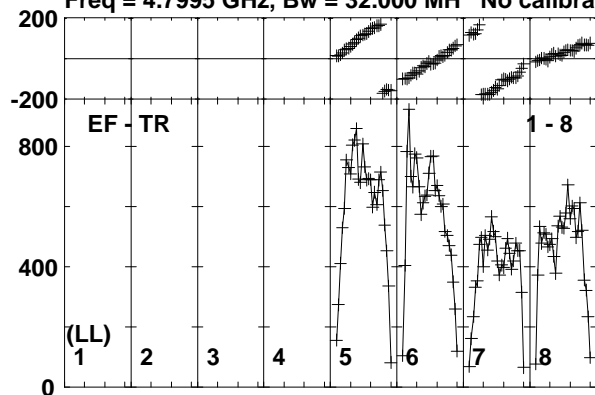

Lower frame: Micro Ampl Jy Top frame: Phas deg
Vector averaged cross-power spectrum Baseline: EF (01) - TR (08)
Timerange: 00/23:10:01 to 00/23:11:59

Plot file version 117 created 20-APR-2018 18:08:00

EM170817 RG009B.UVDATA.1

Freq = 4.7995 GHz, Bw = 32.000 MH No calibration applied and no bandpass applied

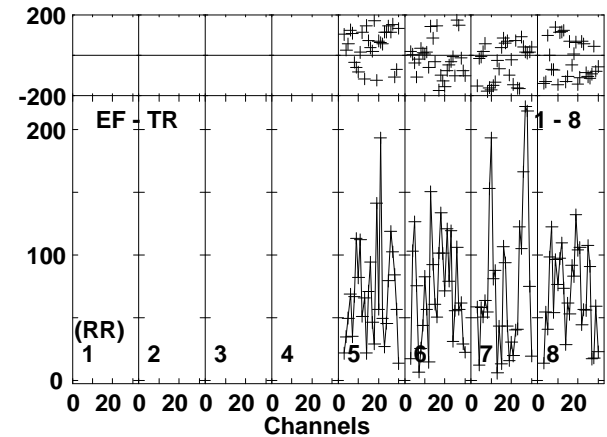
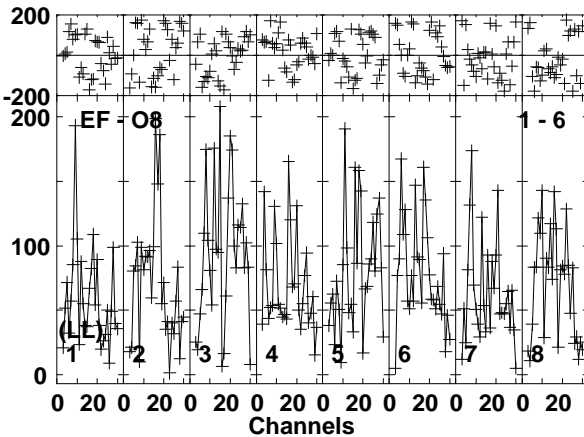
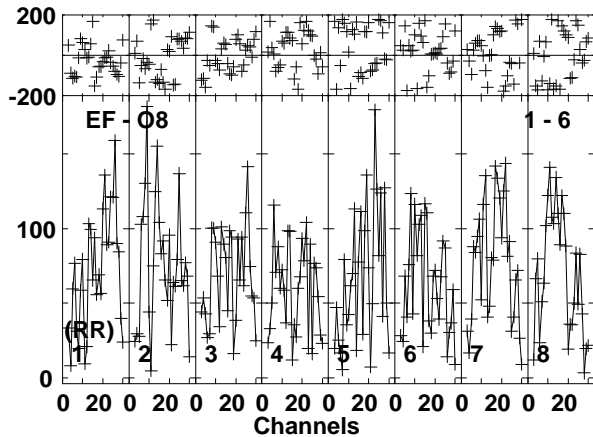
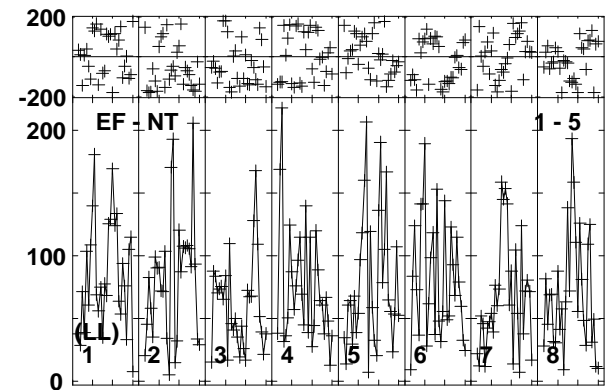
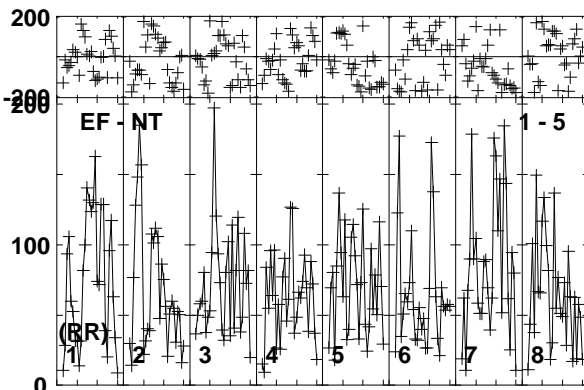
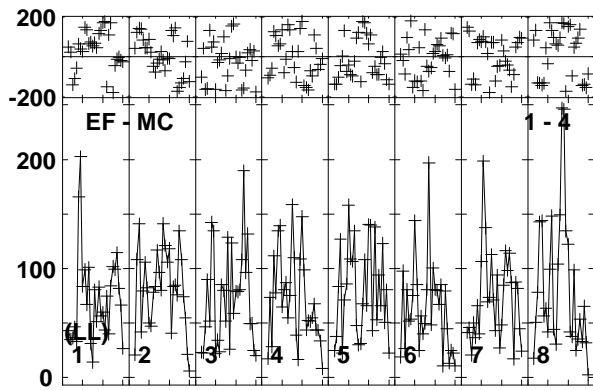
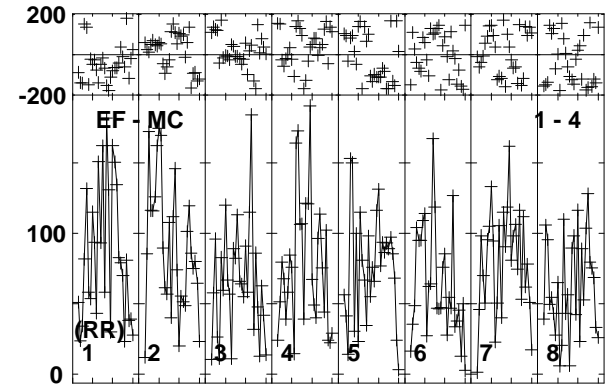
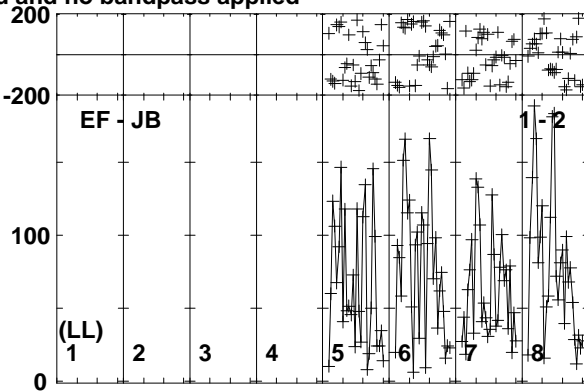
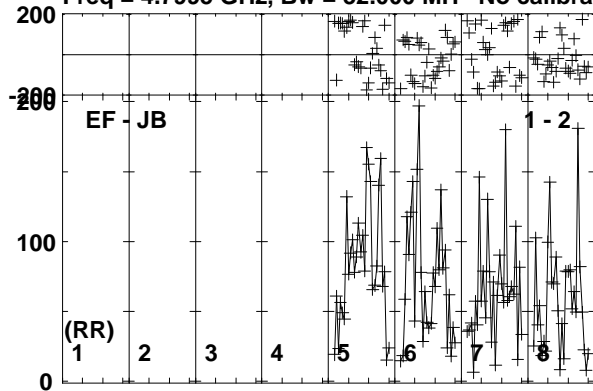

Lower frame: Micro Ampl Jy Top frame: Phas deg
Vector averaged cross-power spectrum Baseline: EF (01) - JB (02)
Timerange: 00/23:12:01 to 00/23:14:29

Plot file version 118 created 20-APR-2018 18:08:01

EM170817 RG009B.UVDATA.1

Freq = 4.7995 GHz, Bw = 32.000 MH No calibration applied and no bandpass applied

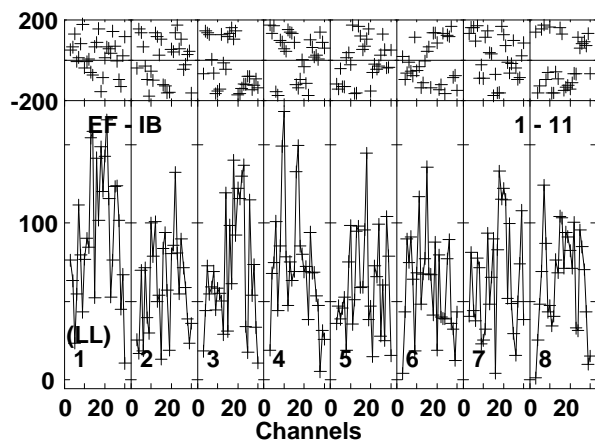
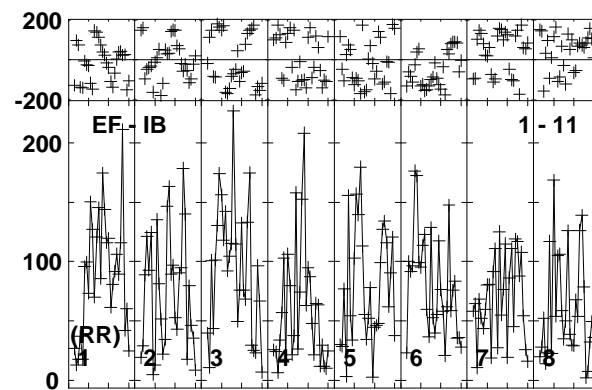
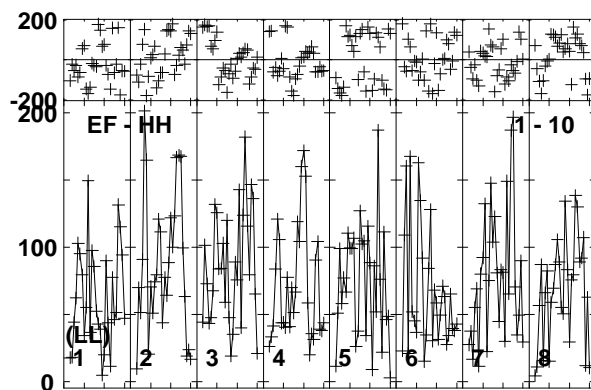
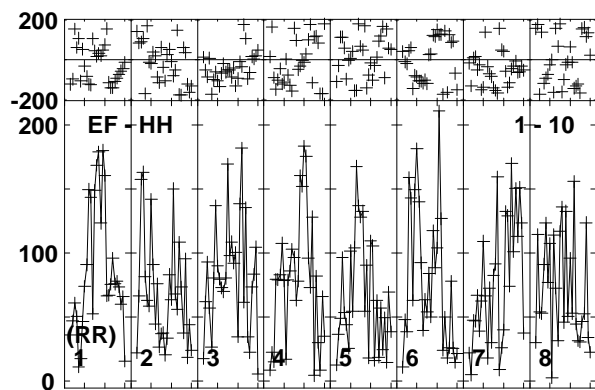
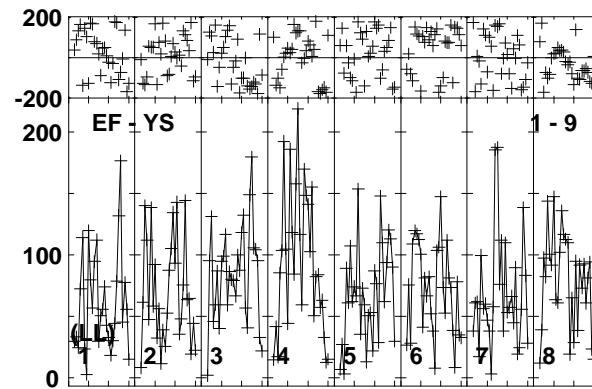
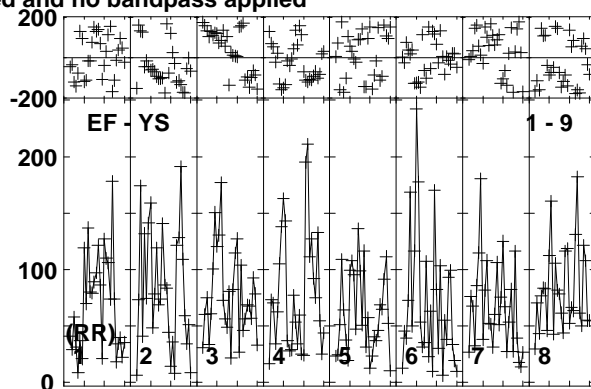
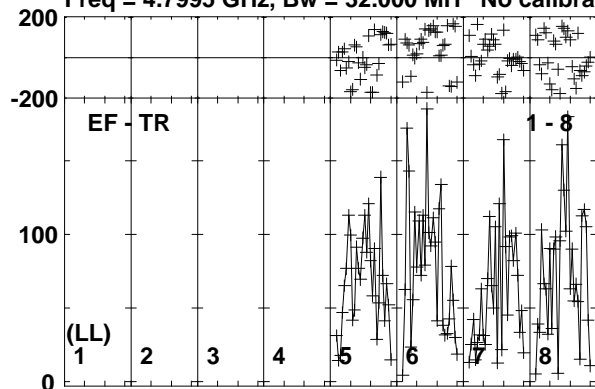

Lower frame: Micro Ampl Jy Top frame: Phas deg
Vector averaged cross-power spectrum Baseline: EF (01) - TR (08)
Timerange: 00:23:12:01 to 00:23:14:29

Plot file version 119 created 20-APR-2018 18:08:01

J1311-2329 RG009B.UVDATA.1

Freq = 4.7995 GHz, Bw = 32.000 MH No calibration applied and no bandpass applied

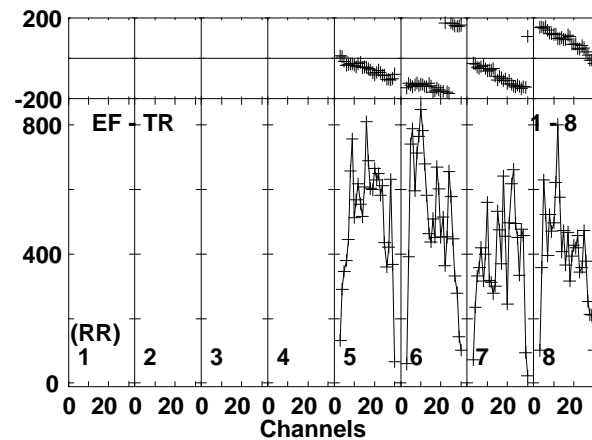
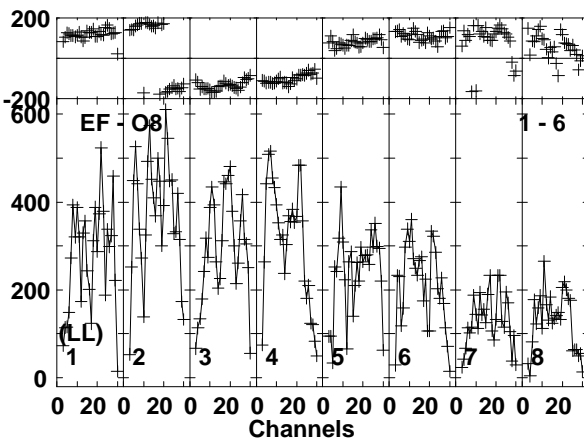
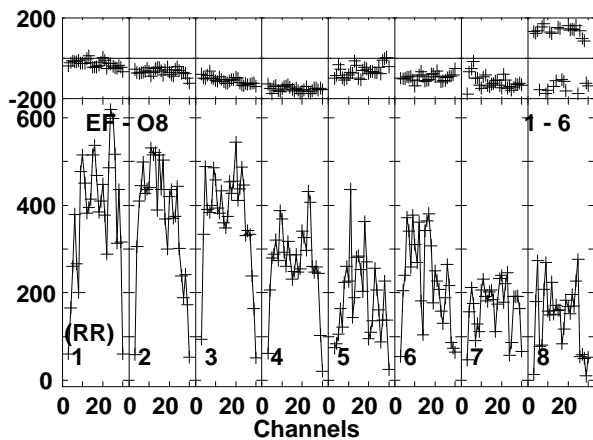
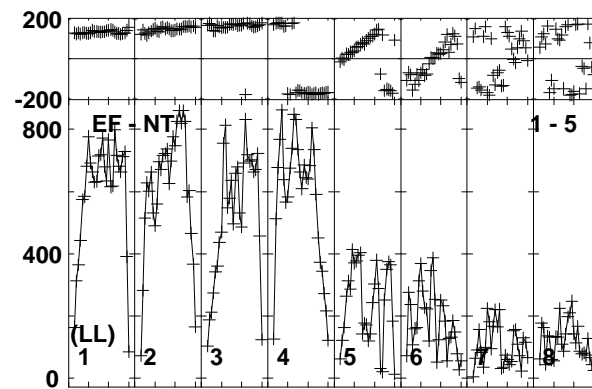
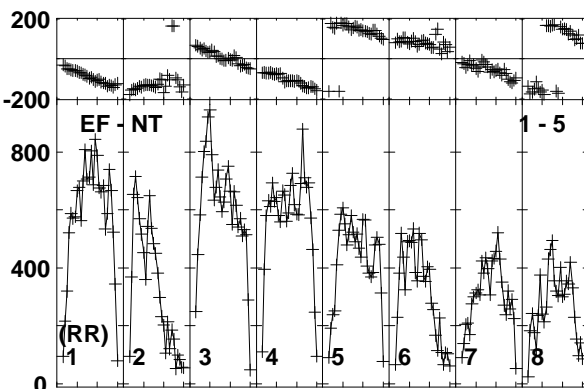
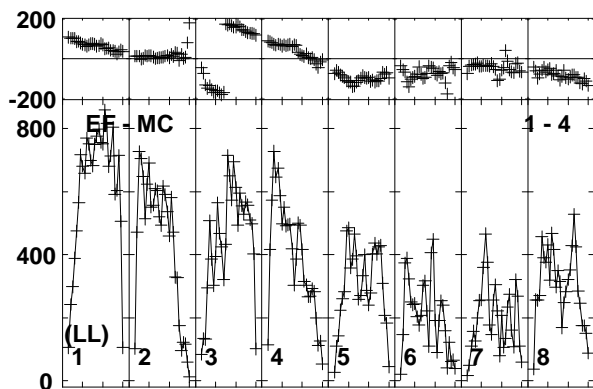
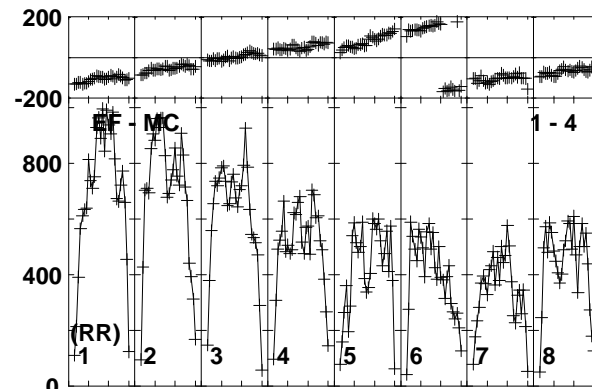
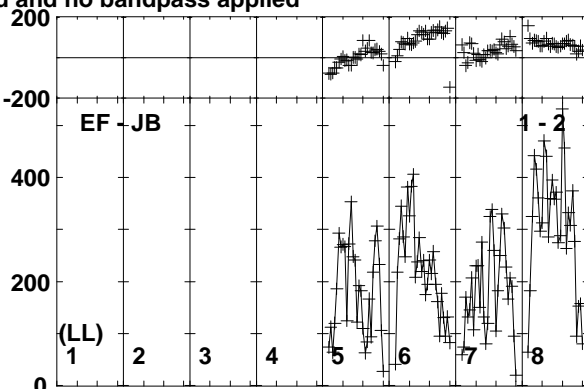
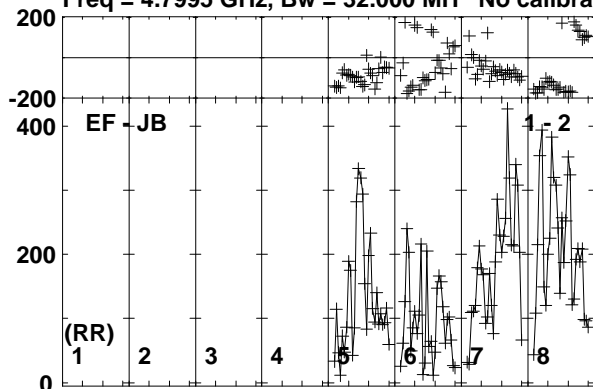

Lower frame: Micro Ampl Jy Top frame: Phas deg
Vector averaged cross-power spectrum Baseline: EF (01) - JB (02)
Timerange: 00/23:14:31 to 00/23:15:59

Plot file version 120 created 20-APR-2018 18:08:01

J1311-2329 RG009B.UVDATA.1

Freq = 4.7995 GHz, Bw = 32.000 MH No calibration applied and no bandpass applied

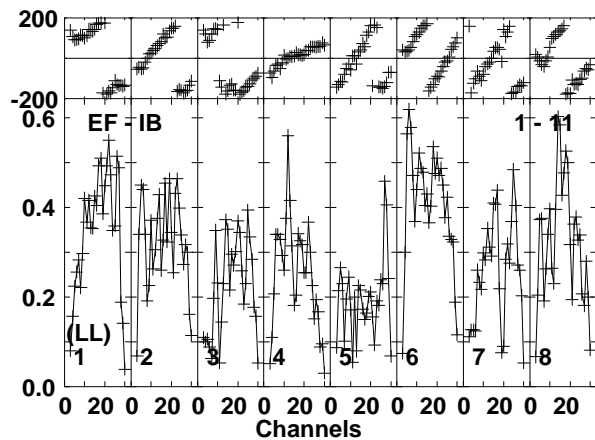
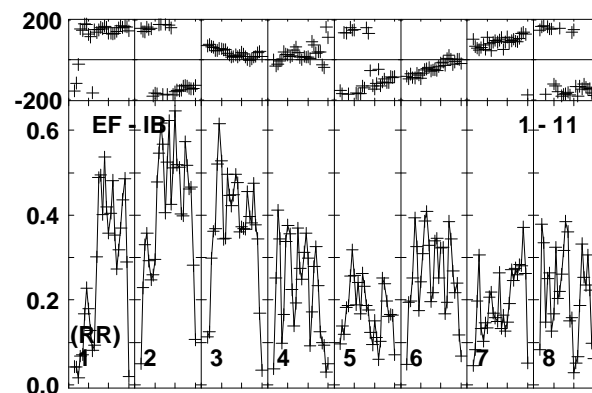
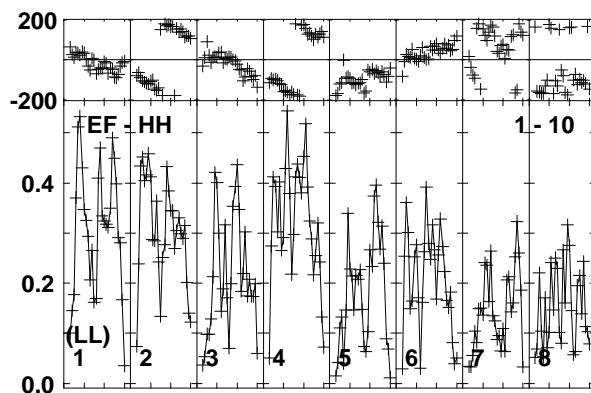
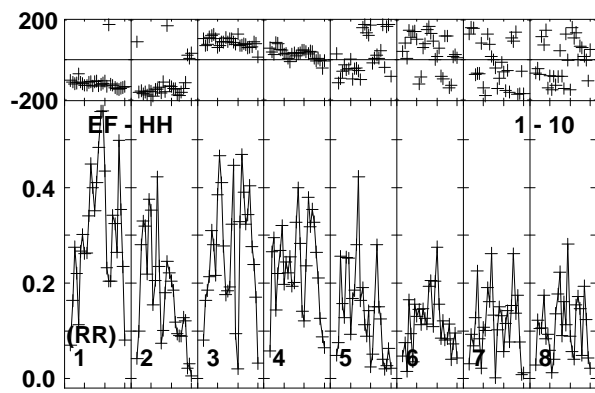
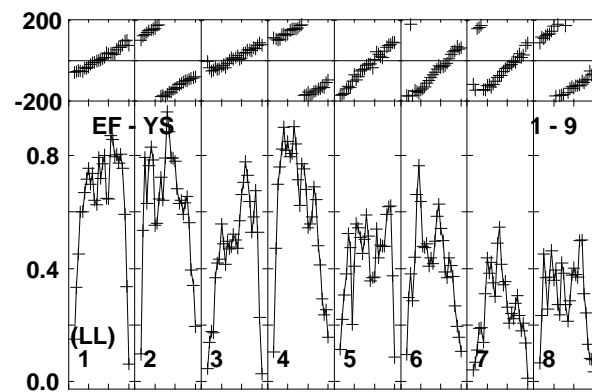
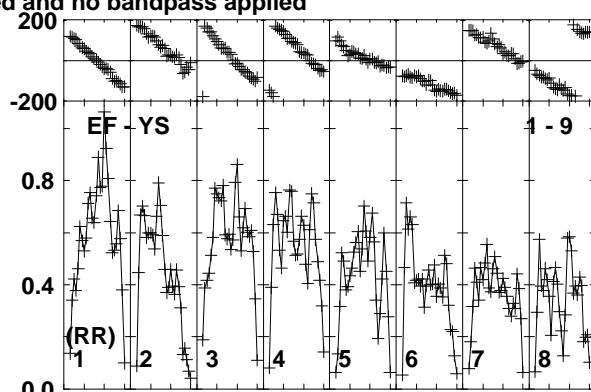
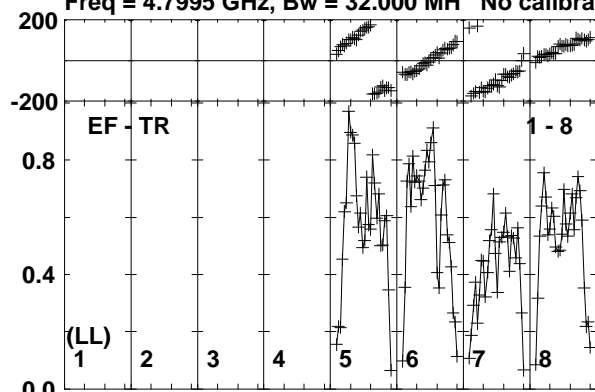

Lower frame: Milli Ampl Jy Top frame: Phas deg
Vector averaged cross-power spectrum Baseline: EF (01) - TR (08)
Timerange: 00/23:14:31 to 00/23:15:59

Plot file version 121 created 20-APR-2018 18:08:01

EM170817 RG009B.UVDATA.1

Freq = 4.7995 GHz, Bw = 32.000 MH No calibration applied and no bandpass applied

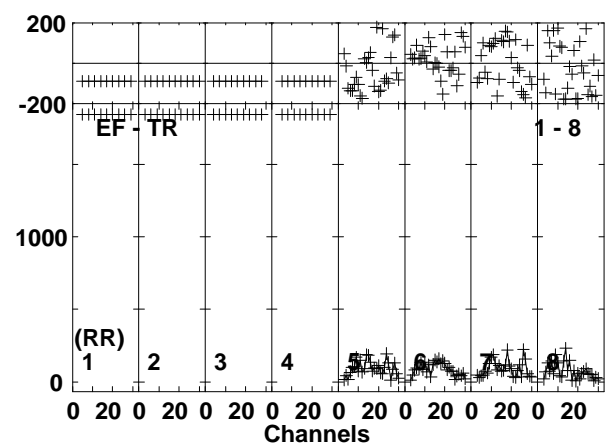
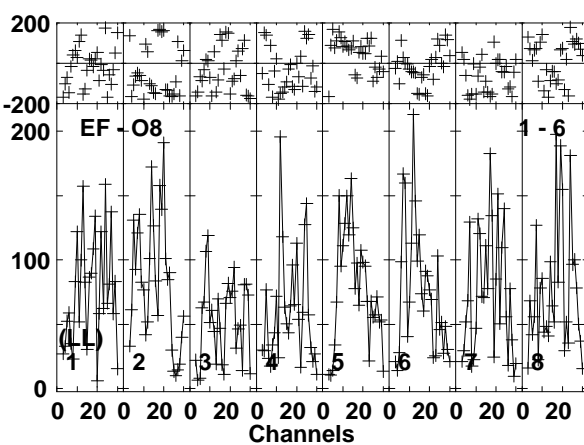
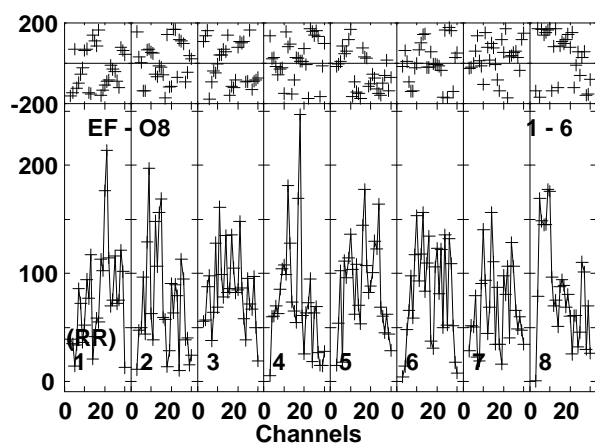
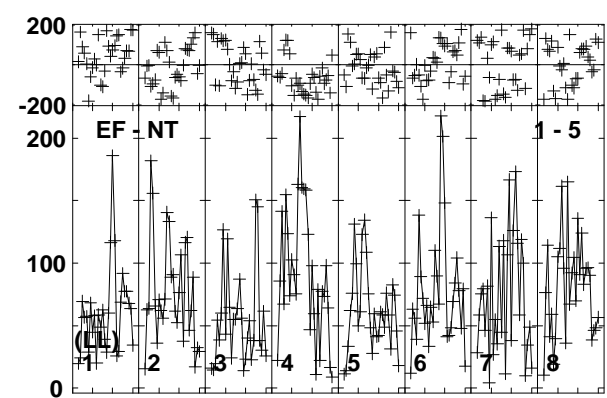
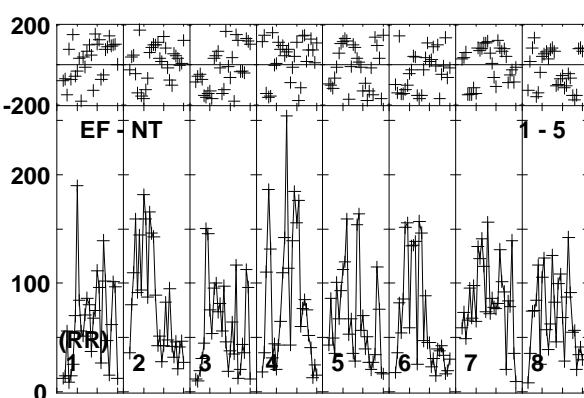
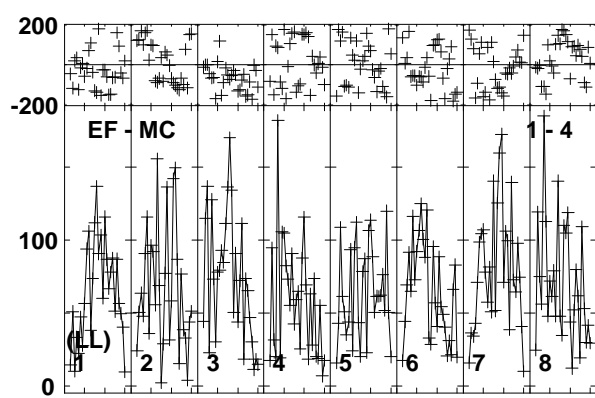
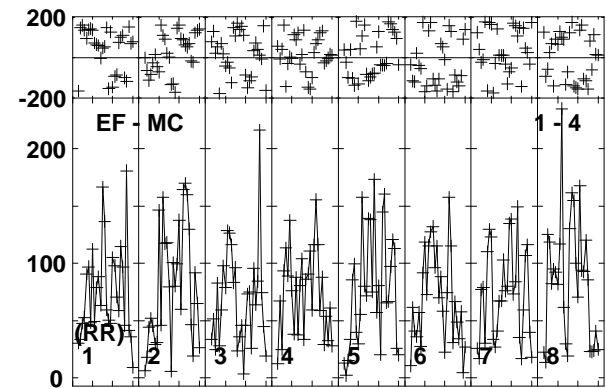
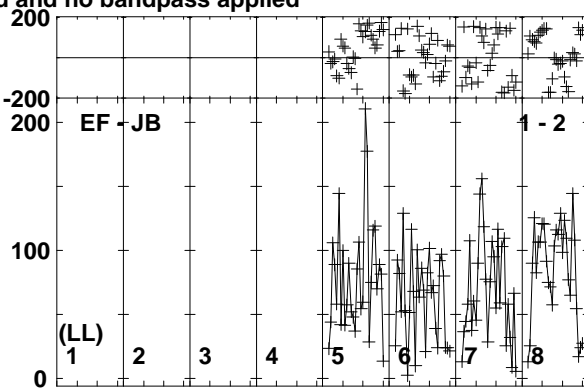
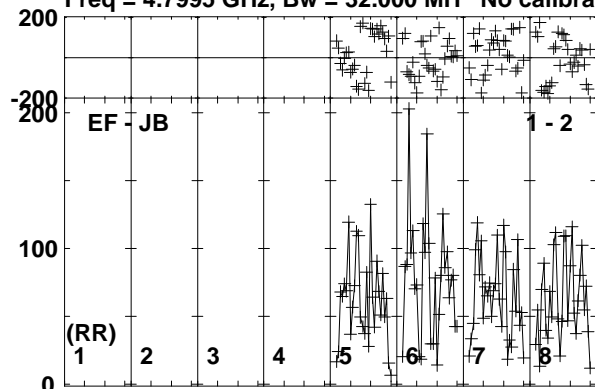

Lower frame: Micro Ampl Jy Top frame: Phas deg
Vector averaged cross-power spectrum Baseline: EF (01) - JB (02)
Timerange: 00/23:16:01 to 00/23:18:29

Plot file version 122 created 20-APR-2018 18:08:01

EM170817 RG009B.UVDATA.1

Freq = 4.7995 GHz, Bw = 32.000 MH No calibration applied and no bandpass applied

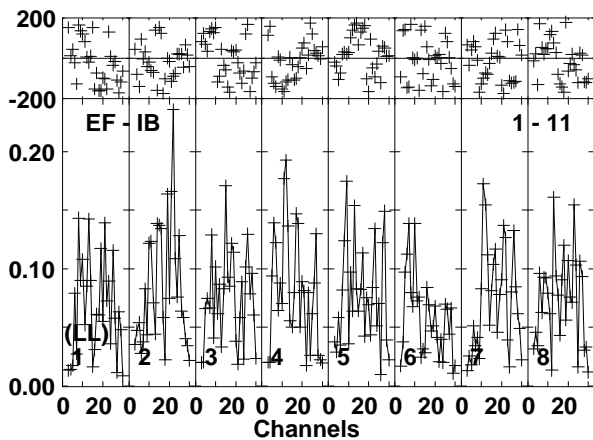
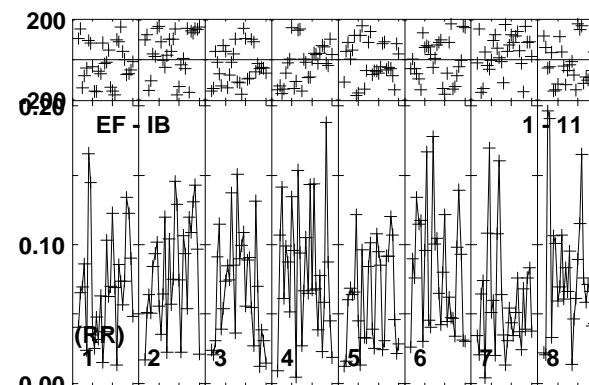
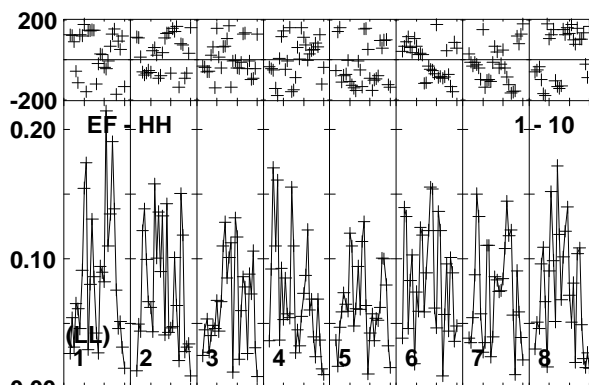
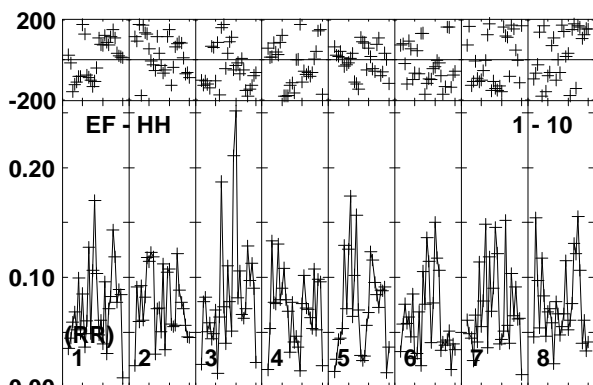
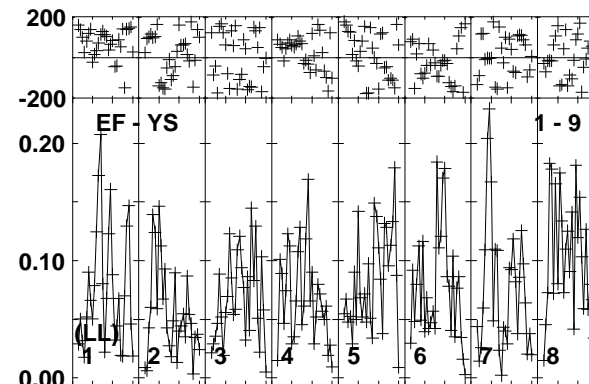
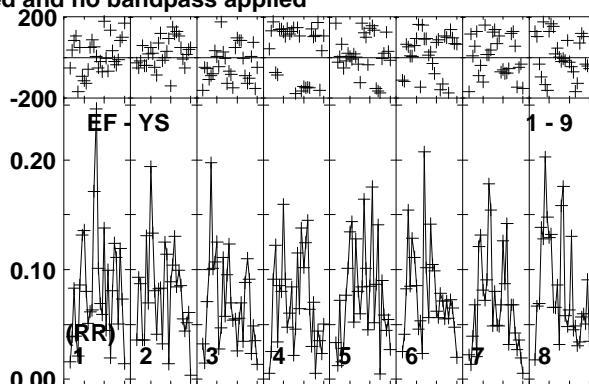
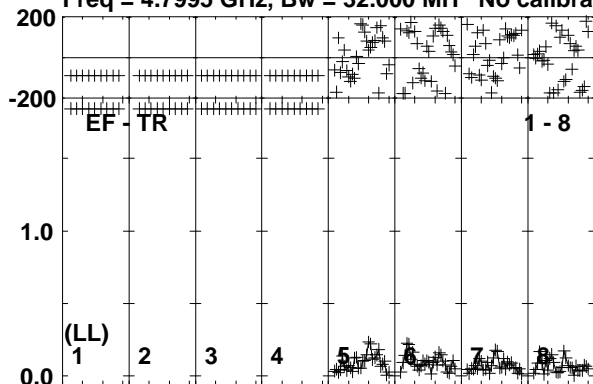

Lower frame: Milli Ampl Jy Top frame: Phas deg
Vector averaged cross-power spectrum Baseline: EF (01) - TR (08)
Timerange: 00/23:16:01 to 00/23:18:29

Plot file version 123 created 20-APR-2018 18:08:01

J1311-2329 RG009B.UVDATA.1

Freq = 4.7995 GHz, Bw = 32.000 MH No calibration applied and no bandpass applied

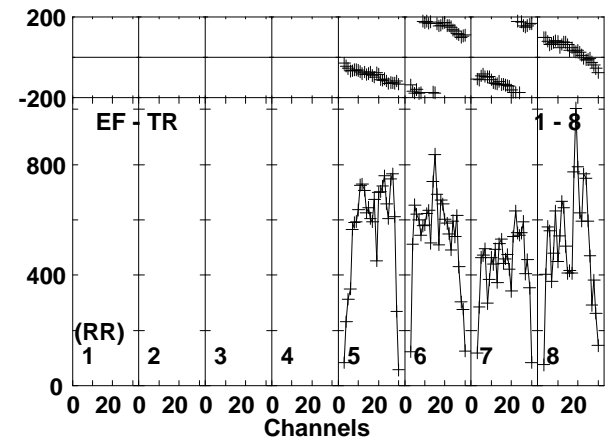
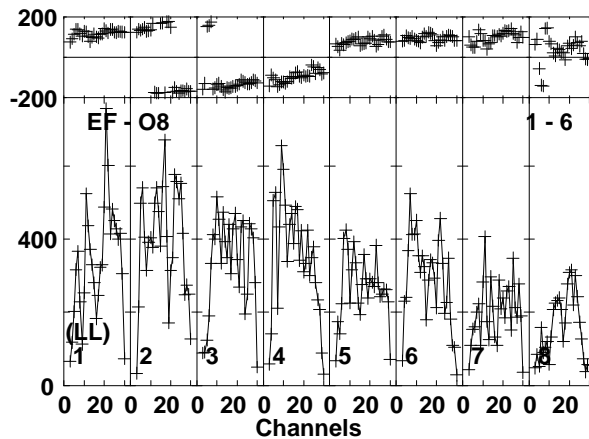
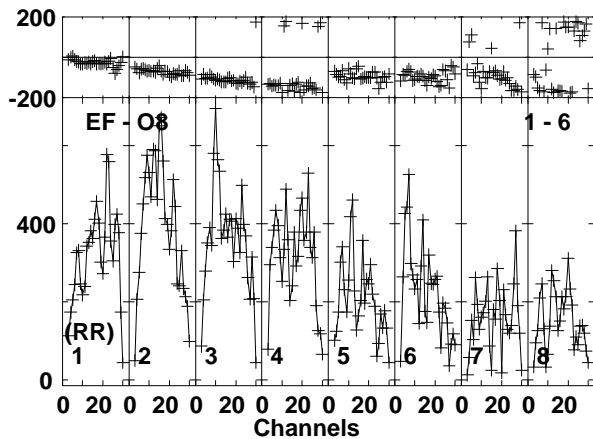
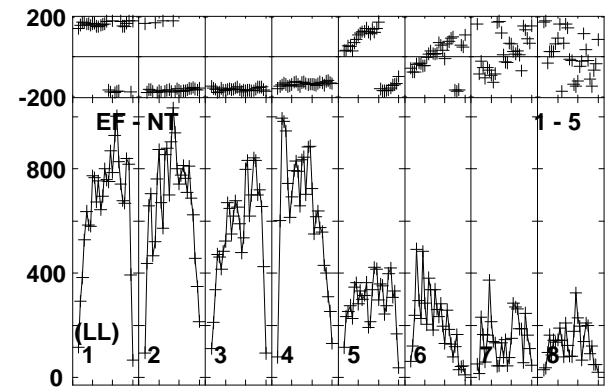
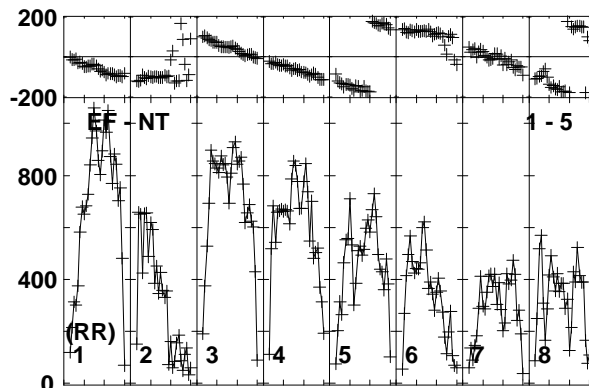
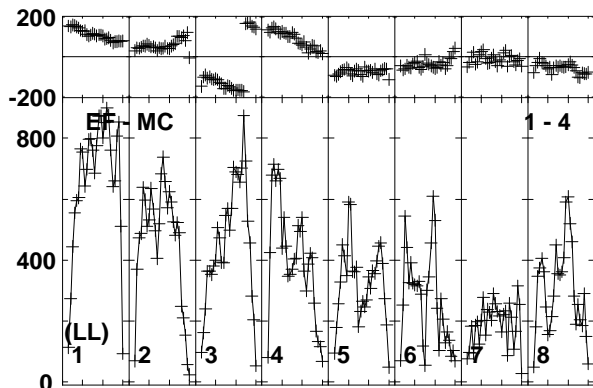
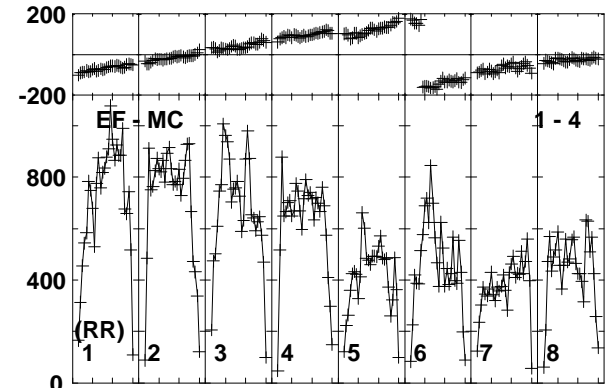
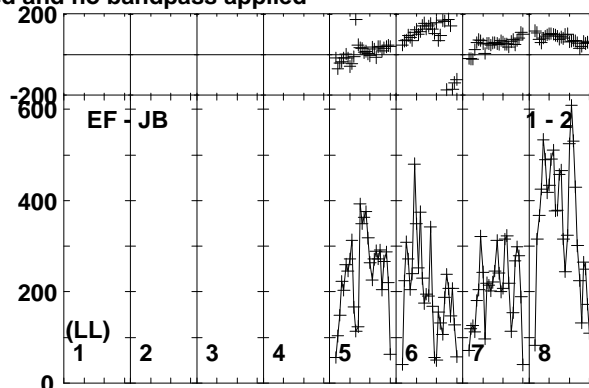
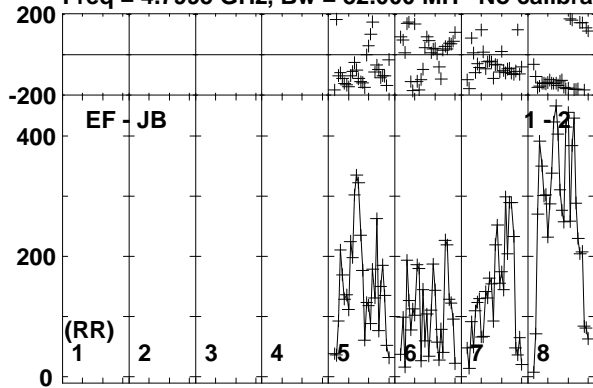

Lower frame: Micro Ampl Jy Top frame: Phas deg
Vector averaged cross-power spectrum Baseline: EF (01) - JB (02)
Timerange: 00/23:19:01 to 00/23:19:59

Plot file version 124 created 20-APR-2018 18:08:01

J1311-2329 RG009B.UVDATA.1

Freq = 4.7995 GHz, Bw = 32.000 MH No calibration applied and no bandpass applied

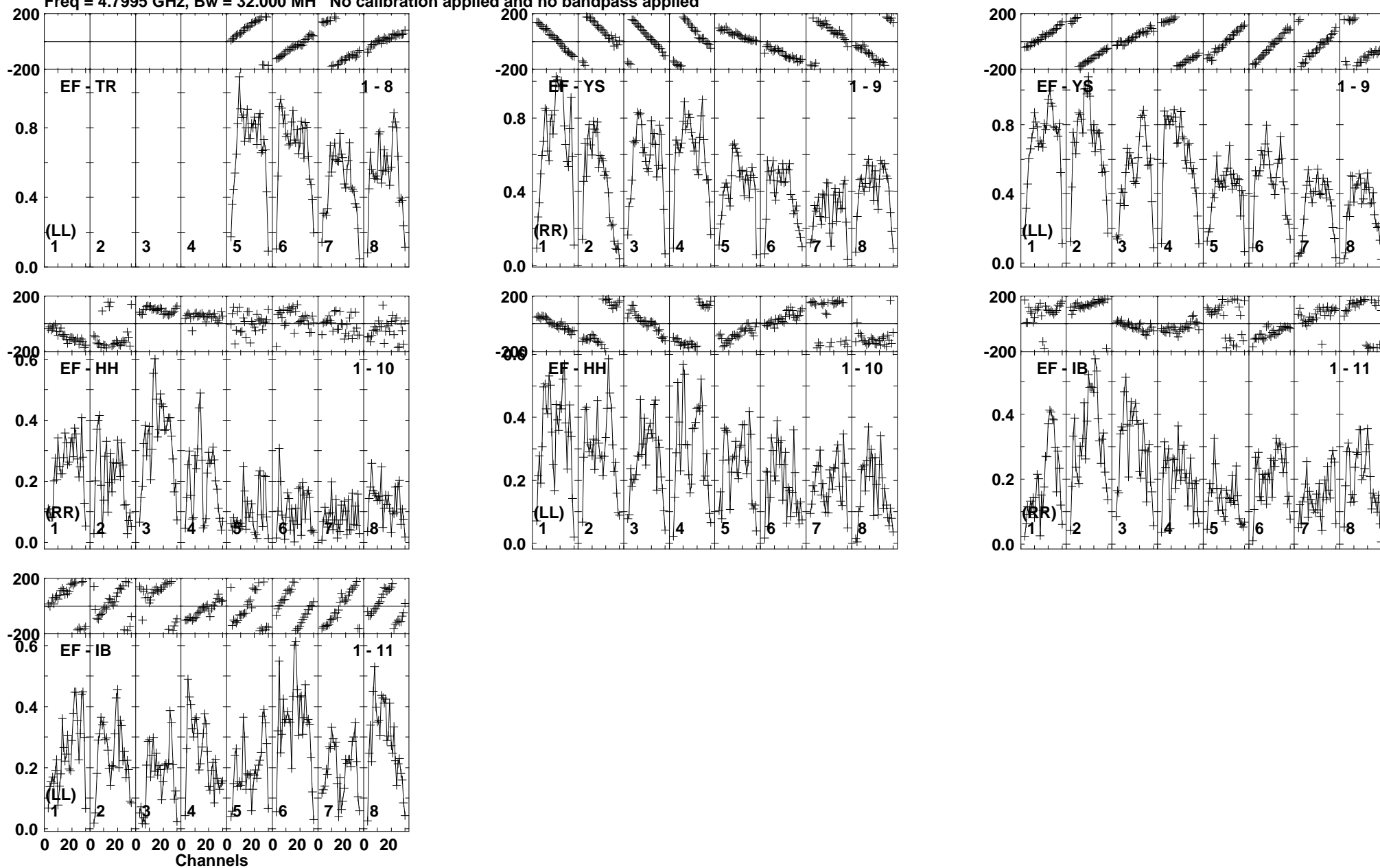

Lower frame: Milli Ampl Jy Top frame: Phas deg
Vector averaged cross-power spectrum Baseline: EF (01) - TR (08)
Timerange: 00/23:19:01 to 00/23:19:59

Plot file version 126 created 20-APR-2018 18:08:01

EM170817 RG009B.UVDATA.1

Freq = 4.7995 GHz, Bw = 32.000 MH No calibration applied and no bandpass applied

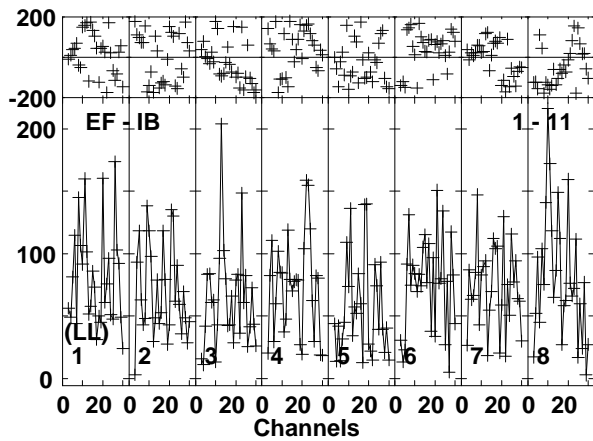
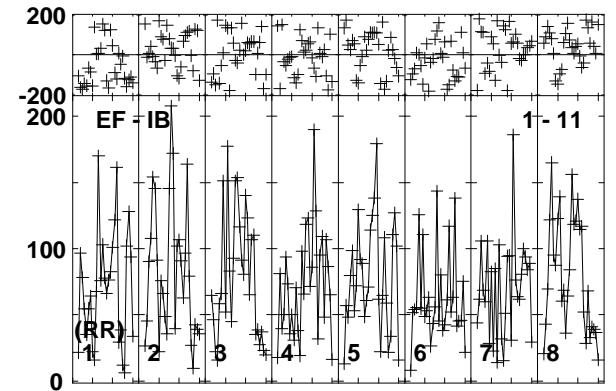
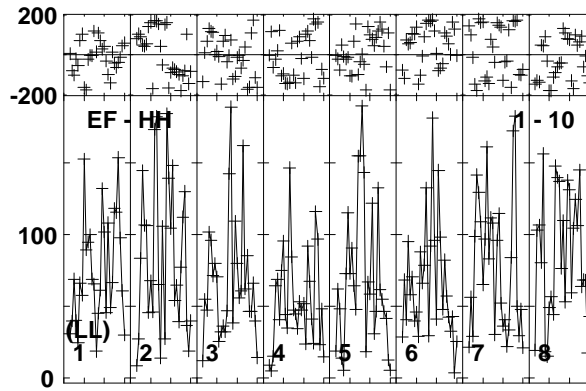
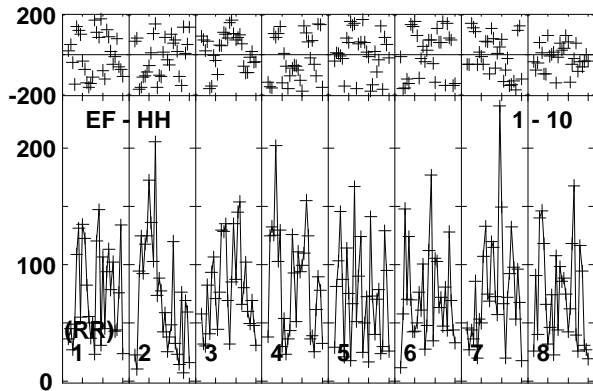
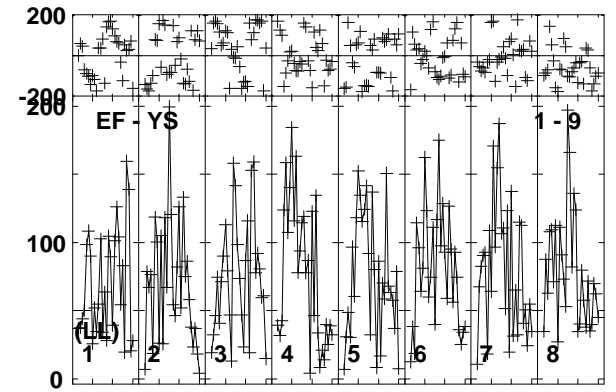
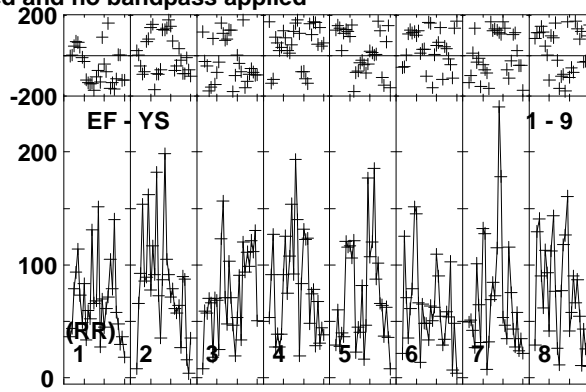
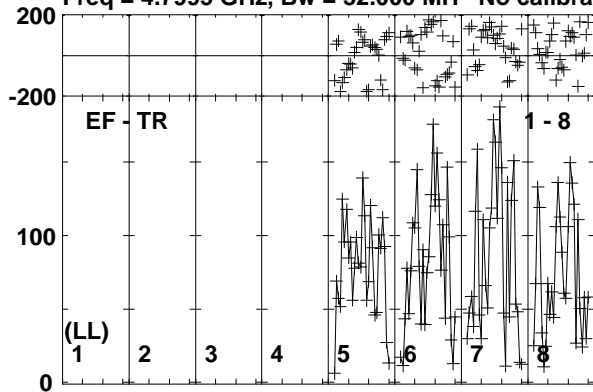

Lower frame: Micro Ampl Jy Top frame: Phas deg
Vector averaged cross-power spectrum Baseline: EF (01) - TR (08)
Timerange: 00/23:20:01 to 00/23:22:29

Plot file version 127 created 20-APR-2018 18:08:01

J1311-2329 RG009B.UVDATA.1

Freq = 4.7995 GHz, Bw = 32.000 MH No calibration applied and no bandpass applied

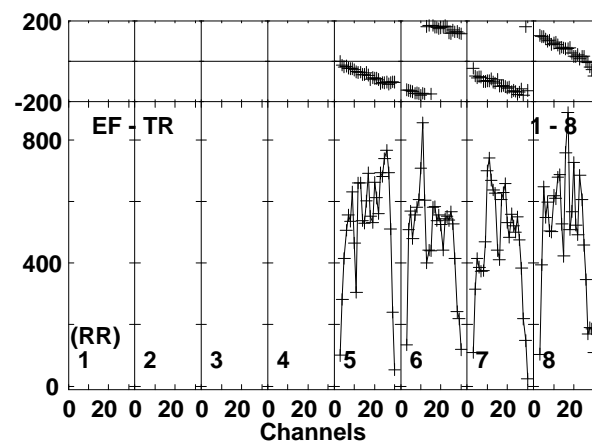
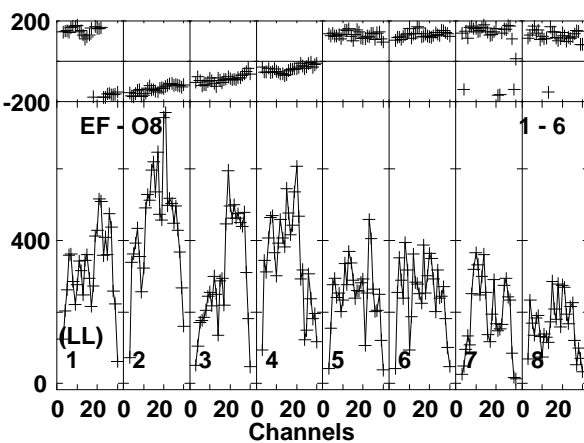
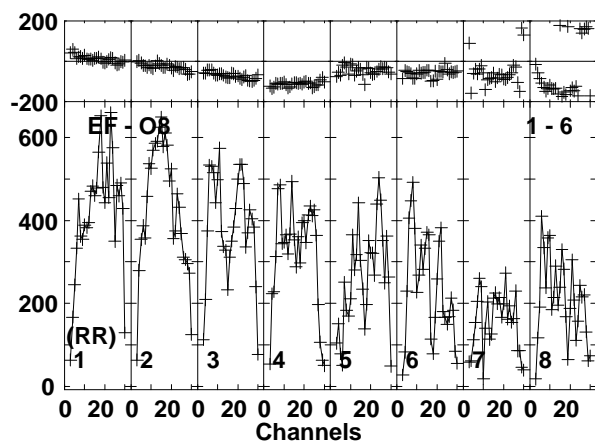
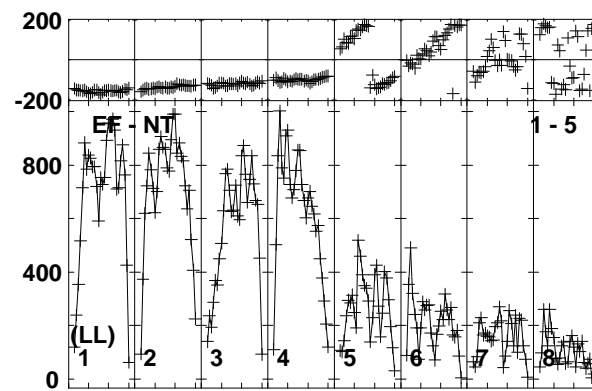
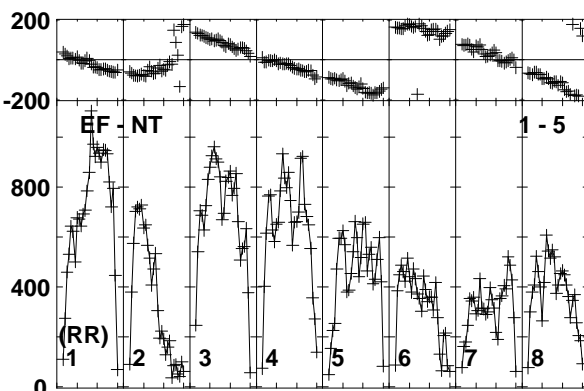
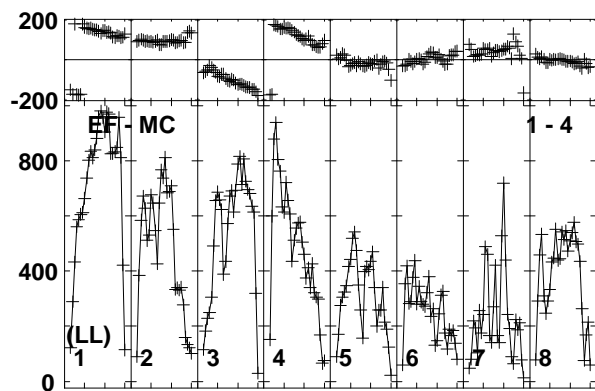
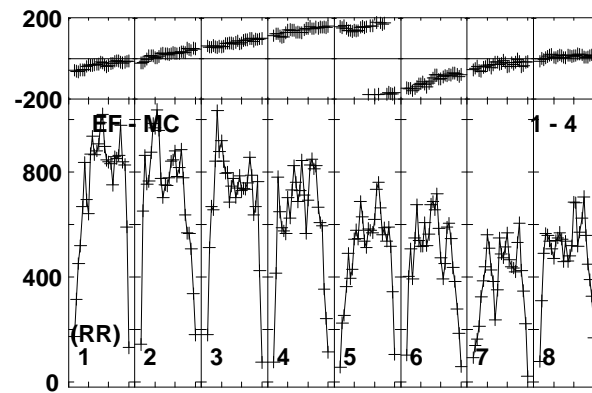
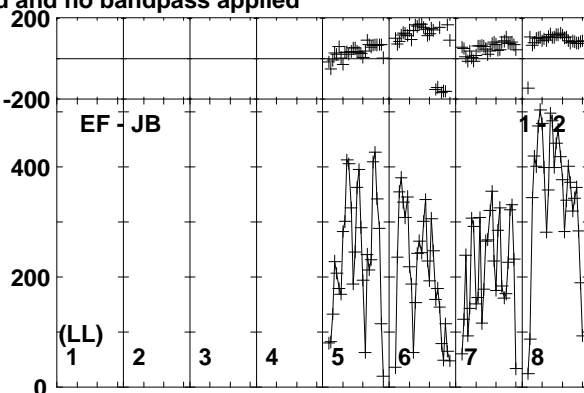
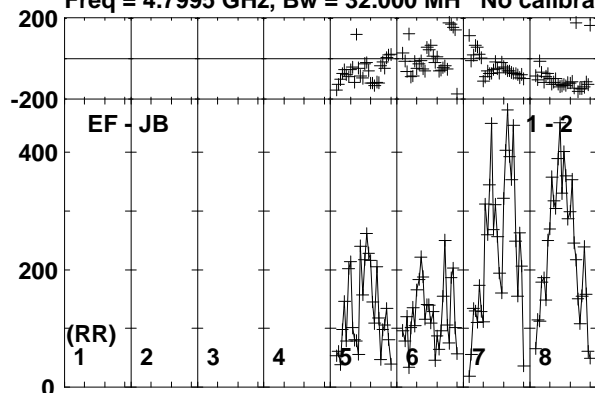

Lower frame: Micro Ampl Jy Top frame: Phas deg
Vector averaged cross-power spectrum Baseline: EF (01) - JB (02)
Timerange: 00/23:22:31 to 00/23:23:59

Plot file version 129 created 20-APR-2018 18:08:01

J1312-2350 RG009B.UVDATA.1

Freq = 4.7995 GHz, Bw = 32.000 MH No calibration applied and no bandpass applied

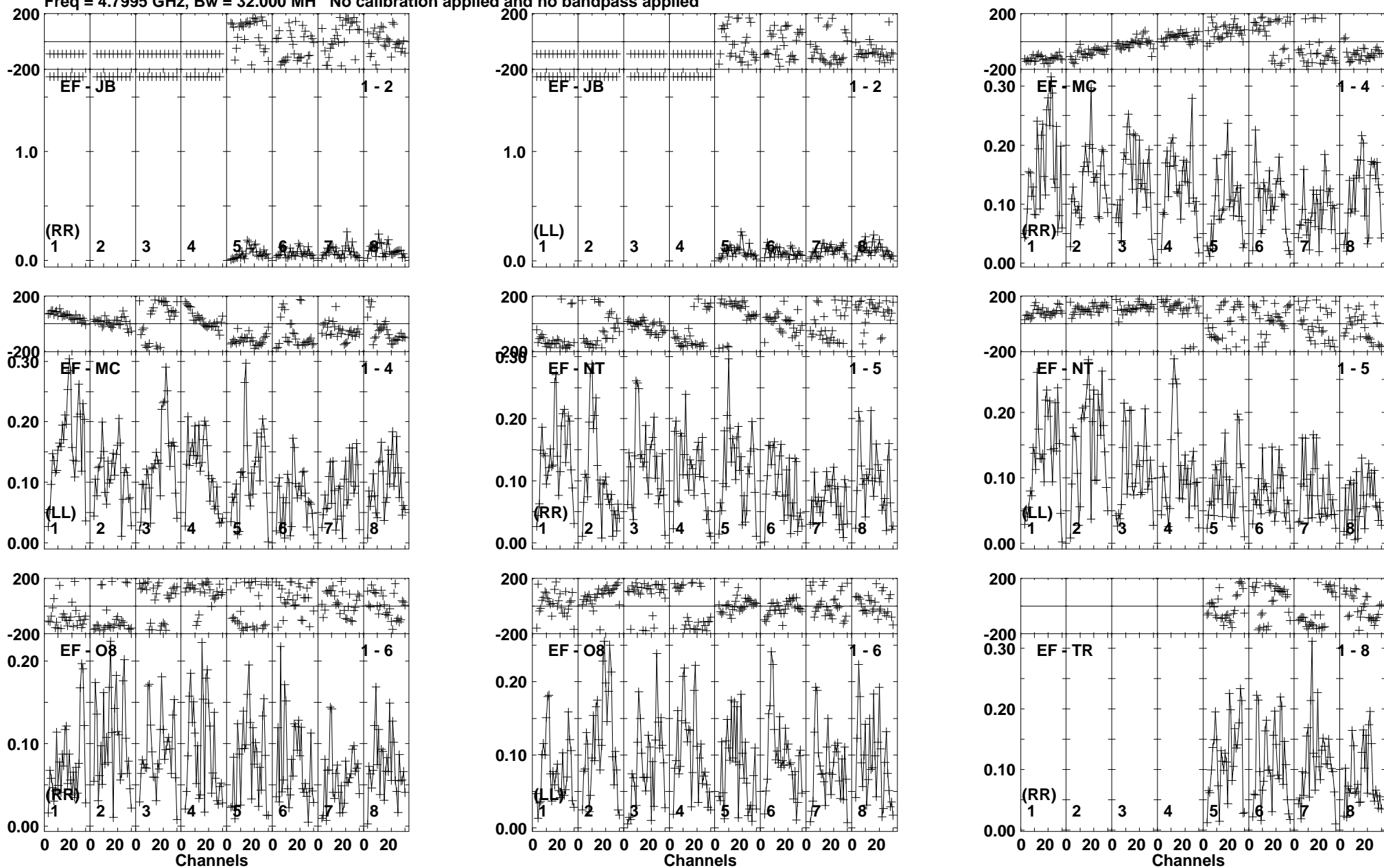

Lower frame: Milli Ampl Jy Top frame: Phas deg
Vector averaged cross-power spectrum Baseline: EF (01) - JB (02)
Timerange: 00/23:24:01 to 00/23:26:29

Plot file version 130 created 20-APR-2018 18:08:01

J1312-2350 RG009B.UVDATA.1

Freq = 4.7995 GHz, Bw = 32.000 MH No calibration applied and no bandpass applied

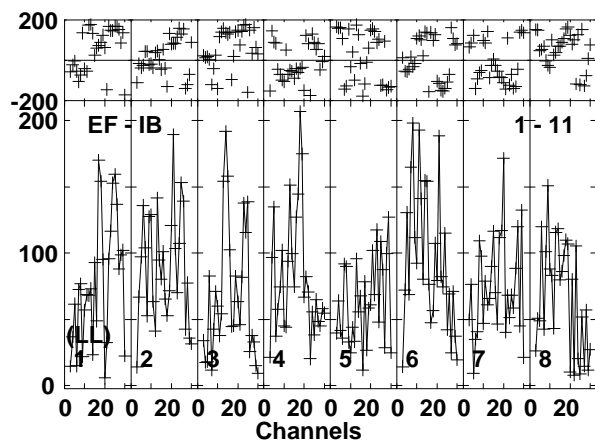
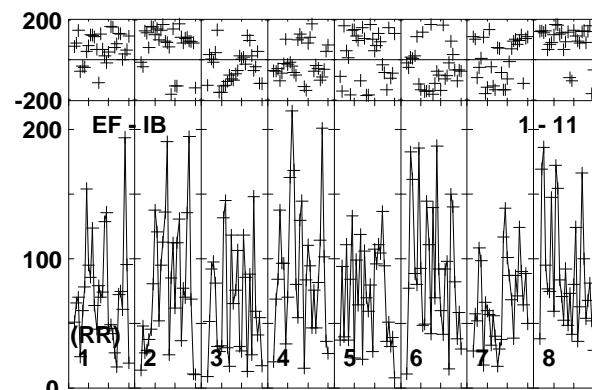
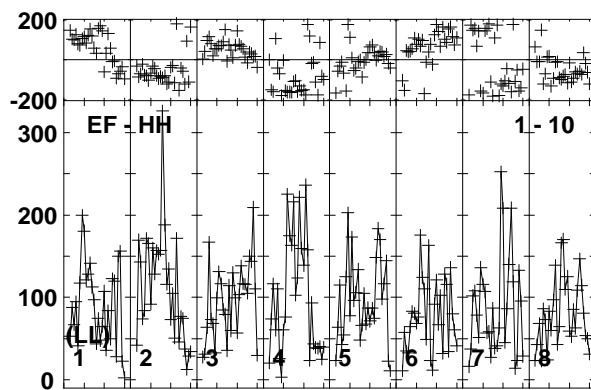
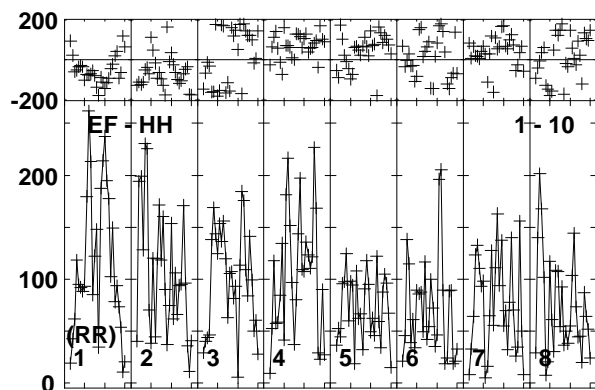
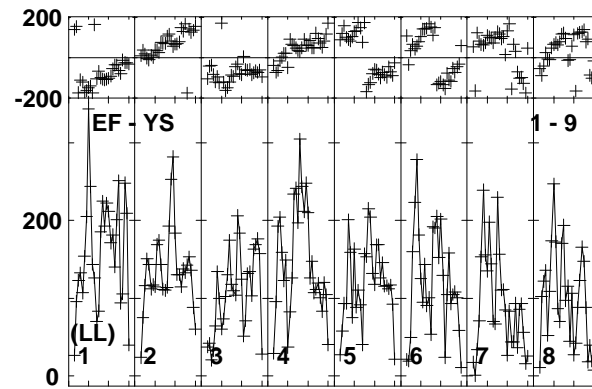
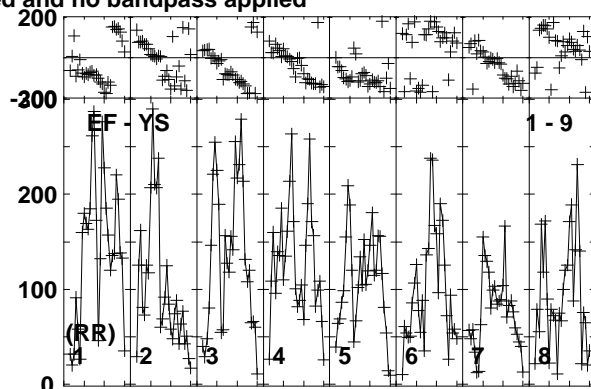
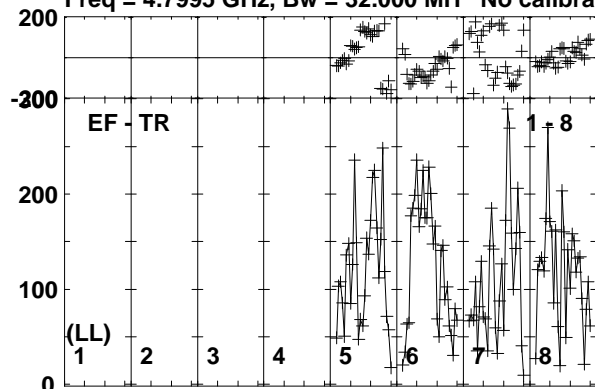

Lower frame: Micro Ampl Jy Top frame: Phas deg
Vector averaged cross-power spectrum Baseline: EF (01) - TR (08)
Timerange: 00/23:24:01 to 00/23:26:29

Plot file version 131 created 20-APR-2018 18:08:02

J1311-2329 RG009B.UVDATA.1

Freq = 4.7995 GHz, Bw = 32.000 MH No calibration applied and no bandpass applied

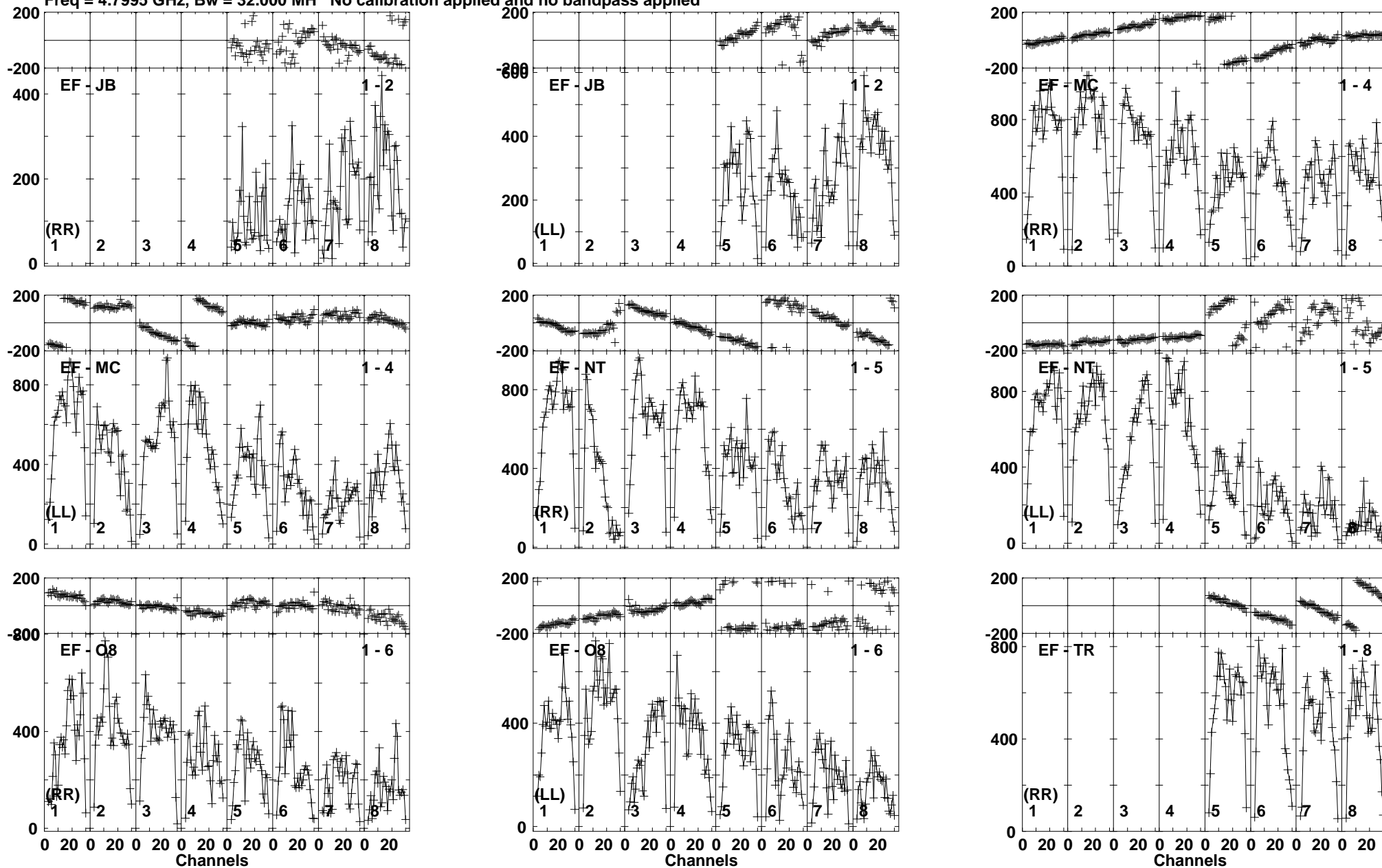

Lower frame: Micro Ampl Jy Top frame: Phas deg
Vector averaged cross-power spectrum Baseline: EF (01) - JB (02)
Timerange: 00/23:27:11 to 00/23:28:09

Plot file version 132 created 20-APR-2018 18:08:02

J1311-2329 RG009B.UVDATA.1

Freq = 4.7995 GHz, Bw = 32.000 MH No calibration applied and no bandpass applied

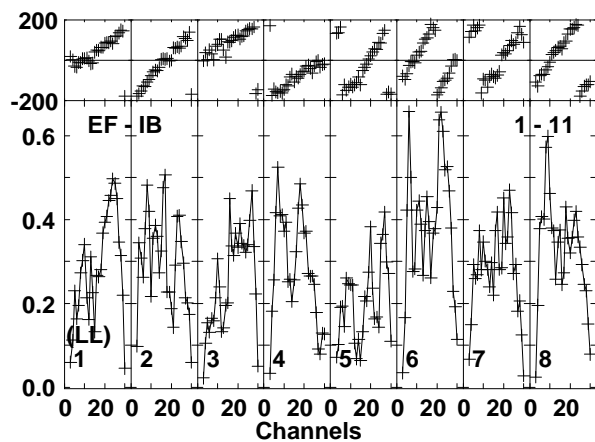
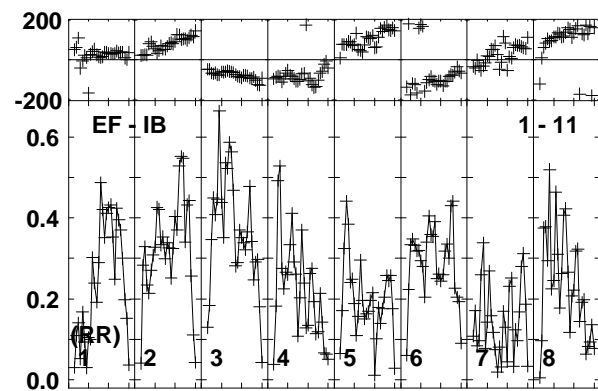
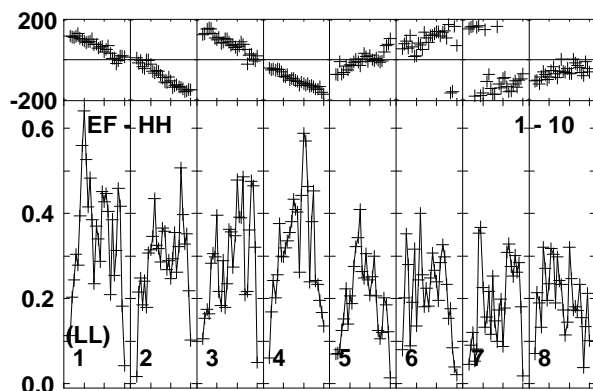
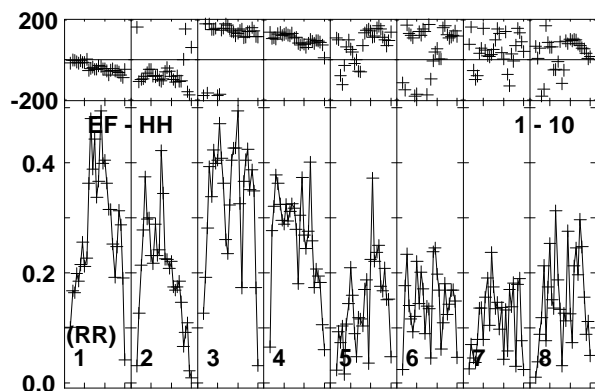
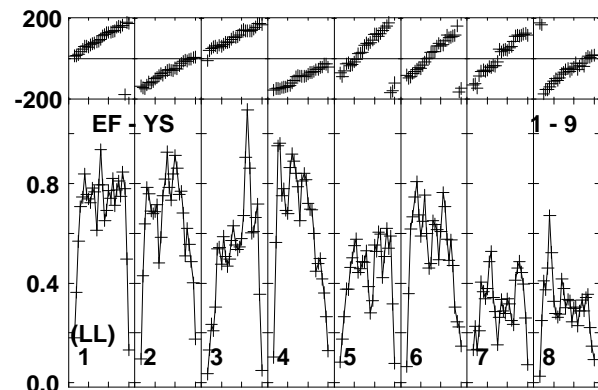
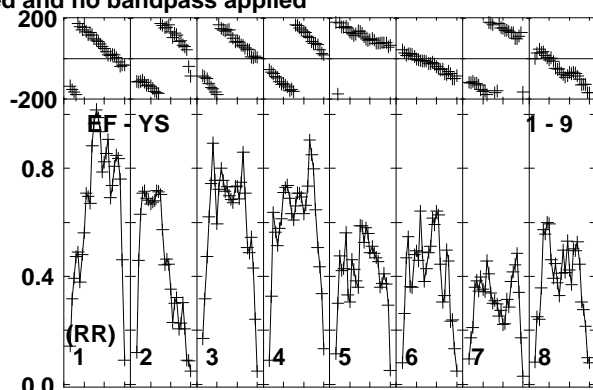
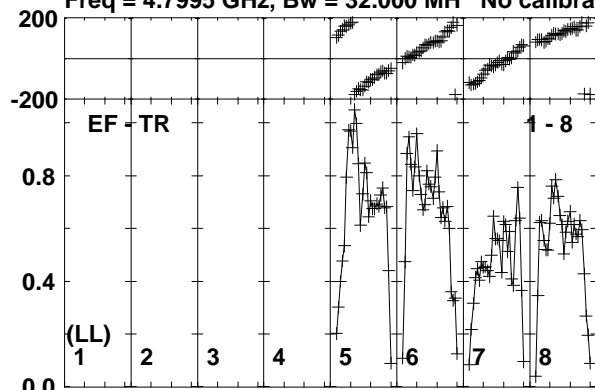

Lower frame: Milli Ampl Jy Top frame: Phas deg
Vector averaged cross-power spectrum Baseline: EF (01) - TR (08)
Timerange: 00/23:27:11 to 00/23:28:09

Plot file version 133 created 20-APR-2018 18:08:02

EM170817 RG009B.UVDATA.1

Freq = 4.7995 GHz, Bw = 32.000 MH No calibration applied and no bandpass applied

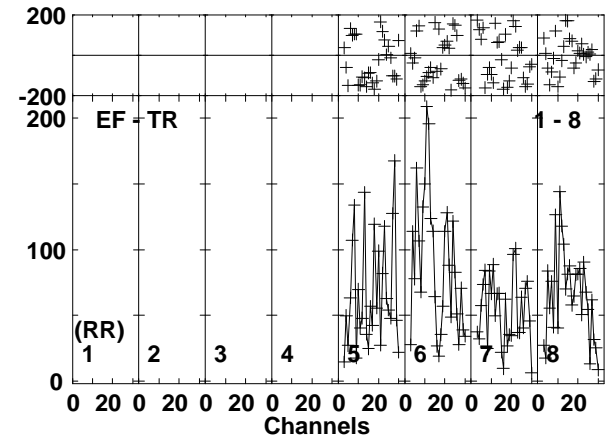
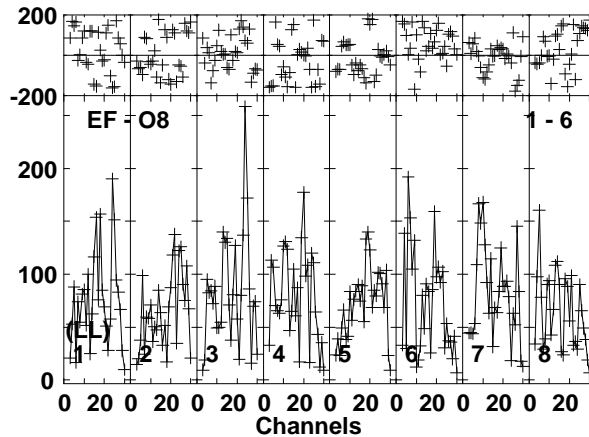
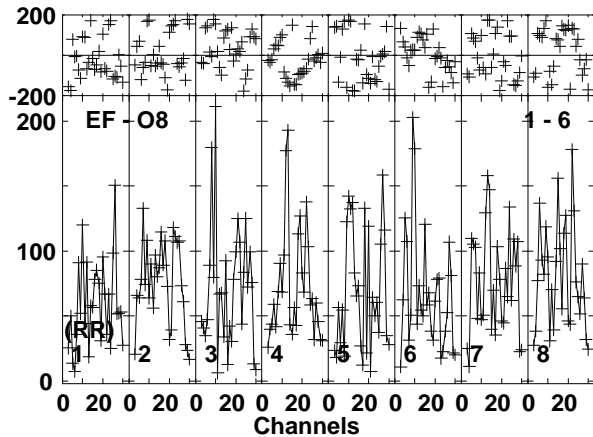
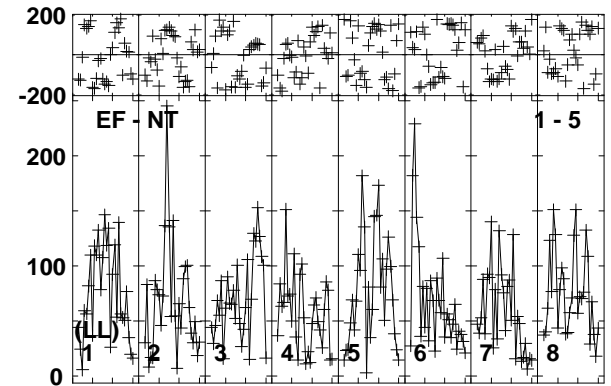
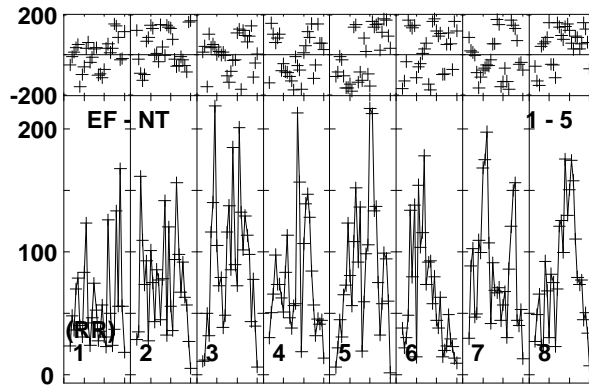
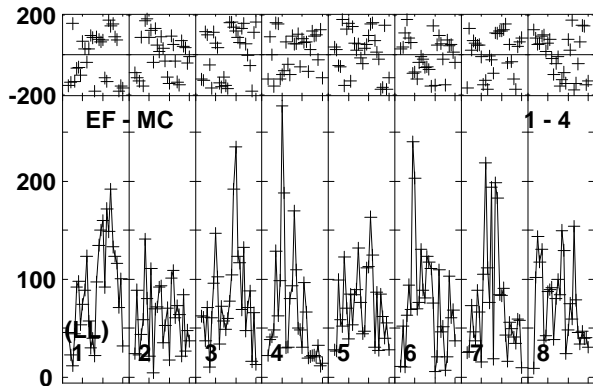
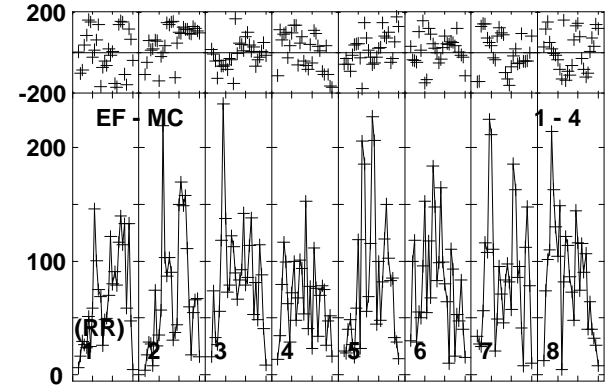
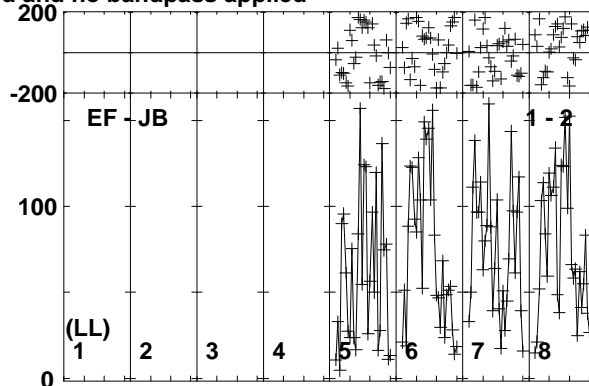
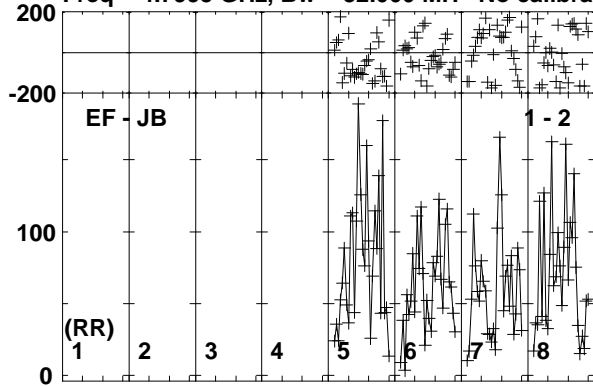

Lower frame: Micro Ampl Jy Top frame: Phas deg
Vector averaged cross-power spectrum Baseline: EF (01) - JB (02)
Timerange: 00/23:28:11 to 00/23:30:39

Plot file version 134 created 20-APR-2018 18:08:02

EM170817 RG009B.UVDATA.1

Freq = 4.7995 GHz, Bw = 32.000 MH No calibration applied and no bandpass applied

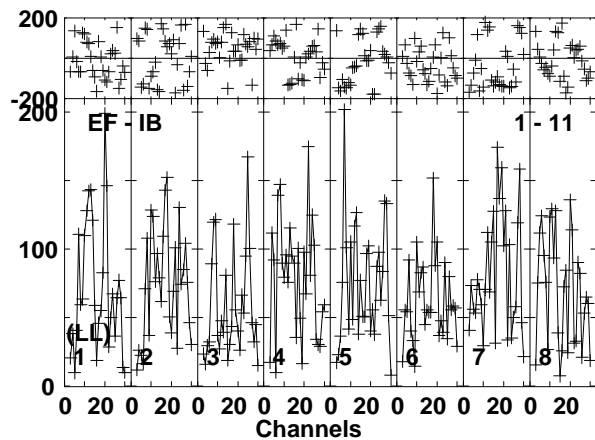
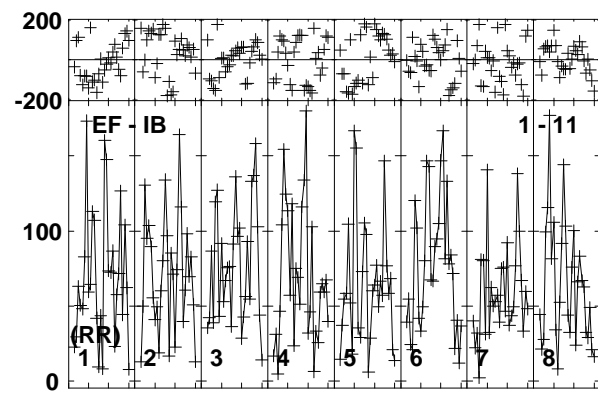
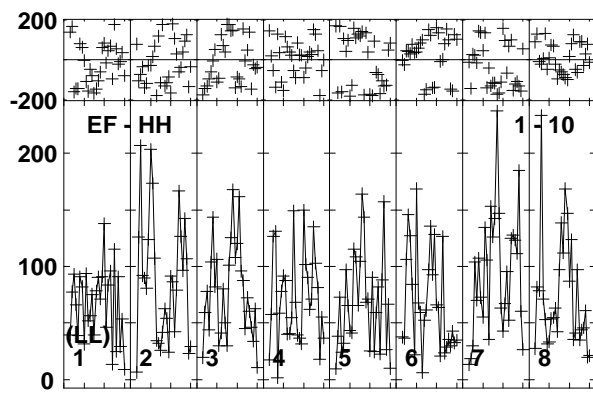
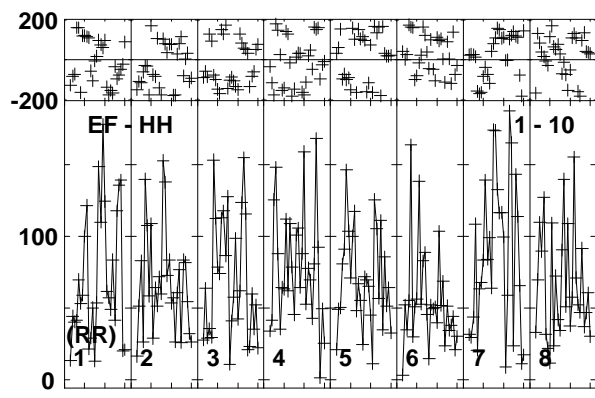
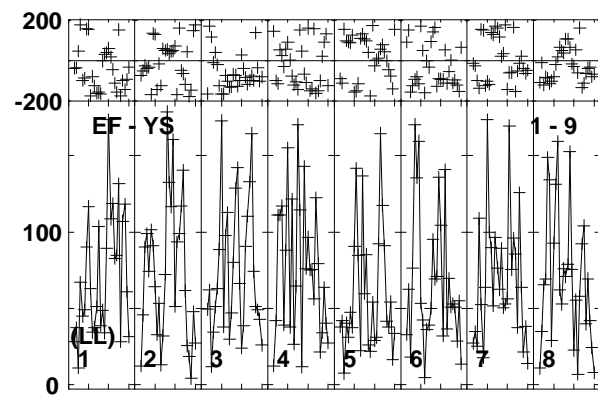
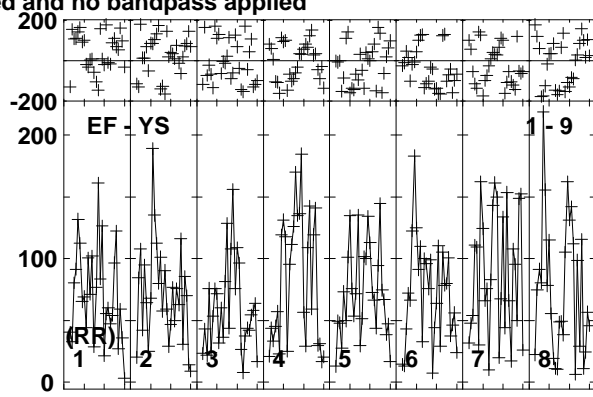
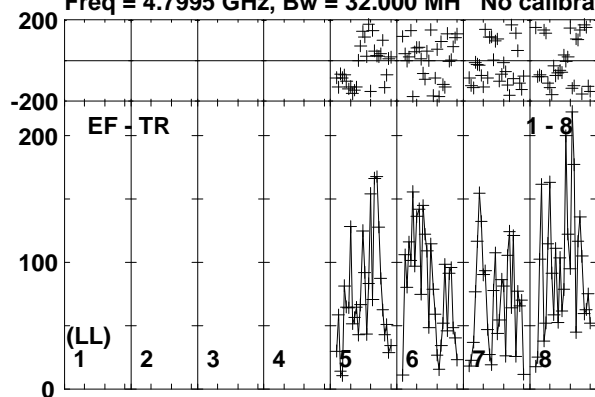

Lower frame: Micro Ampl Jy Top frame: Phas deg
Vector averaged cross-power spectrum Baseline: EF (01) - TR (08)
Timerange: 00/23:28:11 to 00/23:30:39

Plot file version 135 created 20-APR-2018 18:08:02

J1311-2329 RG009B.UVDATA.1

Freq = 4.7995 GHz, Bw = 32.000 MH No calibration applied and no bandpass applied

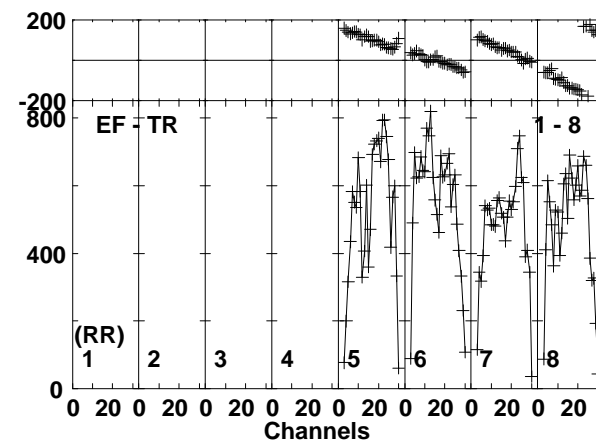
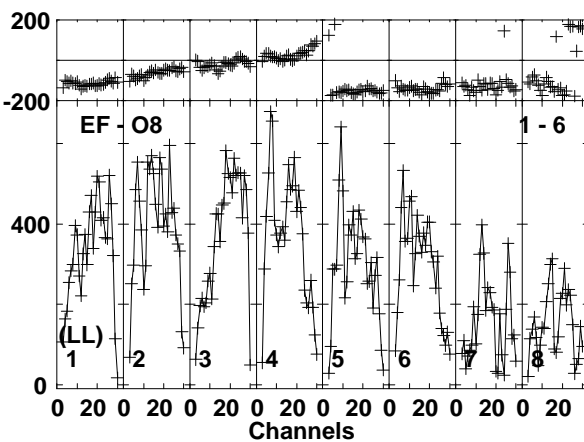
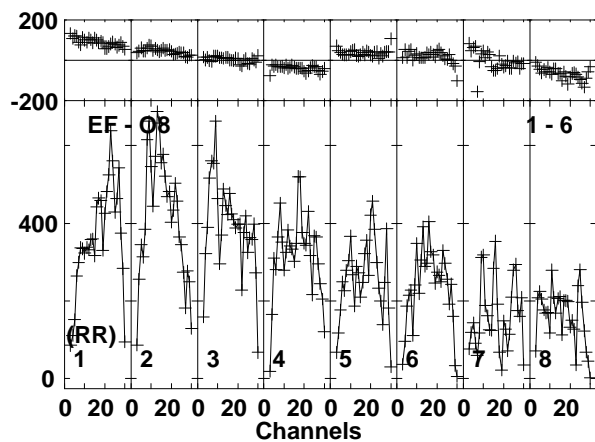
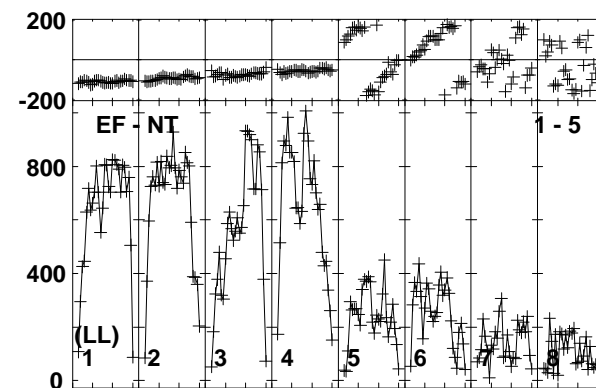
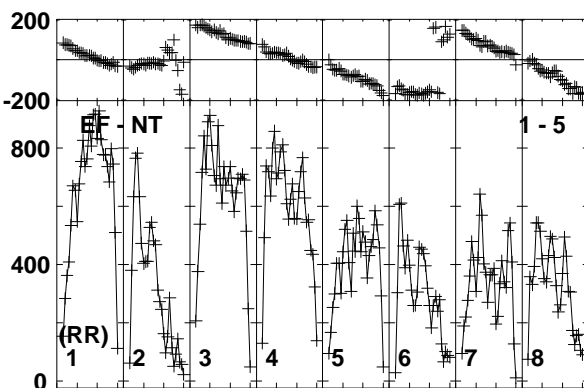
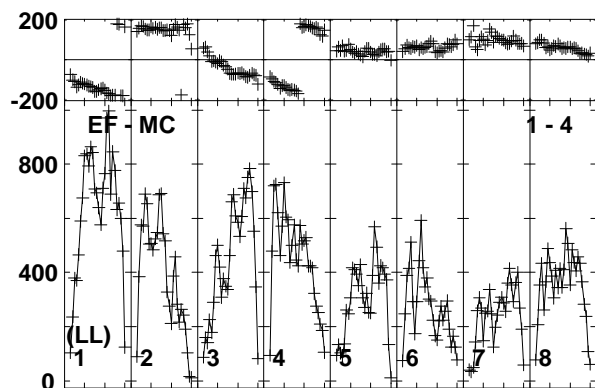
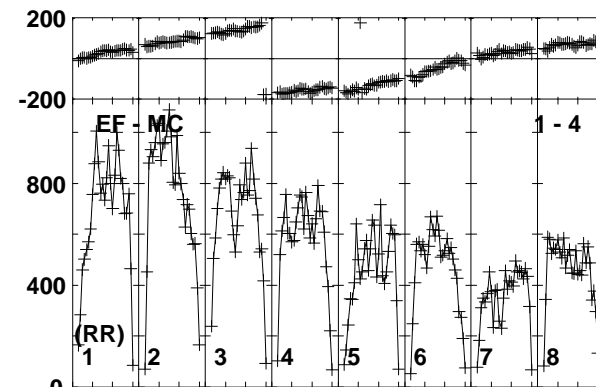
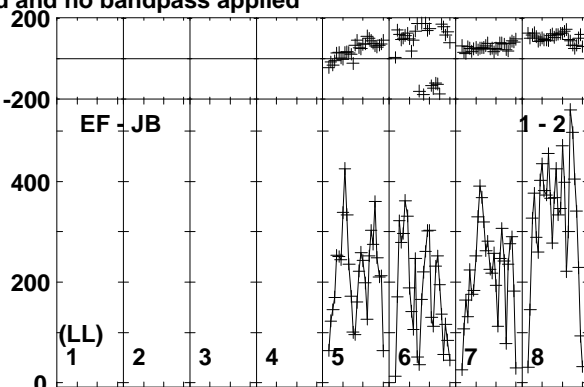
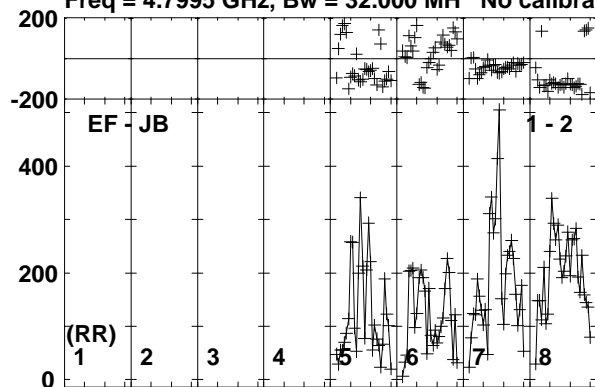

Lower frame: Micro Ampl Jy Top frame: Phas deg
Vector averaged cross-power spectrum Baseline: EF (01) - JB (02)
Timerange: 00/23:30:41 to 00/23:32:09

Plot file version 136 created 20-APR-2018 18:08:02

J1311-2329 RG009B.UVDATA.1

Freq = 4.7995 GHz, Bw = 32.000 MH No calibration applied and no bandpass applied

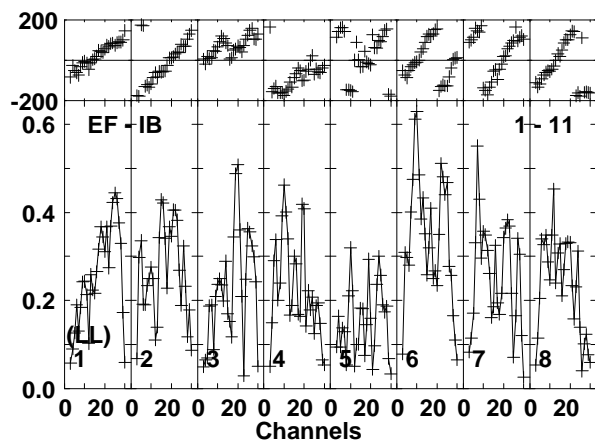
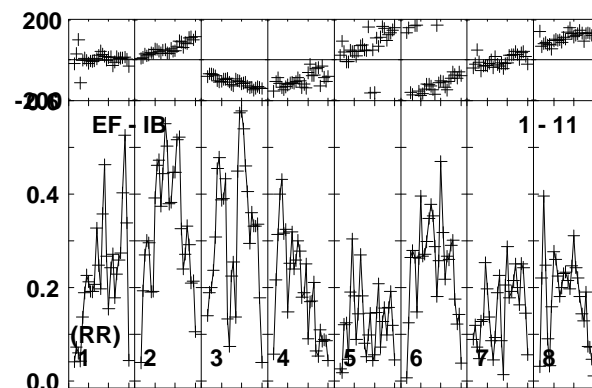
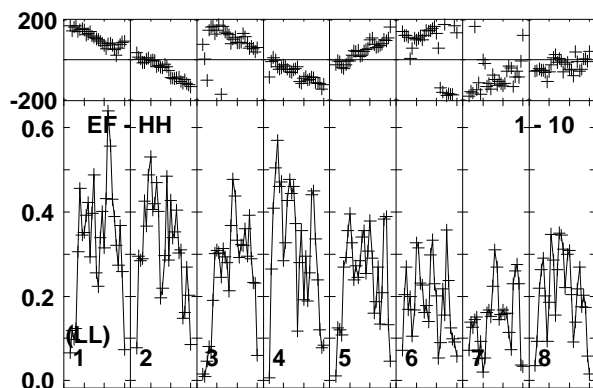
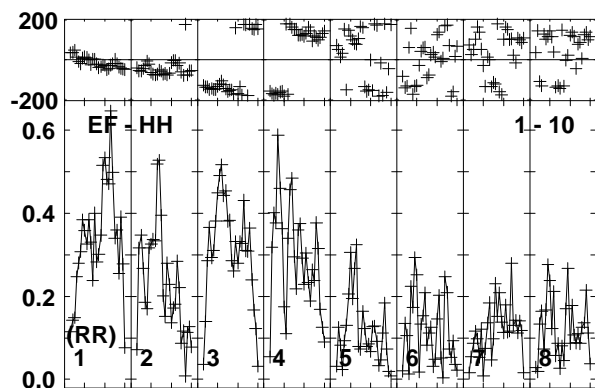
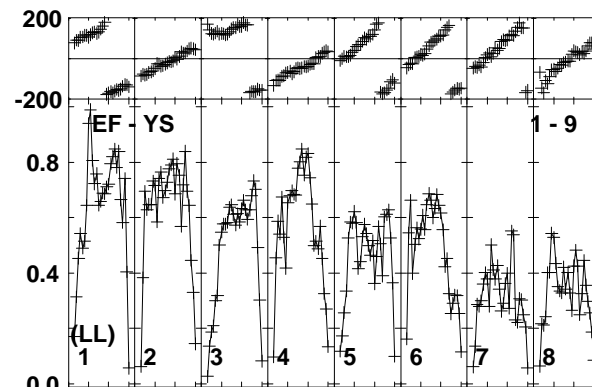
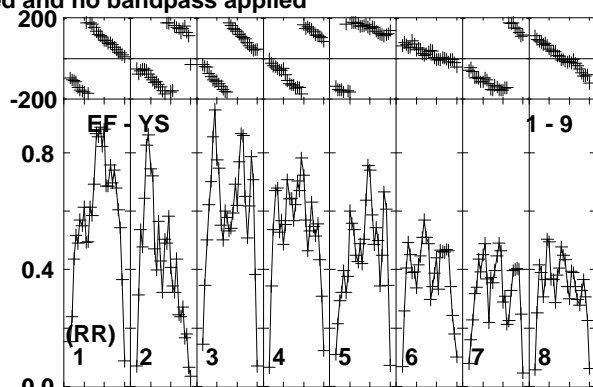
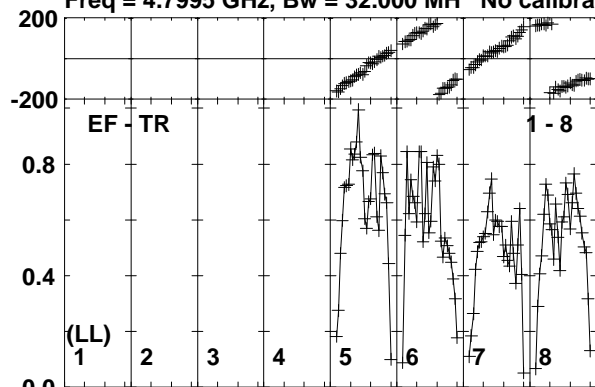

Lower frame: Milli Ampl Jy Top frame: Phas deg
Vector averaged cross-power spectrum Baseline: EF (01) - TR (08)
Timerange: 00/23:30:41 to 00/23:32:09

Plot file version 137 created 20-APR-2018 18:08:02

EM170817 RG009B.UVDATA.1

Freq = 4.7995 GHz, Bw = 32.000 MH No calibration applied and no bandpass applied

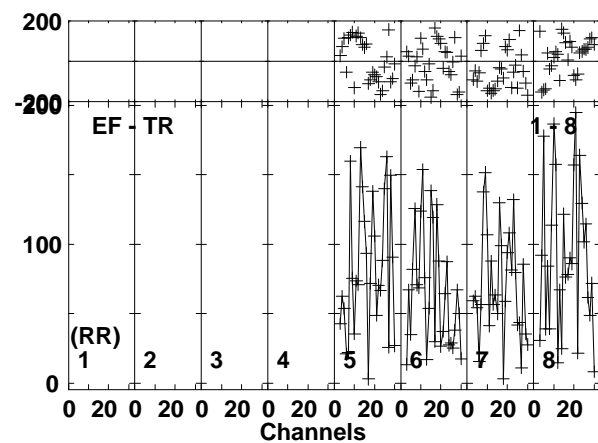
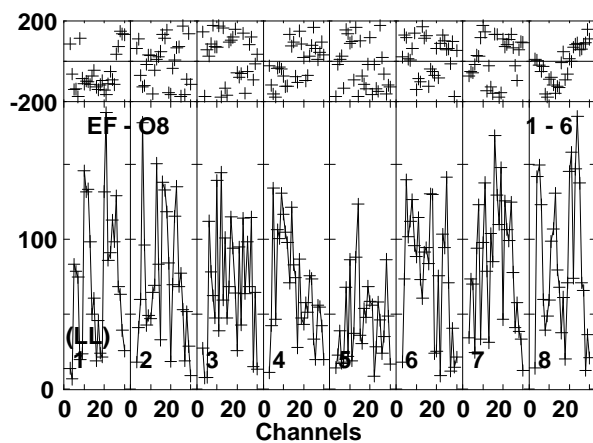
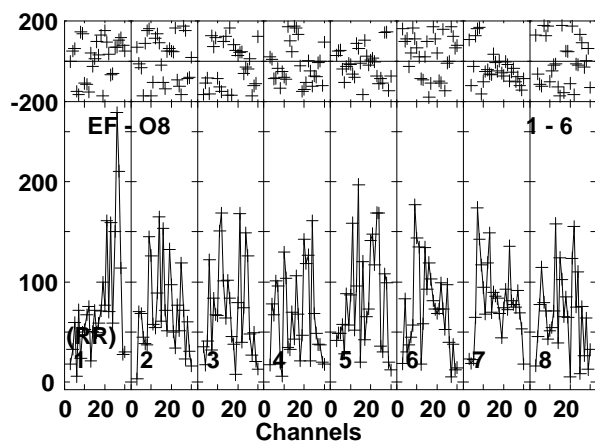
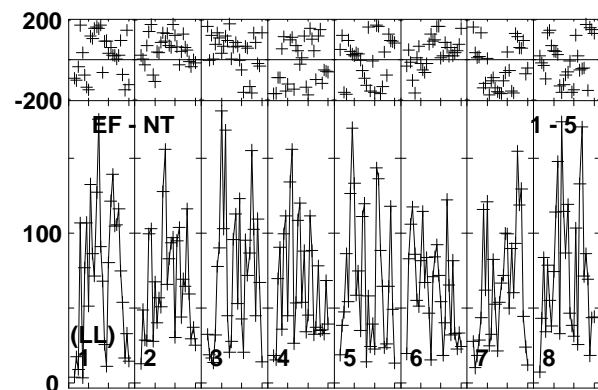
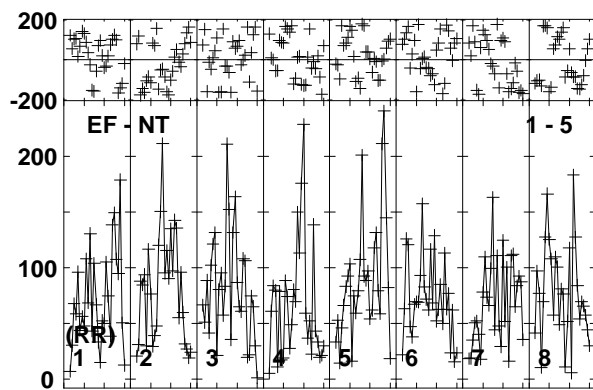
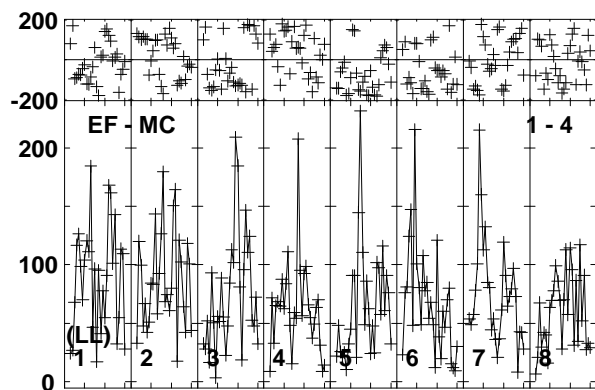
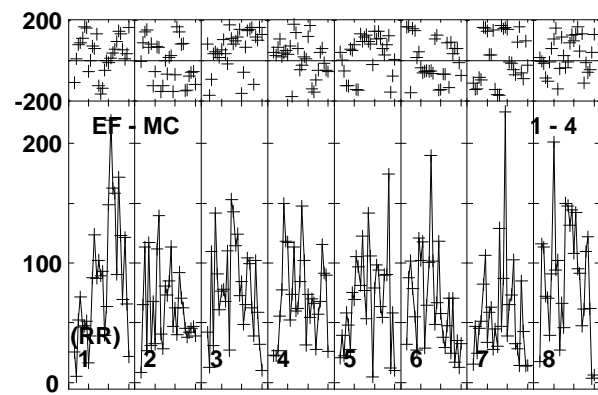
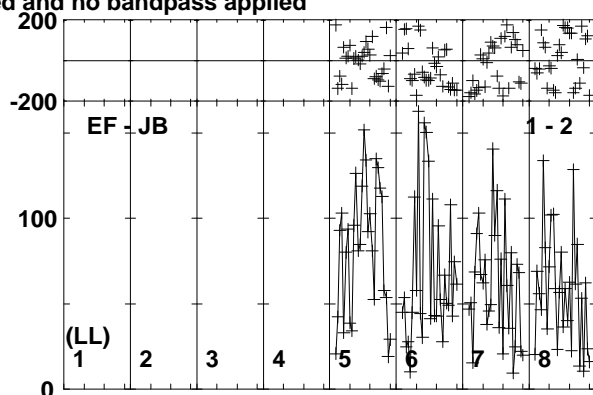
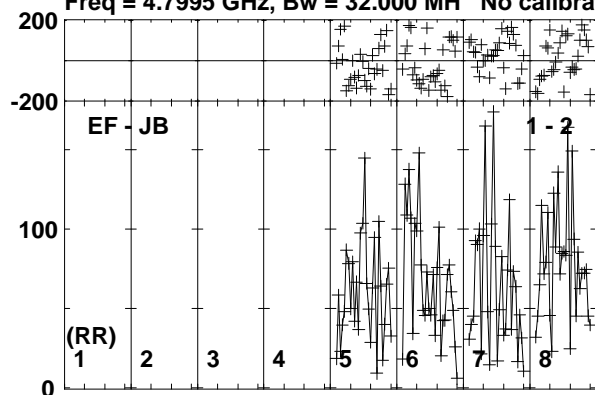

Lower frame: Micro Ampl Jy Top frame: Phas deg
Vector averaged cross-power spectrum Baseline: EF (01) - JB (02)
Timerange: 00/23:32:11 to 00/23:34:39

Plot file version 138 created 20-APR-2018 18:08:02

EM170817 RG009B.UVDATA.1

Freq = 4.7995 GHz, Bw = 32.000 MH No calibration applied and no bandpass applied

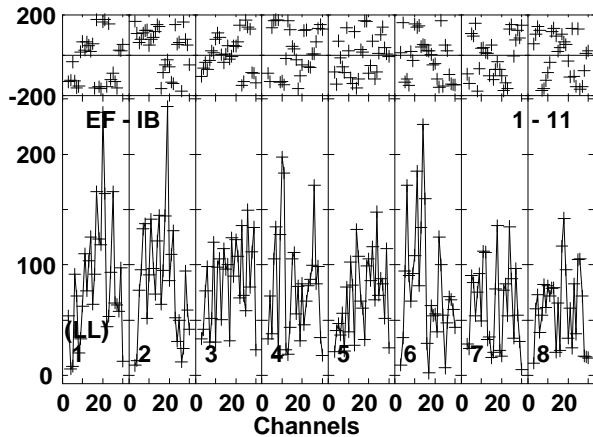
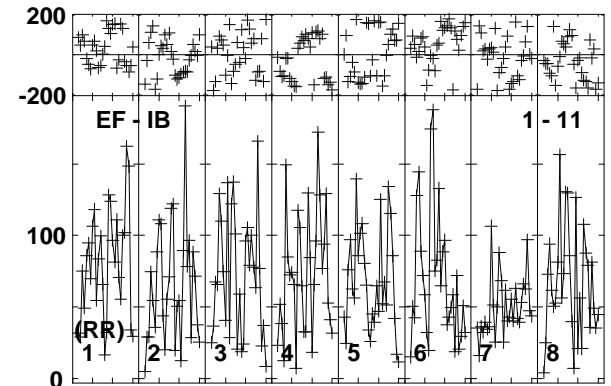
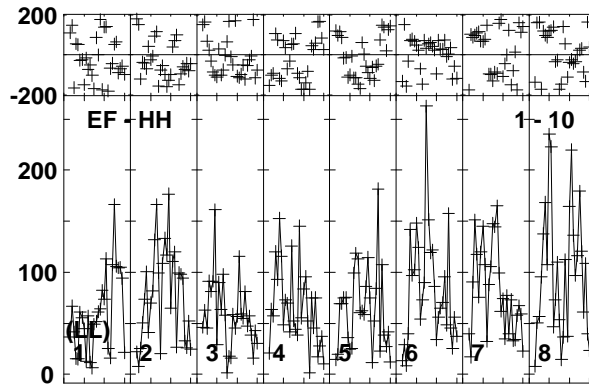
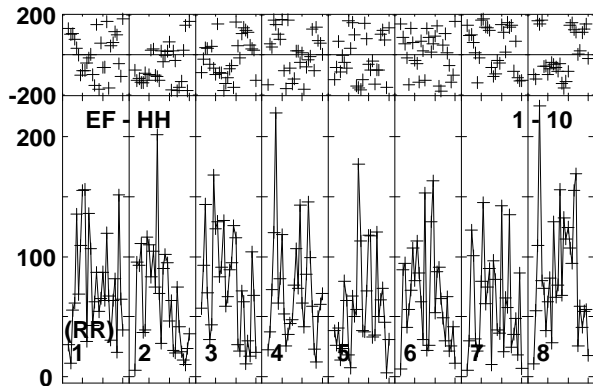
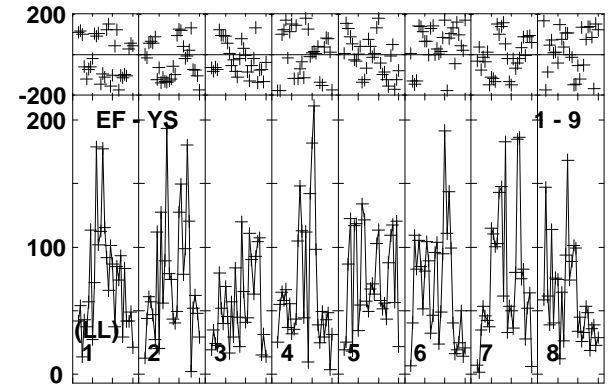
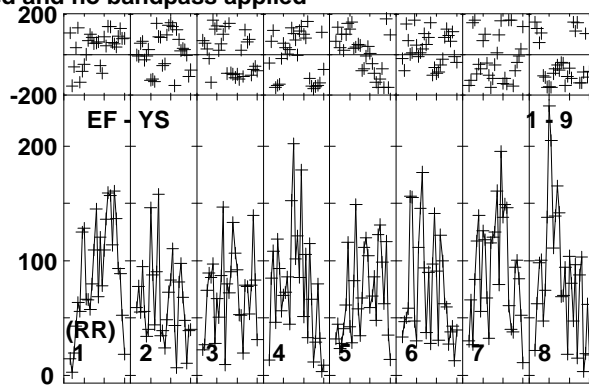
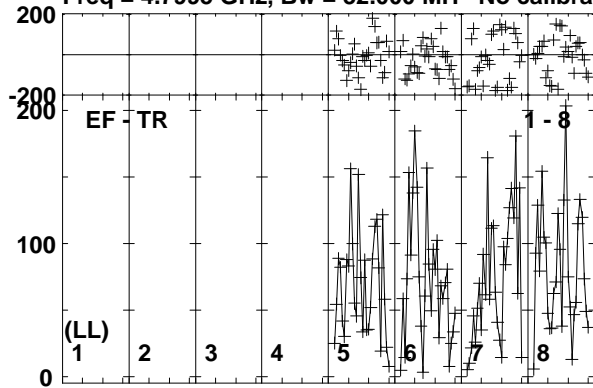

Lower frame: Micro Ampl Jy Top frame: Phas deg
Vector averaged cross-power spectrum Baseline: EF (01) - TR (08)
Timerange: 00/23:32:11 to 00/23:34:39

Plot file version 139 created 20-APR-2018 18:08:02

J1311-2329 RG009B.UVDATA.1

Freq = 4.7995 GHz, Bw = 32.000 MH No calibration applied and no bandpass applied

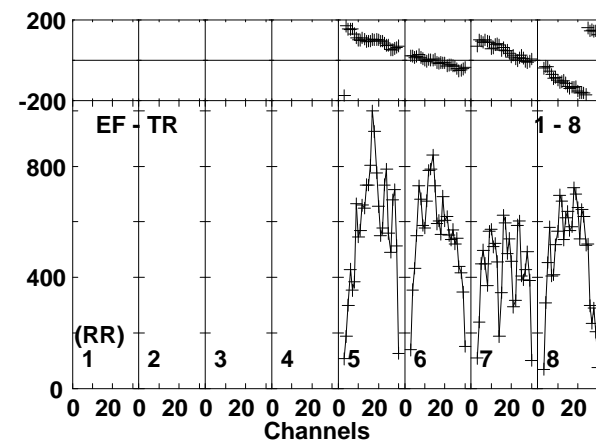
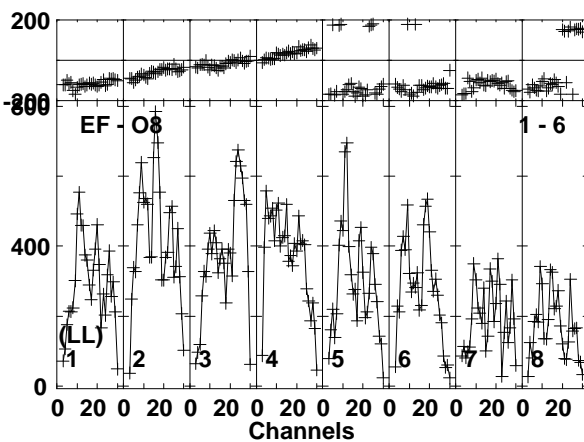
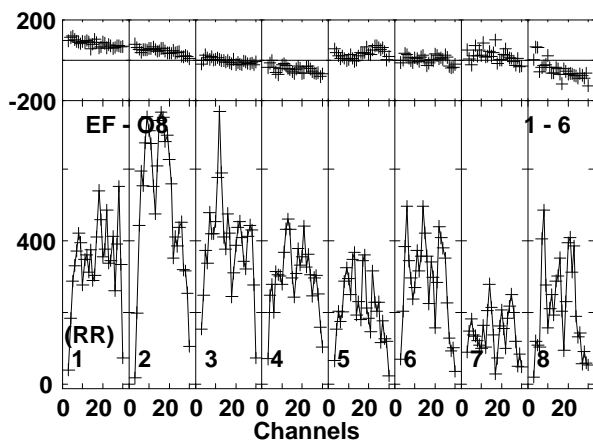
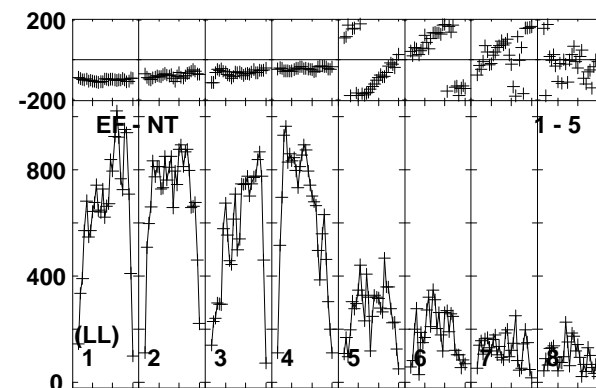
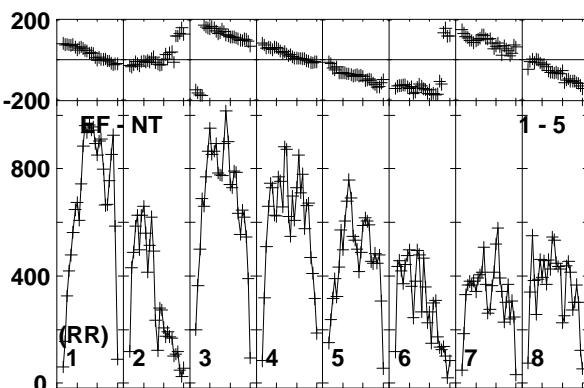
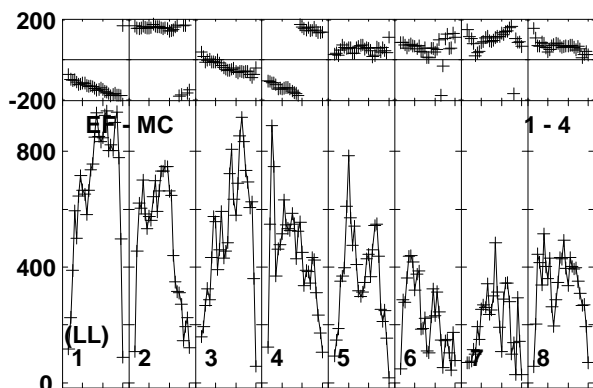
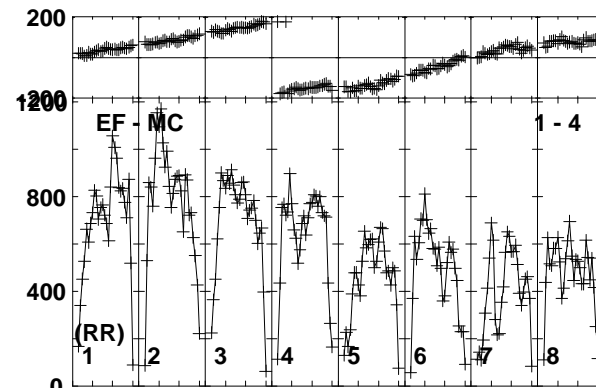
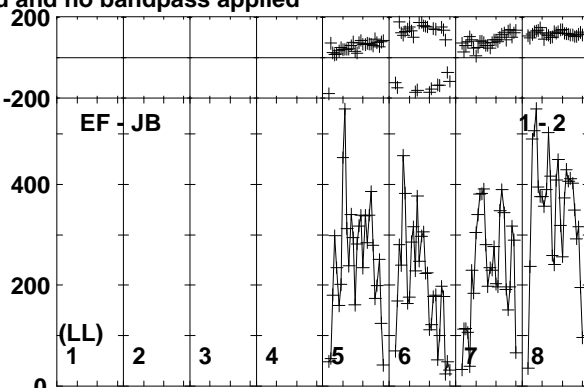
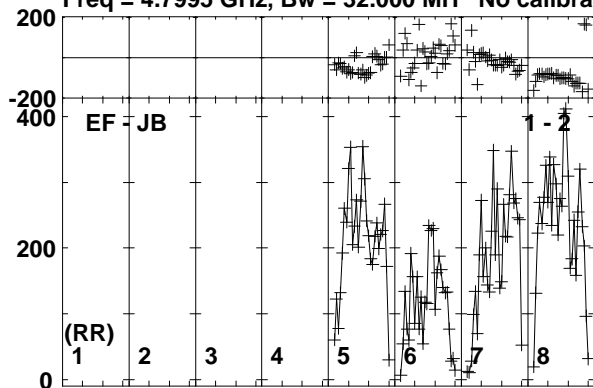

Lower frame: Micro Ampl Jy Top frame: Phas deg
Vector averaged cross-power spectrum Baseline: EF (01) - JB (02)
Timerange: 00/23:35:11 to 00/23:36:09

Plot file version 140 created 20-APR-2018 18:08:02

J1311-2329 RG009B.UVDATA.1

Freq = 4.7995 GHz, Bw = 32.000 MH No calibration applied and no bandpass applied

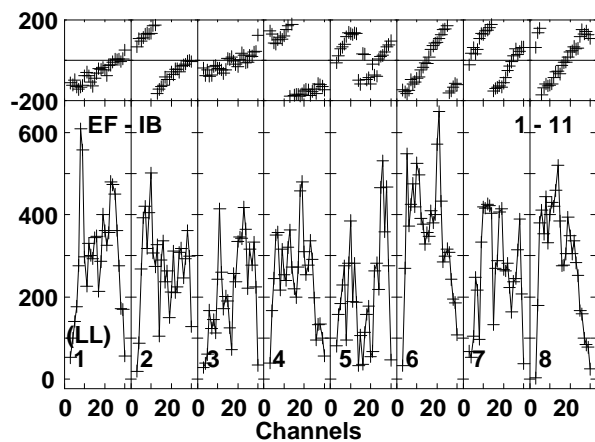
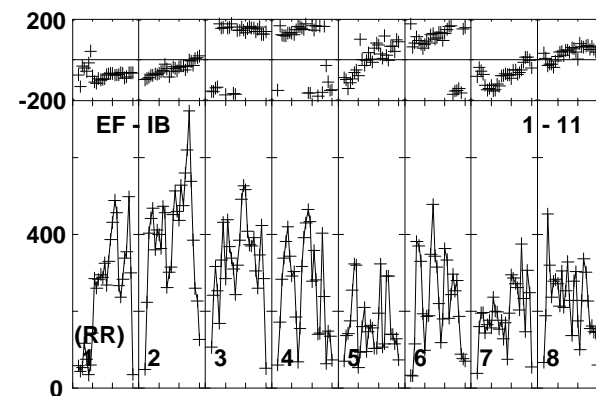
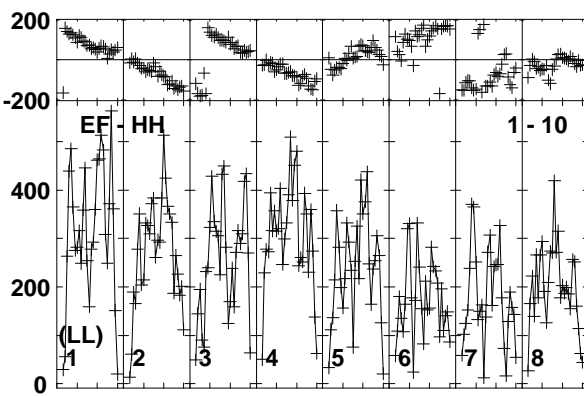
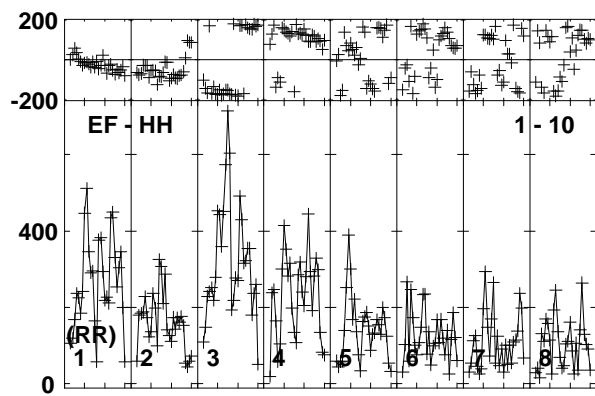
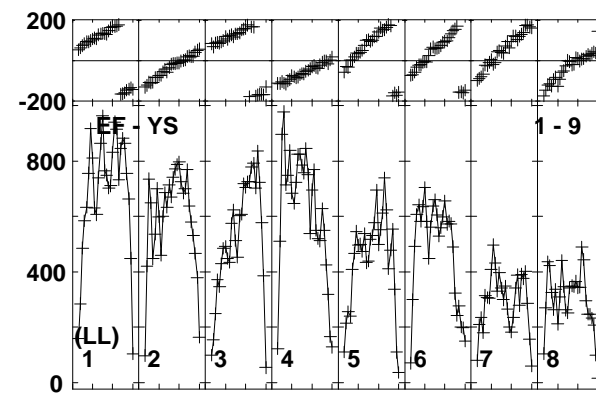
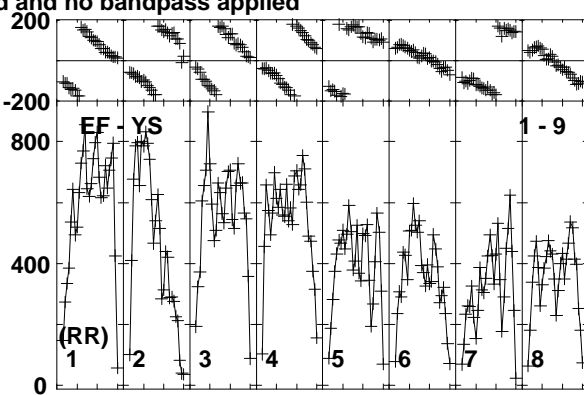
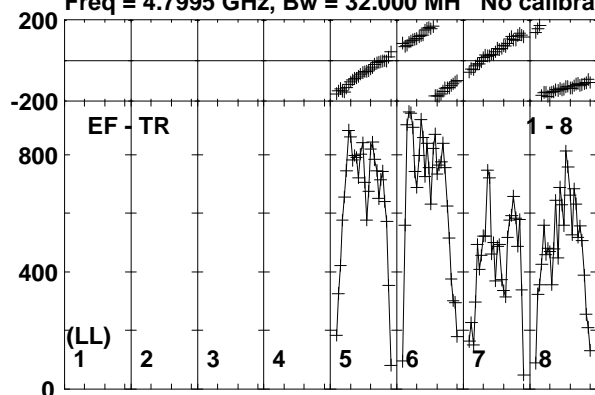

Lower frame: Micro Ampl Jy Top frame: Phas deg
Vector averaged cross-power spectrum Baseline: EF (01) - TR (08)
Timerange: 00/23:35:11 to 00/23:36:09

Plot file version 141 created 20-APR-2018 18:08:02

EM170817 RG009B.UVDATA.1

Freq = 4.7995 GHz, Bw = 32.000 MH No calibration applied and no bandpass applied

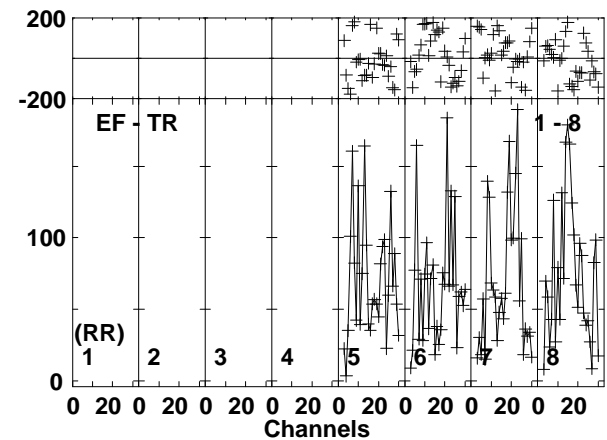
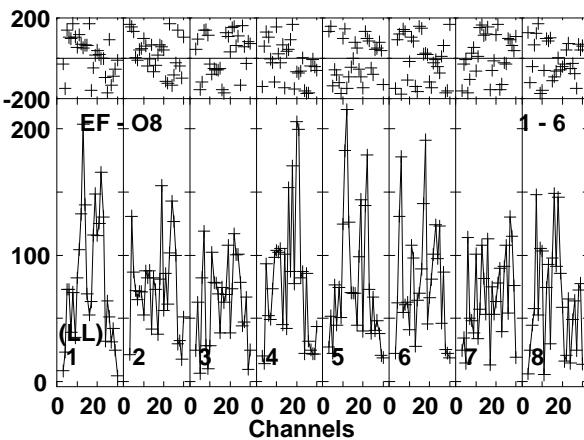
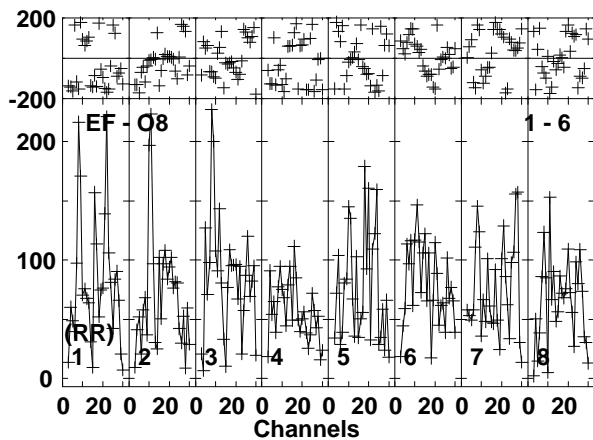
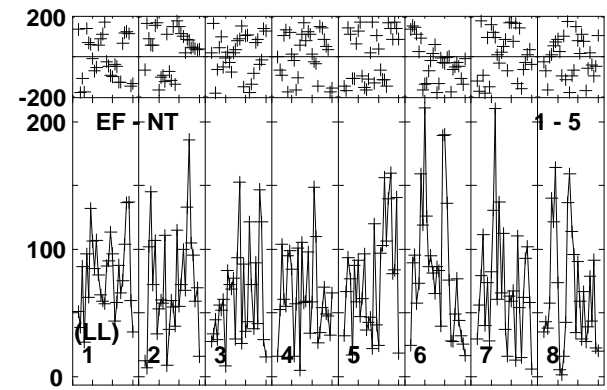
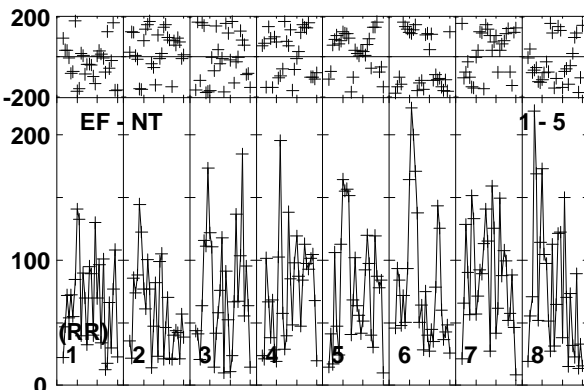
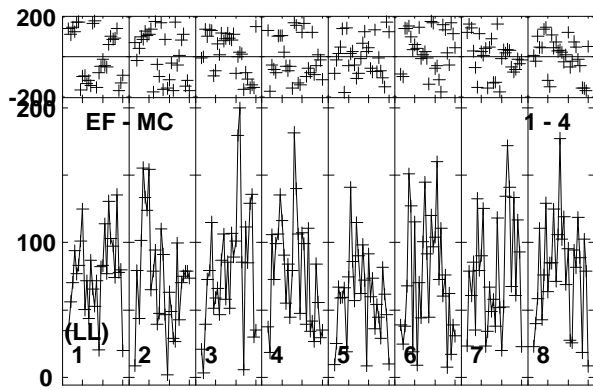
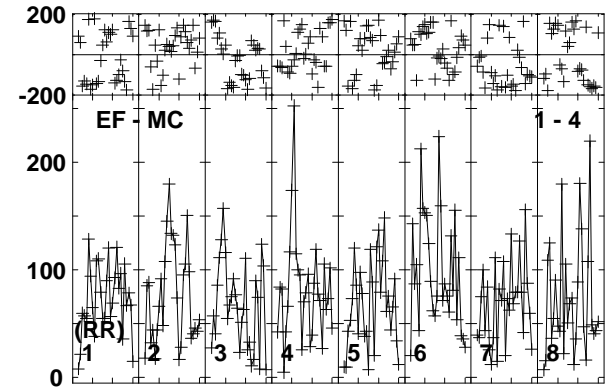
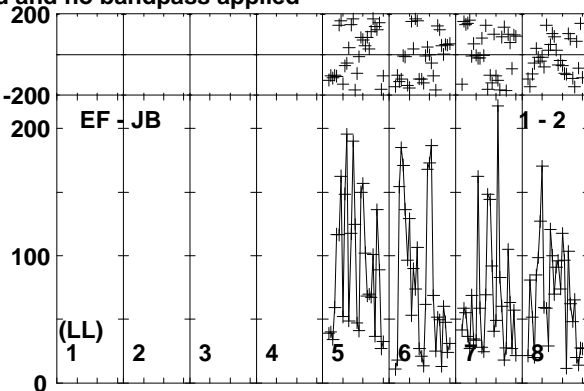
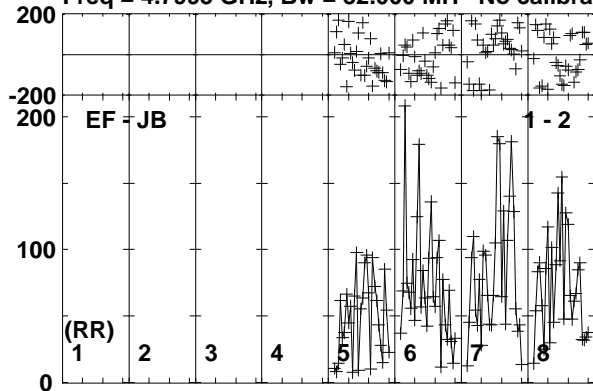

Lower frame: Micro Ampl Jy Top frame: Phas deg
Vector averaged cross-power spectrum Baseline: EF (01) - JB (02)
Timerange: 00/23:36:11 to 00/23:38:39

Plot file version 142 created 20-APR-2018 18:08:02

EM170817 RG009B.UVDATA.1

Freq = 4.7995 GHz, Bw = 32.000 MH No calibration applied and no bandpass applied

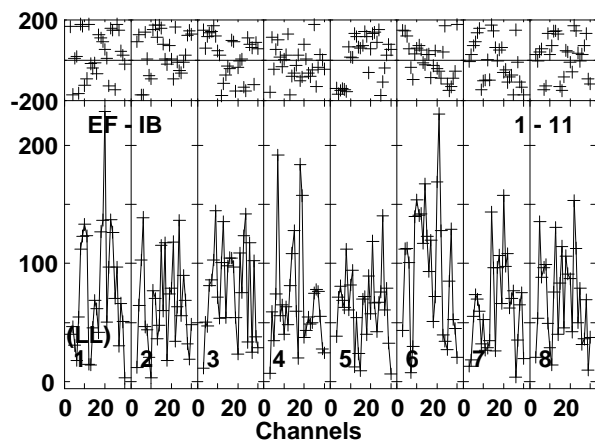
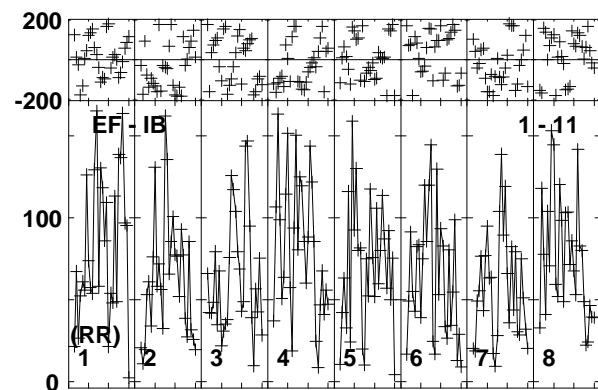
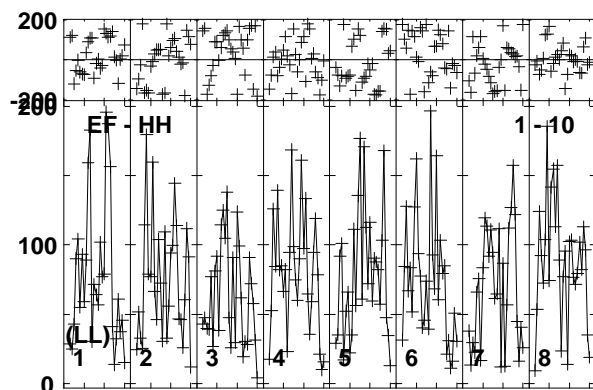
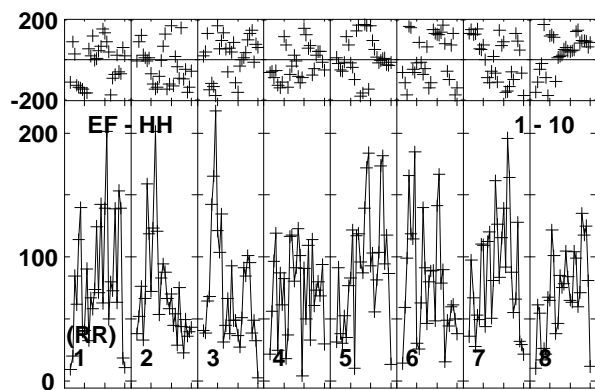
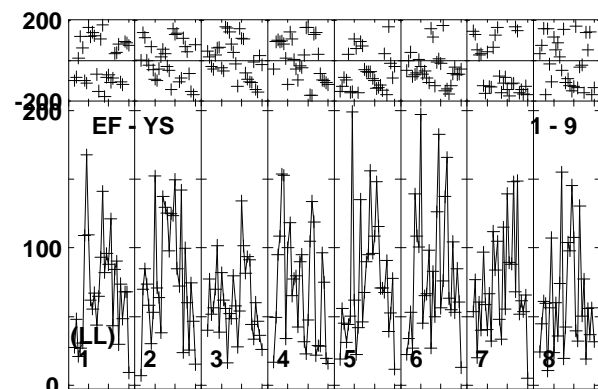
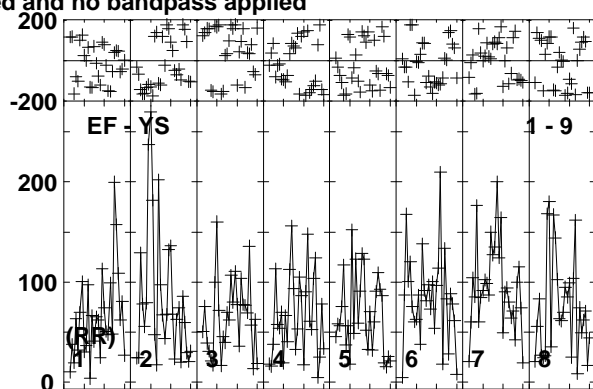
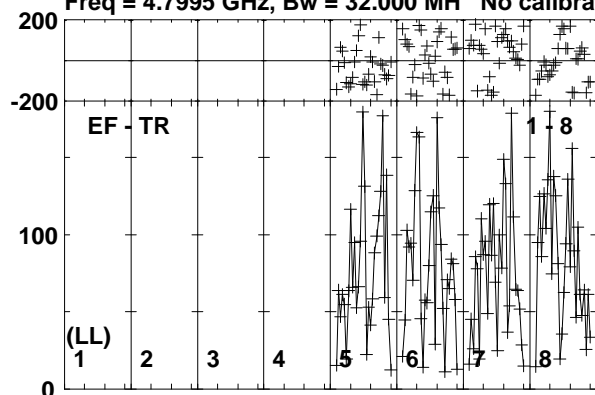

Lower frame: Micro Ampl Jy Top frame: Phas deg
Vector averaged cross-power spectrum Baseline: EF (01) - TR (08)
Timerange: 00/23:36:11 to 00/23:38:39

Plot file version 143 created 20-APR-2018 18:08:02

J1311-2329 RG009B.UVDATA.1

Freq = 4.7995 GHz, Bw = 32.000 MH No calibration applied and no bandpass applied

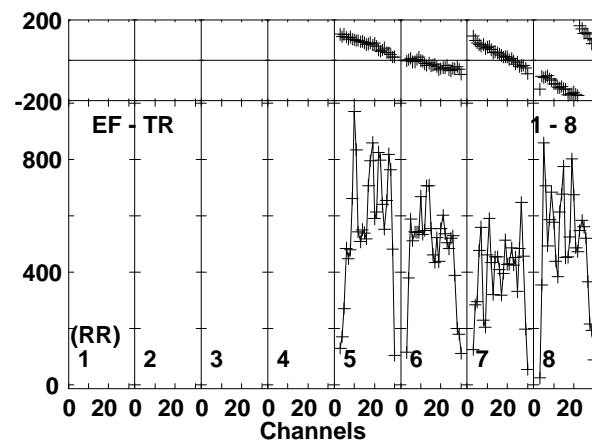
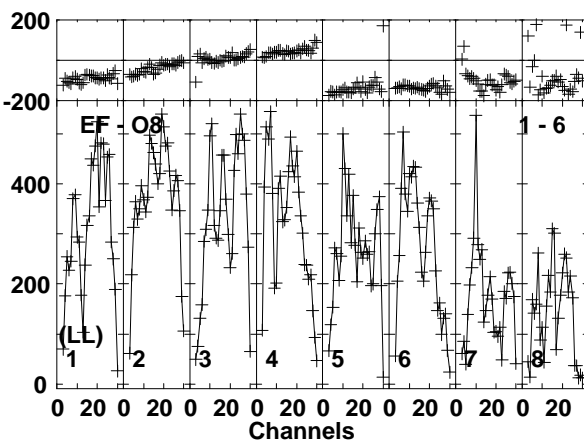
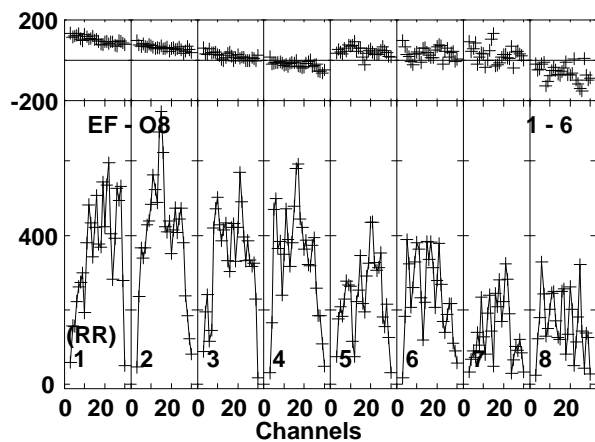
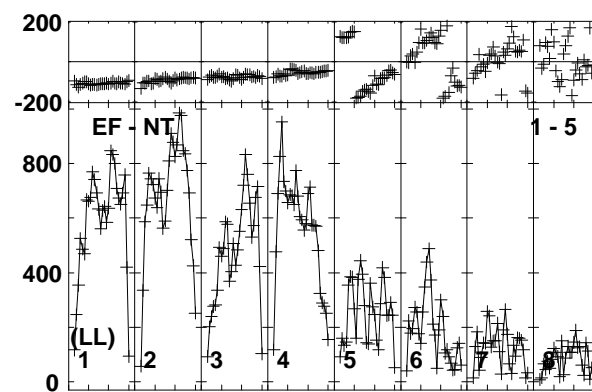
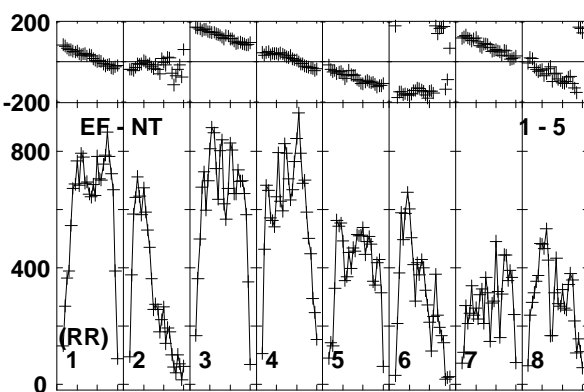
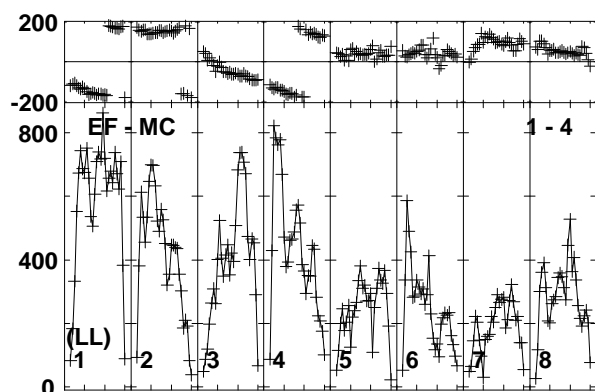
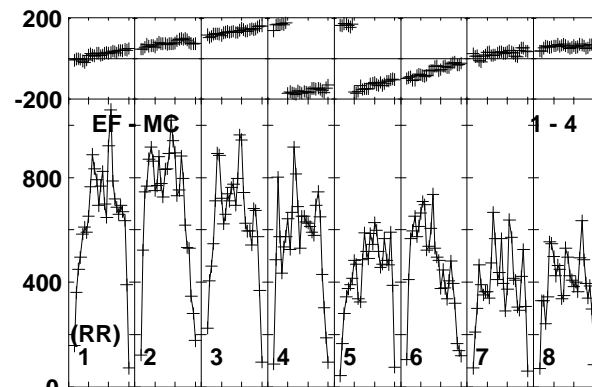
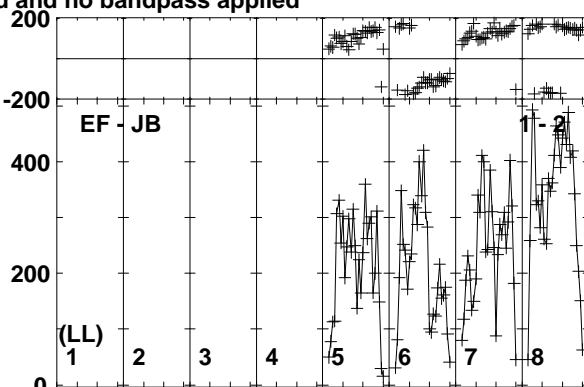
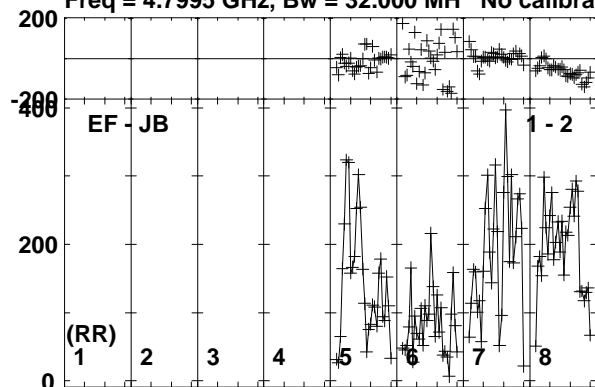

Lower frame: Micro Ampl Jy Top frame: Phas deg
Vector averaged cross-power spectrum Baseline: EF (01) - JB (02)
Timerange: 00/23:38:41 to 00/23:40:09

Plot file version 144 created 20-APR-2018 18:08:02

J1311-2329 RG009B.UVDATA.1

Freq = 4.7995 GHz, Bw = 32.000 MH No calibration applied and no bandpass applied

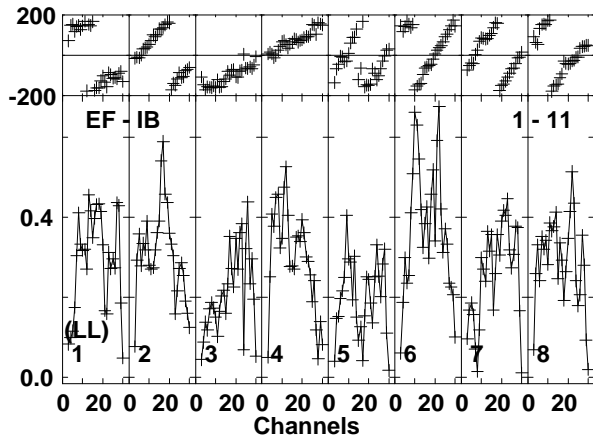
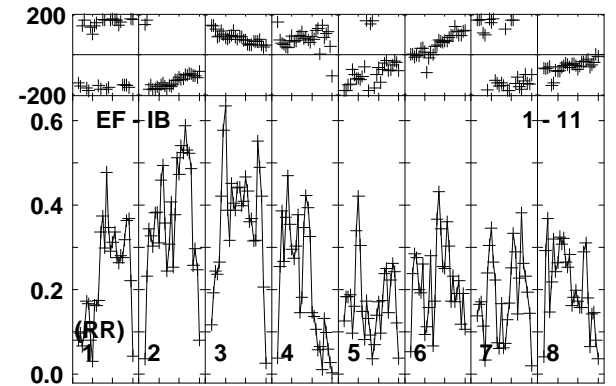
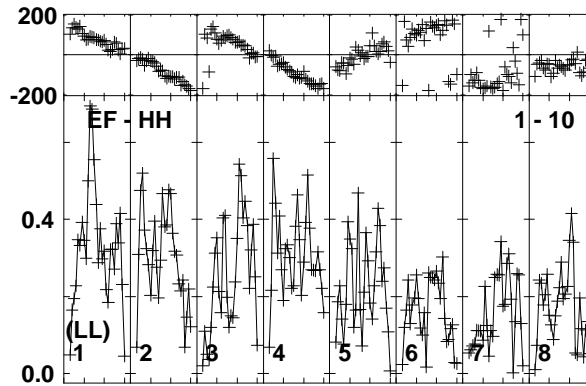
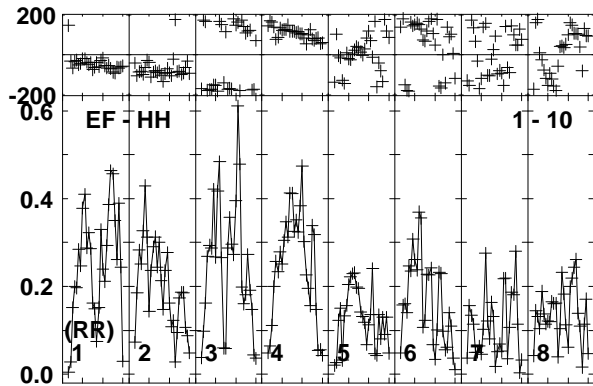
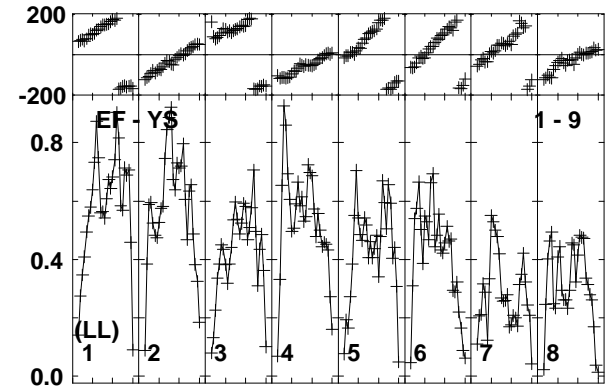
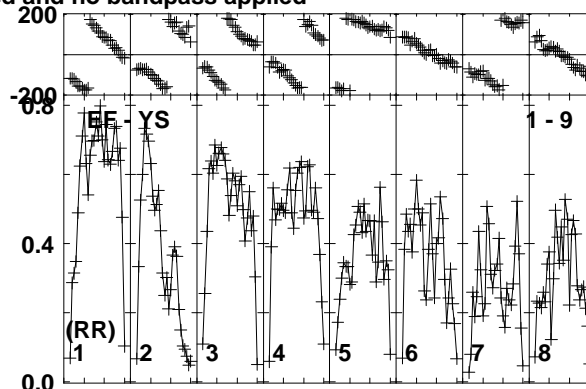
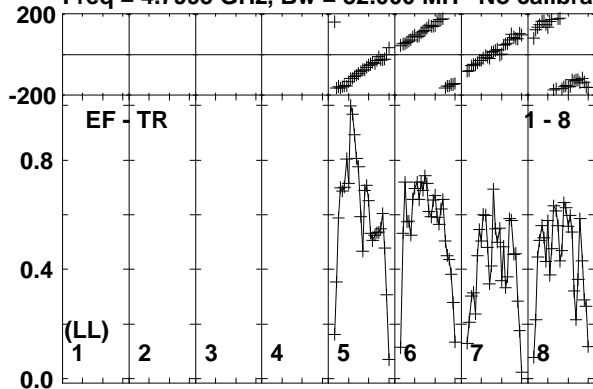

Lower frame: Milli Ampl Jy Top frame: Phas deg
Vector averaged cross-power spectrum Baseline: EF (01) - TR (08)
Timerange: 00/23:38:41 to 00/23:40:09

Plot file version 145 created 20-APR-2018 18:08:03

J1312-2350 RG009B.UVDATA.1

Freq = 4.7995 GHz, Bw = 32.000 MH No calibration applied and no bandpass applied

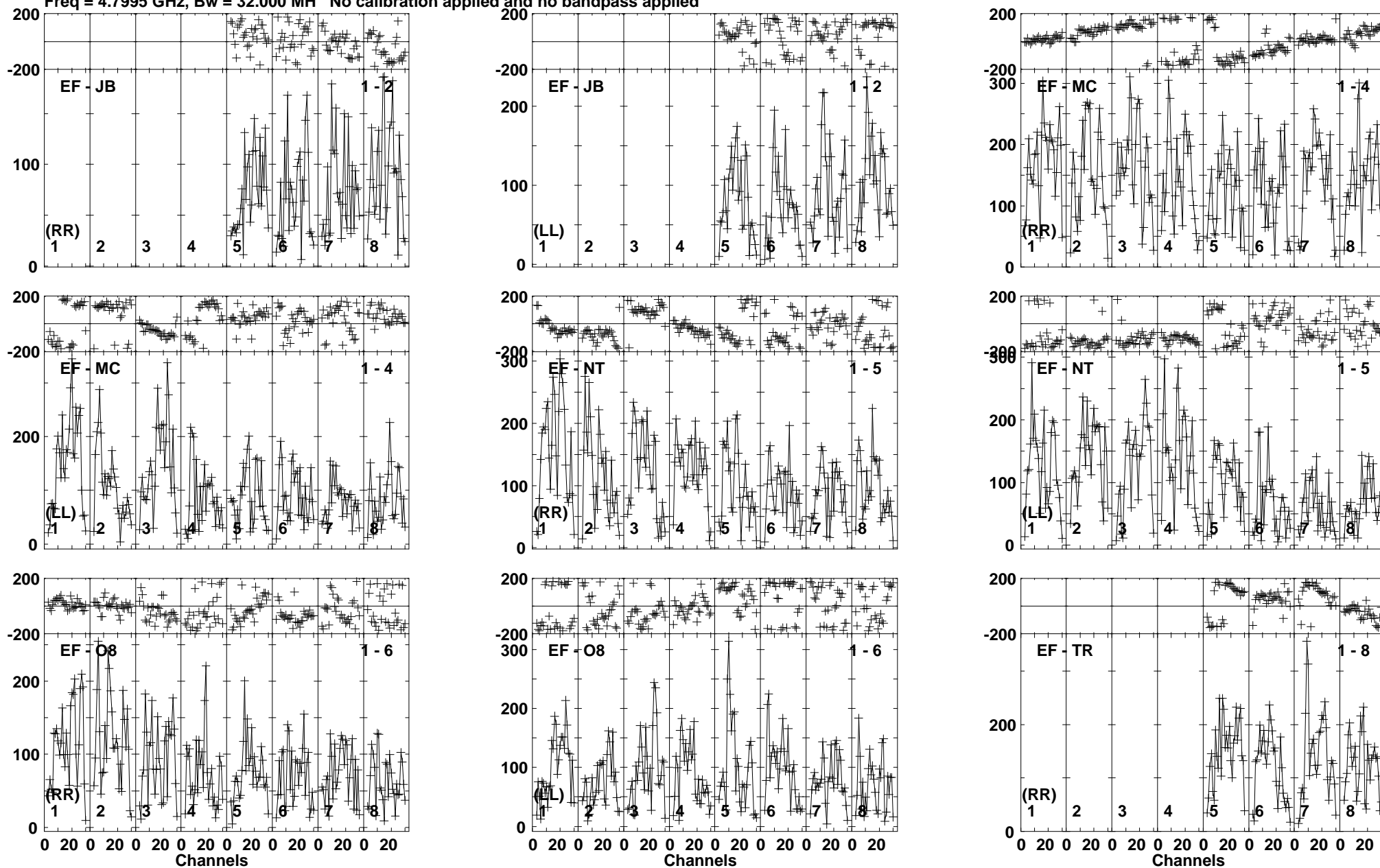

Lower frame: Micro Ampl Jy Top frame: Phas deg
Vector averaged cross-power spectrum Baseline: EF (01) - JB (02)
Timerange: 00/23:40:11 to 00/23:42:39

Plot file version 146 created 20-APR-2018 18:08:03

J1312-2350 RG009B.UVDATA.1

Freq = 4.7995 GHz, Bw = 32.000 MH No calibration applied and no bandpass applied

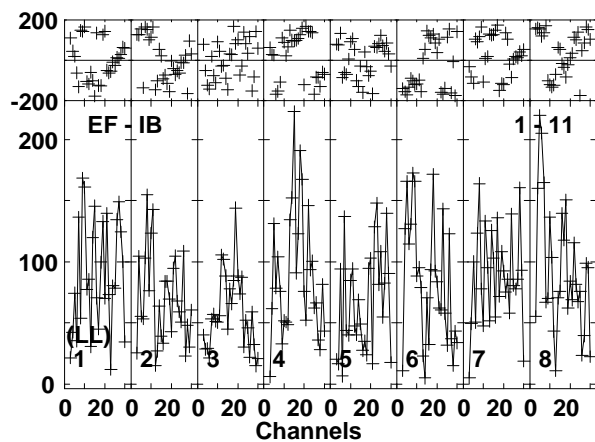
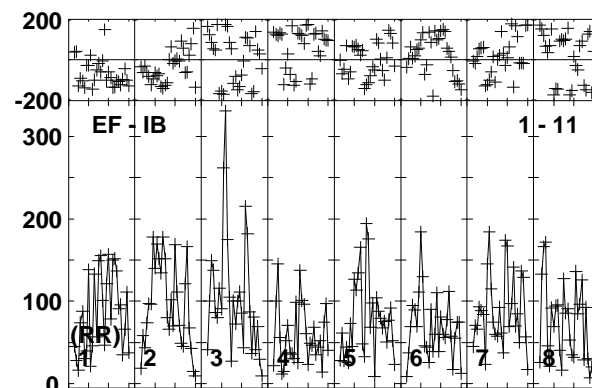
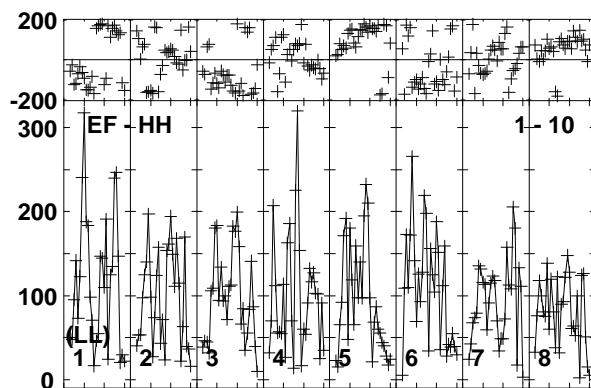
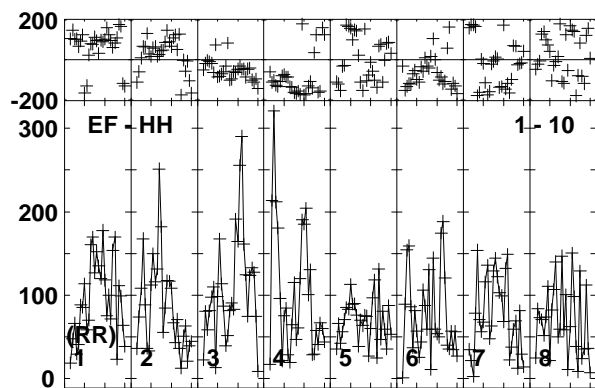
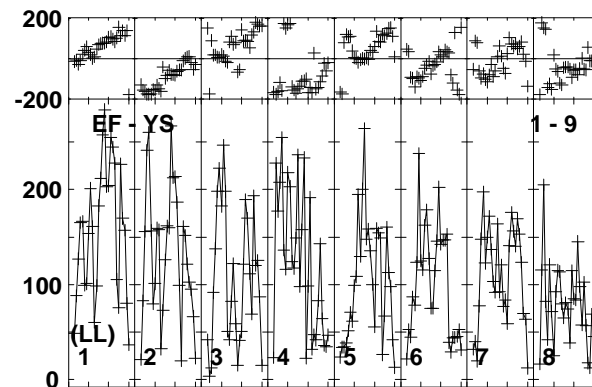
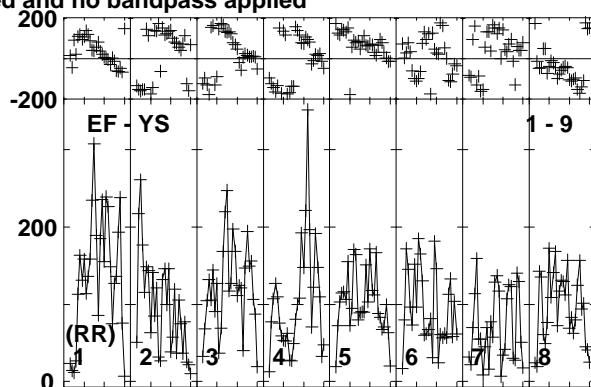
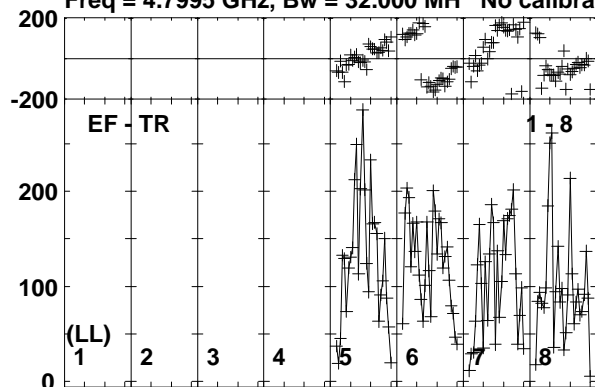

Lower frame: Micro Ampl Jy Top frame: Phas deg
Vector averaged cross-power spectrum Baseline: EF (01) - TR (08)
Timerange: 00/23:40:11 to 00/23:42:39

Plot file version 147 created 20-APR-2018 18:08:03

J1311-2329 RG009B.UVDATA.1

Freq = 4.7995 GHz, Bw = 32.000 MH No calibration applied and no bandpass applied

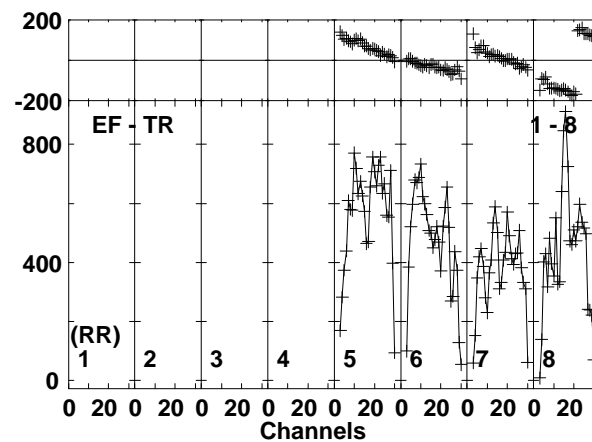
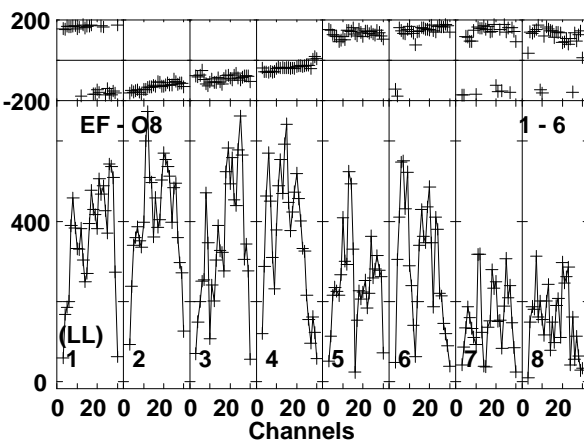
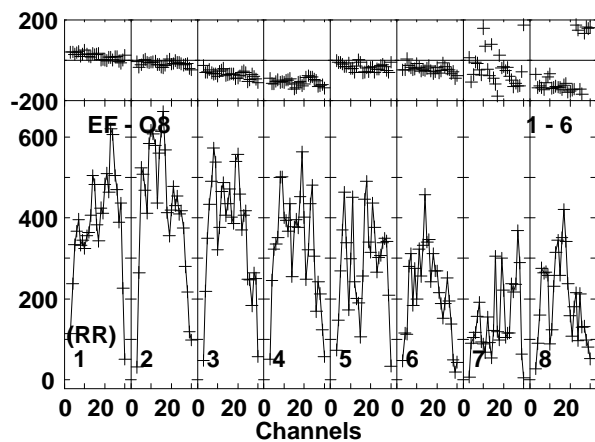
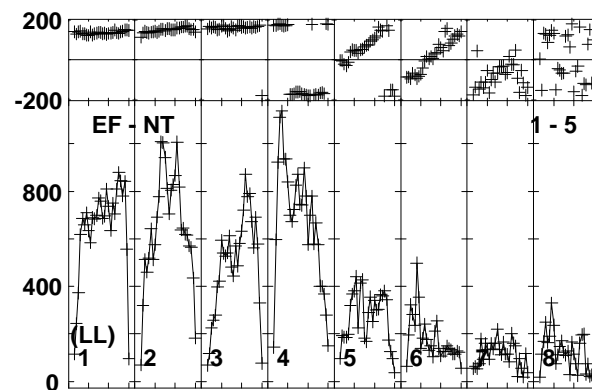
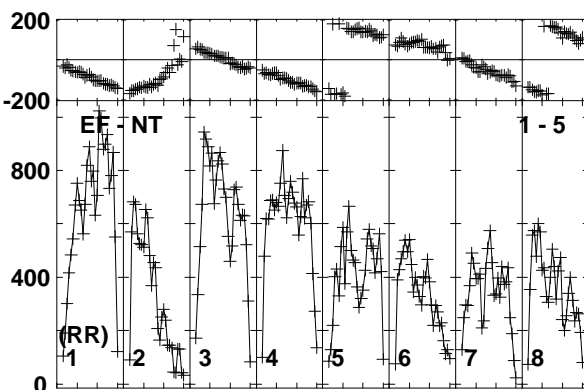
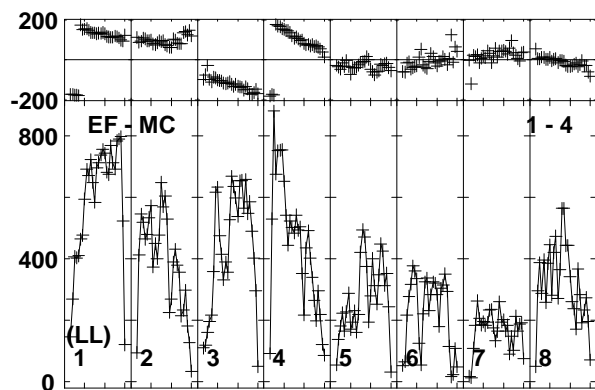
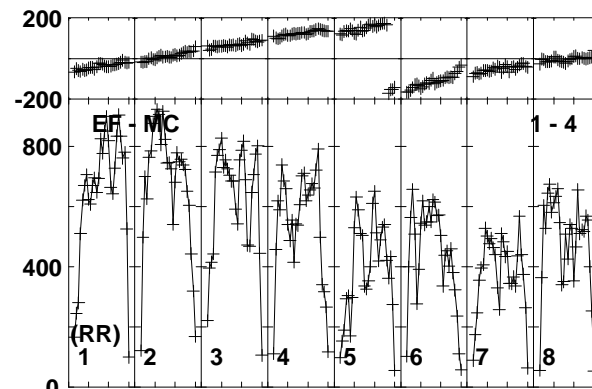
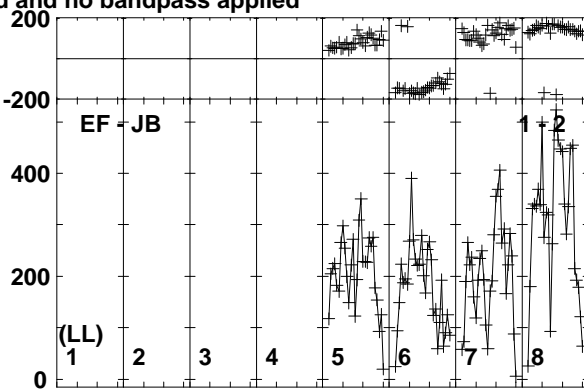
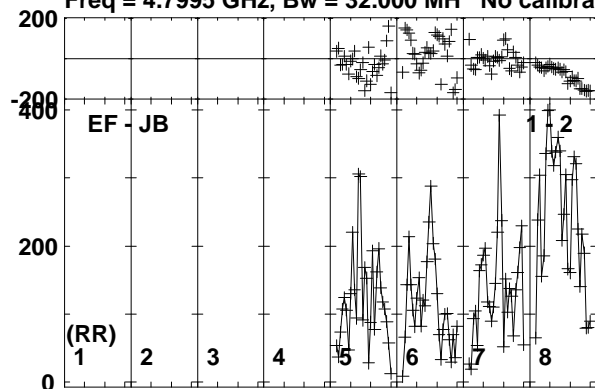

Lower frame: Micro Ampl Jy Top frame: Phas deg
Vector averaged cross-power spectrum Baseline: EF (01) - JB (02)
Timerange: 00/23:42:41 to 00/23:44:09

Plot file version 148 created 20-APR-2018 18:08:03

J1311-2329 RG009B.UVDATA.1

Freq = 4.7995 GHz, Bw = 32.000 MH No calibration applied and no bandpass applied

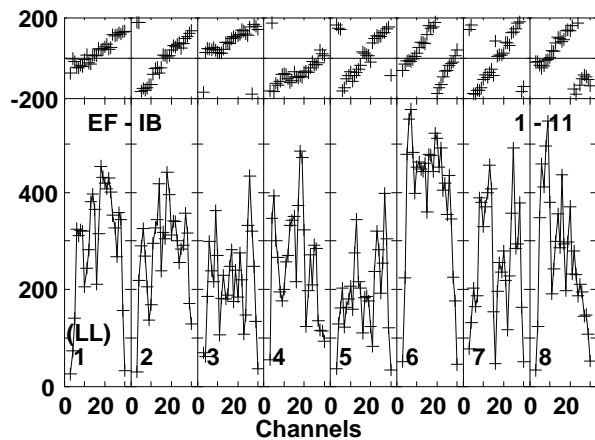
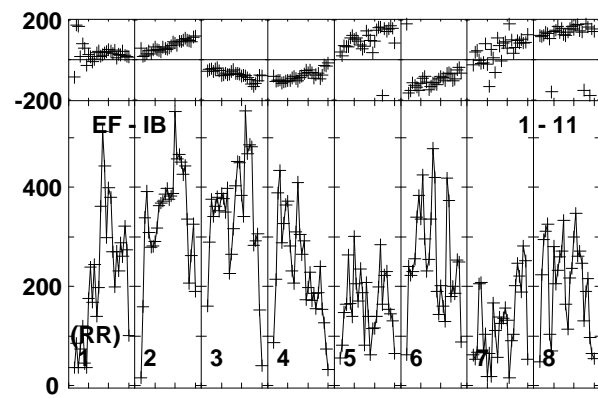
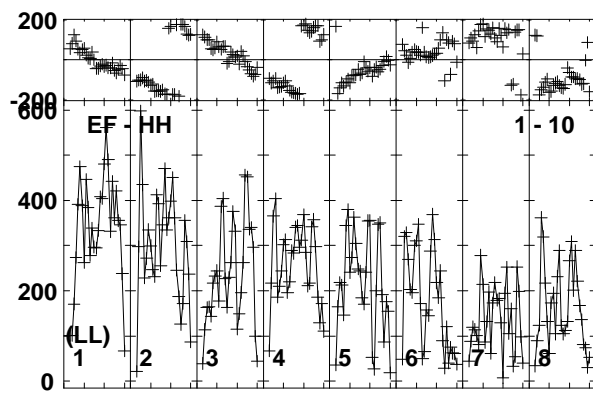
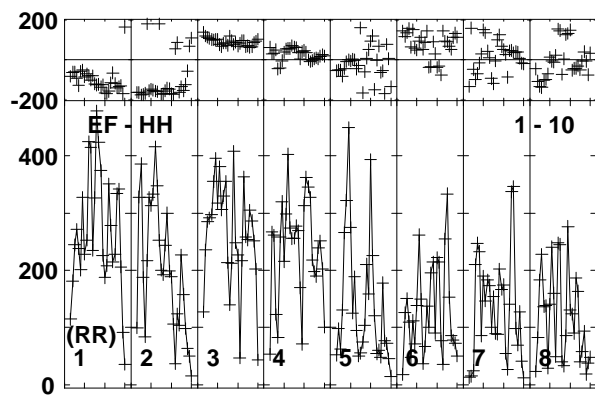
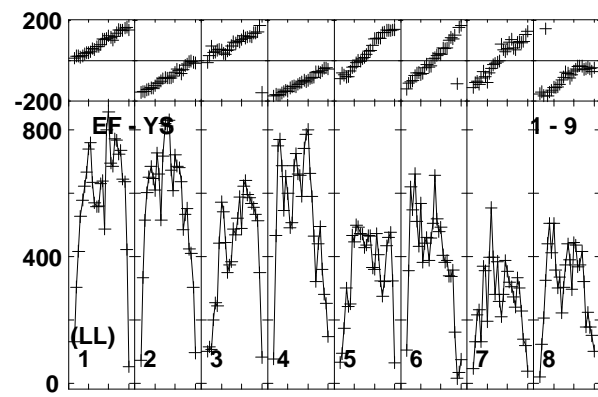
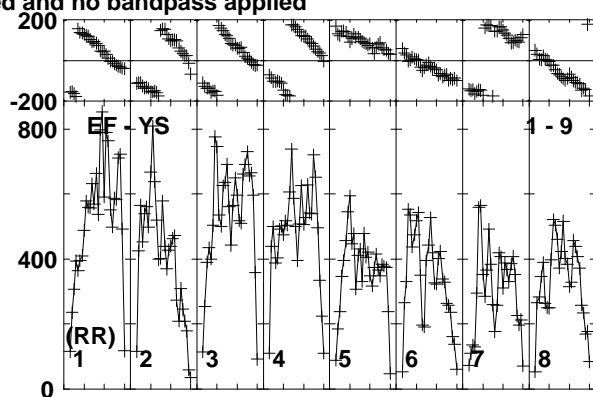
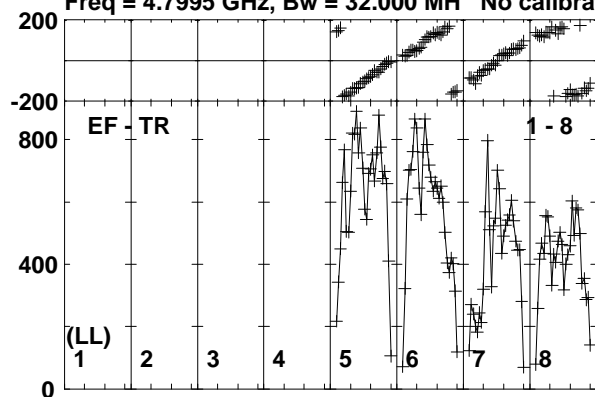

Lower frame: Micro Ampl Jy Top frame: Phas deg
Vector averaged cross-power spectrum Baseline: EF (01) - TR (08)
Timerange: 00:23:42:41 to 00:23:44:09

Plot file version 149 created 20-APR-2018 18:08:03

J1303-2405 RG009B.UVDATA.1

Freq = 4.7995 GHz, Bw = 32.000 MH No calibration applied and no bandpass applied

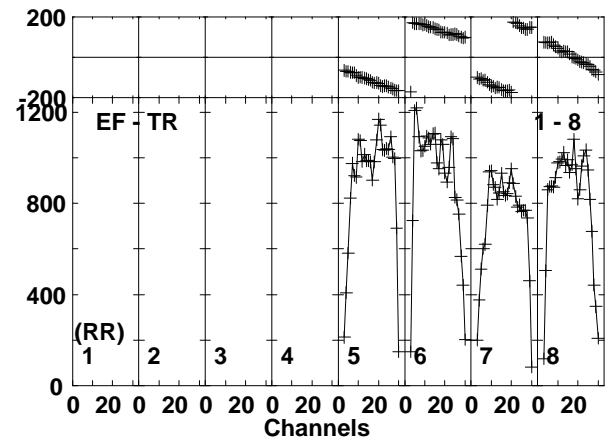
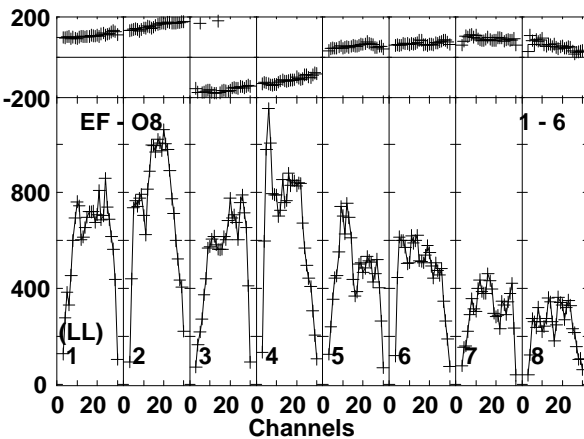
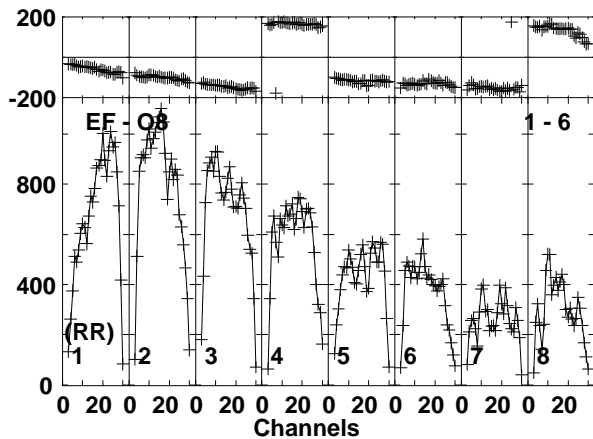
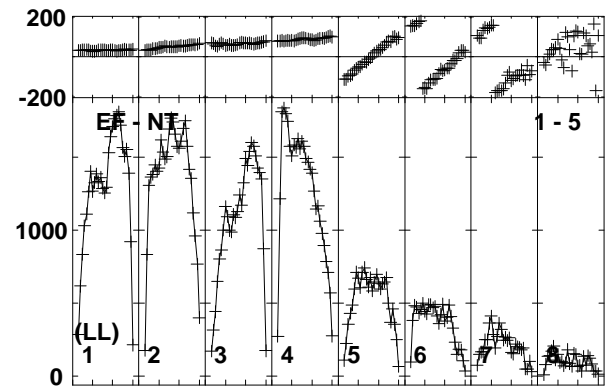
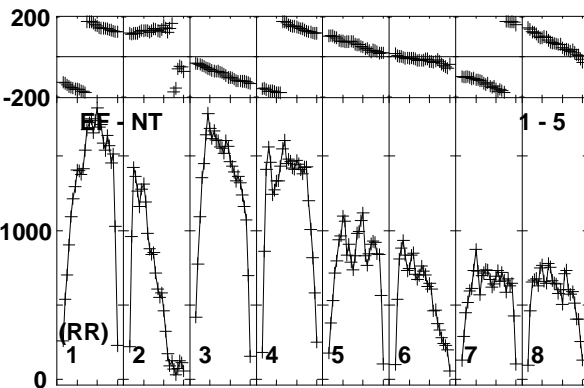
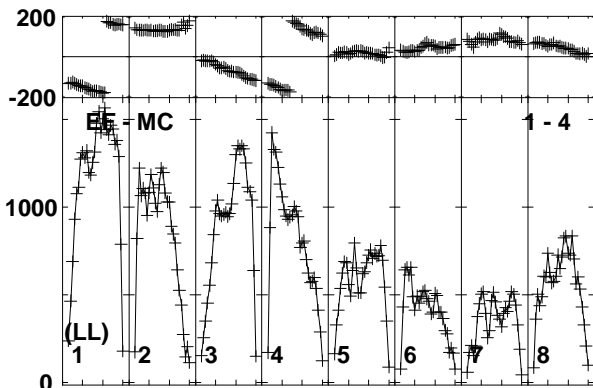
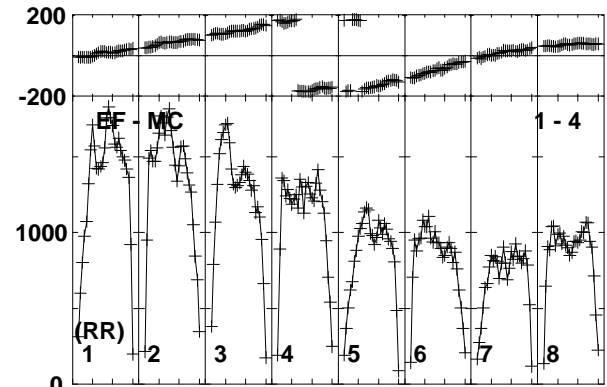
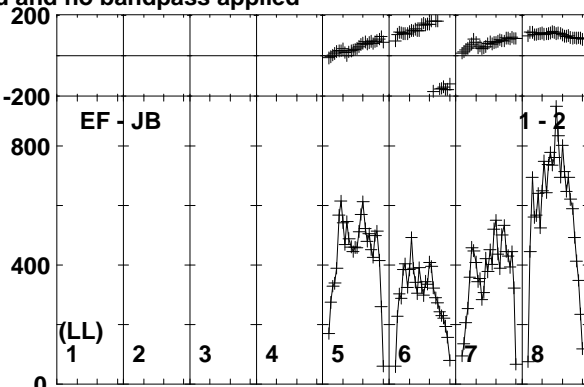
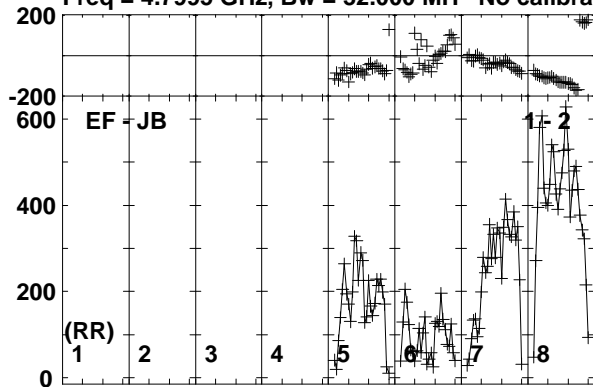

Lower frame: Micro Ampl Jy Top frame: Phas deg
Vector averaged cross-power spectrum Baseline: EF (01) - JB (02)
Timerange: 00/23:44:11 to 00/23:46:39

Plot file version 150 created 20-APR-2018 18:08:03

J1303-2405 RG009B.UVDATA.1

Freq = 4.7995 GHz, Bw = 32.000 MH No calibration applied and no bandpass applied

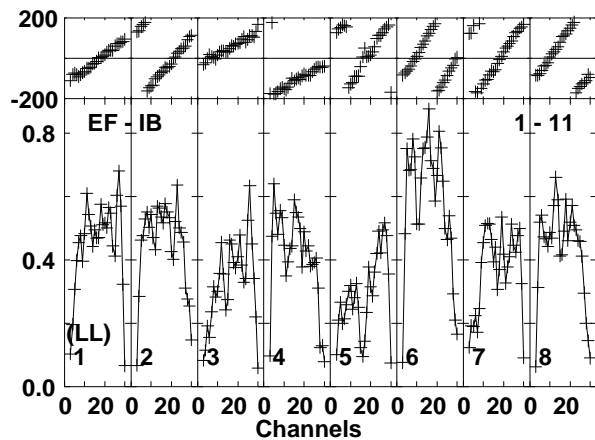
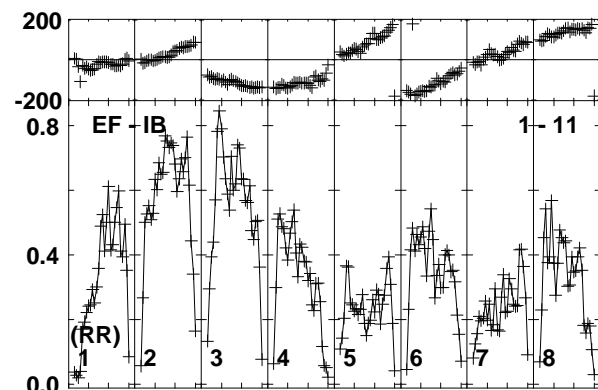
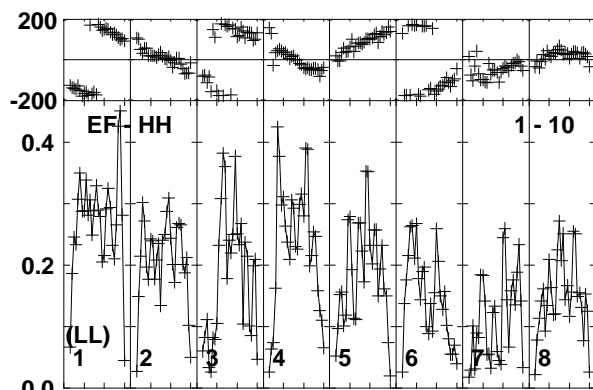
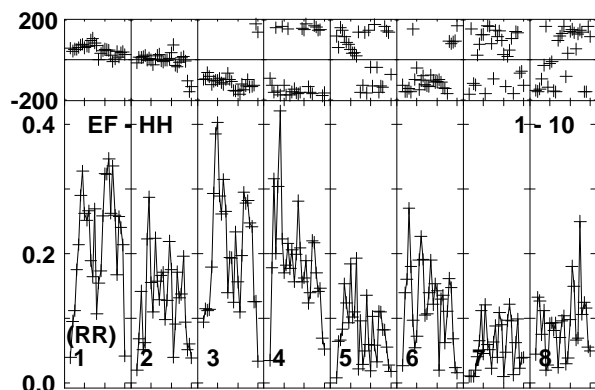
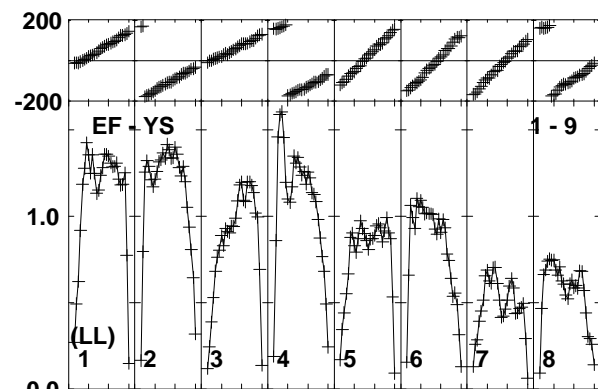
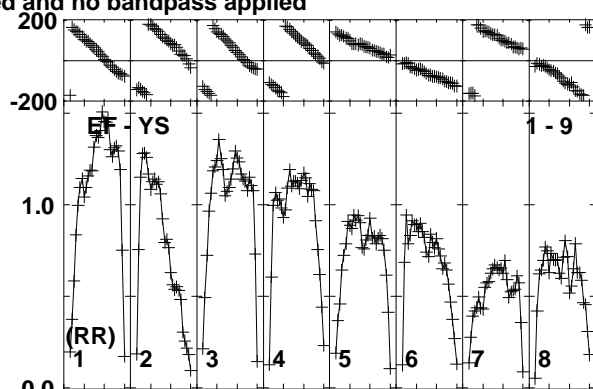
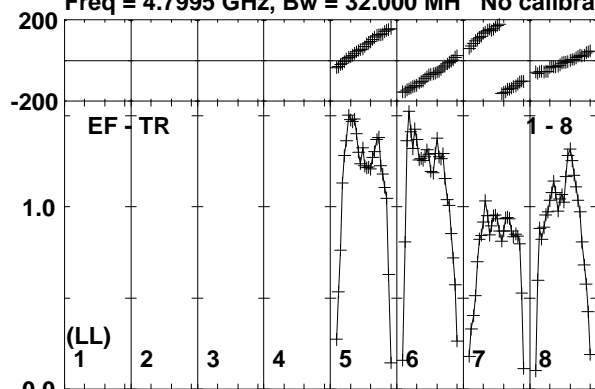

Lower frame: Milli Ampl Jy Top frame: Phas deg
Vector averaged cross-power spectrum Baseline: EF (01) - TR (08)
Timerange: 00/23:44:11 to 00/23:46:39

Plot file version 151 created 20-APR-2018 18:08:03

J1311-2329 RG009B.UVDATA.1

Freq = 4.7995 GHz, Bw = 32.000 MH No calibration applied and no bandpass applied

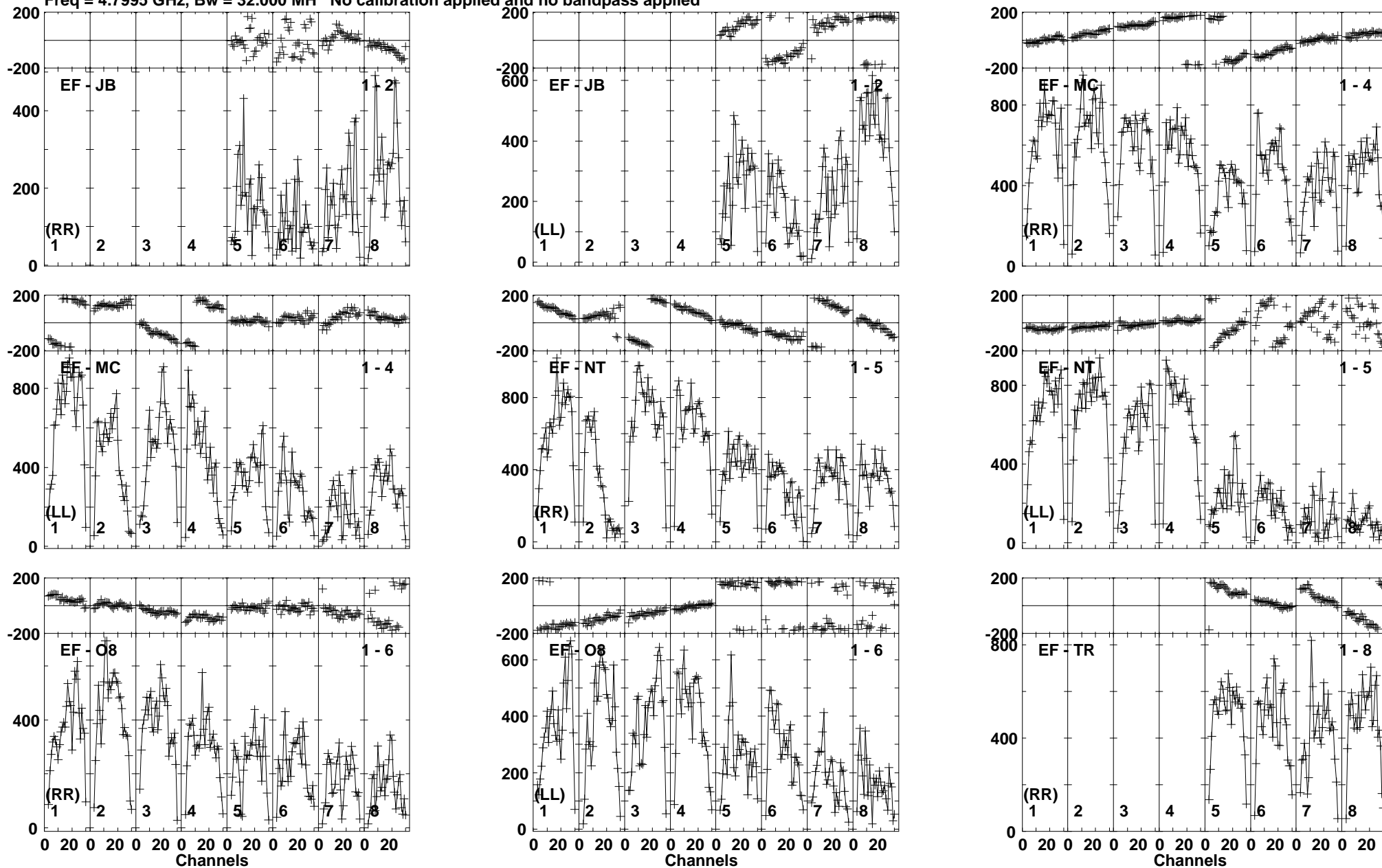

Lower frame: Micro Ampl Jy Top frame: Phas deg
Vector averaged cross-power spectrum Baseline: EF (01) - JB (02)
Timerange: 00/23:47:21 to 00/23:48:19

Plot file version 152 created 20-APR-2018 18:08:03

J1311-2329 RG009B.UVDATA.1

Freq = 4.7995 GHz, Bw = 32.000 MH No calibration applied and no bandpass applied

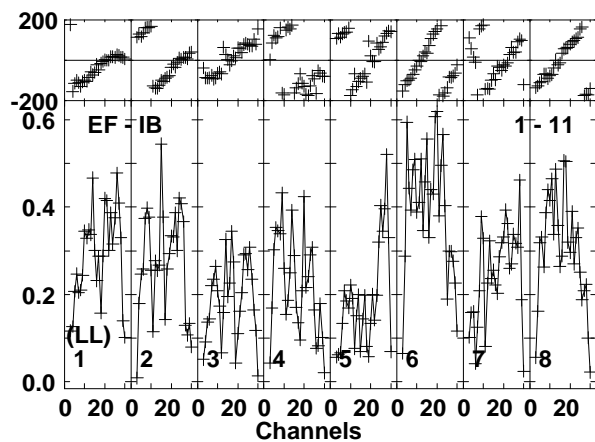
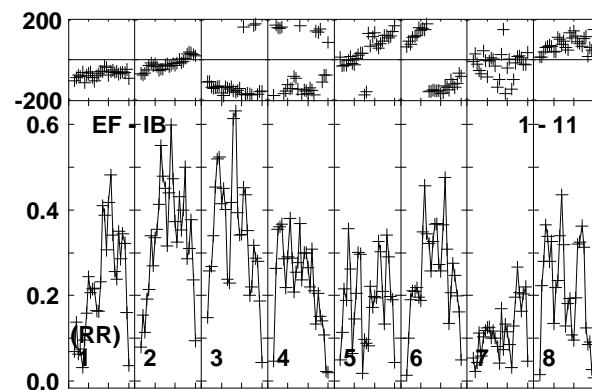
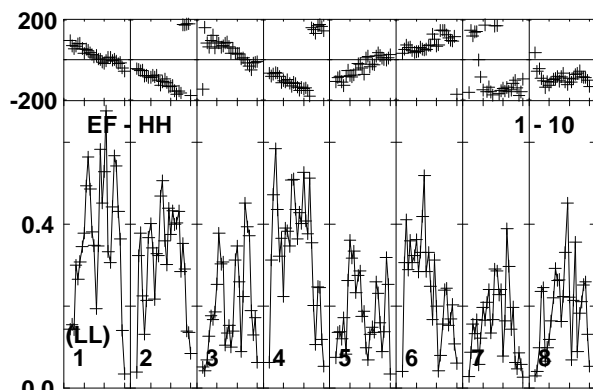
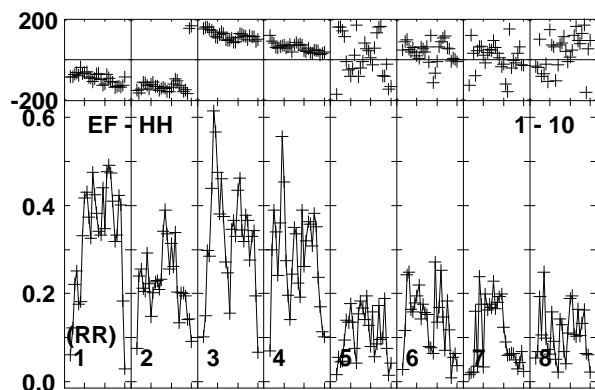
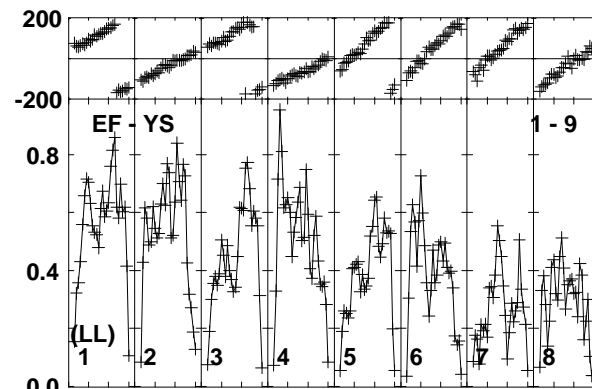
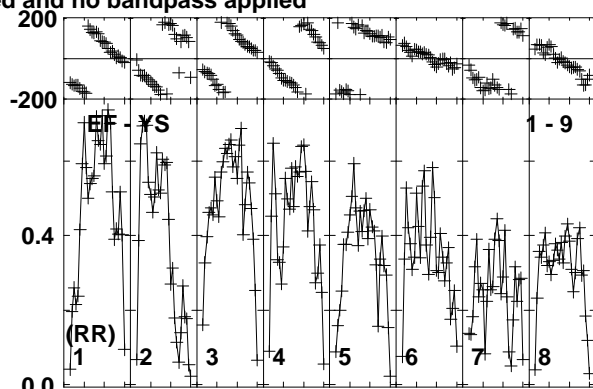
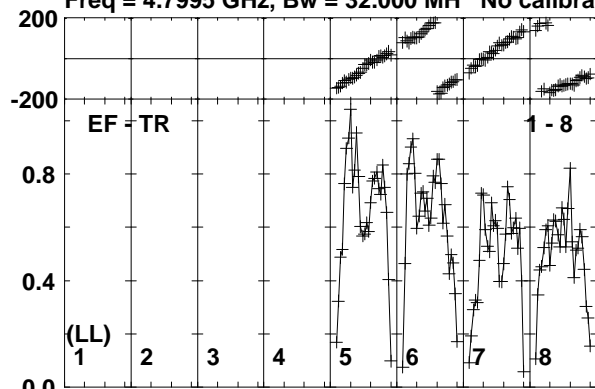

Lower frame: Milli Ampl Jy Top frame: Phas deg
Vector averaged cross-power spectrum Baseline: EF (01) - TR (08)
Timerange: 00/23:47:21 to 00/23:48:19

Plot file version 153 created 20-APR-2018 18:08:03

EM170817 RG009B.UVDATA.1

Freq = 4.7995 GHz, Bw = 32.000 MH No calibration applied and no bandpass applied

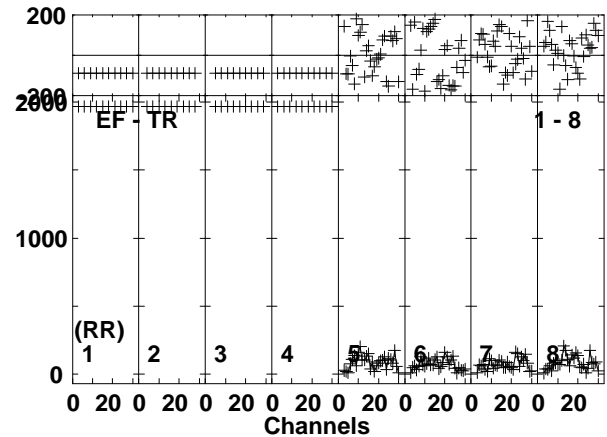
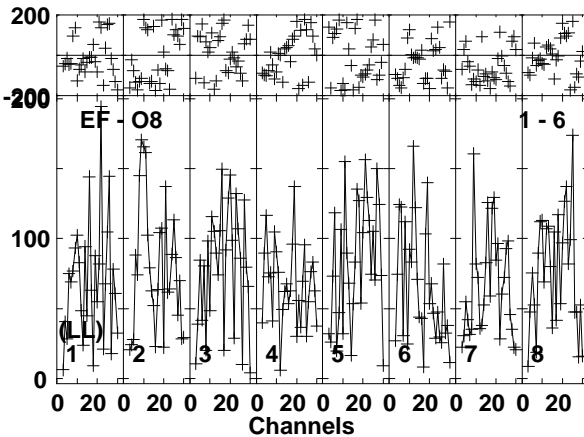
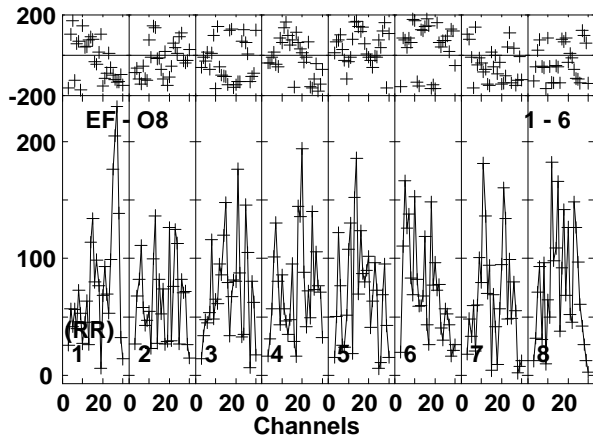
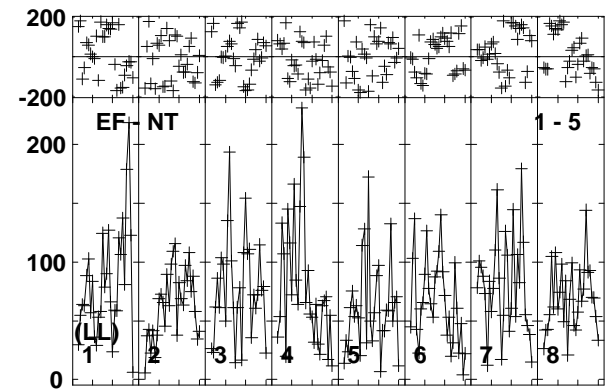
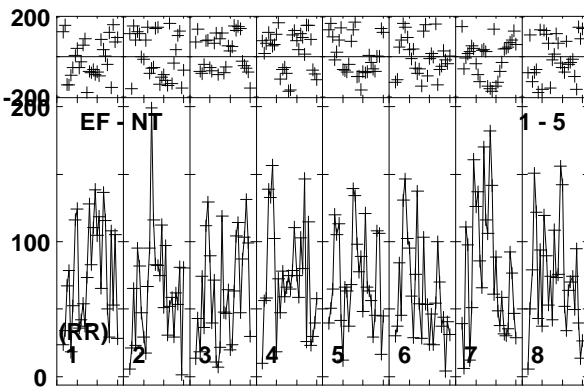
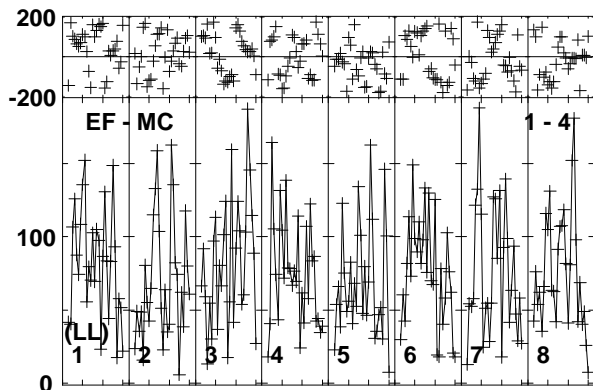
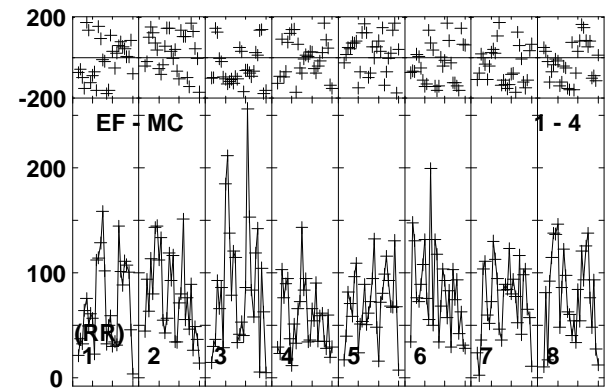
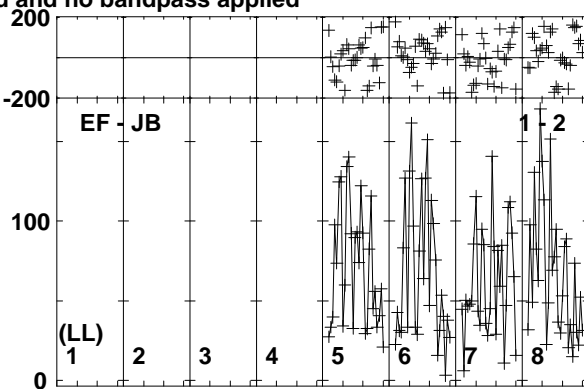
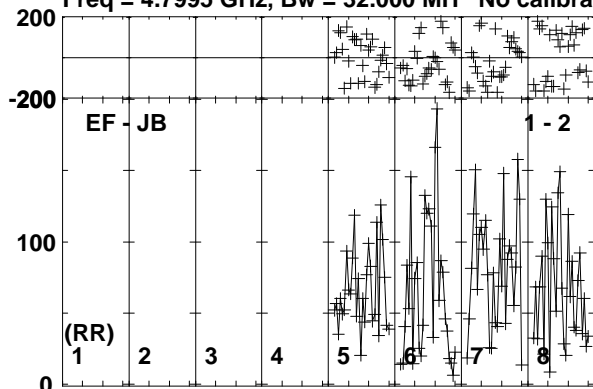

Lower frame: Micro Ampl Jy Top frame: Phas deg
Vector averaged cross-power spectrum Baseline: EF (01) - JB (02)
Timerange: 00/23:48:21 to 00/23:50:49

Plot file version 154 created 20-APR-2018 18:08:03

EM170817 RG009B.UVDATA.1

Freq = 4.7995 GHz, Bw = 32.000 MH No calibration applied and no bandpass applied

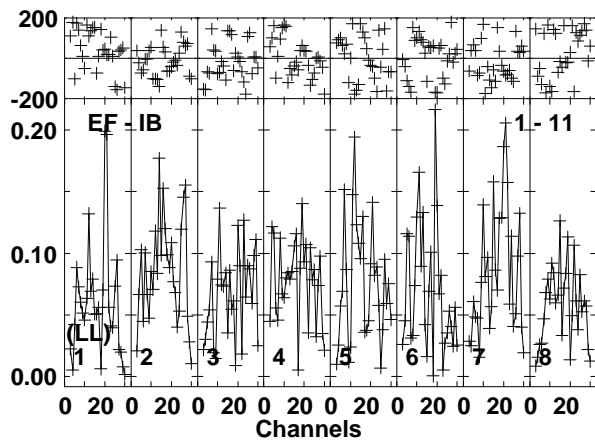
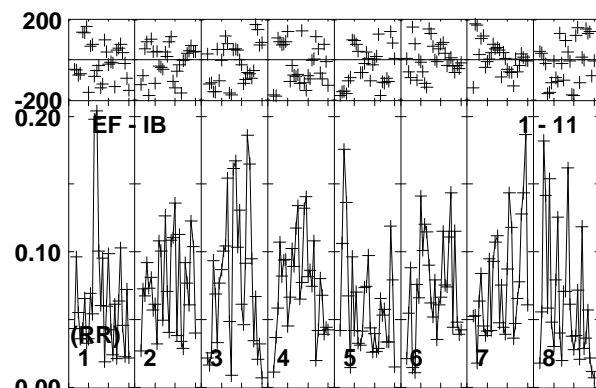
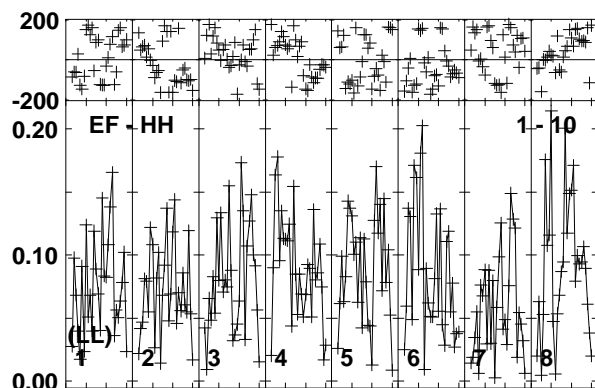
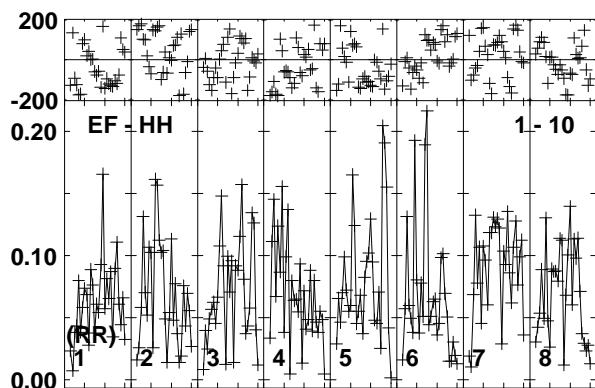
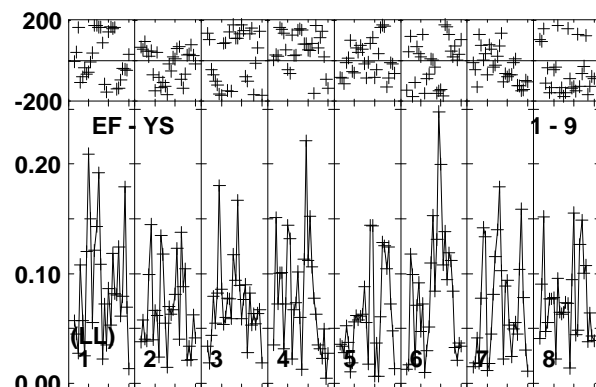
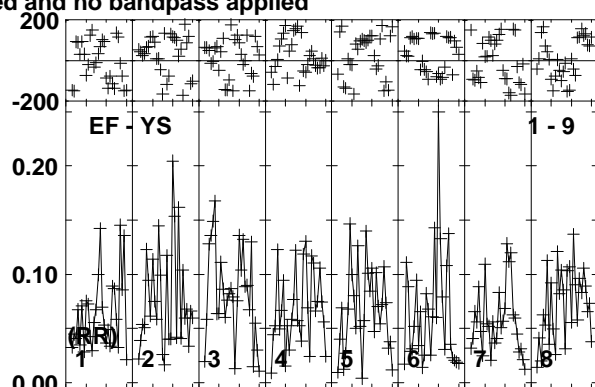
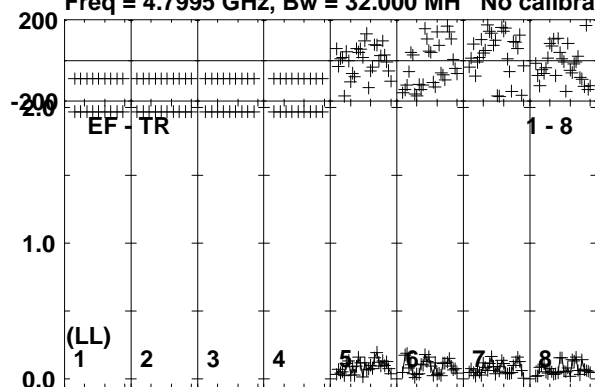

Lower frame: Milli Ampl Jy Top frame: Phas deg
Vector averaged cross-power spectrum Baseline: EF (01) - TR (08)
Timerange: 00/23:48:21 to 00/23:50:49

Plot file version 155 created 20-APR-2018 18:08:03

J1311-2329 RG009B.UVDATA.1

Freq = 4.7995 GHz, Bw = 32.000 MH No calibration applied and no bandpass applied

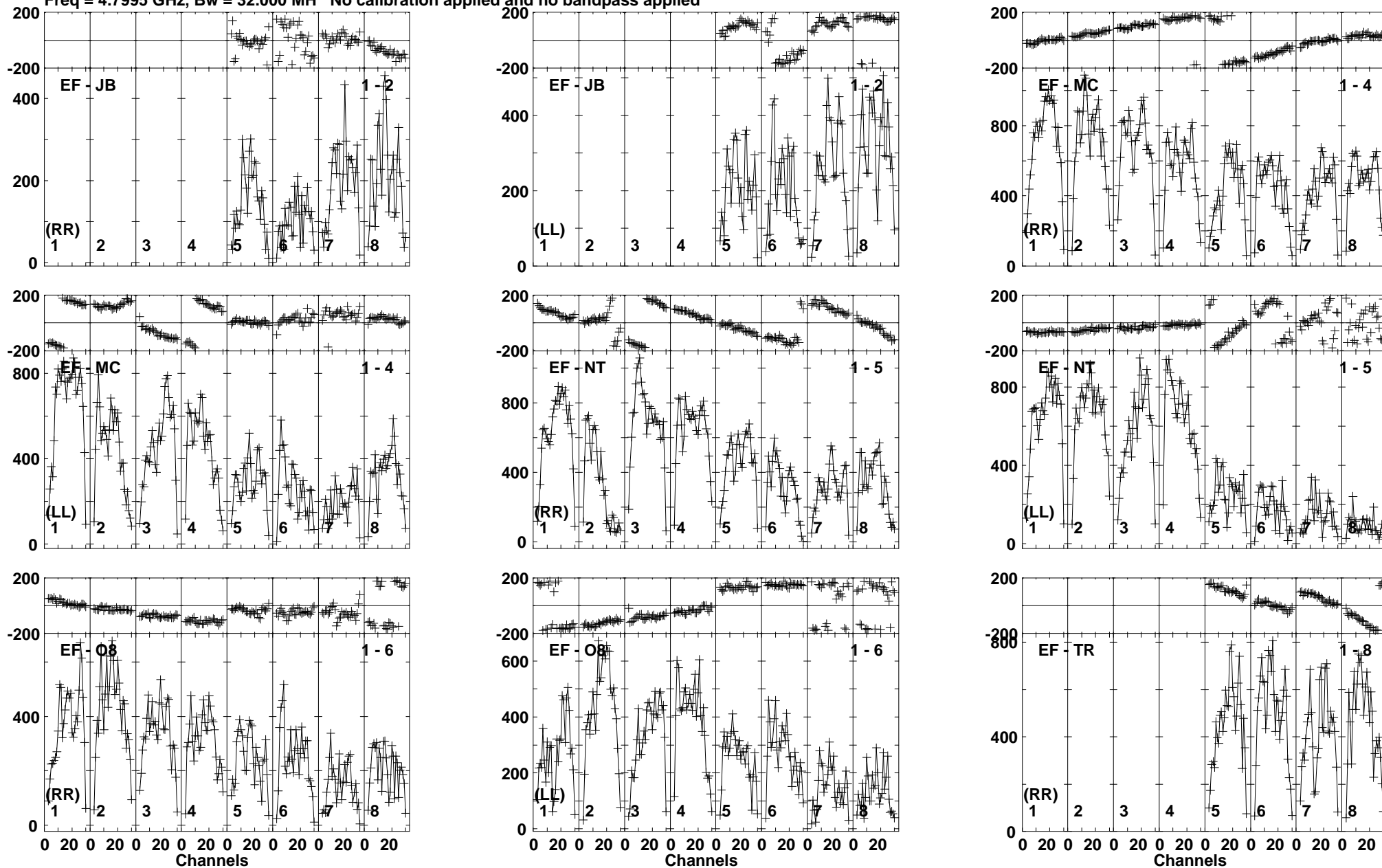

Plot file version 157 created 20-APR-2018 18:08:03

EM170817 RG009B.UVDATA.1

Freq = 4.7995 GHz, Bw = 32.000 MH No calibration applied and no bandpass applied

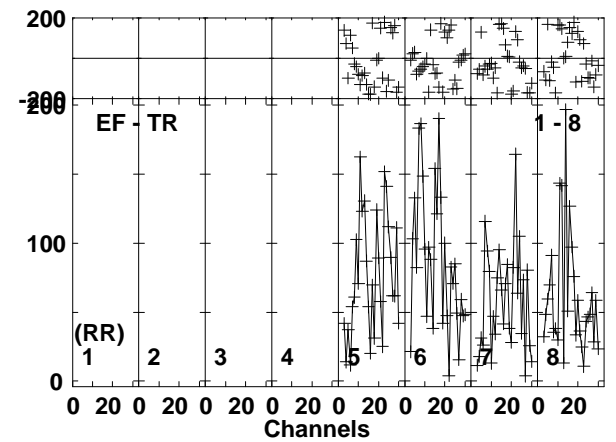
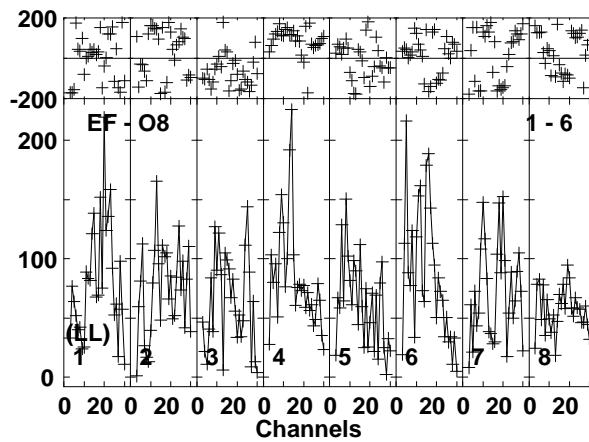
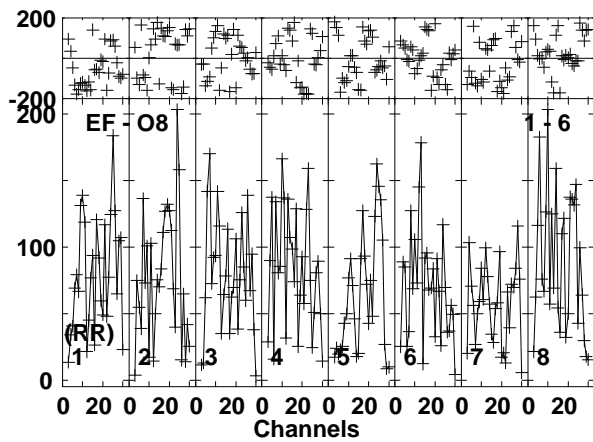
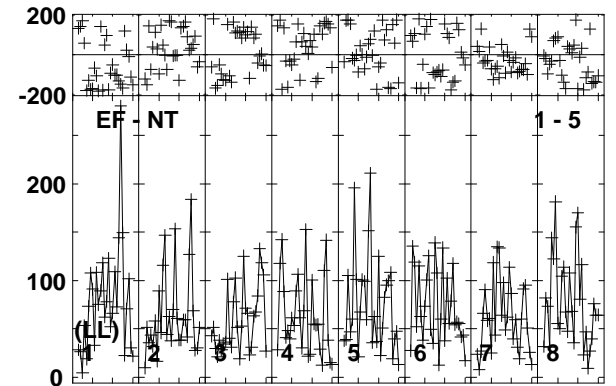
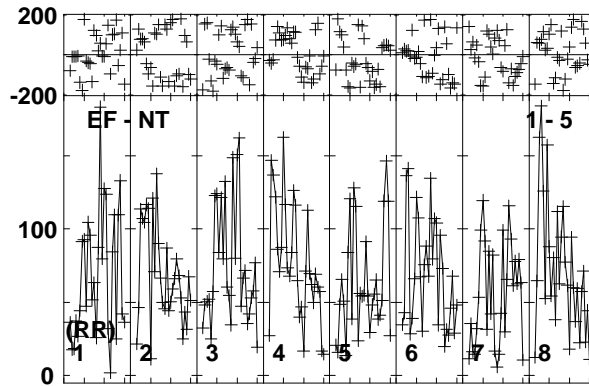
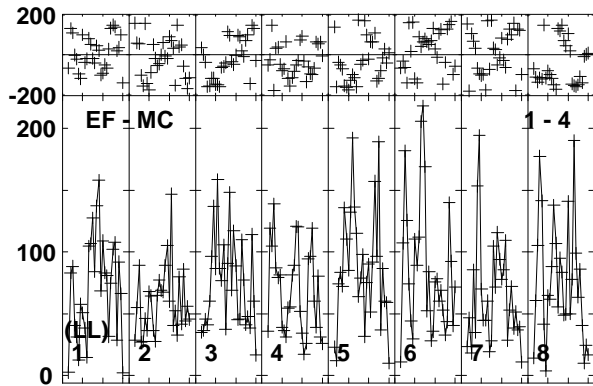
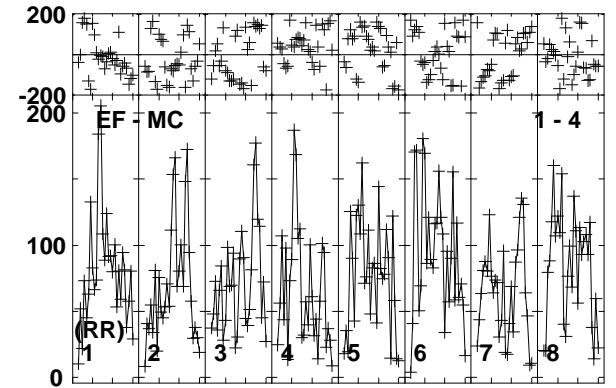
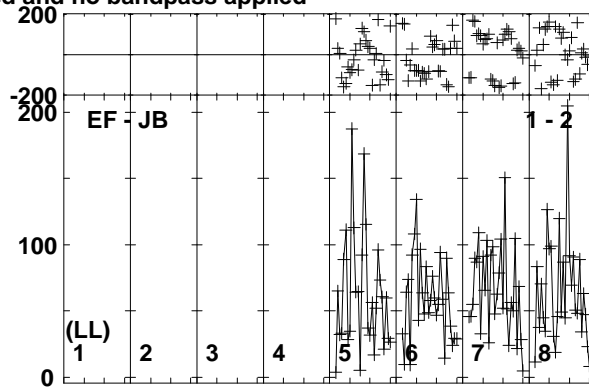
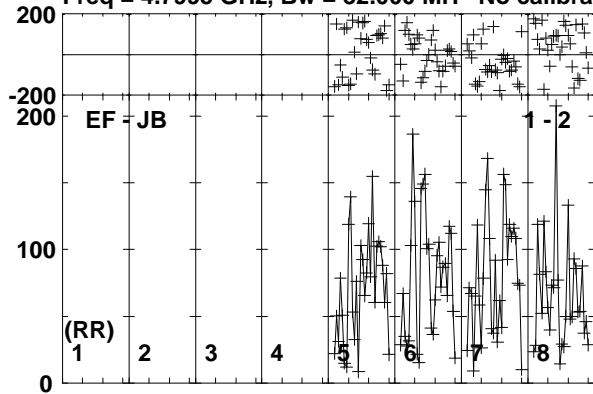

Lower frame: Micro Ampl Jy Top frame: Phas deg
Vector averaged cross-power spectrum Baseline: EF (01) - JB (02)
Timerange: 00/23:52:21 to 00/23:54:49

Plot file version 158 created 20-APR-2018 18:08:04

EM170817 RG009B.UVDATA.1

Freq = 4.7995 GHz, Bw = 32.000 MH No calibration applied and no bandpass applied

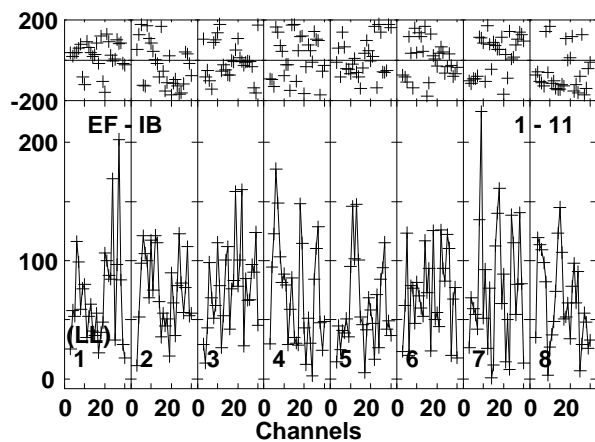
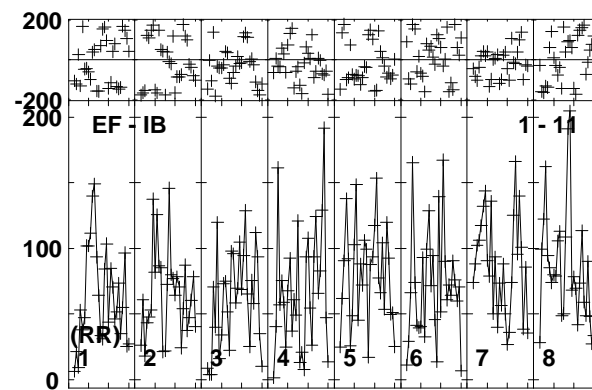
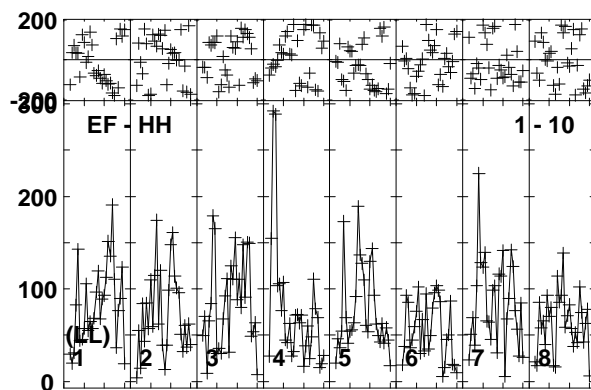
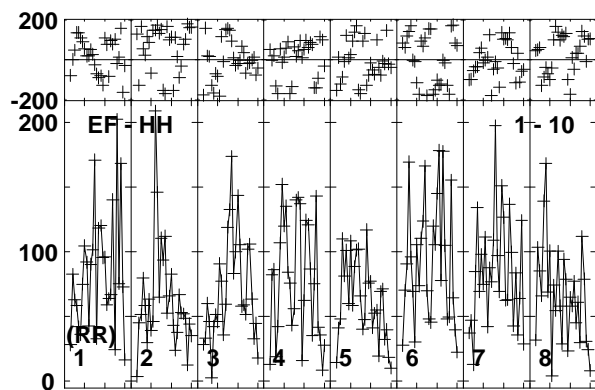
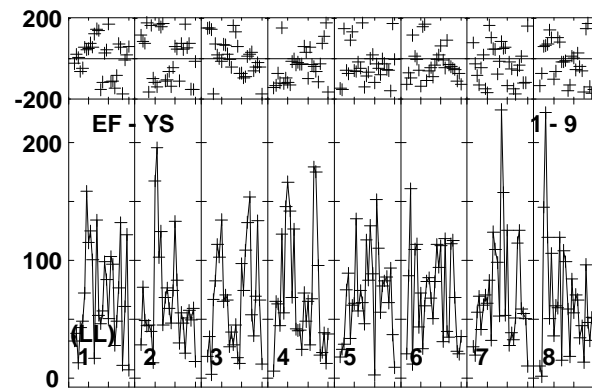
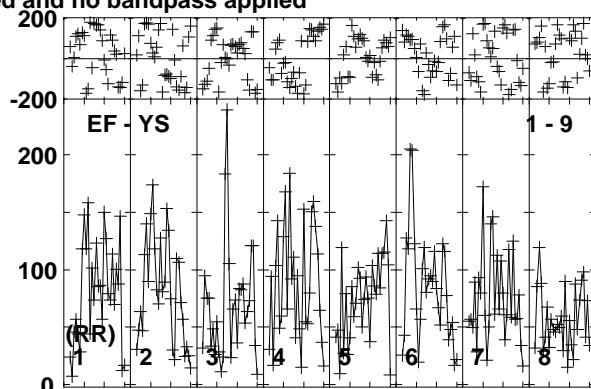
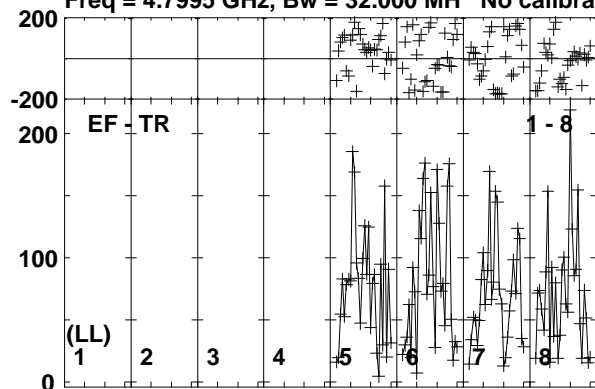

Lower frame: Micro Ampl Jy Top frame: Phas deg
Vector averaged cross-power spectrum Baseline: EF (01) - TR (08)
Timerange: 00/23:52:21 to 00/23:54:49

Plot file version 159 created 20-APR-2018 18:08:04

J1311-2329 RG009B.UVDATA.1

Freq = 4.7995 GHz, Bw = 32.000 MH No calibration applied and no bandpass applied

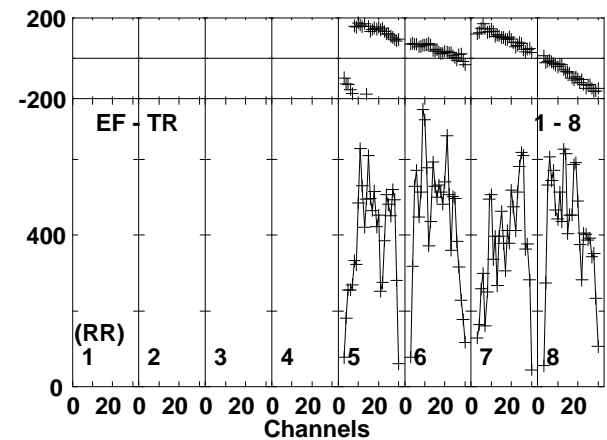
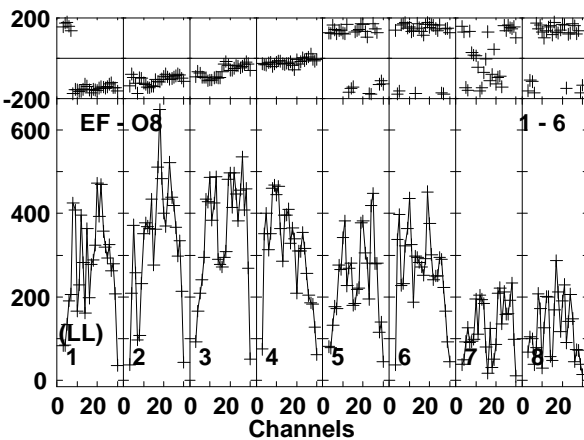
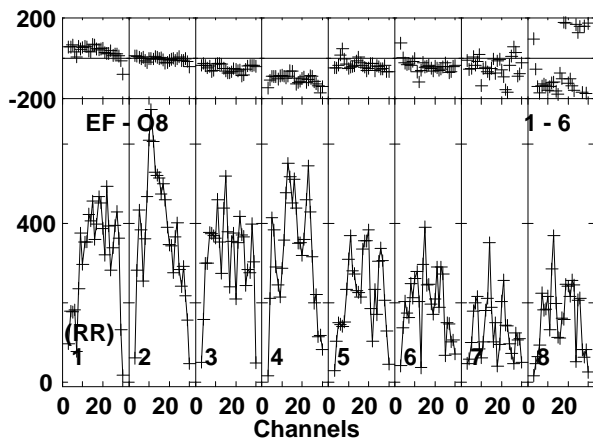
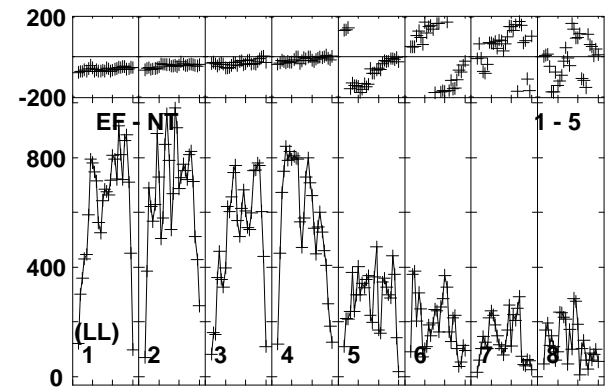
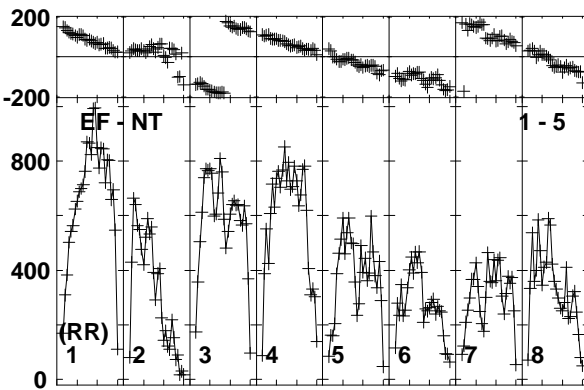
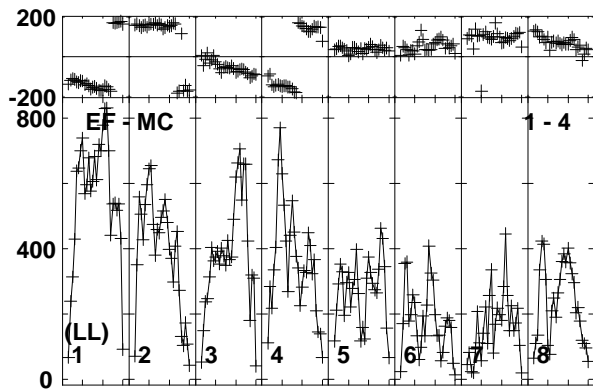
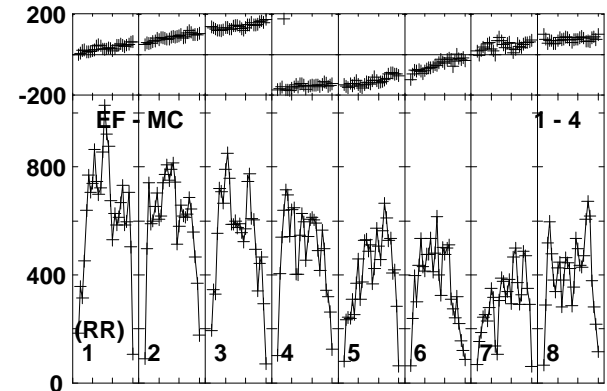
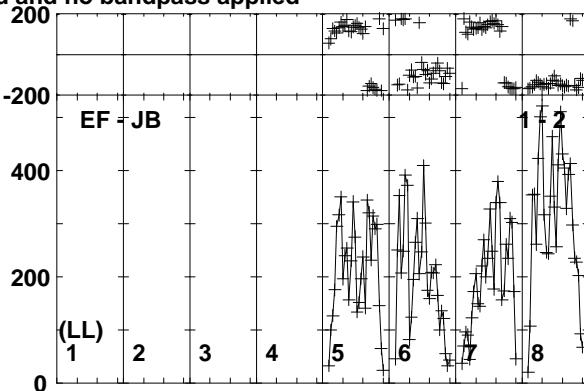
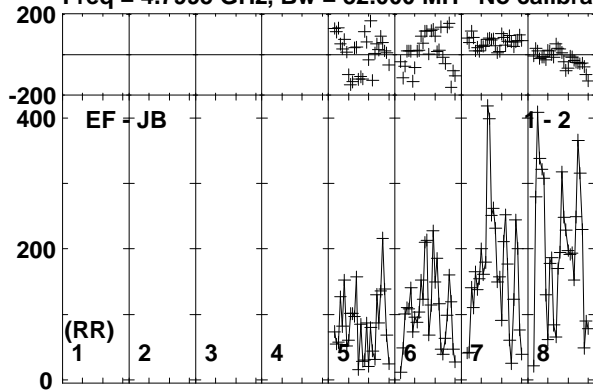

Lower frame: Micro Ampl Jy Top frame: Phas deg
Vector averaged cross-power spectrum Baseline: EF (01) - JB (02)
Timerange: 00/23:55:21 to 00/23:56:19

Plot file version 160 created 20-APR-2018 18:08:04

J1311-2329 RG009B.UVDATA.1

Freq = 4.7995 GHz, Bw = 32.000 MH No calibration applied and no bandpass applied

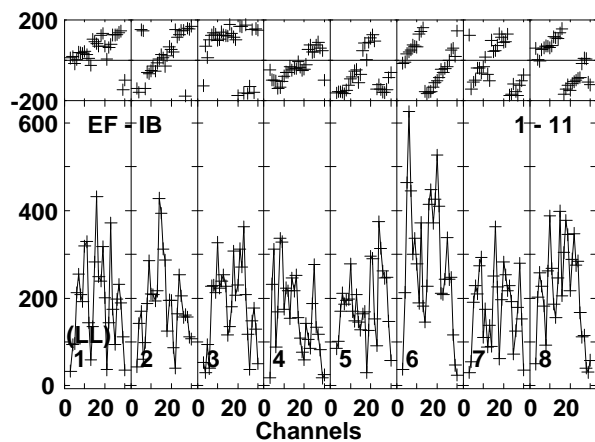
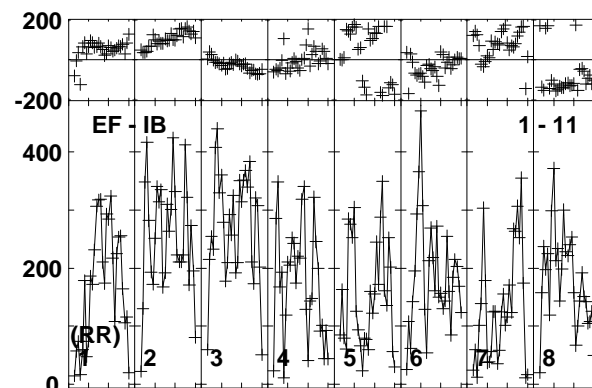
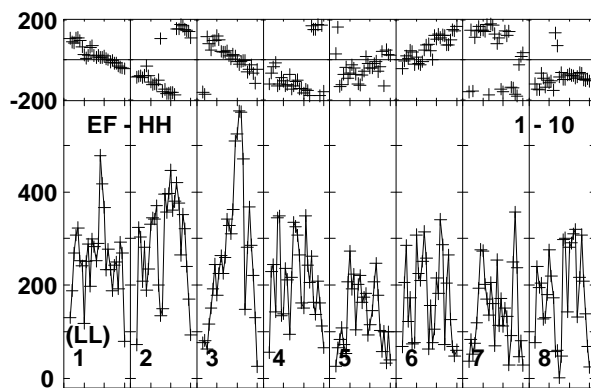
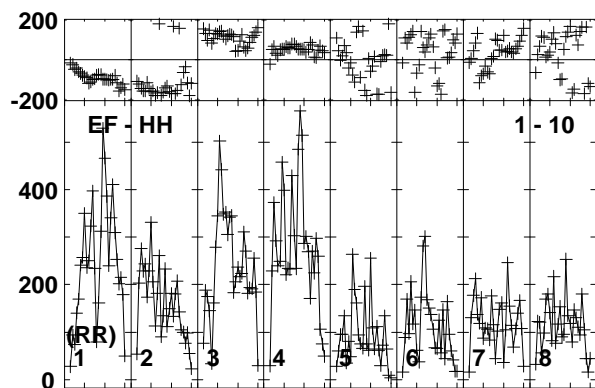
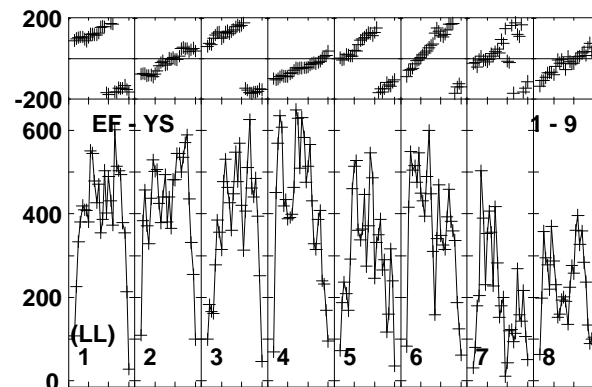
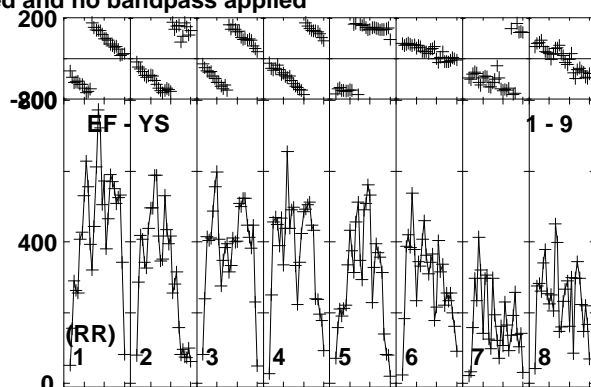
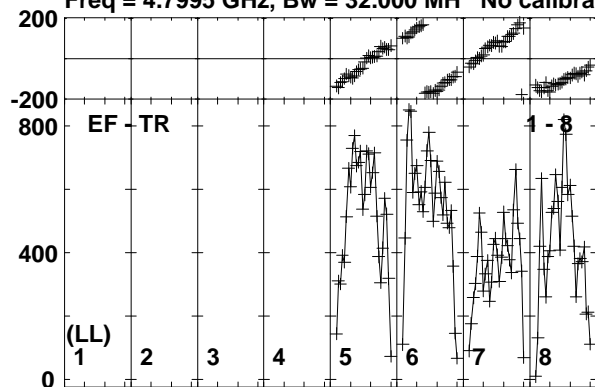

Lower frame: Micro Ampl Jy Top frame: Phas deg
Vector averaged cross-power spectrum Baseline: EF (01) - TR (08)
Timerange: 00/23:55:21 to 00/23:56:19

Plot file version 161 created 20-APR-2018 18:08:04

EM170817 RG009B.UVDATA.1

Freq = 4.7995 GHz, Bw = 32.000 MH No calibration applied and no bandpass applied

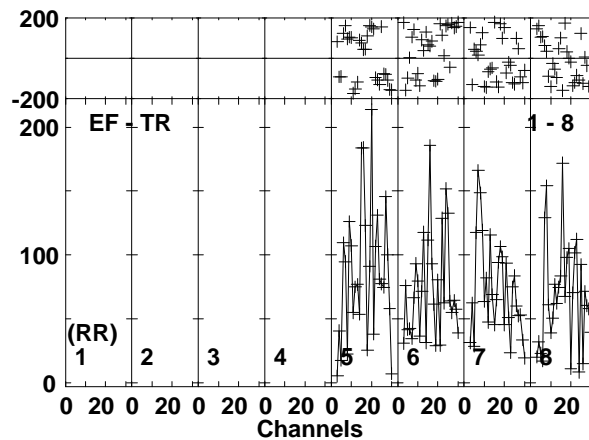
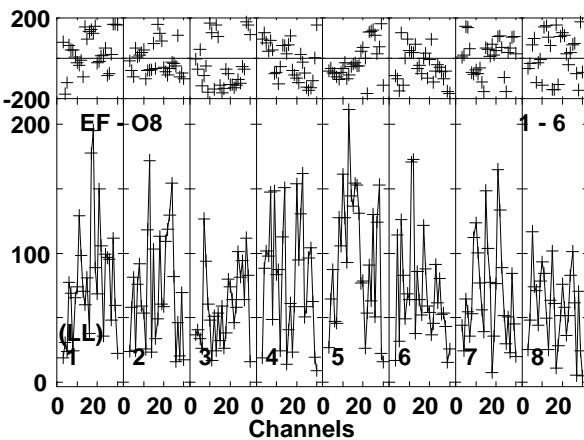
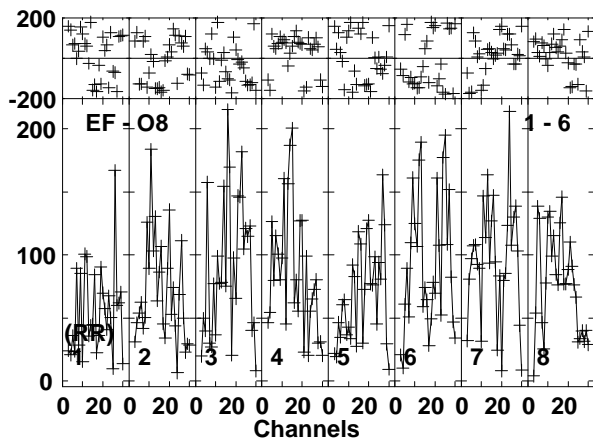
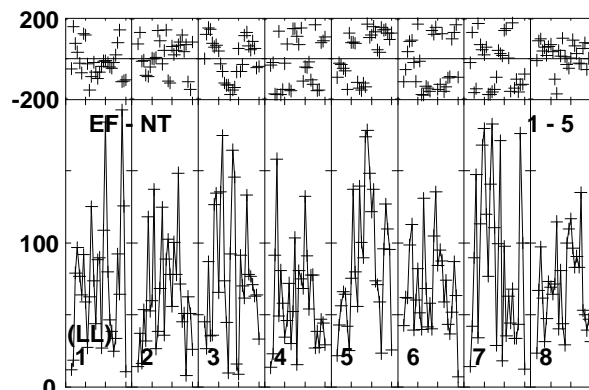
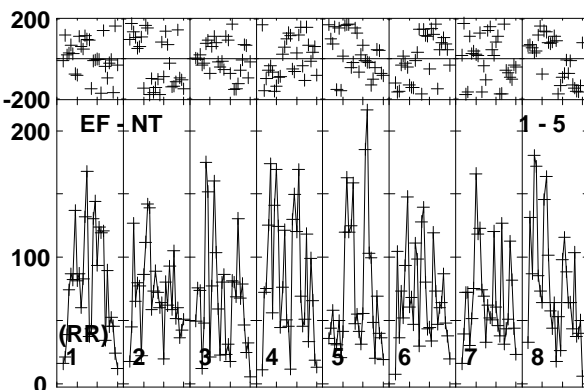
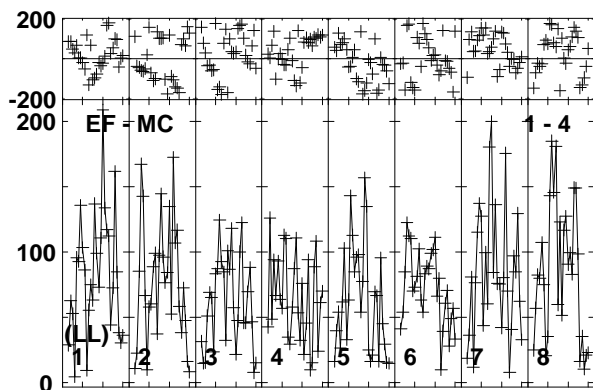
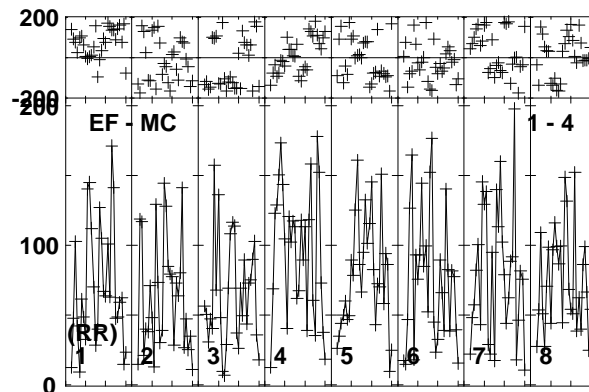
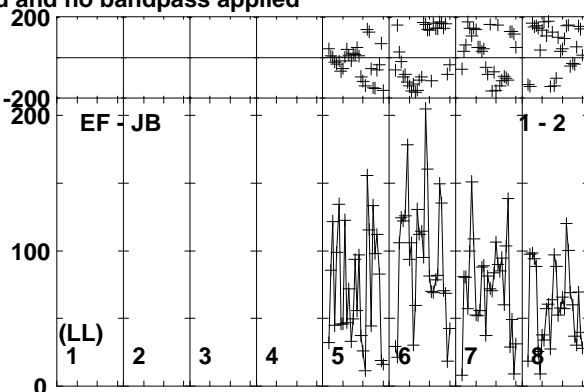
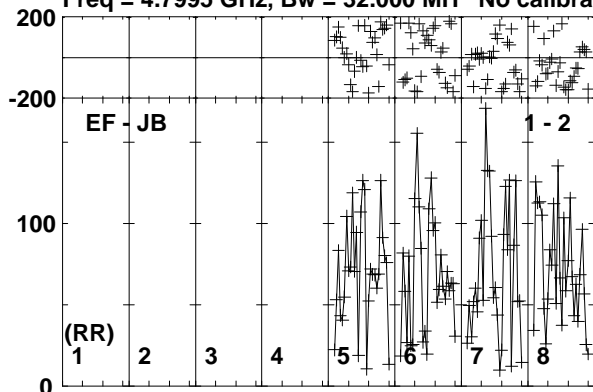

Lower frame: Micro Ampl Jy Top frame: Phas deg
Vector averaged cross-power spectrum Baseline: EF (01) - JB (02)
Timerange: 00/23:56:21 to 00/23:58:49

Plot file version 162 created 20-APR-2018 18:08:04

EM170817 RG009B.UVDATA.1

Freq = 4.7995 GHz, Bw = 32.000 MH No calibration applied and no bandpass applied

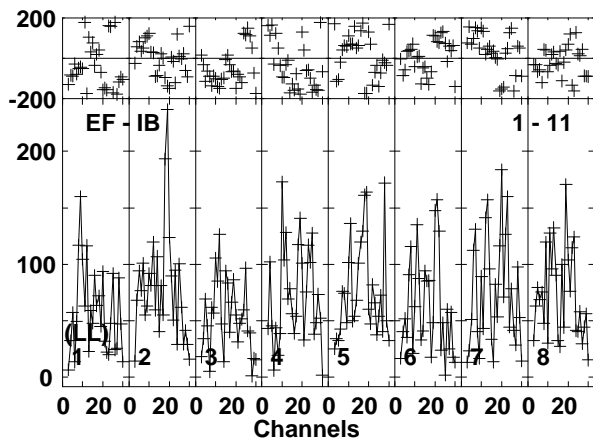
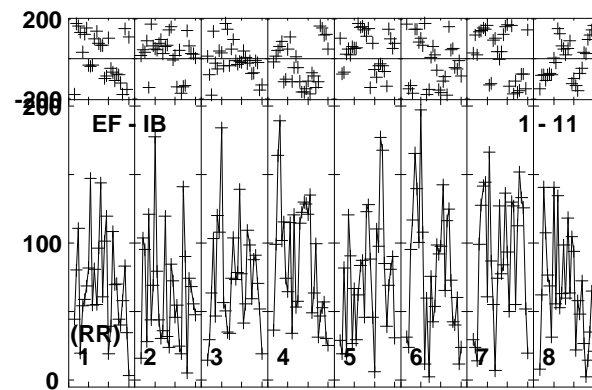
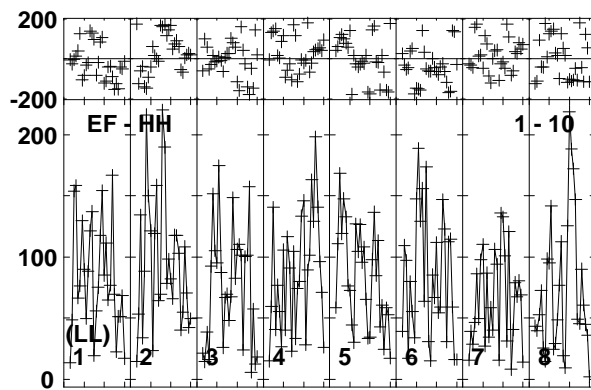
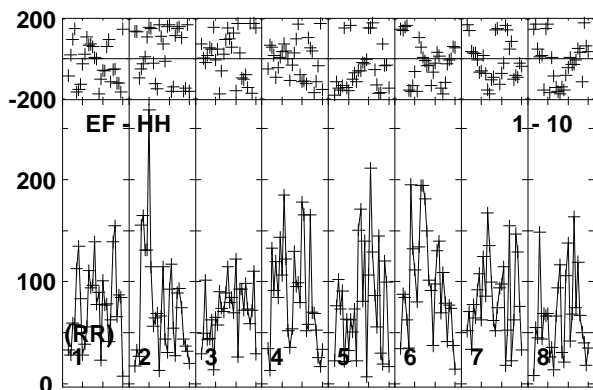
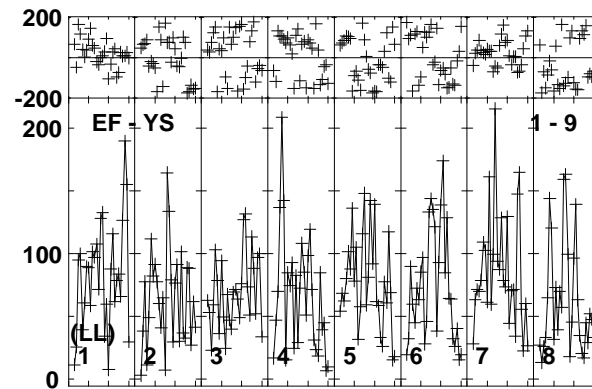
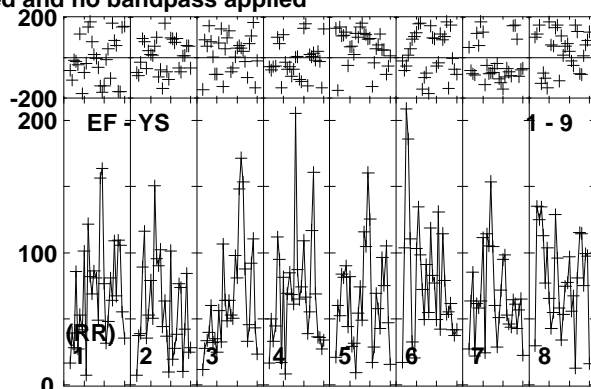
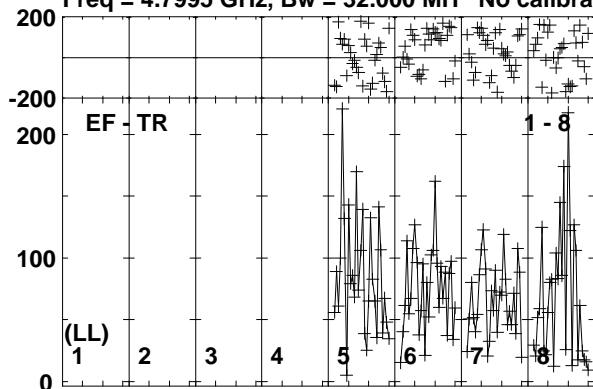

Lower frame: Micro Ampl Jy Top frame: Phas deg
Vector averaged cross-power spectrum Baseline: EF (01) - TR (08)
Timerange: 00/23:56:21 to 00/23:58:49

Plot file version 163 created 20-APR-2018 18:08:04

J1311-2329 RG009B.UVDATA.1

Freq = 4.7995 GHz, Bw = 32.000 MH No calibration applied and no bandpass applied

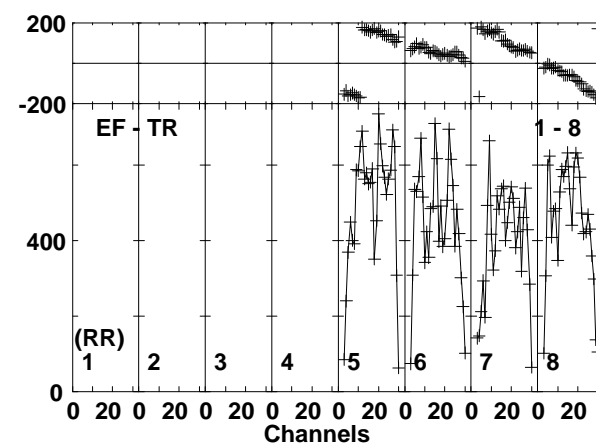
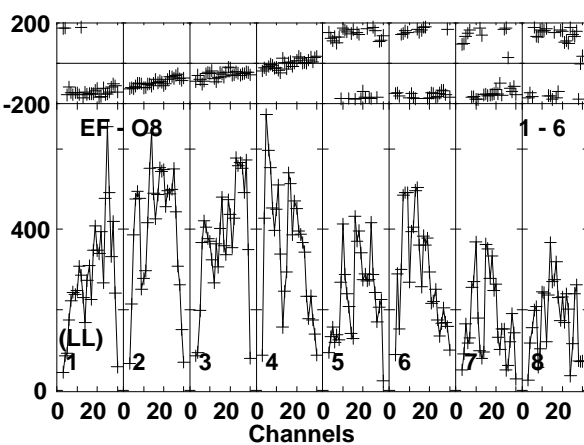
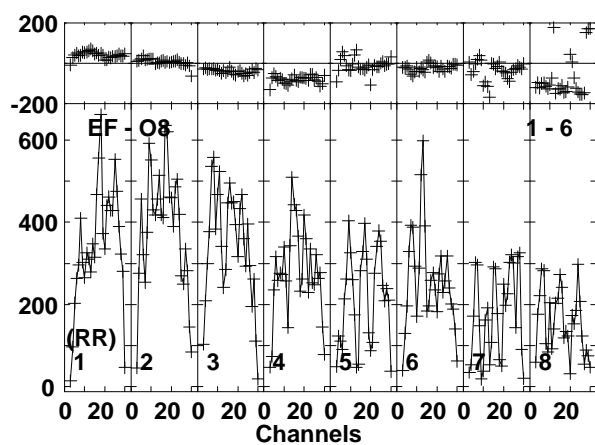
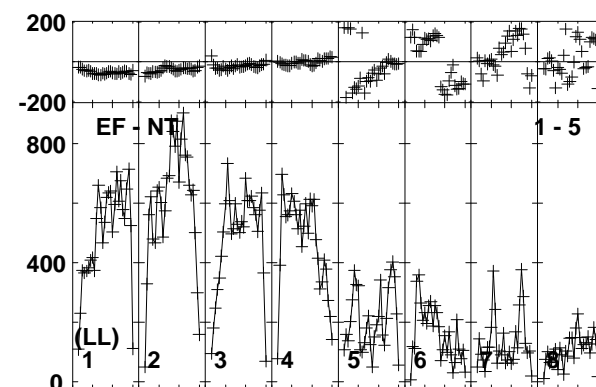
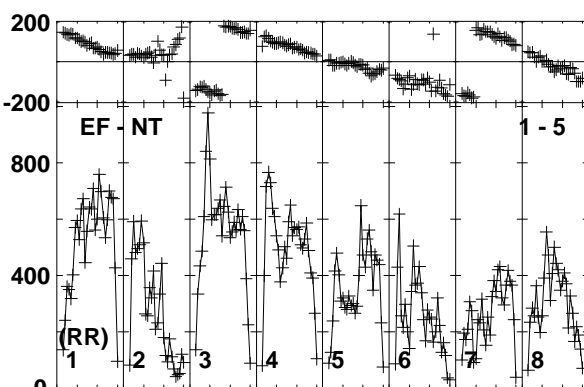
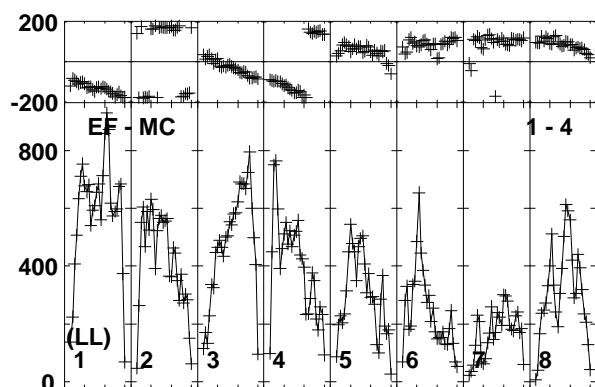
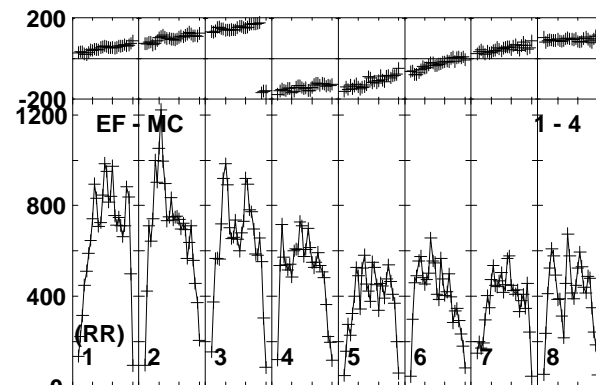
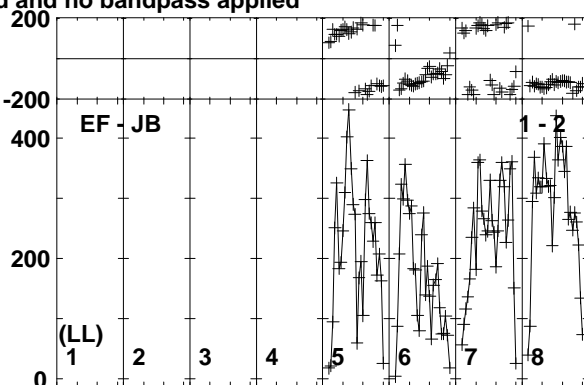
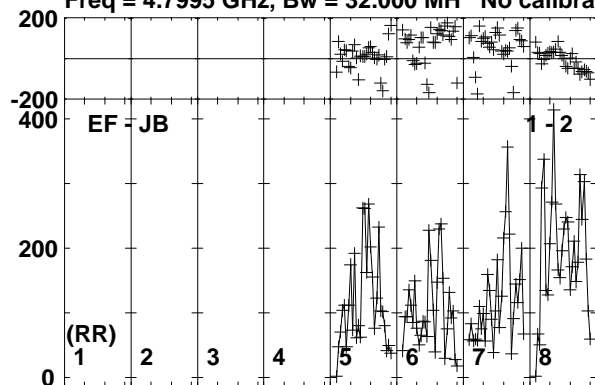

Lower frame: Micro Ampl Jy Top frame: Phas deg
Vector averaged cross-power spectrum Baseline: EF (01) - JB (02)
Timerange: 00/23:58:51 to 01/00:00:19

Plot file version 164 created 20-APR-2018 18:08:04

J1311-2329 RG009B.UVDATA.1

Freq = 4.7995 GHz, Bw = 32.000 MH No calibration applied and no bandpass applied

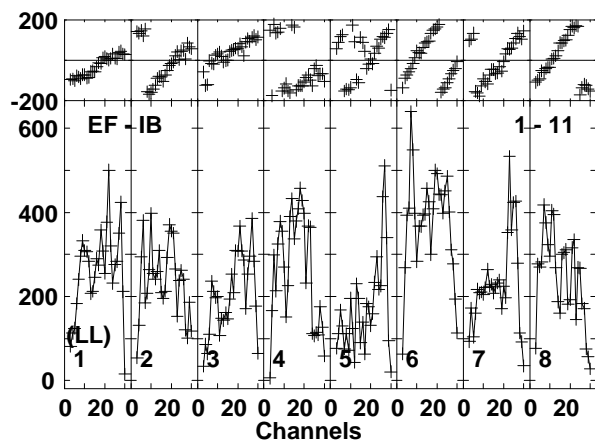
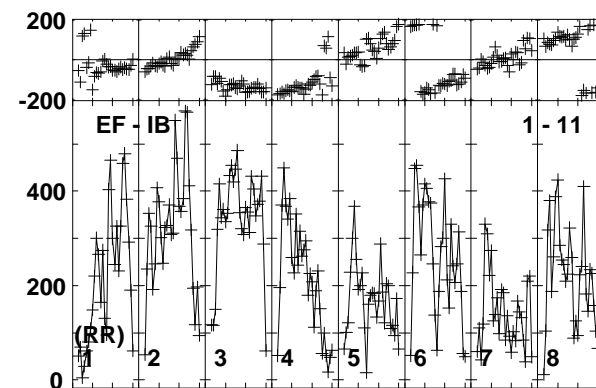
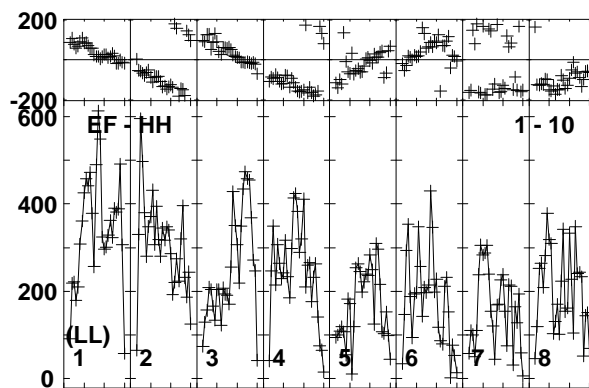
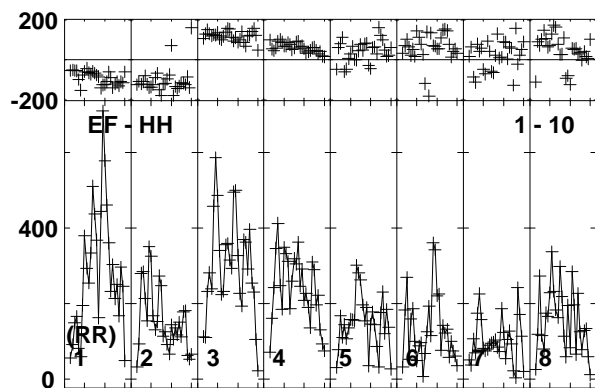
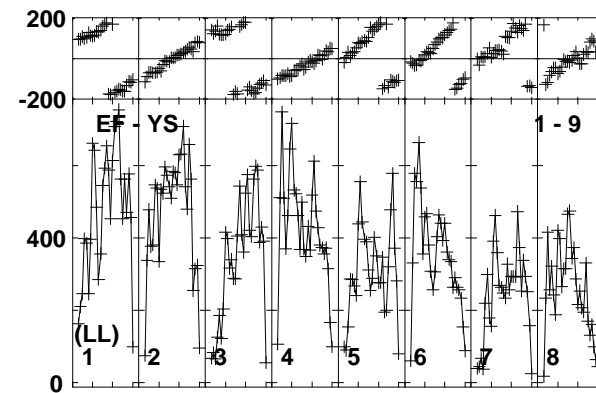
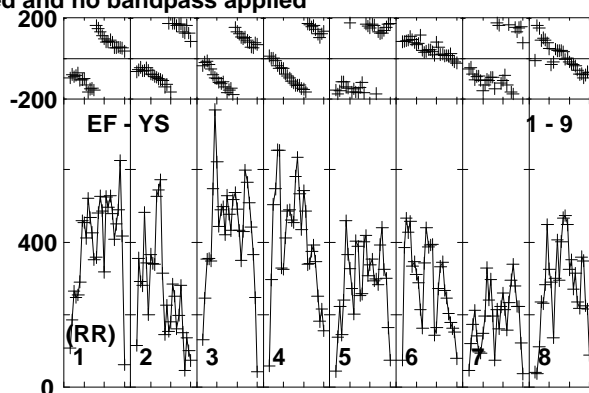
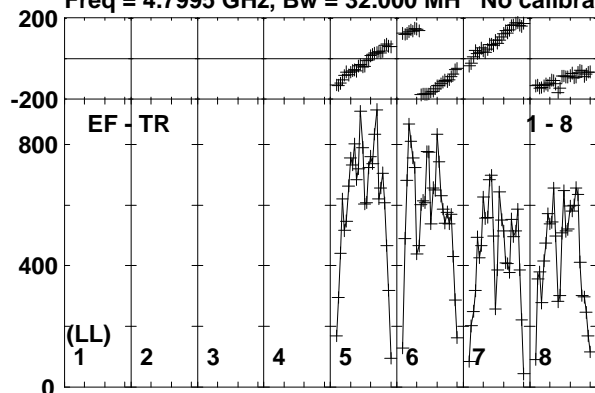

Lower frame: Micro Ampl Jy Top frame: Phas deg
Vector averaged cross-power spectrum Baseline: EF (01) - TR (08)
Timerange: 00/23:58:51 to 01/00:00:19

Plot file version 165 created 20-APR-2018 18:08:04

J1312-2350 RG009B.UVDATA.1

Freq = 4.7995 GHz, Bw = 32.000 MH No calibration applied and no bandpass applied

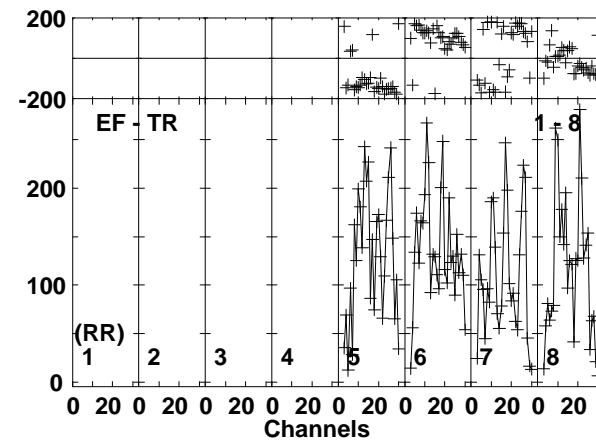
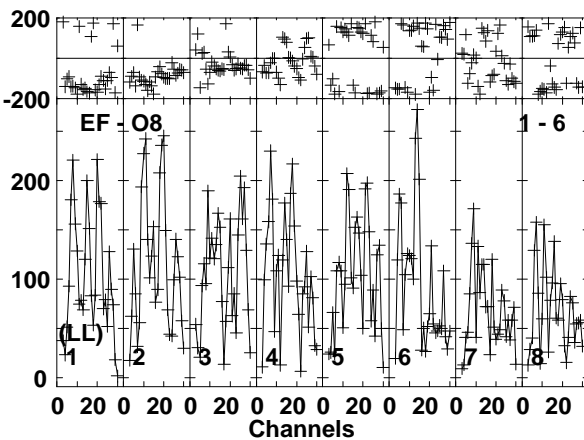
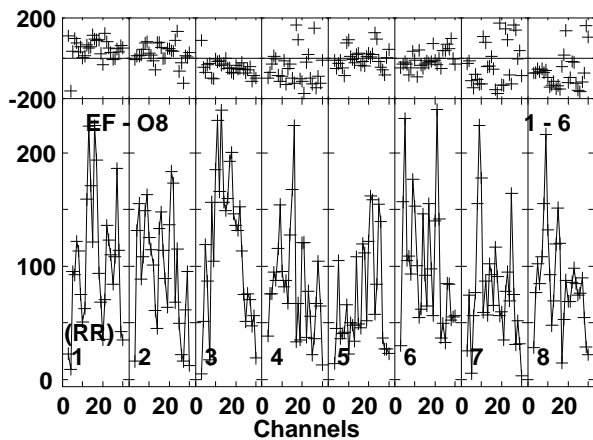
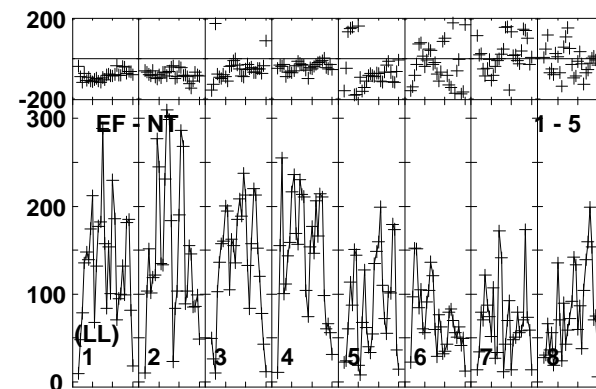
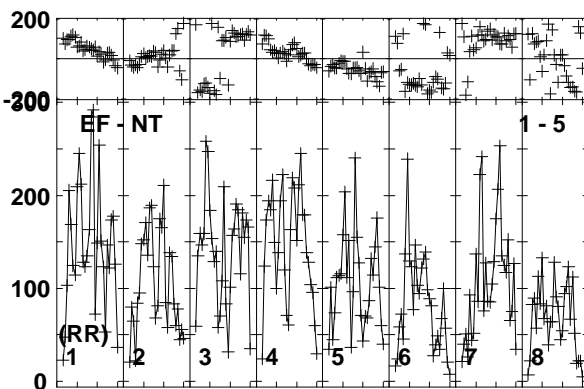
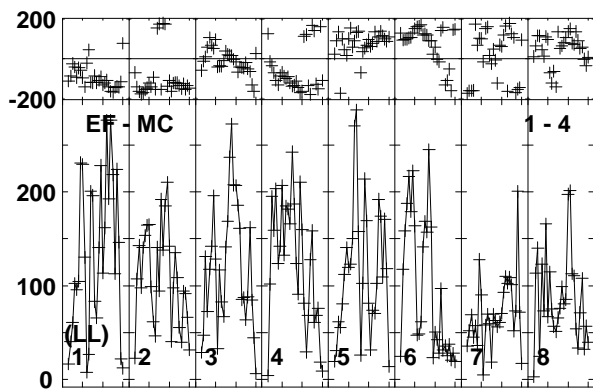
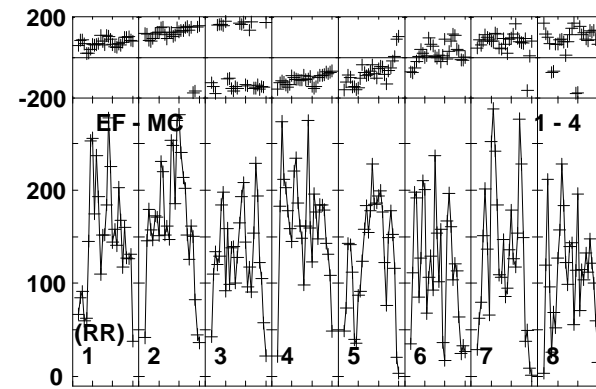
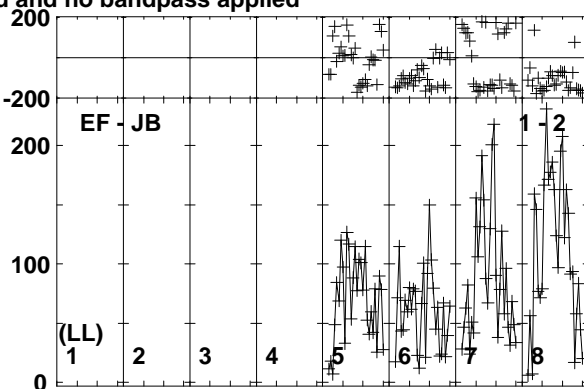
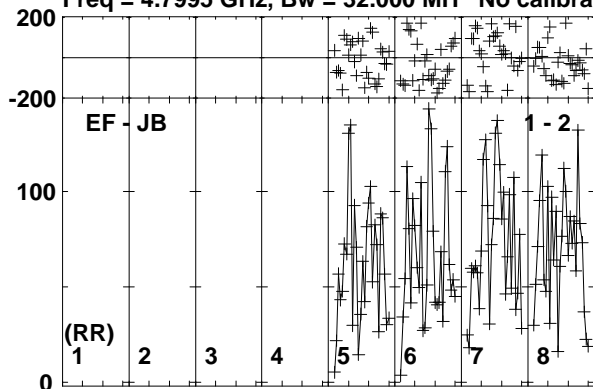

Lower frame: Micro Ampl Jy Top frame: Phas deg
Vector averaged cross-power spectrum Baseline: EF (01) - JB (02)
Timerange: 01/00:00:21 to 01/00:02:49

Plot file version 166 created 20-APR-2018 18:08:04

J1312-2350 RG009B.UVDATA.1

Freq = 4.7995 GHz, Bw = 32.000 MH No calibration applied and no bandpass applied

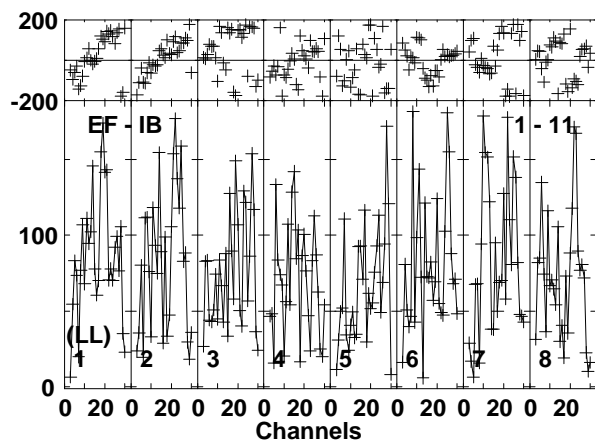
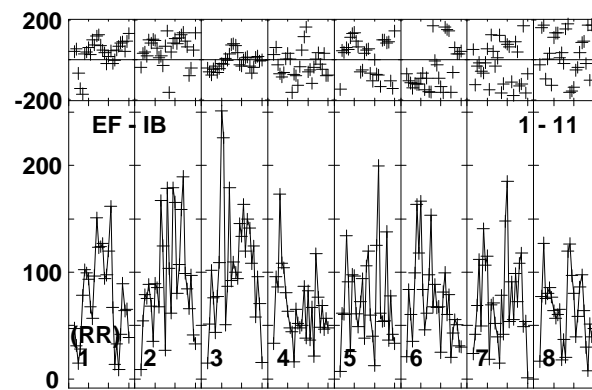
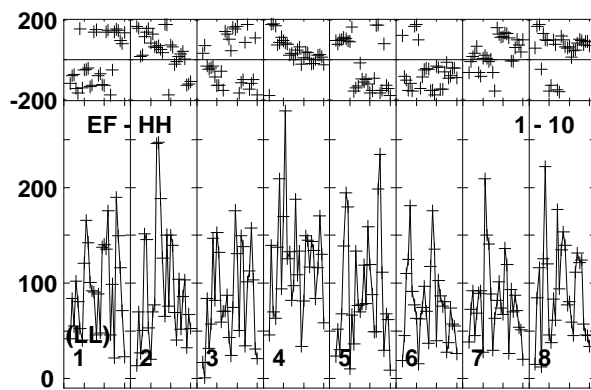
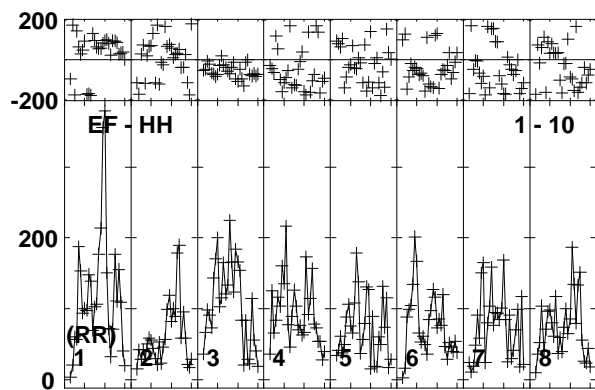
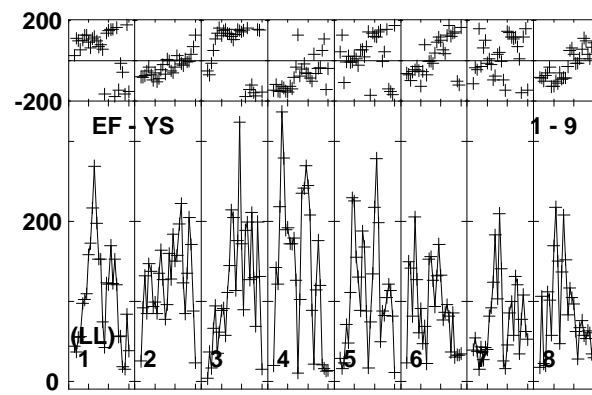
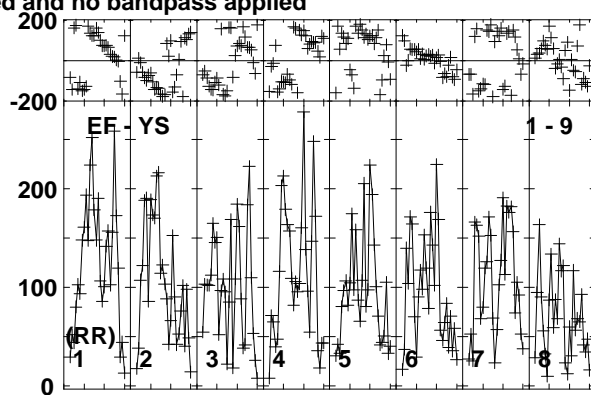
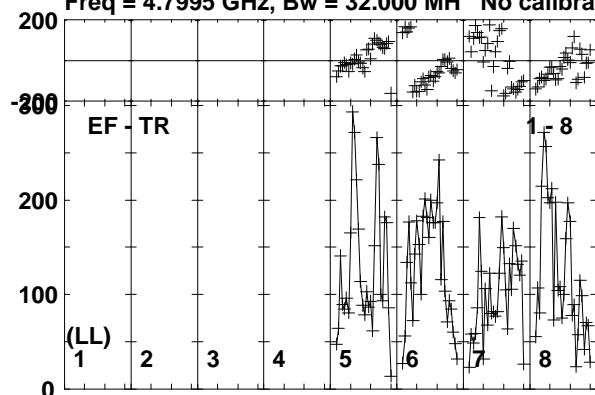

Lower frame: Micro Ampl Jy Top frame: Phas deg
Vector averaged cross-power spectrum Baseline: EF (01) - TR (08)
Timerange: 01/00:00:21 to 01/00:02:49

Plot file version 167 created 20-APR-2018 18:08:04

J1311-2329 RG009B.UVDATA.1

Freq = 4.7995 GHz, Bw = 32.000 MH No calibration applied and no bandpass applied

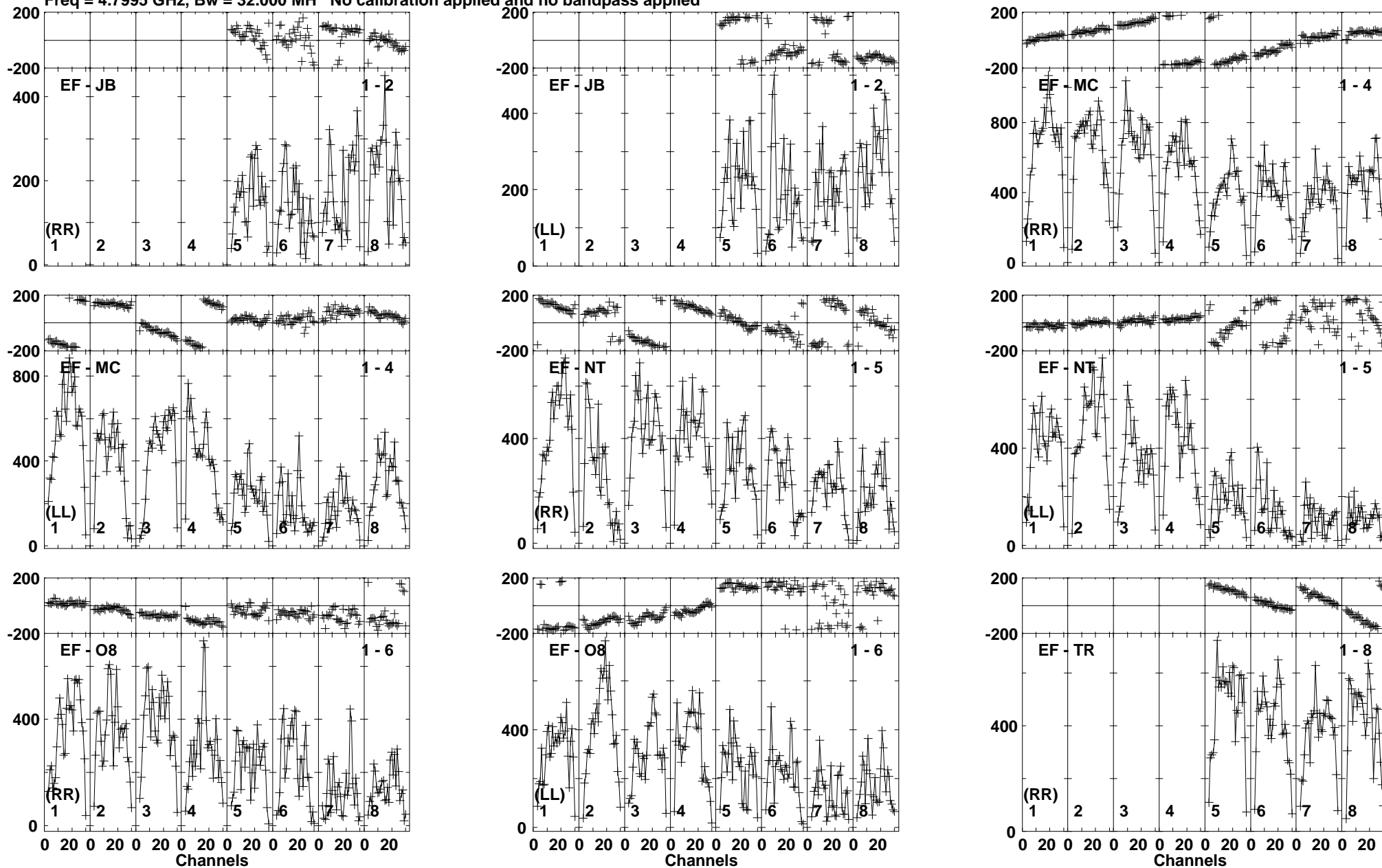

Lower frame: Micro Ampl Jy Top frame: Phas deg
Vector averaged cross-power spectrum Baseline: EF (01) - JB (02)
Timerange: 01/00:03:31 to 01/00:04:29

Plot file version 168 created 20-APR-2018 18:08:04

J1311-2329 RG009B.UVDATA.1

Freq = 4.7995 GHz, Bw = 32.000 MH No calibration applied and no bandpass applied

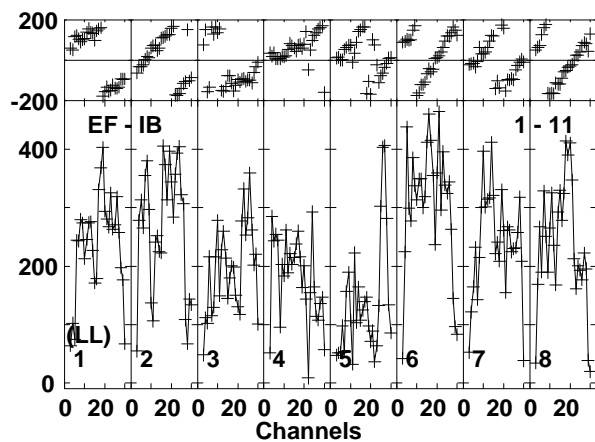
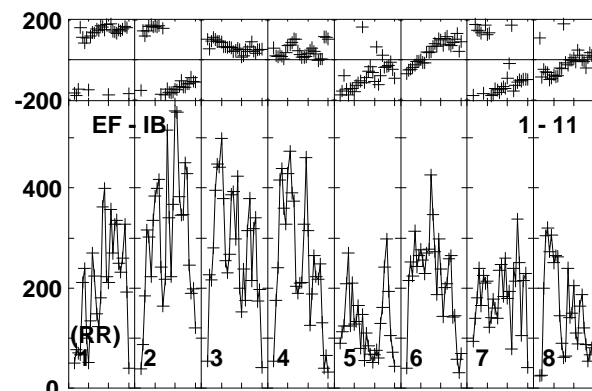
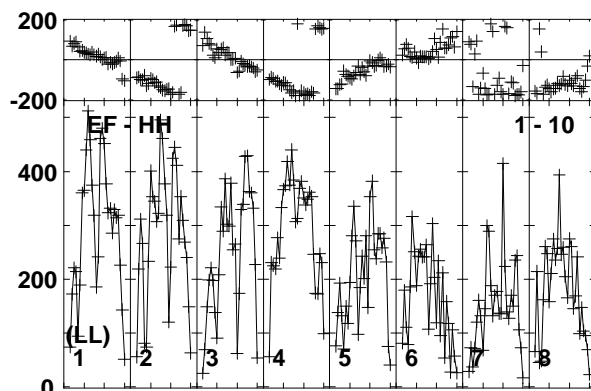
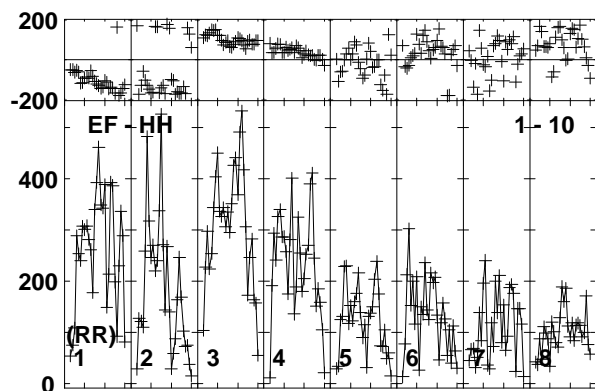
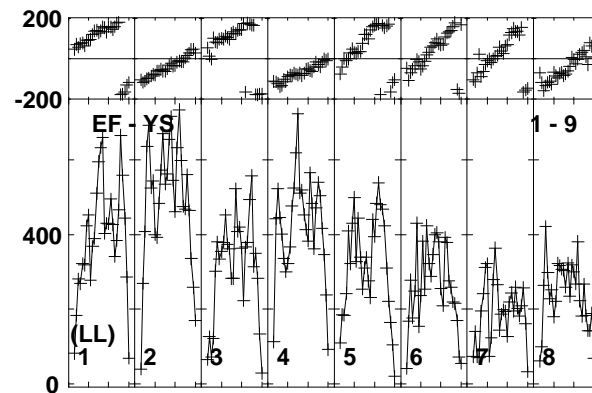
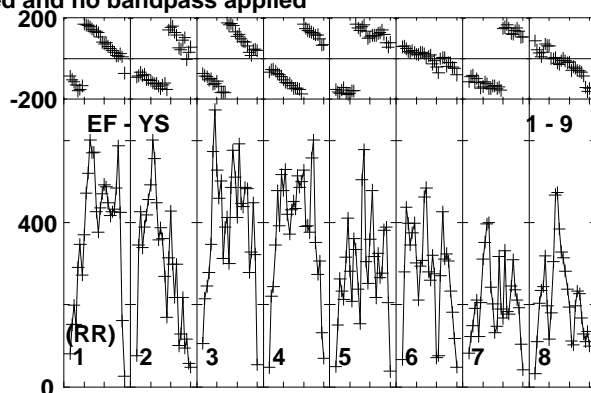
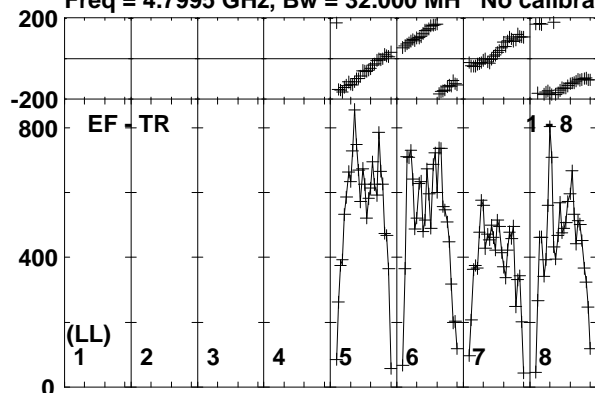

Lower frame: Micro Ampl Jy Top frame: Phas deg
Vector averaged cross-power spectrum Baseline: EF (01) - TR (08)
Timerange: 01/00:03:31 to 01/00:04:29

Plot file version 169 created 20-APR-2018 18:08:04

EM170817 RG009B.UVDATA.1

Freq = 4.7995 GHz, Bw = 32.000 MH No calibration applied and no bandpass applied

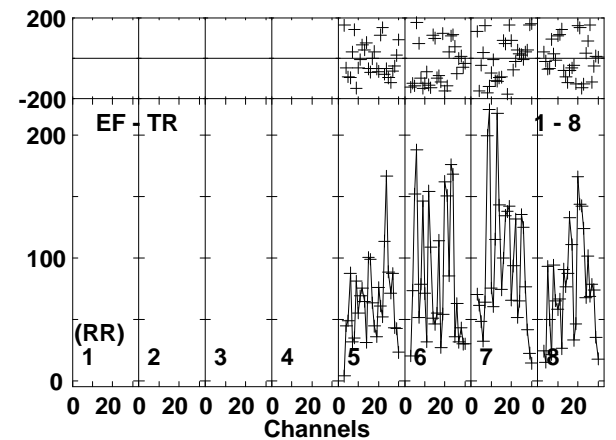
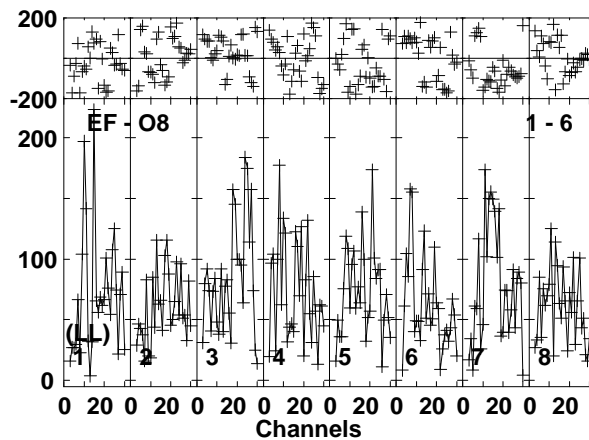
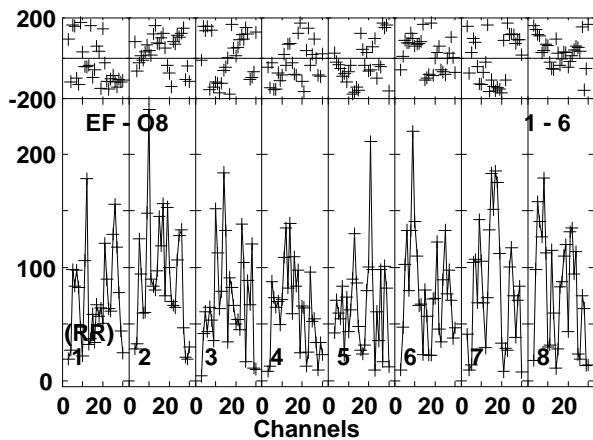
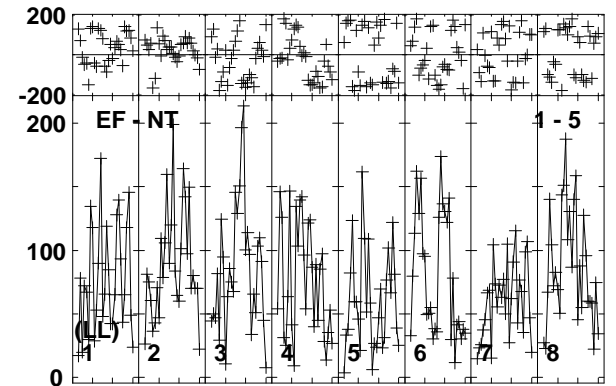
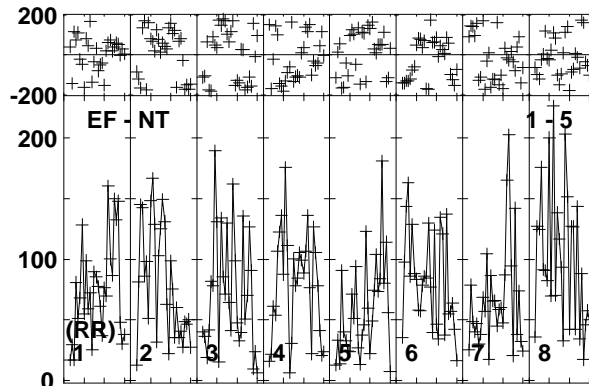
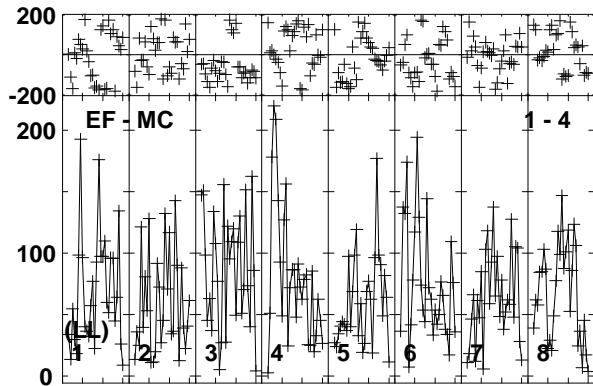
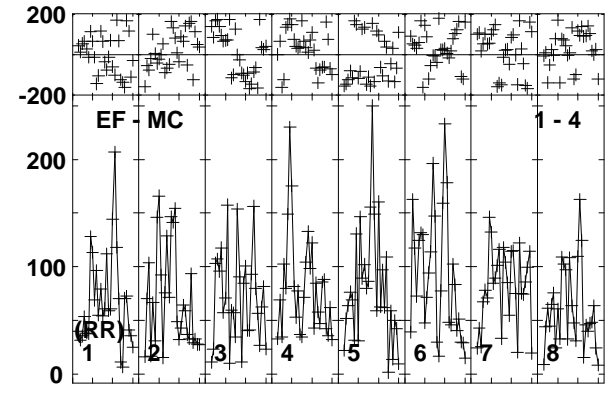
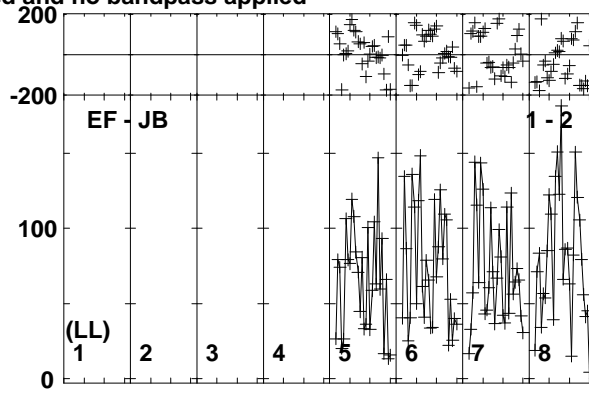
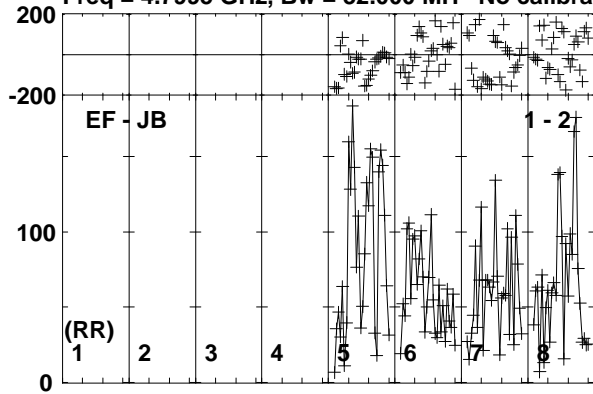

Lower frame: Micro Ampl Jy Top frame: Phas deg
Vector averaged cross-power spectrum Baseline: EF (01) - JB (02)
Timerange: 01/00:04:31 to 01/00:06:59

Plot file version 170 created 20-APR-2018 18:08:04

EM170817 RG009B.UVDATA.1

Freq = 4.7995 GHz, Bw = 32.000 MH No calibration applied and no bandpass applied

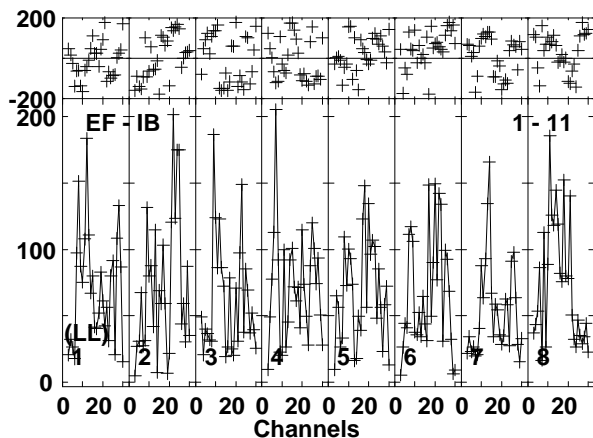
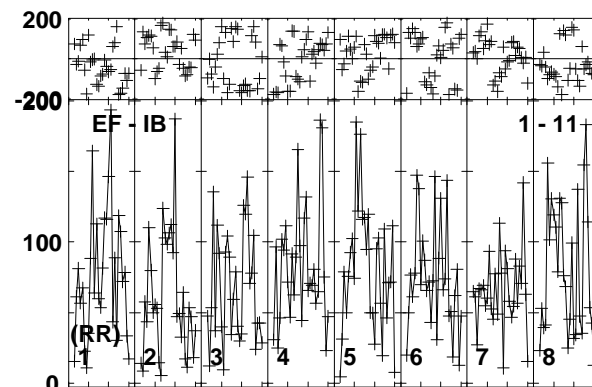
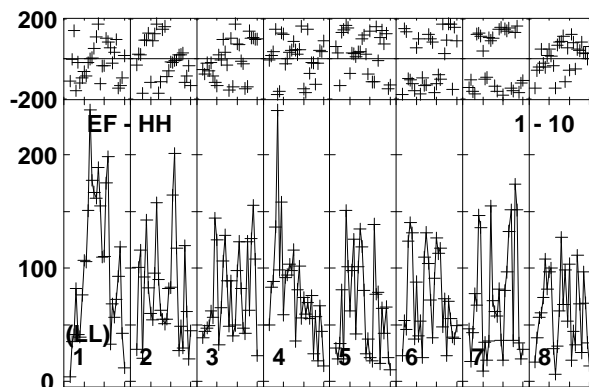
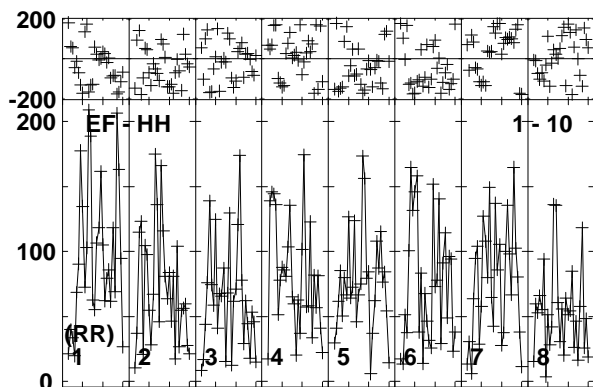
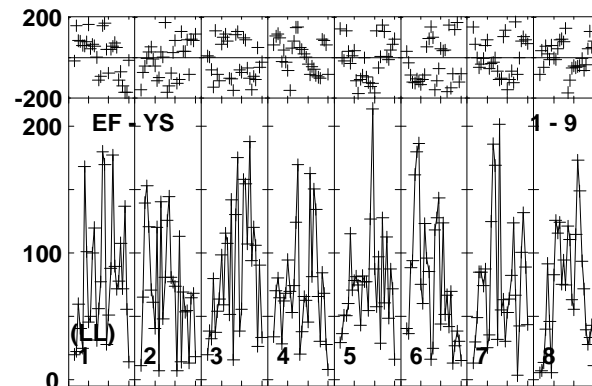
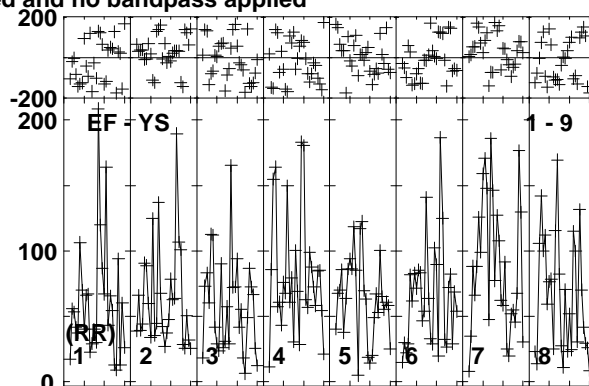
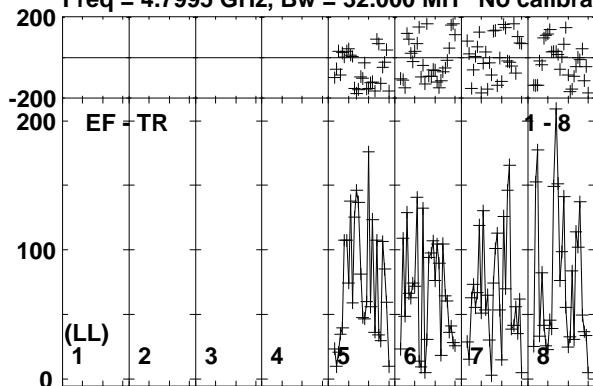

Lower frame: Micro Ampl Jy Top frame: Phas deg
Vector averaged cross-power spectrum Baseline: EF (01) - TR (08)
Timerange: 01/00:04:31 to 01/00:06:59

Plot file version 171 created 20-APR-2018 18:08:04

J1311-2329 RG009B.UVDATA.1

Freq = 4.7995 GHz, Bw = 32.000 MH No calibration applied and no bandpass applied

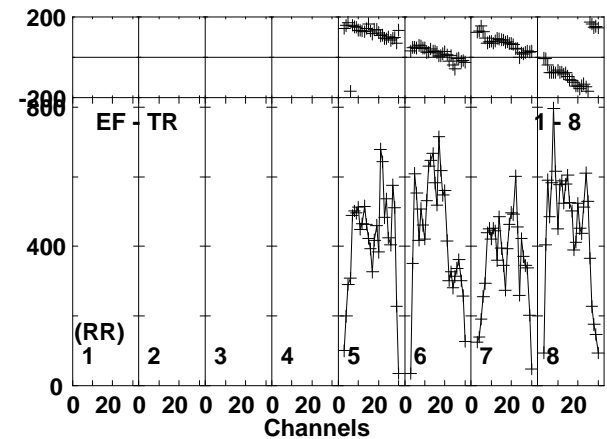
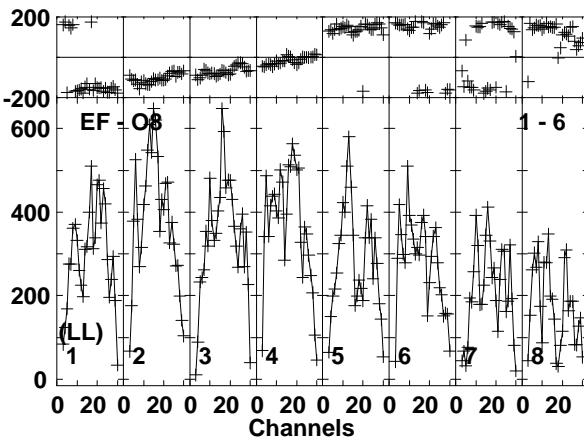
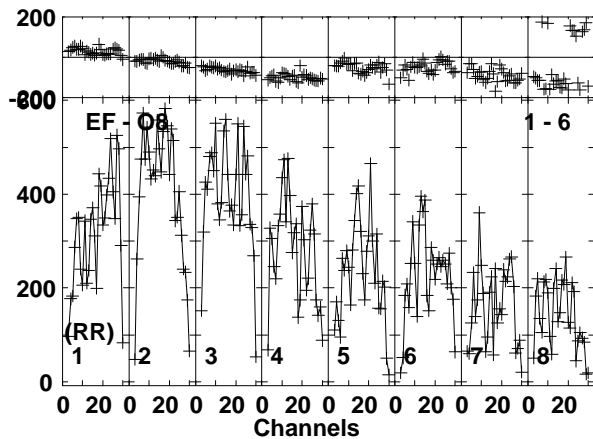
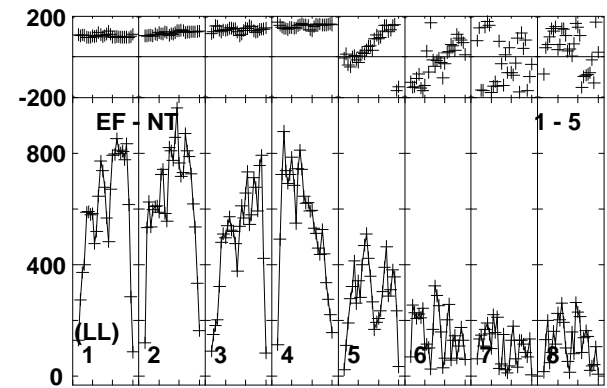
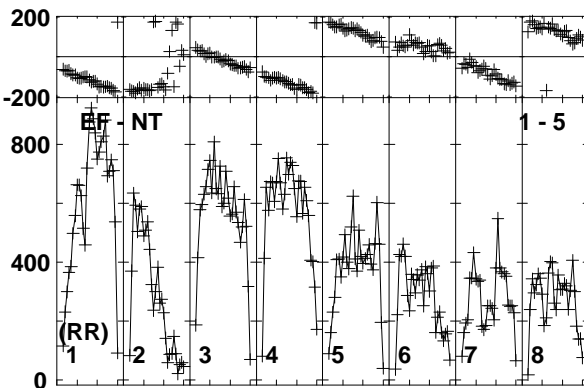
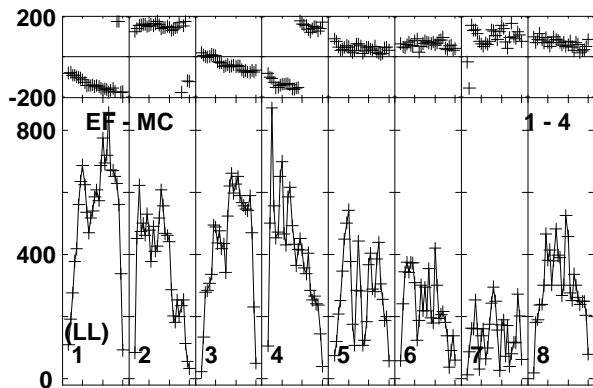
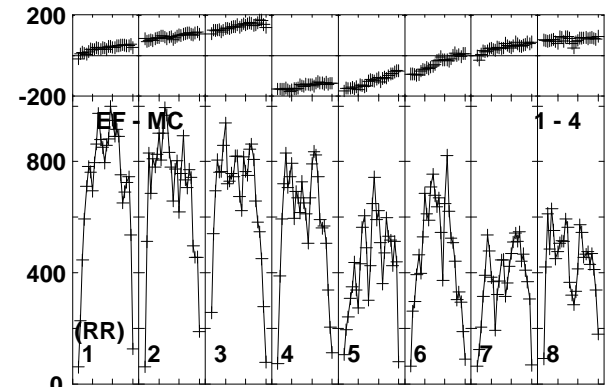
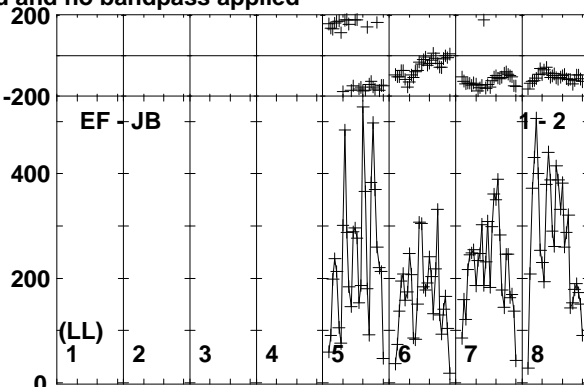
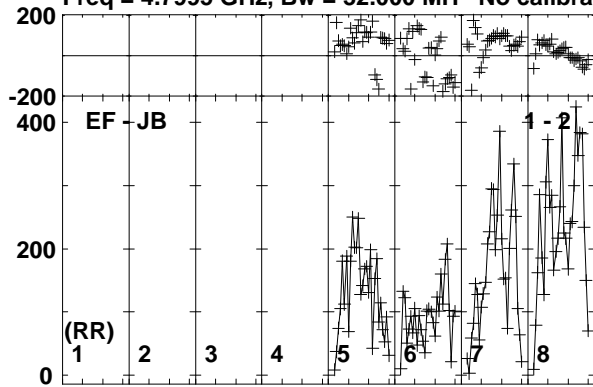

Lower frame: Micro Ampl Jy Top frame: Phas deg
Vector averaged cross-power spectrum Baseline: EF (01) - JB (02)
Timerange: 01/00:07:01 to 01/00:08:29

Plot file version 172 created 20-APR-2018 18:08:05

J1311-2329 RG009B.UVDATA.1

Freq = 4.7995 GHz, Bw = 32.000 MH No calibration applied and no bandpass applied

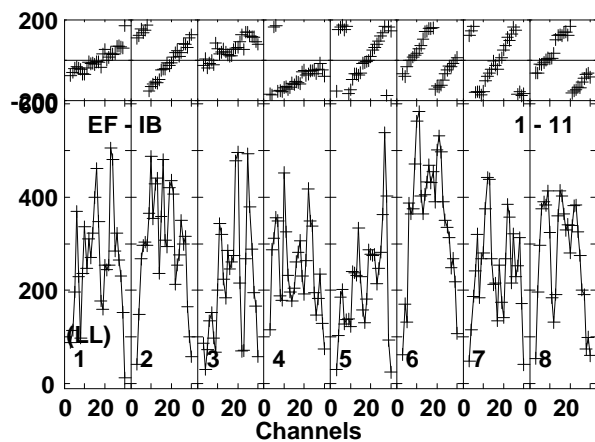
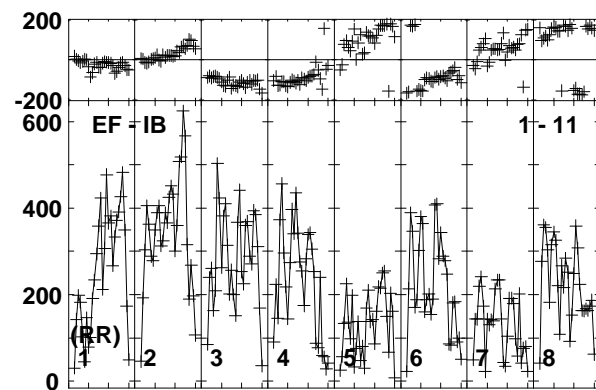
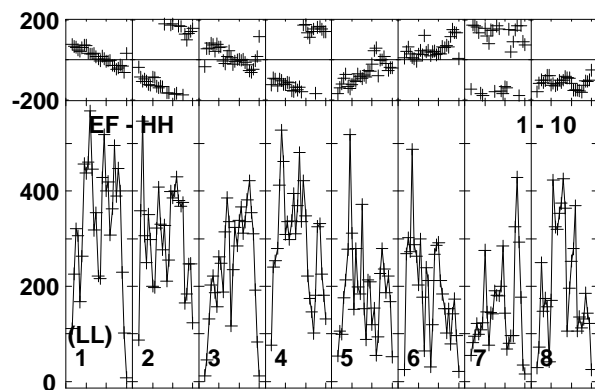
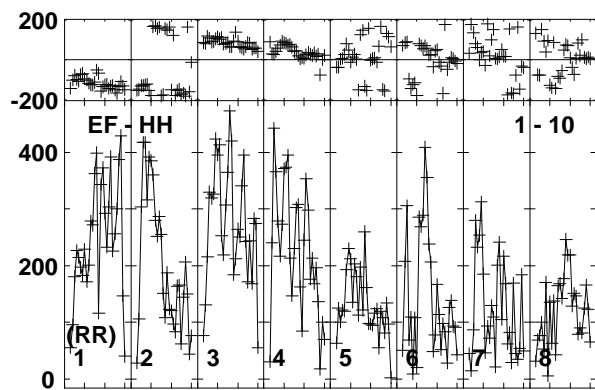
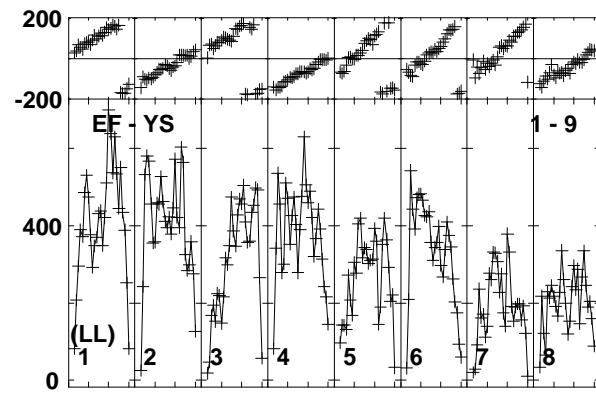
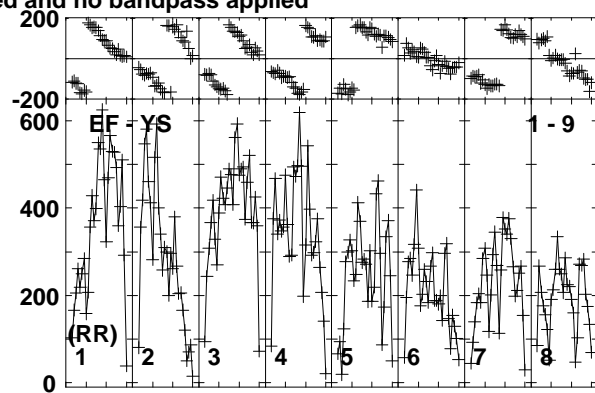
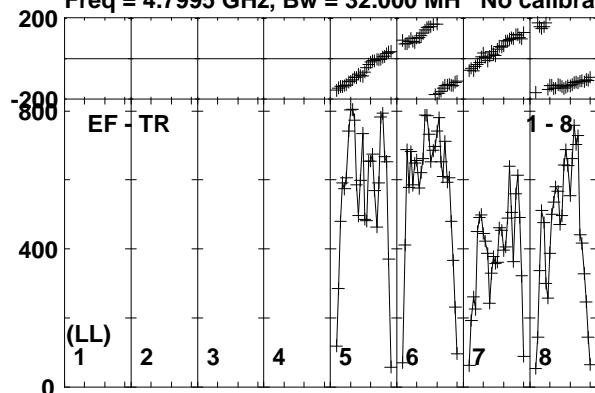

Lower frame: Micro Ampl Jy Top frame: Phas deg
Vector averaged cross-power spectrum Baseline: EF (01) - TR (08)
Timerange: 01/00:07:01 to 01/00:08:29

Plot file version 173 created 20-APR-2018 18:08:05

EM170817 RG009B.UVDATA.1

Freq = 4.7995 GHz, Bw = 32.000 MH No calibration applied and no bandpass applied

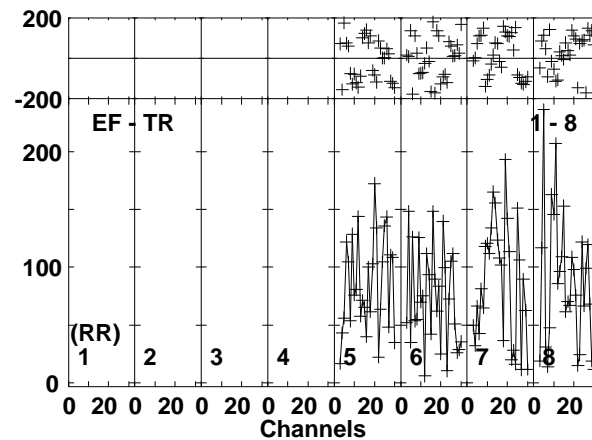
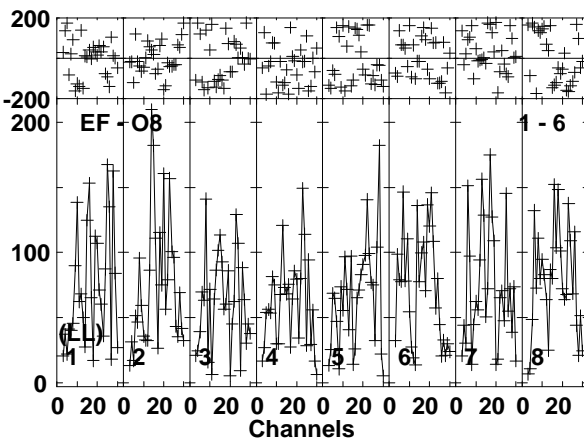
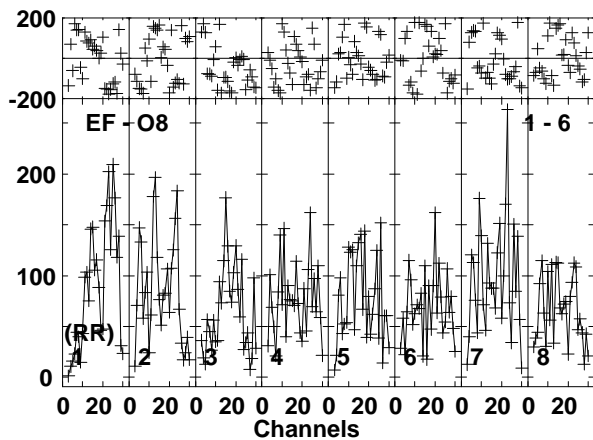
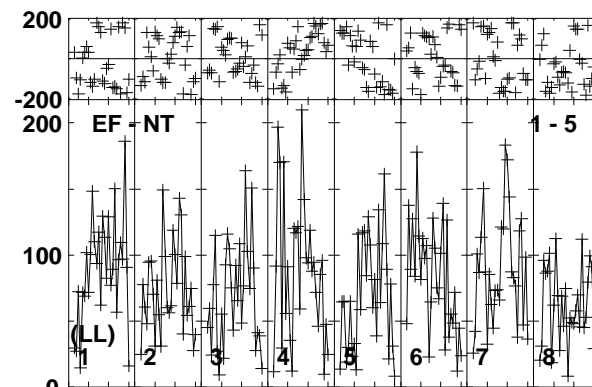
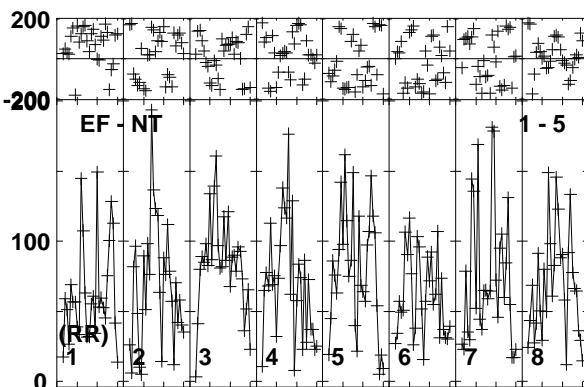
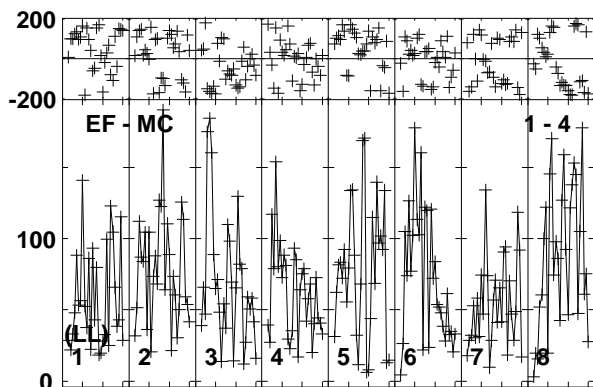
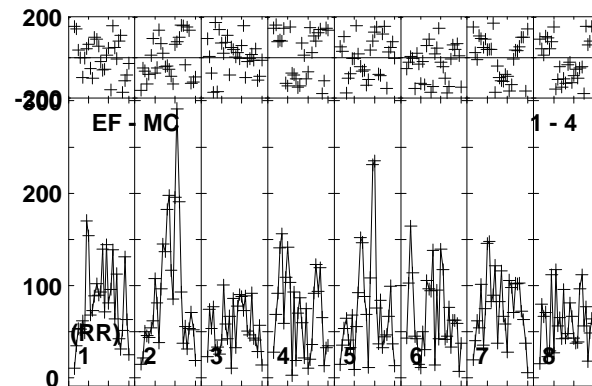
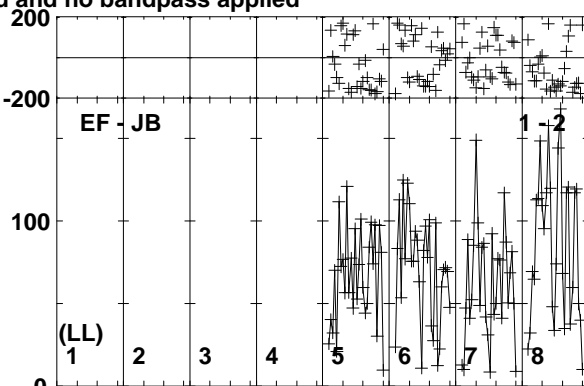
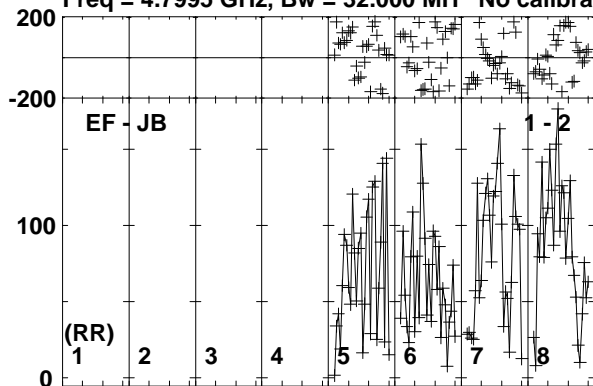

Lower frame: Micro Ampl Jy Top frame: Phas deg
Vector averaged cross-power spectrum Baseline: EF (01) - JB (02)
Timerange: 01/00:08:31 to 01/00:10:59

Plot file version 174 created 20-APR-2018 18:08:05

EM170817 RG009B.UVDATA.1

Freq = 4.7995 GHz, Bw = 32.000 MH No calibration applied and no bandpass applied

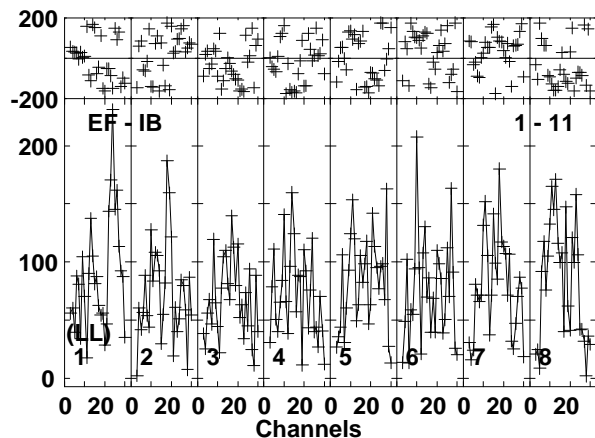
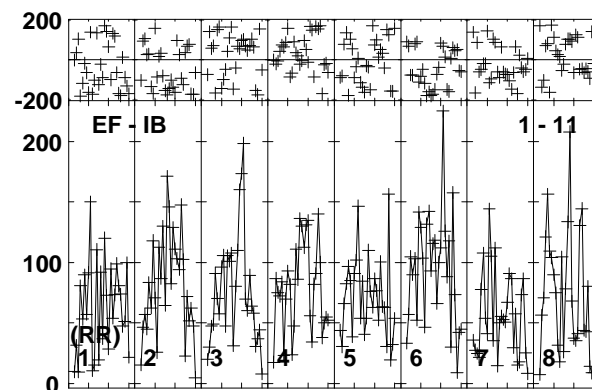
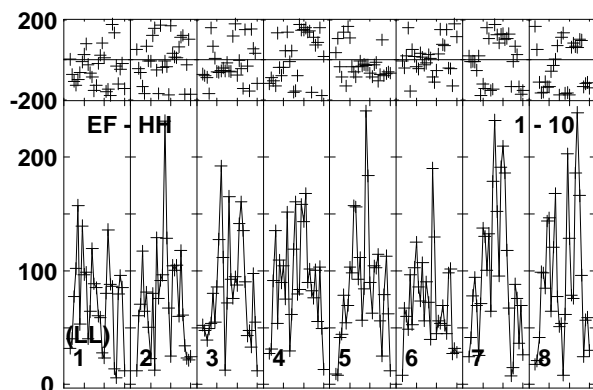
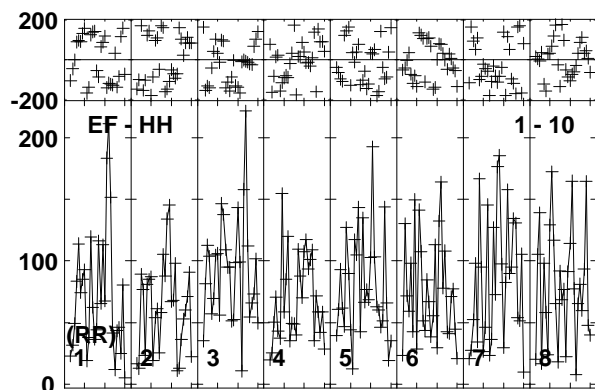
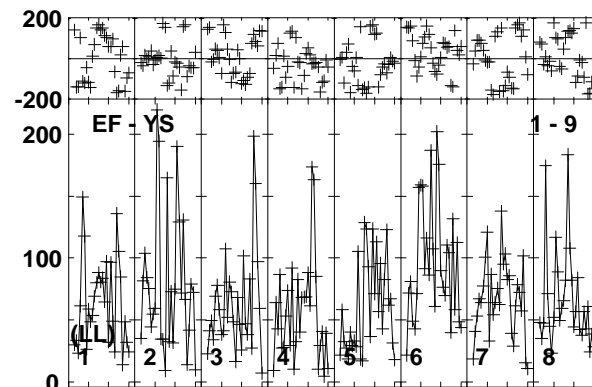
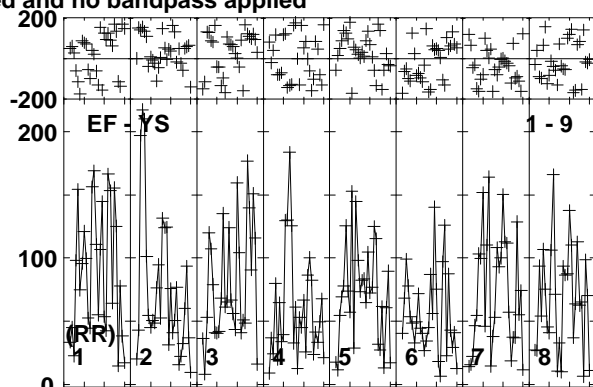
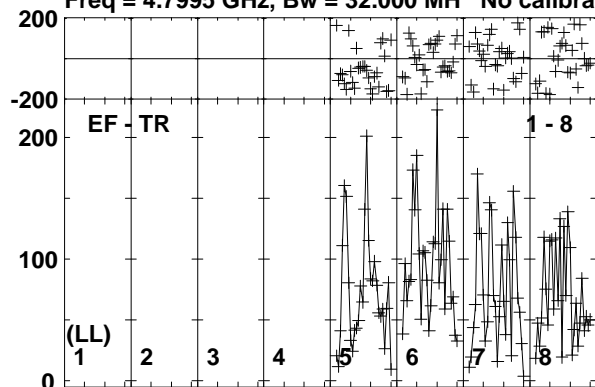

Lower frame: Micro Ampl Jy Top frame: Phas deg
Vector averaged cross-power spectrum Baseline: EF (01) - TR (08)
Timerange: 01/00:08:31 to 01/00:10:59

Plot file version 175 created 20-APR-2018 18:08:05

J1311-2329 RG009B.UVDATA.1

Freq = 4.7995 GHz, Bw = 32.000 MH No calibration applied and no bandpass applied

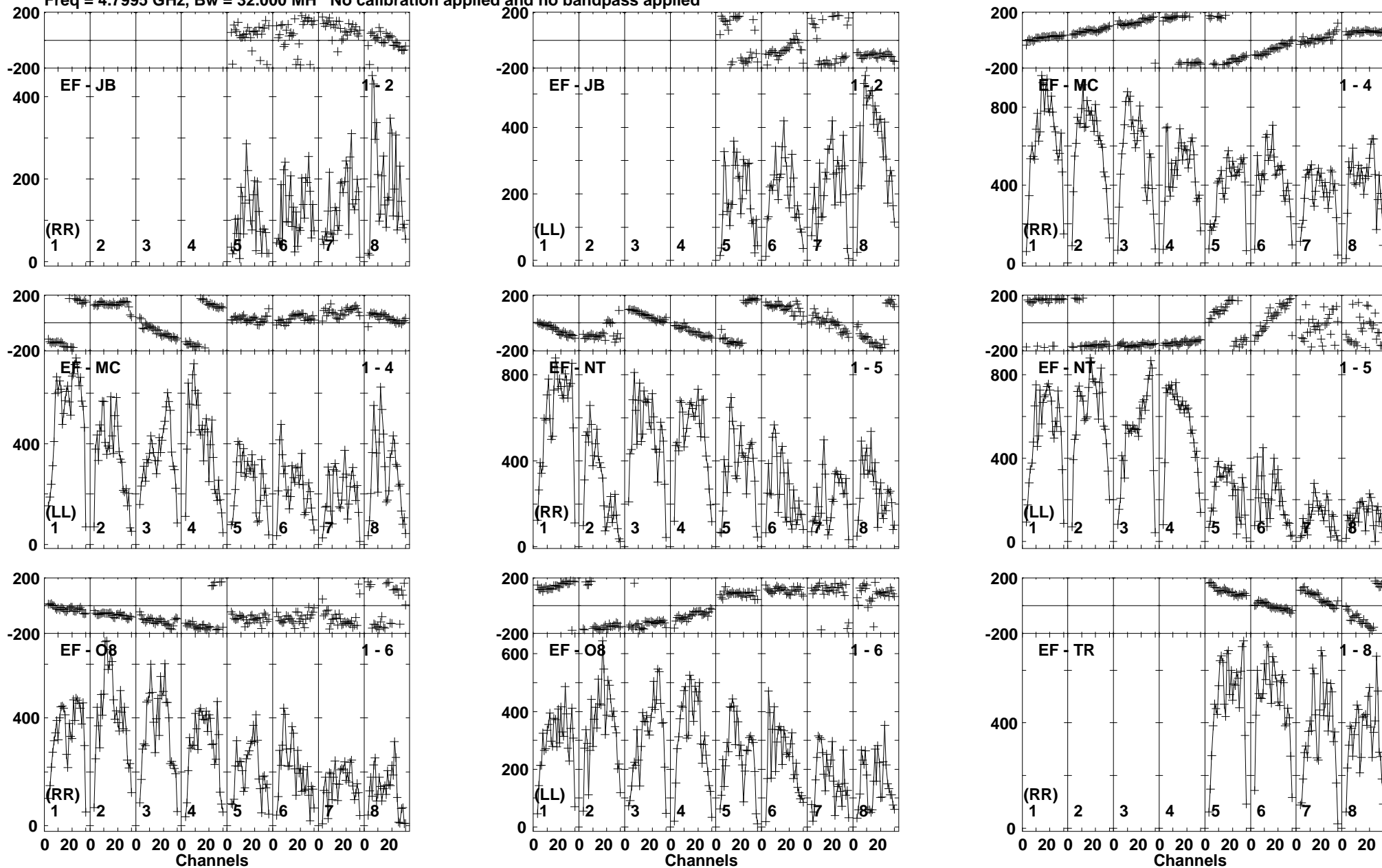

Lower frame: Micro Ampl Jy Top frame: Phas deg
Vector averaged cross-power spectrum Baseline: EF (01) - JB (02)
Timerange: 01/00:11:31 to 01/00:12:29

Plot file version 177 created 20-APR-2018 18:08:05

EM170817 RG009B.UVDATA.1

Freq = 4.7995 GHz, Bw = 32.000 MH No calibration applied and no bandpass applied

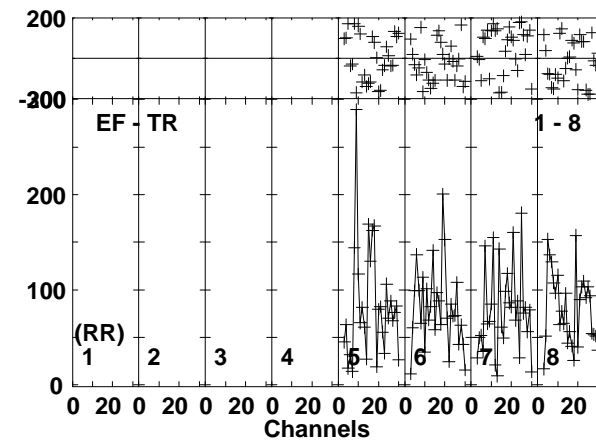
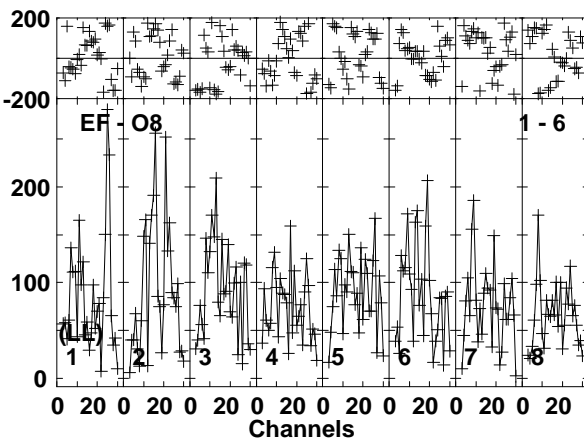
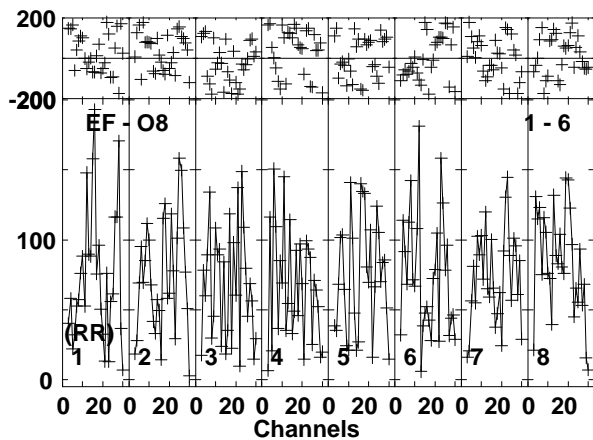
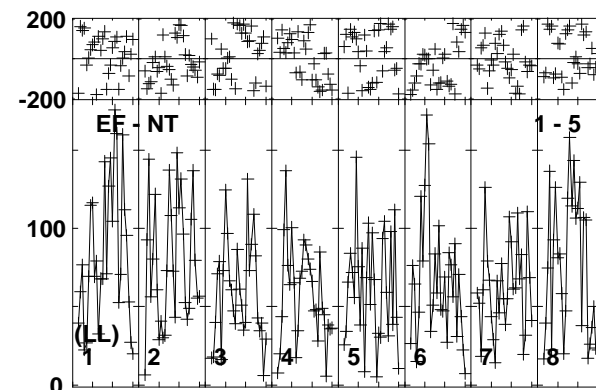
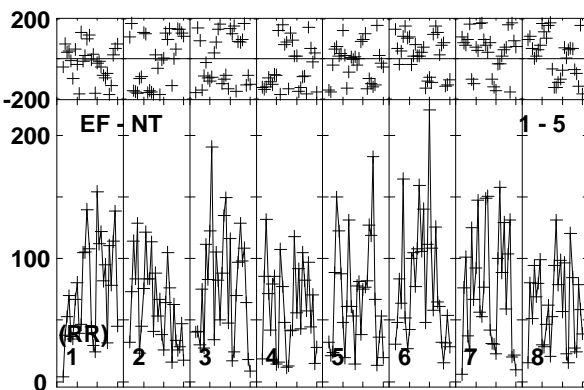
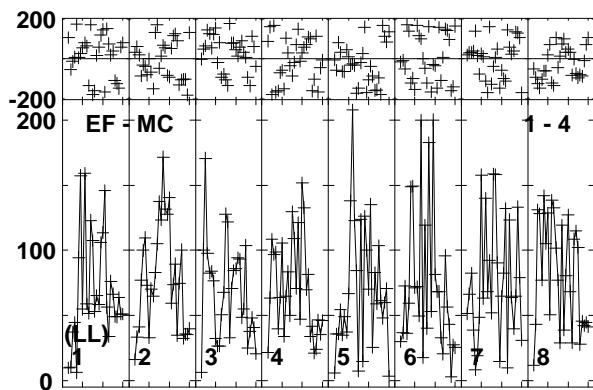
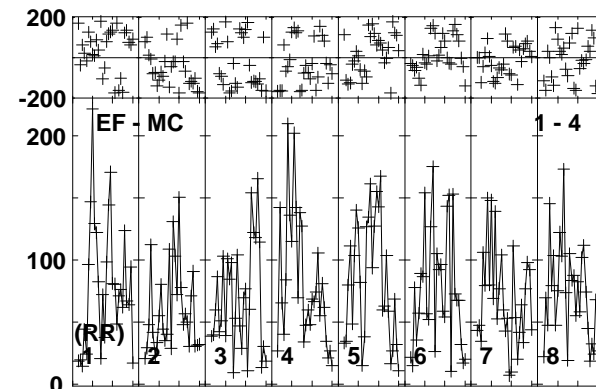
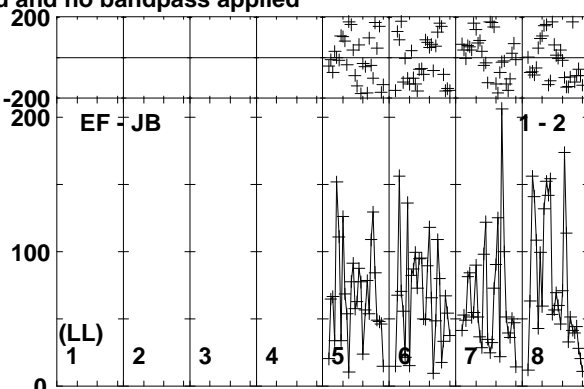
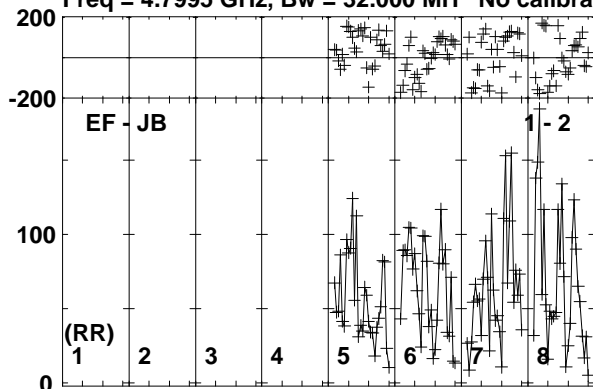

Lower frame: Micro Ampl Jy Top frame: Phas deg
Vector averaged cross-power spectrum Baseline: EF (01) - JB (02)
Timerange: 01/00:12:31 to 01/00:14:59

Plot file version 178 created 20-APR-2018 18:08:05

EM170817 RG009B.UVDATA.1

Freq = 4.7995 GHz, Bw = 32.000 MH No calibration applied and no bandpass applied

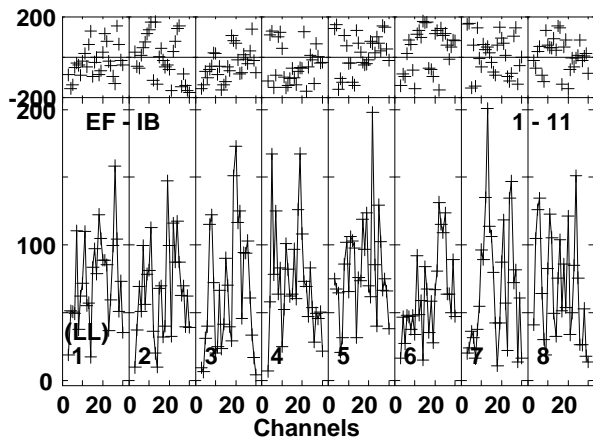
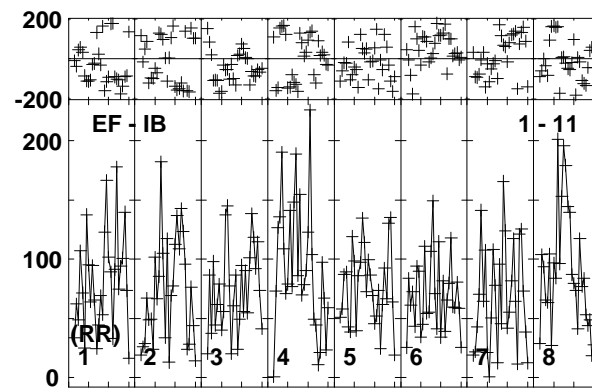
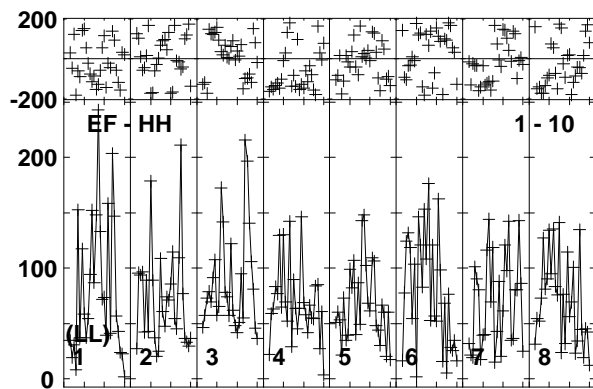
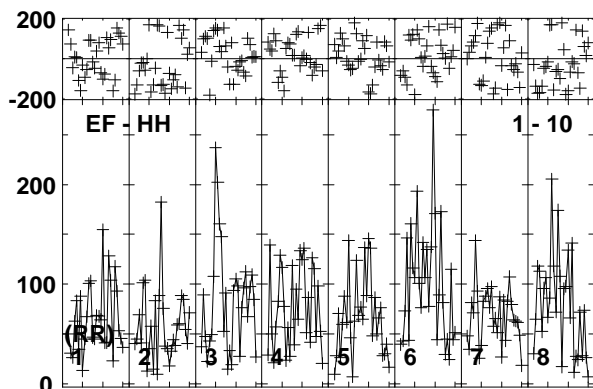
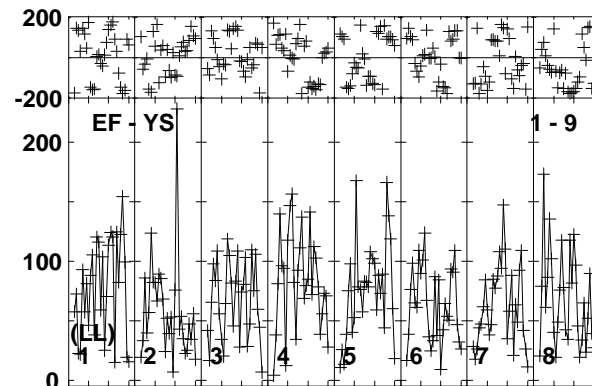
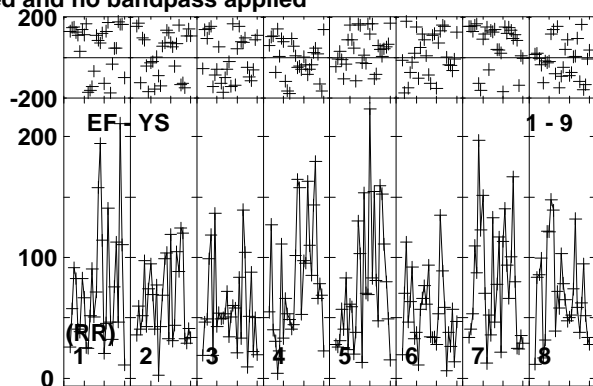
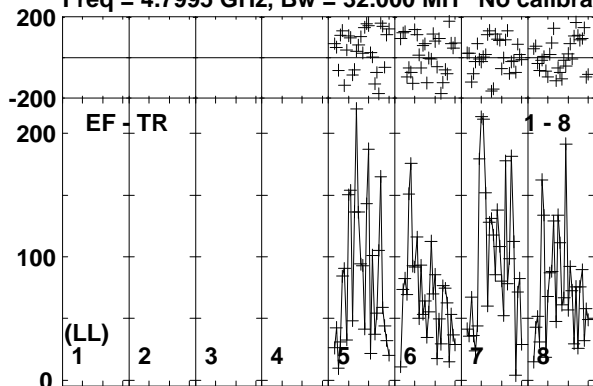

Lower frame: Micro Ampl Jy Top frame: Phas deg
Vector averaged cross-power spectrum Baseline: EF (01) - TR (08)
Timerange: 01/00:12:31 to 01/00:14:59

Plot file version 179 created 20-APR-2018 18:08:05

J1311-2329 RG009B.UVDATA.1

Freq = 4.7995 GHz, Bw = 32.000 MH No calibration applied and no bandpass applied

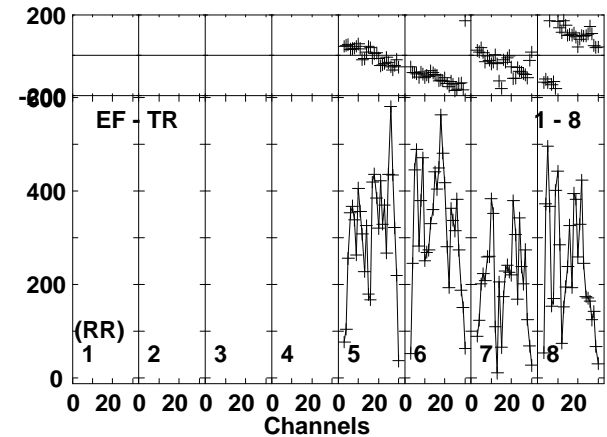
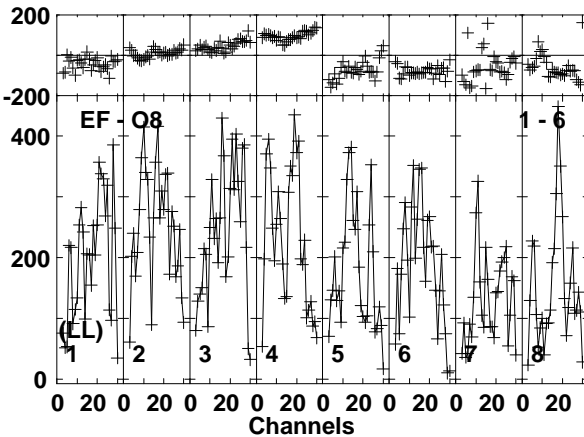
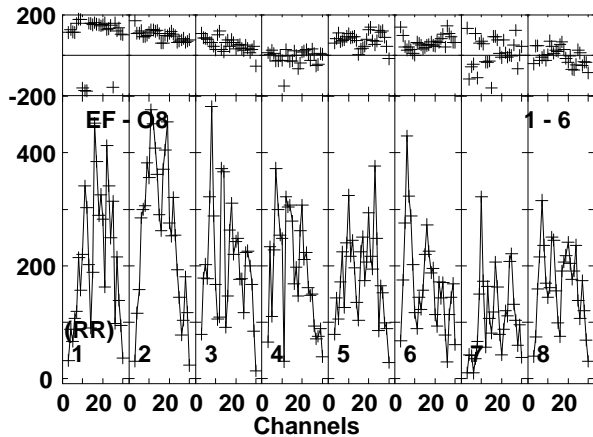
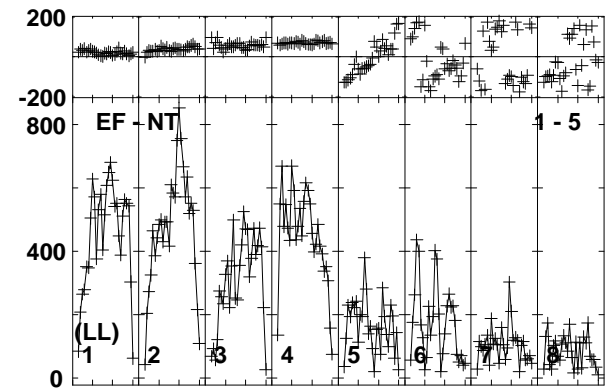
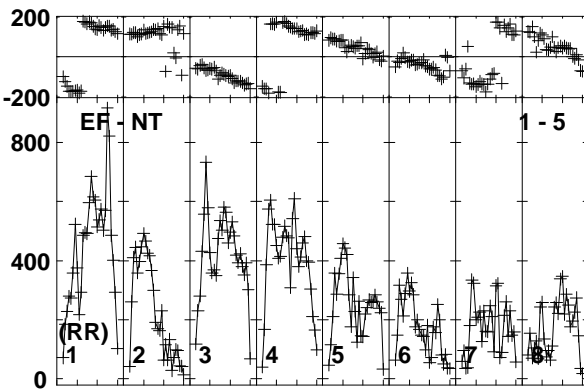
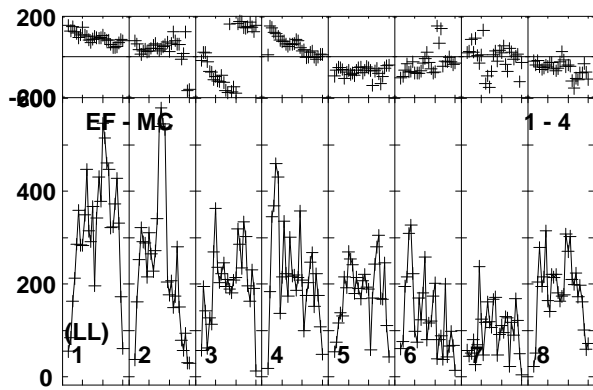
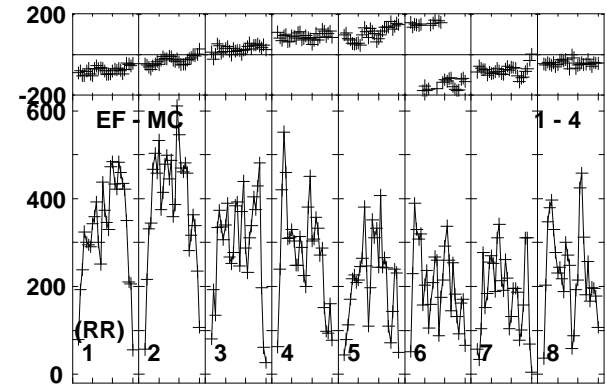
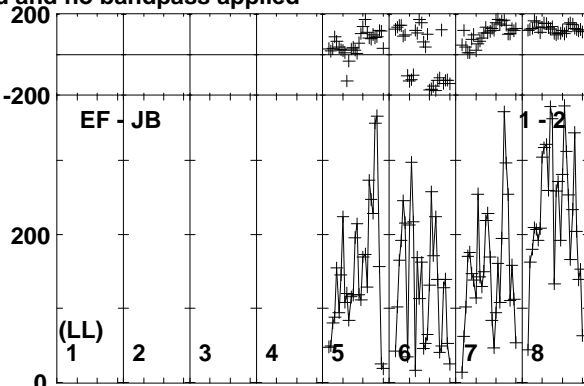
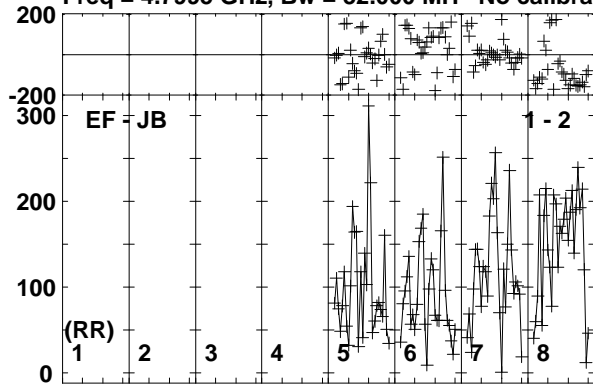

Lower frame: Micro Ampl Jy Top frame: Phas deg
Vector averaged cross-power spectrum Baseline: EF (01) - JB (02)
Timerange: 01/00:15:01 to 01/00:16:29

Plot file version 180 created 20-APR-2018 18:08:05

J1311-2329 RG009B.UVDATA.1

Freq = 4.7995 GHz, Bw = 32.000 MH No calibration applied and no bandpass applied

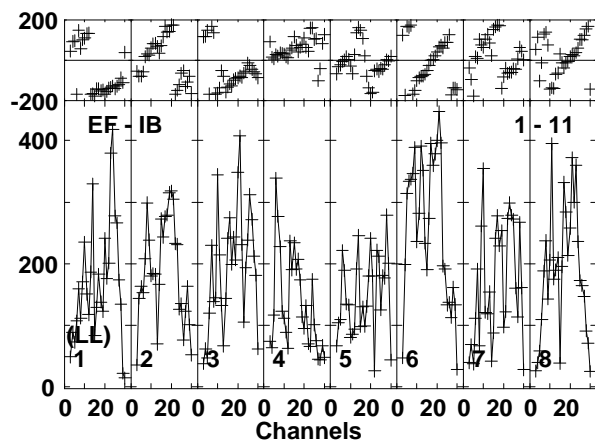
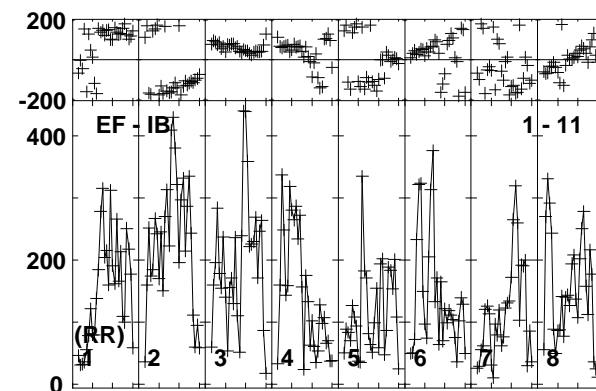
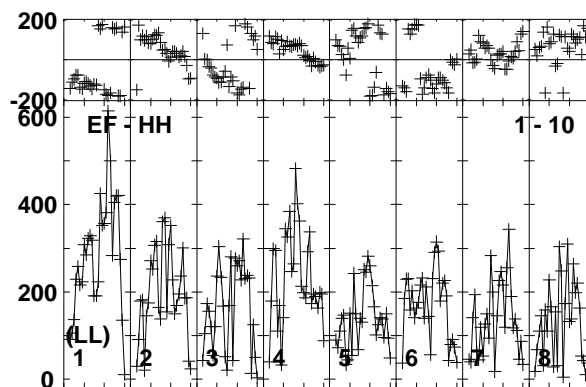
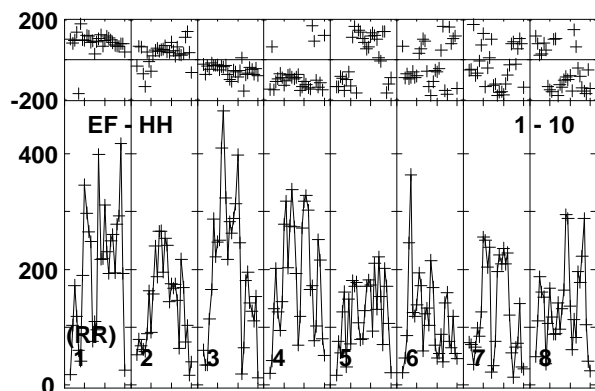
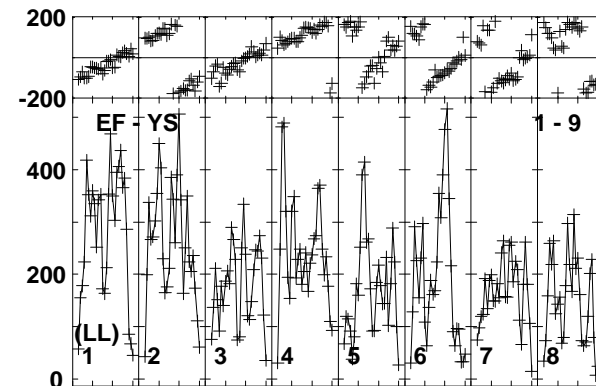
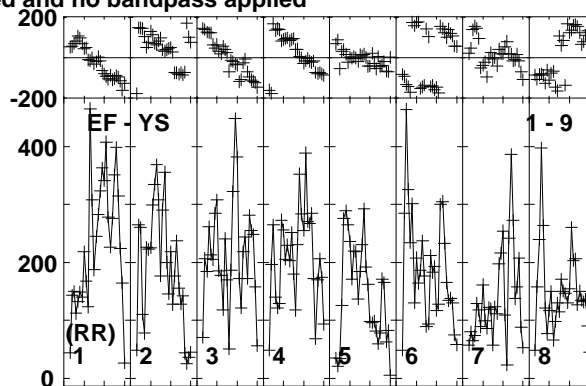
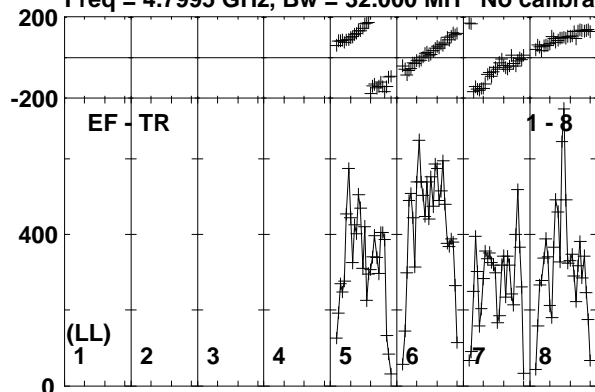

Lower frame: Micro Ampl Jy Top frame: Phas deg
Vector averaged cross-power spectrum Baseline: EF (01) - TR (08)
Timerange: 01/00:15:01 to 01/00:16:29

Plot file version 181 created 20-APR-2018 18:08:05

J1312-2350 RG009B.UVDATA.1

Freq = 4.7995 GHz, Bw = 32.000 MH No calibration applied and no bandpass applied

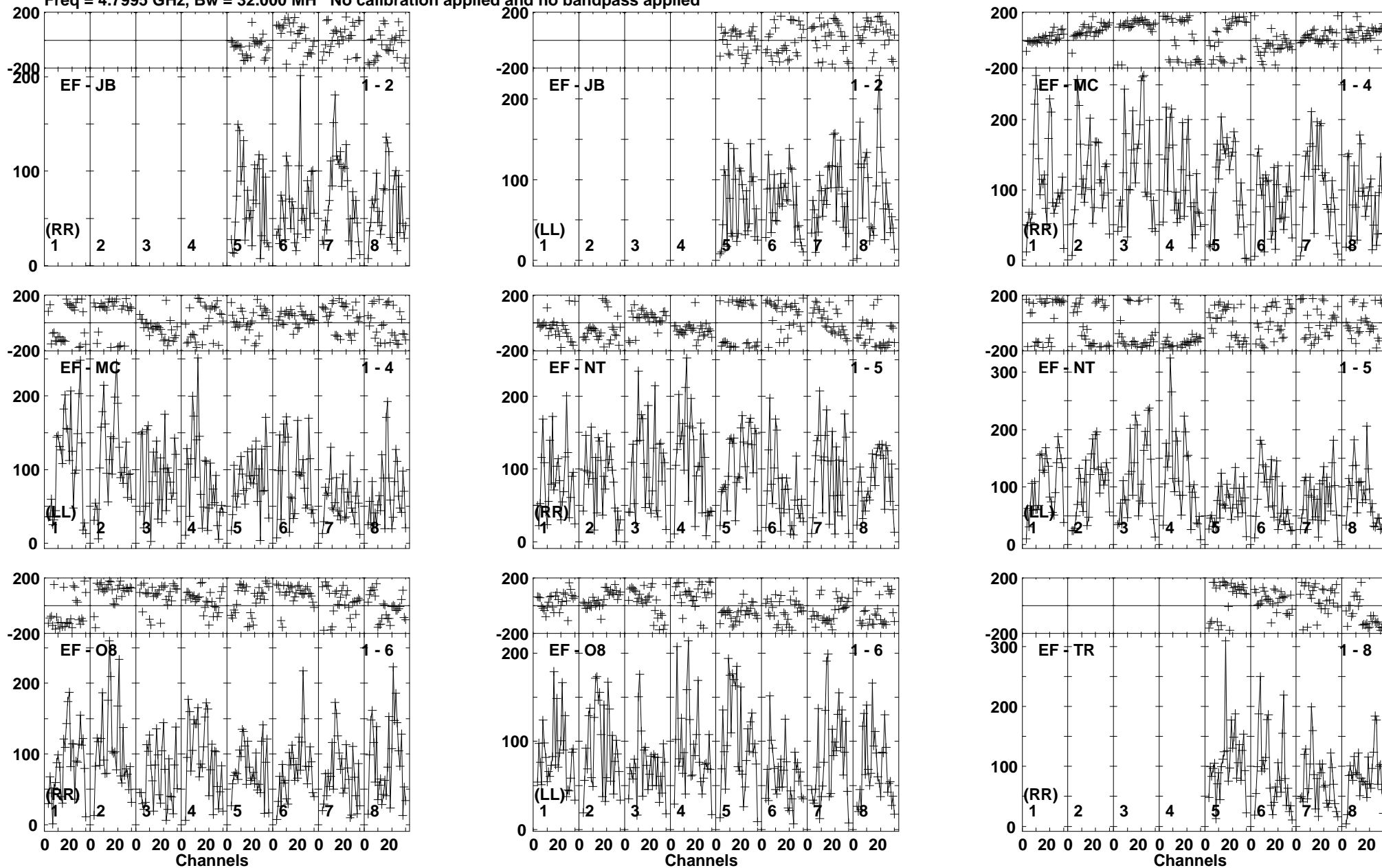

Lower frame: Micro Ampl Jy Top frame: Phas deg
Vector averaged cross-power spectrum Baseline: EF (01) - JB (02)
Timerange: 01/00:16:31 to 01/00:18:59

Plot file version 182 created 20-APR-2018 18:08:05

J1312-2350 RG009B.UVDATA.1

Freq = 4.7995 GHz, Bw = 32.000 MH No calibration applied and no bandpass applied

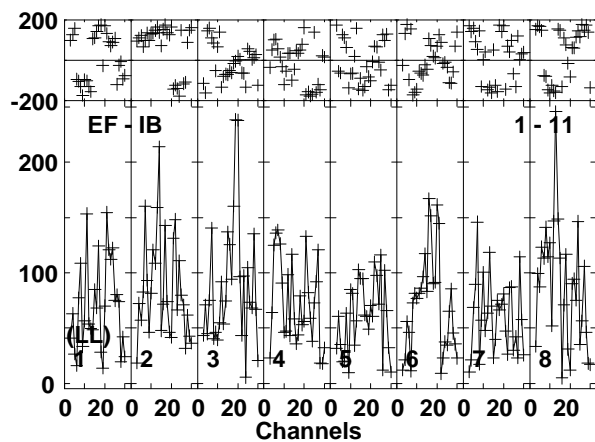
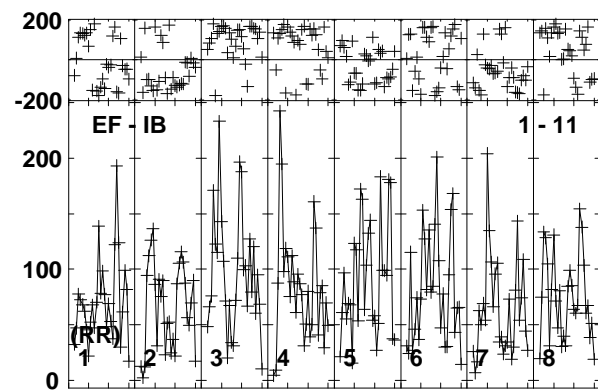
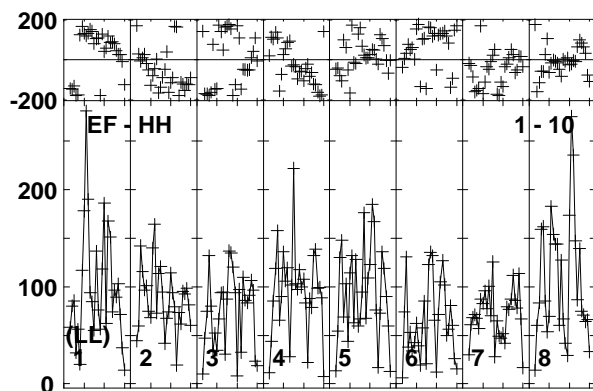
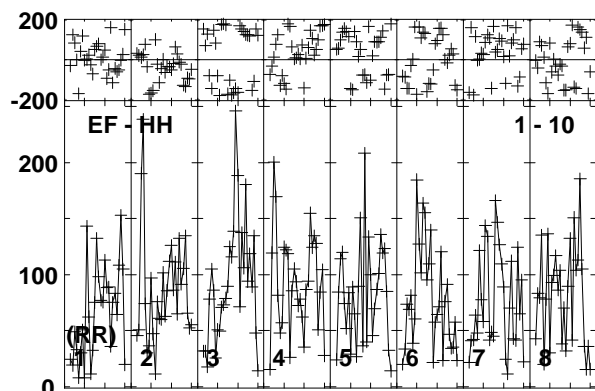
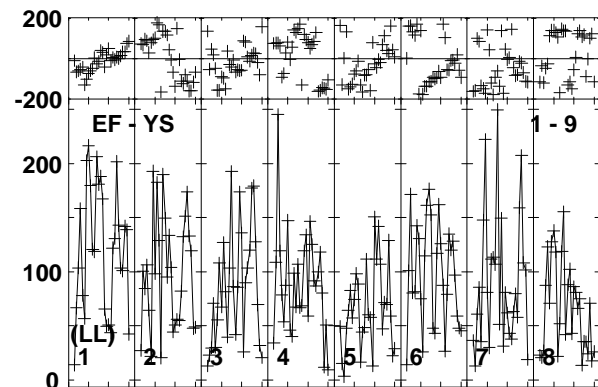
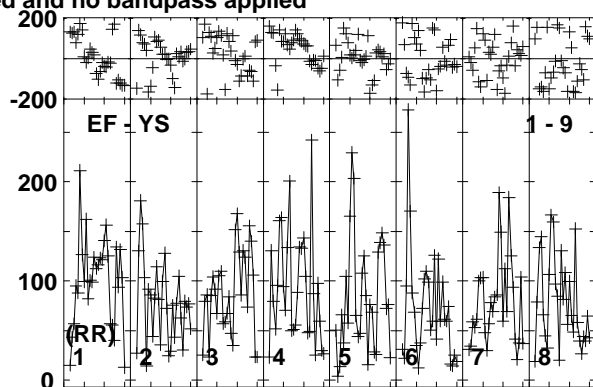
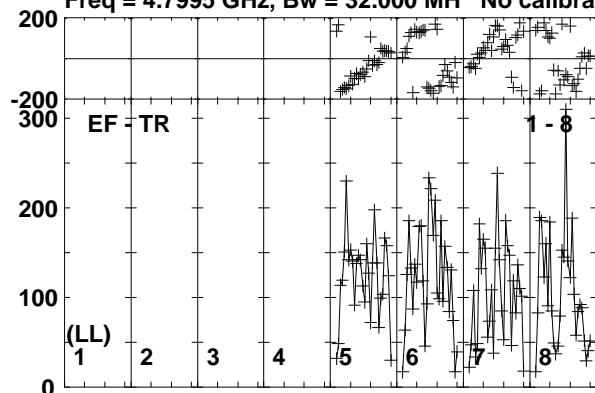

Lower frame: Micro Ampl Jy Top frame: Phas deg
Vector averaged cross-power spectrum Baseline: EF (01) - TR (08)
Timerange: 01/00:16:31 to 01/00:18:59

Plot file version 183 created 20-APR-2018 18:08:05

J1311-2329 RG009B.UVDATA.1

Freq = 4.7995 GHz, Bw = 32.000 MH No calibration applied and no bandpass applied

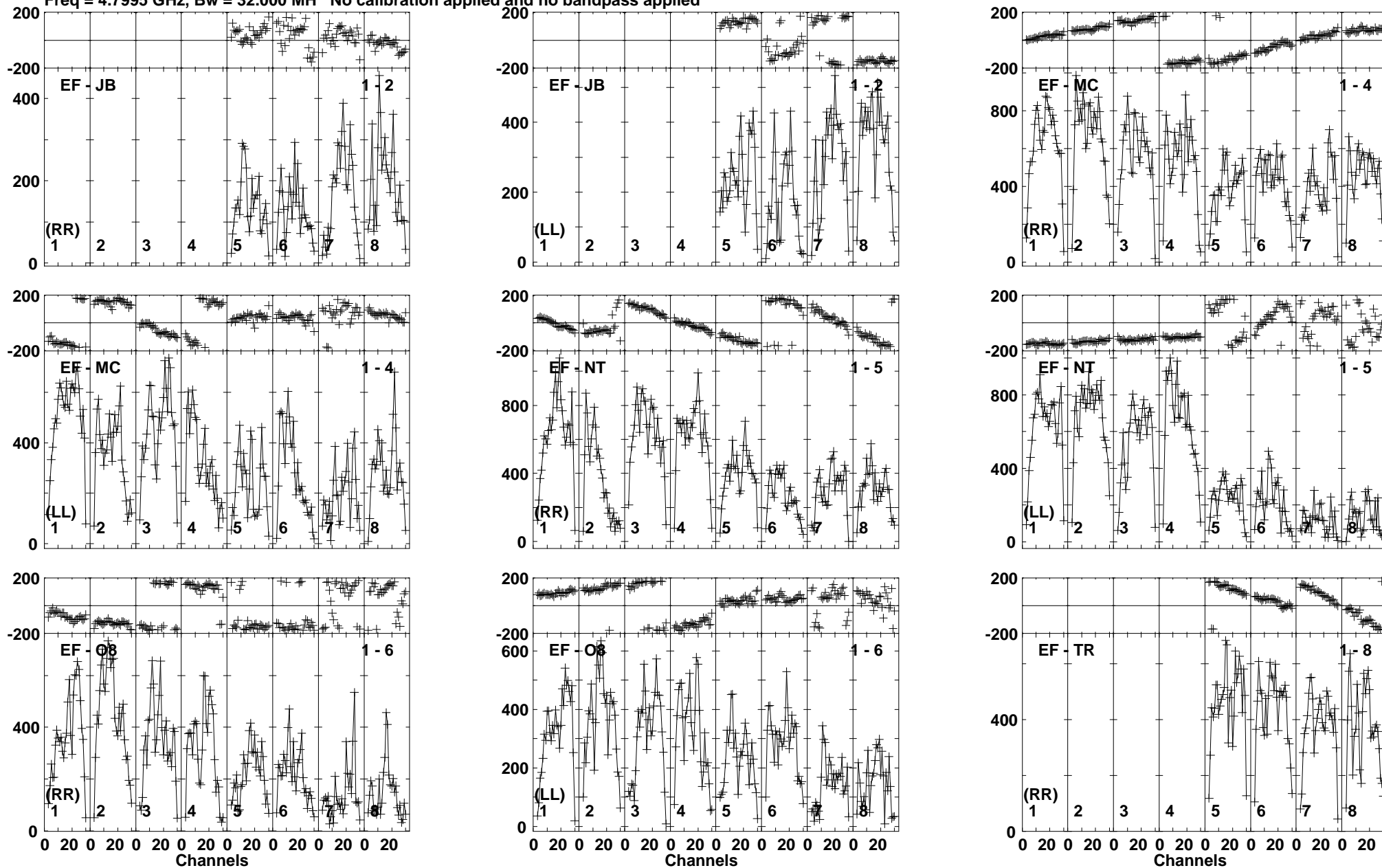

Lower frame: Micro Ampl Jy Top frame: Phas deg
Vector averaged cross-power spectrum Baseline: EF (01) - JB (02)
Timerange: 01/00:19:01 to 01/00:20:29

Plot file version 184 created 20-APR-2018 18:08:06

J1311-2329 RG009B.UVDATA.1

Freq = 4.7995 GHz, Bw = 32.000 MH No calibration applied and no bandpass applied

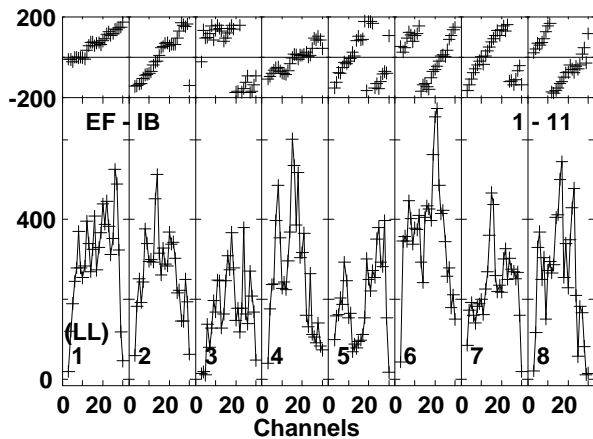
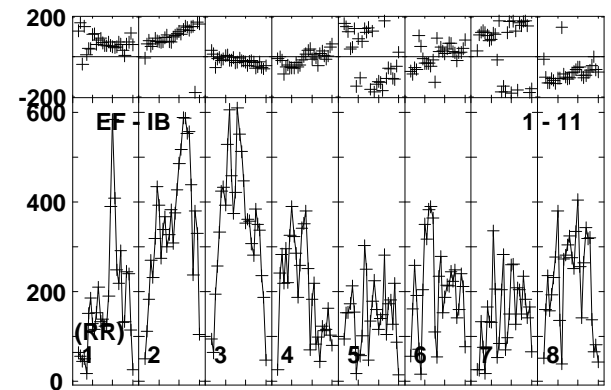
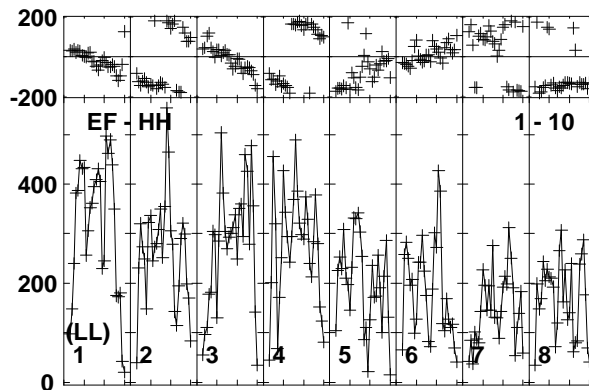
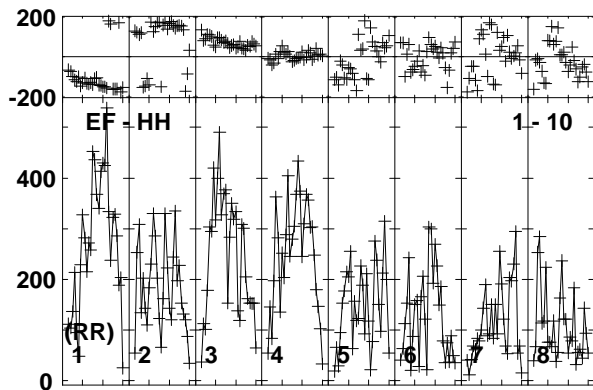
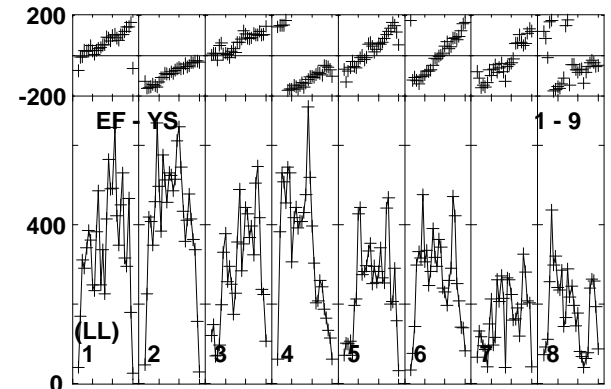
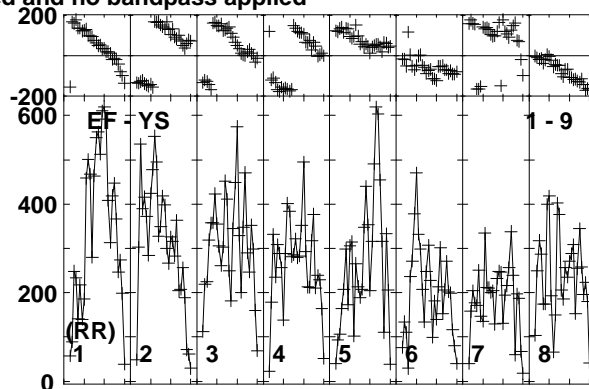
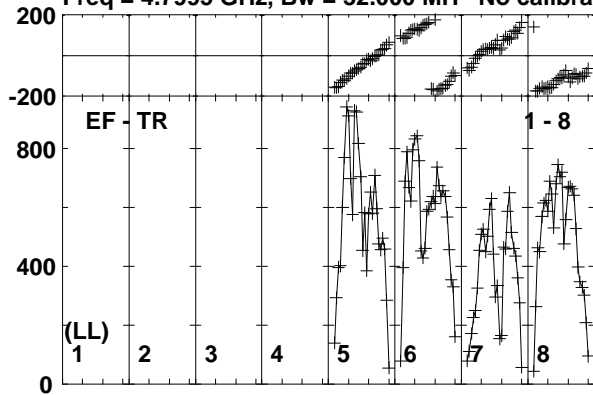

Lower frame: Micro Ampl Jy Top frame: Phas deg
Vector averaged cross-power spectrum Baseline: EF (01) - TR (08)
Timerange: 01/00:19:01 to 01/00:20:29

Plot file version 185 created 20-APR-2018 18:08:06

J1303-2405 RG009B.UVDATA.1

Freq = 4.7995 GHz, Bw = 32.000 MH No calibration applied and no bandpass applied

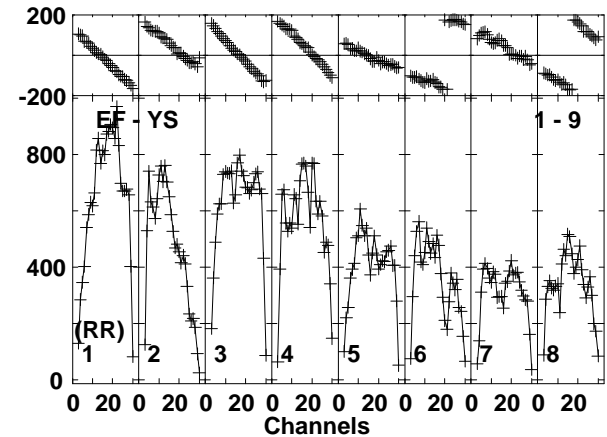
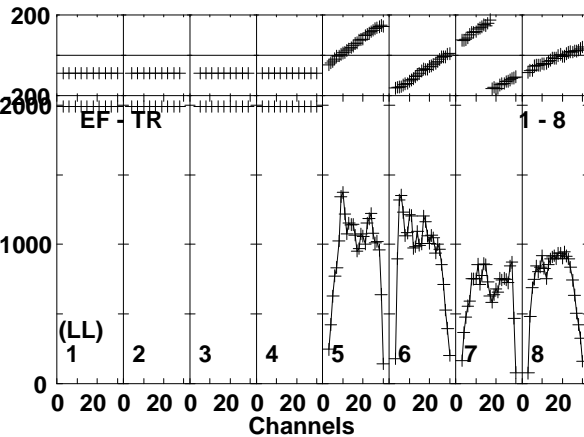
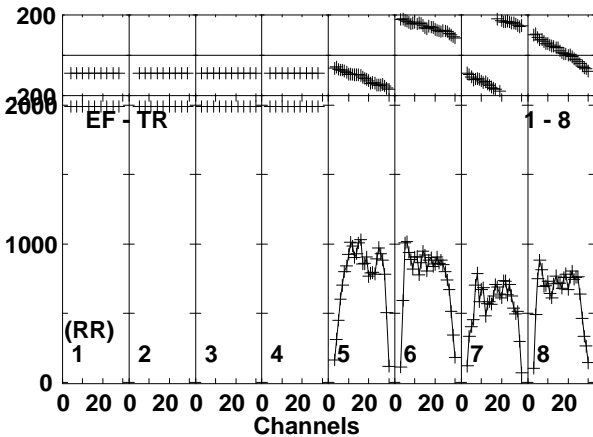
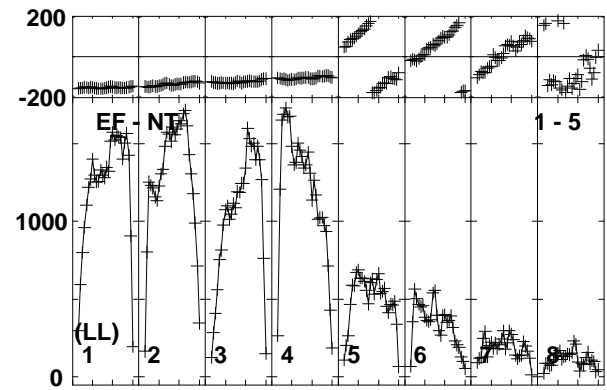
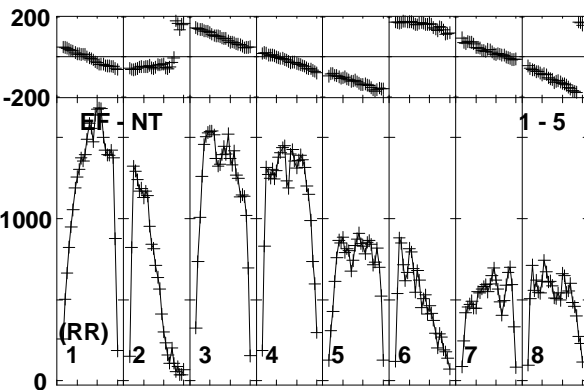
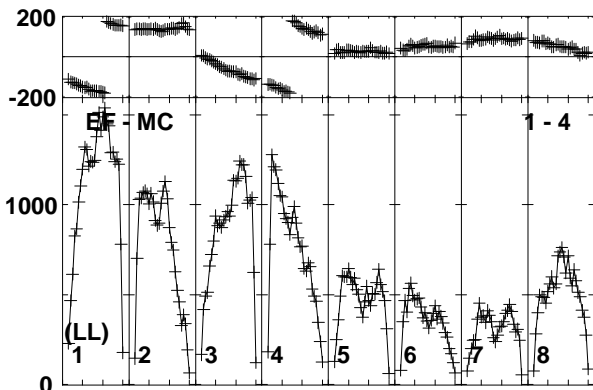
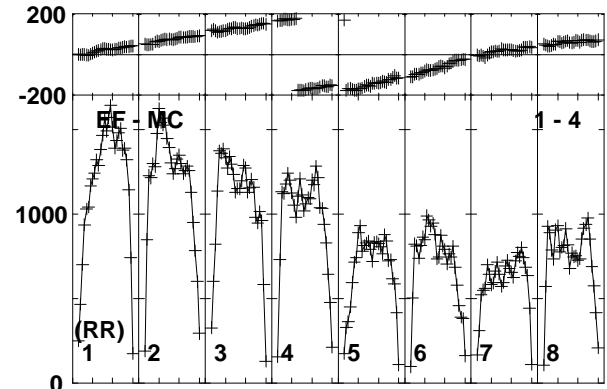
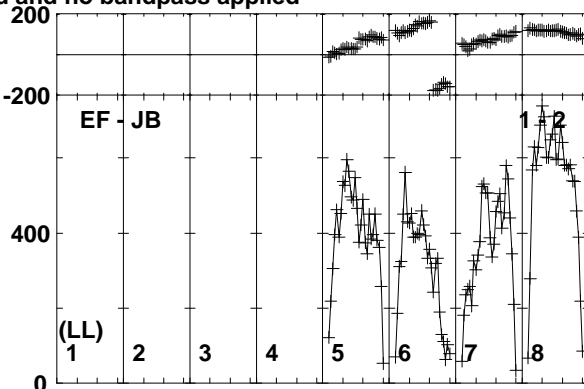
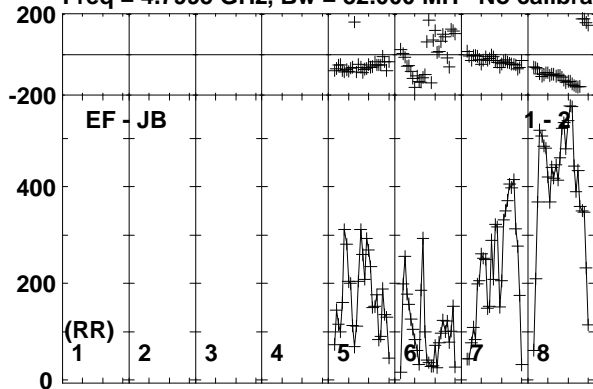

Lower frame: Micro Ampl Jy Top frame: Phas deg
Vector averaged cross-power spectrum Baseline: EF (01) - JB (02)
Timerange: 01/00:20:31 to 01/00:22:59

Plot file version 186 created 20-APR-2018 18:08:06

J1303-2405 RG009B.UVDATA.1

Freq = 4.7995 GHz, Bw = 32.000 MH No calibration applied and no bandpass applied

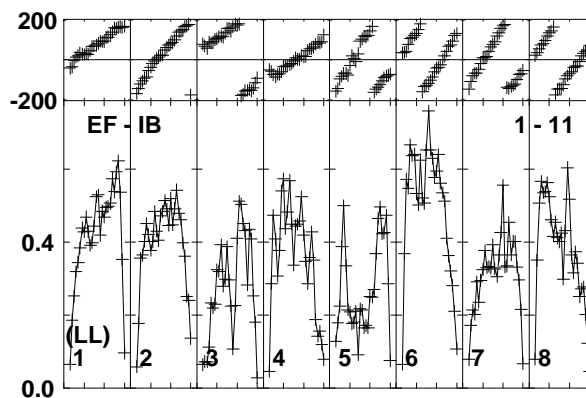
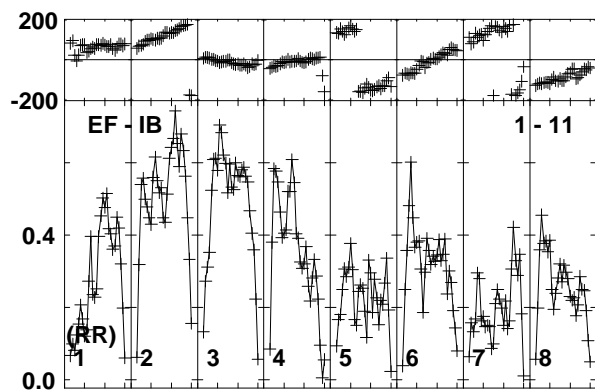
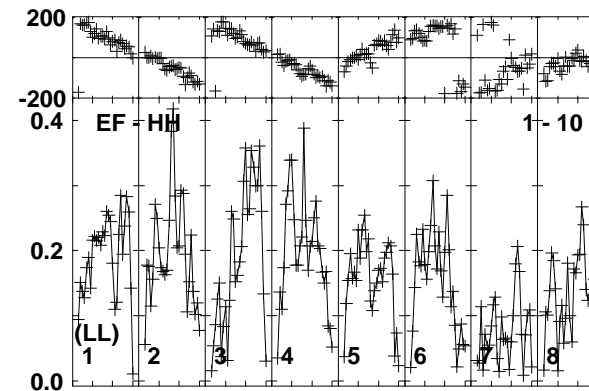
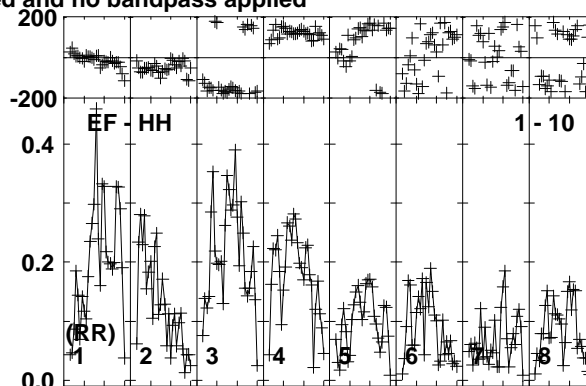
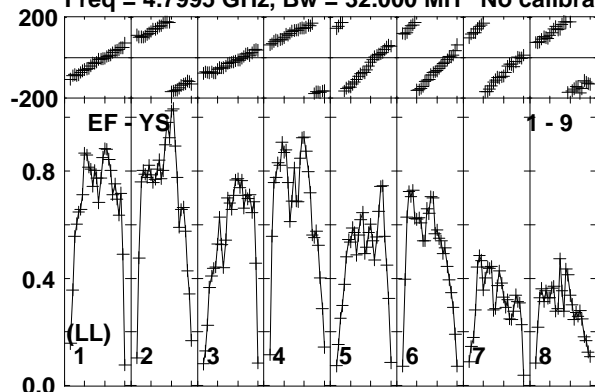

Lower frame: Milli Ampl Jy Top frame: Phas deg
Vector averaged cross-power spectrum Baseline: EF (01) - YS (09)
Timerange: 01/00:20:31 to 01/00:22:59

Plot file version 187 created 20-APR-2018 18:08:06

J1311-2329 RG009B.UVDATA.1

Freq = 4.7995 GHz, Bw = 32.000 MH No calibration applied and no bandpass applied

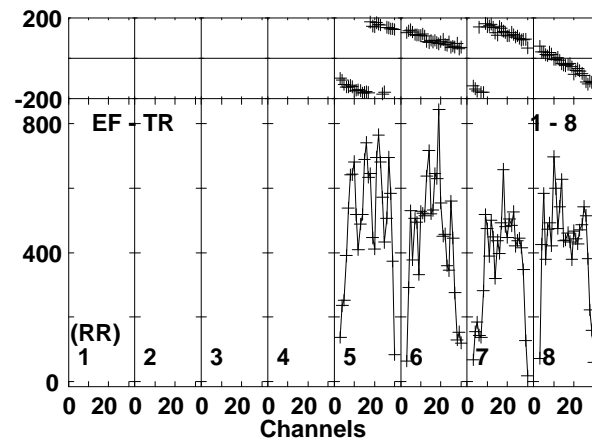
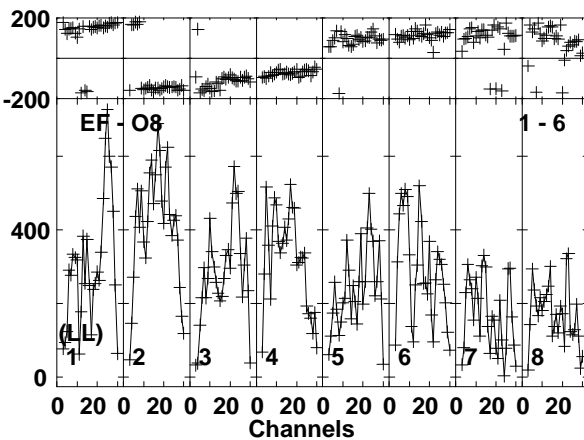
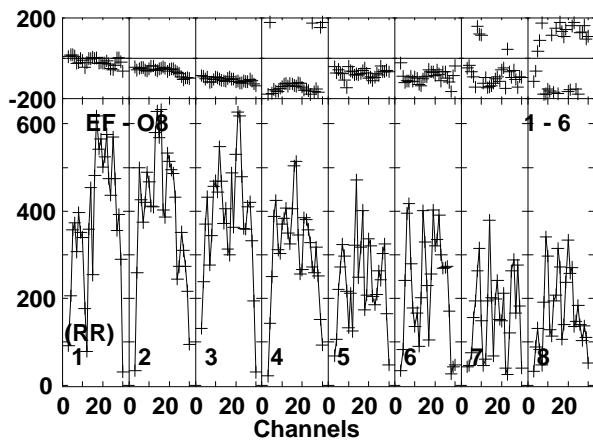
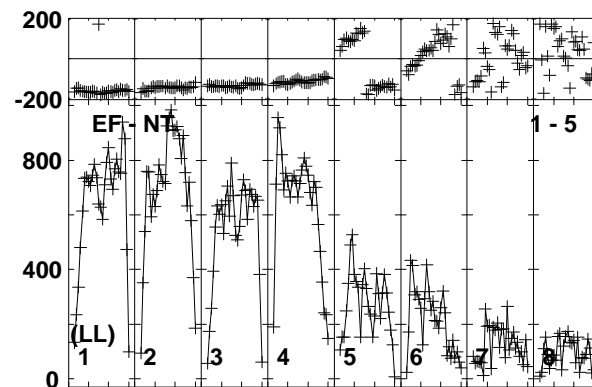
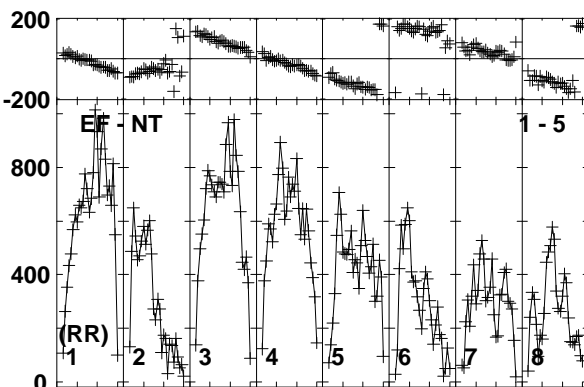
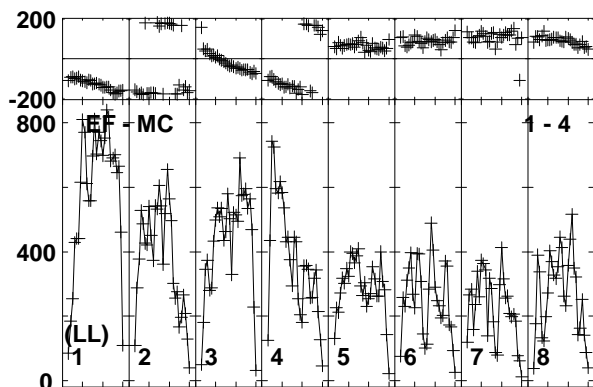
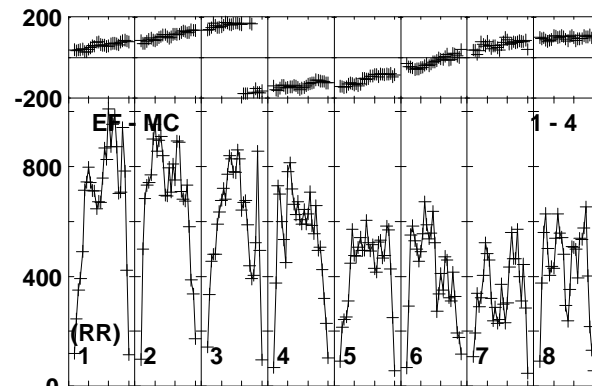
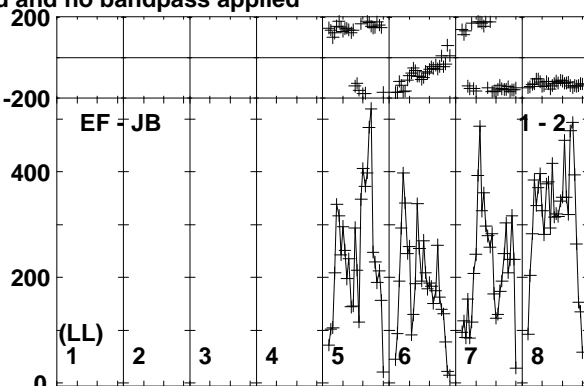
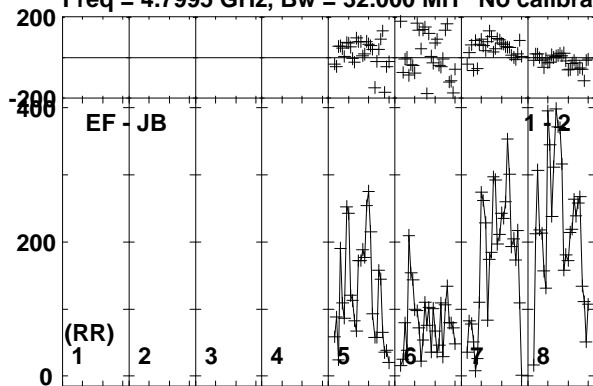

Lower frame: Micro Ampl Jy Top frame: Phas deg
Vector averaged cross-power spectrum Baseline: EF (01) - JB (02)
Timerange: 01/00:23:41 to 01/00:24:39

Plot file version 188 created 20-APR-2018 18:08:06

J1311-2329 RG009B.UVDATA.1

Freq = 4.7995 GHz, Bw = 32.000 MH No calibration applied and no bandpass applied

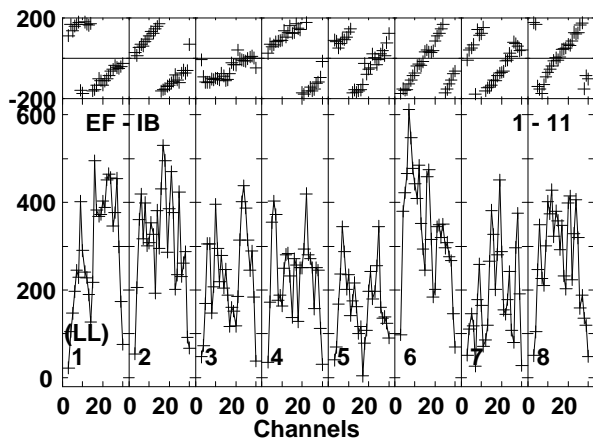
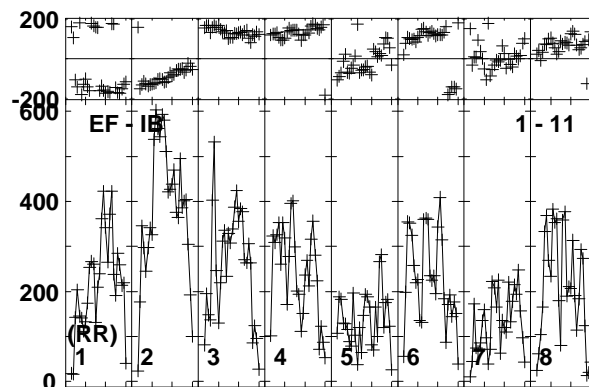
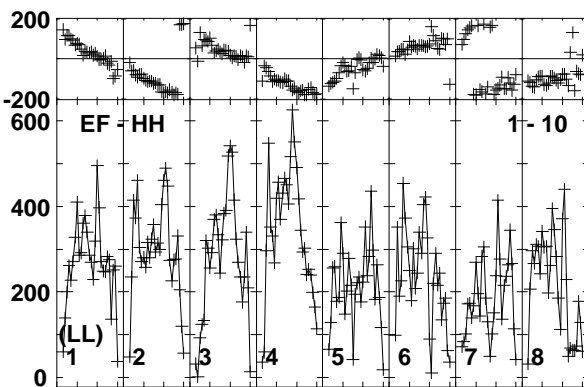
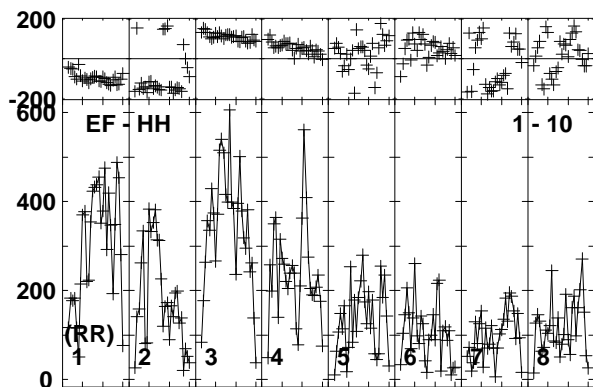
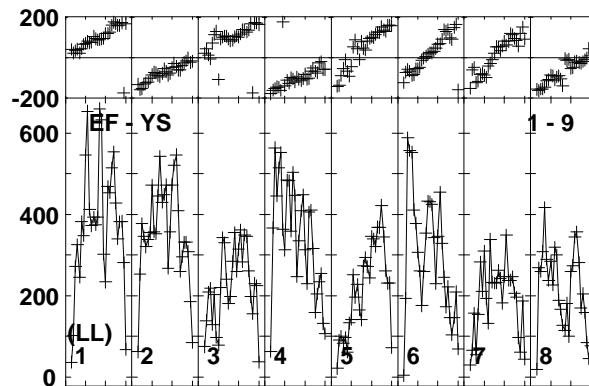
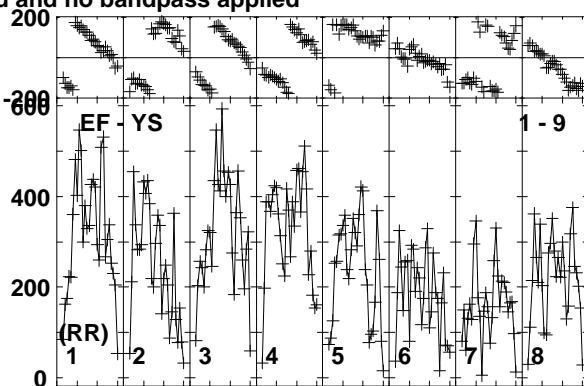
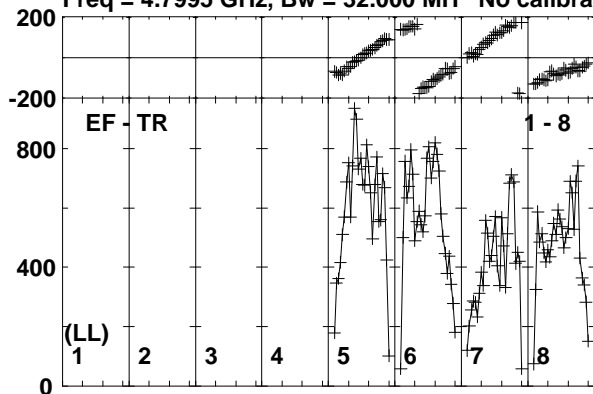

Lower frame: Micro Ampl Jy Top frame: Phas deg
Vector averaged cross-power spectrum Baseline: EF (01) - TR (08)
Timerange: 01/00:23:41 to 01/00:24:39

Plot file version 189 created 20-APR-2018 18:08:06

EM170817 RG009B.UVDATA.1

Freq = 4.7995 GHz, Bw = 32.000 MH No calibration applied and no bandpass applied

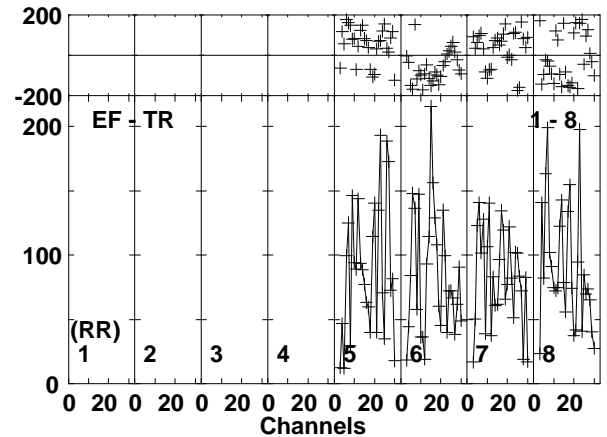
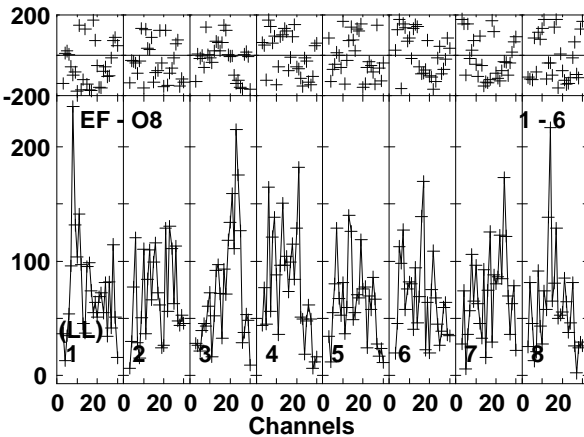
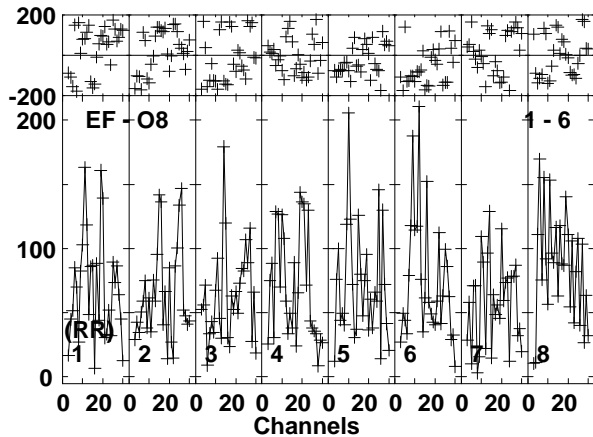
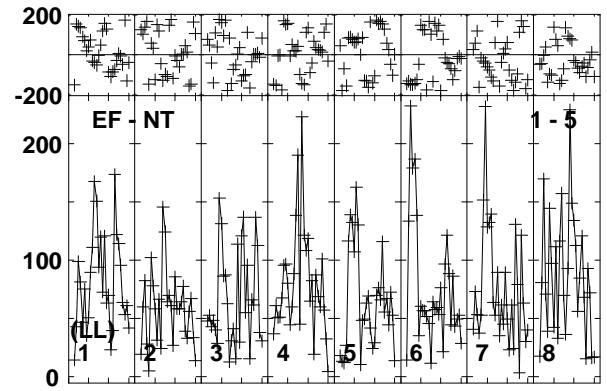
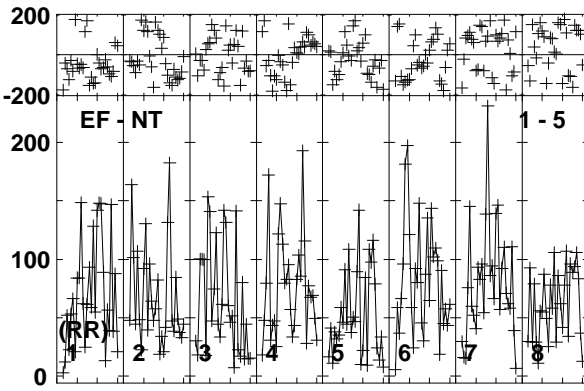
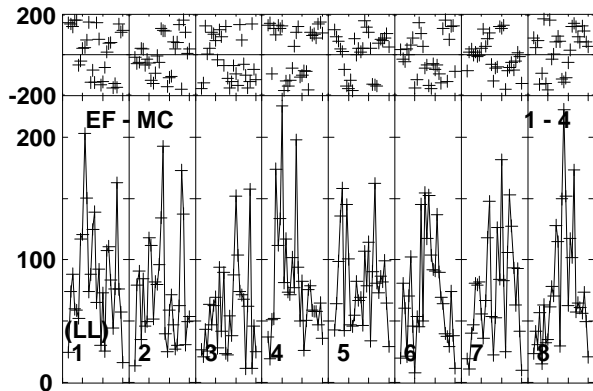
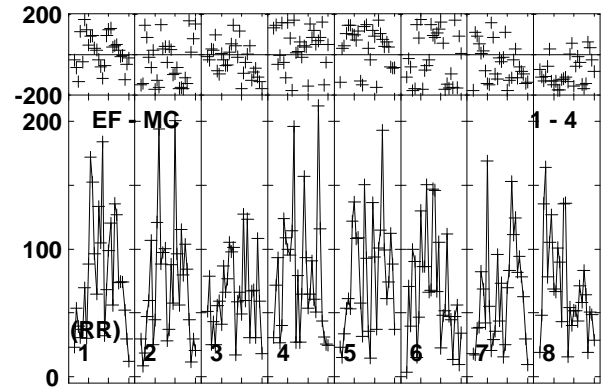
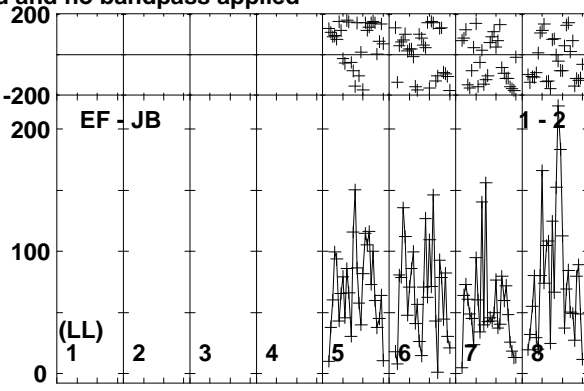
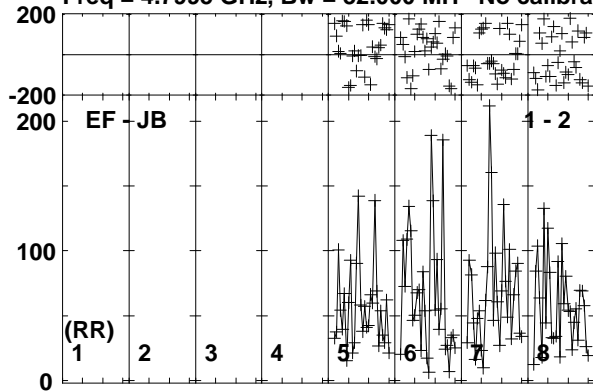

Lower frame: Micro Ampl Jy Top frame: Phas deg
Vector averaged cross-power spectrum Baseline: EF (01) - JB (02)
Timerange: 01/00:24:41 to 01/00:27:09

Plot file version 190 created 20-APR-2018 18:08:06

EM170817 RG009B.UVDATA.1

Freq = 4.7995 GHz, Bw = 32.000 MH No calibration applied and no bandpass applied

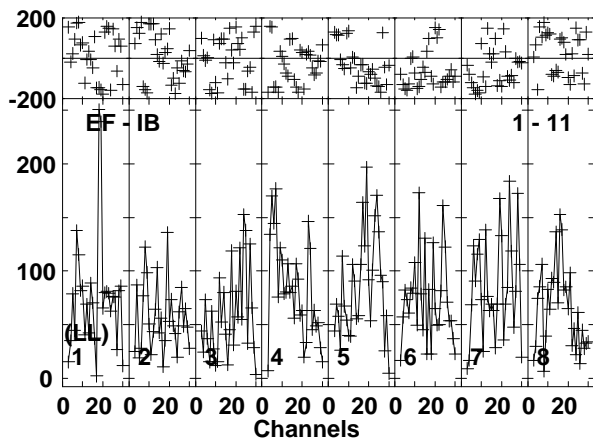
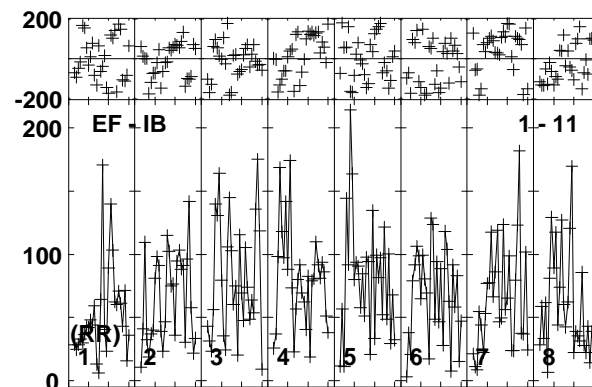
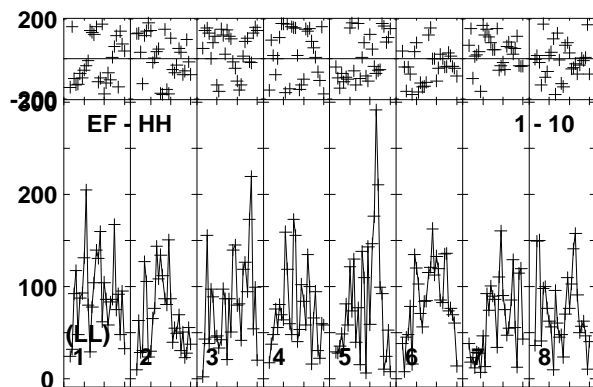
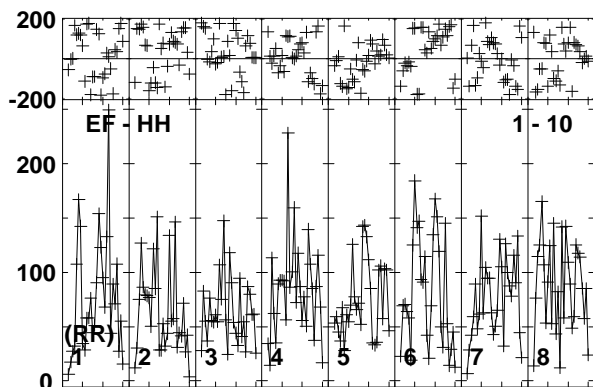
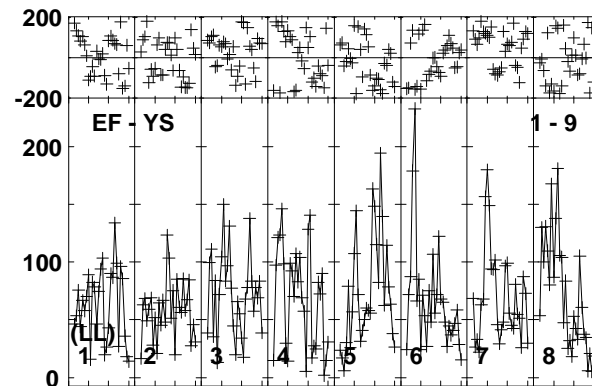
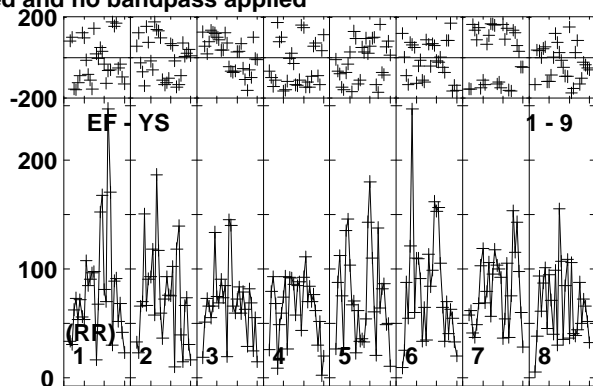
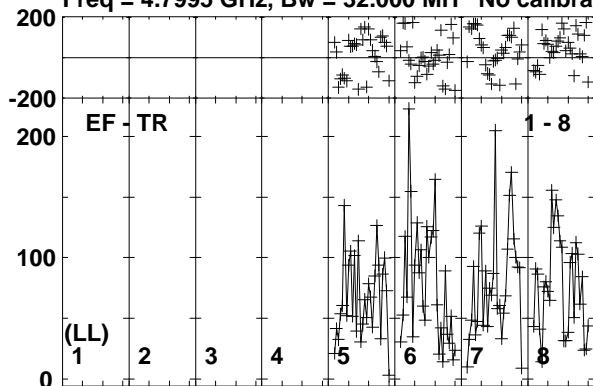

Lower frame: Micro Ampl Jy Top frame: Phas deg
Vector averaged cross-power spectrum Baseline: EF (01) - TR (08)
Timerange: 01/00:24:41 to 01/00:27:09

Plot file version 191 created 20-APR-2018 18:08:06

J1311-2329 RG009B.UVDATA.1

Freq = 4.7995 GHz, Bw = 32.000 MH No calibration applied and no bandpass applied

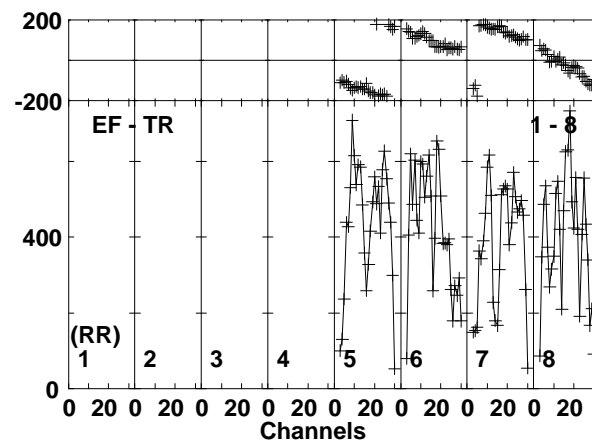
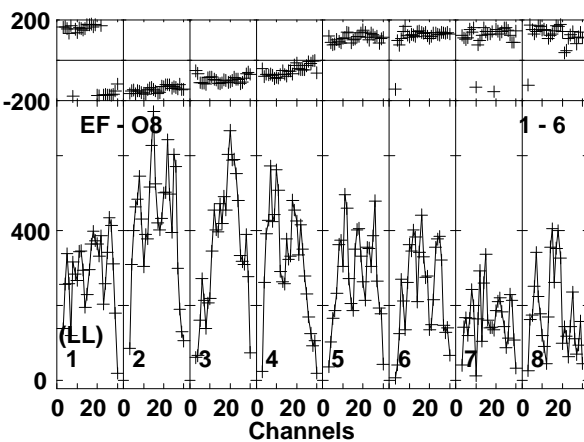
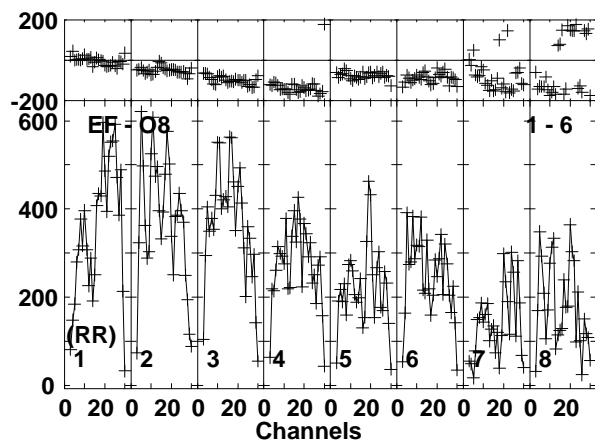
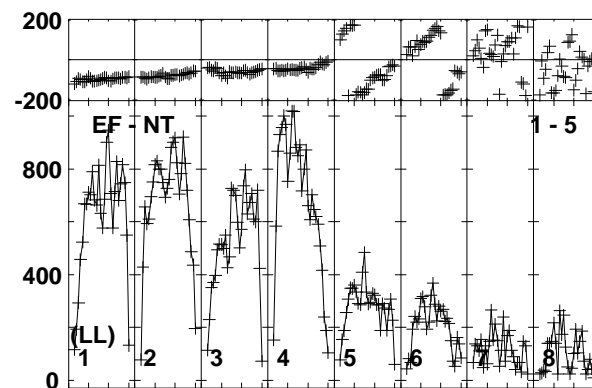
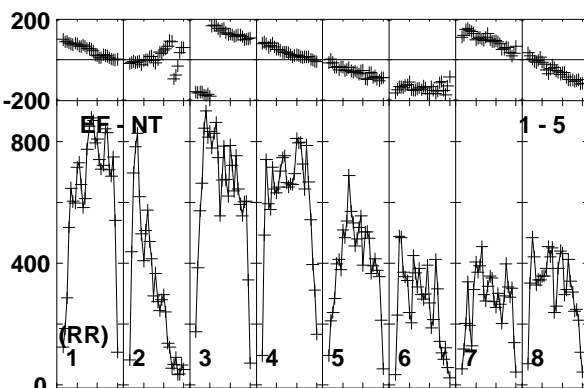
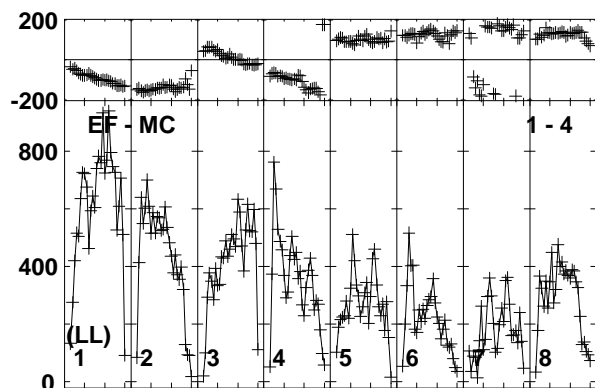
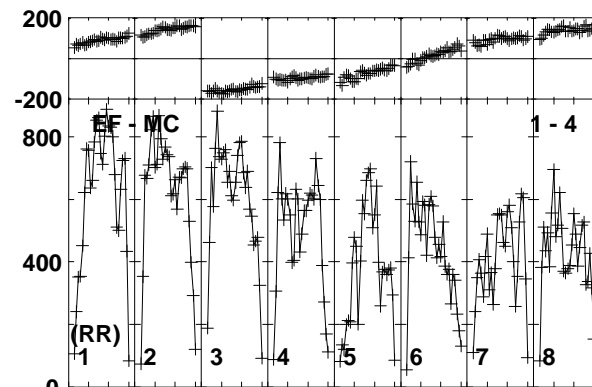
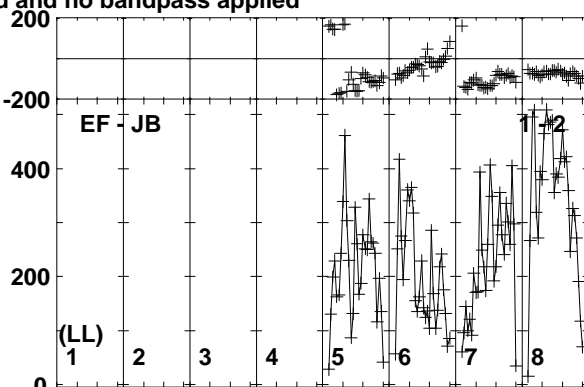
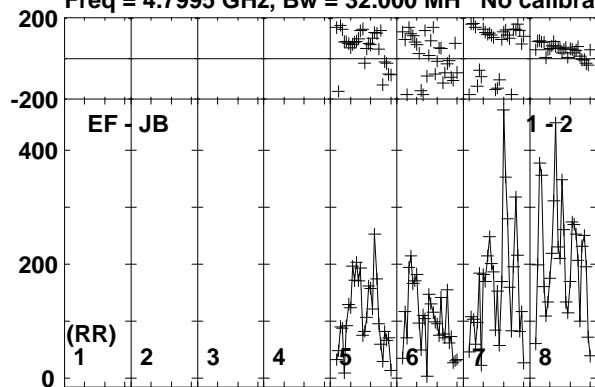

Lower frame: Micro Ampl Jy Top frame: Phas deg
Vector averaged cross-power spectrum Baseline: EF (01) - JB (02)
Timerange: 01/00:27:11 to 01/00:28:39

Plot file version 192 created 20-APR-2018 18:08:06

J1311-2329 RG009B.UVDATA.1

Freq = 4.7995 GHz, Bw = 32.000 MH No calibration applied and no bandpass applied

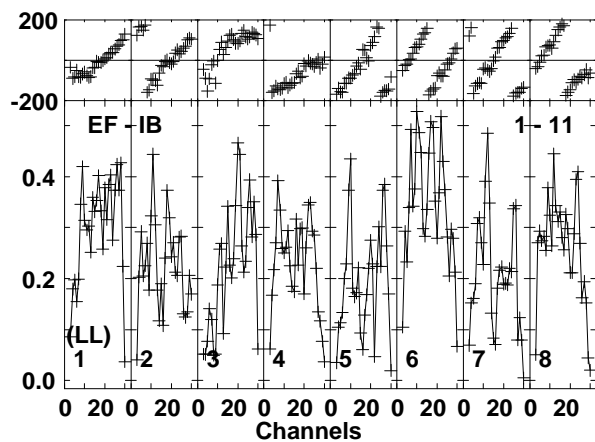
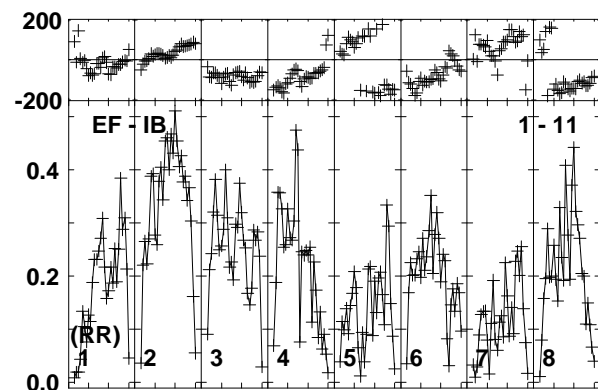
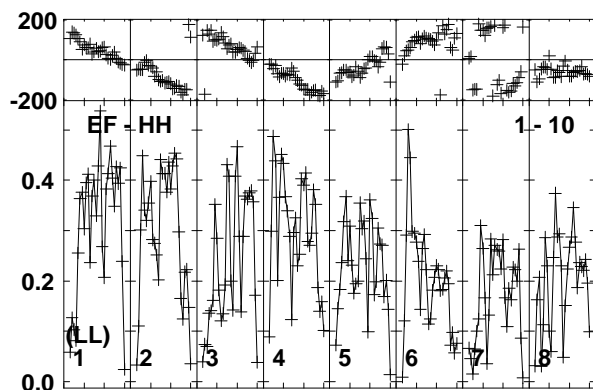
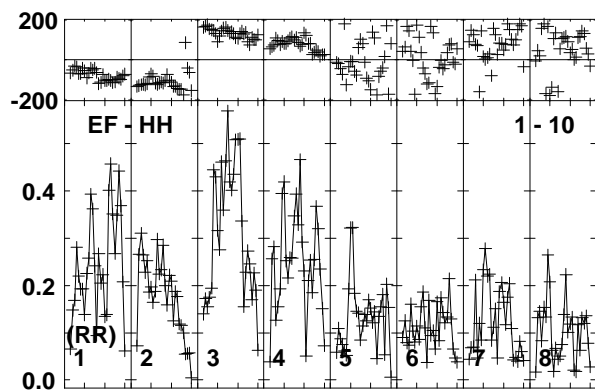
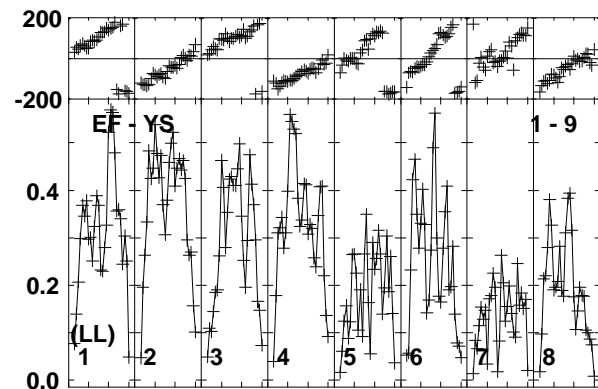
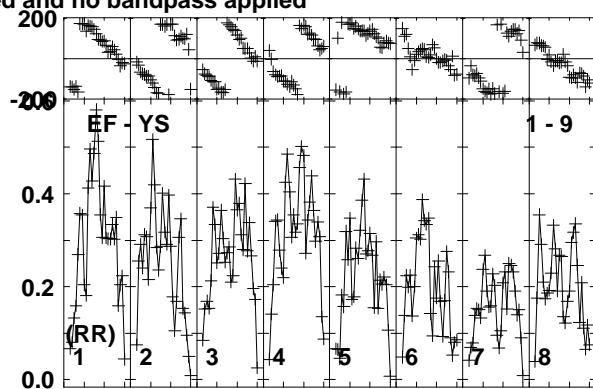
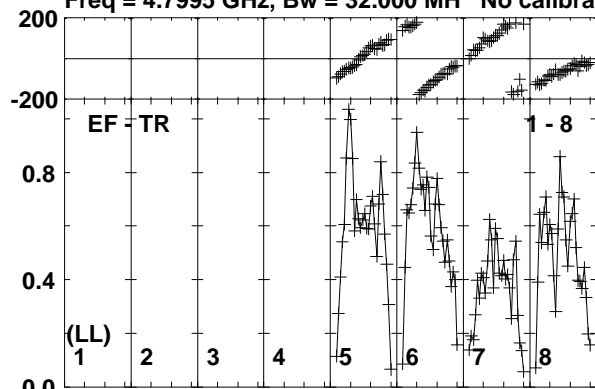

Lower frame: Milli Ampl Jy Top frame: Phas deg
Vector averaged cross-power spectrum Baseline: EF (01) - TR (08)
Timerange: 01/00:27:11 to 01/00:28:39

Plot file version 193 created 20-APR-2018 18:08:06

EM170817 RG009B.UVDATA.1

Freq = 4.7995 GHz, Bw = 32.000 MH No calibration applied and no bandpass applied

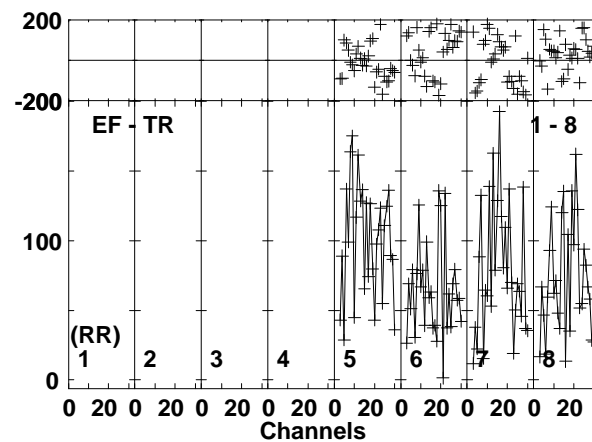
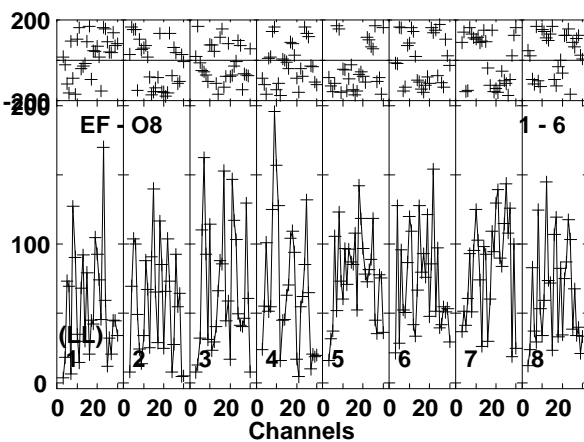
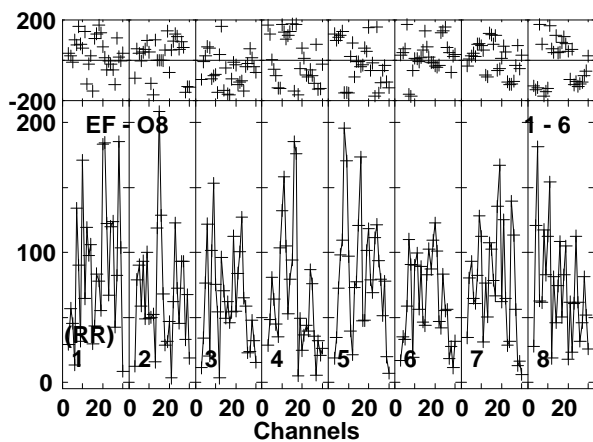
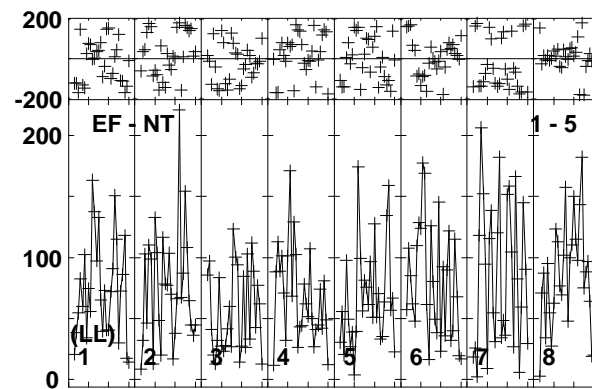
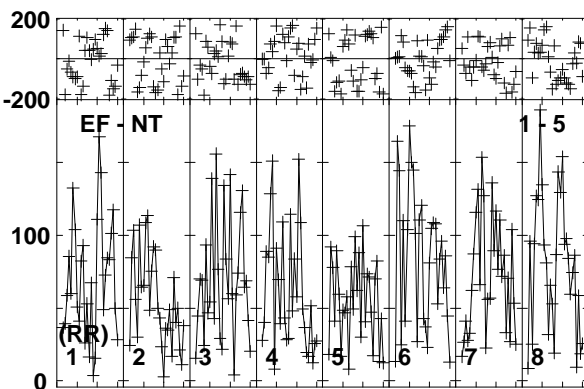
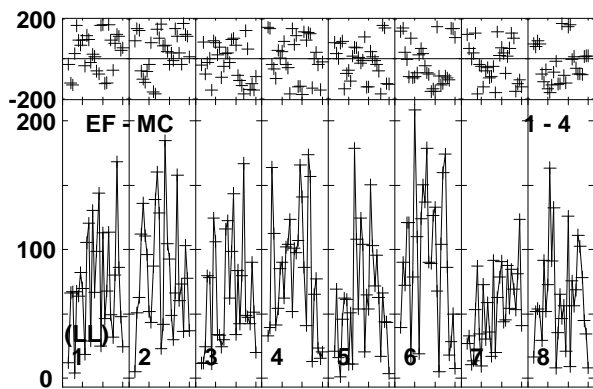
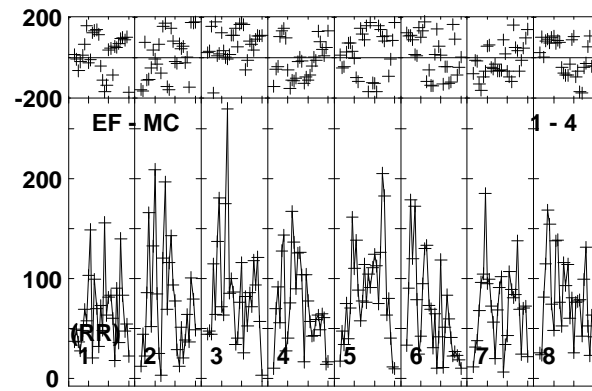
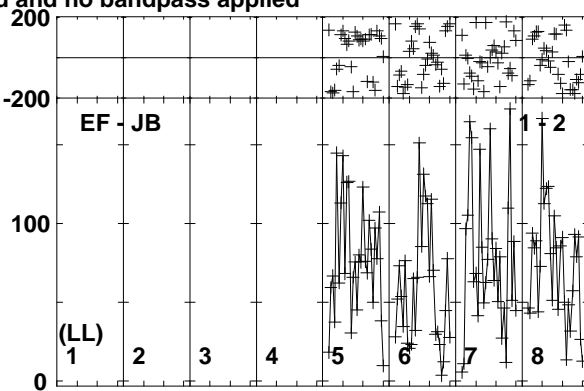
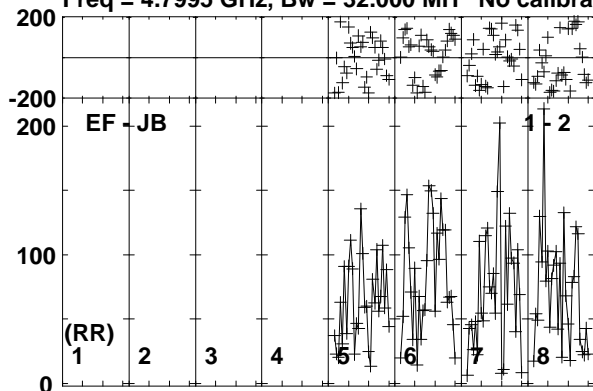

Lower frame: Micro Ampl Jy Top frame: Phas deg
Vector averaged cross-power spectrum Baseline: EF (01) - JB (02)
Timerange: 01/00:28:41 to 01/00:31:09

Plot file version 194 created 20-APR-2018 18:08:06

EM170817 RG009B.UVDATA.1

Freq = 4.7995 GHz, Bw = 32.000 MH No calibration applied and no bandpass applied

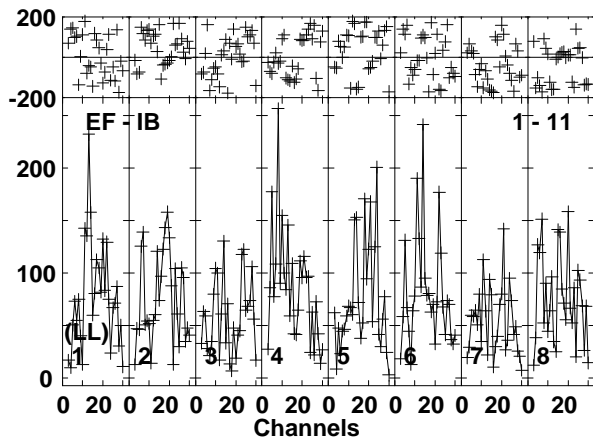
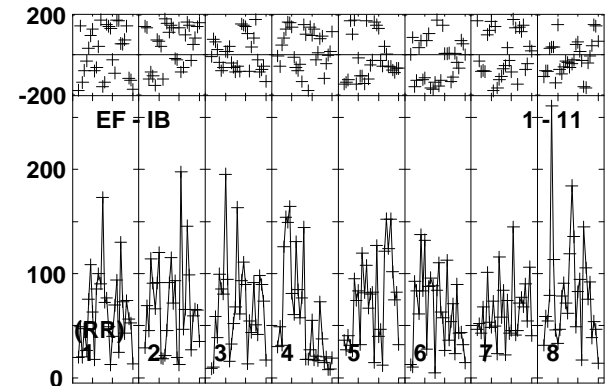
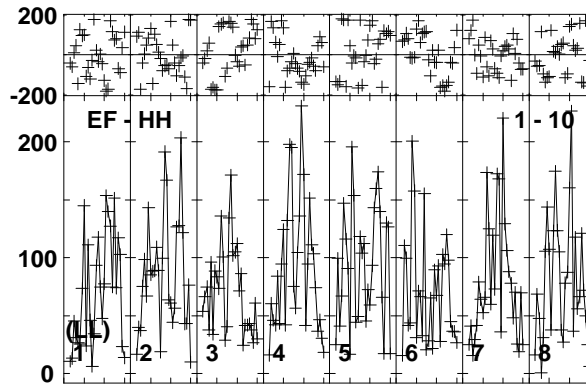
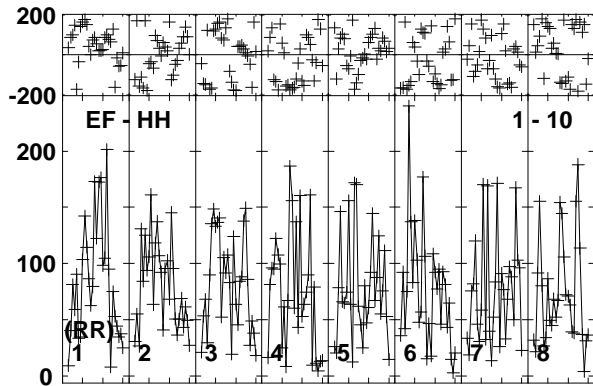
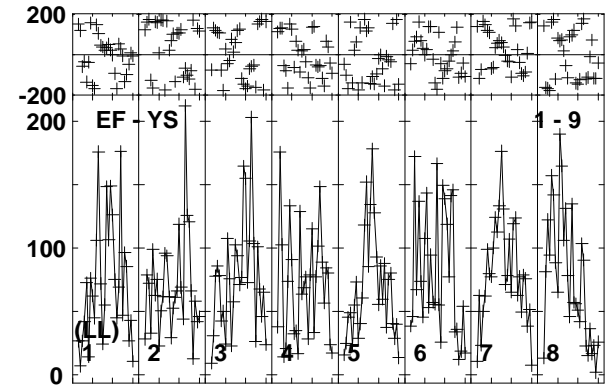
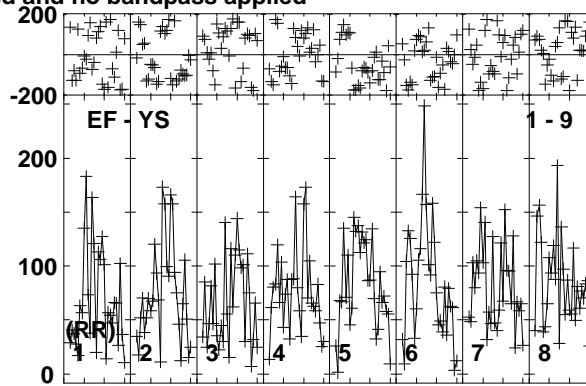
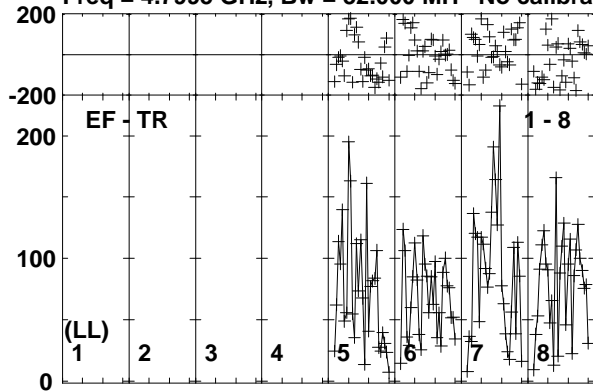

Lower frame: Micro Ampl Jy Top frame: Phas deg
Vector averaged cross-power spectrum Baseline: EF (01) - TR (08)
Timerange: 01/00:28:41 to 01/00:31:09

Plot file version 195 created 20-APR-2018 18:08:06

J1311-2329 RG009B.UVDATA.1

Freq = 4.7995 GHz, Bw = 32.000 MH No calibration applied and no bandpass applied

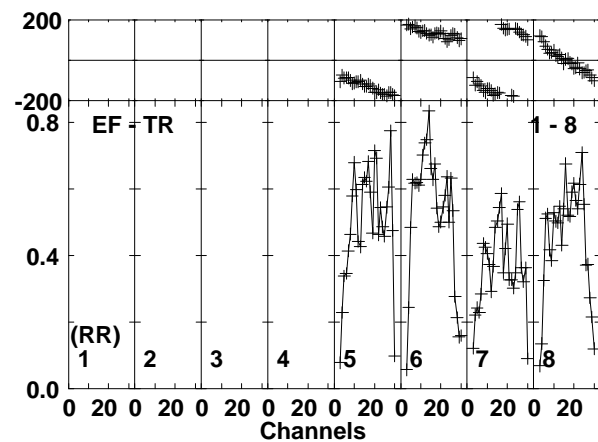
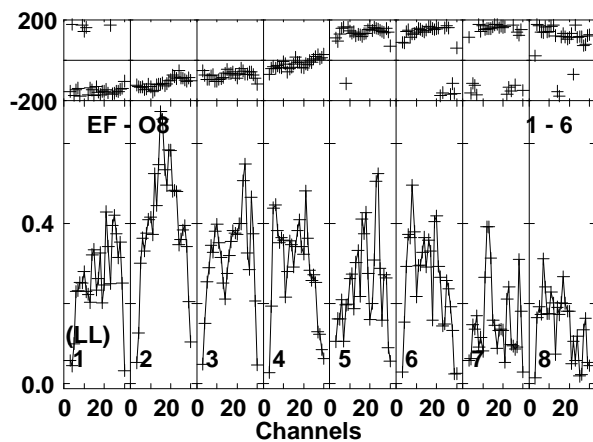
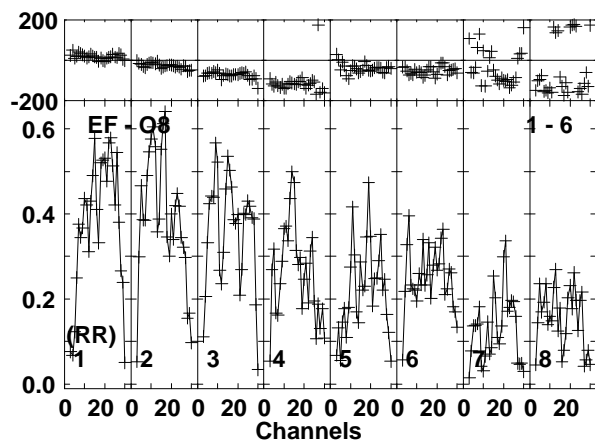
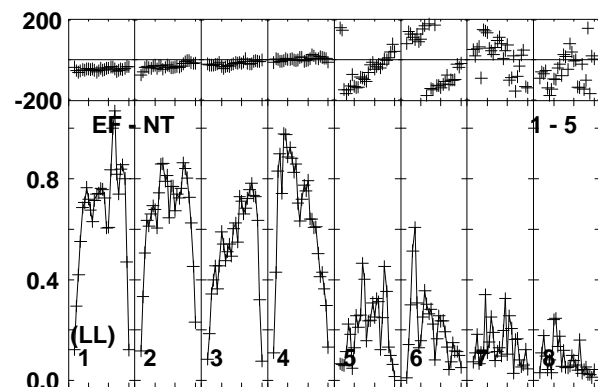
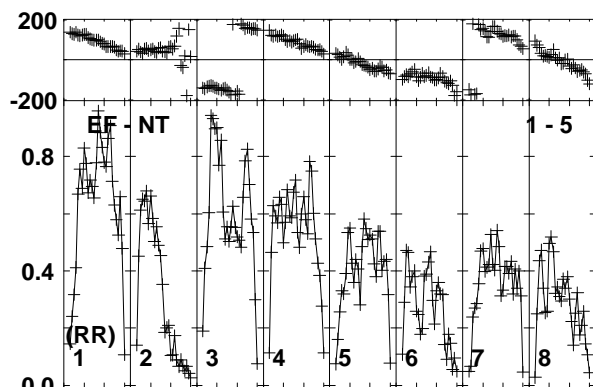
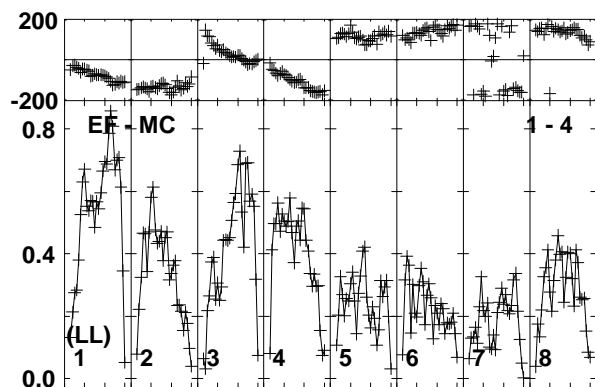
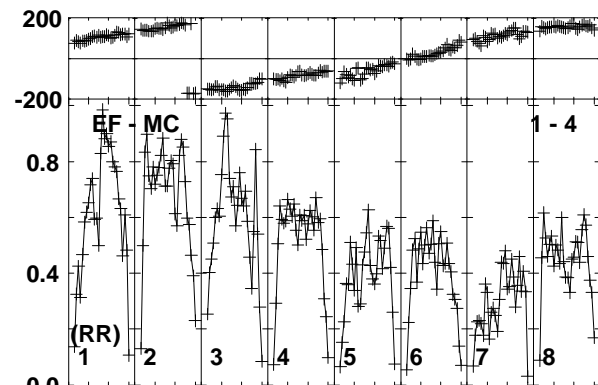
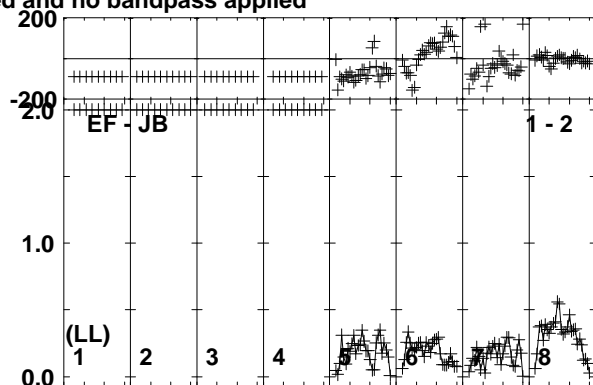
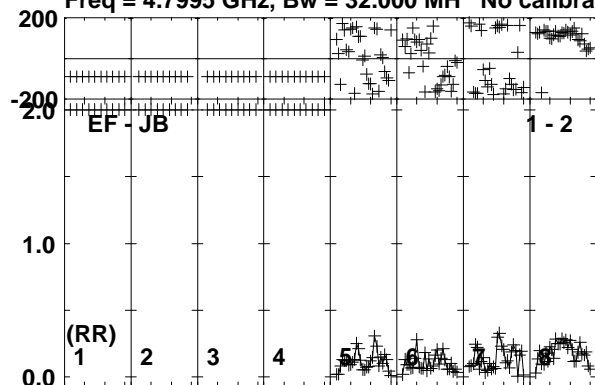

Lower frame: Milli Ampl Jy Top frame: Phas deg
Vector averaged cross-power spectrum Baseline: EF (01) - JB (02)
Timerange: 01/00:31:41 to 01/00:32:39

Plot file version 197 created 20-APR-2018 18:08:06

EM170817 RG009B.UVDATA.1

Freq = 4.7995 GHz, Bw = 32.000 MH No calibration applied and no bandpass applied

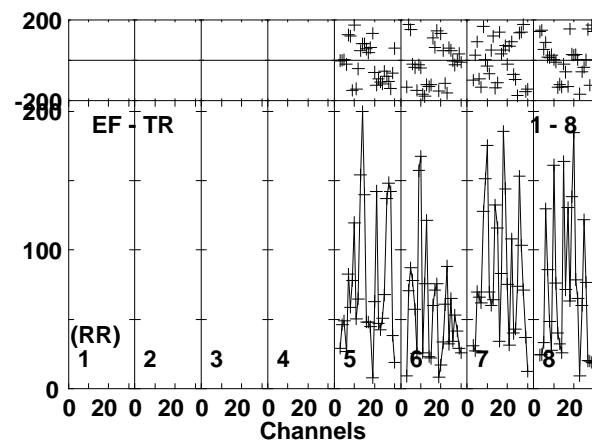
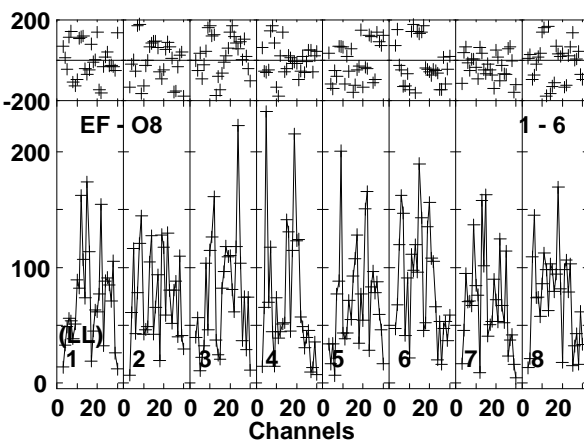
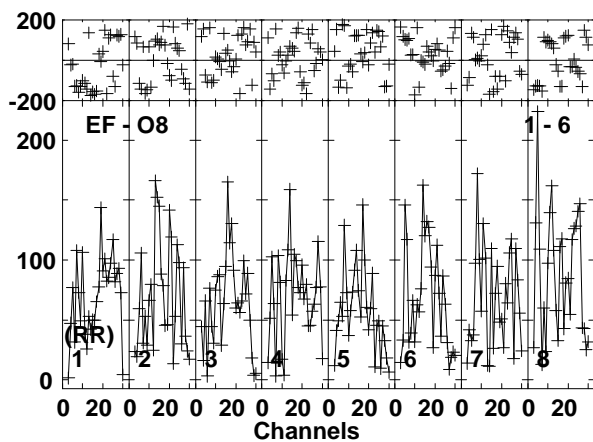
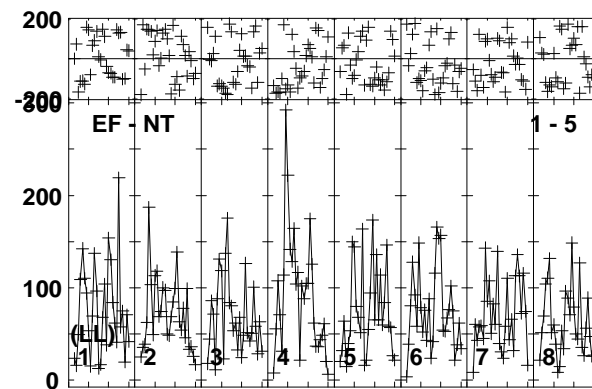
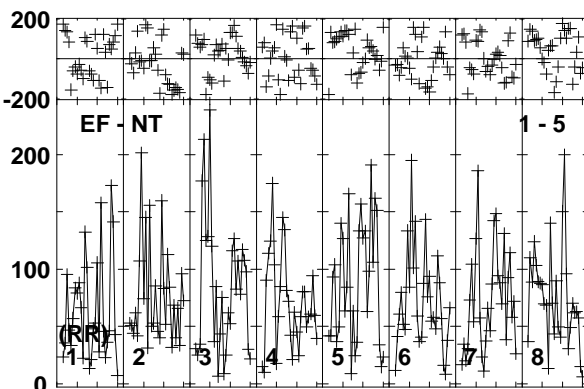
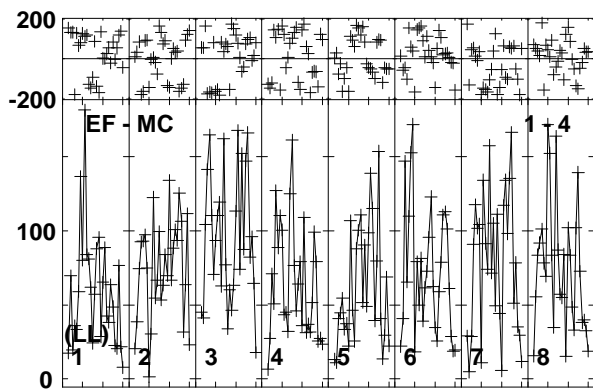
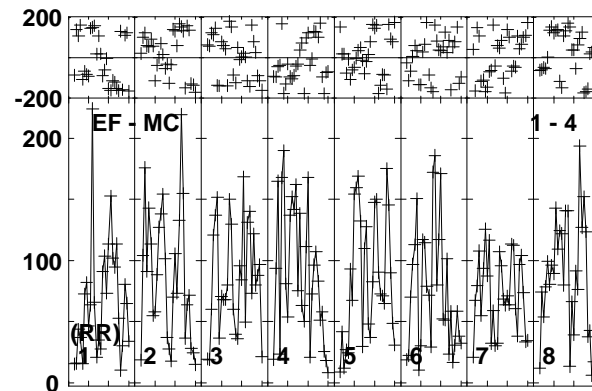
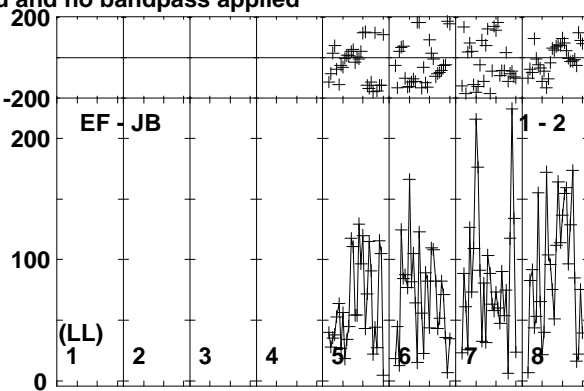
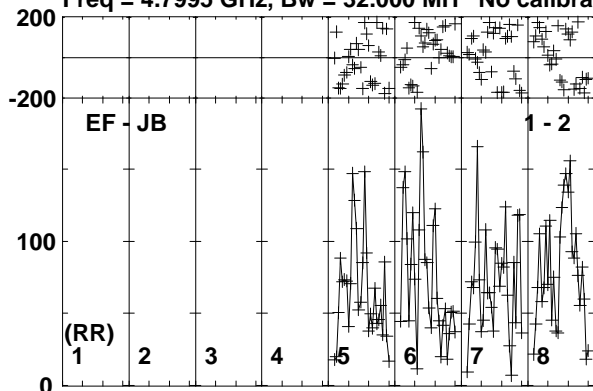

Lower frame: Micro Ampl Jy Top frame: Phas deg
Vector averaged cross-power spectrum Baseline: EF (01) - JB (02)
Timerange: 01/00:32:41 to 01/00:35:09

Plot file version 198 created 20-APR-2018 18:08:07

EM170817 RG009B.UVDATA.1

Freq = 4.7995 GHz, Bw = 32.000 MH No calibration applied and no bandpass applied

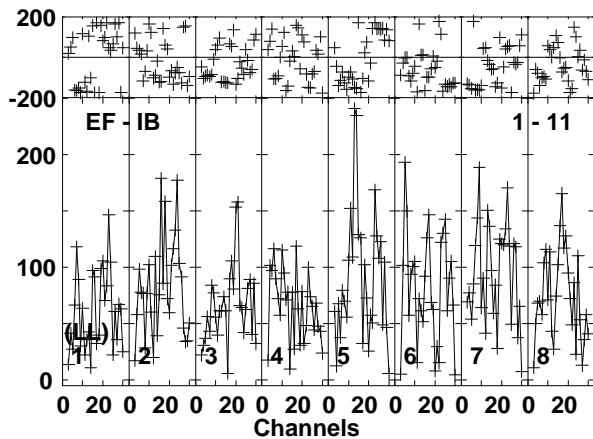
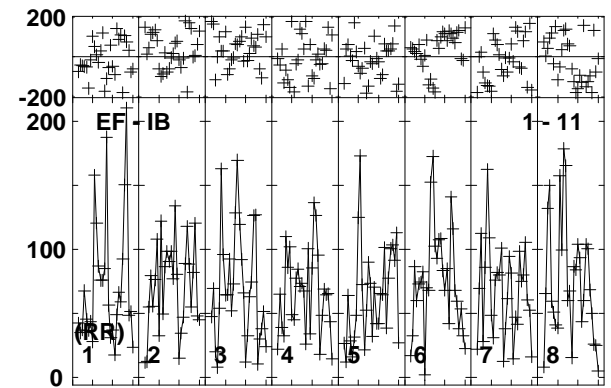
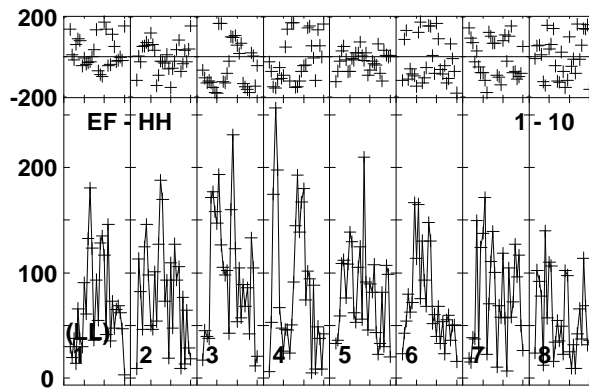
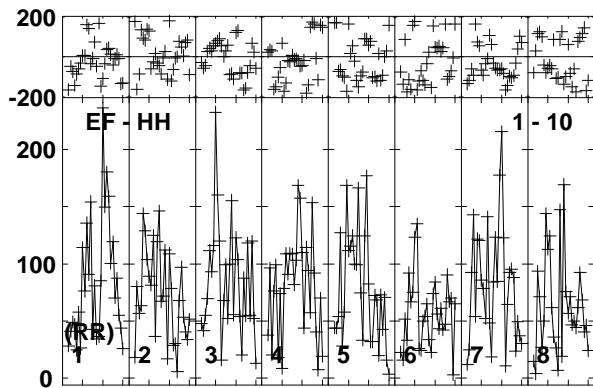
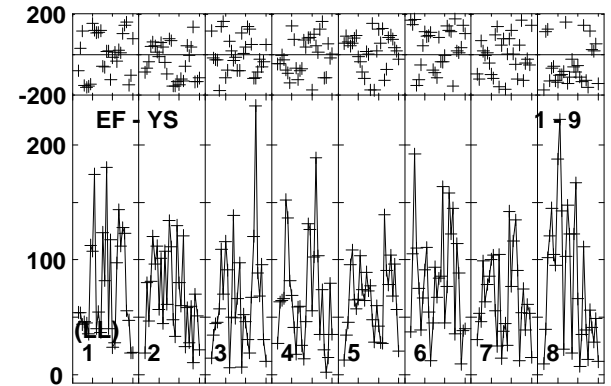
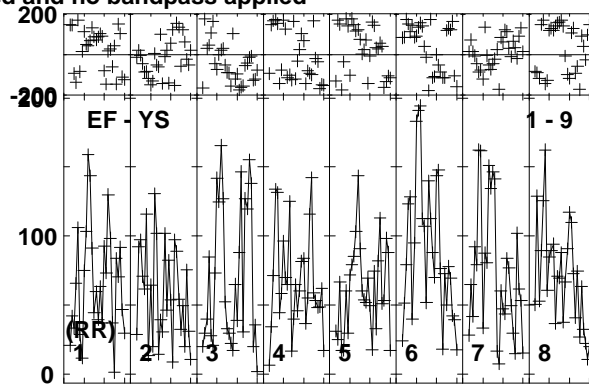
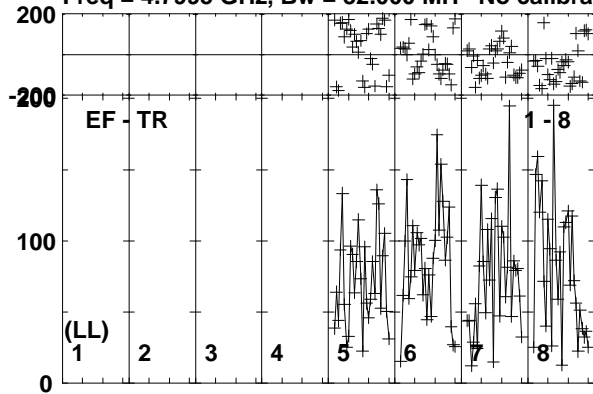

Lower frame: Micro Ampl Jy Top frame: Phas deg
Vector averaged cross-power spectrum Baseline: EF (01) - TR (08)
Timerange: 01/00:32:41 to 01/00:35:09

Plot file version 199 created 20-APR-2018 18:08:07

J1311-2329 RG009B.UVDATA.1

Freq = 4.7995 GHz, Bw = 32.000 MH No calibration applied and no bandpass applied

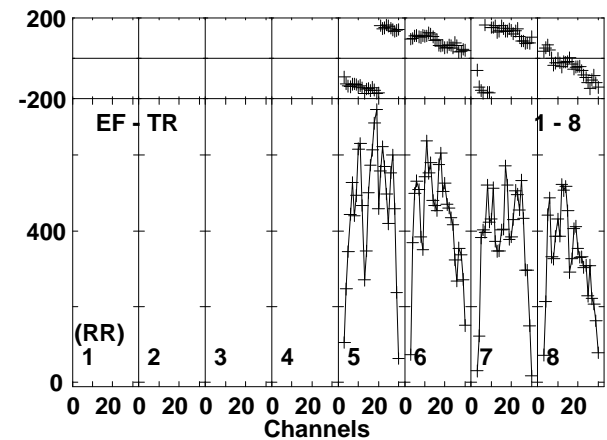
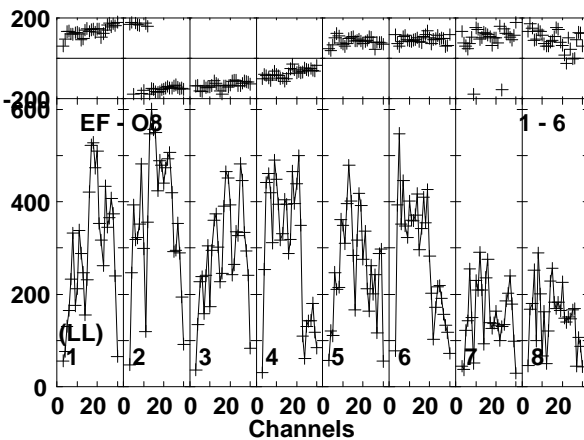
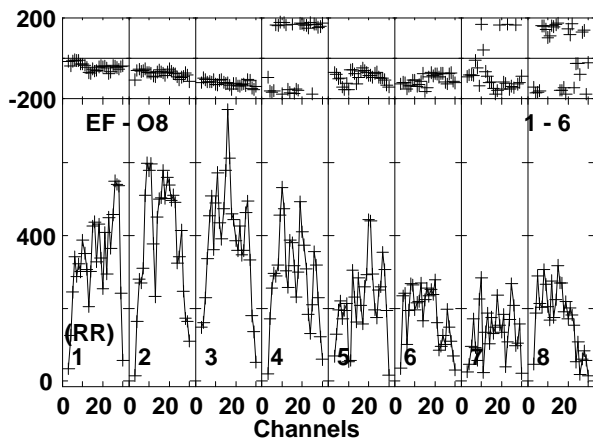
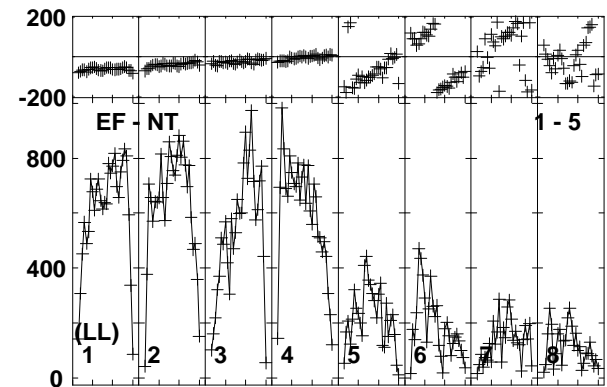
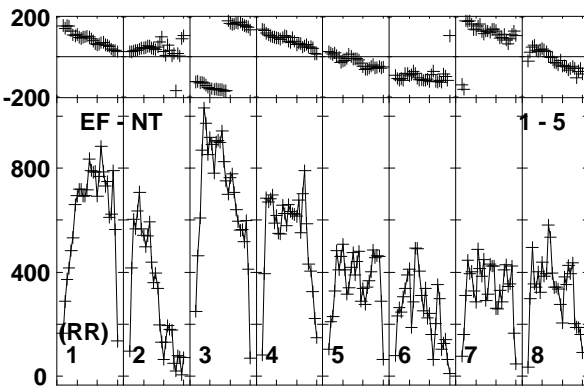
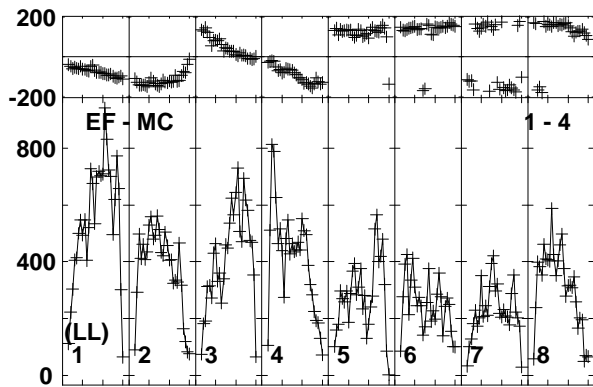
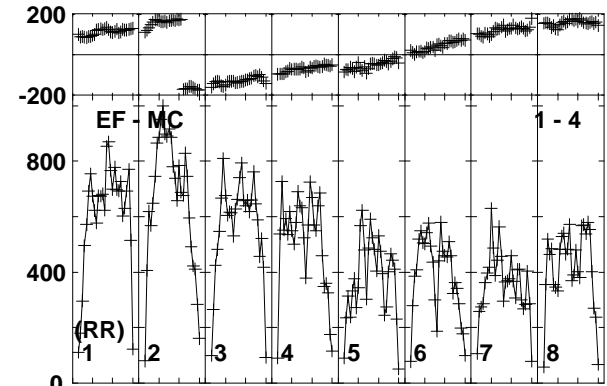
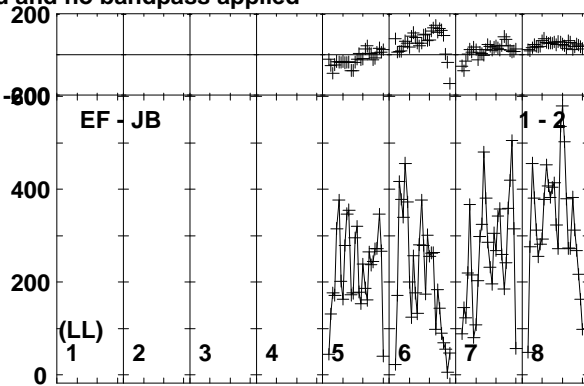
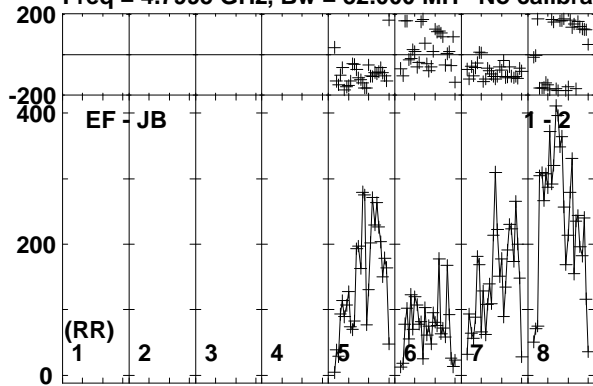

Lower frame: Micro Ampl Jy Top frame: Phas deg
Vector averaged cross-power spectrum Baseline: EF (01) - JB (02)
Timerange: 01/00:35:11 to 01/00:36:39

Plot file version 200 created 20-APR-2018 18:08:07

J1311-2329 RG009B.UVDATA.1

Freq = 4.7995 GHz, Bw = 32.000 MH No calibration applied and no bandpass applied

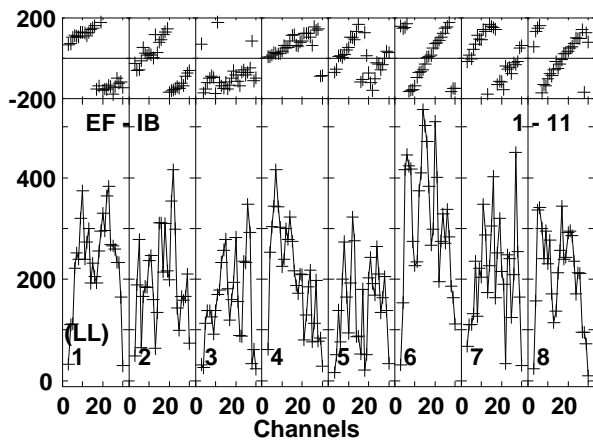
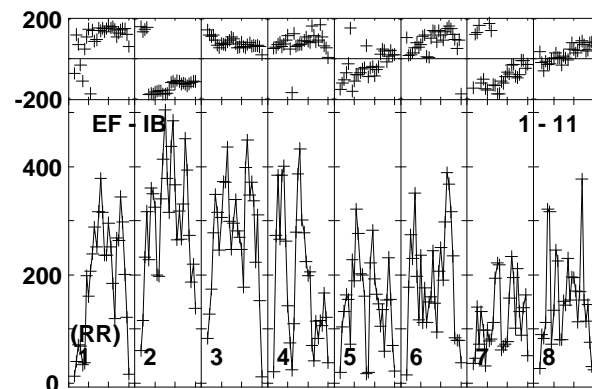
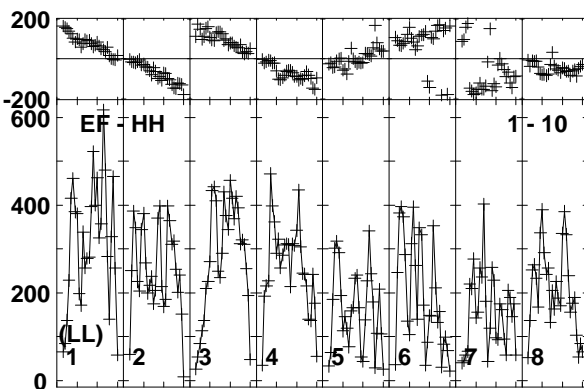
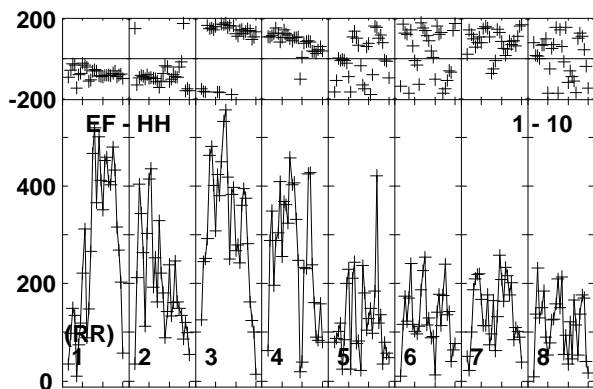
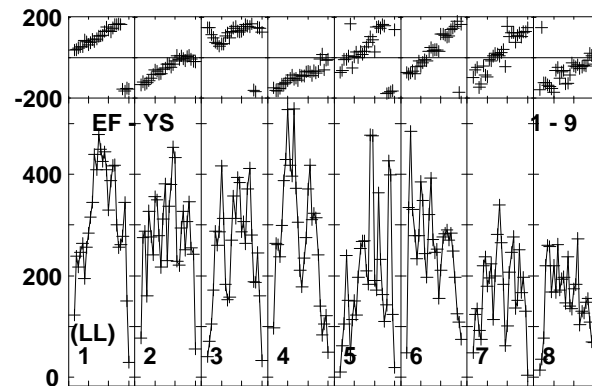
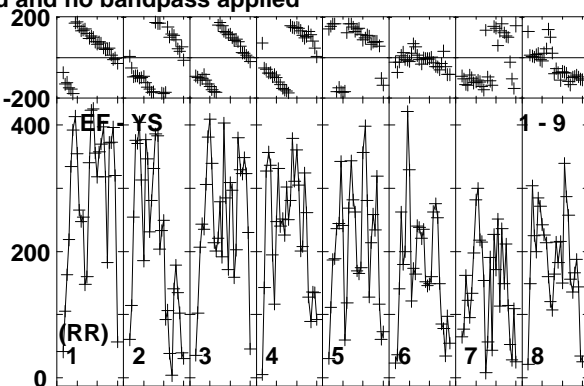
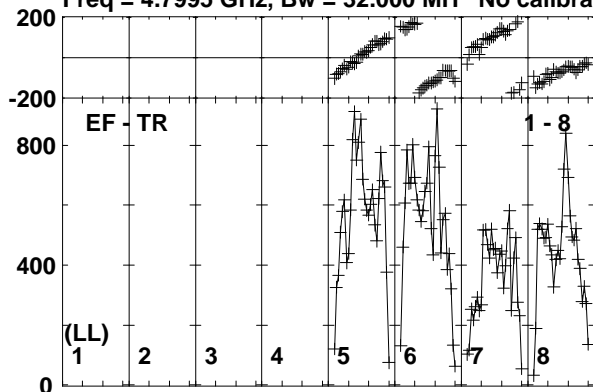

Lower frame: Micro Ampl Jy Top frame: Phas deg
Vector averaged cross-power spectrum Baseline: EF (01) - TR (08)
Timerange: 01/00:35:11 to 01/00:36:39

Plot file version 201 created 20-APR-2018 18:08:07

J1312-2350 RG009B.UVDATA.1

Freq = 4.7995 GHz, Bw = 32.000 MH No calibration applied and no bandpass applied

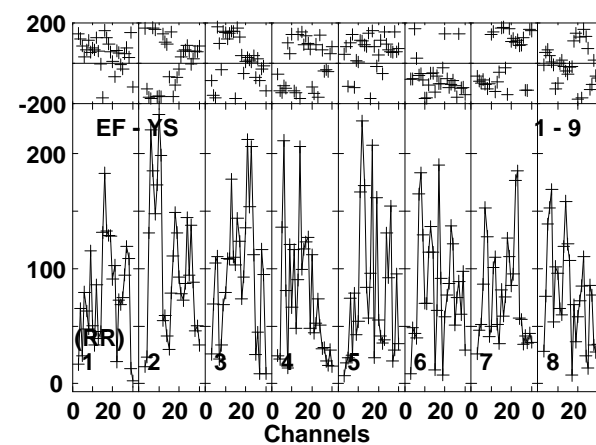
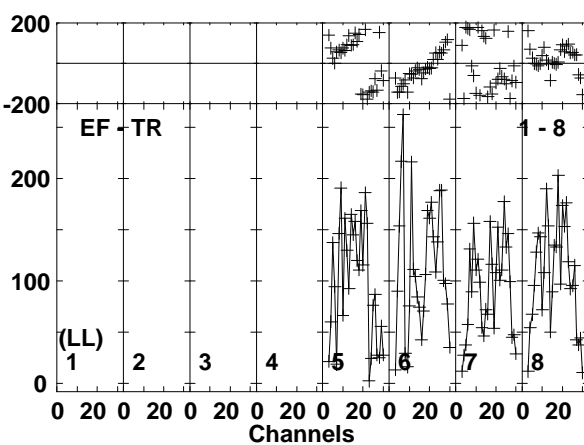
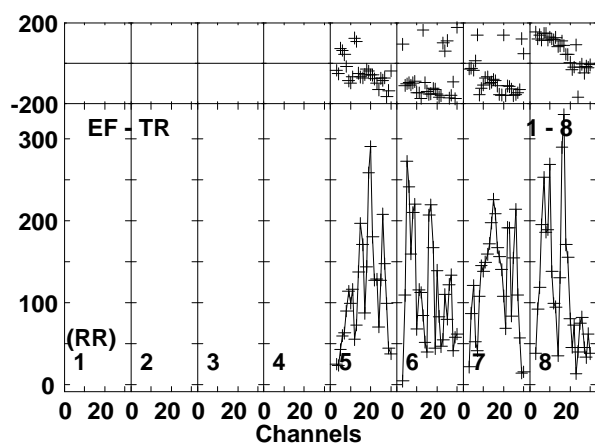
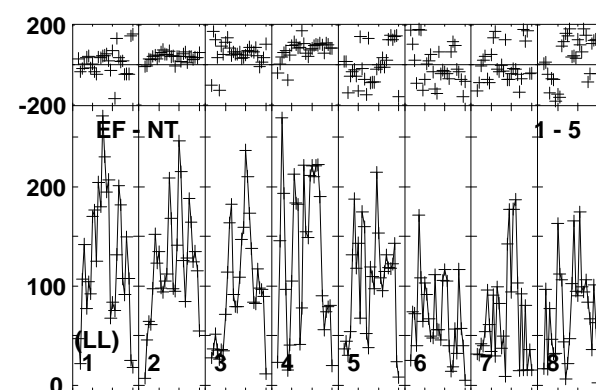
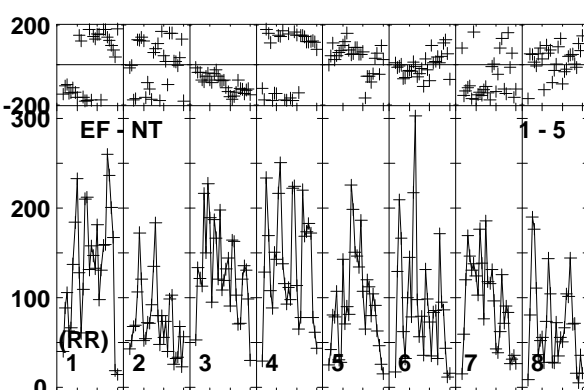
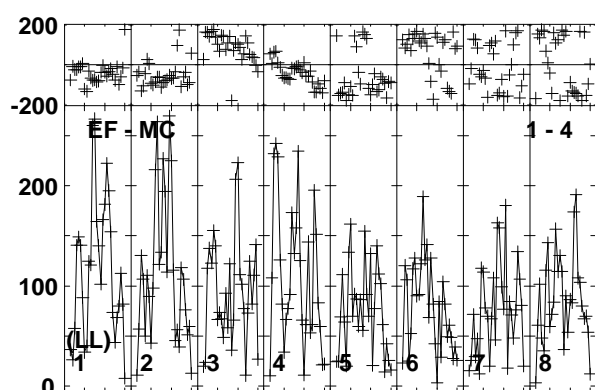
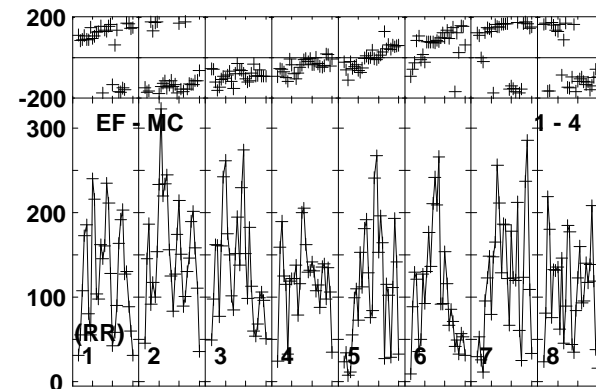
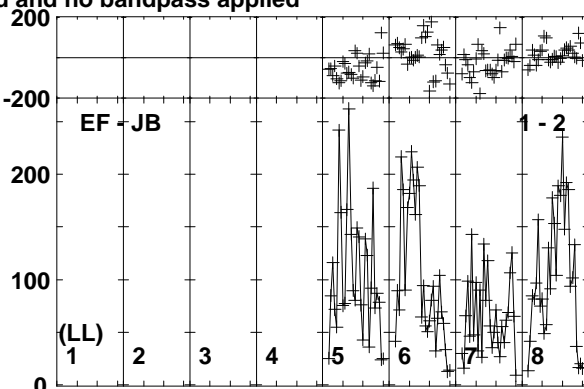
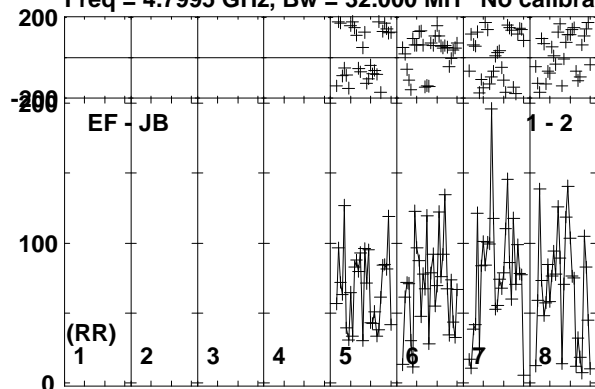

Lower frame: Micro Ampl Jy Top frame: Phas deg
Vector averaged cross-power spectrum Baseline: EF (01) - JB (02)
Timerange: 01/00:36:41 to 01/00:39:09

Plot file version 202 created 20-APR-2018 18:08:07

J1312-2350 RG009B.UVDATA.1

Freq = 4.7995 GHz, Bw = 32.000 MH No calibration applied and no bandpass applied

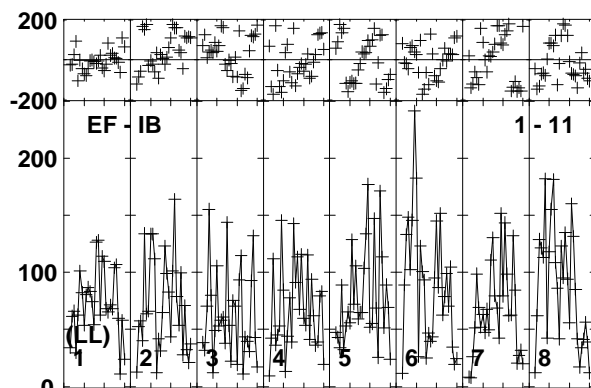
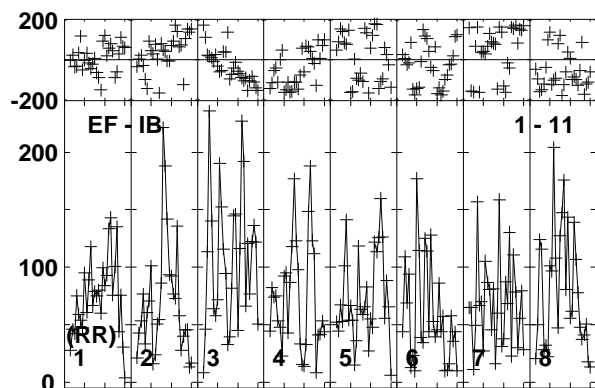
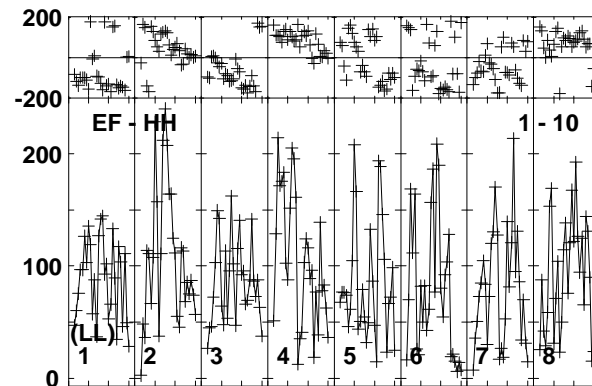
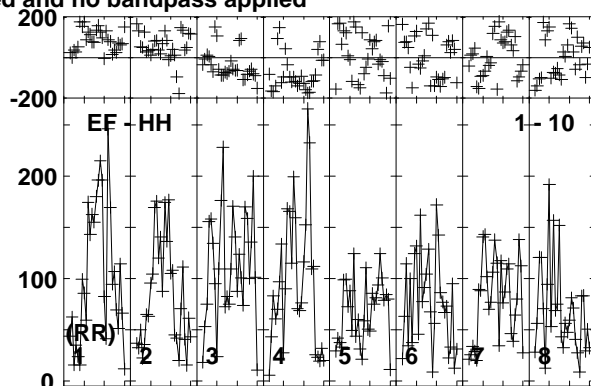
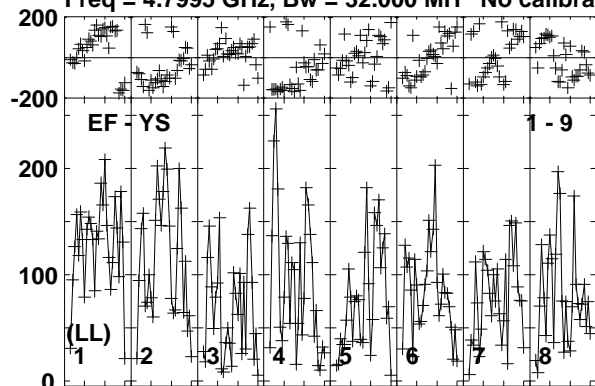

Lower frame: Micro Ampl Jy Top frame: Phas deg
Vector averaged cross-power spectrum Baseline: EF (01) - YS (09)
Timerange: 01/00:36:41 to 01/00:39:09

Plot file version 203 created 20-APR-2018 18:08:07

J1311-2329 RG009B.UVDATA.1

Freq = 4.7995 GHz, Bw = 32.000 MH No calibration applied and no bandpass applied

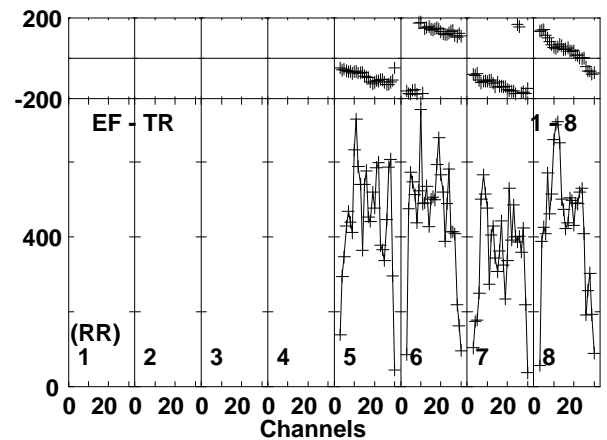
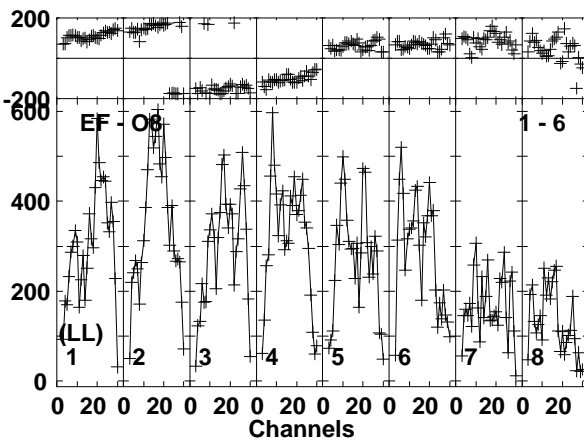
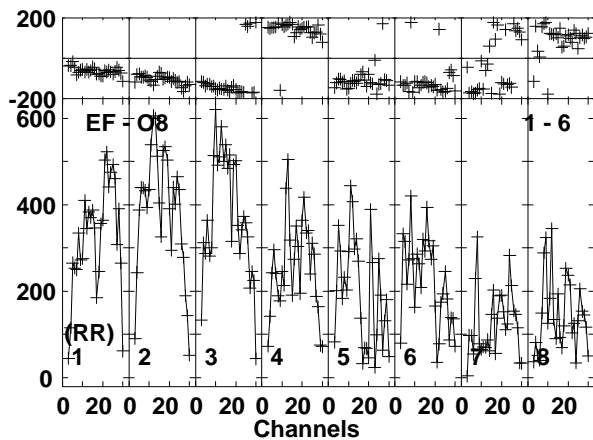
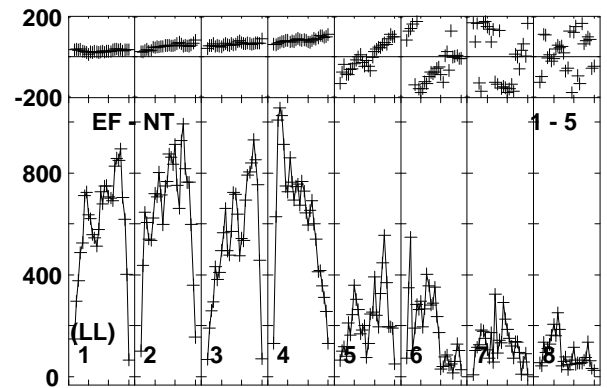
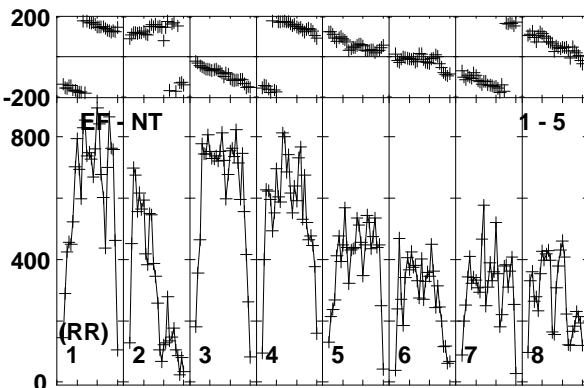
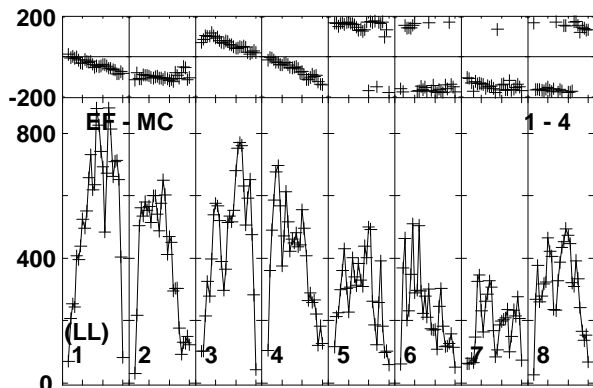
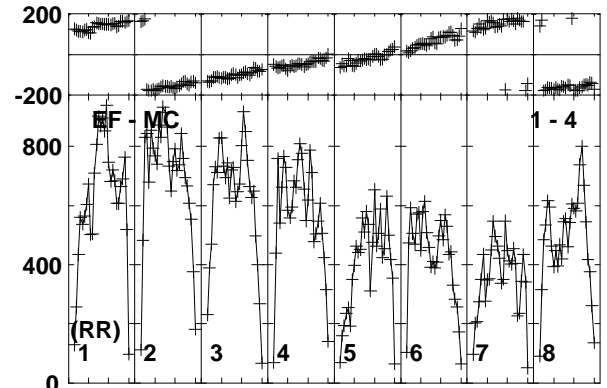
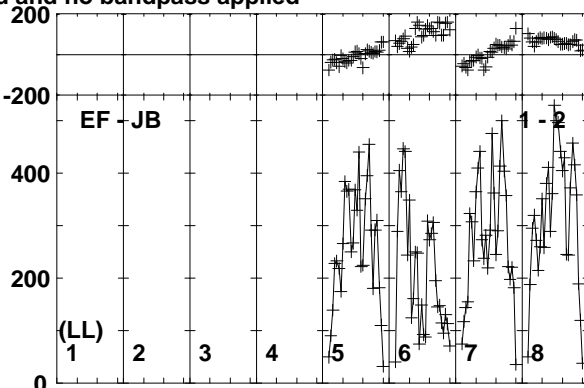
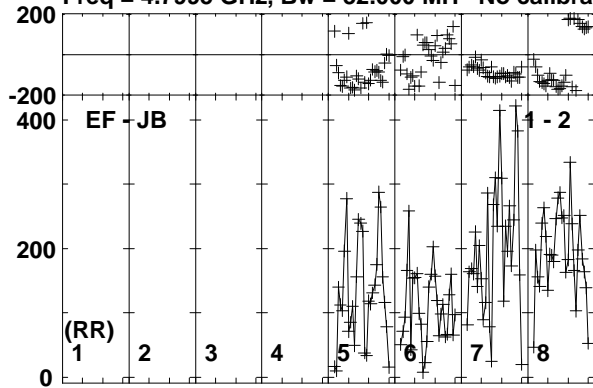

Lower frame: Micro Ampl Jy Top frame: Phas deg
Vector averaged cross-power spectrum Baseline: EF (01) - JB (02)
Timerange: 01/00:39:51 to 01/00:40:49

Plot file version 204 created 20-APR-2018 18:08:07

J1311-2329 RG009B.UVDATA.1

Freq = 4.7995 GHz, Bw = 32.000 MH No calibration applied and no bandpass applied

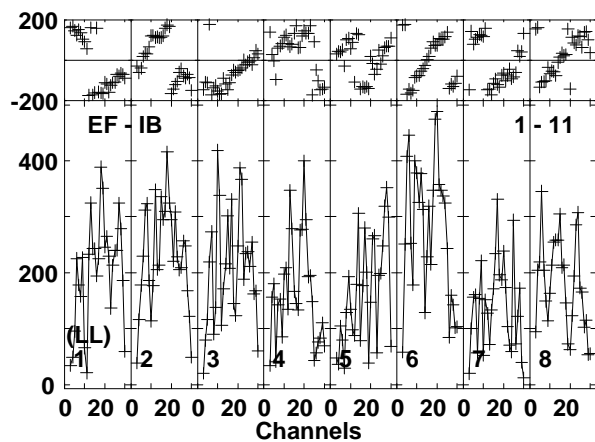
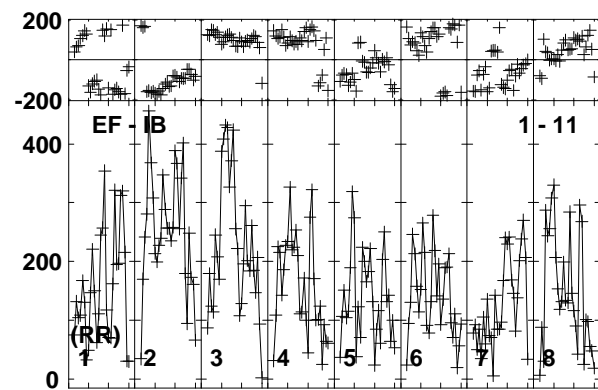
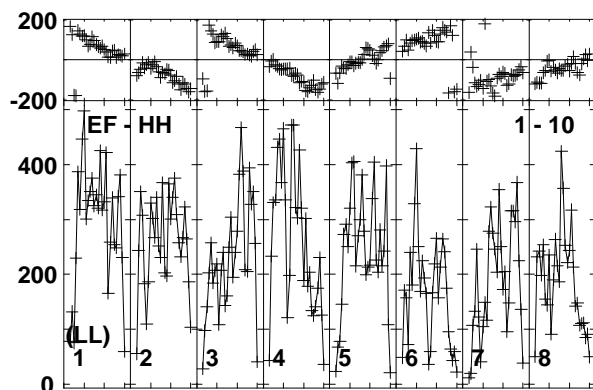
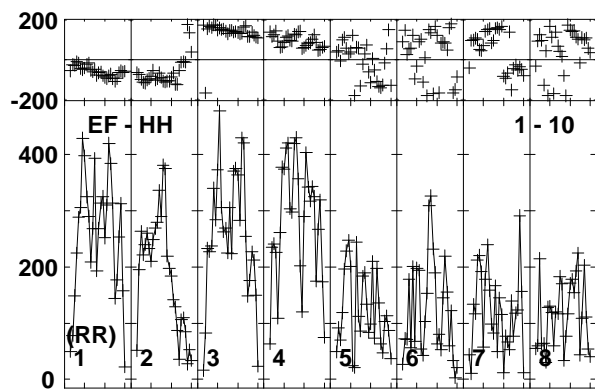
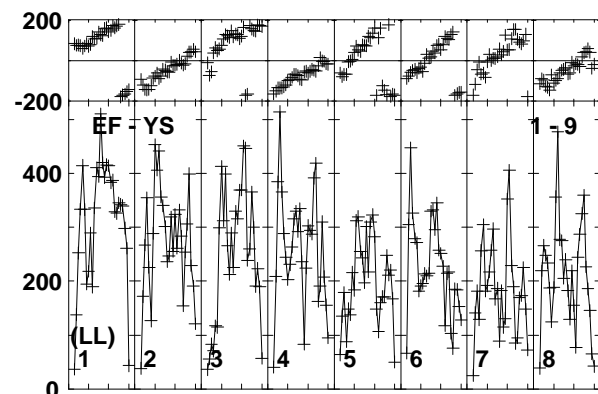
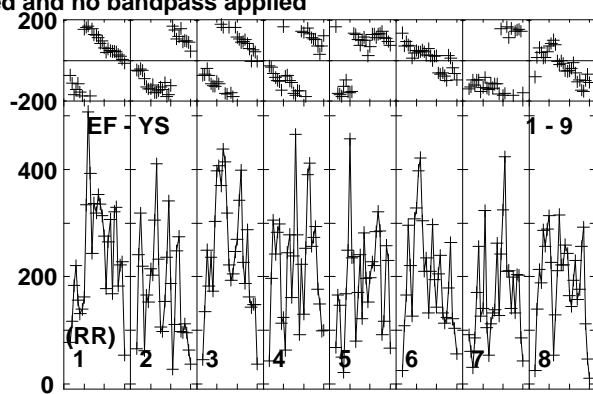
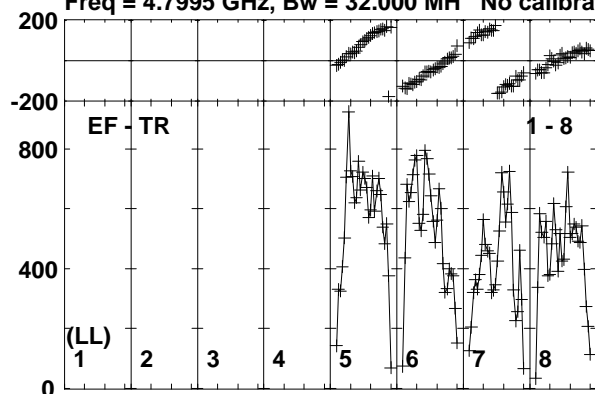

Lower frame: Micro Ampl Jy Top frame: Phas deg
Vector averaged cross-power spectrum Baseline: EF (01) - TR (08)
Timerange: 01/00:39:51 to 01/00:40:49

Plot file version 205 created 20-APR-2018 18:08:07

EM170817 RG009B.UVDATA.1

Freq = 4.7995 GHz, Bw = 32.000 MH No calibration applied and no bandpass applied

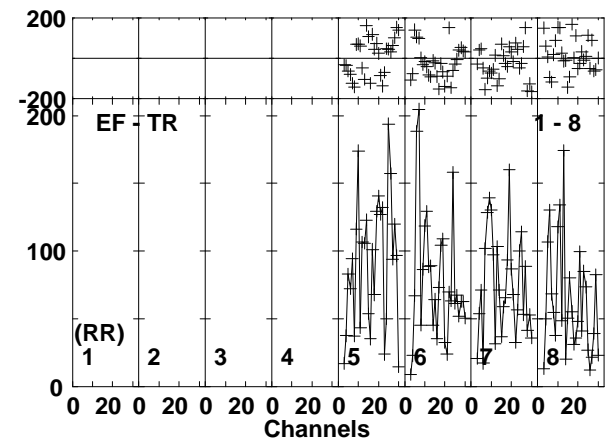
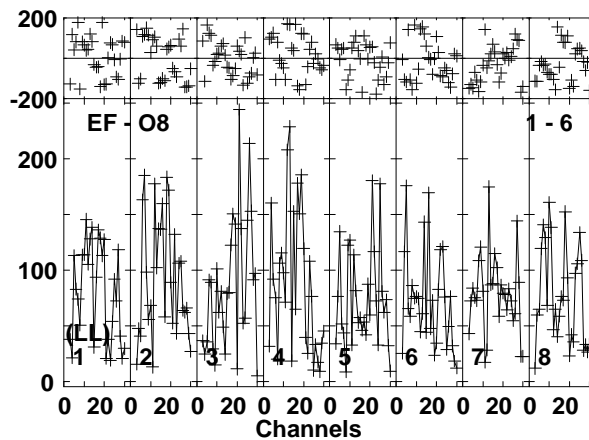
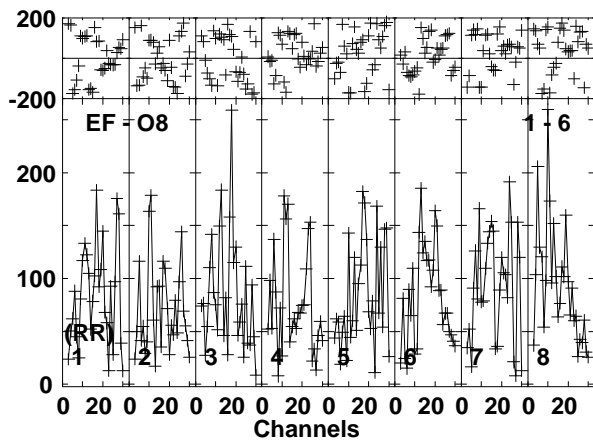
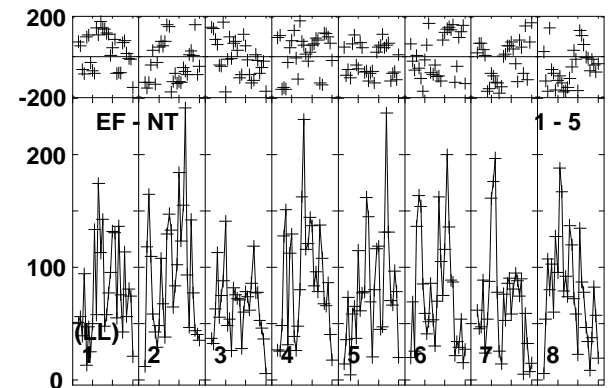
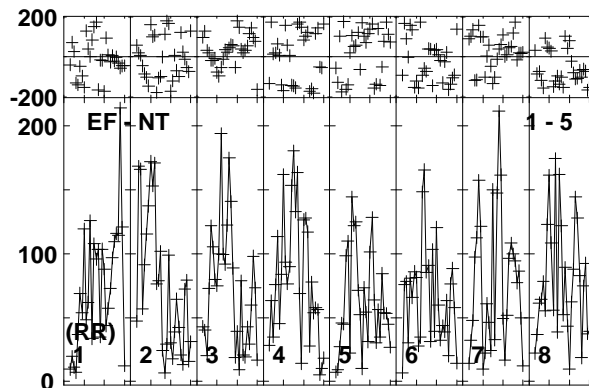
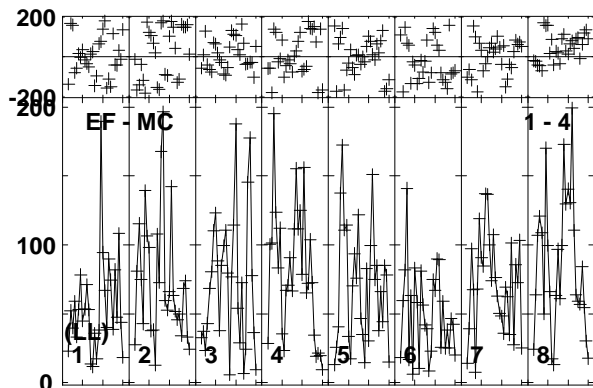
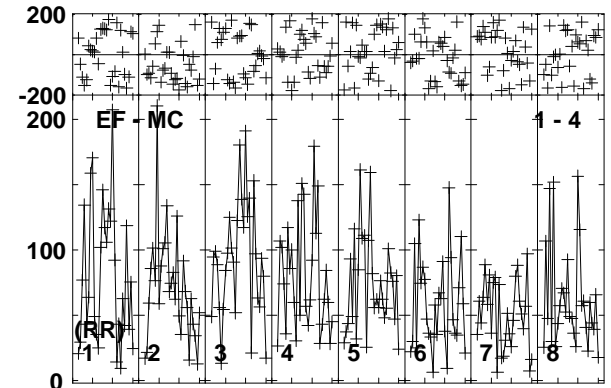
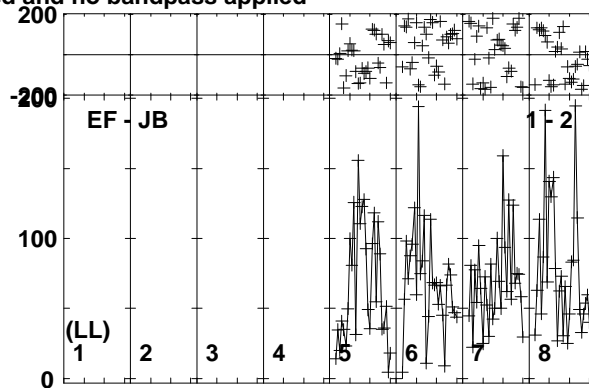
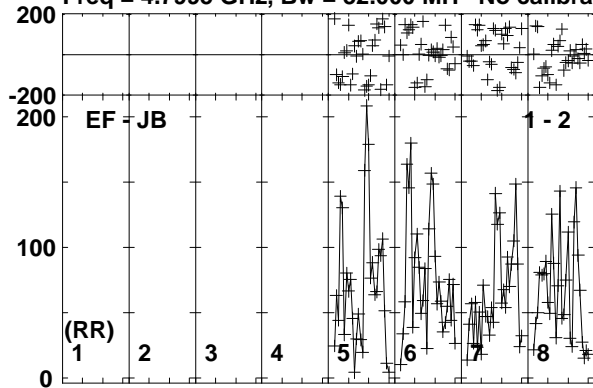

Lower frame: Micro Ampl Jy Top frame: Phas deg
Vector averaged cross-power spectrum Baseline: EF (01) - JB (02)
Timerange: 01/00:40:51 to 01/00:43:19

Plot file version 206 created 20-APR-2018 18:08:07

EM170817 RG009B.UVDATA.1

Freq = 4.7995 GHz, Bw = 32.000 MH No calibration applied and no bandpass applied

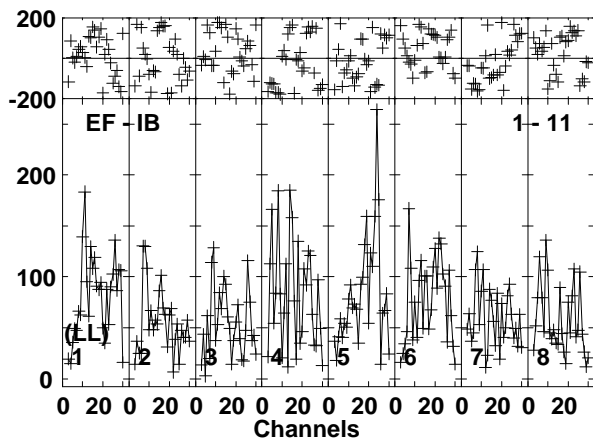
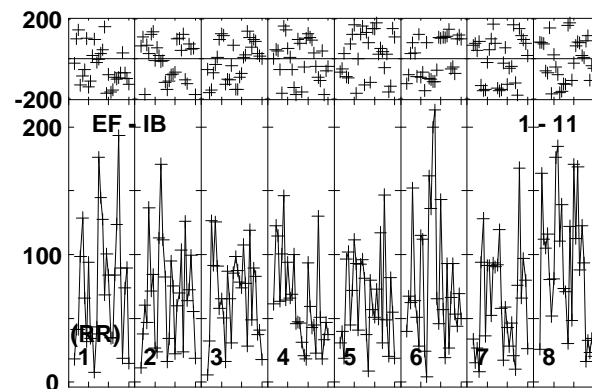
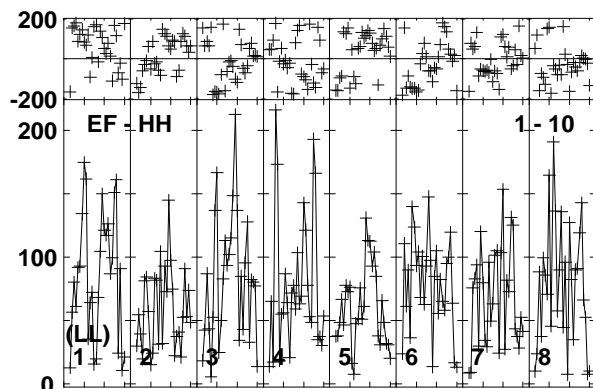
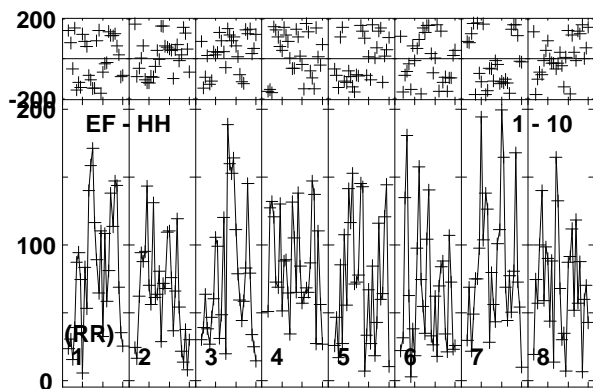
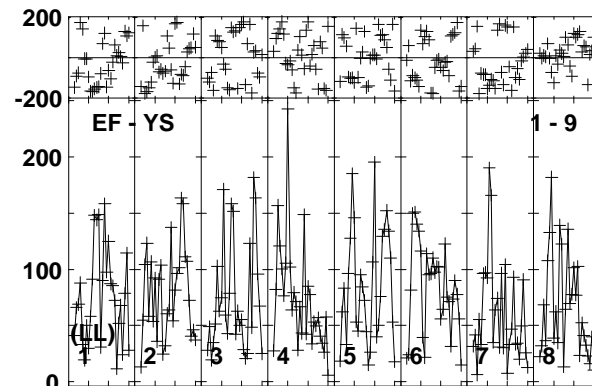
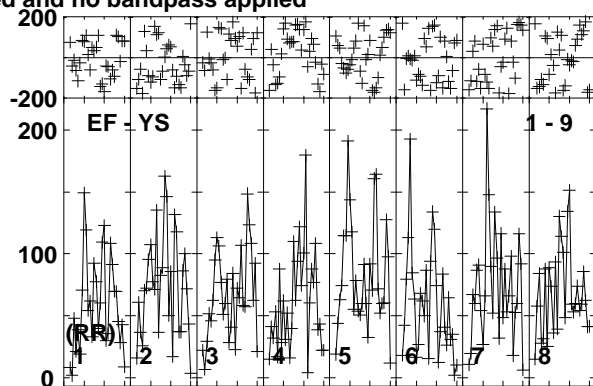
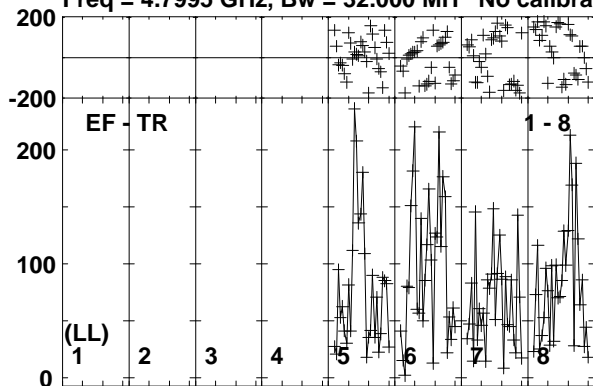

Lower frame: Micro Ampl Jy Top frame: Phas deg
Vector averaged cross-power spectrum Baseline: EF (01) - TR (08)
Timerange: 01/00:40:51 to 01/00:43:19

Plot file version 207 created 20-APR-2018 18:08:07

J1311-2329 RG009B.UVDATA.1

Freq = 4.7995 GHz, Bw = 32.000 MH No calibration applied and no bandpass applied

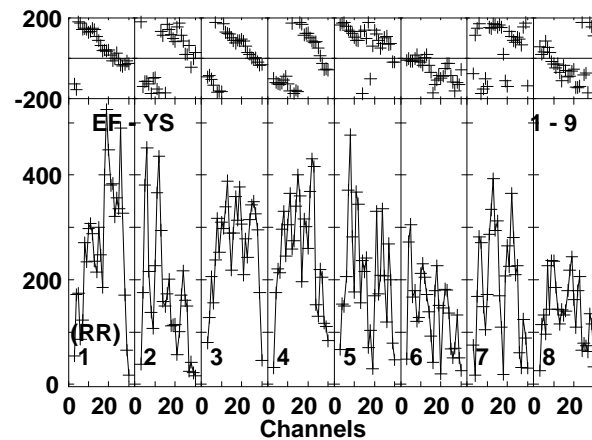
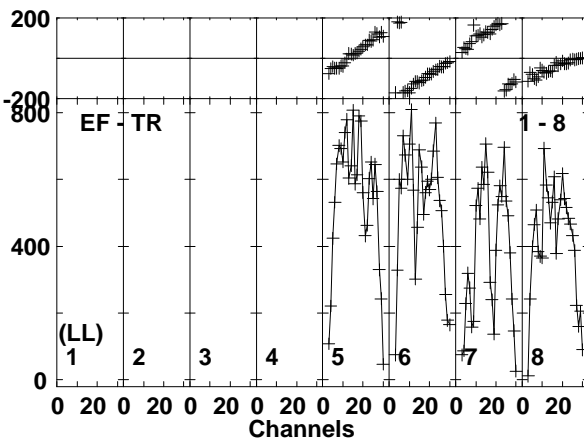
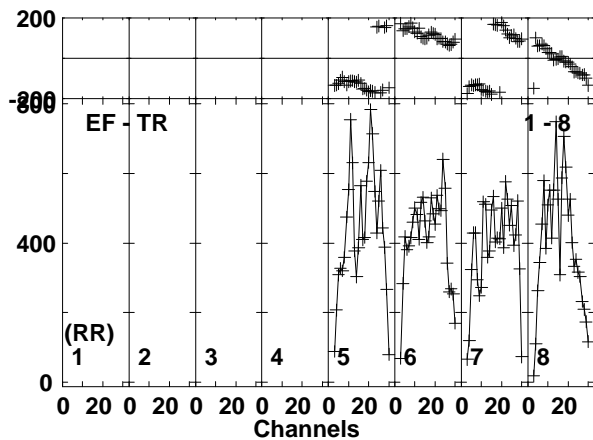
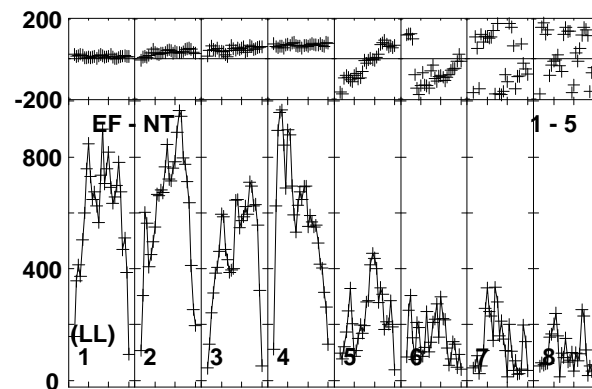
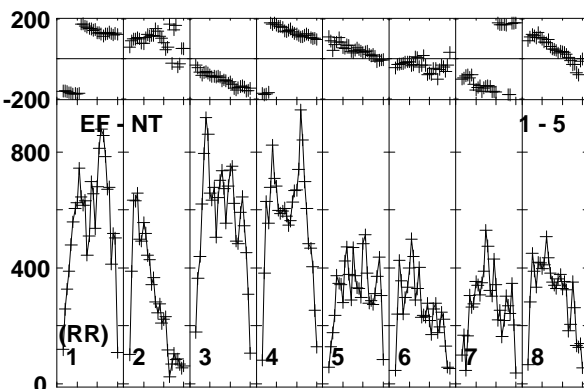
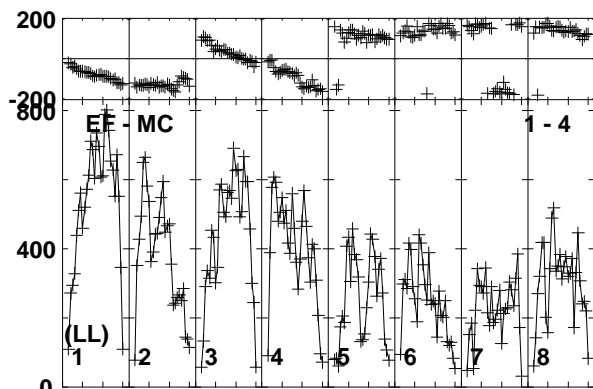
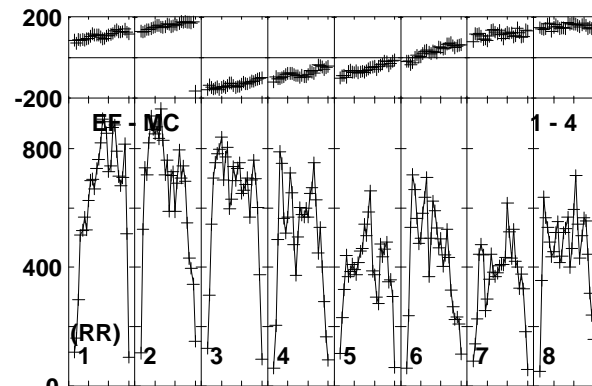
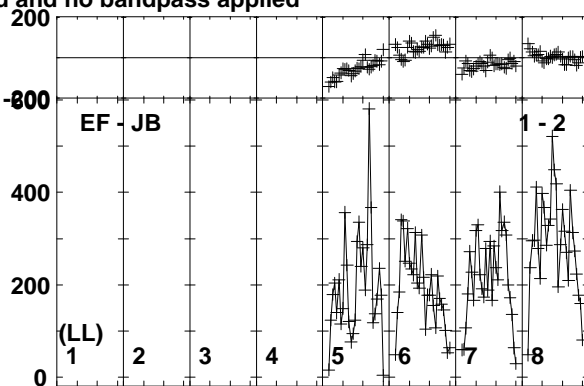
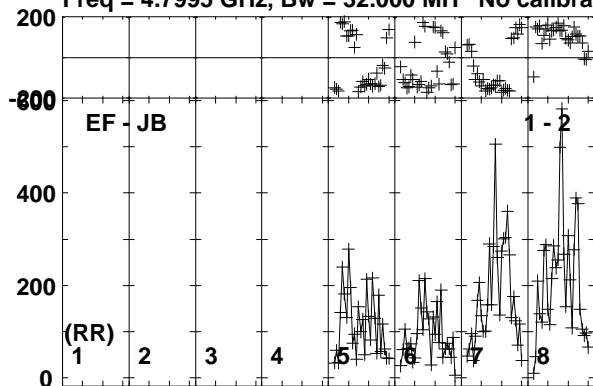

Lower frame: Micro Ampl Jy Top frame: Phas deg
Vector averaged cross-power spectrum Baseline: EF (01) - JB (02)
Timerange: 01/00:43:21 to 01/00:44:49

Plot file version 208 created 20-APR-2018 18:08:07

J1311-2329 RG009B.UVDATA.1

Freq = 4.7995 GHz, Bw = 32.000 MH No calibration applied and no bandpass applied

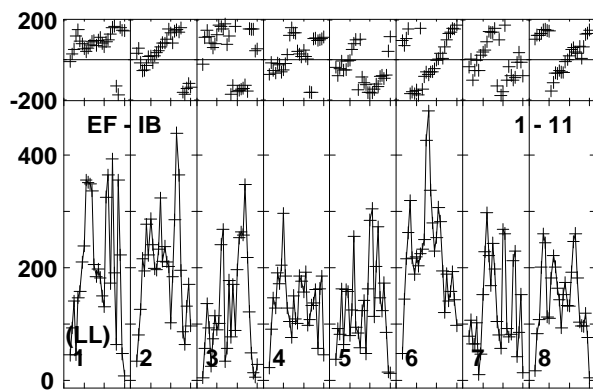
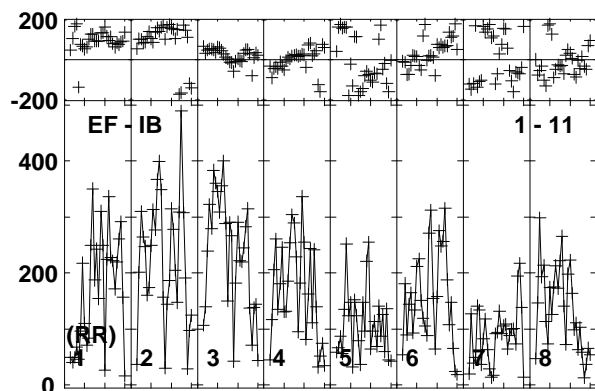
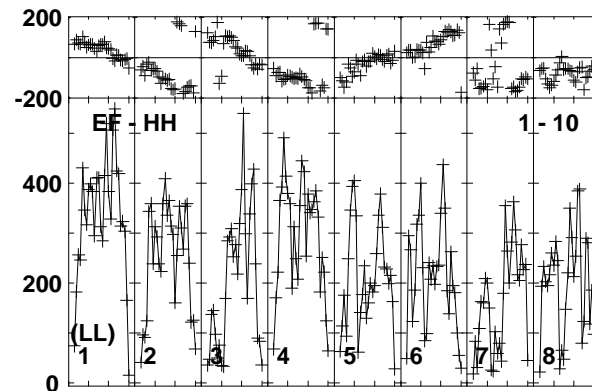
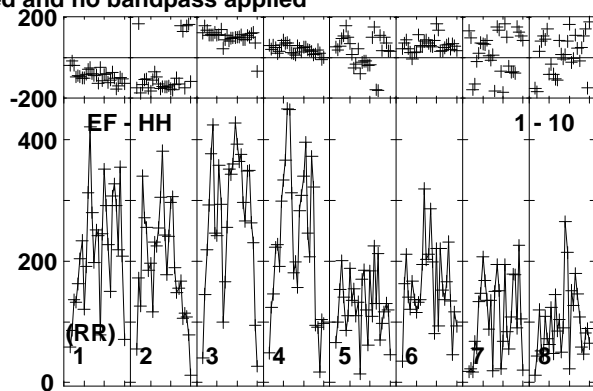
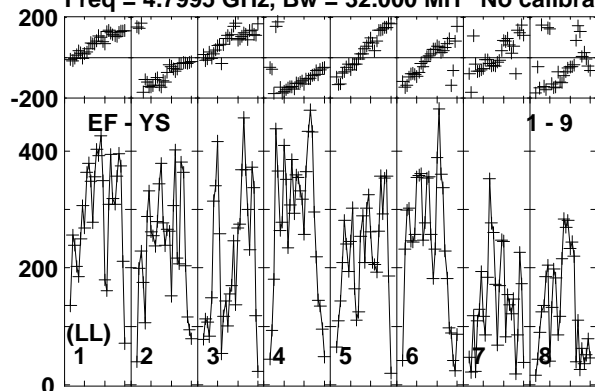

Lower frame: Micro Ampl Jy Top frame: Phas deg
Vector averaged cross-power spectrum Baseline: EF (01) - YS (09)
Timerange: 01/00:43:21 to 01/00:44:49

Plot file version 209 created 20-APR-2018 18:08:07

EM170817 RG009B.UVDATA.1

Freq = 4.7995 GHz, Bw = 32.000 MH No calibration applied and no bandpass applied

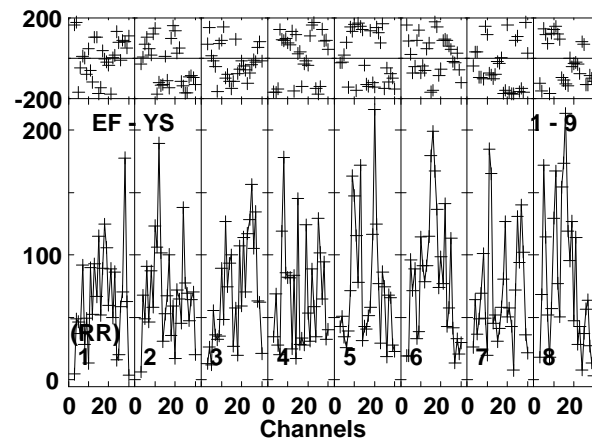
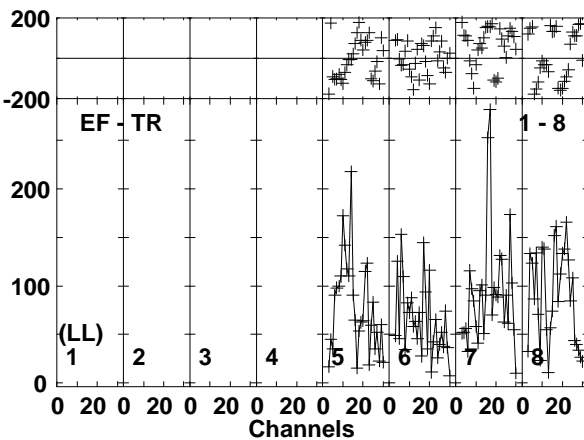
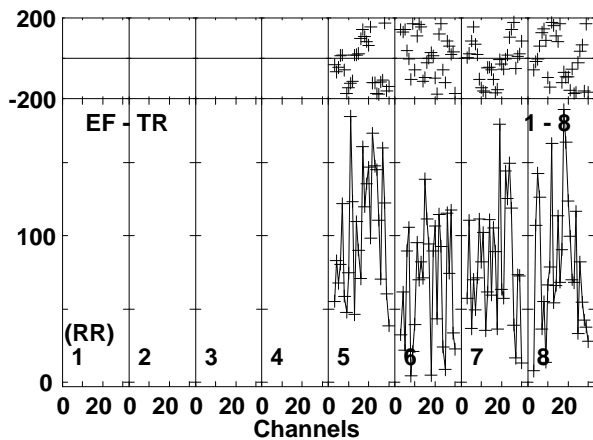
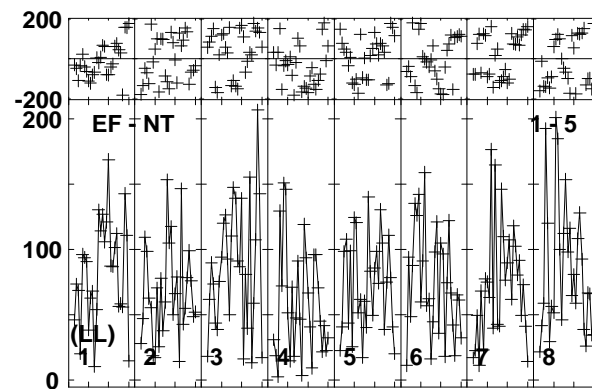
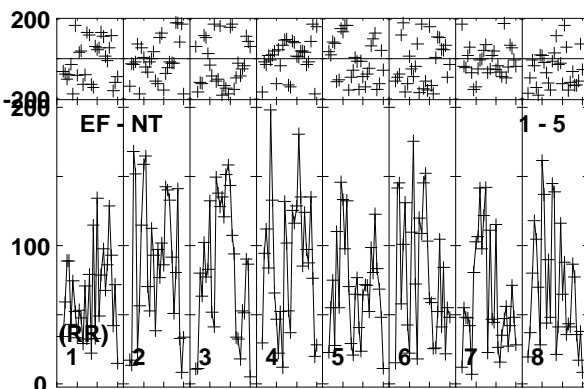
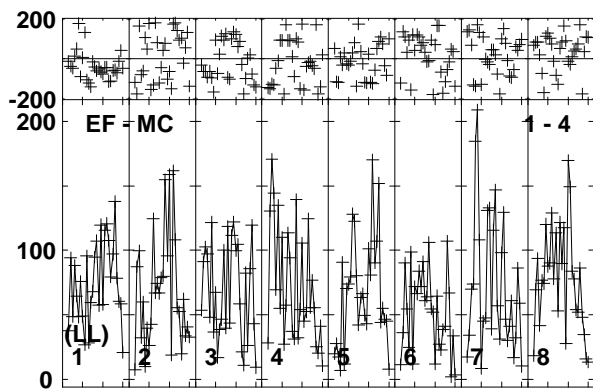
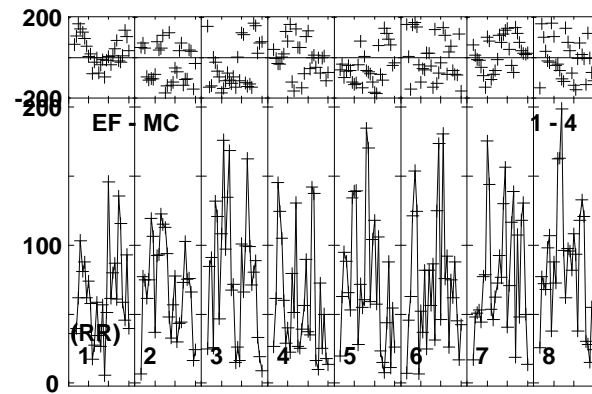
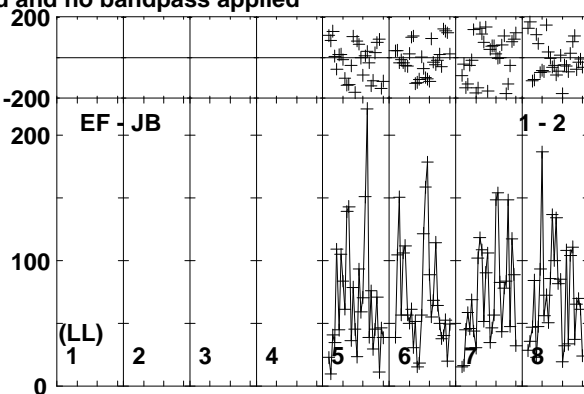
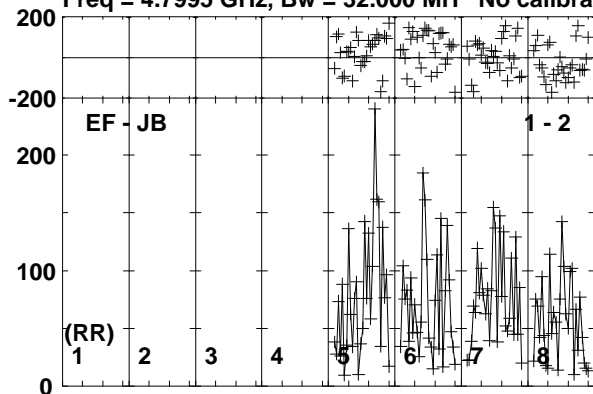

Lower frame: Micro Ampl Jy Top frame: Phas deg
Vector averaged cross-power spectrum Baseline: EF (01) - JB (02)
Timerange: 01/00:44:51 to 01/00:47:19

Plot file version 210 created 20-APR-2018 18:08:07

EM170817 RG009B.UVDATA.1

Freq = 4.7995 GHz, Bw = 32.000 MH No calibration applied and no bandpass applied

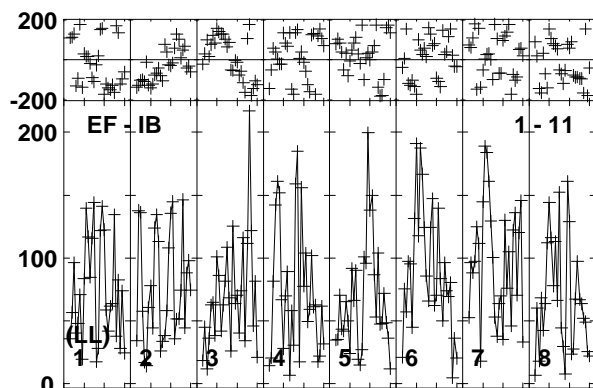
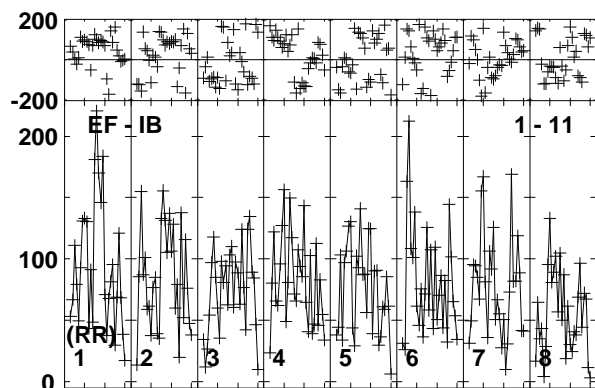
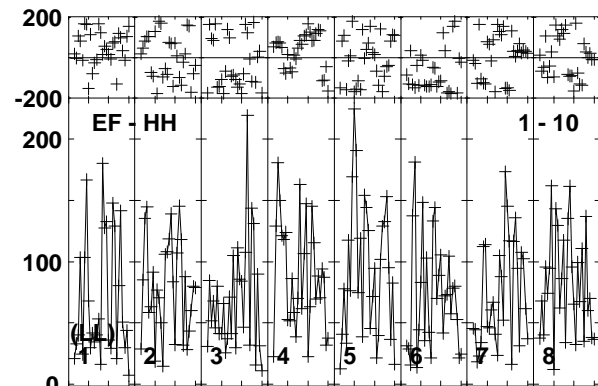
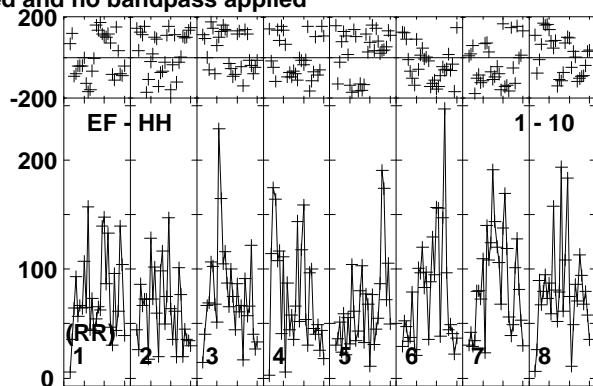
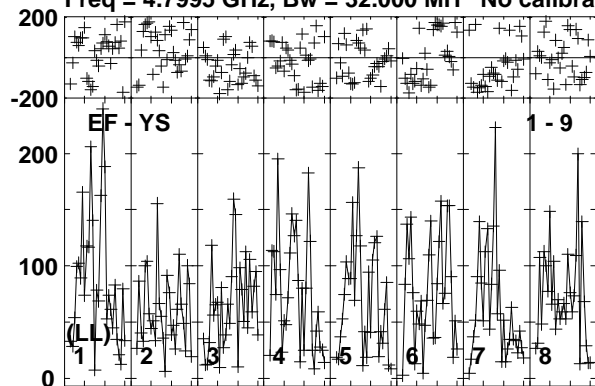

Lower frame: Micro Ampl Jy Top frame: Phas deg
Vector averaged cross-power spectrum Baseline: EF (01) - YS (09)
Timerange: 01/00:44:51 to 01/00:47:19

Plot file version 211 created 20-APR-2018 18:08:08

J1311-2329 RG009B.UVDATA.1

Freq = 4.7995 GHz, Bw = 32.000 MH No calibration applied and no bandpass applied

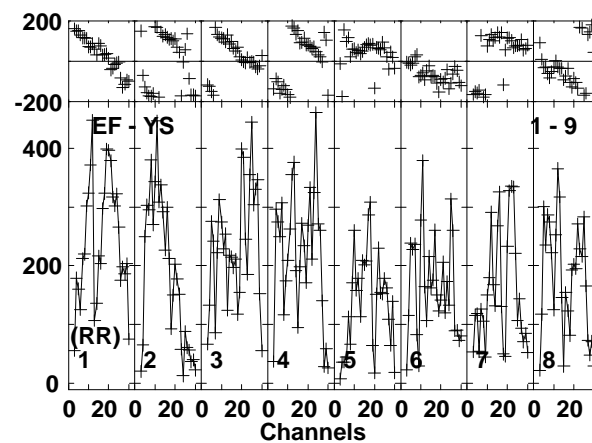
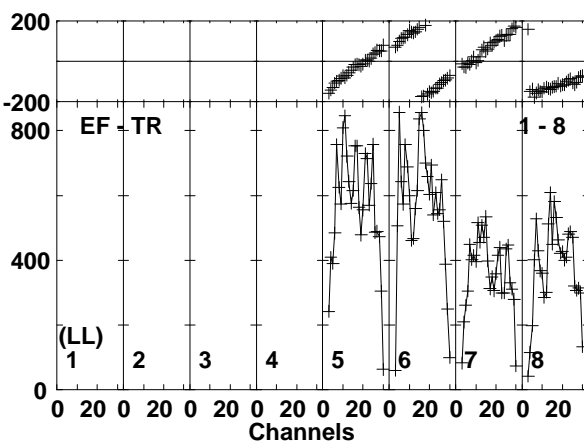
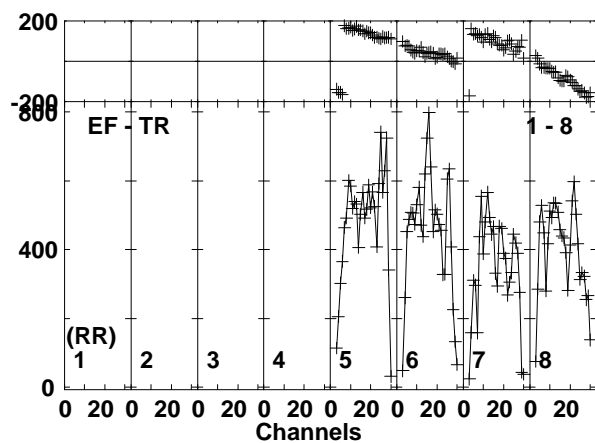
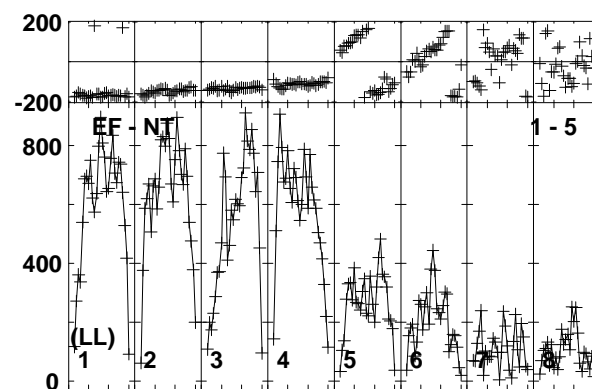
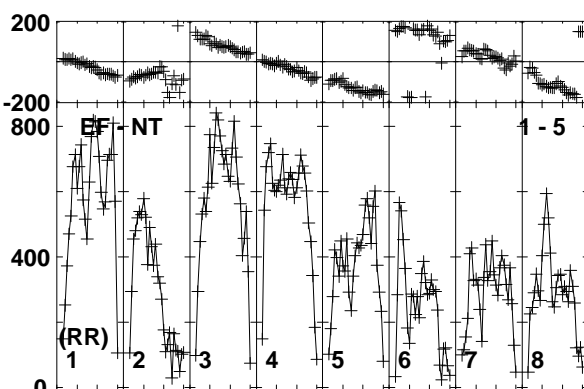
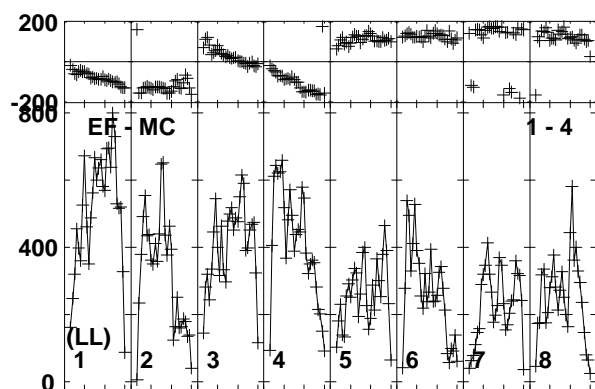
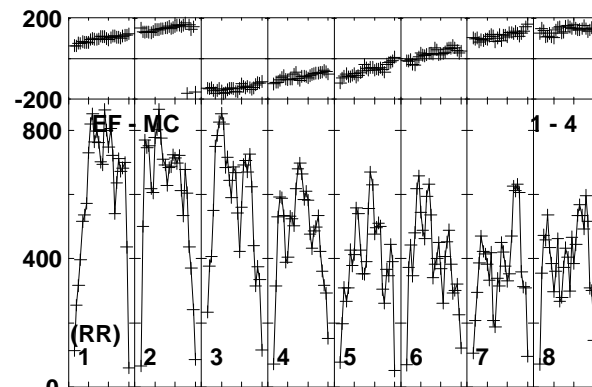
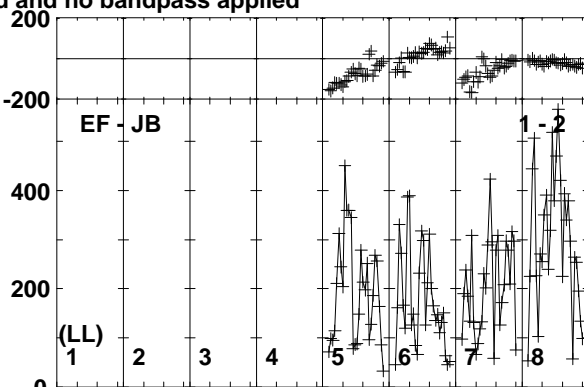
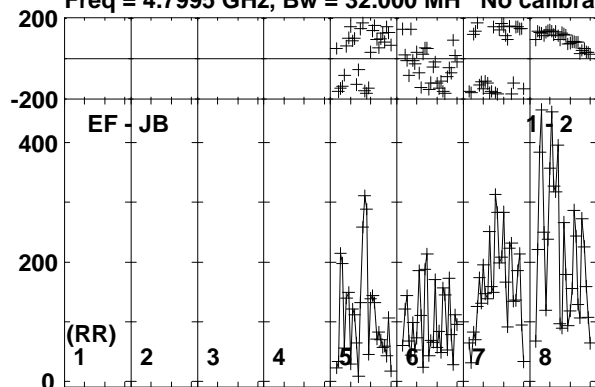

Lower frame: Micro Ampl Jy Top frame: Phas deg
Vector averaged cross-power spectrum Baseline: EF (01) - JB (02)
Timerange: 01/00:47:51 to 01/00:48:49

Plot file version 212 created 20-APR-2018 18:08:08

J1311-2329 RG009B.UVDATA.1

Freq = 4.7995 GHz, Bw = 32.000 MH No calibration applied and no bandpass applied

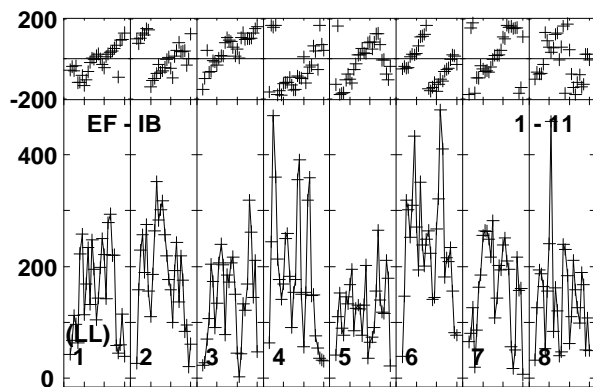
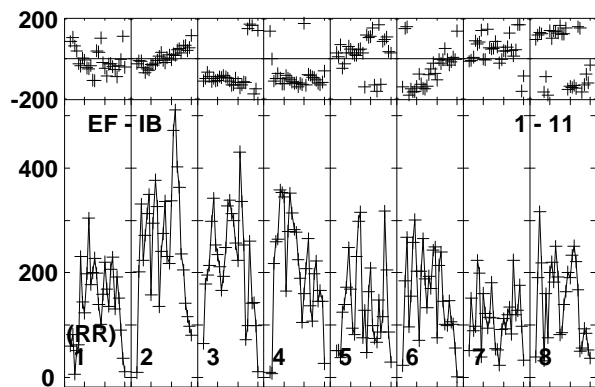
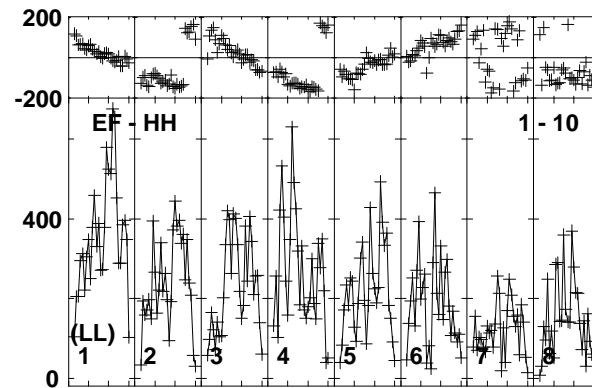
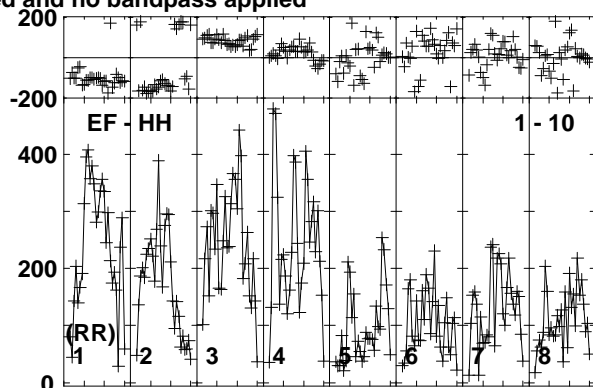
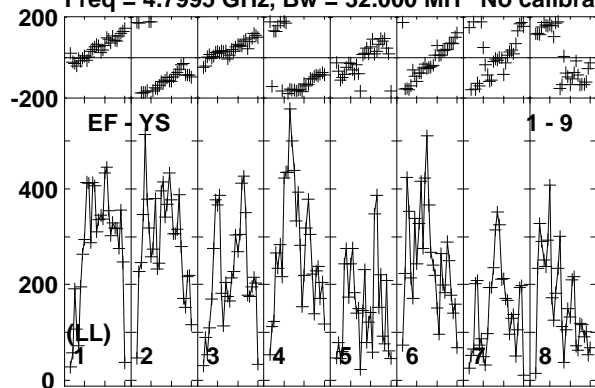

Lower frame: Micro Ampl Jy Top frame: Phas deg
Vector averaged cross-power spectrum Baseline: EF (01) - YS (09)
Timerange: 01/00:47:51 to 01/00:48:49

Plot file version 213 created 20-APR-2018 18:08:08

EM170817 RG009B.UVDATA.1

Freq = 4.7995 GHz, Bw = 32.000 MH No calibration applied and no bandpass applied

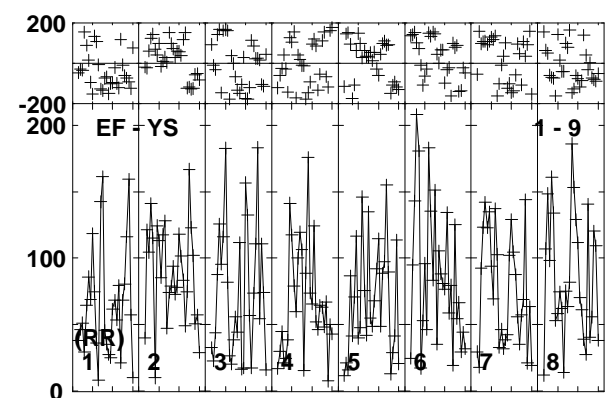
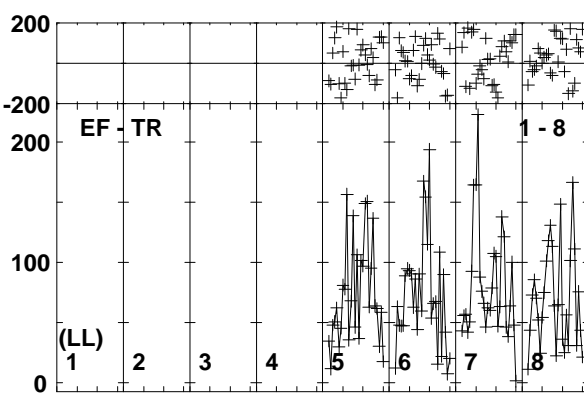
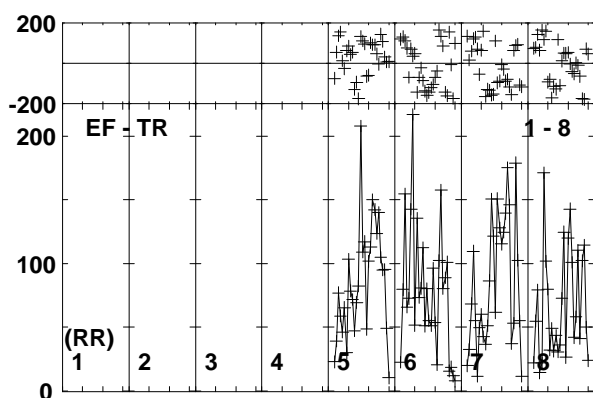
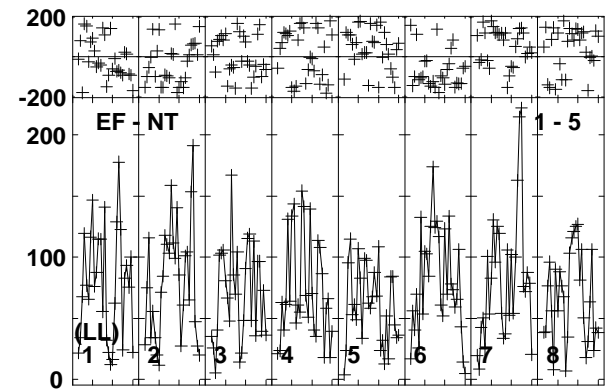
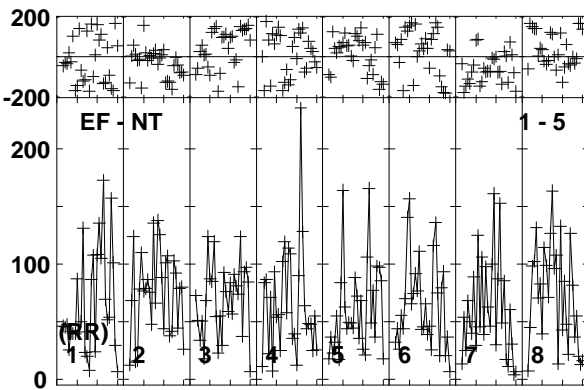
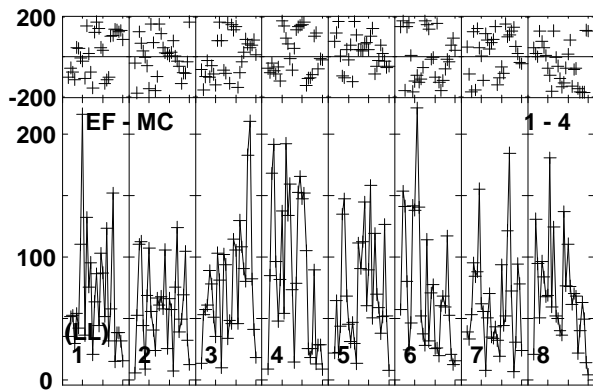
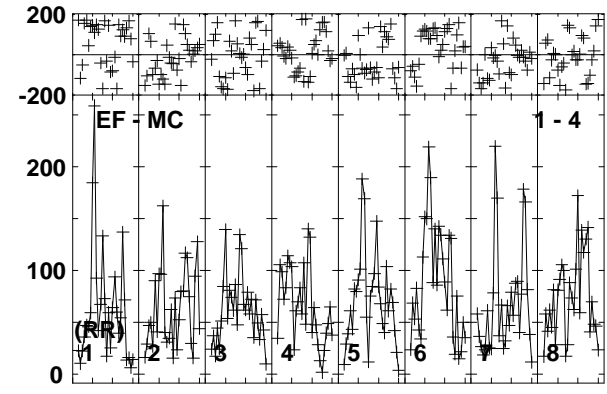
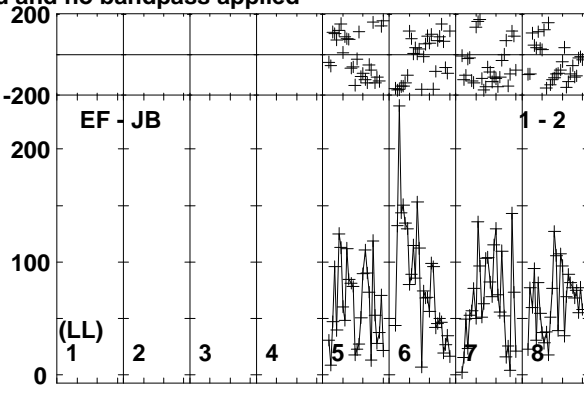
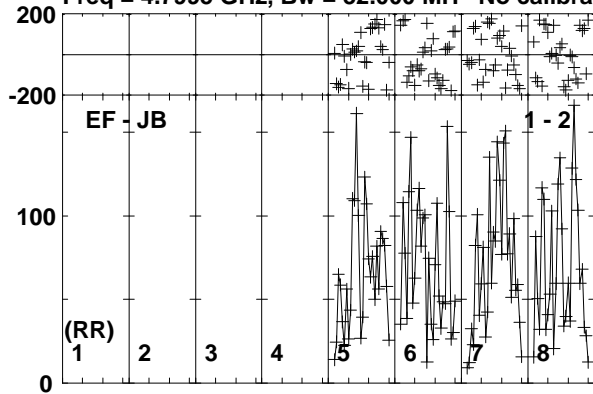

Lower frame: Micro Ampl Jy Top frame: Phas deg
Vector averaged cross-power spectrum Baseline: EF (01) - JB (02)
Timerange: 01/00:48:51 to 01/00:51:19

Plot file version 214 created 20-APR-2018 18:08:08

EM170817 RG009B.UVDATA.1

Freq = 4.7995 GHz, Bw = 32.000 MH No calibration applied and no bandpass applied

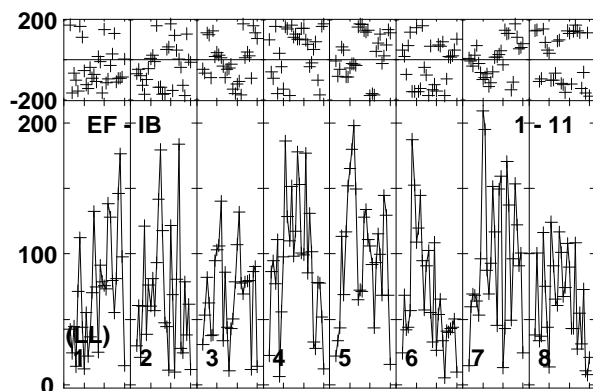
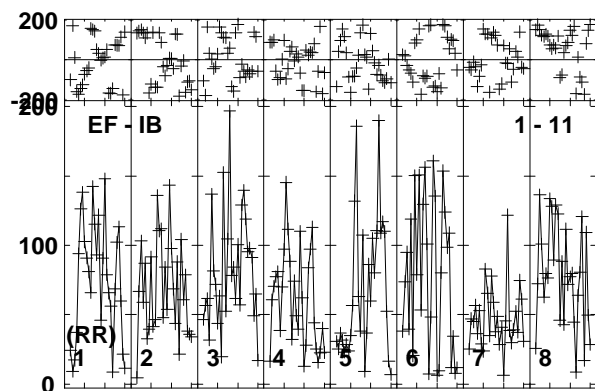
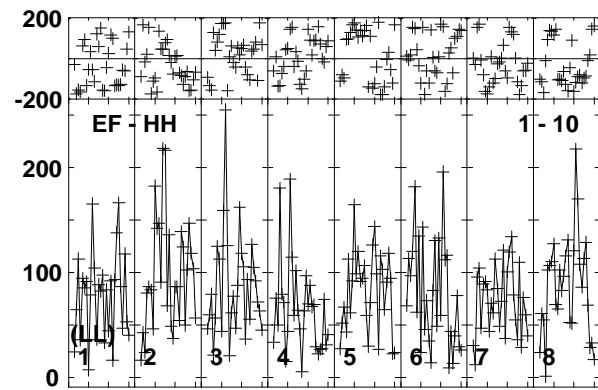
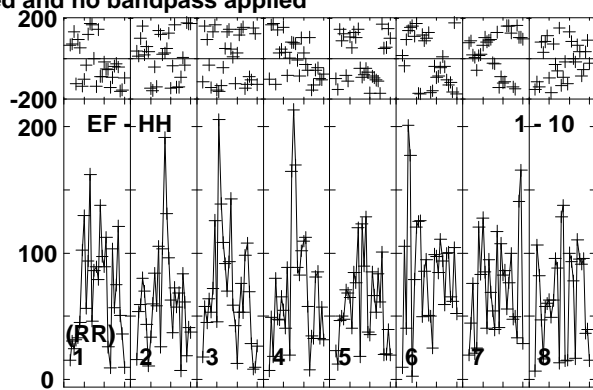
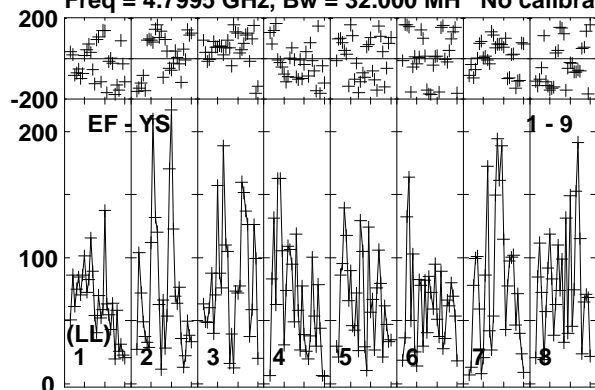

Lower frame: Micro Ampl Jy Top frame: Phas deg
Vector averaged cross-power spectrum Baseline: EF (01) - YS (09)
Timerange: 01/00:48:51 to 01/00:51:19

Plot file version 215 created 20-APR-2018 18:08:08

J1311-2329 RG009B.UVDATA.1

Freq = 4.7995 GHz, Bw = 32.000 MH No calibration applied and no bandpass applied

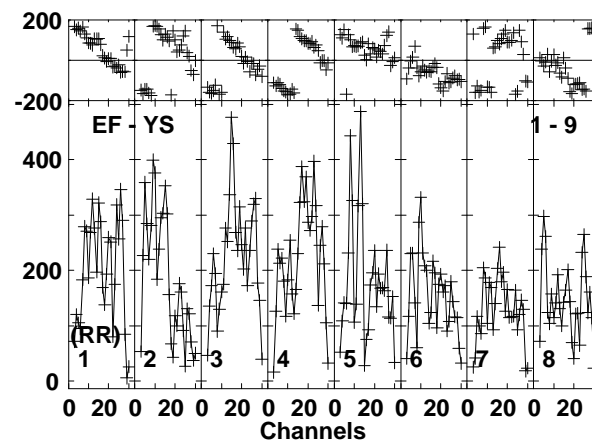
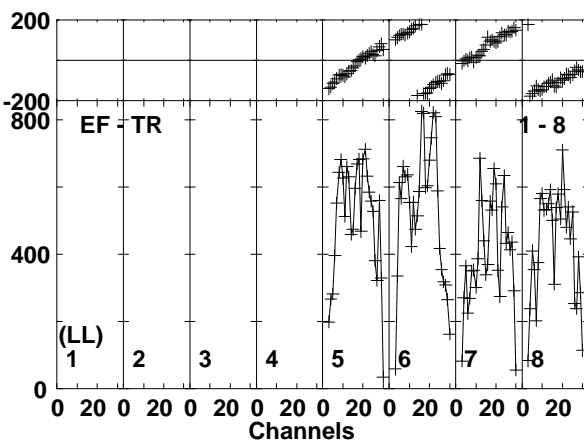
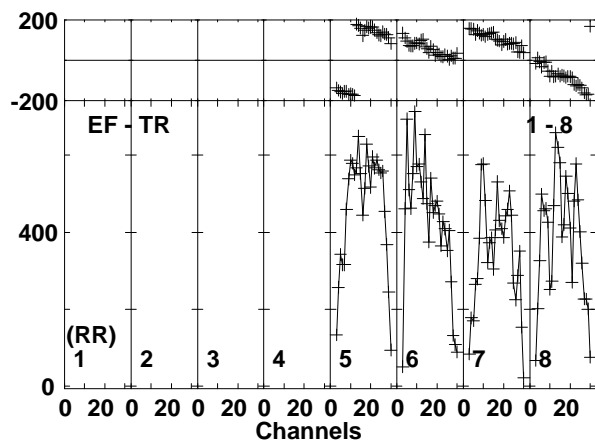
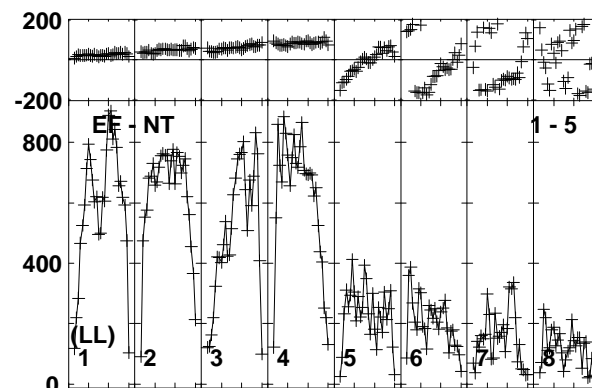
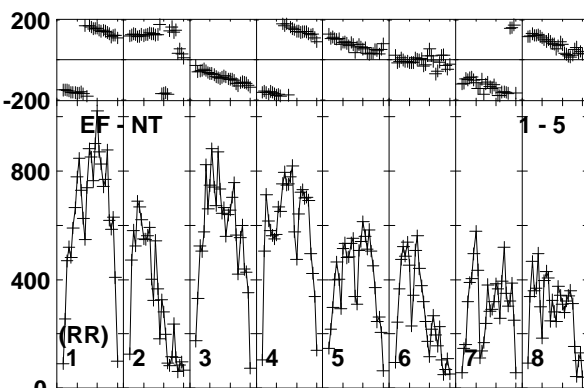
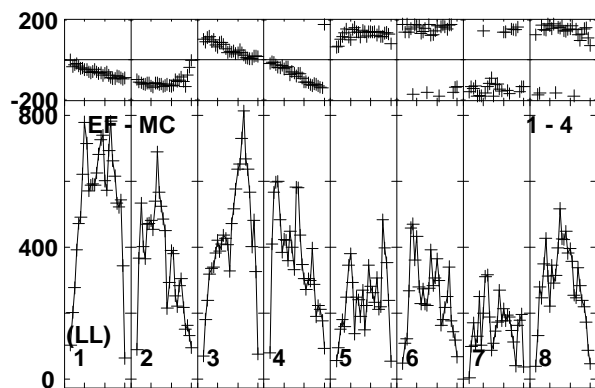
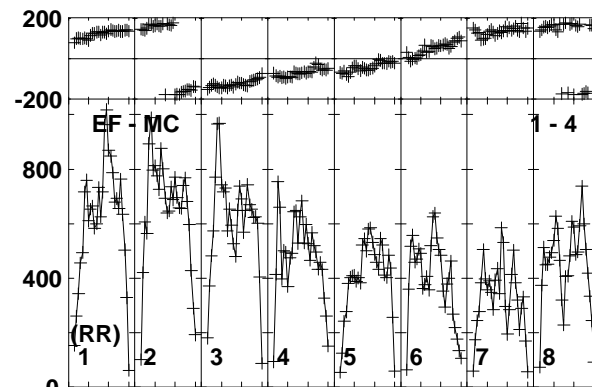
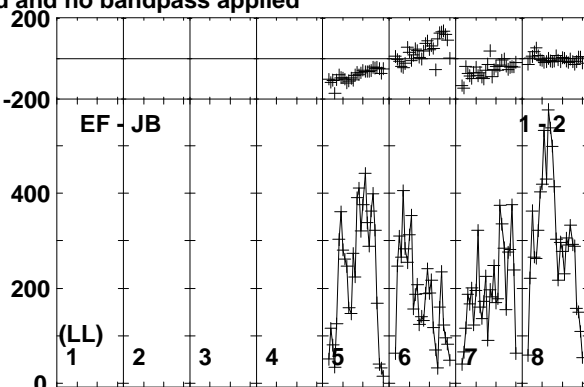
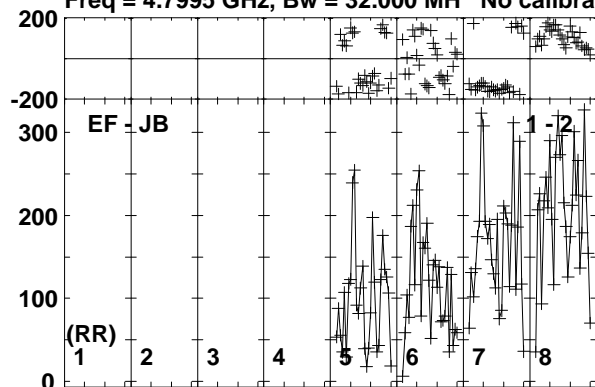

Lower frame: Micro Ampl Jy Top frame: Phas deg
Vector averaged cross-power spectrum Baseline: EF (01) - JB (02)
Timerange: 01/00:51:21 to 01/00:52:49

Plot file version 216 created 20-APR-2018 18:08:08

J1311-2329 RG009B.UVDATA.1

Freq = 4.7995 GHz, Bw = 32.000 MH No calibration applied and no bandpass applied

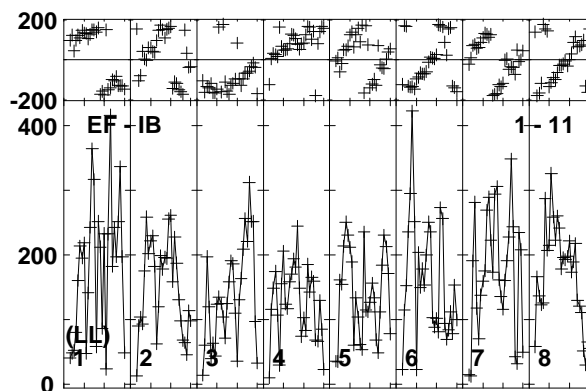
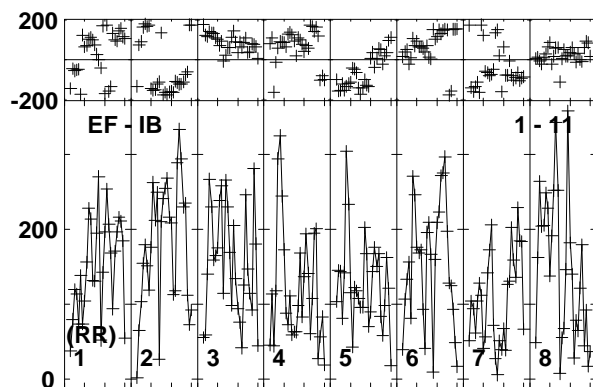
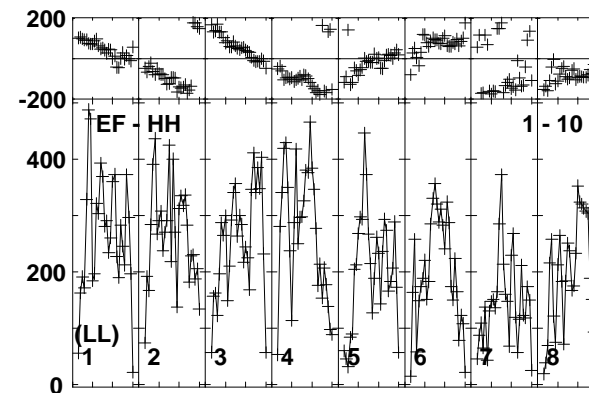
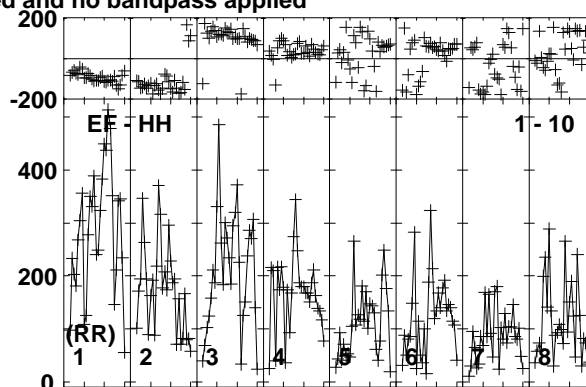
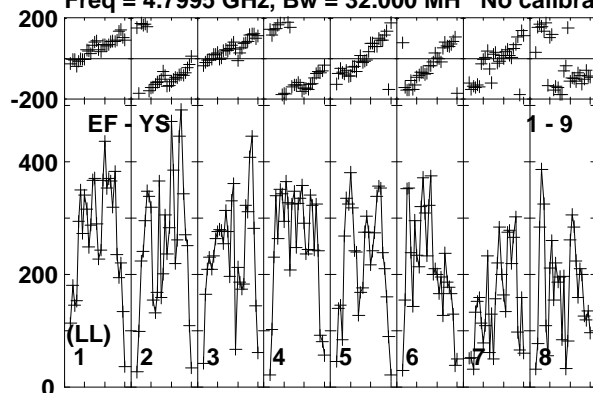

Lower frame: Micro Ampl Jy Top frame: Phas deg
Vector averaged cross-power spectrum Baseline: EF (01) - YS (09)
Timerange: 01/00:51:21 to 01/00:52:49

Plot file version 217 created 20-APR-2018 18:08:08

J1312-2350 RG009B.UVDATA.1

Freq = 4.7995 GHz, Bw = 32.000 MH No calibration applied and no bandpass applied

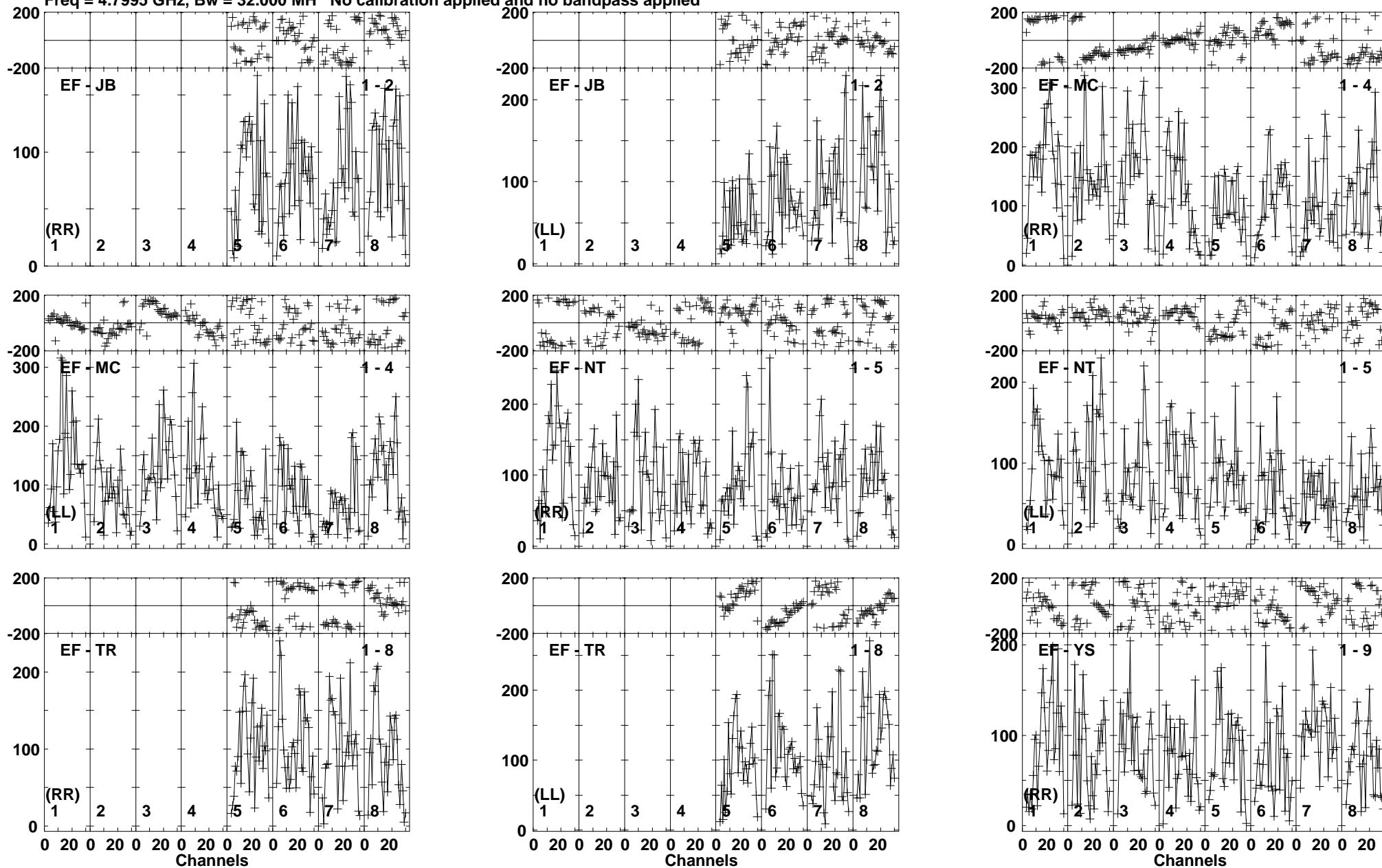

Lower frame: Micro Ampl Jy Top frame: Phas deg
Vector averaged cross-power spectrum Baseline: EF (01) - JB (02)
Timerange: 01/00:52:51 to 01/00:55:19

Plot file version 218 created 20-APR-2018 18:08:08

J1312-2350 RG009B.UVDATA.1

Freq = 4.7995 GHz, Bw = 32.000 MH No calibration applied and no bandpass applied

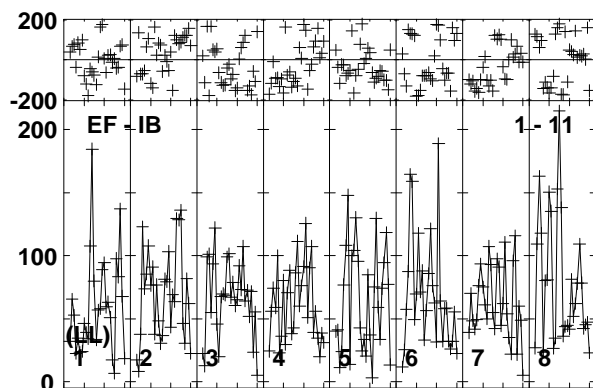
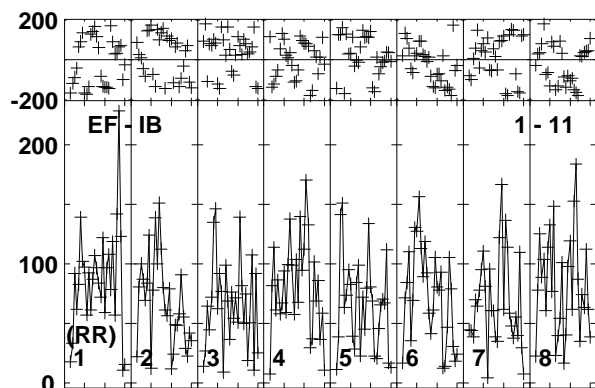
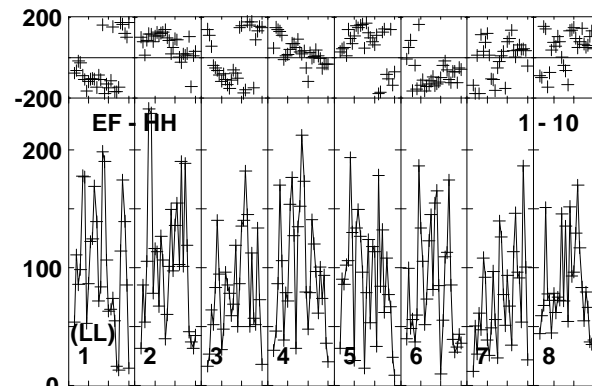
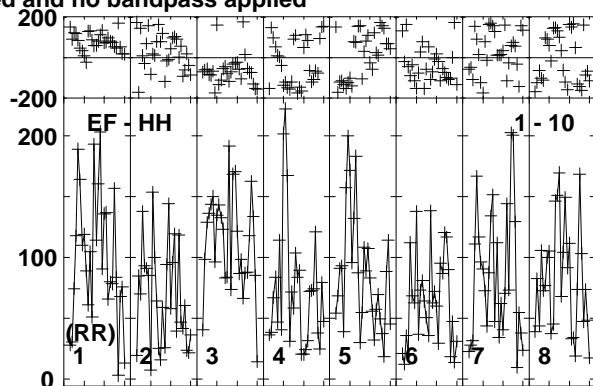
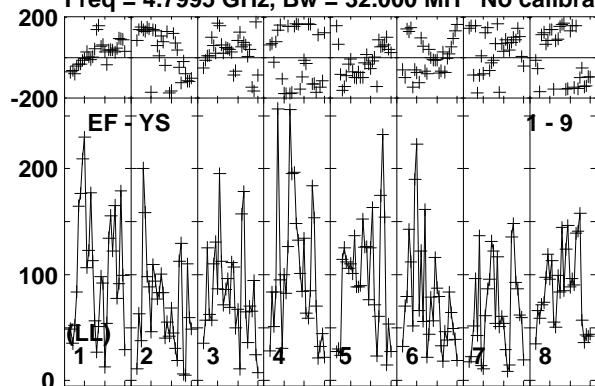

Lower frame: Micro Ampl Jy Top frame: Phas deg
Vector averaged cross-power spectrum Baseline: EF (01) - YS (09)
Timerange: 01/00:52:51 to 01/00:55:19

Plot file version 219 created 20-APR-2018 18:08:08

J1311-2329 RG009B.UVDATA.1

Freq = 4.7995 GHz, Bw = 32.000 MH No calibration applied and no bandpass applied

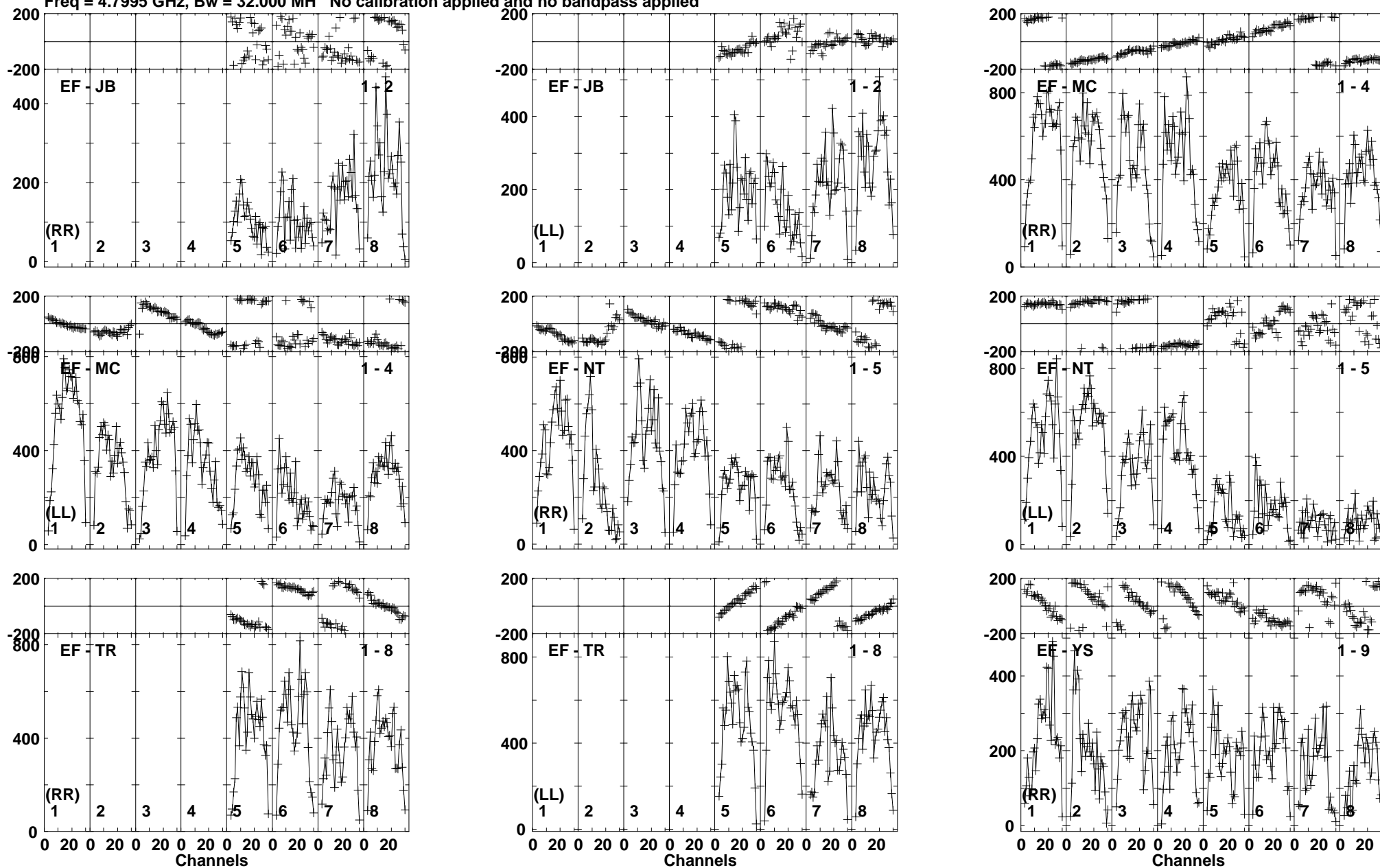

Lower frame: Micro Ampl Jy Top frame: Phas deg
Vector averaged cross-power spectrum Baseline: EF (01) - JB (02)
Timerange: 01/00:55:21 to 01/00:56:49

Plot file version 220 created 20-APR-2018 18:08:08

J1311-2329 RG009B.UVDATA.1

Freq = 4.7995 GHz, Bw = 32.000 MH No calibration applied and no bandpass applied

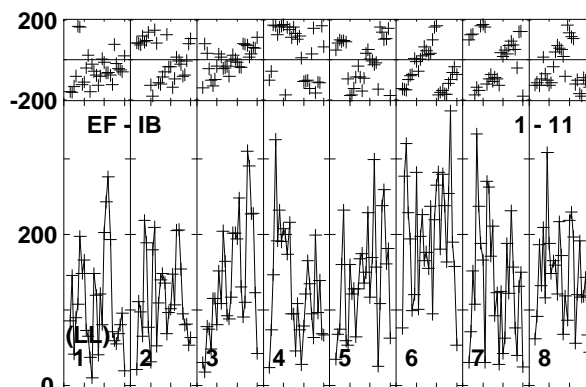
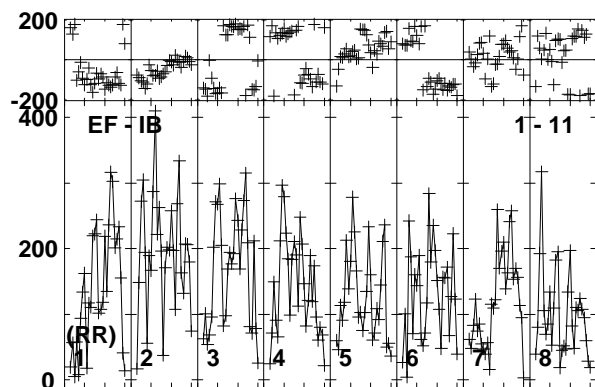
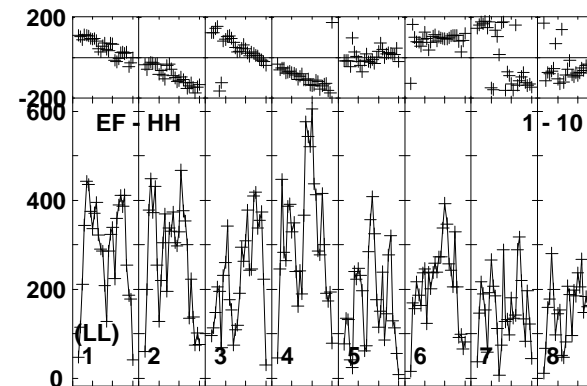
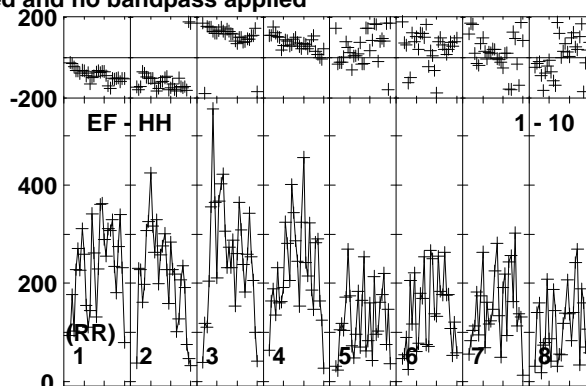
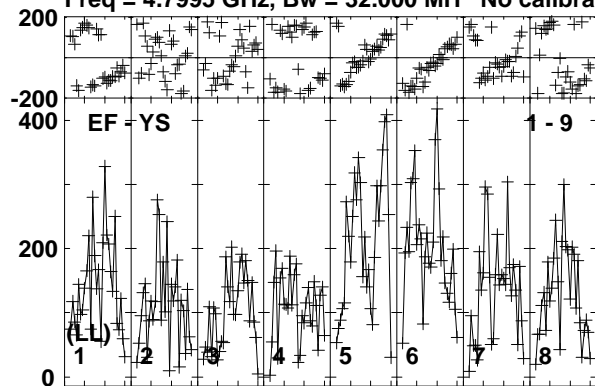

Lower frame: Micro Ampl Jy Top frame: Phas deg
Vector averaged cross-power spectrum Baseline: EF (01) - YS (09)
Timerange: 01/00:55:21 to 01/00:56:49

Plot file version 221 created 20-APR-2018 18:08:08

J1303-2405 RG009B.UVDATA.1

Freq = 4.7995 GHz, Bw = 32.000 MH No calibration applied and no bandpass applied

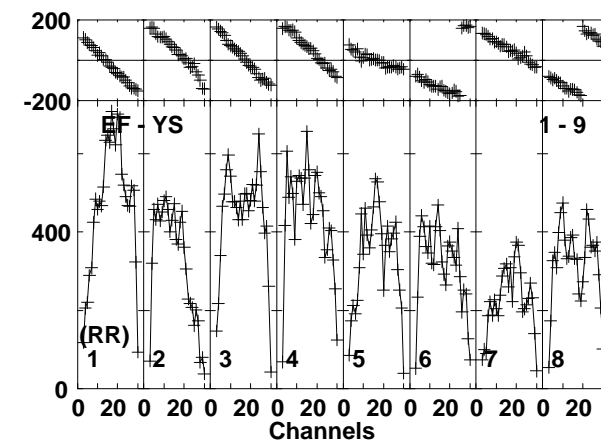
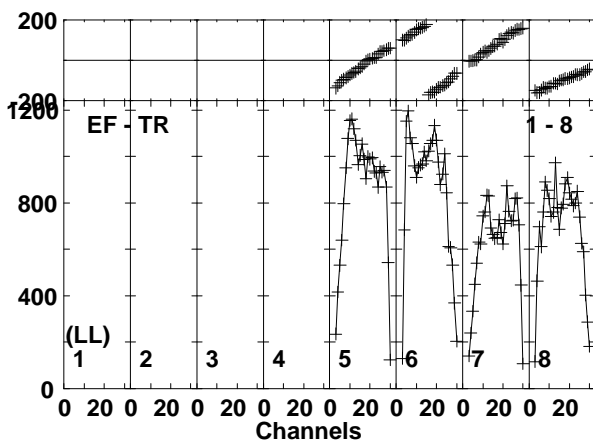
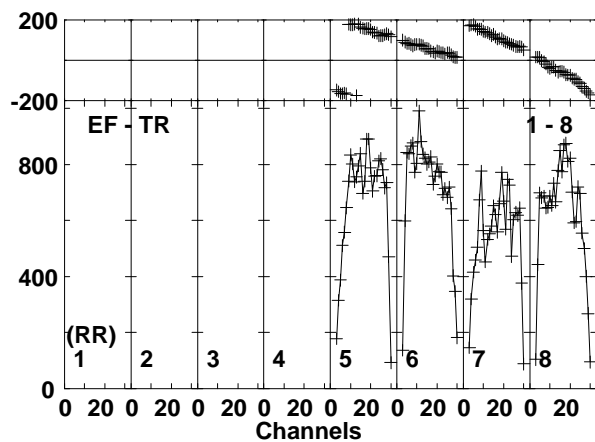
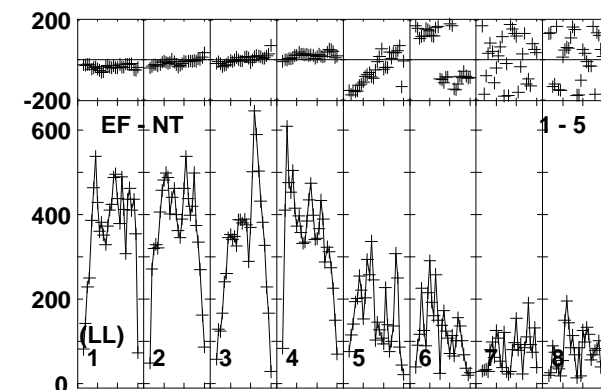
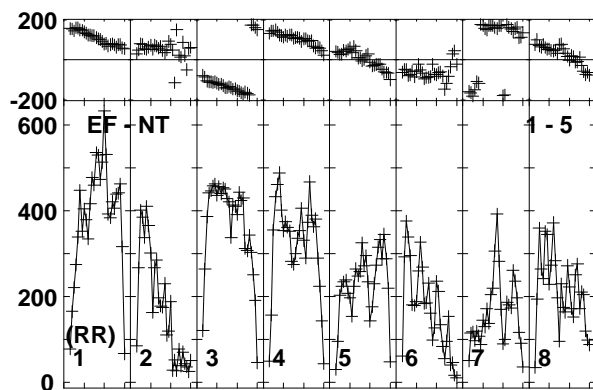
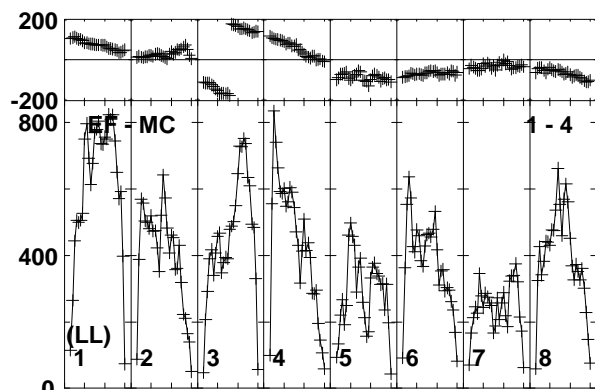
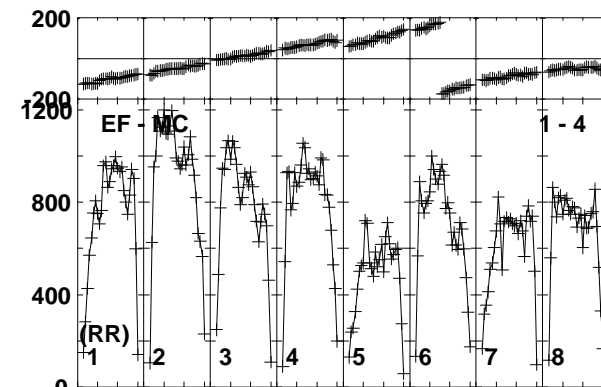
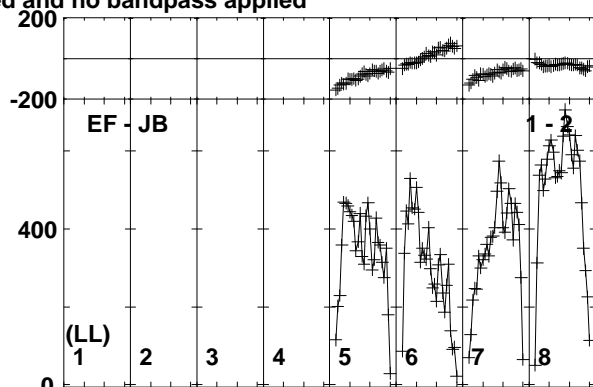
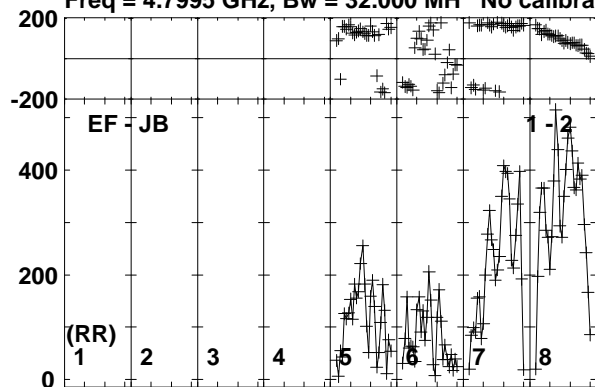

Lower frame: Micro Ampl Jy Top frame: Phas deg
Vector averaged cross-power spectrum Baseline: EF (01) - JB (02)
Timerange: 01/00:56:51 to 01/00:59:19

Plot file version 222 created 20-APR-2018 18:08:08

J1303-2405 RG009B.UVDATA.1

Freq = 4.7995 GHz, Bw = 32.000 MH No calibration applied and no bandpass applied

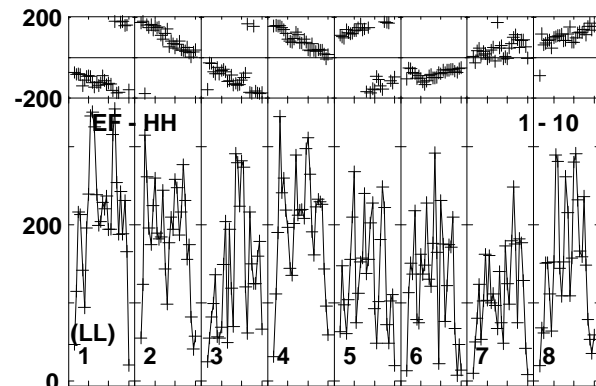
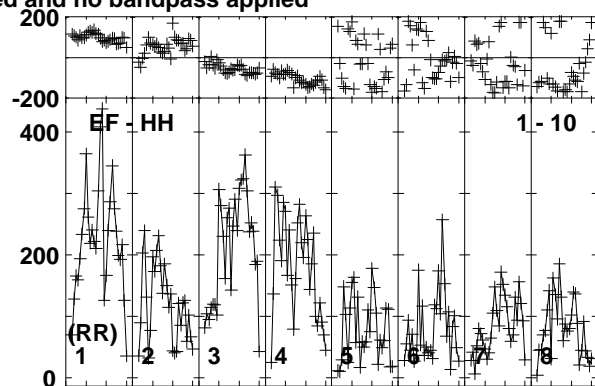
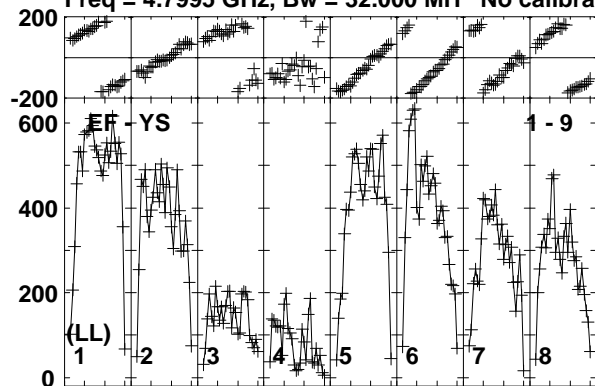

Lower frame: Micro Ampl Jy Top frame: Phas deg
Vector averaged cross-power spectrum Baseline: EF (01) - YS (09)
Timerange: 01/00:56:51 to 01/00:59:19

Plot file version 223 created 20-APR-2018 18:08:08

J1311-2329 RG009B.UVDATA.1

Freq = 4.7995 GHz, Bw = 32.000 MH No calibration applied and no bandpass applied

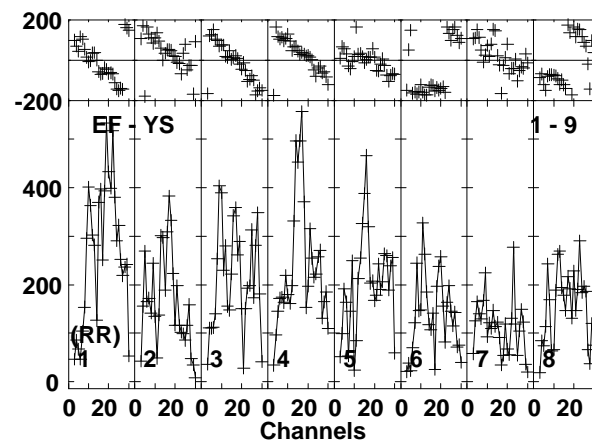
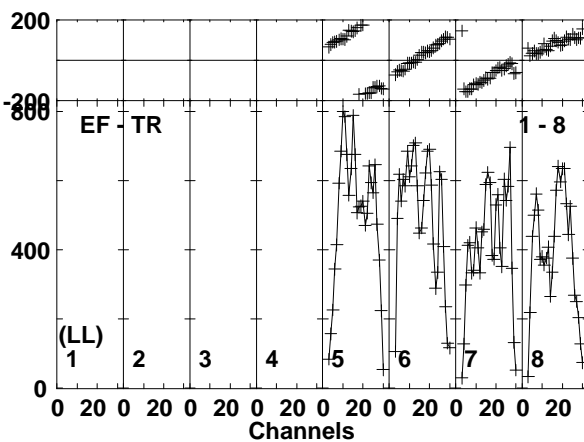
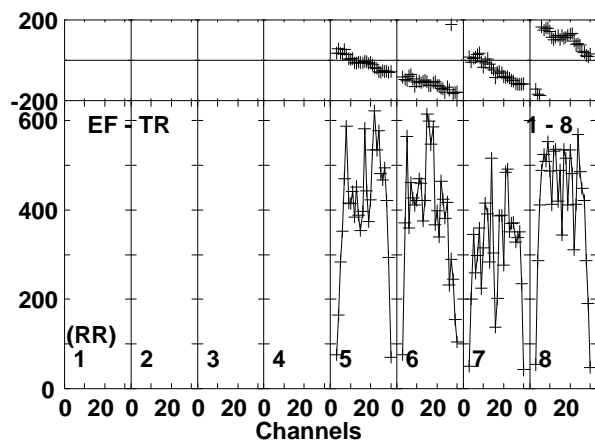
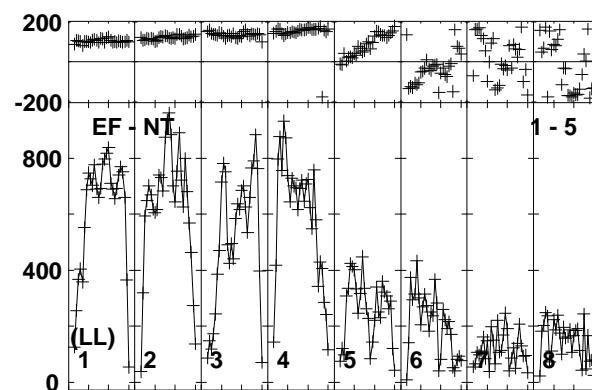
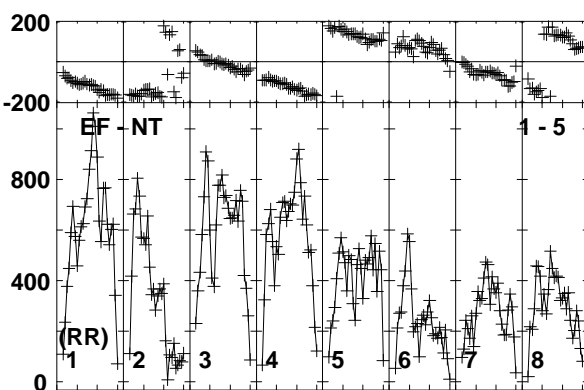
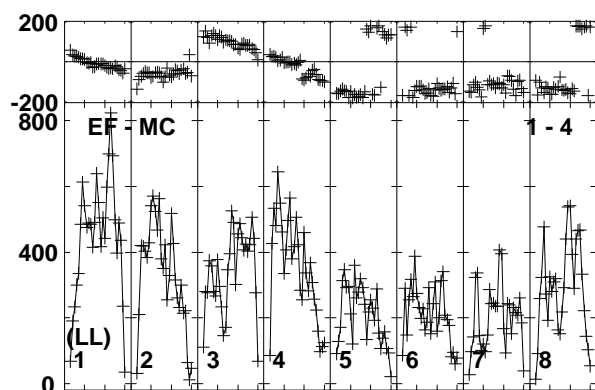
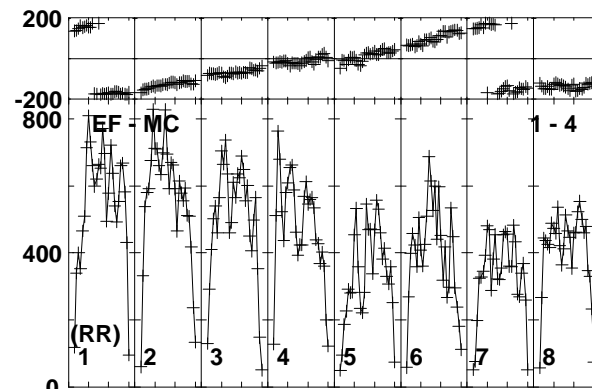
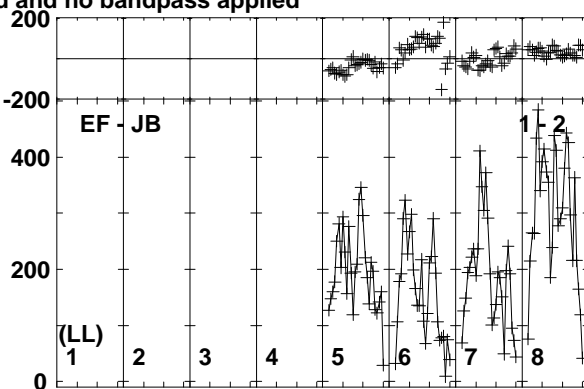
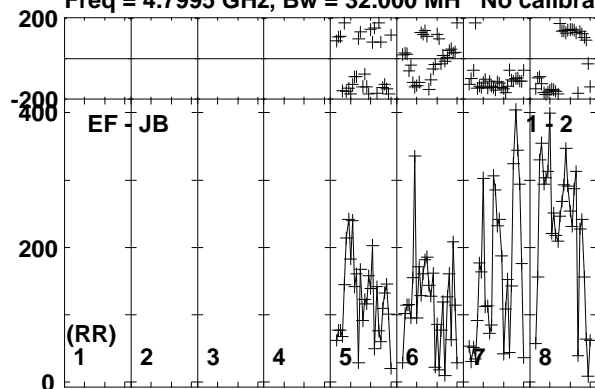

Lower frame: Micro Ampl Jy Top frame: Phas deg
Vector averaged cross-power spectrum Baseline: EF (01) - JB (02)
Timerange: 01/01:00:01 to 01/01:00:59

Plot file version 224 created 20-APR-2018 18:08:08

J1311-2329 RG009B.UVDATA.1

Freq = 4.7995 GHz, Bw = 32.000 MH No calibration applied and no bandpass applied

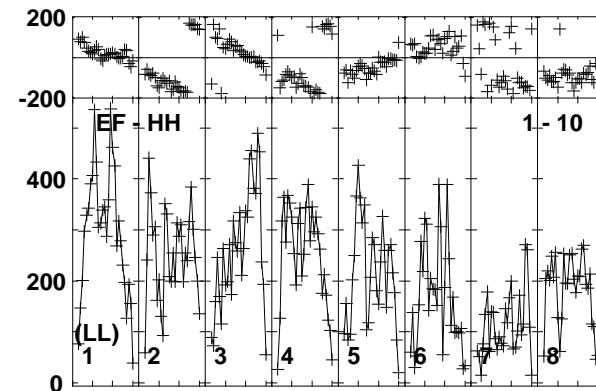
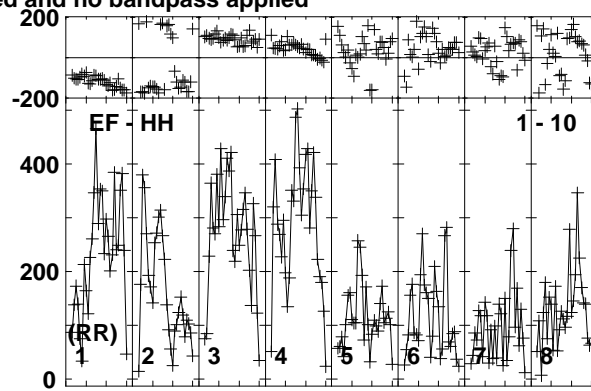
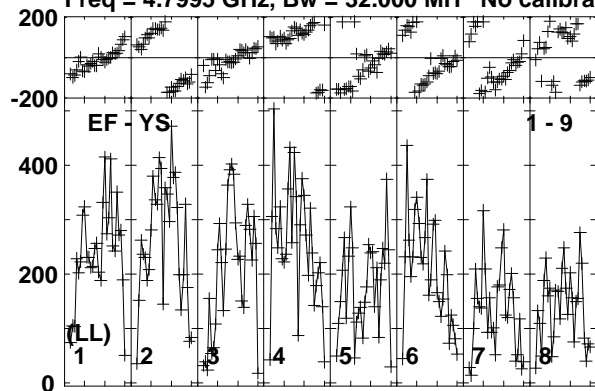

Lower frame: Micro Ampl Jy Top frame: Phas deg
Vector averaged cross-power spectrum Baseline: EF (01) - YS (09)
Timerange: 01/01:00:01 to 01/01:00:59

Plot file version 225 created 20-APR-2018 18:08:08

EM170817 RG009B.UVDATA.1

Freq = 4.7995 GHz, Bw = 32.000 MH No calibration applied and no bandpass applied

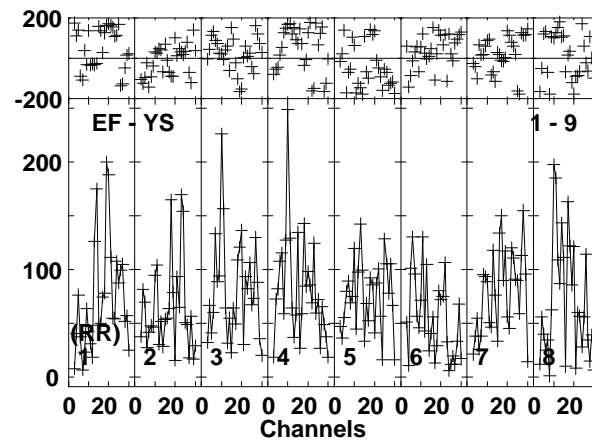
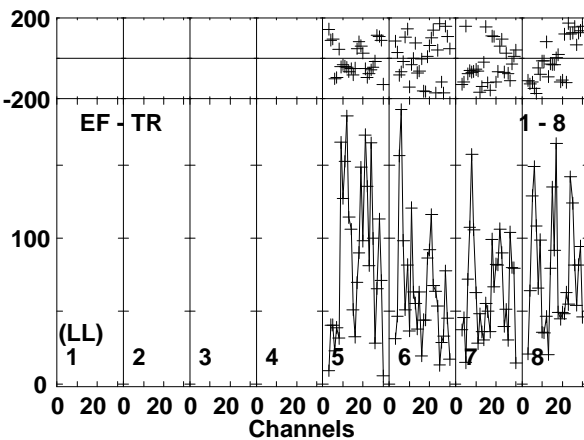
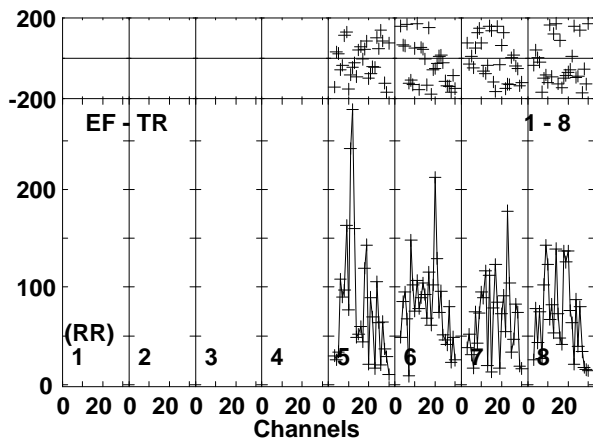
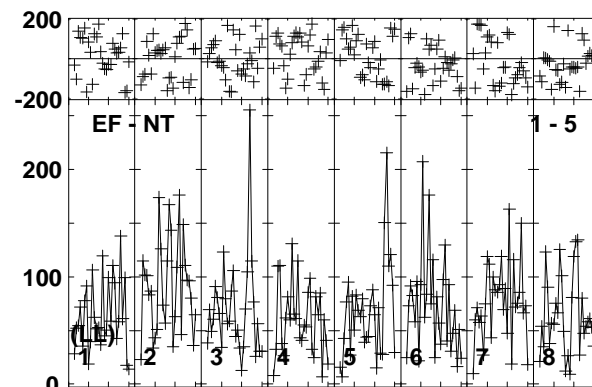
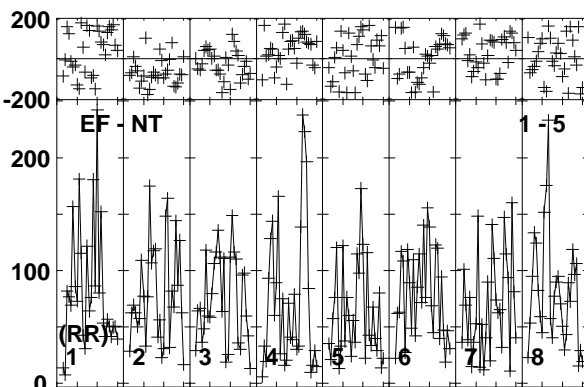
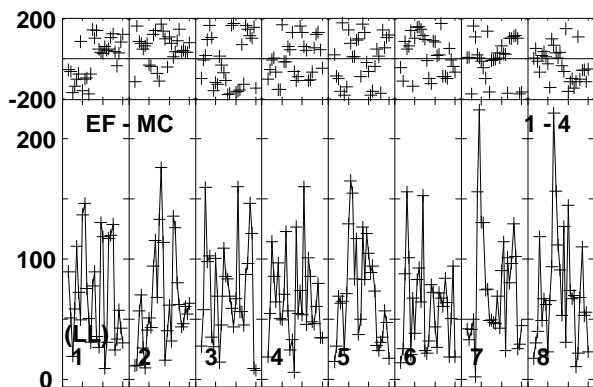
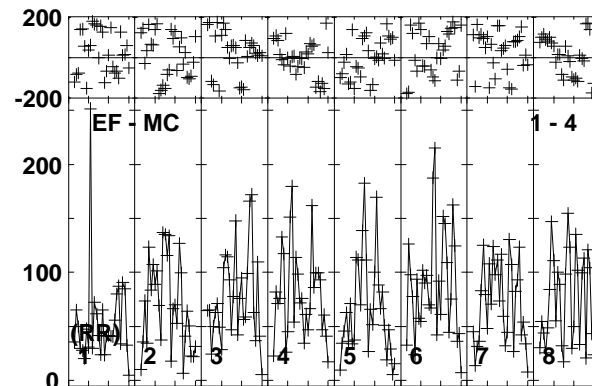
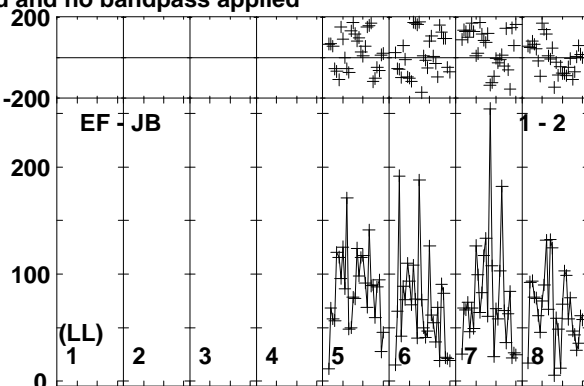
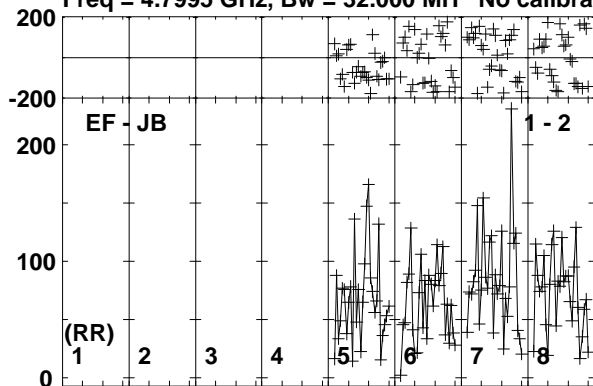

Lower frame: Micro Ampl Jy Top frame: Phas deg
Vector averaged cross-power spectrum Baseline: EF (01) - JB (02)
Timerange: 01/01:01:01 to 01/01:03:29

Plot file version 226 created 20-APR-2018 18:08:09

EM170817 RG009B.UVDATA.1

Freq = 4.7995 GHz, Bw = 32.000 MH No calibration applied and no bandpass applied

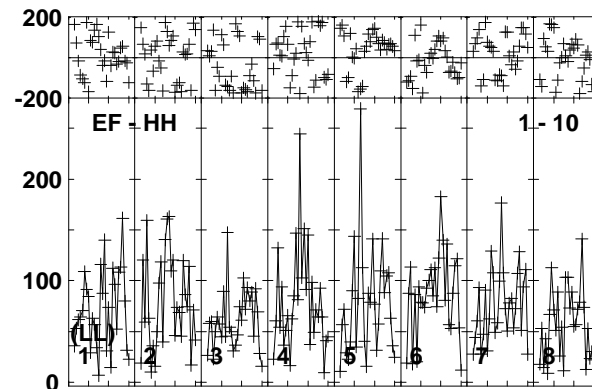
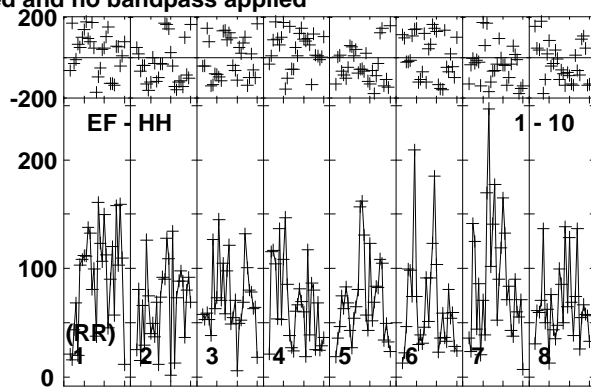
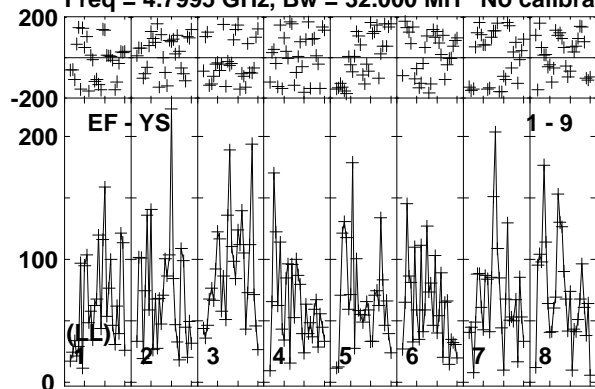

Lower frame: Micro Ampl Jy Top frame: Phas deg
Vector averaged cross-power spectrum Baseline: EF (01) - YS (09)
Timerange: 01/01:01:01 to 01/01:03:29

Plot file version 227 created 20-APR-2018 18:08:09

J1311-2329 RG009B.UVDATA.1

Freq = 4.7995 GHz, Bw = 32.000 MH No calibration applied and no bandpass applied

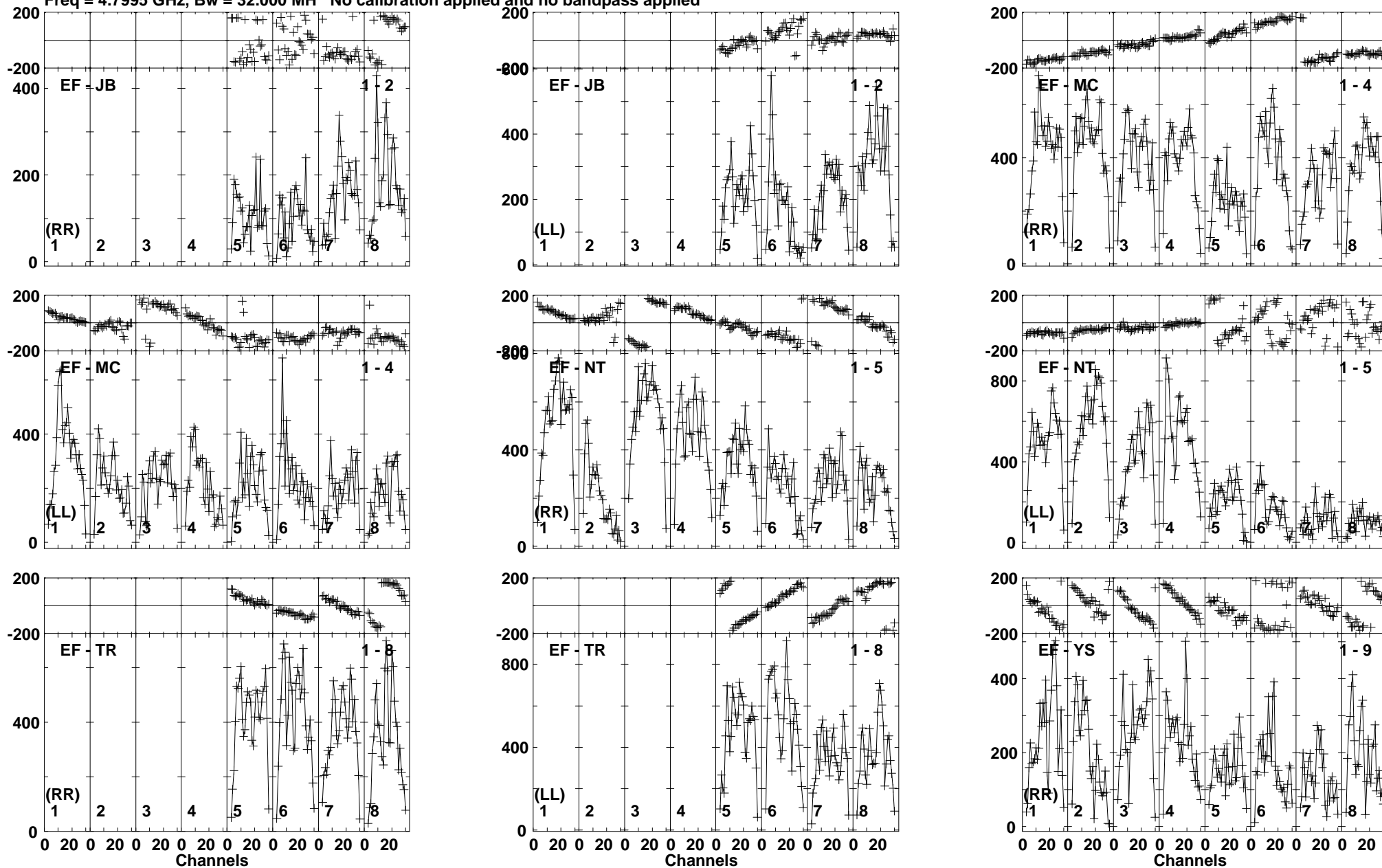

Lower frame: Micro Ampl Jy Top frame: Phas deg
Vector averaged cross-power spectrum Baseline: EF (01) - JB (02)
Timerange: 01/01:03:31 to 01/01:04:59

Plot file version 228 created 20-APR-2018 18:08:09

J1311-2329 RG009B.UVDATA.1

Freq = 4.7995 GHz, Bw = 32.000 MH No calibration applied and no bandpass applied

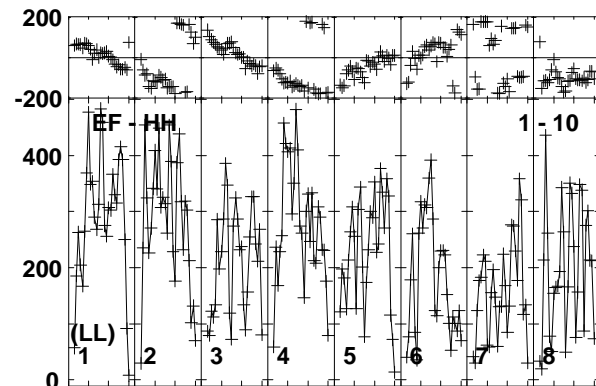
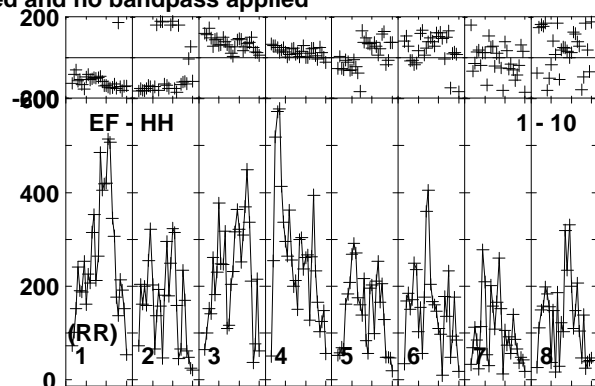
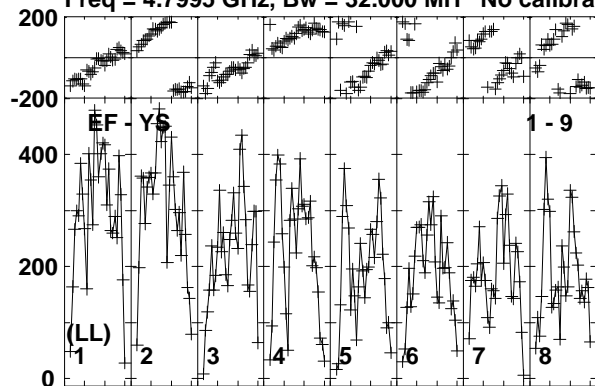

Lower frame: Micro Ampl Jy Top frame: Phas deg
Vector averaged cross-power spectrum Baseline: EF (01) - YS (09)
Timerange: 01/01:03:31 to 01/01:04:59

Plot file version 229 created 20-APR-2018 18:08:09

EM170817 RG009B.UVDATA.1

Freq = 4.7995 GHz, Bw = 32.000 MH No calibration applied and no bandpass applied

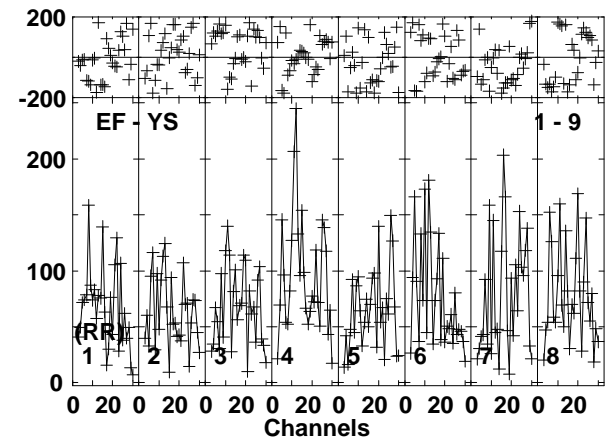
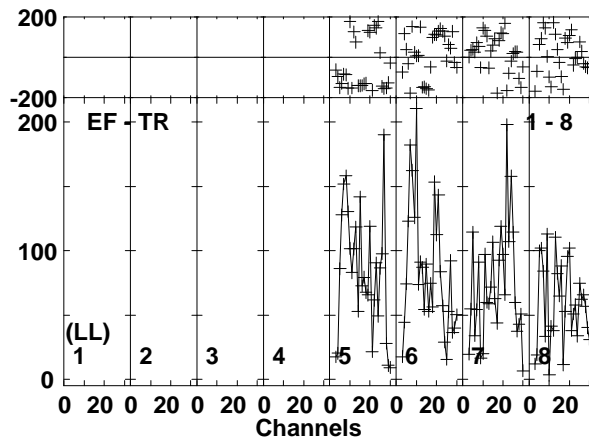
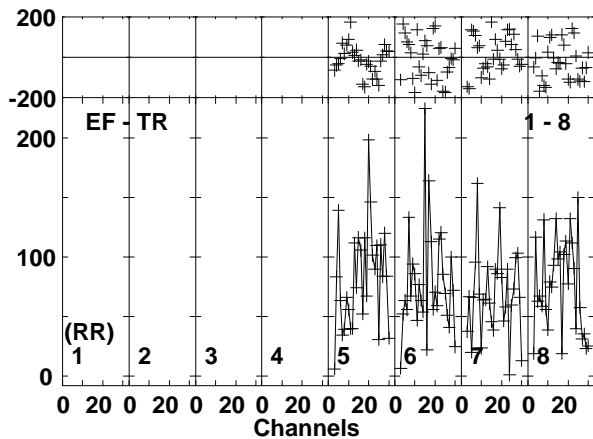
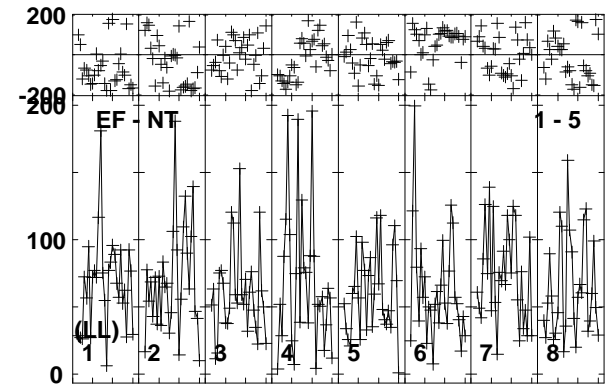
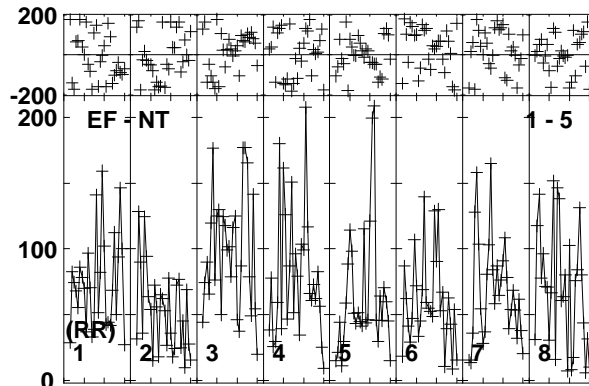
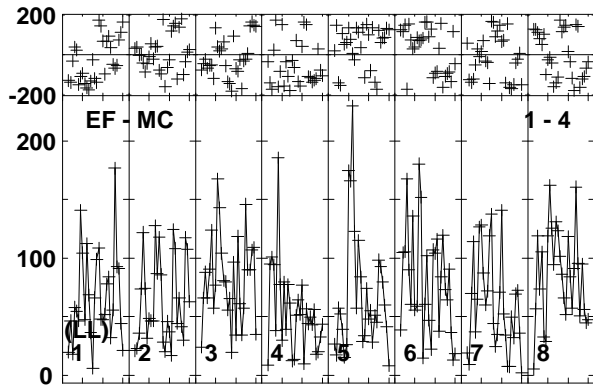
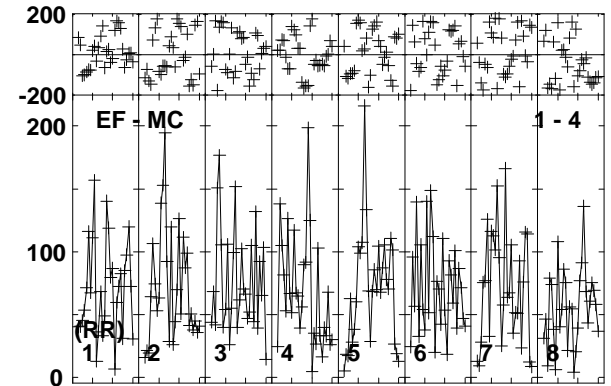
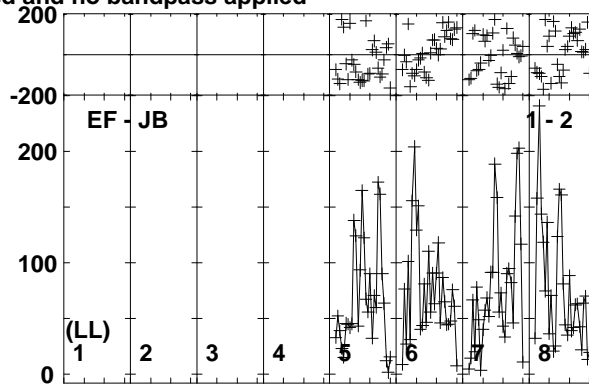
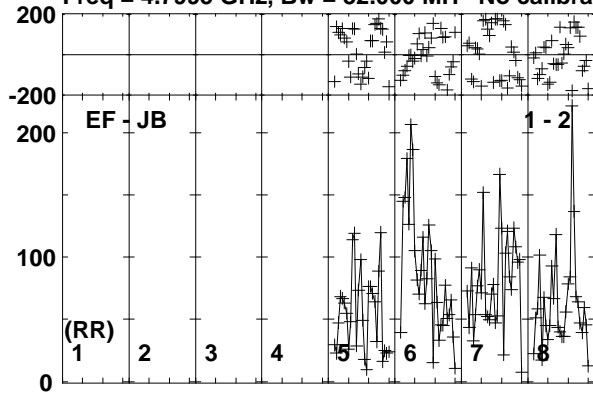

Lower frame: Micro Ampl Jy Top frame: Phas deg
Vector averaged cross-power spectrum Baseline: EF (01) - JB (02)
Timerange: 01/01:05:01 to 01/01:07:29

Plot file version 230 created 20-APR-2018 18:08:09

EM170817 RG009B.UVDATA.1

Freq = 4.7995 GHz, Bw = 32.000 MH No calibration applied and no bandpass applied

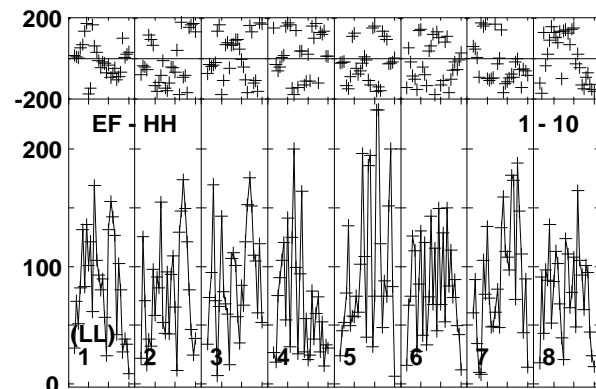
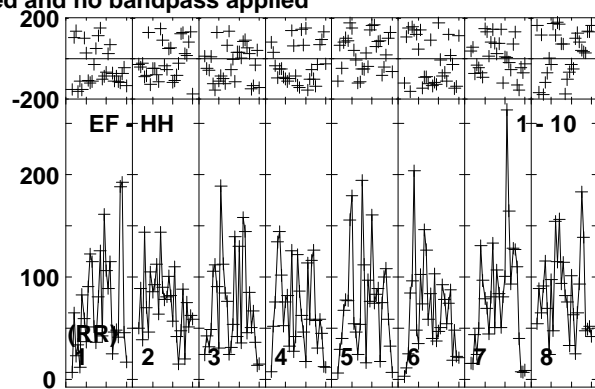
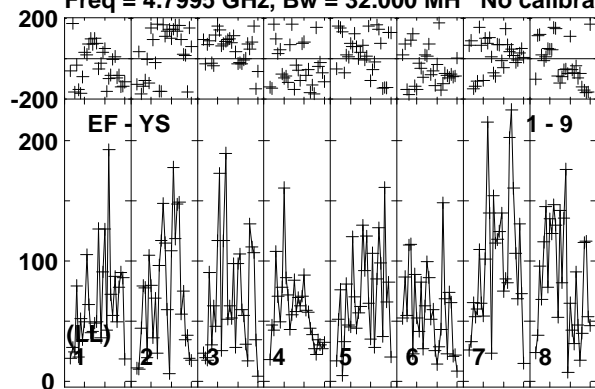

Lower frame: Micro Ampl Jy Top frame: Phas deg
Vector averaged cross-power spectrum Baseline: EF (01) - YS (09)
Timerange: 01/01:05:01 to 01/01:07:29

Plot file version 231 created 20-APR-2018 18:08:09

J1311-2329 RG009B.UVDATA.1

Freq = 4.7995 GHz, Bw = 32.000 MH No calibration applied and no bandpass applied

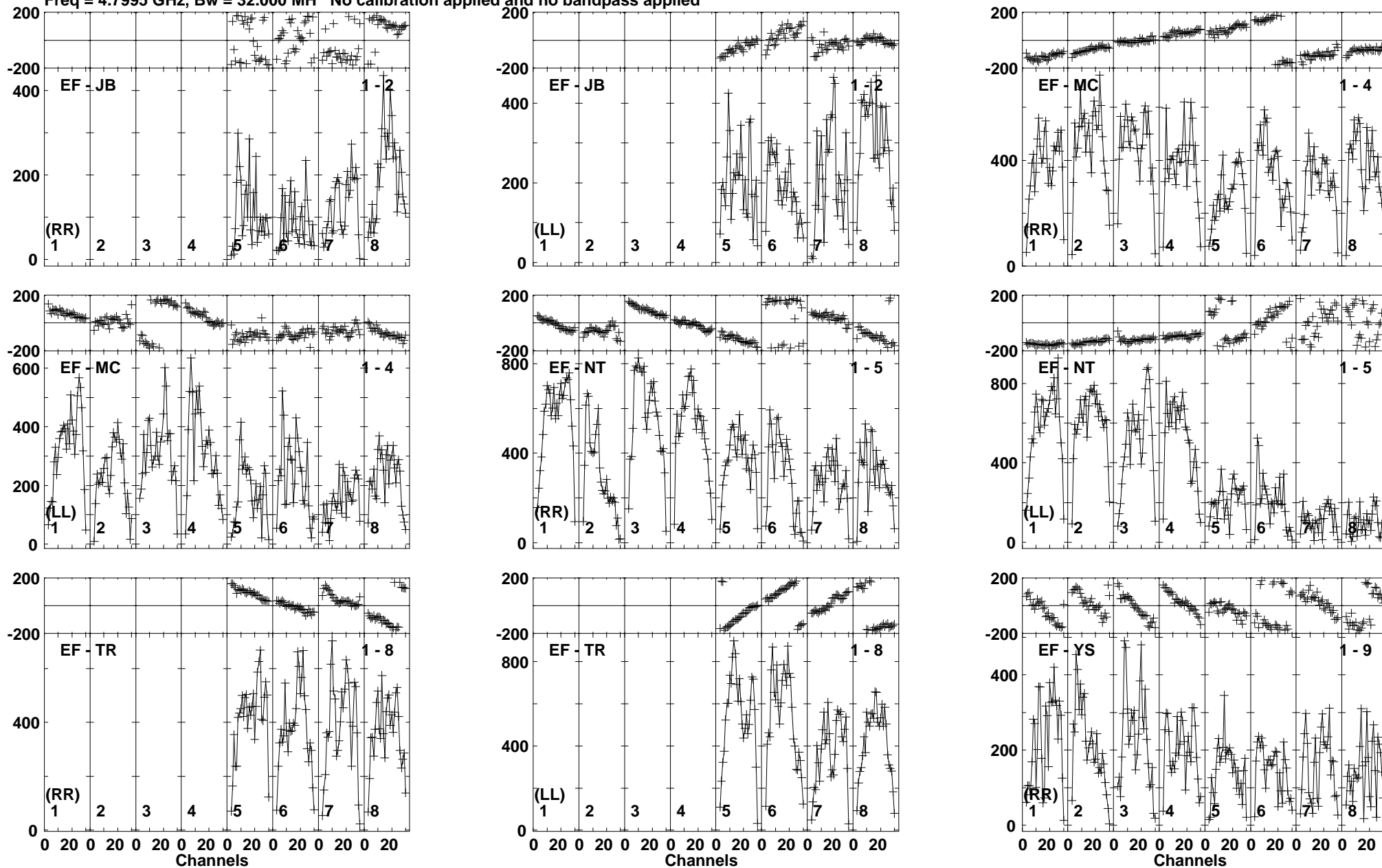

Lower frame: Micro Ampl Jy Top frame: Phas deg
Vector averaged cross-power spectrum Baseline: EF (01) - JB (02)
Timerange: 01/01:08:01 to 01/01:08:59

Plot file version 232 created 20-APR-2018 18:08:09

J1311-2329 RG009B.UVDATA.1

Freq = 4.7995 GHz, Bw = 32.000 MH No calibration applied and no bandpass applied

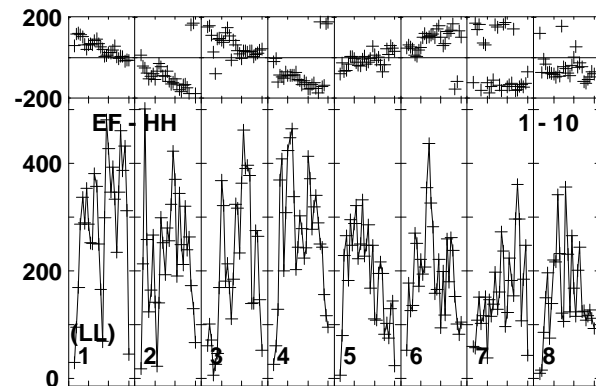
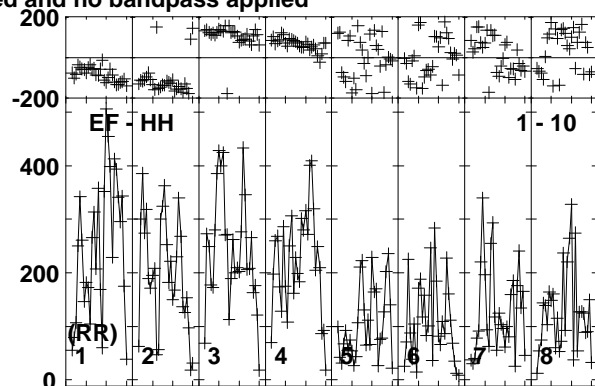
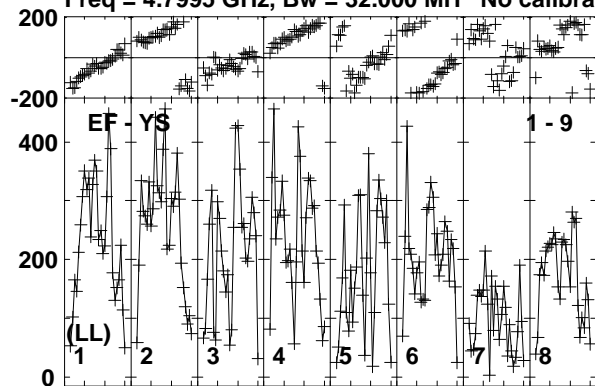

Lower frame: Micro Ampl Jy Top frame: Phas deg
Vector averaged cross-power spectrum Baseline: EF (01) - YS (09)
Timerange: 01/01:08:01 to 01/01:08:59

Plot file version 233 created 20-APR-2018 18:08:09

EM170817 RG009B.UVDATA.1

Freq = 4.7995 GHz, Bw = 32.000 MH No calibration applied and no bandpass applied

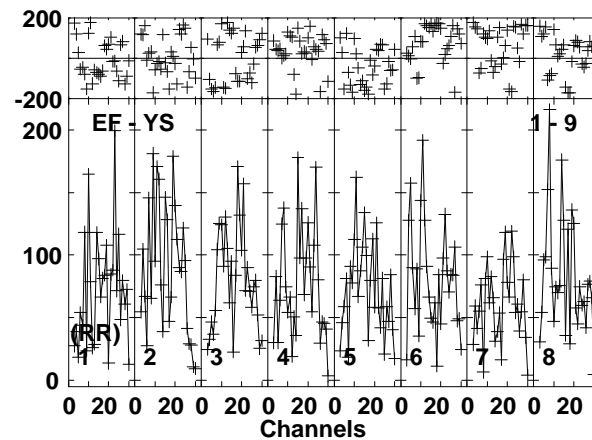
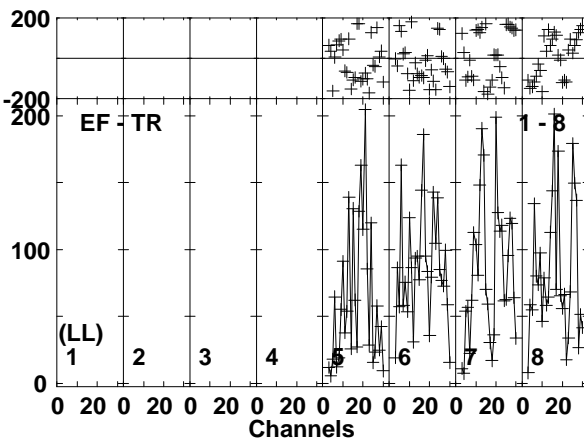
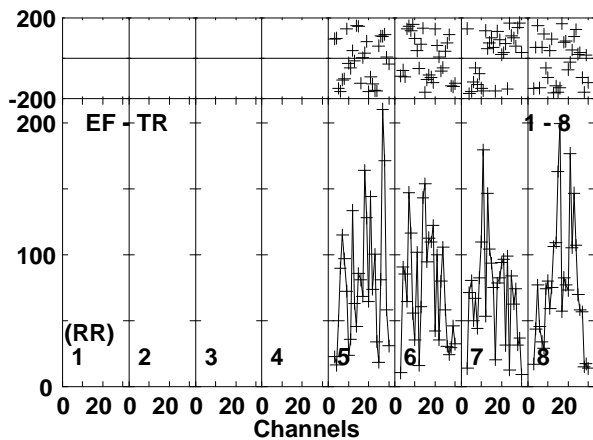
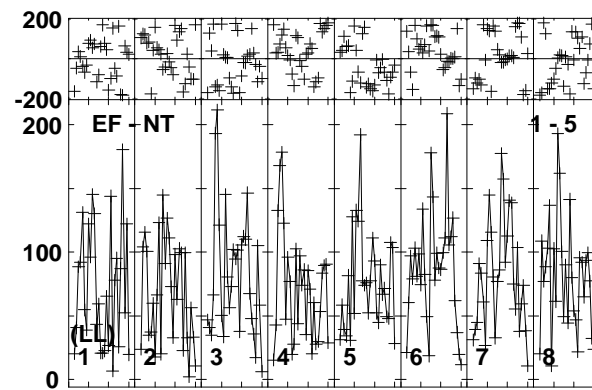
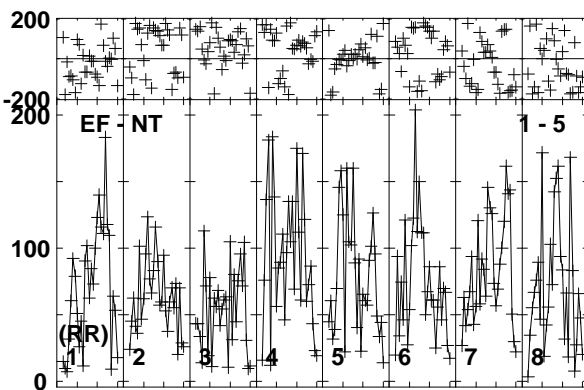
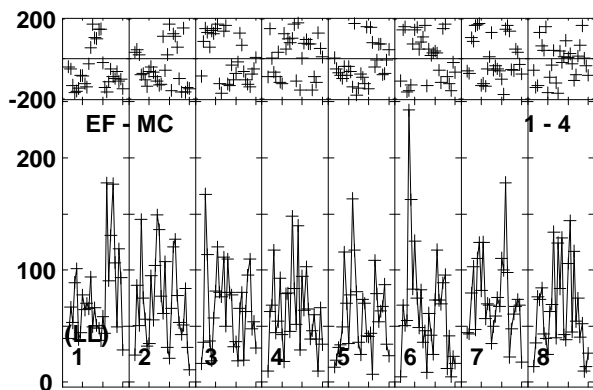
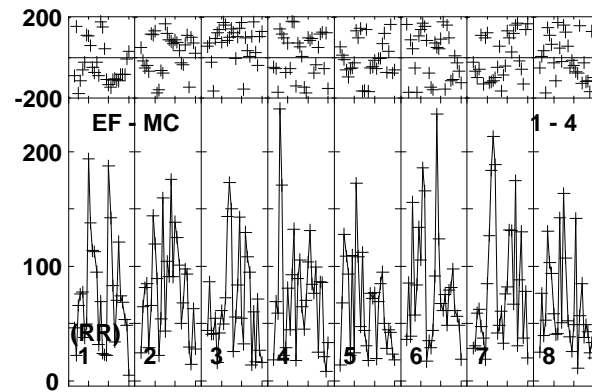
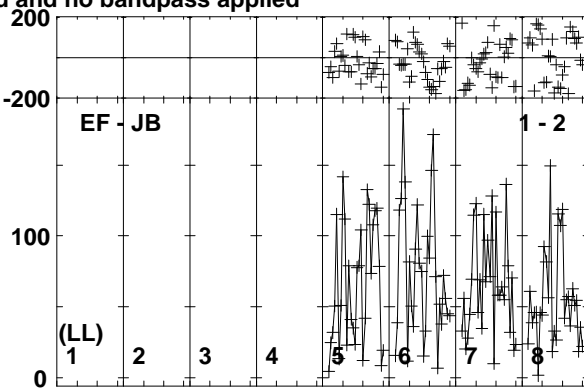
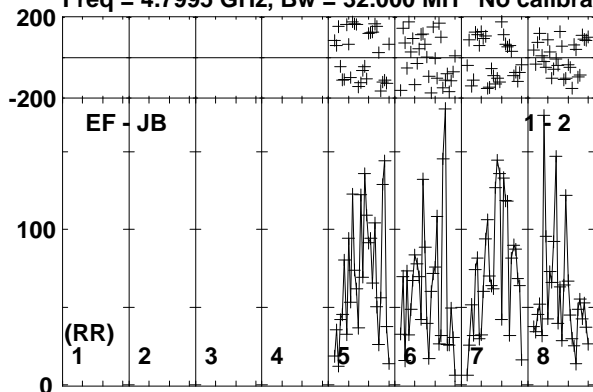

Lower frame: Micro Ampl Jy Top frame: Phas deg
Vector averaged cross-power spectrum Baseline: EF (01) - JB (02)
Timerange: 01/01:09:01 to 01/01:11:29

Plot file version 234 created 20-APR-2018 18:08:09

EM170817 RG009B.UVDATA.1

Freq = 4.7995 GHz, Bw = 32.000 MH No calibration applied and no bandpass applied

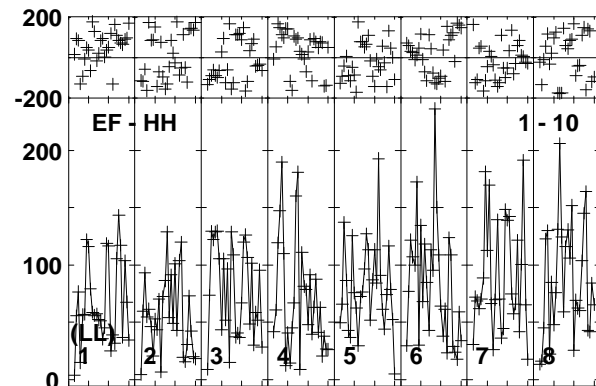
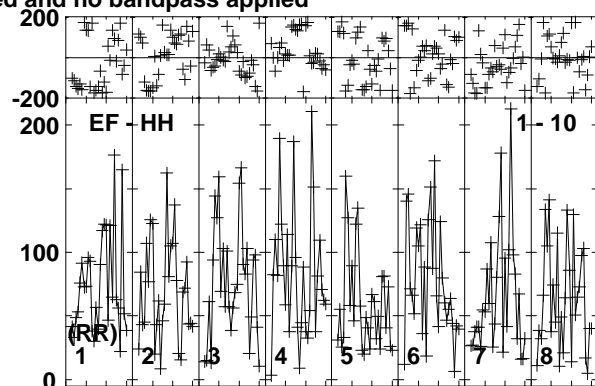
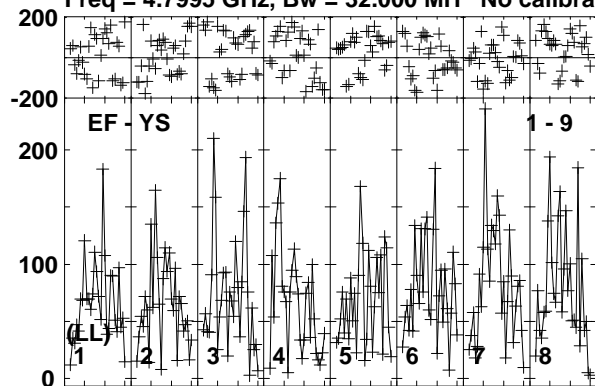

Lower frame: Micro Ampl Jy Top frame: Phas deg
Vector averaged cross-power spectrum Baseline: EF (01) - YS (09)
Timerange: 01/01:09:01 to 01/01:11:29

Plot file version 235 created 20-APR-2018 18:08:09

J1311-2329 RG009B.UVDATA.1

Freq = 4.7995 GHz, Bw = 32.000 MH No calibration applied and no bandpass applied

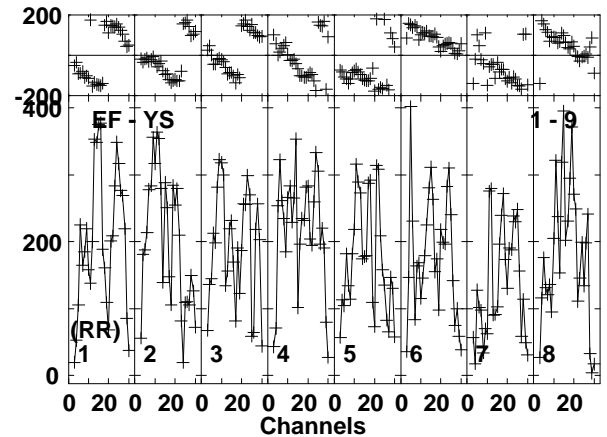
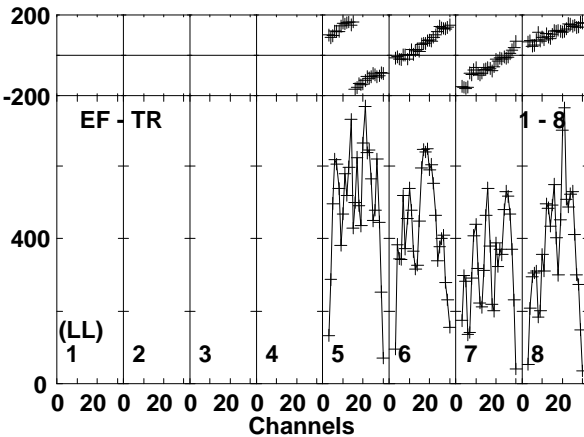
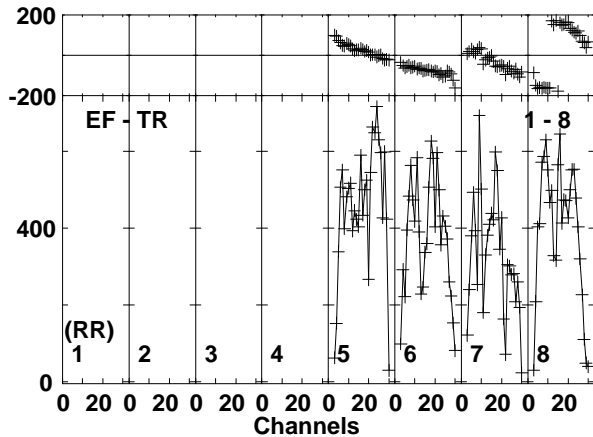
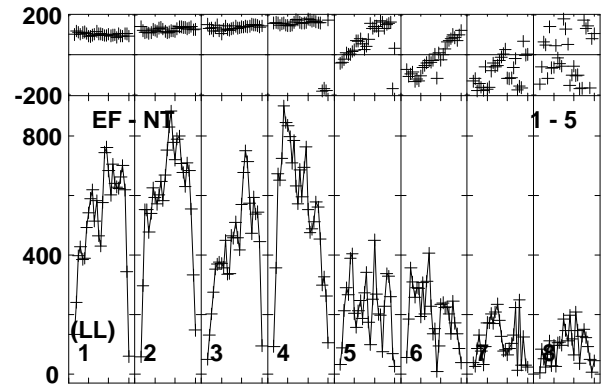
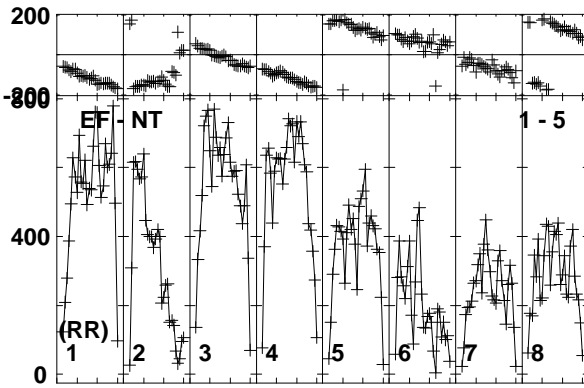
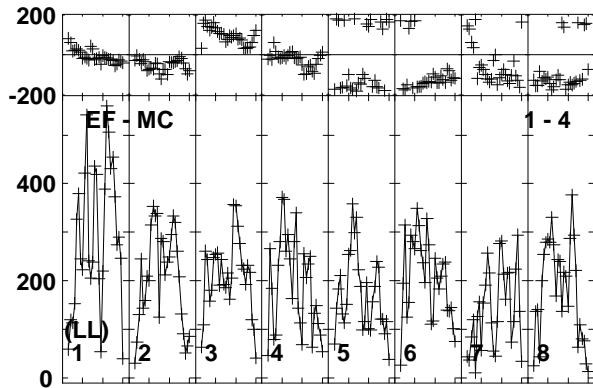
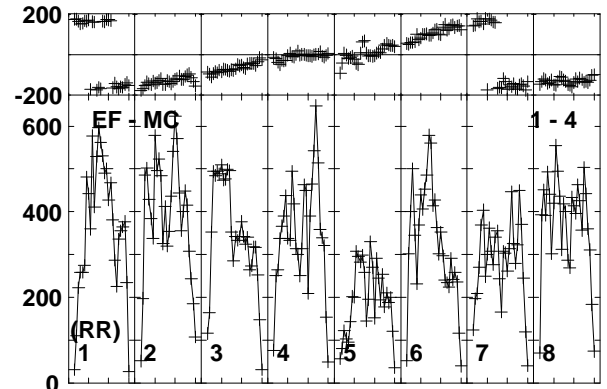
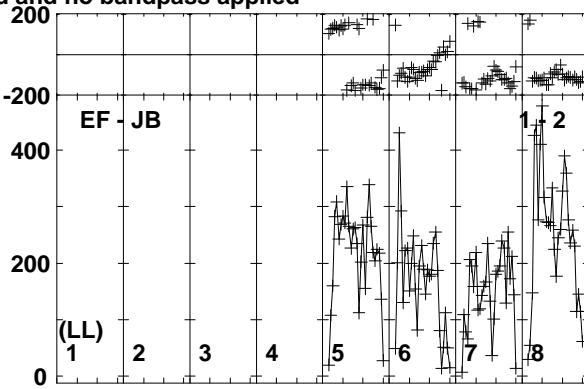
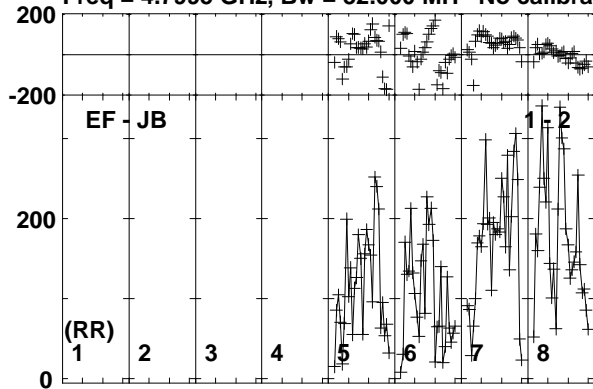

Lower frame: Micro Ampl Jy Top frame: Phas deg
Vector averaged cross-power spectrum Baseline: EF (01) - JB (02)
Timerange: 01/01:11:31 to 01/01:12:59

Plot file version 236 created 20-APR-2018 18:08:09

J1311-2329 RG009B.UVDATA.1

Freq = 4.7995 GHz, Bw = 32.000 MH No calibration applied and no bandpass applied

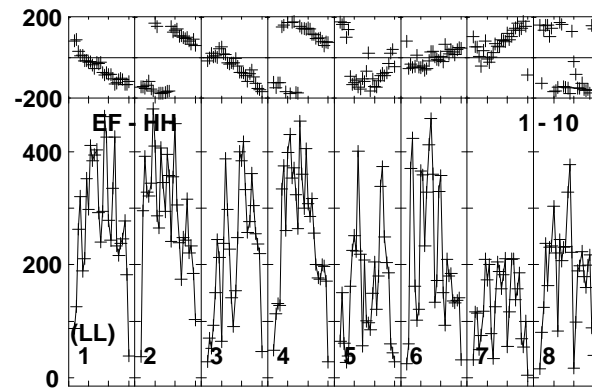
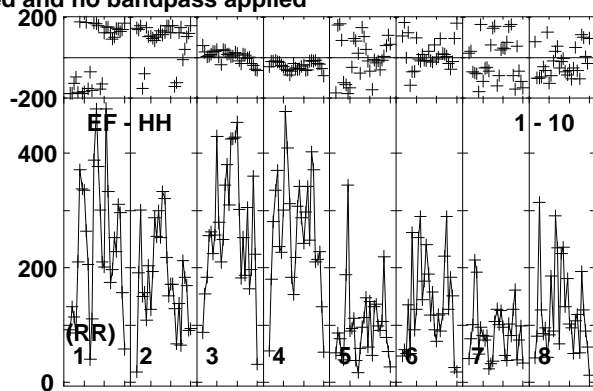
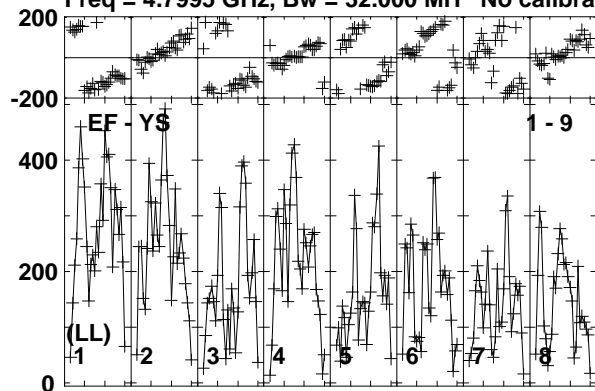

Lower frame: Micro Ampl Jy Top frame: Phas deg
Vector averaged cross-power spectrum Baseline: EF (01) - YS (09)
Timerange: 01/01:11:31 to 01/01:12:59

Plot file version 237 created 20-APR-2018 18:08:09

J1312-2350 RG009B.UVDATA.1

Freq = 4.7995 GHz, Bw = 32.000 MH No calibration applied and no bandpass applied

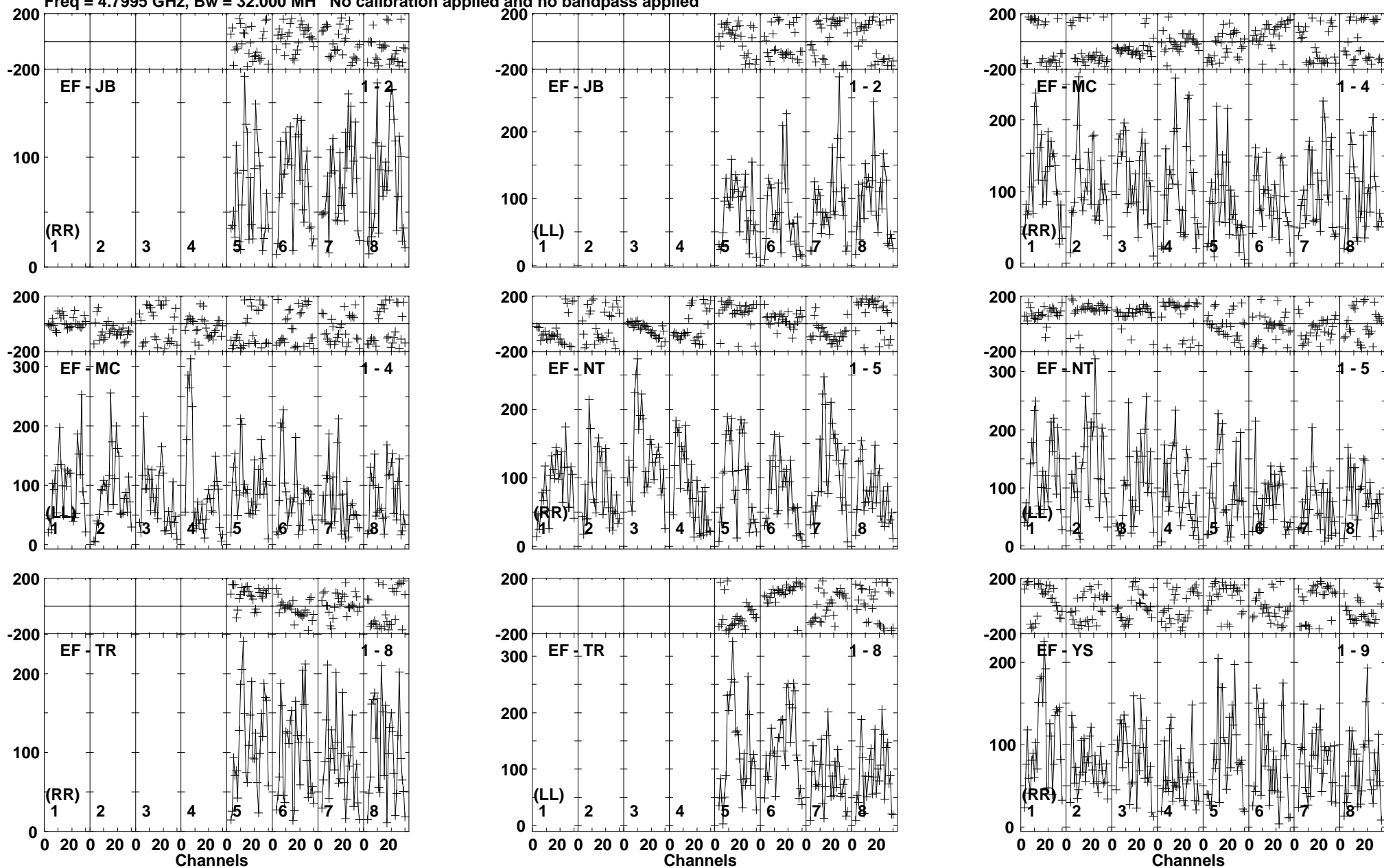

Lower frame: Micro Ampl Jy Top frame: Phas deg
Vector averaged cross-power spectrum Baseline: EF (01) - JB (02)
Timerange: 01/01:13:01 to 01/01:15:29

Plot file version 238 created 20-APR-2018 18:08:09

J1312-2350 RG009B.UVDATA.1

Freq = 4.7995 GHz, Bw = 32.000 MH No calibration applied and no bandpass applied

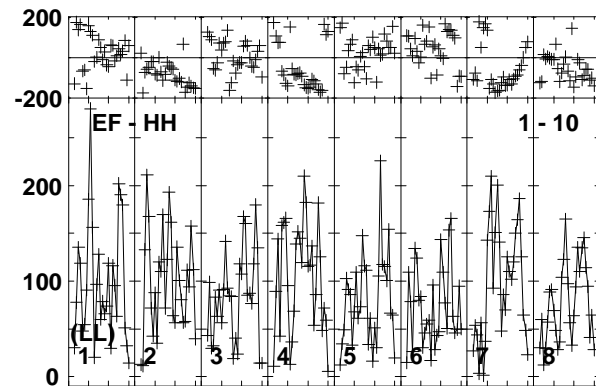
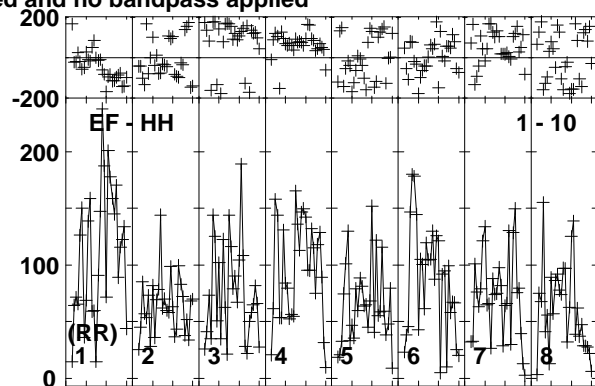
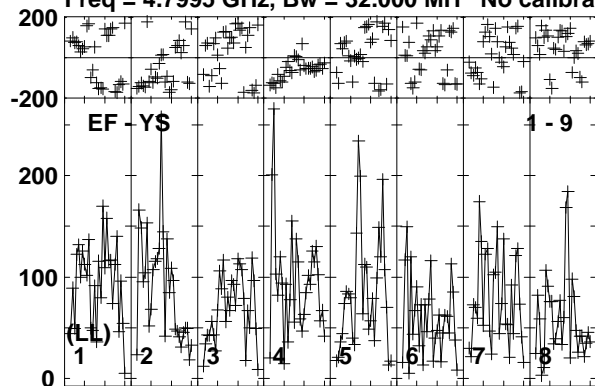

Lower frame: Micro Ampl Jy Top frame: Phas deg
Vector averaged cross-power spectrum Baseline: EF (01) - YS (09)
Timerange: 01/01:13:01 to 01/01:15:29

Plot file version 239 created 20-APR-2018 18:08:09

J1311-2329 RG009B.UVDATA.1

Freq = 4.7995 GHz, Bw = 32.000 MH No calibration applied and no bandpass applied

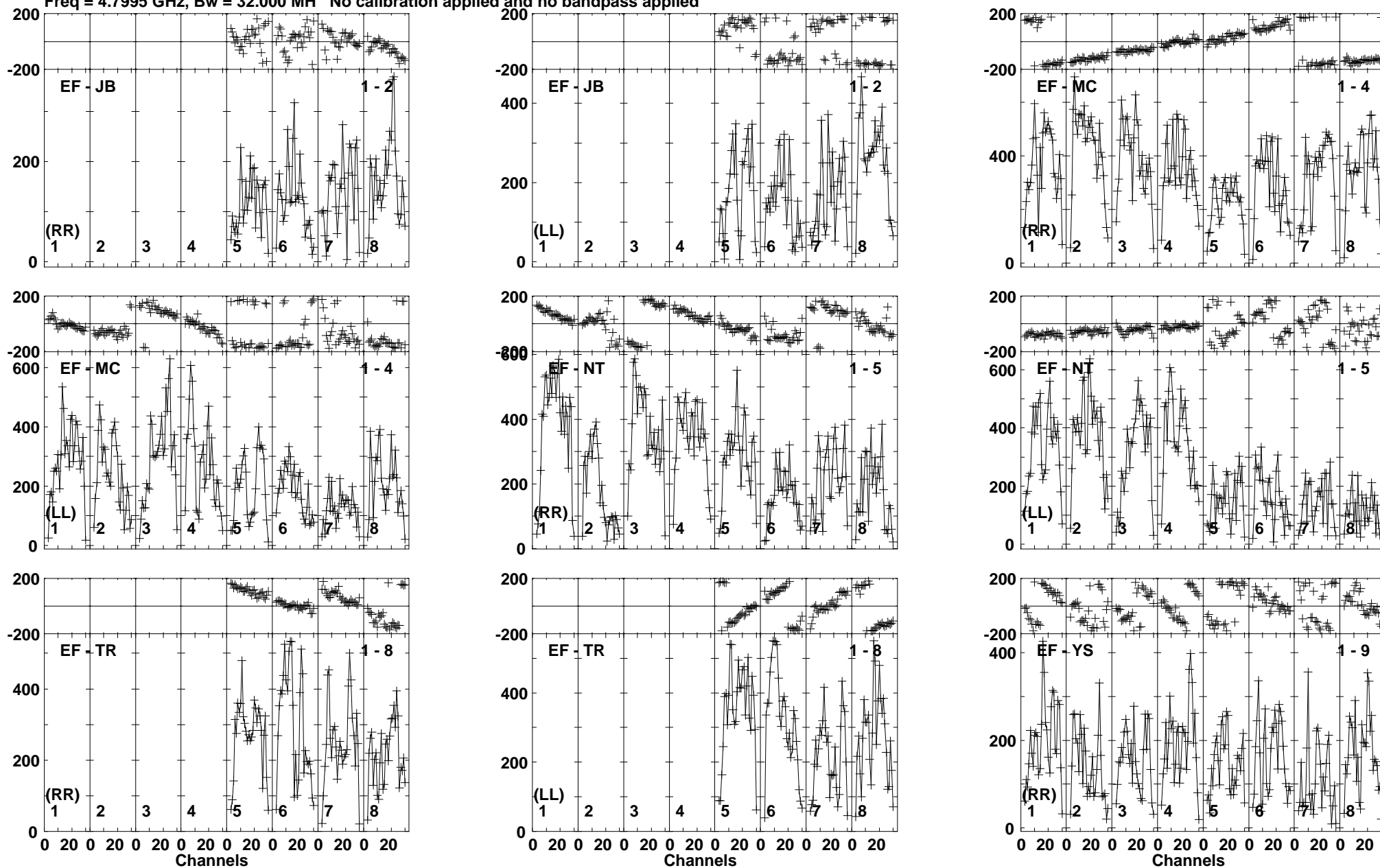

Lower frame: Micro Ampl Jy Top frame: Phas deg
Vector averaged cross-power spectrum Baseline: EF (01) - JB (02)
Timerange: 01/01:16:11 to 01/01:17:09

Plot file version 240 created 20-APR-2018 18:08:09

J1311-2329 RG009B.UVDATA.1

Freq = 4.7995 GHz, Bw = 32.000 MH No calibration applied and no bandpass applied

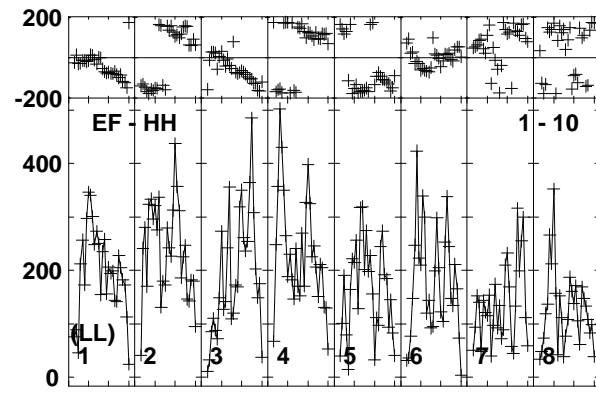
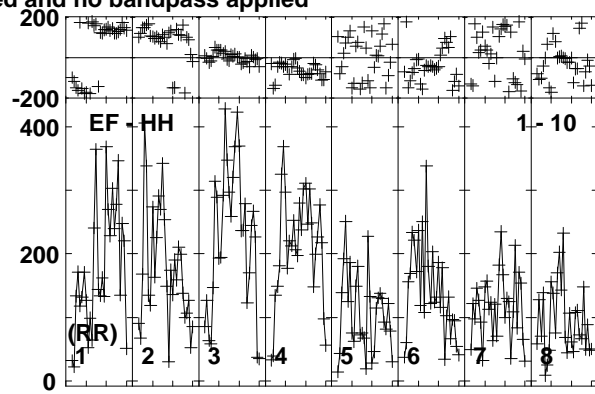
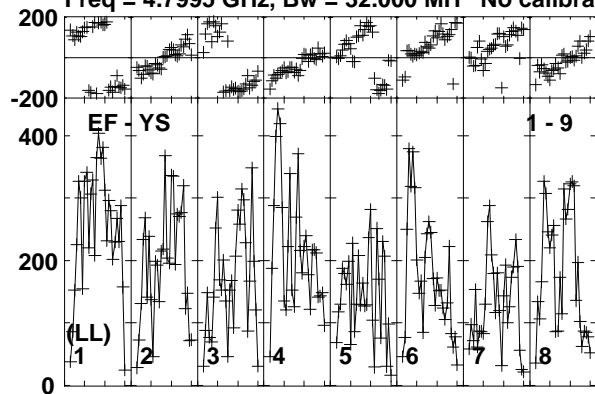

Lower frame: Micro Ampl Jy Top frame: Phas deg
Vector averaged cross-power spectrum Baseline: EF (01) - YS (09)
Timerange: 01/01:16:11 to 01/01:17:09

Plot file version 241 created 20-APR-2018 18:08:09

EM170817 RG009B.UVDATA.1

Freq = 4.7995 GHz, Bw = 32.000 MH No calibration applied and no bandpass applied

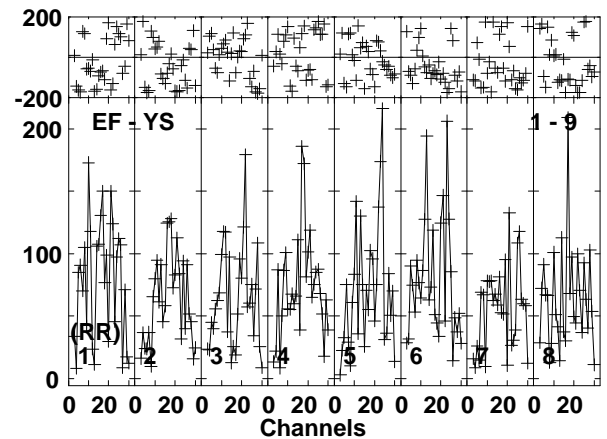
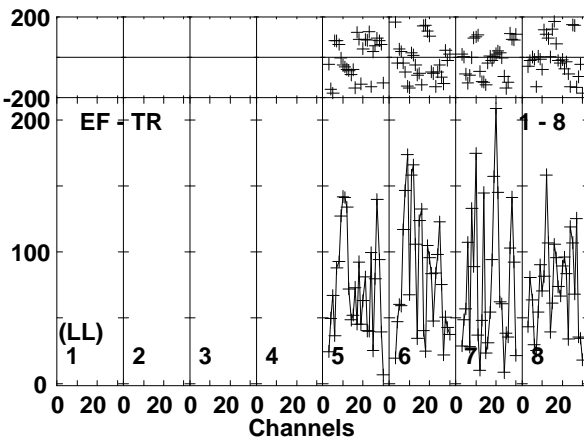
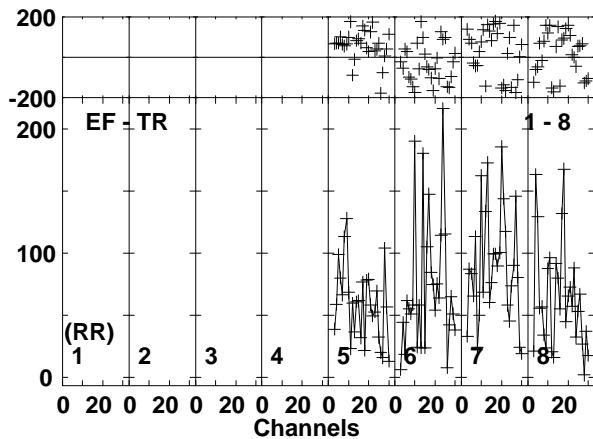
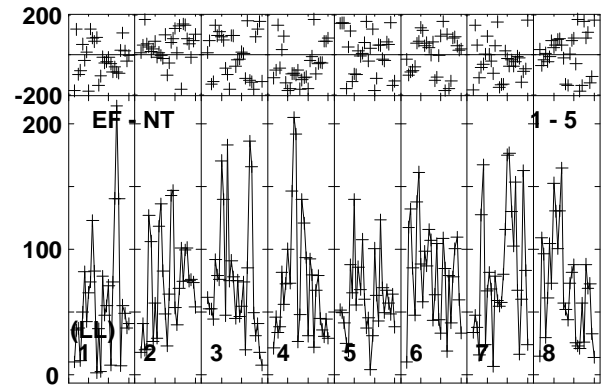
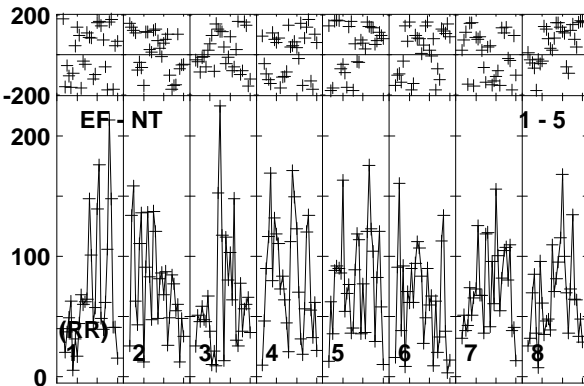
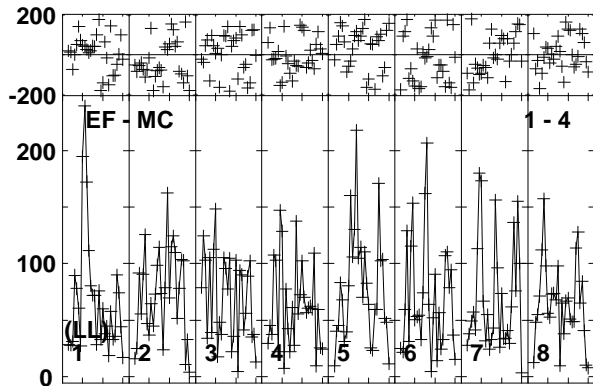
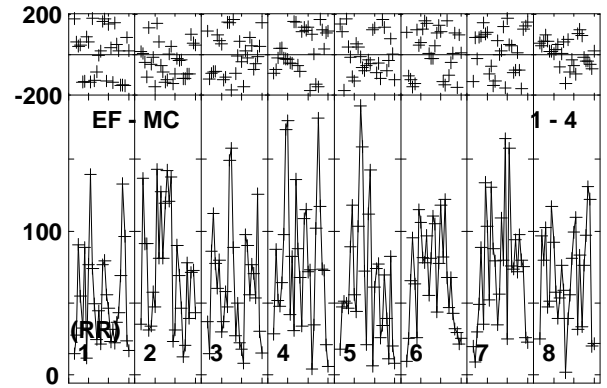
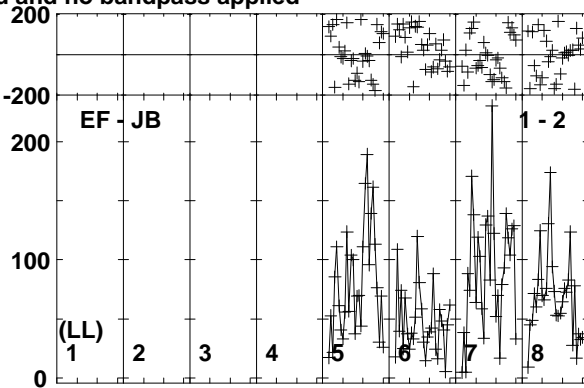
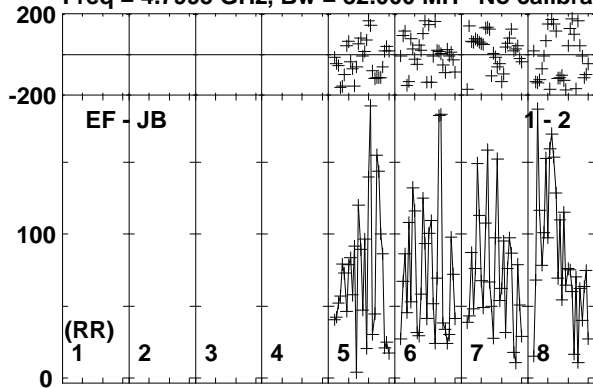

Lower frame: Micro Ampl Jy Top frame: Phas deg
Vector averaged cross-power spectrum Baseline: EF (01) - JB (02)
Timerange: 01/01:17:11 to 01/01:19:39

Plot file version 242 created 20-APR-2018 18:08:10

EM170817 RG009B.UVDATA.1

Freq = 4.7995 GHz, Bw = 32.000 MH No calibration applied and no bandpass applied

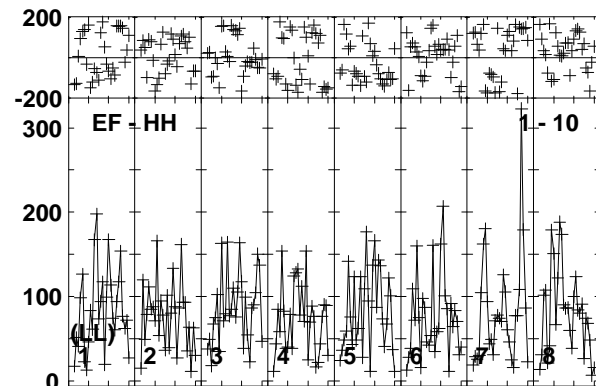
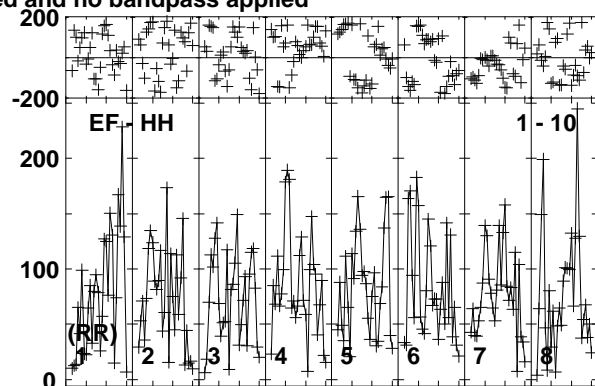
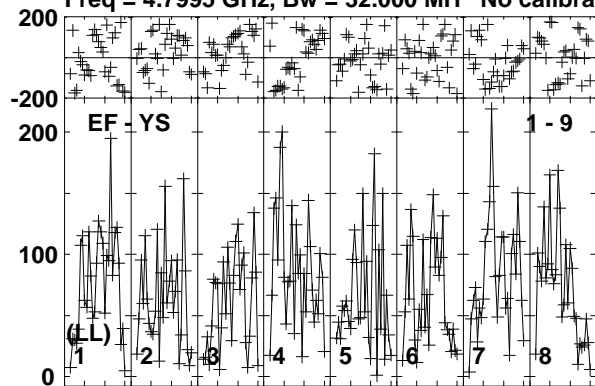

Lower frame: Micro Ampl Jy Top frame: Phas deg
Vector averaged cross-power spectrum Baseline: EF (01) - YS (09)
Timerange: 01/01:17:11 to 01/01:19:39

Plot file version 243 created 20-APR-2018 18:08:10

J1311-2329 RG009B.UVDATA.1

Freq = 4.7995 GHz, Bw = 32.000 MH No calibration applied and no bandpass applied

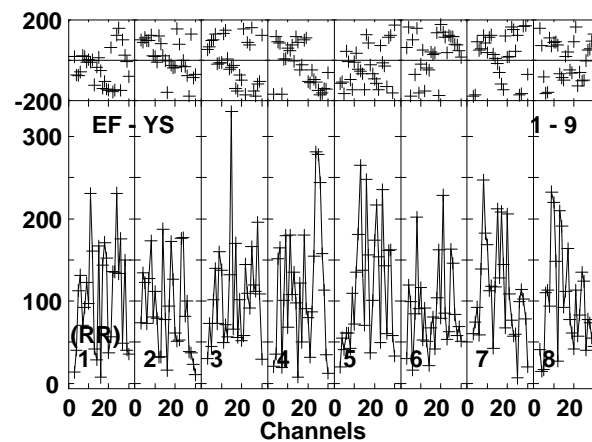
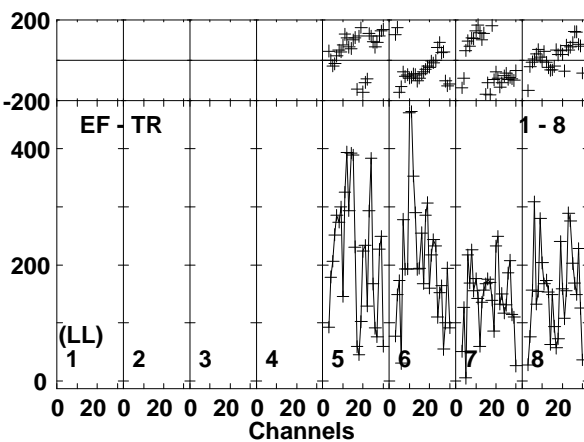
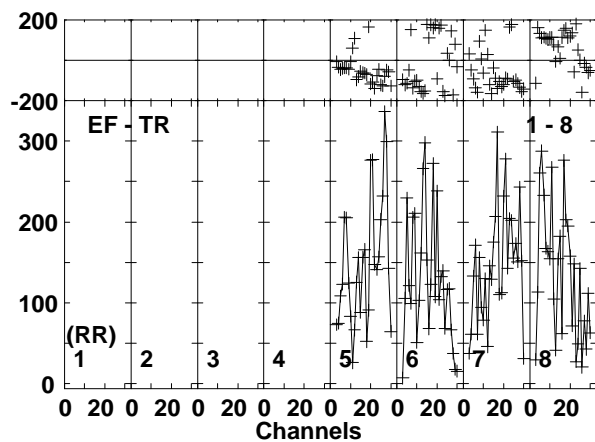
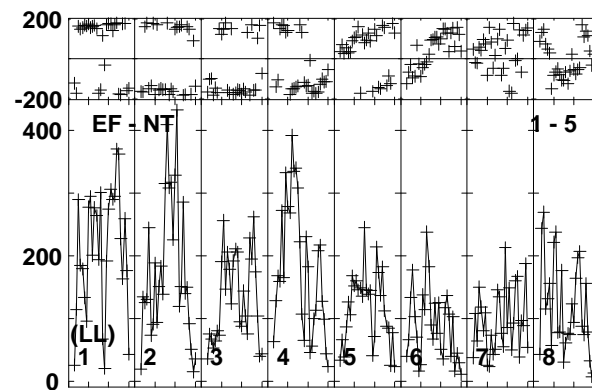
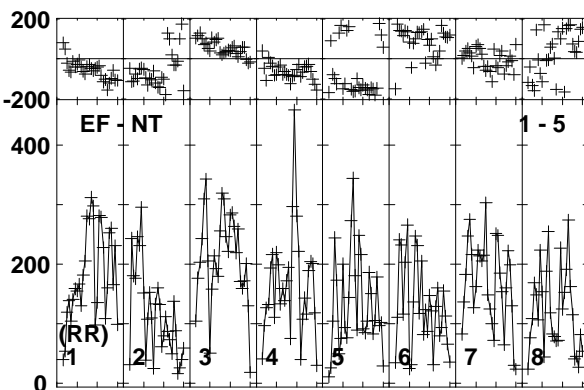
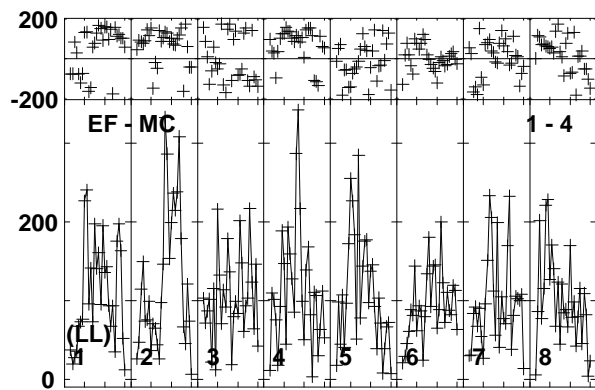
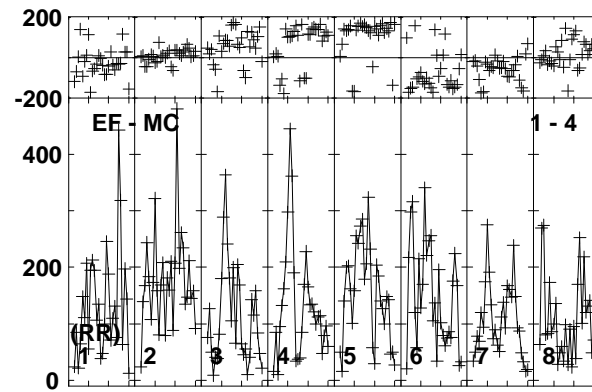
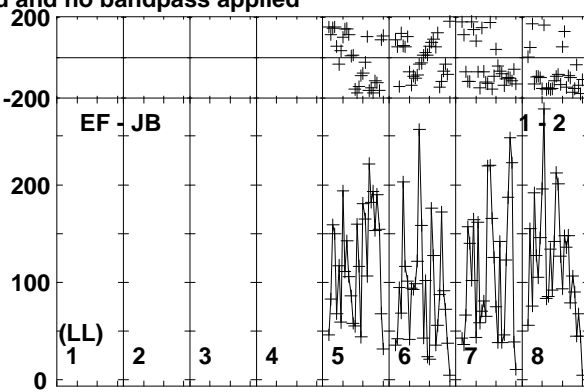
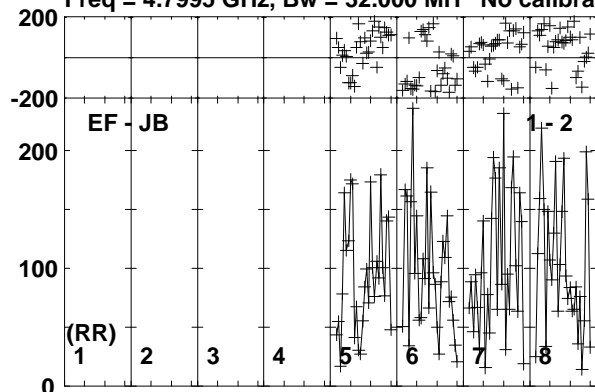

Lower frame: Micro Ampl Jy Top frame: Phas deg
Vector averaged cross-power spectrum Baseline: EF (01) - JB (02)
Timerange: 01/01:19:41 to 01/01:21:09

Plot file version 244 created 20-APR-2018 18:08:10

J1311-2329 RG009B.UVDATA.1

Freq = 4.7995 GHz, Bw = 32.000 MH No calibration applied and no bandpass applied

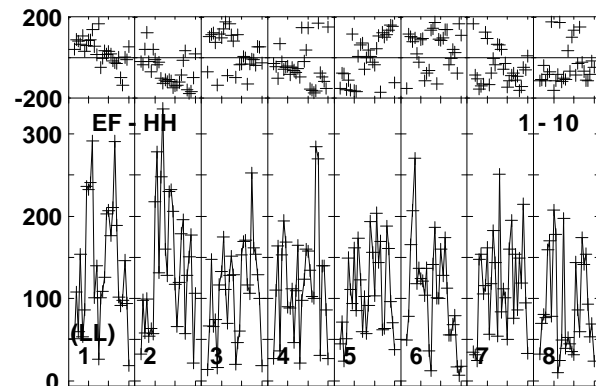
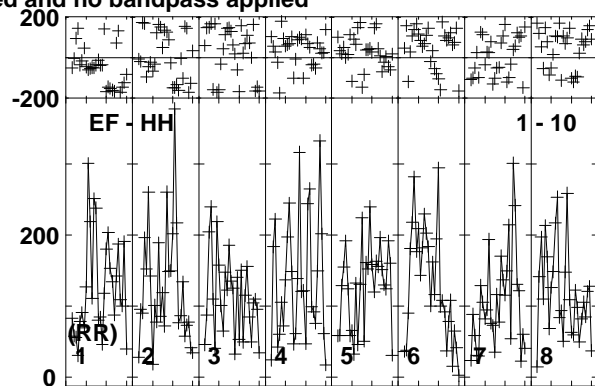
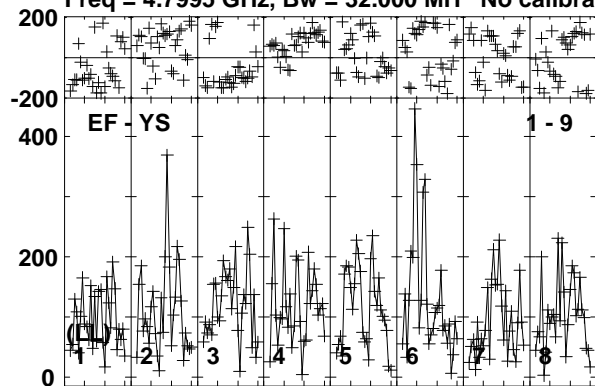

Lower frame: Micro Ampl Jy Top frame: Phas deg
Vector averaged cross-power spectrum Baseline: EF (01) - YS (09)
Timerange: 01/01:19:41 to 01/01:21:09

Plot file version 245 created 20-APR-2018 18:08:10

J1310+3220 RG009B.UVDATA.1

Freq = 4.7995 GHz, Bw = 32.000 MH No calibration applied and no bandpass applied

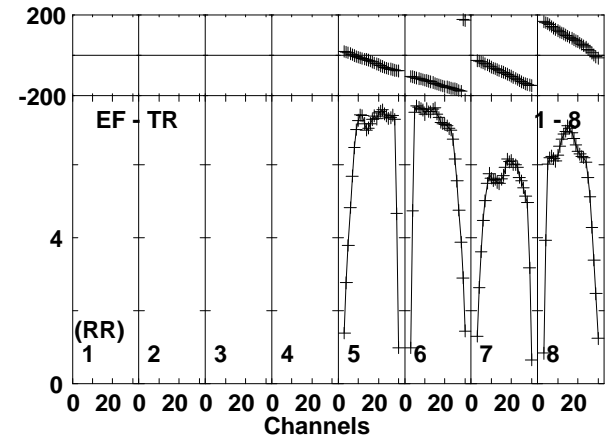
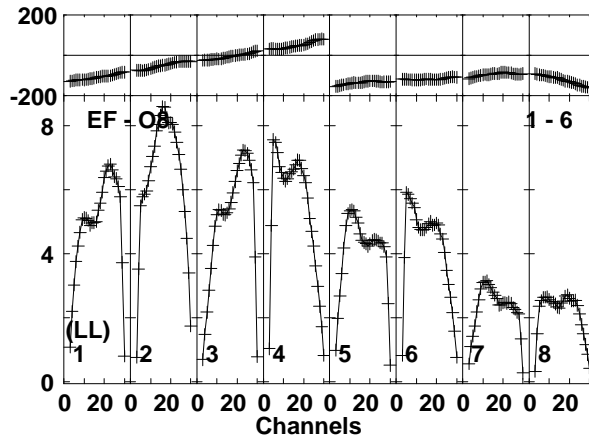
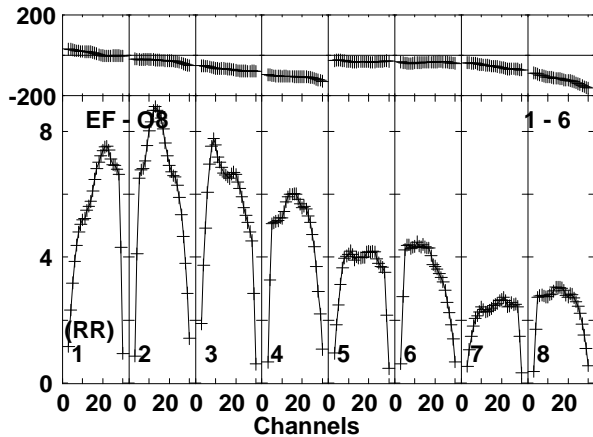
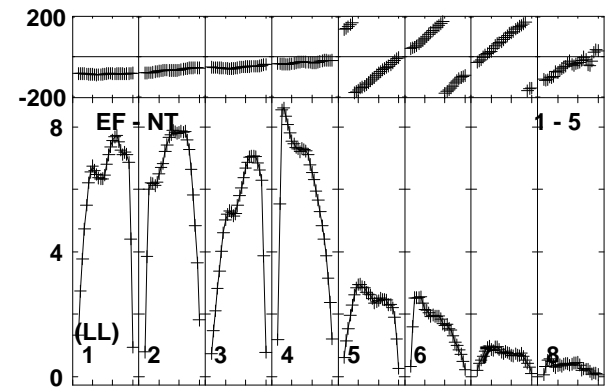
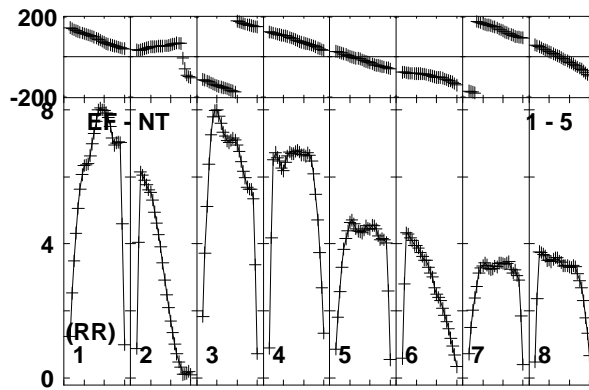
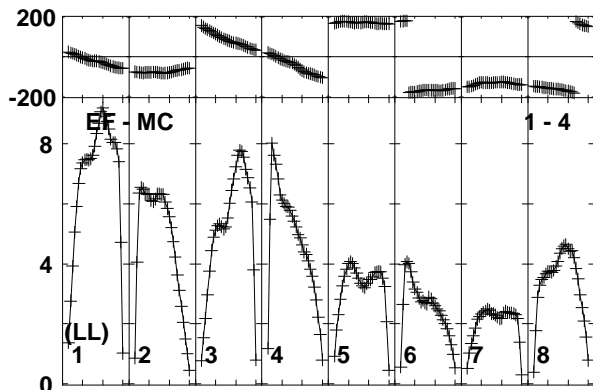
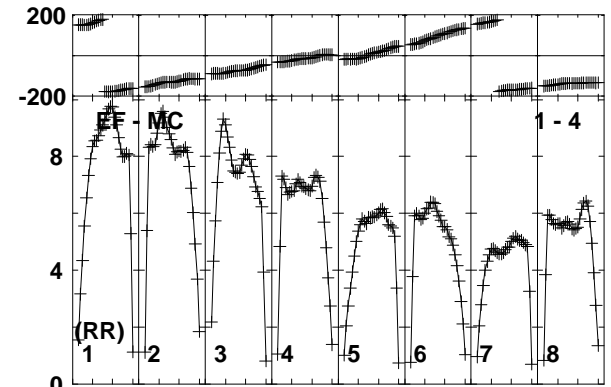
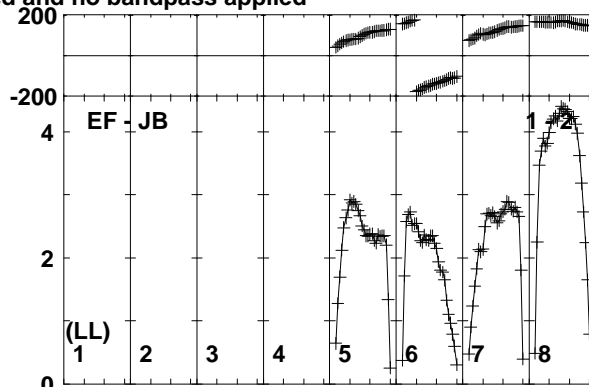
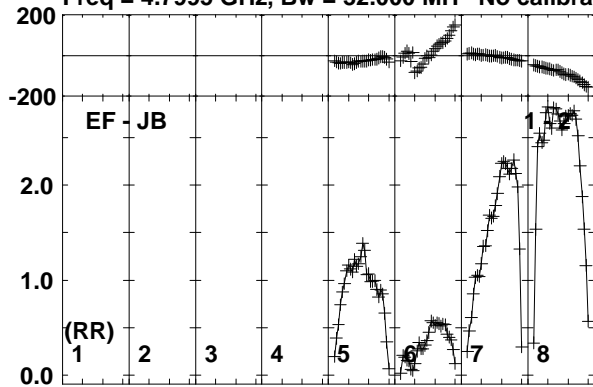

Lower frame: Milli Ampl Jy Top frame: Phas deg
Vector averaged cross-power spectrum Baseline: EF (01) - JB (02)
Timerange: 01/01:21:11 to 01/01:27:09

Plot file version 246 created 20-APR-2018 18:08:10

J1310+3220 RG009B.UVDATA.1

Freq = 4.7995 GHz, Bw = 32.000 MH No calibration applied and no bandpass applied

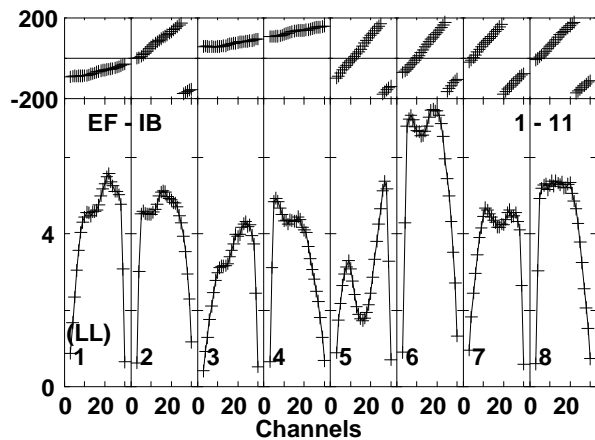
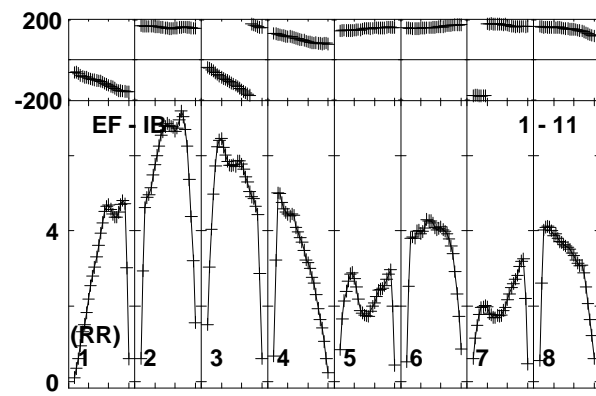
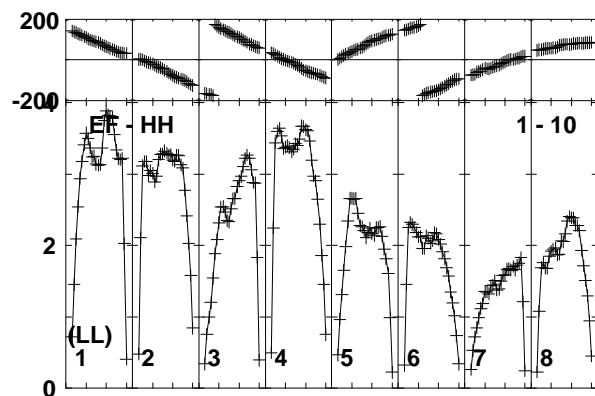
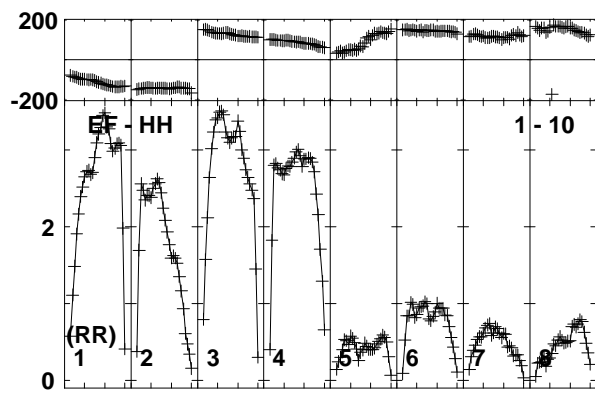
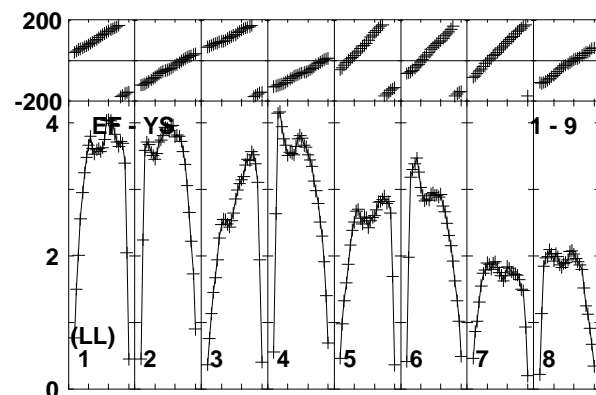
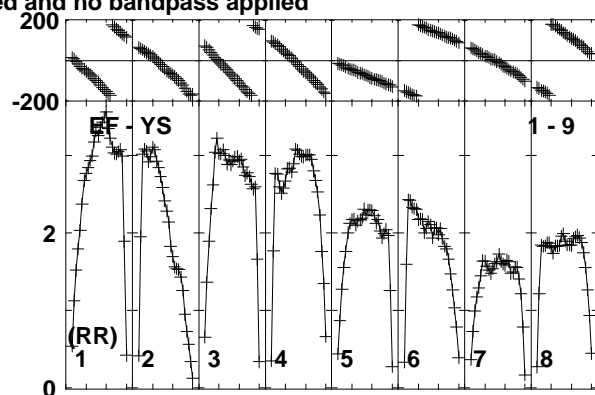
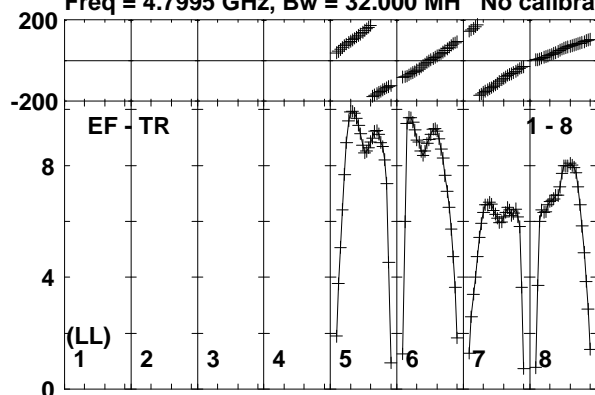

Lower frame: Milli Ampl Jy Top frame: Phas deg
Vector averaged cross-power spectrum Baseline: EF (01) - TR (08)
Timerange: 01/01:21:11 to 01/01:27:09