

Plot file version 1 created 26-SEP-2019 10:39:09

0234+285 RG010A.UVDATA.1

Freq = 4.7990 GHz, Bw = 32.000 MH No calibration applied and no bandpass applied

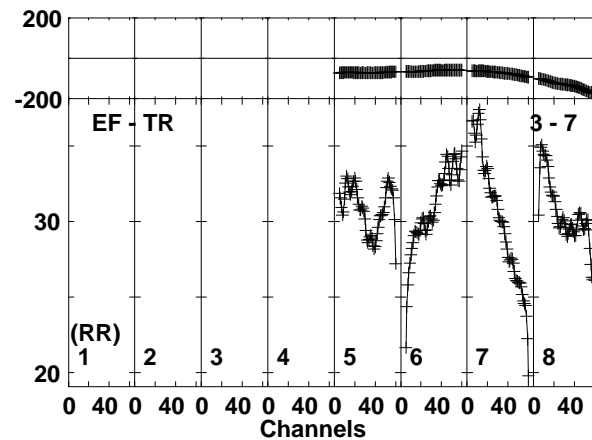
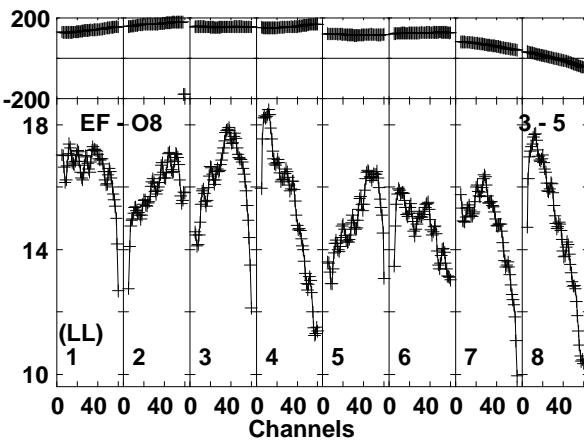
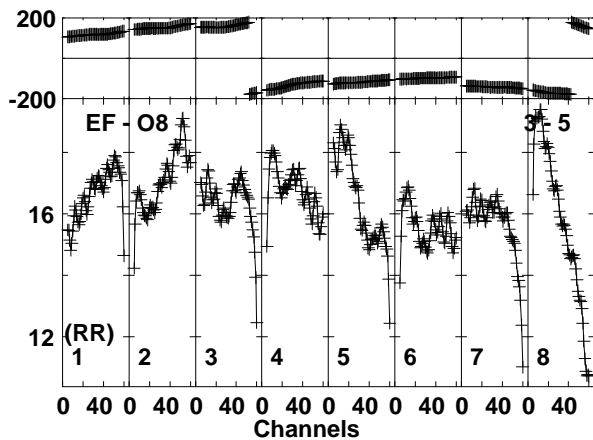
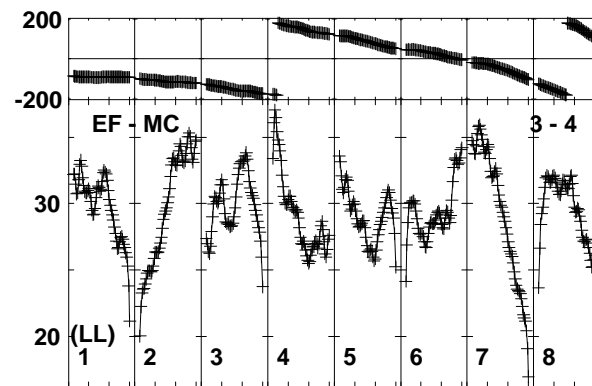
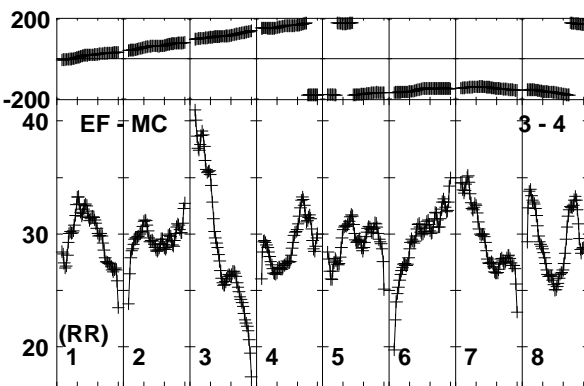
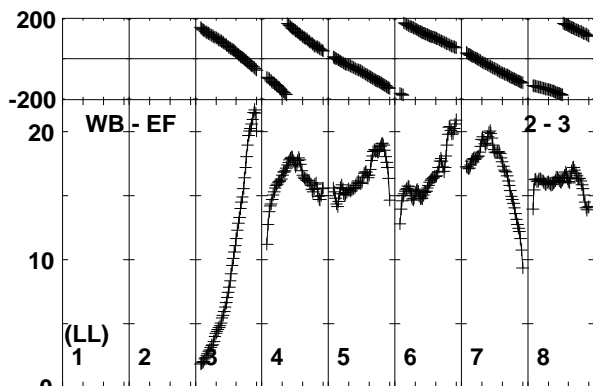
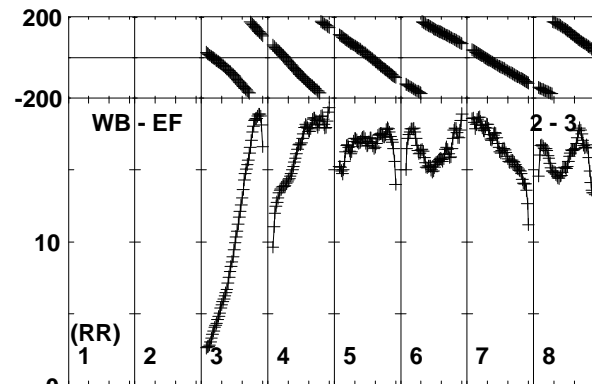
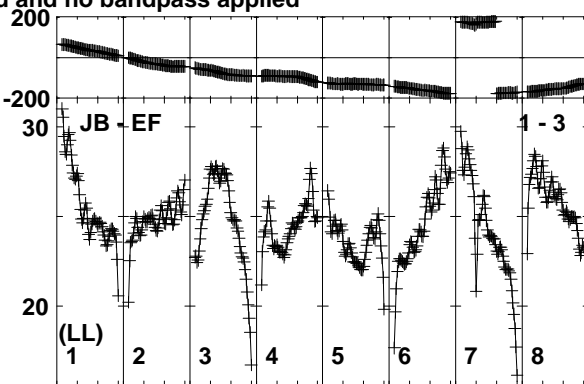
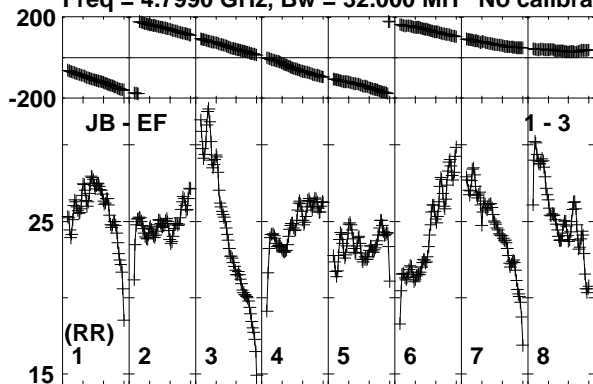

Lower frame: Milli Ampl Jy Top frame: Phas deg
Vector averaged cross-power spectrum Baseline: JB (01) - EF (03)
Timerange: 00:22:32:57 to 00:22:35:50

Plot file version 2 created 26-SEP-2019 10:39:09
 0234+285 RG010A.UVDATA.1
 Freq = 4.7990 GHz, Bw = 32.000 MH No calibration applied and no bandpass applied

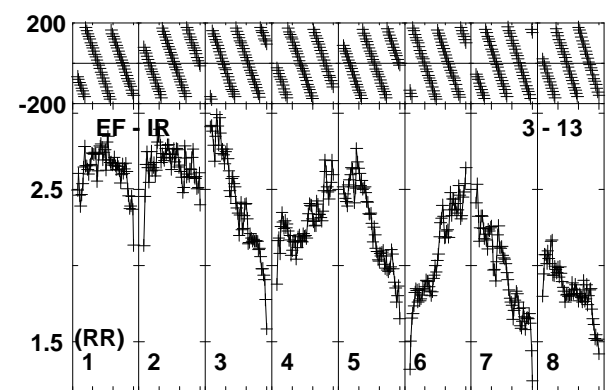
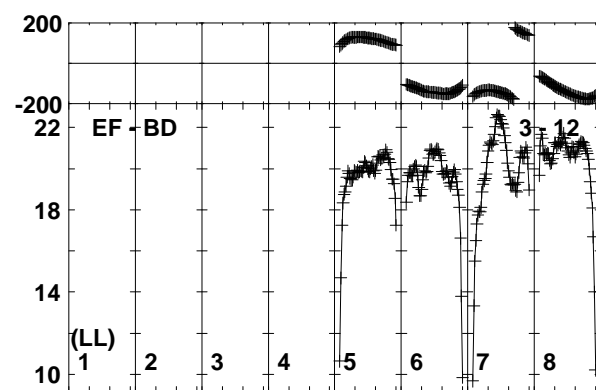
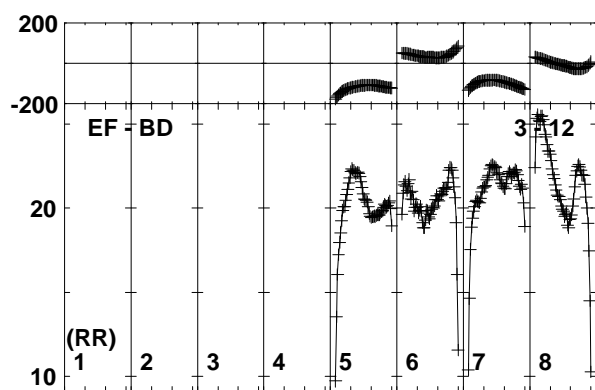
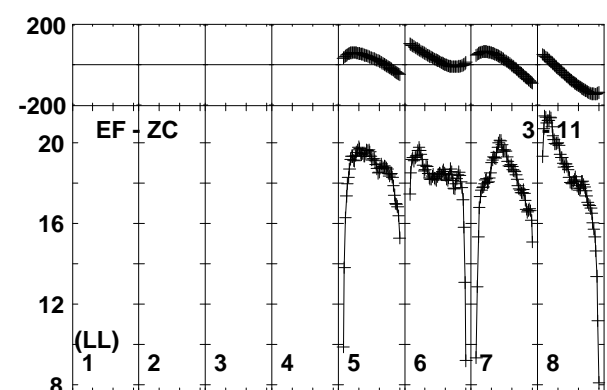
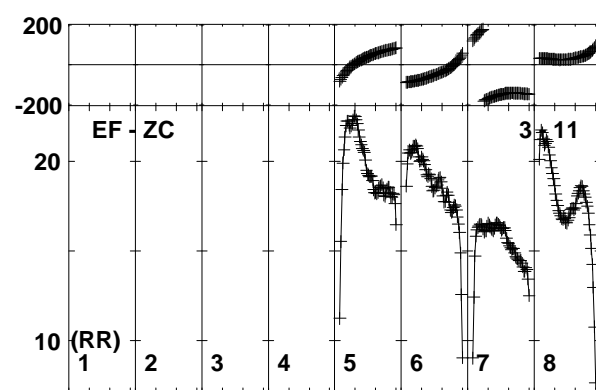
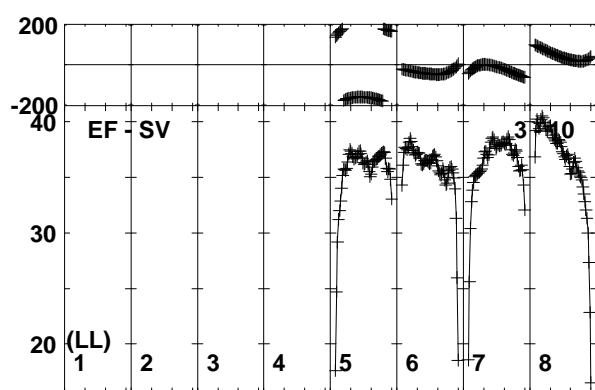
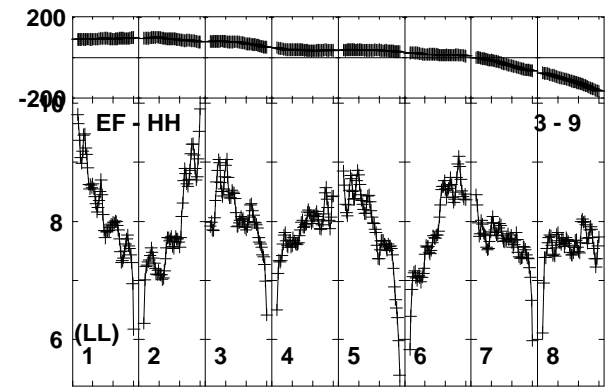
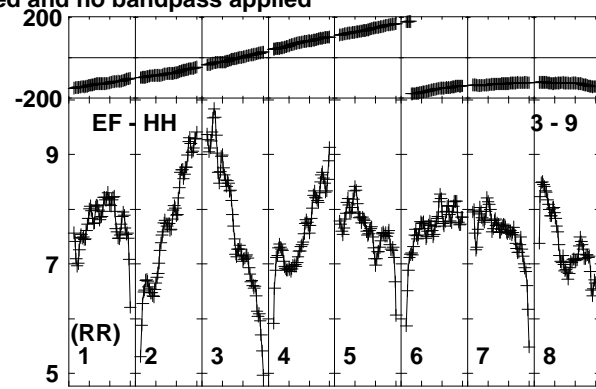
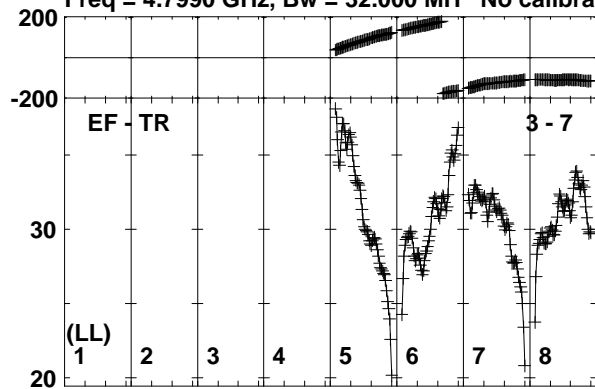

Lower frame: Milli Ampl Jy Top frame: Phas deg
 Vector averaged cross-power spectrum Baseline: EF (03) - TR (07)
 Timerange: 00/22:32:57 to 00/22:35:50

Plot file version 3 created 26-SEP-2019 10:39:10

0234+285 RG010A.UVDATA.1

Freq = 4.7990 GHz, Bw = 32.000 MH No calibration applied and no bandpass applied

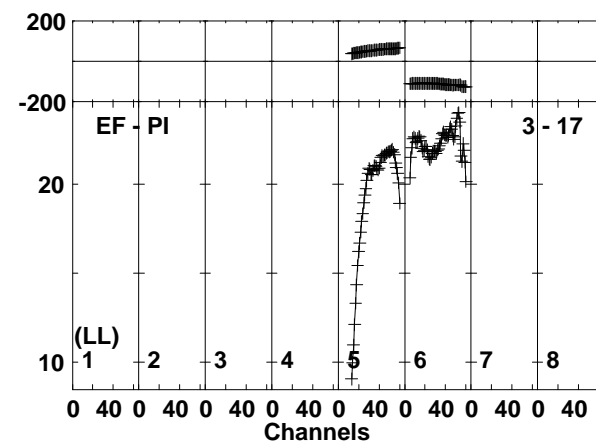
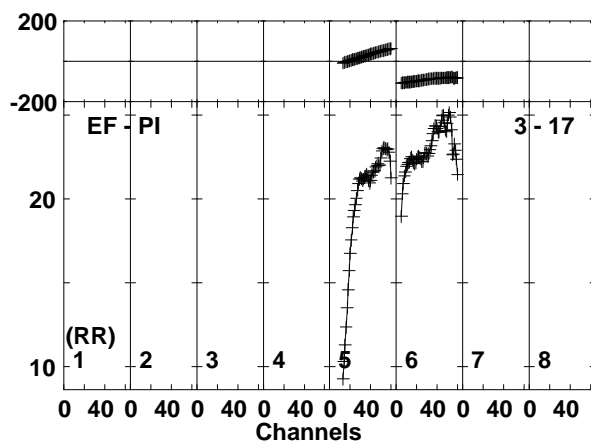
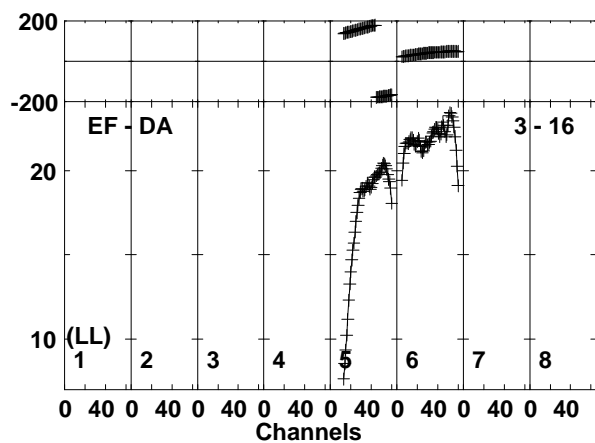
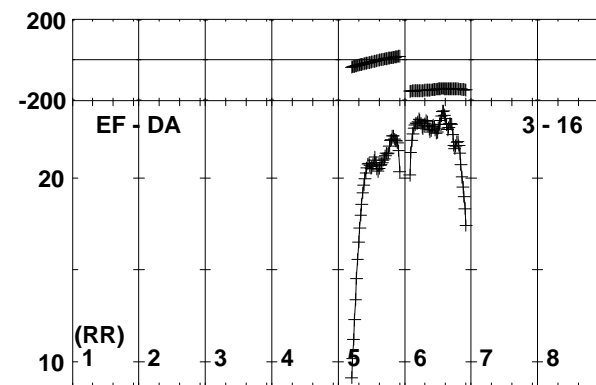
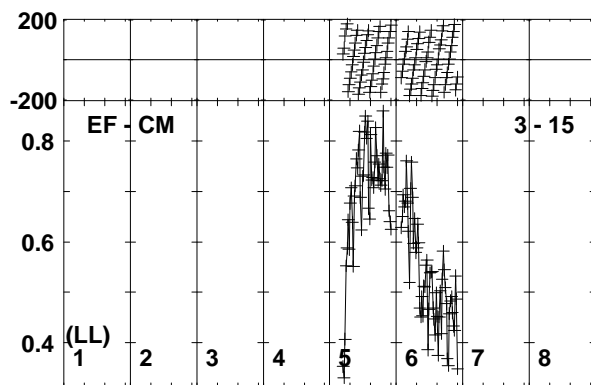
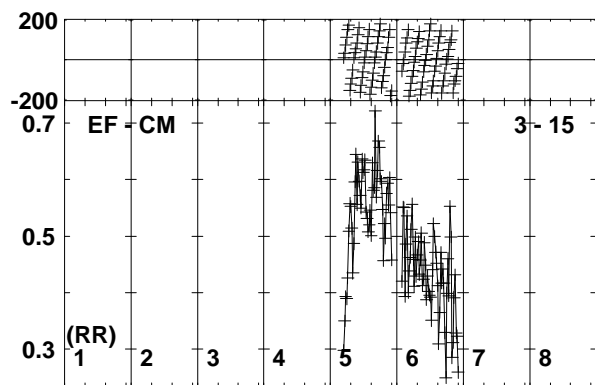
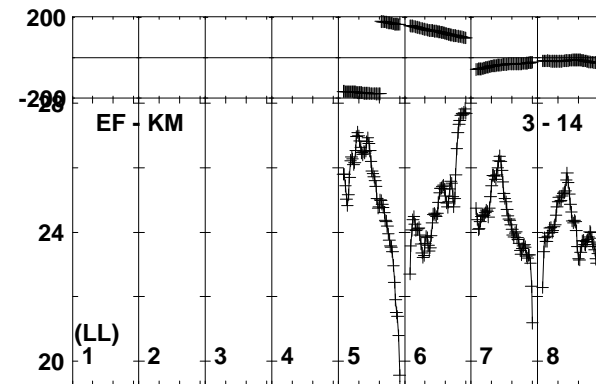
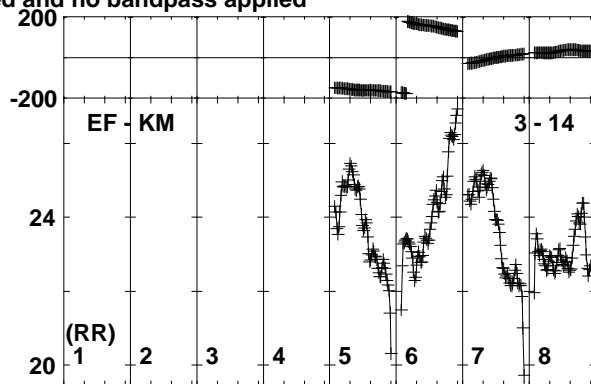
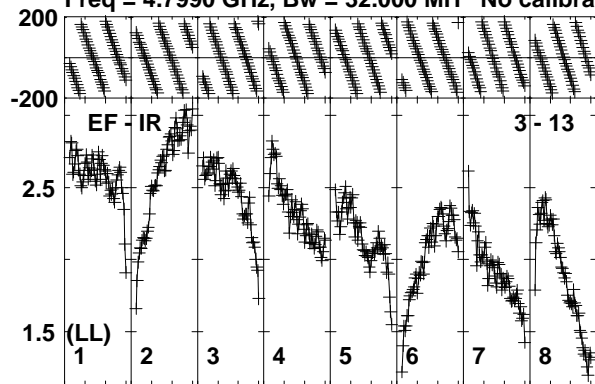

Lower frame: Milli Ampl Jy Top frame: Phas deg
Vector averaged cross-power spectrum Baseline: EF (03) - IR (13)
Timerange: 00/22:32:57 to 00/22:35:50

Plot file version 4 created 26-SEP-2019 10:39:10

0234+285 RG010A.UVDATA.1

Freq = 4.7990 GHz, Bw = 32.000 MH No calibration applied and no bandpass applied

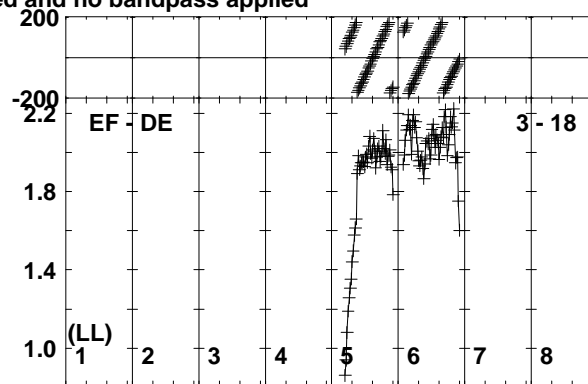
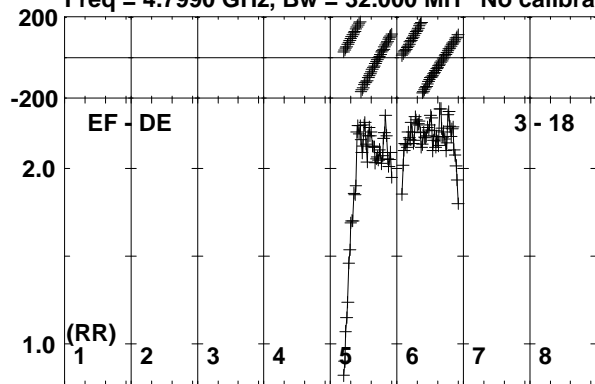

Lower frame: Milli Ampl Jy Top frame: Phas deg
Vector averaged cross-power spectrum Baseline: EF (03) - DE (18)
Timerange: 00/22:32:57 to 00/22:35:50

Plot file version 5 created 26-SEP-2019 10:39:11

J0300-0846 RG010A.UVDATA.1

Freq = 4.7990 GHz, Bw = 32.000 MH No calibration applied and no bandpass applied

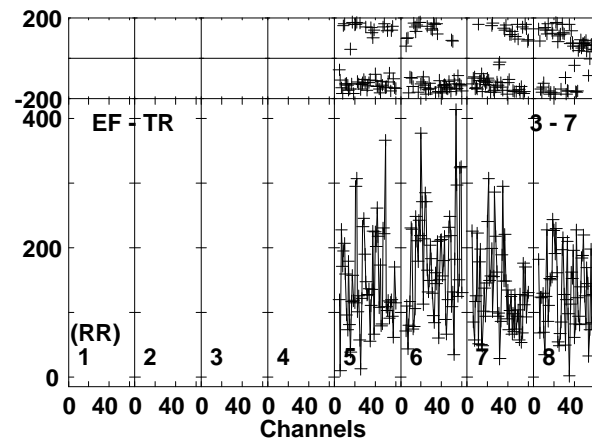
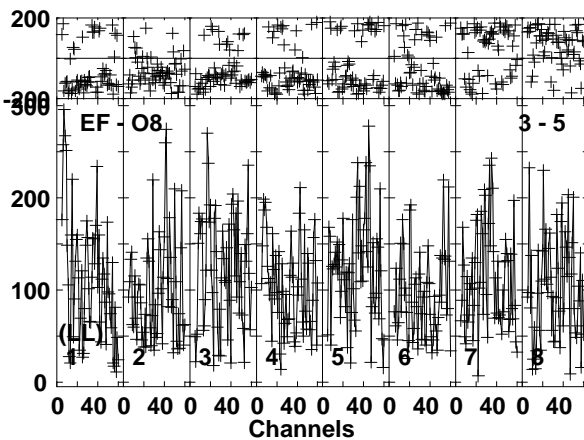
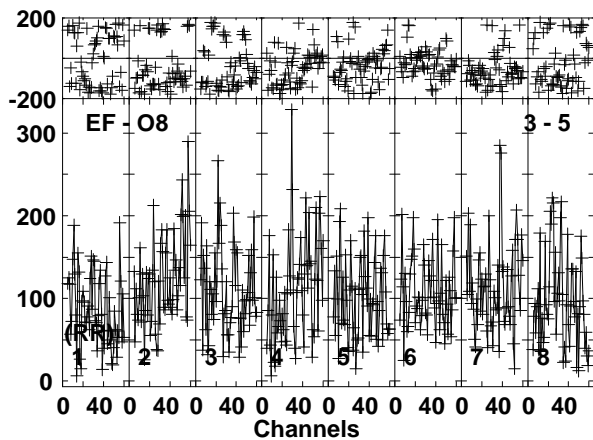
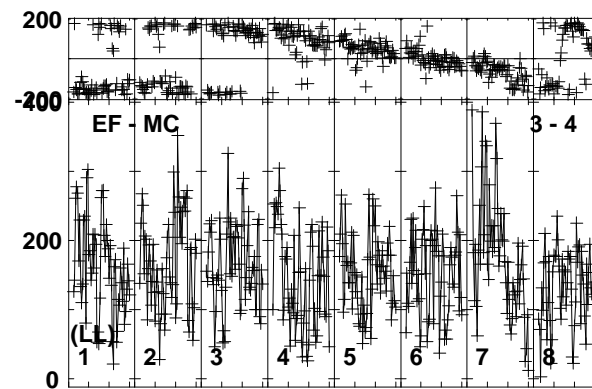
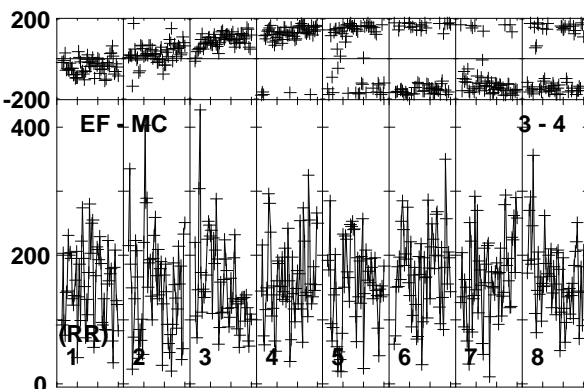
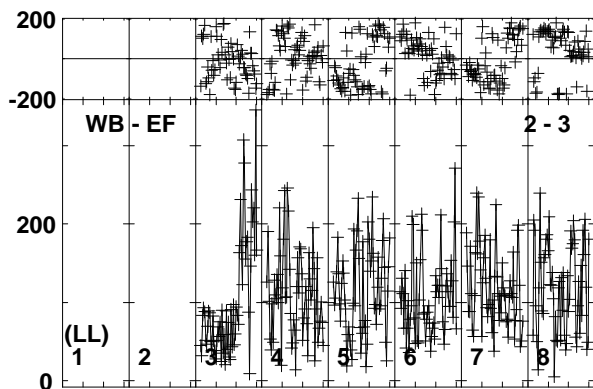
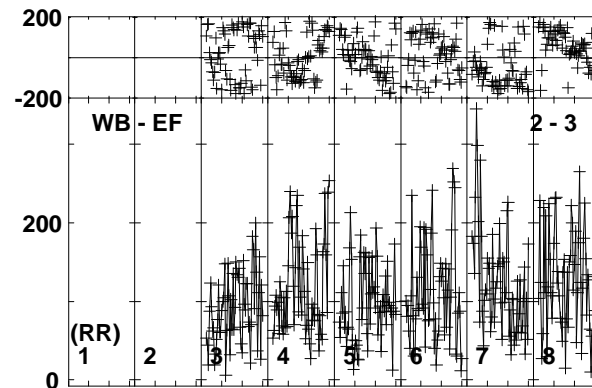
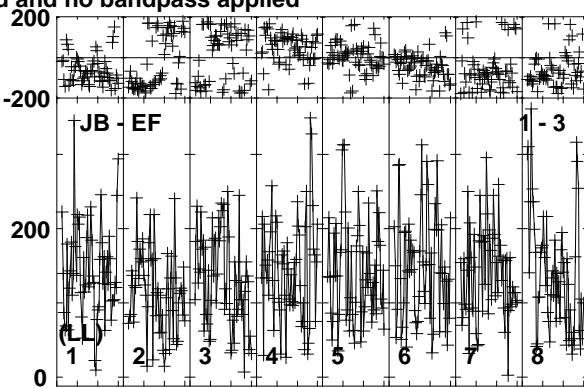
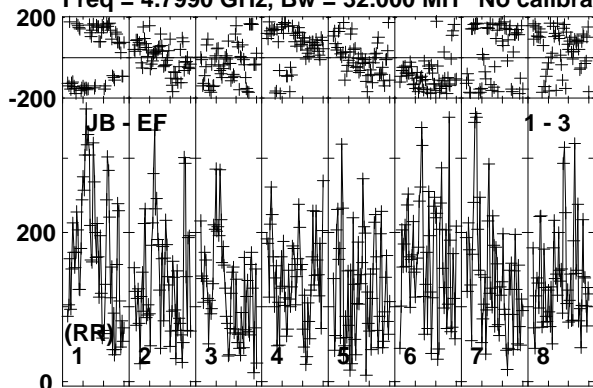

Lower frame: Micro Ampl Jy Top frame: Phas deg
Vector averaged cross-power spectrum Baseline: JB (01) - EF (03)
Timerange: 00:22:40:10 to 00:22:42:20

Plot file version 6 created 26-SEP-2019 10:39:12

J0300-0846 RG010A.UVDATA.1

Freq = 4.7990 GHz, Bw = 32.000 MH No calibration applied and no bandpass applied

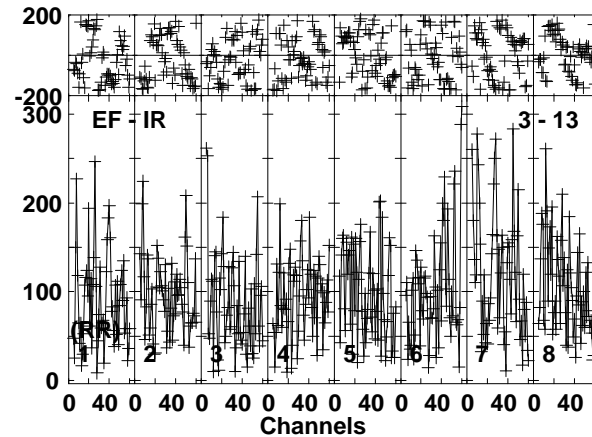
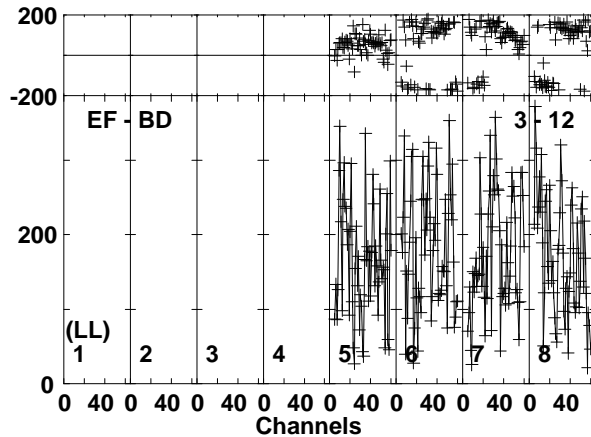
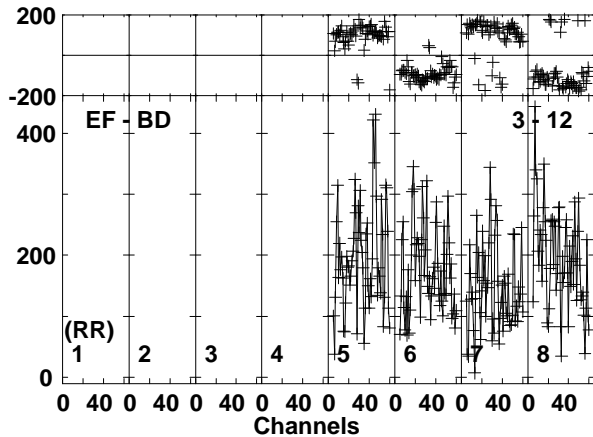
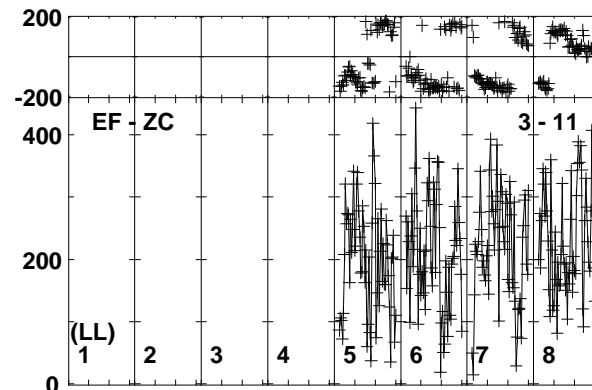
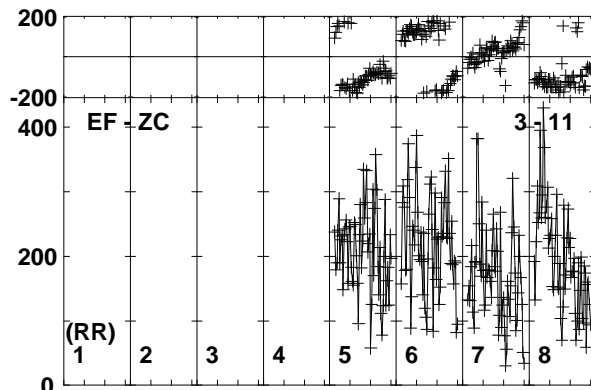
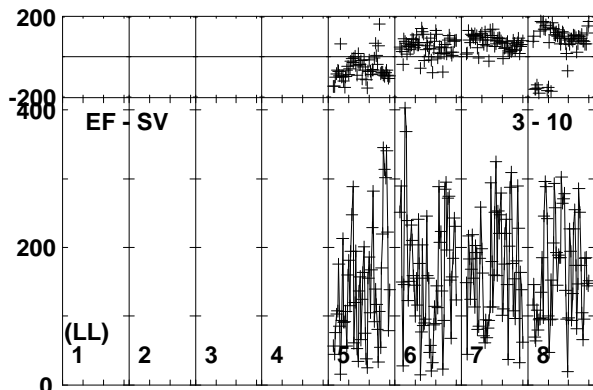
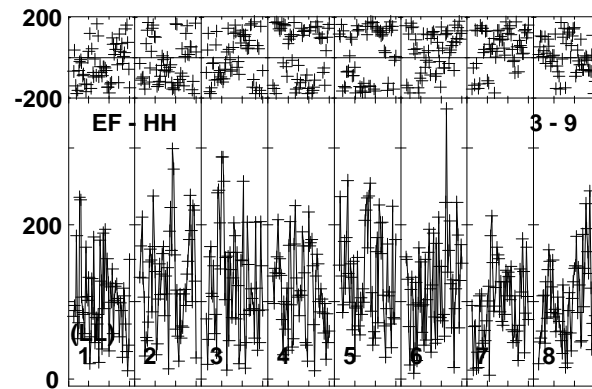
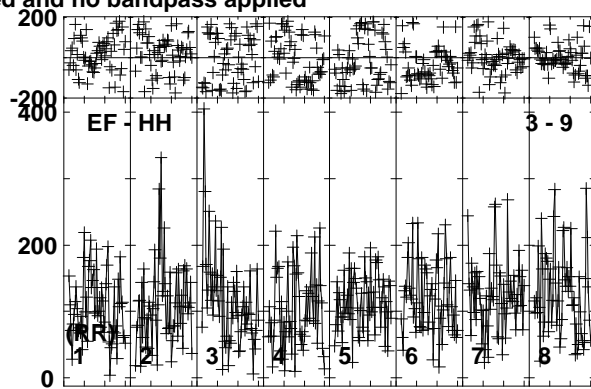
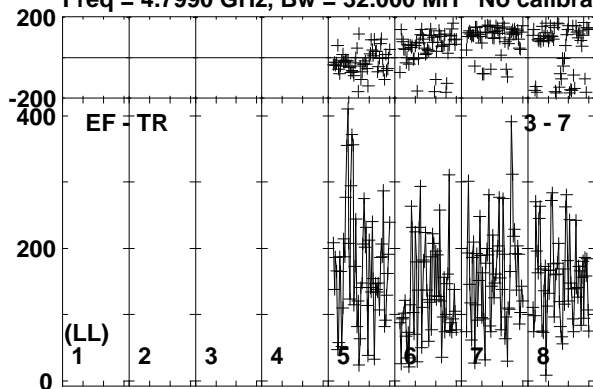

Lower frame: Micro Ampl Jy Top frame: Phas deg
Vector averaged cross-power spectrum Baseline: EF (03) - TR (07)
Timerange: 00/22:40:10 to 00/22:42:20

Plot file version 7 created 26-SEP-2019 10:39:12

J0300-0846 RG010A.UVDATA.1

Freq = 4.7990 GHz, Bw = 32.000 MH No calibration applied and no bandpass applied

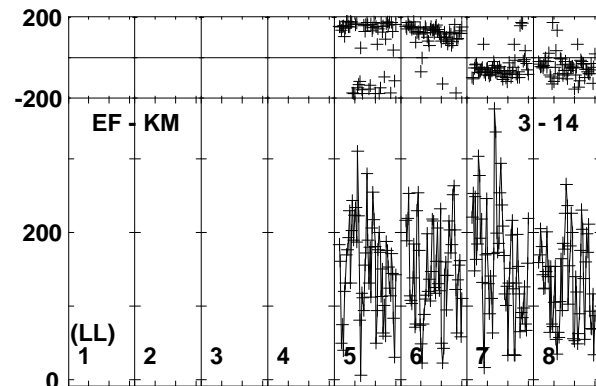
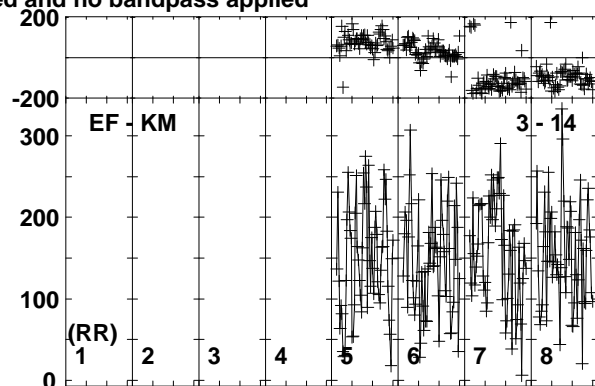
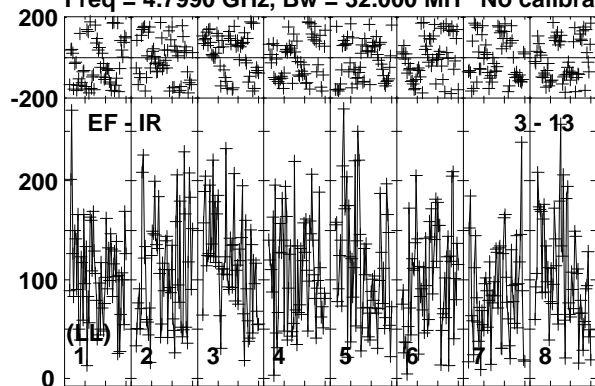

Lower frame: Micro Ampl Jy Top frame: Phas deg
Vector averaged cross-power spectrum Baseline: EF (03) - IR (13)
Timerange: 00/22:40:10 to 00/22:42:20

Plot file version 8 created 26-SEP-2019 10:39:14

190829A RG010A.UVDATA.1

Freq = 4.7990 GHz, Bw = 32.000 MH No calibration applied and no bandpass applied

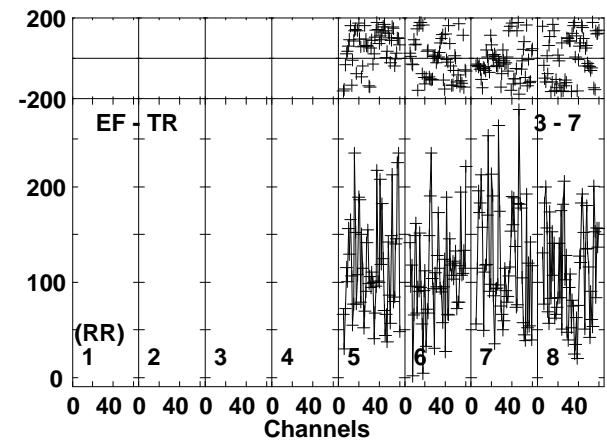
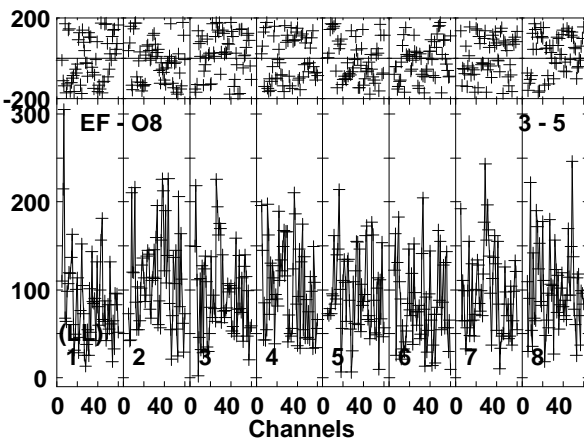
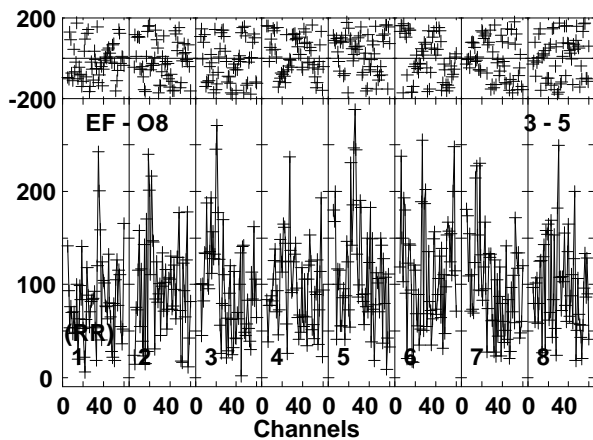
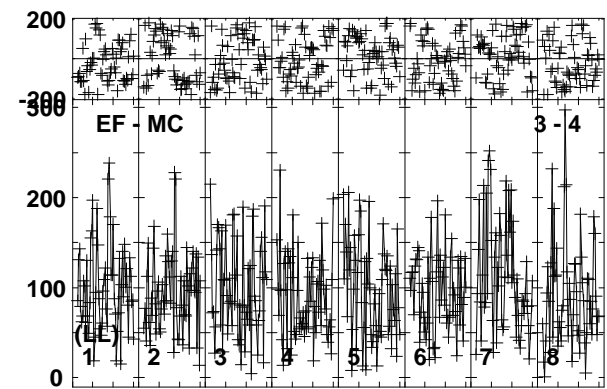
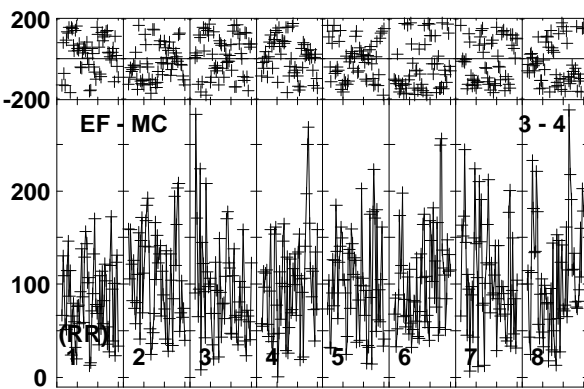
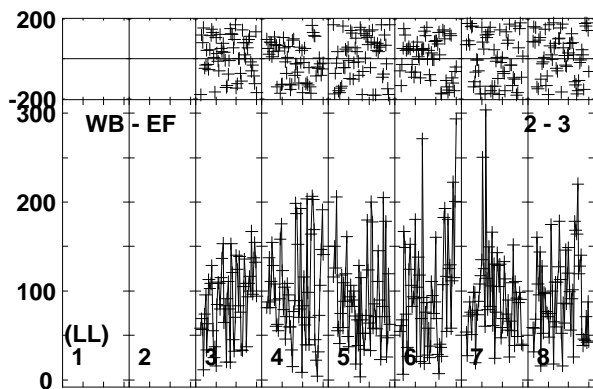
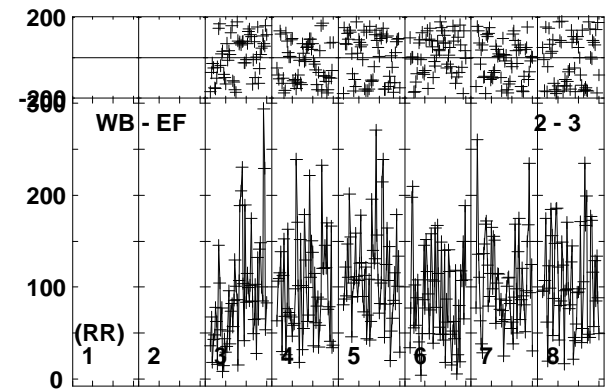
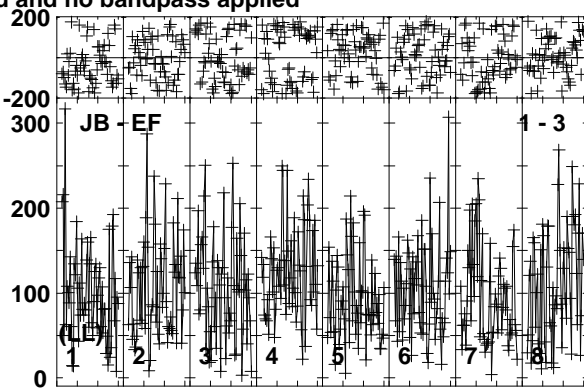
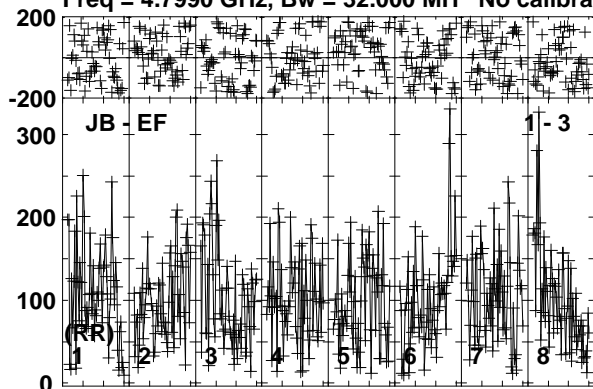

Lower frame: Micro Ampl Jy Top frame: Phas deg
Vector averaged cross-power spectrum Baseline: JB (01) - EF (03)
Timerange: 00:22:43:21 to 00:22:45:29

Plot file version 9 created 26-SEP-2019 10:39:14

190829A RG010A.UVDATA.1

Freq = 4.7990 GHz, Bw = 32.000 MH No calibration applied and no bandpass applied

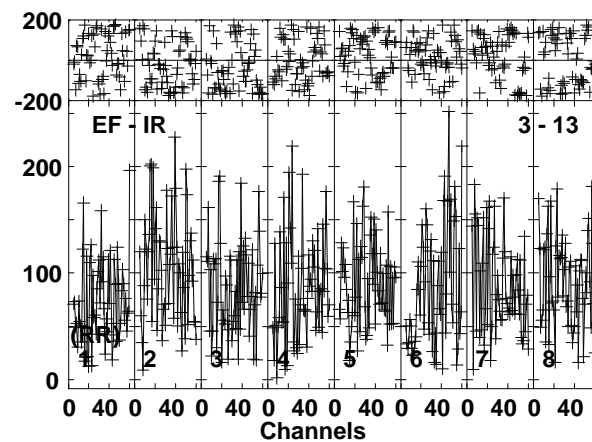
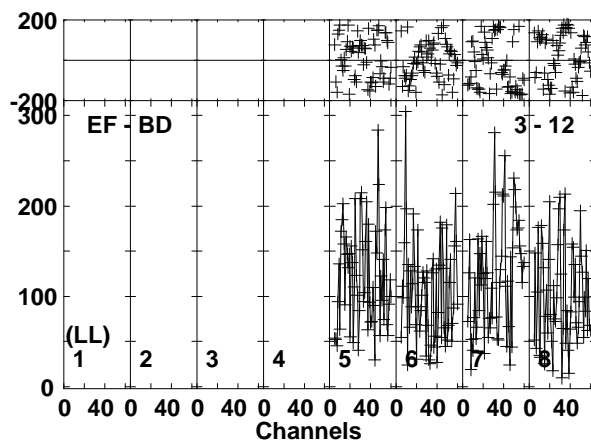
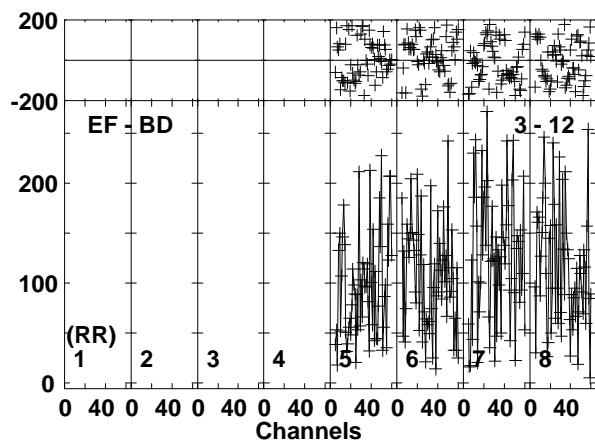
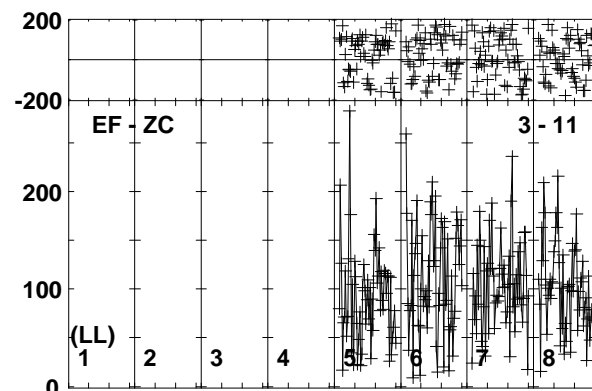
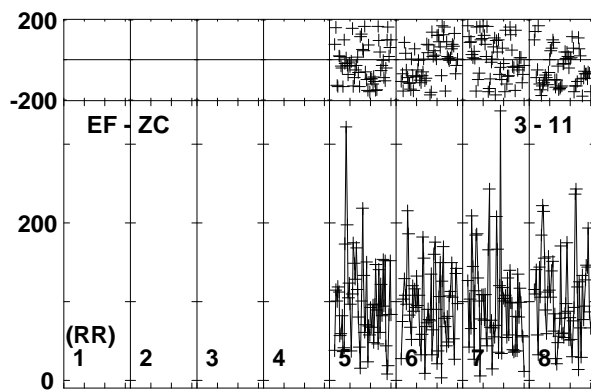
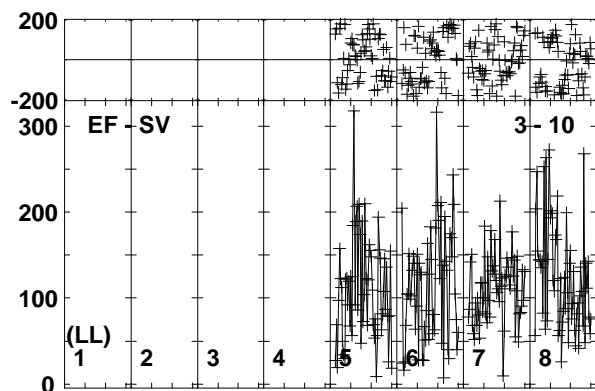
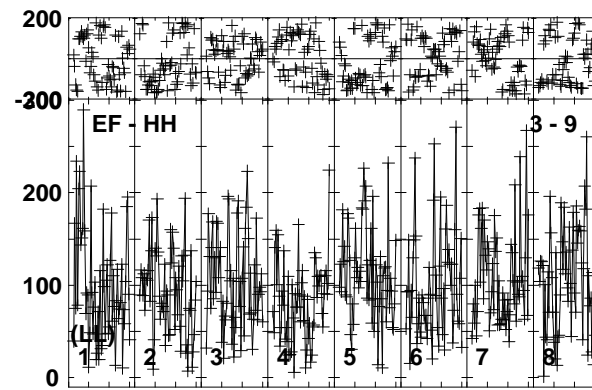
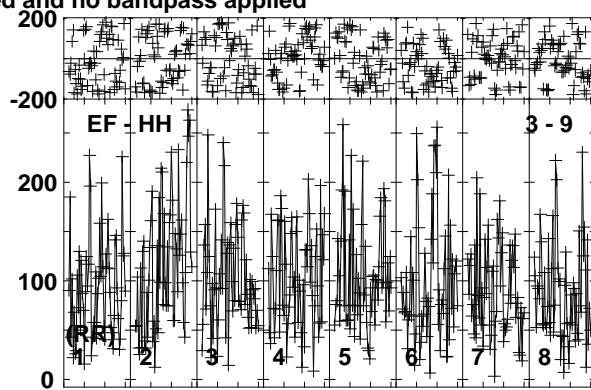
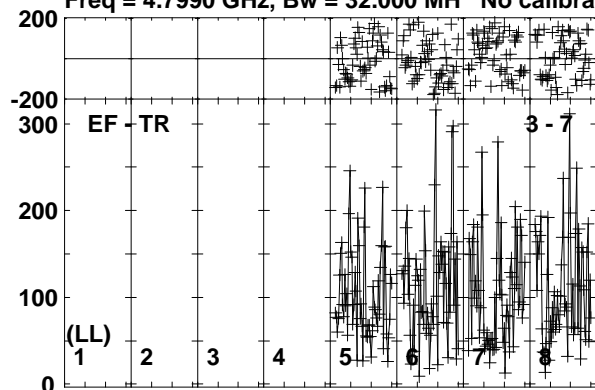

Lower frame: Micro Ampl Jy Top frame: Phas deg
Vector averaged cross-power spectrum Baseline: EF (03) - TR (07)
Timerange: 00/22:43:21 to 00/22:45:29

Plot file version 10 created 26-SEP-2019 10:39:14

190829A RG010A.UVDATA.1

Freq = 4.7990 GHz, Bw = 32.000 MH No calibration applied and no bandpass applied

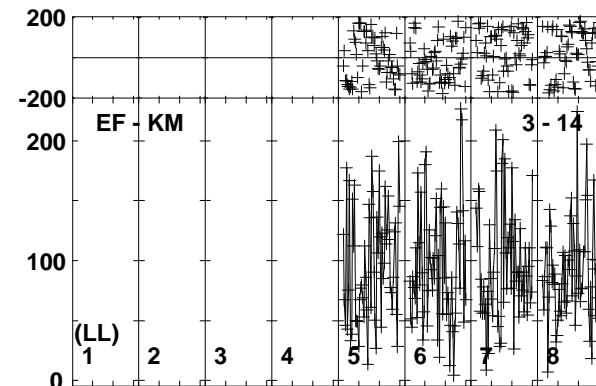
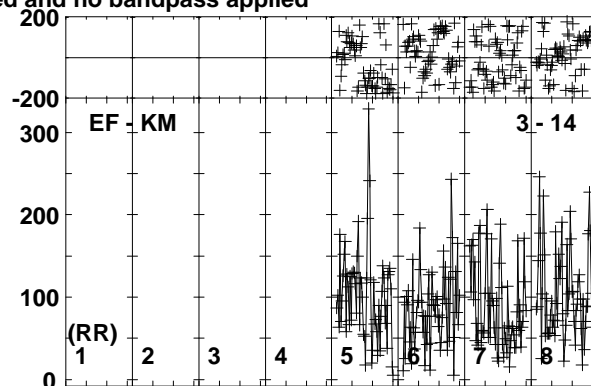
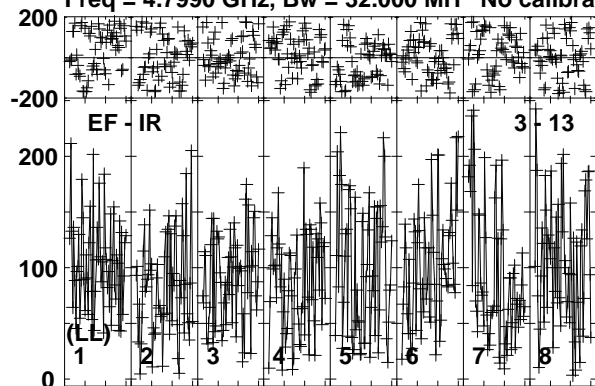

Lower frame: Micro Ampl Jy Top frame: Phas deg
Vector averaged cross-power spectrum Baseline: EF (03) - IR (13)
Timerange: 00/22:43:21 to 00/22:45:29

Plot file version 11 created 26-SEP-2019 10:39:16

190829A RG010A.UVDATA.1

Freq = 4.7990 GHz, Bw = 32.000 MH No calibration applied and no bandpass applied

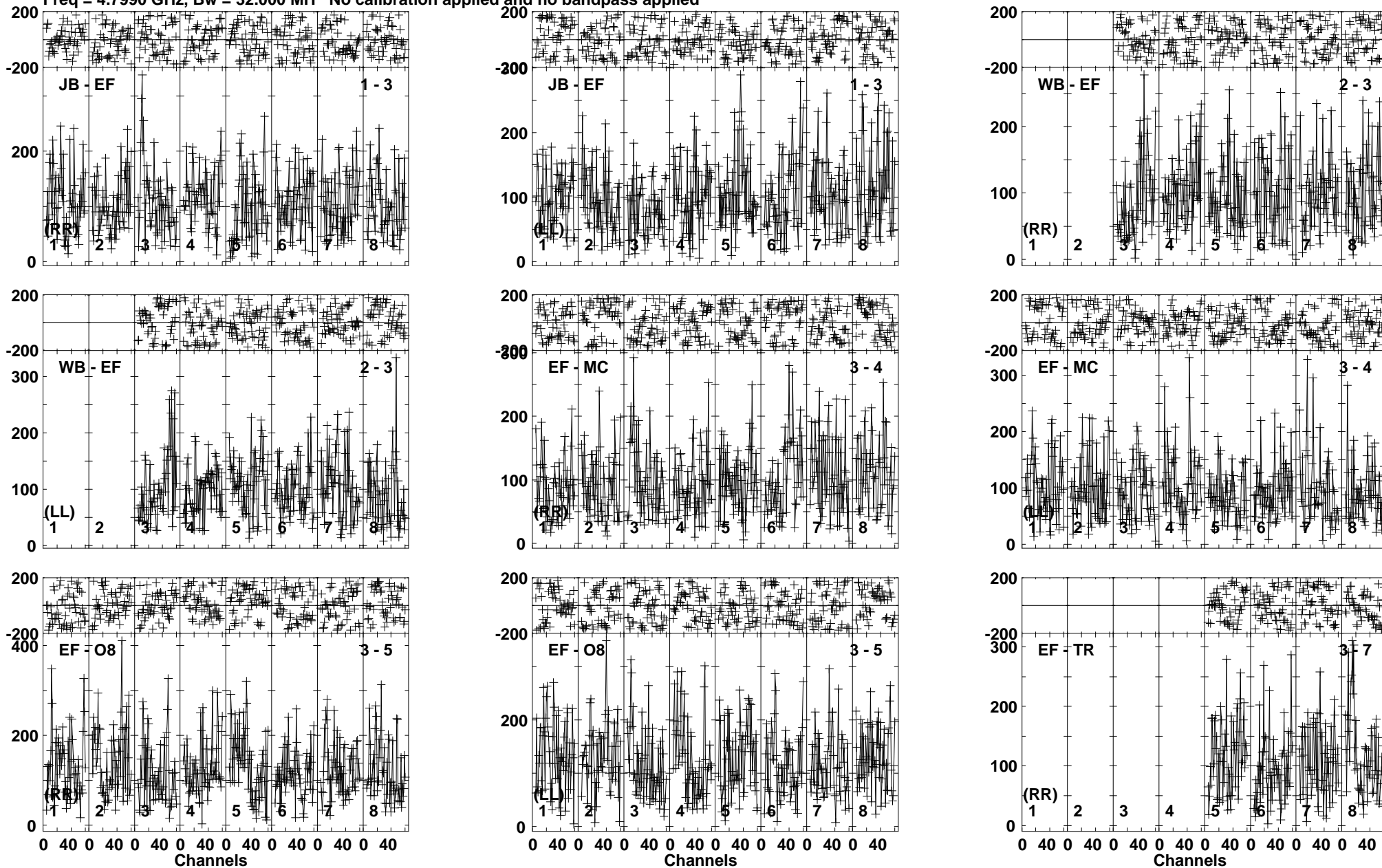

Lower frame: Micro Ampl Jy Top frame: Phas deg
Vector averaged cross-power spectrum Baseline: JB (01) - EF (03)
Timerange: 00:22:46:30 to 00:22:48:39

Plot file version 12 created 26-SEP-2019 10:39:16

190829A RG010A.UVDATA.1

Freq = 4.7990 GHz, Bw = 32.000 MH No calibration applied and no bandpass applied

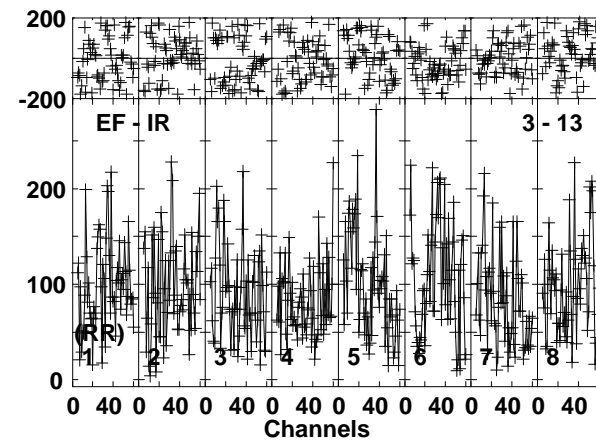
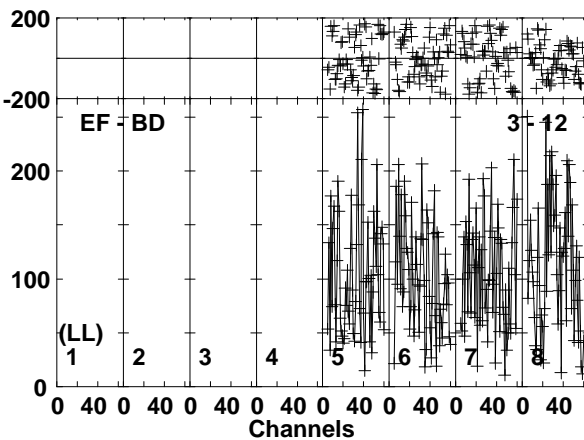
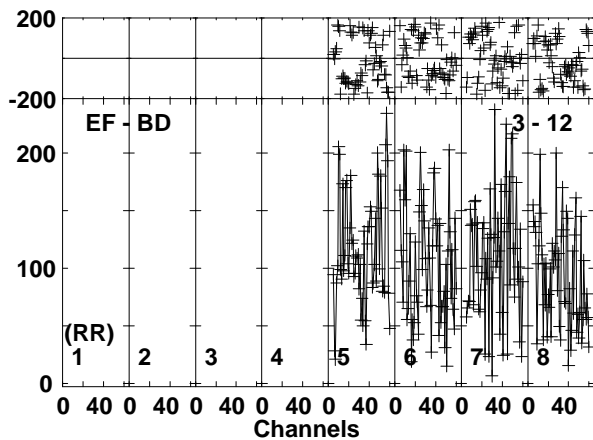
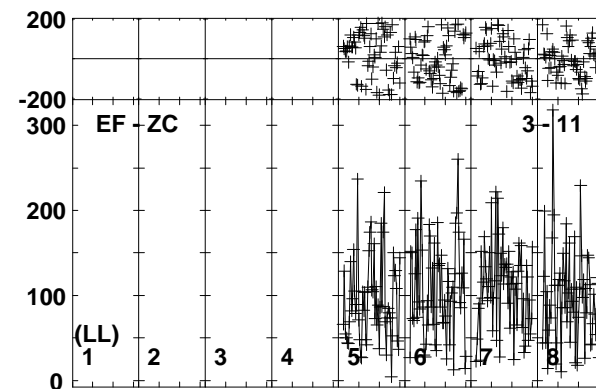
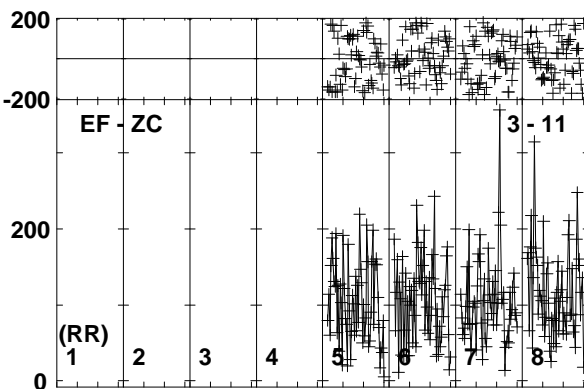
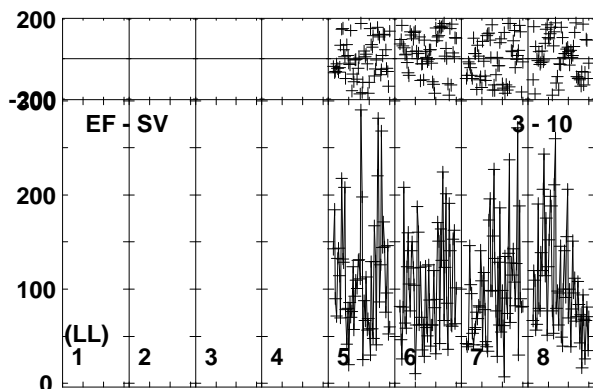
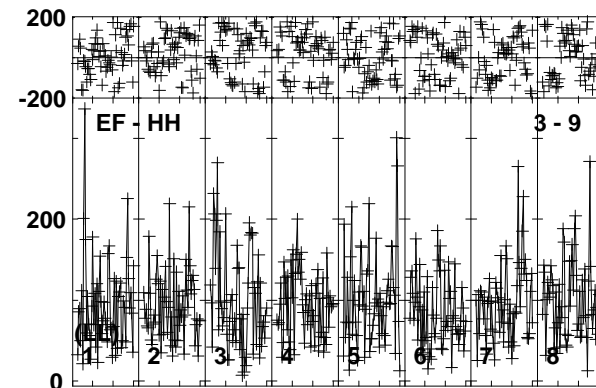
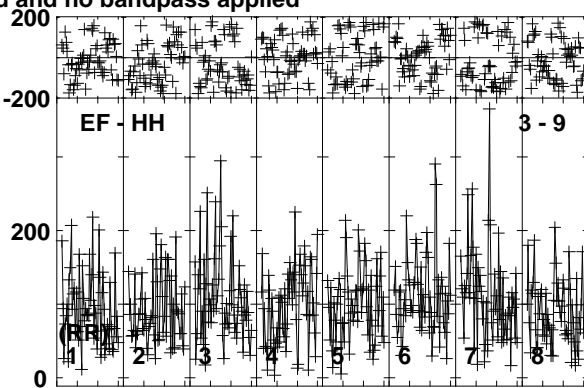
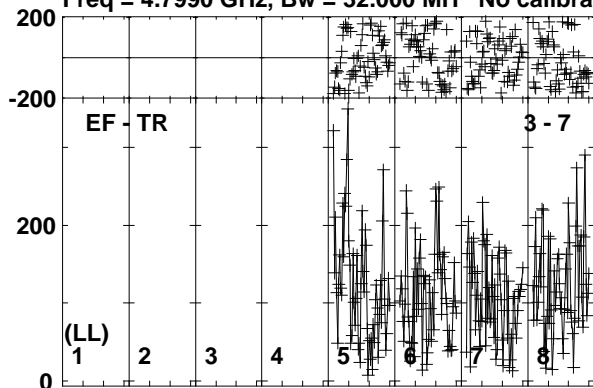

Lower frame: Micro Ampl Jy Top frame: Phas deg
Vector averaged cross-power spectrum Baseline: EF (03) - TR (07)
Timerange: 00/22:46:30 to 00/22:48:39

Plot file version 13 created 26-SEP-2019 10:39:17

190829A RG010A.UVDATA.1

Freq = 4.7990 GHz, Bw = 32.000 MH No calibration applied and no bandpass applied

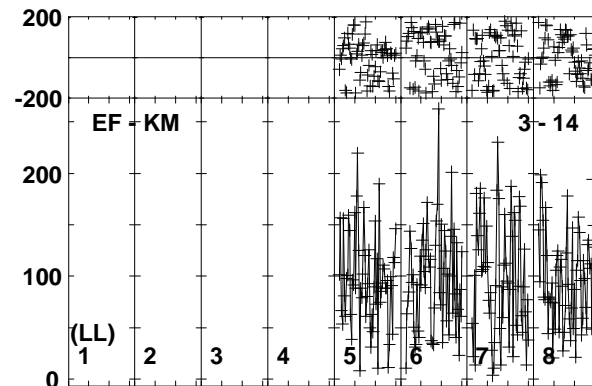
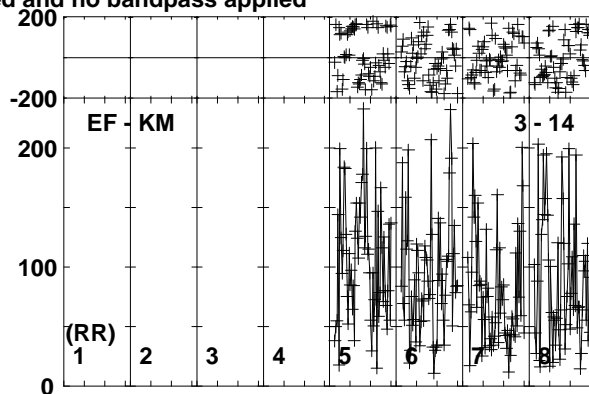
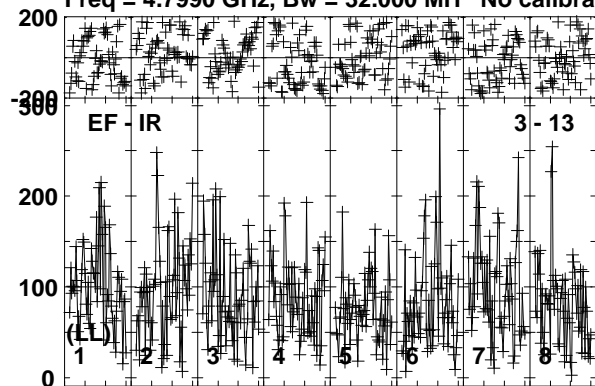

Lower frame: Micro Ampl Jy Top frame: Phas deg
Vector averaged cross-power spectrum Baseline: EF (03) - IR (13)
Timerange: 00/22:46:30 to 00/22:48:39

Plot file version 14 created 26-SEP-2019 10:39:17

J0257-1212 RG010A.UVDATA.1

Freq = 4.7990 GHz, Bw = 32.000 MH No calibration applied and no bandpass applied

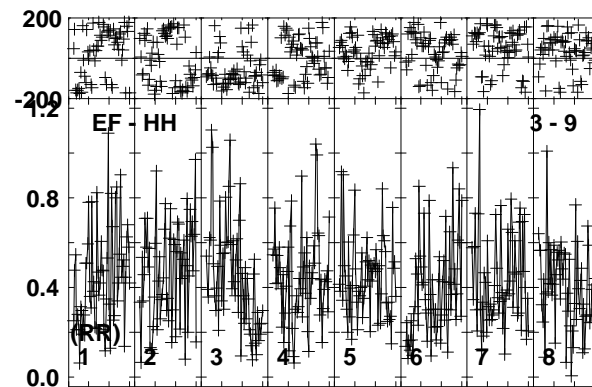
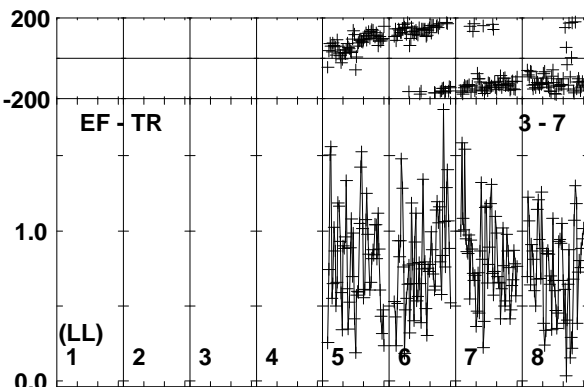
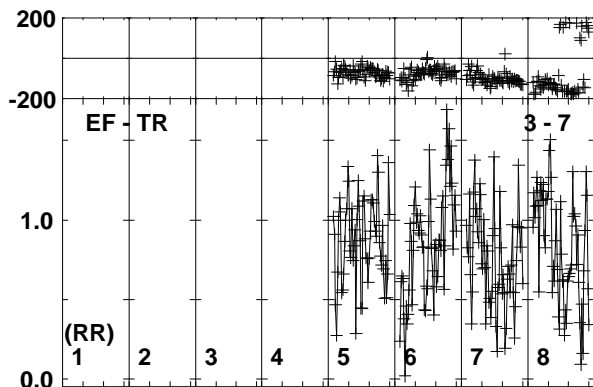
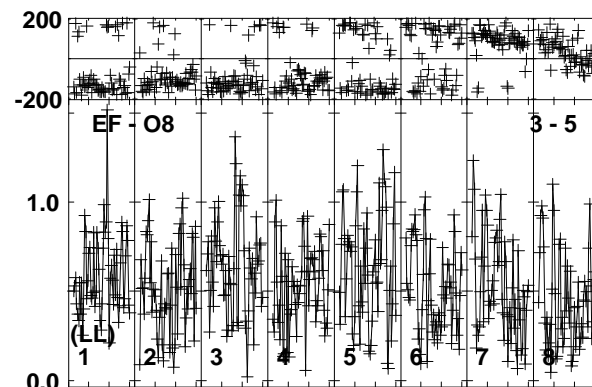
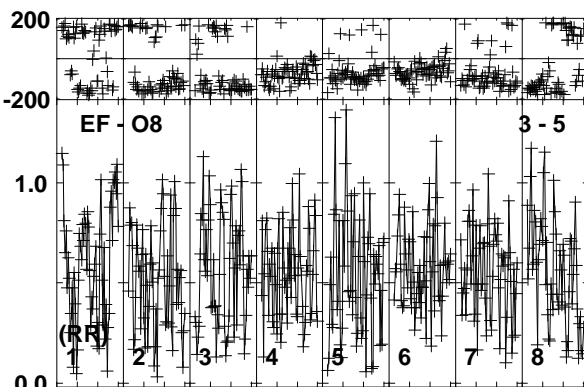
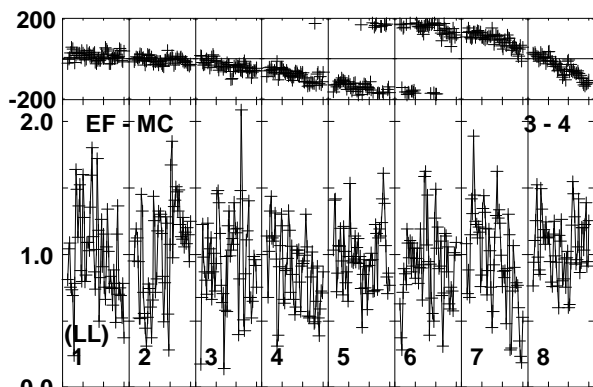
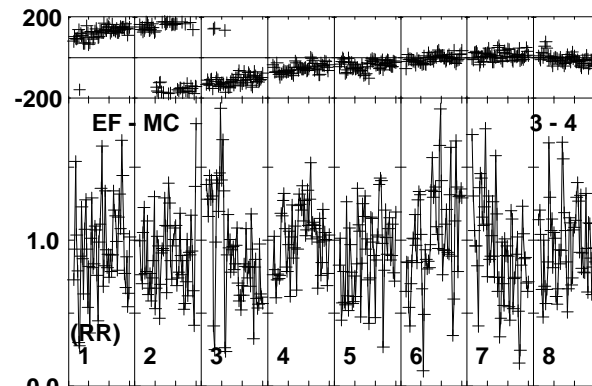
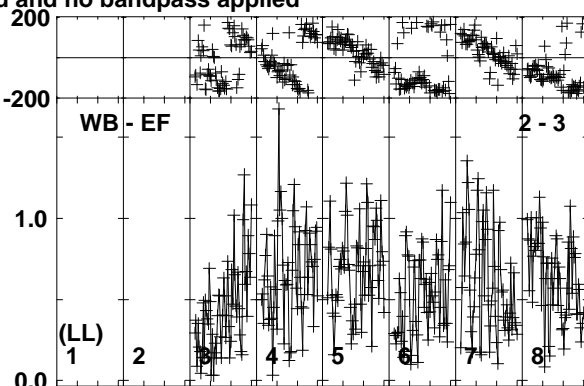
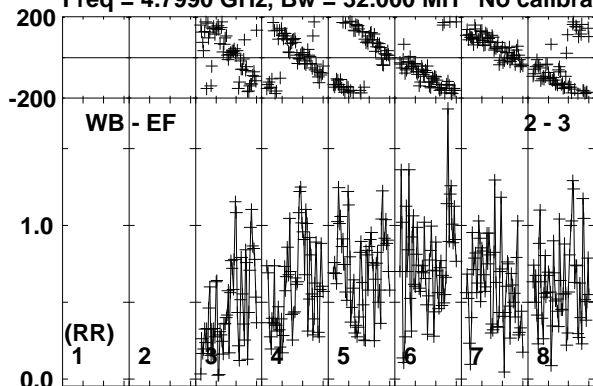

Lower frame: Milli Ampl Jy Top frame: Phas deg
Vector averaged cross-power spectrum Baseline: WB (02) - EF (03)
Timerange: 00:22:48:41 to 00:22:49:39

Plot file version 15 created 26-SEP-2019 10:39:18

J0257-1212 RG010A.UVDATA.1

Freq = 4.7990 GHz, Bw = 32.000 MH No calibration applied and no bandpass applied

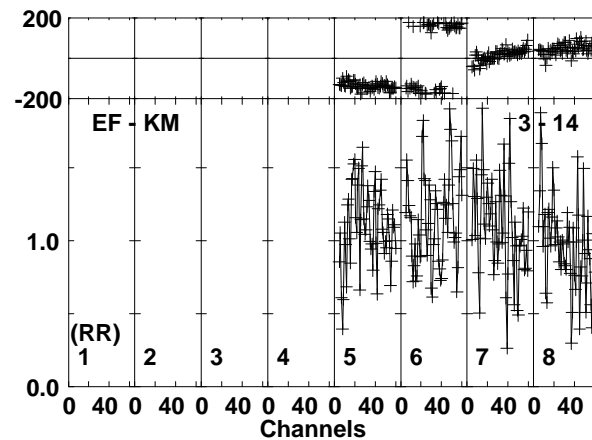
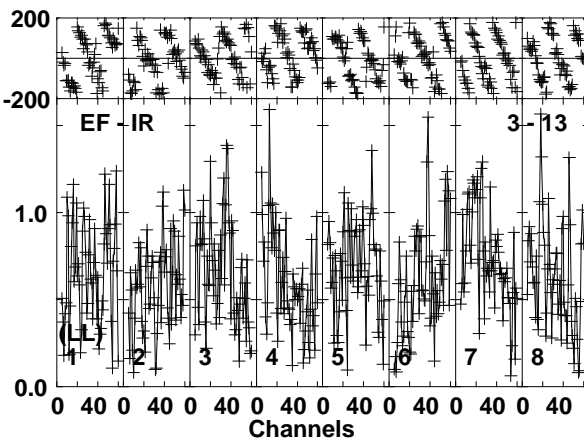
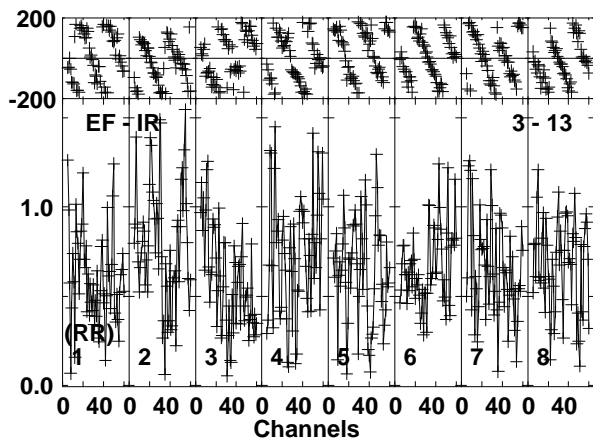
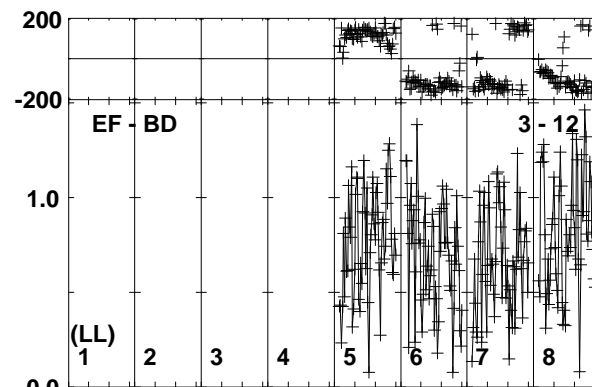
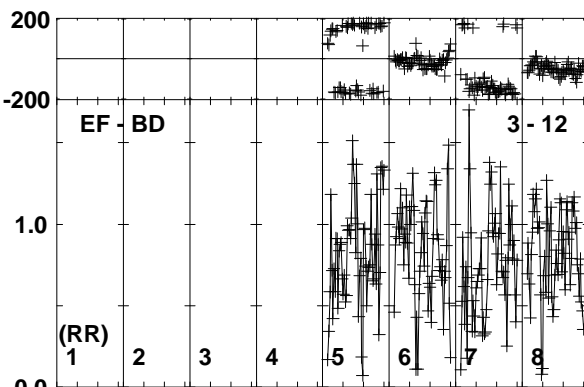
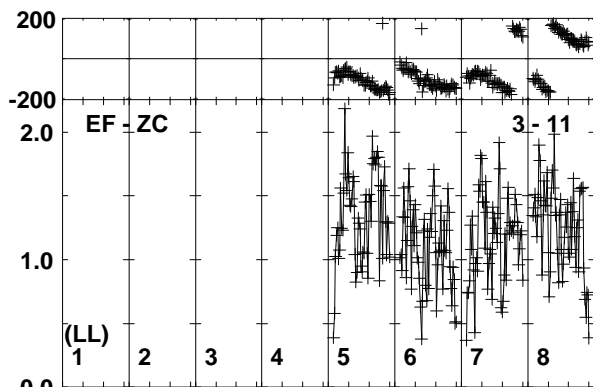
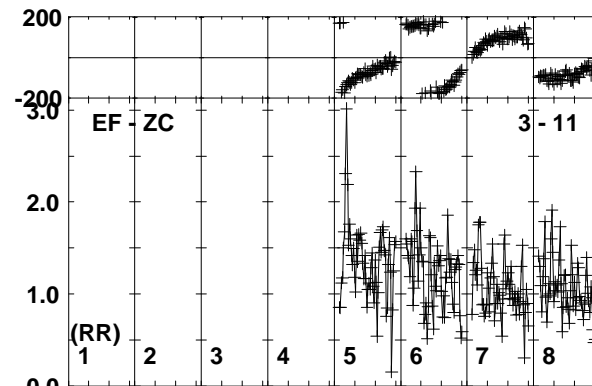
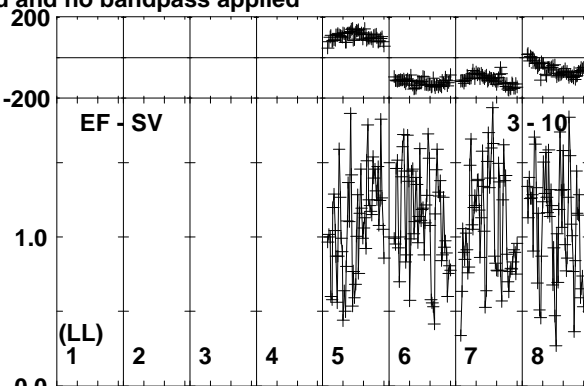
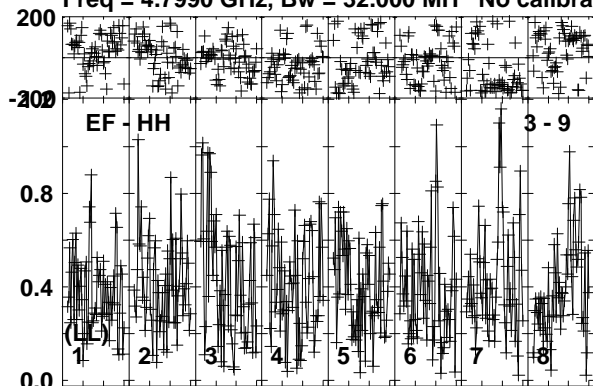

Lower frame: Milli Ampl Jy Top frame: Phas deg
Vector averaged cross-power spectrum Baseline: EF (03) - HH (09)
Timerange: 00/22:48:41 to 00/22:49:39

Plot file version 16 created 26-SEP-2019 10:39:18
J0257-1212 RG010A.UVDATA.1
Freq = 4.7990 GHz, Bw = 32.000 MH No calibration applied and no bandpass applied

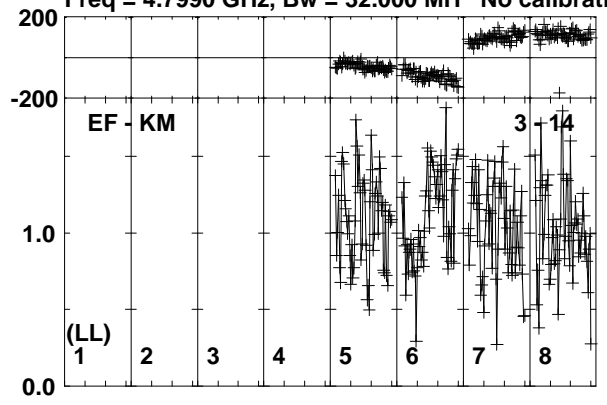

Lower frame: Milli Ampl Jy Top frame: Phas deg
Vector averaged cross-power spectrum Baseline: EF (03) - KM (14)
Timerange: 00/22:48:41 to 00/22:49:39

Plot file version 17 created 26-SEP-2019 10:39:19

190829A RG010A.UVDATA.1

Freq = 4.7990 GHz, Bw = 32.000 MH No calibration applied and no bandpass applied

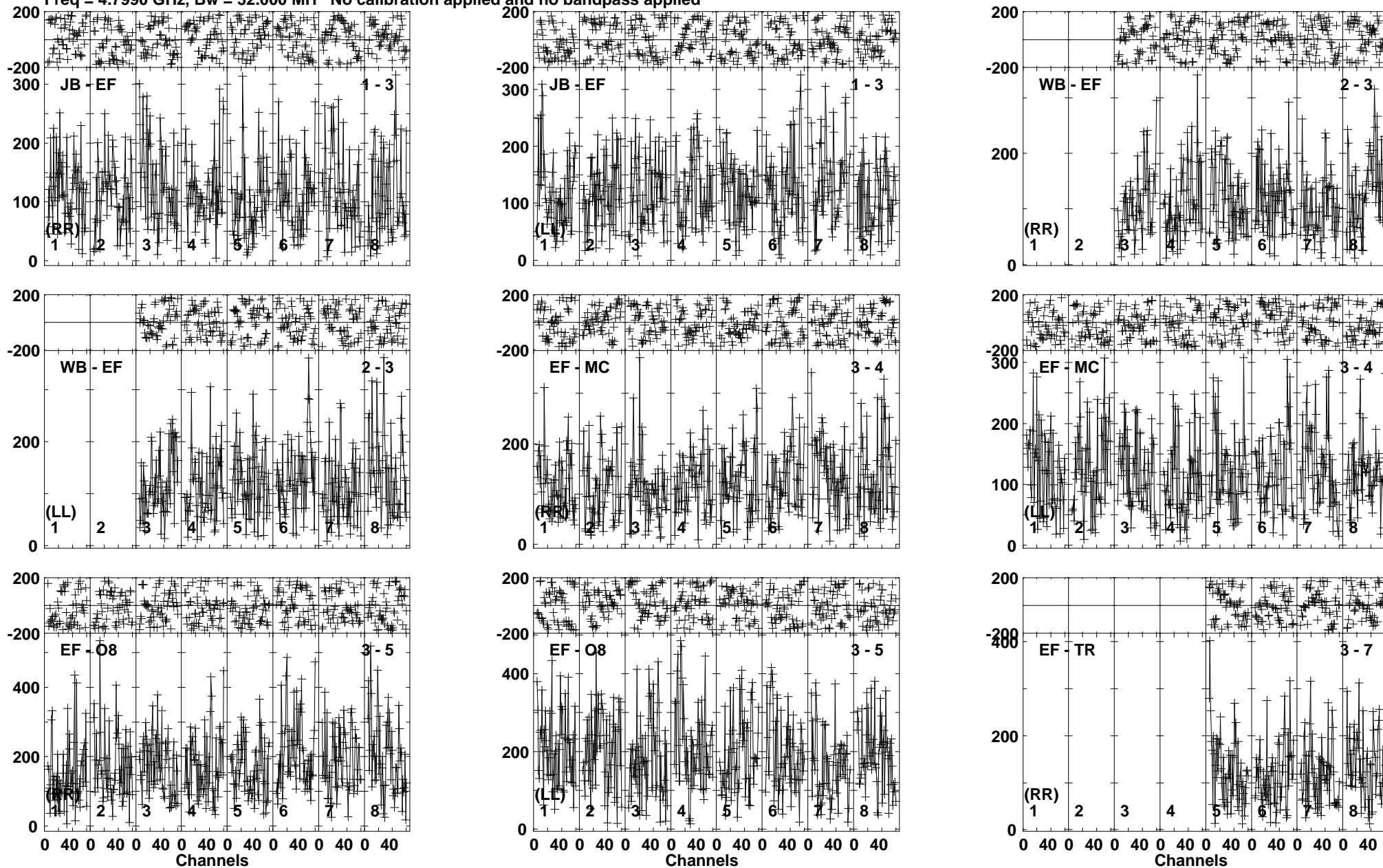

Lower frame: Micro Ampl Jy Top frame: Phas deg
Vector averaged cross-power spectrum Baseline: JB (01) - EF (03)
Timerange: 00:22:49:40 to 00:22:51:50

Plot file version 18 created 26-SEP-2019 10:39:19

190829A RG010A.UVDATA.1

Freq = 4.7990 GHz, Bw = 32.000 MH No calibration applied and no bandpass applied

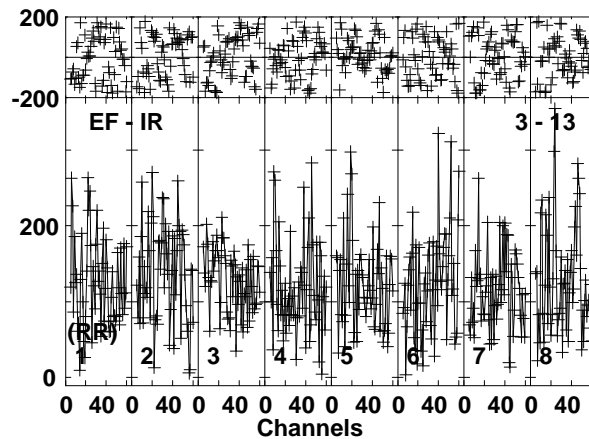
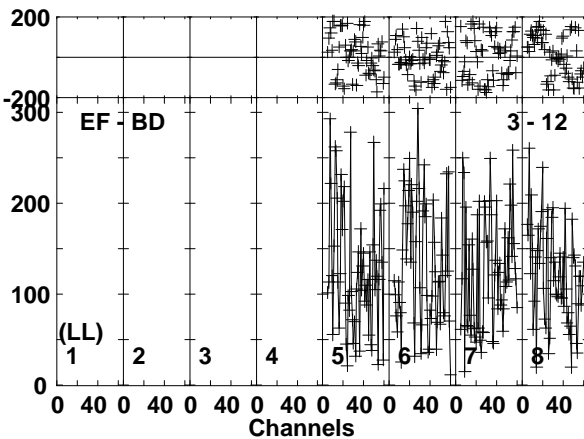
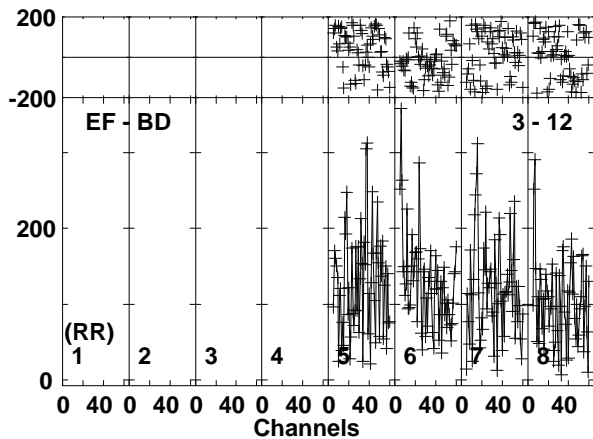
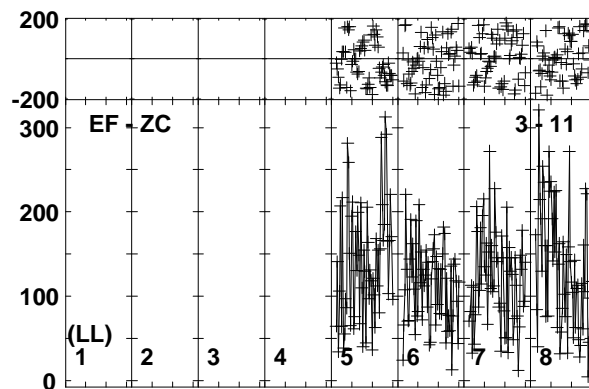
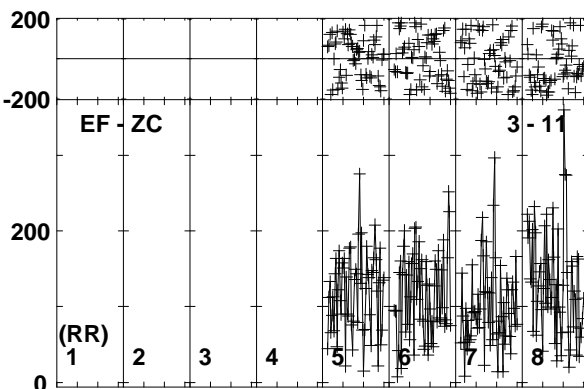
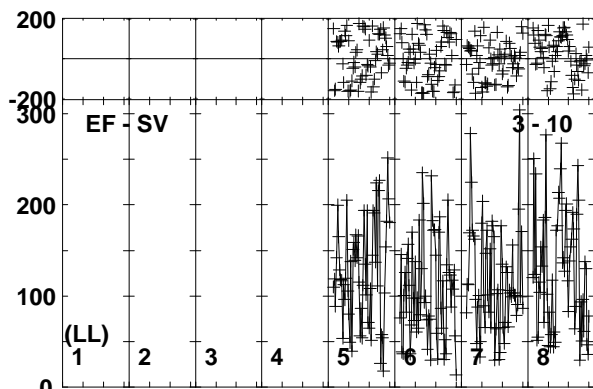
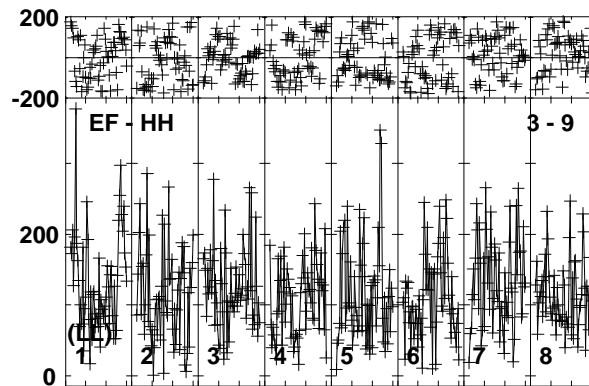
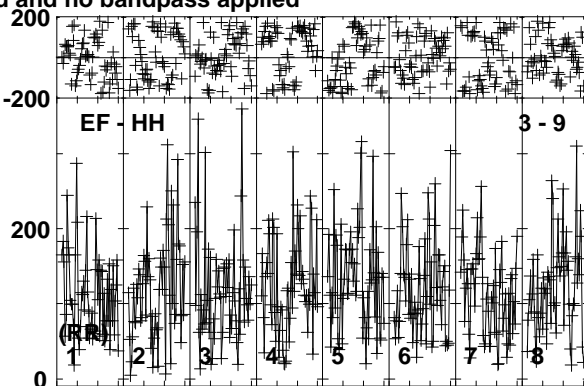
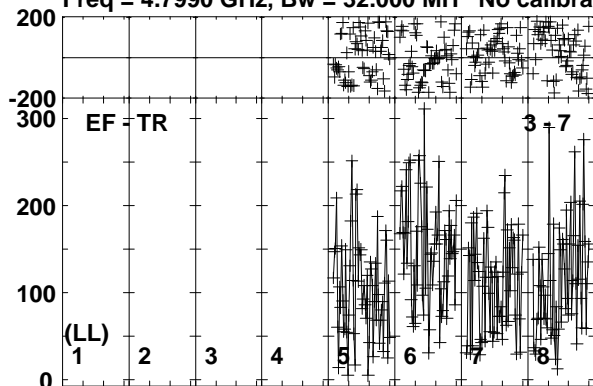

Lower frame: Micro Ampl Jy Top frame: Phas deg
Vector averaged cross-power spectrum Baseline: EF (03) - TR (07)
Timerange: 00/22:49:40 to 00/22:51:50

Plot file version 19 created 26-SEP-2019 10:39:19

190829A RG010A.UVDATA.1

Freq = 4.7990 GHz, Bw = 32.000 MH No calibration applied and no bandpass applied

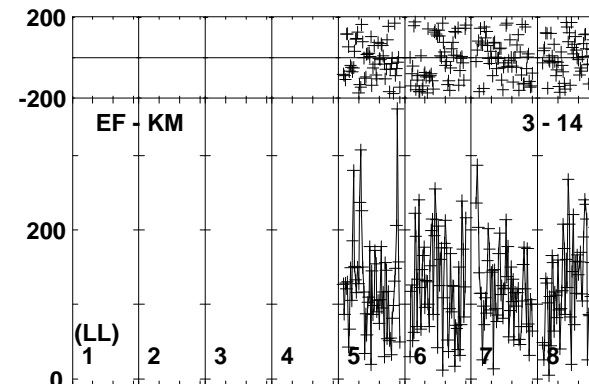
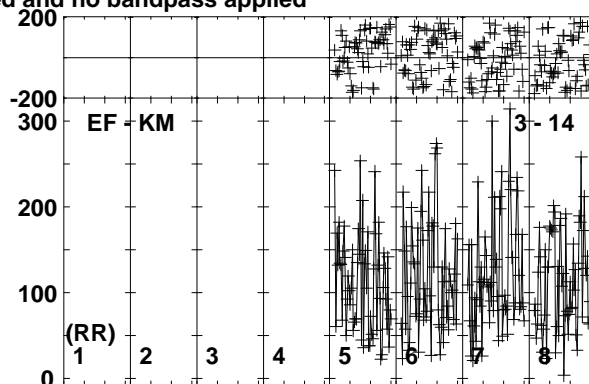
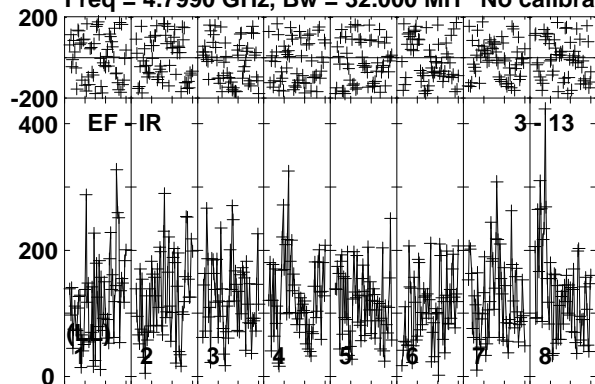

Lower frame: Micro Ampl Jy Top frame: Phas deg
Vector averaged cross-power spectrum Baseline: EF (03) - IR (13)
Timerange: 00/22:49:40 to 00/22:51:50

Plot file version 20 created 26-SEP-2019 10:39:20

J0257-1212 RG010A.UVDATA.1

Freq = 4.7990 GHz, Bw = 32.000 MH No calibration applied and no bandpass applied

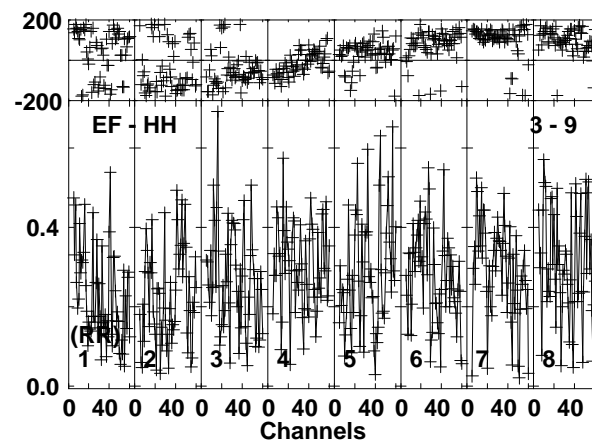
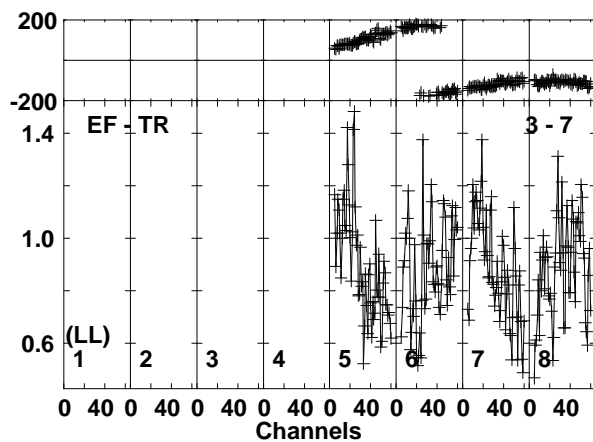
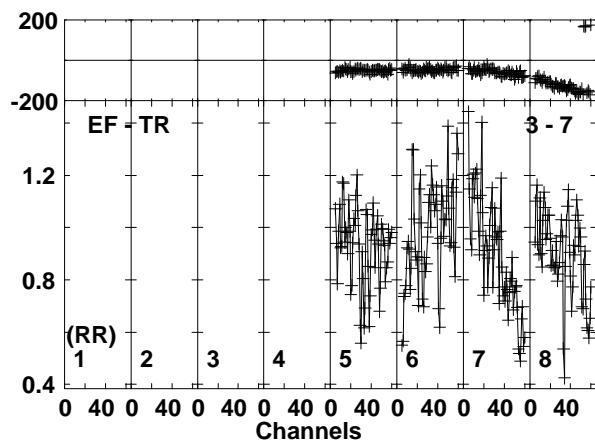
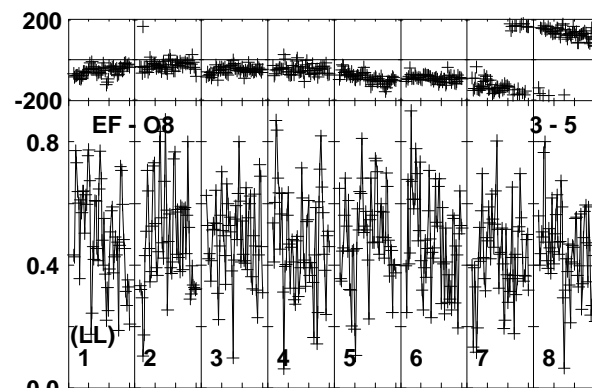
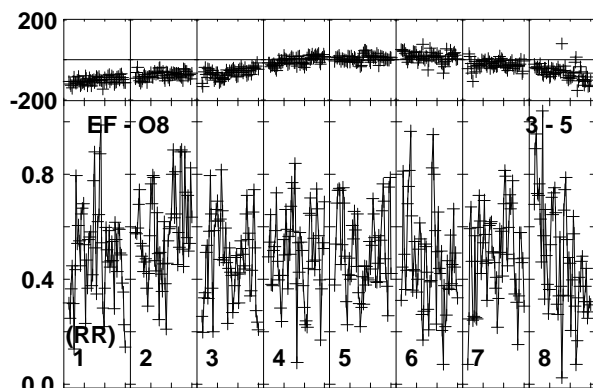
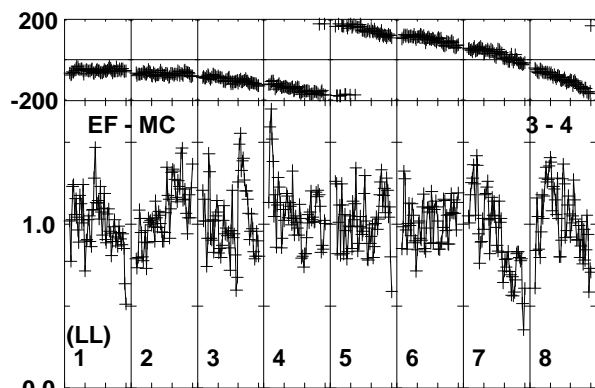
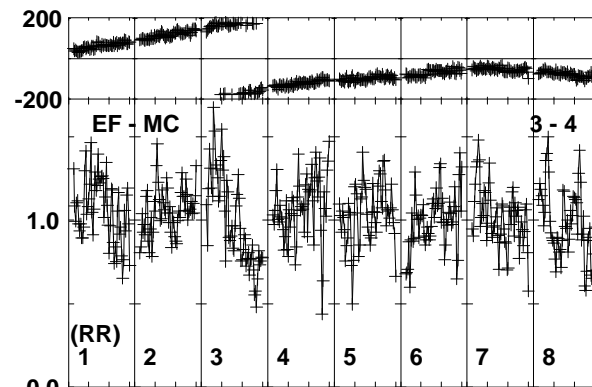
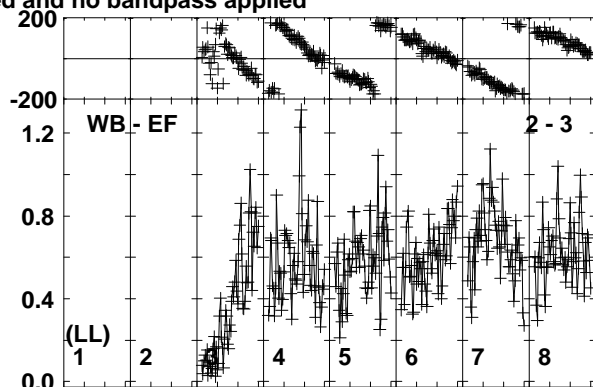
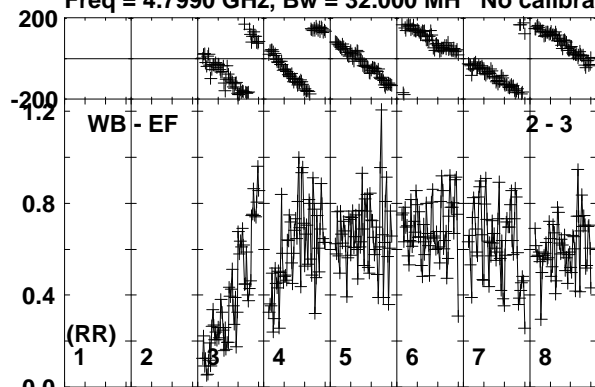

Lower frame: Milli Ampl Jy Top frame: Phas deg
Vector averaged cross-power spectrum Baseline: WB (02) - EF (03)
Timerange: 00/22:52:40 to 00/22:53:09

Plot file version 21 created 26-SEP-2019 10:39:20

J0257-1212 RG010A.UVDATA.1

Freq = 4.7990 GHz, Bw = 32.000 MH No calibration applied and no bandpass applied

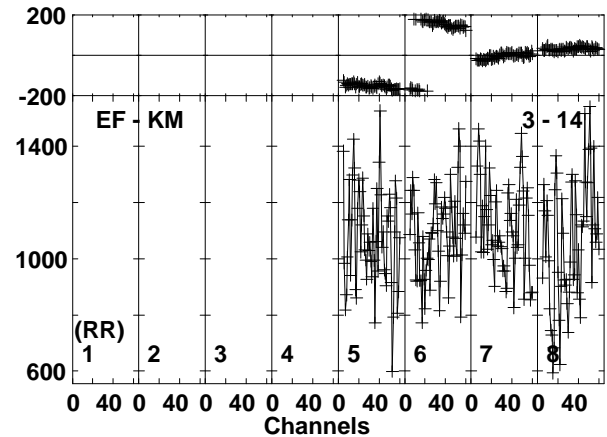
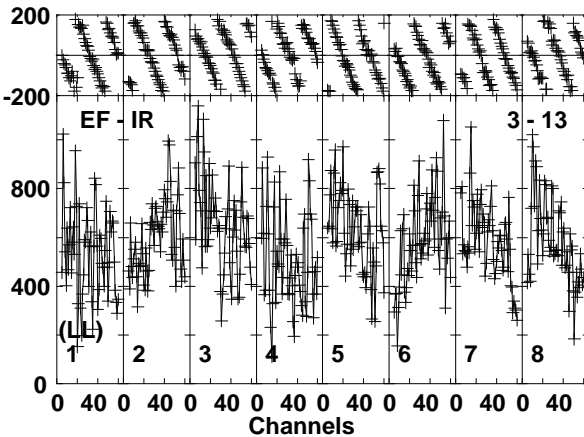
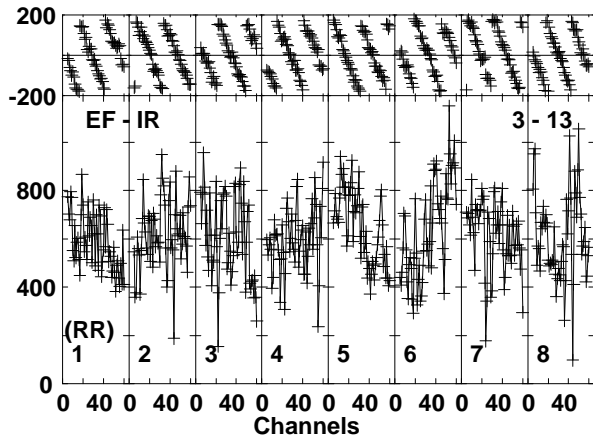
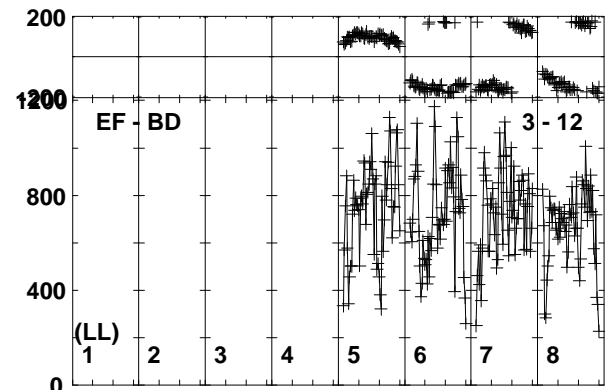
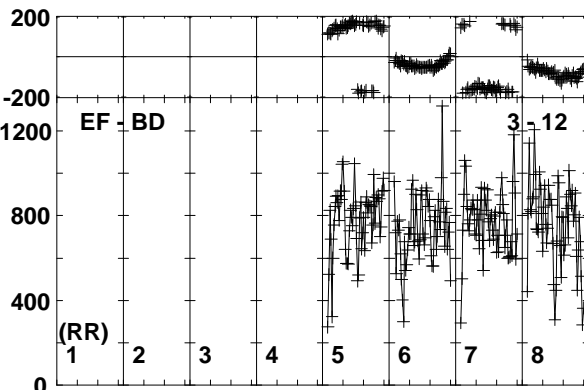
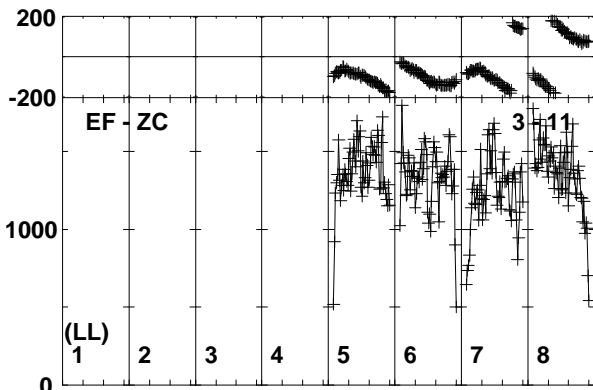
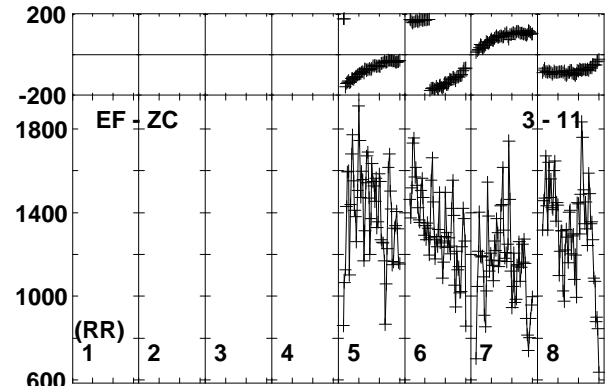
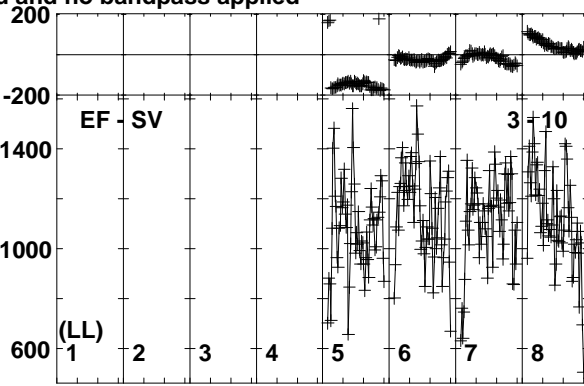
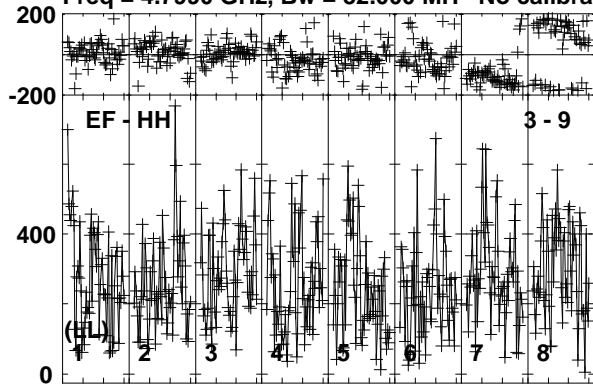

Lower frame: Micro Ampl Jy Top frame: Phas deg
Vector averaged cross-power spectrum Baseline: EF (03) - HH (09)
Timerange: 00/22:52:40 to 00/22:53:09

Plot file version 22 created 26-SEP-2019 10:39:21

J0257-1212 RG010A.UVDATA.1

Freq = 4.7990 GHz, Bw = 32.000 MH No calibration applied and no bandpass applied

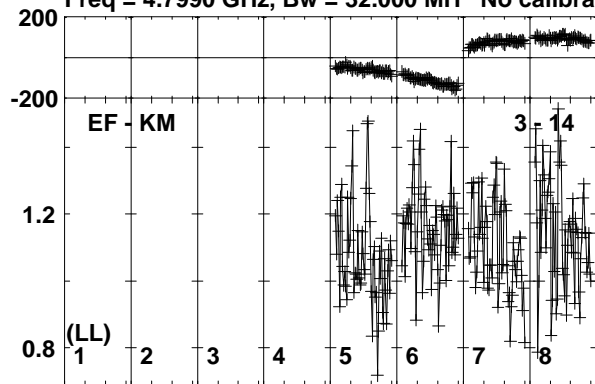

Lower frame: Milli Ampl Jy Top frame: Phas deg
Vector averaged cross-power spectrum Baseline: EF (03) - KM (14)
Timerange: 00/22:52:40 to 00/22:53:09

Plot file version 23 created 26-SEP-2019 10:39:23

J0300-0846 RG010A.UVDATA.1

Freq = 4.7990 GHz, Bw = 32.000 MH No calibration applied and no bandpass applied

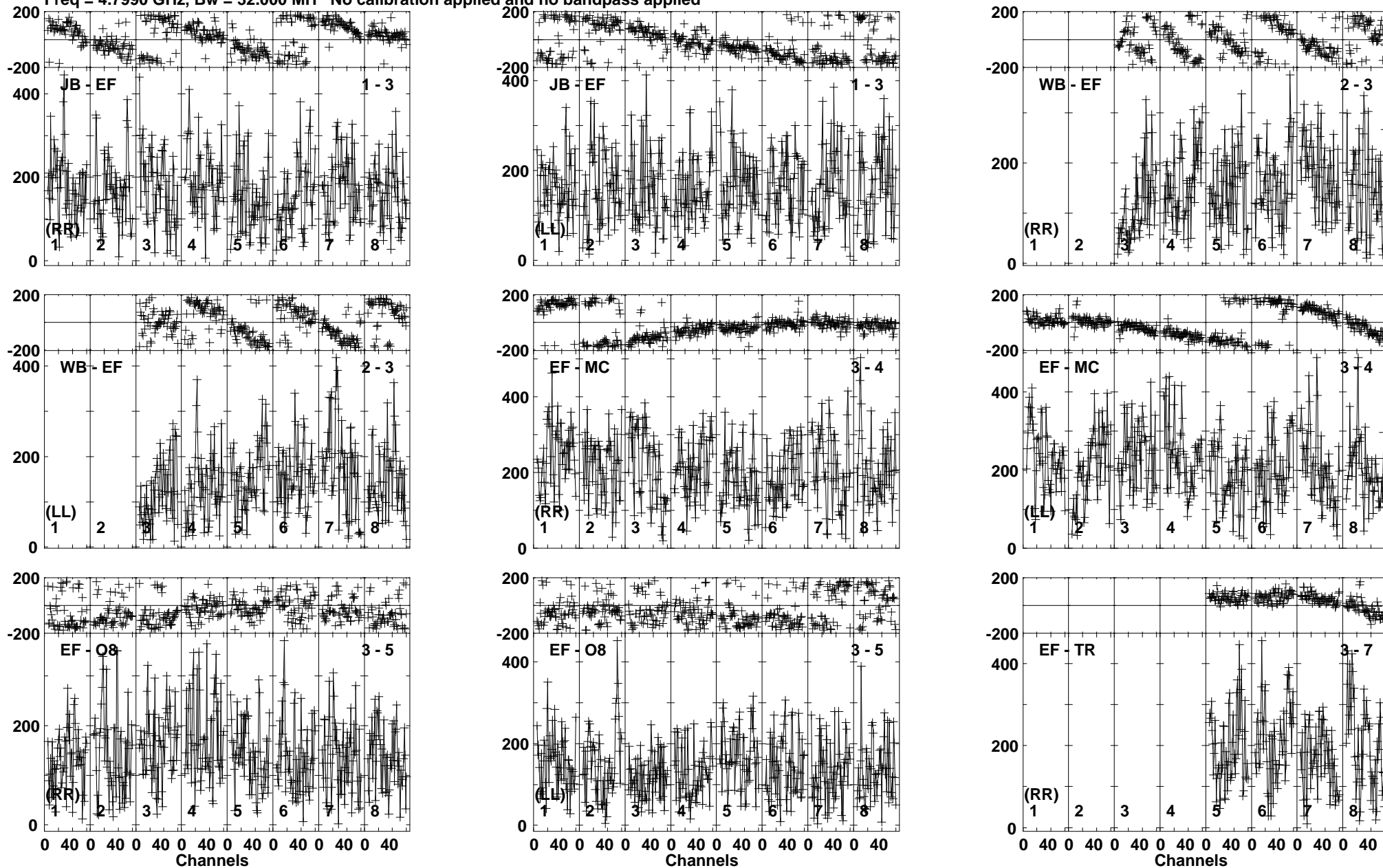

Lower frame: Micro Ampl Jy Top frame: Phas deg
Vector averaged cross-power spectrum Baseline: JB (01) - EF (03)
Timerange: 00:22:53:10 to 00:22:55:20

Plot file version 24 created 26-SEP-2019 10:39:23

J0300-0846 RG010A.UVDATA.1

Freq = 4.7990 GHz, Bw = 32.000 MH No calibration applied and no bandpass applied

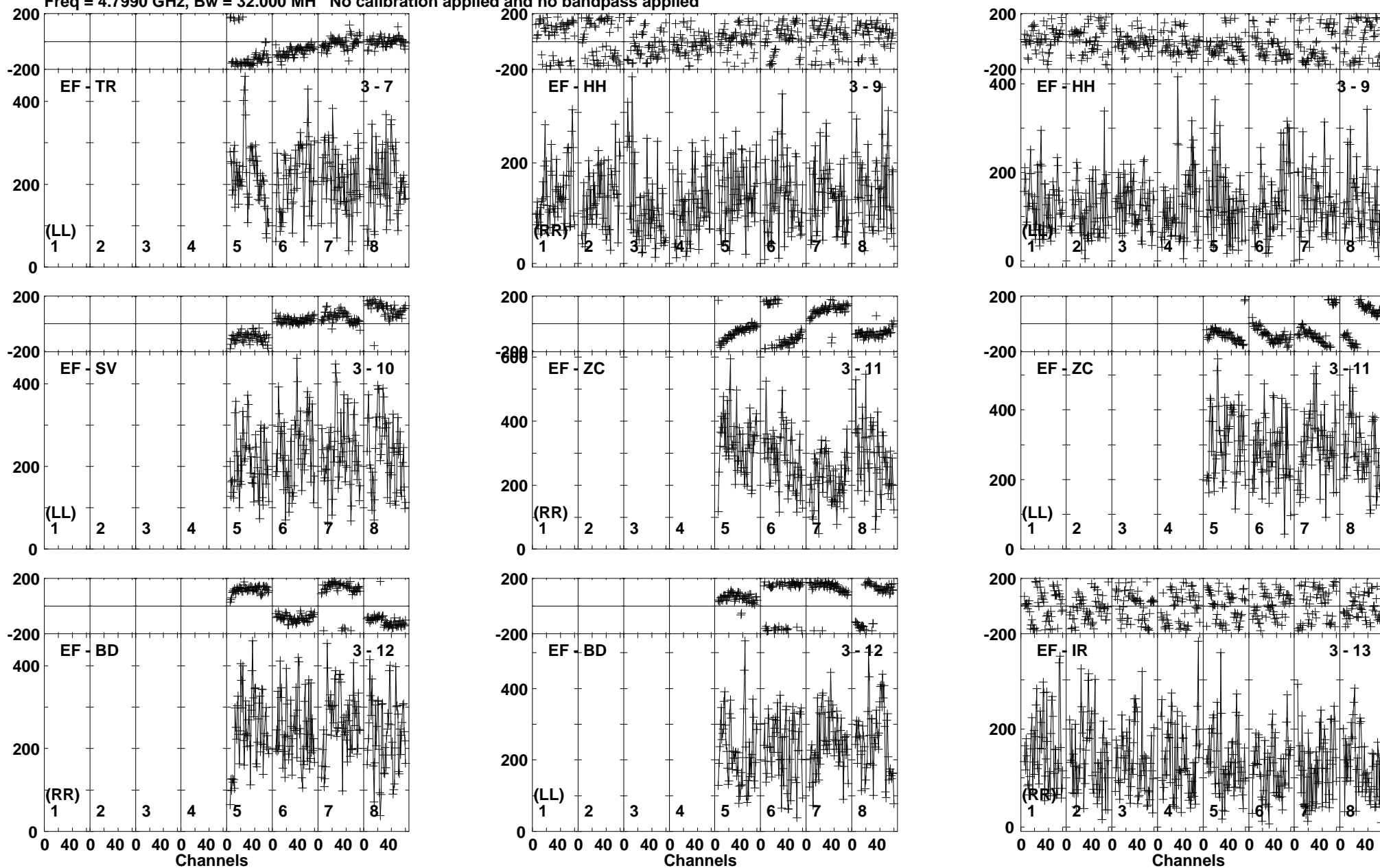

Lower frame: Micro Ampl Jy Top frame: Phas deg
Vector averaged cross-power spectrum Baseline: EF (03) - TR (07)
Timerange: 00:22:53:10 to 00:22:55:20

Plot file version 25 created 26-SEP-2019 10:39:24

J0300-0846 RG010A.UVDATA.1

Freq = 4.7990 GHz, Bw = 32.000 MH No calibration applied and no bandpass applied

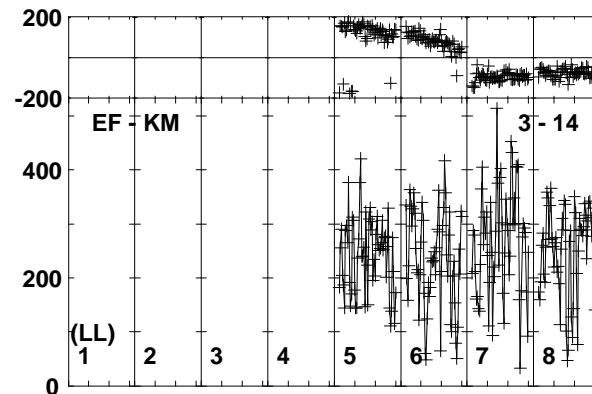
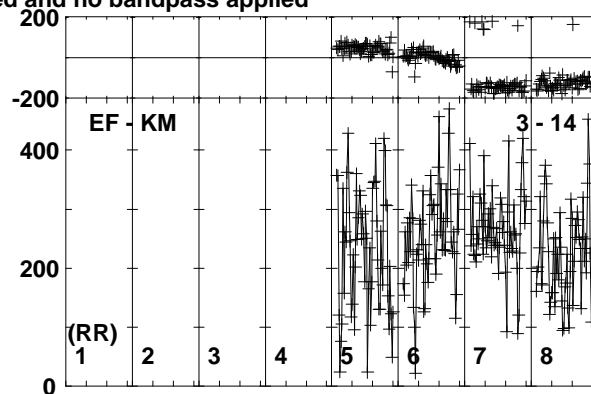
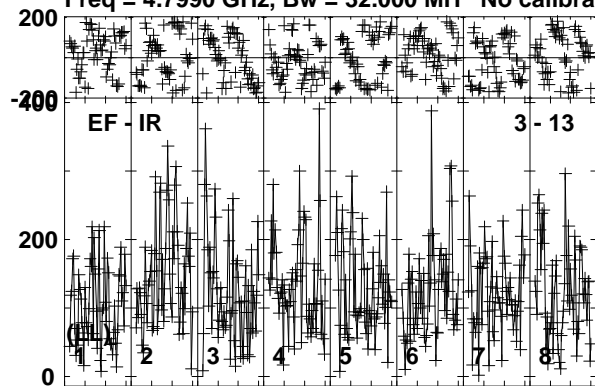

Lower frame: Micro Ampl Jy Top frame: Phas deg
Vector averaged cross-power spectrum Baseline: EF (03) - IR (13)
Timerange: 00/22:53:10 to 00/22:55:20

Plot file version 26 created 26-SEP-2019 10:39:25

J0257-1212 RG010A.UVDATA.1

Freq = 4.7990 GHz, Bw = 32.000 MH No calibration applied and no bandpass applied

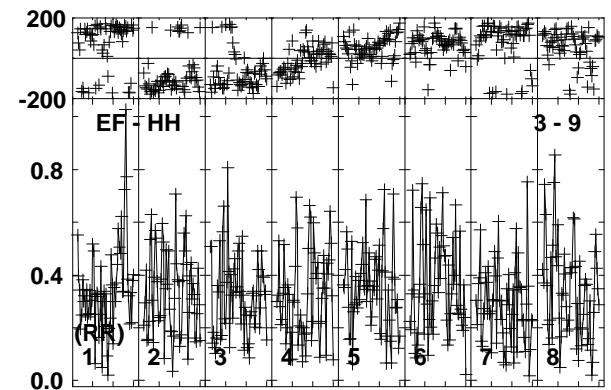
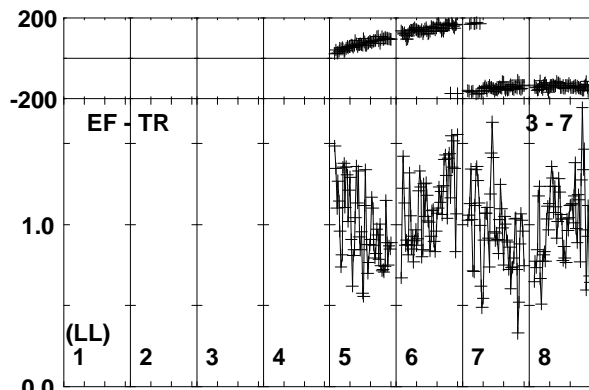
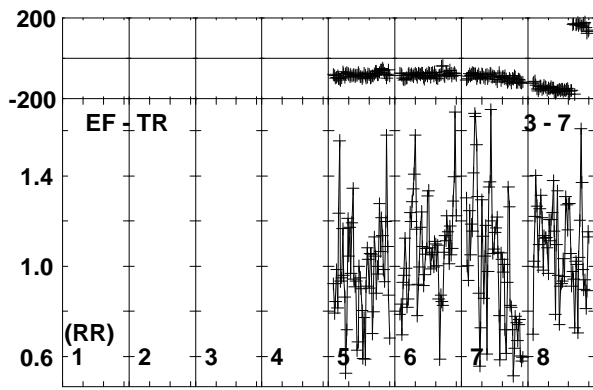
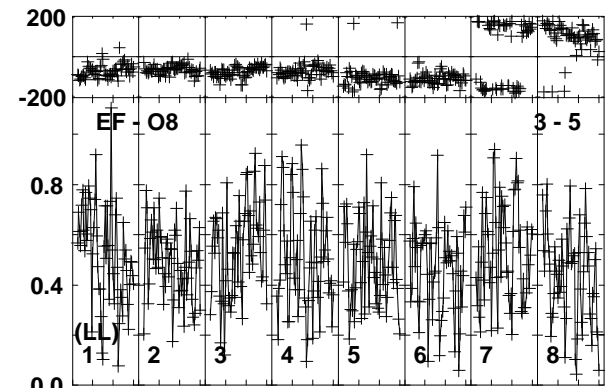
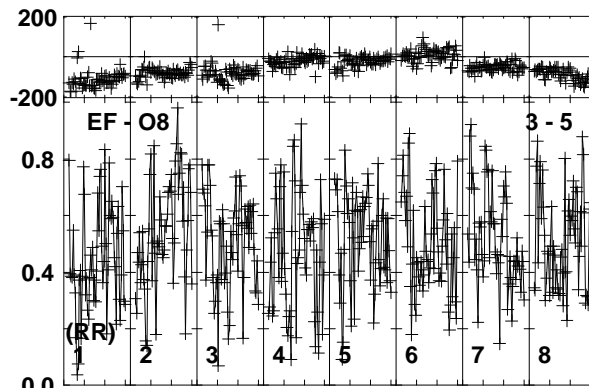
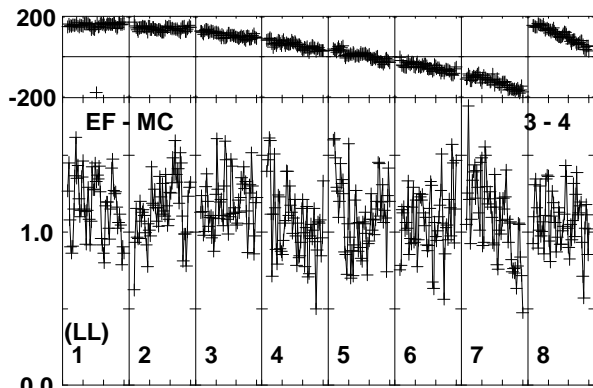
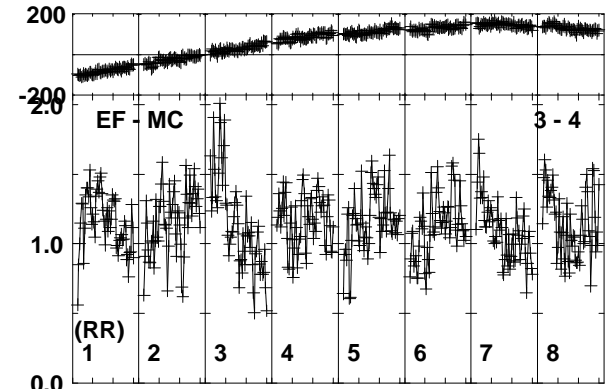
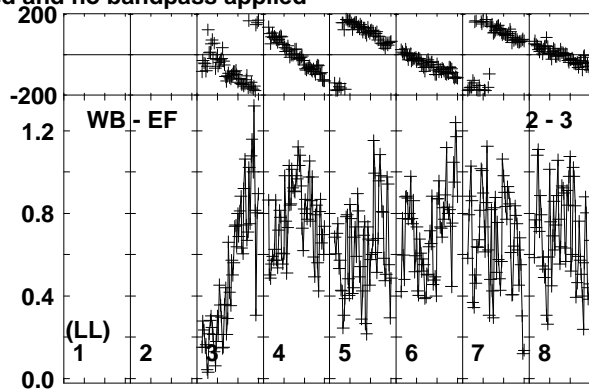
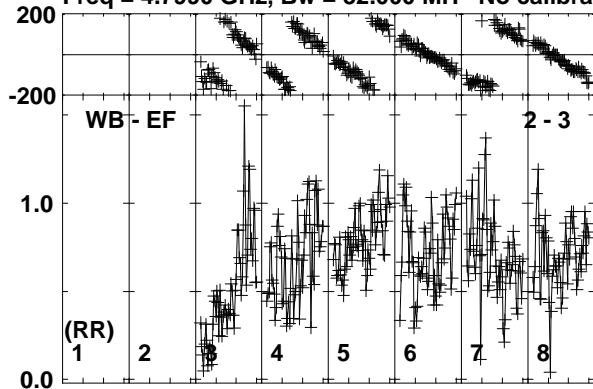

Lower frame: Milli Ampl Jy Top frame: Phas deg
Vector averaged cross-power spectrum Baseline: WB (02) - EF (03)
Timerange: 00/22:55:21 to 00/22:56:19

Plot file version 27 created 26-SEP-2019 10:39:25

J0257-1212 RG010A.UVDATA.1

Freq = 4.7990 GHz, Bw = 32.000 MH No calibration applied and no bandpass applied

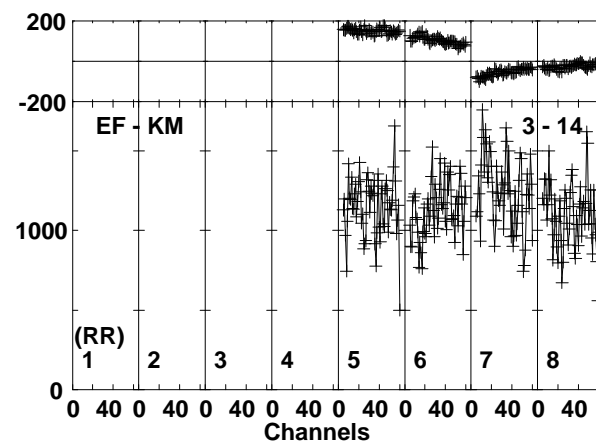
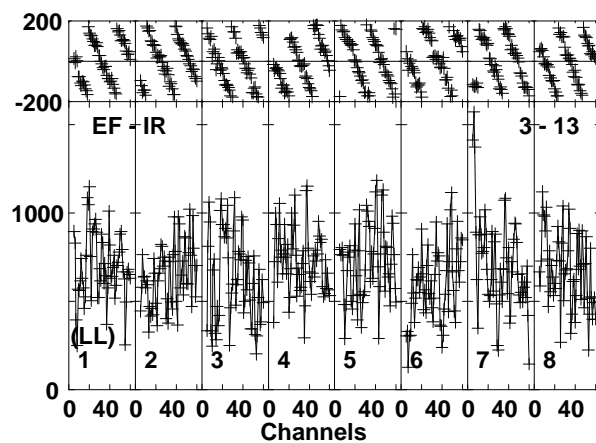
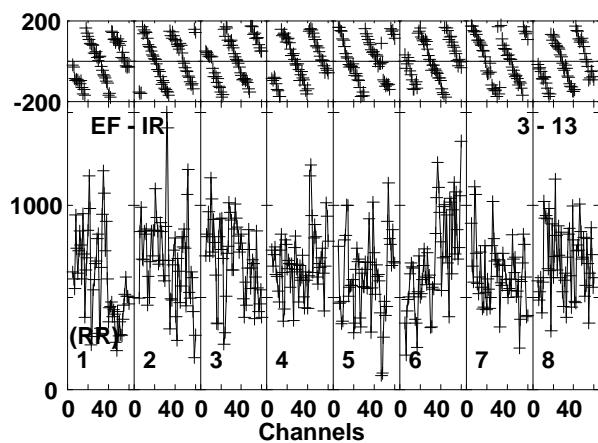
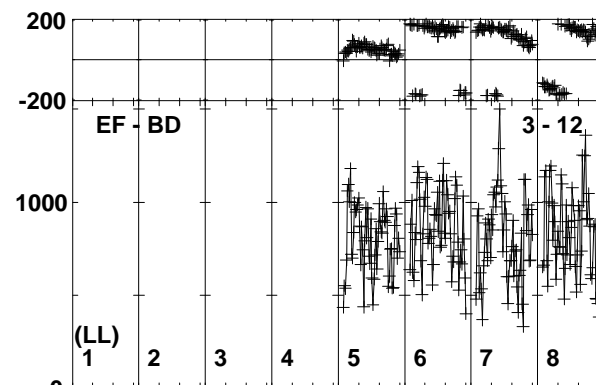
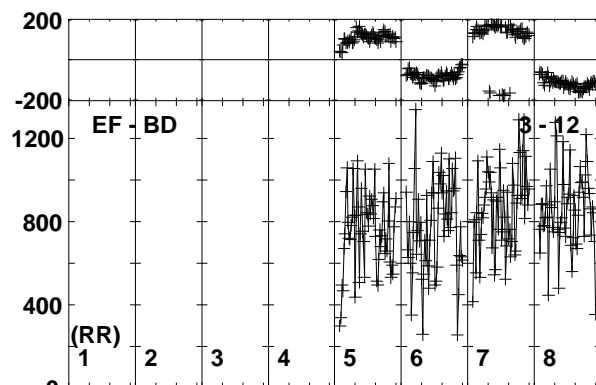
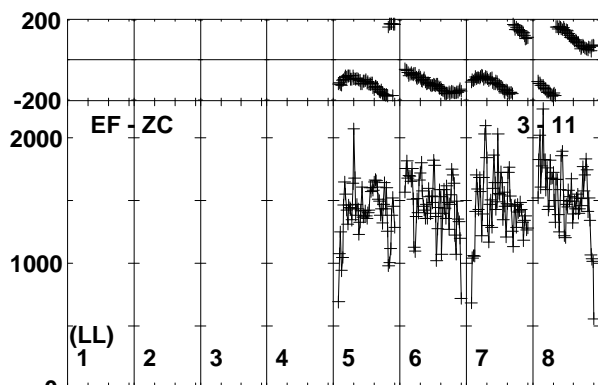
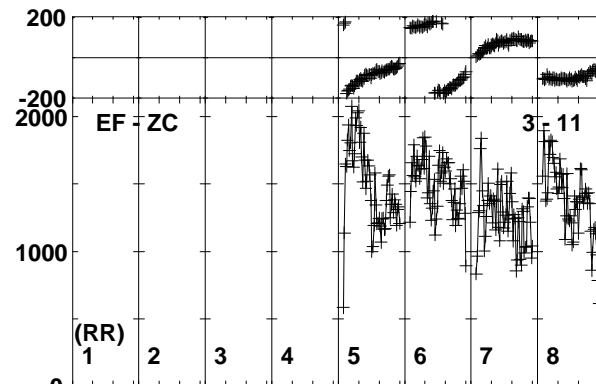
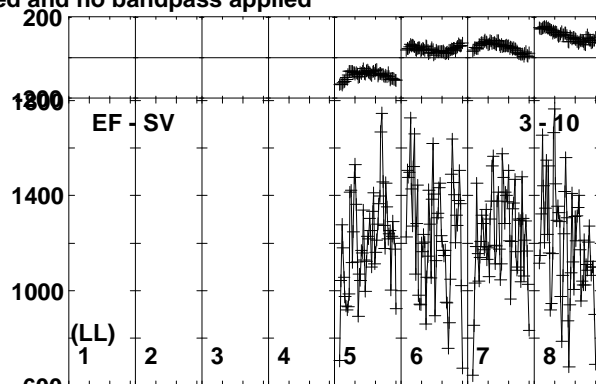
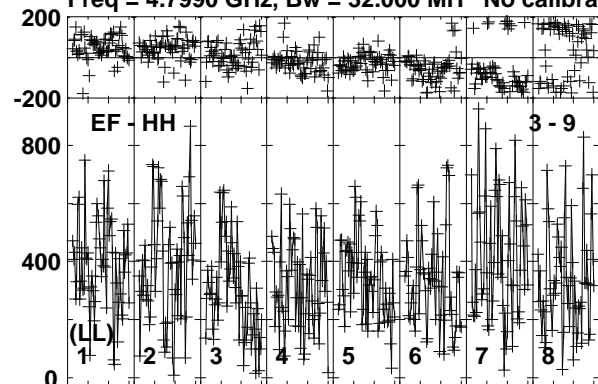

Lower frame: Micro Ampl Jy Top frame: Phas deg
Vector averaged cross-power spectrum Baseline: EF (03) - HH (09)
Timerange: 00/22:55:21 to 00/22:56:19

Plot file version 28 created 26-SEP-2019 10:39:25

J0257-1212 RG010A.UVDATA.1

Freq = 4.7990 GHz, Bw = 32.000 MH No calibration applied and no bandpass applied

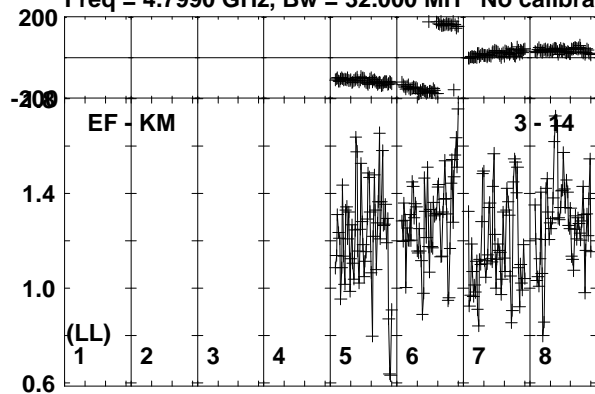

Lower frame: Milli Ampl Jy Top frame: Phas deg
Vector averaged cross-power spectrum Baseline: EF (03) - KM (14)
Timerange: 00/22:55:21 to 00/22:56:19

Plot file version 30 created 26-SEP-2019 10:39:26

190829A RG010A.UVDATA.1

Freq = 4.7990 GHz, Bw = 32.000 MH No calibration applied and no bandpass applied

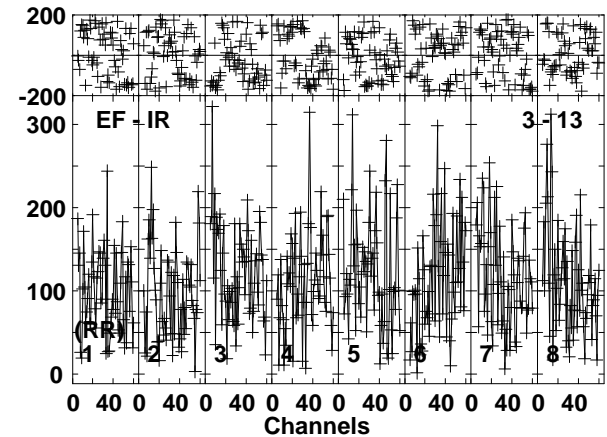
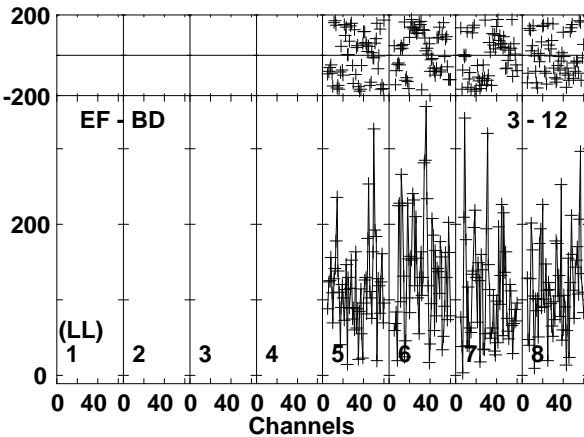
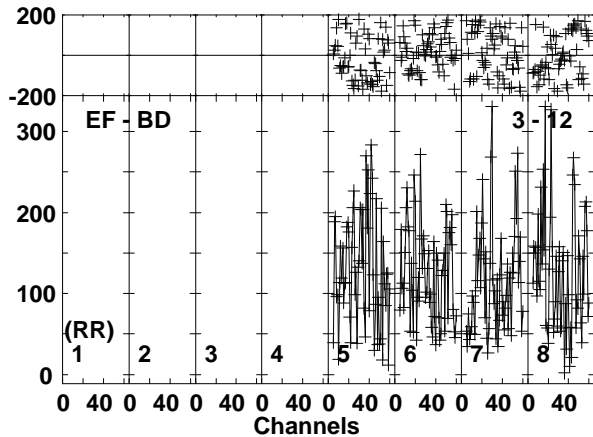
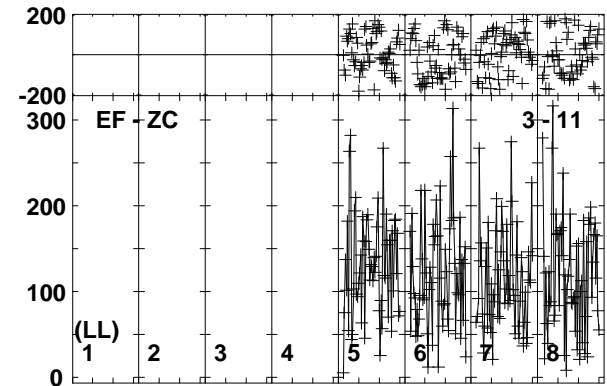
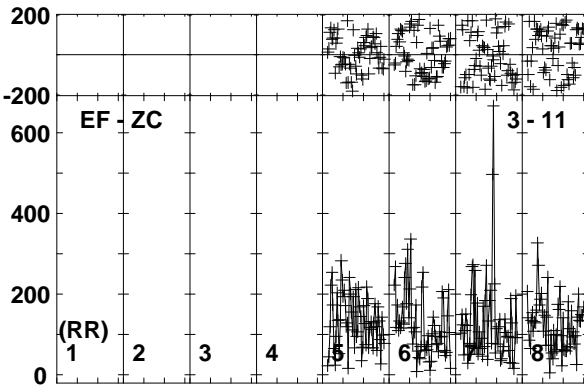
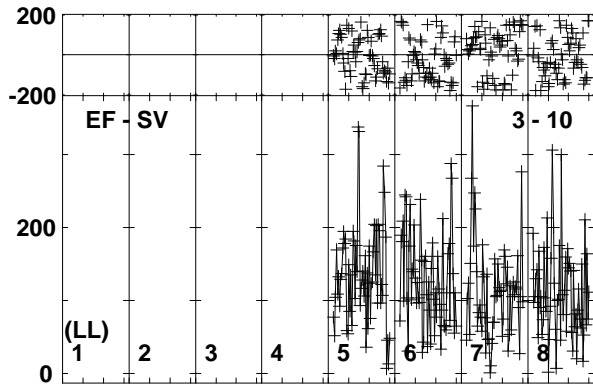
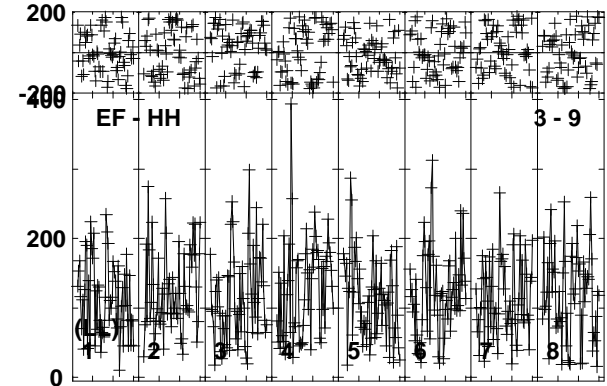
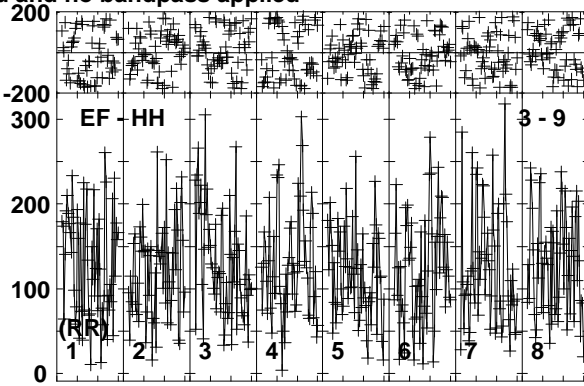
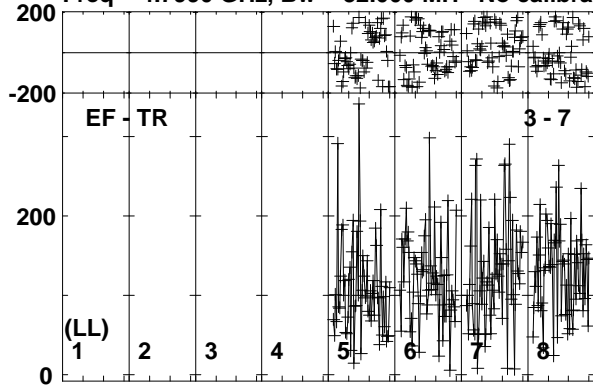

Lower frame: Micro Ampl Jy Top frame: Phas deg
Vector averaged cross-power spectrum Baseline: EF (03) - TR (07)
Timerange: 00/22:56:21 to 00/22:58:30

Plot file version 31 created 26-SEP-2019 10:39:27

190829A RG010A.UVDATA.1

Freq = 4.7990 GHz, Bw = 32.000 MH No calibration applied and no bandpass applied

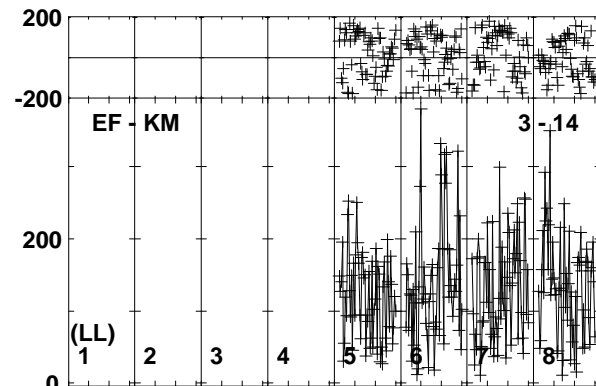
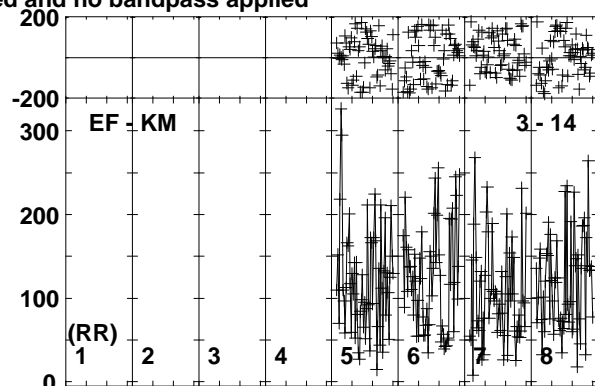
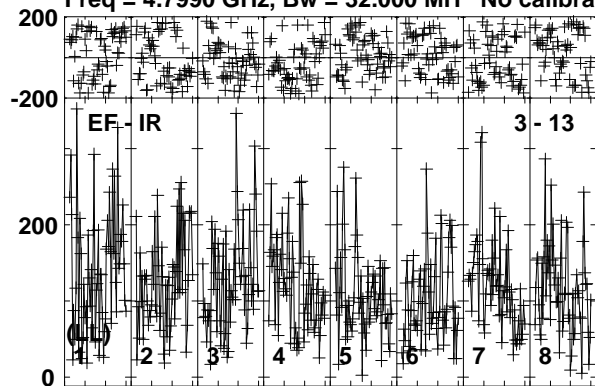

Lower frame: Micro Ampl Jy Top frame: Phas deg
Vector averaged cross-power spectrum Baseline: EF (03) - IR (13)
Timerange: 00/22:56:21 to 00/22:58:30

Plot file version 32 created 26-SEP-2019 10:39:27

J0257-1212 RG010A.UVDATA.1

Freq = 4.7990 GHz, Bw = 32.000 MH No calibration applied and no bandpass applied

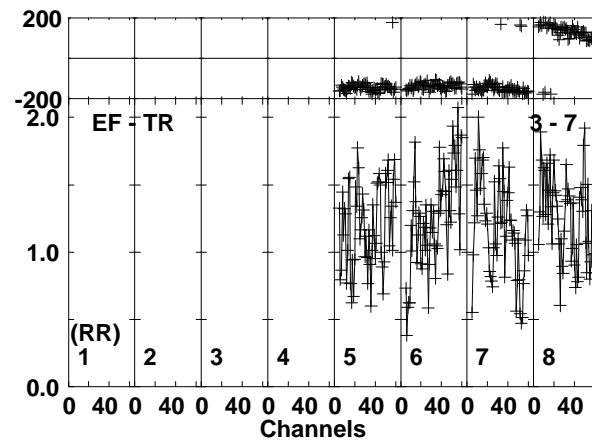
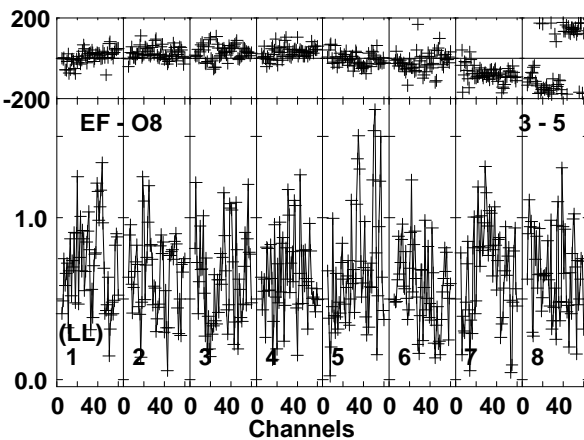
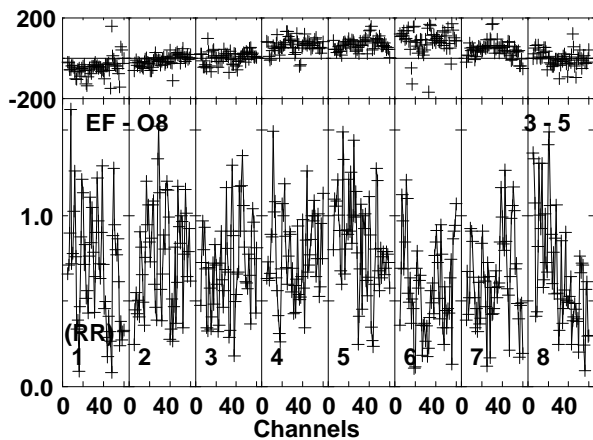
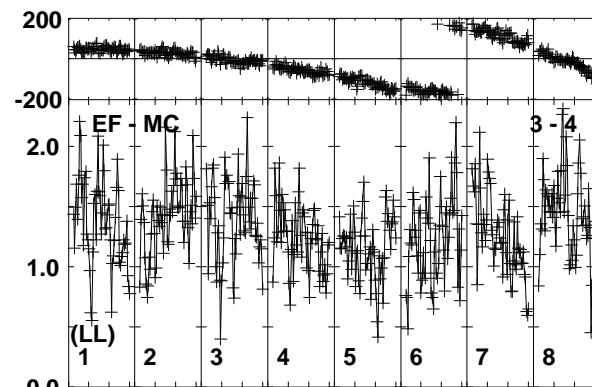
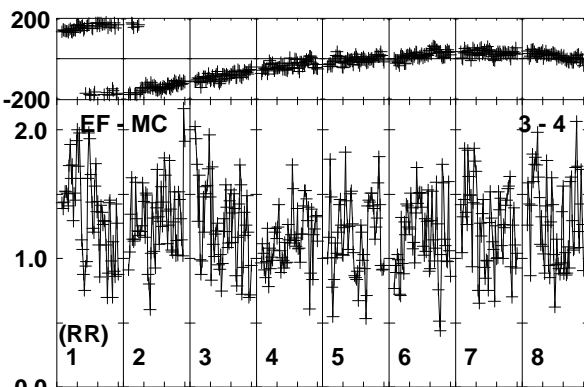
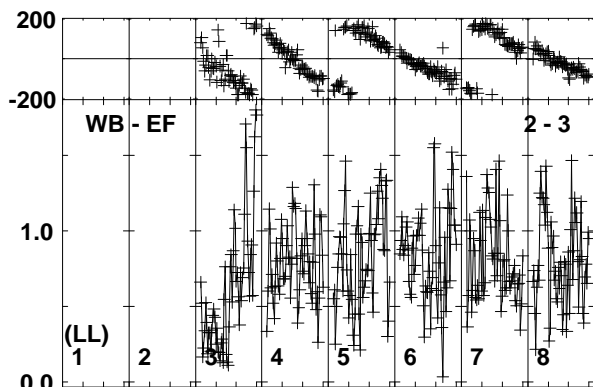
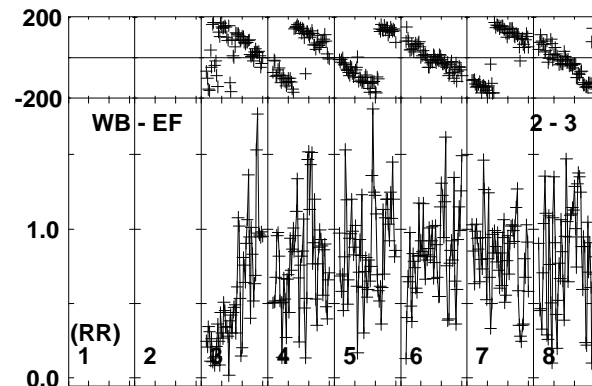
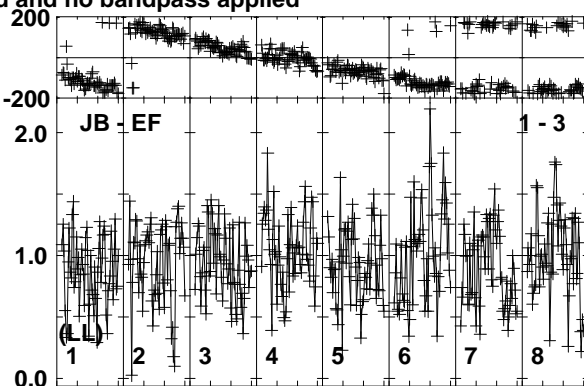
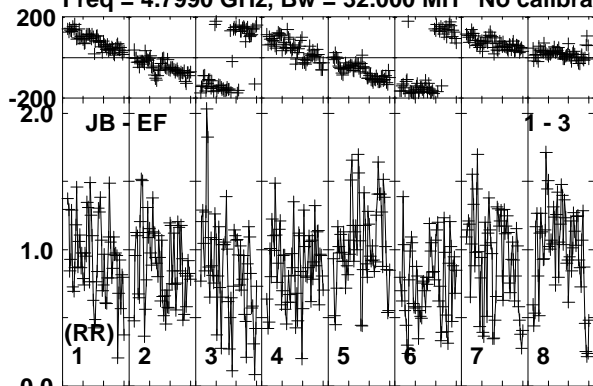

Lower frame: Milli Ampl Jy Top frame: Phas deg
Vector averaged cross-power spectrum Baseline: JB (01) - EF (03)
Timerange: 00:22:58:31 to 00:22:59:29

Plot file version 33 created 26-SEP-2019 10:39:27

J0257-1212 RG010A.UVDATA.1

Freq = 4.7990 GHz, Bw = 32.000 MH No calibration applied and no bandpass applied

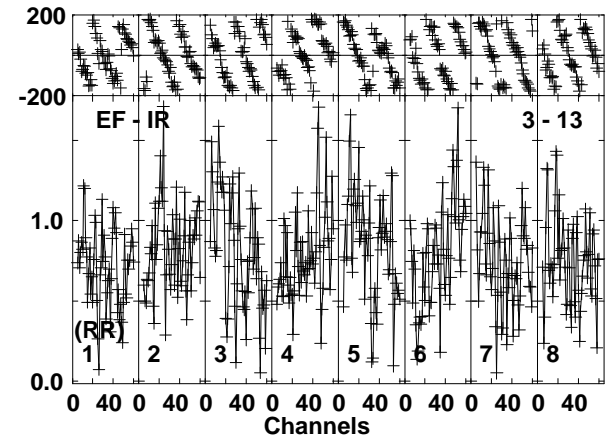
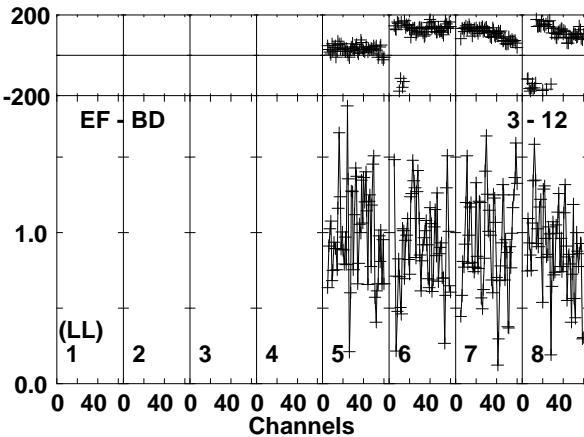
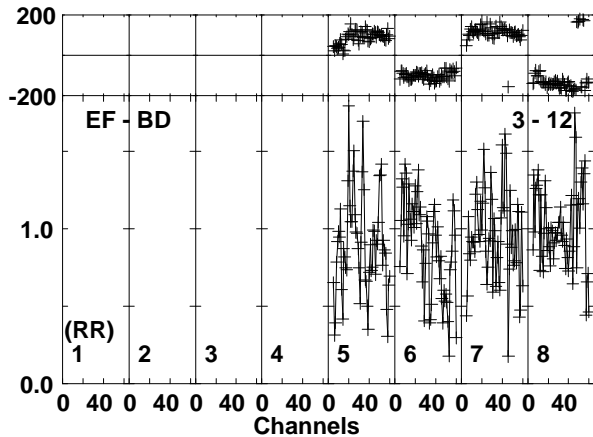
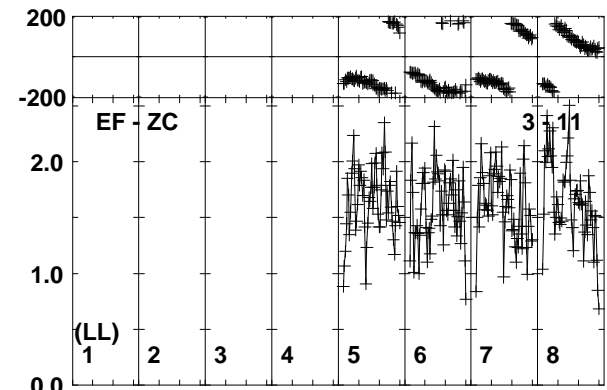
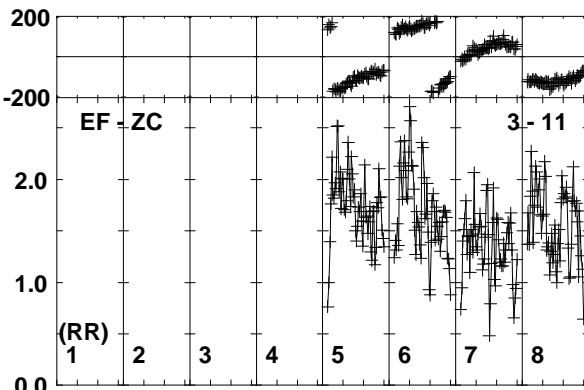
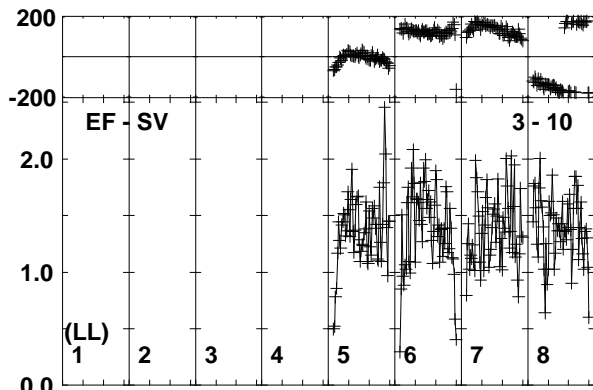
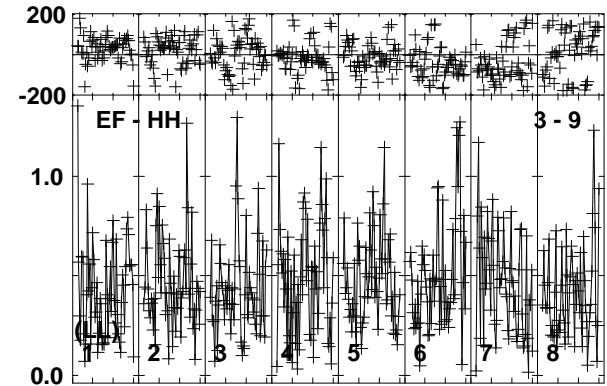
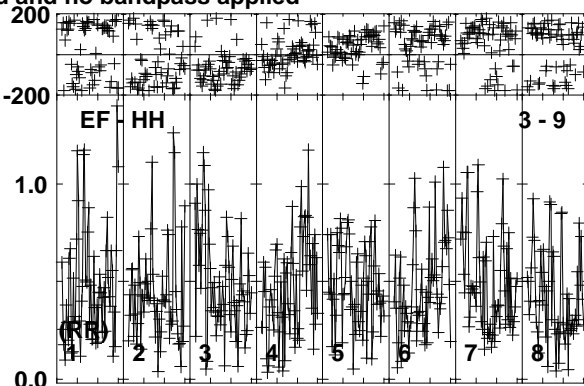
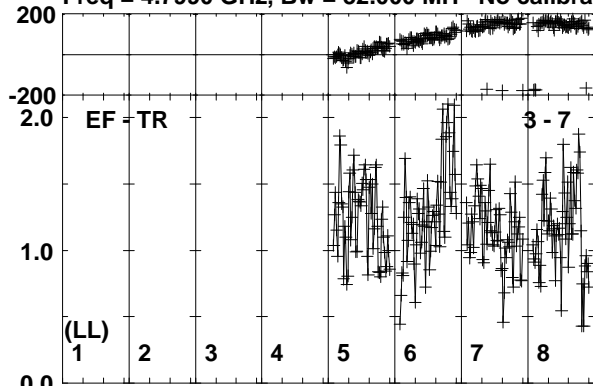

Lower frame: Milli Ampl Jy Top frame: Phas deg
Vector averaged cross-power spectrum Baseline: EF (03) - TR (07)
Timerange: 00/22:58:31 to 00/22:59:29

Plot file version 34 created 26-SEP-2019 10:39:28

J0257-1212 RG010A.UVDATA.1

Freq = 4.7990 GHz, Bw = 32.000 MH No calibration applied and no bandpass applied

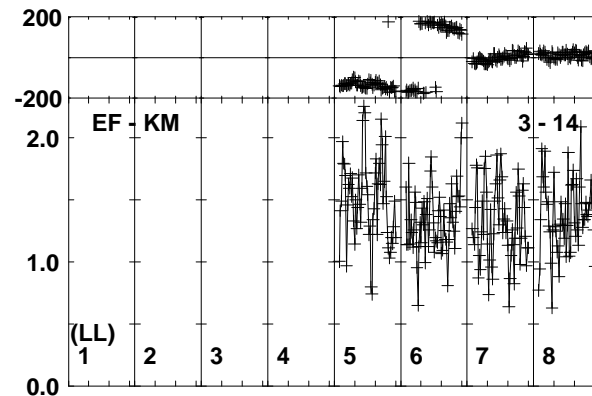
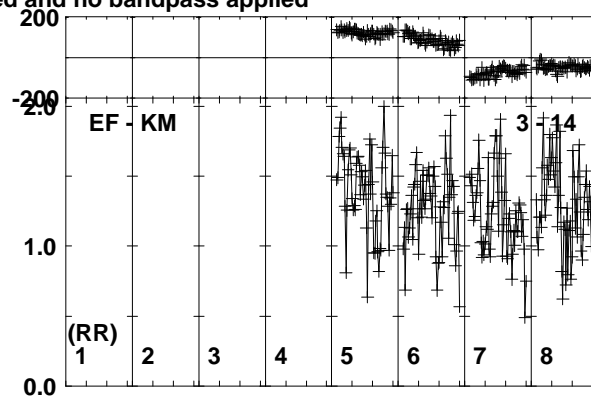
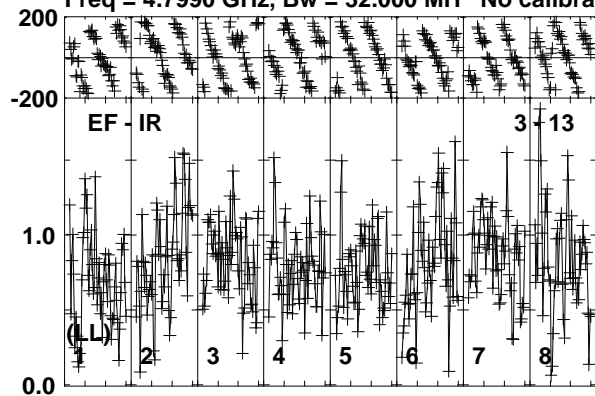

Lower frame: Milli Ampl Jy Top frame: Phas deg
Vector averaged cross-power spectrum Baseline: EF (03) - IR (13)
Timerange: 00/22:58:31 to 00/22:59:29

Plot file version 35 created 26-SEP-2019 10:39:28

190829A RG010A.UVDATA.1

Freq = 4.7990 GHz, Bw = 32.000 MH No calibration applied and no bandpass applied

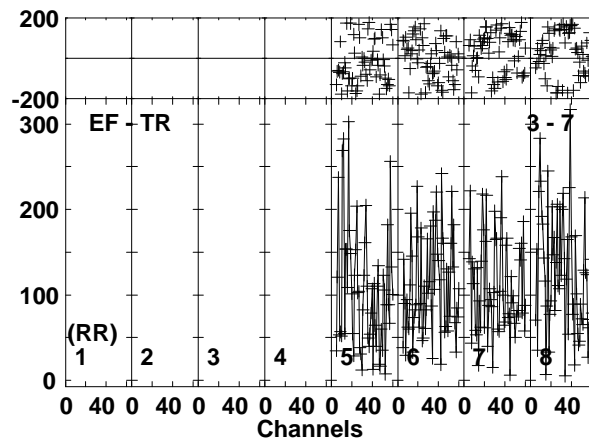
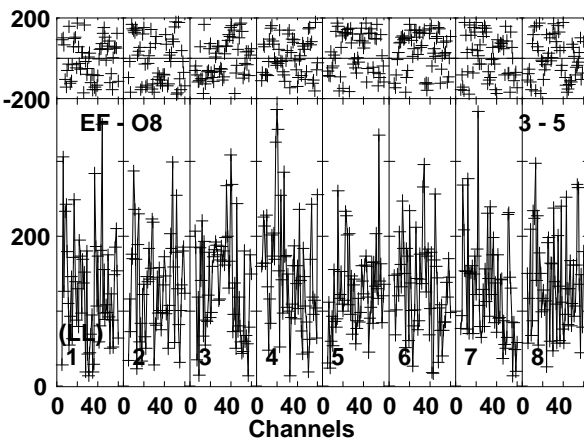
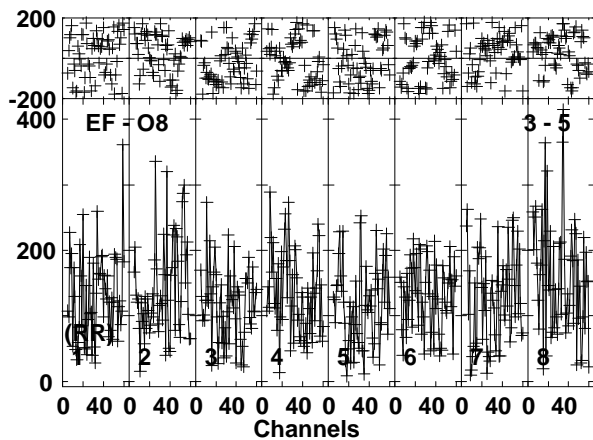
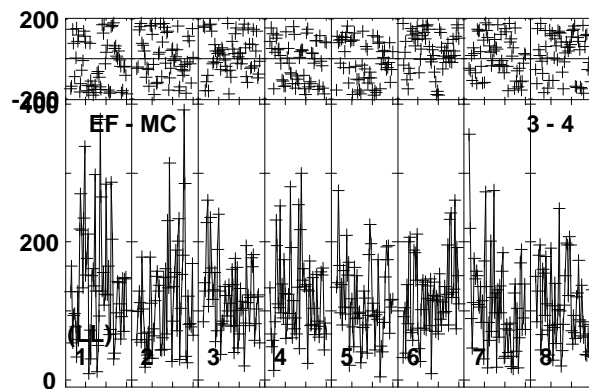
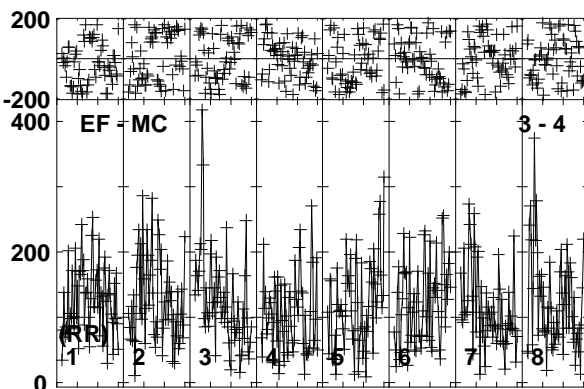
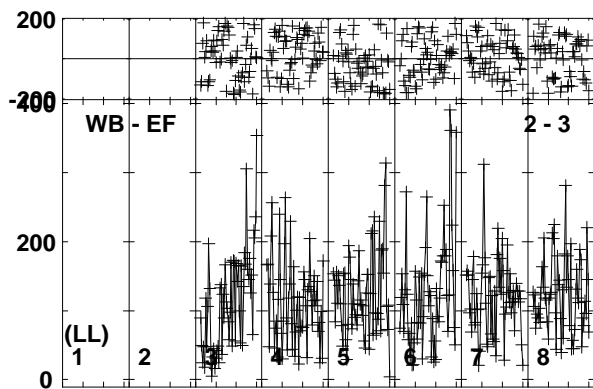
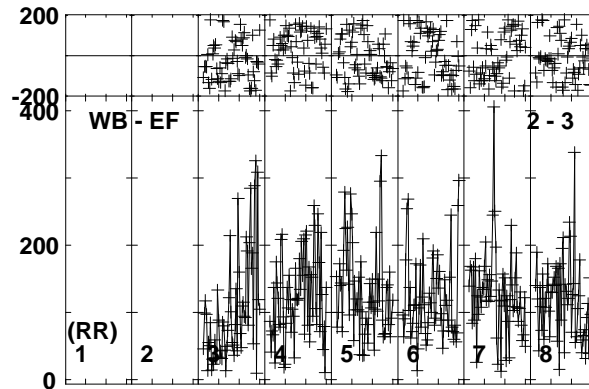
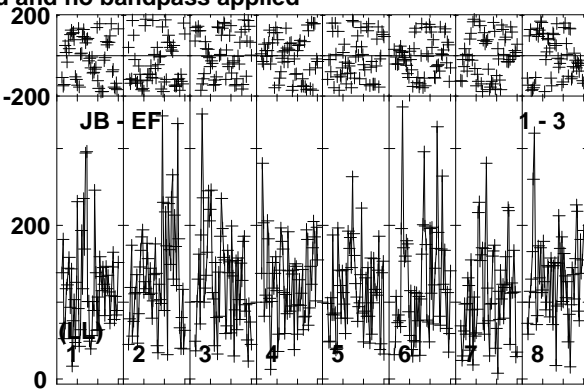
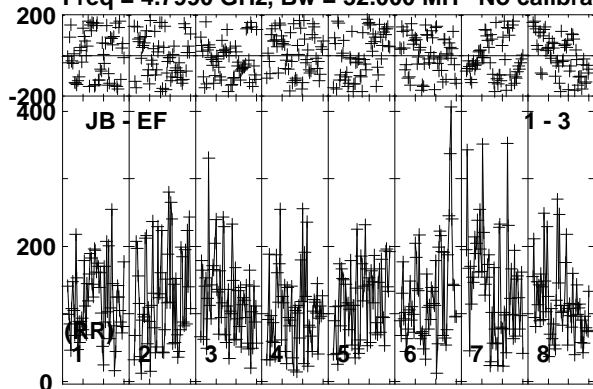

Lower frame: Micro Ampl Jy Top frame: Phas deg
Vector averaged cross-power spectrum Baseline: JB (01) - EF (03)
Timerange: 00/22:59:31 to 00/23:01:39

Plot file version 36 created 26-SEP-2019 10:39:28

190829A RG010A.UVDATA.1

Freq = 4.7990 GHz, Bw = 32.000 MH No calibration applied and no bandpass applied

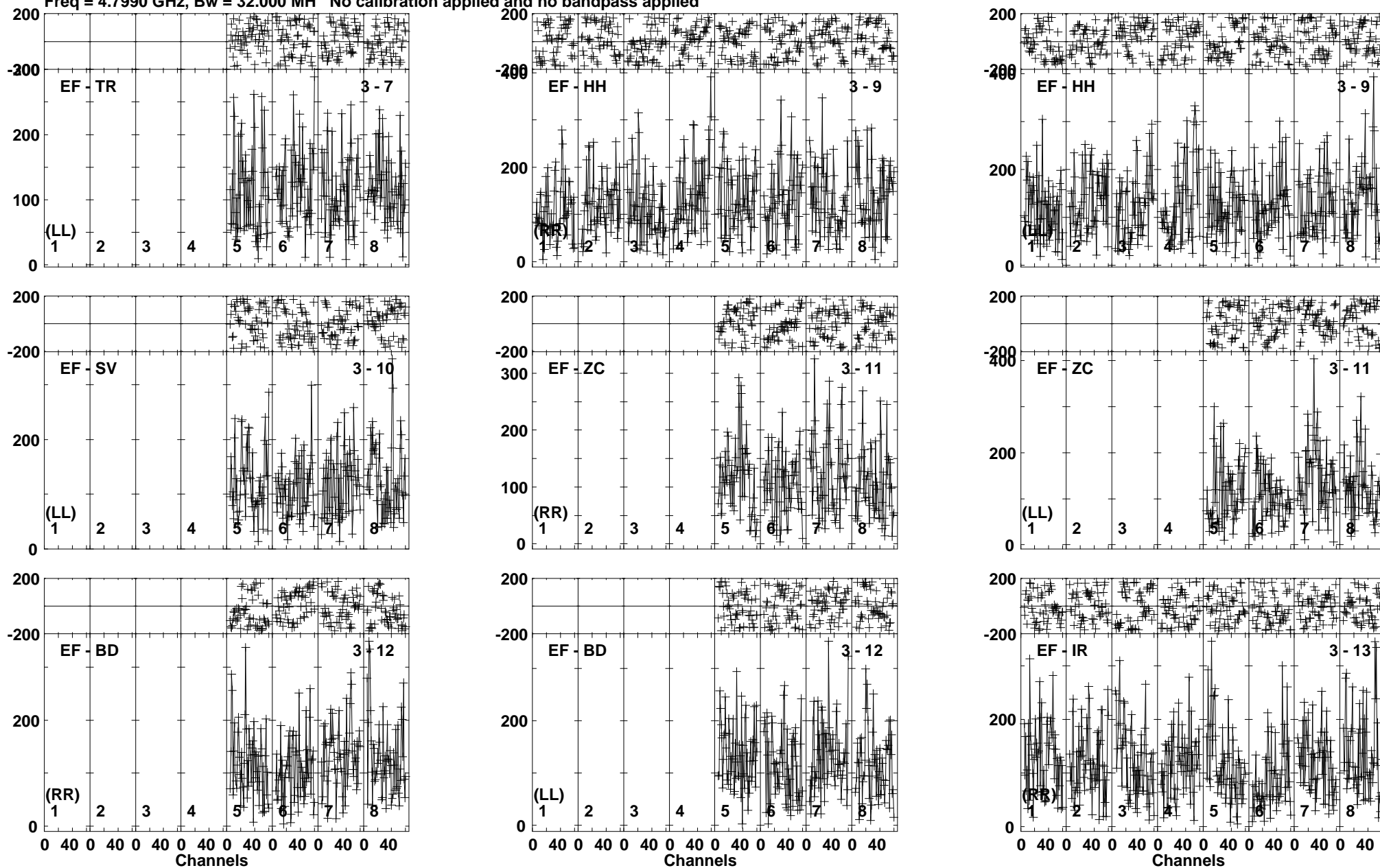

Lower frame: Micro Ampl Jy Top frame: Phas deg
Vector averaged cross-power spectrum Baseline: EF (03) - TR (07)
Timerange: 00/22:59:31 to 00/23:01:39

Plot file version 37 created 26-SEP-2019 10:39:29

190829A RG010A.UVDATA.1

Freq = 4.7990 GHz, Bw = 32.000 MH No calibration applied and no bandpass applied

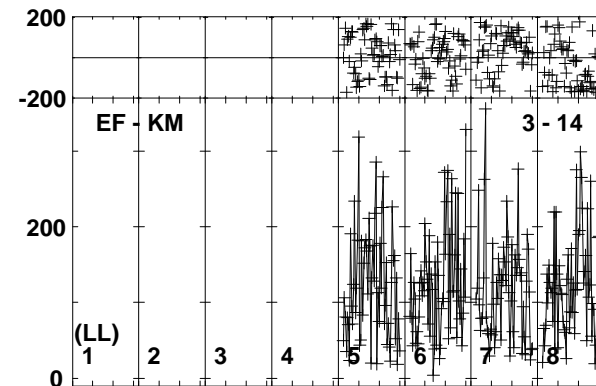
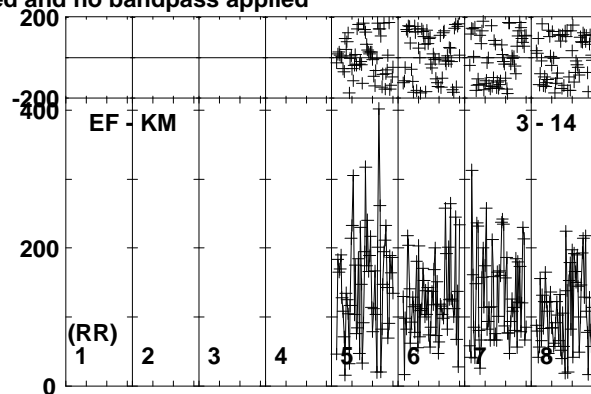
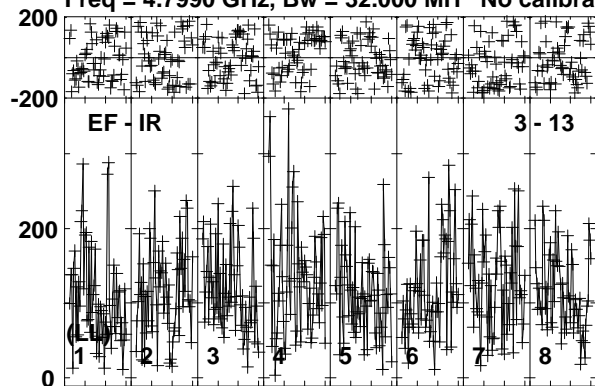

Lower frame: Micro Ampl Jy Top frame: Phas deg
Vector averaged cross-power spectrum Baseline: EF (03) - IR (13)
Timerange: 00/22:59:31 to 00/23:01:39

Plot file version 38 created 26-SEP-2019 10:39:29

J0257-1212 RG010A.UVDATA.1

Freq = 4.7990 GHz, Bw = 32.000 MH No calibration applied and no bandpass applied

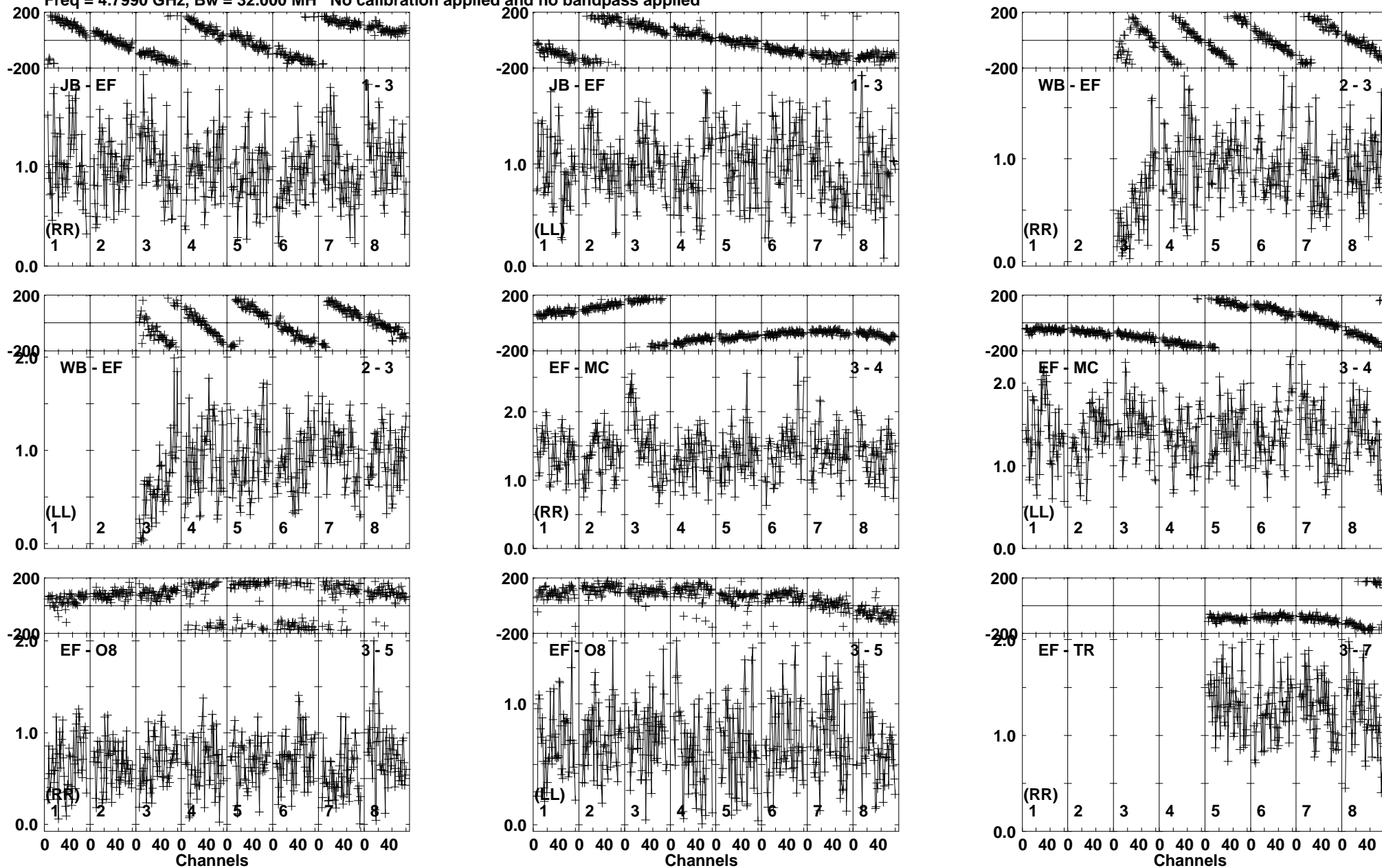

Lower frame: Milli Ampl Jy Top frame: Phas deg
Vector averaged cross-power spectrum Baseline: JB (01) - EF (03)
Timerange: 00/23:01:40 to 00/23:02:39

Plot file version 39 created 26-SEP-2019 10:39:29

J0257-1212 RG010A.UVDATA.1

Freq = 4.7990 GHz, Bw = 32.000 MH No calibration applied and no bandpass applied

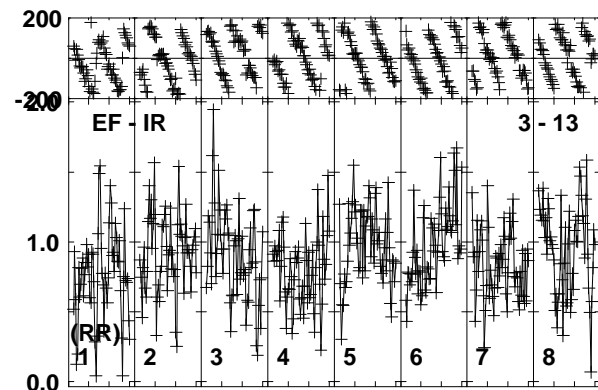
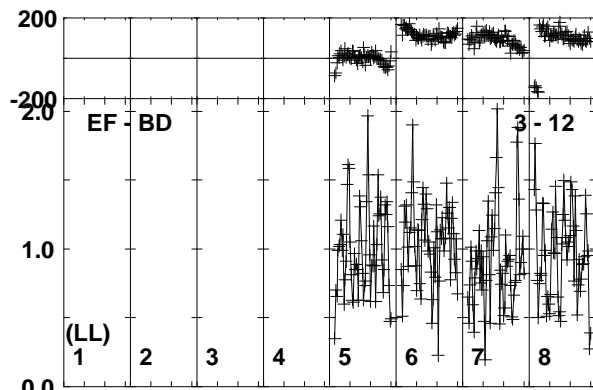
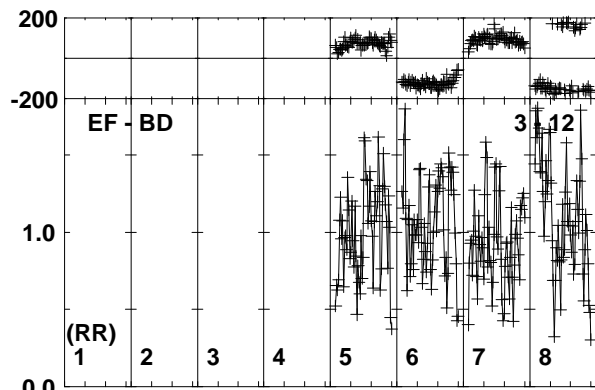
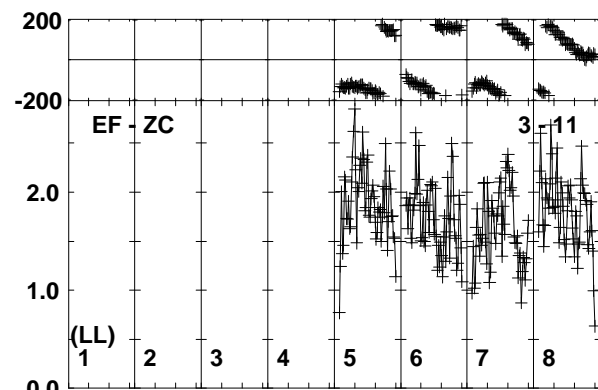
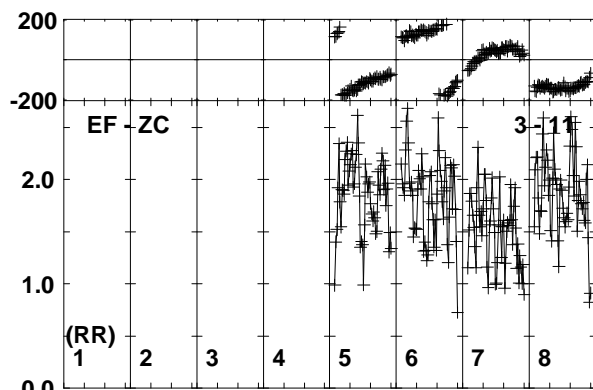
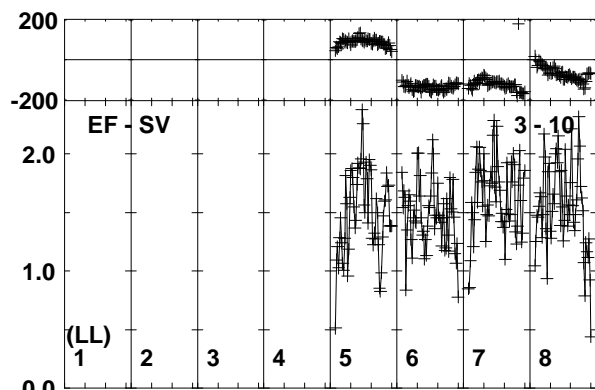
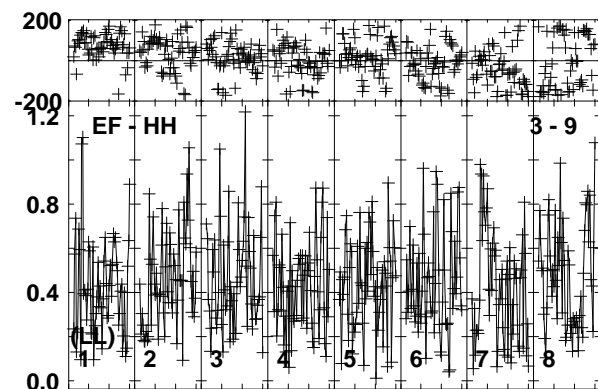
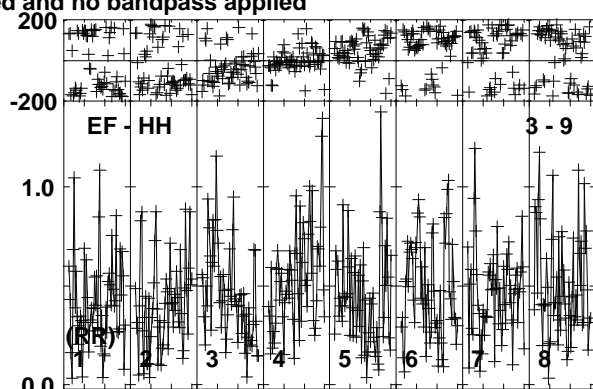
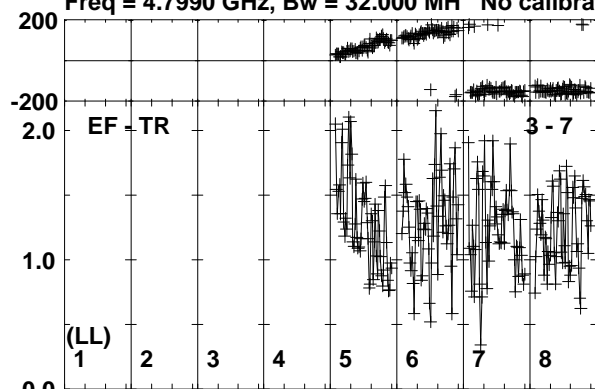

Lower frame: Milli Ampl Jy Top frame: Phas deg
Vector averaged cross-power spectrum Baseline: EF (03) - TR (07)
Timerange: 00/23:01:40 to 00/23:02:39

Plot file version 40 created 26-SEP-2019 10:39:30

J0257-1212 RG010A.UVDATA.1

Freq = 4.7990 GHz, Bw = 32.000 MH No calibration applied and no bandpass applied

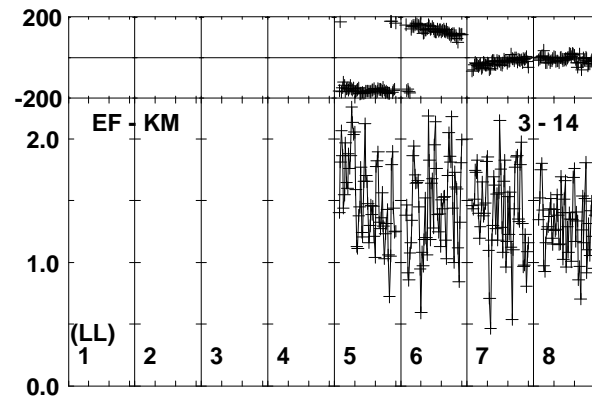
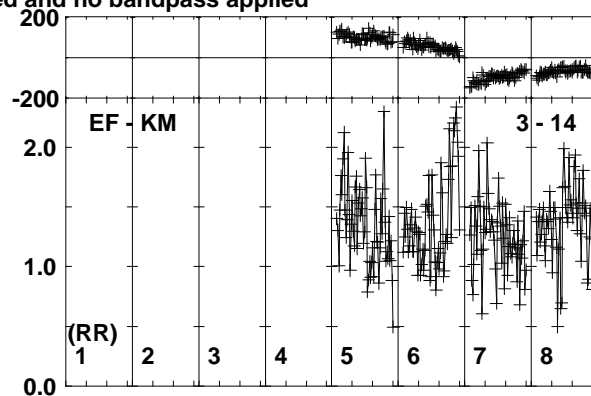
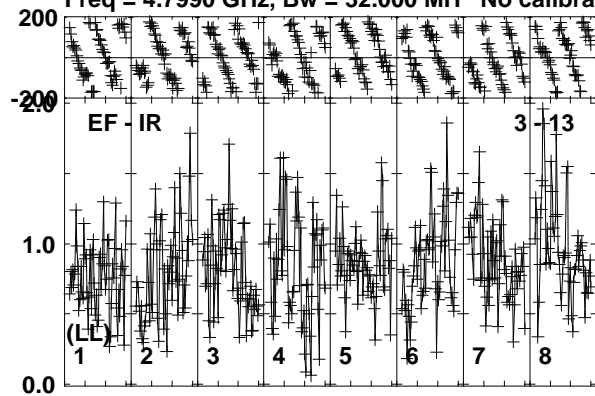

Lower frame: Milli Ampl Jy Top frame: Phas deg
Vector averaged cross-power spectrum Baseline: EF (03) - IR (13)
Timerange: 00/23:01:40 to 00/23:02:39

Plot file version 41 created 26-SEP-2019 10:39:30

190829A RG010A.UVDATA.1

Freq = 4.7990 GHz, Bw = 32.000 MH No calibration applied and no bandpass applied

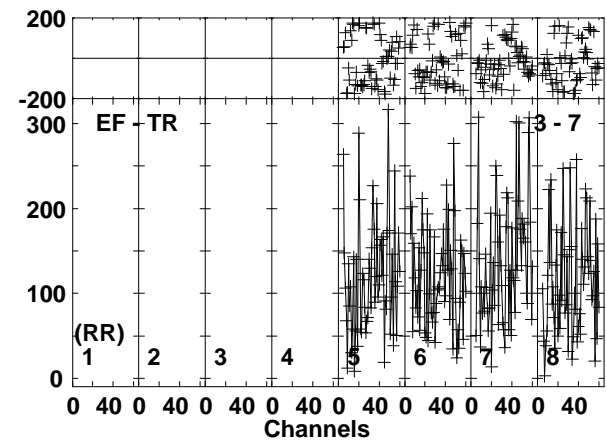
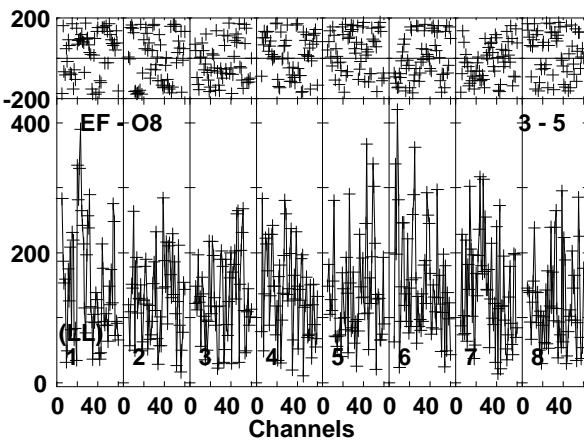
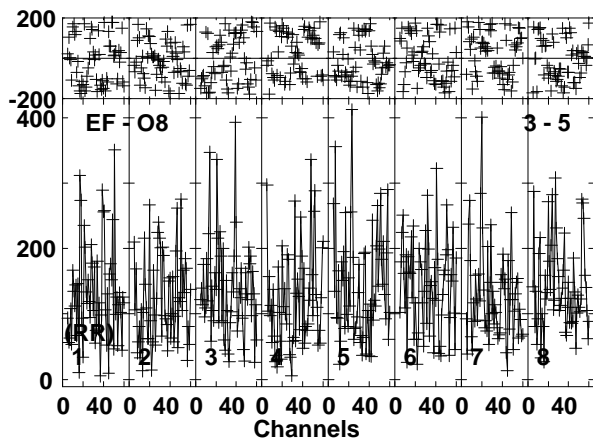
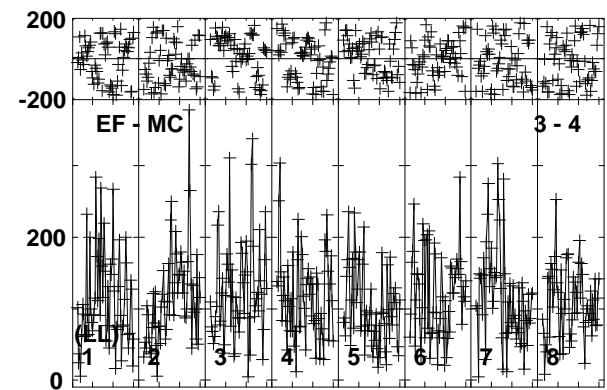
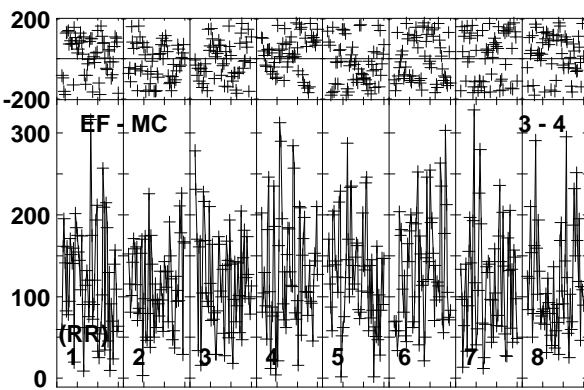
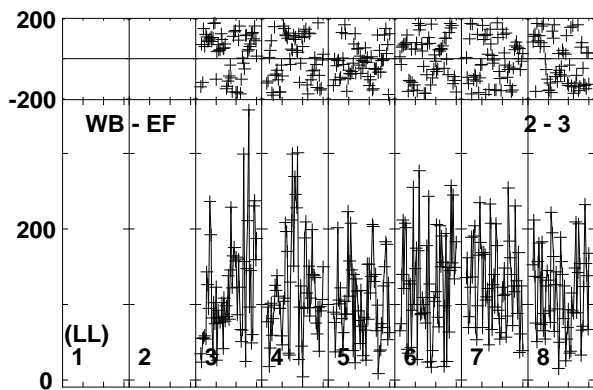
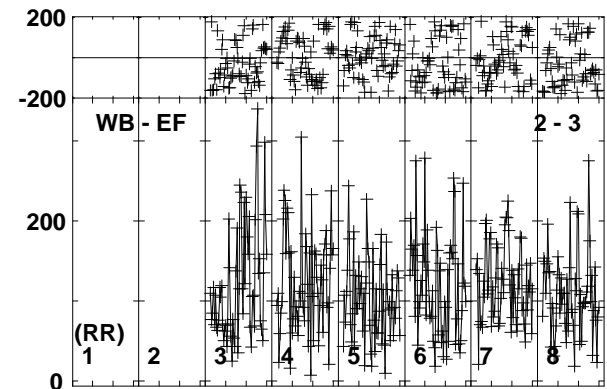
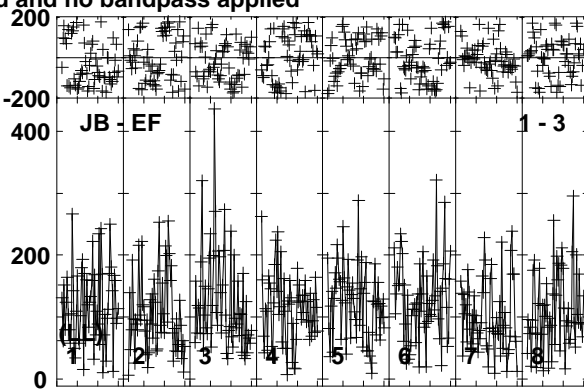
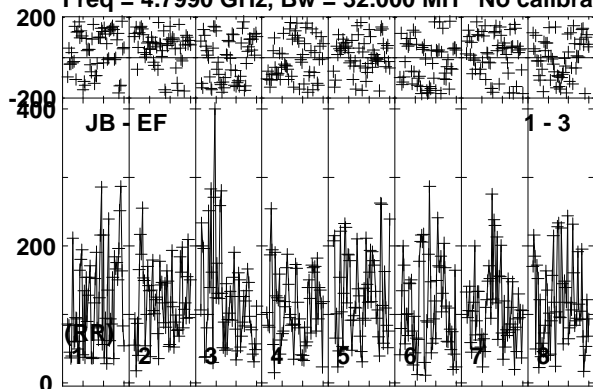

Lower frame: Micro Ampl Jy Top frame: Phas deg
Vector averaged cross-power spectrum Baseline: JB (01) - EF (03)
Timerange: 00/23:02:40 to 00/23:04:50

Plot file version 42 created 26-SEP-2019 10:39:30

190829A RG010A.UVDATA.1

Freq = 4.7990 GHz, Bw = 32.000 MH No calibration applied and no bandpass applied

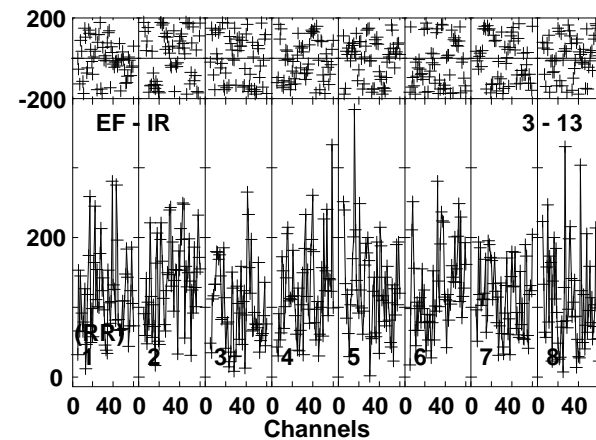
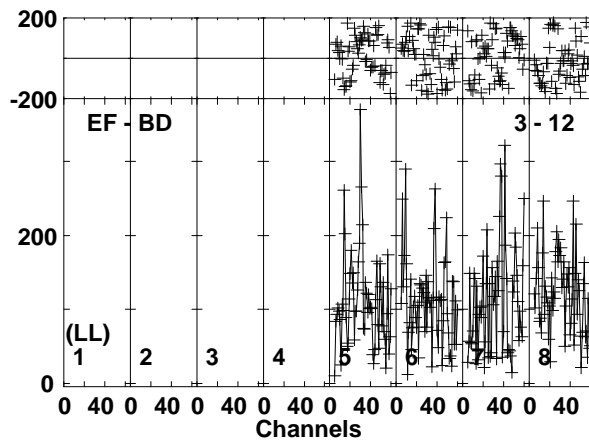
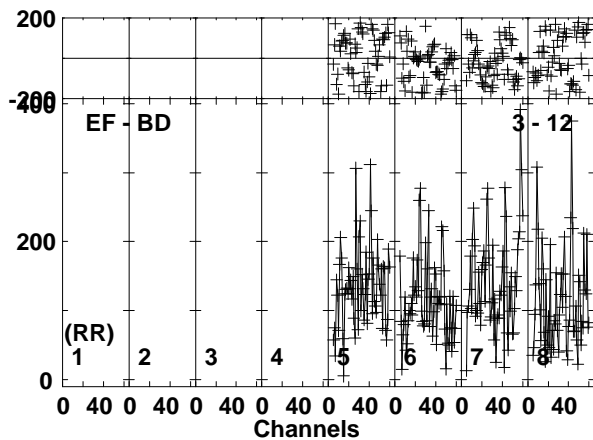
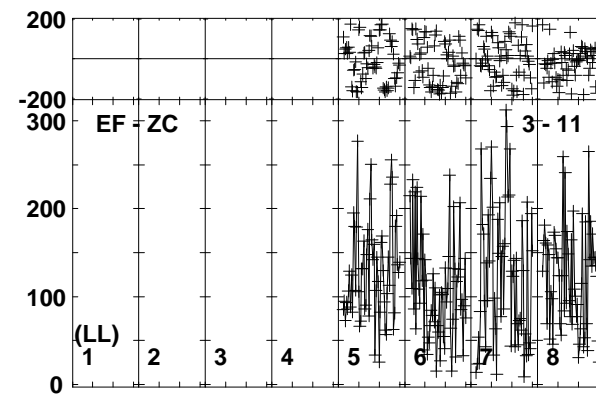
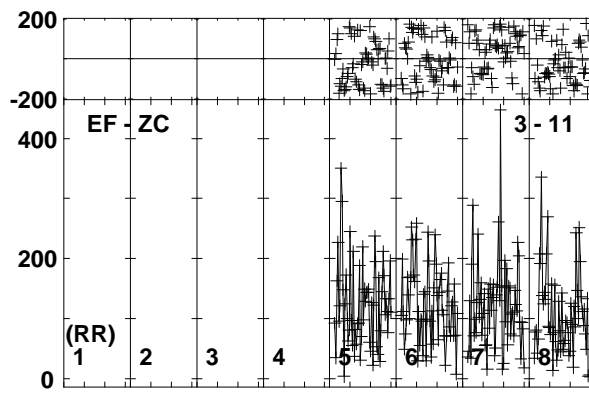
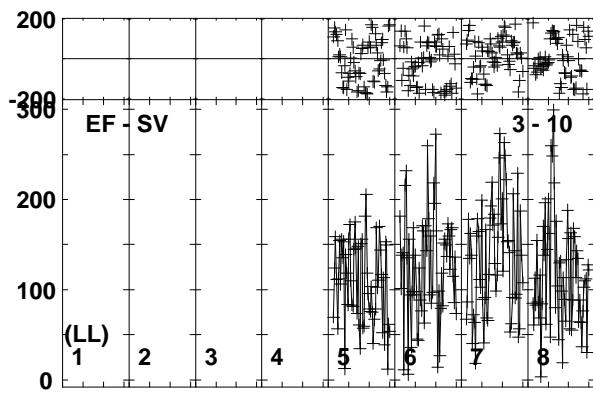
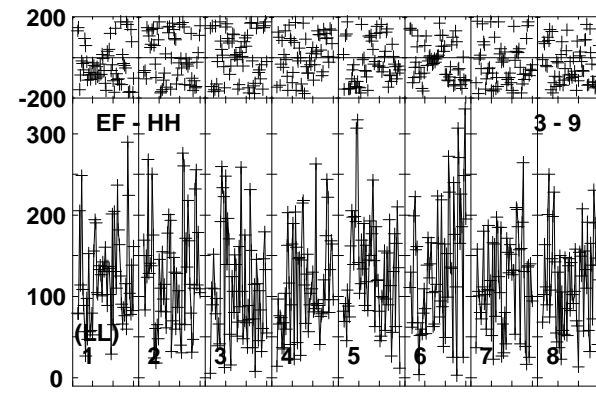
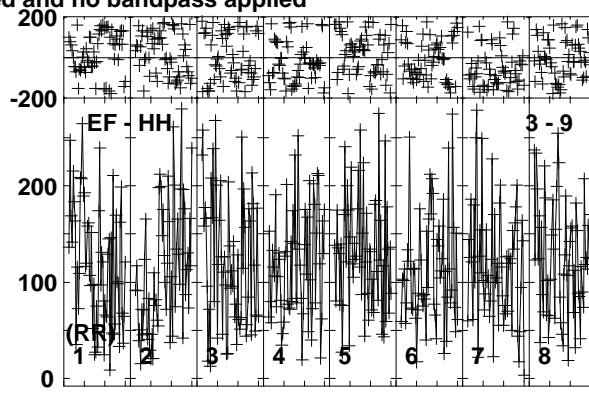
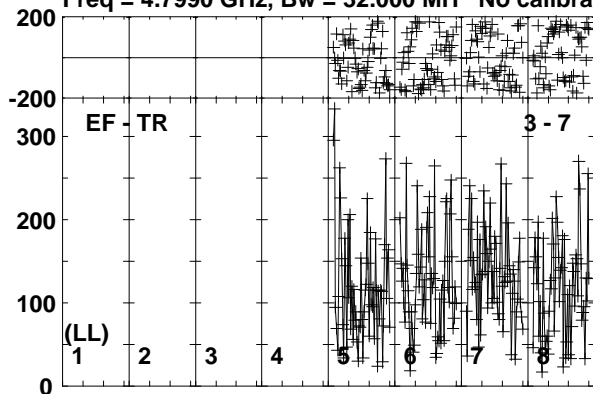

Lower frame: Micro Ampl Jy Top frame: Phas deg
Vector averaged cross-power spectrum Baseline: EF (03) - TR (07)
Timerange: 00/23:02:40 to 00/23:04:50

Plot file version 43 created 26-SEP-2019 10:39:31

190829A RG010A.UVDATA.1

Freq = 4.7990 GHz, Bw = 32.000 MH No calibration applied and no bandpass applied

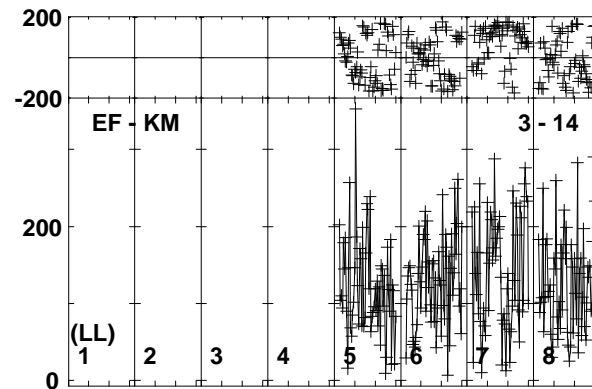
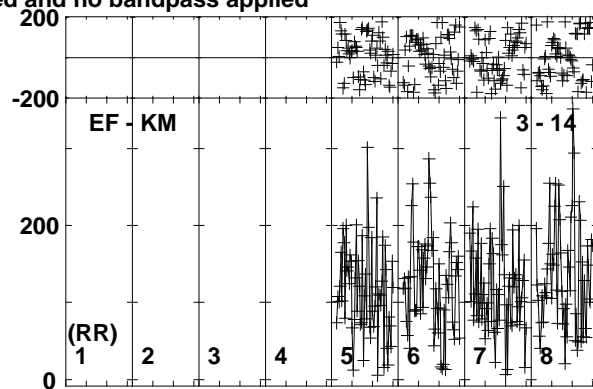
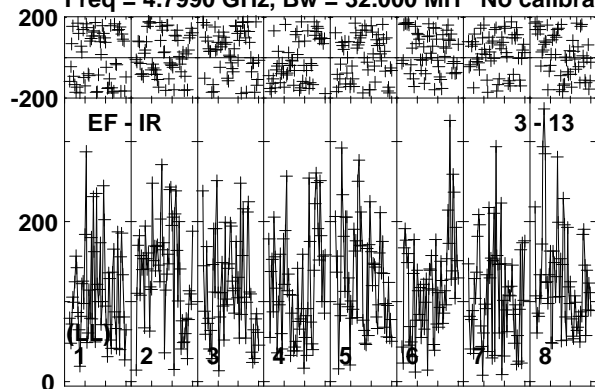

Lower frame: Micro Ampl Jy Top frame: Phas deg
Vector averaged cross-power spectrum Baseline: EF (03) - IR (13)
Timerange: 00/23:02:40 to 00/23:04:50

Plot file version 44 created 26-SEP-2019 10:39:31

J0257-1212 RG010A.UVDATA.1

Freq = 4.7990 GHz, Bw = 32.000 MH No calibration applied and no bandpass applied

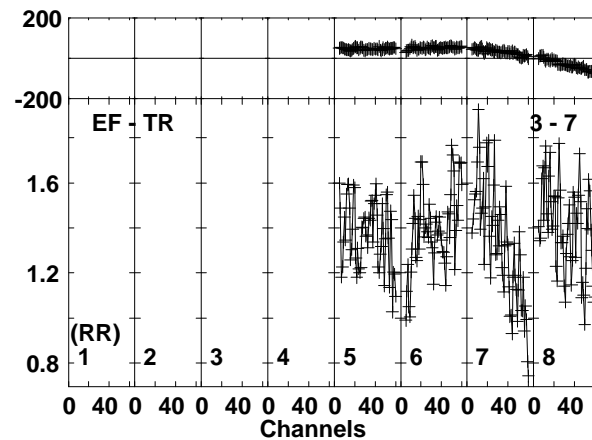
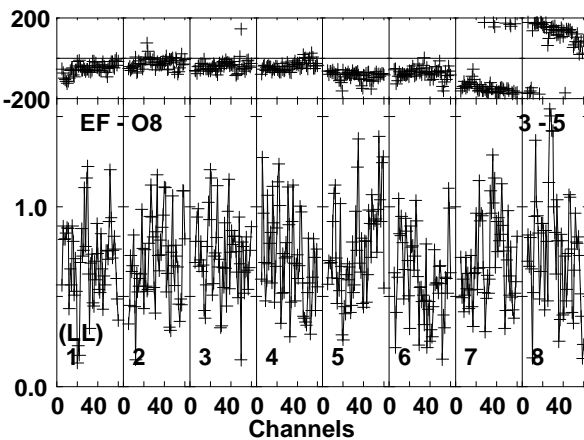
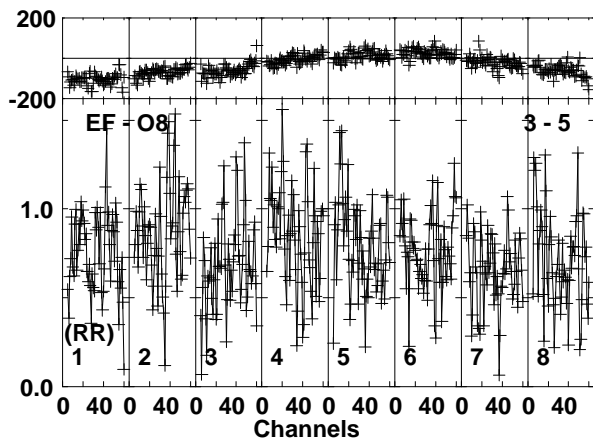
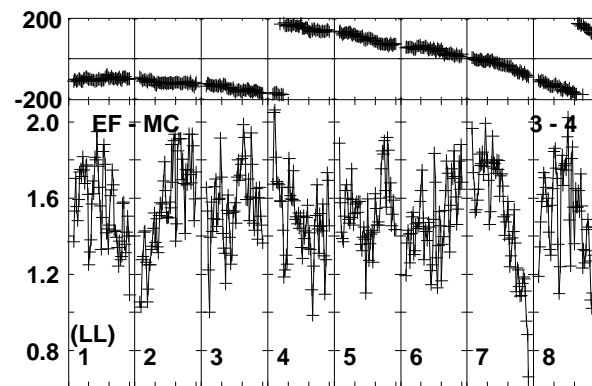
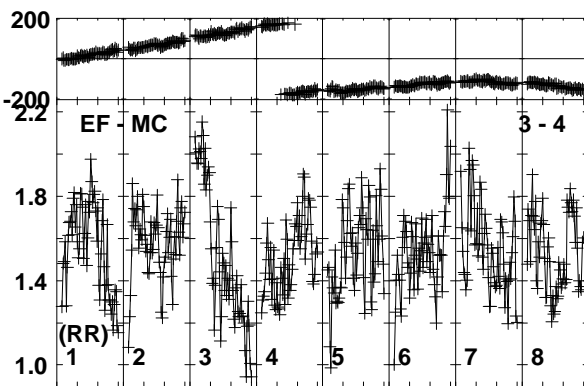
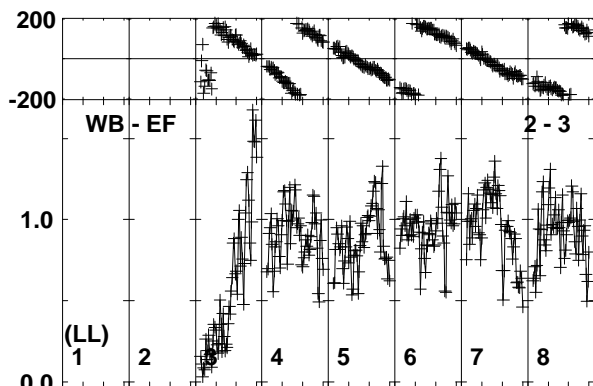
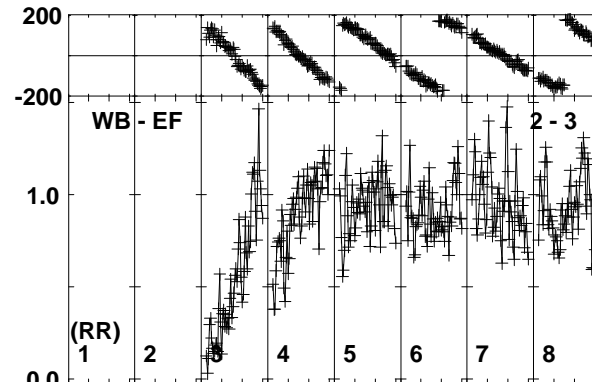
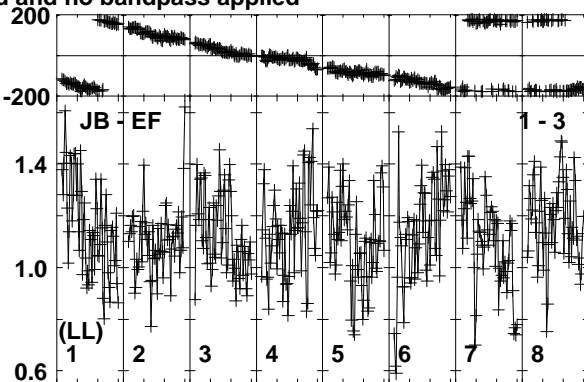
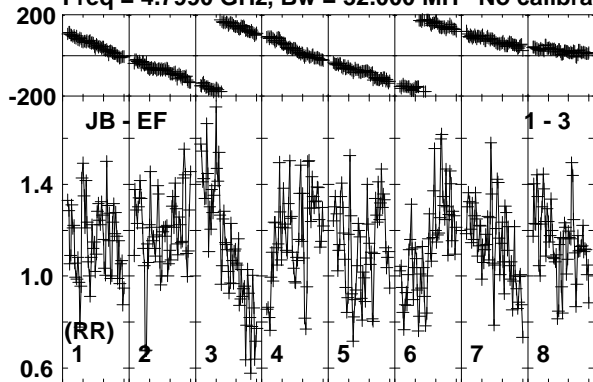

Lower frame: Milli Ampl Jy Top frame: Phas deg
Vector averaged cross-power spectrum Baseline: JB (01) - EF (03)
Timerange: 00/23:05:41 to 00/23:06:10

Plot file version 45 created 26-SEP-2019 10:39:31

J0257-1212 RG010A.UVDATA.1

Freq = 4.7990 GHz, Bw = 32.000 MH No calibration applied and no bandpass applied

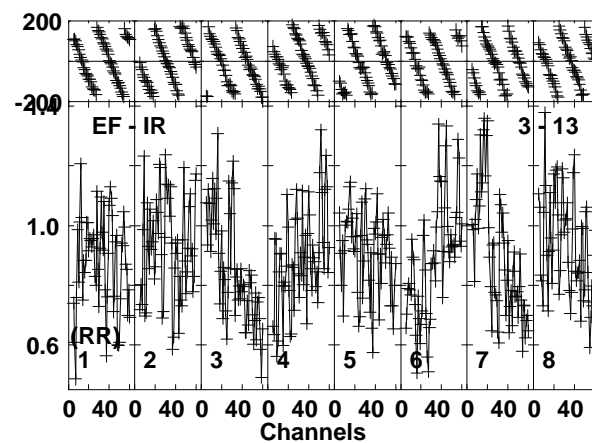
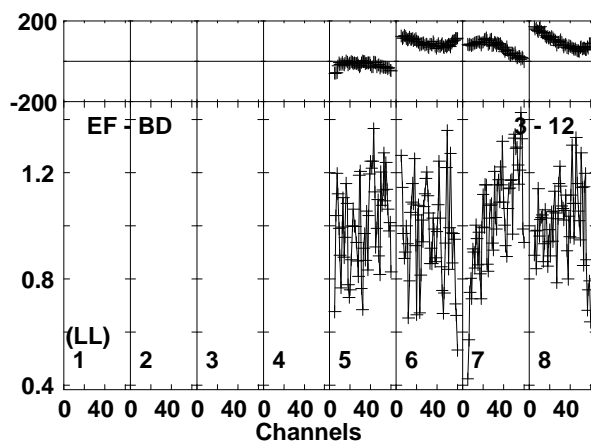
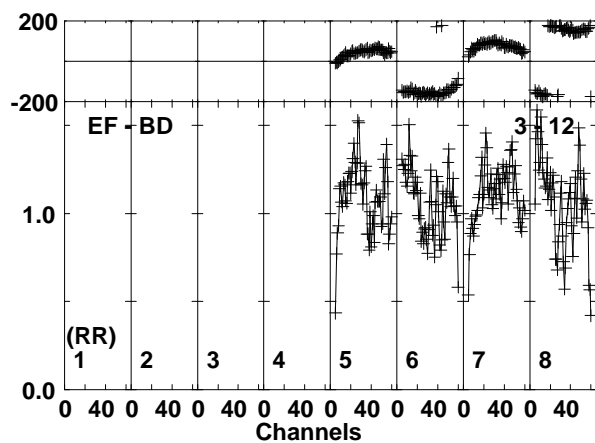
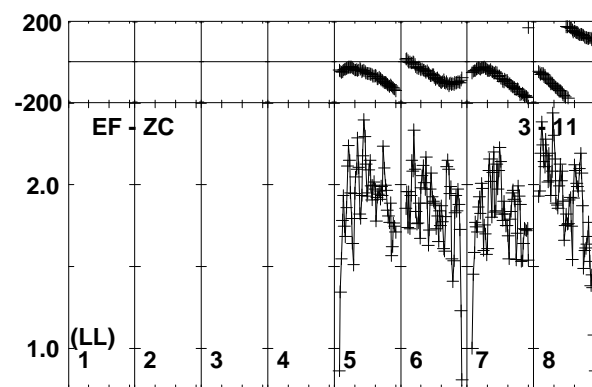
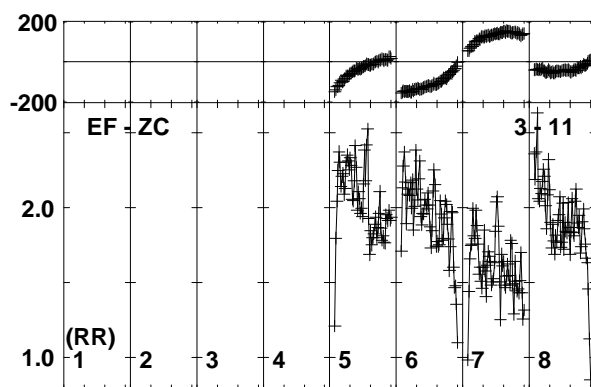
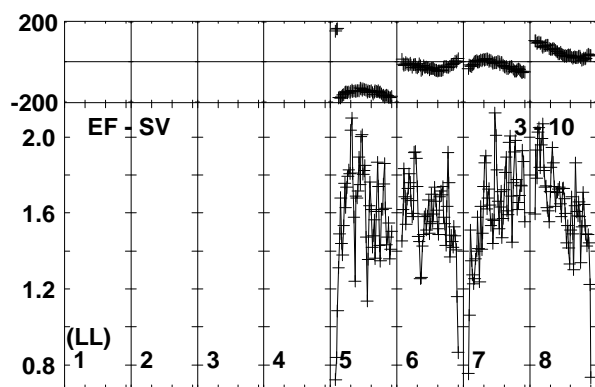
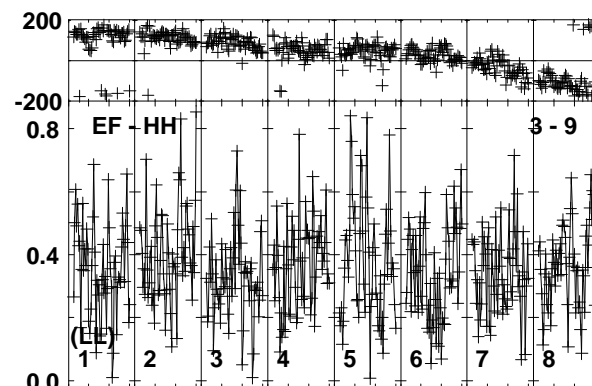
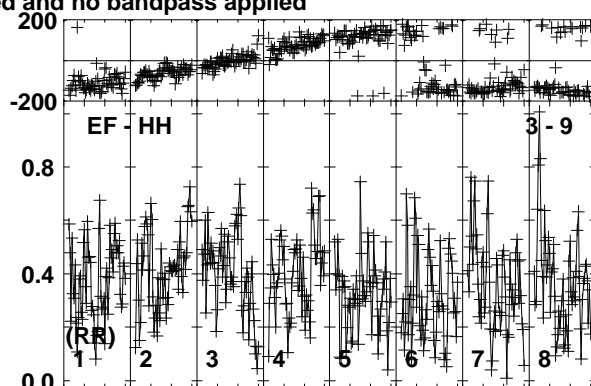
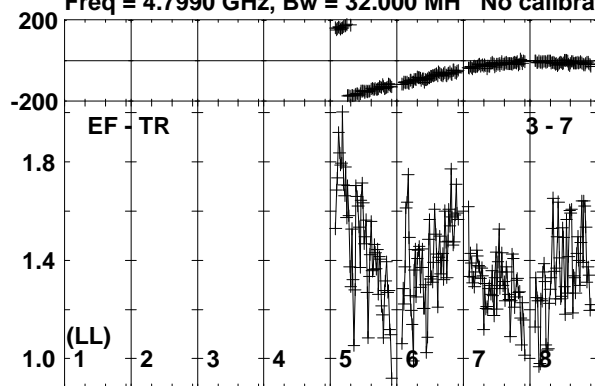

Lower frame: Milli Ampl Jy Top frame: Phas deg
Vector averaged cross-power spectrum Baseline: EF (03) - TR (07)
Timerange: 00/23:05:41 to 00/23:06:10

Plot file version 46 created 26-SEP-2019 10:39:32

J0257-1212 RG010A.UVDATA.1

Freq = 4.7990 GHz, Bw = 32.000 MH No calibration applied and no bandpass applied

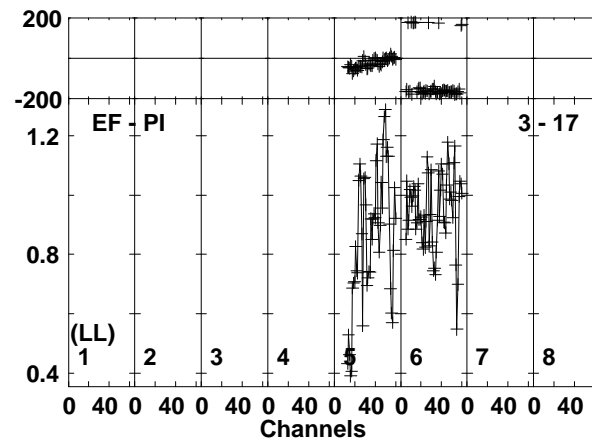
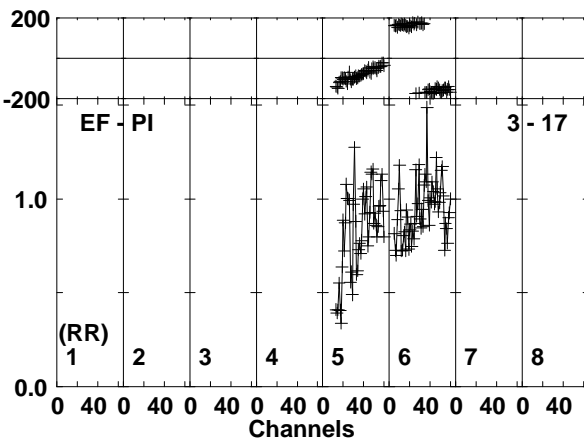
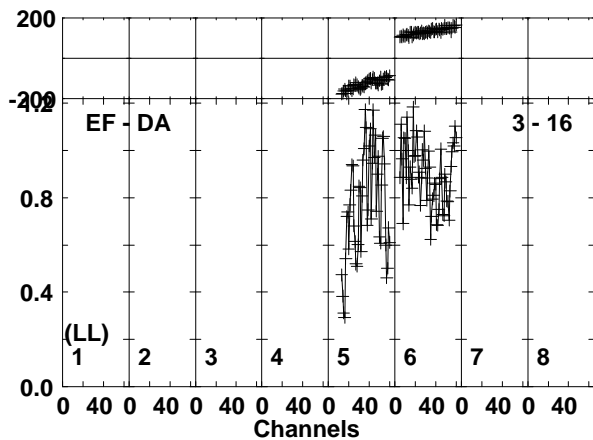
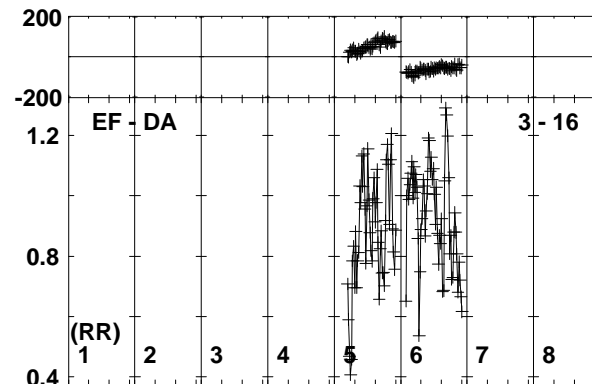
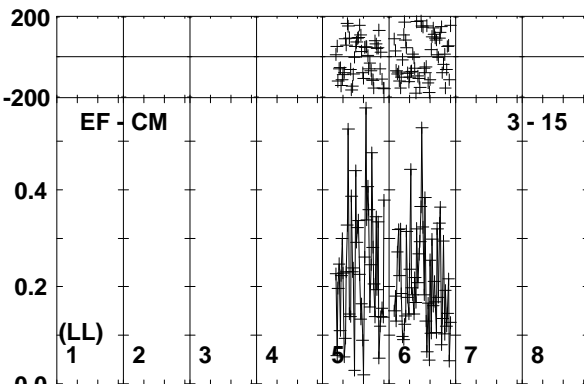
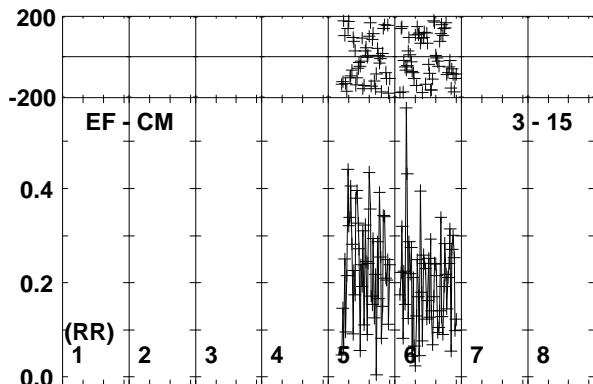
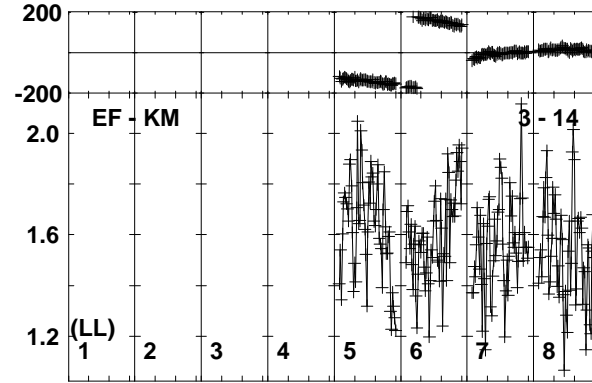
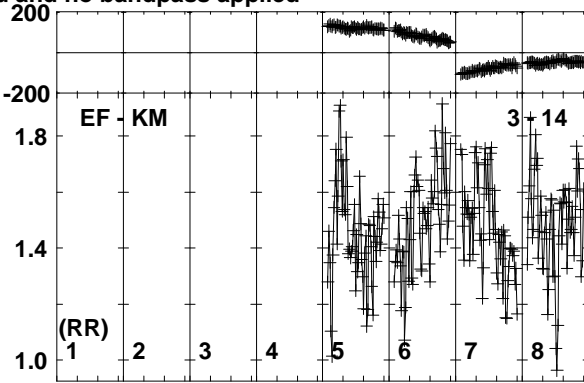
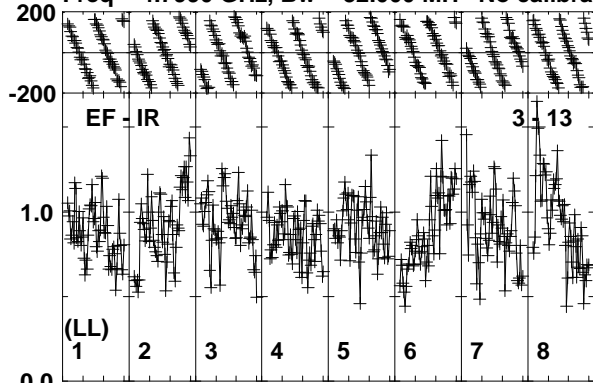

Lower frame: Milli Ampl Jy Top frame: Phas deg
Vector averaged cross-power spectrum Baseline: EF (03) - IR (13)
Timerange: 00/23:05:41 to 00/23:06:10

Plot file version 47 created 26-SEP-2019 10:39:32

J0257-1212 RG010A.UVDATA.1

Freq = 4.7990 GHz, Bw = 32.000 MH No calibration applied and no bandpass applied

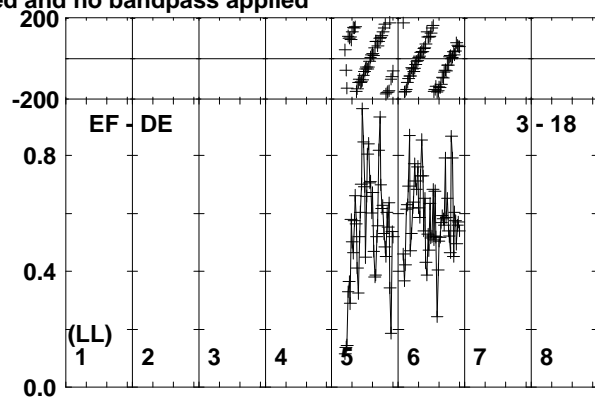
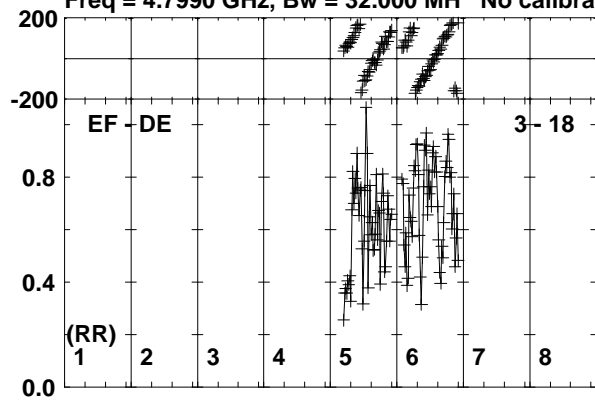

Lower frame: Milli Ampl Jy Top frame: Phas deg
Vector averaged cross-power spectrum Baseline: EF (03) - DE (18)
Timerange: 00/23:05:41 to 00/23:06:10

Plot file version 48 created 26-SEP-2019 10:39:32

J0300-0846 RG010A.UVDATA.1

Freq = 4.7990 GHz, Bw = 32.000 MH No calibration applied and no bandpass applied

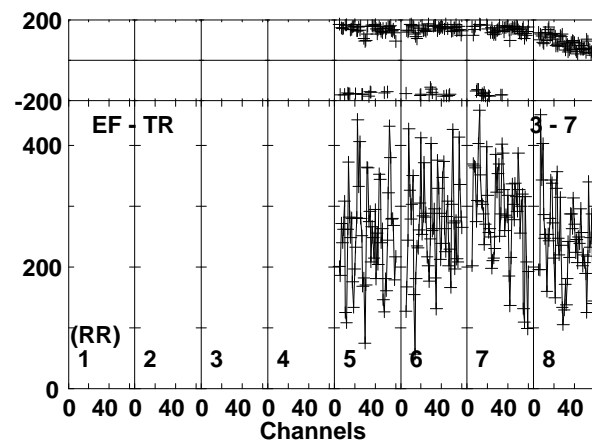
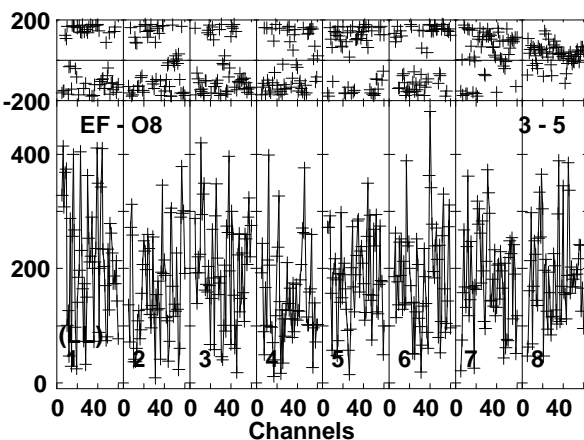
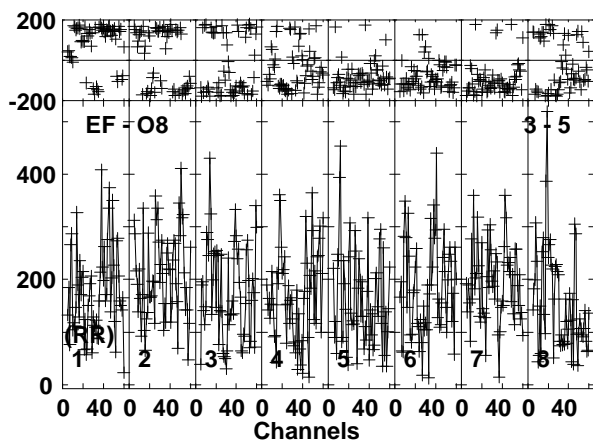
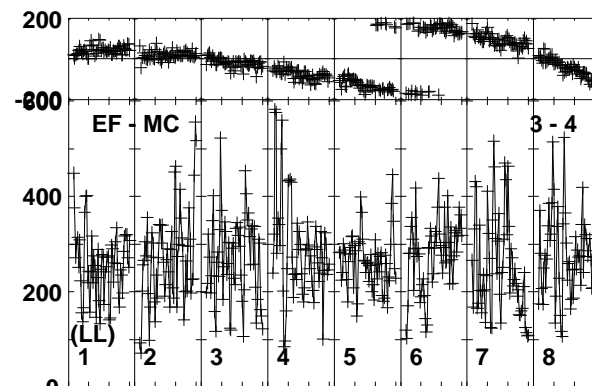
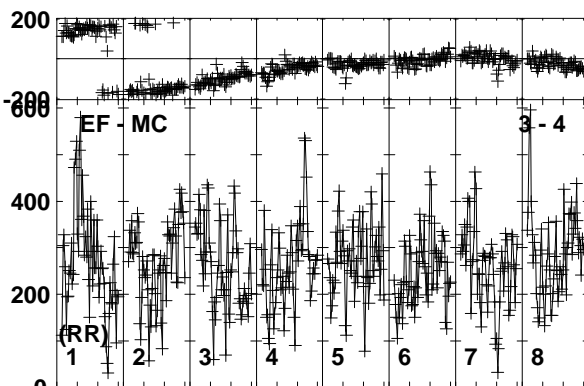
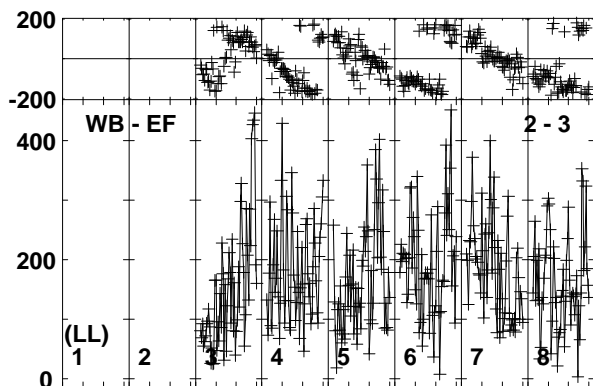
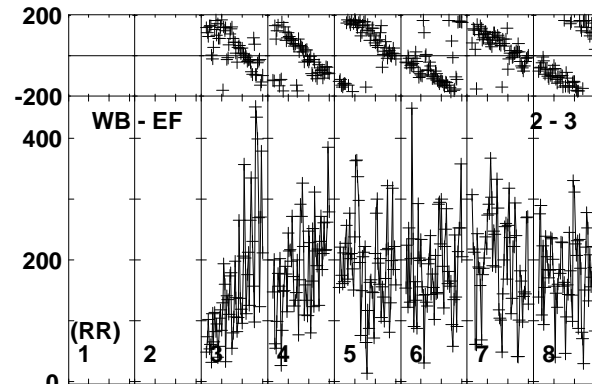
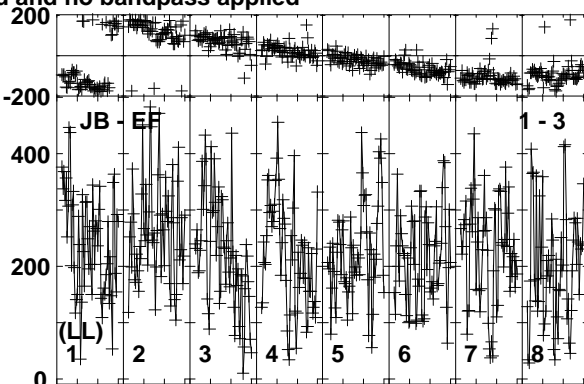
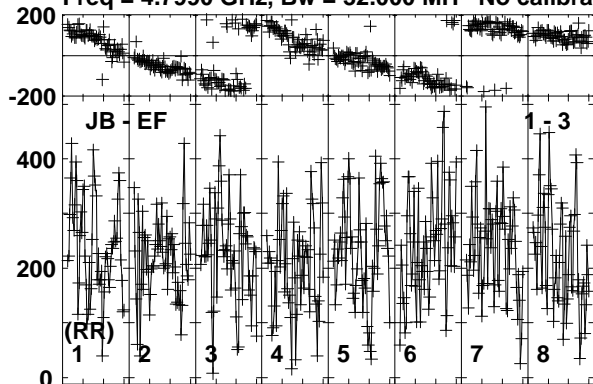

Lower frame: Micro Ampl Jy Top frame: Phas deg
Vector averaged cross-power spectrum Baseline: JB (01) - EF (03)
Timerange: 00/23:06:11 to 00/23:08:20

Plot file version 49 created 26-SEP-2019 10:39:33

J0300-0846 RG010A.UVDATA.1

Freq = 4.7990 GHz, Bw = 32.000 MH No calibration applied and no bandpass applied

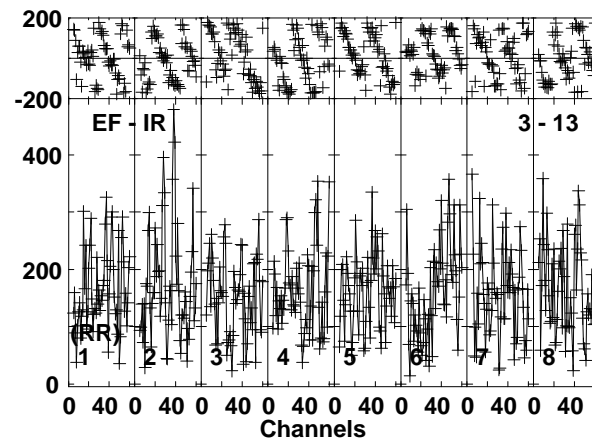
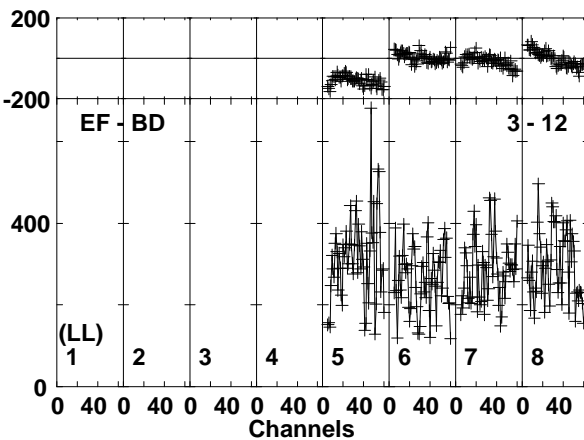
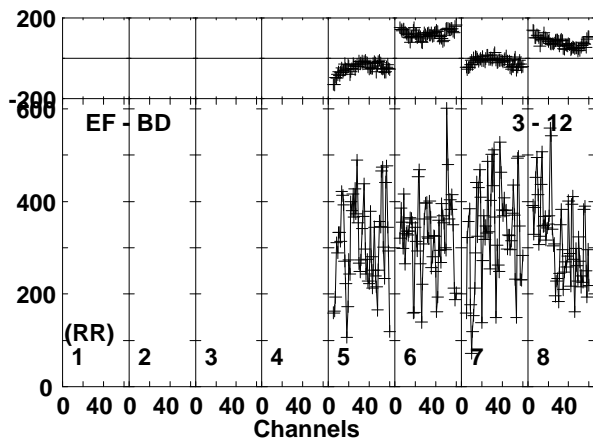
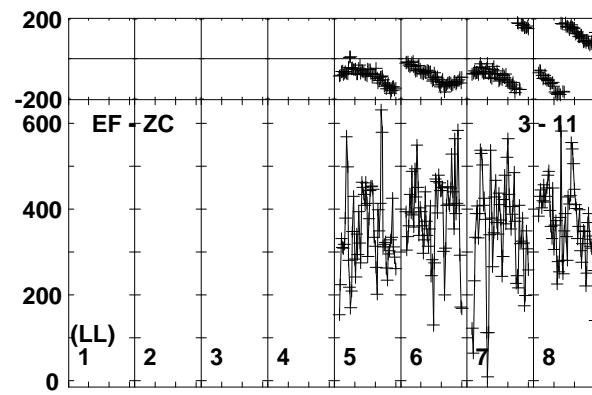
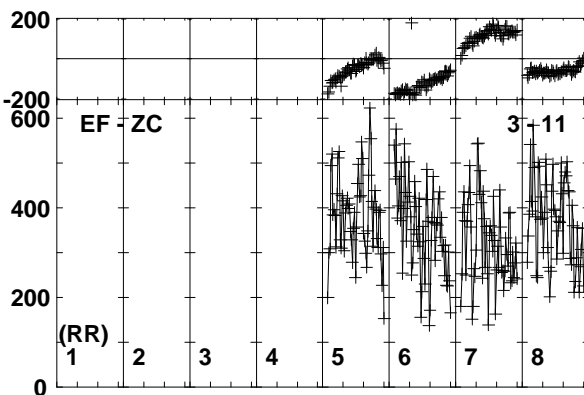
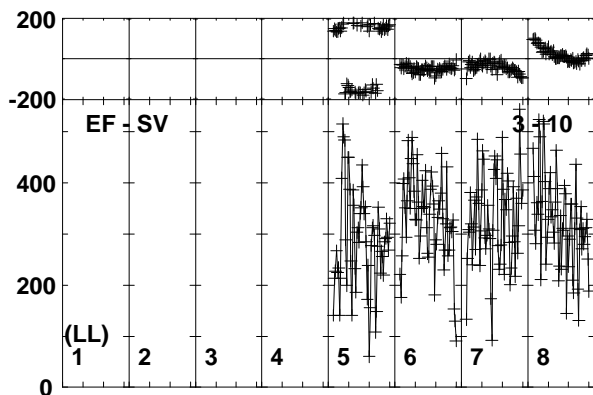
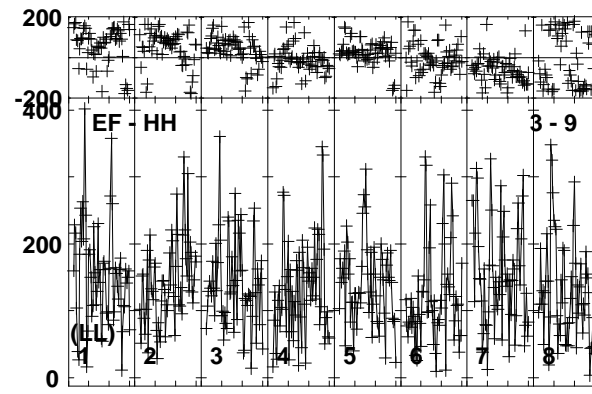
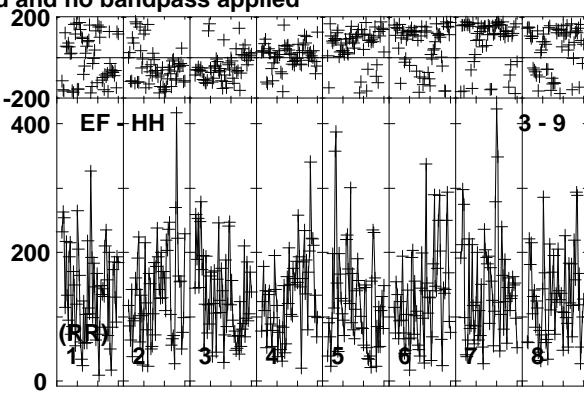
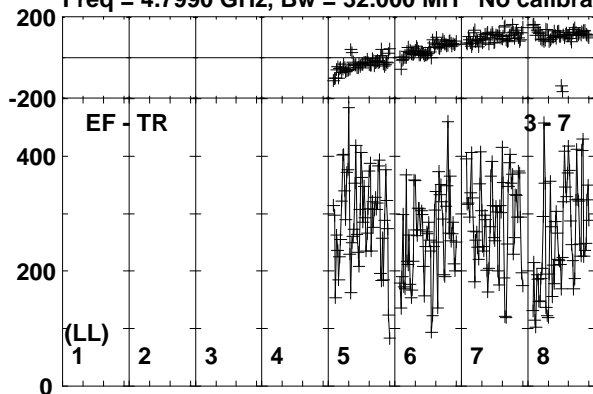

Lower frame: Micro Ampl Jy Top frame: Phas deg
Vector averaged cross-power spectrum Baseline: EF (03) - TR (07)
Timerange: 00/23:06:11 to 00/23:08:20

Plot file version 50 created 26-SEP-2019 10:39:33

J0300-0846 RG010A.UVDATA.1

Freq = 4.7990 GHz, Bw = 32.000 MH No calibration applied and no bandpass applied

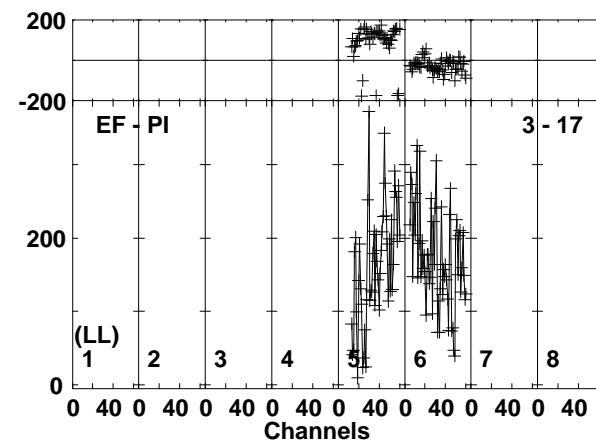
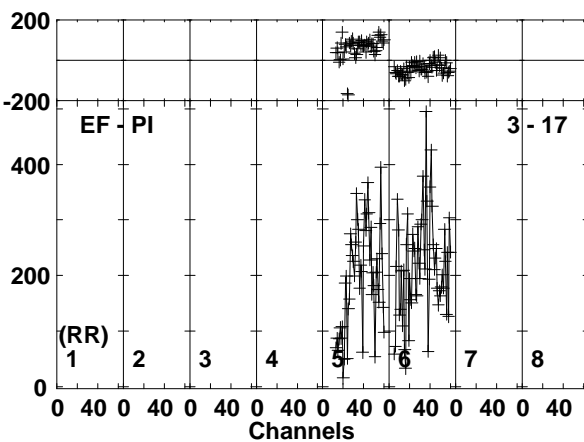
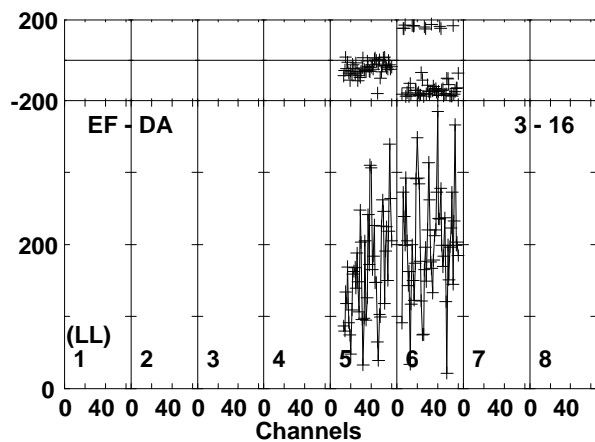
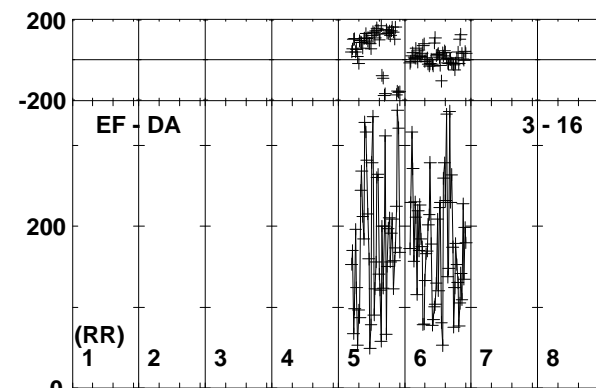
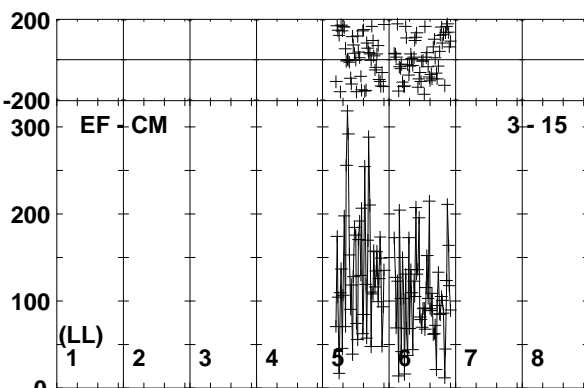
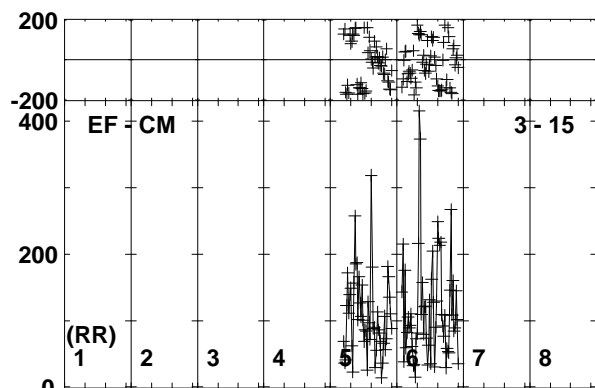
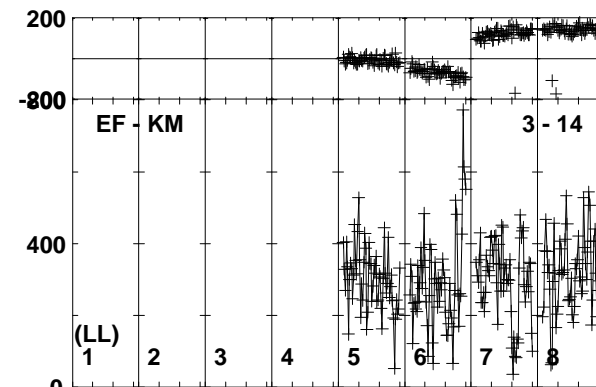
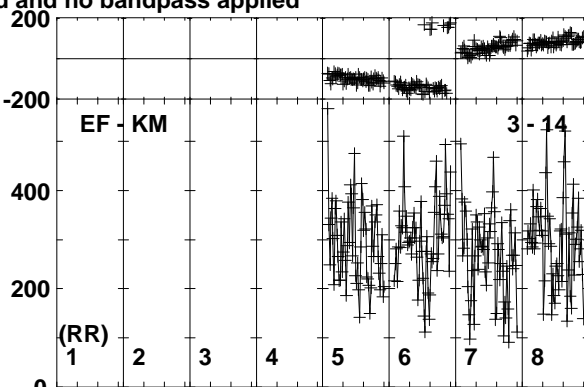
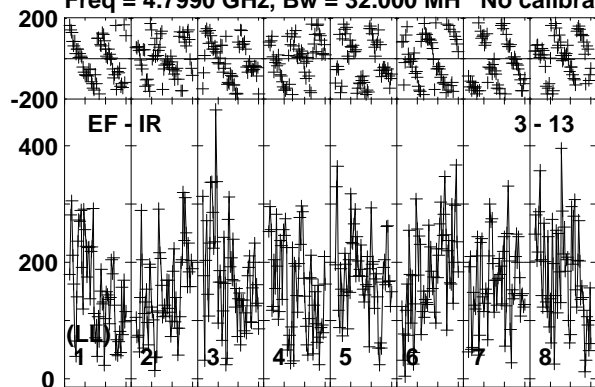

Lower frame: Micro Ampl Jy Top frame: Phas deg
Vector averaged cross-power spectrum Baseline: EF (03) - IR (13)
Timerange: 00/23:06:11 to 00/23:08:20

Plot file version 51 created 26-SEP-2019 10:39:34

J0300-0846 RG010A.UVDATA.1

Freq = 4.7990 GHz, Bw = 32.000 MH No calibration applied and no bandpass applied

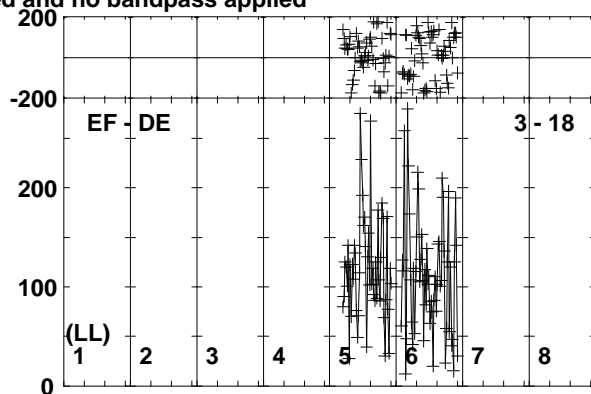
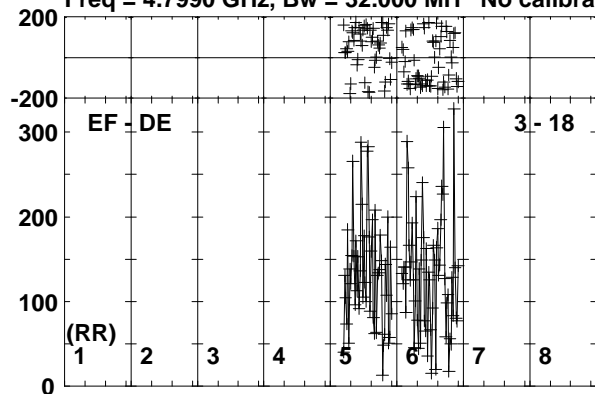

Lower frame: Micro Ampl Jy Top frame: Phas deg
Vector averaged cross-power spectrum Baseline: EF (03) - DE (18)
Timerange: 00/23:06:11 to 00/23:08:20

Plot file version 52 created 26-SEP-2019 10:39:34

J0257-1212 RG010A.UVDATA.1

Freq = 4.7990 GHz, Bw = 32.000 MH No calibration applied and no bandpass applied

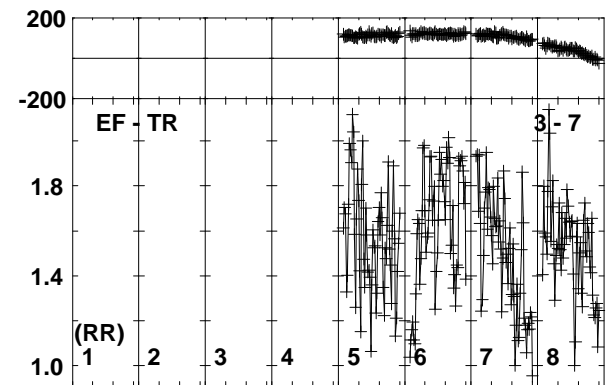
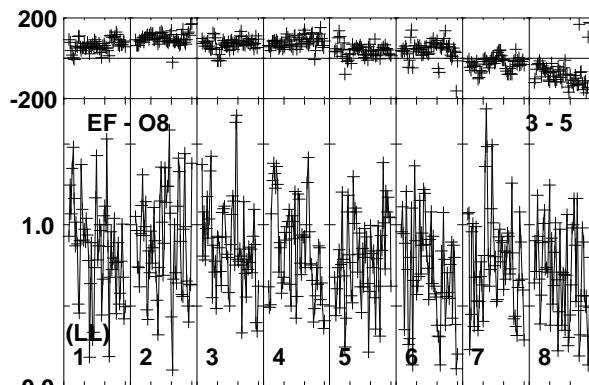
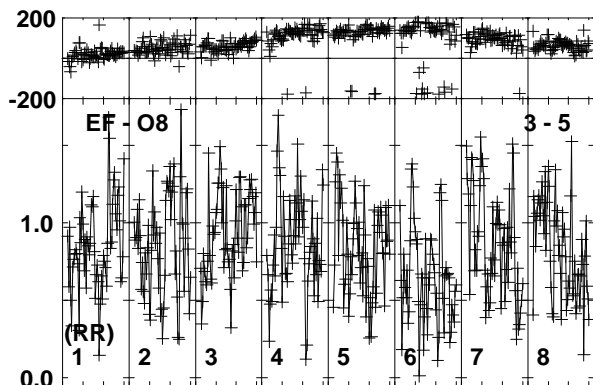
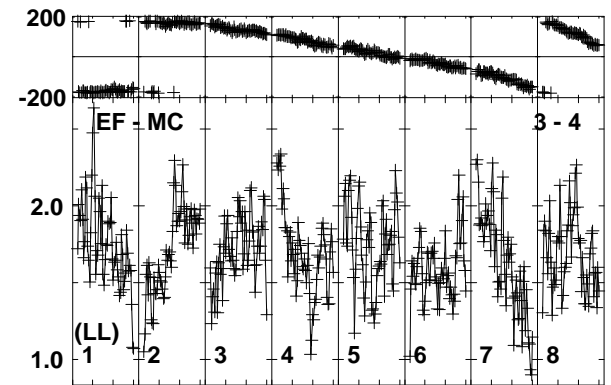
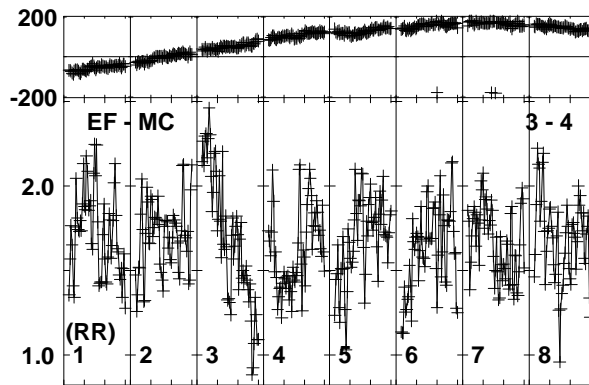
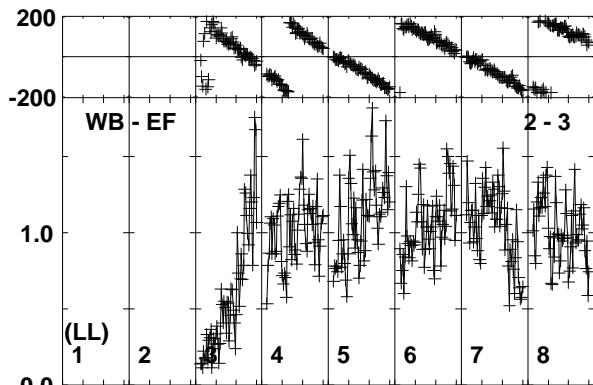
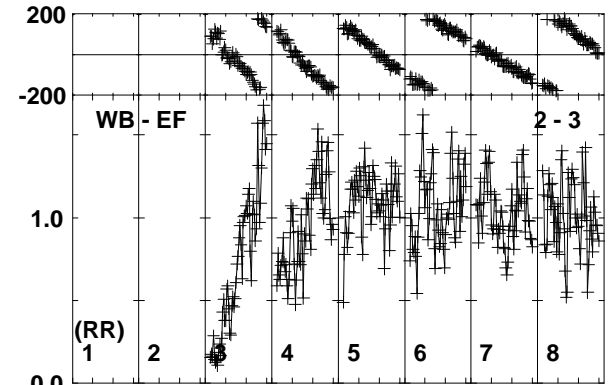
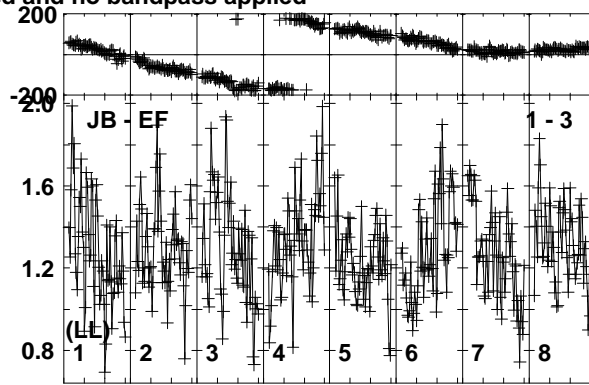
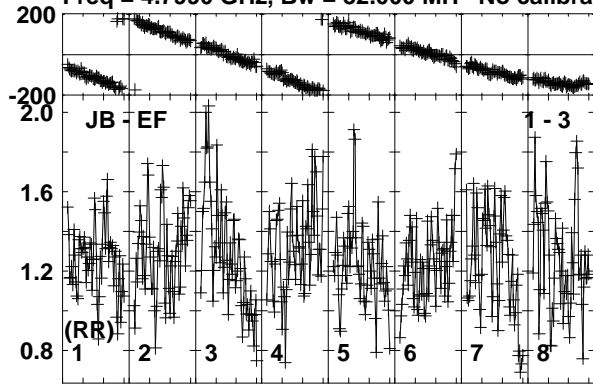

Lower frame: Milli Ampl Jy Top frame: Phas deg
Vector averaged cross-power spectrum Baseline: JB (01) - EF (03)
Timerange: 00/23:08:21 to 00/23:09:19

Plot file version 53 created 26-SEP-2019 10:39:34

J0257-1212 RG010A.UVDATA.1

Freq = 4.7990 GHz, Bw = 32.000 MH No calibration applied and no bandpass applied

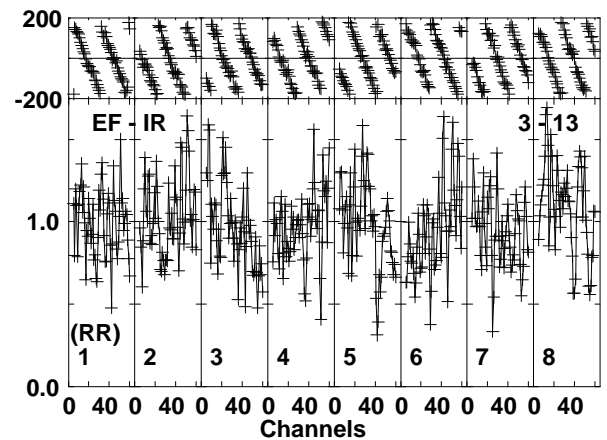
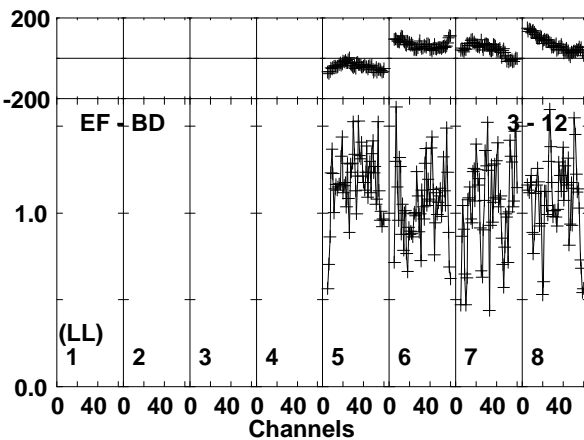
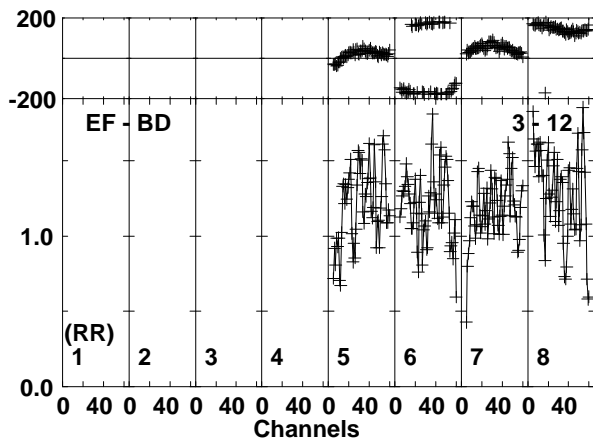
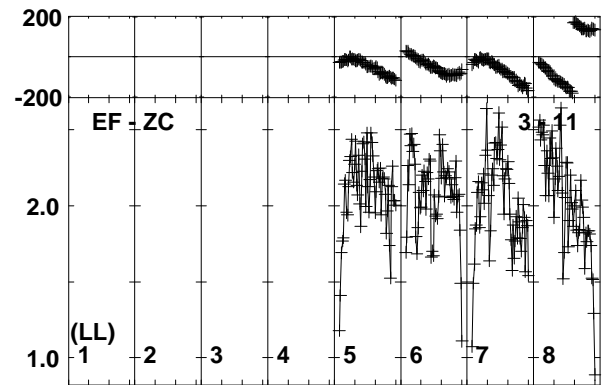
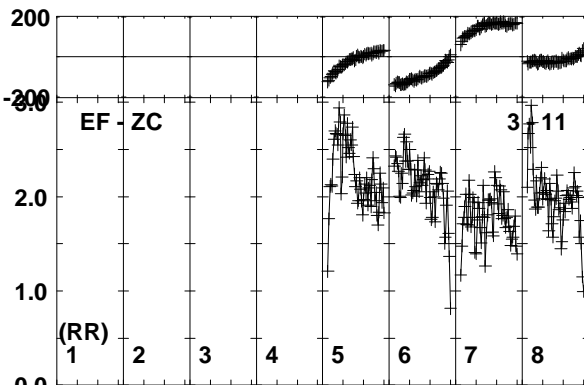
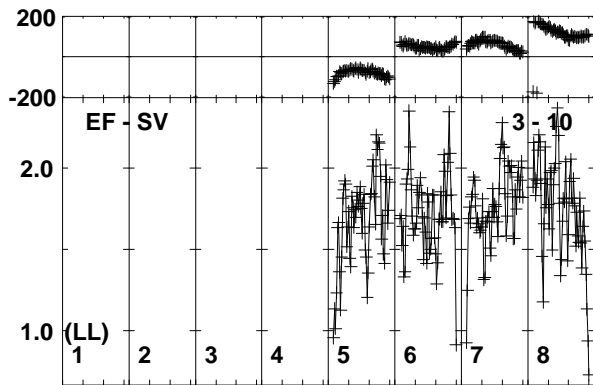
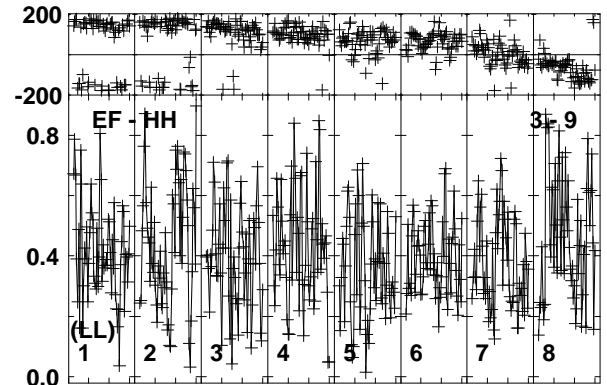
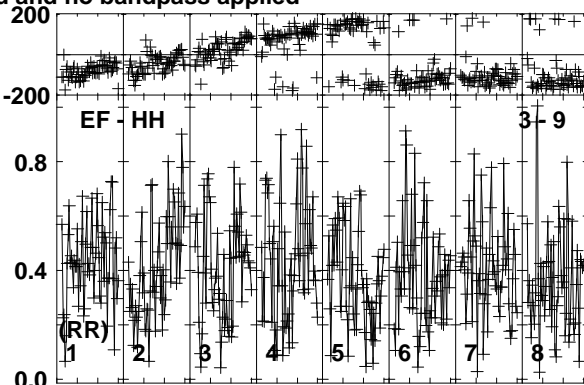
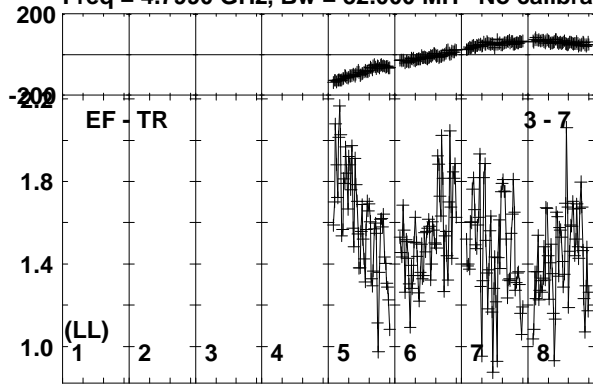

Lower frame: Milli Ampl Jy Top frame: Phas deg
Vector averaged cross-power spectrum Baseline: EF (03) - TR (07)
Timerange: 00/23:08:21 to 00/23:09:19

Plot file version 54 created 26-SEP-2019 10:39:37

J0257-1212 RG010A.UVDATA.1

Freq = 4.7990 GHz, Bw = 32.000 MH No calibration applied and no bandpass applied

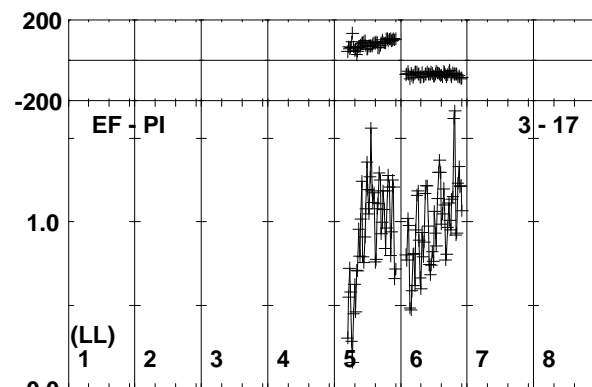
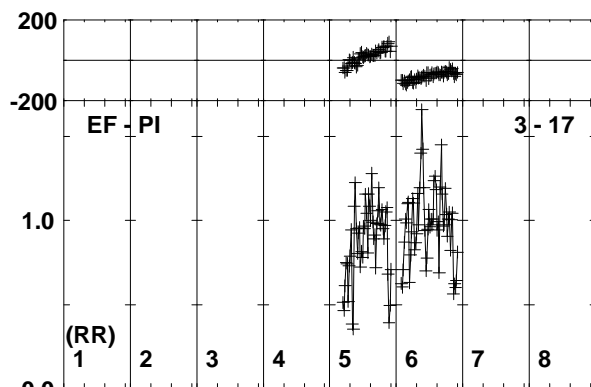
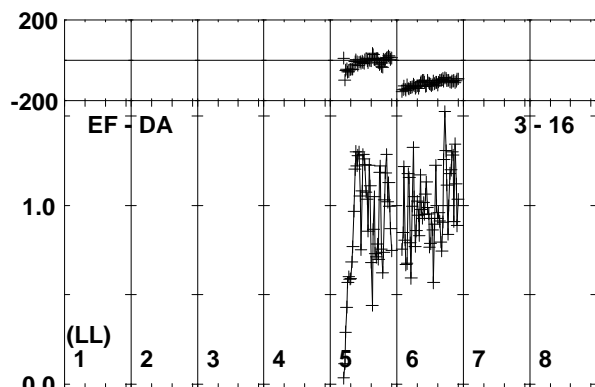
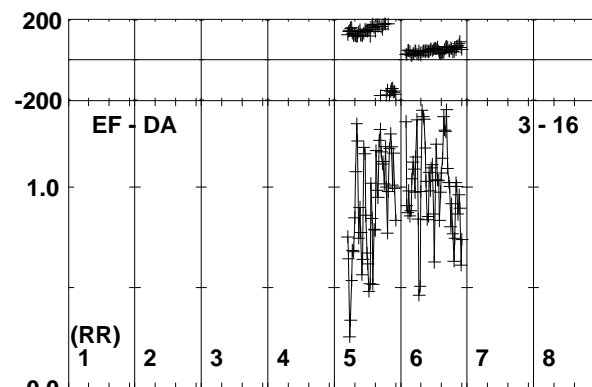
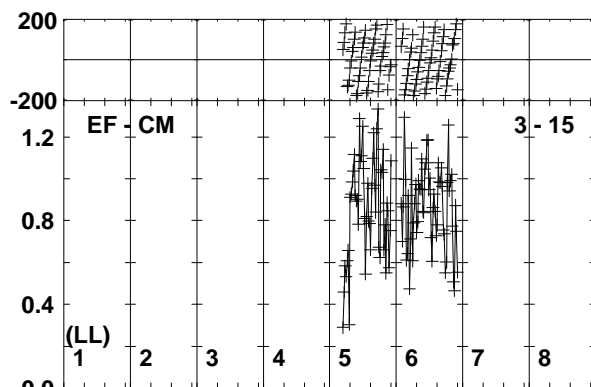
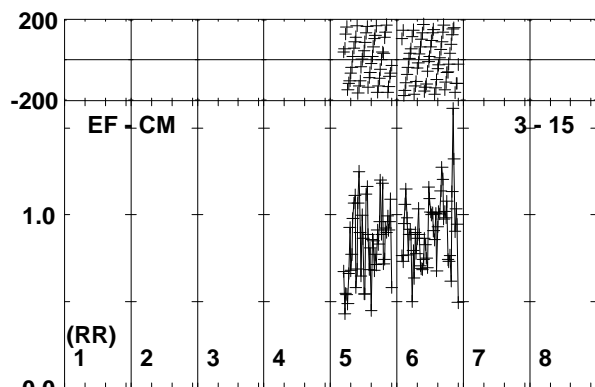
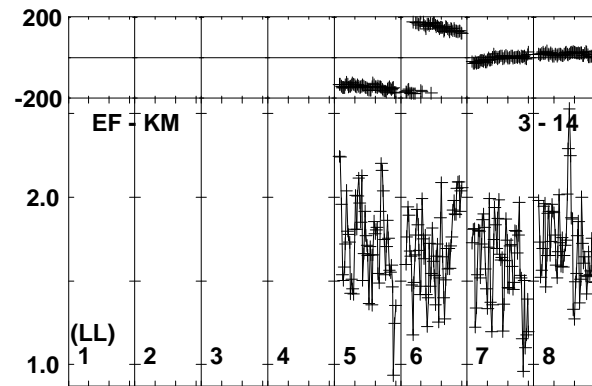
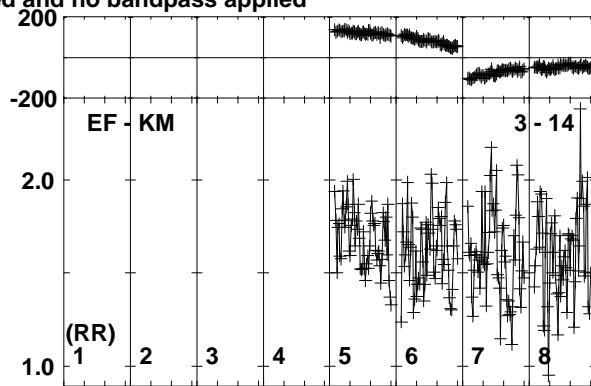
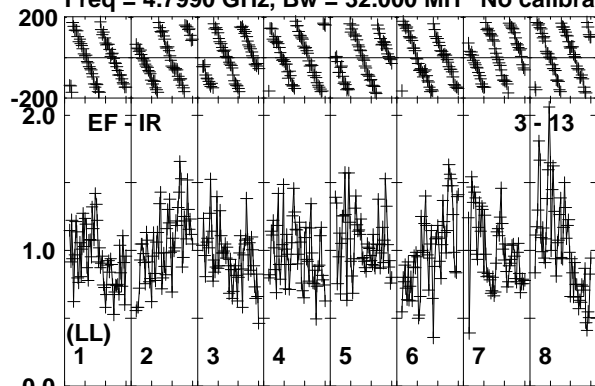

Lower frame: Milli Ampl Jy Top frame: Phas deg
Vector averaged cross-power spectrum Baseline: EF (03) - IR (13)
Timerange: 00/23:08:21 to 00/23:09:19

Plot file version 55 created 26-SEP-2019 10:39:37

J0257-1212 RG010A.UVDATA.1

Freq = 4.7990 GHz, Bw = 32.000 MH No calibration applied and no bandpass applied

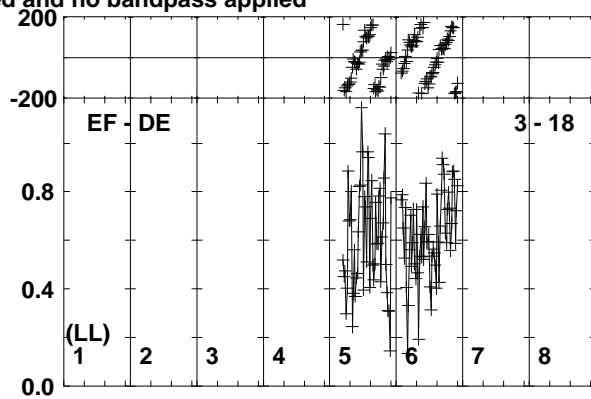
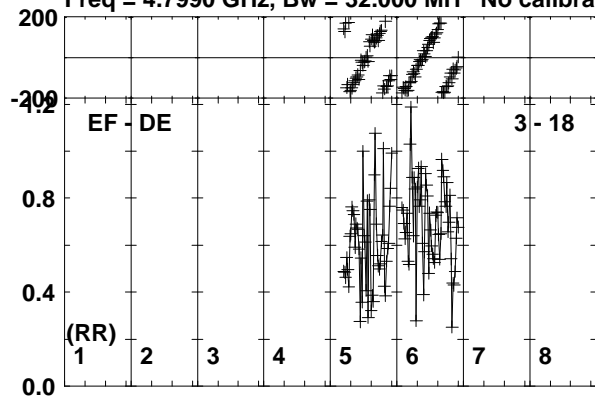

Lower frame: Milli Ampl Jy Top frame: Phas deg
Vector averaged cross-power spectrum Baseline: EF (03) - DE (18)
Timerange: 00/23:08:21 to 00/23:09:19

Plot file version 56 created 26-SEP-2019 10:39:37

190829A RG010A.UVDATA.1

Freq = 4.7990 GHz, Bw = 32.000 MH No calibration applied and no bandpass applied

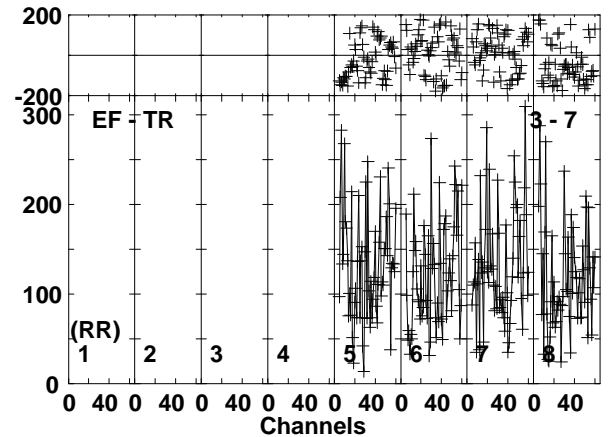
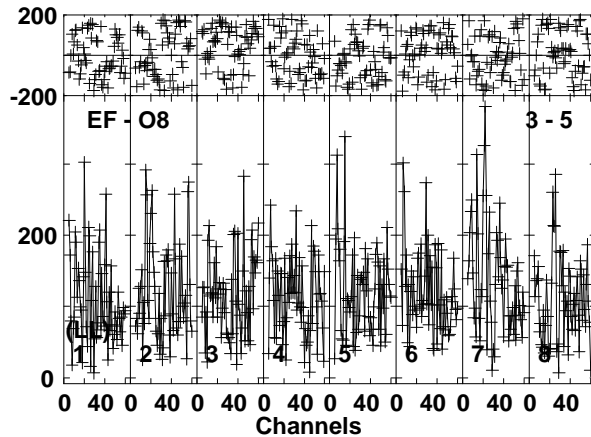
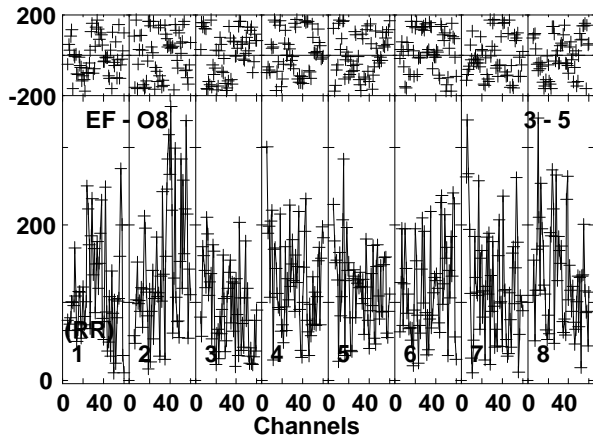
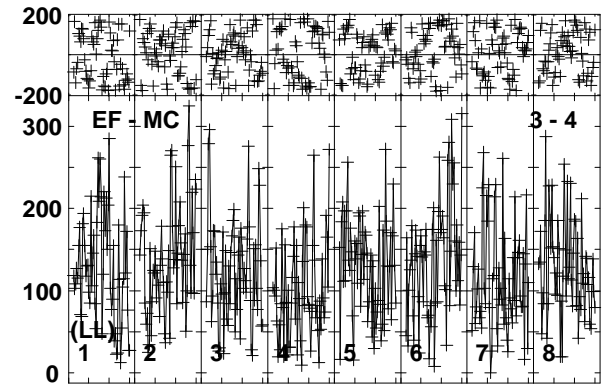
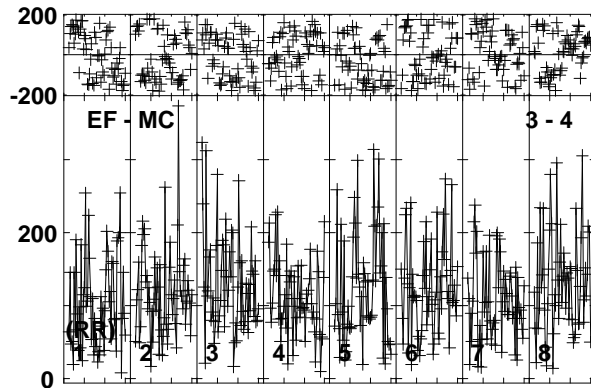
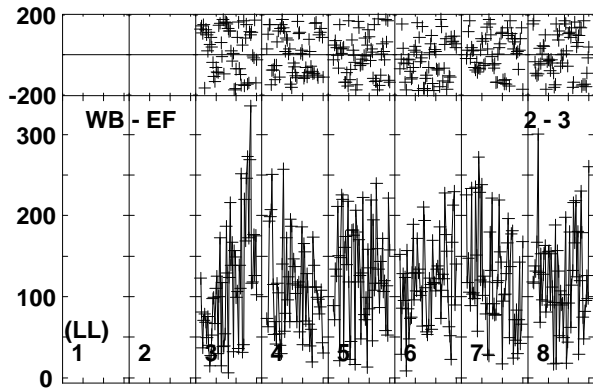
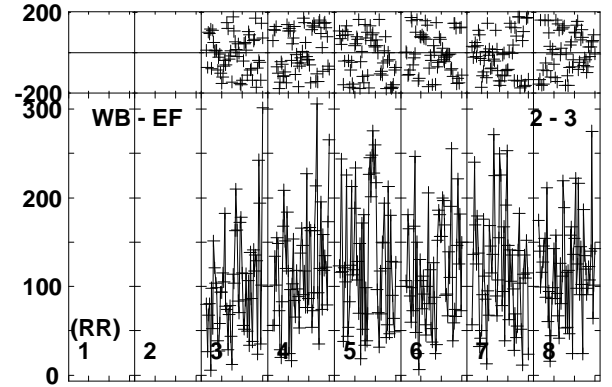
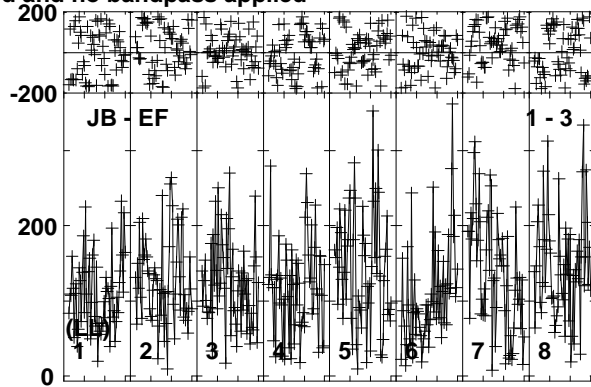
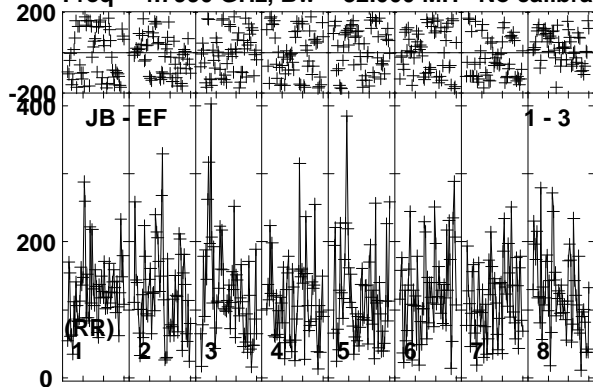

Lower frame: Micro Ampl Jy Top frame: Phas deg
Vector averaged cross-power spectrum Baseline: JB (01) - EF (03)
Timerange: 00/23:09:21 to 00/23:11:29

Plot file version 57 created 26-SEP-2019 10:39:38

190829A RG010A.UVDATA.1

Freq = 4.7990 GHz, Bw = 32.000 MH No calibration applied and no bandpass applied

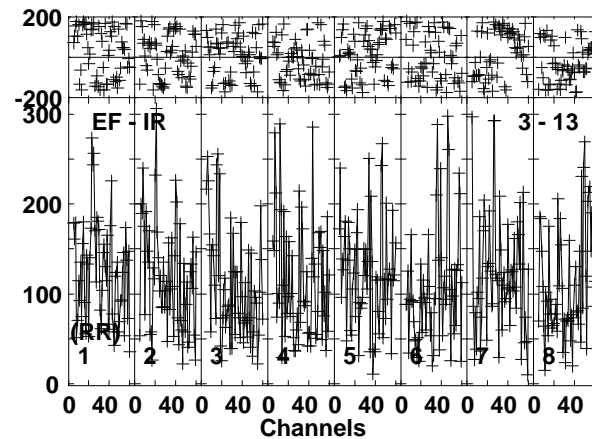
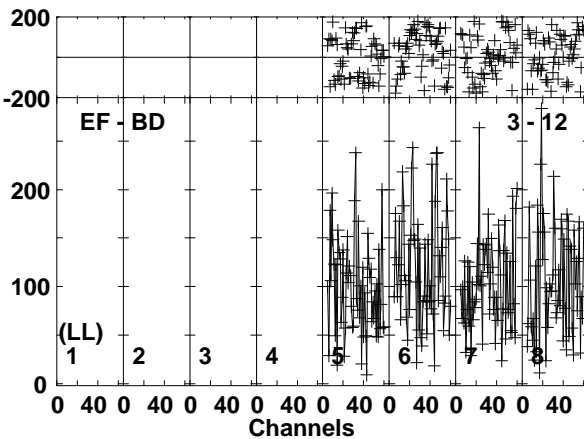
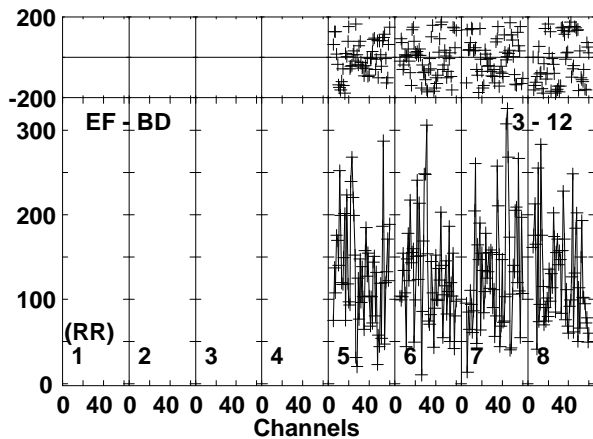
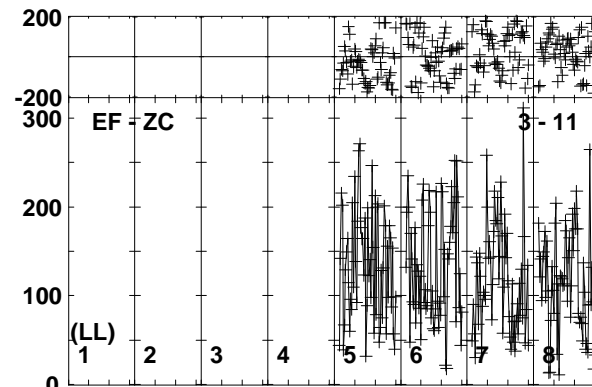
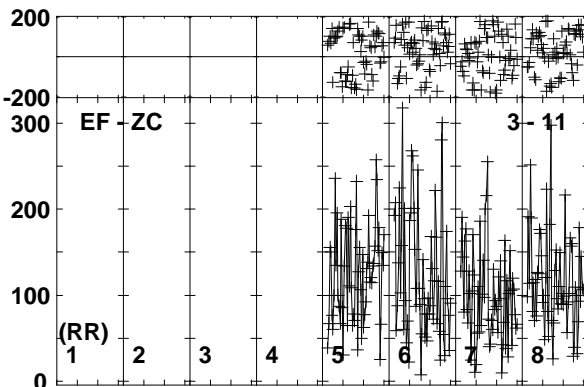
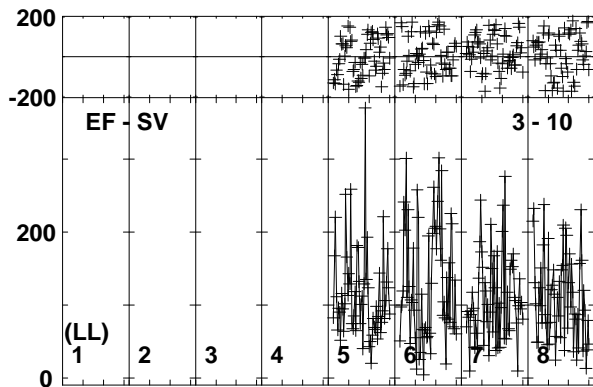
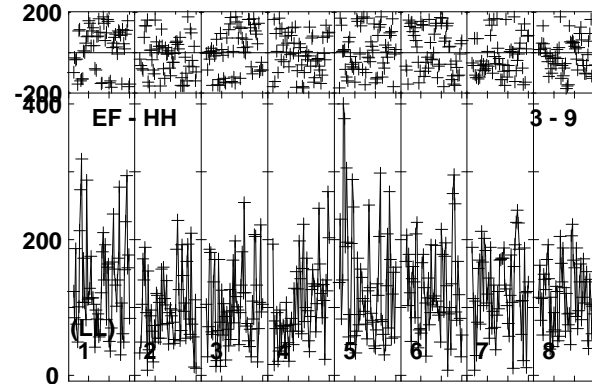
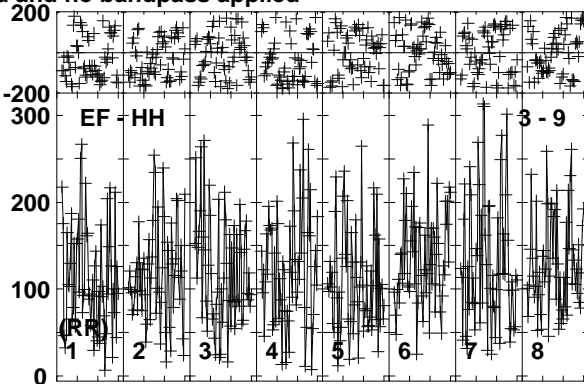
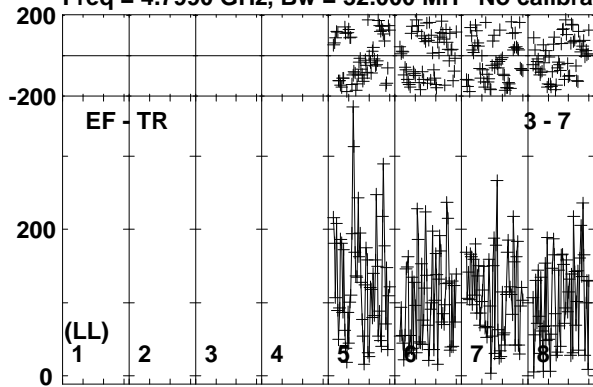

Lower frame: Micro Ampl Jy Top frame: Phas deg
Vector averaged cross-power spectrum Baseline: EF (03) - TR (07)
Timerange: 00/23:09:21 to 00/23:11:29

Plot file version 58 created 26-SEP-2019 10:39:38

190829A RG010A.UVDATA.1

Freq = 4.7990 GHz, Bw = 32.000 MH No calibration applied and no bandpass applied

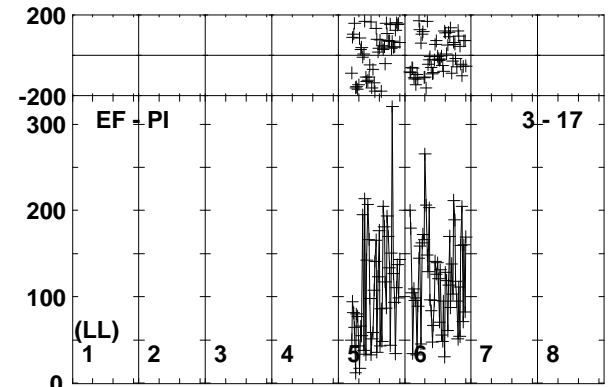
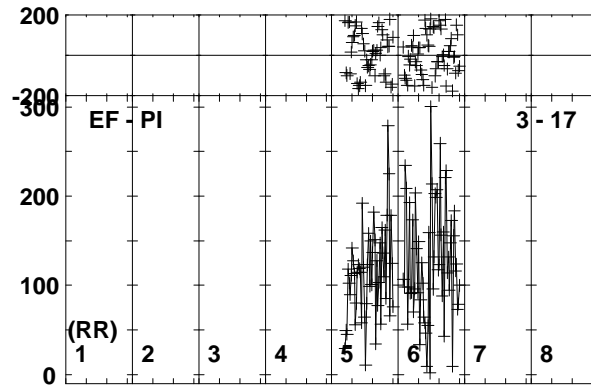
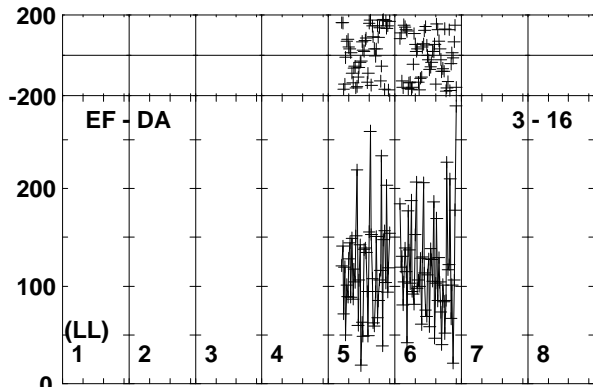
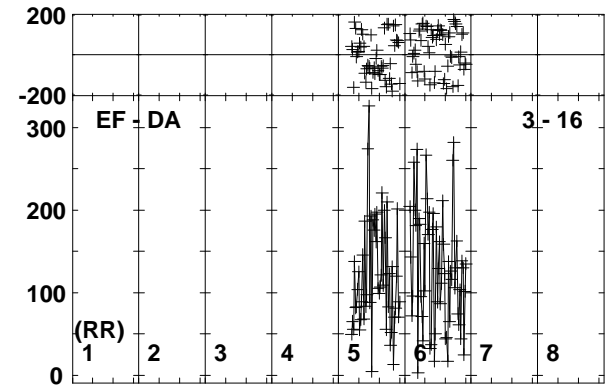
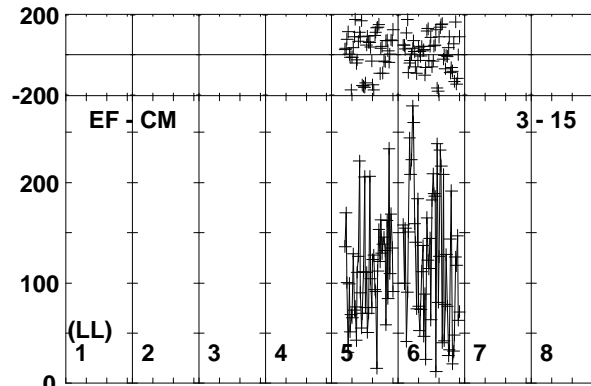
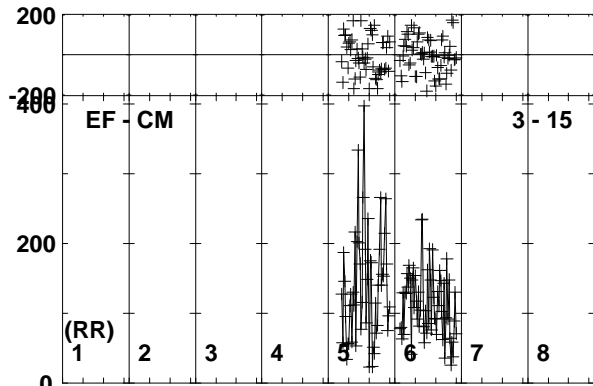
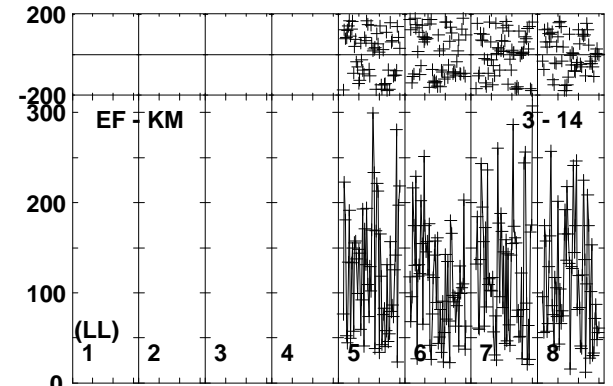
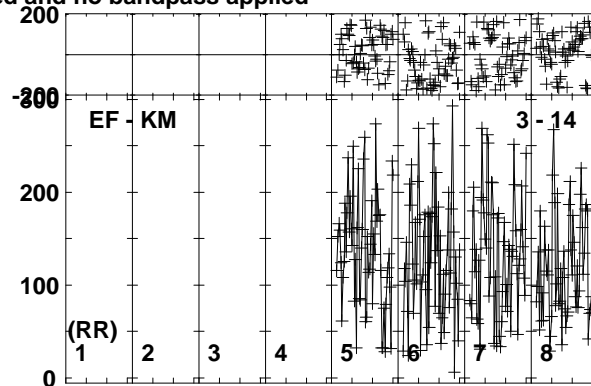
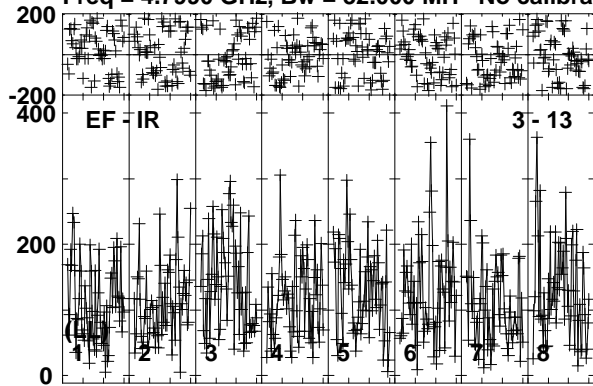

Lower frame: Micro Ampl Jy Top frame: Phas deg
Vector averaged cross-power spectrum Baseline: EF (03) - IR (13)
Timerange: 00/23:09:21 to 00/23:11:29

Plot file version 59 created 26-SEP-2019 10:39:38

190829A RG010A.UVDATA.1

Freq = 4.7990 GHz, Bw = 32.000 MH No calibration applied and no bandpass applied

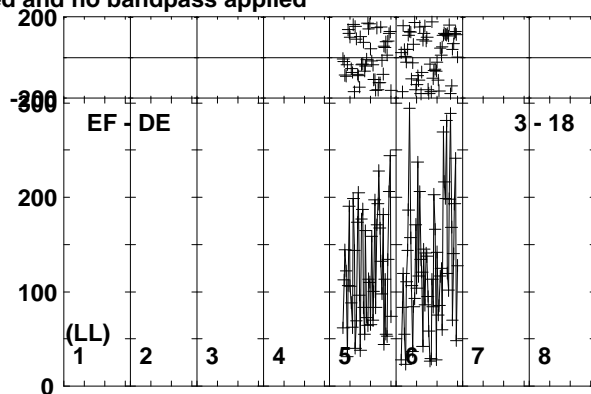
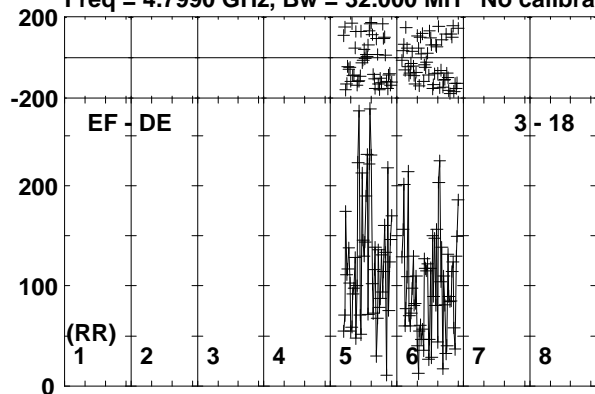

Lower frame: Micro Ampl Jy Top frame: Phas deg
Vector averaged cross-power spectrum Baseline: EF (03) - DE (18)
Timerange: 00/23:09:21 to 00/23:11:29

Plot file version 60 created 26-SEP-2019 10:39:39

J0257-1212 RG010A.UVDATA.1

Freq = 4.7990 GHz, Bw = 32.000 MH No calibration applied and no bandpass applied

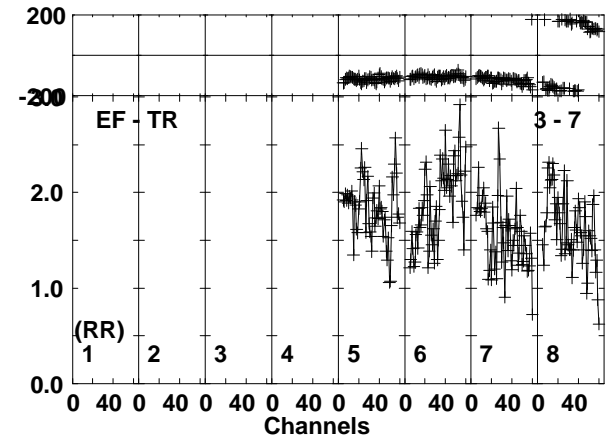
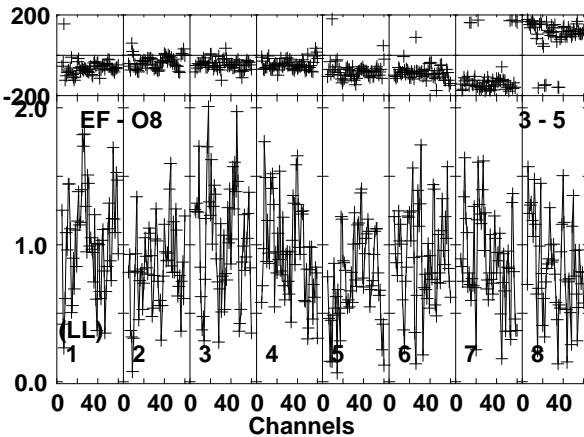
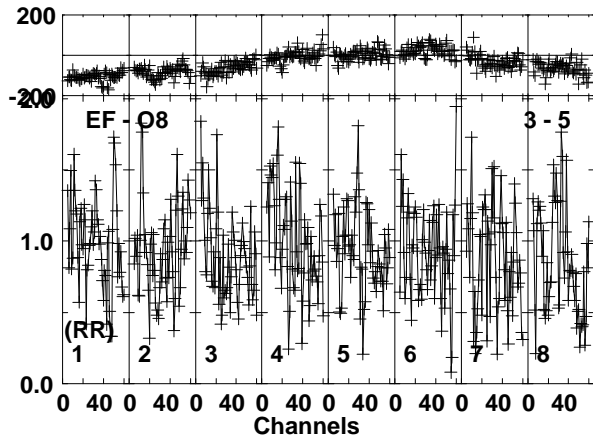
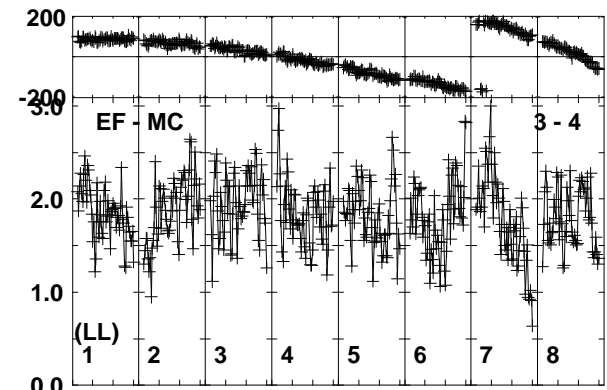
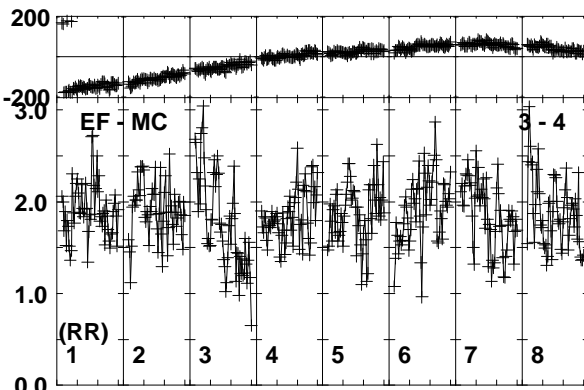
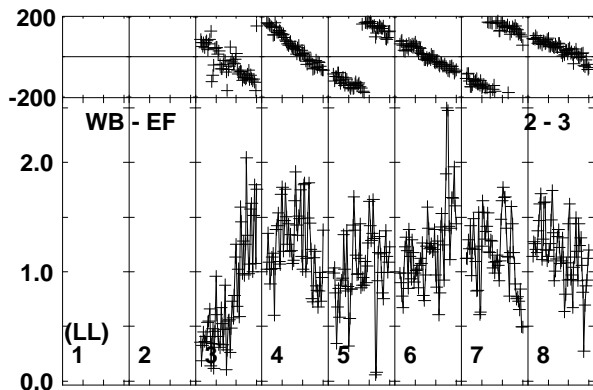
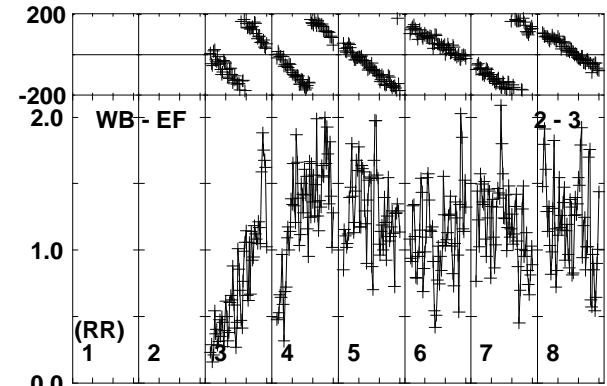
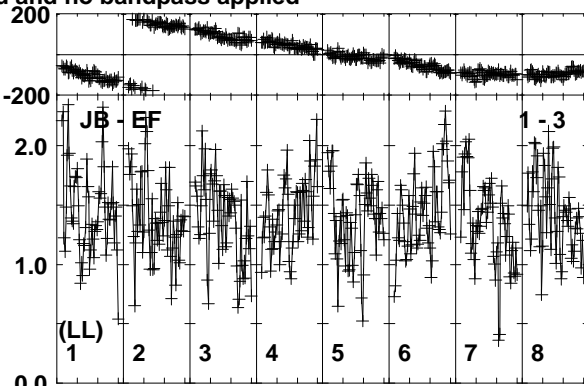
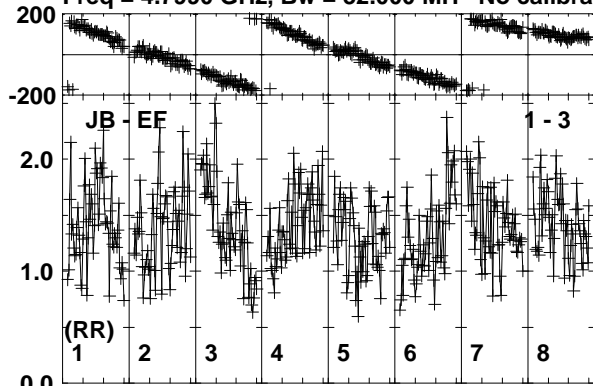

Lower frame: Milli Ampl Jy Top frame: Phas deg
Vector averaged cross-power spectrum Baseline: JB (01) - EF (03)
Timerange: 00/23:11:31 to 00/23:12:30

Plot file version 61 created 26-SEP-2019 10:39:39

J0257-1212 RG010A.UVDATA.1

Freq = 4.7990 GHz, Bw = 32.000 MH No calibration applied and no bandpass applied

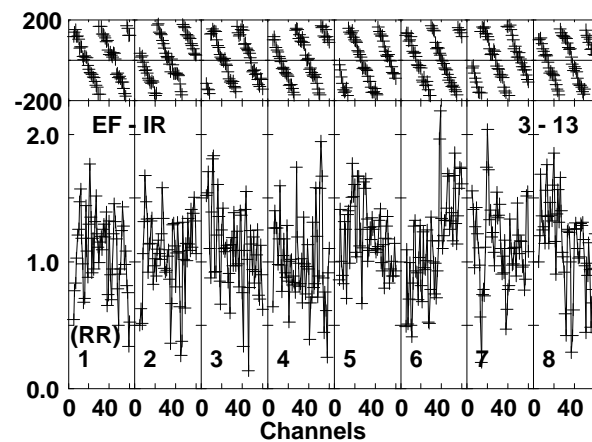
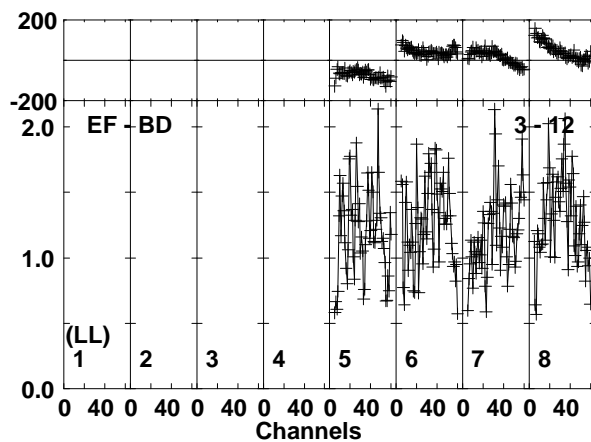
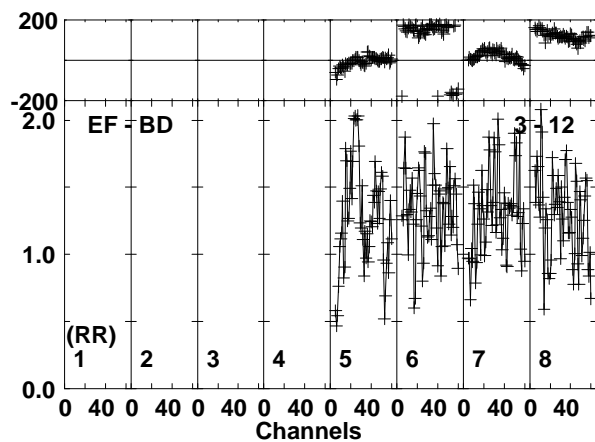
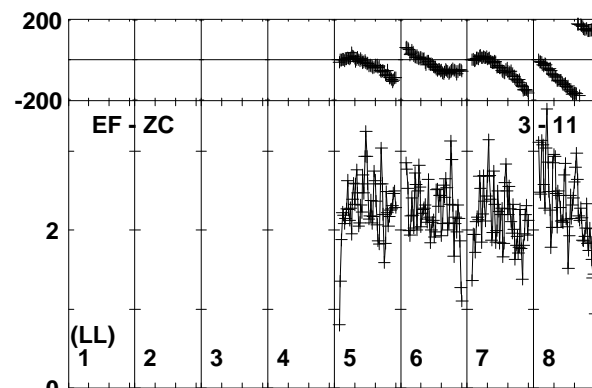
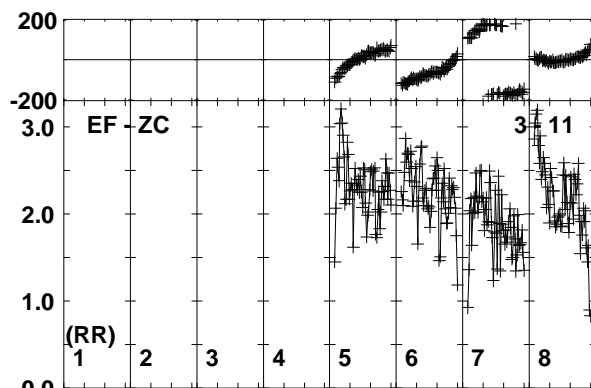
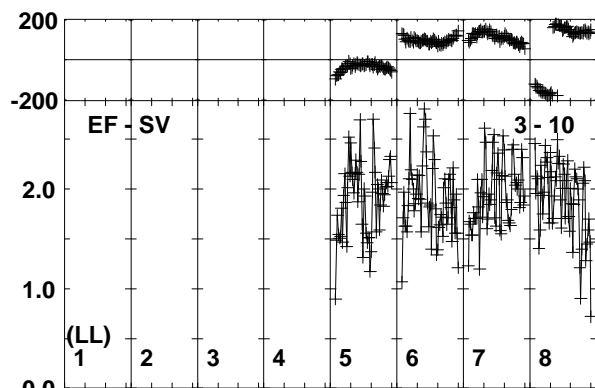
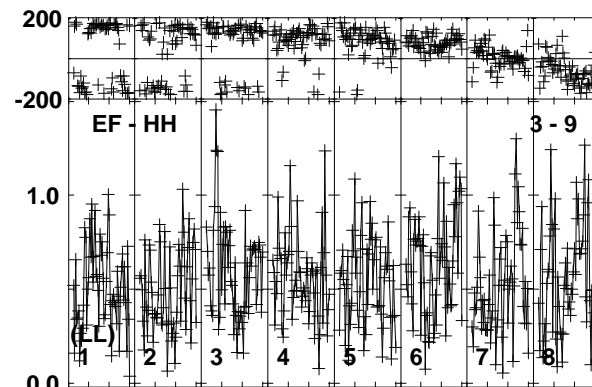
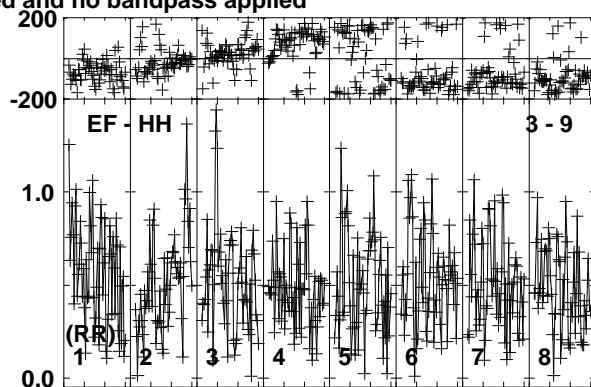
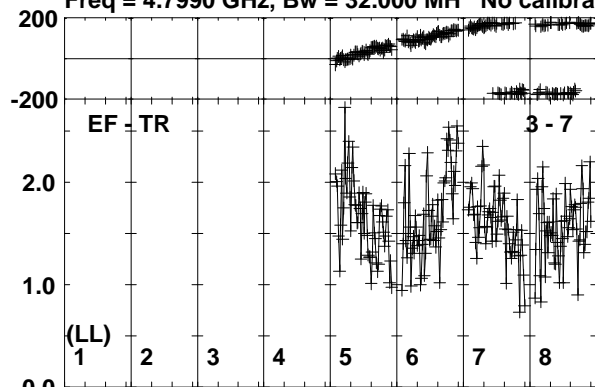

Lower frame: Milli Ampl Jy Top frame: Phas deg
Vector averaged cross-power spectrum Baseline: EF (03) - TR (07)
Timerange: 00/23:11:31 to 00/23:12:30

Plot file version 62 created 26-SEP-2019 10:39:39

J0257-1212 RG010A.UVDATA.1

Freq = 4.7990 GHz, Bw = 32.000 MH No calibration applied and no bandpass applied

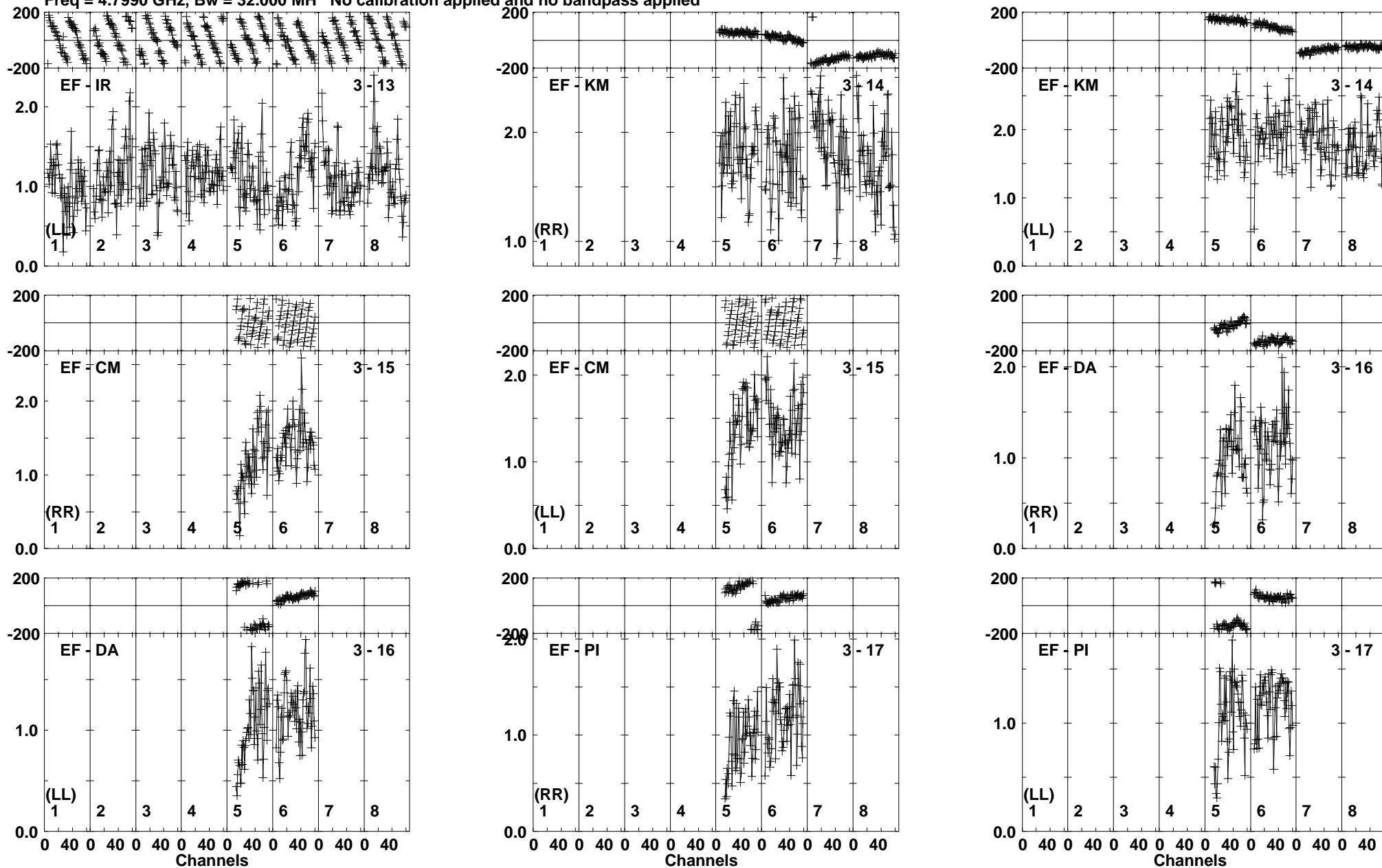

Lower frame: Milli Ampl Jy Top frame: Phas deg
Vector averaged cross-power spectrum Baseline: EF (03) - IR (13)
Timerange: 00/23:11:31 to 00/23:12:30

Plot file version 63 created 26-SEP-2019 10:39:40

J0257-1212 RG010A.UVDATA.1

Freq = 4.7990 GHz, Bw = 32.000 MH No calibration applied and no bandpass applied

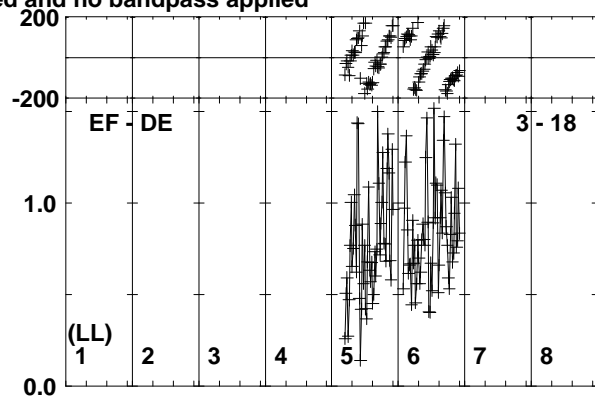
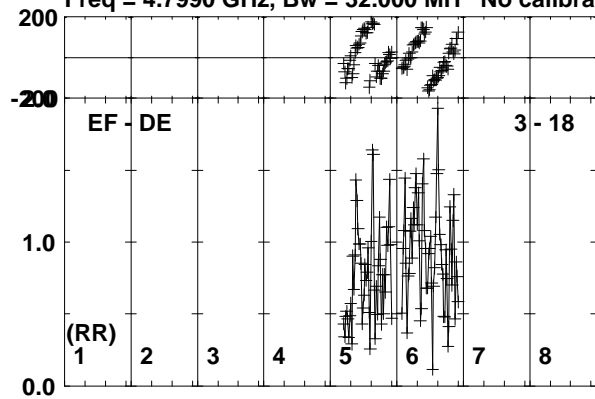

Lower frame: Milli Ampl Jy Top frame: Phas deg
Vector averaged cross-power spectrum Baseline: EF (03) - DE (18)
Timerange: 00/23:11:31 to 00/23:12:30

Plot file version 64 created 26-SEP-2019 10:39:40

190829A RG010A.UVDATA.1

Freq = 4.7990 GHz, Bw = 32.000 MH No calibration applied and no bandpass applied

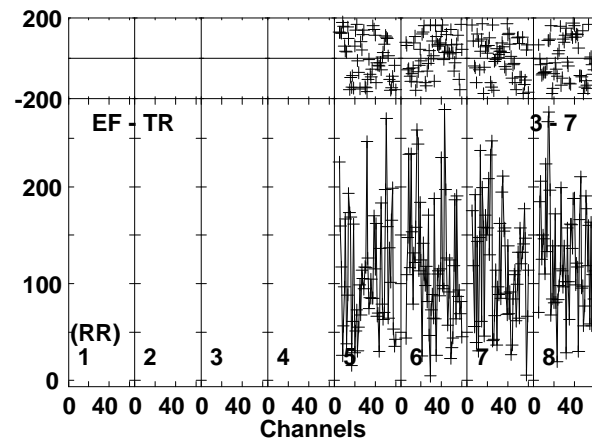
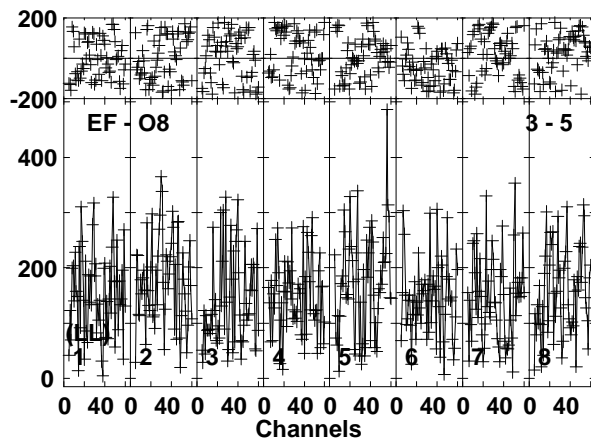
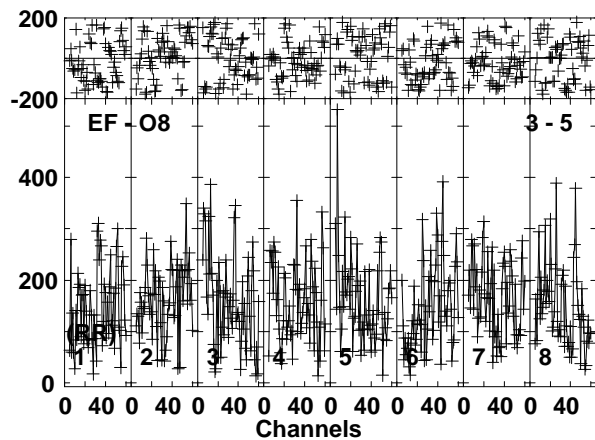
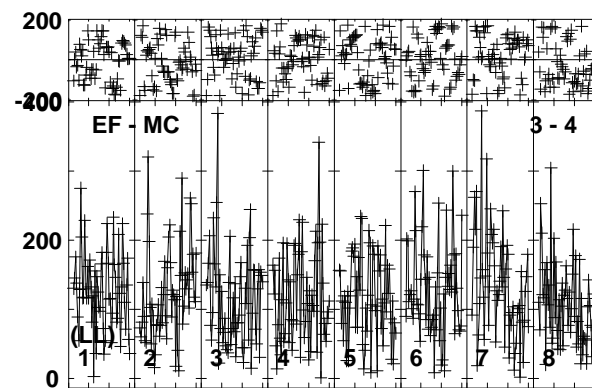
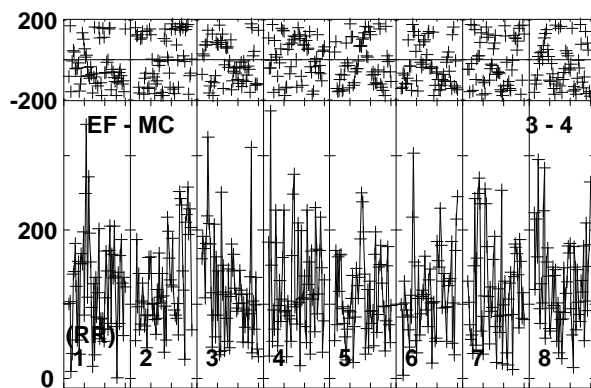
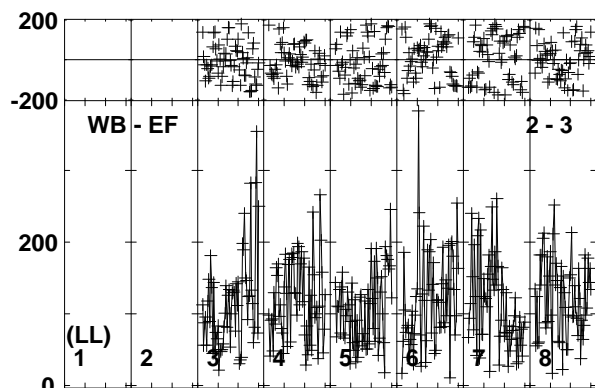
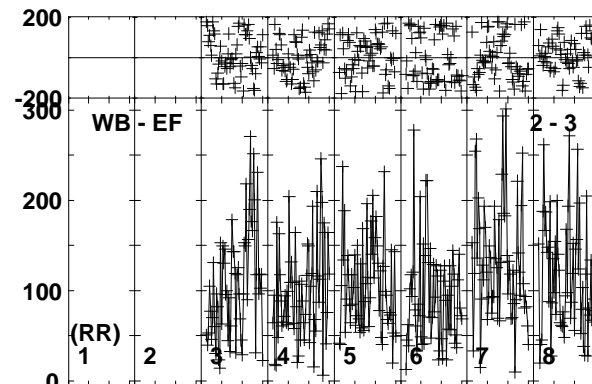
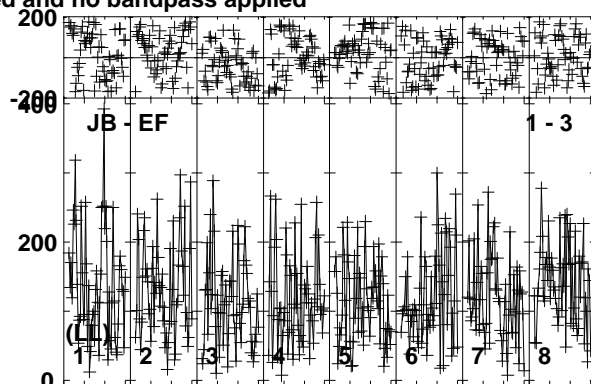
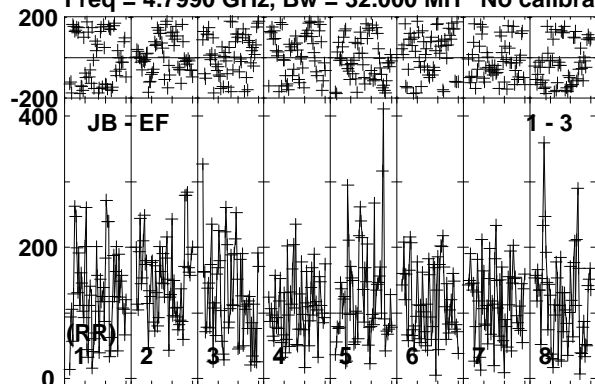

Lower frame: Micro Ampl Jy Top frame: Phas deg
Vector averaged cross-power spectrum Baseline: JB (01) - EF (03)
Timerange: 00/23:12:31 to 00/23:14:39

Plot file version 65 created 26-SEP-2019 10:39:40

190829A RG010A.UVDATA.1

Freq = 4.7990 GHz, Bw = 32.000 MH No calibration applied and no bandpass applied

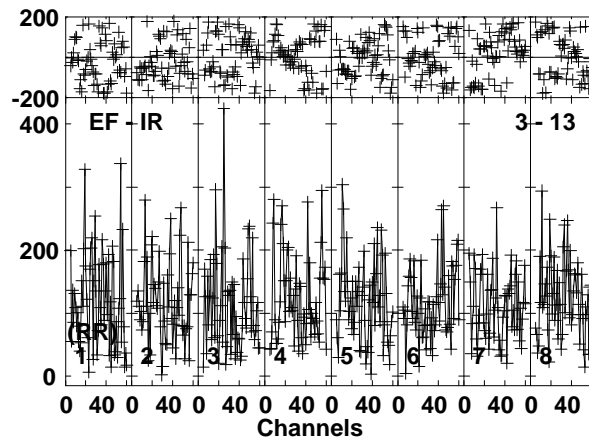
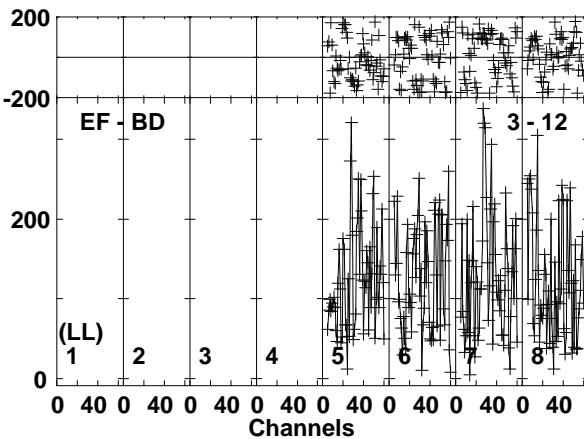
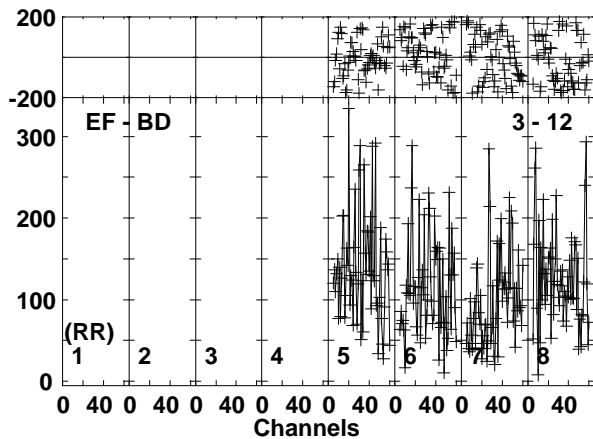
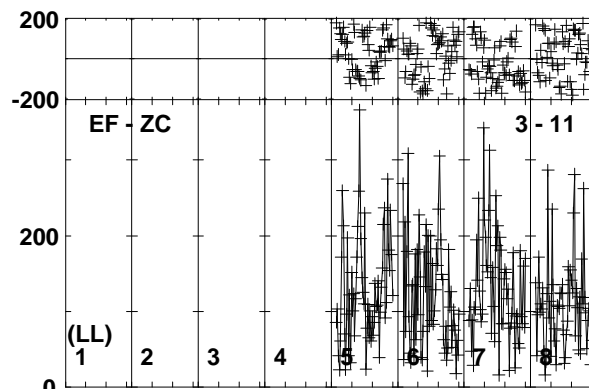
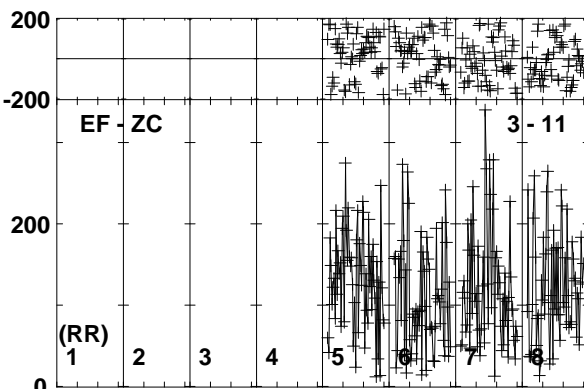
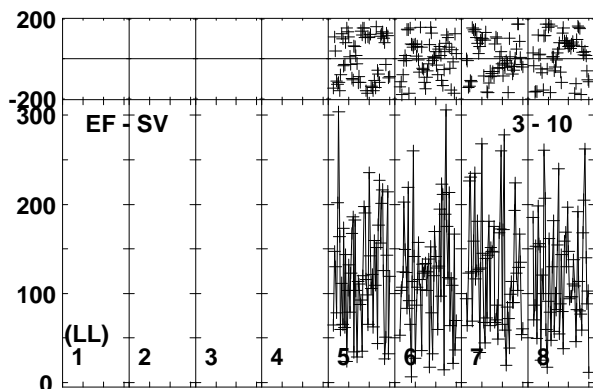
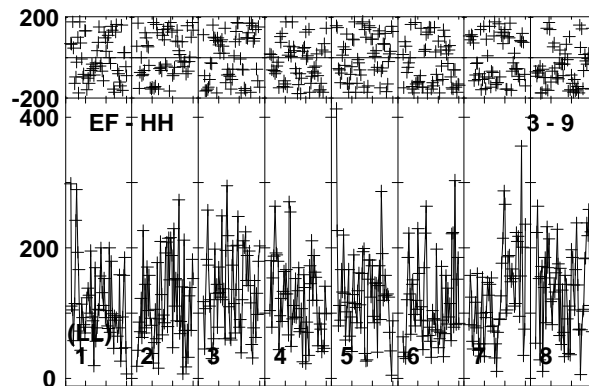
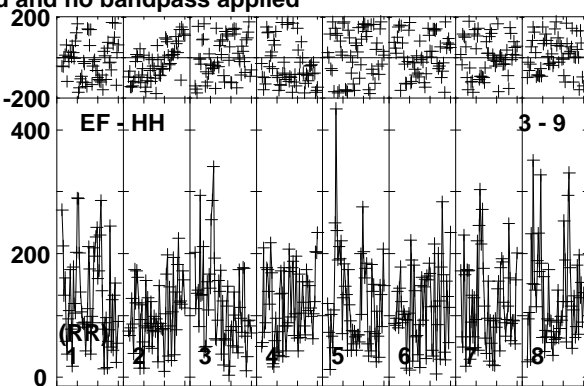
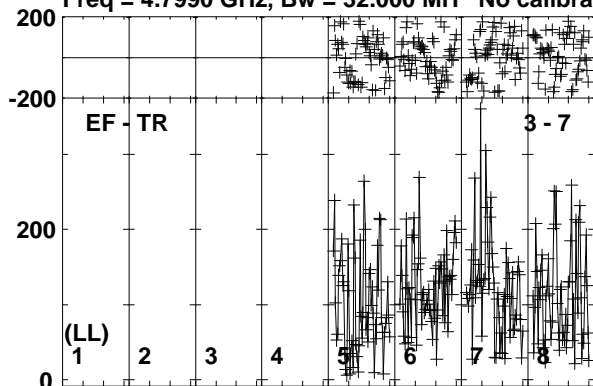

Lower frame: Micro Ampl Jy Top frame: Phas deg
Vector averaged cross-power spectrum Baseline: EF (03) - TR (07)
Timerange: 00/23:12:31 to 00/23:14:39

Plot file version 66 created 26-SEP-2019 10:39:41

190829A RG010A.UVDATA.1

Freq = 4.7990 GHz, Bw = 32.000 MH No calibration applied and no bandpass applied

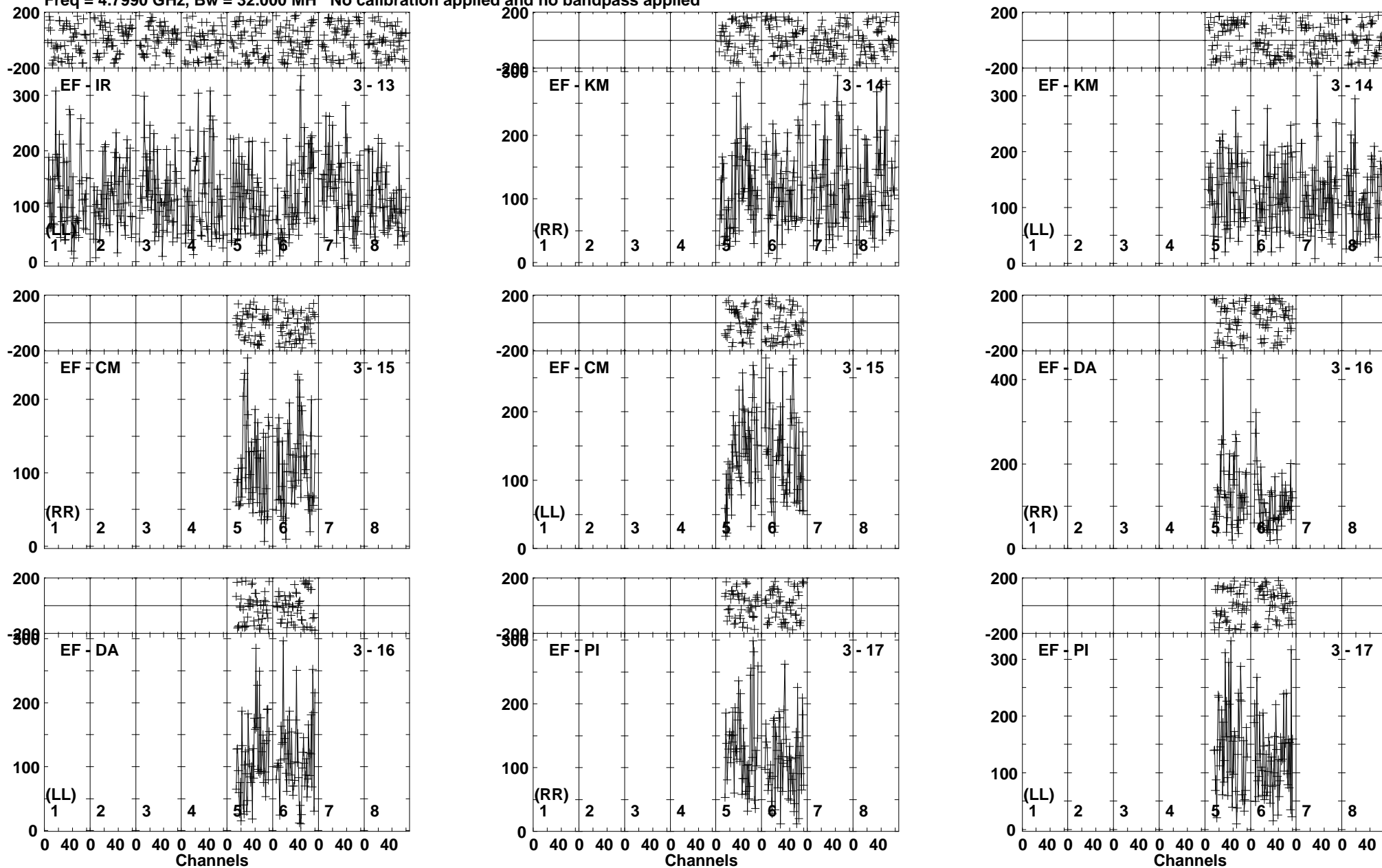

Lower frame: Micro Ampl Jy Top frame: Phas deg
Vector averaged cross-power spectrum Baseline: EF (03) - IR (13)
Timerange: 00/23:12:31 to 00/23:14:39

Plot file version 67 created 26-SEP-2019 10:39:41

190829A RG010A.UVDATA.1

Freq = 4.7990 GHz, Bw = 32.000 MH No calibration applied and no bandpass applied

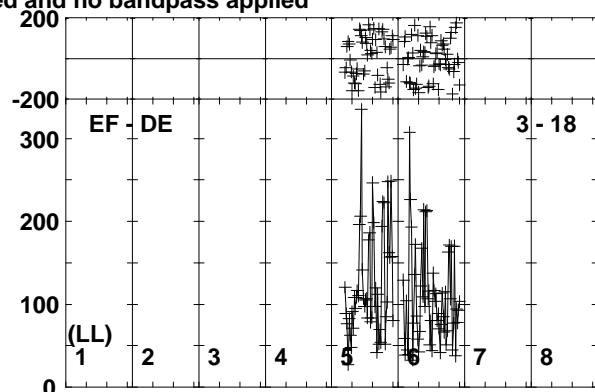
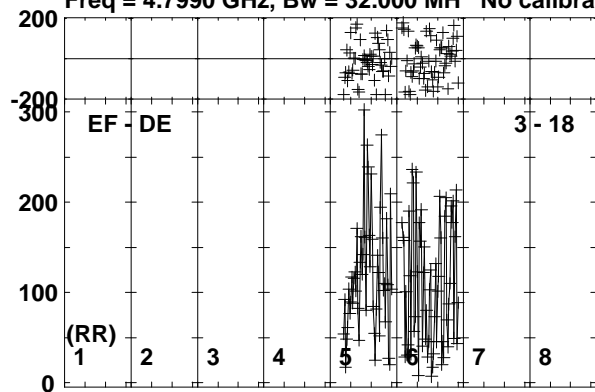

Lower frame: Micro Ampl Jy Top frame: Phas deg
Vector averaged cross-power spectrum Baseline: EF (03) - DE (18)
Timerange: 00/23:12:31 to 00/23:14:39

Plot file version 68 created 26-SEP-2019 10:39:41

J0257-1212 RG010A.UVDATA.1

Freq = 4.7990 GHz, Bw = 32.000 MH No calibration applied and no bandpass applied

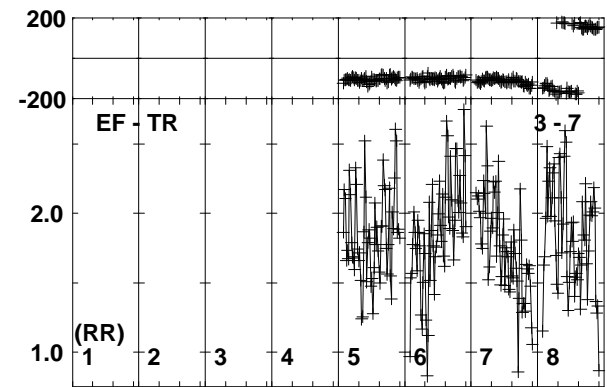
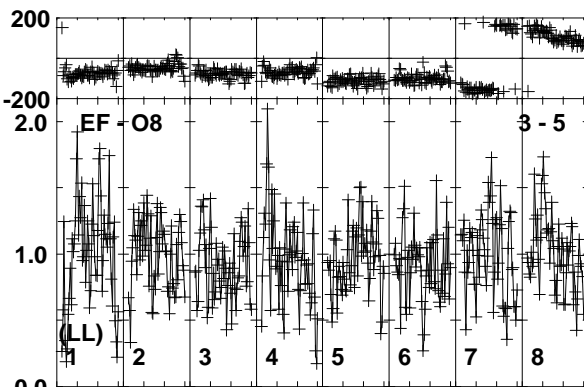
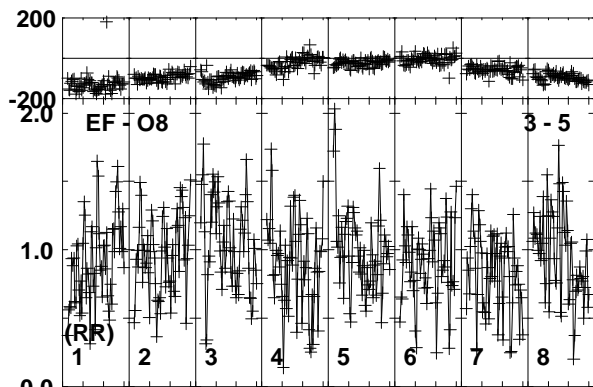
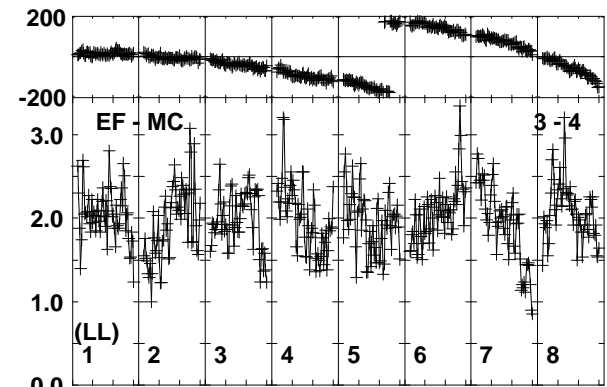
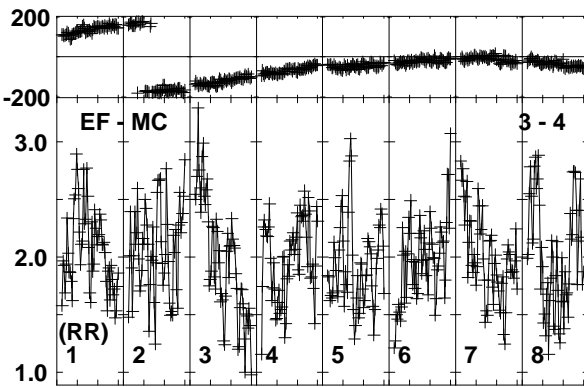
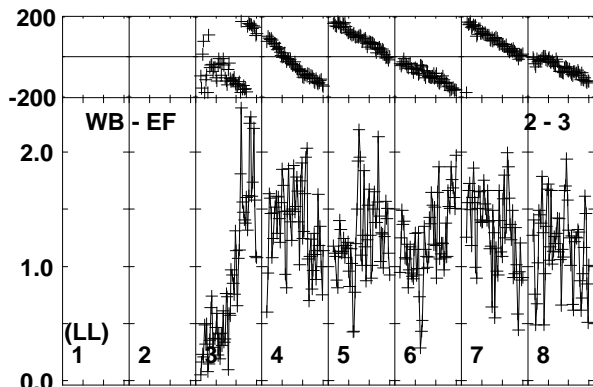
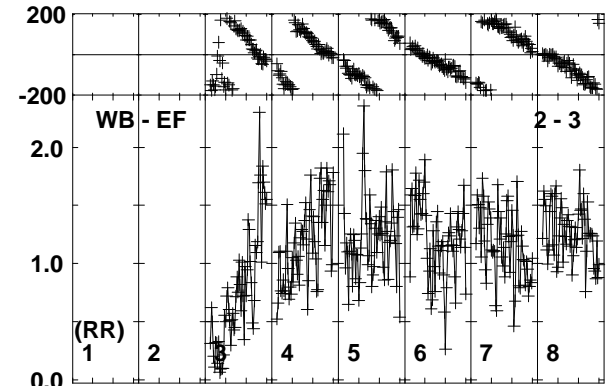
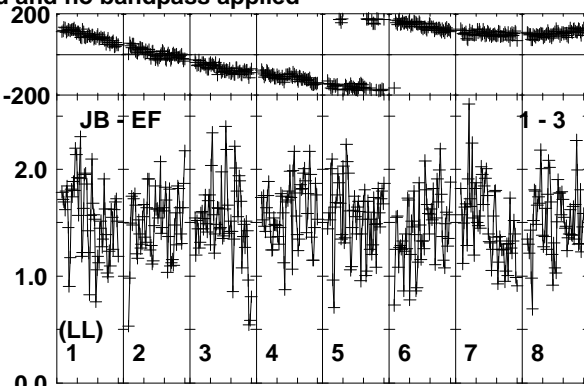
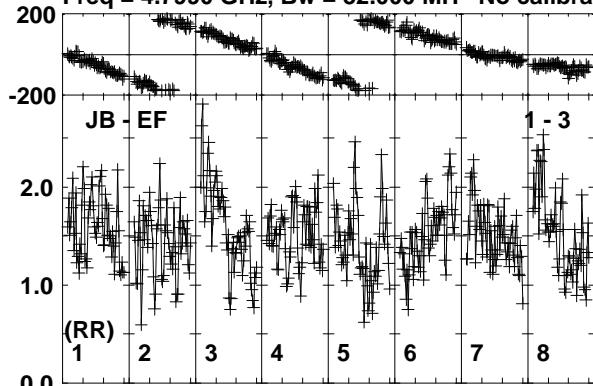

Lower frame: Milli Ampl Jy Top frame: Phas deg
Vector averaged cross-power spectrum Baseline: JB (01) - EF (03)
Timerange: 00/23:14:40 to 00/23:15:39

Plot file version 69 created 26-SEP-2019 10:39:42

J0257-1212 RG010A.UVDATA.1

Freq = 4.7990 GHz, Bw = 32.000 MH No calibration applied and no bandpass applied

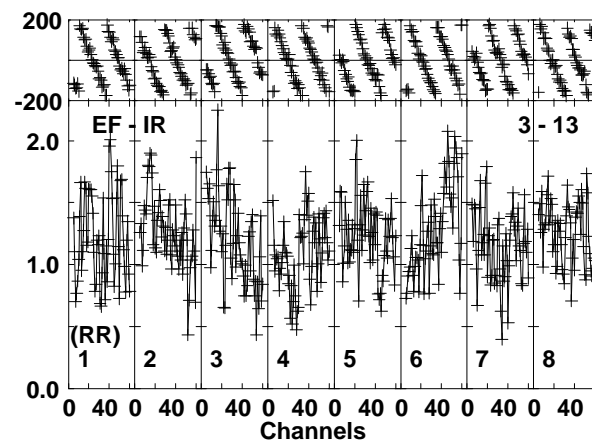
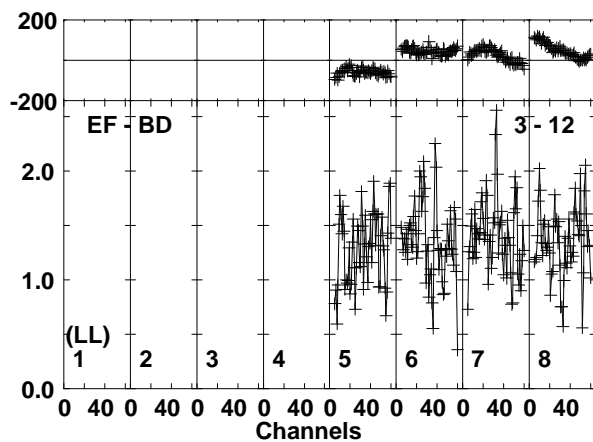
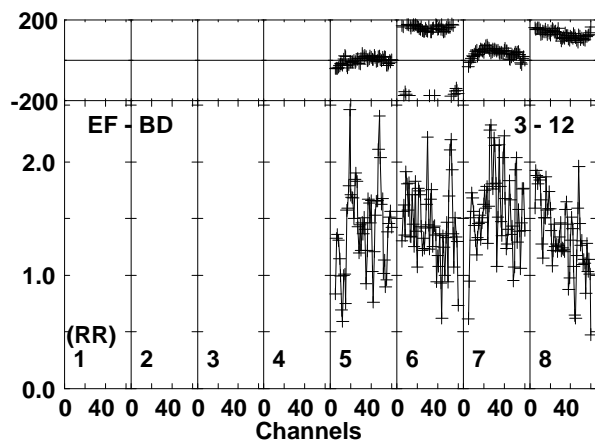
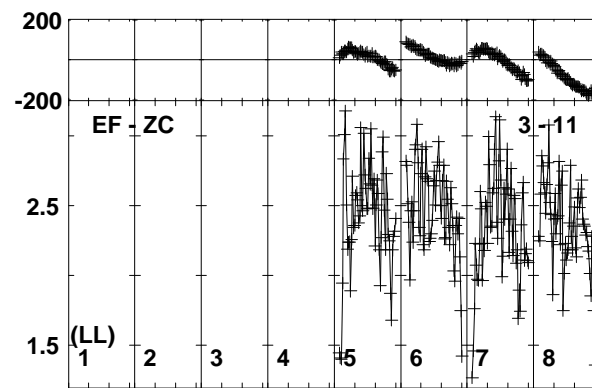
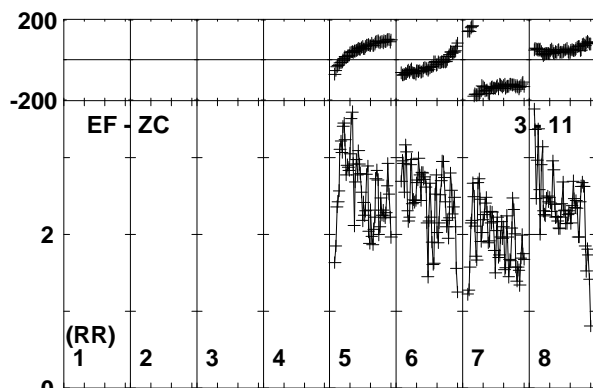
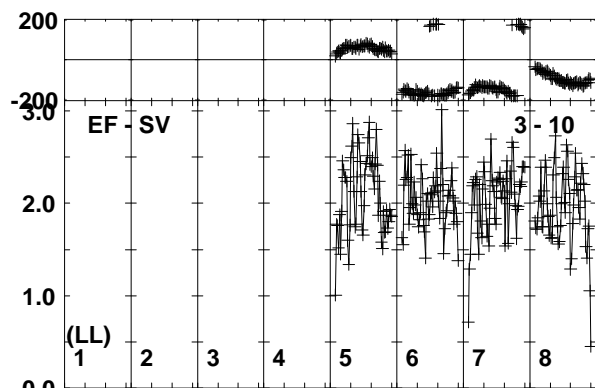
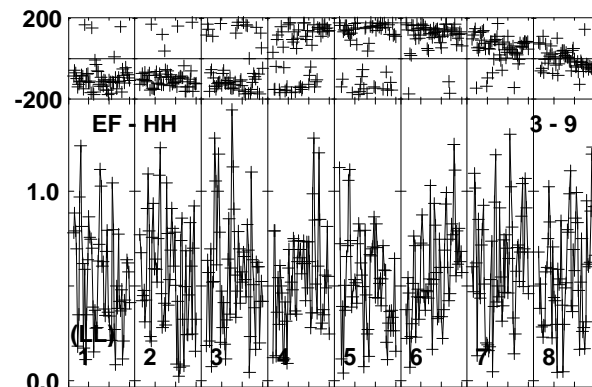
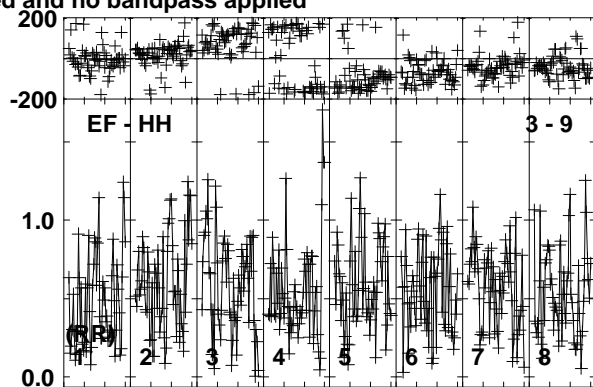
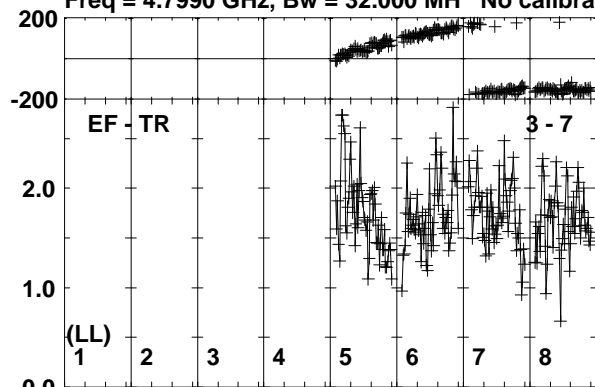

Lower frame: Milli Ampl Jy Top frame: Phas deg
Vector averaged cross-power spectrum Baseline: EF (03) - TR (07)
Timerange: 00/23:14:40 to 00/23:15:39

Plot file version 70 created 26-SEP-2019 10:39:42

J0257-1212 RG010A.UVDATA.1

Freq = 4.7990 GHz, Bw = 32.000 MH No calibration applied and no bandpass applied

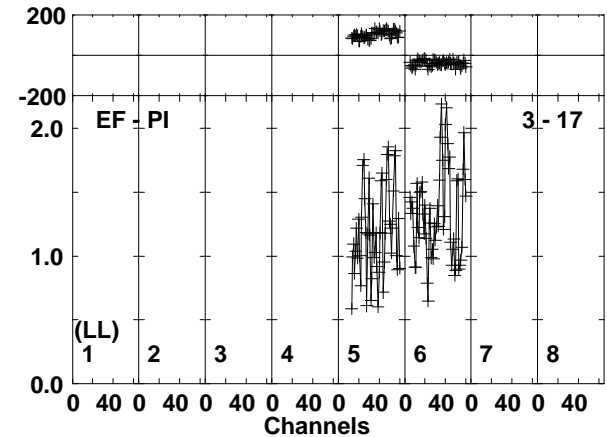
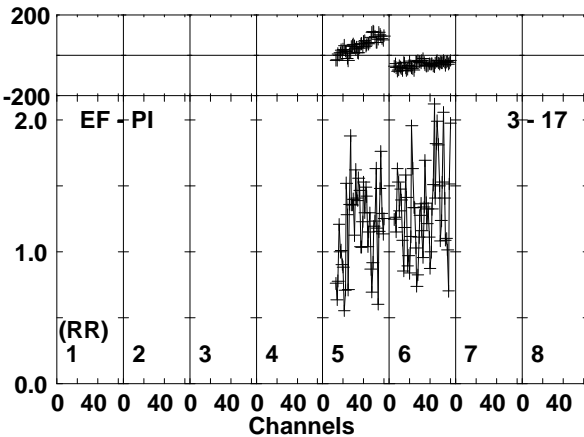
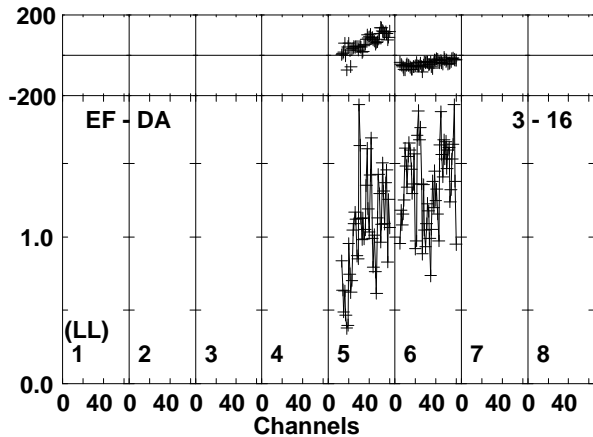
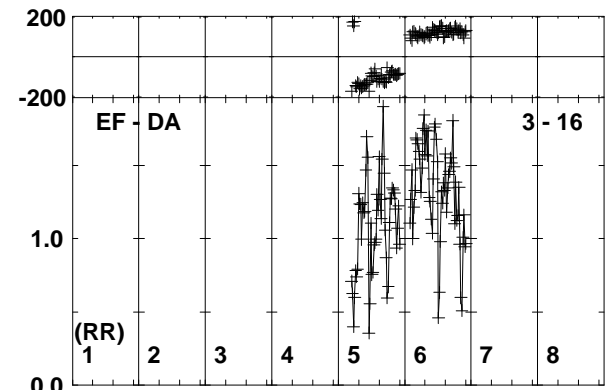
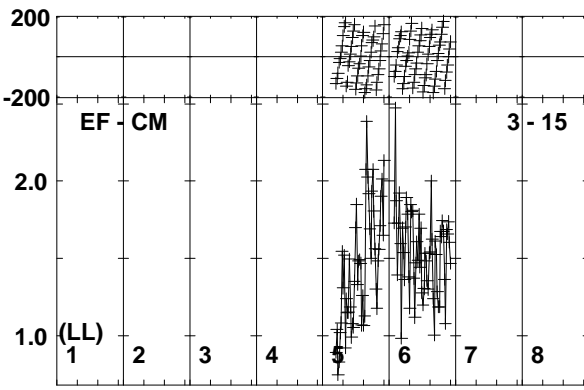
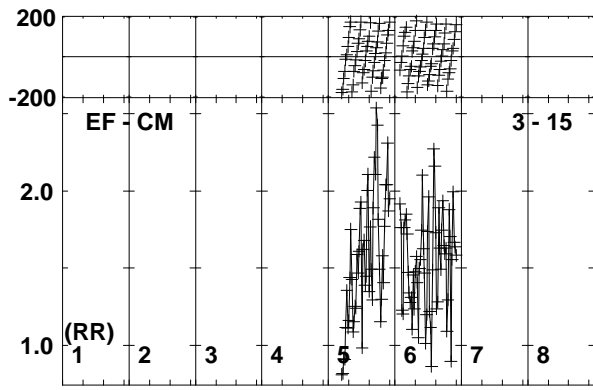
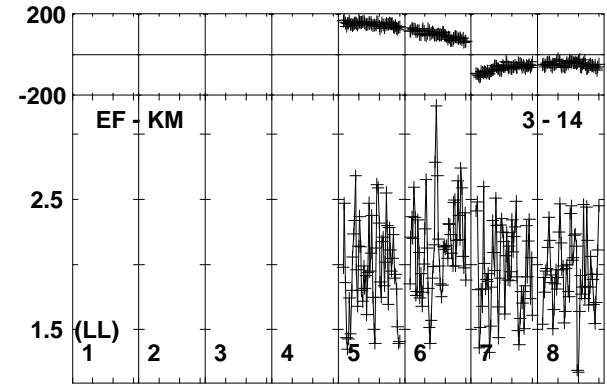
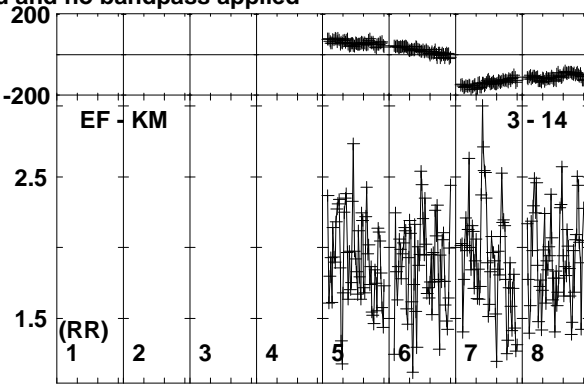
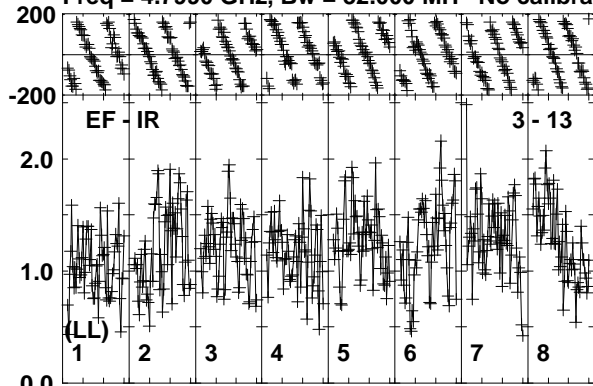

Lower frame: Milli Ampl Jy Top frame: Phas deg
Vector averaged cross-power spectrum Baseline: EF (03) - IR (13)
Timerange: 00/23:14:40 to 00/23:15:39

Plot file version 71 created 26-SEP-2019 10:39:42

J0257-1212 RG010A.UVDATA.1

Freq = 4.7990 GHz, Bw = 32.000 MH No calibration applied and no bandpass applied

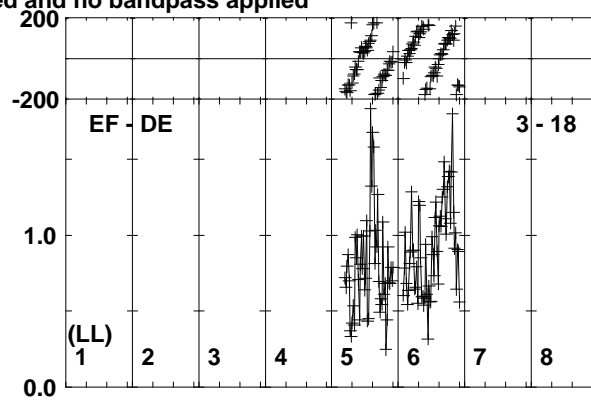
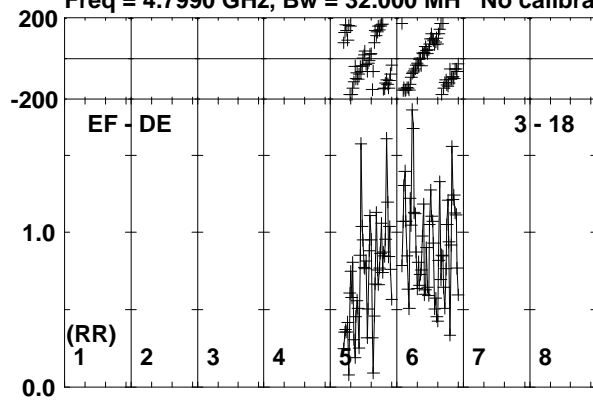

Lower frame: Milli Ampl Jy Top frame: Phas deg
Vector averaged cross-power spectrum Baseline: EF (03) - DE (18)
Timerange: 00/23:14:40 to 00/23:15:39

Plot file version 72 created 26-SEP-2019 10:39:43

190829A RG010A.UVDATA.1

Freq = 4.7990 GHz, Bw = 32.000 MH No calibration applied and no bandpass applied

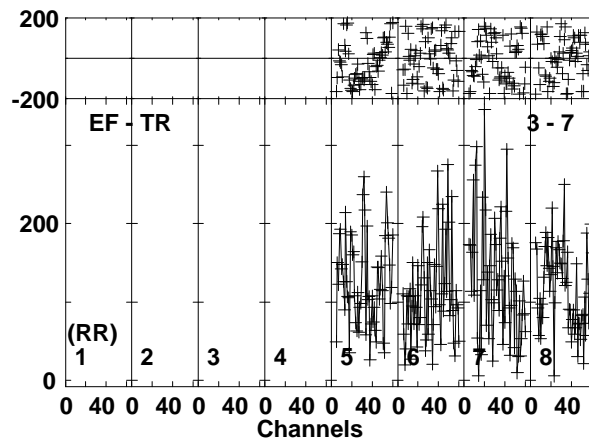
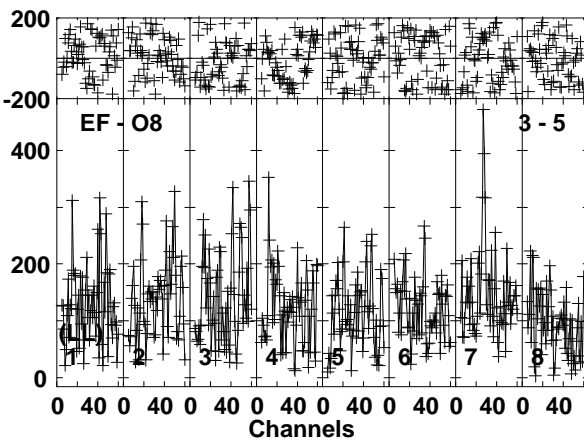
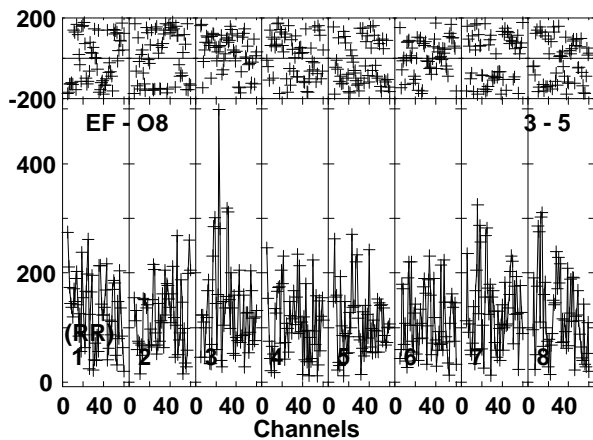
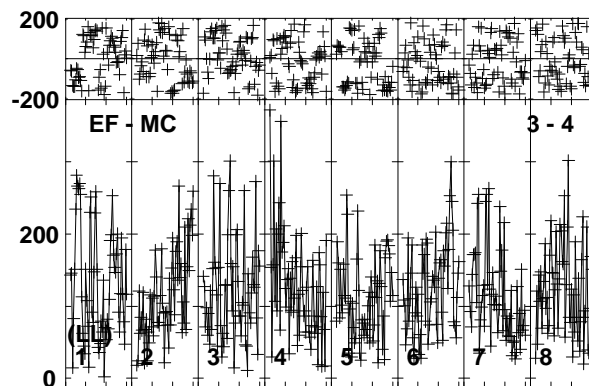
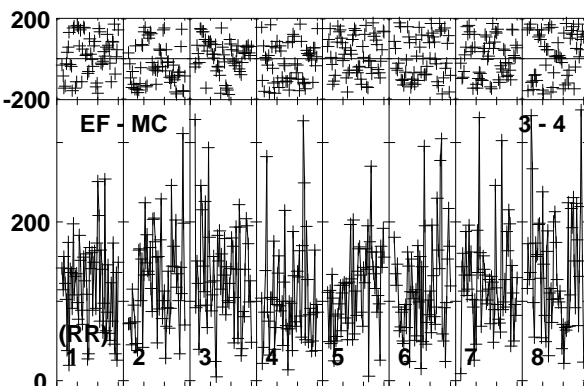
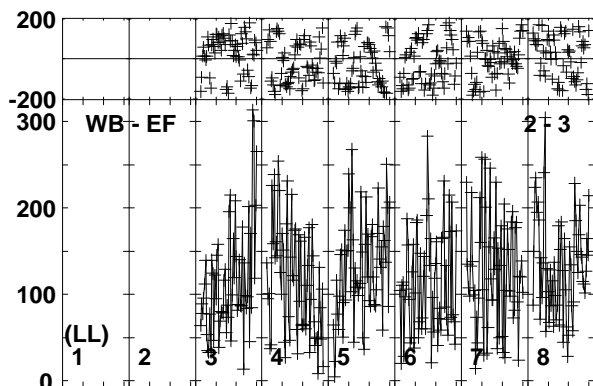
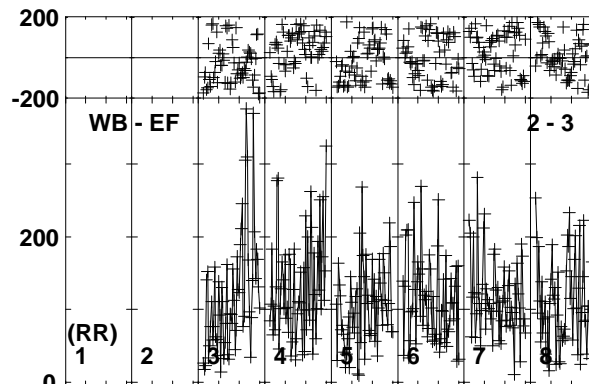
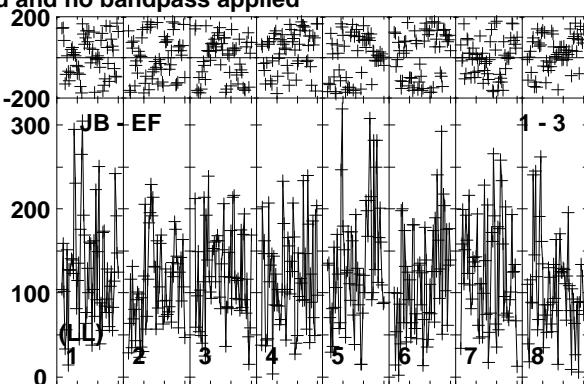
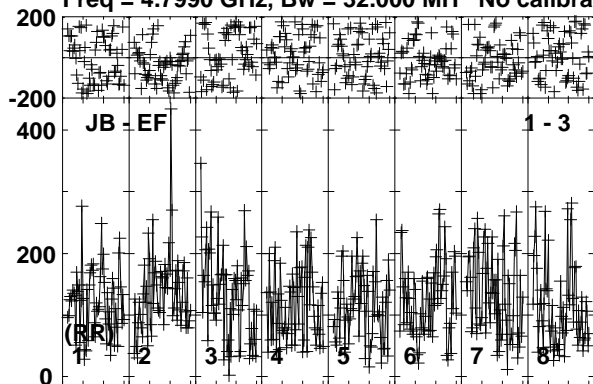

Lower frame: Micro Ampl Jy Top frame: Phas deg
Vector averaged cross-power spectrum Baseline: JB (01) - EF (03)
Timerange: 00/23:15:40 to 00/23:17:50

Plot file version 73 created 26-SEP-2019 10:39:43

190829A RG010A.UVDATA.1

Freq = 4.7990 GHz, Bw = 32.000 MH No calibration applied and no bandpass applied

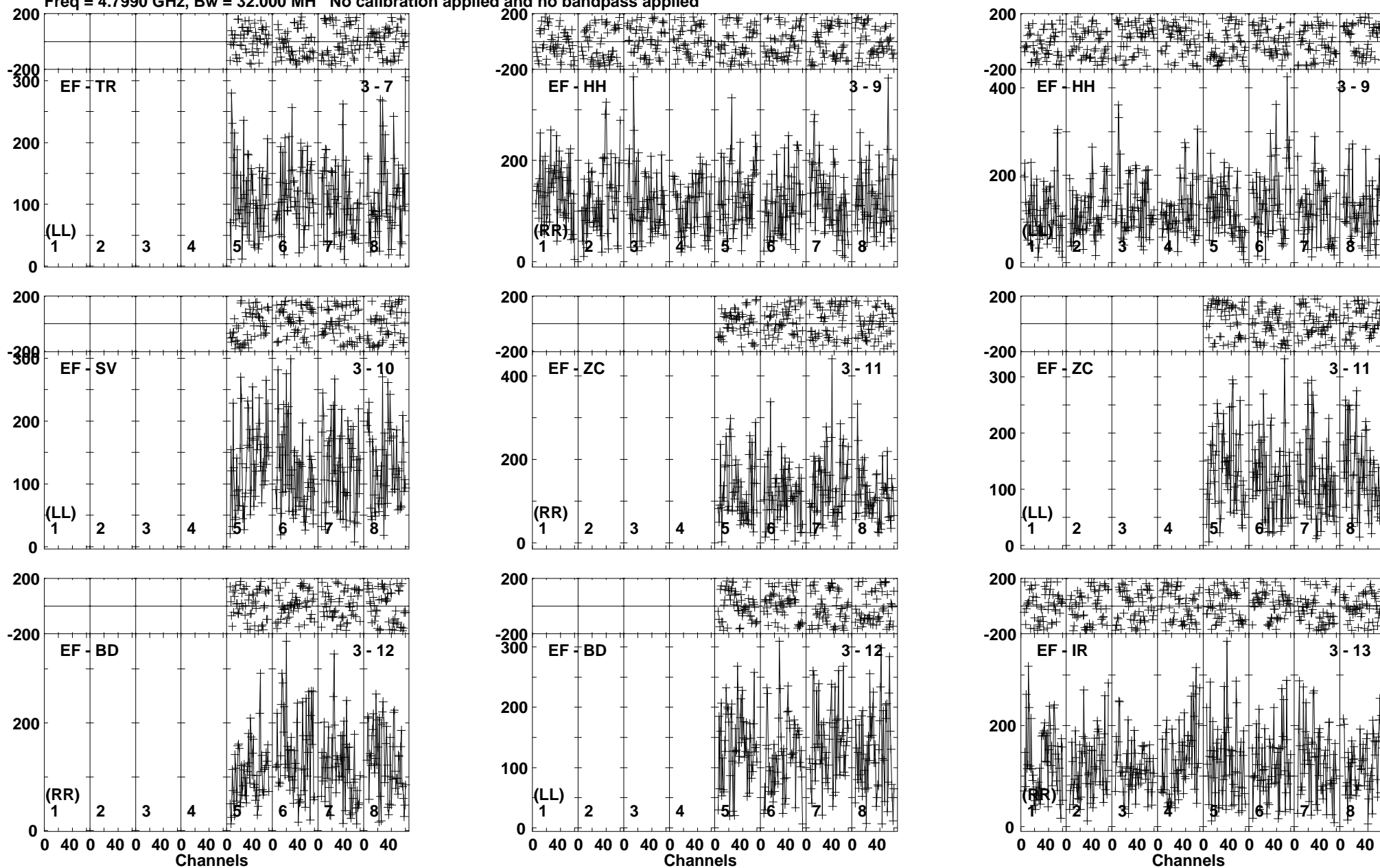

Lower frame: Micro Ampl Jy Top frame: Phas deg
Vector averaged cross-power spectrum Baseline: EF (03) - TR (07)
Timerange: 00/23:15:40 to 00/23:17:50

Plot file version 74 created 26-SEP-2019 10:39:43

190829A RG010A.UVDATA.1

Freq = 4.7990 GHz, Bw = 32.000 MH No calibration applied and no bandpass applied

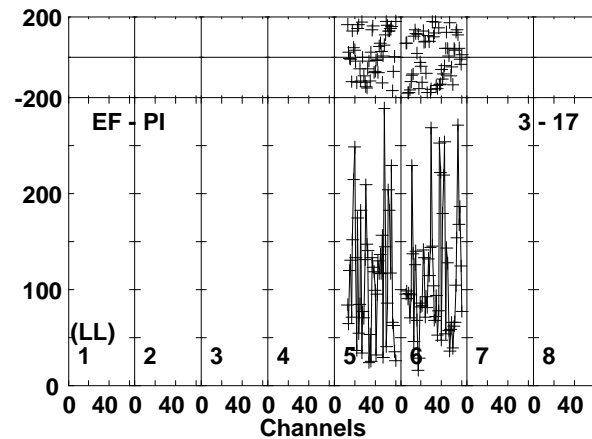
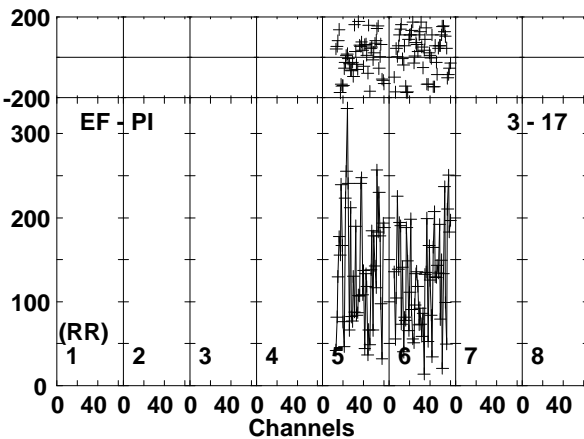
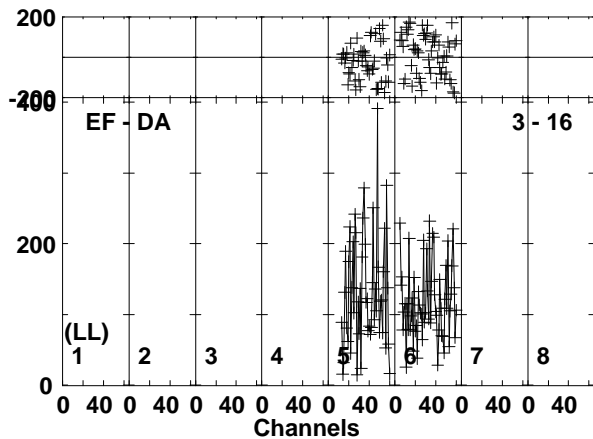
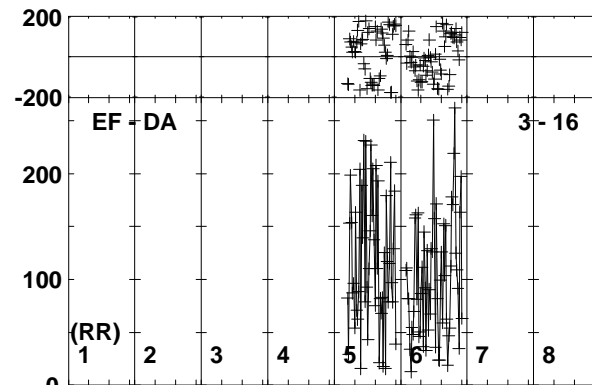
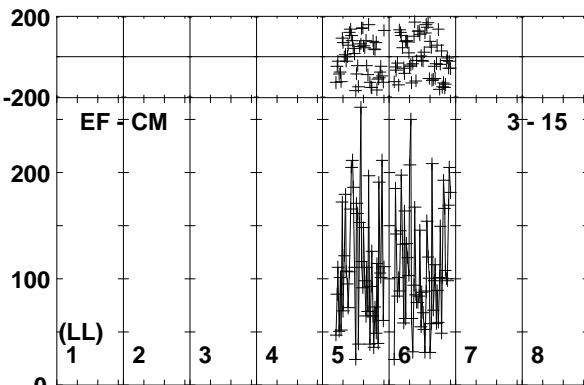
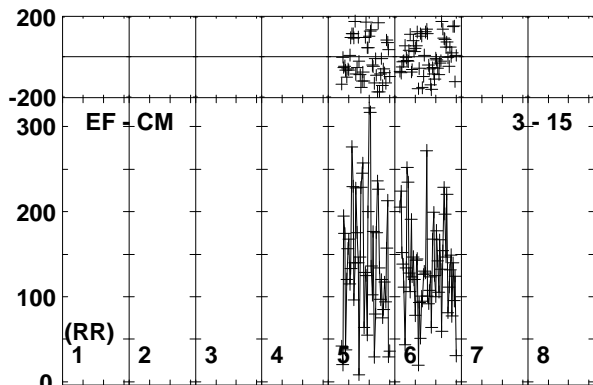
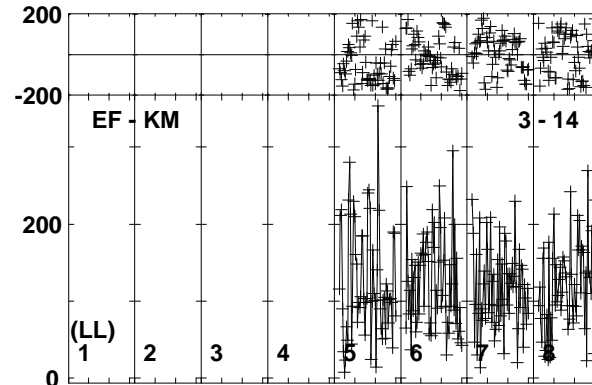
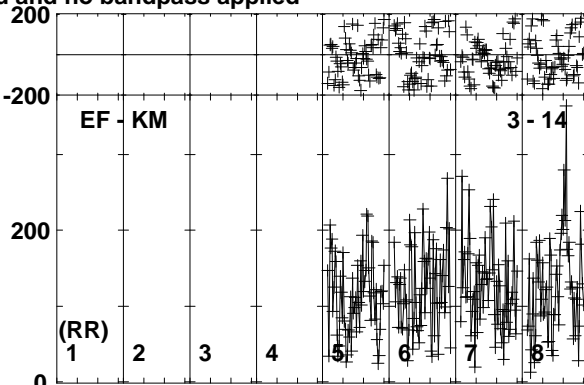
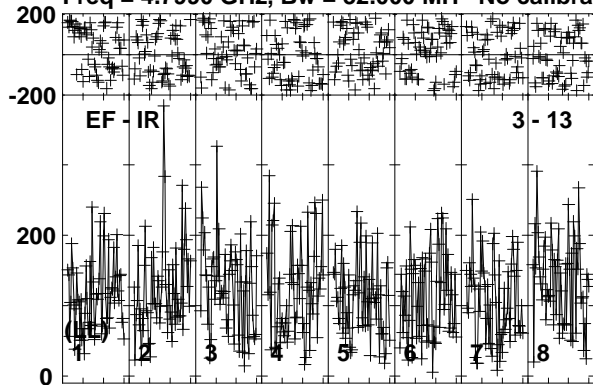

Lower frame: Micro Ampl Jy Top frame: Phas deg
Vector averaged cross-power spectrum Baseline: EF (03) - IR (13)
Timerange: 00/23:15:40 to 00/23:17:50

Plot file version 75 created 26-SEP-2019 10:39:44

190829A RG010A.UVDATA.1

Freq = 4.7990 GHz, Bw = 32.000 MH No calibration applied and no bandpass applied

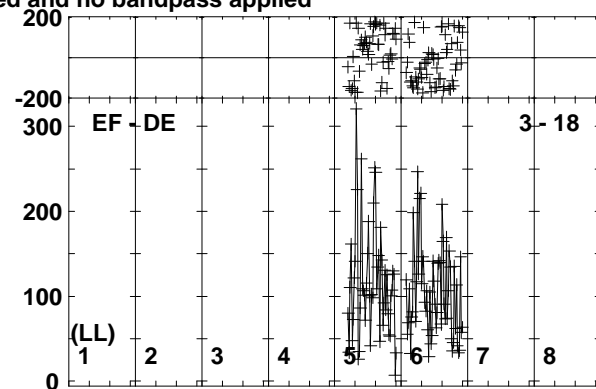
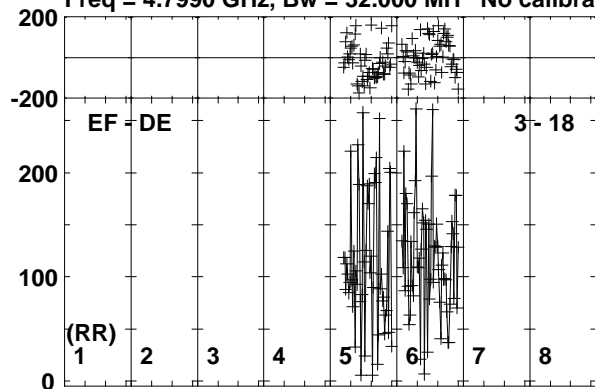

Lower frame: Micro Ampl Jy Top frame: Phas deg
Vector averaged cross-power spectrum Baseline: EF (03) - DE (18)
Timerange: 00/23:15:40 to 00/23:17:50

Plot file version 76 created 26-SEP-2019 10:39:44

J0257-1212 RG010A.UVDATA.1

Freq = 4.7990 GHz, Bw = 32.000 MH No calibration applied and no bandpass applied

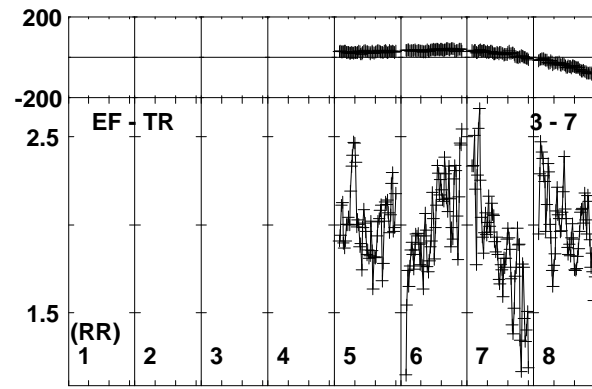
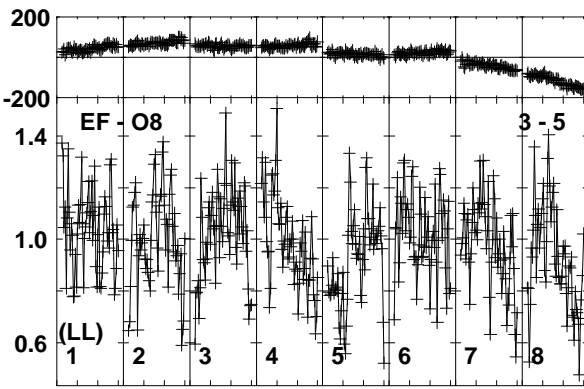
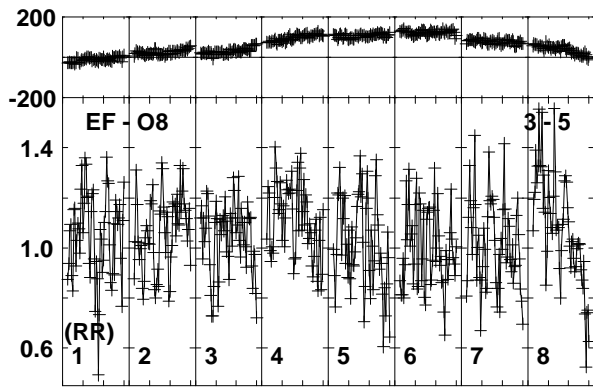
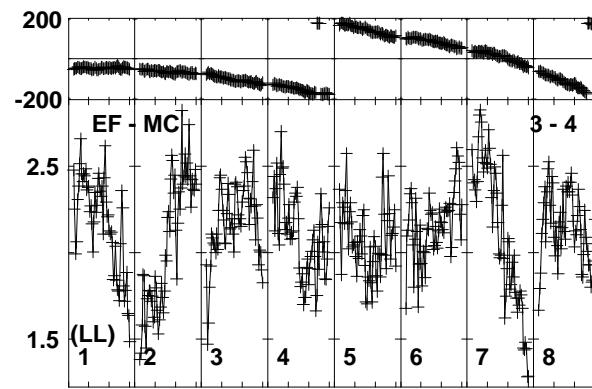
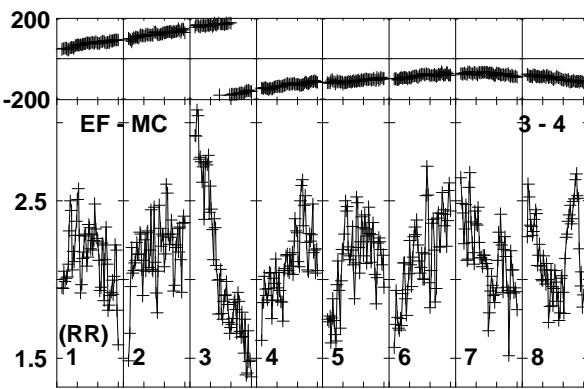
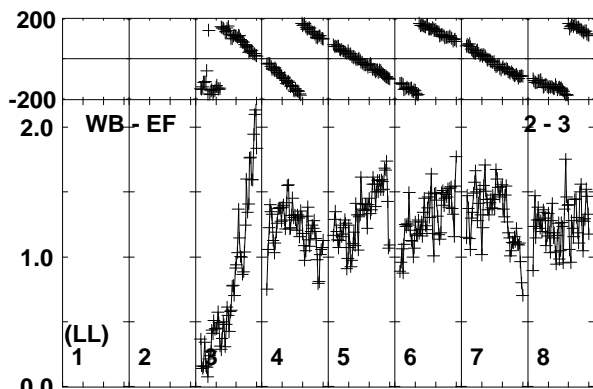
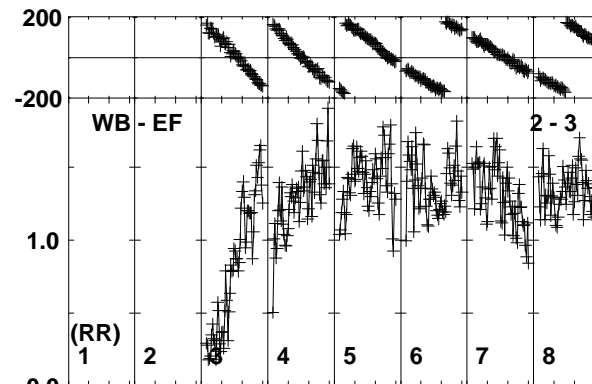
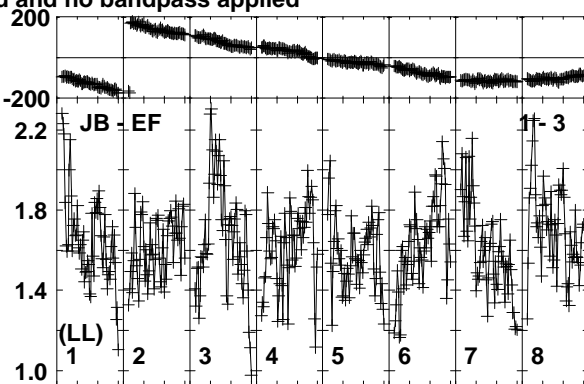
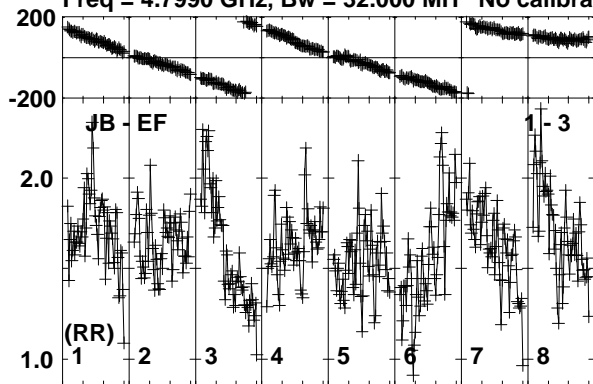

Lower frame: Milli Ampl Jy Top frame: Phas deg
Vector averaged cross-power spectrum Baseline: JB (01) - EF (03)
Timerange: 00/23:18:40 to 00/23:19:09

Plot file version 77 created 26-SEP-2019 10:39:44

J0257-1212 RG010A.UVDATA.1

Freq = 4.7990 GHz, Bw = 32.000 MH No calibration applied and no bandpass applied

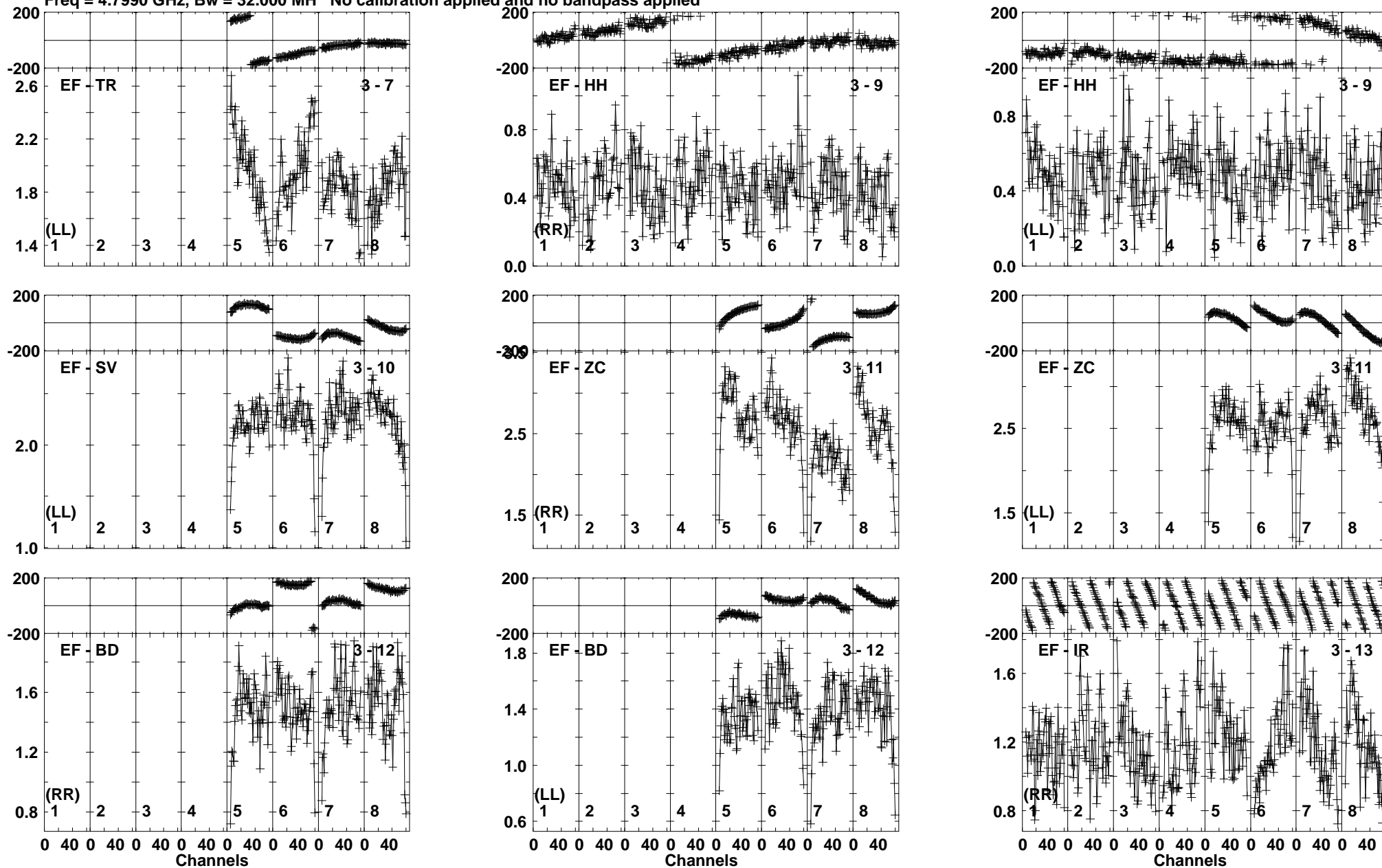

Lower frame: Milli Ampl Jy Top frame: Phas deg
Vector averaged cross-power spectrum Baseline: EF (03) - TR (07)
Timerange: 00/23:18:40 to 00/23:19:09

Plot file version 78 created 26-SEP-2019 10:39:44

J0257-1212 RG010A.UVDATA.1

Freq = 4.7990 GHz, Bw = 32.000 MH No calibration applied and no bandpass applied

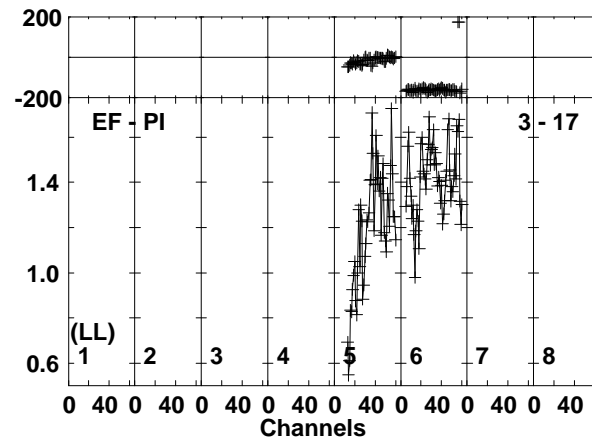
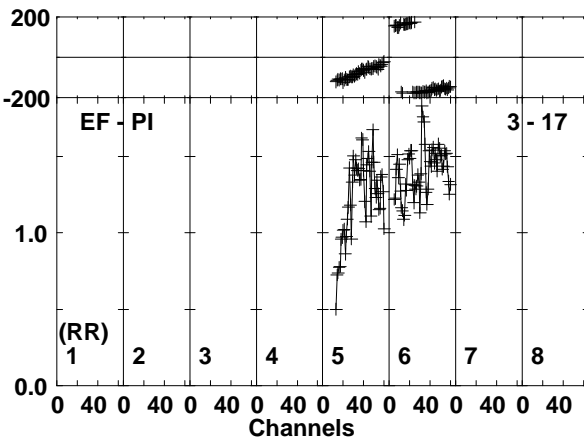
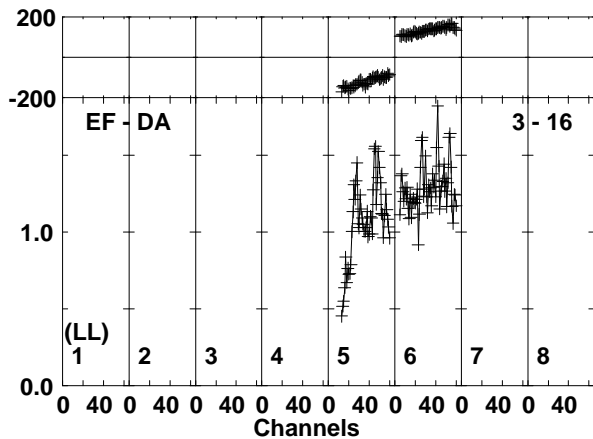
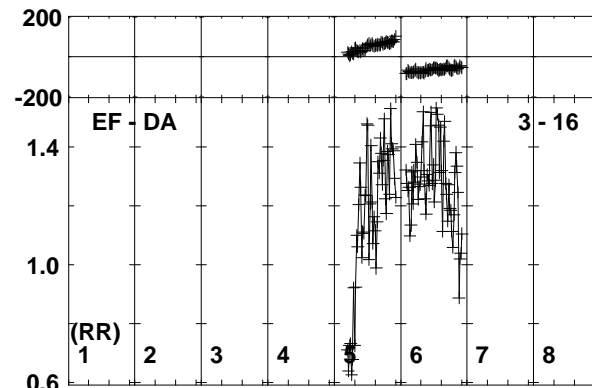
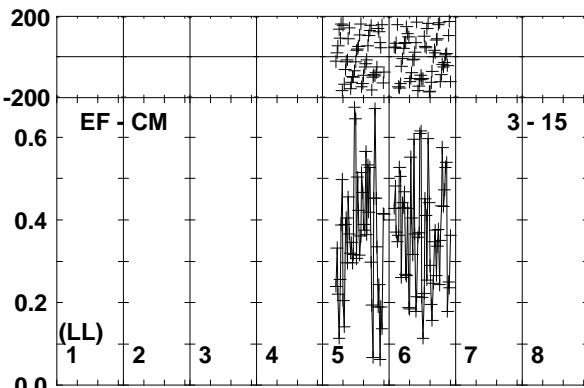
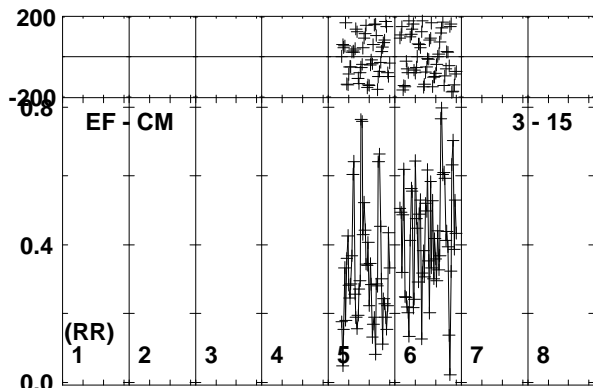
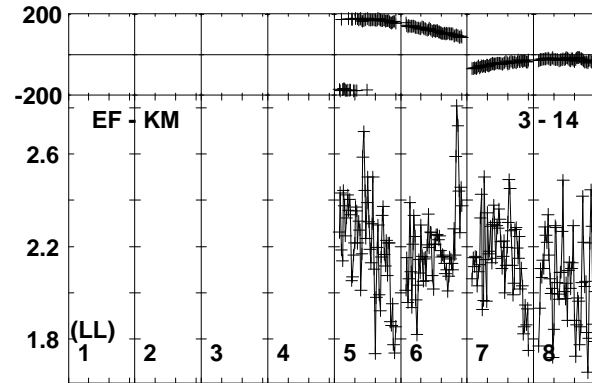
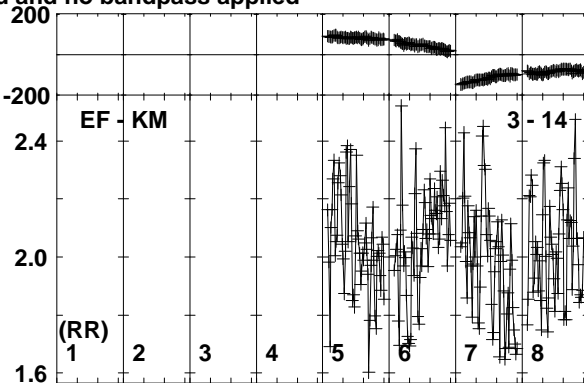
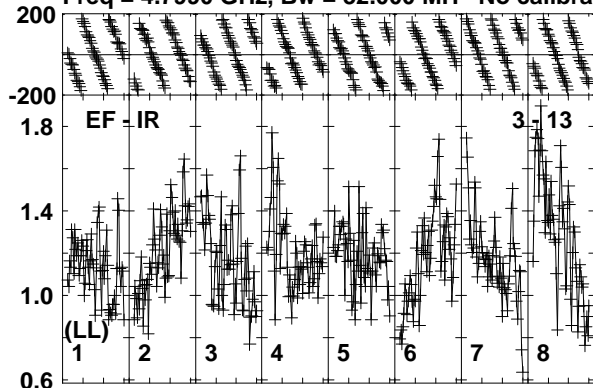

Lower frame: Milli Ampl Jy Top frame: Phas deg
Vector averaged cross-power spectrum Baseline: EF (03) - IR (13)
Timerange: 00/23:18:40 to 00/23:19:09

Plot file version 79 created 26-SEP-2019 10:39:45

J0257-1212 RG010A.UVDATA.1

Freq = 4.7990 GHz, Bw = 32.000 MH No calibration applied and no bandpass applied

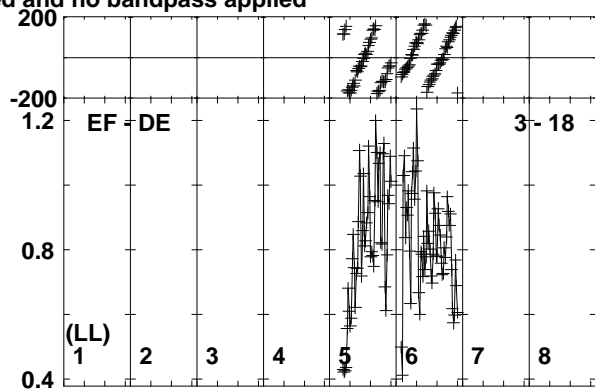
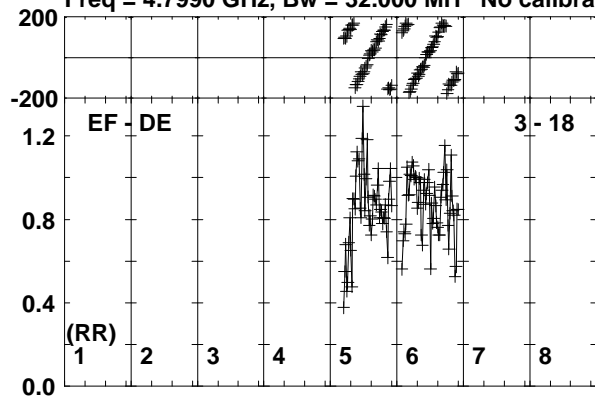

Lower frame: Milli Ampl Jy Top frame: Phas deg
Vector averaged cross-power spectrum Baseline: EF (03) - DE (18)
Timerange: 00/23:18:40 to 00/23:19:09

Plot file version 80 created 26-SEP-2019 10:39:45

J0300-0846 RG010A.UVDATA.1

Freq = 4.7990 GHz, Bw = 32.000 MH No calibration applied and no bandpass applied

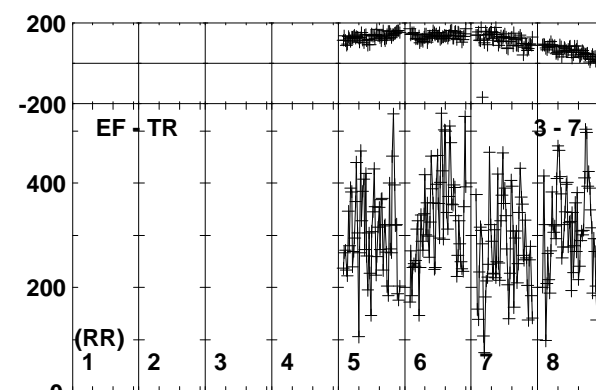
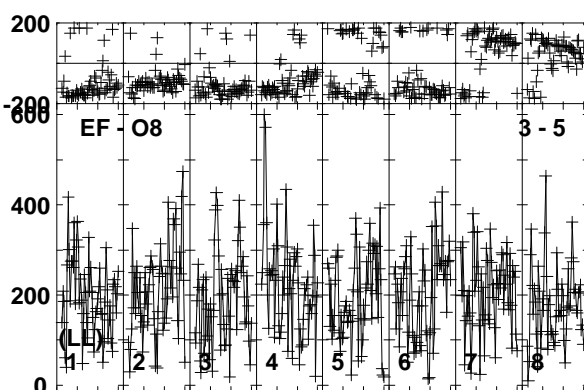
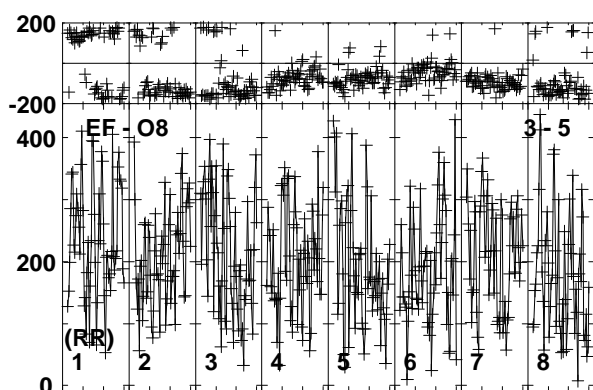
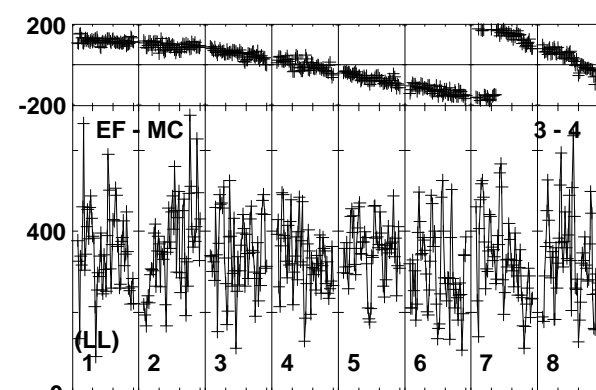
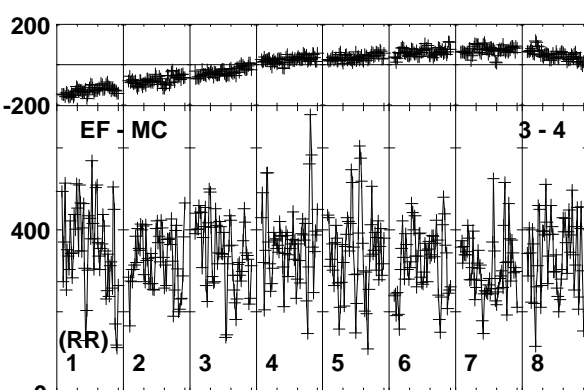
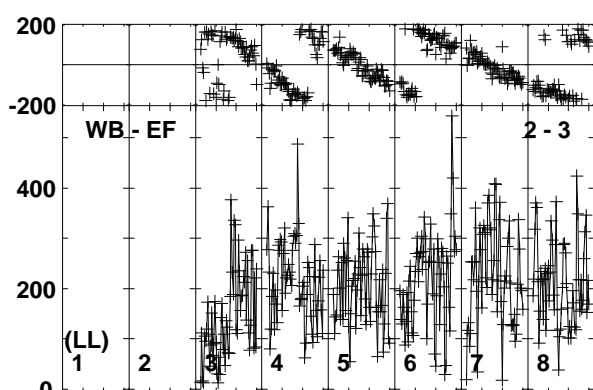
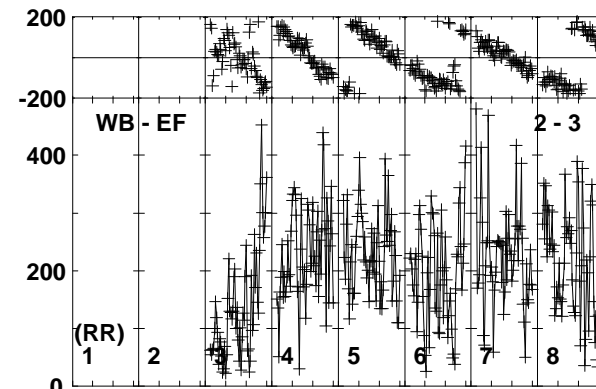
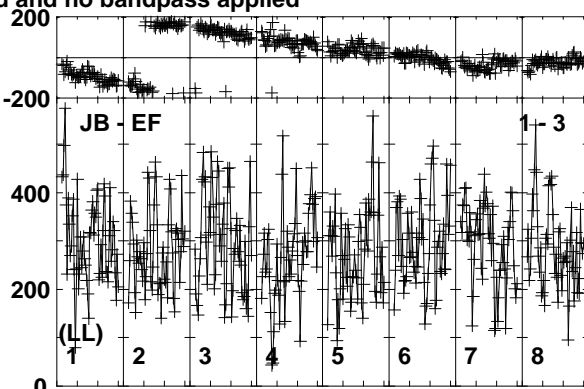
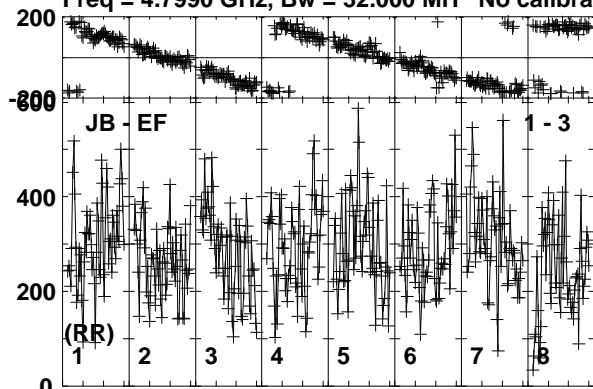

Lower frame: Micro Ampl Jy Top frame: Phas deg
Vector averaged cross-power spectrum Baseline: JB (01) - EF (03)
Timerange: 00/23:19:11 to 00/23:21:20

Plot file version 81 created 26-SEP-2019 10:39:45

J0300-0846 RG010A.UVDATA.1

Freq = 4.7990 GHz, Bw = 32.000 MH No calibration applied and no bandpass applied

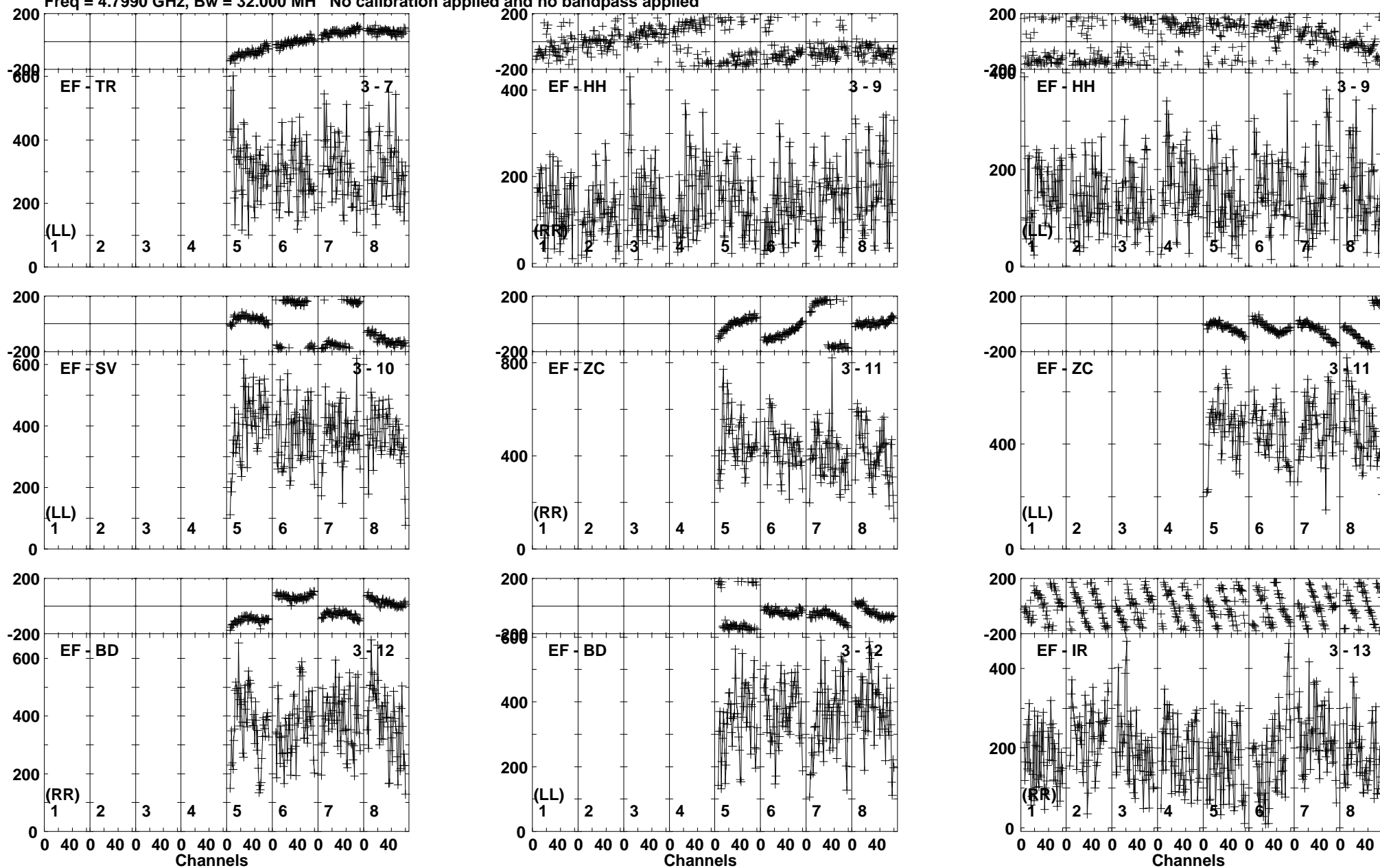

Lower frame: Micro Ampl Jy Top frame: Phas deg
Vector averaged cross-power spectrum Baseline: EF (03) - TR (07)
Timerange: 00/23:19:11 to 00/23:21:20

Plot file version 82 created 26-SEP-2019 10:39:46

J0300-0846 RG010A.UVDATA.1

Freq = 4.7990 GHz, Bw = 32.000 MH No calibration applied and no bandpass applied

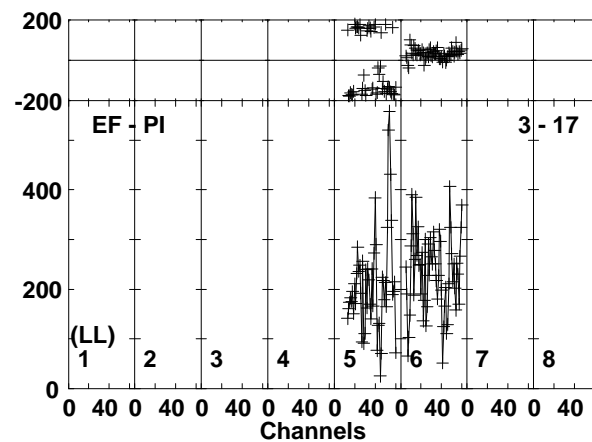
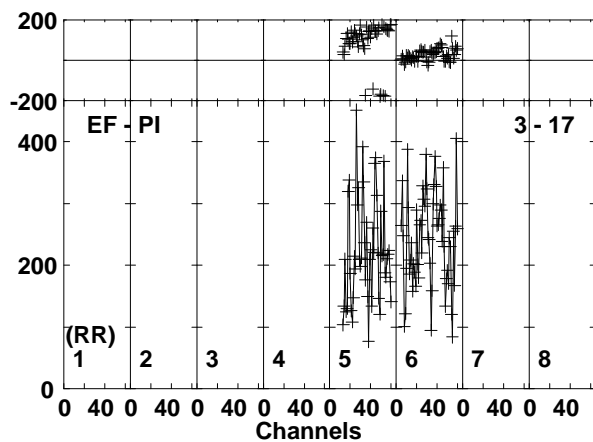
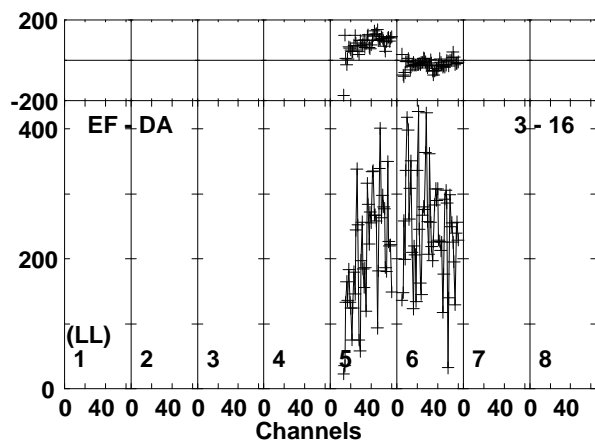
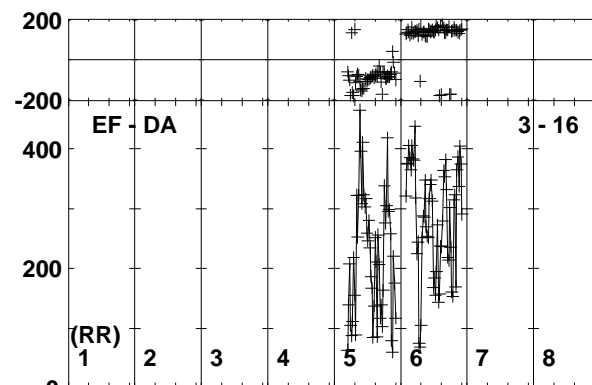
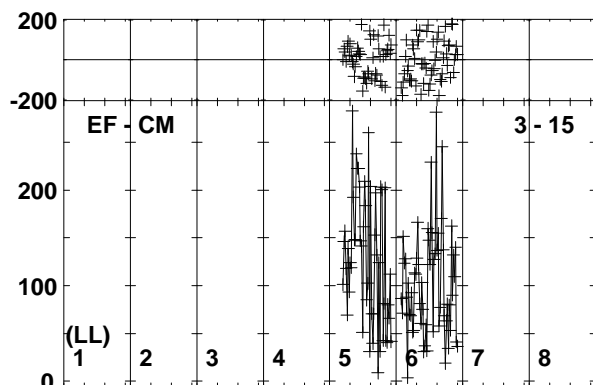
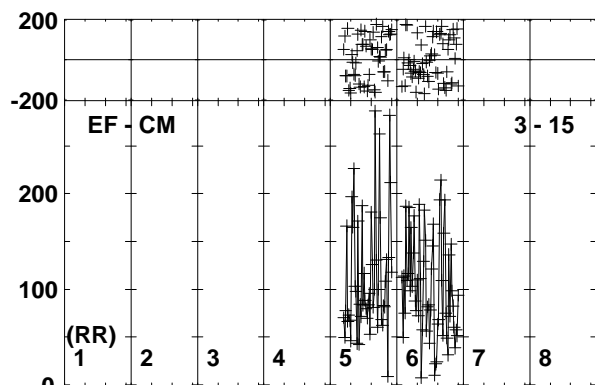
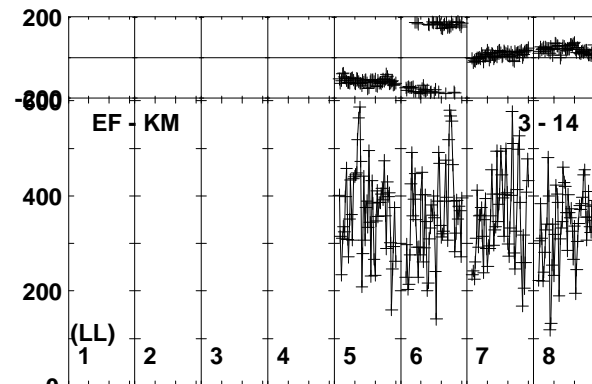
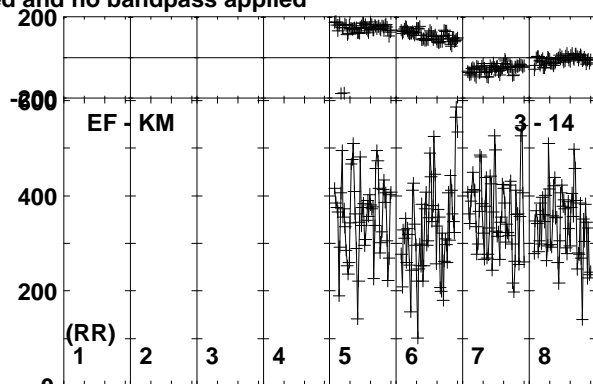
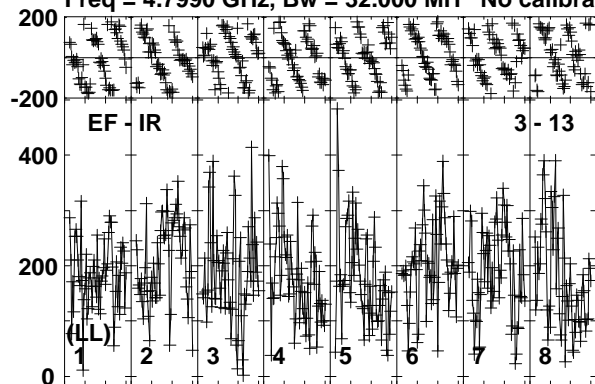

Lower frame: Micro Ampl Jy Top frame: Phas deg
Vector averaged cross-power spectrum Baseline: EF (03) - IR (13)
Timerange: 00/23:19:11 to 00/23:21:20

Plot file version 83 created 26-SEP-2019 10:39:46

J0300-0846 RG010A.UVDATA.1

Freq = 4.7990 GHz, Bw = 32.000 MH No calibration applied and no bandpass applied

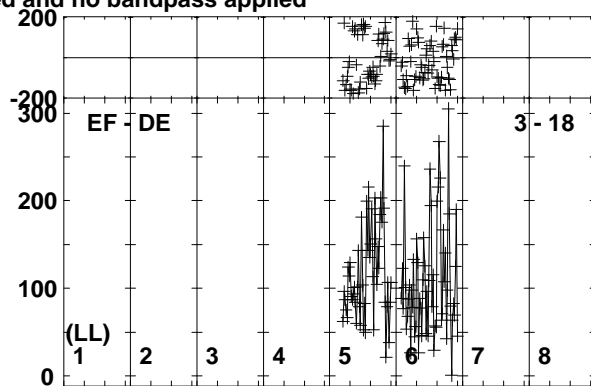
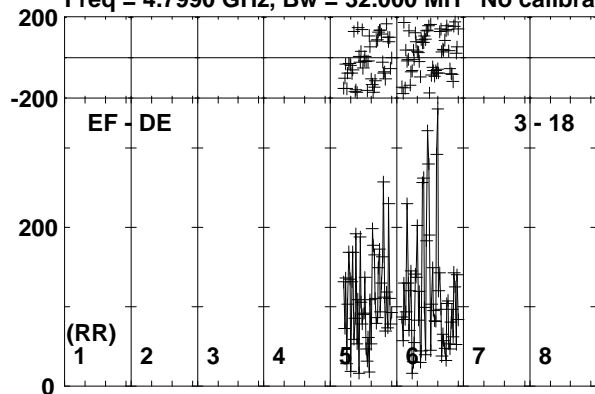

Lower frame: Micro Ampl Jy Top frame: Phas deg
Vector averaged cross-power spectrum Baseline: EF (03) - DE (18)
Timerange: 00/23:19:11 to 00/23:21:20

Plot file version 84 created 26-SEP-2019 10:39:46

J0257-1212 RG010A.UVDATA.1

Freq = 4.7990 GHz, Bw = 32.000 MH No calibration applied and no bandpass applied

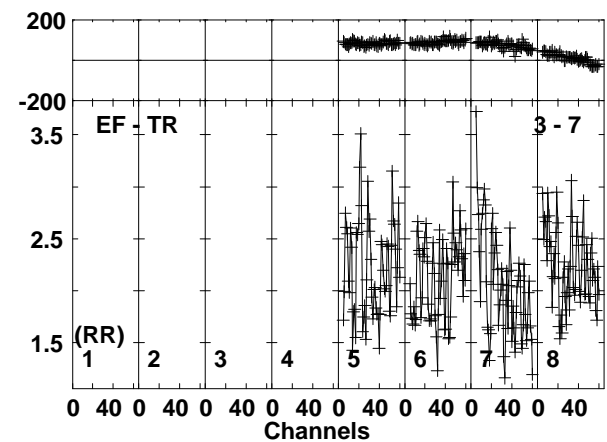
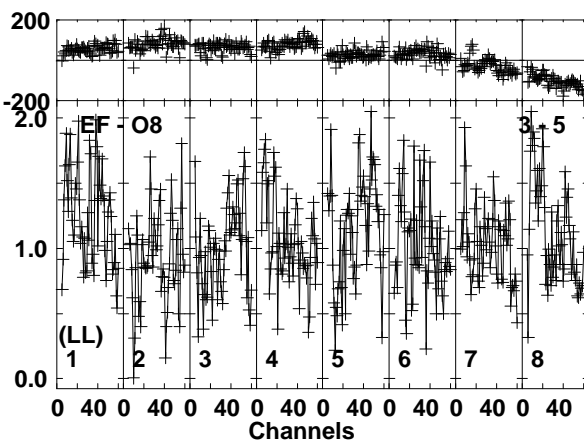
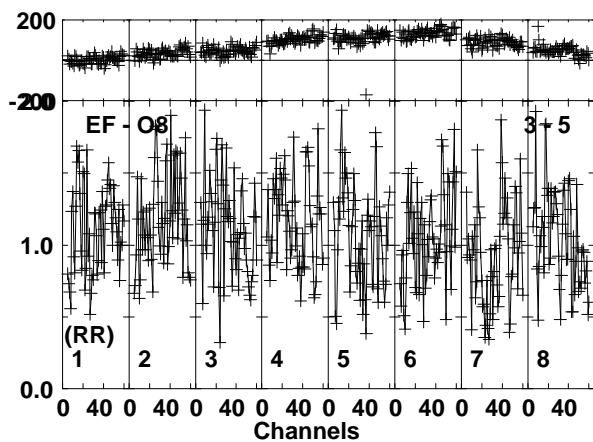
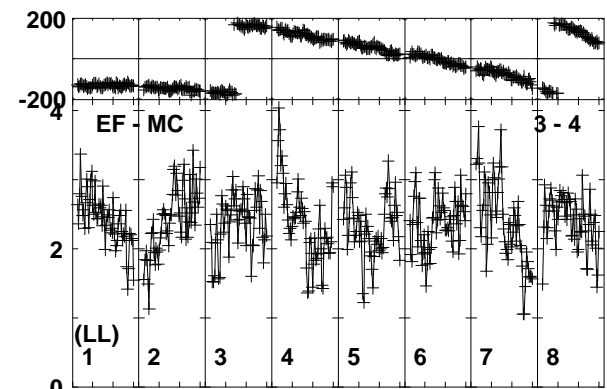
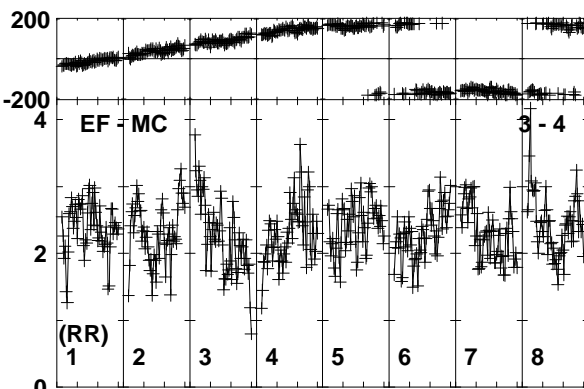
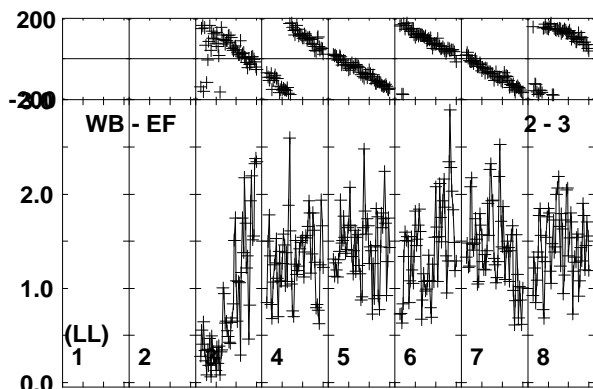
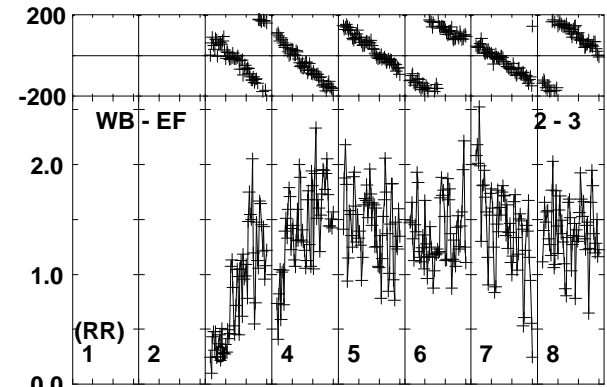
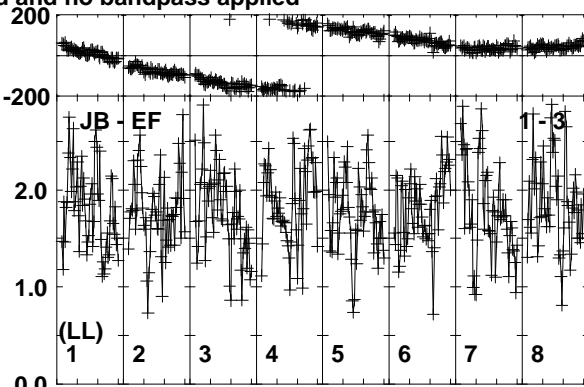
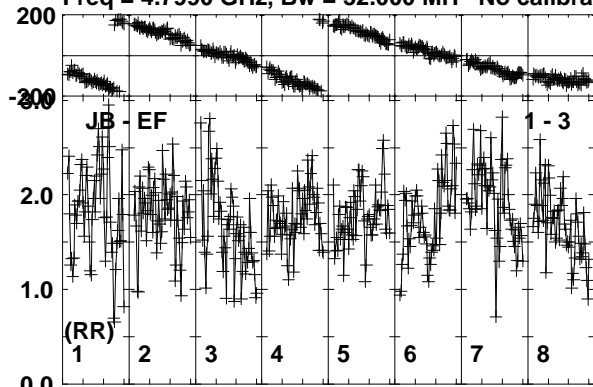

Lower frame: Milli Ampl Jy Top frame: Phas deg
Vector averaged cross-power spectrum Baseline: JB (01) - EF (03)
Timerange: 00/23:21:20 to 00/23:22:19

Plot file version 85 created 26-SEP-2019 10:39:47

J0257-1212 RG010A.UVDATA.1

Freq = 4.7990 GHz, Bw = 32.000 MH No calibration applied and no bandpass applied

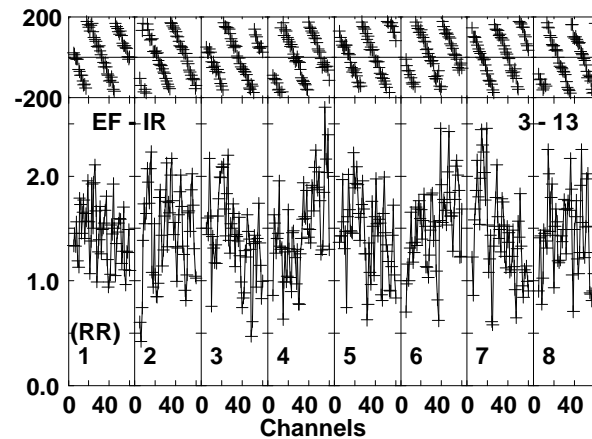
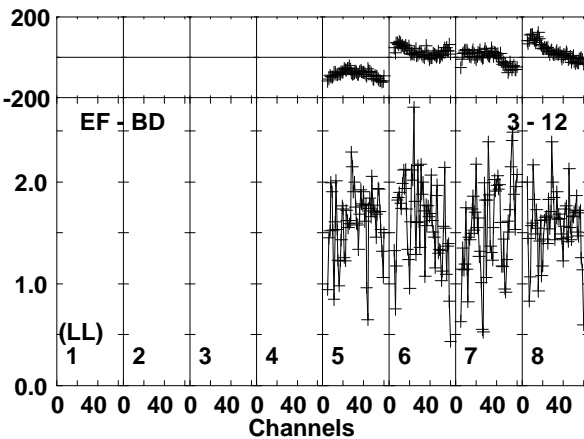
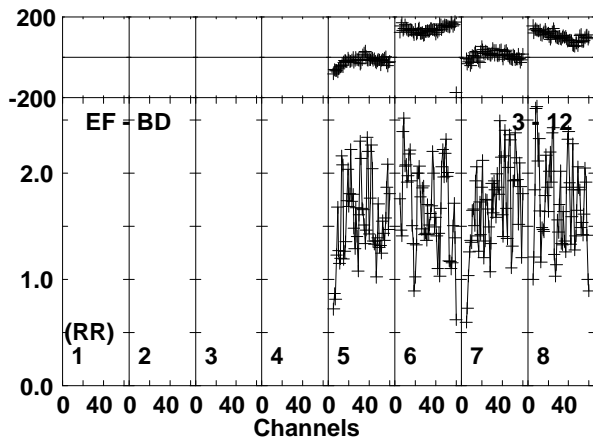
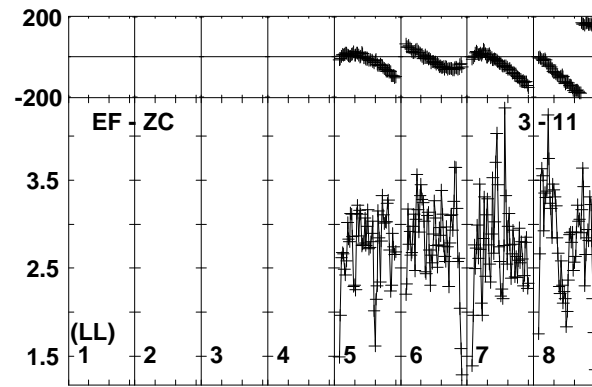
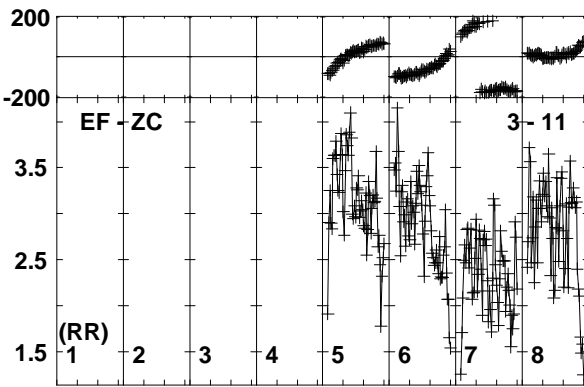
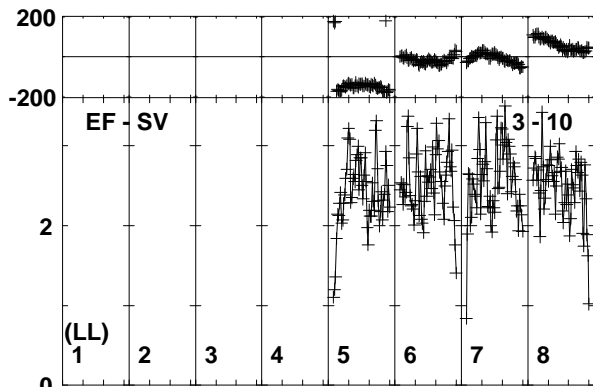
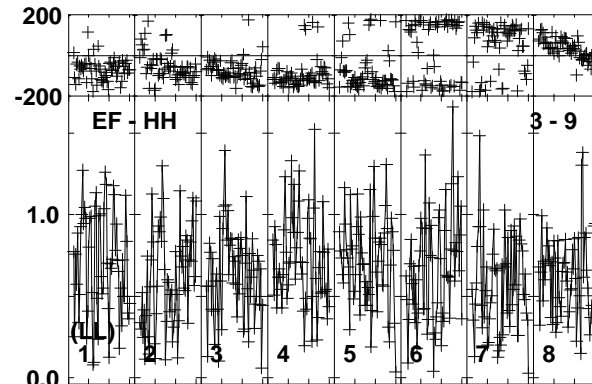
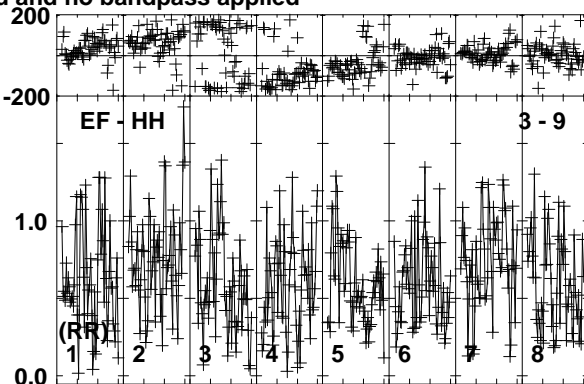
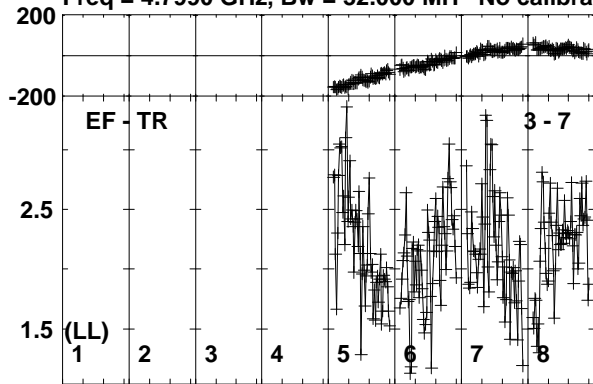

Lower frame: Milli Ampl Jy Top frame: Phas deg
Vector averaged cross-power spectrum Baseline: EF (03) - TR (07)
Timerange: 00/23:21:20 to 00/23:22:19

Plot file version 86 created 26-SEP-2019 10:39:47

J0257-1212 RG010A.UVDATA.1

Freq = 4.7990 GHz, Bw = 32.000 MH No calibration applied and no bandpass applied

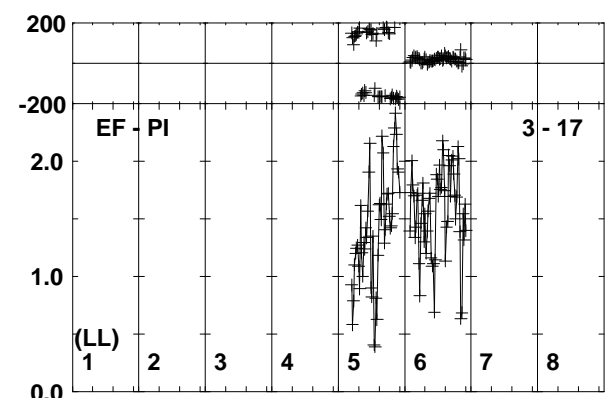
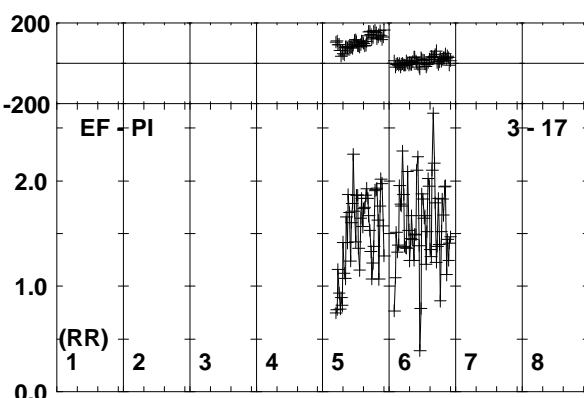
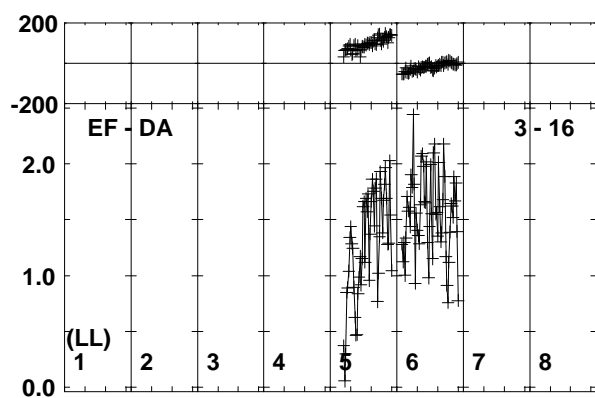
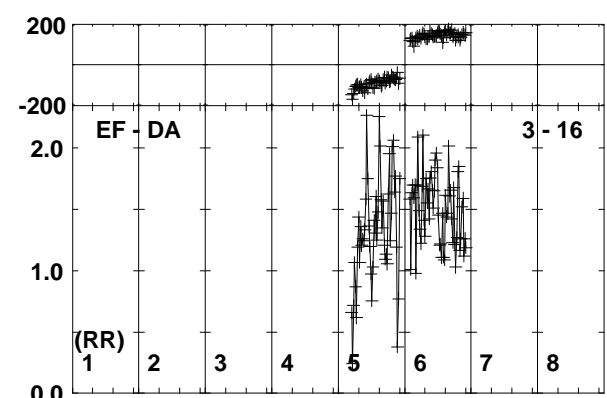
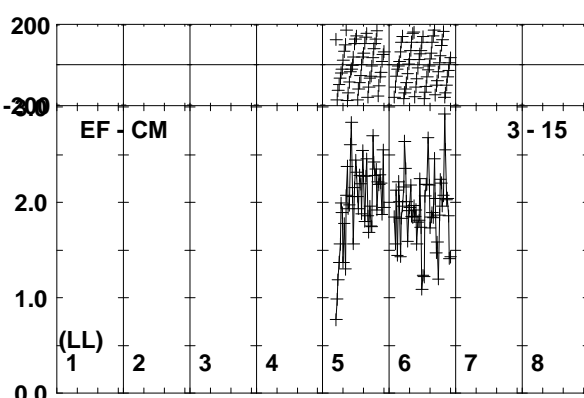
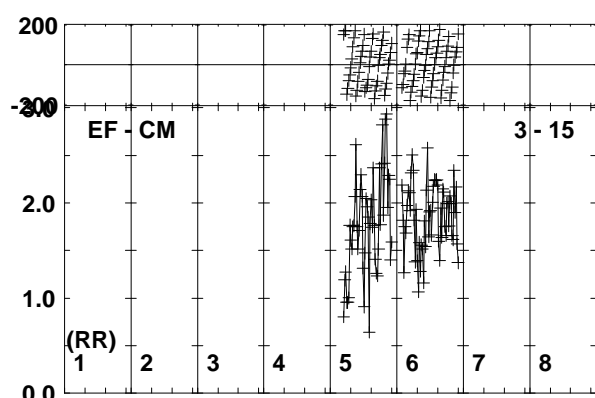
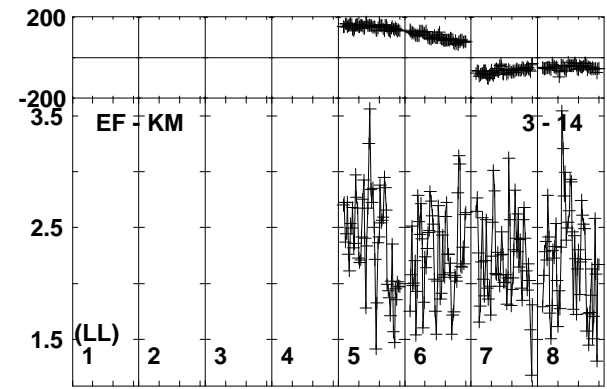
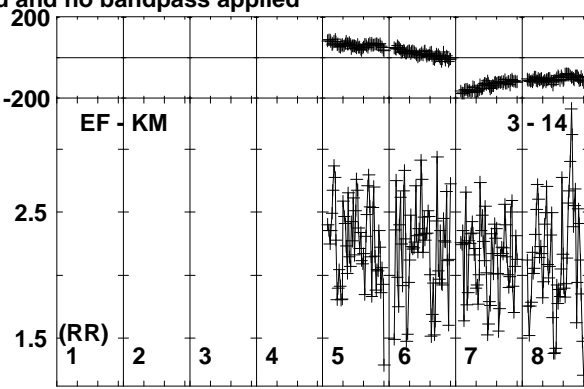
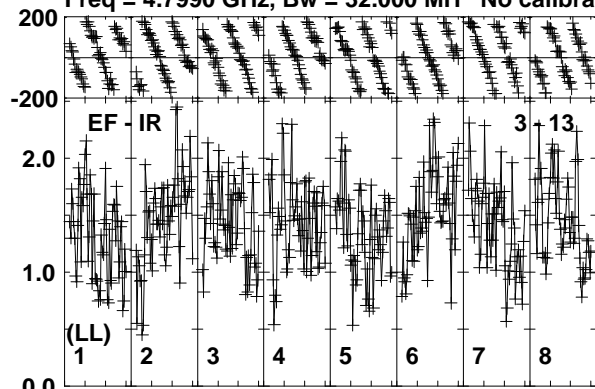

Lower frame: Milli Ampl Jy Top frame: Phas deg
Vector averaged cross-power spectrum Baseline: EF (03) - IR (13)
Timerange: 00/23:21:20 to 00/23:22:19

Plot file version 87 created 26-SEP-2019 10:39:47

J0257-1212 RG010A.UVDATA.1

Freq = 4.7990 GHz, Bw = 32.000 MH No calibration applied and no bandpass applied

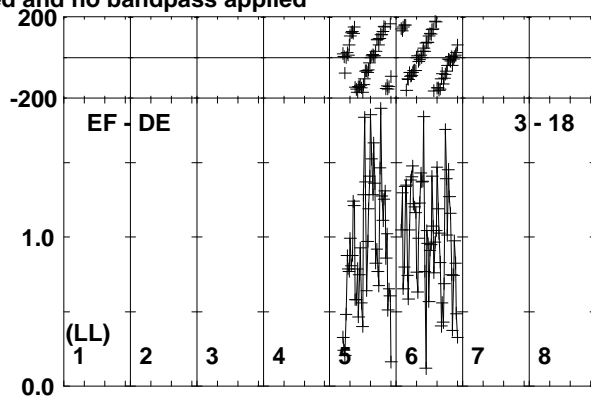
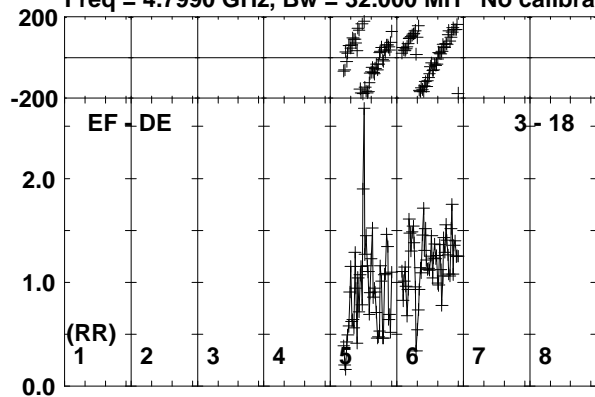

Lower frame: Milli Ampl Jy Top frame: Phas deg
Vector averaged cross-power spectrum Baseline: EF (03) - DE (18)
Timerange: 00/23:21:20 to 00/23:22:19

Plot file version 88 created 26-SEP-2019 10:39:48

190829A RG010A.UVDATA.1

Freq = 4.7990 GHz, Bw = 32.000 MH No calibration applied and no bandpass applied

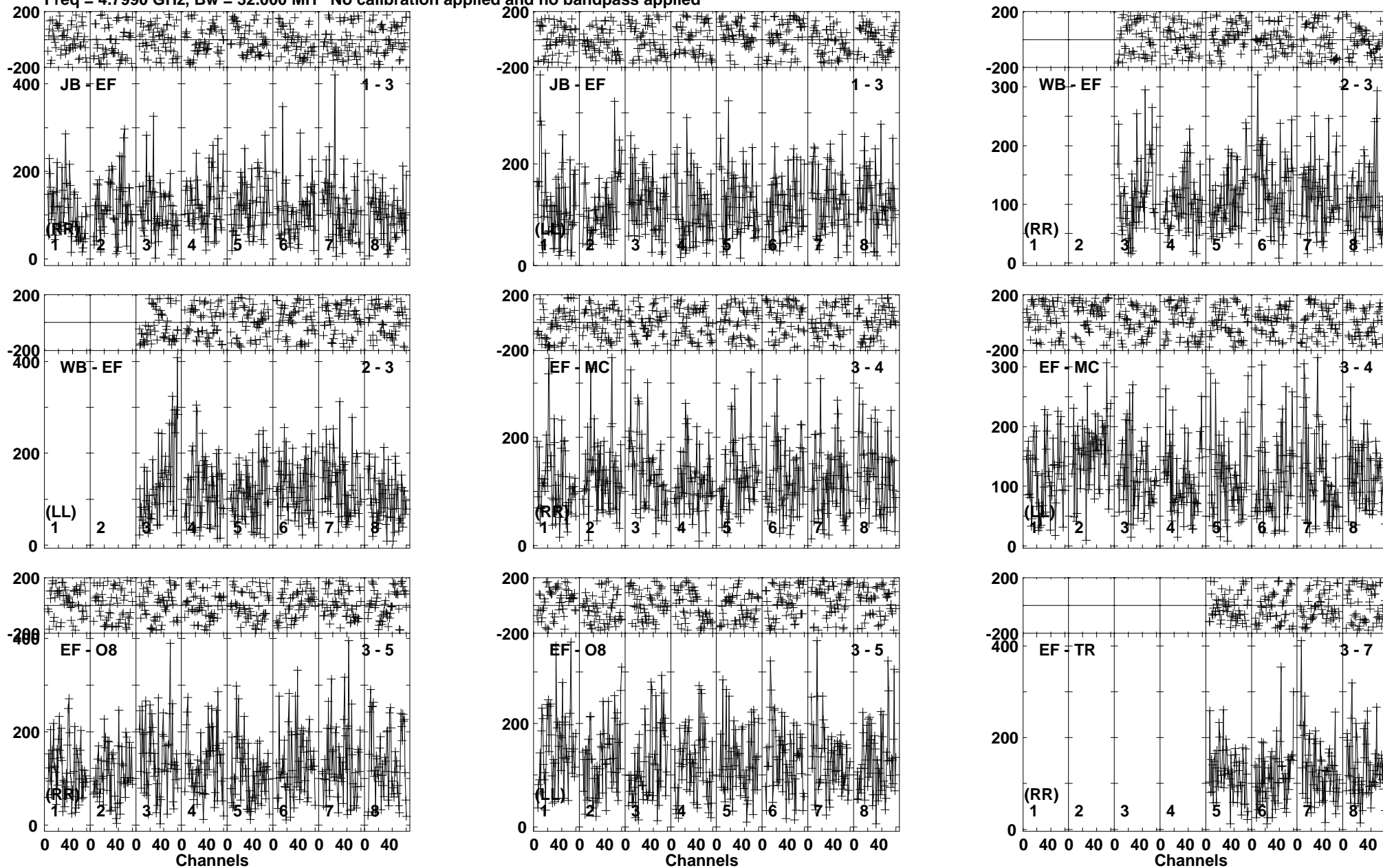

Lower frame: Micro Ampl Jy Top frame: Phas deg
Vector averaged cross-power spectrum Baseline: JB (01) - EF (03)
Timerange: 00/23:22:21 to 00/23:24:30

Plot file version 89 created 26-SEP-2019 10:39:48

190829A RG010A.UVDATA.1

Freq = 4.7990 GHz, Bw = 32.000 MH No calibration applied and no bandpass applied

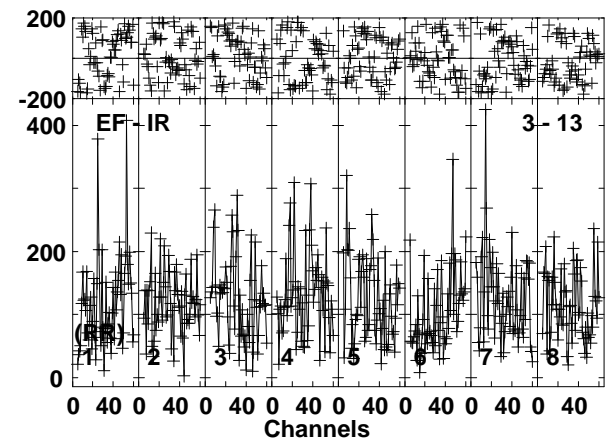
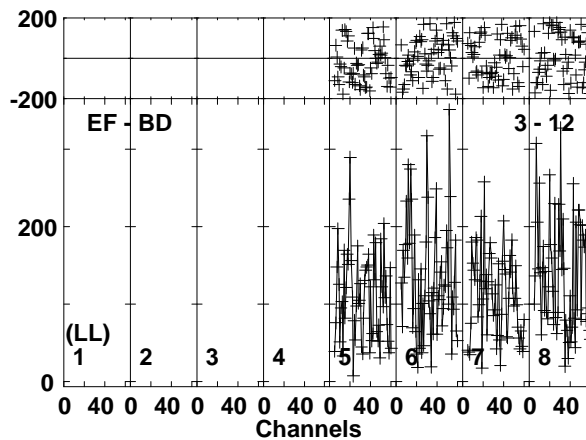
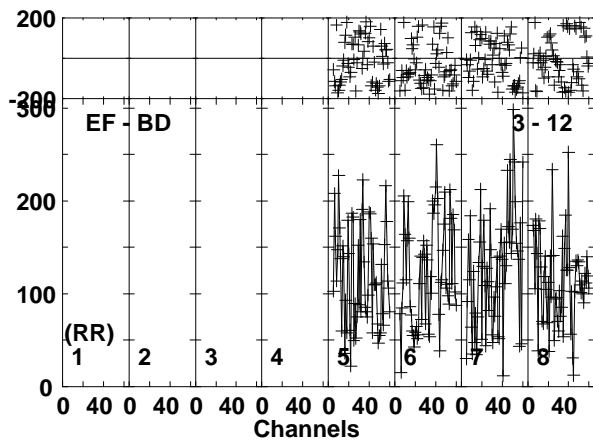
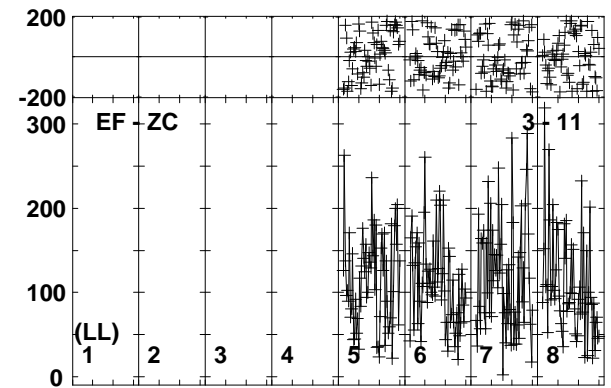
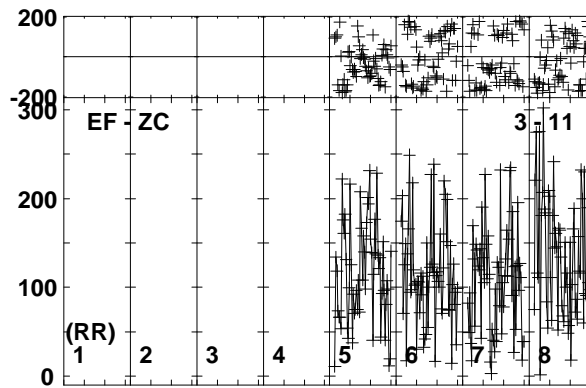
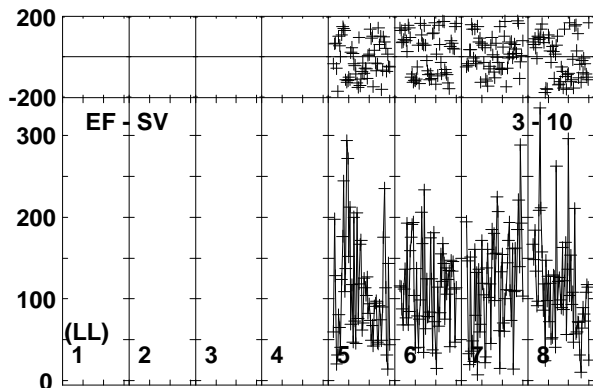
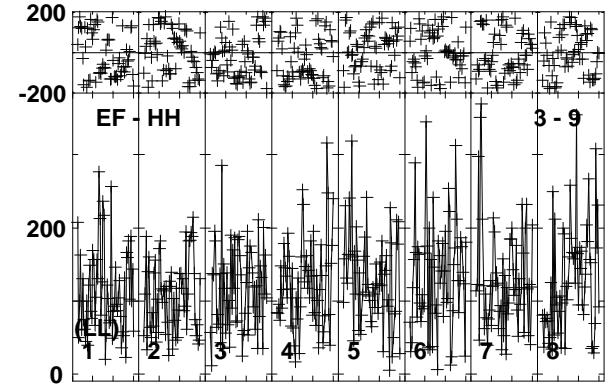
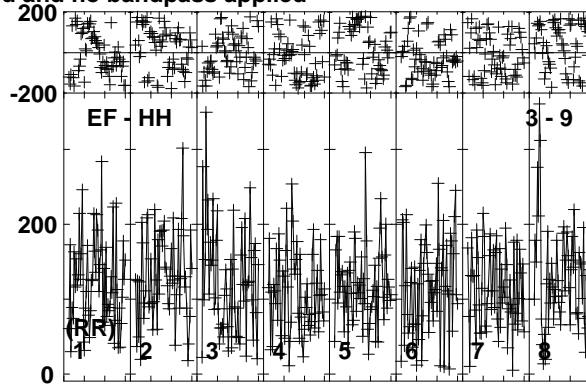
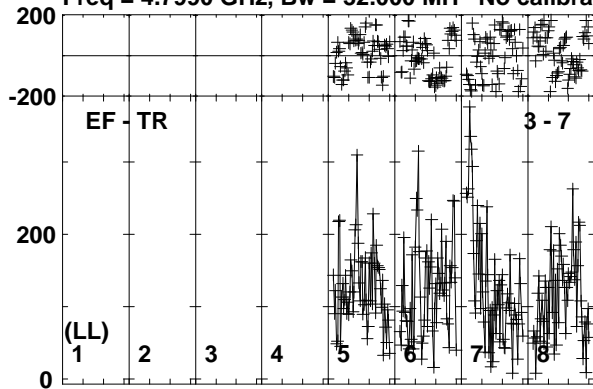

Lower frame: Micro Ampl Jy Top frame: Phas deg
Vector averaged cross-power spectrum Baseline: EF (03) - TR (07)
Timerange: 00/23:22:21 to 00/23:24:30

Plot file version 90 created 26-SEP-2019 10:39:48

190829A RG010A.UVDATA.1

Freq = 4.7990 GHz, Bw = 32.000 MH No calibration applied and no bandpass applied

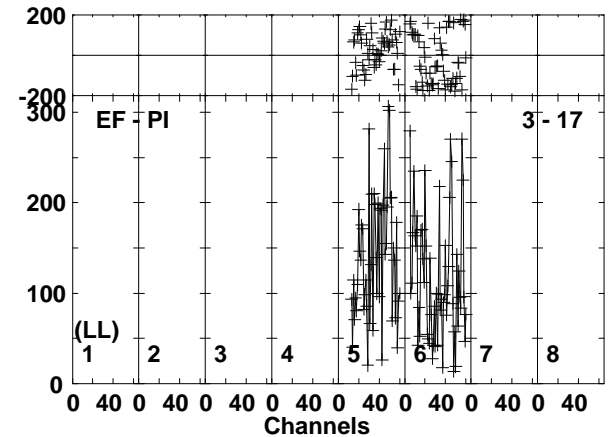
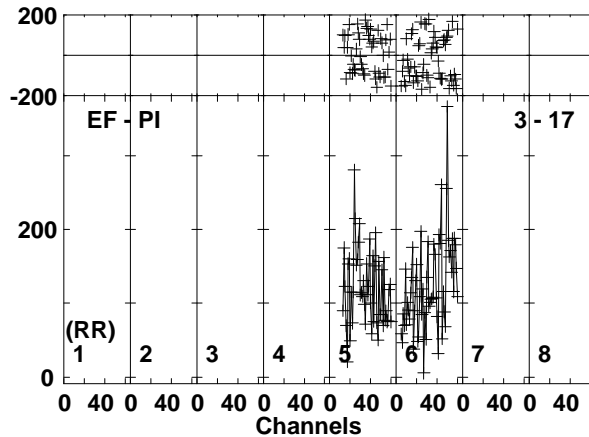
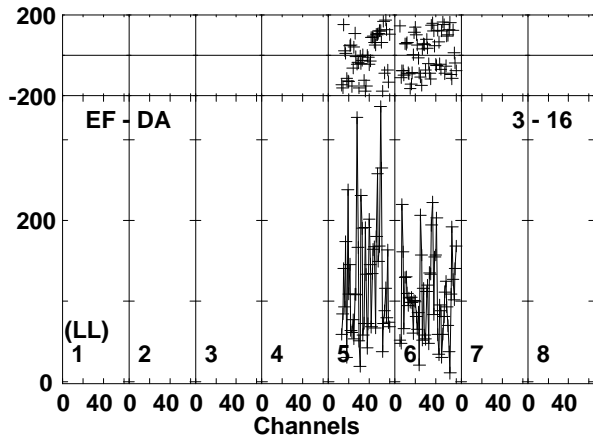
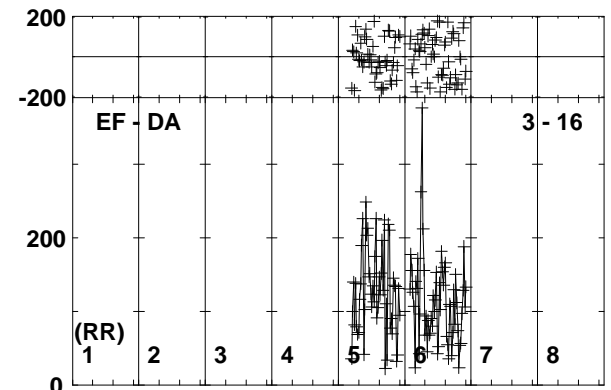
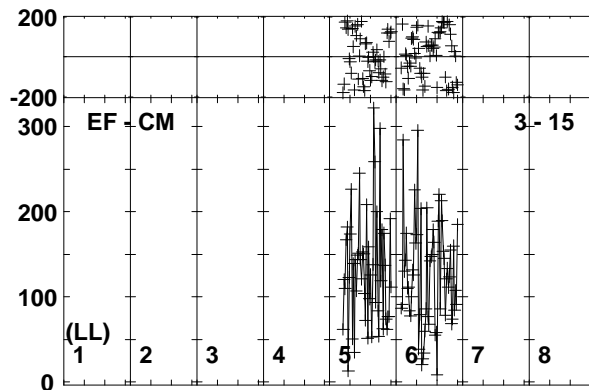
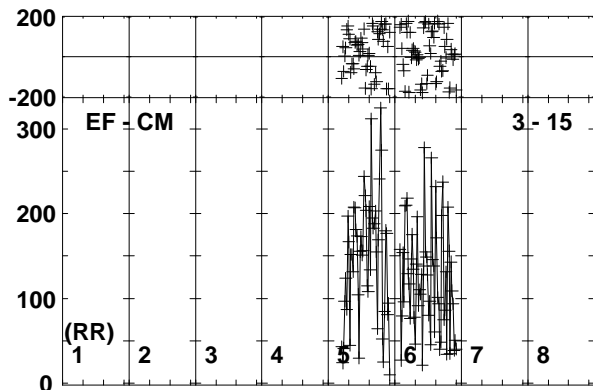
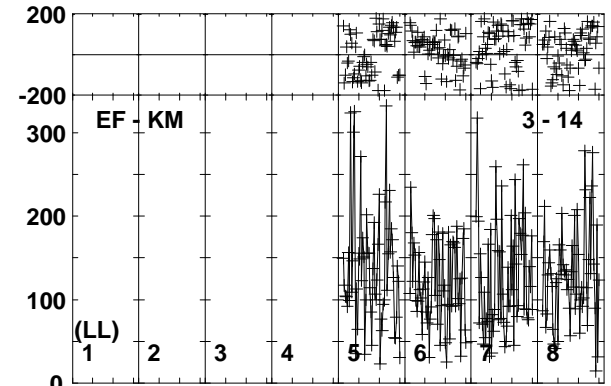
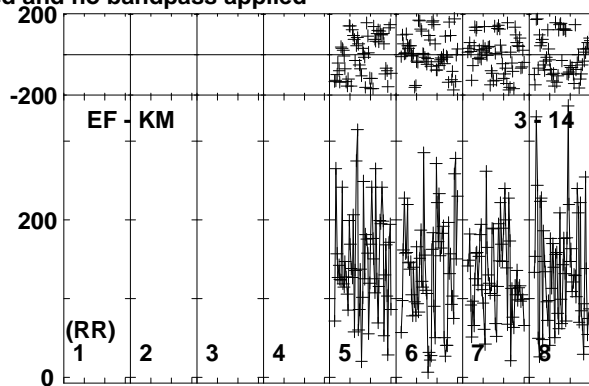
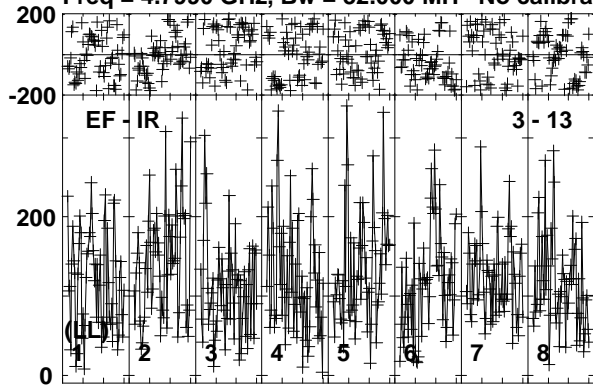

Lower frame: Micro Ampl Jy Top frame: Phas deg
Vector averaged cross-power spectrum Baseline: EF (03) - IR (13)
Timerange: 00/23:22:21 to 00/23:24:30

Plot file version 91 created 26-SEP-2019 10:39:49

190829A RG010A.UVDATA.1

Freq = 4.7990 GHz, Bw = 32.000 MH No calibration applied and no bandpass applied

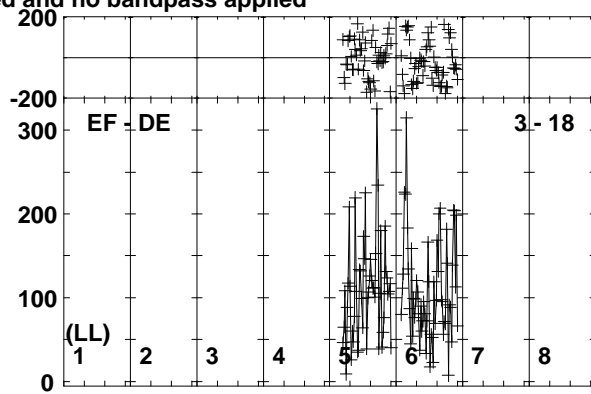
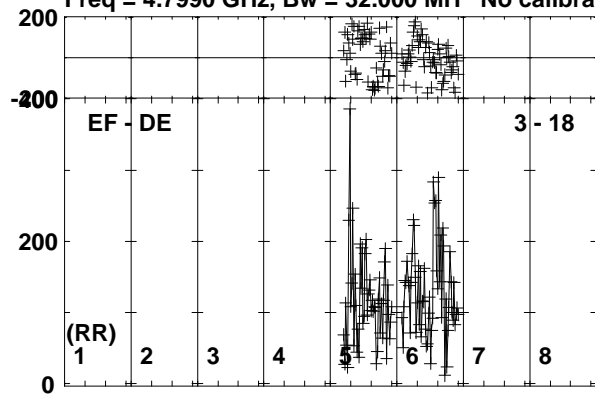

Lower frame: Micro Ampl Jy Top frame: Phas deg
Vector averaged cross-power spectrum Baseline: EF (03) - DE (18)
Timerange: 00/23:22:21 to 00/23:24:30

Plot file version 92 created 26-SEP-2019 10:39:49

J0257-1212 RG010A.UVDATA.1

Freq = 4.7990 GHz, Bw = 32.000 MH No calibration applied and no bandpass applied

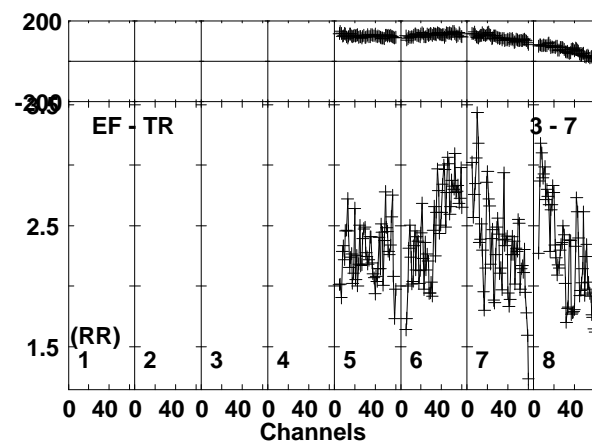
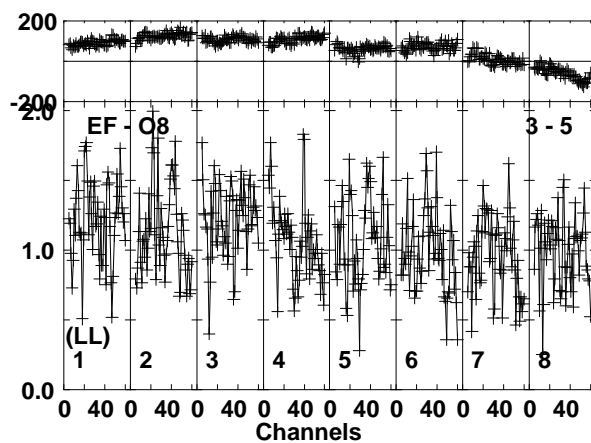
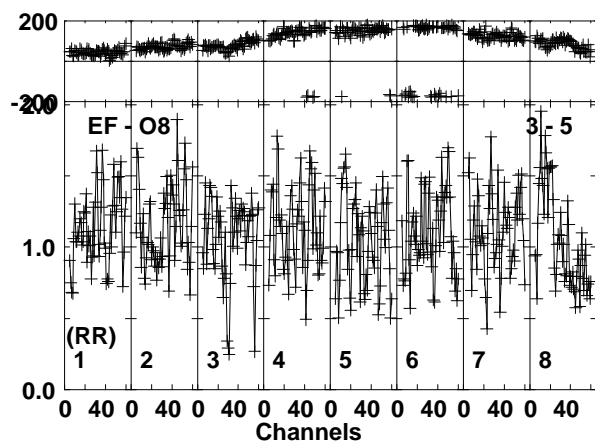
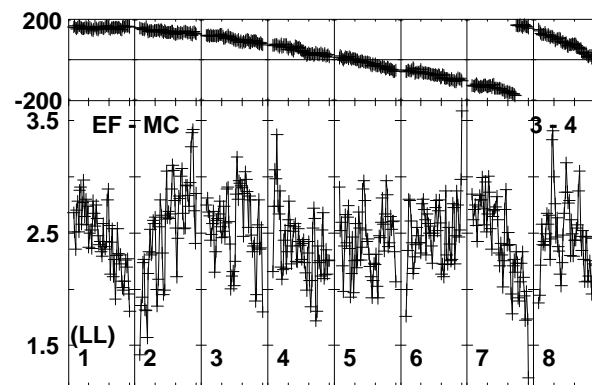
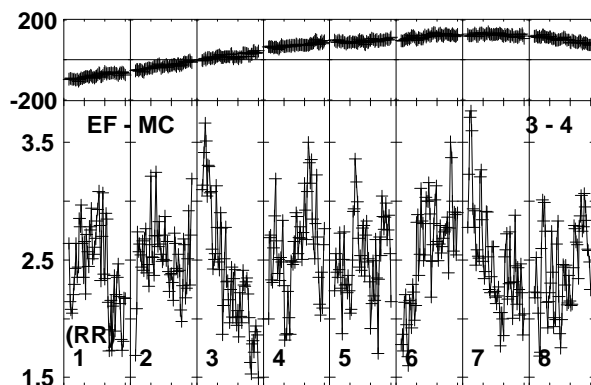
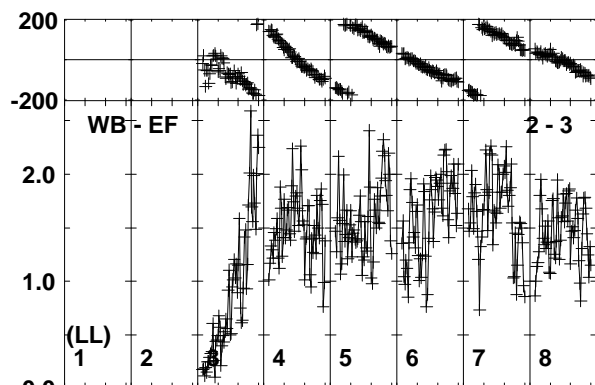
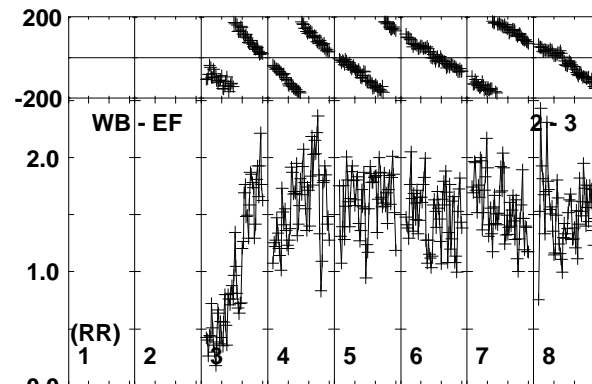
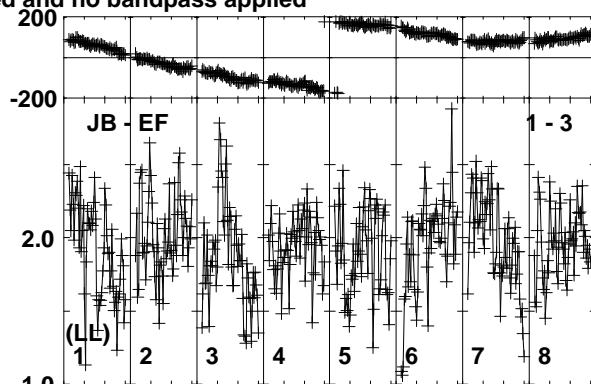
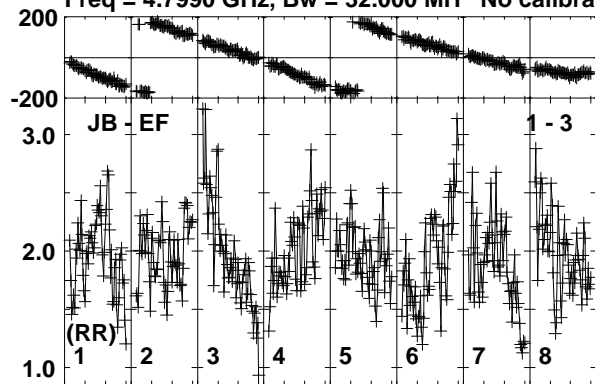

Lower frame: Milli Ampl Jy Top frame: Phas deg
Vector averaged cross-power spectrum Baseline: JB (01) - EF (03)
Timerange: 00/23:24:30 to 00/23:25:29

Plot file version 93 created 26-SEP-2019 10:39:49

J0257-1212 RG010A.UVDATA.1

Freq = 4.7990 GHz, Bw = 32.000 MH No calibration applied and no bandpass applied

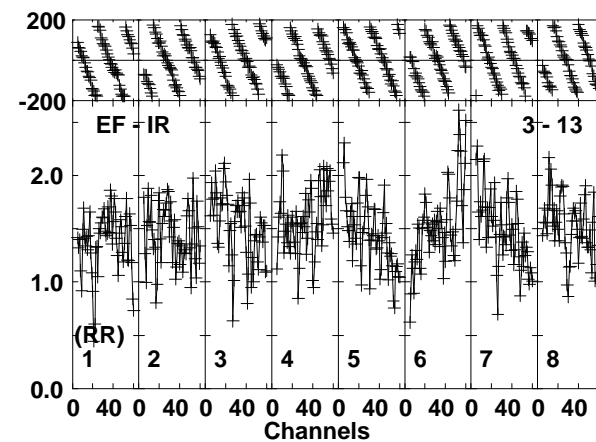
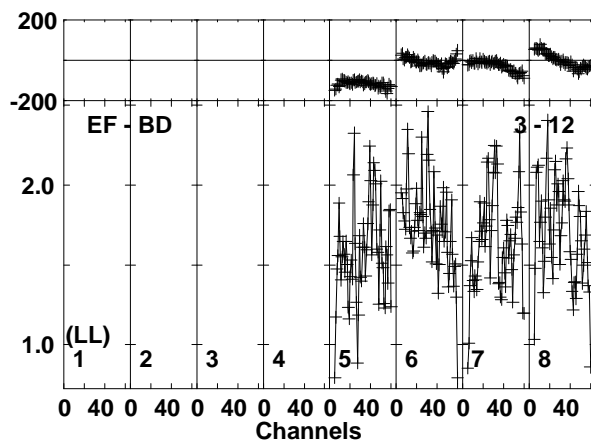
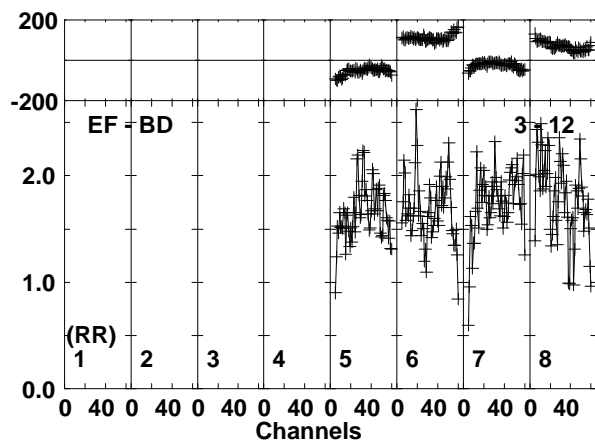
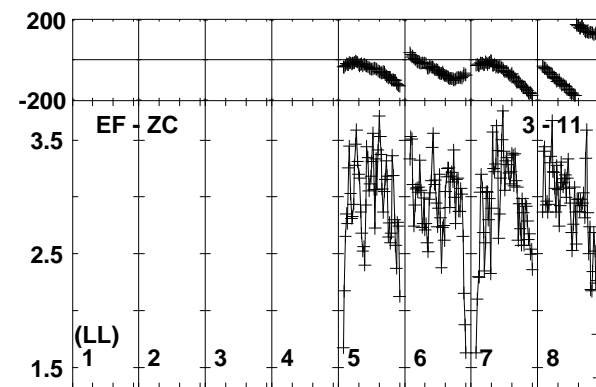
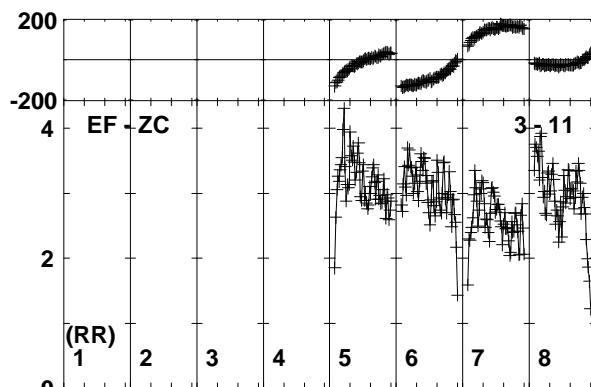
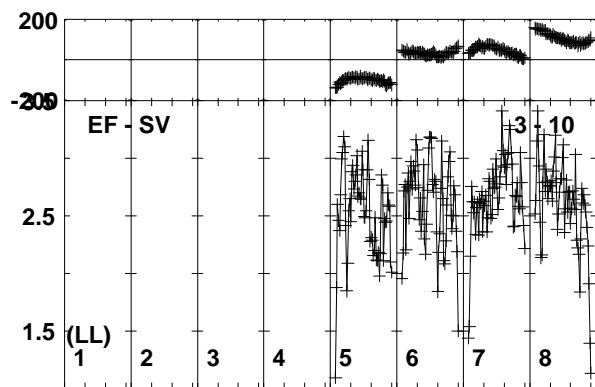
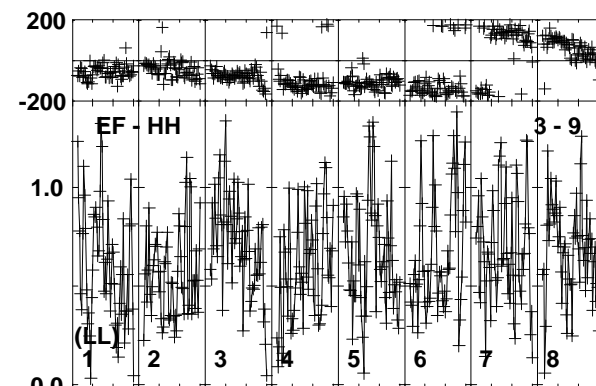
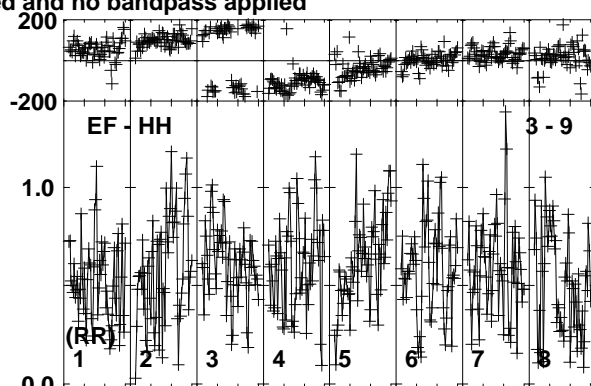
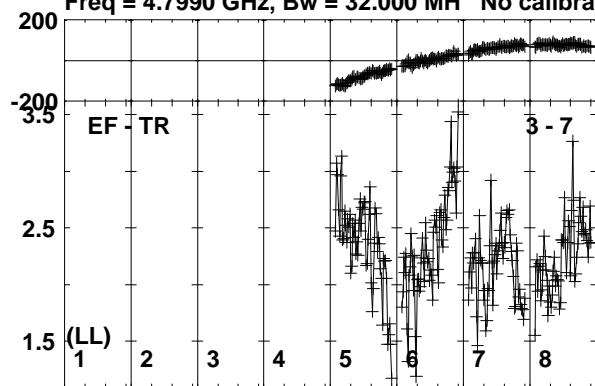

Lower frame: Milli Ampl Jy Top frame: Phas deg
Vector averaged cross-power spectrum Baseline: EF (03) - TR (07)
Timerange: 00/23:24:30 to 00/23:25:29

Plot file version 94 created 26-SEP-2019 10:39:49

J0257-1212 RG010A.UVDATA.1

Freq = 4.7990 GHz, Bw = 32.000 MH No calibration applied and no bandpass applied

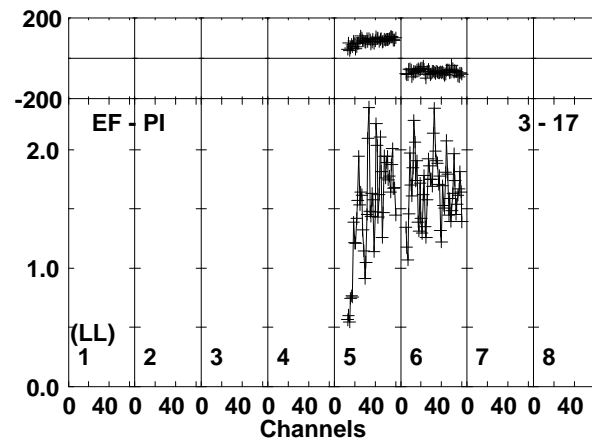
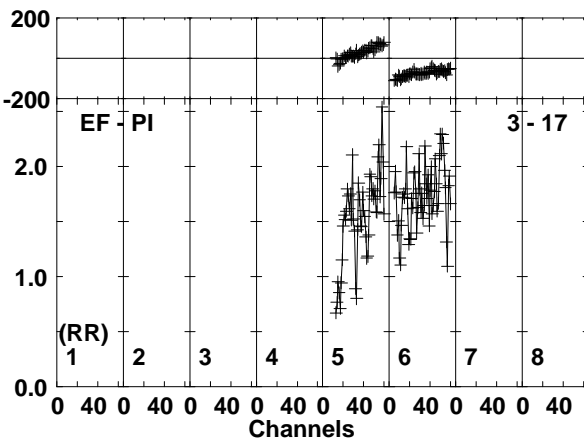
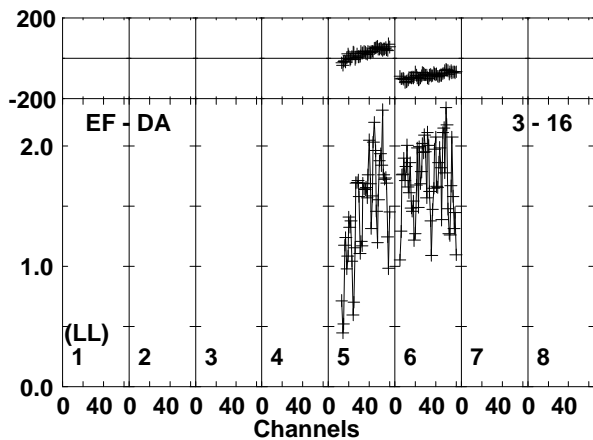
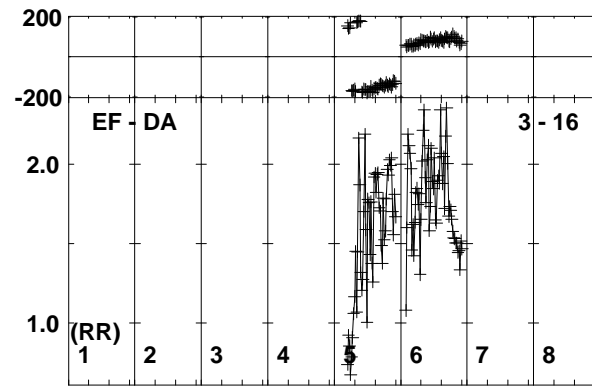
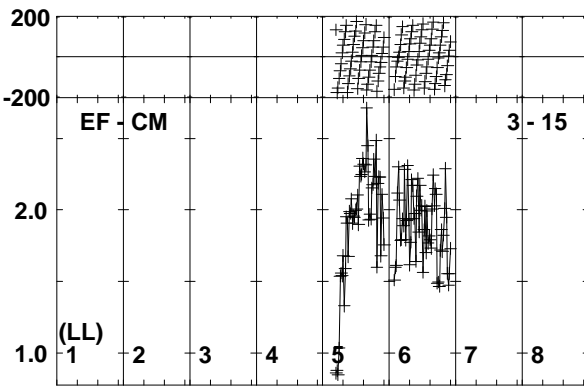
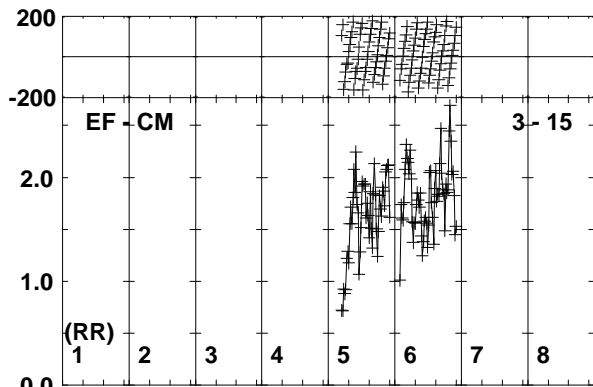
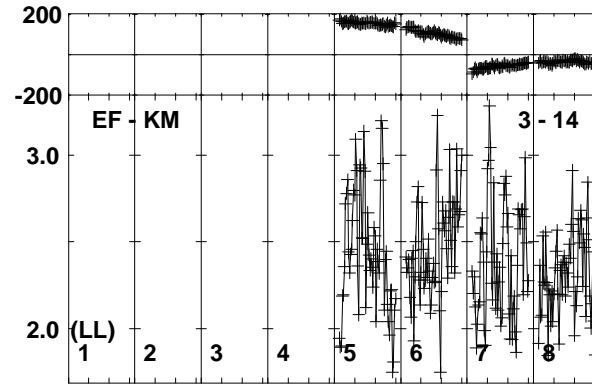
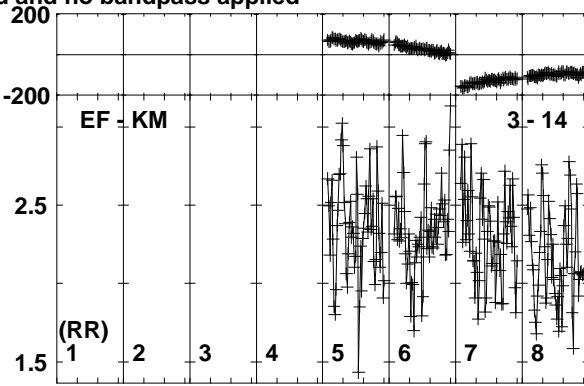
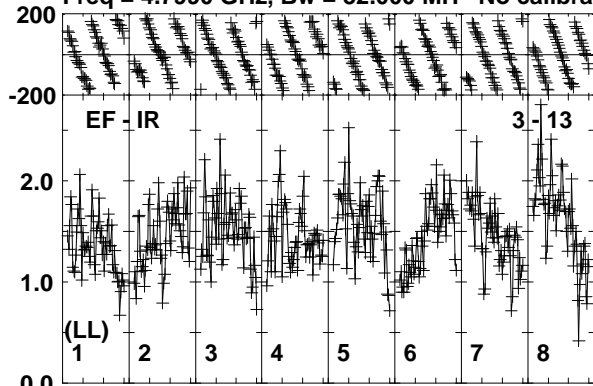

Lower frame: Milli Ampl Jy Top frame: Phas deg
Vector averaged cross-power spectrum Baseline: EF (03) - IR (13)
Timerange: 00/23:24:30 to 00/23:25:29

Plot file version 95 created 26-SEP-2019 10:39:49

J0257-1212 RG010A.UVDATA.1

Freq = 4.7990 GHz, Bw = 32.000 MH No calibration applied and no bandpass applied

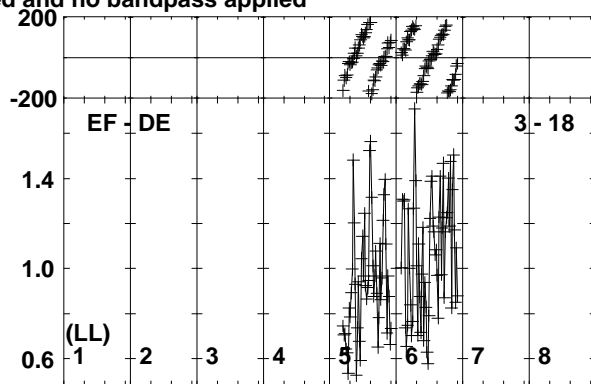
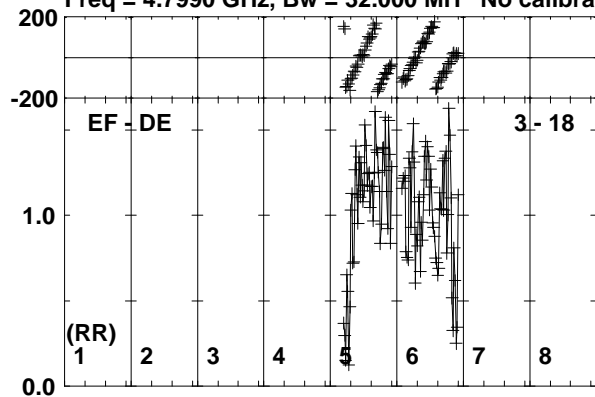

Lower frame: Milli Ampl Jy Top frame: Phas deg
Vector averaged cross-power spectrum Baseline: EF (03) - DE (18)
Timerange: 00/23:24:30 to 00/23:25:29

Plot file version 96 created 26-SEP-2019 10:39:50

190829A RG010A.UVDATA.1

Freq = 4.7990 GHz, Bw = 32.000 MH No calibration applied and no bandpass applied

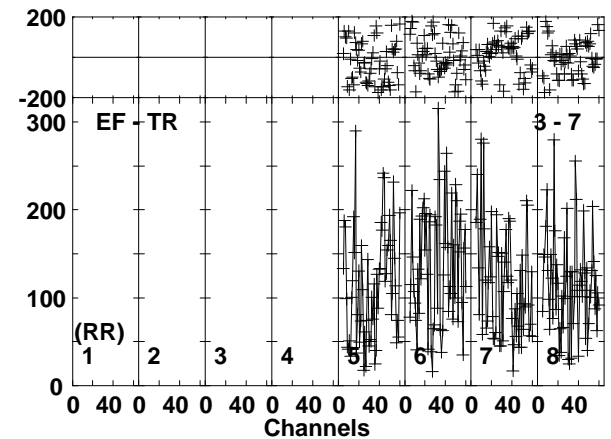
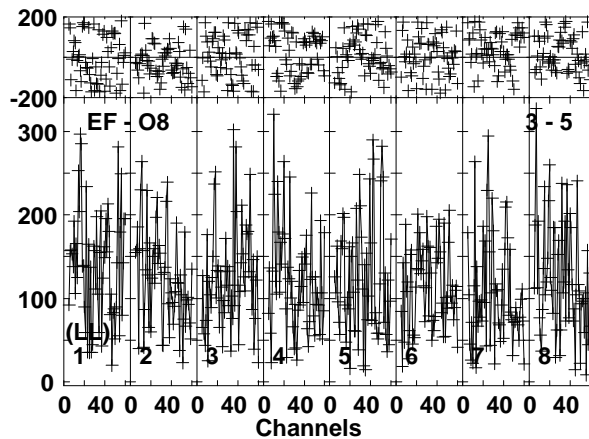
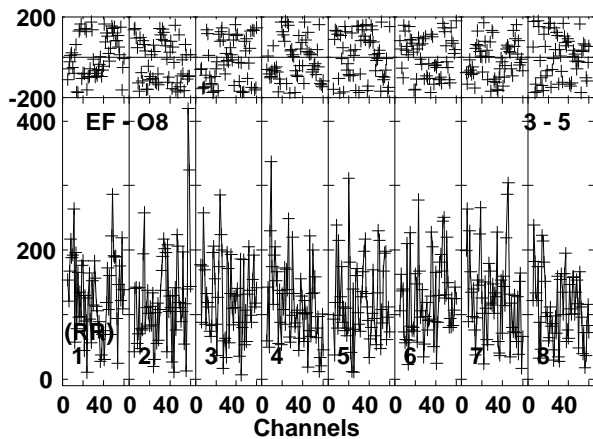
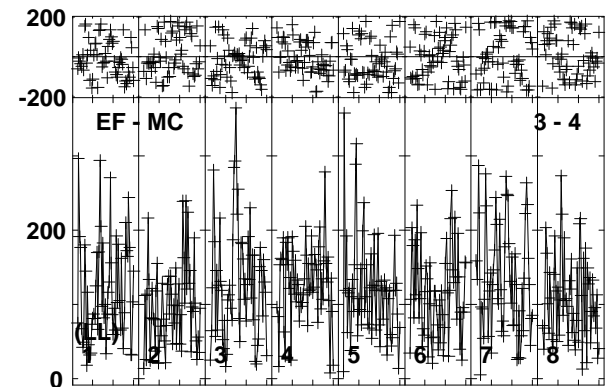
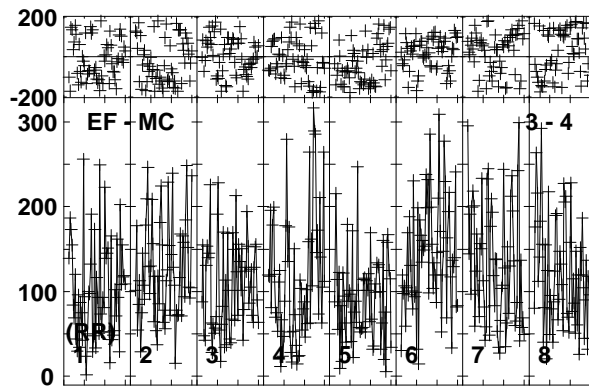
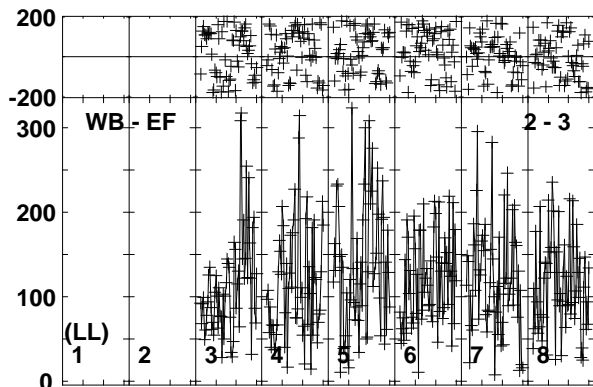
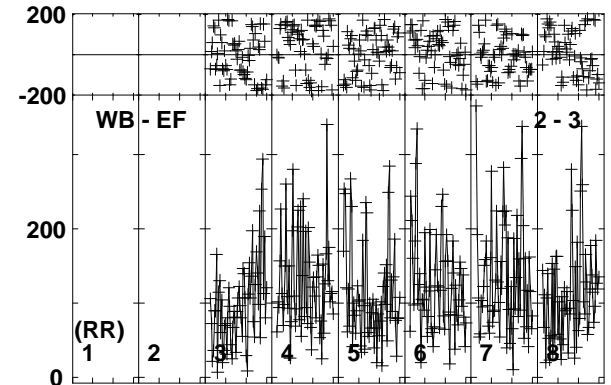
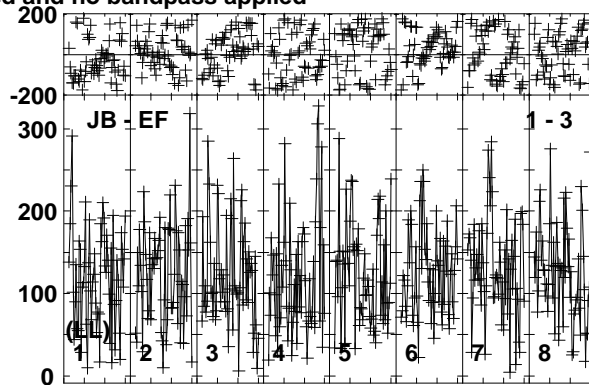
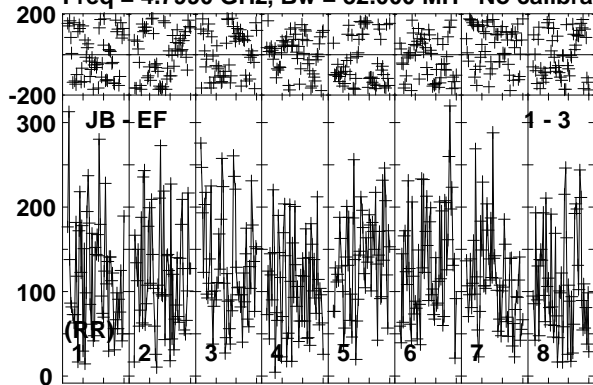

Lower frame: Micro Ampl Jy Top frame: Phas deg
Vector averaged cross-power spectrum Baseline: JB (01) - EF (03)
Timerange: 00/23:25:31 to 00/23:27:39

Plot file version 97 created 26-SEP-2019 10:39:50

190829A RG010A.UVDATA.1

Freq = 4.7990 GHz, Bw = 32.000 MH No calibration applied and no bandpass applied

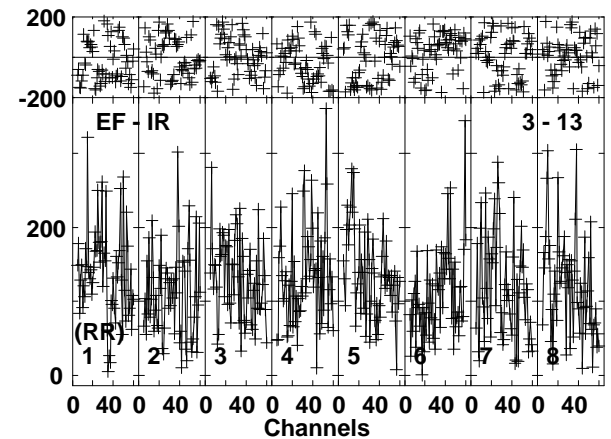
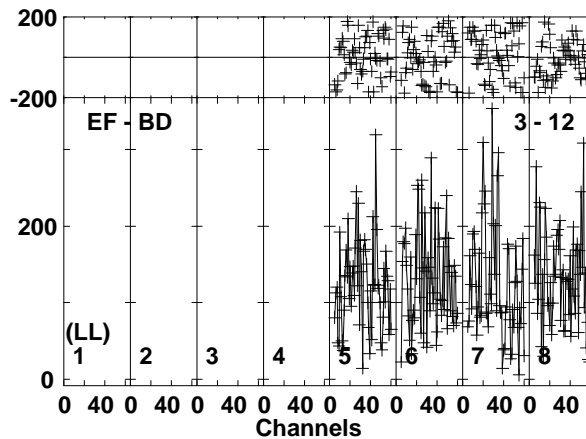
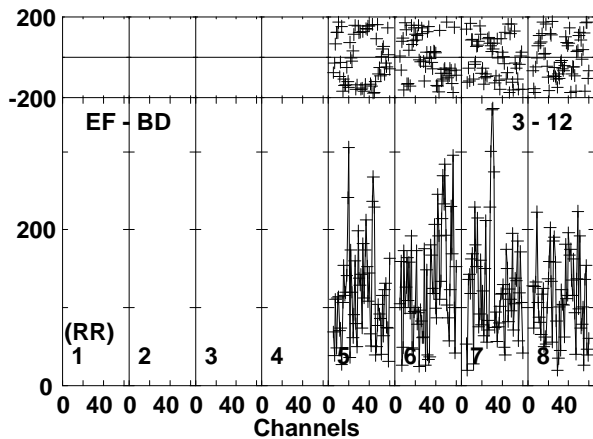
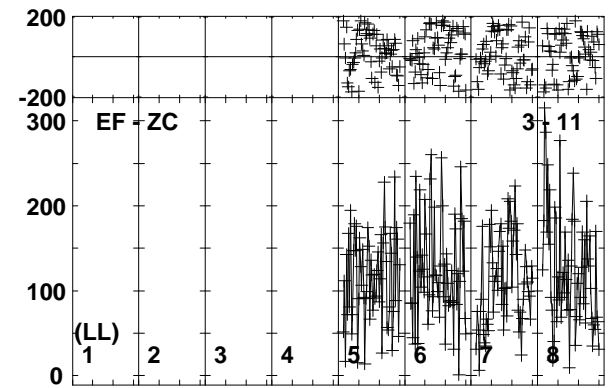
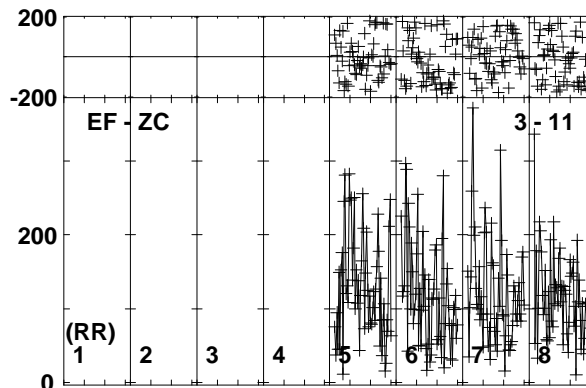
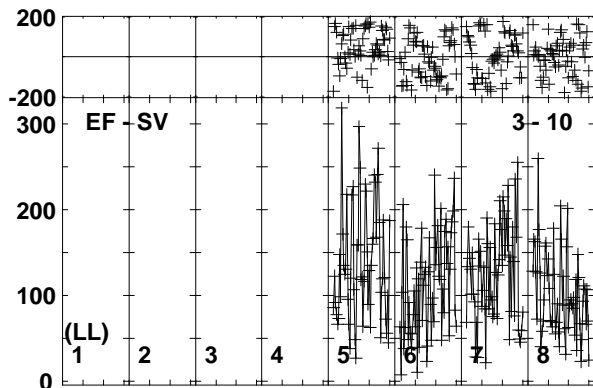
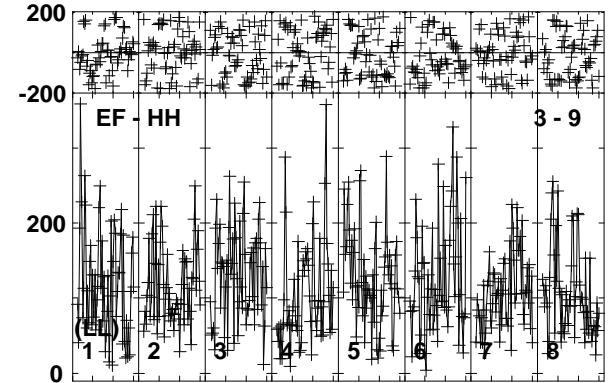
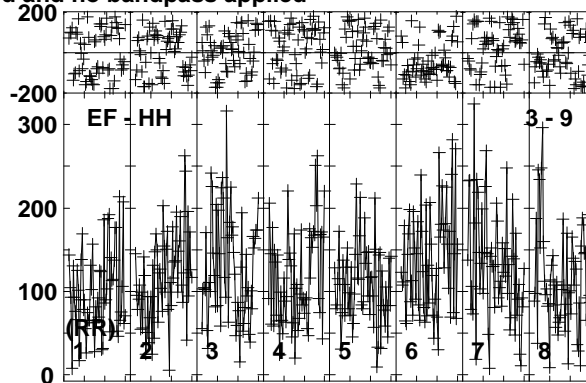
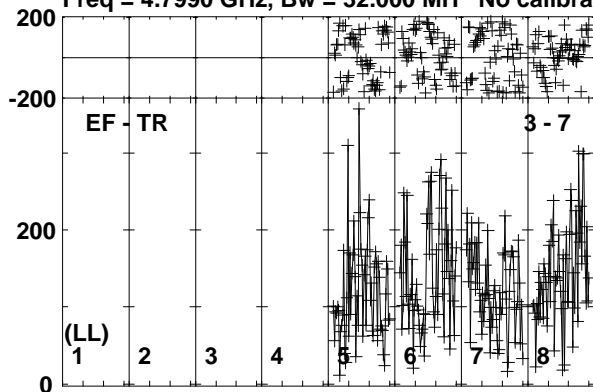

Lower frame: Micro Ampl Jy Top frame: Phas deg
Vector averaged cross-power spectrum Baseline: EF (03) - TR (07)
Timerange: 00/23:25:31 to 00/23:27:39

Plot file version 98 created 26-SEP-2019 10:39:51

190829A RG010A.UVDATA.1

Freq = 4.7990 GHz, Bw = 32.000 MH No calibration applied and no bandpass applied

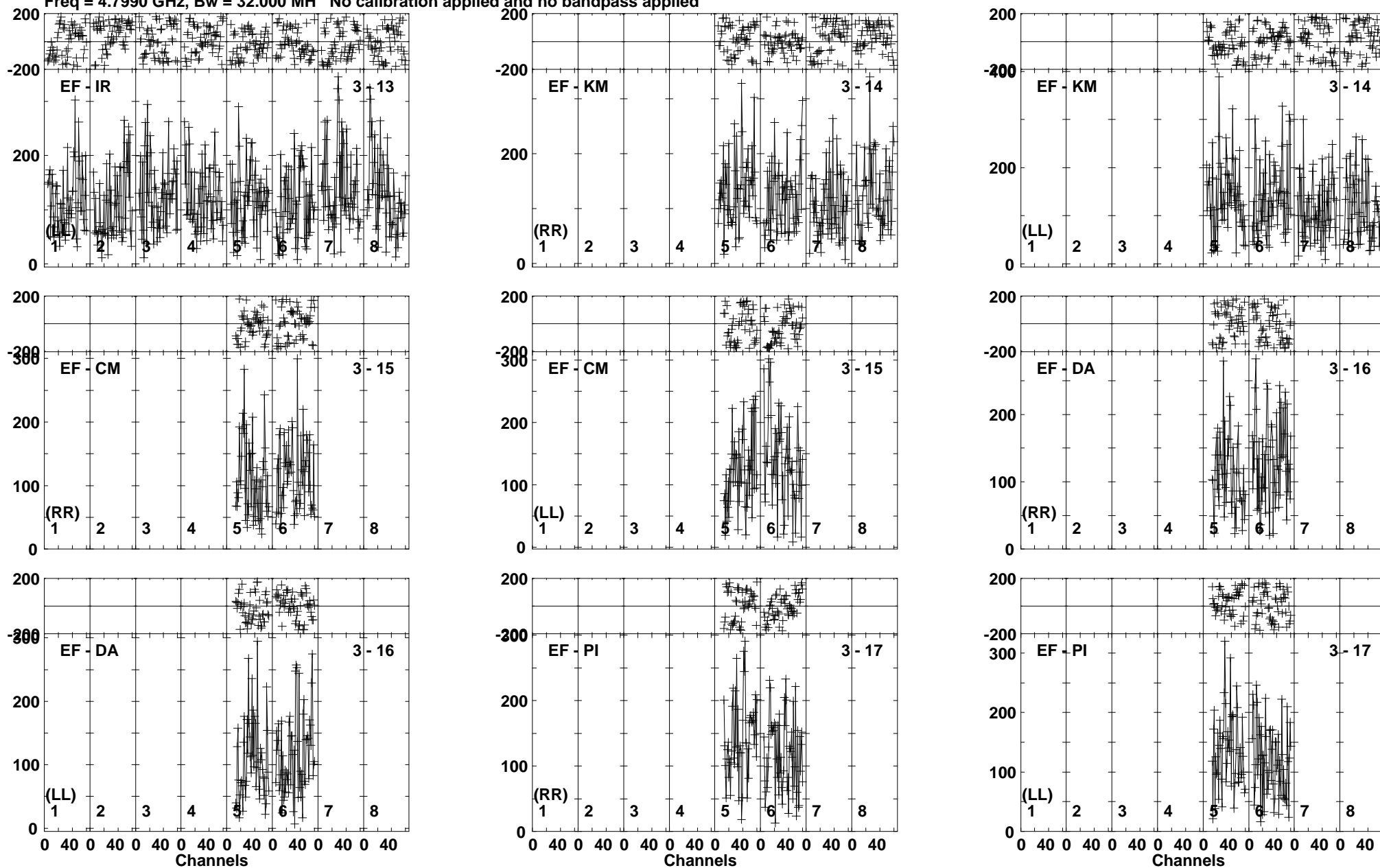

Lower frame: Micro Ampl Jy Top frame: Phas deg
Vector averaged cross-power spectrum Baseline: EF (03) - IR (13)
Timerange: 00/23:25:31 to 00/23:27:39

Plot file version 99 created 26-SEP-2019 10:39:51

190829A RG010A.UVDATA.1

Freq = 4.7990 GHz, Bw = 32.000 MH No calibration applied and no bandpass applied

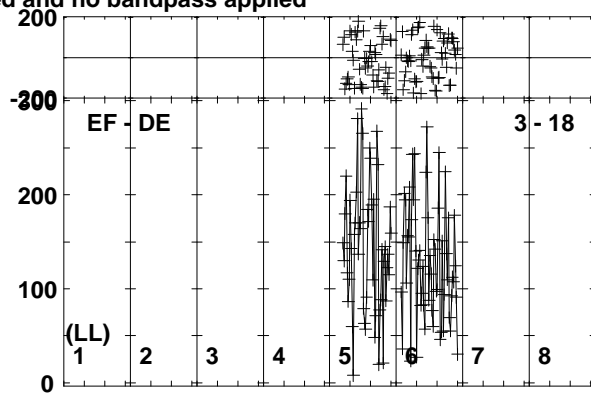
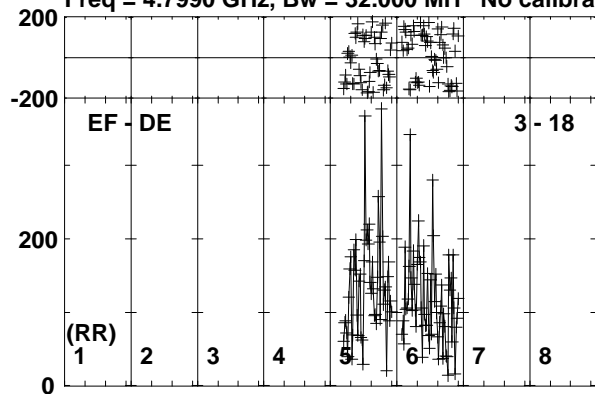

Lower frame: Micro Ampl Jy Top frame: Phas deg
Vector averaged cross-power spectrum Baseline: EF (03) - DE (18)
Timerange: 00/23:25:31 to 00/23:27:39

Plot file version 100 created 26-SEP-2019 10:39:51

J0257-1212 RG010A.UVDATA.1

Freq = 4.7990 GHz, Bw = 32.000 MH No calibration applied and no bandpass applied

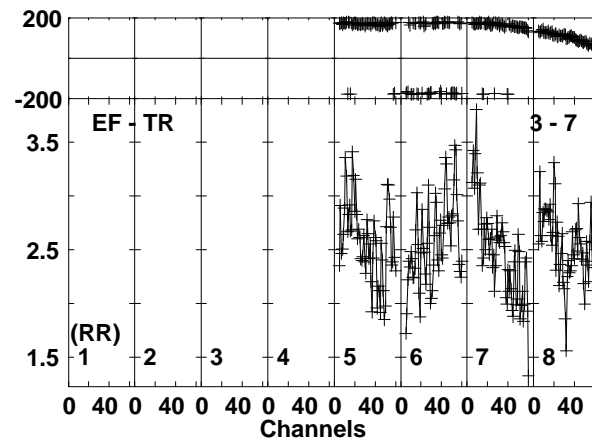
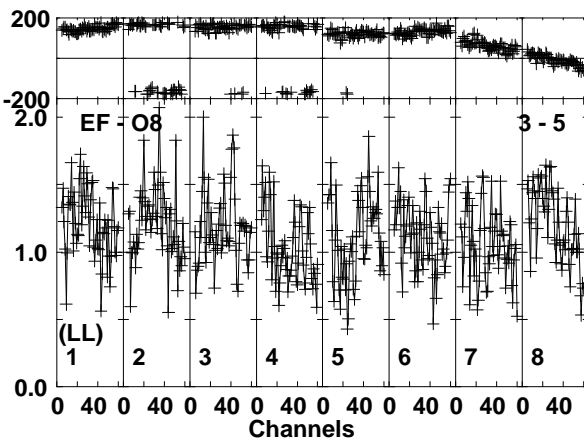
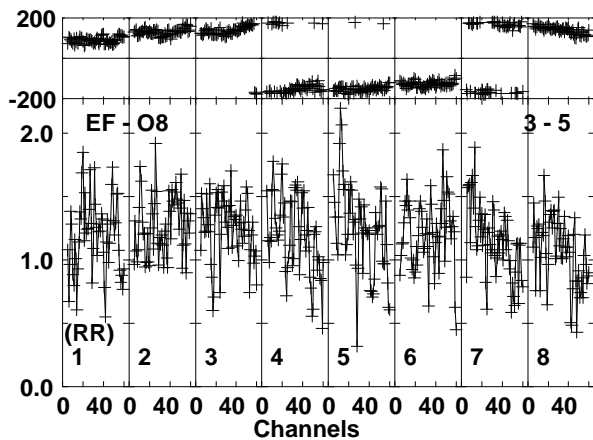
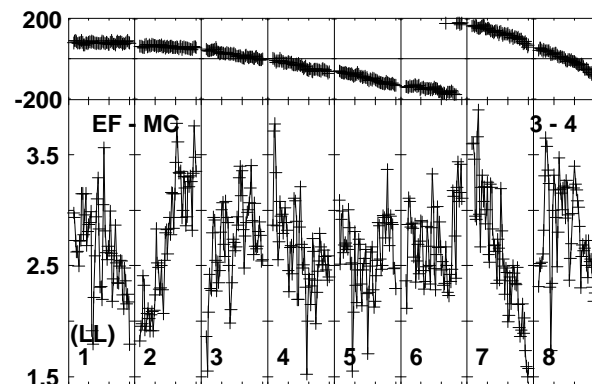
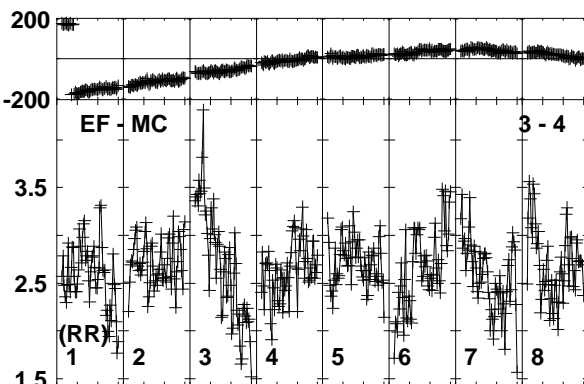
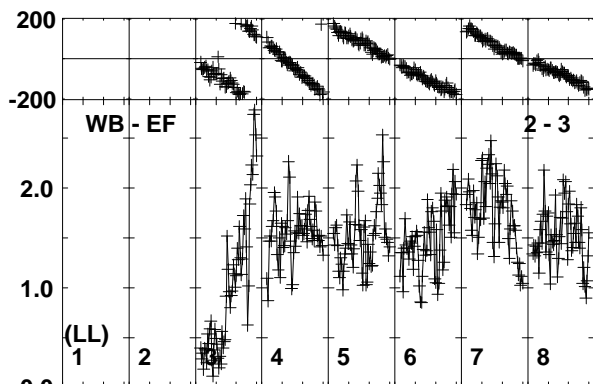
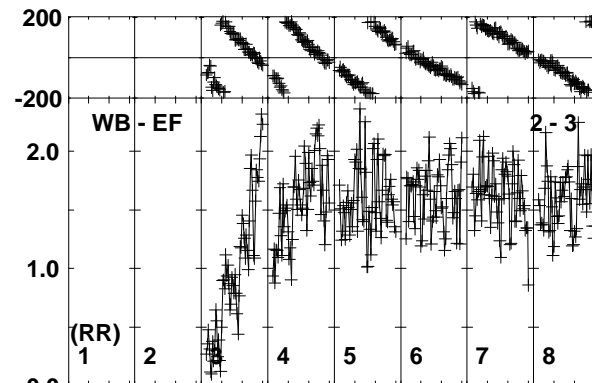
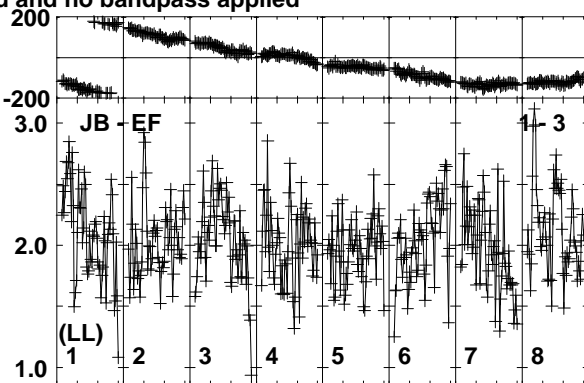
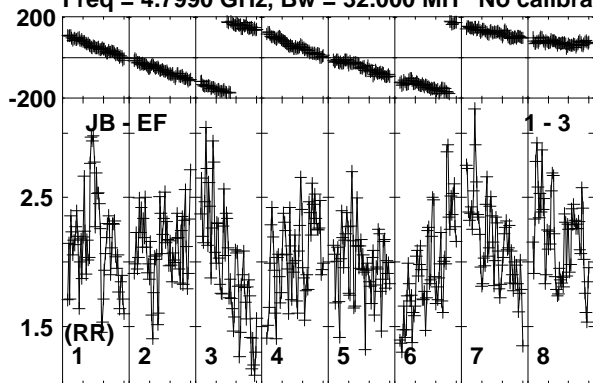

Lower frame: Milli Ampl Jy Top frame: Phas deg
Vector averaged cross-power spectrum Baseline: JB (01) - EF (03)
Timerange: 00/23:27:41 to 00/23:28:39

Plot file version 101 created 26-SEP-2019 10:39:51

J0257-1212 RG010A.UVDATA.1

Freq = 4.7990 GHz, Bw = 32.000 MH No calibration applied and no bandpass applied

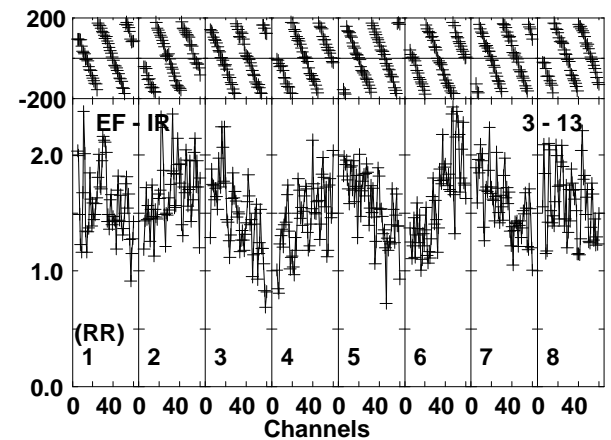
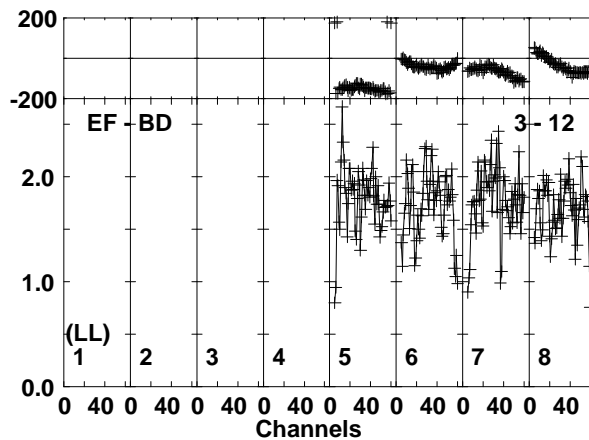
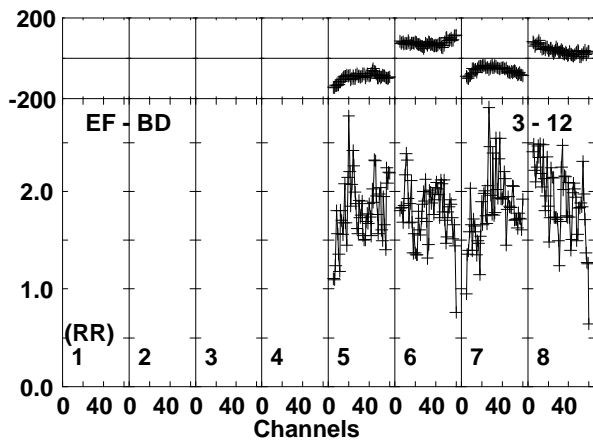
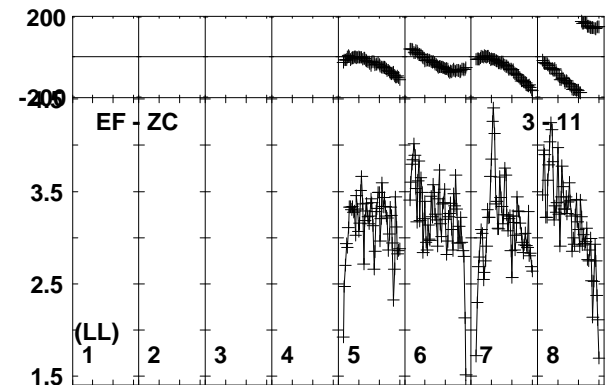
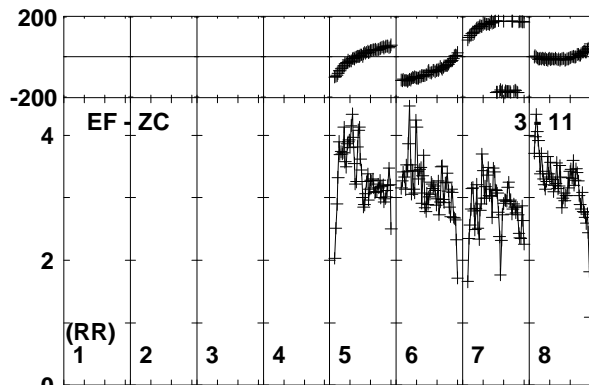
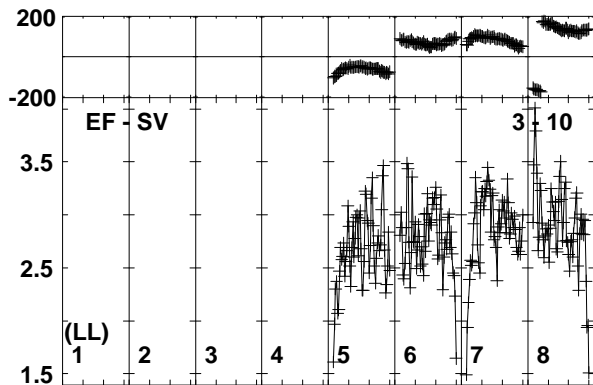
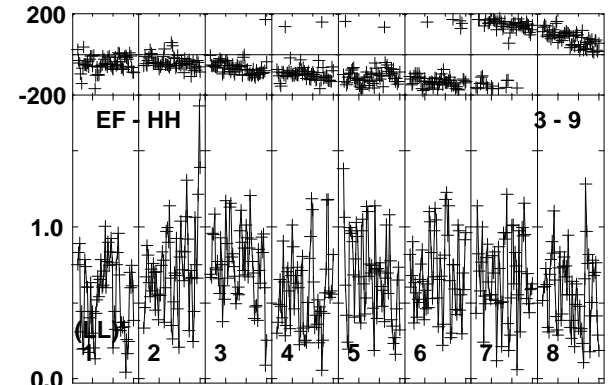
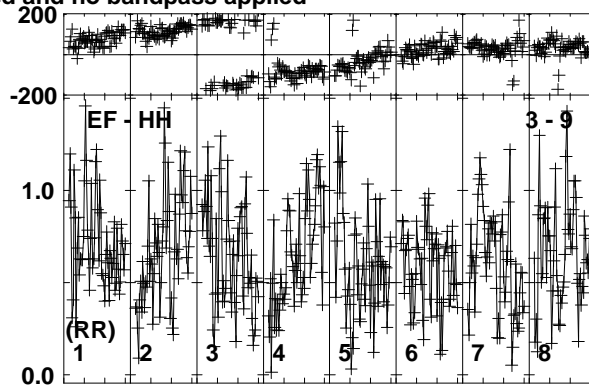
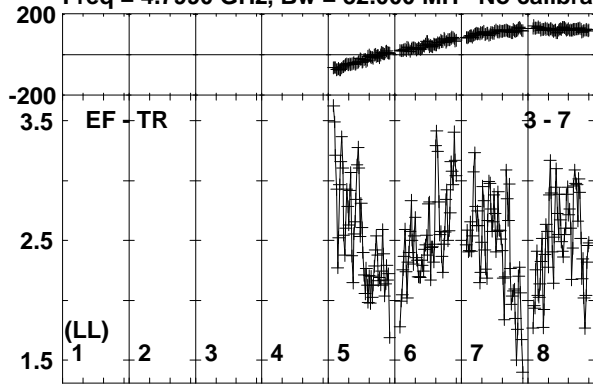

Lower frame: Milli Ampl Jy Top frame: Phas deg
Vector averaged cross-power spectrum Baseline: EF (03) - TR (07)
Timerange: 00/23:27:41 to 00/23:28:39

Plot file version 102 created 26-SEP-2019 10:39:51

J0257-1212 RG010A.UVDATA.1

Freq = 4.7990 GHz, Bw = 32.000 MH No calibration applied and no bandpass applied

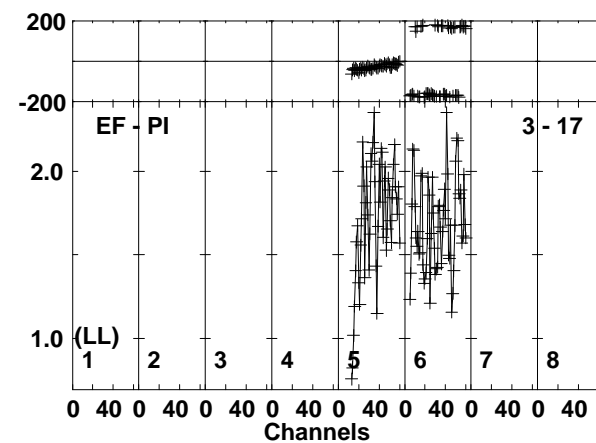
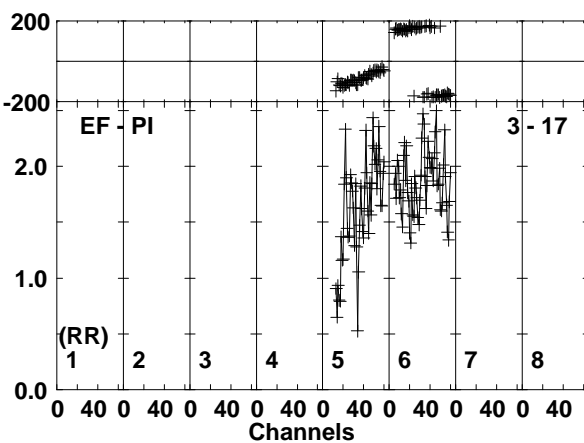
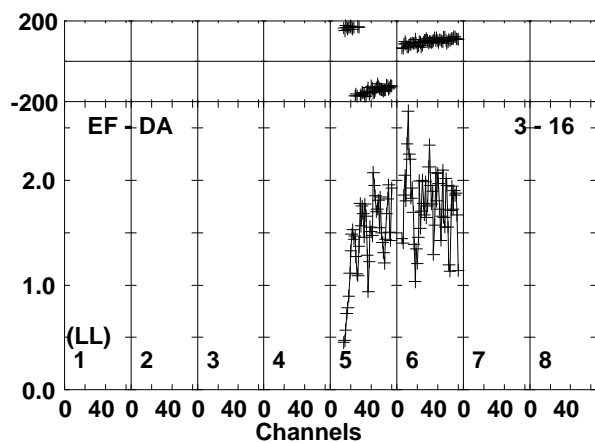
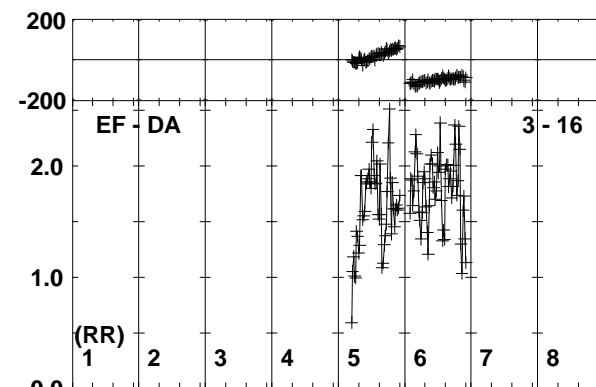
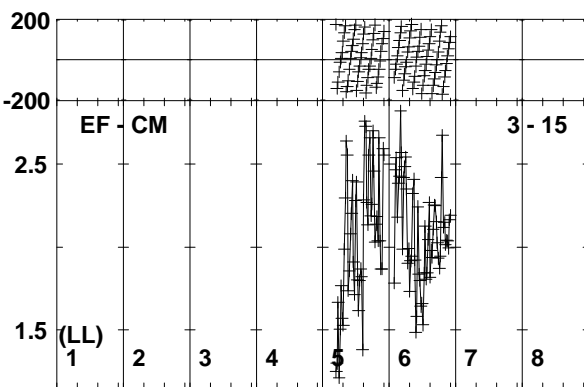
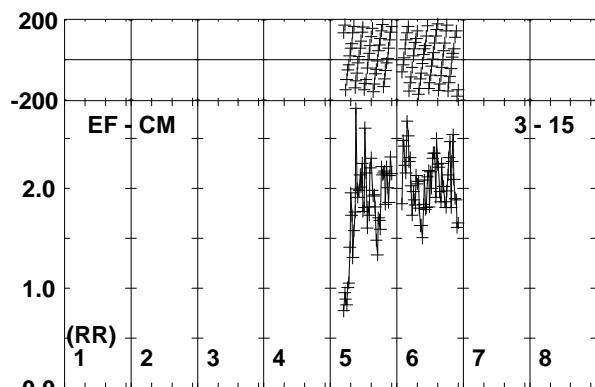
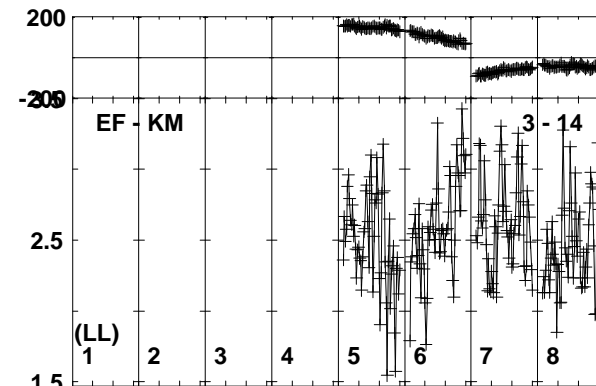
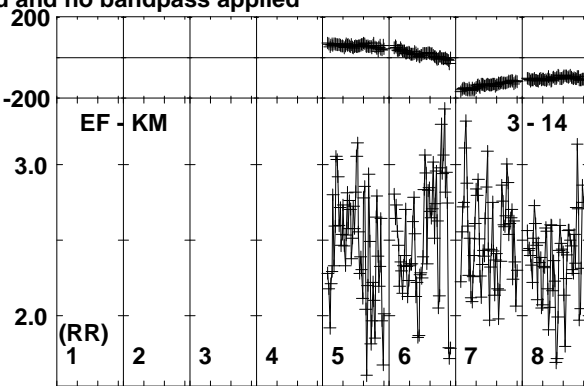
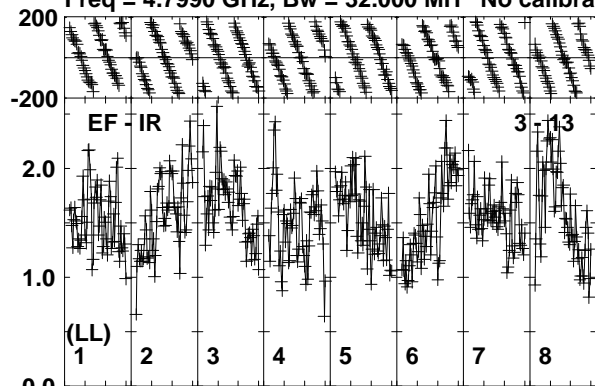

Lower frame: Milli Ampl Jy Top frame: Phas deg
Vector averaged cross-power spectrum Baseline: EF (03) - IR (13)
Timerange: 00/23:27:41 to 00/23:28:39

Plot file version 103 created 26-SEP-2019 10:39:51

J0257-1212 RG010A.UVDATA.1

Freq = 4.7990 GHz, Bw = 32.000 MH No calibration applied and no bandpass applied

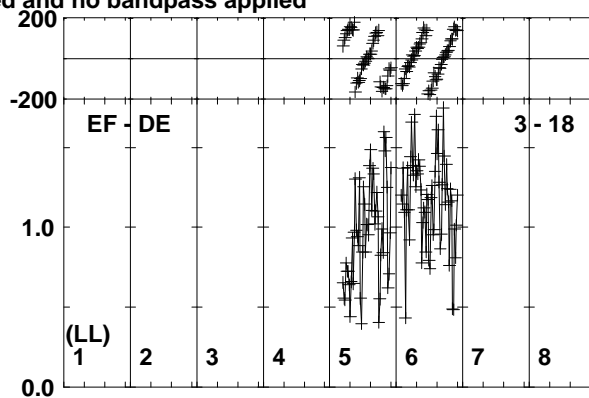
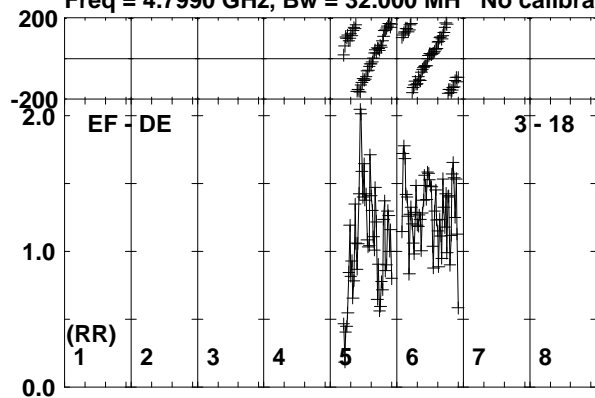

Lower frame: Milli Ampl Jy Top frame: Phas deg
Vector averaged cross-power spectrum Baseline: EF (03) - DE (18)
Timerange: 00/23:27:41 to 00/23:28:39

Plot file version 104 created 26-SEP-2019 10:39:52

190829A RG010A.UVDATA.1

Freq = 4.7990 GHz, Bw = 32.000 MH No calibration applied and no bandpass applied

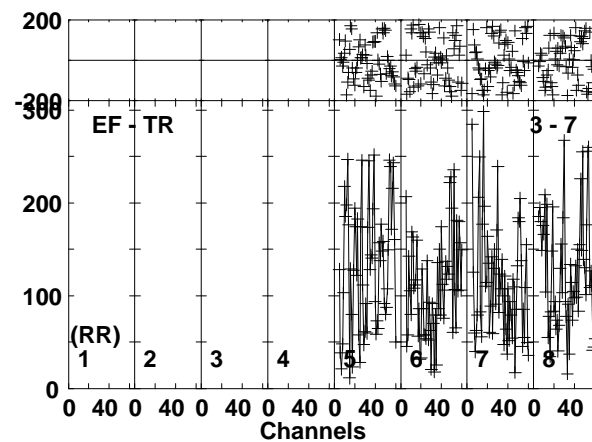
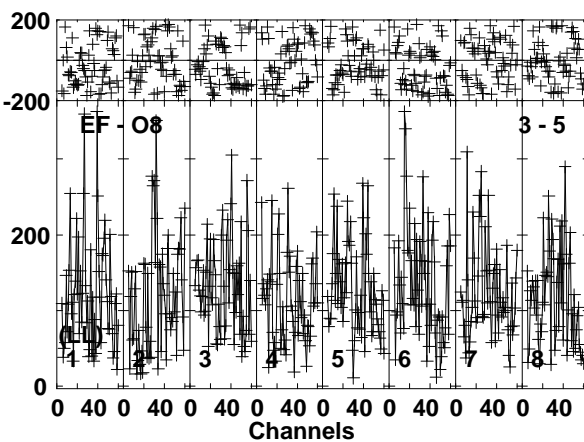
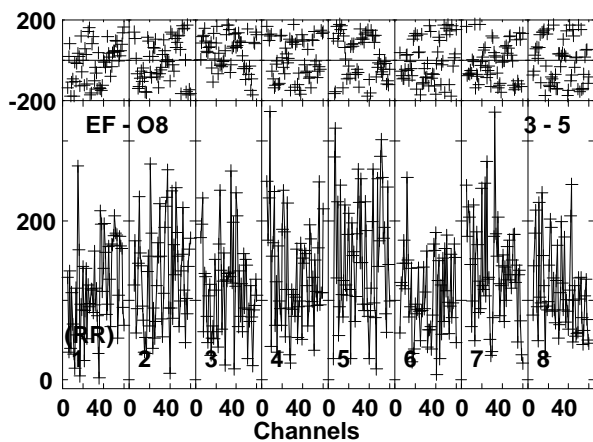
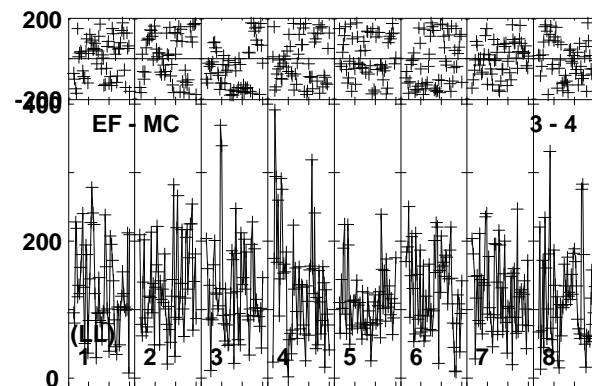
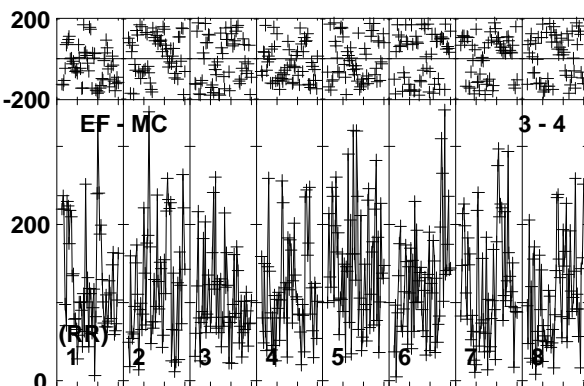
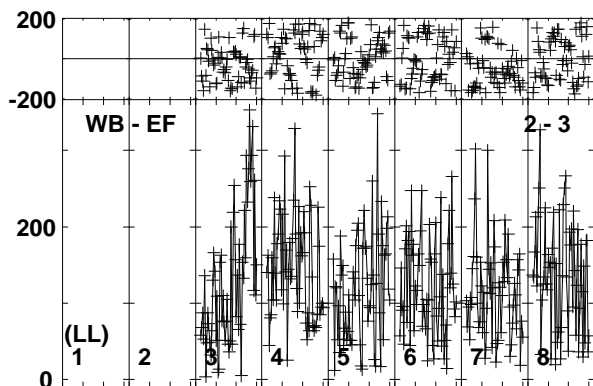
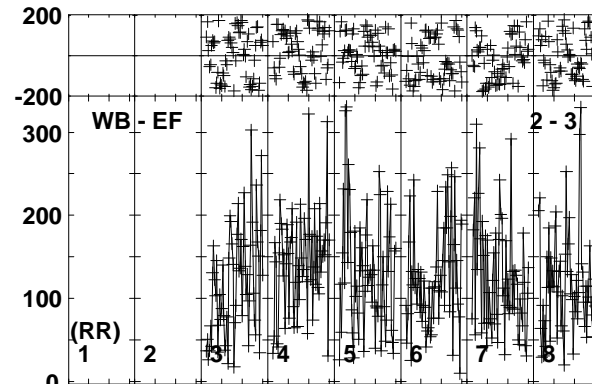
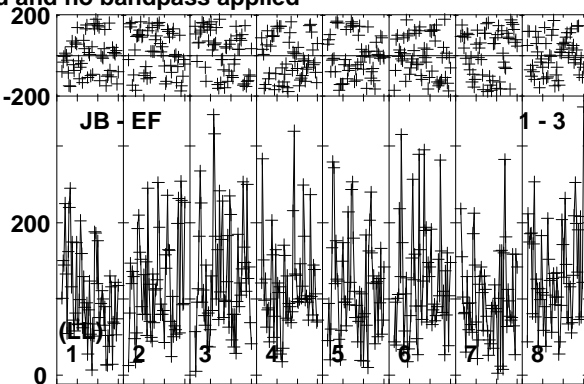
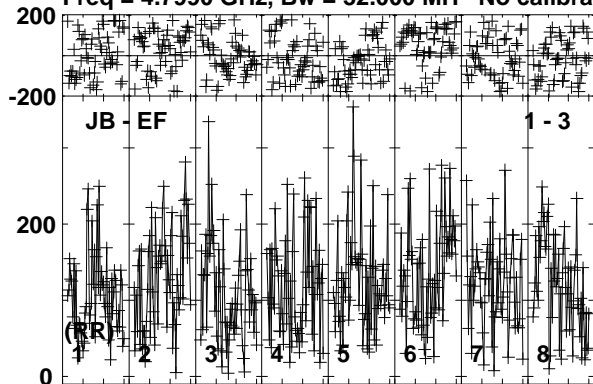

Lower frame: Micro Ampl Jy Top frame: Phas deg
Vector averaged cross-power spectrum Baseline: JB (01) - EF (03)
Timerange: 00/23:28:41 to 00/23:30:50

Plot file version 105 created 26-SEP-2019 10:39:52

190829A RG010A.UVDATA.1

Freq = 4.7990 GHz, Bw = 32.000 MH No calibration applied and no bandpass applied

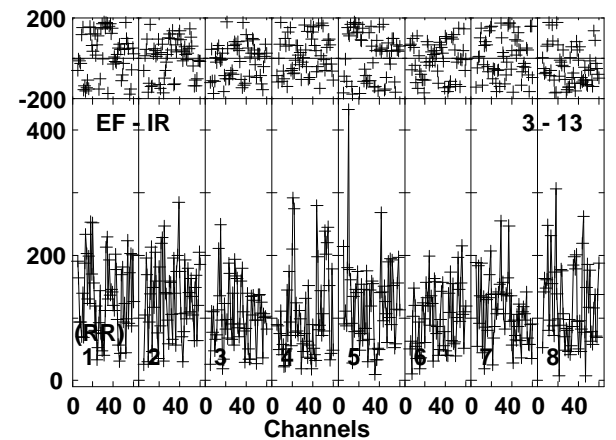
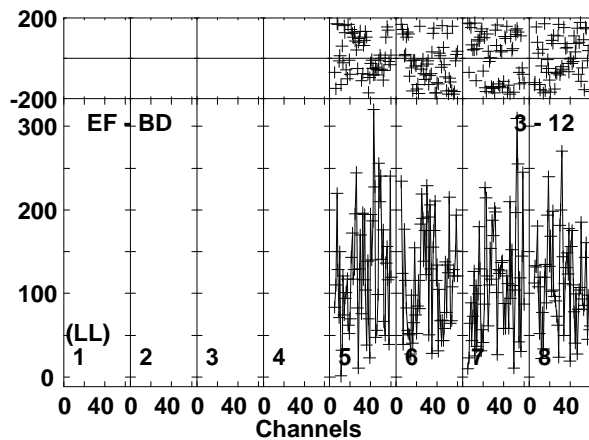
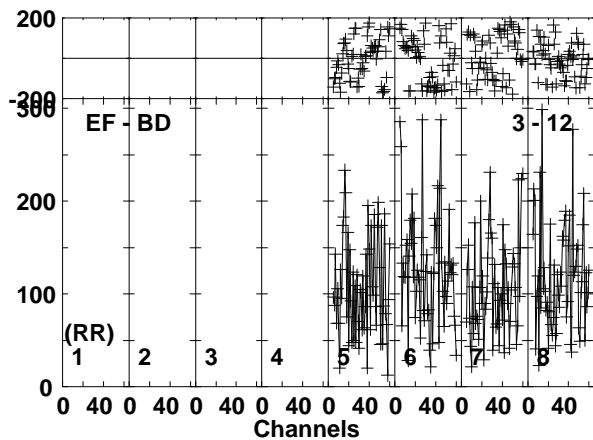
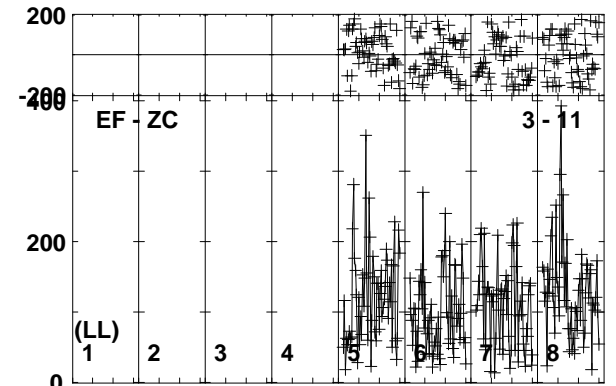
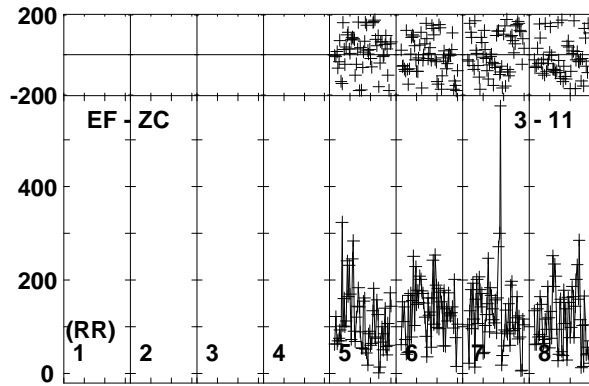
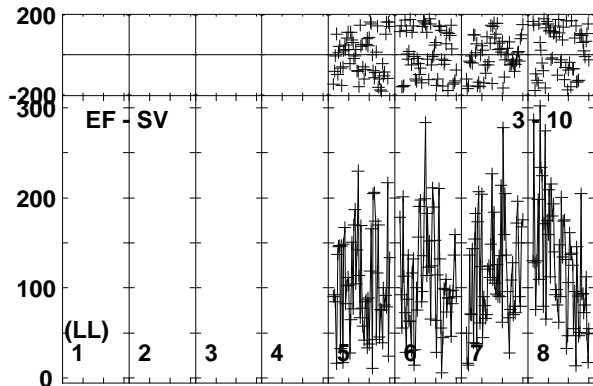
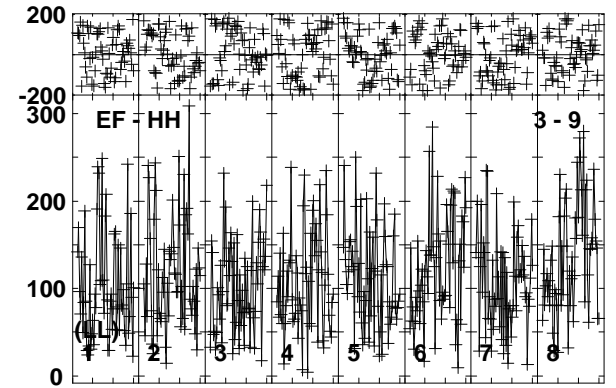
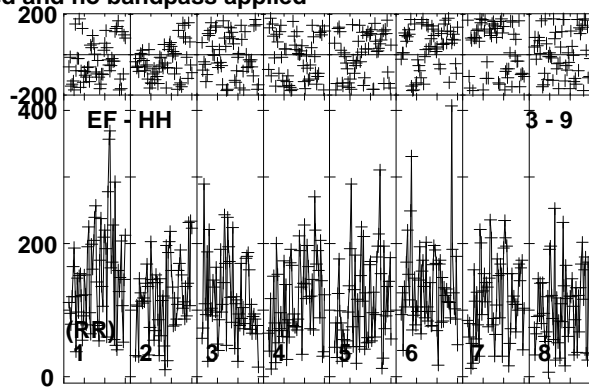
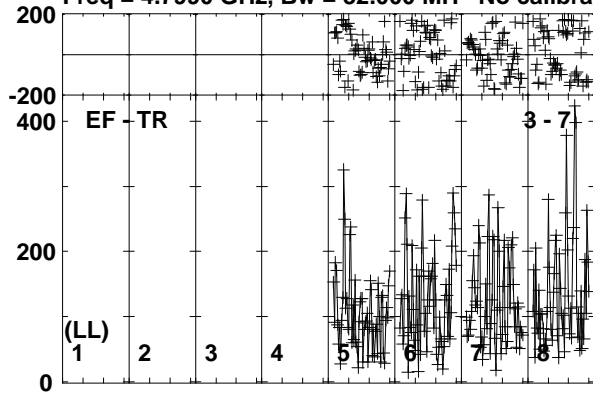

Lower frame: Micro Ampl Jy Top frame: Phas deg
Vector averaged cross-power spectrum Baseline: EF (03) - TR (07)
Timerange: 00/23:28:41 to 00/23:30:50

Plot file version 106 created 26-SEP-2019 10:39:52

190829A RG010A.UVDATA.1

Freq = 4.7990 GHz, Bw = 32.000 MH No calibration applied and no bandpass applied

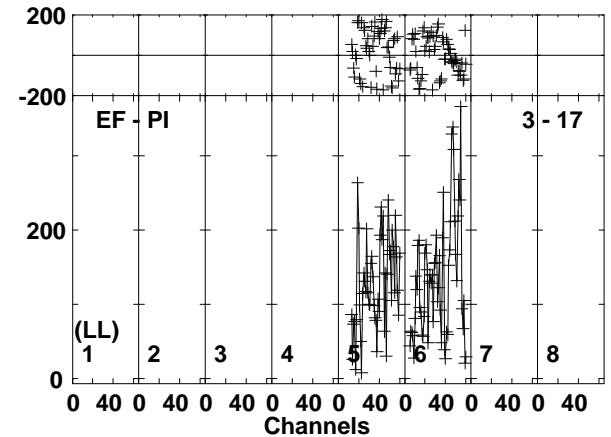
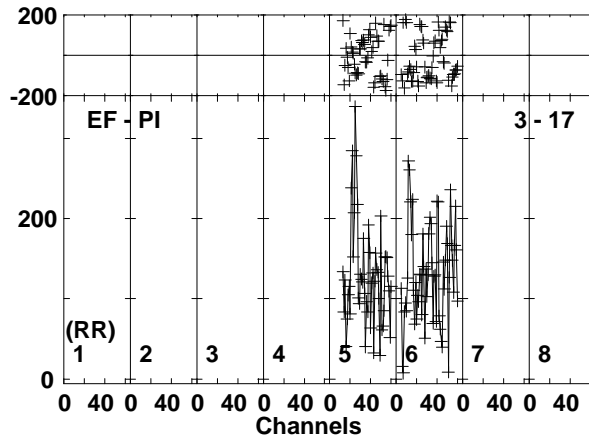
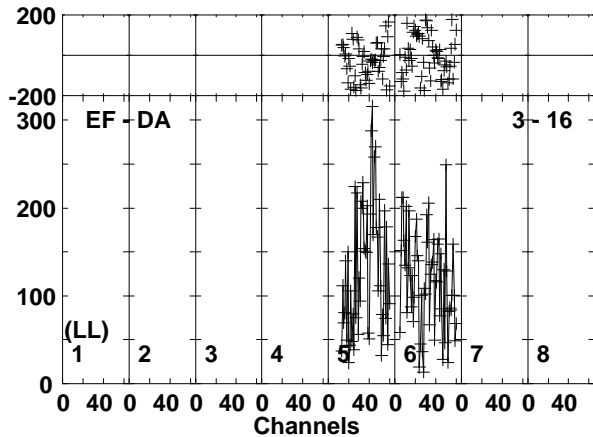
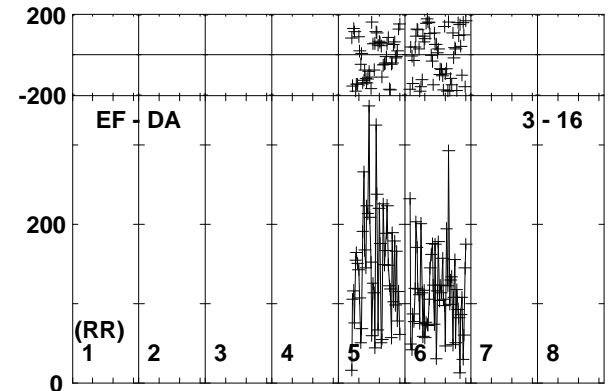
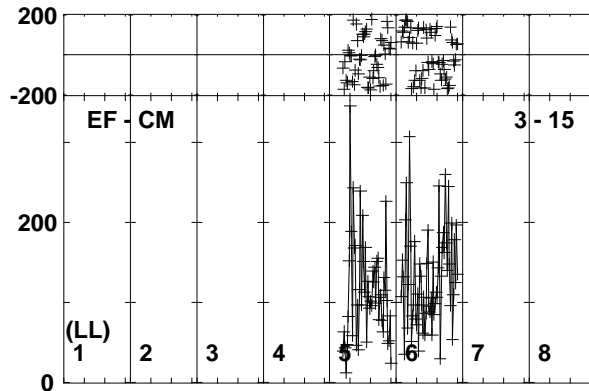
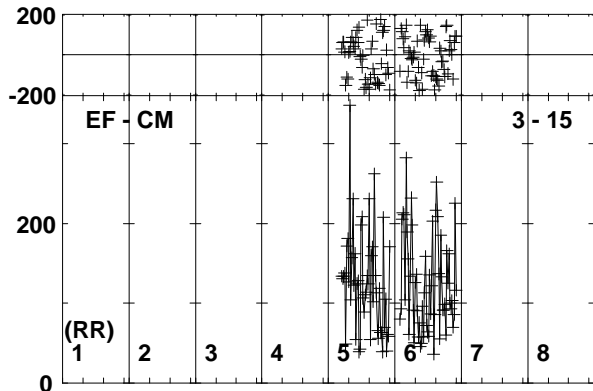
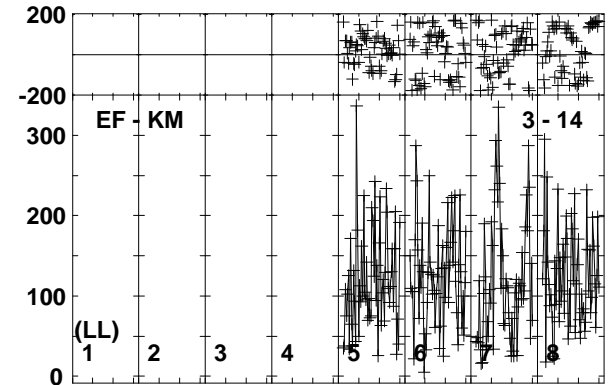
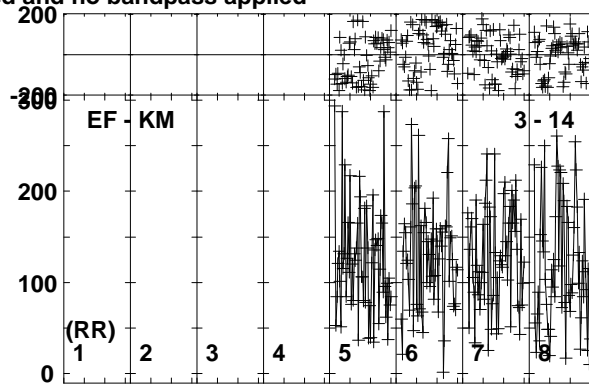
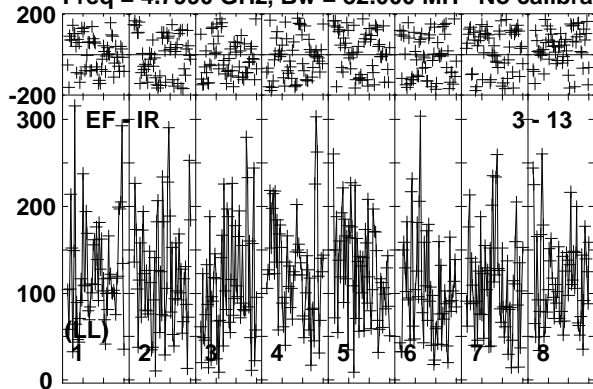

Lower frame: Micro Ampl Jy Top frame: Phas deg
Vector averaged cross-power spectrum Baseline: EF (03) - IR (13)
Timerange: 00/23:28:41 to 00/23:30:50

Plot file version 107 created 26-SEP-2019 10:39:53

190829A RG010A.UVDATA.1

Freq = 4.7990 GHz, Bw = 32.000 MH No calibration applied and no bandpass applied

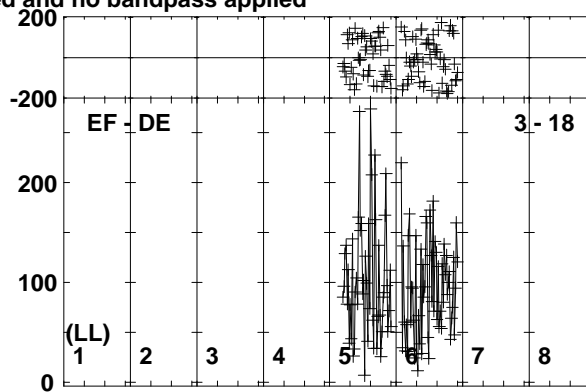
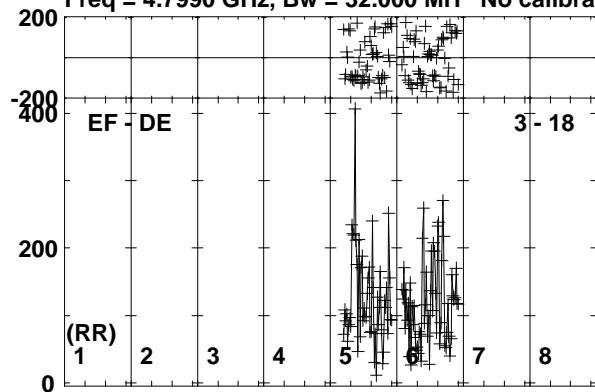

Lower frame: Micro Ampl Jy Top frame: Phas deg
Vector averaged cross-power spectrum Baseline: EF (03) - DE (18)
Timerange: 00/23:28:41 to 00/23:30:50

Plot file version 108 created 26-SEP-2019 10:39:53

J0257-1212 RG010A.UVDATA.1

Freq = 4.7990 GHz, Bw = 32.000 MH No calibration applied and no bandpass applied

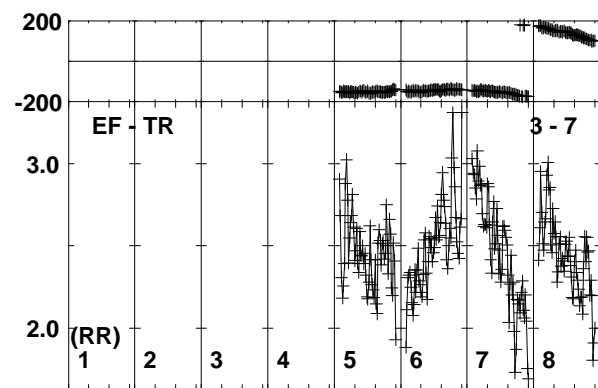
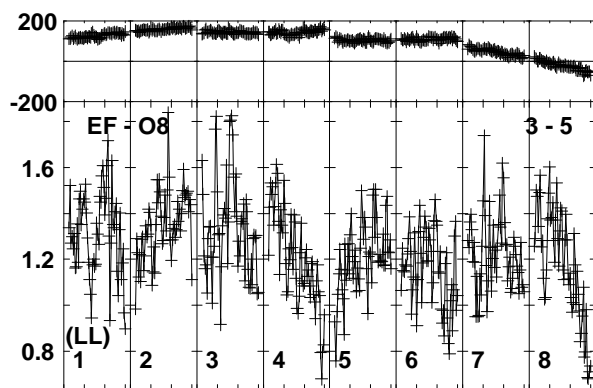
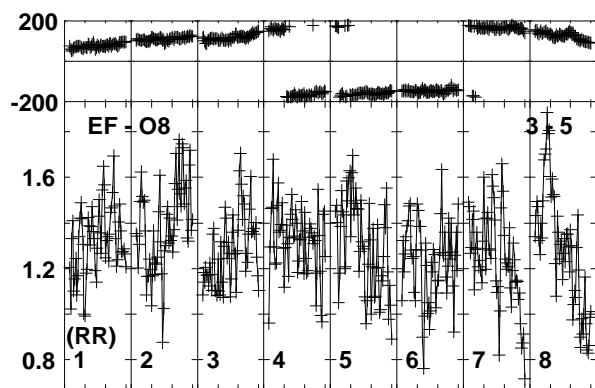
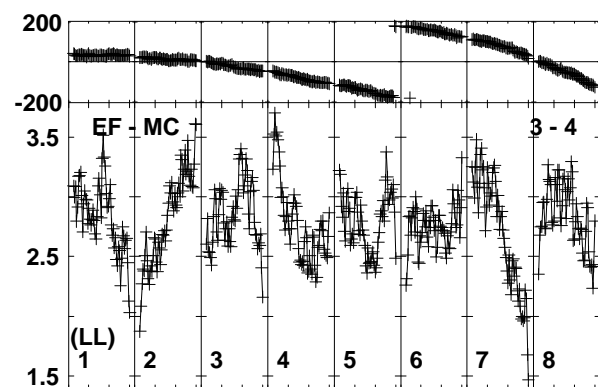
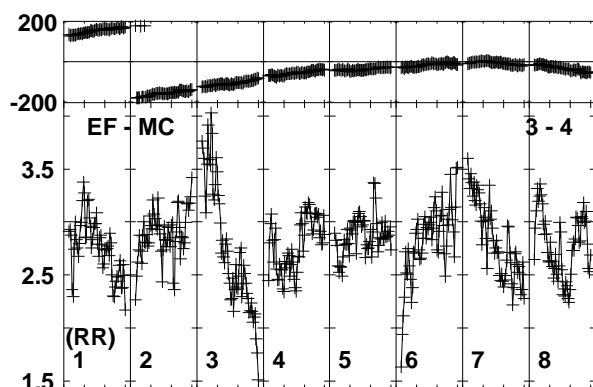
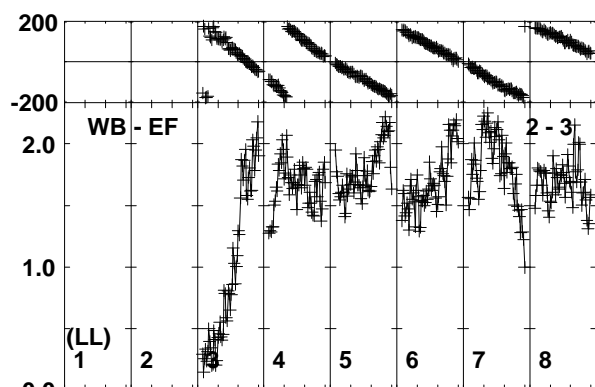
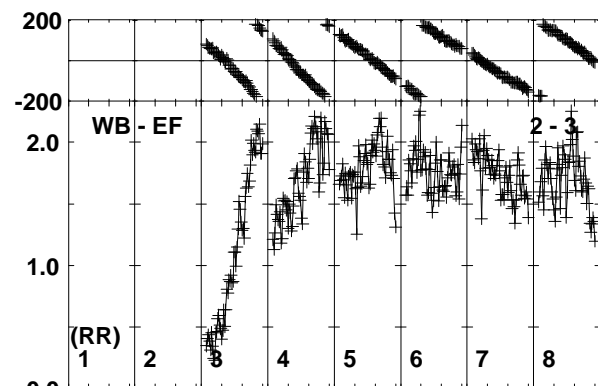
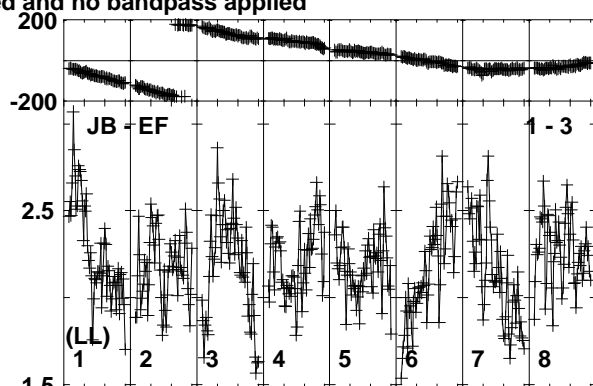
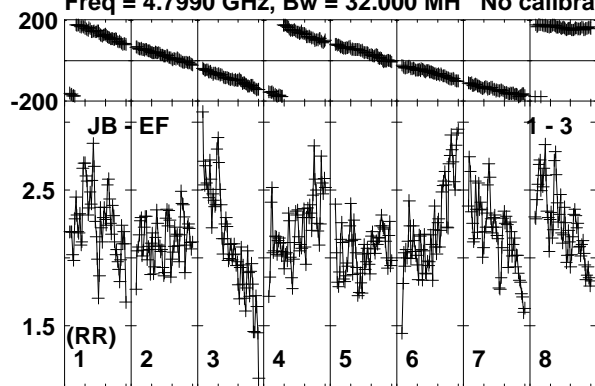

Lower frame: Milli Ampl Jy Top frame: Phas deg
Vector averaged cross-power spectrum Baseline: JB (01) - EF (03)
Timerange: 00/23:31:40 to 00/23:32:10

Plot file version 109 created 26-SEP-2019 10:39:53

J0257-1212 RG010A.UVDATA.1

Freq = 4.7990 GHz, Bw = 32.000 MH No calibration applied and no bandpass applied

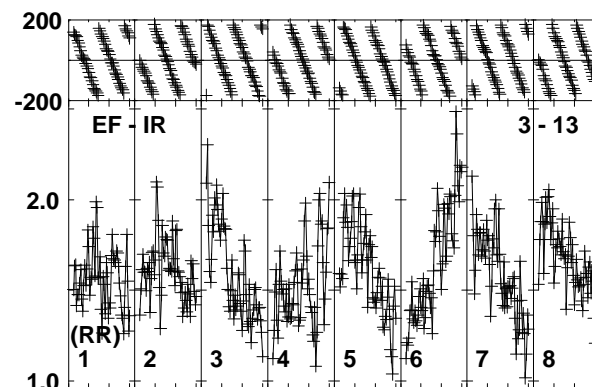
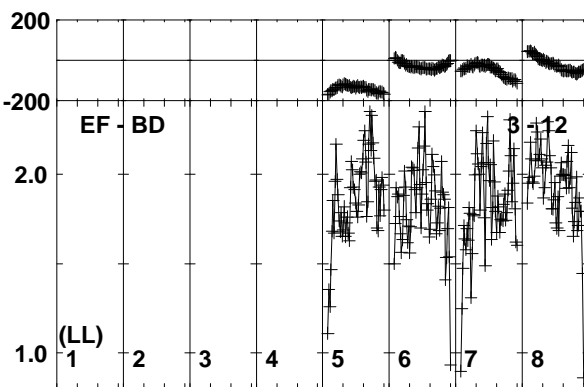
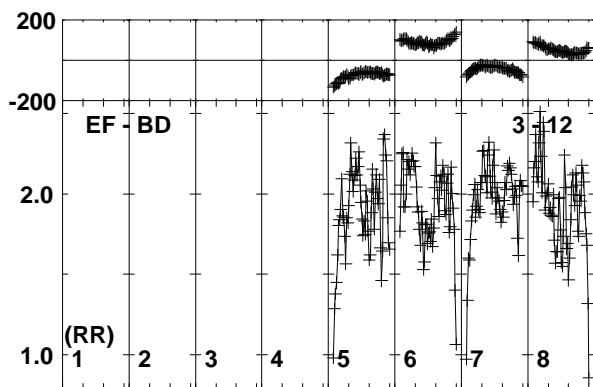
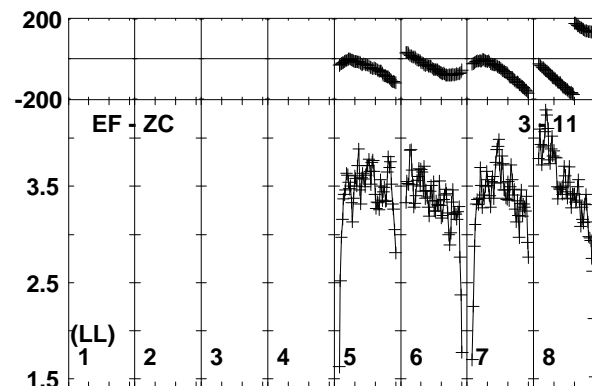
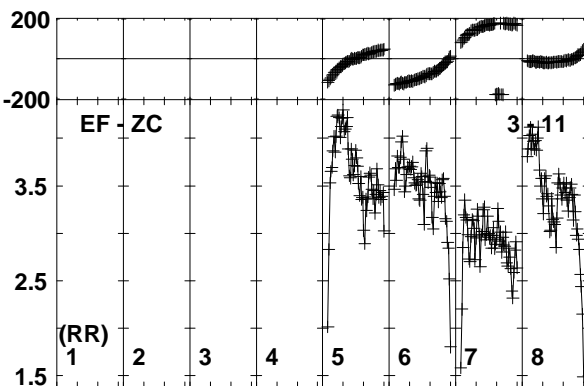
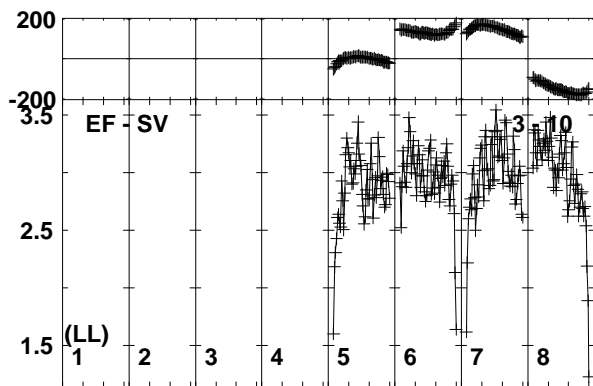
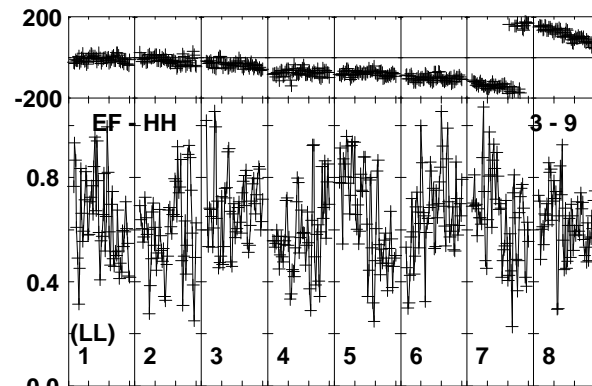
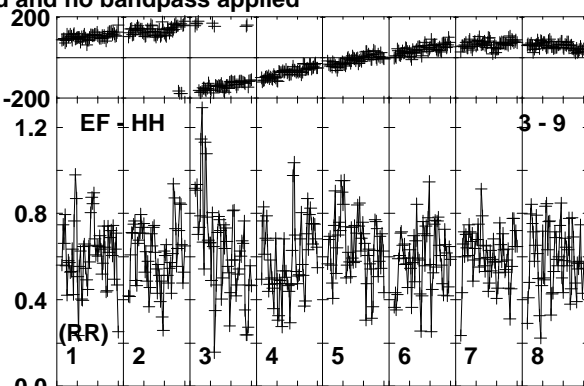
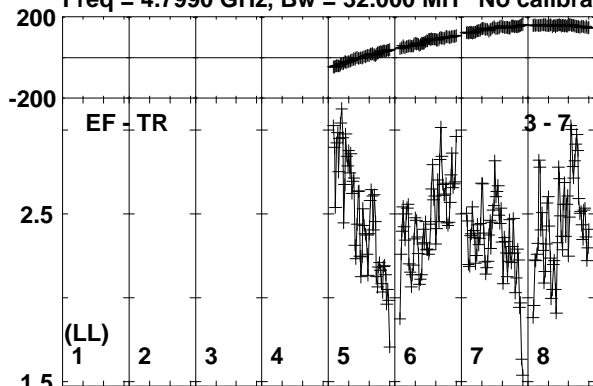

Lower frame: Milli Ampl Jy Top frame: Phas deg
Vector averaged cross-power spectrum Baseline: EF (03) - TR (07)
Timerange: 00/23:31:40 to 00/23:32:10

Plot file version 110 created 26-SEP-2019 10:39:54

J0257-1212 RG010A.UVDATA.1

Freq = 4.7990 GHz, Bw = 32.000 MH No calibration applied and no bandpass applied

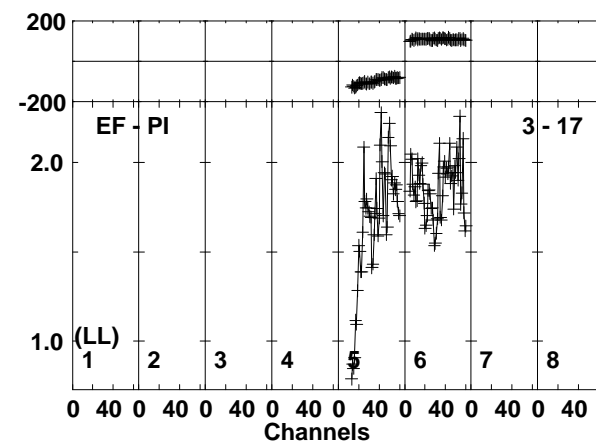
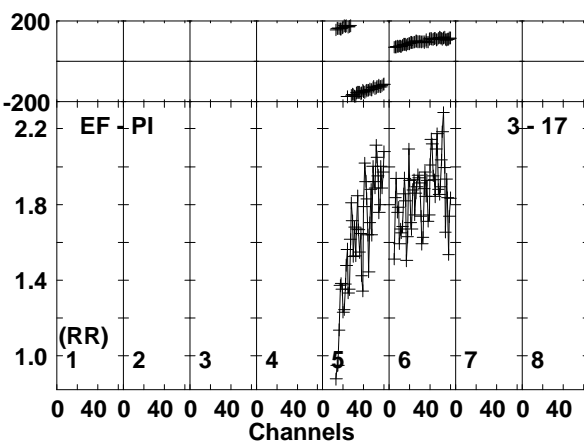
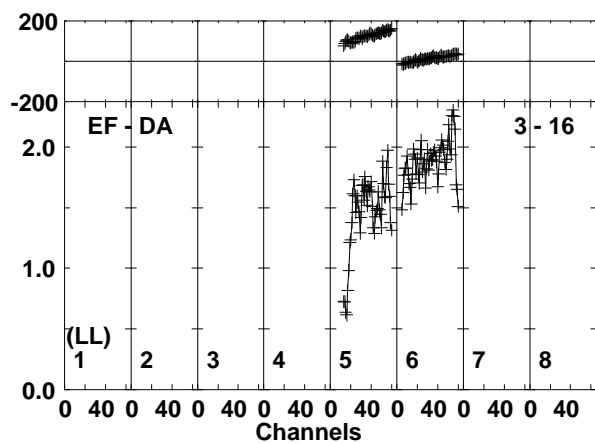
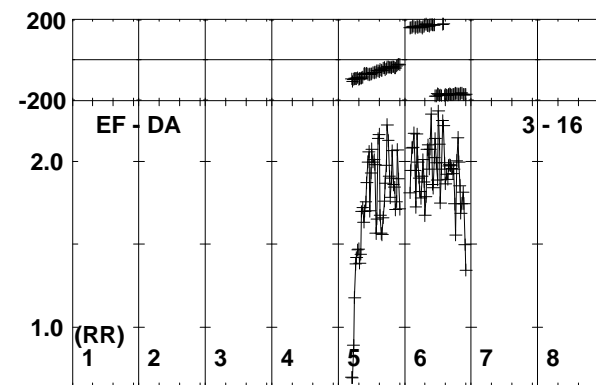
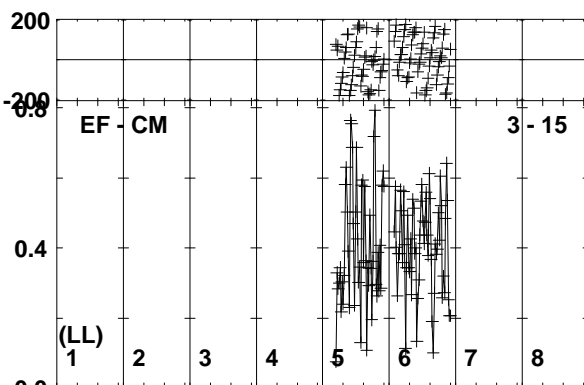
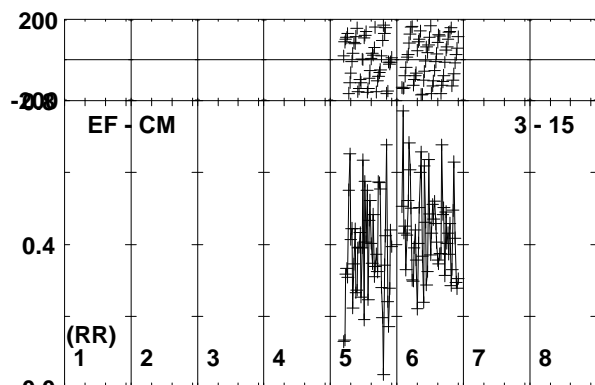
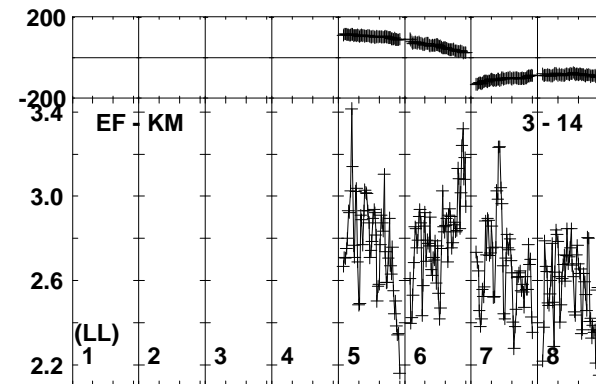
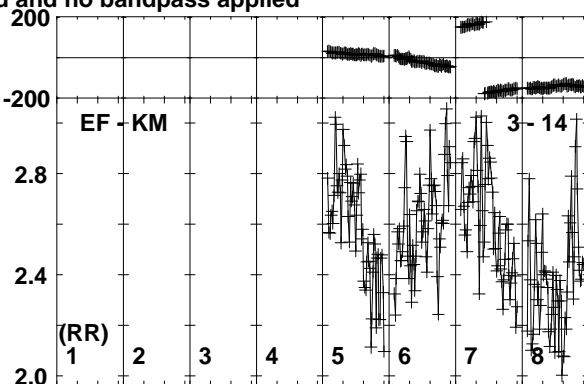
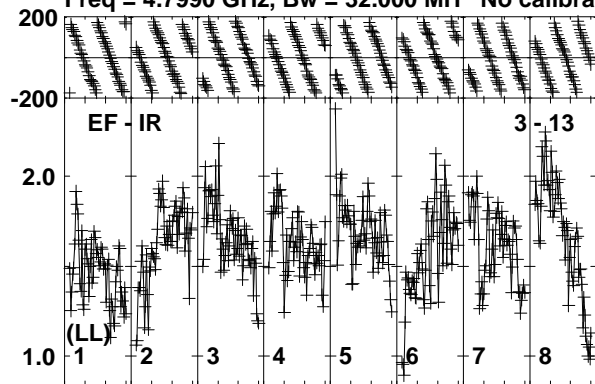

Lower frame: Milli Ampl Jy Top frame: Phas deg
Vector averaged cross-power spectrum Baseline: EF (03) - IR (13)
Timerange: 00/23:31:40 to 00/23:32:10

Plot file version 111 created 26-SEP-2019 10:39:54

J0257-1212 RG010A.UVDATA.1

Freq = 4.7990 GHz, Bw = 32.000 MH No calibration applied and no bandpass applied

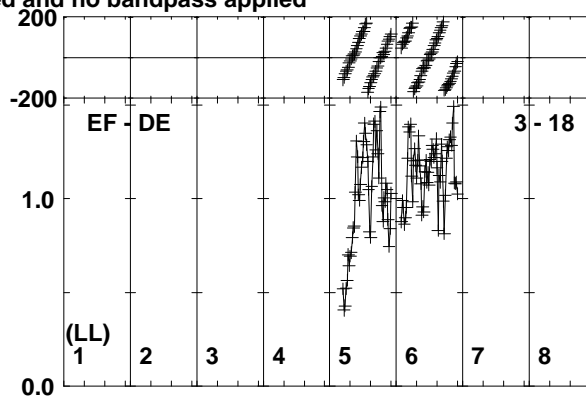
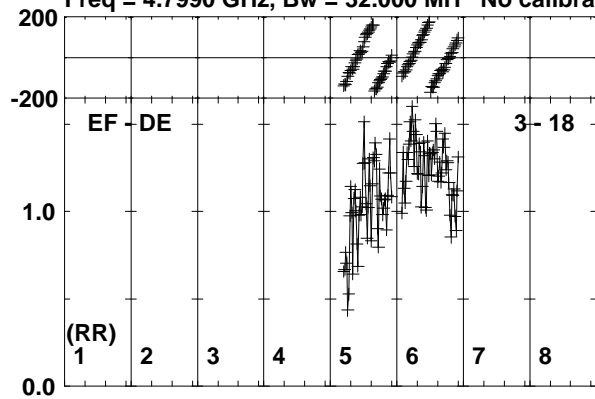

Lower frame: Milli Ampl Jy Top frame: Phas deg
Vector averaged cross-power spectrum Baseline: EF (03) - DE (18)
Timerange: 00/23:31:40 to 00/23:32:10

Plot file version 112 created 26-SEP-2019 10:39:54

J0300-0846 RG010A.UVDATA.1

Freq = 4.7990 GHz, Bw = 32.000 MH No calibration applied and no bandpass applied

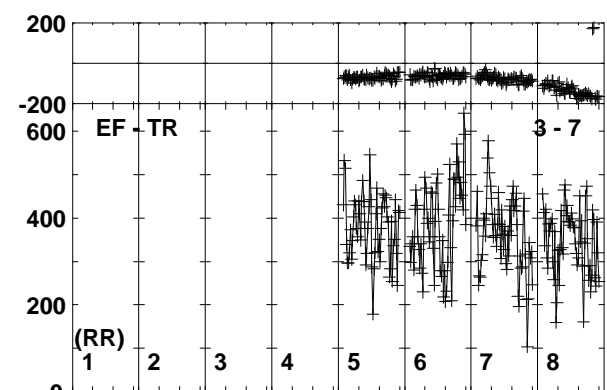
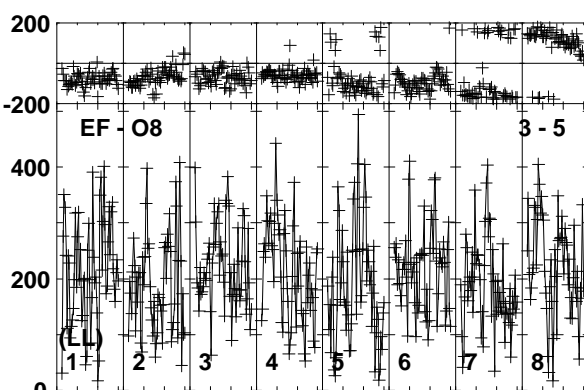
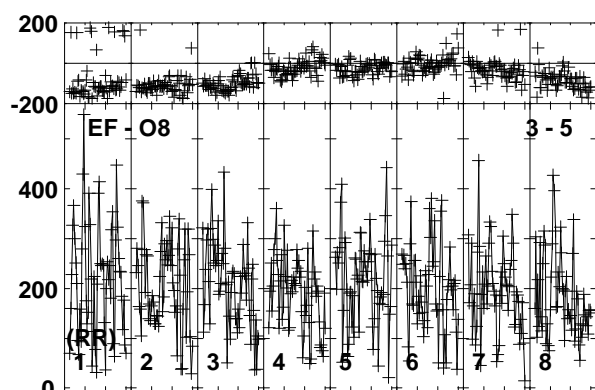
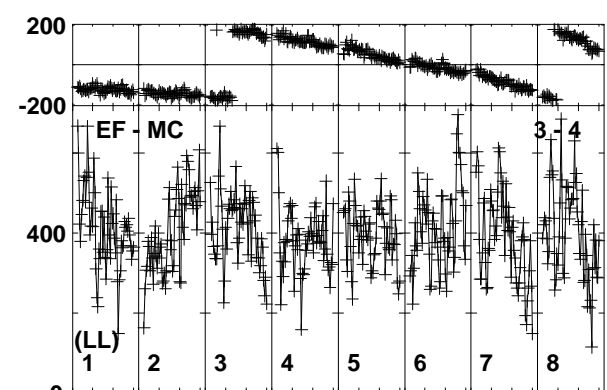
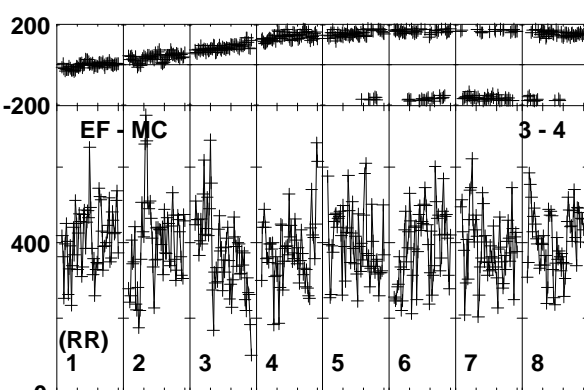
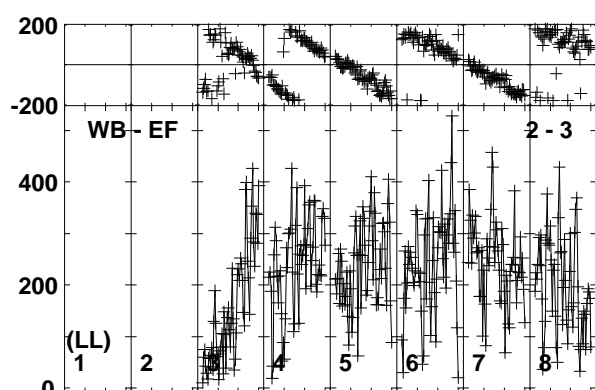
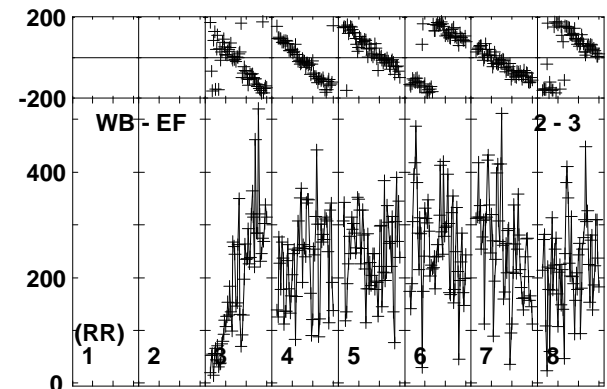
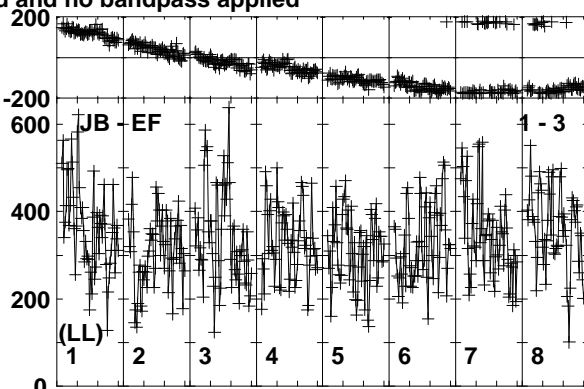
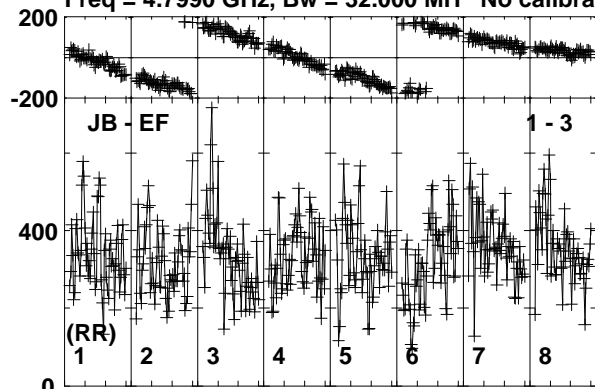

Lower frame: Micro Ampl Jy Top frame: Phas deg
Vector averaged cross-power spectrum Baseline: JB (01) - EF (03)
Timerange: 00/23:32:10 to 00/23:34:20

Plot file version 113 created 26-SEP-2019 10:39:54

J0300-0846 RG010A.UVDATA.1

Freq = 4.7990 GHz, Bw = 32.000 MH No calibration applied and no bandpass applied

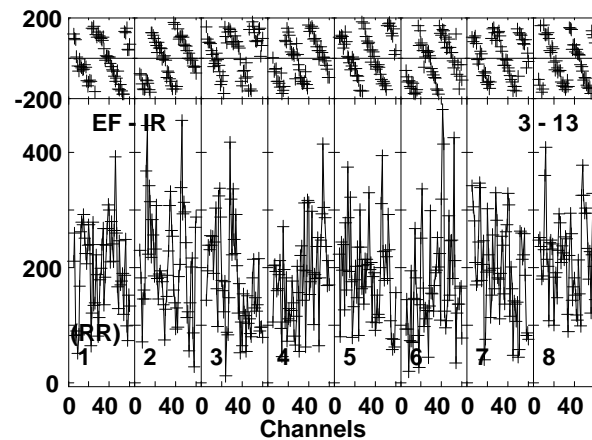
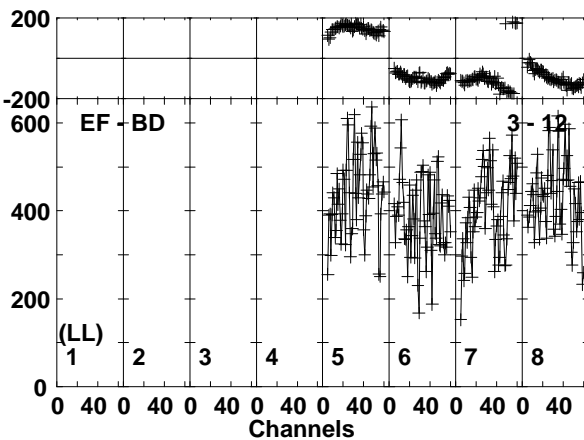
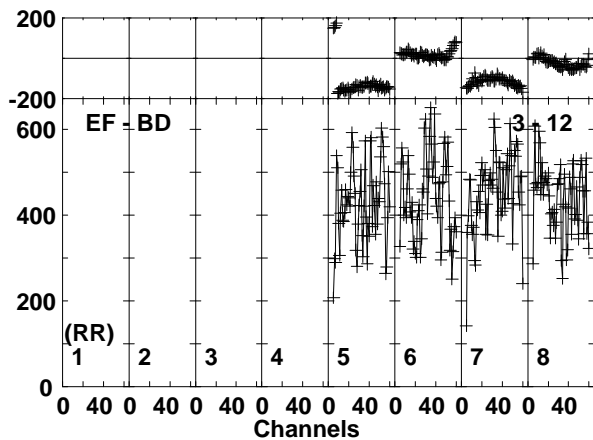
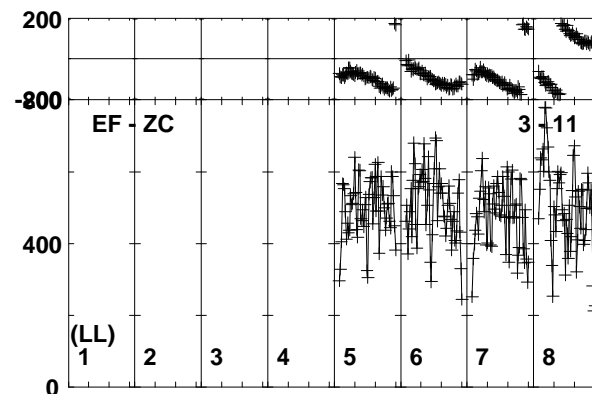
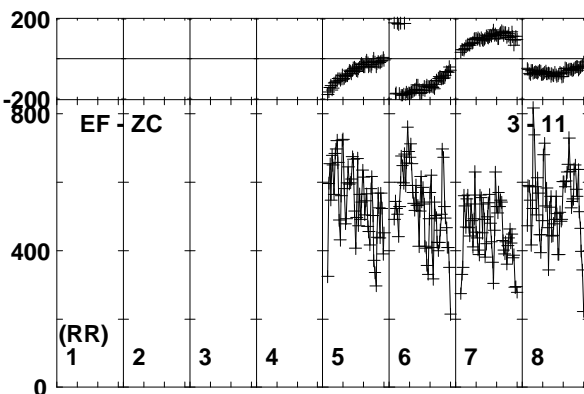
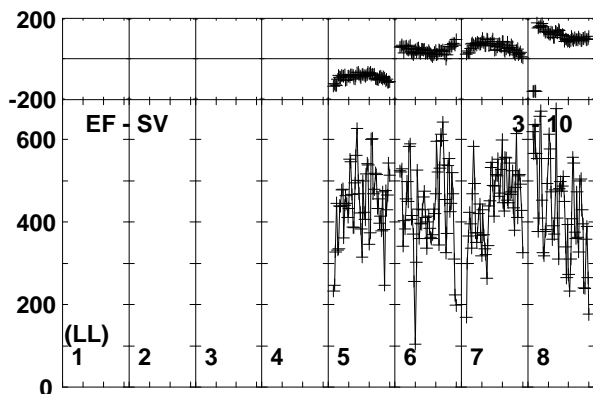
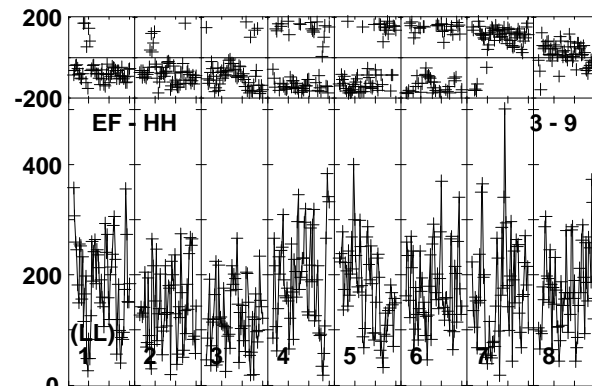
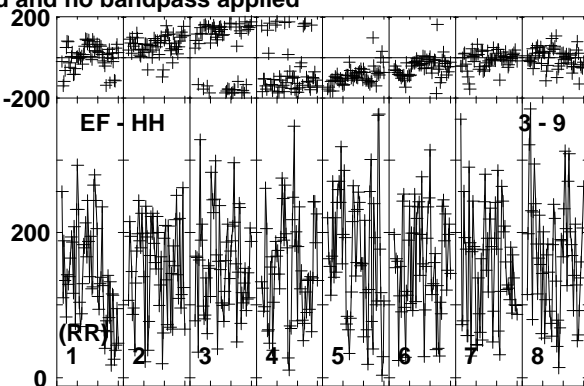
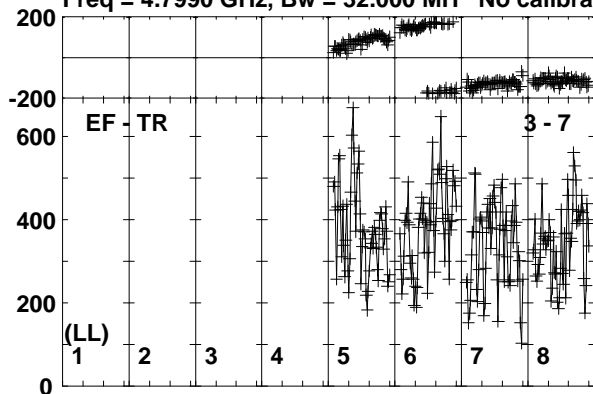

Lower frame: Micro Ampl Jy Top frame: Phas deg
 Vector averaged cross-power spectrum Baseline: EF (03) - TR (07)
 Timerange: 00/23:32:10 to 00/23:34:20

Plot file version 114 created 26-SEP-2019 10:39:55

J0300-0846 RG010A.UVDATA.1

Freq = 4.7990 GHz, Bw = 32.000 MH No calibration applied and no bandpass applied

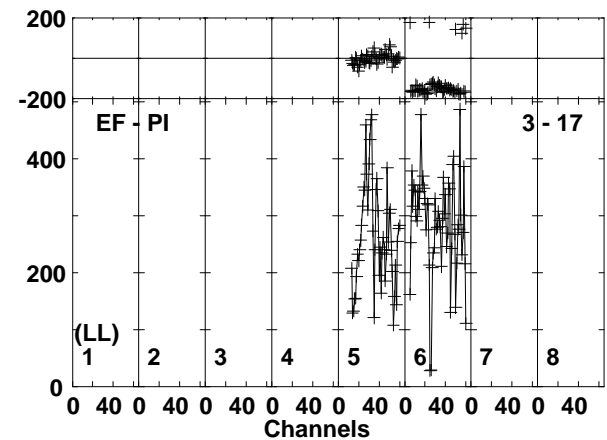
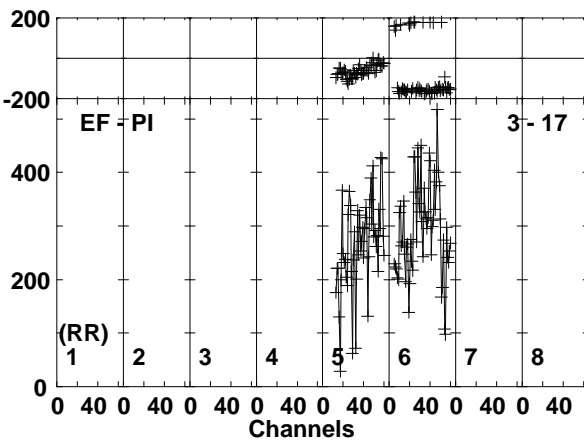
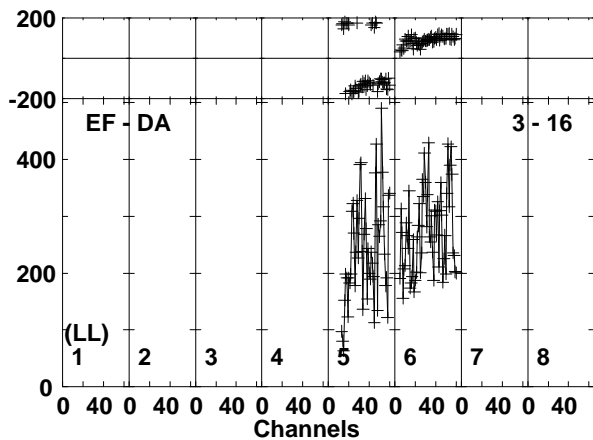
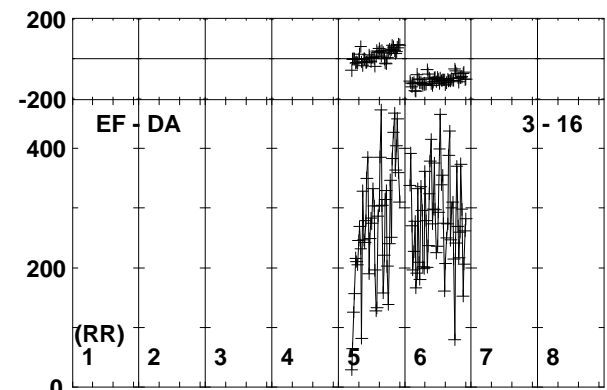
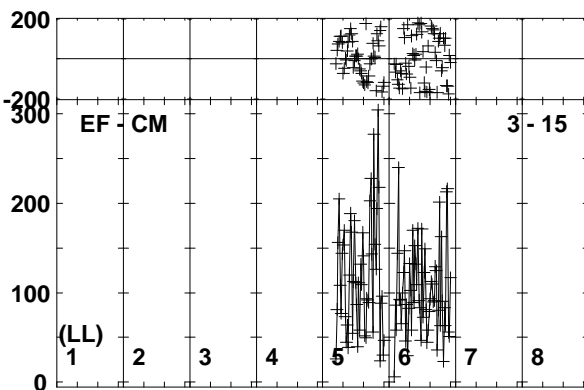
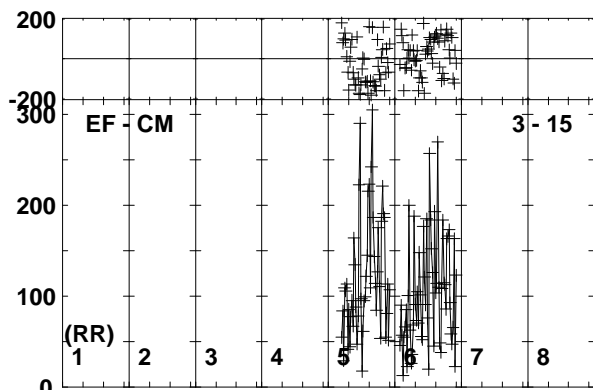
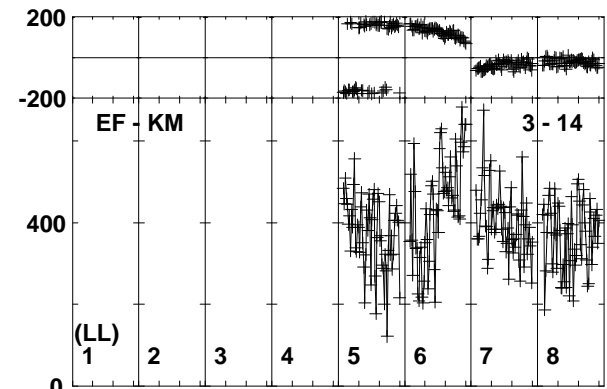
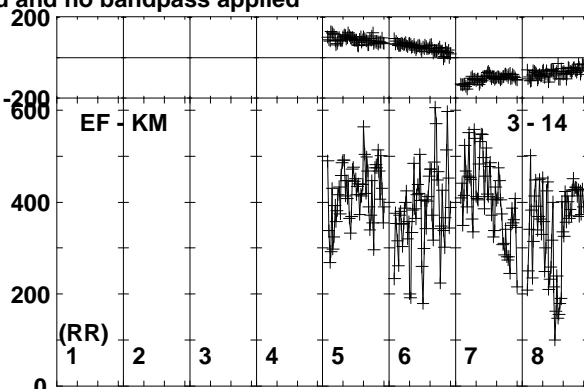
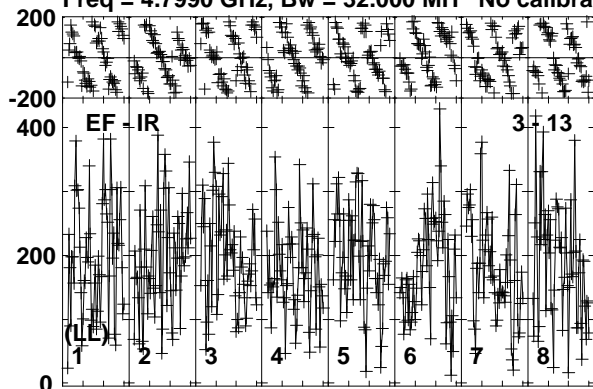

Lower frame: Micro Ampl Jy Top frame: Phas deg
Vector averaged cross-power spectrum Baseline: EF (03) - IR (13)
Timerange: 00/23:32:10 to 00/23:34:20

Plot file version 115 created 26-SEP-2019 10:39:55

J0300-0846 RG010A.UVDATA.1

Freq = 4.7990 GHz, Bw = 32.000 MH No calibration applied and no bandpass applied

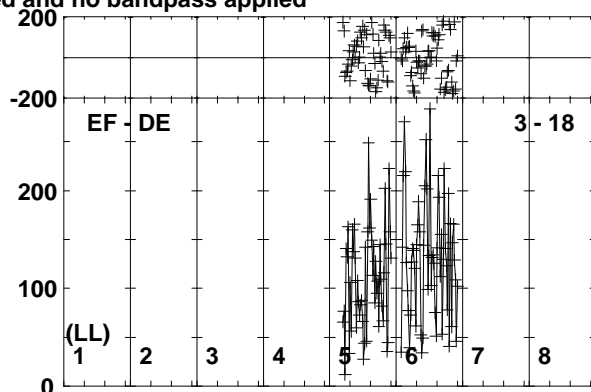
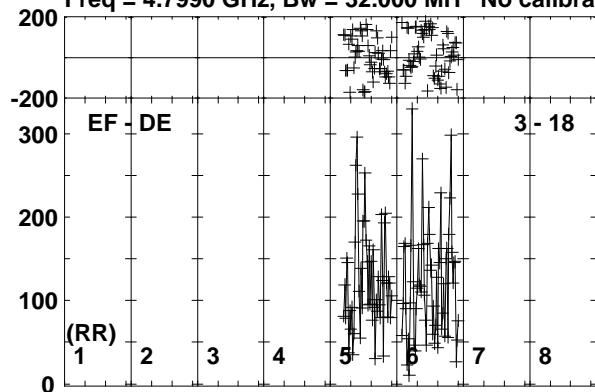

Lower frame: Micro Ampl Jy Top frame: Phas deg
Vector averaged cross-power spectrum Baseline: EF (03) - DE (18)
Timerange: 00/23:32:10 to 00/23:34:20

Plot file version 116 created 26-SEP-2019 10:39:55

J0257-1212 RG010A.UVDATA.1

Freq = 4.7990 GHz, Bw = 32.000 MH No calibration applied and no bandpass applied

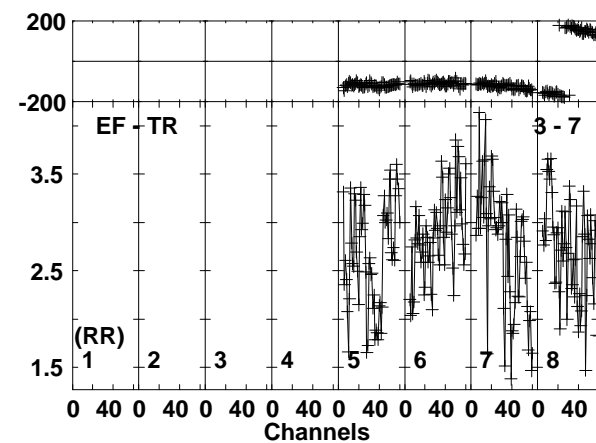
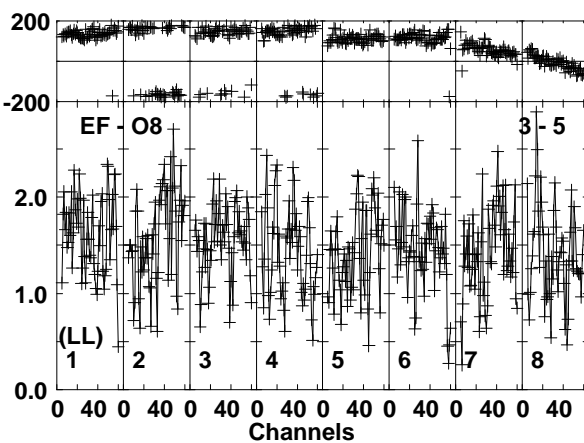
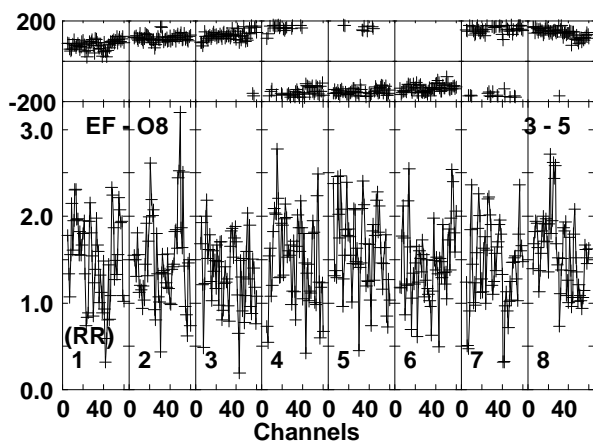
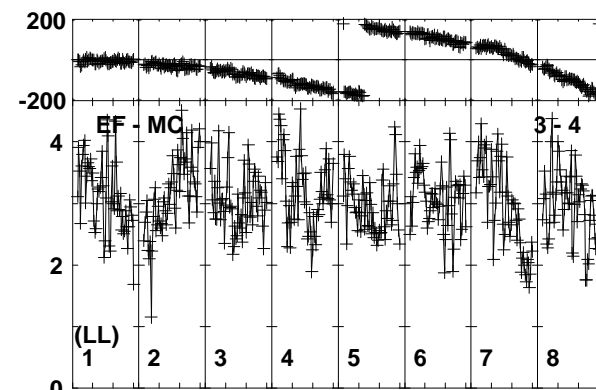
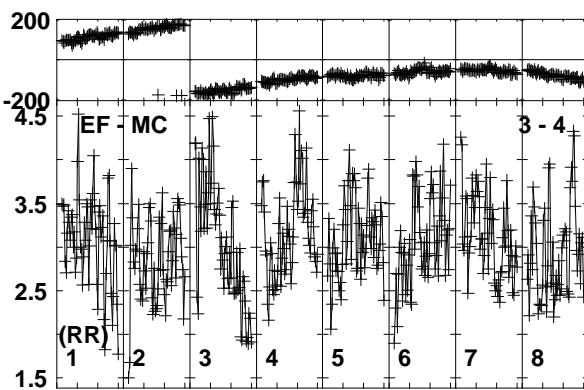
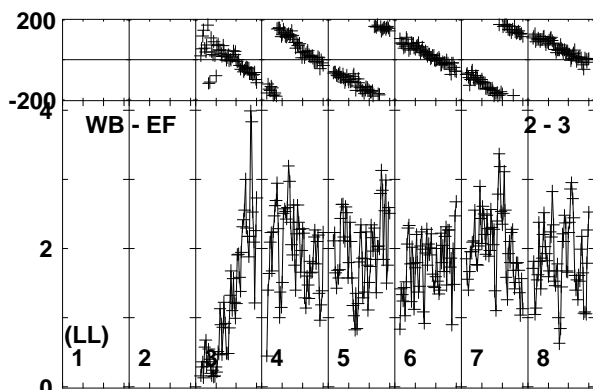
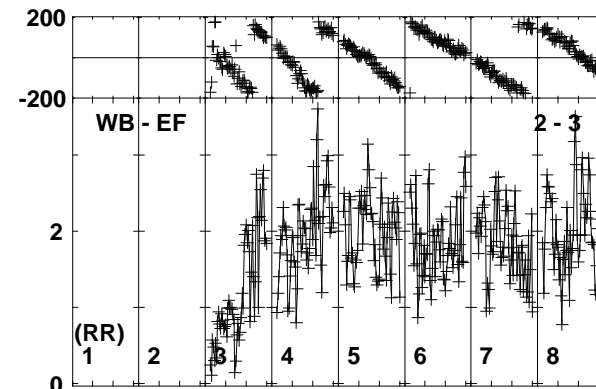
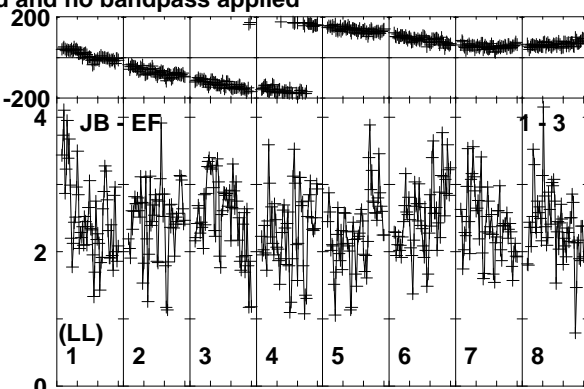
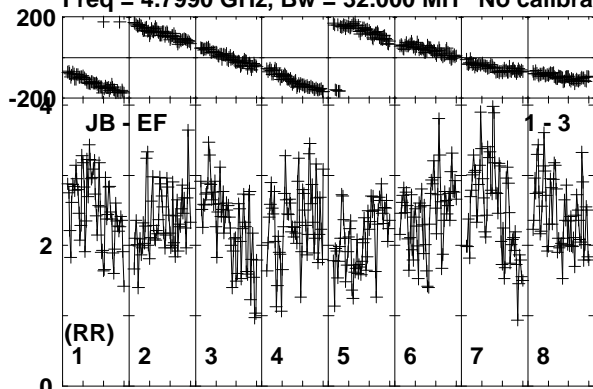

Lower frame: Milli Ampl Jy Top frame: Phas deg
Vector averaged cross-power spectrum Baseline: JB (01) - EF (03)
Timerange: 00/23:34:20 to 00/23:35:19

Plot file version 117 created 26-SEP-2019 10:39:56

J0257-1212 RG010A.UVDATA.1

Freq = 4.7990 GHz, Bw = 32.000 MH No calibration applied and no bandpass applied

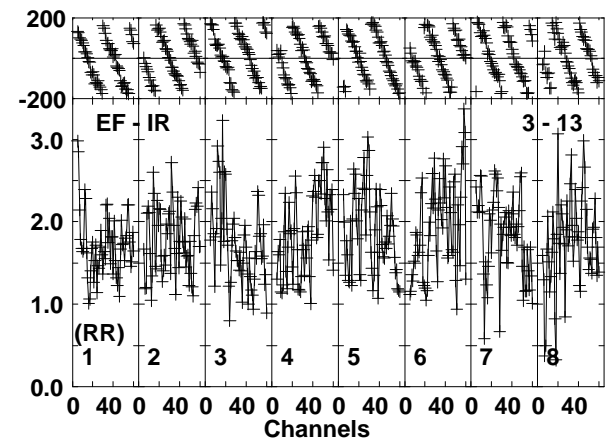
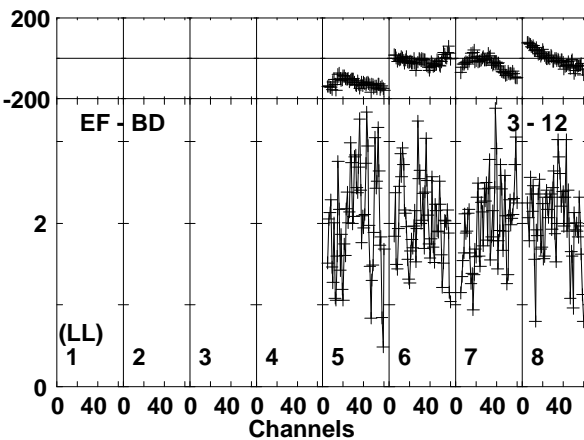
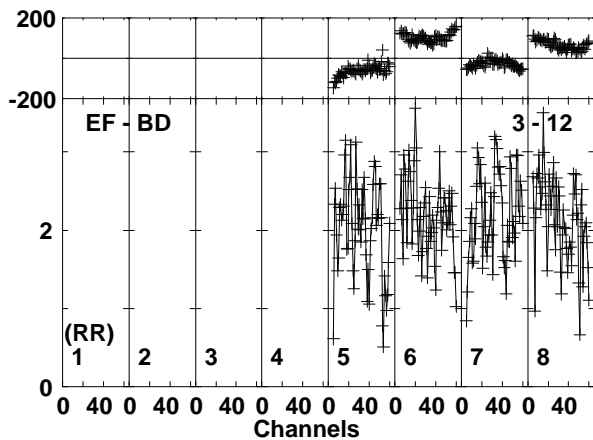
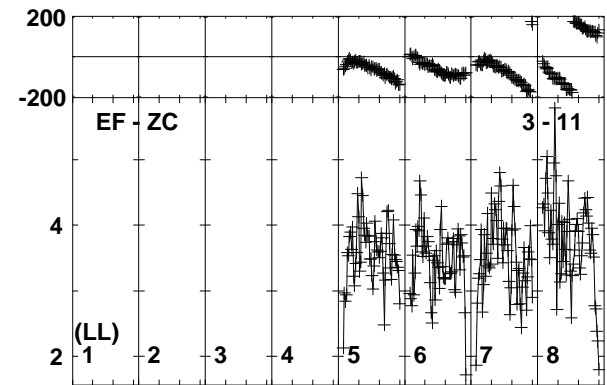
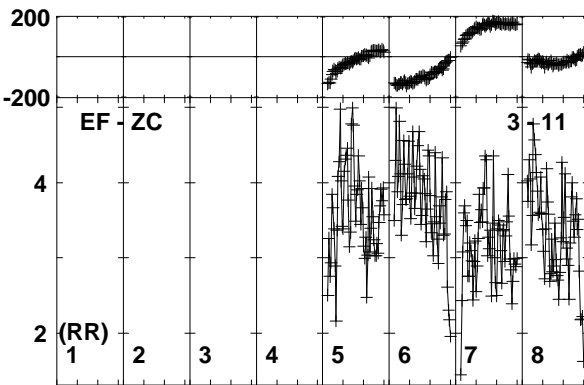
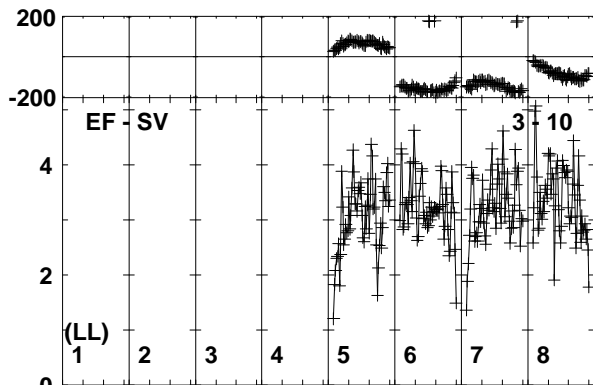
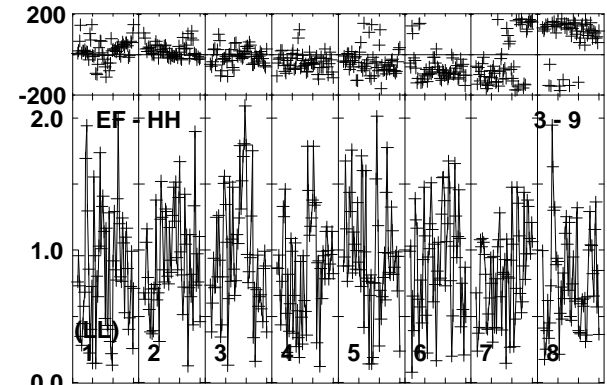
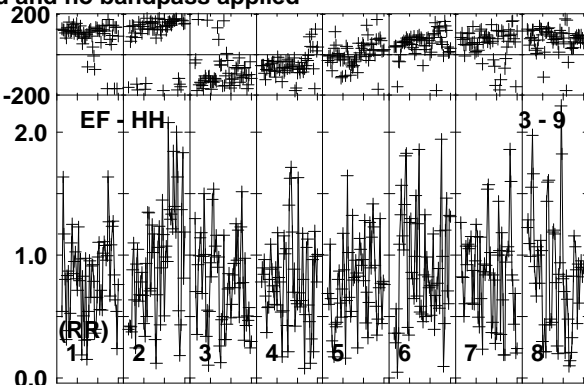
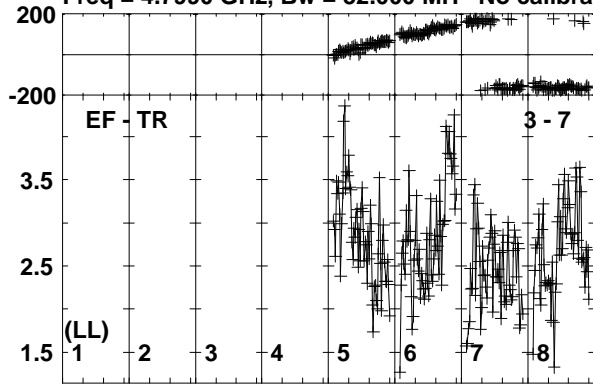

Lower frame: Milli Ampl Jy Top frame: Phas deg
Vector averaged cross-power spectrum Baseline: EF (03) - TR (07)
Timerange: 00/23:34:20 to 00/23:35:19

Plot file version 118 created 26-SEP-2019 10:39:56

J0257-1212 RG010A.UVDATA.1

Freq = 4.7990 GHz, Bw = 32.000 MH No calibration applied and no bandpass applied

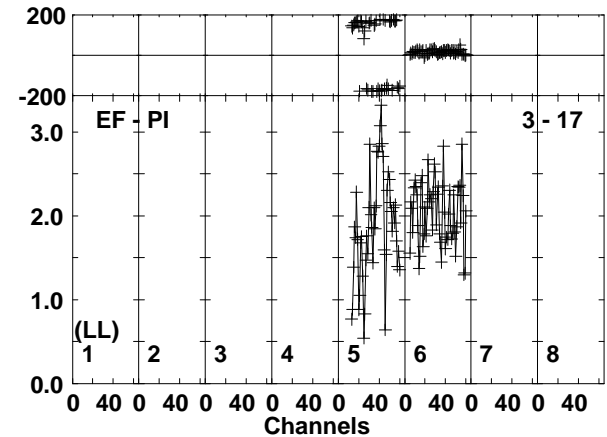
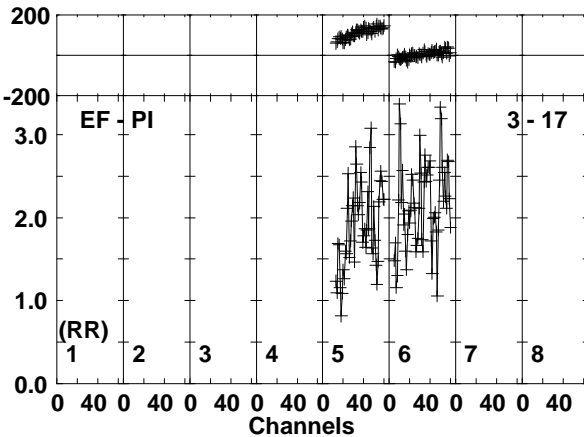
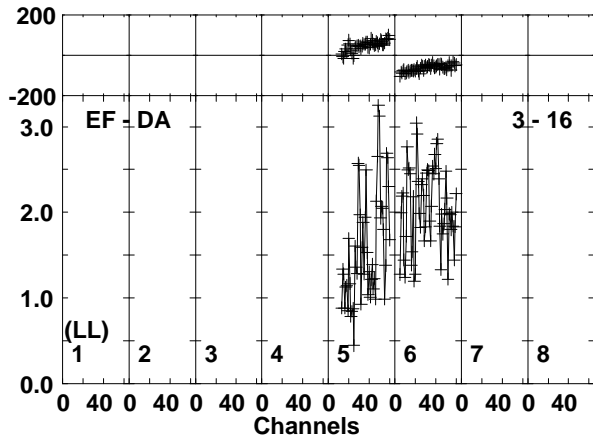
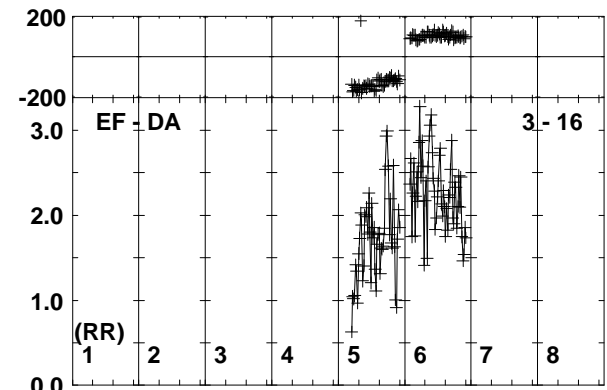
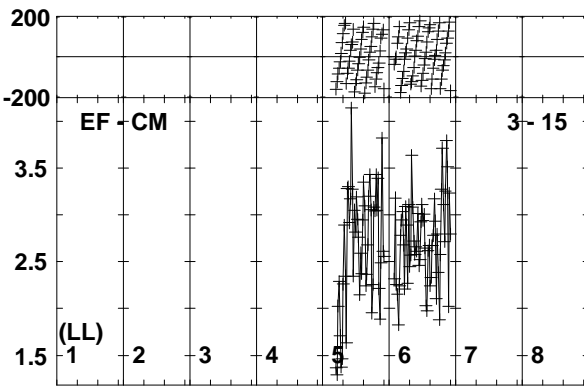
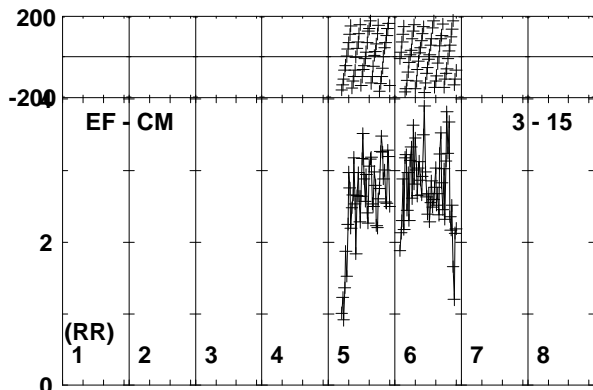
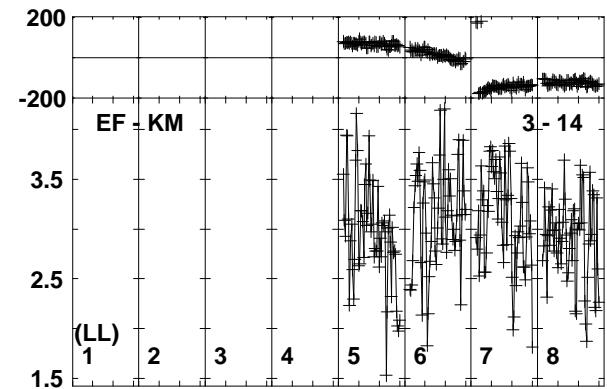
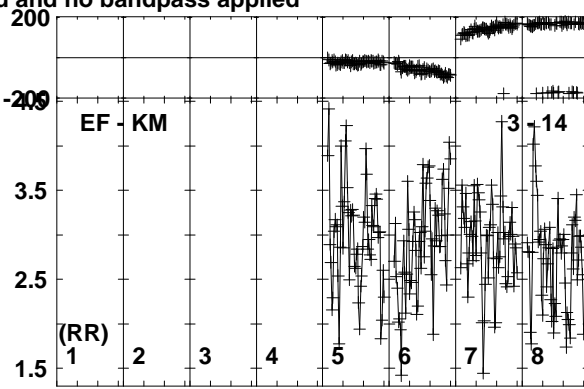
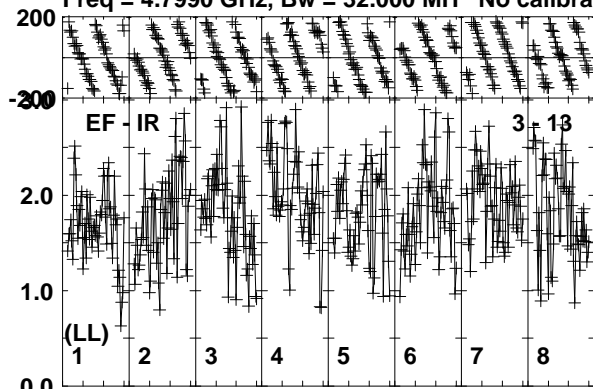

Lower frame: Milli Ampl Jy Top frame: Phas deg
Vector averaged cross-power spectrum Baseline: EF (03) - IR (13)
Timerange: 00/23:34:20 to 00/23:35:19

Plot file version 119 created 26-SEP-2019 10:39:57

J0257-1212 RG010A.UVDATA.1

Freq = 4.7990 GHz, Bw = 32.000 MH No calibration applied and no bandpass applied

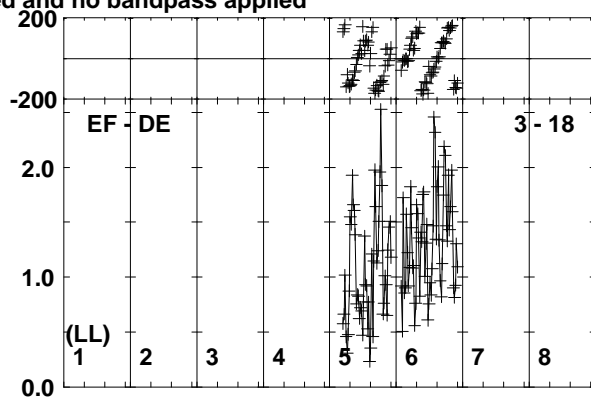
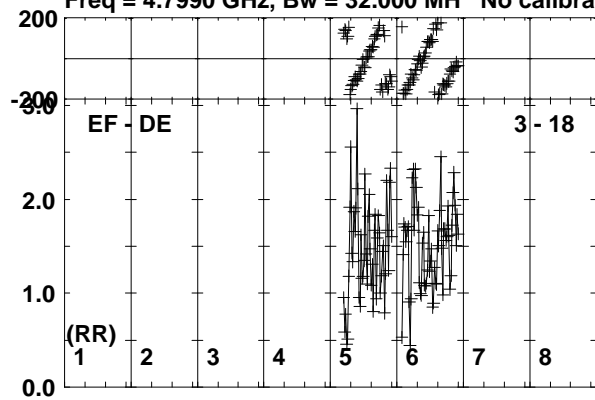

Lower frame: Milli Ampl Jy Top frame: Phas deg
Vector averaged cross-power spectrum Baseline: EF (03) - DE (18)
Timerange: 00/23:34:20 to 00/23:35:19

Plot file version 120 created 26-SEP-2019 10:39:57

190829A RG010A.UVDATA.1

Freq = 4.7990 GHz, Bw = 32.000 MH No calibration applied and no bandpass applied

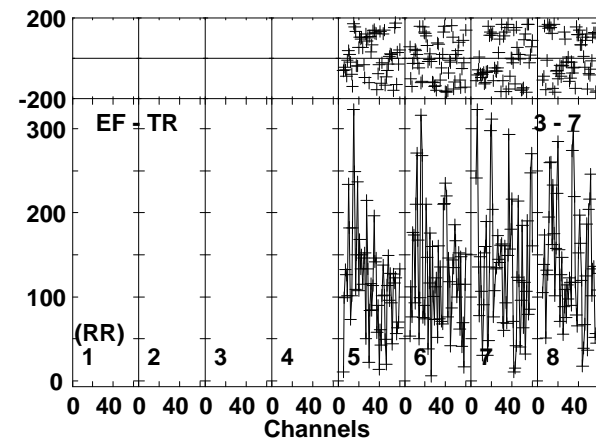
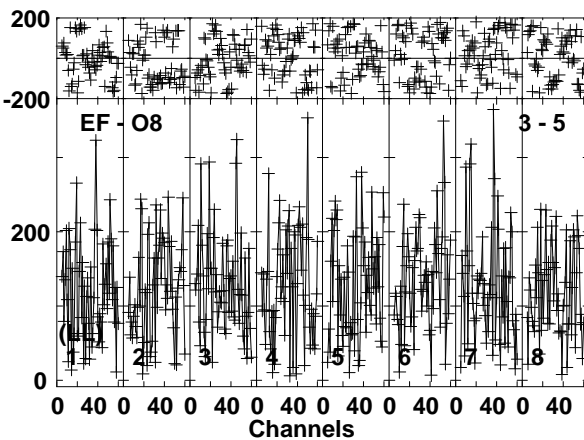
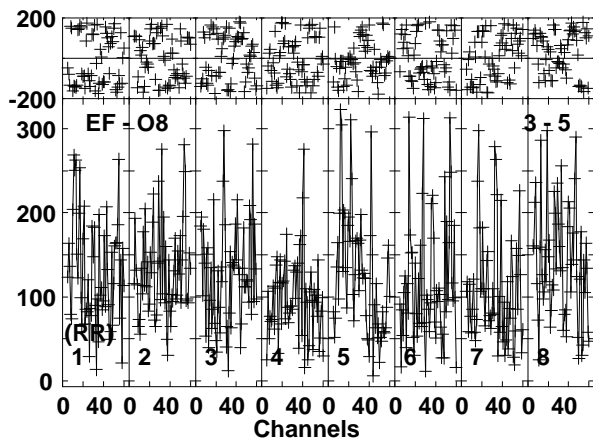
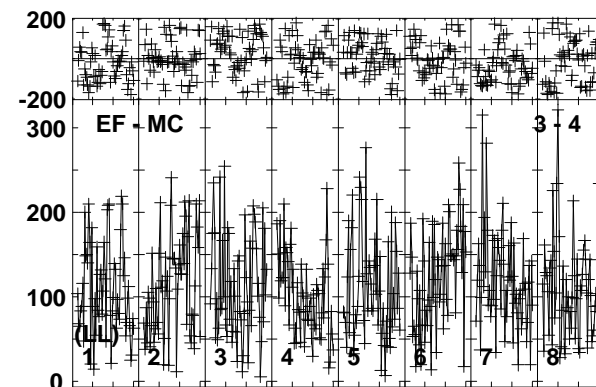
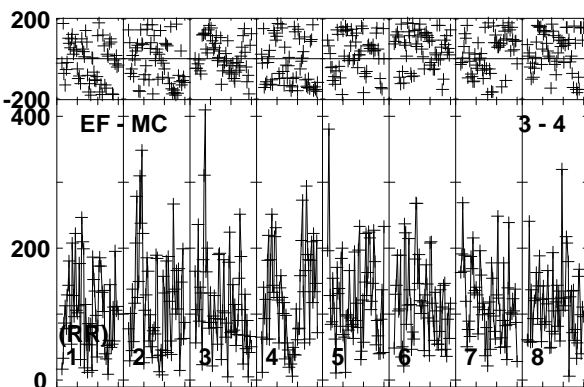
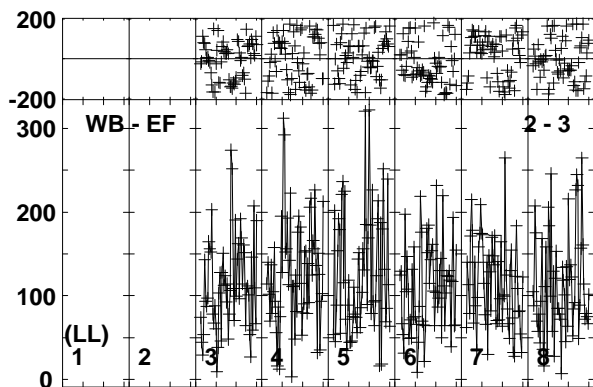
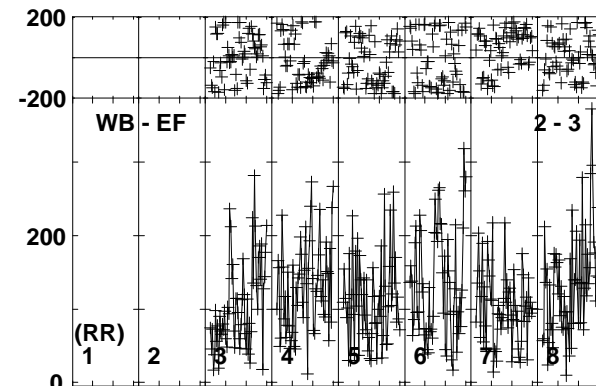
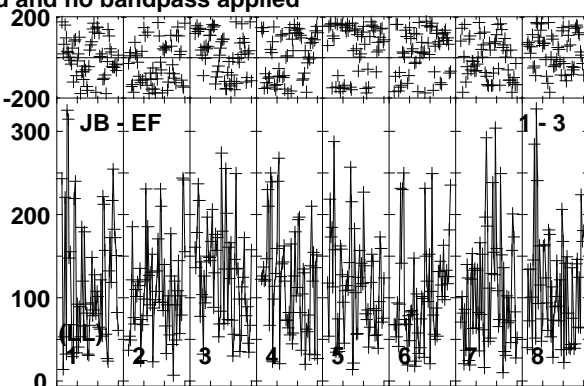
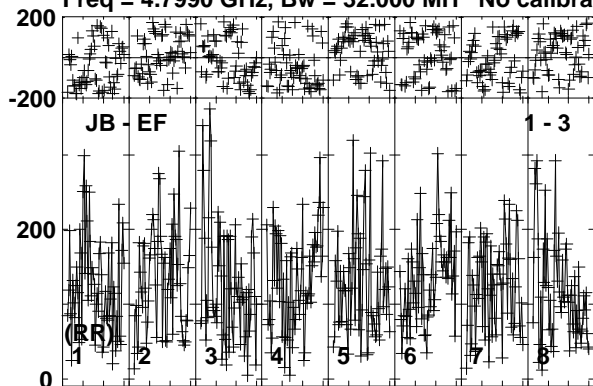

Lower frame: Micro Ampl Jy Top frame: Phas deg
Vector averaged cross-power spectrum Baseline: JB (01) - EF (03)
Timerange: 00/23:35:20 to 00/23:37:29

Plot file version 121 created 26-SEP-2019 10:39:57

190829A RG010A.UVDATA.1

Freq = 4.7990 GHz, Bw = 32.000 MH No calibration applied and no bandpass applied

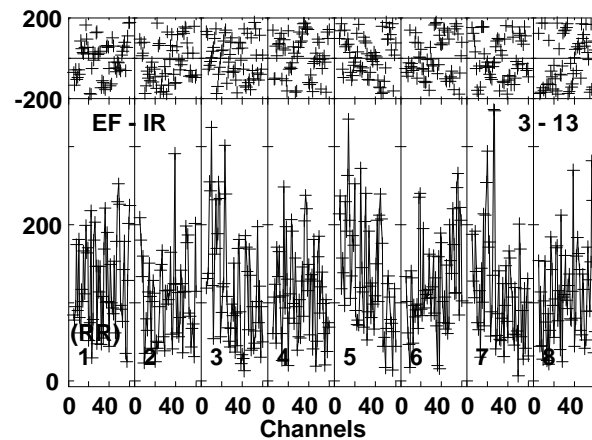
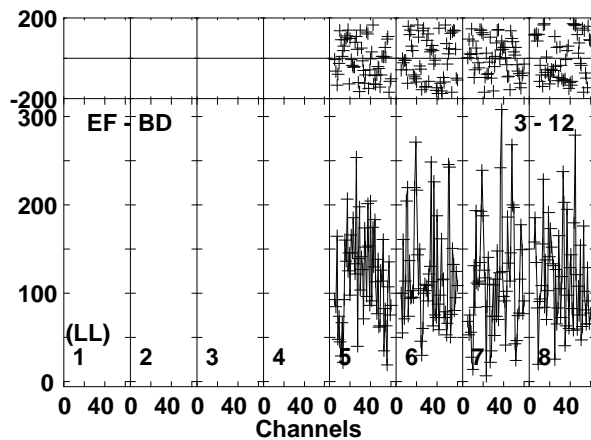
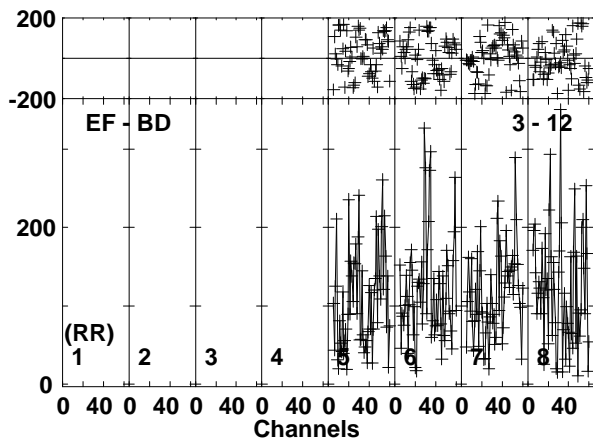
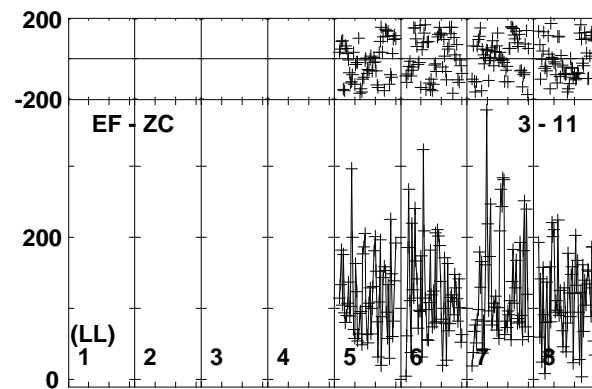
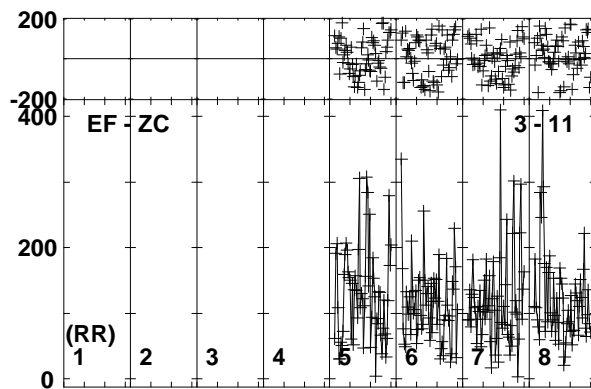
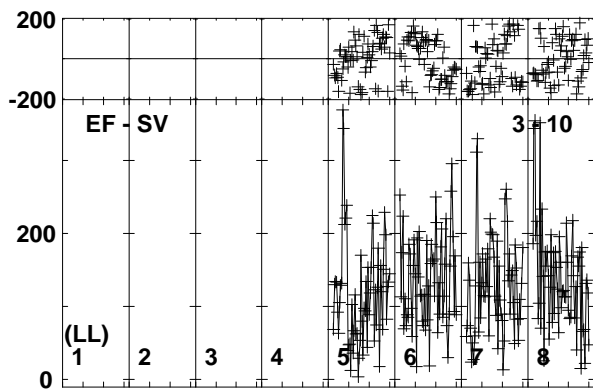
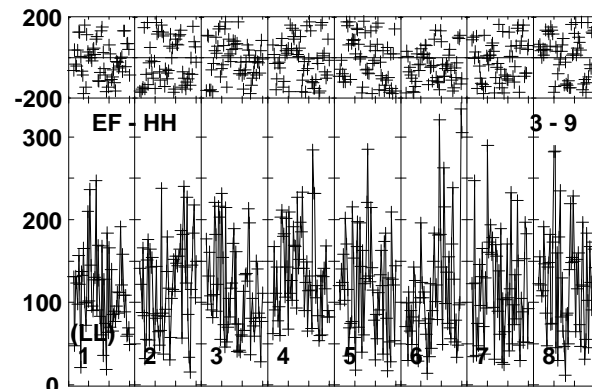
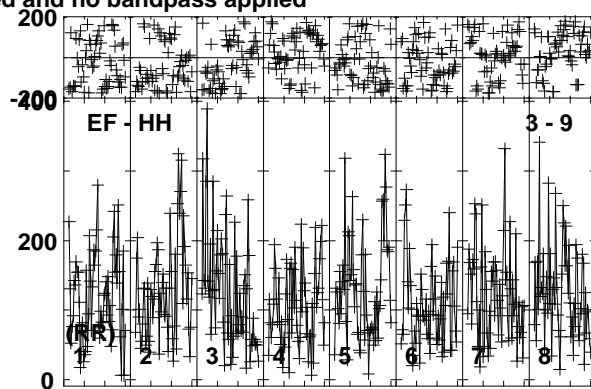
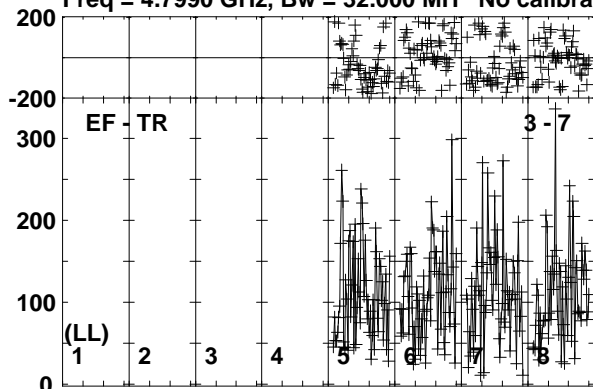

Lower frame: Micro Ampl Jy Top frame: Phas deg
Vector averaged cross-power spectrum Baseline: EF (03) - TR (07)
Timerange: 00/23:35:20 to 00/23:37:29

Plot file version 122 created 26-SEP-2019 10:39:58

190829A RG010A.UVDATA.1

Freq = 4.7990 GHz, Bw = 32.000 MH No calibration applied and no bandpass applied

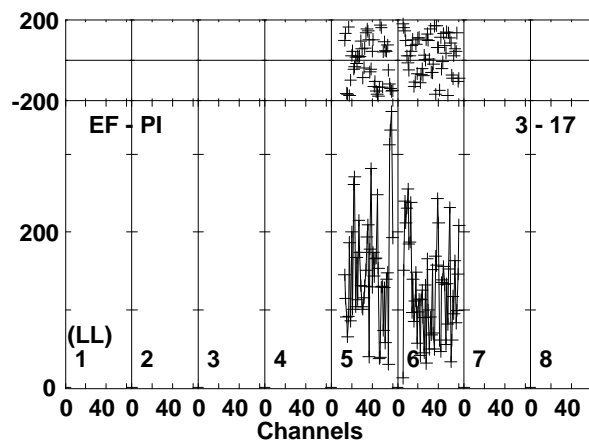
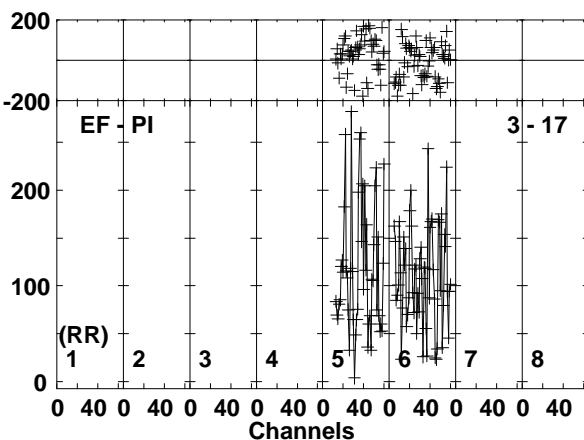
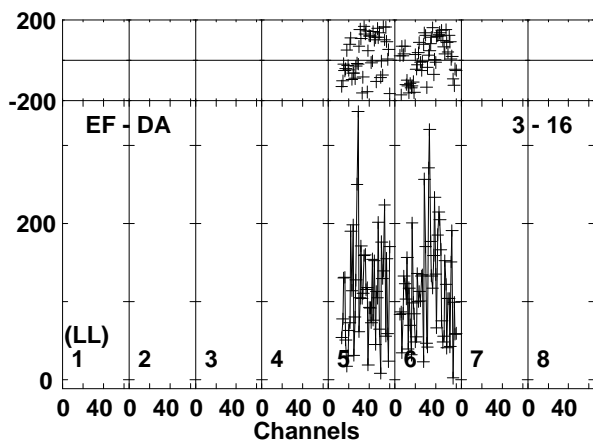
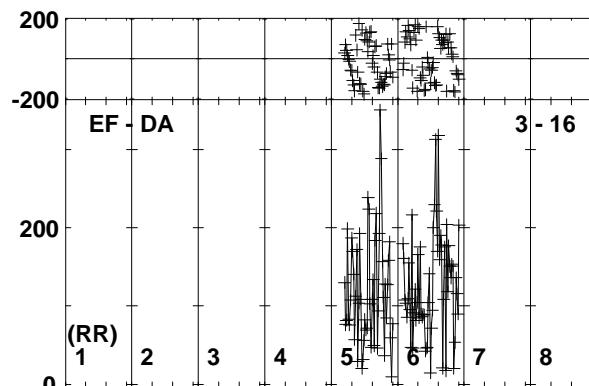
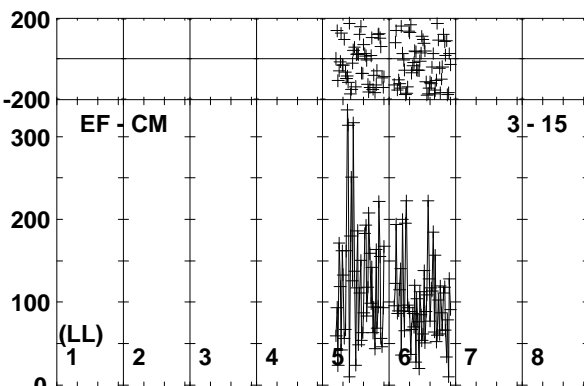
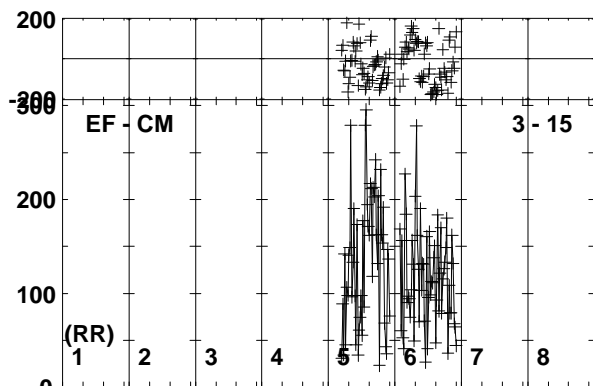
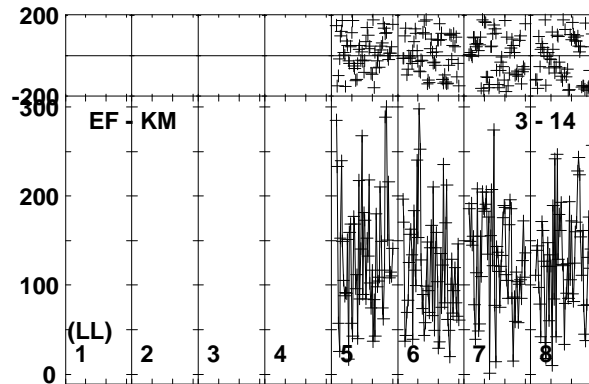
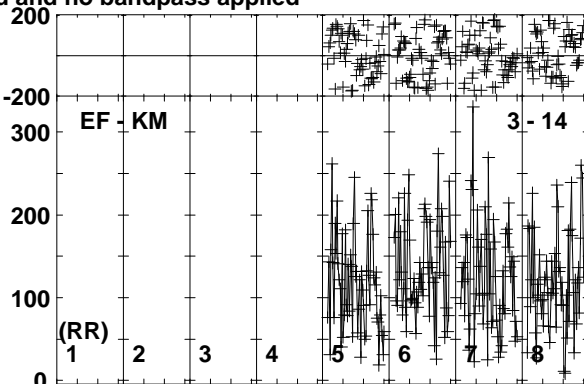
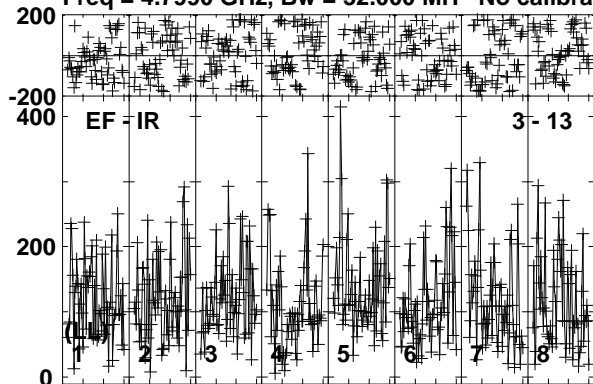

Lower frame: Micro Ampl Jy Top frame: Phas deg
Vector averaged cross-power spectrum Baseline: EF (03) - IR (13)
Timerange: 00/23:35:20 to 00/23:37:29

Plot file version 123 created 26-SEP-2019 10:39:58

190829A RG010A.UVDATA.1

Freq = 4.7990 GHz, Bw = 32.000 MH No calibration applied and no bandpass applied

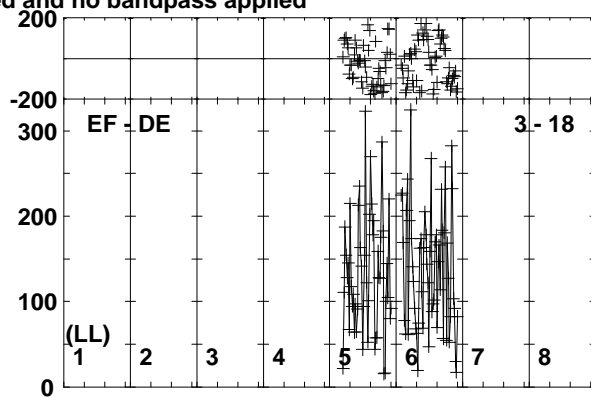
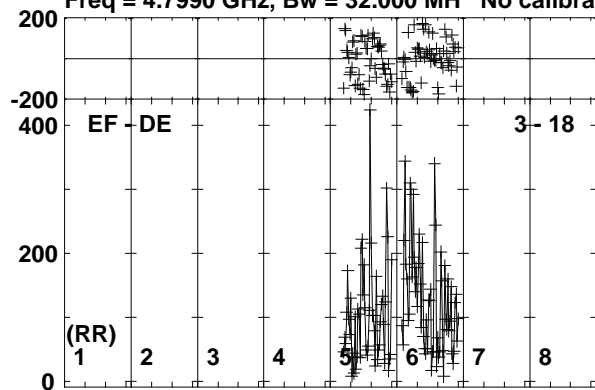

Lower frame: Micro Ampl Jy Top frame: Phas deg
Vector averaged cross-power spectrum Baseline: EF (03) - DE (18)
Timerange: 00/23:35:20 to 00/23:37:29

Plot file version 124 created 26-SEP-2019 10:39:58

J0257-1212 RG010A.UVDATA.1

Freq = 4.7990 GHz, Bw = 32.000 MH No calibration applied and no bandpass applied

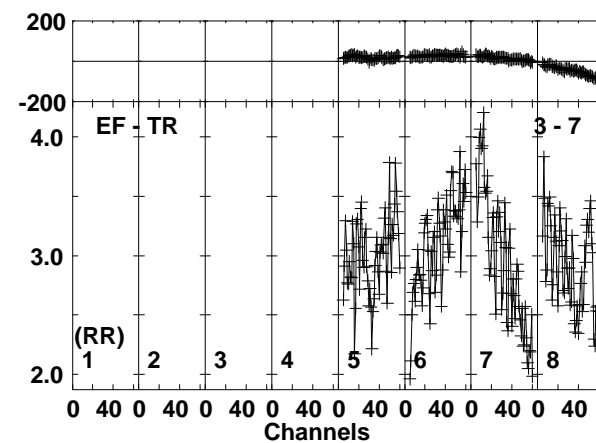
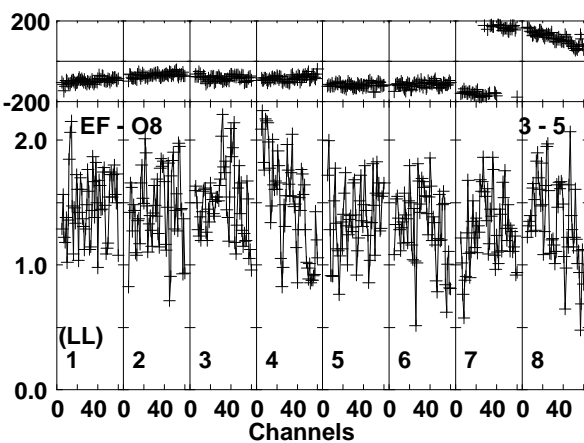
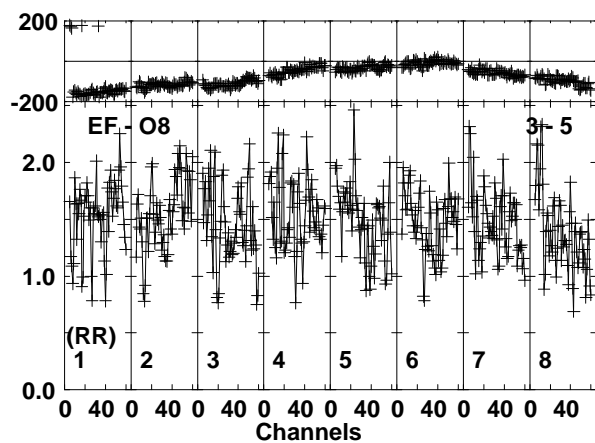
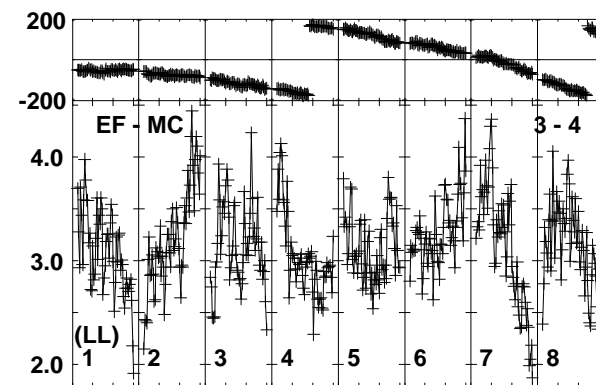
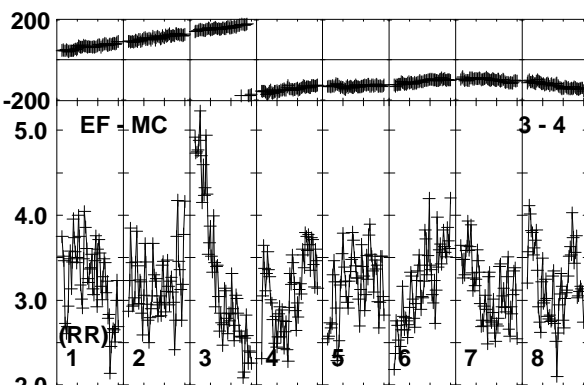
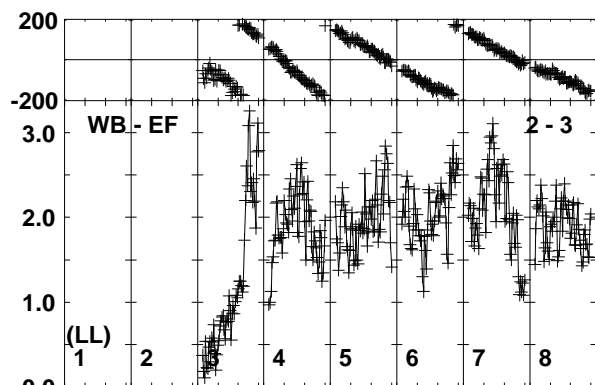
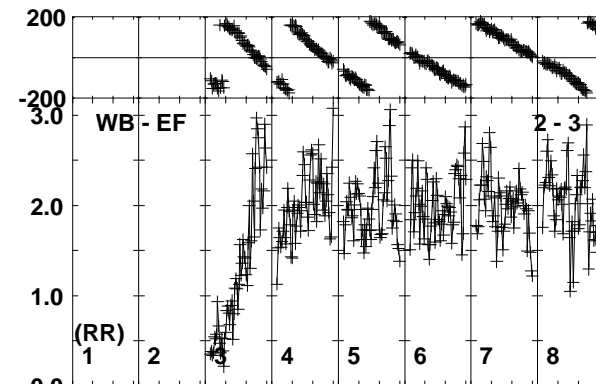
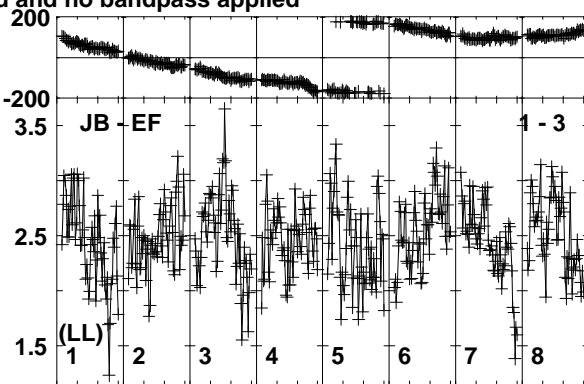
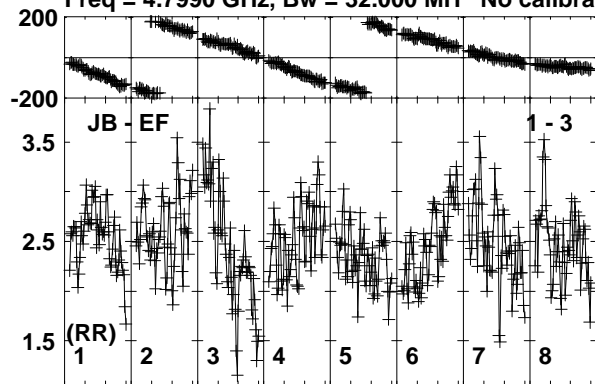

Lower frame: Milli Ampl Jy Top frame: Phas deg
Vector averaged cross-power spectrum Baseline: JB (01) - EF (03)
Timerange: 00/23:37:31 to 00/23:38:30

Plot file version 125 created 26-SEP-2019 10:39:59

J0257-1212 RG010A.UVDATA.1

Freq = 4.7990 GHz, Bw = 32.000 MH No calibration applied and no bandpass applied

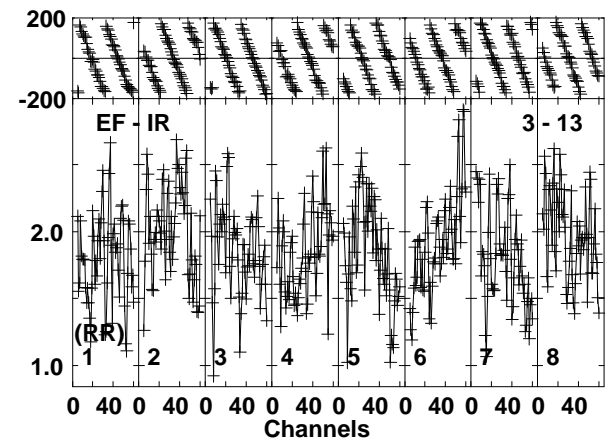
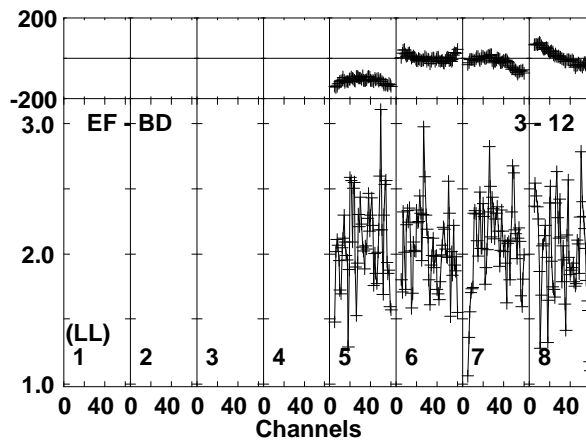
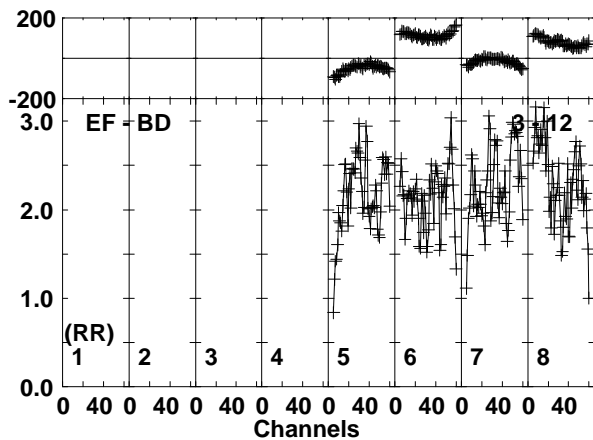
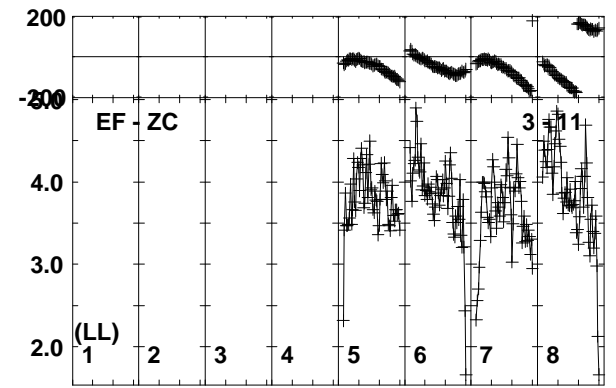
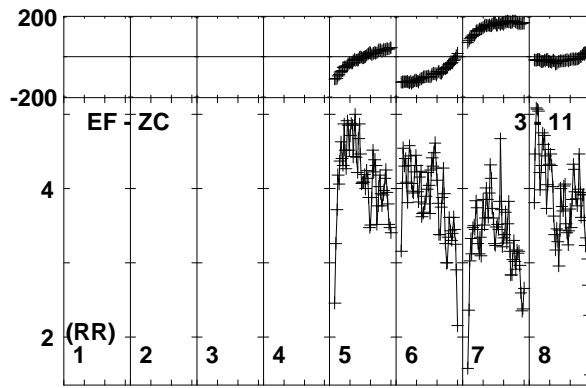
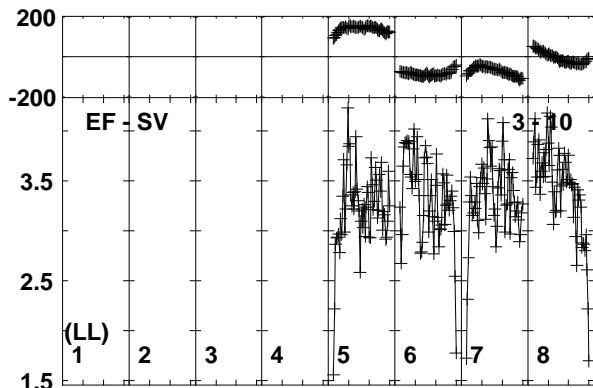
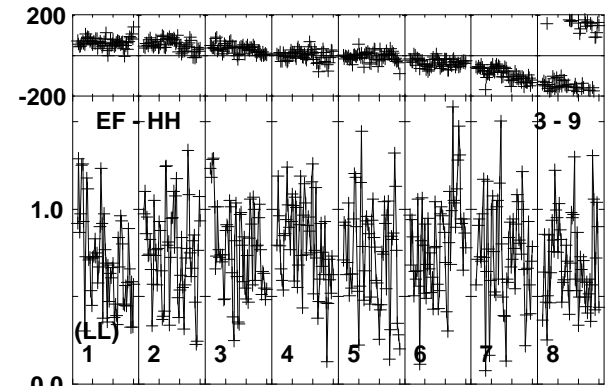
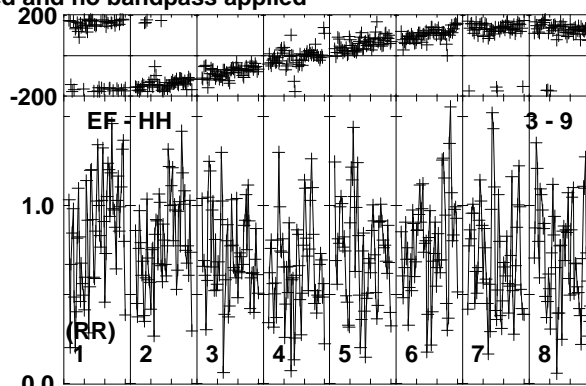
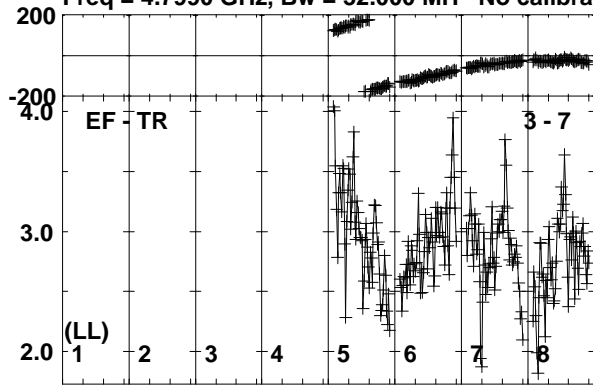

Lower frame: Milli Ampl Jy Top frame: Phas deg
Vector averaged cross-power spectrum Baseline: EF (03) - TR (07)
Timerange: 00/23:37:31 to 00/23:38:30

Plot file version 126 created 26-SEP-2019 10:39:59

J0257-1212 RG010A.UVDATA.1

Freq = 4.7990 GHz, Bw = 32.000 MH No calibration applied and no bandpass applied

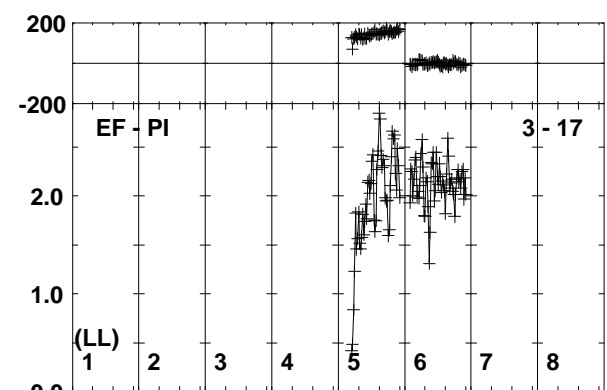
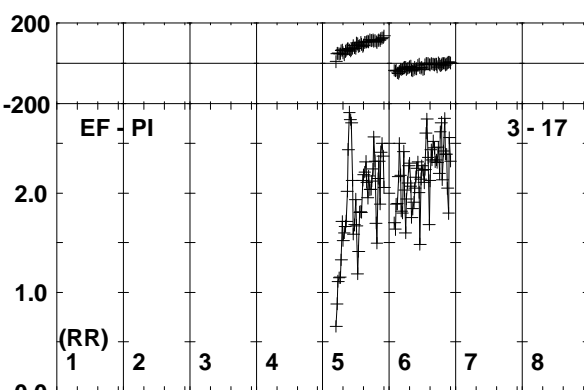
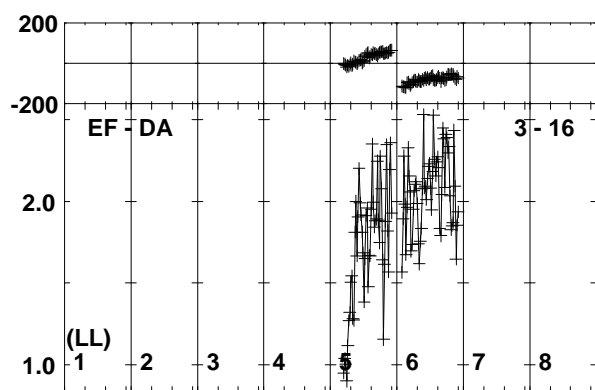
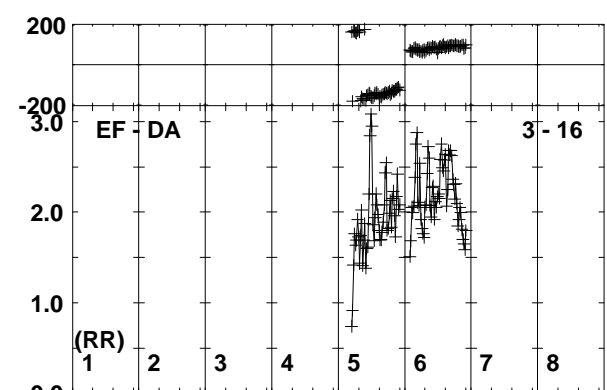
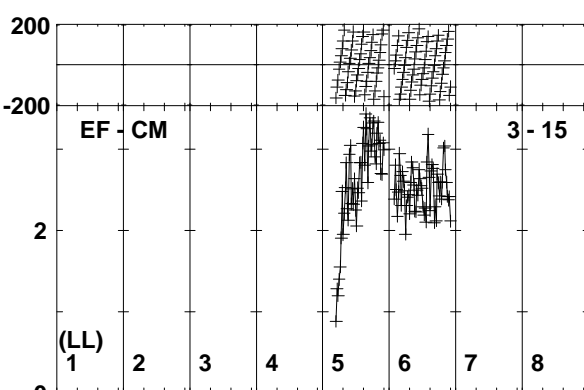
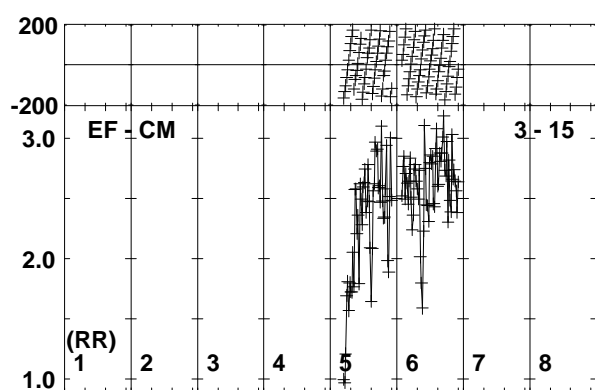
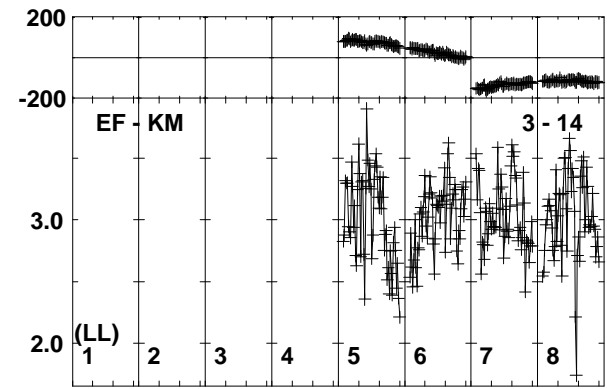
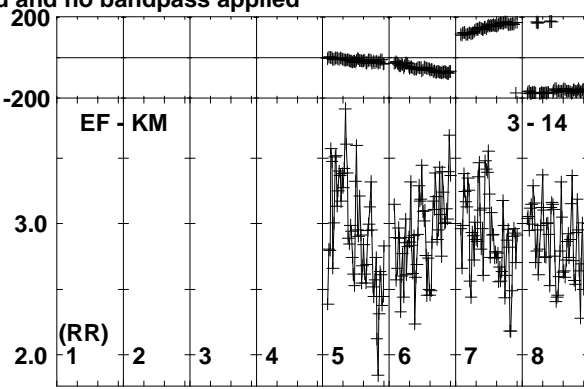
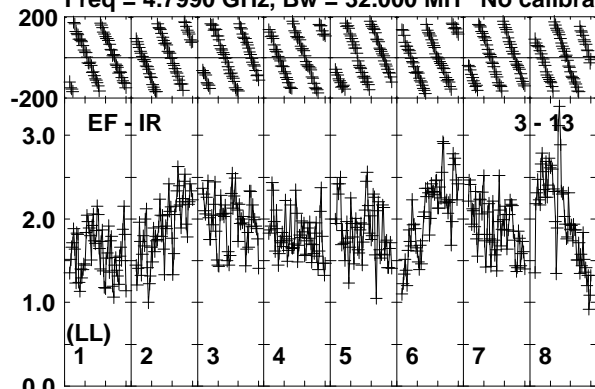

Lower frame: Milli Ampl Jy Top frame: Phas deg
Vector averaged cross-power spectrum Baseline: EF (03) - IR (13)
Timerange: 00/23:37:31 to 00/23:38:30

Plot file version 127 created 26-SEP-2019 10:39:59

J0257-1212 RG010A.UVDATA.1

Freq = 4.7990 GHz, Bw = 32.000 MH No calibration applied and no bandpass applied

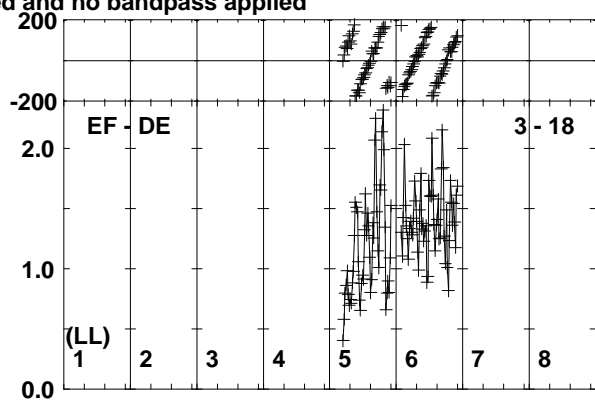
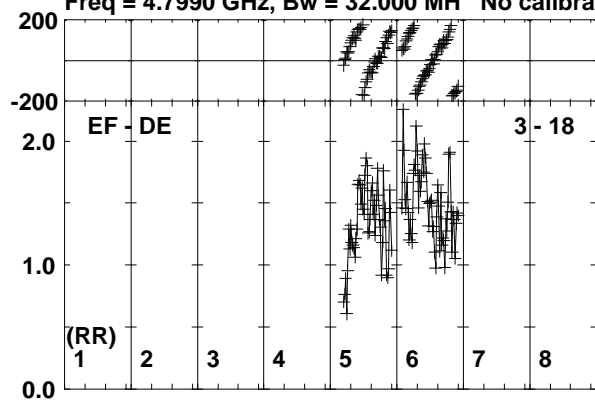

Lower frame: Milli Ampl Jy Top frame: Phas deg
Vector averaged cross-power spectrum Baseline: EF (03) - DE (18)
Timerange: 00/23:37:31 to 00/23:38:30

Plot file version 128 created 26-SEP-2019 10:39:59

190829A RG010A.UVDATA.1

Freq = 4.7990 GHz, Bw = 32.000 MH No calibration applied and no bandpass applied

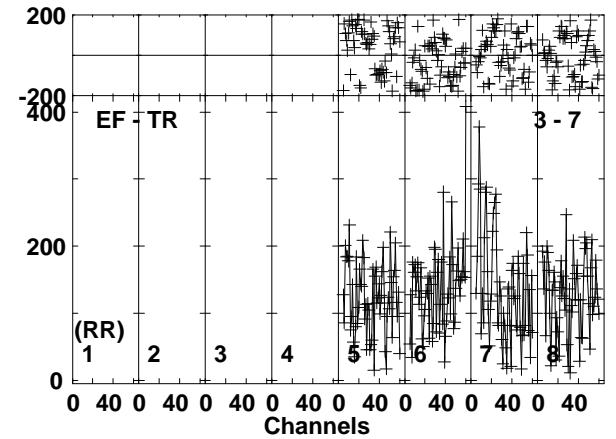
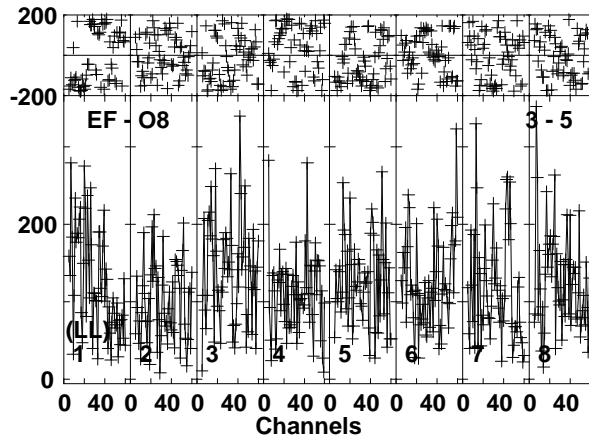
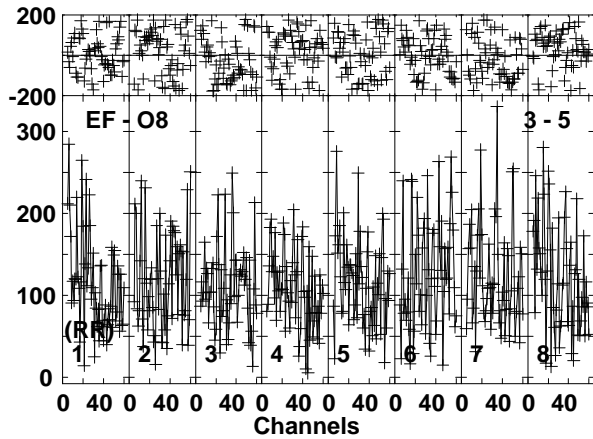
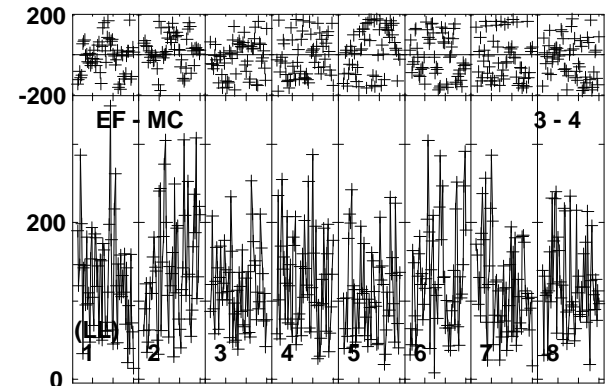
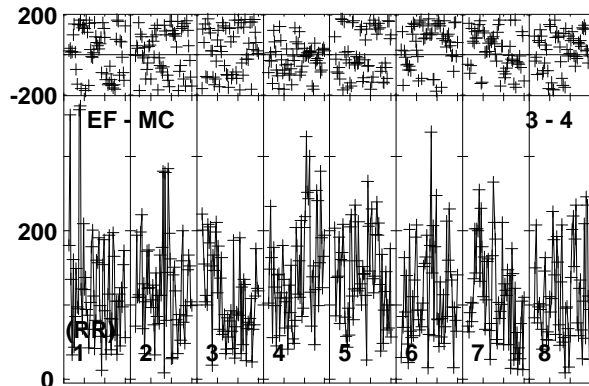
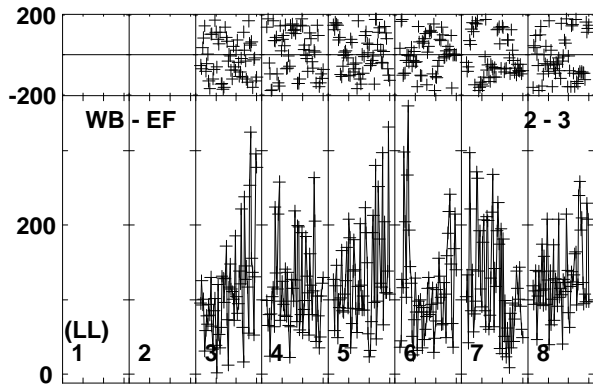
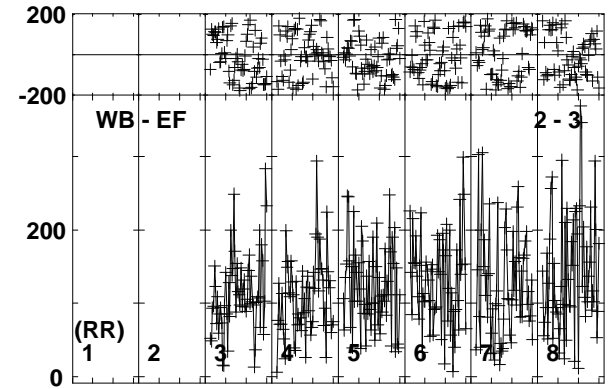
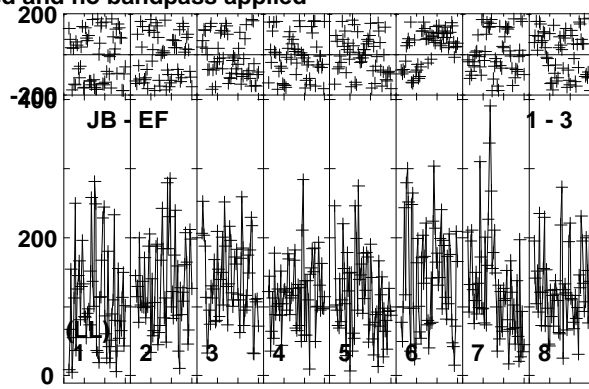
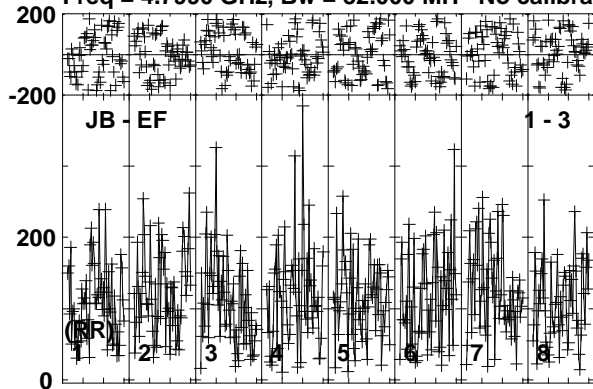

Lower frame: Micro Ampl Jy Top frame: Phas deg
Vector averaged cross-power spectrum Baseline: JB (01) - EF (03)
Timerange: 00/23:38:31 to 00/23:40:39

Plot file version 129 created 26-SEP-2019 10:40:00

190829A RG010A.UVDATA.1

Freq = 4.7990 GHz, Bw = 32.000 MH No calibration applied and no bandpass applied

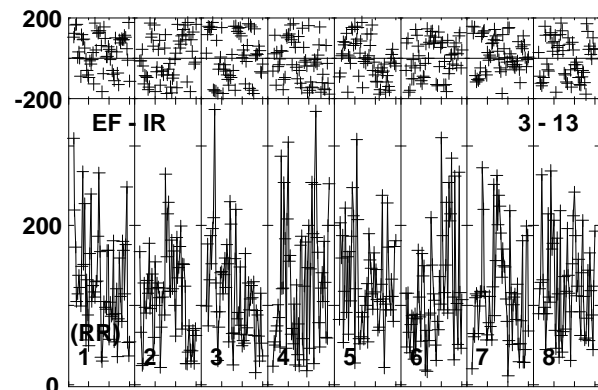
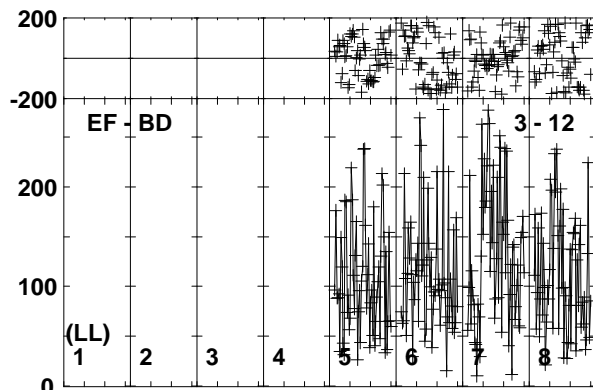
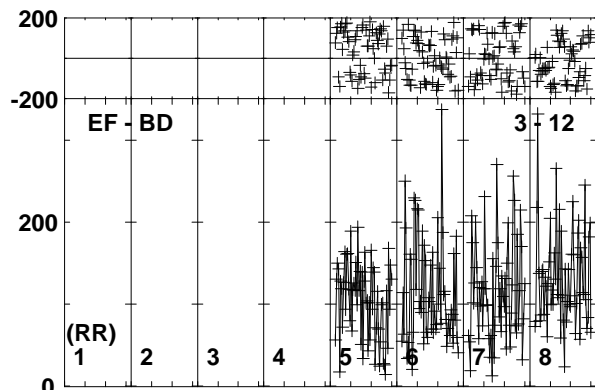
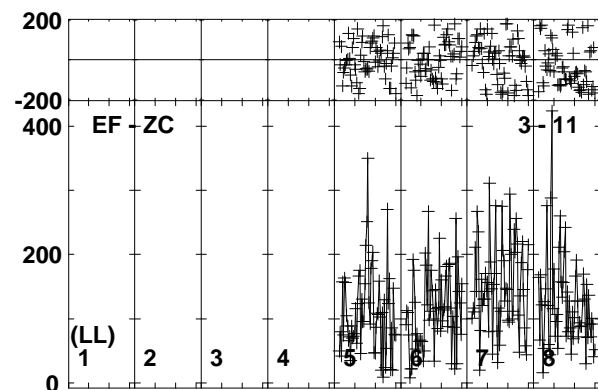
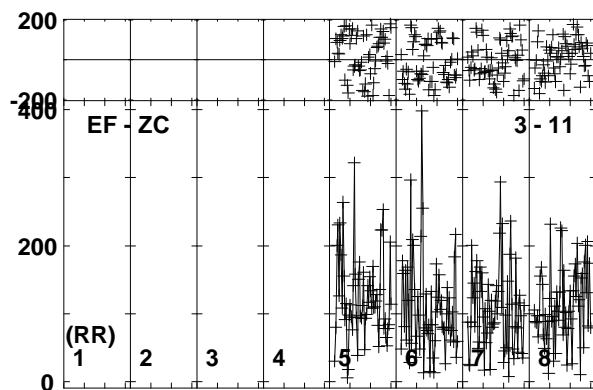
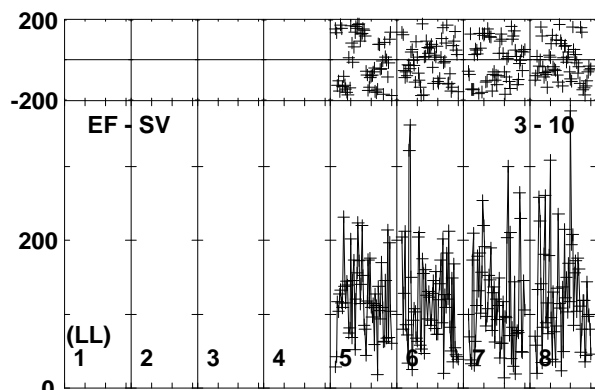
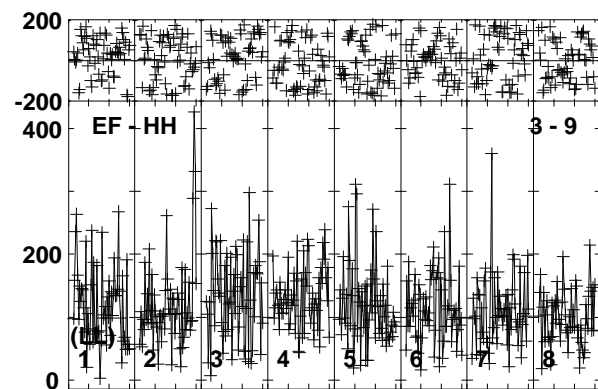
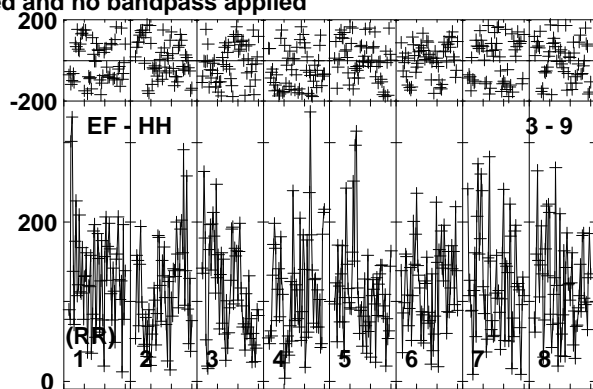
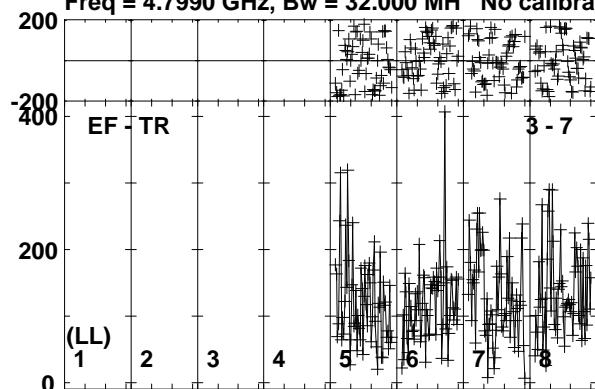

Lower frame: Micro Ampl Jy Top frame: Phas deg
Vector averaged cross-power spectrum Baseline: EF (03) - TR (07)
Timerange: 00/23:38:31 to 00/23:40:39

Plot file version 130 created 26-SEP-2019 10:40:00

190829A RG010A.UVDATA.1

Freq = 4.7990 GHz, Bw = 32.000 MH No calibration applied and no bandpass applied

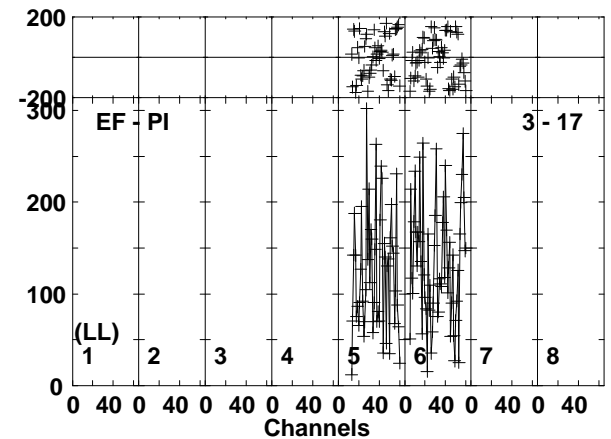
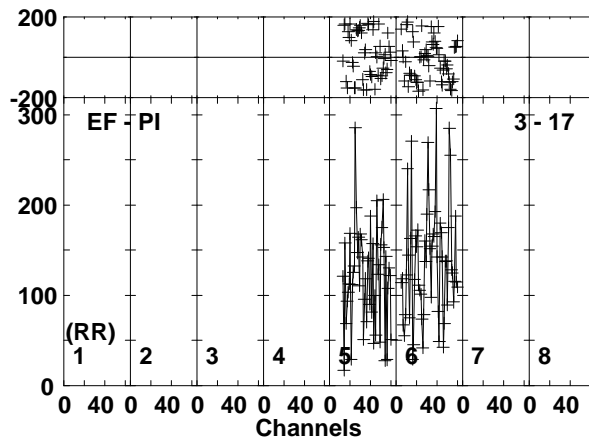
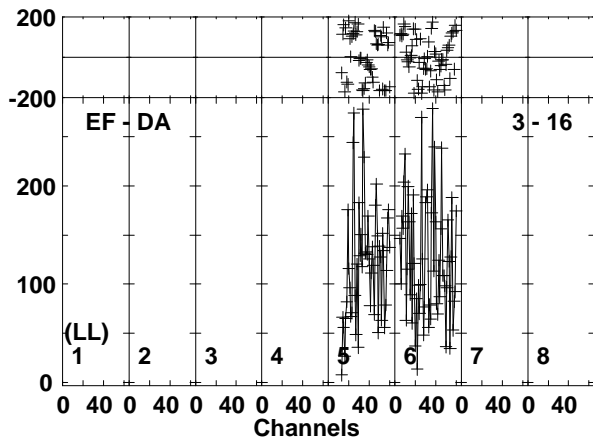
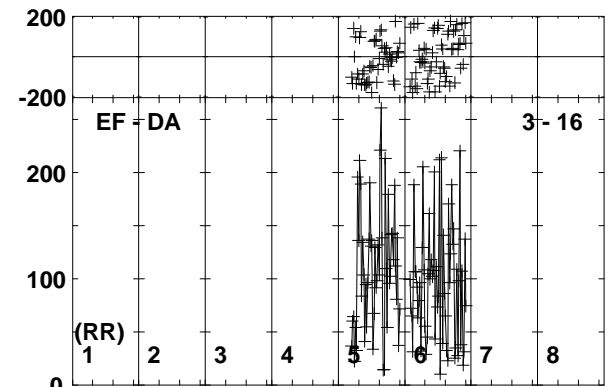
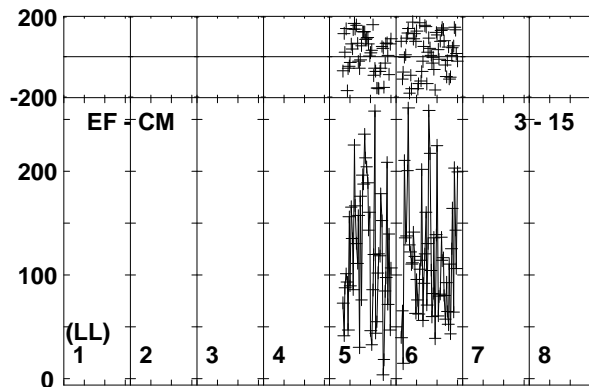
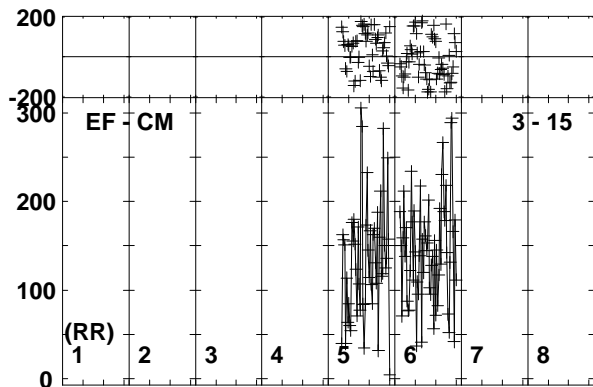
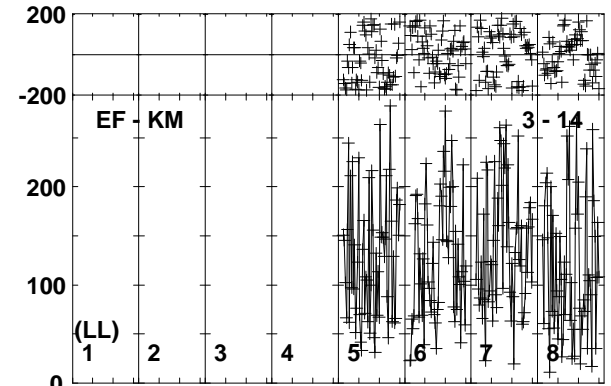
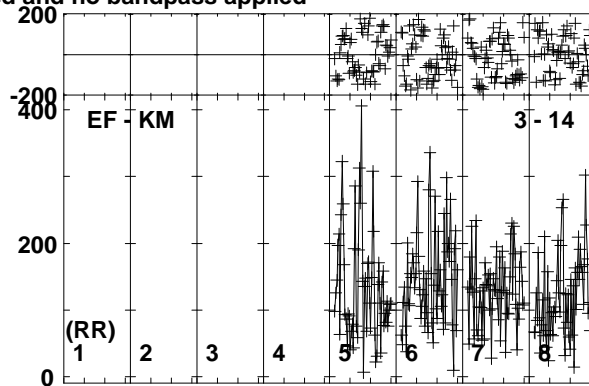
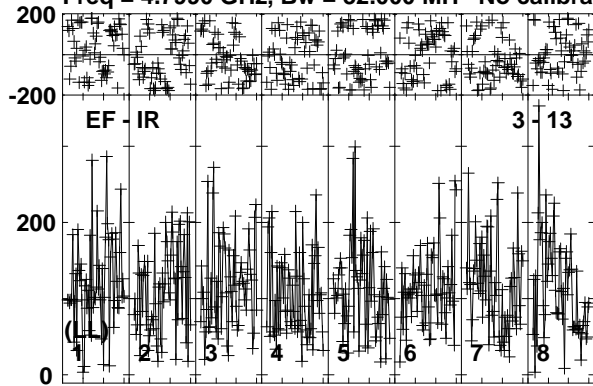

Lower frame: Micro Ampl Jy Top frame: Phas deg
Vector averaged cross-power spectrum Baseline: EF (03) - IR (13)
Timerange: 00/23:38:31 to 00/23:40:39

Plot file version 131 created 26-SEP-2019 10:40:01

190829A RG010A.UVDATA.1

Freq = 4.7990 GHz, Bw = 32.000 MH No calibration applied and no bandpass applied

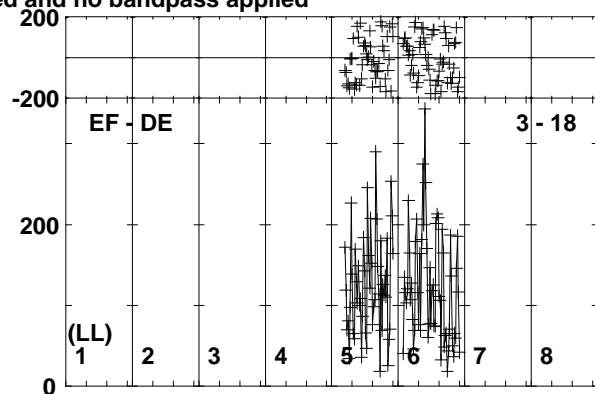
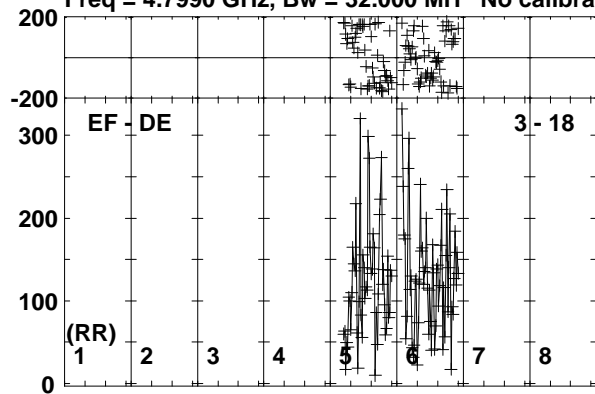

Lower frame: Micro Ampl Jy Top frame: Phas deg
Vector averaged cross-power spectrum Baseline: EF (03) - DE (18)
Timerange: 00/23:38:31 to 00/23:40:39

Plot file version 132 created 26-SEP-2019 10:40:01

J0257-1212 RG010A.UVDATA.1

Freq = 4.7990 GHz, Bw = 32.000 MH No calibration applied and no bandpass applied

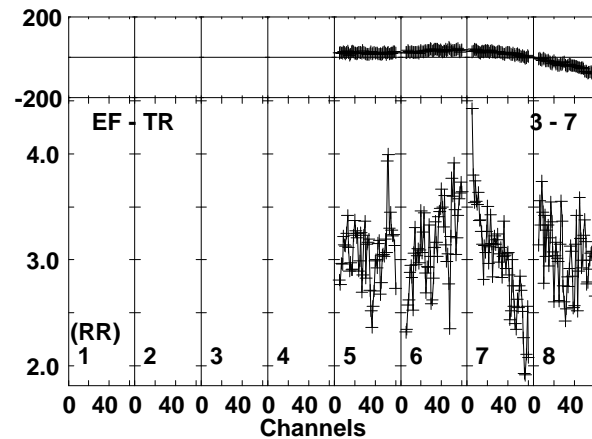
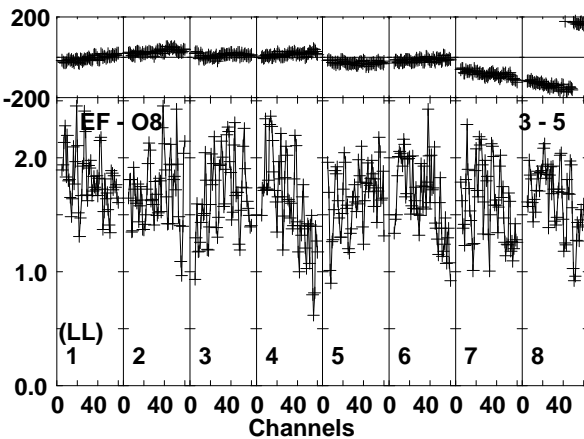
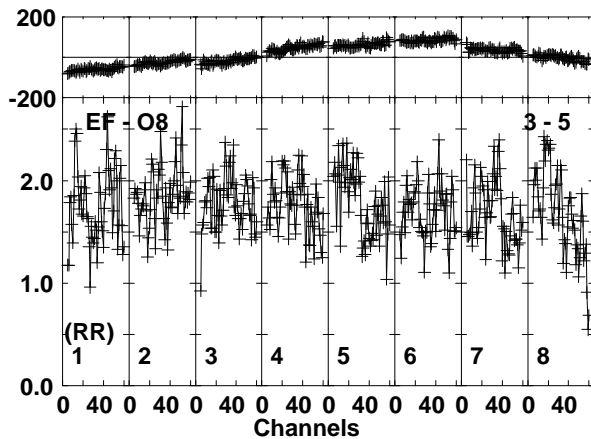
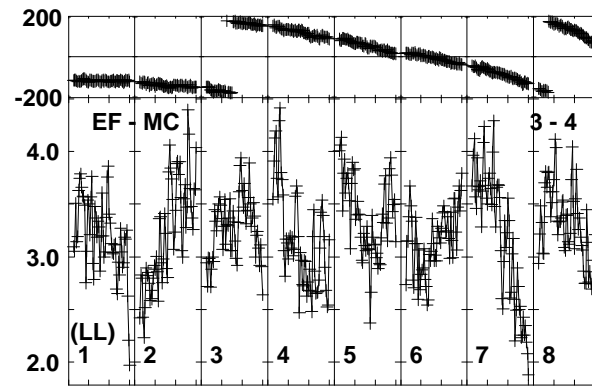
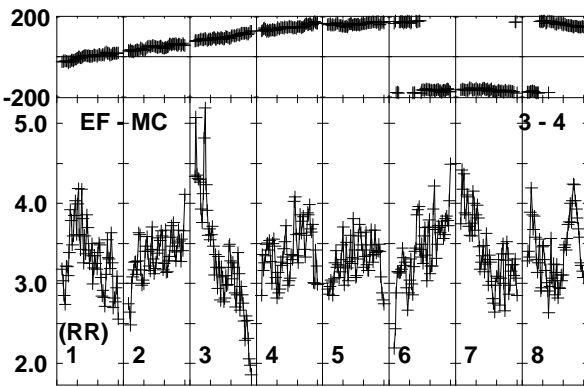
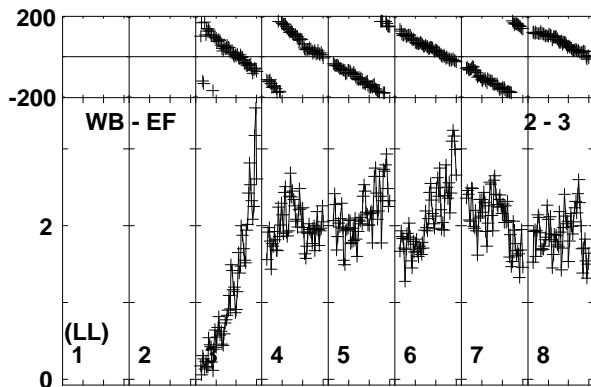
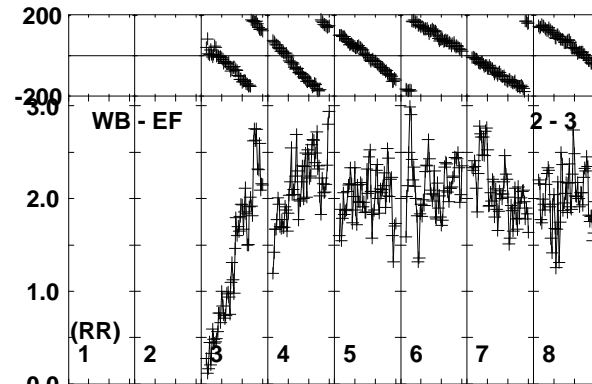
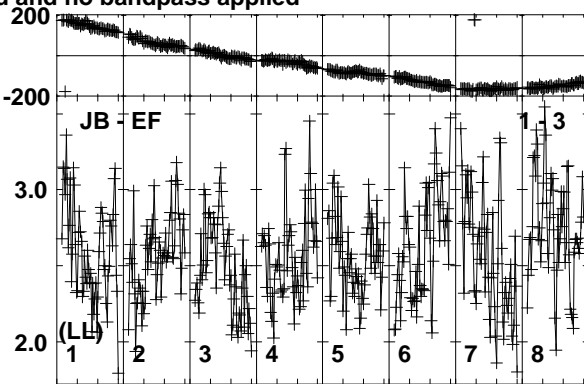
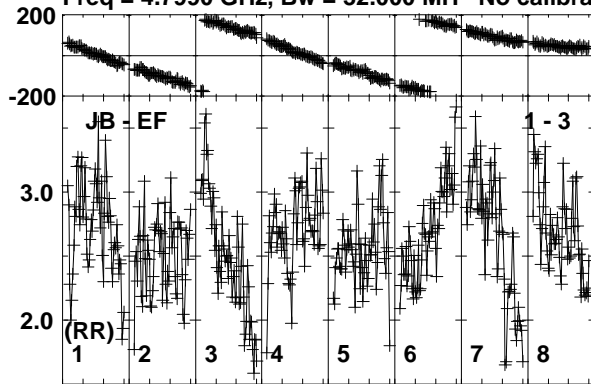

Lower frame: Milli Ampl Jy Top frame: Phas deg
Vector averaged cross-power spectrum Baseline: JB (01) - EF (03)
Timerange: 00/23:40:41 to 00/23:41:39

Plot file version 133 created 26-SEP-2019 10:40:01

J0257-1212 RG010A.UVDATA.1

Freq = 4.7990 GHz, Bw = 32.000 MH No calibration applied and no bandpass applied

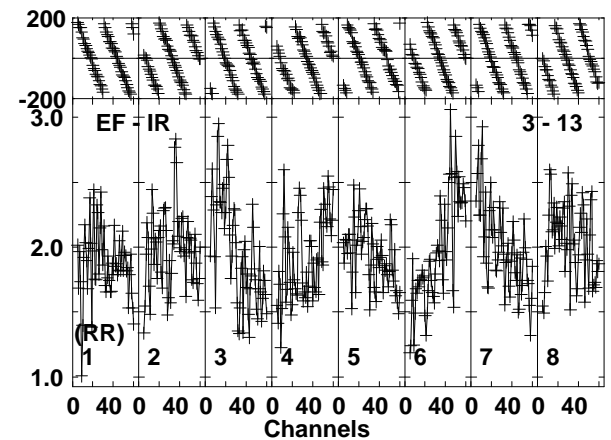
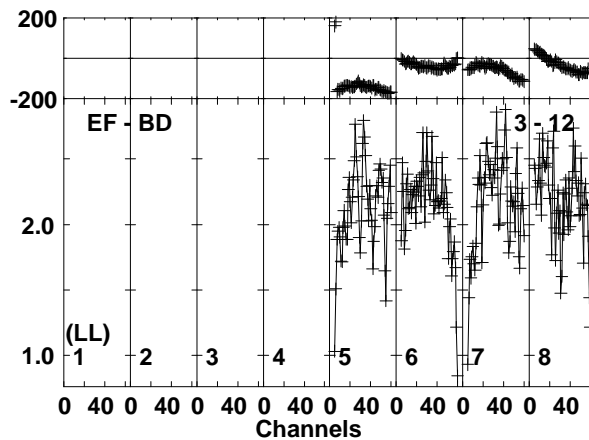
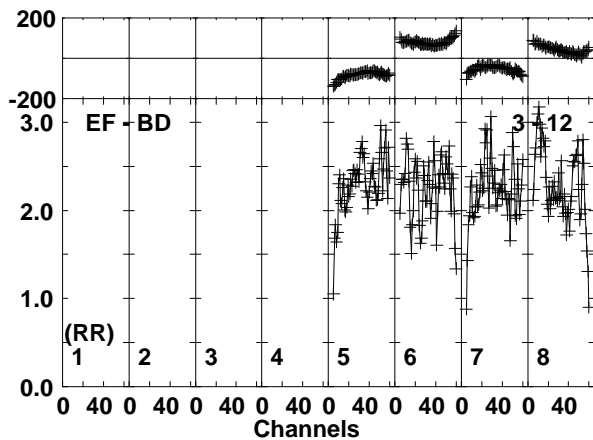
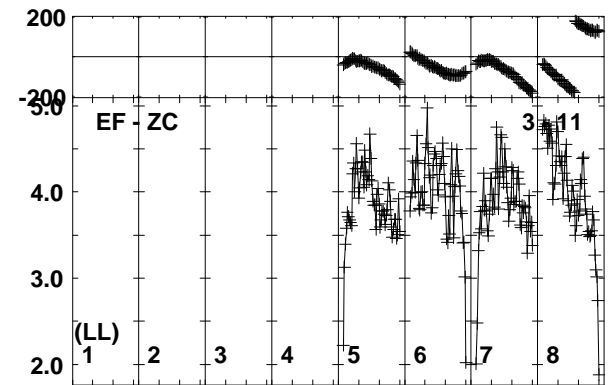
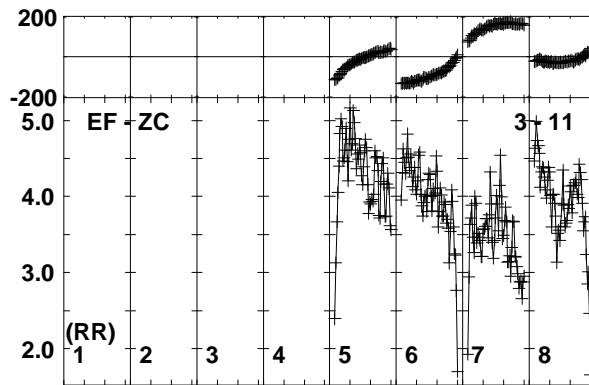
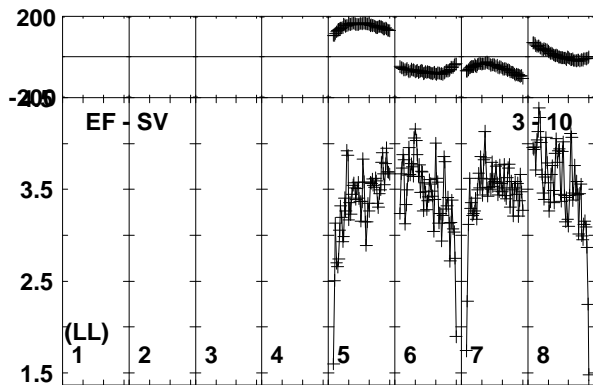
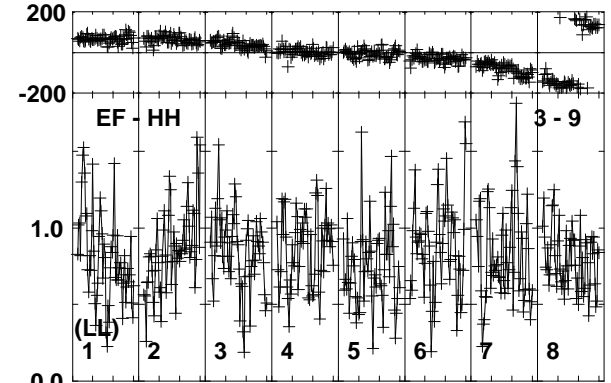
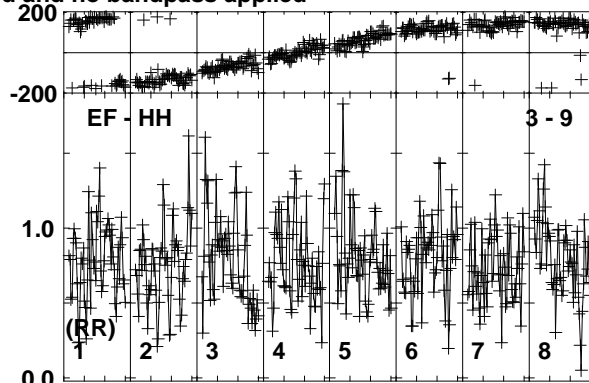
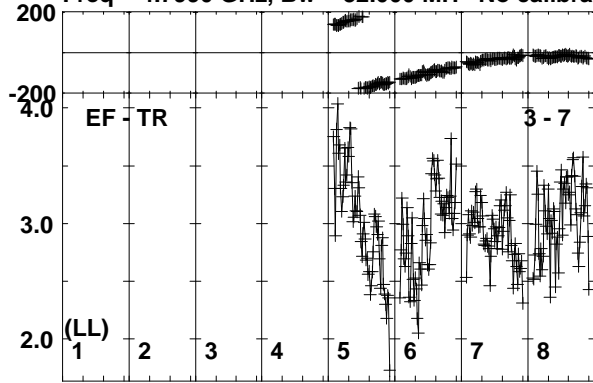

Lower frame: Milli Ampl Jy Top frame: Phas deg
Vector averaged cross-power spectrum Baseline: EF (03) - TR (07)
Timerange: 00/23:40:41 to 00/23:41:39

Plot file version 134 created 26-SEP-2019 10:40:02

J0257-1212 RG010A.UVDATA.1

Freq = 4.7990 GHz, Bw = 32.000 MH No calibration applied and no bandpass applied

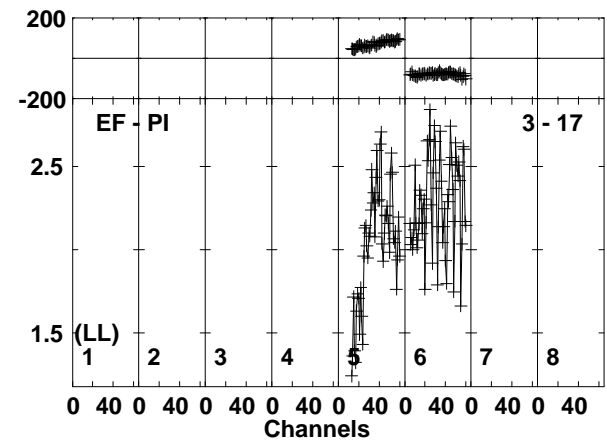
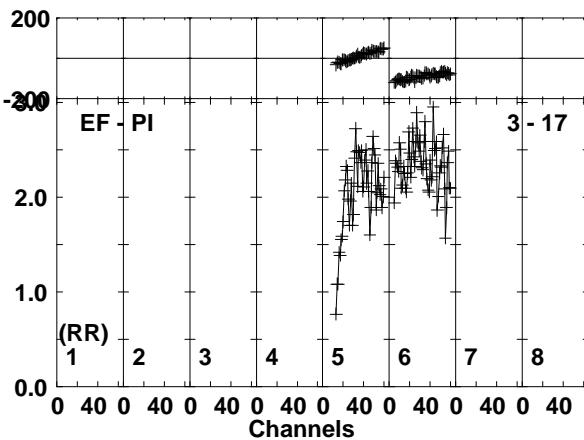
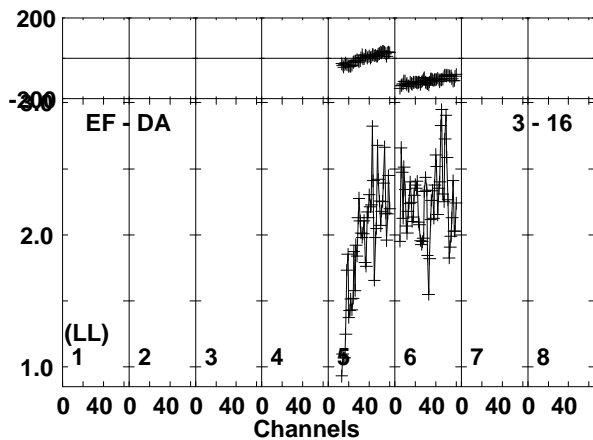
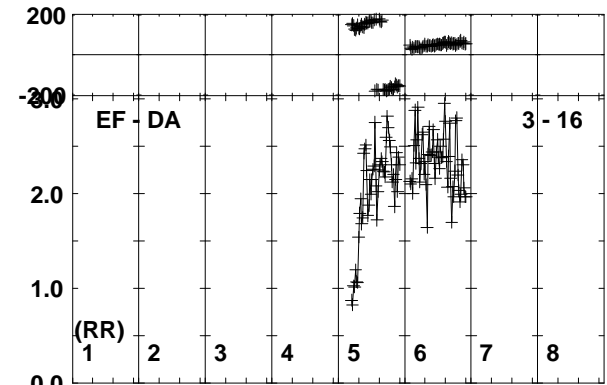
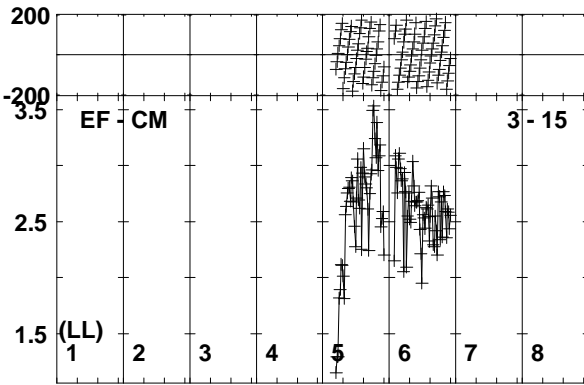
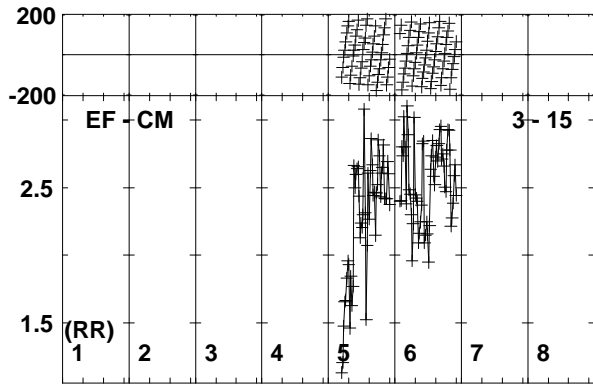
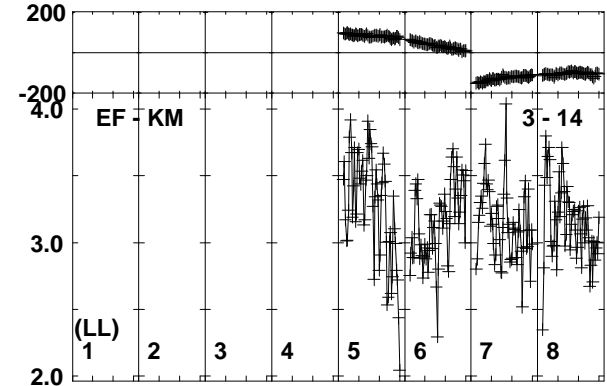
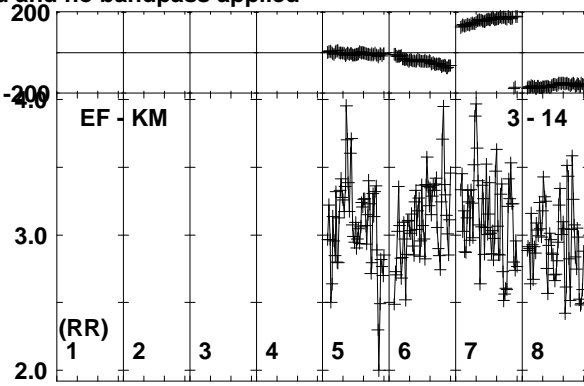
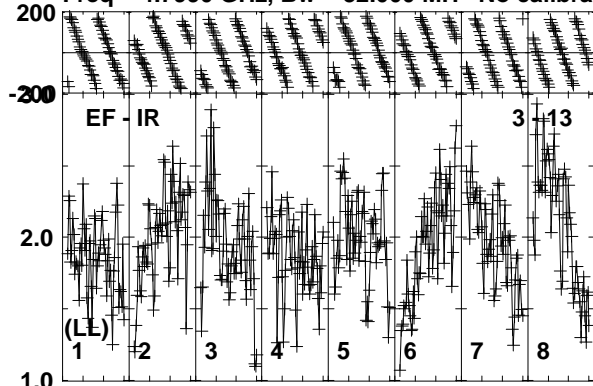

Lower frame: Milli Ampl Jy Top frame: Phas deg
Vector averaged cross-power spectrum Baseline: EF (03) - IR (13)
Timerange: 00/23:40:41 to 00/23:41:39

Plot file version 135 created 26-SEP-2019 10:40:02

J0257-1212 RG010A.UVDATA.1

Freq = 4.7990 GHz, Bw = 32.000 MH No calibration applied and no bandpass applied

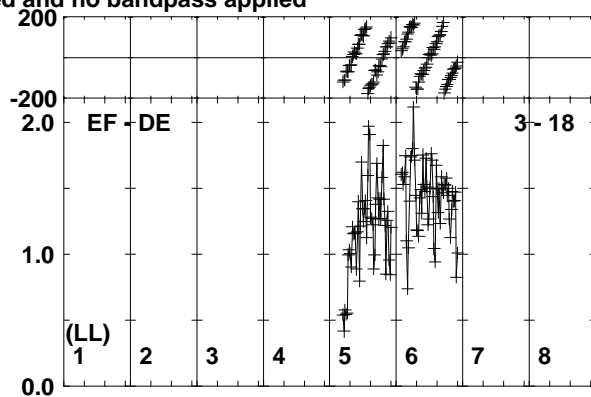
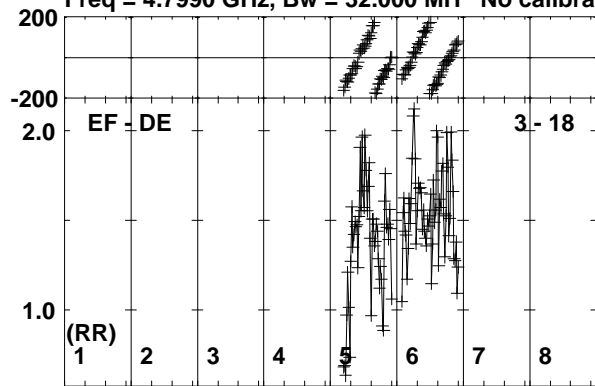

Lower frame: Milli Ampl Jy Top frame: Phas deg
Vector averaged cross-power spectrum Baseline: EF (03) - DE (18)
Timerange: 00/23:40:41 to 00/23:41:39

Plot file version 136 created 26-SEP-2019 10:40:02
 190829A RG010A.UVDATA.1

Freq = 4.7990 GHz, Bw = 32.000 MH No calibration applied and no bandpass applied

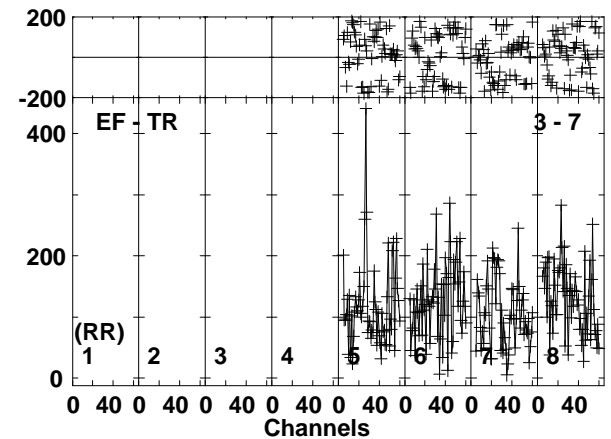
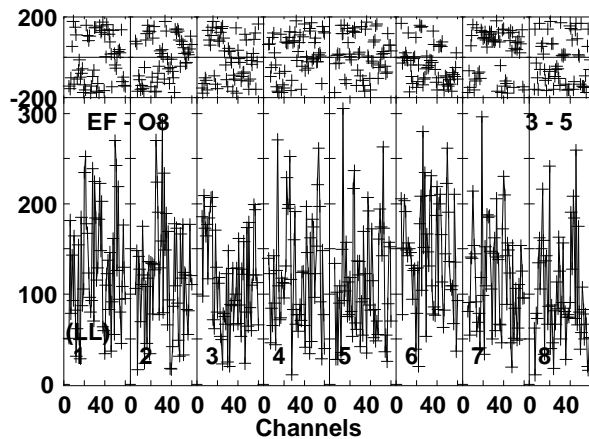
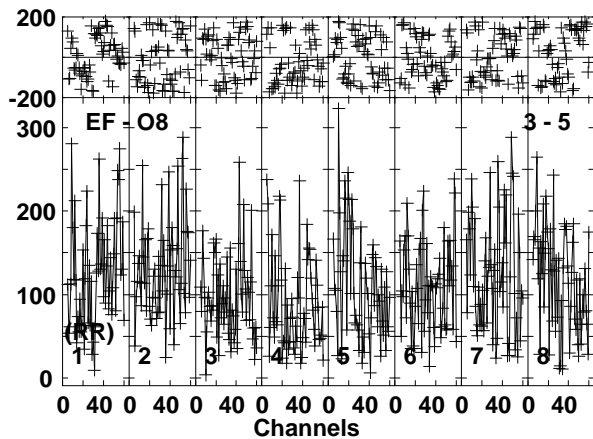
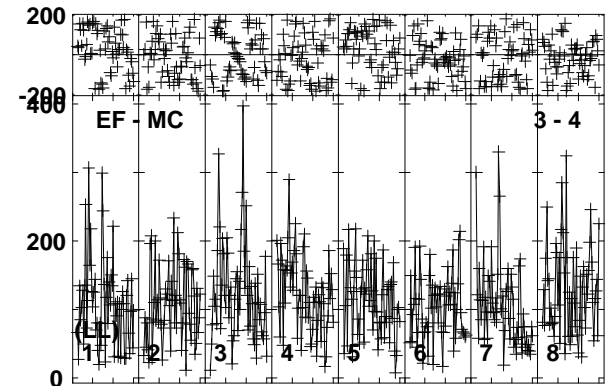
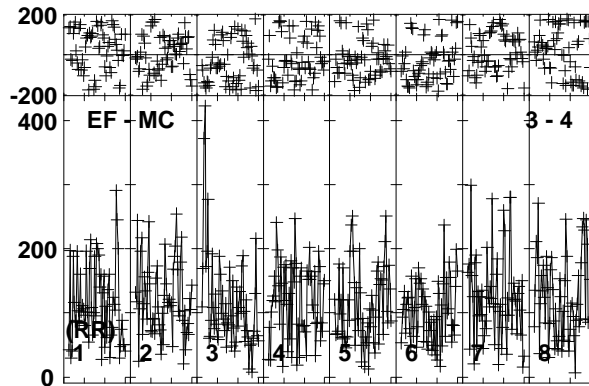
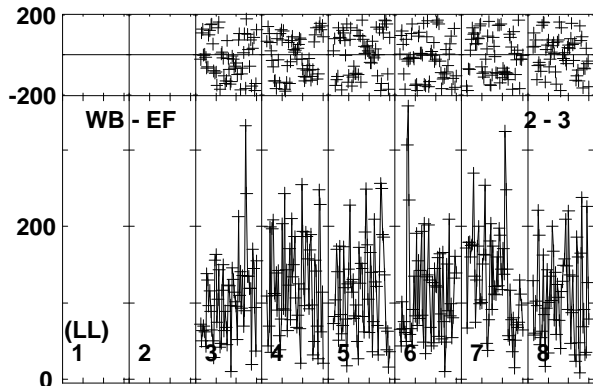
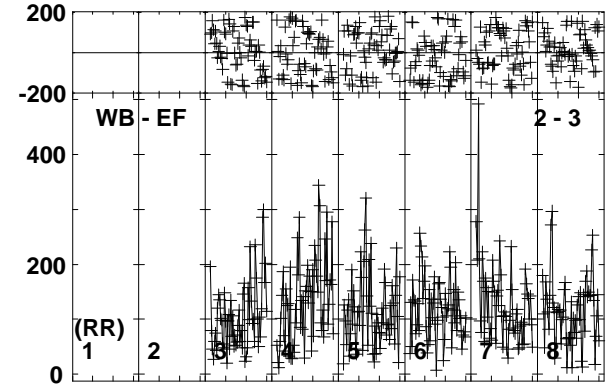
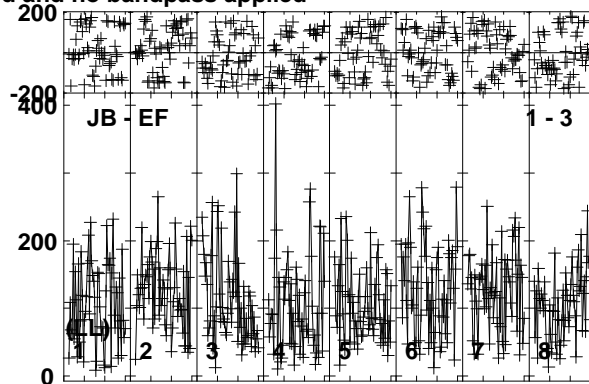
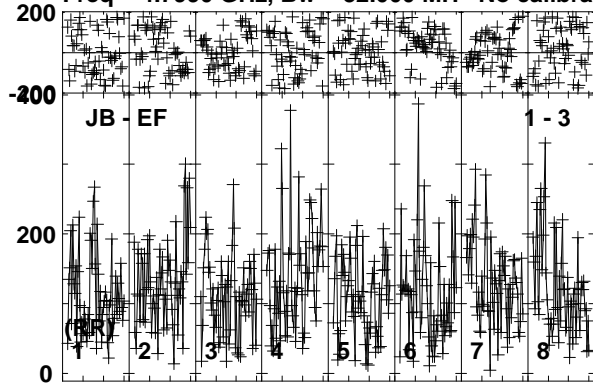

Lower frame: Micro Ampl Jy Top frame: Phas deg
 Vector averaged cross-power spectrum Baseline: JB (01) - EF (03)
 Timerange: 00/23:41:41 to 00/23:43:50

Plot file version 137 created 26-SEP-2019 10:40:03

190829A RG010A.UVDATA.1

Freq = 4.7990 GHz, Bw = 32.000 MH No calibration applied and no bandpass applied

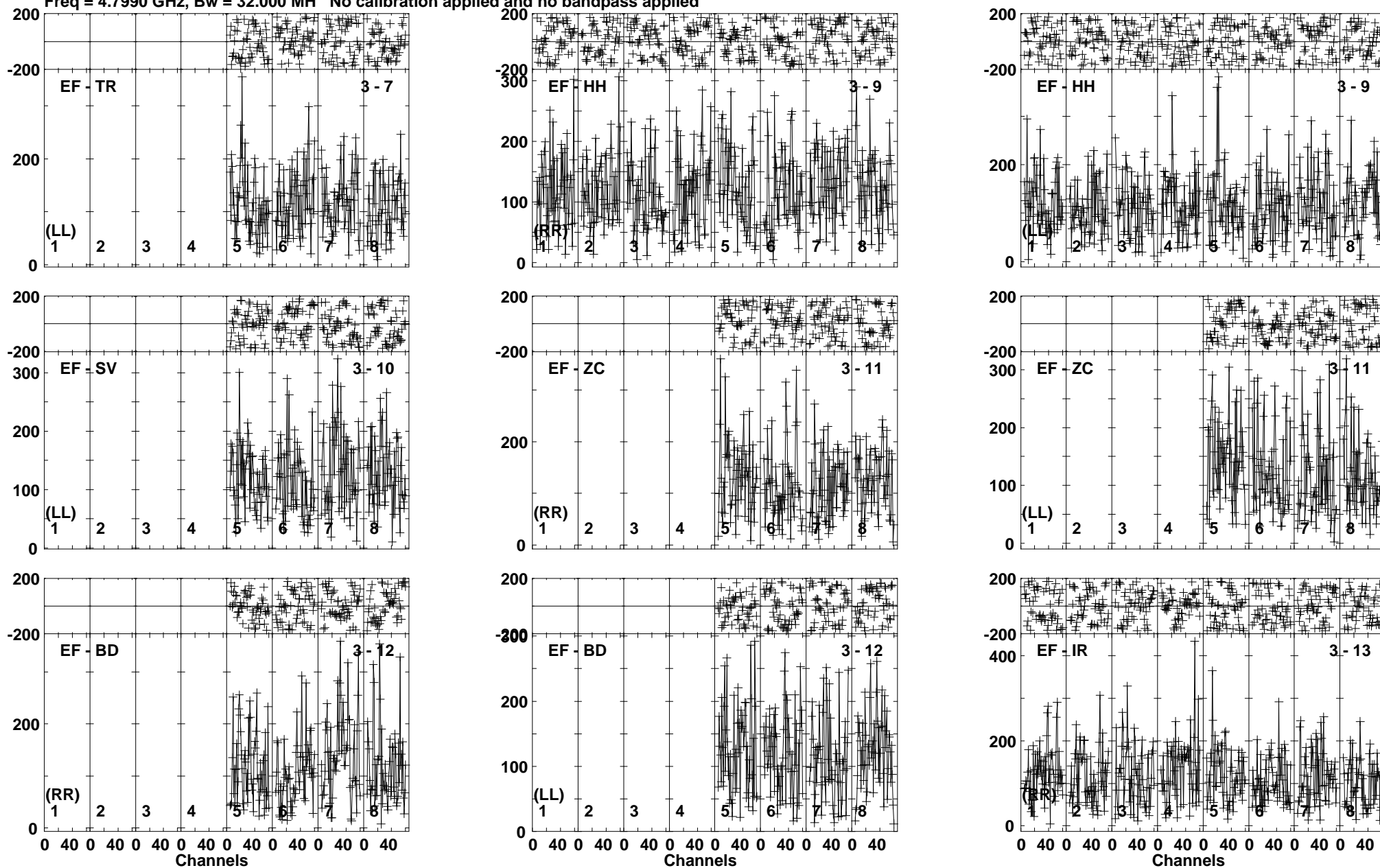

Lower frame: Micro Ampl Jy Top frame: Phas deg
Vector averaged cross-power spectrum Baseline: EF (03) - TR (07)
Timerange: 00/23:41:41 to 00/23:43:50

Plot file version 138 created 26-SEP-2019 10:40:03

190829A RG010A.UVDATA.1

Freq = 4.7990 GHz, Bw = 32.000 MH No calibration applied and no bandpass applied

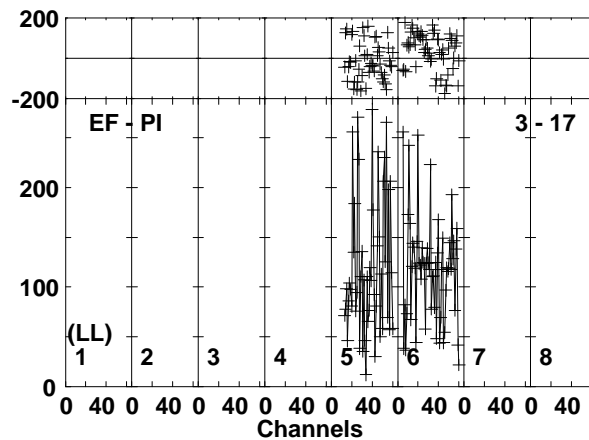
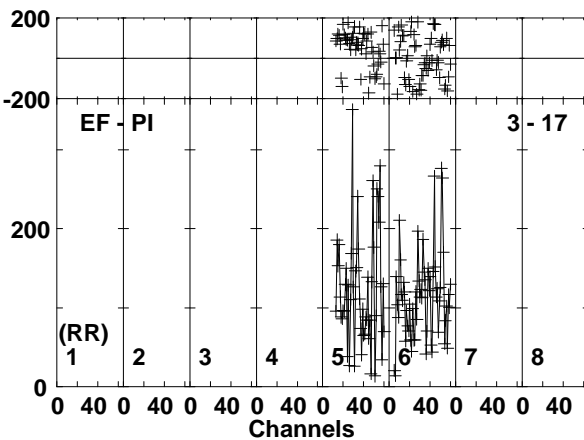
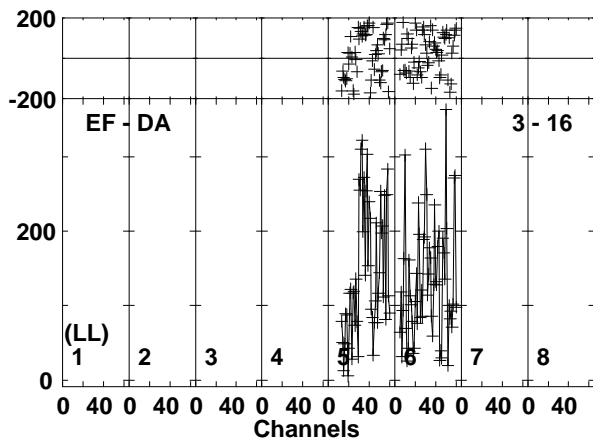
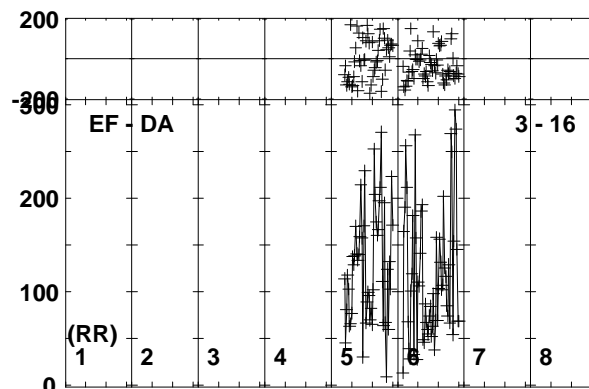
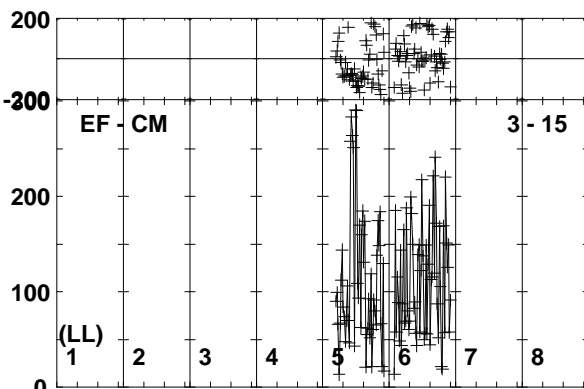
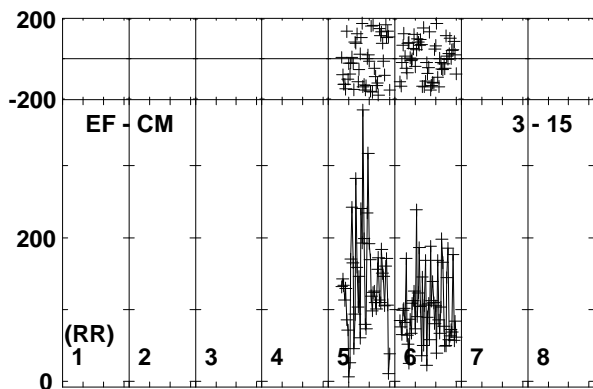
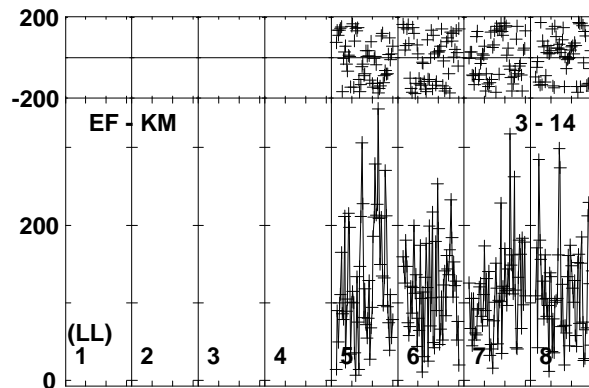
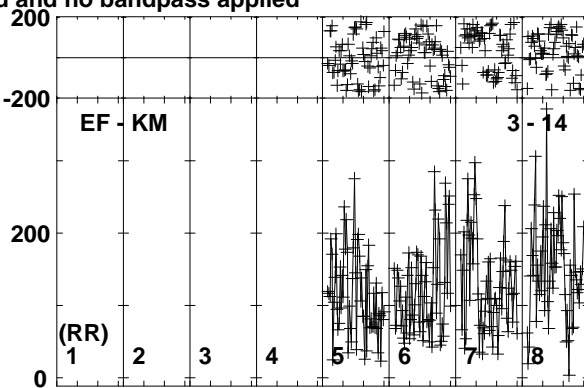
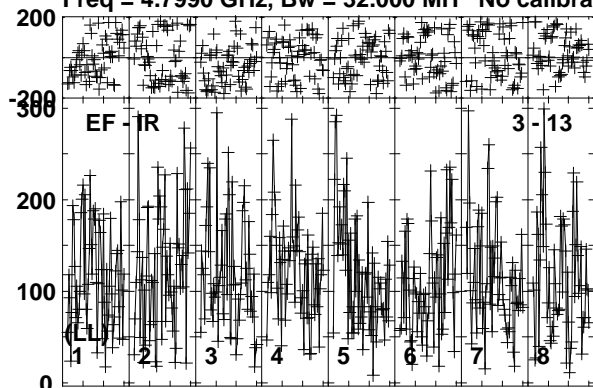

Lower frame: Micro Ampl Jy Top frame: Phas deg
Vector averaged cross-power spectrum Baseline: EF (03) - IR (13)
Timerange: 00/23:41:41 to 00/23:43:50

Plot file version 139 created 26-SEP-2019 10:40:03

190829A RG010A.UVDATA.1

Freq = 4.7990 GHz, Bw = 32.000 MH No calibration applied and no bandpass applied

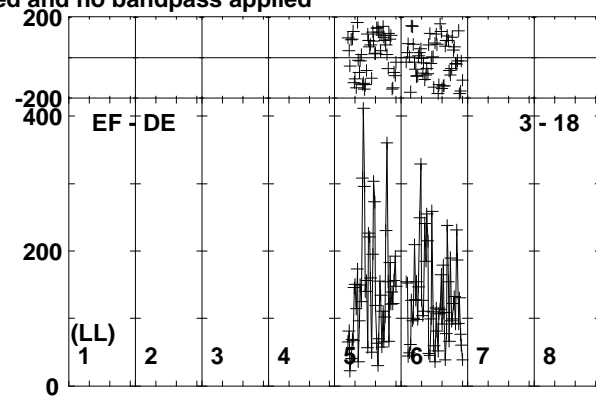
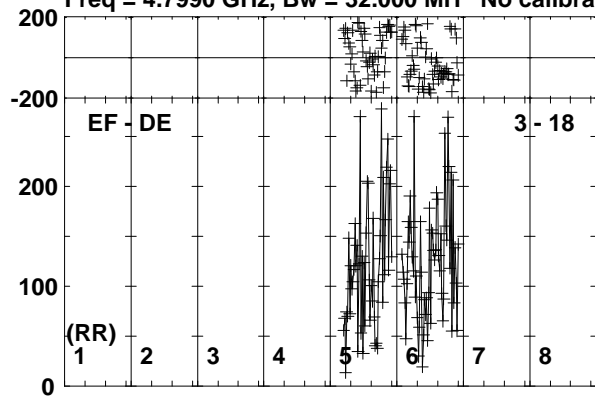

Lower frame: Micro Ampl Jy Top frame: Phas deg
Vector averaged cross-power spectrum Baseline: EF (03) - DE (18)
Timerange: 00/23:41:41 to 00/23:43:50

Plot file version 140 created 26-SEP-2019 10:40:03

J0257-1212 RG010A.UVDATA.1

Freq = 4.7990 GHz, Bw = 32.000 MH No calibration applied and no bandpass applied

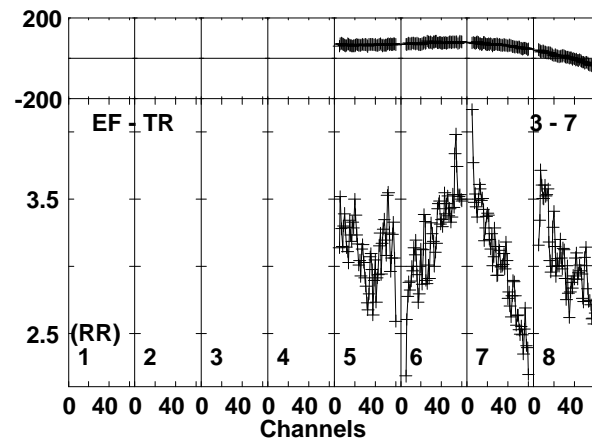
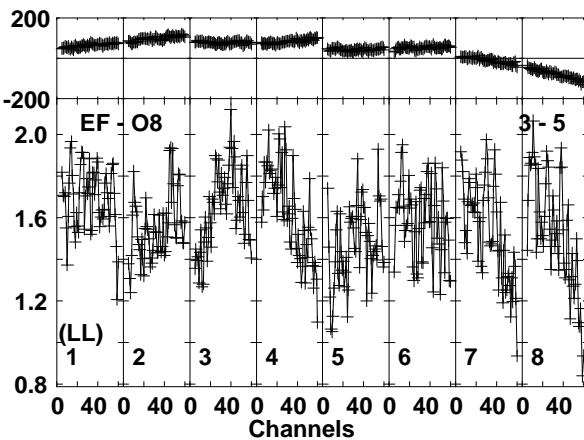
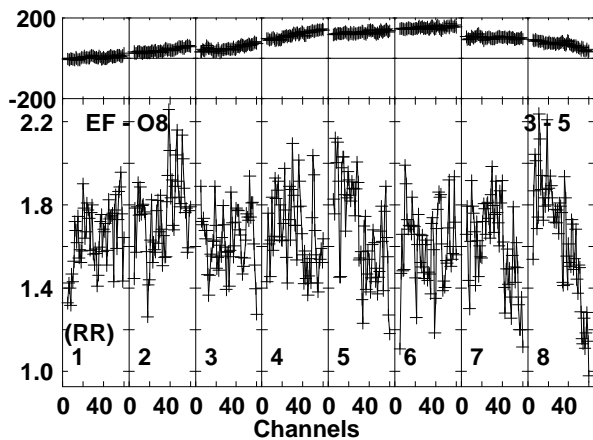
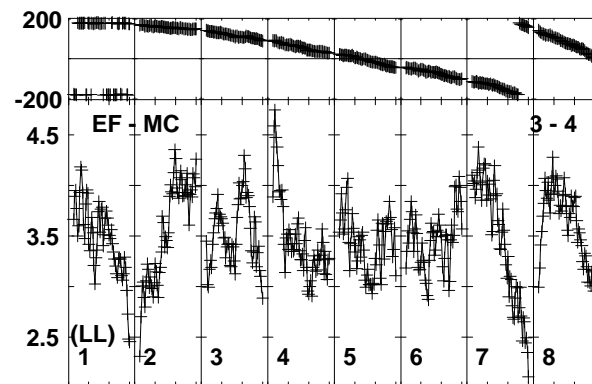
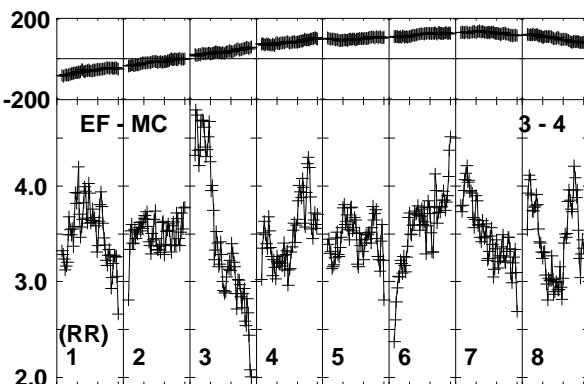
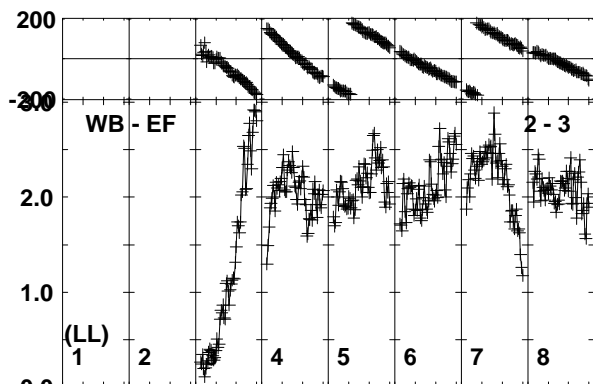
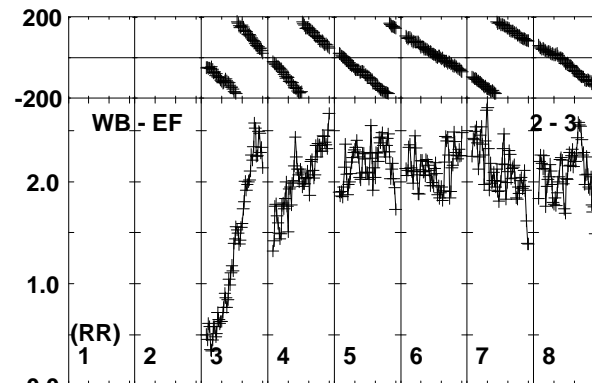
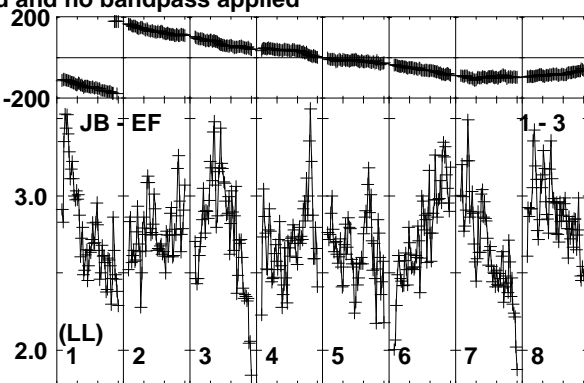
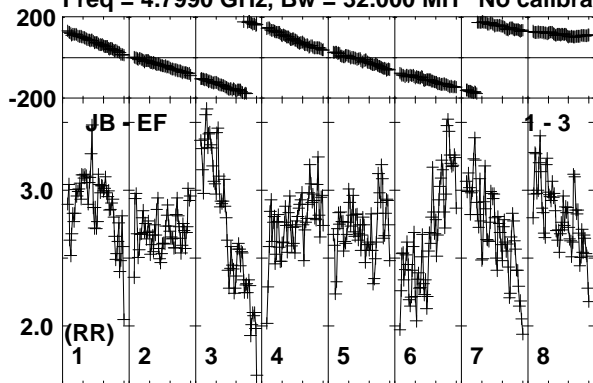

Lower frame: Milli Ampl Jy Top frame: Phas deg
Vector averaged cross-power spectrum Baseline: JB (01) - EF (03)
Timerange: 00/23:44:40 to 00/23:45:10

Plot file version 141 created 26-SEP-2019 10:40:04

J0257-1212 RG010A.UVDATA.1

Freq = 4.7990 GHz, Bw = 32.000 MH No calibration applied and no bandpass applied

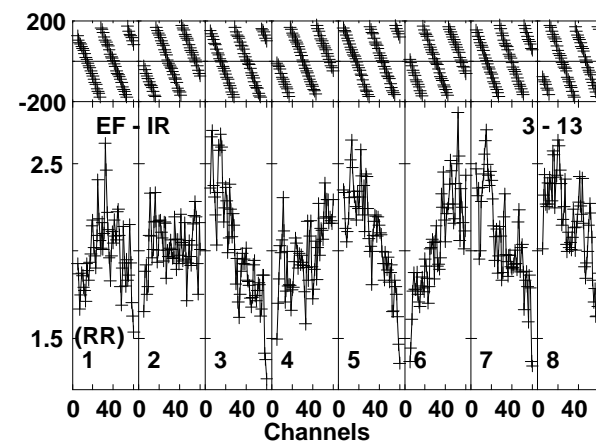
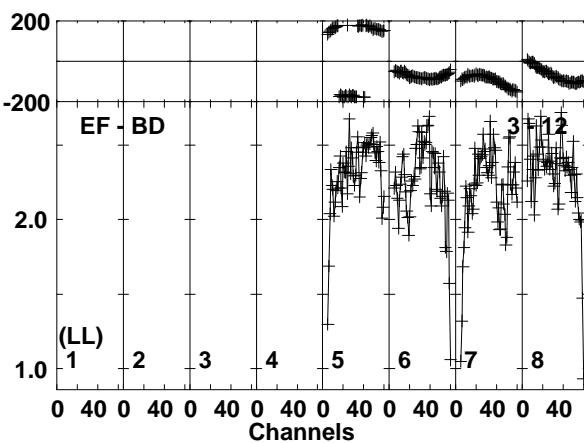
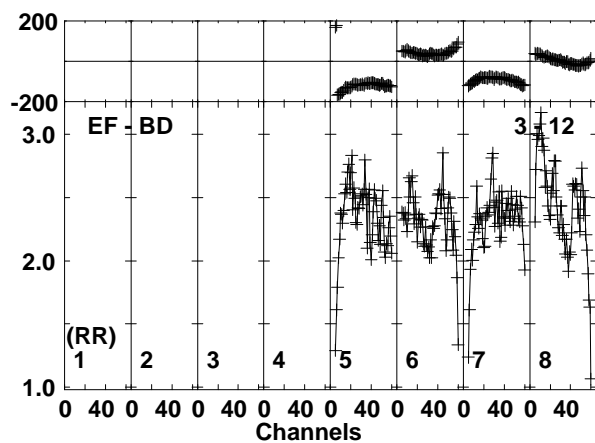
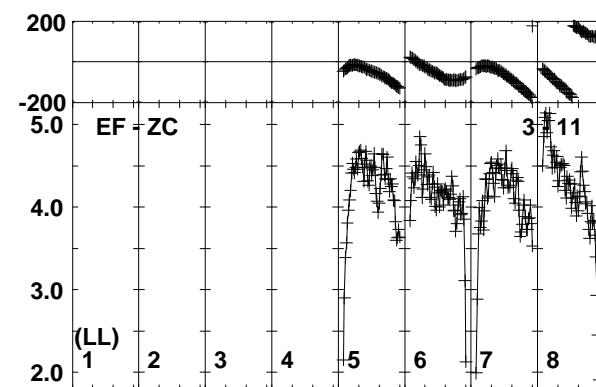
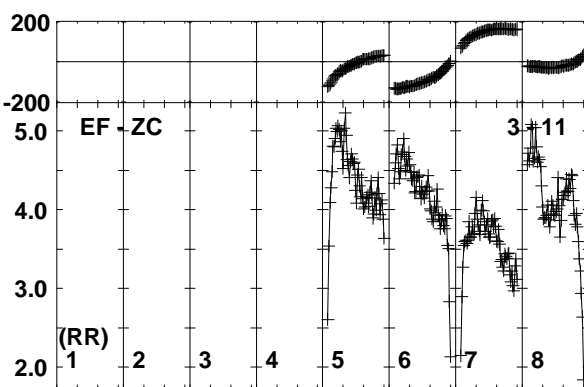
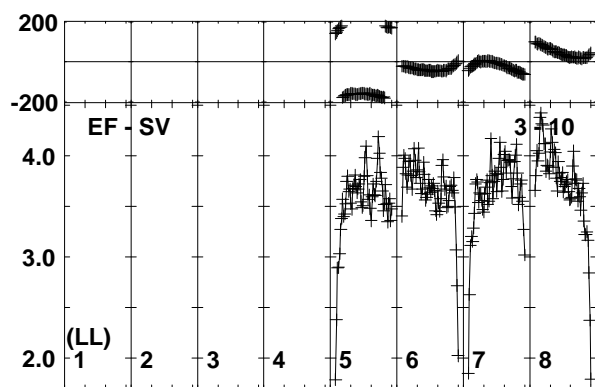
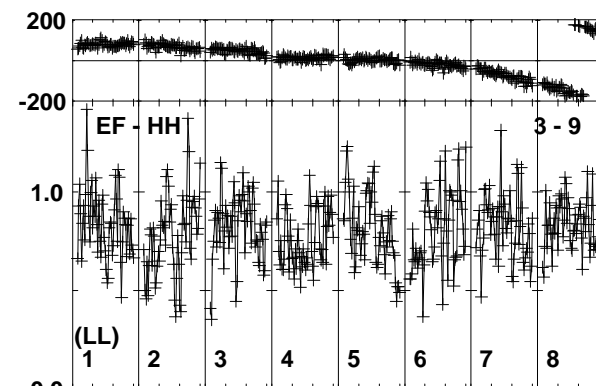
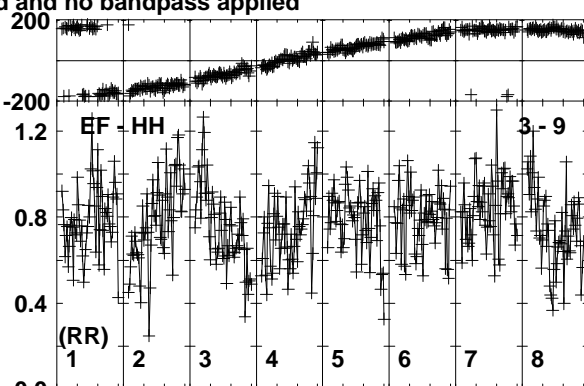
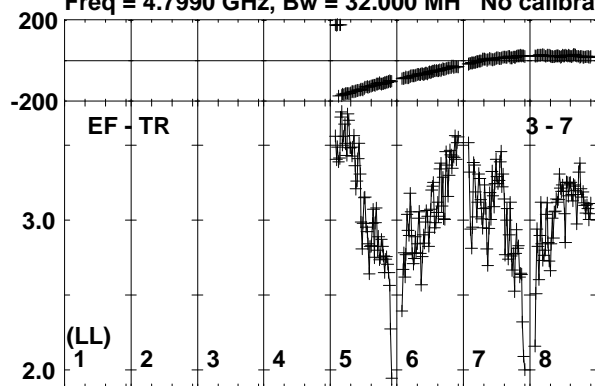

Lower frame: Milli Ampl Jy Top frame: Phas deg
Vector averaged cross-power spectrum Baseline: EF (03) - TR (07)
Timerange: 00/23:44:40 to 00/23:45:10

Plot file version 142 created 26-SEP-2019 10:40:04

J0257-1212 RG010A.UVDATA.1

Freq = 4.7990 GHz, Bw = 32.000 MH No calibration applied and no bandpass applied

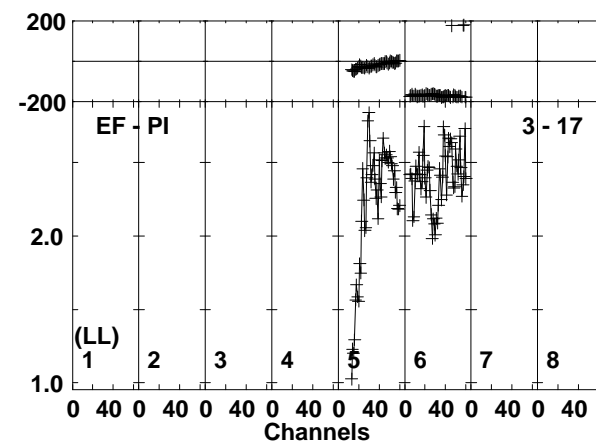
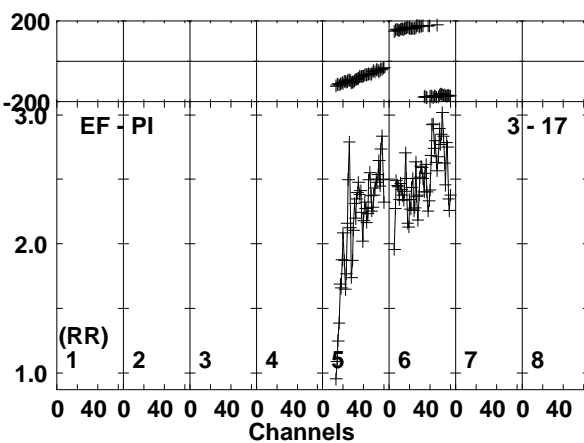
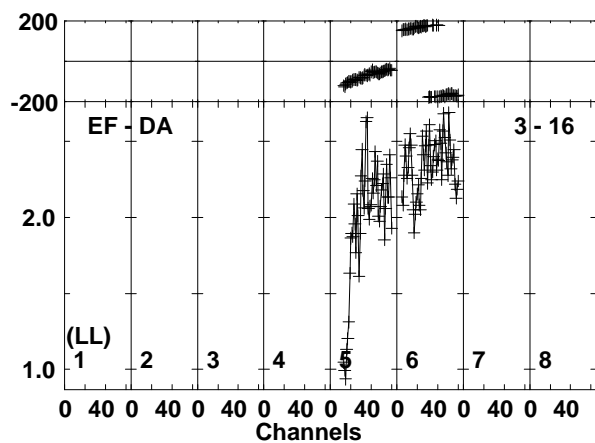
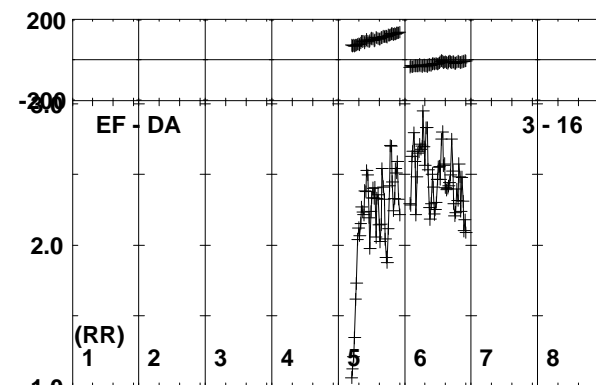
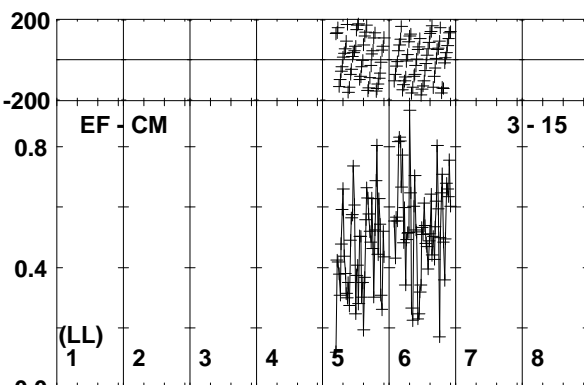
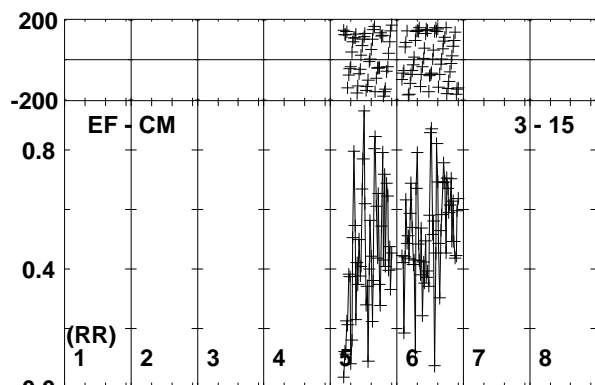
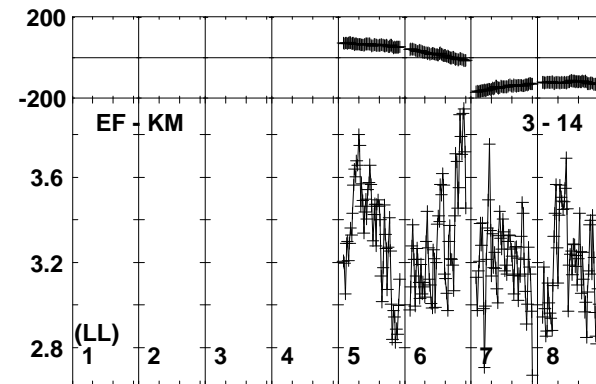
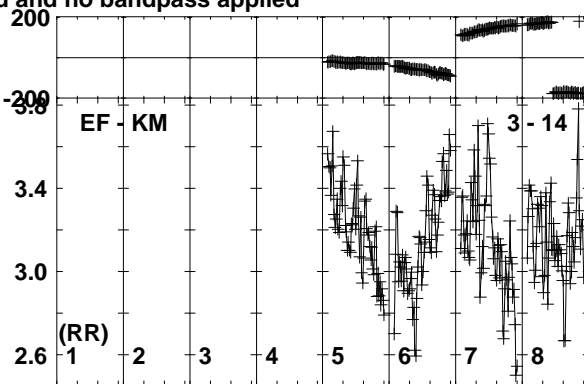
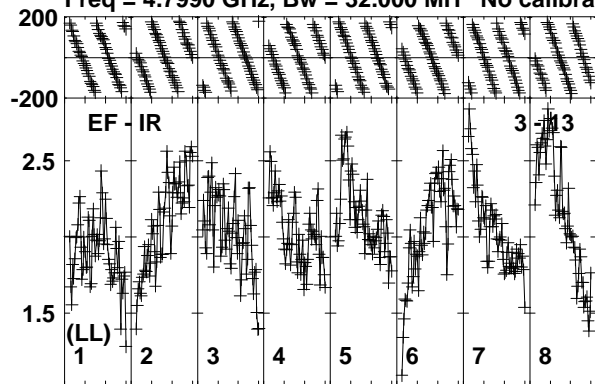

Lower frame: Milli Ampl Jy Top frame: Phas deg
Vector averaged cross-power spectrum Baseline: EF (03) - IR (13)
Timerange: 00/23:44:40 to 00/23:45:10

Plot file version 143 created 26-SEP-2019 10:40:04

J0257-1212 RG010A.UVDATA.1

Freq = 4.7990 GHz, Bw = 32.000 MH No calibration applied and no bandpass applied

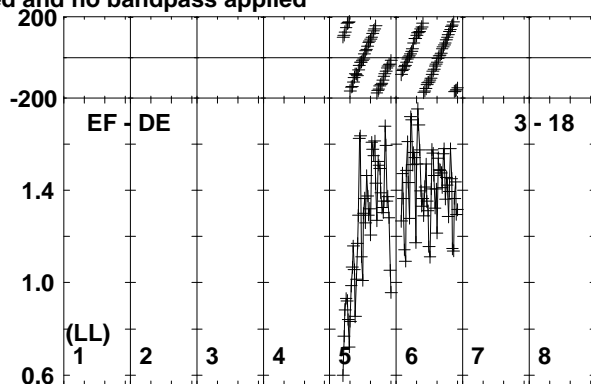
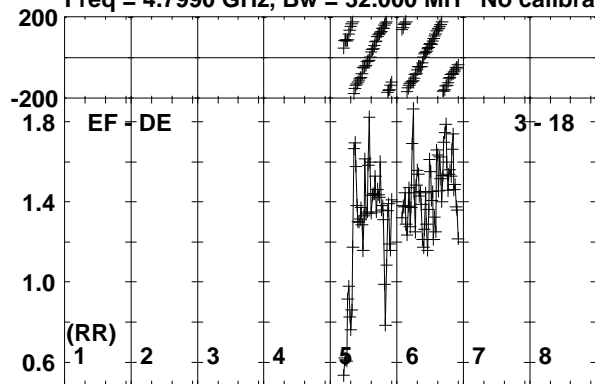

Lower frame: Milli Ampl Jy Top frame: Phas deg
Vector averaged cross-power spectrum Baseline: EF (03) - DE (18)
Timerange: 00/23:44:40 to 00/23:45:10

Plot file version 144 created 26-SEP-2019 10:40:05

J0300-0846 RG010A.UVDATA.1

Freq = 4.7990 GHz, Bw = 32.000 MH No calibration applied and no bandpass applied

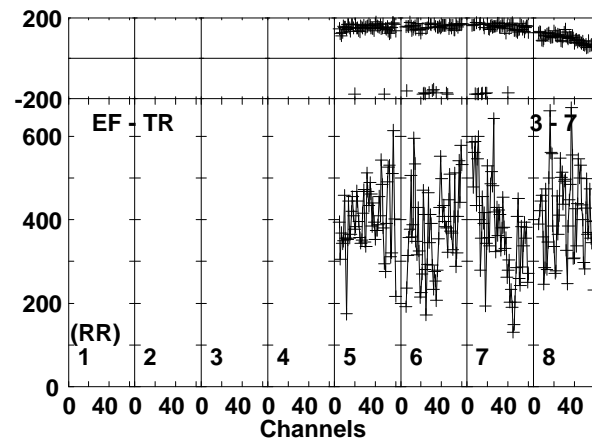
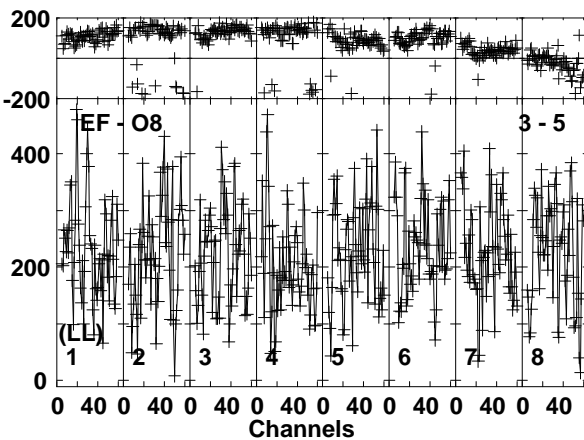
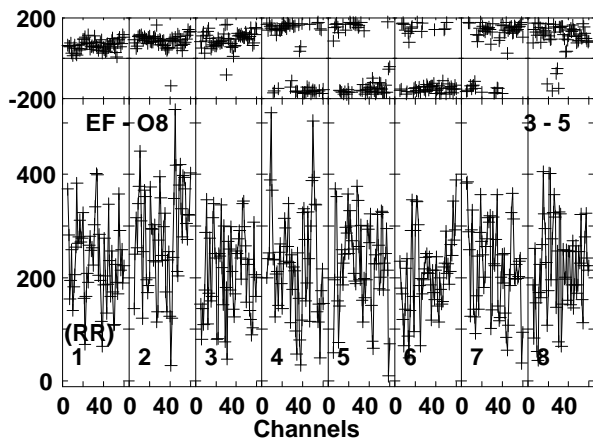
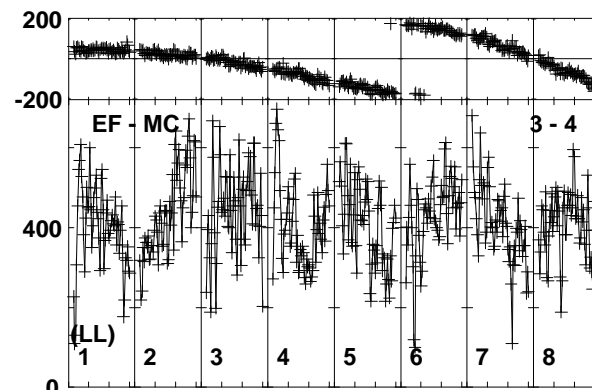
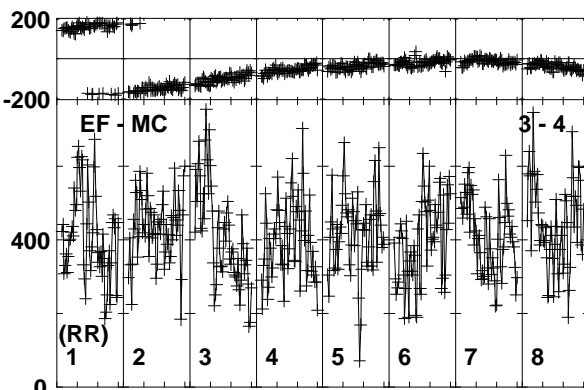
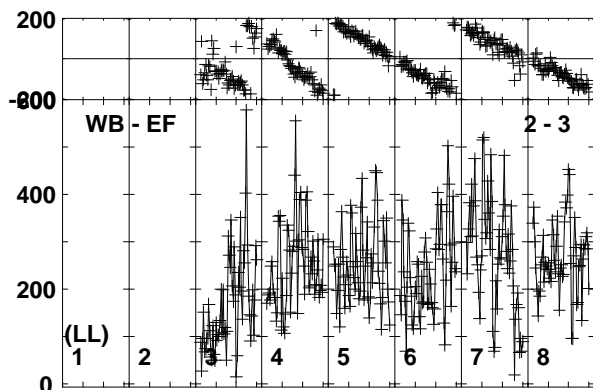
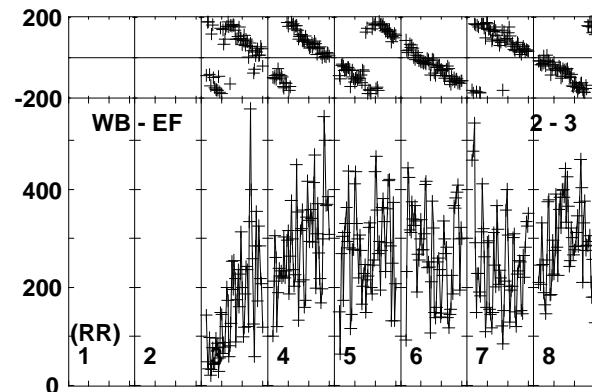
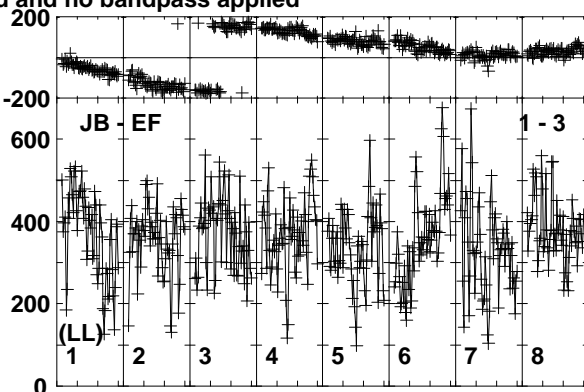
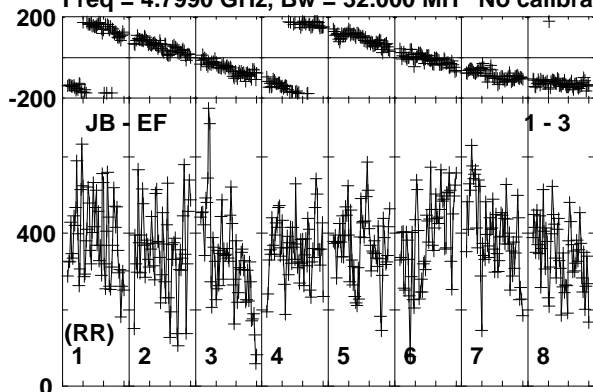

Lower frame: Micro Ampl Jy Top frame: Phas deg
Vector averaged cross-power spectrum Baseline: JB (01) - EF (03)
Timerange: 00/23:45:10 to 00/23:47:19

Plot file version 145 created 26-SEP-2019 10:40:05

J0300-0846 RG010A.UVDATA.1

Freq = 4.7990 GHz, Bw = 32.000 MH No calibration applied and no bandpass applied

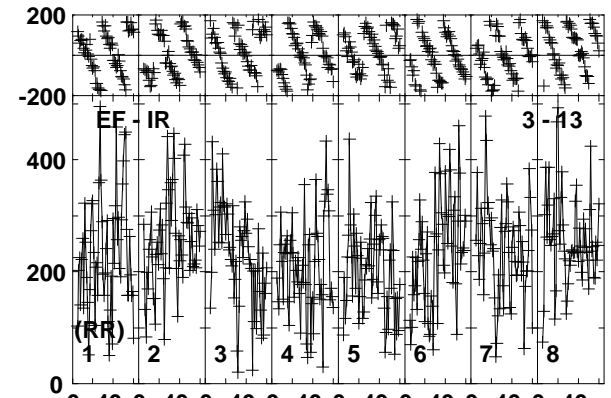
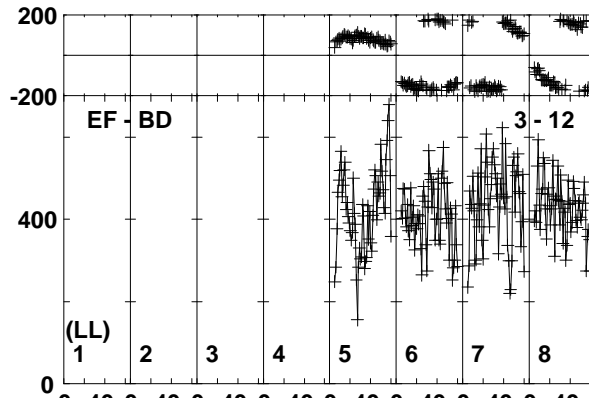
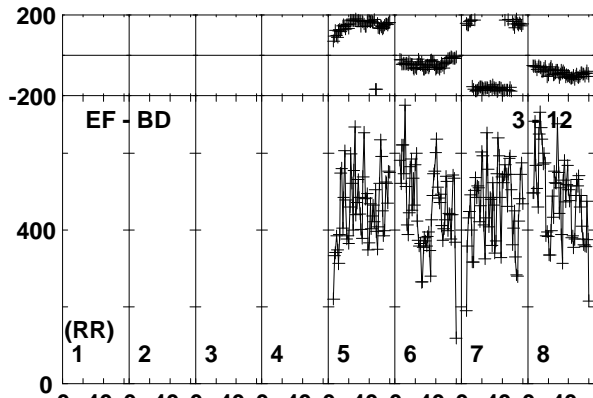
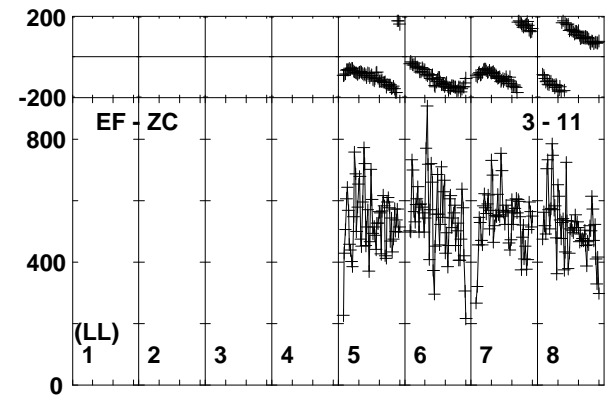
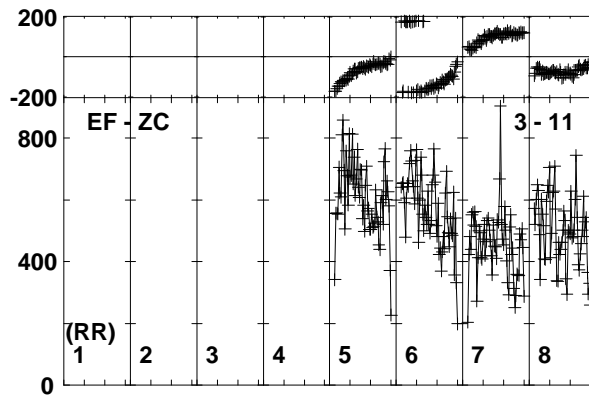
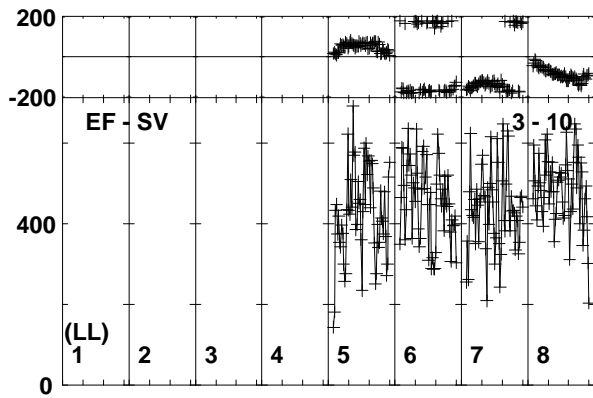
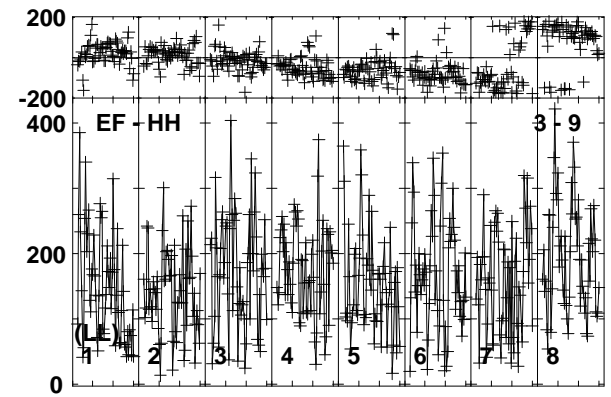
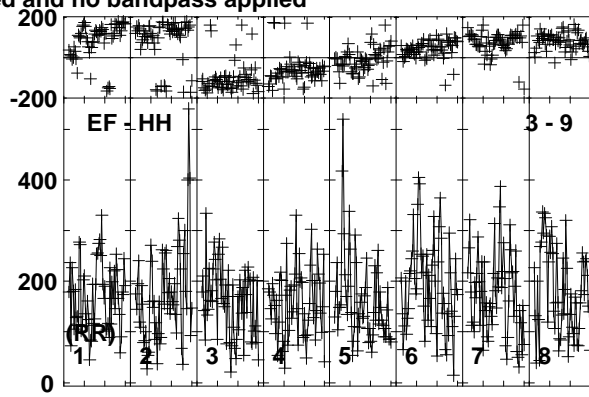
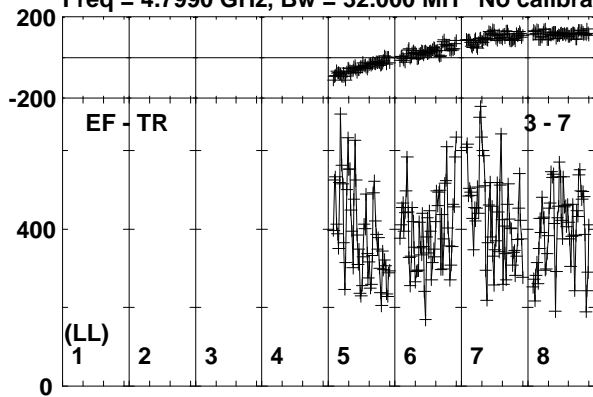

Lower frame: Micro Ampl Jy Top frame: Phas deg
Vector averaged cross-power spectrum Baseline: EF (03) - TR (07)
Timerange: 00/23:45:10 to 00/23:47:19

Plot file version 146 created 26-SEP-2019 10:40:05

J0300-0846 RG010A.UVDATA.1

Freq = 4.7990 GHz, Bw = 32.000 MH No calibration applied and no bandpass applied

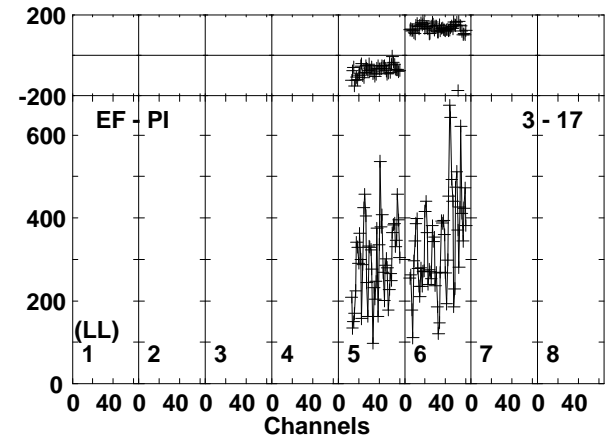
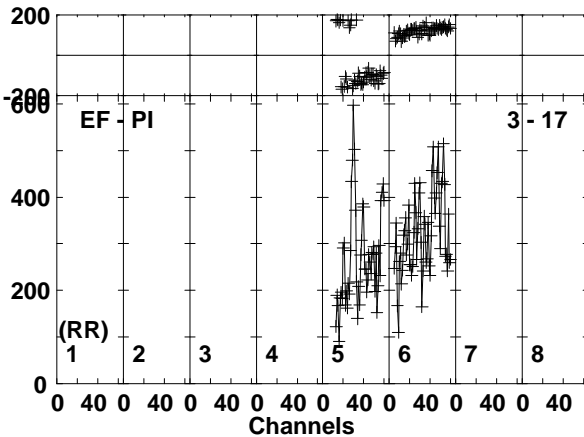
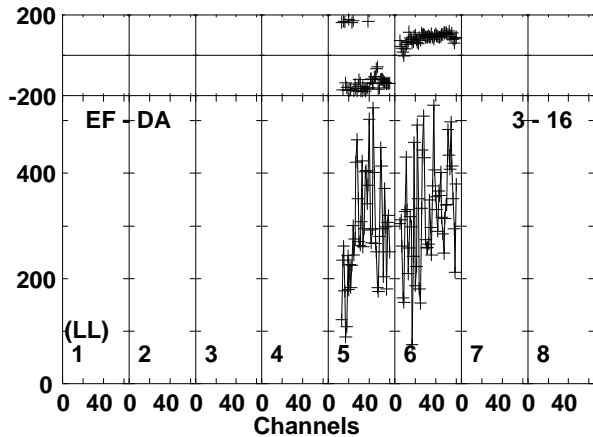
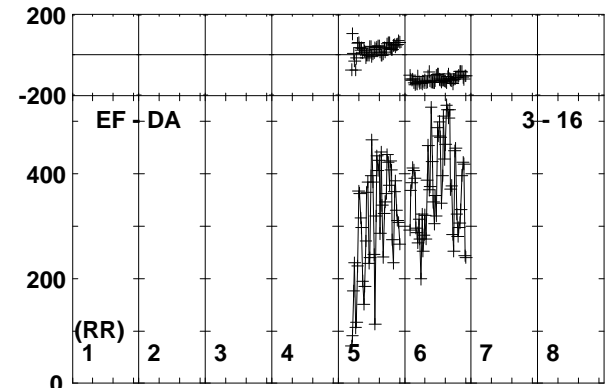
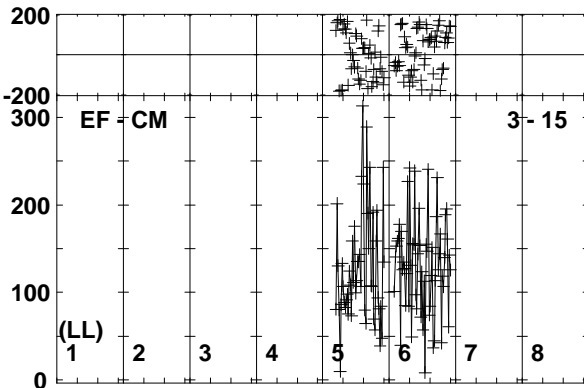
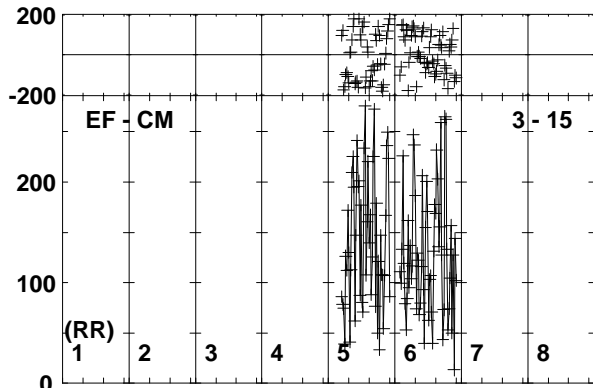
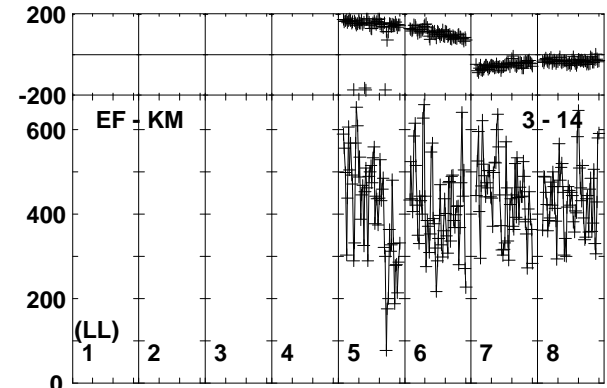
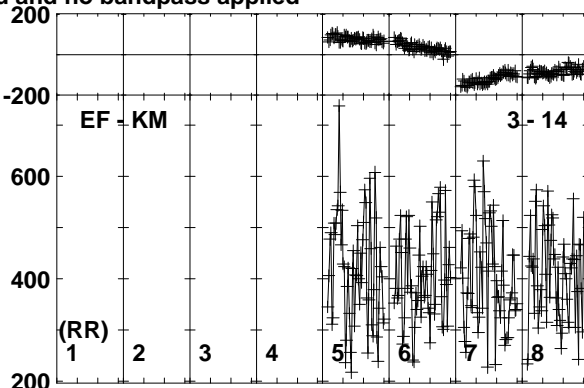
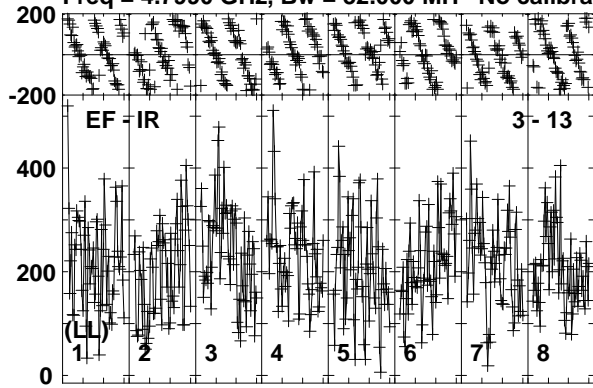

Lower frame: Micro Ampl Jy Top frame: Phas deg
Vector averaged cross-power spectrum Baseline: EF (03) - IR (13)
Timerange: 00/23:45:10 to 00/23:47:19

Plot file version 147 created 26-SEP-2019 10:40:06

J0300-0846 RG010A.UVDATA.1

Freq = 4.7990 GHz, Bw = 32.000 MH No calibration applied and no bandpass applied

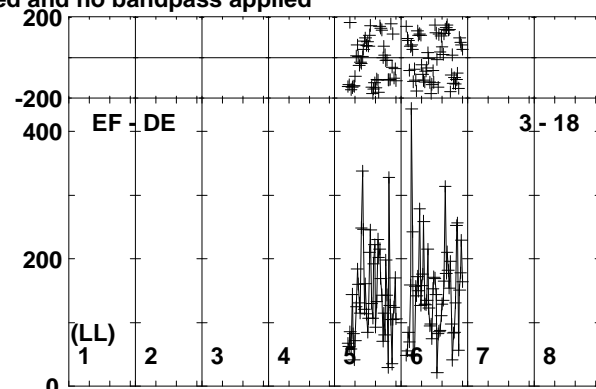
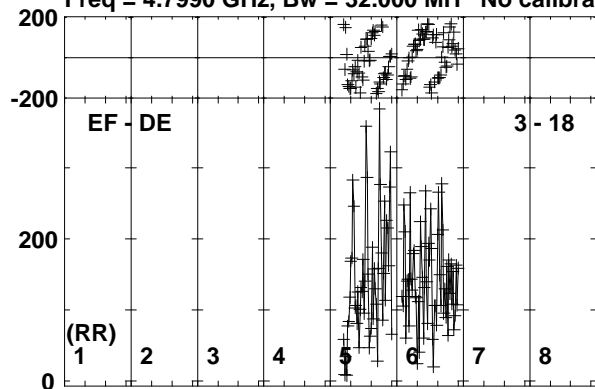

Lower frame: Micro Ampl Jy Top frame: Phas deg
Vector averaged cross-power spectrum Baseline: EF (03) - DE (18)
Timerange: 00/23:45:10 to 00/23:47:19

Plot file version 148 created 26-SEP-2019 10:40:06

J0257-1212 RG010A.UVDATA.1

Freq = 4.7990 GHz, Bw = 32.000 MH No calibration applied and no bandpass applied

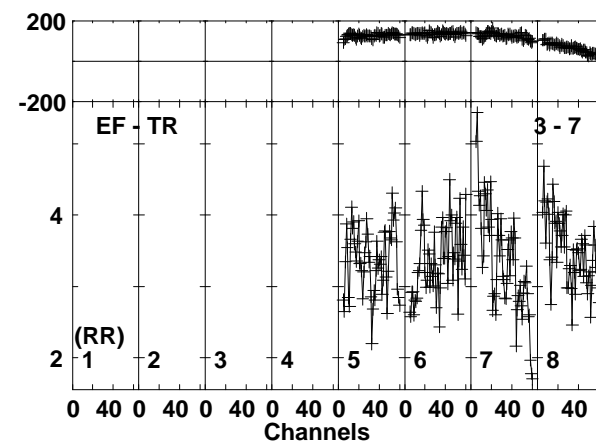
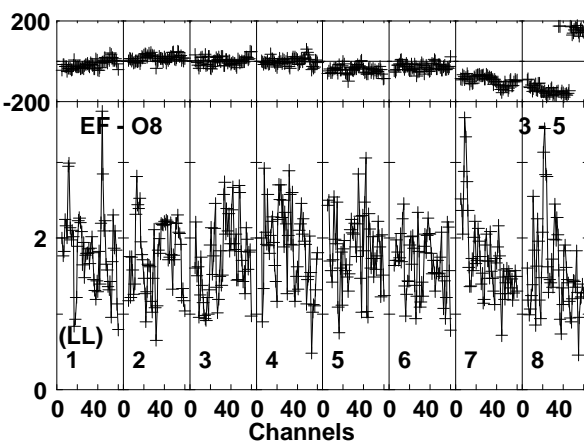
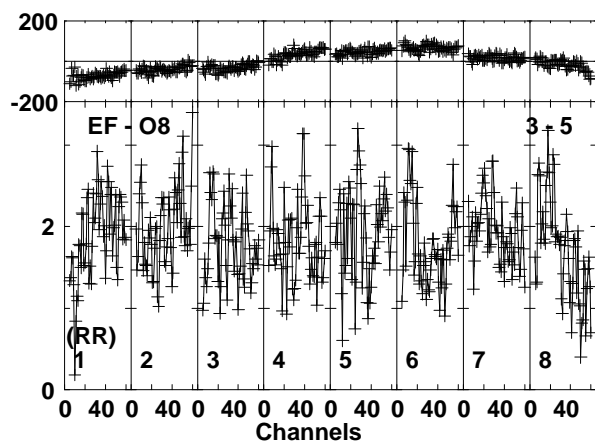
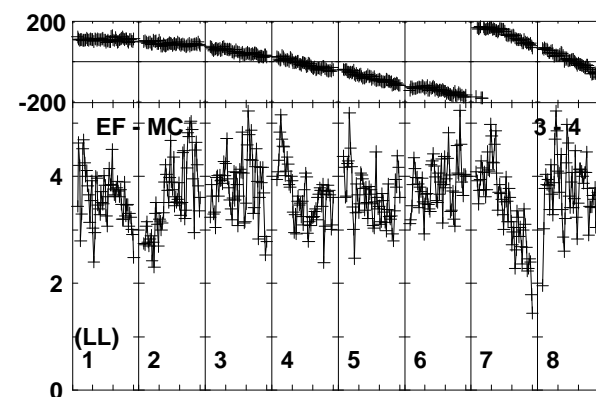
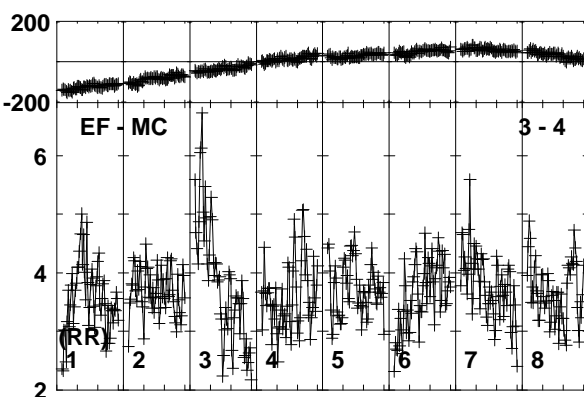
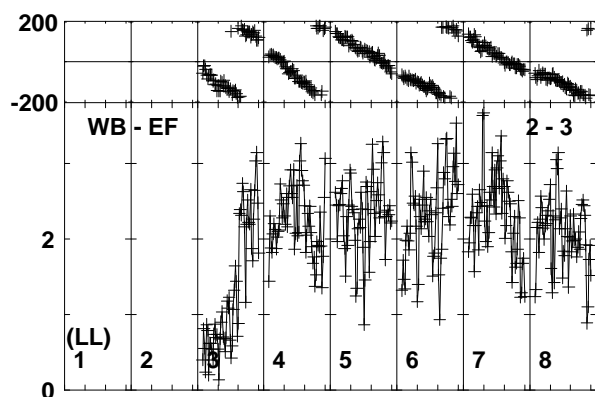
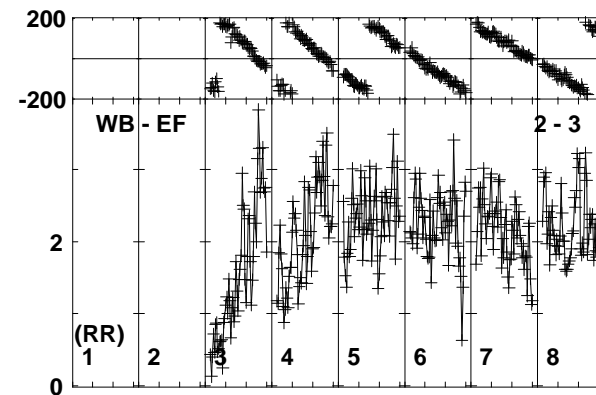
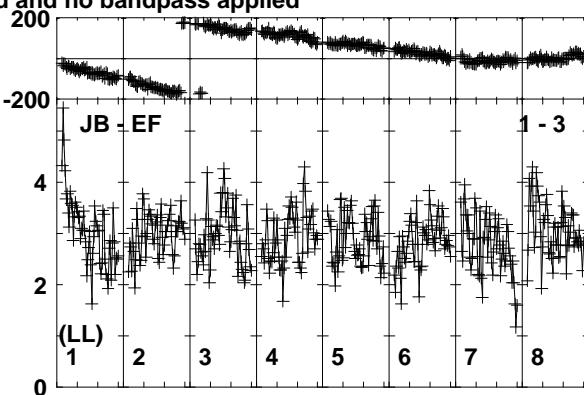
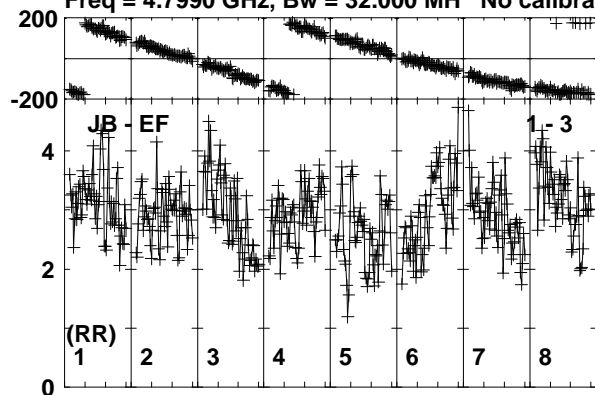

Lower frame: Milli Ampl Jy Top frame: Phas deg
Vector averaged cross-power spectrum Baseline: JB (01) - EF (03)
Timerange: 00/23:47:21 to 00/23:48:19

Plot file version 149 created 26-SEP-2019 10:40:06

J0257-1212 RG010A.UVDATA.1

Freq = 4.7990 GHz, Bw = 32.000 MH No calibration applied and no bandpass applied

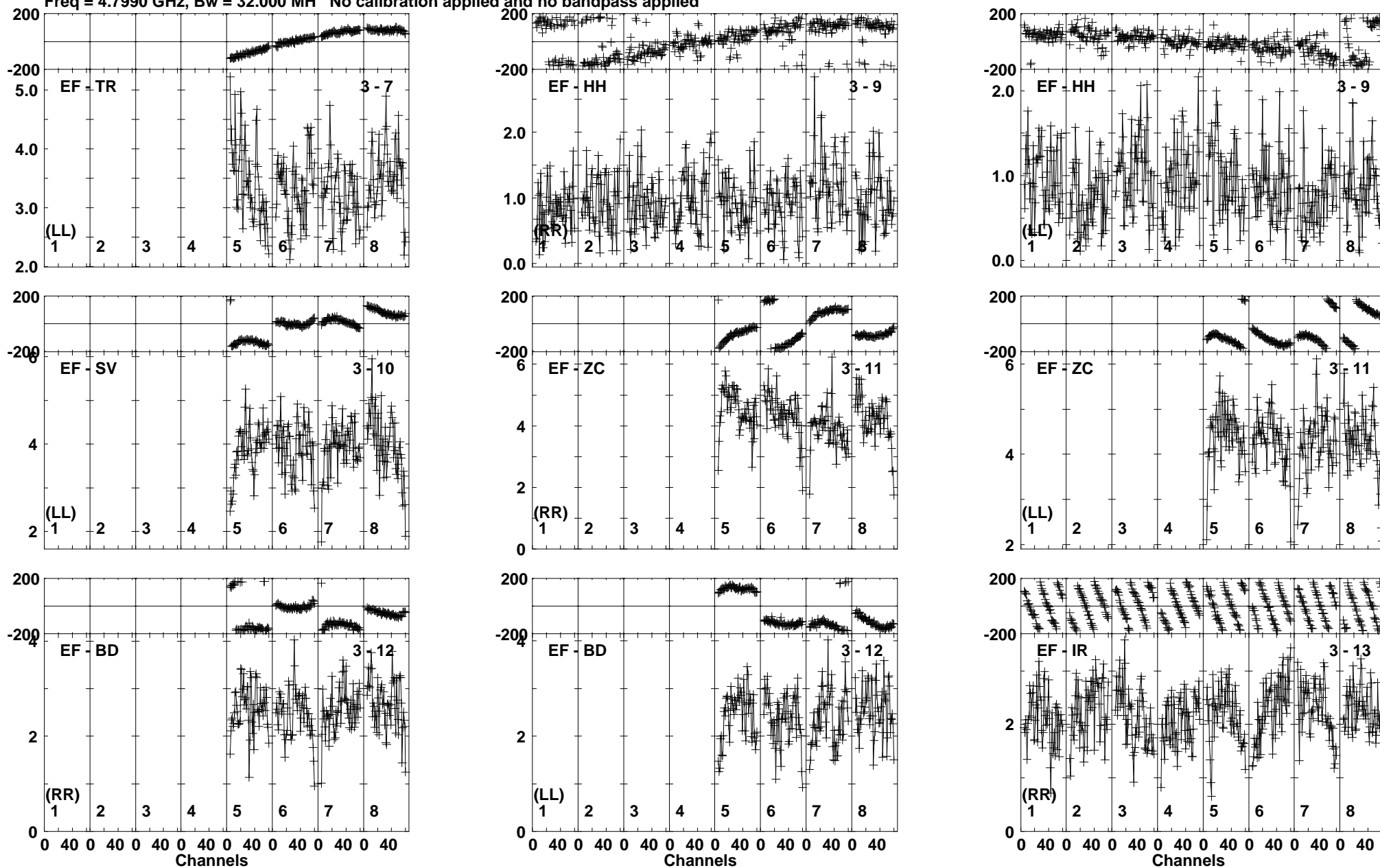

Lower frame: Milli Ampl Jy Top frame: Phas deg
Vector averaged cross-power spectrum Baseline: EF (03) - TR (07)
Timerange: 00/23:47:21 to 00/23:48:19

Plot file version 150 created 26-SEP-2019 10:40:07

J0257-1212 RG010A.UVDATA.1

Freq = 4.7990 GHz, Bw = 32.000 MH No calibration applied and no bandpass applied

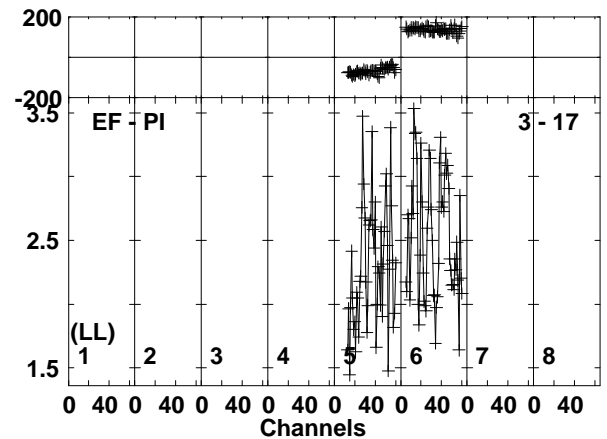
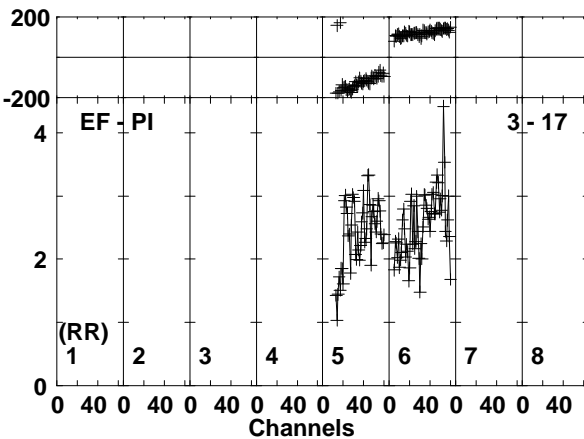
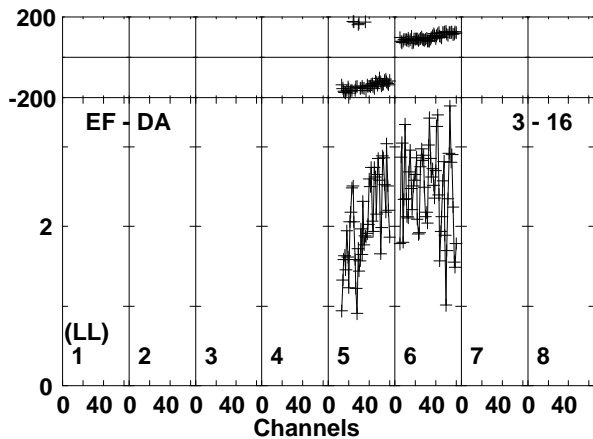
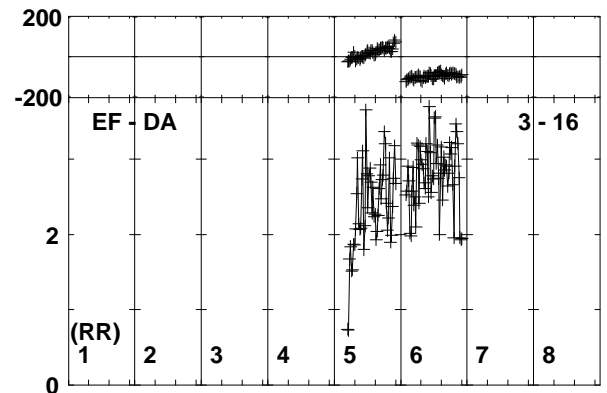
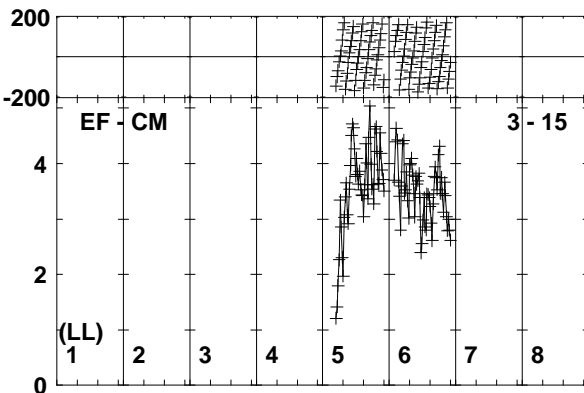
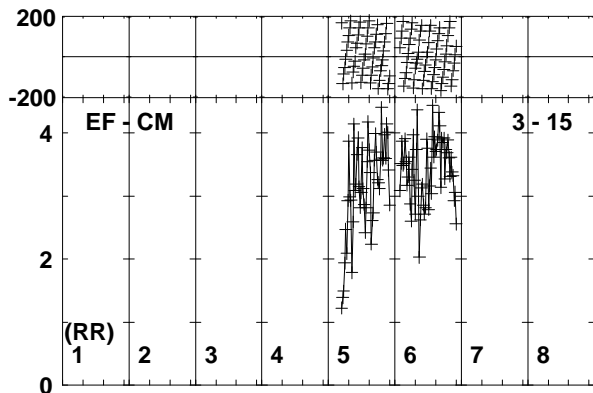
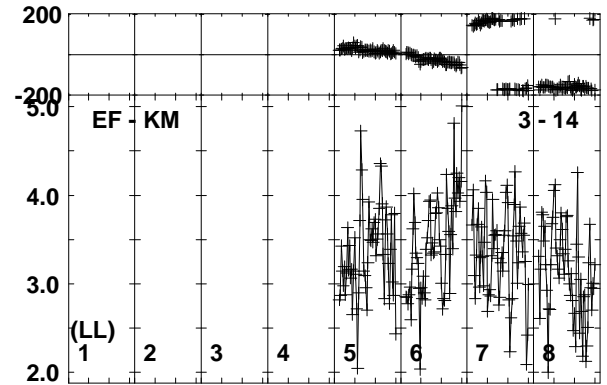
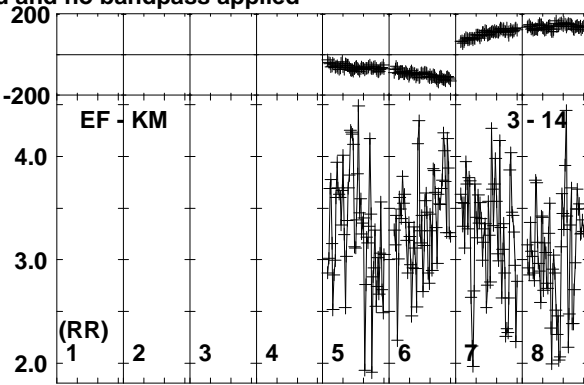
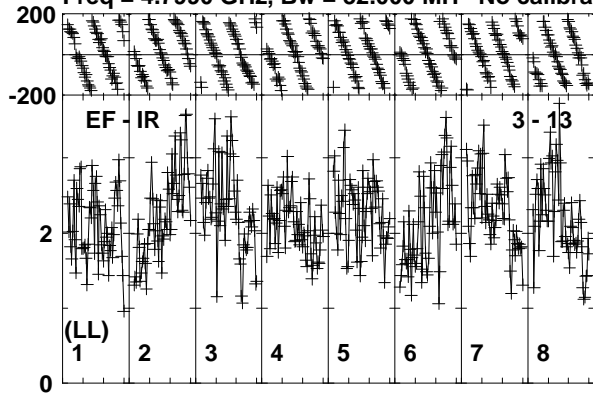

Lower frame: Milli Ampl Jy Top frame: Phas deg
Vector averaged cross-power spectrum Baseline: EF (03) - IR (13)
Timerange: 00/23:47:21 to 00/23:48:19

Plot file version 151 created 26-SEP-2019 10:40:07

J0257-1212 RG010A.UVDATA.1

Freq = 4.7990 GHz, Bw = 32.000 MH No calibration applied and no bandpass applied

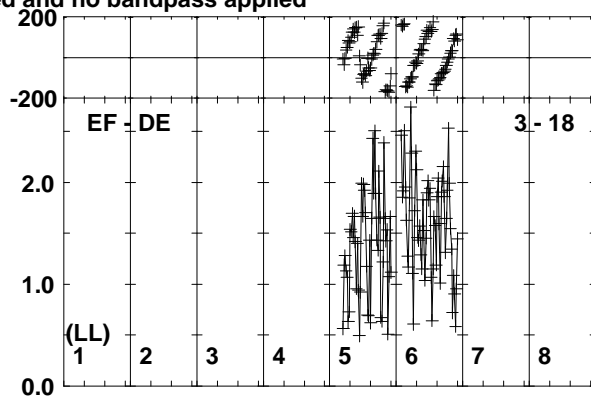
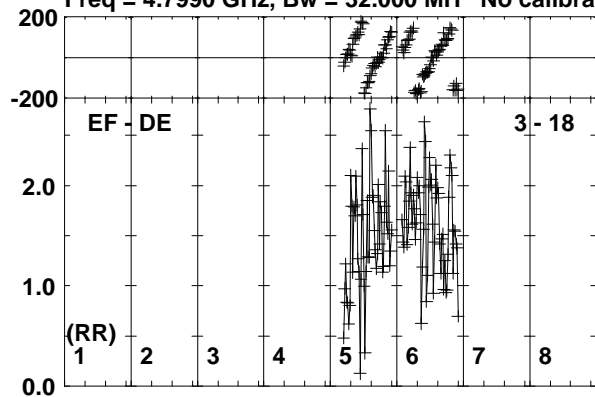

Lower frame: Milli Ampl Jy Top frame: Phas deg
Vector averaged cross-power spectrum Baseline: EF (03) - DE (18)
Timerange: 00/23:47:21 to 00/23:48:19

Plot file version 152 created 26-SEP-2019 10:40:07

190829A RG010A.UVDATA.1

Freq = 4.7990 GHz, Bw = 32.000 MH No calibration applied and no bandpass applied

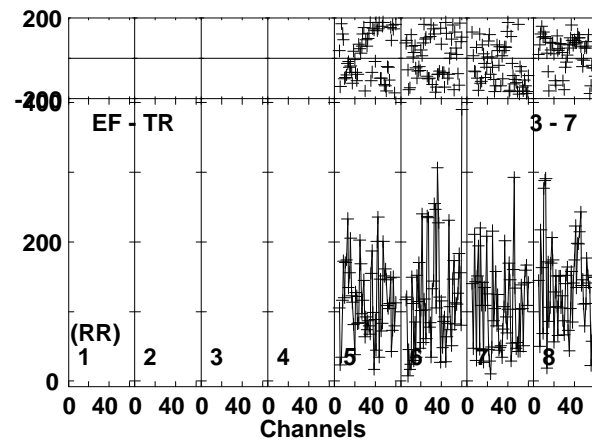
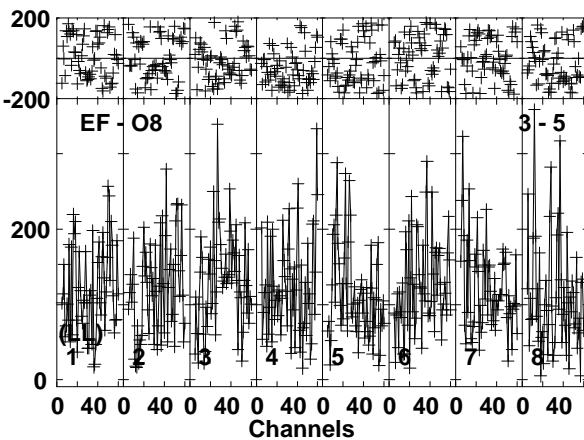
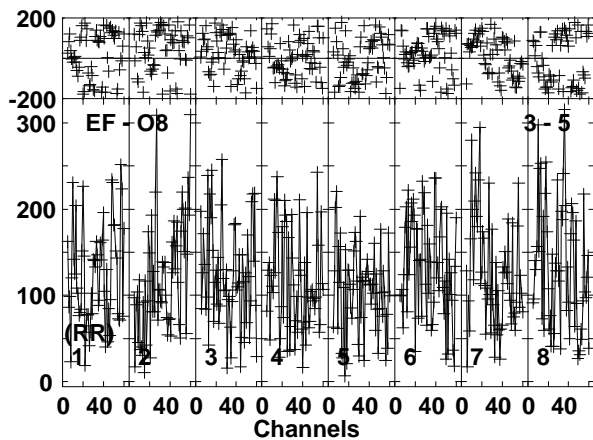
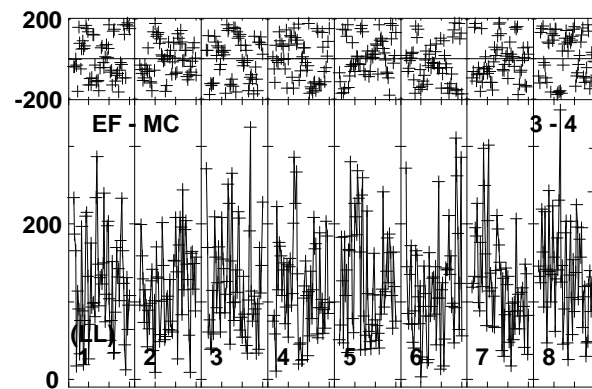
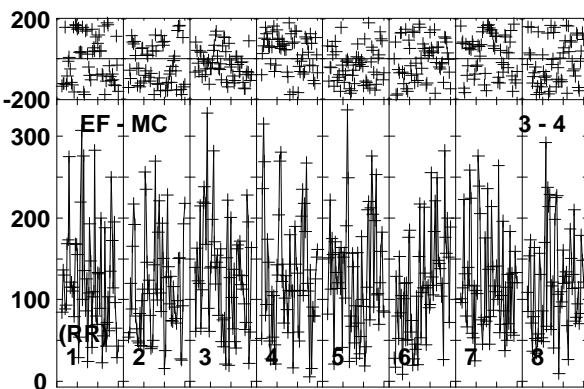
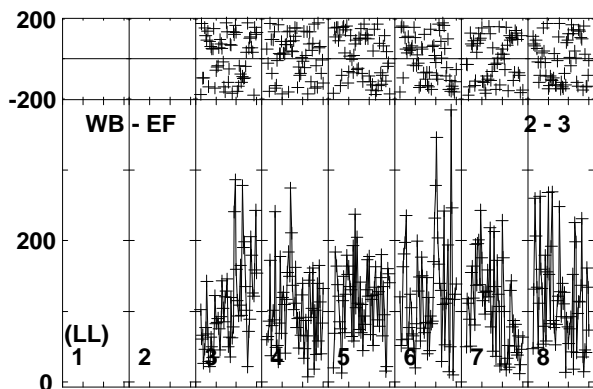
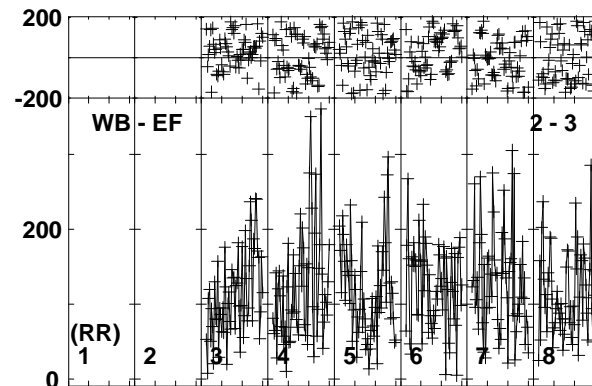
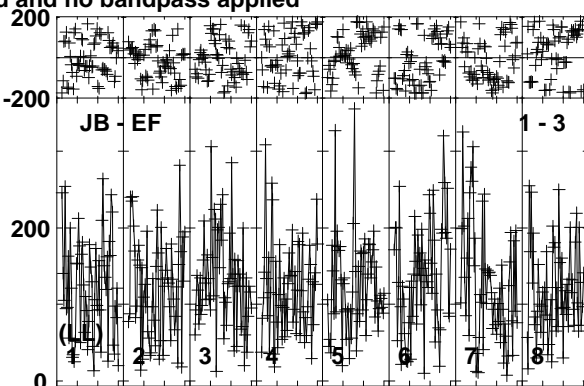
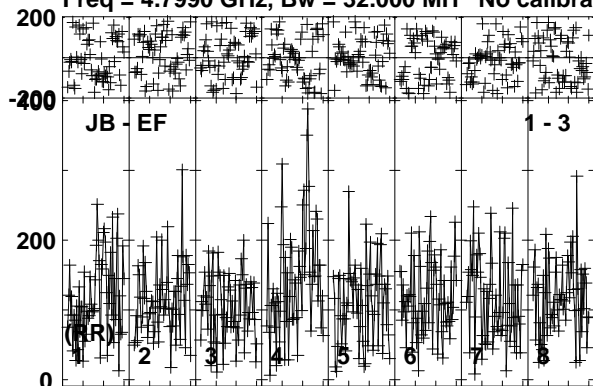

Lower frame: Micro Ampl Jy Top frame: Phas deg
Vector averaged cross-power spectrum Baseline: JB (01) - EF (03)
Timerange: 00/23:48:21 to 00/23:50:30

Plot file version 153 created 26-SEP-2019 10:40:08

190829A RG010A.UVDATA.1

Freq = 4.7990 GHz, Bw = 32.000 MH No calibration applied and no bandpass applied

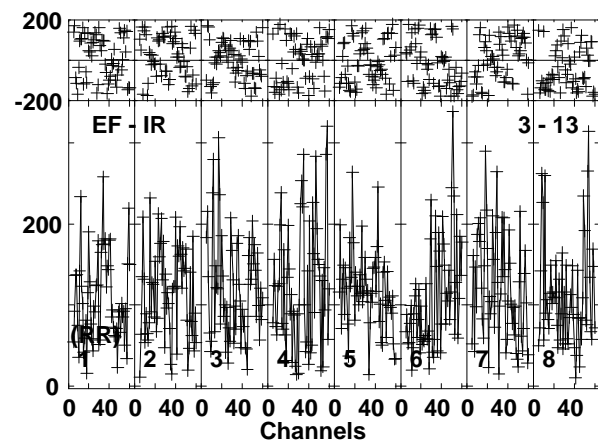
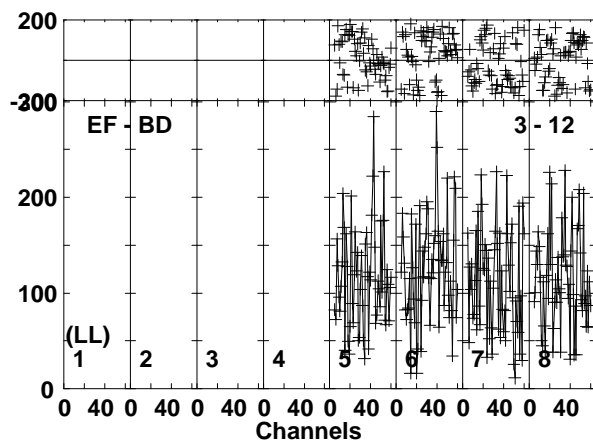
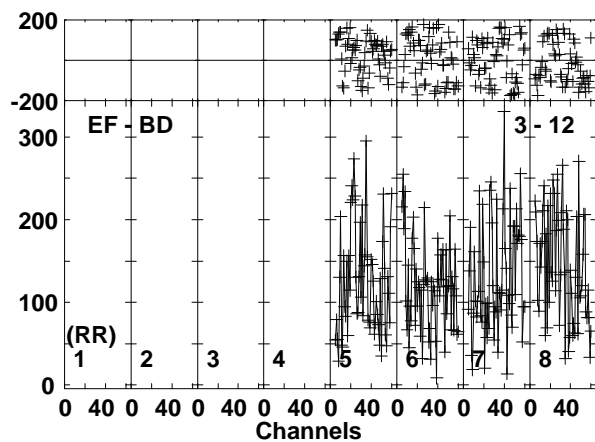
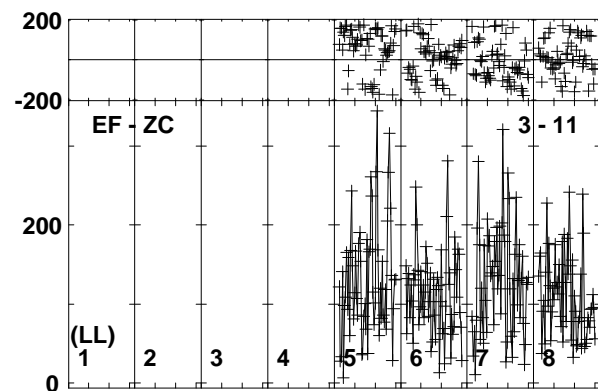
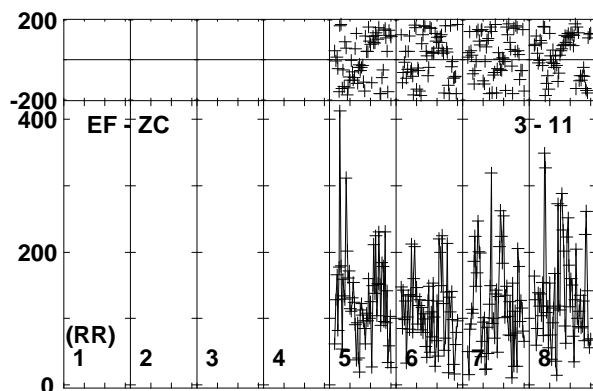
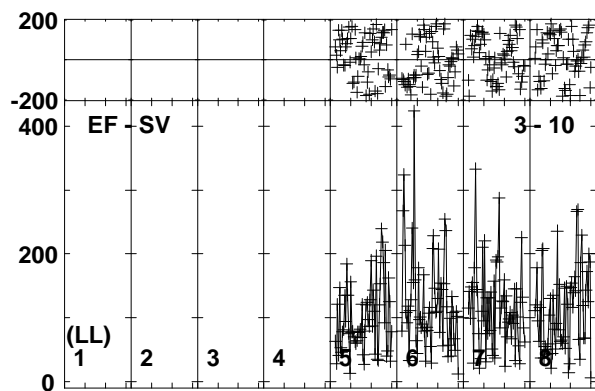
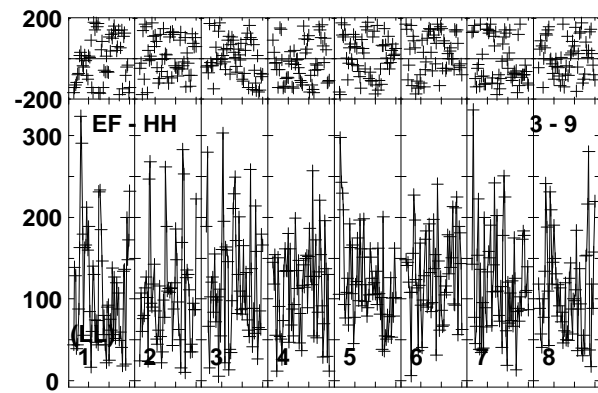
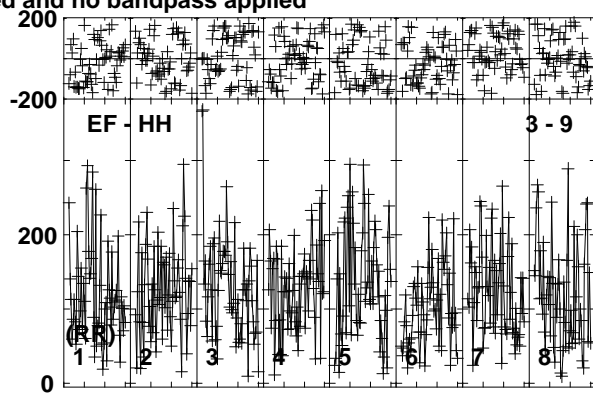
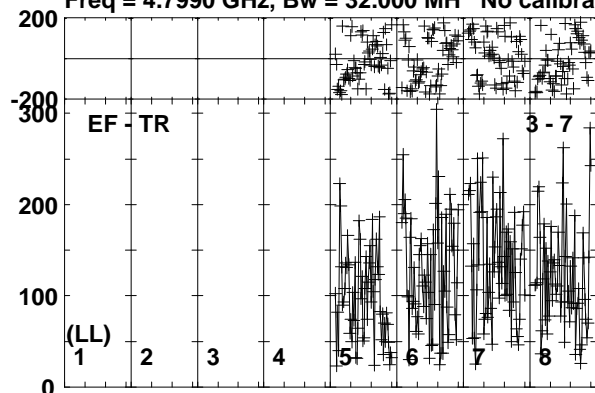

Lower frame: Micro Ampl Jy Top frame: Phas deg
Vector averaged cross-power spectrum Baseline: EF (03) - TR (07)
Timerange: 00/23:48:21 to 00/23:50:30

Plot file version 154 created 26-SEP-2019 10:40:08

190829A RG010A.UVDATA.1

Freq = 4.7990 GHz, Bw = 32.000 MH No calibration applied and no bandpass applied

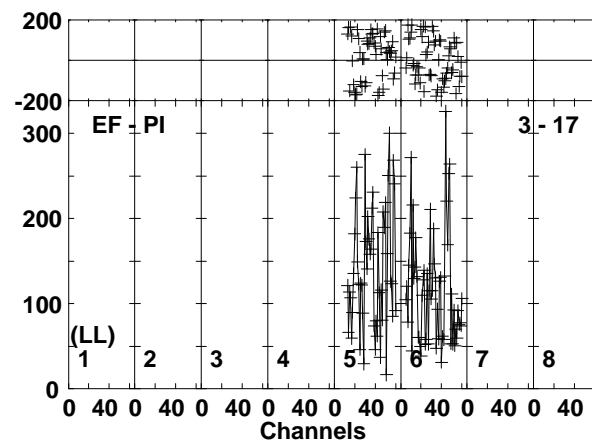
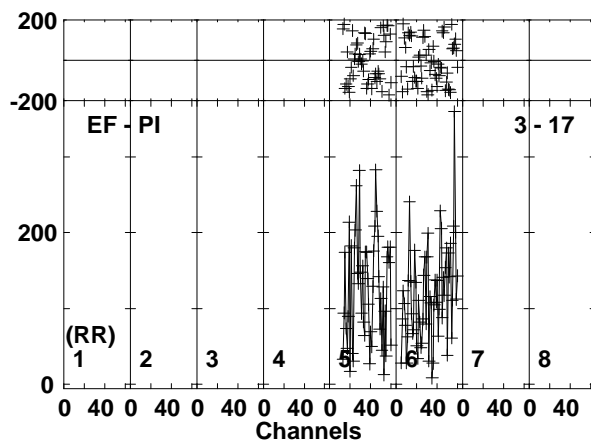
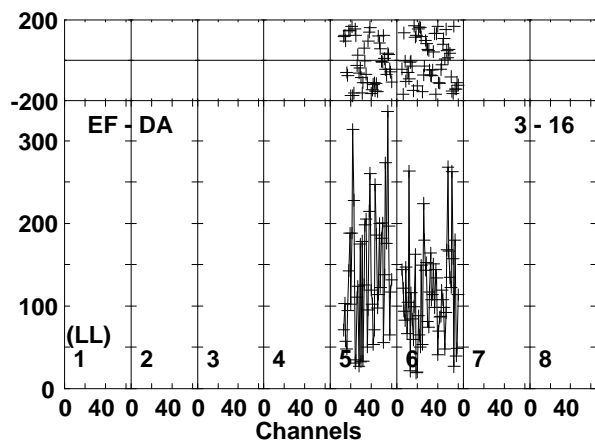
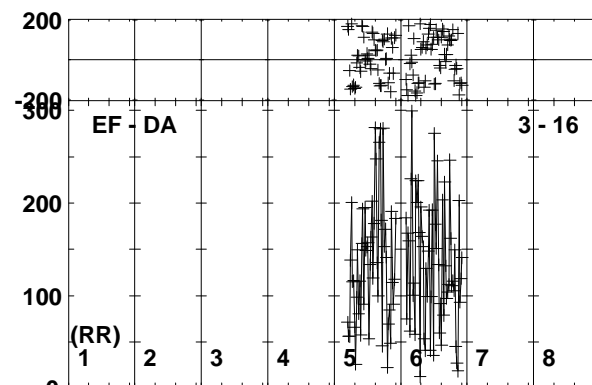
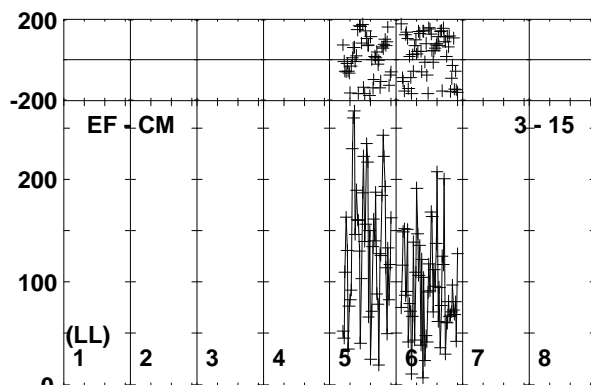
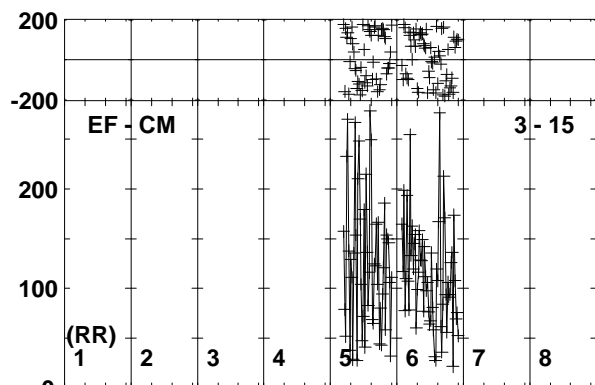
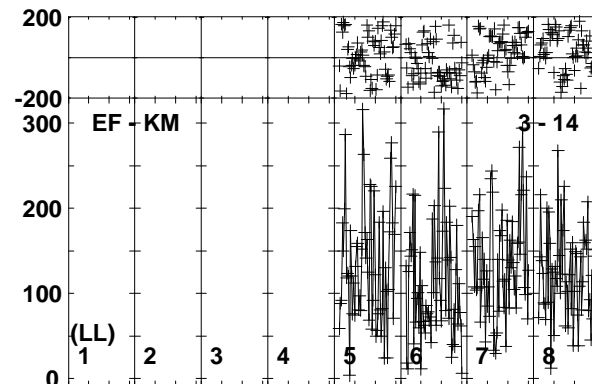
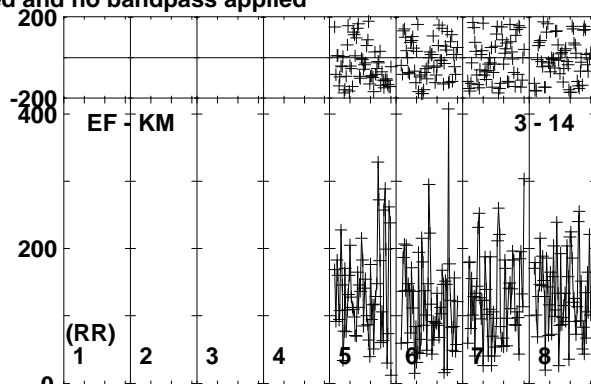
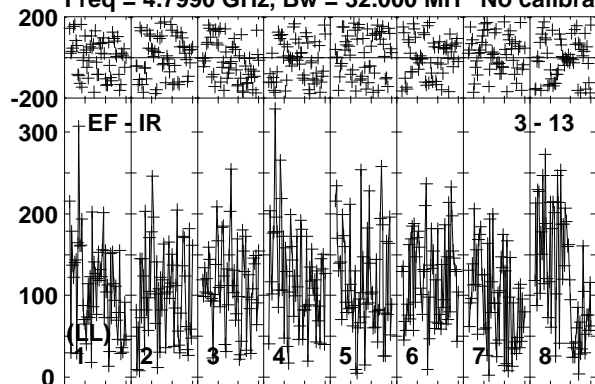

Lower frame: Micro Ampl Jy Top frame: Phas deg
Vector averaged cross-power spectrum Baseline: EF (03) - IR (13)
Timerange: 00/23:48:21 to 00/23:50:30

Plot file version 155 created 26-SEP-2019 10:40:09

190829A RG010A.UVDATA.1

Freq = 4.7990 GHz, Bw = 32.000 MH No calibration applied and no bandpass applied

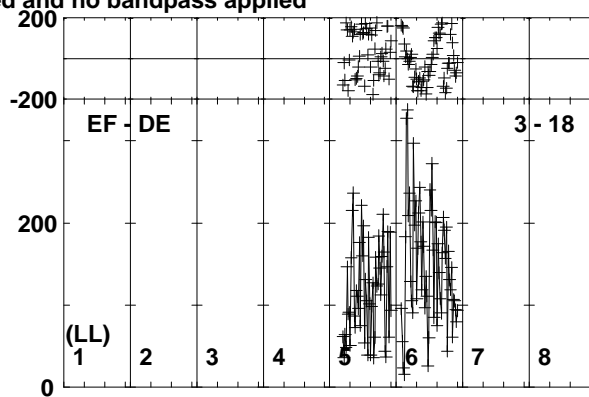
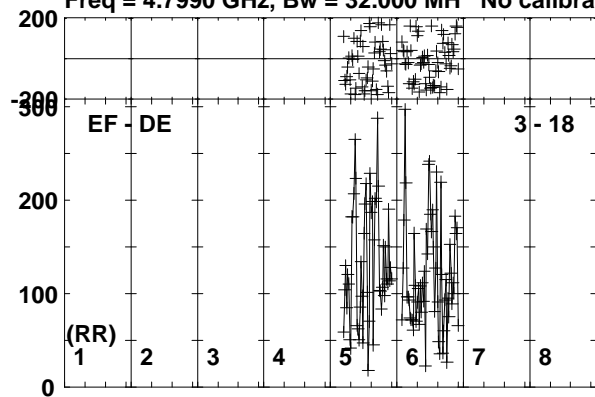

Lower frame: Micro Ampl Jy Top frame: Phas deg
Vector averaged cross-power spectrum Baseline: EF (03) - DE (18)
Timerange: 00/23:48:21 to 00/23:50:30

Plot file version 156 created 26-SEP-2019 10:40:09

J0257-1212 RG010A.UVDATA.1

Freq = 4.7990 GHz, Bw = 32.000 MH No calibration applied and no bandpass applied

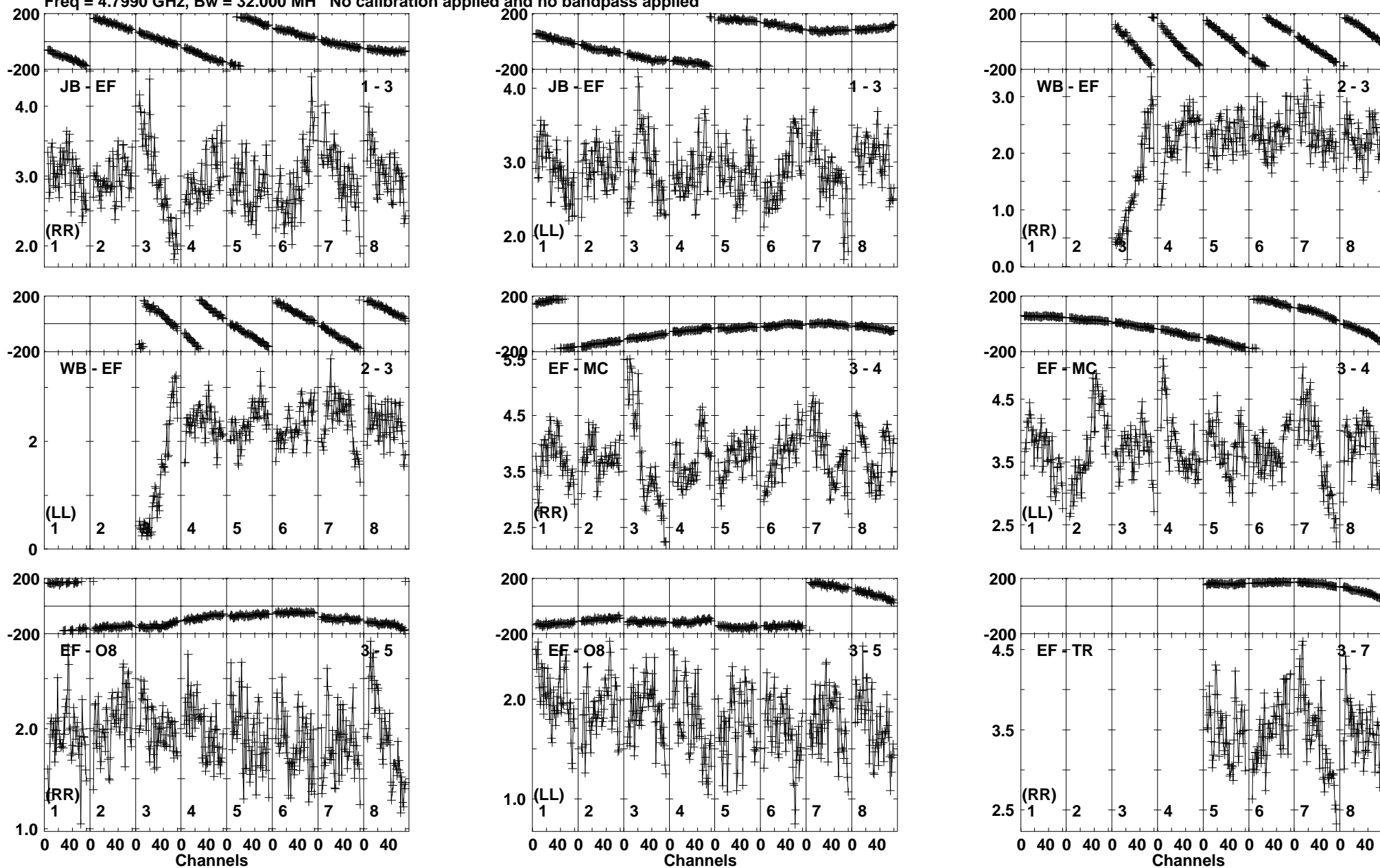

Lower frame: Milli Ampl Jy Top frame: Phas deg
Vector averaged cross-power spectrum Baseline: JB (01) - EF (03)
Timerange: 00/23:50:30 to 00/23:51:29

Plot file version 157 created 26-SEP-2019 10:40:09

J0257-1212 RG010A.UVDATA.1

Freq = 4.7990 GHz, Bw = 32.000 MH No calibration applied and no bandpass applied

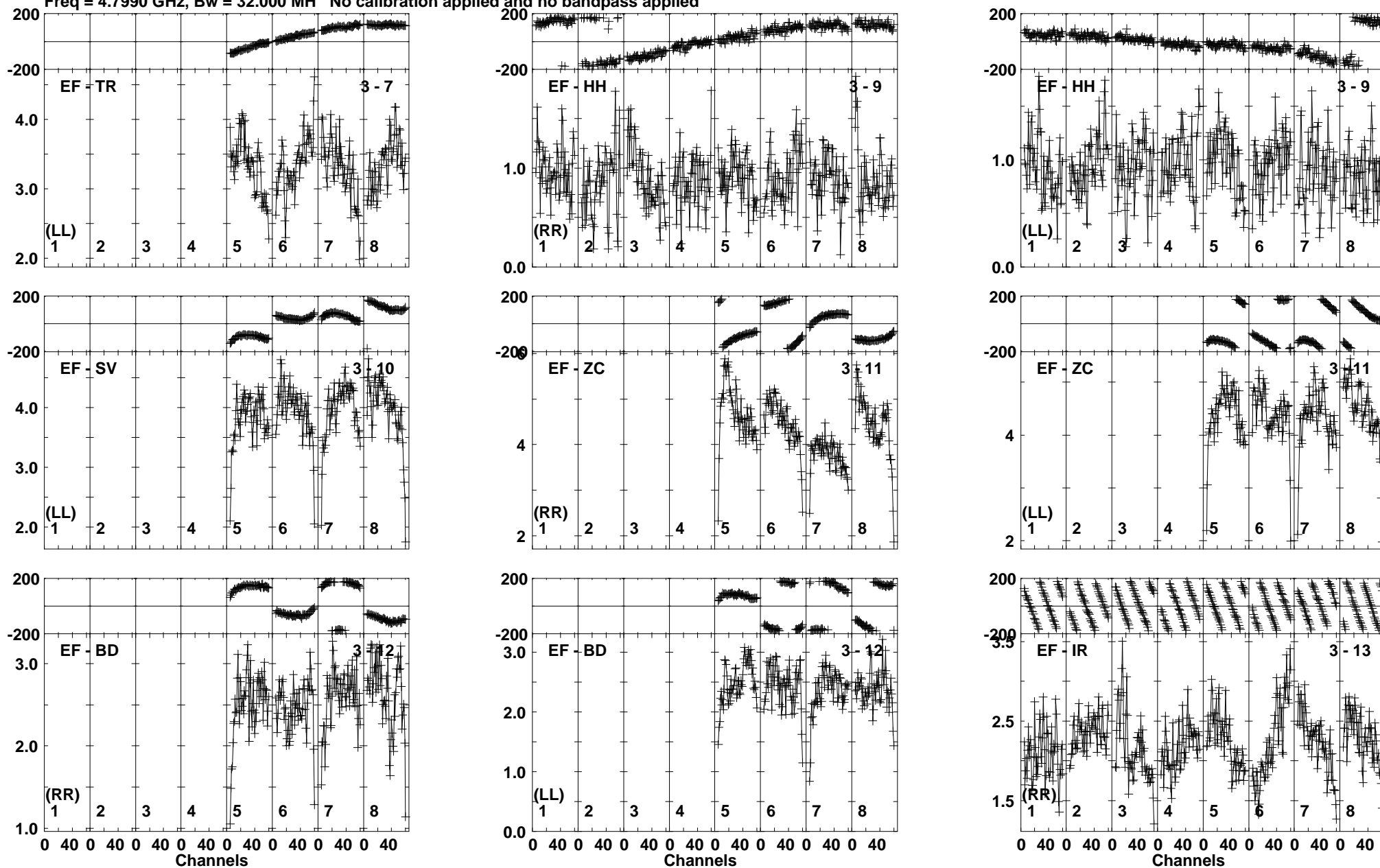

Lower frame: Milli Ampl Jy Top frame: Phas deg
Vector averaged cross-power spectrum Baseline: EF (03) - TR (07)
Timerange: 00/23:50:30 to 00/23:51:29

Plot file version 158 created 26-SEP-2019 10:40:09

J0257-1212 RG010A.UVDATA.1

Freq = 4.7990 GHz, Bw = 32.000 MH No calibration applied and no bandpass applied

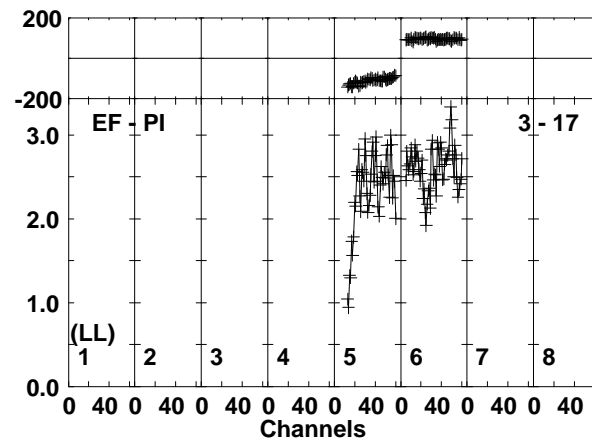
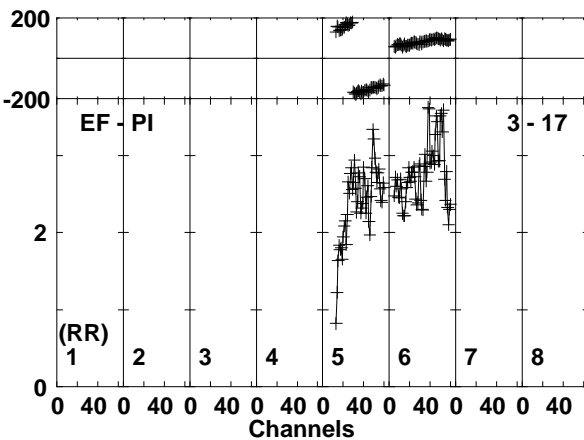
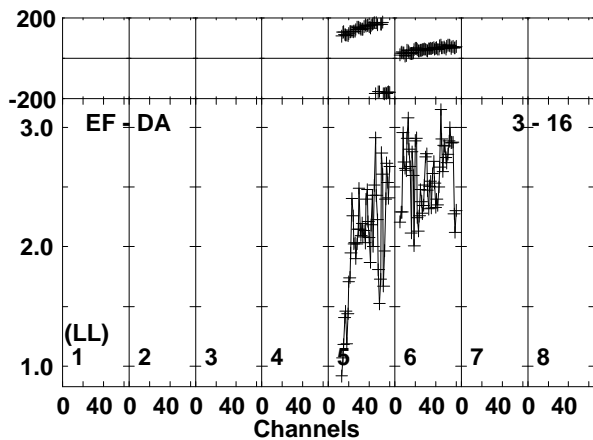
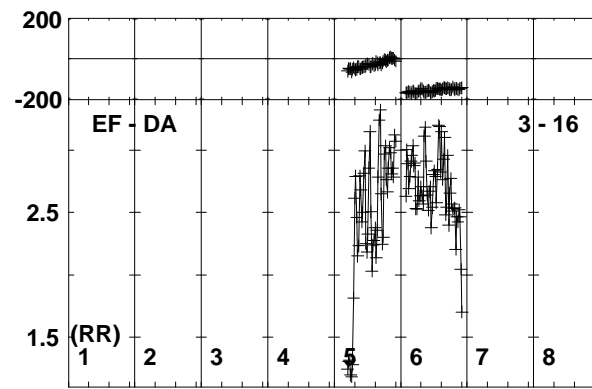
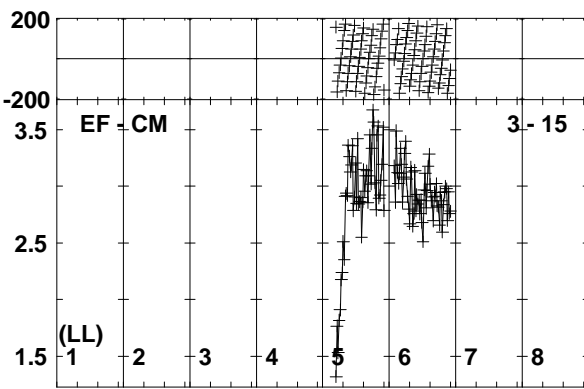
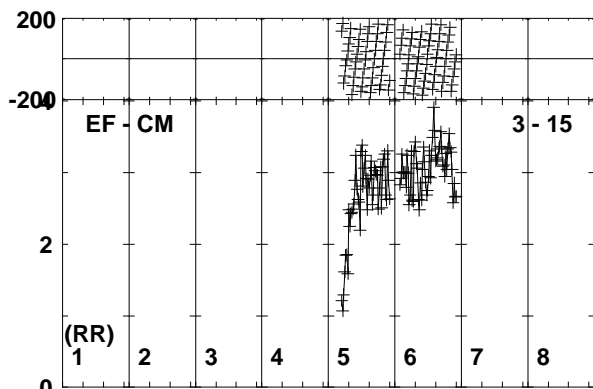
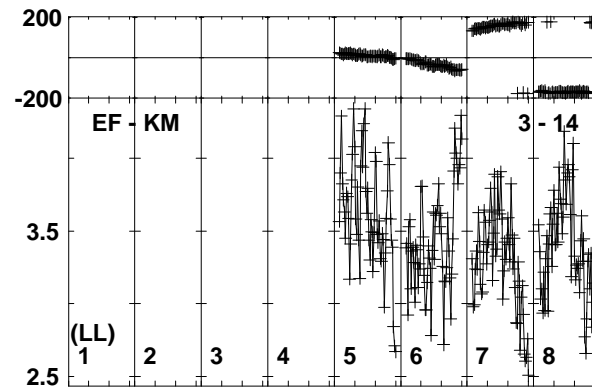
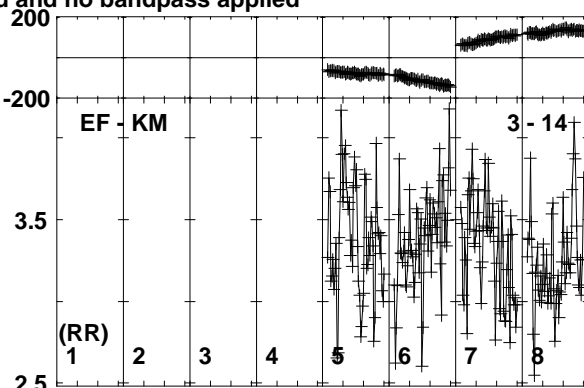
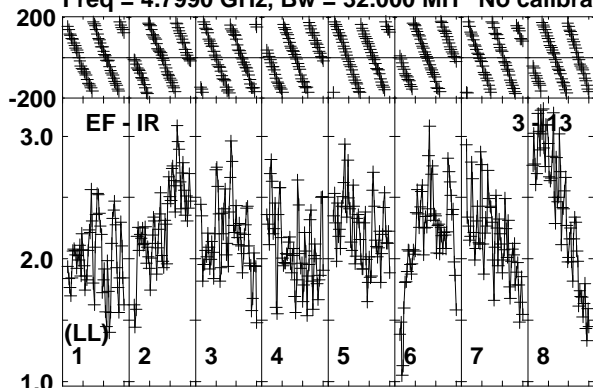

Lower frame: Milli Ampl Jy Top frame: Phas deg
Vector averaged cross-power spectrum Baseline: EF (03) - IR (13)
Timerange: 00/23:50:30 to 00/23:51:29

Plot file version 159 created 26-SEP-2019 10:40:09

J0257-1212 RG010A.UVDATA.1

Freq = 4.7990 GHz, Bw = 32.000 MH No calibration applied and no bandpass applied

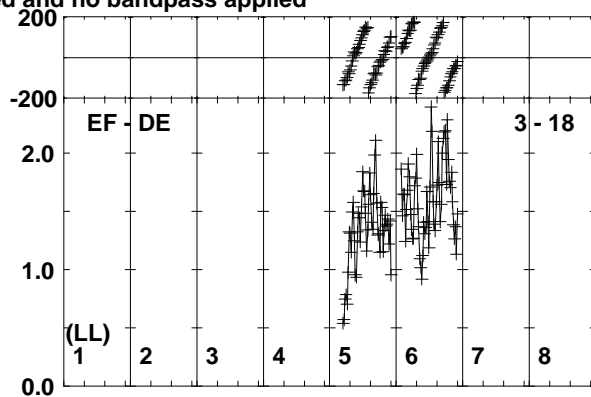
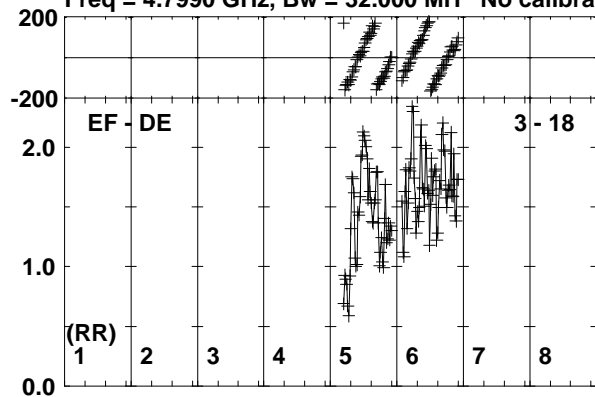

Lower frame: Milli Ampl Jy Top frame: Phas deg
Vector averaged cross-power spectrum Baseline: EF (03) - DE (18)
Timerange: 00/23:50:30 to 00/23:51:29

Plot file version 160 created 26-SEP-2019 10:40:09

190829A RG010A.UVDATA.1

Freq = 4.7990 GHz, Bw = 32.000 MH No calibration applied and no bandpass applied

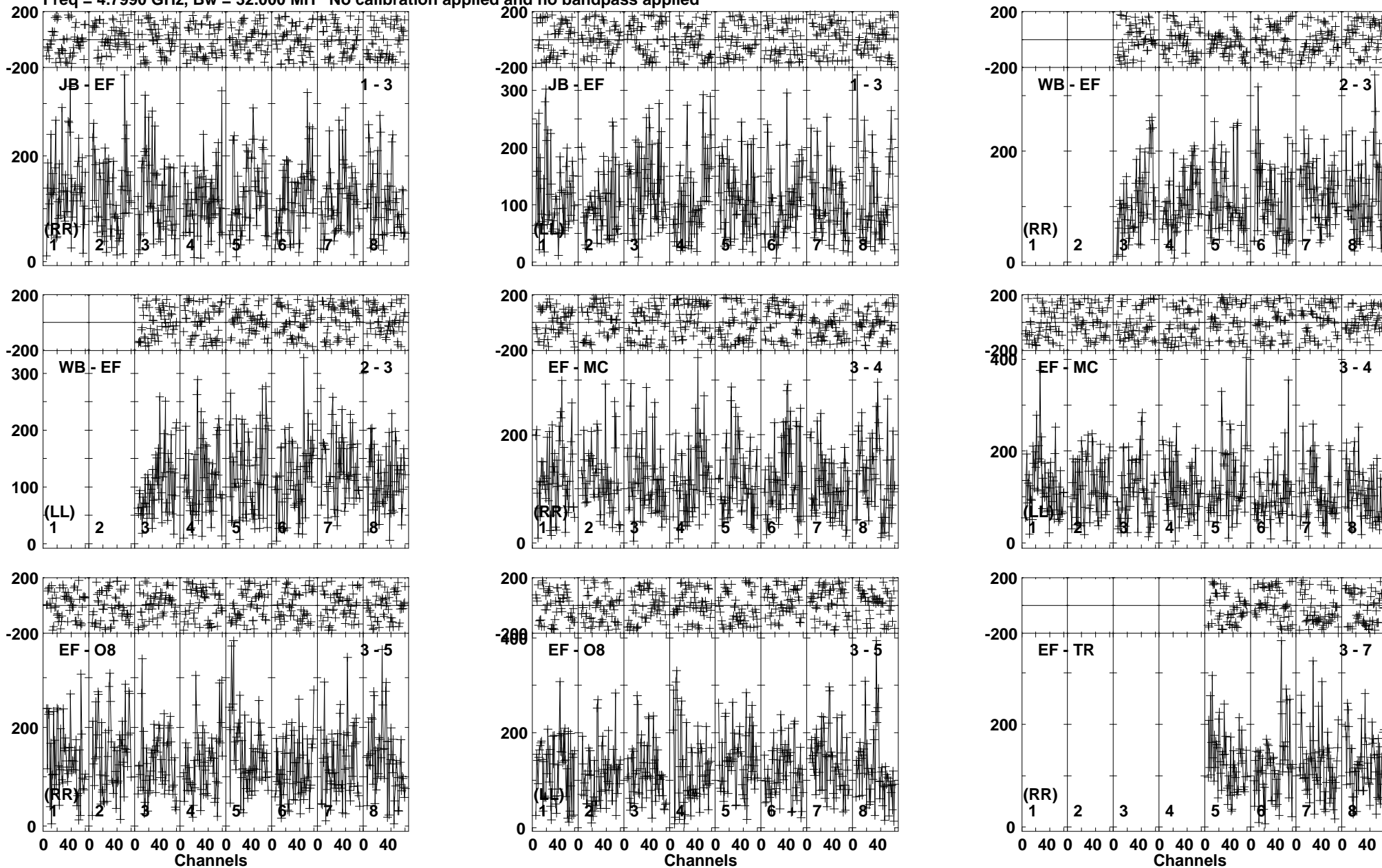

Lower frame: Micro Ampl Jy Top frame: Phas deg
Vector averaged cross-power spectrum Baseline: JB (01) - EF (03)
Timerange: 00/23:51:31 to 00/23:53:40

Plot file version 161 created 26-SEP-2019 10:40:10

190829A RG010A.UVDATA.1

Freq = 4.7990 GHz, Bw = 32.000 MH No calibration applied and no bandpass applied

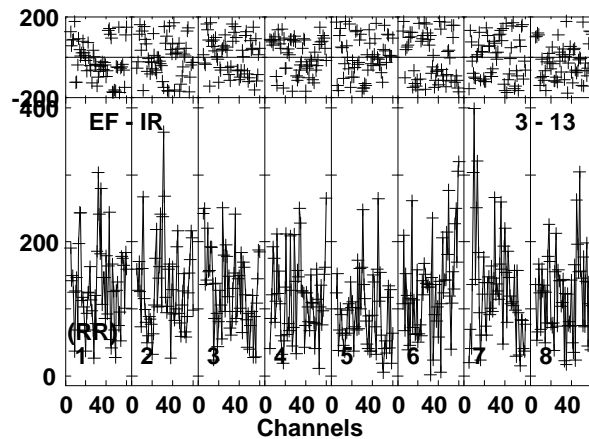
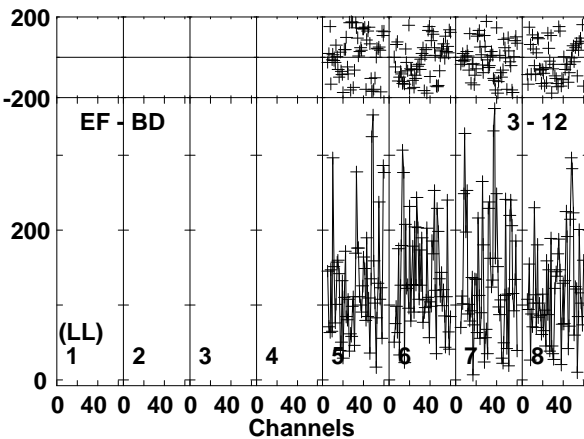
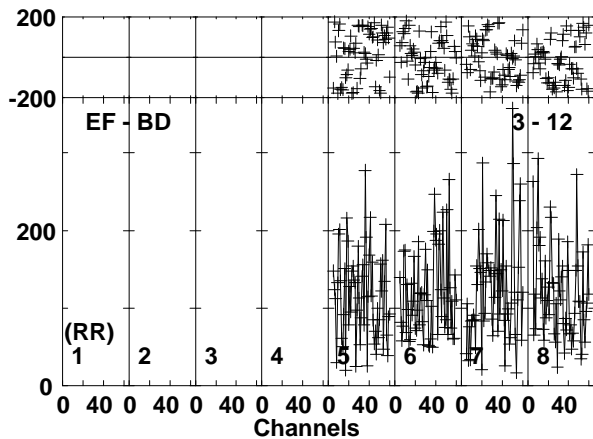
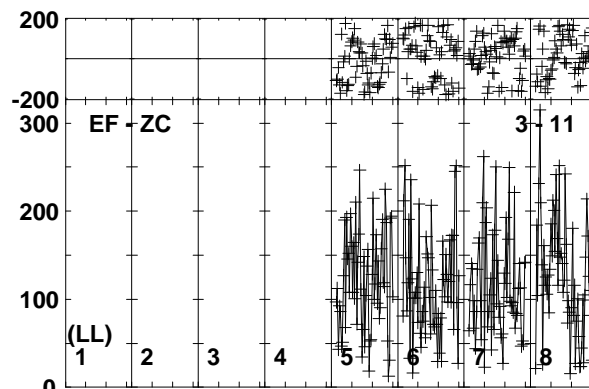
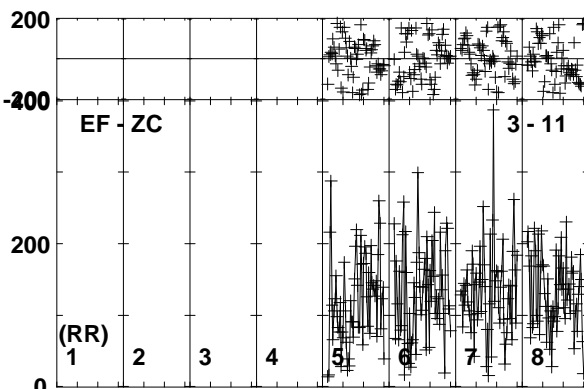
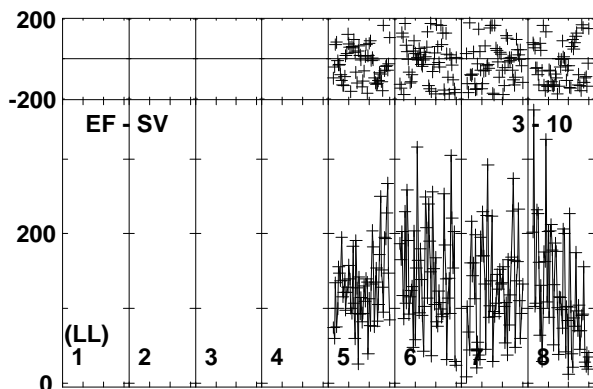
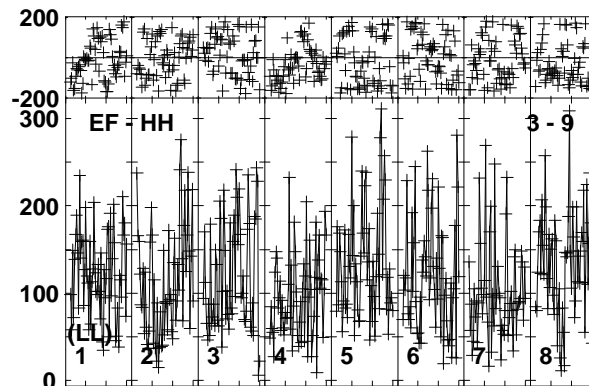
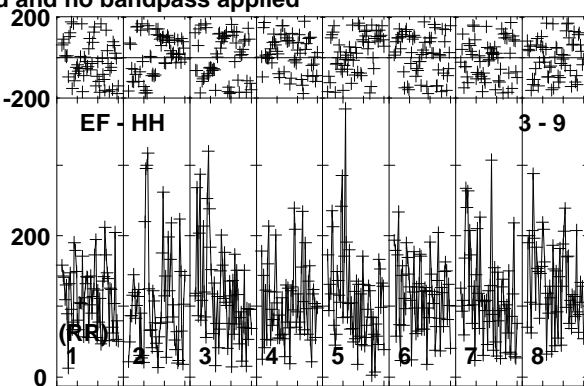
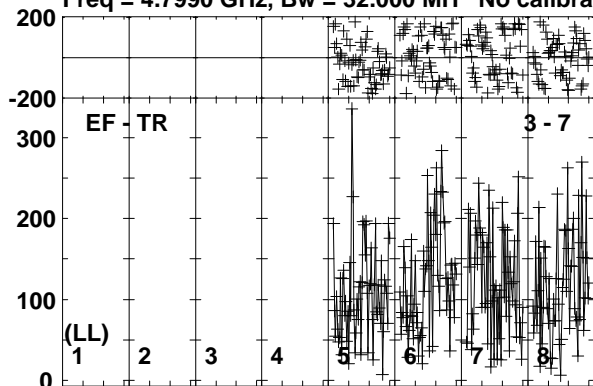

Lower frame: Micro Ampl Jy Top frame: Phas deg
Vector averaged cross-power spectrum Baseline: EF (03) - TR (07)
Timerange: 00/23:51:31 to 00/23:53:40

Plot file version 162 created 26-SEP-2019 10:40:10

190829A RG010A.UVDATA.1

Freq = 4.7990 GHz, Bw = 32.000 MH No calibration applied and no bandpass applied

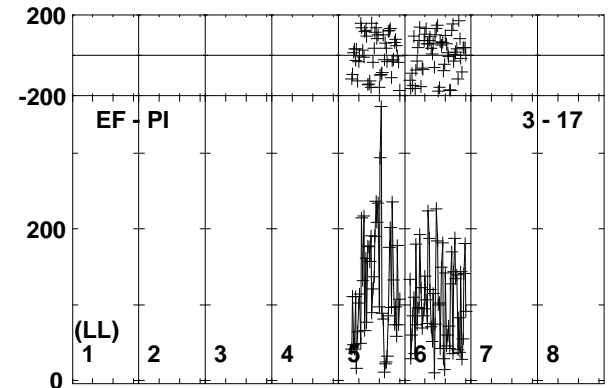
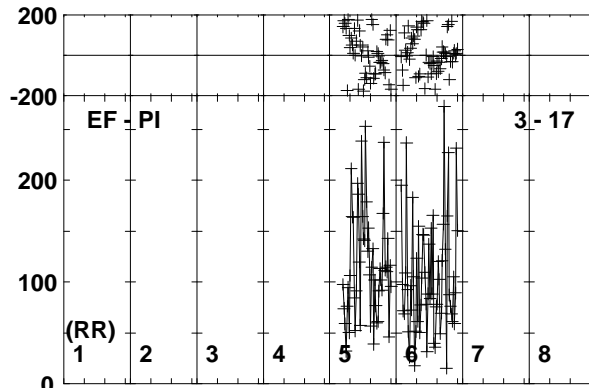
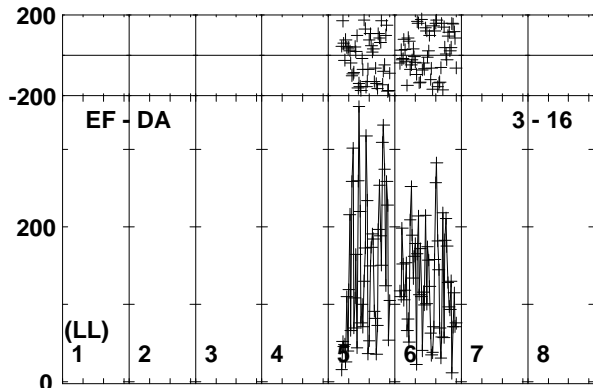
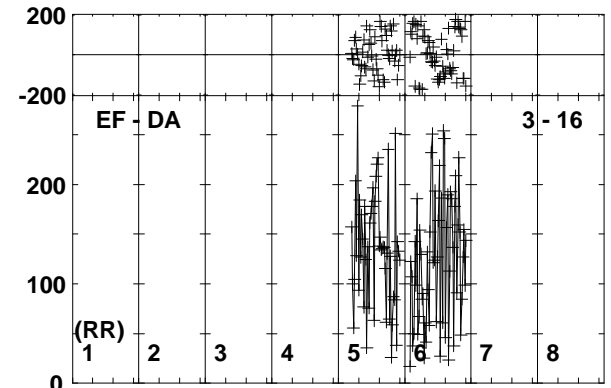
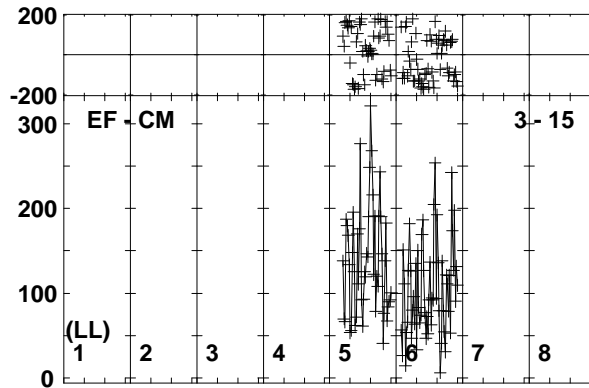
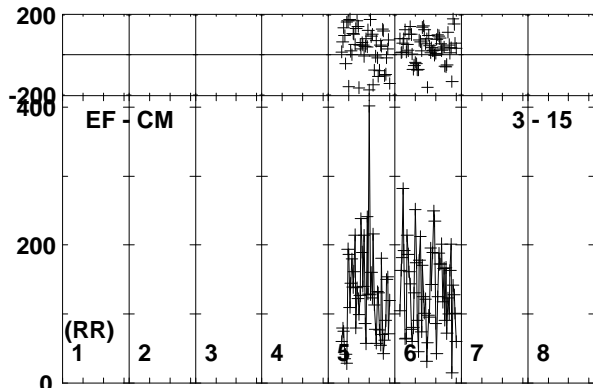
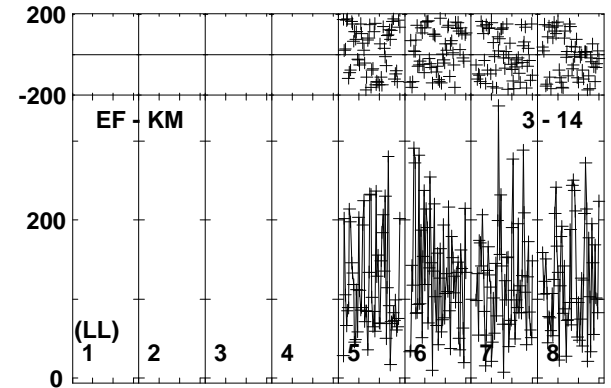
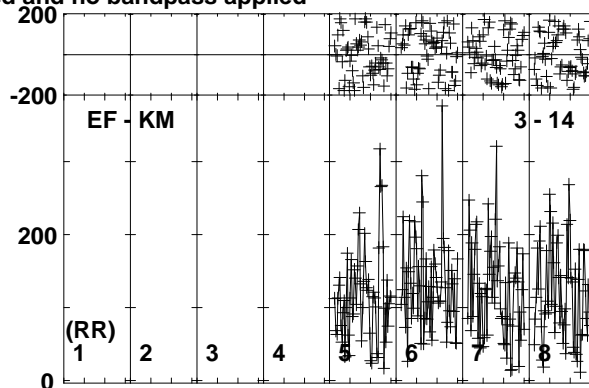
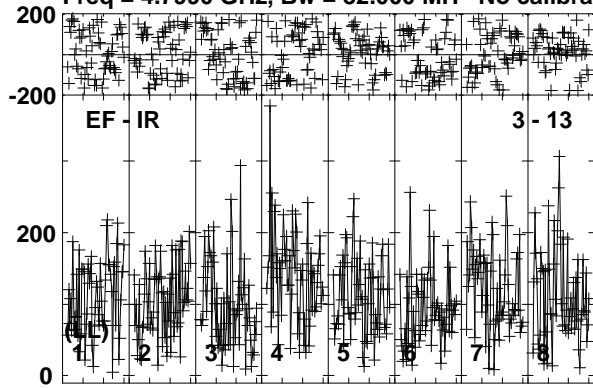

Lower frame: Micro Ampl Jy Top frame: Phas deg
Vector averaged cross-power spectrum Baseline: EF (03) - IR (13)
Timerange: 00/23:51:31 to 00/23:53:40

Plot file version 163 created 26-SEP-2019 10:40:11

190829A RG010A.UVDATA.1

Freq = 4.7990 GHz, Bw = 32.000 MH No calibration applied and no bandpass applied

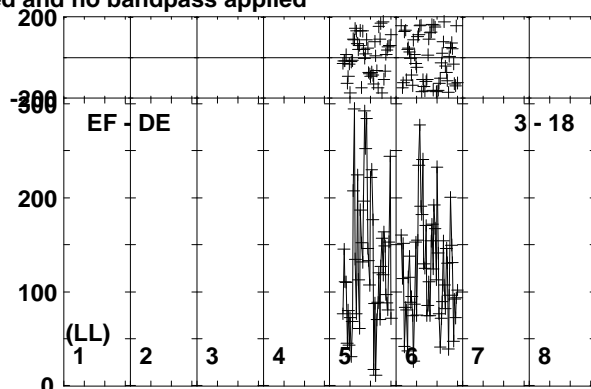
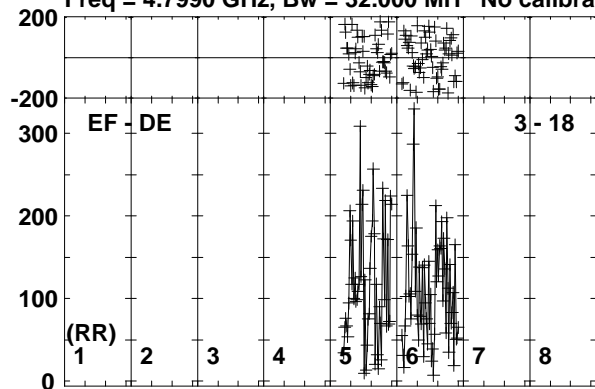

Lower frame: Micro Ampl Jy Top frame: Phas deg
Vector averaged cross-power spectrum Baseline: EF (03) - DE (18)
Timerange: 00/23:51:31 to 00/23:53:40

Plot file version 164 created 26-SEP-2019 10:40:11

J0257-1212 RG010A.UVDATA.1

Freq = 4.7990 GHz, Bw = 32.000 MH No calibration applied and no bandpass applied

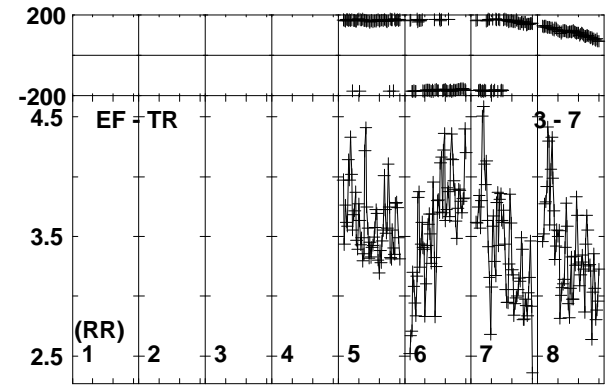
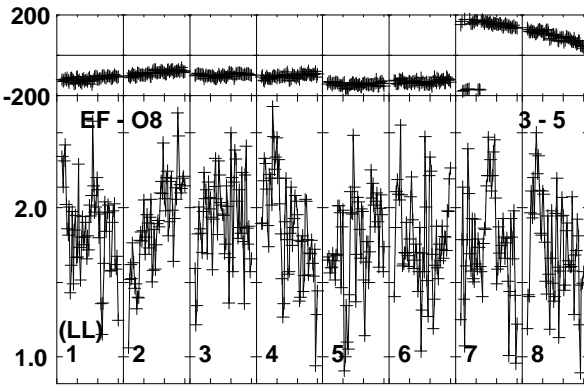
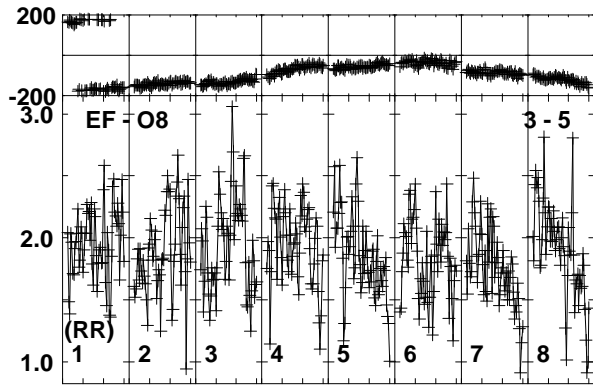
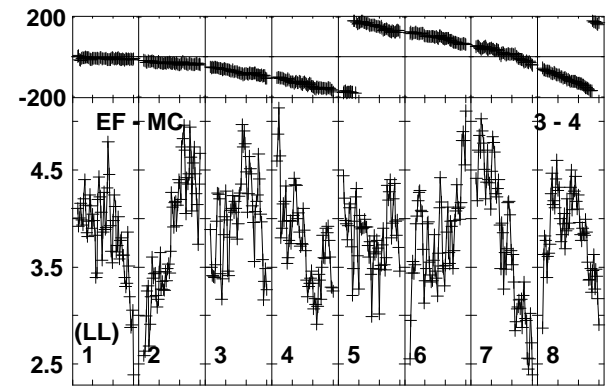
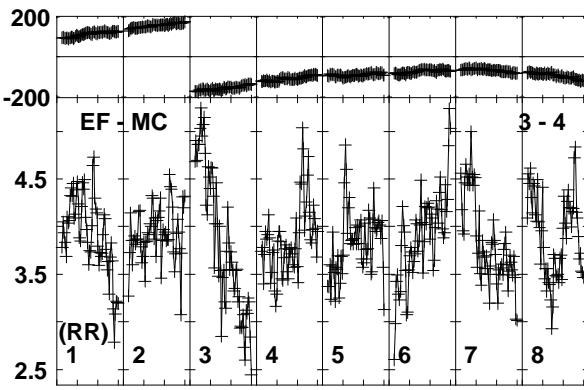
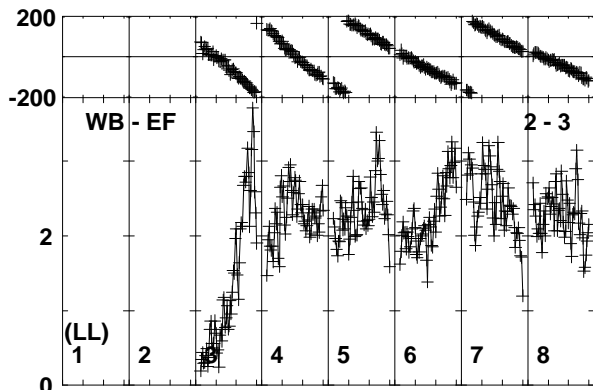
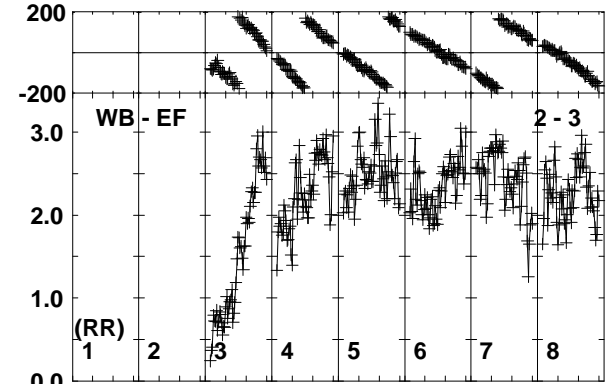
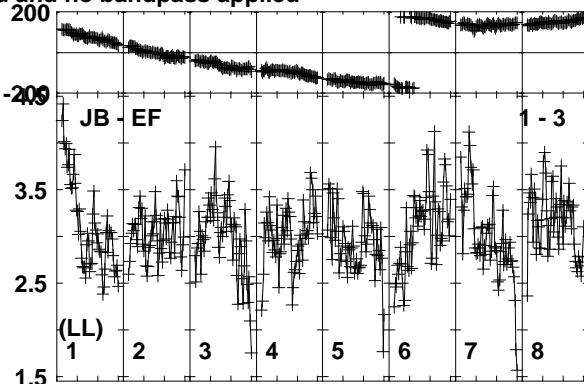
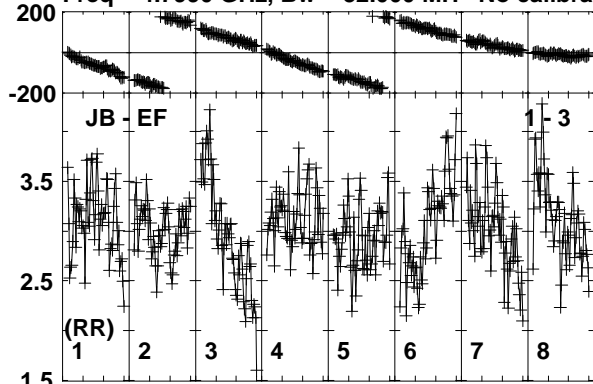

Lower frame: Milli Ampl Jy Top frame: Phas deg
Vector averaged cross-power spectrum Baseline: JB (01) - EF (03)
Timerange: 00/23:53:40 to 00/23:54:39

Plot file version 165 created 26-SEP-2019 10:40:11

J0257-1212 RG010A.UVDATA.1

Freq = 4.7990 GHz, Bw = 32.000 MH No calibration applied and no bandpass applied

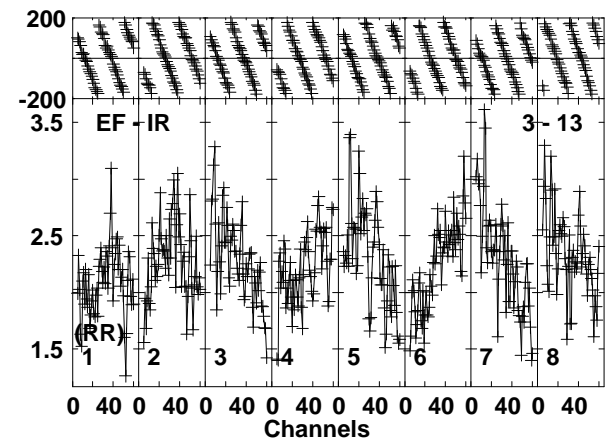
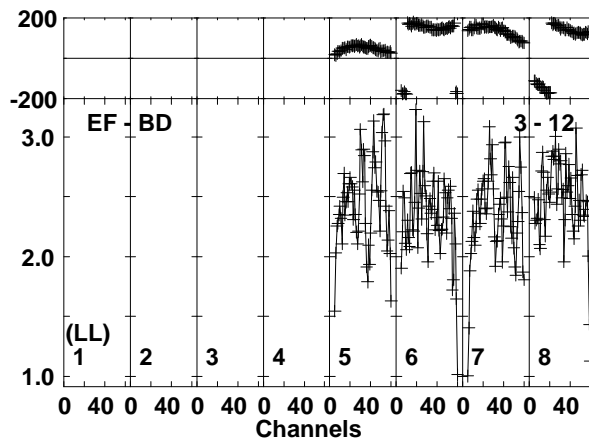
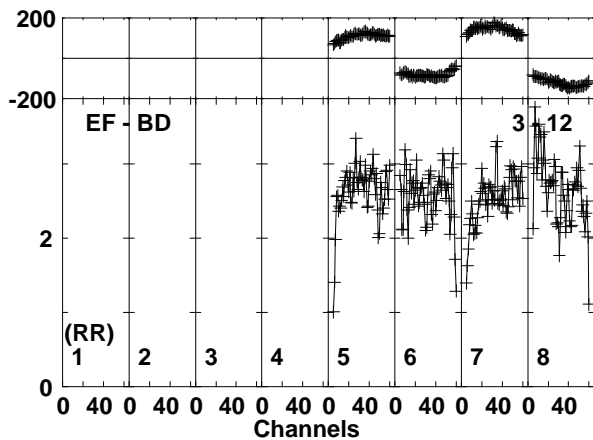
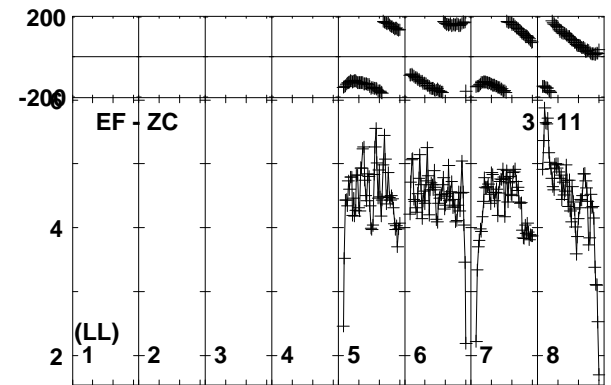
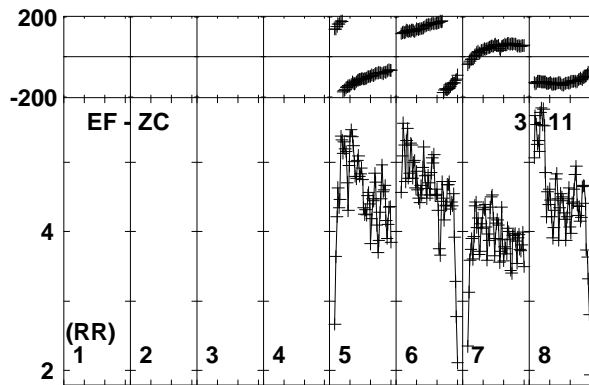
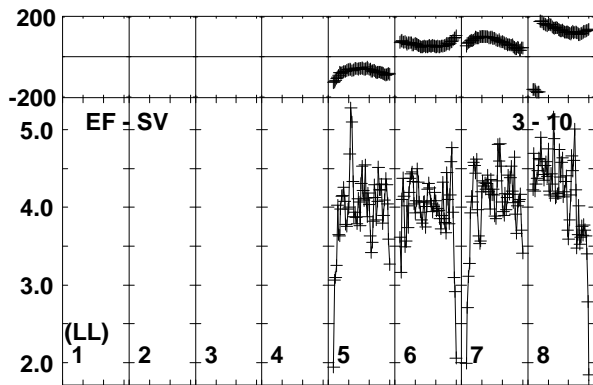
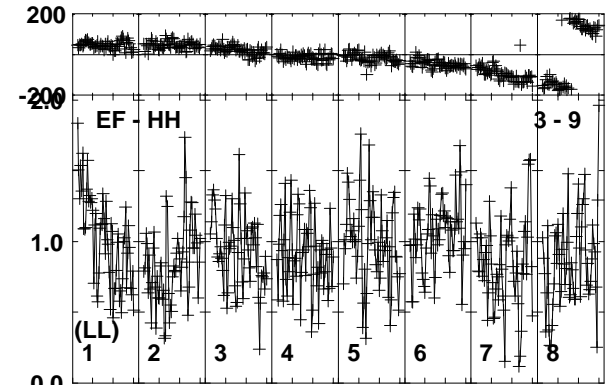
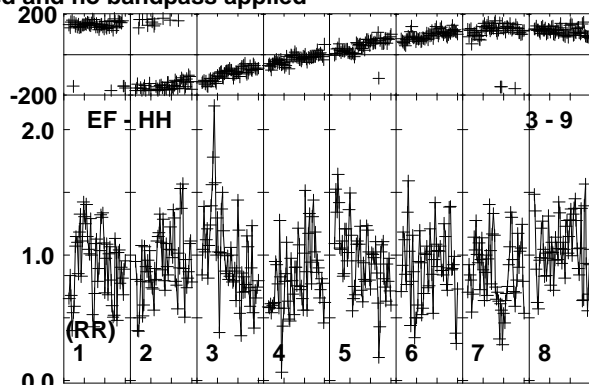
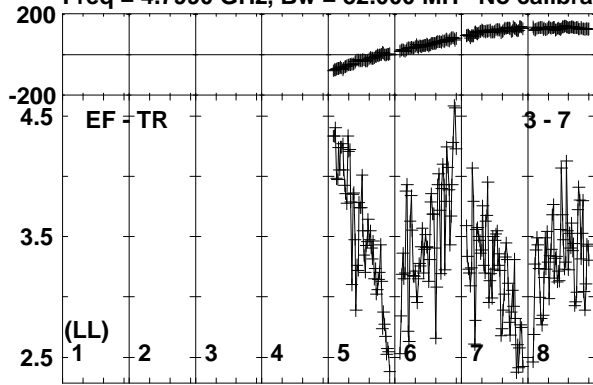

Lower frame: Milli Amp Jy Top frame: Phas deg
Vector averaged cross-power spectrum Baseline: EF (03) - TR (07)
Timerange: 00/23:53:40 to 00/23:54:39

Plot file version 166 created 26-SEP-2019 10:40:11

J0257-1212 RG010A.UVDATA.1

Freq = 4.7990 GHz, Bw = 32.000 MH No calibration applied and no bandpass applied

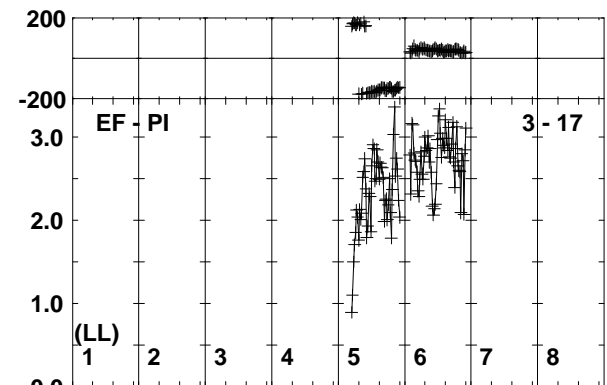
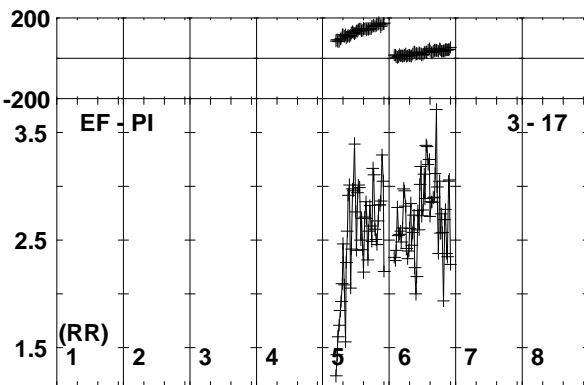
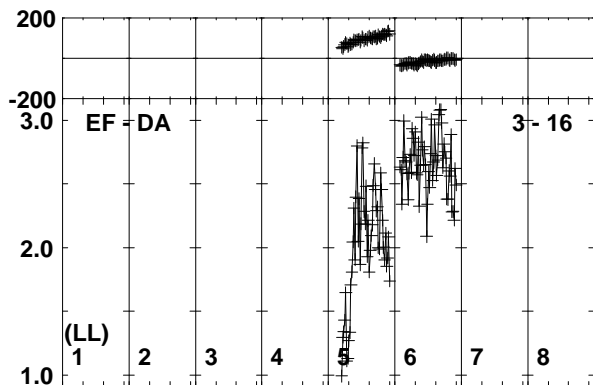
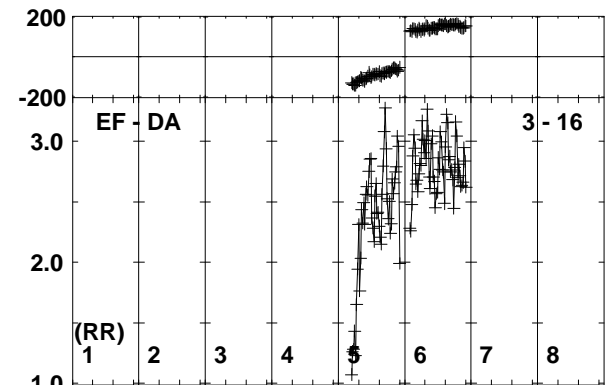
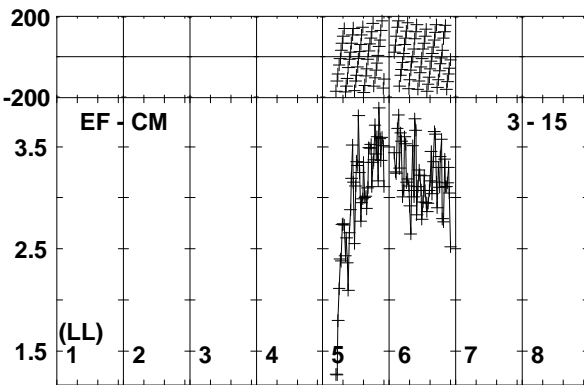
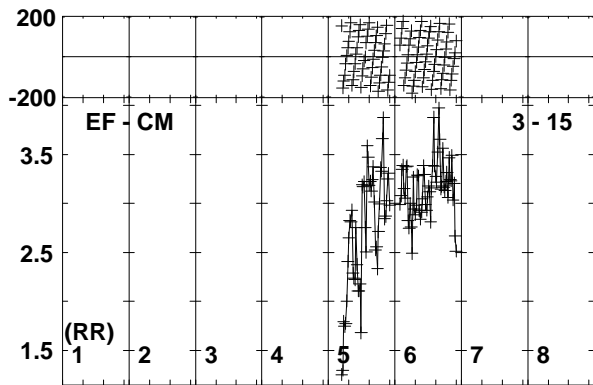
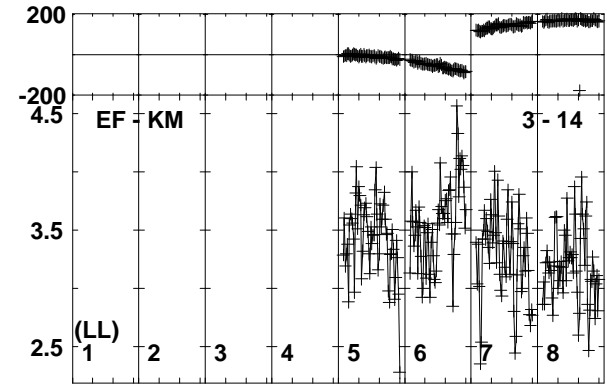
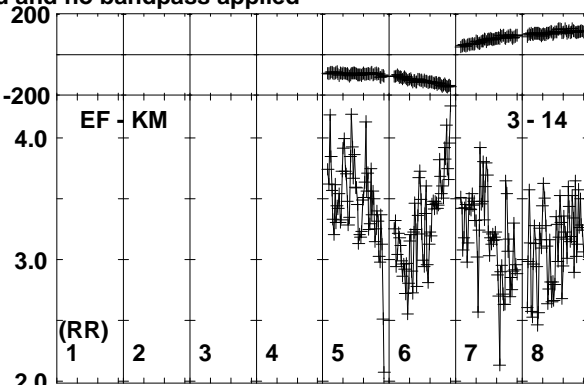
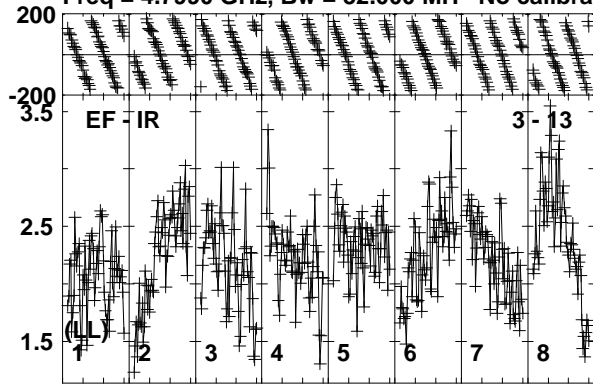

Lower frame: Milli Ampl Jy Top frame: Phas deg
Vector averaged cross-power spectrum Baseline: EF (03) - IR (13)
Timerange: 00/23:53:40 to 00/23:54:39

Plot file version 167 created 26-SEP-2019 10:40:11

J0257-1212 RG010A.UVDATA.1

Freq = 4.7990 GHz, Bw = 32.000 MH No calibration applied and no bandpass applied

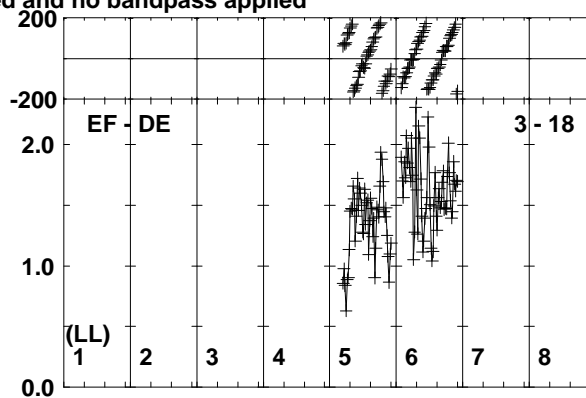
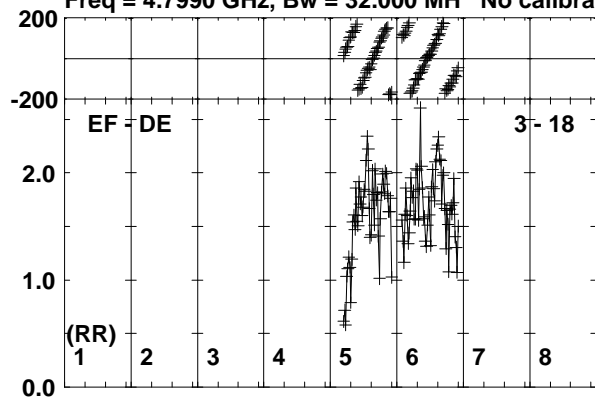

Lower frame: Milli Ampl Jy Top frame: Phas deg
Vector averaged cross-power spectrum Baseline: EF (03) - DE (18)
Timerange: 00/23:53:40 to 00/23:54:39

Plot file version 168 created 26-SEP-2019 10:40:11

190829A RG010A.UVDATA.1

Freq = 4.7990 GHz, Bw = 32.000 MH No calibration applied and no bandpass applied

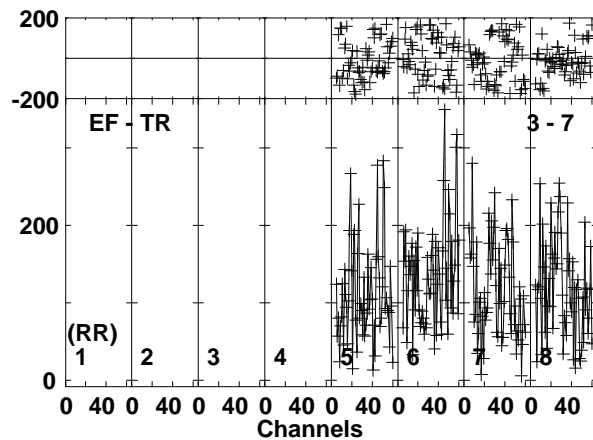
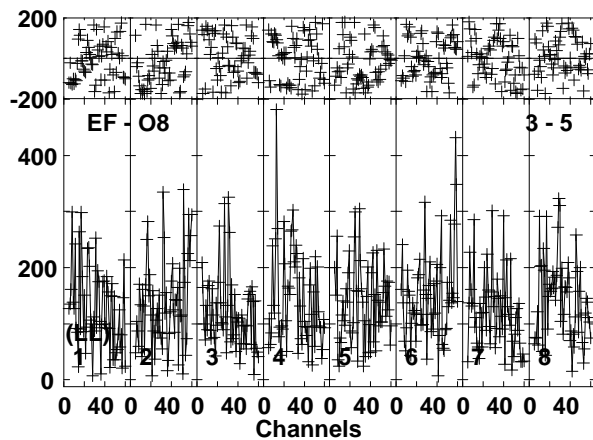
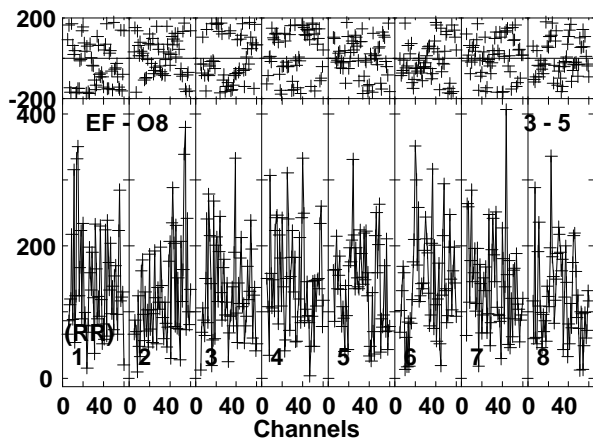
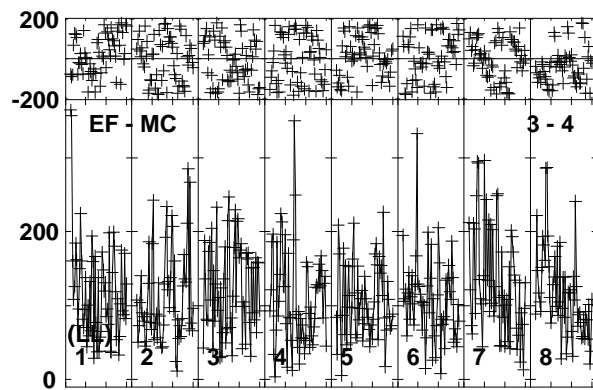
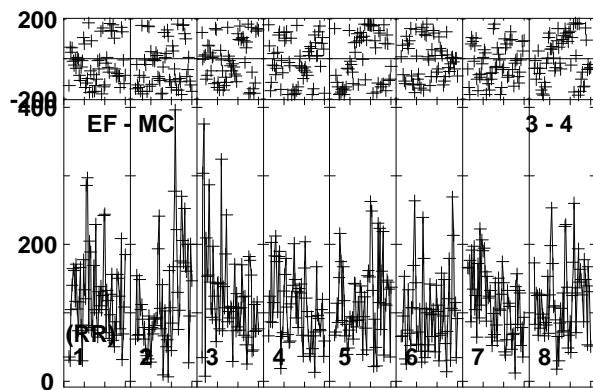
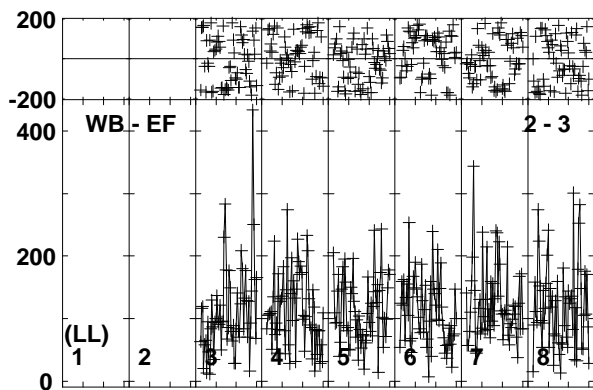
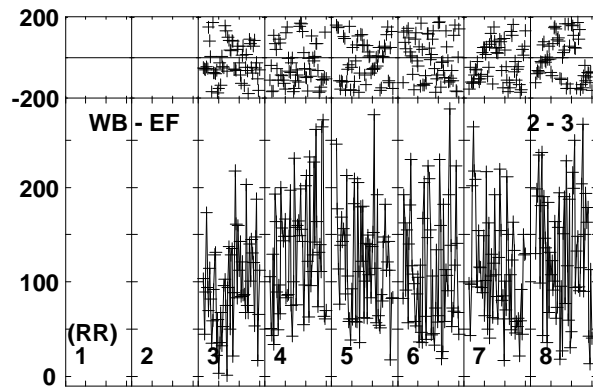
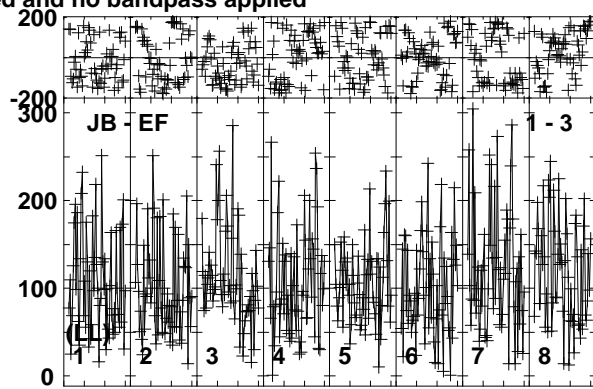
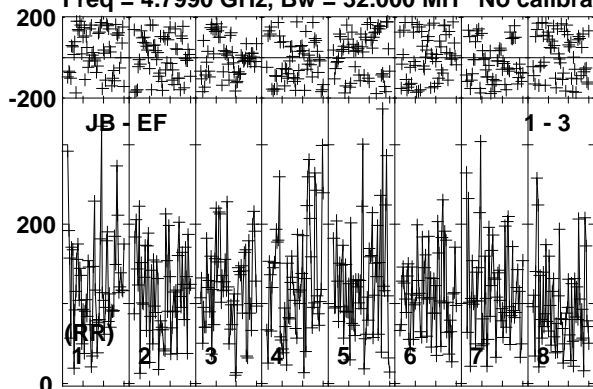

Lower frame: Micro Ampl Jy Top frame: Phas deg
Vector averaged cross-power spectrum Baseline: JB (01) - EF (03)
Timerange: 00/23:54:40 to 00/23:56:50

Plot file version 169 created 26-SEP-2019 10:40:12

190829A RG010A.UVDATA.1

Freq = 4.7990 GHz, Bw = 32.000 MH No calibration applied and no bandpass applied

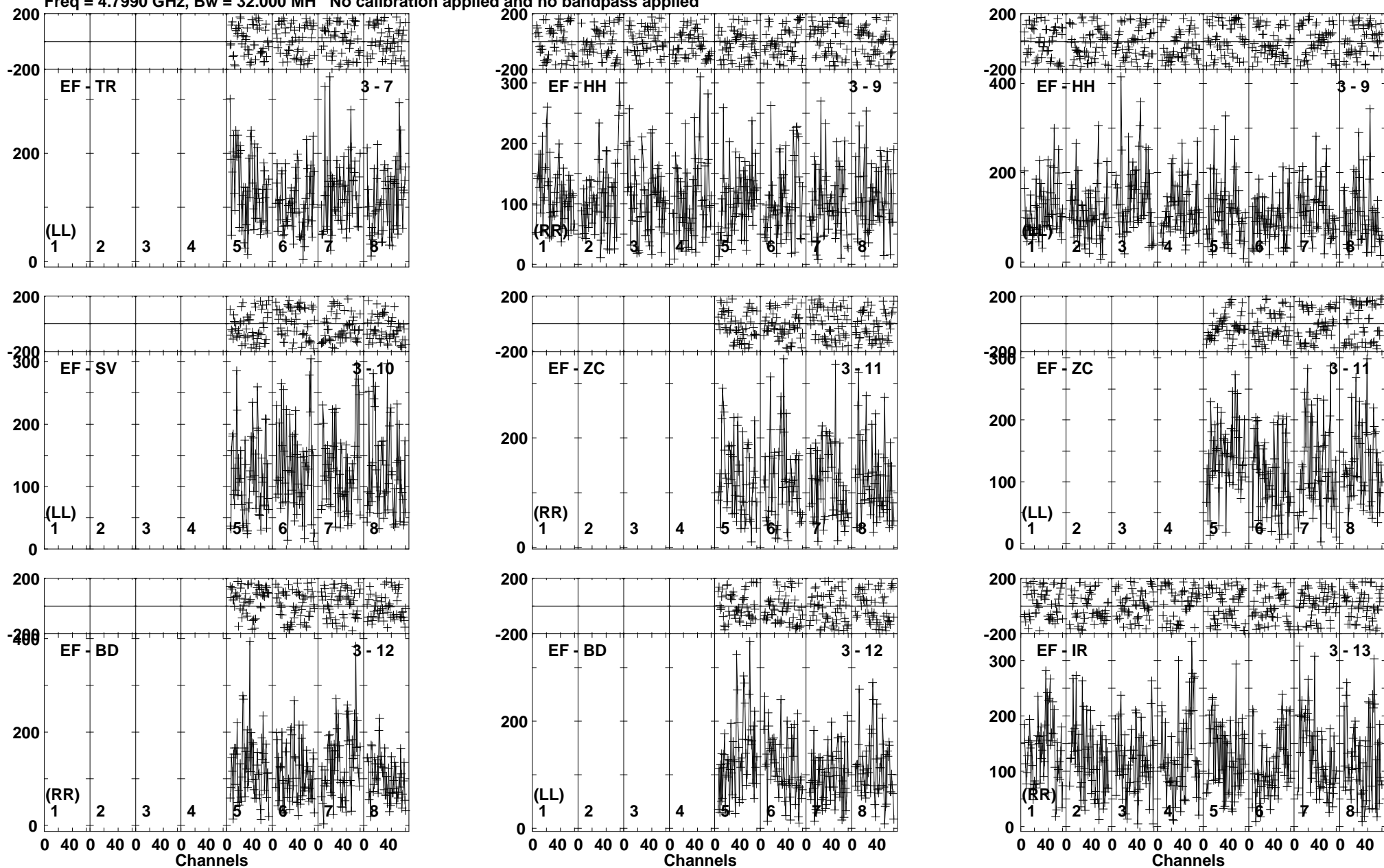

Lower frame: Micro Ampl Jy Top frame: Phas deg
Vector averaged cross-power spectrum Baseline: EF (03) - TR (07)
Timerange: 00/23:54:40 to 00/23:56:50

Plot file version 170 created 26-SEP-2019 10:40:12

190829A RG010A.UVDATA.1

Freq = 4.7990 GHz, Bw = 32.000 MH No calibration applied and no bandpass applied

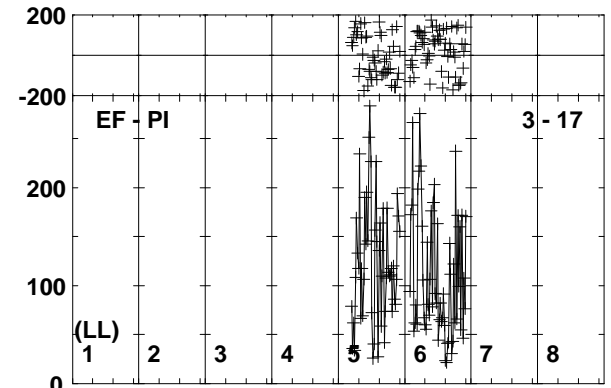
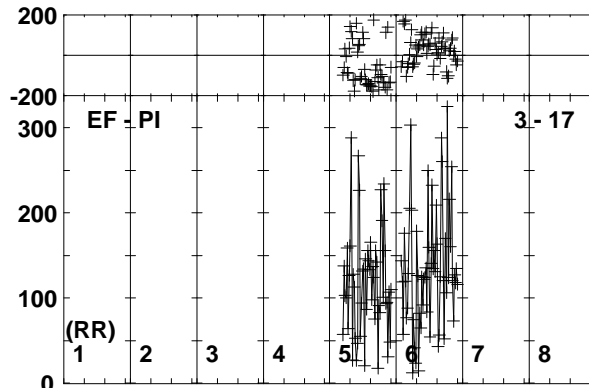
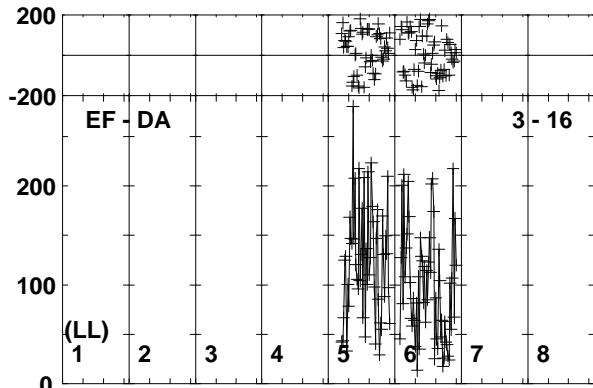
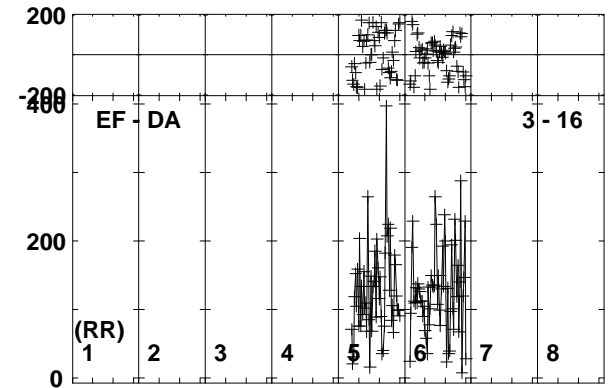
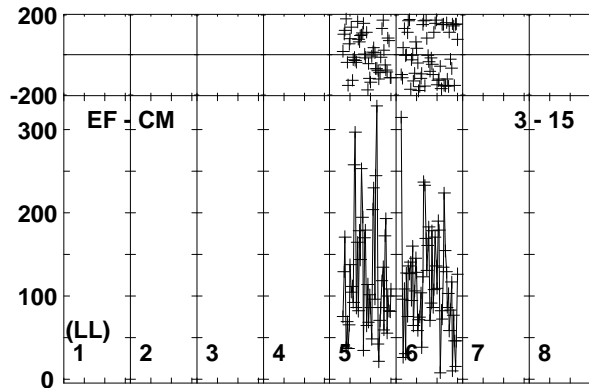
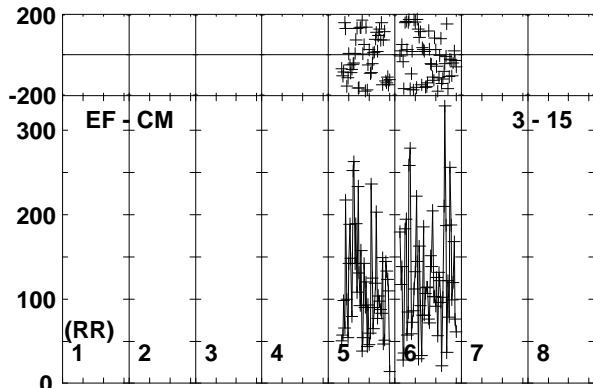
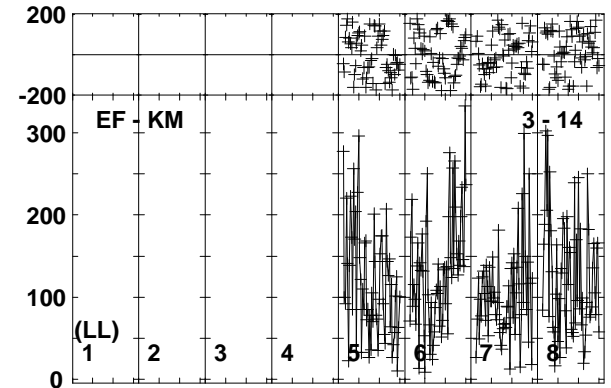
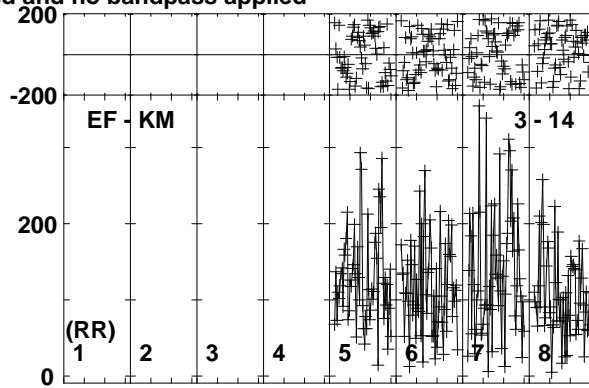
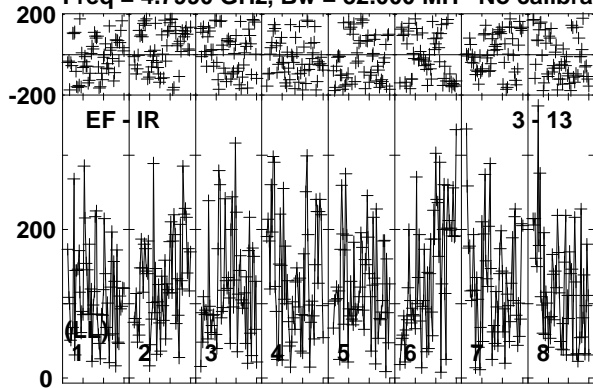

Lower frame: Micro Ampl Jy Top frame: Phas deg
Vector averaged cross-power spectrum Baseline: EF (03) - IR (13)
Timerange: 00/23:54:40 to 00/23:56:50

Plot file version 171 created 26-SEP-2019 10:40:13

190829A RG010A.UVDATA.1

Freq = 4.7990 GHz, Bw = 32.000 MH No calibration applied and no bandpass applied

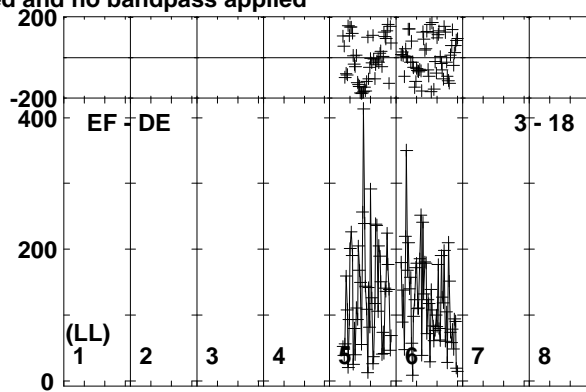
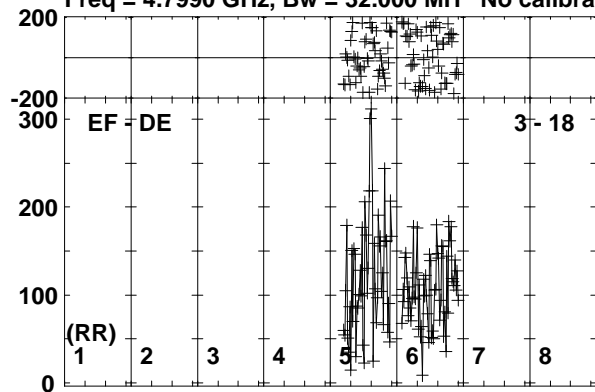

Lower frame: Micro Ampl Jy Top frame: Phas deg
Vector averaged cross-power spectrum Baseline: EF (03) - DE (18)
Timerange: 00/23:54:40 to 00/23:56:50

Plot file version 172 created 26-SEP-2019 10:40:13

J0257-1212 RG010A.UVDATA.1

Freq = 4.7990 GHz, Bw = 32.000 MH No calibration applied and no bandpass applied

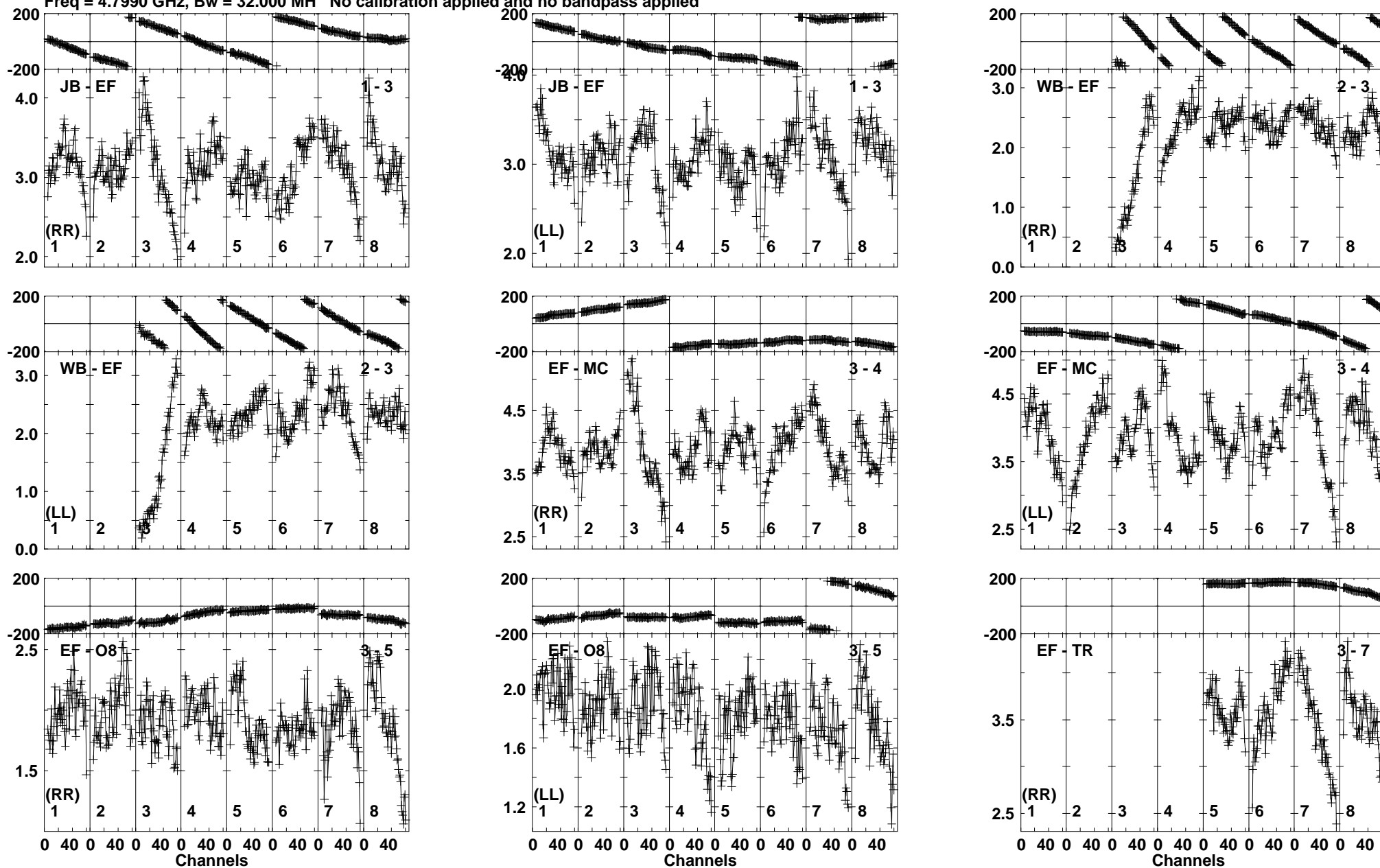

Lower frame: Milli Ampl Jy Top frame: Phas deg
Vector averaged cross-power spectrum Baseline: JB (01) - EF (03)
Timerange: 00/23:57:41 to 00/23:58:10

Plot file version 173 created 26-SEP-2019 10:40:13

J0257-1212 RG010A.UVDATA.1

Freq = 4.7990 GHz, Bw = 32.000 MH No calibration applied and no bandpass applied

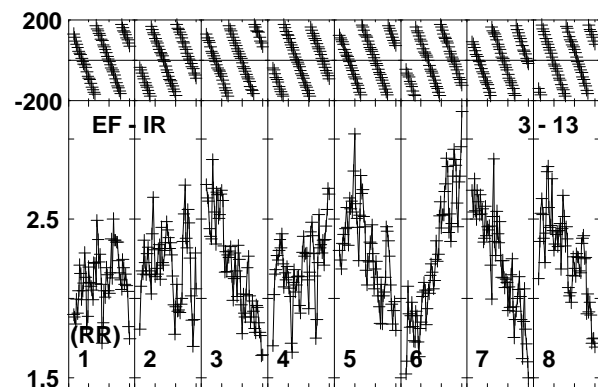
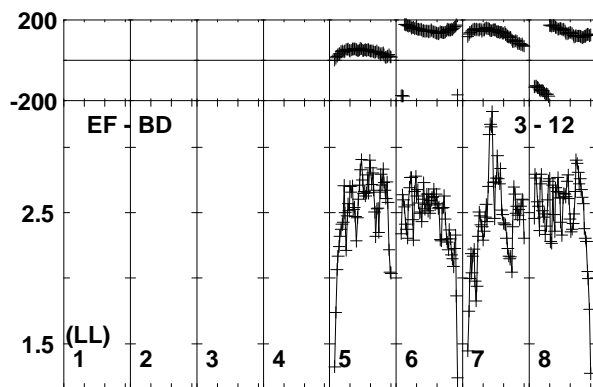
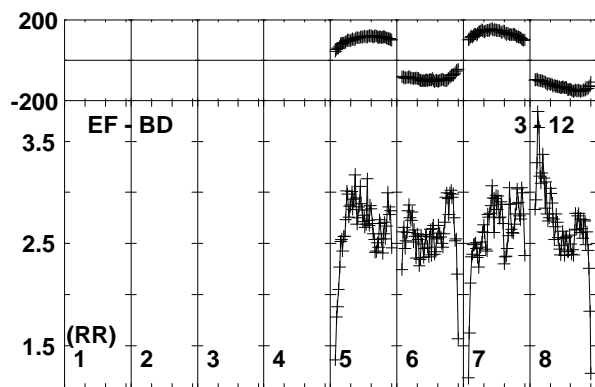
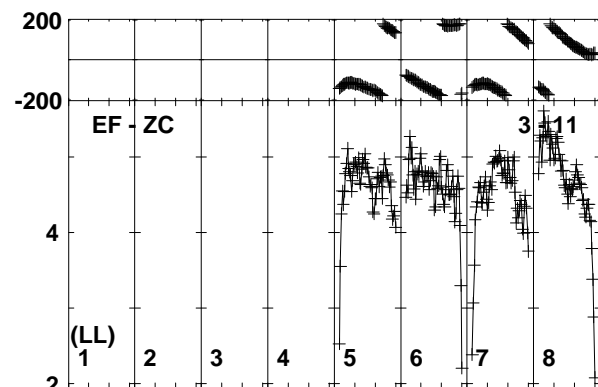
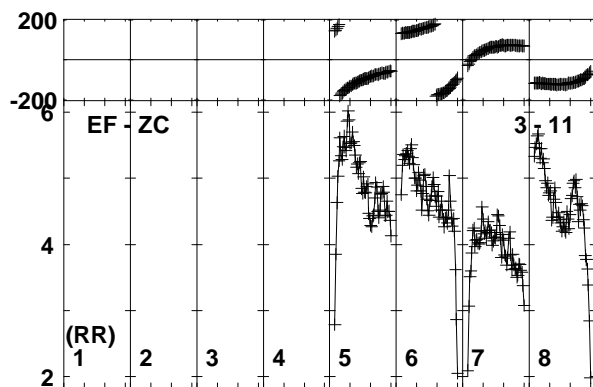
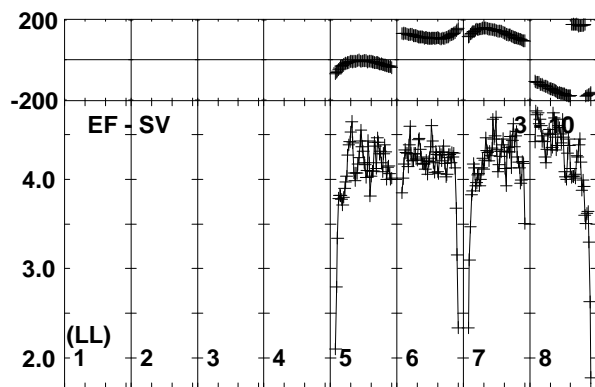
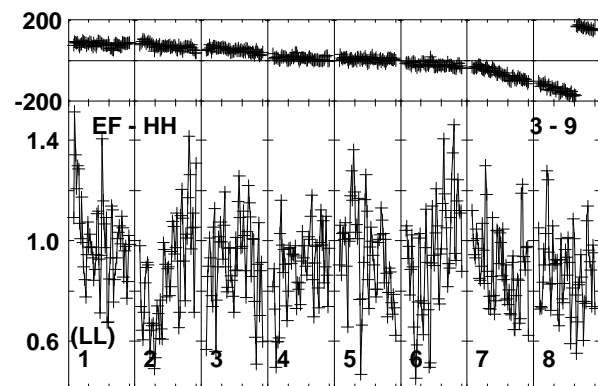
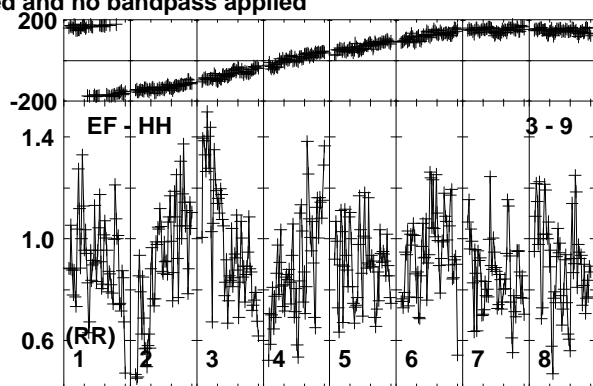
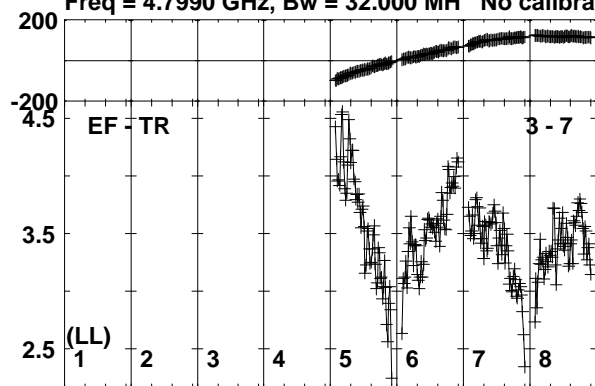

Lower frame: Milli Ampl Jy Top frame: Phas deg
Vector averaged cross-power spectrum Baseline: EF (03) - TR (07)
Timerange: 00/23:57:41 to 00/23:58:10

Plot file version 174 created 26-SEP-2019 10:40:13

J0257-1212 RG010A.UVDATA.1

Freq = 4.7990 GHz, Bw = 32.000 MH No calibration applied and no bandpass applied

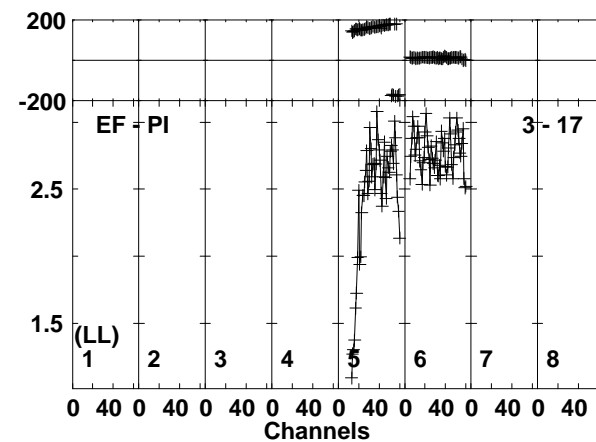
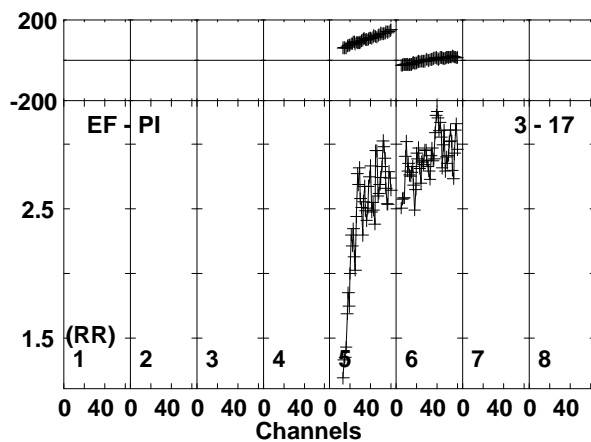
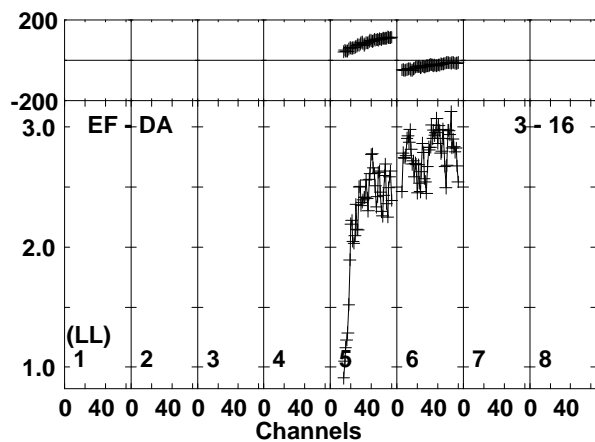
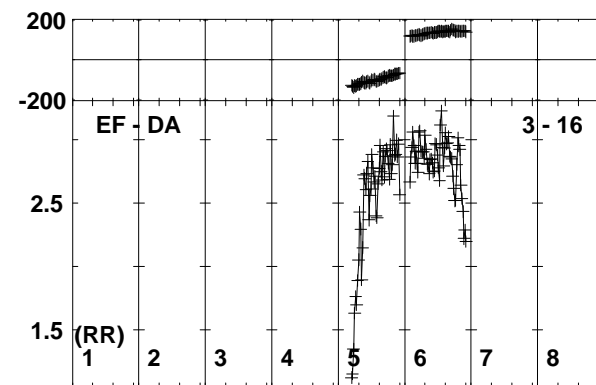
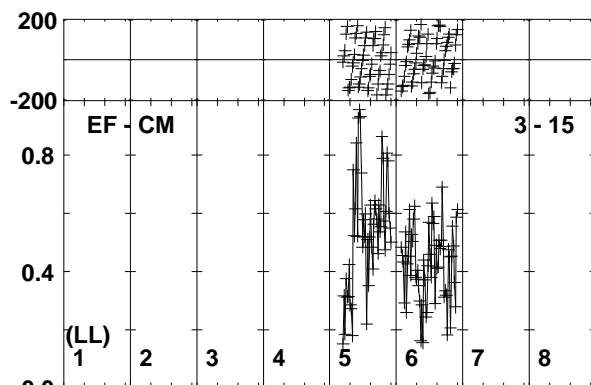
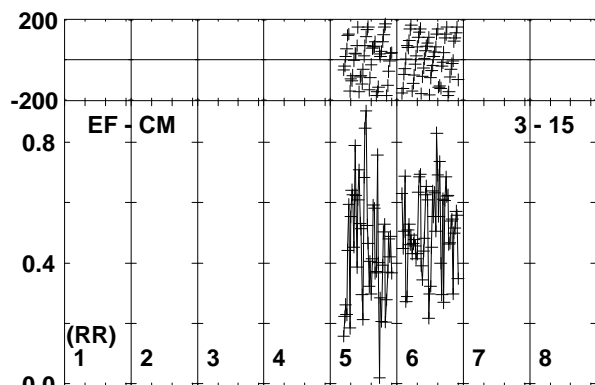
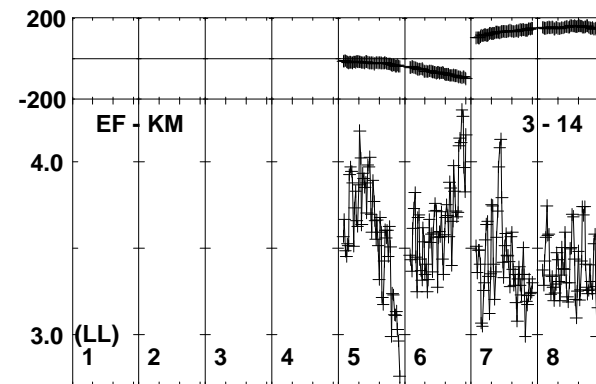
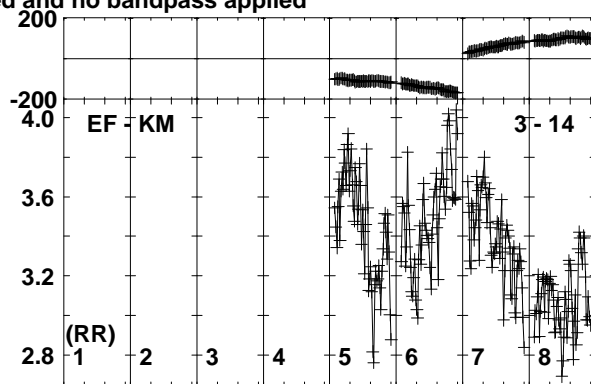
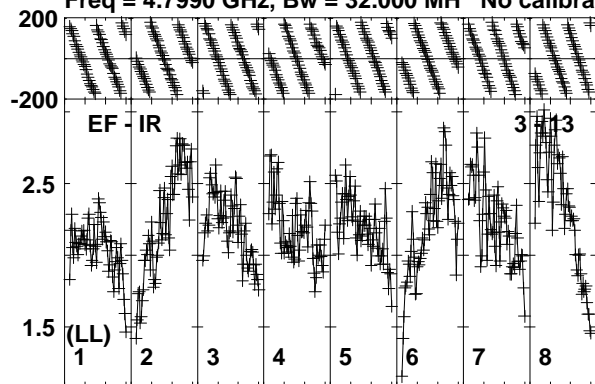

Lower frame: Milli Ampl Jy Top frame: Phas deg
Vector averaged cross-power spectrum Baseline: EF (03) - IR (13)
Timerange: 00/23:57:41 to 00/23:58:10

Plot file version 175 created 26-SEP-2019 10:40:14

J0257-1212 RG010A.UVDATA.1

Freq = 4.7990 GHz, Bw = 32.000 MH No calibration applied and no bandpass applied

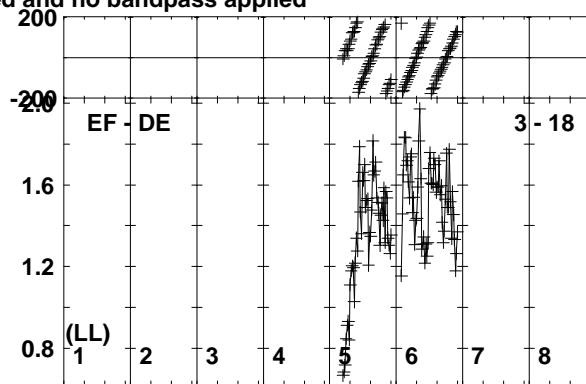
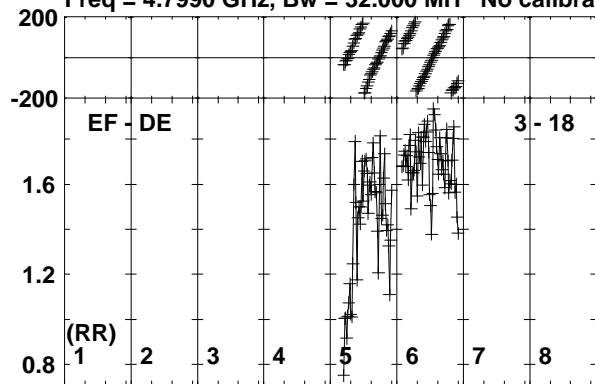

Lower frame: Milli Ampl Jy Top frame: Phas deg
Vector averaged cross-power spectrum Baseline: EF (03) - DE (18)
Timerange: 00/23:57:41 to 00/23:58:10

Plot file version 176 created 26-SEP-2019 10:40:14

J0300-0846 RG010A.UVDATA.1

Freq = 4.7990 GHz, Bw = 32.000 MH No calibration applied and no bandpass applied

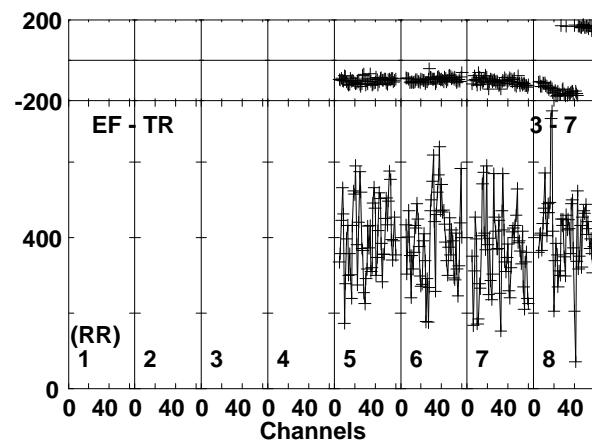
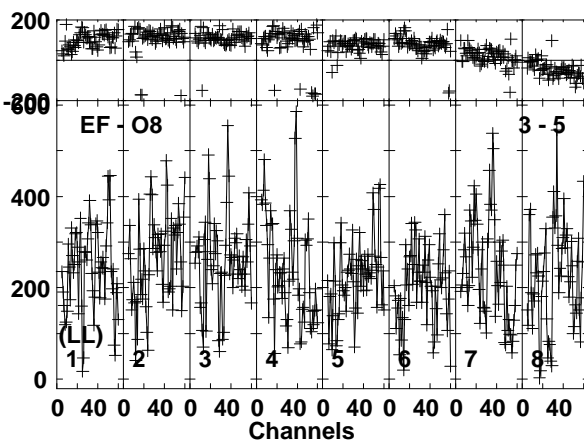
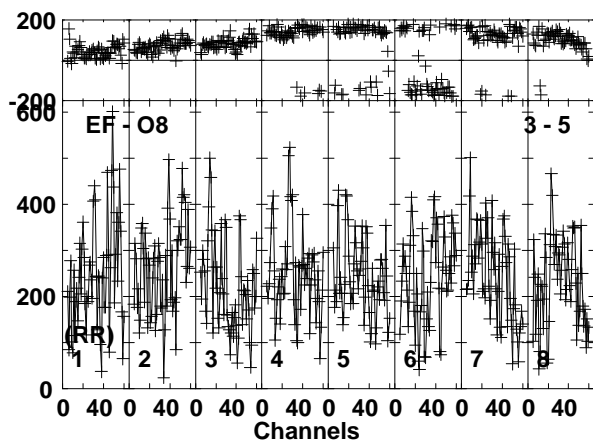
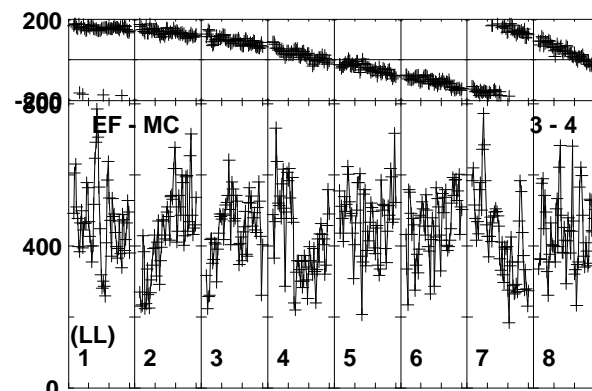
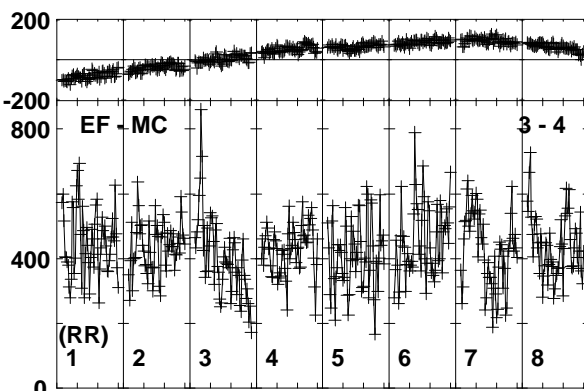
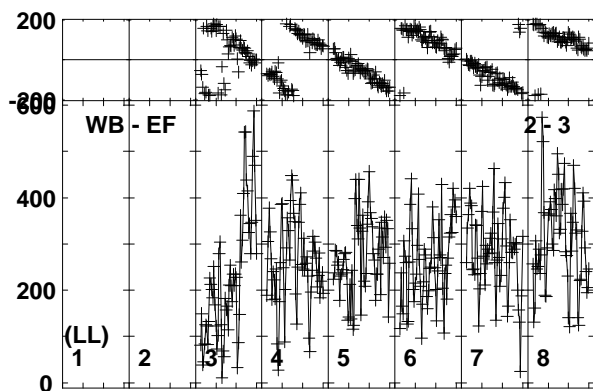
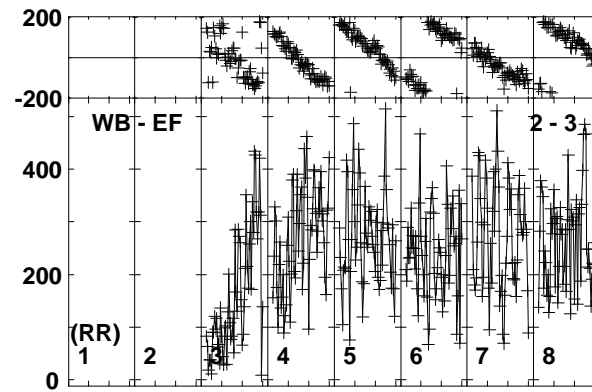
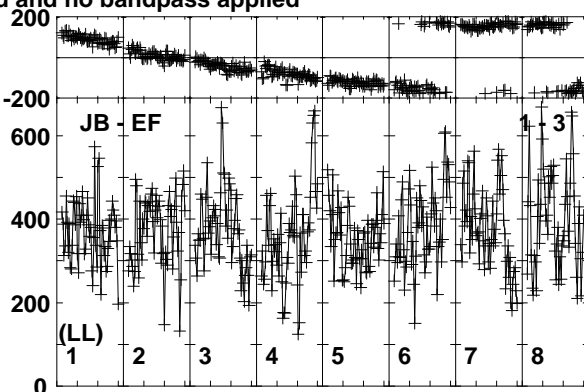
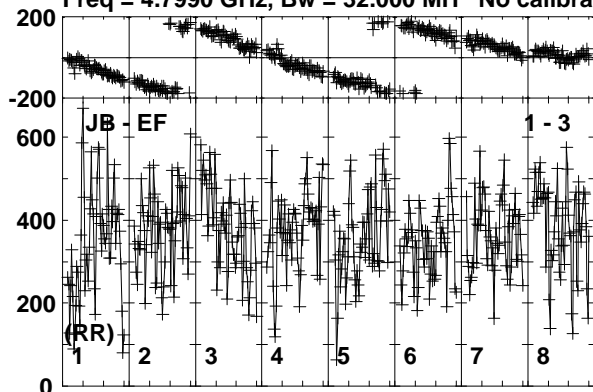

Lower frame: Micro Ampl Jy Top frame: Phas deg
Vector averaged cross-power spectrum Baseline: JB (01) - EF (03)
Timerange: 00/23:58:11 to 01/00:00:19

Plot file version 177 created 26-SEP-2019 10:40:14

J0300-0846 RG010A.UVDATA.1

Freq = 4.7990 GHz, Bw = 32.000 MH No calibration applied and no bandpass applied

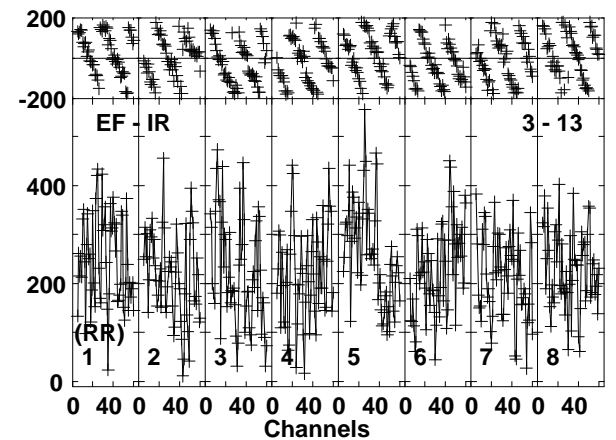
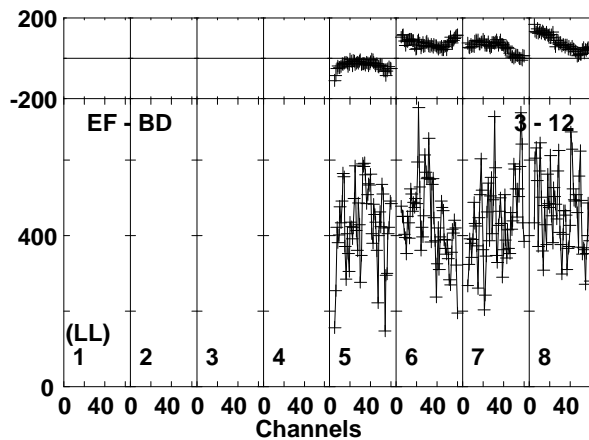
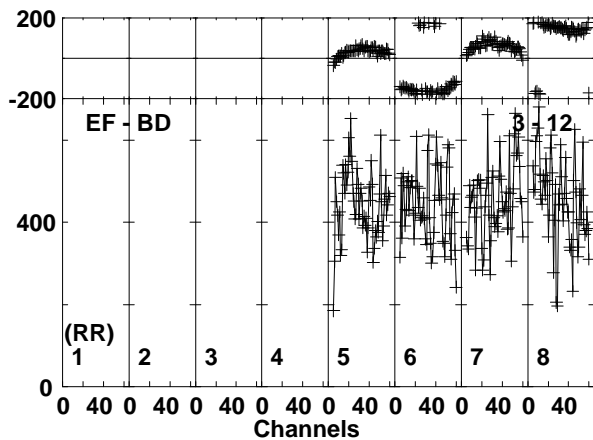
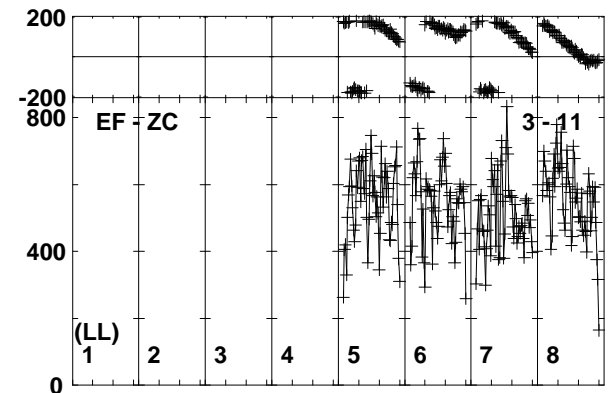
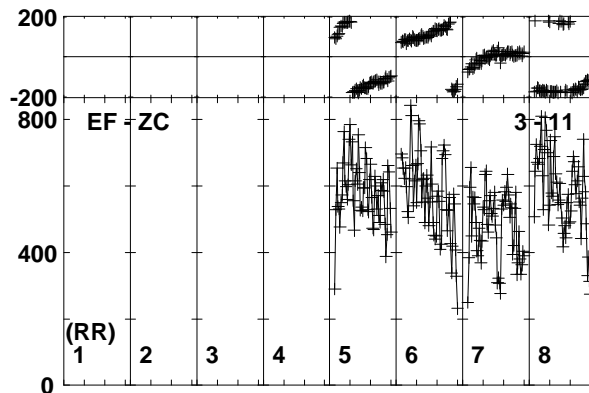
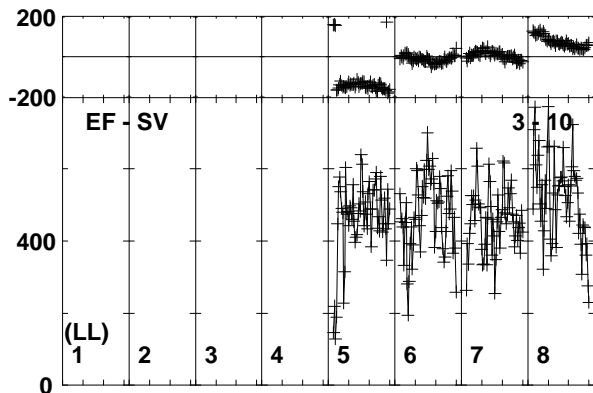
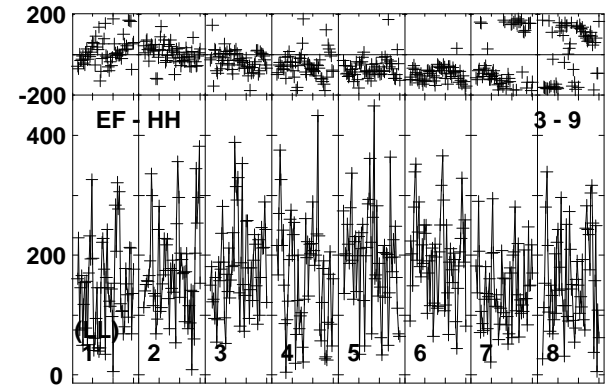
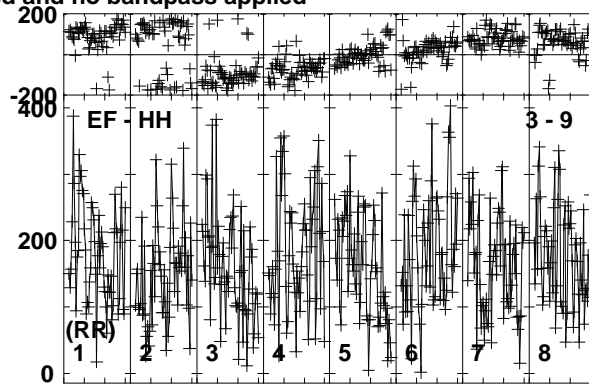
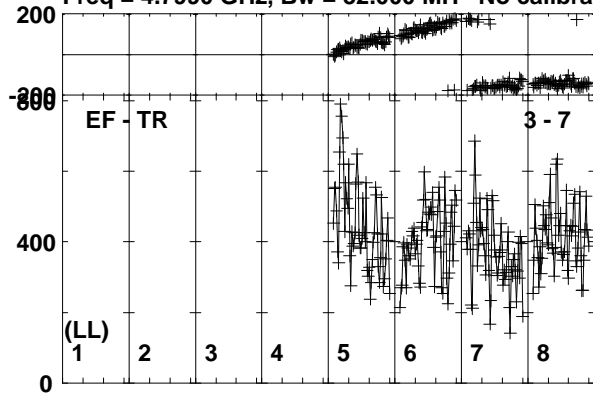

Lower frame: Micro Ampl Jy Top frame: Phas deg
Vector averaged cross-power spectrum Baseline: EF (03) - TR (07)
Timerange: 00/23:58:11 to 01/00:00:19

Plot file version 178 created 26-SEP-2019 10:40:15

J0300-0846 RG010A.UVDATA.1

Freq = 4.7990 GHz, Bw = 32.000 MH No calibration applied and no bandpass applied

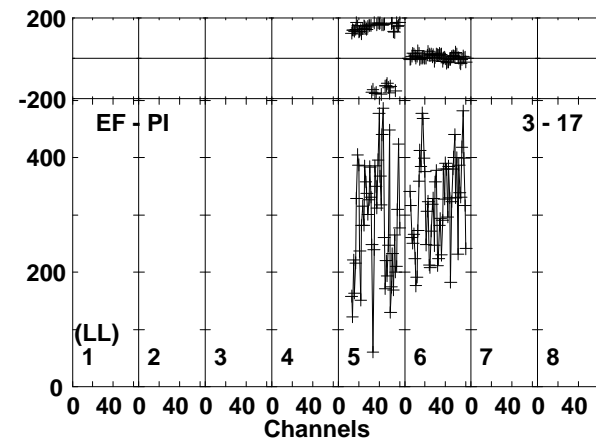
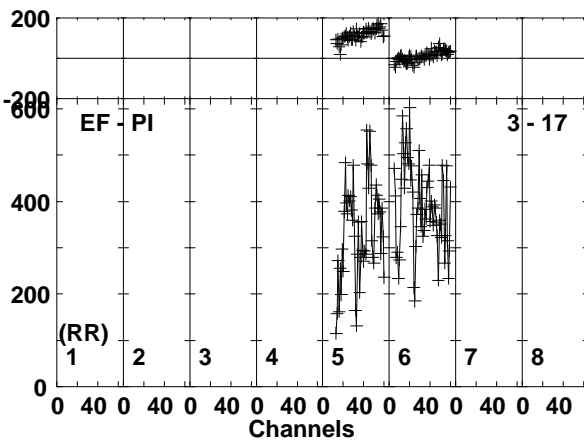
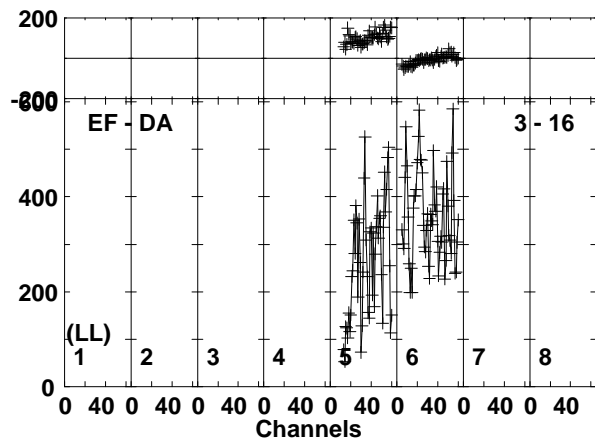
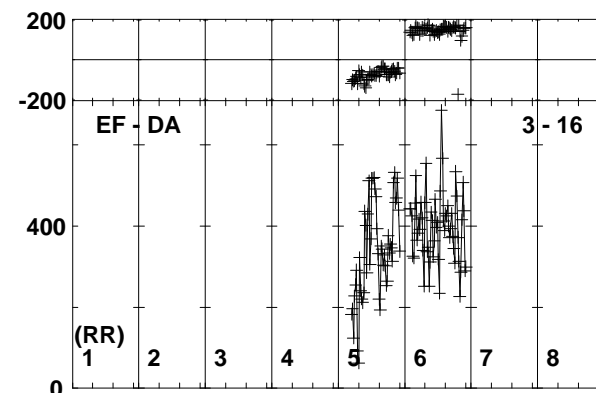
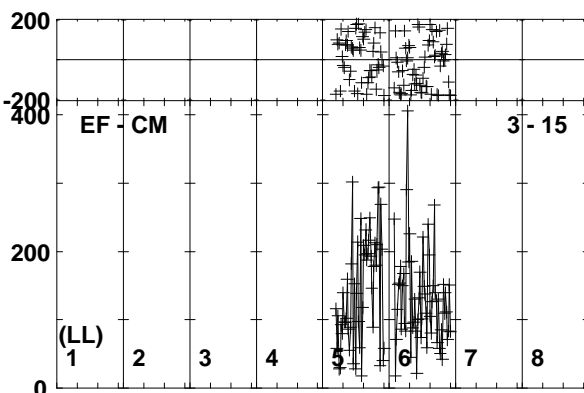
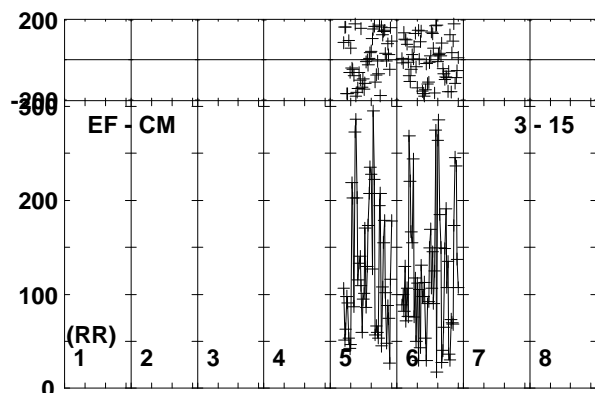
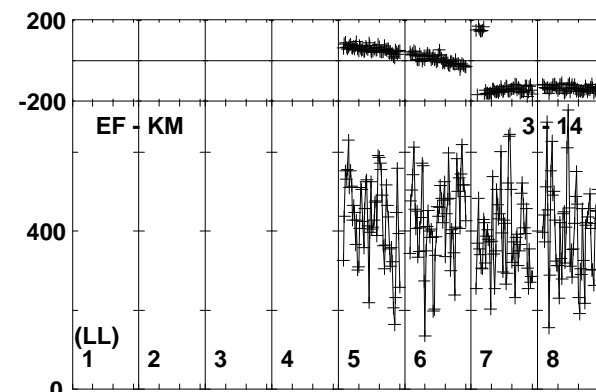
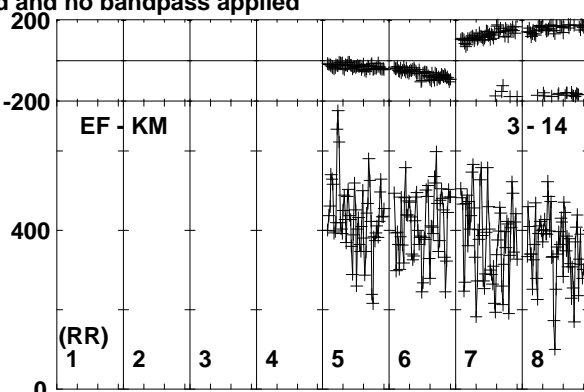
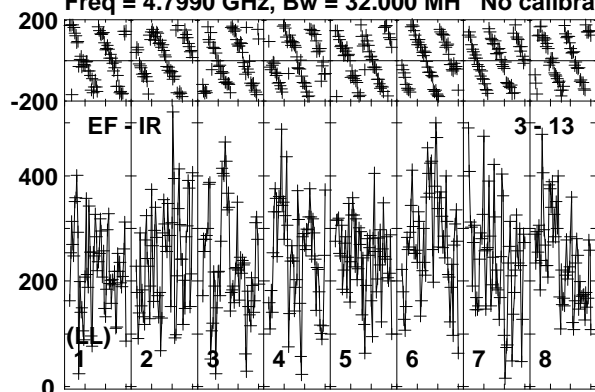

Lower frame: Micro Ampl Jy Top frame: Phas deg
Vector averaged cross-power spectrum Baseline: EF (03) - IR (13)
Timerange: 00/23:58:11 to 01/00:00:19

Plot file version 179 created 26-SEP-2019 10:40:15

J0300-0846 RG010A.UVDATA.1

Freq = 4.7990 GHz, Bw = 32.000 MH No calibration applied and no bandpass applied

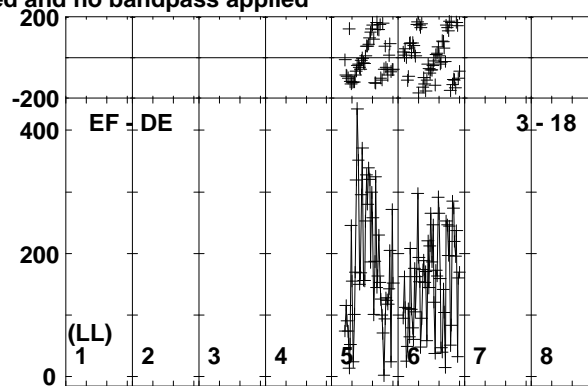
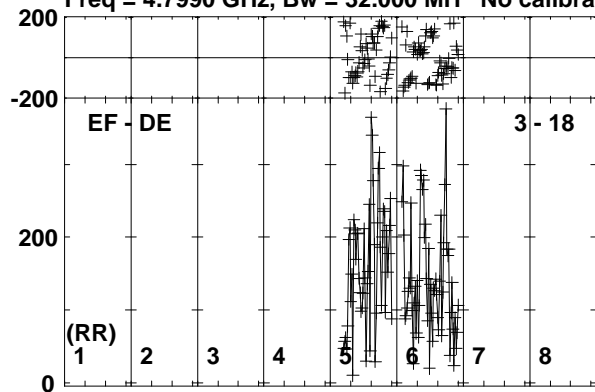

Lower frame: Micro Ampl Jy Top frame: Phas deg
Vector averaged cross-power spectrum Baseline: EF (03) - DE (18)
Timerange: 00/23:58:11 to 01/00:00:19

Plot file version 180 created 26-SEP-2019 10:40:15

J0257-1212 RG010A.UVDATA.1

Freq = 4.7990 GHz, Bw = 32.000 MH No calibration applied and no bandpass applied

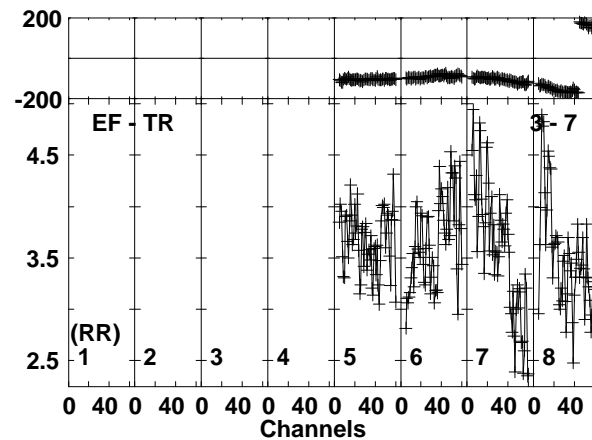
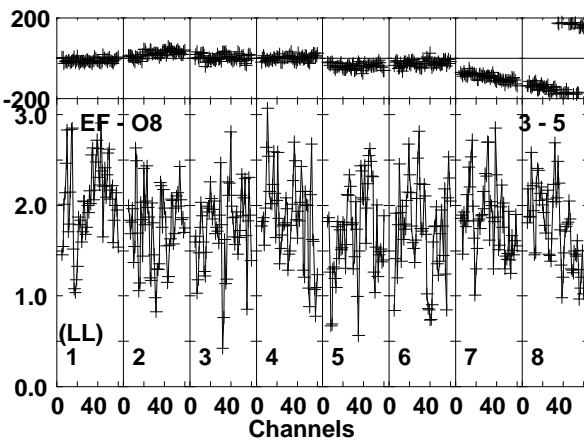
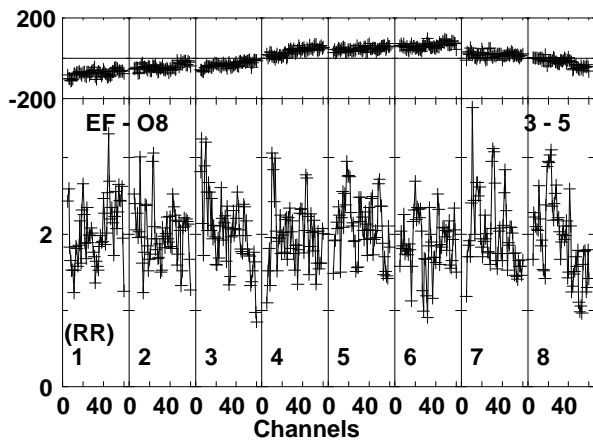
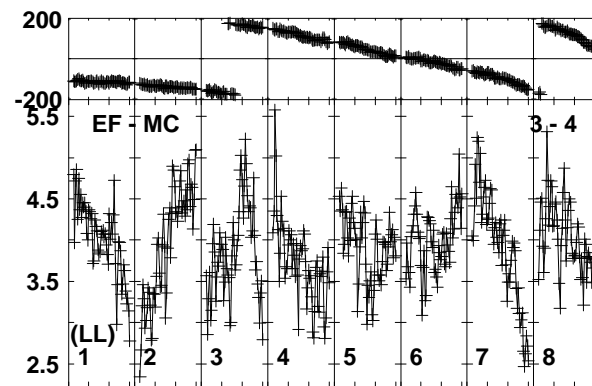
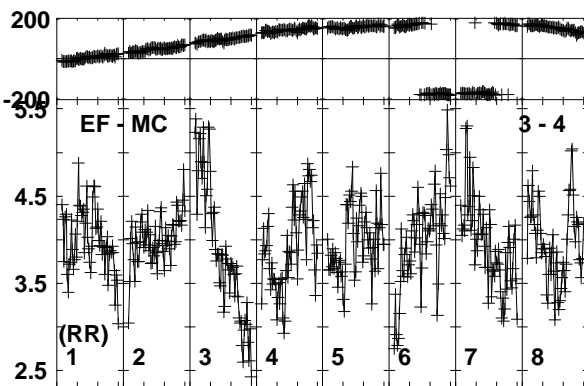
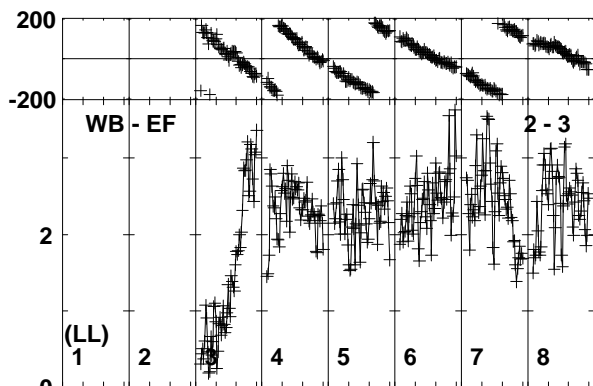
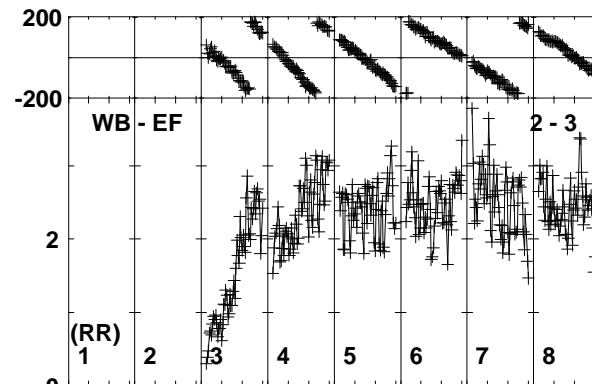
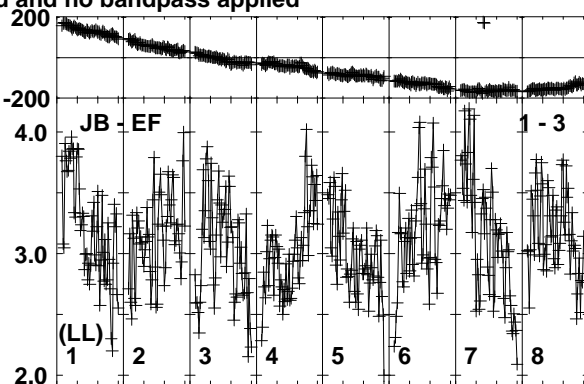
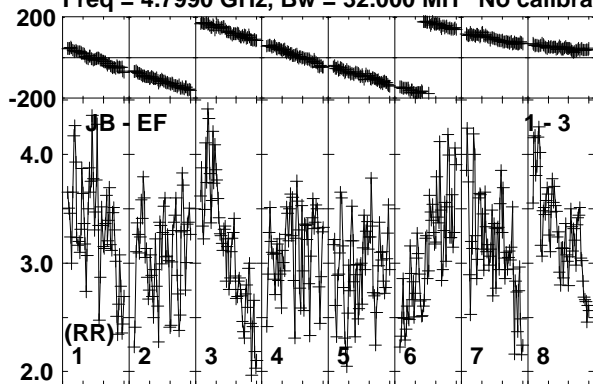

Lower frame: Milli Ampl Jy Top frame: Phas deg
Vector averaged cross-power spectrum Baseline: JB (01) - EF (03)
Timerange: 01/00:00:20 to 01/00:01:19

Plot file version 181 created 26-SEP-2019 10:40:15

J0257-1212 RG010A.UVDATA.1

Freq = 4.7990 GHz, Bw = 32.000 MH No calibration applied and no bandpass applied

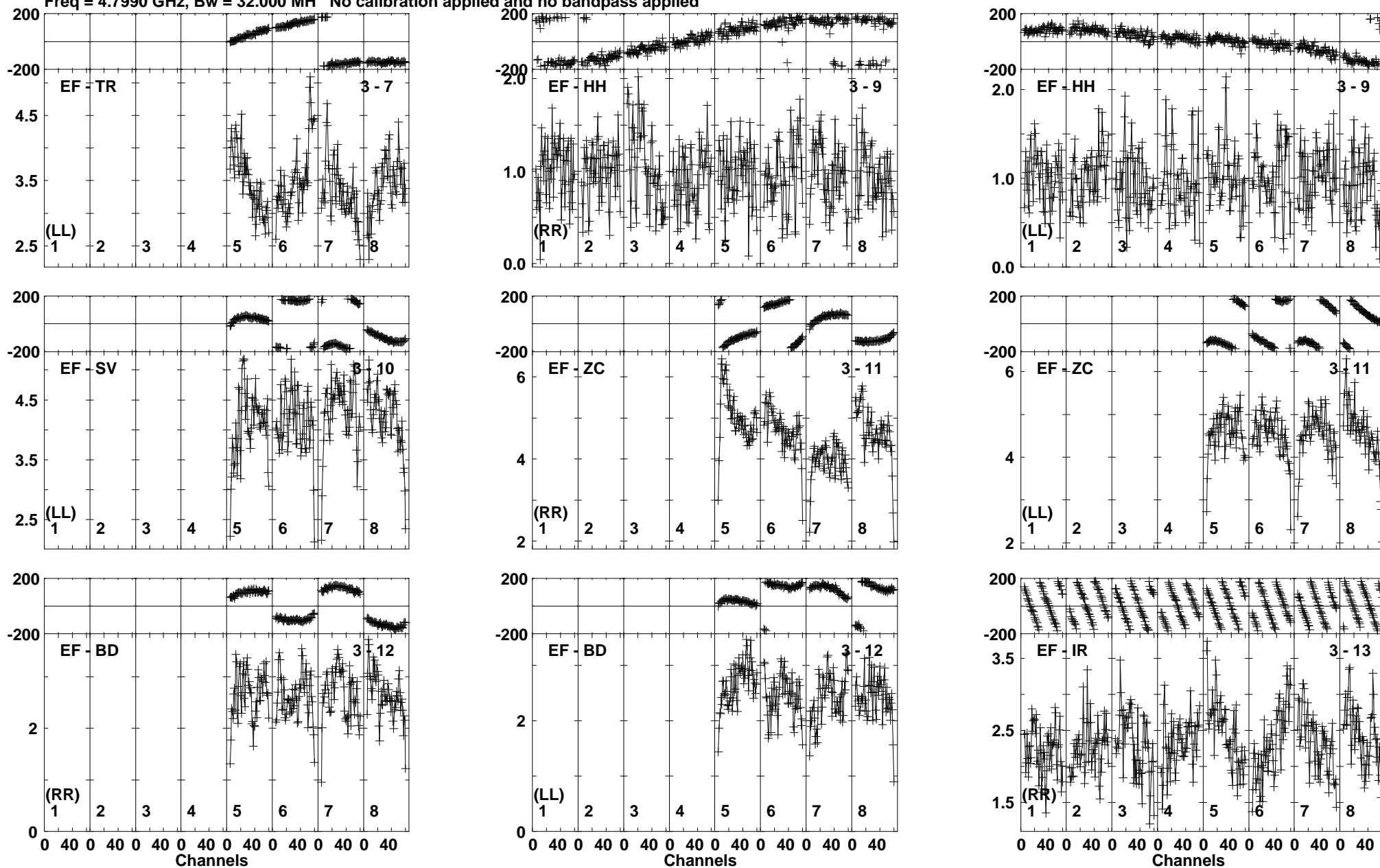

Lower frame: Milli Ampl Jy Top frame: Phas deg
Vector averaged cross-power spectrum Baseline: EF (03) - TR (07)
Timerange: 01/00:00:20 to 01/00:01:19

Plot file version 182 created 26-SEP-2019 10:40:16

J0257-1212 RG010A.UVDATA.1

Freq = 4.7990 GHz, Bw = 32.000 MH No calibration applied and no bandpass applied

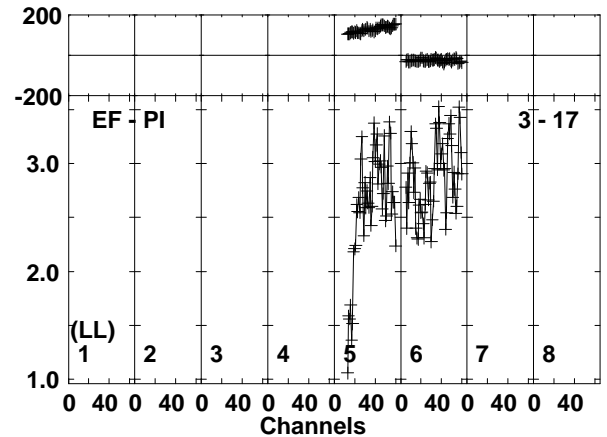
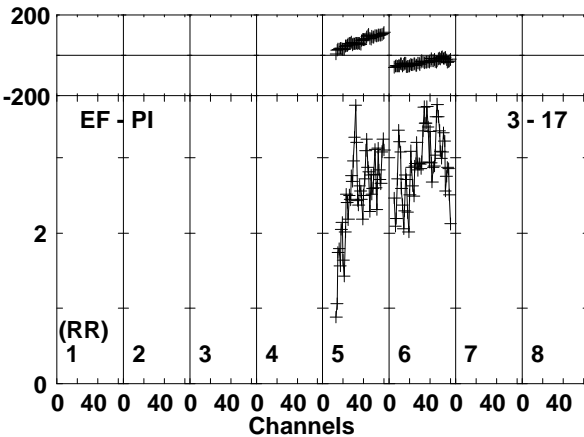
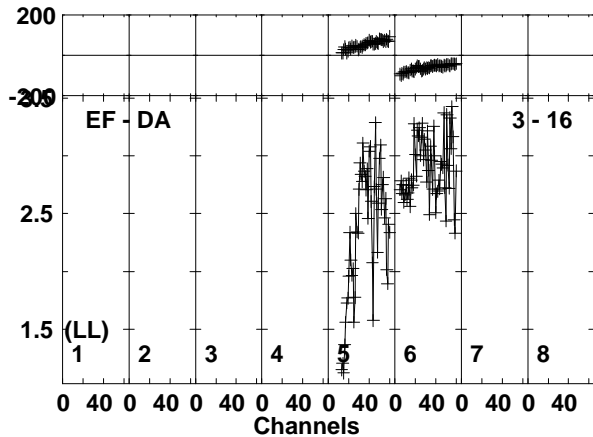
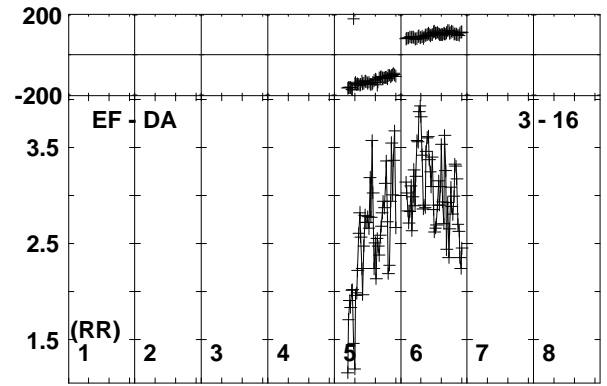
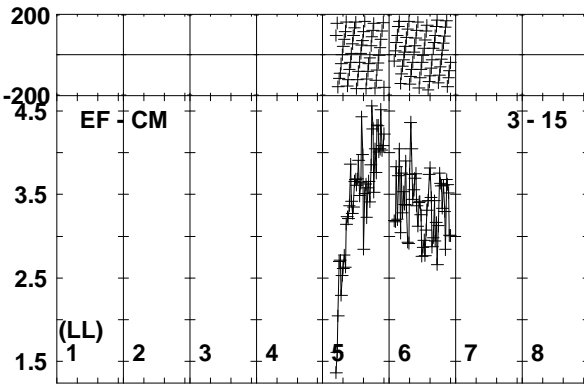
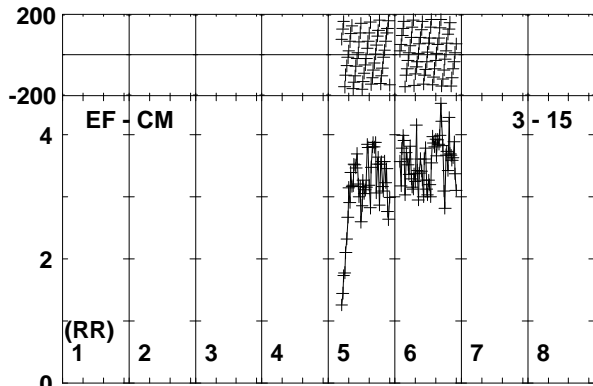
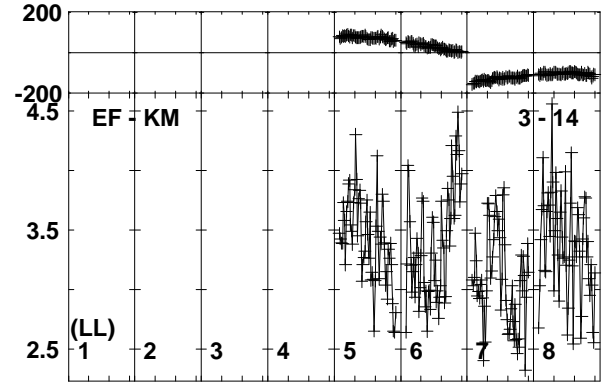
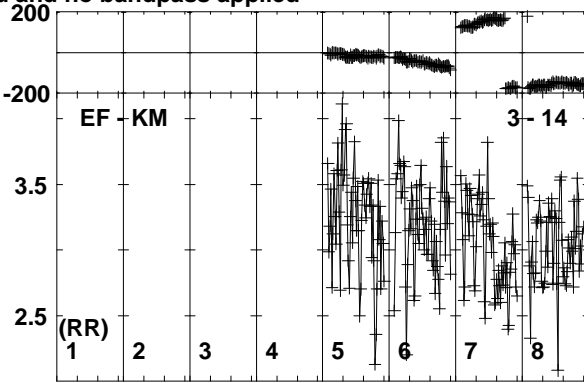
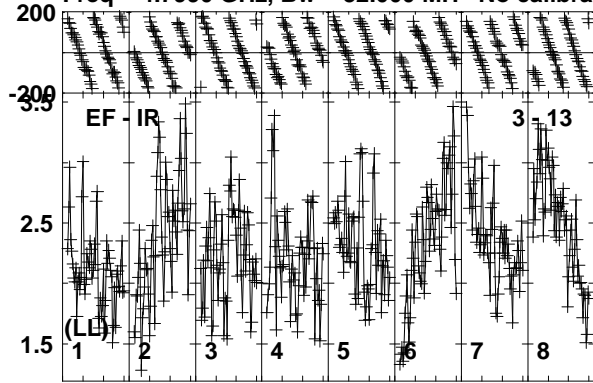

Lower frame: Milli Ampl Jy Top frame: Phas deg
Vector averaged cross-power spectrum Baseline: EF (03) - IR (13)
Timerange: 01/00:00:20 to 01/00:01:19

Plot file version 183 created 26-SEP-2019 10:40:16

J0257-1212 RG010A.UVDATA.1

Freq = 4.7990 GHz, Bw = 32.000 MH No calibration applied and no bandpass applied

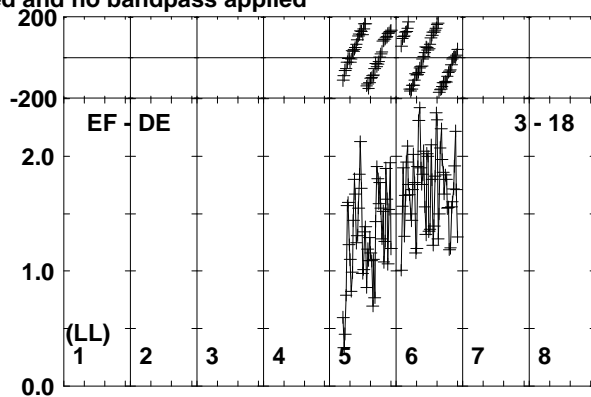
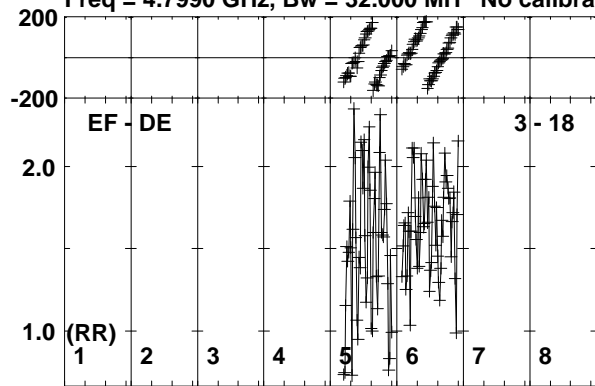

Lower frame: Milli Ampl Jy Top frame: Phas deg
Vector averaged cross-power spectrum Baseline: EF (03) - DE (18)
Timerange: 01/00:00:20 to 01/00:01:19

Plot file version 184 created 26-SEP-2019 10:40:16
190829A RG010A.UVDATA.1

Freq = 4.7990 GHz, Bw = 32.000 MH No calibration applied and no bandpass applied

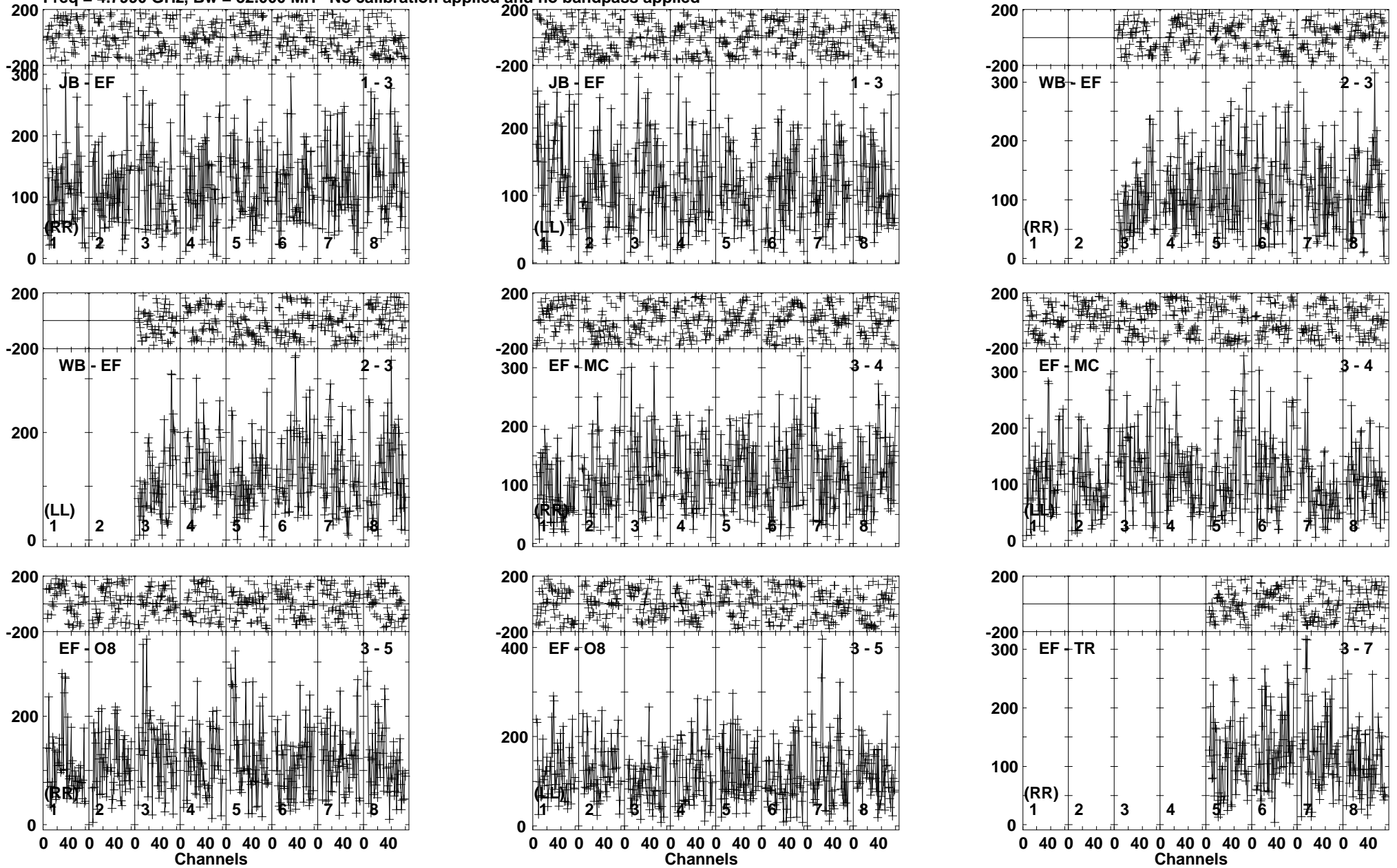

Lower frame: Micro Ampl Jy Top frame: Phas deg
Vector averaged cross-power spectrum Baseline: JB (01) - EF (03)
Timerange: 01/00:01:21 to 01/00:03:29

Plot file version 185 created 26-SEP-2019 10:40:16

190829A RG010A.UVDATA.1

Freq = 4.7990 GHz, Bw = 32.000 MH No calibration applied and no bandpass applied

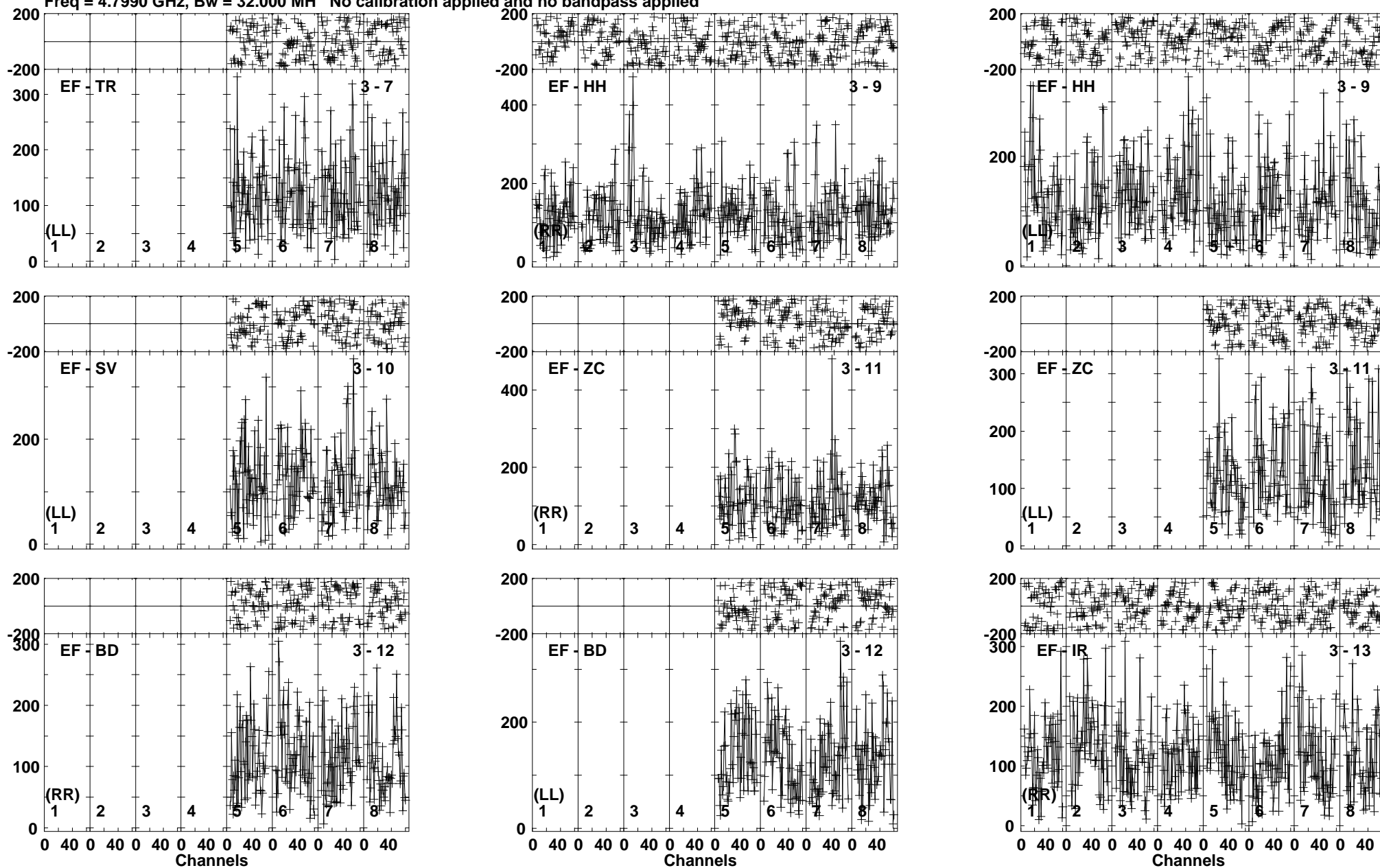

Lower frame: Micro Ampl Jy Top frame: Phas deg
Vector averaged cross-power spectrum Baseline: EF (03) - TR (07)
Timerange: 01/00:01:21 to 01/00:03:29

Plot file version 186 created 26-SEP-2019 10:40:17

190829A RG010A.UVDATA.1

Freq = 4.7990 GHz, Bw = 32.000 MH No calibration applied and no bandpass applied

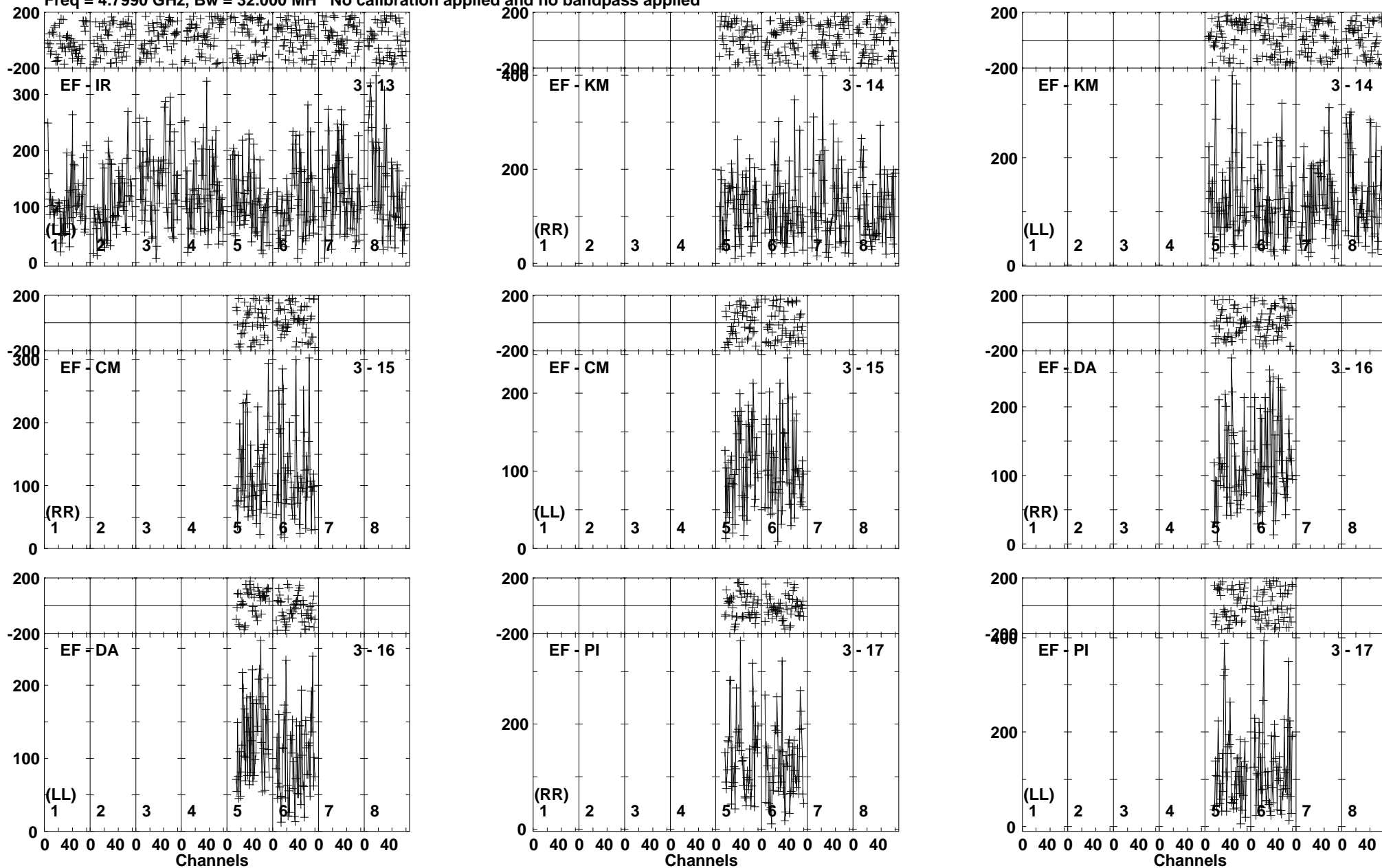

Lower frame: Micro Ampl Jy Top frame: Phas deg
Vector averaged cross-power spectrum Baseline: EF (03) - IR (13)
Timerange: 01/00:01:21 to 01/00:03:29

Plot file version 187 created 26-SEP-2019 10:40:17

190829A RG010A.UVDATA.1

Freq = 4.7990 GHz, Bw = 32.000 MH No calibration applied and no bandpass applied

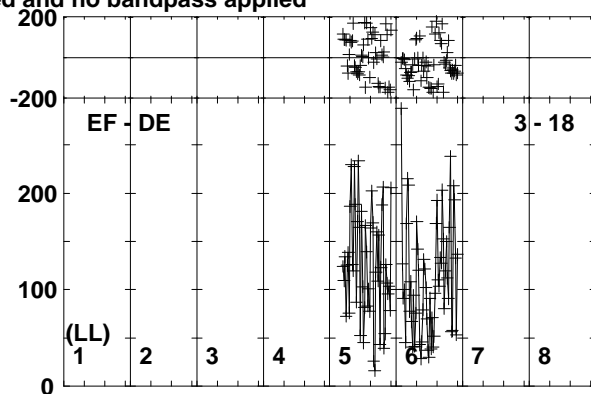
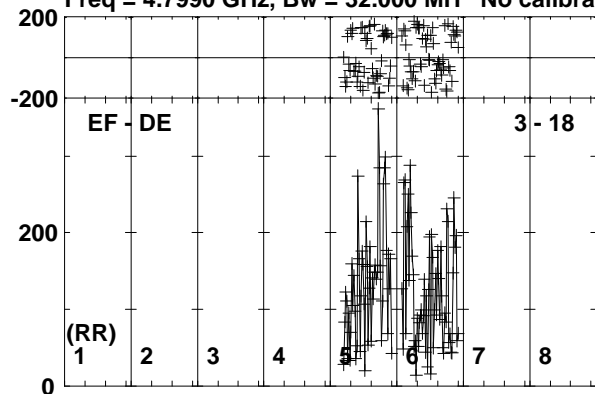

Lower frame: Micro Ampl Jy Top frame: Phas deg
Vector averaged cross-power spectrum Baseline: EF (03) - DE (18)
Timerange: 01/00:01:21 to 01/00:03:29

Plot file version 188 created 26-SEP-2019 10:40:17

J0257-1212 RG010A.UVDATA.1

Freq = 4.7990 GHz, Bw = 32.000 MH No calibration applied and no bandpass applied

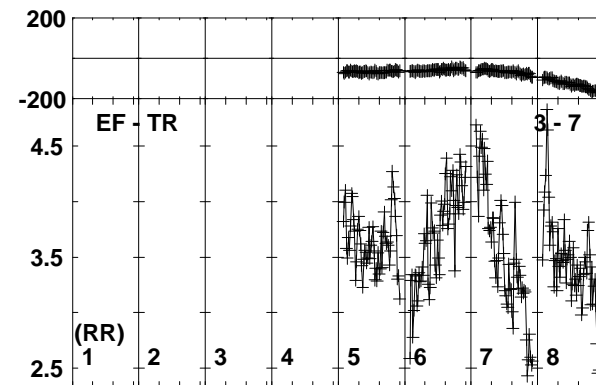
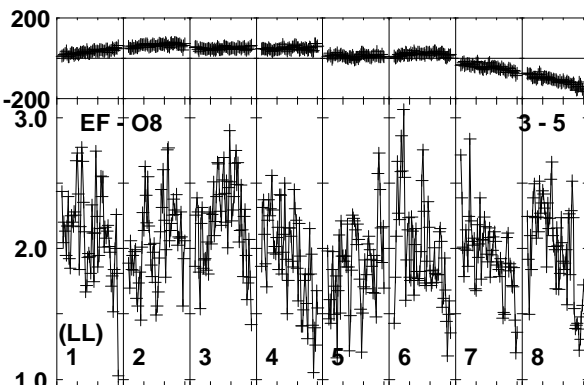
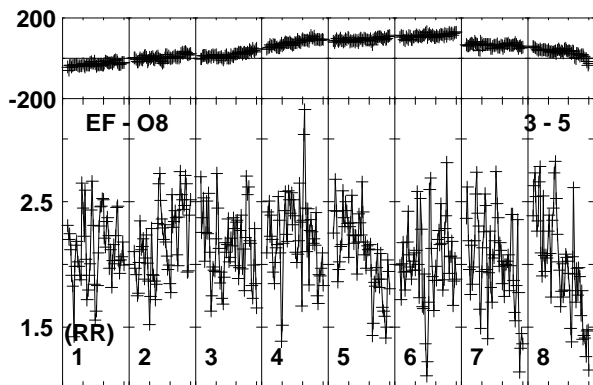
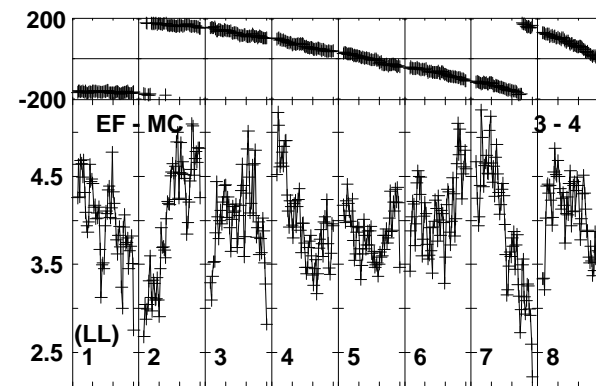
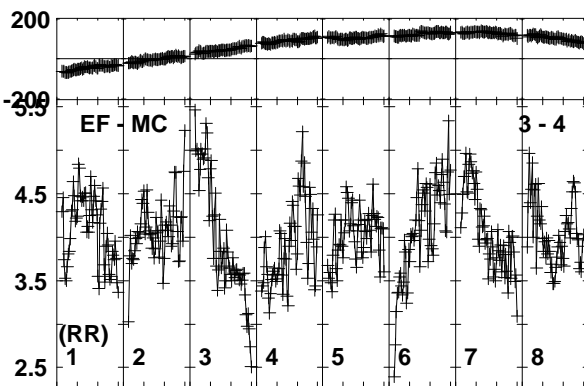
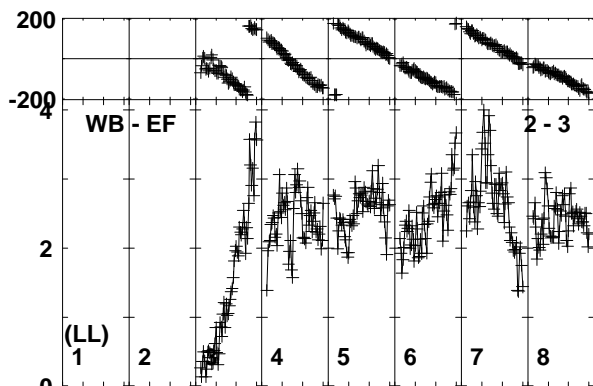
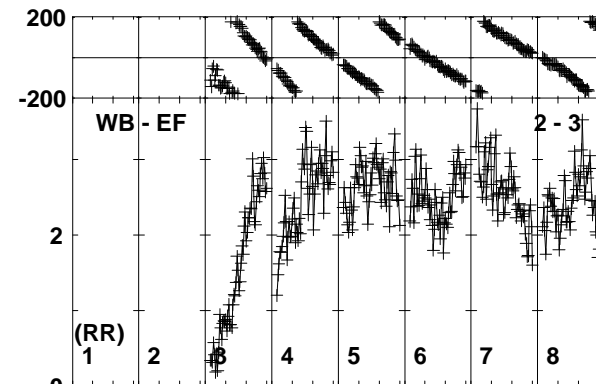
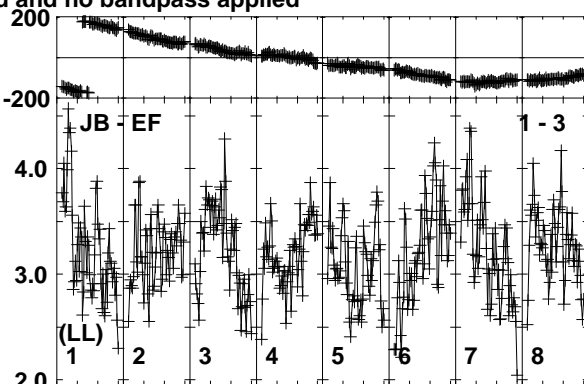
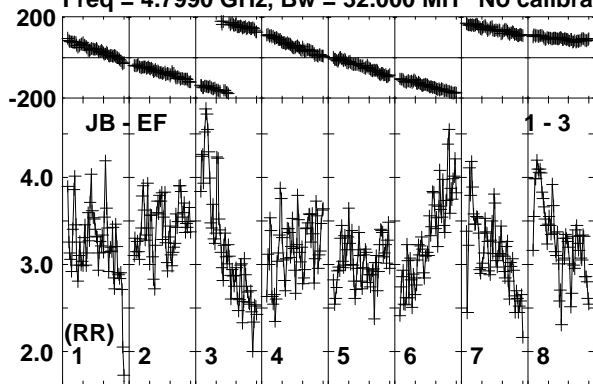

Lower frame: Milli Ampl Jy Top frame: Phas deg
Vector averaged cross-power spectrum Baseline: JB (01) - EF (03)
Timerange: 01/00:03:31 to 01/00:04:30

Plot file version 189 created 26-SEP-2019 10:40:18

J0257-1212 RG010A.UVDATA.1

Freq = 4.7990 GHz, Bw = 32.000 MH No calibration applied and no bandpass applied

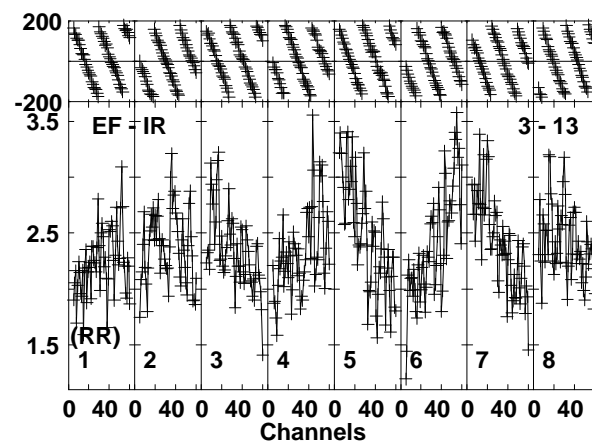
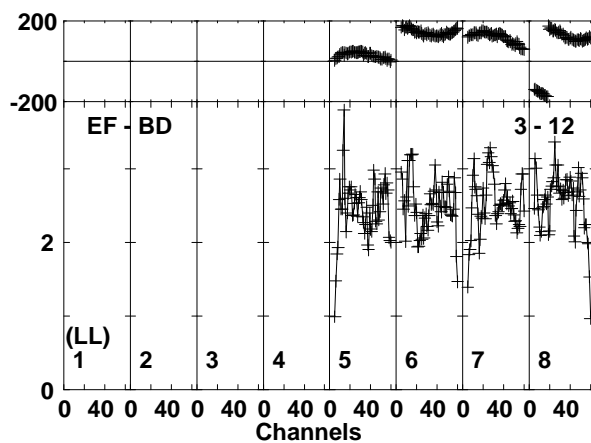
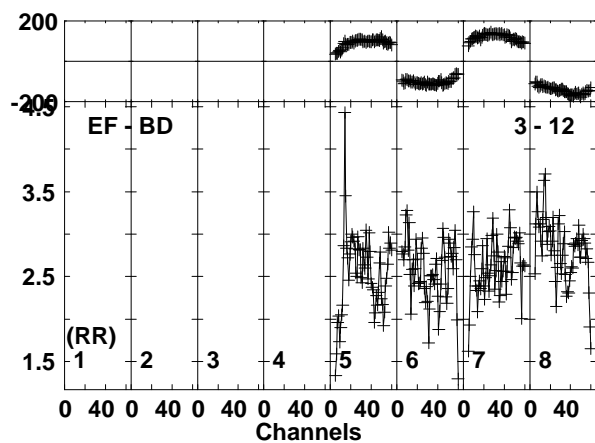
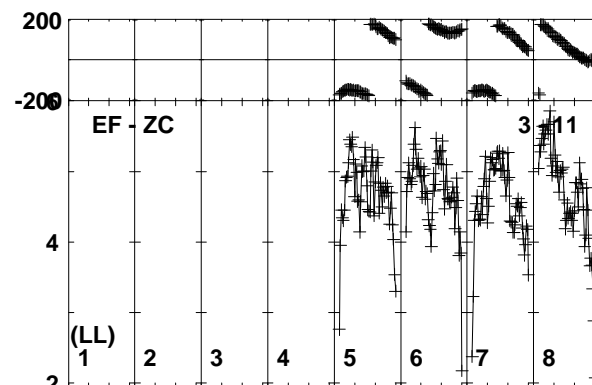
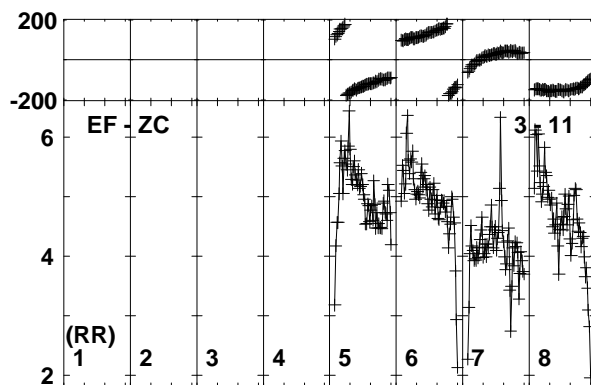
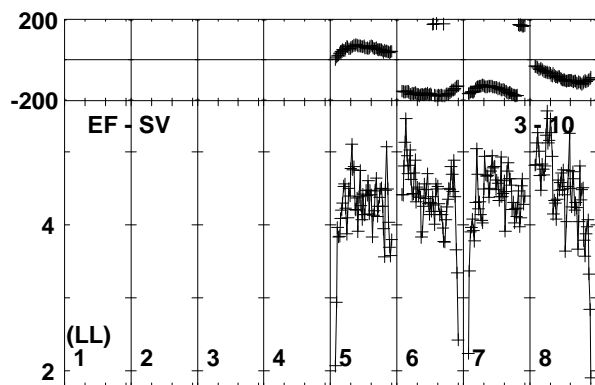
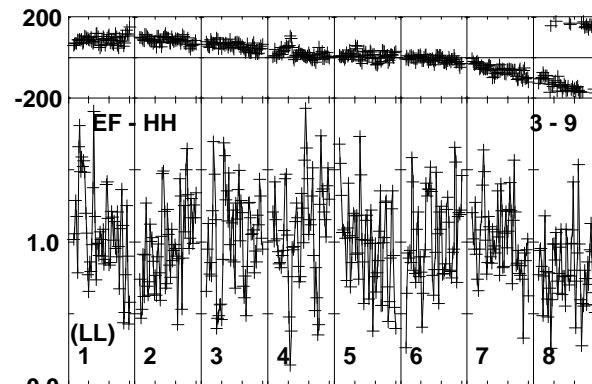
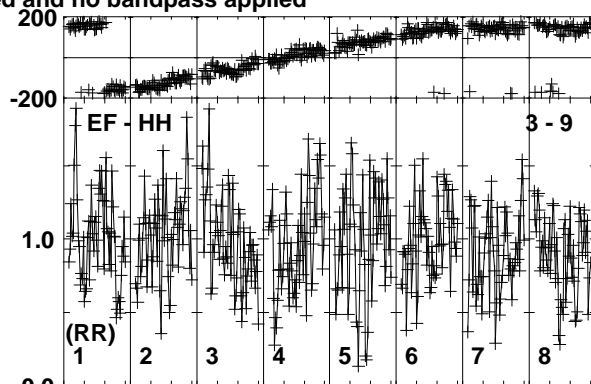
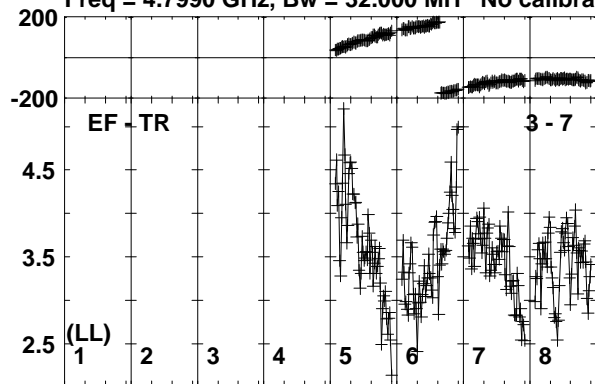

Lower frame: Milli Ampl Jy Top frame: Phas deg
Vector averaged cross-power spectrum Baseline: EF (03) - TR (07)
Timerange: 01/00:03:31 to 01/00:04:30

Plot file version 190 created 26-SEP-2019 10:40:18

J0257-1212 RG010A.UVDATA.1

Freq = 4.7990 GHz, Bw = 32.000 MH No calibration applied and no bandpass applied

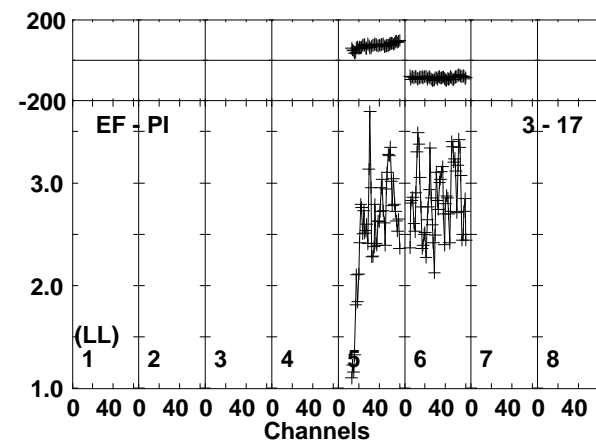
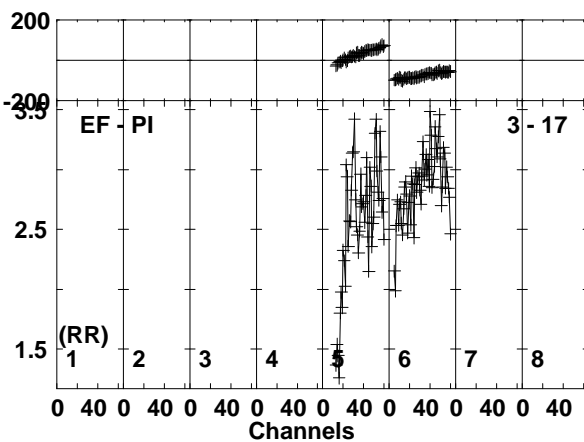
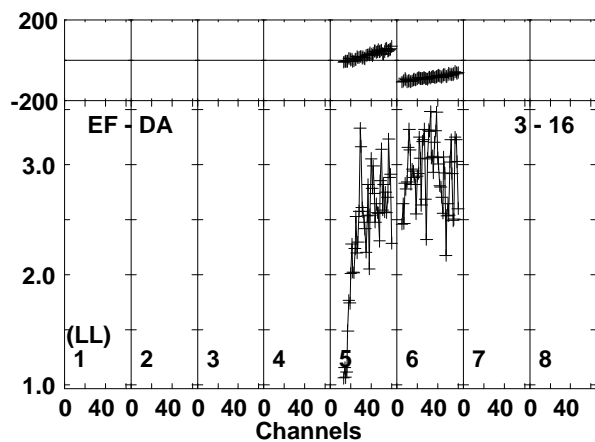
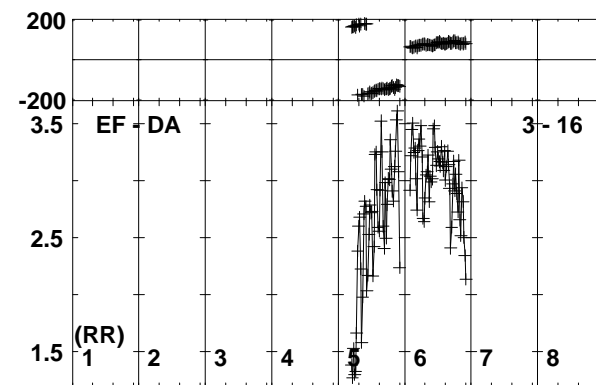
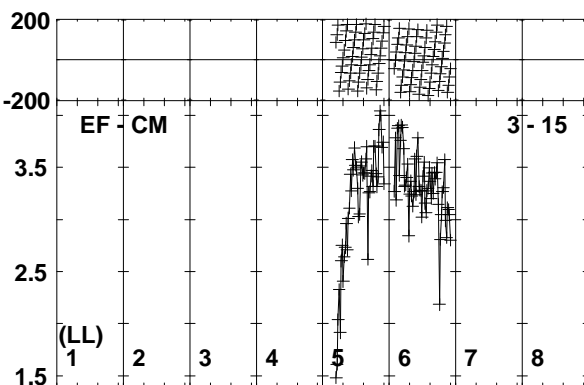
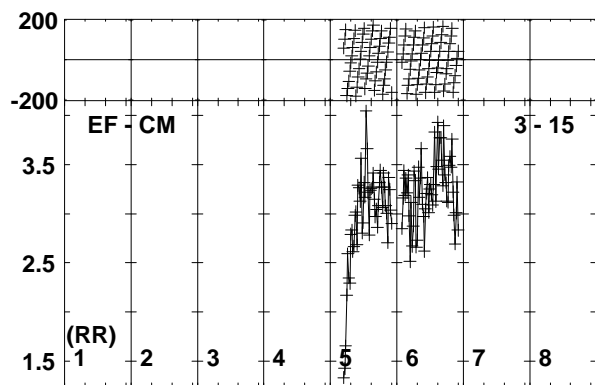
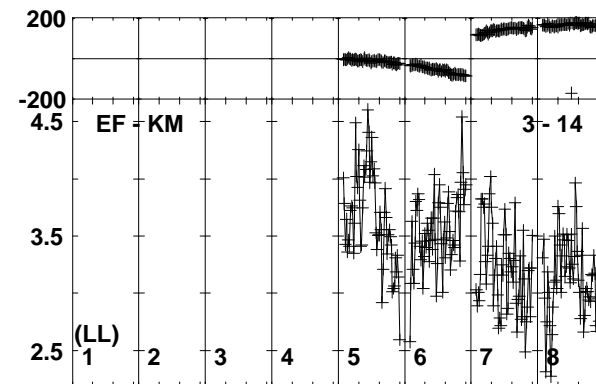
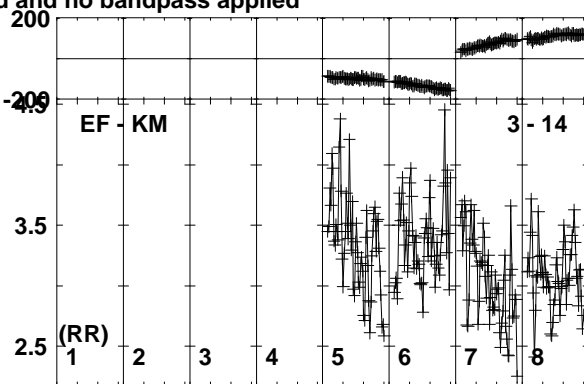
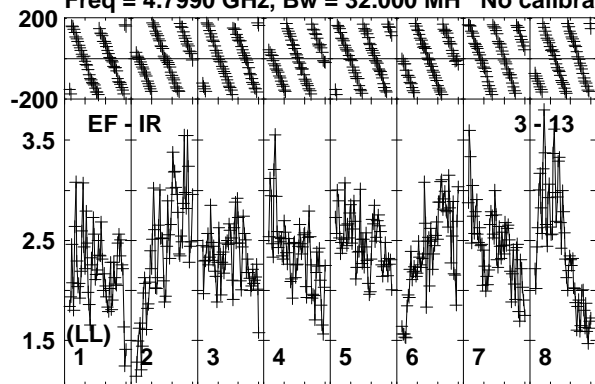

Lower frame: Milli Ampl Jy Top frame: Phas deg
Vector averaged cross-power spectrum Baseline: EF (03) - IR (13)
Timerange: 01/00:03:31 to 01/00:04:30

Plot file version 191 created 26-SEP-2019 10:40:18

J0257-1212 RG010A.UVDATA.1

Freq = 4.7990 GHz, Bw = 32.000 MH No calibration applied and no bandpass applied

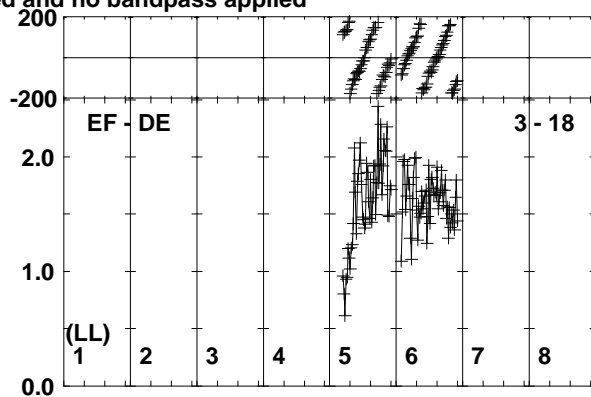
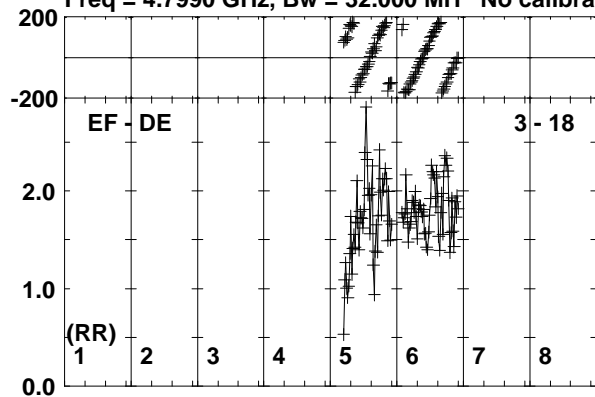

Lower frame: Milli Ampl Jy Top frame: Phas deg
Vector averaged cross-power spectrum Baseline: EF (03) - DE (18)
Timerange: 01/00:03:31 to 01/00:04:30

Plot file version 192 created 26-SEP-2019 10:40:19
190829A RG010A.UVDATA.1

Freq = 4.7990 GHz, Bw = 32.000 MH No calibration applied and no bandpass applied

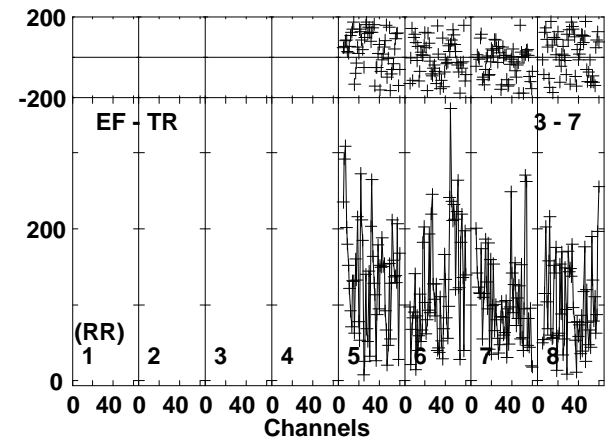
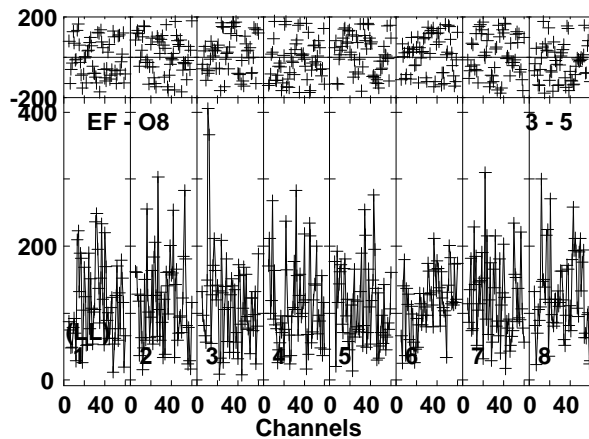
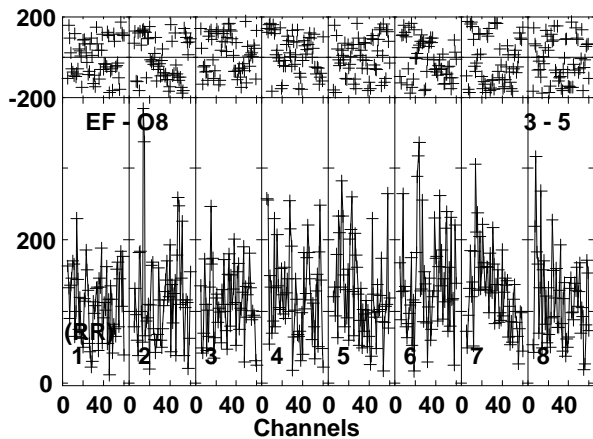
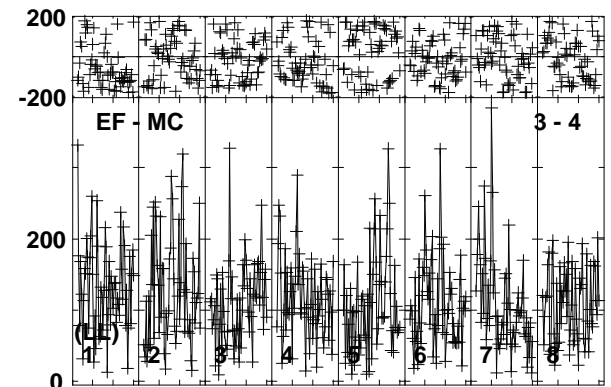
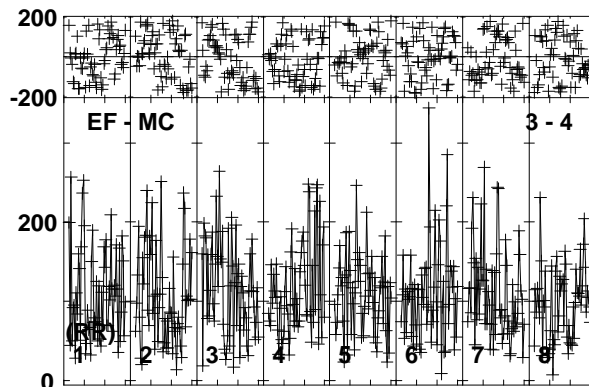
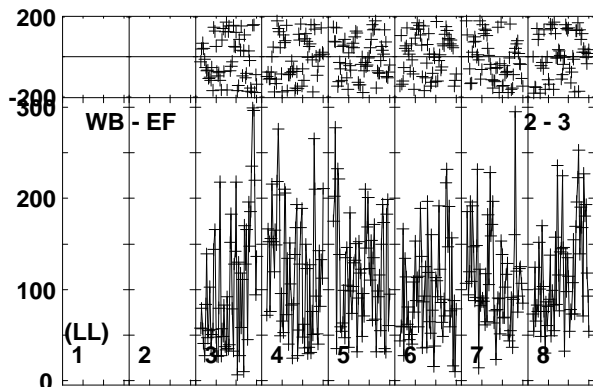
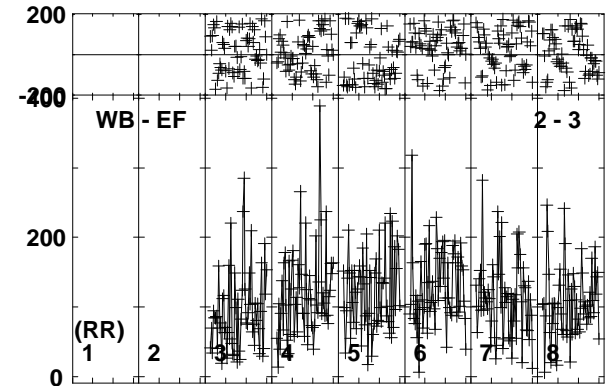
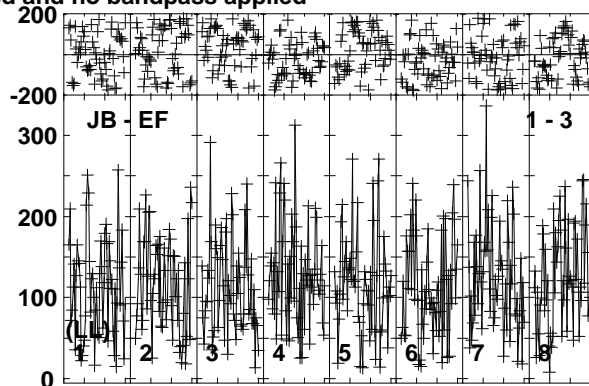
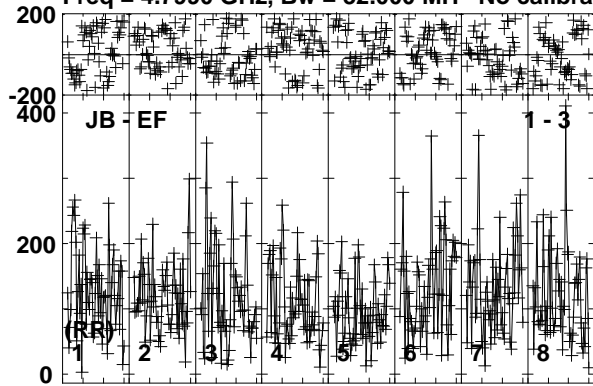

Lower frame: Micro Ampl Jy Top frame: Phas deg
Vector averaged cross-power spectrum Baseline: JB (01) - EF (03)
Timerange: 01/00:04:31 to 01/00:06:40

Plot file version 193 created 26-SEP-2019 10:40:19

190829A RG010A.UVDATA.1

Freq = 4.7990 GHz, Bw = 32.000 MH No calibration applied and no bandpass applied

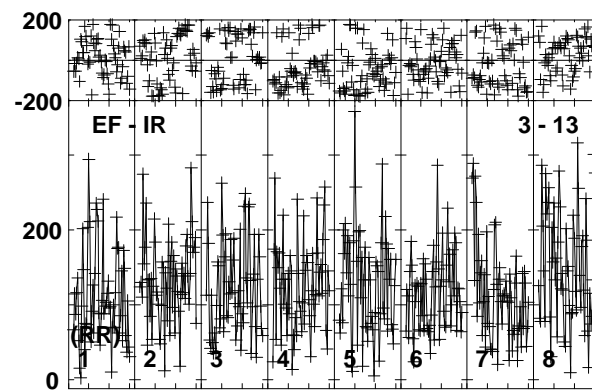
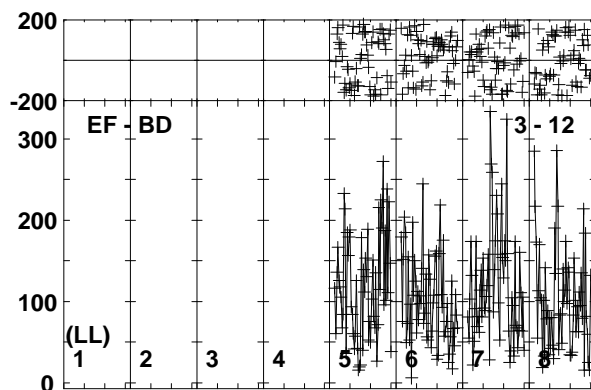
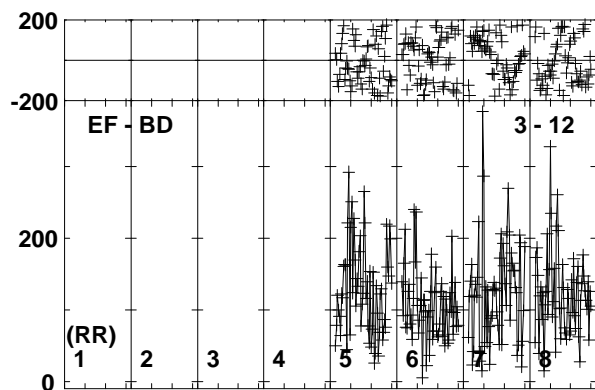
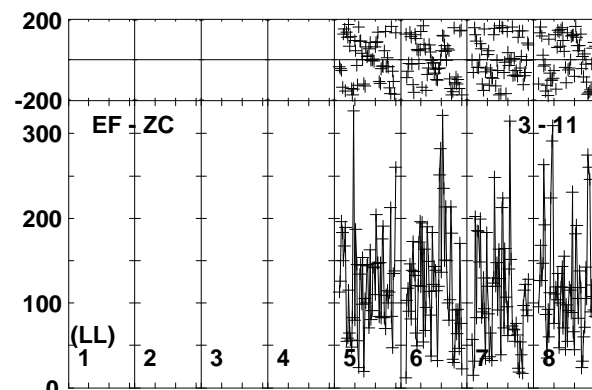
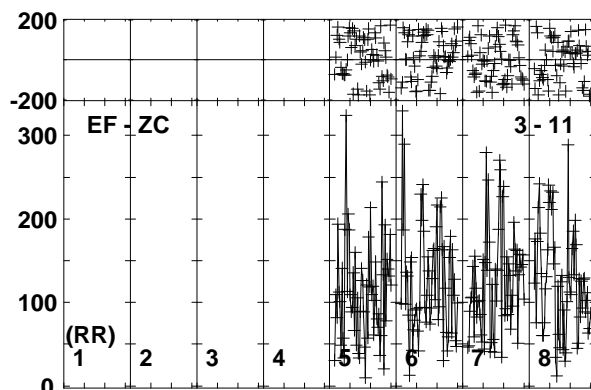
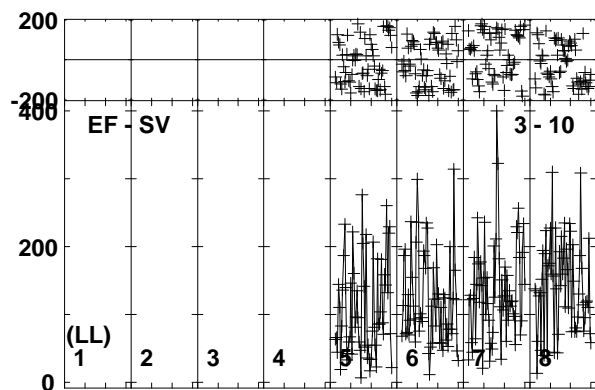
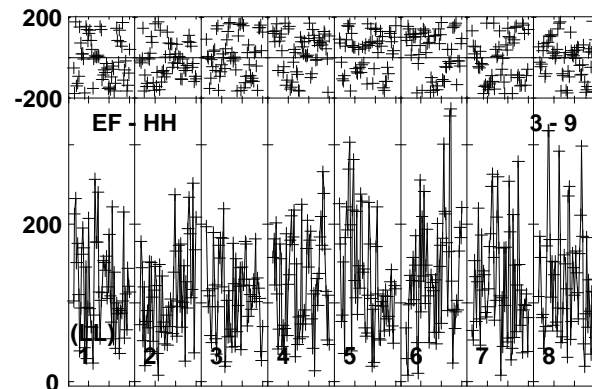
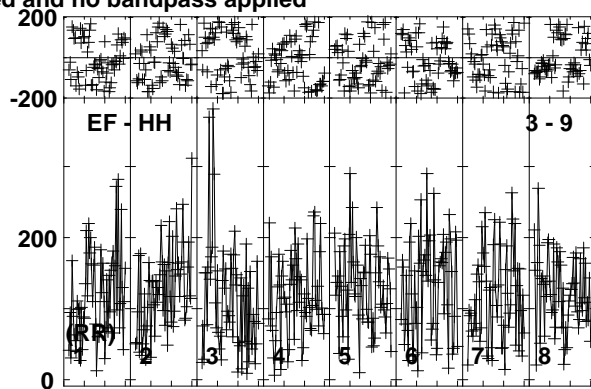
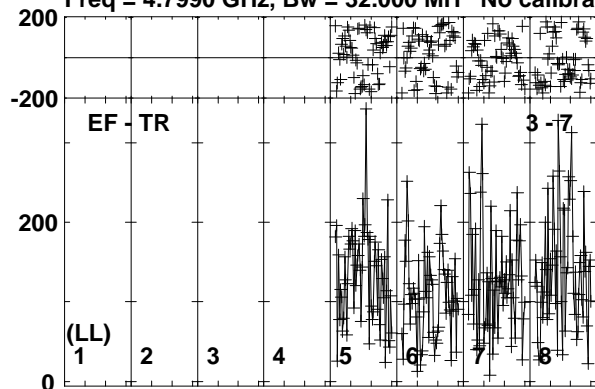

Lower frame: Micro Ampl Jy Top frame: Phas deg
Vector averaged cross-power spectrum Baseline: EF (03) - TR (07)
Timerange: 01/00:04:31 to 01/00:06:40

Plot file version 194 created 26-SEP-2019 10:40:19

190829A RG010A.UVDATA.1

Freq = 4.7990 GHz, Bw = 32.000 MH No calibration applied and no bandpass applied

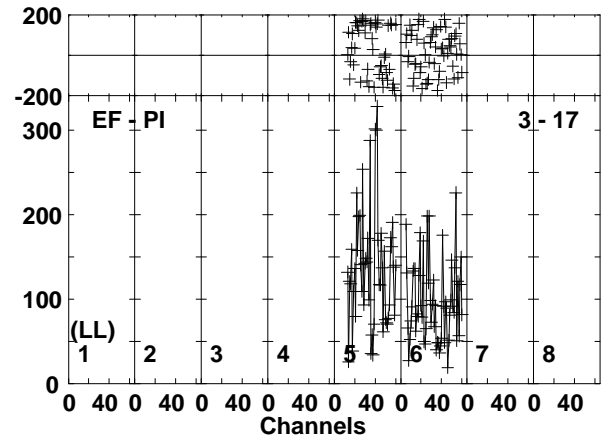
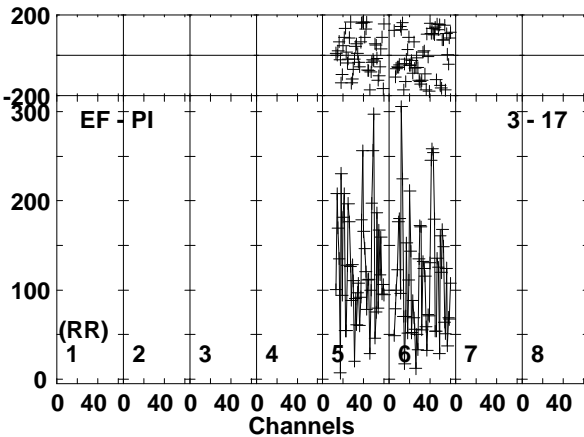
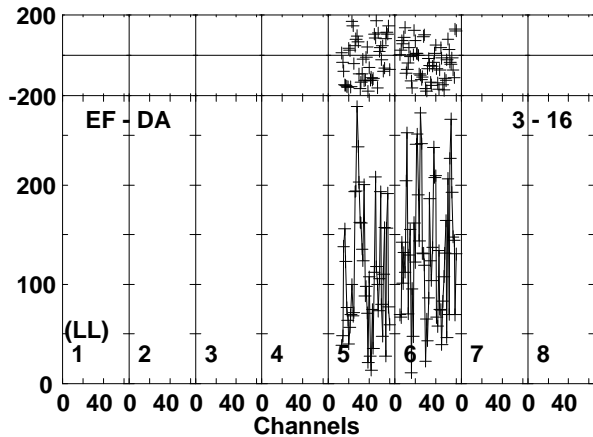
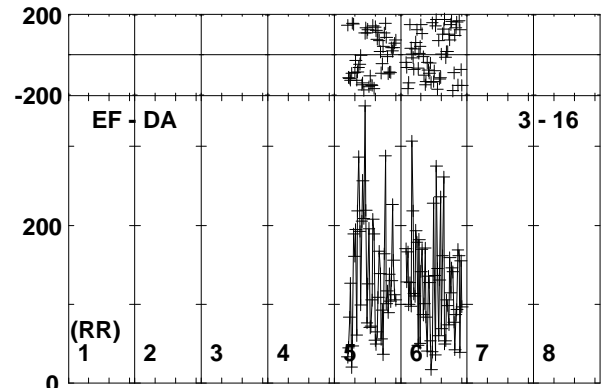
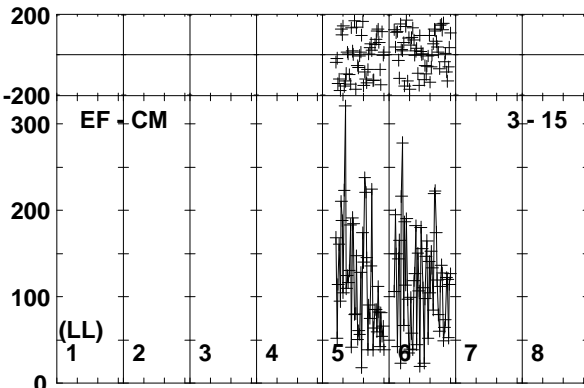
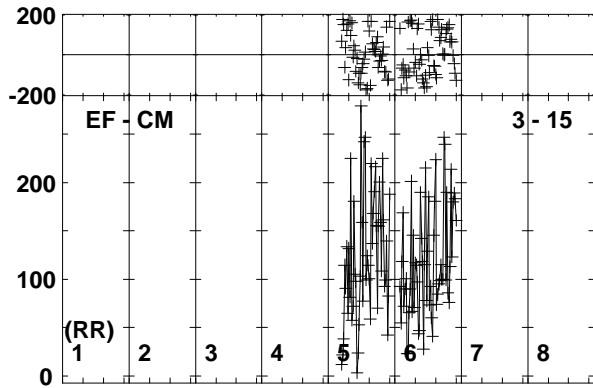
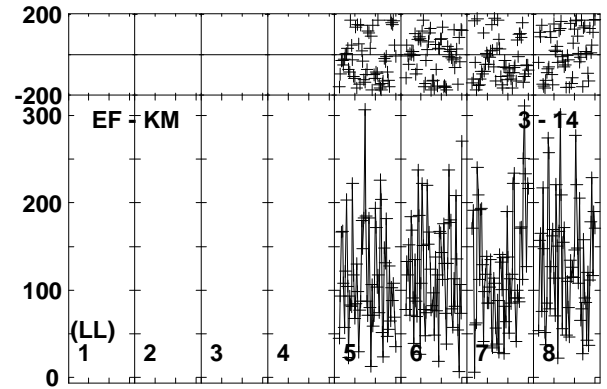
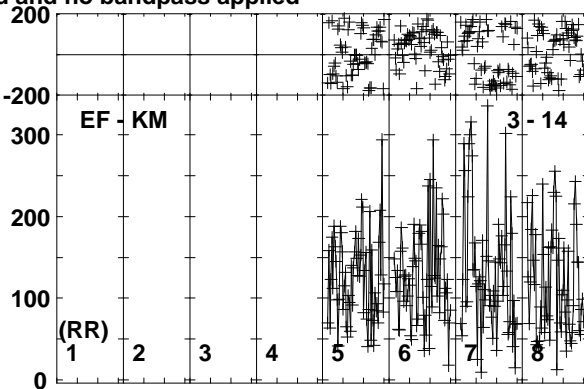
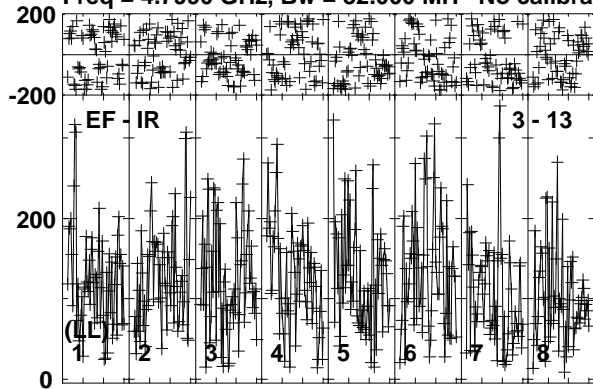

Lower frame: Micro Ampl Jy Top frame: Phas deg
Vector averaged cross-power spectrum Baseline: EF (03) - IR (13)
Timerange: 01/00:04:31 to 01/00:06:40

Plot file version 195 created 26-SEP-2019 10:40:20

190829A RG010A.UVDATA.1

Freq = 4.7990 GHz, Bw = 32.000 MH No calibration applied and no bandpass applied

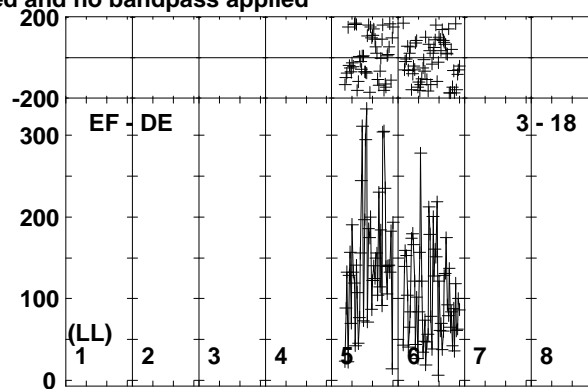
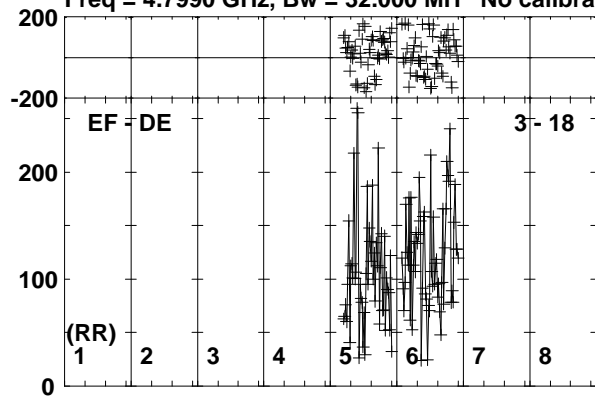

Lower frame: Micro Ampl Jy Top frame: Phas deg
Vector averaged cross-power spectrum Baseline: EF (03) - DE (18)
Timerange: 01/00:04:31 to 01/00:06:40

Plot file version 196 created 26-SEP-2019 10:40:20

J0257-1212 RG010A.UVDATA.1

Freq = 4.7990 GHz, Bw = 32.000 MH No calibration applied and no bandpass applied

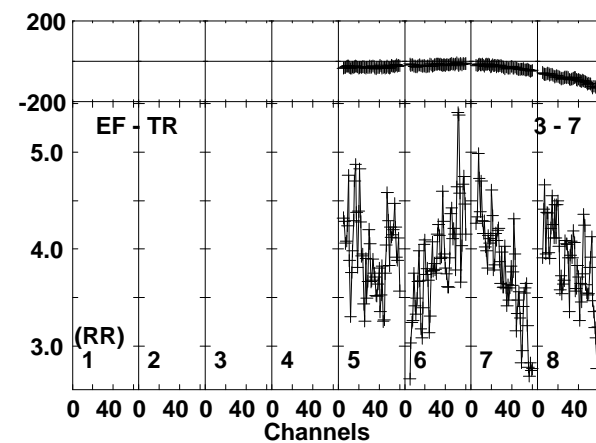
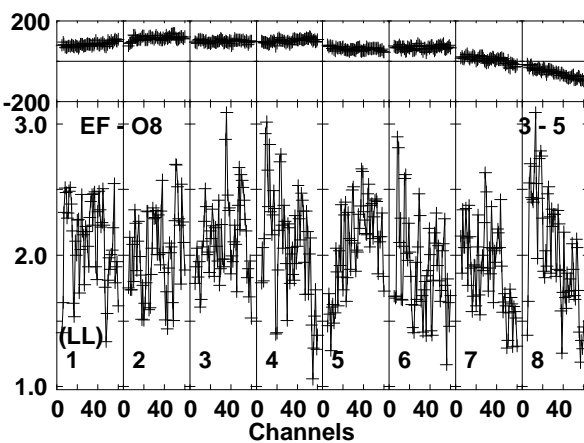
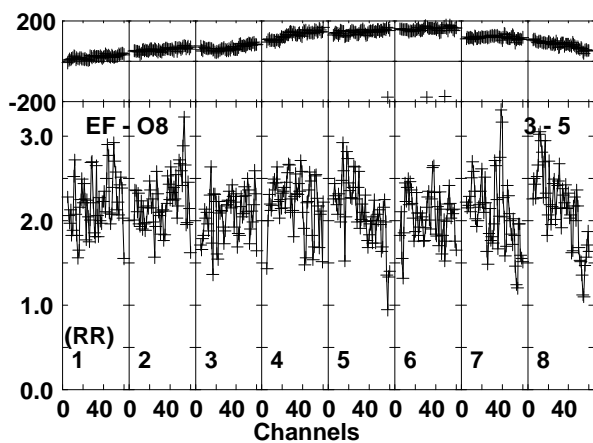
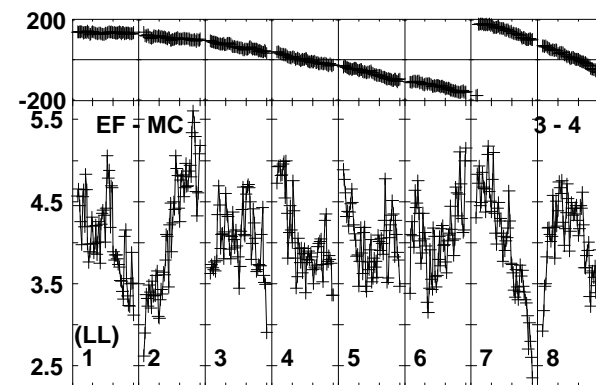
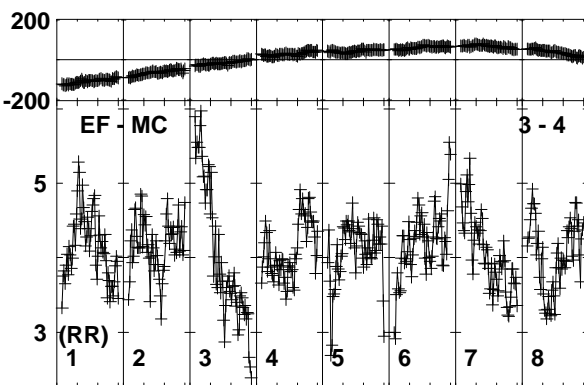
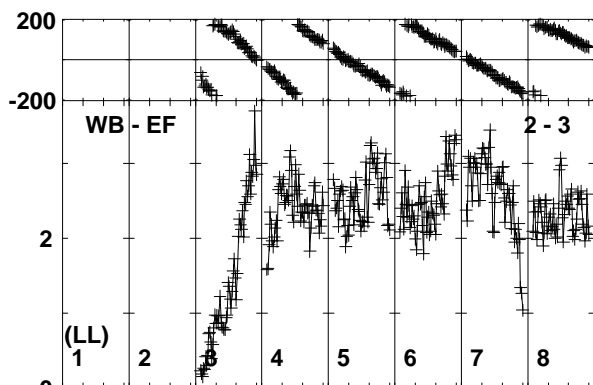
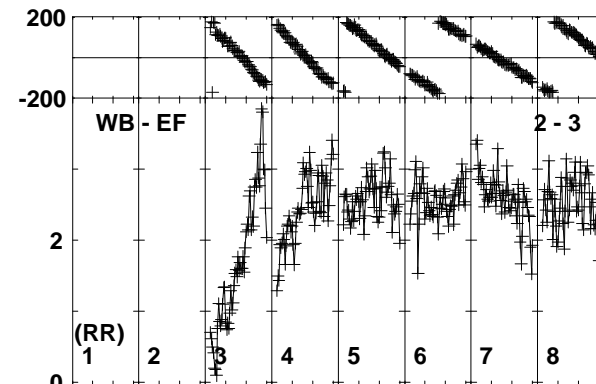
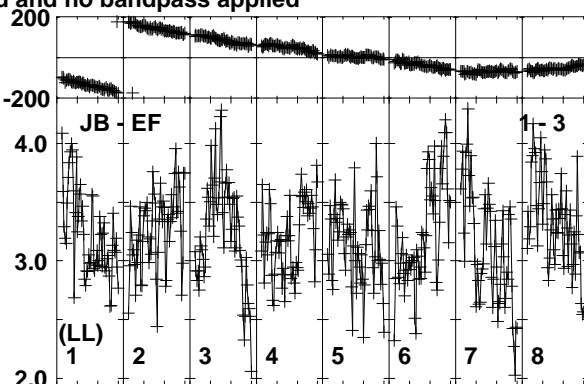
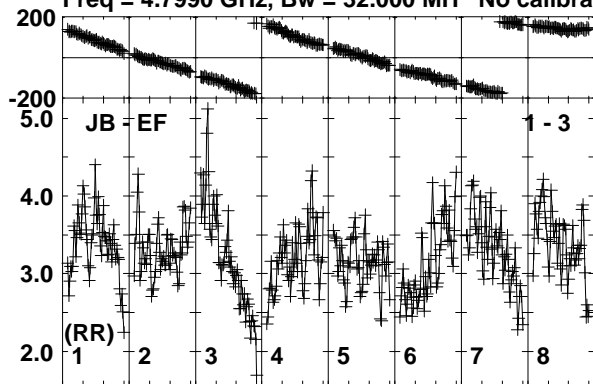

Lower frame: Milli Ampl Jy Top frame: Phas deg
Vector averaged cross-power spectrum Baseline: JB (01) - EF (03)
Timerange: 01/00:06:41 to 01/00:07:39

Plot file version 197 created 26-SEP-2019 10:40:20

J0257-1212 RG010A.UVDATA.1

Freq = 4.7990 GHz, Bw = 32.000 MH No calibration applied and no bandpass applied

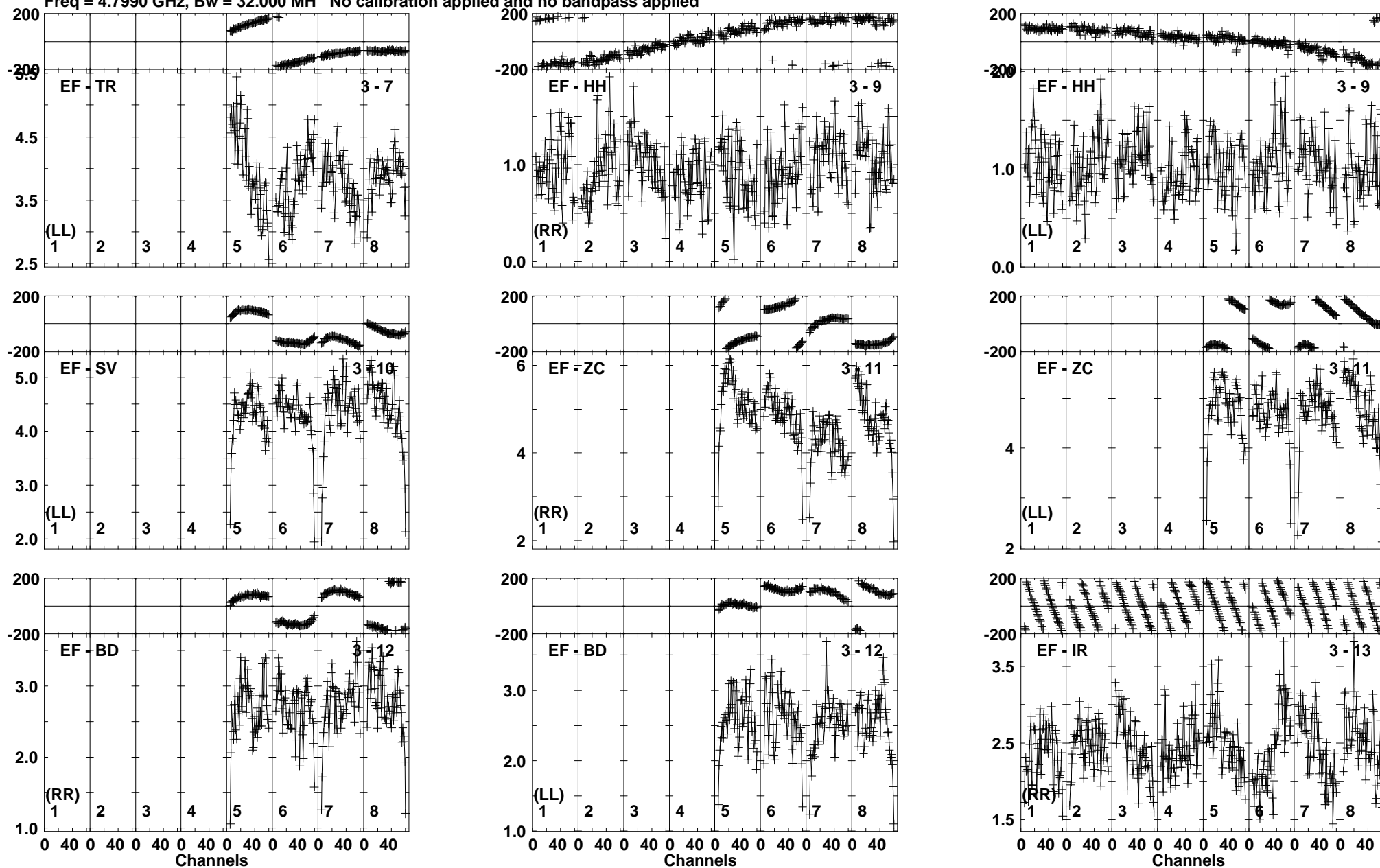

Lower frame: Milli Ampl Jy Top frame: Phas deg
Vector averaged cross-power spectrum Baseline: EF (03) - TR (07)
Timerange: 01/00:06:41 to 01/00:07:39

Plot file version 198 created 26-SEP-2019 10:40:21

J0257-1212 RG010A.UVDATA.1

Freq = 4.7990 GHz, Bw = 32.000 MH No calibration applied and no bandpass applied

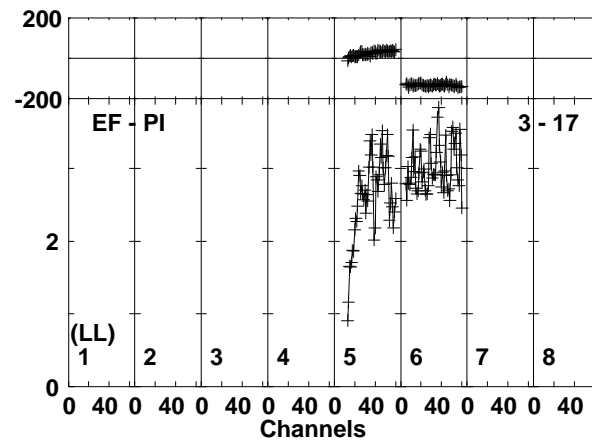
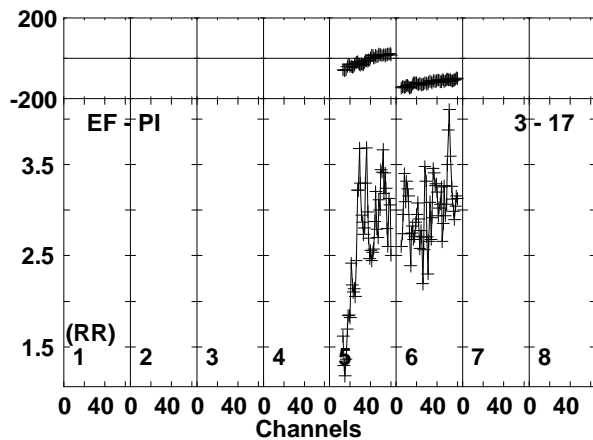
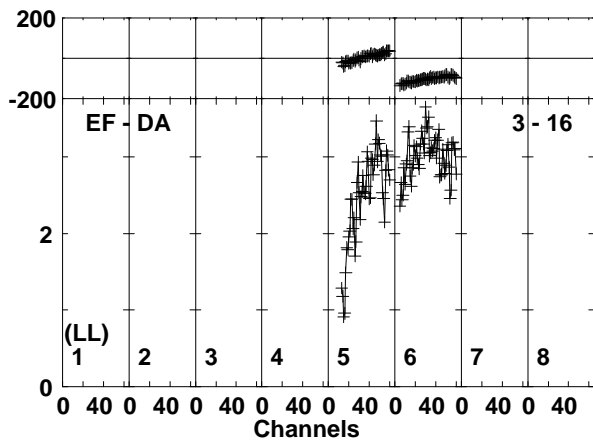
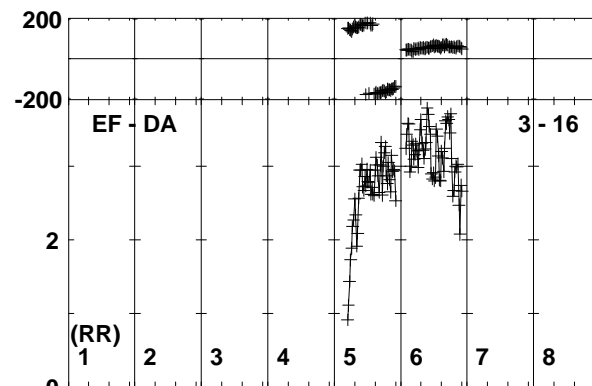
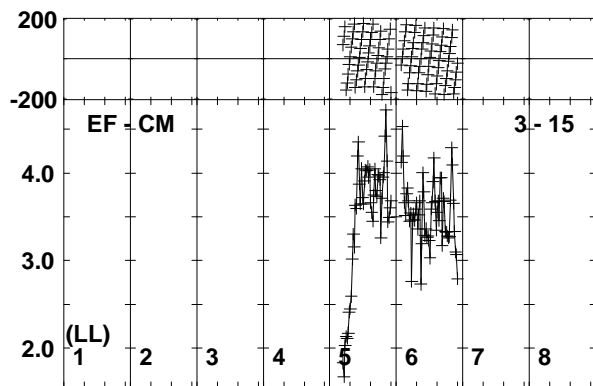
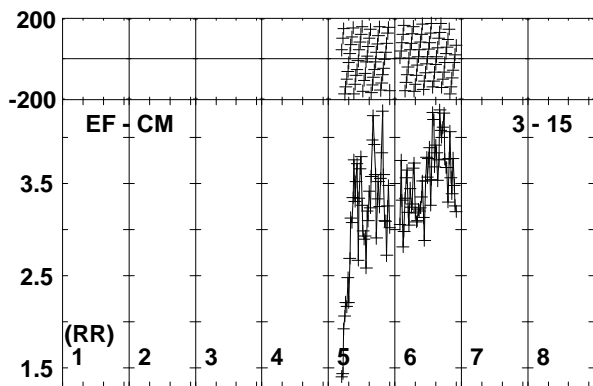
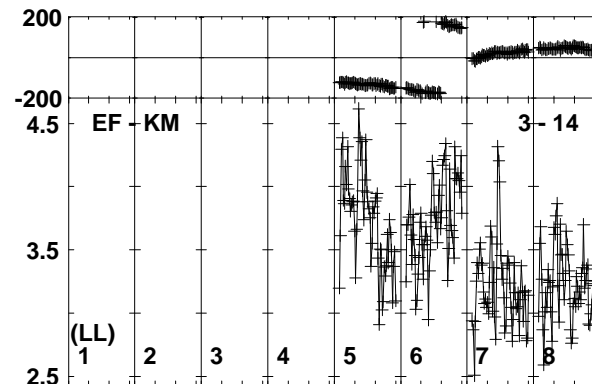
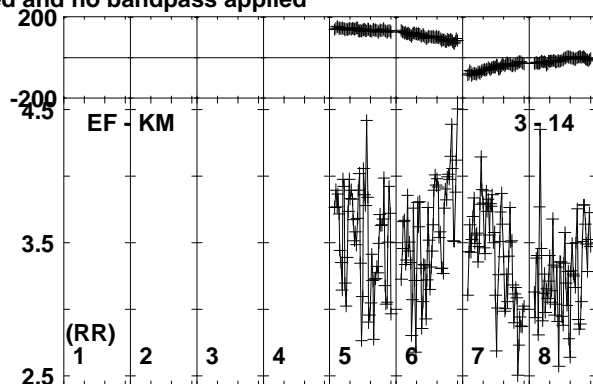
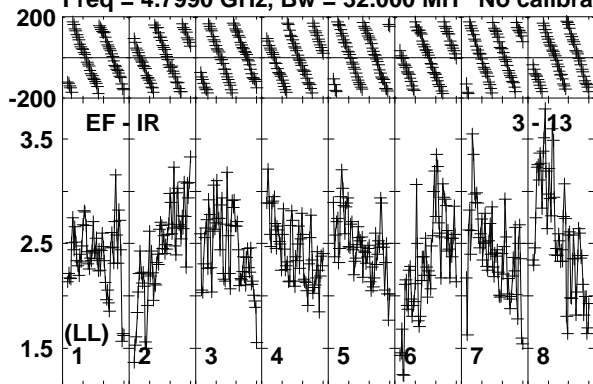

Lower frame: Milli Ampl Jy Top frame: Phas deg
Vector averaged cross-power spectrum Baseline: EF (03) - IR (13)
Timerange: 01/00:06:41 to 01/00:07:39

Plot file version 199 created 26-SEP-2019 10:40:21

J0257-1212 RG010A.UVDATA.1

Freq = 4.7990 GHz, Bw = 32.000 MH No calibration applied and no bandpass applied

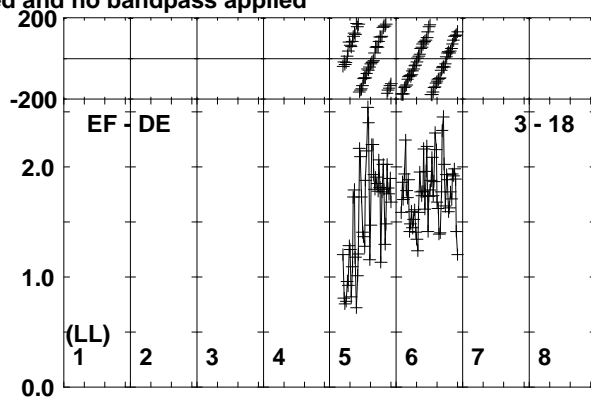
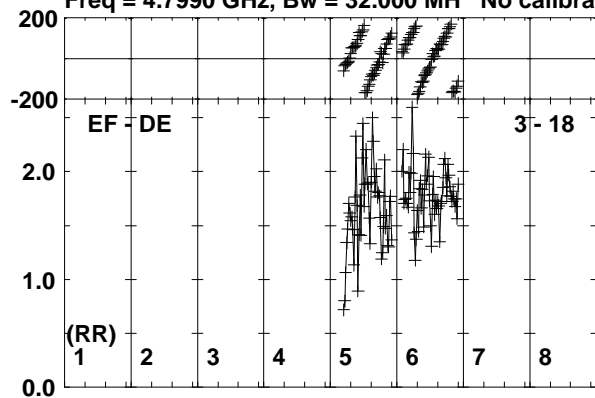

Lower frame: Milli Ampl Jy Top frame: Phas deg
Vector averaged cross-power spectrum Baseline: EF (03) - DE (18)
Timerange: 01/00:06:41 to 01/00:07:39

Plot file version 200 created 26-SEP-2019 10:40:21

190829A RG010A.UVDATA.1

Freq = 4.7990 GHz, Bw = 32.000 MH No calibration applied and no bandpass applied

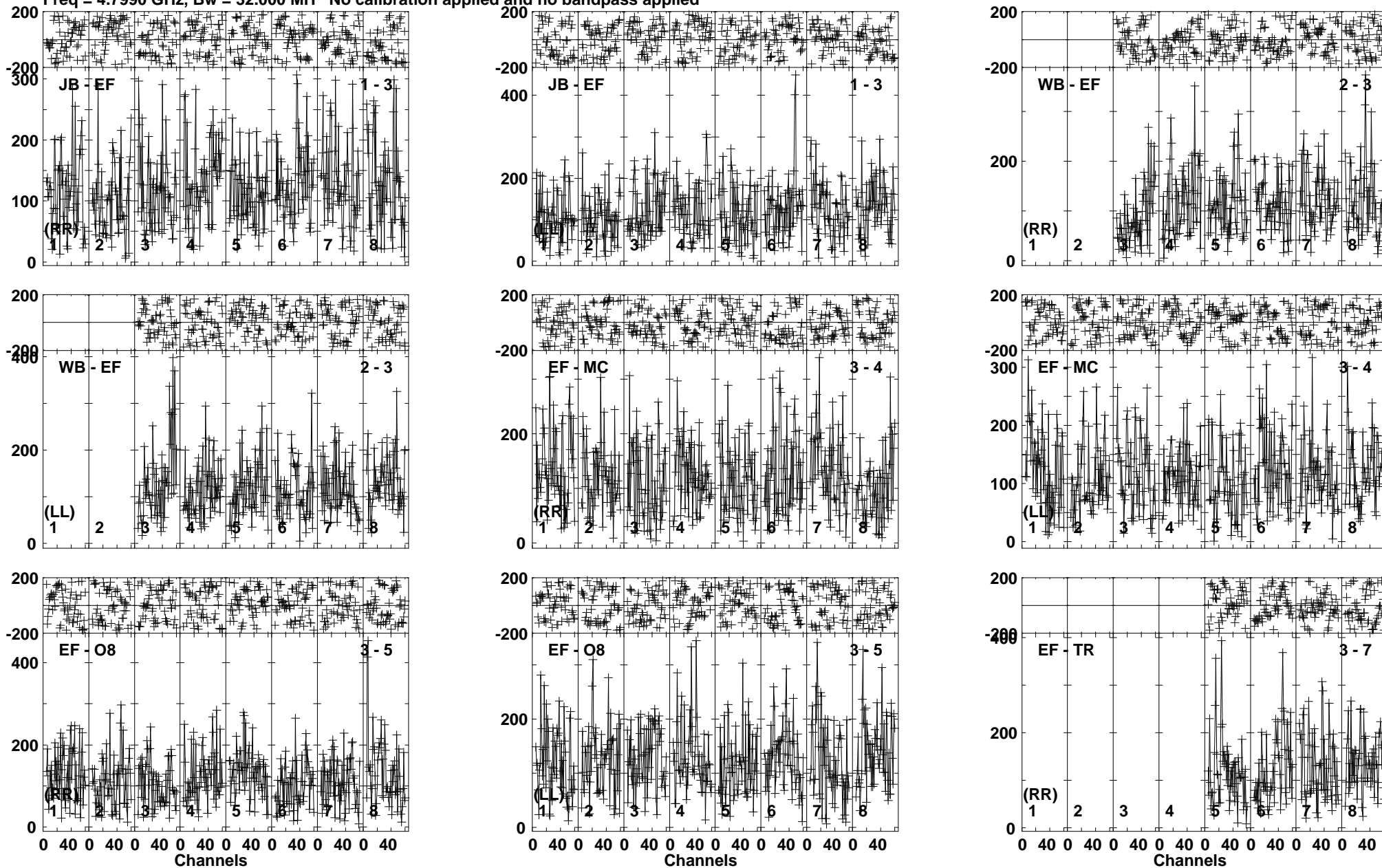

Lower frame: Micro Ampl Jy Top frame: Phas deg
Vector averaged cross-power spectrum Baseline: JB (01) - EF (03)
Timerange: 01/00:07:40 to 01/00:09:49

Plot file version 201 created 26-SEP-2019 10:40:22

190829A RG010A.UVDATA.1

Freq = 4.7990 GHz, Bw = 32.000 MH No calibration applied and no bandpass applied

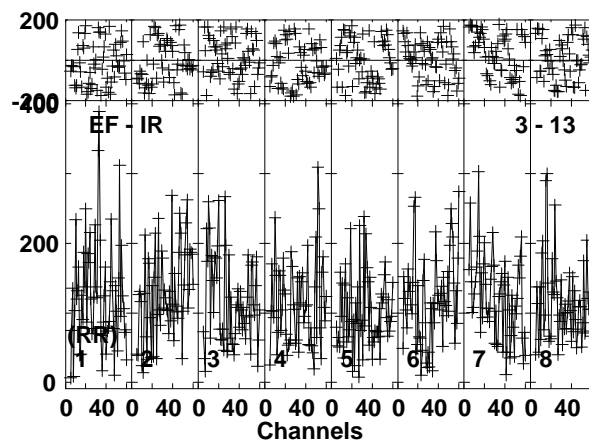
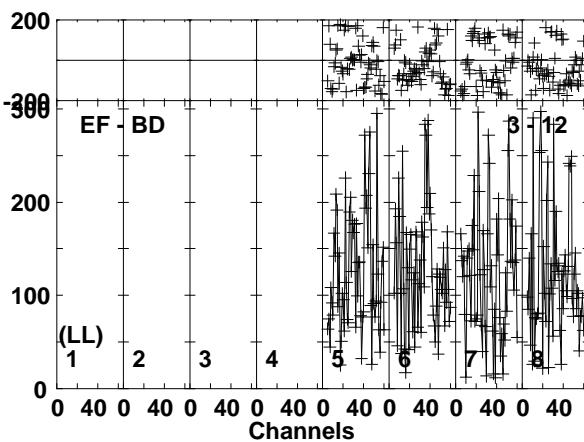
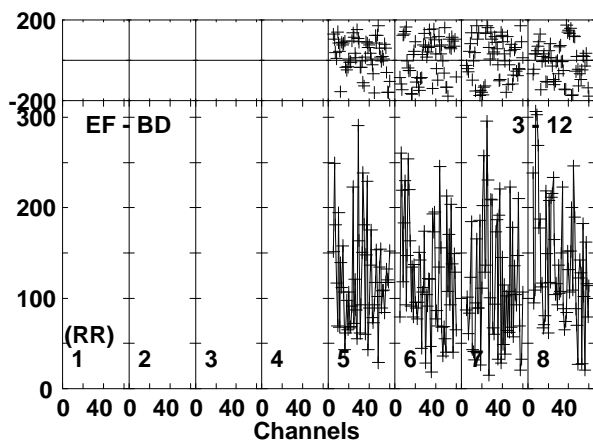
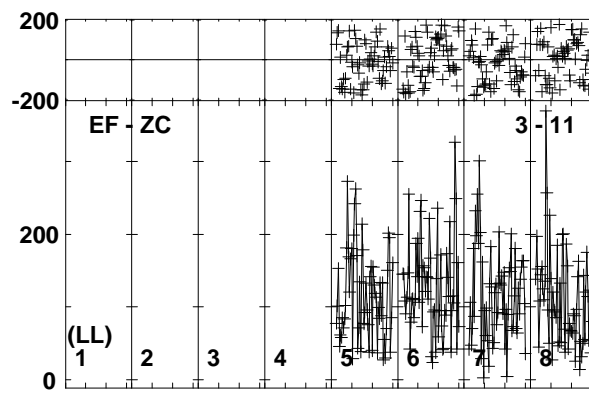
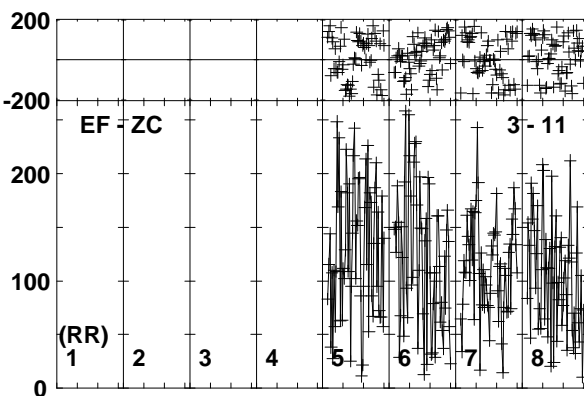
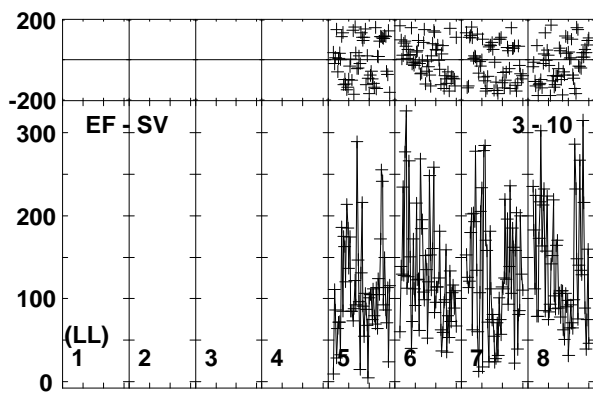
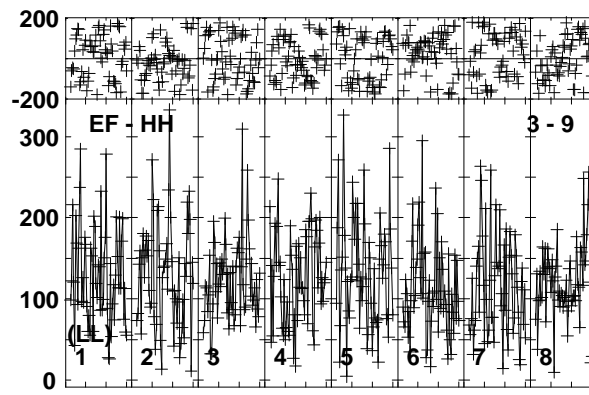
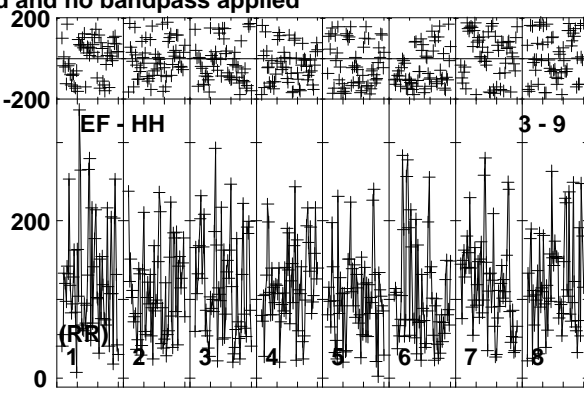
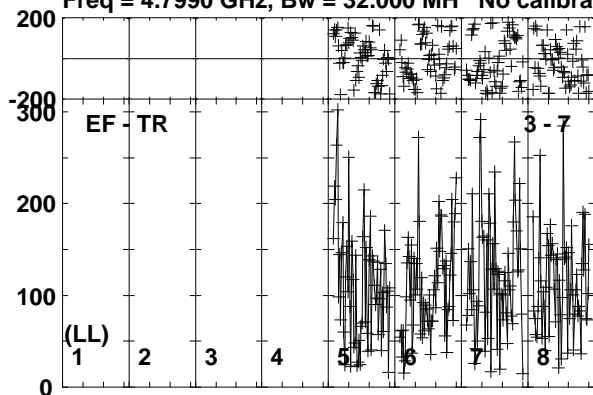

Lower frame: Micro Ampl Jy Top frame: Phas deg
Vector averaged cross-power spectrum Baseline: EF (03) - TR (07)
Timerange: 01/00:07:40 to 01/00:09:49

Plot file version 202 created 26-SEP-2019 10:40:22

190829A RG010A.UVDATA.1

Freq = 4.7990 GHz, Bw = 32.000 MH No calibration applied and no bandpass applied

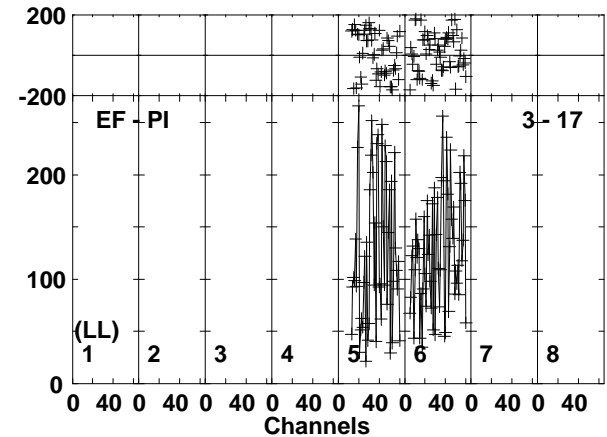
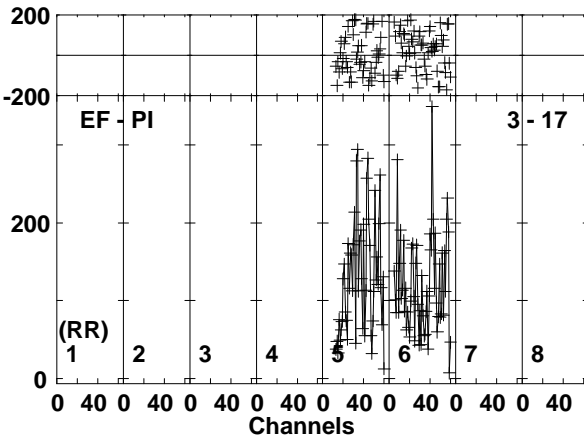
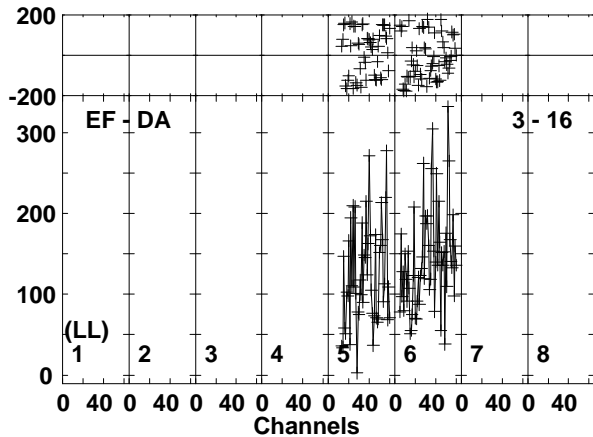
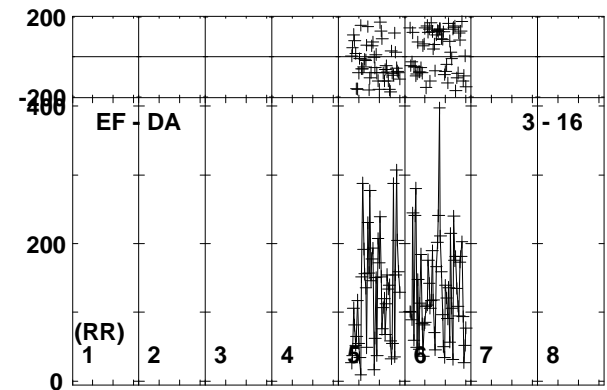
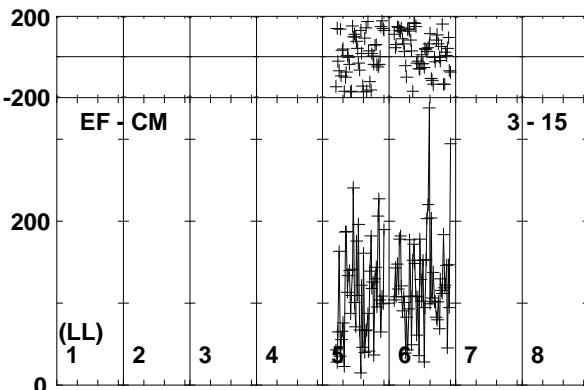
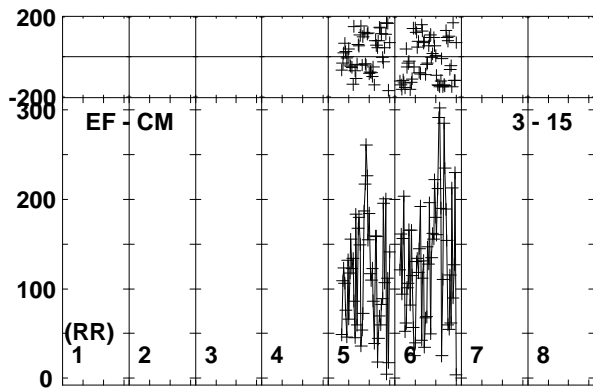
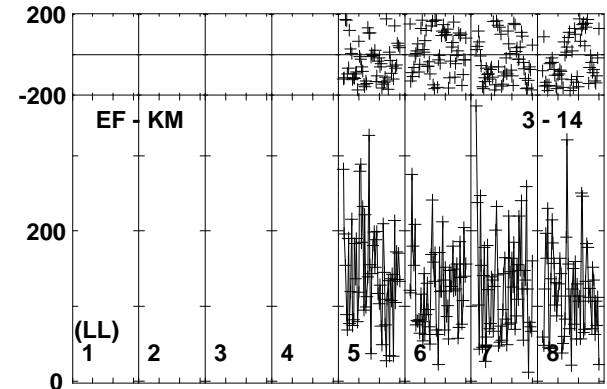
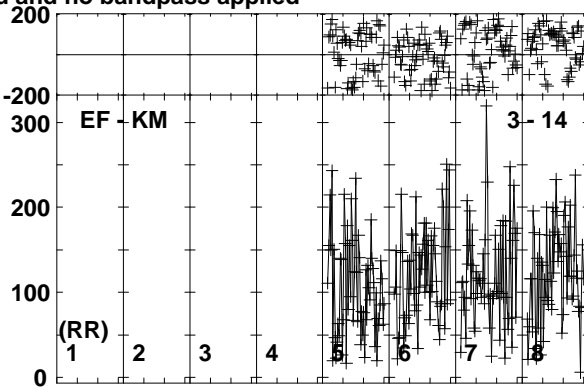
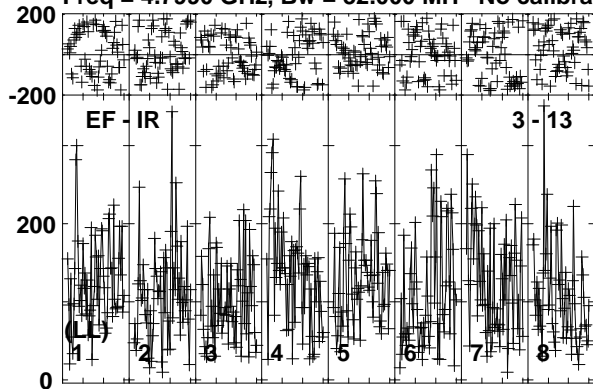

Lower frame: Micro Ampl Jy Top frame: Phas deg
Vector averaged cross-power spectrum Baseline: EF (03) - IR (13)
Timerange: 01/00:07:40 to 01/00:09:49

Plot file version 203 created 26-SEP-2019 10:40:22

190829A RG010A.UVDATA.1

Freq = 4.7990 GHz, Bw = 32.000 MH No calibration applied and no bandpass applied

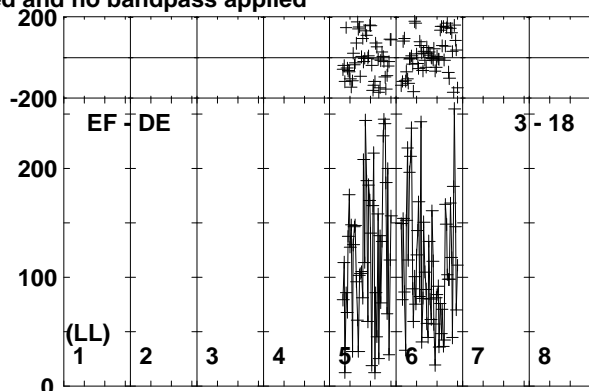
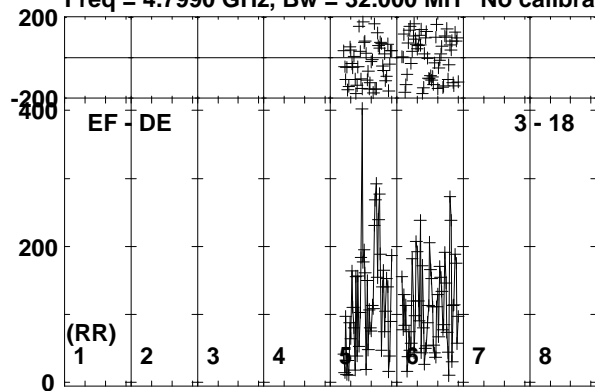

Lower frame: Micro Ampl Jy Top frame: Phas deg
Vector averaged cross-power spectrum Baseline: EF (03) - DE (18)
Timerange: 01/00:07:40 to 01/00:09:49

Plot file version 204 created 26-SEP-2019 10:40:22

J0257-1212 RG010A.UVDATA.1

Freq = 4.7990 GHz, Bw = 32.000 MH No calibration applied and no bandpass applied

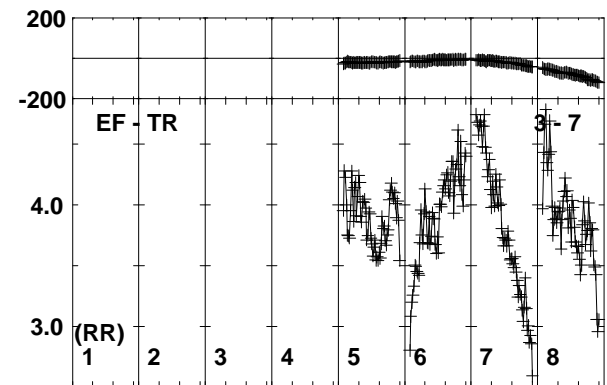
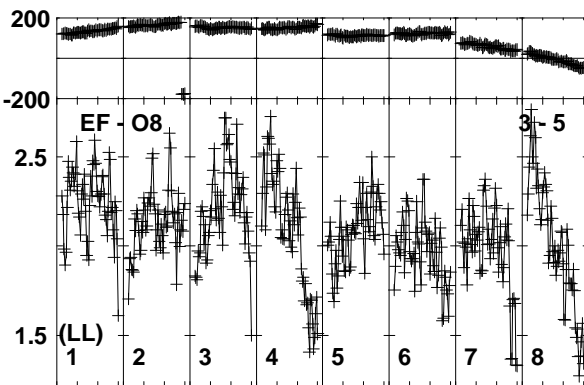
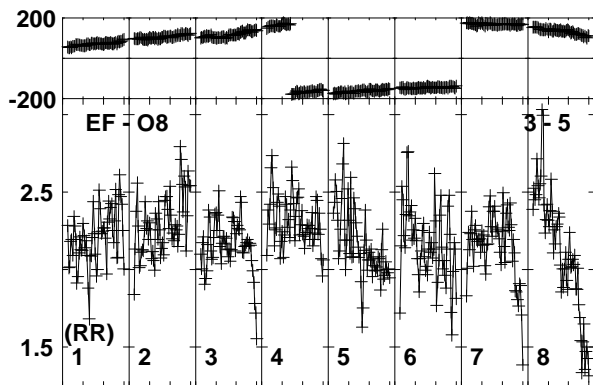
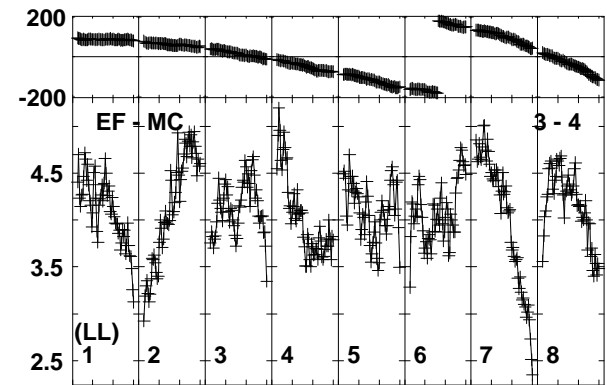
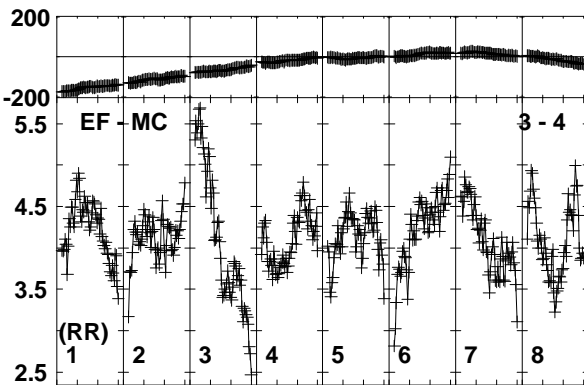
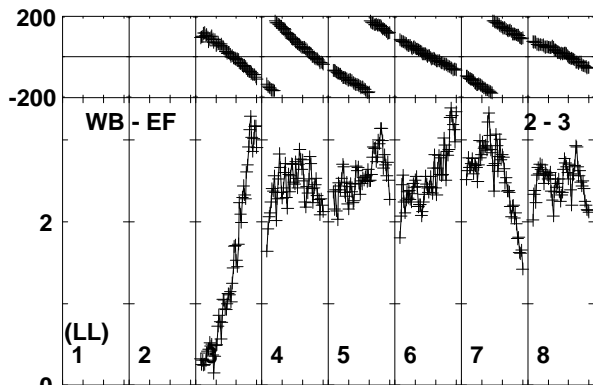
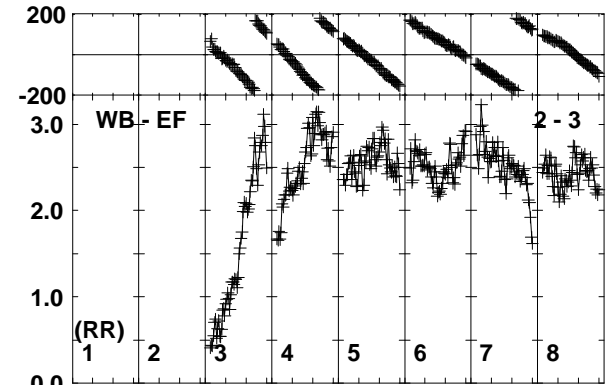
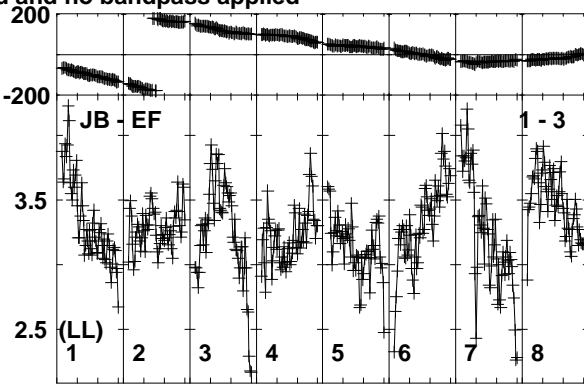
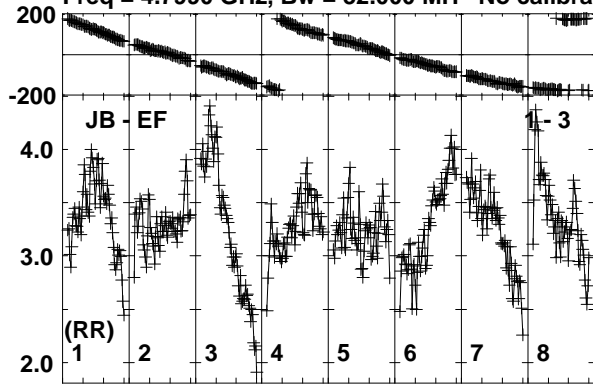

Lower frame: Milli Ampl Jy Top frame: Phas deg
Vector averaged cross-power spectrum Baseline: JB (01) - EF (03)
Timerange: 01/00:10:40 to 01/00:11:09

Plot file version 205 created 26-SEP-2019 10:40:23

J0257-1212 RG010A.UVDATA.1

Freq = 4.7990 GHz, Bw = 32.000 MH No calibration applied and no bandpass applied

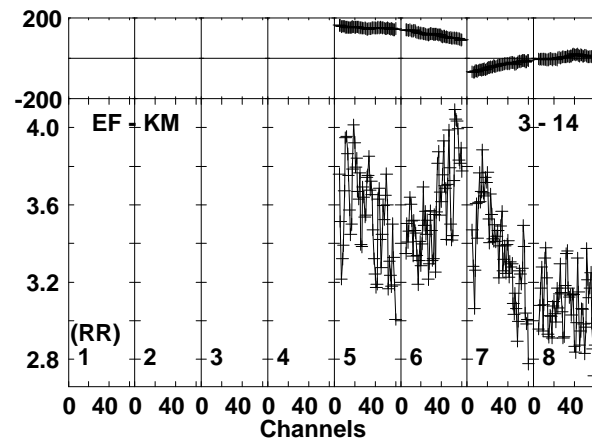
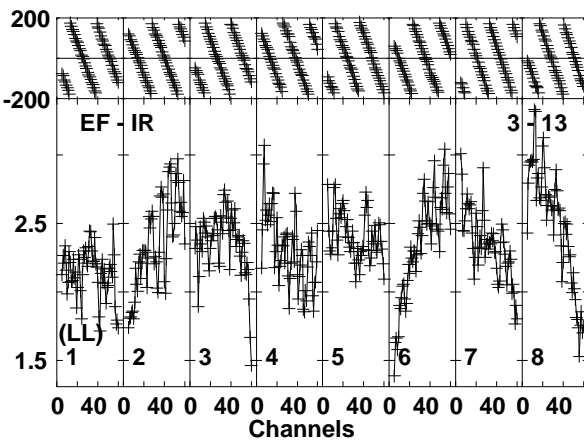
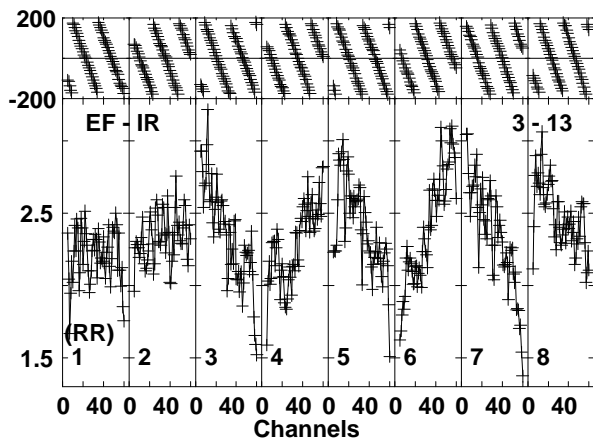
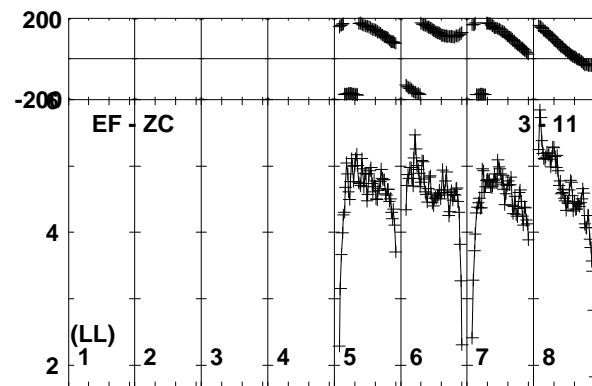
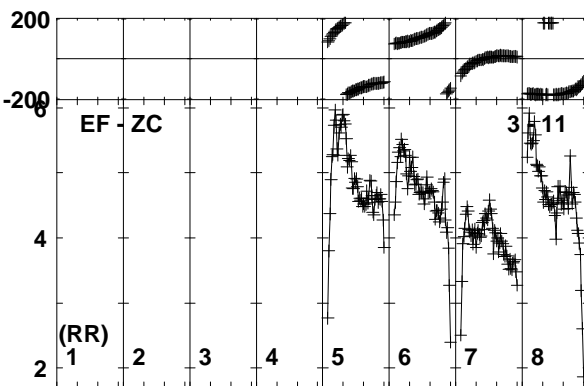
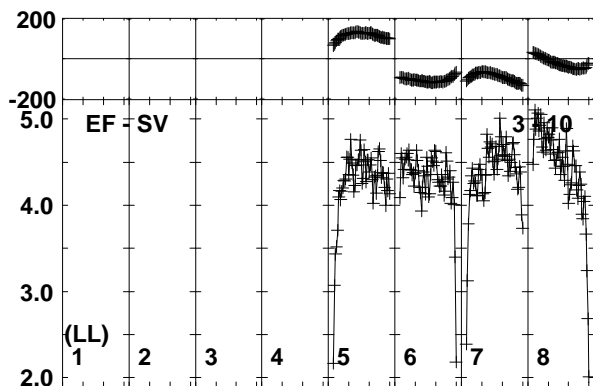
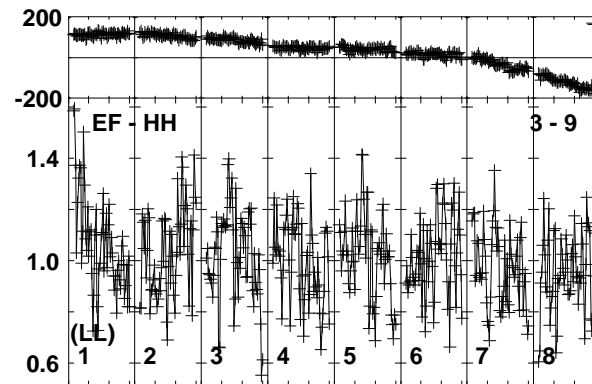
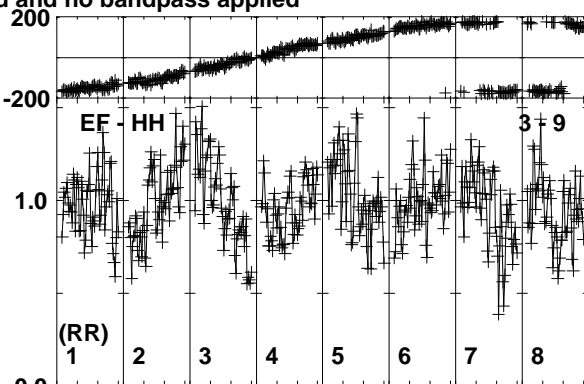
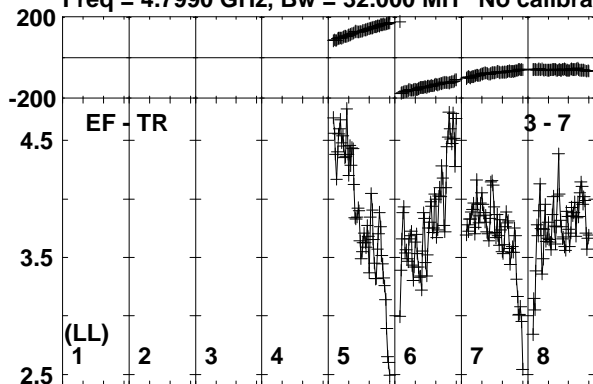

Lower frame: Milli Ampl Jy Top frame: Phas deg
Vector averaged cross-power spectrum Baseline: EF (03) - TR (07)
Timerange: 01/00:10:40 to 01/00:11:09

Plot file version 206 created 26-SEP-2019 10:40:23

J0257-1212 RG010A.UVDATA.1

Freq = 4.7990 GHz, Bw = 32.000 MH No calibration applied and no bandpass applied

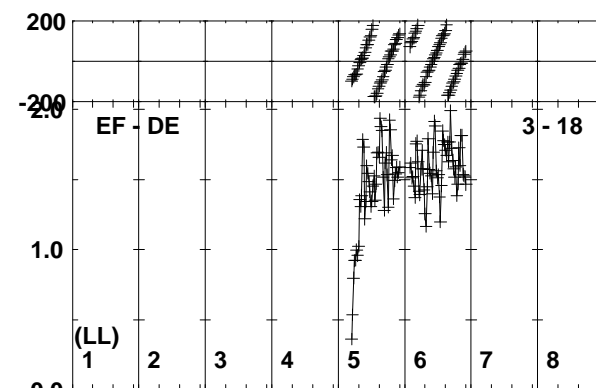
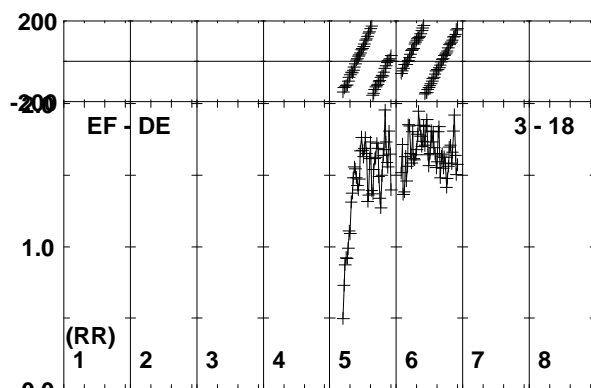
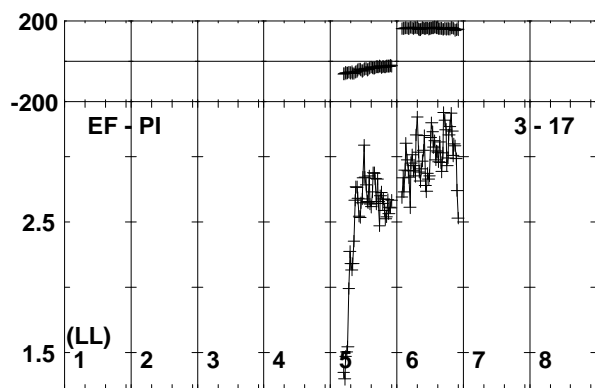
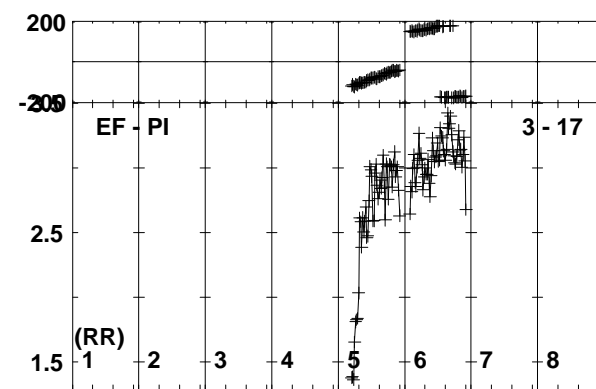
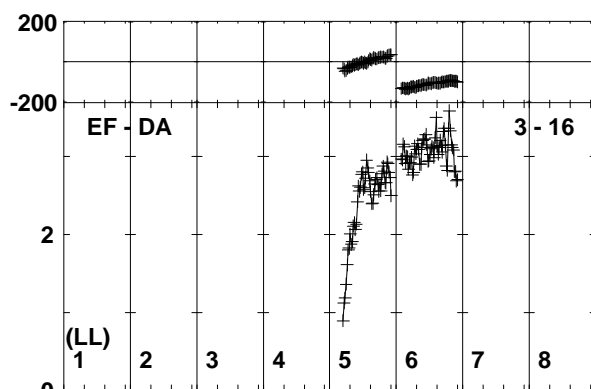
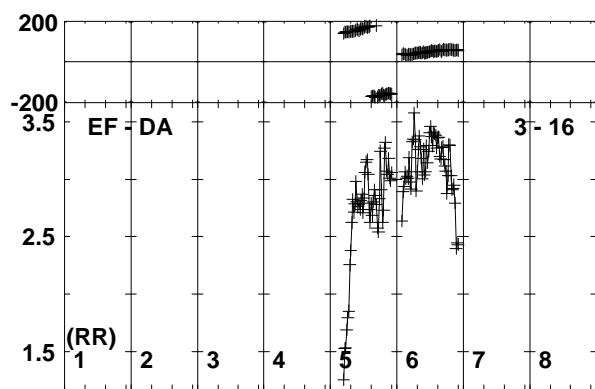
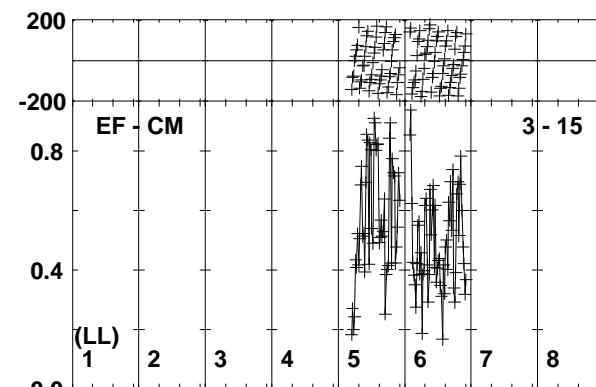
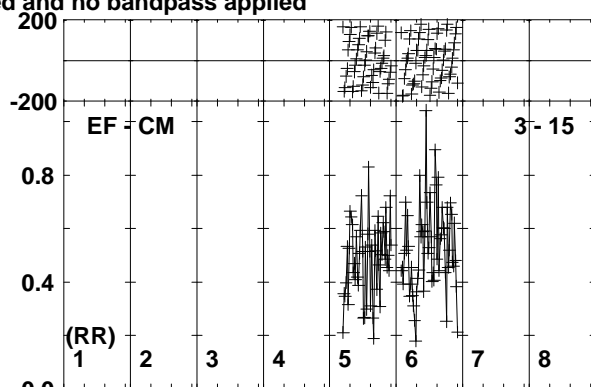
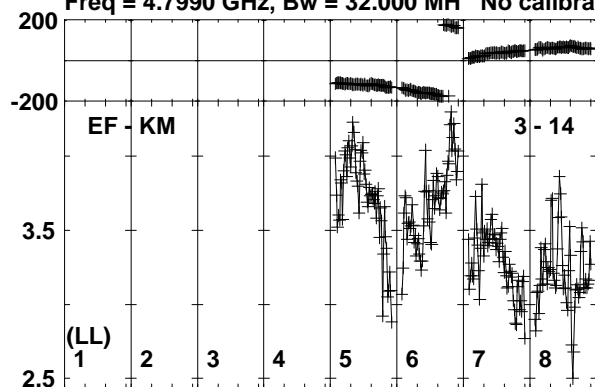

Lower frame: Milli Ampl Jy Top frame: Phas deg
Vector averaged cross-power spectrum Baseline: EF (03) - KM (14)
Timerange: 01/00:10:40 to 01/00:11:09

Plot file version 207 created 26-SEP-2019 10:40:23

J0300-0846 RG010A.UVDATA.1

Freq = 4.7990 GHz, Bw = 32.000 MH No calibration applied and no bandpass applied

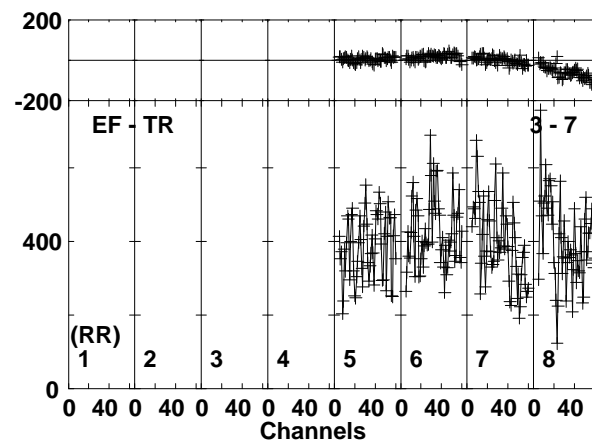
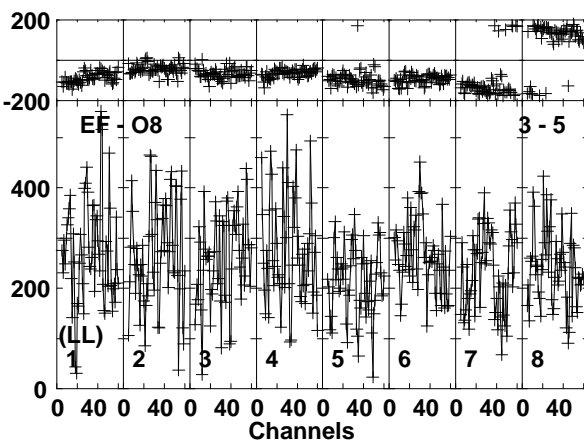
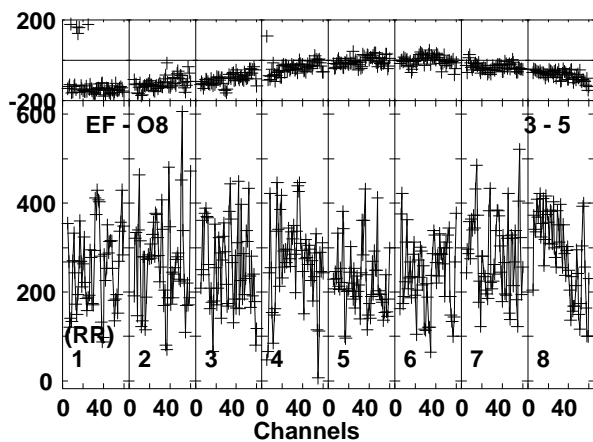
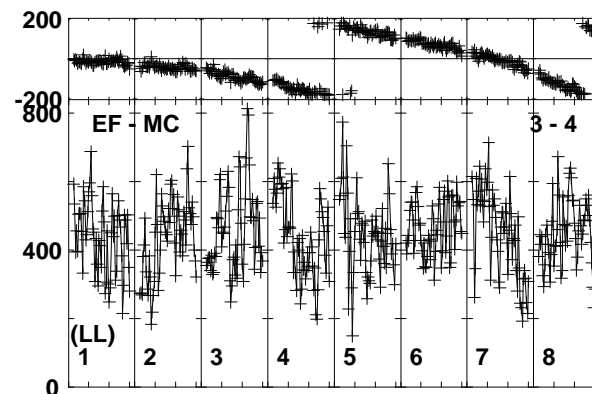
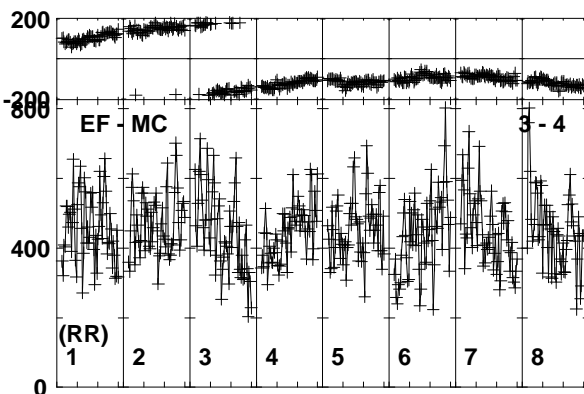
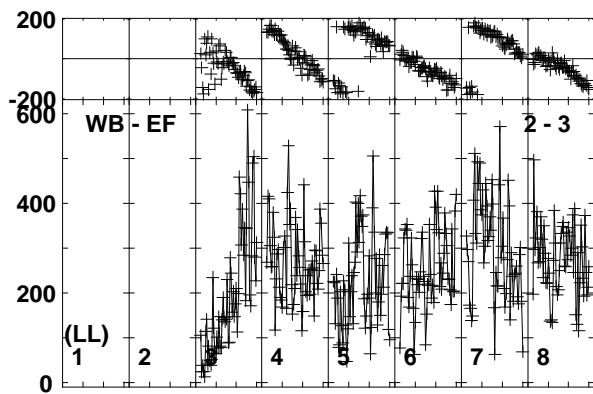
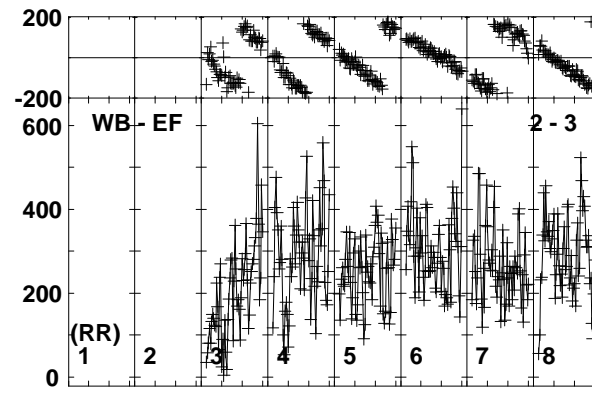
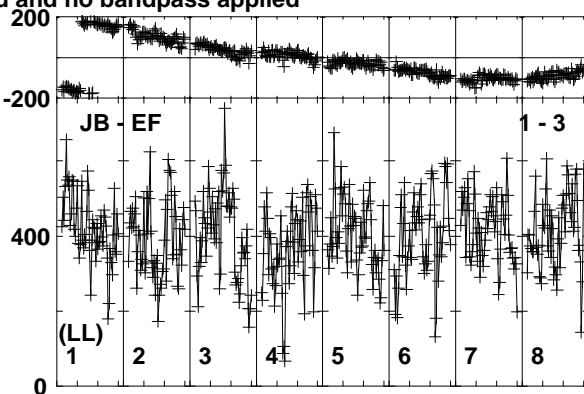
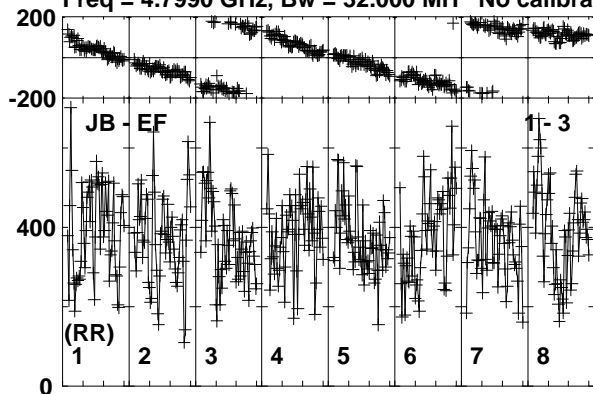

Lower frame: Micro Ampl Jy Top frame: Phas deg
Vector averaged cross-power spectrum Baseline: JB (01) - EF (03)
Timerange: 01/00:11:11 to 01/00:13:20

Plot file version 208 created 26-SEP-2019 10:40:24

J0300-0846 RG010A.UVDATA.1

Freq = 4.7990 GHz, Bw = 32.000 MH No calibration applied and no bandpass applied

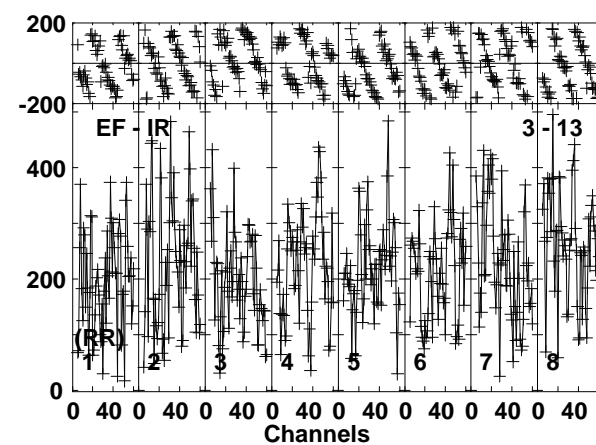
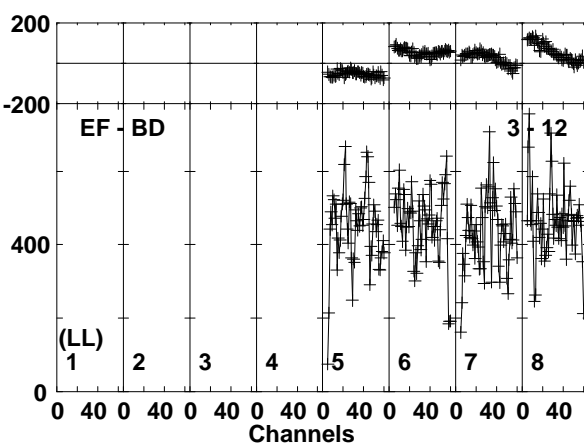
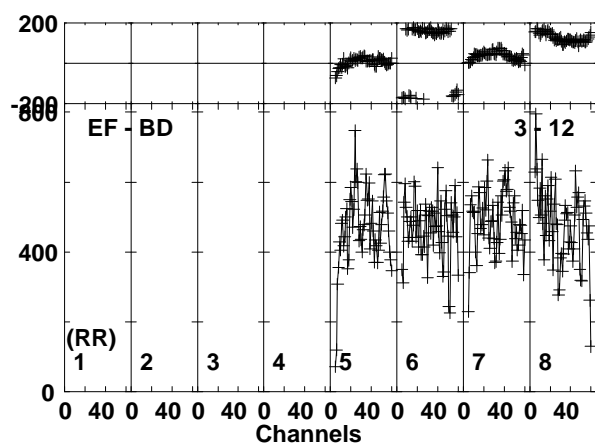
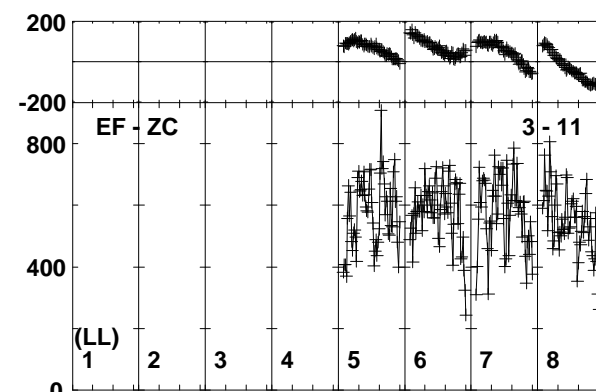
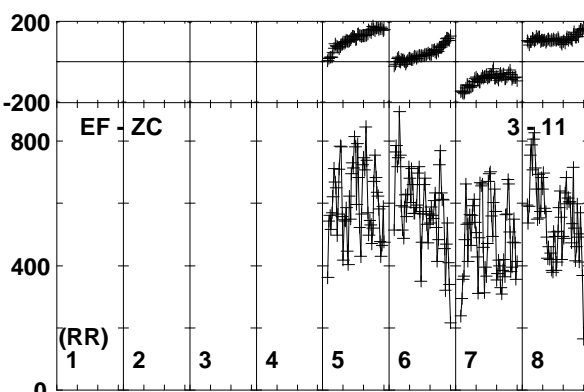
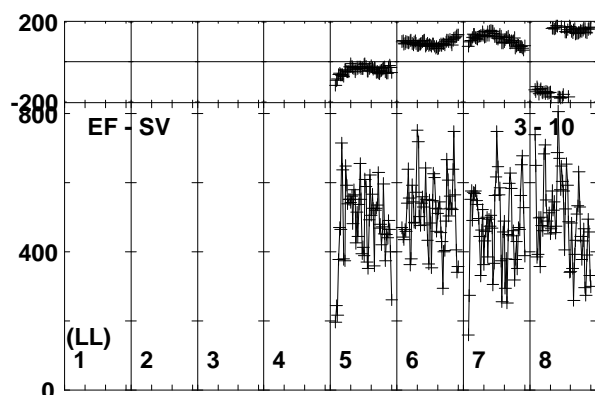
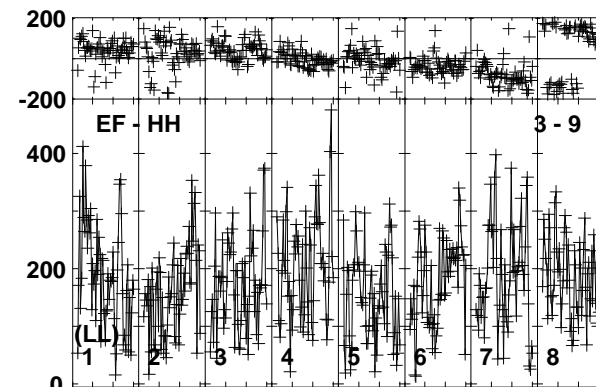
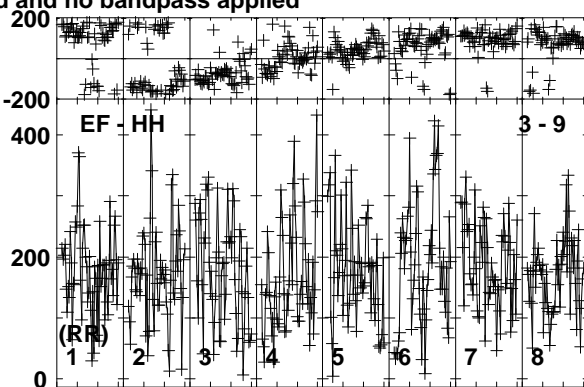
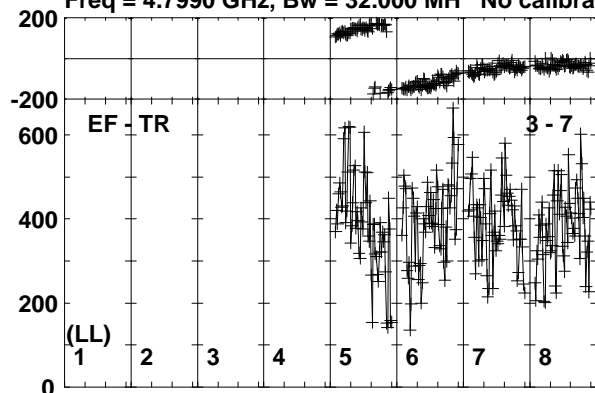

Lower frame: Micro Ampl Jy Top frame: Phas deg
Vector averaged cross-power spectrum Baseline: EF (03) - TR (07)
Timerange: 01/00:11:11 to 01/00:13:20

Plot file version 209 created 26-SEP-2019 10:40:24

J0300-0846 RG010A.UVDATA.1

Freq = 4.7990 GHz, Bw = 32.000 MH No calibration applied and no bandpass applied

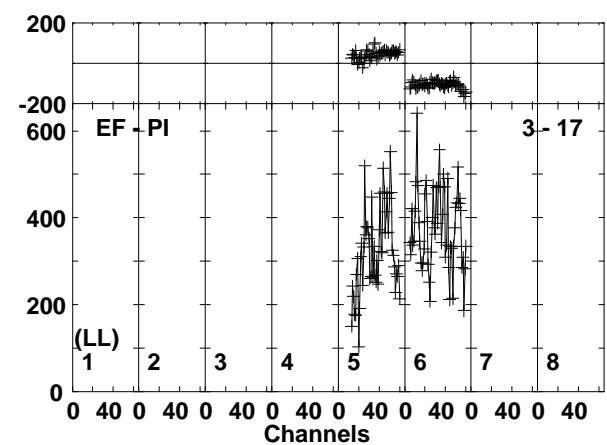
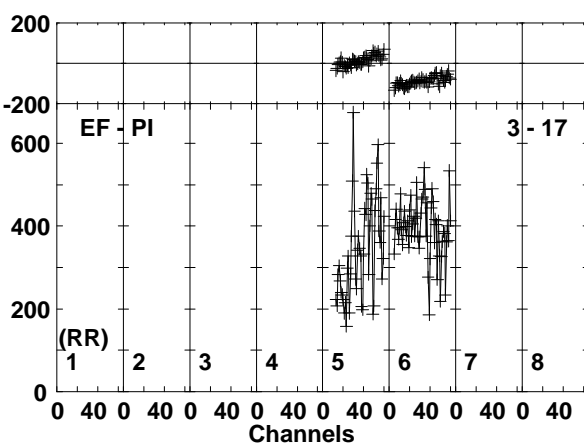
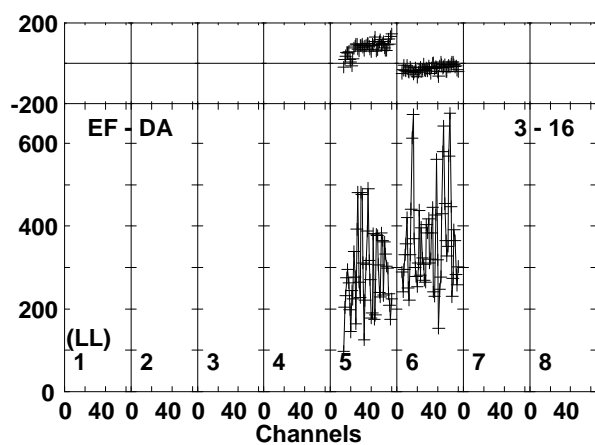
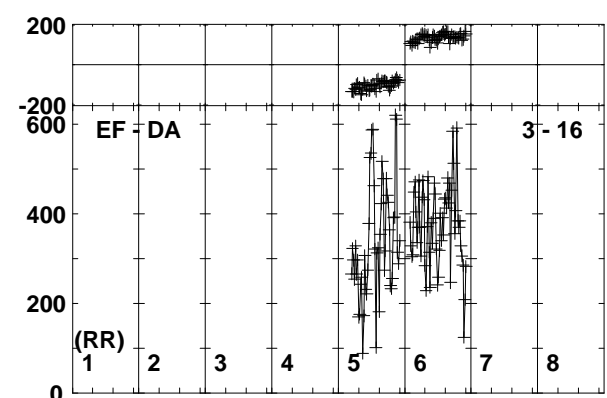
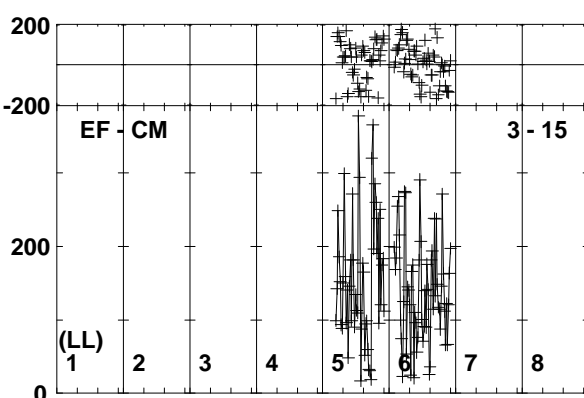
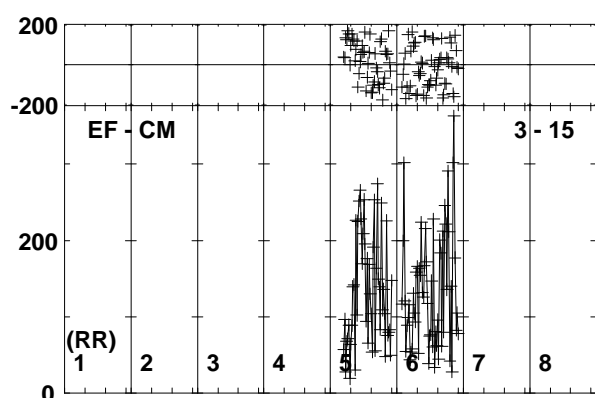
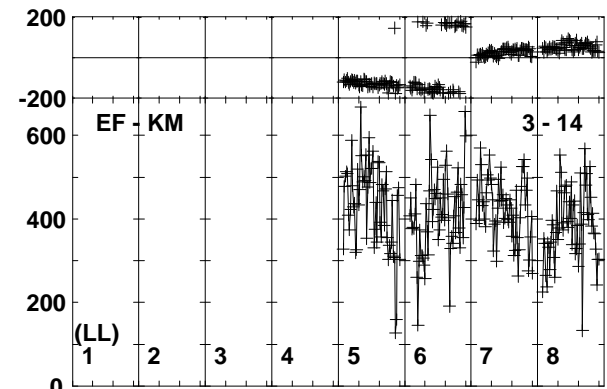
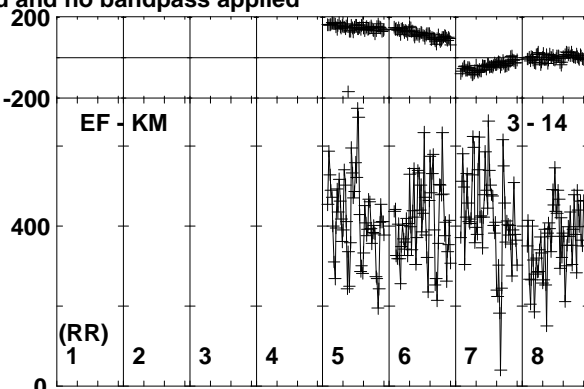
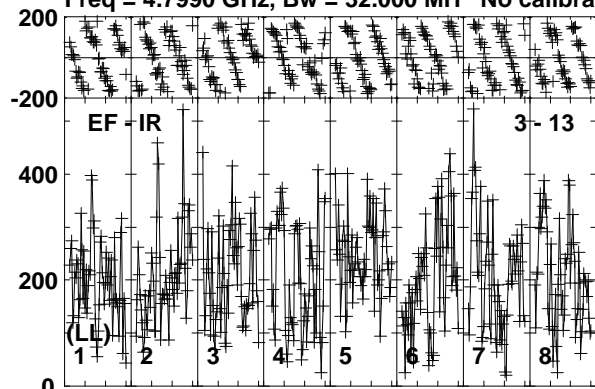

Lower frame: Micro Ampl Jy Top frame: Phas deg
Vector averaged cross-power spectrum Baseline: EF (03) - IR (13)
Timerange: 01/00:11:11 to 01/00:13:20

Plot file version 210 created 26-SEP-2019 10:40:25

J0300-0846 RG010A.UVDATA.1

Freq = 4.7990 GHz, Bw = 32.000 MH No calibration applied and no bandpass applied

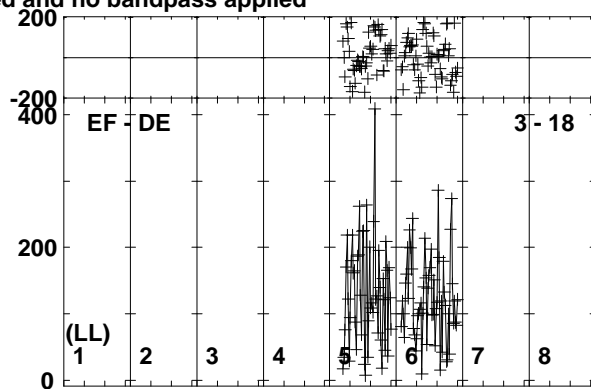
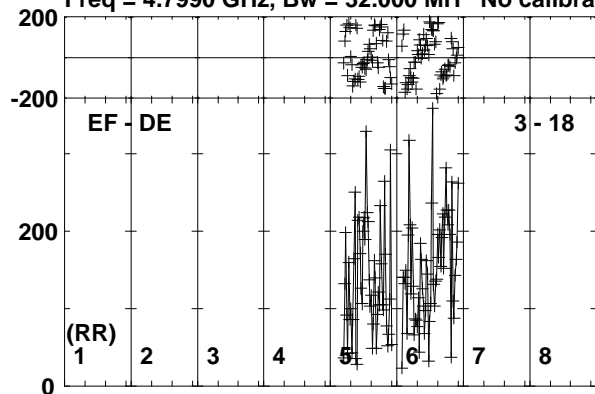

Lower frame: Micro Ampl Jy Top frame: Phas deg
Vector averaged cross-power spectrum Baseline: EF (03) - DE (18)
Timerange: 01/00:11:11 to 01/00:13:20

Plot file version 211 created 26-SEP-2019 10:40:25

J0257-1212 RG010A.UVDATA.1

Freq = 4.7990 GHz, Bw = 32.000 MH No calibration applied and no bandpass applied

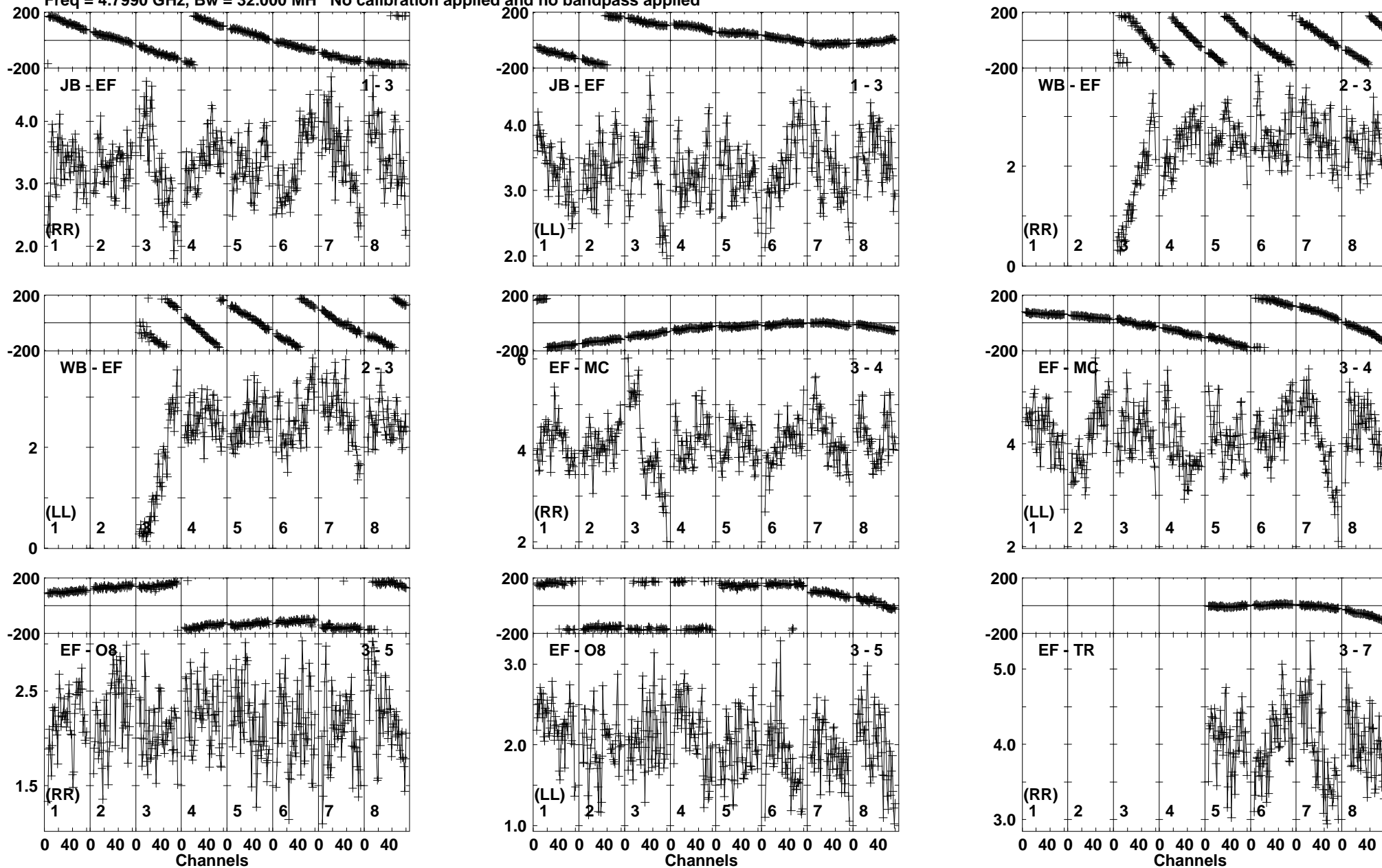

Lower frame: Milli Ampl Jy Top frame: Phas deg
Vector averaged cross-power spectrum Baseline: JB (01) - EF (03)
Timerange: 01/00:13:21 to 01/00:14:19

Plot file version 212 created 26-SEP-2019 10:40:25

J0257-1212 RG010A.UVDATA.1

Freq = 4.7990 GHz, Bw = 32.000 MH No calibration applied and no bandpass applied

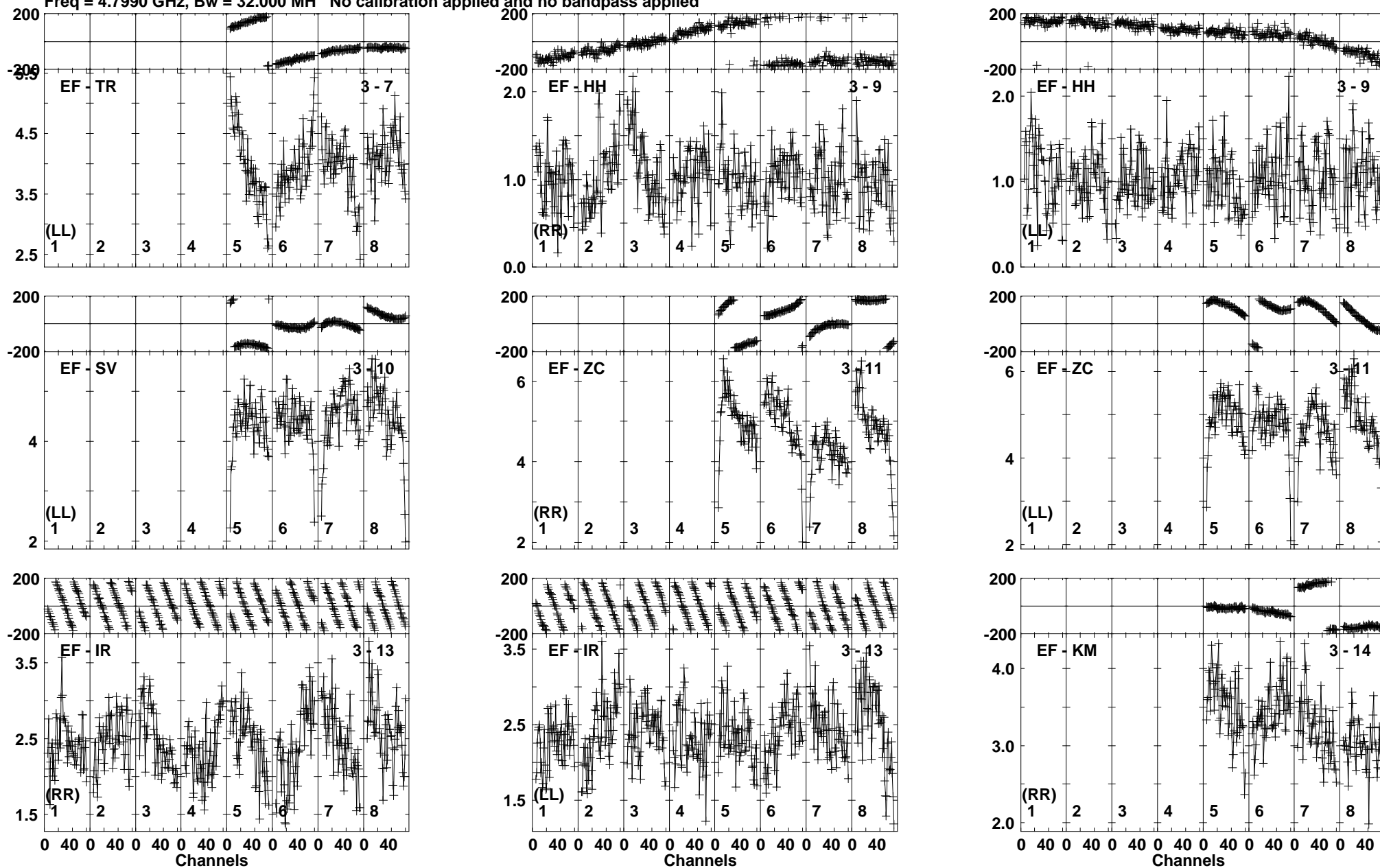

Lower frame: Milli Ampl Jy Top frame: Phas deg
Vector averaged cross-power spectrum Baseline: EF (03) - TR (07)
Timerange: 01/00:13:21 to 01/00:14:19

Plot file version 213 created 26-SEP-2019 10:40:25

J0257-1212 RG010A.UVDATA.1

Freq = 4.7990 GHz, Bw = 32.000 MH No calibration applied and no bandpass applied

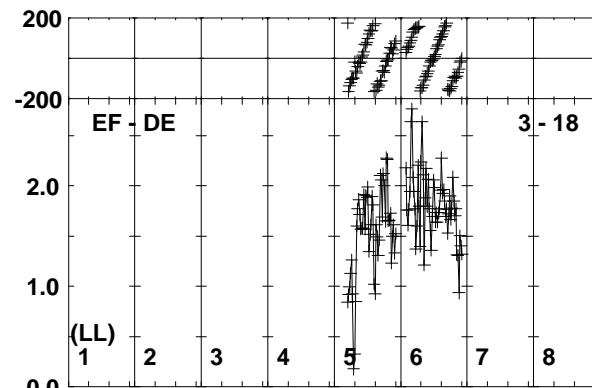
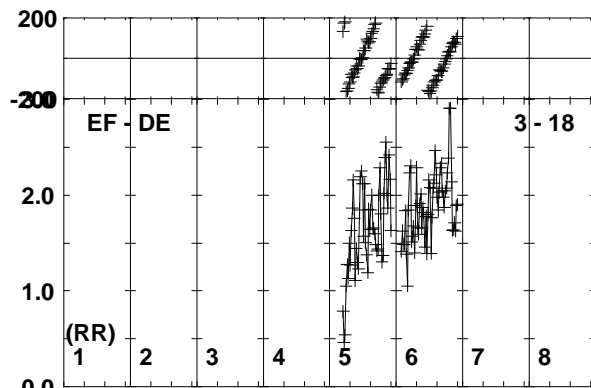
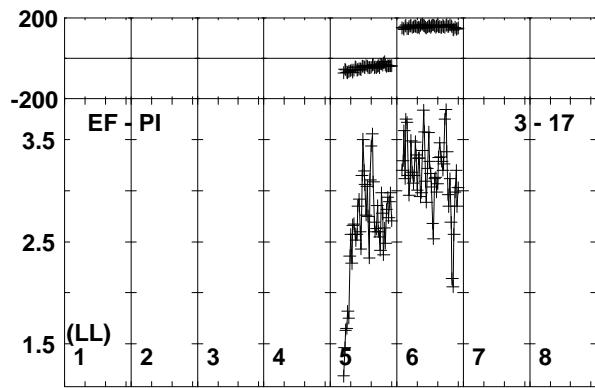
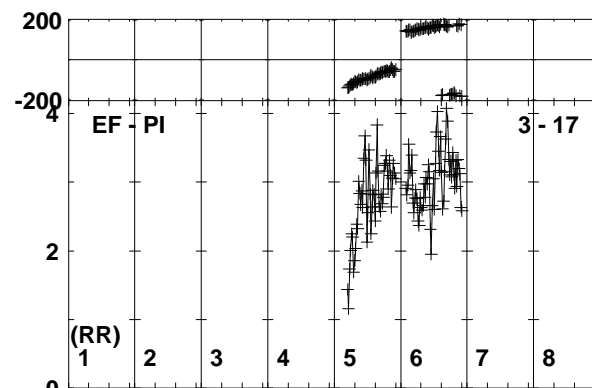
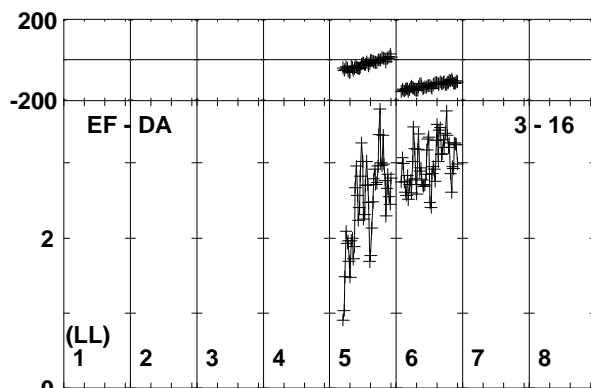
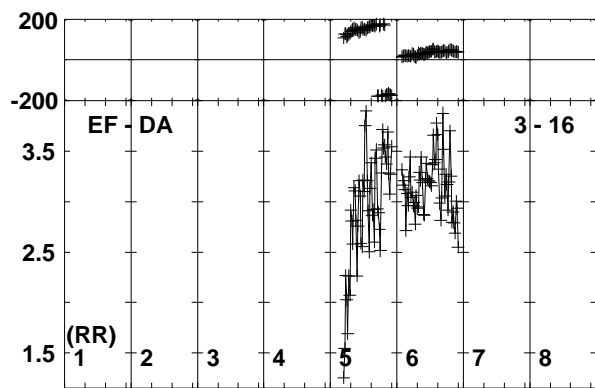
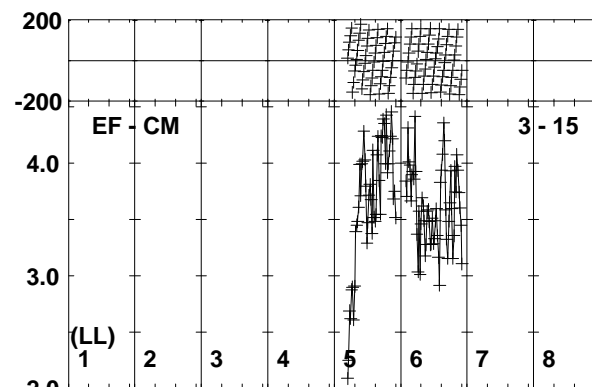
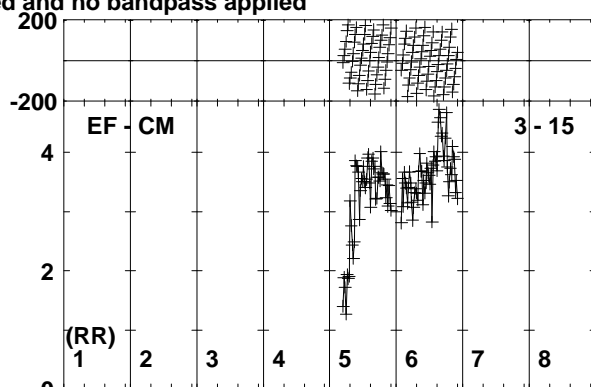
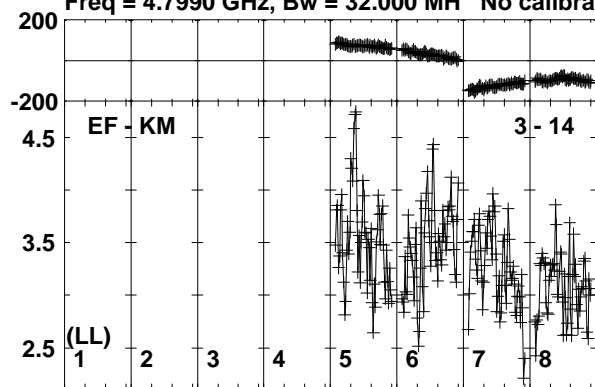

Lower frame: Milli Ampl Jy Top frame: Phas deg
Vector averaged cross-power spectrum Baseline: EF (03) - KM (14)
Timerange: 01/00:13:21 to 01/00:14:19

Plot file version 214 created 26-SEP-2019 10:40:26

190829A RG010A.UVDATA.1

Freq = 4.7990 GHz, Bw = 32.000 MH No calibration applied and no bandpass applied

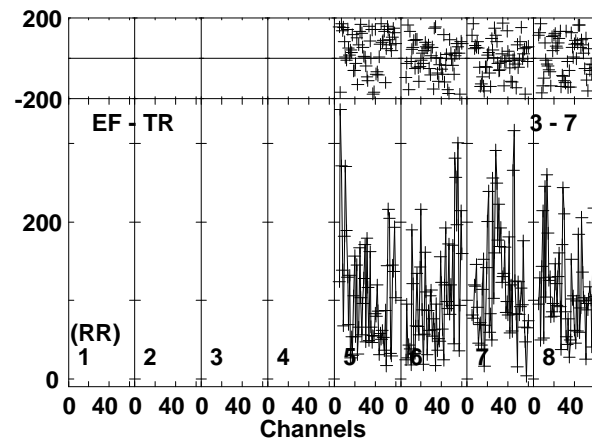
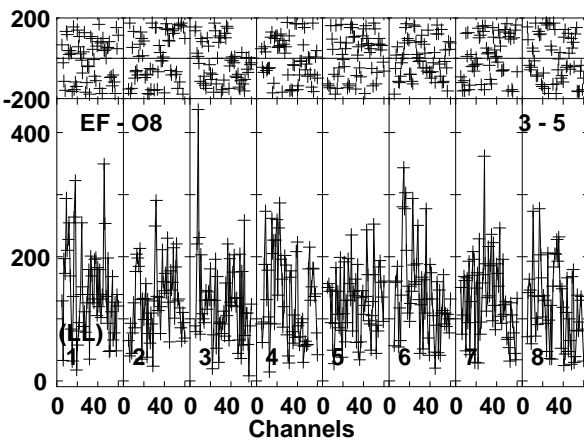
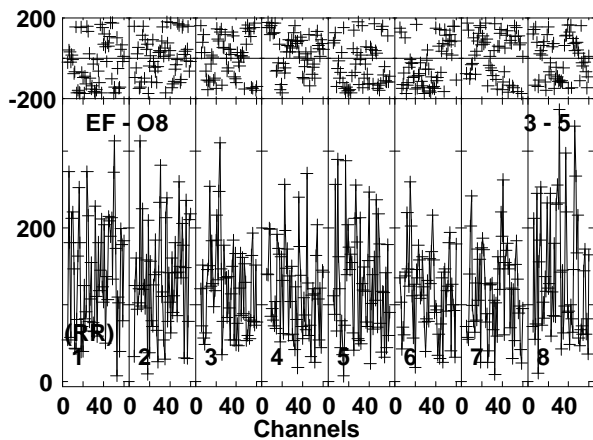
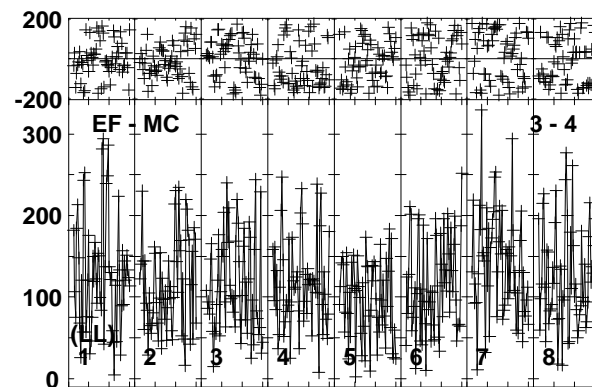
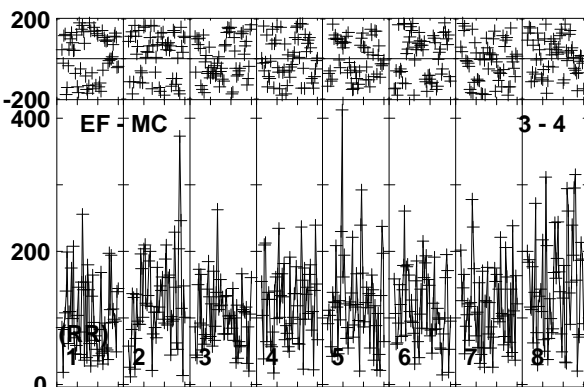
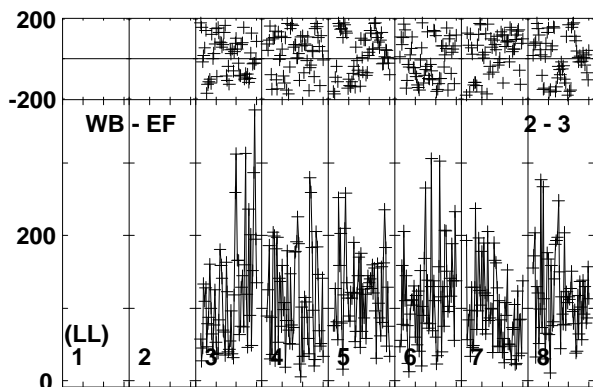
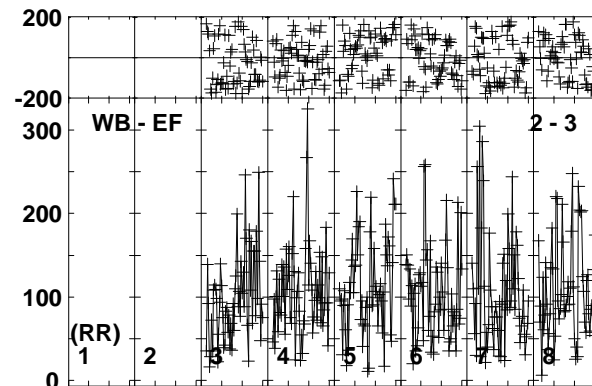
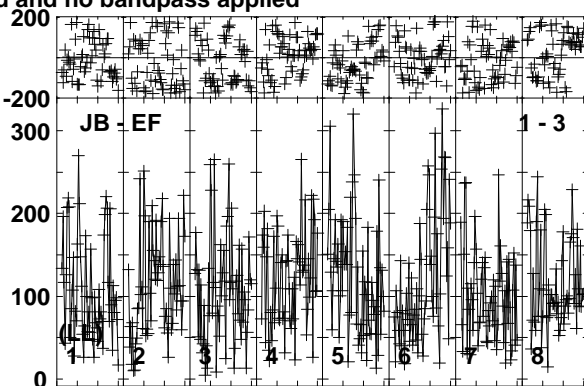
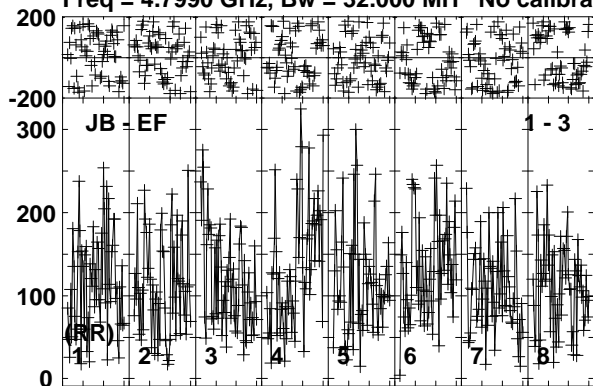

Lower frame: Micro Ampl Jy Top frame: Phas deg
Vector averaged cross-power spectrum Baseline: JB (01) - EF (03)
Timerange: 01/00:14:20 to 01/00:16:29

Plot file version 215 created 26-SEP-2019 10:40:26

190829A RG010A.UVDATA.1

Freq = 4.7990 GHz, Bw = 32.000 MH No calibration applied and no bandpass applied

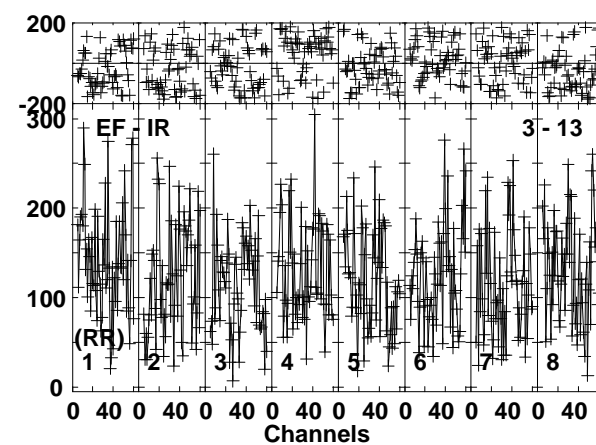
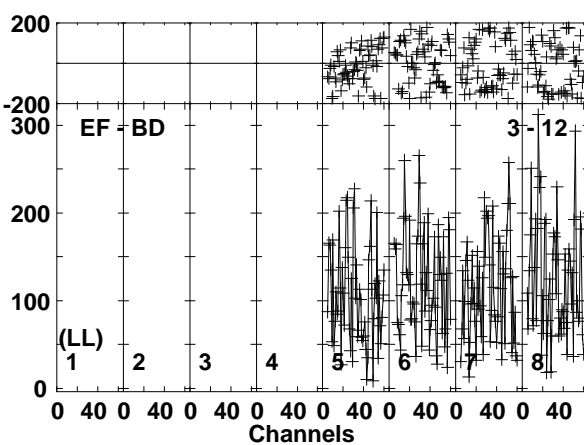
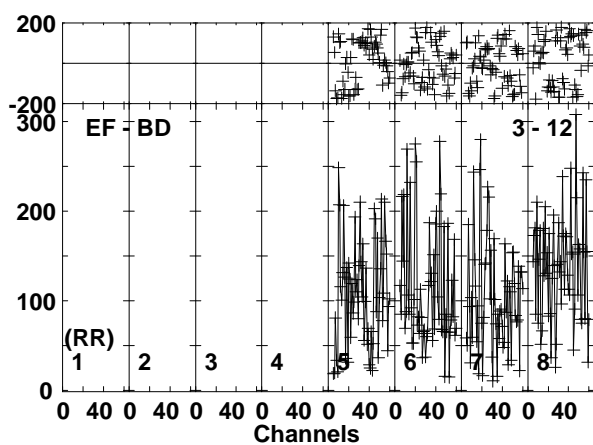
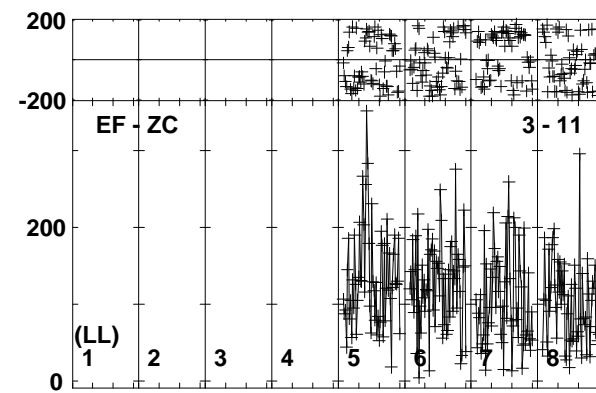
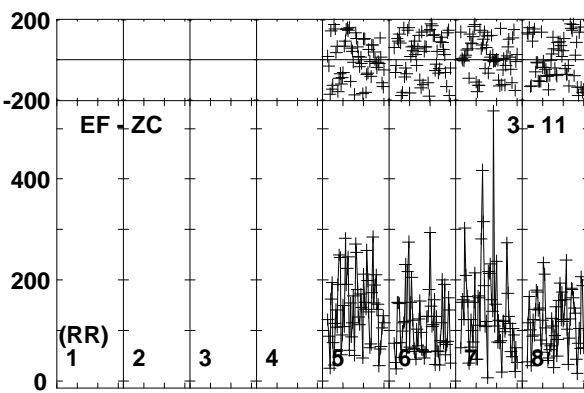
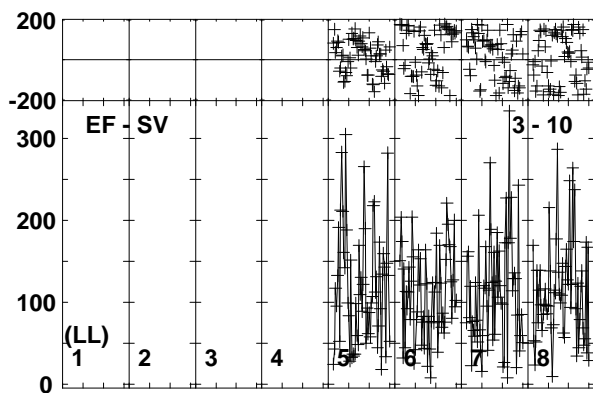
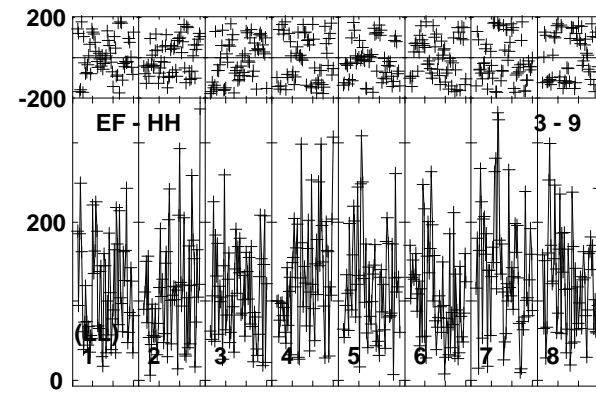
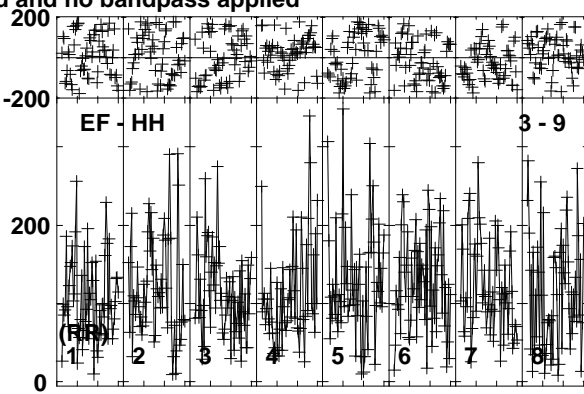
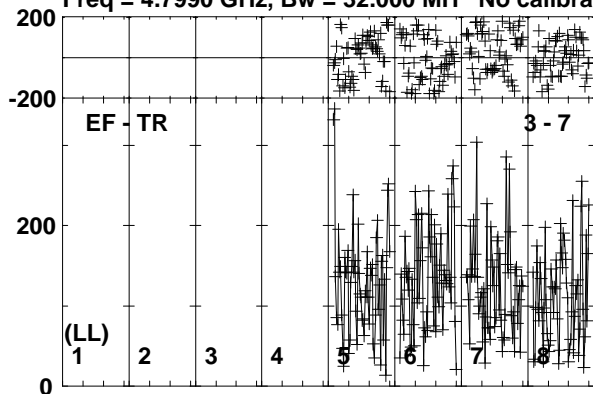

Lower frame: Micro Ampl Jy Top frame: Phas deg
Vector averaged cross-power spectrum Baseline: EF (03) - TR (07)
Timerange: 01/00:14:20 to 01/00:16:29

Plot file version 216 created 26-SEP-2019 10:40:27

190829A RG010A.UVDATA.1

Freq = 4.7990 GHz, Bw = 32.000 MH No calibration applied and no bandpass applied

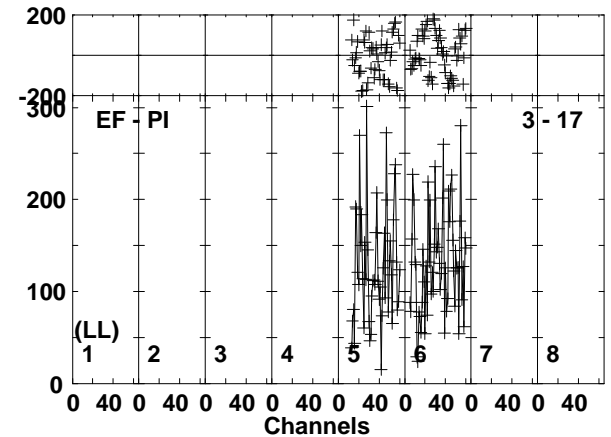
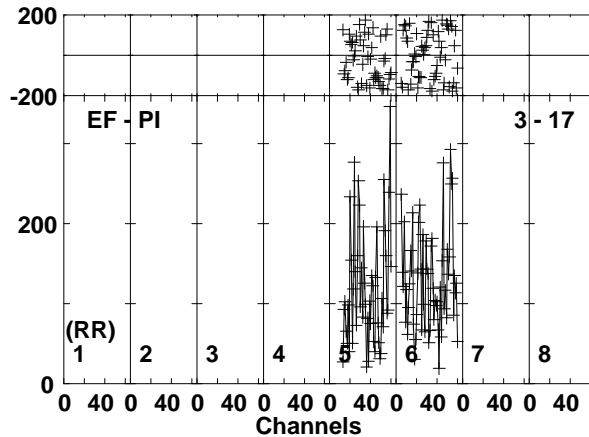
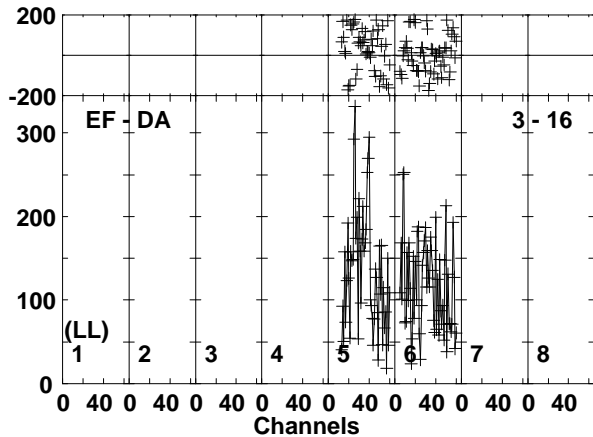
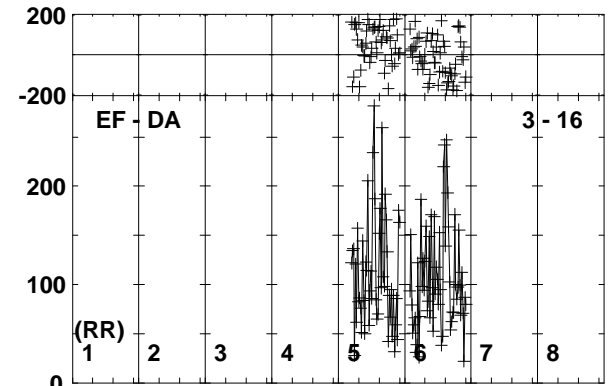
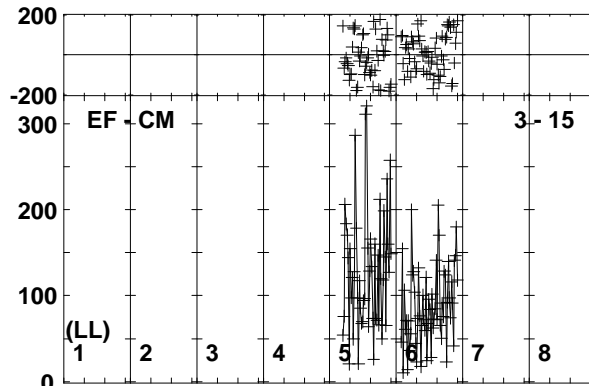
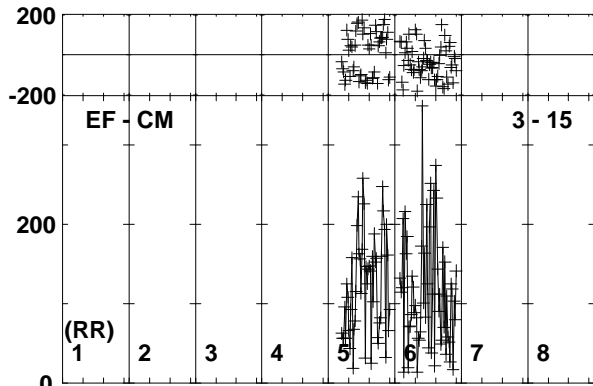
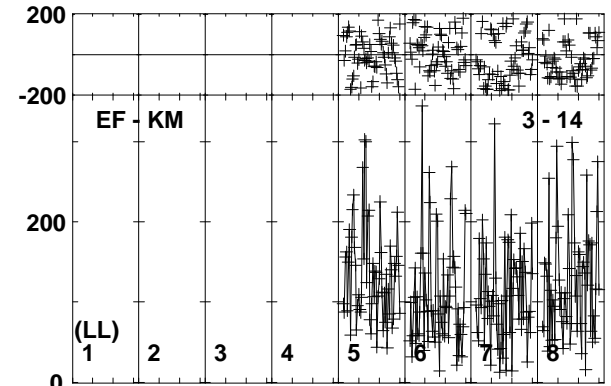
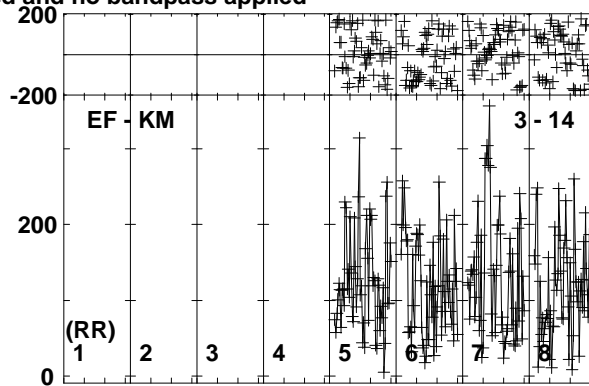
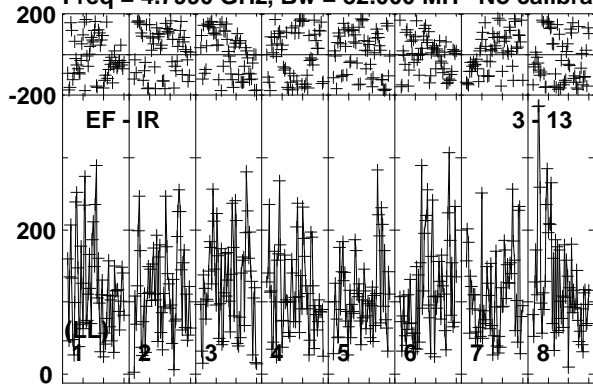

Lower frame: Micro Ampl Jy Top frame: Phas deg
Vector averaged cross-power spectrum Baseline: EF (03) - IR (13)
Timerange: 01/00:14:20 to 01/00:16:29

Plot file version 217 created 26-SEP-2019 10:40:27

190829A RG010A.UVDATA.1

Freq = 4.7990 GHz, Bw = 32.000 MH No calibration applied and no bandpass applied

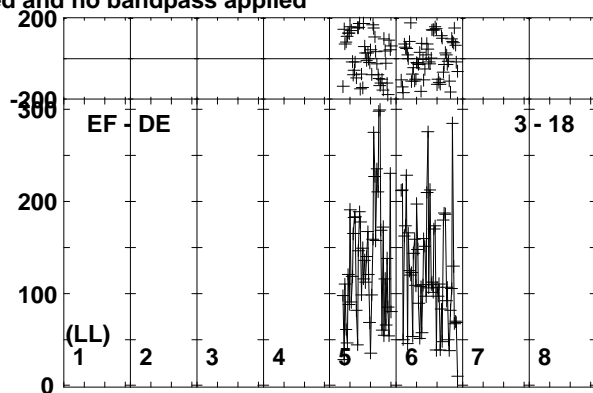
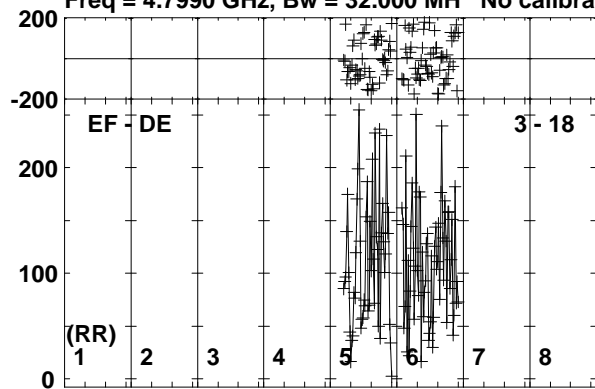

Lower frame: Micro Ampl Jy Top frame: Phas deg
Vector averaged cross-power spectrum Baseline: EF (03) - DE (18)
Timerange: 01/00:14:20 to 01/00:16:29

Plot file version 218 created 26-SEP-2019 10:40:27

J0257-1212 RG010A.UVDATA.1

Freq = 4.7990 GHz, Bw = 32.000 MH No calibration applied and no bandpass applied

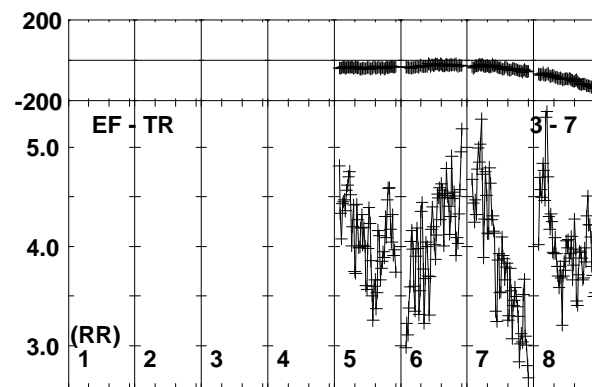
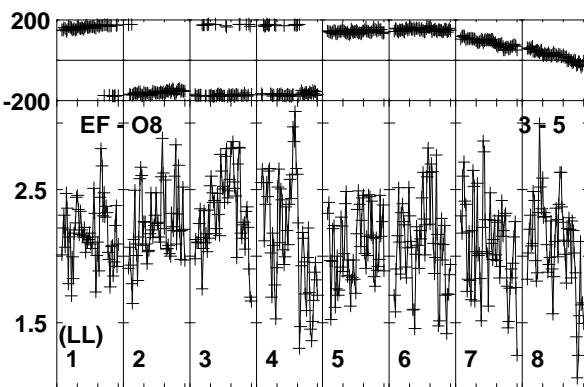
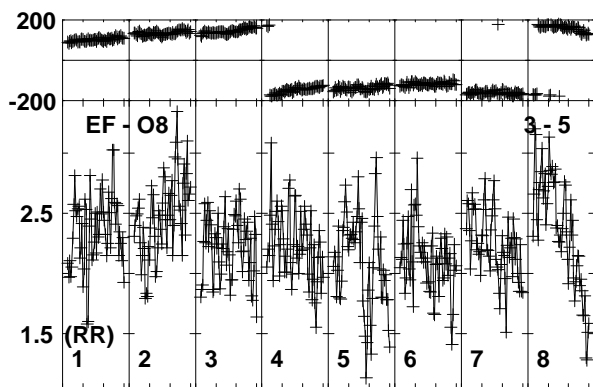
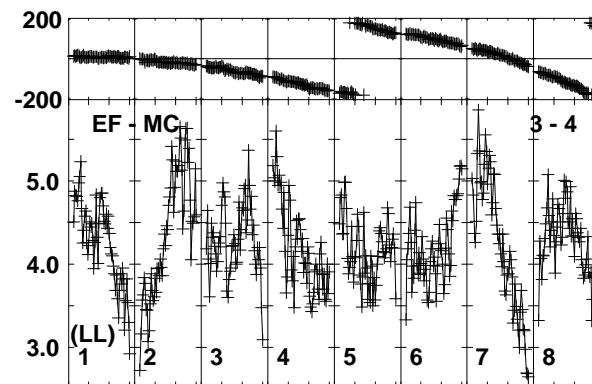
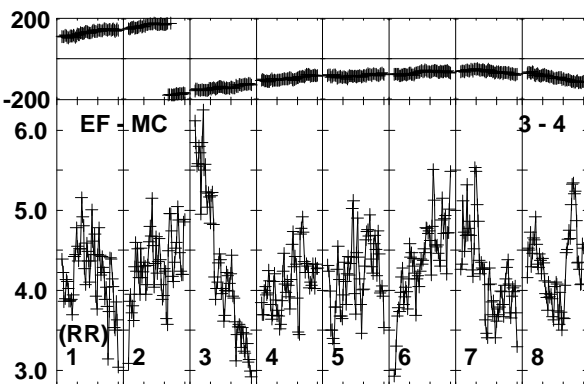
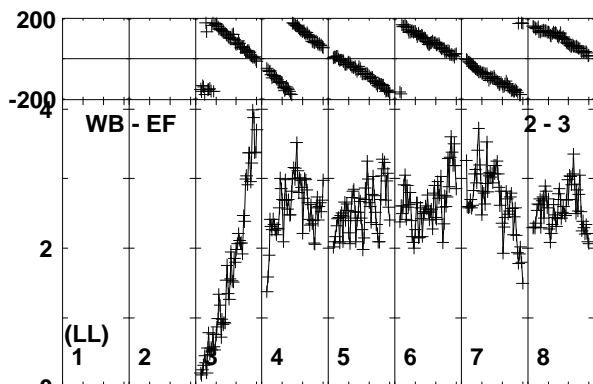
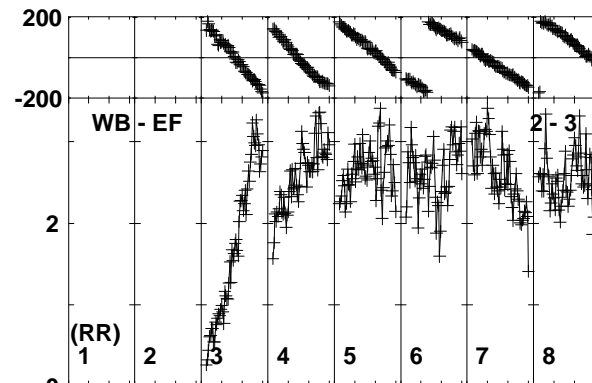
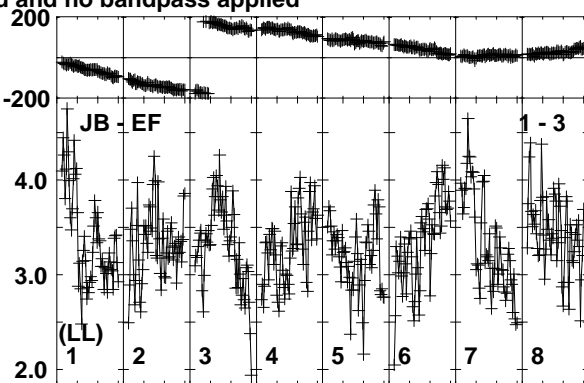
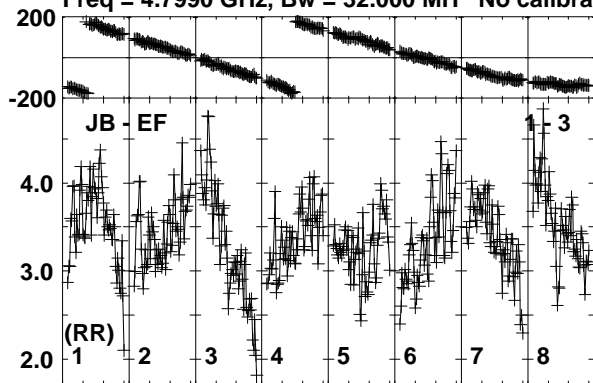

Lower frame: Milli Ampl Jy Top frame: Phas deg

Vector averaged cross-power spectrum Baseline: JB (01) - EF (03)

Timerange: 01/00:16:30 to 01/00:17:29

Plot file version 219 created 26-SEP-2019 10:40:27

J0257-1212 RG010A.UVDATA.1

Freq = 4.7990 GHz, Bw = 32.000 MH No calibration applied and no bandpass applied

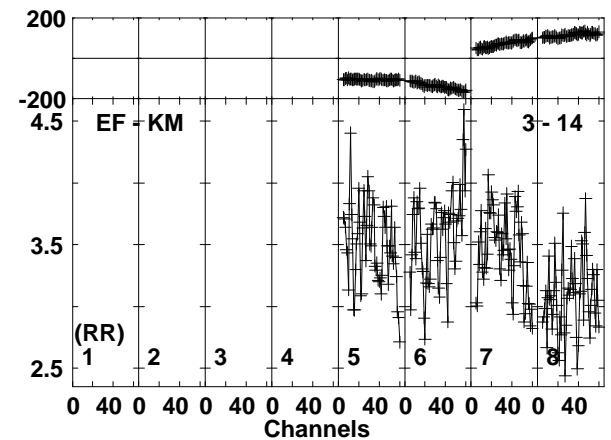
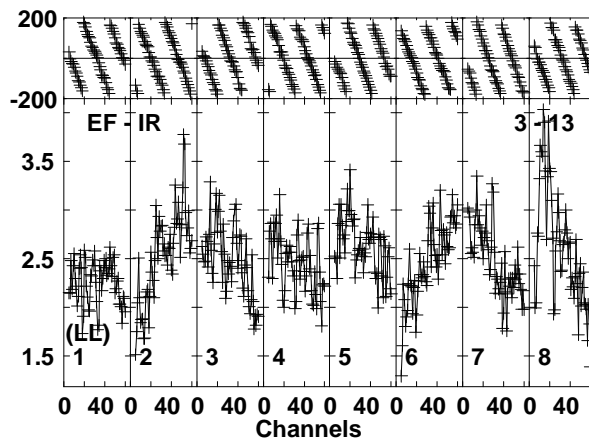
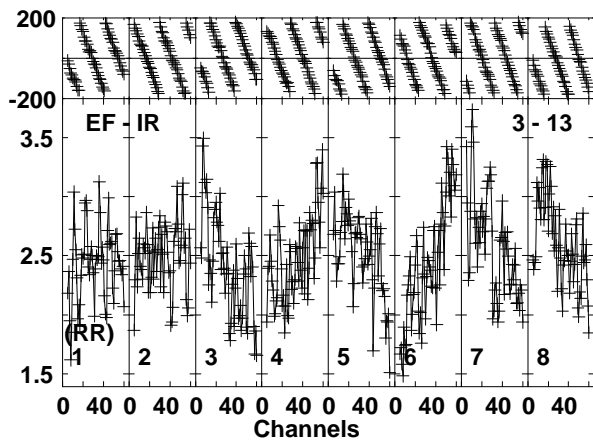
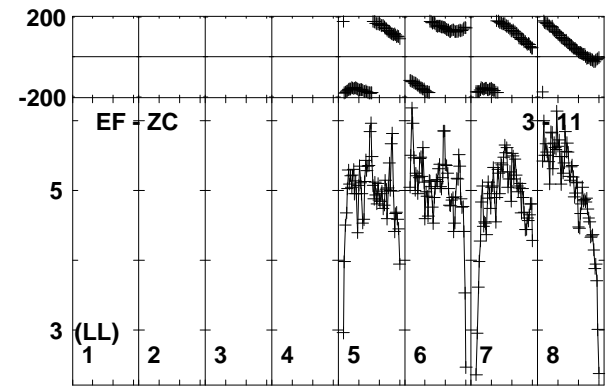
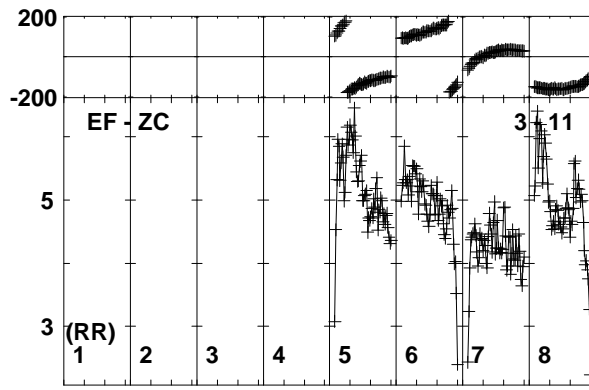
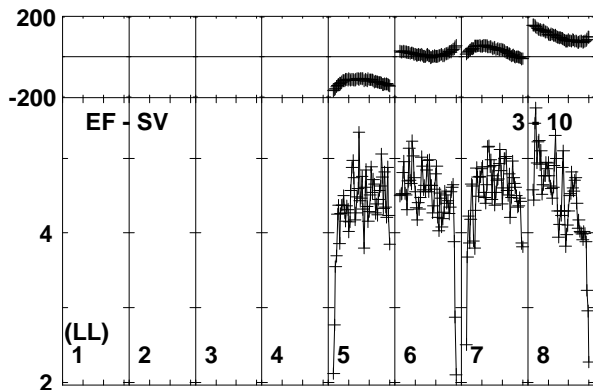
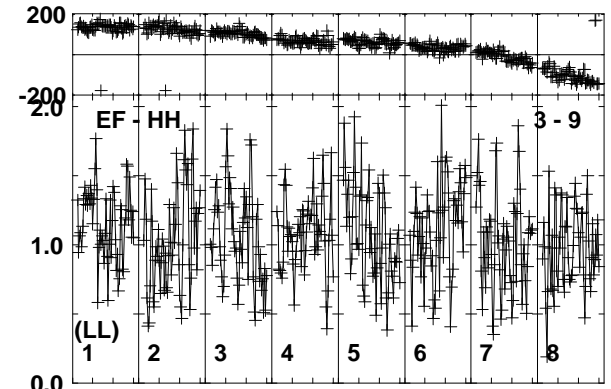
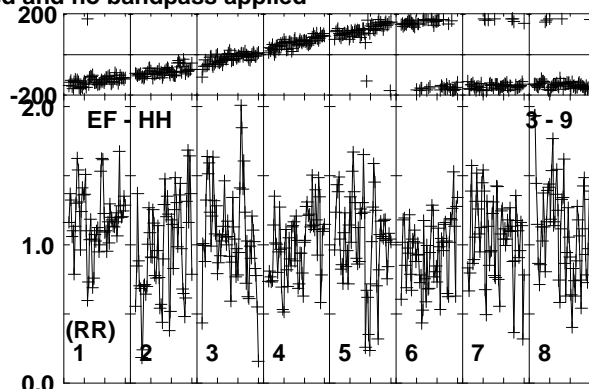
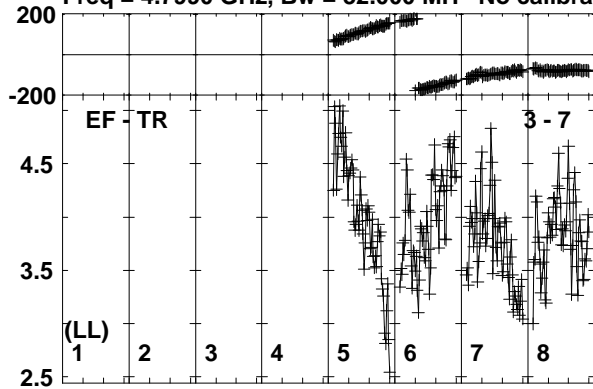

Lower frame: Milli Ampl Jy Top frame: Phas deg
Vector averaged cross-power spectrum Baseline: EF (03) - TR (07)
Timerange: 01/00:16:30 to 01/00:17:29

Plot file version 220 created 26-SEP-2019 10:40:28

J0257-1212 RG010A.UVDATA.1

Freq = 4.7990 GHz, Bw = 32.000 MH No calibration applied and no bandpass applied

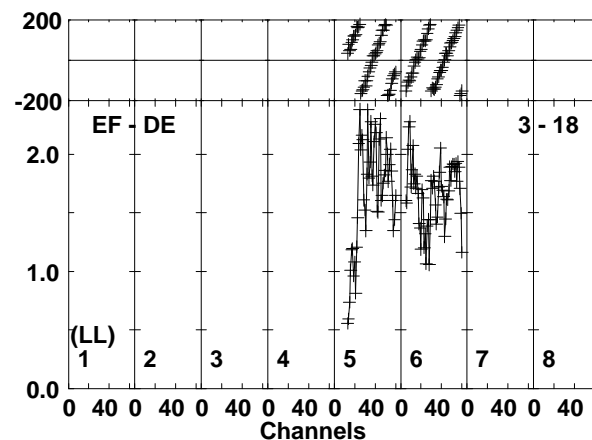
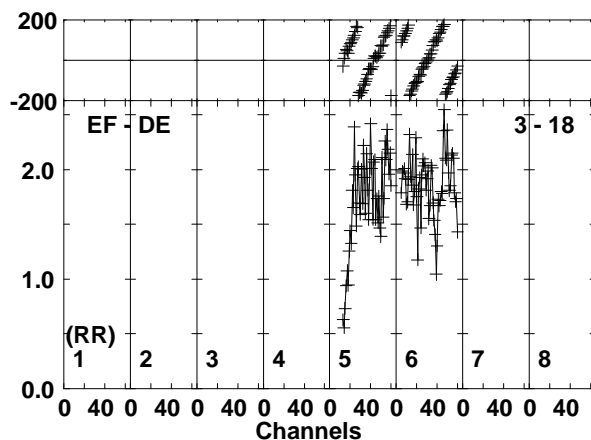
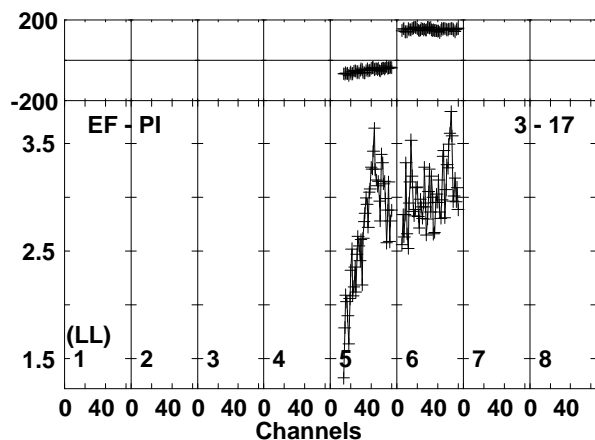
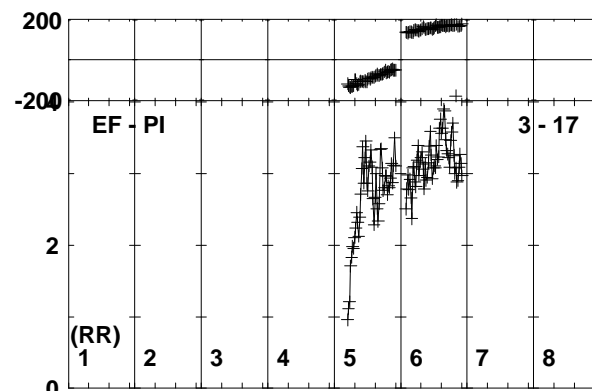
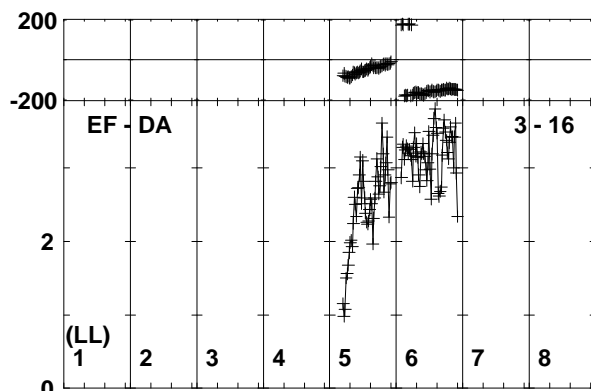
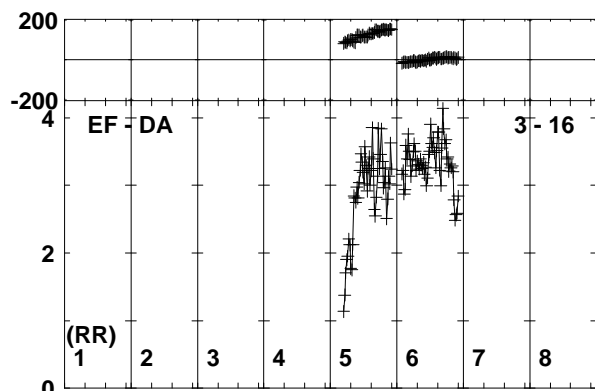
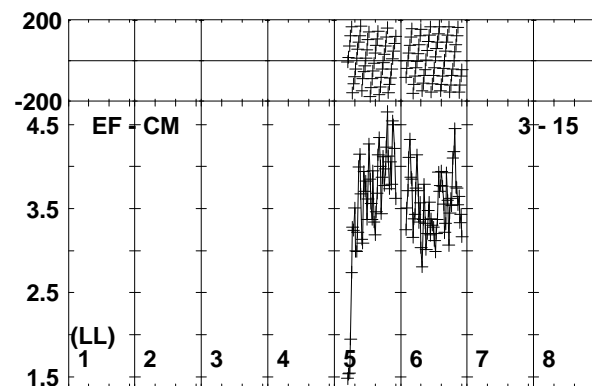
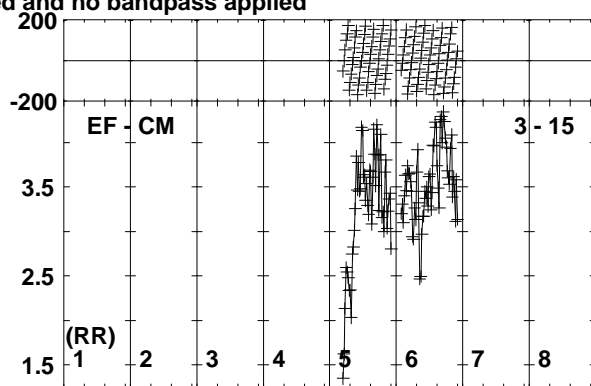
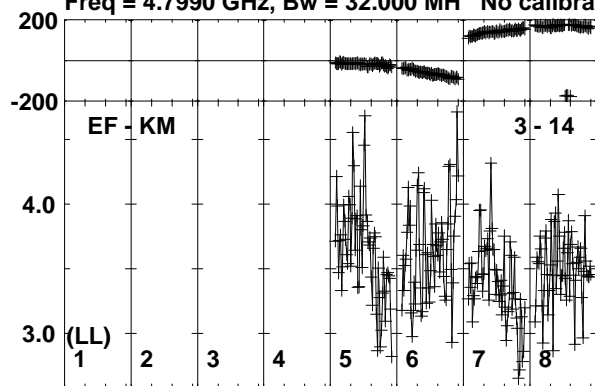

Lower frame: Milli Ampl Jy Top frame: Phas deg
Vector averaged cross-power spectrum Baseline: EF (03) - KM (14)
Timerange: 01/00:16:30 to 01/00:17:29

Plot file version 221 created 26-SEP-2019 10:40:28

190829A RG010A.UVDATA.1

Freq = 4.7990 GHz, Bw = 32.000 MH No calibration applied and no bandpass applied

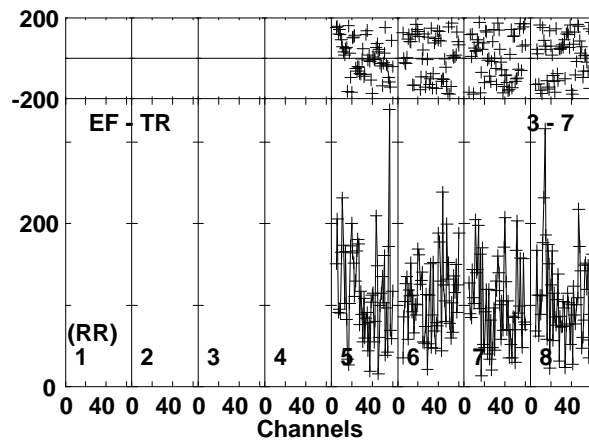
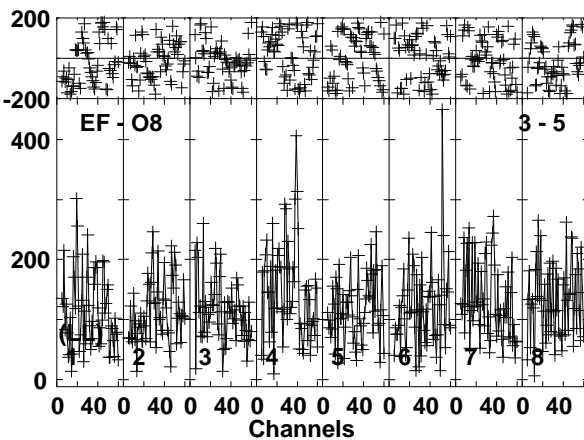
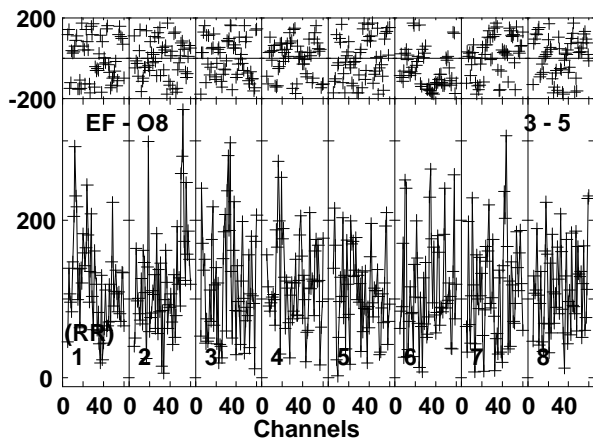
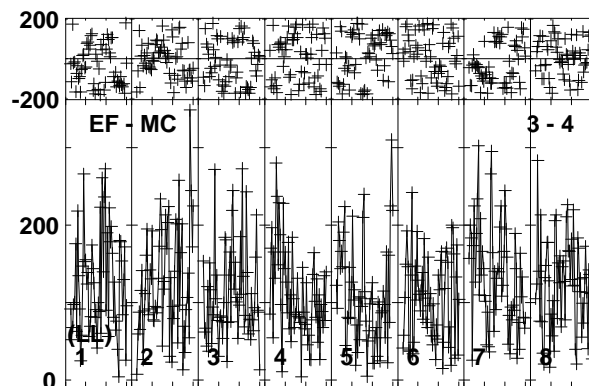
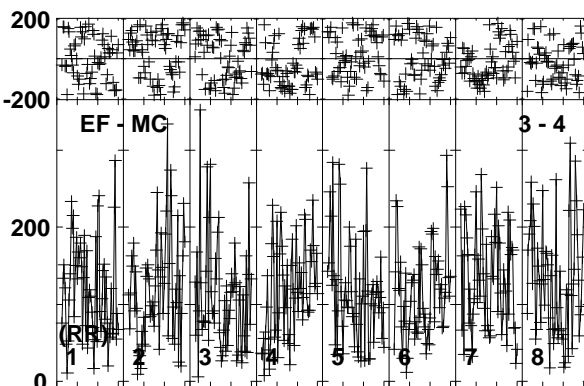
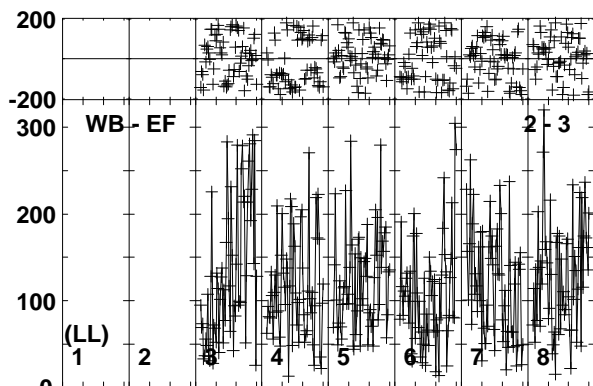
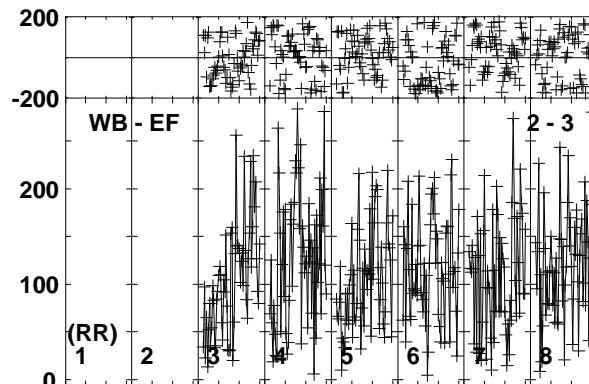
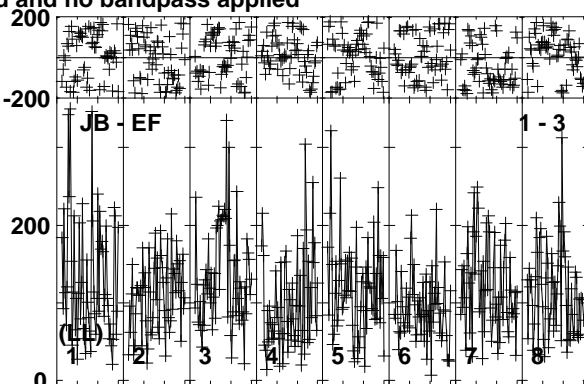
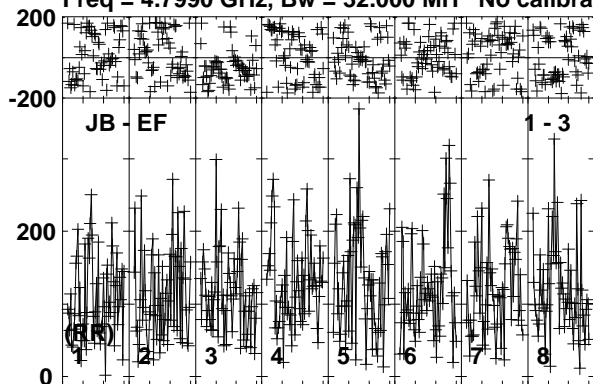

Lower frame: Micro Ampl Jy Top frame: Phas deg
Vector averaged cross-power spectrum Baseline: JB (01) - EF (03)
Timerange: 01/00:17:31 to 01/00:19:39

Plot file version 222 created 26-SEP-2019 10:40:29

190829A RG010A.UVDATA.1

Freq = 4.7990 GHz, Bw = 32.000 MH No calibration applied and no bandpass applied

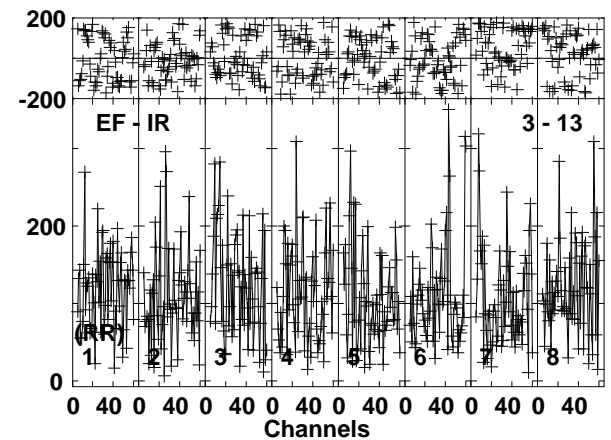
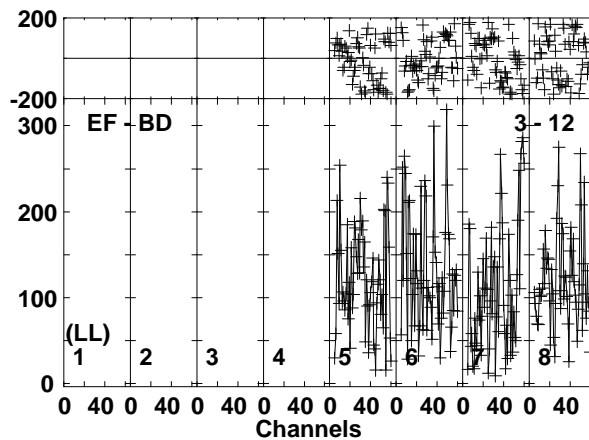
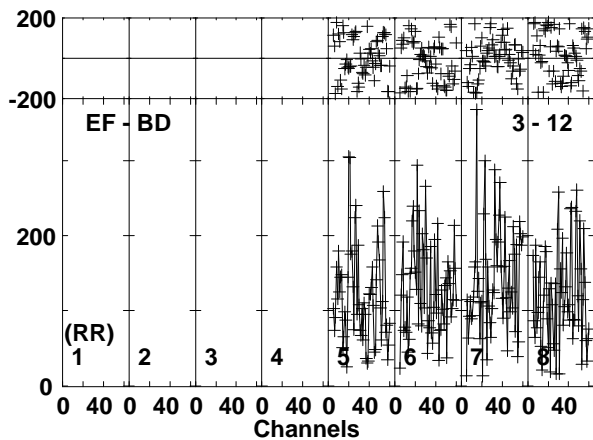
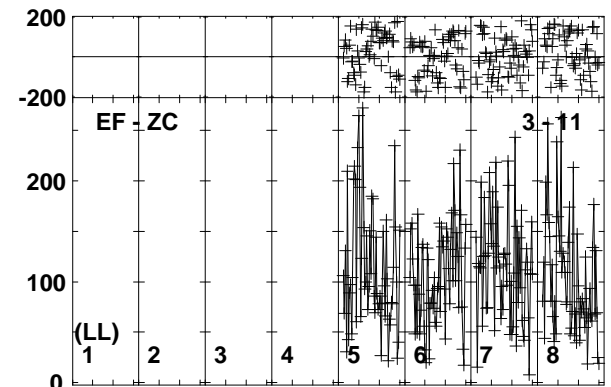
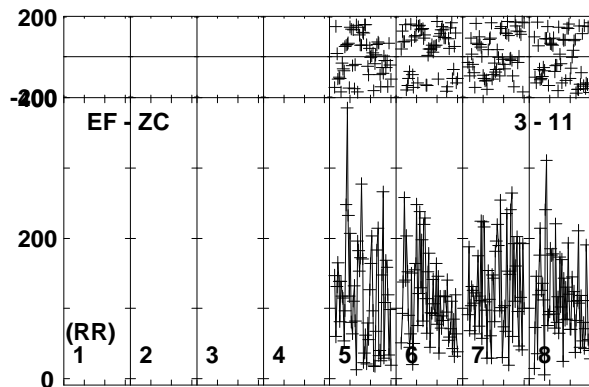
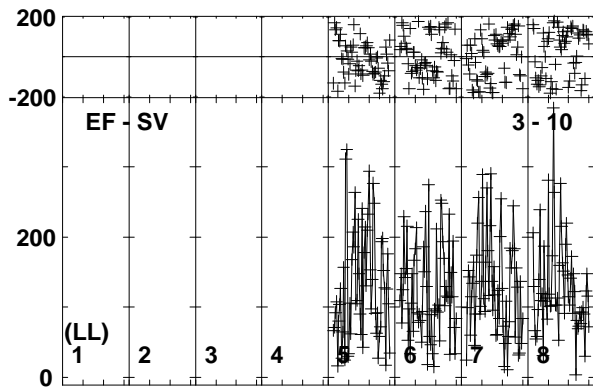
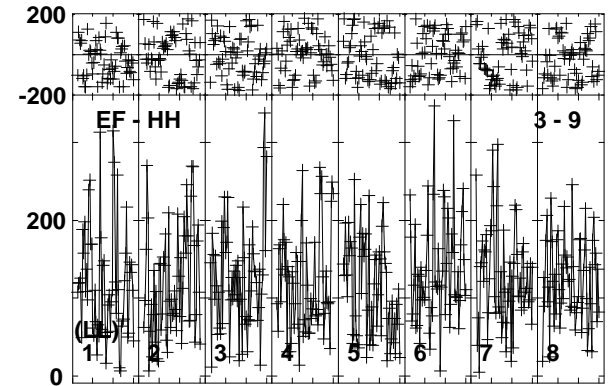
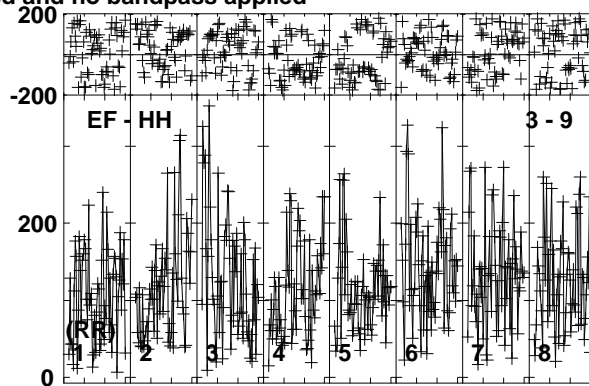
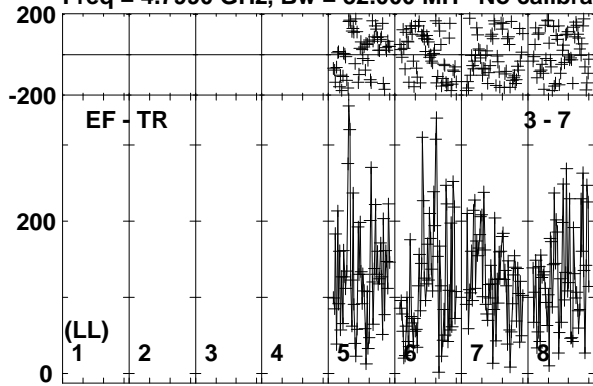

Lower frame: Micro Ampl Jy Top frame: Phas deg
Vector averaged cross-power spectrum Baseline: EF (03) - TR (07)
Timerange: 01/00:17:31 to 01/00:19:39

Plot file version 223 created 26-SEP-2019 10:40:29

190829A RG010A.UVDATA.1

Freq = 4.7990 GHz, Bw = 32.000 MH No calibration applied and no bandpass applied

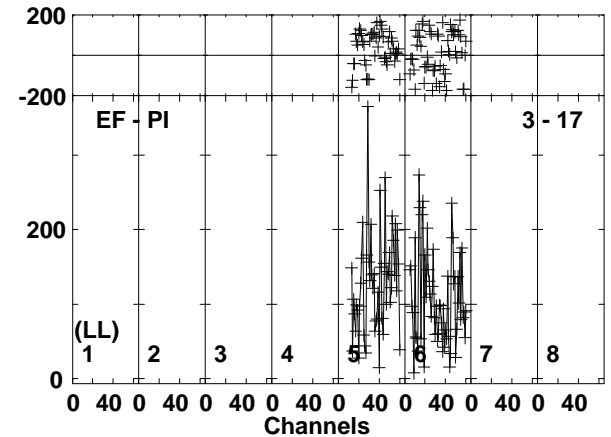
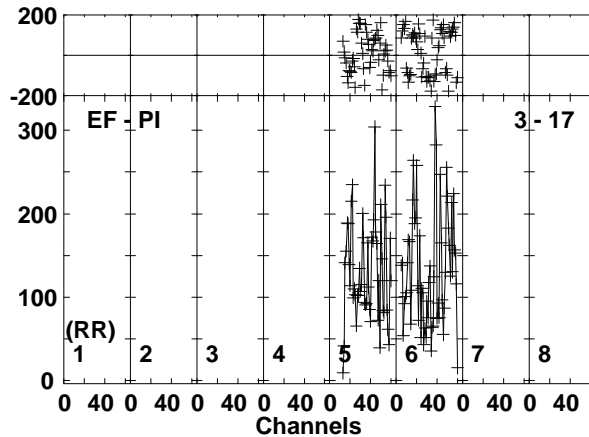
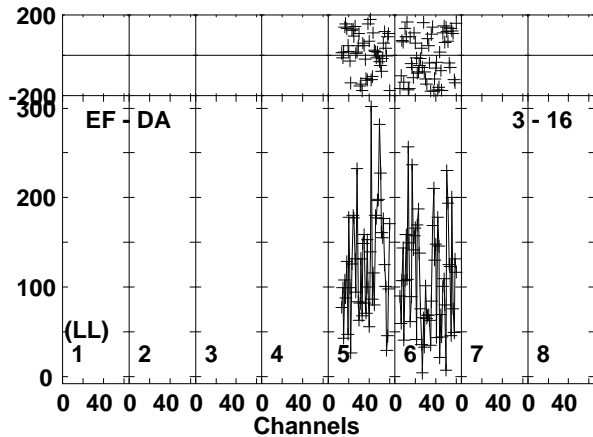
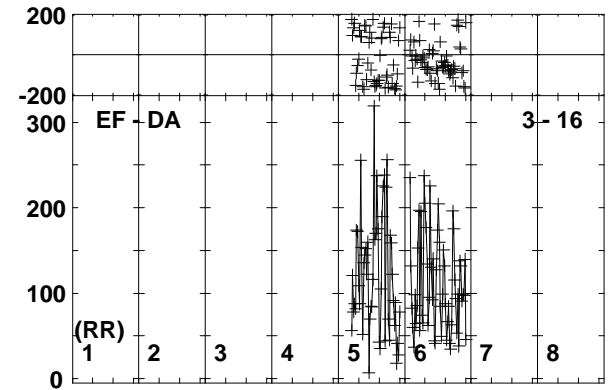
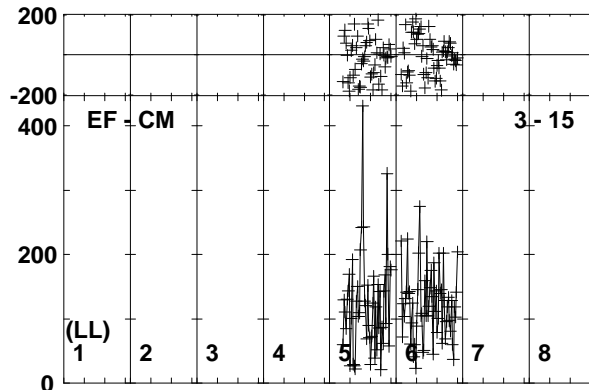
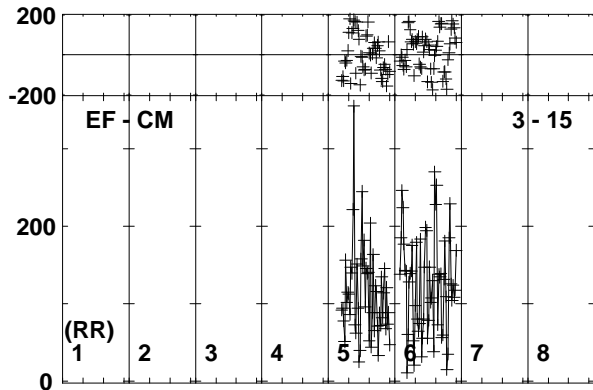
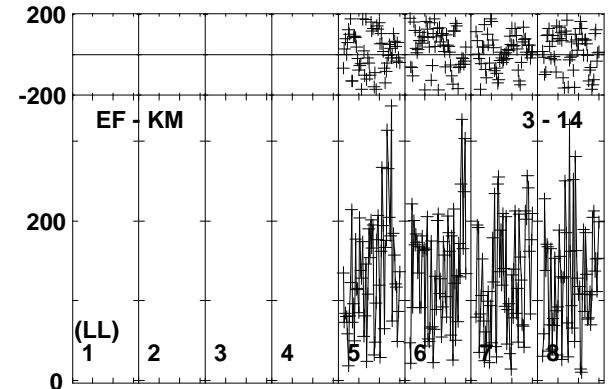
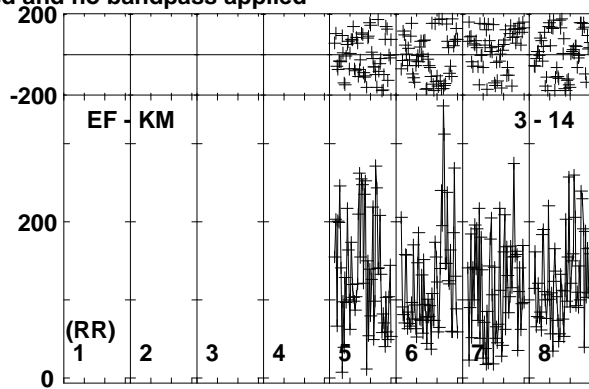
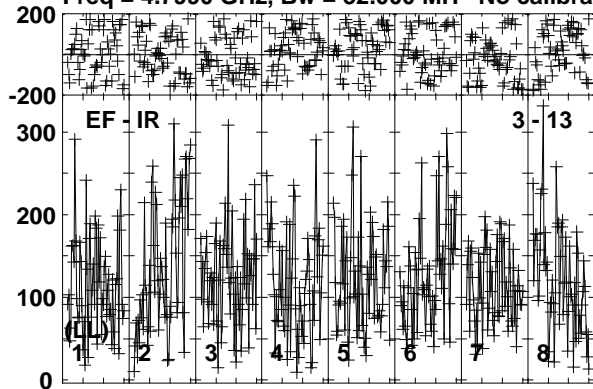

Lower frame: Micro Ampl Jy Top frame: Phas deg
Vector averaged cross-power spectrum Baseline: EF (03) - IR (13)
Timerange: 01/00:17:31 to 01/00:19:39

Plot file version 224 created 26-SEP-2019 10:40:29

190829A RG010A.UVDATA.1

Freq = 4.7990 GHz, Bw = 32.000 MH No calibration applied and no bandpass applied

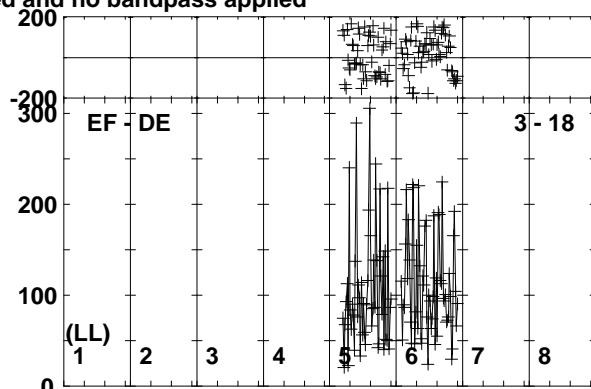
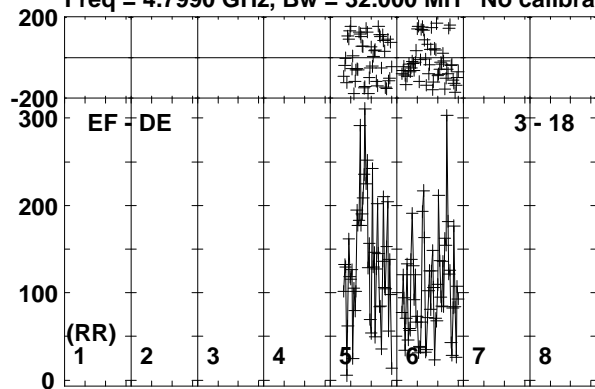

Lower frame: Micro Ampl Jy Top frame: Phas deg
Vector averaged cross-power spectrum Baseline: EF (03) - DE (18)
Timerange: 01/00:17:31 to 01/00:19:39

Plot file version 225 created 26-SEP-2019 10:40:30

J0257-1212 RG010A.UVDATA.1

Freq = 4.7990 GHz, Bw = 32.000 MH No calibration applied and no bandpass applied

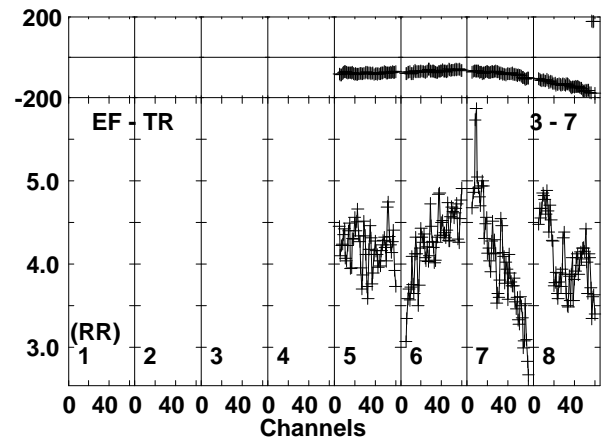
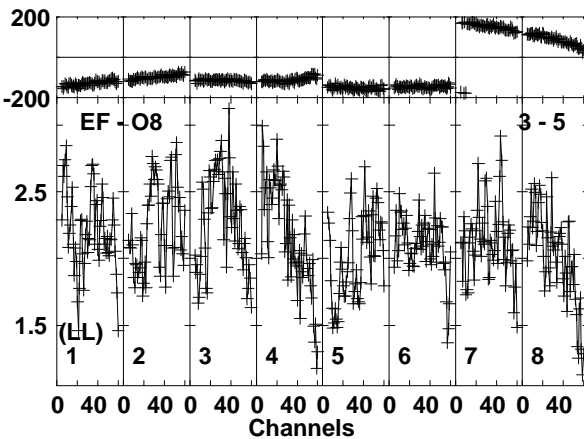
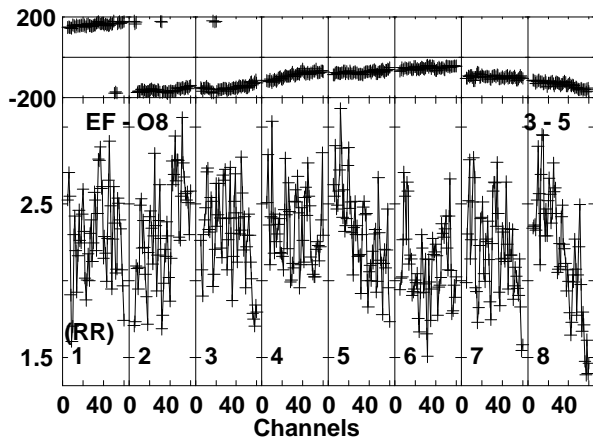
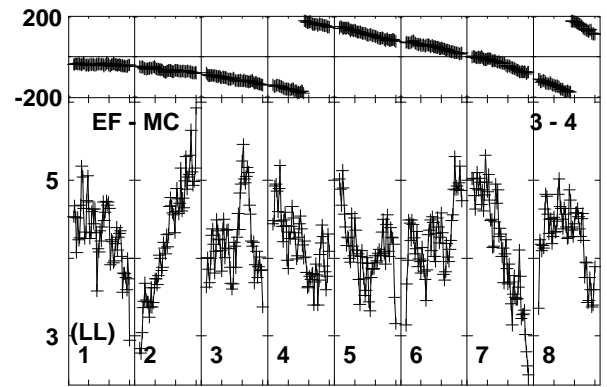
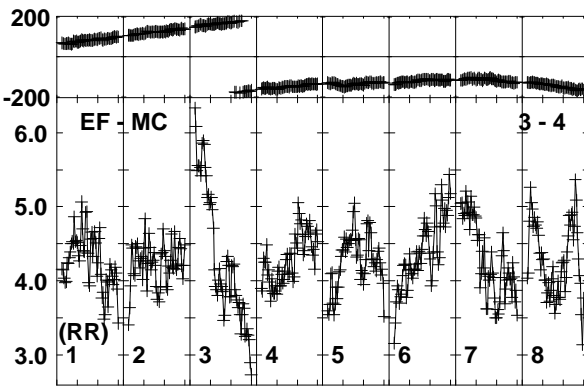
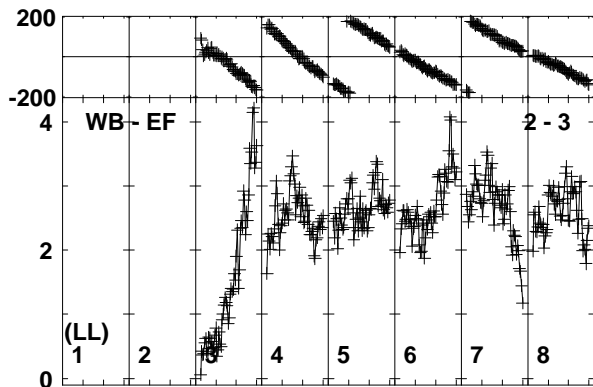
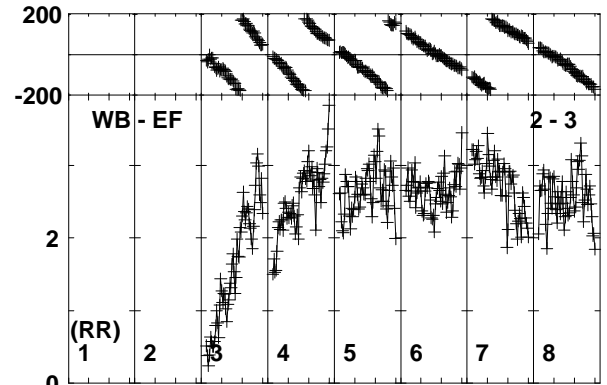
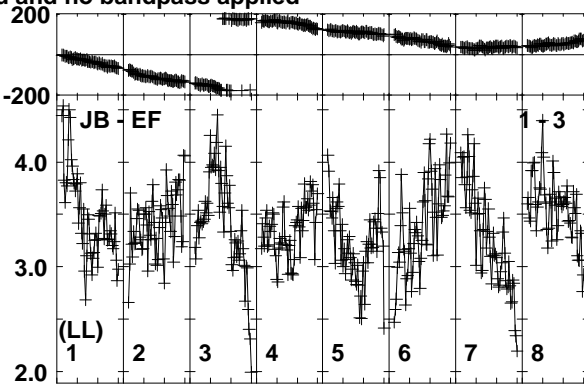
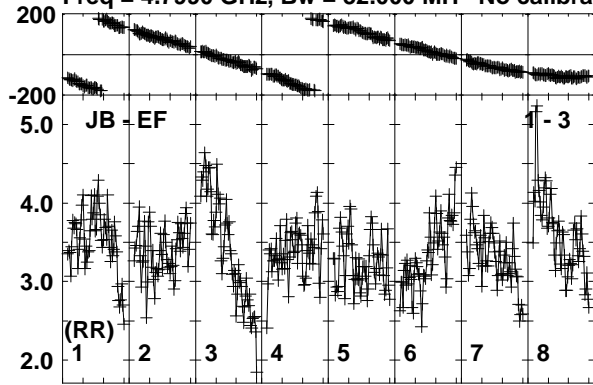

Lower frame: Milli Ampl Jy Top frame: Phas deg
Vector averaged cross-power spectrum Baseline: JB (01) - EF (03)
Timerange: 01/00:19:41 to 01/00:20:40

Plot file version 226 created 26-SEP-2019 10:40:30

J0257-1212 RG010A.UVDATA.1

Freq = 4.7990 GHz, Bw = 32.000 MH No calibration applied and no bandpass applied

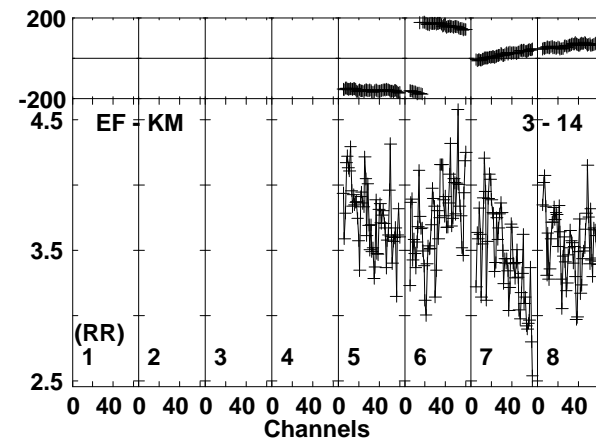
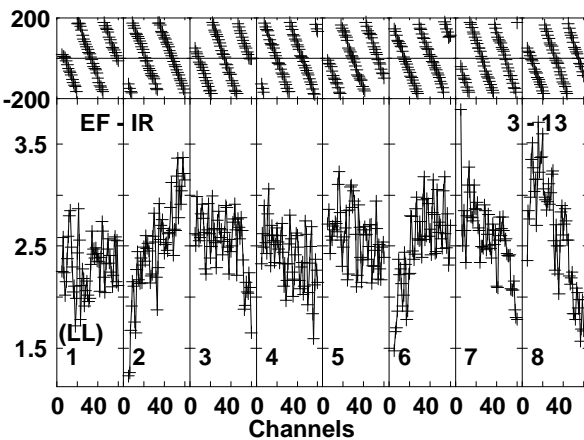
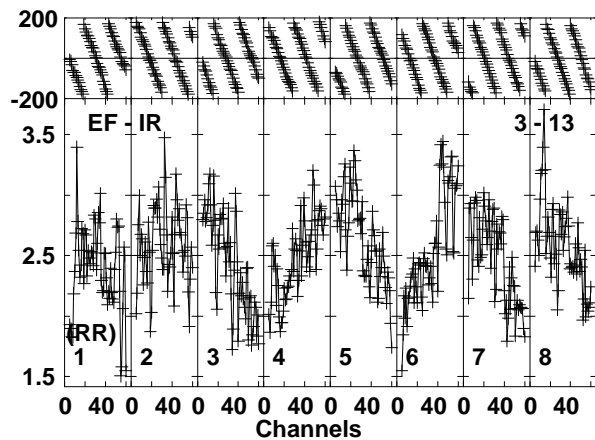
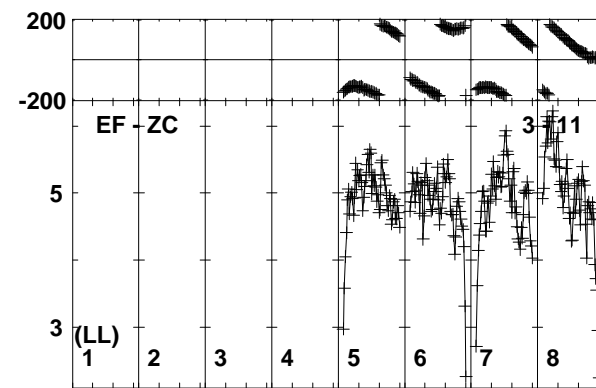
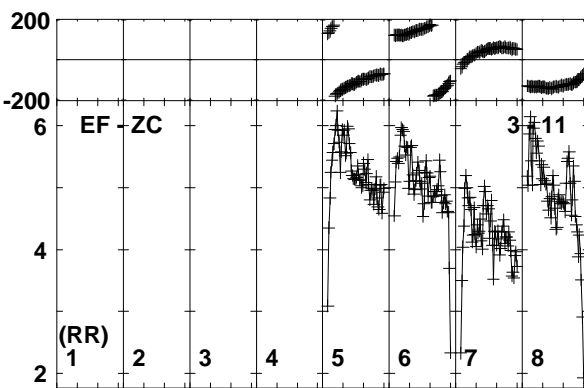
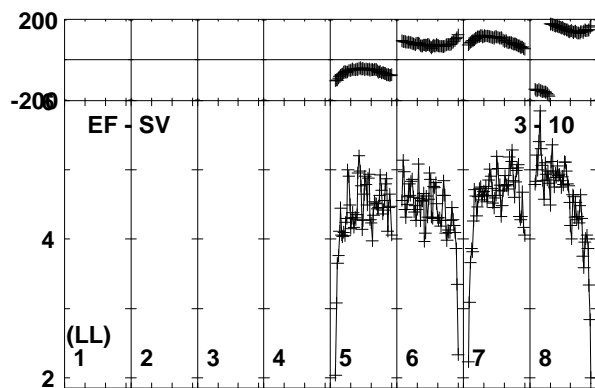
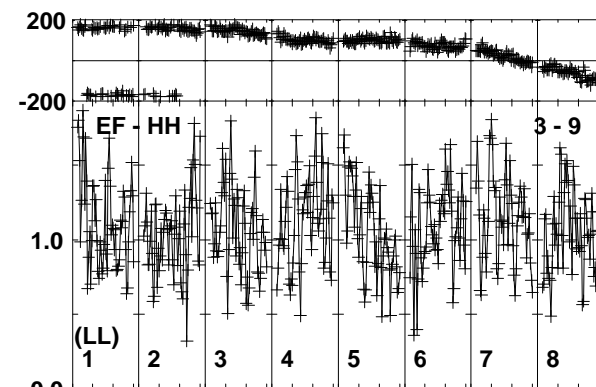
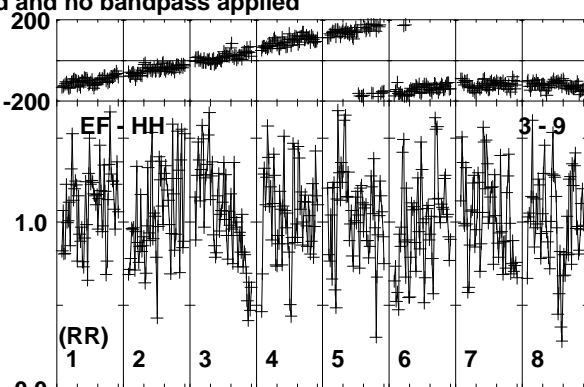
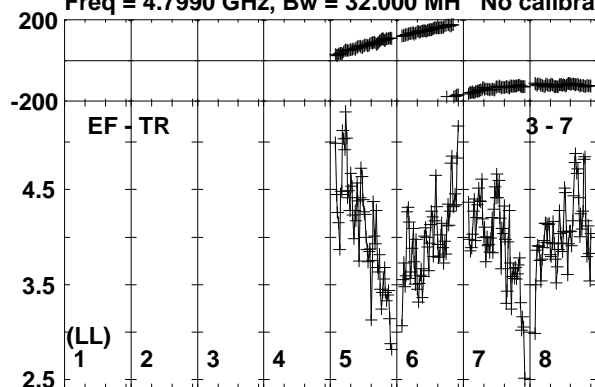

Lower frame: Milli Ampl Jy Top frame: Phas deg
Vector averaged cross-power spectrum Baseline: EF (03) - TR (07)
Timerange: 01/00:19:41 to 01/00:20:40

Plot file version 227 created 26-SEP-2019 10:40:30

J0257-1212 RG010A.UVDATA.1

Freq = 4.7990 GHz, Bw = 32.000 MH No calibration applied and no bandpass applied

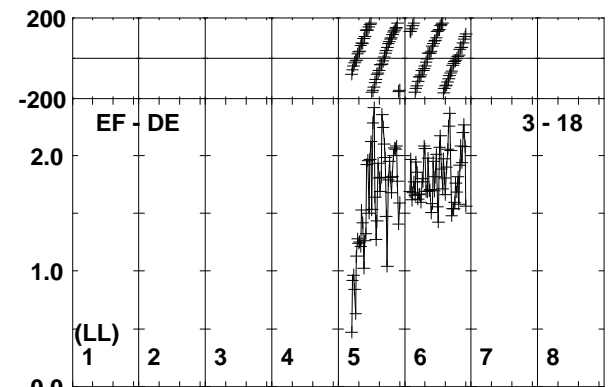
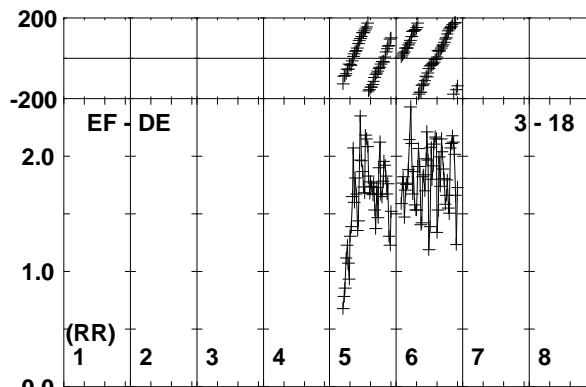
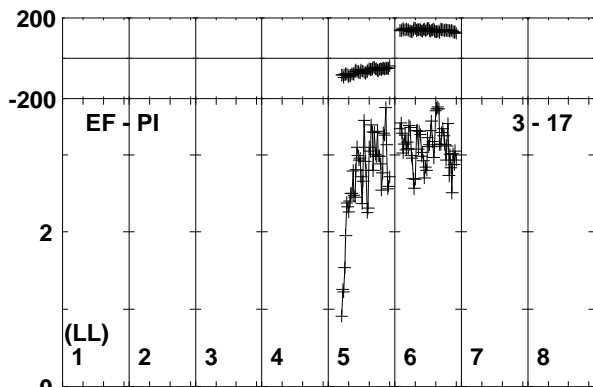
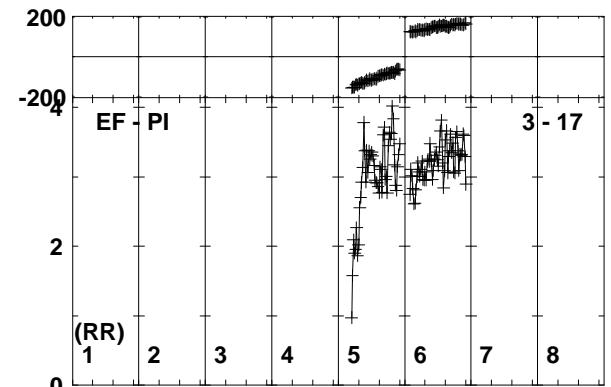
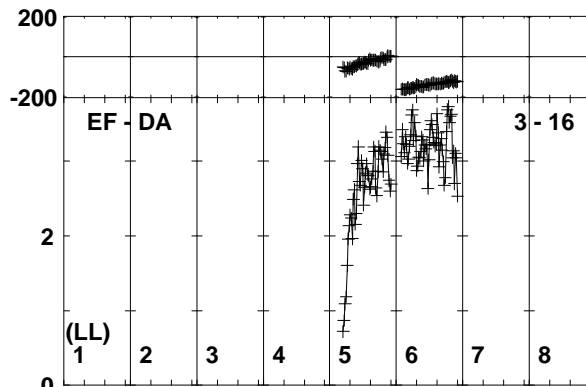
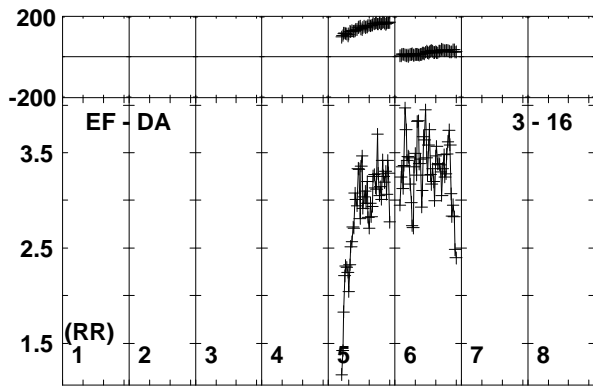
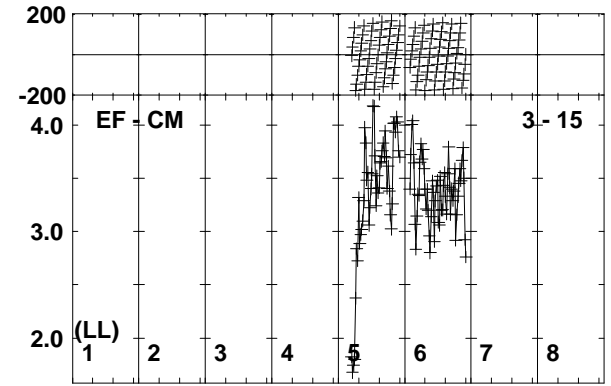
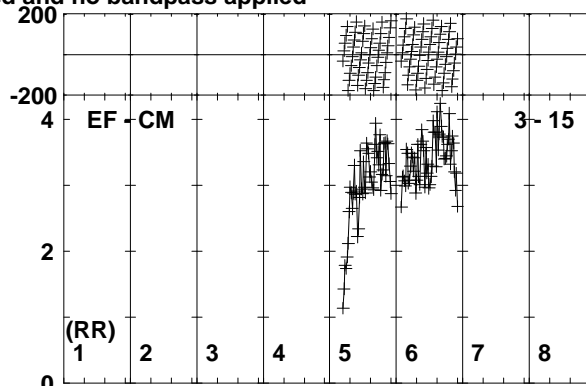
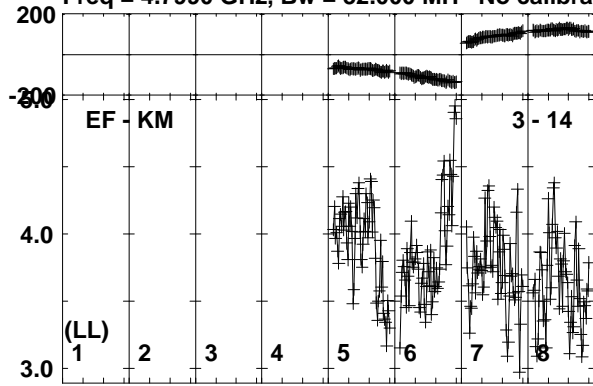

Lower frame: Milli Ampl Jy Top frame: Phas deg
Vector averaged cross-power spectrum Baseline: EF (03) - KM (14)
Timerange: 01/00:19:41 to 01/00:20:40

Plot file version 228 created 26-SEP-2019 10:40:31

190829A RG010A.UVDATA.1

Freq = 4.7990 GHz, Bw = 32.000 MH No calibration applied and no bandpass applied

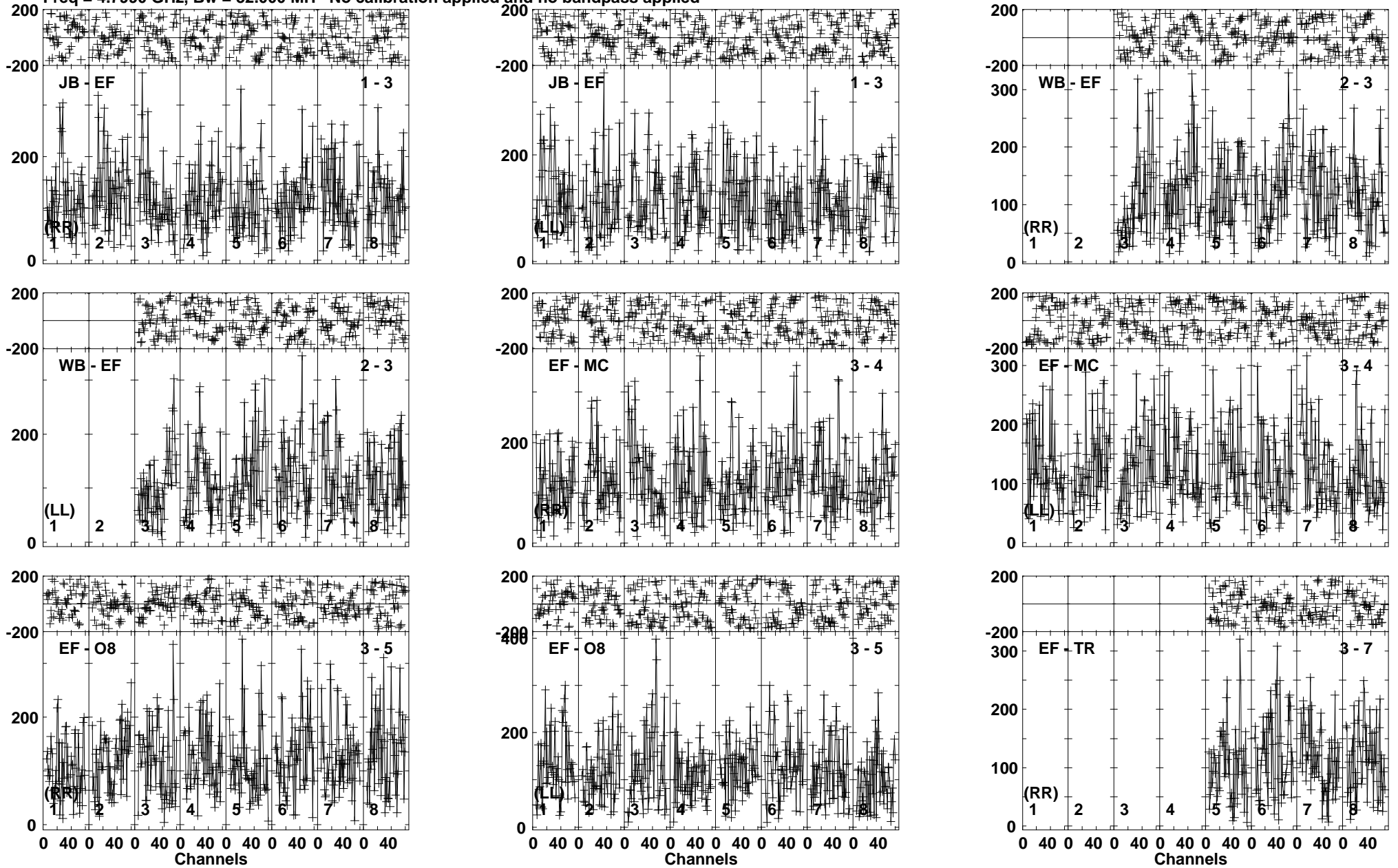

Lower frame: Micro Ampl Jy Top frame: Phas deg
Vector averaged cross-power spectrum Baseline: JB (01) - EF (03)
Timerange: 01/00:20:41 to 01/00:22:49

Plot file version 229 created 26-SEP-2019 10:40:33

190829A RG010A.UVDATA.1

Freq = 4.7990 GHz, Bw = 32.000 MH No calibration applied and no bandpass applied

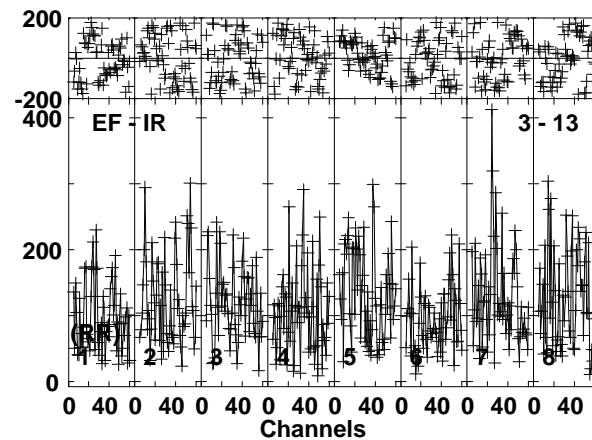
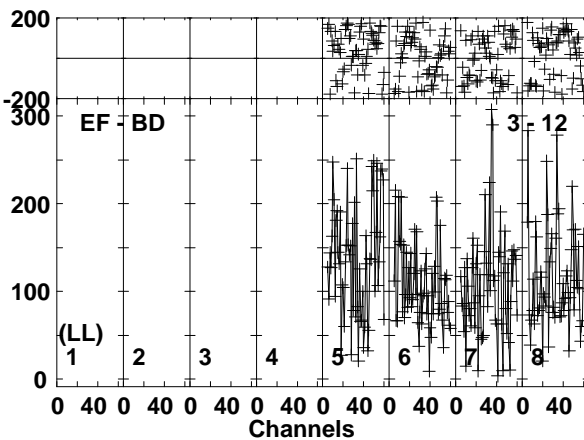
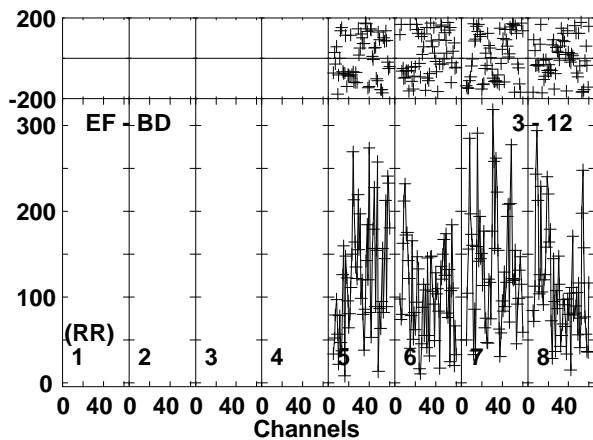
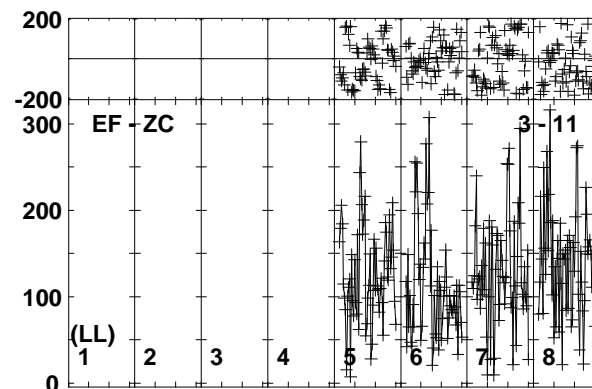
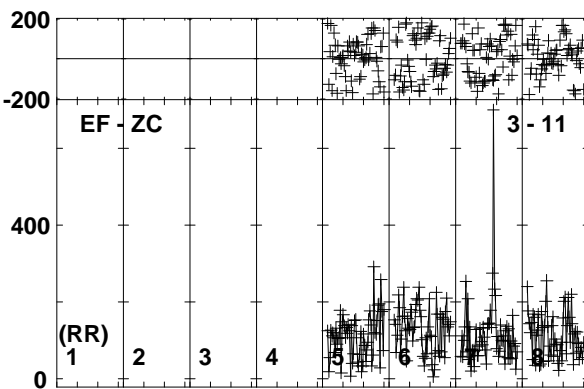
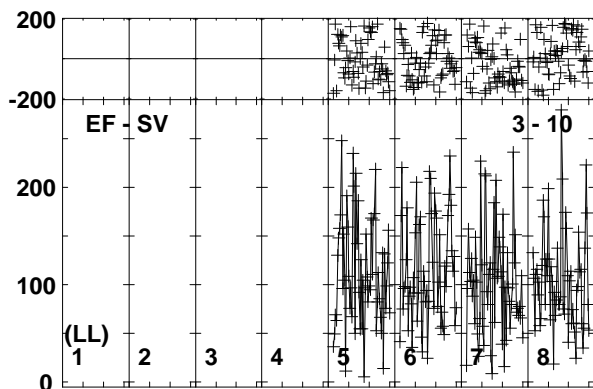
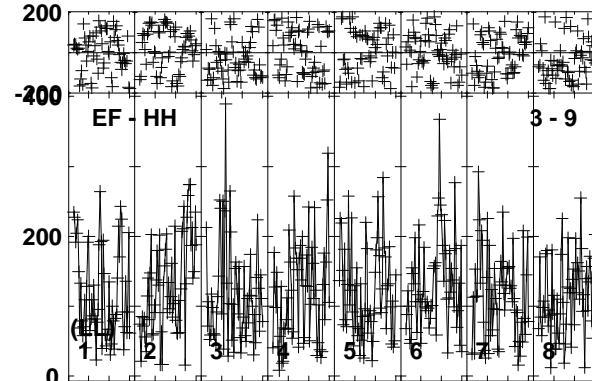
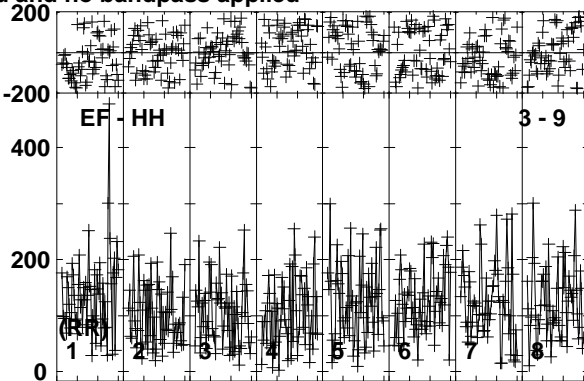
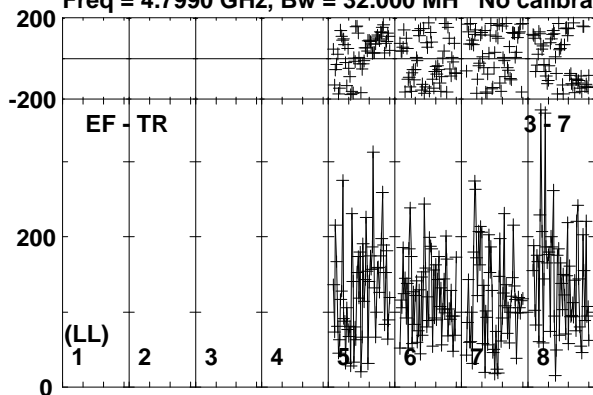

Lower frame: Micro Ampl Jy Top frame: Phas deg
Vector averaged cross-power spectrum Baseline: EF (03) - TR (07)
Timerange: 01/00:20:41 to 01/00:22:49

Plot file version 230 created 26-SEP-2019 10:40:34

190829A RG010A.UVDATA.1

Freq = 4.7990 GHz, Bw = 32.000 MH No calibration applied and no bandpass applied

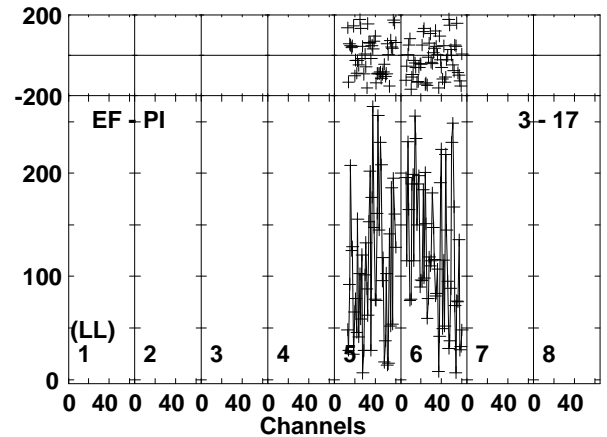
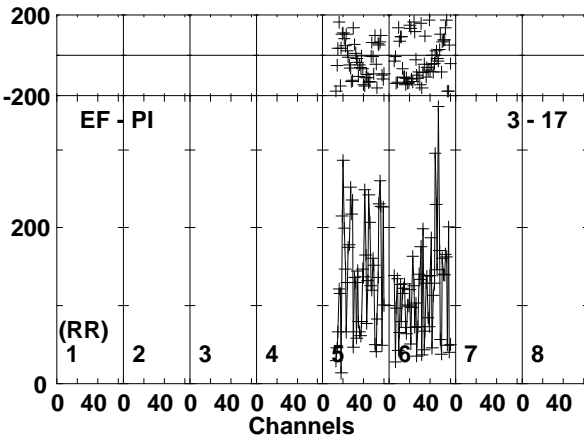
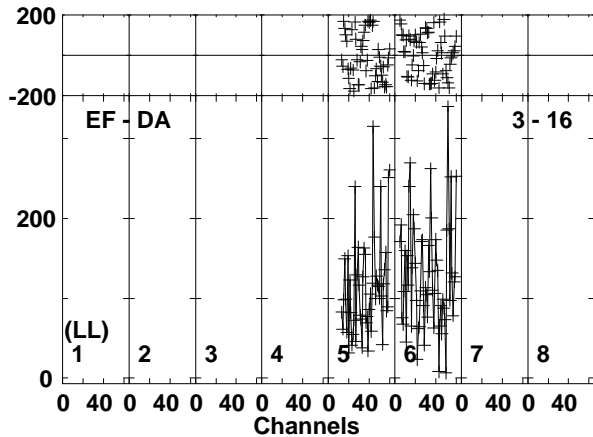
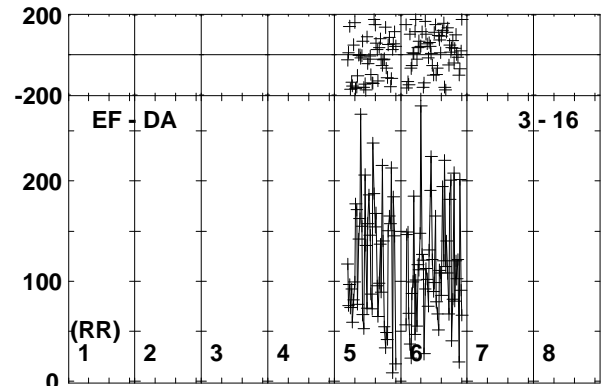
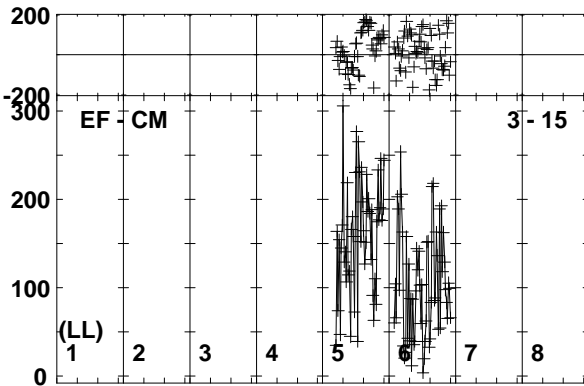
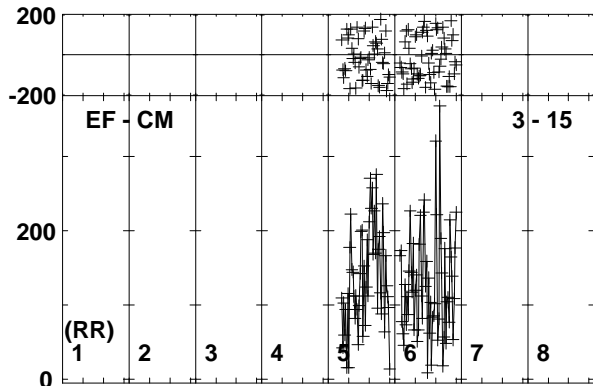
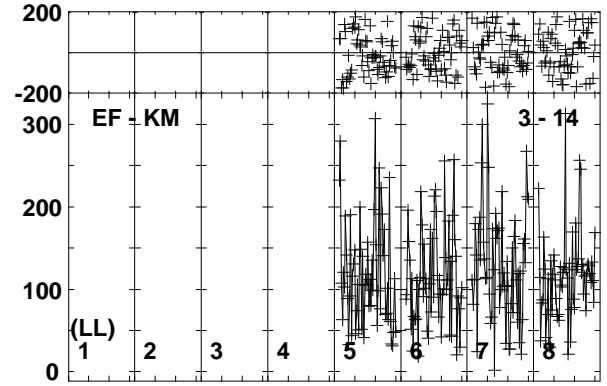
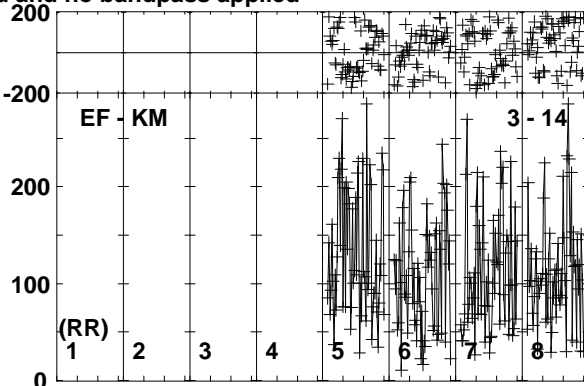
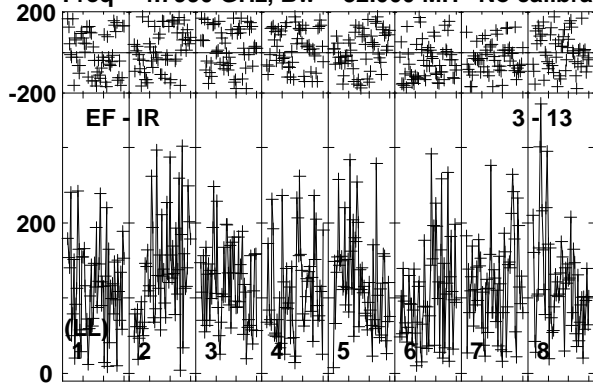

Lower frame: Micro Ampl Jy Top frame: Phas deg
Vector averaged cross-power spectrum Baseline: EF (03) - IR (13)
Timerange: 01/00:20:41 to 01/00:22:49

Plot file version 231 created 26-SEP-2019 10:40:34

190829A RG010A.UVDATA.1

Freq = 4.7990 GHz, Bw = 32.000 MH No calibration applied and no bandpass applied

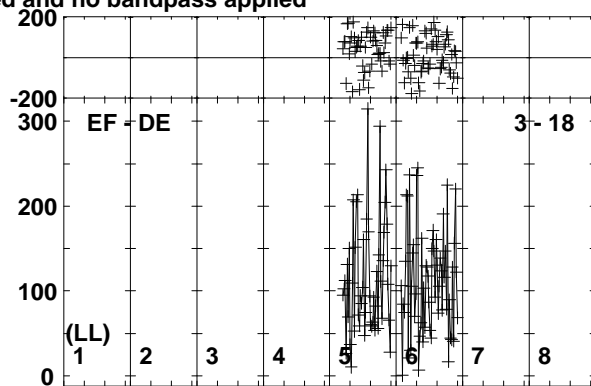
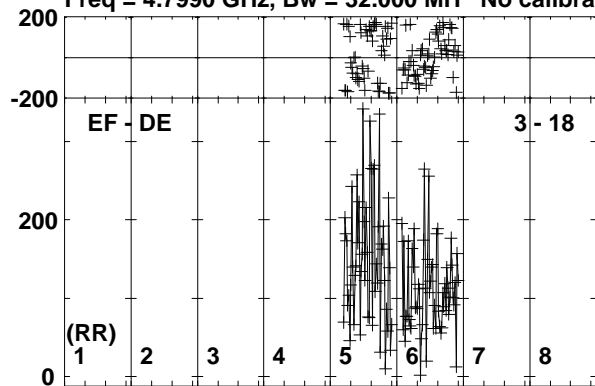

Lower frame: Micro Ampl Jy Top frame: Phas deg
Vector averaged cross-power spectrum Baseline: EF (03) - DE (18)
Timerange: 01/00:20:41 to 01/00:22:49

Plot file version 232 created 26-SEP-2019 10:40:34

J0257-1212 RG010A.UVDATA.1

Freq = 4.7990 GHz, Bw = 32.000 MH No calibration applied and no bandpass applied

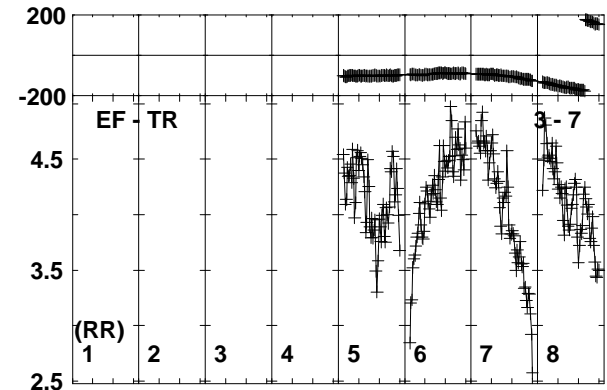
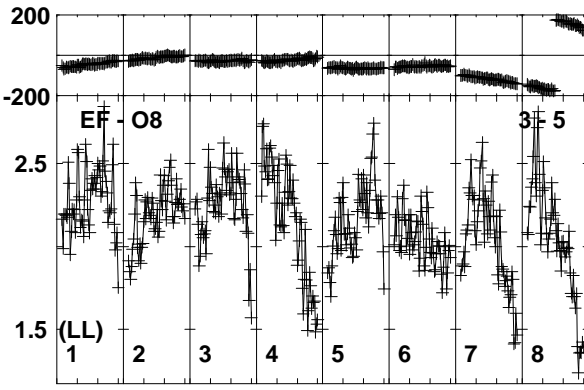
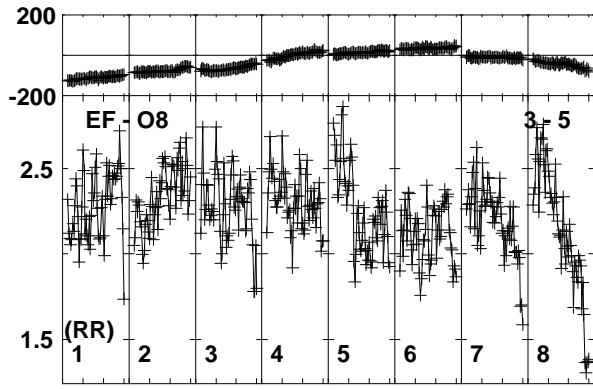
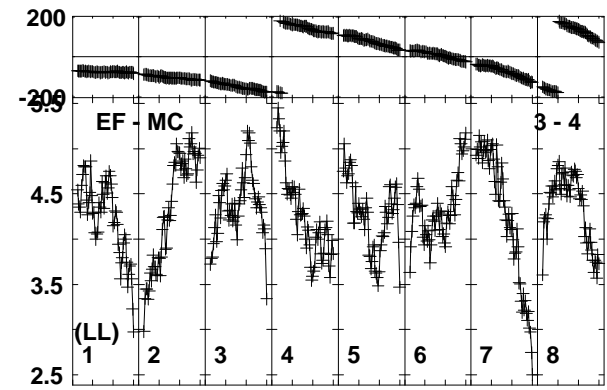
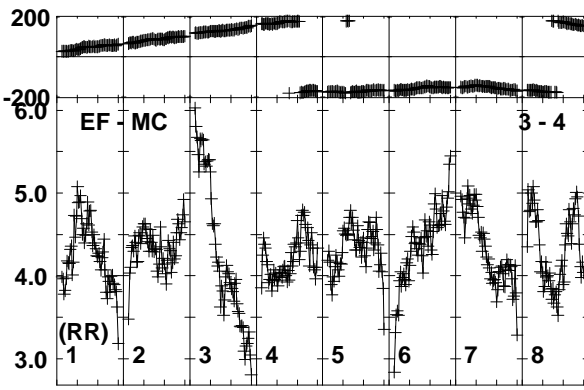
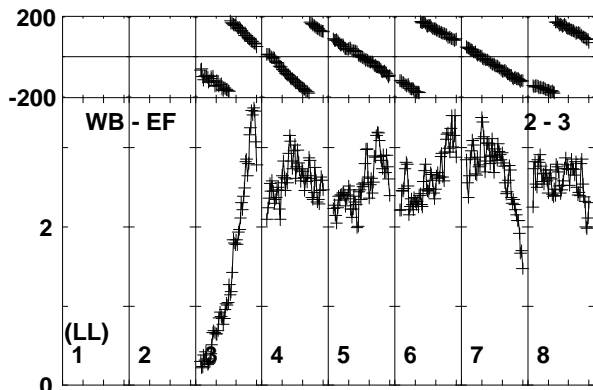
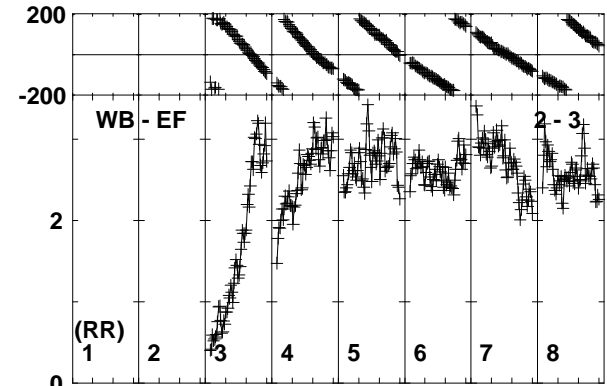
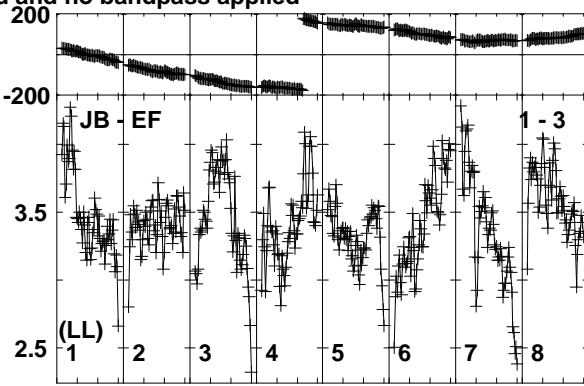
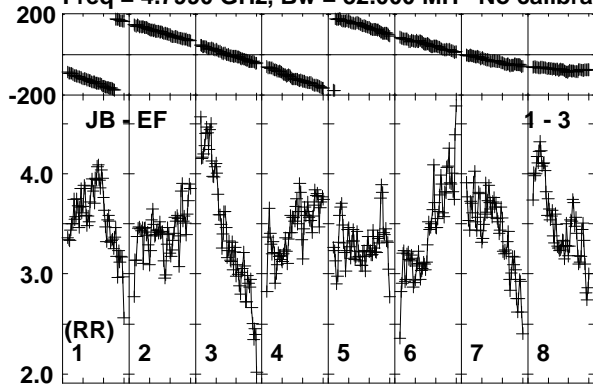

Lower frame: Milli Ampl Jy Top frame: Phas deg
Vector averaged cross-power spectrum Baseline: JB (01) - EF (03)
Timerange: 01/00:23:40 to 01/00:24:09

Plot file version 233 created 26-SEP-2019 10:40:34
 J0257-1212 RG010A.UVDATA.1

Freq = 4.7990 GHz, Bw = 32.000 MH No calibration applied and no bandpass applied

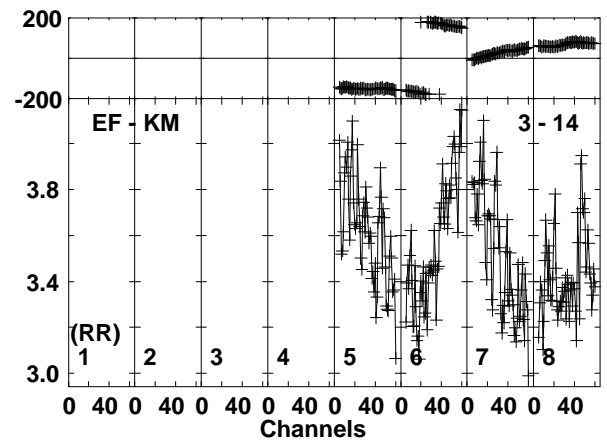
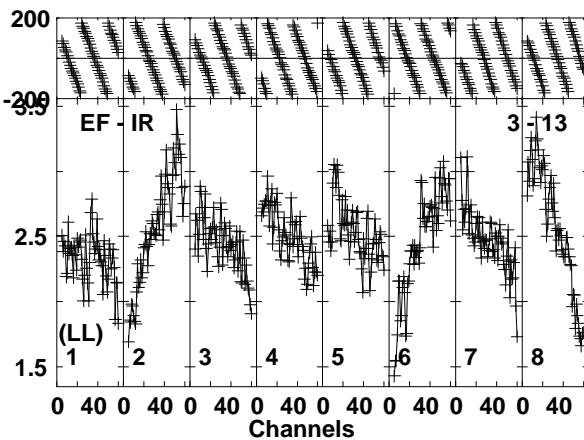
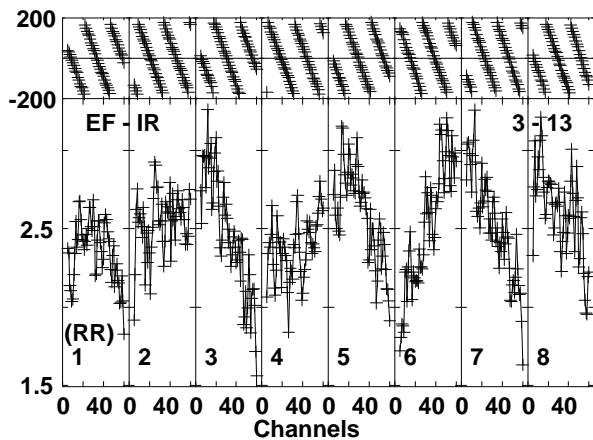
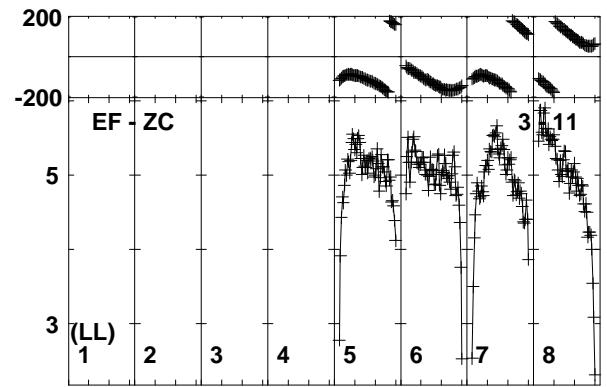
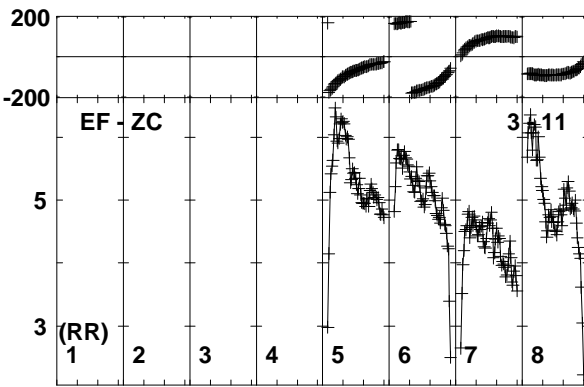
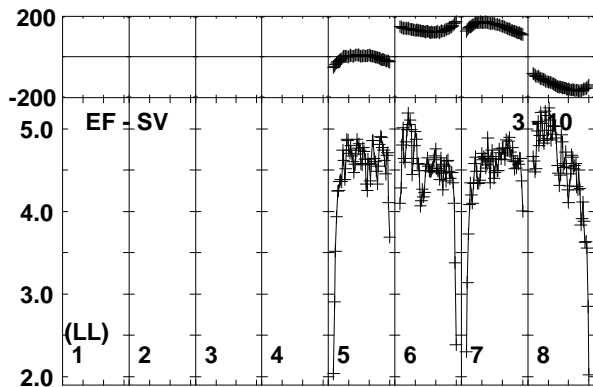
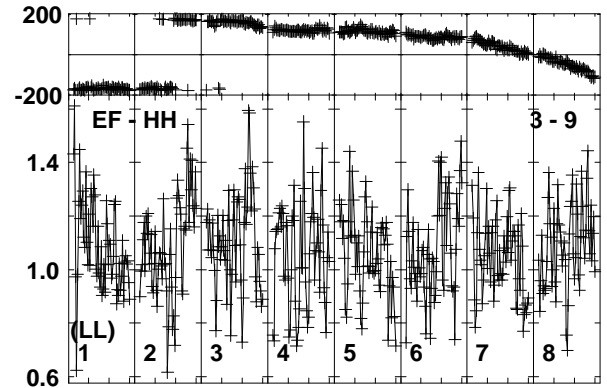
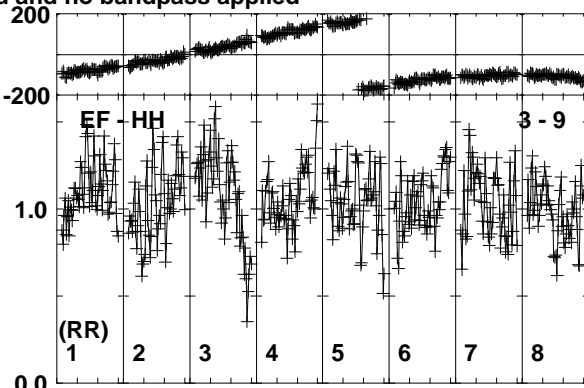
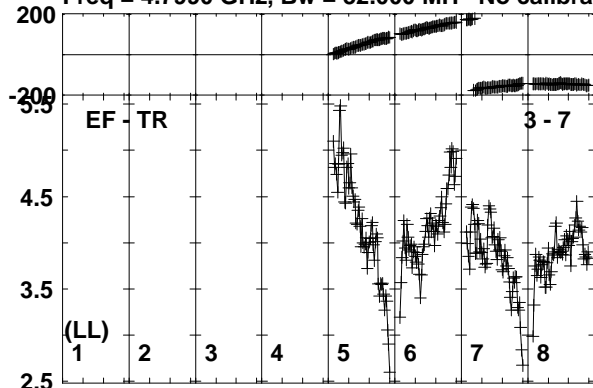

Lower frame: Milli Ampl Jy Top frame: Phas deg
 Vector averaged cross-power spectrum Baseline: EF (03) - TR (07)
 Timerange: 01/00:23:40 to 01/00:24:09

Plot file version 234 created 26-SEP-2019 10:40:35

J0257-1212 RG010A.UVDATA.1

Freq = 4.7990 GHz, Bw = 32.000 MH No calibration applied and no bandpass applied

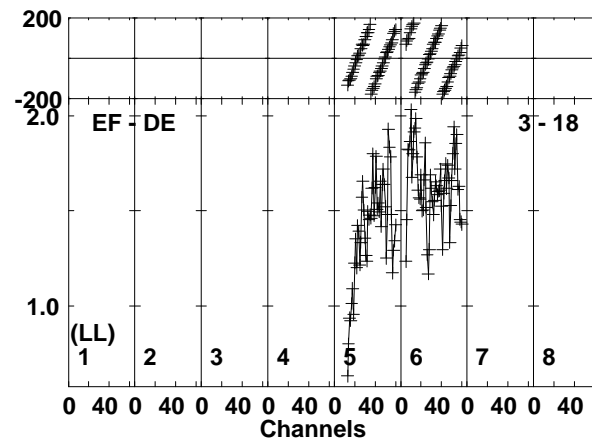
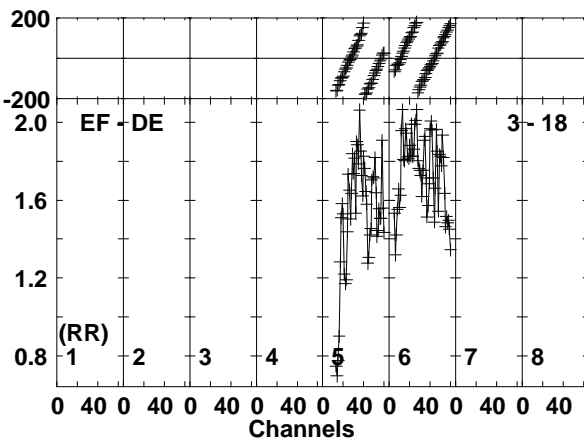
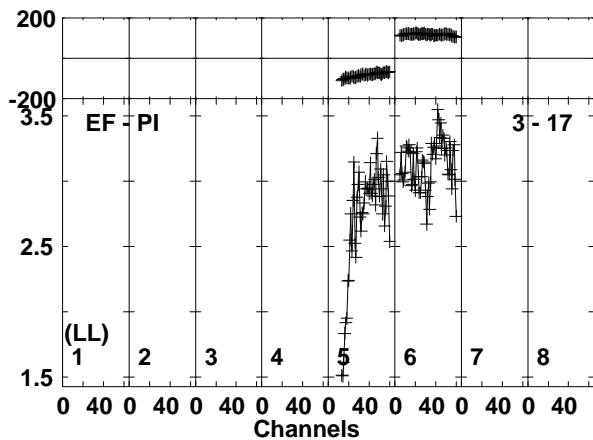
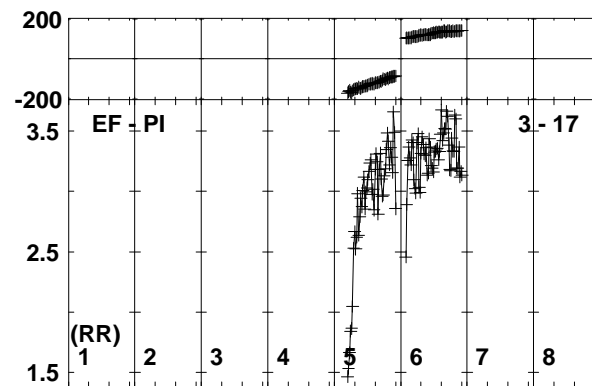
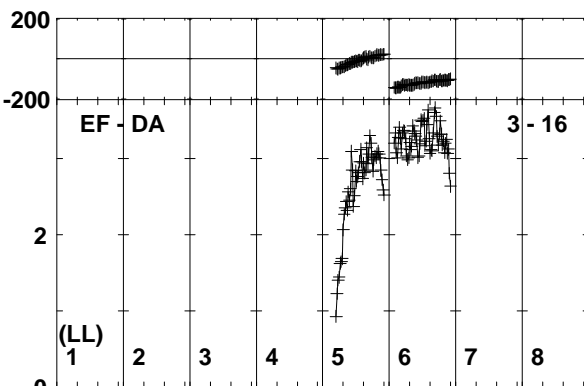
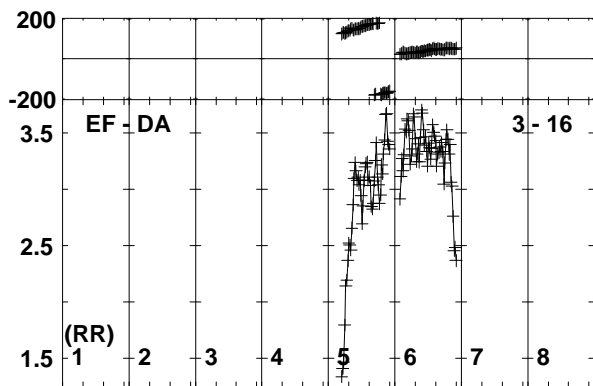
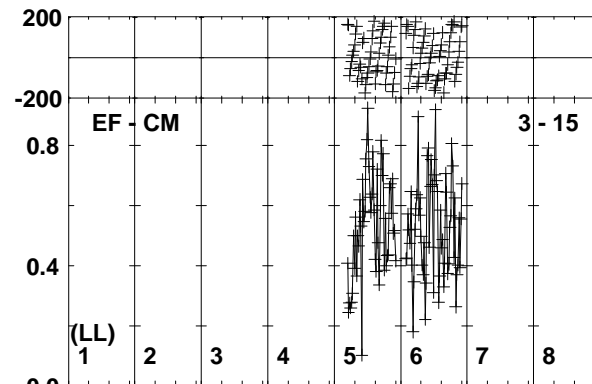
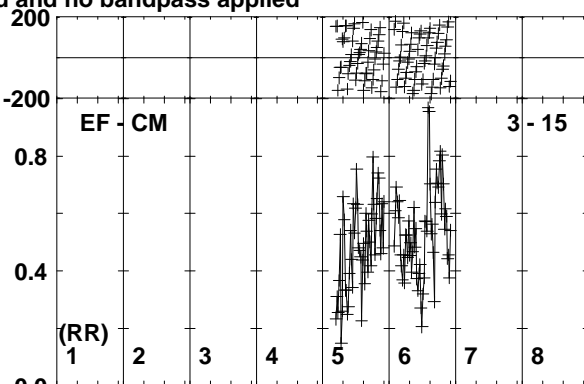
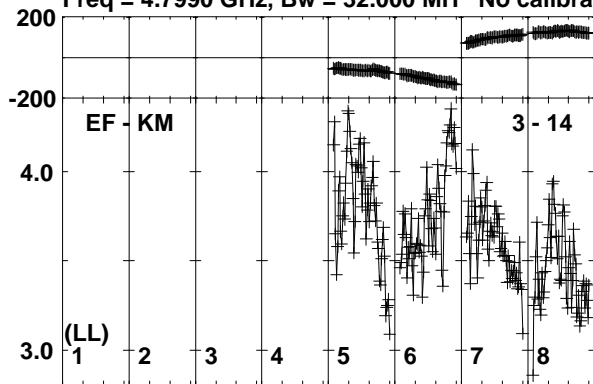

Lower frame: Milli Ampl Jy Top frame: Phas deg
Vector averaged cross-power spectrum Baseline: EF (03) - KM (14)
Timerange: 01/00:23:40 to 01/00:24:09

Plot file version 235 created 26-SEP-2019 10:40:35

J0300-0846 RG010A.UVDATA.1

Freq = 4.7990 GHz, Bw = 32.000 MH No calibration applied and no bandpass applied

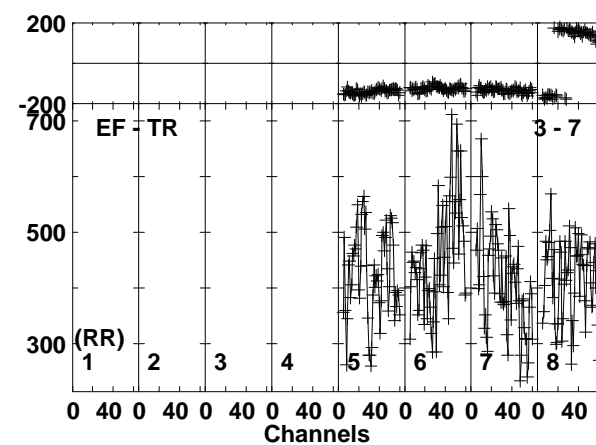
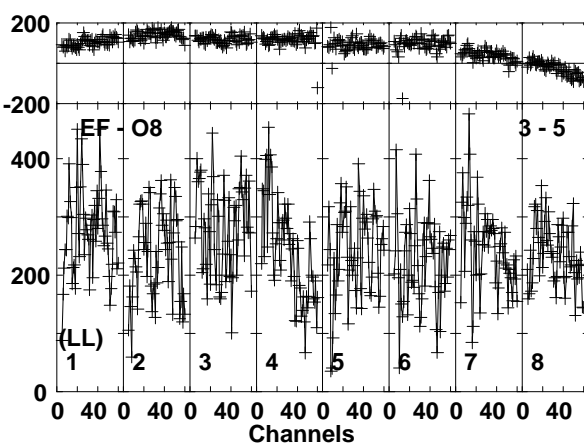
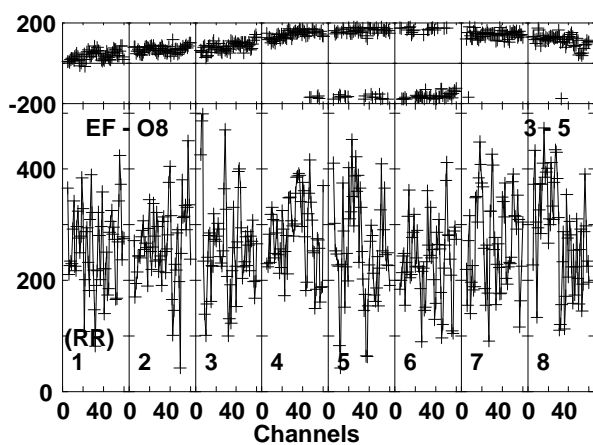
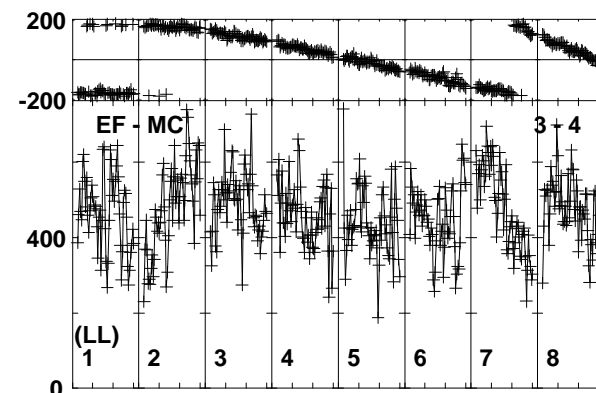
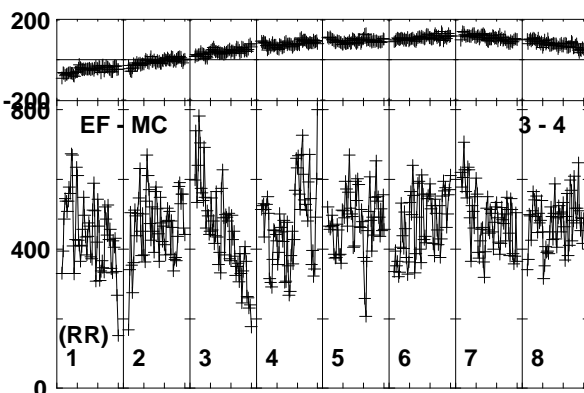
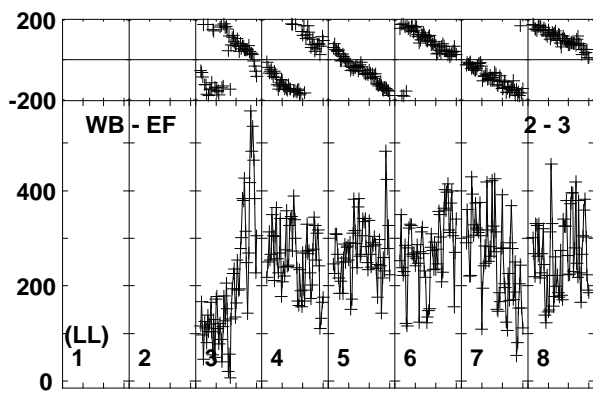
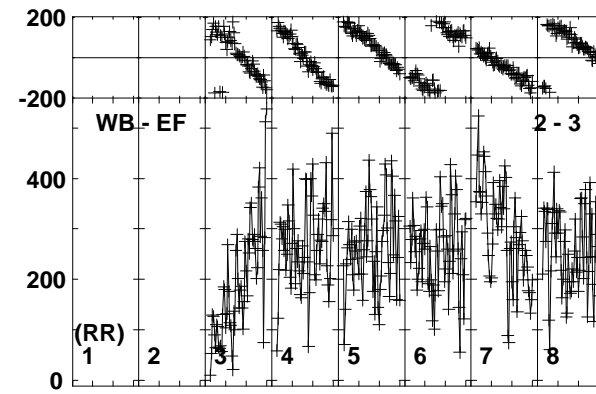
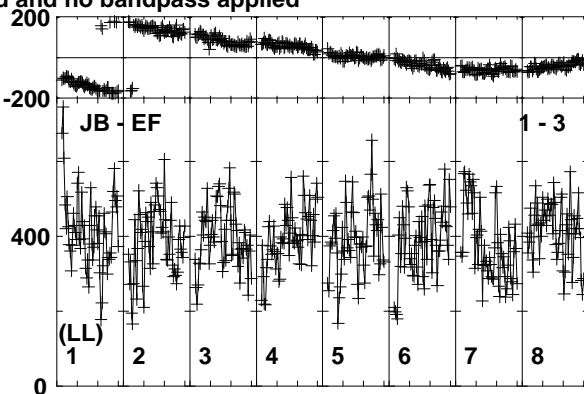
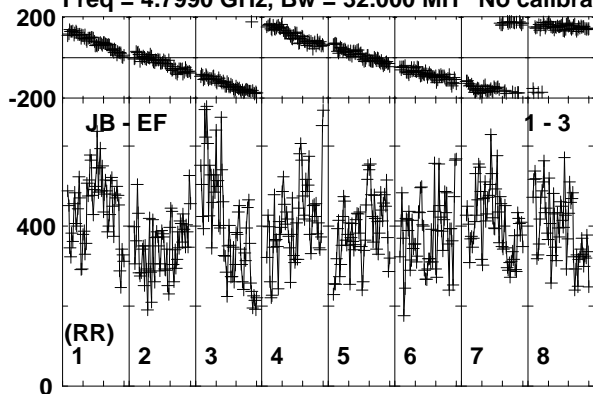

Lower frame: Micro Ampl Jy Top frame: Phas deg
Vector averaged cross-power spectrum Baseline: JB (01) - EF (03)
Timerange: 01/00:24:11 to 01/00:26:45

Plot file version 236 created 26-SEP-2019 10:40:36

J0300-0846 RG010A.UVDATA.1

Freq = 4.7990 GHz, Bw = 32.000 MH No calibration applied and no bandpass applied

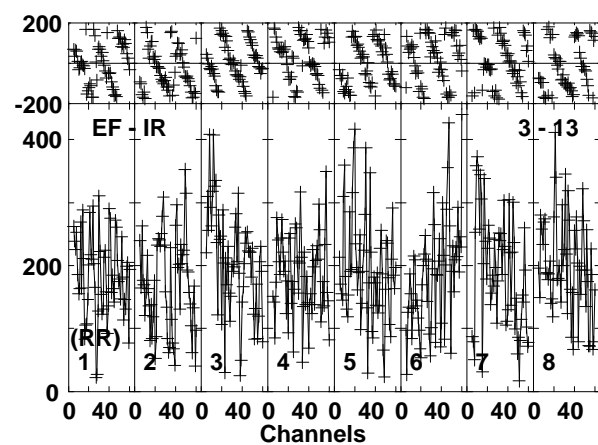
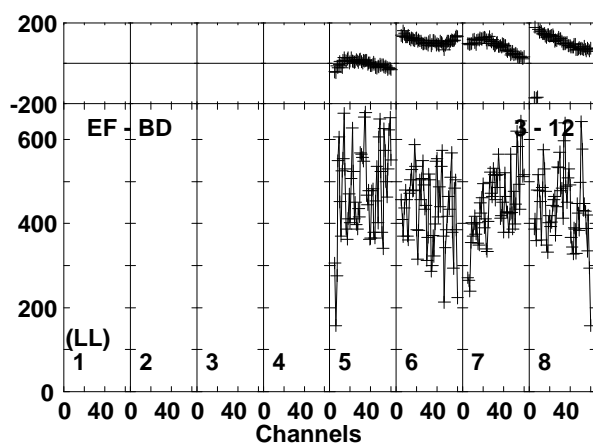
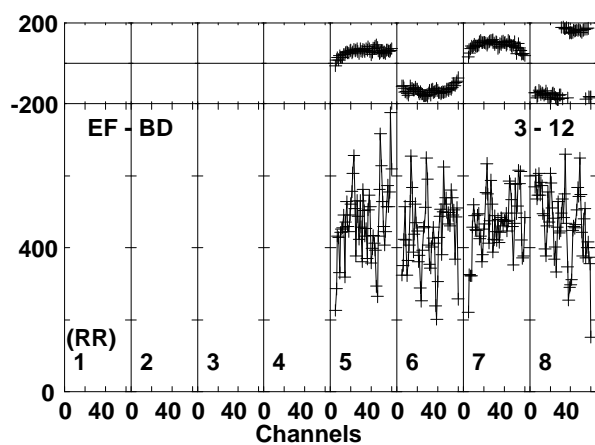
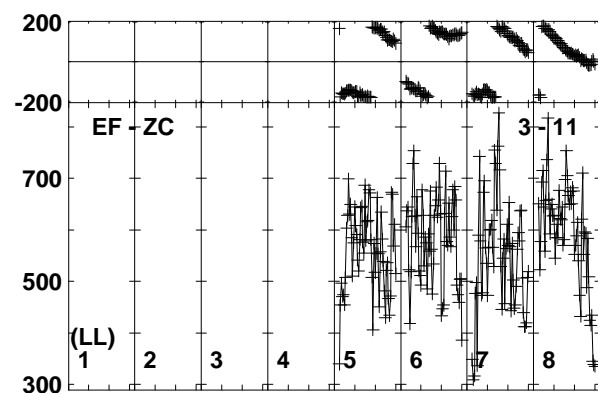
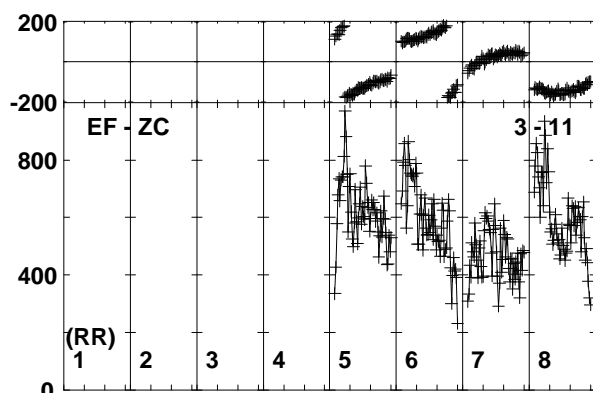
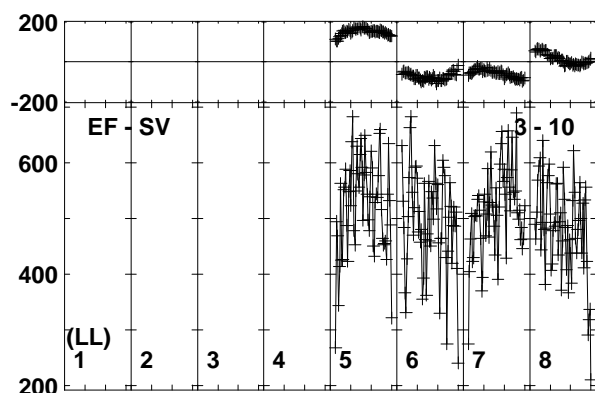
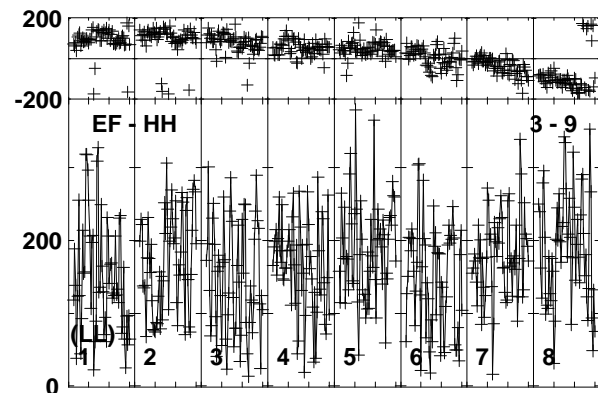
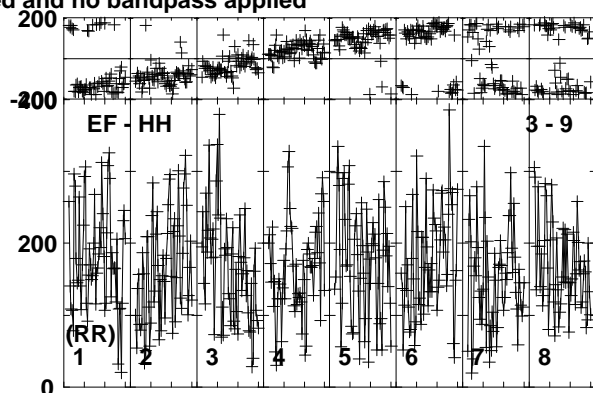
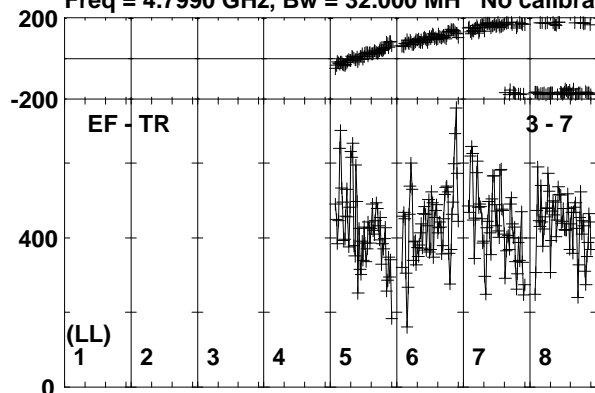

Lower frame: Micro Ampl Jy Top frame: Phas deg
Vector averaged cross-power spectrum Baseline: EF (03) - TR (07)
Timerange: 01/00:24:11 to 01/00:26:45

Plot file version 237 created 26-SEP-2019 10:40:37

J0300-0846 RG010A.UVDATA.1

Freq = 4.7990 GHz, Bw = 32.000 MH No calibration applied and no bandpass applied

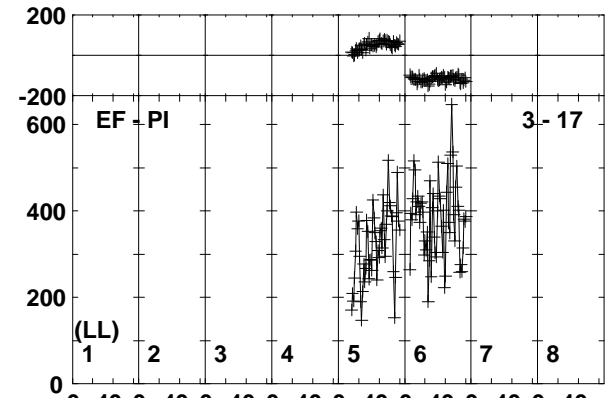
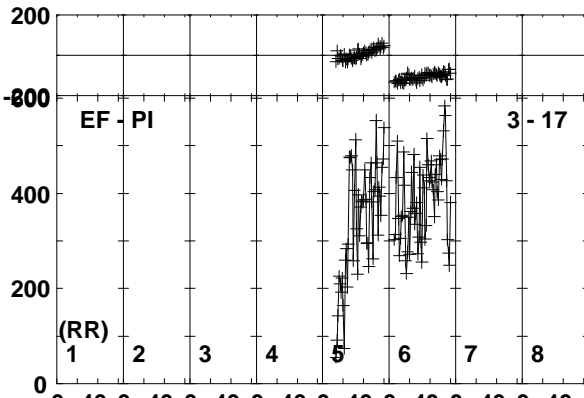
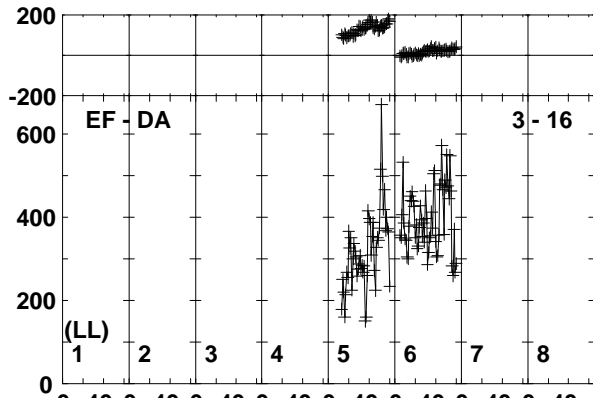
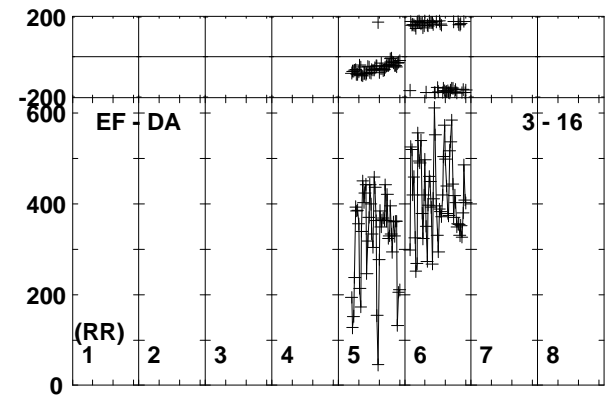
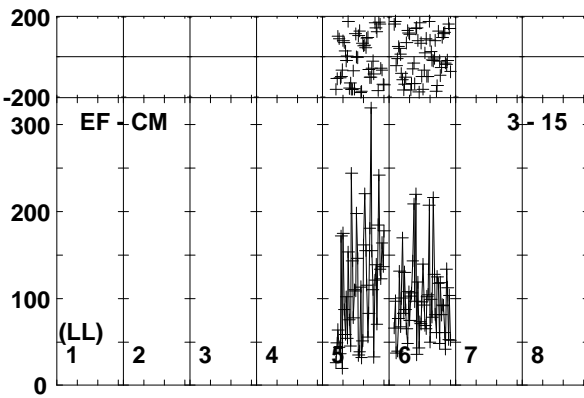
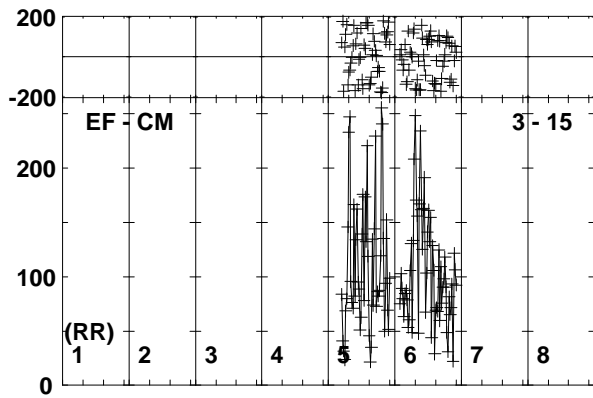
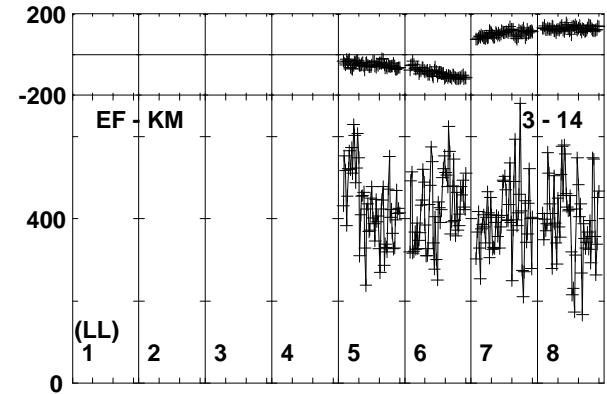
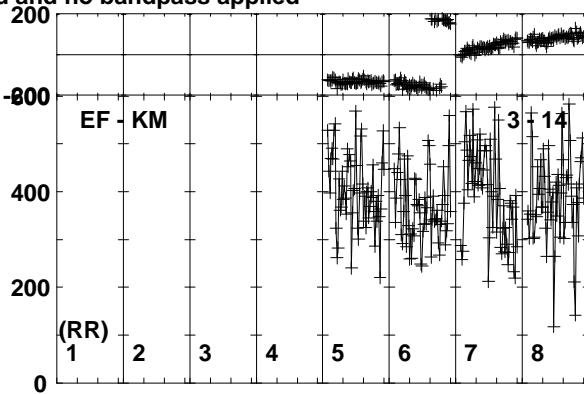
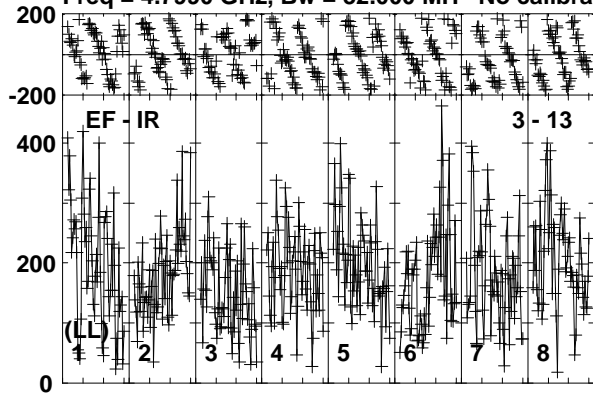

Lower frame: Micro Ampl Jy Top frame: Phas deg
Vector averaged cross-power spectrum Baseline: EF (03) - IR (13)
Timerange: 01/00:24:11 to 01/00:26:45

Plot file version 238 created 26-SEP-2019 10:40:38

J0300-0846 RG010A.UVDATA.1

Freq = 4.7990 GHz, Bw = 32.000 MH No calibration applied and no bandpass applied

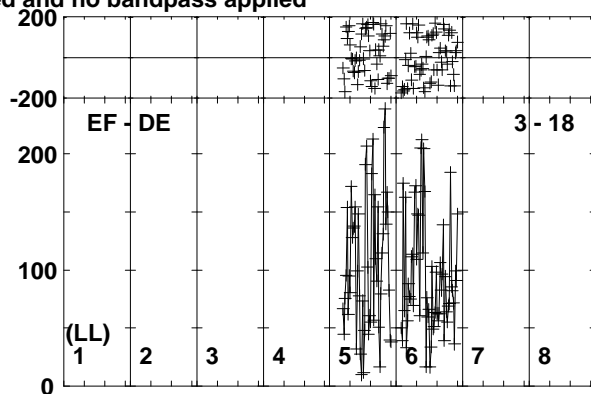
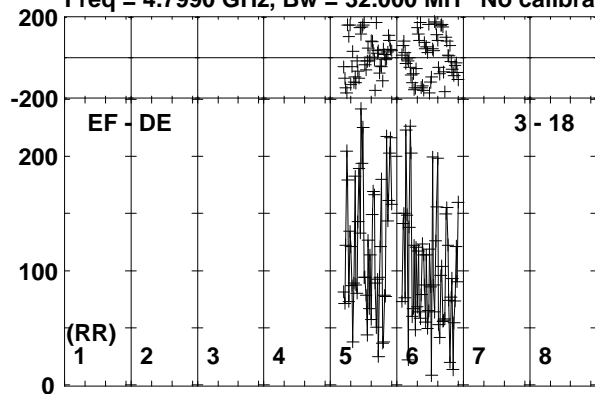

Lower frame: Micro Ampl Jy Top frame: Phas deg
Vector averaged cross-power spectrum Baseline: EF (03) - DE (18)
Timerange: 01/00:24:11 to 01/00:26:45

Plot file version 239 created 26-SEP-2019 10:40:38

190829A RG010A.UVDATA.1

Freq = 4.7990 GHz, Bw = 32.000 MH No calibration applied and no bandpass applied

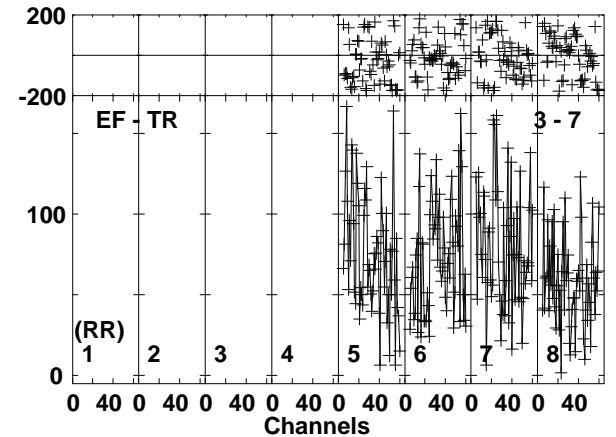
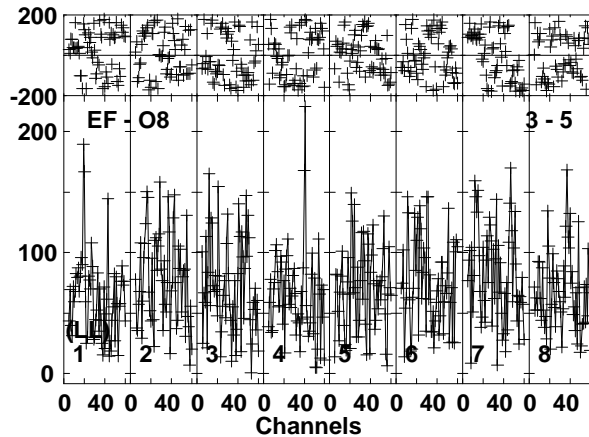
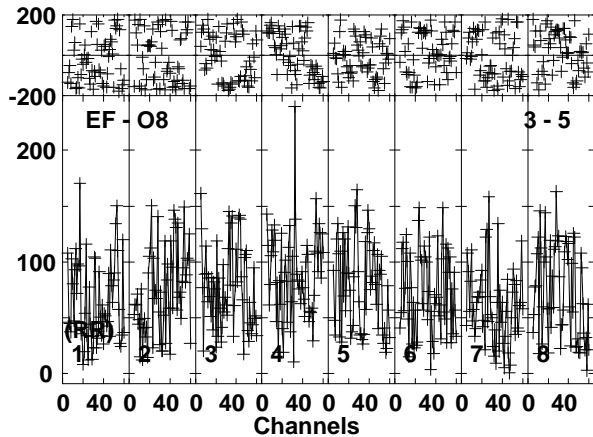
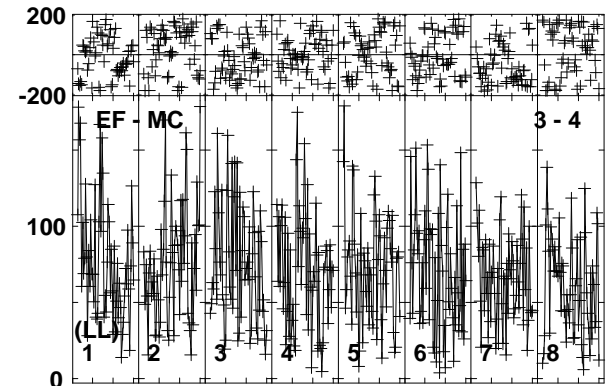
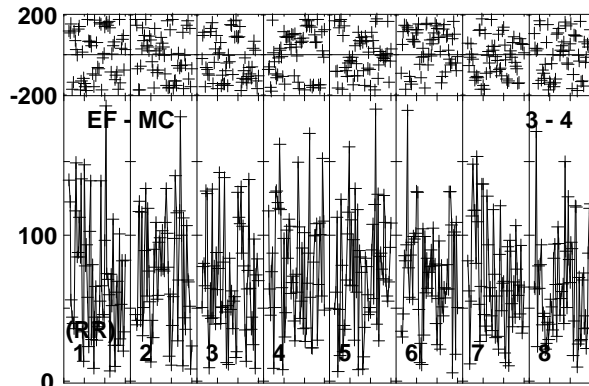
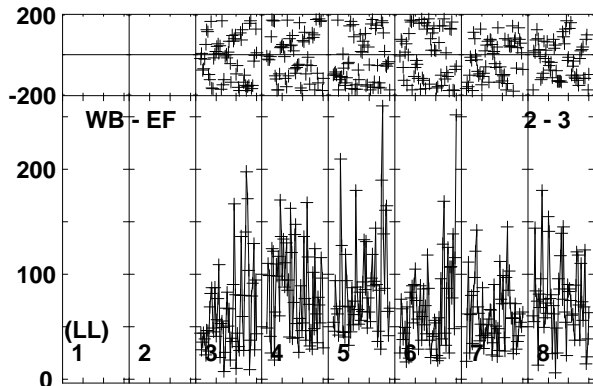
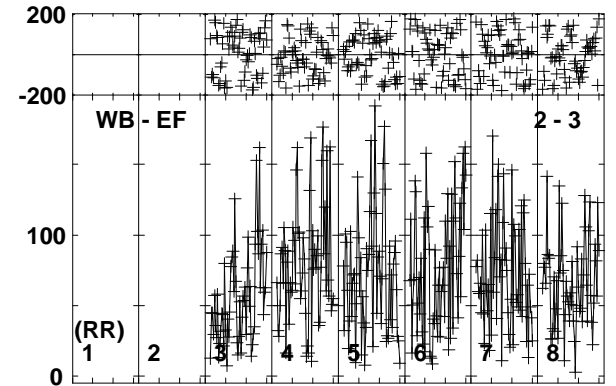
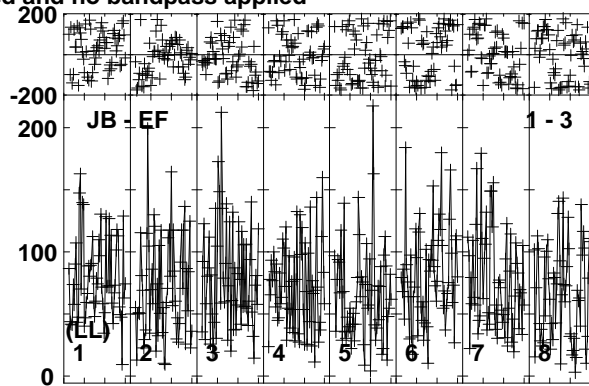
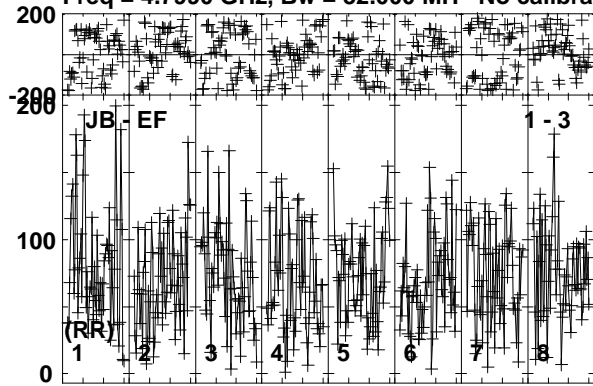

Lower frame: Micro Ampl Jy Top frame: Phas deg
Vector averaged cross-power spectrum Baseline: JB (01) - EF (03)
Timerange: 01/00:26:46 to 01/00:30:44

Plot file version 240 created 26-SEP-2019 10:40:39

190829A RG010A.UVDATA.1

Freq = 4.7990 GHz, Bw = 32.000 MH No calibration applied and no bandpass applied

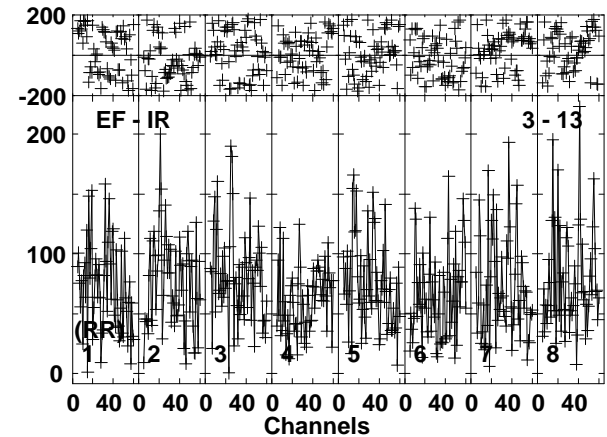
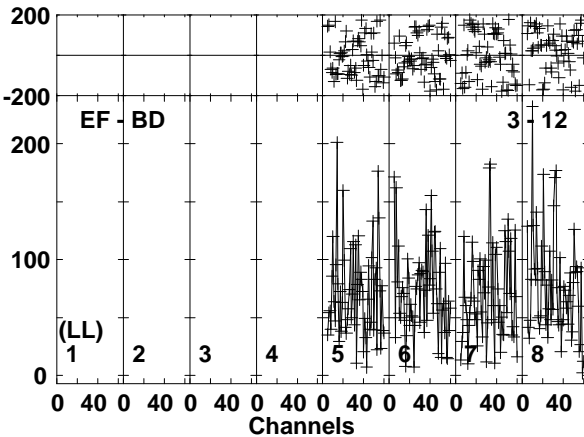
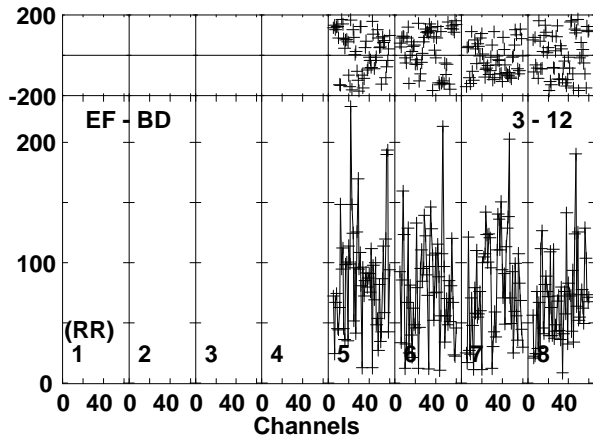
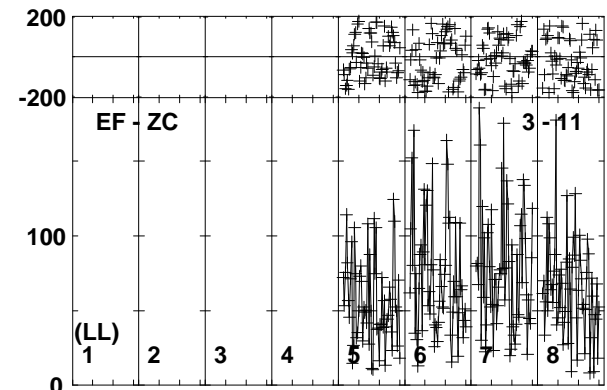
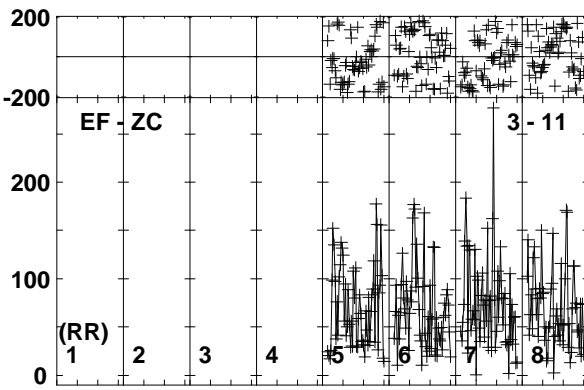
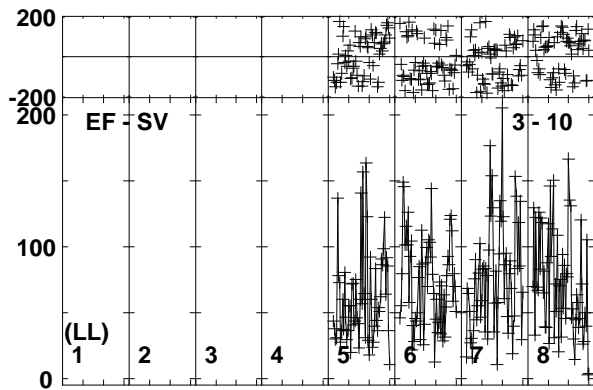
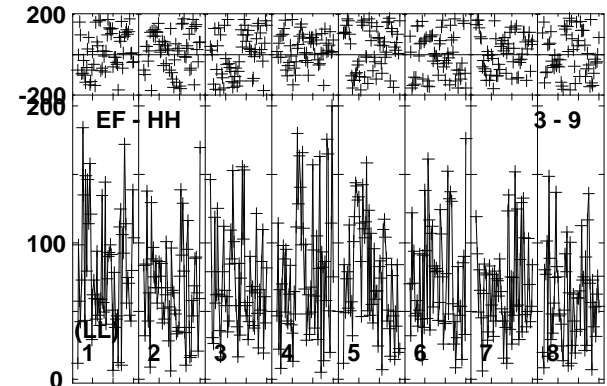
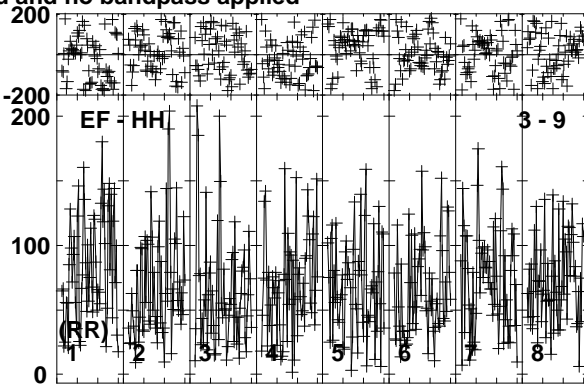
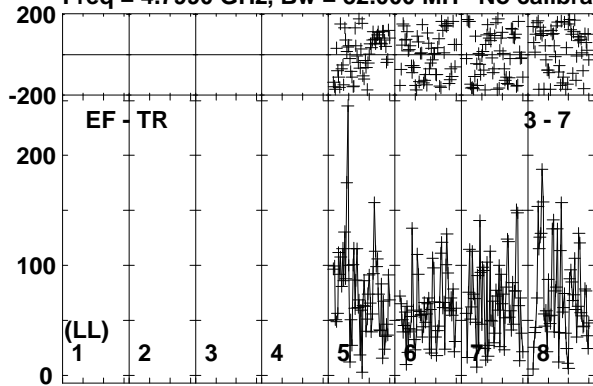

Lower frame: Micro Ampl Jy Top frame: Phas deg
Vector averaged cross-power spectrum Baseline: EF (03) - TR (07)
Timerange: 01/00:26:46 to 01/00:30:44

Plot file version 241 created 26-SEP-2019 10:40:39

190829A RG010A.UVDATA.1

Freq = 4.7990 GHz, Bw = 32.000 MH No calibration applied and no bandpass applied

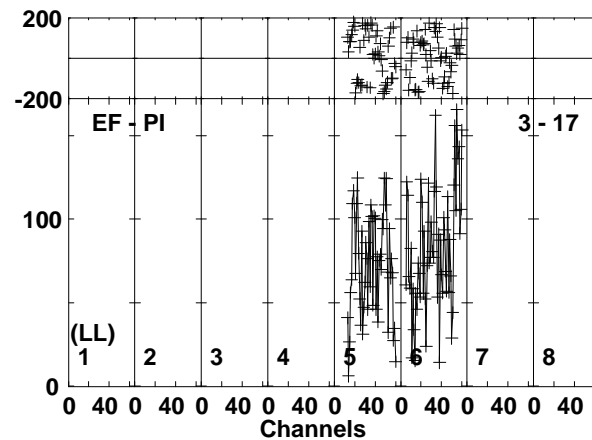
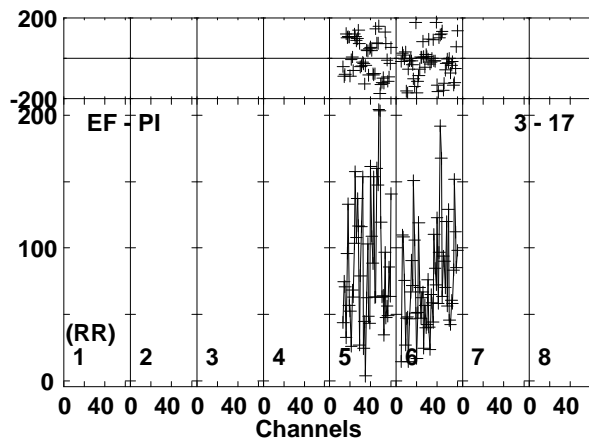
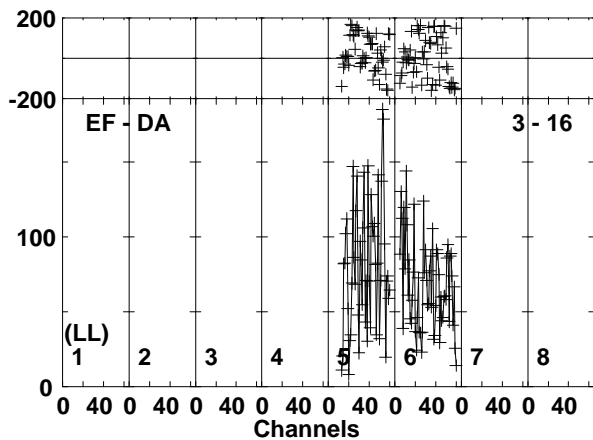
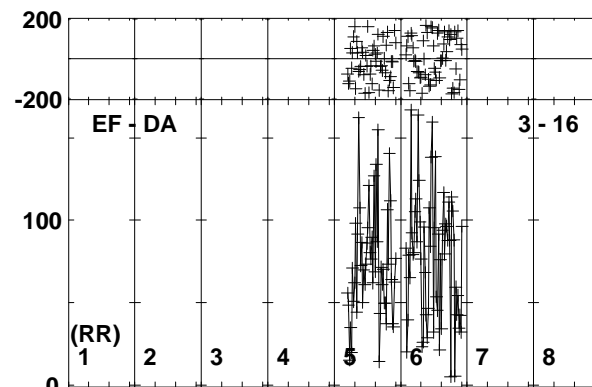
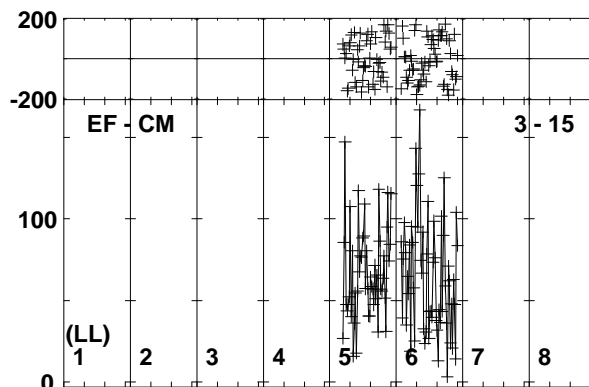
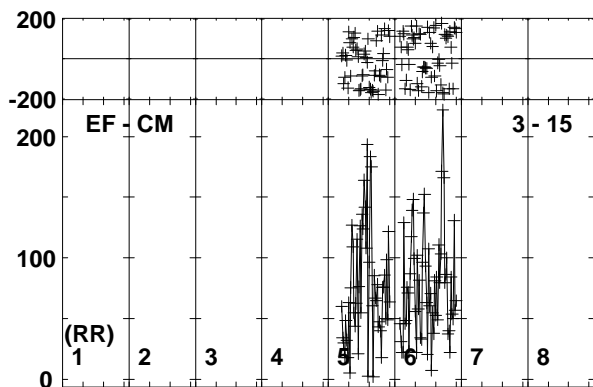
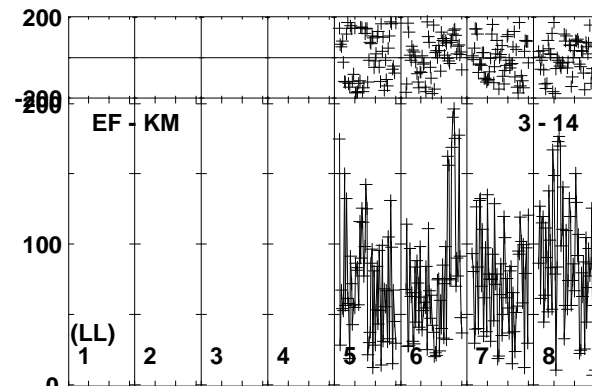
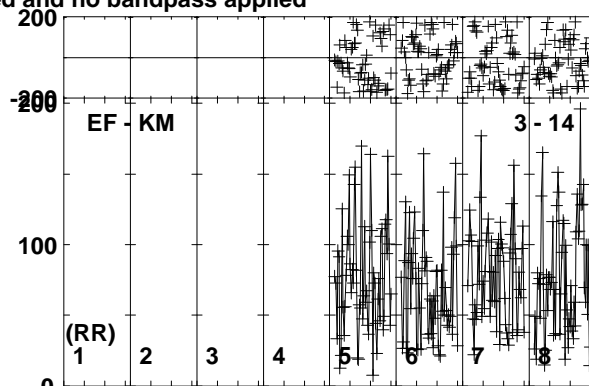
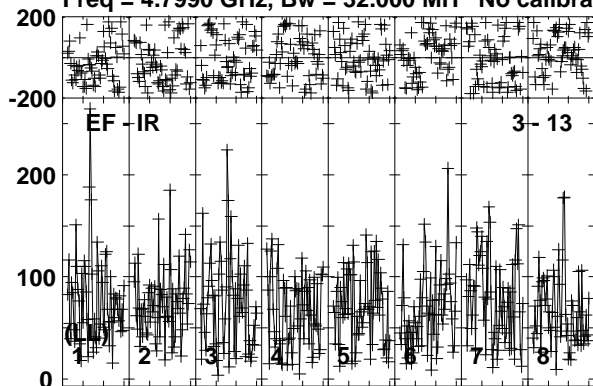

Lower frame: Micro Ampl Jy Top frame: Phas deg
Vector averaged cross-power spectrum Baseline: EF (03) - IR (13)
Timerange: 01/00:26:46 to 01/00:30:44

Plot file version 242 created 26-SEP-2019 10:40:40

190829A RG010A.UVDATA.1

Freq = 4.7990 GHz, Bw = 32.000 MH No calibration applied and no bandpass applied

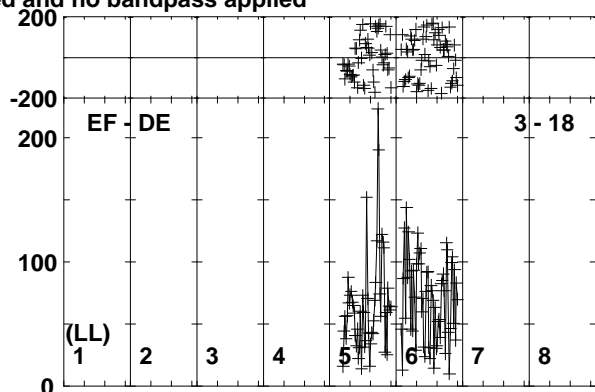
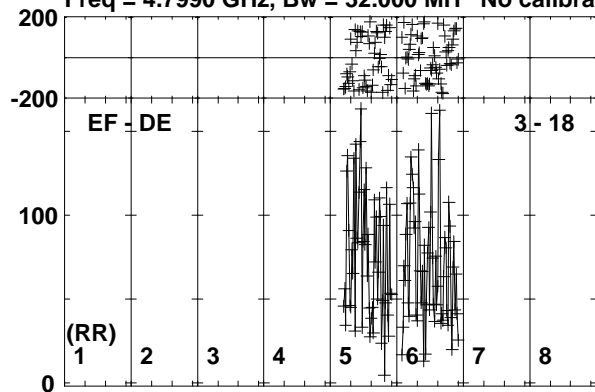

Lower frame: Micro Ampl Jy Top frame: Phas deg
Vector averaged cross-power spectrum Baseline: EF (03) - DE (18)
Timerange: 01/00:26:46 to 01/00:30:44

Plot file version 243 created 26-SEP-2019 10:40:40

J0257-1212 RG010A.UVDATA.1

Freq = 4.7990 GHz, Bw = 32.000 MH No calibration applied and no bandpass applied

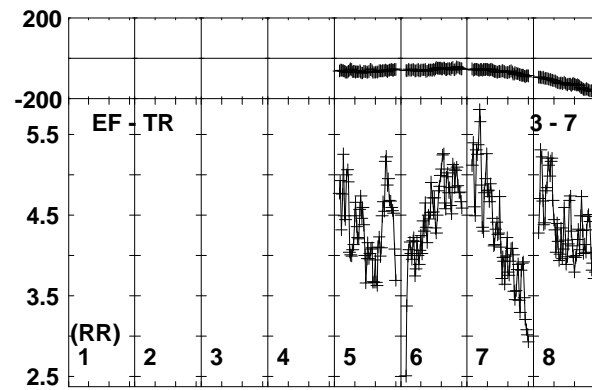
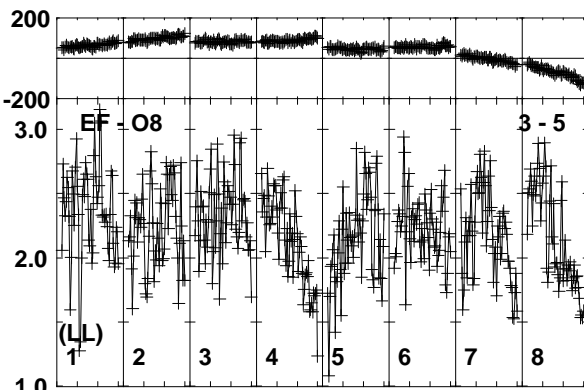
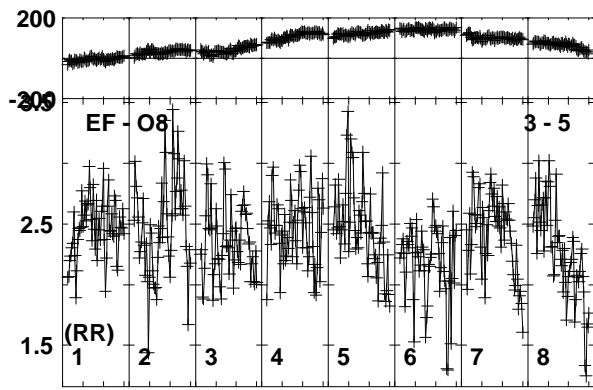
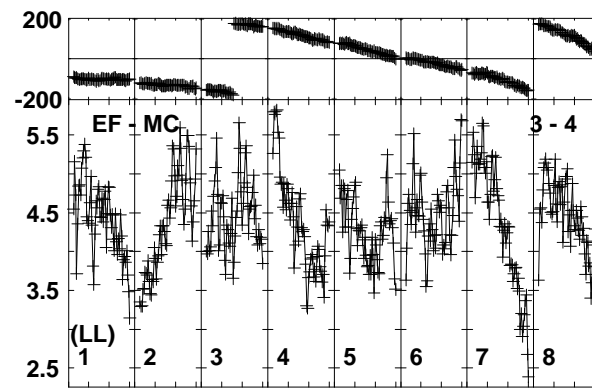
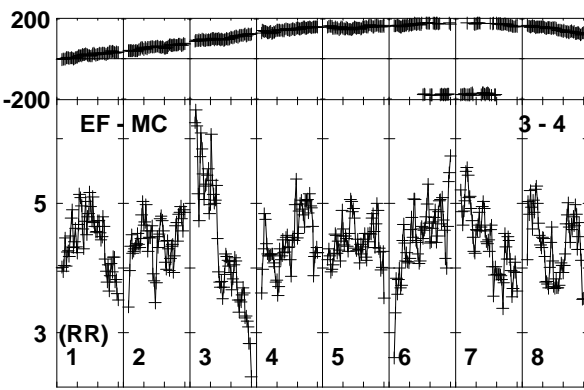
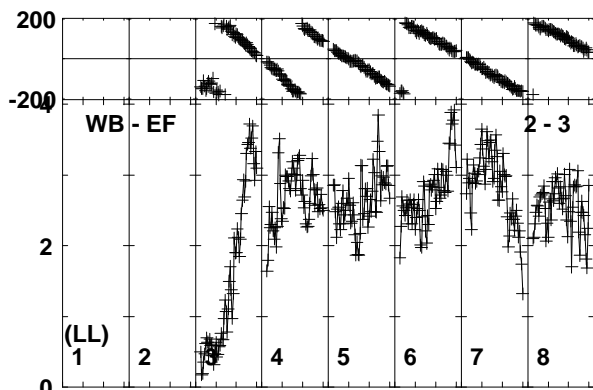
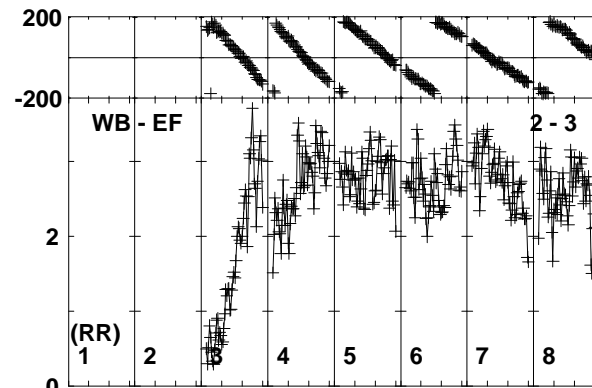
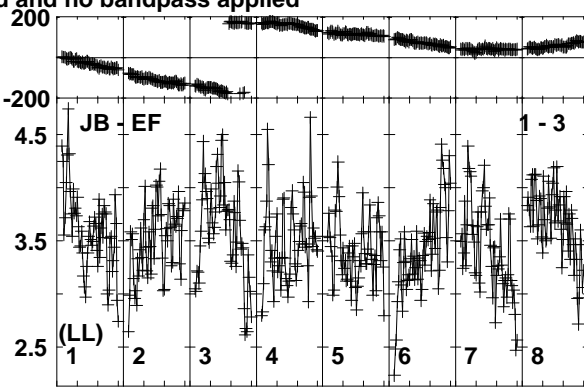
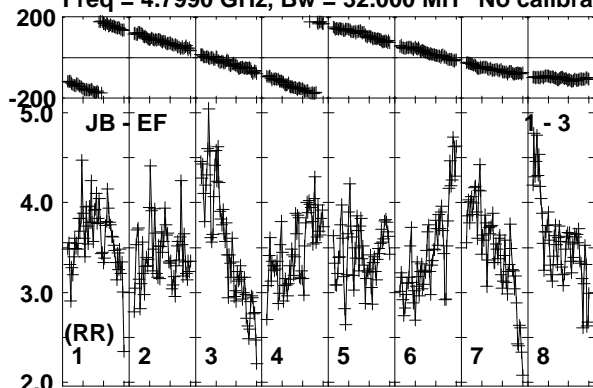

Lower frame: Milli Ampl Jy Top frame: Phas deg
Vector averaged cross-power spectrum Baseline: JB (01) - EF (03)
Timerange: 01/00:30:45 to 01/00:31:44

Plot file version 244 created 26-SEP-2019 10:40:40

J0257-1212 RG010A.UVDATA.1

Freq = 4.7990 GHz, Bw = 32.000 MH No calibration applied and no bandpass applied

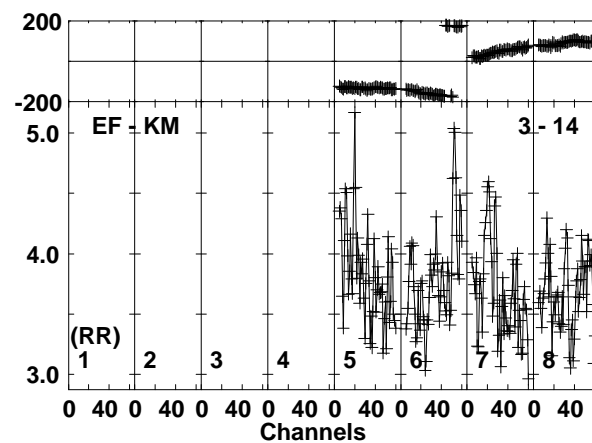
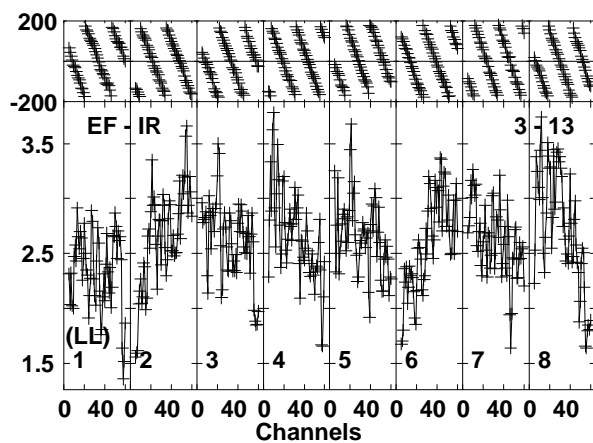
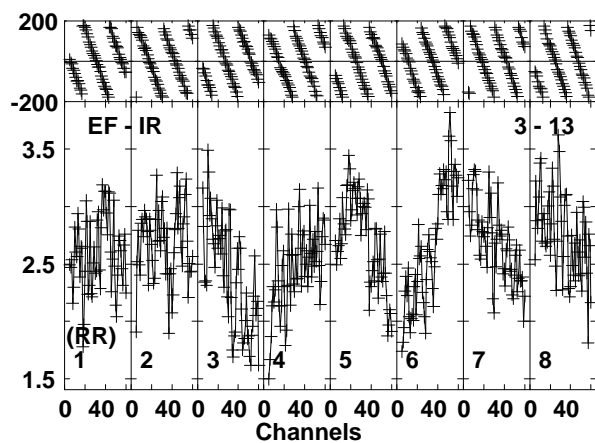
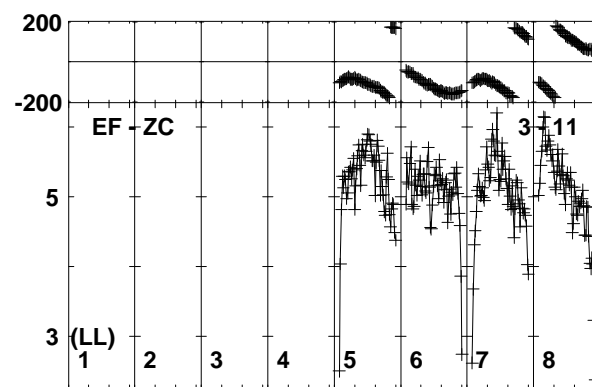
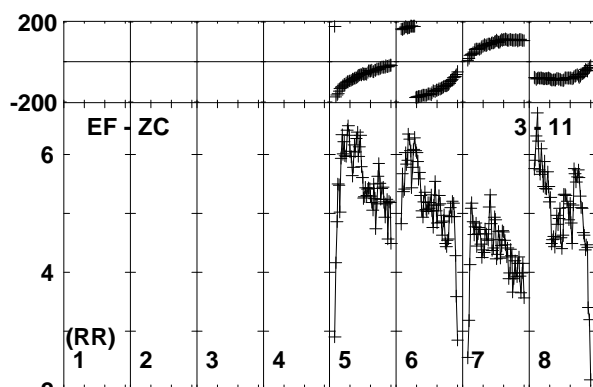
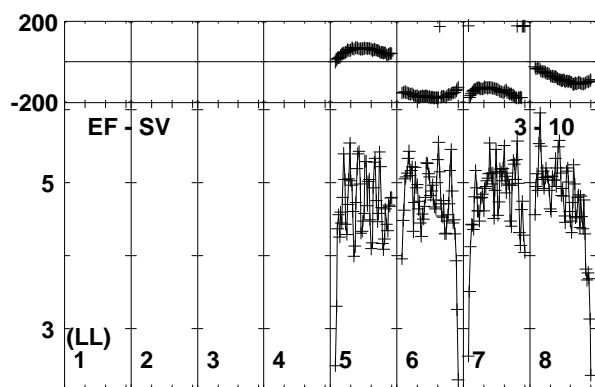
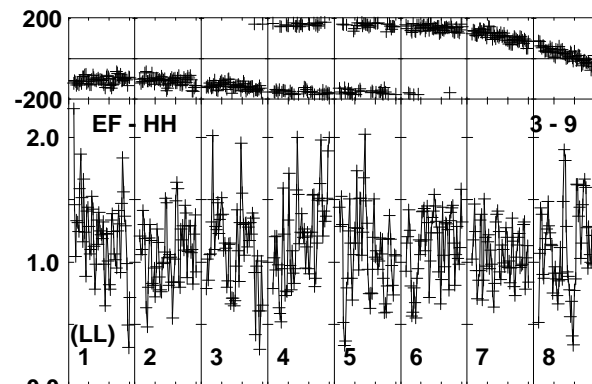
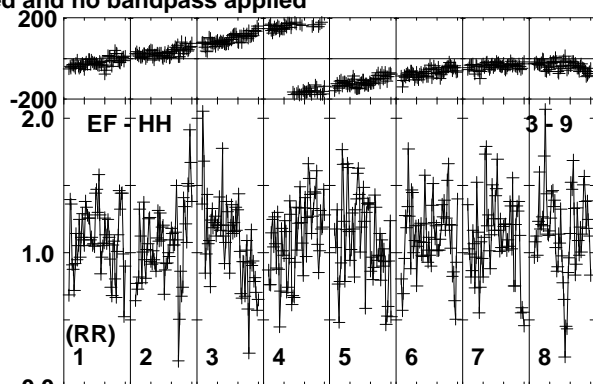
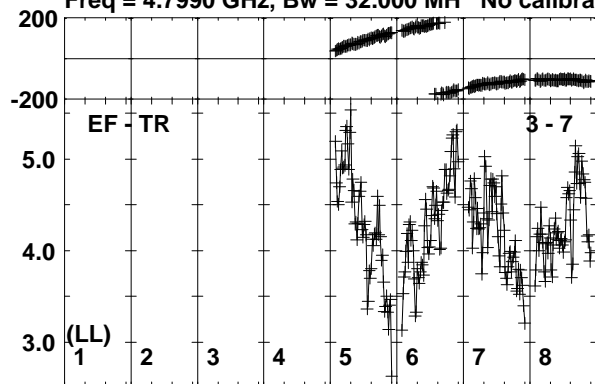

Lower frame: Milli Ampl Jy Top frame: Phas deg
Vector averaged cross-power spectrum Baseline: EF (03) - TR (07)
Timerange: 01/00:30:45 to 01/00:31:44

Plot file version 245 created 26-SEP-2019 10:40:41

J0257-1212 RG010A.UVDATA.1

Freq = 4.7990 GHz, Bw = 32.000 MH No calibration applied and no bandpass applied

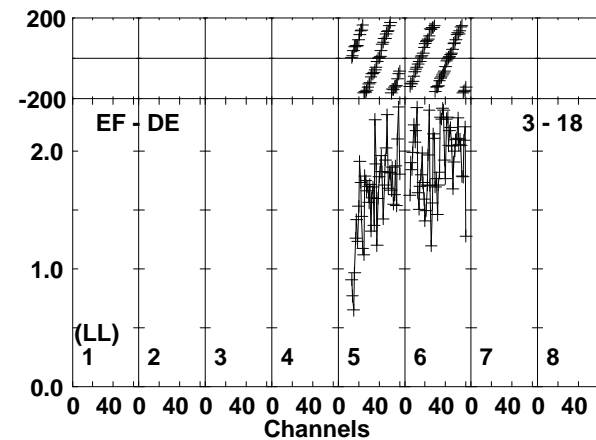
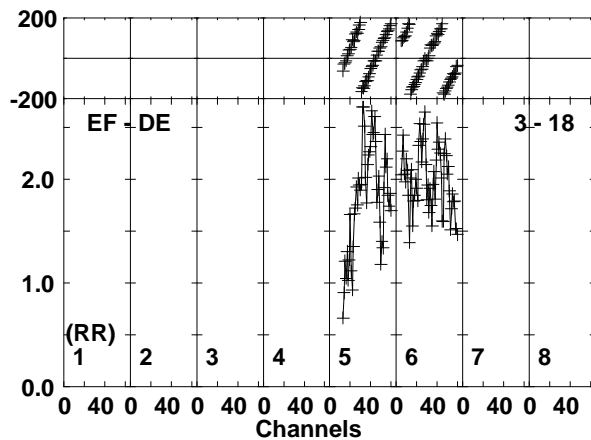
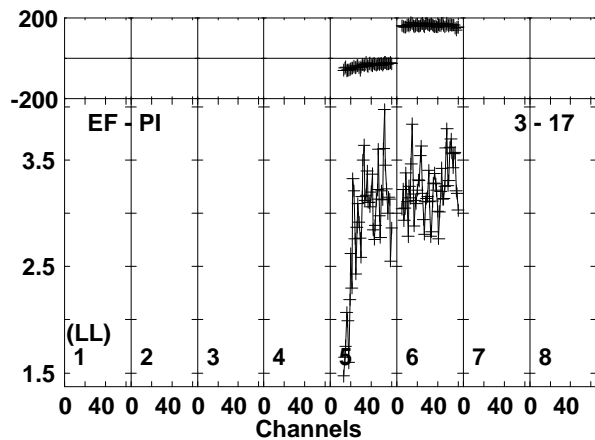
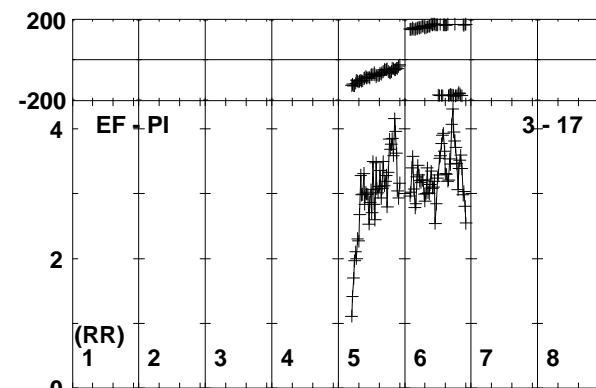
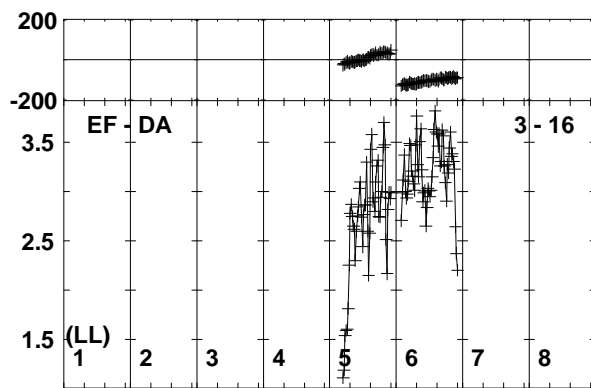
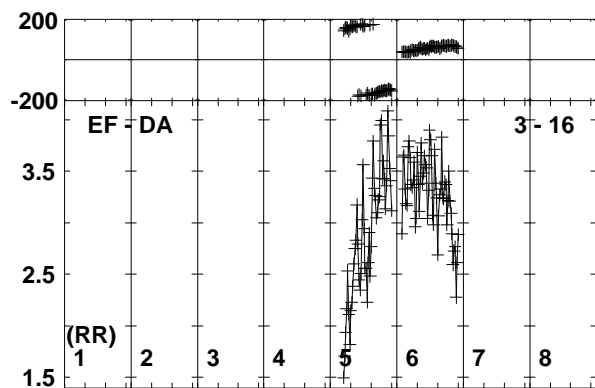
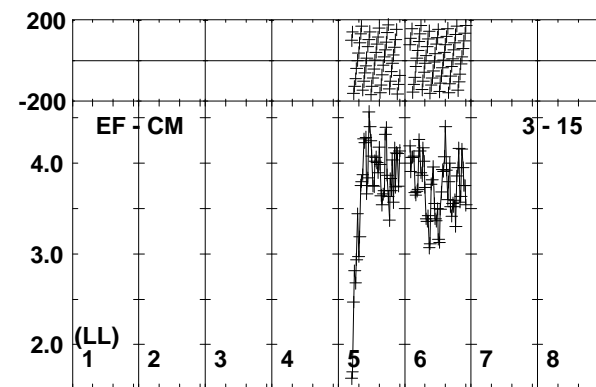
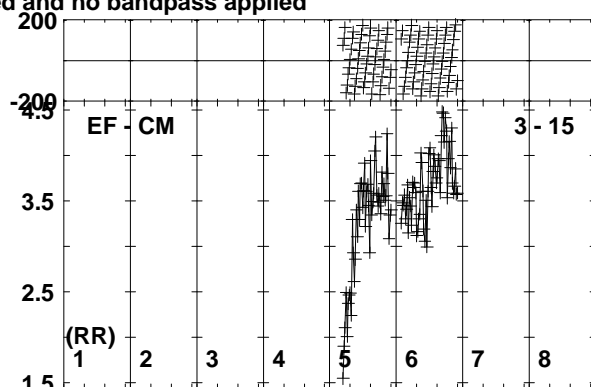
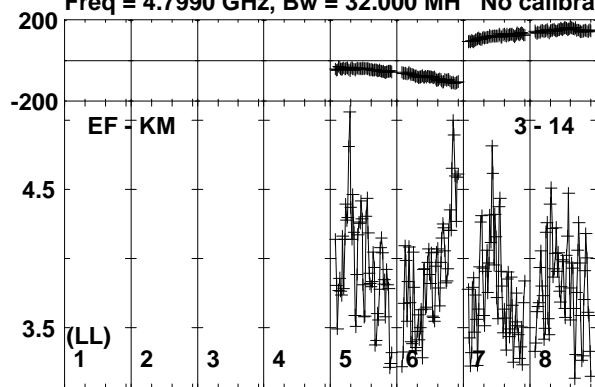

Lower frame: Milli Ampl Jy Top frame: Phas deg
Vector averaged cross-power spectrum Baseline: EF (03) - KM (14)
Timerange: 01/00:30:45 to 01/00:31:44

Plot file version 246 created 26-SEP-2019 10:40:41

NVSS-1 RG010A.UVDATA.1

Freq = 4.7990 GHz, Bw = 32.000 MH No calibration applied and no bandpass applied

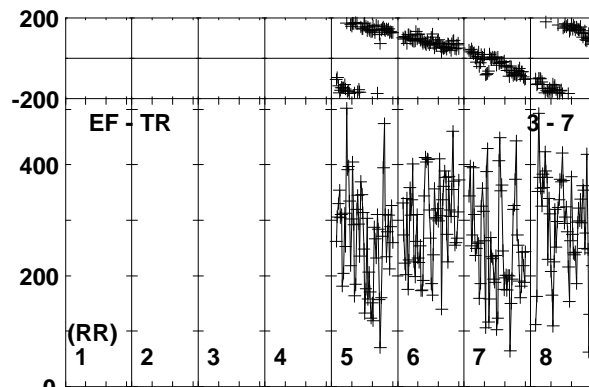
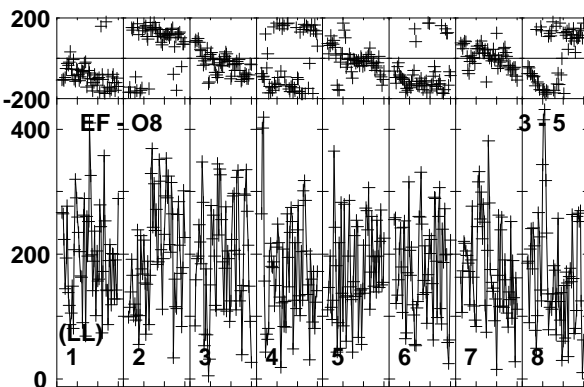
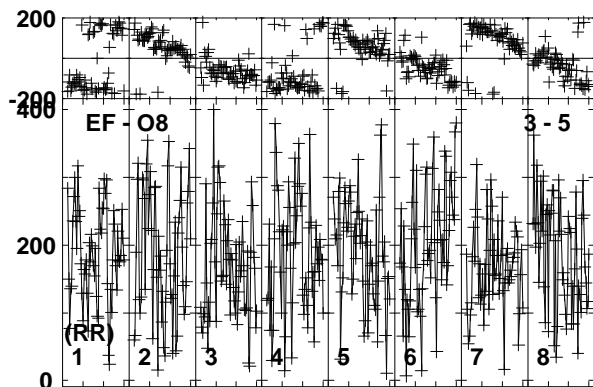
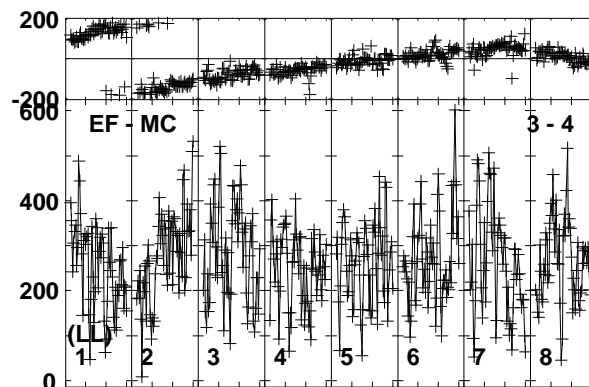
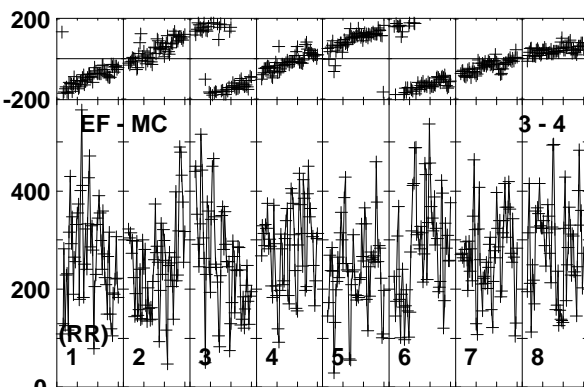
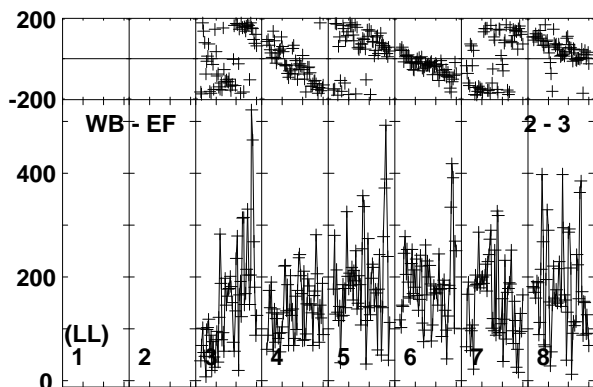
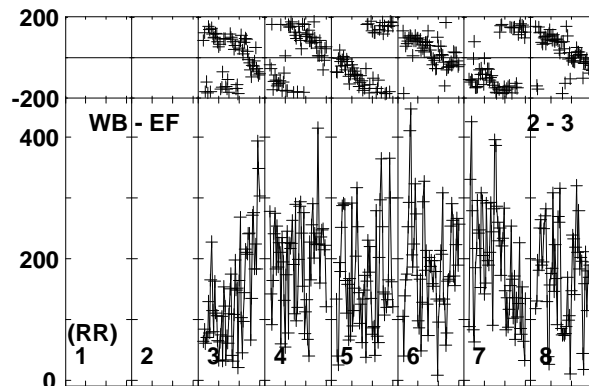
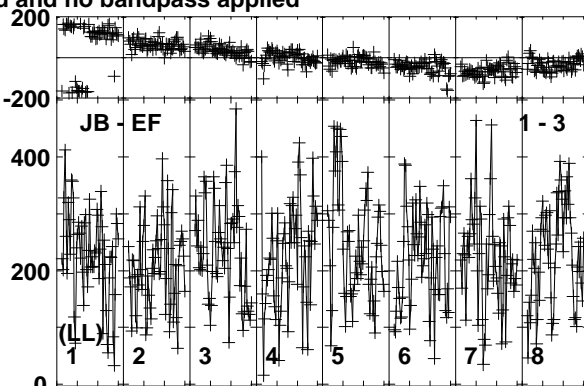
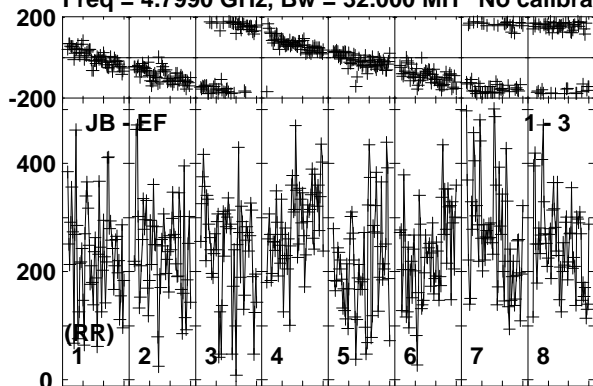

Lower frame: Micro Ampl Jy Top frame: Phas deg
Vector averaged cross-power spectrum Baseline: JB (01) - EF (03)
Timerange: 01/00:31:46 to 01/00:33:54

Plot file version 247 created 26-SEP-2019 10:40:41

NVSS-1 RG010A.UVDATA.1

Freq = 4.7990 GHz, Bw = 32.000 MH No calibration applied and no bandpass applied

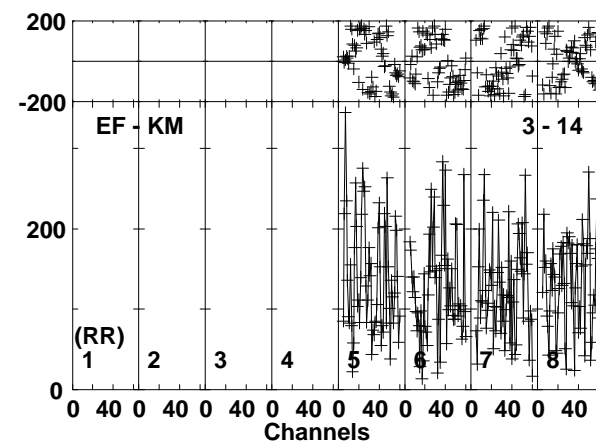
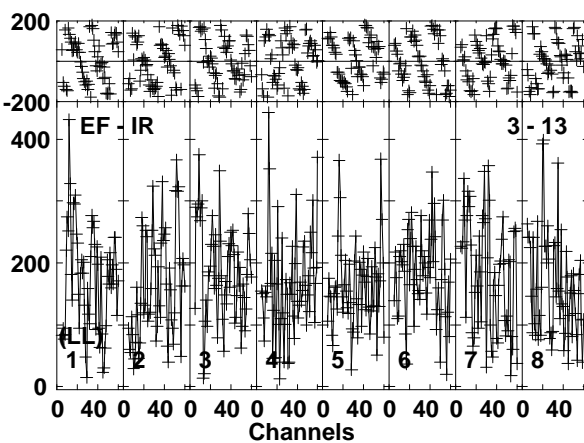
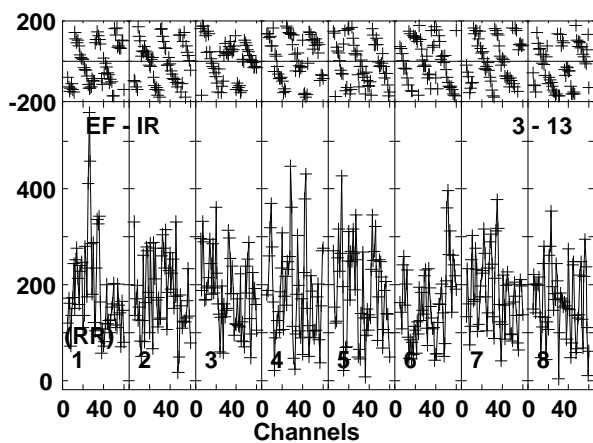
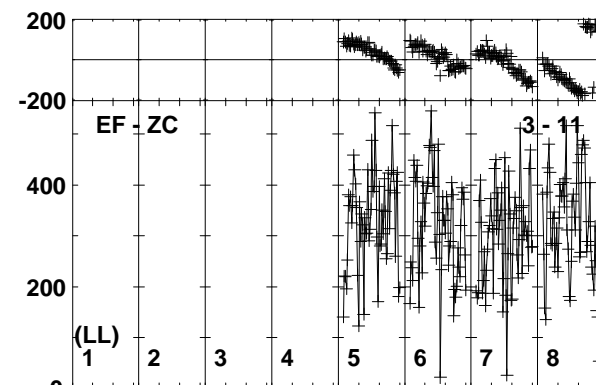
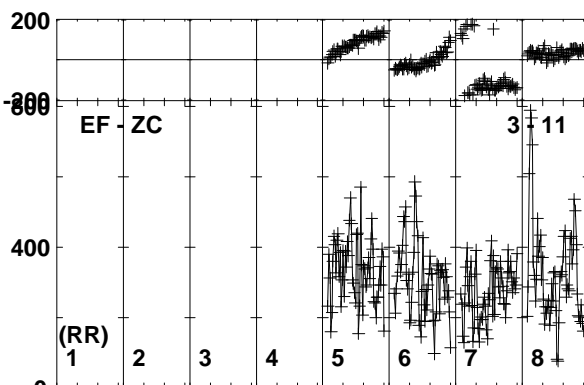
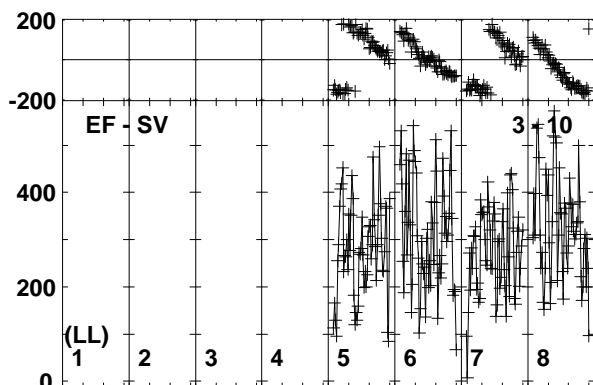
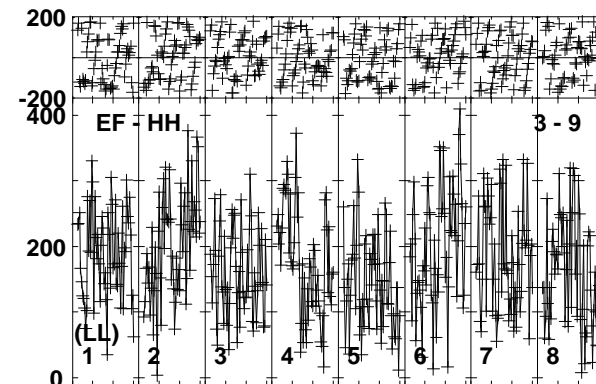
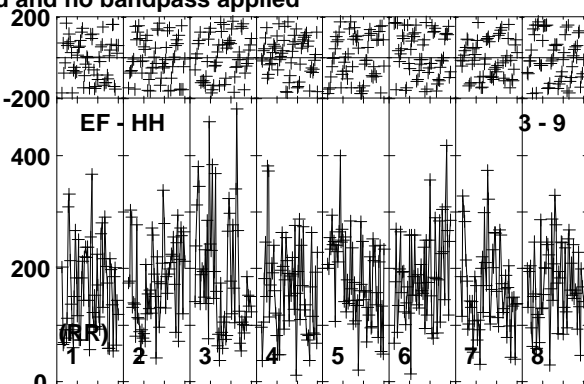
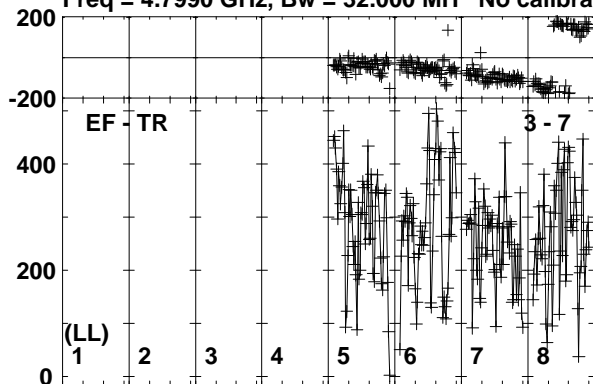

Lower frame: Micro Ampl Jy Top frame: Phas deg
Vector averaged cross-power spectrum Baseline: EF (03) - TR (07)
Timerange: 01/00:31:46 to 01/00:33:54

Plot file version 248 created 26-SEP-2019 10:40:42
 NVSS-1 RG010A.UVDATA.1
 Freq = 4.7990 GHz, Bw = 32.000 MH No calibration applied and no bandpass applied

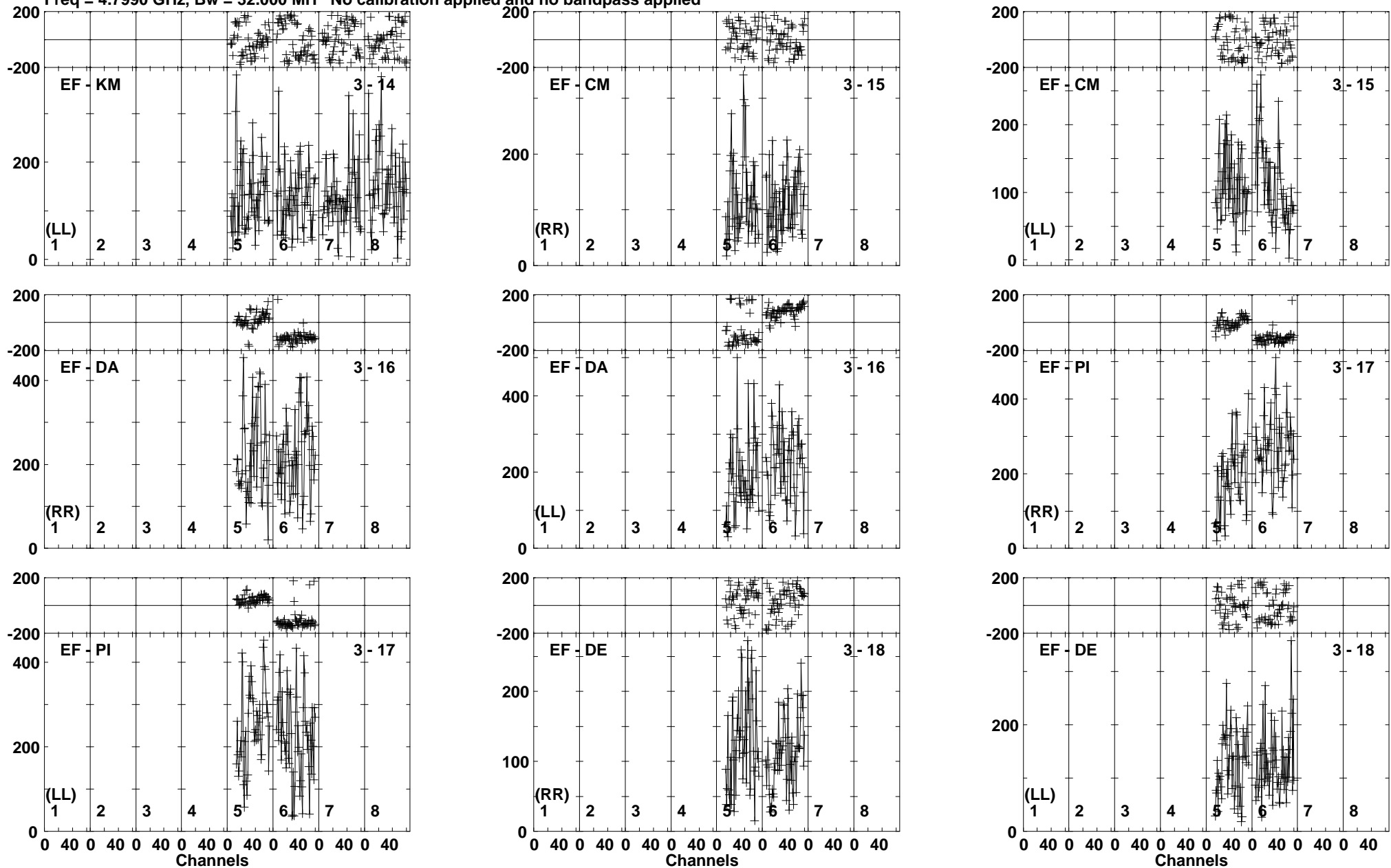

Lower frame: Micro Ampl Jy Top frame: Phas deg
 Vector averaged cross-power spectrum Baseline: EF (03) - KM (14)
 Timerange: 01/00:31:46 to 01/00:33:54

Plot file version 249 created 26-SEP-2019 10:40:42

J0257-1212 RG010A.UVDATA.1

Freq = 4.7990 GHz, Bw = 32.000 MH No calibration applied and no bandpass applied

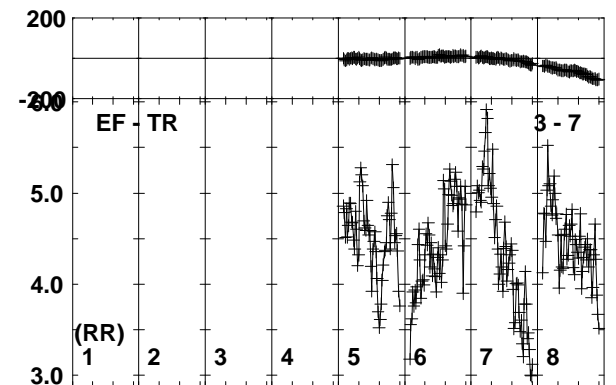
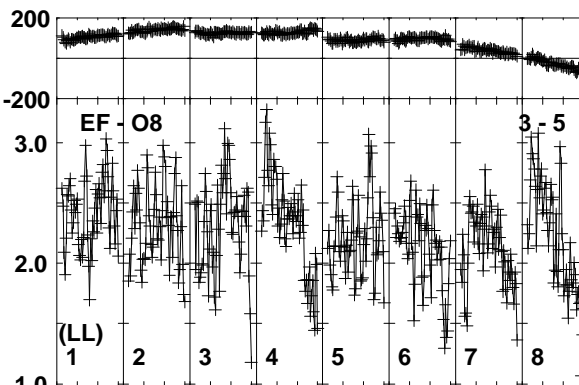
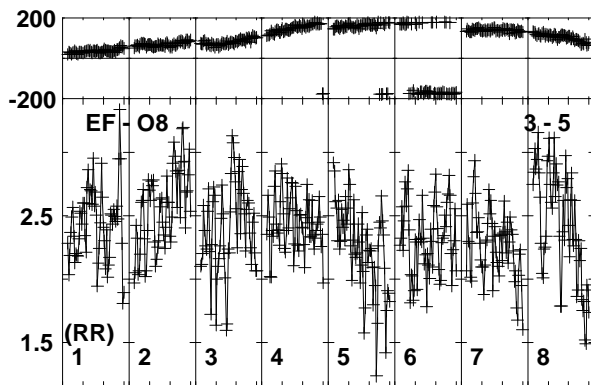
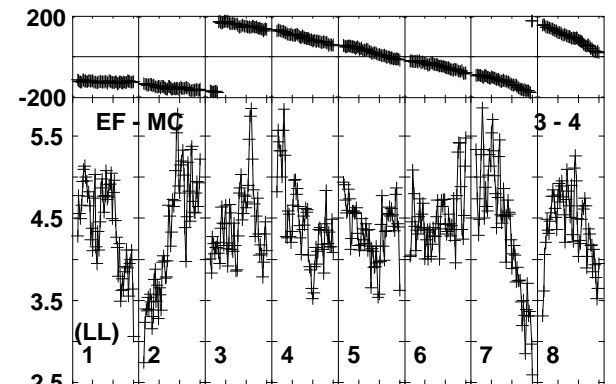
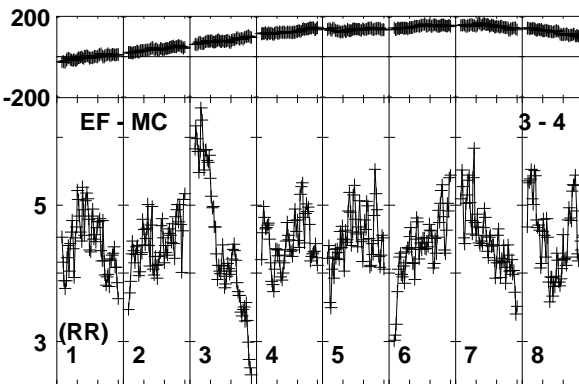
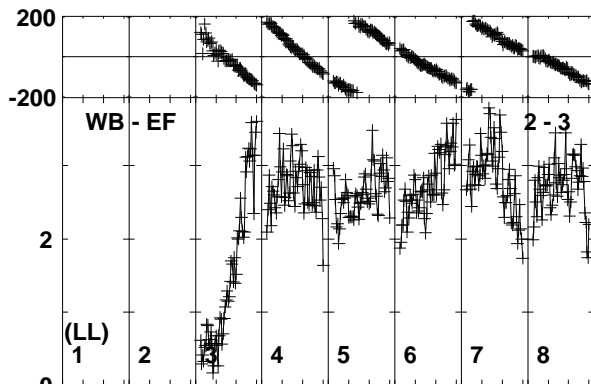
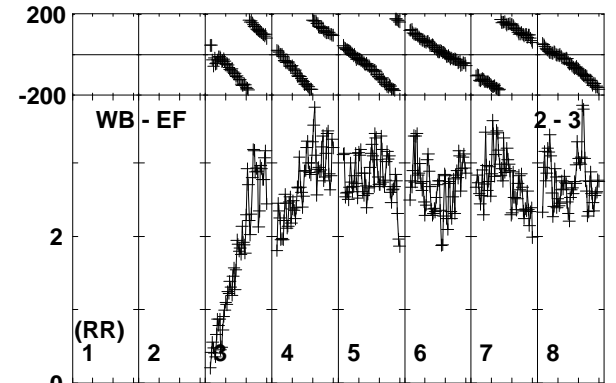
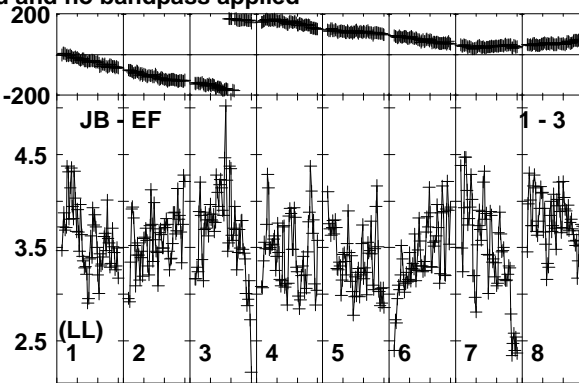
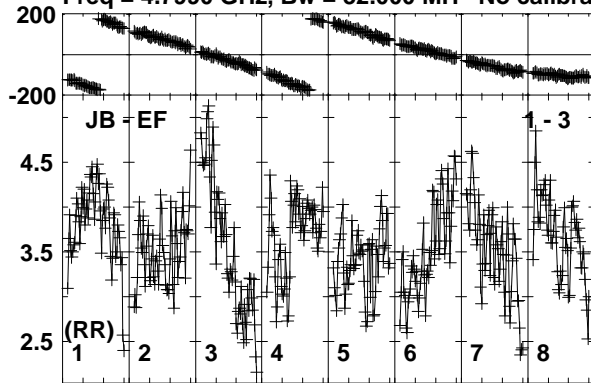

Lower frame: Milli Ampl Jy Top frame: Phas deg

Vector averaged cross-power spectrum Baseline: JB (01) - EF (03)

Timerange: 01/00:33:56 to 01/00:34:55

Plot file version 250 created 26-SEP-2019 10:40:43
 J0257-1212 RG010A.UVDATA.1
 Freq = 4.7990 GHz, Bw = 32.000 MH No calibration applied and no bandpass applied

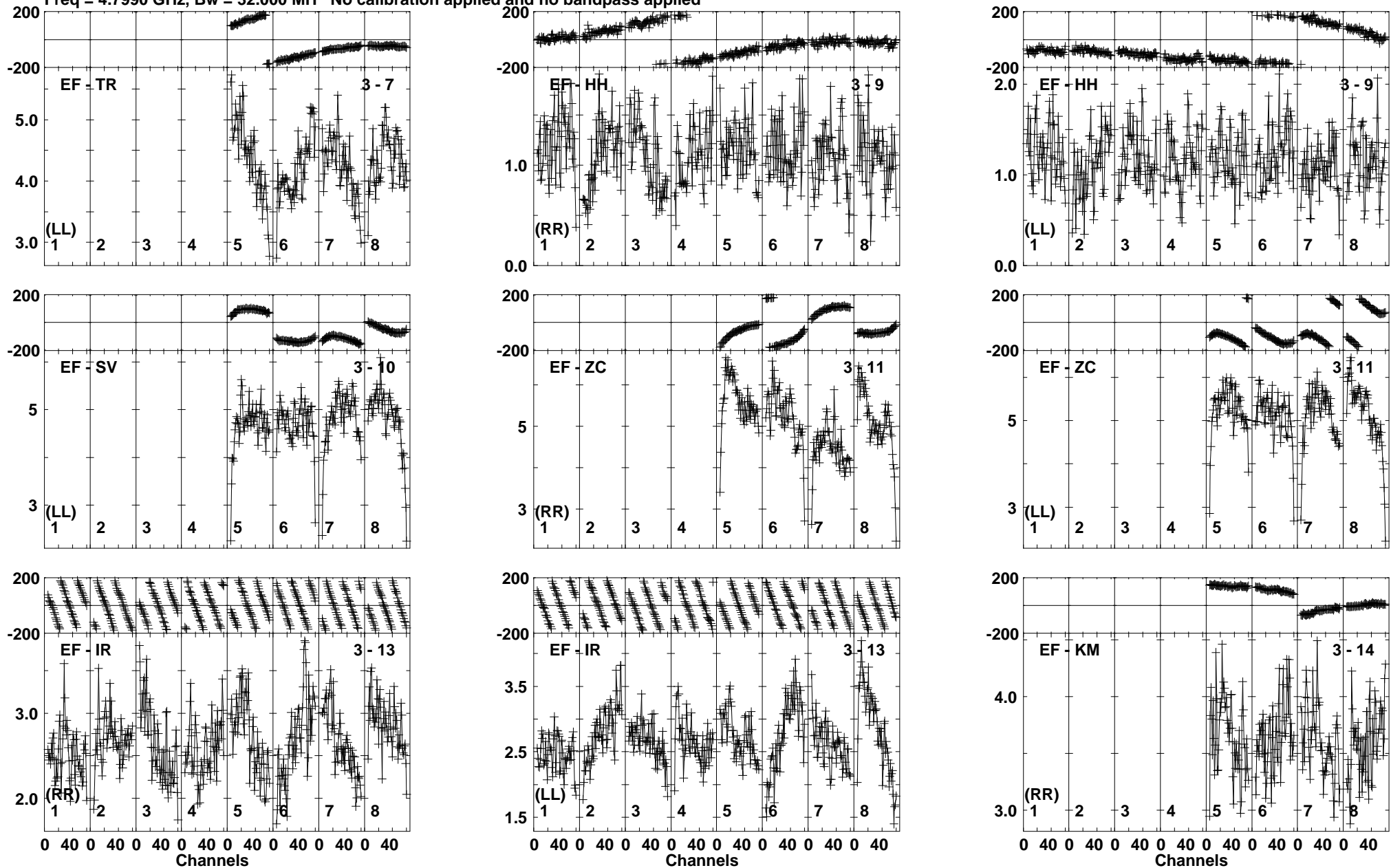

Lower frame: Milli Ampl Jy Top frame: Phas deg
 Vector averaged cross-power spectrum Baseline: EF (03) - TR (07)
 Timerange: 01/00:33:56 to 01/00:34:55

Plot file version 251 created 26-SEP-2019 10:40:43

J0257-1212 RG010A.UVDATA.1

Freq = 4.7990 GHz, Bw = 32.000 MH No calibration applied and no bandpass applied

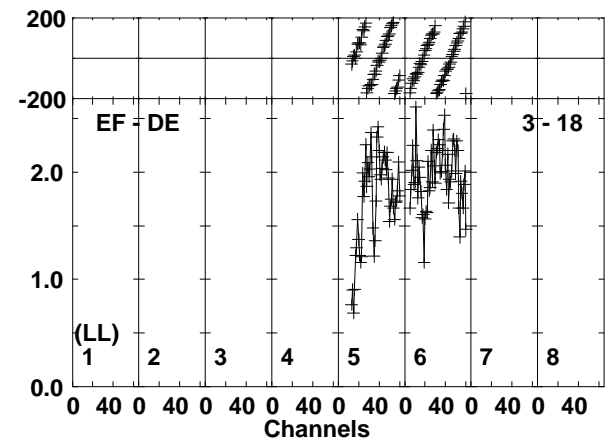
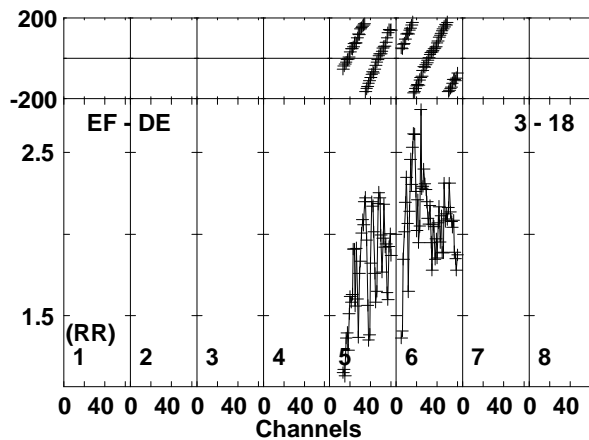
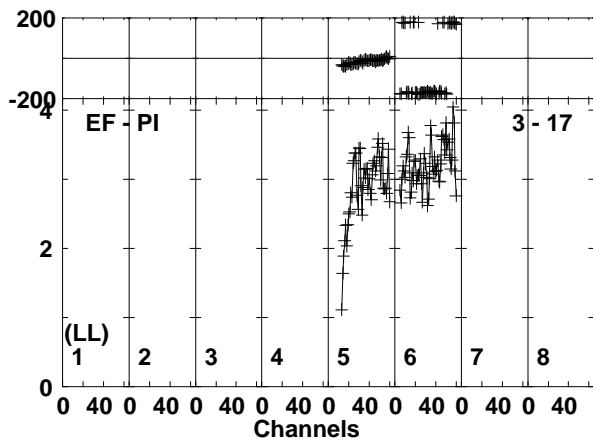
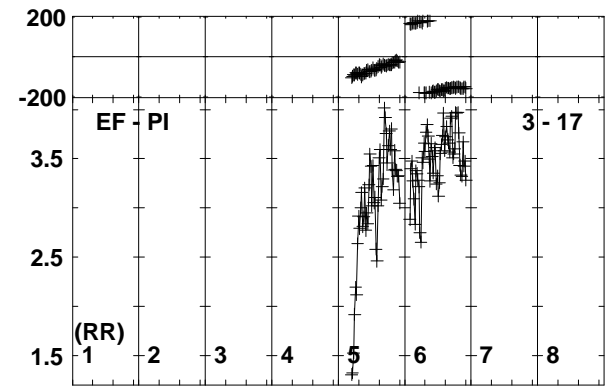
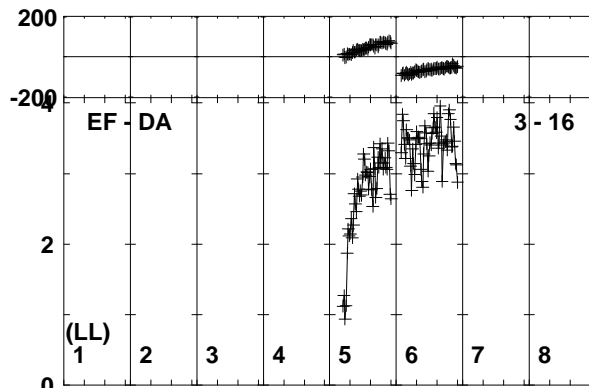
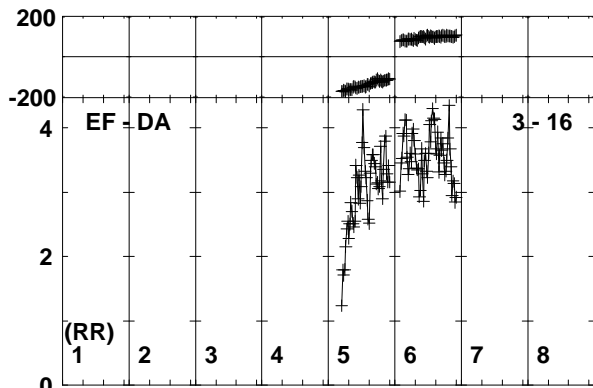
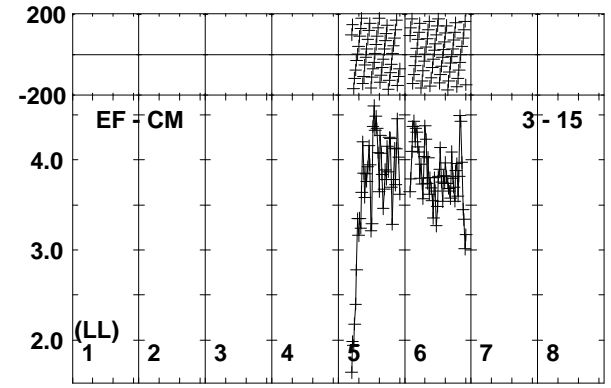
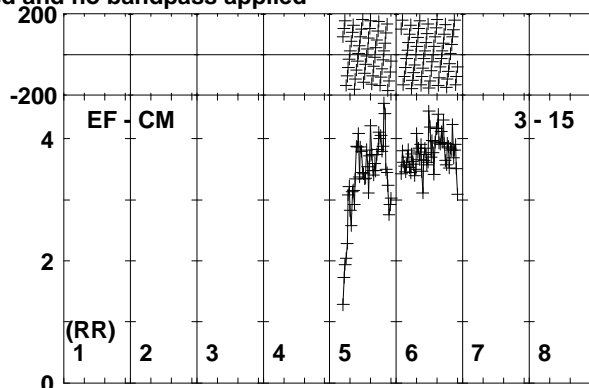
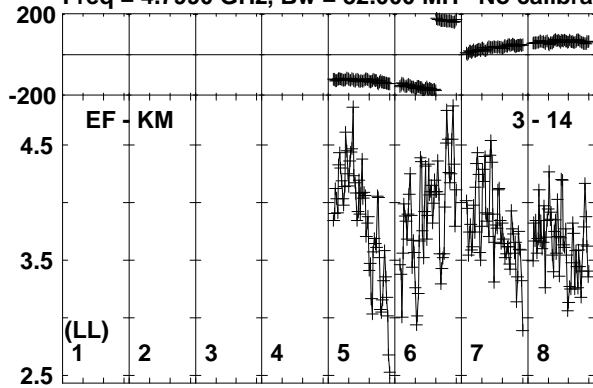

Lower frame: Milli Ampl Jy Top frame: Phas deg
Vector averaged cross-power spectrum Baseline: EF (03) - KM (14)
Timerange: 01/00:33:56 to 01/00:34:55

Plot file version 252 created 26-SEP-2019 10:40:44

0234+285 RG010A.UVDATA.1

Freq = 4.7990 GHz, Bw = 32.000 MH No calibration applied and no bandpass applied

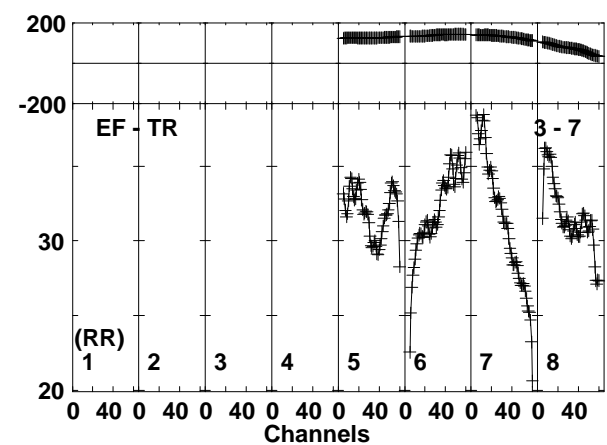
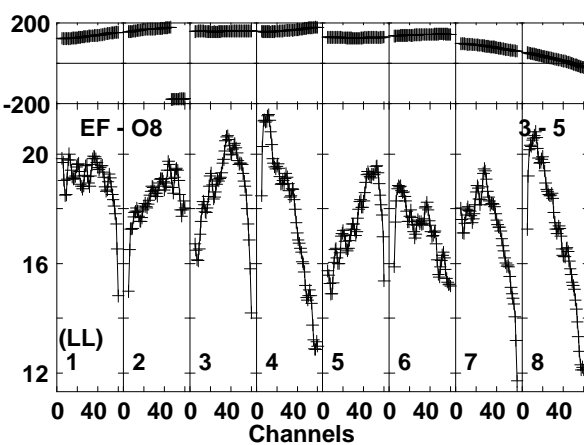
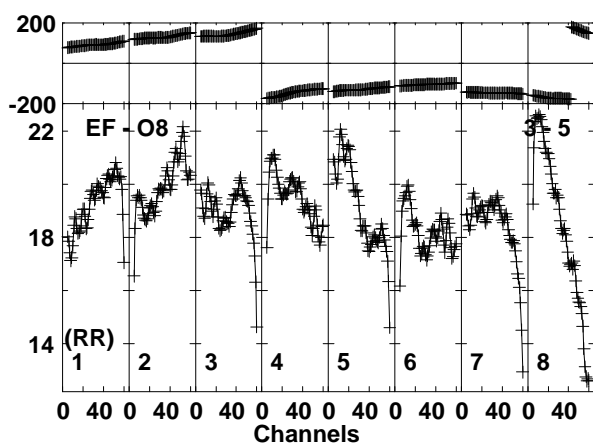
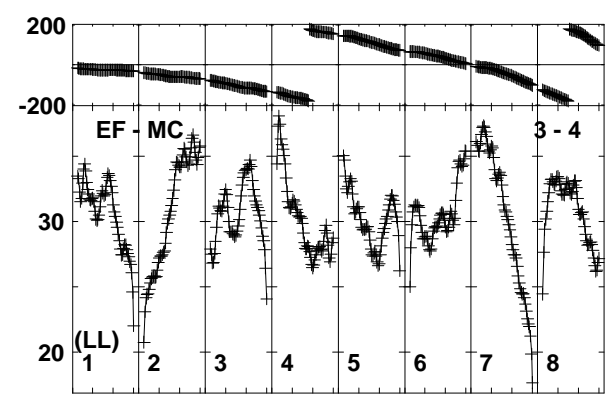
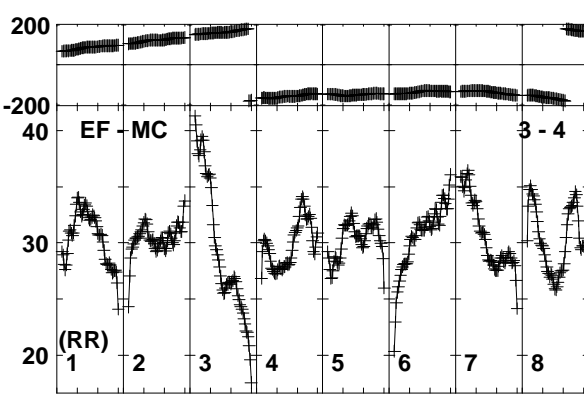
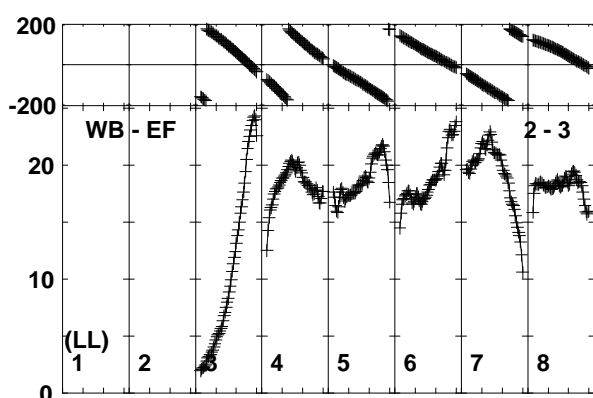
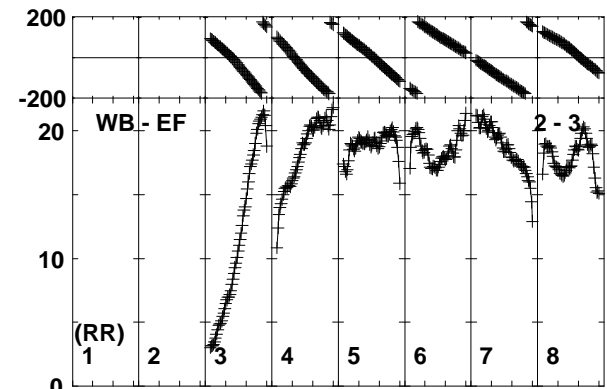
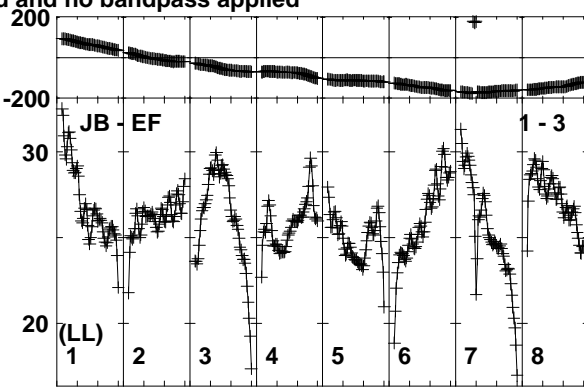
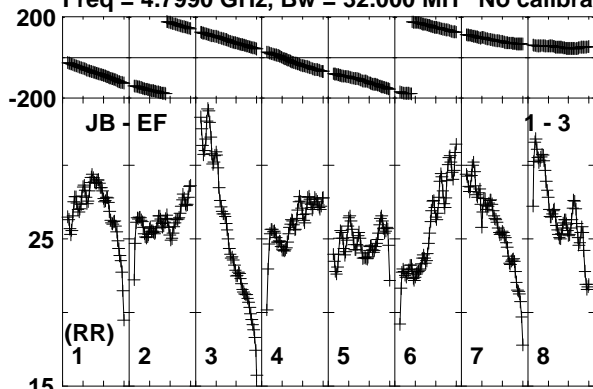

Lower frame: Milli Ampl Jy Top frame: Phas deg
Vector averaged cross-power spectrum Baseline: JB (01) - EF (03)
Timerange: 01/00:36:56 to 01/00:39:55

Plot file version 253 created 26-SEP-2019 10:40:44

0234+285 RG010A.UVDATA.1

Freq = 4.7990 GHz, Bw = 32.000 MH No calibration applied and no bandpass applied

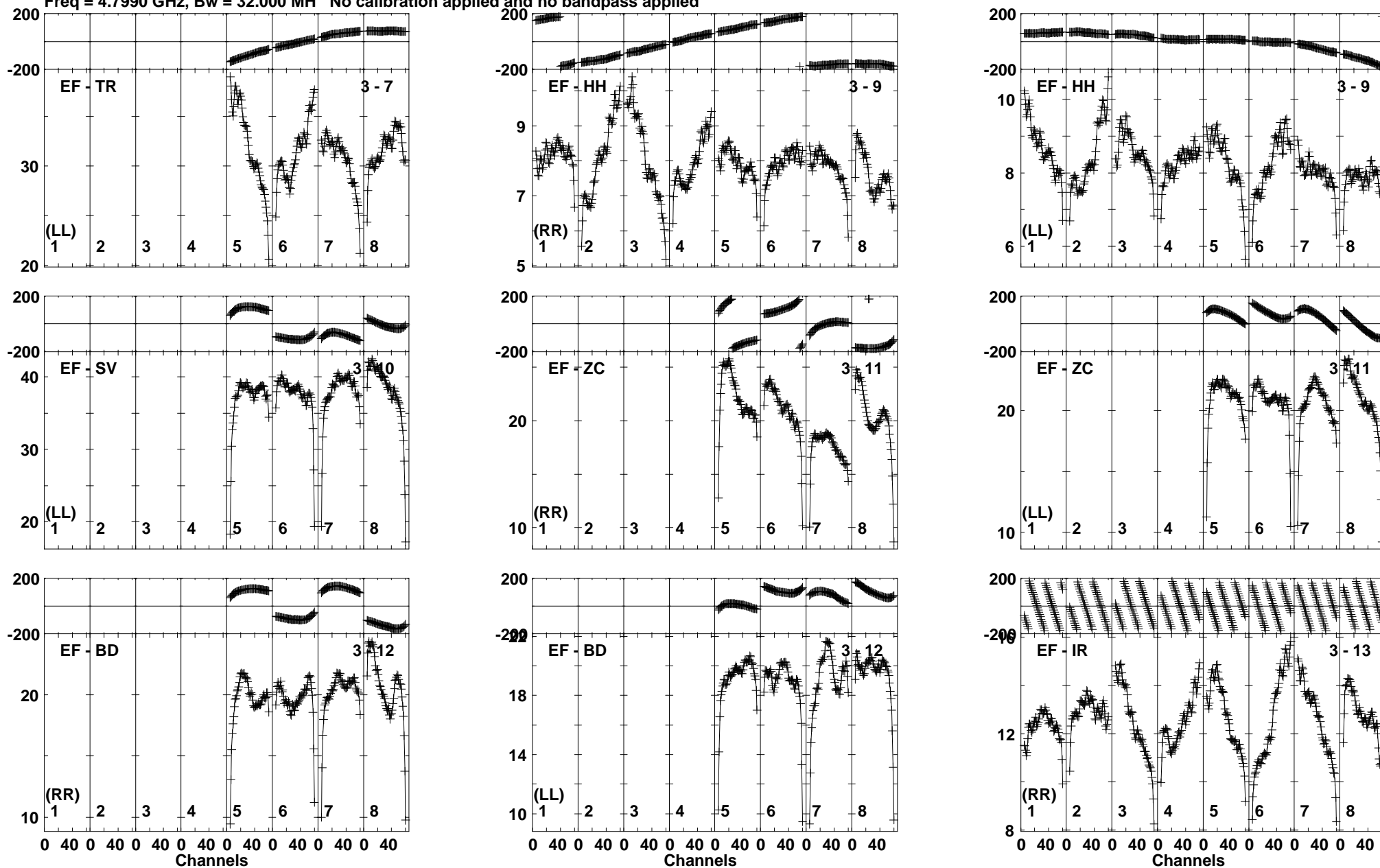

Lower frame: Milli Ampl Jy Top frame: Phas deg
Vector averaged cross-power spectrum Baseline: EF (03) - TR (07)
Timerange: 01/00:36:56 to 01/00:39:55

Plot file version 254 created 26-SEP-2019 10:40:45
 0234+285 RG010A.UVDATA.1
 Freq = 4.7990 GHz, Bw = 32.000 MH No calibration applied and no bandpass applied

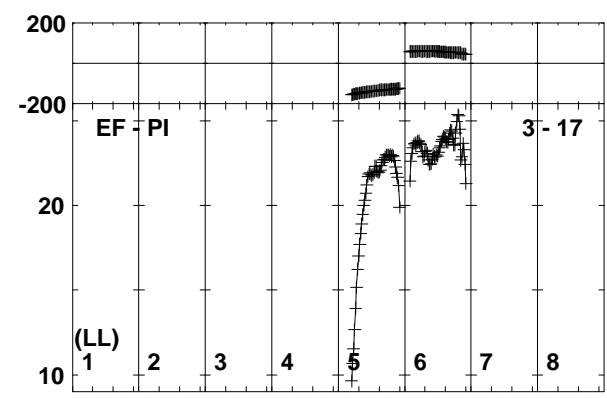
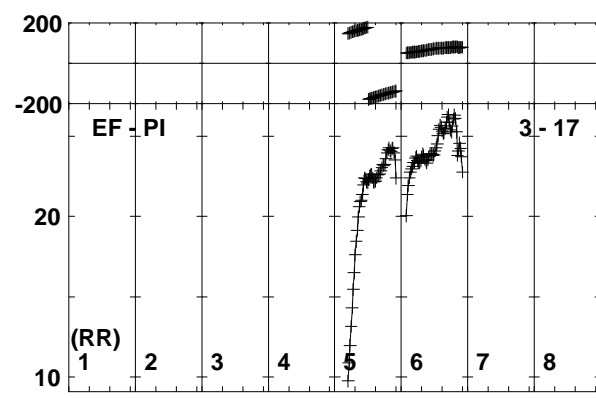
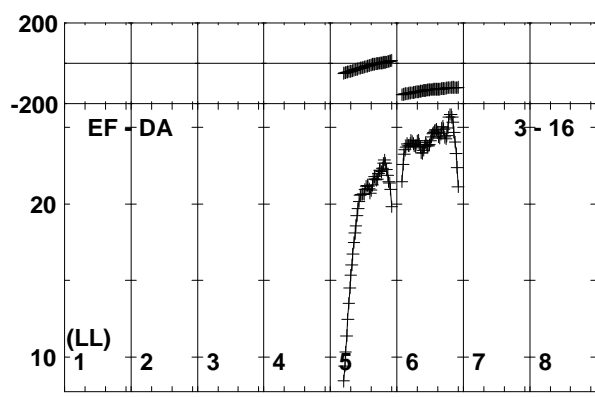
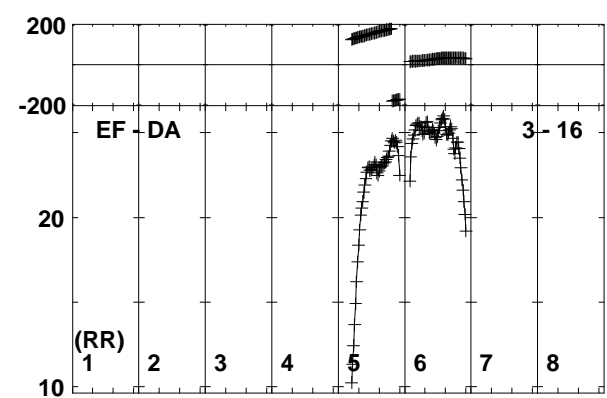
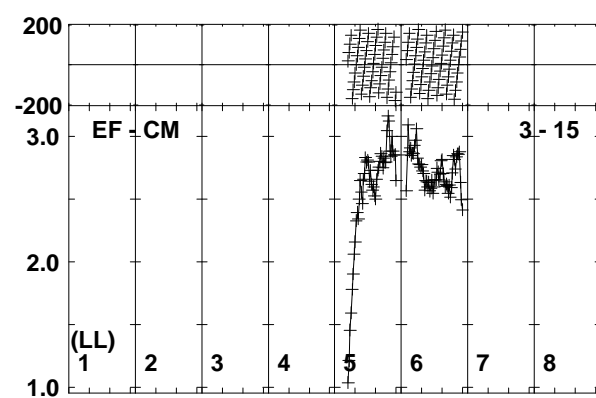
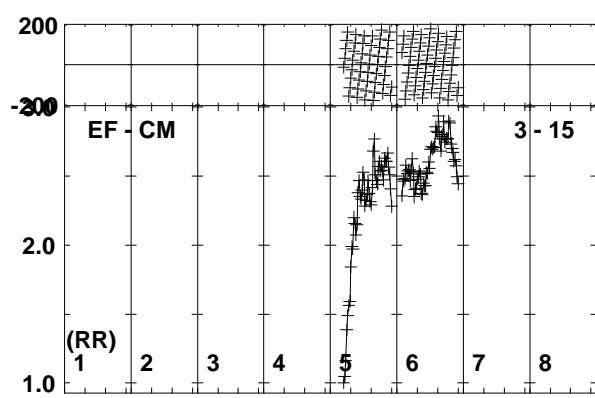
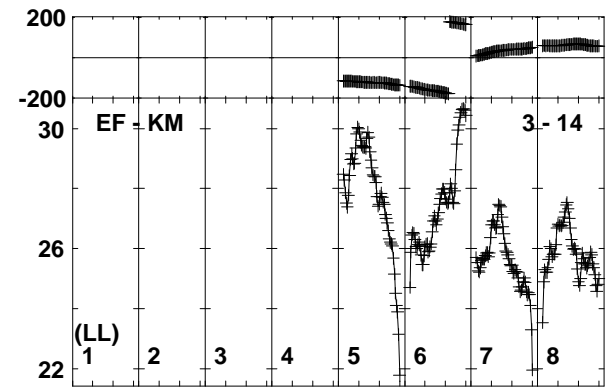
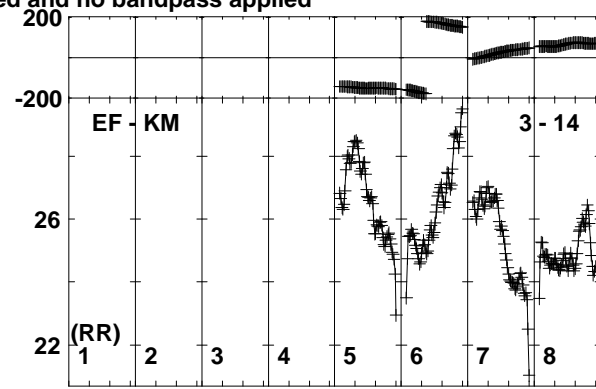
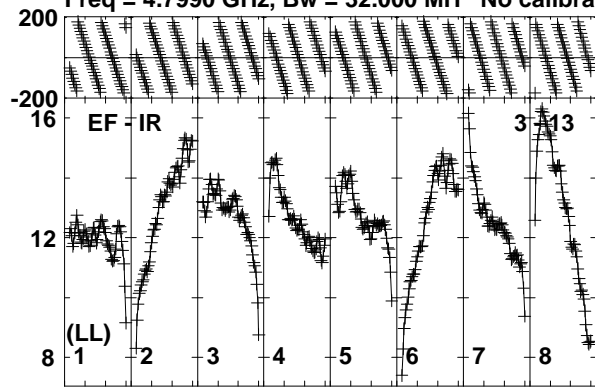

Lower frame: Milli Ampl Jy Top frame: Phas deg
 Vector averaged cross-power spectrum Baseline: EF (03) - IR (13)
 Timerange: 01/00:36:56 to 01/00:39:55

Plot file version 255 created 26-SEP-2019 10:40:46

0234+285 RG010A.UVDATA.1

Freq = 4.7990 GHz, Bw = 32.000 MH No calibration applied and no bandpass applied

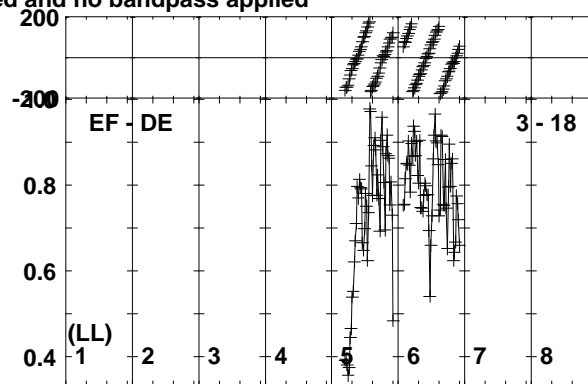
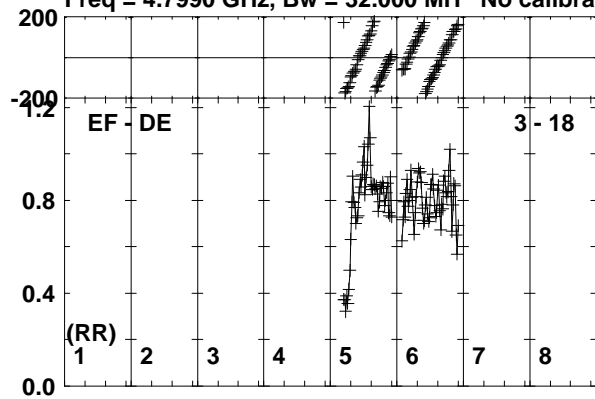

Lower frame: Milli Ampl Jy Top frame: Phas deg
Vector averaged cross-power spectrum Baseline: EF (03) - DE (18)
Timerange: 01/00:36:56 to 01/00:39:55

Plot file version 256 created 26-SEP-2019 10:40:46

J0257-1212 RG010A.UVDATA.1

Freq = 4.7990 GHz, Bw = 32.000 MH No calibration applied and no bandpass applied

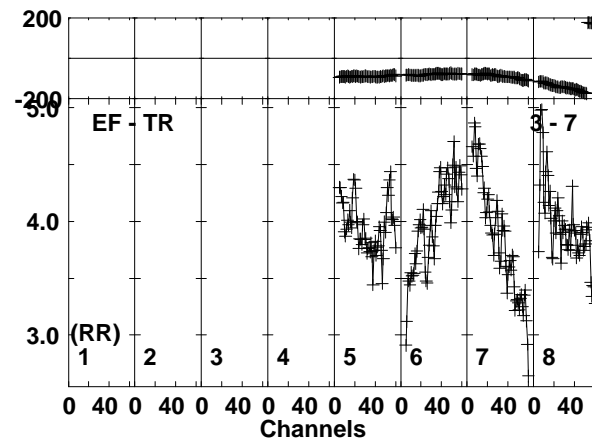
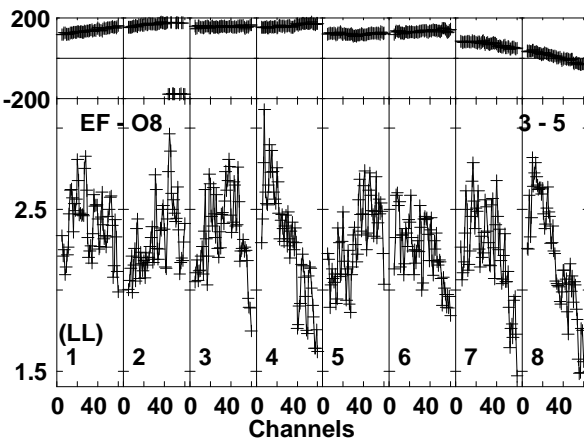
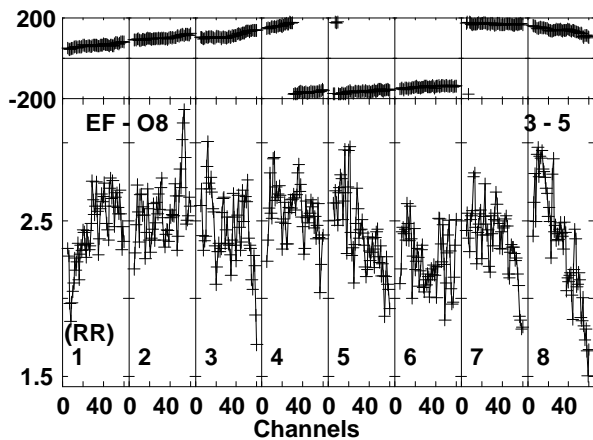
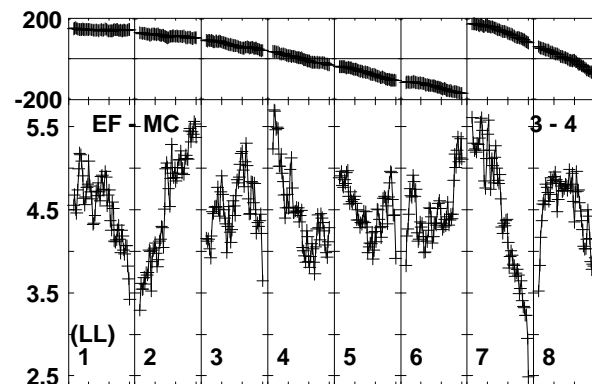
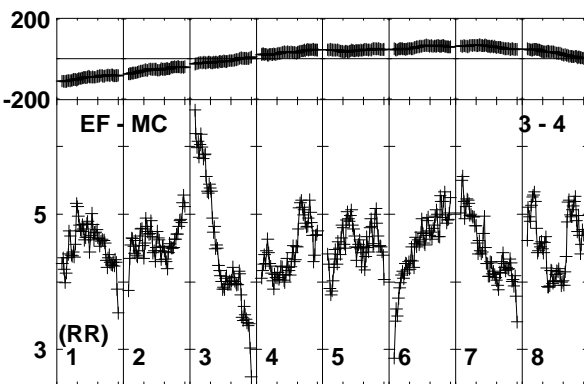
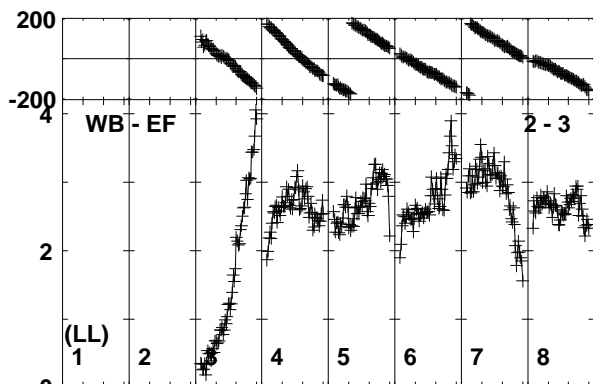
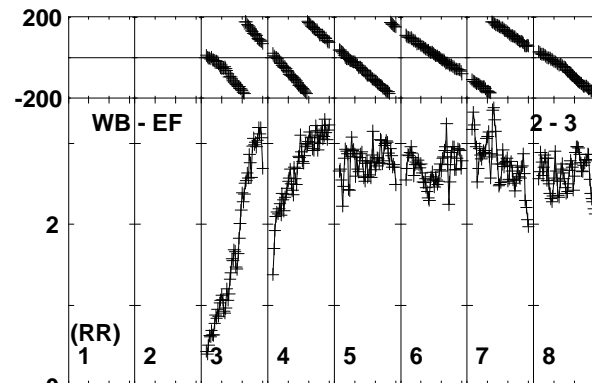
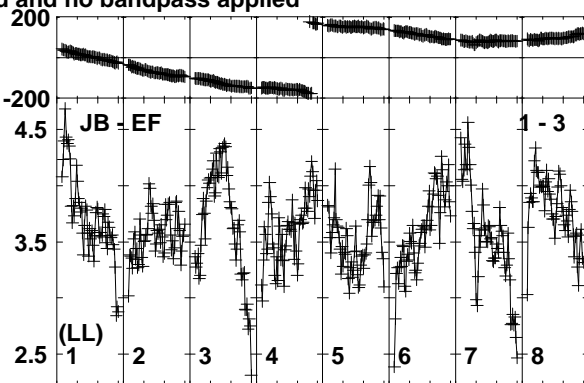
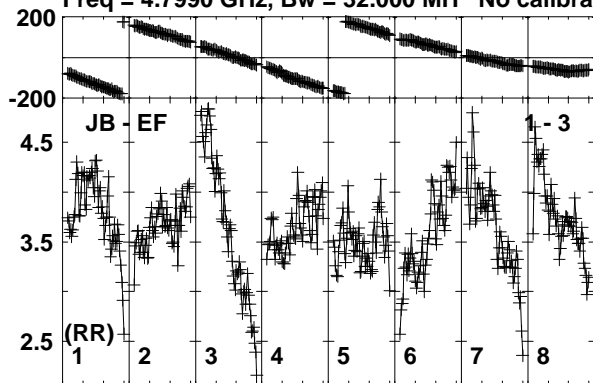

Lower frame: Milli Ampl Jy Top frame: Phas deg
Vector averaged cross-power spectrum Baseline: JB (01) - EF (03)
Timerange: 01/00:43:45 to 01/00:44:14

Plot file version 257 created 26-SEP-2019 10:40:46

J0257-1212 RG010A.UVDATA.1

Freq = 4.7990 GHz, Bw = 32.000 MH No calibration applied and no bandpass applied

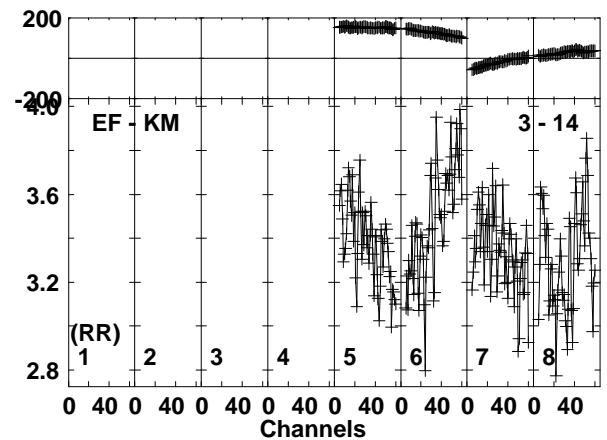
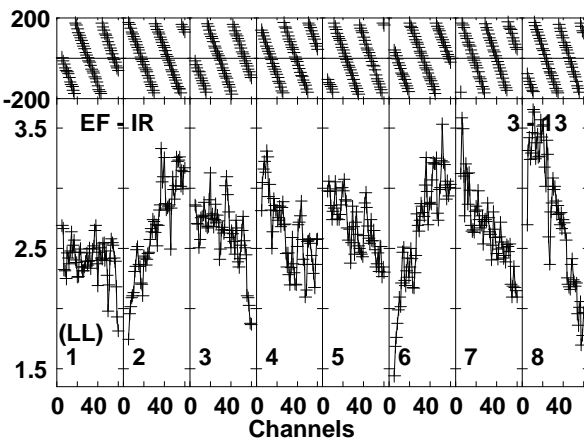
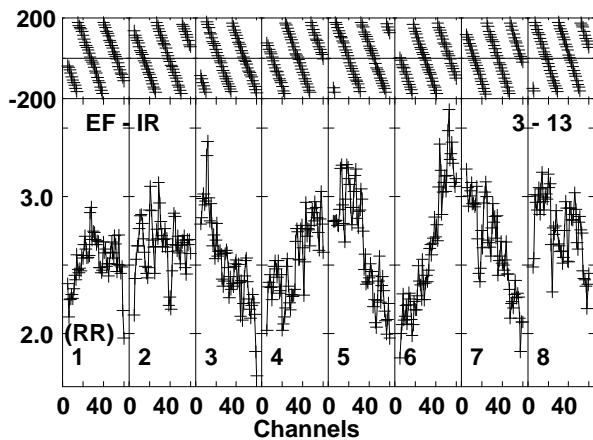
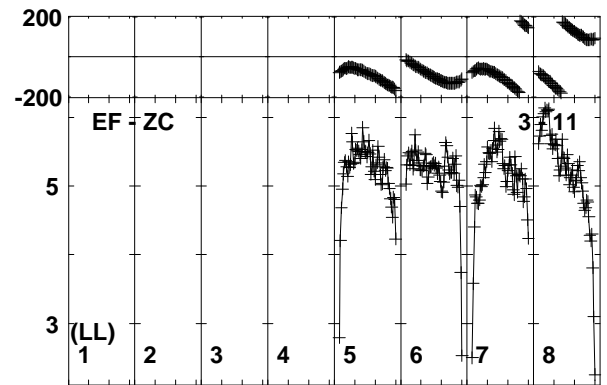
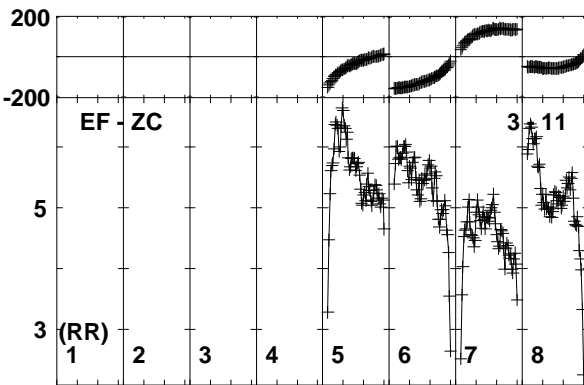
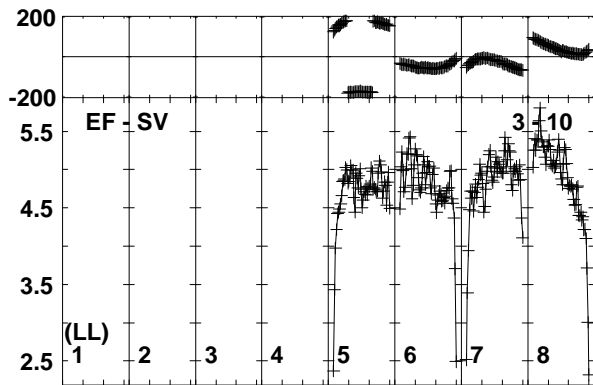
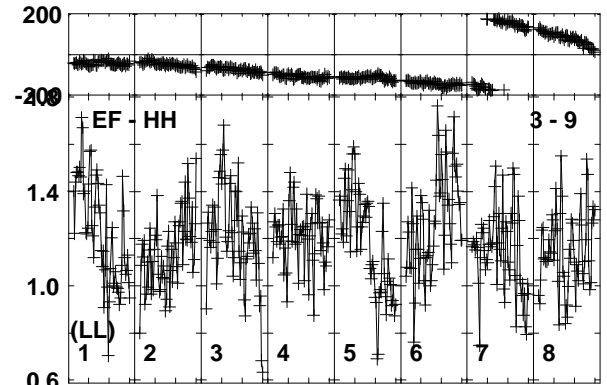
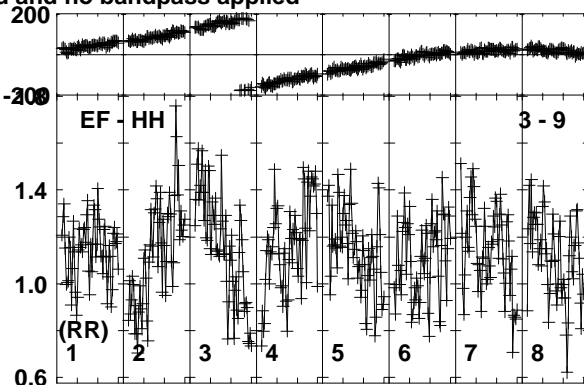
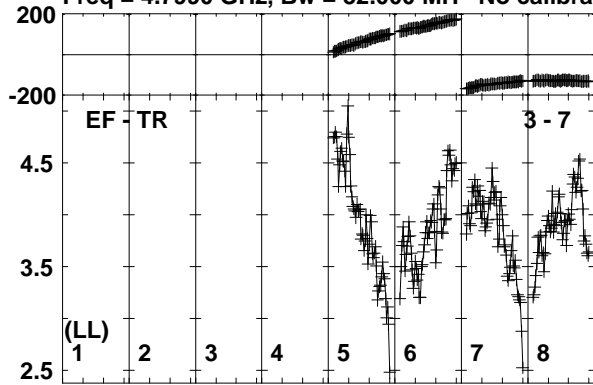

Lower frame: Milli Ampl Jy Top frame: Phas deg
Vector averaged cross-power spectrum Baseline: EF (03) - TR (07)
Timerange: 01/00:43:45 to 01/00:44:14

Plot file version 258 created 26-SEP-2019 10:40:47

J0257-1212 RG010A.UVDATA.1

Freq = 4.7990 GHz, Bw = 32.000 MH No calibration applied and no bandpass applied

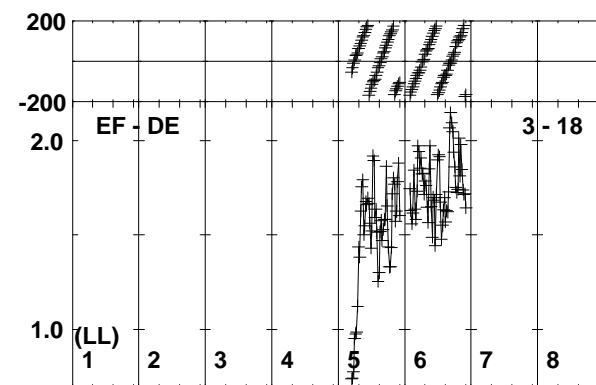
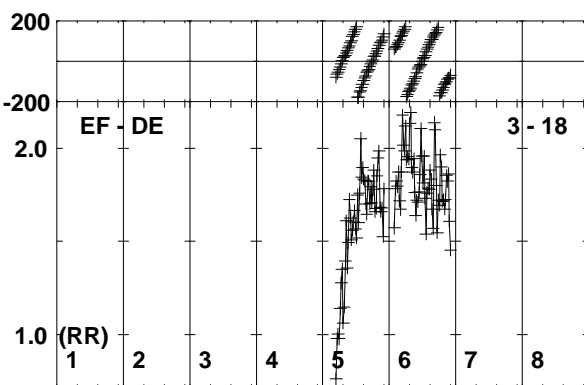
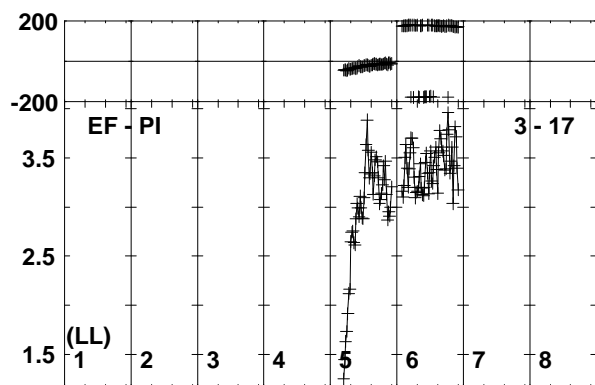
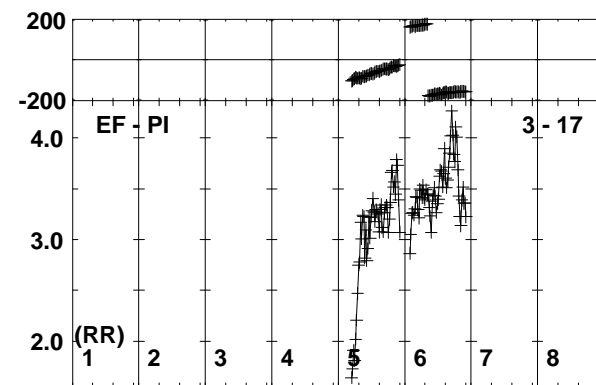
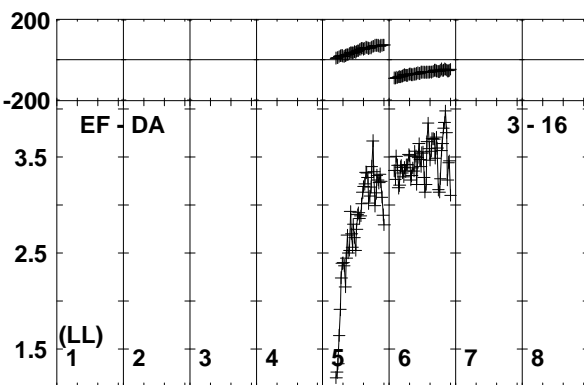
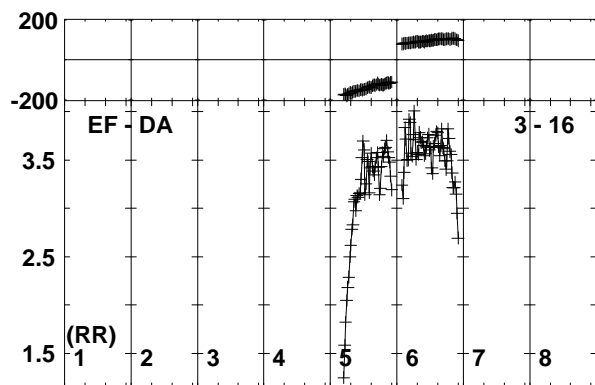
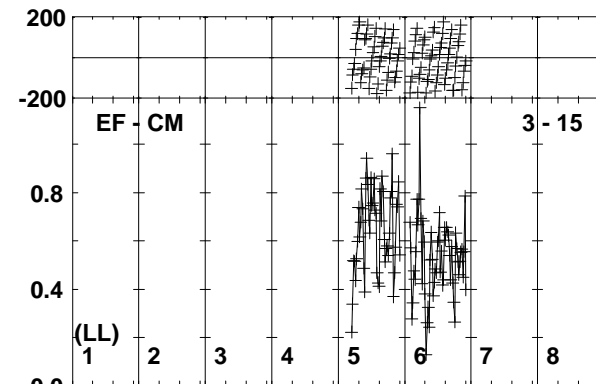
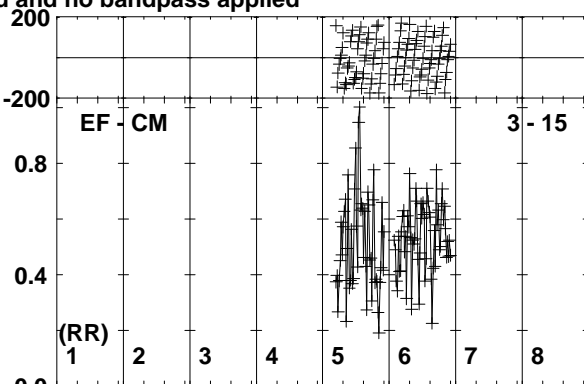
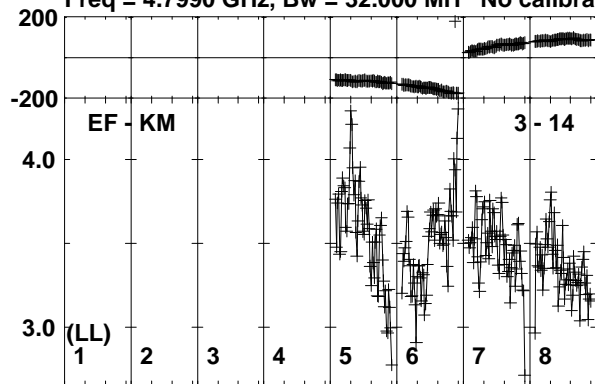

Lower frame: Milli Ampl Jy Top frame: Phas deg
Vector averaged cross-power spectrum Baseline: EF (03) - KM (14)
Timerange: 01/00:43:45 to 01/00:44:14

Plot file version 259 created 26-SEP-2019 10:40:47

J0300-0846 RG010A.UVDATA.1

Freq = 4.7990 GHz, Bw = 32.000 MH No calibration applied and no bandpass applied

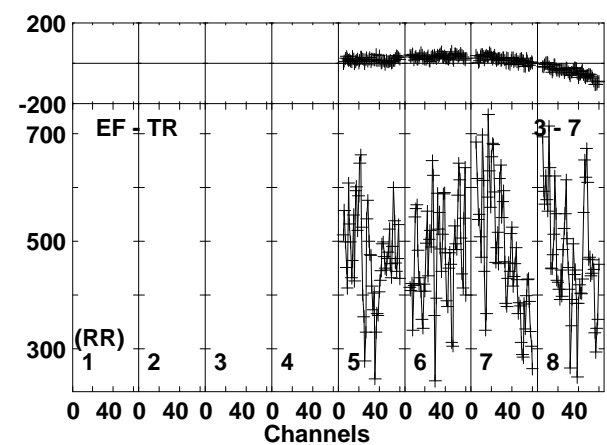
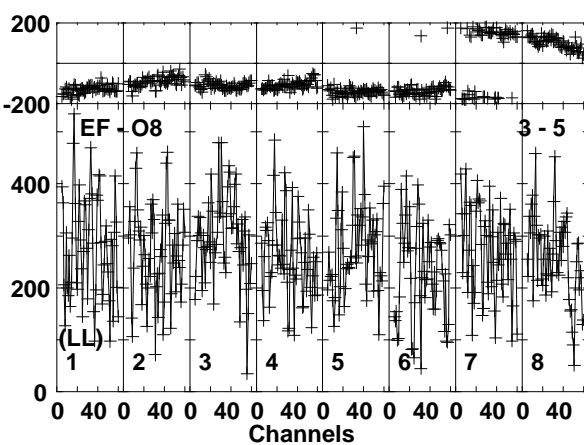
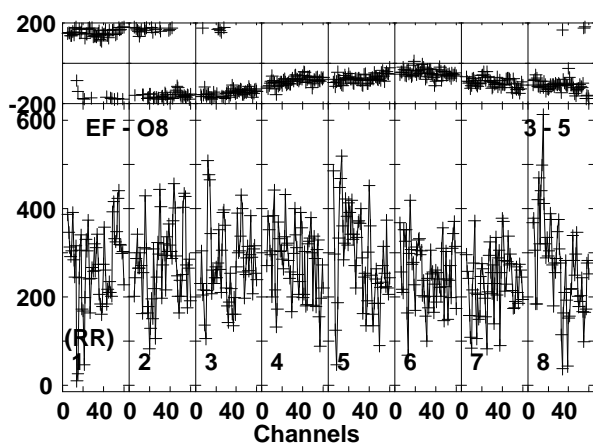
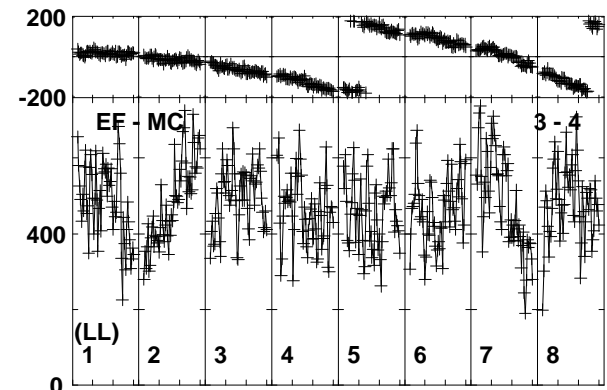
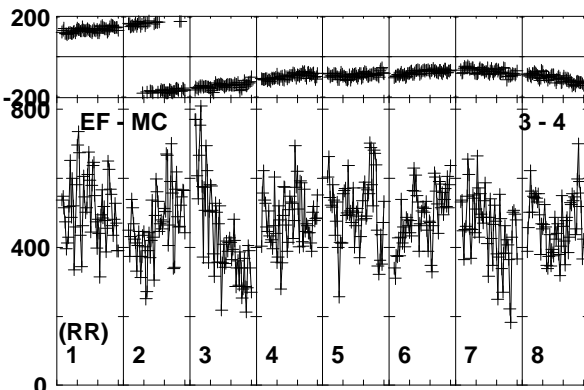
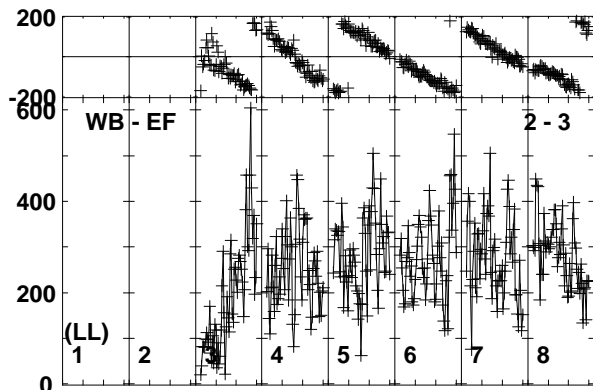
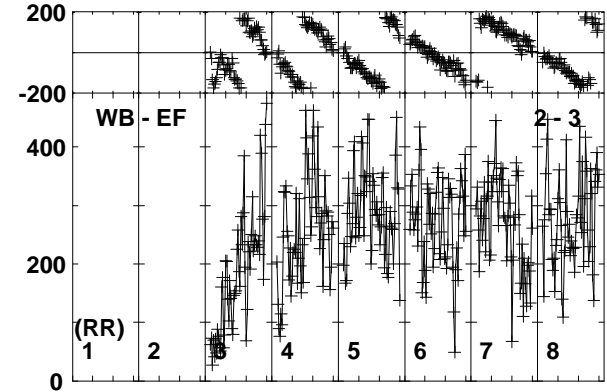
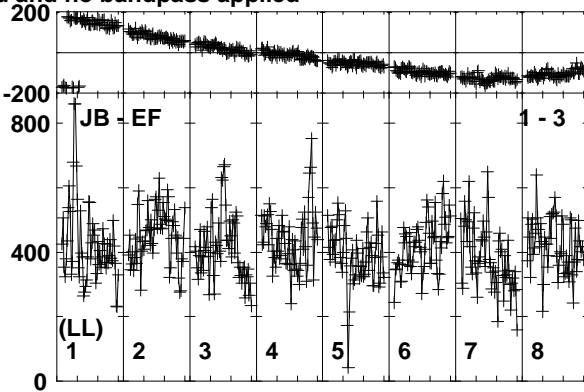
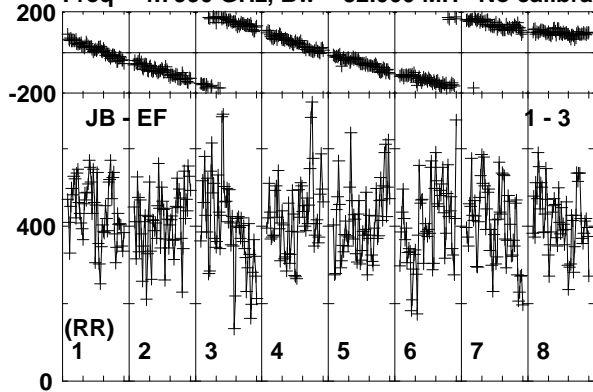

Lower frame: Micro Ampl Jy Top frame: Phas deg
Vector averaged cross-power spectrum Baseline: JB (01) - EF (03)
Timerange: 01/00:44:15 to 01/00:46:45

Plot file version 260 created 26-SEP-2019 10:40:48

J0300-0846 RG010A.UVDATA.1

Freq = 4.7990 GHz, Bw = 32.000 MH No calibration applied and no bandpass applied

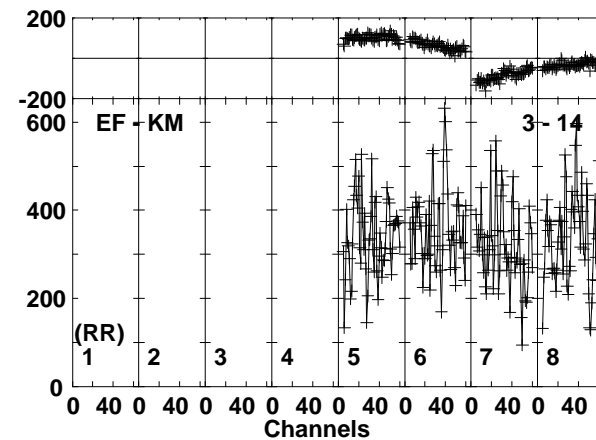
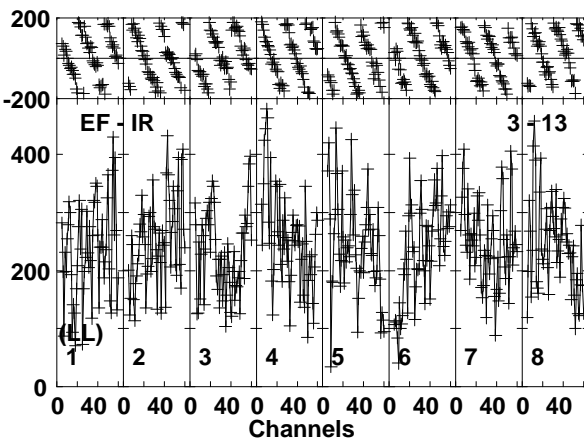
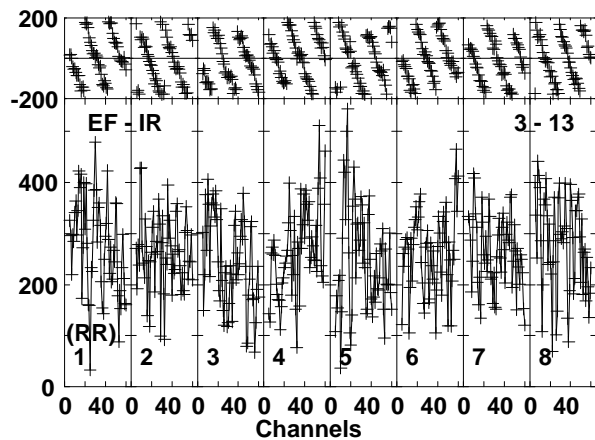
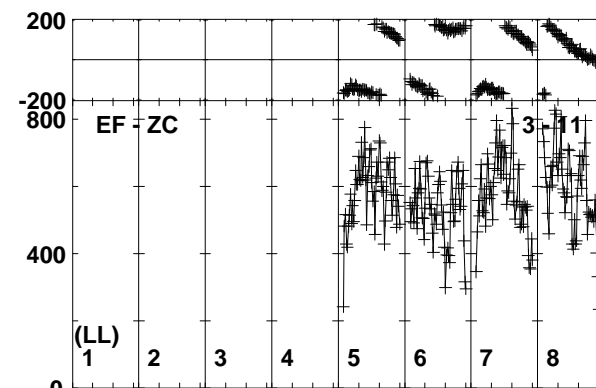
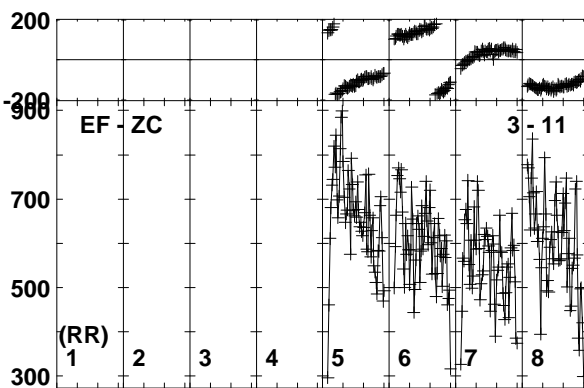
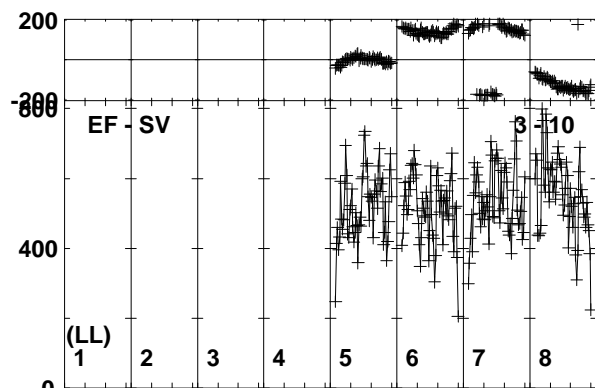
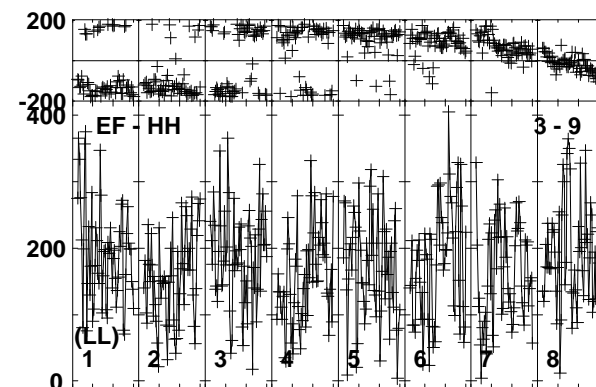
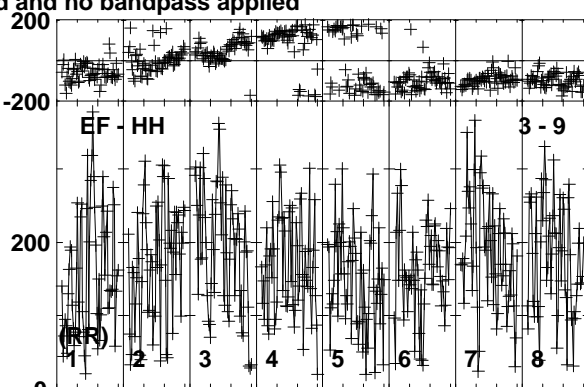
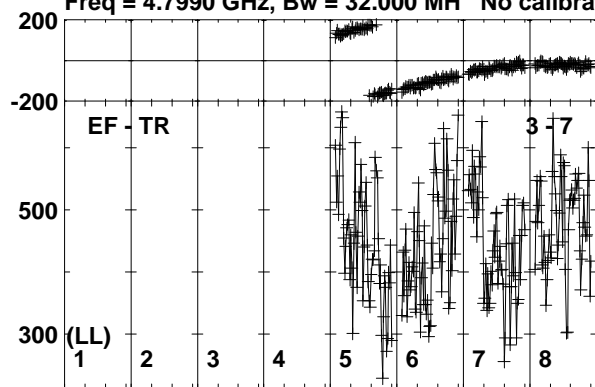

Lower frame: Micro Ampl Jy Top frame: Phas deg
Vector averaged cross-power spectrum Baseline: EF (03) - TR (07)
Timerange: 01/00:44:15 to 01/00:46:45

Plot file version 261 created 26-SEP-2019 10:40:48

J0300-0846 RG010A.UVDATA.1

Freq = 4.7990 GHz, Bw = 32.000 MH No calibration applied and no bandpass applied

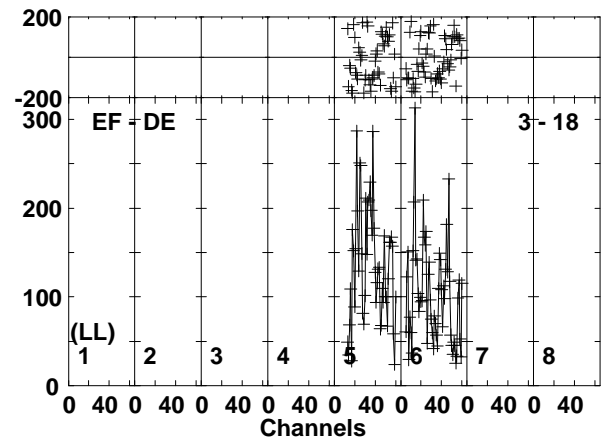
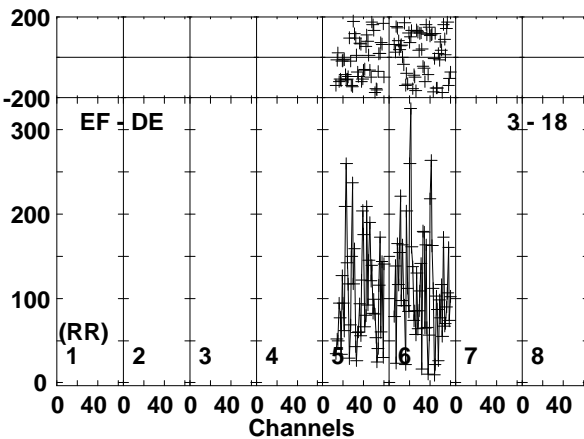
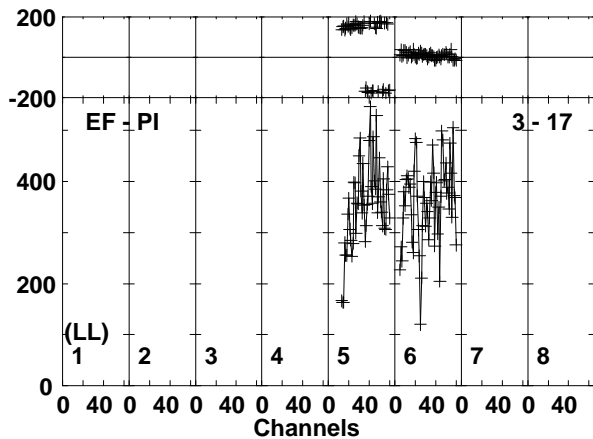
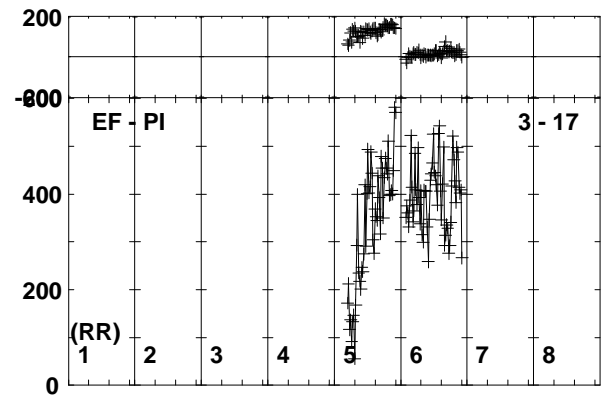
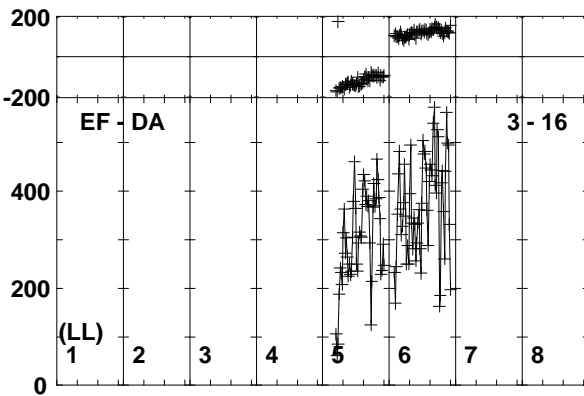
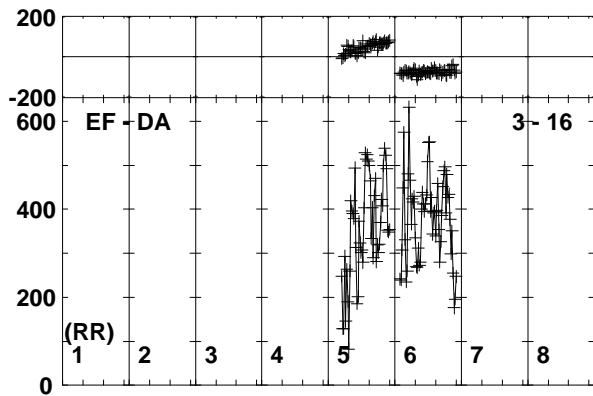
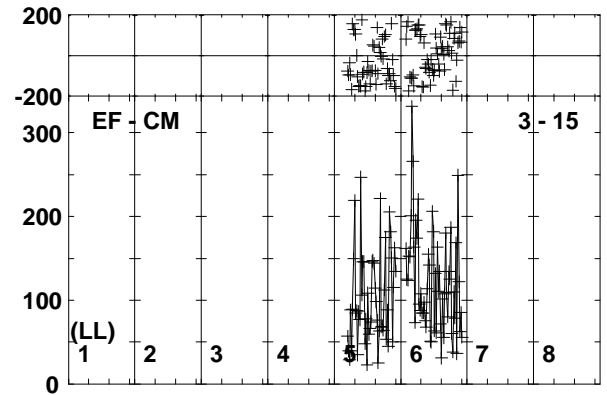
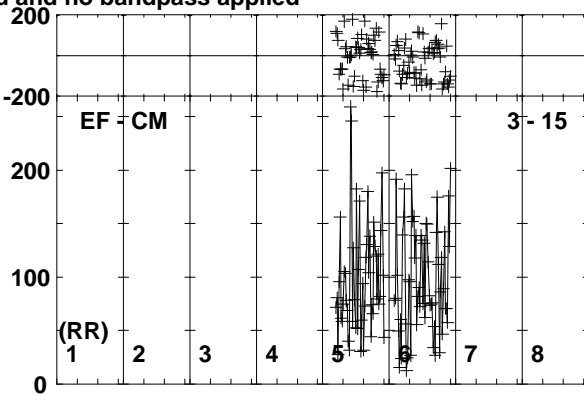
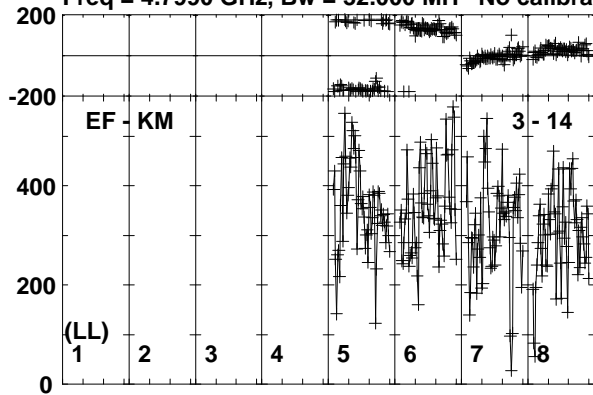

Lower frame: Micro Ampl Jy Top frame: Phas deg
Vector averaged cross-power spectrum Baseline: EF (03) - KM (14)
Timerange: 01/00:44:15 to 01/00:46:45

Plot file version 262 created 26-SEP-2019 10:40:49

190829A RG010A.UVDATA.1

Freq = 4.7990 GHz, Bw = 32.000 MH No calibration applied and no bandpass applied

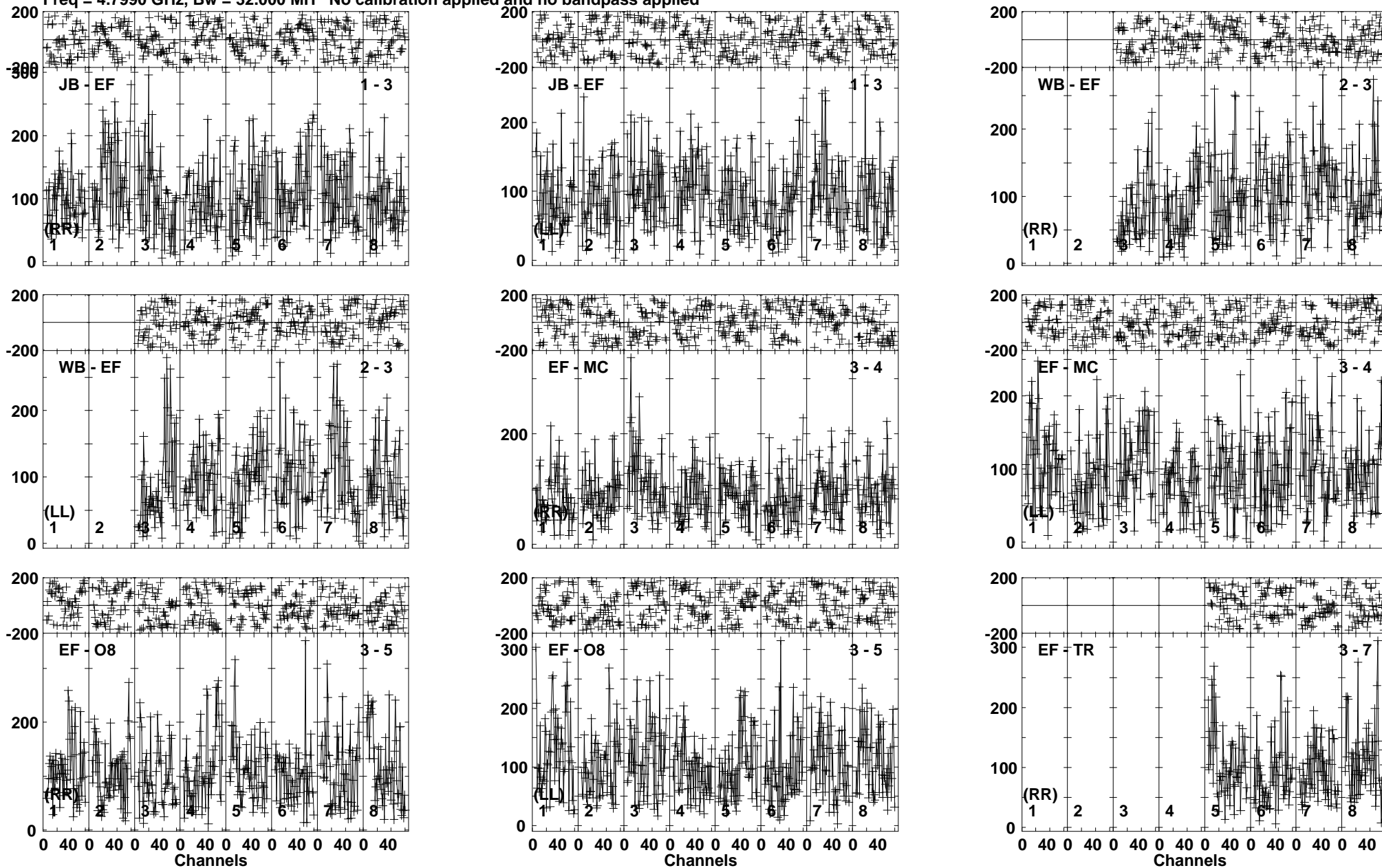

Lower frame: Micro Ampl Jy Top frame: Phas deg
Vector averaged cross-power spectrum Baseline: JB (01) - EF (03)
Timerange: 01/00:46:45 to 01/00:49:15

Plot file version 263 created 26-SEP-2019 10:40:49

190829A RG010A.UVDATA.1

Freq = 4.7990 GHz, Bw = 32.000 MH No calibration applied and no bandpass applied

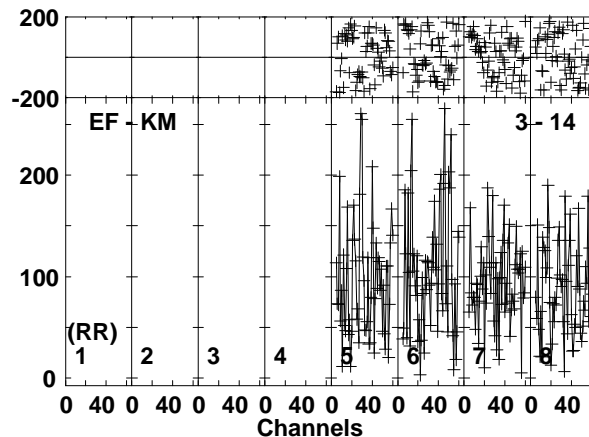
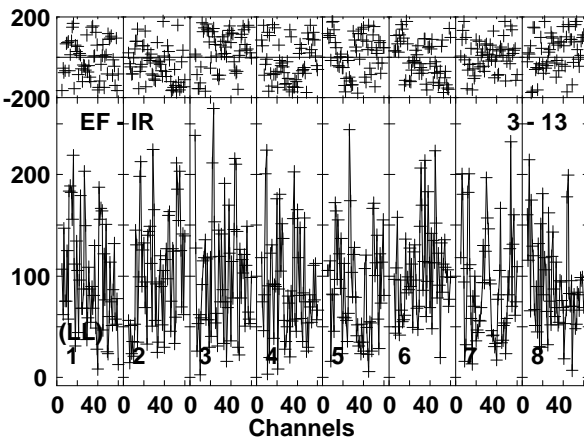
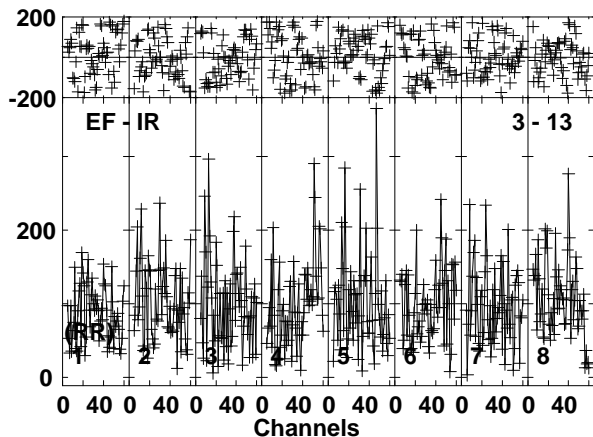
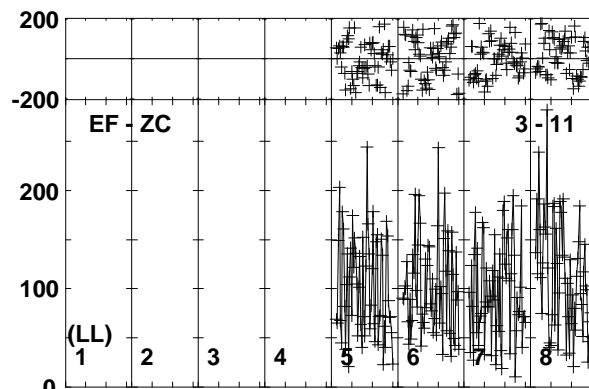
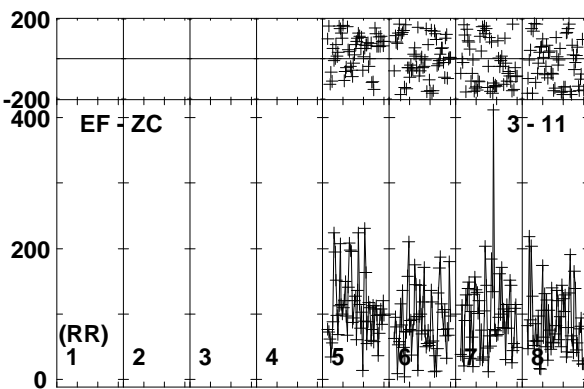
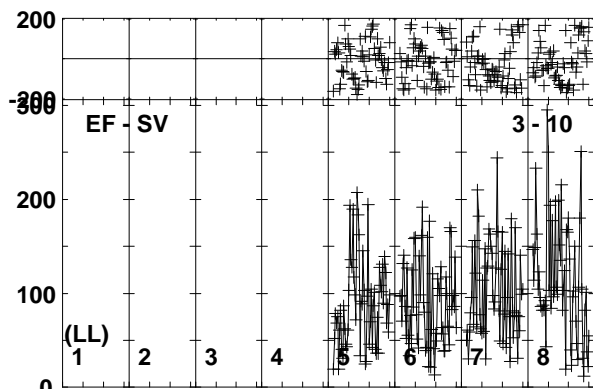
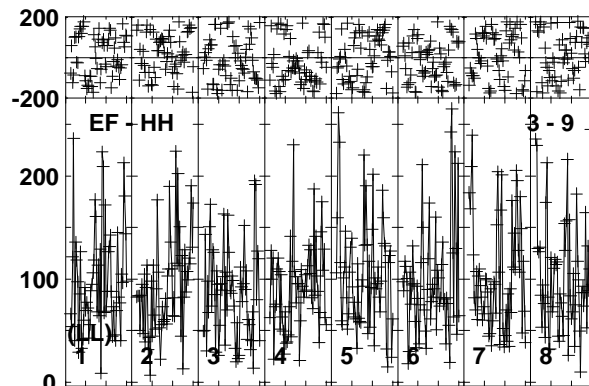
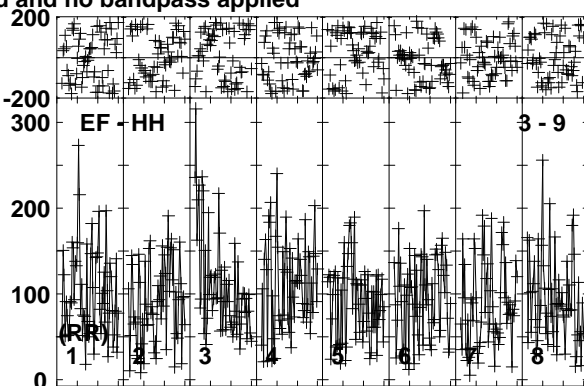
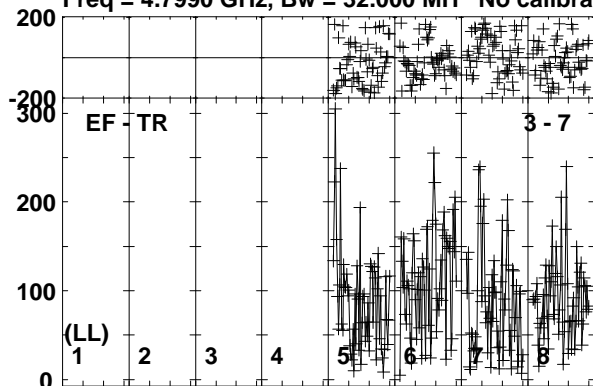

Lower frame: Micro Ampl Jy Top frame: Phas deg
Vector averaged cross-power spectrum Baseline: EF (03) - TR (07)
Timerange: 01/00:46:45 to 01/00:49:15

Plot file version 264 created 26-SEP-2019 10:40:50

190829A RG010A.UVDATA.1

Freq = 4.7990 GHz, Bw = 32.000 MH No calibration applied and no bandpass applied

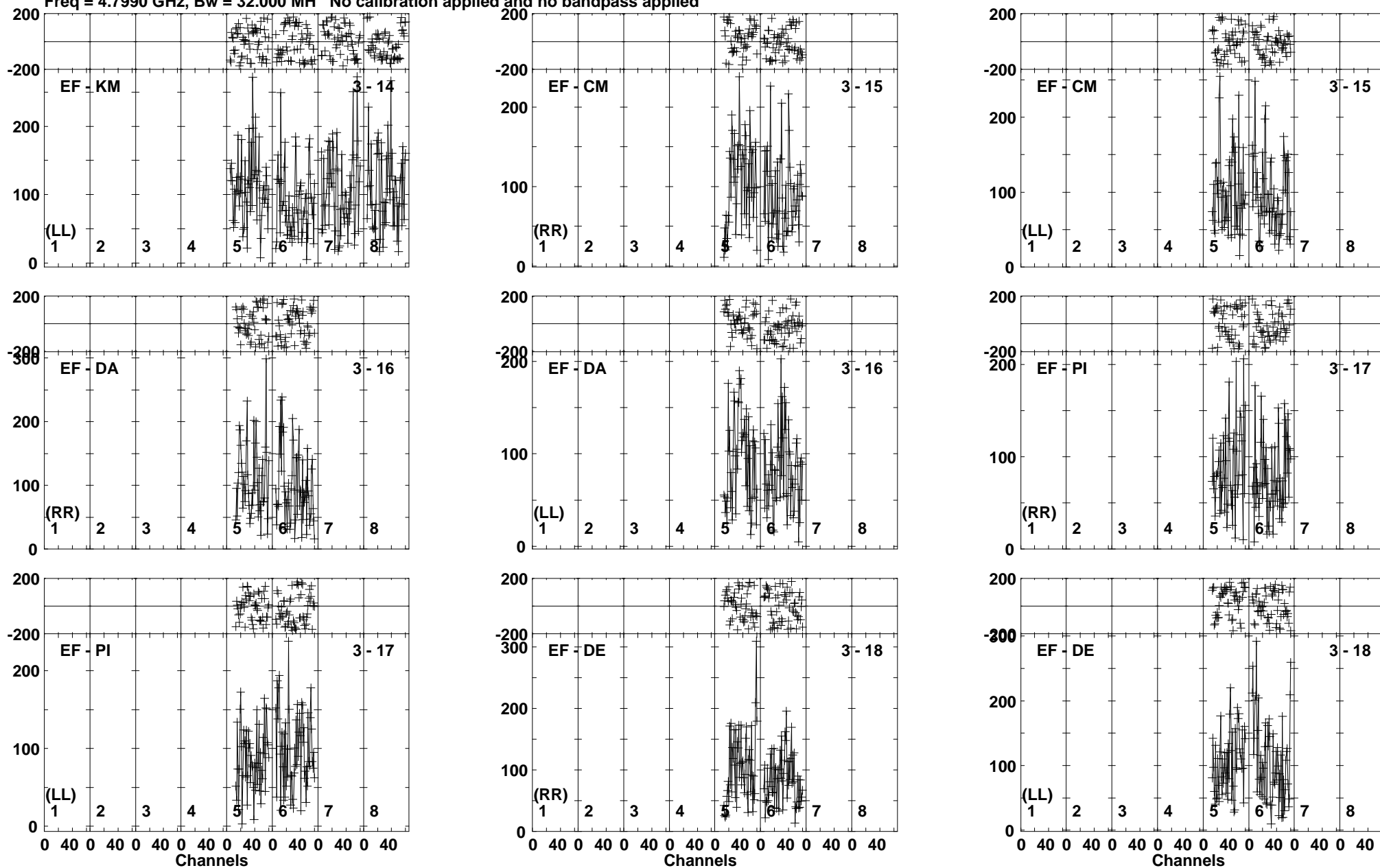

Lower frame: Micro Ampl Jy Top frame: Phas deg
Vector averaged cross-power spectrum Baseline: EF (03) - KM (14)
Timerange: 01/00:46:45 to 01/00:49:15

Plot file version 265 created 26-SEP-2019 10:40:50

J0257-1212 RG010A.UVDATA.1

Freq = 4.7990 GHz, Bw = 32.000 MH No calibration applied and no bandpass applied

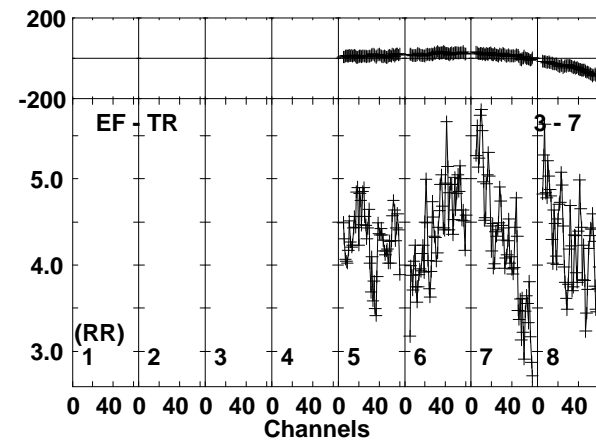
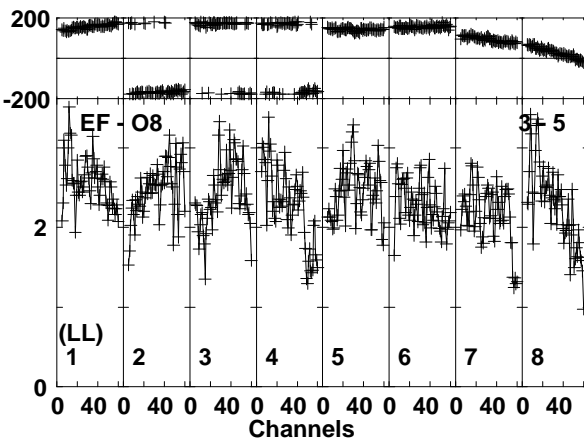
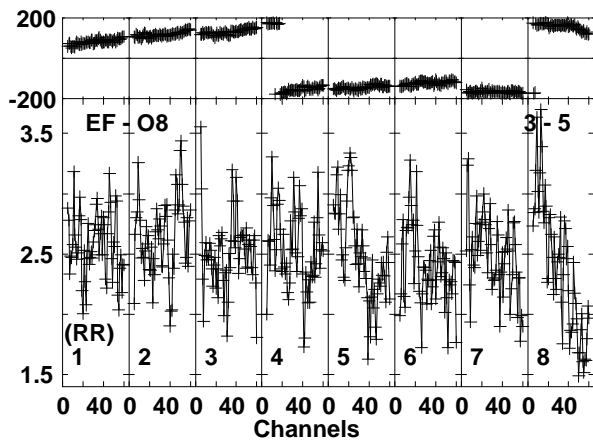
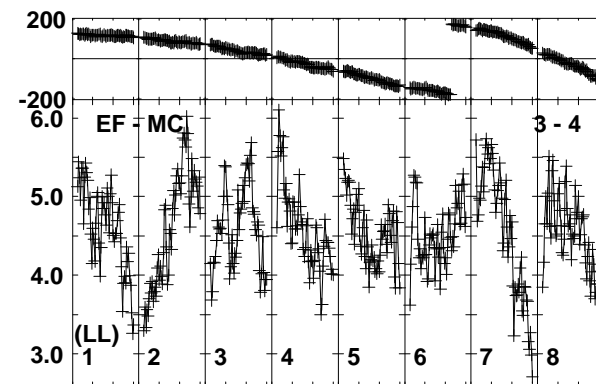
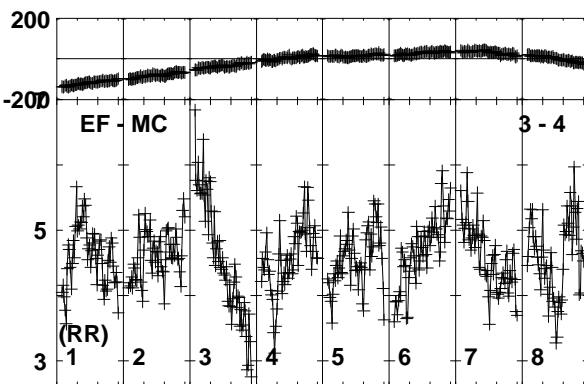
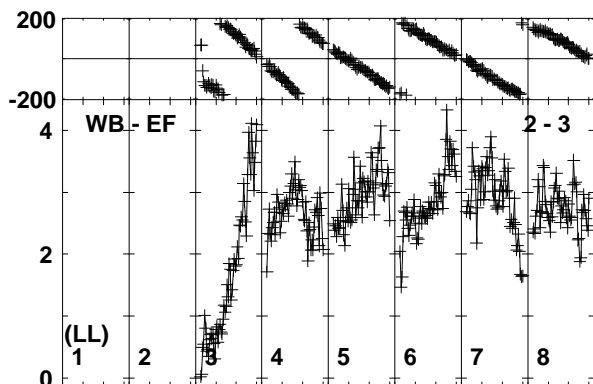
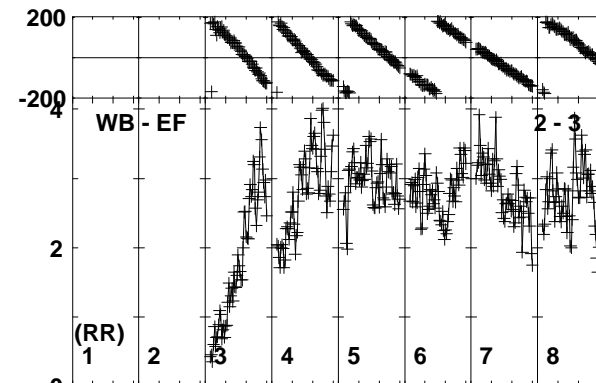
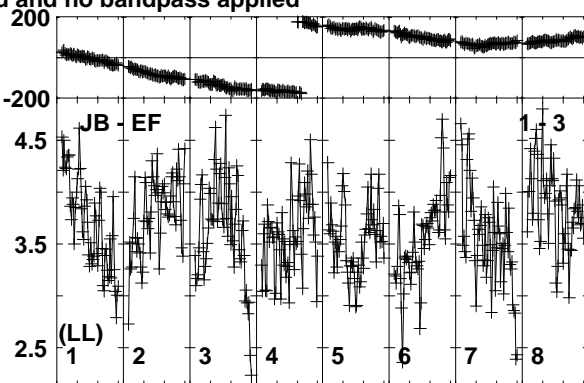
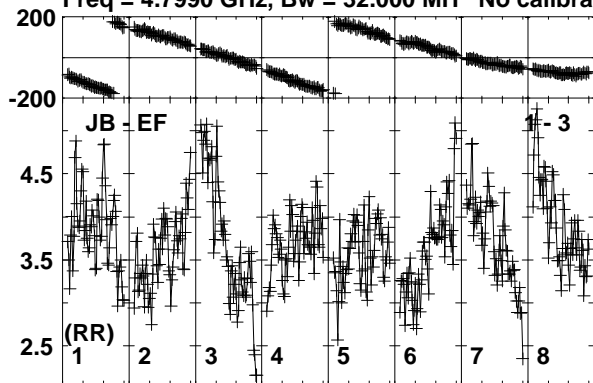

Lower frame: Milli Ampl Jy Top frame: Phas deg
Vector averaged cross-power spectrum Baseline: JB (01) - EF (03)
Timerange: 01/00:49:16 to 01/00:50:15

Plot file version 266 created 26-SEP-2019 10:40:51

J0257-1212 RG010A.UVDATA.1

Freq = 4.7990 GHz, Bw = 32.000 MH No calibration applied and no bandpass applied

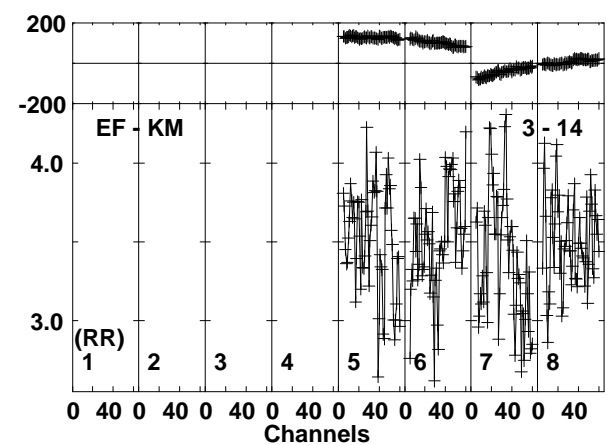
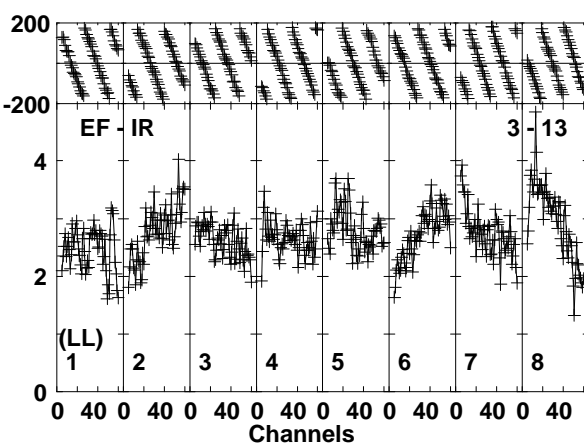
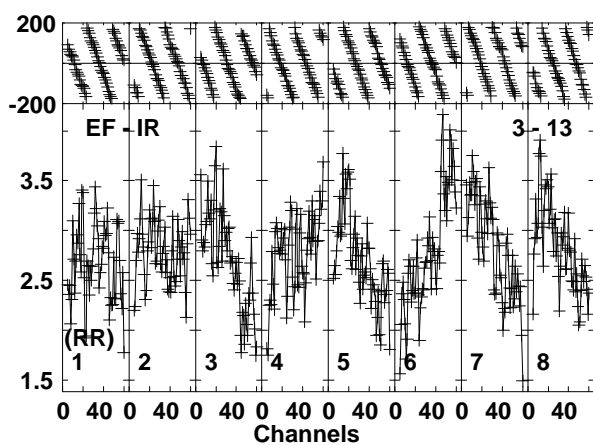
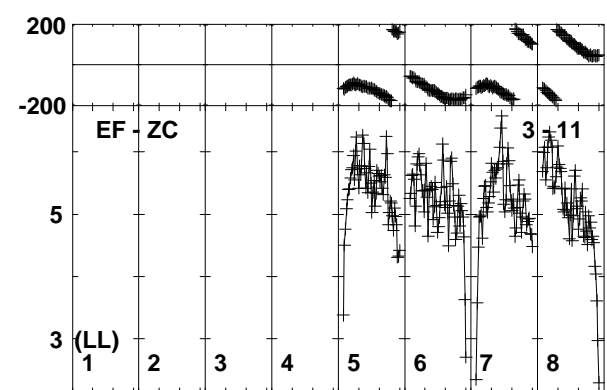
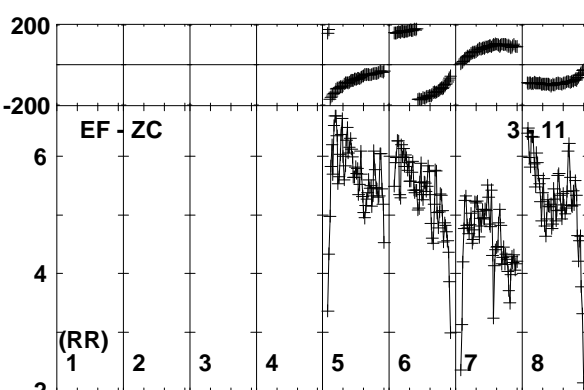
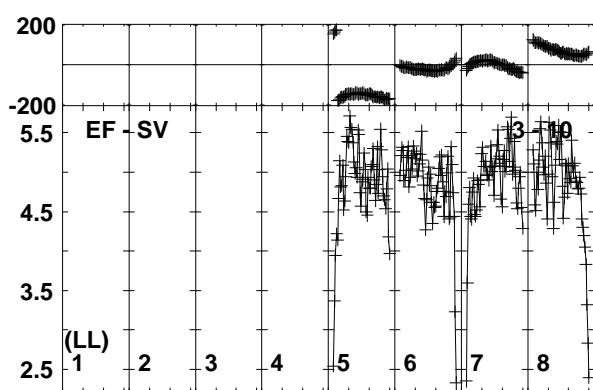
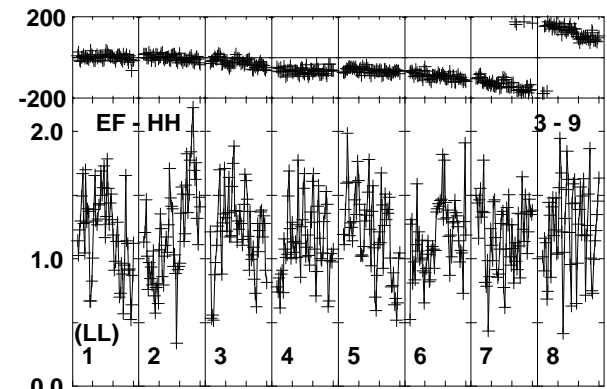
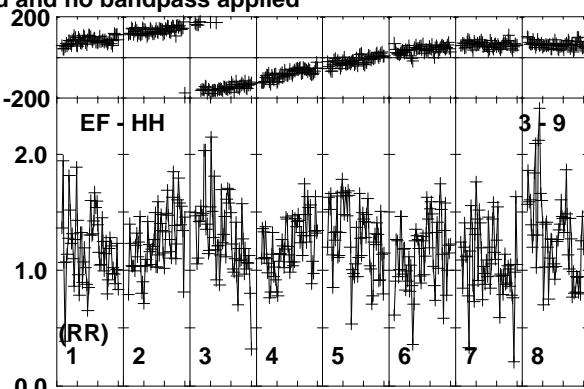
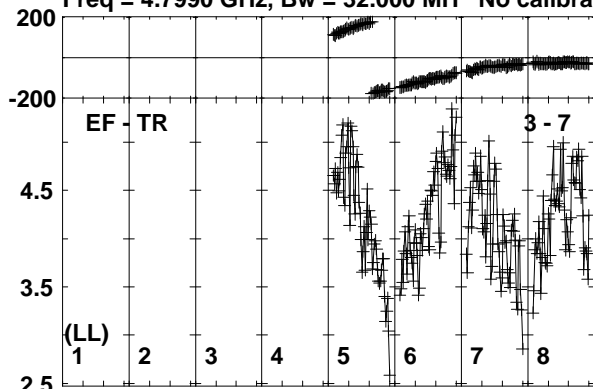

Lower frame: Milli Ampl Jy Top frame: Phas deg
Vector averaged cross-power spectrum Baseline: EF (03) - TR (07)
Timerange: 01/00:49:16 to 01/00:50:15

Plot file version 267 created 26-SEP-2019 10:40:52

J0257-1212 RG010A.UVDATA.1

Freq = 4.7990 GHz, Bw = 32.000 MH No calibration applied and no bandpass applied

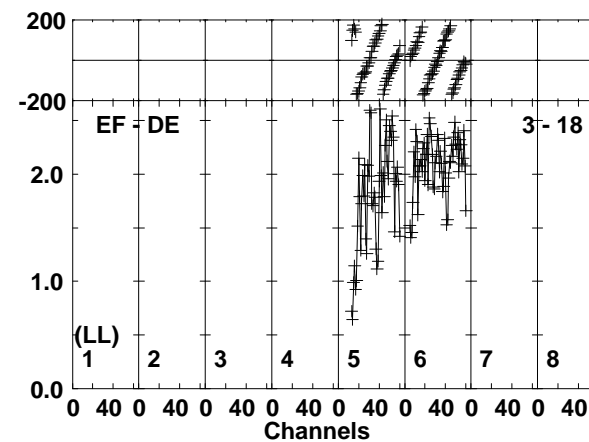
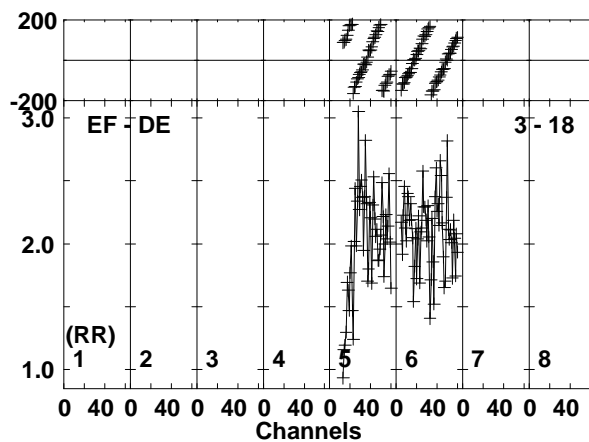
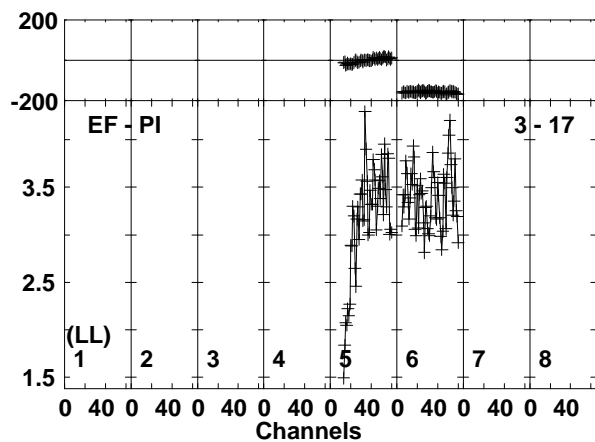
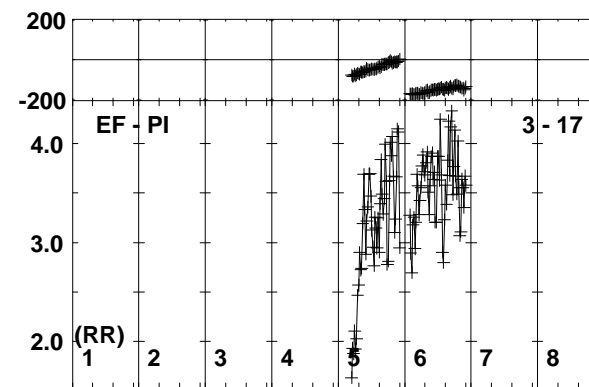
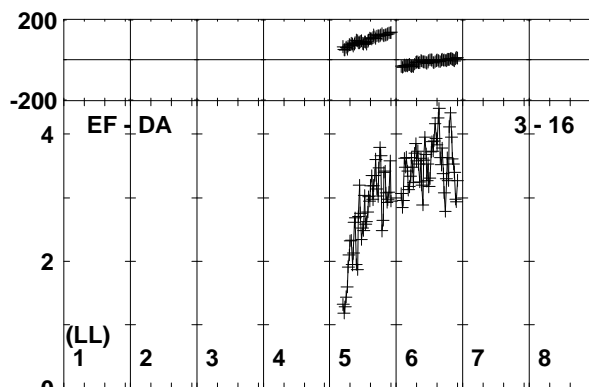
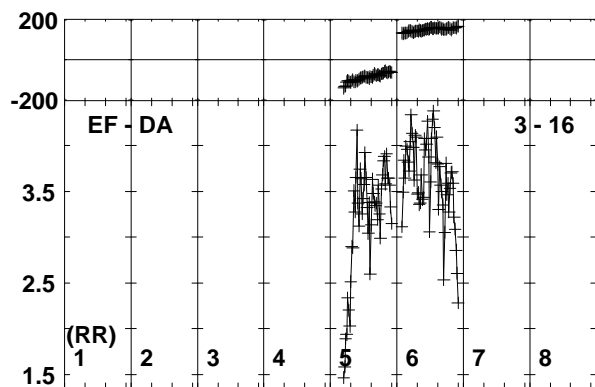
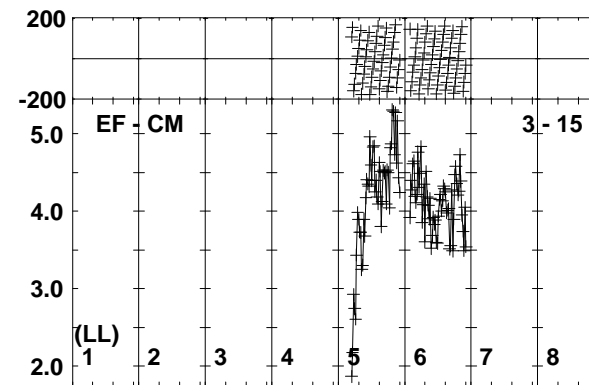
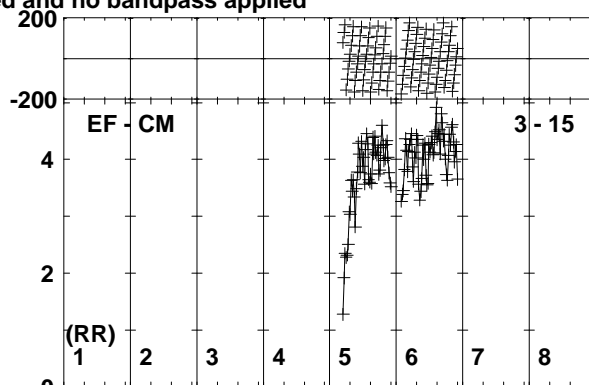
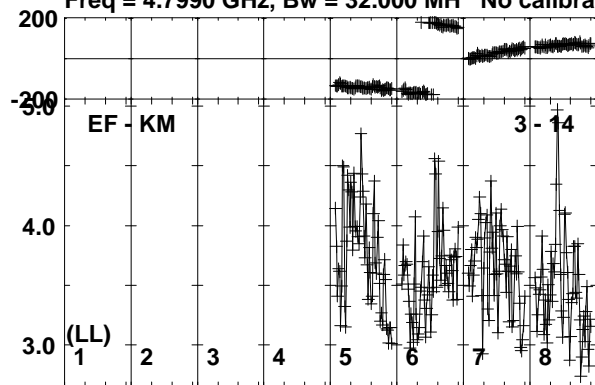

Lower frame: Milli Ampl Jy Top frame: Phas deg
Vector averaged cross-power spectrum Baseline: EF (03) - KM (14)
Timerange: 01/00:49:16 to 01/00:50:15

Plot file version 268 created 26-SEP-2019 10:40:52
 190829A RG010A.UVDATA.1

Freq = 4.7990 GHz, Bw = 32.000 MH No calibration applied and no bandpass applied

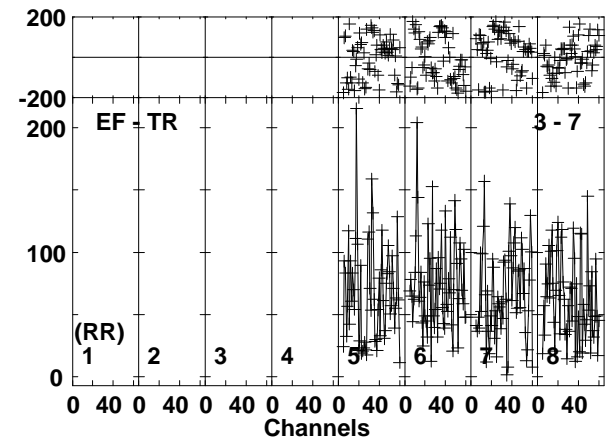
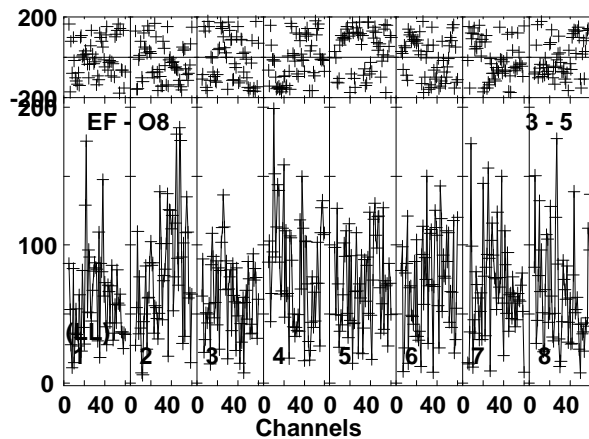
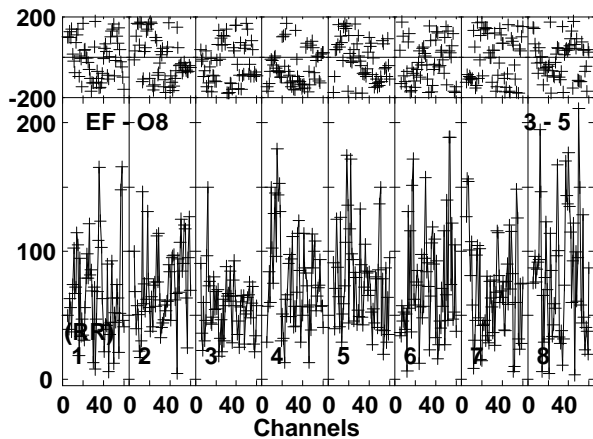
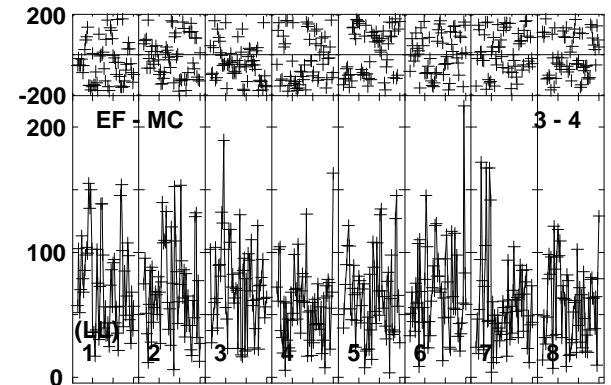
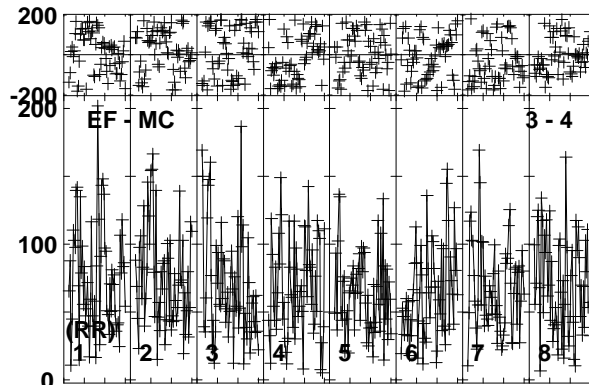
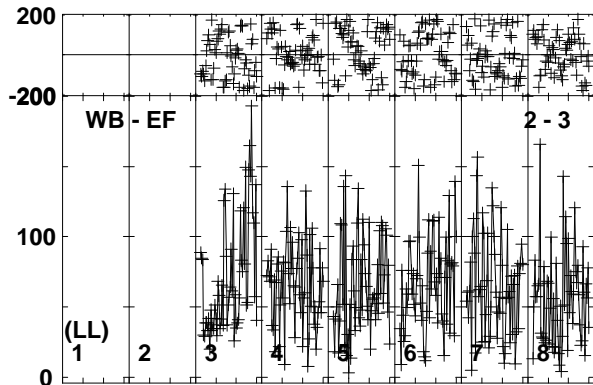
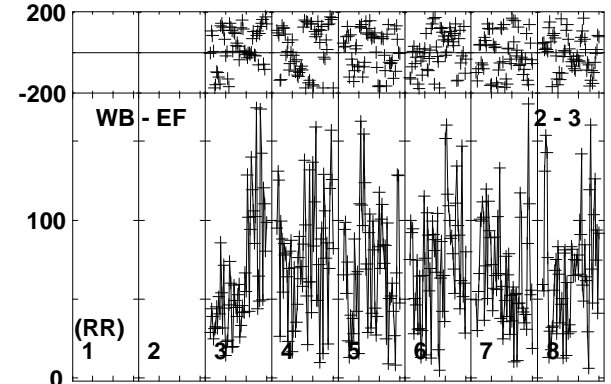
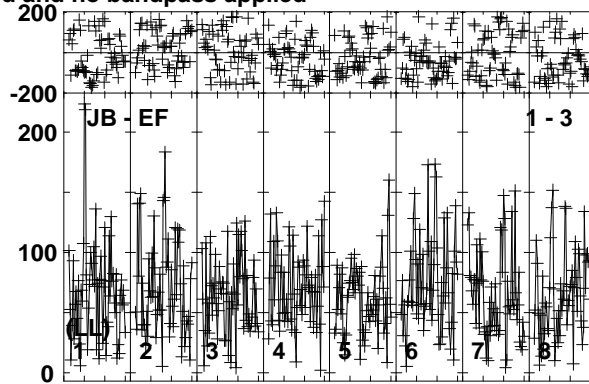
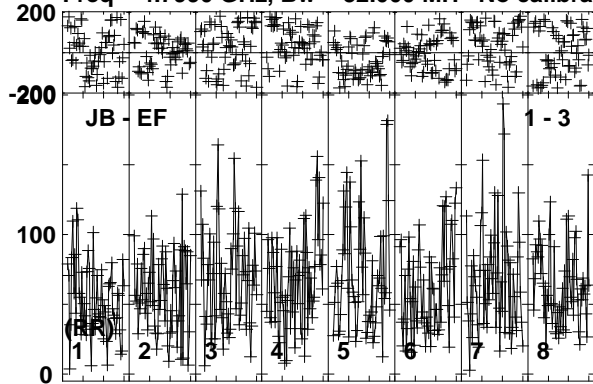

Lower frame: Micro Ampl Jy Top frame: Phas deg
 Vector averaged cross-power spectrum Baseline: JB (01) - EF (03)
 Timerange: 01/00:50:15 to 01/00:55:14

Plot file version 269 created 26-SEP-2019 10:40:53

190829A RG010A.UVDATA.1

Freq = 4.7990 GHz, Bw = 32.000 MH No calibration applied and no bandpass applied

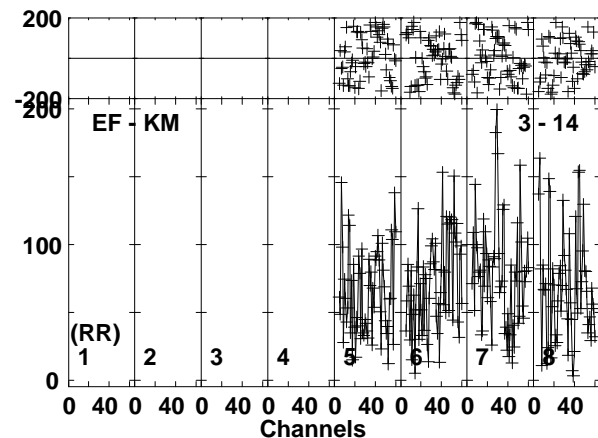
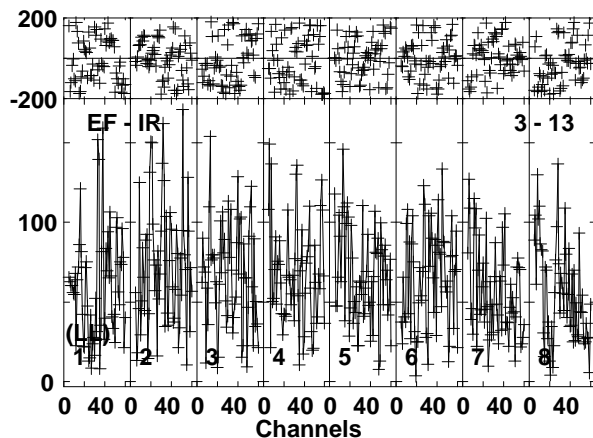
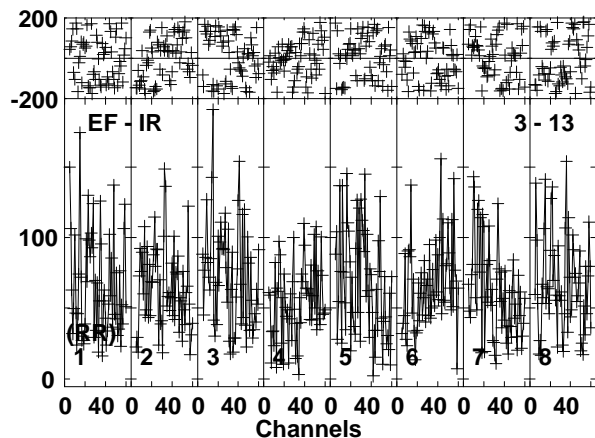
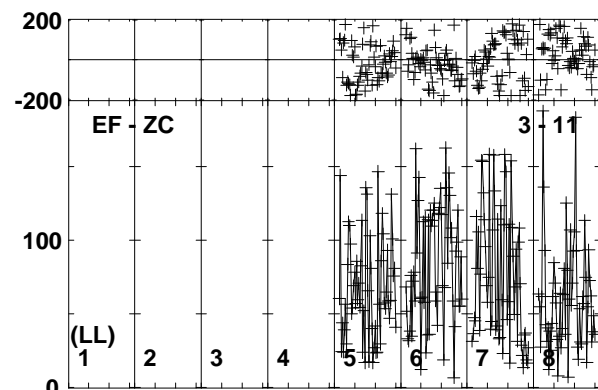
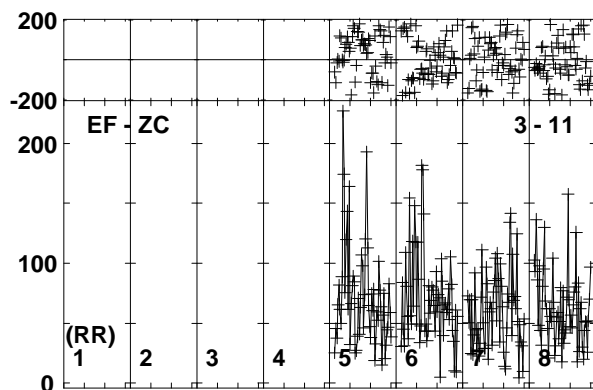
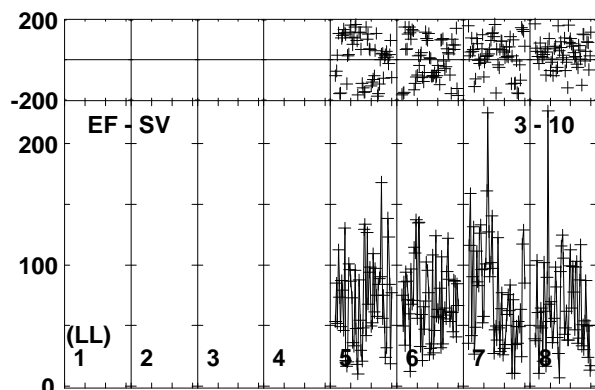
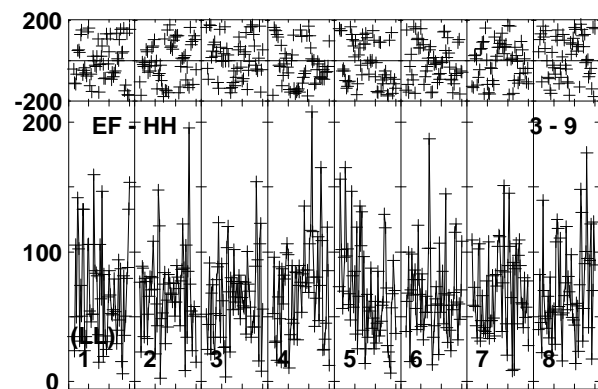
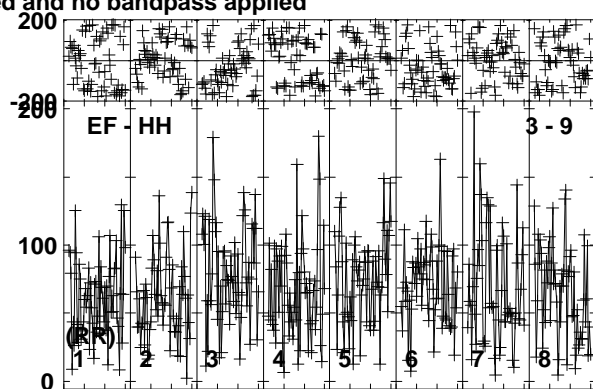
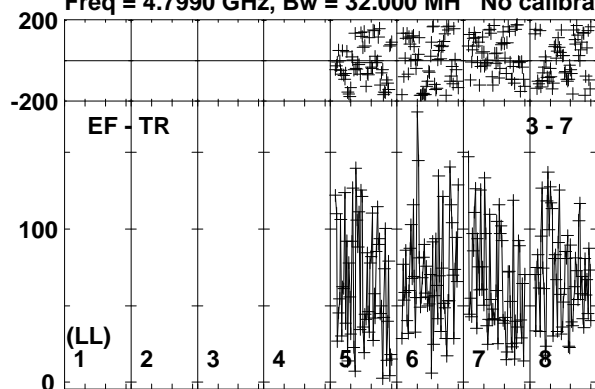

Lower frame: Micro Ampl Jy Top frame: Phas deg
Vector averaged cross-power spectrum Baseline: EF (03) - TR (07)
Timerange: 01/00:50:15 to 01/00:55:14

Plot file version 270 created 26-SEP-2019 10:40:54

190829A RG010A.UVDATA.1

Freq = 4.7990 GHz, Bw = 32.000 MH No calibration applied and no bandpass applied

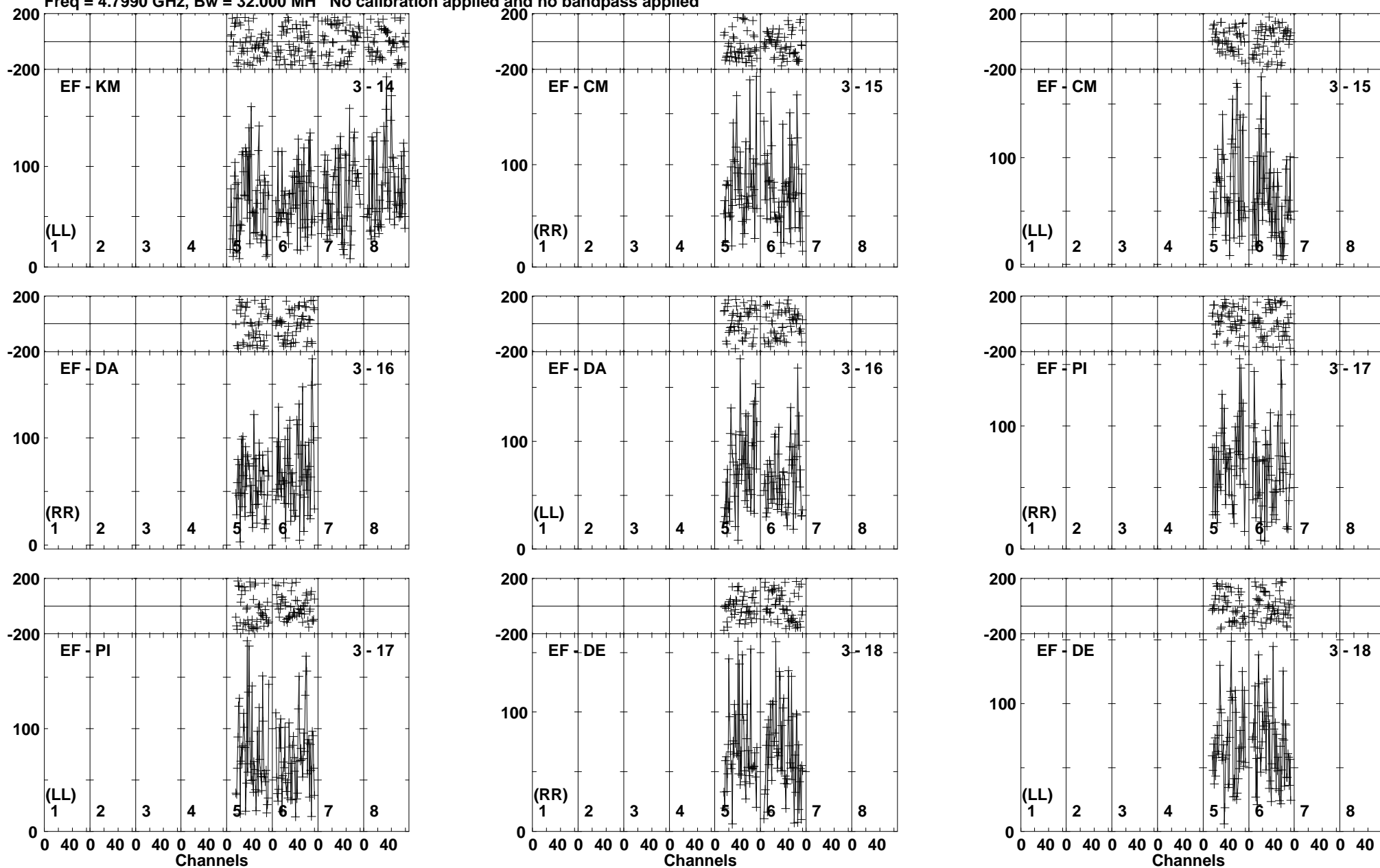

Lower frame: Micro Ampl Jy Top frame: Phas deg
Vector averaged cross-power spectrum Baseline: EF (03) - KM (14)
Timerange: 01/00:50:15 to 01/00:55:14

Plot file version 271 created 26-SEP-2019 10:40:55

J0257-1212 RG010A.UVDATA.1

Freq = 4.7990 GHz, Bw = 32.000 MH No calibration applied and no bandpass applied

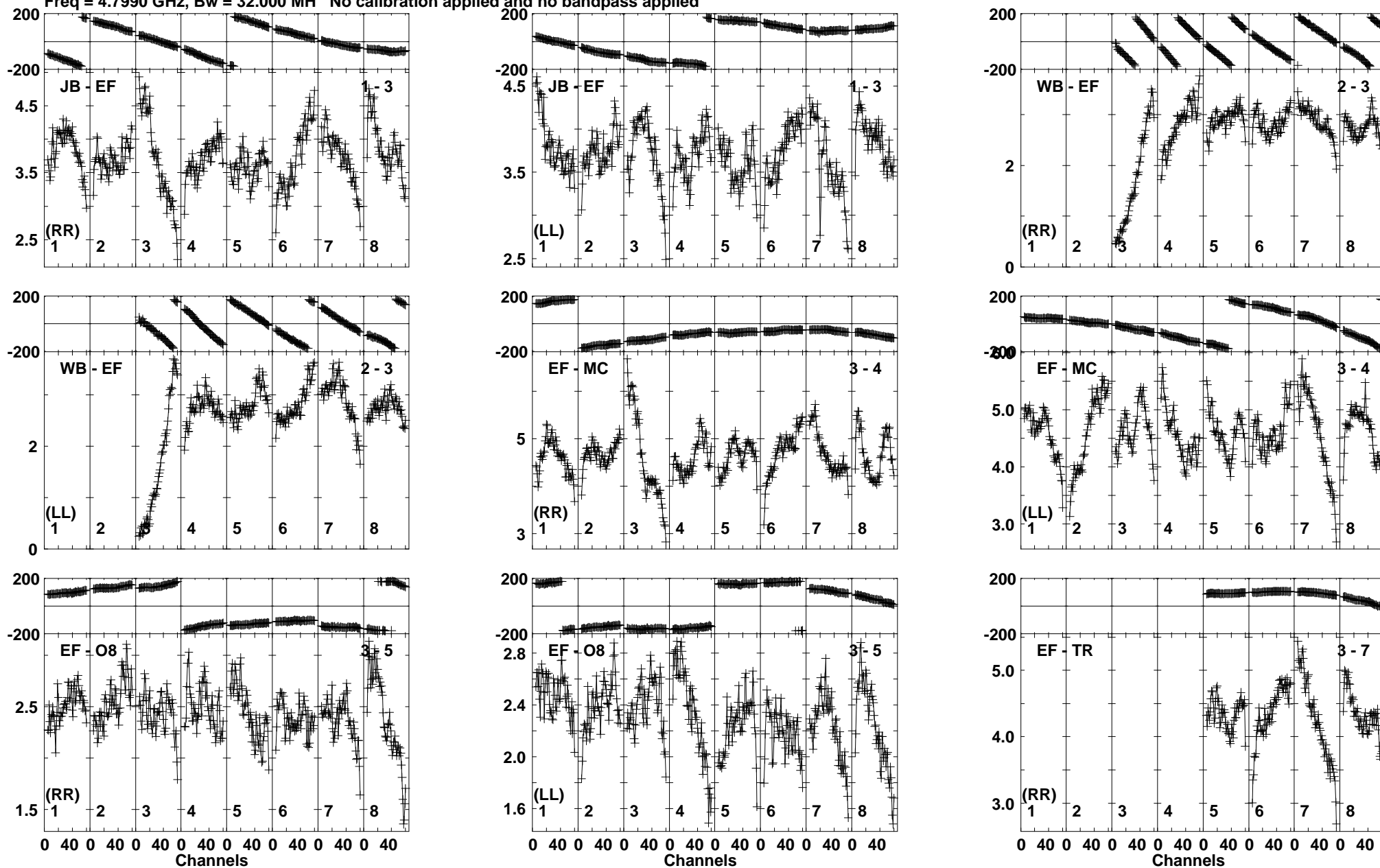

Lower frame: Milli Ampl Jy Top frame: Phas deg
Vector averaged cross-power spectrum Baseline: JB (01) - EF (03)
Timerange: 01/00:55:56 to 01/00:56:54

Plot file version 272 created 26-SEP-2019 10:40:56

J0257-1212 RG010A.UVDATA.1

Freq = 4.7990 GHz, Bw = 32.000 MH No calibration applied and no bandpass applied

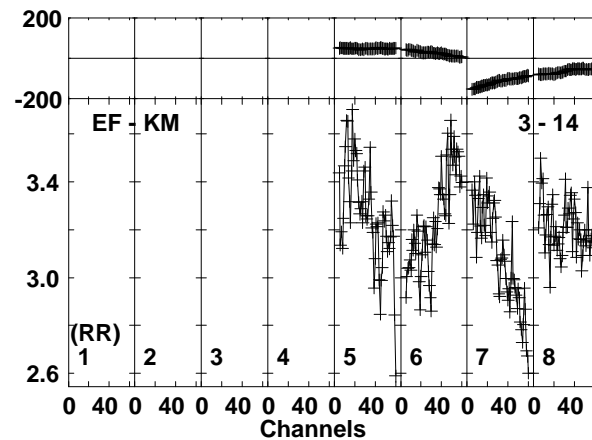
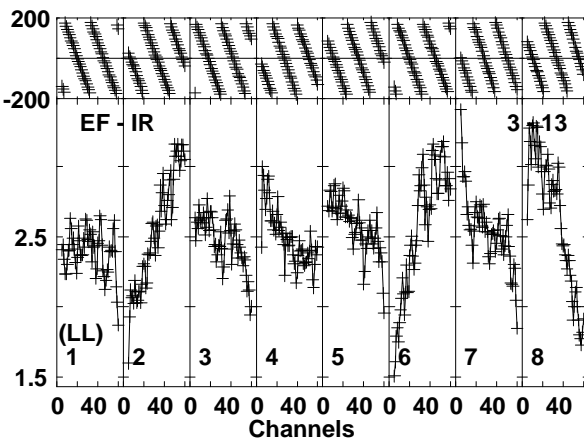
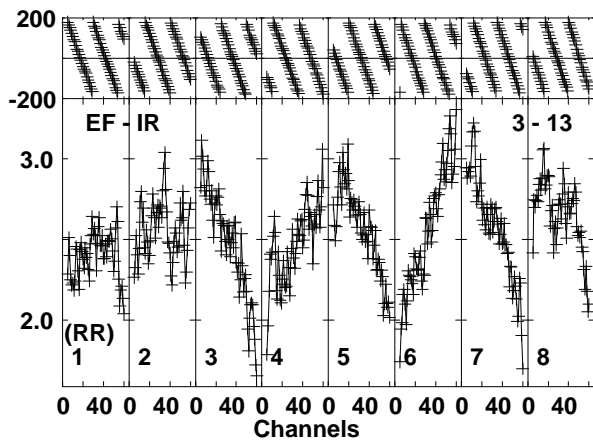
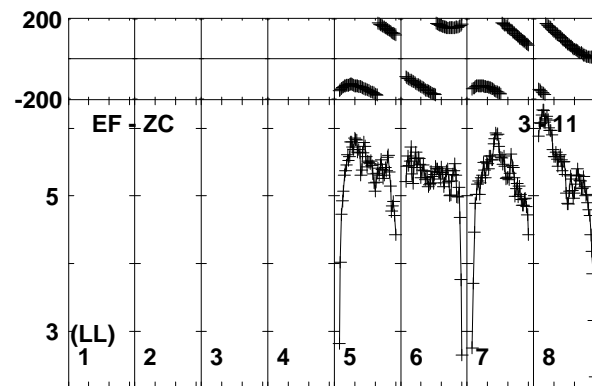
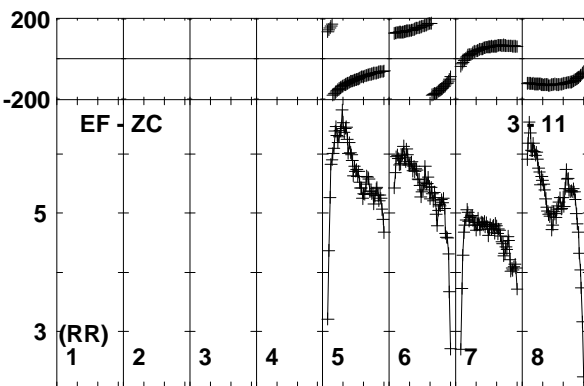
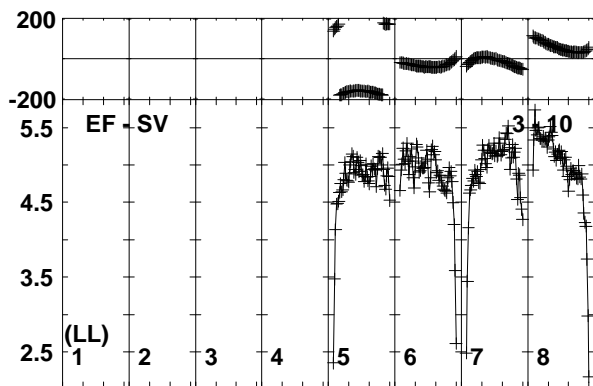
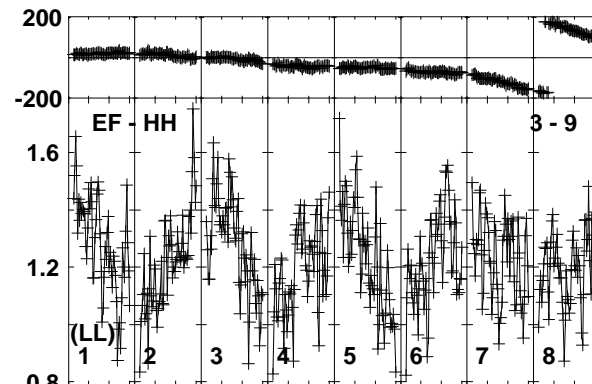
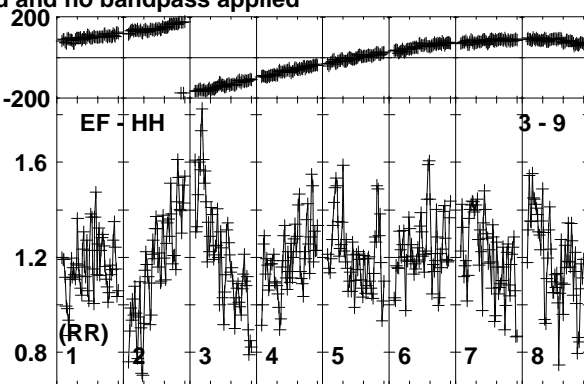
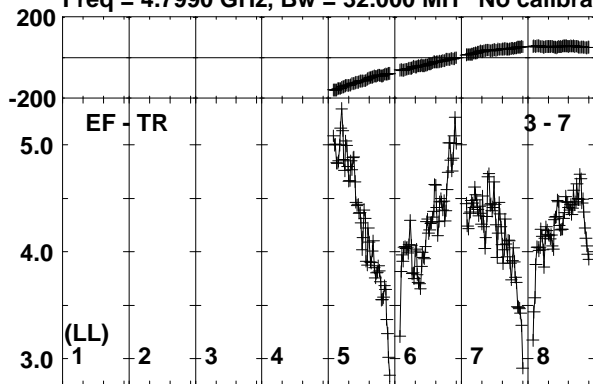

Lower frame: Milli Ampl Jy Top frame: Phas deg
Vector averaged cross-power spectrum Baseline: EF (03) - TR (07)
Timerange: 01/00:55:56 to 01/00:56:54

Plot file version 273 created 26-SEP-2019 10:40:56

J0257-1212 RG010A.UVDATA.1

Freq = 4.7990 GHz, Bw = 32.000 MH No calibration applied and no bandpass applied

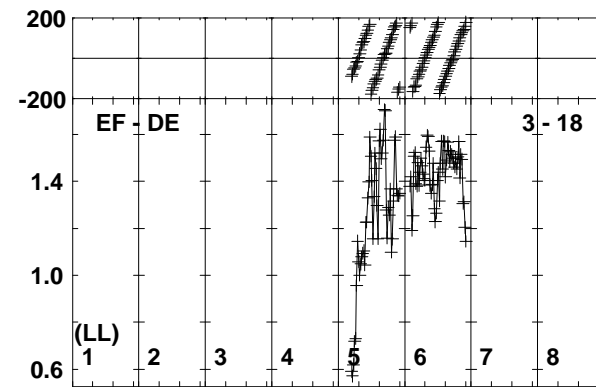
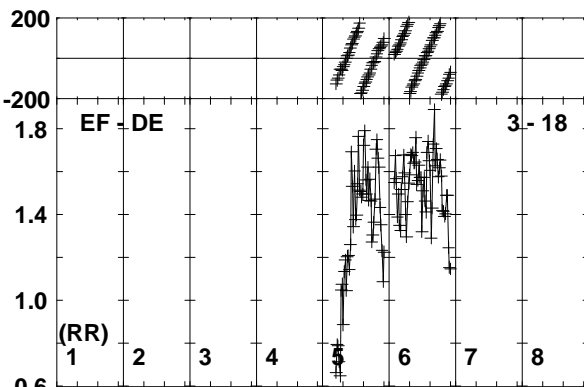
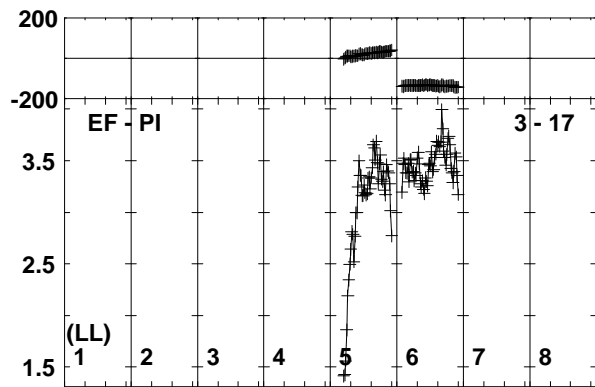
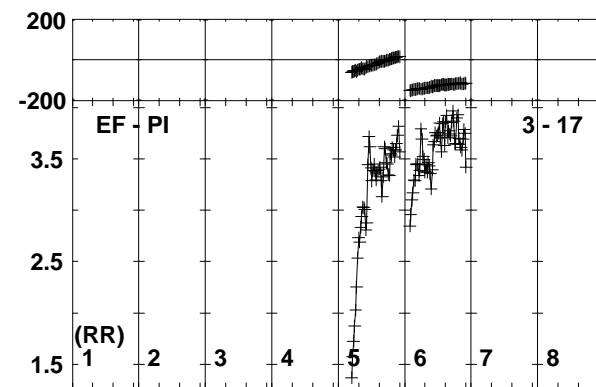
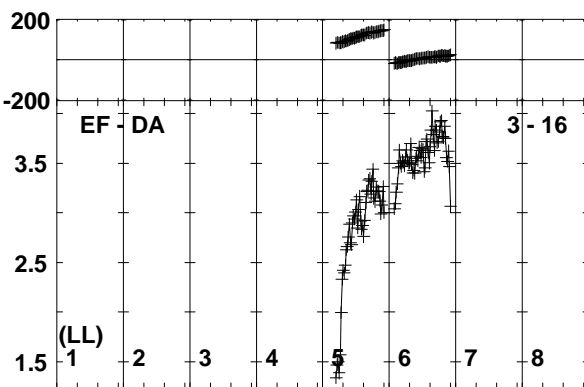
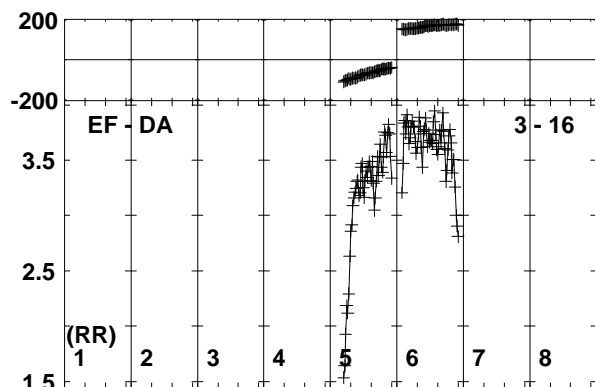
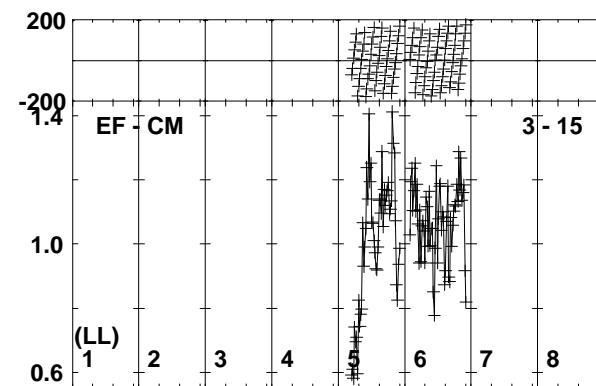
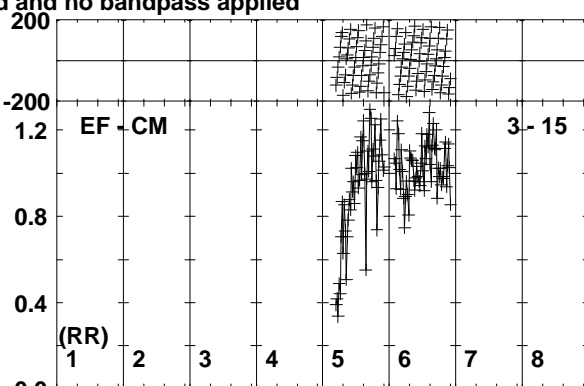
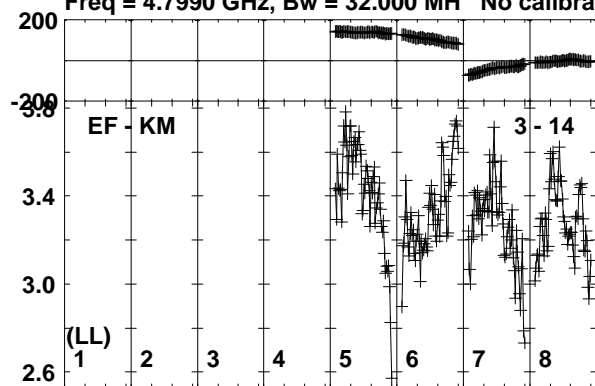

Lower frame: Milli Ampl Jy Top frame: Phas deg
Vector averaged cross-power spectrum Baseline: EF (03) - KM (14)
Timerange: 01/00:55:56 to 01/00:56:54

Plot file version 274 created 26-SEP-2019 10:40:57

190829A RG010A.UVDATA.1

Freq = 4.7990 GHz, Bw = 32.000 MH No calibration applied and no bandpass applied

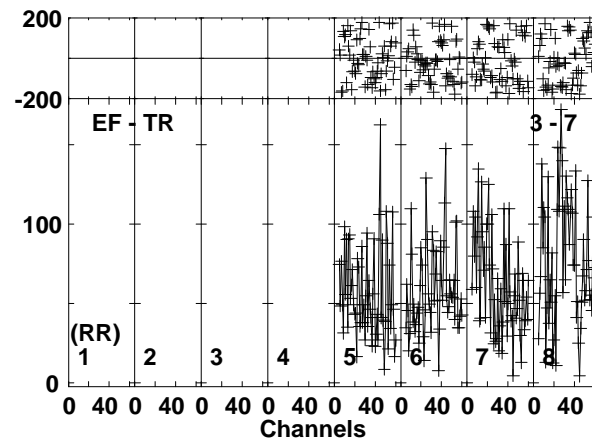
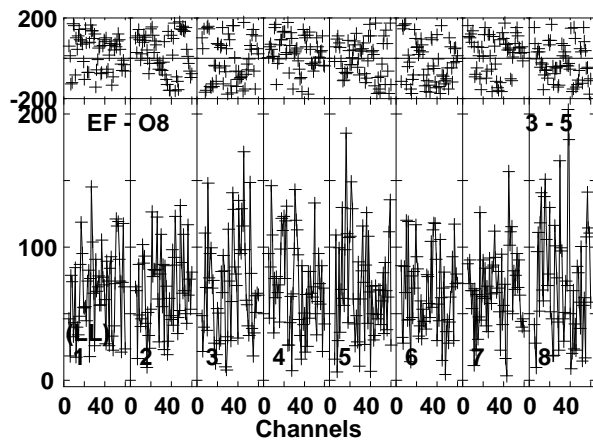
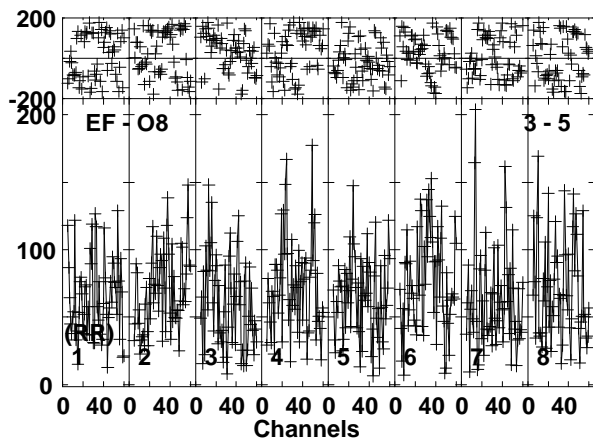
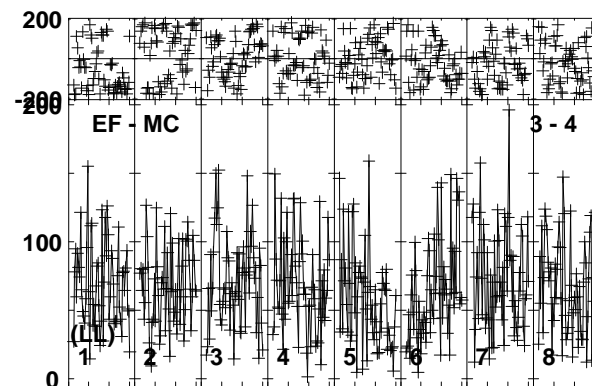
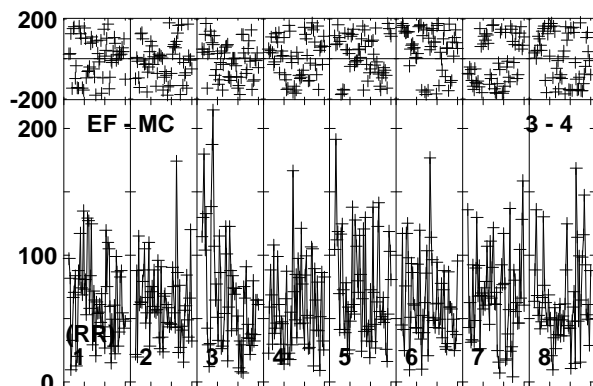
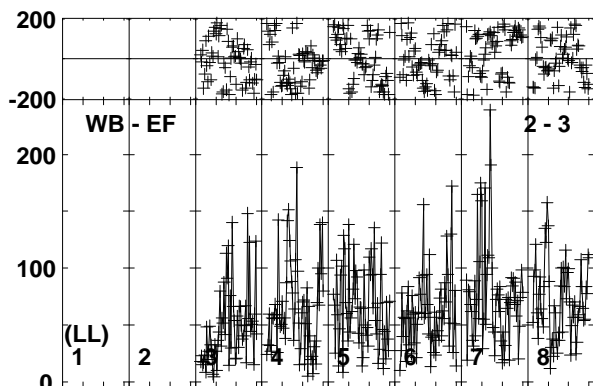
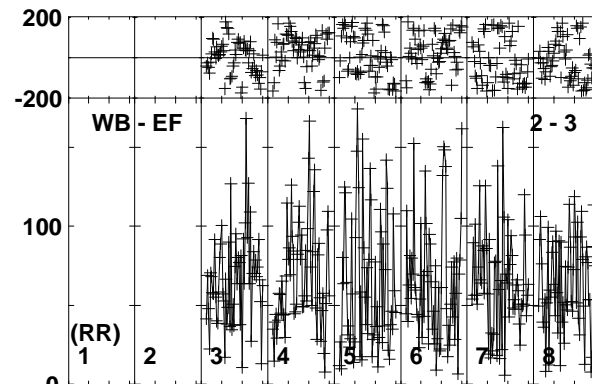
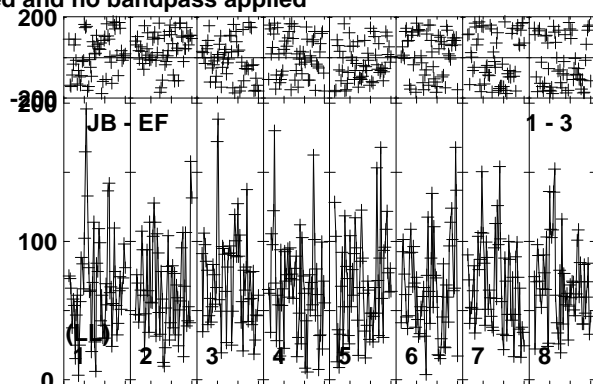
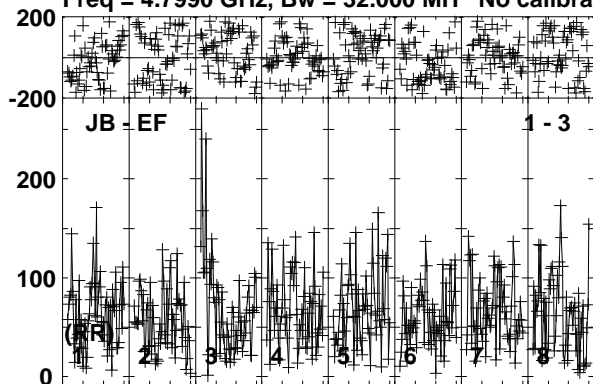

Lower frame: Micro Ampl Jy Top frame: Phas deg
Vector averaged cross-power spectrum Baseline: JB (01) - EF (03)
Timerange: 01/00:56:55 to 01/01:01:54

Plot file version 275 created 26-SEP-2019 10:40:58

190829A RG010A.UVDATA.1

Freq = 4.7990 GHz, Bw = 32.000 MH No calibration applied and no bandpass applied

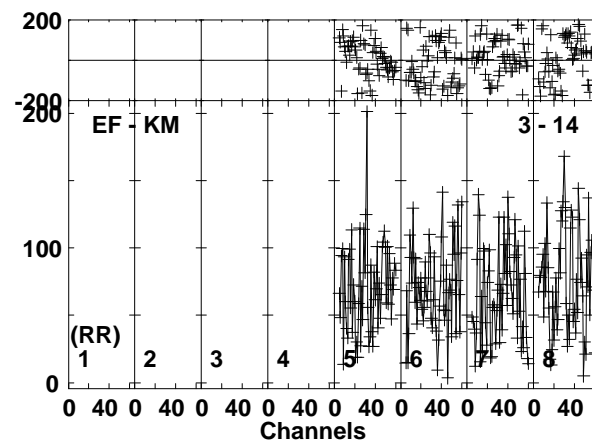
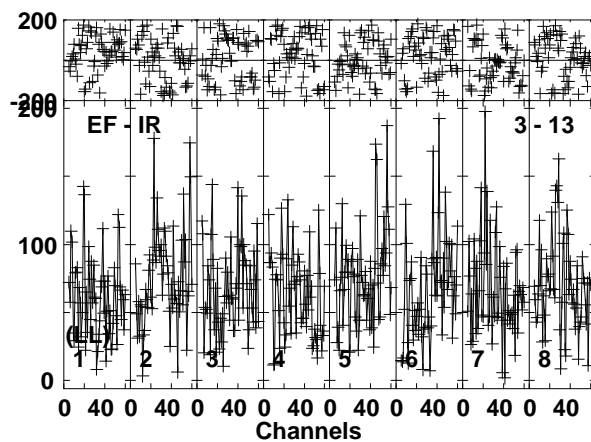
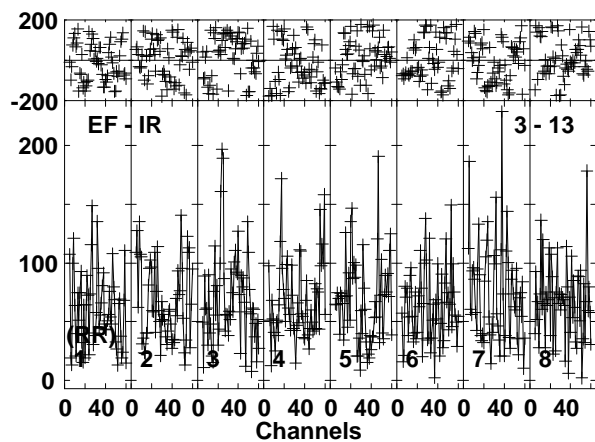
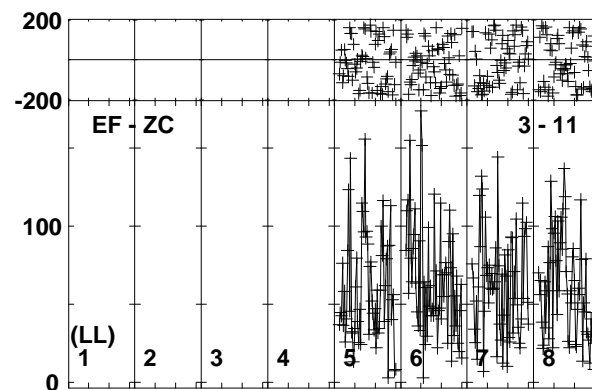
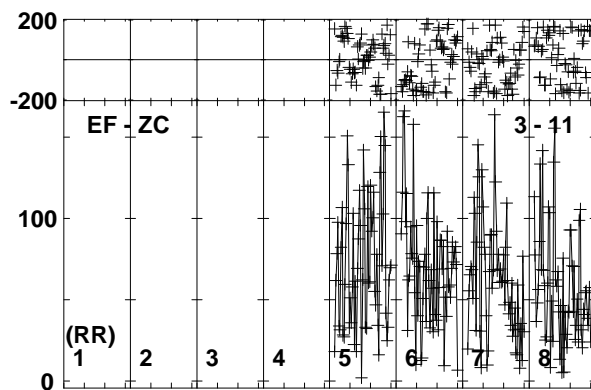
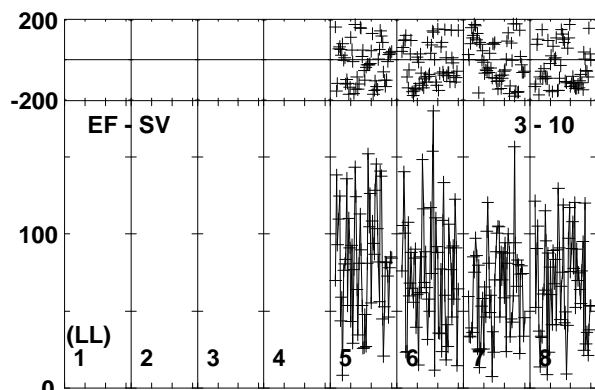
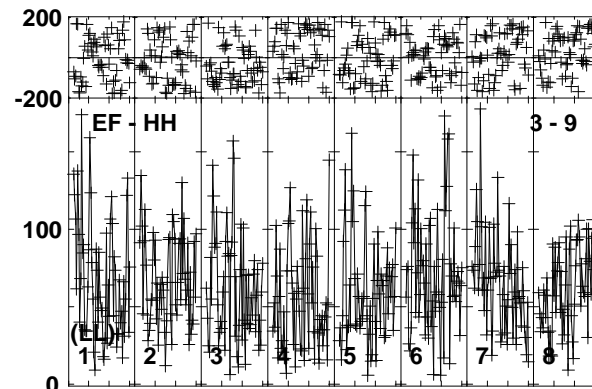
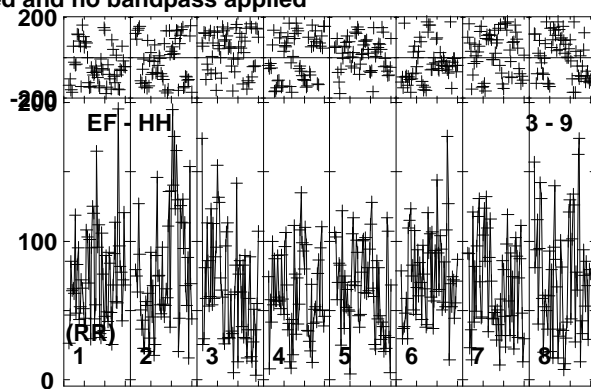
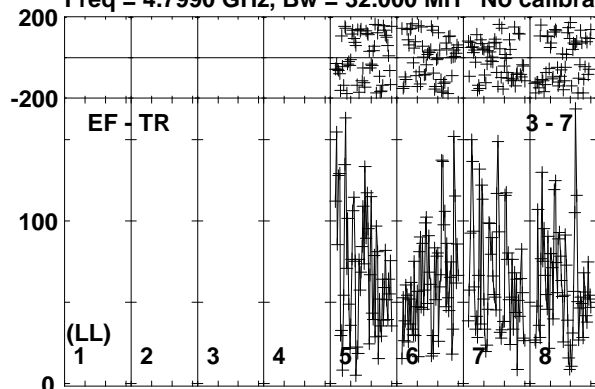

Lower frame: Micro Ampl Jy Top frame: Phas deg
Vector averaged cross-power spectrum Baseline: EF (03) - TR (07)
Timerange: 01/00:56:55 to 01/01:01:54

Plot file version 276 created 26-SEP-2019 10:40:59

190829A RG010A.UVDATA.1

Freq = 4.7990 GHz, Bw = 32.000 MH No calibration applied and no bandpass applied

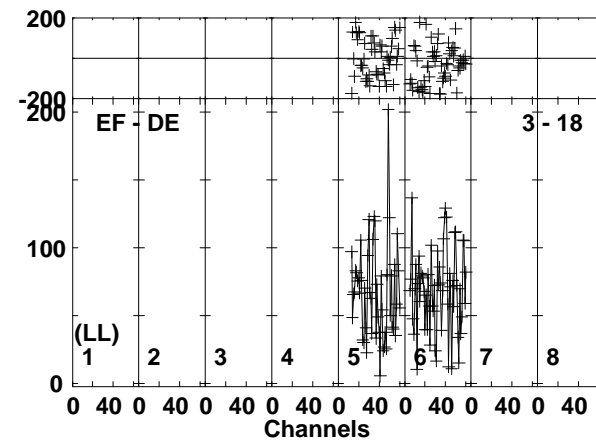
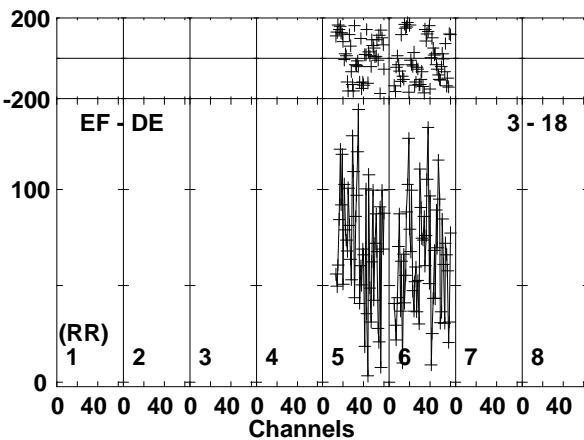
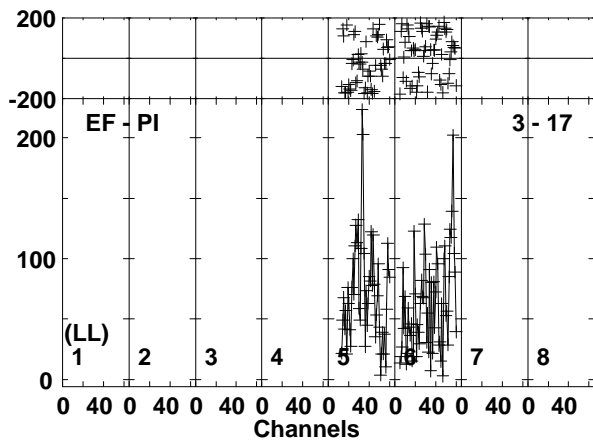
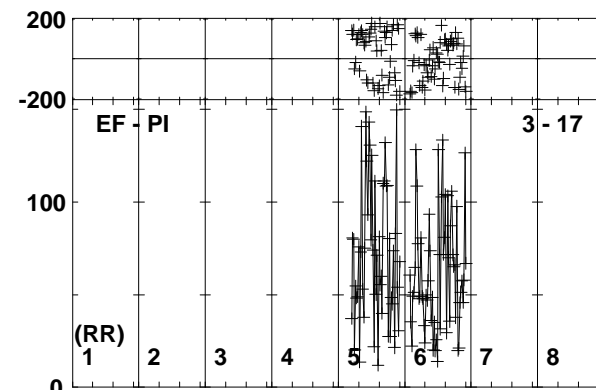
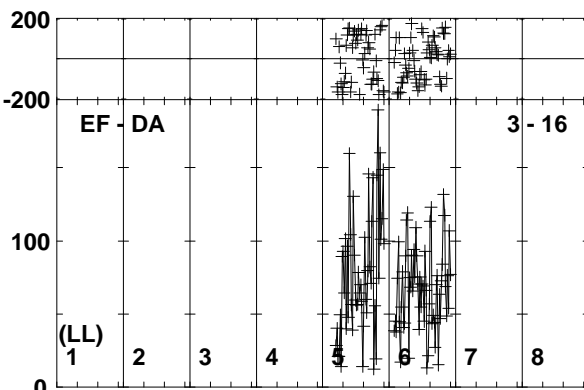
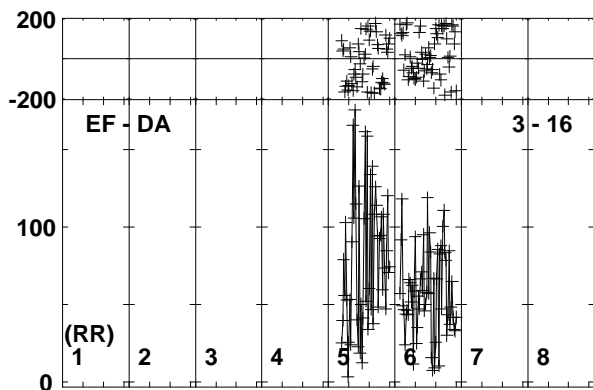
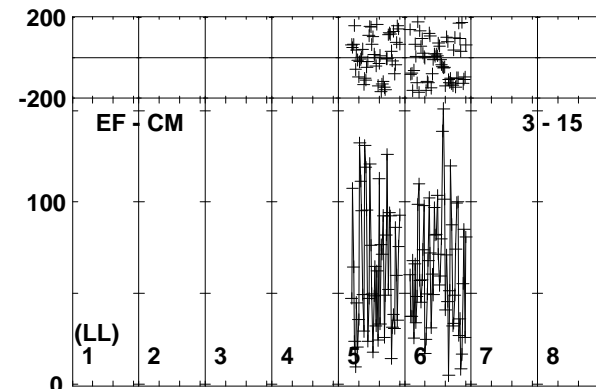
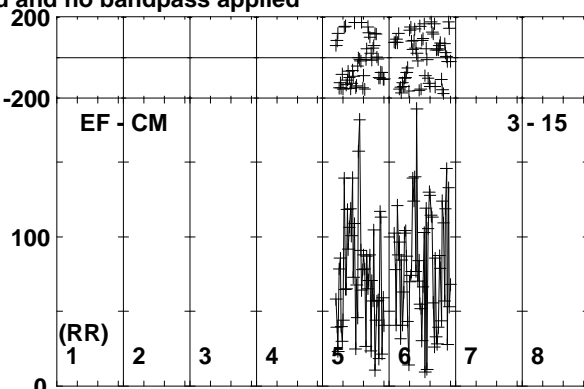
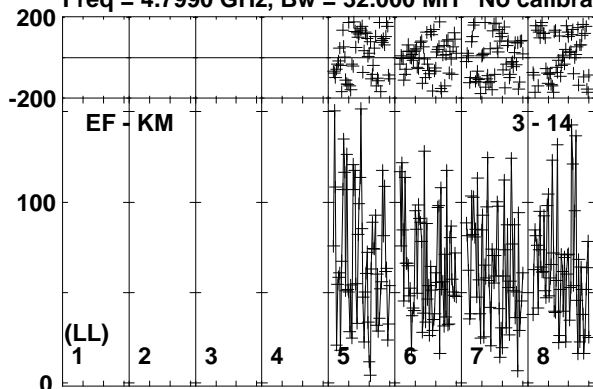

Lower frame: Micro Ampl Jy Top frame: Phas deg
Vector averaged cross-power spectrum Baseline: EF (03) - KM (14)
Timerange: 01/00:56:55 to 01/01:01:54

Plot file version 277 created 26-SEP-2019 10:40:59

J0257-1212 RG010A.UVDATA.1

Freq = 4.7990 GHz, Bw = 32.000 MH No calibration applied and no bandpass applied

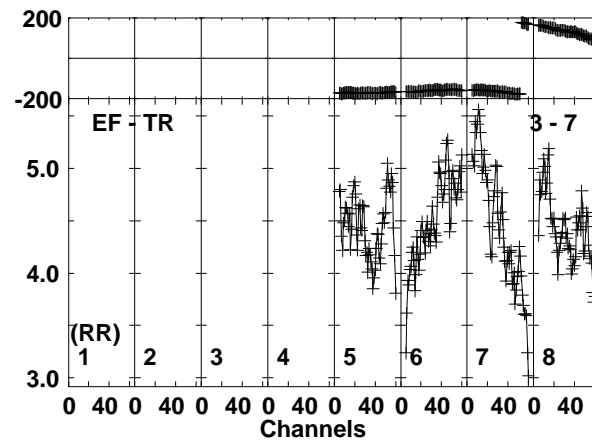
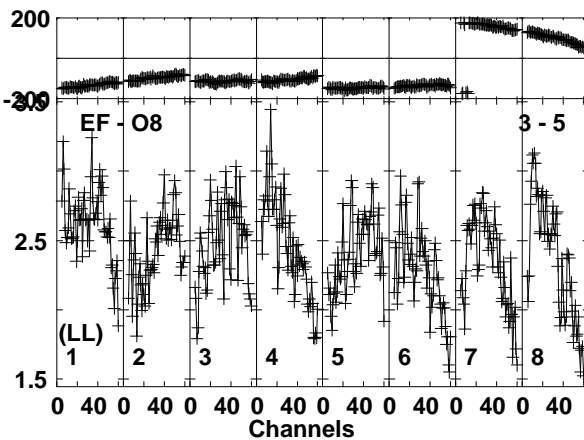
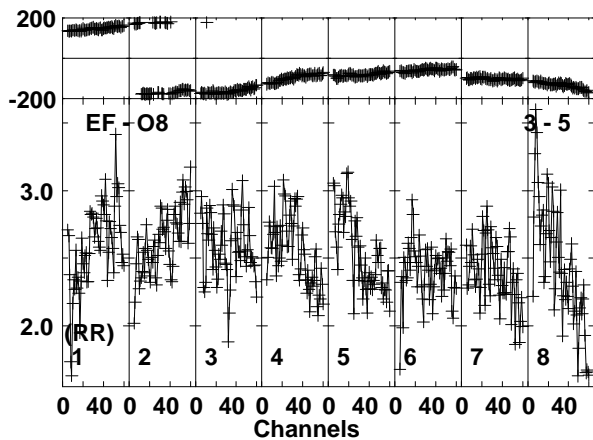
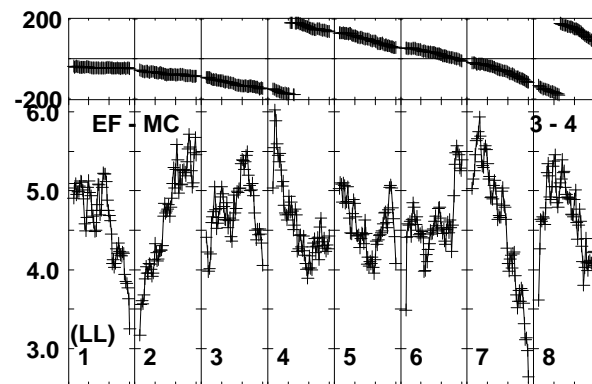
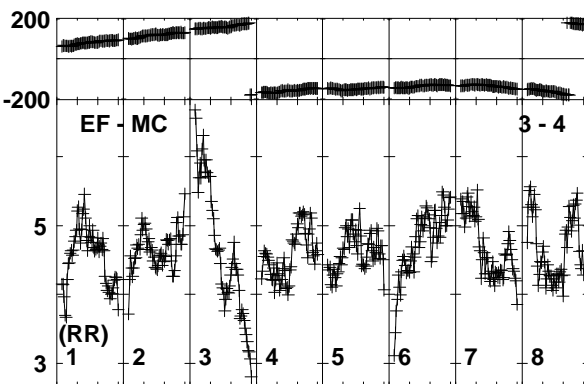
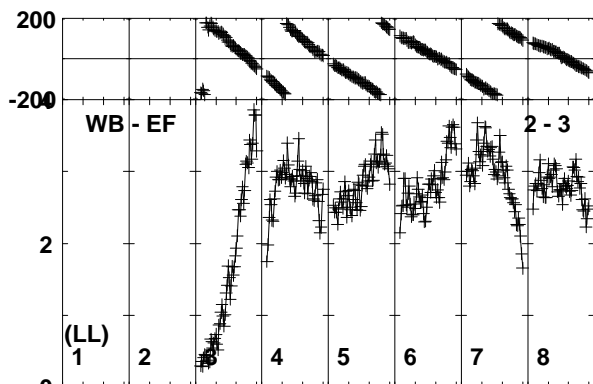
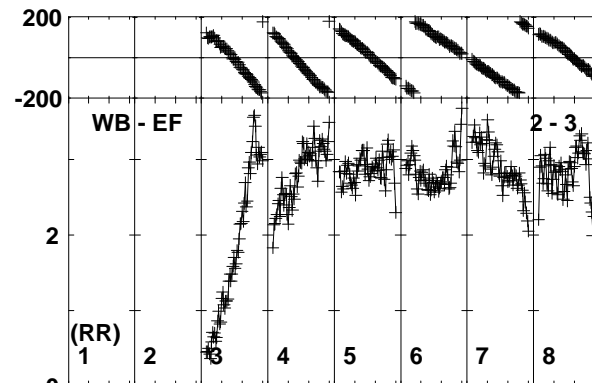
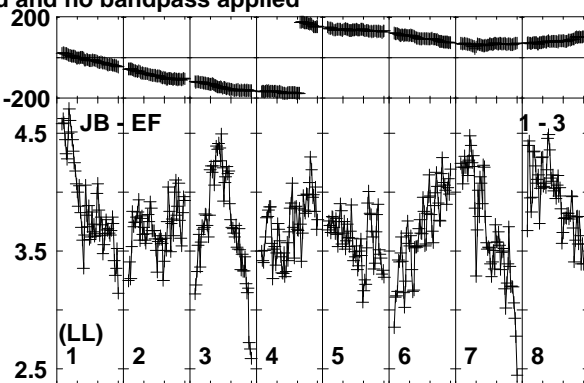
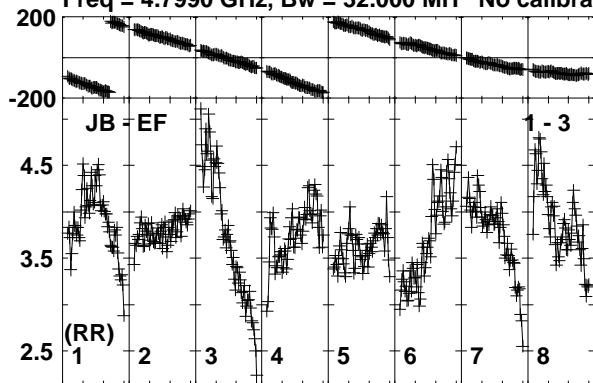

Lower frame: Milli Ampl Jy Top frame: Phas deg
Vector averaged cross-power spectrum Baseline: JB (01) - EF (03)
Timerange: 01/01:02:46 to 01/01:03:15

Plot file version 278 created 26-SEP-2019 10:40:59

J0257-1212 RG010A.UVDATA.1

Freq = 4.7990 GHz, Bw = 32.000 MH No calibration applied and no bandpass applied

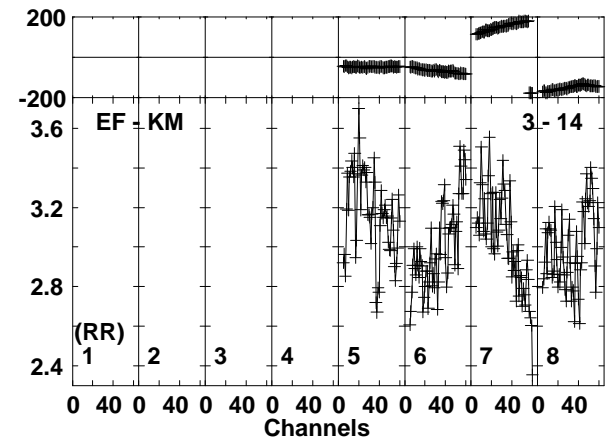
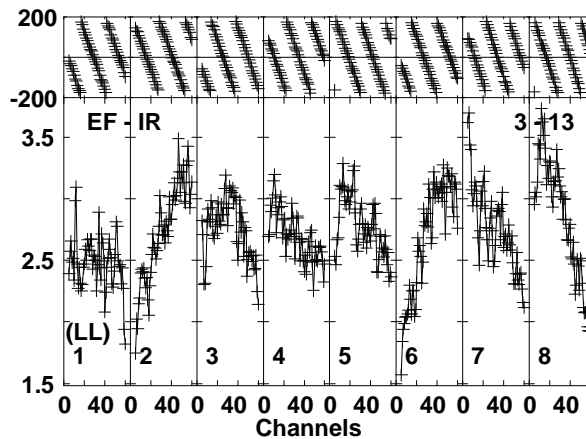
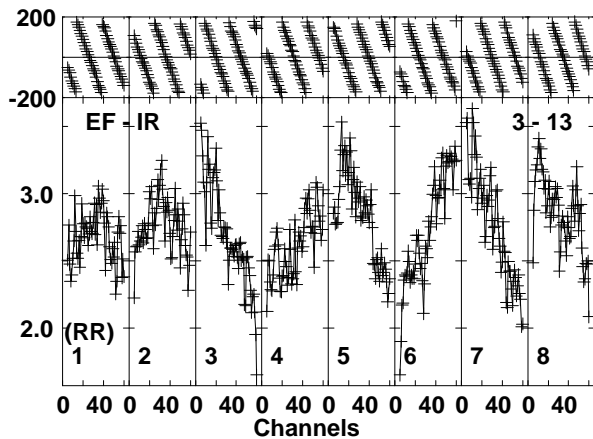
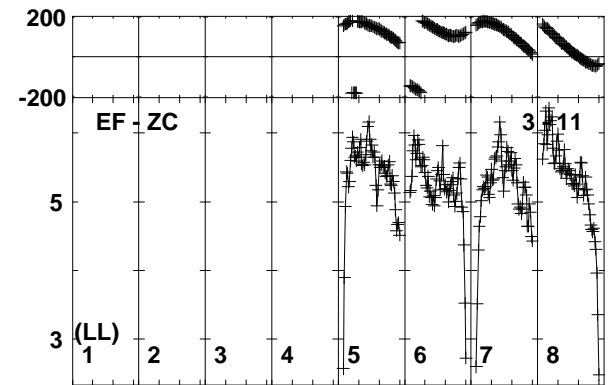
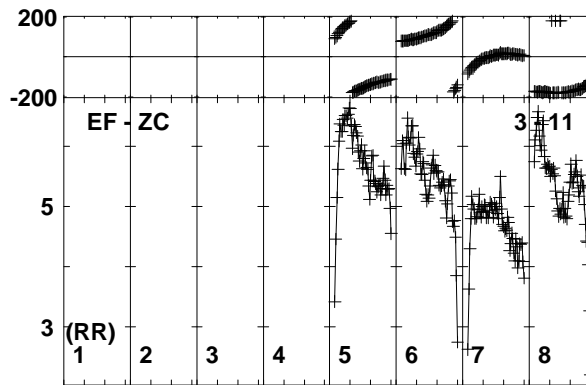
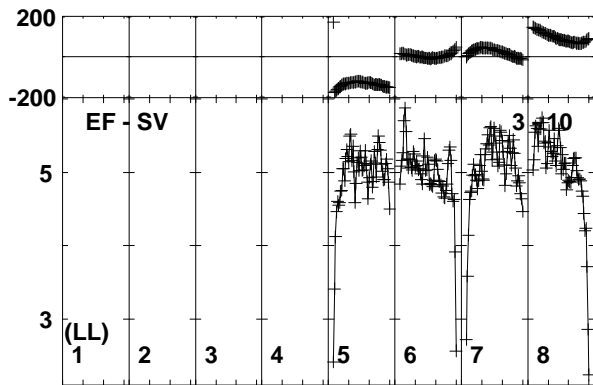
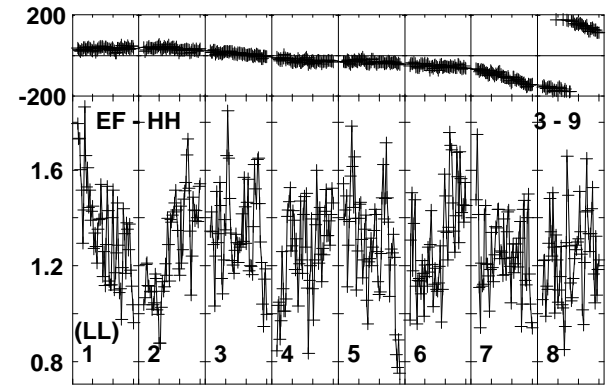
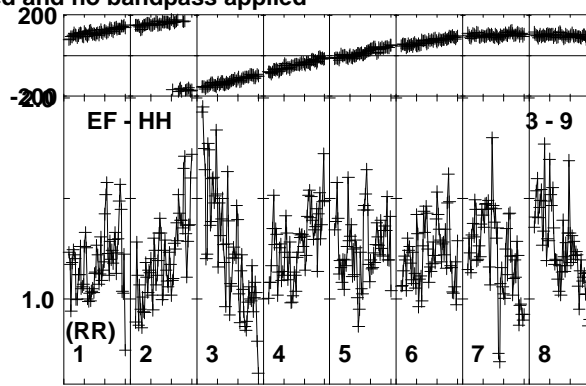
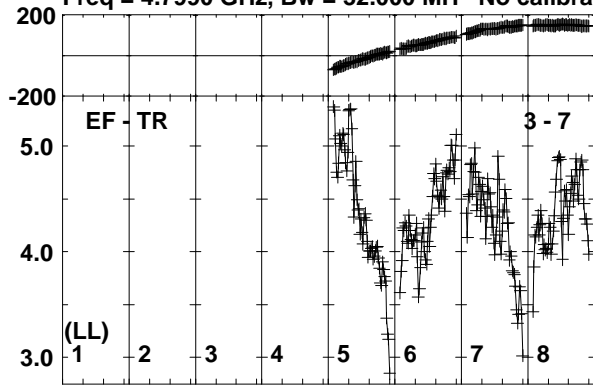

Lower frame: Milli Ampl Jy Top frame: Phas deg
Vector averaged cross-power spectrum Baseline: EF (03) - TR (07)
Timerange: 01/01:02:46 to 01/01:03:15

Plot file version 279 created 26-SEP-2019 10:41:00
J0257-1212 RG010A.UVDATA.1
Freq = 4.7990 GHz, Bw = 32.000 MH No calibration applied and no bandpass applied

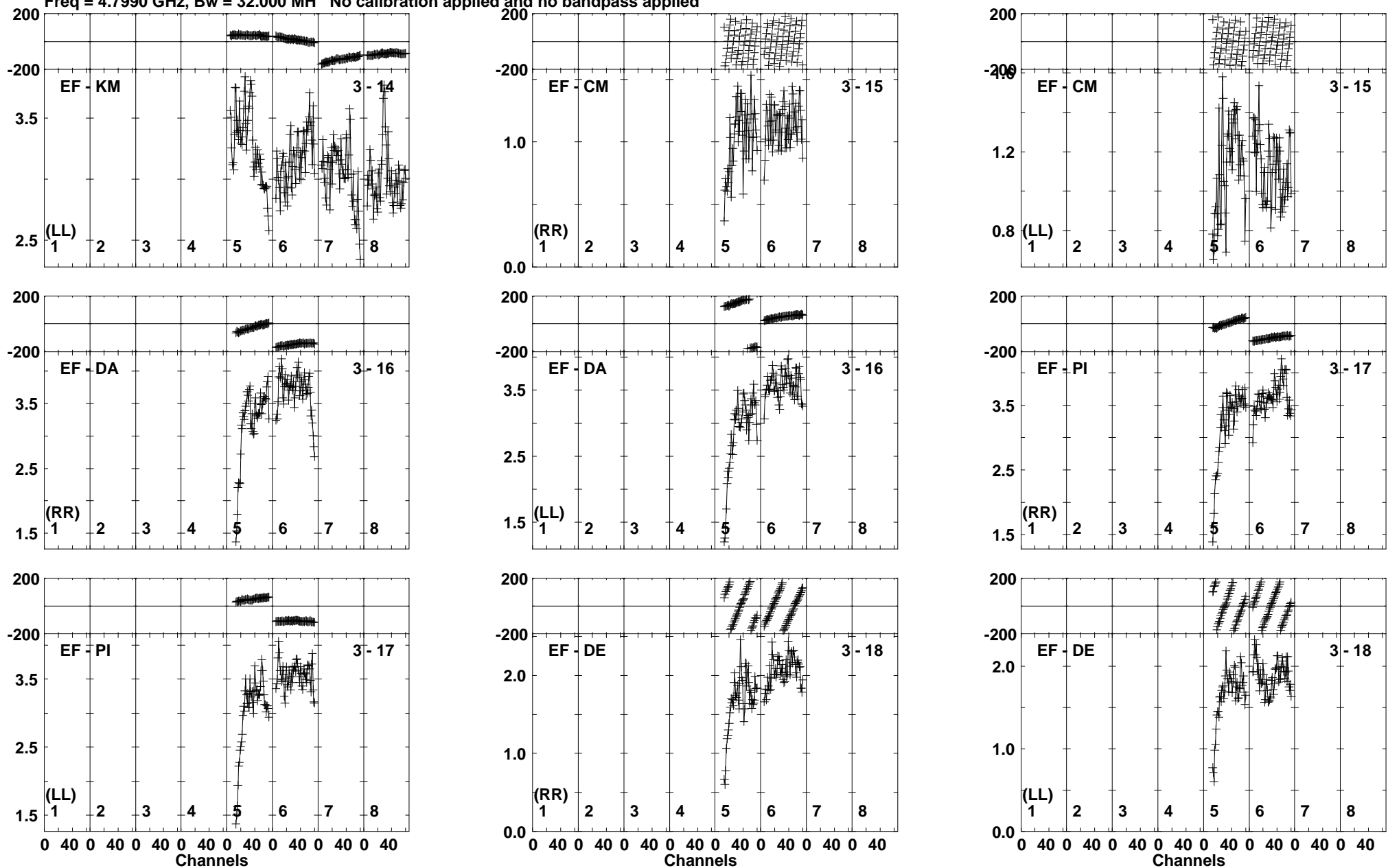

Lower frame: Milli Ampl Jy Top frame: Phas deg
Vector averaged cross-power spectrum Baseline: EF (03) - KM (14)
Timerange: 01/01:02:46 to 01/01:03:15

Plot file version 280 created 26-SEP-2019 10:41:00

J0300-0846 RG010A.UVDATA.1

Freq = 4.7990 GHz, Bw = 32.000 MH No calibration applied and no bandpass applied

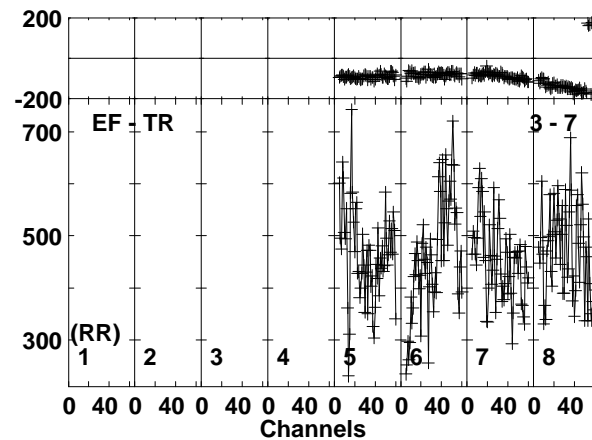
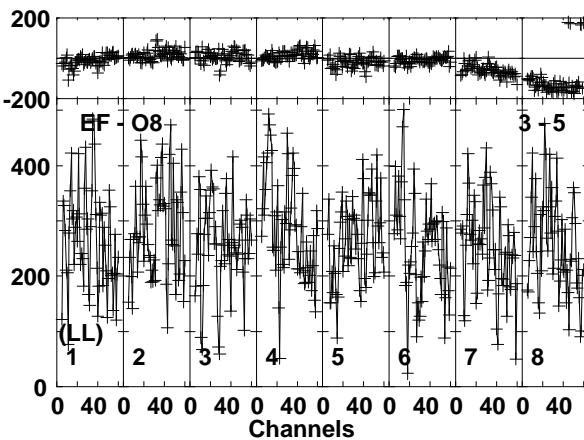
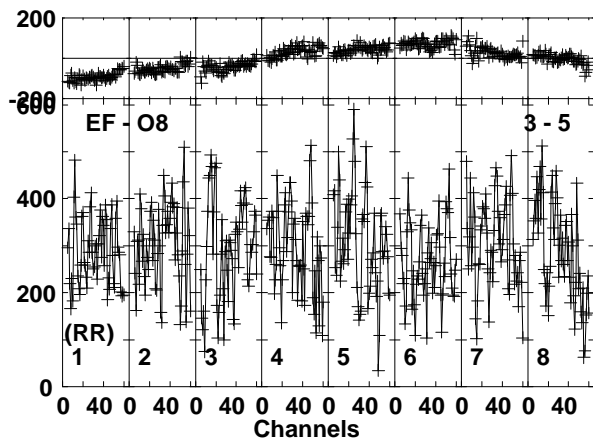
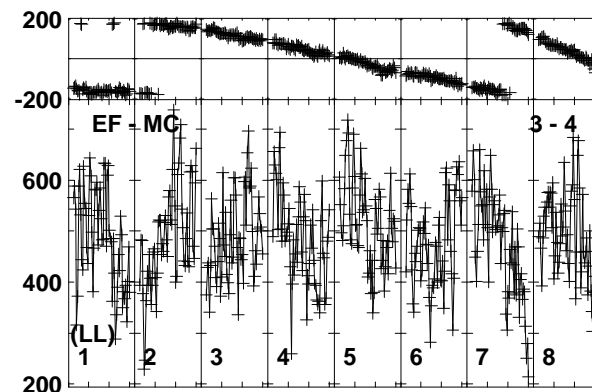
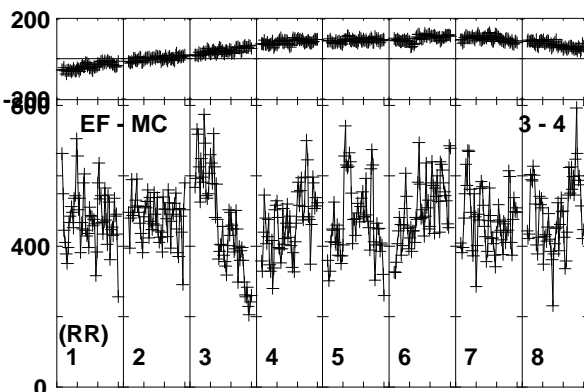
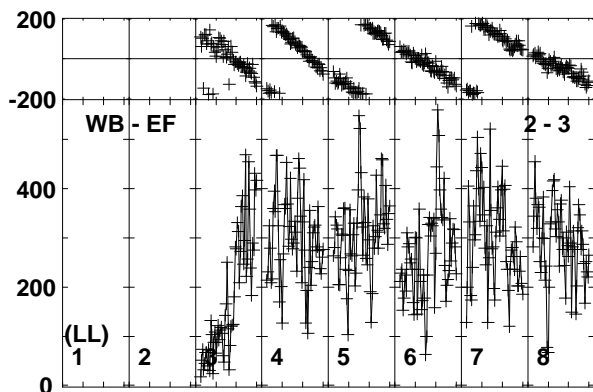
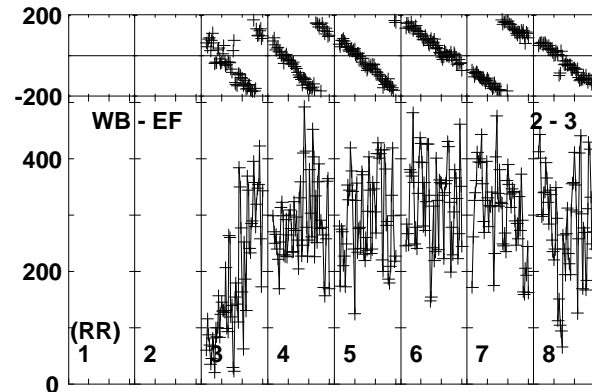
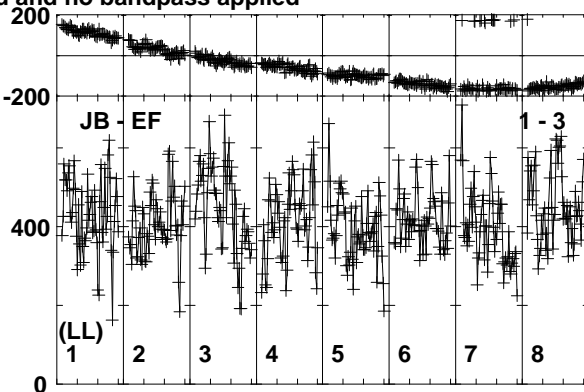
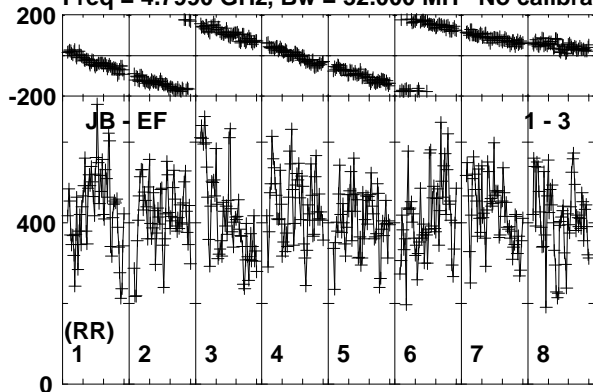

Lower frame: Micro Ampl Jy Top frame: Phas deg
Vector averaged cross-power spectrum Baseline: JB (01) - EF (03)
Timerange: 01/01:03:15 to 01/01:05:45

Plot file version 281 created 26-SEP-2019 10:41:01

J0300-0846 RG010A.UVDATA.1

Freq = 4.7990 GHz, Bw = 32.000 MH No calibration applied and no bandpass applied

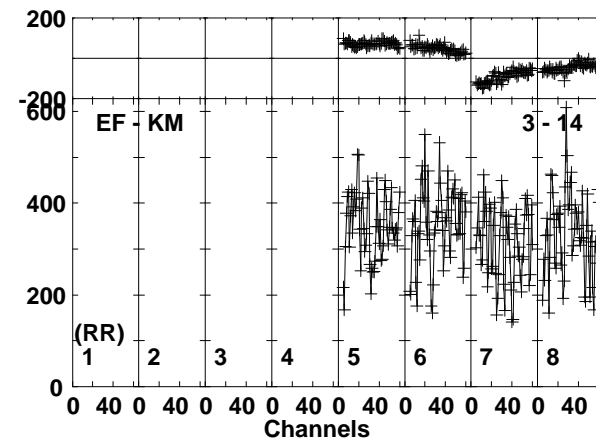
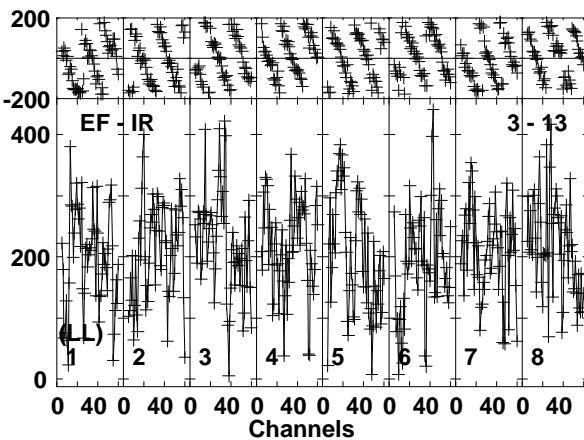
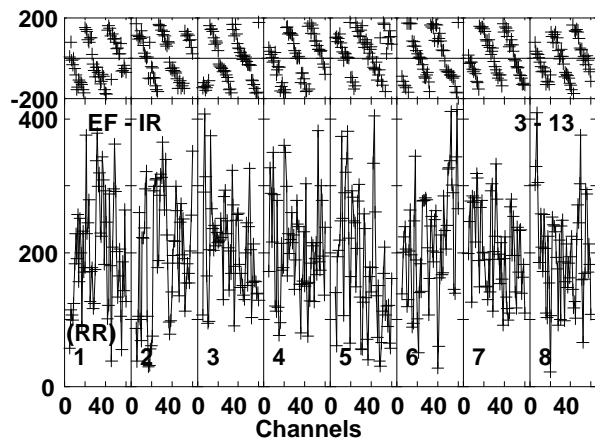
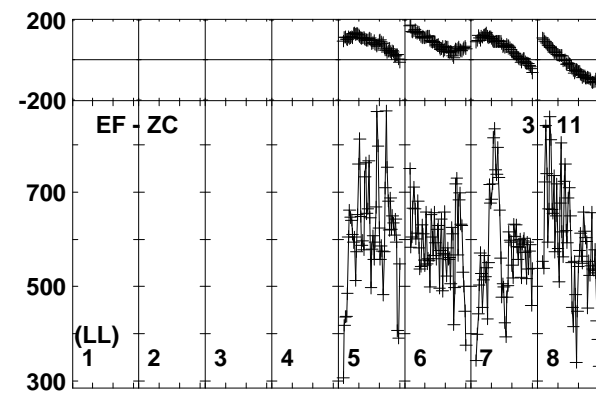
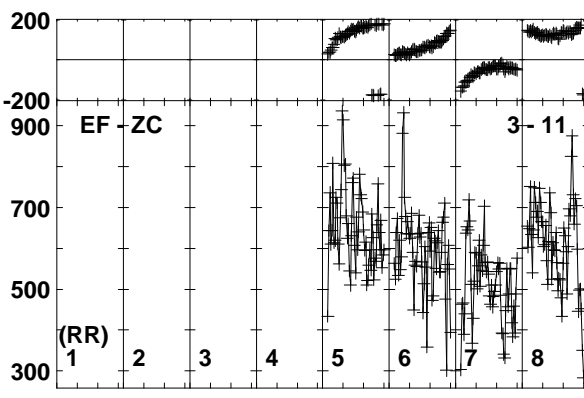
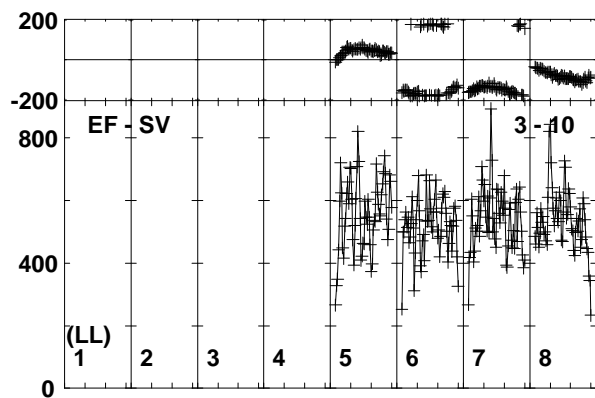
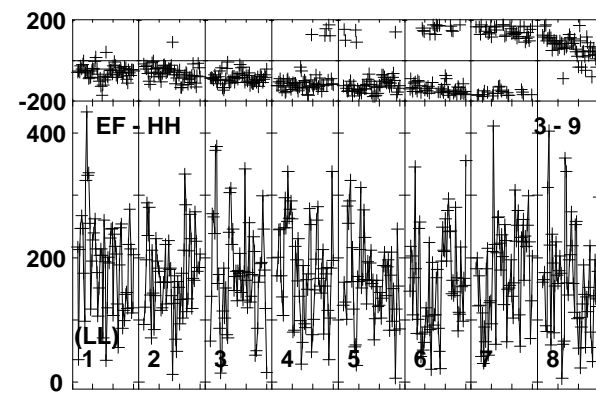
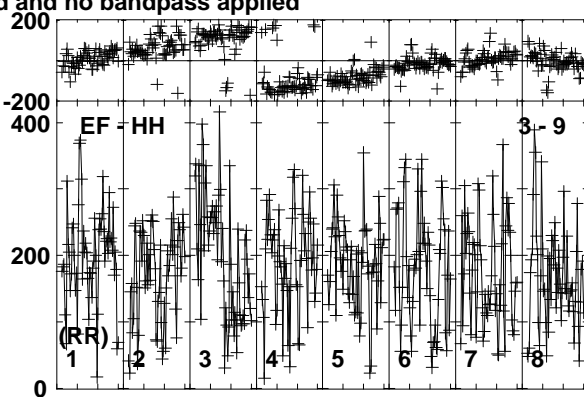
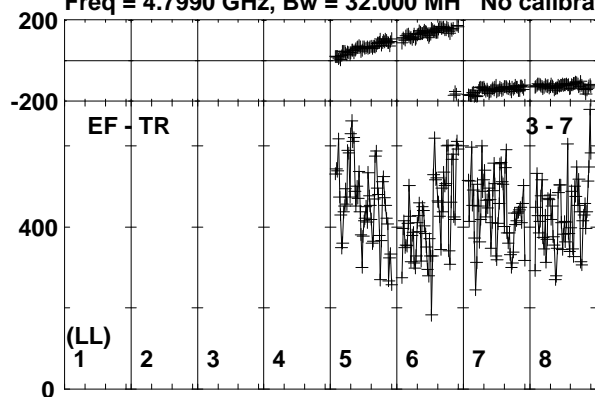

Lower frame: Micro Ampl Jy Top frame: Phas deg
Vector averaged cross-power spectrum Baseline: EF (03) - TR (07)
Timerange: 01/01:03:15 to 01/01:05:45

Plot file version 282 created 26-SEP-2019 10:41:02

J0300-0846 RG010A.UVDATA.1

Freq = 4.7990 GHz, Bw = 32.000 MH No calibration applied and no bandpass applied

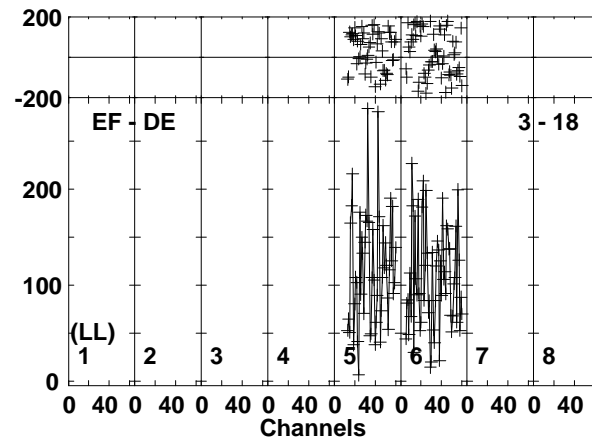
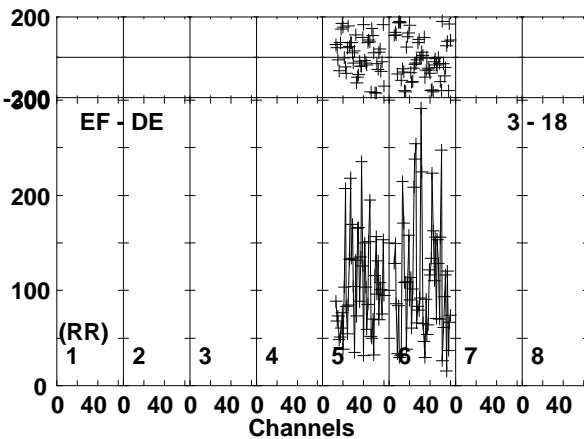
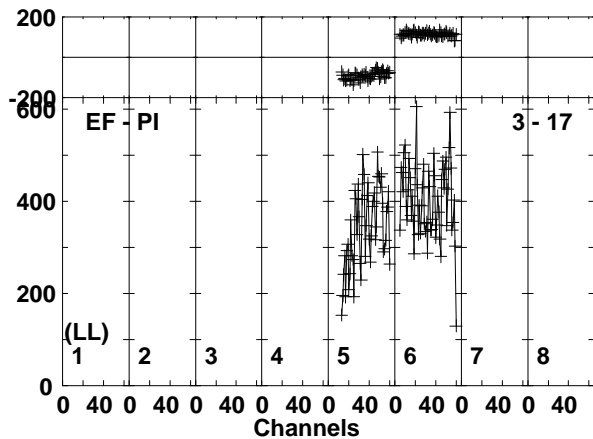
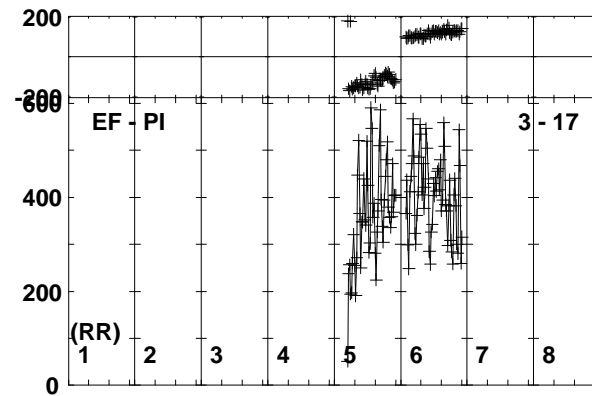
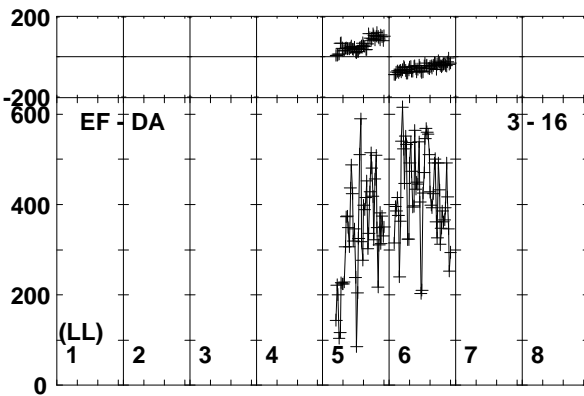
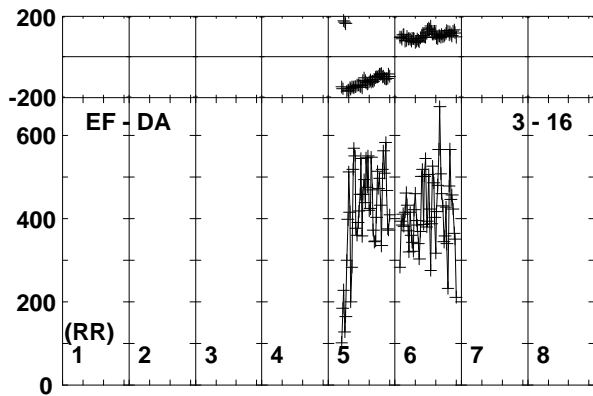
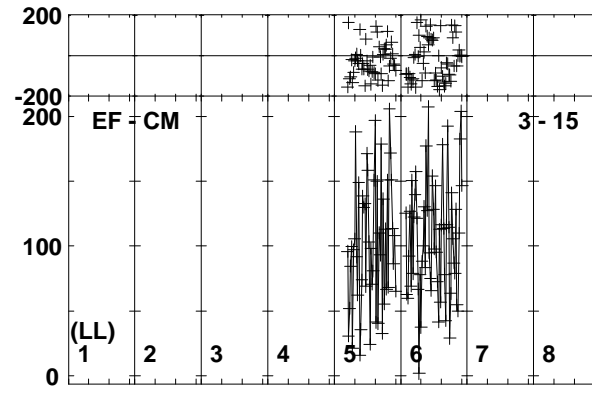
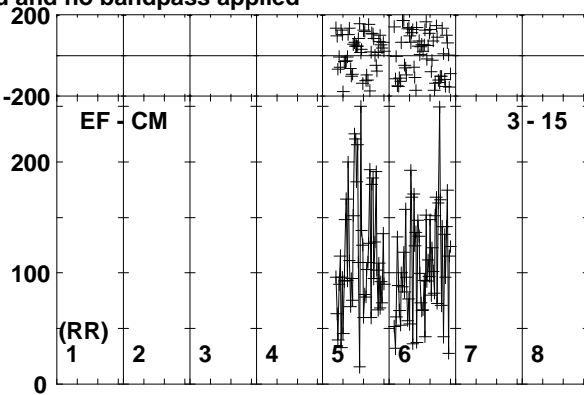
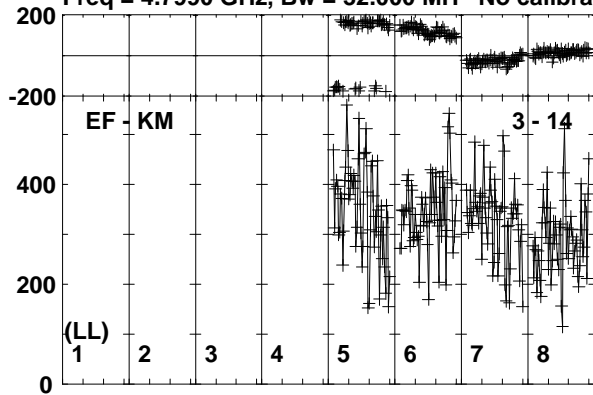

Lower frame: Micro Ampl Jy Top frame: Phas deg
Vector averaged cross-power spectrum Baseline: EF (03) - KM (14)
Timerange: 01/01:03:15 to 01/01:05:45

Plot file version 283 created 26-SEP-2019 10:41:02

190829A RG010A.UVDATA.1

Freq = 4.7990 GHz, Bw = 32.000 MH No calibration applied and no bandpass applied

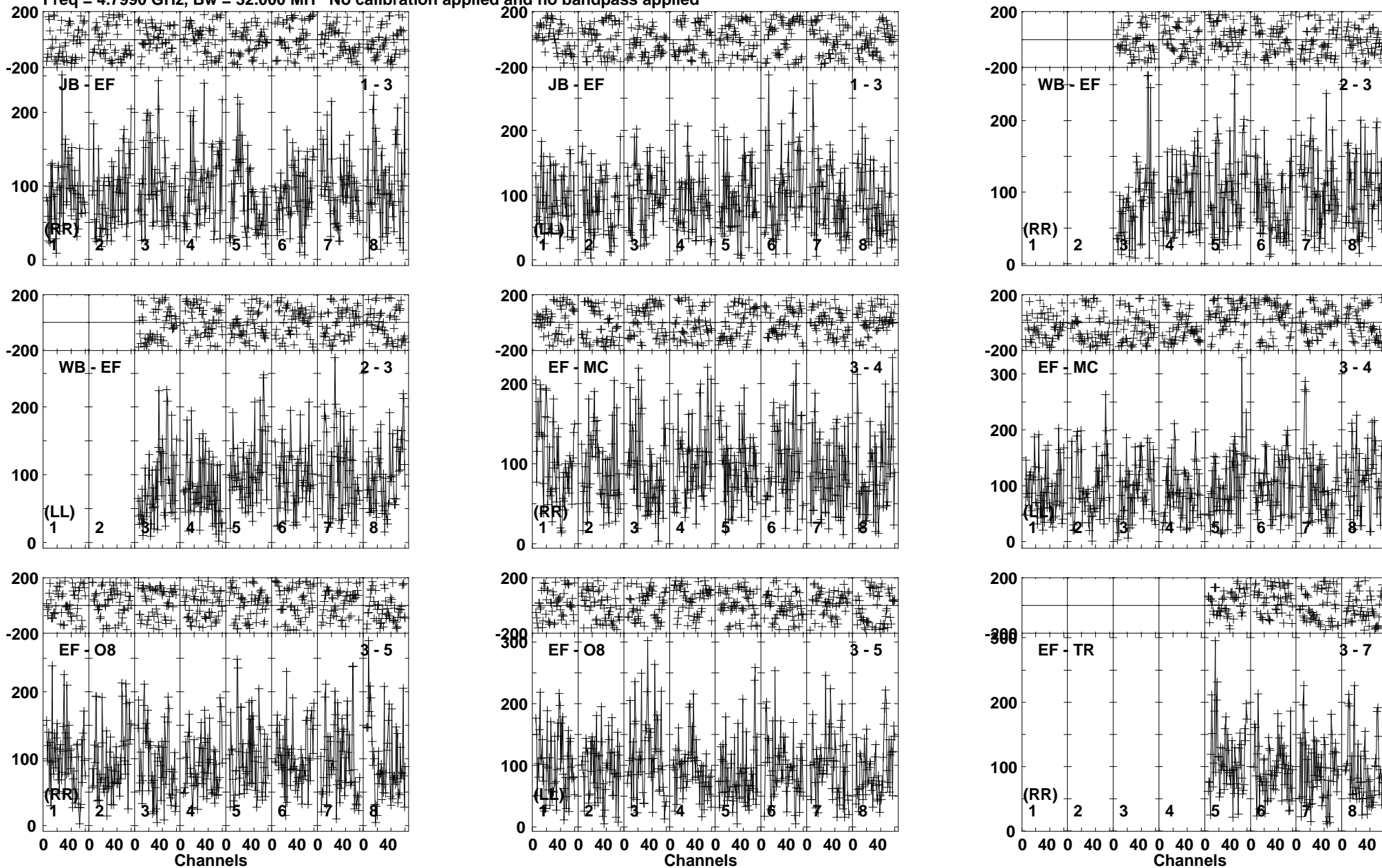

Lower frame: Micro Ampl Jy Top frame: Phas deg
Vector averaged cross-power spectrum Baseline: JB (01) - EF (03)
Timerange: 01/01:05:45 to 01/01:08:15

Plot file version 284 created 26-SEP-2019 10:41:03

190829A RG010A.UVDATA.1

Freq = 4.7990 GHz, Bw = 32.000 MH No calibration applied and no bandpass applied

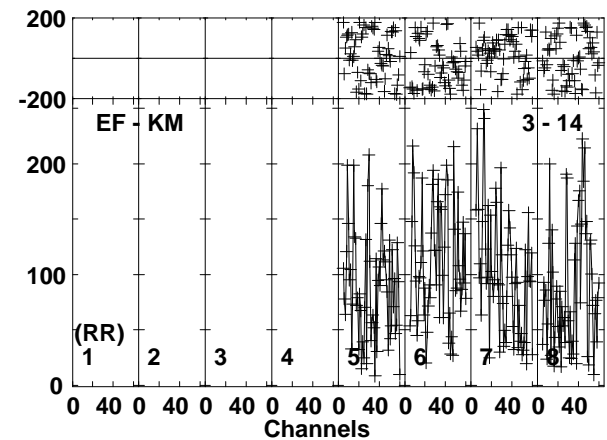
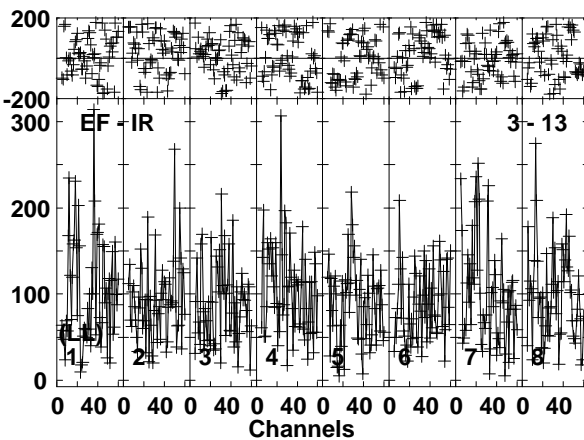
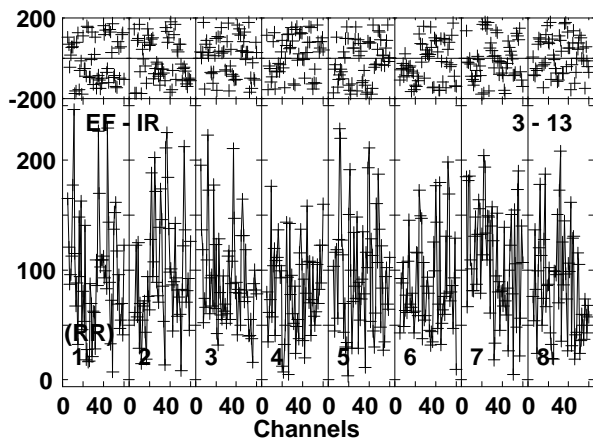
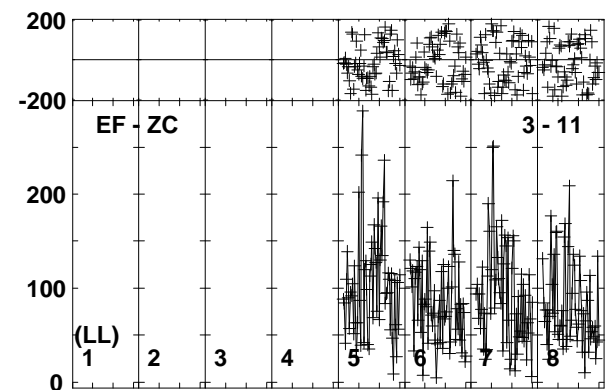
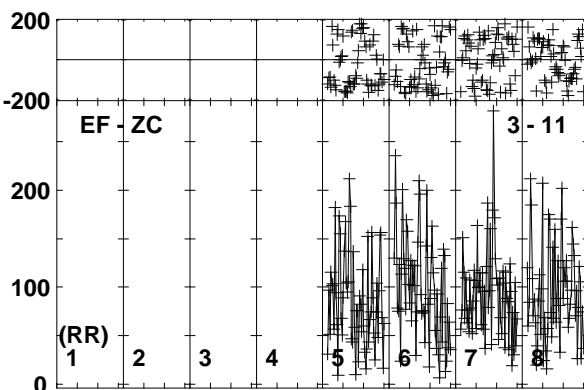
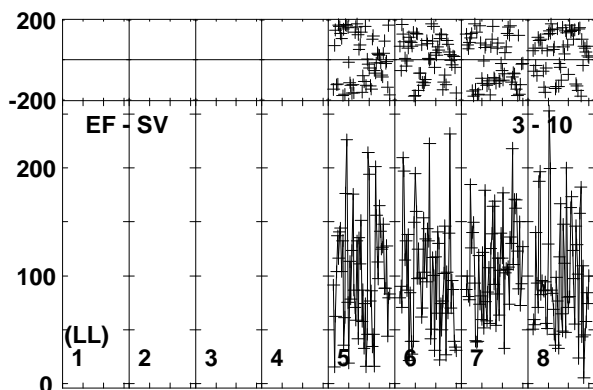
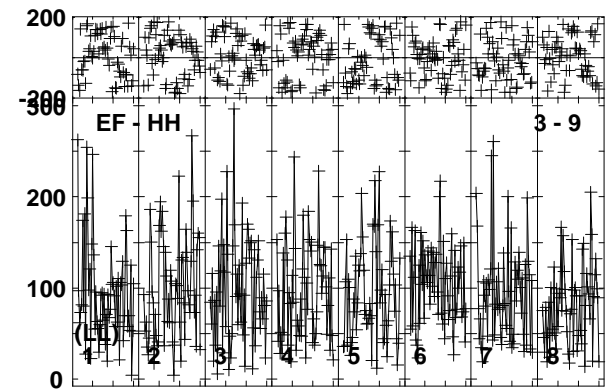
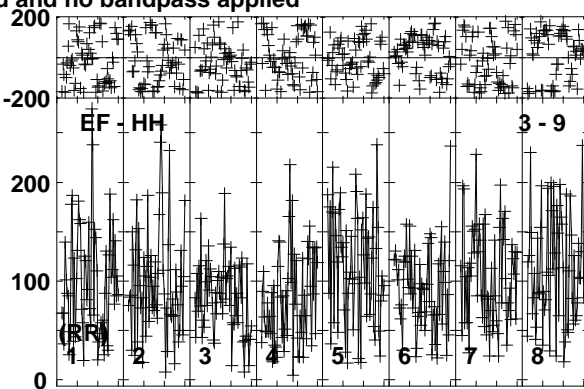
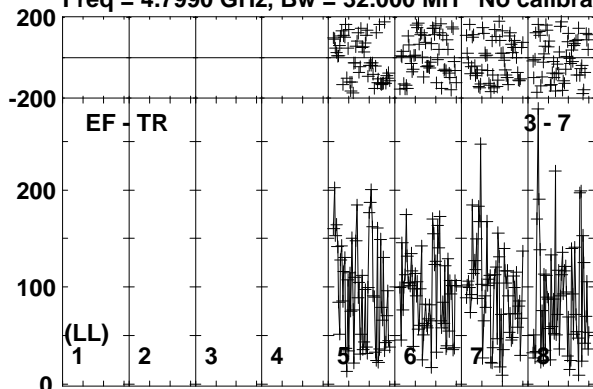

Lower frame: Micro Ampl Jy Top frame: Phas deg
Vector averaged cross-power spectrum Baseline: EF (03) - TR (07)
Timerange: 01/01:05:45 to 01/01:08:15

Plot file version 285 created 26-SEP-2019 10:41:03

190829A RG010A.UVDATA.1

Freq = 4.7990 GHz, Bw = 32.000 MH No calibration applied and no bandpass applied

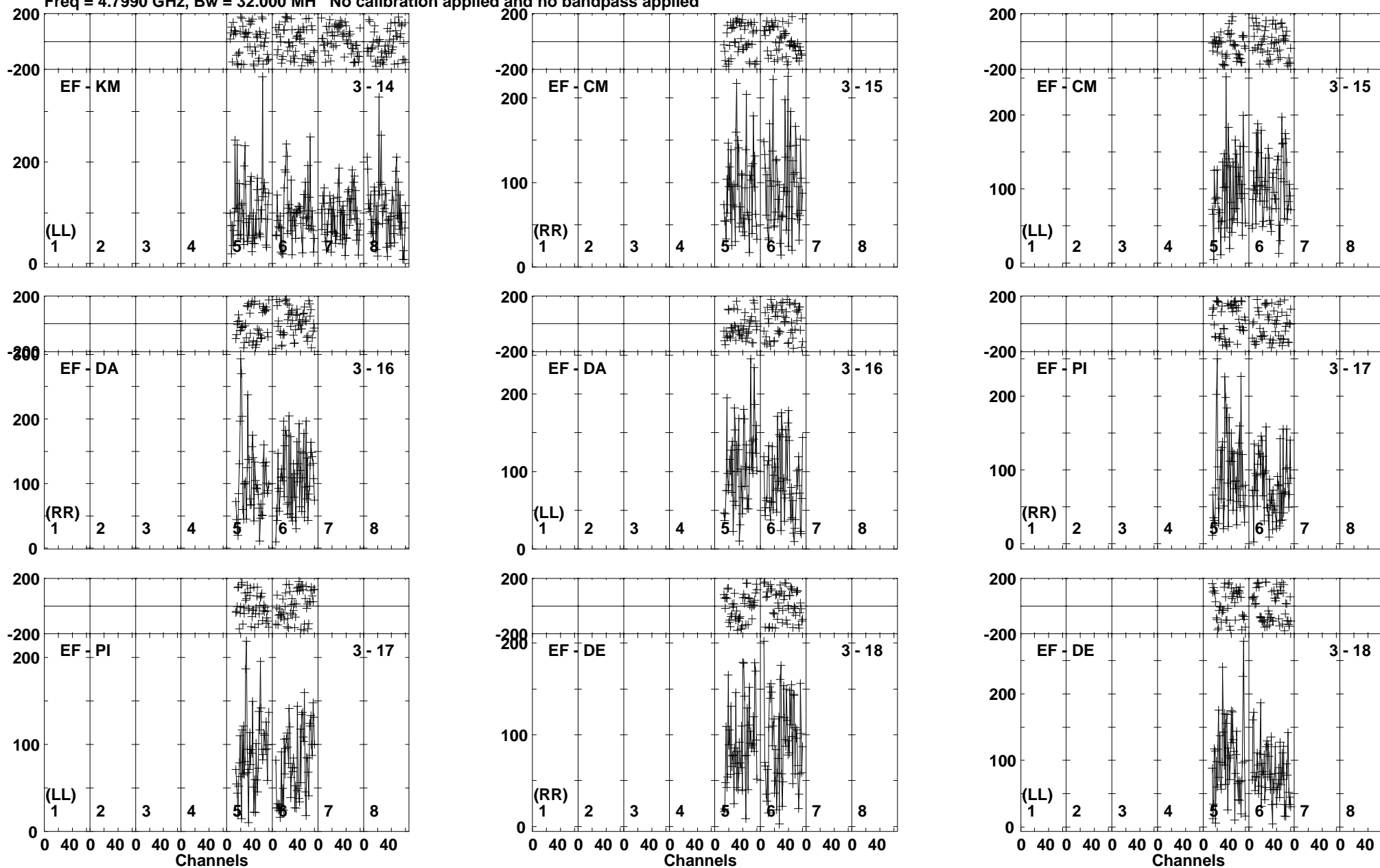

Lower frame: Micro Ampl Jy Top frame: Phas deg
Vector averaged cross-power spectrum Baseline: EF (03) - KM (14)
Timerange: 01/01:05:45 to 01/01:08:15

Plot file version 286 created 26-SEP-2019 10:41:04

J0257-1212 RG010A.UVDATA.1

Freq = 4.7990 GHz, Bw = 32.000 MH No calibration applied and no bandpass applied

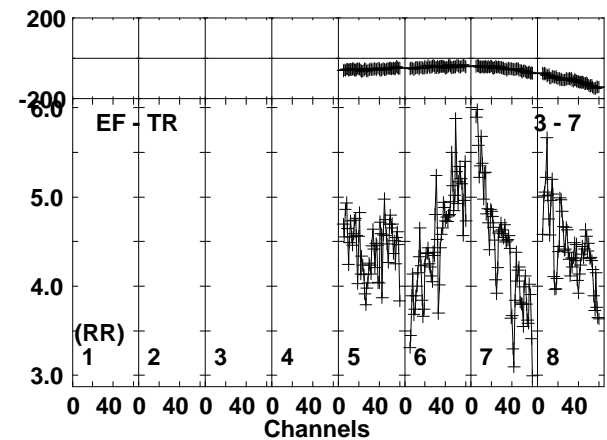
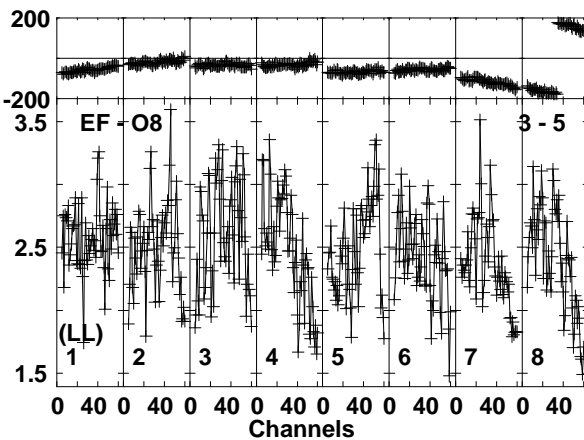
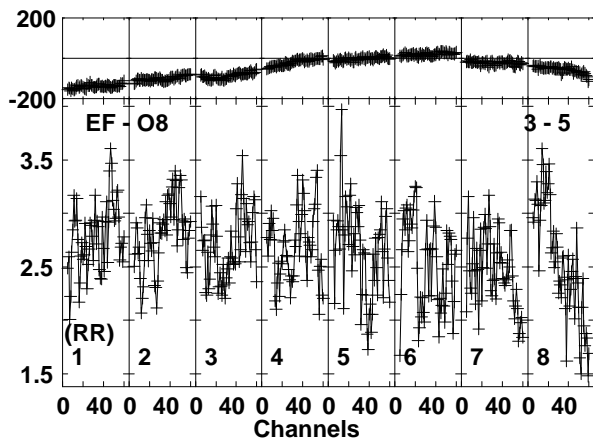
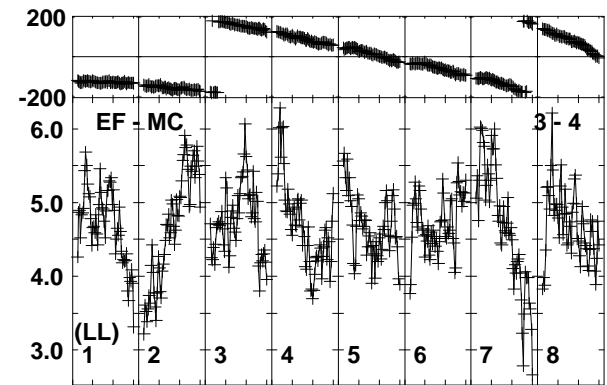
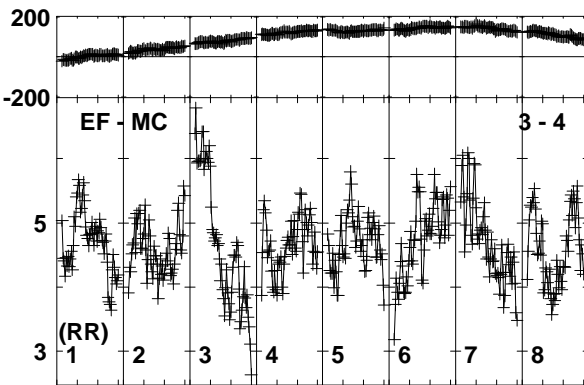
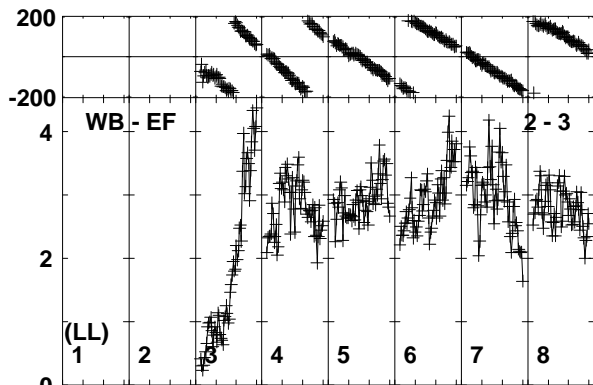
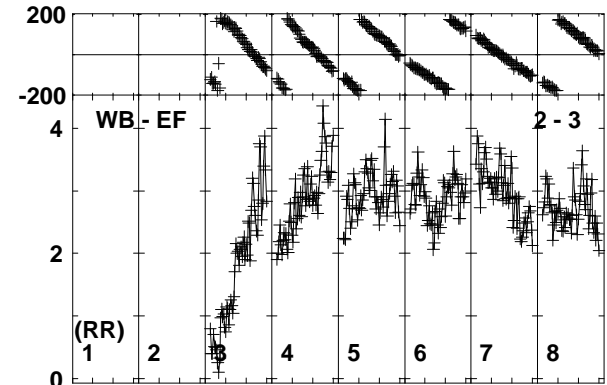
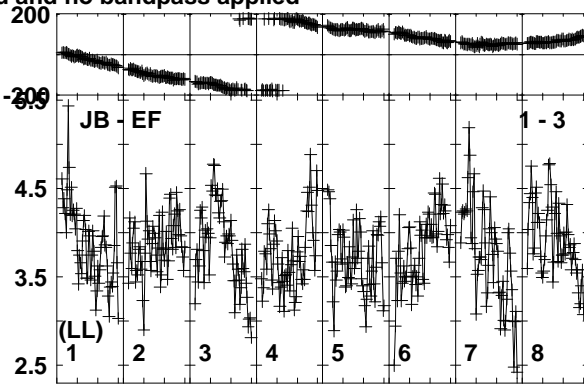
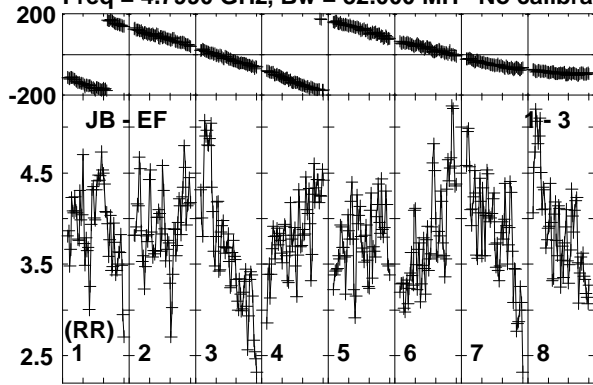

Lower frame: Milli Ampl Jy Top frame: Phas deg
Vector averaged cross-power spectrum Baseline: JB (01) - EF (03)
Timerange: 01/01:08:16 to 01/01:09:15

Plot file version 287 created 26-SEP-2019 10:41:04
 J0257-1212 RG010A.UVDATA.1
 Freq = 4.7990 GHz, Bw = 32.000 MH No calibration applied and no bandpass applied

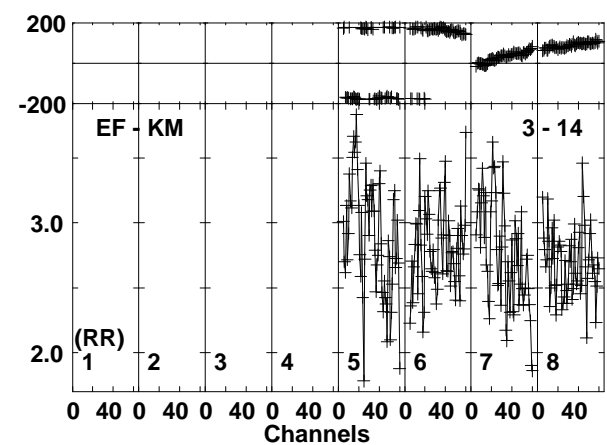
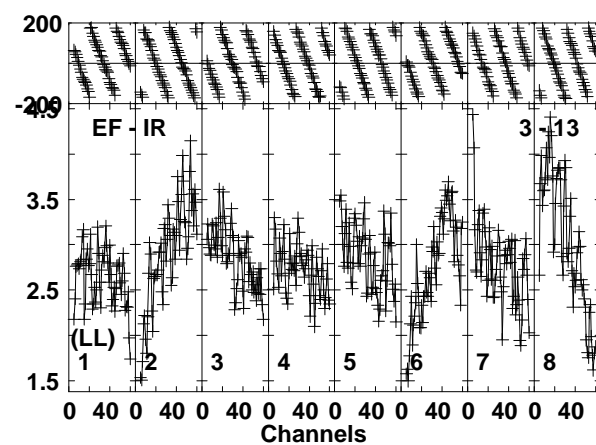
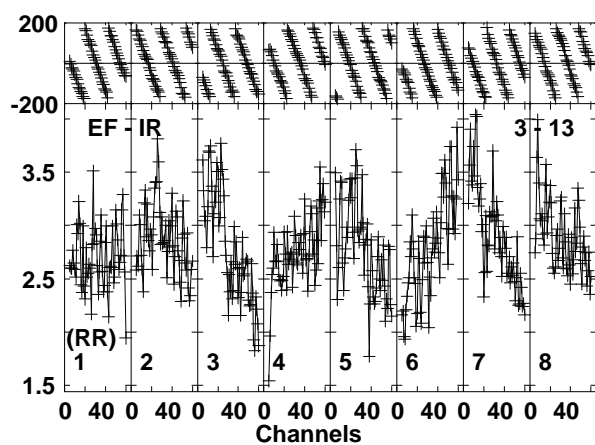
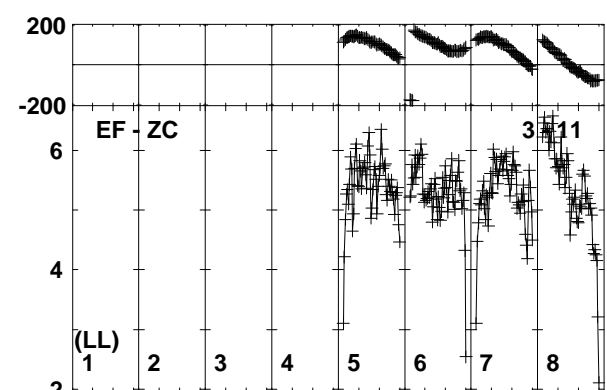
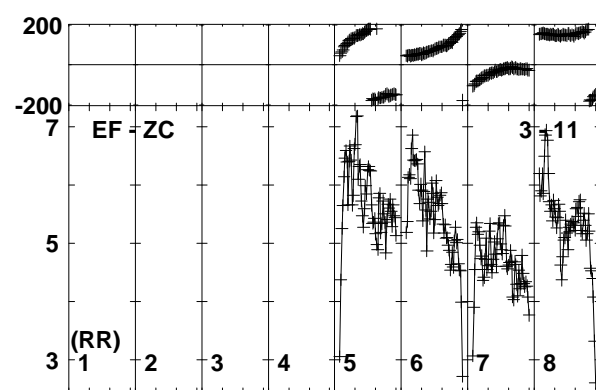
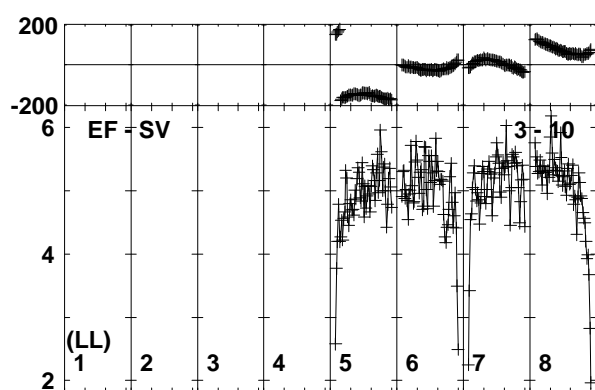
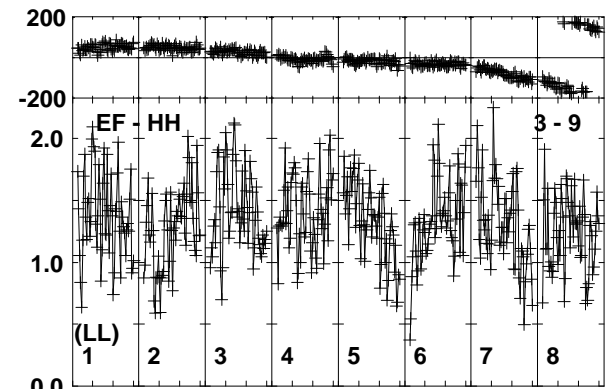
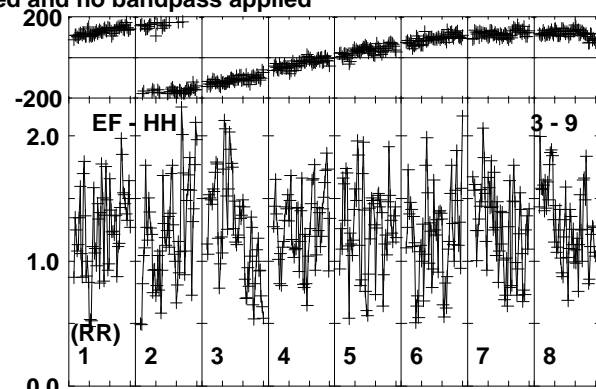
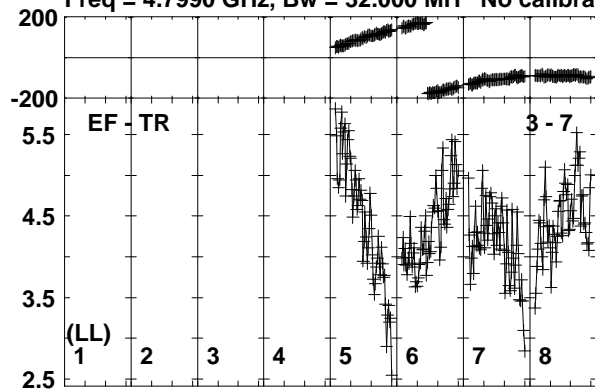

Lower frame: Milli Ampl Jy Top frame: Phas deg
 Vector averaged cross-power spectrum Baseline: EF (03) - TR (07)
 Timerange: 01/01:08:16 to 01/01:09:15

Plot file version 288 created 26-SEP-2019 10:41:05

J0257-1212 RG010A.UVDATA.1

Freq = 4.7990 GHz, Bw = 32.000 MH No calibration applied and no bandpass applied

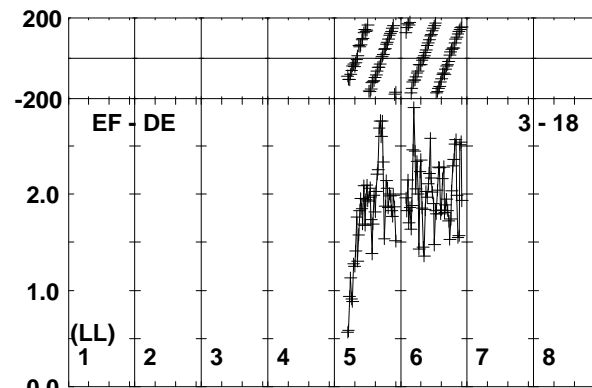
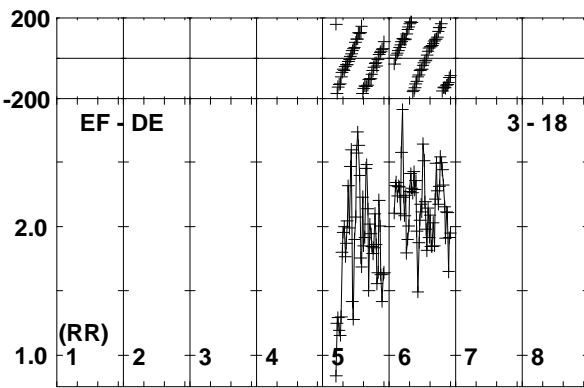
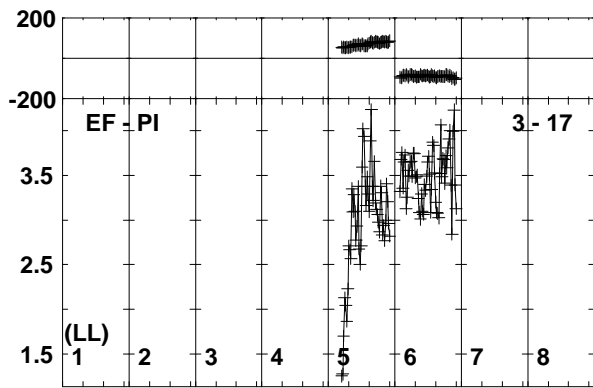
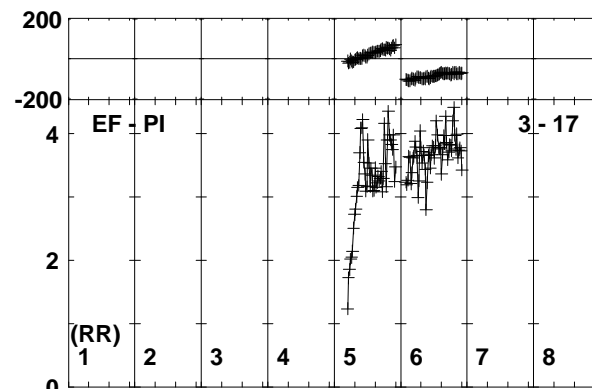
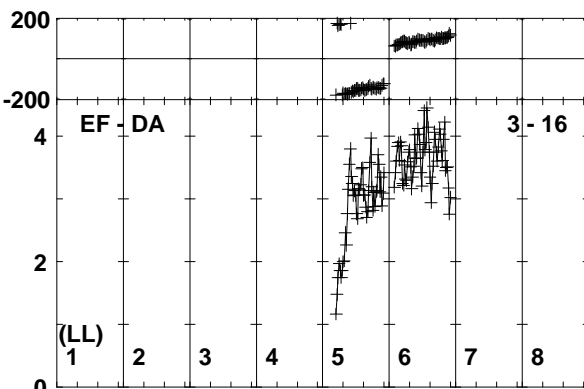
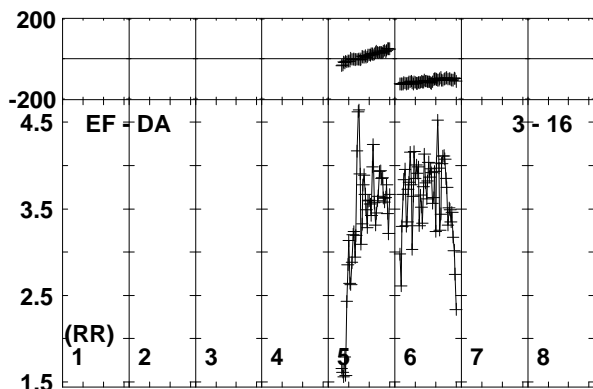
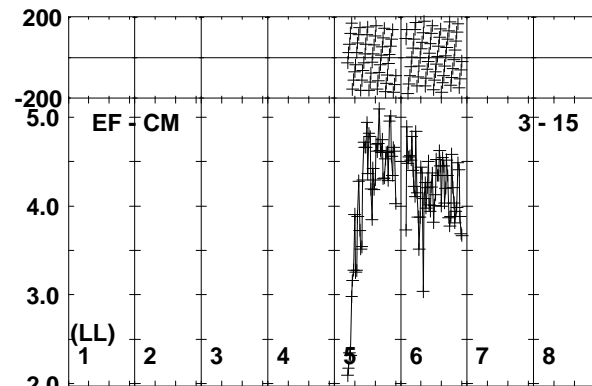
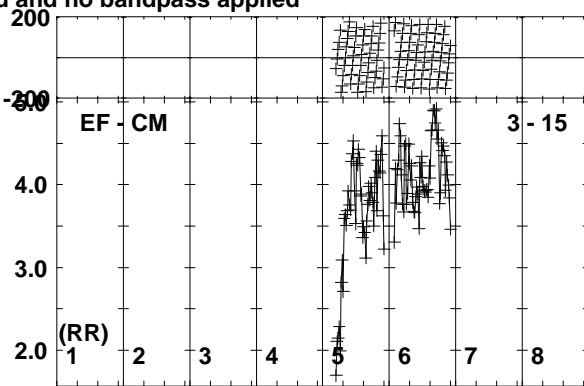
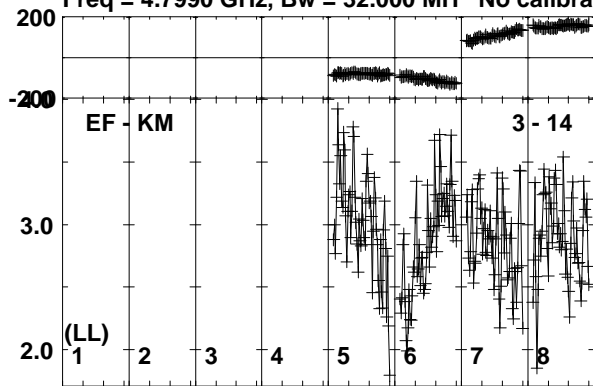

Lower frame: Milli Ampl Jy Top frame: Phas deg
Vector averaged cross-power spectrum Baseline: EF (03) - KM (14)
Timerange: 01/01:08:16 to 01/01:09:15

Plot file version 289 created 26-SEP-2019 10:41:05

190829A RG010A.UVDATA.1

Freq = 4.7990 GHz, Bw = 32.000 MH No calibration applied and no bandpass applied

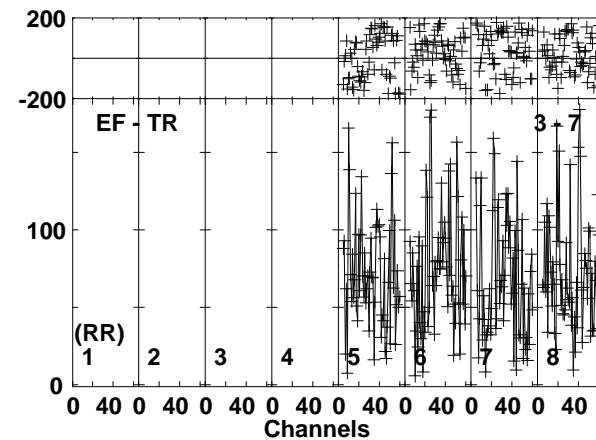
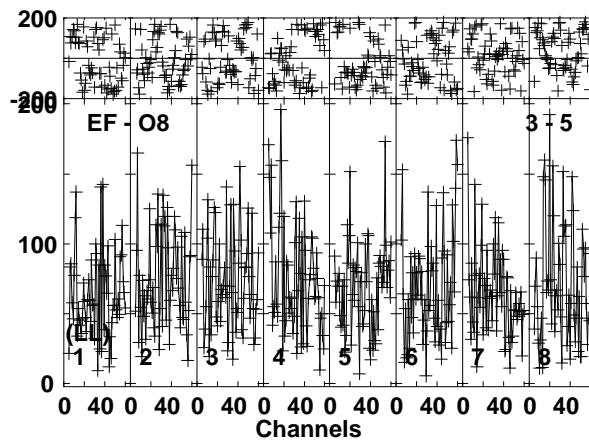
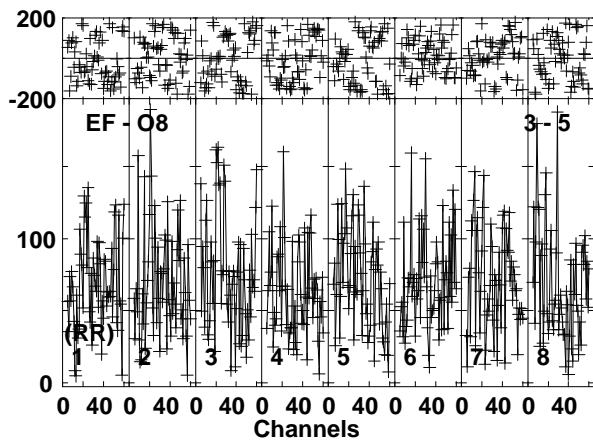
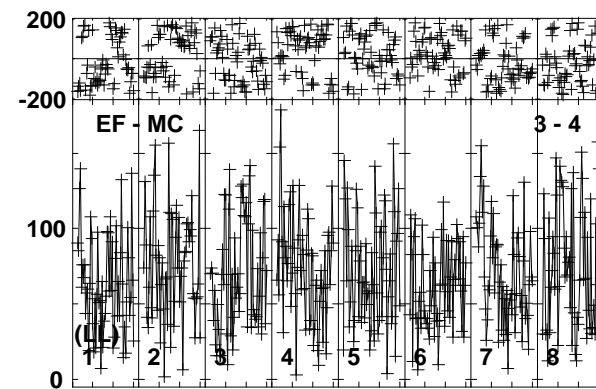
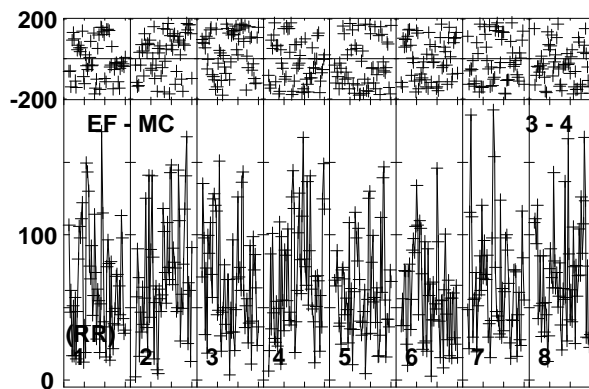
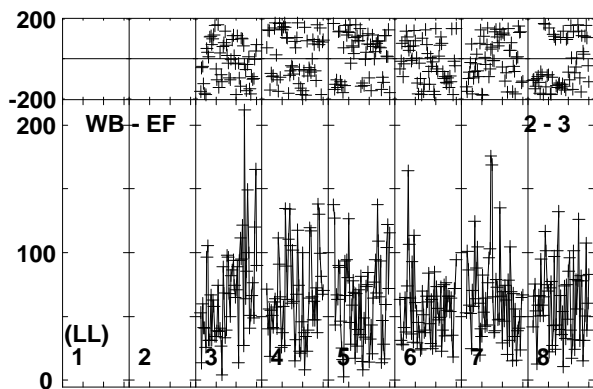
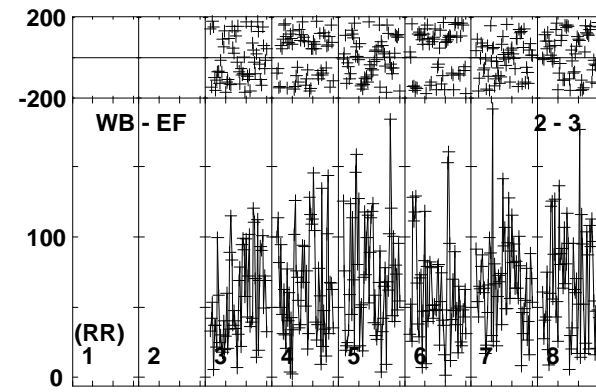
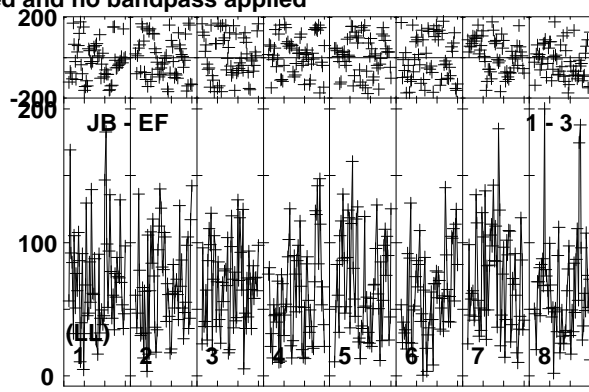
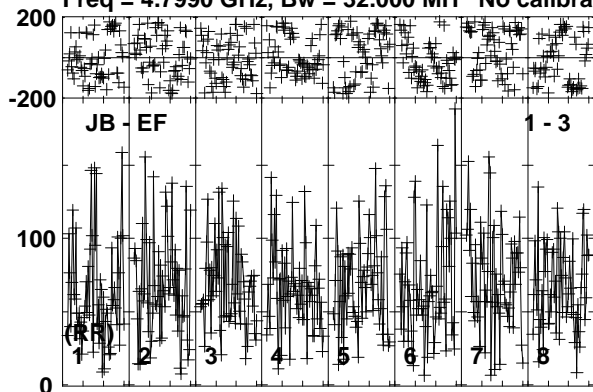

Lower frame: Micro Ampl Jy Top frame: Phas deg
Vector averaged cross-power spectrum Baseline: JB (01) - EF (03)
Timerange: 01/01:09:15 to 01/01:14:14

Plot file version 290 created 26-SEP-2019 10:41:06

190829A RG010A.UVDATA.1

Freq = 4.7990 GHz, Bw = 32.000 MH No calibration applied and no bandpass applied

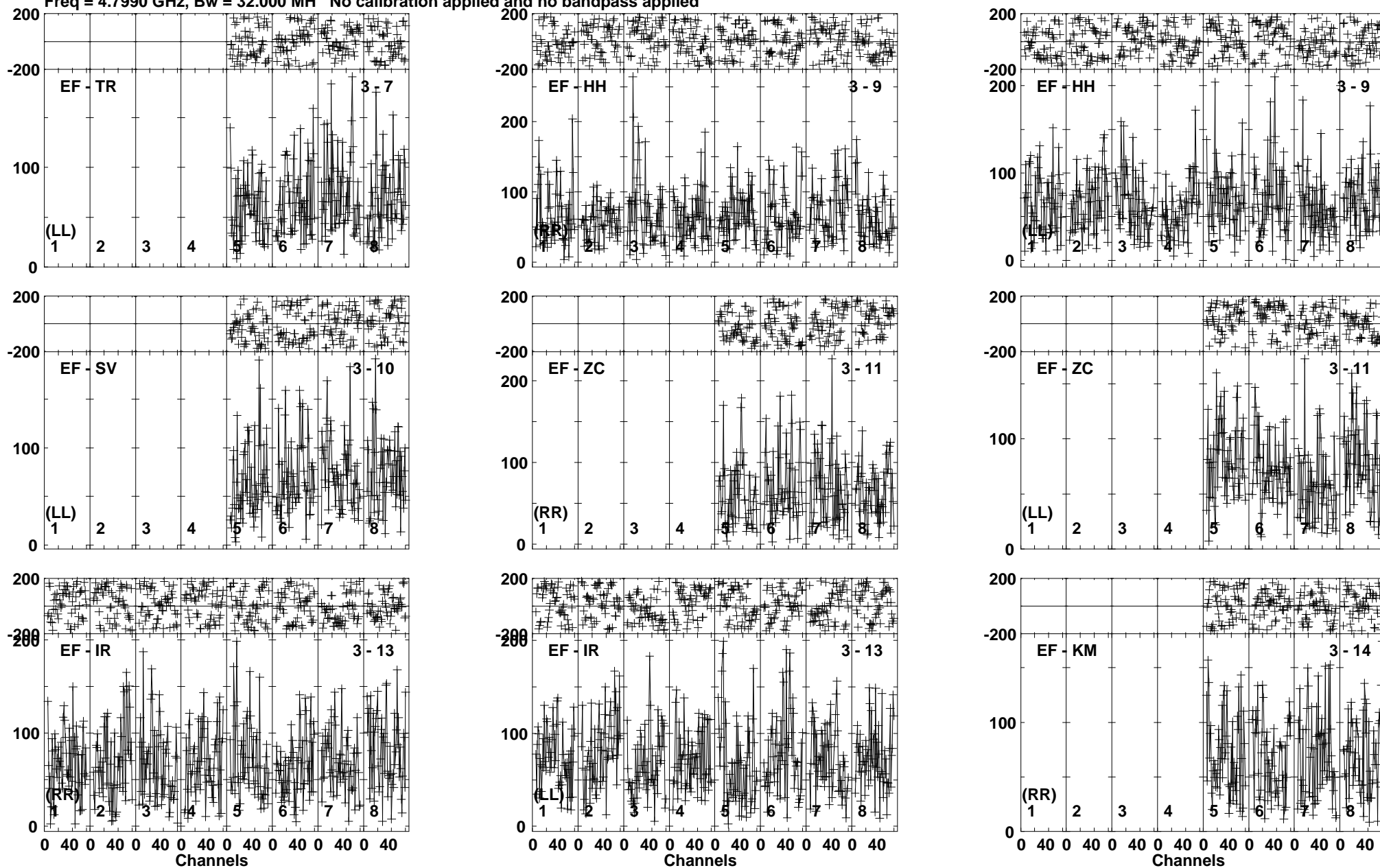

Lower frame: Micro Ampl Jy Top frame: Phas deg
Vector averaged cross-power spectrum Baseline: EF (03) - TR (07)
Timerange: 01/01:09:15 to 01/01:14:14

Plot file version 291 created 26-SEP-2019 10:41:07

190829A RG010A.UVDATA.1

Freq = 4.7990 GHz, Bw = 32.000 MH No calibration applied and no bandpass applied

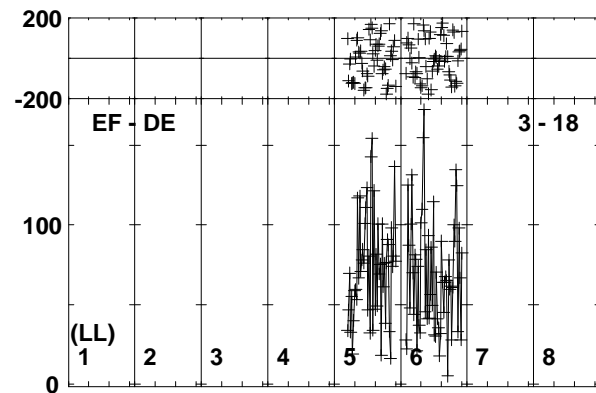
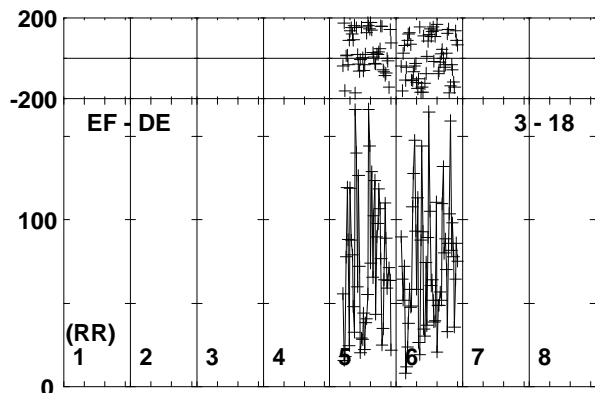
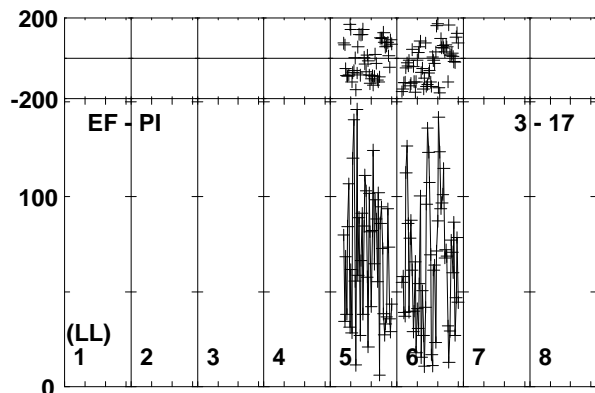
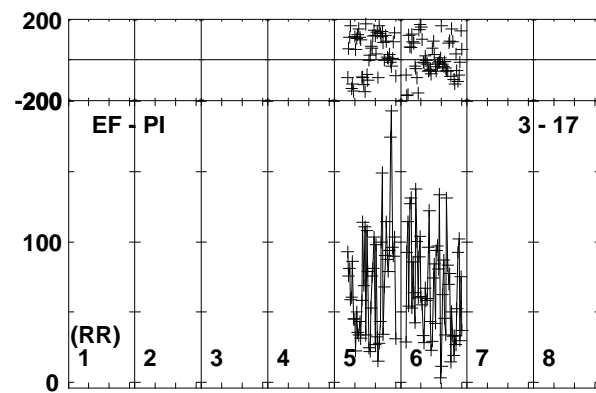
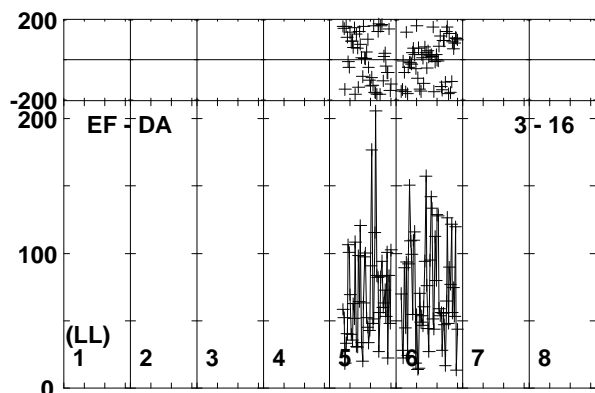
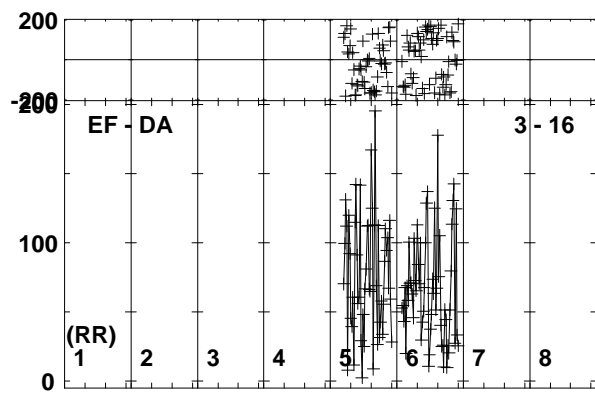
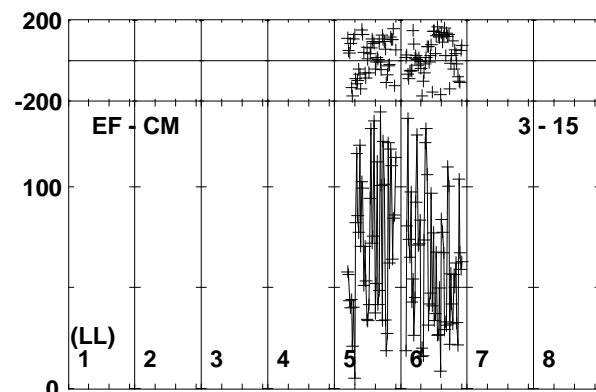
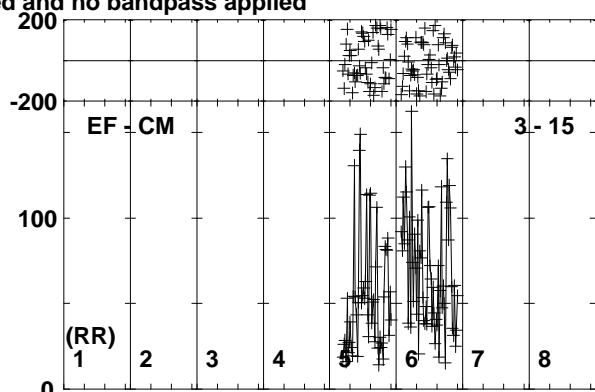
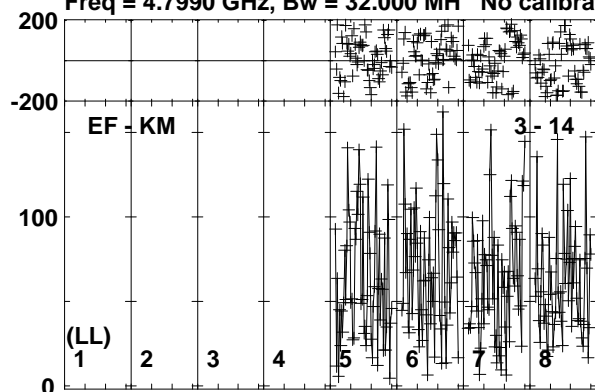

Lower frame: Micro Ampl Jy Top frame: Phas deg
Vector averaged cross-power spectrum Baseline: EF (03) - KM (14)
Timerange: 01/01:09:15 to 01/01:14:14

Plot file version 292 created 26-SEP-2019 10:41:08

J0257-1212 RG010A.UVDATA.1

Freq = 4.7990 GHz, Bw = 32.000 MH No calibration applied and no bandpass applied

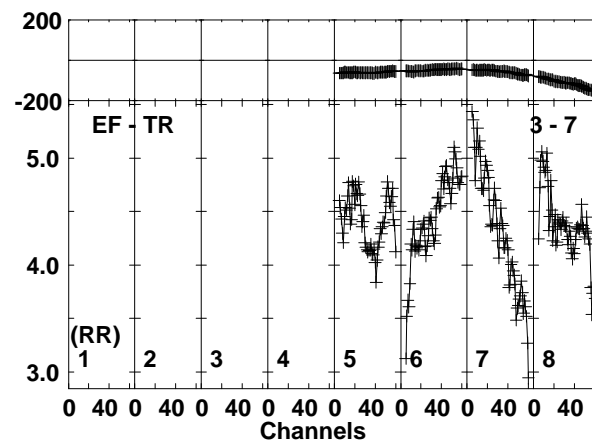
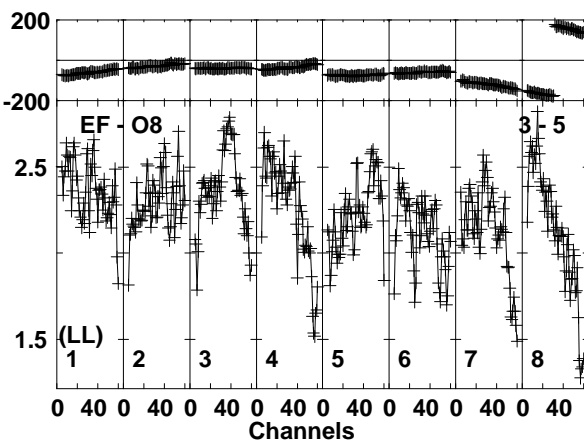
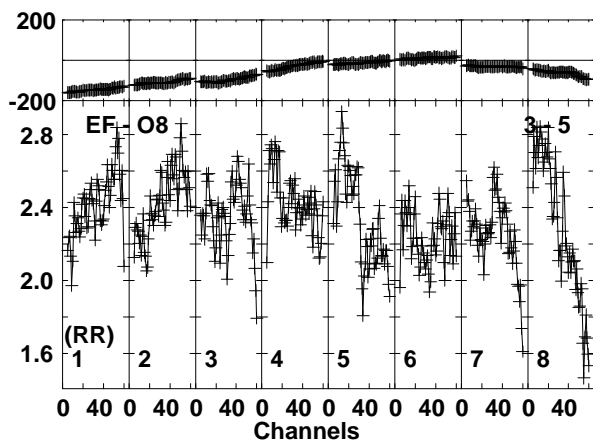
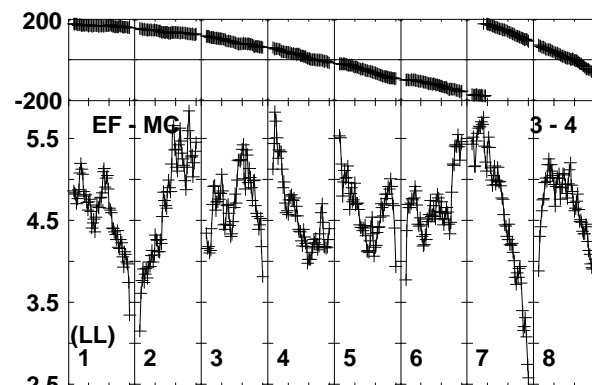
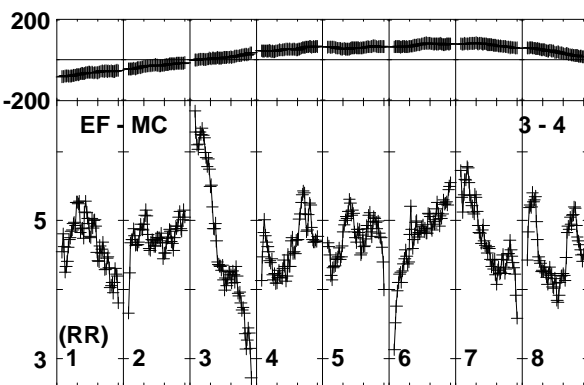
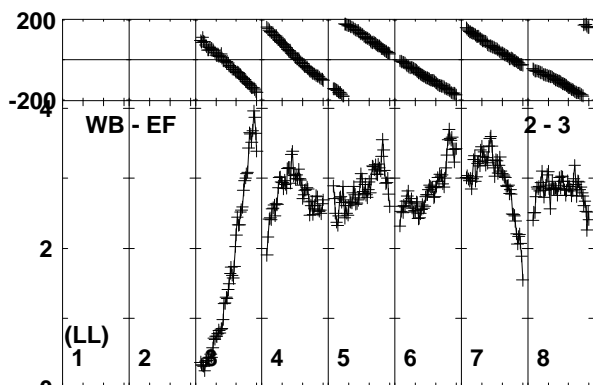
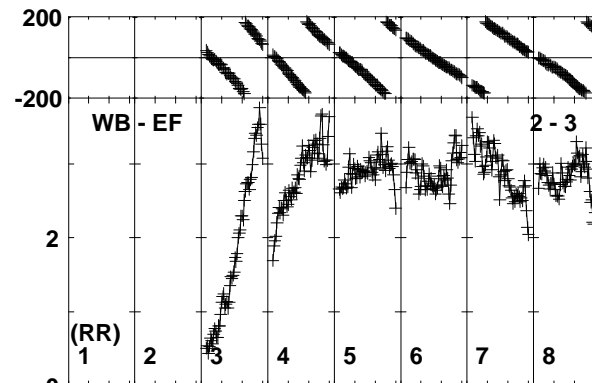
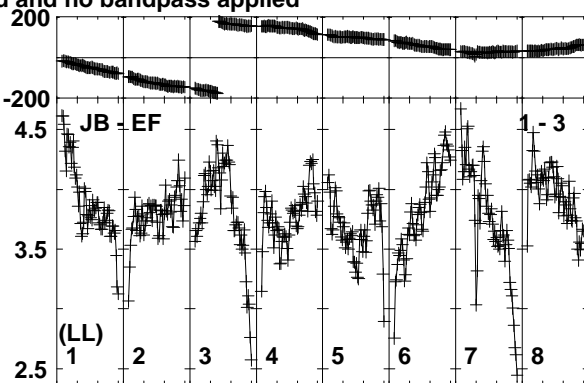
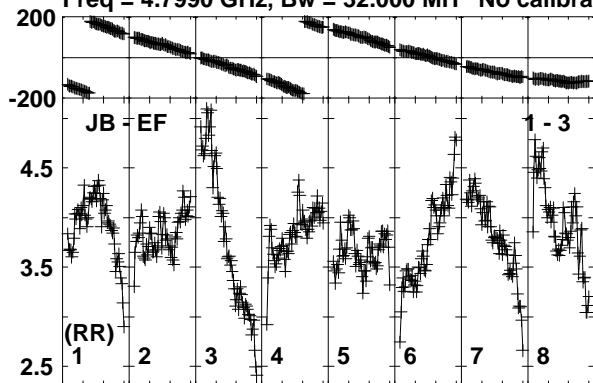

Lower frame: Milli Ampl Jy Top frame: Phas deg
Vector averaged cross-power spectrum Baseline: JB (01) - EF (03)
Timerange: 01/01:14:56 to 01/01:15:54

Plot file version 293 created 26-SEP-2019 10:41:08

J0257-1212 RG010A.UVDATA.1

Freq = 4.7990 GHz, Bw = 32.000 MH No calibration applied and no bandpass applied

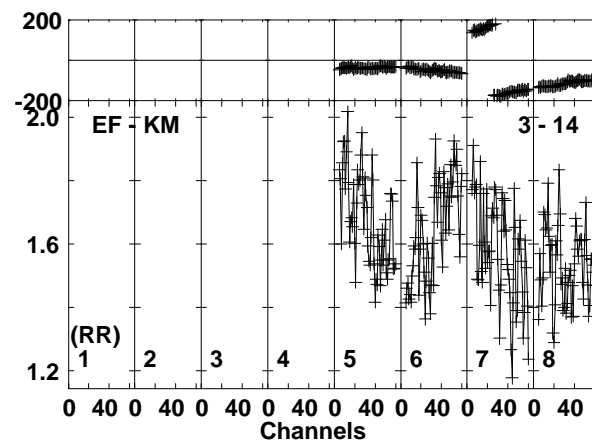
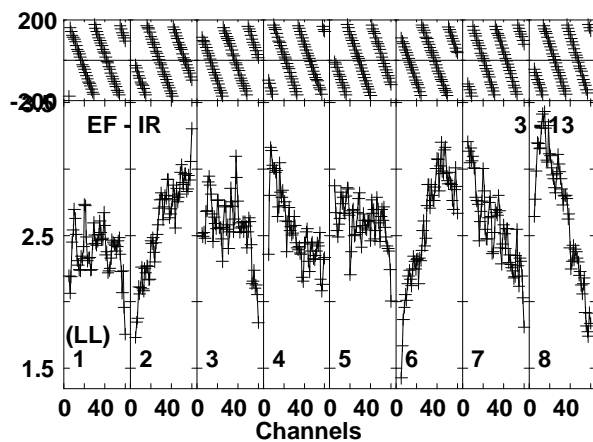
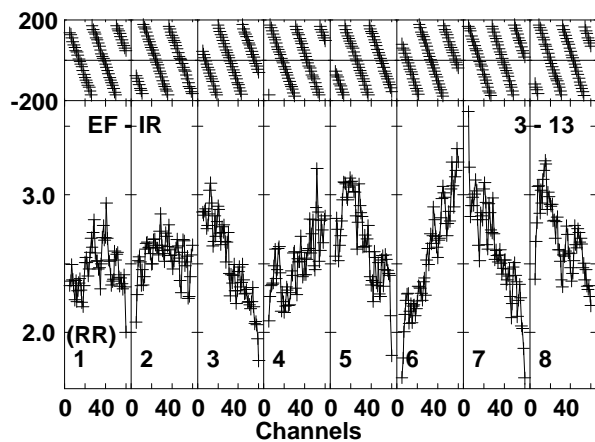
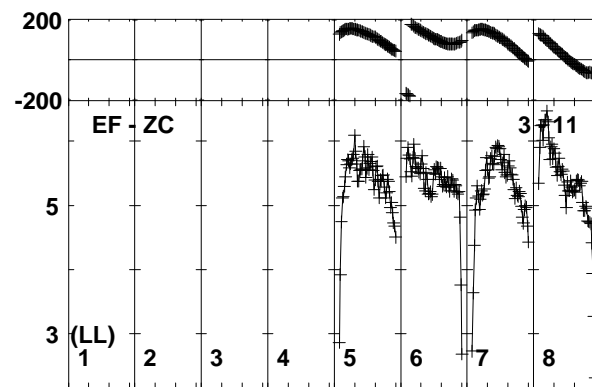
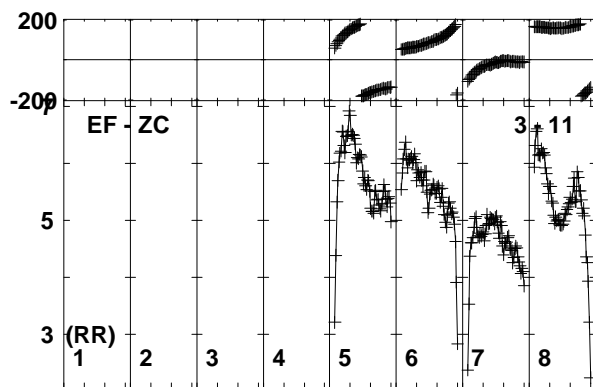
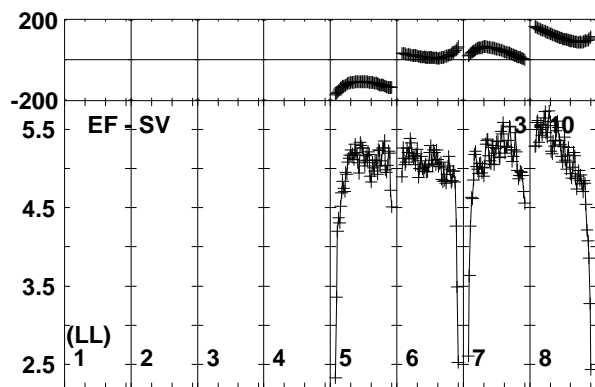
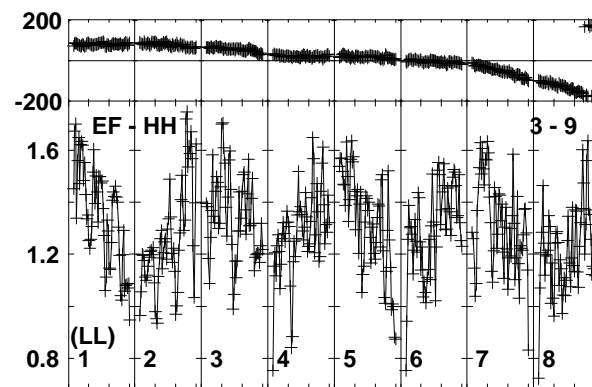
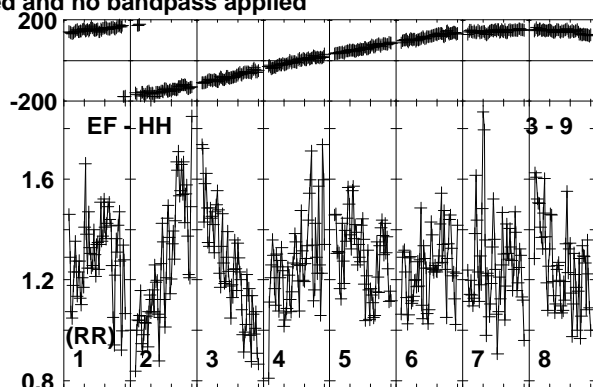
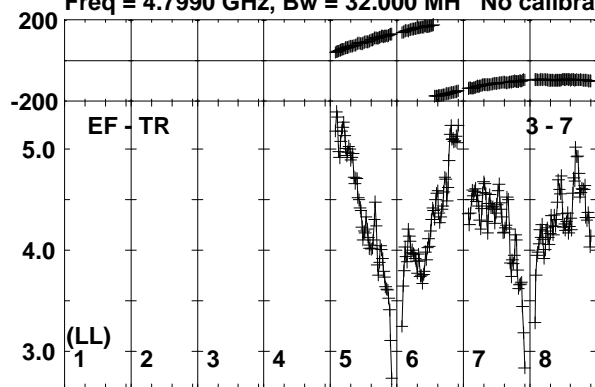

Lower frame: Milli Ampl Jy Top frame: Phas deg
Vector averaged cross-power spectrum Baseline: EF (03) - TR (07)
Timerange: 01/01:14:56 to 01/01:15:54

Plot file version 294 created 26-SEP-2019 10:41:09

J0257-1212 RG010A.UVDATA.1

Freq = 4.7990 GHz, Bw = 32.000 MH No calibration applied and no bandpass applied

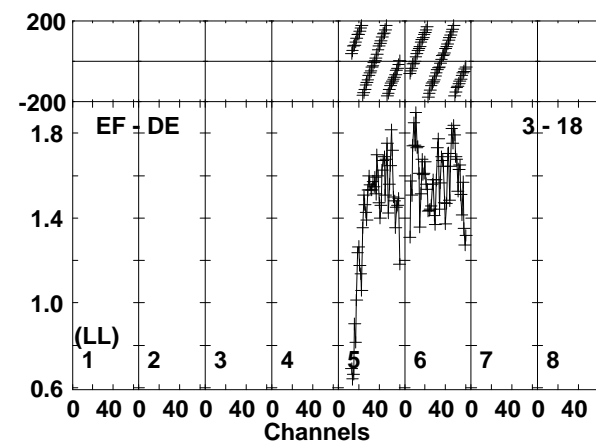
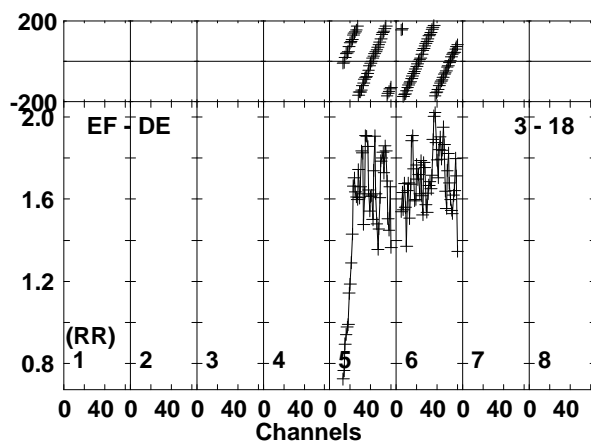
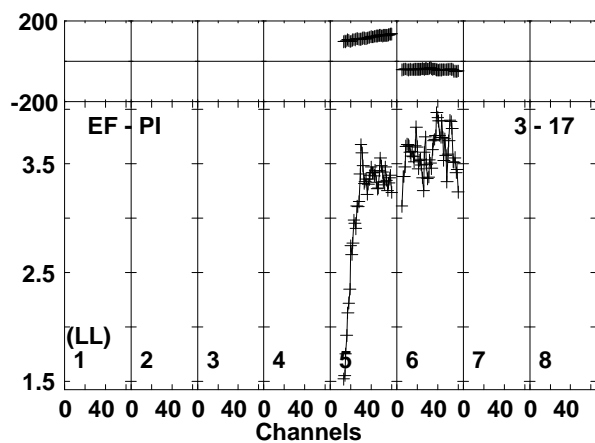
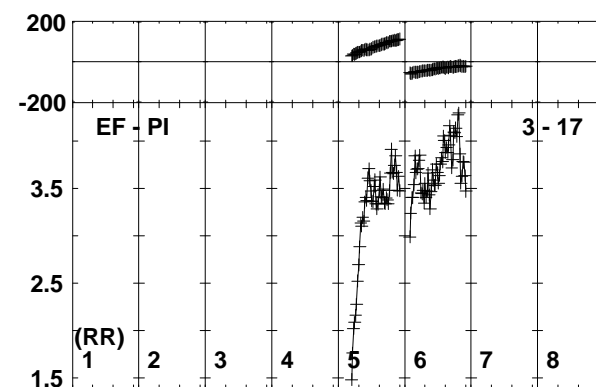
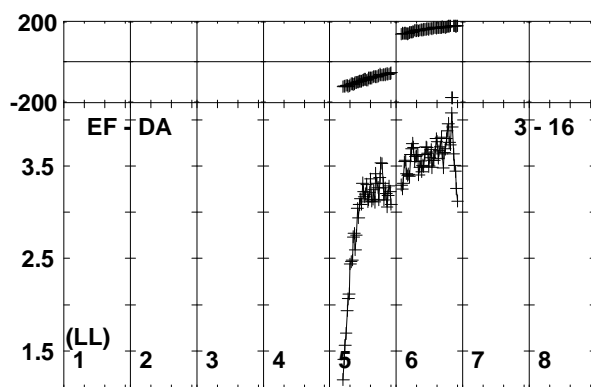
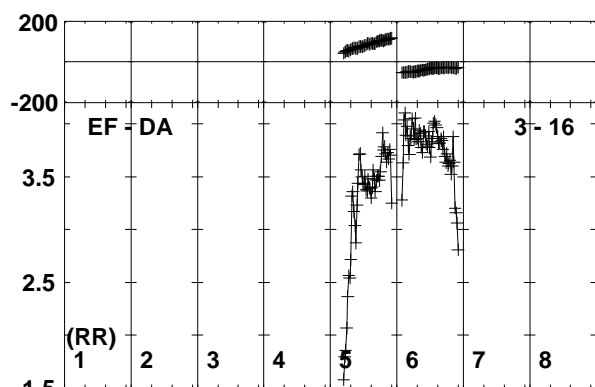
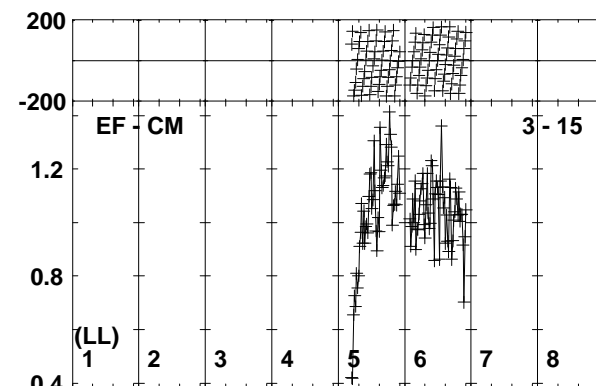
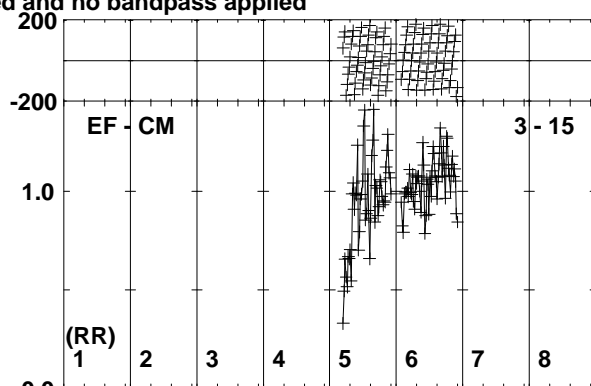
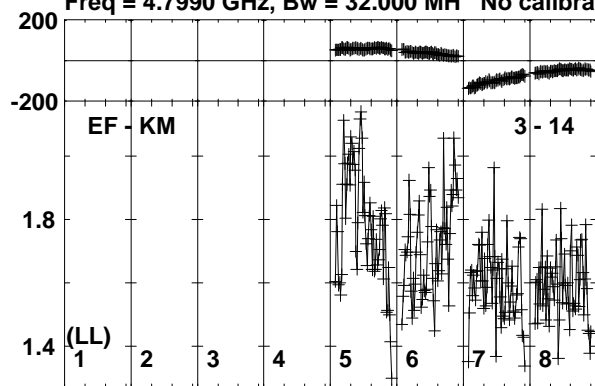

Lower frame: Milli Ampl Jy Top frame: Phas deg
Vector averaged cross-power spectrum Baseline: EF (03) - KM (14)
Timerange: 01/01:14:56 to 01/01:15:54

Plot file version 295 created 26-SEP-2019 10:41:10

190829A RG010A.UVDATA.1

Freq = 4.7990 GHz, Bw = 32.000 MH No calibration applied and no bandpass applied

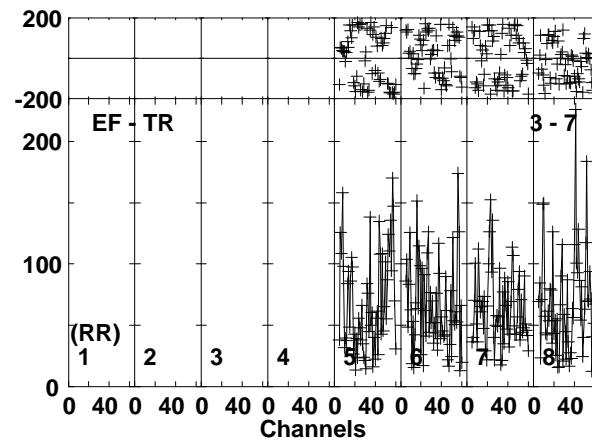
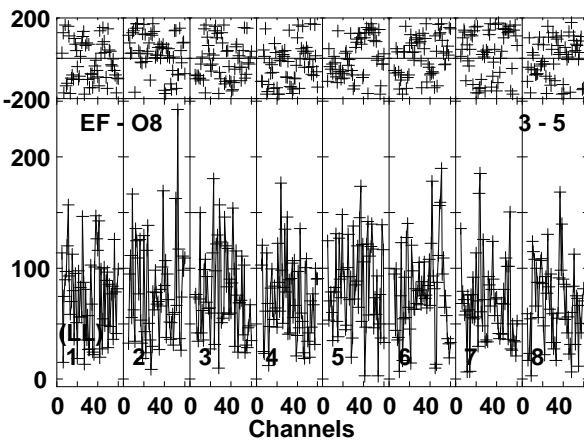
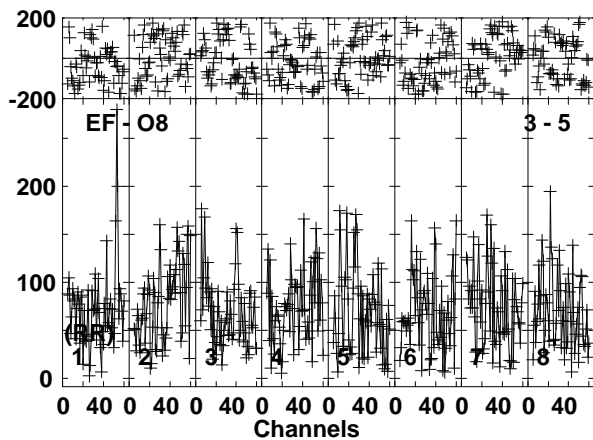
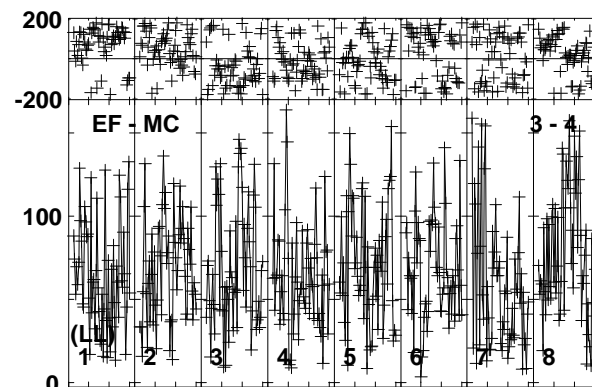
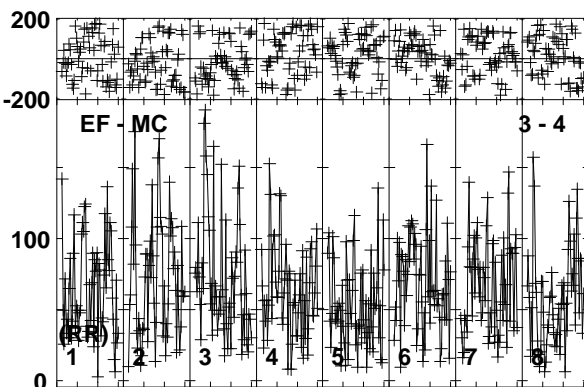
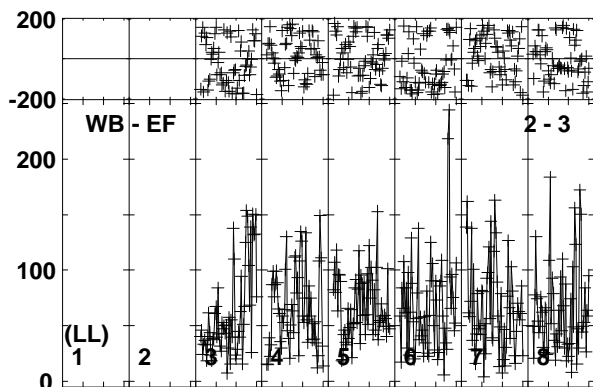
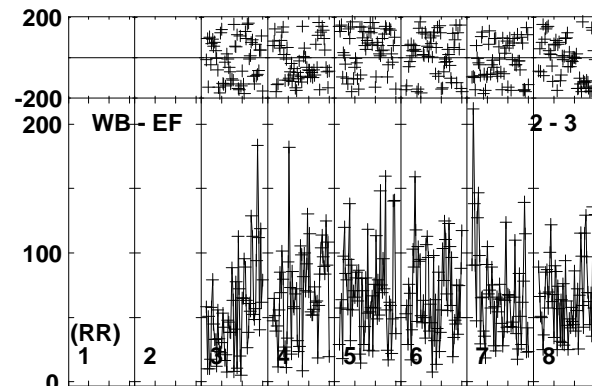
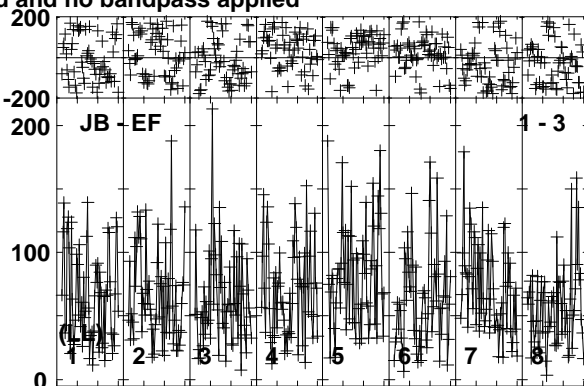
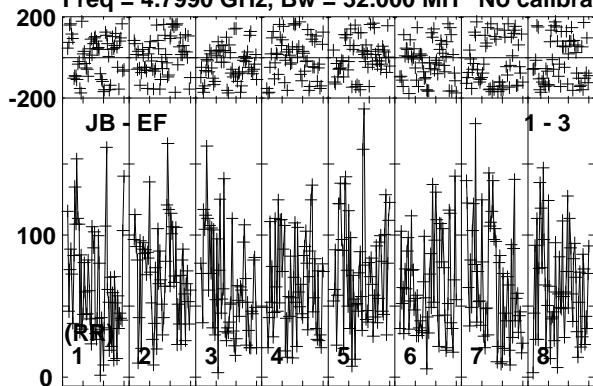

Lower frame: Micro Ampl Jy Top frame: Phas deg
Vector averaged cross-power spectrum Baseline: JB (01) - EF (03)
Timerange: 01/01:15:55 to 01/01:20:54

Plot file version 296 created 26-SEP-2019 10:41:11

190829A RG010A.UVDATA.1

Freq = 4.7990 GHz, Bw = 32.000 MH No calibration applied and no bandpass applied

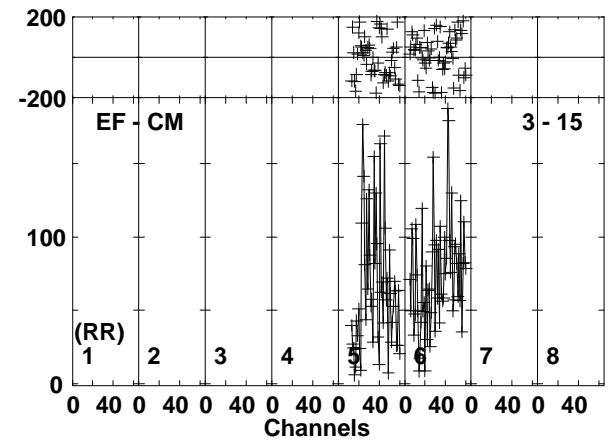
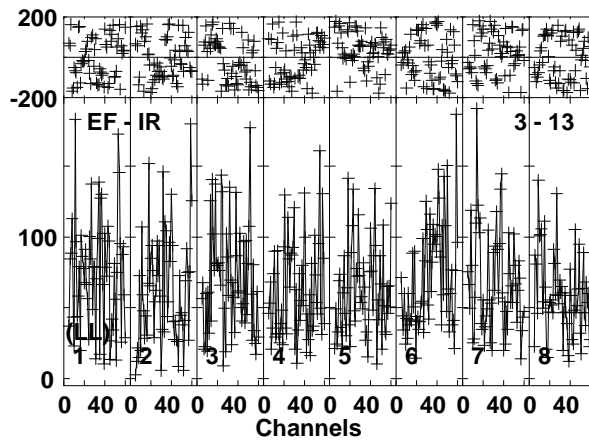
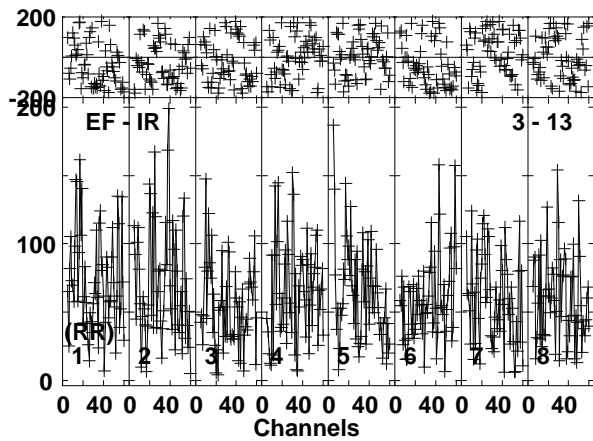
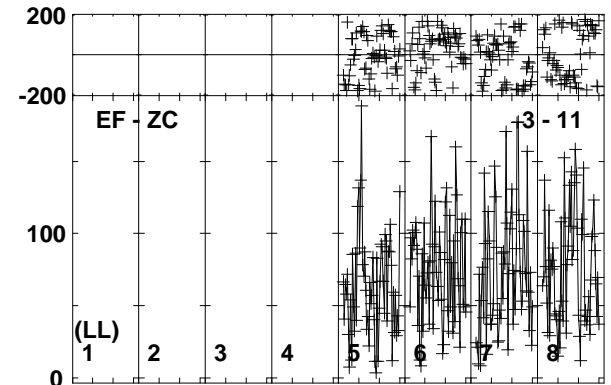
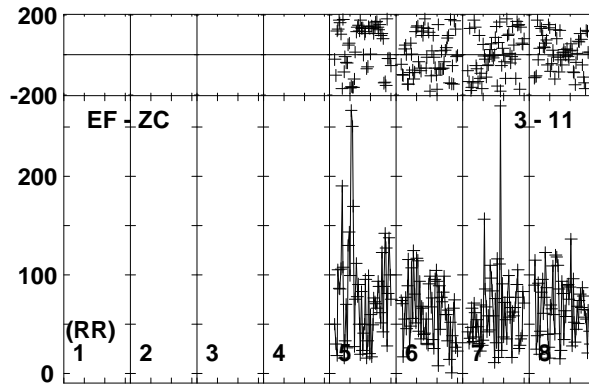
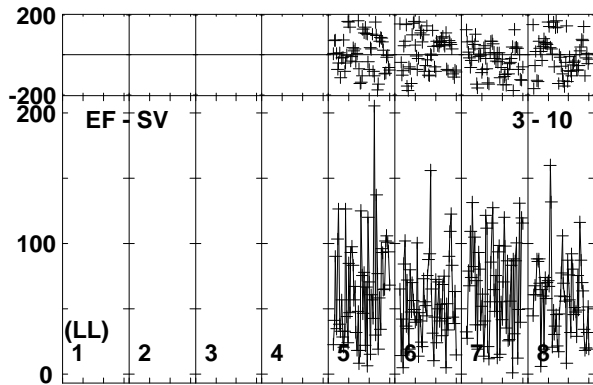
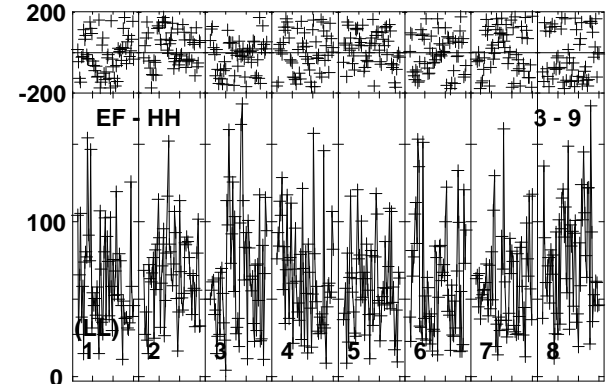
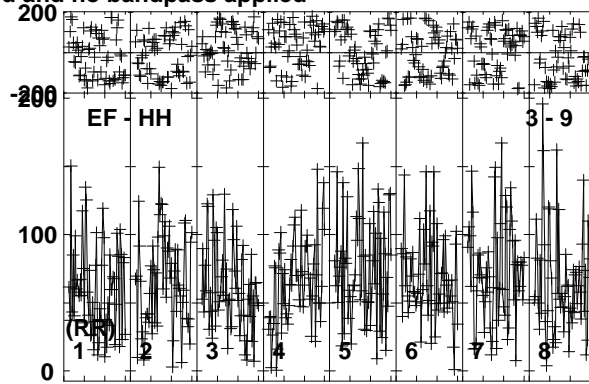
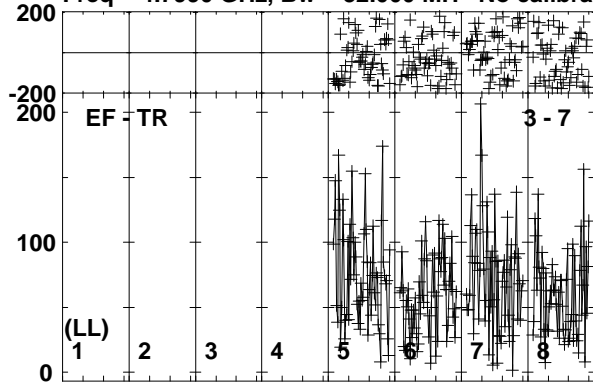

Lower frame: Micro Ampl Jy Top frame: Phas deg
Vector averaged cross-power spectrum Baseline: EF (03) - TR (07)
Timerange: 01/01:15:55 to 01/01:20:54

Plot file version 297 created 26-SEP-2019 10:41:12

190829A RG010A.UVDATA.1

Freq = 4.7990 GHz, Bw = 32.000 MH No calibration applied and no bandpass applied

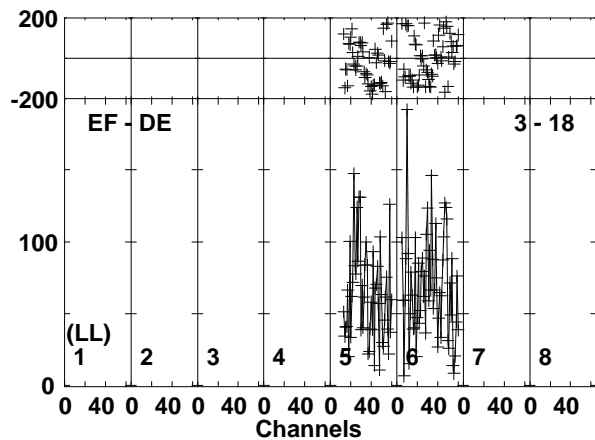
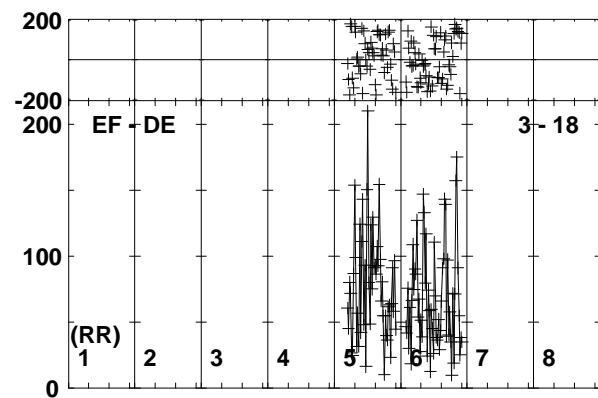
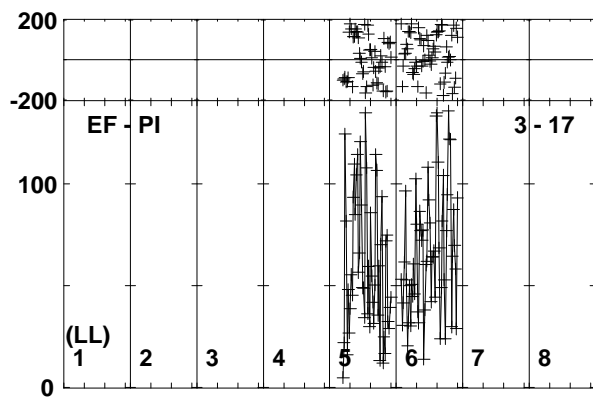
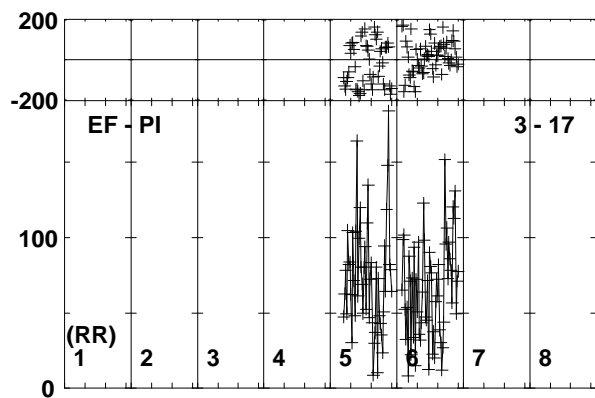
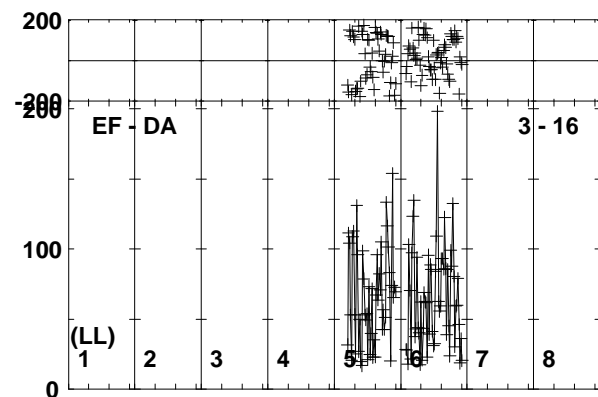
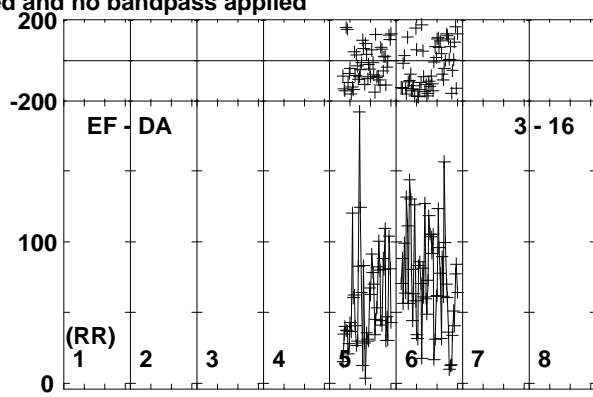
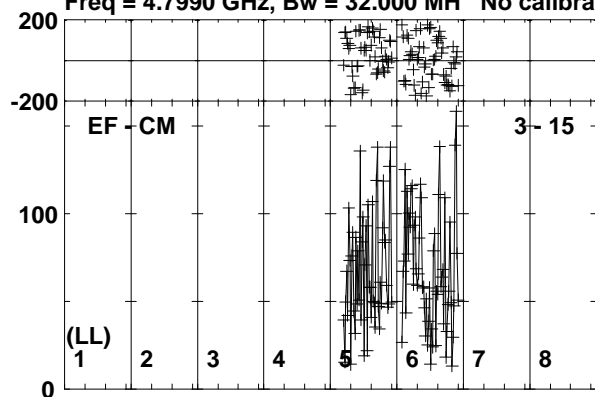

Lower frame: Micro Ampl Jy Top frame: Phas deg
Vector averaged cross-power spectrum Baseline: EF (03) - CM (15)
Timerange: 01/01:15:55 to 01/01:20:54

Plot file version 298 created 26-SEP-2019 10:41:12

J0257-1212 RG010A.UVDATA.1

Freq = 4.7990 GHz, Bw = 32.000 MH No calibration applied and no bandpass applied

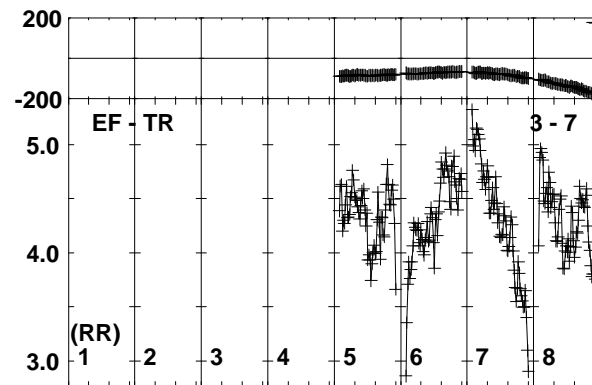
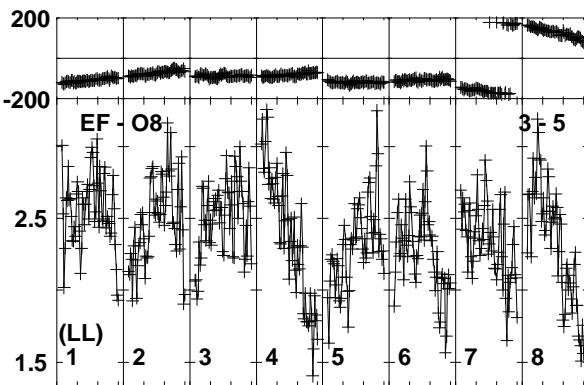
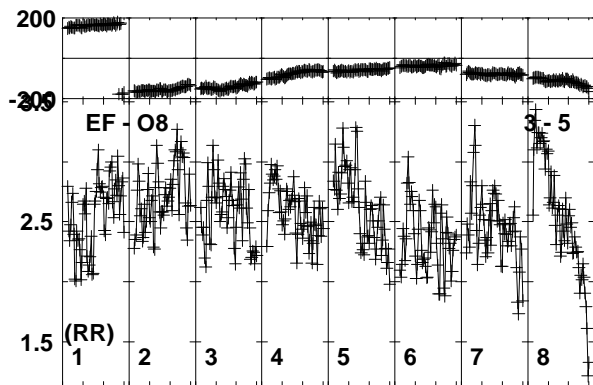
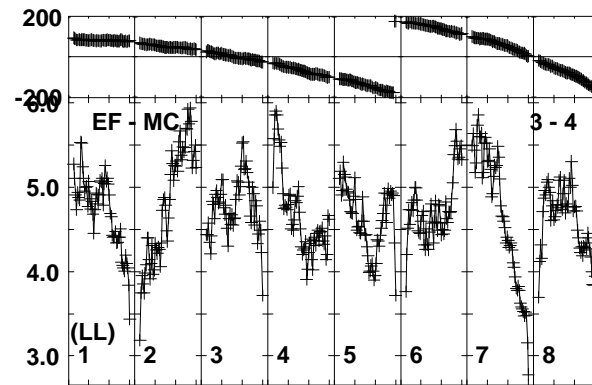
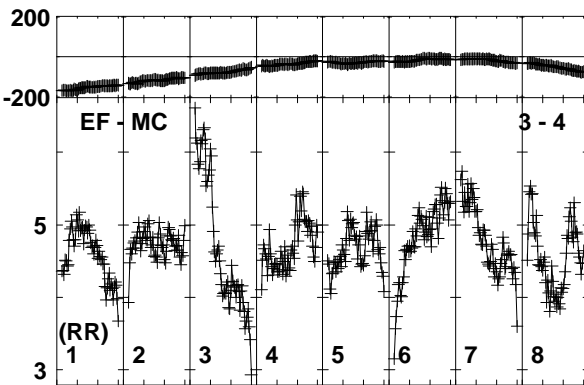
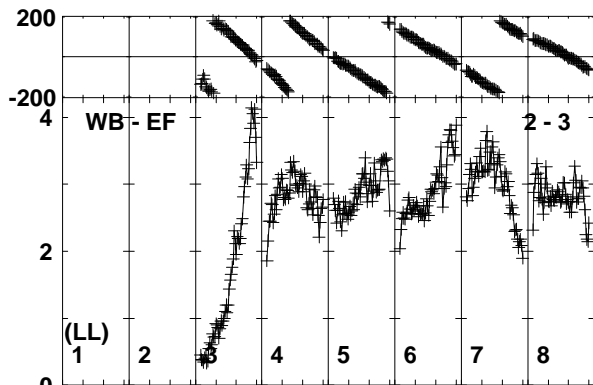
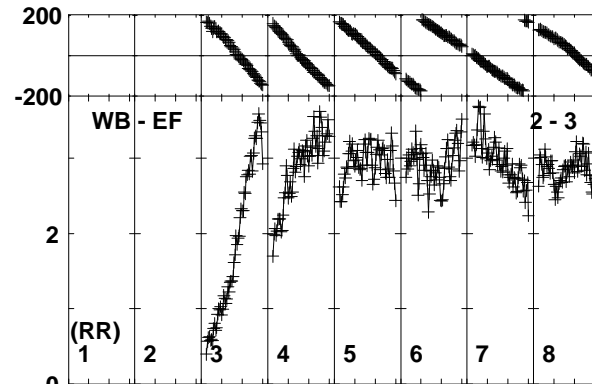
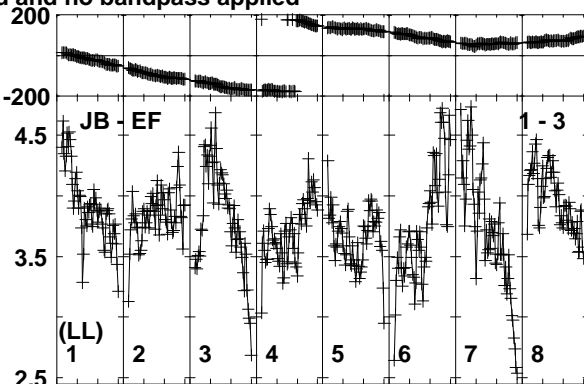
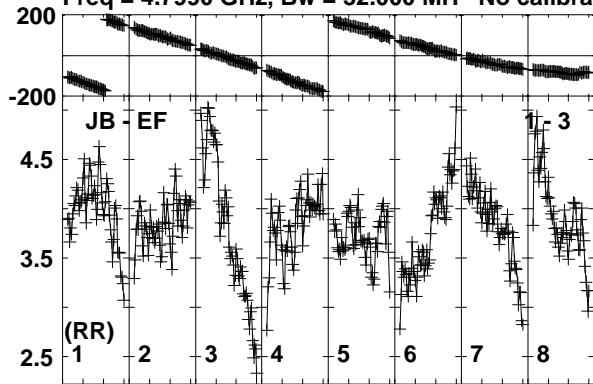

Lower frame: Milli Ampl Jy Top frame: Phas deg

Vector averaged cross-power spectrum Baseline: JB (01) - EF (03)

Timerange: 01/01:21:45 to 01/01:22:14

Plot file version 299 created 26-SEP-2019 10:41:13

J0257-1212 RG010A.UVDATA.1

Freq = 4.7990 GHz, Bw = 32.000 MH No calibration applied and no bandpass applied

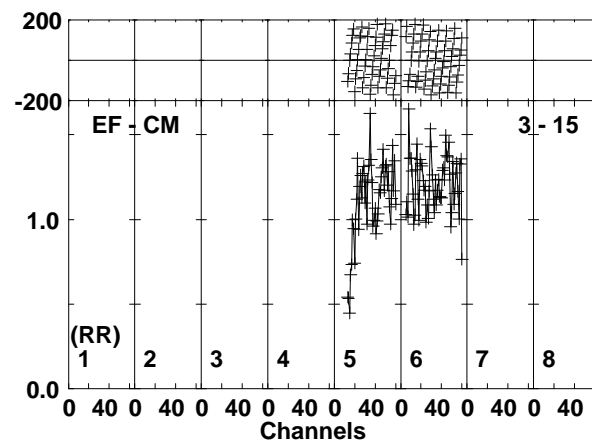
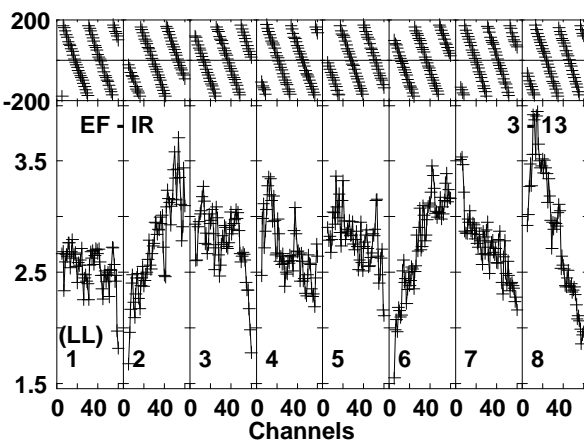
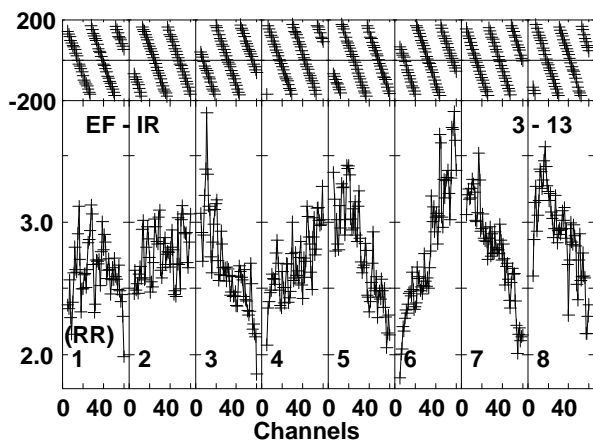
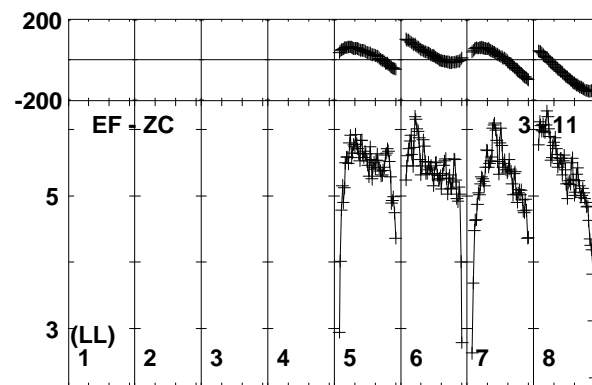
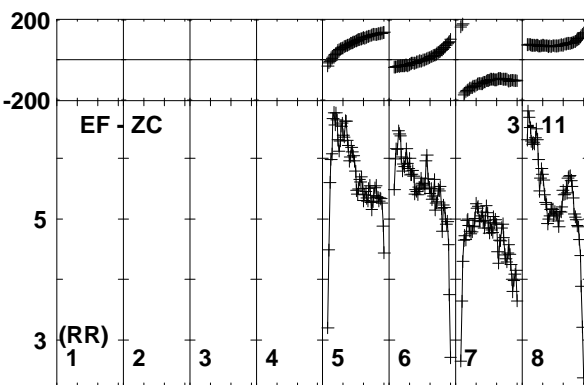
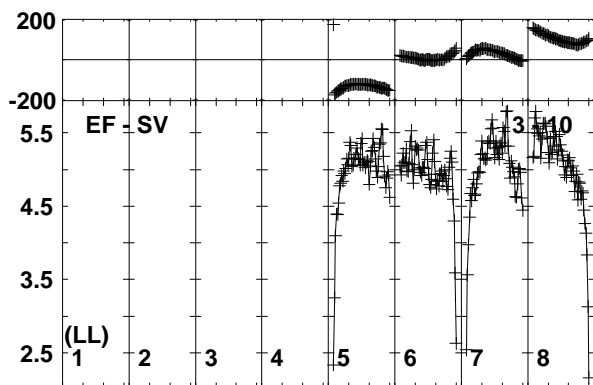
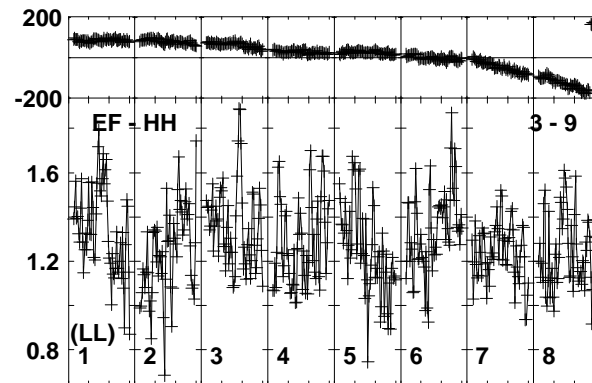
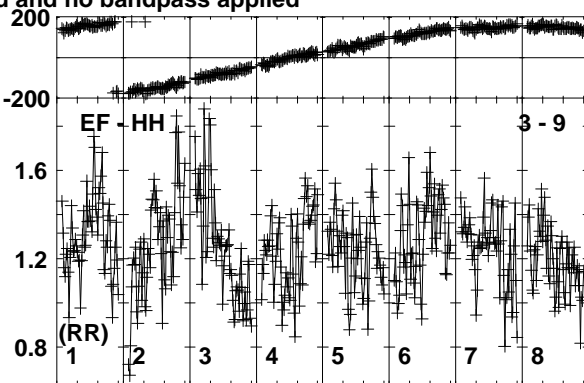
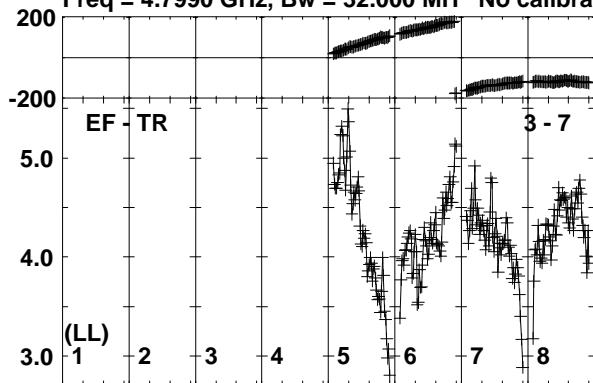

Lower frame: Milli Ampl Jy Top frame: Phas deg
Vector averaged cross-power spectrum Baseline: EF (03) - TR (07)
Timerange: 01/01:21:45 to 01/01:22:14

Plot file version 300 created 26-SEP-2019 10:41:13

J0257-1212 RG010A.UVDATA.1

Freq = 4.7990 GHz, Bw = 32.000 MH No calibration applied and no bandpass applied

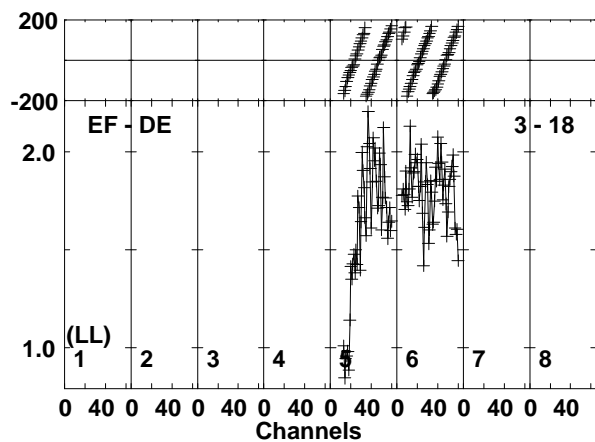
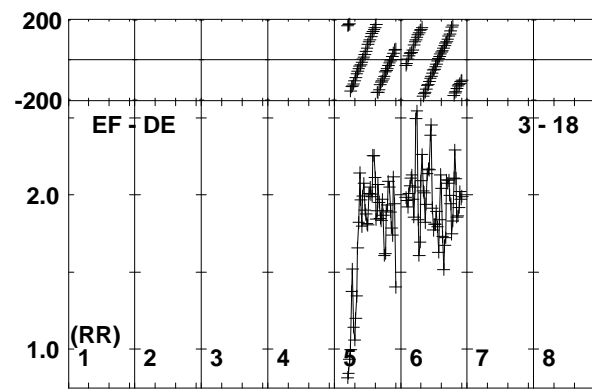
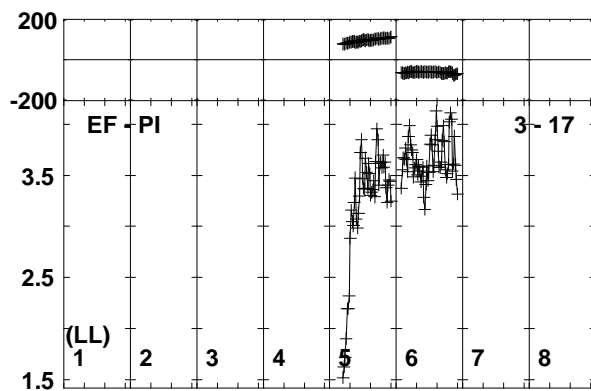
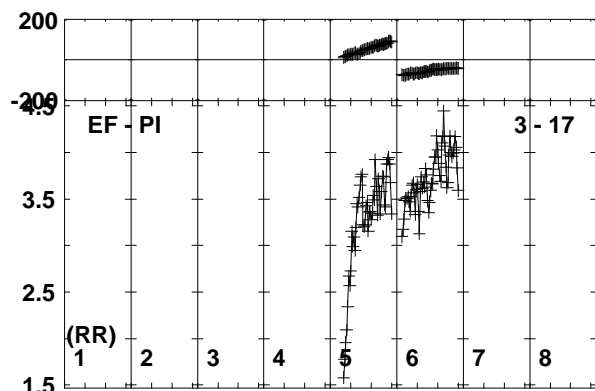
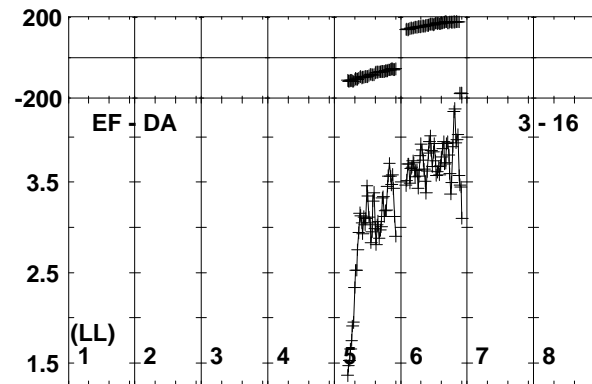
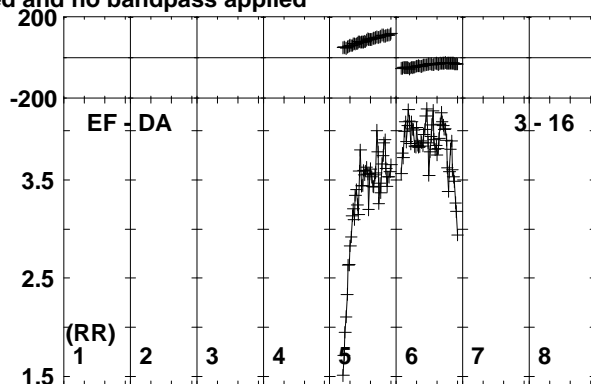
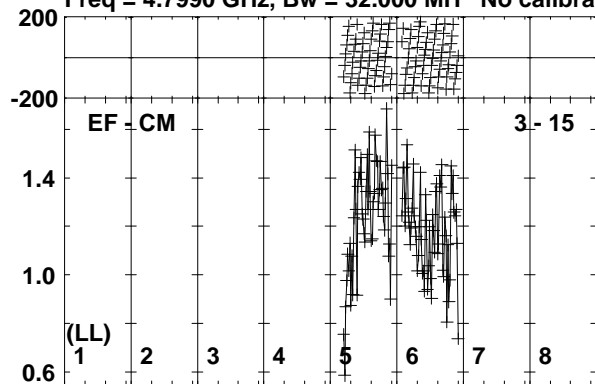

0 40 0 40 0 40 0 40 0 40 0 40 0 40 0 40 0 40 0 40
Channels
Lower frame: Milli Ampl Jy Top frame: Phas deg
Vector averaged cross-power spectrum Baseline: EF (03) - CM (15)
Timerange: 01/01:21:45 to 01/01:22:14

Plot file version 301 created 26-SEP-2019 10:41:13

J0300-0846 RG010A.UVDATA.1

Freq = 4.7990 GHz, Bw = 32.000 MH No calibration applied and no bandpass applied

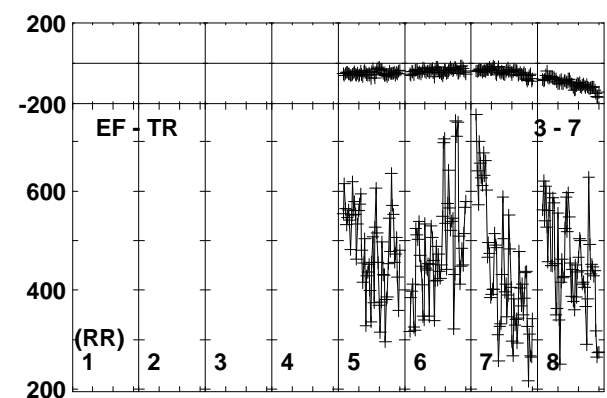
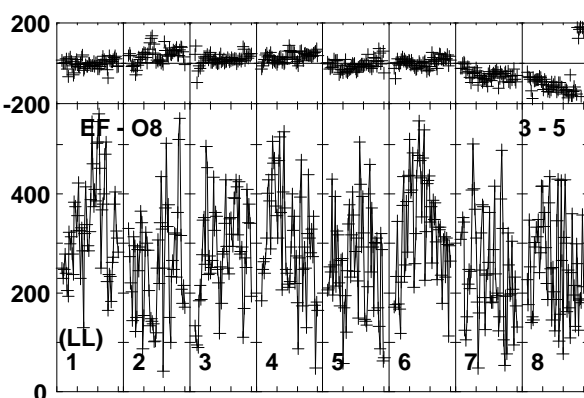
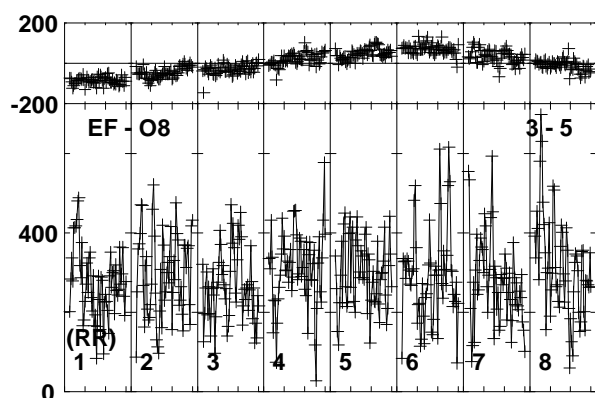
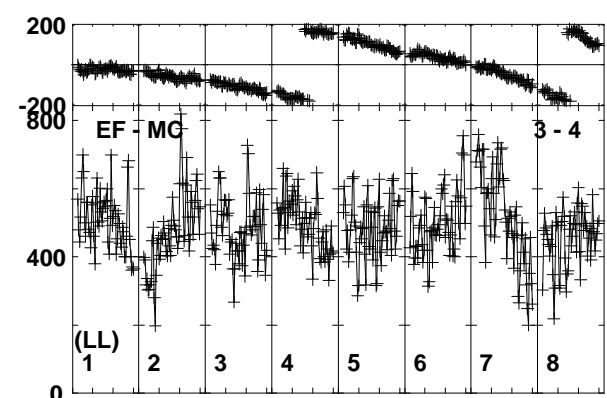
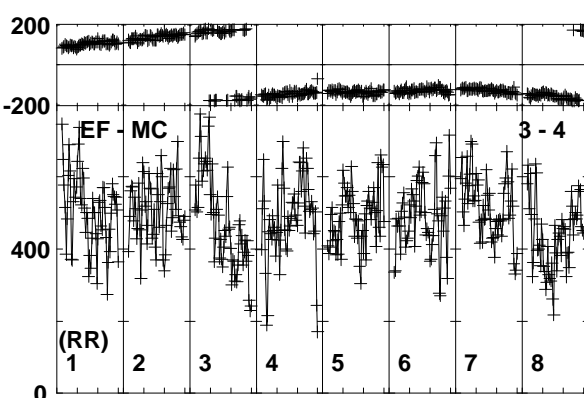
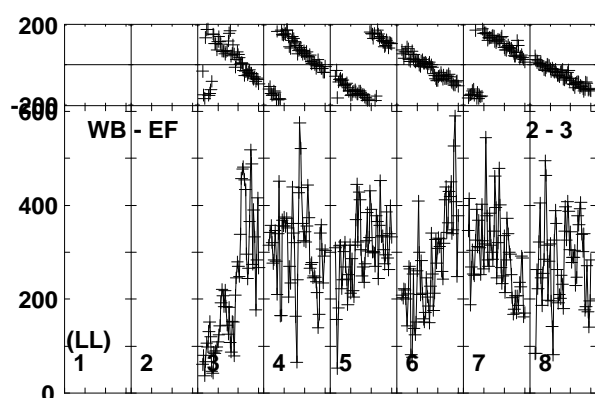
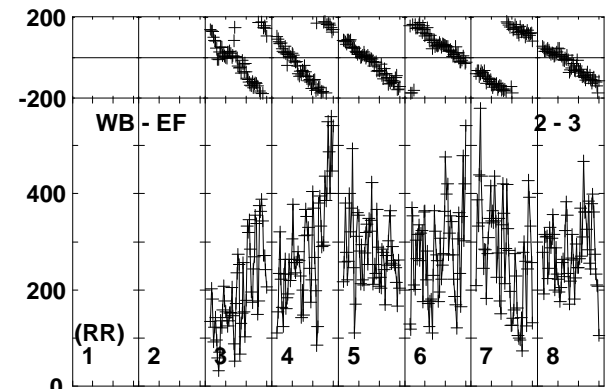
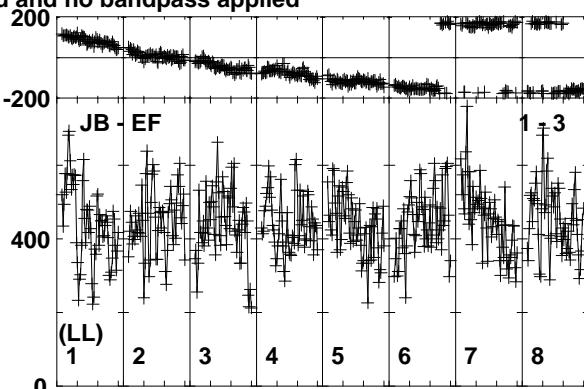
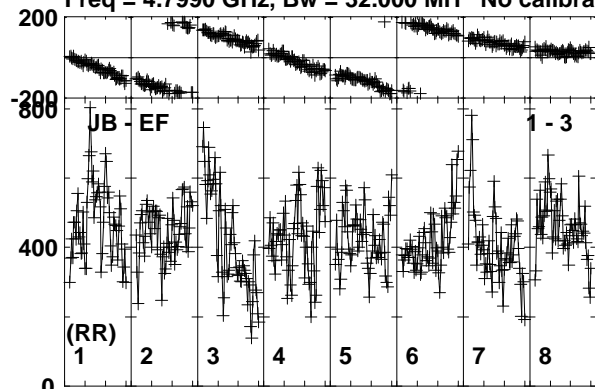

Lower frame: Micro Ampl Jy Top frame: Phas deg
Vector averaged cross-power spectrum Baseline: JB (01) - EF (03)
Timerange: 01/01:22:16 to 01/01:24:45

Plot file version 302 created 26-SEP-2019 10:41:14

J0300-0846 RG010A.UVDATA.1

Freq = 4.7990 GHz, Bw = 32.000 MH No calibration applied and no bandpass applied

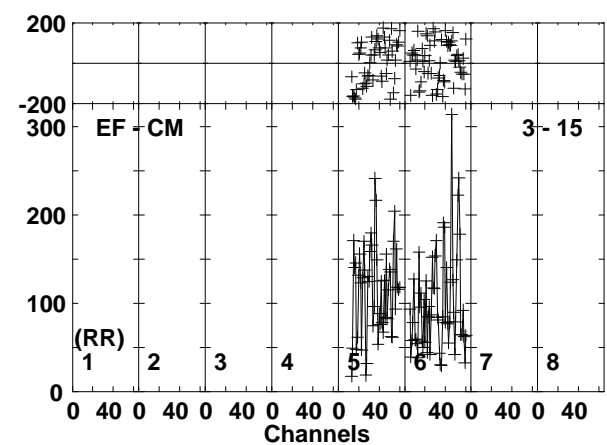
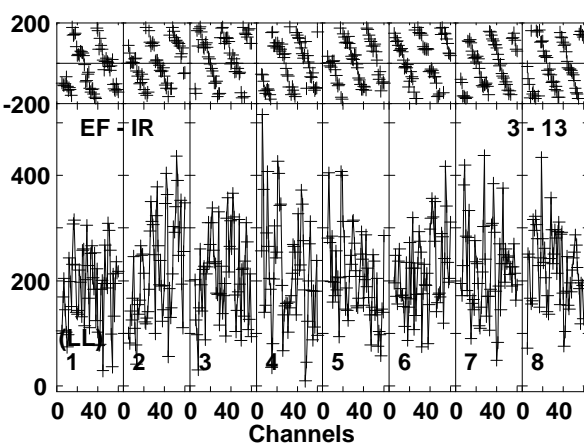
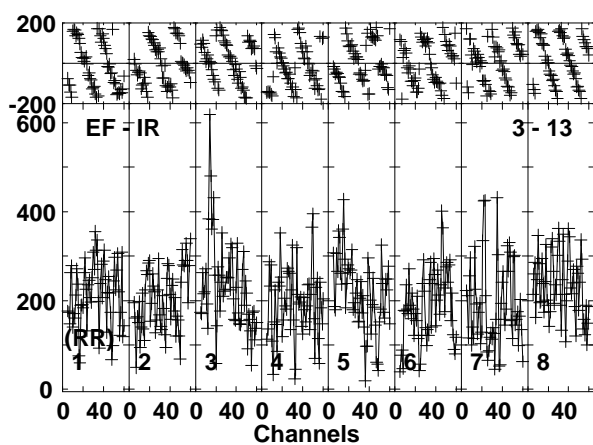
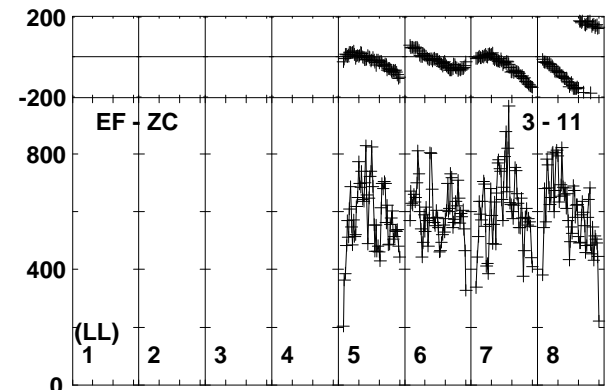
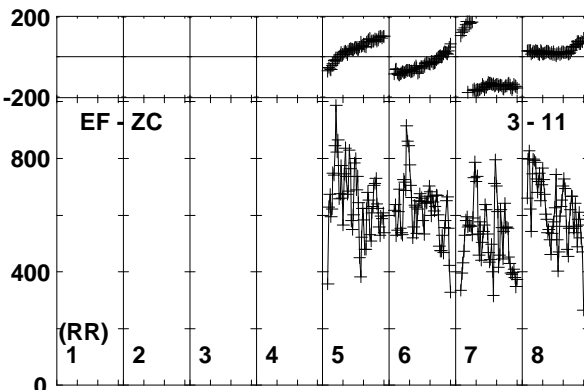
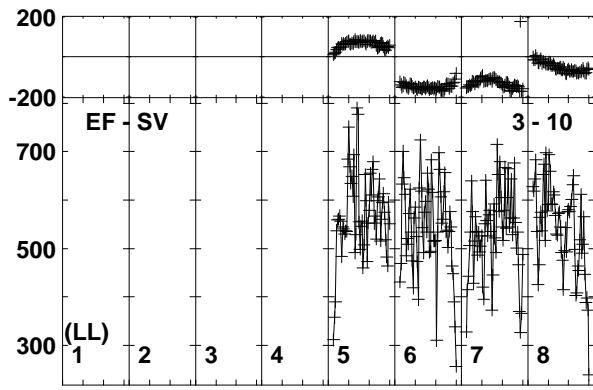
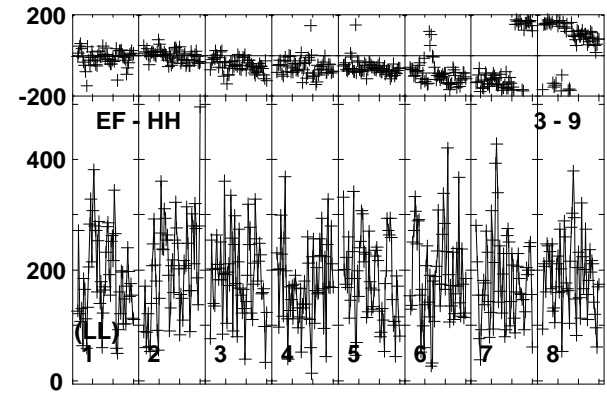
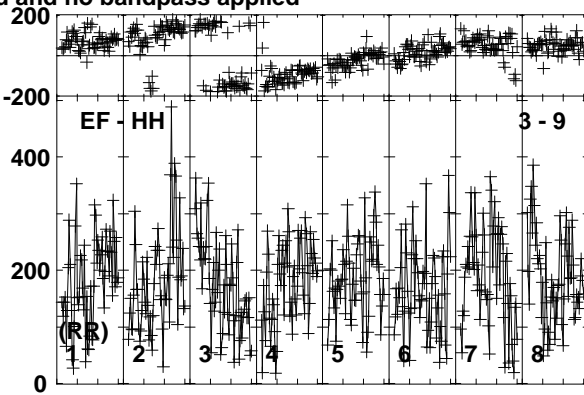
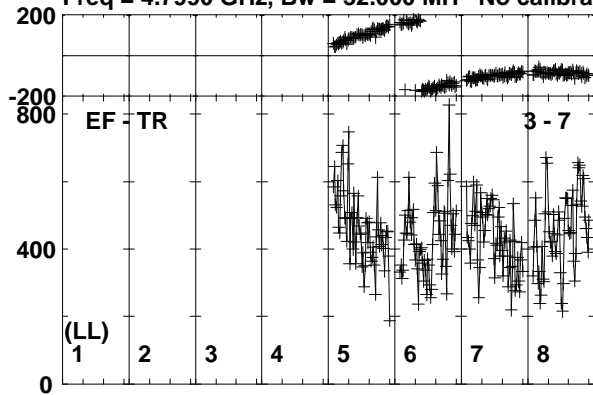

Lower frame: Micro Ampl Jy Top frame: Phas deg
Vector averaged cross-power spectrum Baseline: EF (03) - TR (07)
Timerange: 01/01:22:16 to 01/01:24:45

Plot file version 303 created 26-SEP-2019 10:41:15
 J0300-0846 RG010A.UVDATA.1
 Freq = 4.7990 GHz, Bw = 32.000 MH No calibration applied and no bandpass applied

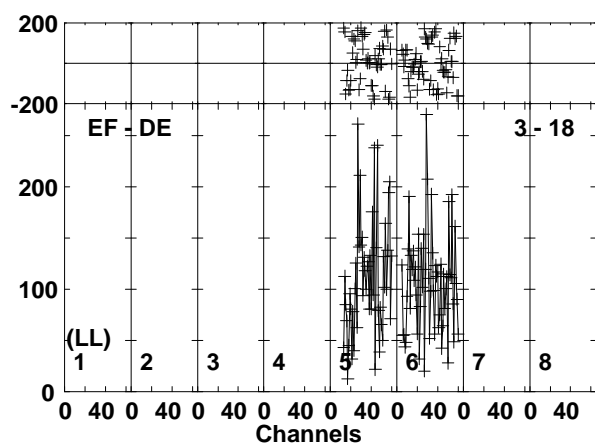
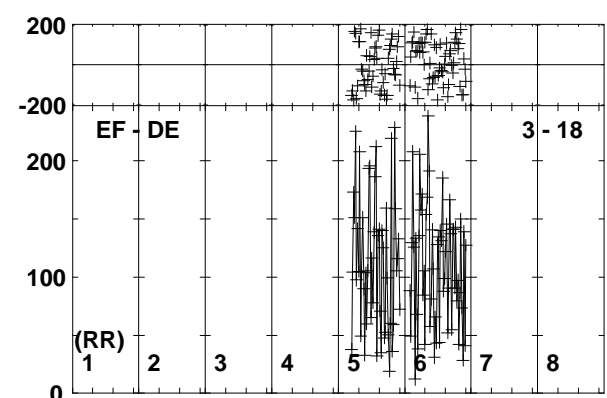
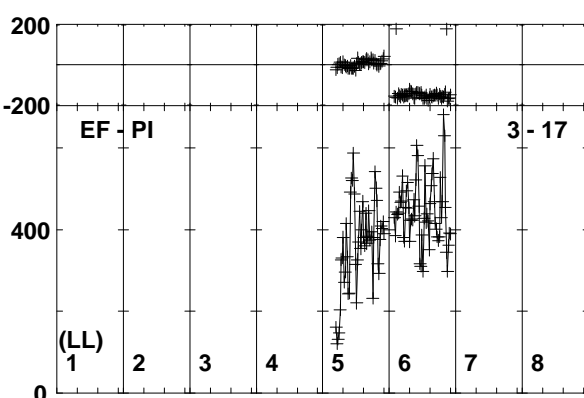
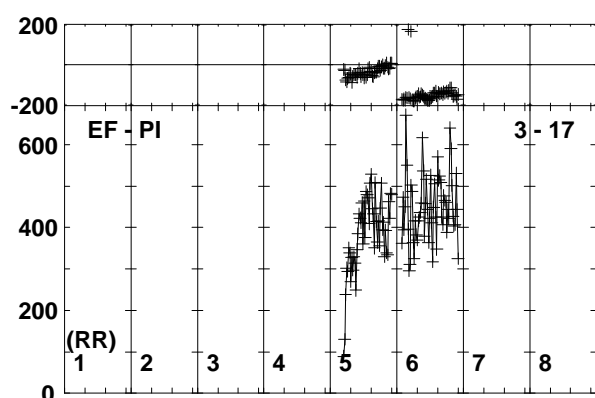
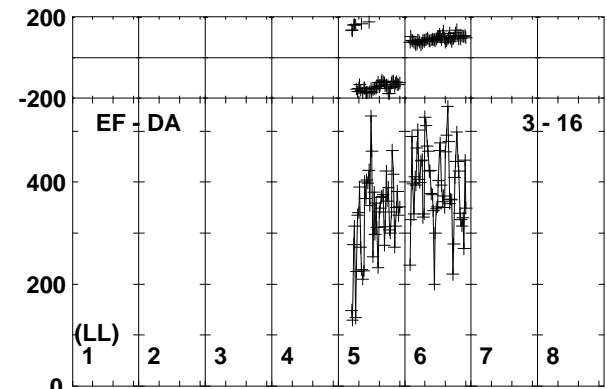
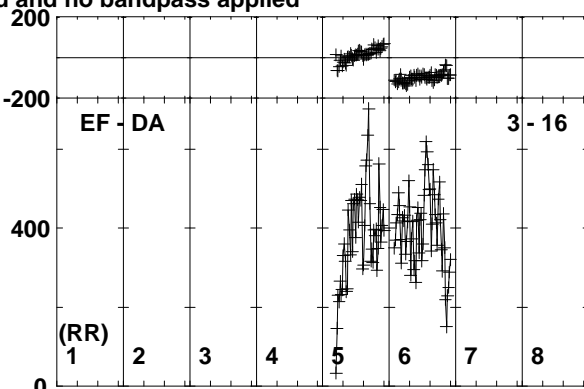
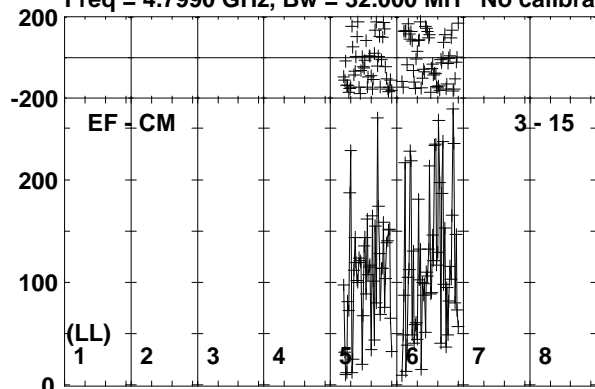

Lower frame: Micro Ampl Jy Top frame: Phas deg
 Vector averaged cross-power spectrum Baseline: EF (03) - CM (15)
 Timerange: 01/01:22:16 to 01/01:24:45

Plot file version 304 created 26-SEP-2019 10:41:15

190829A RG010A.UVDATA.1

Freq = 4.7990 GHz, Bw = 32.000 MH No calibration applied and no bandpass applied

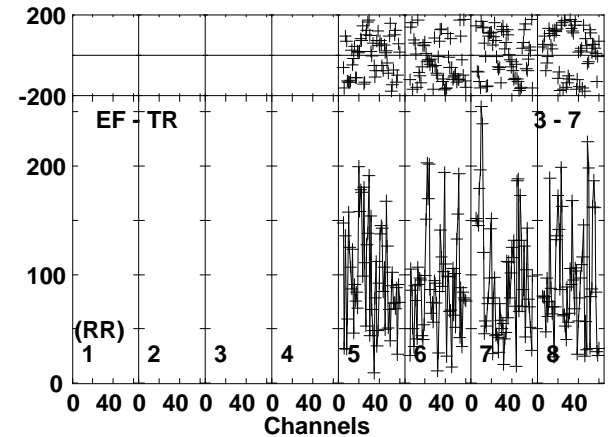
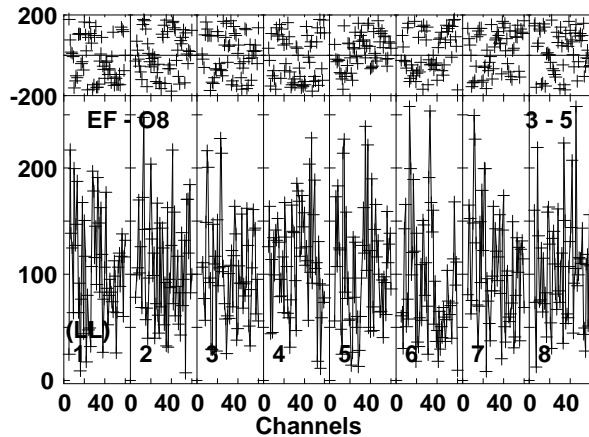
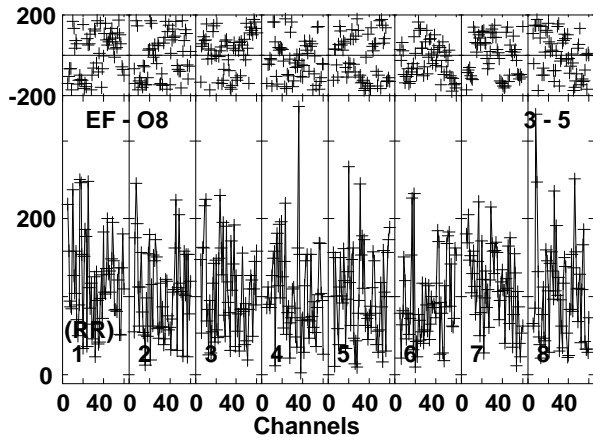
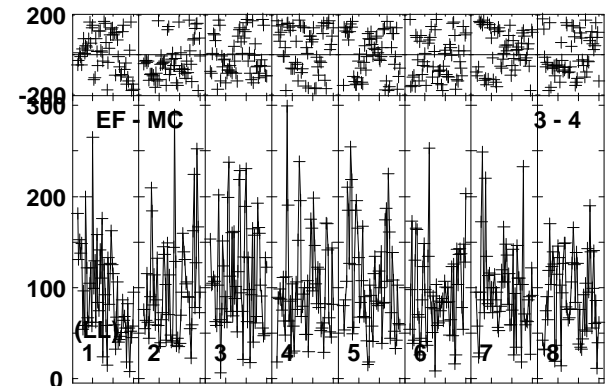
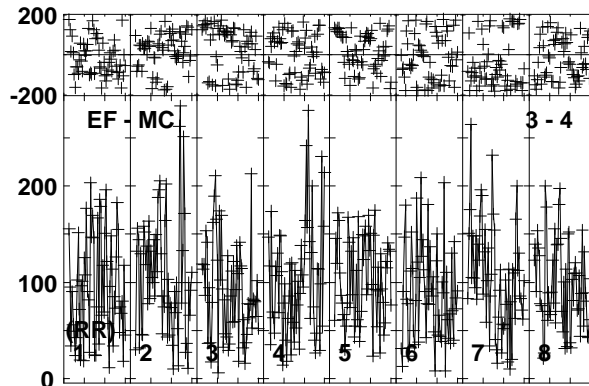
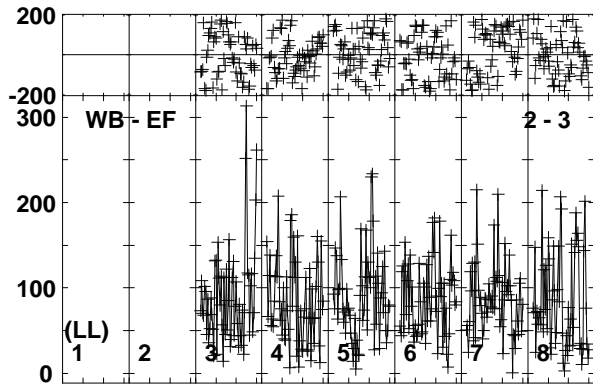
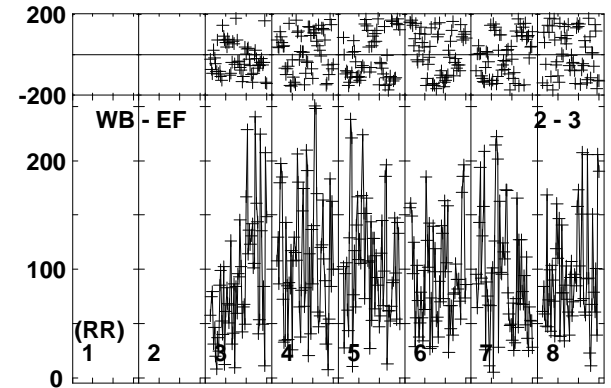
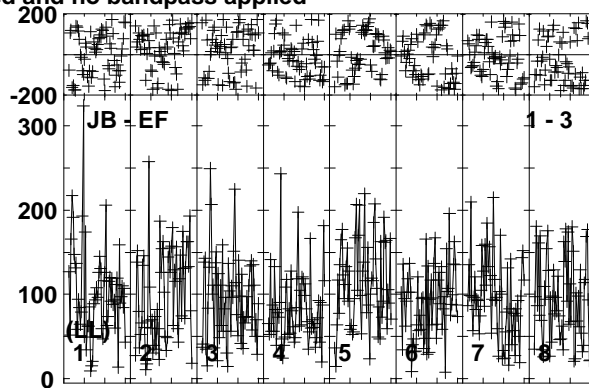
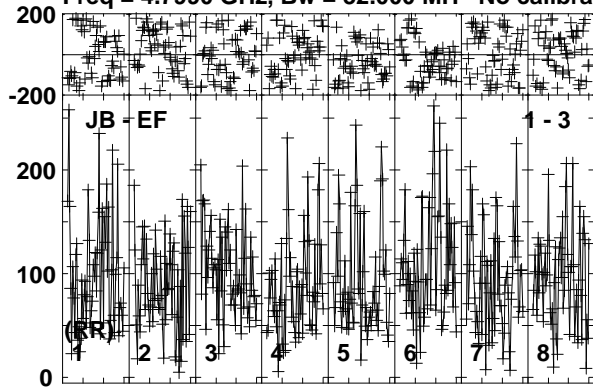

Lower frame: Micro Ampl Jy Top frame: Phas deg
Vector averaged cross-power spectrum Baseline: JB (01) - EF (03)
Timerange: 01/01:24:45 to 01/01:27:15

Plot file version 305 created 26-SEP-2019 10:41:16

190829A RG010A.UVDATA.1

Freq = 4.7990 GHz, Bw = 32.000 MH No calibration applied and no bandpass applied

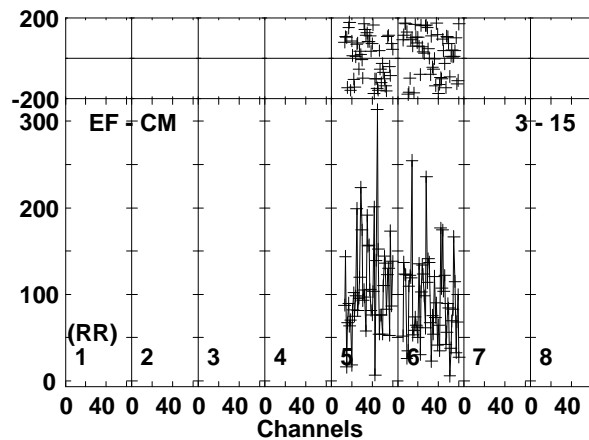
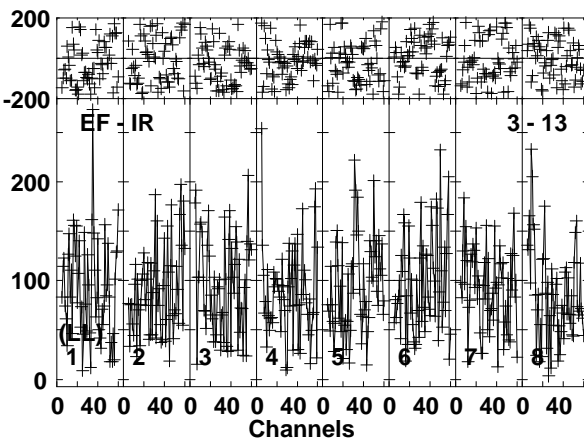
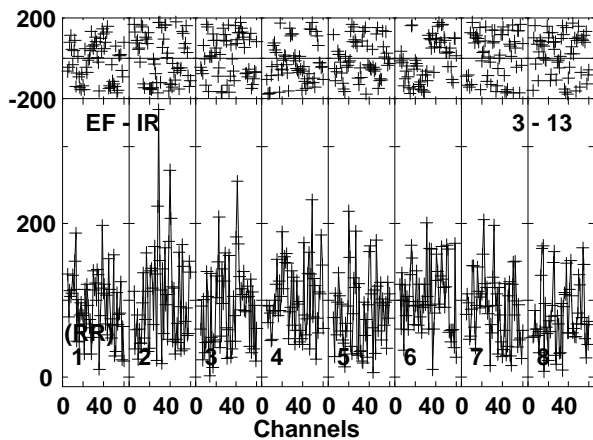
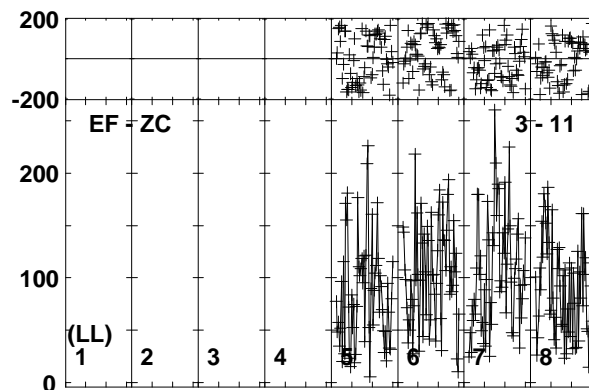
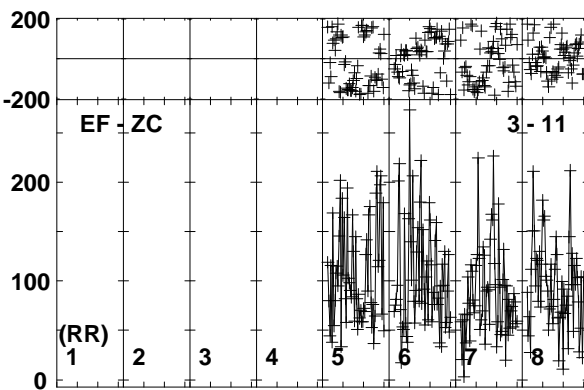
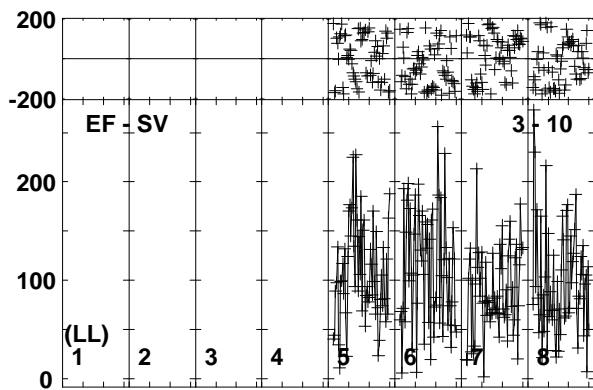
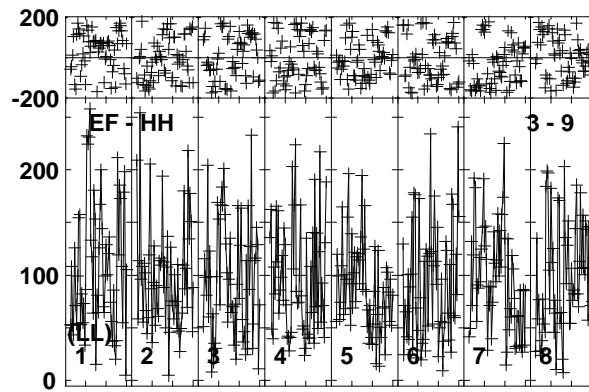
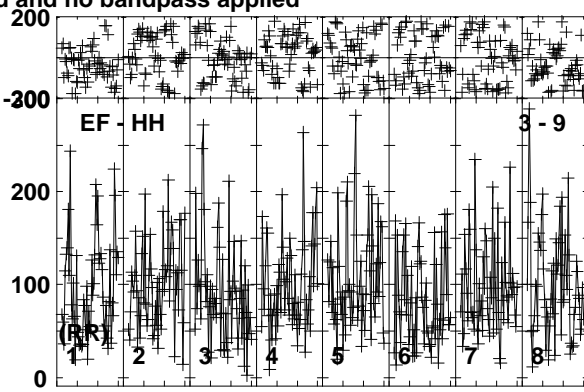
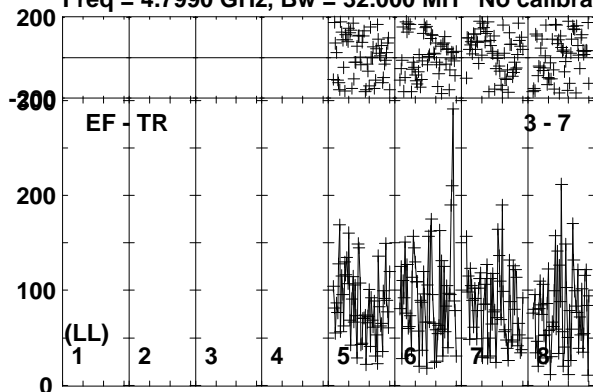

Lower frame: Micro Ampl Jy Top frame: Phas deg
Vector averaged cross-power spectrum Baseline: EF (03) - TR (07)
Timerange: 01/01:24:45 to 01/01:27:15

Plot file version 306 created 26-SEP-2019 10:41:16

190829A RG010A.UVDATA.1

Freq = 4.7990 GHz, Bw = 32.000 MH No calibration applied and no bandpass applied

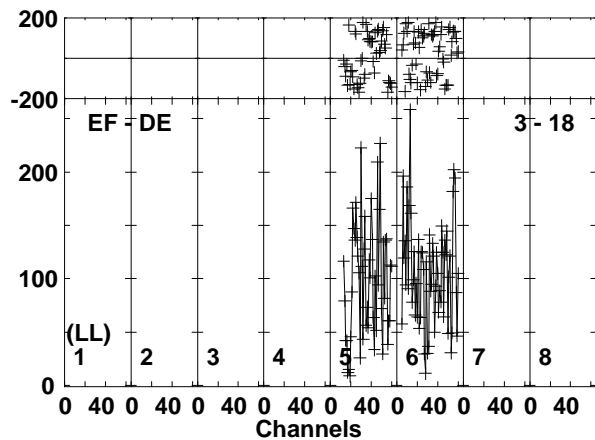
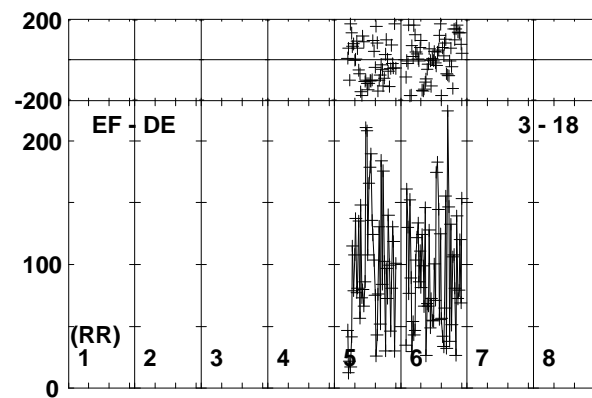
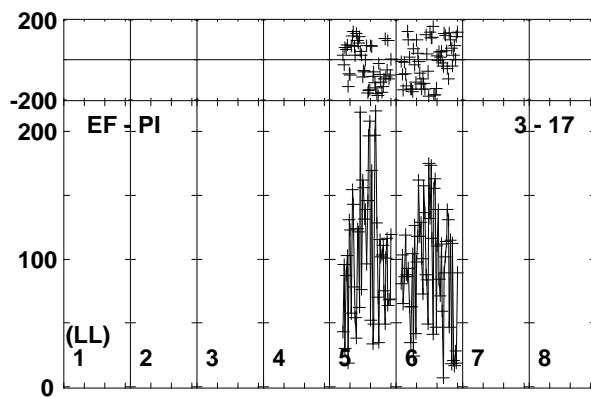
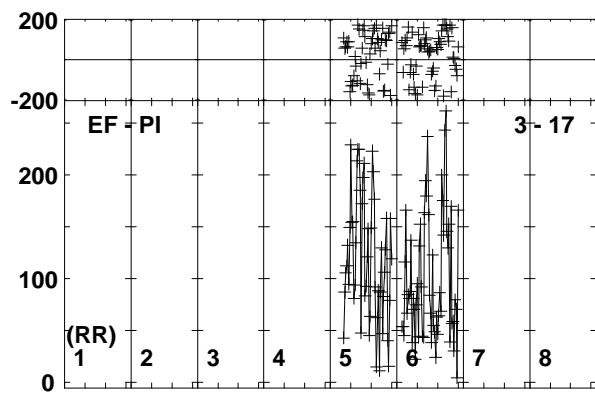
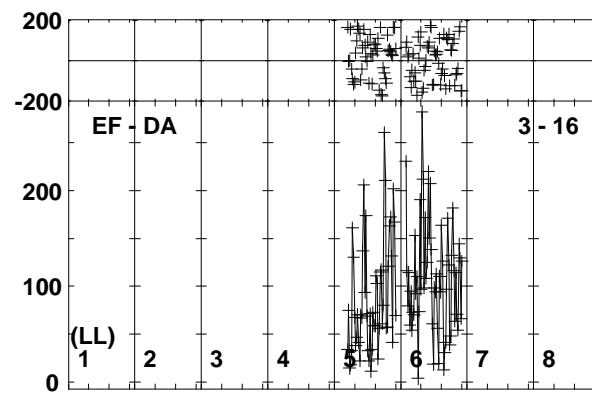
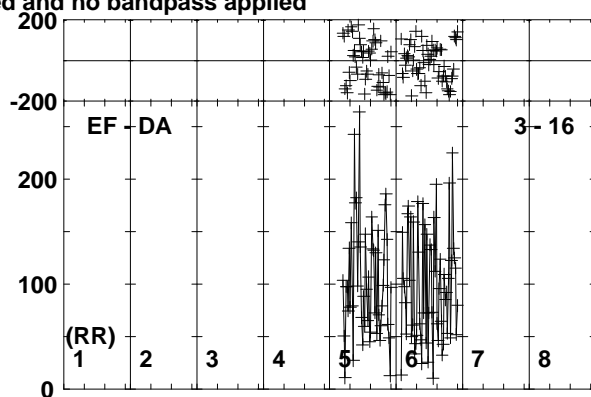
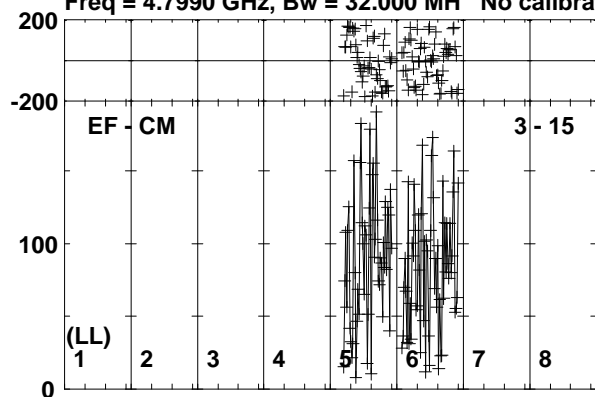

Lower frame: Micro Ampl Jy Top frame: Phas deg
Vector averaged cross-power spectrum Baseline: EF (03) - CM (15)
Timerange: 01/01:24:45 to 01/01:27:15

Plot file version 307 created 26-SEP-2019 10:41:17

J0257-1212 RG010A.UVDATA.1

Freq = 4.7990 GHz, Bw = 32.000 MH No calibration applied and no bandpass applied

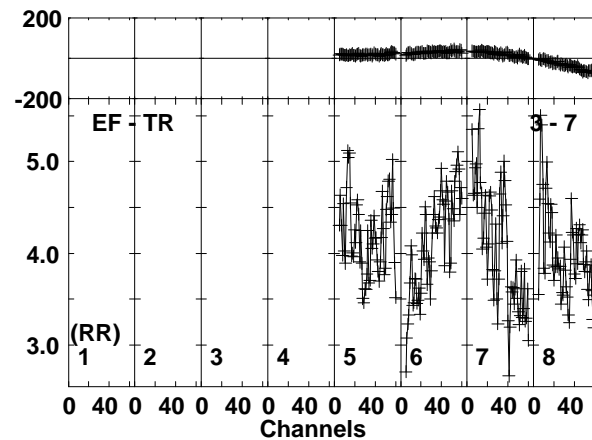
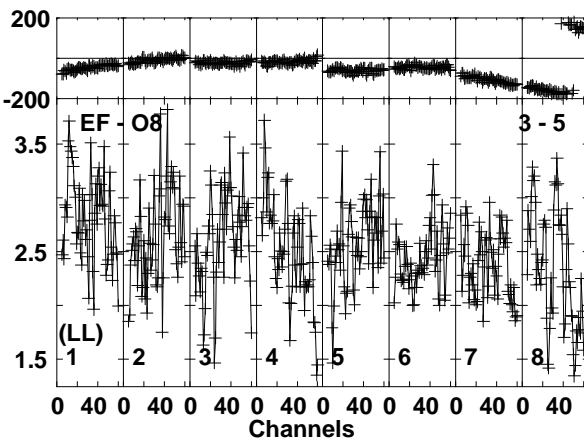
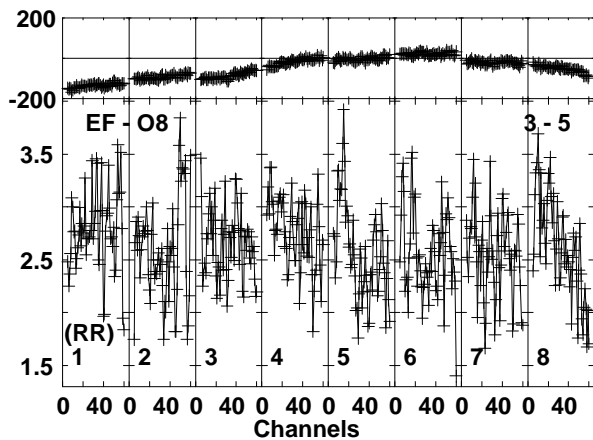
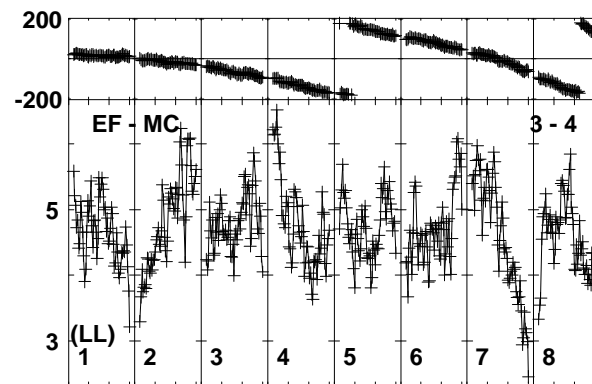
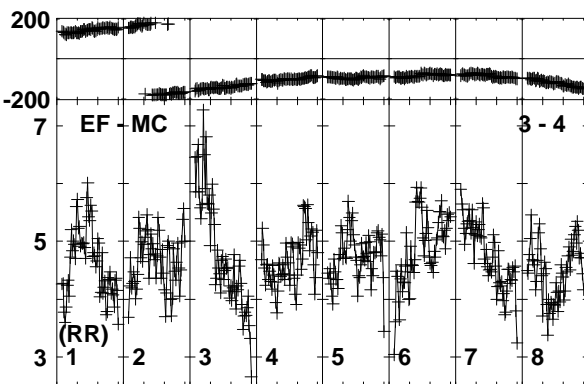
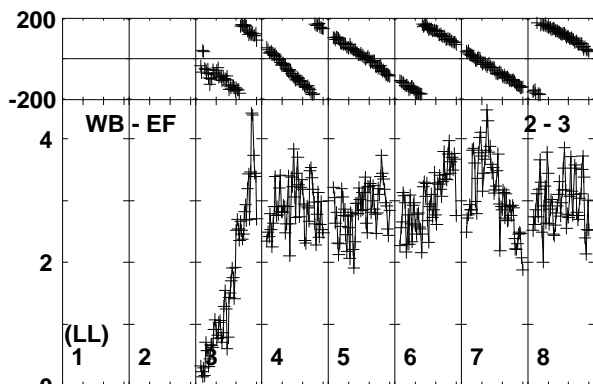
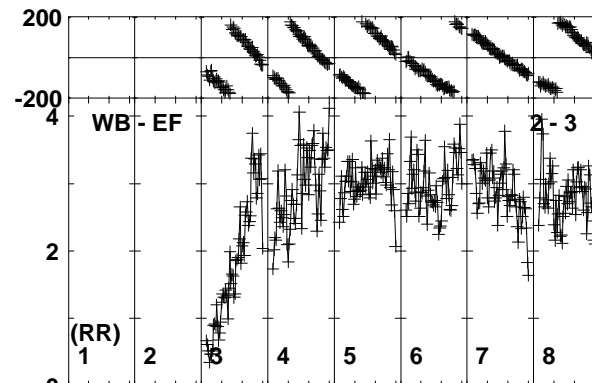
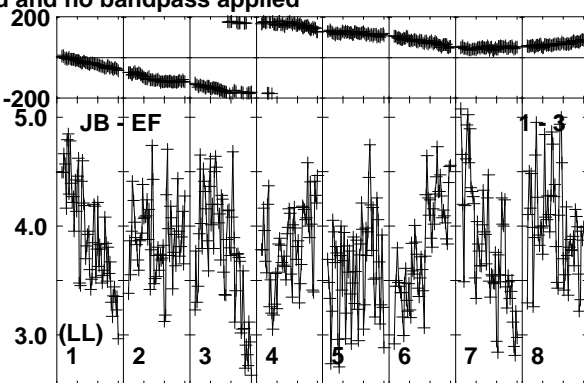
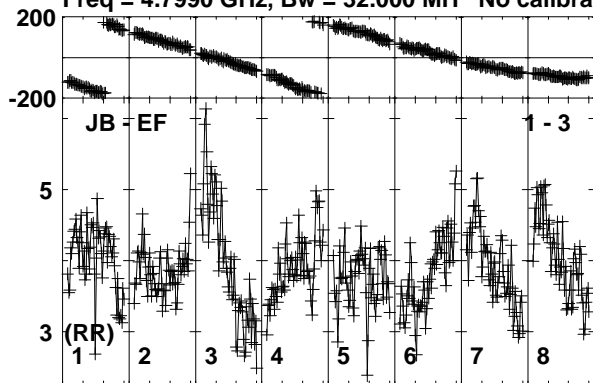

Lower frame: Milli Ampl Jy Top frame: Phas deg
Vector averaged cross-power spectrum Baseline: JB (01) - EF (03)
Timerange: 01/01:27:16 to 01/01:28:15

Plot file version 308 created 26-SEP-2019 10:41:17

J0257-1212 RG010A.UVDATA.1

Freq = 4.7990 GHz, Bw = 32.000 MH No calibration applied and no bandpass applied

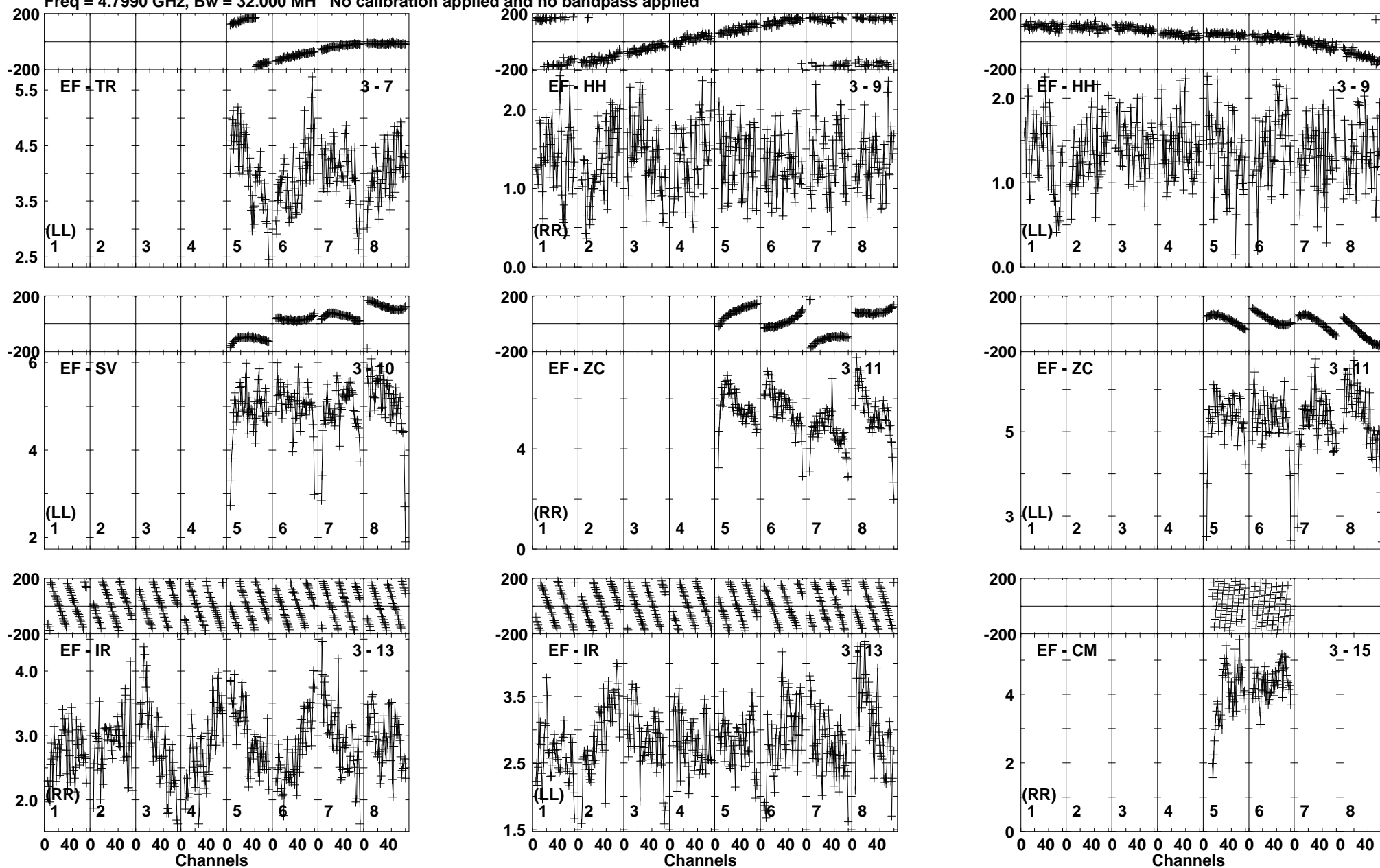

Lower frame: Milli Ampl Jy Top frame: Phas deg
Vector averaged cross-power spectrum Baseline: EF (03) - TR (07)
Timerange: 01/01:27:16 to 01/01:28:15

Plot file version 309 created 26-SEP-2019 10:41:18

J0257-1212 RG010A.UVDATA.1

Freq = 4.7990 GHz, Bw = 32.000 MH No calibration applied and no bandpass applied

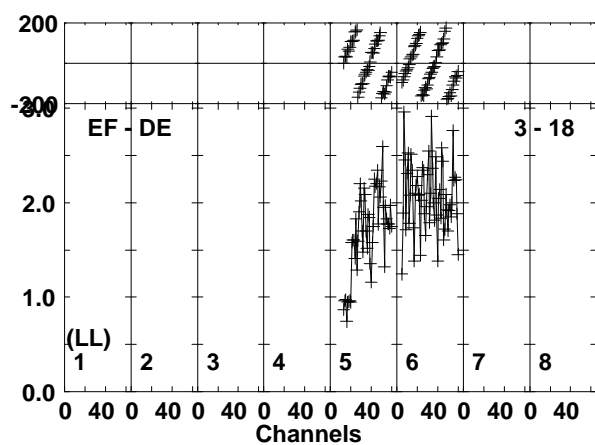
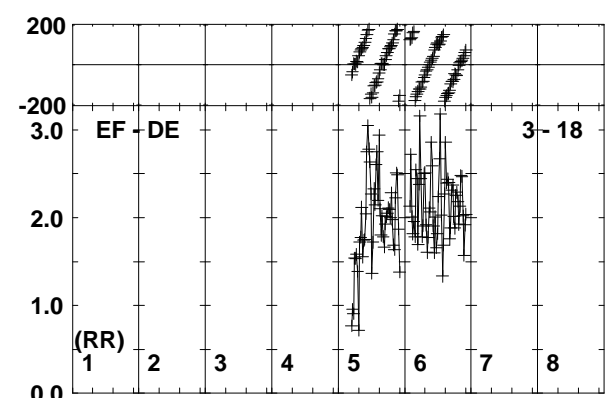
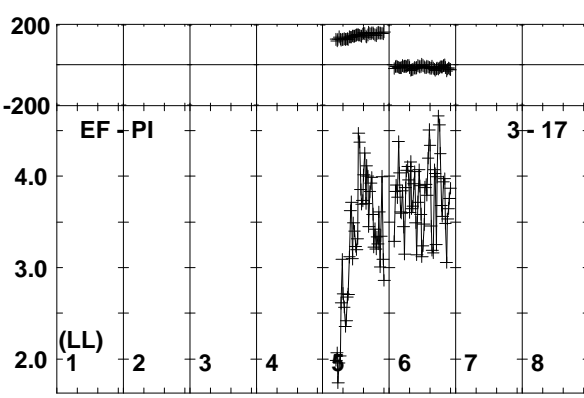
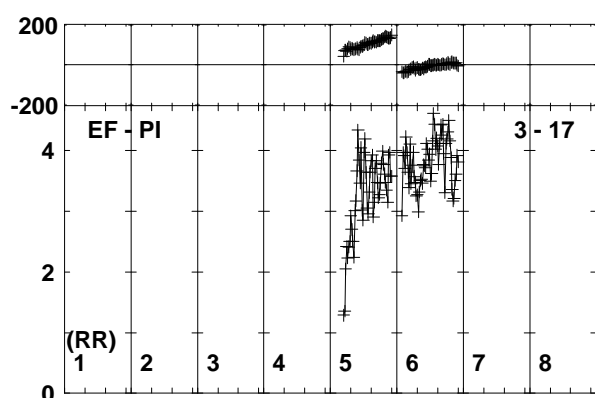
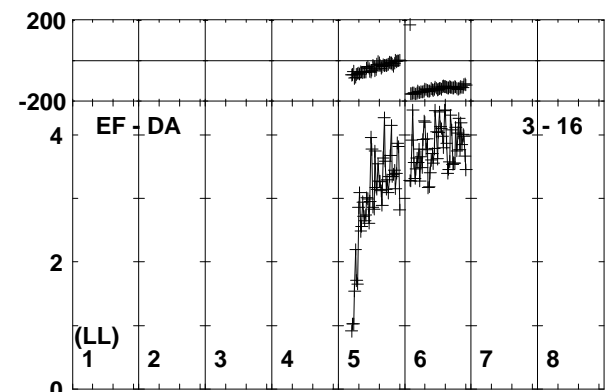
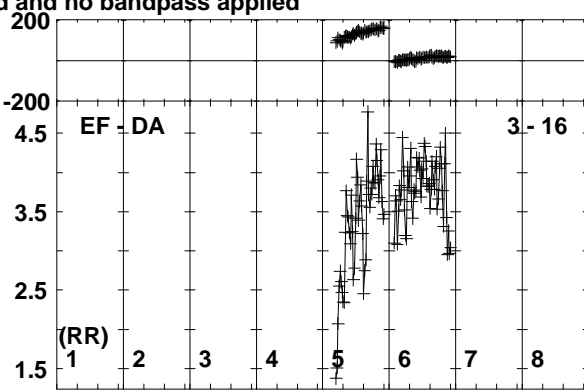
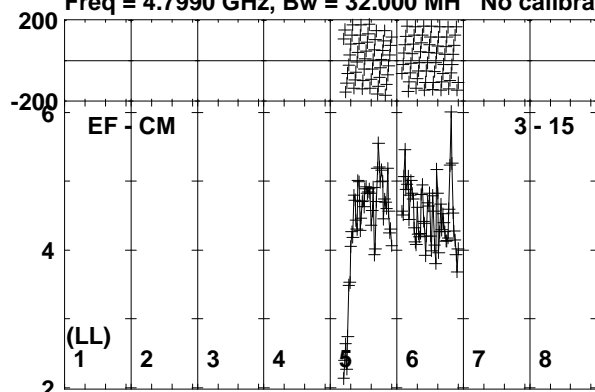

Lower frame: Milli Ampl Jy Top frame: Phas deg
Vector averaged cross-power spectrum Baseline: EF (03) - CM (15)
Timerange: 01/01:27:16 to 01/01:28:15

Plot file version 310 created 26-SEP-2019 10:41:19

190829A RG010A.UVDATA.1

Freq = 4.7990 GHz, Bw = 32.000 MH No calibration applied and no bandpass applied

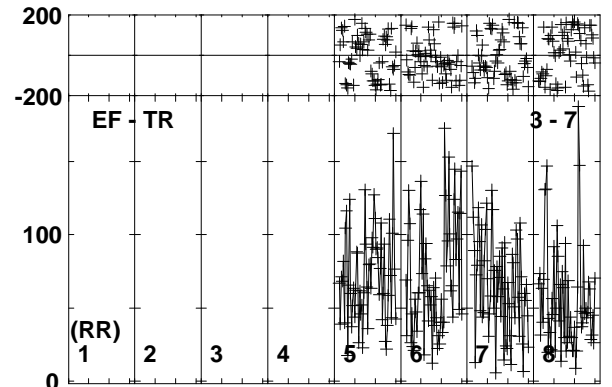
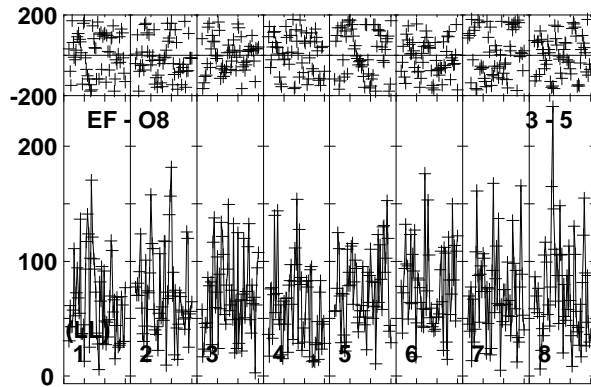
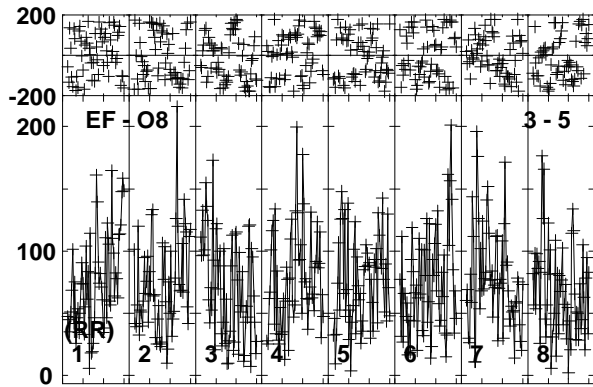
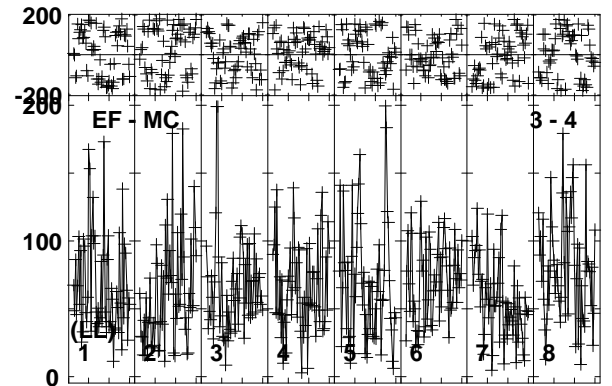
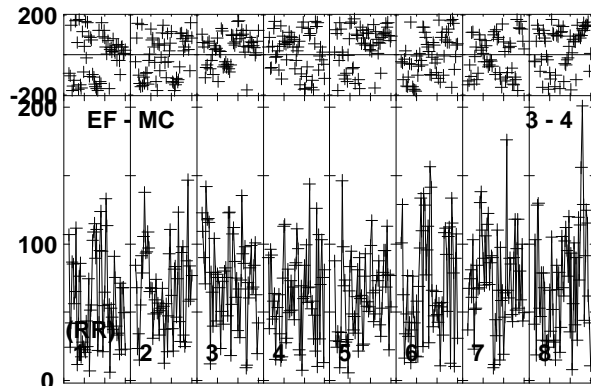
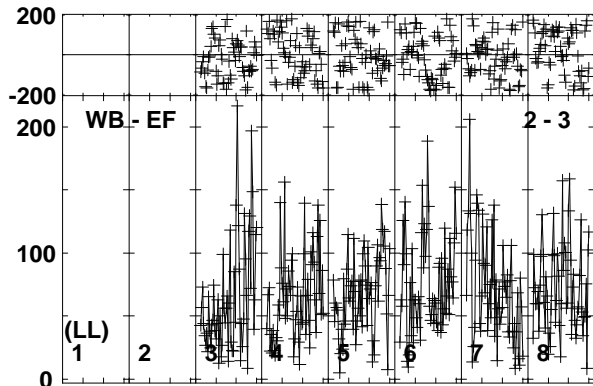
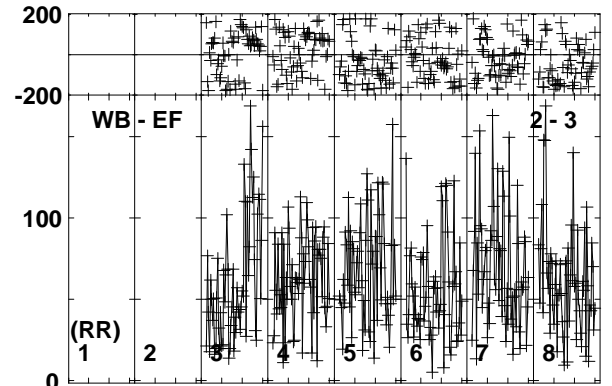
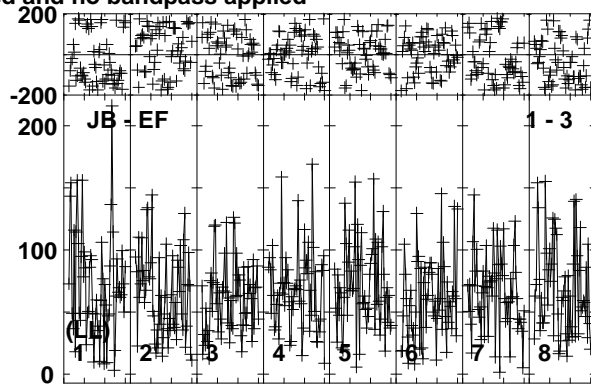
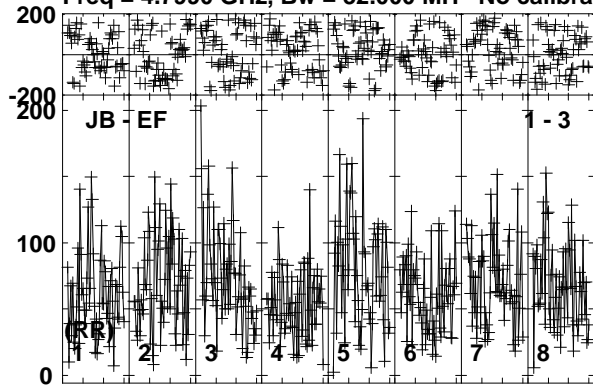

Lower frame: Micro Ampl Jy Top frame: Phas deg
Vector averaged cross-power spectrum Baseline: JB (01) - EF (03)
Timerange: 01/01:28:15 to 01/01:33:14

Plot file version 311 created 26-SEP-2019 10:41:19

190829A RG010A.UVDATA.1

Freq = 4.7990 GHz, Bw = 32.000 MH No calibration applied and no bandpass applied

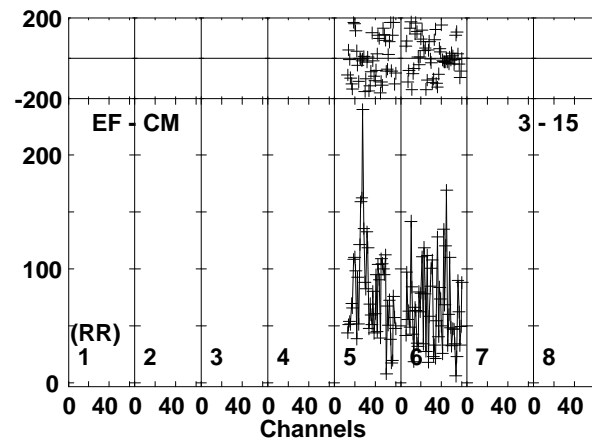
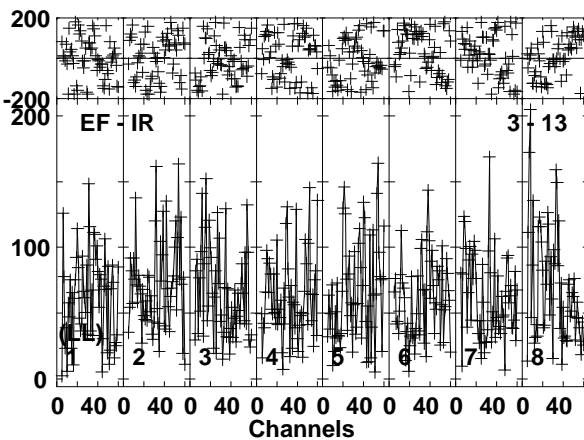
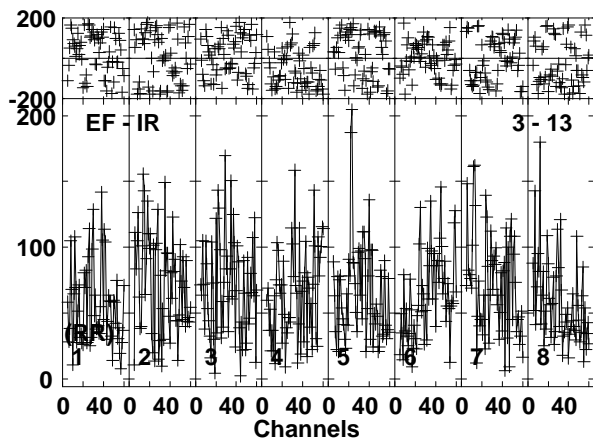
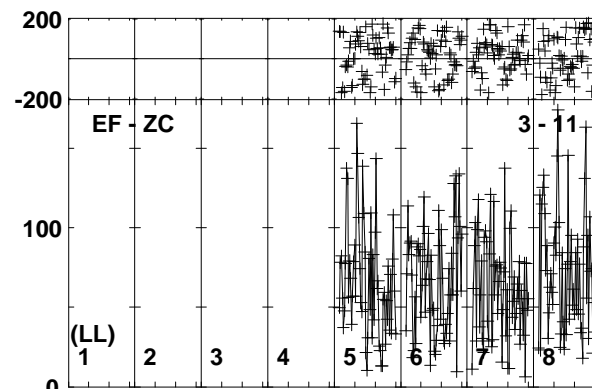
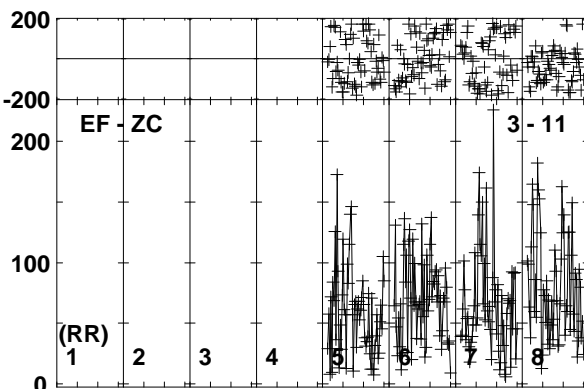
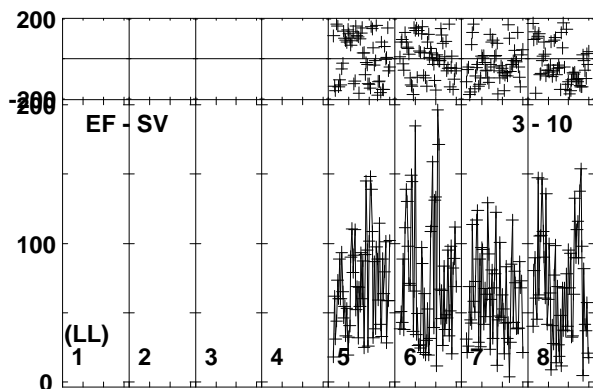
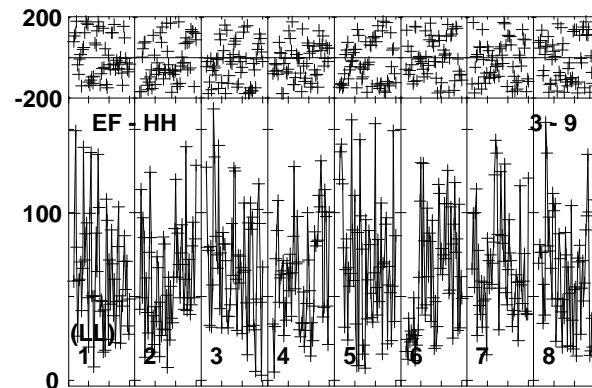
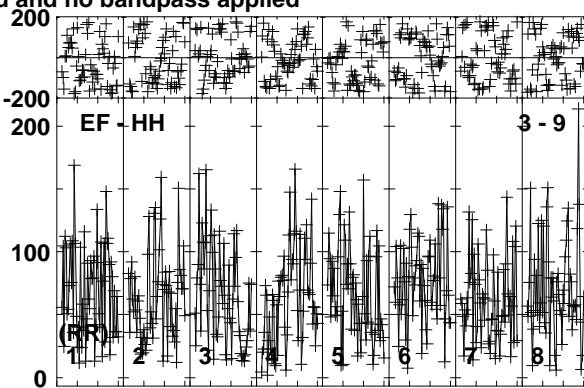
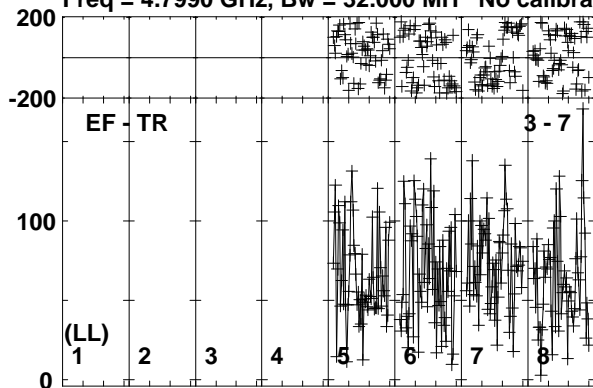

Lower frame: Micro Ampl Jy Top frame: Phas deg
Vector averaged cross-power spectrum Baseline: EF (03) - TR (07)
Timerange: 01/01:28:15 to 01/01:33:14

Plot file version 312 created 26-SEP-2019 10:41:21

190829A RG010A.UVDATA.1

Freq = 4.7990 GHz, Bw = 32.000 MH No calibration applied and no bandpass applied

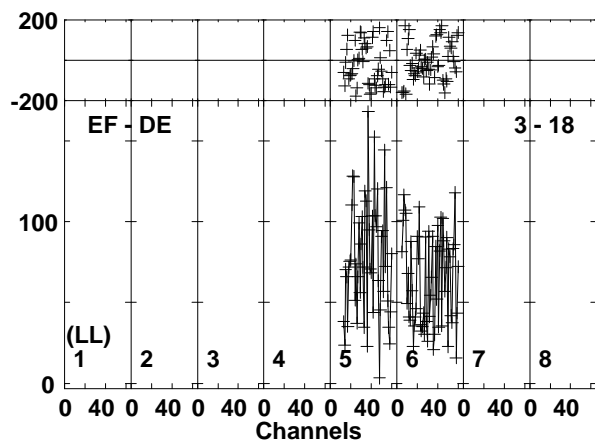
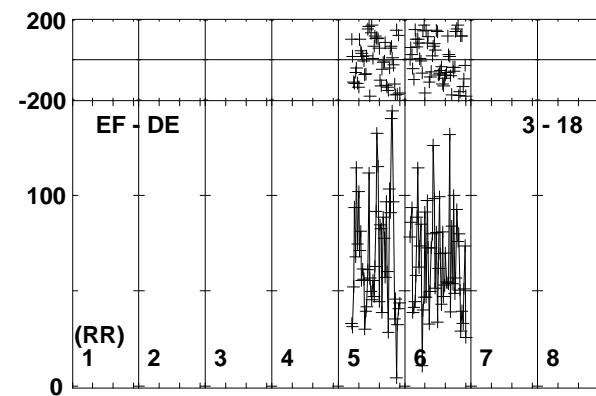
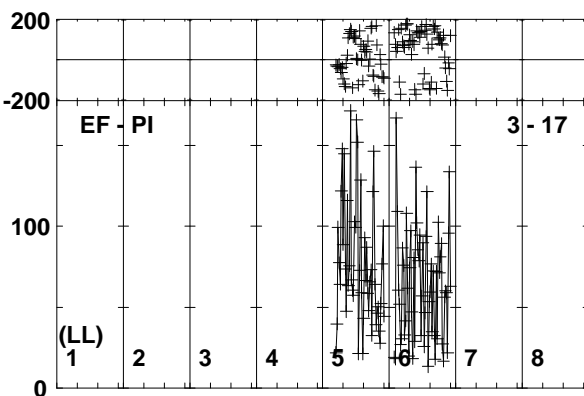
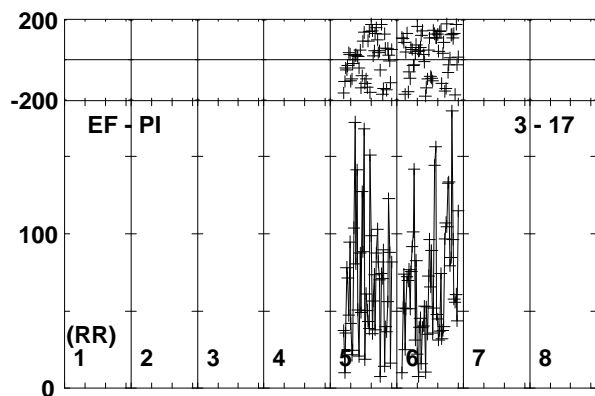
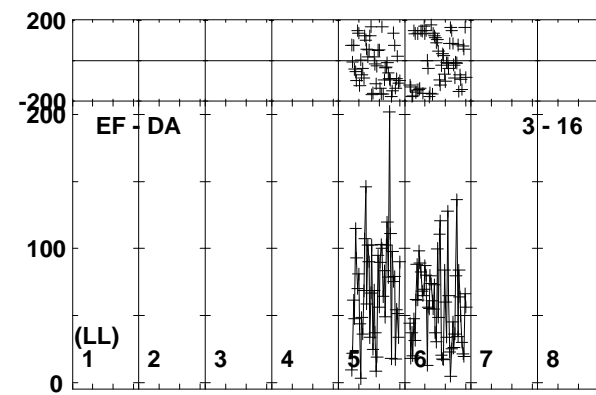
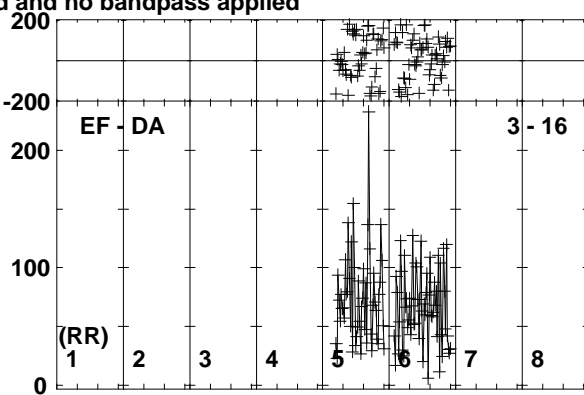
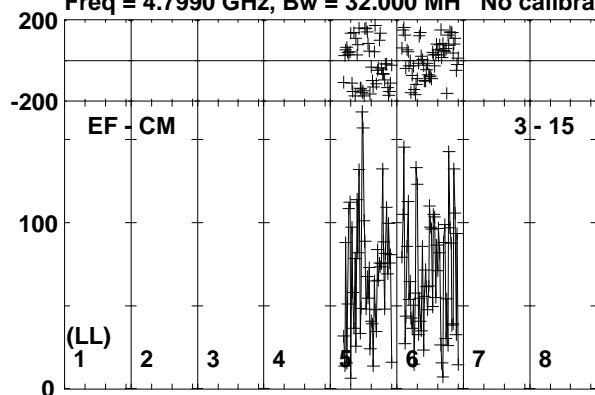

Lower frame: Micro Ampl Jy Top frame: Phas deg
Vector averaged cross-power spectrum Baseline: EF (03) - CM (15)
Timerange: 01/01:28:15 to 01/01:33:14

Plot file version 313 created 26-SEP-2019 10:41:21

J0257-1212 RG010A.UVDATA.1

Freq = 4.7990 GHz, Bw = 32.000 MH No calibration applied and no bandpass applied

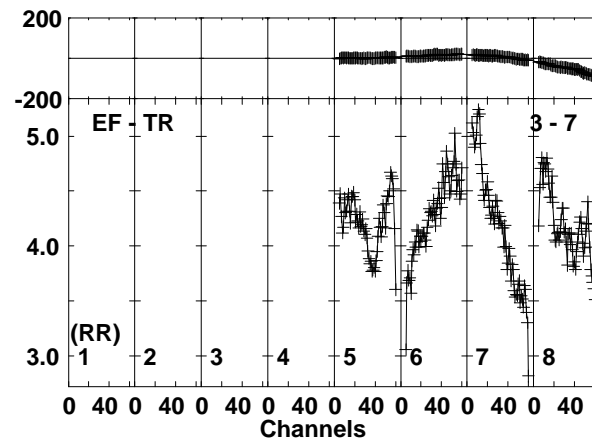
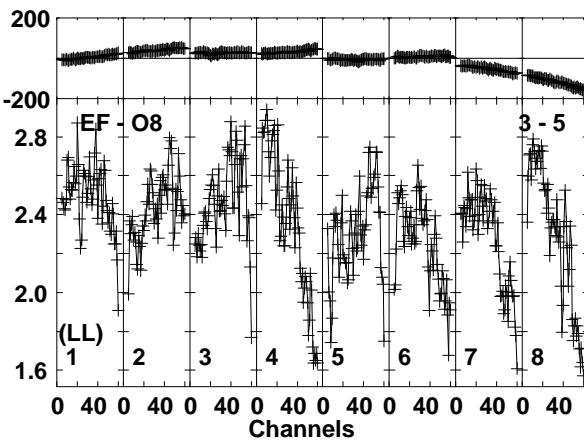
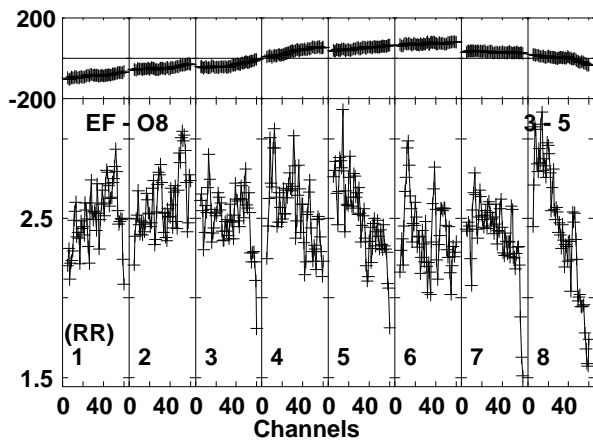
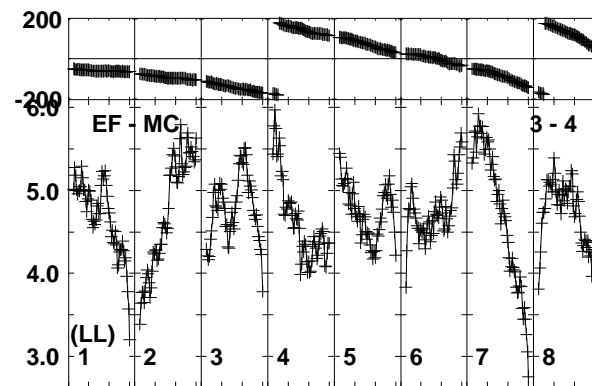
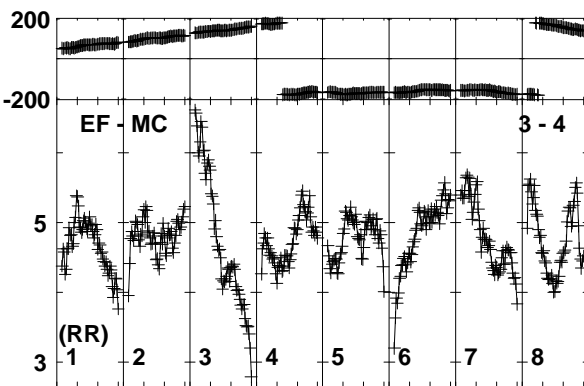
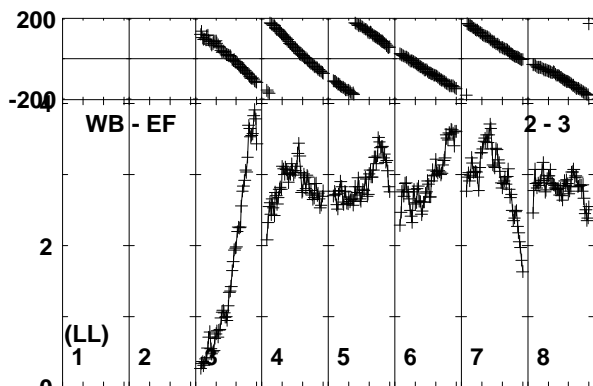
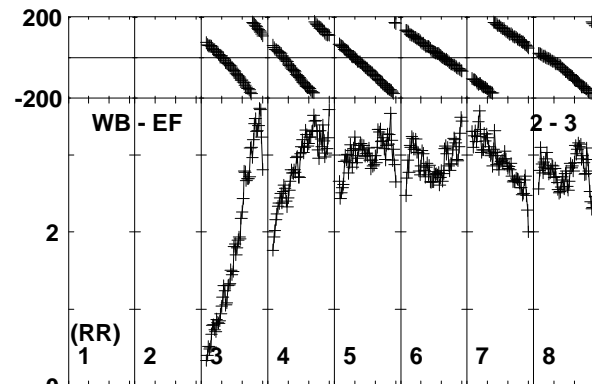
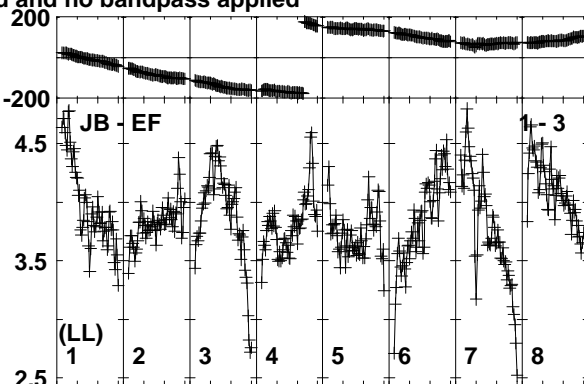
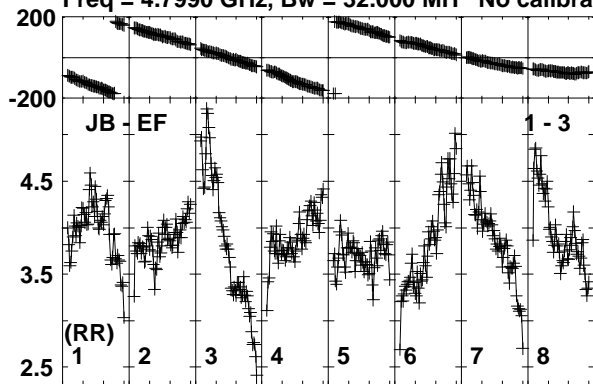

Lower frame: Milli Ampl Jy Top frame: Phas deg
Vector averaged cross-power spectrum Baseline: JB (01) - EF (03)
Timerange: 01/01:33:56 to 01/01:34:54

Plot file version 314 created 26-SEP-2019 10:41:22

J0257-1212 RG010A.UVDATA.1

Freq = 4.7990 GHz, Bw = 32.000 MH No calibration applied and no bandpass applied

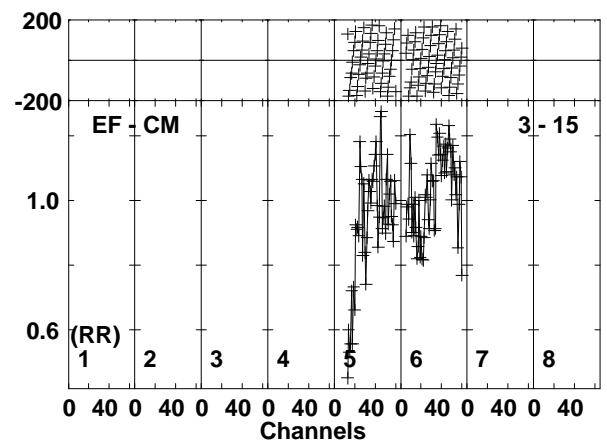
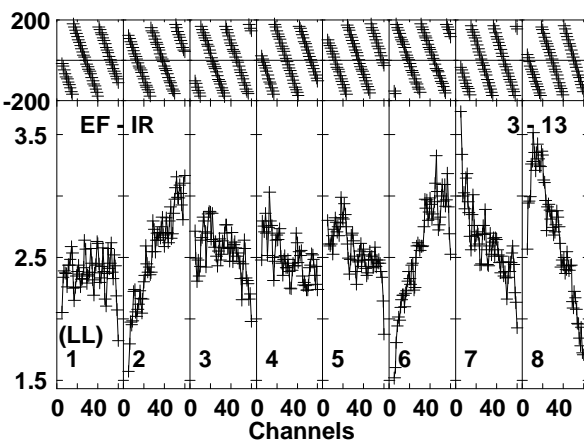
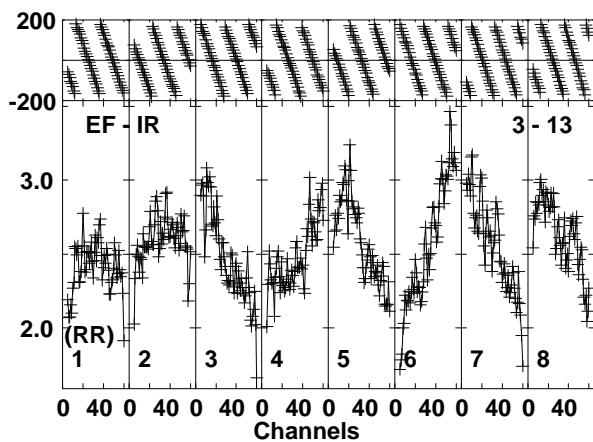
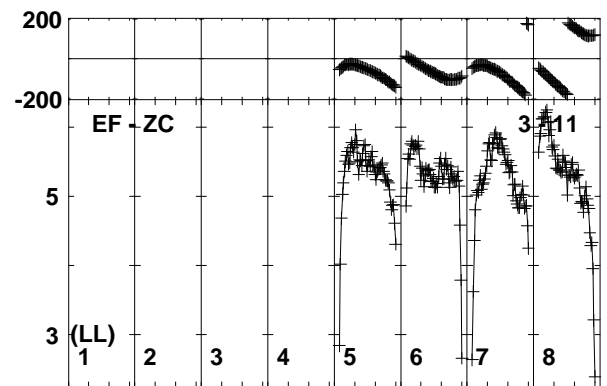
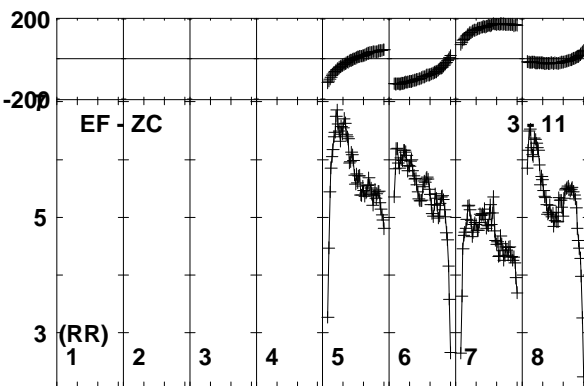
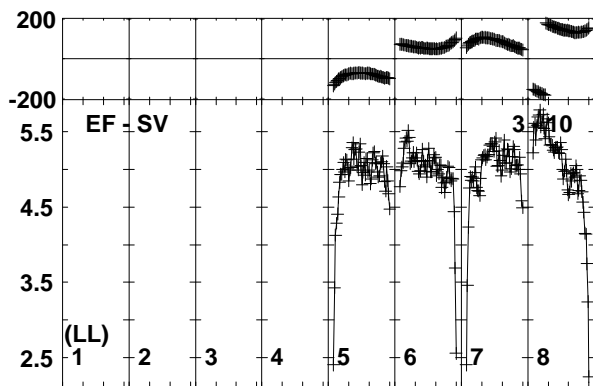
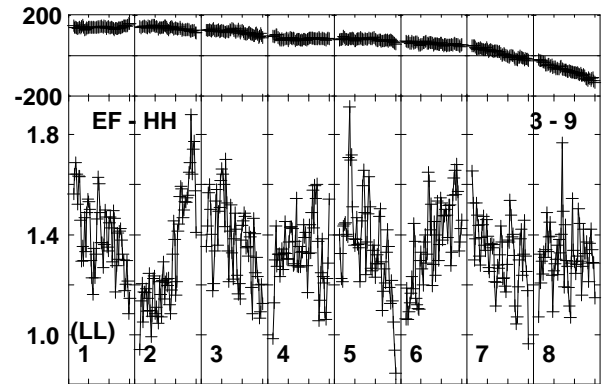
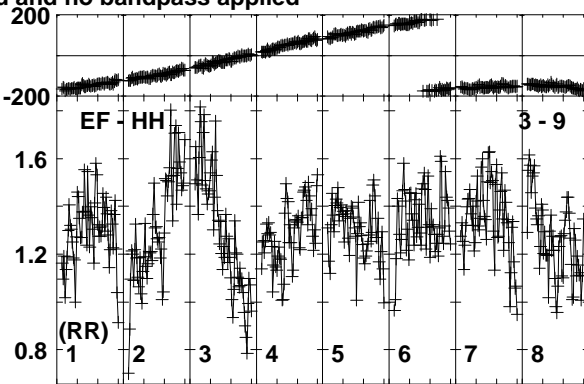
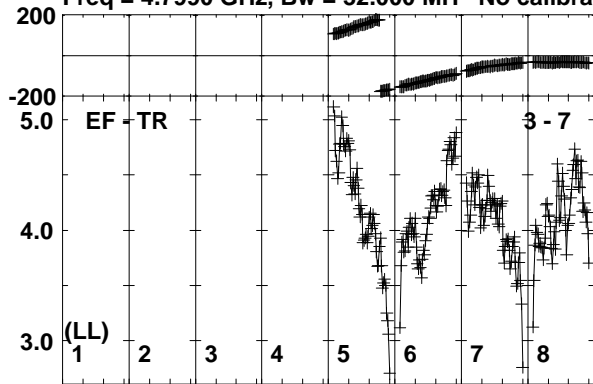

Lower frame: Milli Ampl Jy Top frame: Phas deg
Vector averaged cross-power spectrum Baseline: EF (03) - TR (07)
Timerange: 01/01:33:56 to 01/01:34:54

Plot file version 315 created 26-SEP-2019 10:41:23

J0257-1212 RG010A.UVDATA.1

Freq = 4.7990 GHz, Bw = 32.000 MH No calibration applied and no bandpass applied

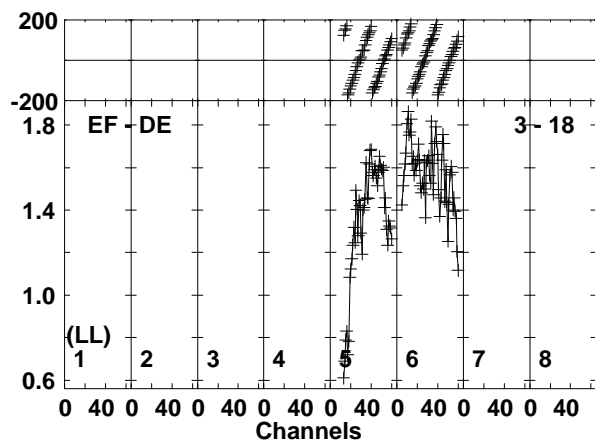
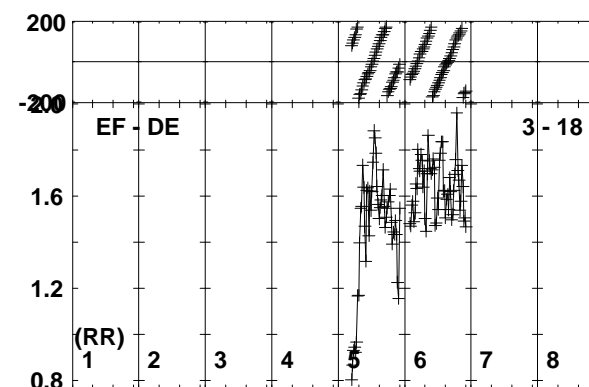
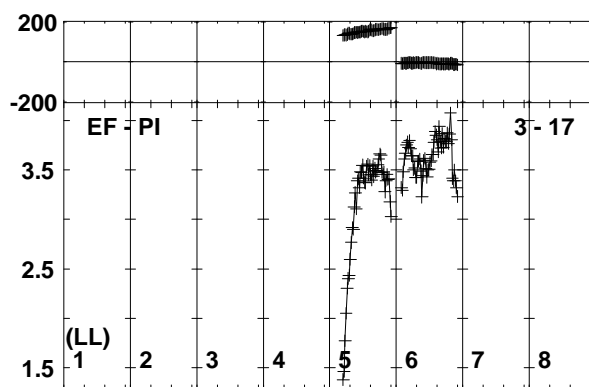
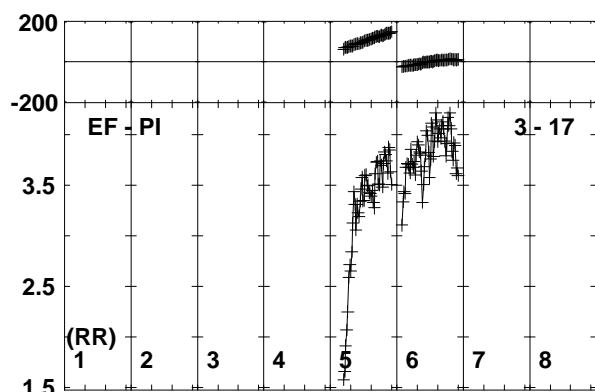
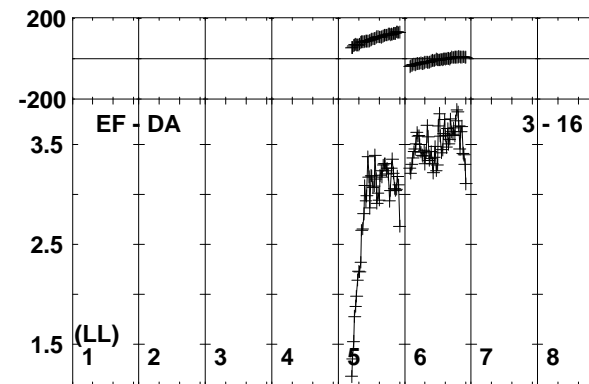
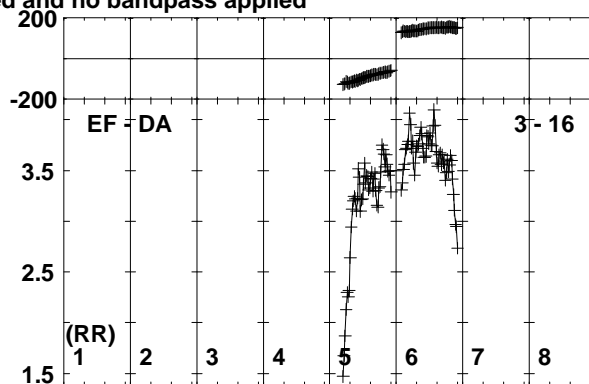
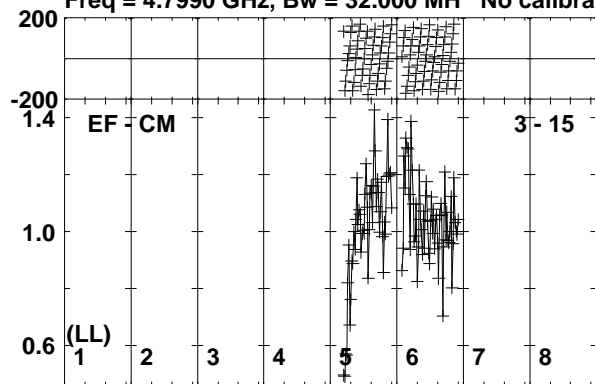

Lower frame: Milli Ampl Jy Top frame: Phas deg
Vector averaged cross-power spectrum Baseline: EF (03) - CM (15)
Timerange: 01/01:33:56 to 01/01:34:54

Plot file version 316 created 26-SEP-2019 10:41:23

190829A RG010A.UVDATA.1

Freq = 4.7990 GHz, Bw = 32.000 MH No calibration applied and no bandpass applied

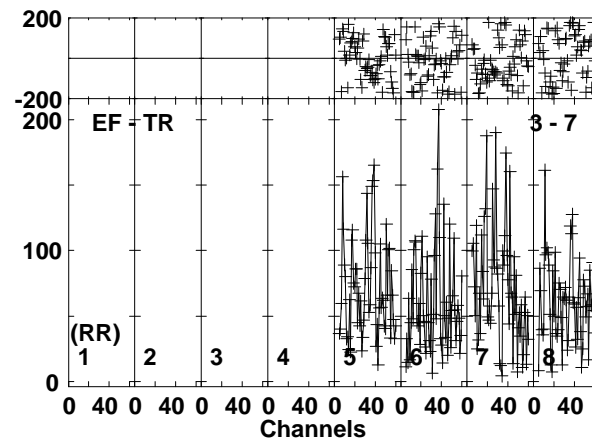
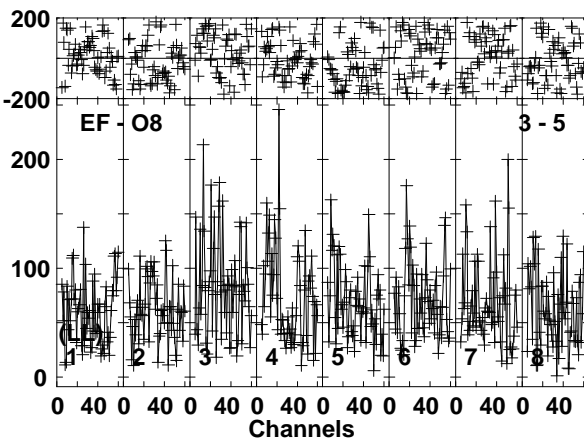
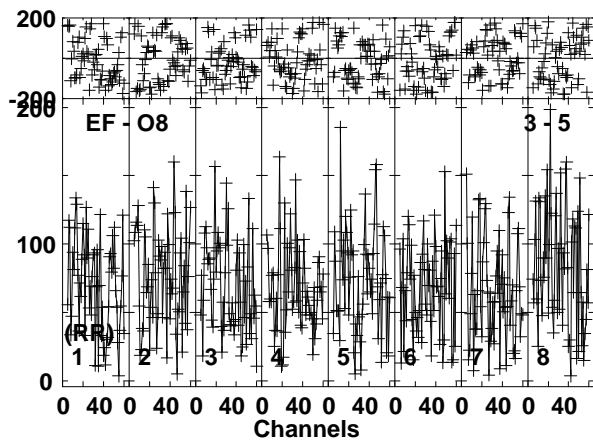
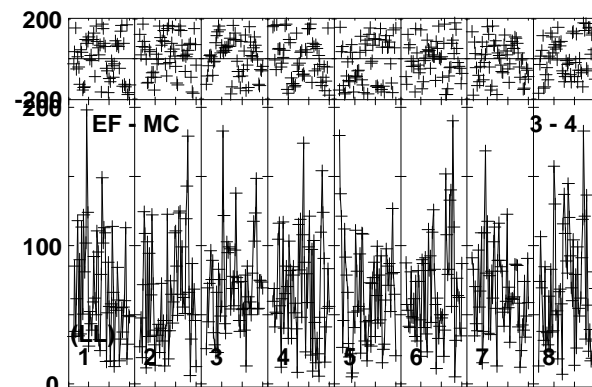
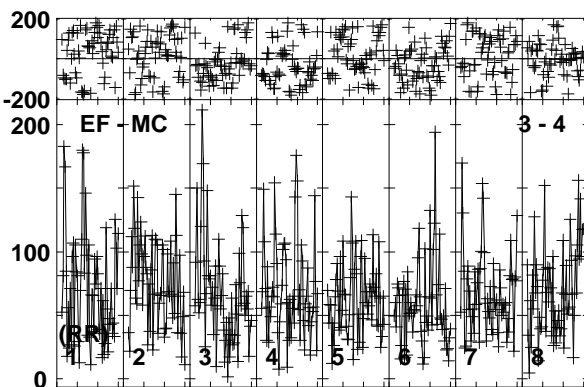
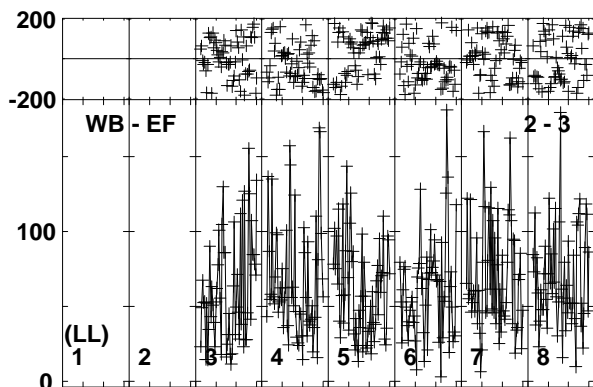
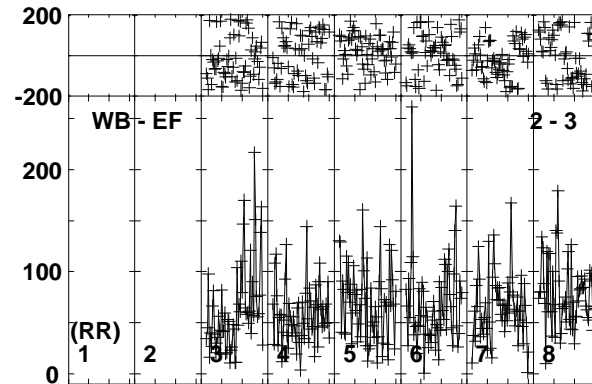
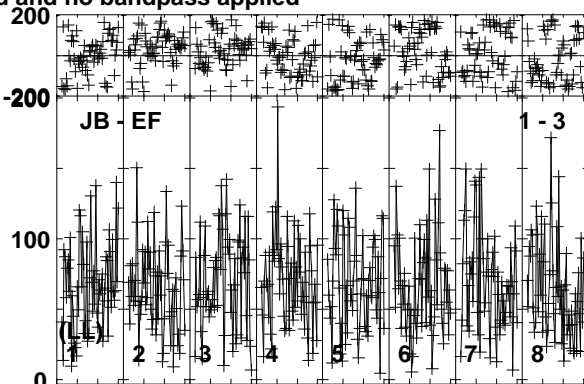
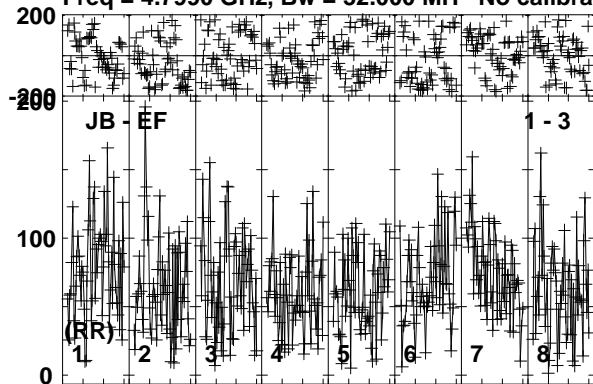

Lower frame: Micro Ampl Jy Top frame: Phas deg
Vector averaged cross-power spectrum Baseline: JB (01) - EF (03)
Timerange: 01/01:34:55 to 01/01:39:54

Plot file version 317 created 26-SEP-2019 10:41:24
190829A RG010A.UVDATA.1
Freq = 4.7990 GHz, Bw = 32.000 MH No calibration applied and no bandpass applied

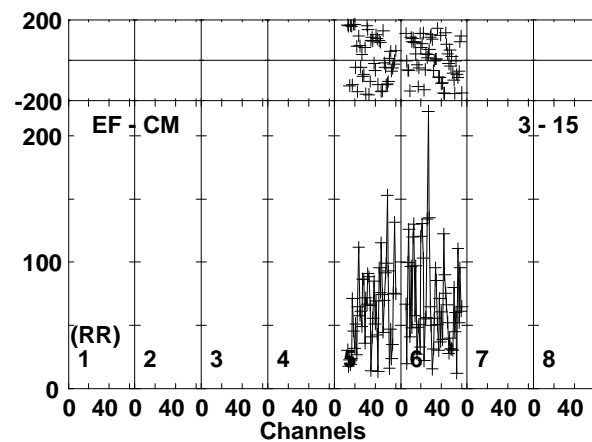
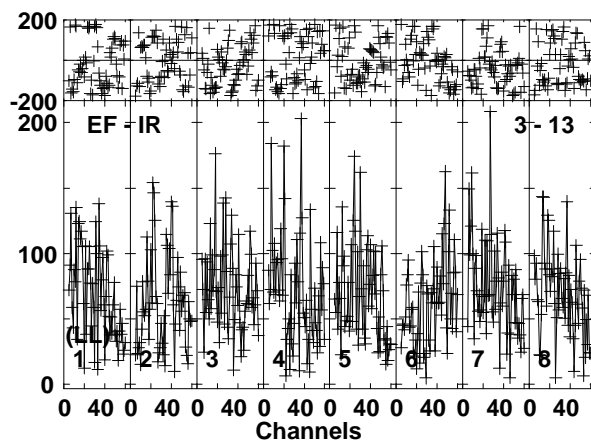
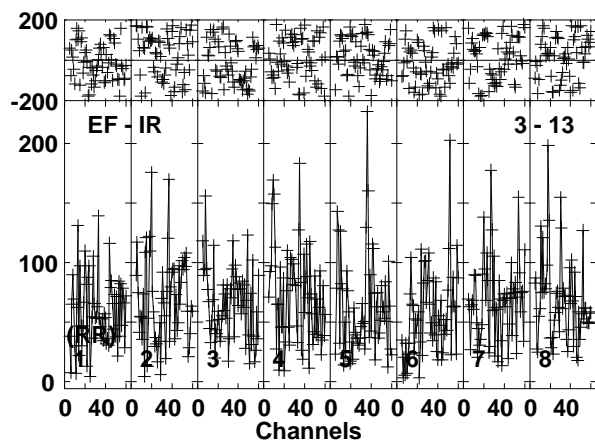
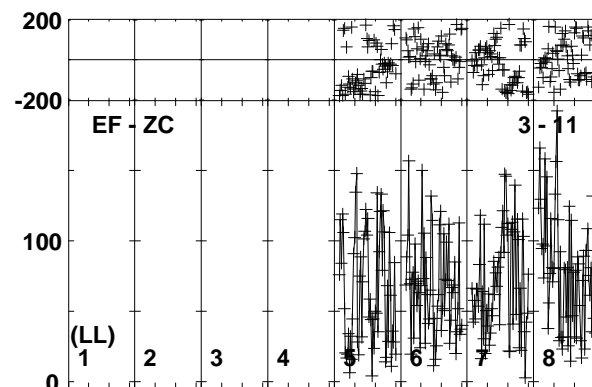
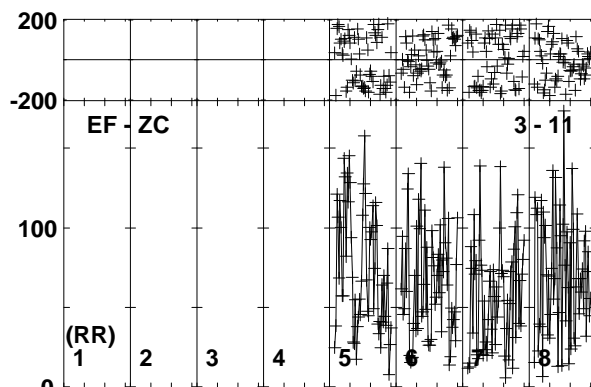
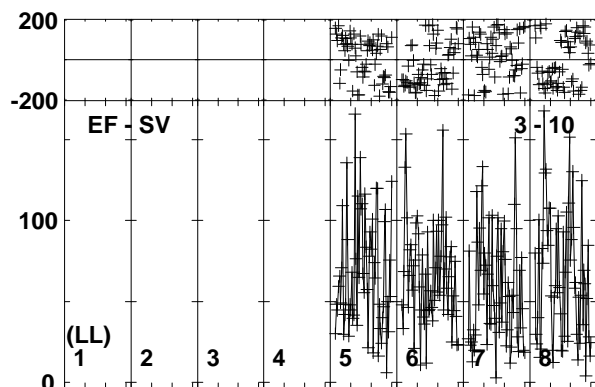
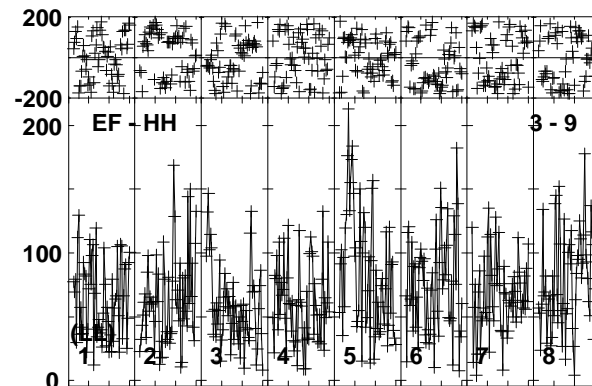
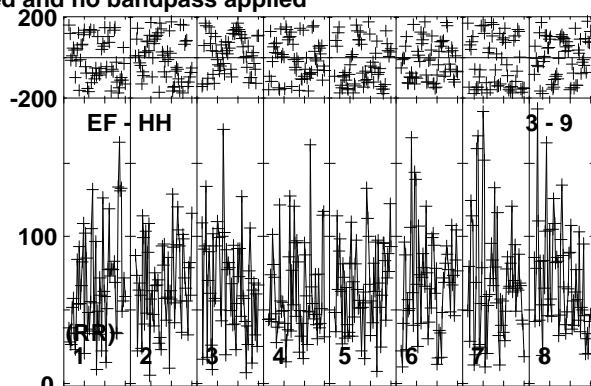
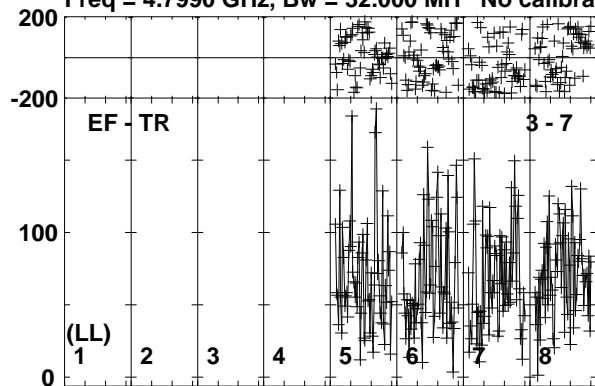

Lower frame: Micro Ampl Jy Top frame: Phas deg
Vector averaged cross-power spectrum Baseline: EF (03) - TR (07)
Timerange: 01/01:34:55 to 01/01:39:54

Plot file version 318 created 26-SEP-2019 10:41:25

190829A RG010A.UVDATA.1

Freq = 4.7990 GHz, Bw = 32.000 MH No calibration applied and no bandpass applied

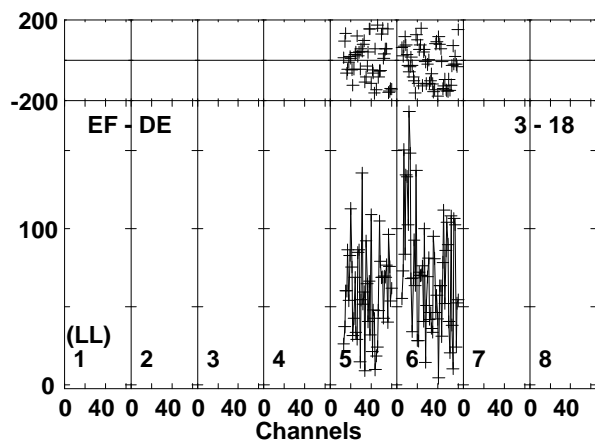
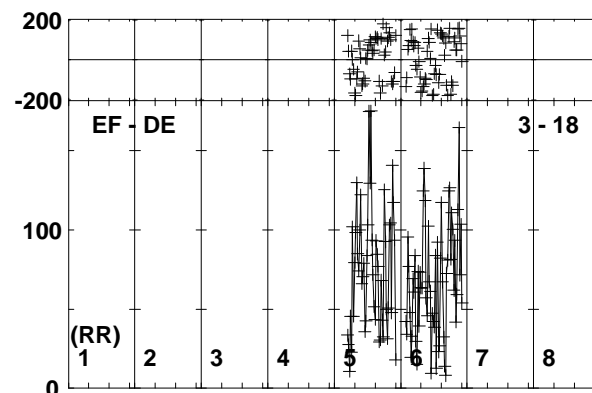
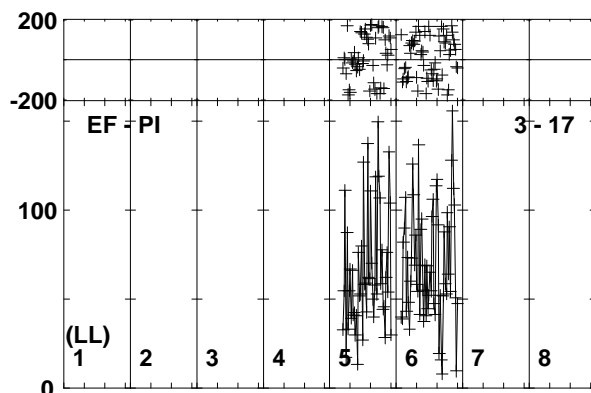
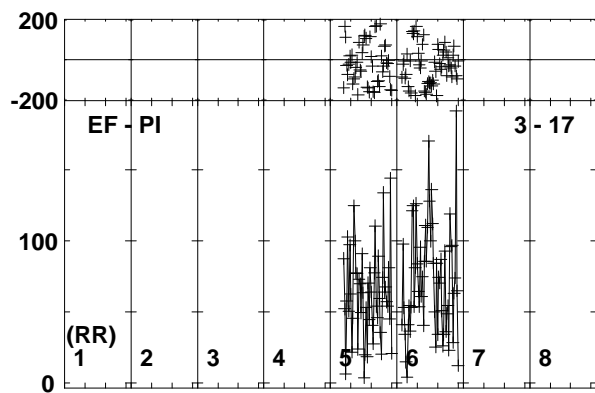
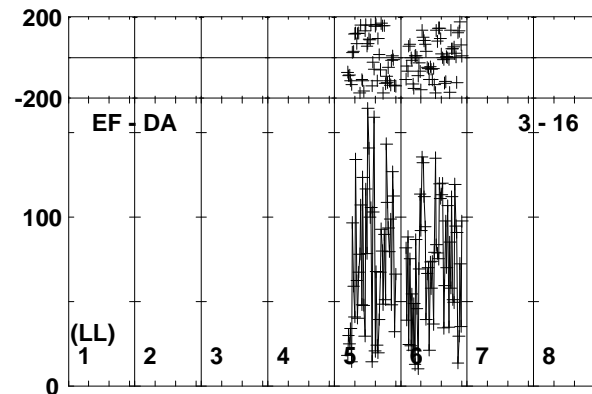
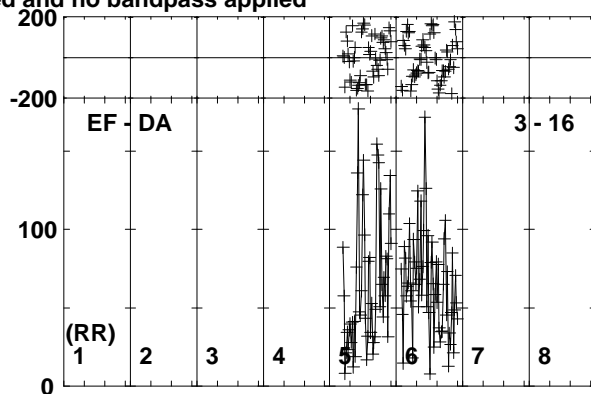
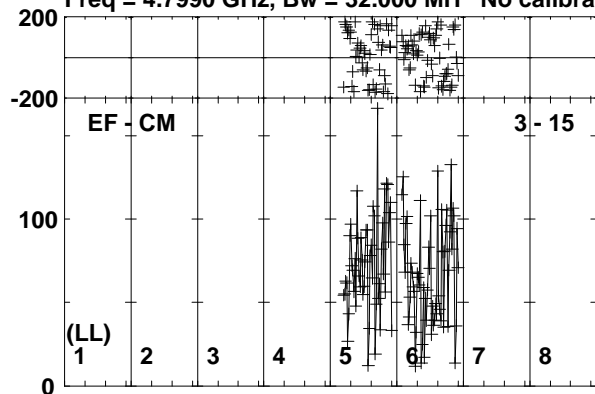

Lower frame: Micro Ampl Jy Top frame: Phas deg
Vector averaged cross-power spectrum Baseline: EF (03) - CM (15)
Timerange: 01/01:34:55 to 01/01:39:54

Plot file version 319 created 26-SEP-2019 10:41:25

J0257-1212 RG010A.UVDATA.1

Freq = 4.7990 GHz, Bw = 32.000 MH No calibration applied and no bandpass applied

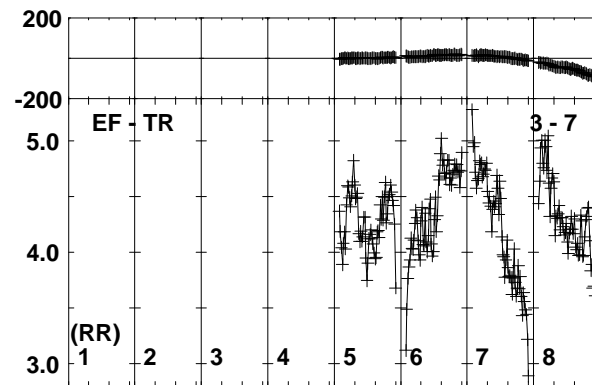
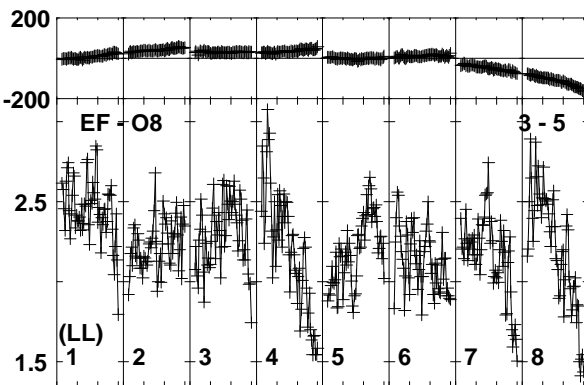
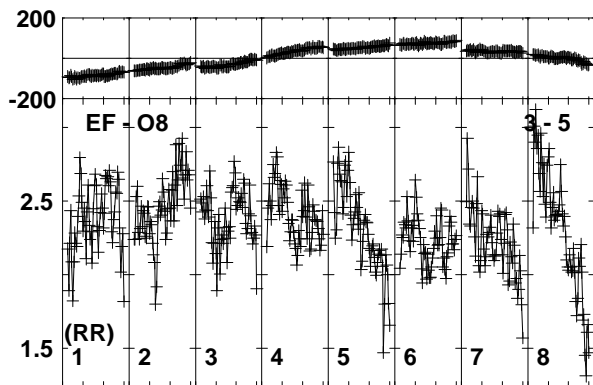
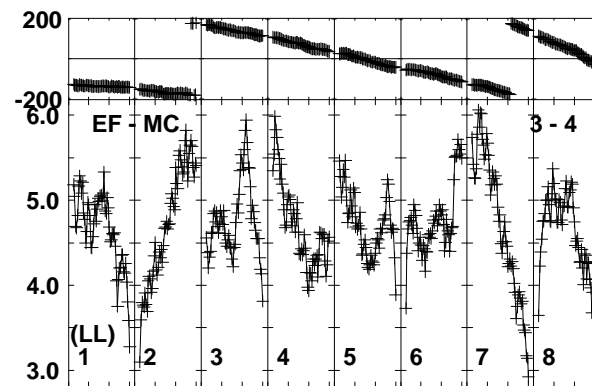
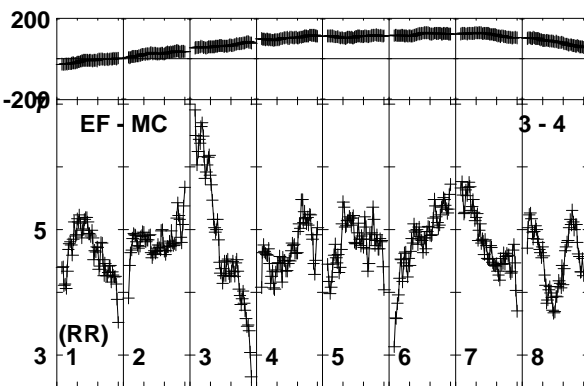
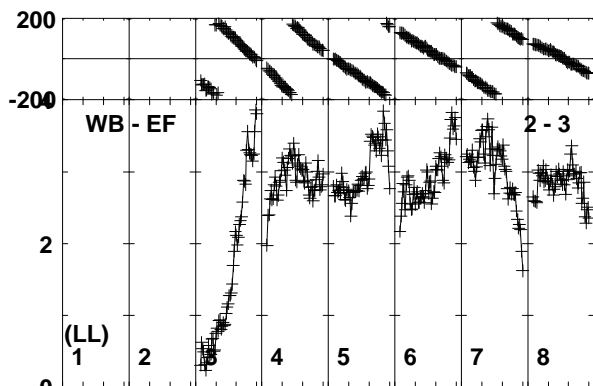
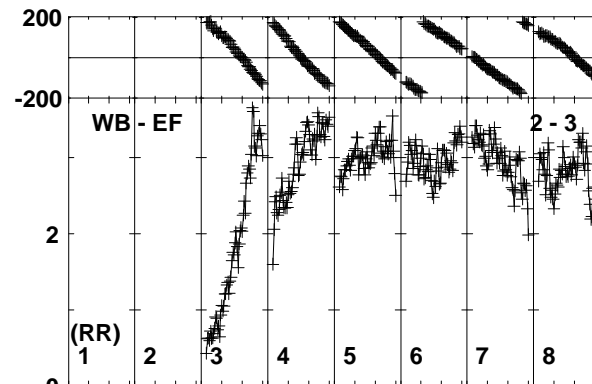
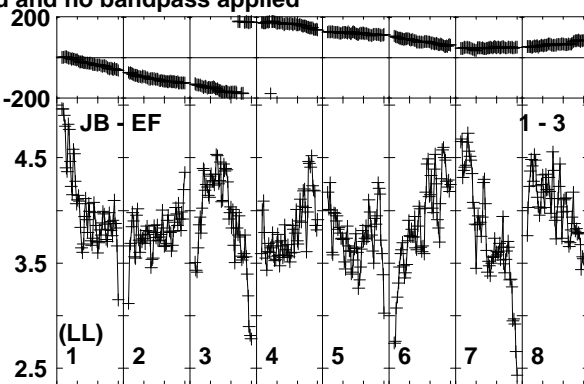
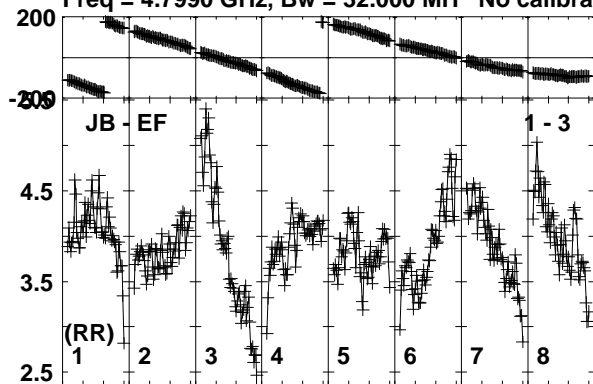

Lower frame: Milli Ampl Jy Top frame: Phas deg

Vector averaged cross-power spectrum Baseline: JB (01) - EF (03)

Timerange: 01/01:40:46 to 01/01:41:15

Plot file version 320 created 26-SEP-2019 10:41:26

J0257-1212 RG010A.UVDATA.1

Freq = 4.7990 GHz, Bw = 32.000 MH No calibration applied and no bandpass applied

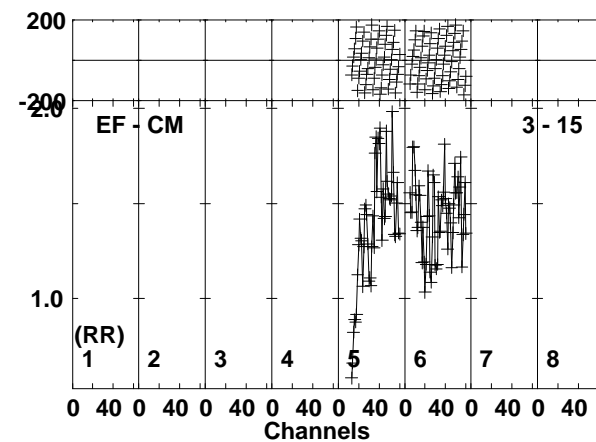
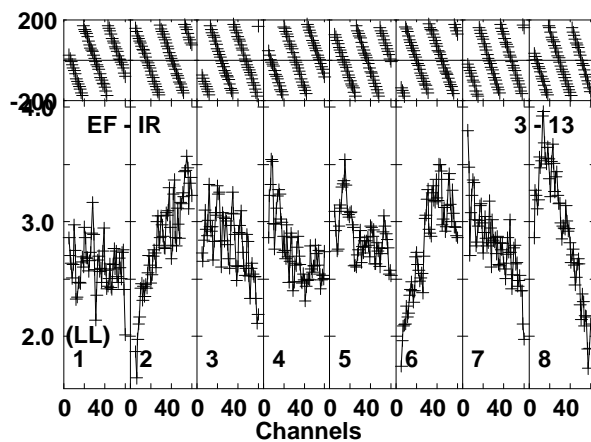
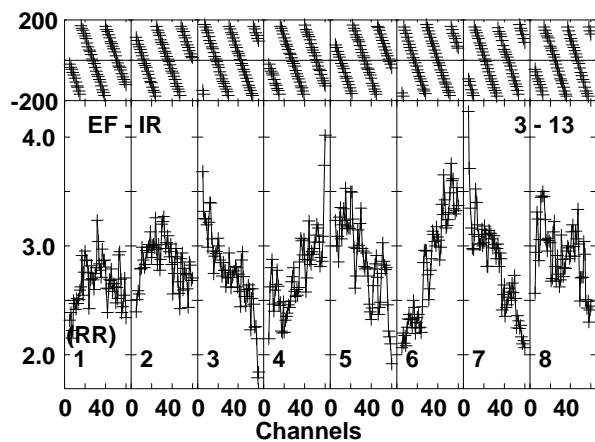
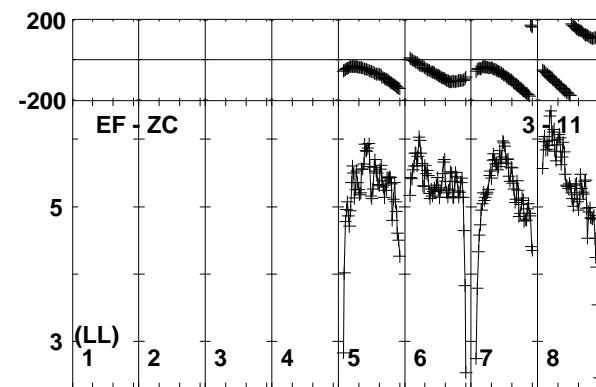
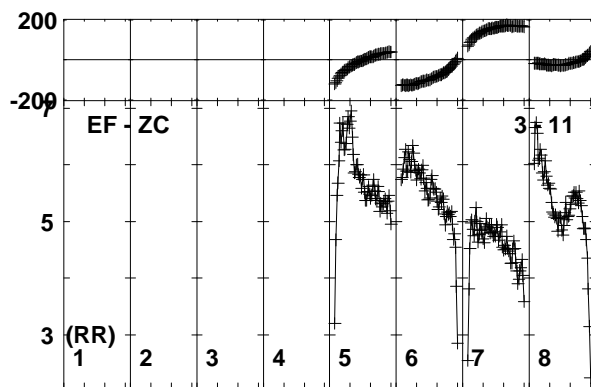
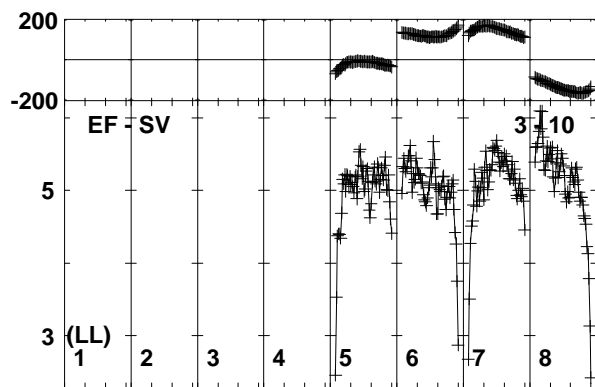
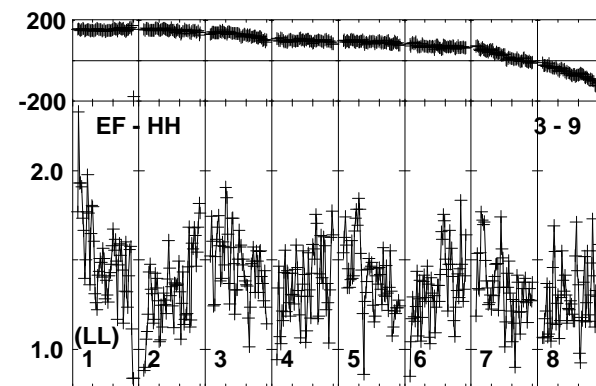
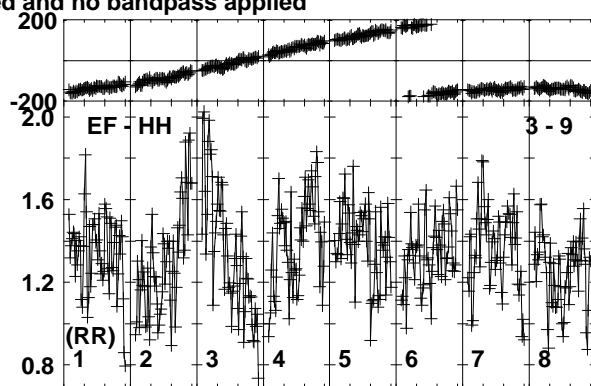
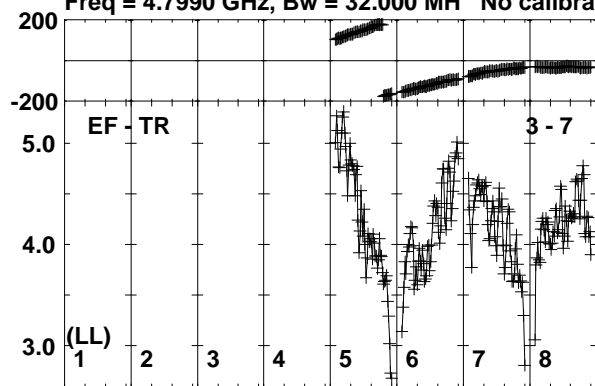

Lower frame: Milli Ampl Jy Top frame: Phas deg
Vector averaged cross-power spectrum Baseline: EF (03) - TR (07)
Timerange: 01/01:40:46 to 01/01:41:15

Plot file version 321 created 26-SEP-2019 10:41:26

J0257-1212 RG010A.UVDATA.1

Freq = 4.7990 GHz, Bw = 32.000 MH No calibration applied and no bandpass applied

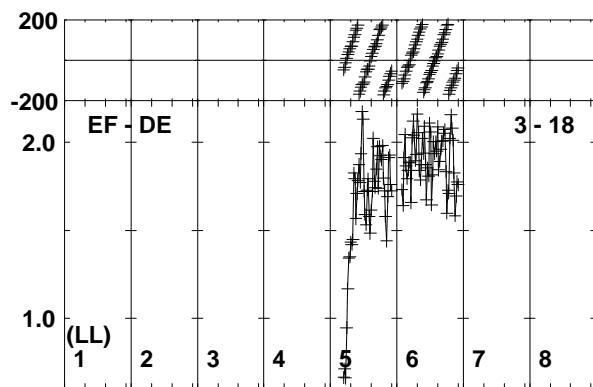
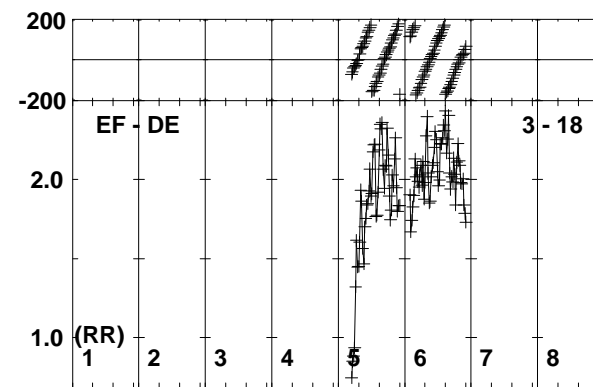
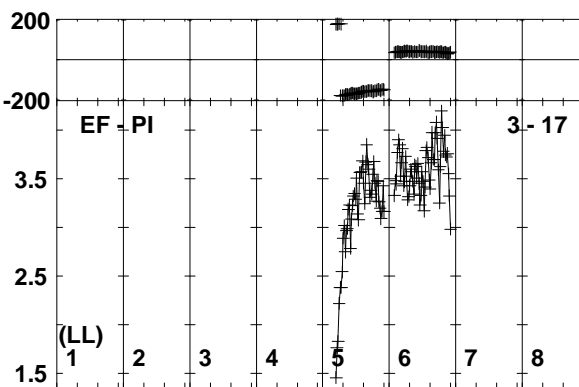
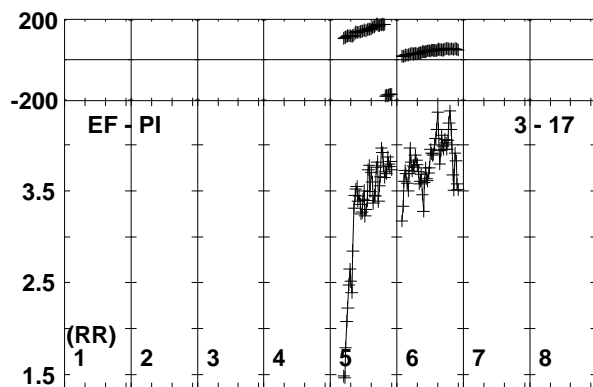
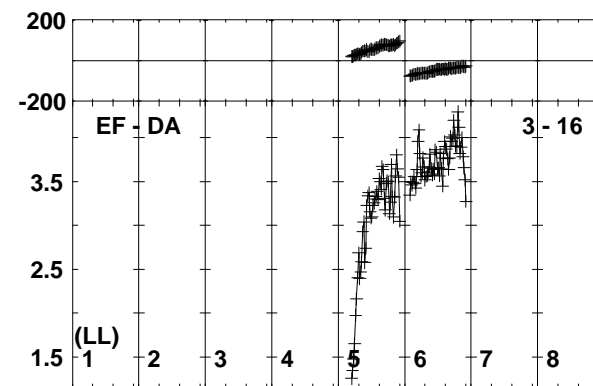
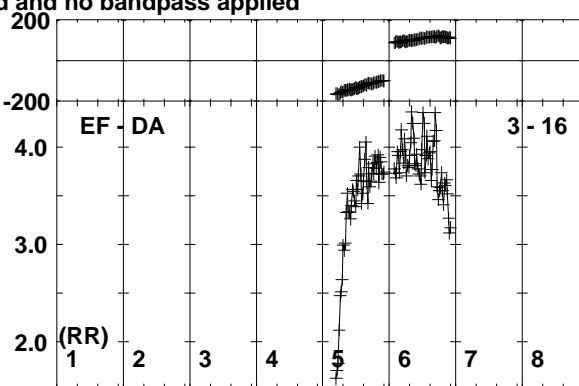
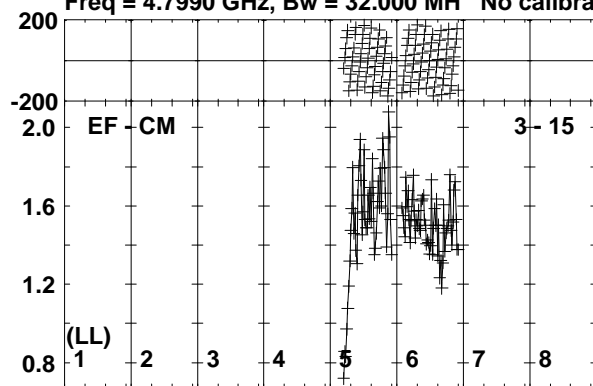

0 40 0 40 0 40 0 40 0 40 0 40 0 40 0 40 0 40 0 40
Channels

Lower frame: Milli Ampl Jy Top frame: Phas deg
Vector averaged cross-power spectrum Baseline: EF (03) - CM (15)
Timerange: 01/01:40:46 to 01/01:41:15

Plot file version 322 created 26-SEP-2019 10:41:26

J0300-0846 RG010A.UVDATA.1

Freq = 4.7990 GHz, Bw = 32.000 MH No calibration applied and no bandpass applied

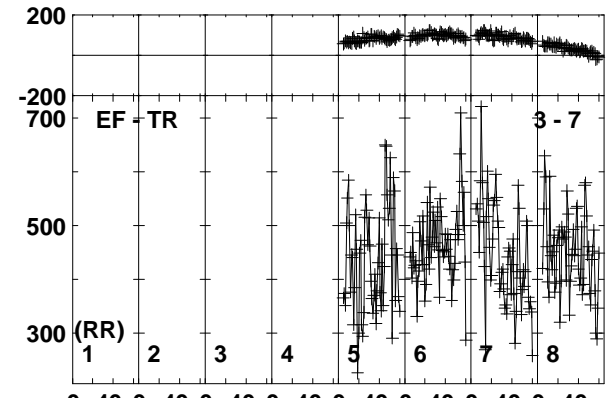
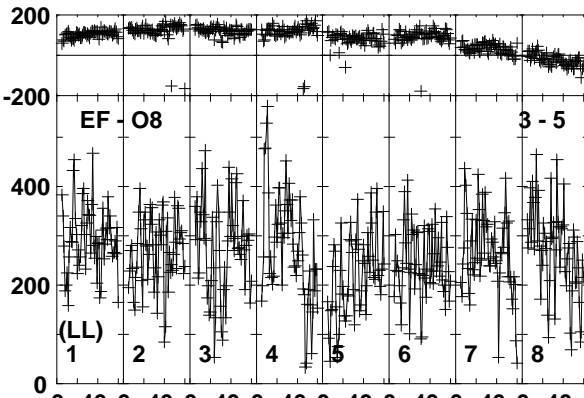
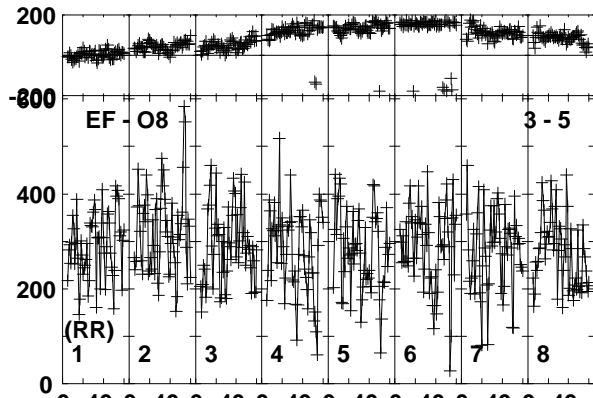
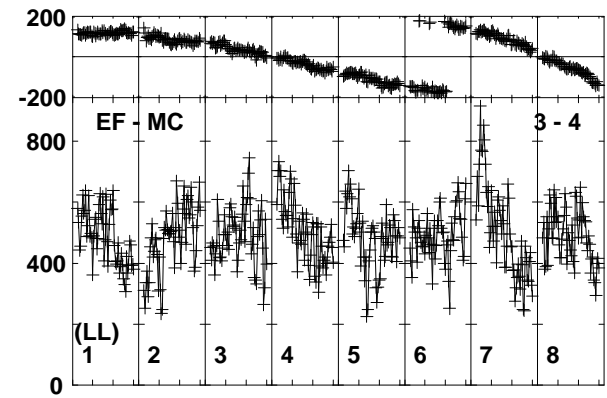
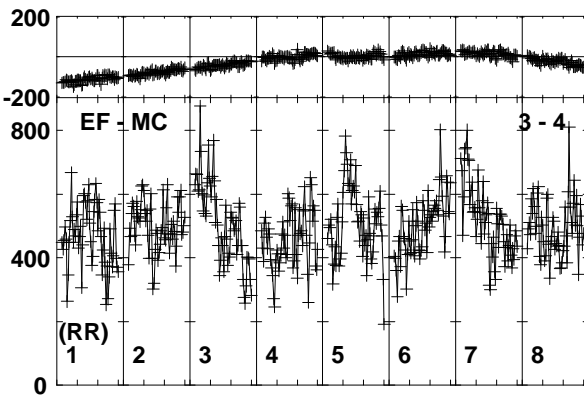
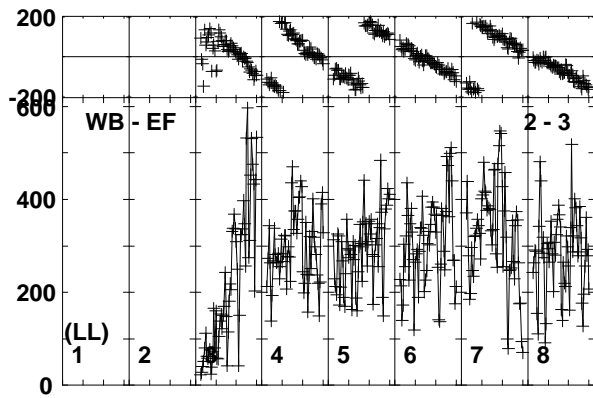
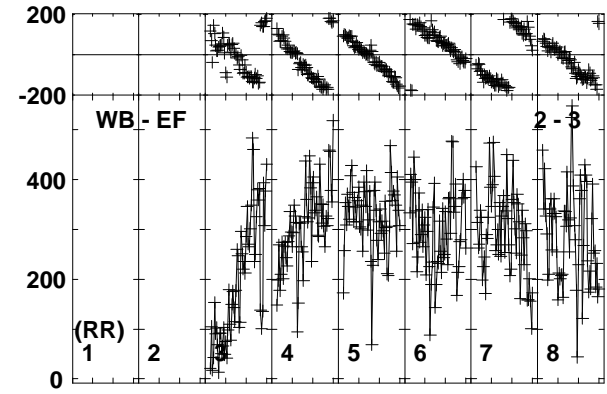
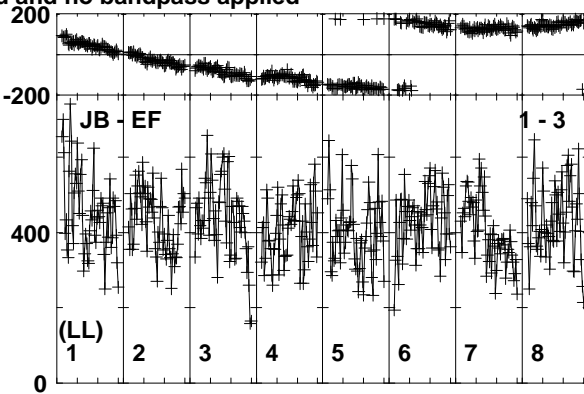
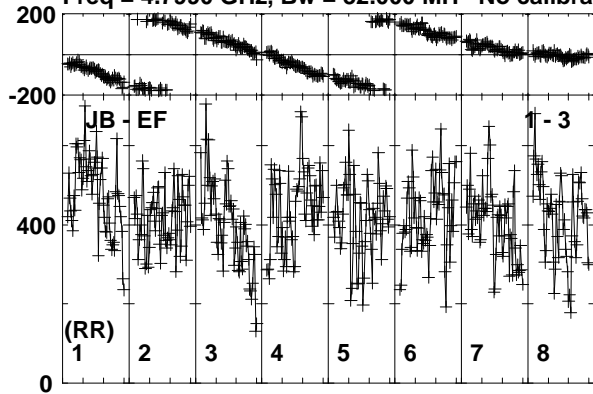

Lower frame: Micro Ampl Jy Top frame: Phas deg
Vector averaged cross-power spectrum Baseline: JB (01) - EF (03)
Timerange: 01/01:41:16 to 01/01:43:44

Plot file version 323 created 26-SEP-2019 10:41:27

J0300-0846 RG010A.UVDATA.1

Freq = 4.7990 GHz, Bw = 32.000 MH No calibration applied and no bandpass applied

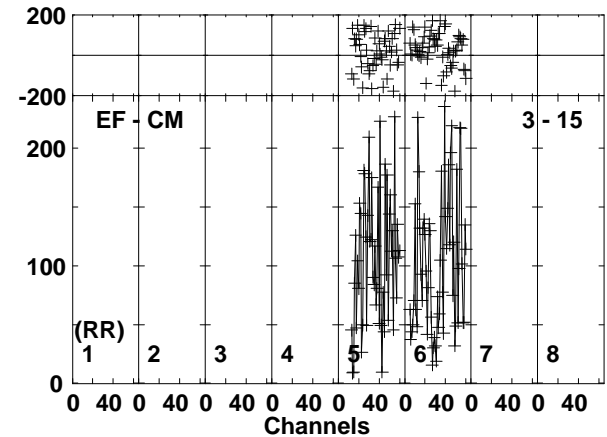
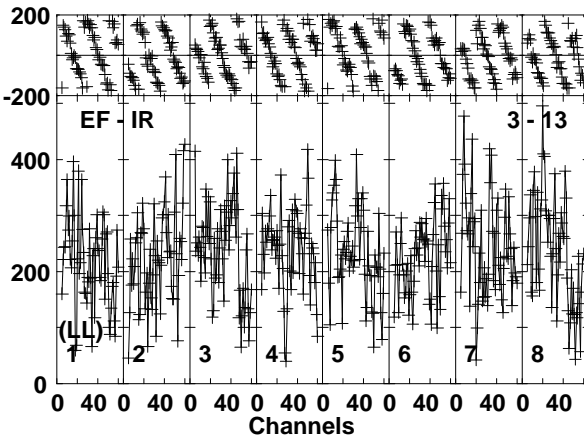
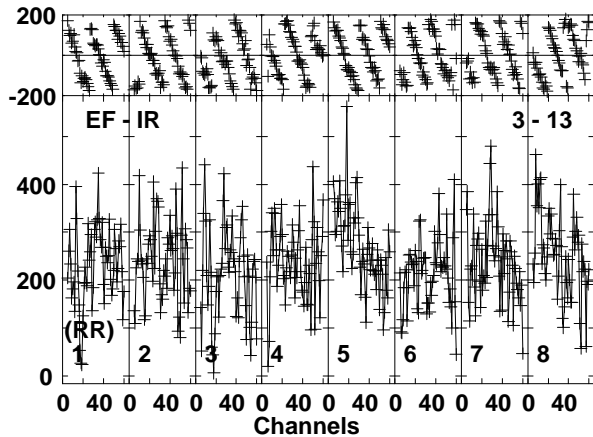
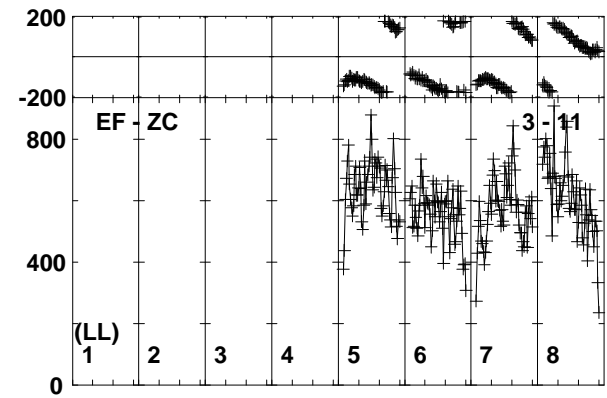
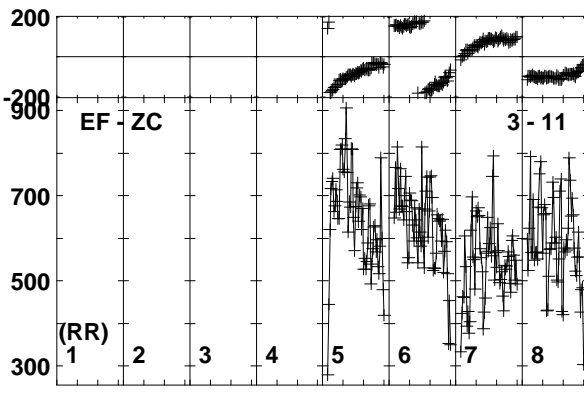
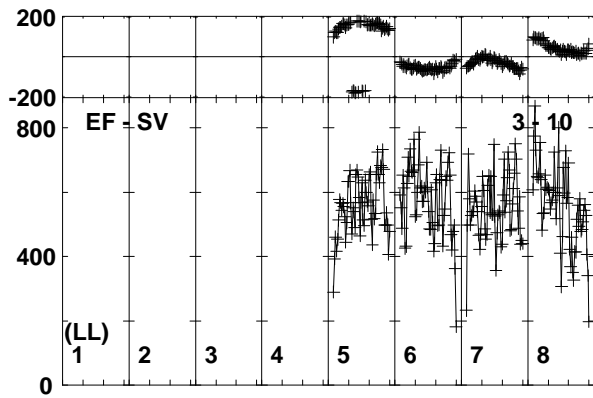
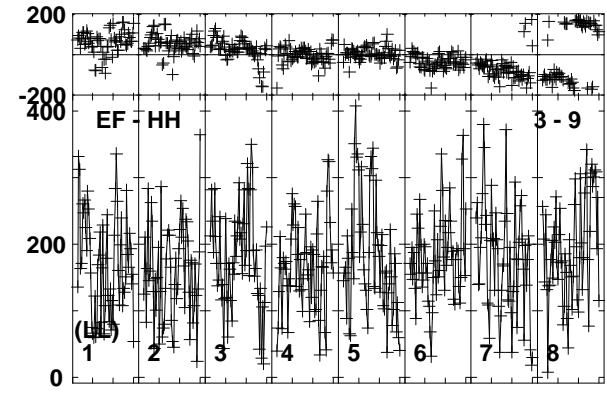
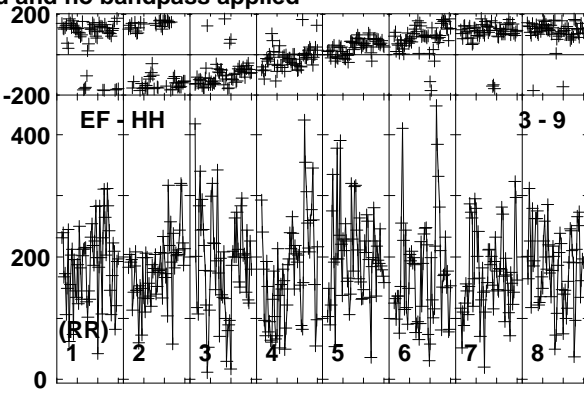
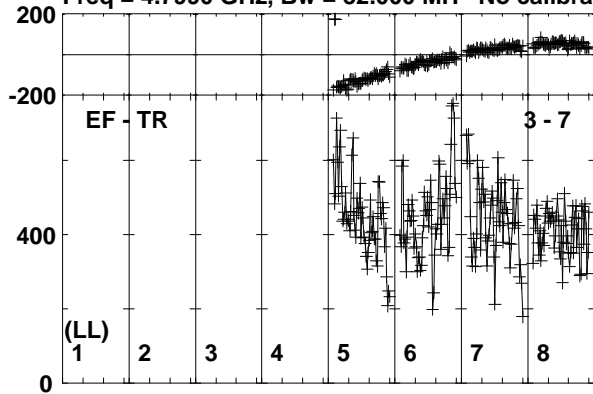

Lower frame: Micro Ampl Jy Top frame: Phas deg
Vector averaged cross-power spectrum Baseline: EF (03) - TR (07)
Timerange: 01/01:41:16 to 01/01:43:44

Plot file version 324 created 26-SEP-2019 10:41:28

J0300-0846 RG010A.UVDATA.1

Freq = 4.7990 GHz, Bw = 32.000 MH No calibration applied and no bandpass applied

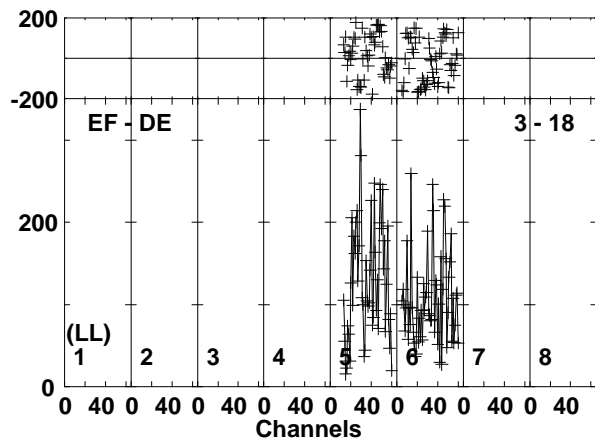
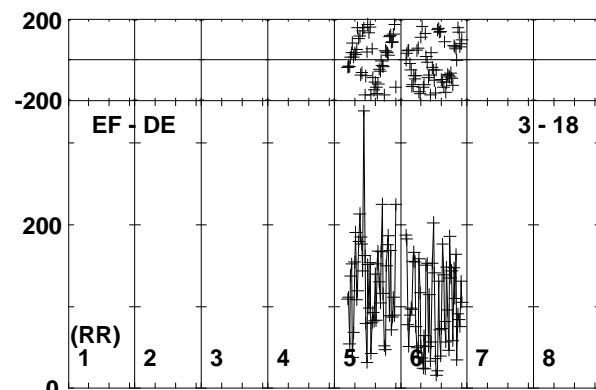
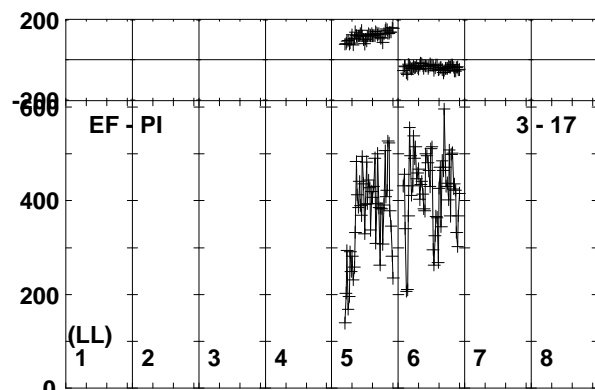
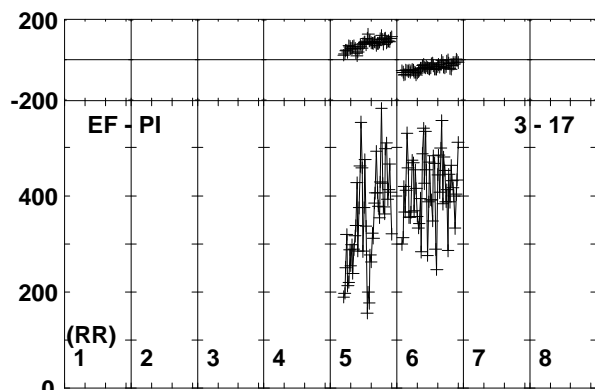
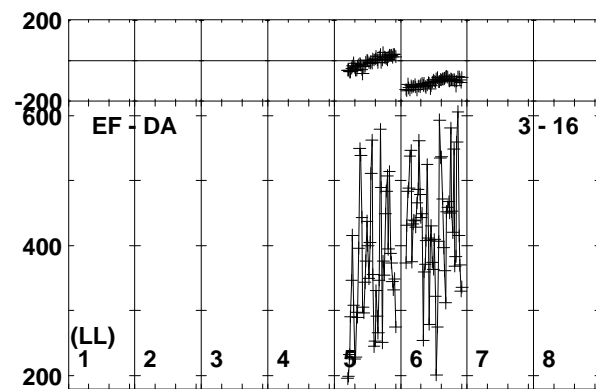
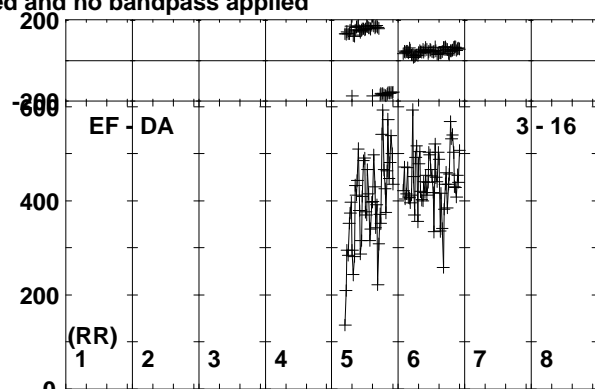
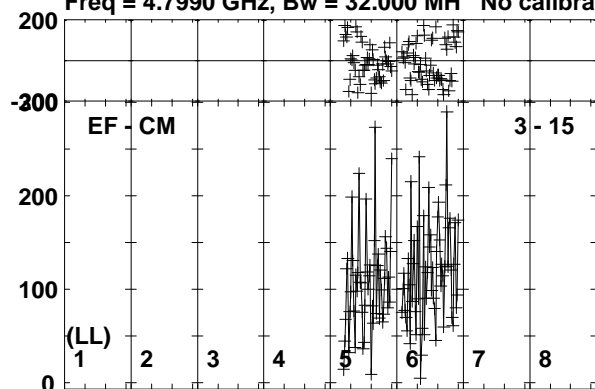

Lower frame: Micro Ampl Jy Top frame: Phas deg
Vector averaged cross-power spectrum Baseline: EF (03) - CM (15)
Timerange: 01/01:41:16 to 01/01:43:44

Plot file version 325 created 26-SEP-2019 10:41:28

190829A RG010A.UVDATA.1

Freq = 4.7990 GHz, Bw = 32.000 MH No calibration applied and no bandpass applied

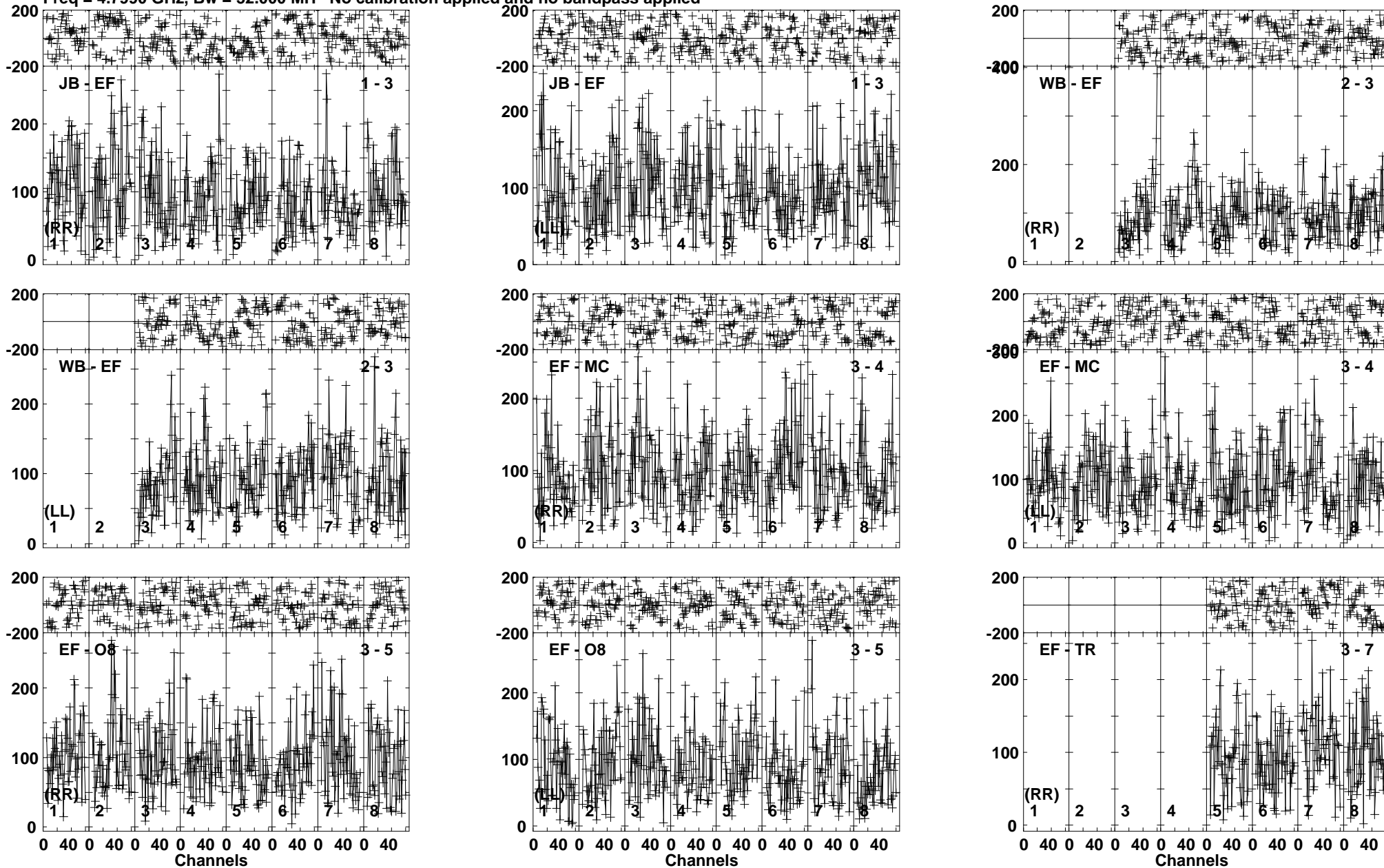

Lower frame: Micro Ampl Jy Top frame: Phas deg
Vector averaged cross-power spectrum Baseline: JB (01) - EF (03)
Timerange: 01/01:43:45 to 01/01:46:15

Plot file version 326 created 26-SEP-2019 10:41:29

190829A RG010A.UVDATA.1

Freq = 4.7990 GHz, Bw = 32.000 MH No calibration applied and no bandpass applied

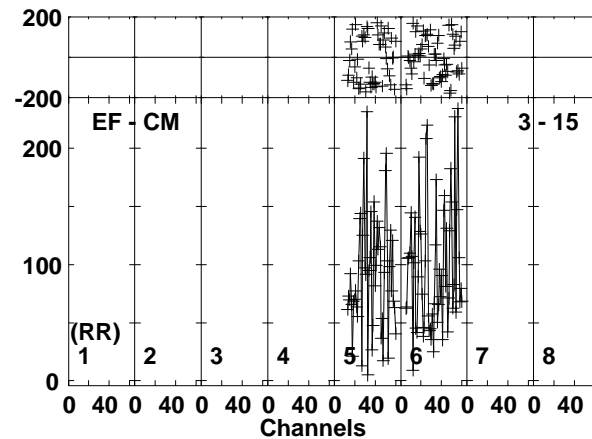
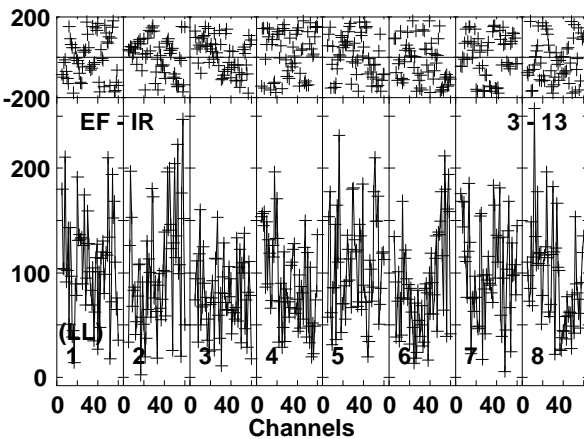
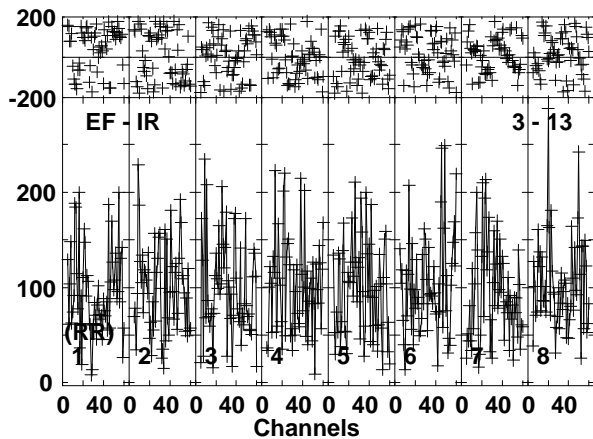
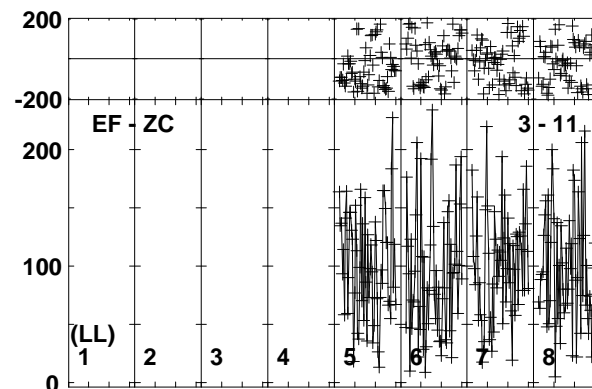
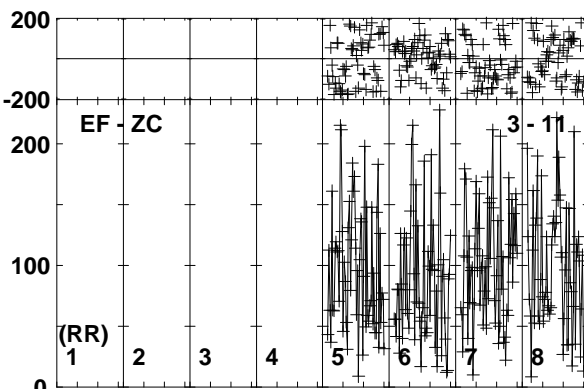
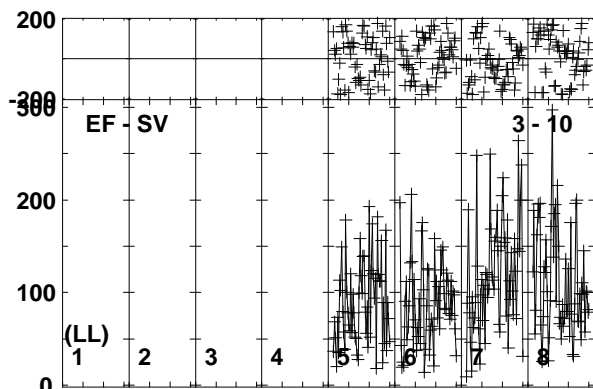
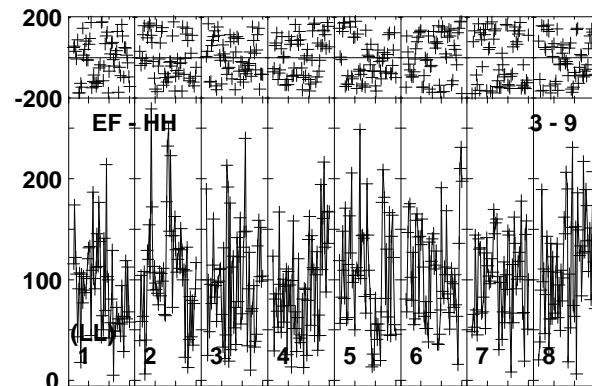
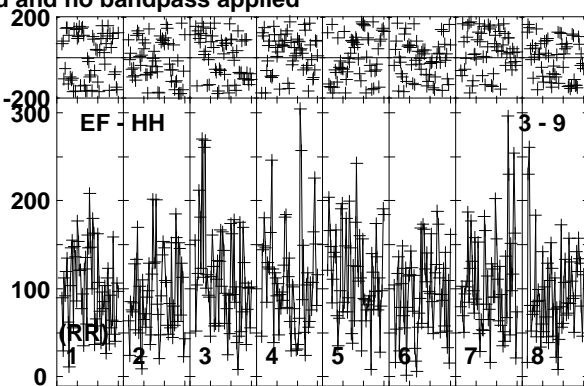
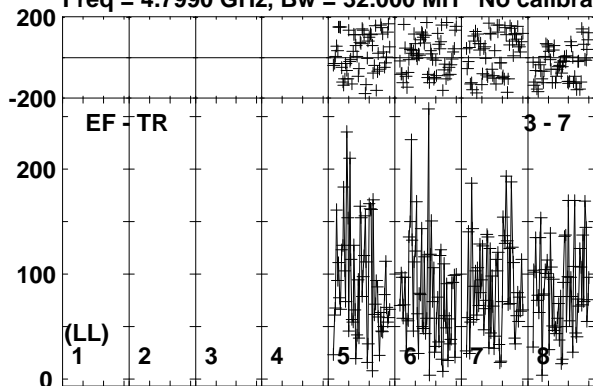

Lower frame: Micro Ampl Jy Top frame: Phas deg
Vector averaged cross-power spectrum Baseline: EF (03) - TR (07)
Timerange: 01/01:43:45 to 01/01:46:15

Plot file version 327 created 26-SEP-2019 10:41:29

190829A RG010A.UVDATA.1

Freq = 4.7990 GHz, Bw = 32.000 MH No calibration applied and no bandpass applied

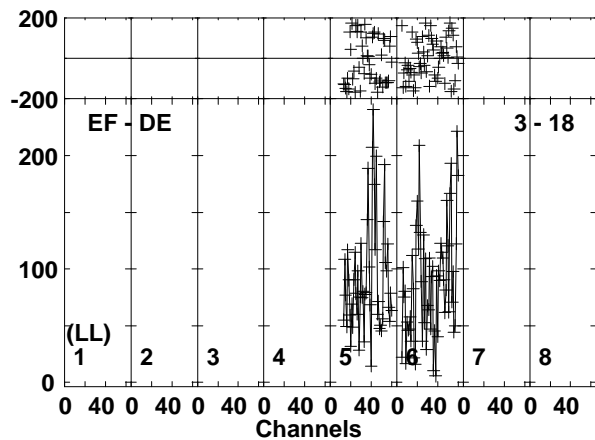
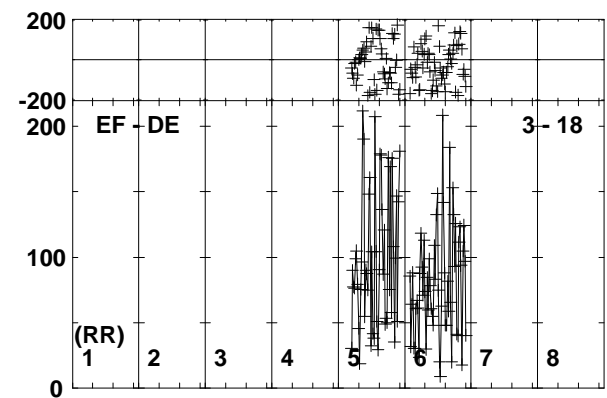
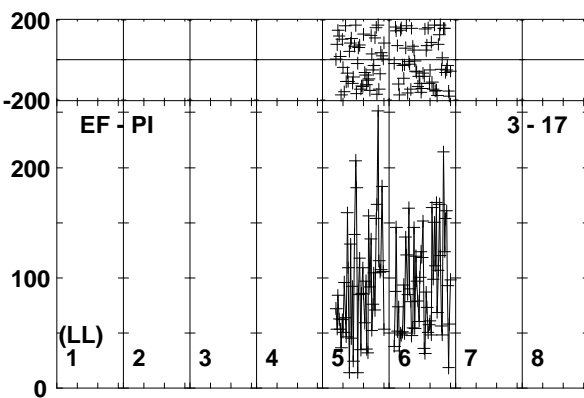
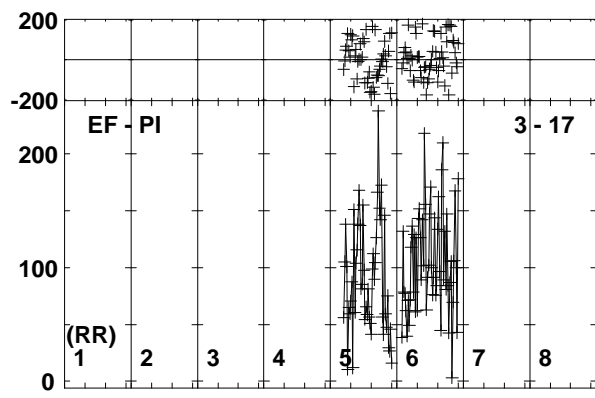
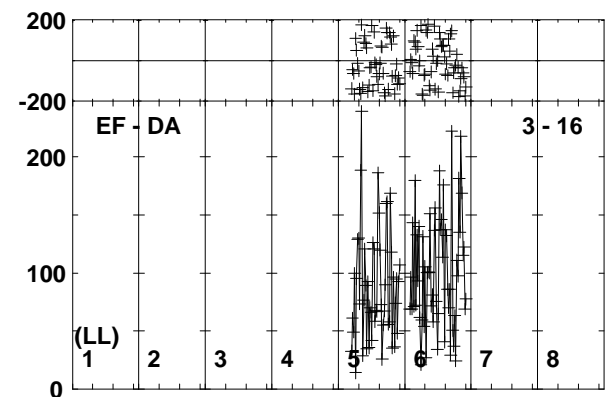
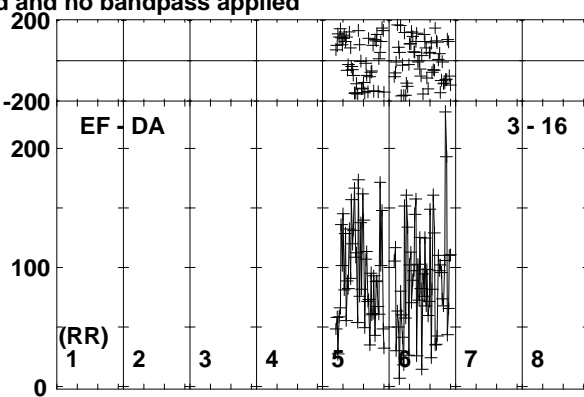
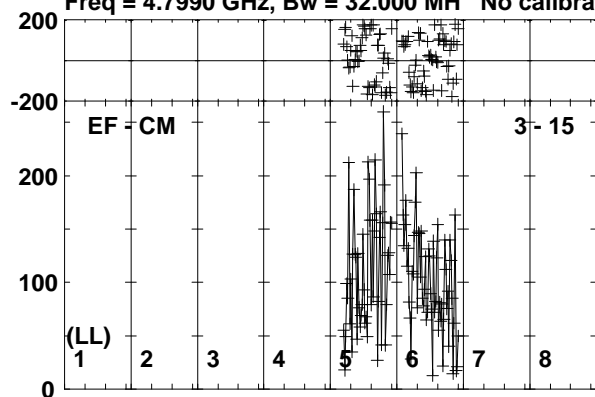

Lower frame: Micro Ampl Jy Top frame: Phas deg
Vector averaged cross-power spectrum Baseline: EF (03) - CM (15)
Timerange: 01/01:43:45 to 01/01:46:15

Plot file version 328 created 26-SEP-2019 10:41:30

J0257-1212 RG010A.UVDATA.1

Freq = 4.7990 GHz, Bw = 32.000 MH No calibration applied and no bandpass applied

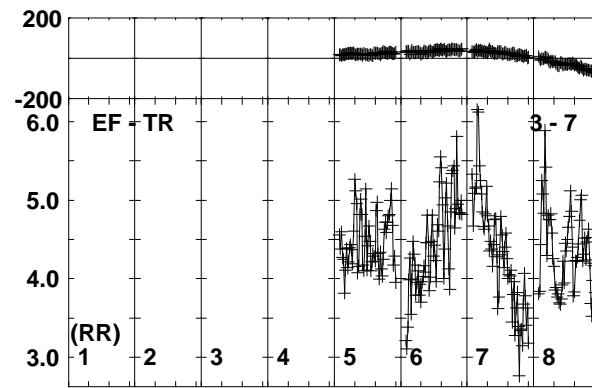
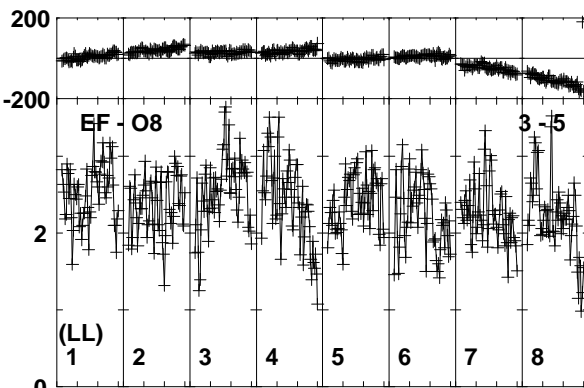
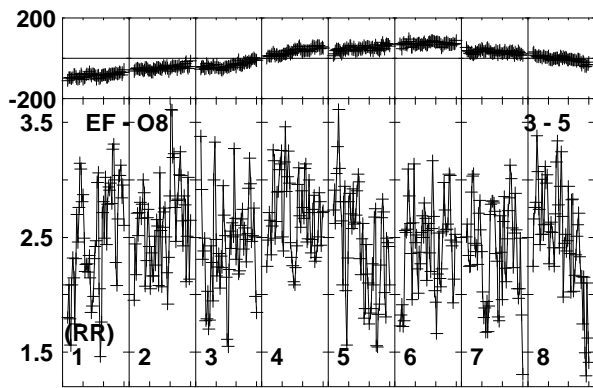
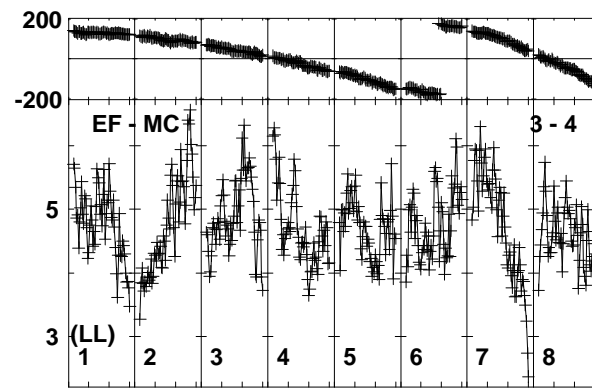
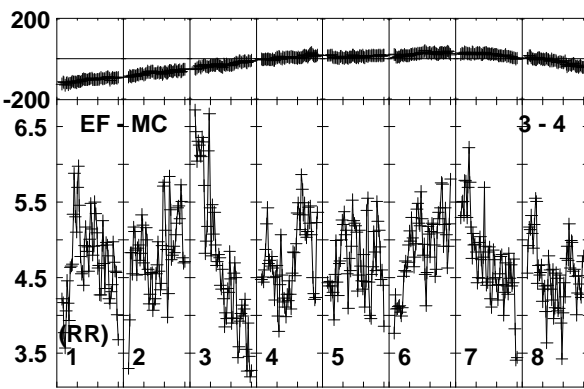
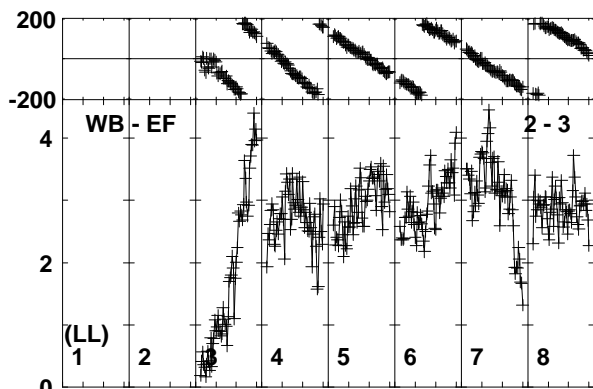
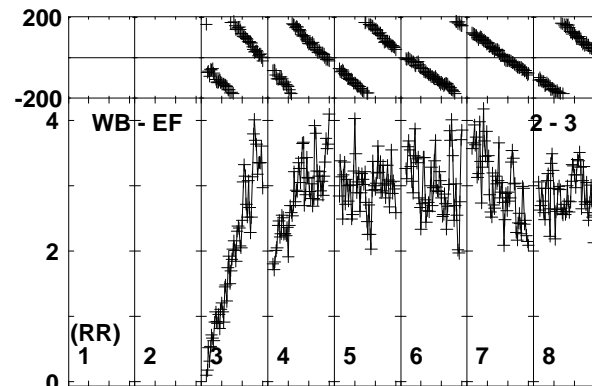
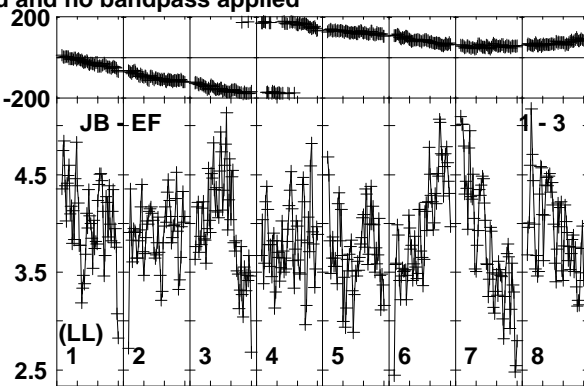
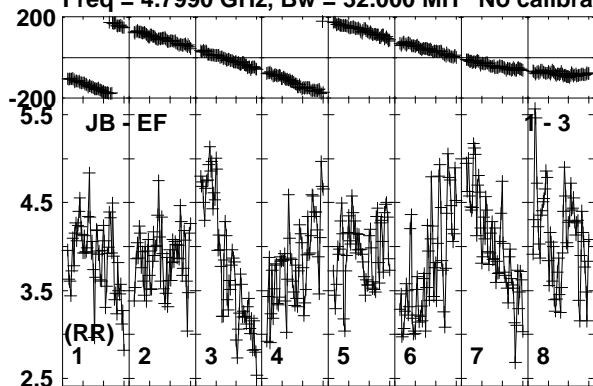

Lower frame: Milli Ampl Jy Top frame: Phas deg
Vector averaged cross-power spectrum Baseline: JB (01) - EF (03)
Timerange: 01/01:46:16 to 01/01:47:15

Plot file version 329 created 26-SEP-2019 10:41:30

J0257-1212 RG010A.UVDATA.1

Freq = 4.7990 GHz, Bw = 32.000 MH No calibration applied and no bandpass applied

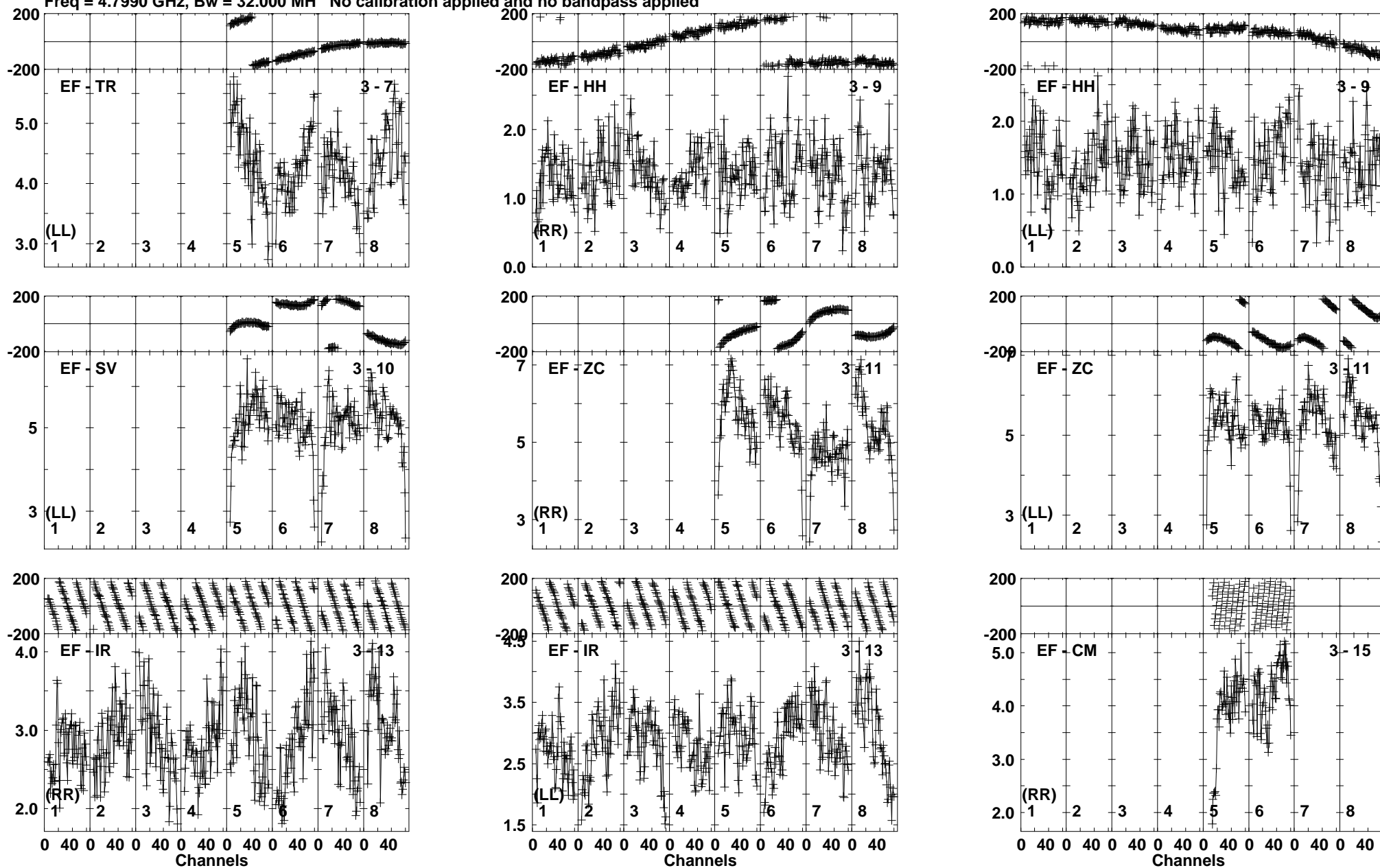

Lower frame: Milli Ampl Jy Top frame: Phas deg
Vector averaged cross-power spectrum Baseline: EF (03) - TR (07)
Timerange: 01/01:46:16 to 01/01:47:15

Plot file version 330 created 26-SEP-2019 10:41:31

J0257-1212 RG010A.UVDATA.1

Freq = 4.7990 GHz, Bw = 32.000 MH No calibration applied and no bandpass applied

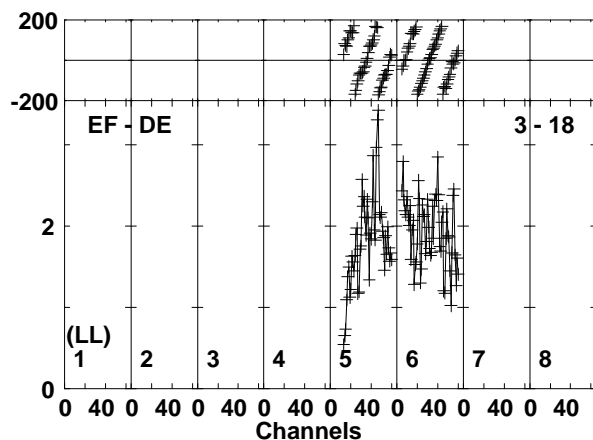
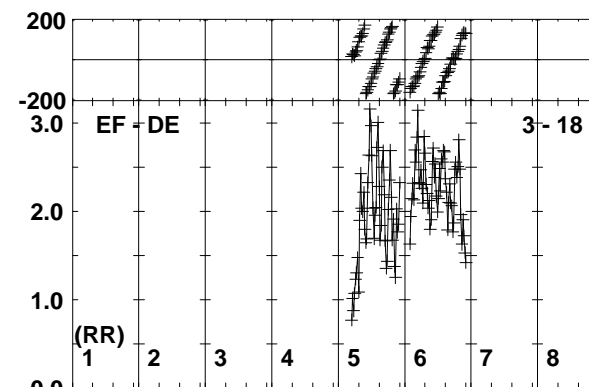
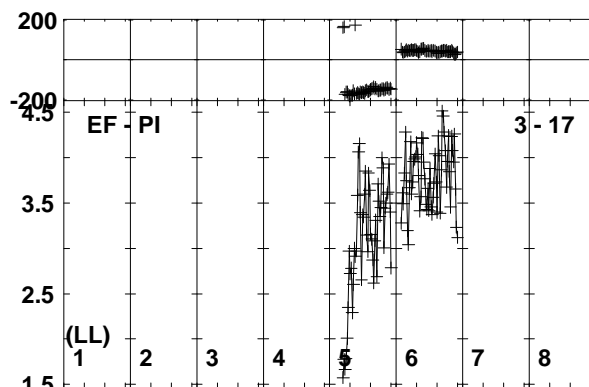
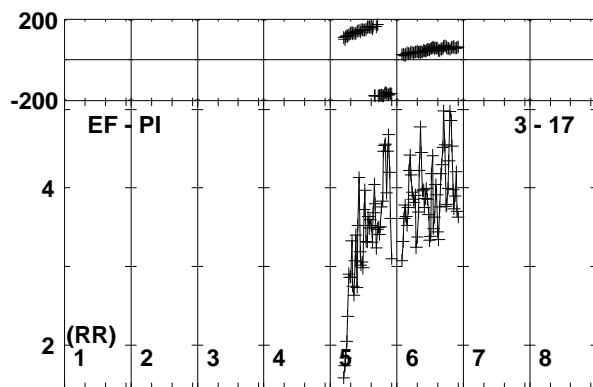
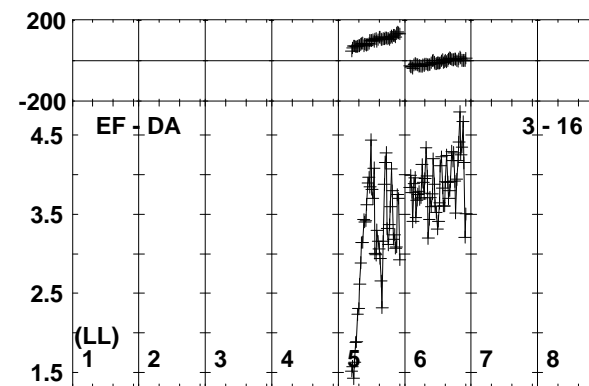
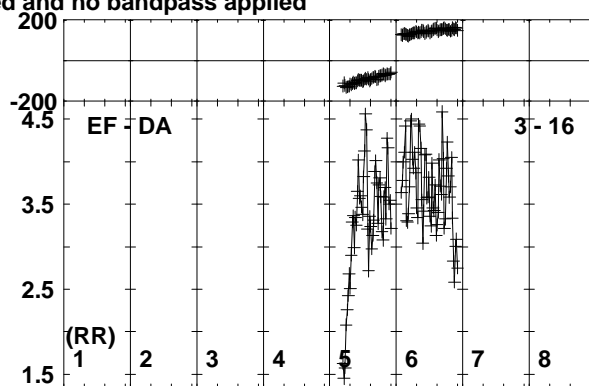
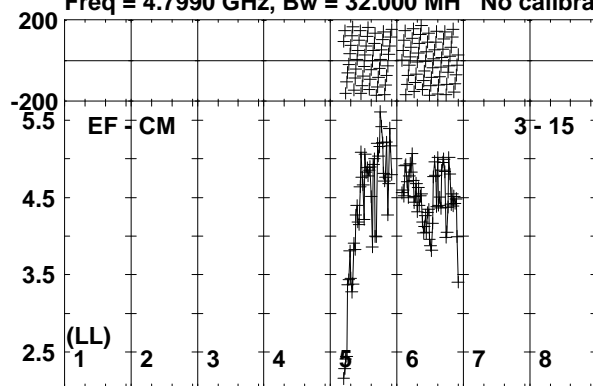

Lower frame: Milli Ampl Jy Top frame: Phas deg
Vector averaged cross-power spectrum Baseline: EF (03) - CM (15)
Timerange: 01/01:46:16 to 01/01:47:15

Plot file version 331 created 26-SEP-2019 10:41:31

190829A RG010A.UVDATA.1

Freq = 4.7990 GHz, Bw = 32.000 MH No calibration applied and no bandpass applied

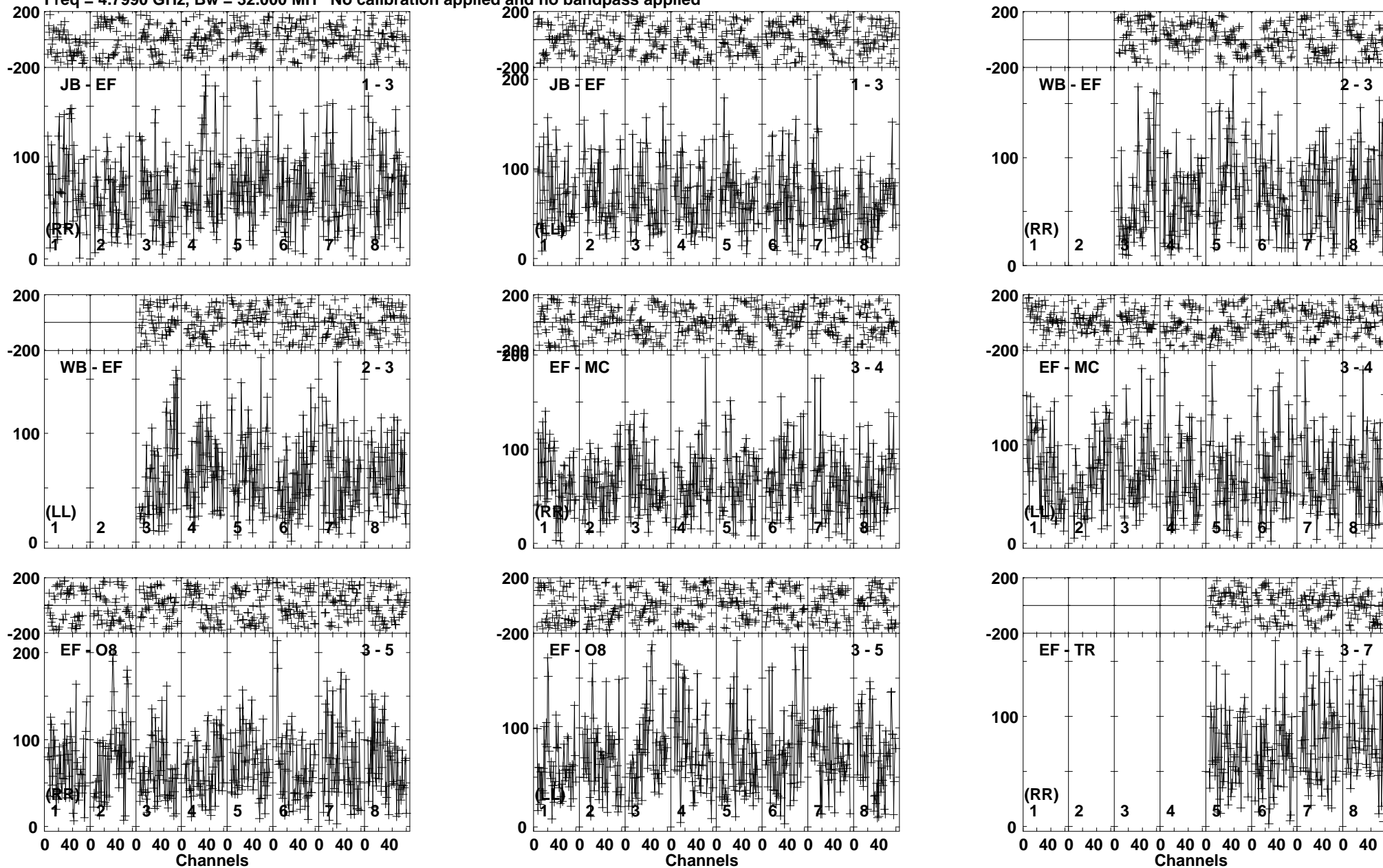

Lower frame: Micro Ampl Jy Top frame: Phas deg
Vector averaged cross-power spectrum Baseline: JB (01) - EF (03)
Timerange: 01/01:47:15 to 01/01:52:14

Plot file version 332 created 26-SEP-2019 10:41:32

190829A RG010A.UVDATA.1

Freq = 4.7990 GHz, Bw = 32.000 MH No calibration applied and no bandpass applied

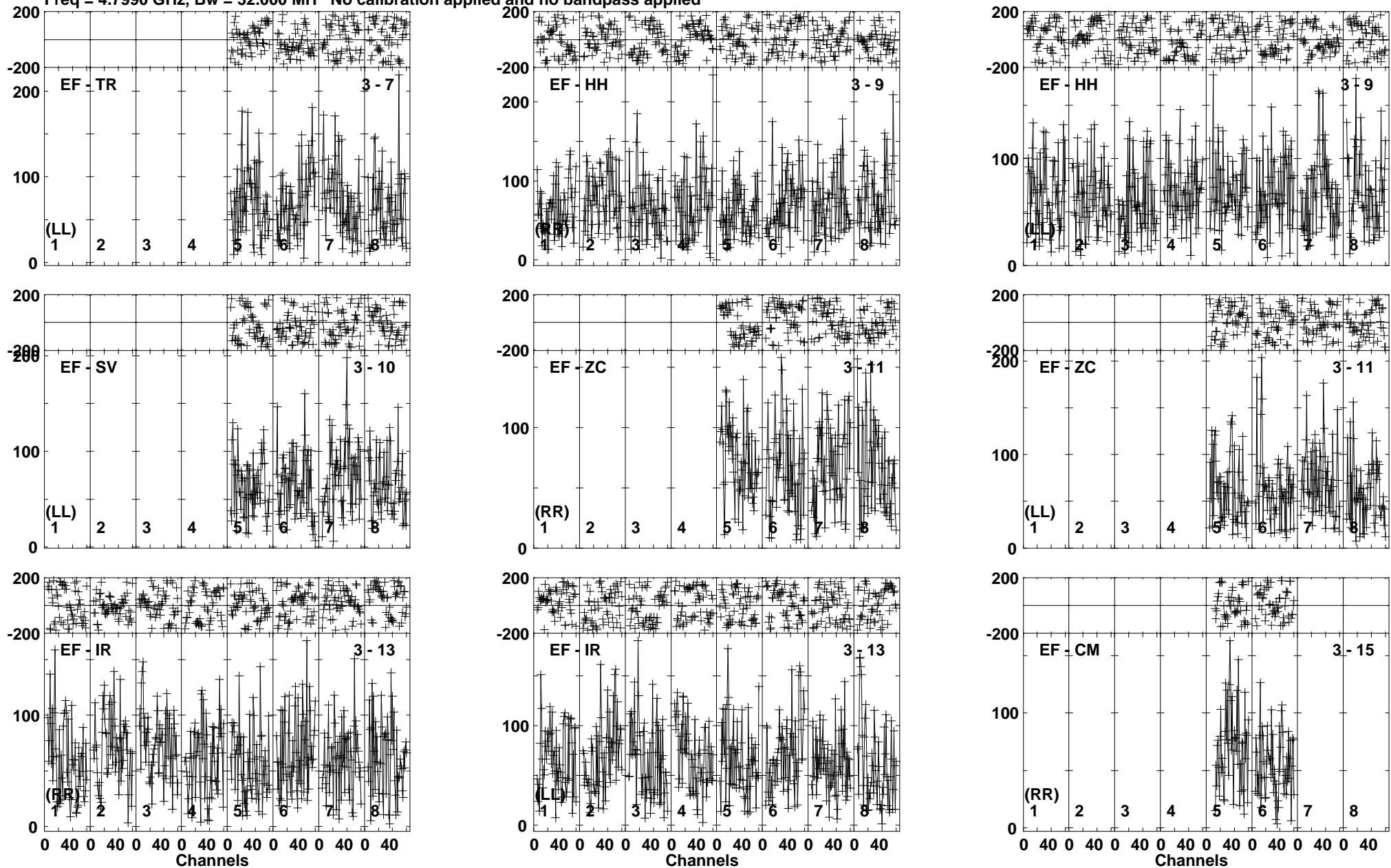

Lower frame: Micro Ampl Jy Top frame: Phas deg
Vector averaged cross-power spectrum Baseline: EF (03) - TR (07)
Timerange: 01/01:47:15 to 01/01:52:14

Plot file version 333 created 26-SEP-2019 10:41:33

190829A RG010A.UVDATA.1

Freq = 4.7990 GHz, Bw = 32.000 MH No calibration applied and no bandpass applied

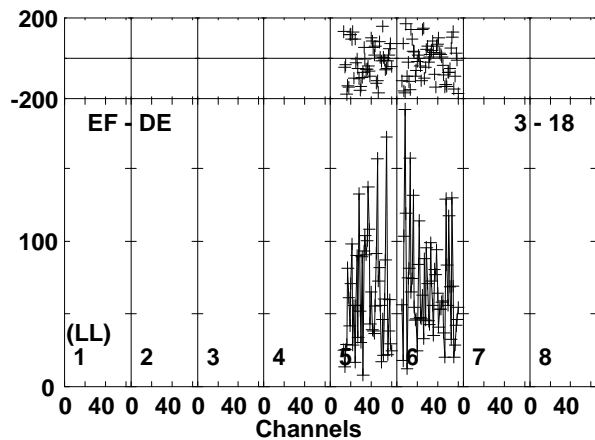
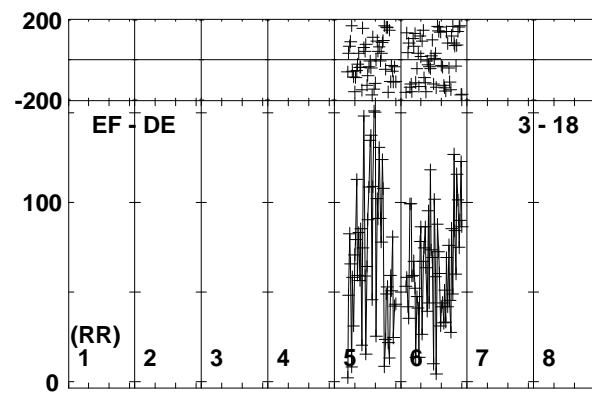
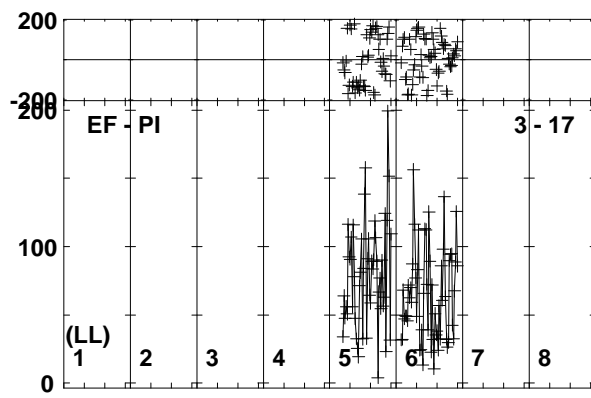
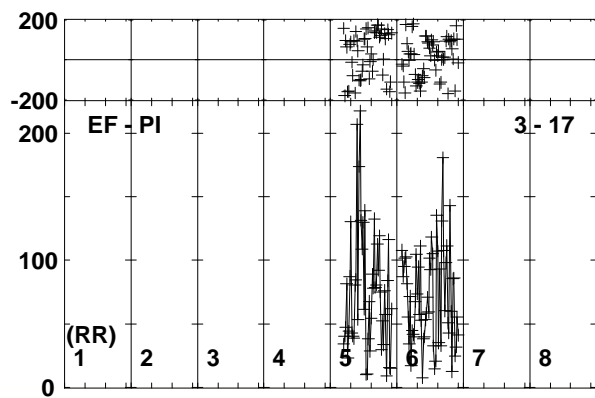
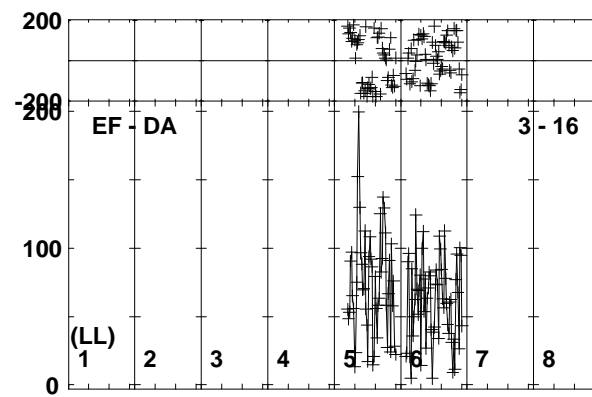
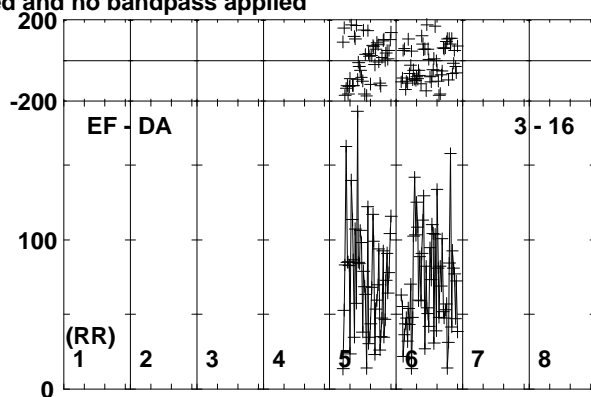
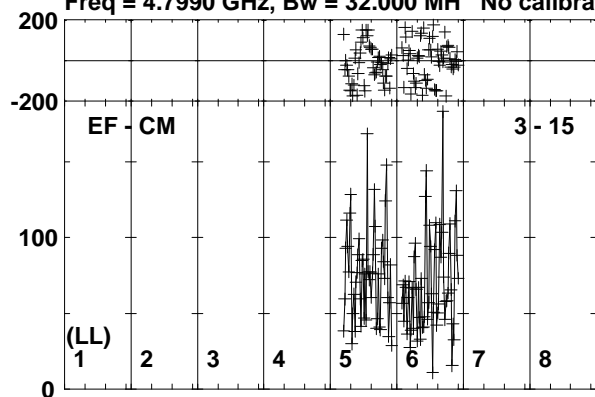

Lower frame: Micro Ampl Jy Top frame: Phas deg
Vector averaged cross-power spectrum Baseline: EF (03) - CM (15)
Timerange: 01/01:47:15 to 01/01:52:14

Plot file version 334 created 26-SEP-2019 10:41:34

J0257-1212 RG010A.UVDATA.1

Freq = 4.7990 GHz, Bw = 32.000 MH No calibration applied and no bandpass applied

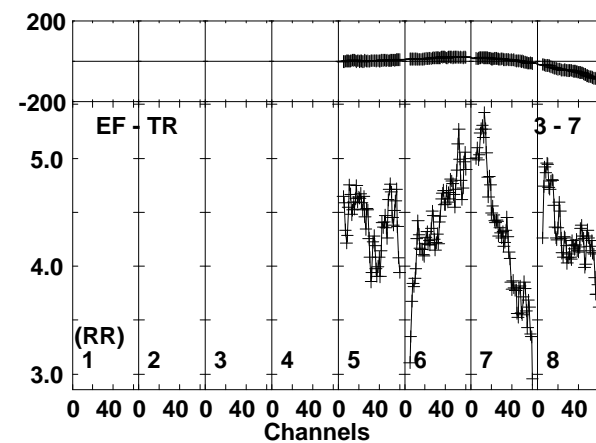
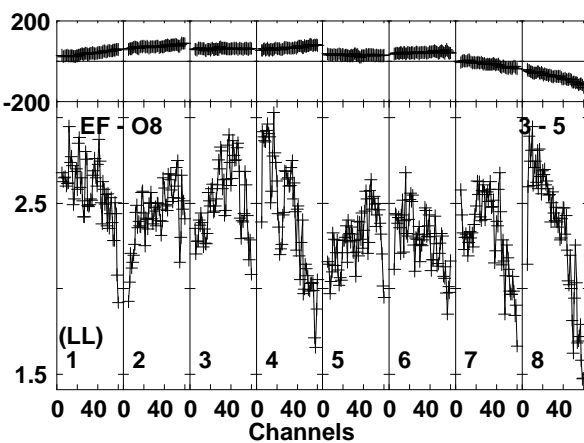
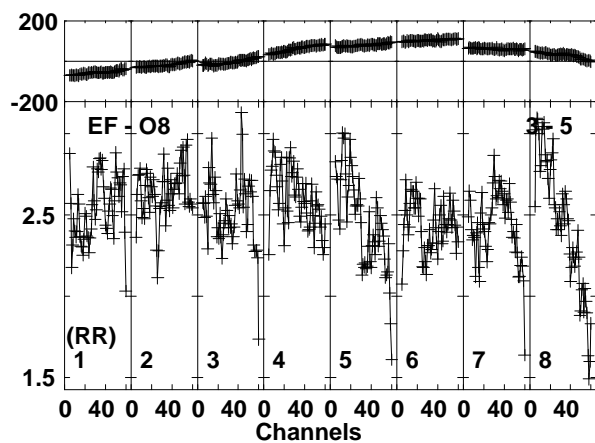
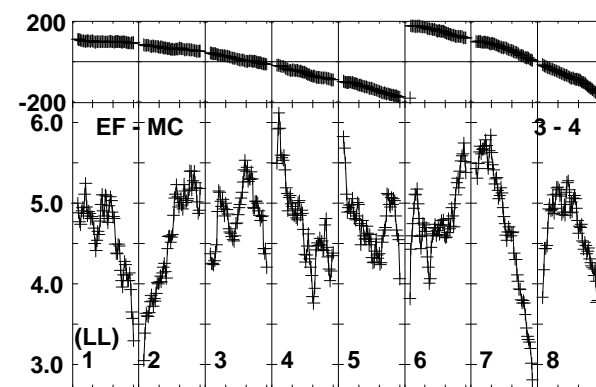
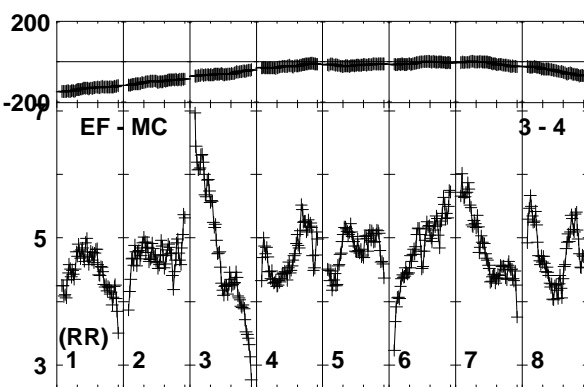
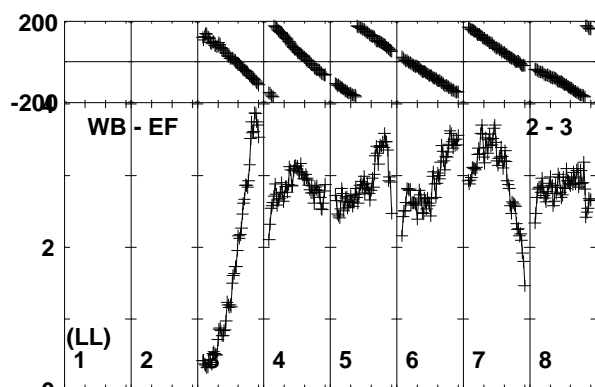
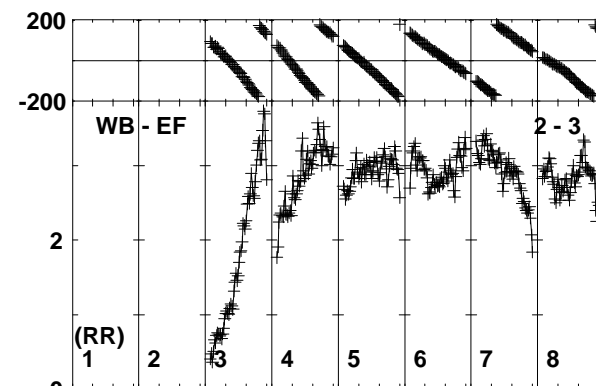
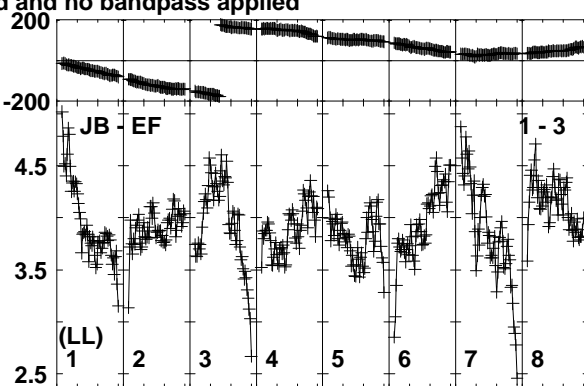
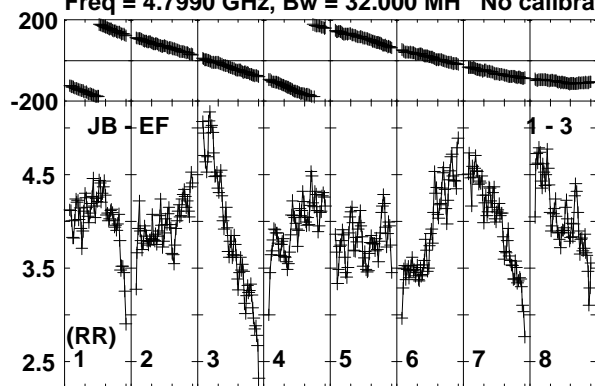

Lower frame: Milli Ampl Jy Top frame: Phas deg
Vector averaged cross-power spectrum Baseline: JB (01) - EF (03)
Timerange: 01/01:52:56 to 01/01:53:54

Plot file version 335 created 26-SEP-2019 10:41:34

J0257-1212 RG010A.UVDATA.1

Freq = 4.7990 GHz, Bw = 32.000 MH No calibration applied and no bandpass applied

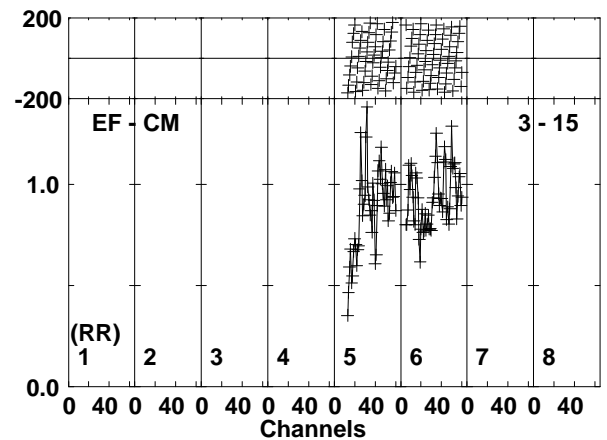
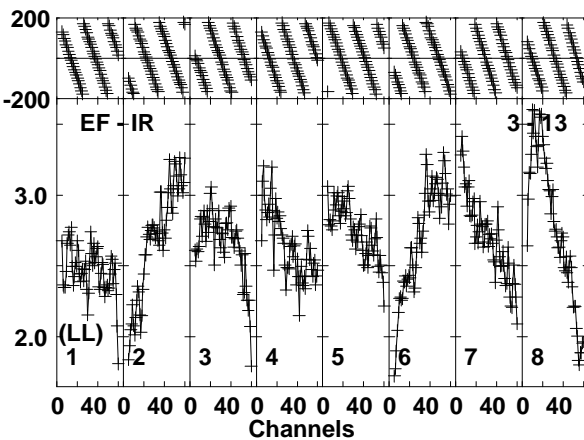
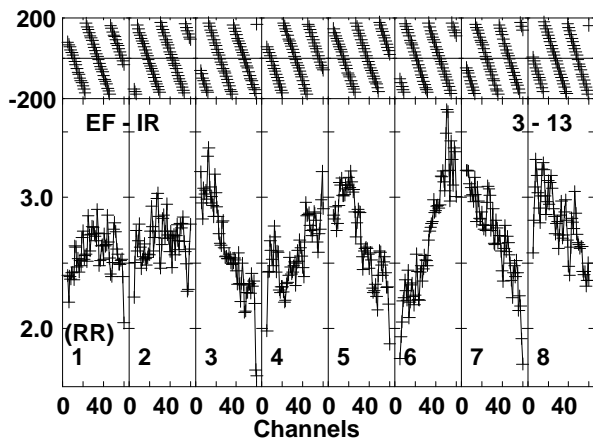
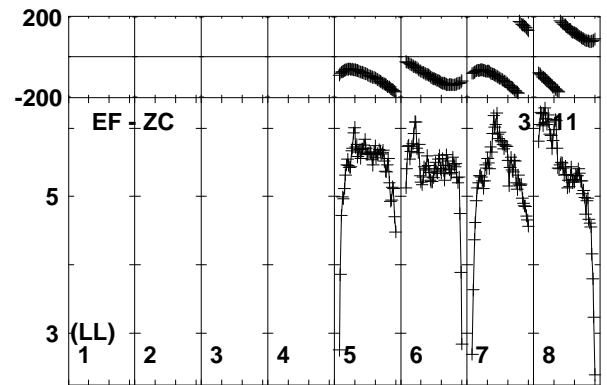
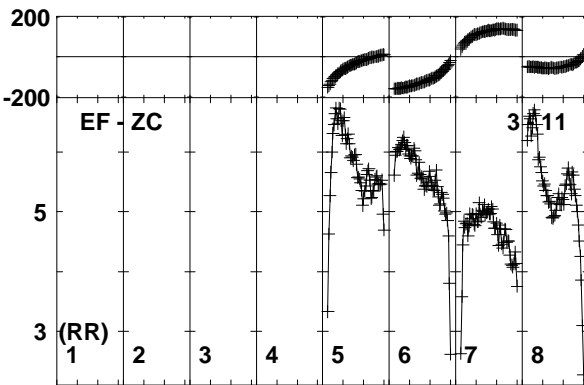
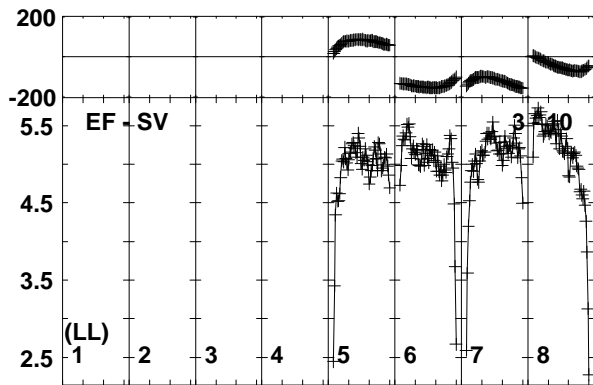
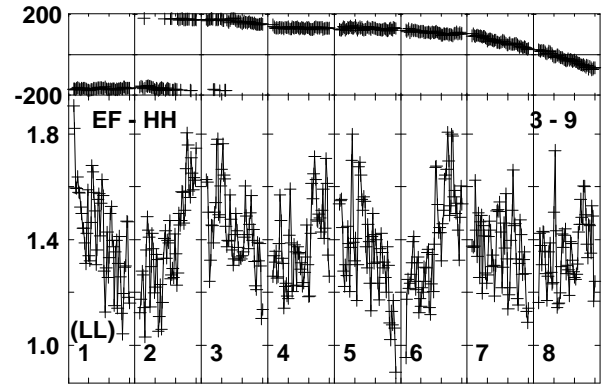
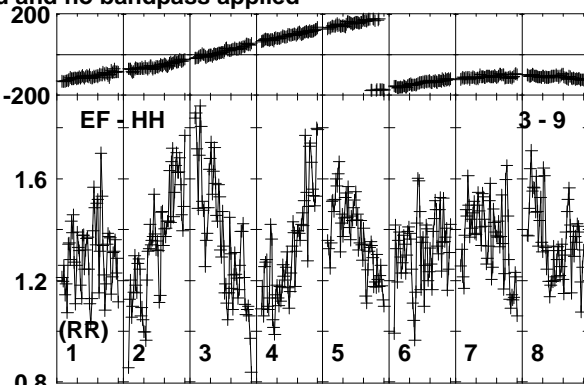
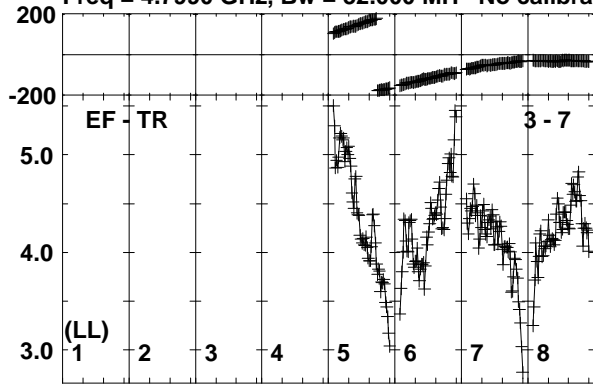

Lower frame: Milli Ampl Jy Top frame: Phas deg
Vector averaged cross-power spectrum Baseline: EF (03) - TR (07)
Timerange: 01/01:52:56 to 01/01:53:54

Plot file version 336 created 26-SEP-2019 10:41:35

J0257-1212 RG010A.UVDATA.1

Freq = 4.7990 GHz, Bw = 32.000 MH No calibration applied and no bandpass applied

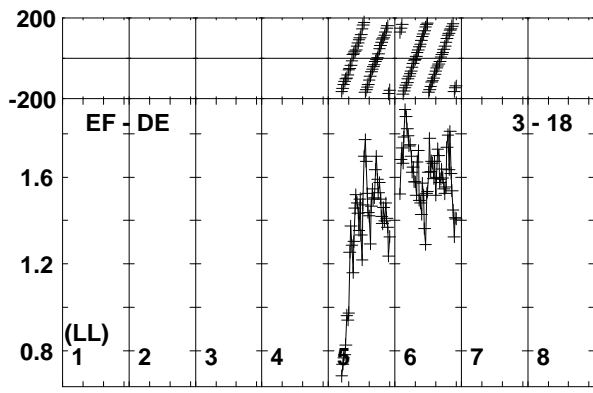
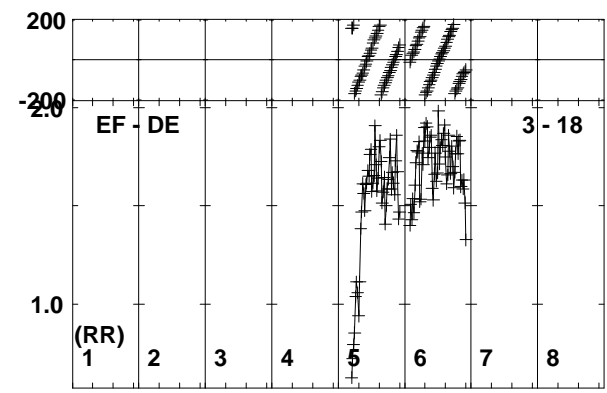
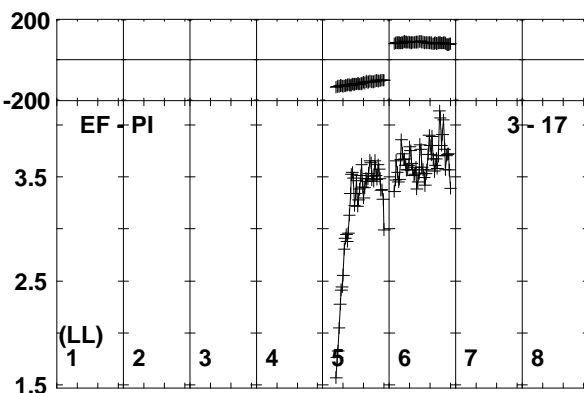
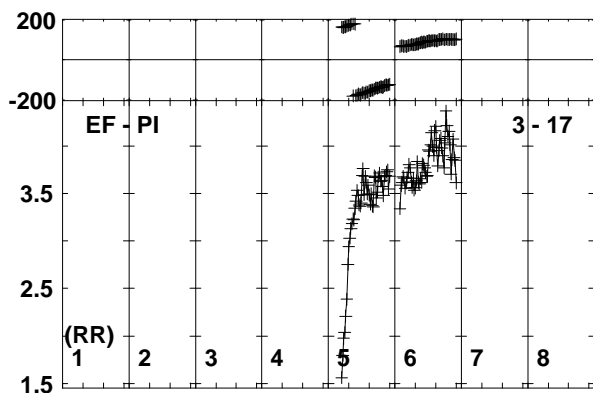
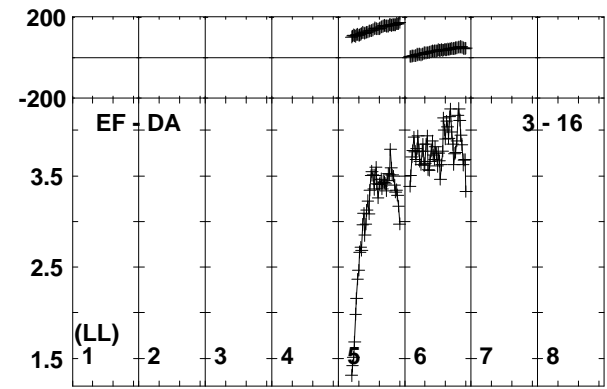
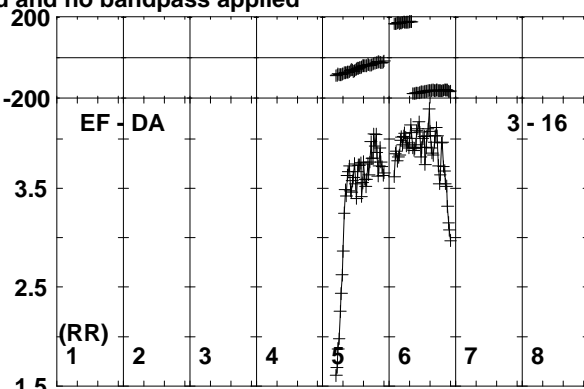
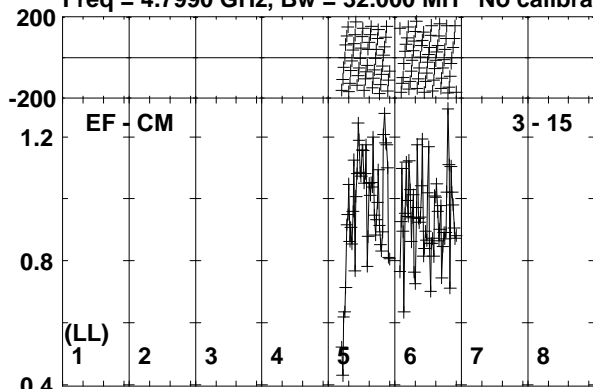

0 40 0 40 0 40 0 40 0 40 0 40 0 40 0 40 0 40

Channels

Lower frame: Milli Ampl Jy Top frame: Phas deg
Vector averaged cross-power spectrum Baseline: EF (03) - CM (15)
Timerange: 01/01:52:56 to 01/01:53:54

Plot file version 337 created 26-SEP-2019 10:41:35

190829A RG010A.UVDATA.1

Freq = 4.7990 GHz, Bw = 32.000 MH No calibration applied and no bandpass applied

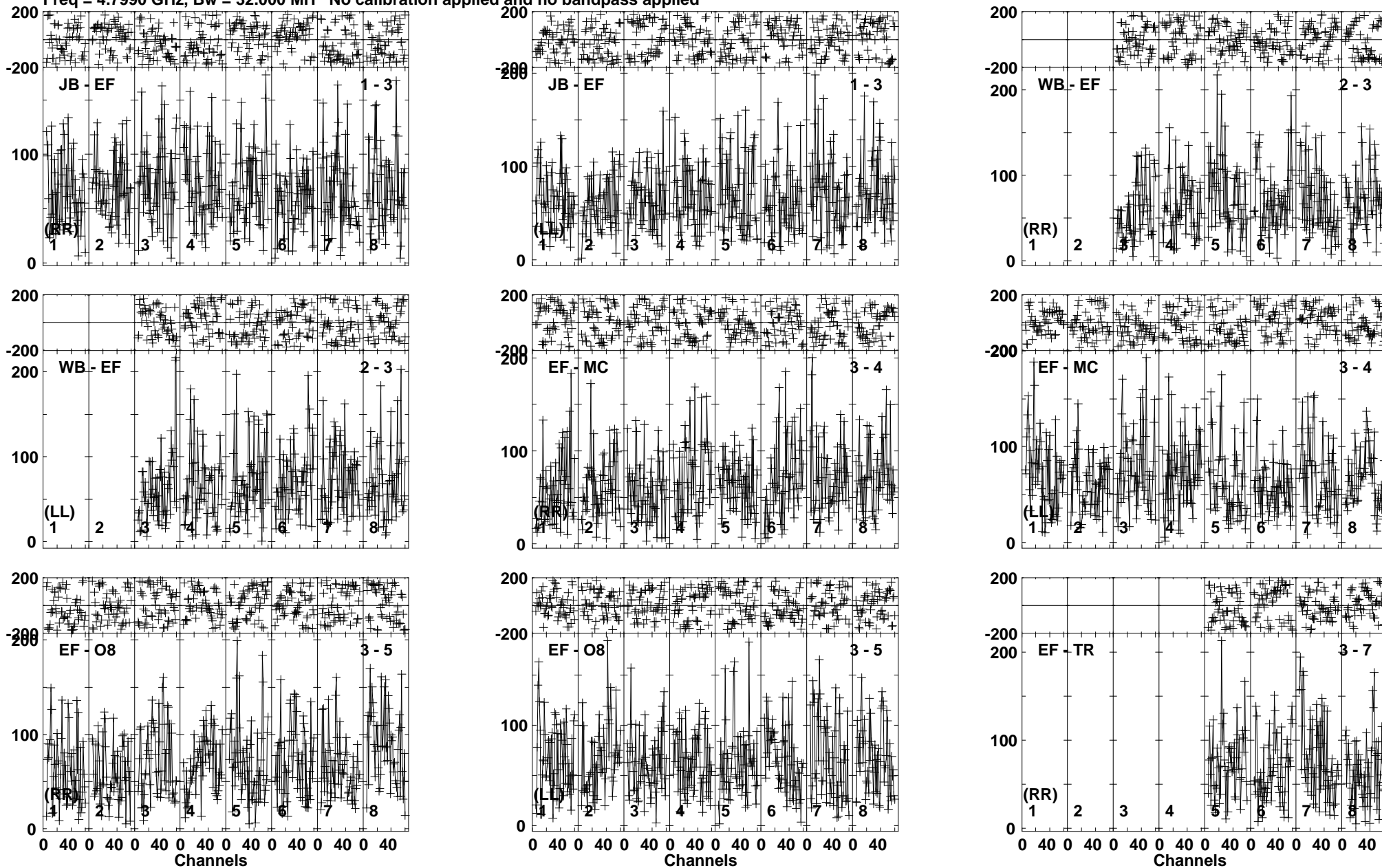

Lower frame: Micro Ampl Jy Top frame: Phas deg
Vector averaged cross-power spectrum Baseline: JB (01) - EF (03)
Timerange: 01/01:53:55 to 01/01:58:54

Plot file version 338 created 26-SEP-2019 10:41:36

190829A RG010A.UVDATA.1

Freq = 4.7990 GHz, Bw = 32.000 MH No calibration applied and no bandpass applied

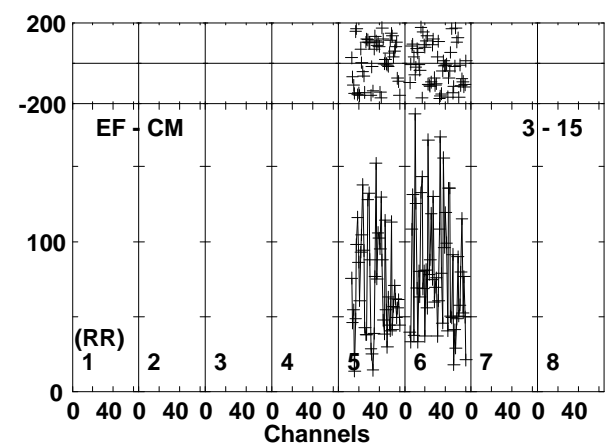
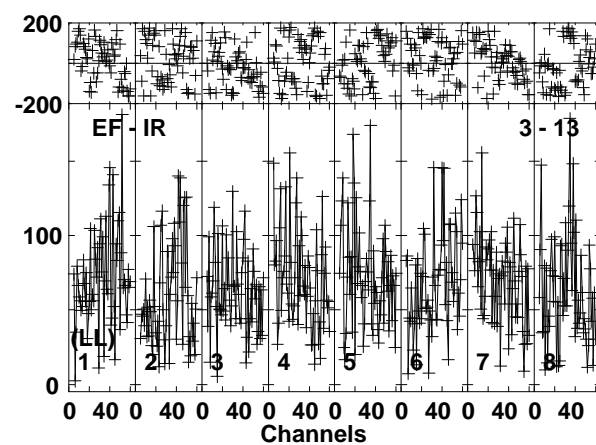
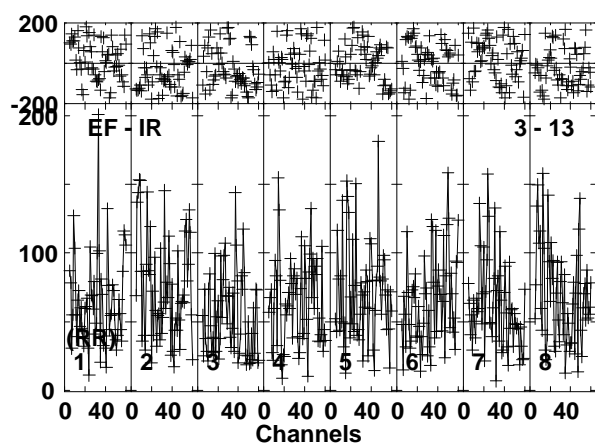
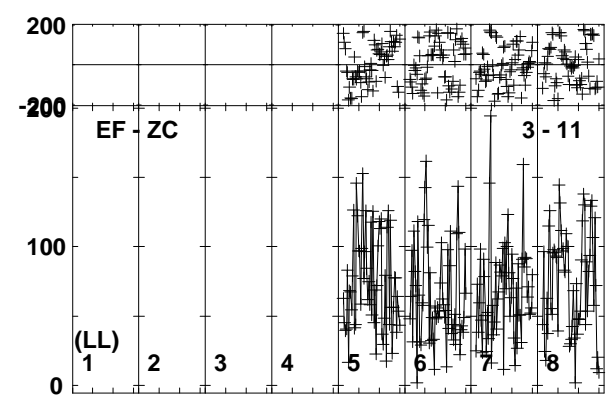
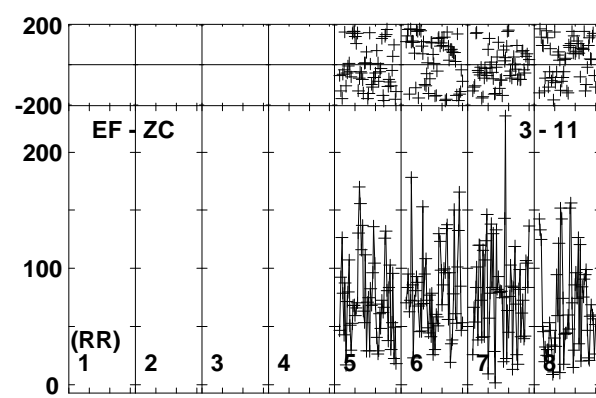
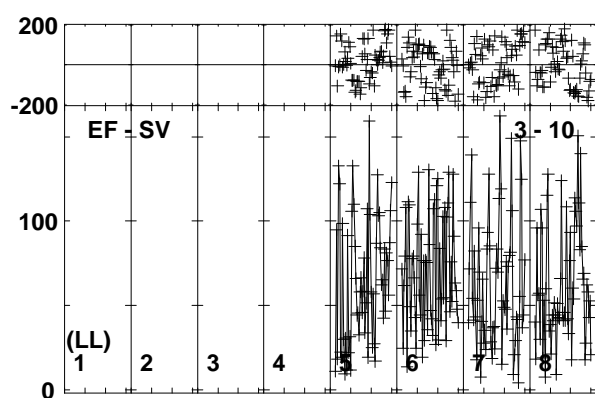
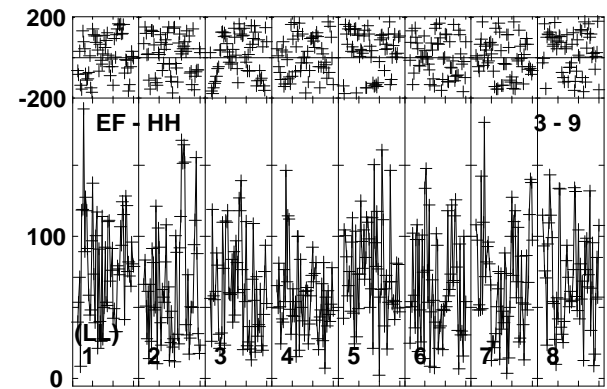
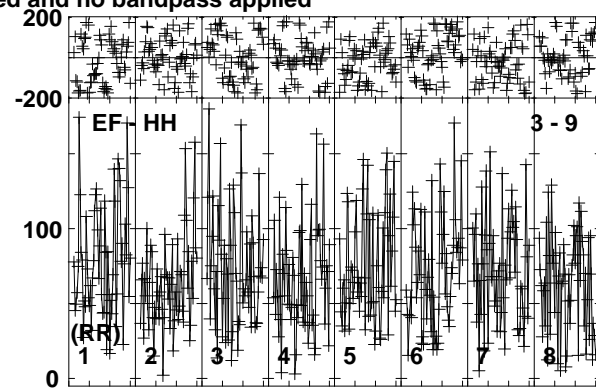
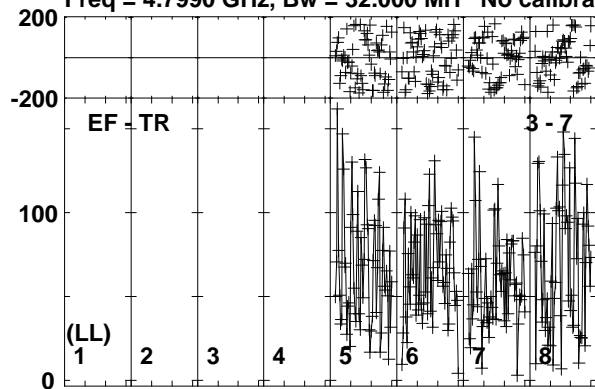

Lower frame: Micro Ampl Jy Top frame: Phas deg
Vector averaged cross-power spectrum Baseline: EF (03) - TR (07)
Timerange: 01/01:53:55 to 01/01:58:54

Plot file version 339 created 26-SEP-2019 10:41:37

190829A RG010A.UVDATA.1

Freq = 4.7990 GHz, Bw = 32.000 MH No calibration applied and no bandpass applied

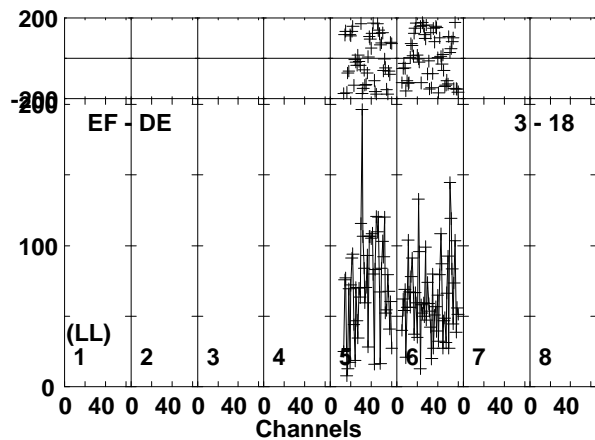
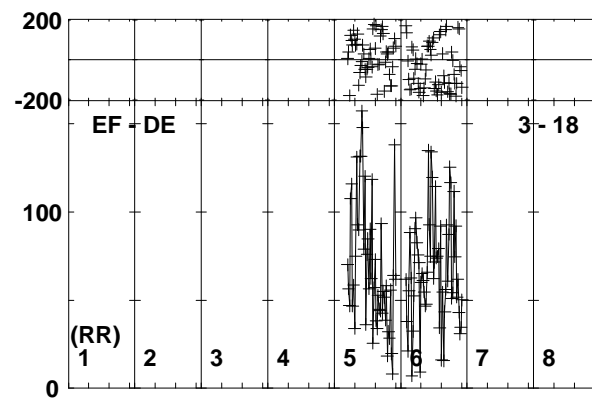
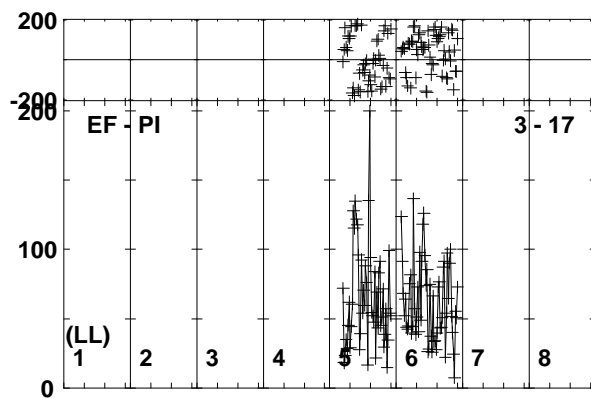
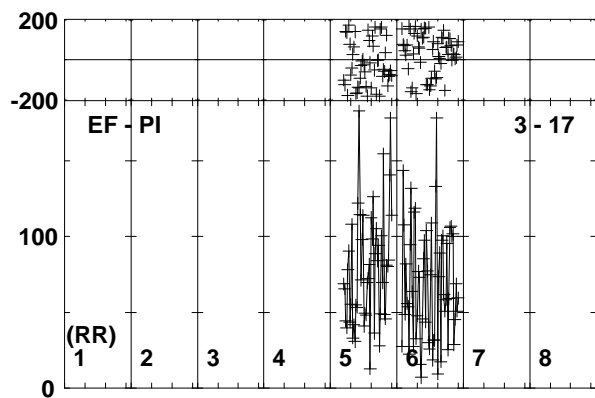
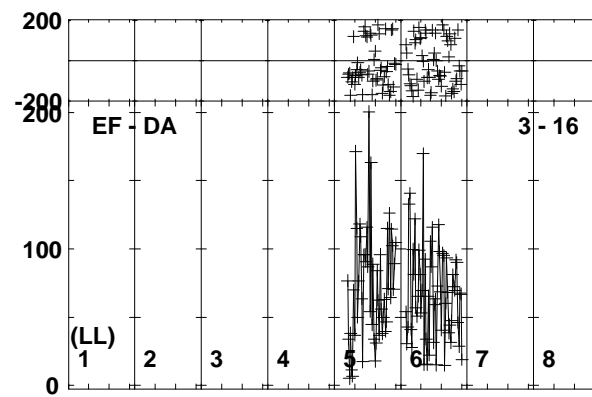
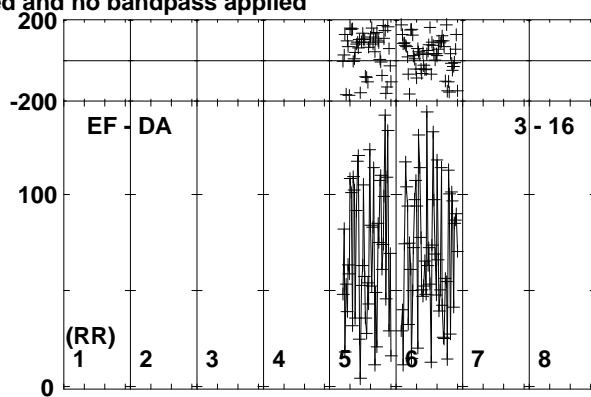
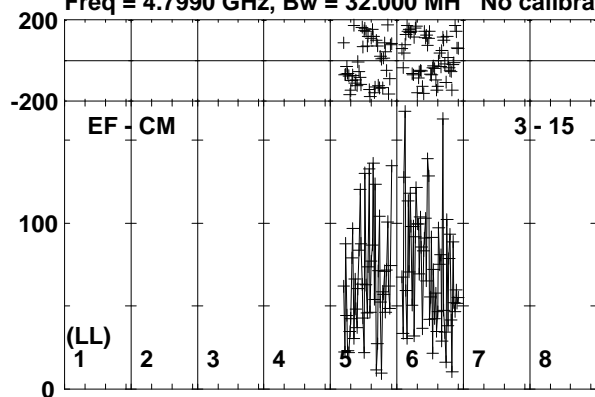

Lower frame: Micro Ampl Jy Top frame: Phas deg
Vector averaged cross-power spectrum Baseline: EF (03) - CM (15)
Timerange: 01/01:53:55 to 01/01:58:54

Plot file version 340 created 26-SEP-2019 10:41:37

J0257-1212 RG010A.UVDATA.1

Freq = 4.7990 GHz, Bw = 32.000 MH No calibration applied and no bandpass applied

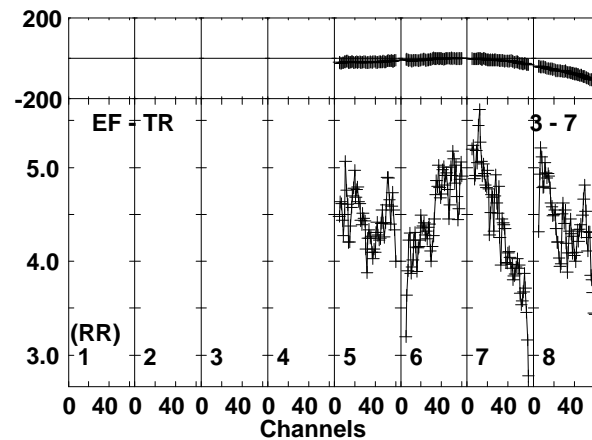
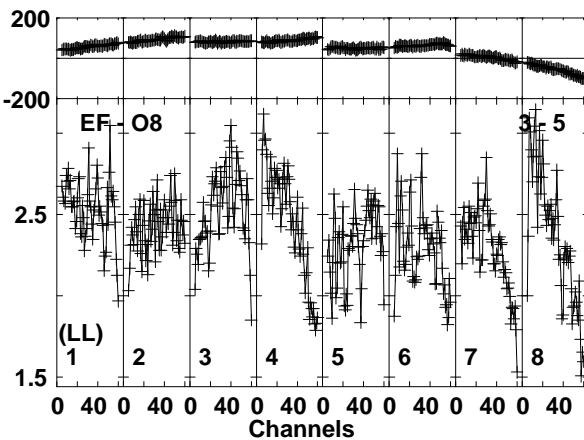
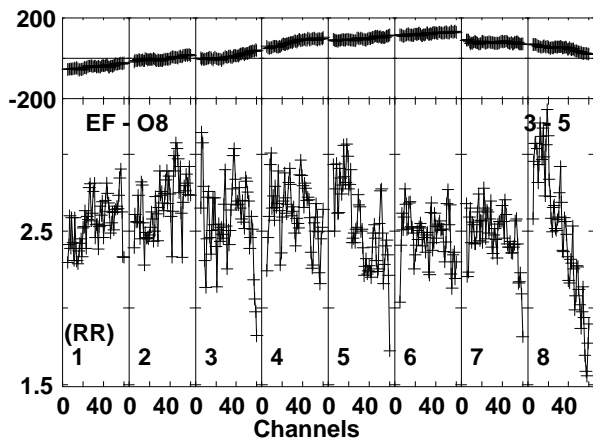
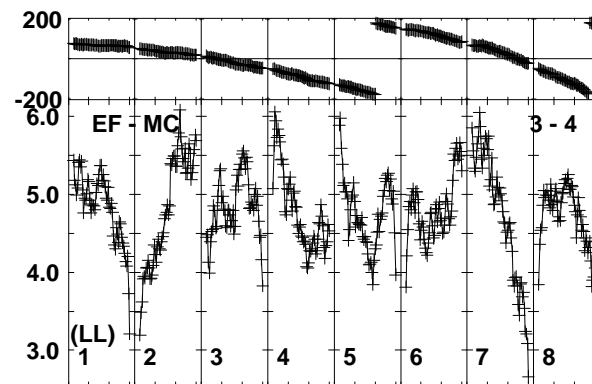
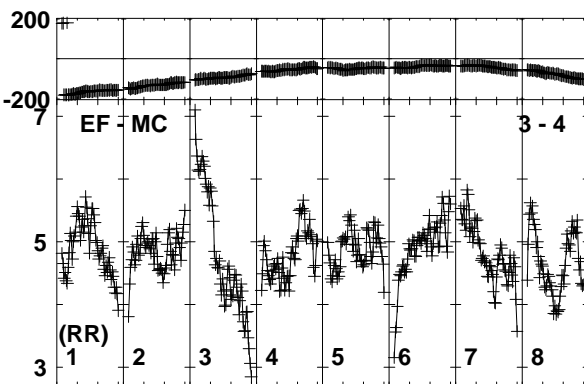
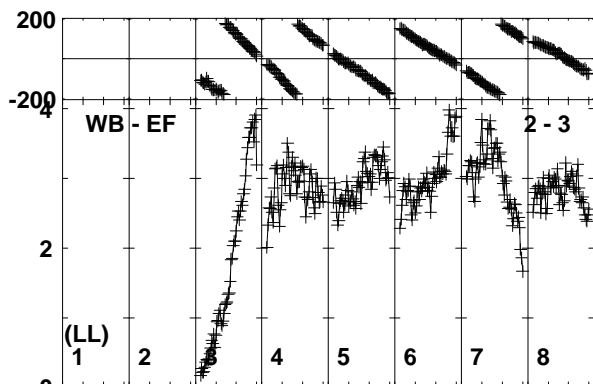
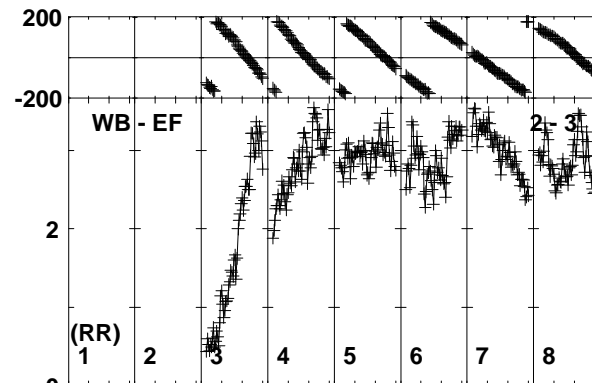
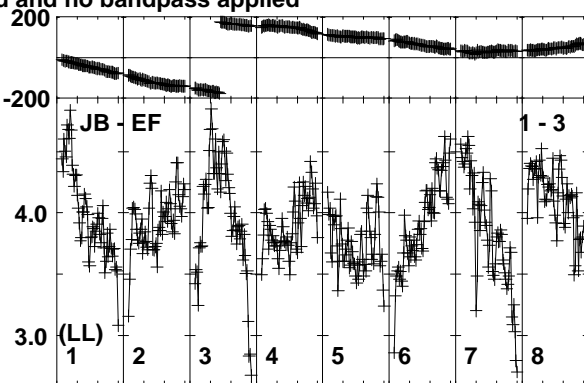
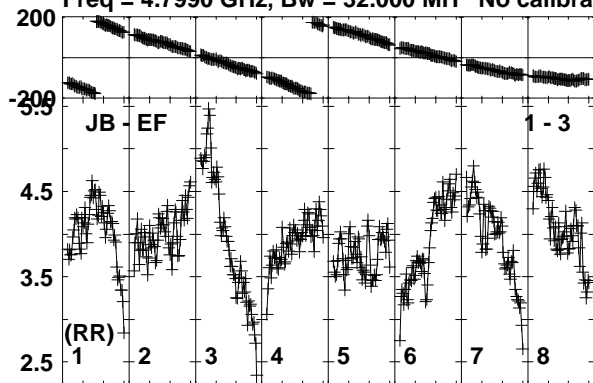

Lower frame: Milli Ampl Jy Top frame: Phas deg
Vector averaged cross-power spectrum Baseline: JB (01) - EF (03)
Timerange: 01/01:59:45 to 01/02:00:14

Plot file version 341 created 26-SEP-2019 10:41:38

J0257-1212 RG010A.UVDATA.1

Freq = 4.7990 GHz, Bw = 32.000 MH No calibration applied and no bandpass applied

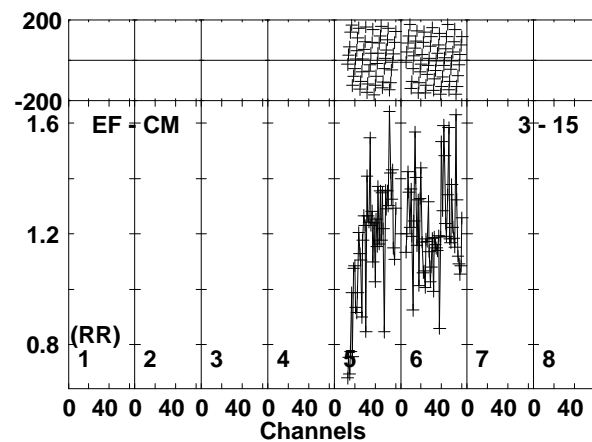
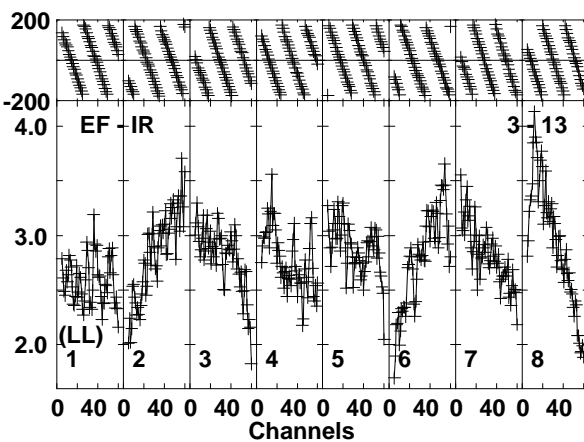
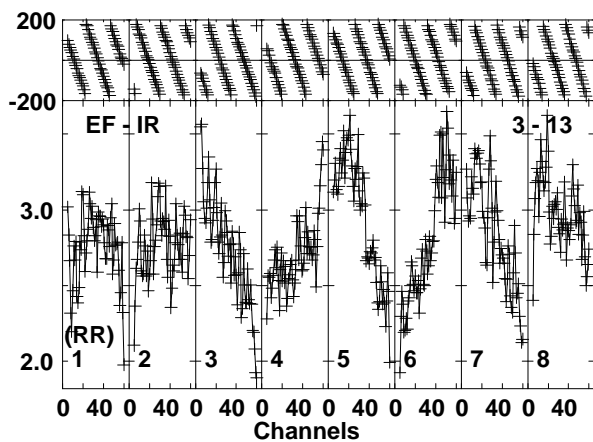
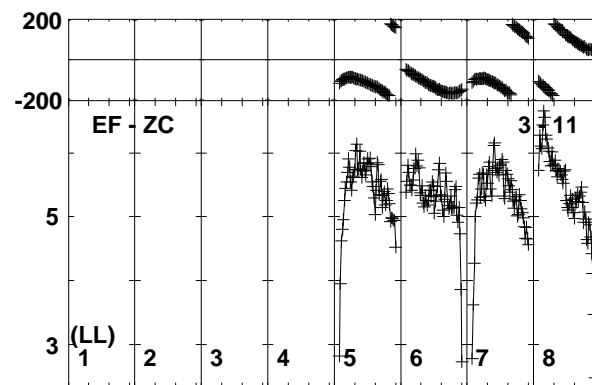
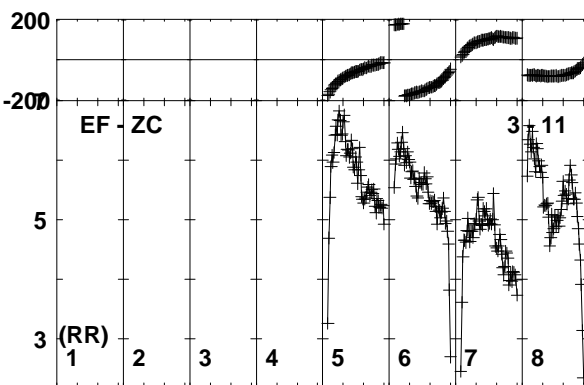
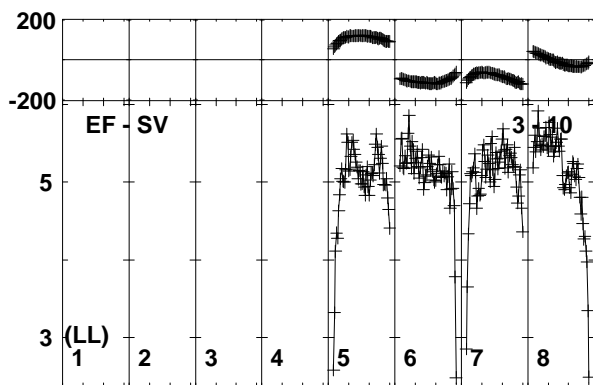
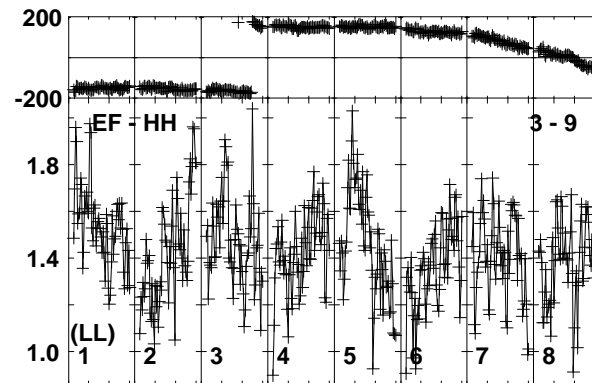
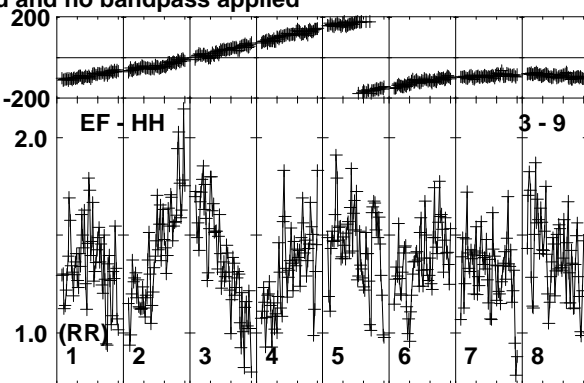
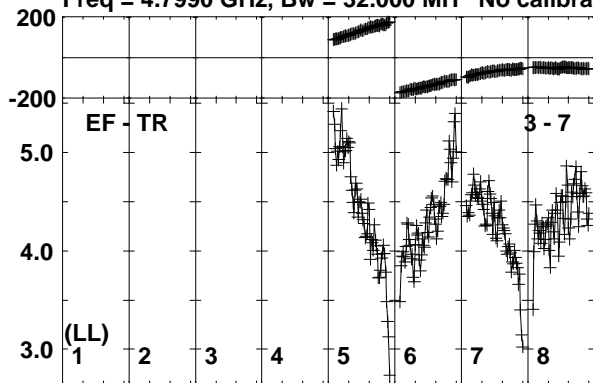

Lower frame: Milli Ampl Jy Top frame: Phas deg
Vector averaged cross-power spectrum Baseline: EF (03) - TR (07)
Timerange: 01/01:59:45 to 01/02:00:14

Plot file version 342 created 26-SEP-2019 10:41:38

J0257-1212 RG010A.UVDATA.1

Freq = 4.7990 GHz, Bw = 32.000 MH No calibration applied and no bandpass applied

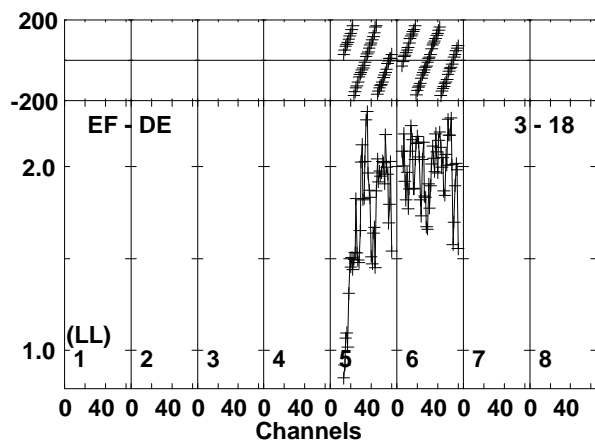
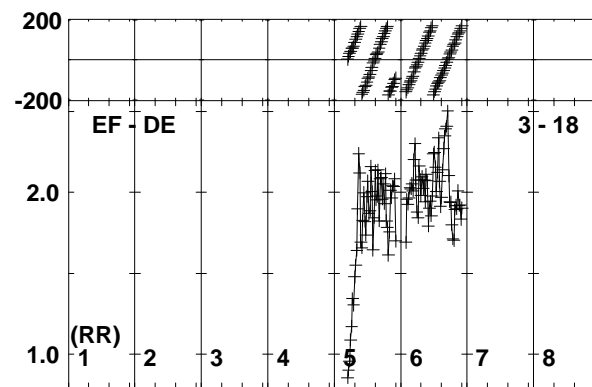
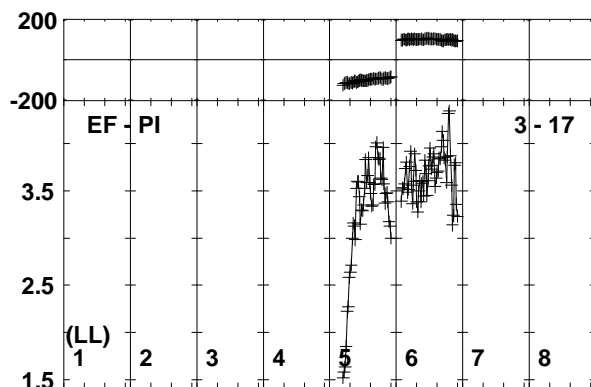
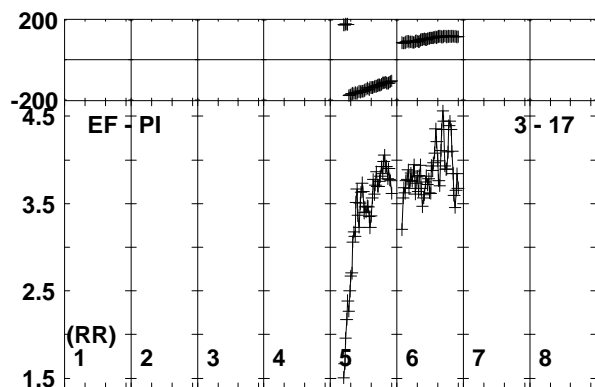
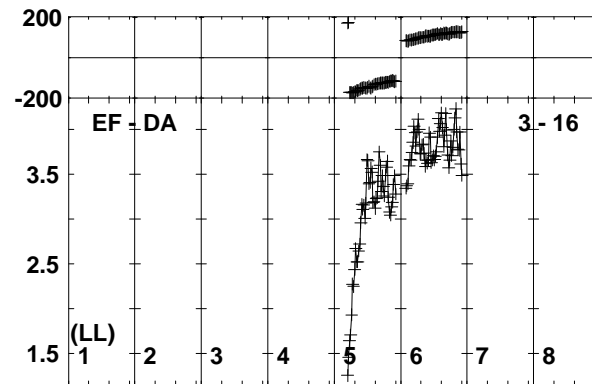
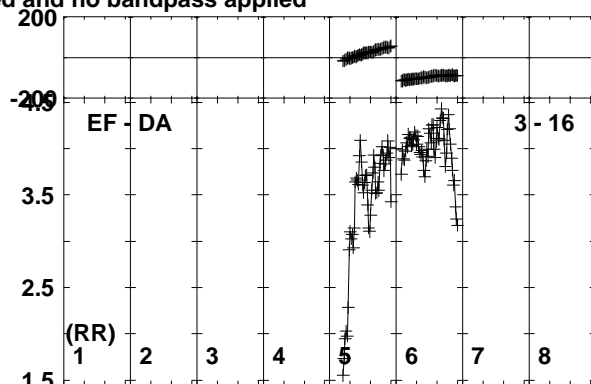
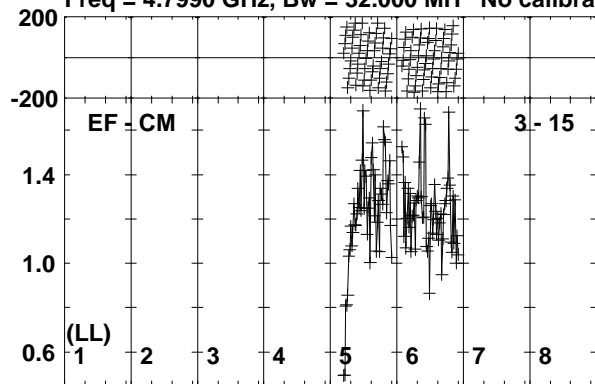

0 40 0 40 0 40 0 40 0 40 0 40 0 40 0 40 0 40 0 40
Channels
Lower frame: Milli Ampl Jy Top frame: Phas deg
Vector averaged cross-power spectrum Baseline: EF (03) - CM (15)
Timerange: 01/01:59:45 to 01/02:00:14

Plot file version 343 created 26-SEP-2019 10:41:41

J0300-0846 RG010A.UVDATA.1

Freq = 4.7990 GHz, Bw = 32.000 MH No calibration applied and no bandpass applied

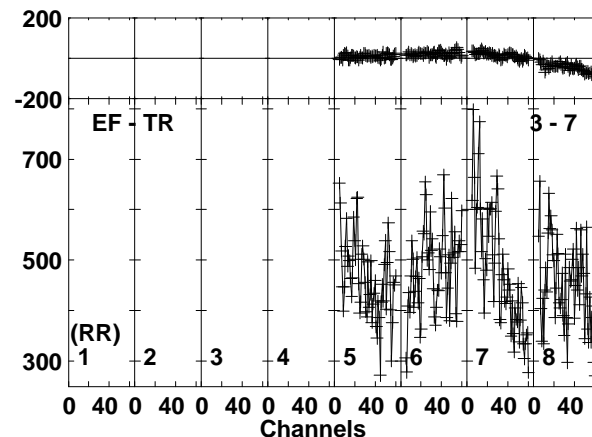
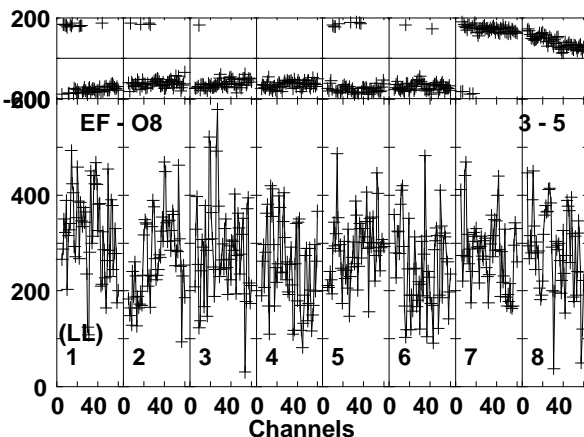
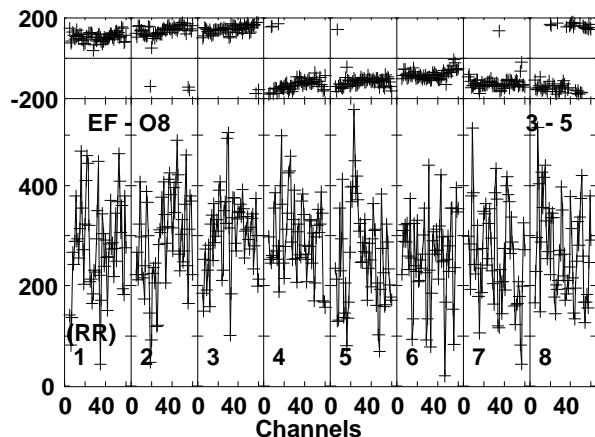
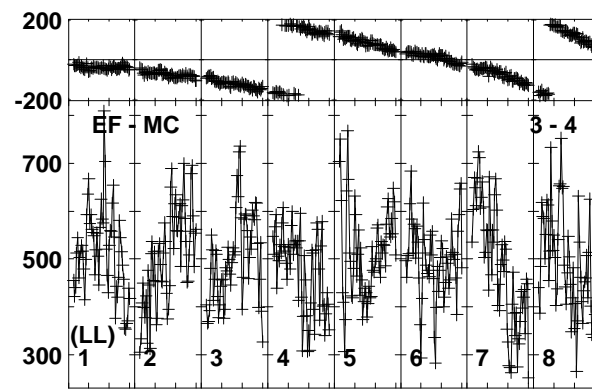
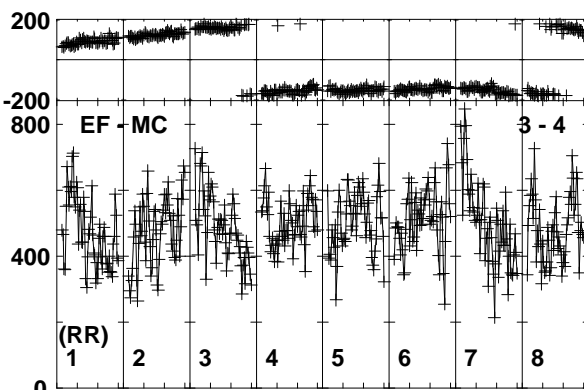
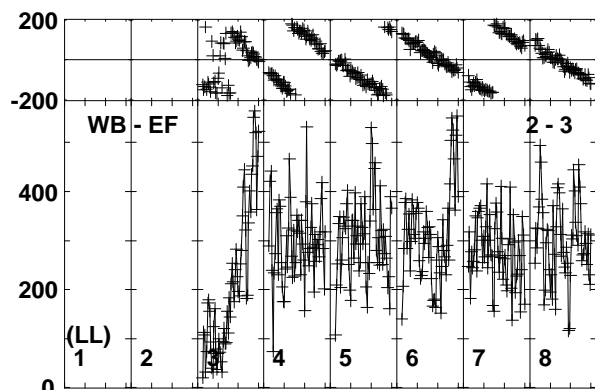
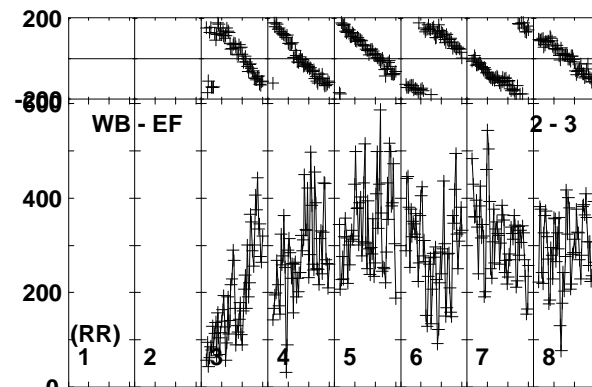
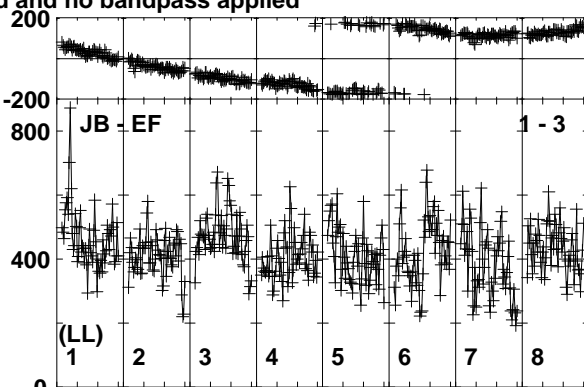
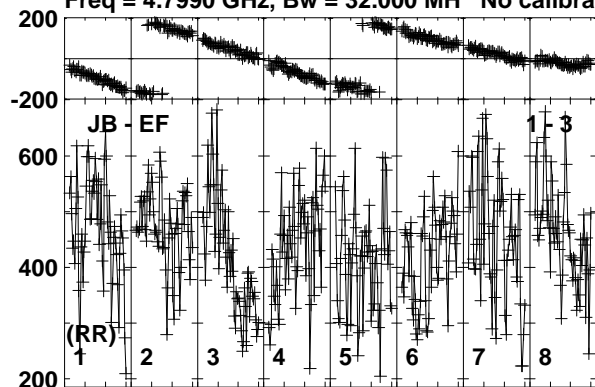

Lower frame: Micro Ampl Jy Top frame: Phas deg
Vector averaged cross-power spectrum Baseline: JB (01) - EF (03)
Timerange: 01/02:00:16 to 01/02:02:44

Plot file version 344 created 26-SEP-2019 10:41:41

J0300-0846 RG010A.UVDATA.1

Freq = 4.7990 GHz, Bw = 32.000 MH No calibration applied and no bandpass applied

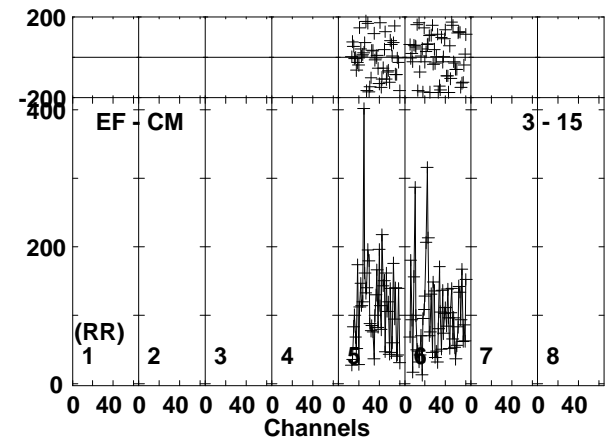
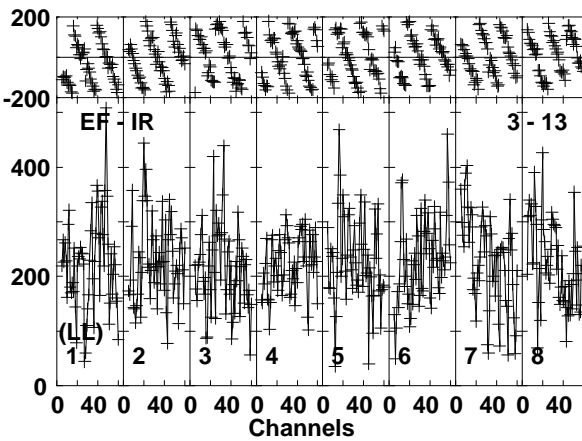
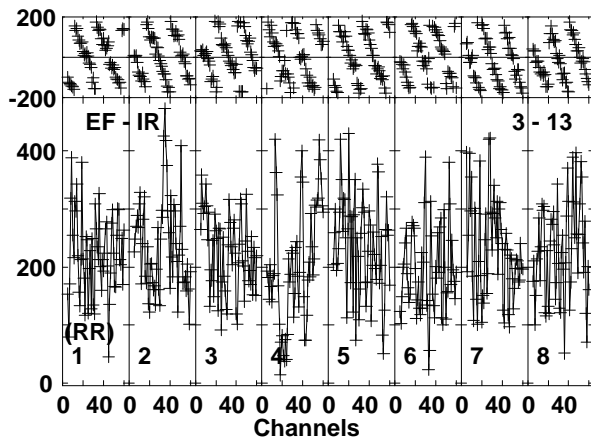
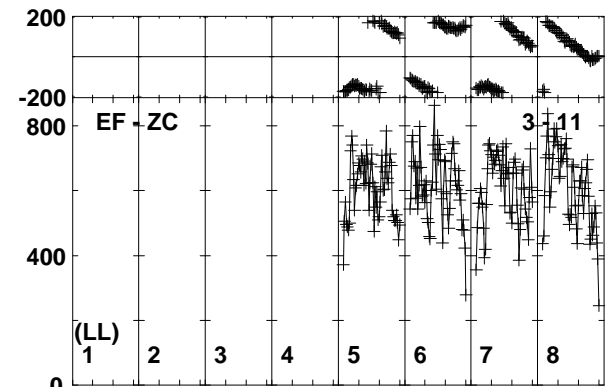
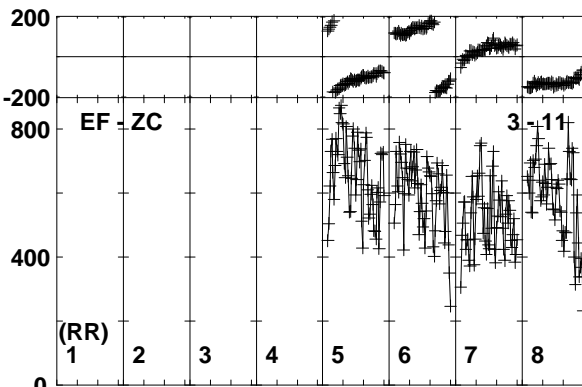
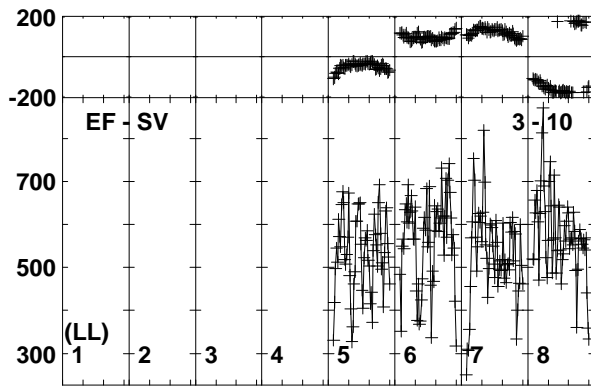
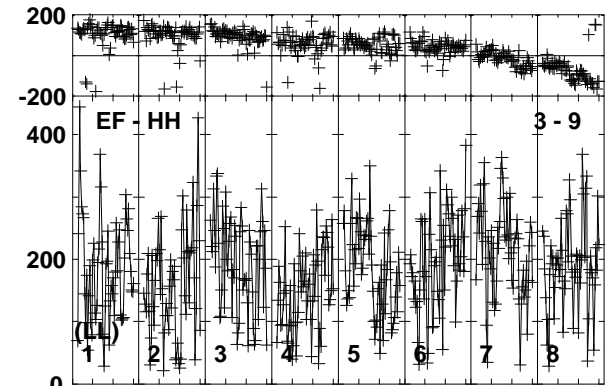
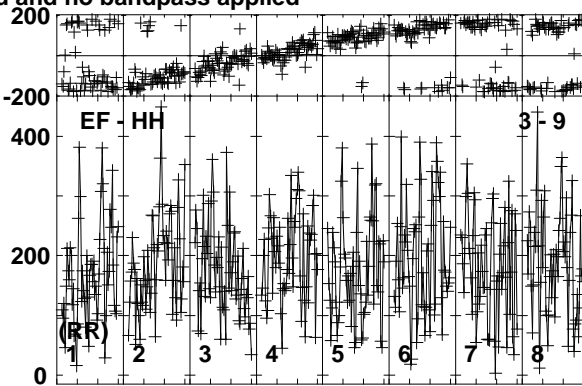
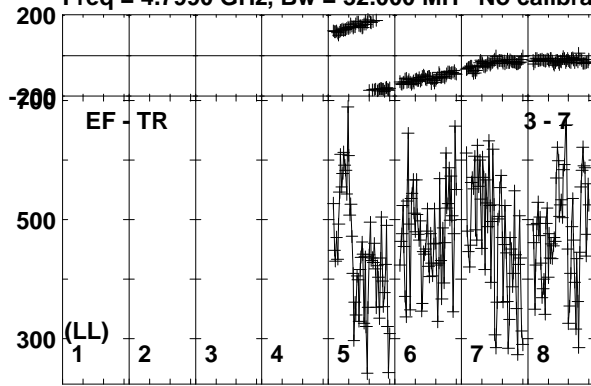

Lower frame: Micro Ampl Jy Top frame: Phas deg
Vector averaged cross-power spectrum Baseline: EF (03) - TR (07)
Timerange: 01/02:00:16 to 01/02:02:44

Plot file version 345 created 26-SEP-2019 10:41:42

J0300-0846 RG010A.UVDATA.1

Freq = 4.7990 GHz, Bw = 32.000 MH No calibration applied and no bandpass applied

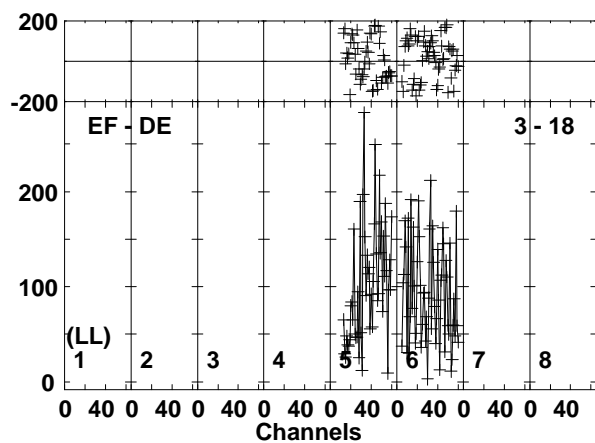
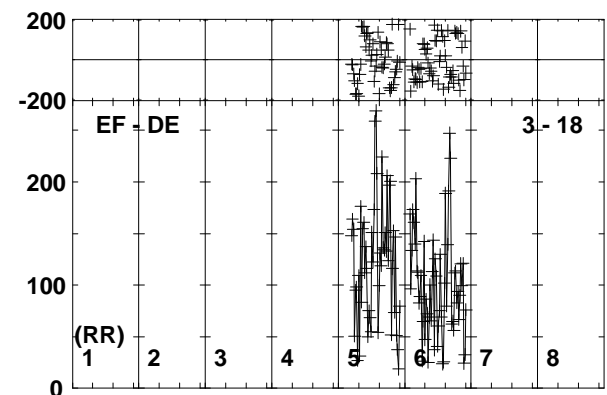
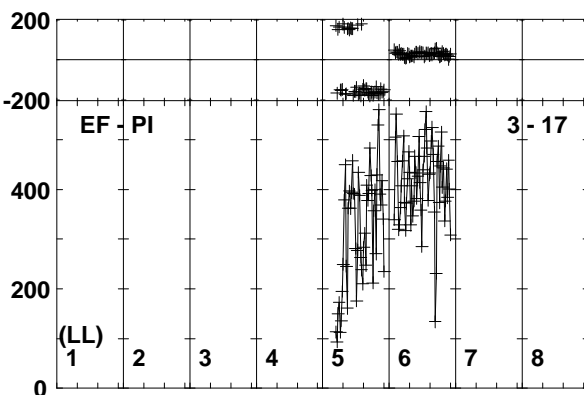
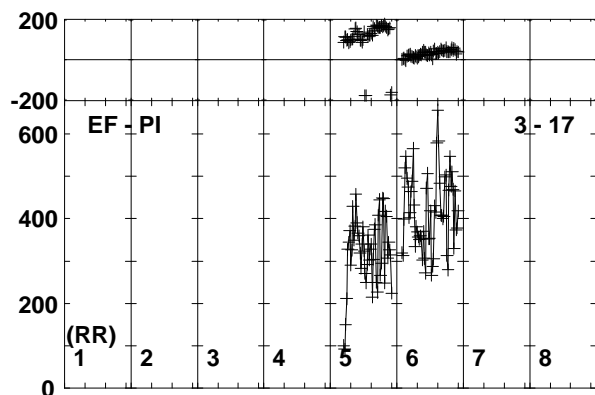
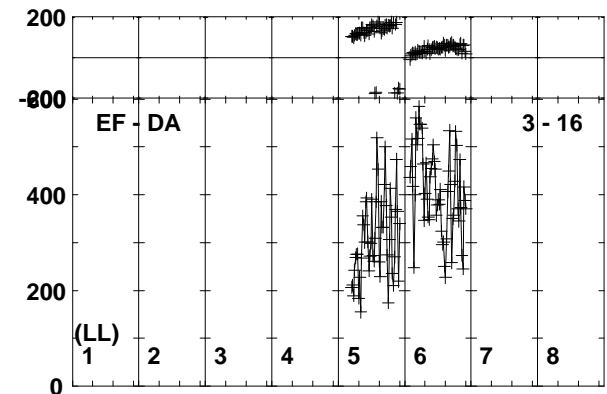
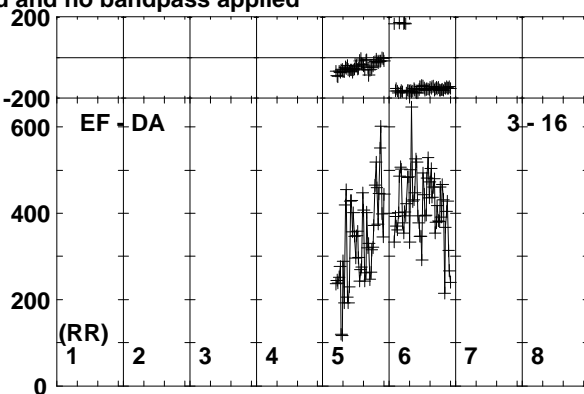
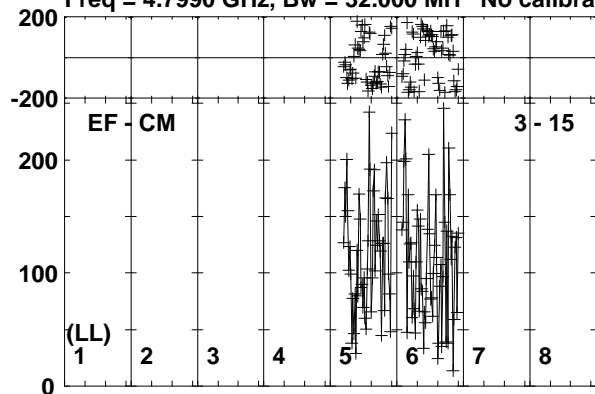

Lower frame: Micro Ampl Jy Top frame: Phas deg
Vector averaged cross-power spectrum Baseline: EF (03) - CM (15)
Timerange: 01/02:00:16 to 01/02:02:44

Plot file version 346 created 26-SEP-2019 10:41:43

190829A RG010A.UVDATA.1

Freq = 4.7990 GHz, Bw = 32.000 MH No calibration applied and no bandpass applied

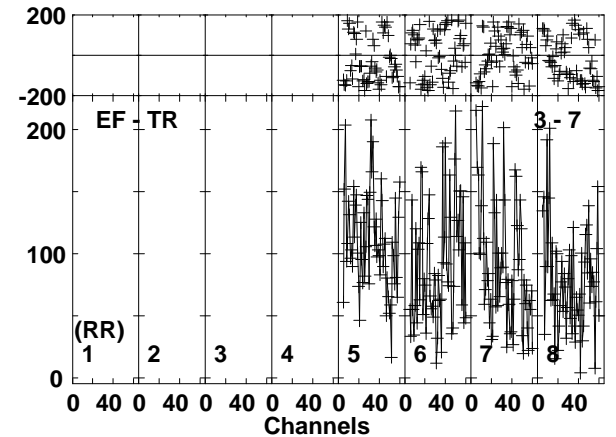
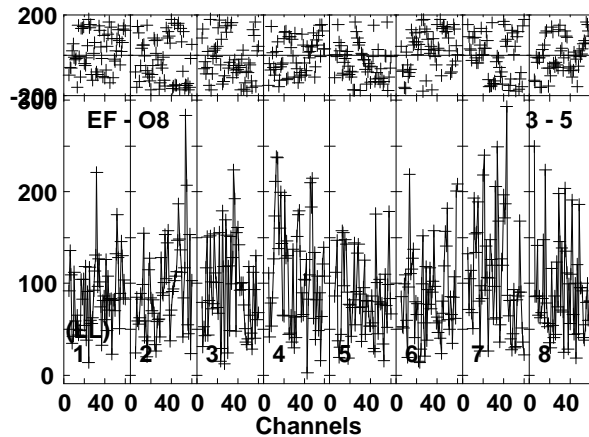
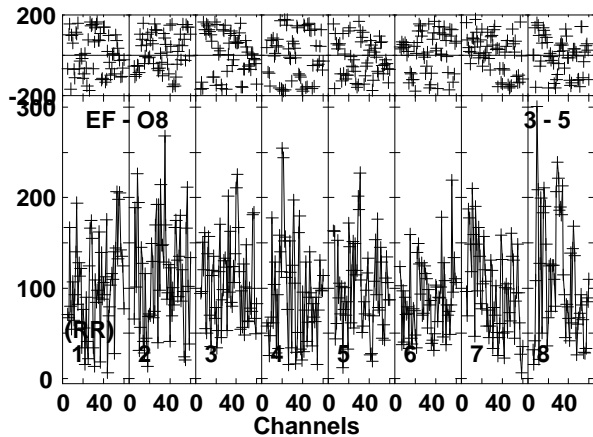
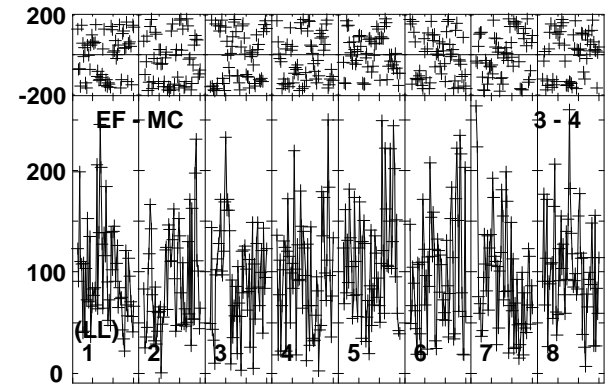
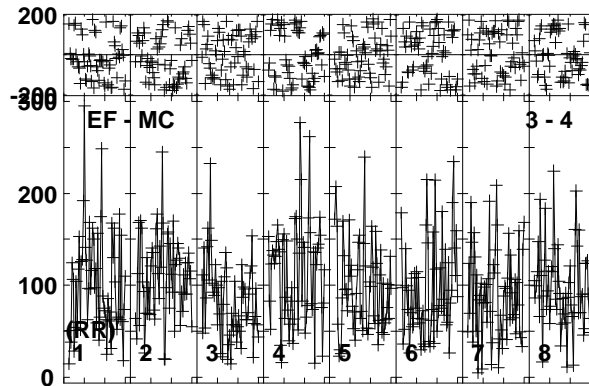
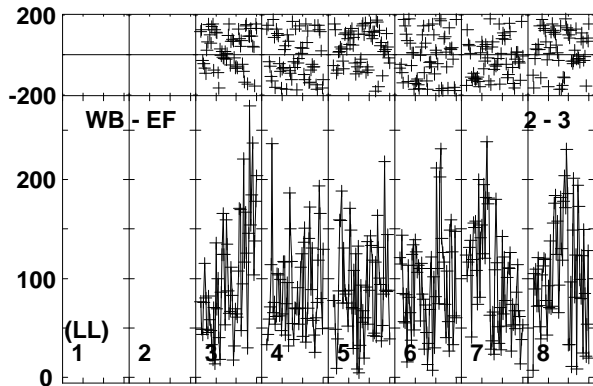
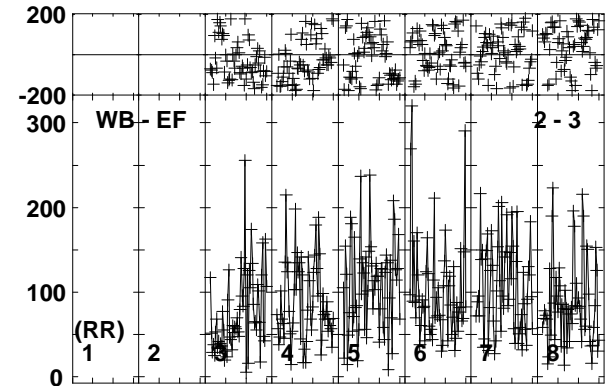
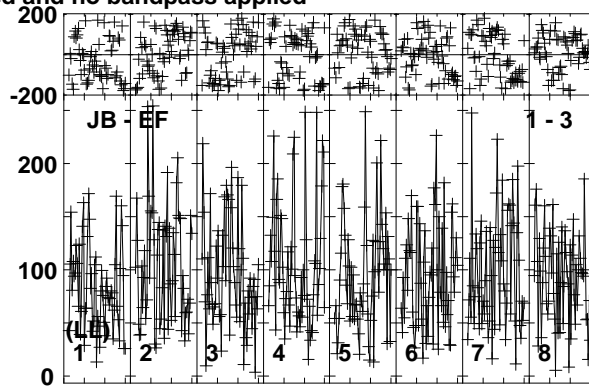
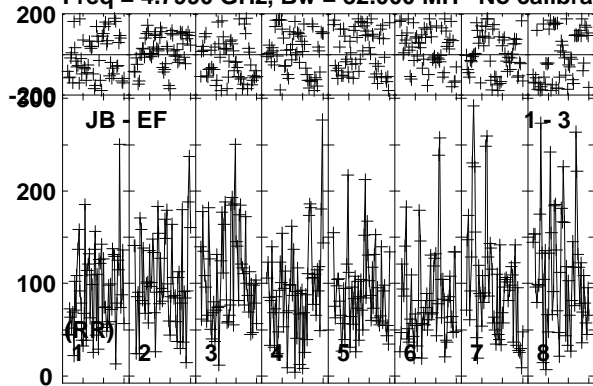

Lower frame: Micro Ampl Jy Top frame: Phas deg
Vector averaged cross-power spectrum Baseline: JB (01) - EF (03)
Timerange: 01/02:02:45 to 01/02:05:15

Plot file version 347 created 26-SEP-2019 10:41:43

190829A RG010A.UVDATA.1

Freq = 4.7990 GHz, Bw = 32.000 MH No calibration applied and no bandpass applied

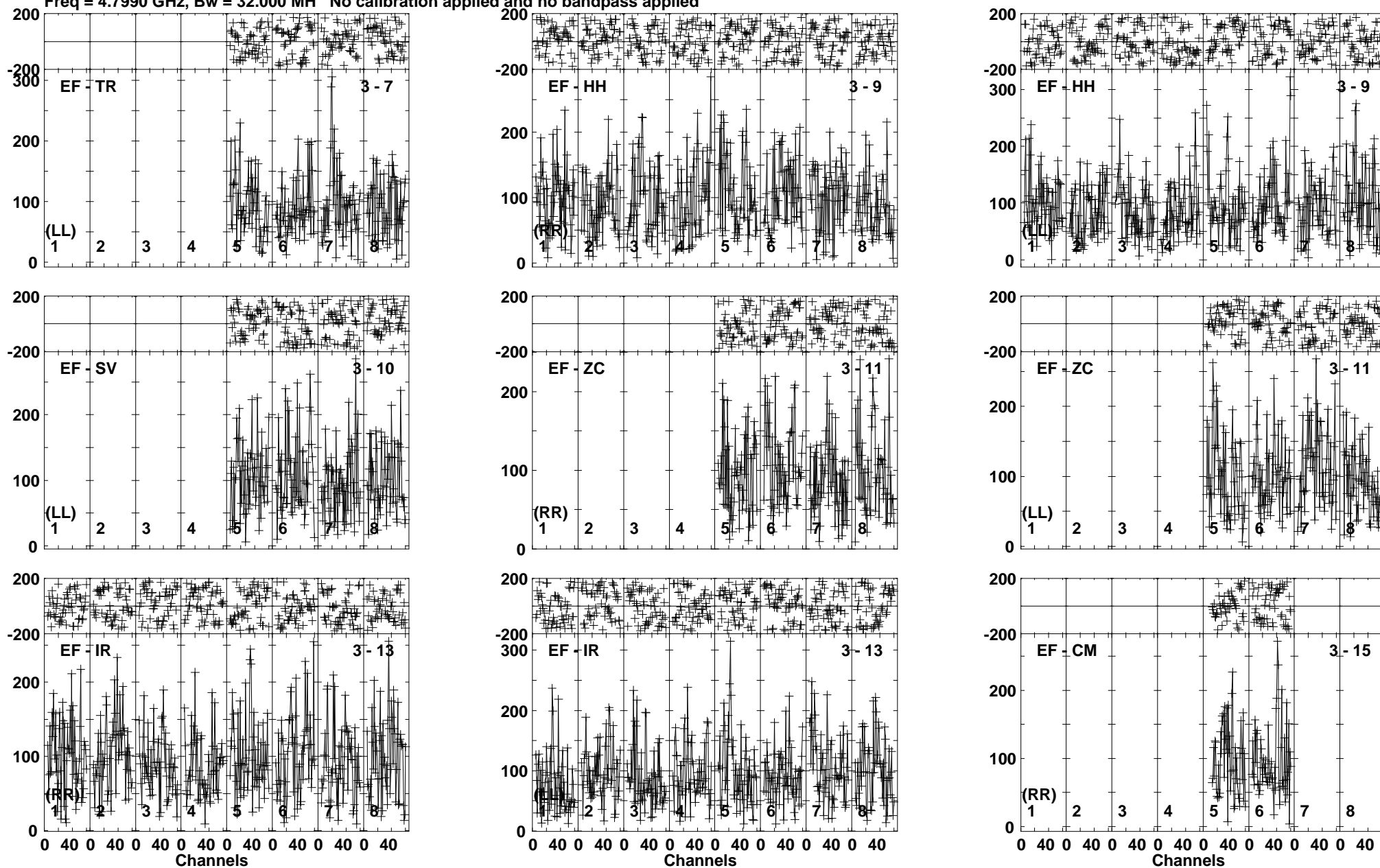

Lower frame: Micro Ampl Jy Top frame: Phas deg
Vector averaged cross-power spectrum Baseline: EF (03) - TR (07)
Timerange: 01/02:02:45 to 01/02:05:15

Plot file version 348 created 26-SEP-2019 10:41:43

190829A RG010A.UVDATA.1

Freq = 4.7990 GHz, Bw = 32.000 MH No calibration applied and no bandpass applied

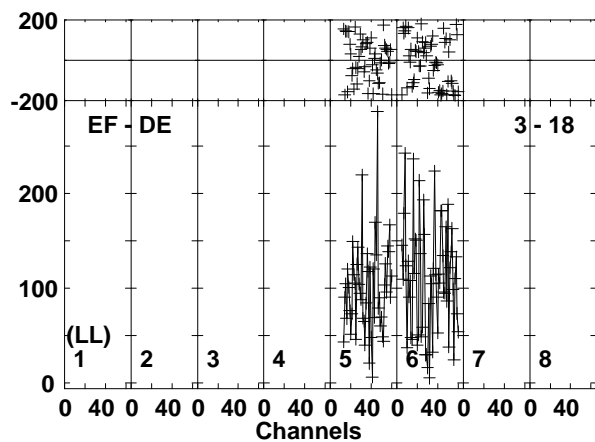
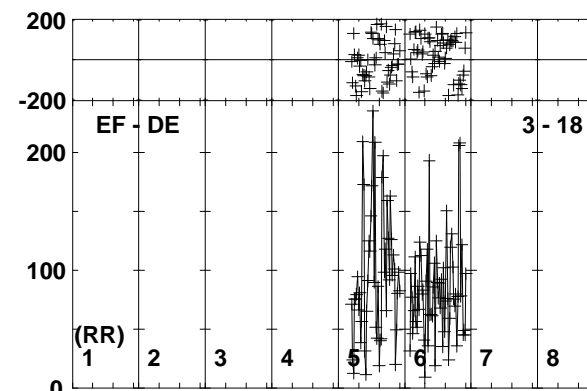
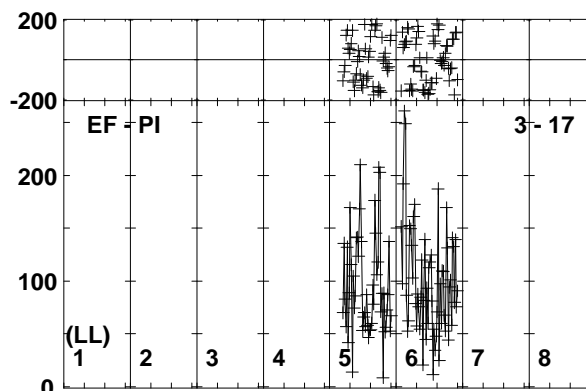
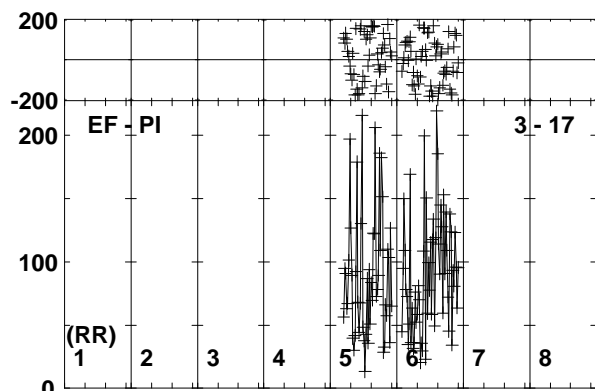
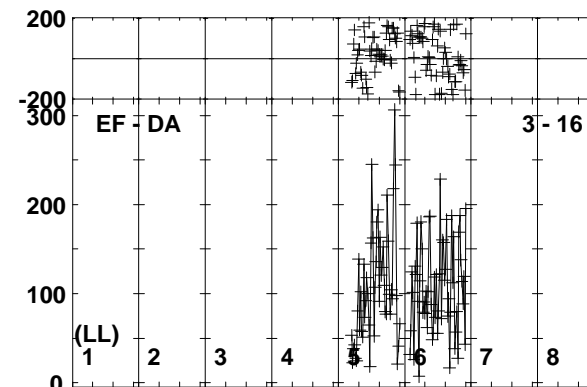
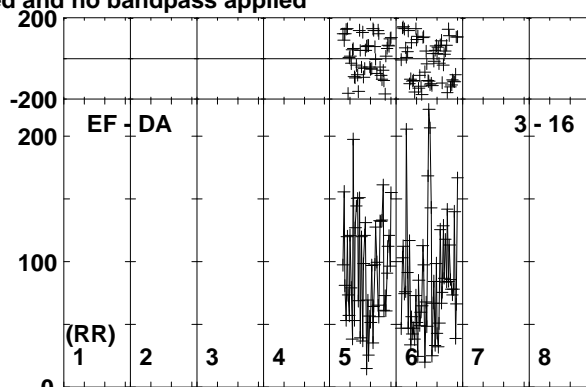
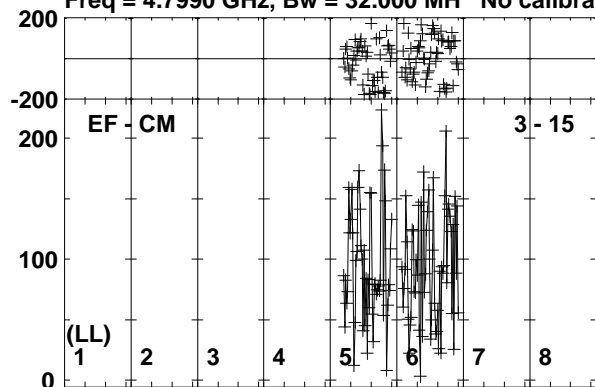

Lower frame: Micro Ampl Jy Top frame: Phas deg
Vector averaged cross-power spectrum Baseline: EF (03) - CM (15)
Timerange: 01/02:02:45 to 01/02:05:15

Plot file version 349 created 26-SEP-2019 10:41:44

J0257-1212 RG010A.UVDATA.1

Freq = 4.7990 GHz, Bw = 32.000 MH No calibration applied and no bandpass applied

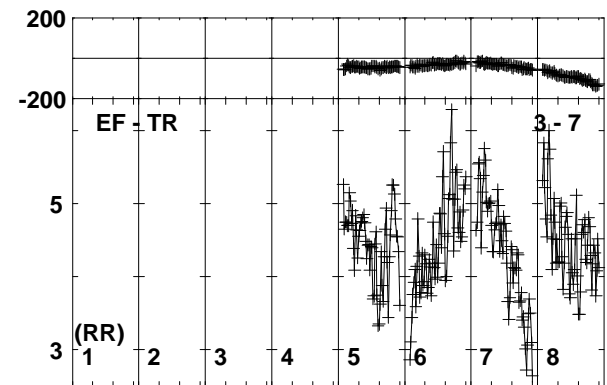
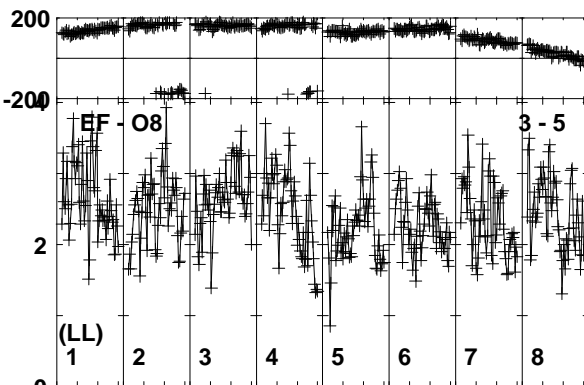
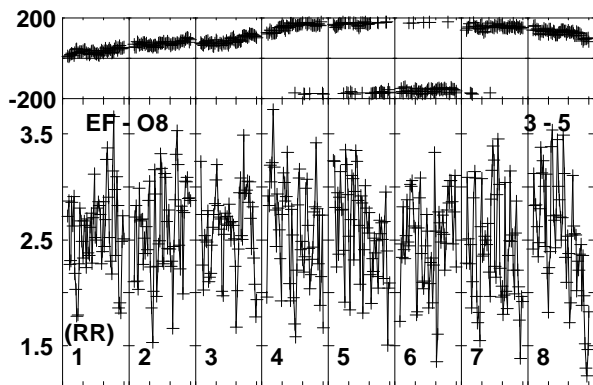
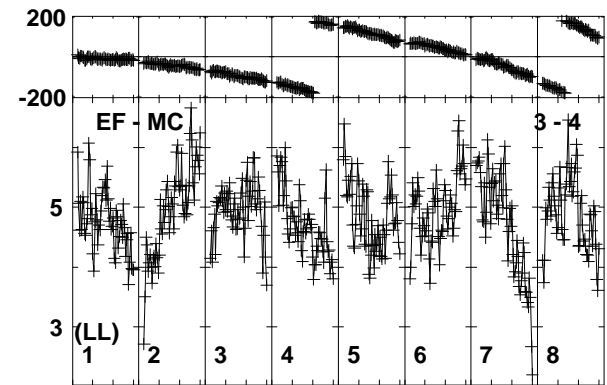
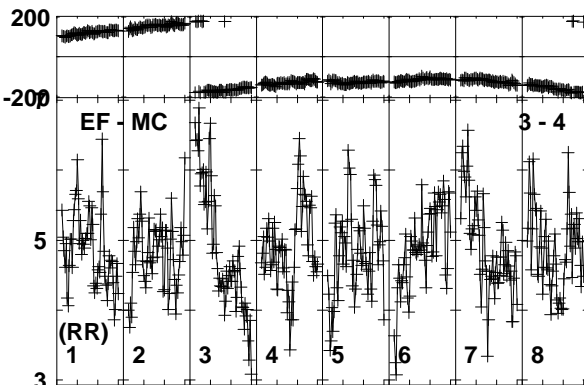
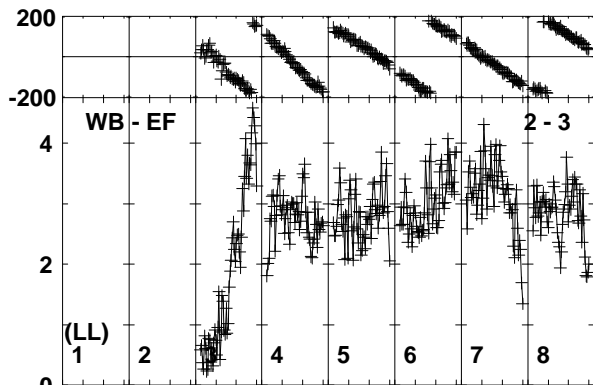
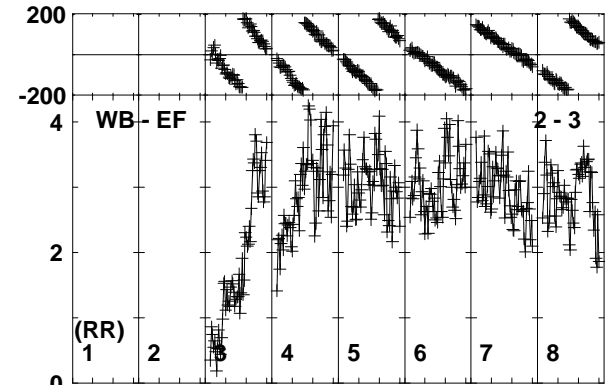
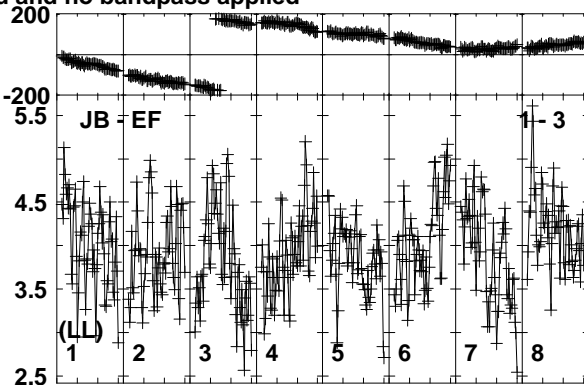
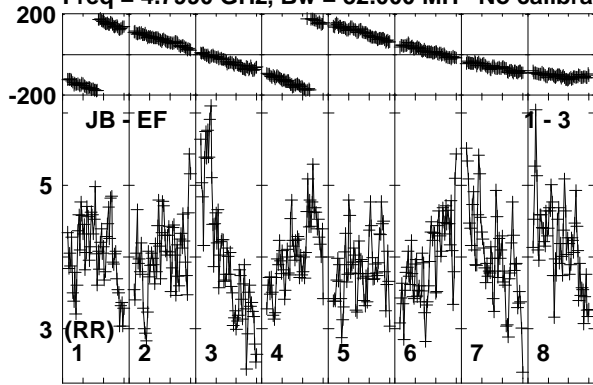

Lower frame: Milli Ampl Jy Top frame: Phas deg
Vector averaged cross-power spectrum Baseline: JB (01) - EF (03)
Timerange: 01/02:05:16 to 01/02:06:14

Plot file version 350 created 26-SEP-2019 10:41:44

J0257-1212 RG010A.UVDATA.1

Freq = 4.7990 GHz, Bw = 32.000 MH No calibration applied and no bandpass applied

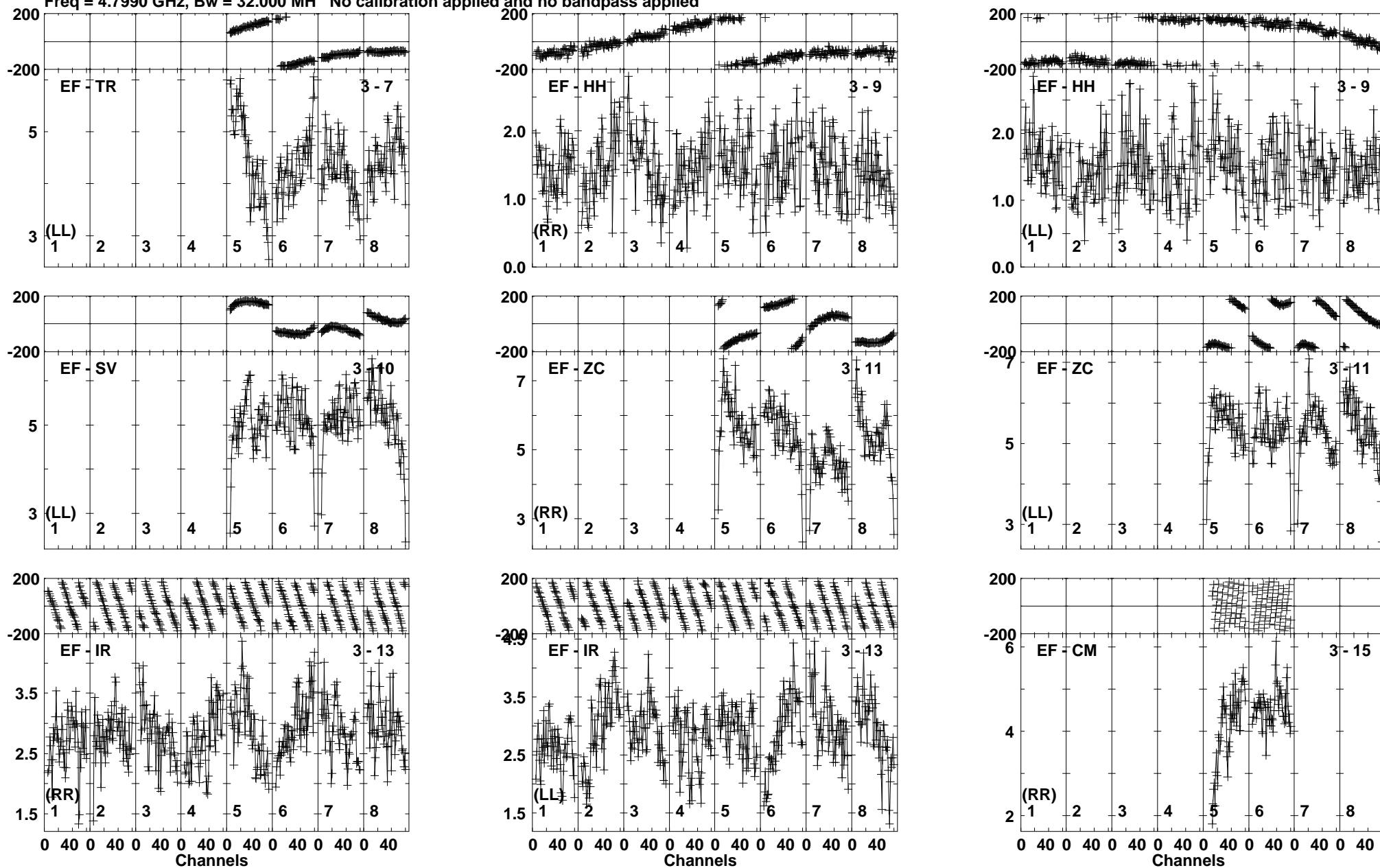

Lower frame: Milli Ampl Jy Top frame: Phas deg
Vector averaged cross-power spectrum Baseline: EF (03) - TR (07)
Timerange: 01/02:05:16 to 01/02:06:14

Plot file version 351 created 26-SEP-2019 10:41:45

J0257-1212 RG010A.UVDATA.1

Freq = 4.7990 GHz, Bw = 32.000 MH No calibration applied and no bandpass applied

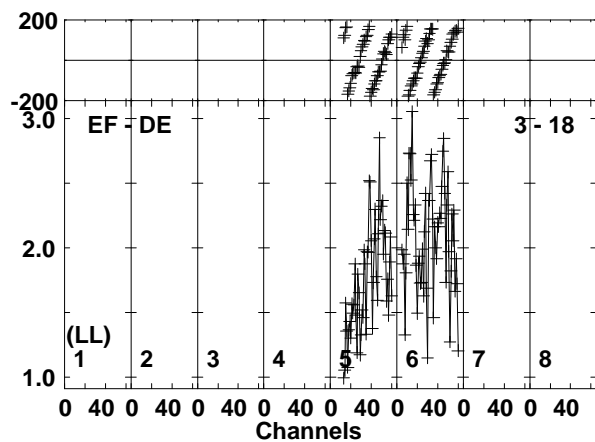
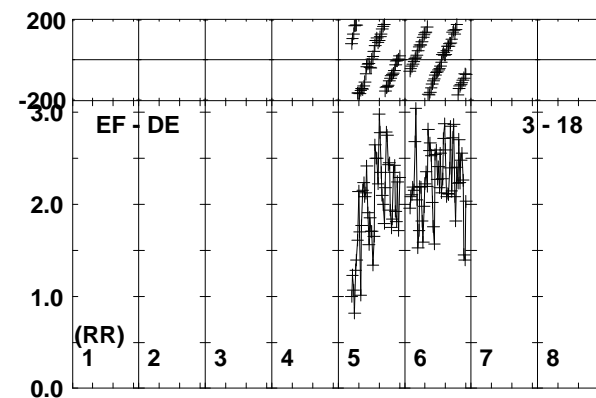
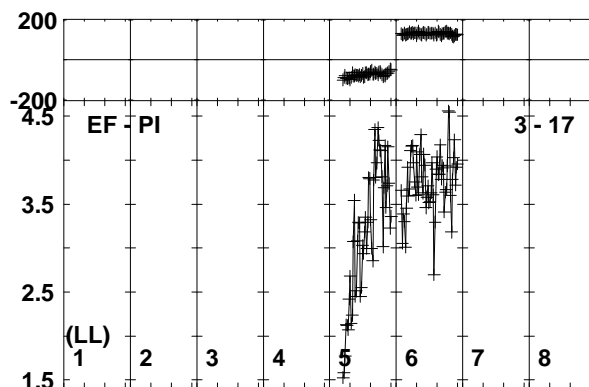
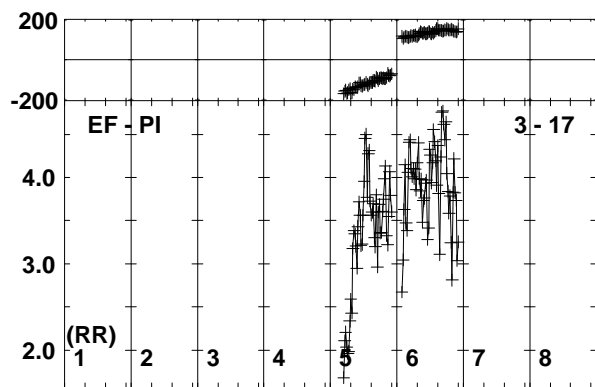
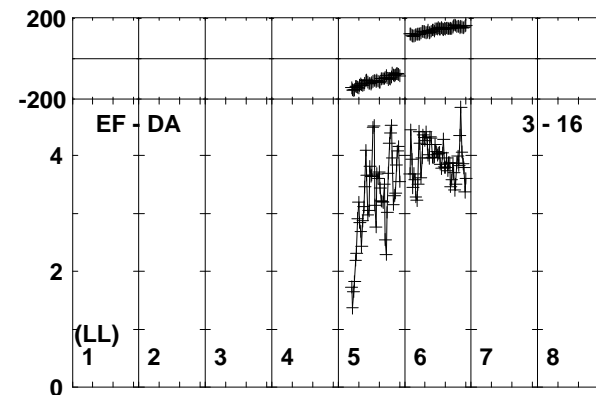
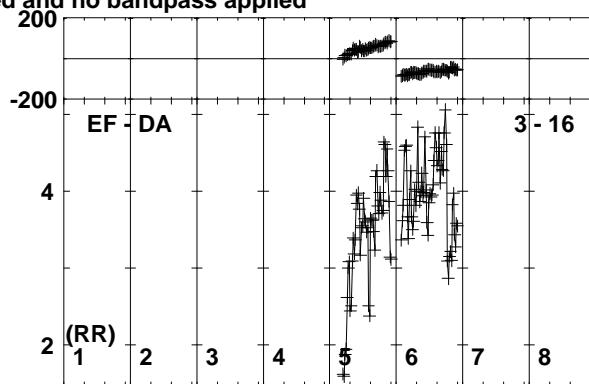
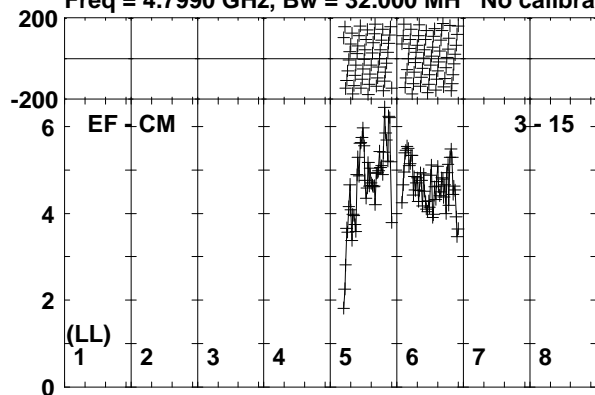

Lower frame: Milli Ampl Jy Top frame: Phas deg
Vector averaged cross-power spectrum Baseline: EF (03) - CM (15)
Timerange: 01/02:05:16 to 01/02:06:14

Plot file version 352 created 26-SEP-2019 10:41:46
190829A RG010A.UVDATA.1

Freq = 4.7990 GHz, Bw = 32.000 MH No calibration applied and no bandpass applied

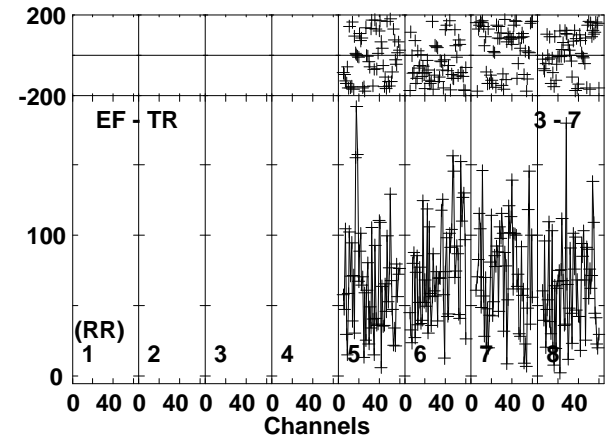
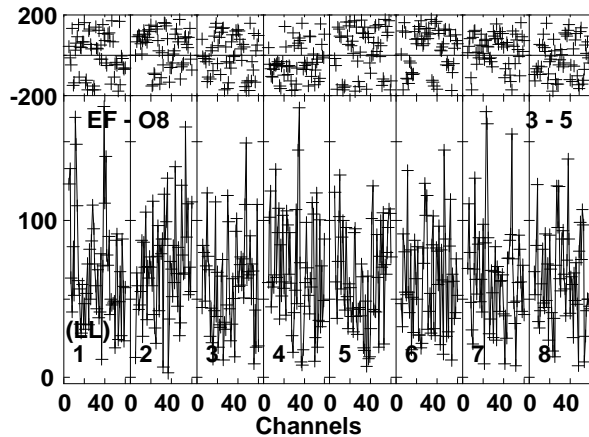
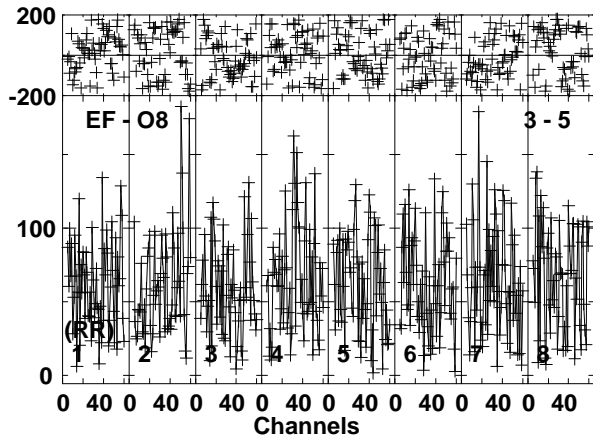
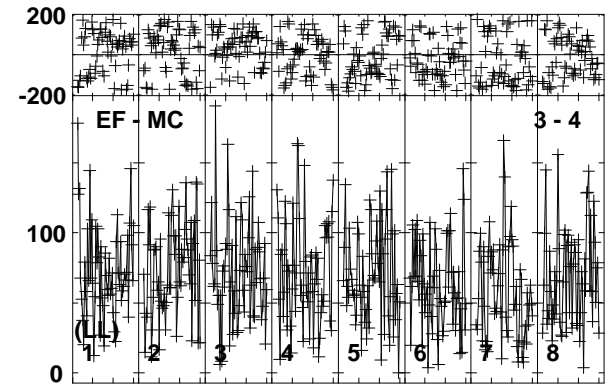
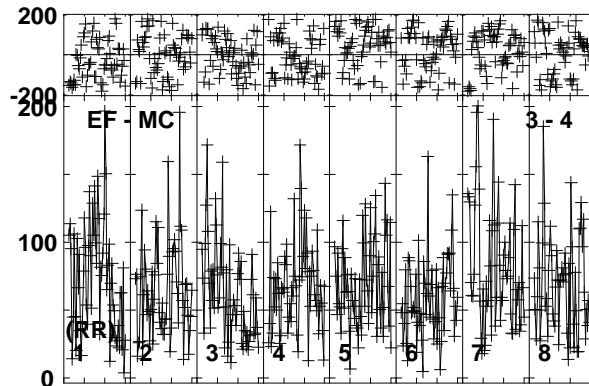
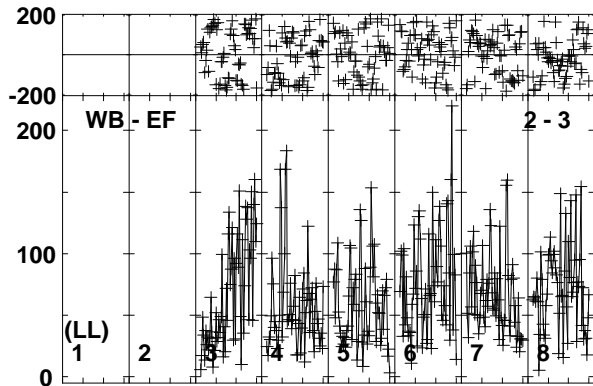
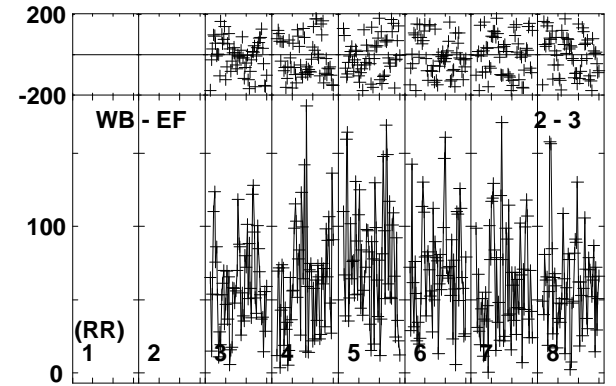
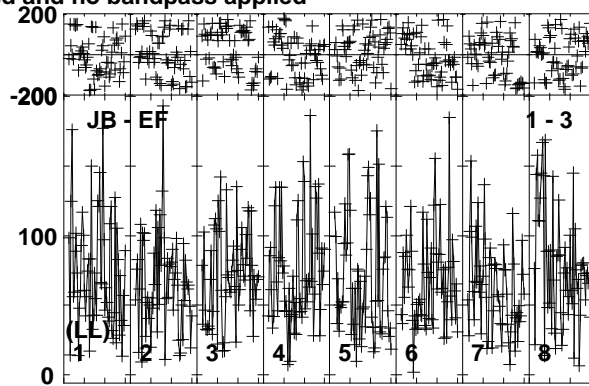
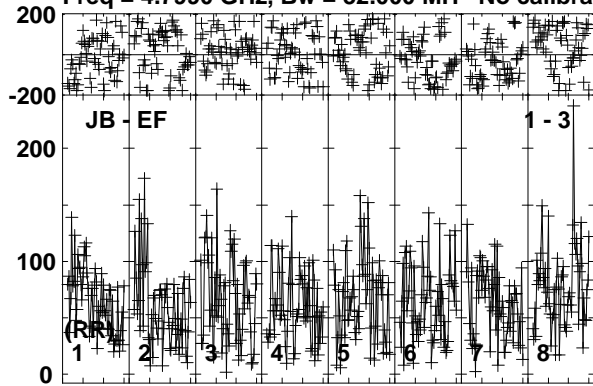

Lower frame: Micro Ampl Jy Top frame: Phas deg
Vector averaged cross-power spectrum Baseline: JB (01) - EF (03)
Timerange: 01/02:06:15 to 01/02:11:14

Plot file version 353 created 26-SEP-2019 10:41:46

190829A RG010A.UVDATA.1

Freq = 4.7990 GHz, Bw = 32.000 MH No calibration applied and no bandpass applied

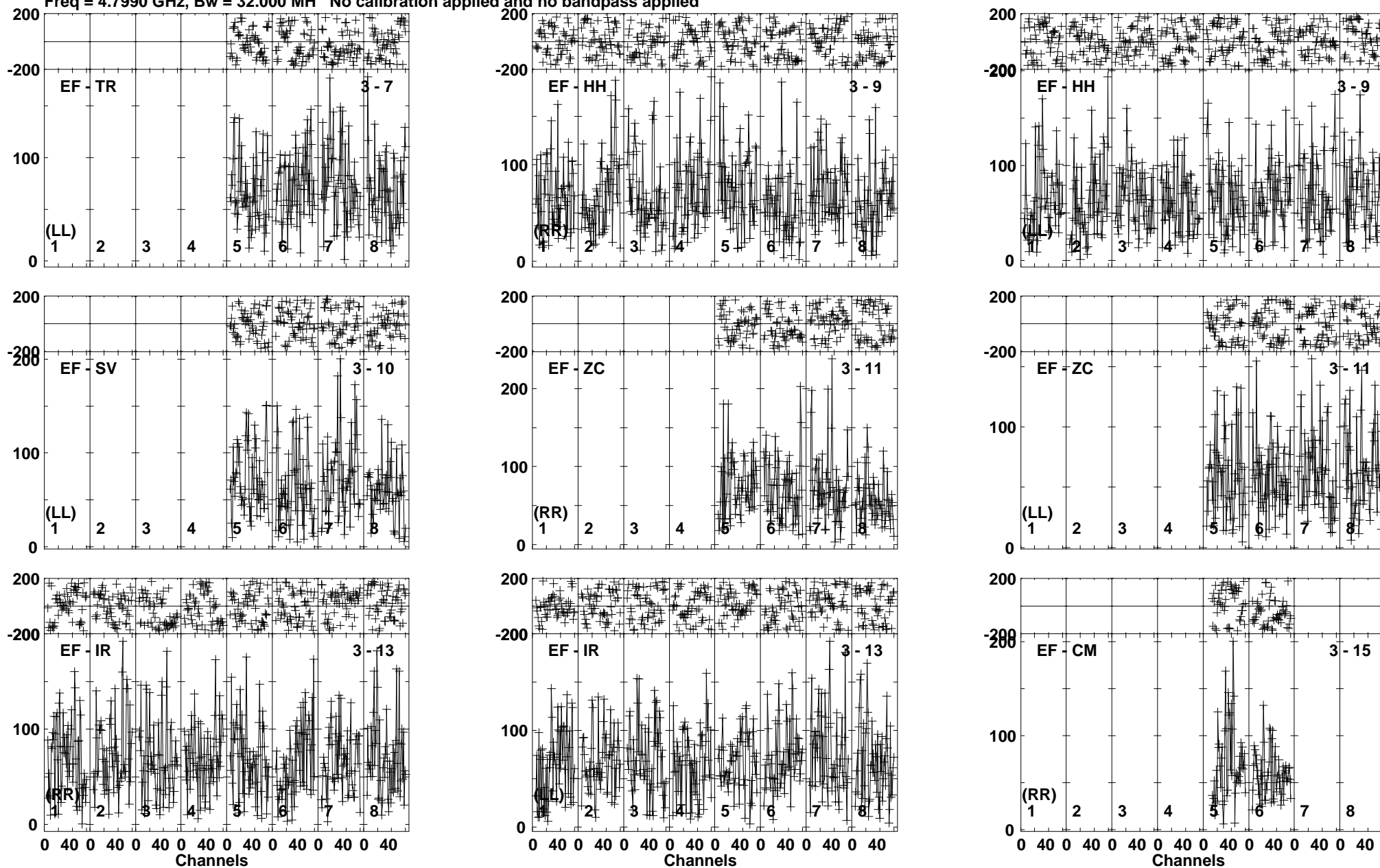

Lower frame: Micro Ampl Jy Top frame: Phas deg
Vector averaged cross-power spectrum Baseline: EF (03) - TR (07)
Timerange: 01/02:06:15 to 01/02:11:14

Plot file version 354 created 26-SEP-2019 10:41:47

190829A RG010A.UVDATA.1

Freq = 4.7990 GHz, Bw = 32.000 MH No calibration applied and no bandpass applied

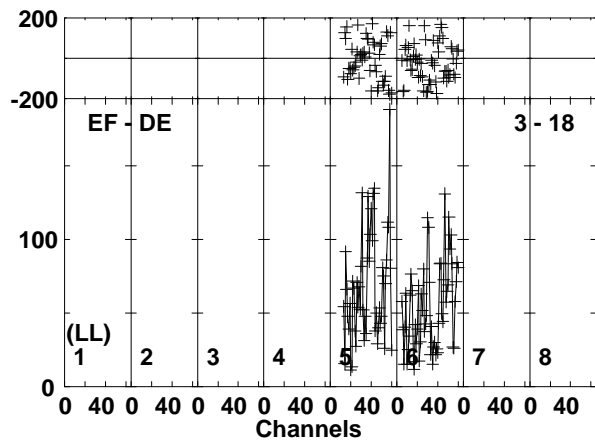
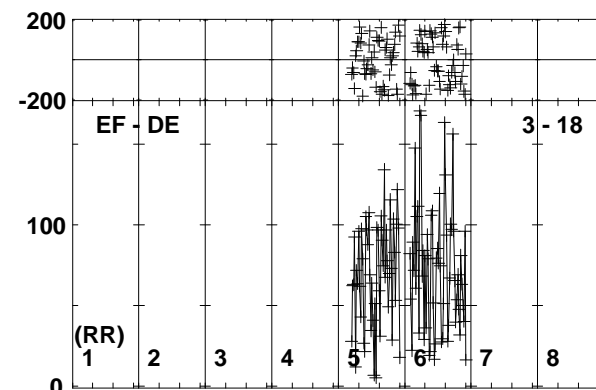
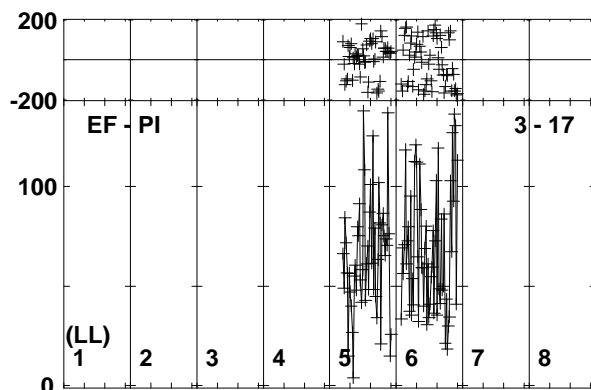
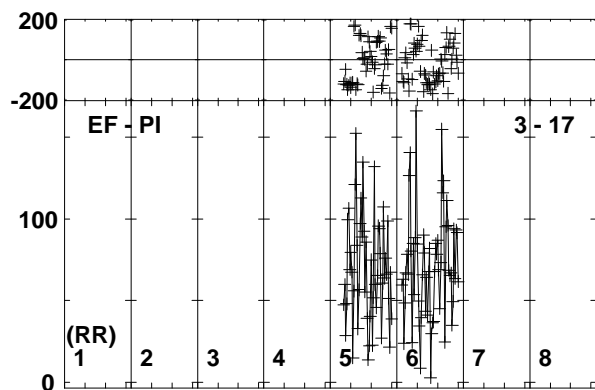
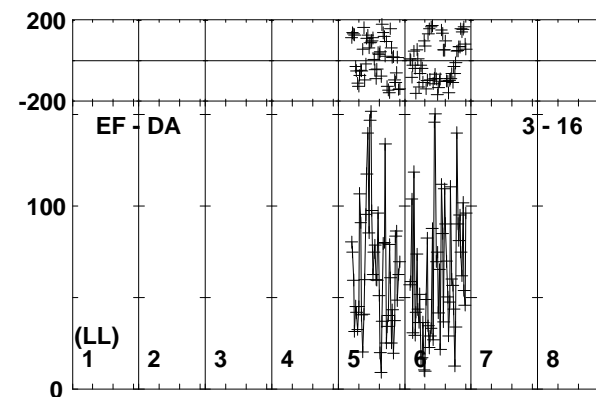
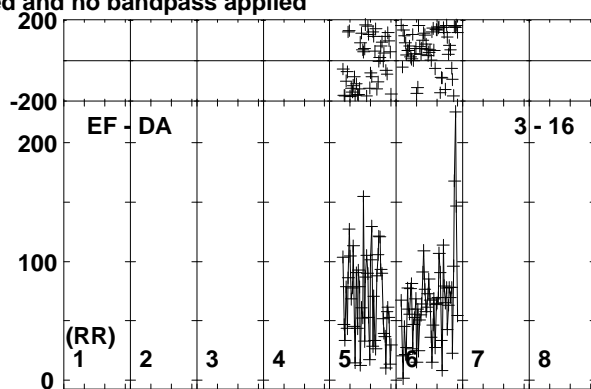
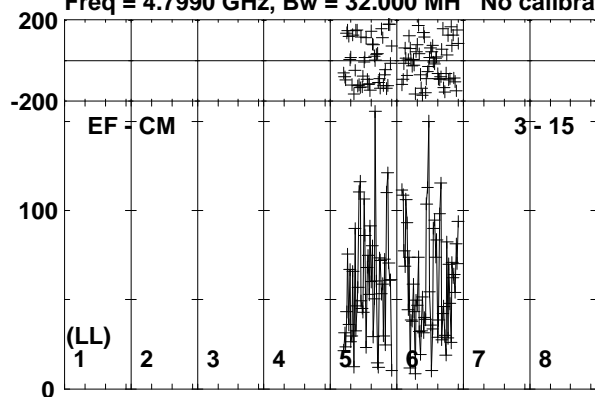

Lower frame: Micro Ampl Jy Top frame: Phas deg
Vector averaged cross-power spectrum Baseline: EF (03) - CM (15)
Timerange: 01/02:06:15 to 01/02:11:14

Plot file version 355 created 26-SEP-2019 10:41:48

J0257-1212 RG010A.UVDATA.1

Freq = 4.7990 GHz, Bw = 32.000 MH No calibration applied and no bandpass applied

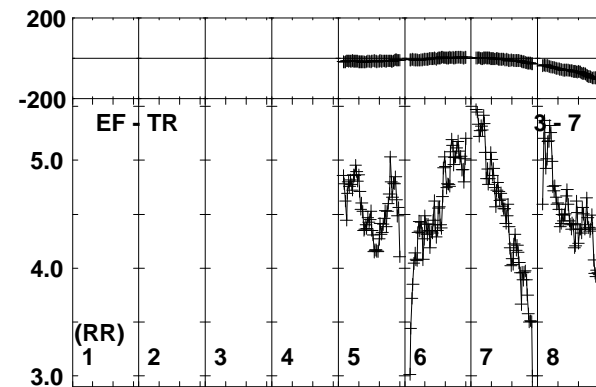
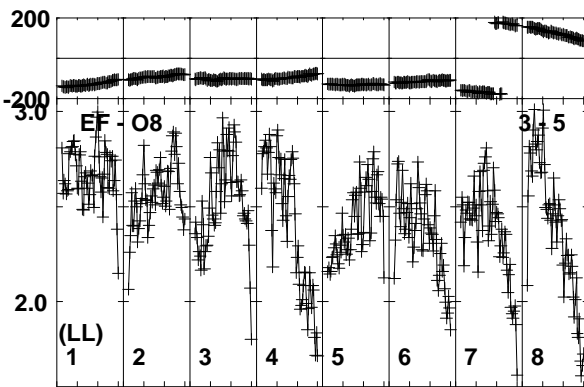
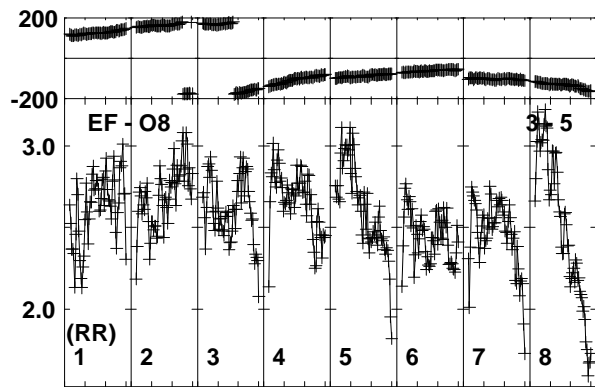
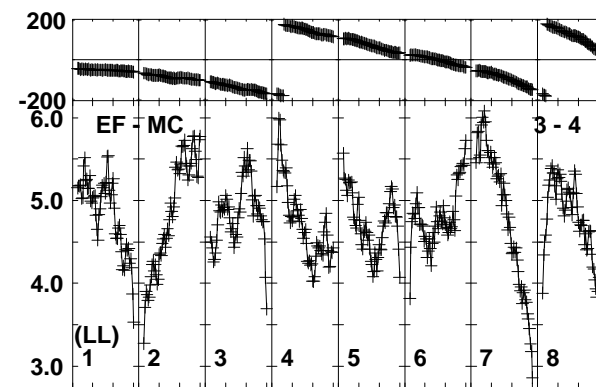
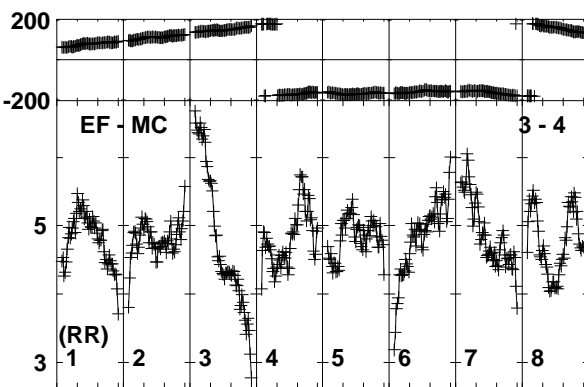
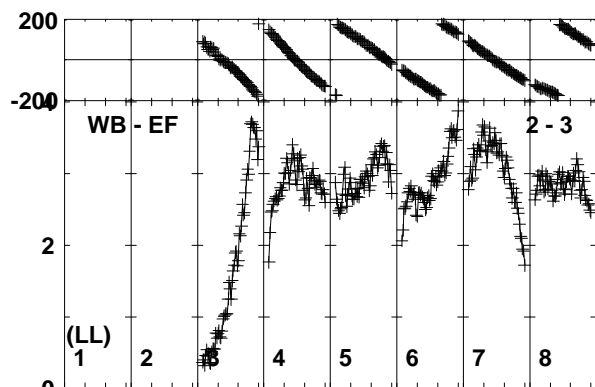
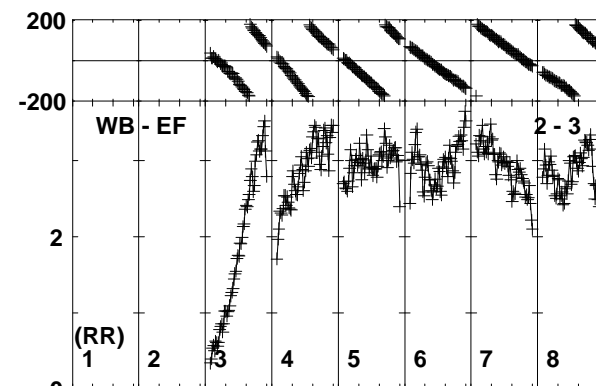
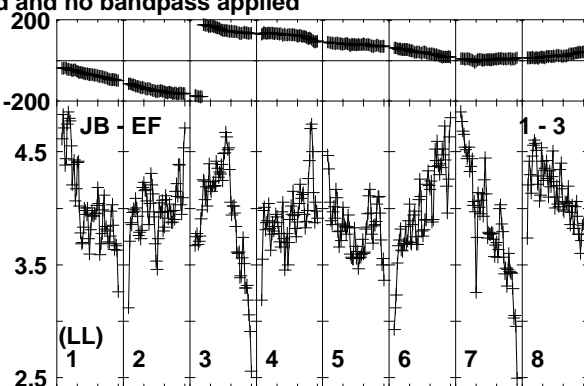
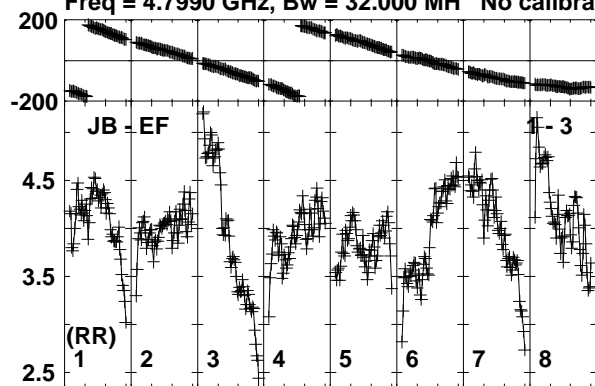

Lower frame: Milli Ampl Jy Top frame: Phas deg
Vector averaged cross-power spectrum Baseline: JB (01) - EF (03)
Timerange: 01/02:11:56 to 01/02:12:54

Plot file version 356 created 26-SEP-2019 10:41:48

J0257-1212 RG010A.UVDATA.1

Freq = 4.7990 GHz, Bw = 32.000 MH No calibration applied and no bandpass applied

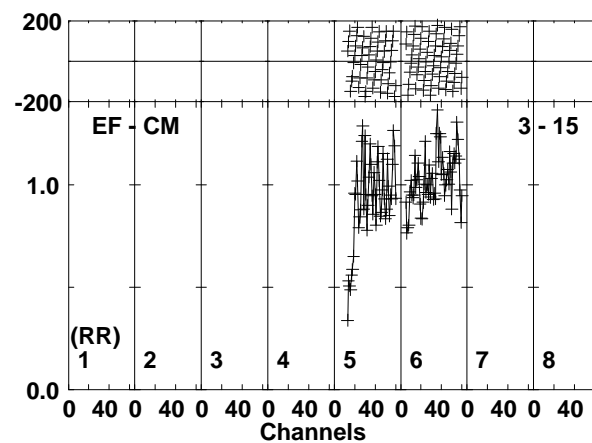
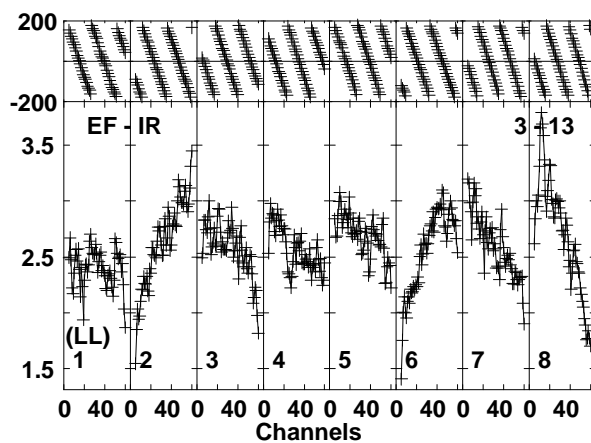
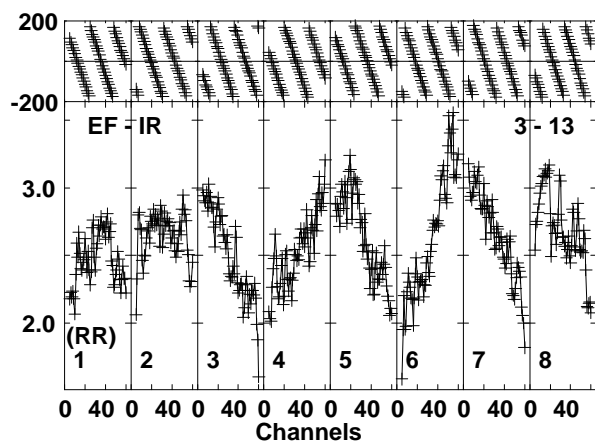
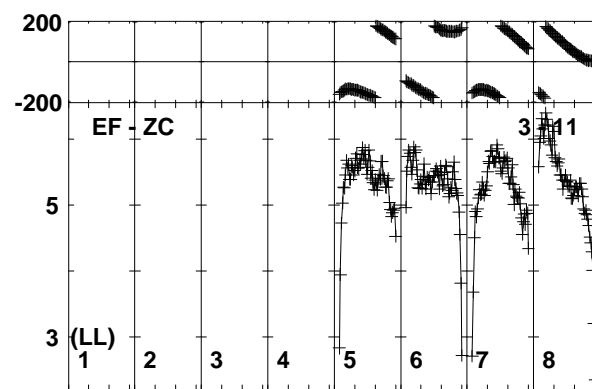
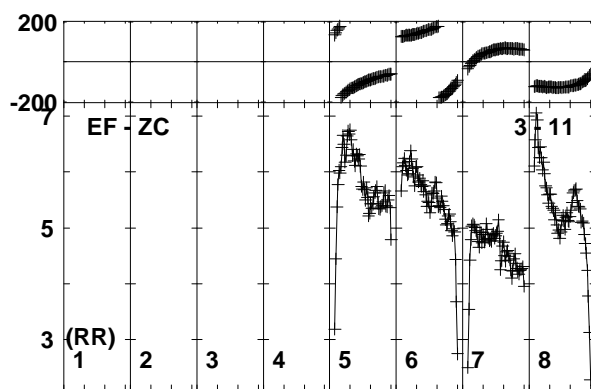
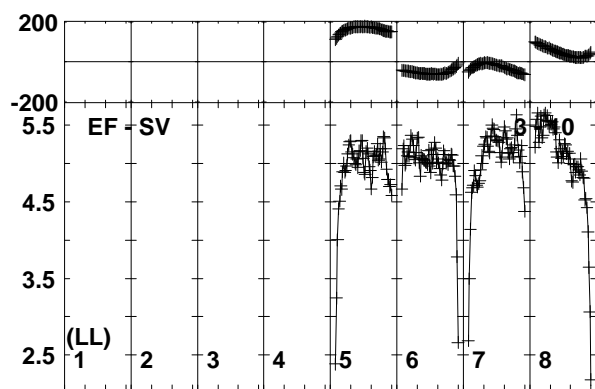
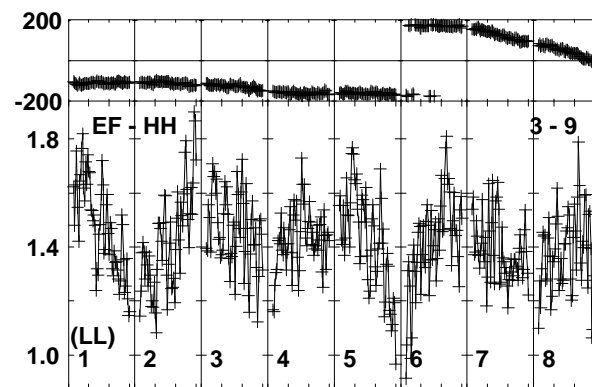
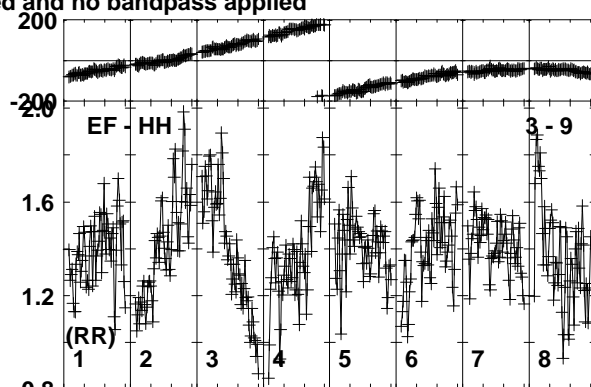
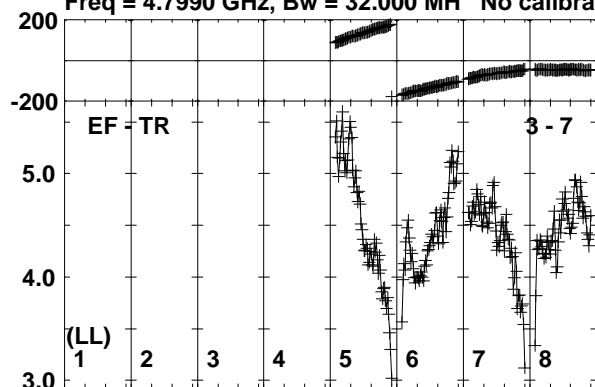

Lower frame: Milli Ampl Jy Top frame: Phas deg
Vector averaged cross-power spectrum Baseline: EF (03) - TR (07)
Timerange: 01/02:11:56 to 01/02:12:54

Plot file version 357 created 26-SEP-2019 10:41:49

J0257-1212 RG010A.UVDATA.1

Freq = 4.7990 GHz, Bw = 32.000 MH No calibration applied and no bandpass applied

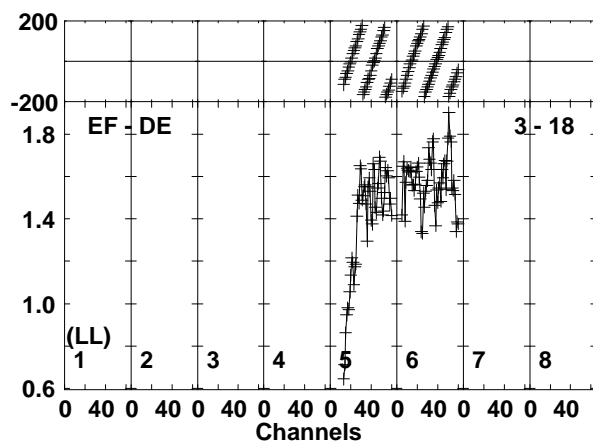
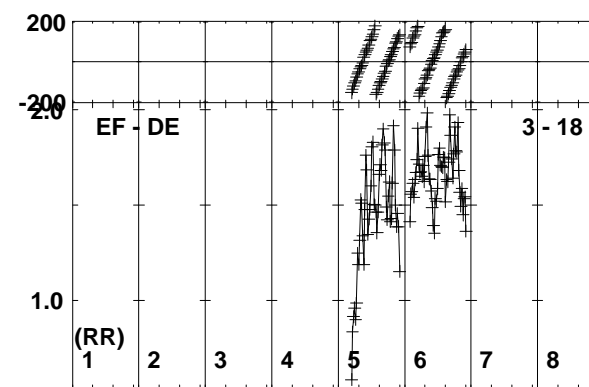
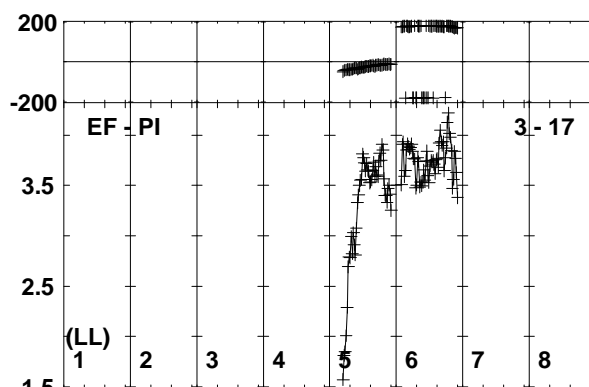
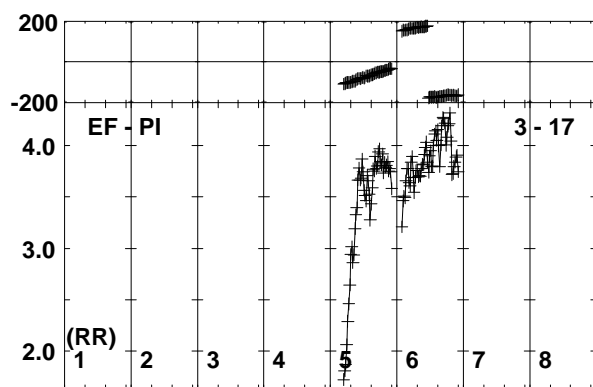
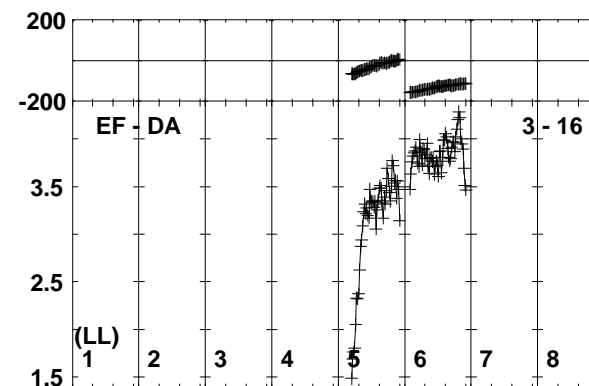
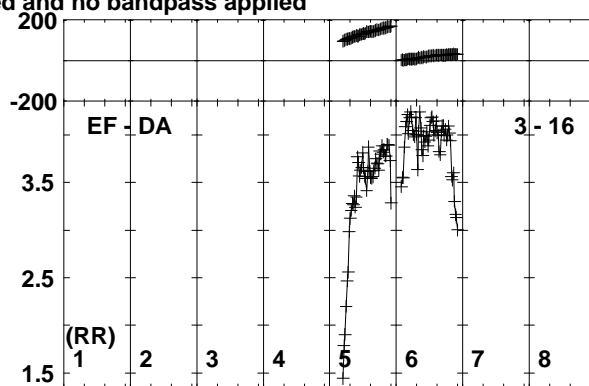
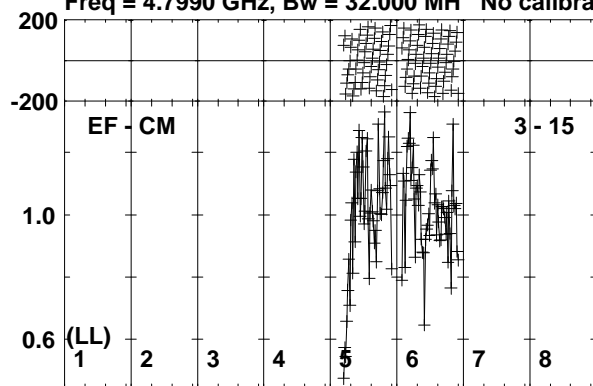

Lower frame: Milli Ampl Jy Top frame: Phas deg
Vector averaged cross-power spectrum Baseline: EF (03) - CM (15)
Timerange: 01/02:11:56 to 01/02:12:54

Plot file version 358 created 26-SEP-2019 10:41:50

190829A RG010A.UVDATA.1

Freq = 4.7990 GHz, Bw = 32.000 MH No calibration applied and no bandpass applied

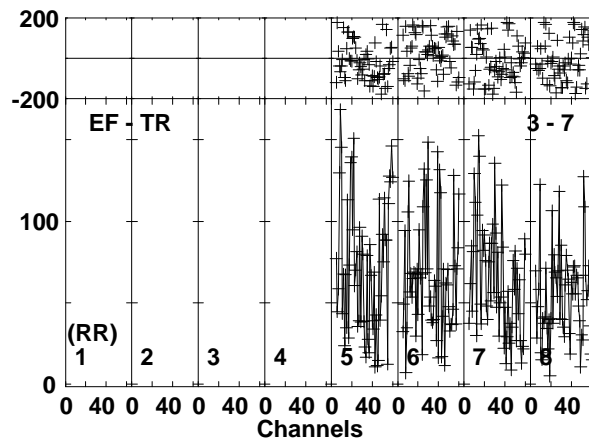
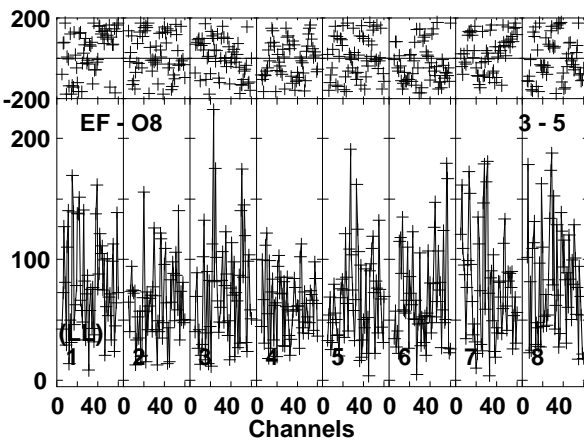
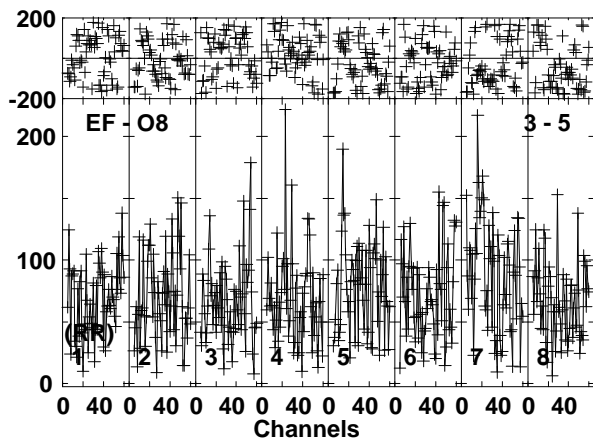
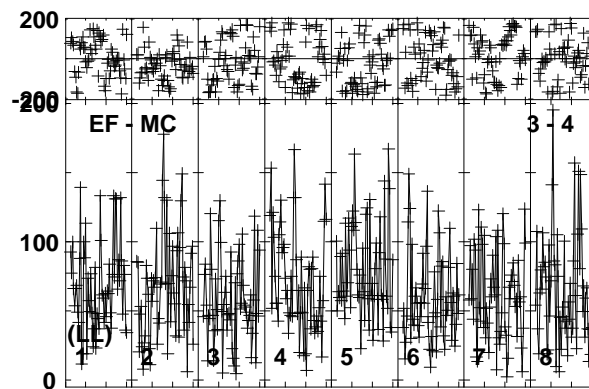
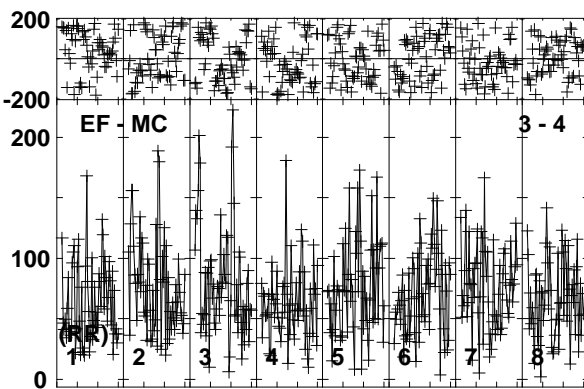
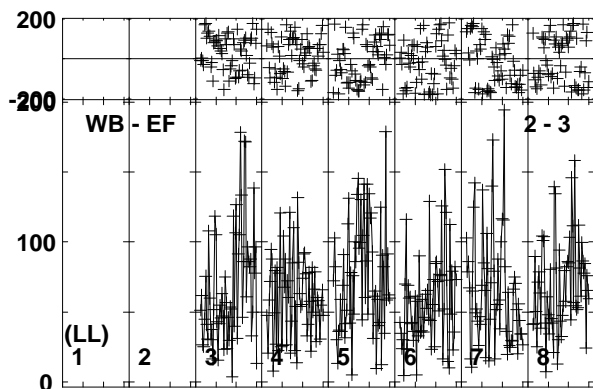
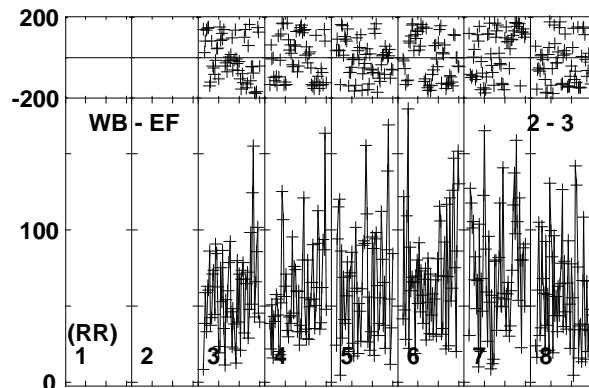
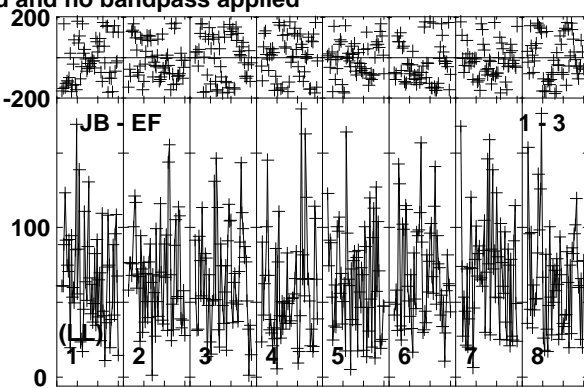
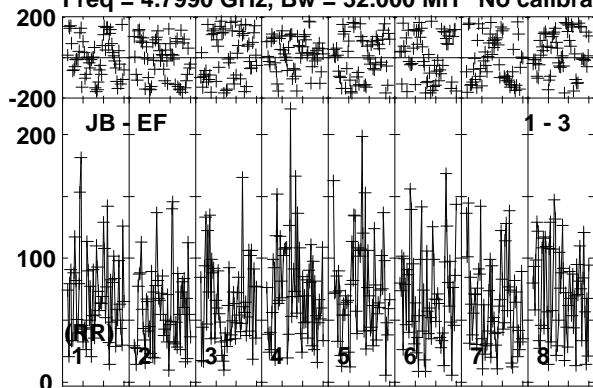

Lower frame: Micro Ampl Jy Top frame: Phas deg
Vector averaged cross-power spectrum Baseline: JB (01) - EF (03)
Timerange: 01/02:12:55 to 01/02:17:54

Plot file version 359 created 26-SEP-2019 10:41:50

190829A RG010A.UVDATA.1

Freq = 4.7990 GHz, Bw = 32.000 MH No calibration applied and no bandpass applied

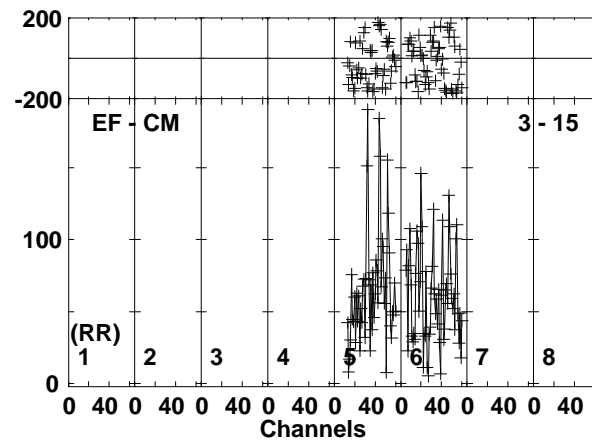
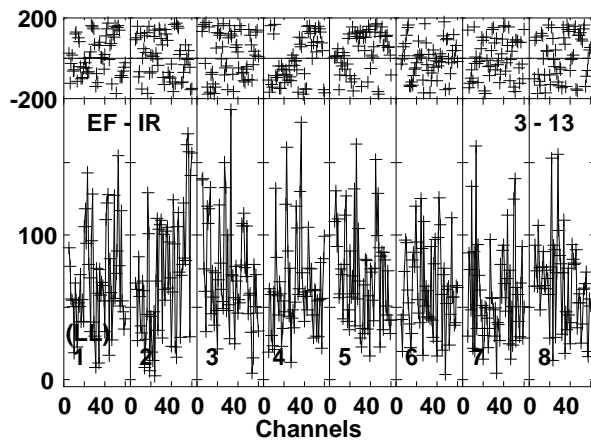
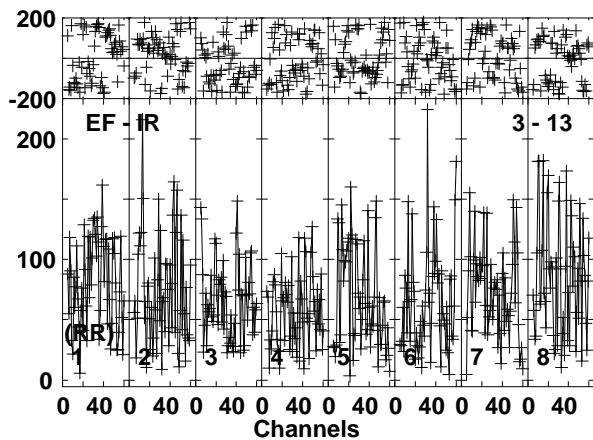
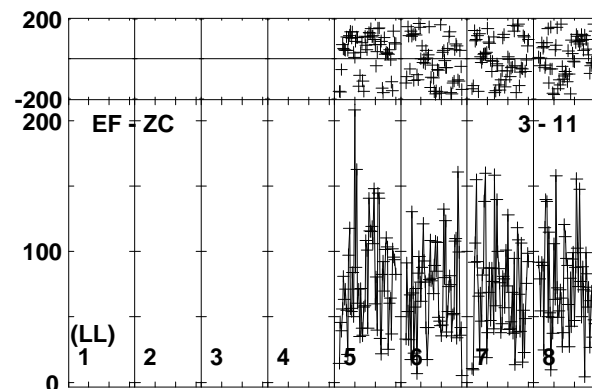
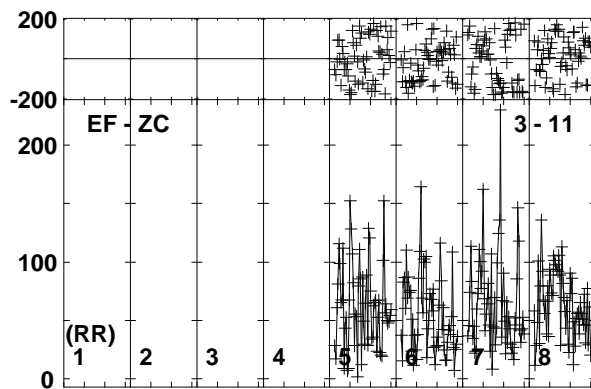
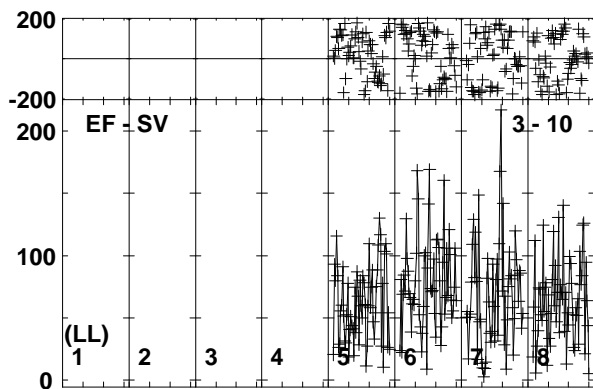
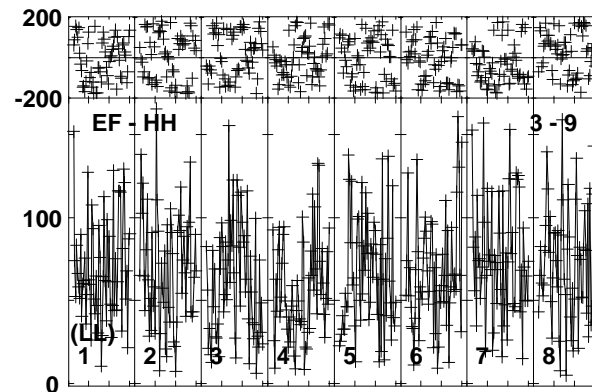
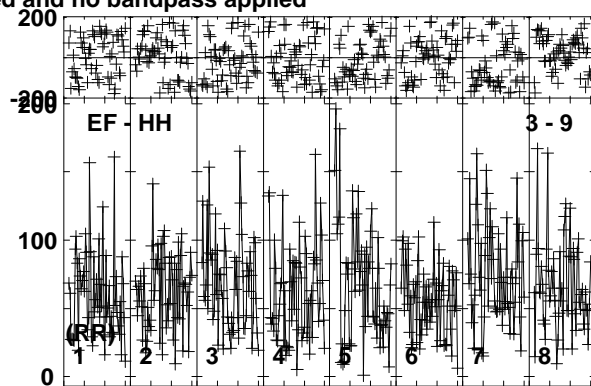
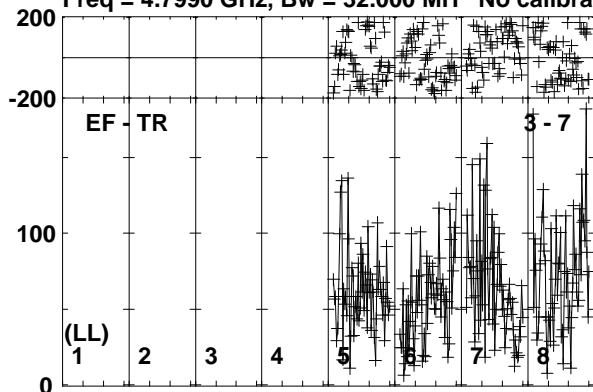

Lower frame: Micro Ampl Jy Top frame: Phas deg
Vector averaged cross-power spectrum Baseline: EF (03) - TR (07)
Timerange: 01/02:12:55 to 01/02:17:54

Plot file version 360 created 26-SEP-2019 10:41:51

190829A RG010A.UVDATA.1

Freq = 4.7990 GHz, Bw = 32.000 MH No calibration applied and no bandpass applied

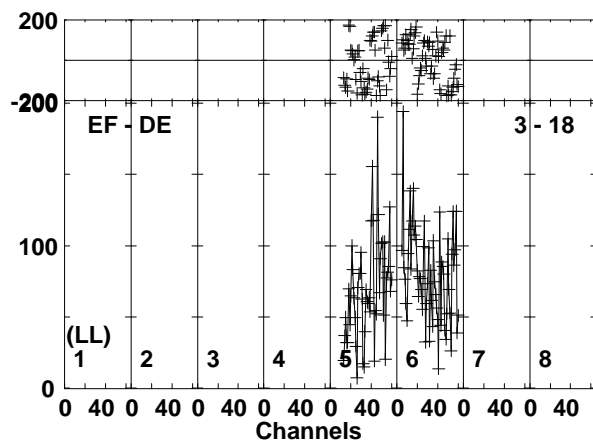
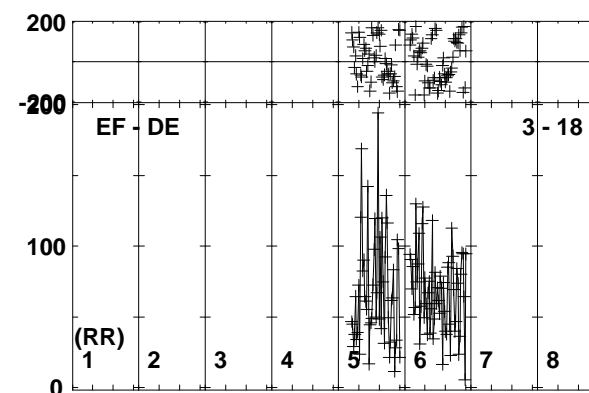
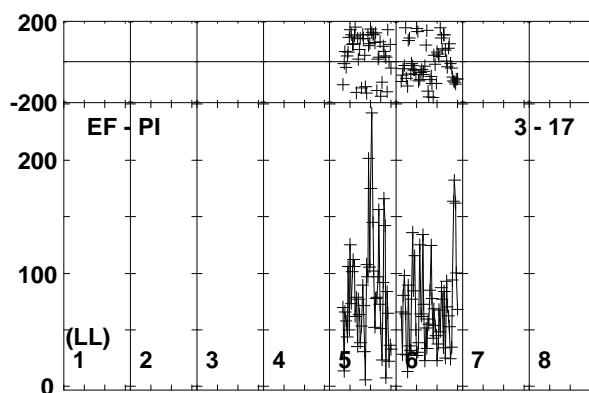
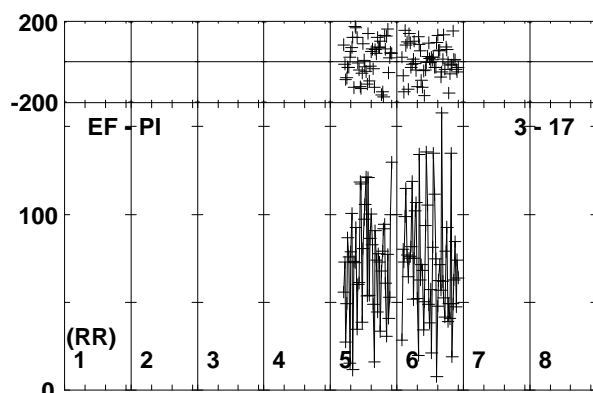
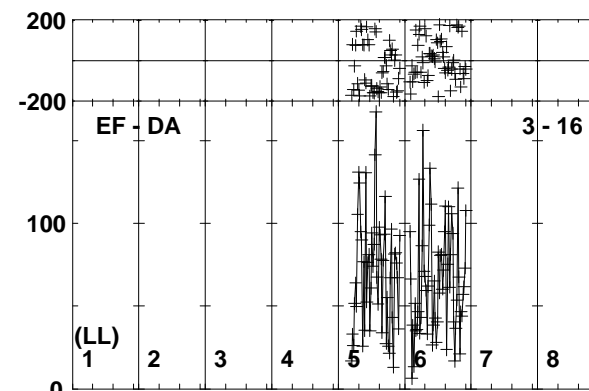
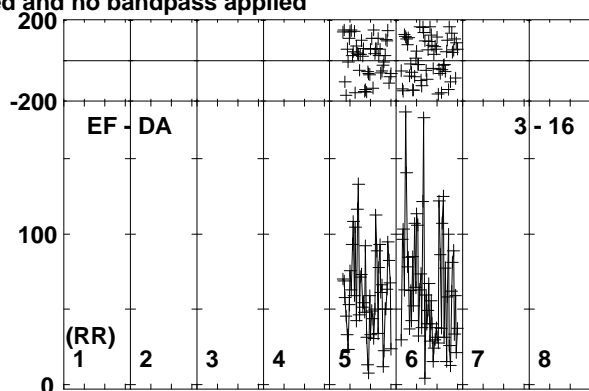
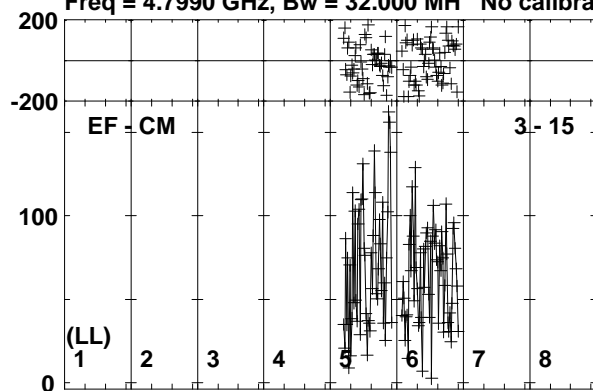

Lower frame: Micro Ampl Jy Top frame: Phas deg
Vector averaged cross-power spectrum Baseline: EF (03) - CM (15)
Timerange: 01/02:12:55 to 01/02:17:54

Plot file version 361 created 26-SEP-2019 10:41:52

J0257-1212 RG010A.UVDATA.1

Freq = 4.7990 GHz, Bw = 32.000 MH No calibration applied and no bandpass applied

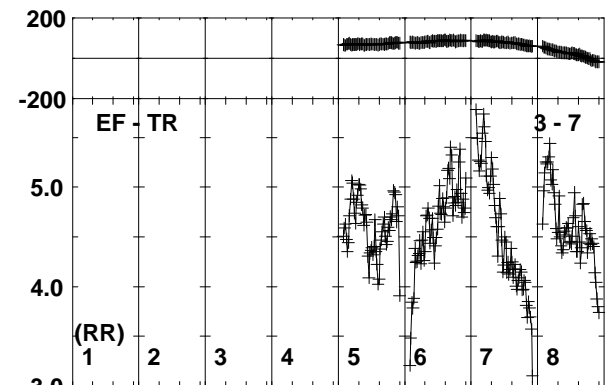
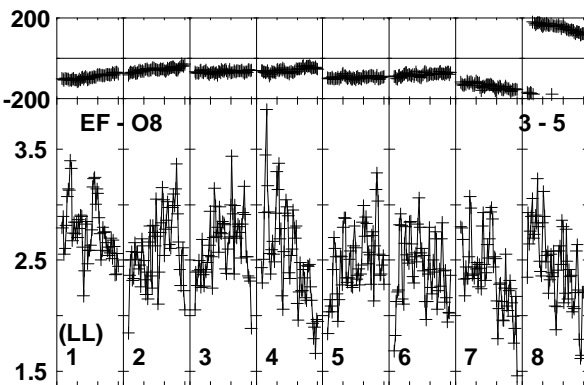
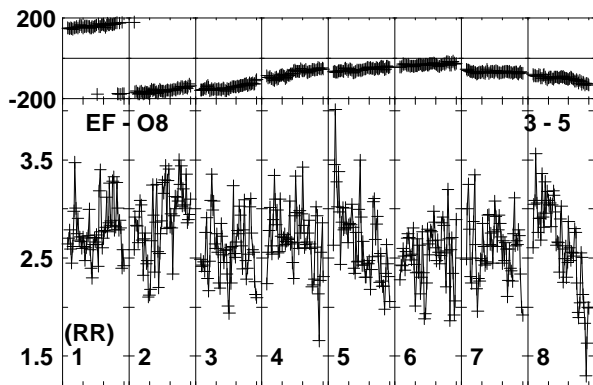
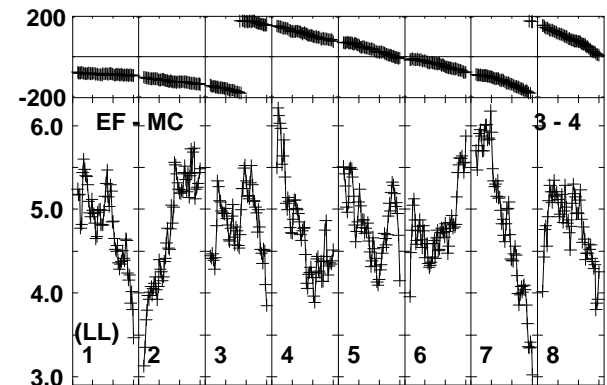
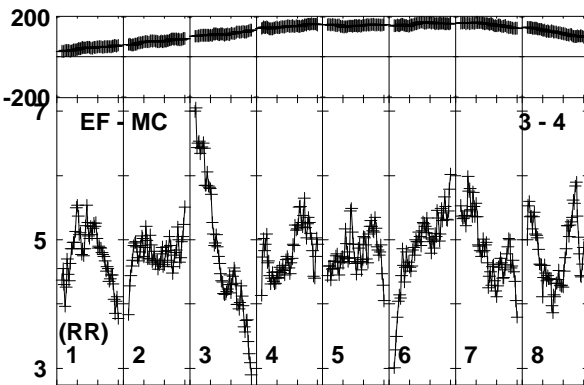
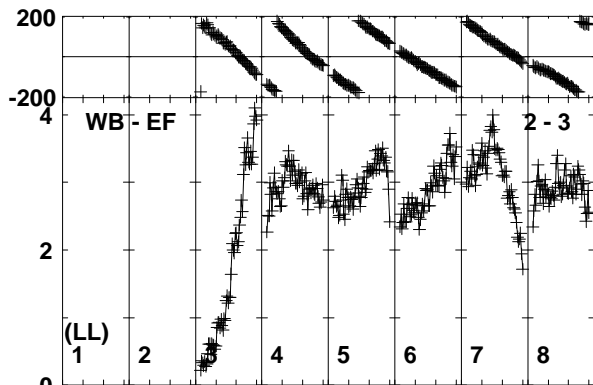
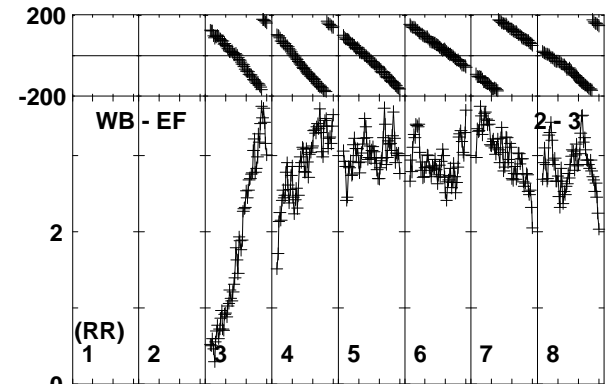
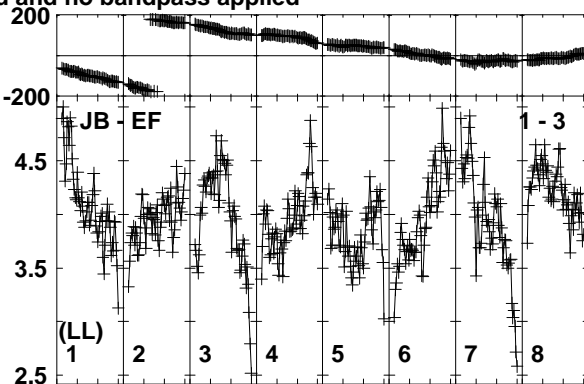
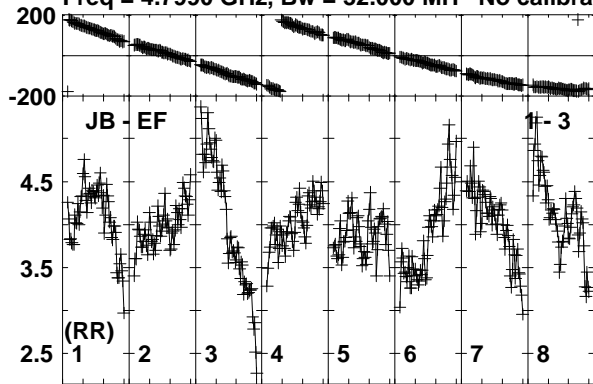

Lower frame: Milli Ampl Jy Top frame: Phas deg
Vector averaged cross-power spectrum Baseline: JB (01) - EF (03)
Timerange: 01/02:18:46 to 01/02:19:15

Plot file version 362 created 26-SEP-2019 10:41:52

J0257-1212 RG010A.UVDATA.1

Freq = 4.7990 GHz, Bw = 32.000 MH No calibration applied and no bandpass applied

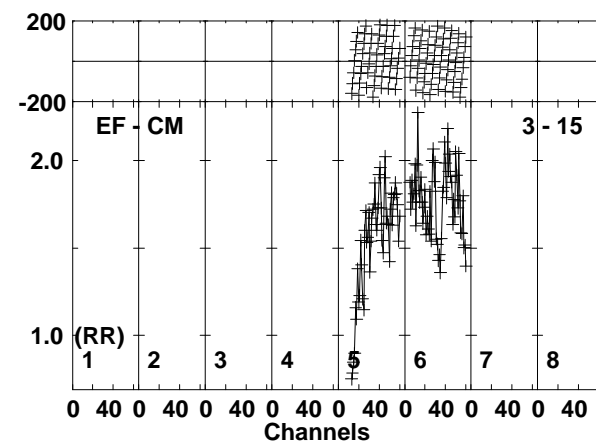
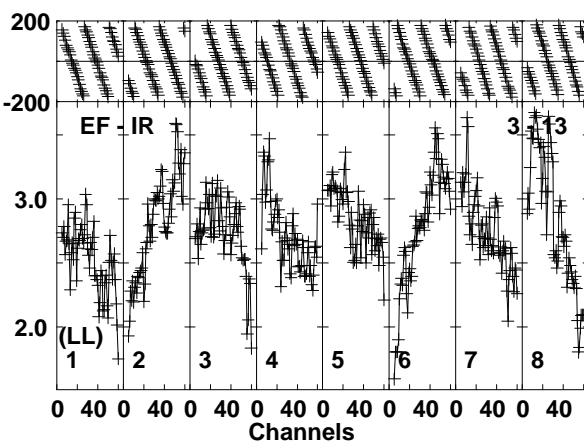
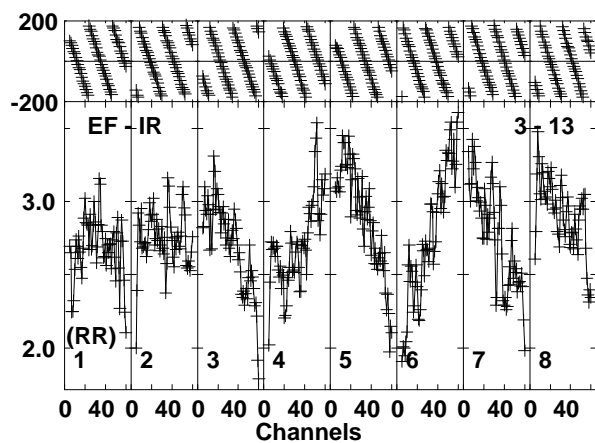
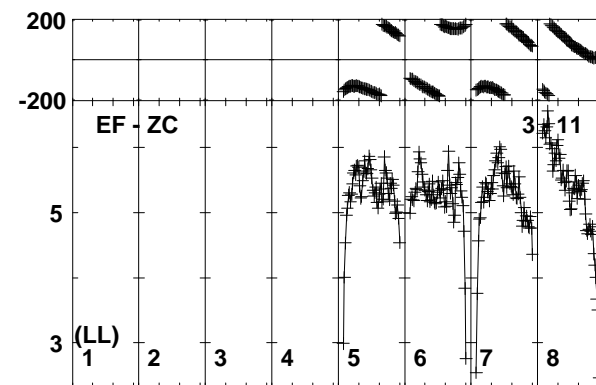
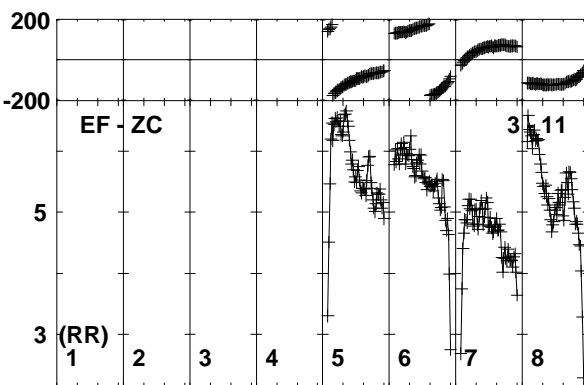
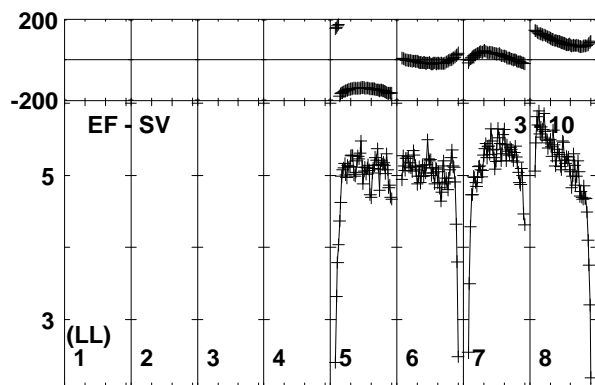
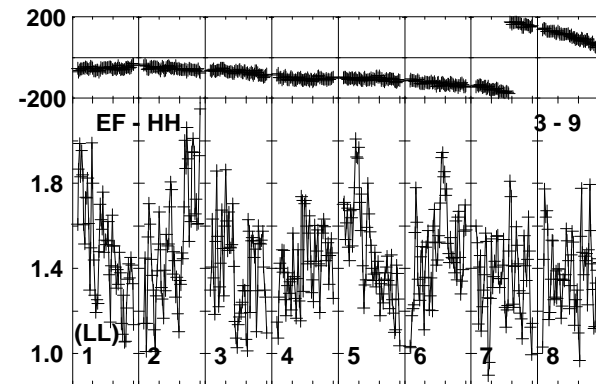
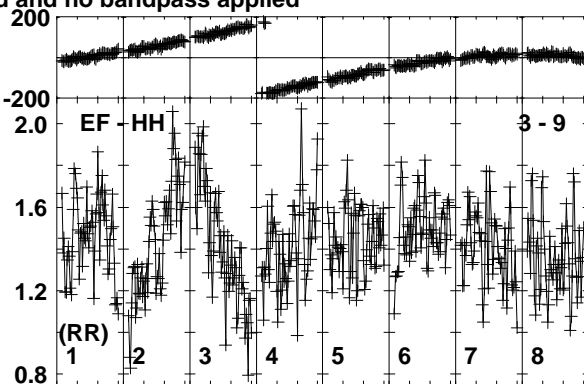
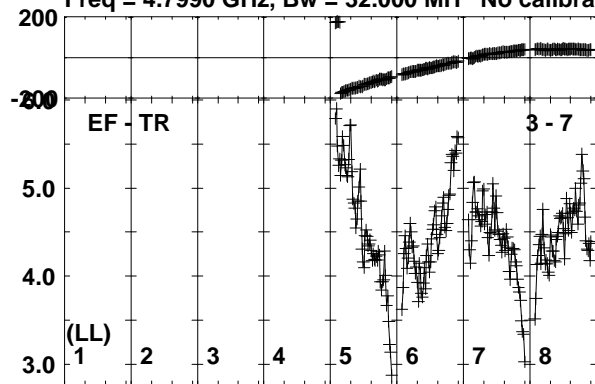

Lower frame: Milli Ampl Jy Top frame: Phas deg
 Vector averaged cross-power spectrum Baseline: EF (03) - TR (07)
 Timerange: 01/02:18:46 to 01/02:19:15

Plot file version 363 created 26-SEP-2019 10:41:52

J0257-1212 RG010A.UVDATA.1

Freq = 4.7990 GHz, Bw = 32.000 MH No calibration applied and no bandpass applied

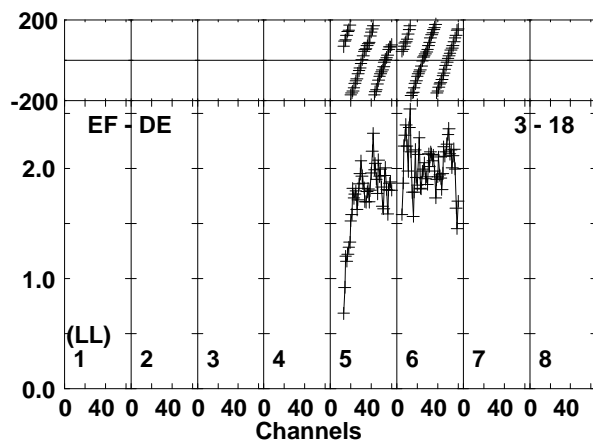
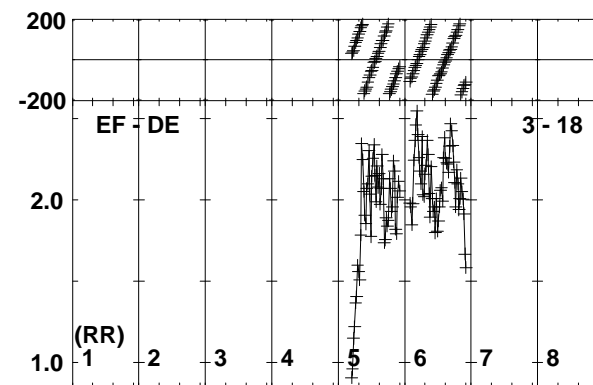
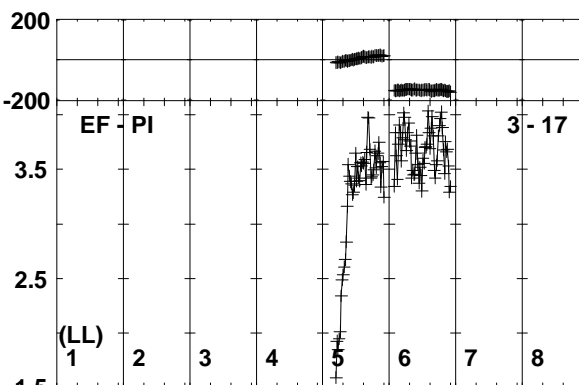
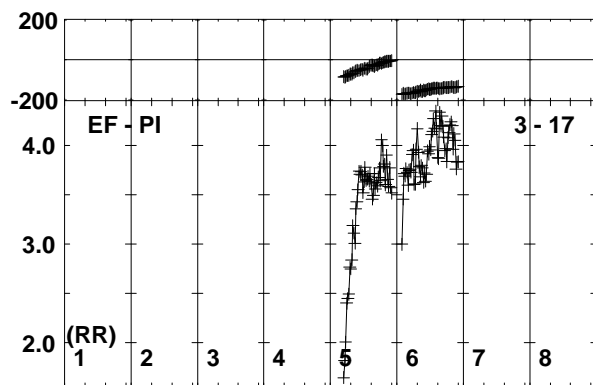
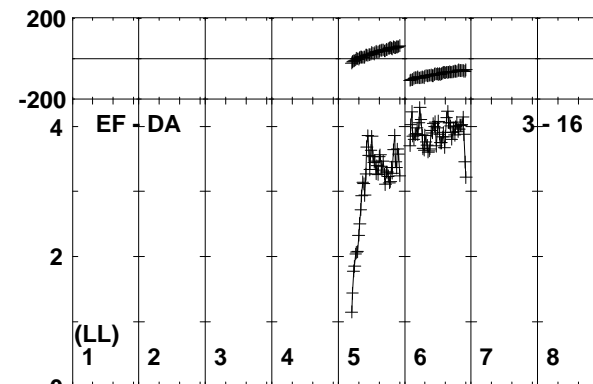
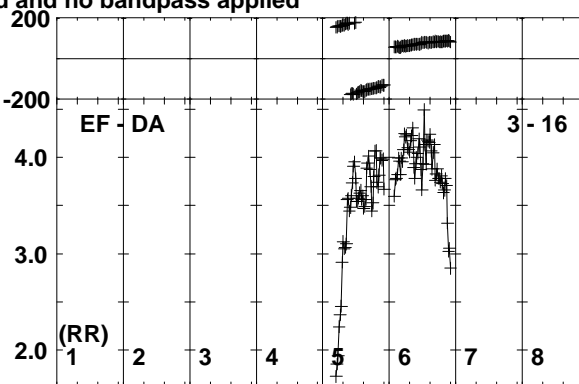
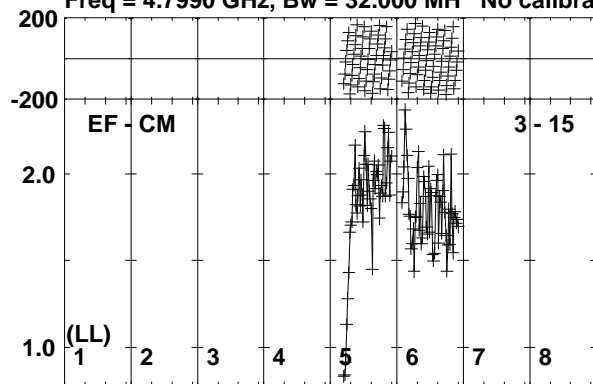

Lower frame: Milli Ampl Jy Top frame: Phas deg
Vector averaged cross-power spectrum Baseline: EF (03) - CM (15)
Timerange: 01/02:18:46 to 01/02:19:15

Plot file version 364 created 26-SEP-2019 10:41:53

J0300-0846 RG010A.UVDATA.1

Freq = 4.7990 GHz, Bw = 32.000 MH No calibration applied and no bandpass applied

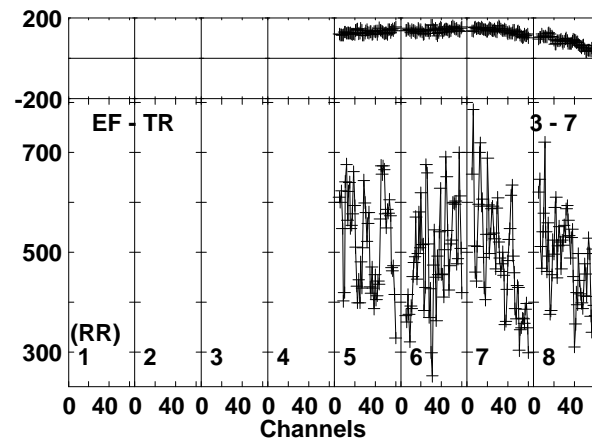
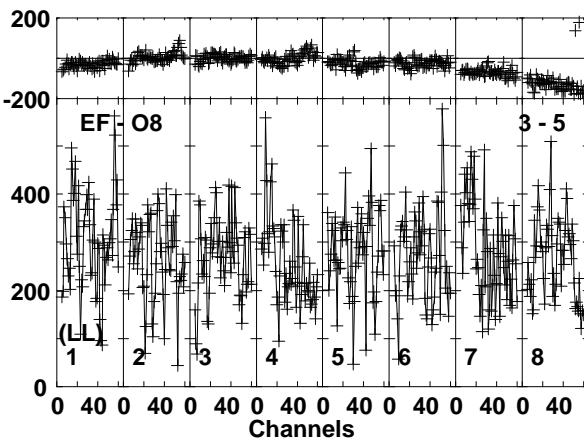
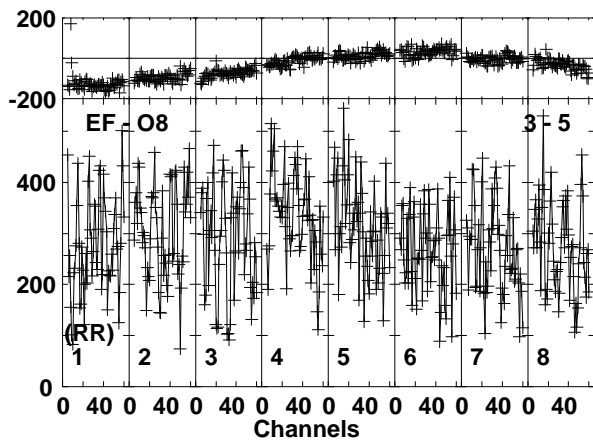
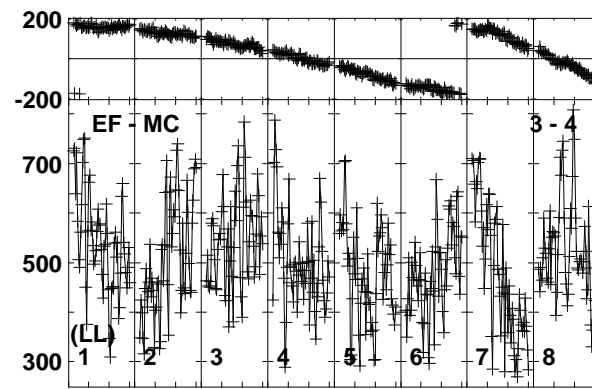
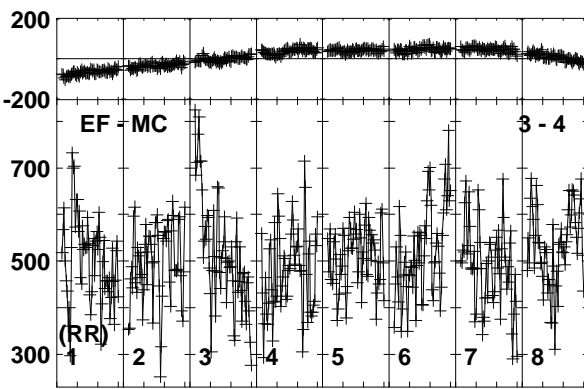
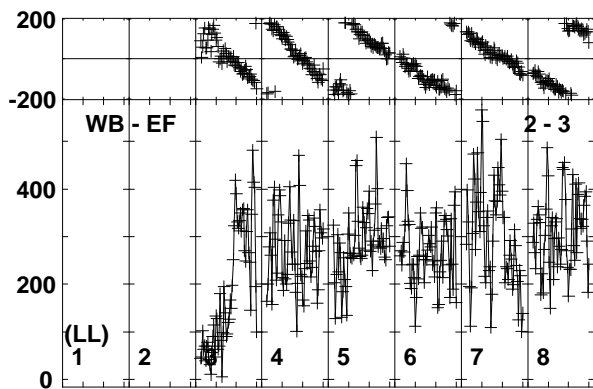
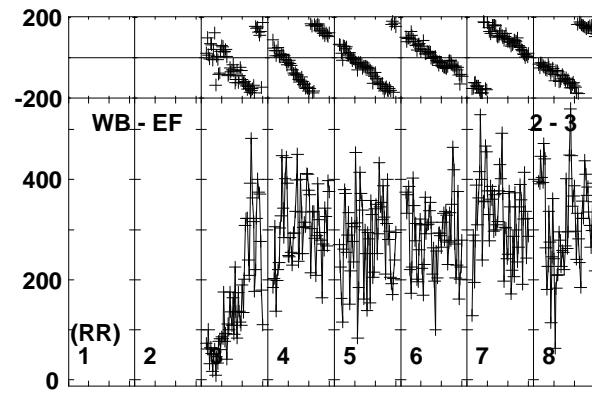
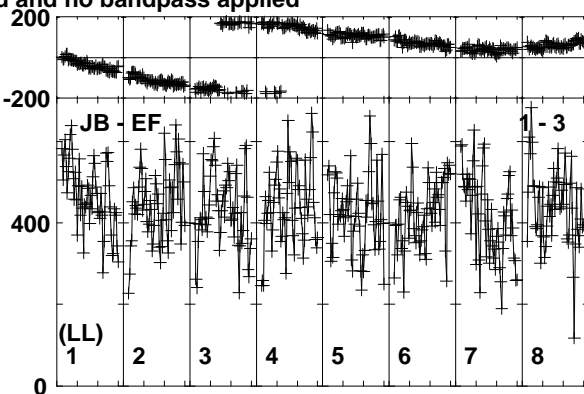
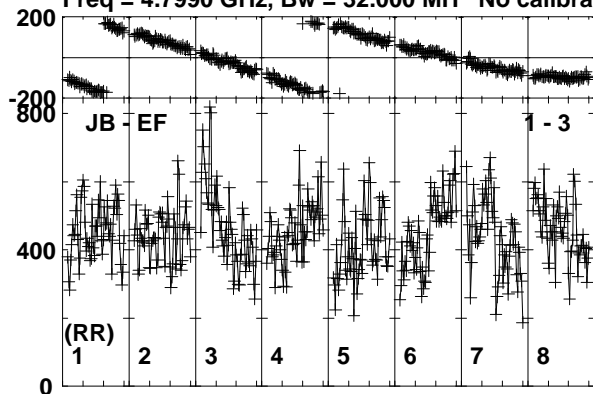

Lower frame: Micro Ampl Jy Top frame: Phas deg
Vector averaged cross-power spectrum Baseline: JB (01) - EF (03)
Timerange: 01/02:19:16 to 01/02:21:44

Plot file version 365 created 26-SEP-2019 10:41:53

J0300-0846 RG010A.UVDATA.1

Freq = 4.7990 GHz, Bw = 32.000 MH No calibration applied and no bandpass applied

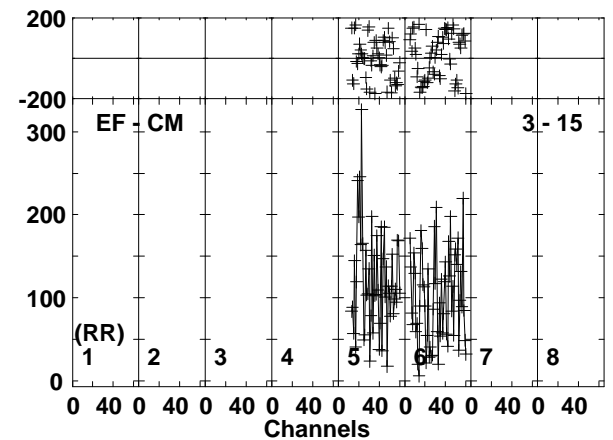
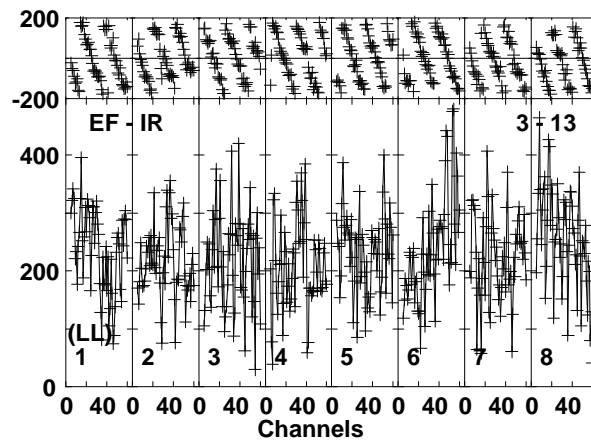
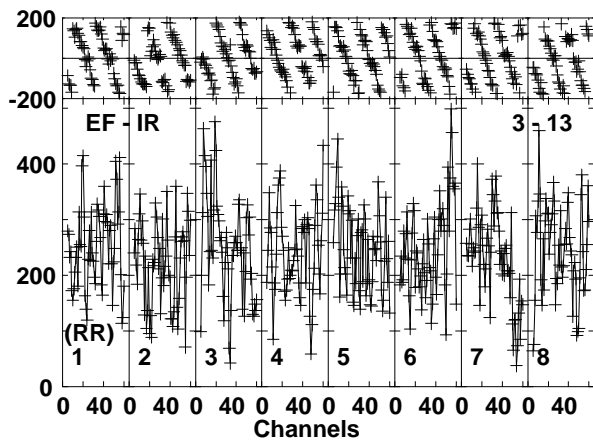
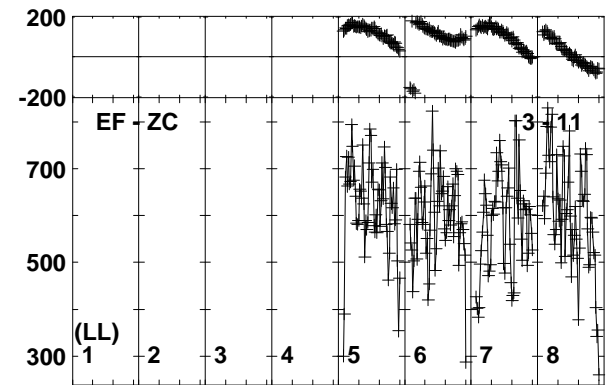
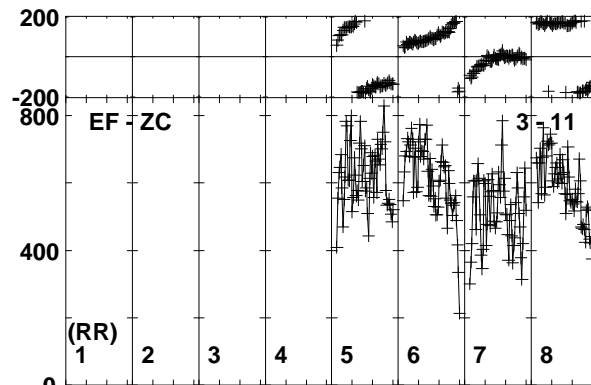
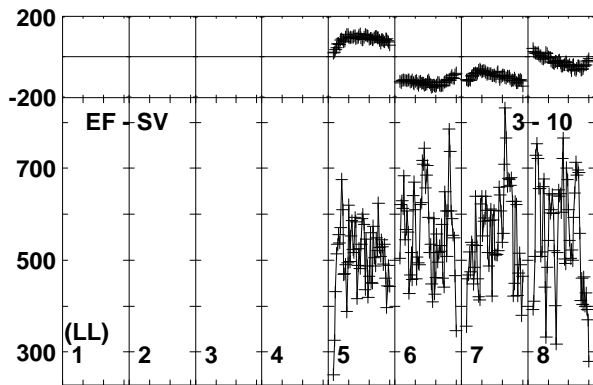
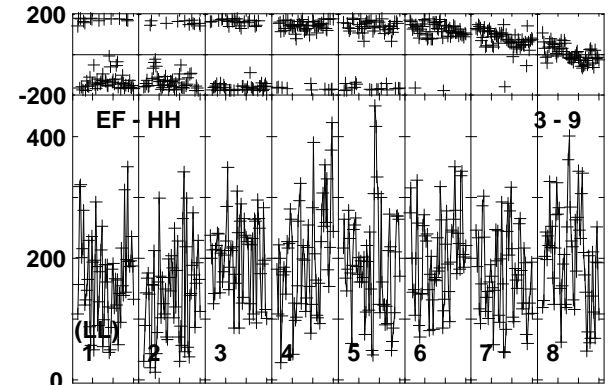
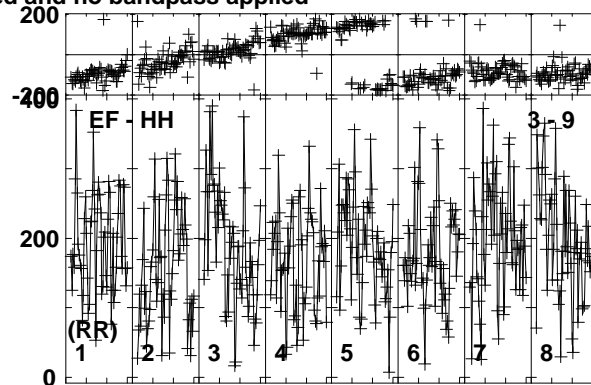
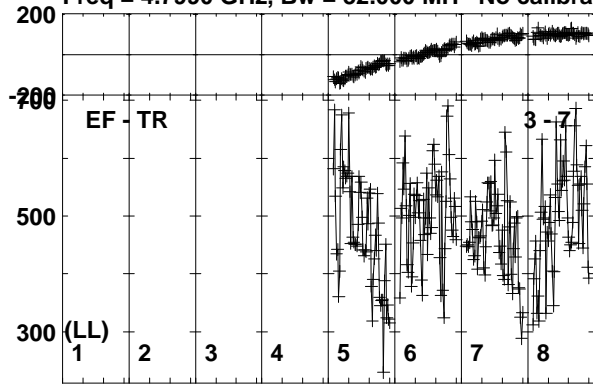

Lower frame: Micro Ampl Jy Top frame: Phas deg
Vector averaged cross-power spectrum Baseline: EF (03) - TR (07)
Timerange: 01/02:19:16 to 01/02:21:44

Plot file version 366 created 26-SEP-2019 10:41:54

J0300-0846 RG010A.UVDATA.1

Freq = 4.7990 GHz, Bw = 32.000 MH No calibration applied and no bandpass applied

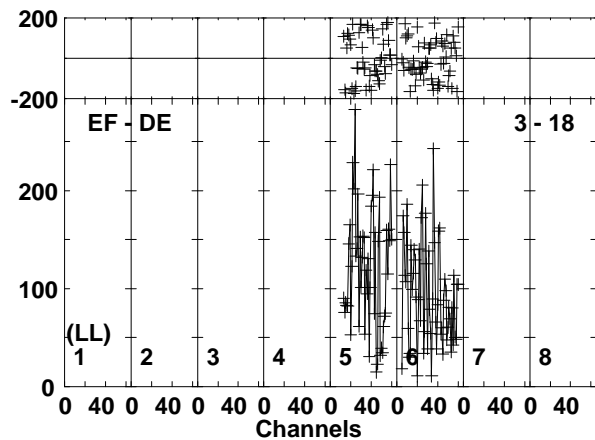
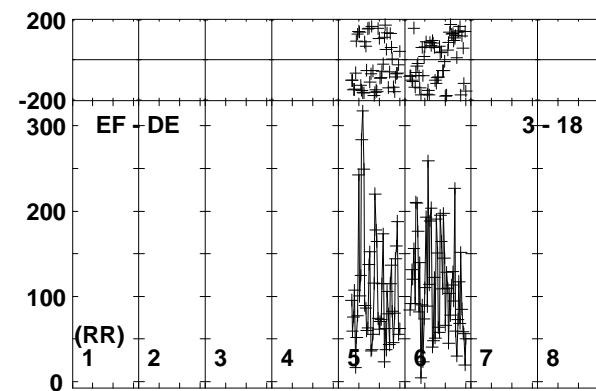
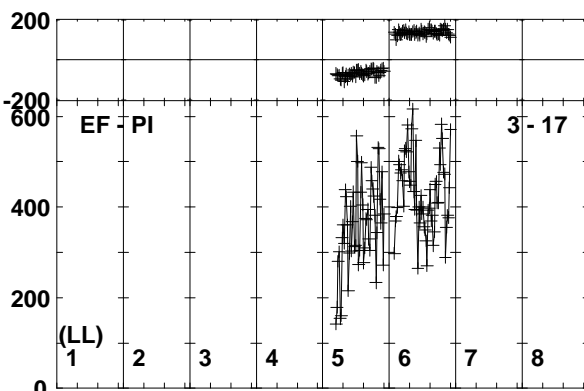
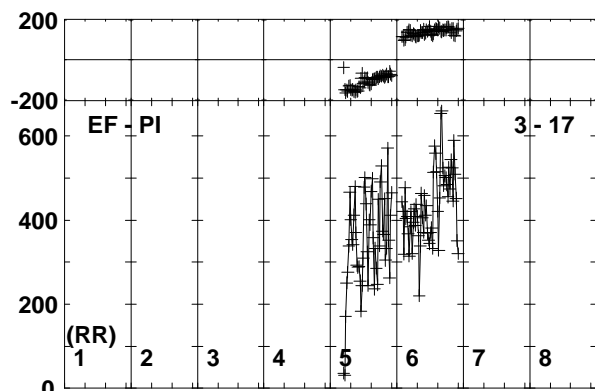
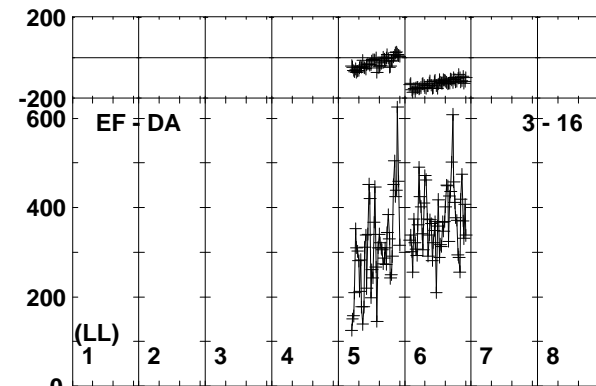
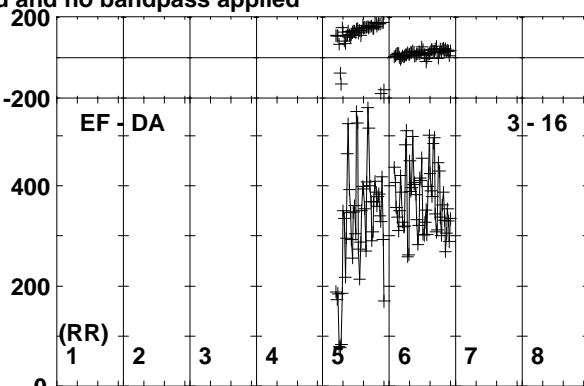
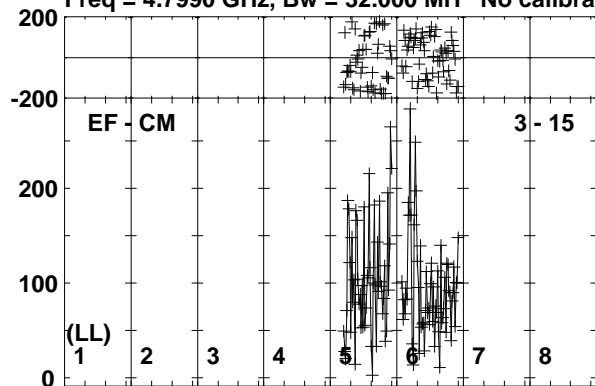

Lower frame: Micro Ampl Jy Top frame: Phas deg
Vector averaged cross-power spectrum Baseline: EF (03) - CM (15)
Timerange: 01/02:19:16 to 01/02:21:44

Plot file version 367 created 26-SEP-2019 10:41:54

190829A RG010A.UVDATA.1

Freq = 4.7990 GHz, Bw = 32.000 MH No calibration applied and no bandpass applied

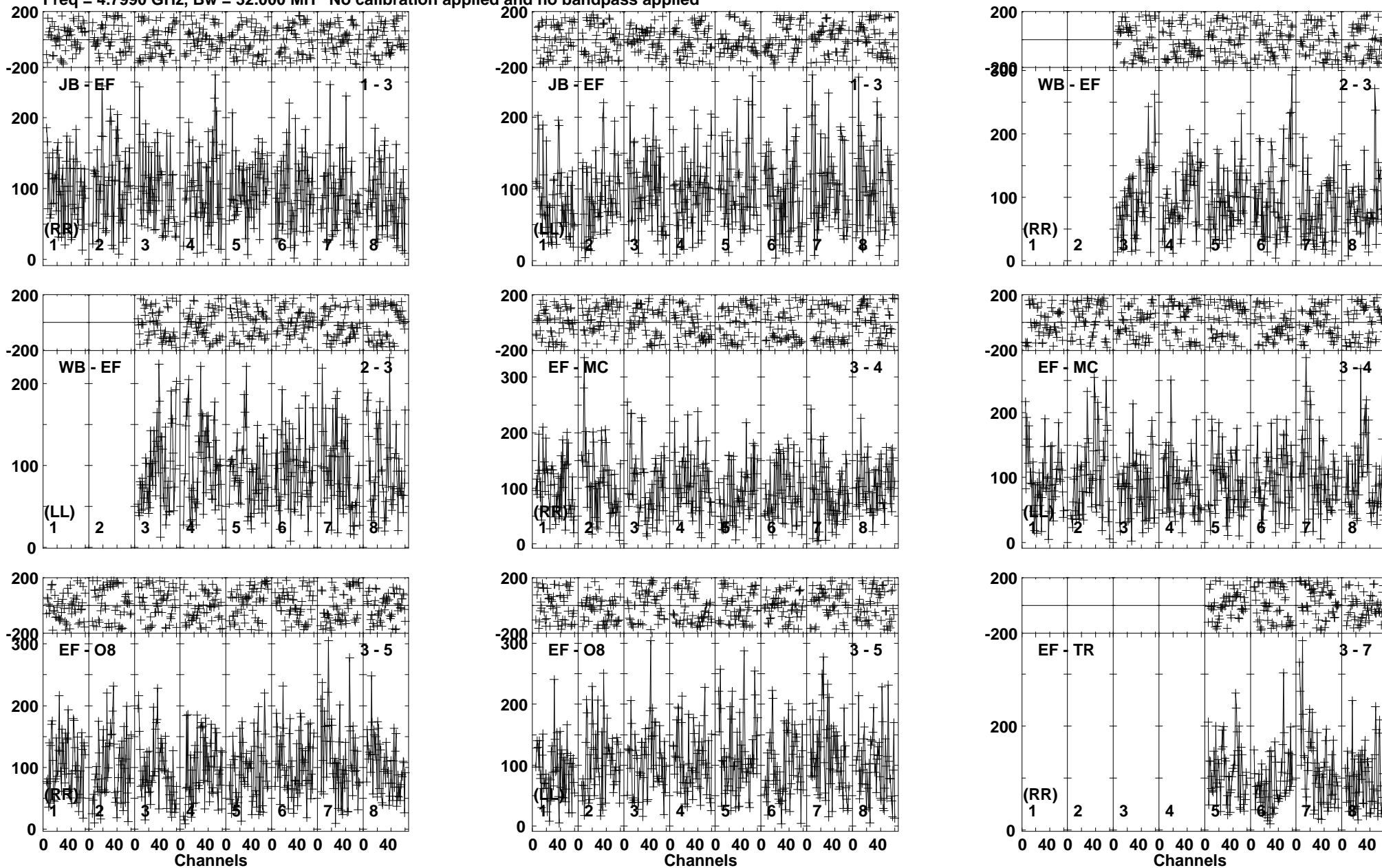

Lower frame: Micro Ampl Jy Top frame: Phas deg
Vector averaged cross-power spectrum Baseline: JB (01) - EF (03)
Timerange: 01/02:21:45 to 01/02:24:15

Plot file version 368 created 26-SEP-2019 10:41:55

190829A RG010A.UVDATA.1

Freq = 4.7990 GHz, Bw = 32.000 MH No calibration applied and no bandpass applied

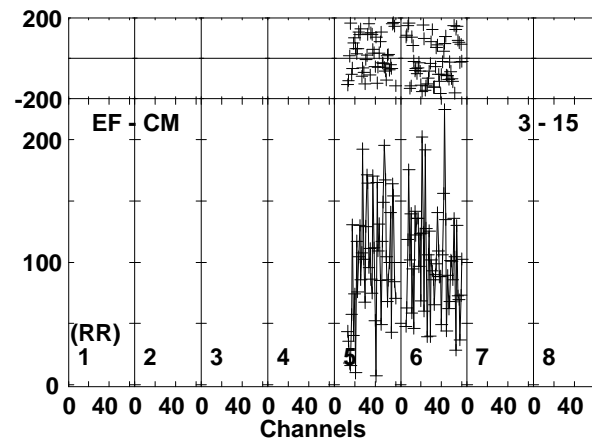
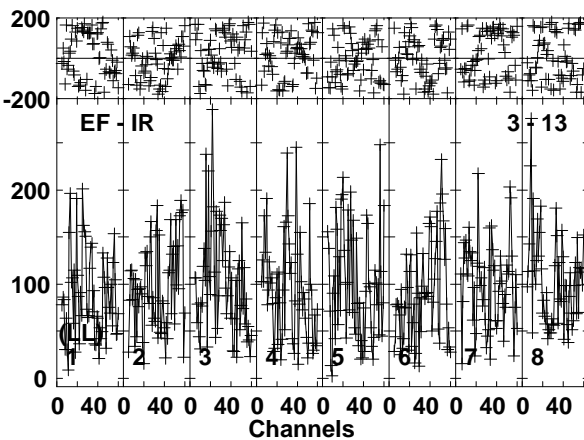
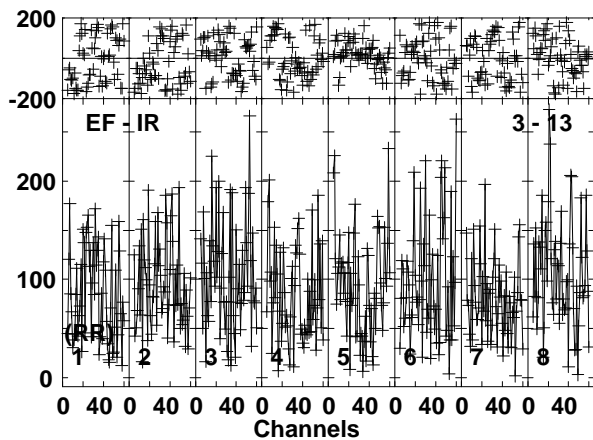
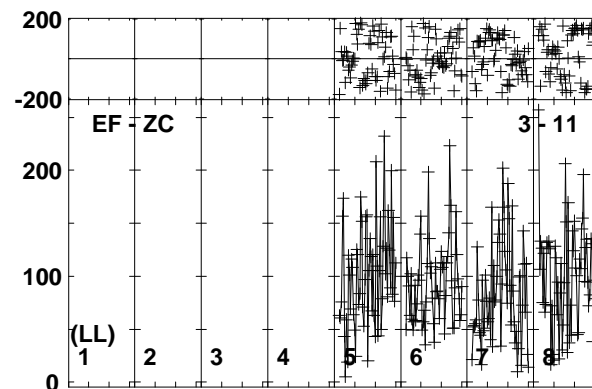
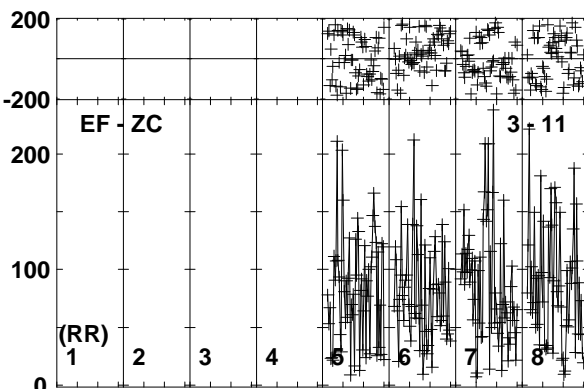
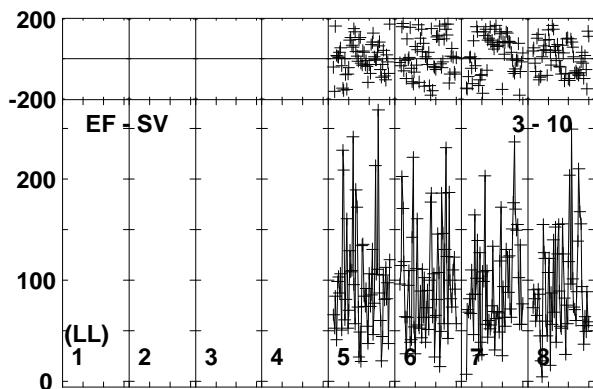
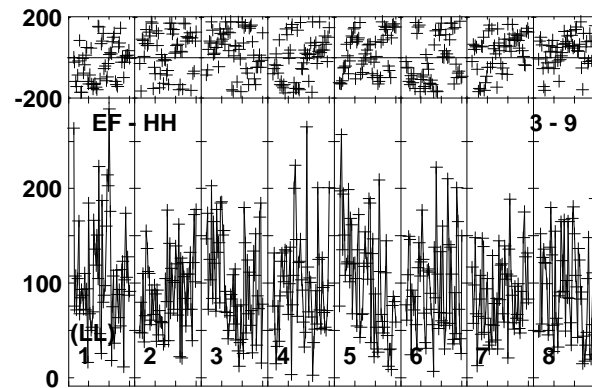
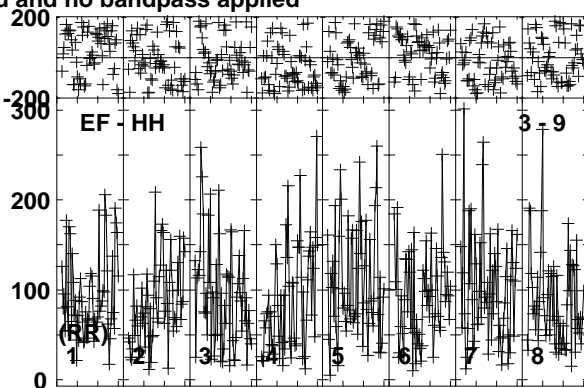
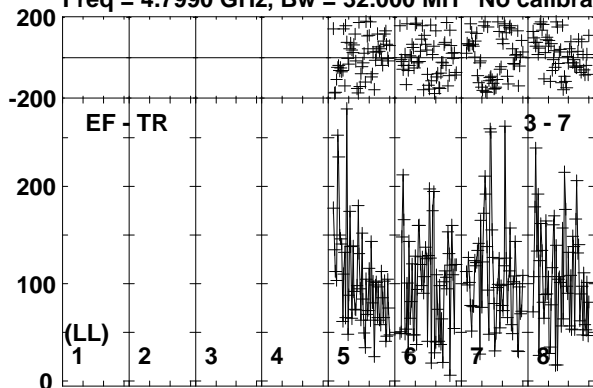

Lower frame: Micro Ampl Jy Top frame: Phas deg
Vector averaged cross-power spectrum Baseline: EF (03) - TR (07)
Timerange: 01/02:21:45 to 01/02:24:15

Plot file version 369 created 26-SEP-2019 10:41:55

190829A RG010A.UVDATA.1

Freq = 4.7990 GHz, Bw = 32.000 MH No calibration applied and no bandpass applied

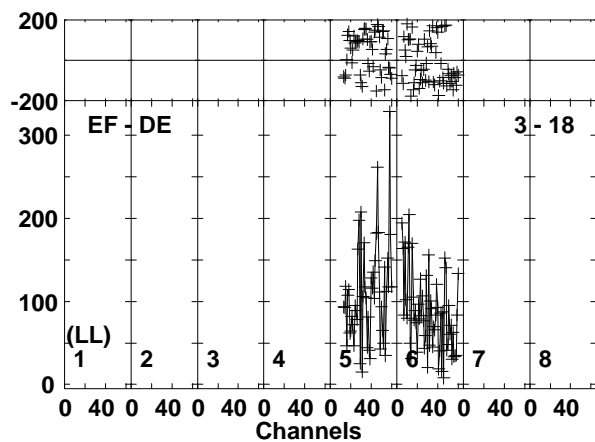
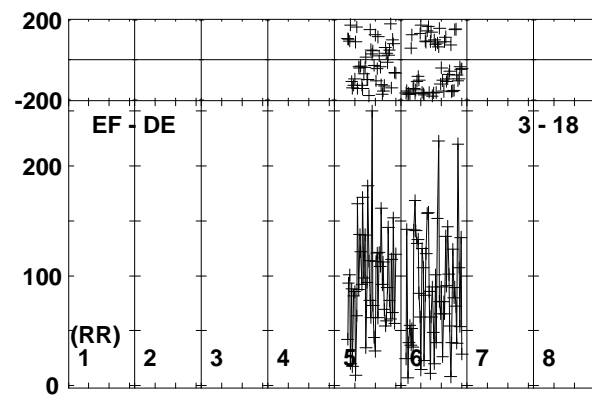
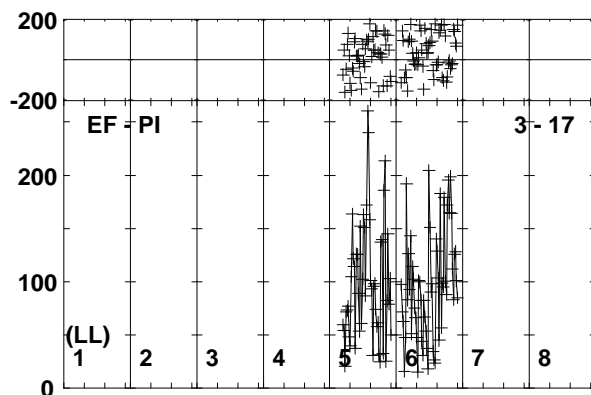
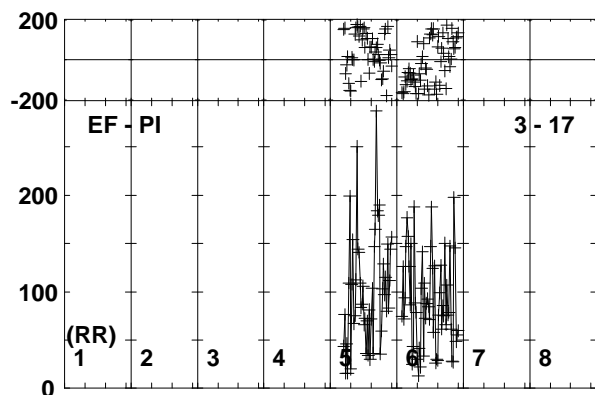
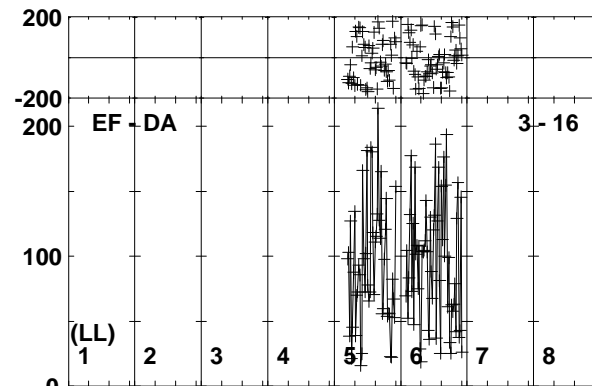
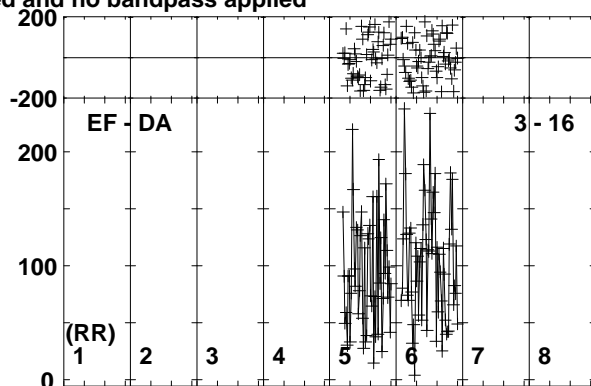
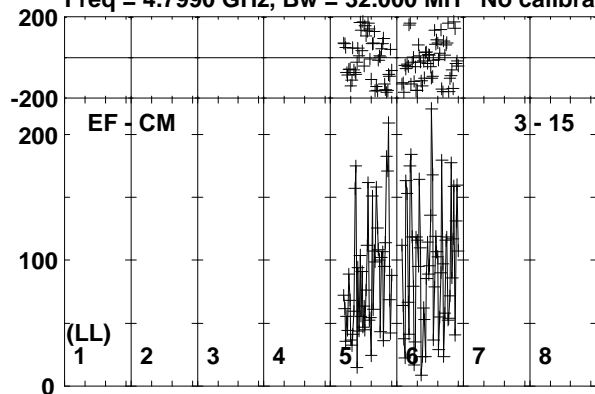

Lower frame: Micro Ampl Jy Top frame: Phas deg
Vector averaged cross-power spectrum Baseline: EF (03) - CM (15)
Timerange: 01/02:21:45 to 01/02:24:15

Plot file version 370 created 26-SEP-2019 10:41:56

J0257-1212 RG010A.UVDATA.1

Freq = 4.7990 GHz, Bw = 32.000 MH No calibration applied and no bandpass applied

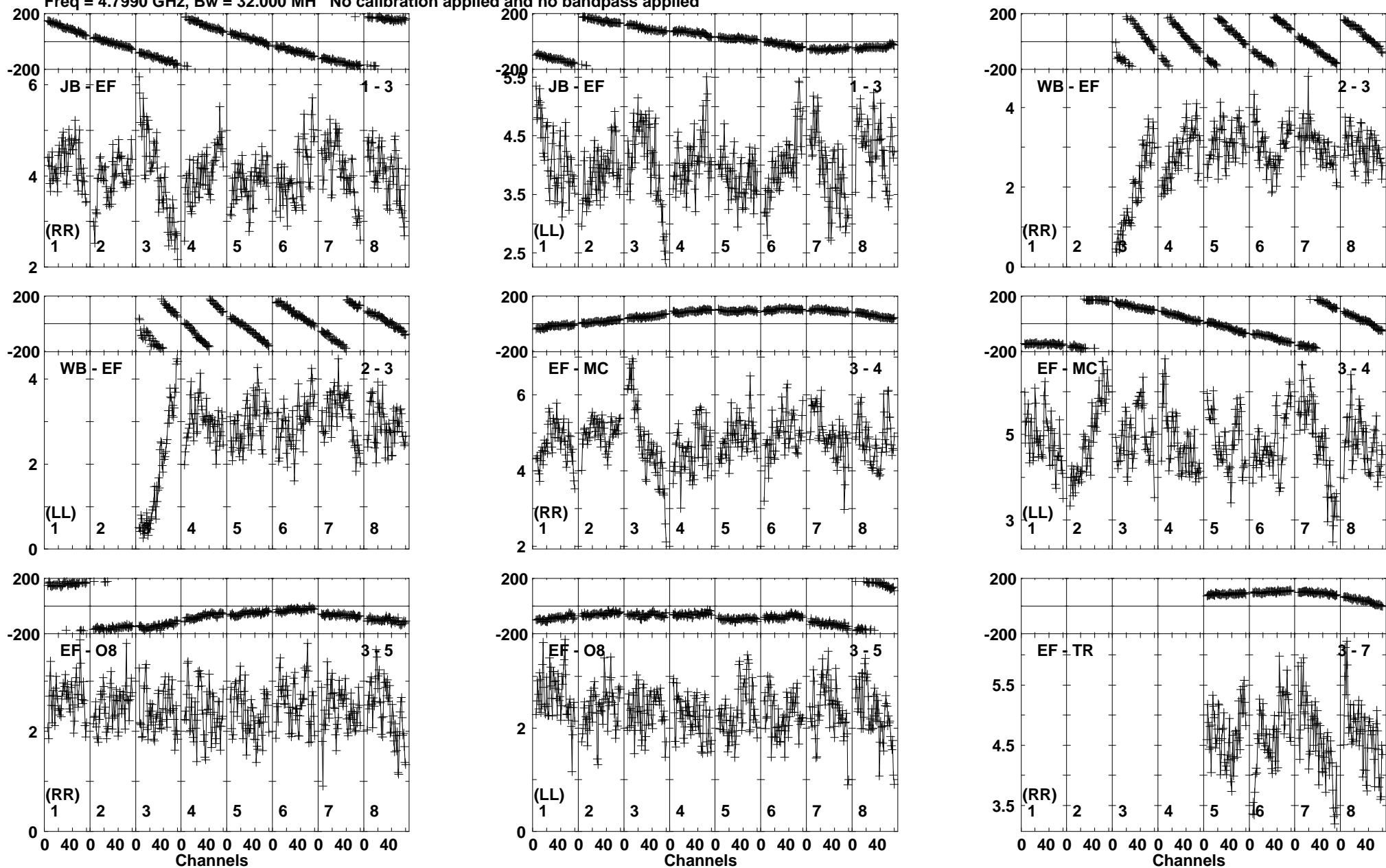

Lower frame: Milli Ampl Jy Top frame: Phas deg
Vector averaged cross-power spectrum Baseline: JB (01) - EF (03)
Timerange: 01/02:24:16 to 01/02:25:14

Plot file version 371 created 26-SEP-2019 10:41:56

J0257-1212 RG010A.UVDATA.1

Freq = 4.7990 GHz, Bw = 32.000 MH No calibration applied and no bandpass applied

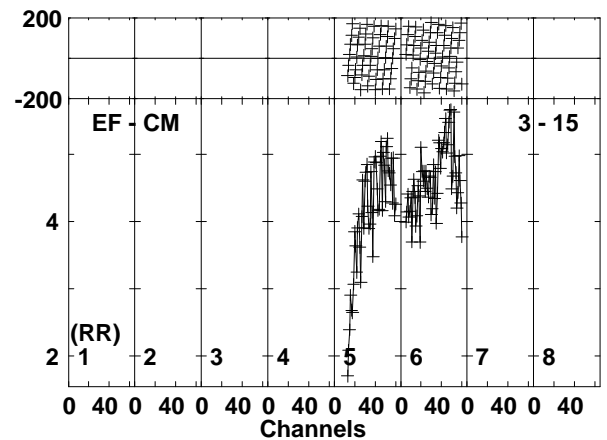
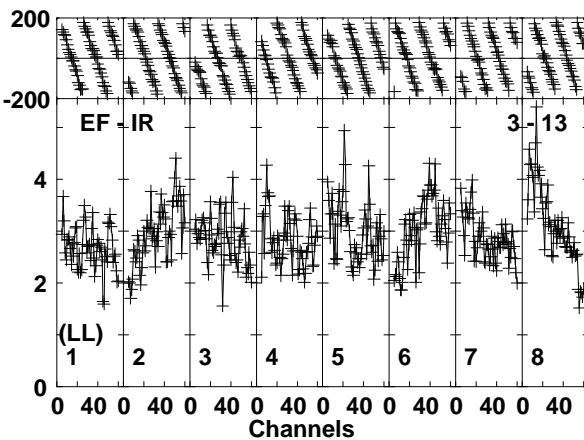
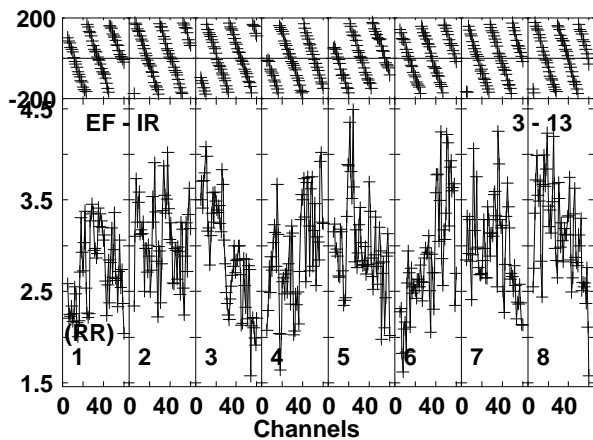
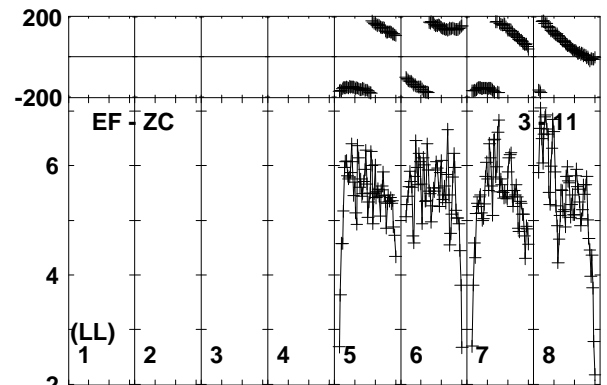
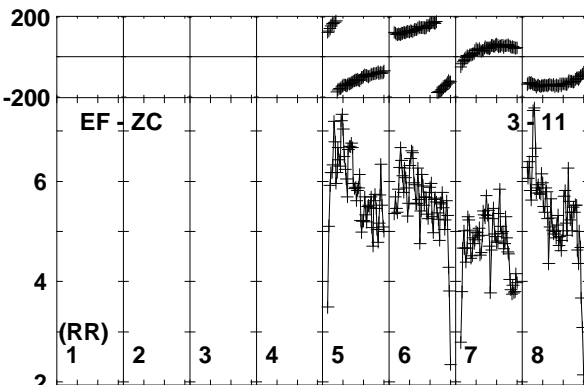
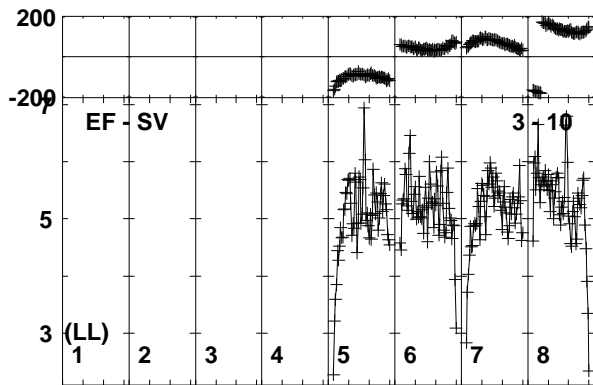
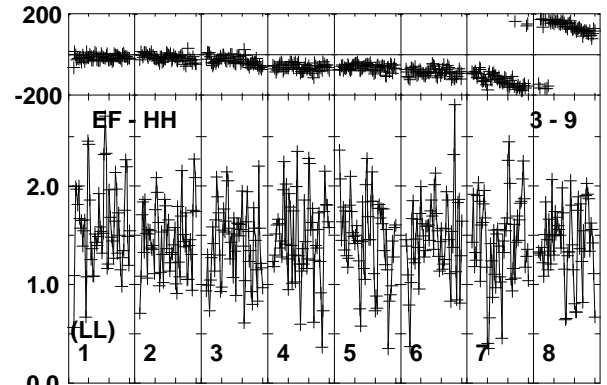
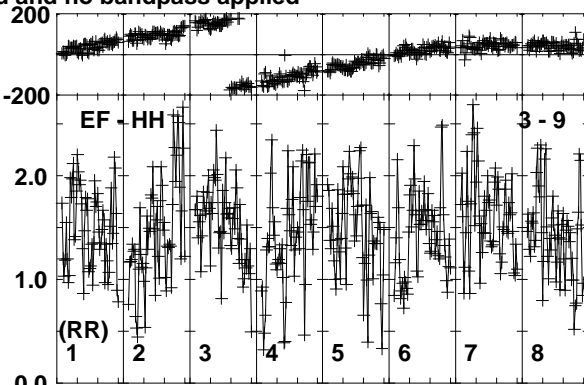
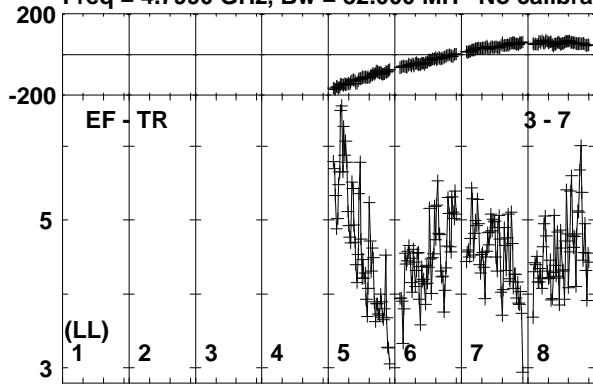

Lower frame: Milli Ampl Jy Top frame: Phas deg
Vector averaged cross-power spectrum Baseline: EF (03) - TR (07)
Timerange: 01/02:24:16 to 01/02:25:14

Plot file version 372 created 26-SEP-2019 10:41:57

J0257-1212 RG010A.UVDATA.1

Freq = 4.7990 GHz, Bw = 32.000 MH No calibration applied and no bandpass applied

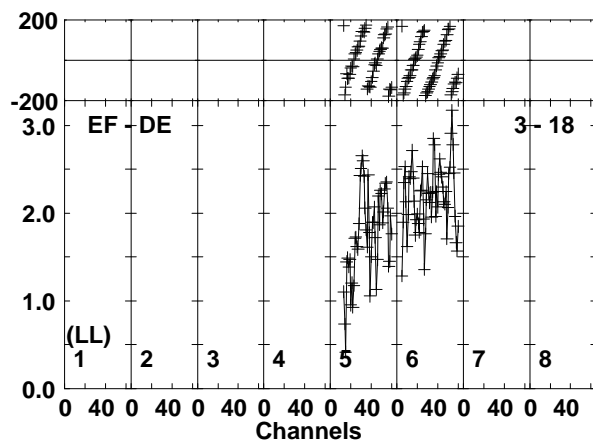
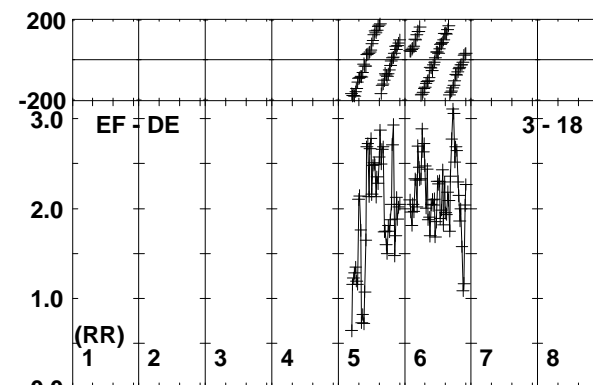
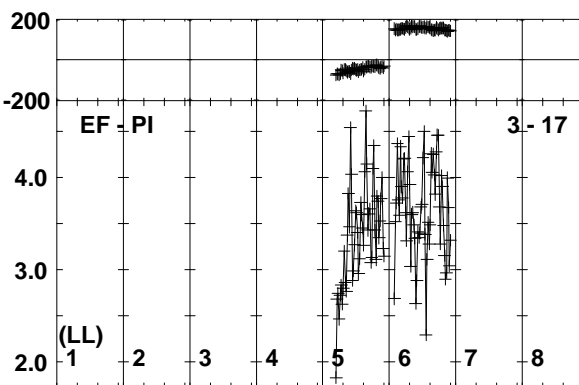
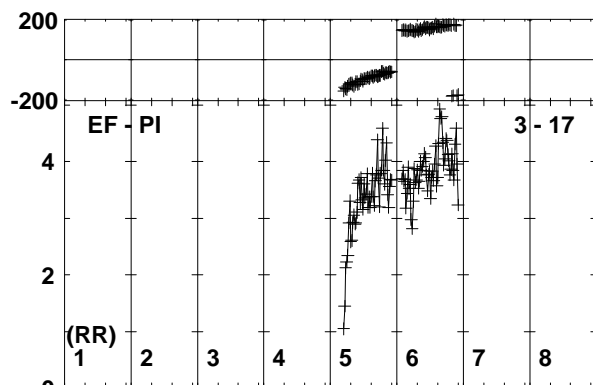
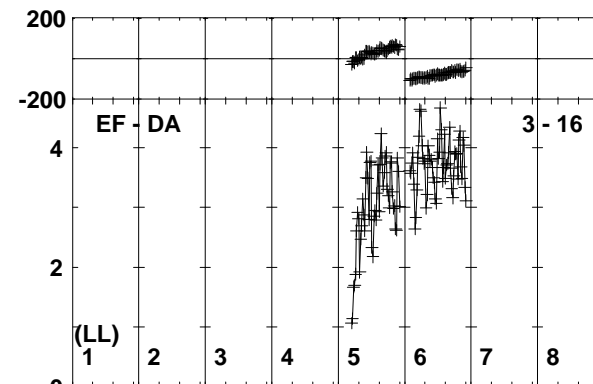
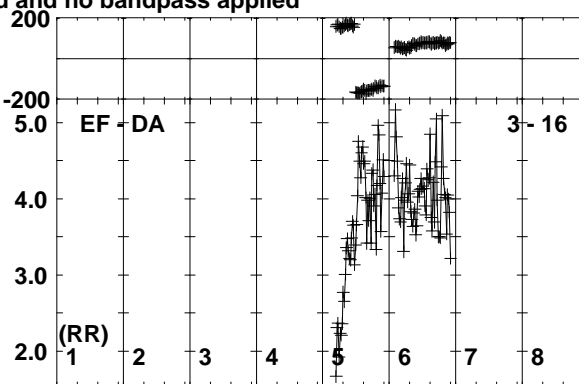
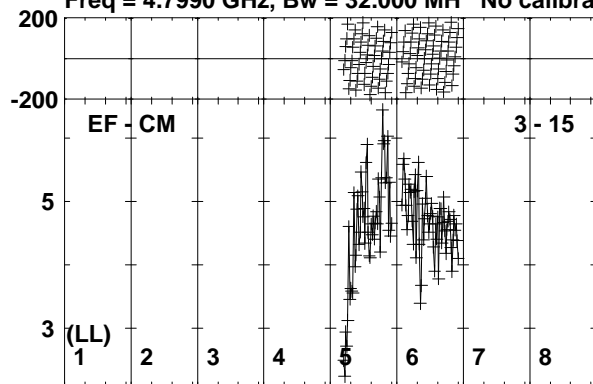

Lower frame: Milli Ampl Jy Top frame: Phas deg
Vector averaged cross-power spectrum Baseline: EF (03) - CM (15)
Timerange: 01/02:24:16 to 01/02:25:14

Plot file version 373 created 26-SEP-2019 10:41:58

190829A RG010A.UVDATA.1

Freq = 4.7990 GHz, Bw = 32.000 MH No calibration applied and no bandpass applied

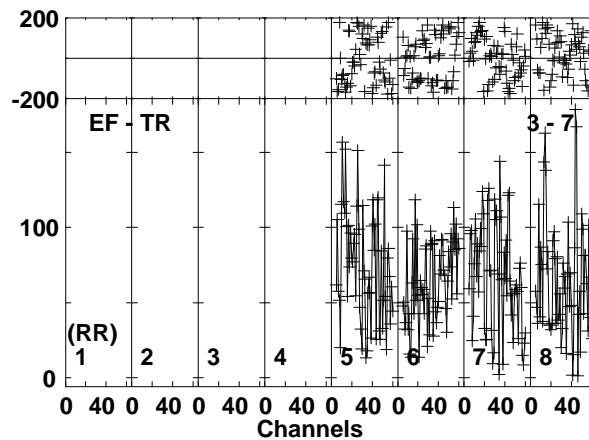
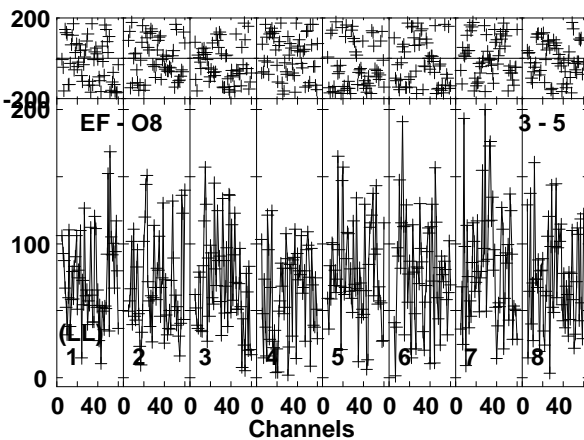
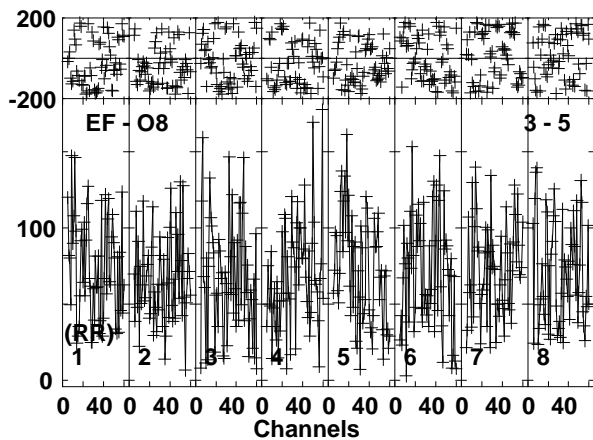
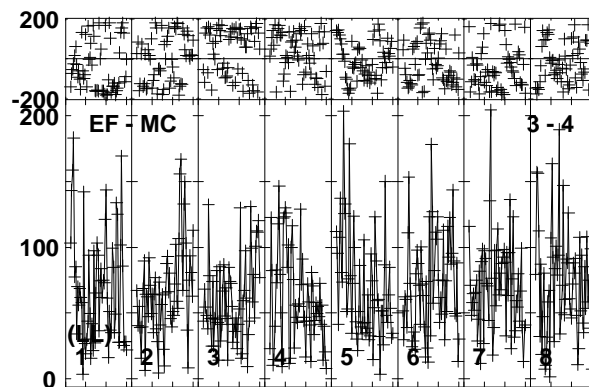
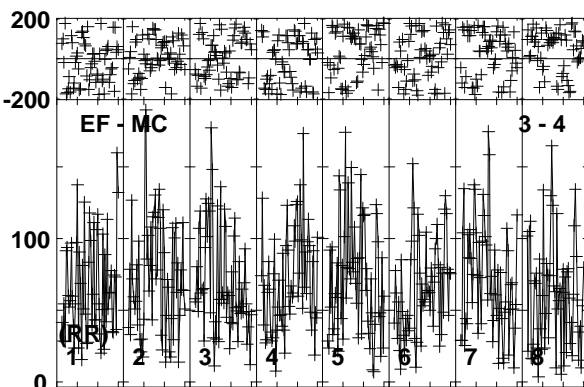
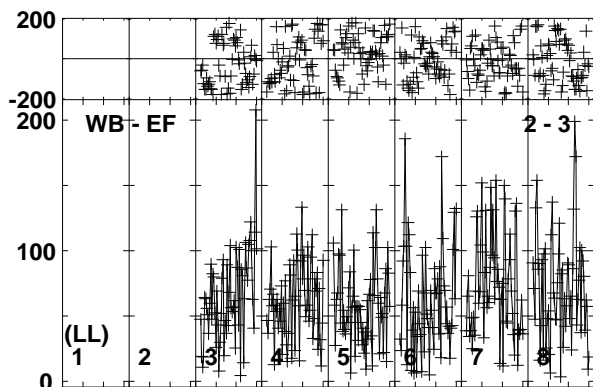
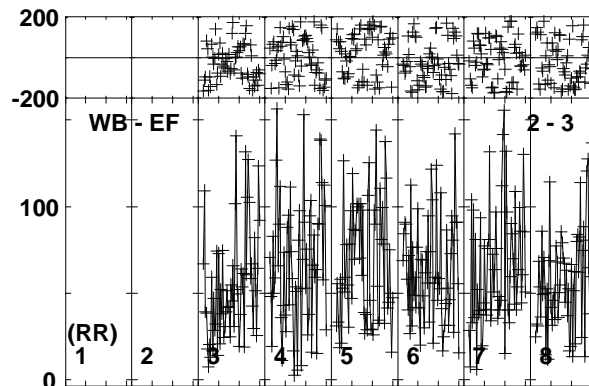
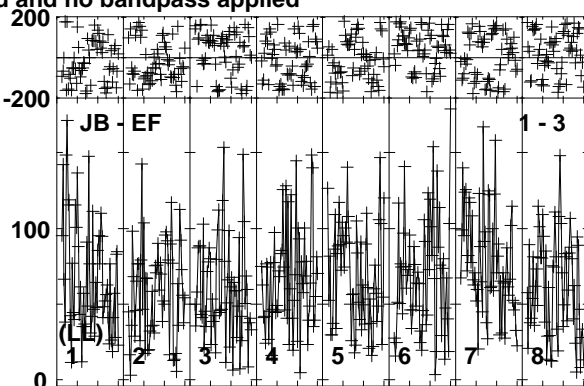
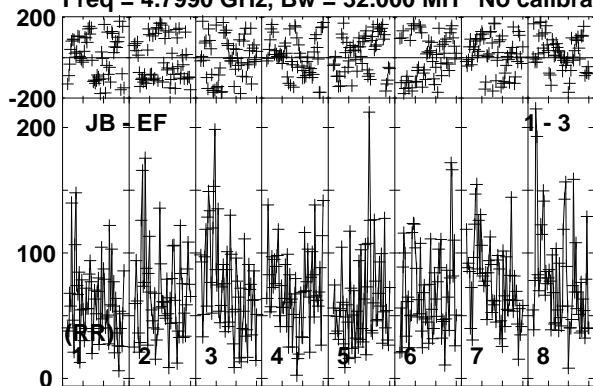

Lower frame: Micro Ampl Jy Top frame: Phas deg
Vector averaged cross-power spectrum Baseline: JB (01) - EF (03)
Timerange: 01/02:25:15 to 01/02:30:14

Plot file version 374 created 26-SEP-2019 10:41:59

190829A RG010A.UVDATA.1

Freq = 4.7990 GHz, Bw = 32.000 MH No calibration applied and no bandpass applied

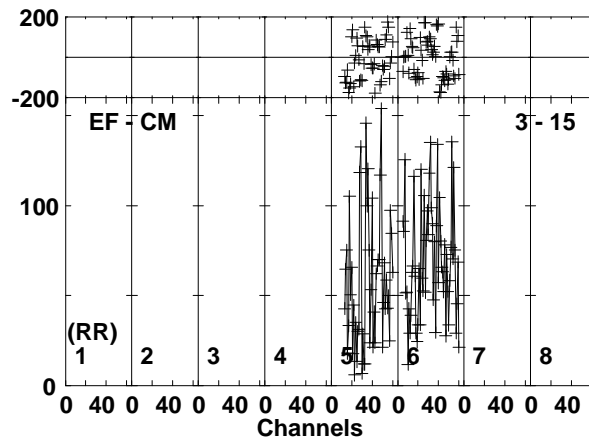
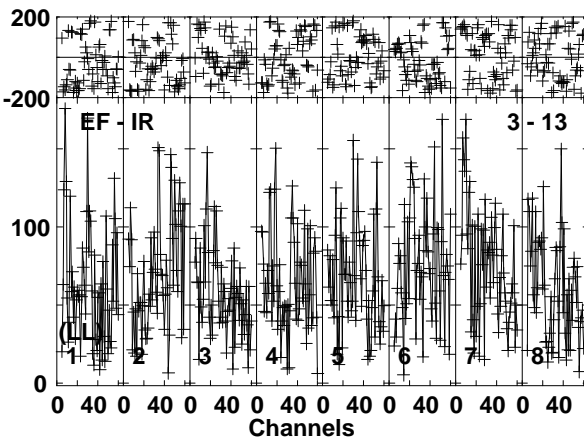
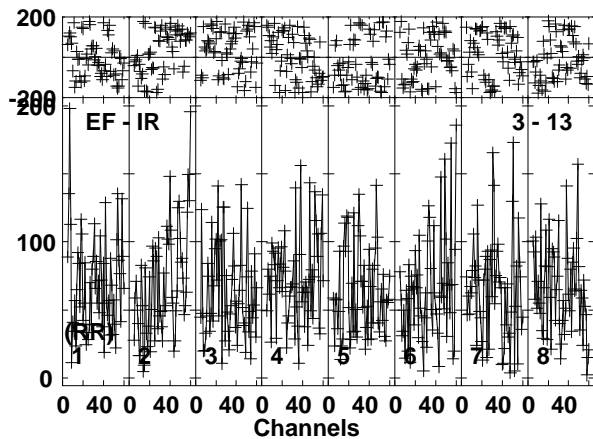
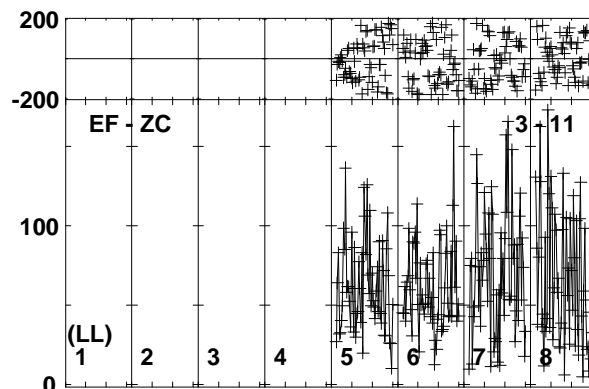
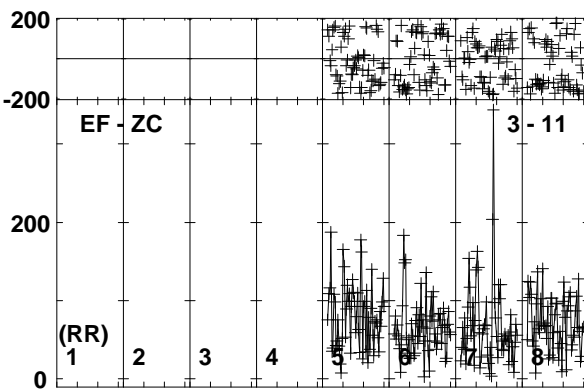
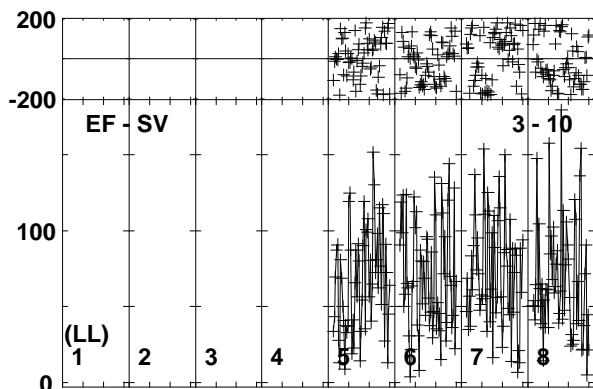
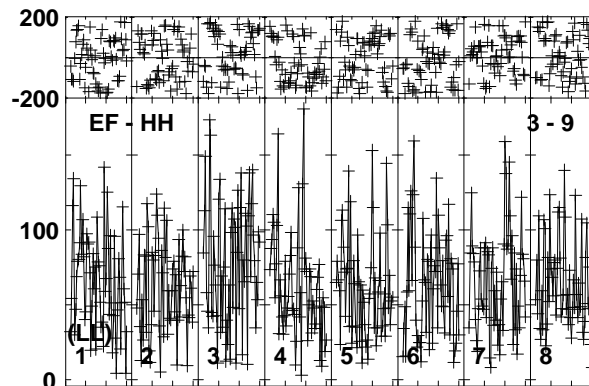
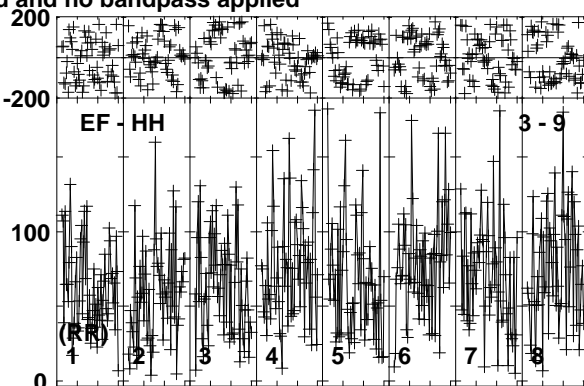
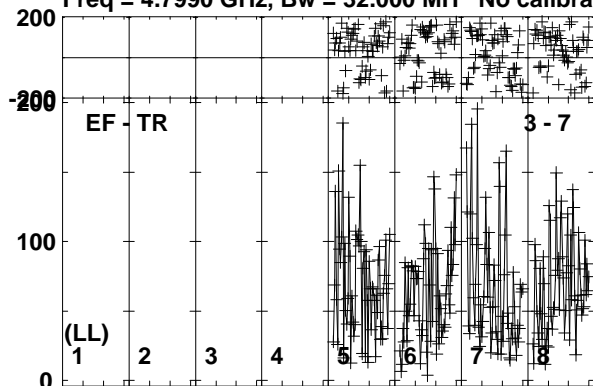

Lower frame: Micro Ampl Jy Top frame: Phas deg
Vector averaged cross-power spectrum Baseline: EF (03) - TR (07)
Timerange: 01/02:25:15 to 01/02:30:14

Plot file version 375 created 26-SEP-2019 10:42:00

190829A RG010A.UVDATA.1

Freq = 4.7990 GHz, Bw = 32.000 MH No calibration applied and no bandpass applied

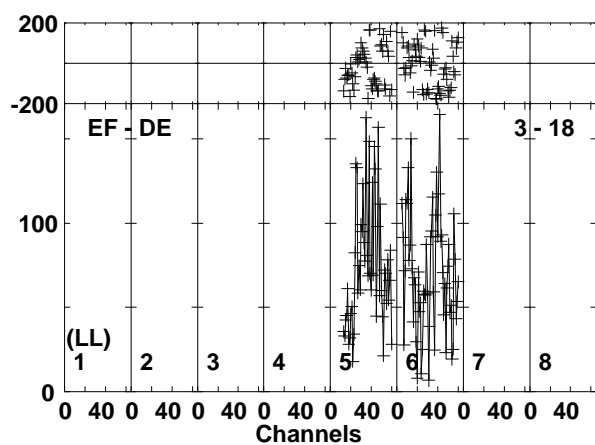
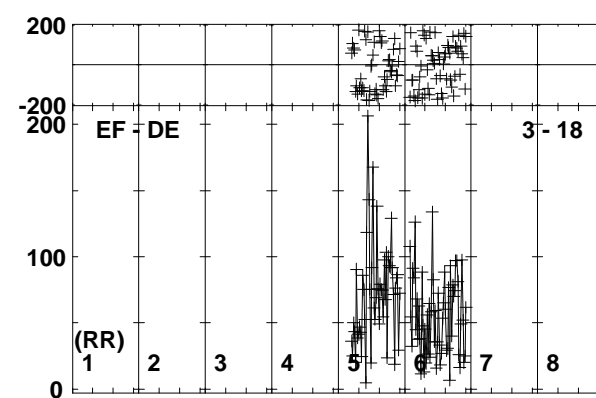
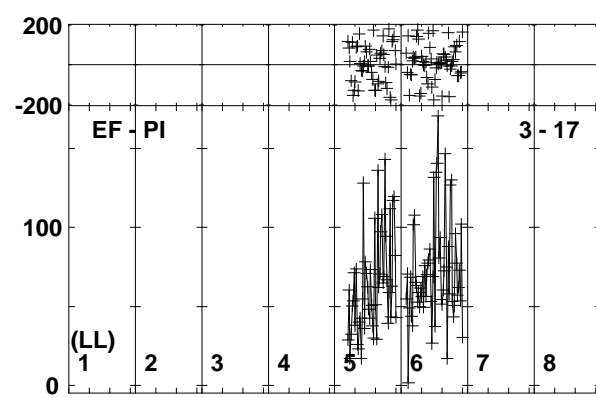
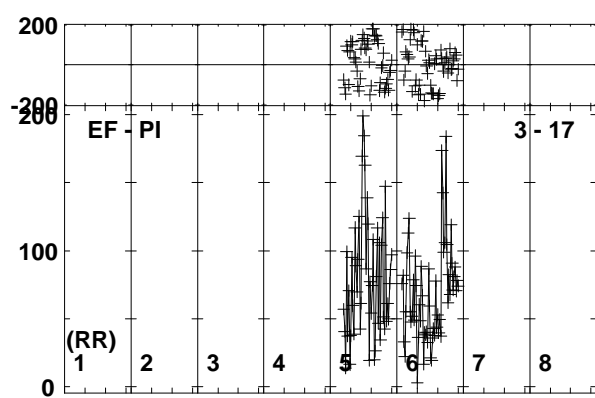
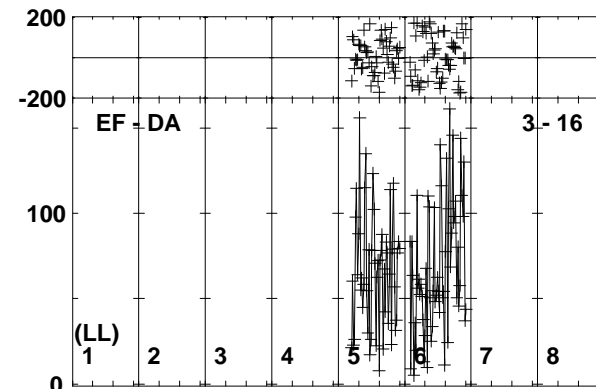
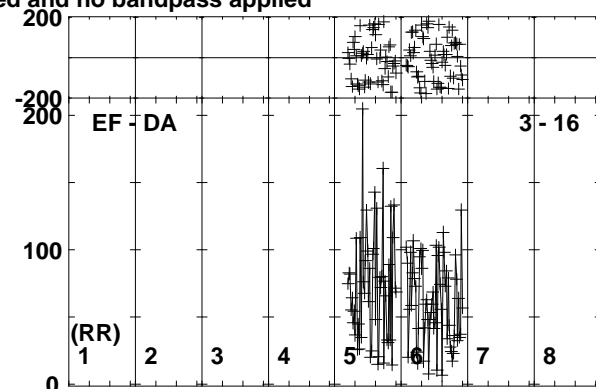
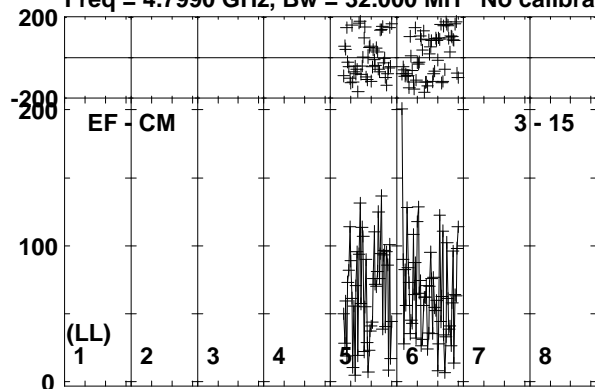

Lower frame: Micro Ampl Jy Top frame: Phas deg
Vector averaged cross-power spectrum Baseline: EF (03) - CM (15)
Timerange: 01/02:25:15 to 01/02:30:14

Plot file version 376 created 26-SEP-2019 10:42:00

J0257-1212 RG010A.UVDATA.1

Freq = 4.7990 GHz, Bw = 32.000 MH No calibration applied and no bandpass applied

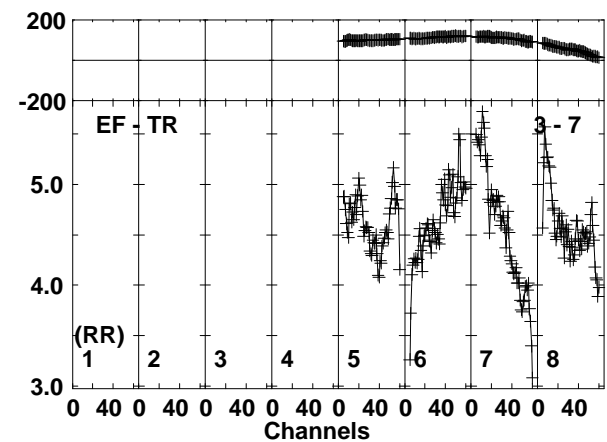
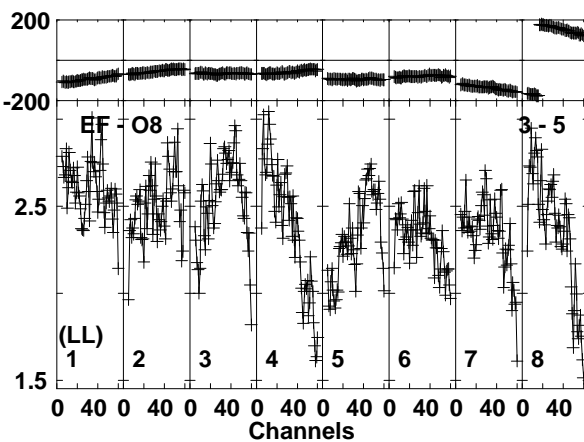
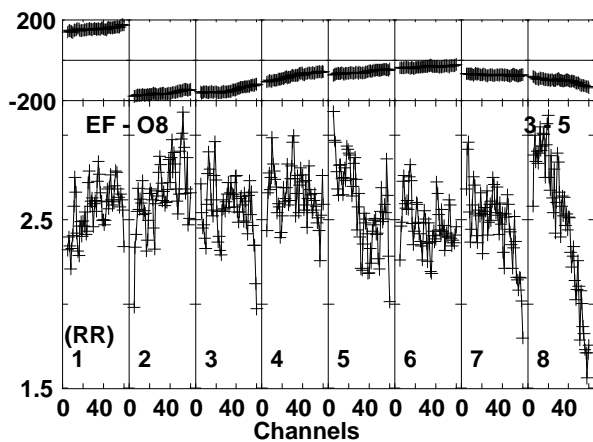
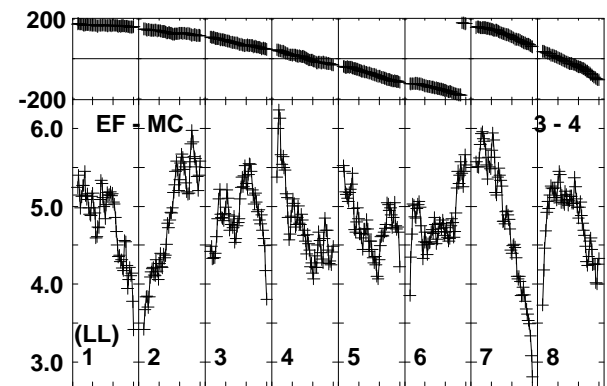
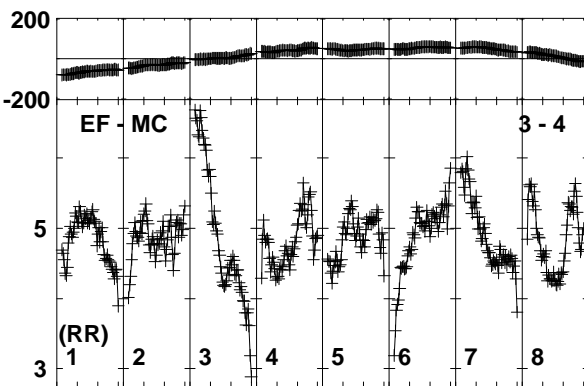
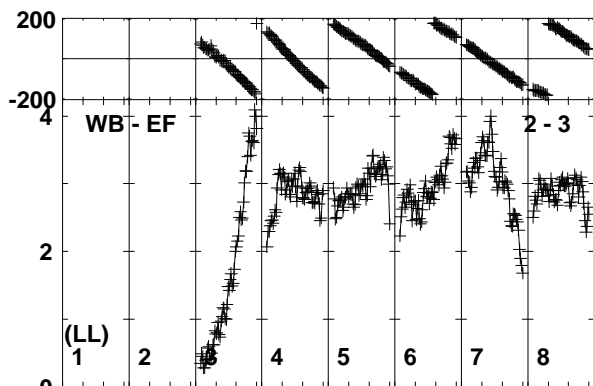
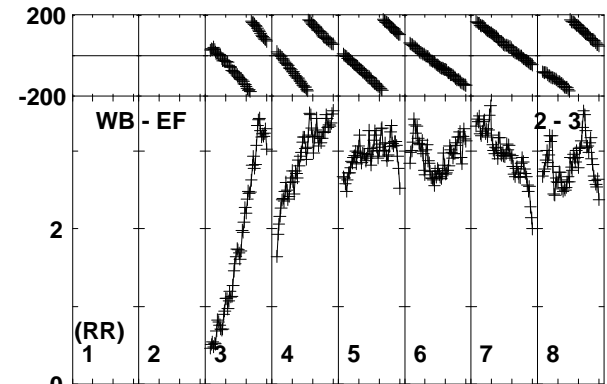
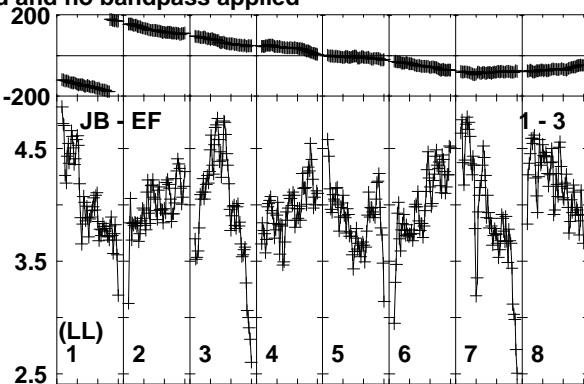
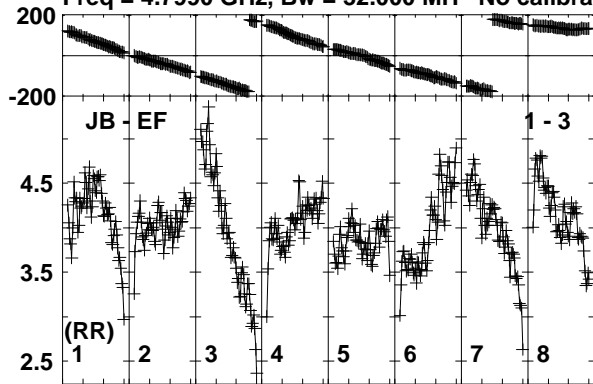

Lower frame: Milli Ampl Jy Top frame: Phas deg
Vector averaged cross-power spectrum Baseline: JB (01) - EF (03)
Timerange: 01/02:30:56 to 01/02:31:54

Plot file version 377 created 26-SEP-2019 10:42:01

J0257-1212 RG010A.UVDATA.1

Freq = 4.7990 GHz, Bw = 32.000 MH No calibration applied and no bandpass applied

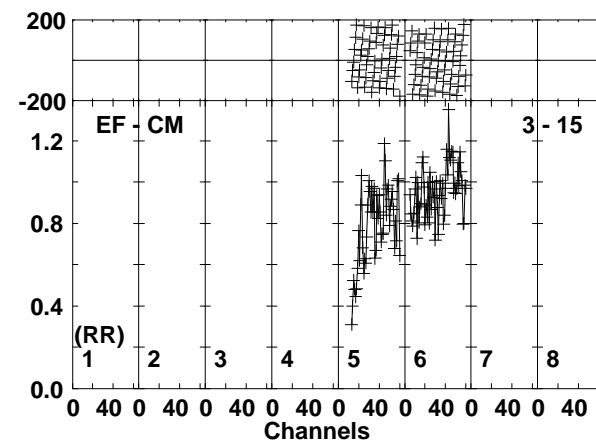
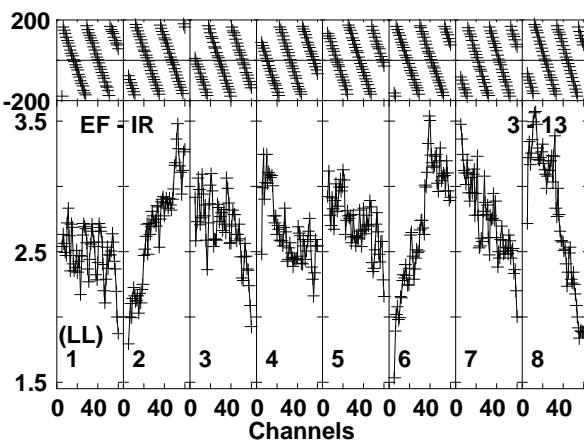
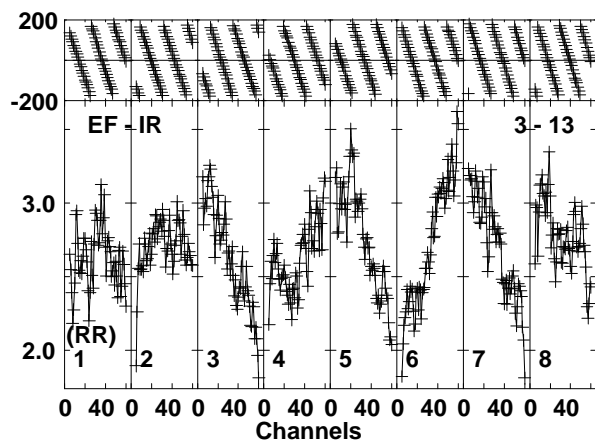
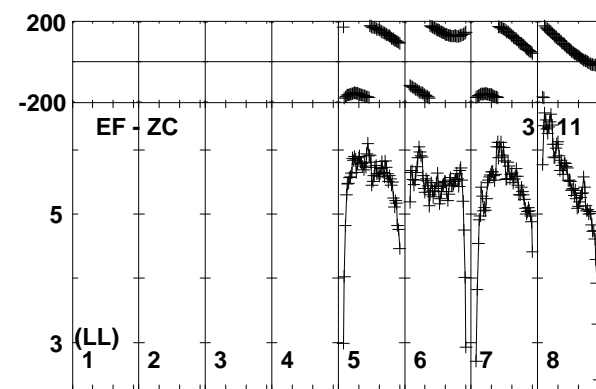
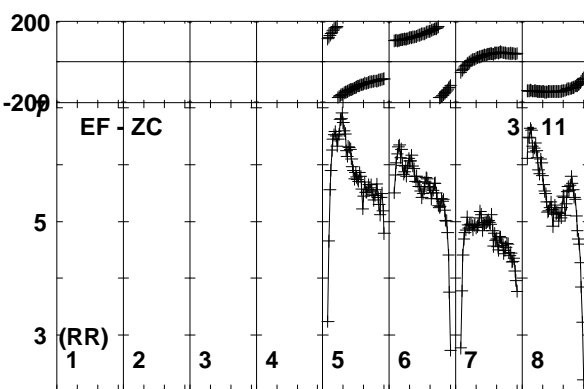
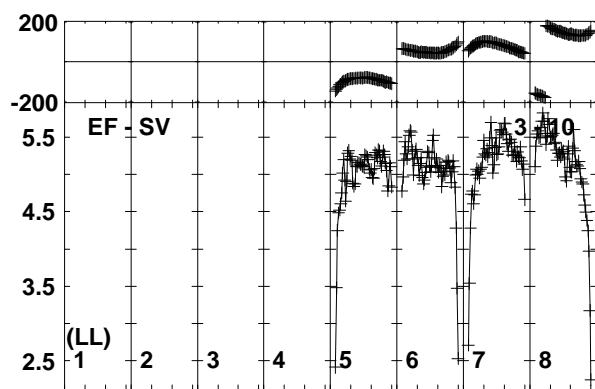
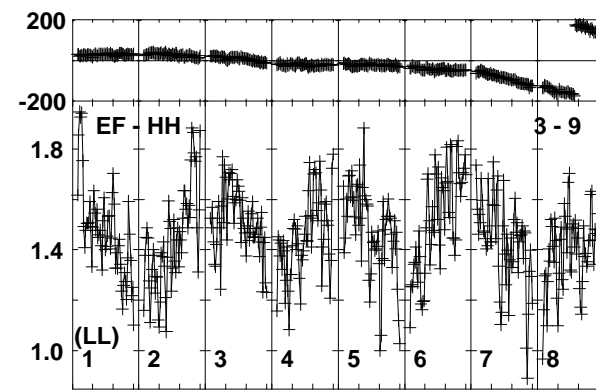
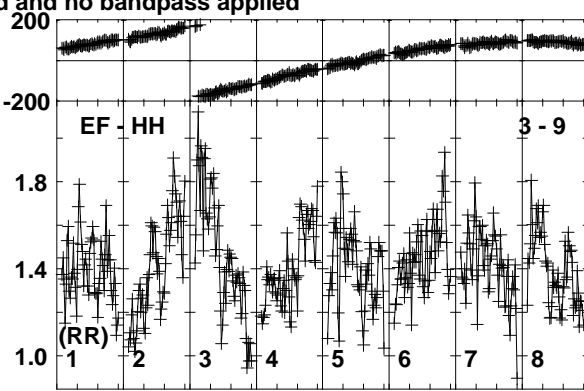
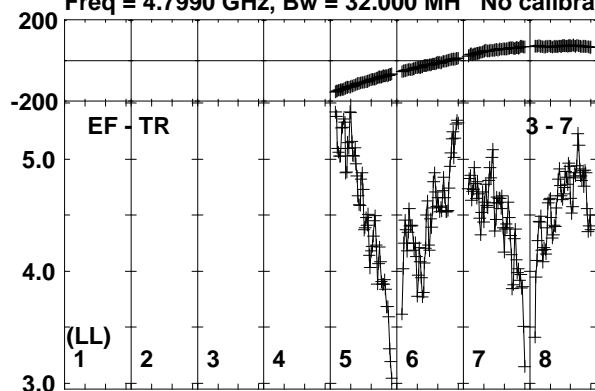

Lower frame: Milli Ampl Jy Top frame: Phas deg
Vector averaged cross-power spectrum Baseline: EF (03) - TR (07)
Timerange: 01/02:30:56 to 01/02:31:54

Plot file version 378 created 26-SEP-2019 10:42:02

J0257-1212 RG010A.UVDATA.1

Freq = 4.7990 GHz, Bw = 32.000 MH No calibration applied and no bandpass applied

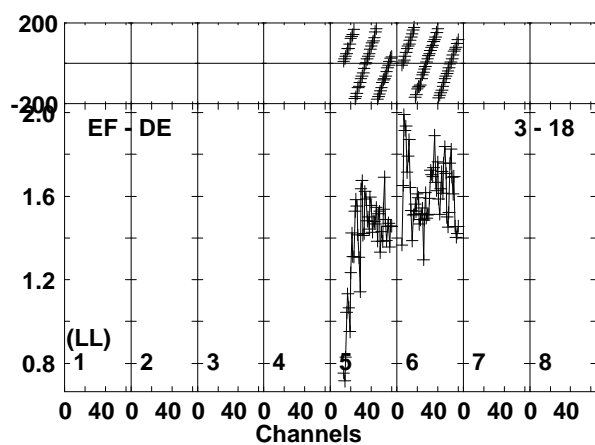
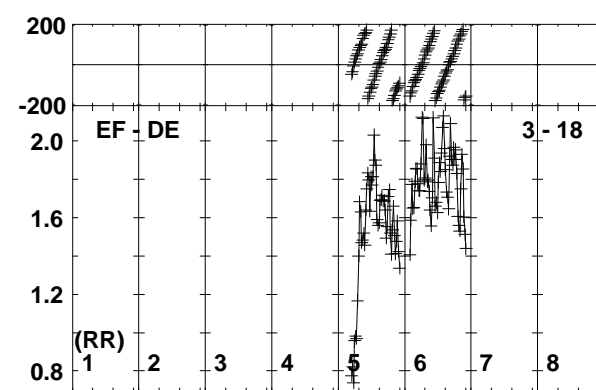
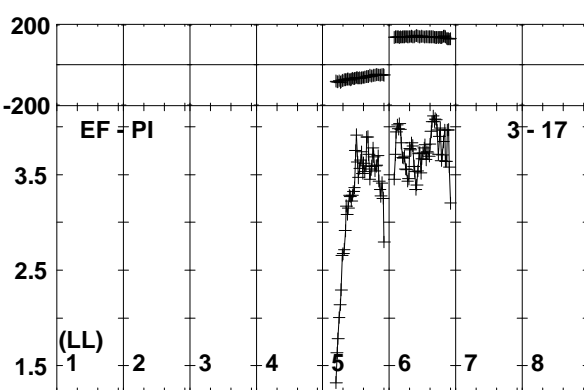
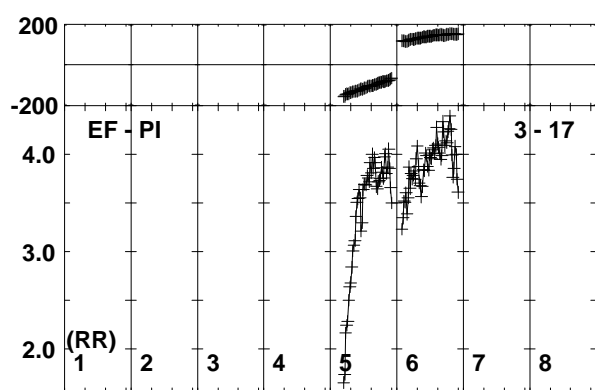
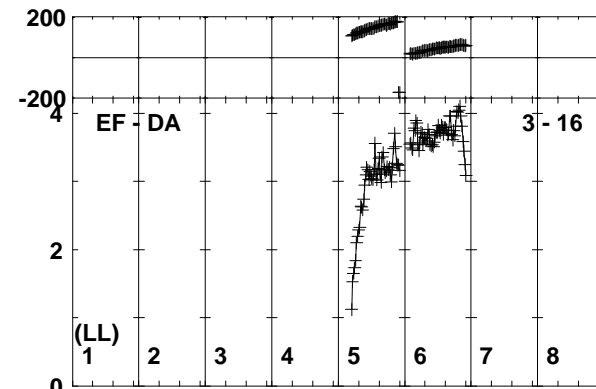
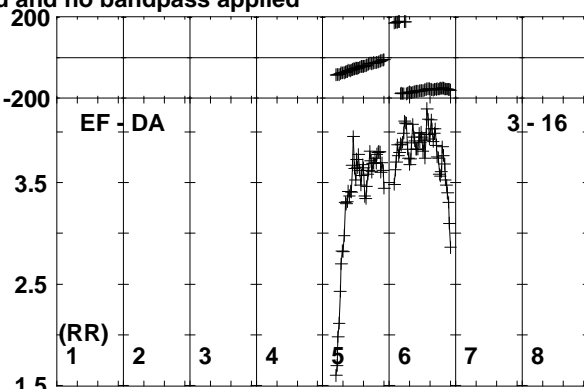
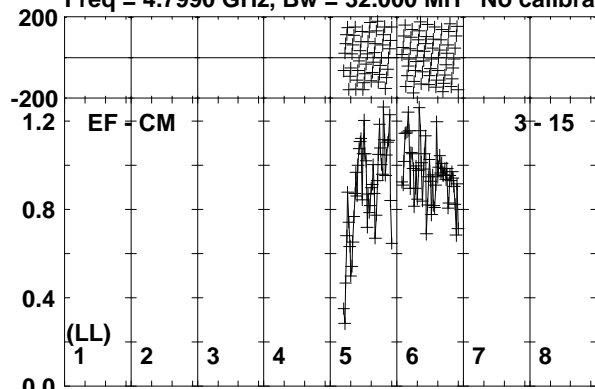

Lower frame: Milli Ampl Jy Top frame: Phas deg
Vector averaged cross-power spectrum Baseline: EF (03) - CM (15)
Timerange: 01/02:30:56 to 01/02:31:54

Plot file version 379 created 26-SEP-2019 10:42:03

190829A RG010A.UVDATA.1

Freq = 4.7990 GHz, Bw = 32.000 MH No calibration applied and no bandpass applied

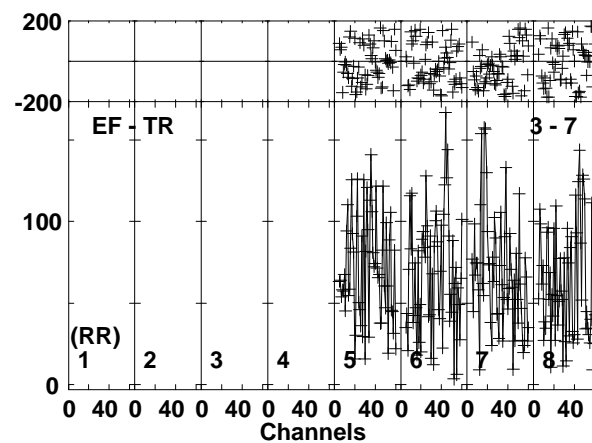
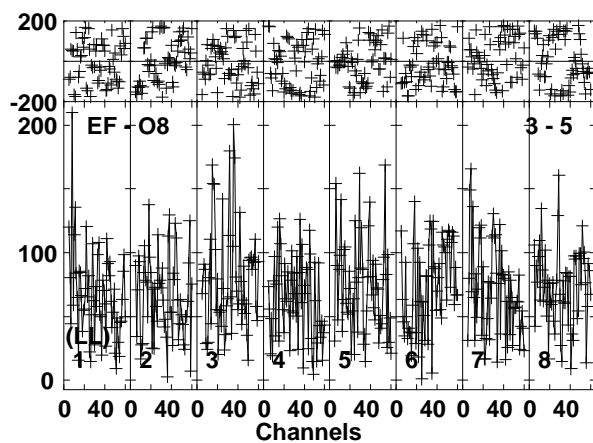
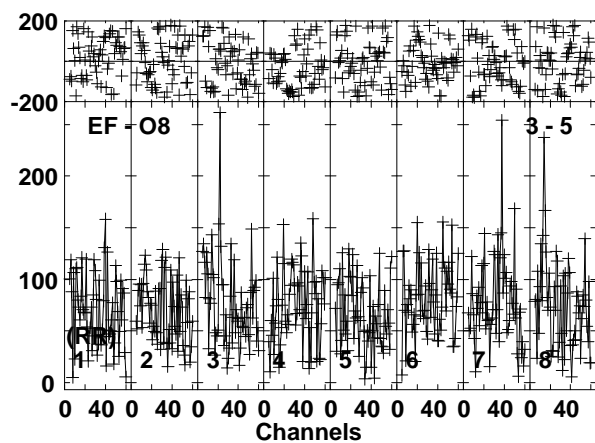
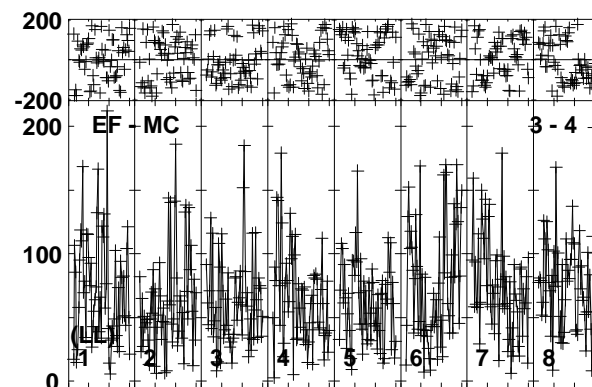
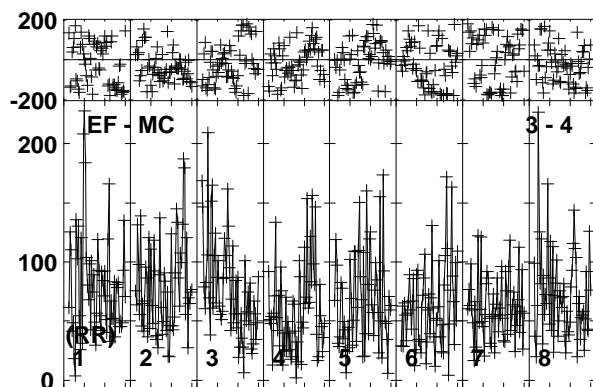
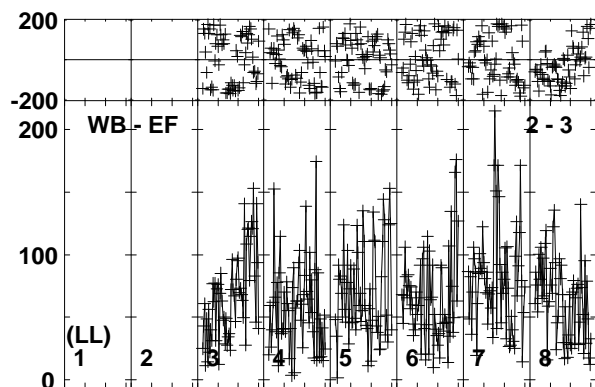
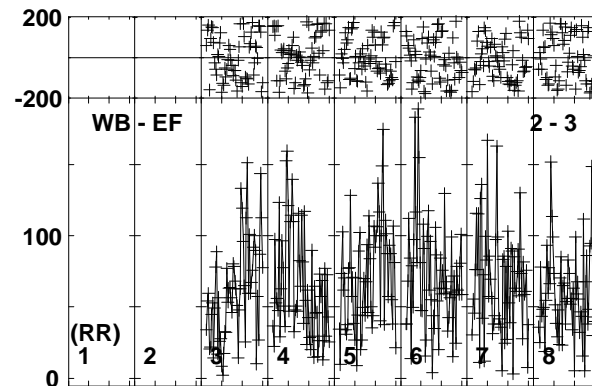
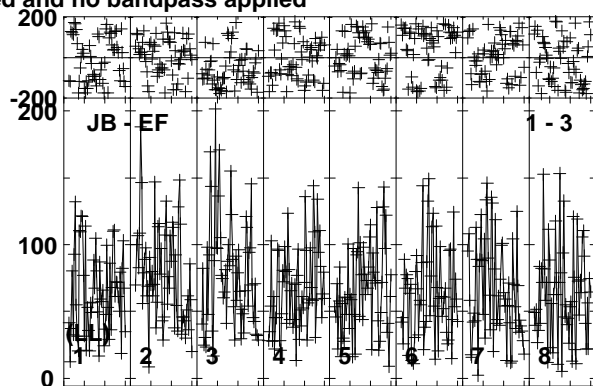
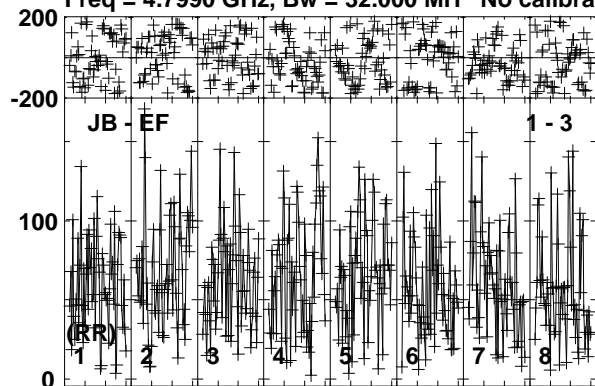

Lower frame: Micro Ampl Jy Top frame: Phas deg
Vector averaged cross-power spectrum Baseline: JB (01) - EF (03)
Timerange: 01/02:31:55 to 01/02:36:54

Plot file version 380 created 26-SEP-2019 10:42:03

190829A RG010A.UVDATA.1

Freq = 4.7990 GHz, Bw = 32.000 MH No calibration applied and no bandpass applied

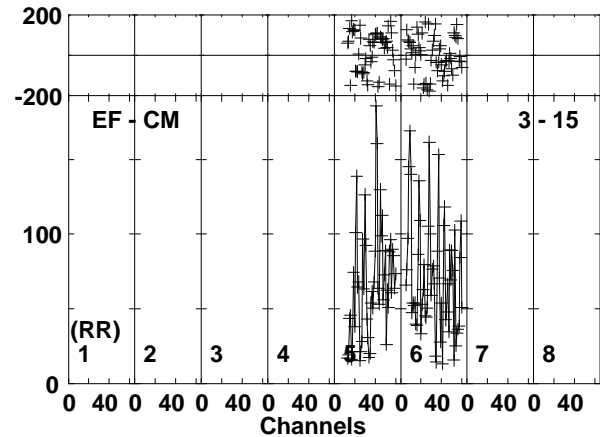
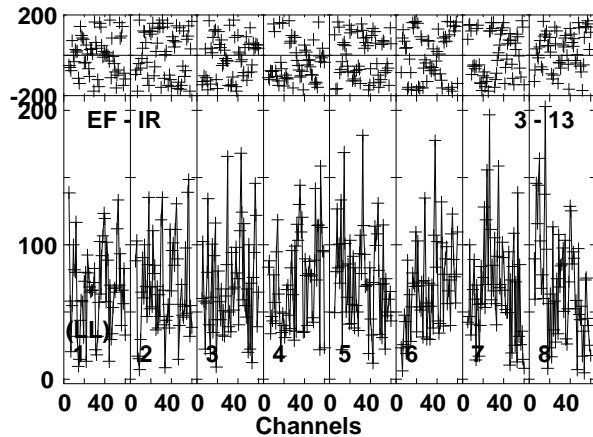
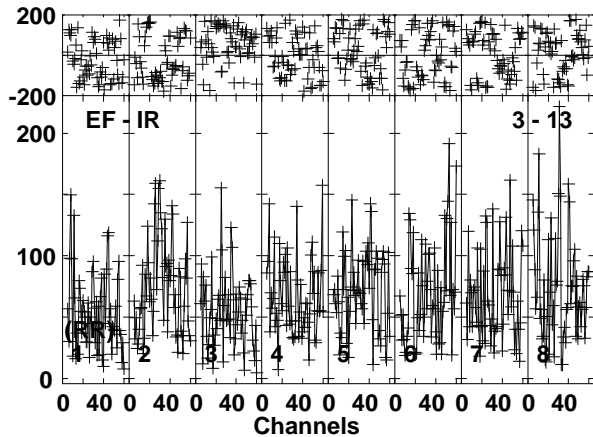
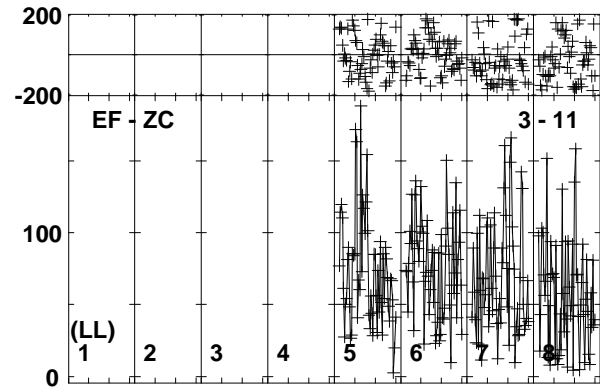
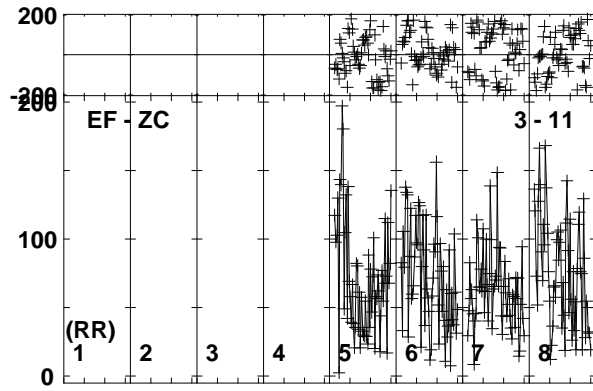
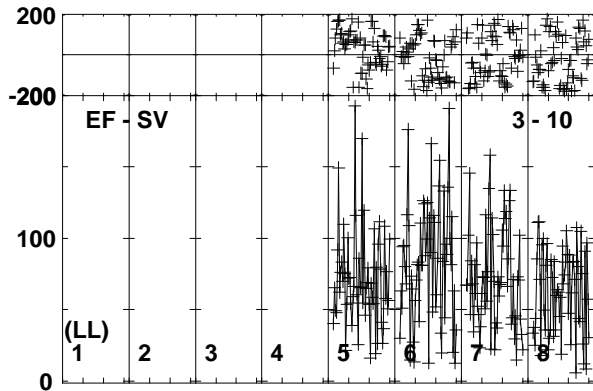
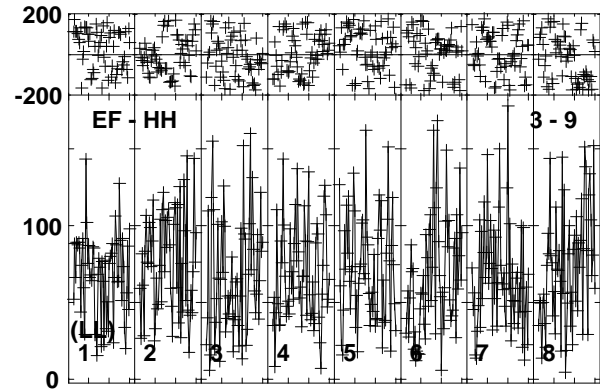
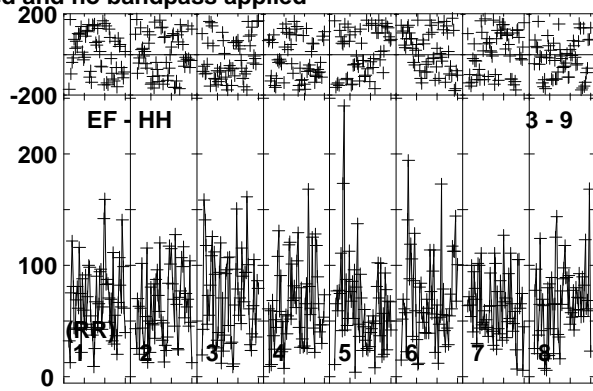
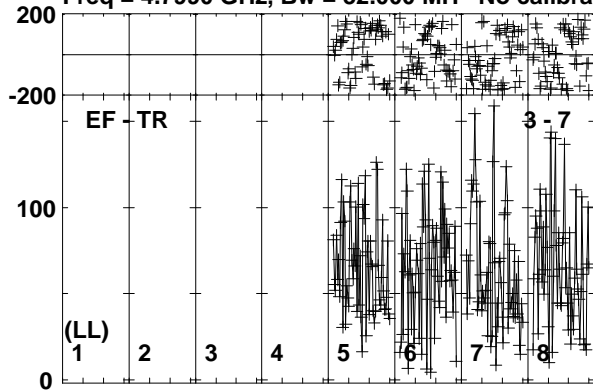

Lower frame: Micro Ampl Jy Top frame: Phas deg
Vector averaged cross-power spectrum Baseline: EF (03) - TR (07)
Timerange: 01/02:31:55 to 01/02:36:54

Plot file version 381 created 26-SEP-2019 10:42:05

190829A RG010A.UVDATA.1

Freq = 4.7990 GHz, Bw = 32.000 MH No calibration applied and no bandpass applied

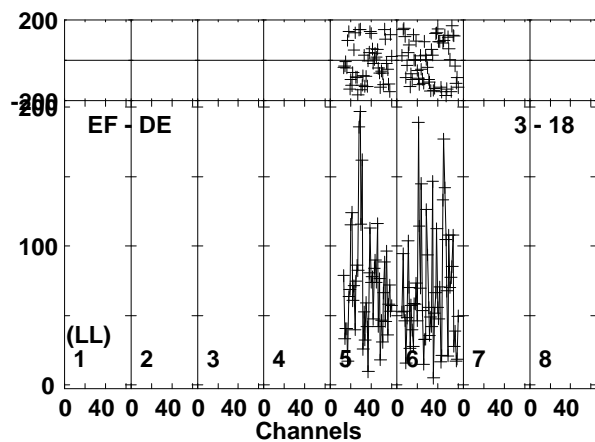
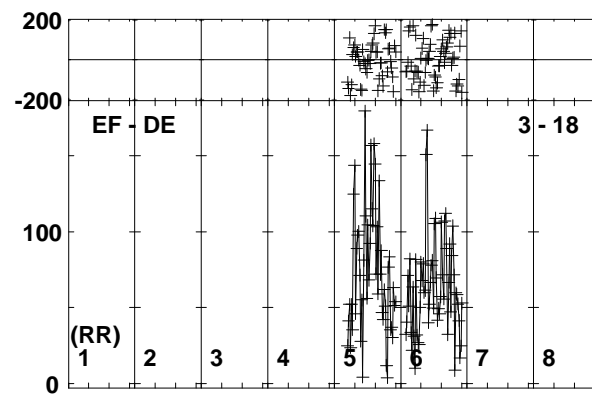
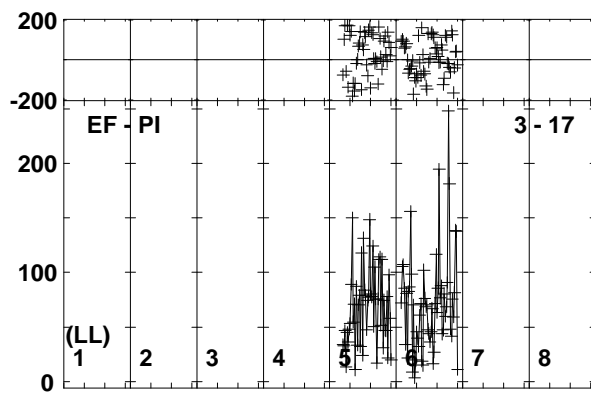
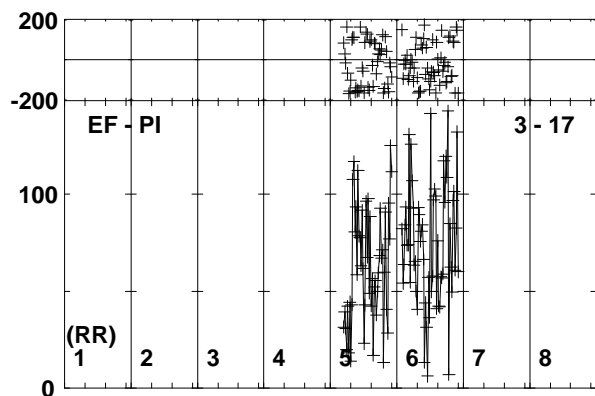
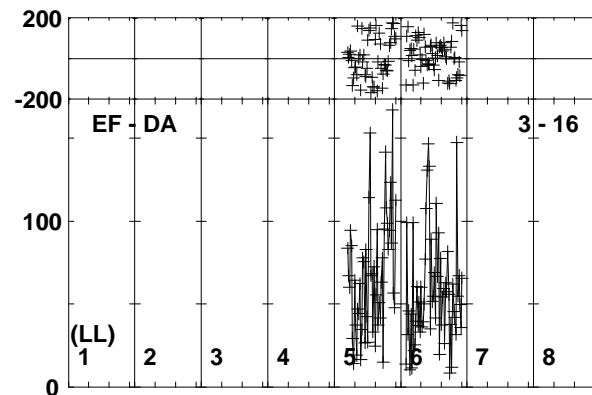
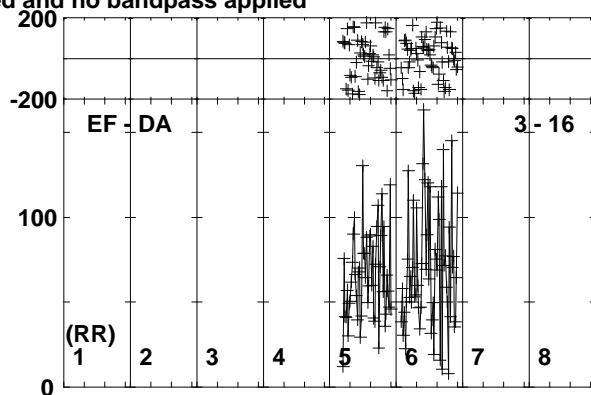
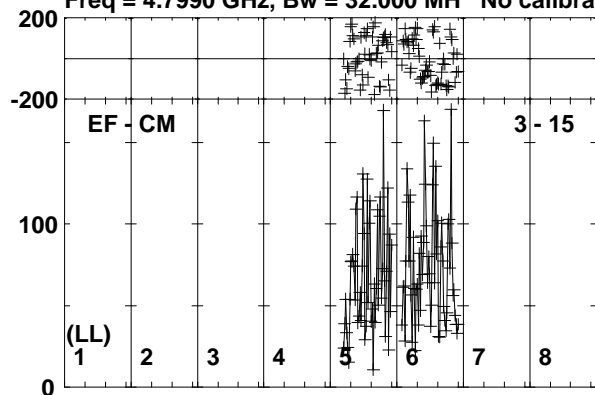

Lower frame: Micro Ampl Jy Top frame: Phas deg
Vector averaged cross-power spectrum Baseline: EF (03) - CM (15)
Timerange: 01/02:31:55 to 01/02:36:54

Plot file version 382 created 26-SEP-2019 10:42:05

J0257-1212 RG010A.UVDATA.1

Freq = 4.7990 GHz, Bw = 32.000 MH No calibration applied and no bandpass applied

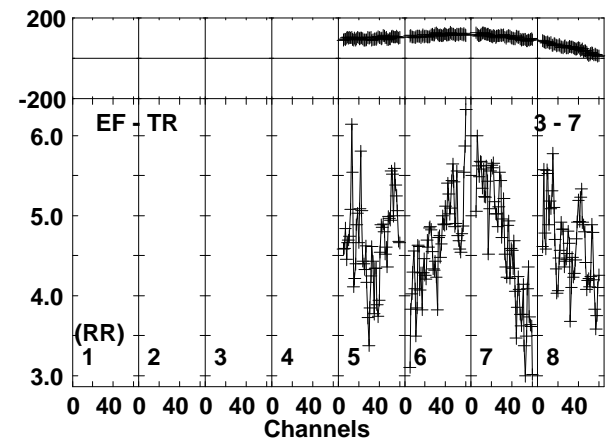
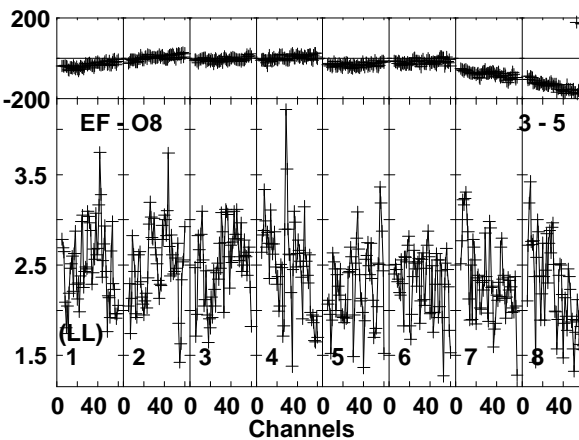
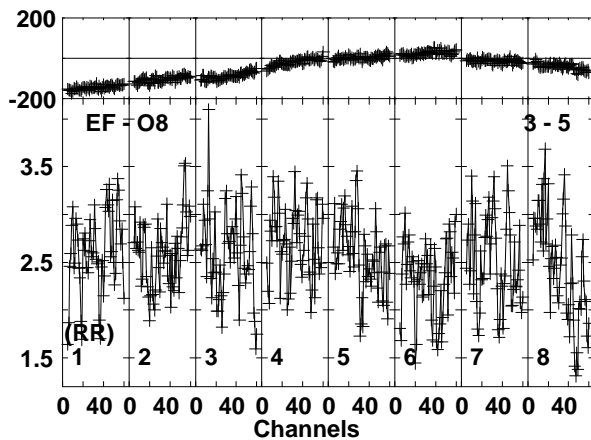
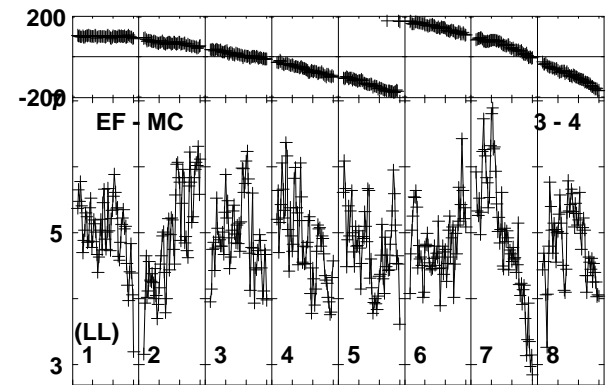
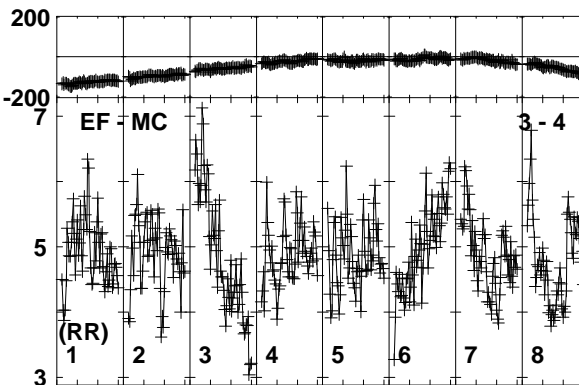
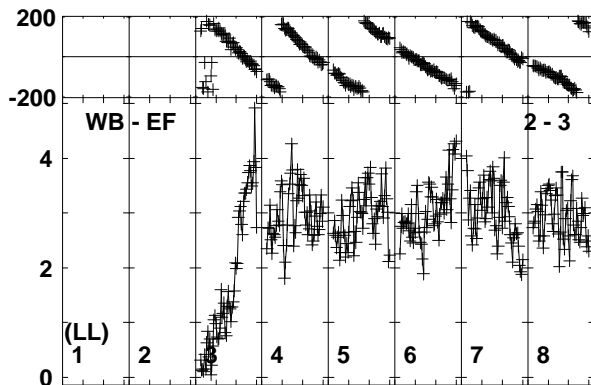
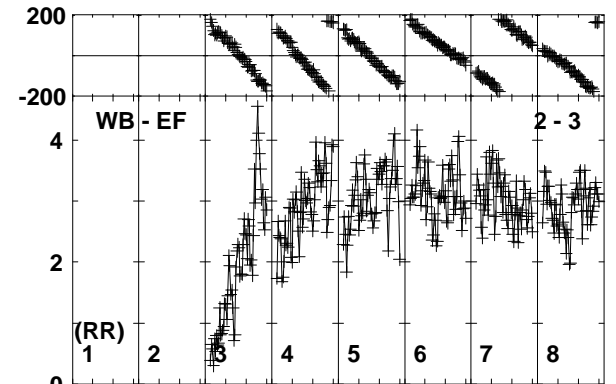
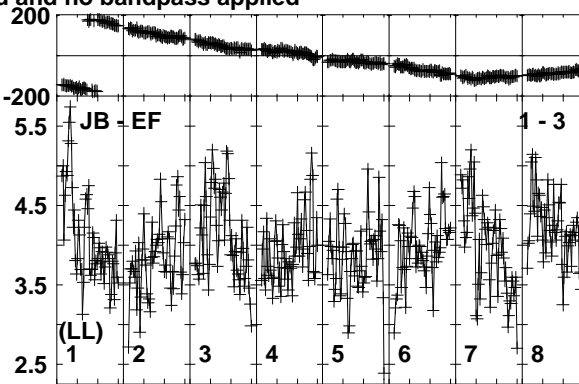
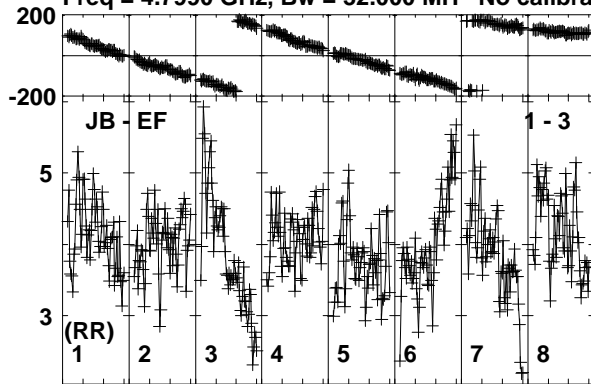

Lower frame: Milli Ampl Jy Top frame: Phas deg
Vector averaged cross-power spectrum Baseline: JB (01) - EF (03)
Timerange: 01/02:36:55 to 01/02:37:54

Plot file version 383 created 26-SEP-2019 10:42:05

J0257-1212 RG010A.UVDATA.1

Freq = 4.7990 GHz, Bw = 32.000 MH No calibration applied and no bandpass applied

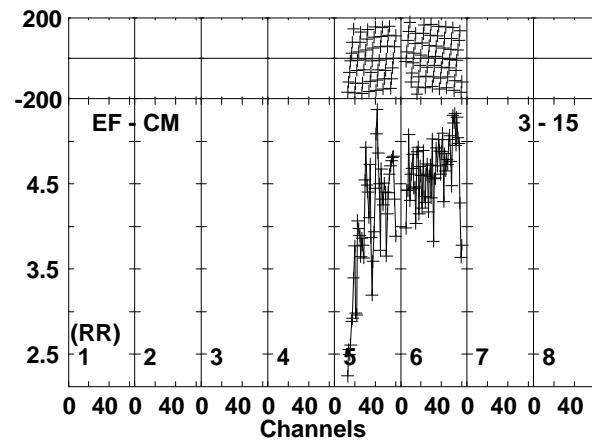
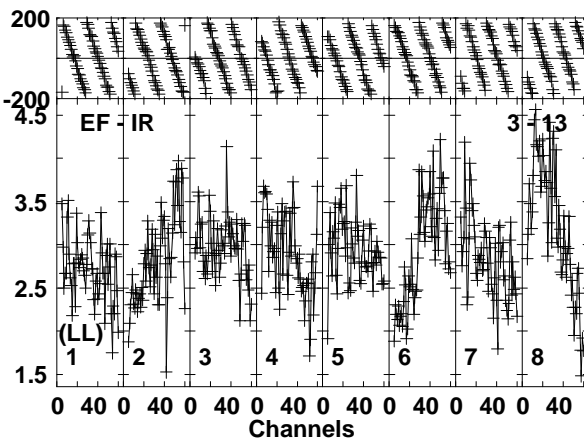
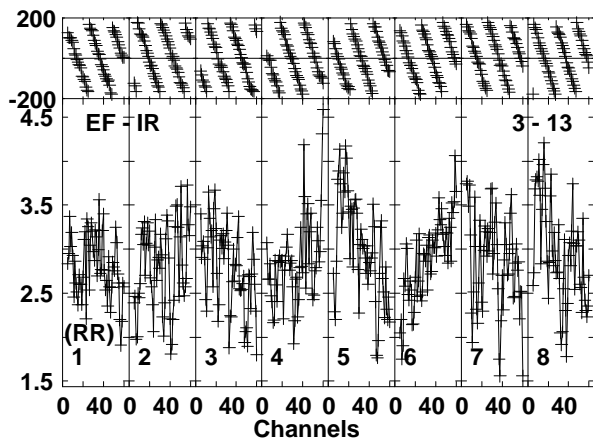
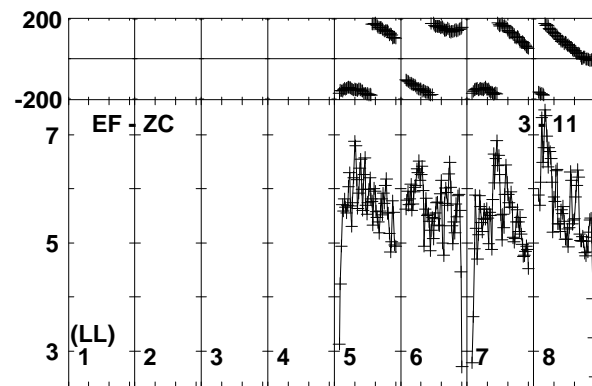
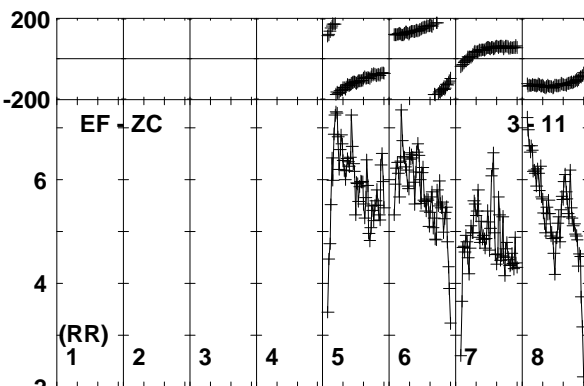
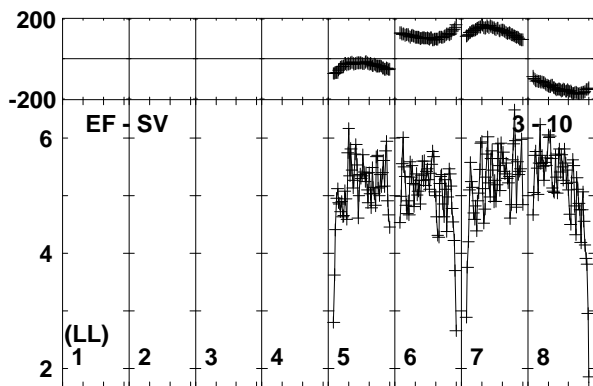
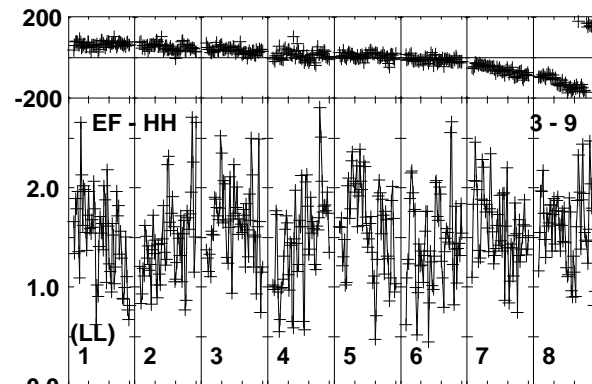
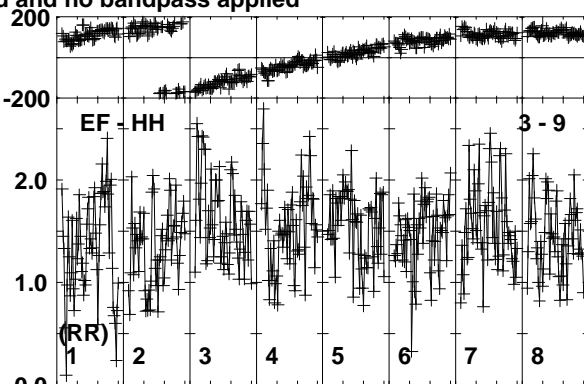
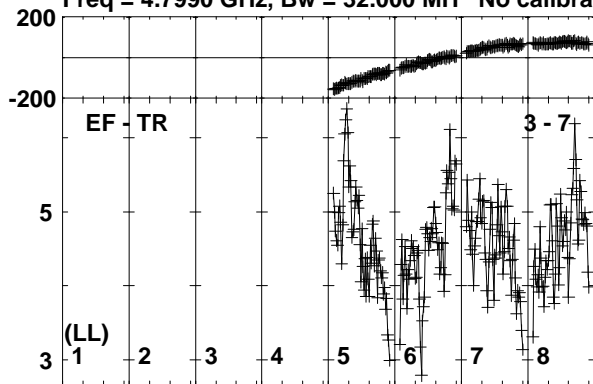

Lower frame: Milli Ampl Jy Top frame: Phas deg
Vector averaged cross-power spectrum Baseline: EF (03) - TR (07)
Timerange: 01/02:36:55 to 01/02:37:54

Plot file version 384 created 26-SEP-2019 10:42:06

J0257-1212 RG010A.UVDATA.1

Freq = 4.7990 GHz, Bw = 32.000 MH No calibration applied and no bandpass applied

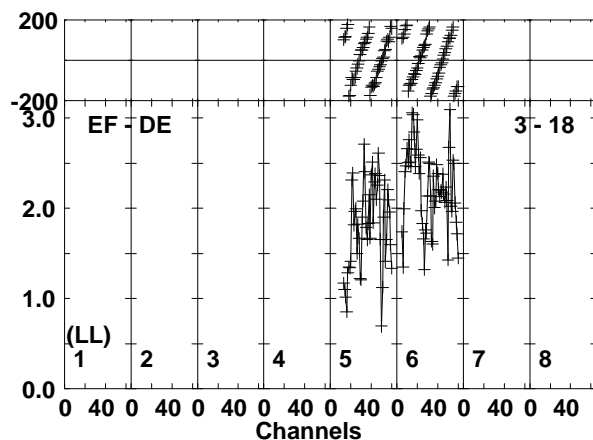
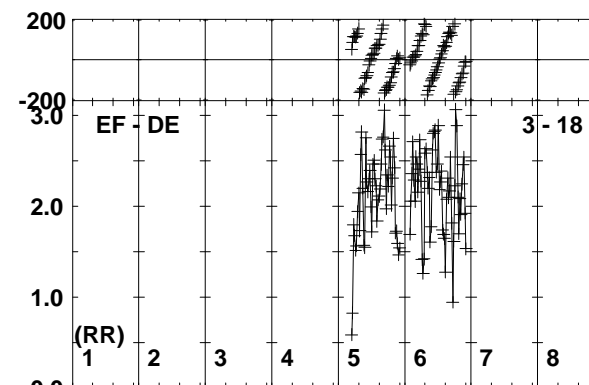
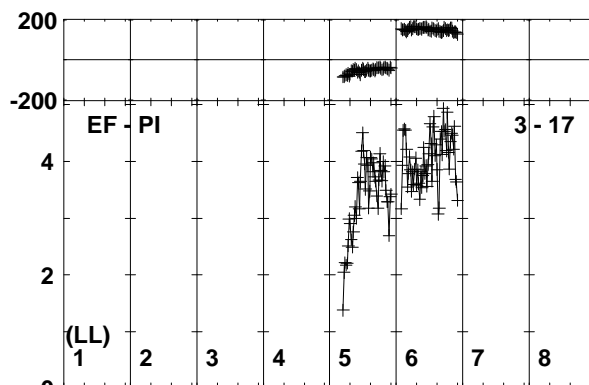
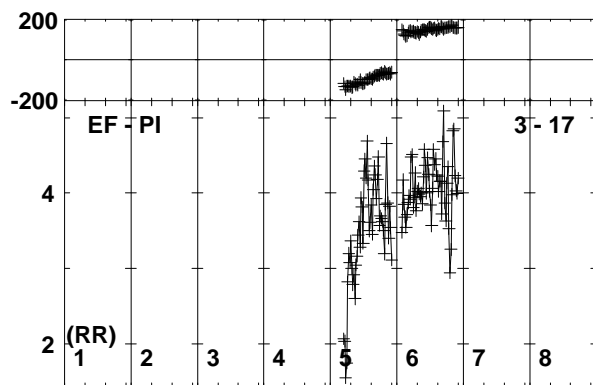
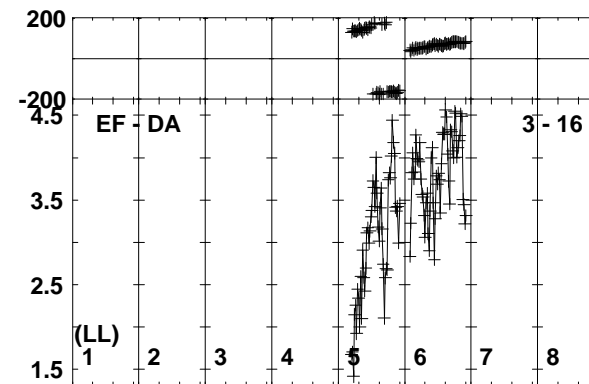
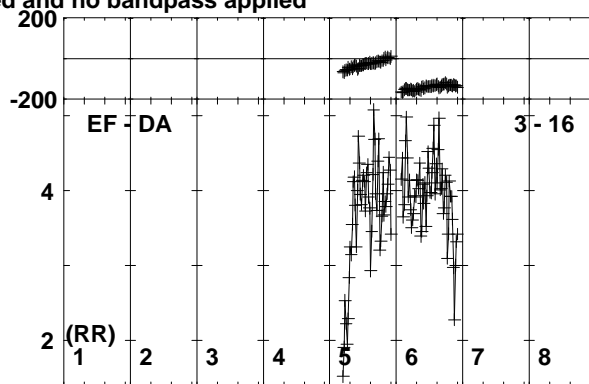
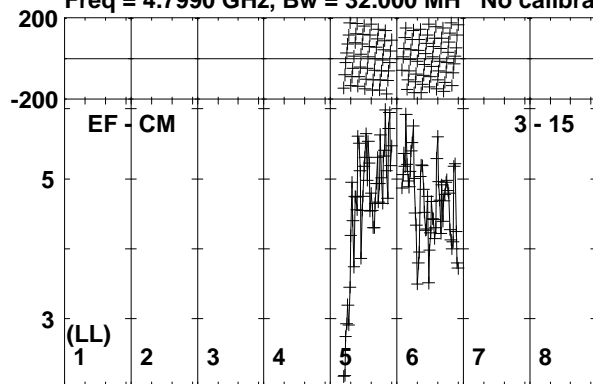

Lower frame: Milli Ampl Jy Top frame: Phas deg
Vector averaged cross-power spectrum Baseline: EF (03) - CM (15)
Timerange: 01/02:36:55 to 01/02:37:54

Plot file version 385 created 26-SEP-2019 10:42:06

NVSS-1 RG010A.UVDATA.1

Freq = 4.7990 GHz, Bw = 32.000 MH No calibration applied and no bandpass applied

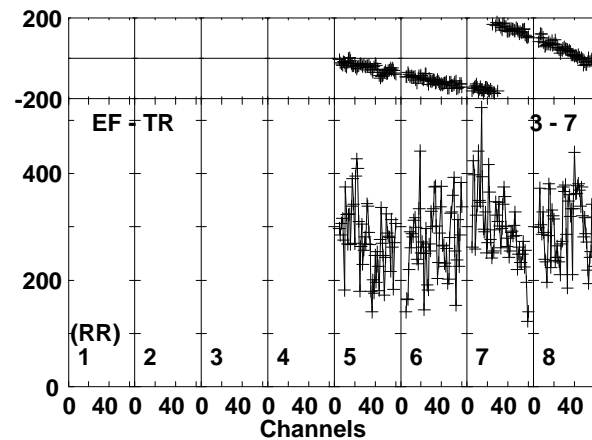
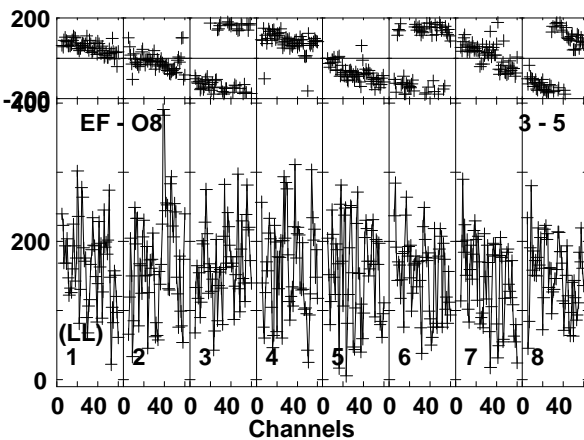
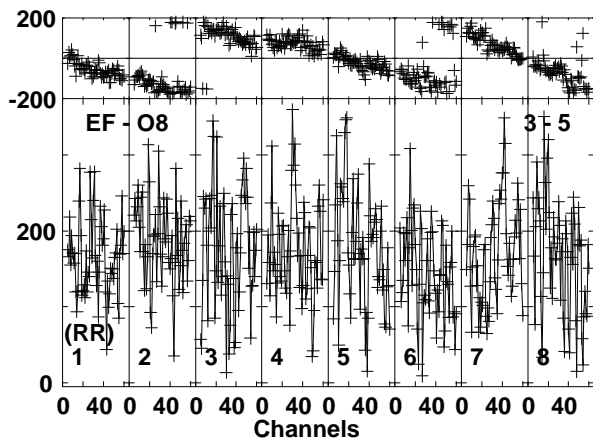
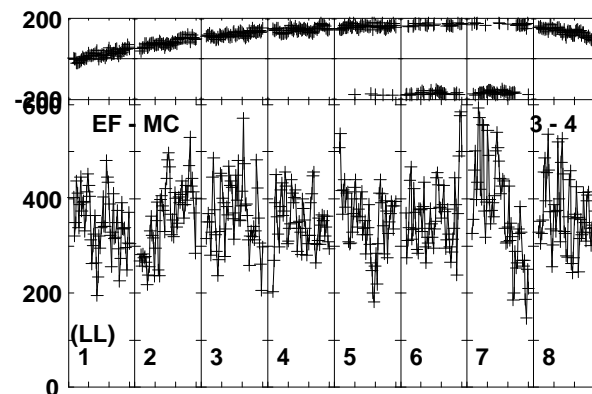
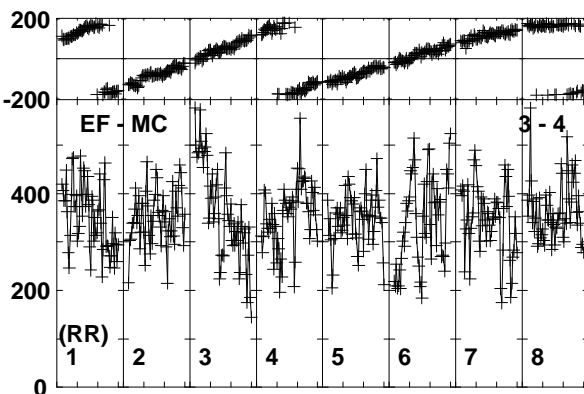
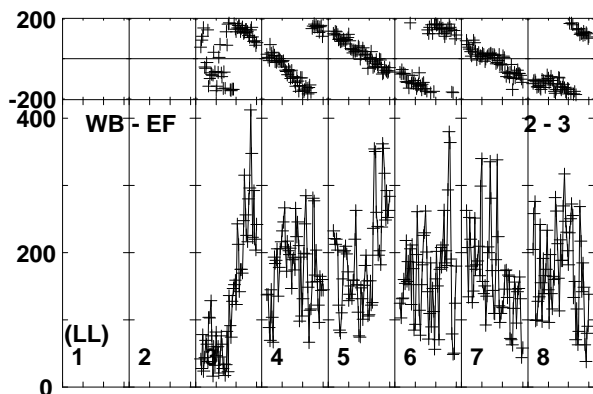
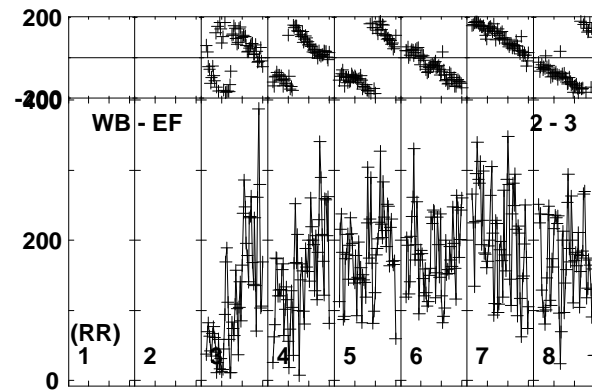
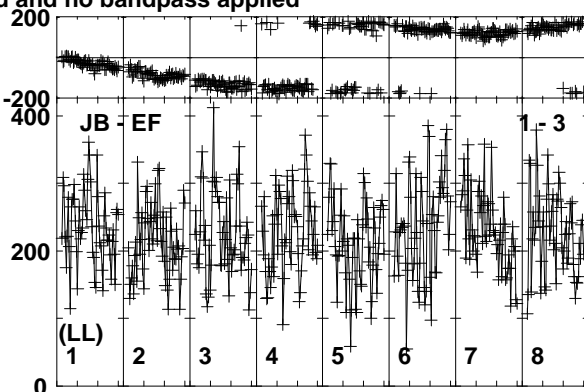
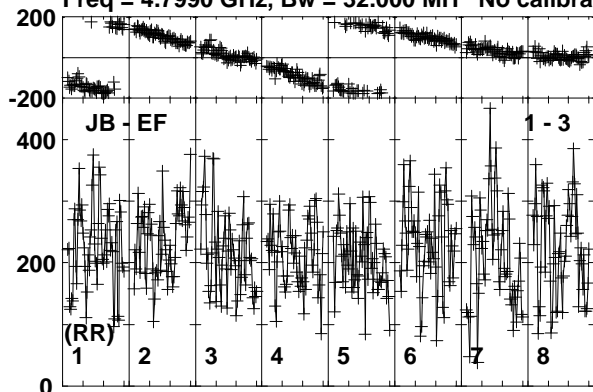

Lower frame: Micro Ampl Jy Top frame: Phas deg
Vector averaged cross-power spectrum Baseline: JB (01) - EF (03)
Timerange: 01/02:37:56 to 01/02:41:35

Plot file version 386 created 26-SEP-2019 10:42:07

NVSS-1 RG010A.UVDATA.1

Freq = 4.7990 GHz, Bw = 32.000 MH No calibration applied and no bandpass applied

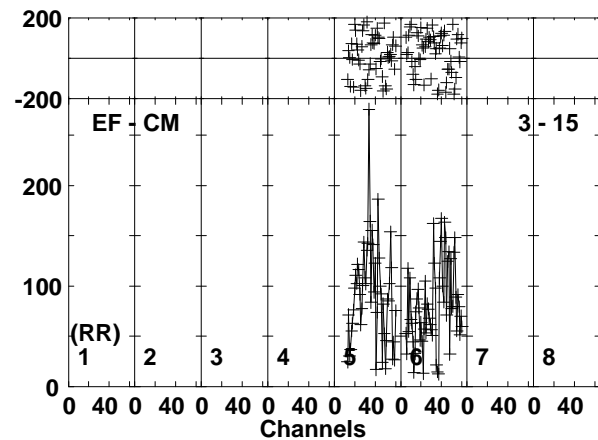
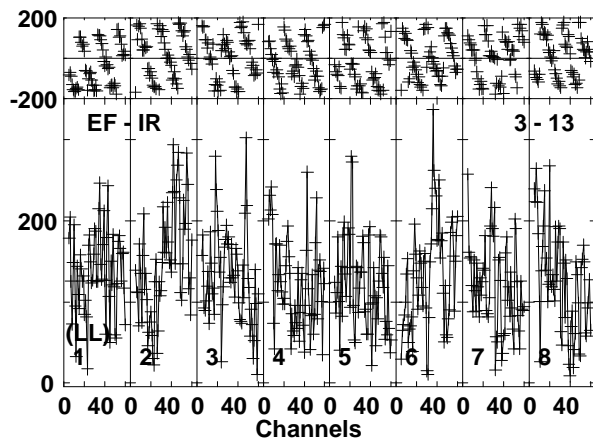
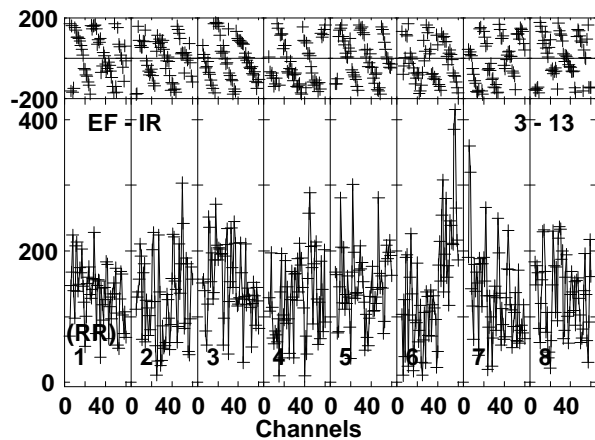
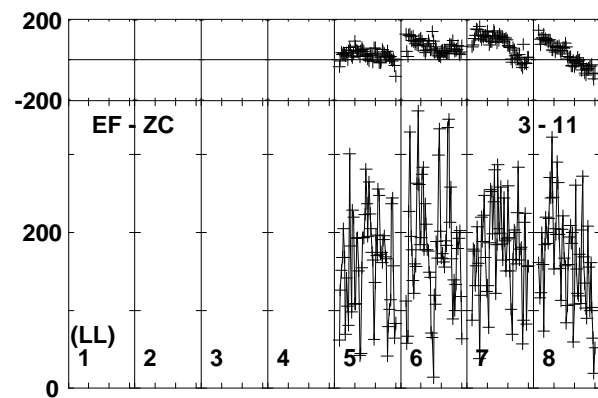
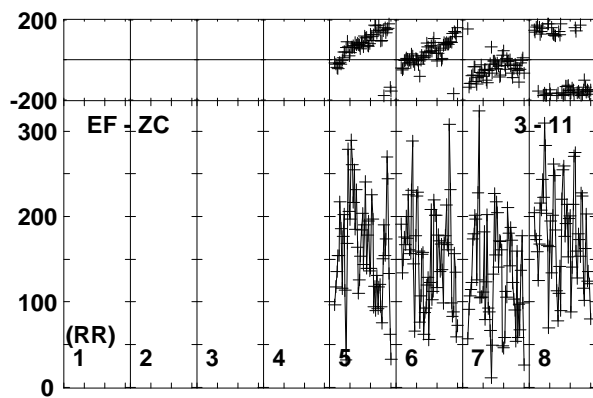
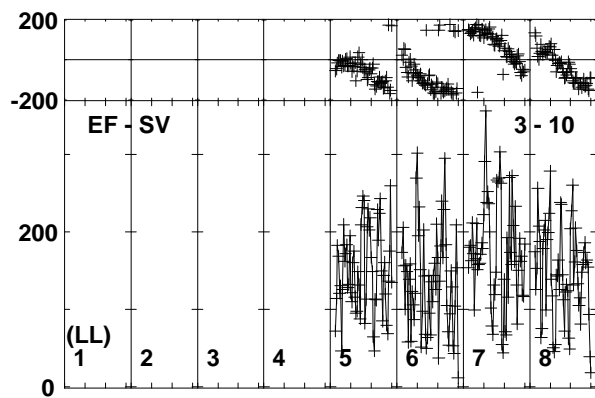
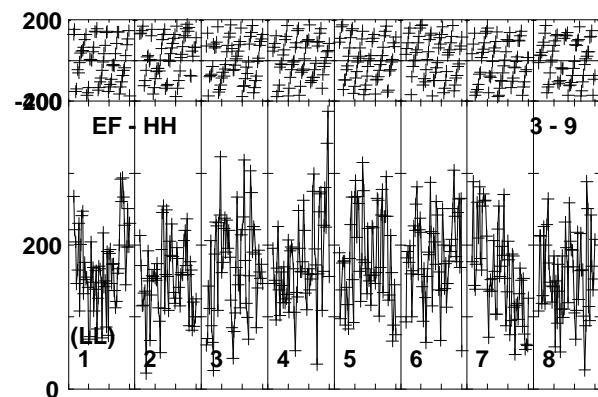
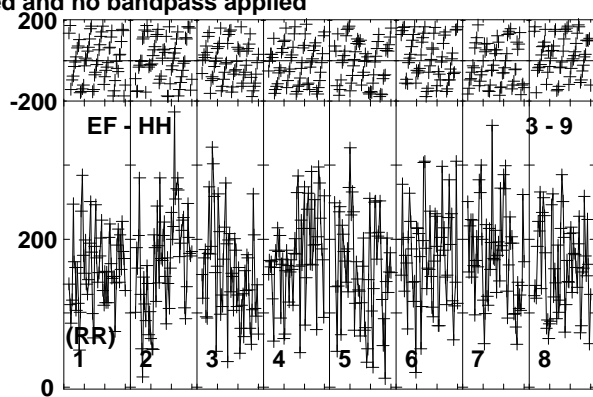
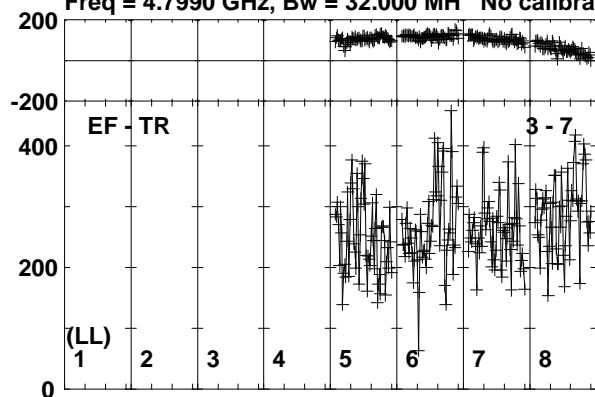

Lower frame: Micro Ampl Jy Top frame: Phas deg
Vector averaged cross-power spectrum Baseline: EF (03) - TR (07)
Timerange: 01/02:37:56 to 01/02:41:35

Plot file version 387 created 26-SEP-2019 10:42:08

NVSS-1 RG010A.UVDATA.1

Freq = 4.7990 GHz, Bw = 32.000 MH No calibration applied and no bandpass applied

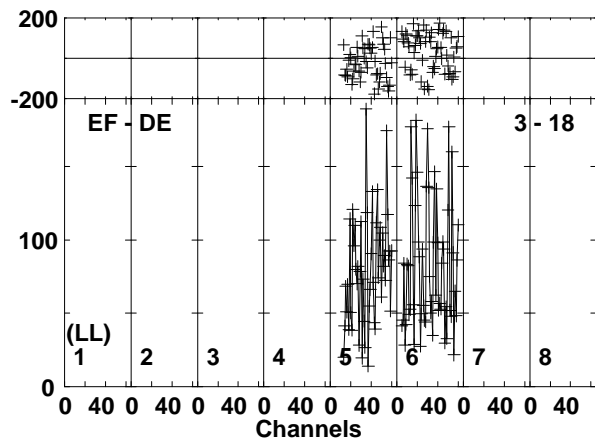
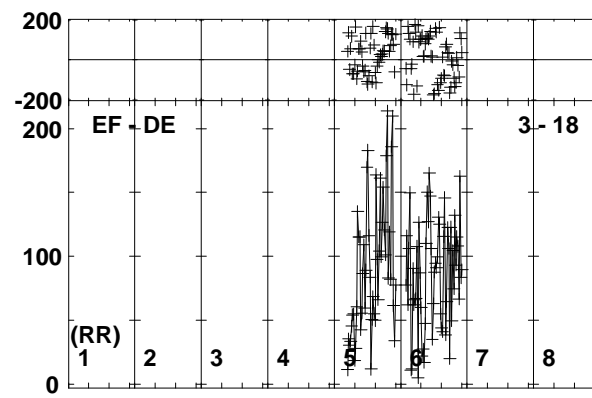
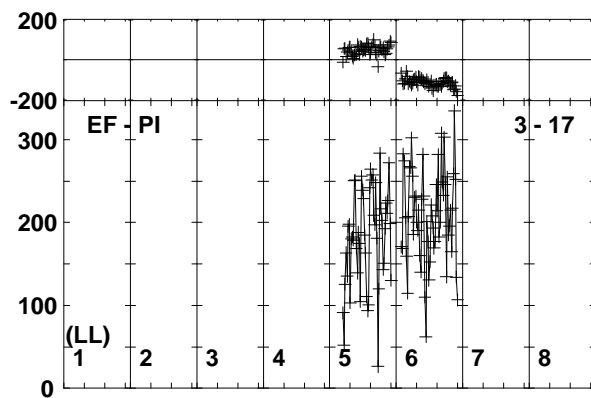
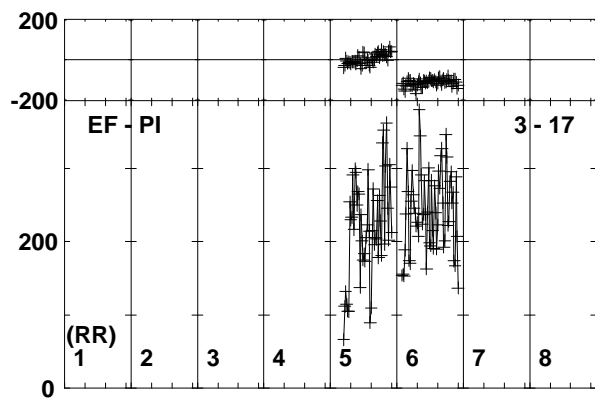
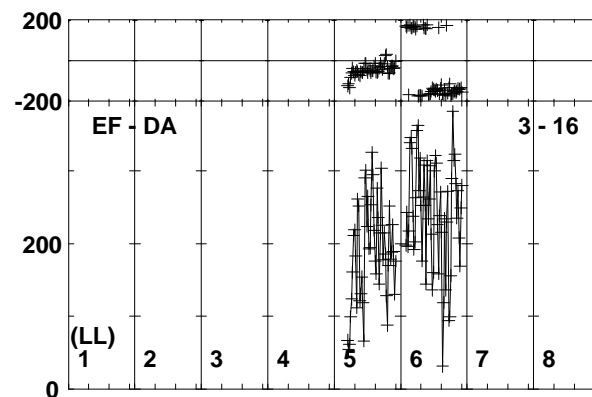
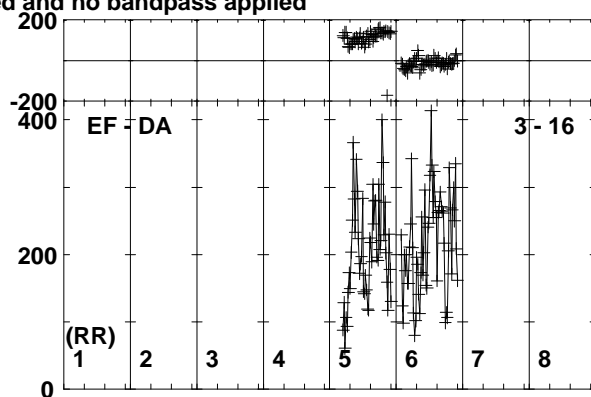
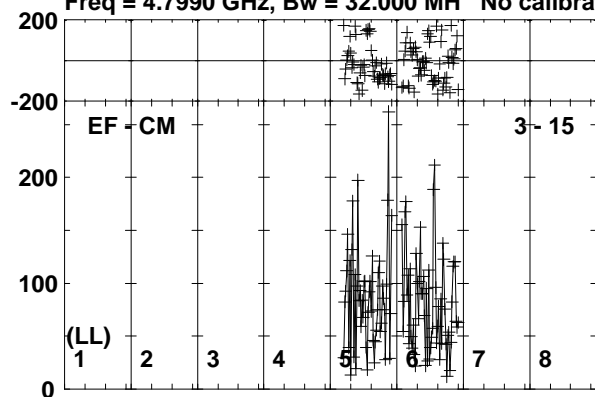

Lower frame: Micro Ampl Jy Top frame: Phas deg
Vector averaged cross-power spectrum Baseline: EF (03) - CM (15)
Timerange: 01/02:37:56 to 01/02:41:35

Plot file version 388 created 26-SEP-2019 10:42:08

J0257-1212 RG010A.UVDATA.1

Freq = 4.7990 GHz, Bw = 32.000 MH No calibration applied and no bandpass applied

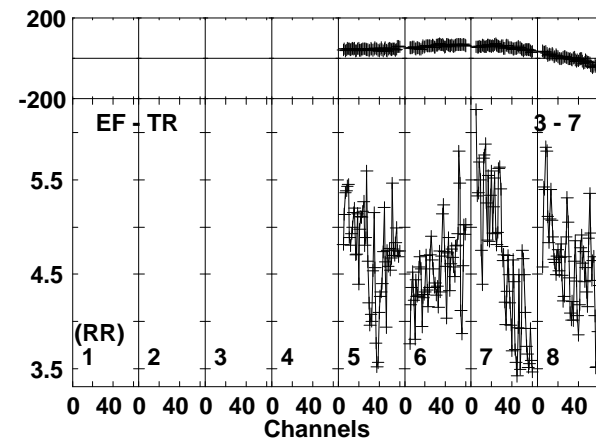
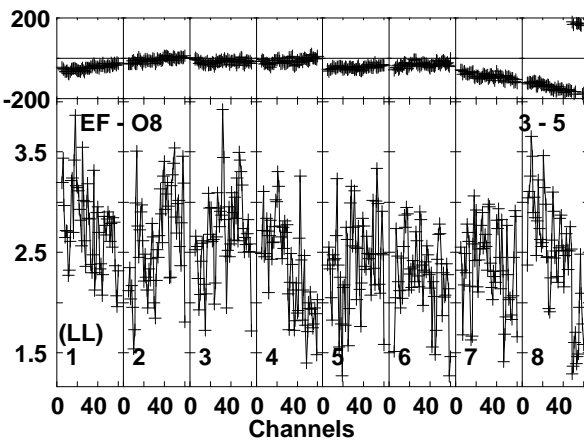
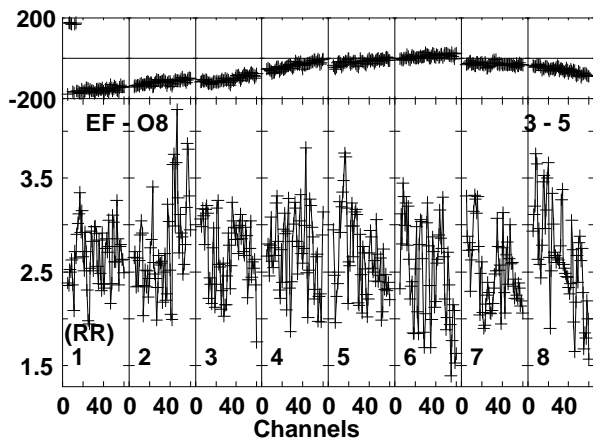
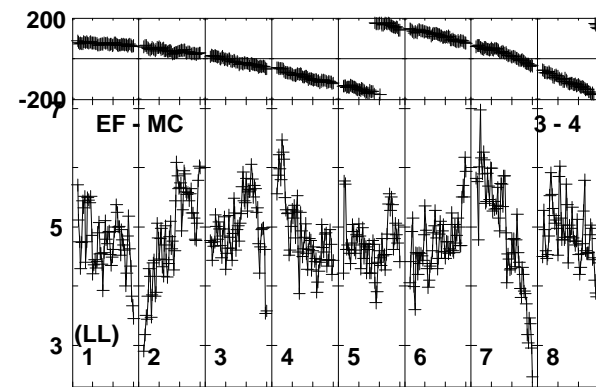
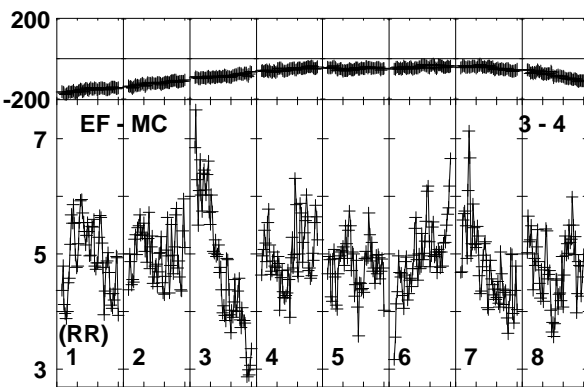
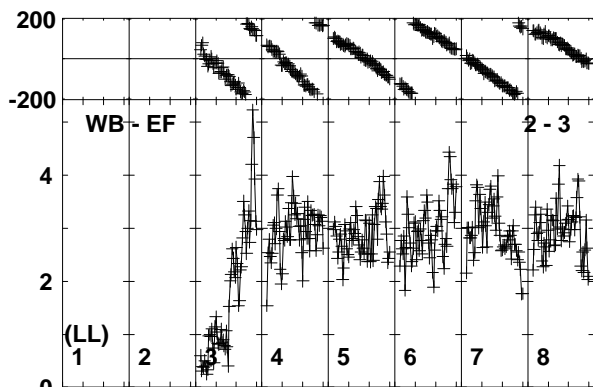
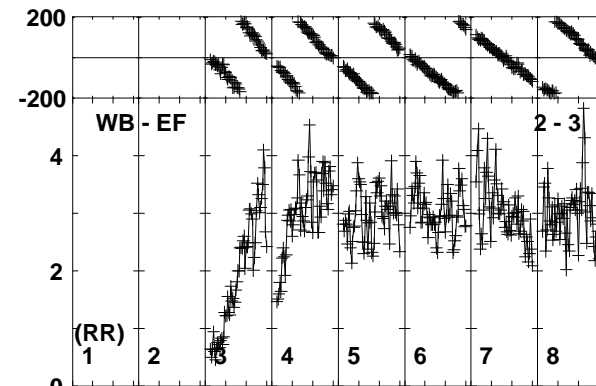
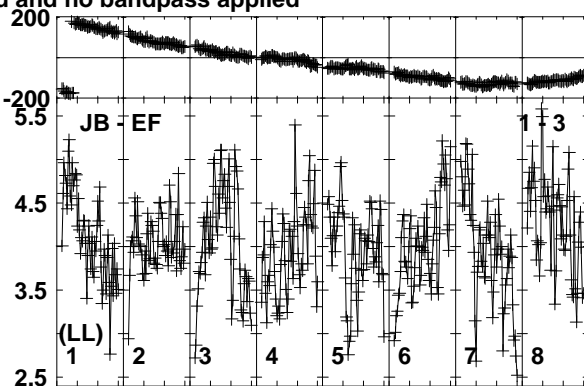
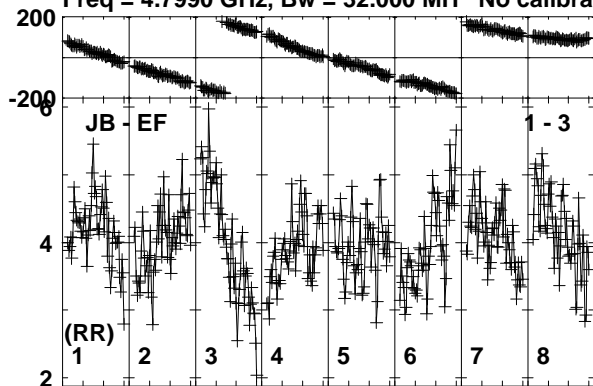

Lower frame: Milli Ampl Jy Top frame: Phas deg
Vector averaged cross-power spectrum Baseline: JB (01) - EF (03)
Timerange: 01/02:41:36 to 01/02:42:34

Plot file version 389 created 26-SEP-2019 10:42:09

J0257-1212 RG010A.UVDATA.1

Freq = 4.7990 GHz, Bw = 32.000 MH No calibration applied and no bandpass applied

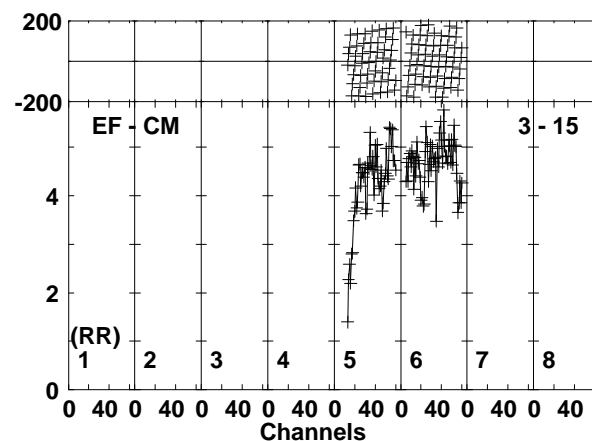
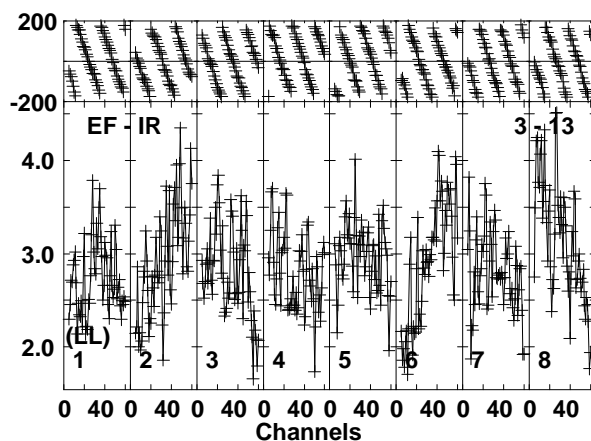
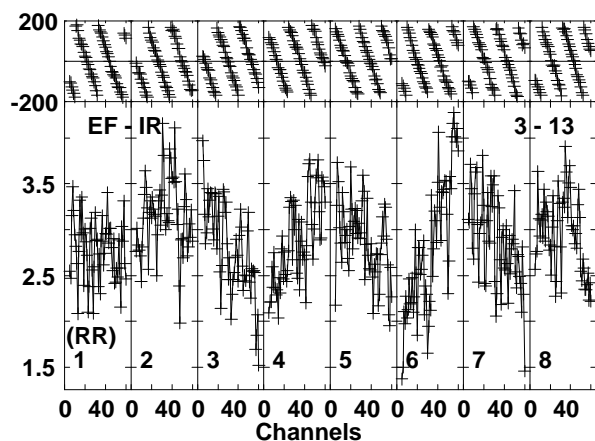
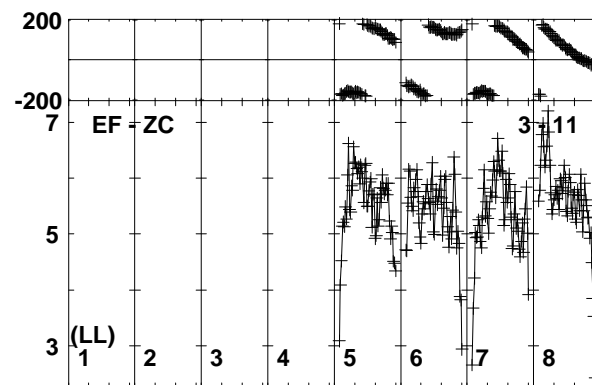
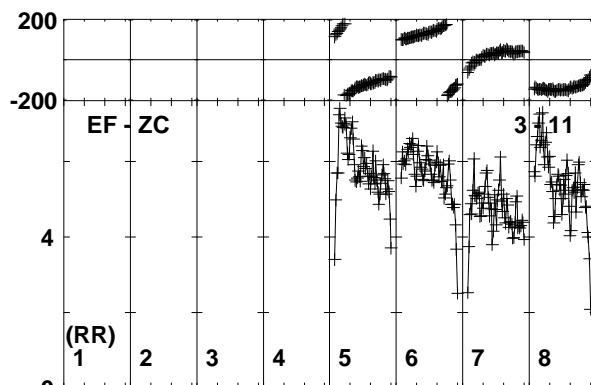
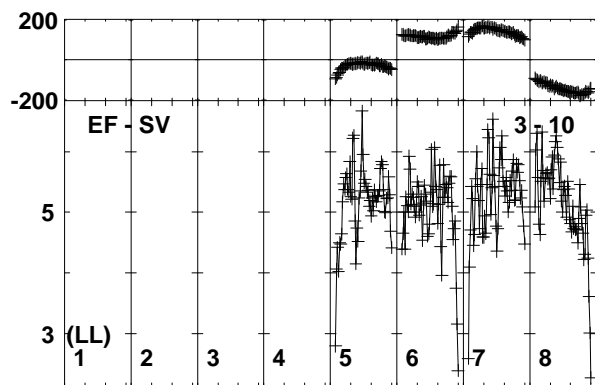
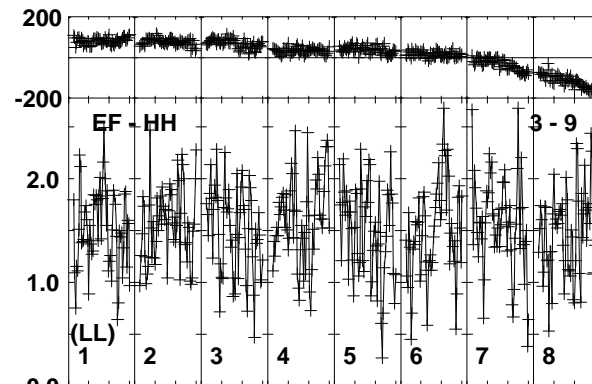
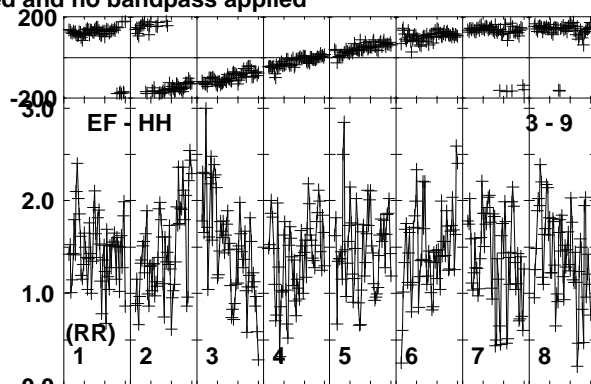
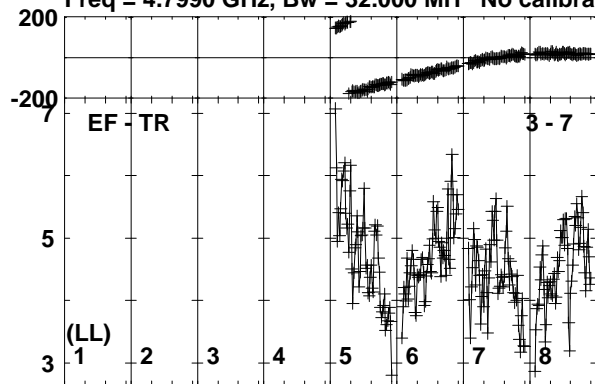

Lower frame: Milli Ampl Jy Top frame: Phas deg
Vector averaged cross-power spectrum Baseline: EF (03) - TR (07)
Timerange: 01/02:41:36 to 01/02:42:34

Plot file version 390 created 26-SEP-2019 10:42:09

J0257-1212 RG010A.UVDATA.1

Freq = 4.7990 GHz, Bw = 32.000 MH No calibration applied and no bandpass applied

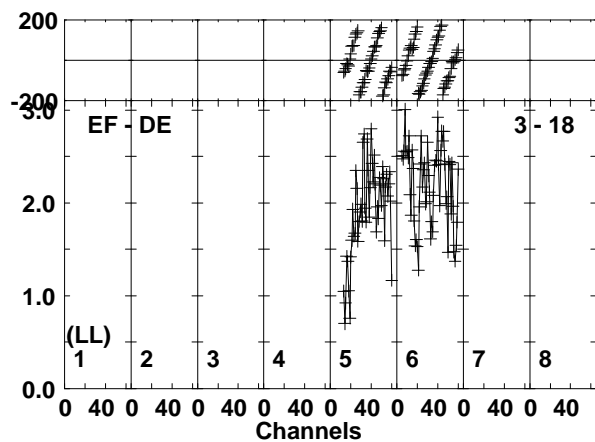
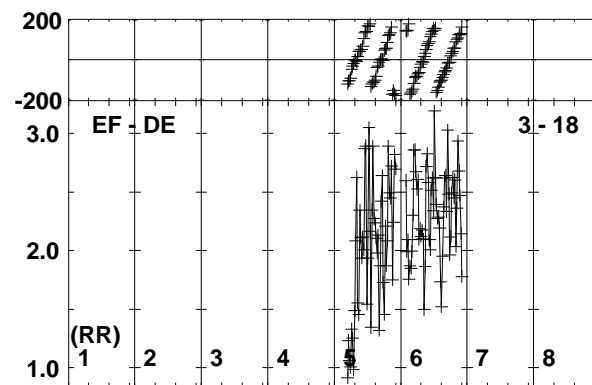
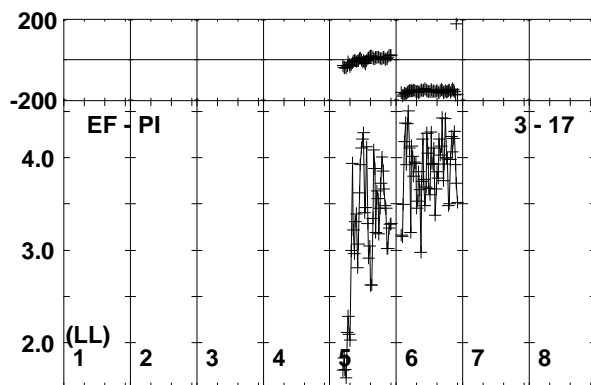
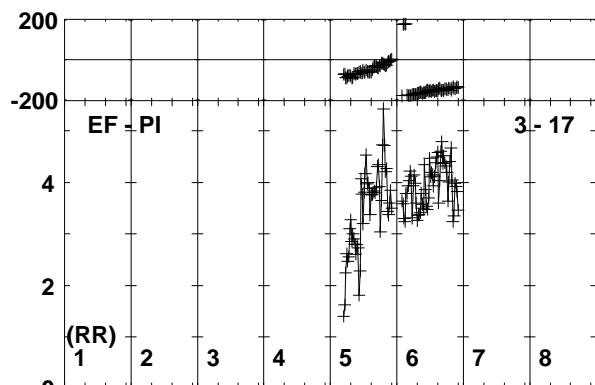
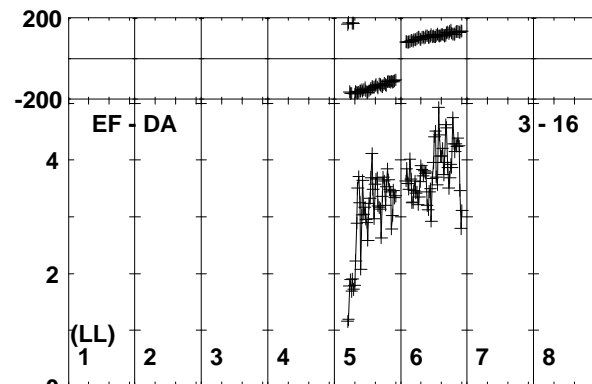
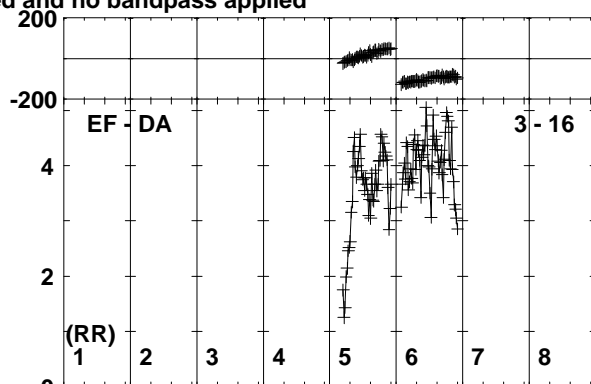
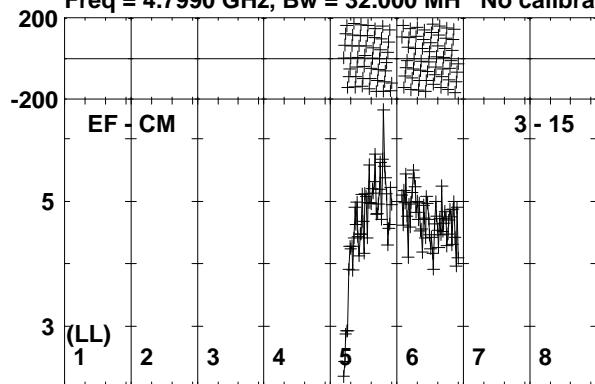

Lower frame: Milli Ampl Jy Top frame: Phas deg
Vector averaged cross-power spectrum Baseline: EF (03) - CM (15)
Timerange: 01/02:41:36 to 01/02:42:34

Plot file version 391 created 26-SEP-2019 10:42:10

0234+285 RG010A.UVDATA.1

Freq = 4.7990 GHz, Bw = 32.000 MH No calibration applied and no bandpass applied

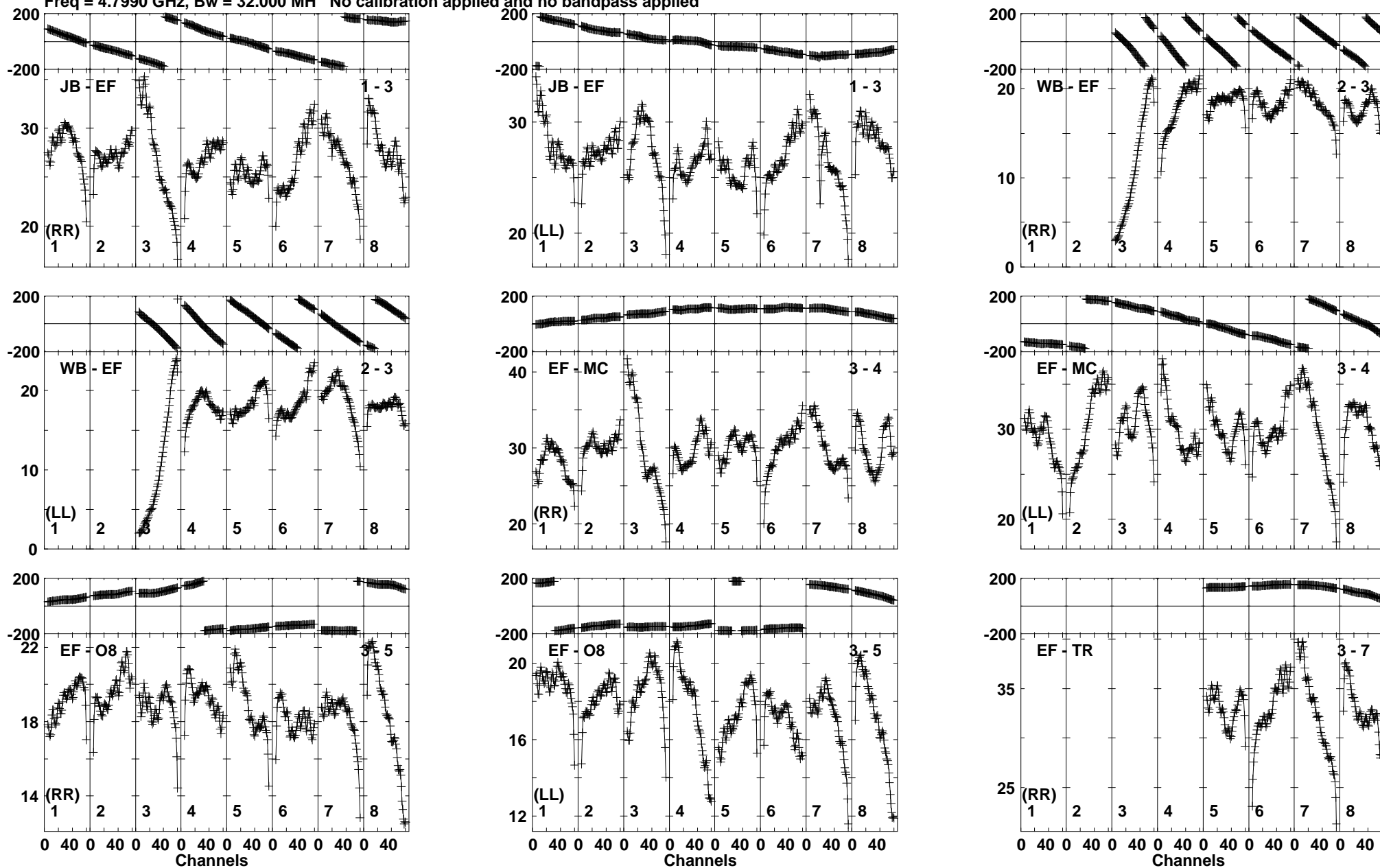

Lower frame: Milli Ampl Jy Top frame: Phas deg
Vector averaged cross-power spectrum Baseline: JB (01) - EF (03)
Timerange: 01/02:44:36 to 01/02:47:35

Plot file version 392 created 26-SEP-2019 10:42:10

0234+285 RG010A.UVDATA.1

Freq = 4.7990 GHz, Bw = 32.000 MH No calibration applied and no bandpass applied

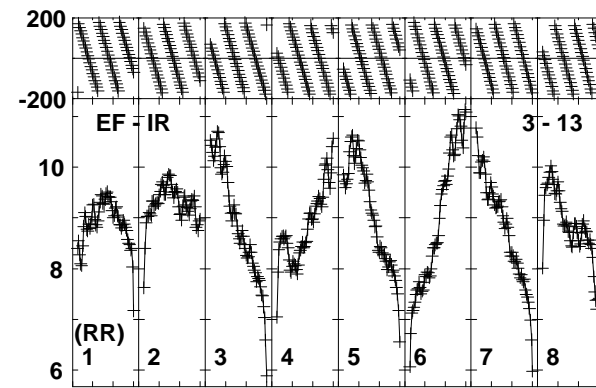
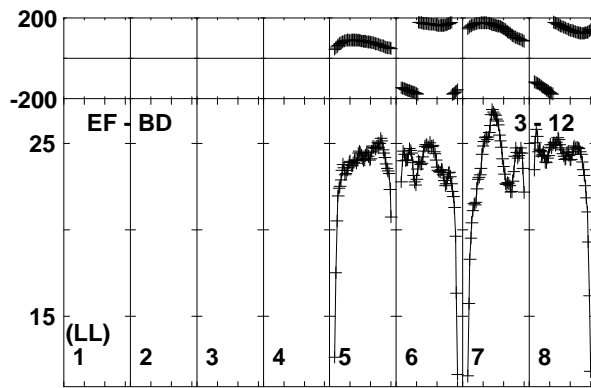
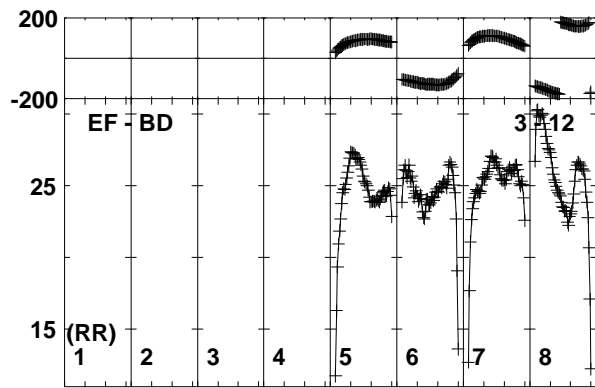
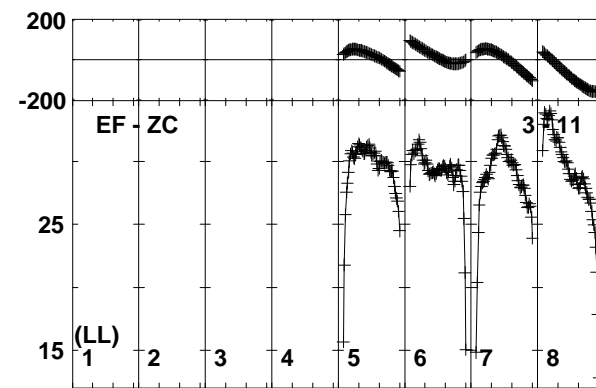
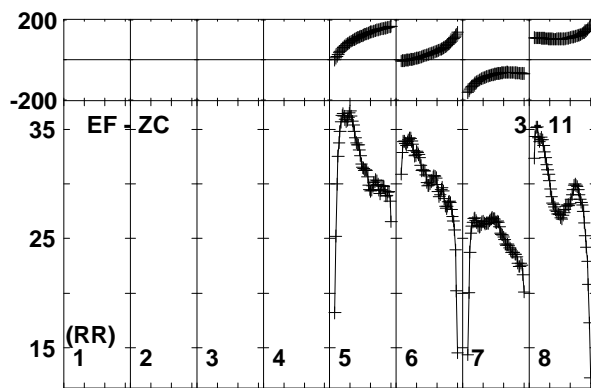
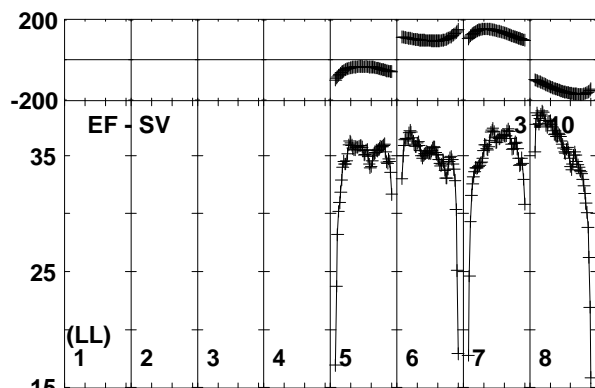
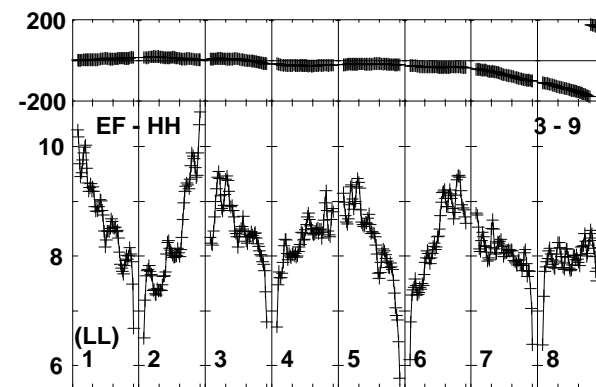
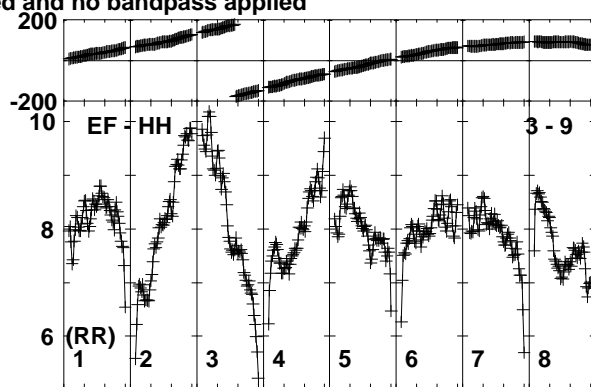
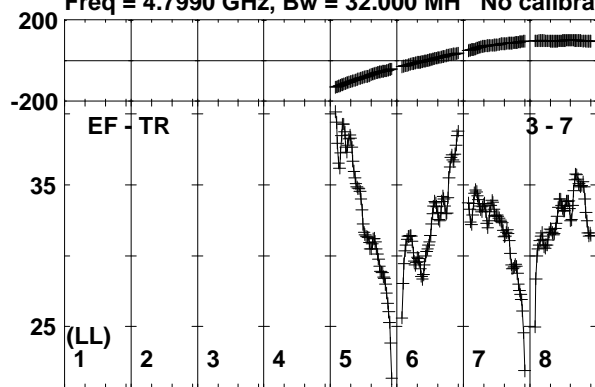

Lower frame: Milli Ampl Jy Top frame: Phas deg
Vector averaged cross-power spectrum Baseline: EF (03) - TR (07)
Timerange: 01/02:44:36 to 01/02:47:35

Plot file version 394 created 26-SEP-2019 10:42:12

J0257-1212 RG010A.UVDATA.1

Freq = 4.7990 GHz, Bw = 32.000 MH No calibration applied and no bandpass applied

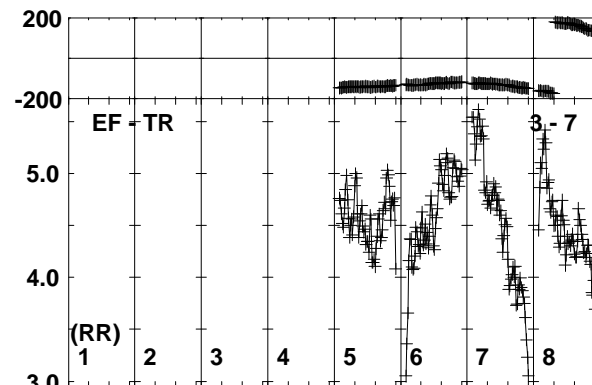
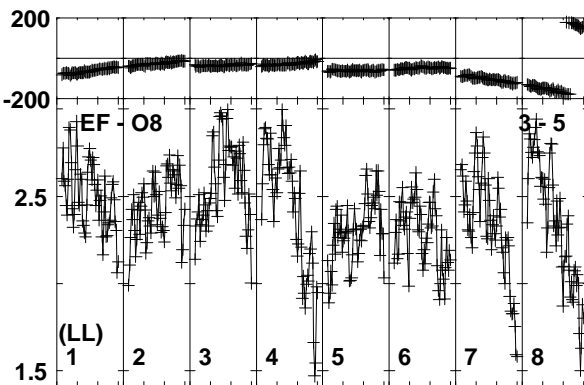
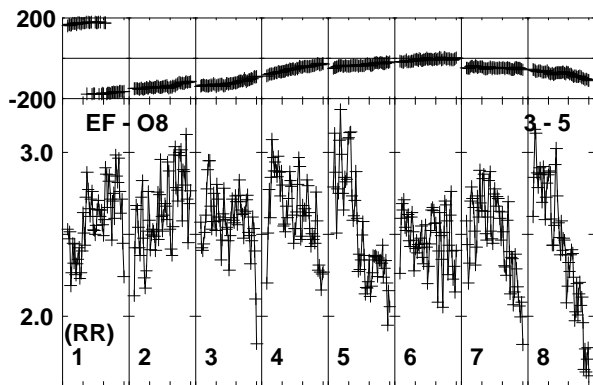
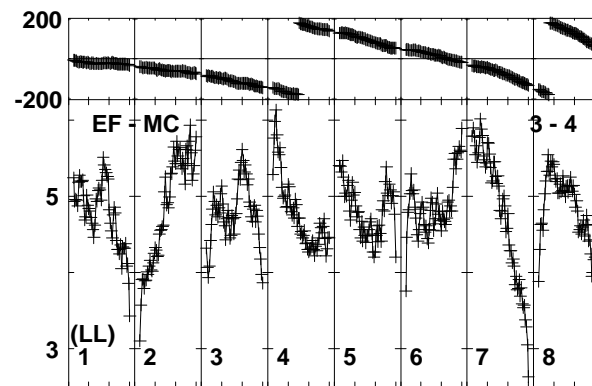
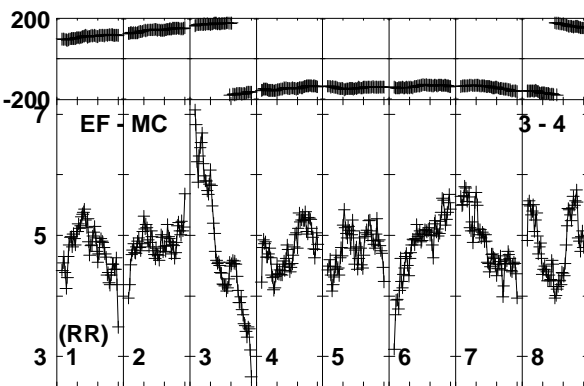
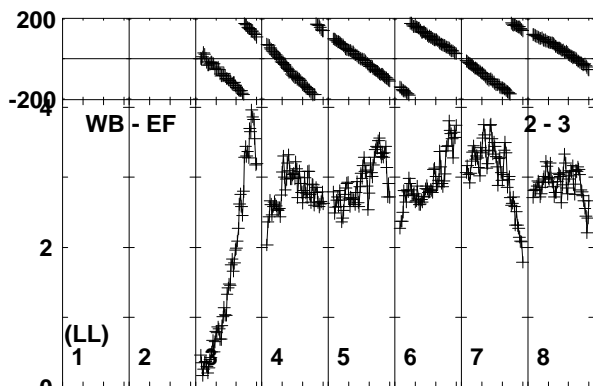
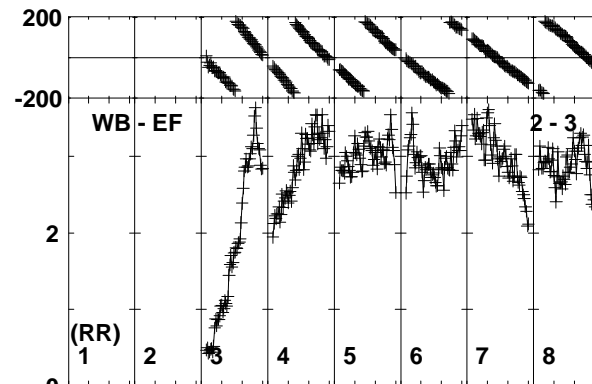
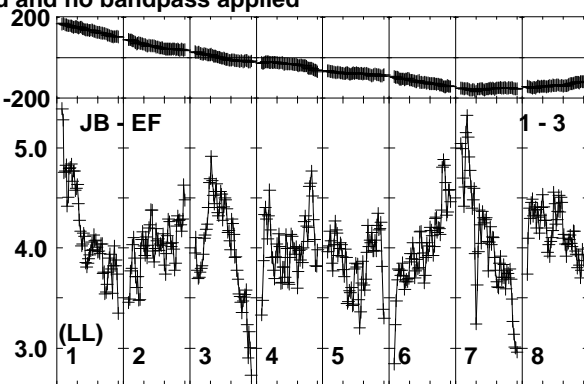
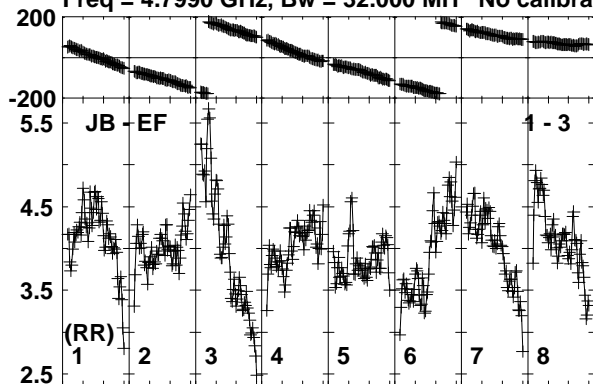

Lower frame: Milli Ampl Jy Top frame: Phas deg
Vector averaged cross-power spectrum Baseline: JB (01) - EF (03)
Timerange: 01/02:51:15 to 01/02:51:45

Plot file version 395 created 26-SEP-2019 10:42:12

J0257-1212 RG010A.UVDATA.1

Freq = 4.7990 GHz, Bw = 32.000 MH No calibration applied and no bandpass applied

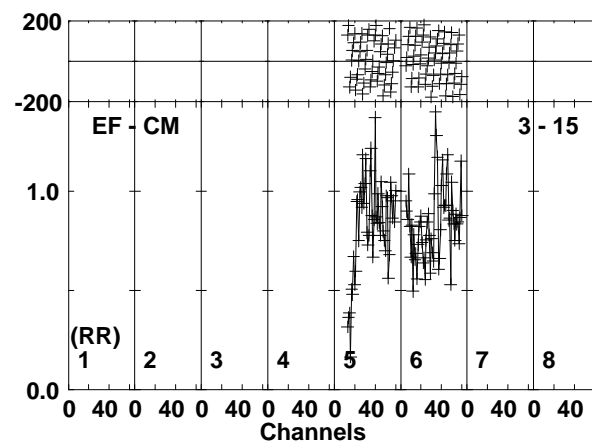
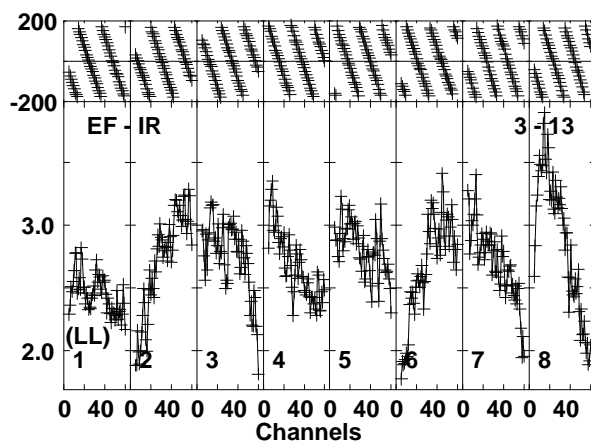
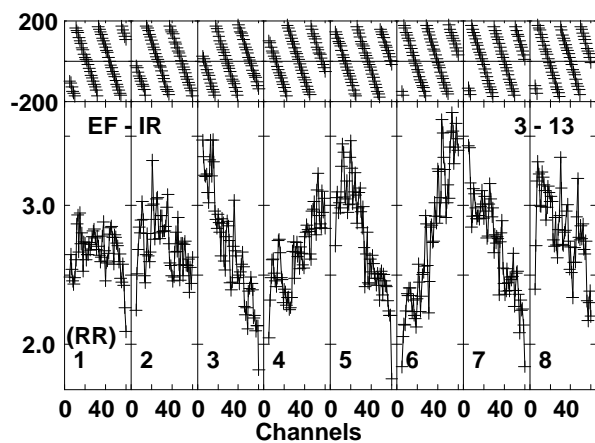
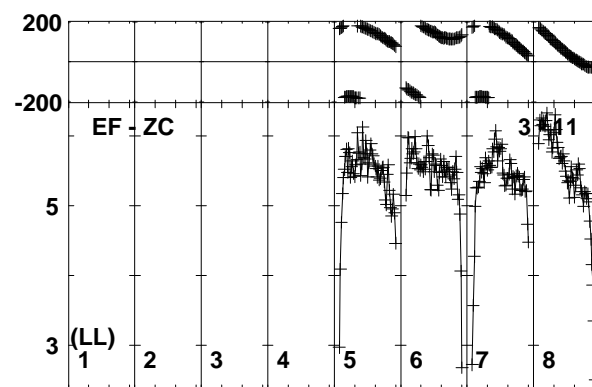
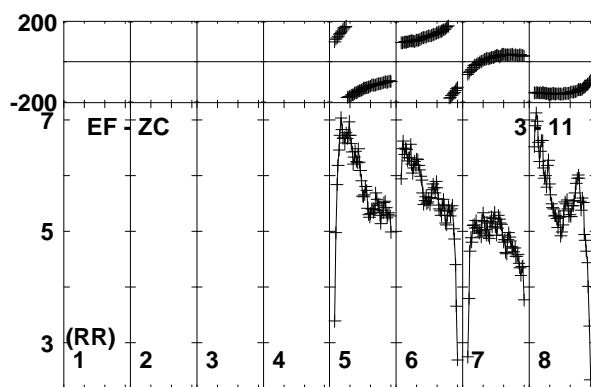
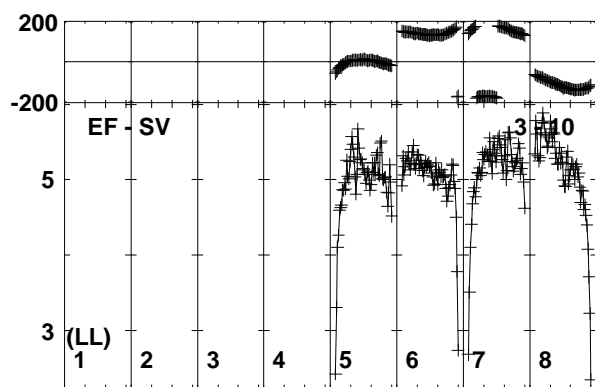
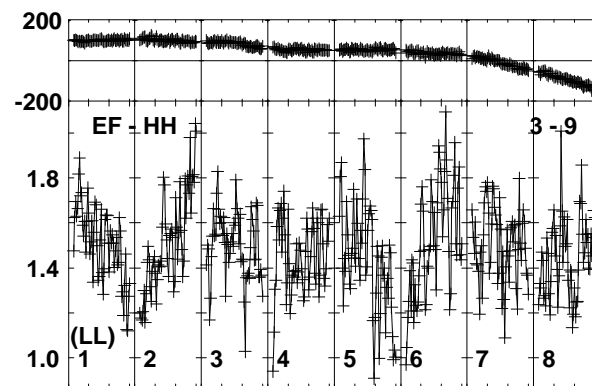
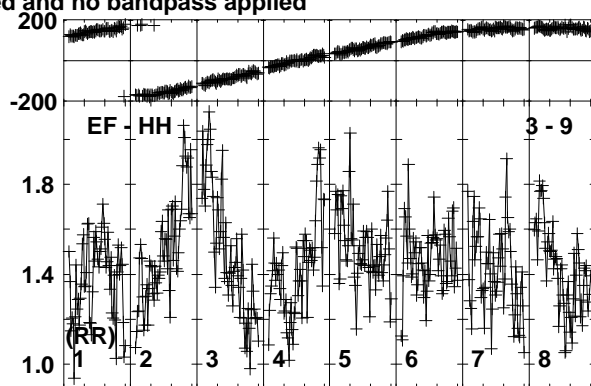
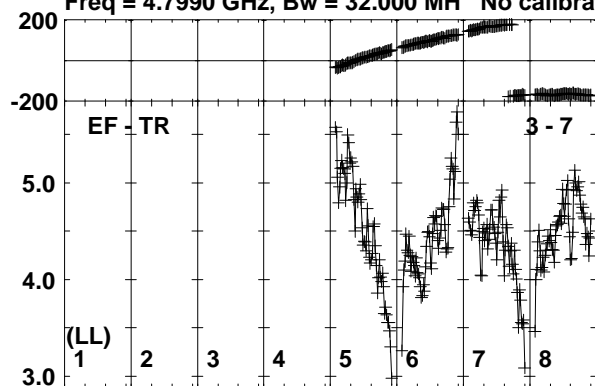

Lower frame: Milli Ampl Jy Top frame: Phas deg
Vector averaged cross-power spectrum Baseline: EF (03) - TR (07)
Timerange: 01/02:51:15 to 01/02:51:45

Plot file version 396 created 26-SEP-2019 10:42:13

J0257-1212 RG010A.UVDATA.1

Freq = 4.7990 GHz, Bw = 32.000 MH No calibration applied and no bandpass applied

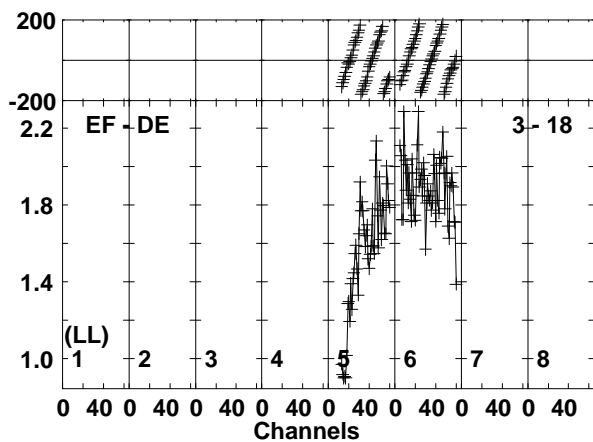
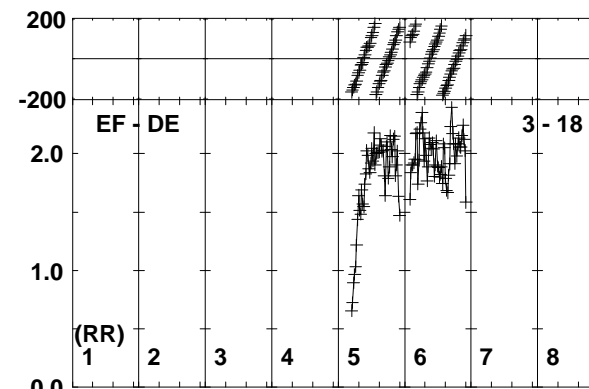
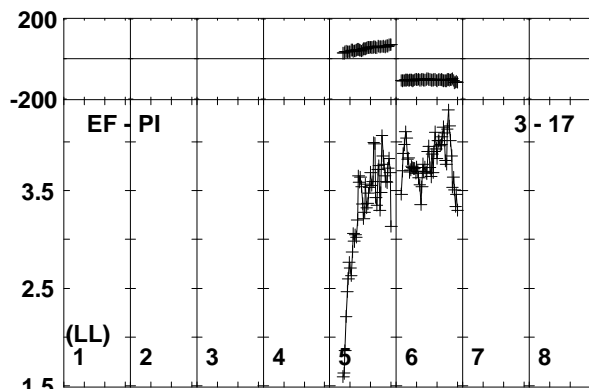
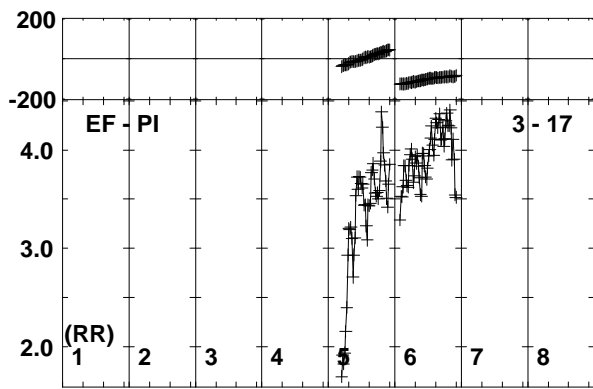
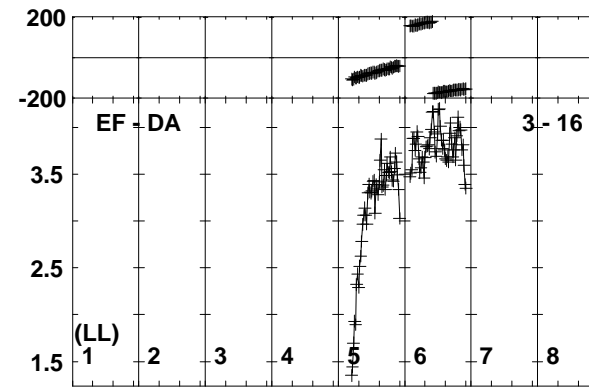
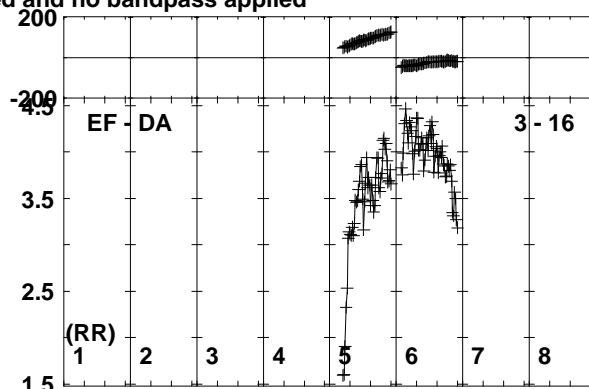
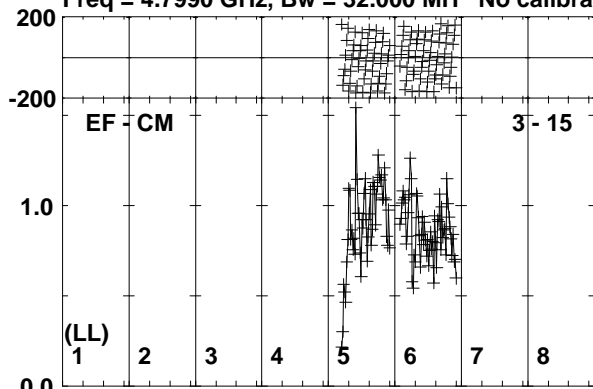

Lower frame: Milli Ampl Jy Top frame: Phas deg
Vector averaged cross-power spectrum Baseline: EF (03) - CM (15)
Timerange: 01/02:51:15 to 01/02:51:45

Plot file version 397 created 26-SEP-2019 10:42:13

J0300-0846 RG010A.UVDATA.1

Freq = 4.7990 GHz, Bw = 32.000 MH No calibration applied and no bandpass applied

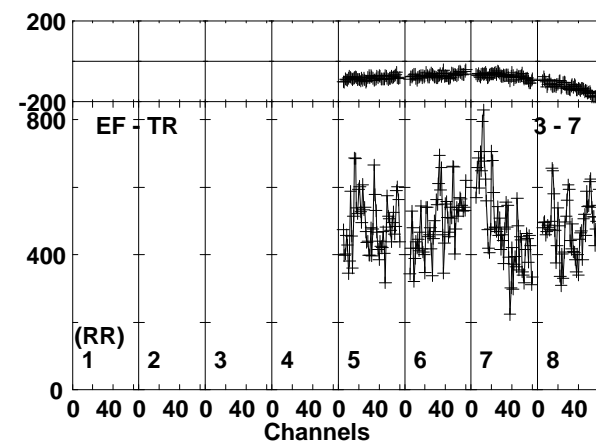
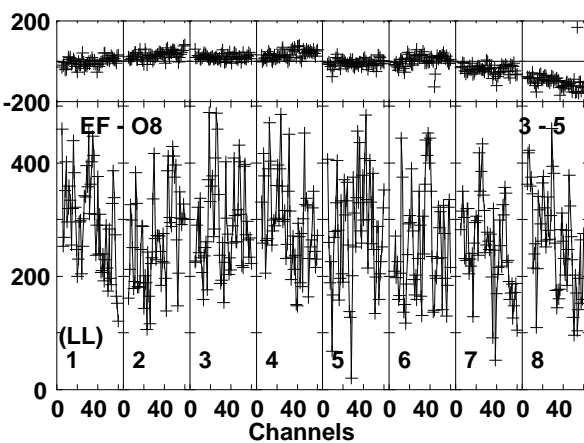
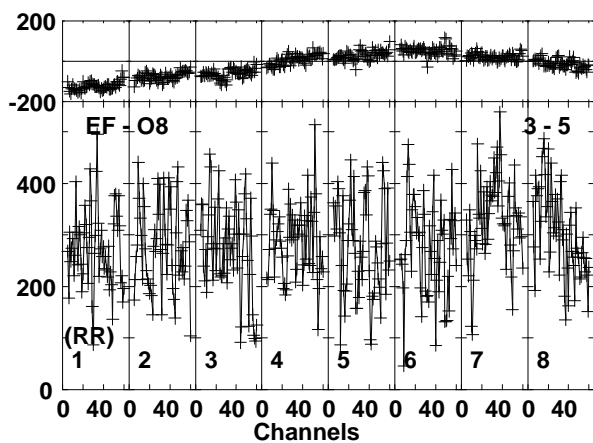
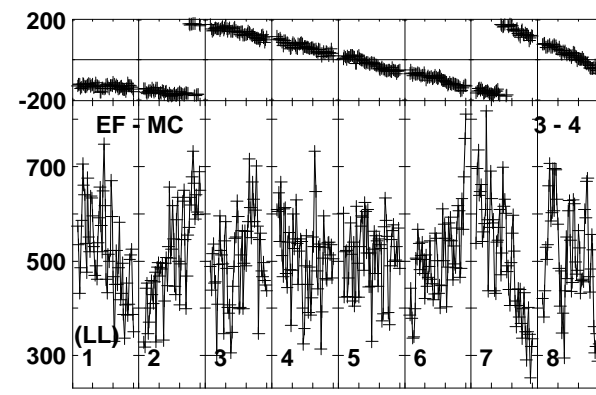
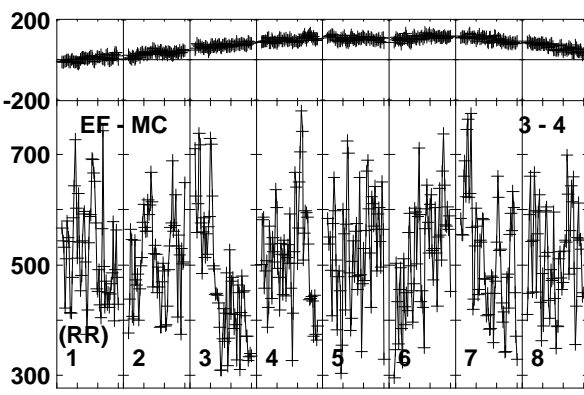
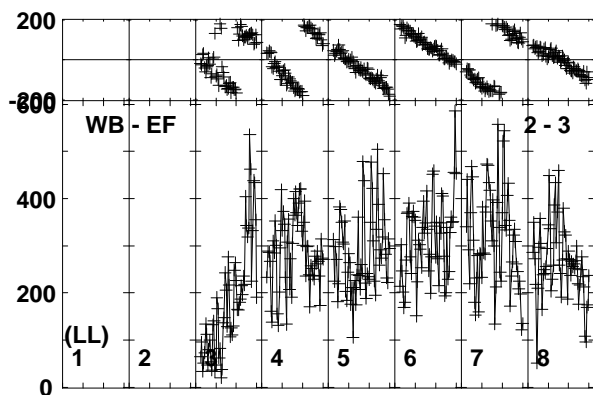
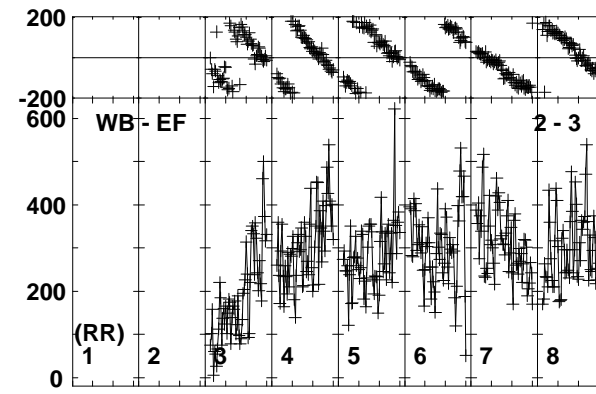
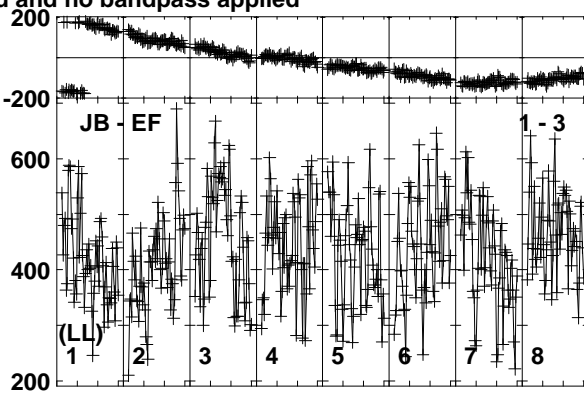
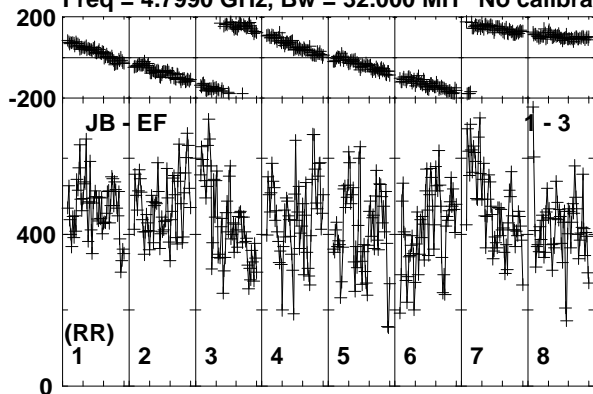

Lower frame: Micro Ampl Jy Top frame: Phas deg
Vector averaged cross-power spectrum Baseline: JB (01) - EF (03)
Timerange: 01/02:51:46 to 01/02:54:14

Plot file version 398 created 26-SEP-2019 10:42:14
J0300-0846 RG010A.UVDATA.1

Freq = 4.7990 GHz, Bw = 32.000 MH No calibration applied and no bandpass applied

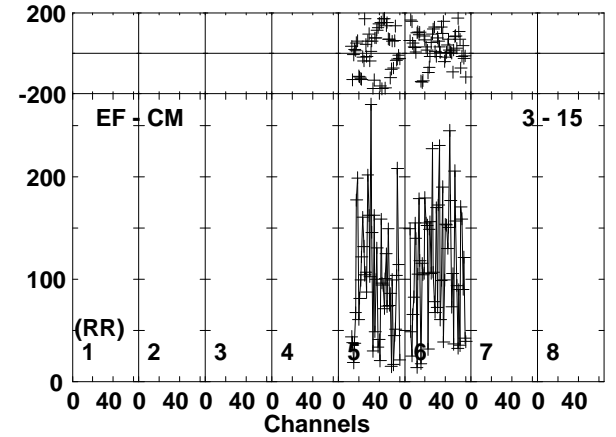
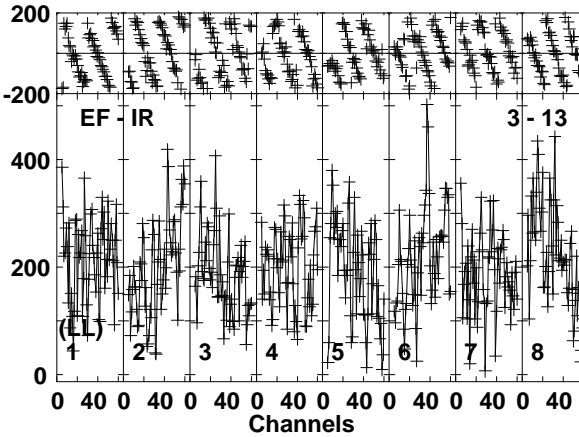
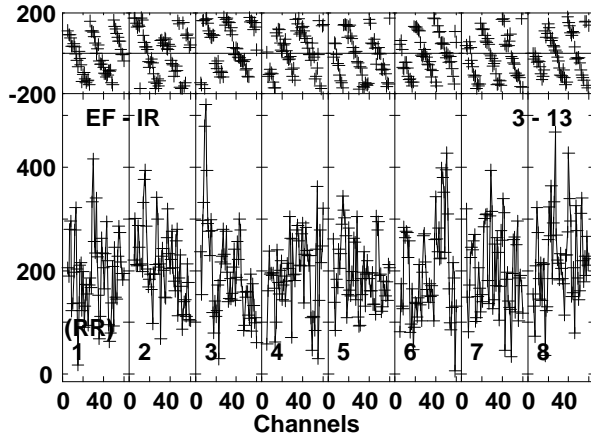
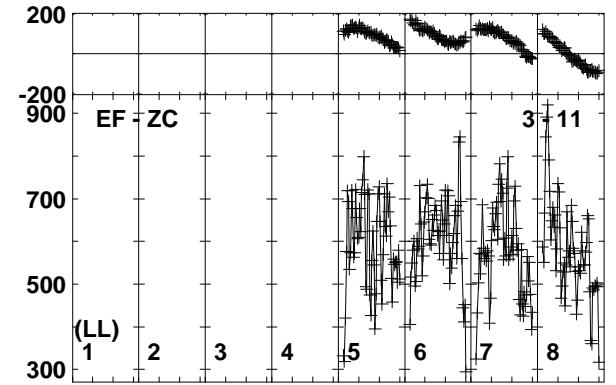
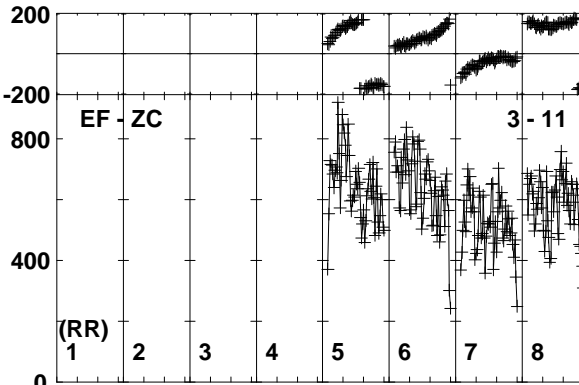
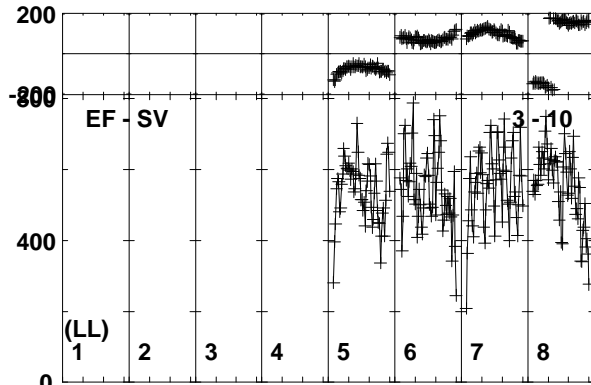
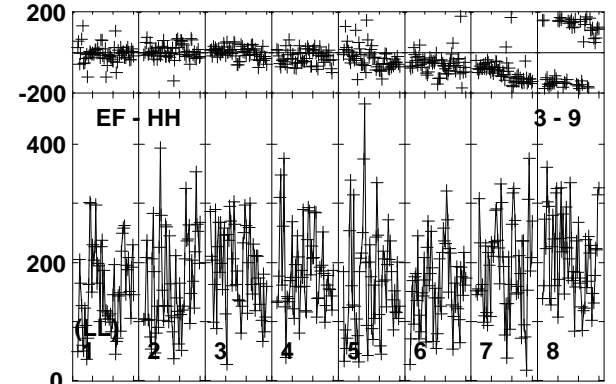
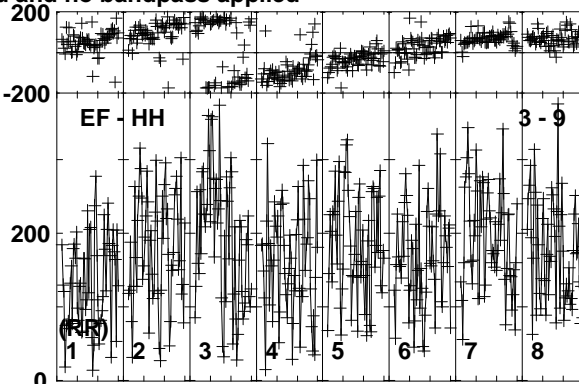
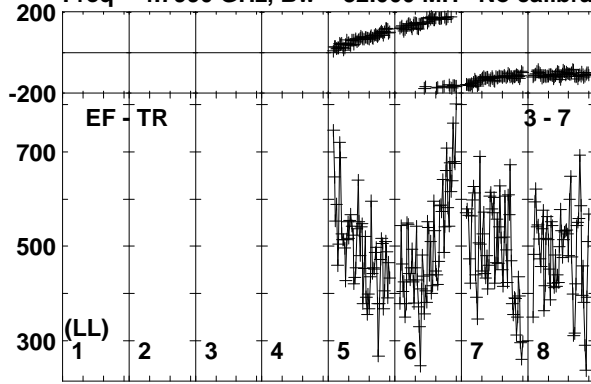

Lower frame: Micro Ampl Jy Top frame: Phas deg
Vector averaged cross-power spectrum Baseline: EF (03) - TR (07)
Timerange: 01/02:51:46 to 01/02:54:14

Plot file version 399 created 26-SEP-2019 10:42:15

J0300-0846 RG010A.UVDATA.1

Freq = 4.7990 GHz, Bw = 32.000 MH No calibration applied and no bandpass applied

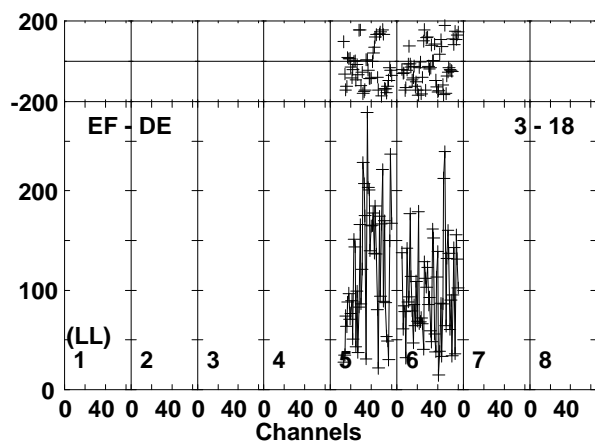
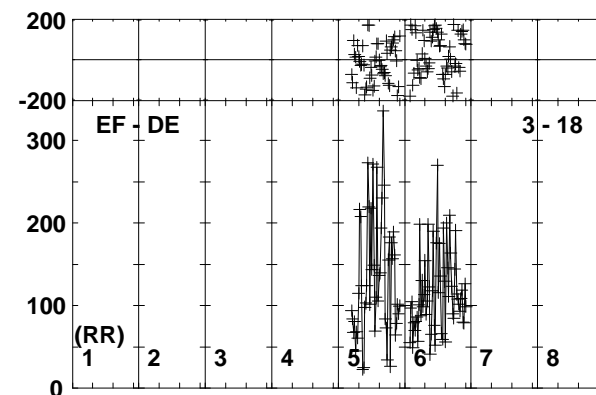
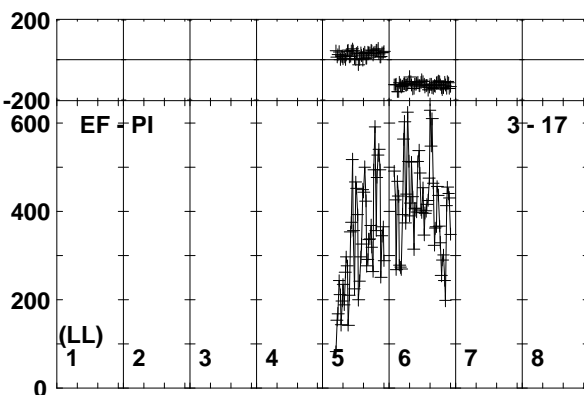
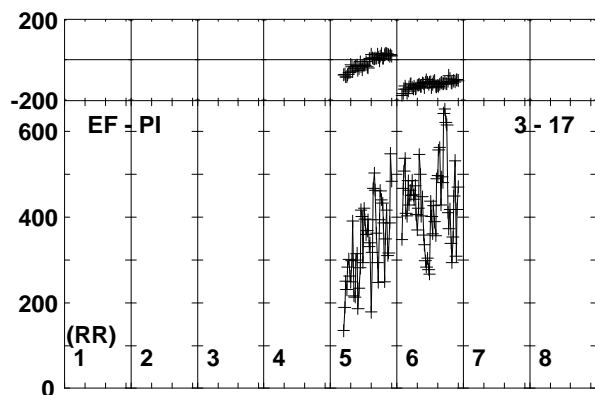
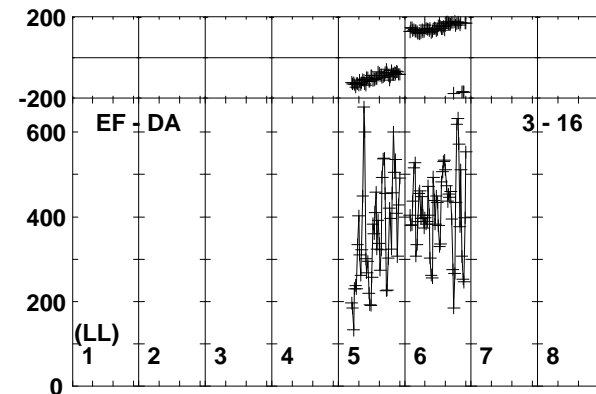
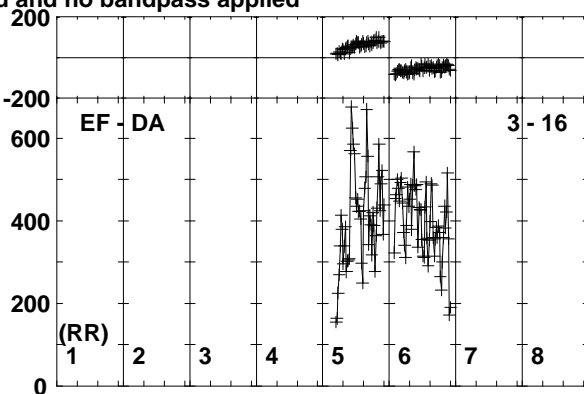
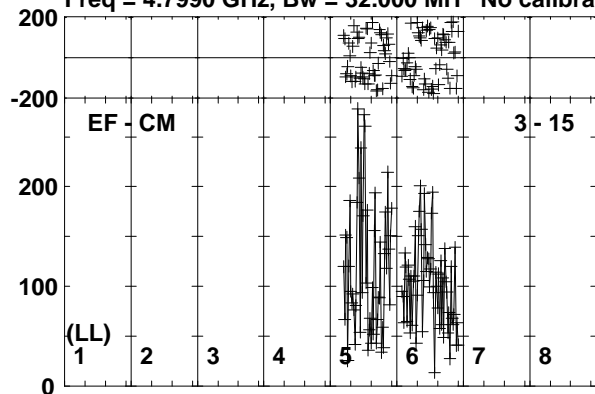

Lower frame: Micro Ampl Jy Top frame: Phas deg
Vector averaged cross-power spectrum Baseline: EF (03) - CM (15)
Timerange: 01/02:51:46 to 01/02:54:14

Plot file version 400 created 26-SEP-2019 10:42:15

190829A RG010A.UVDATA.1

Freq = 4.7990 GHz, Bw = 32.000 MH No calibration applied and no bandpass applied

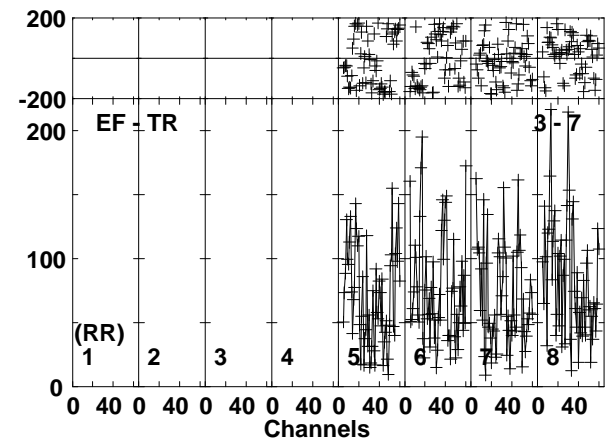
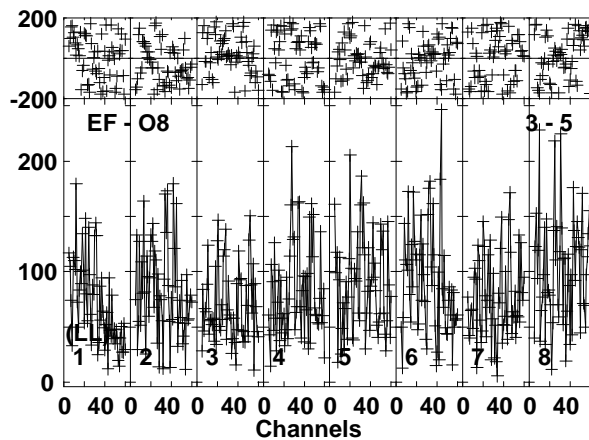
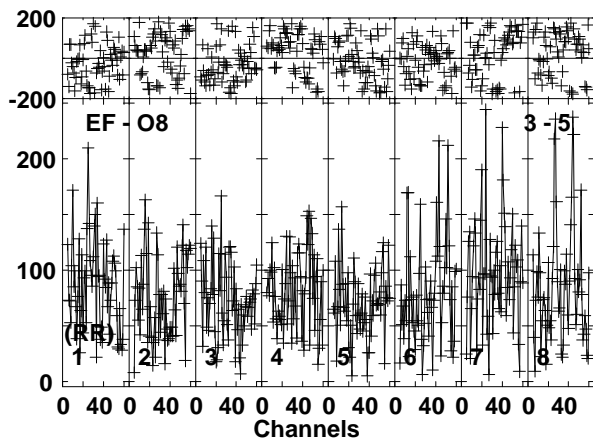
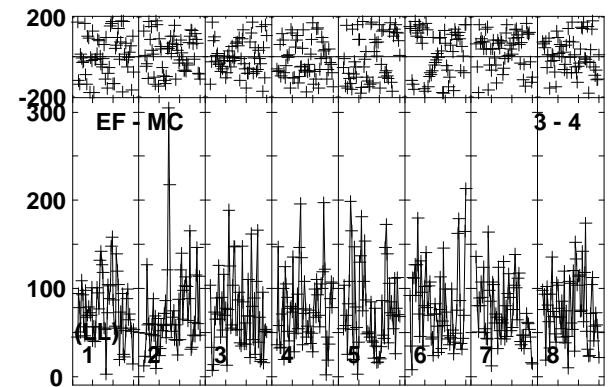
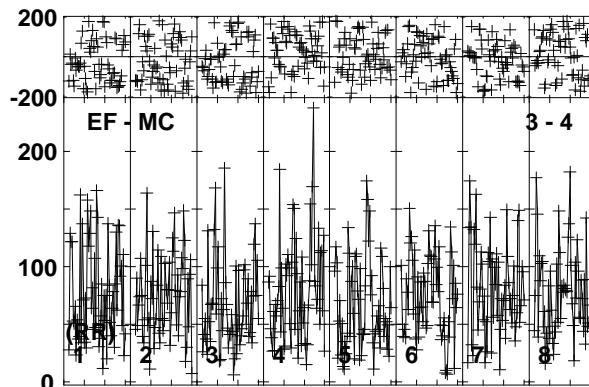
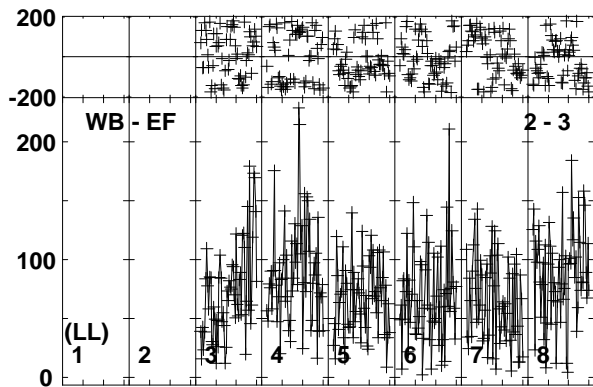
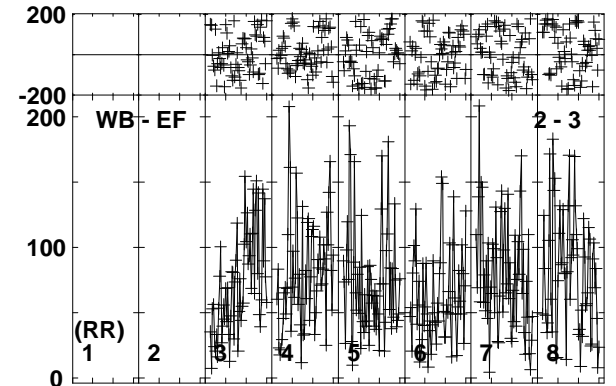
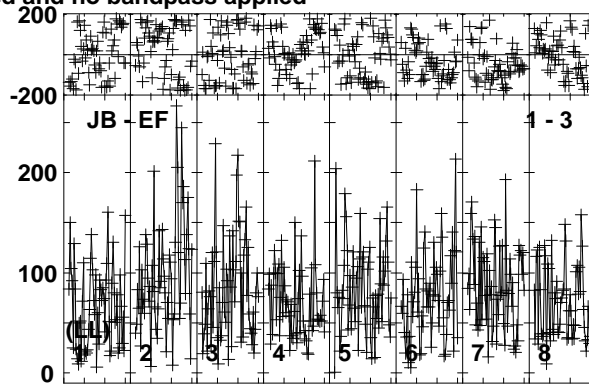
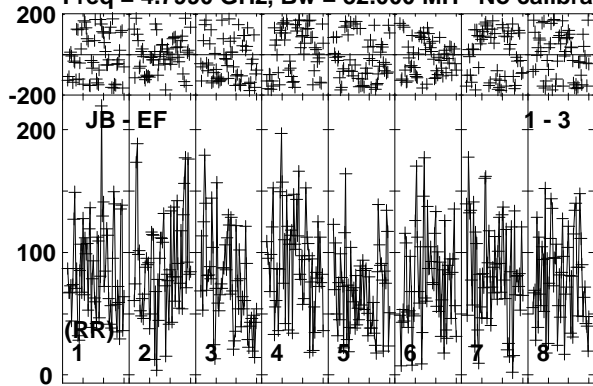

Lower frame: Micro Ampl Jy Top frame: Phas deg
Vector averaged cross-power spectrum Baseline: JB (01) - EF (03)
Timerange: 01/02:54:15 to 01/02:57:44

Plot file version 401 created 26-SEP-2019 10:42:16

190829A RG010A.UVDATA.1

Freq = 4.7990 GHz, Bw = 32.000 MH No calibration applied and no bandpass applied

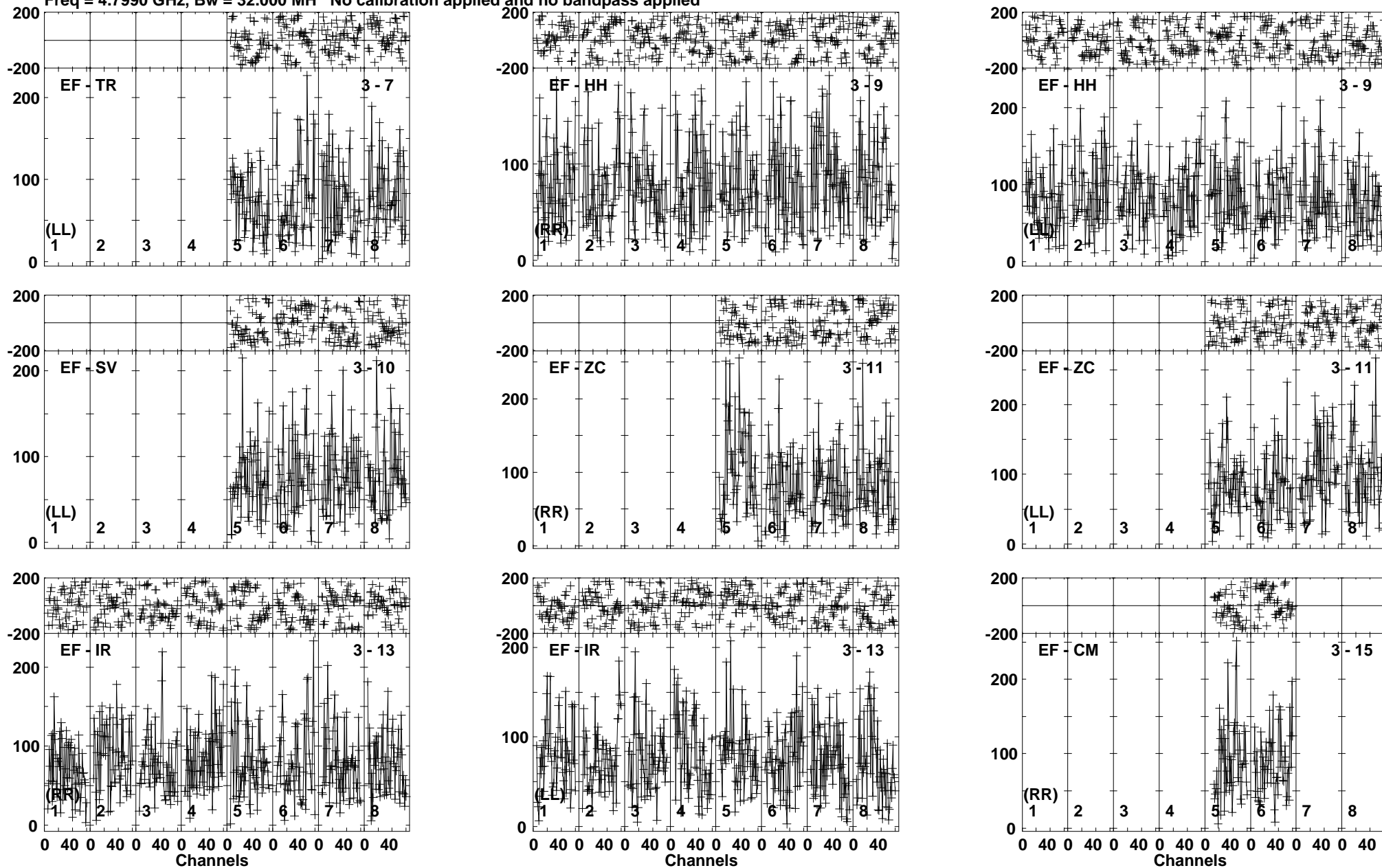

Lower frame: Micro Ampl Jy Top frame: Phas deg
Vector averaged cross-power spectrum Baseline: EF (03) - TR (07)
Timerange: 01/02:54:15 to 01/02:57:44

Plot file version 402 created 26-SEP-2019 10:42:16

190829A RG010A.UVDATA.1

Freq = 4.7990 GHz, Bw = 32.000 MH No calibration applied and no bandpass applied

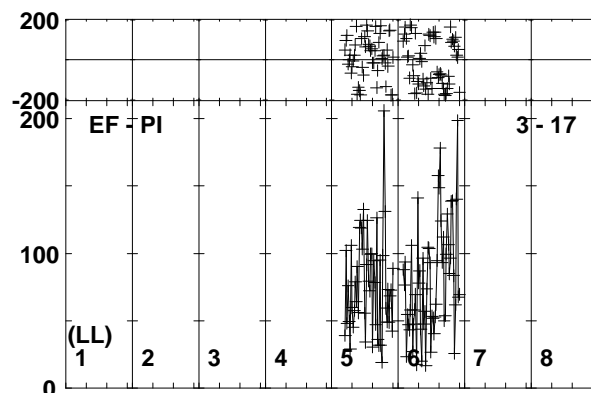
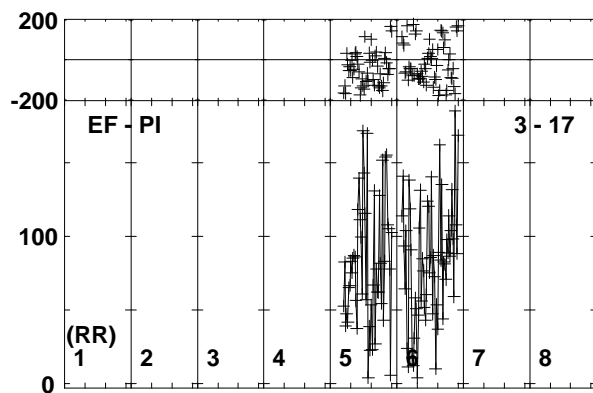
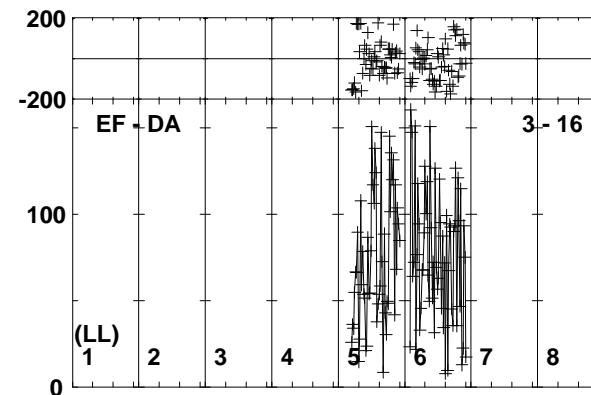
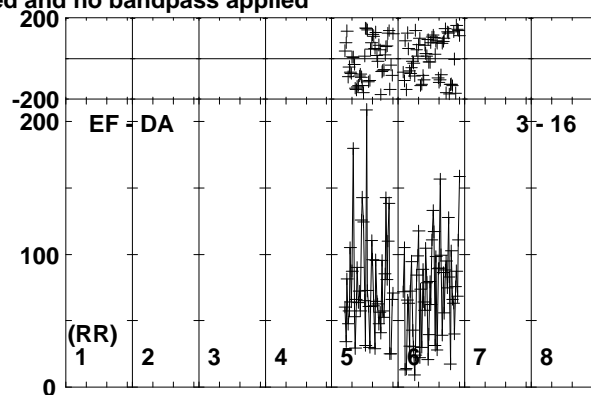
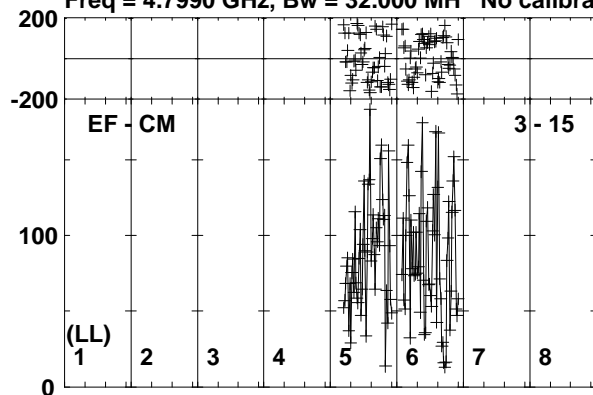

Lower frame: Micro Ampl Jy Top frame: Phas deg
Vector averaged cross-power spectrum Baseline: EF (03) - CM (15)
Timerange: 01/02:54:15 to 01/02:57:44

Plot file version 403 created 26-SEP-2019 10:42:17

J0257-1212 RG010A.UVDATA.1

Freq = 4.7990 GHz, Bw = 32.000 MH No calibration applied and no bandpass applied

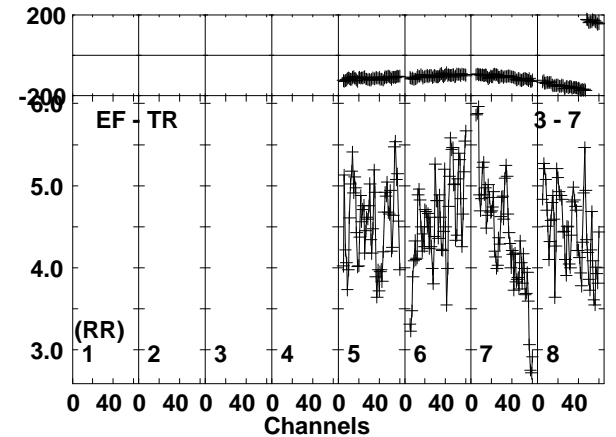
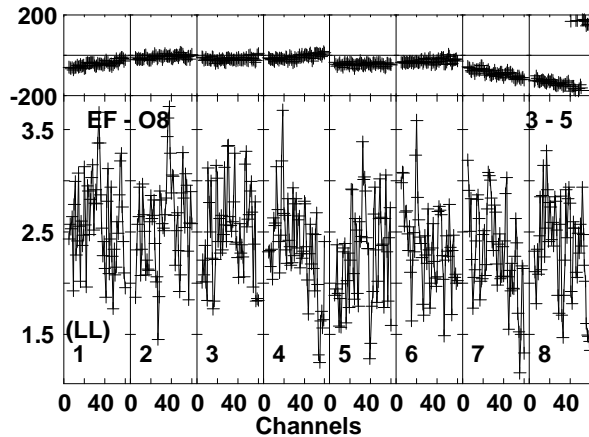
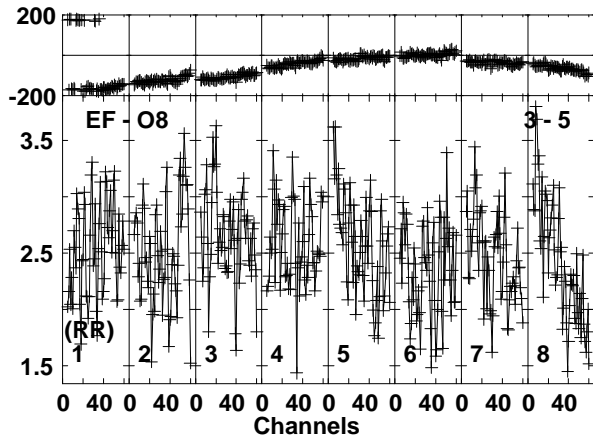
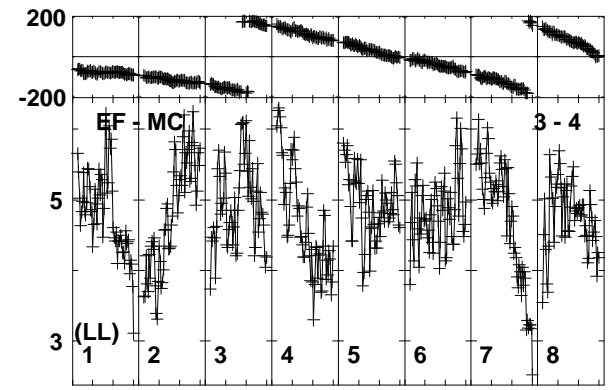
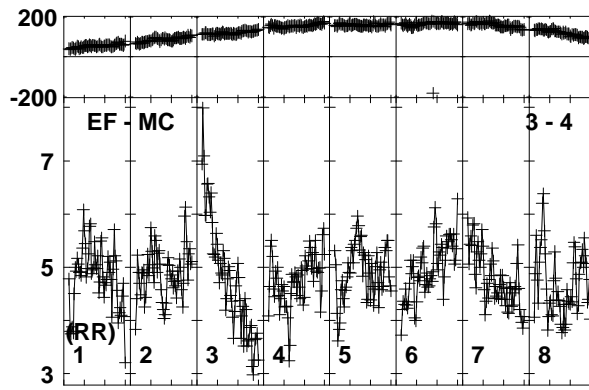
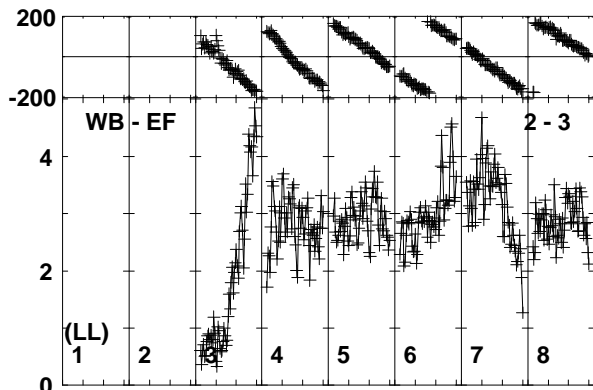
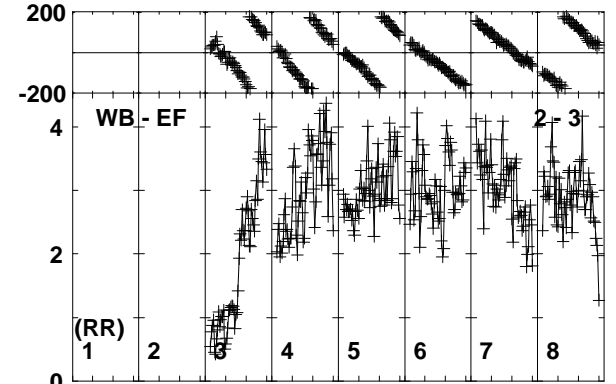
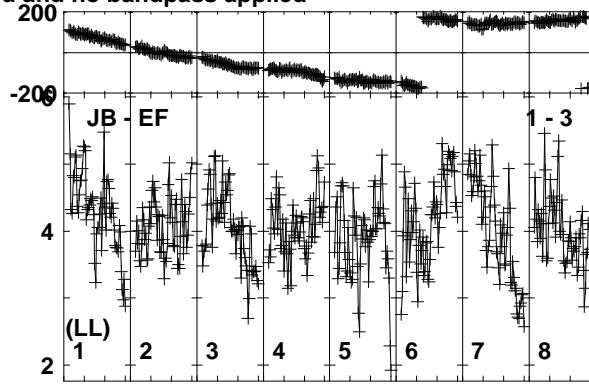
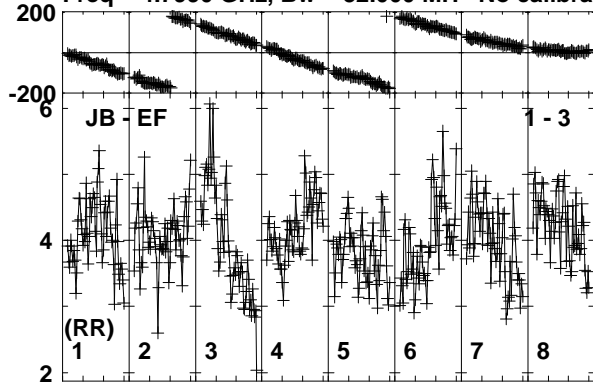

Lower frame: Milli Ampl Jy Top frame: Phas deg
Vector averaged cross-power spectrum Baseline: JB (01) - EF (03)
Timerange: 01/02:57:46 to 01/02:58:45

Plot file version 404 created 26-SEP-2019 10:42:17

J0257-1212 RG010A.UVDATA.1

Freq = 4.7990 GHz, Bw = 32.000 MH No calibration applied and no bandpass applied

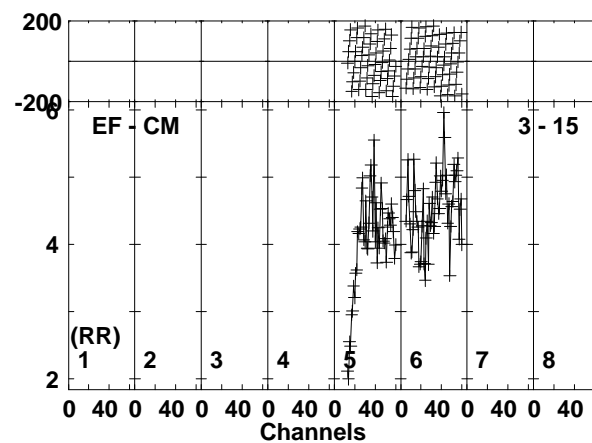
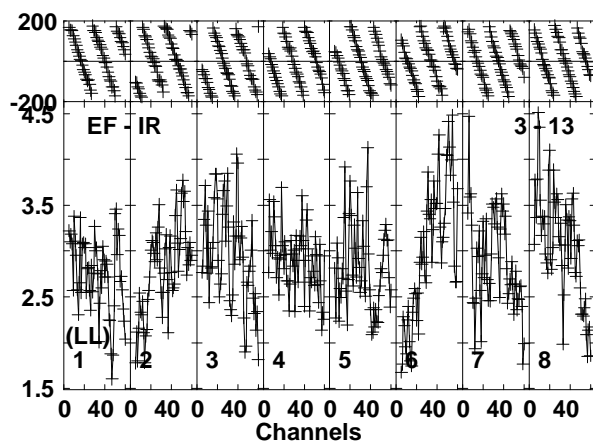
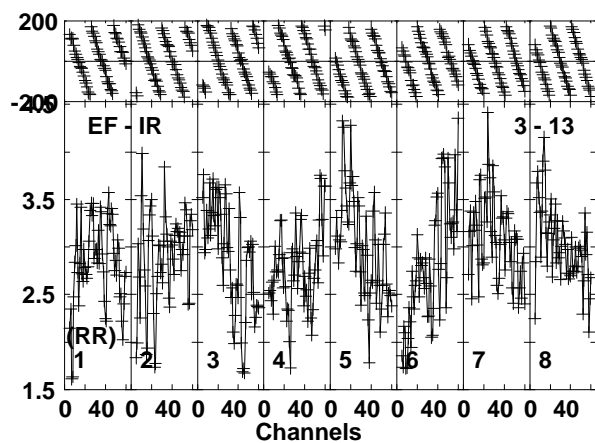
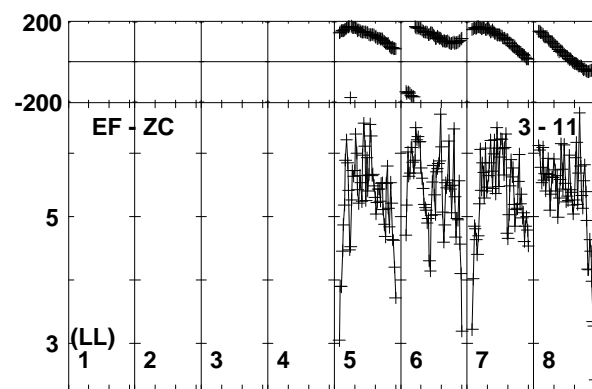
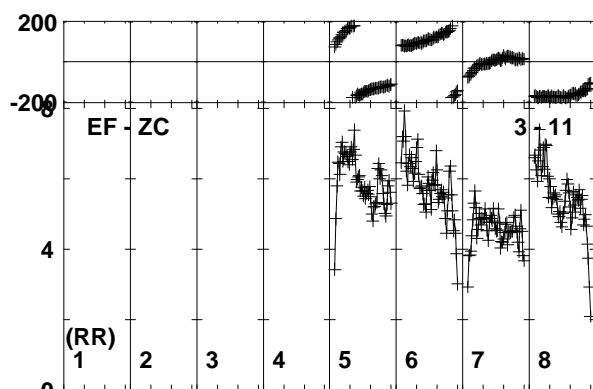
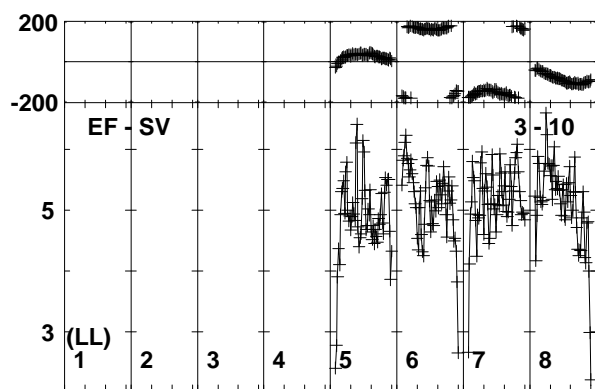
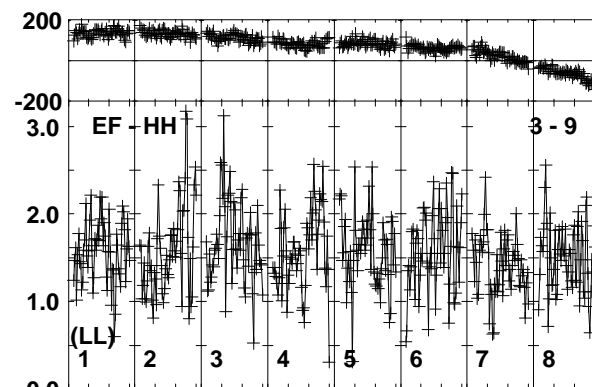
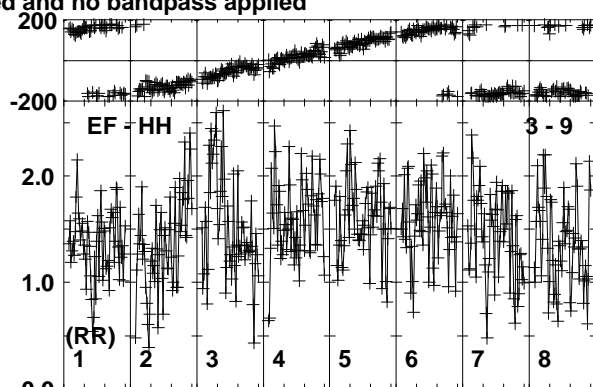
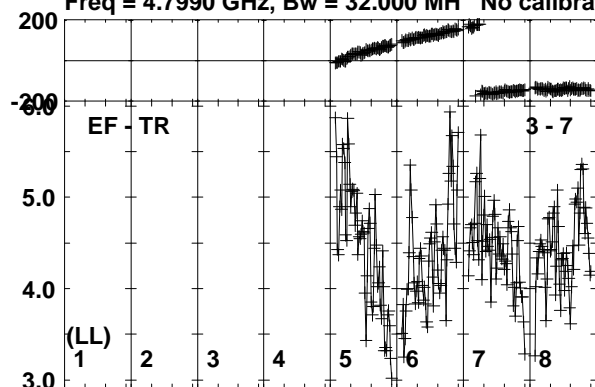

Lower frame: Milli Ampl Jy Top frame: Phas deg
Vector averaged cross-power spectrum Baseline: EF (03) - TR (07)
Timerange: 01/02:57:46 to 01/02:58:45

Plot file version 405 created 26-SEP-2019 10:42:18

J0257-1212 RG010A.UVDATA.1

Freq = 4.7990 GHz, Bw = 32.000 MH No calibration applied and no bandpass applied

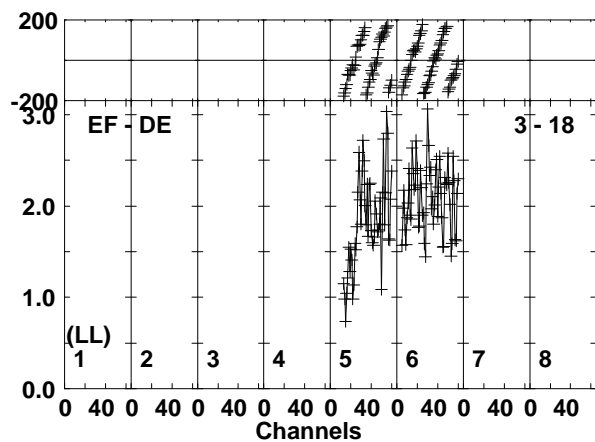
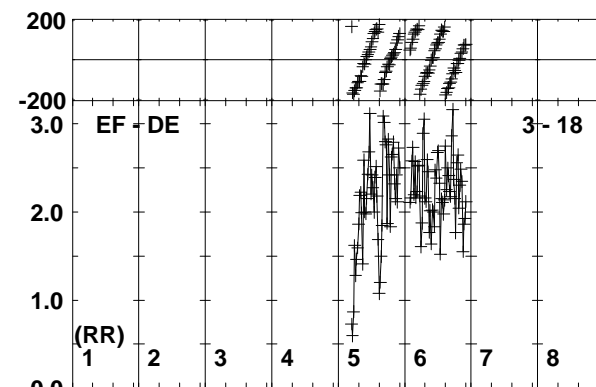
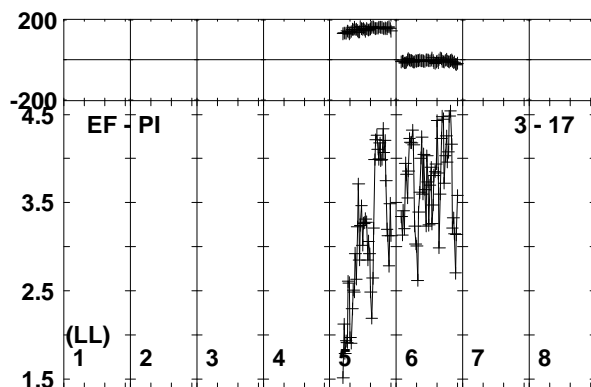
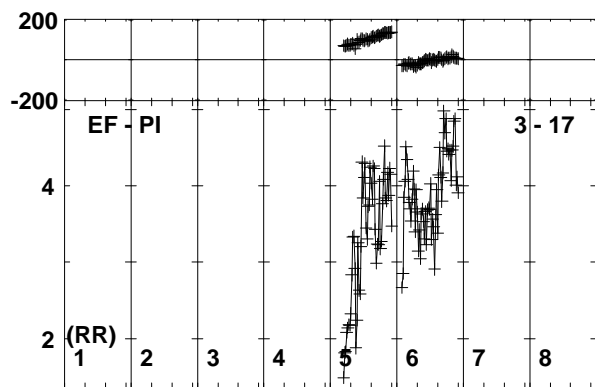
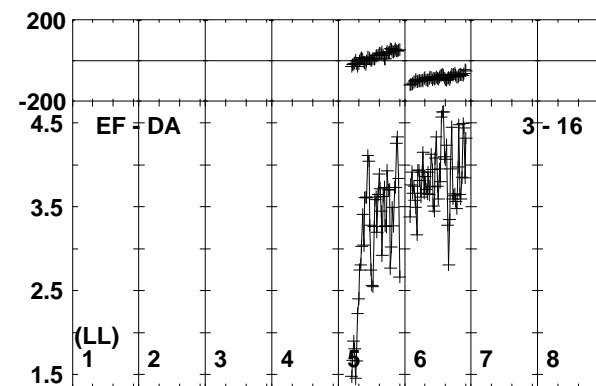
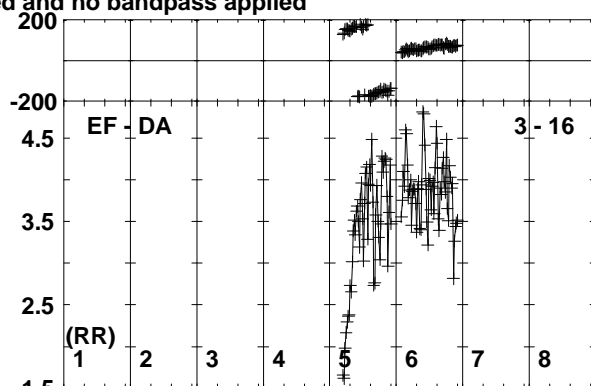
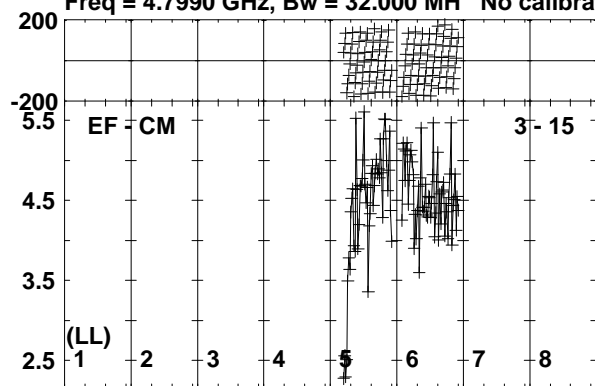

Lower frame: Milli Ampl Jy Top frame: Phas deg
Vector averaged cross-power spectrum Baseline: EF (03) - CM (15)
Timerange: 01/02:57:46 to 01/02:58:45

Plot file version 406 created 26-SEP-2019 10:42:18

190829A RG010A.UVDATA.1

Freq = 4.7990 GHz, Bw = 32.000 MH No calibration applied and no bandpass applied

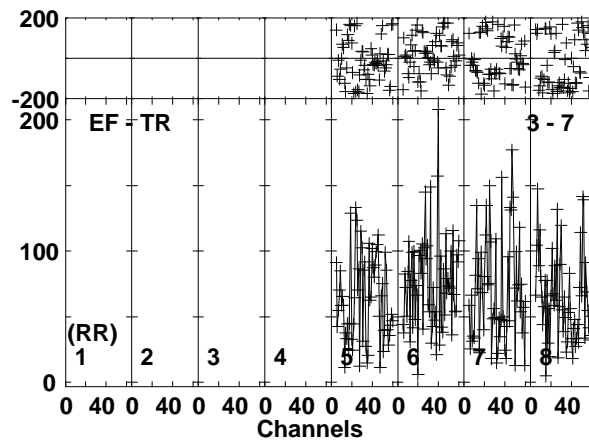
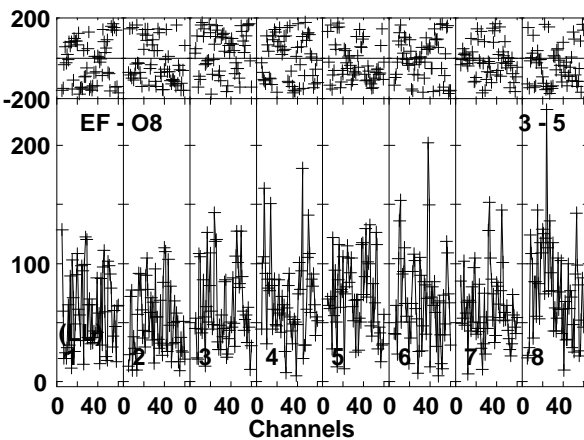
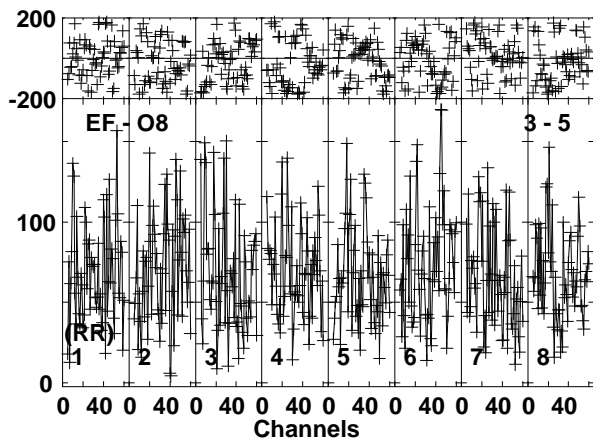
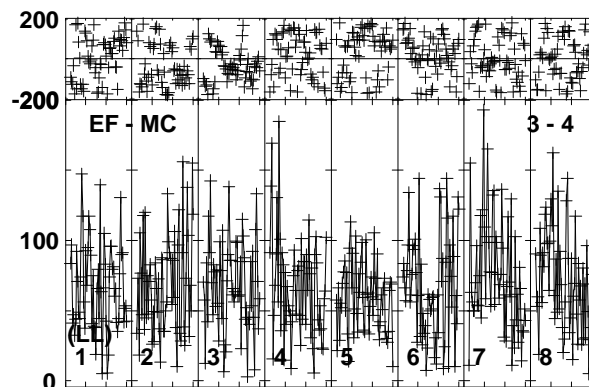
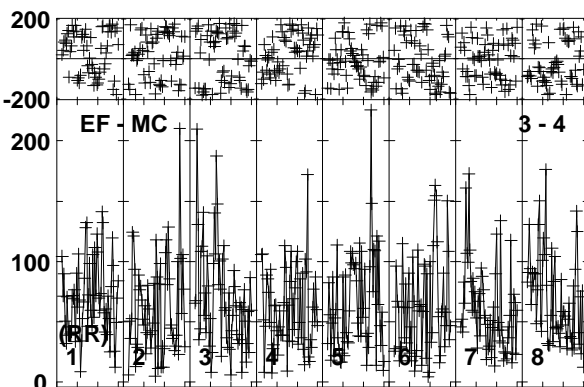
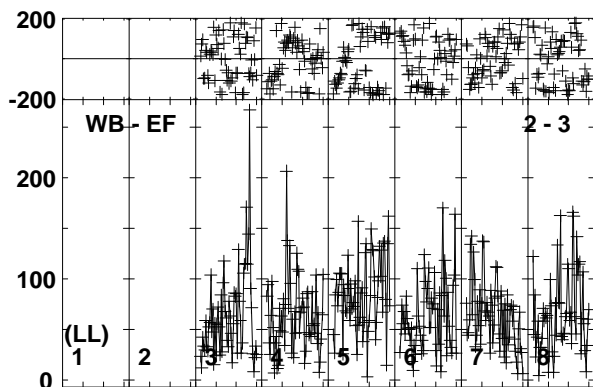
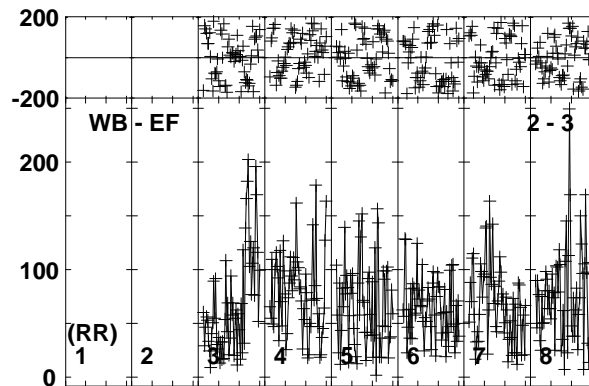
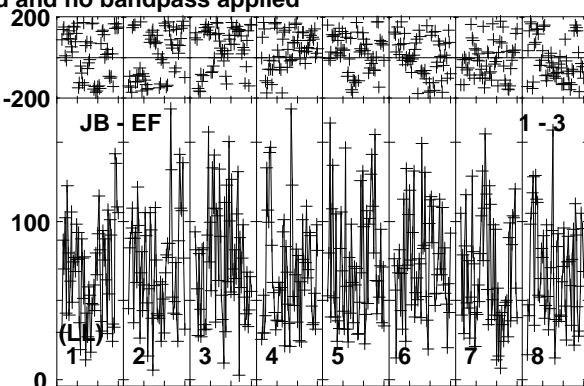
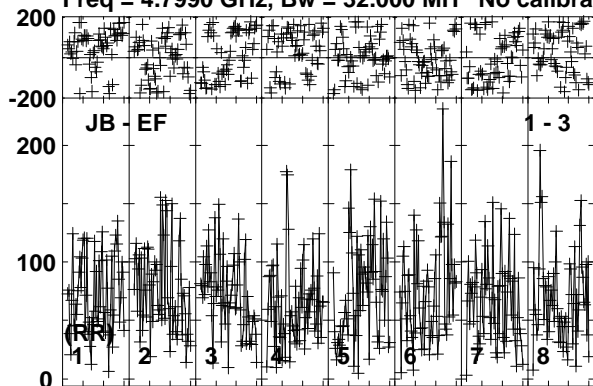

Lower frame: Micro Ampl Jy Top frame: Phas deg
Vector averaged cross-power spectrum Baseline: JB (01) - EF (03)
Timerange: 01/02:58:46 to 01/03:03:45

Plot file version 407 created 26-SEP-2019 10:42:19
190829A RG010A.UVDATA.1

Freq = 4.7990 GHz, Bw = 32.000 MH No calibration applied and no bandpass applied

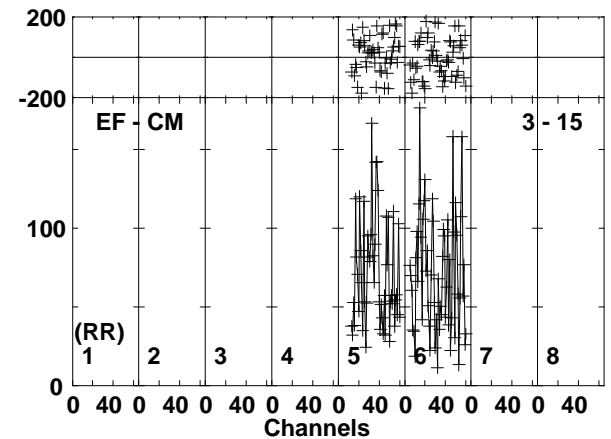
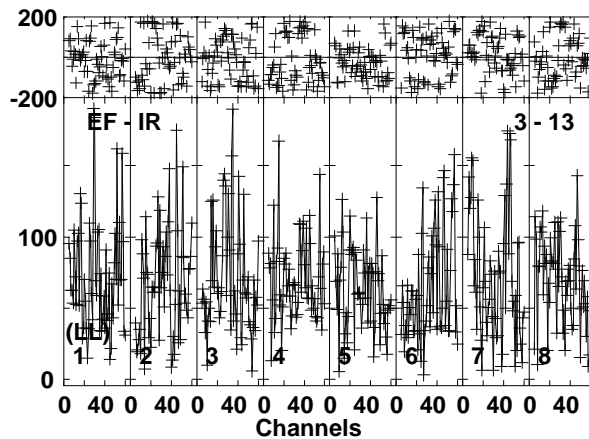
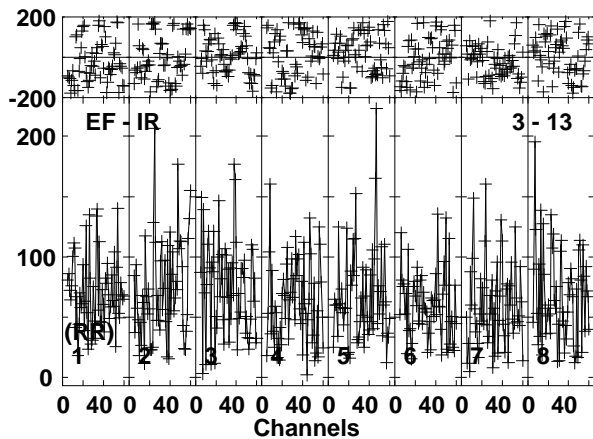
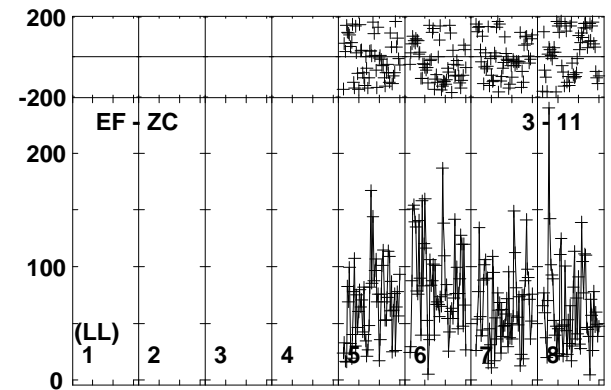
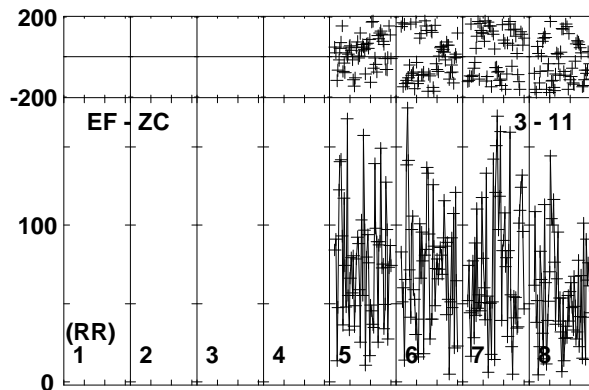
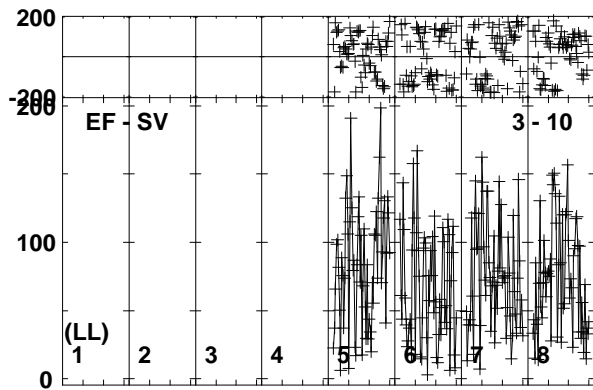
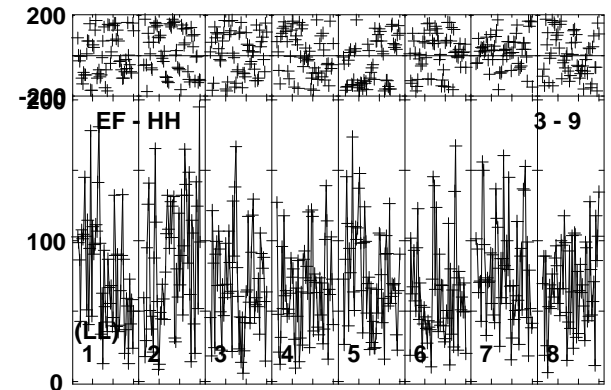
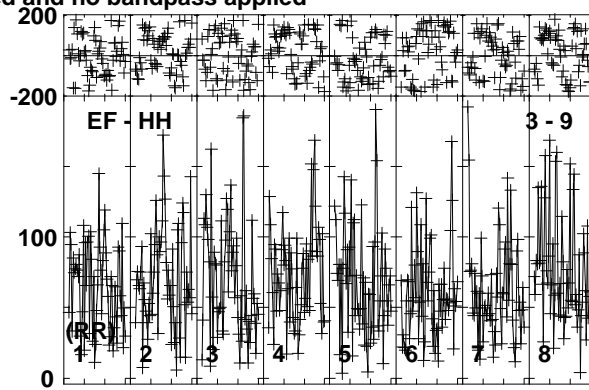
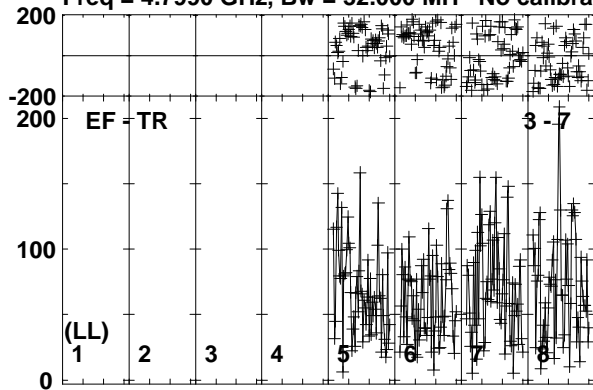

Lower frame: Micro Ampl Jy Top frame: Phas deg
Vector averaged cross-power spectrum Baseline: EF (03) - TR (07)
Timerange: 01/02:58:46 to 01/03:03:45

Plot file version 408 created 26-SEP-2019 10:42:20

190829A RG010A.UVDATA.1

Freq = 4.7990 GHz, Bw = 32.000 MH No calibration applied and no bandpass applied

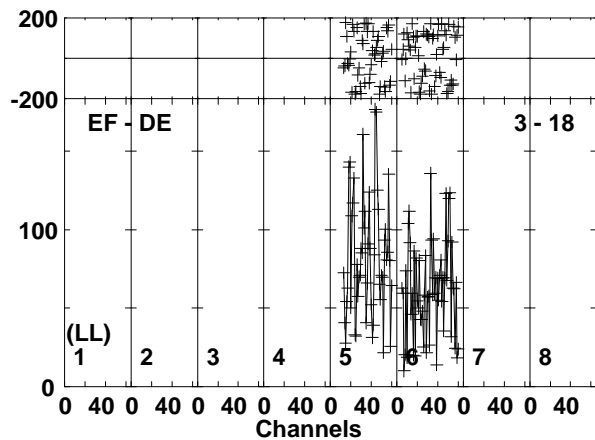
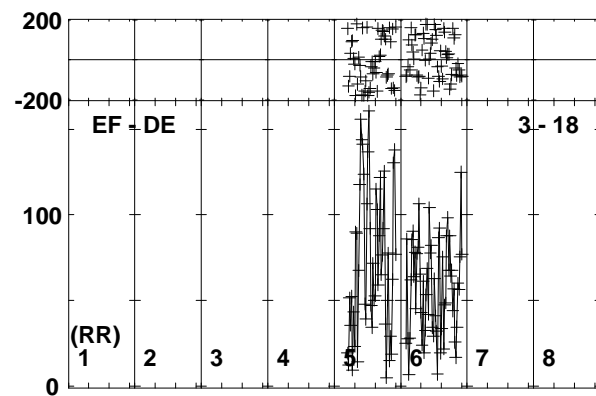
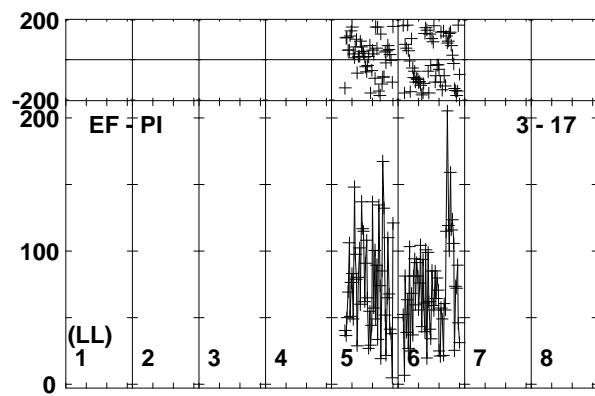
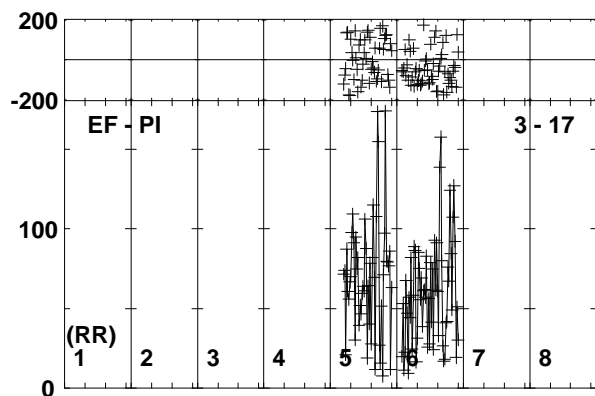
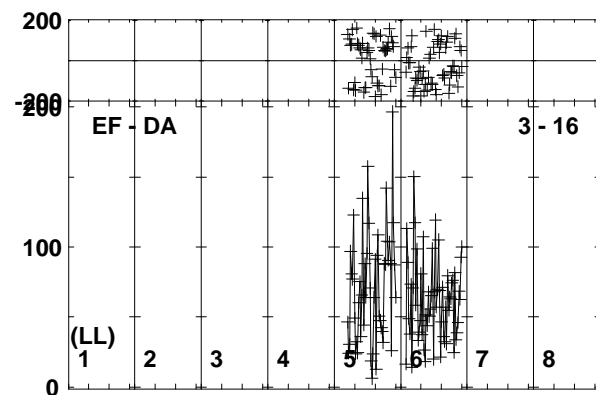
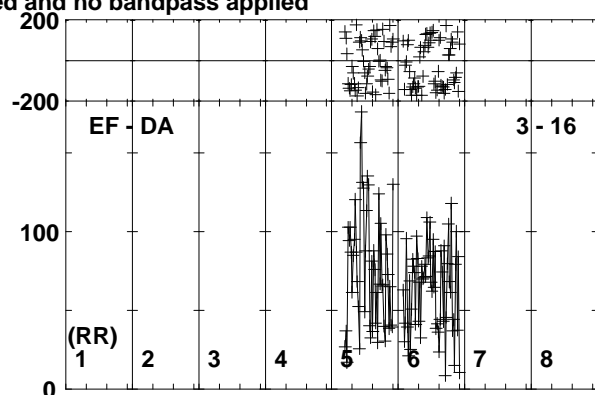
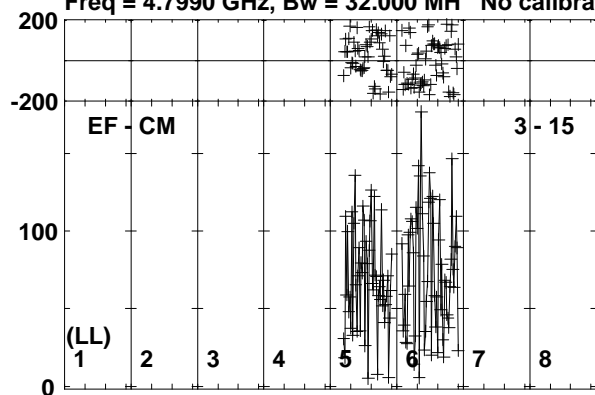

Lower frame: Micro Ampl Jy Top frame: Phas deg
Vector averaged cross-power spectrum Baseline: EF (03) - CM (15)
Timerange: 01/02:58:46 to 01/03:03:45

Plot file version 409 created 26-SEP-2019 10:42:20

J0257-1212 RG010A.UVDATA.1

Freq = 4.7990 GHz, Bw = 32.000 MH No calibration applied and no bandpass applied

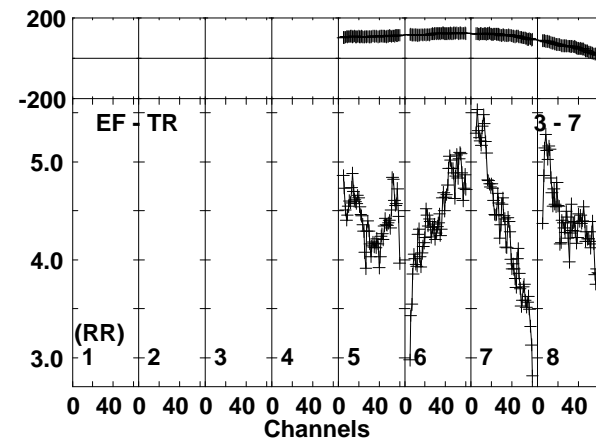
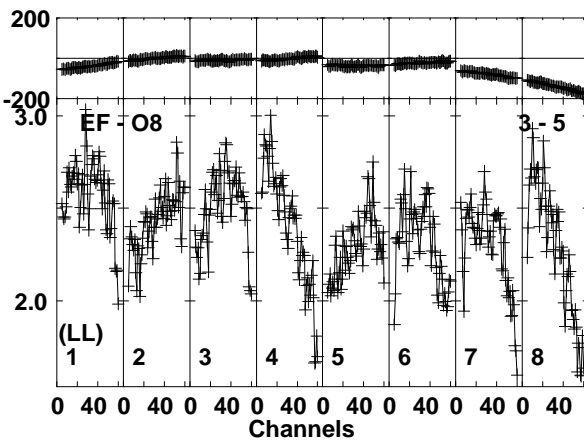
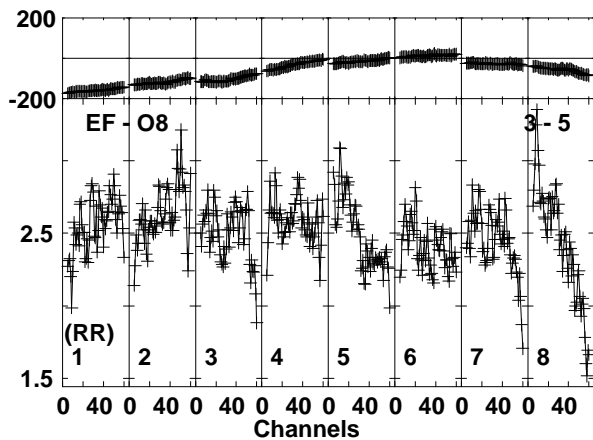
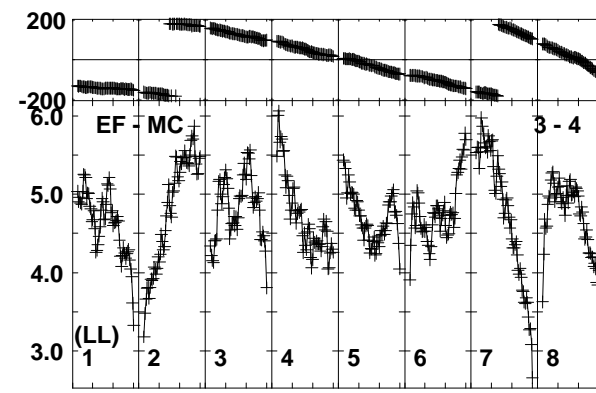
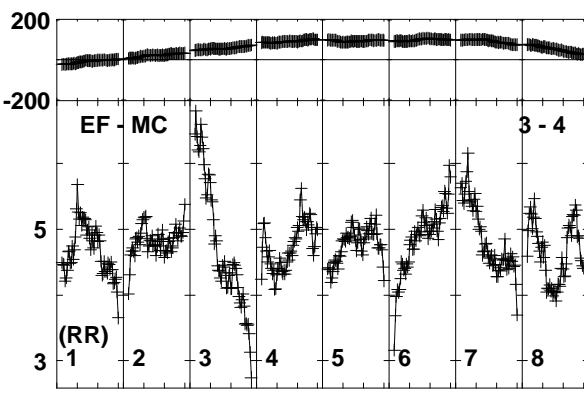
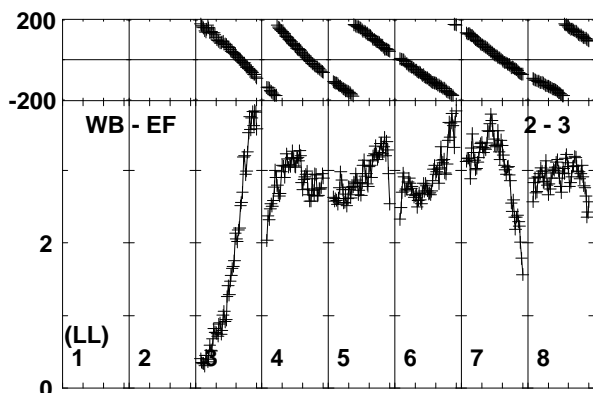
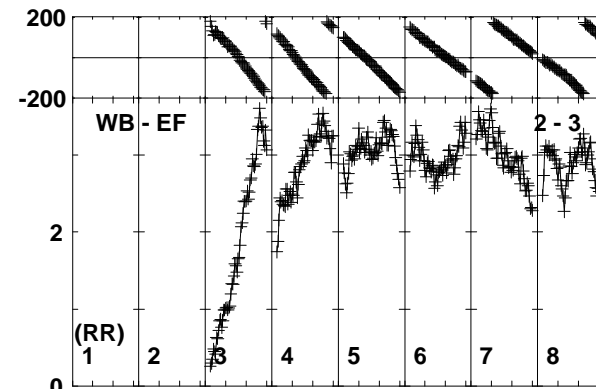
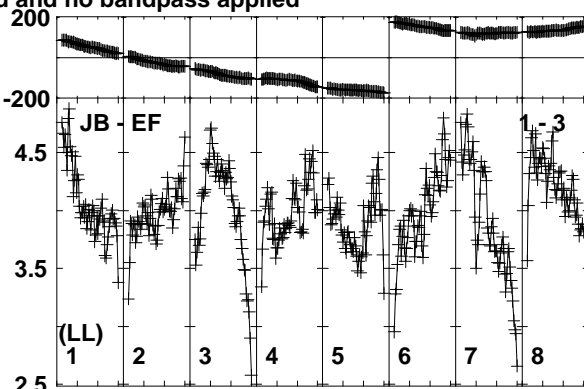
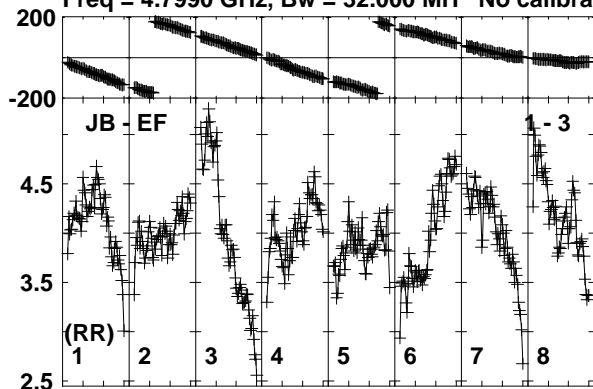

Lower frame: Milli Ampl Jy Top frame: Phas deg
Vector averaged cross-power spectrum Baseline: JB (01) - EF (03)
Timerange: 01/03:04:26 to 01/03:05:25

Plot file version 410 created 26-SEP-2019 10:42:21

J0257-1212 RG010A.UVDATA.1

Freq = 4.7990 GHz, Bw = 32.000 MH No calibration applied and no bandpass applied

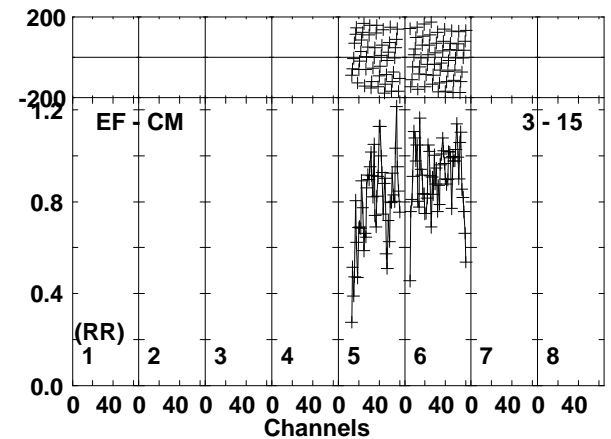
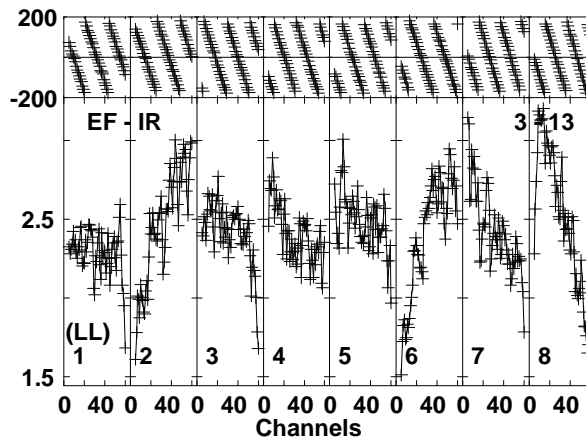
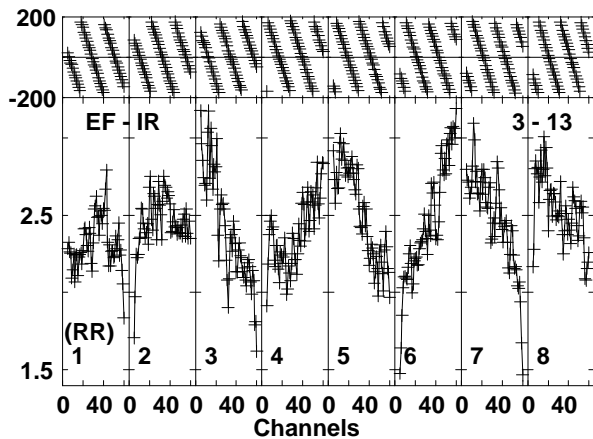
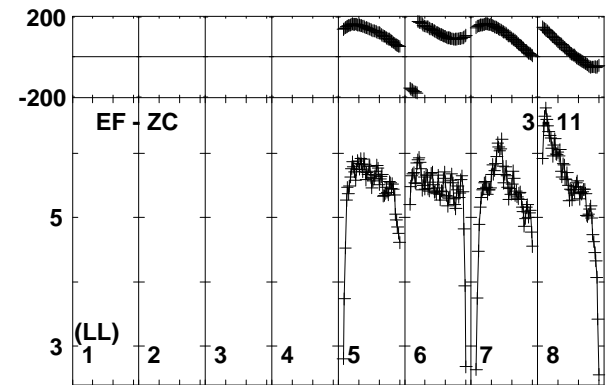
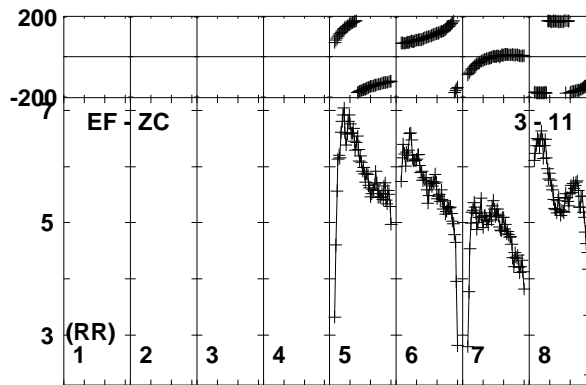
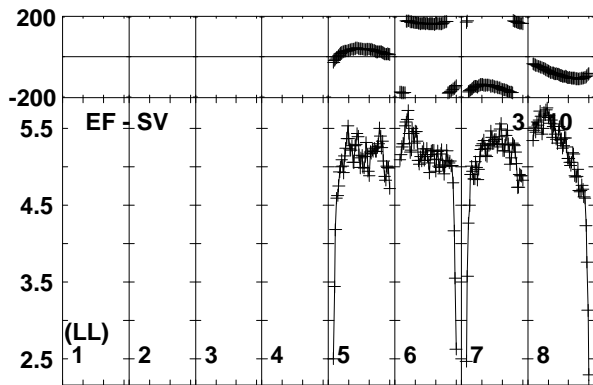
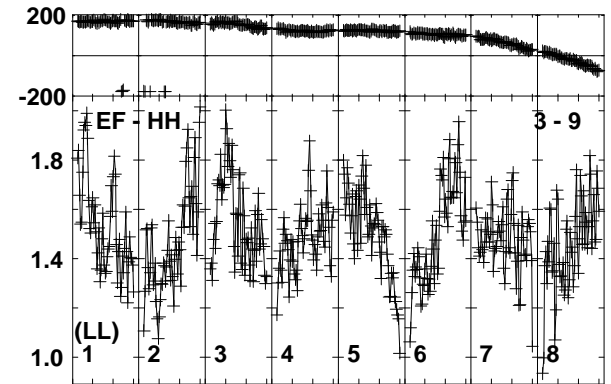
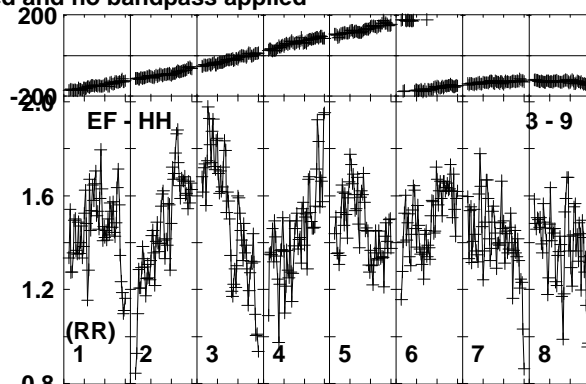
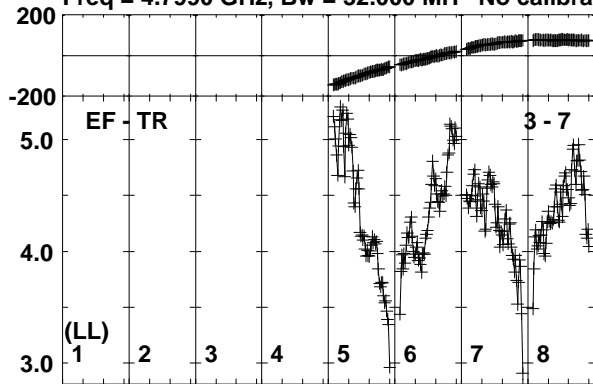

Lower frame: Milli Ampl Jy Top frame: Phas deg
Vector averaged cross-power spectrum Baseline: EF (03) - TR (07)
Timerange: 01/03:04:26 to 01/03:05:25

Plot file version 411 created 26-SEP-2019 10:42:22

J0257-1212 RG010A.UVDATA.1

Freq = 4.7990 GHz, Bw = 32.000 MH No calibration applied and no bandpass applied

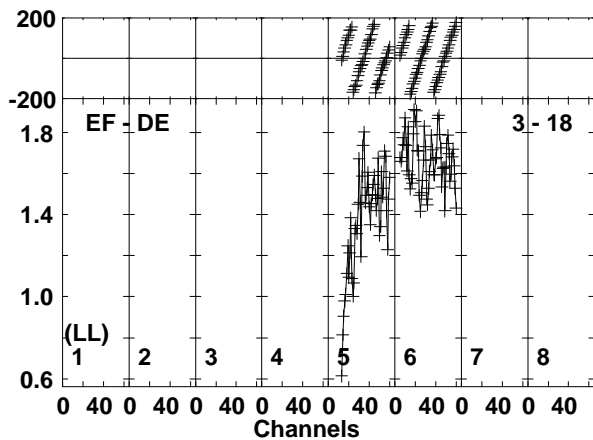
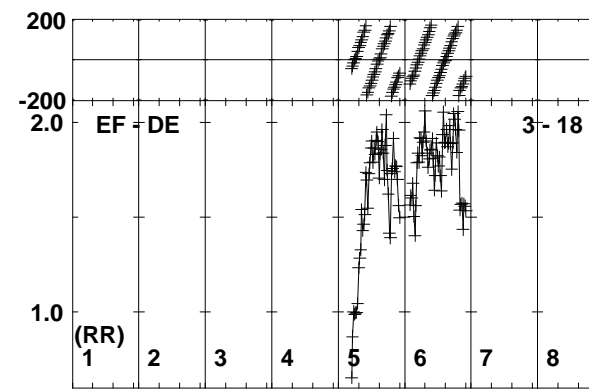
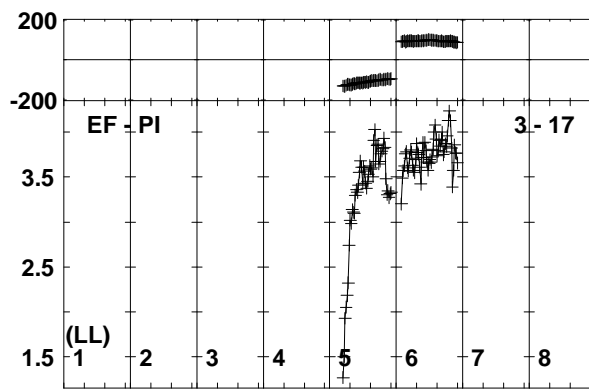
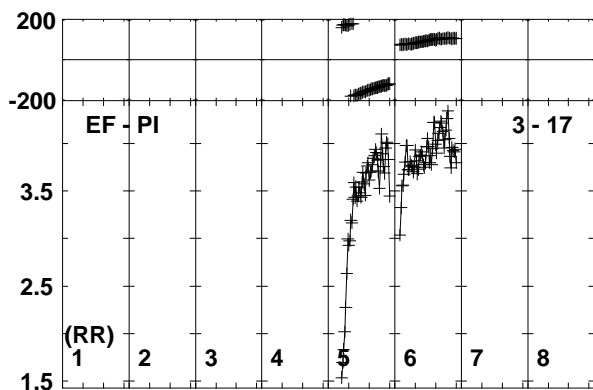
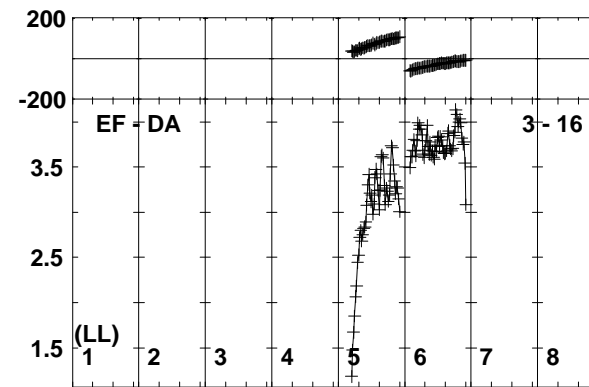
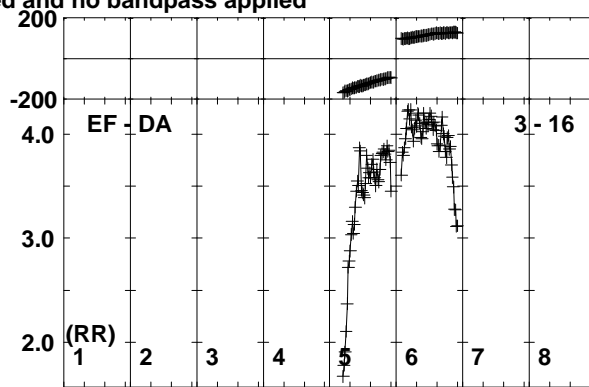
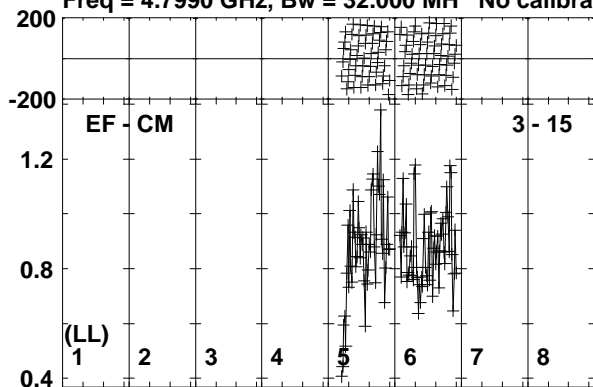

Lower frame: Milli Ampl Jy Top frame: Phas deg
Vector averaged cross-power spectrum Baseline: EF (03) - CM (15)
Timerange: 01/03:04:26 to 01/03:05:25

Plot file version 412 created 26-SEP-2019 10:42:22

190829A RG010A.UVDATA.1

Freq = 4.7990 GHz, Bw = 32.000 MH No calibration applied and no bandpass applied

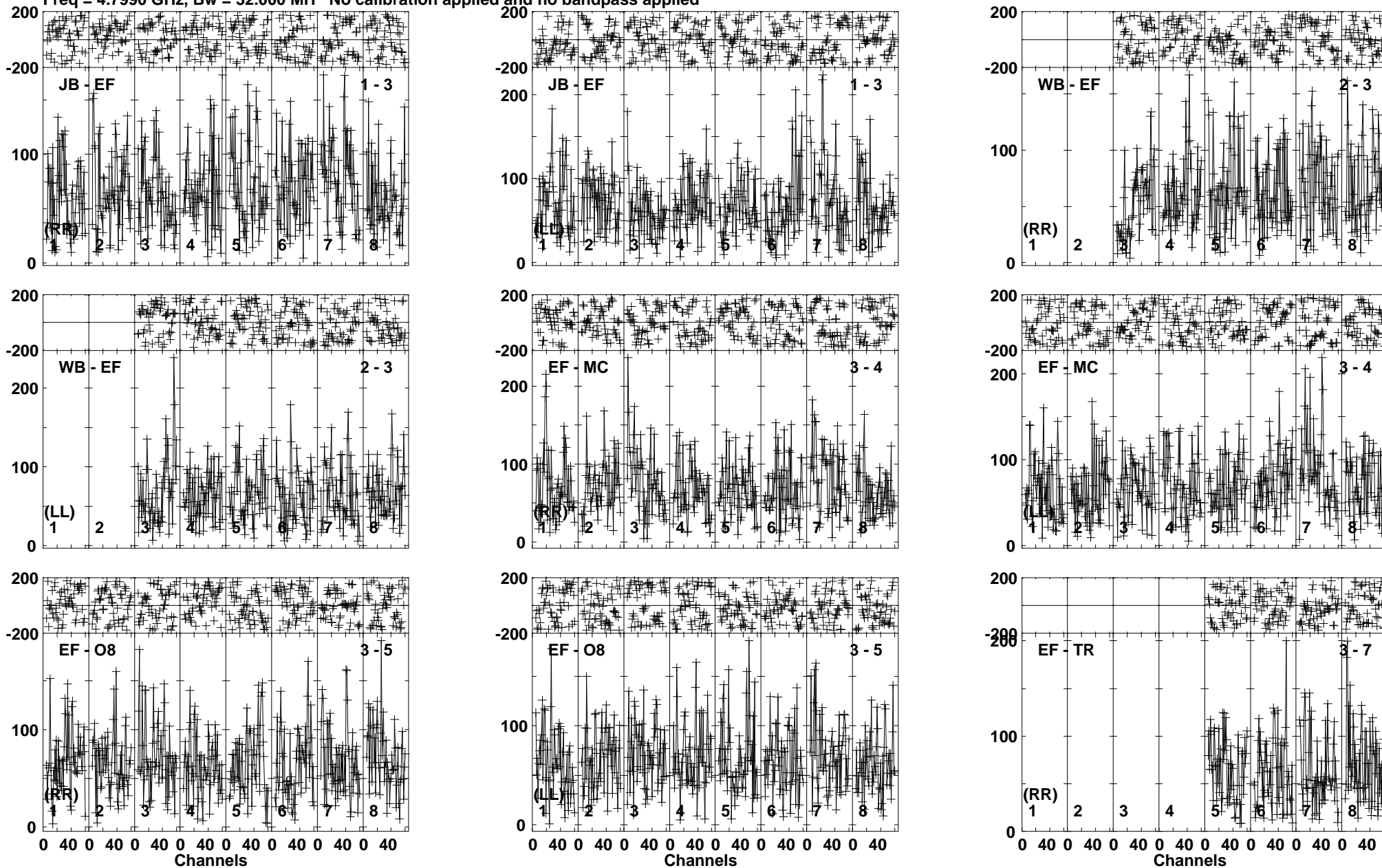

Lower frame: Micro Ampl Jy Top frame: Phas deg
Vector averaged cross-power spectrum Baseline: JB (01) - EF (03)
Timerange: 01/03:05:26 to 01/03:10:25

Plot file version 413 created 26-SEP-2019 10:42:23

190829A RG010A.UVDATA.1

Freq = 4.7990 GHz, Bw = 32.000 MH No calibration applied and no bandpass applied

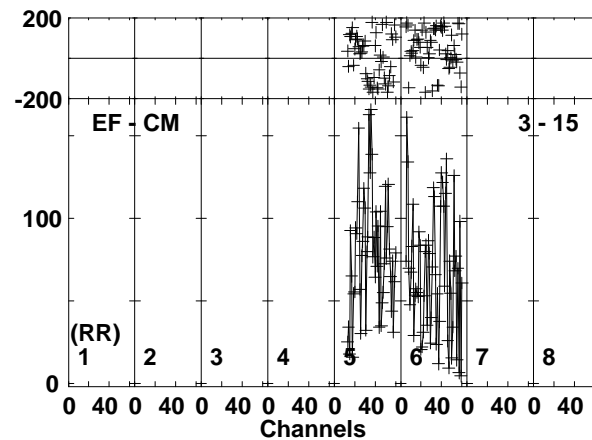
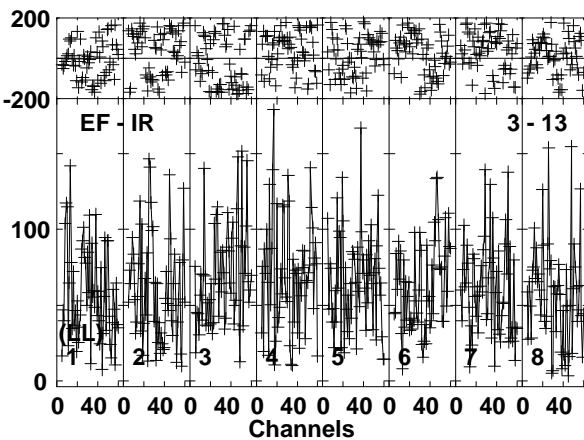
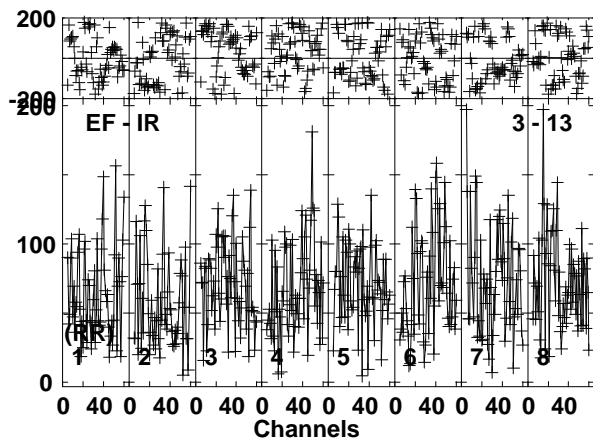
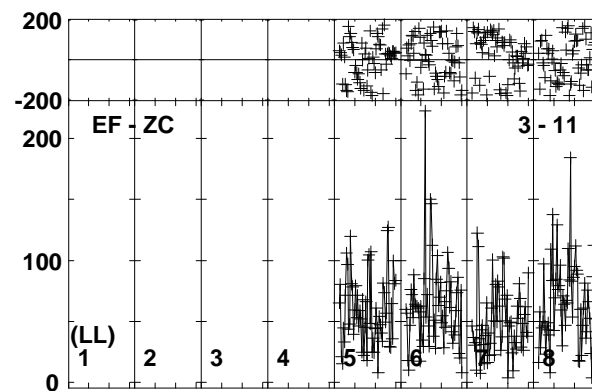
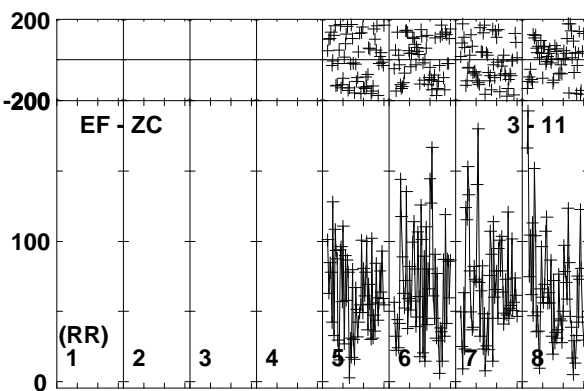
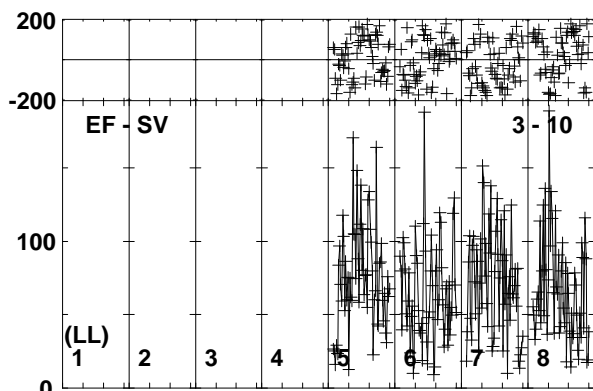
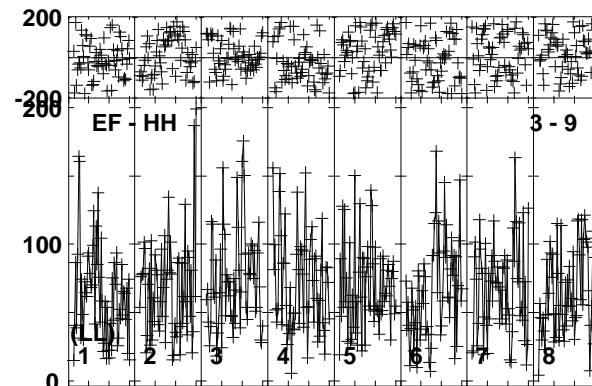
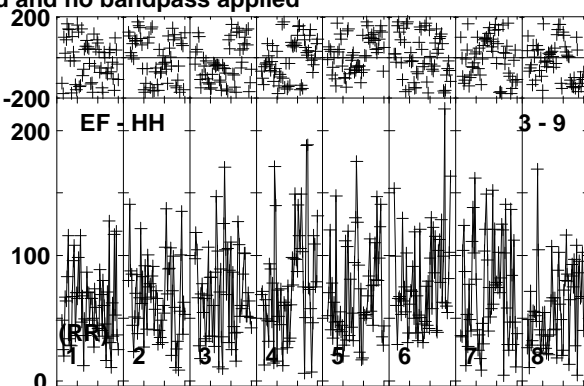
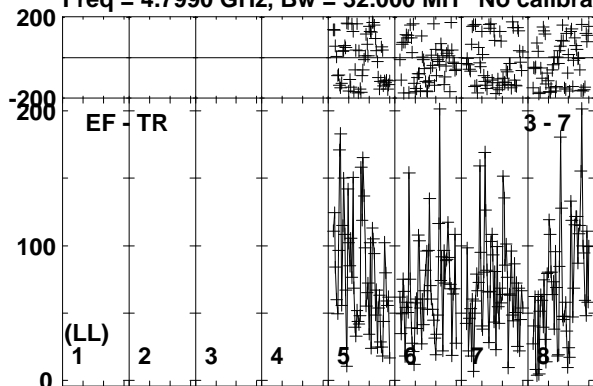

Lower frame: Micro Ampl Jy Top frame: Phas deg
Vector averaged cross-power spectrum Baseline: EF (03) - TR (07)
Timerange: 01/03:05:26 to 01/03:10:25

Plot file version 414 created 26-SEP-2019 10:42:24

190829A RG010A.UVDATA.1

Freq = 4.7990 GHz, Bw = 32.000 MH No calibration applied and no bandpass applied

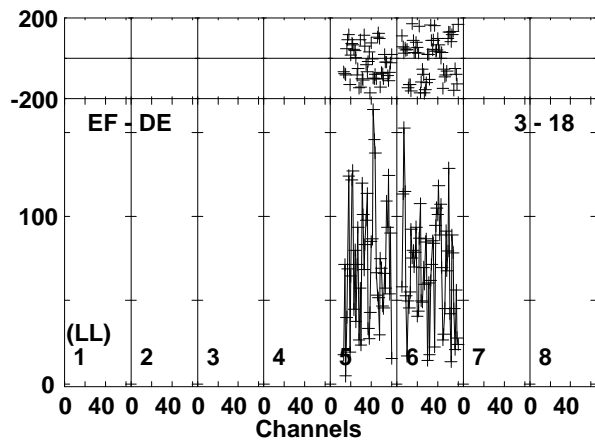
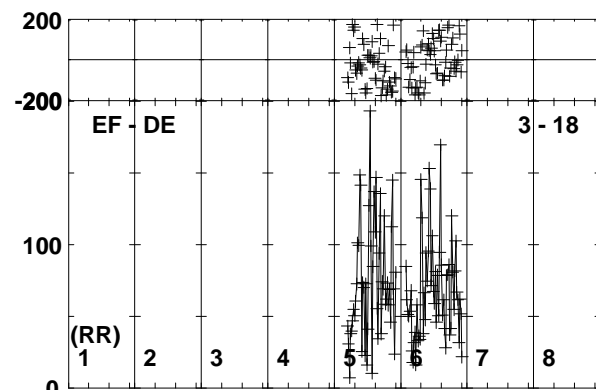
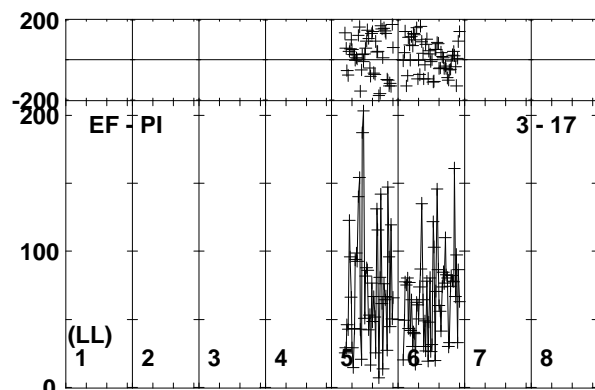
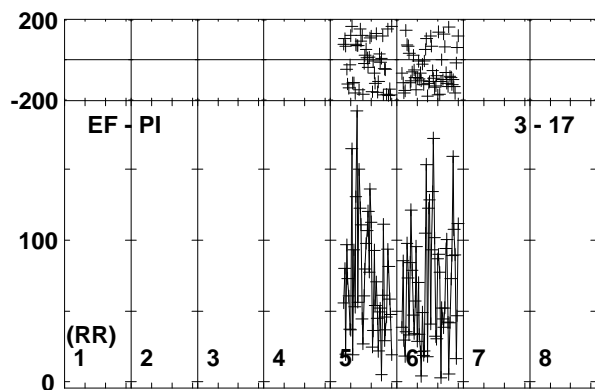
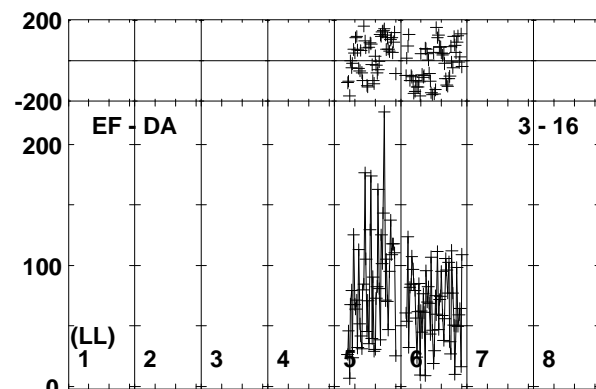
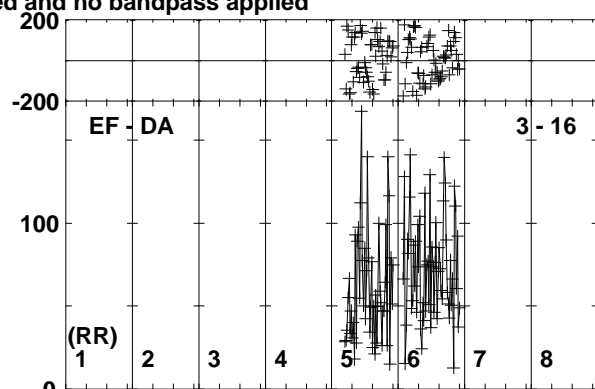
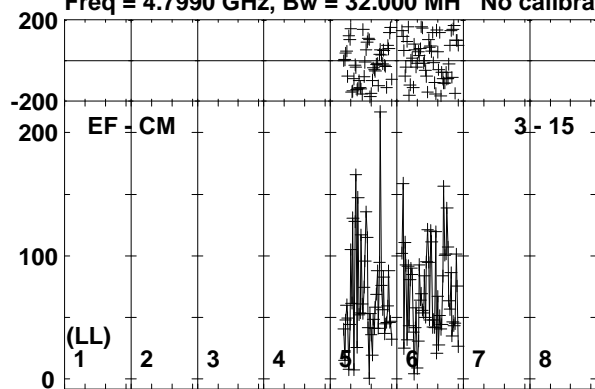

Lower frame: Micro Ampl Jy Top frame: Phas deg
Vector averaged cross-power spectrum Baseline: EF (03) - CM (15)
Timerange: 01/03:05:26 to 01/03:10:25

Plot file version 415 created 26-SEP-2019 10:42:24

J0257-1212 RG010A.UVDATA.1

Freq = 4.7990 GHz, Bw = 32.000 MH No calibration applied and no bandpass applied

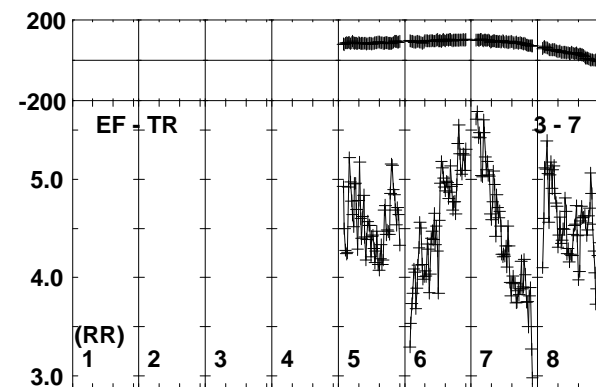
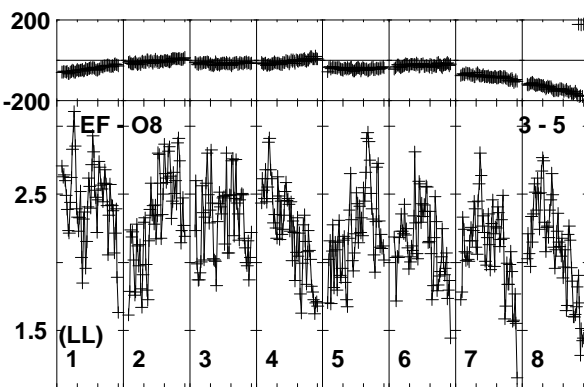
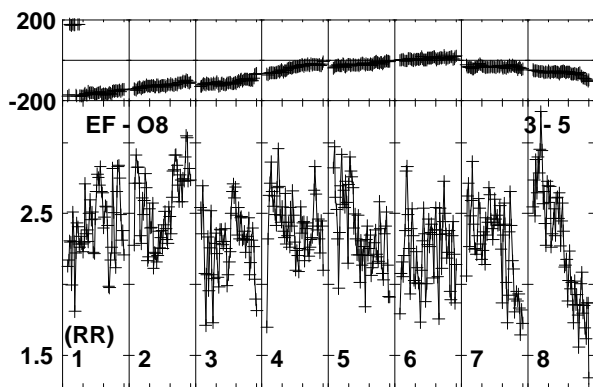
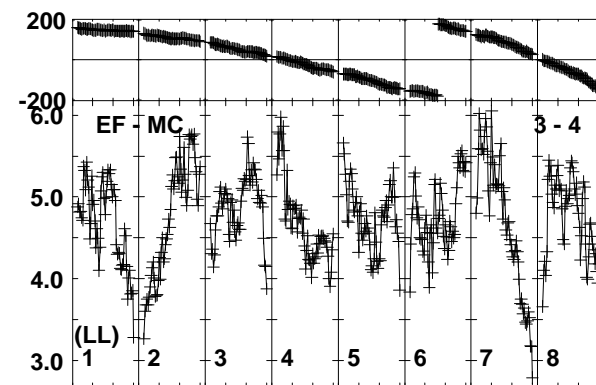
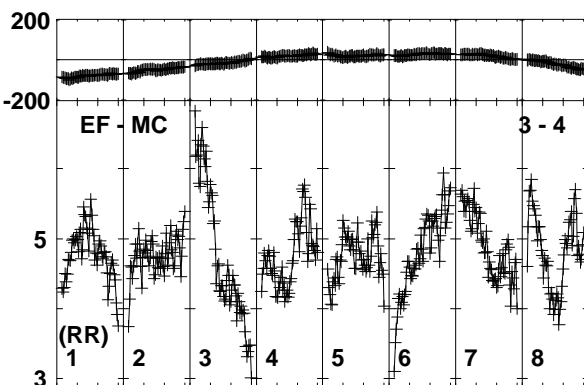
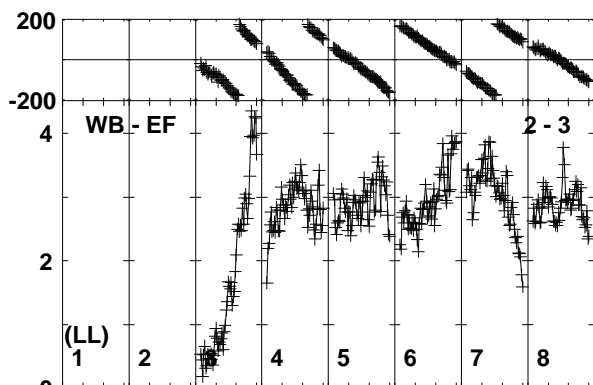
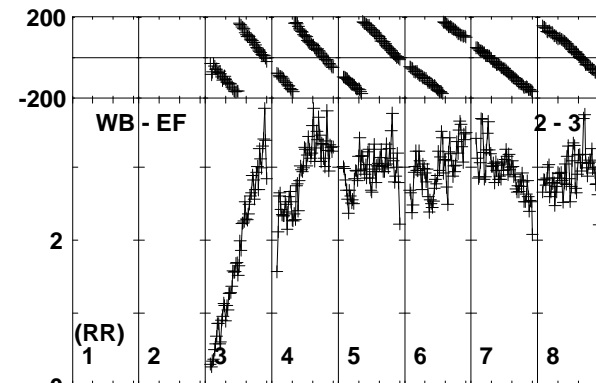
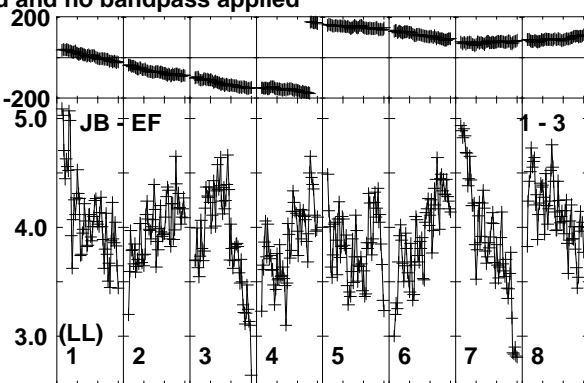
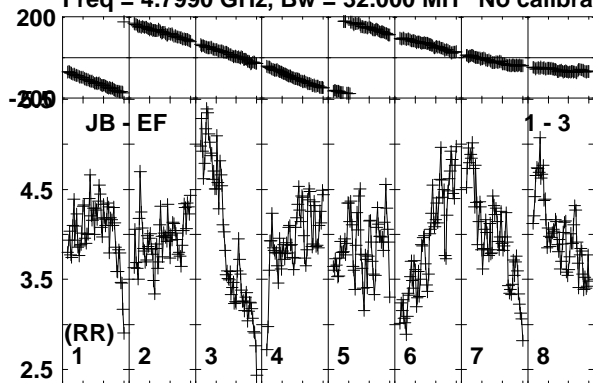

Lower frame: Milli Ampl Jy Top frame: Phas deg
Vector averaged cross-power spectrum Baseline: JB (01) - EF (03)
Timerange: 01/03:11:06 to 01/03:11:35

Plot file version 416 created 26-SEP-2019 10:42:24

J0257-1212 RG010A.UVDATA.1

Freq = 4.7990 GHz, Bw = 32.000 MH No calibration applied and no bandpass applied

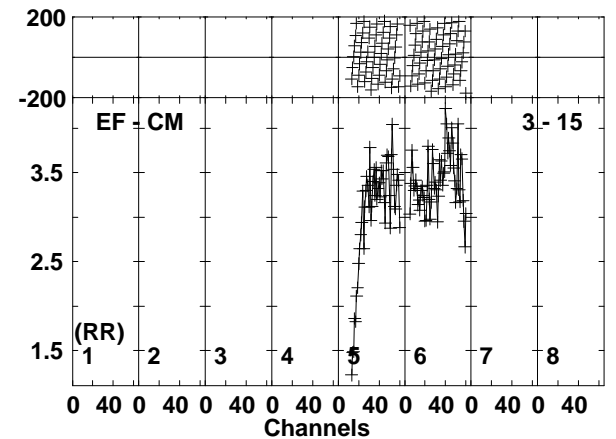
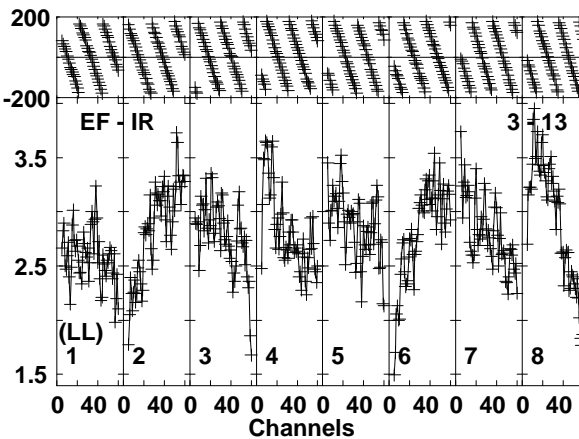
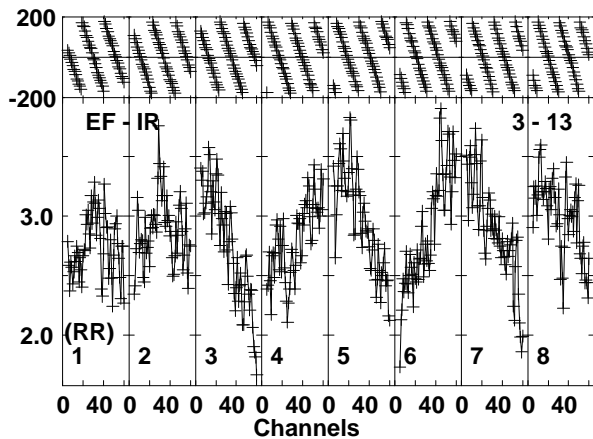
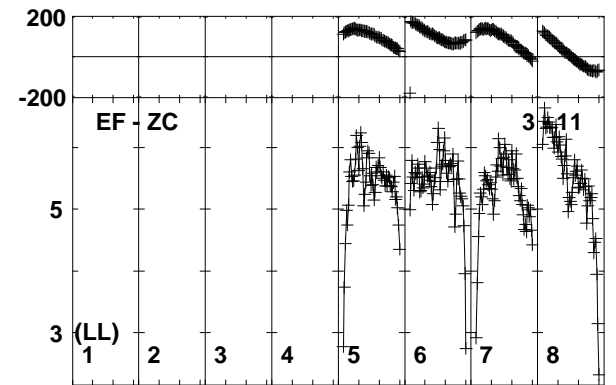
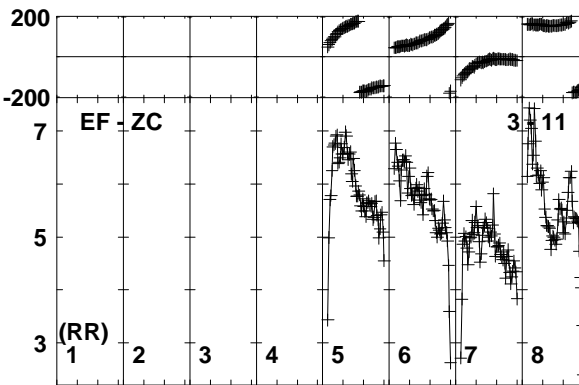
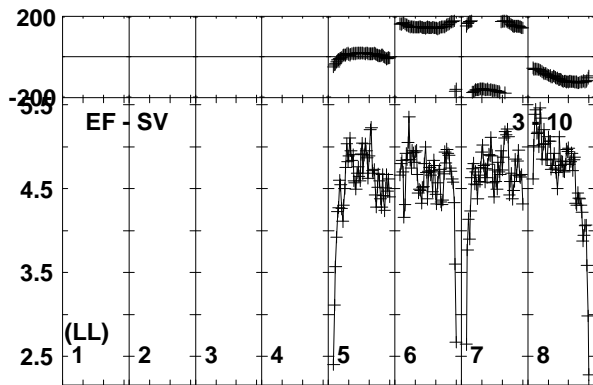
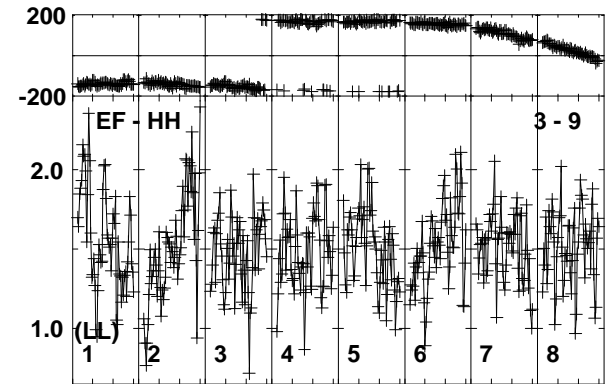
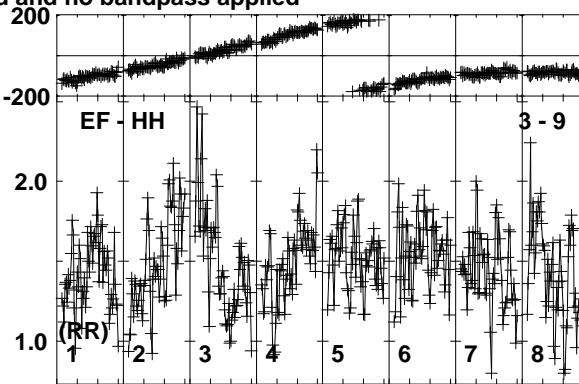
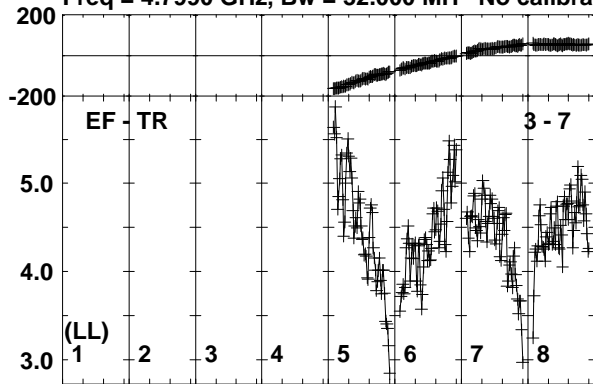

Lower frame: Milli Ampl Jy Top frame: Phas deg
Vector averaged cross-power spectrum Baseline: EF (03) - TR (07)
Timerange: 01/03:11:06 to 01/03:11:35

Plot file version 417 created 26-SEP-2019 10:42:25
 J0257-1212 RG010A.UVDATA.1
 Freq = 4.7990 GHz, Bw = 32.000 MH No calibration applied and no bandpass applied

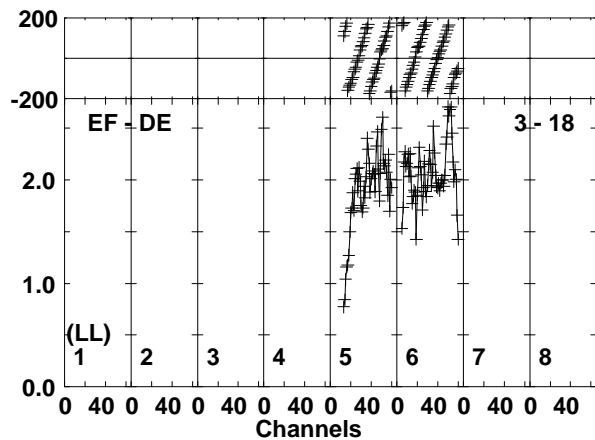
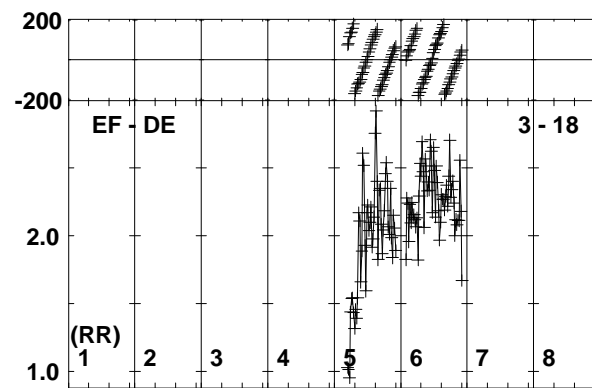
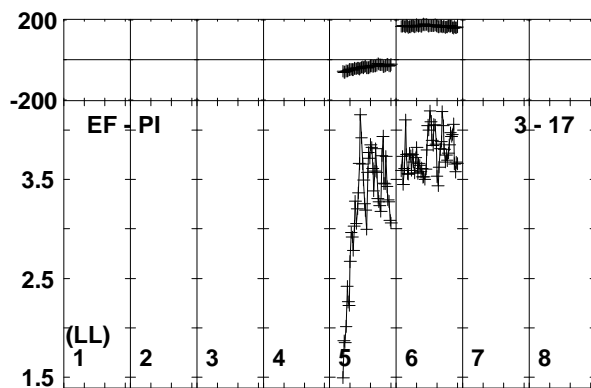
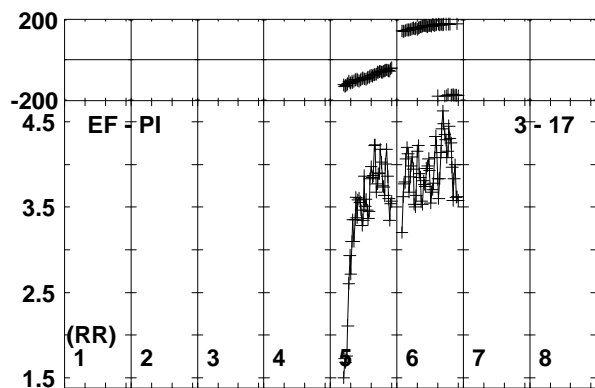
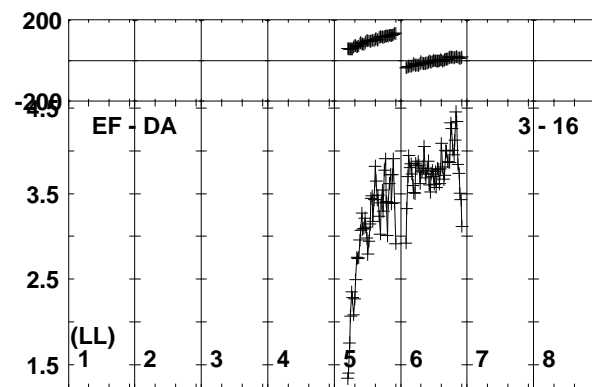
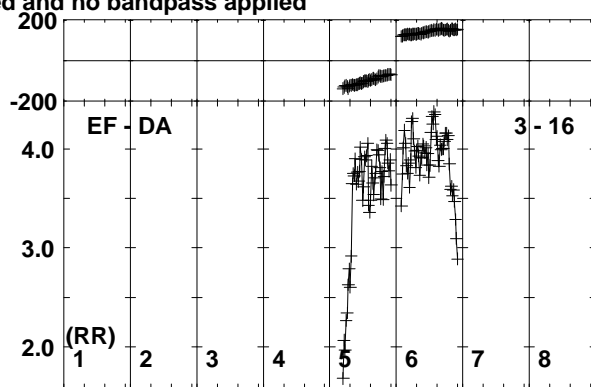
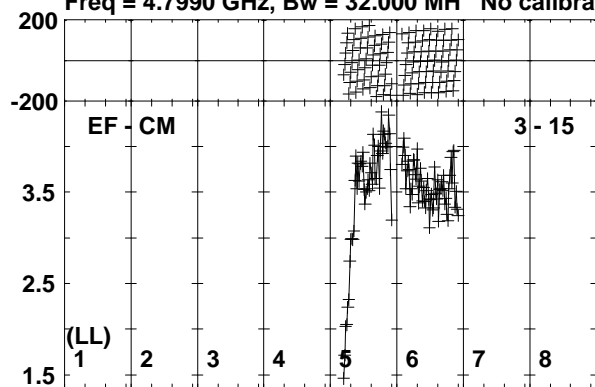

Lower frame: Milli Ampl Jy Top frame: Phas deg
 Vector averaged cross-power spectrum Baseline: EF (03) - CM (15)
 Timerange: 01/03:11:06 to 01/03:11:35

Plot file version 418 created 26-SEP-2019 10:42:25

J0300-0846 RG010A.UVDATA.1

Freq = 4.7990 GHz, Bw = 32.000 MH No calibration applied and no bandpass applied

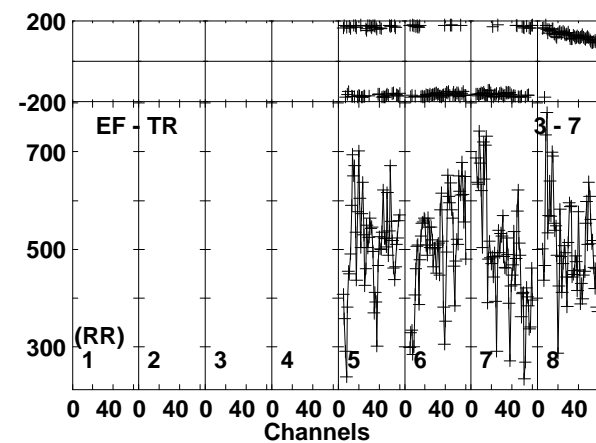
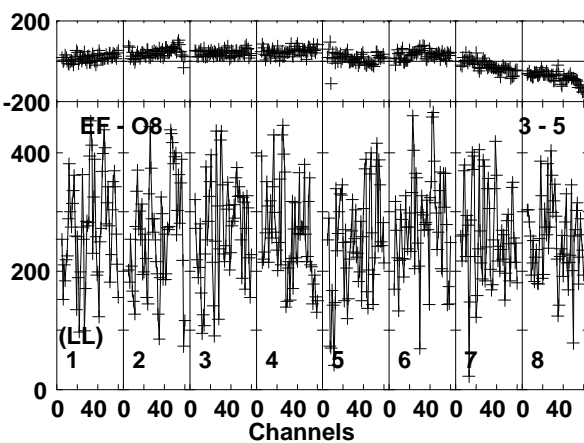
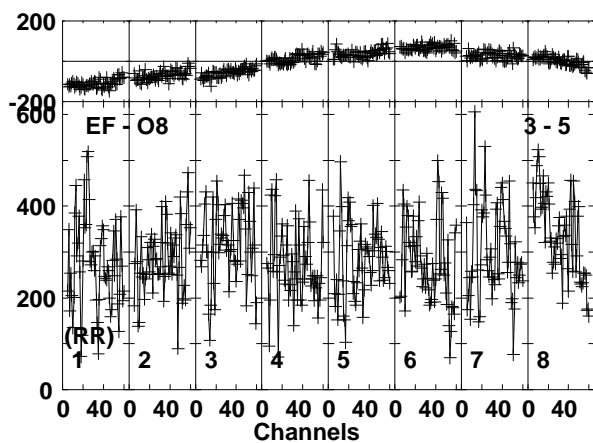
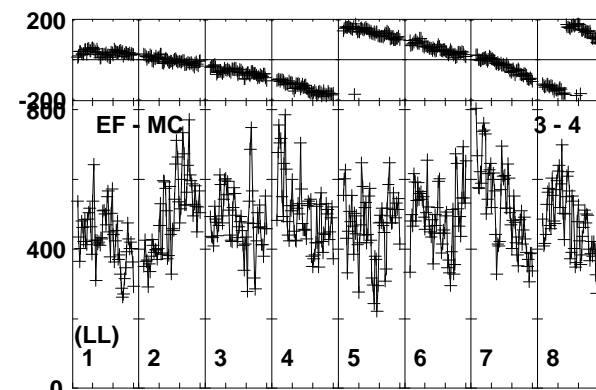
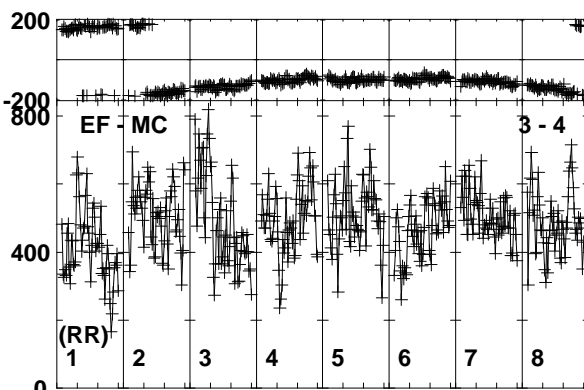
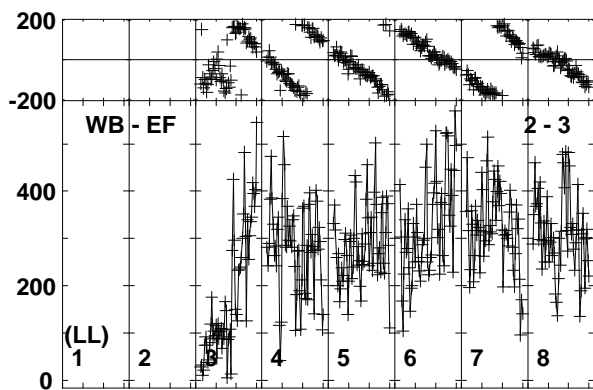
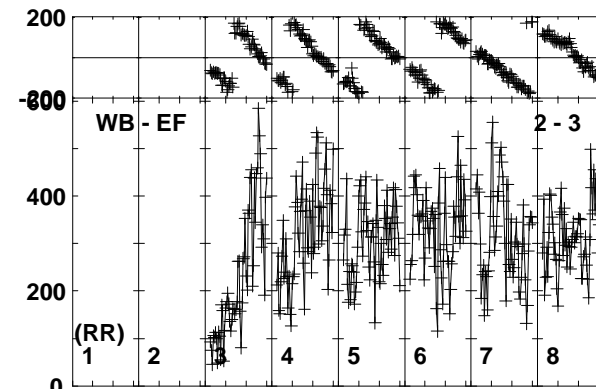
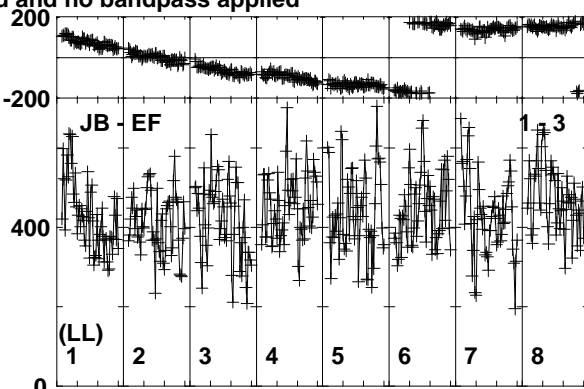
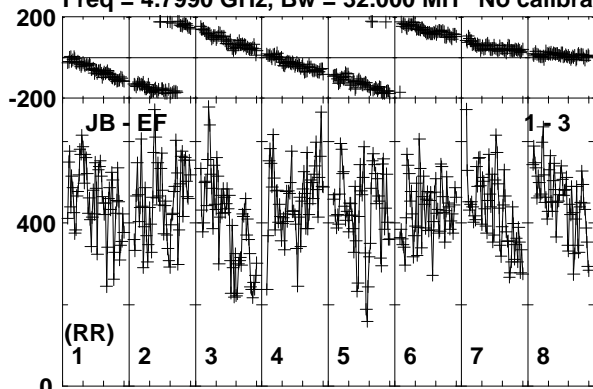

Lower frame: Micro Ampl Jy Top frame: Phas deg
Vector averaged cross-power spectrum Baseline: JB (01) - EF (03)
Timerange: 01/03:11:35 to 01/03:14:05

Plot file version 419 created 26-SEP-2019 10:42:25

J0300-0846 RG010A.UVDATA.1

Freq = 4.7990 GHz, Bw = 32.000 MH No calibration applied and no bandpass applied

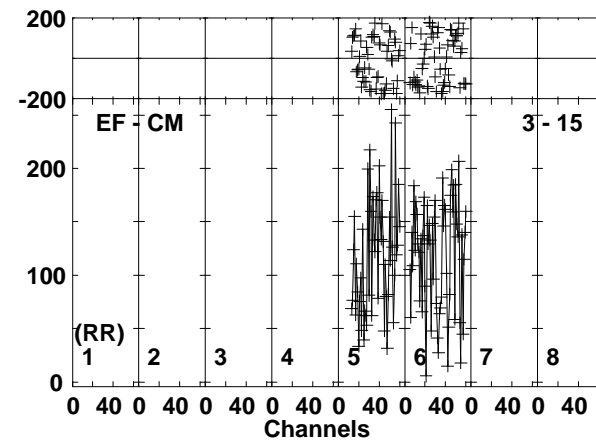
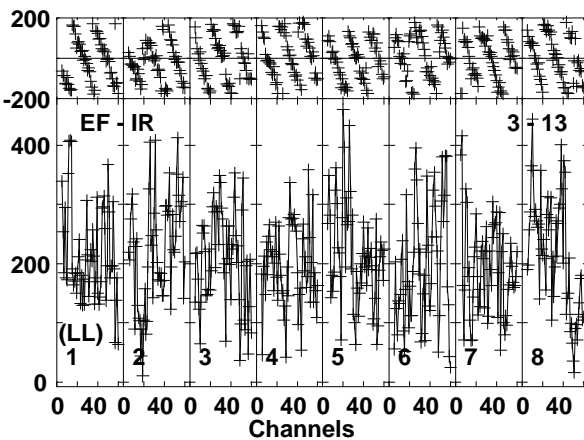
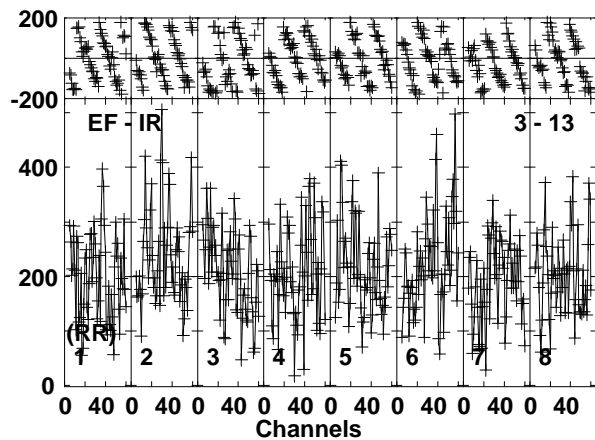
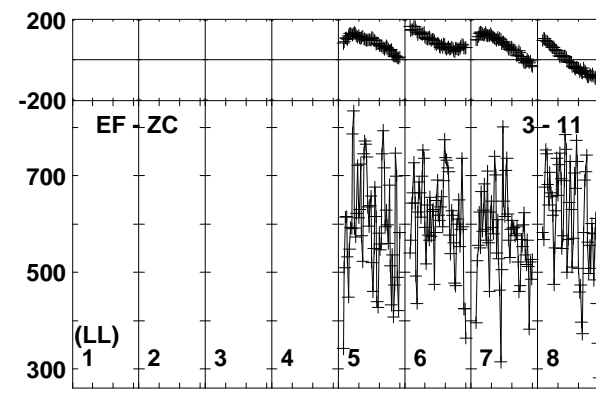
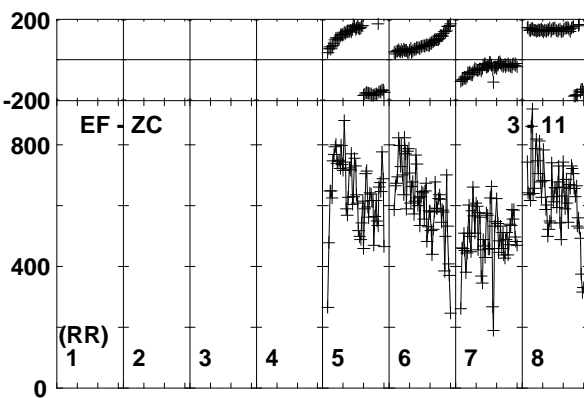
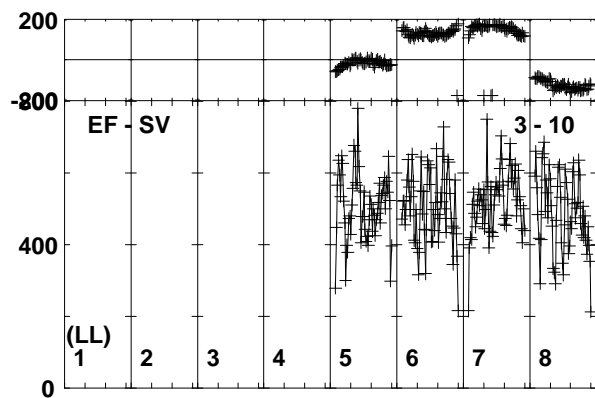
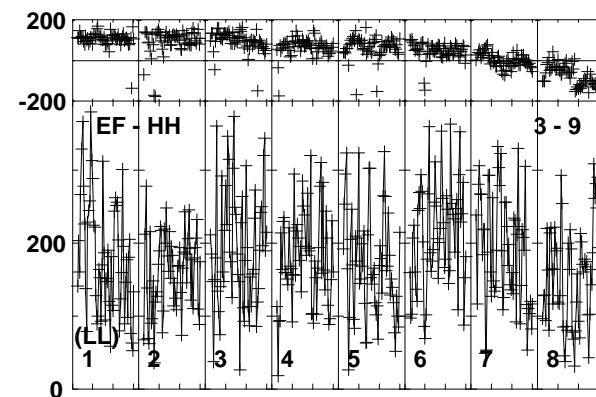
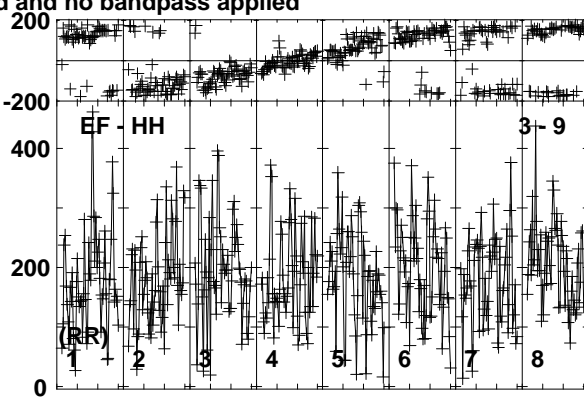
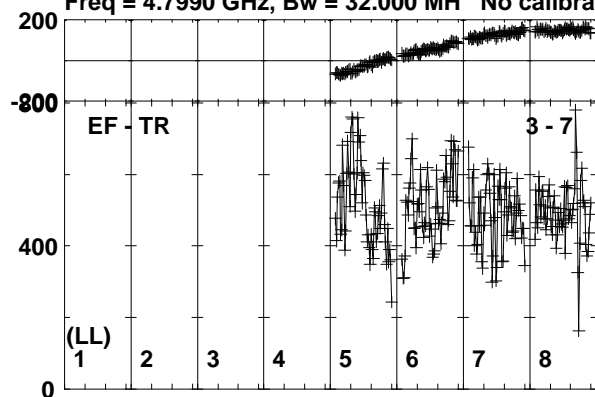

Lower frame: Micro Ampl Jy Top frame: Phas deg
Vector averaged cross-power spectrum Baseline: EF (03) - TR (07)
Timerange: 01/03:11:35 to 01/03:14:05

Plot file version 420 created 26-SEP-2019 10:42:26

J0300-0846 RG010A.UVDATA.1

Freq = 4.7990 GHz, Bw = 32.000 MH No calibration applied and no bandpass applied

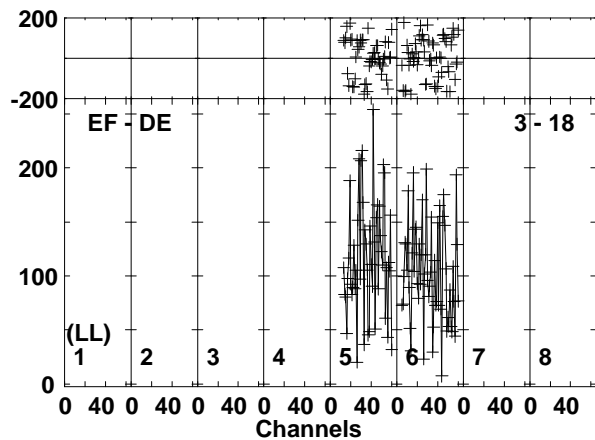
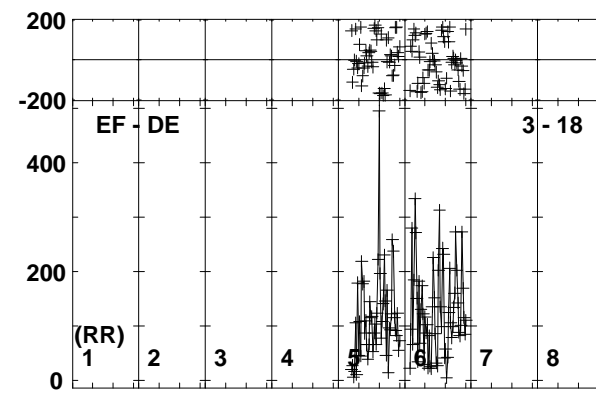
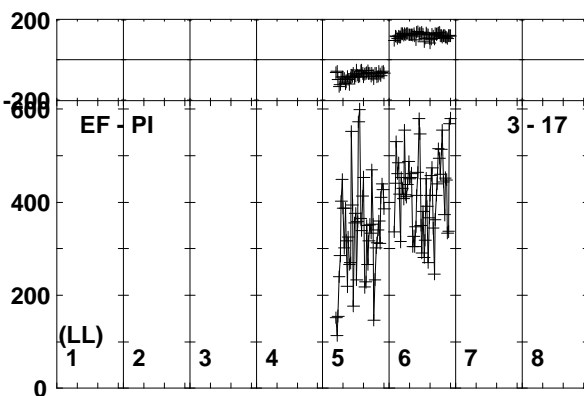
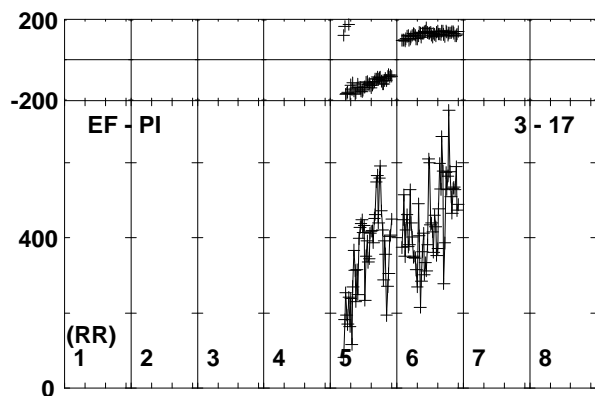
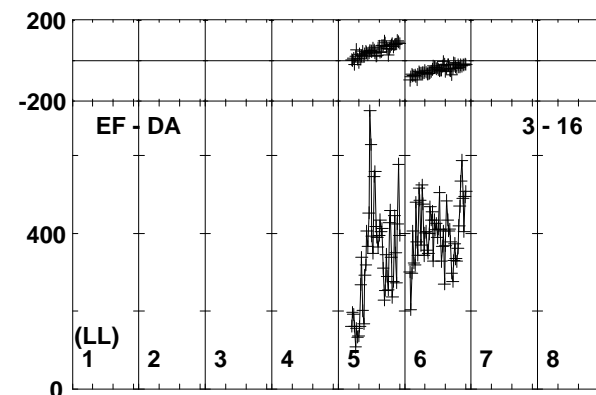
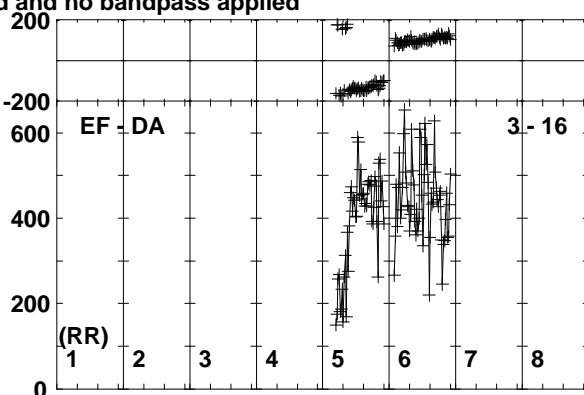
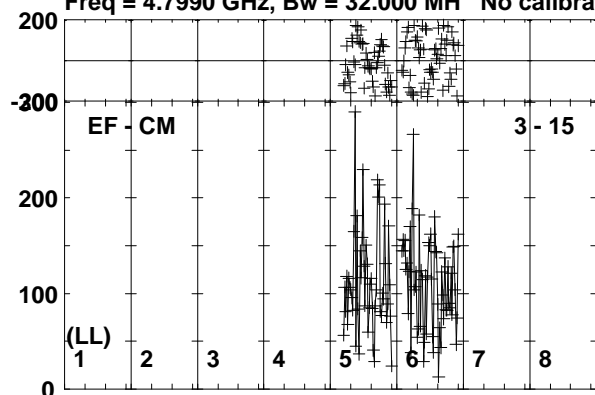

Lower frame: Micro Ampl Jy Top frame: Phas deg
Vector averaged cross-power spectrum Baseline: EF (03) - CM (15)
Timerange: 01/03:11:35 to 01/03:14:05

Plot file version 421 created 26-SEP-2019 10:42:27

190829A RG010A.UVDATA.1

Freq = 4.7990 GHz, Bw = 32.000 MH No calibration applied and no bandpass applied

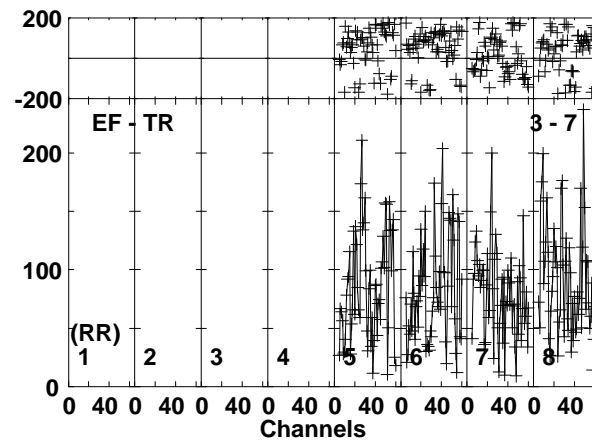
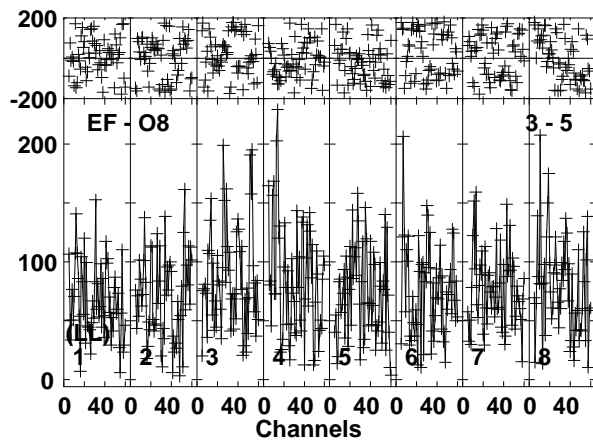
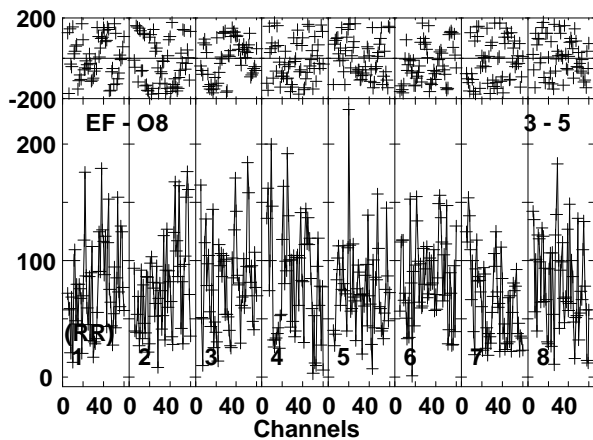
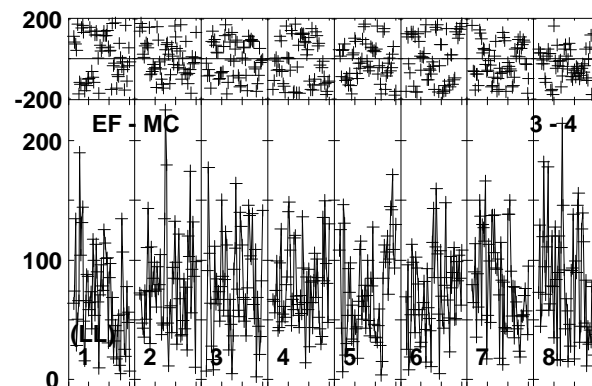
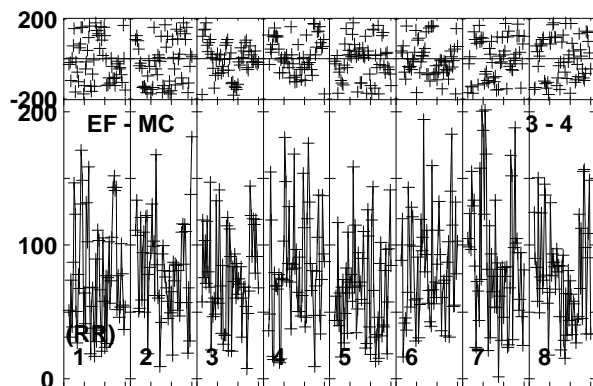
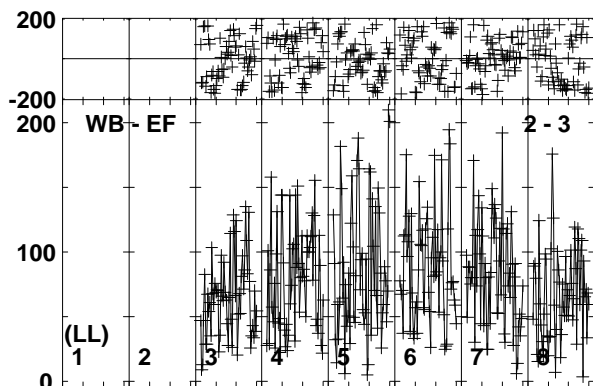
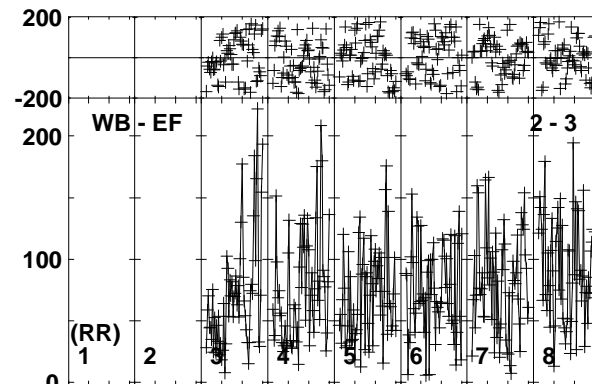
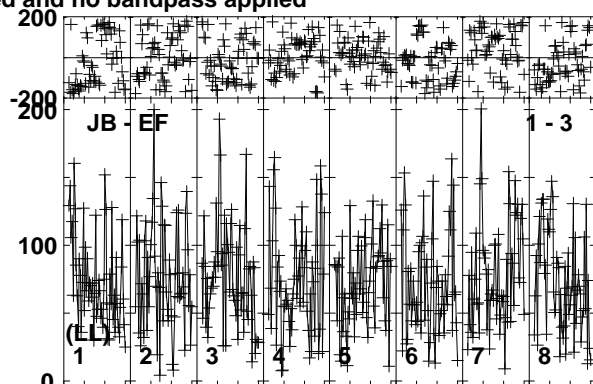
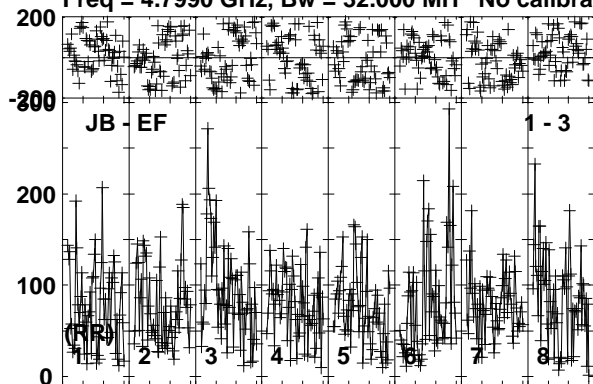

Lower frame: Micro Ampl Jy Top frame: Phas deg
Vector averaged cross-power spectrum Baseline: JB (01) - EF (03)
Timerange: 01/03:14:06 to 01/03:17:35

Plot file version 422 created 26-SEP-2019 10:42:27

190829A RG010A.UVDATA.1

Freq = 4.7990 GHz, Bw = 32.000 MH No calibration applied and no bandpass applied

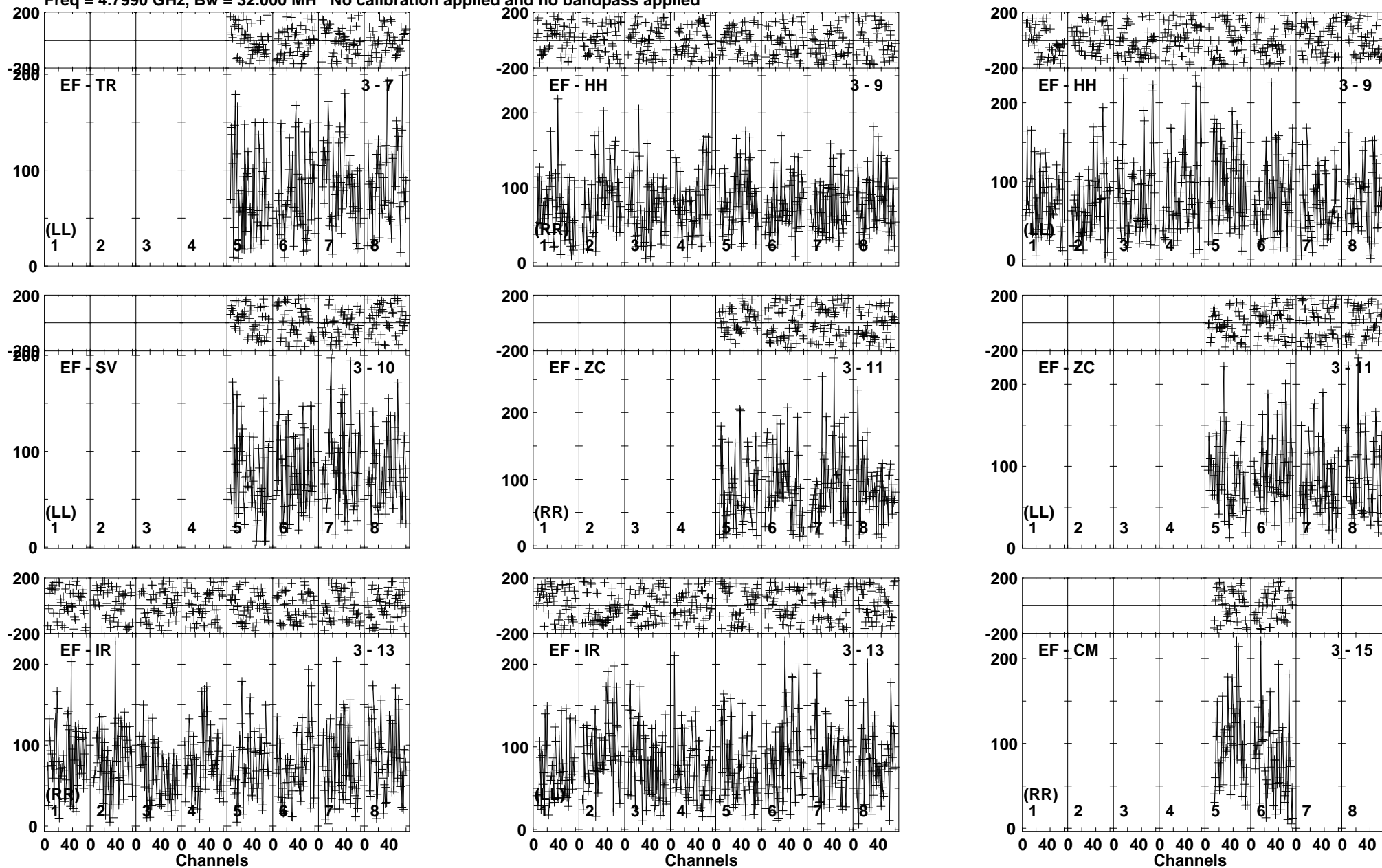

Lower frame: Micro Ampl Jy Top frame: Phas deg
Vector averaged cross-power spectrum Baseline: EF (03) - TR (07)
Timerange: 01/03:14:06 to 01/03:17:35

Plot file version 423 created 26-SEP-2019 10:42:28

190829A RG010A.UVDATA.1

Freq = 4.7990 GHz, Bw = 32.000 MH No calibration applied and no bandpass applied

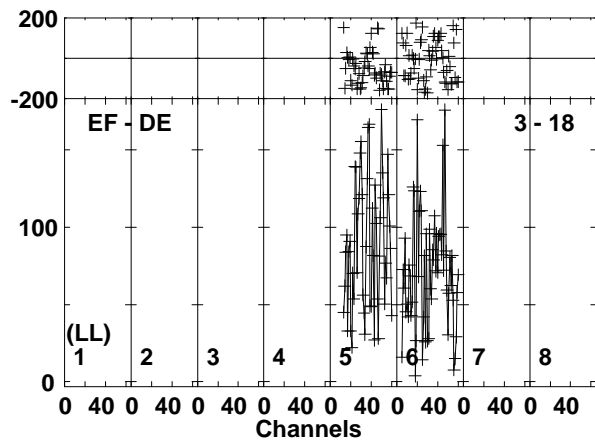
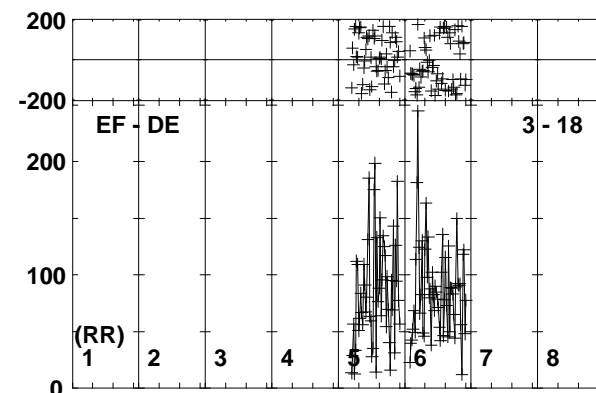
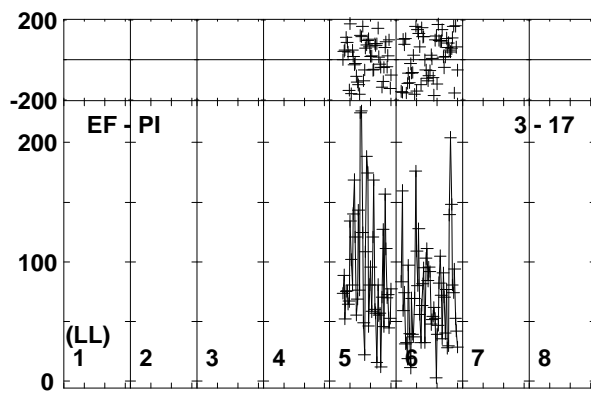
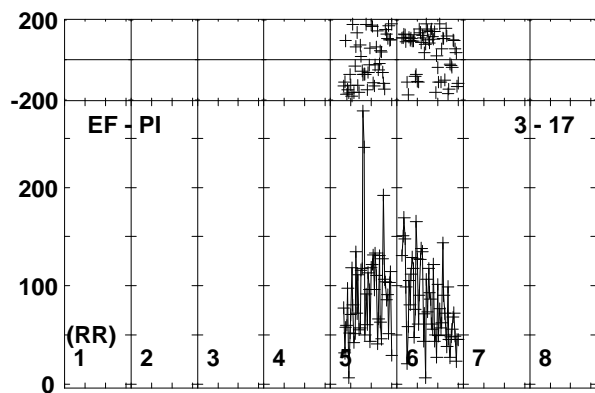
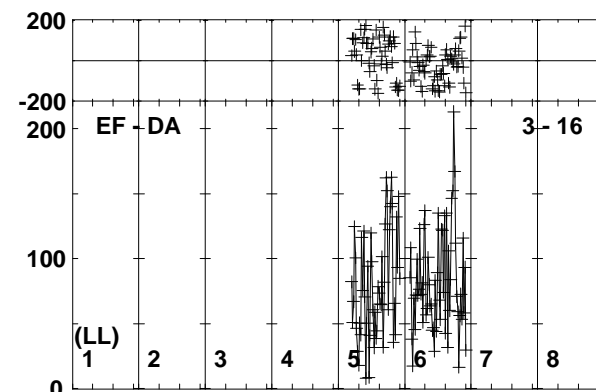
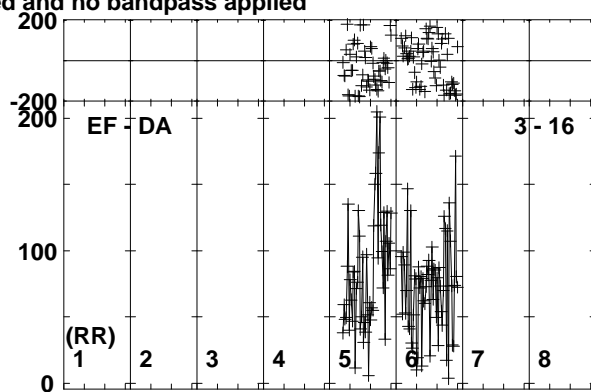
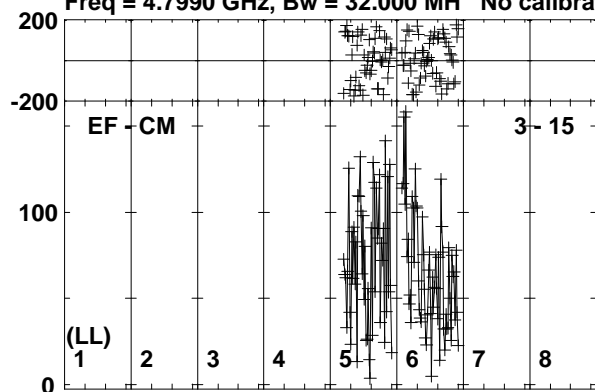

Lower frame: Micro Ampl Jy Top frame: Phas deg
Vector averaged cross-power spectrum Baseline: EF (03) - CM (15)
Timerange: 01/03:14:06 to 01/03:17:35

Plot file version 424 created 26-SEP-2019 10:42:28

J0257-1212 RG010A.UVDATA.1

Freq = 4.7990 GHz, Bw = 32.000 MH No calibration applied and no bandpass applied

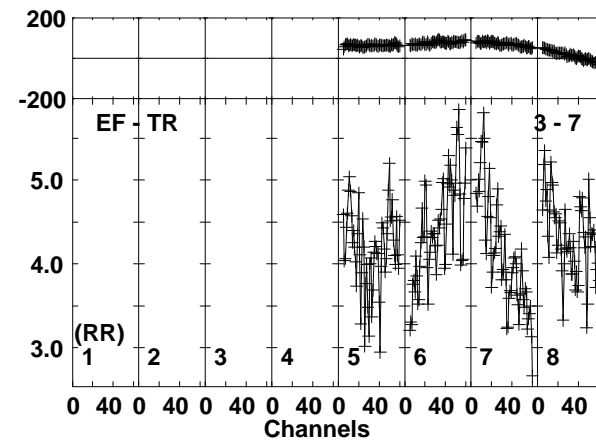
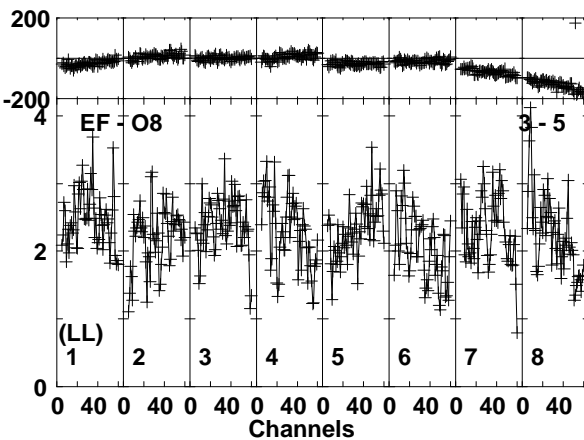
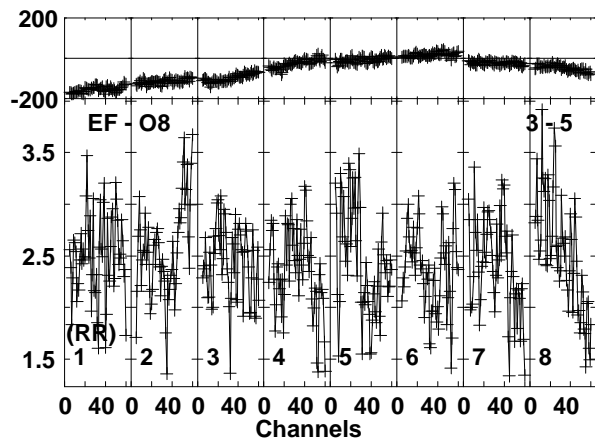
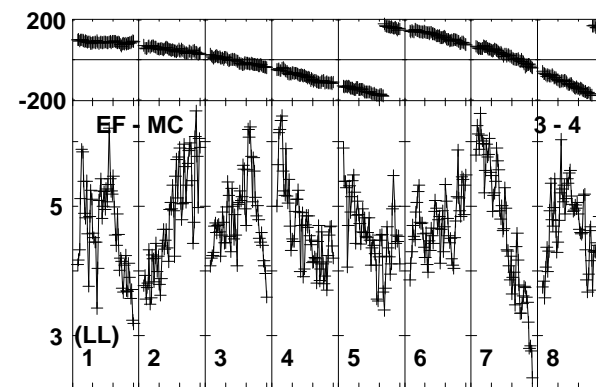
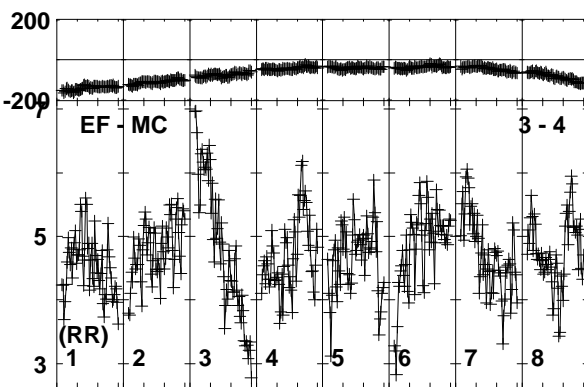
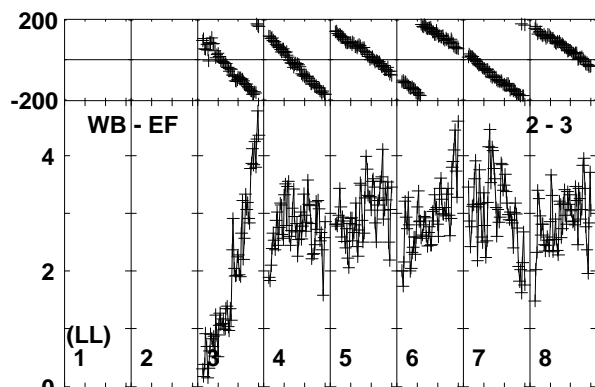
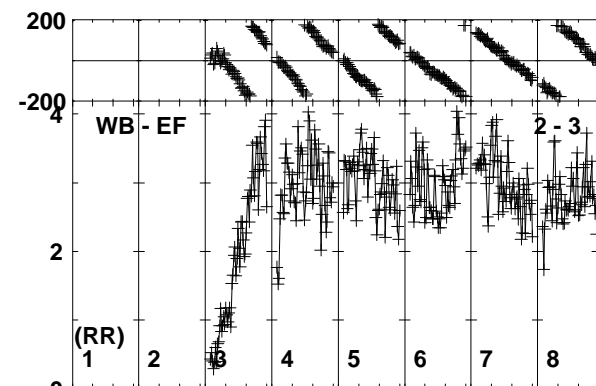
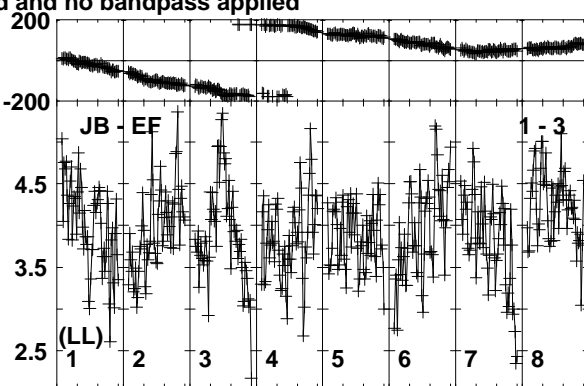
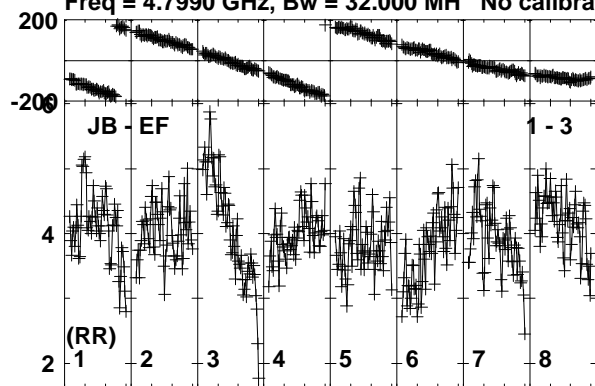

Lower frame: Milli Ampl Jy Top frame: Phas deg
Vector averaged cross-power spectrum Baseline: JB (01) - EF (03)
Timerange: 01/03:17:36 to 01/03:18:34

Plot file version 425 created 26-SEP-2019 10:42:29

J0257-1212 RG010A.UVDATA.1

Freq = 4.7990 GHz, Bw = 32.000 MH No calibration applied and no bandpass applied

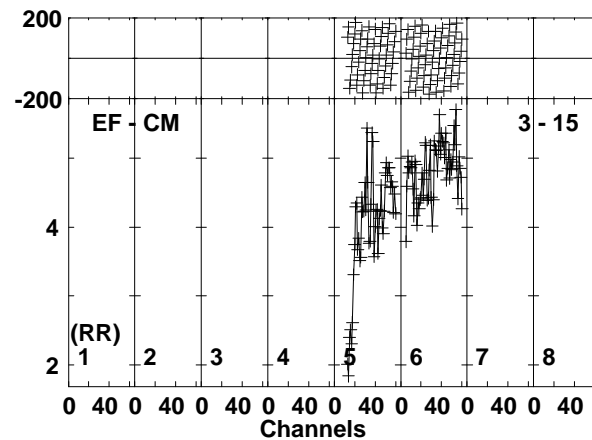
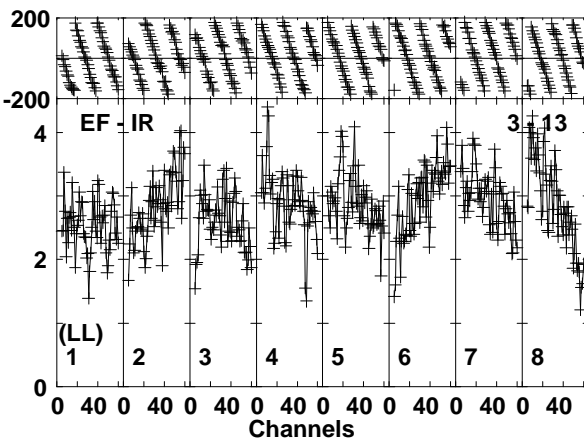
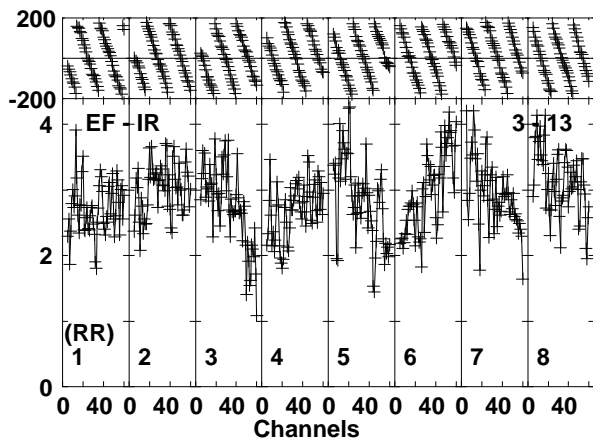
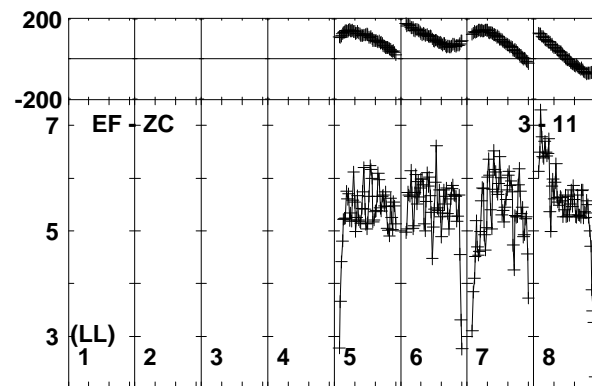
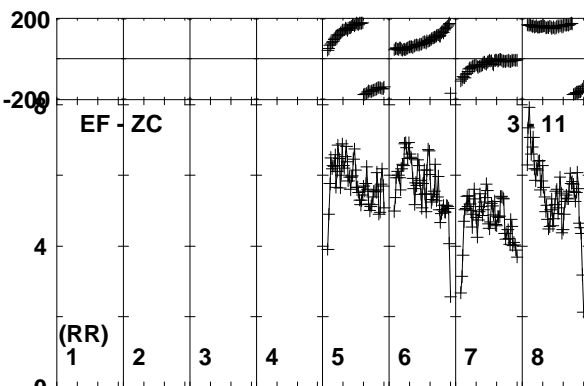
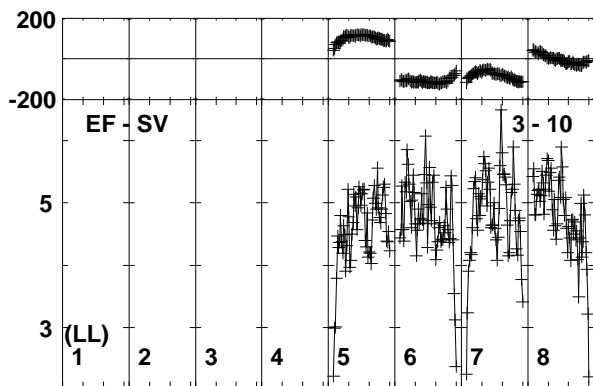
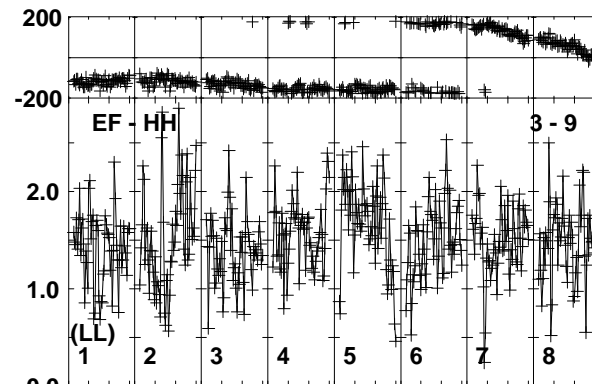
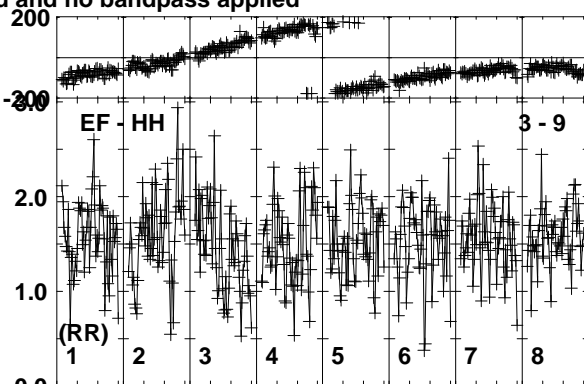
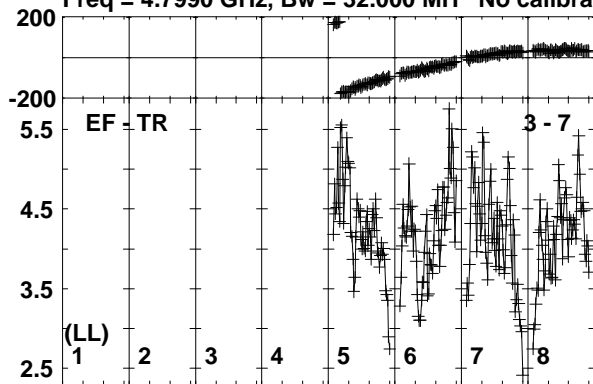

Lower frame: Milli Ampl Jy Top frame: Phas deg
Vector averaged cross-power spectrum Baseline: EF (03) - TR (07)
Timerange: 01/03:17:36 to 01/03:18:34

Plot file version 426 created 26-SEP-2019 10:42:29

J0257-1212 RG010A.UVDATA.1

Freq = 4.7990 GHz, Bw = 32.000 MH No calibration applied and no bandpass applied

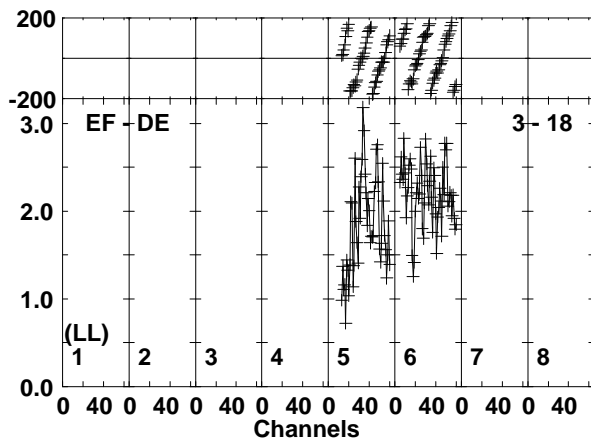
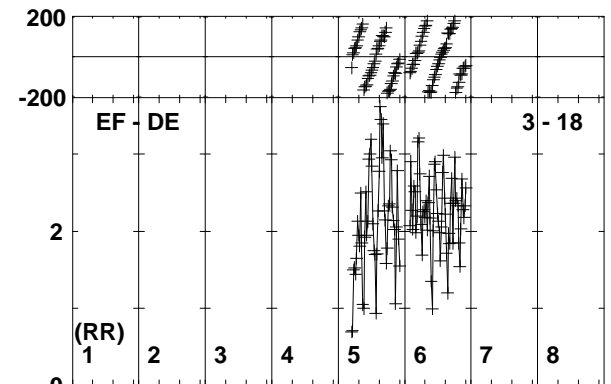
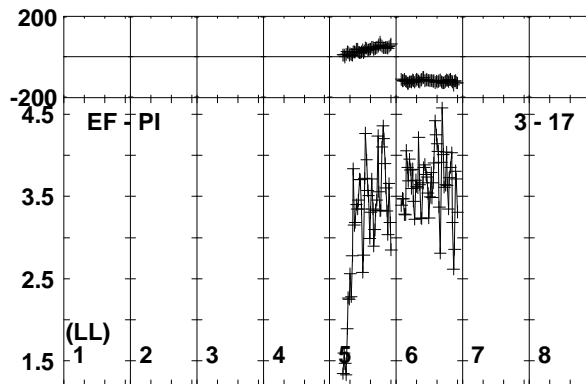
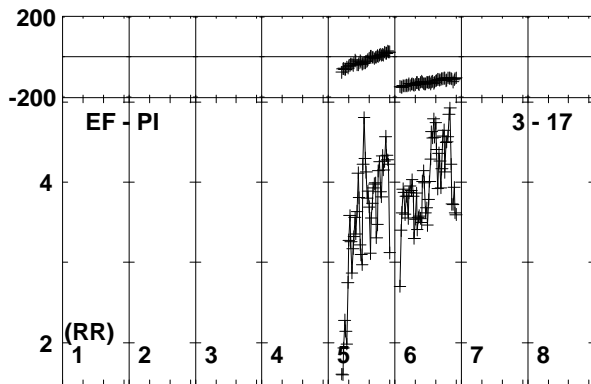
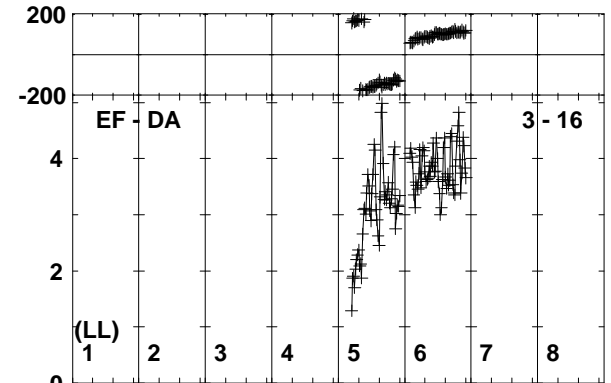
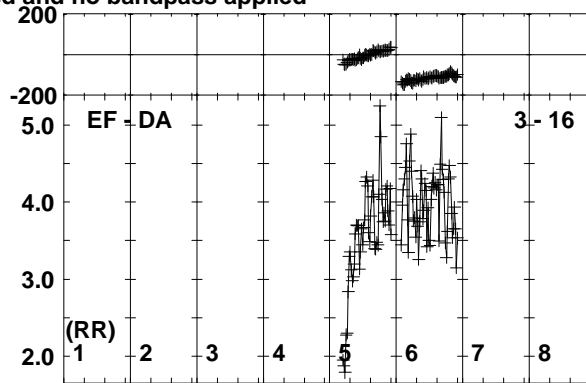
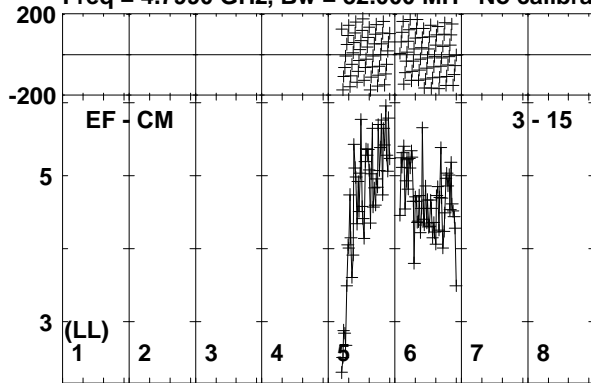

Lower frame: Milli Ampl Jy Top frame: Phas deg
Vector averaged cross-power spectrum Baseline: EF (03) - CM (15)
Timerange: 01/03:17:36 to 01/03:18:34

Plot file version 427 created 26-SEP-2019 10:42:30

190829A RG010A.UVDATA.1

Freq = 4.7990 GHz, Bw = 32.000 MH No calibration applied and no bandpass applied

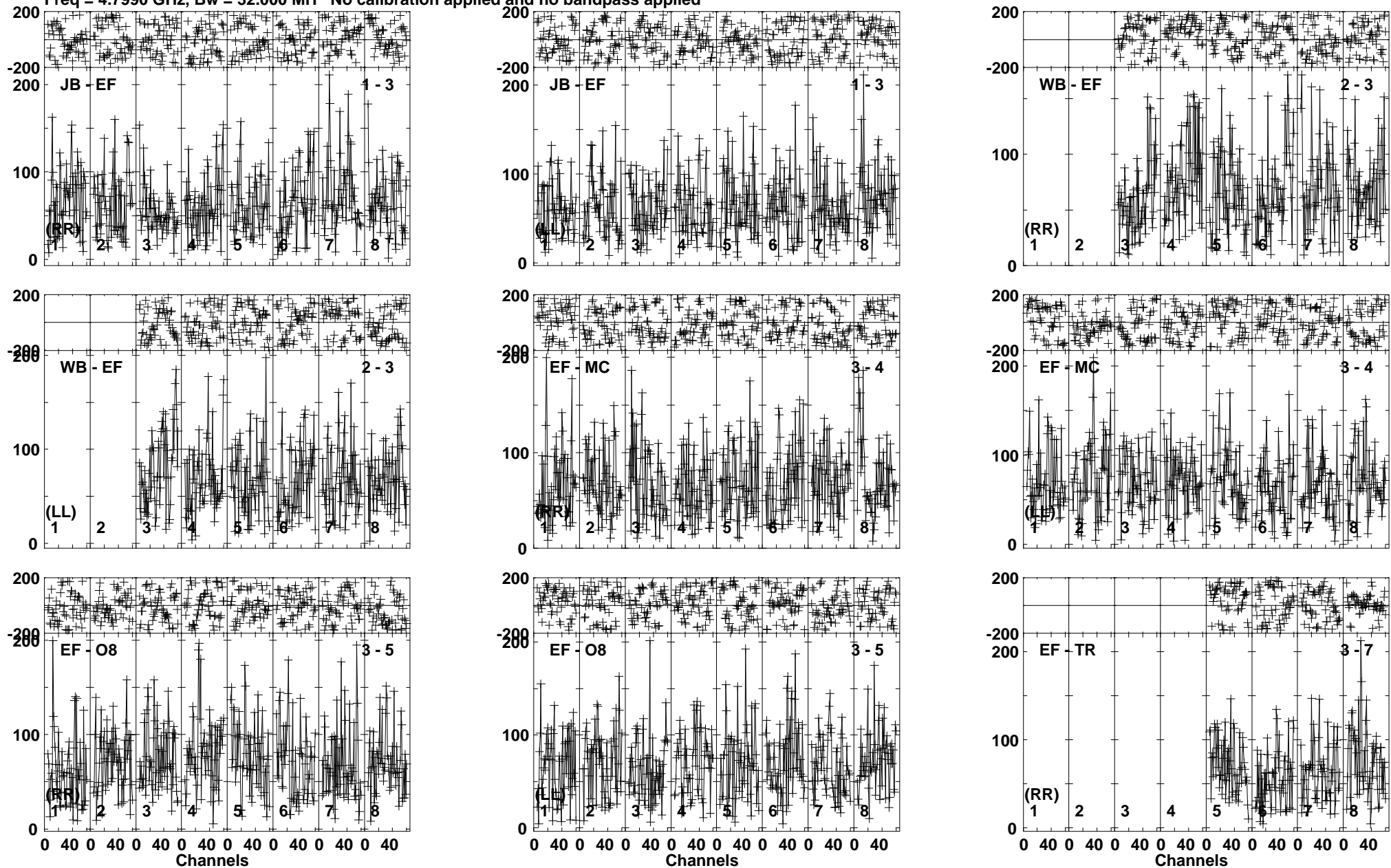

Lower frame: Micro Ampl Jy Top frame: Phas deg
Vector averaged cross-power spectrum Baseline: JB (01) - EF (03)
Timerange: 01/03:18:35 to 01/03:23:34

Plot file version 428 created 26-SEP-2019 10:42:30

190829A RG010A.UVDATA.1

Freq = 4.7990 GHz, Bw = 32.000 MH No calibration applied and no bandpass applied

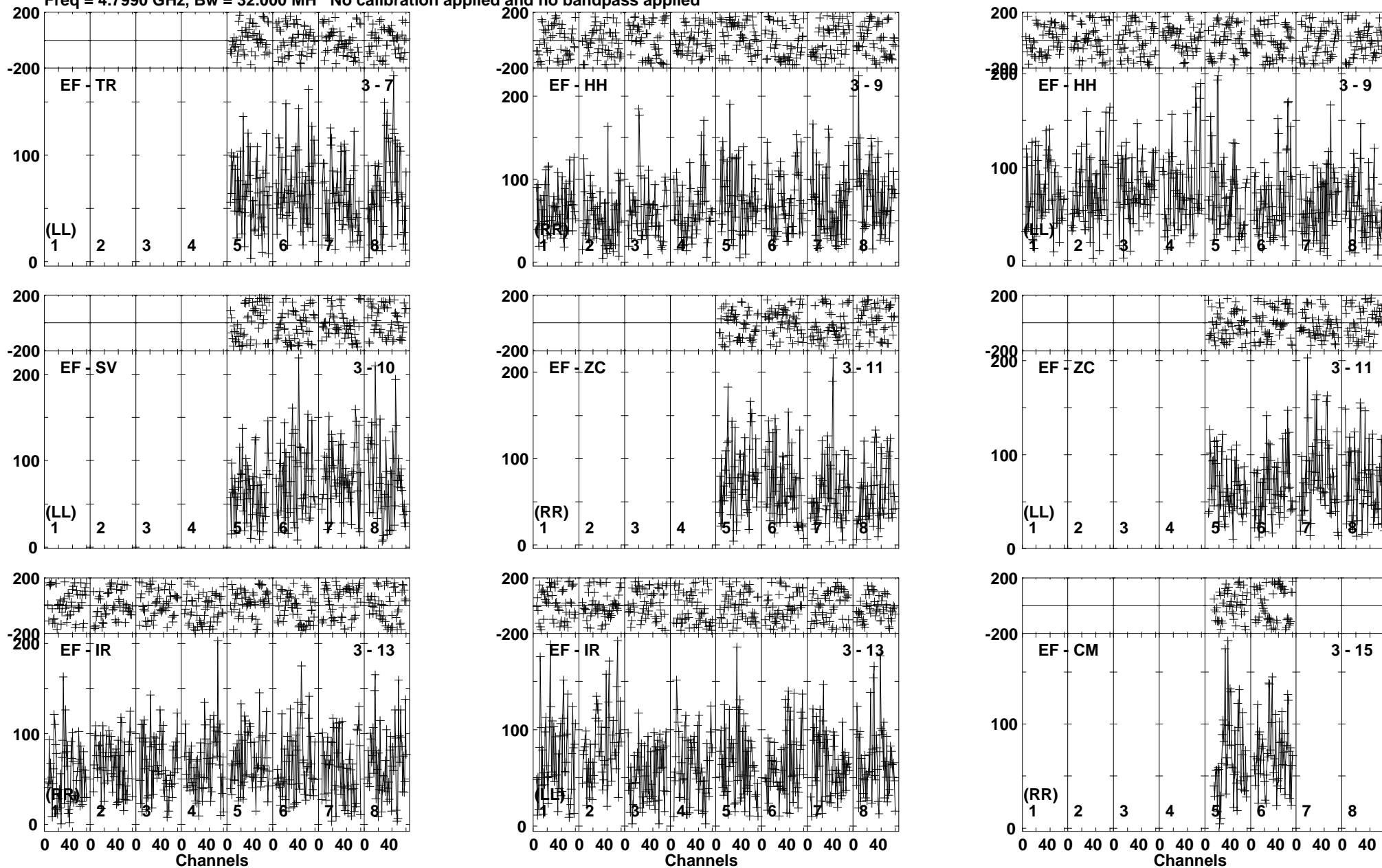

Lower frame: Micro Ampl Jy Top frame: Phas deg
Vector averaged cross-power spectrum Baseline: EF (03) - TR (07)
Timerange: 01/03:18:35 to 01/03:23:34

Plot file version 429 created 26-SEP-2019 10:42:31

190829A RG010A.UVDATA.1

Freq = 4.7990 GHz, Bw = 32.000 MH No calibration applied and no bandpass applied

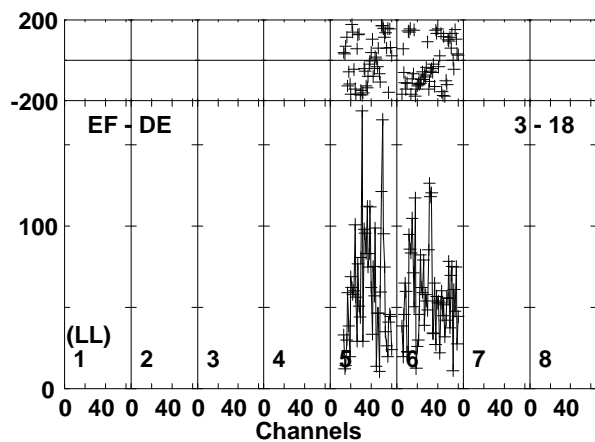
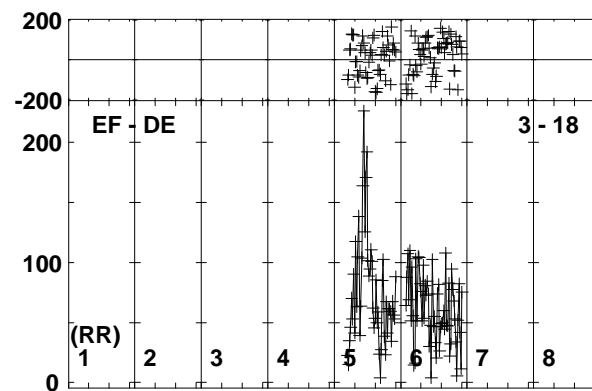
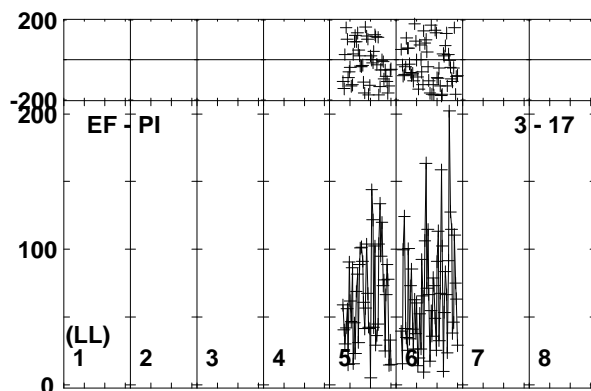
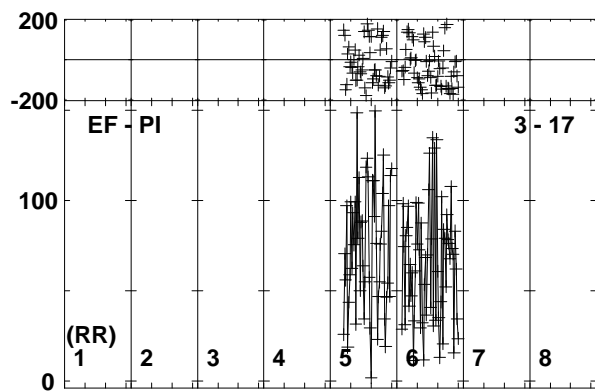
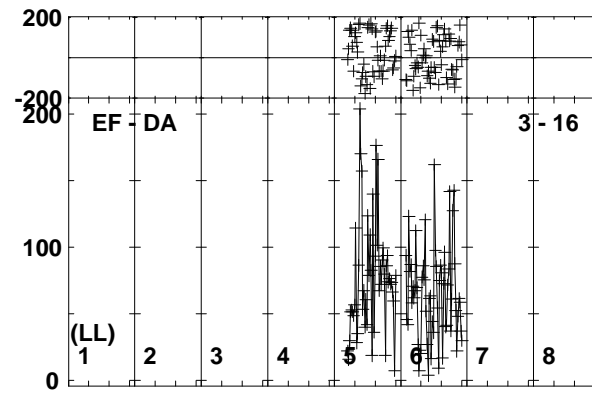
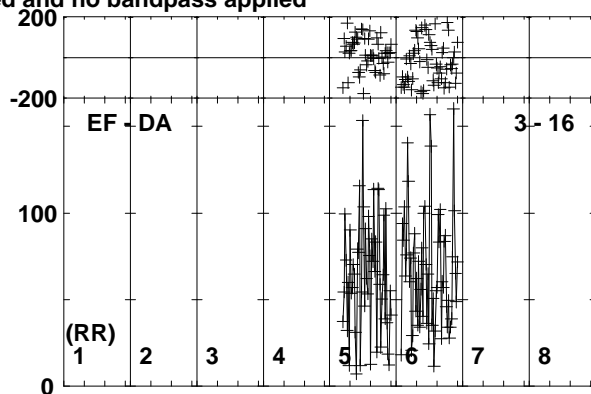
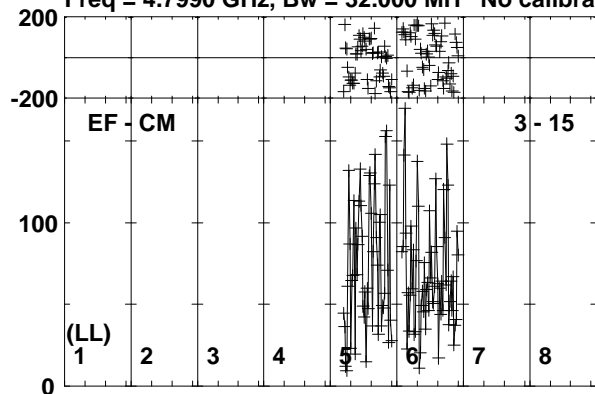

Lower frame: Micro Ampl Jy Top frame: Phas deg
Vector averaged cross-power spectrum Baseline: EF (03) - CM (15)
Timerange: 01/03:18:35 to 01/03:23:34

Plot file version 430 created 26-SEP-2019 10:42:32

J0257-1212 RG010A.UVDATA.1

Freq = 4.7990 GHz, Bw = 32.000 MH No calibration applied and no bandpass applied

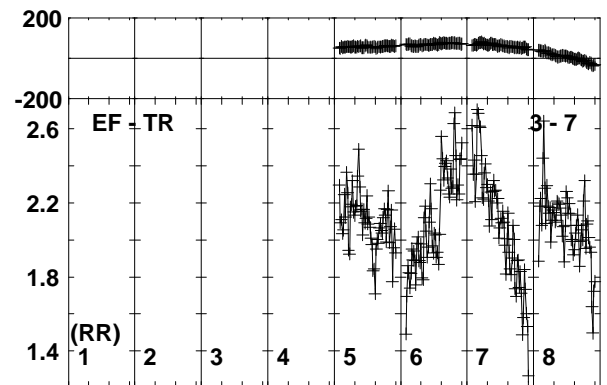
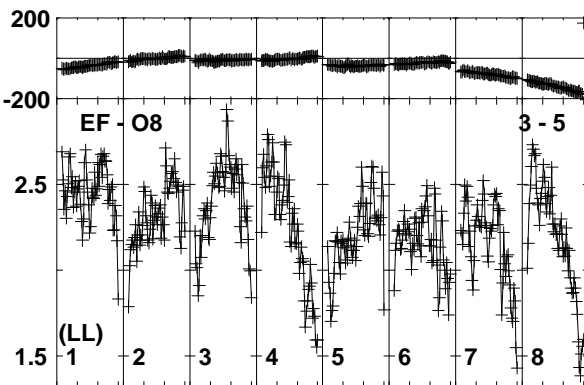
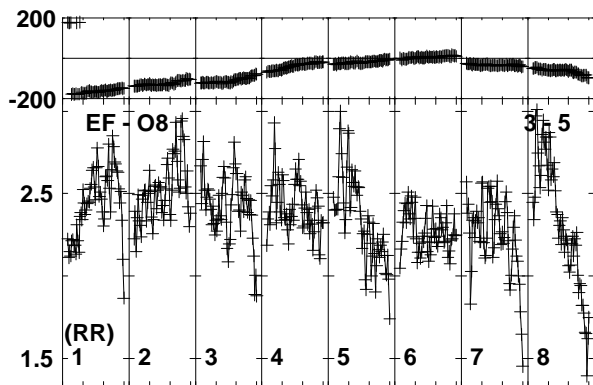
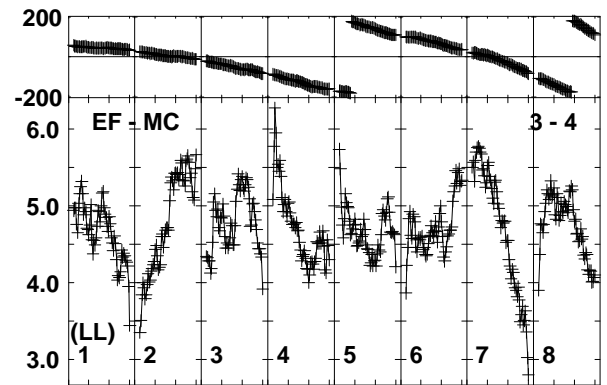
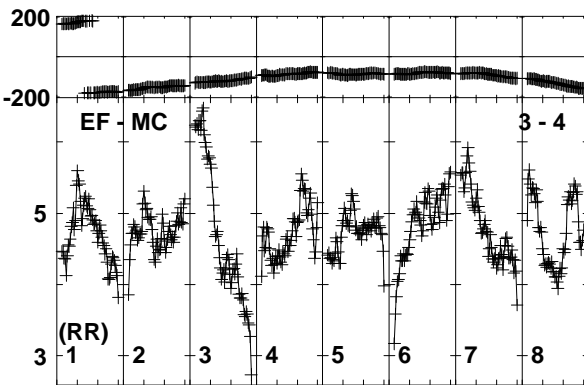
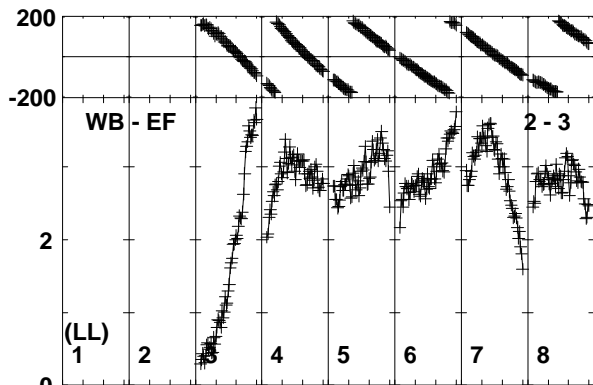
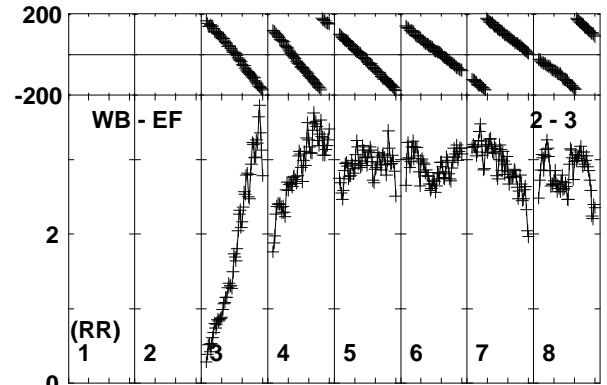
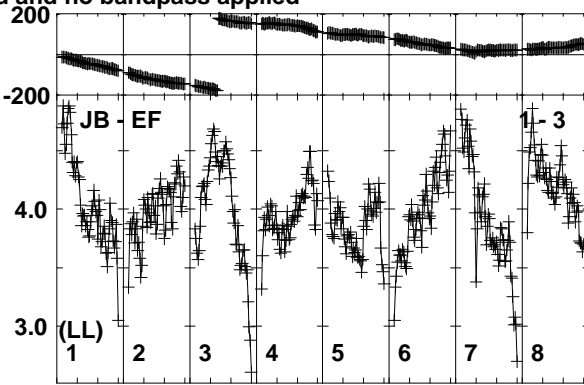
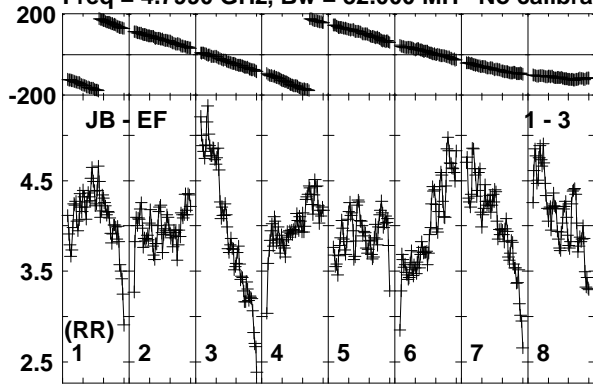

Lower frame: Milli Ampl Jy Top frame: Phas deg
Vector averaged cross-power spectrum Baseline: JB (01) - EF (03)
Timerange: 01/03:24:15 to 01/03:25:14

Plot file version 431 created 26-SEP-2019 10:42:32

J0257-1212 RG010A.UVDATA.1

Freq = 4.7990 GHz, Bw = 32.000 MH No calibration applied and no bandpass applied

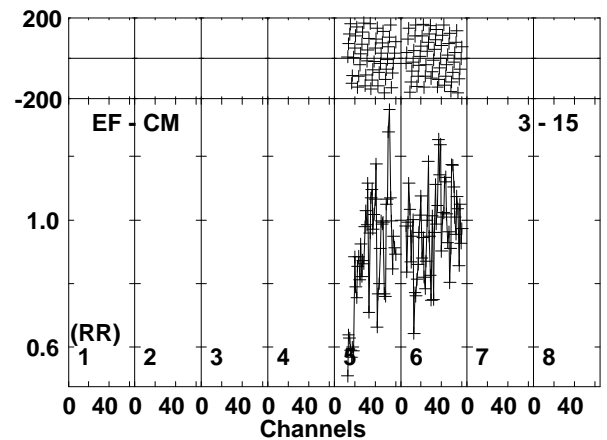
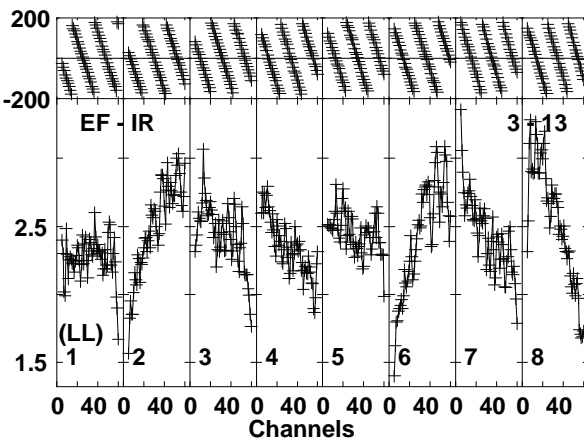
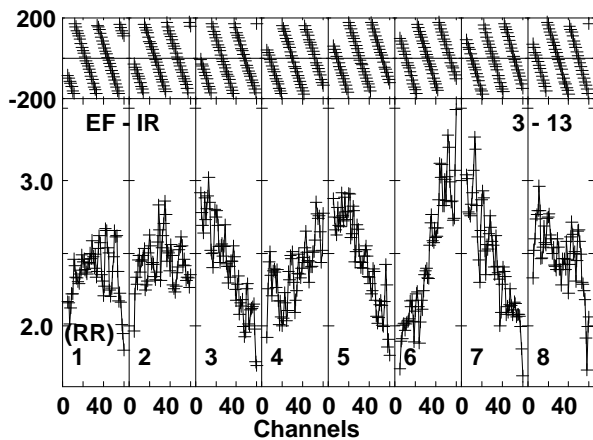
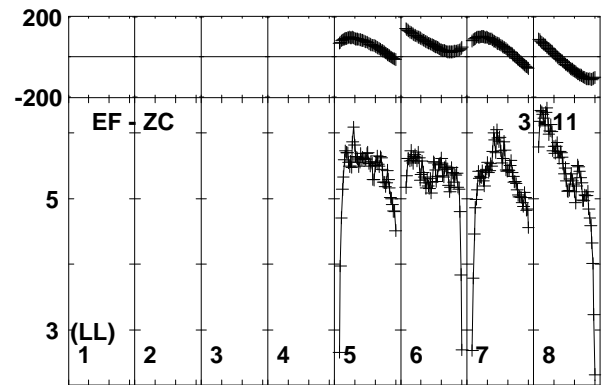
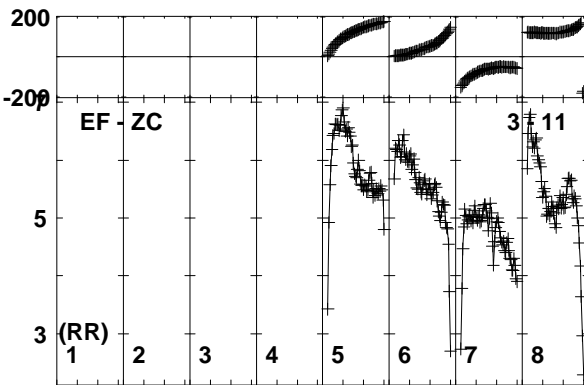
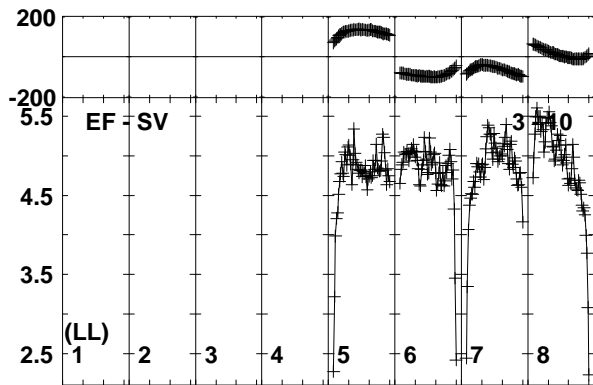
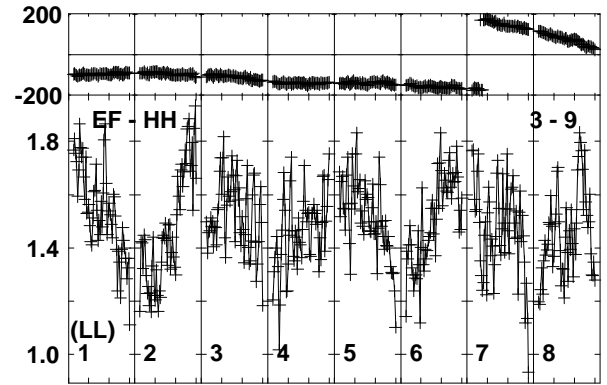
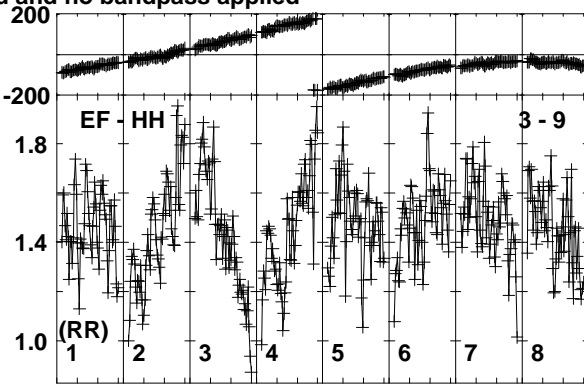
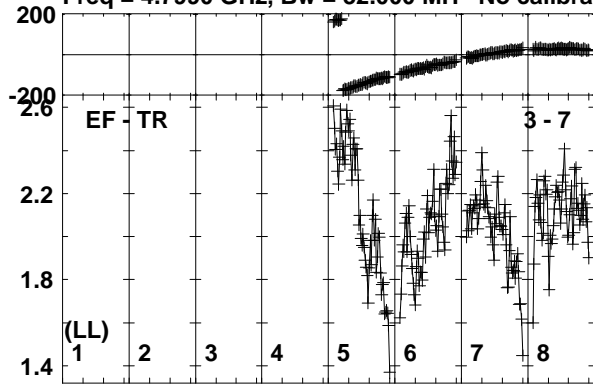

Lower frame: Milli Ampl Jy Top frame: Phas deg
Vector averaged cross-power spectrum Baseline: EF (03) - TR (07)
Timerange: 01/03:24:15 to 01/03:25:14

Plot file version 432 created 26-SEP-2019 10:42:33

J0257-1212 RG010A.UVDATA.1

Freq = 4.7990 GHz, Bw = 32.000 MH No calibration applied and no bandpass applied

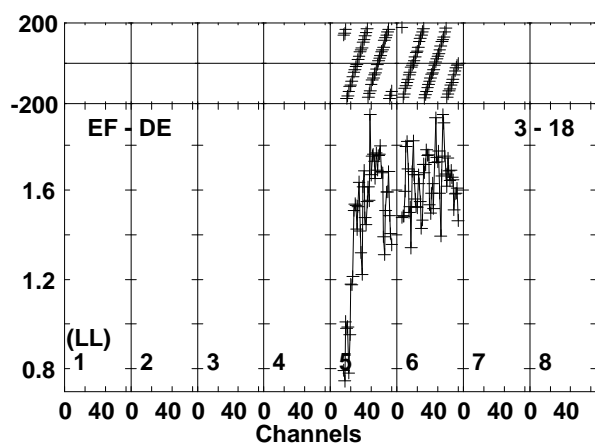
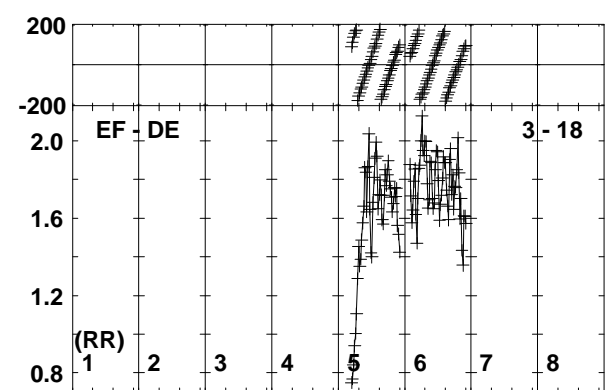
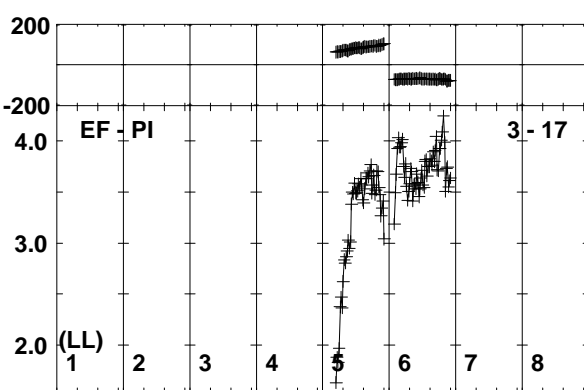
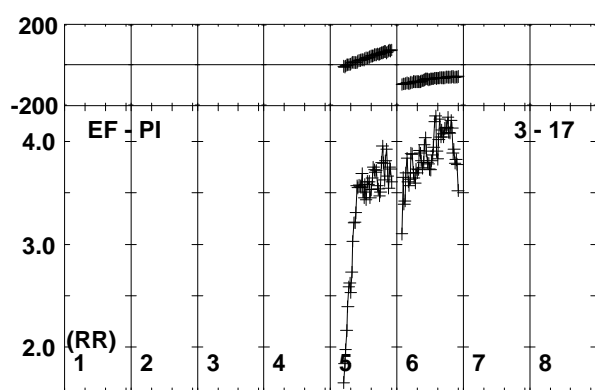
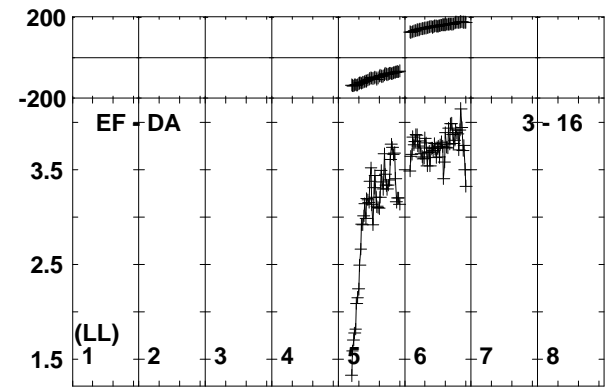
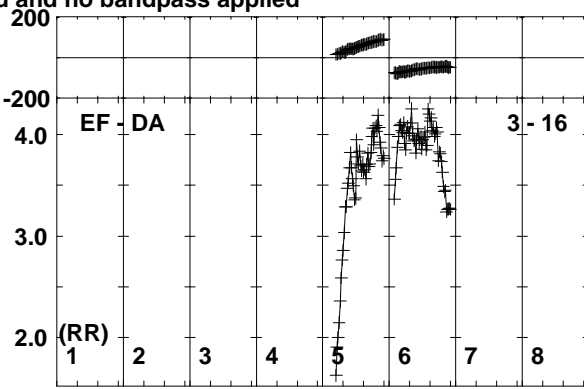
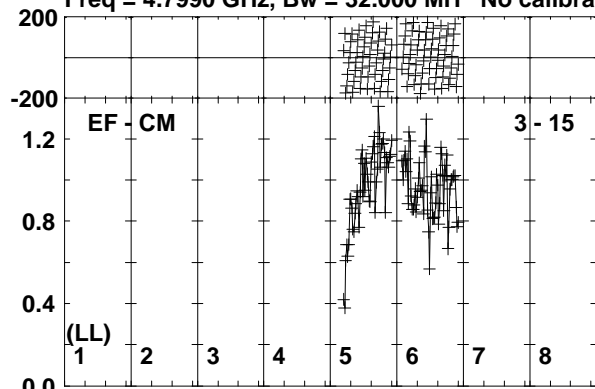

Lower frame: Milli Ampl Jy Top frame: Phas deg
Vector averaged cross-power spectrum Baseline: EF (03) - CM (15)
Timerange: 01/03:24:15 to 01/03:25:14

Plot file version 433 created 26-SEP-2019 10:42:33

190829A RG010A.UVDATA.1

Freq = 4.7990 GHz, Bw = 32.000 MH No calibration applied and no bandpass applied

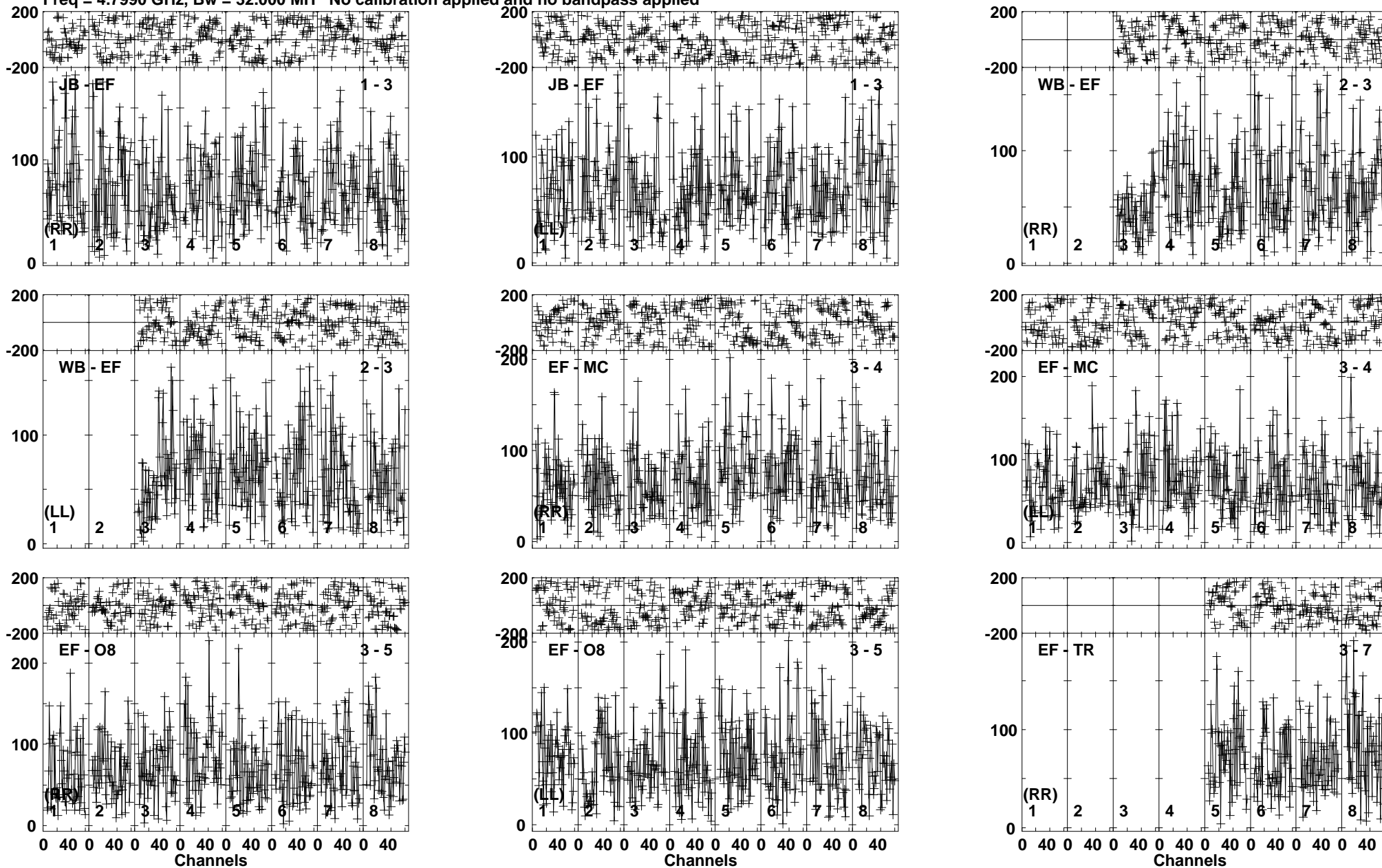

Lower frame: Micro Ampl Jy Top frame: Phas deg
Vector averaged cross-power spectrum Baseline: JB (01) - EF (03)
Timerange: 01/03:25:15 to 01/03:30:14

Plot file version 434 created 26-SEP-2019 10:42:34

190829A RG010A.UVDATA.1

Freq = 4.7990 GHz, Bw = 32.000 MH No calibration applied and no bandpass applied

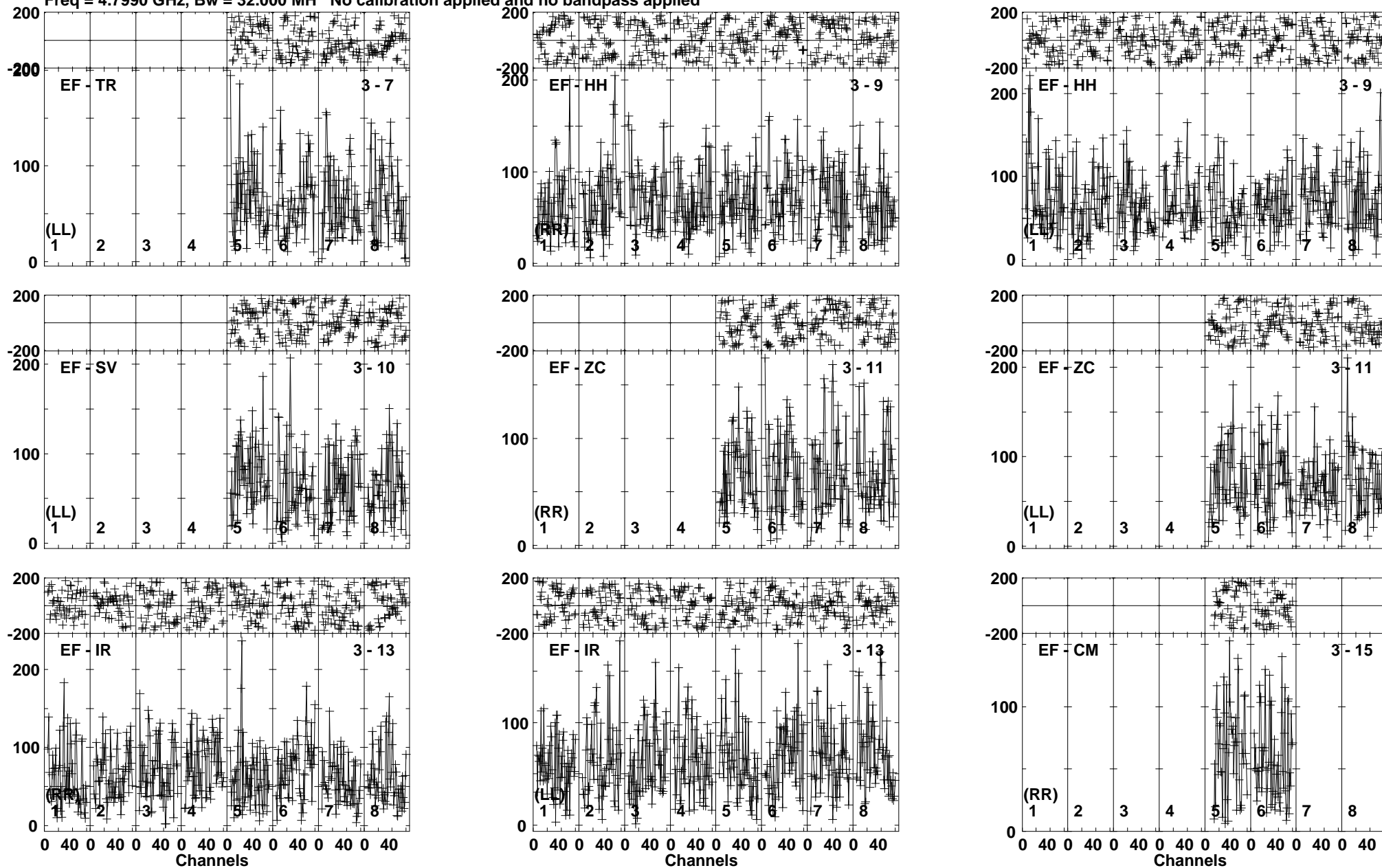

Lower frame: Micro Ampl Jy Top frame: Phas deg
Vector averaged cross-power spectrum Baseline: EF (03) - TR (07)
Timerange: 01/03:25:15 to 01/03:30:14

Plot file version 435 created 26-SEP-2019 10:42:35

190829A RG010A.UVDATA.1

Freq = 4.7990 GHz, Bw = 32.000 MH No calibration applied and no bandpass applied

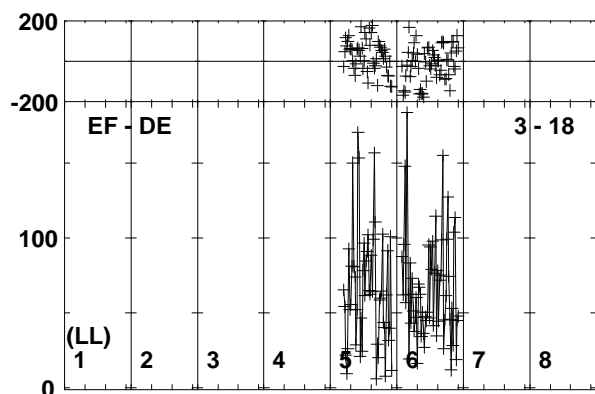
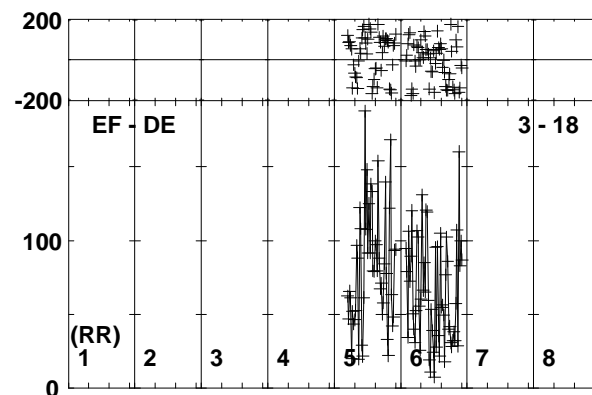
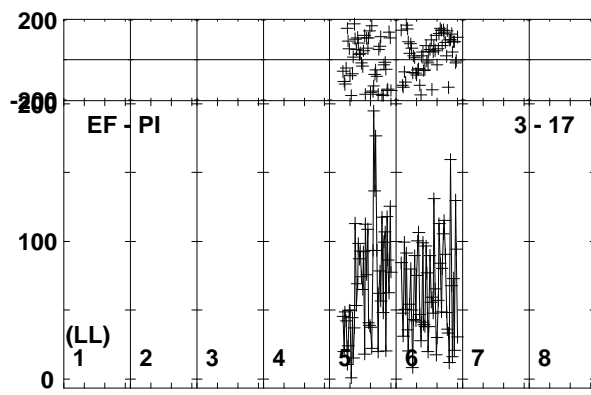
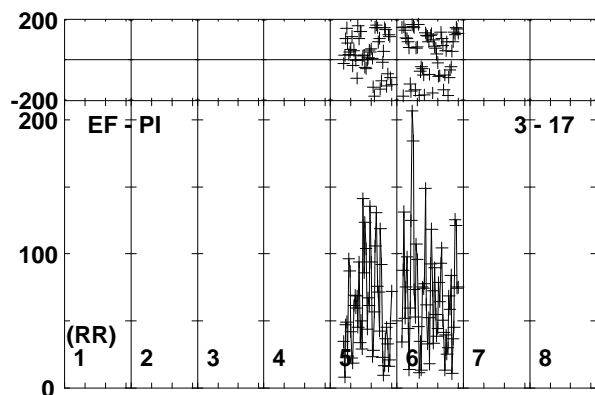
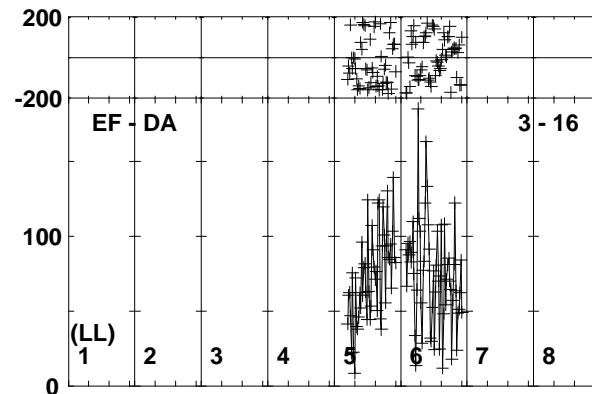
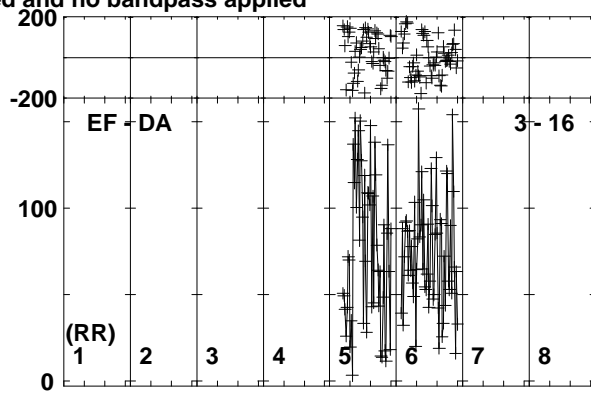
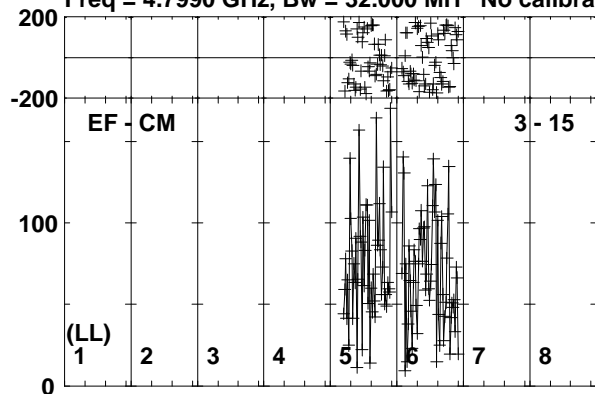

Lower frame: Micro Ampl Jy Top frame: Phas deg
Vector averaged cross-power spectrum Baseline: EF (03) - CM (15)
Timerange: 01/03:25:15 to 01/03:30:14

Plot file version 436 created 26-SEP-2019 10:42:35

J0257-1212 RG010A.UVDATA.1

Freq = 4.7990 GHz, Bw = 32.000 MH No calibration applied and no bandpass applied

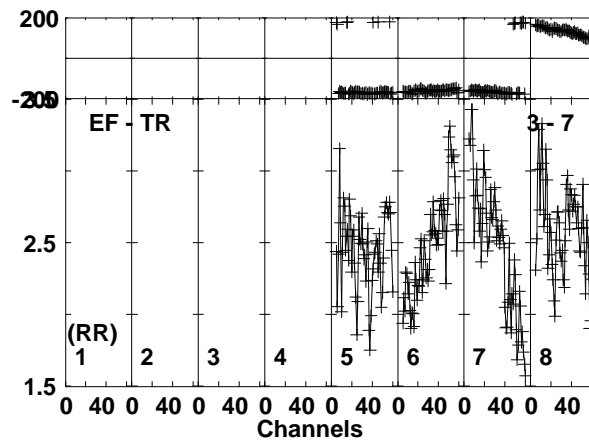
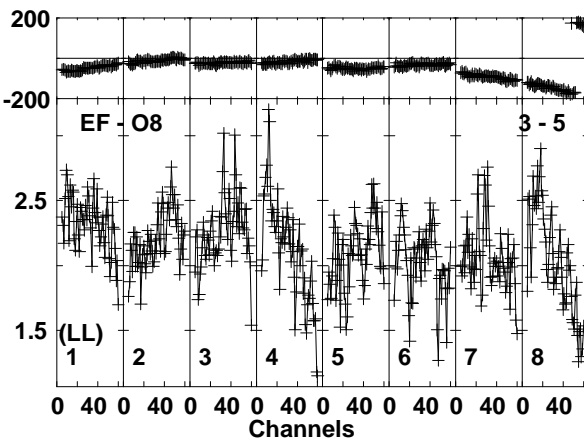
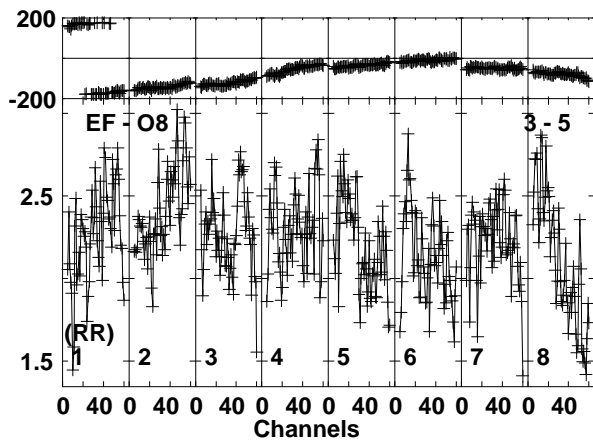
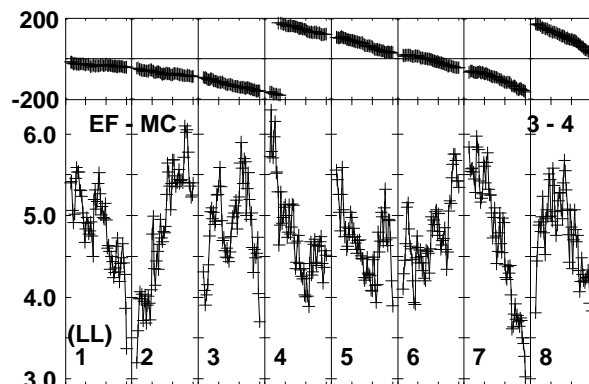
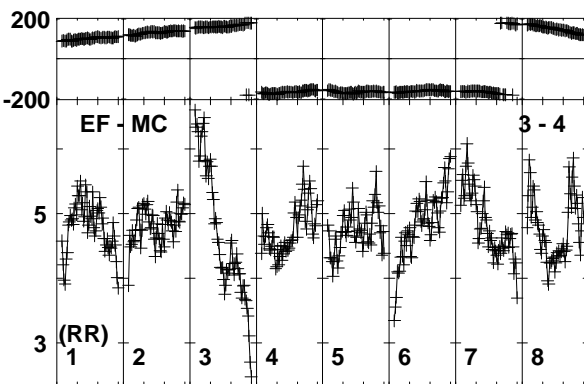
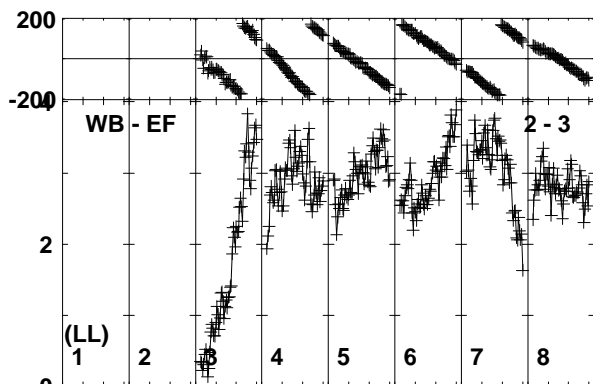
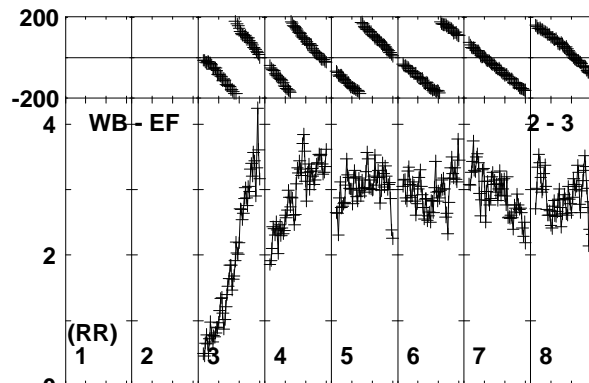
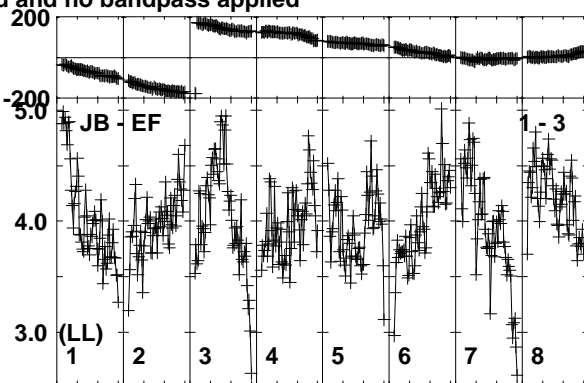
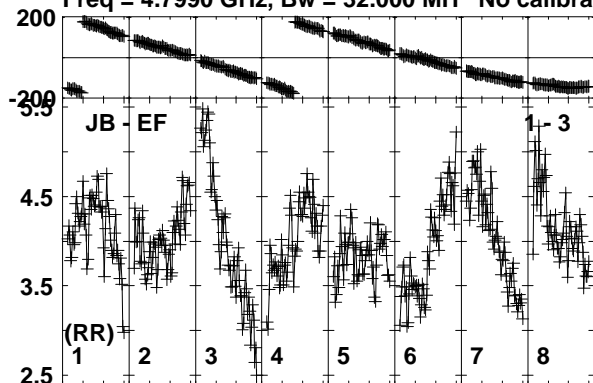

Lower frame: Milli Ampl Jy Top frame: Phas deg
Vector averaged cross-power spectrum Baseline: JB (01) - EF (03)
Timerange: 01/03:30:55 to 01/03:31:25

Plot file version 437 created 26-SEP-2019 10:42:36

J0257-1212 RG010A.UVDATA.1

Freq = 4.7990 GHz, Bw = 32.000 MH No calibration applied and no bandpass applied

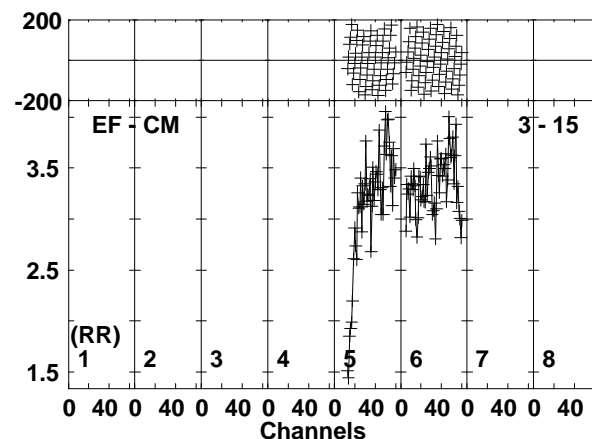
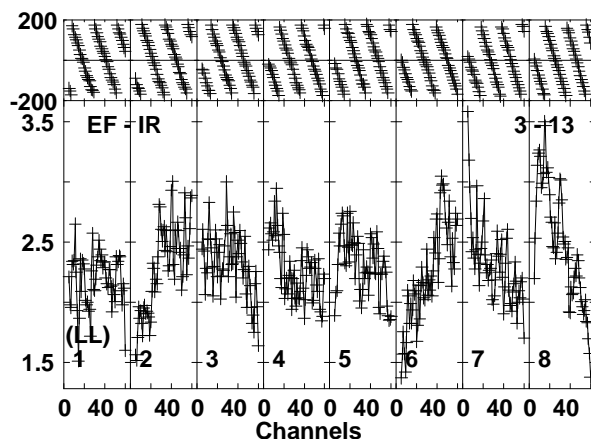
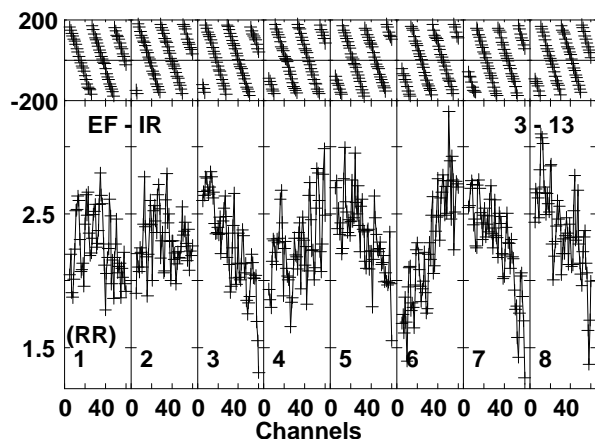
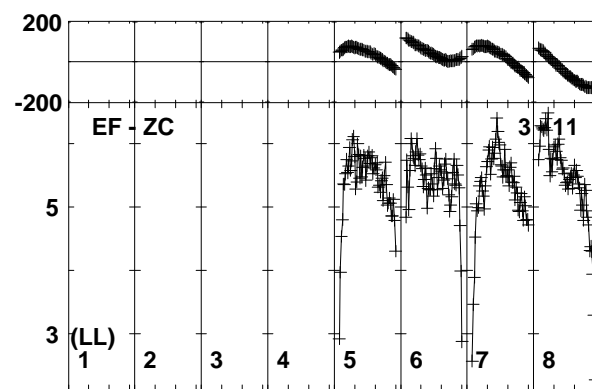
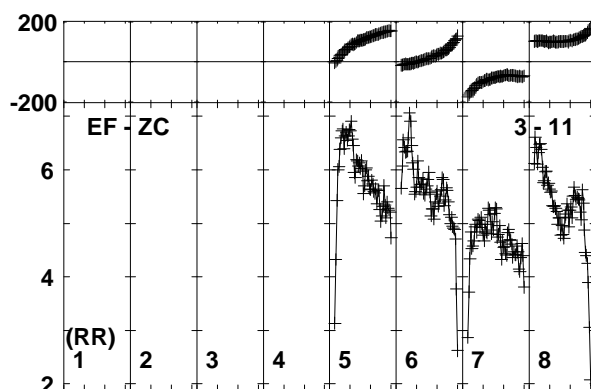
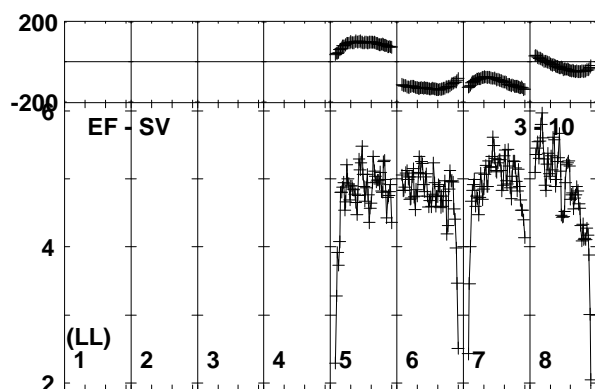
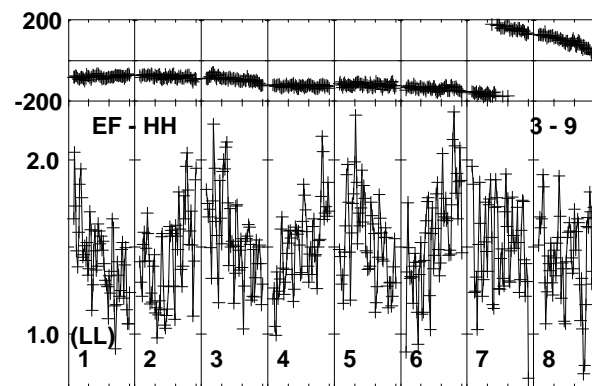
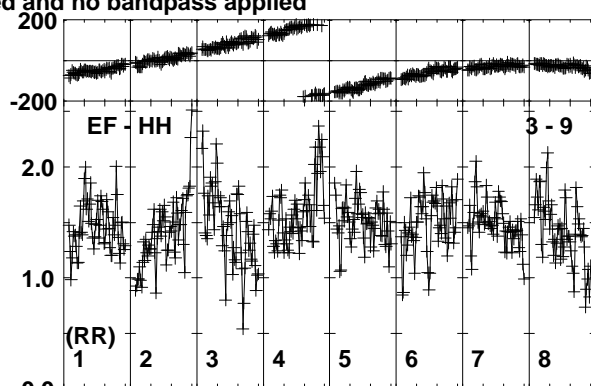
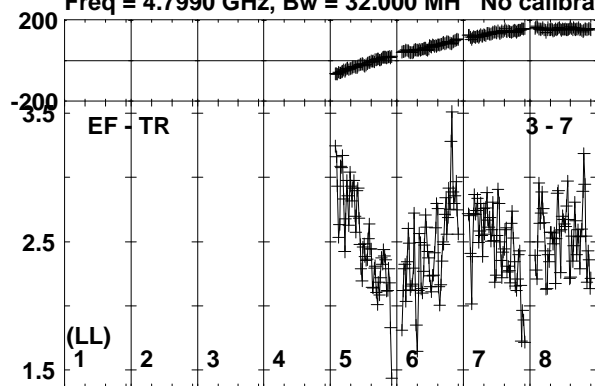

Lower frame: Milli Ampl Jy Top frame: Phas deg
Vector averaged cross-power spectrum Baseline: EF (03) - TR (07)
Timerange: 01/03:30:55 to 01/03:31:25

Plot file version 438 created 26-SEP-2019 10:42:36

J0257-1212 RG010A.UVDATA.1

Freq = 4.7990 GHz, Bw = 32.000 MH No calibration applied and no bandpass applied

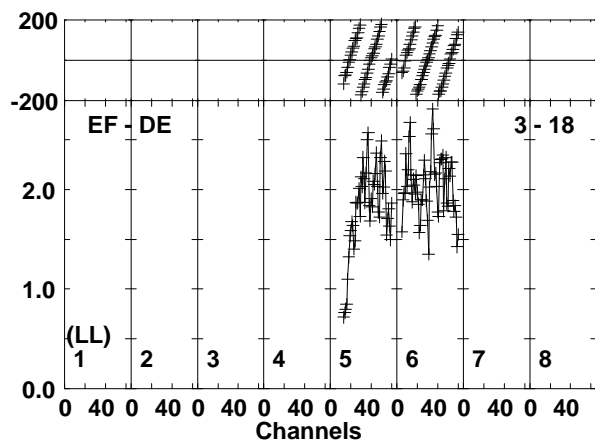
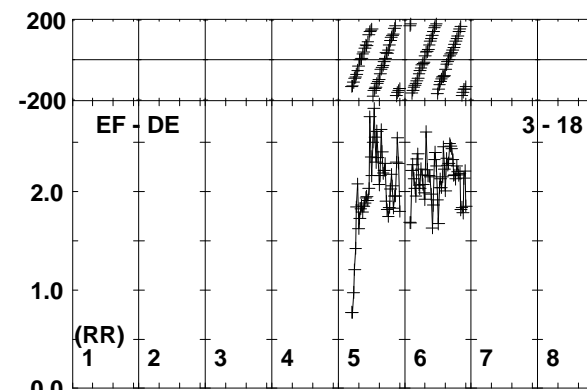
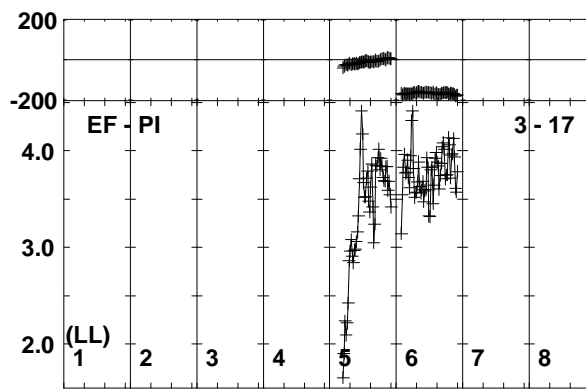
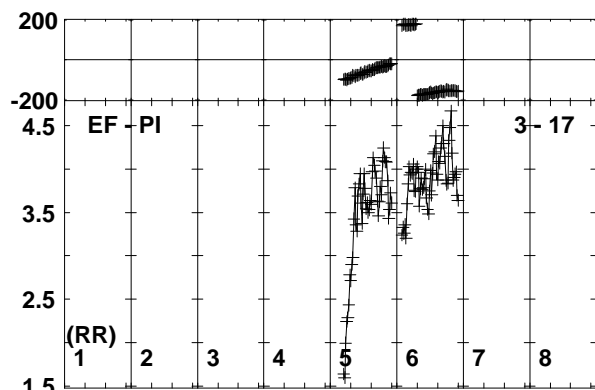
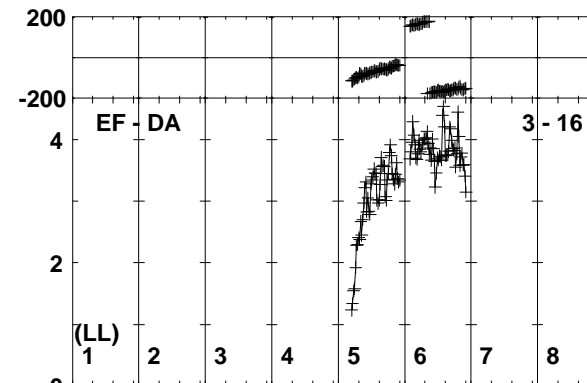
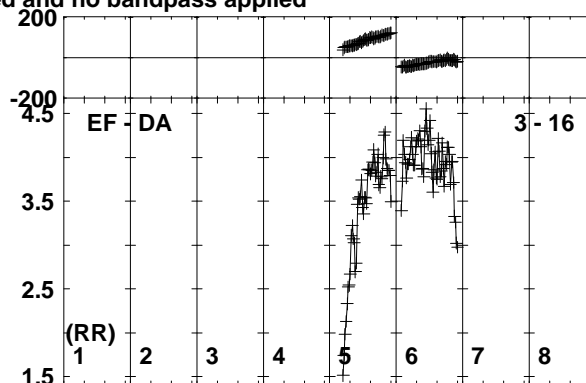
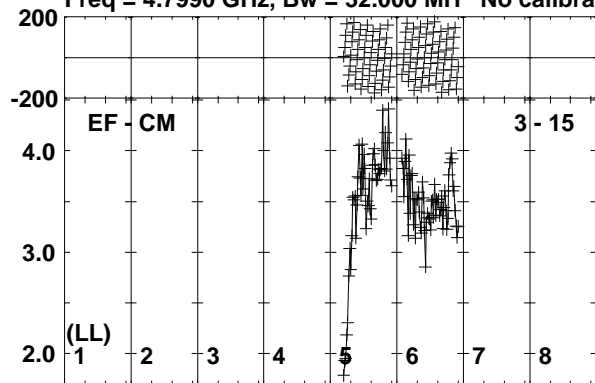

Lower frame: Milli Ampl Jy Top frame: Phas deg
Vector averaged cross-power spectrum Baseline: EF (03) - CM (15)
Timerange: 01/03:30:55 to 01/03:31:25

Plot file version 439 created 26-SEP-2019 10:42:36

J0300-0846 RG010A.UVDATA.1

Freq = 4.7990 GHz, Bw = 32.000 MH No calibration applied and no bandpass applied

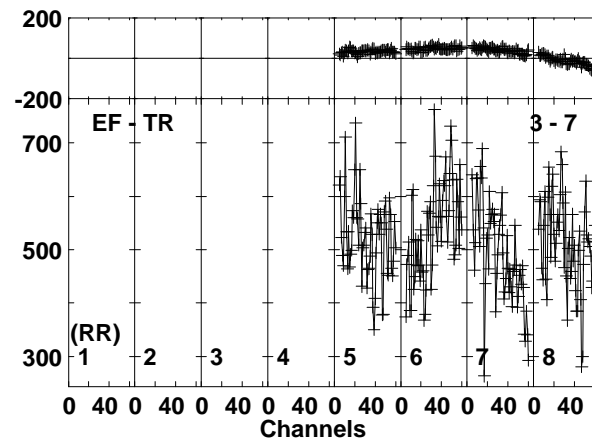
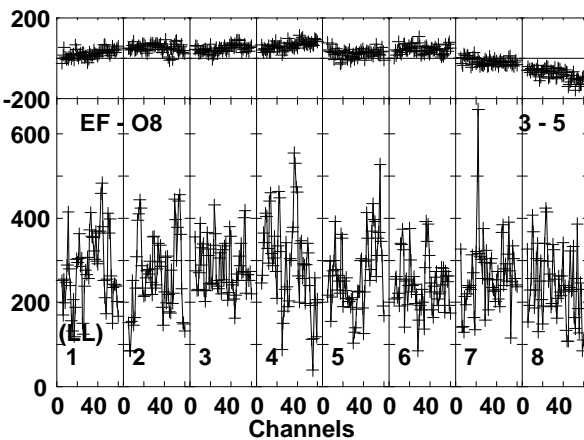
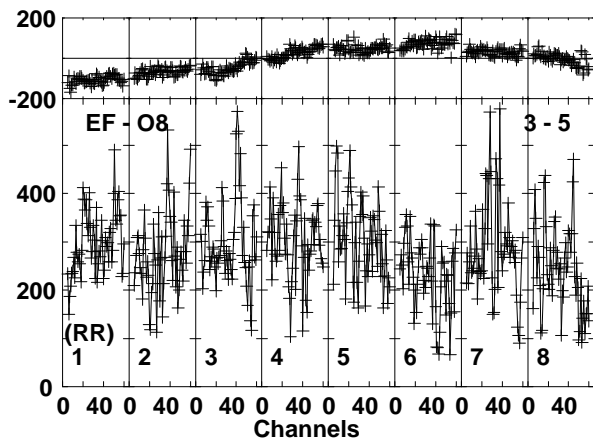
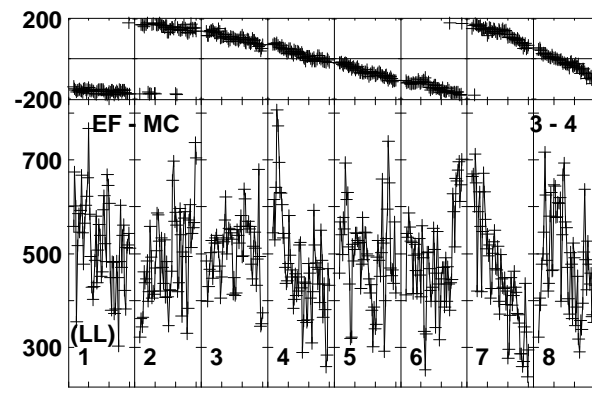
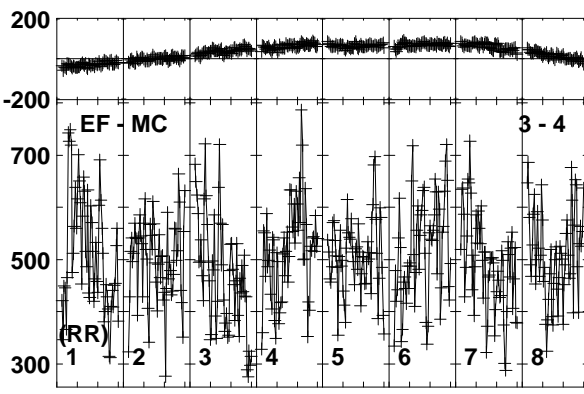
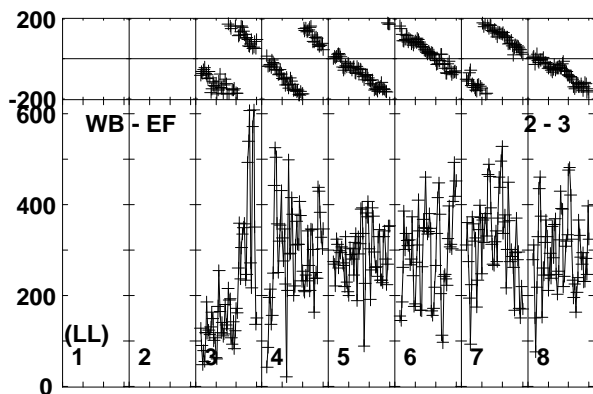
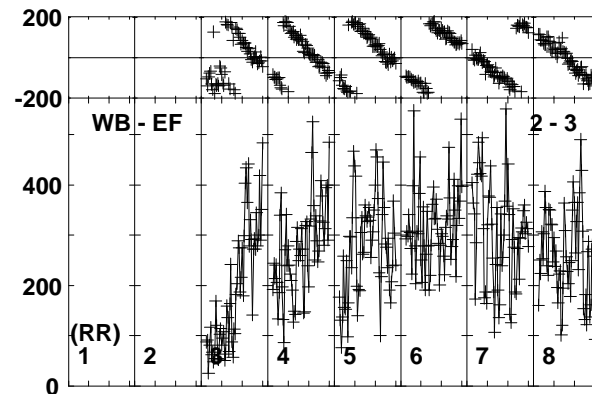
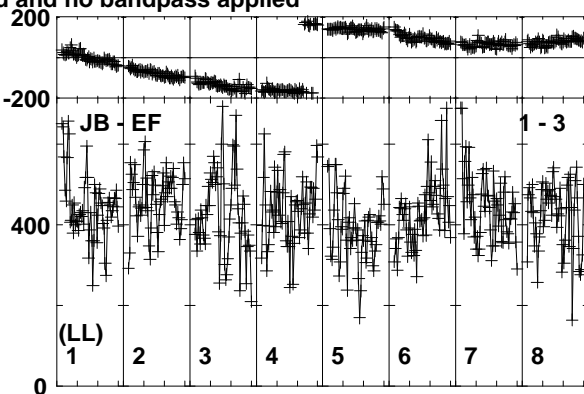
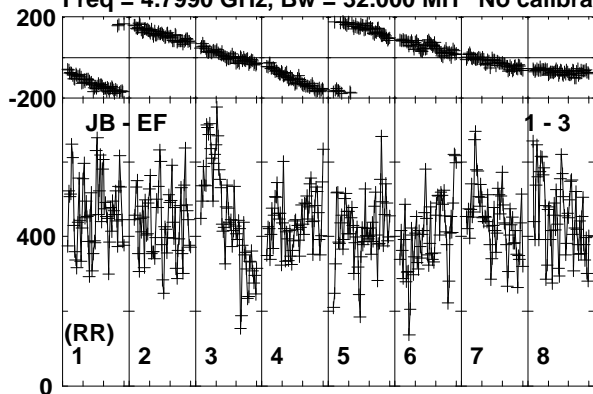

Lower frame: Micro Ampl Jy Top frame: Phas deg
Vector averaged cross-power spectrum Baseline: JB (01) - EF (03)
Timerange: 01/03:31:26 to 01/03:33:54

Plot file version 440 created 26-SEP-2019 10:42:37

J0300-0846 RG010A.UVDATA.1

Freq = 4.7990 GHz, Bw = 32.000 MH No calibration applied and no bandpass applied

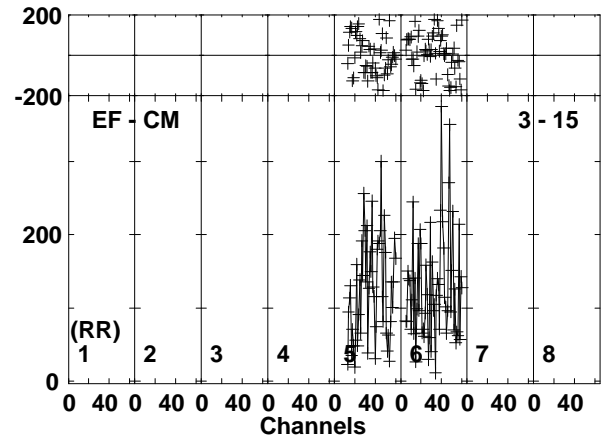
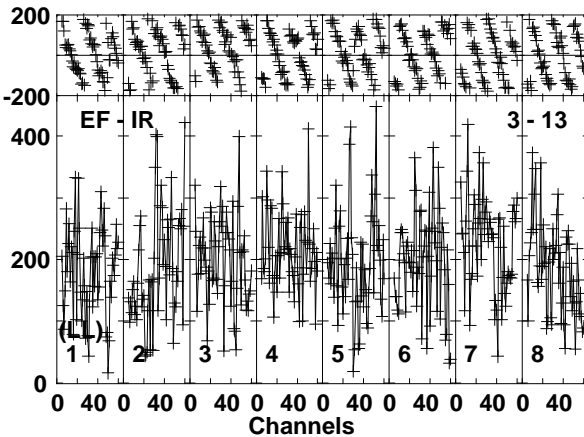
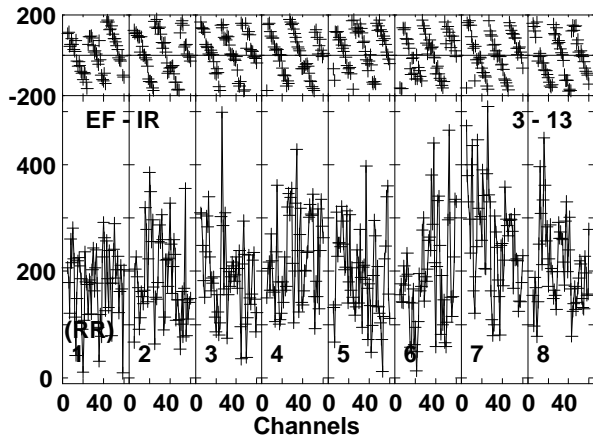
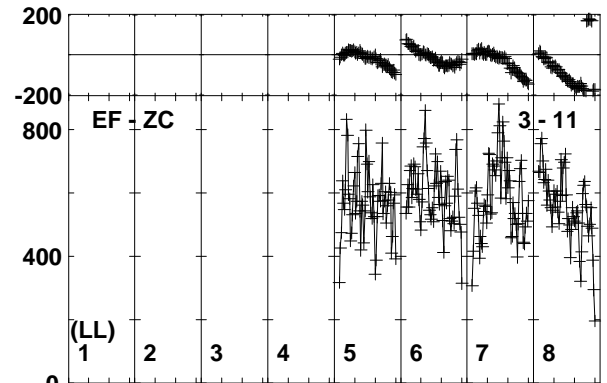
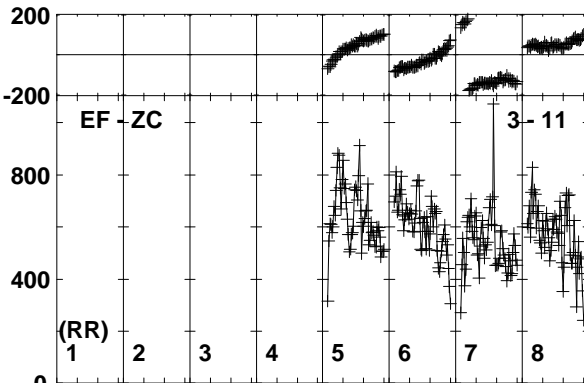
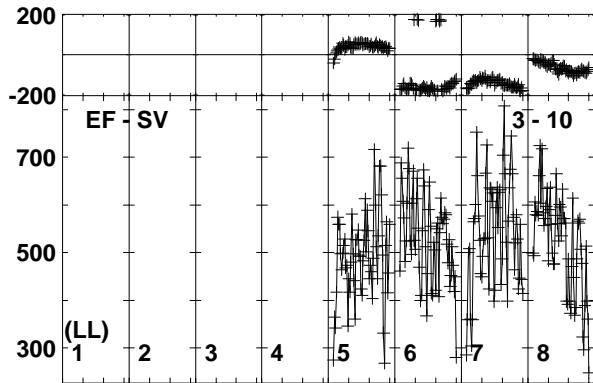
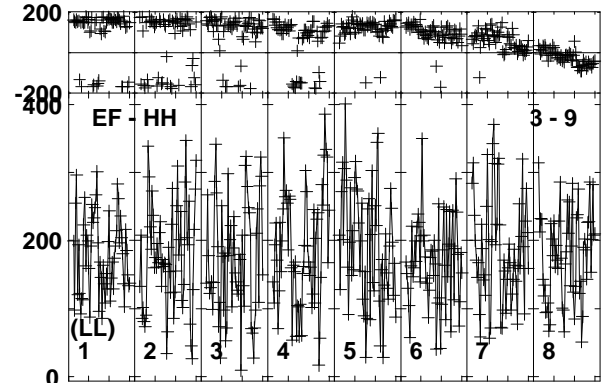
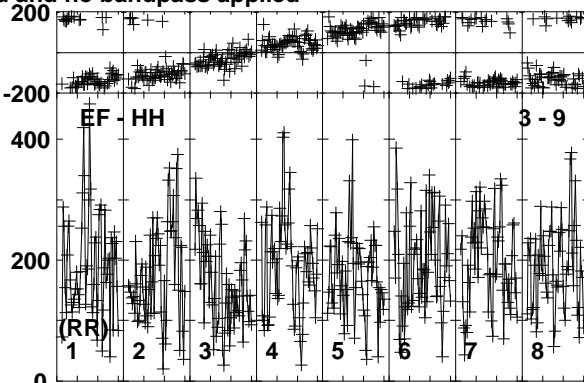
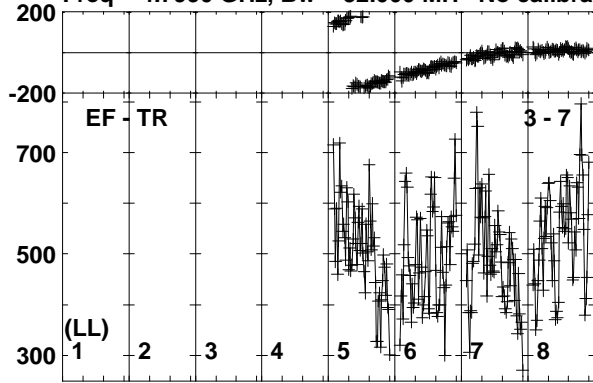

Lower frame: Micro Ampl Jy Top frame: Phas deg
Vector averaged cross-power spectrum Baseline: EF (03) - TR (07)
Timerange: 01/03:31:26 to 01/03:33:54

Plot file version 441 created 26-SEP-2019 10:42:38

J0300-0846 RG010A.UVDATA.1

Freq = 4.7990 GHz, Bw = 32.000 MH No calibration applied and no bandpass applied

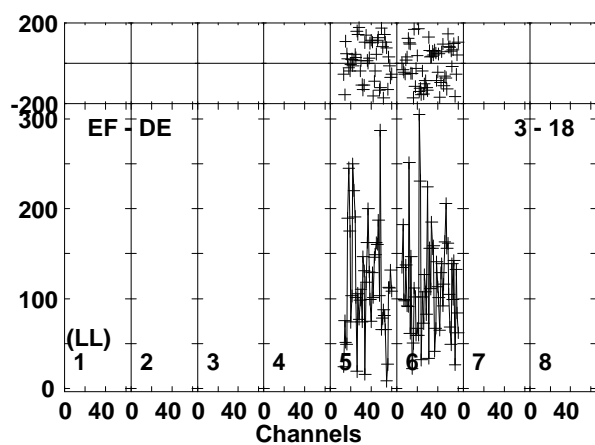
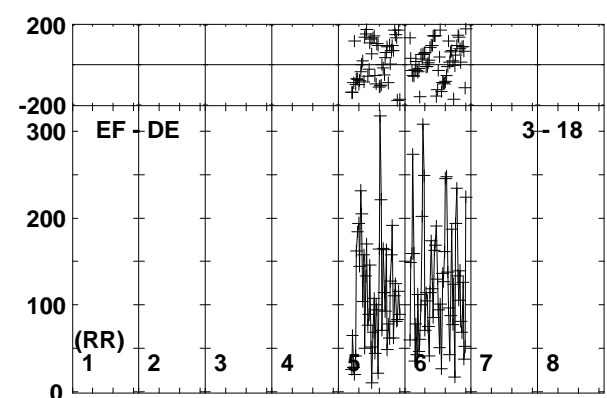
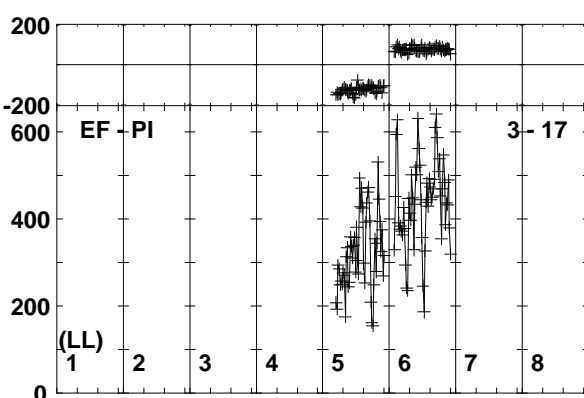
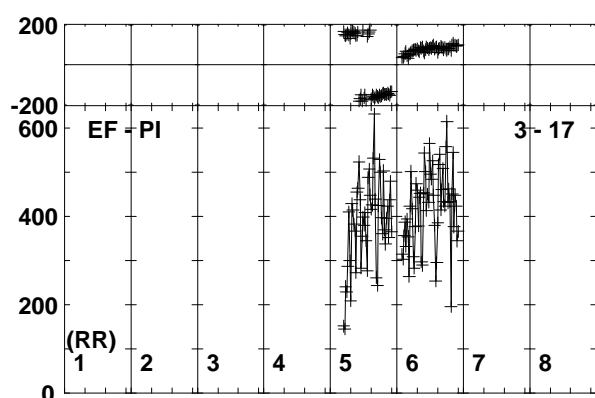
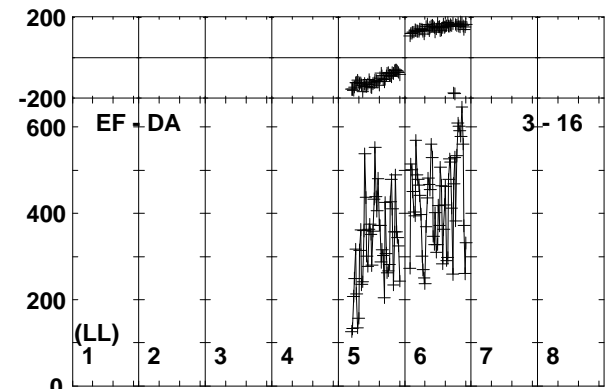
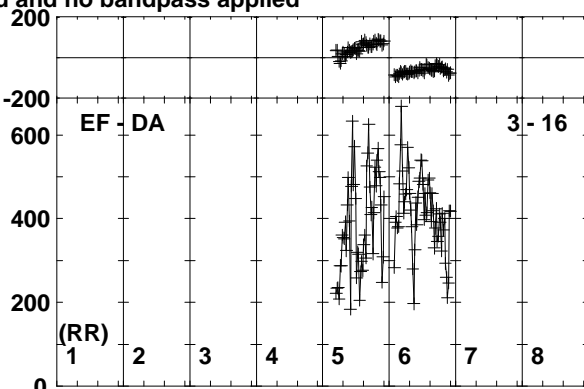
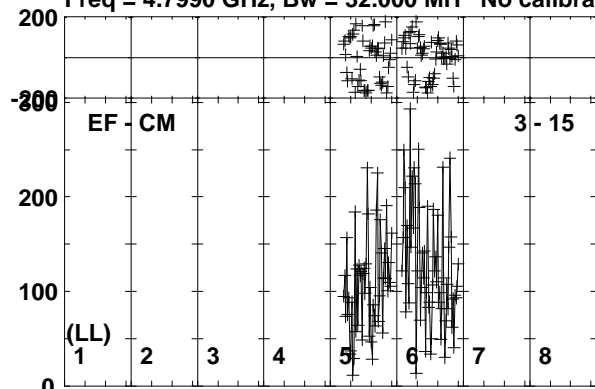

Lower frame: Micro Ampl Jy Top frame: Phas deg
Vector averaged cross-power spectrum Baseline: EF (03) - CM (15)
Timerange: 01/03:31:26 to 01/03:33:54

Plot file version 442 created 26-SEP-2019 10:42:38

190829A RG010A.UVDATA.1

Freq = 4.7990 GHz, Bw = 32.000 MH No calibration applied and no bandpass applied

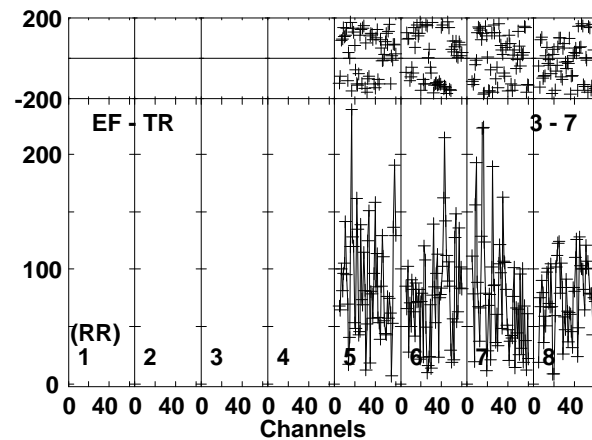
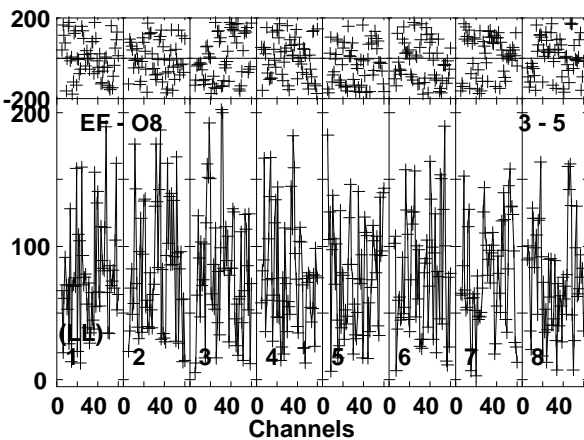
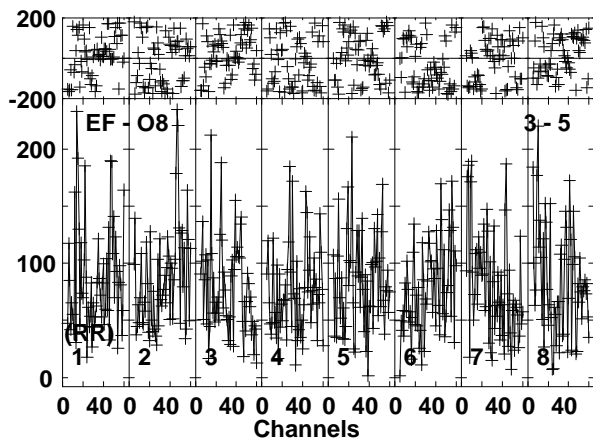
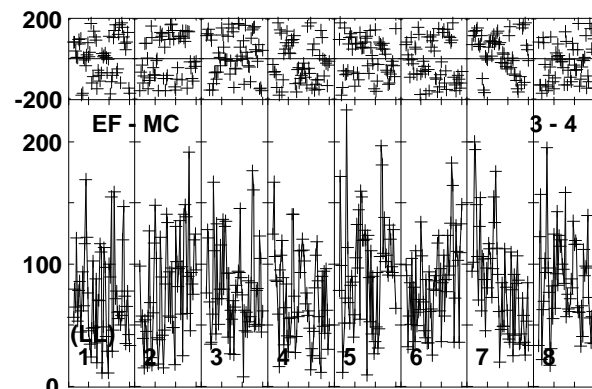
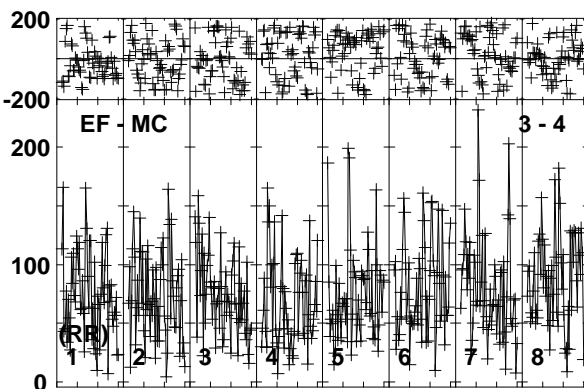
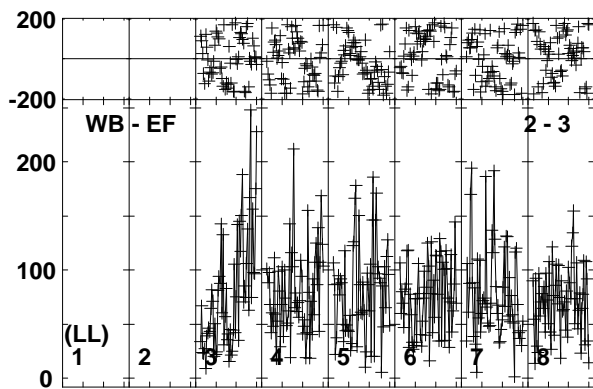
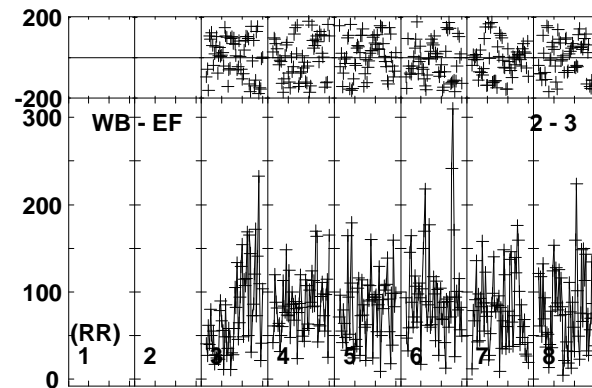
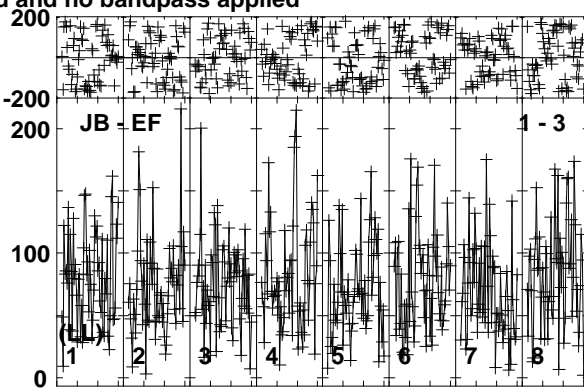
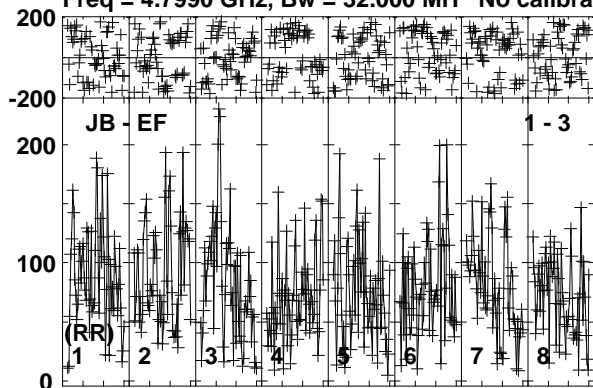

Lower frame: Micro Ampl Jy Top frame: Phas deg
Vector averaged cross-power spectrum Baseline: JB (01) - EF (03)
Timerange: 01/03:33:56 to 01/03:37:25

Plot file version 443 created 26-SEP-2019 10:42:39

190829A RG010A.UVDATA.1

Freq = 4.7990 GHz, Bw = 32.000 MH No calibration applied and no bandpass applied

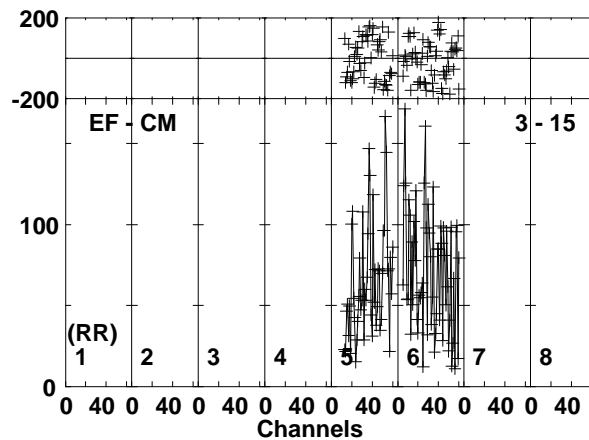
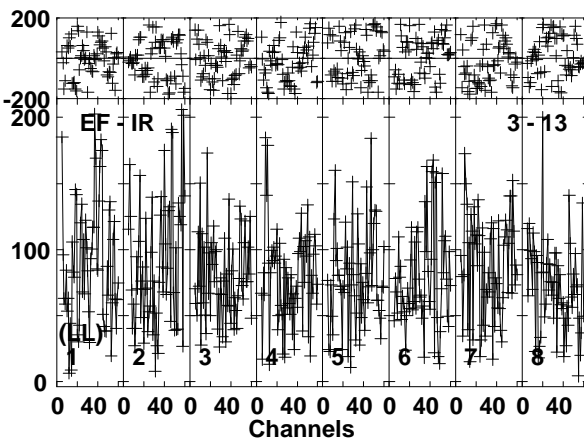
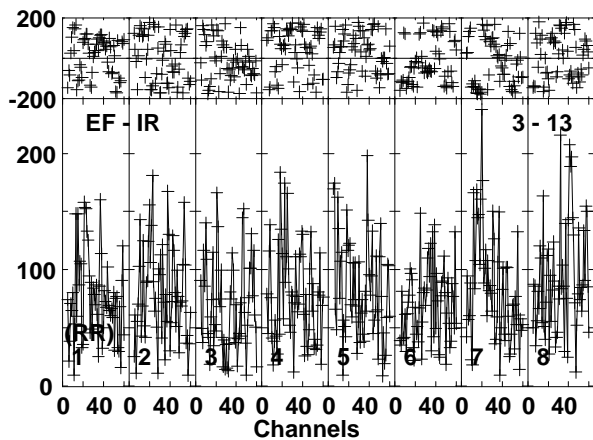
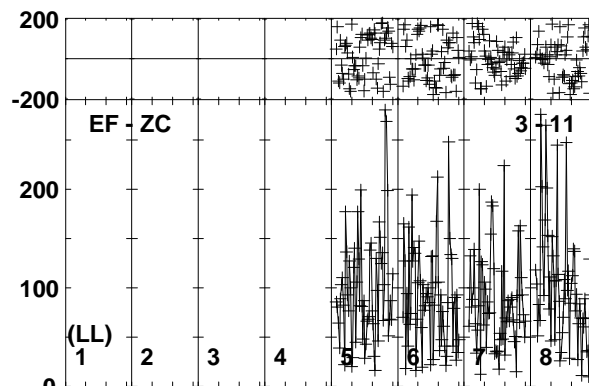
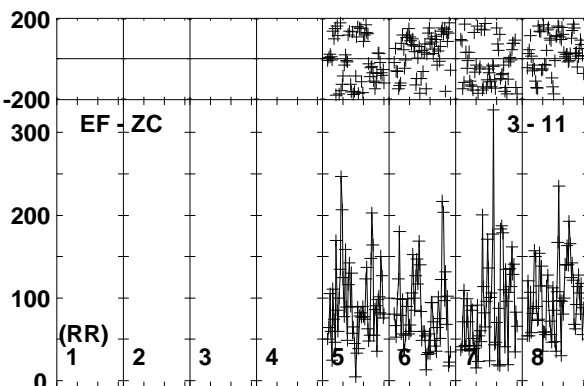
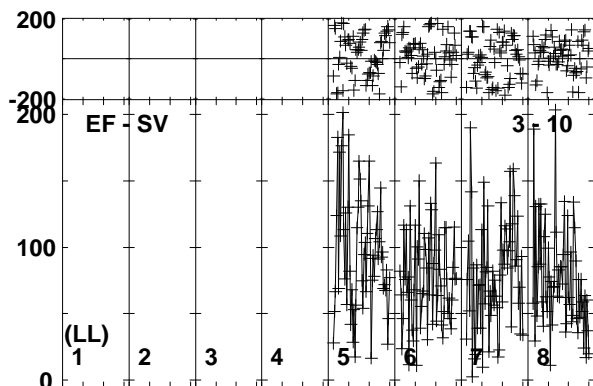
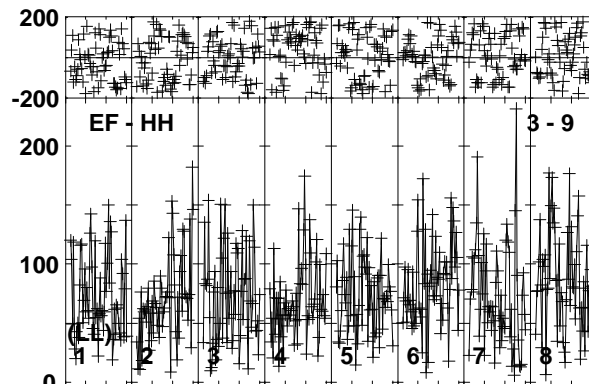
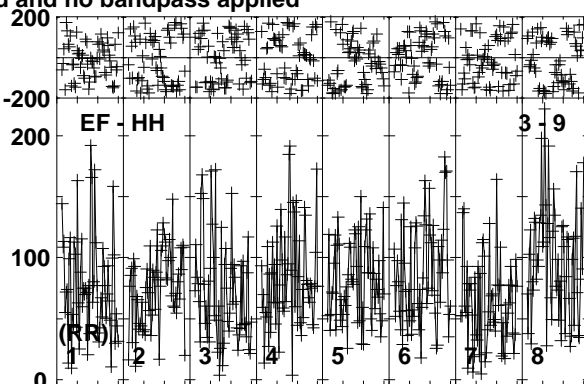
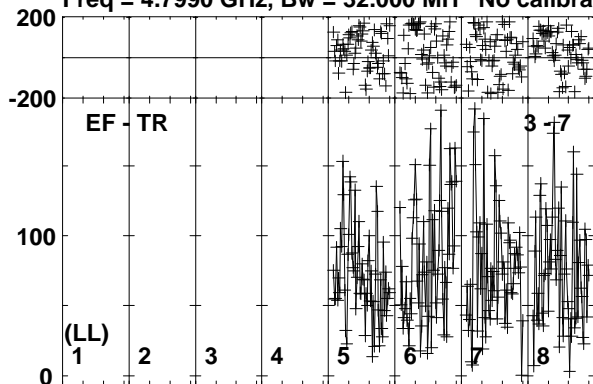

Lower frame: Micro Ampl Jy Top frame: Phas deg
Vector averaged cross-power spectrum Baseline: EF (03) - TR (07)
Timerange: 01/03:33:56 to 01/03:37:25

Plot file version 444 created 26-SEP-2019 10:42:39

190829A RG010A.UVDATA.1

Freq = 4.7990 GHz, Bw = 32.000 MH No calibration applied and no bandpass applied

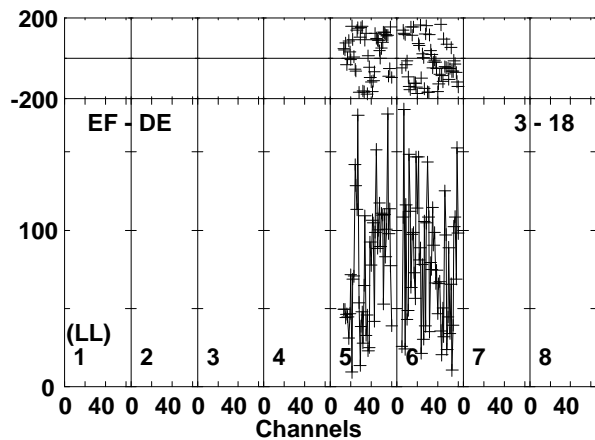
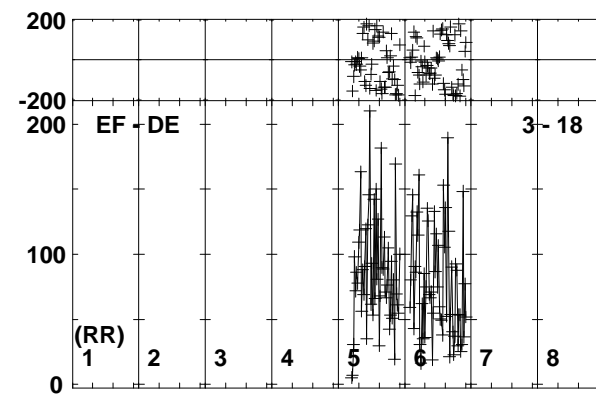
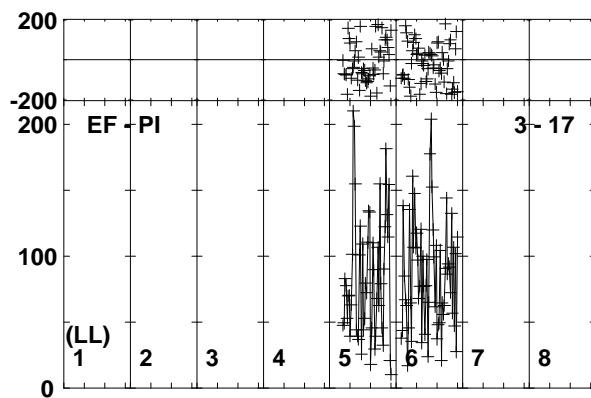
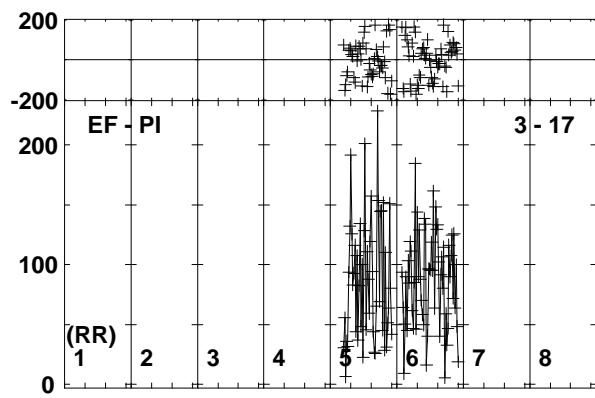
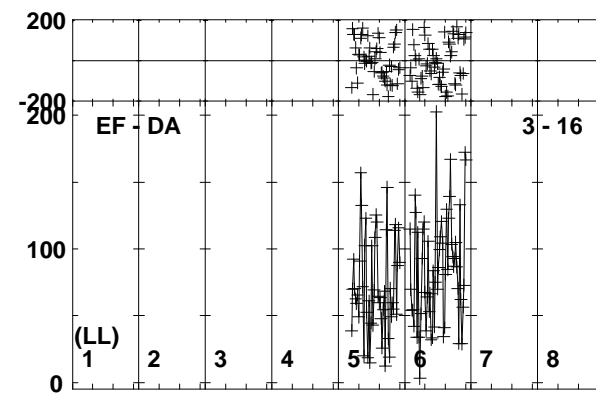
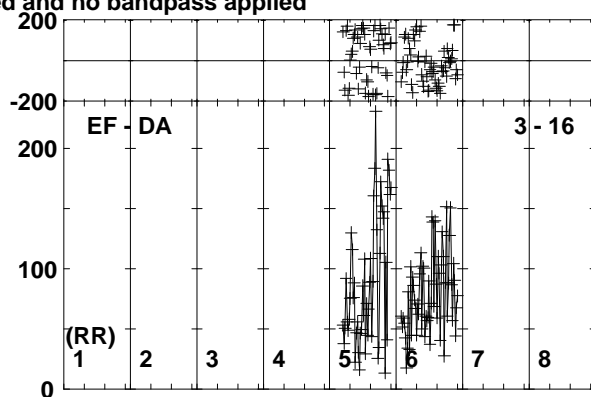
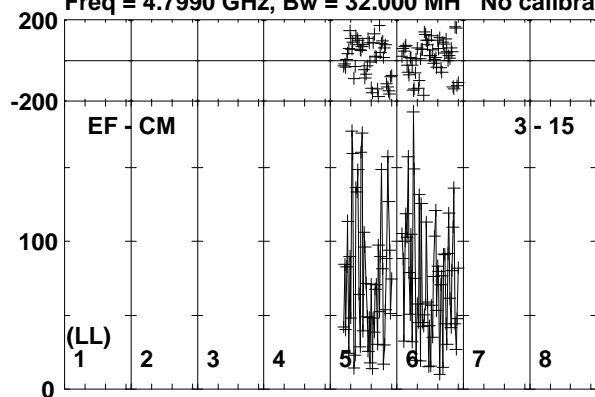

Lower frame: Micro Ampl Jy Top frame: Phas deg
Vector averaged cross-power spectrum Baseline: EF (03) - CM (15)
Timerange: 01/03:33:56 to 01/03:37:25

Plot file version 445 created 26-SEP-2019 10:42:40

J0257-1212 RG010A.UVDATA.1

Freq = 4.7990 GHz, Bw = 32.000 MH No calibration applied and no bandpass applied

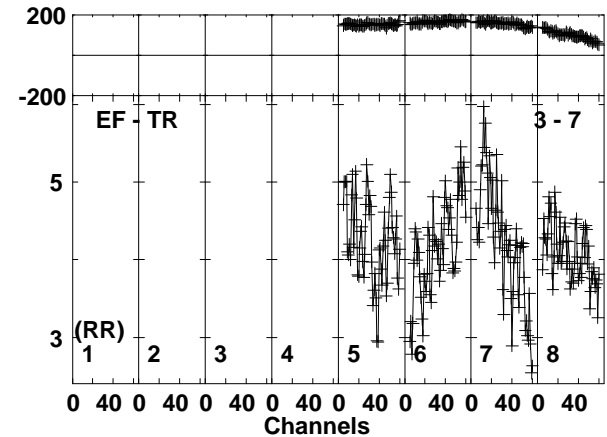
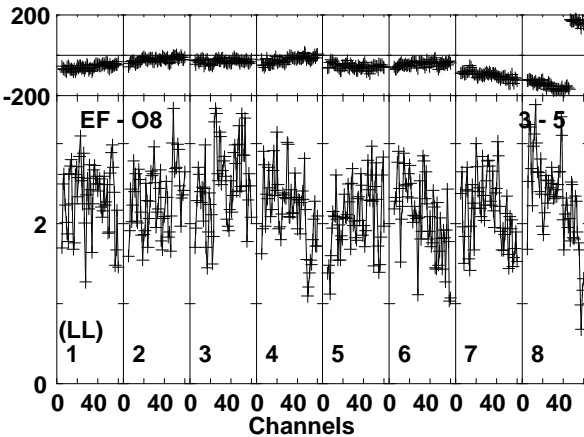
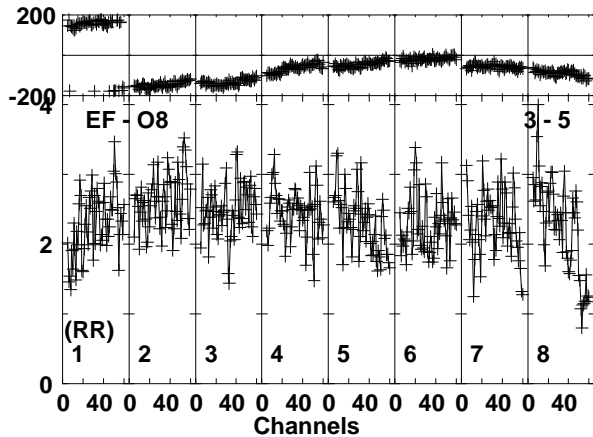
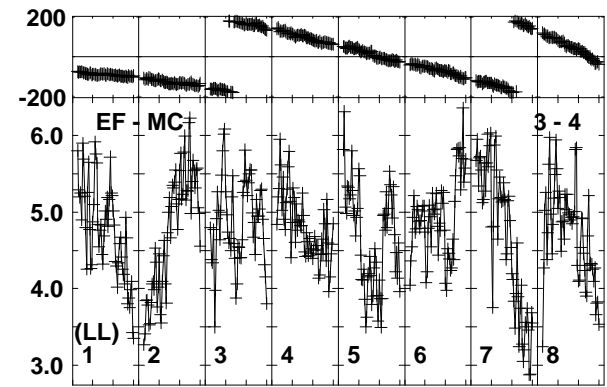
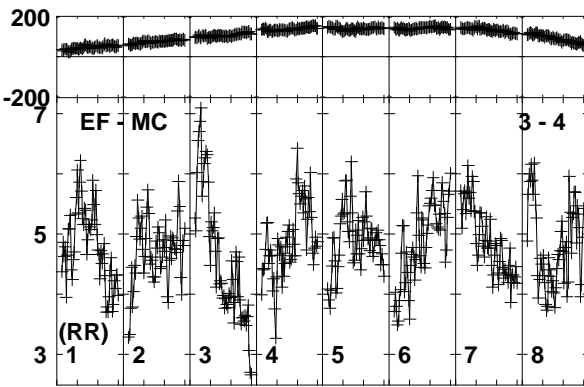
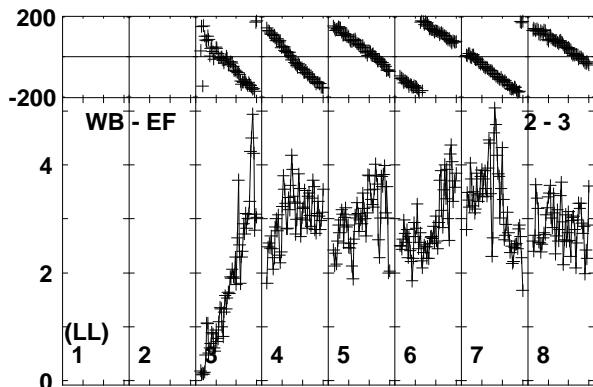
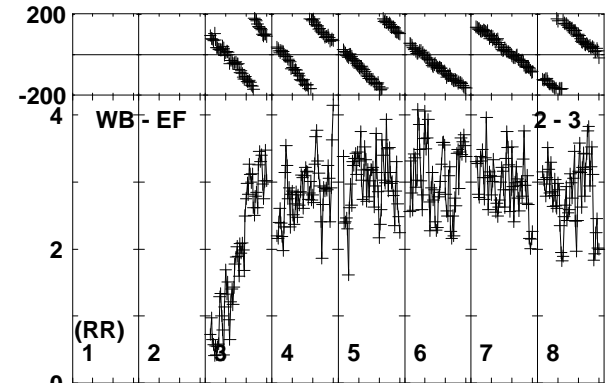
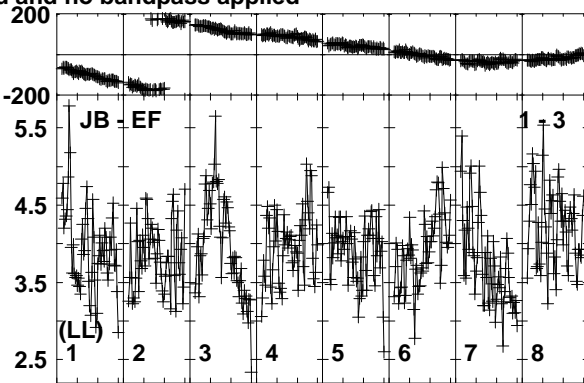
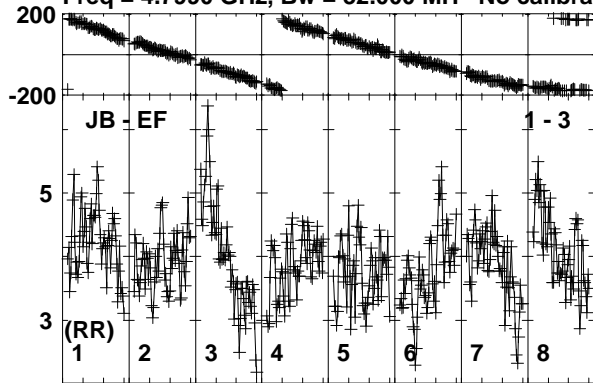

Lower frame: Milli Ampl Jy Top frame: Phas deg
Vector averaged cross-power spectrum Baseline: JB (01) - EF (03)
Timerange: 01/03:37:25 to 01/03:38:24

Plot file version 446 created 26-SEP-2019 10:42:40

J0257-1212 RG010A.UVDATA.1

Freq = 4.7990 GHz, Bw = 32.000 MH No calibration applied and no bandpass applied

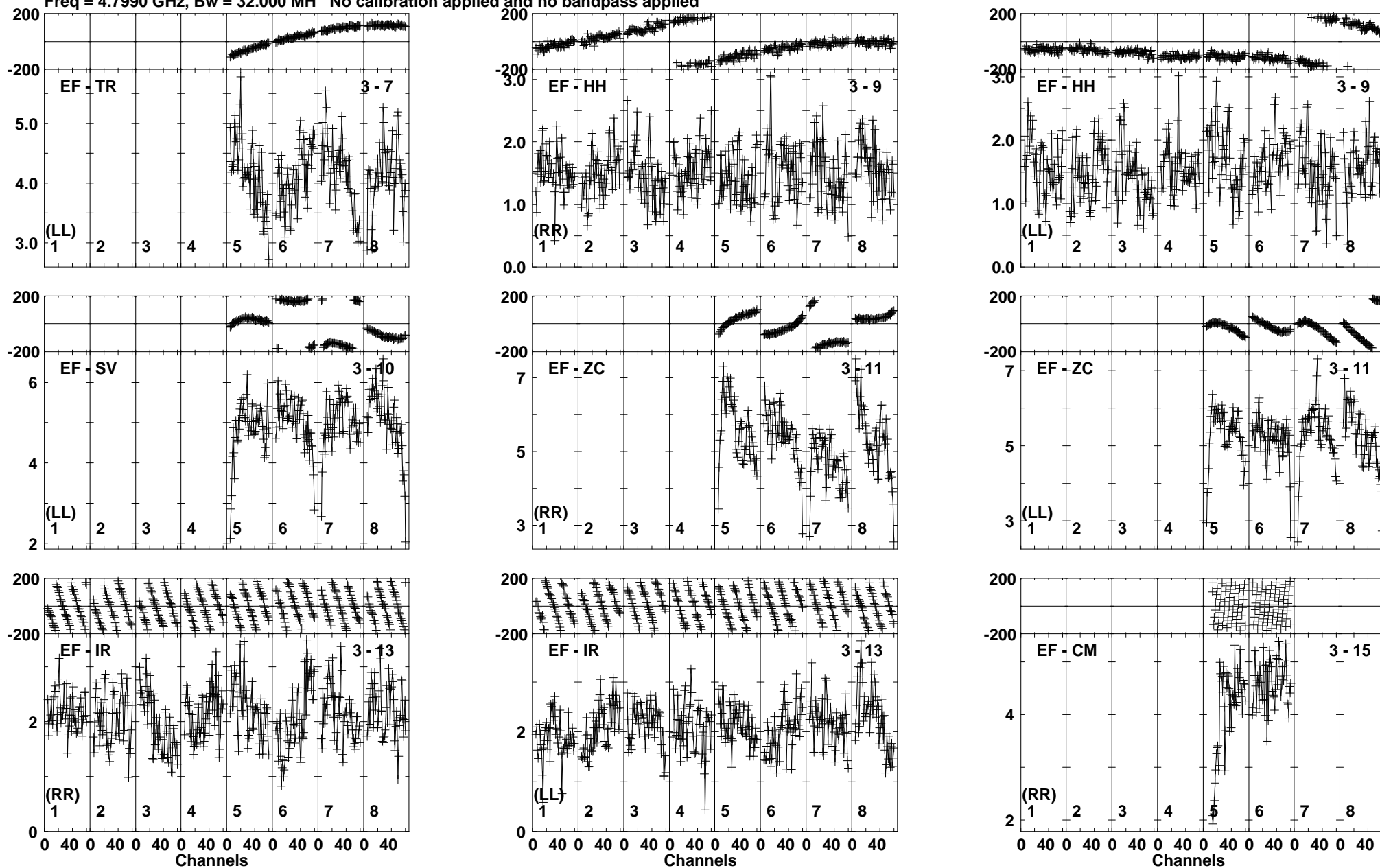

Lower frame: Milli Ampl Jy Top frame: Phas deg
Vector averaged cross-power spectrum Baseline: EF (03) - TR (07)
Timerange: 01/03:37:25 to 01/03:38:24

Plot file version 447 created 26-SEP-2019 10:42:41

J0257-1212 RG010A.UVDATA.1

Freq = 4.7990 GHz, Bw = 32.000 MH No calibration applied and no bandpass applied

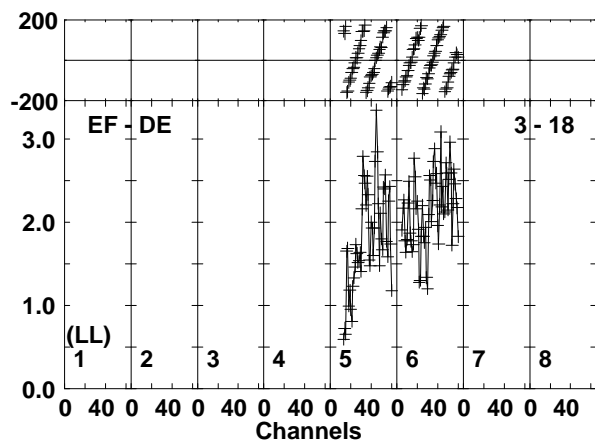
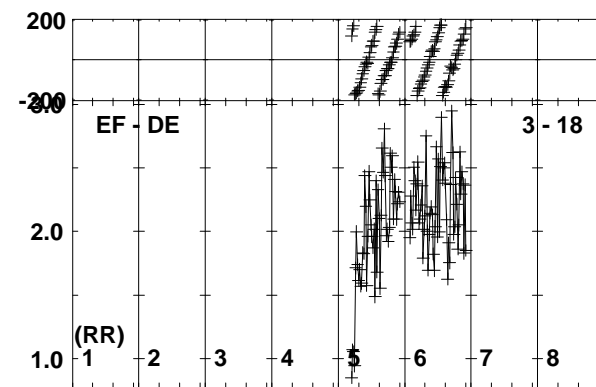
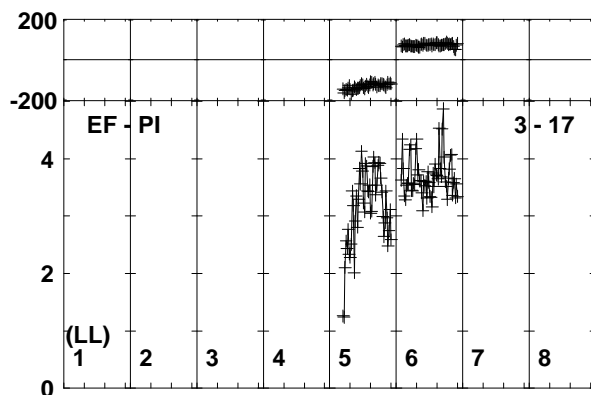
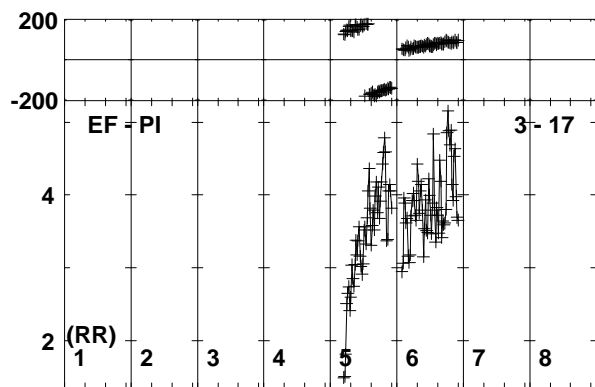
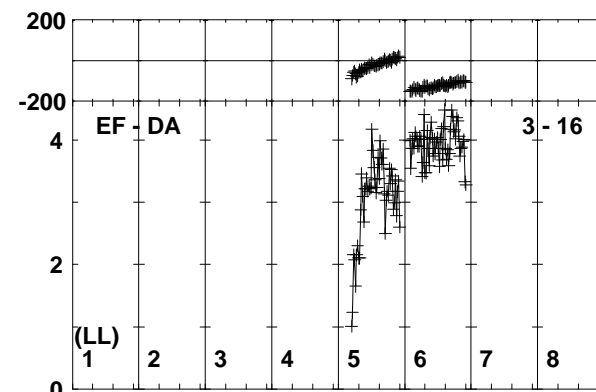
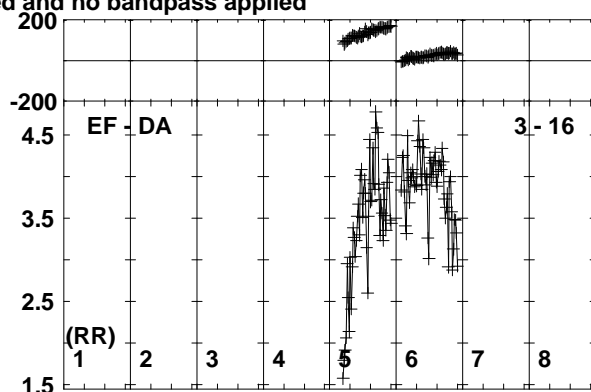
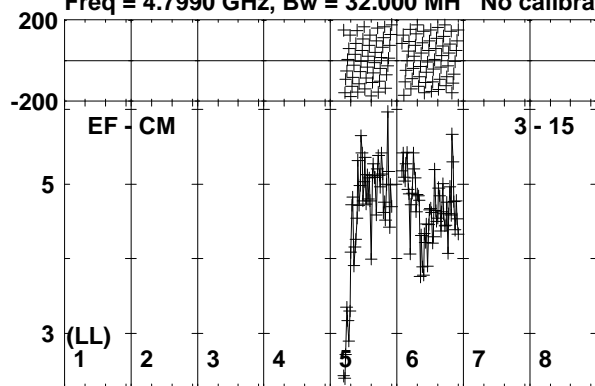

Lower frame: Milli Ampl Jy Top frame: Phas deg
Vector averaged cross-power spectrum Baseline: EF (03) - CM (15)
Timerange: 01/03:37:25 to 01/03:38:24

Plot file version 448 created 26-SEP-2019 10:42:41

190829A RG010A.UVDATA.1

Freq = 4.7990 GHz, Bw = 32.000 MH No calibration applied and no bandpass applied

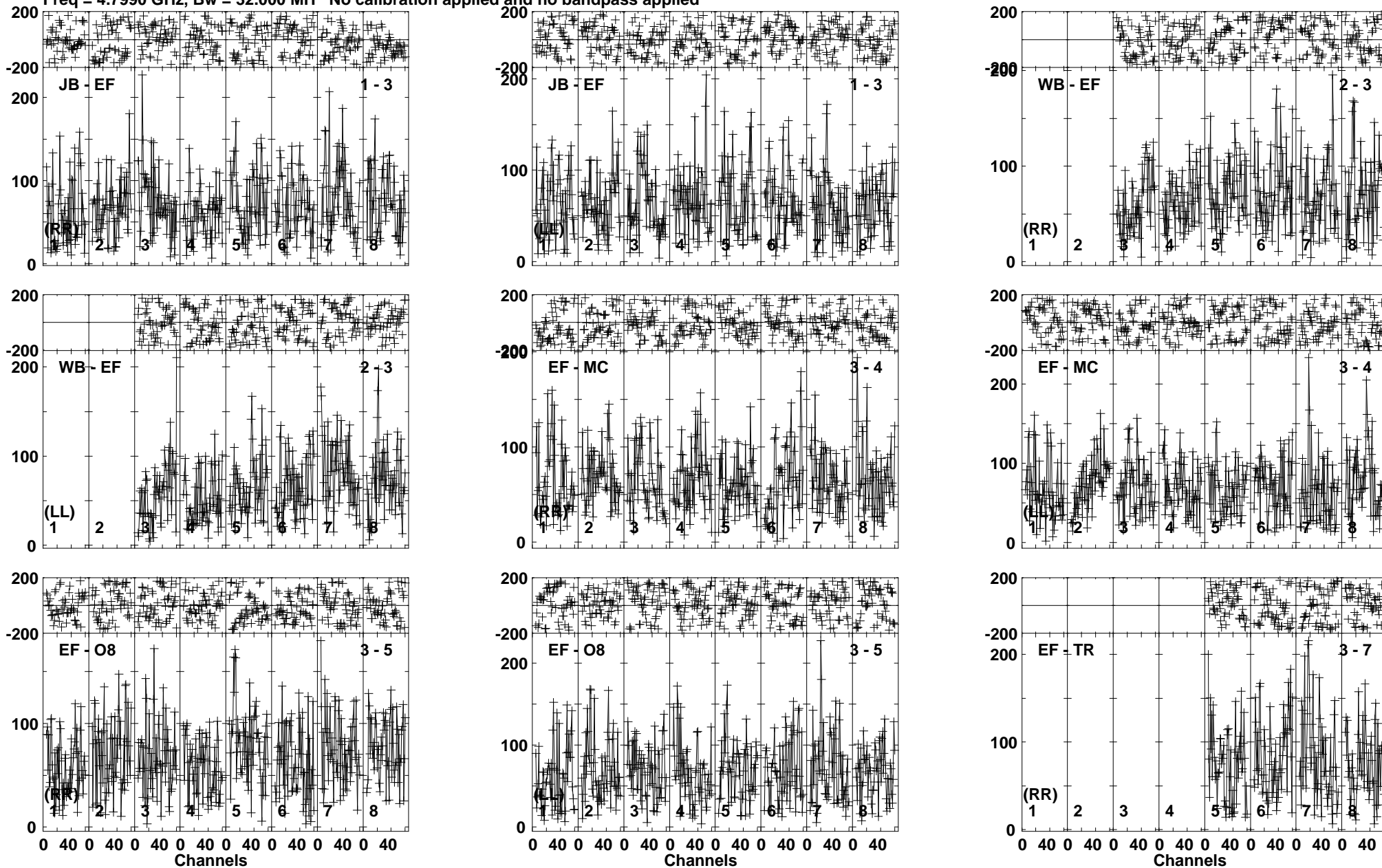

Lower frame: Micro Ampl Jy Top frame: Phas deg
Vector average cross-power spectrum Baseline: JB (01) - EF (03)
Timerange: 01/03:38:26 to 01/03:43:25

Plot file version 449 created 26-SEP-2019 10:42:42

190829A RG010A.UVDATA.1

Freq = 4.7990 GHz, Bw = 32.000 MH No calibration applied and no bandpass applied

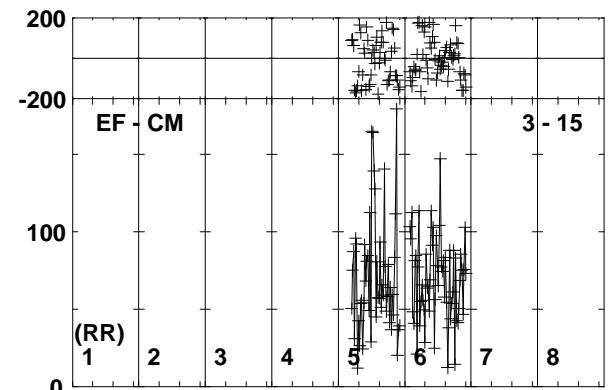
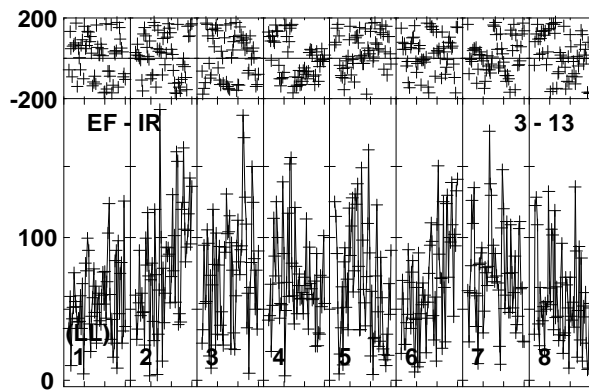
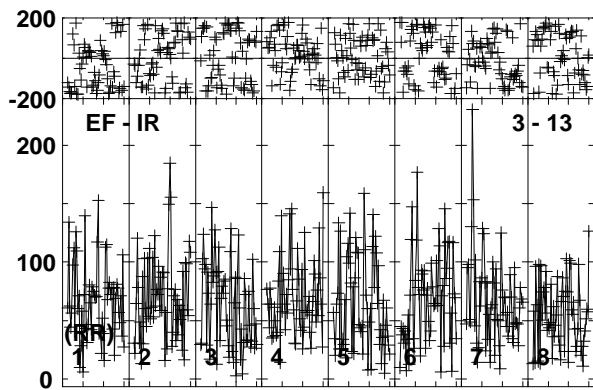
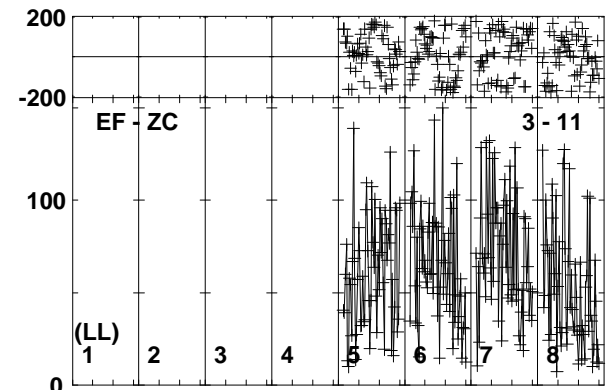
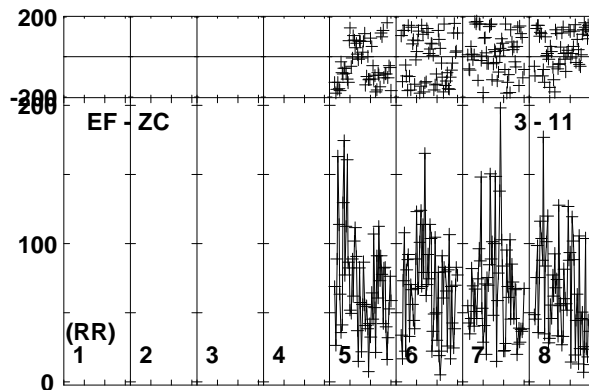
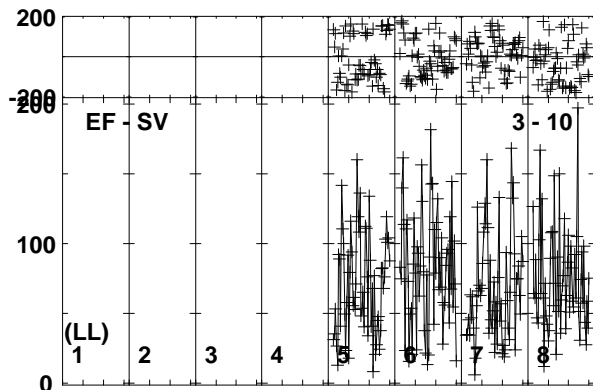
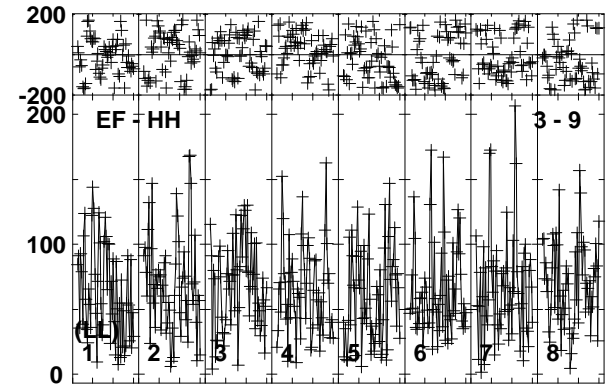
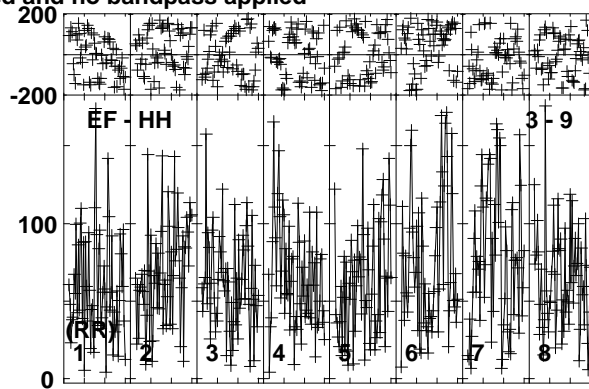
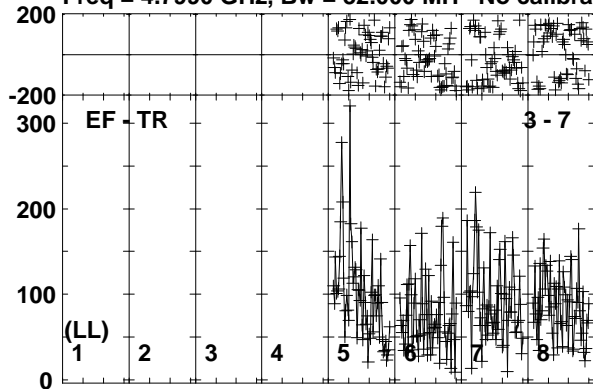

Lower frame: Micro Ampl Jy Top frame: Phas deg
Vector averaged cross-power spectrum Baseline: EF (03) - TR (07)
Timerange: 01/03:38:26 to 01/03:43:25

Plot file version 450 created 26-SEP-2019 10:42:43

190829A RG010A.UVDATA.1

Freq = 4.7990 GHz, Bw = 32.000 MH No calibration applied and no bandpass applied

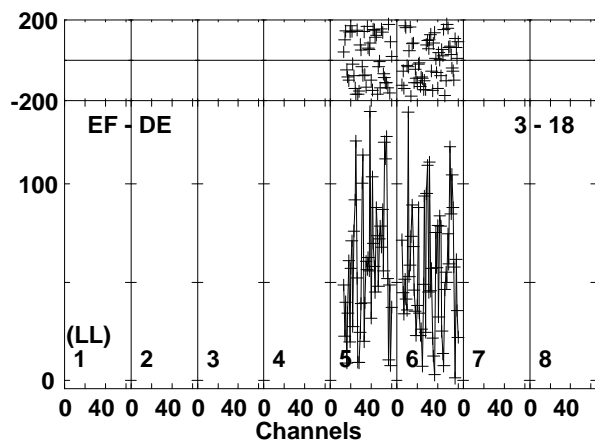
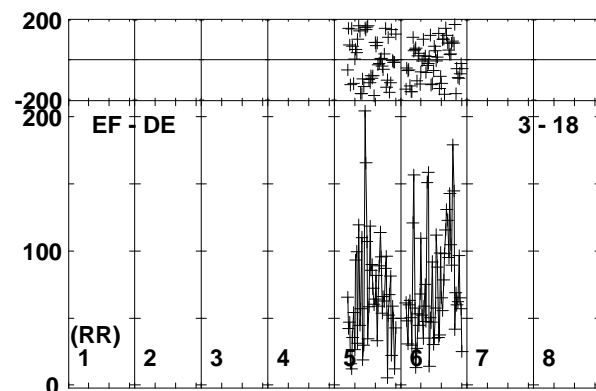
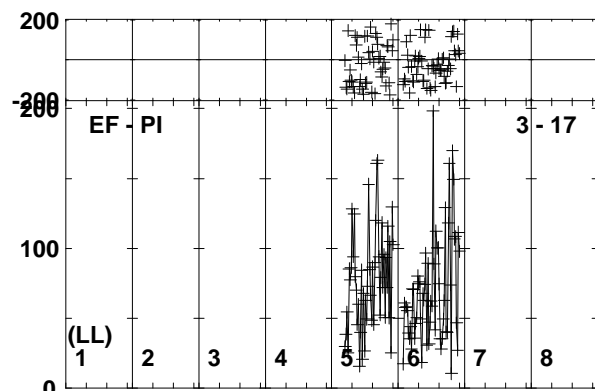
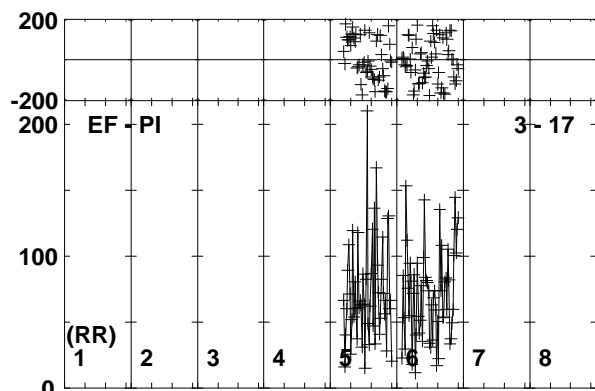
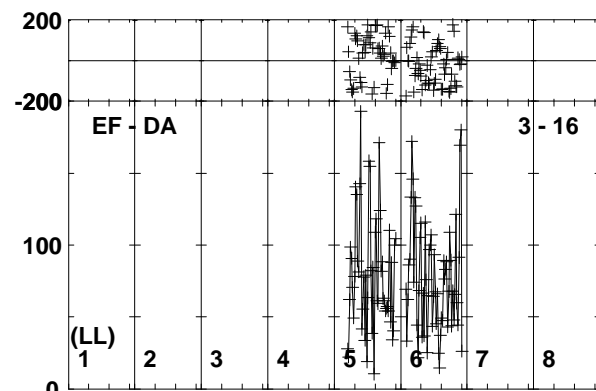
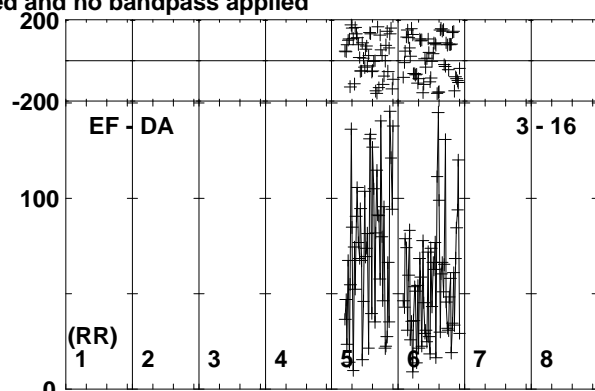
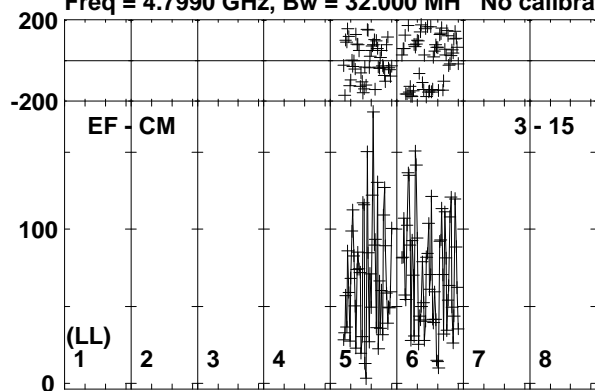

Lower frame: Micro Ampl Jy Top frame: Phas deg
Vector averaged cross-power spectrum Baseline: EF (03) - CM (15)
Timerange: 01/03:38:26 to 01/03:43:25

Plot file version 451 created 26-SEP-2019 10:42:43

J0257-1212 RG010A.UVDATA.1

Freq = 4.7990 GHz, Bw = 32.000 MH No calibration applied and no bandpass applied

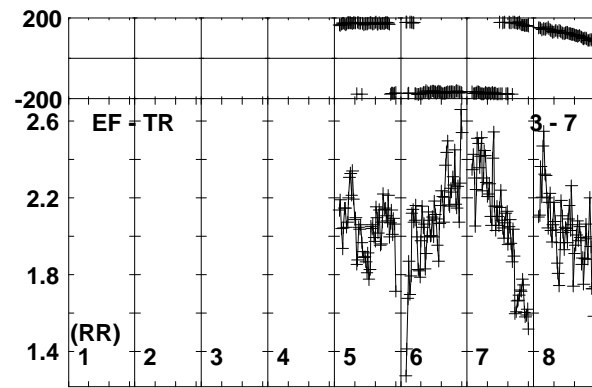
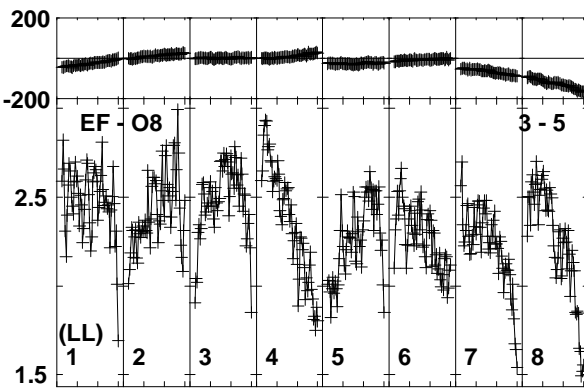
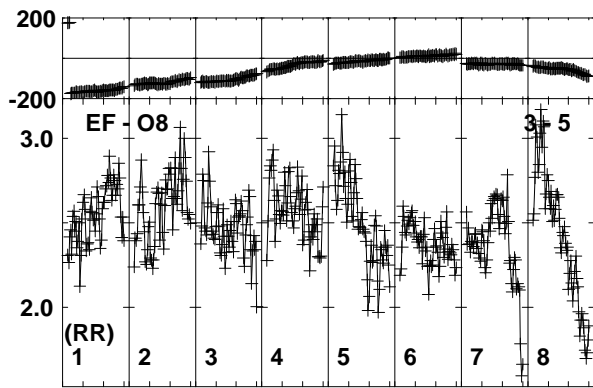
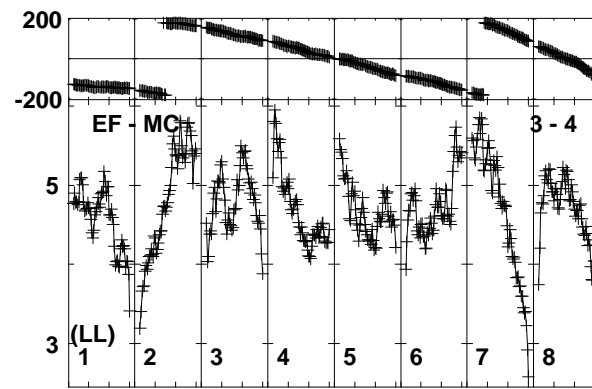
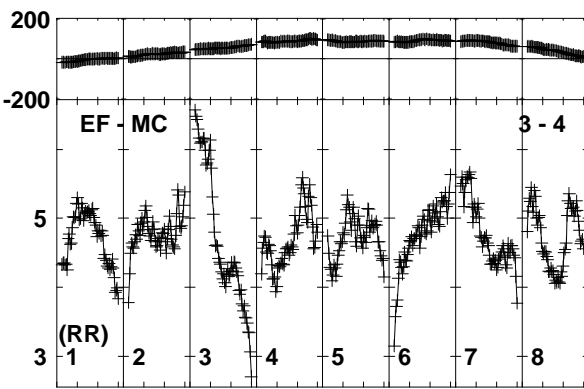
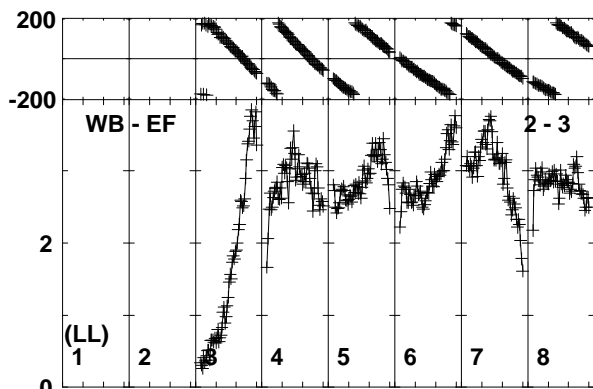
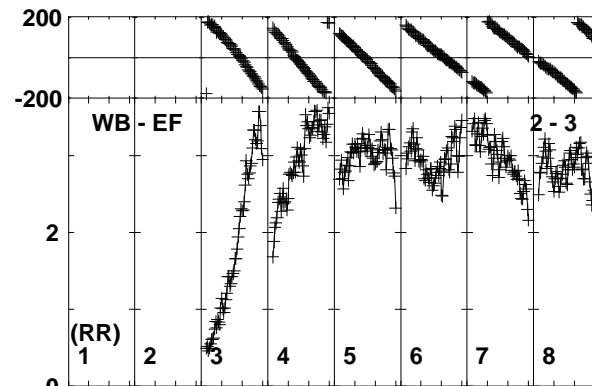
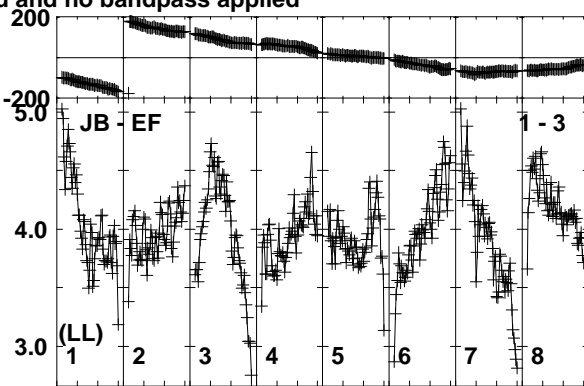
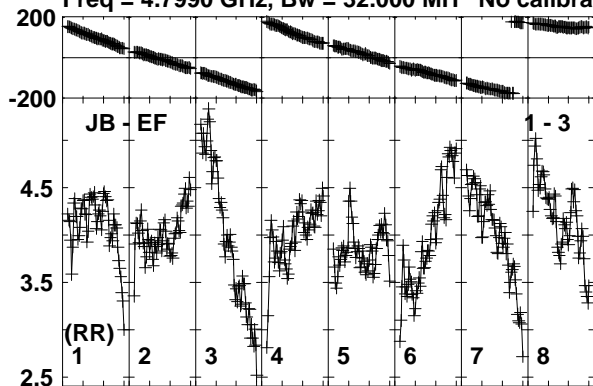

Lower frame: Milli Ampl Jy Top frame: Phas deg
Vector averaged cross-power spectrum Baseline: JB (01) - EF (03)
Timerange: 01/03:44:06 to 01/03:45:05

Plot file version 452 created 26-SEP-2019 10:42:44

J0257-1212 RG010A.UVDATA.1

Freq = 4.7990 GHz, Bw = 32.000 MH No calibration applied and no bandpass applied

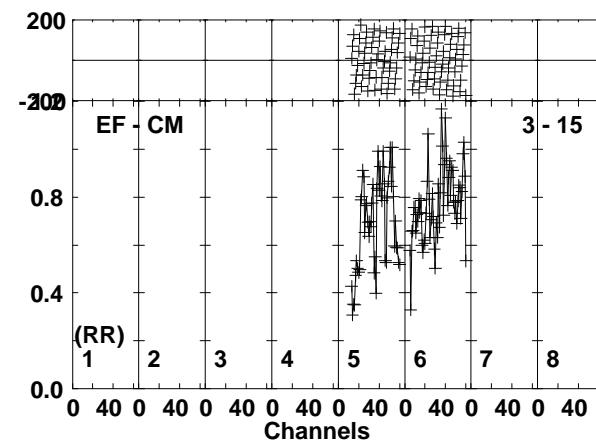
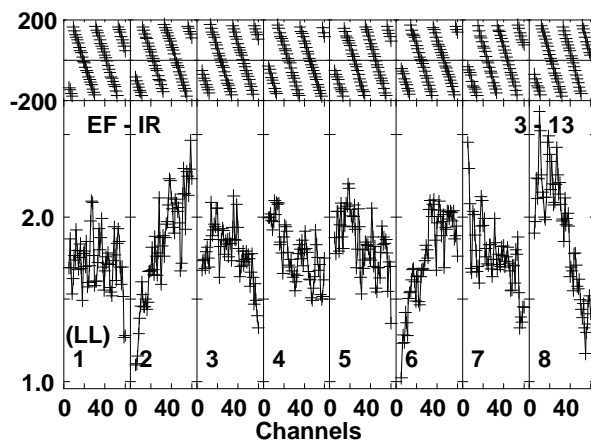
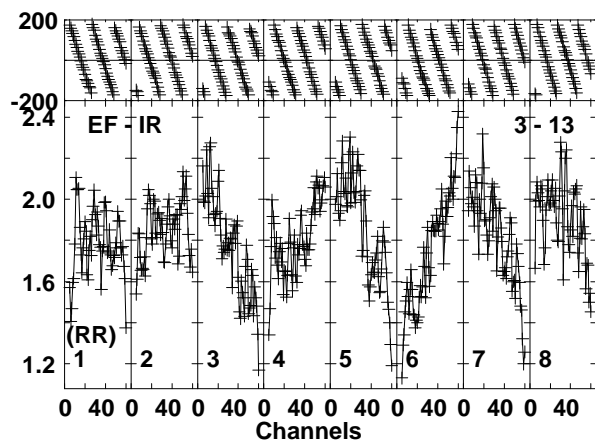
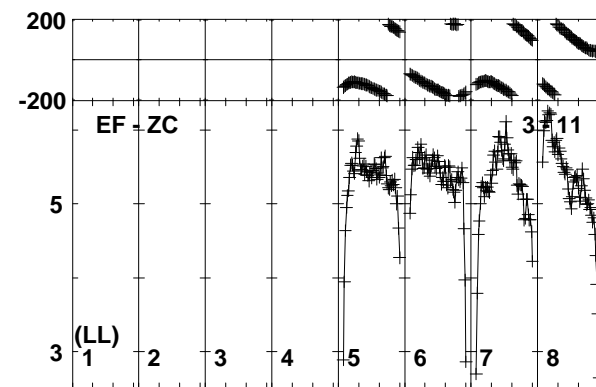
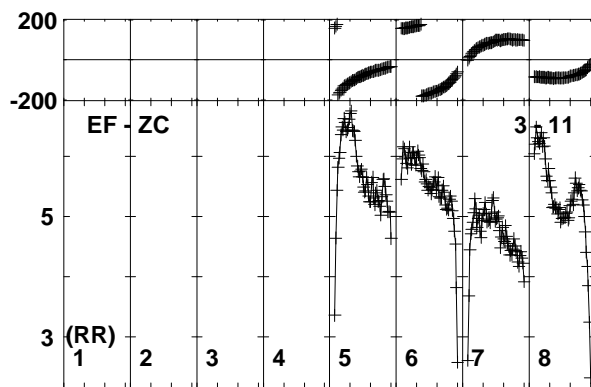
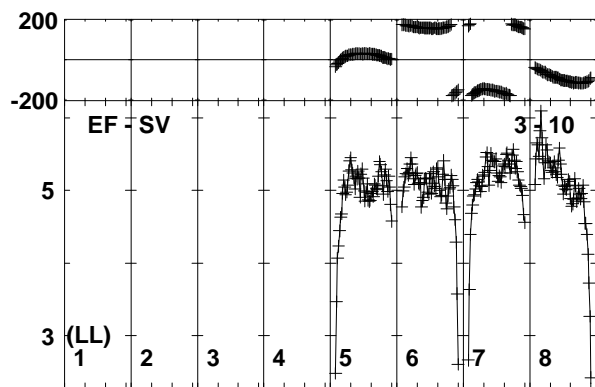
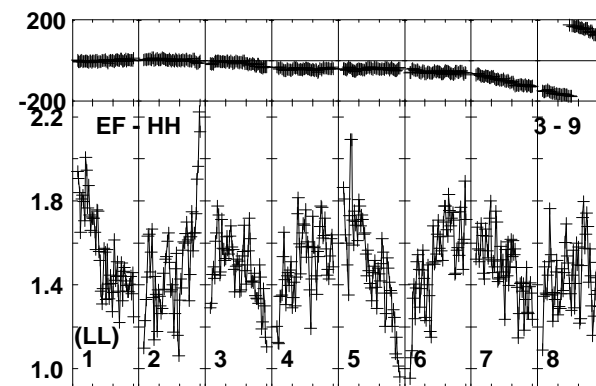
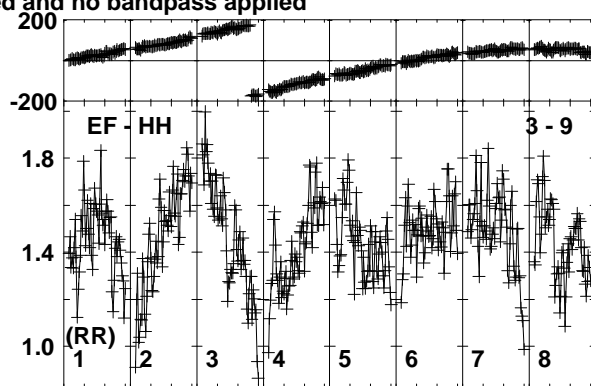
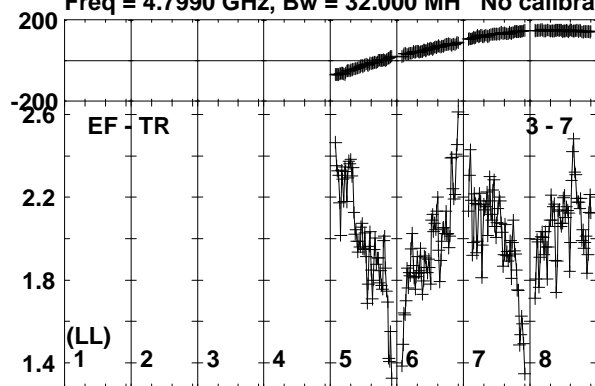

Lower frame: Milli Ampl Jy Top frame: Phas deg
Vector averaged cross-power spectrum Baseline: EF (03) - TR (07)
Timerange: 01/03:44:06 to 01/03:45:05

Plot file version 455 created 26-SEP-2019 10:42:46

190829A RG010A.UVDATA.1

Freq = 4.7990 GHz, Bw = 32.000 MH No calibration applied and no bandpass applied

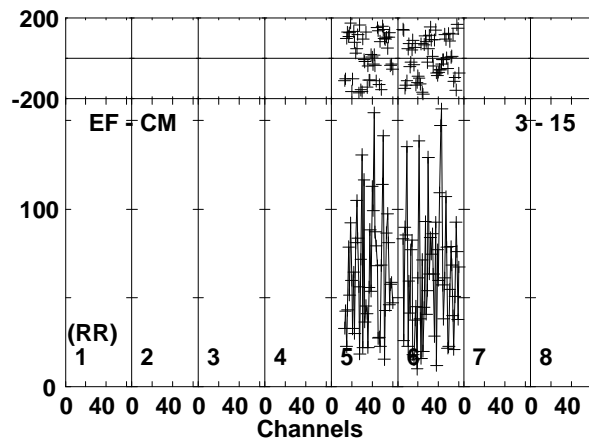
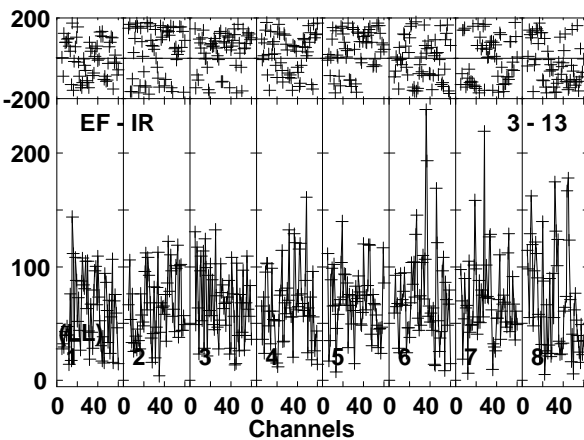
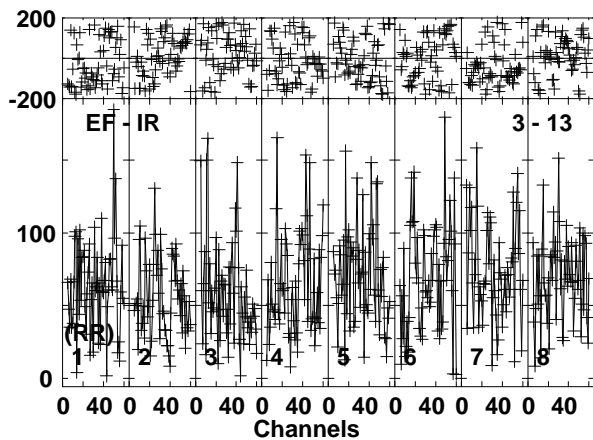
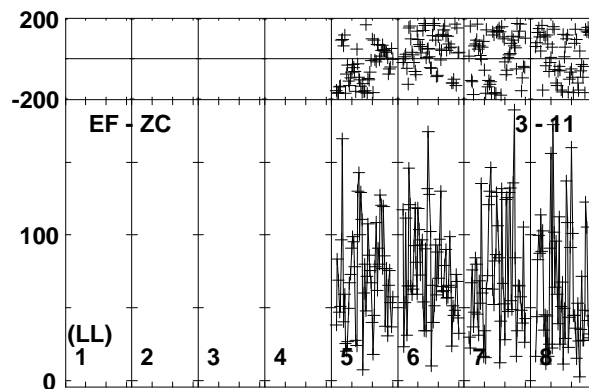
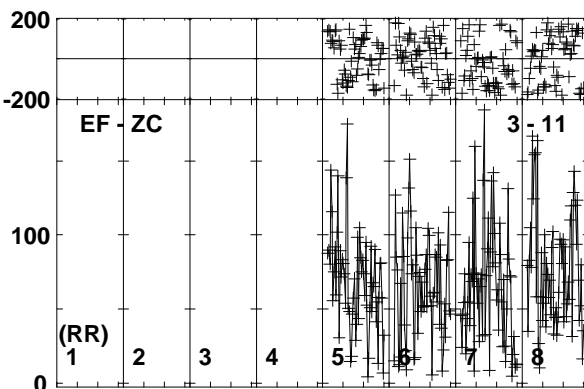
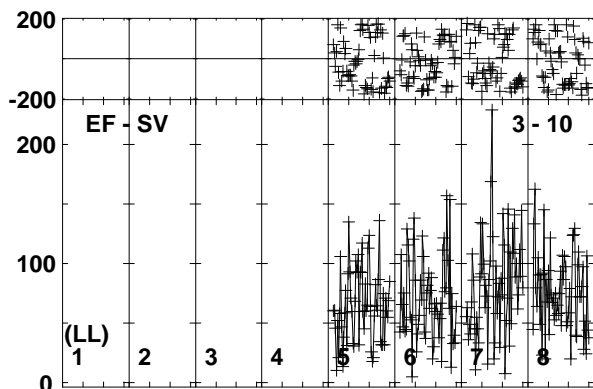
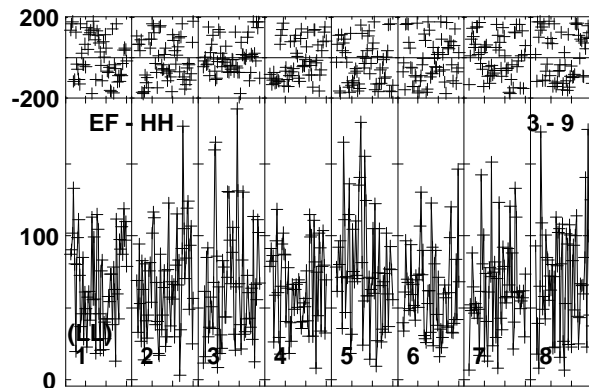
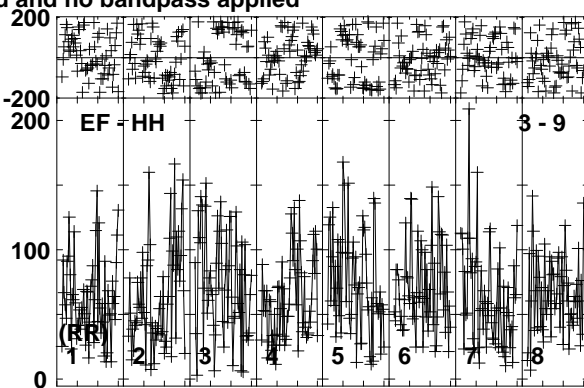
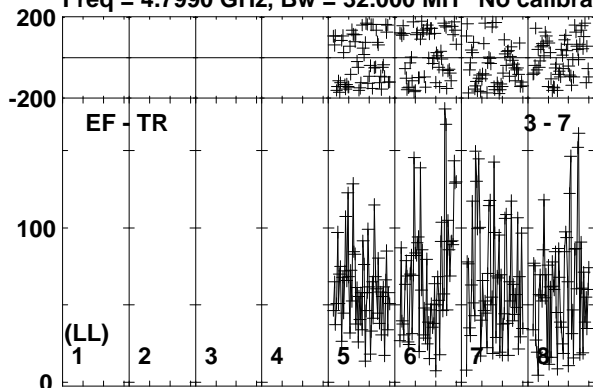

Lower frame: Micro Ampl Jy Top frame: Phas deg
Vector averaged cross-power spectrum Baseline: EF (03) - TR (07)
Timerange: 01/03:45:06 to 01/03:50:04

Plot file version 456 created 26-SEP-2019 10:42:47

190829A RG010A.UVDATA.1

Freq = 4.7990 GHz, Bw = 32.000 MH No calibration applied and no bandpass applied

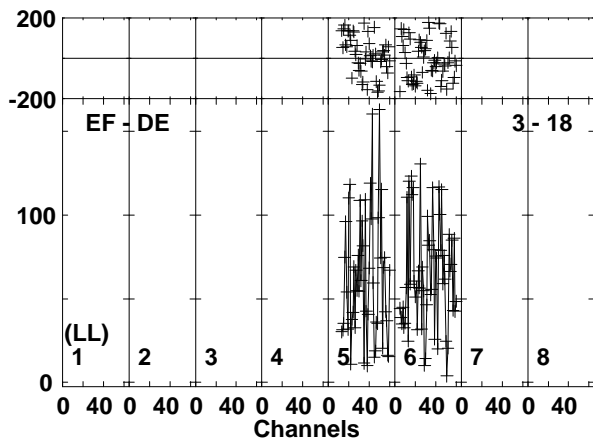
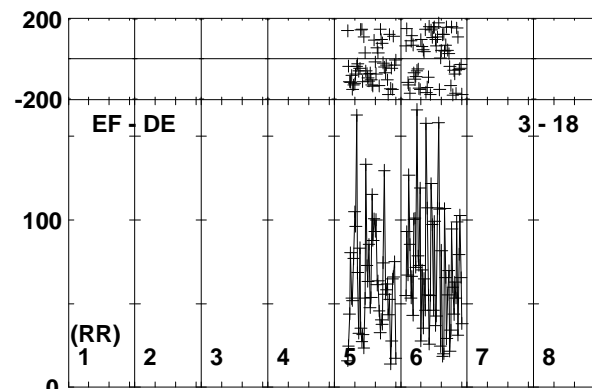
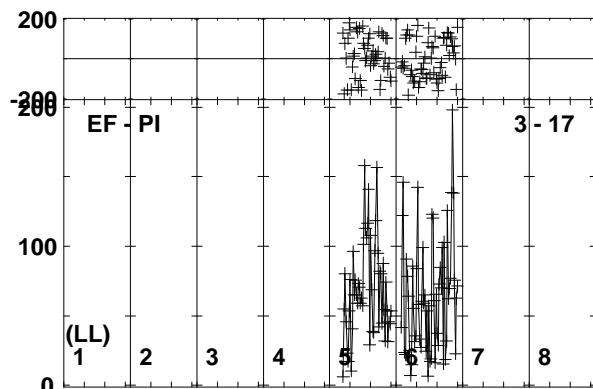
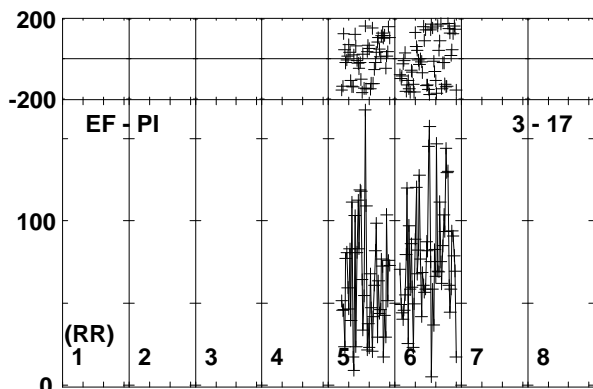
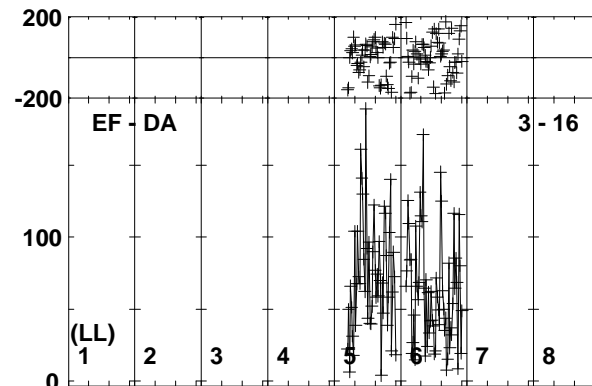
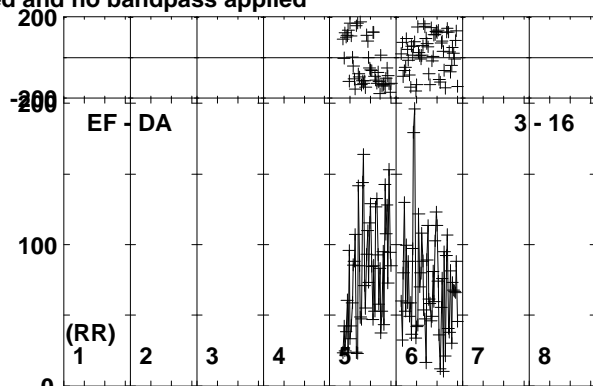
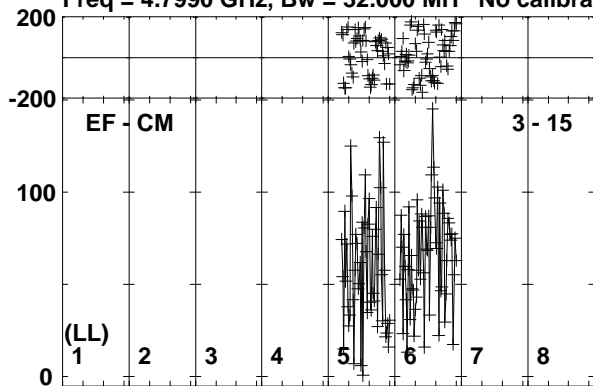

Lower frame: Micro Ampl Jy Top frame: Phas deg
Vector averaged cross-power spectrum Baseline: EF (03) - CM (15)
Timerange: 01/03:45:06 to 01/03:50:04

Plot file version 457 created 26-SEP-2019 10:42:47

J0257-1212 RG010A.UVDATA.1

Freq = 4.7990 GHz, Bw = 32.000 MH No calibration applied and no bandpass applied

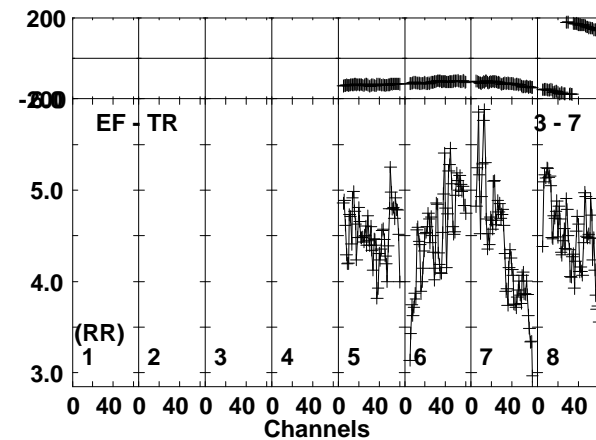
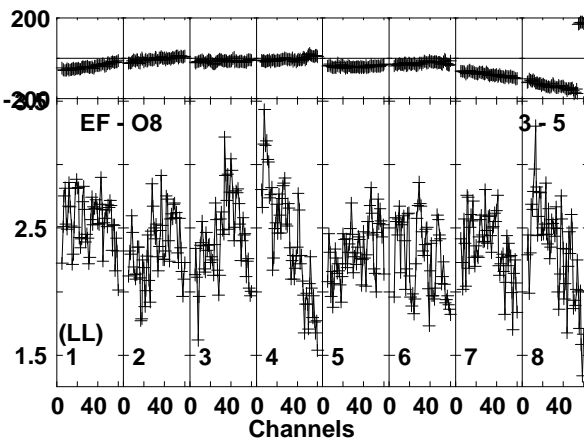
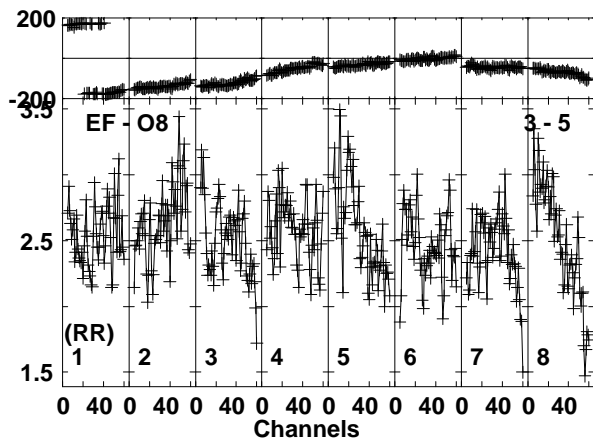
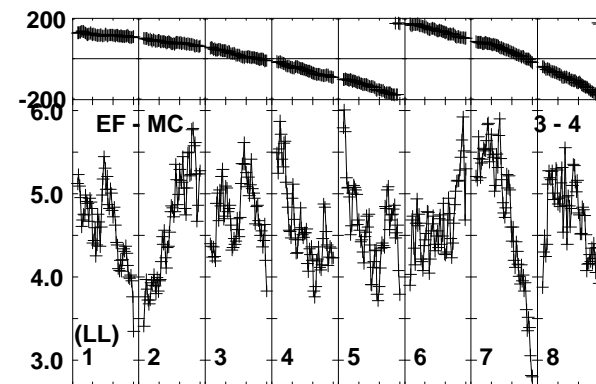
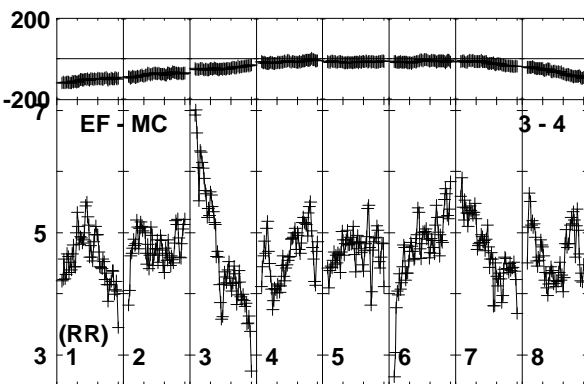
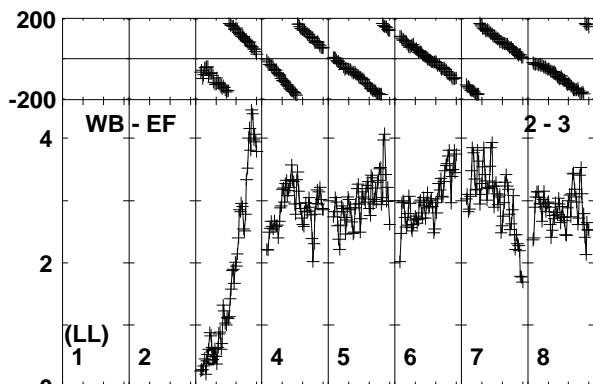
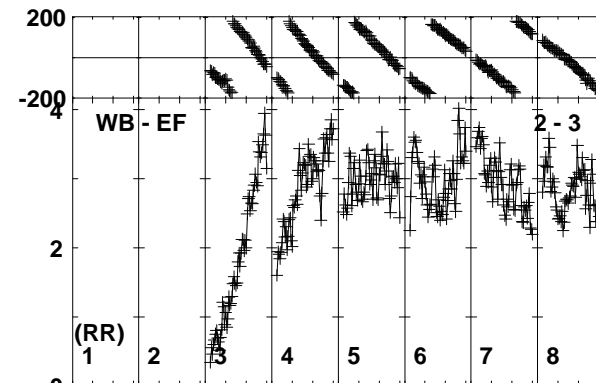
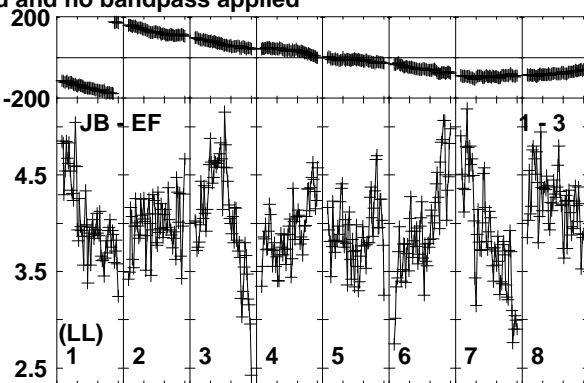
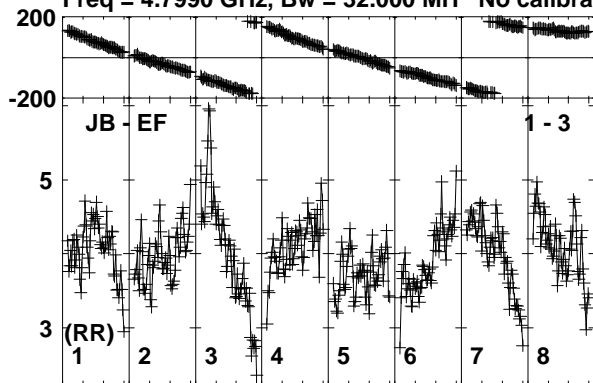

Lower frame: Milli Ampl Jy Top frame: Phas deg
Vector averaged cross-power spectrum Baseline: JB (01) - EF (03)
Timerange: 01/03:50:45 to 01/03:51:14

Plot file version 458 created 26-SEP-2019 10:42:48

J0257-1212 RG010A.UVDATA.1

Freq = 4.7990 GHz, Bw = 32.000 MH No calibration applied and no bandpass applied

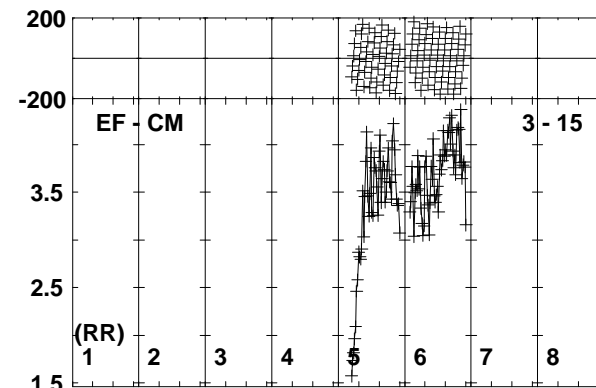
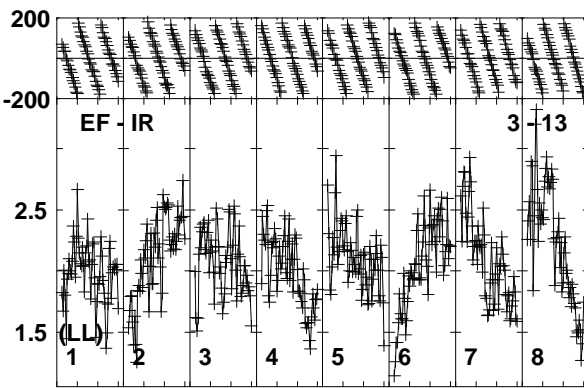
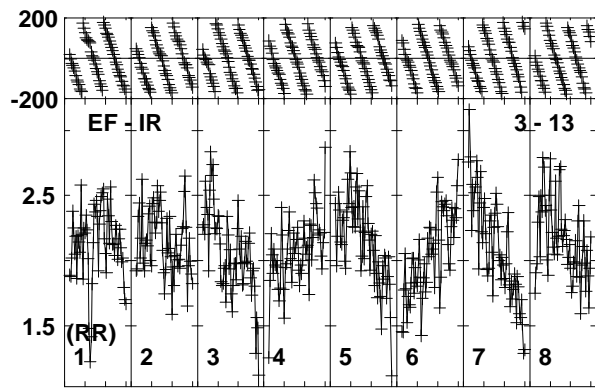
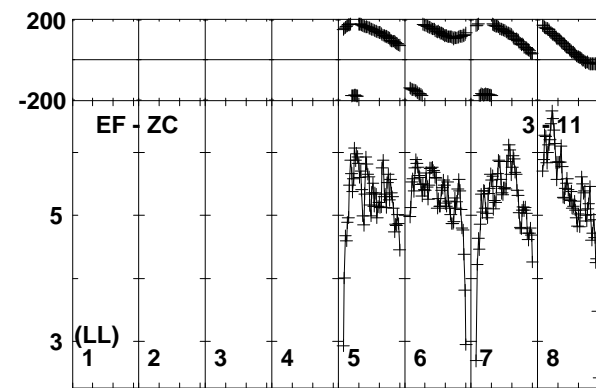
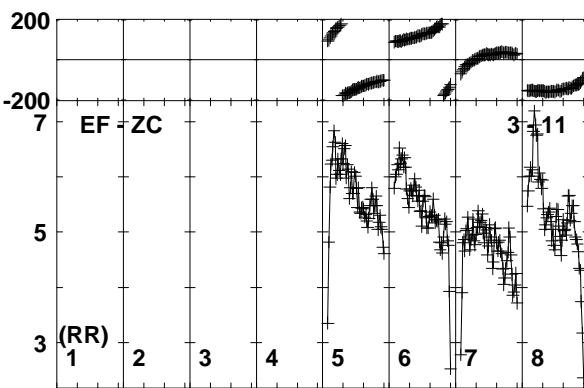
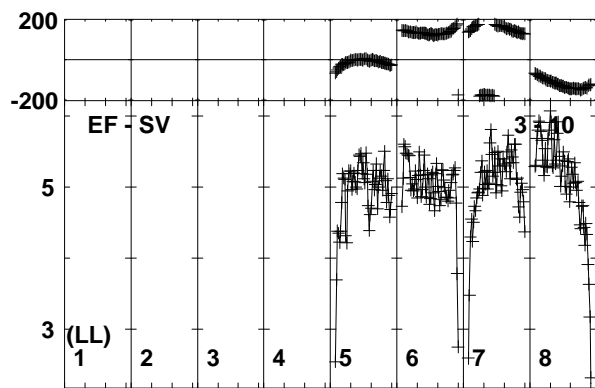
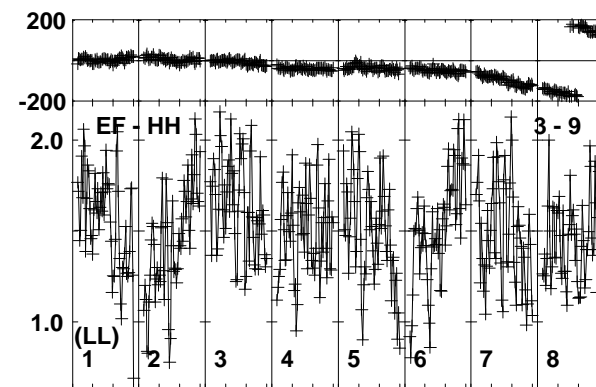
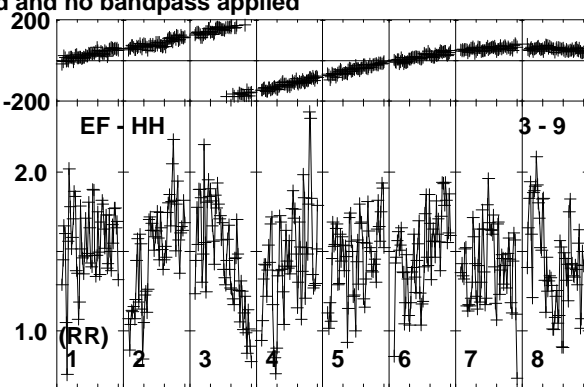
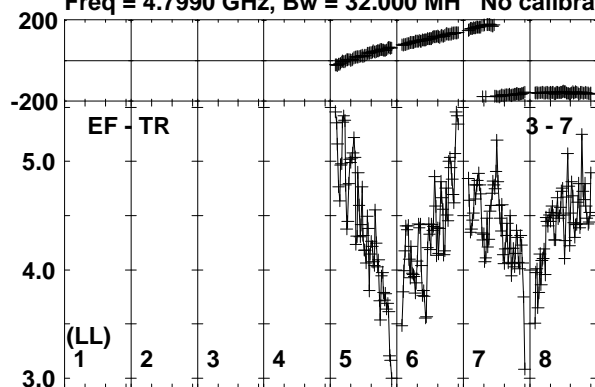

Lower frame: Milli Ampl Jy Top frame: Phas deg
Vector averaged cross-power spectrum Baseline: EF (03) - TR (07)
Timerange: 01/03:50:45 to 01/03:51:14

Plot file version 459 created 26-SEP-2019 10:42:48

J0257-1212 RG010A.UVDATA.1

Freq = 4.7990 GHz, Bw = 32.000 MH No calibration applied and no bandpass applied

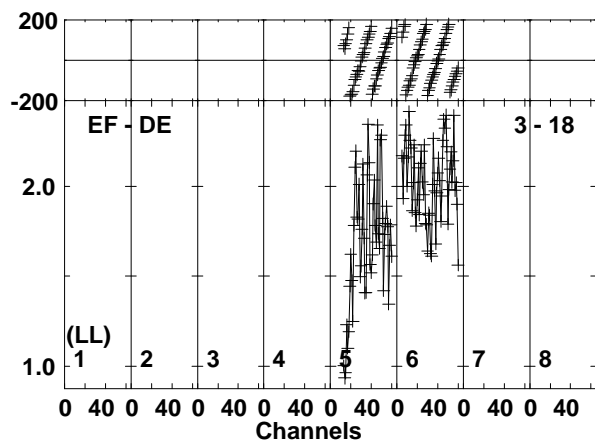
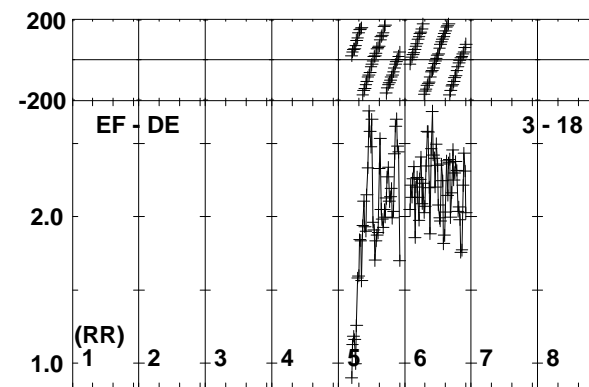
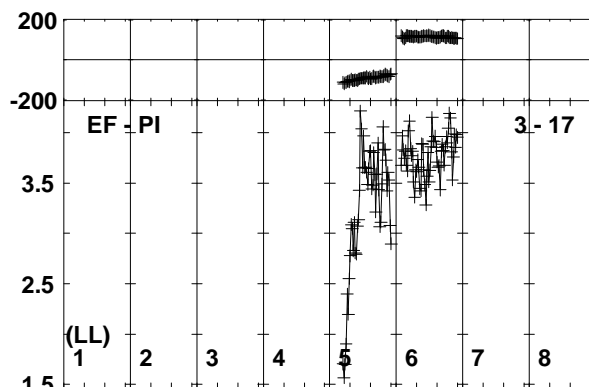
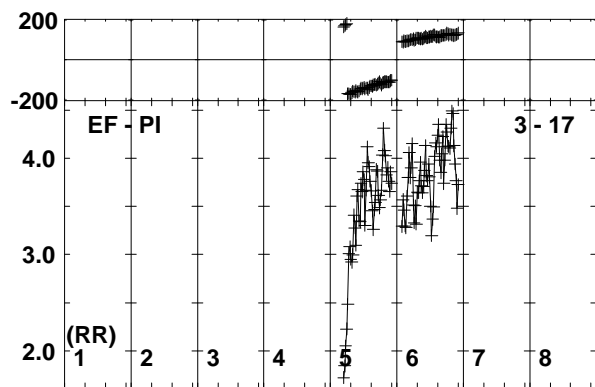
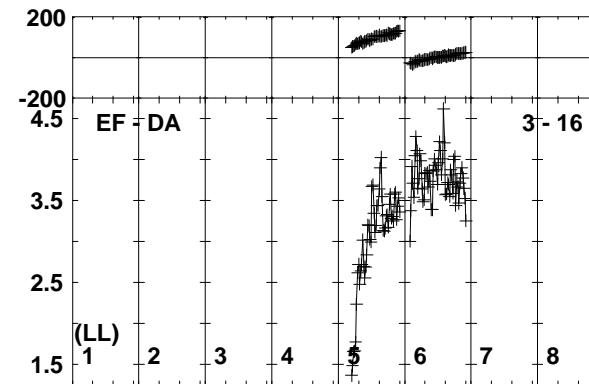
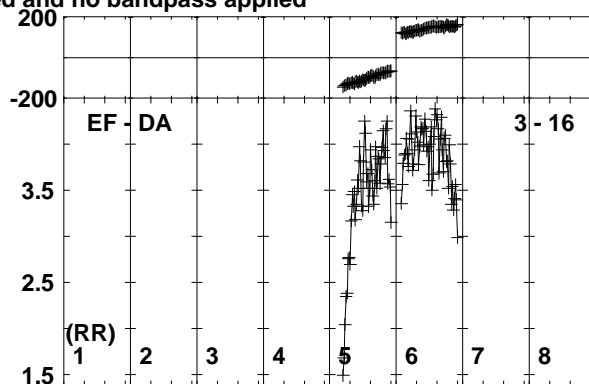
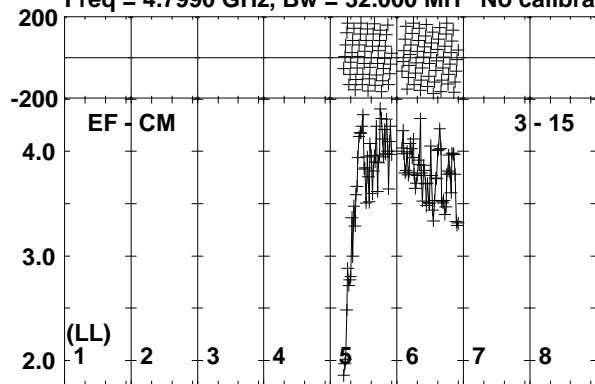

0 40 0 40 0 40 0 40 0 40 0 40 0 40 0 40 0 40 0 40
Channels
Lower frame: Milli Ampl Jy Top frame: Phas deg
Vector averaged cross-power spectrum Baseline: EF (03) - CM (15)
Timerange: 01/03:50:45 to 01/03:51:14

Plot file version 460 created 26-SEP-2019 10:42:48

J0300-0846 RG010A.UVDATA.1

Freq = 4.7990 GHz, Bw = 32.000 MH No calibration applied and no bandpass applied

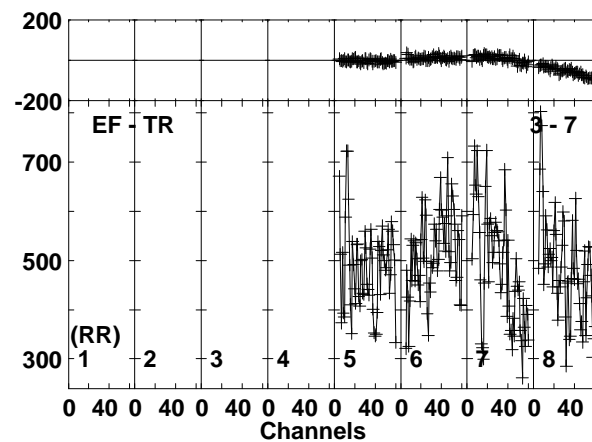
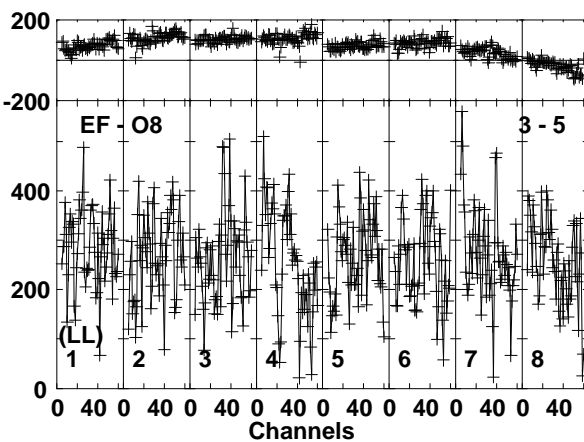
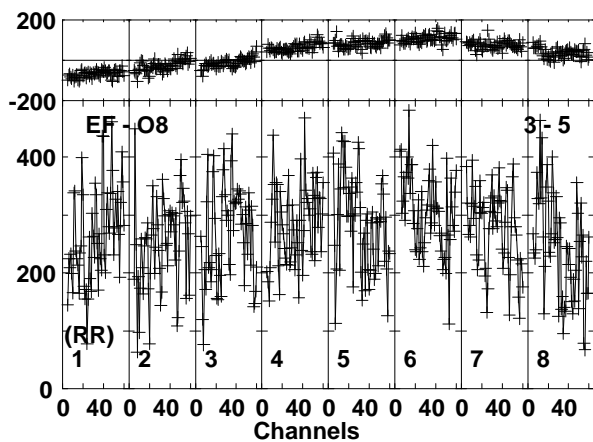
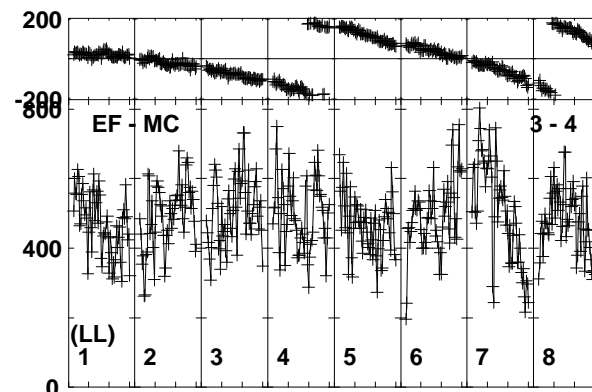
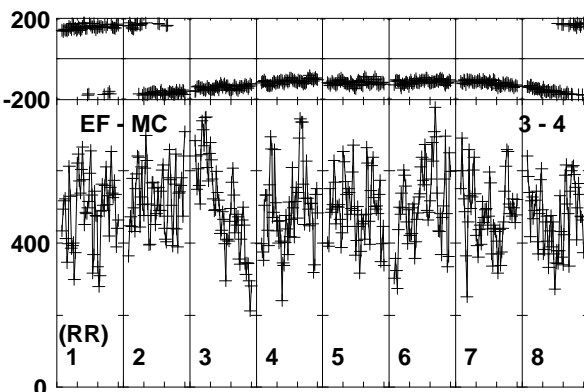
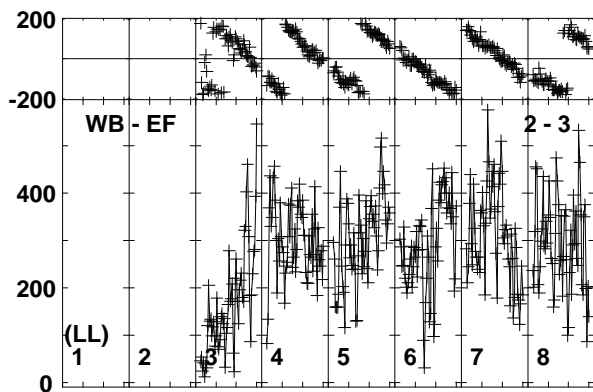
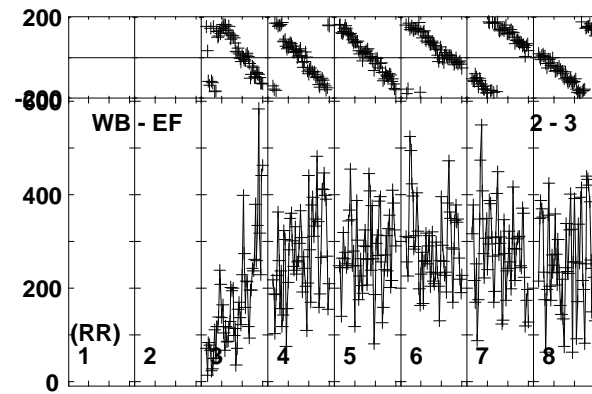
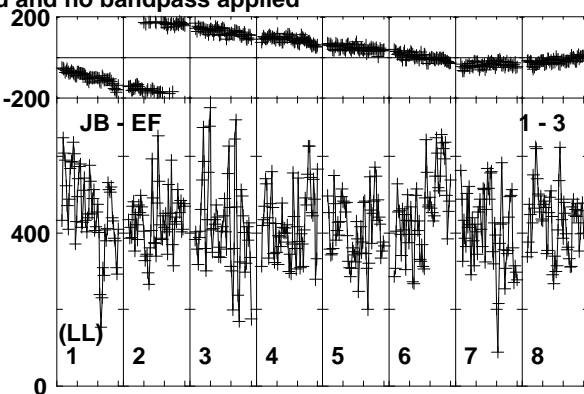
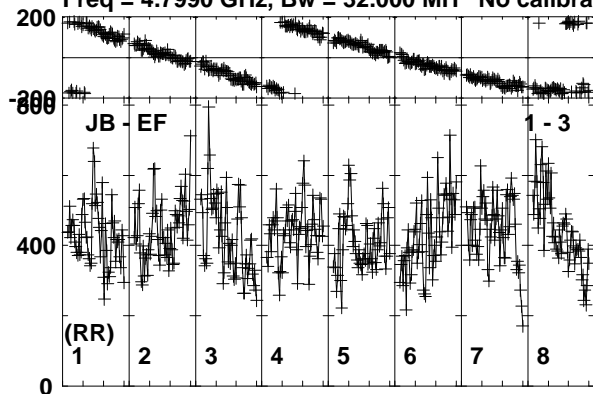

Lower frame: Micro Ampl Jy Top frame: Phas deg
Vector averaged cross-power spectrum Baseline: JB (01) - EF (03)
Timerange: 01/03:51:15 to 01/03:53:45

Plot file version 461 created 26-SEP-2019 10:42:49

J0300-0846 RG010A.UVDATA.1

Freq = 4.7990 GHz, Bw = 32.000 MH No calibration applied and no bandpass applied

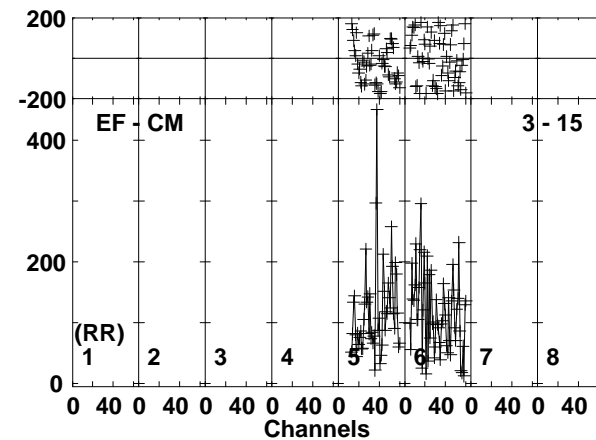
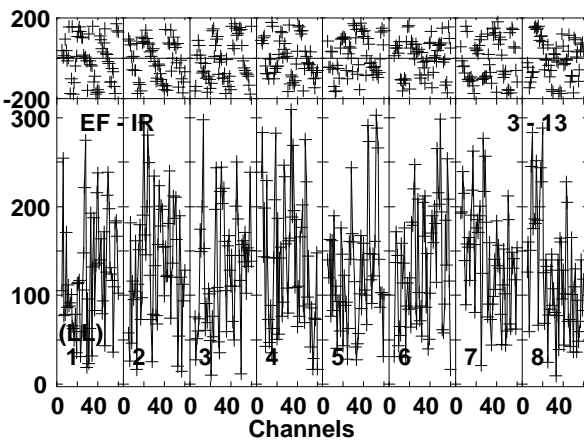
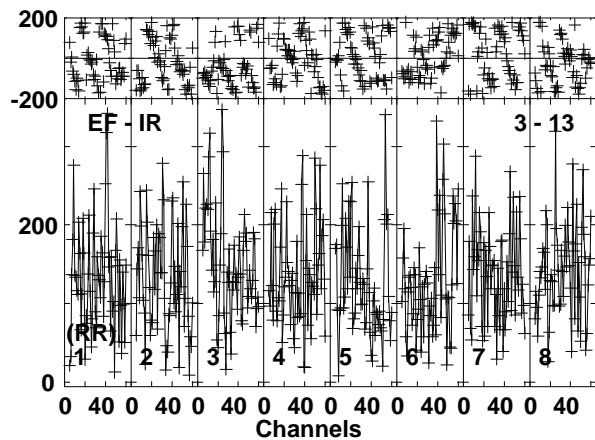
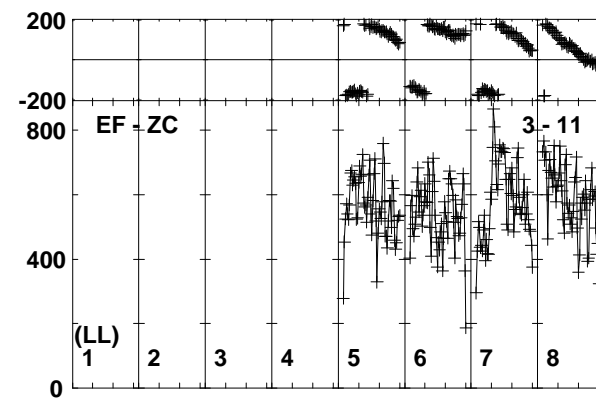
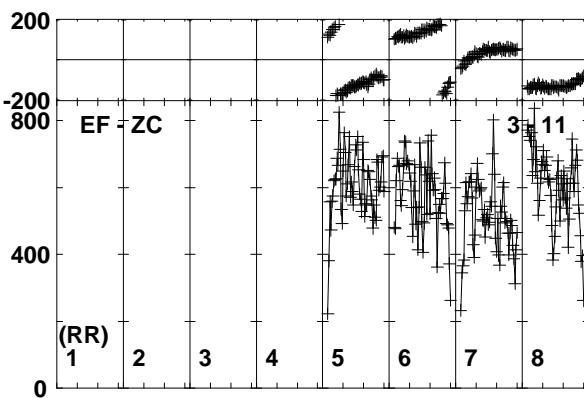
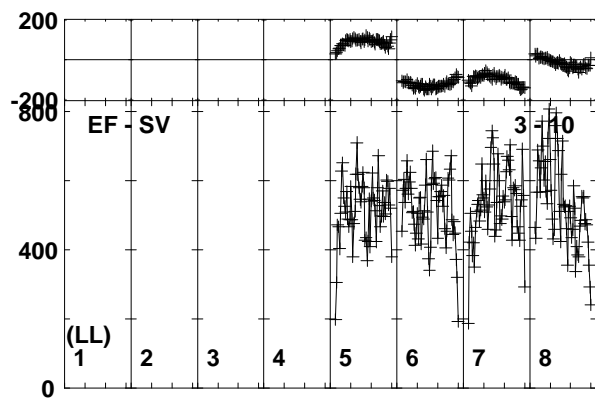
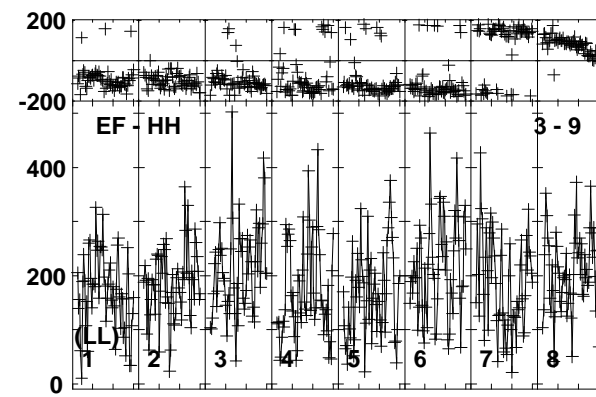
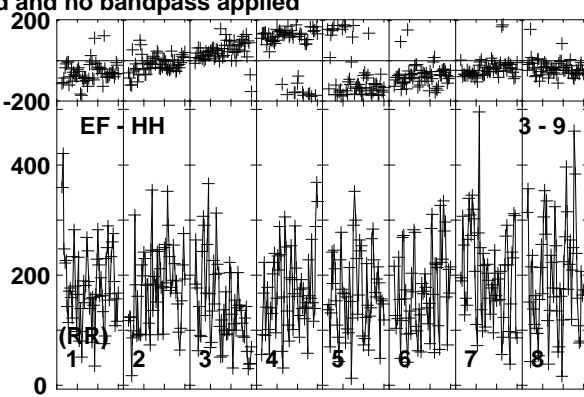
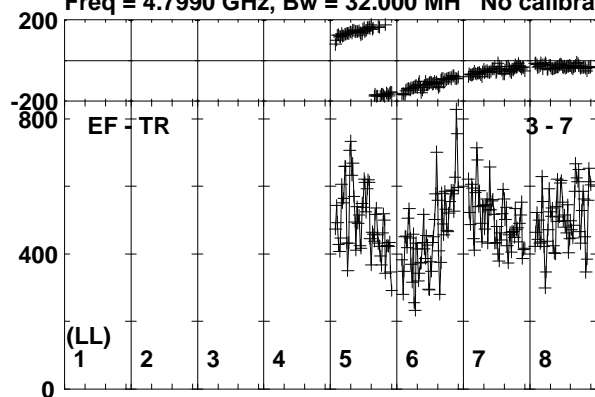

Lower frame: Micro Ampl Jy Top frame: Phas deg
Vector averaged cross-power spectrum Baseline: EF (03) - TR (07)
Timerange: 01/03:51:15 to 01/03:53:45

Plot file version 462 created 26-SEP-2019 10:42:50

J0300-0846 RG010A.UVDATA.1

Freq = 4.7990 GHz, Bw = 32.000 MH No calibration applied and no bandpass applied

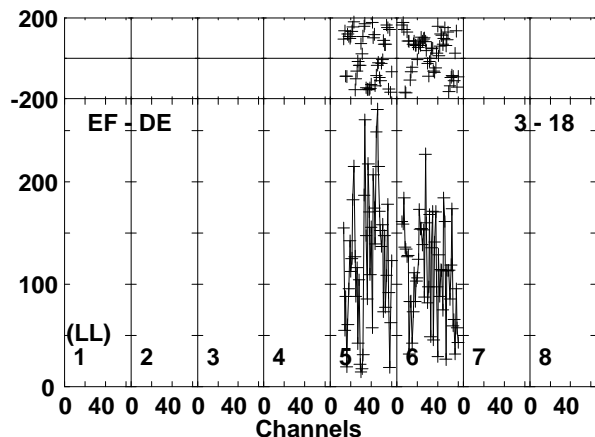
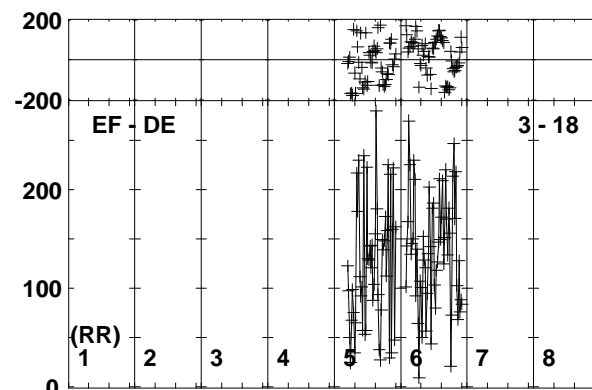
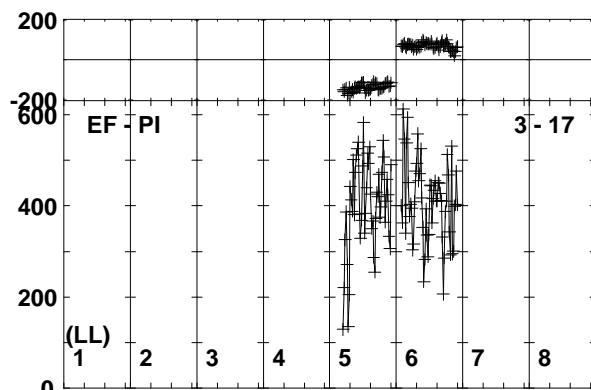
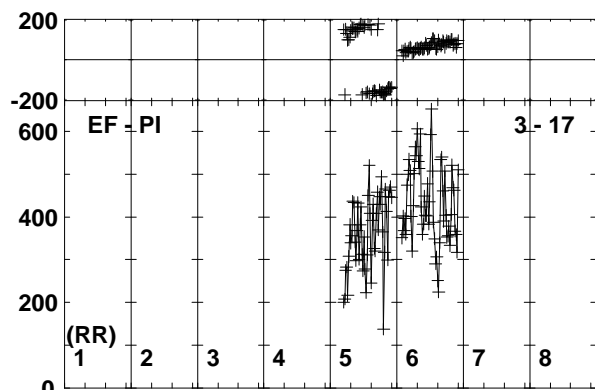
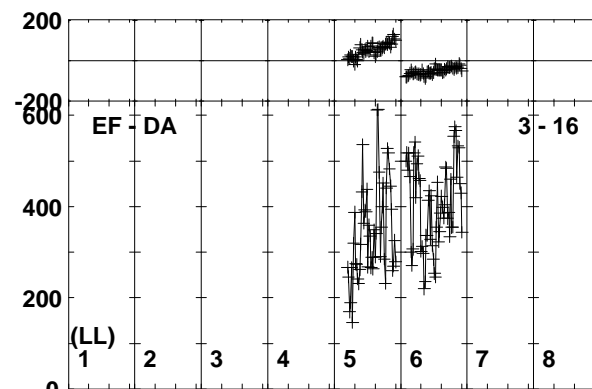
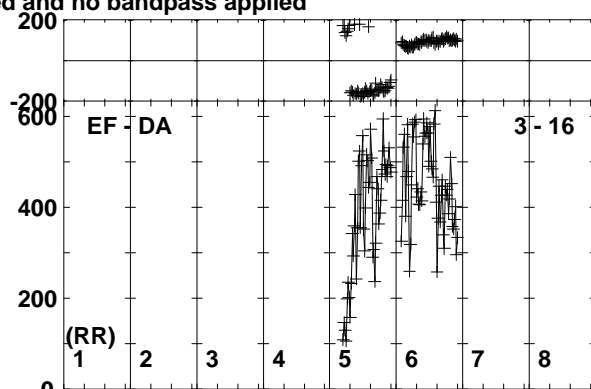
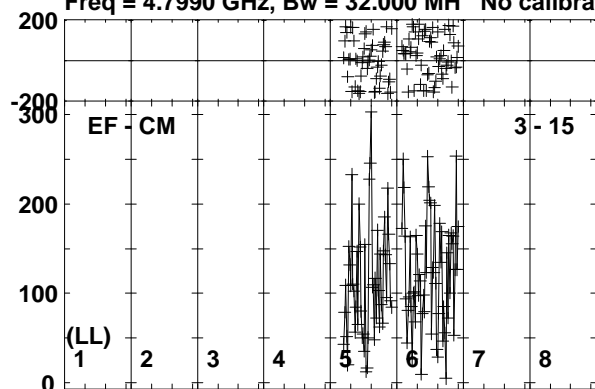

Lower frame: Micro Ampl Jy Top frame: Phas deg
Vector averaged cross-power spectrum Baseline: EF (03) - CM (15)
Timerange: 01/03:51:15 to 01/03:53:45

Plot file version 463 created 26-SEP-2019 10:42:50

190829A RG010A.UVDATA.1

Freq = 4.7990 GHz, Bw = 32.000 MH No calibration applied and no bandpass applied

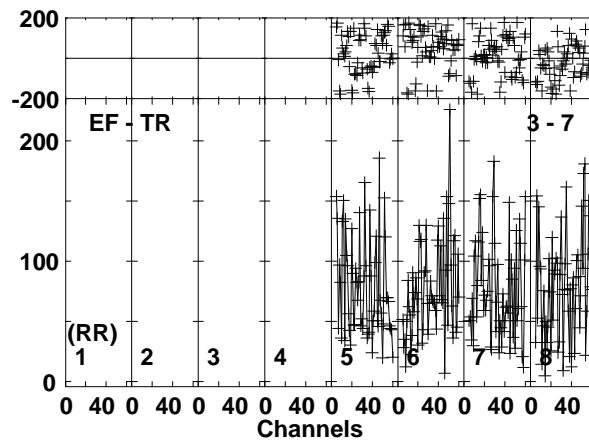
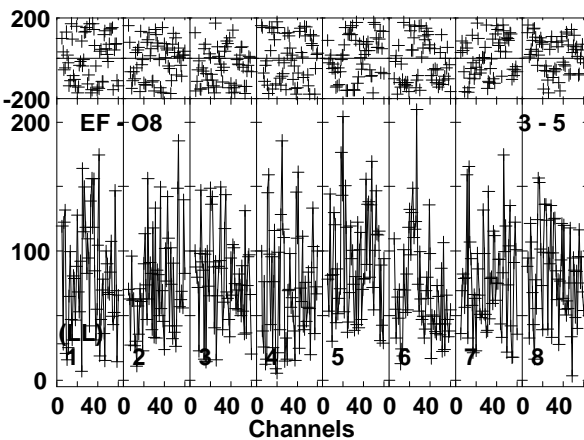
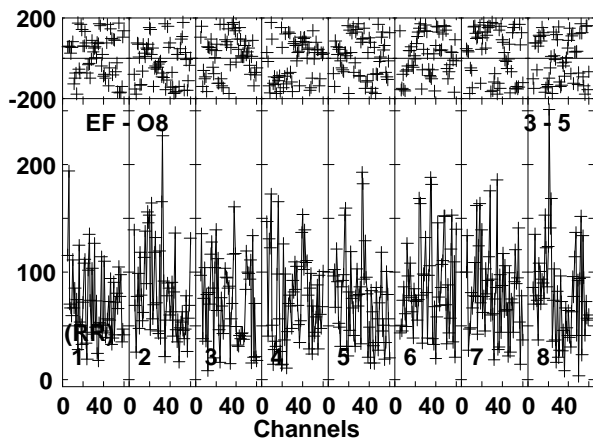
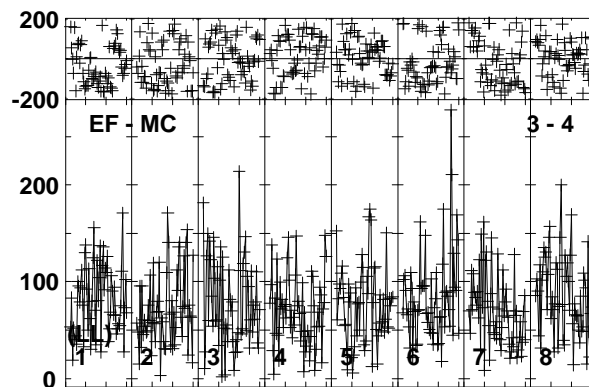
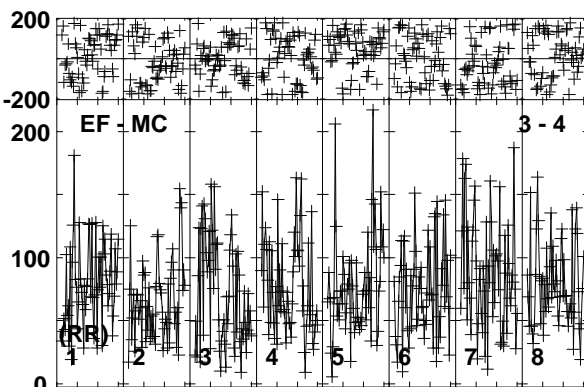
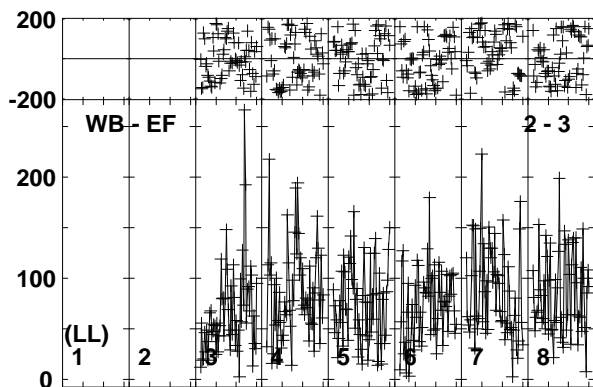
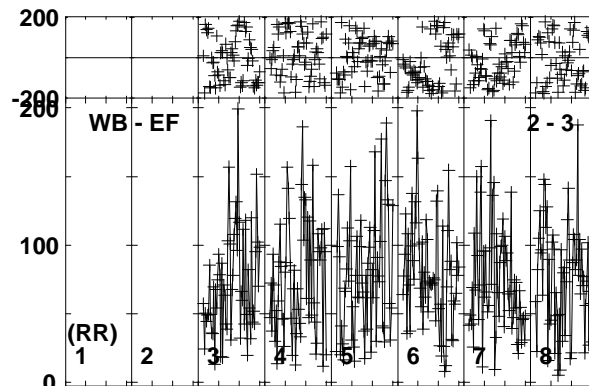
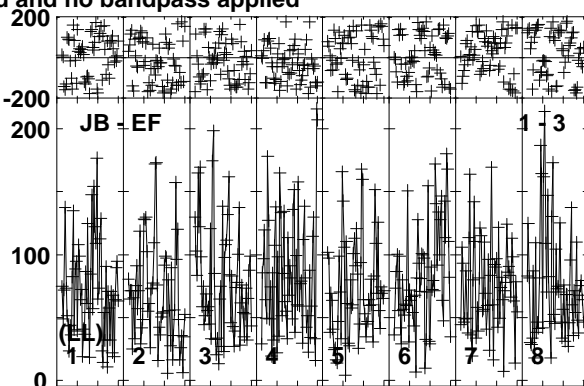
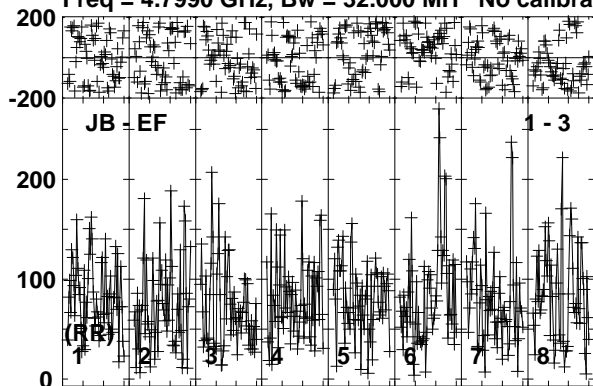

Lower frame: Micro Ampl Jy Top frame: Phas deg
Vector averaged cross-power spectrum Baseline: JB (01) - EF (03)
Timerange: 01/03:53:46 to 01/03:57:15

Plot file version 464 created 26-SEP-2019 10:42:51

190829A RG010A.UVDATA.1

Freq = 4.7990 GHz, Bw = 32.000 MH No calibration applied and no bandpass applied

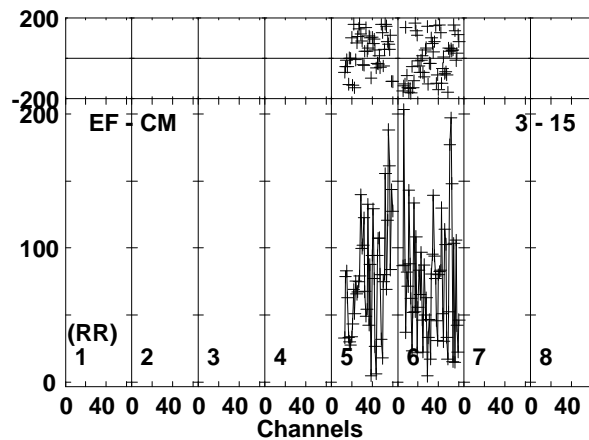
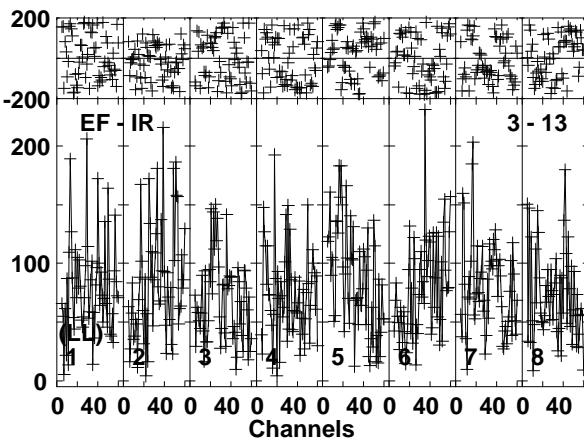
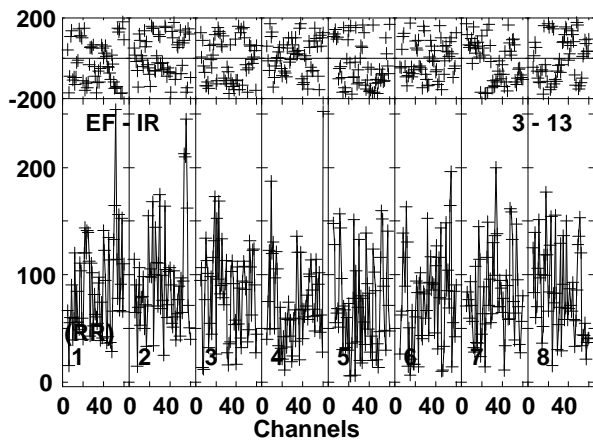
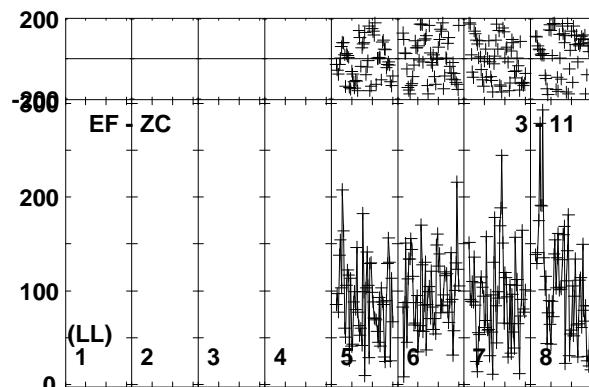
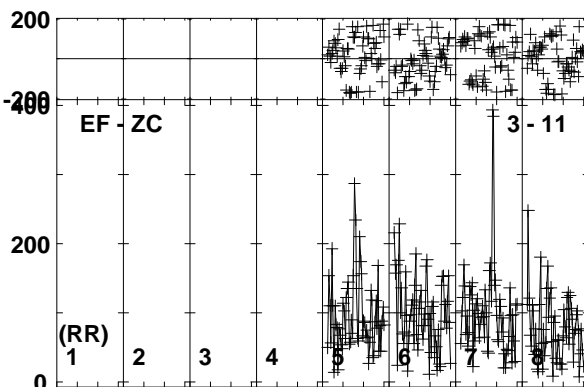
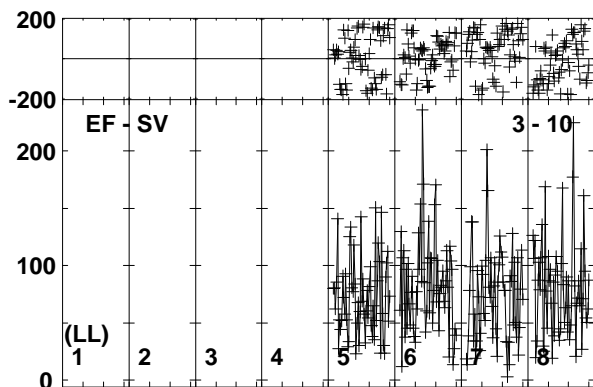
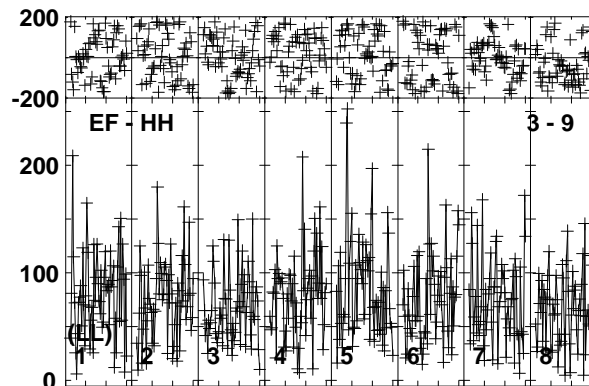
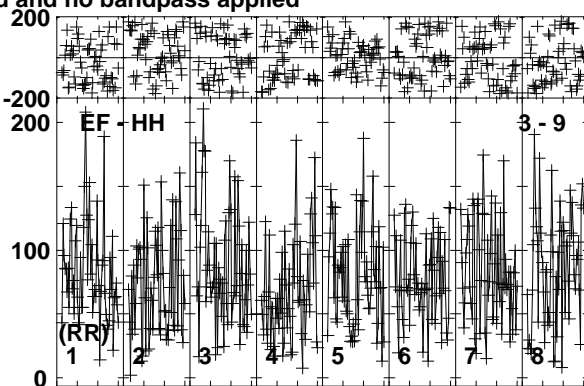
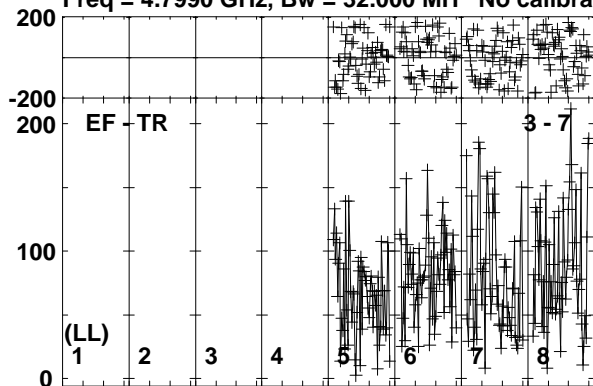

Lower frame: Micro Ampl Jy Top frame: Phas deg
Vector averaged cross-power spectrum Baseline: EF (03) - TR (07)
Timerange: 01/03:53:46 to 01/03:57:15

Plot file version 465 created 26-SEP-2019 10:42:51
 190829A RG010A.UVDATA.1
 Freq = 4.7990 GHz, Bw = 32.000 MH No calibration applied and no bandpass applied

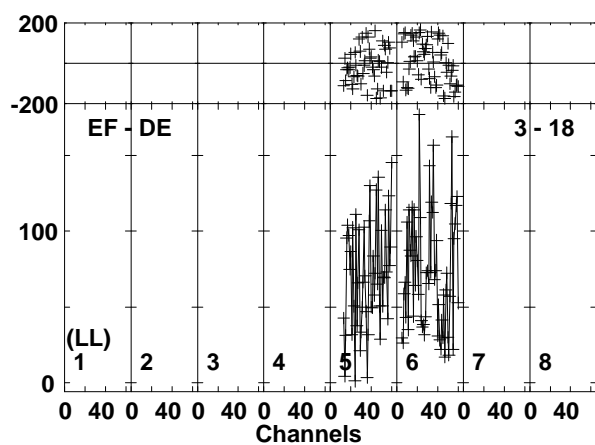
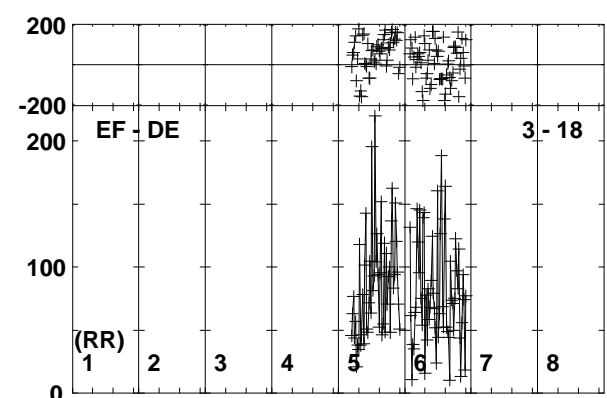
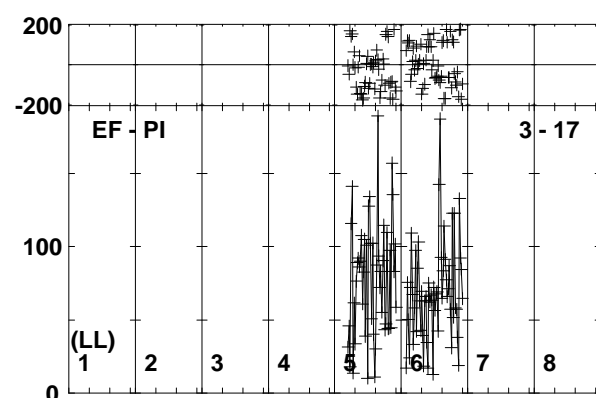
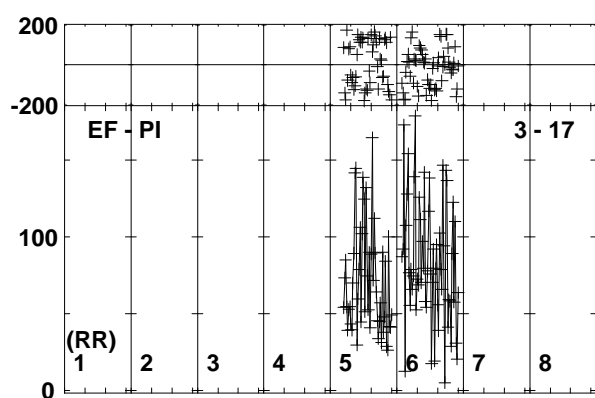
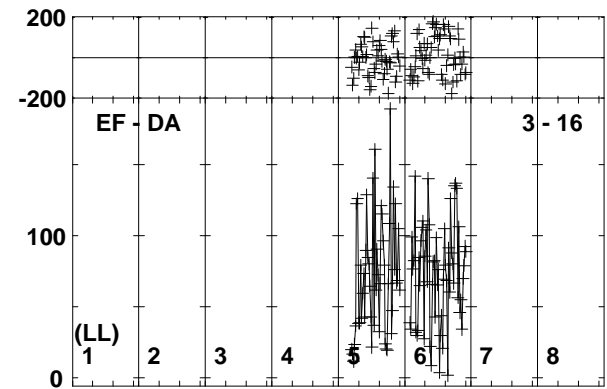
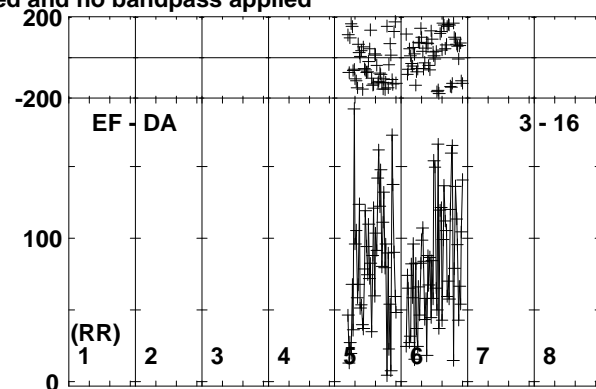
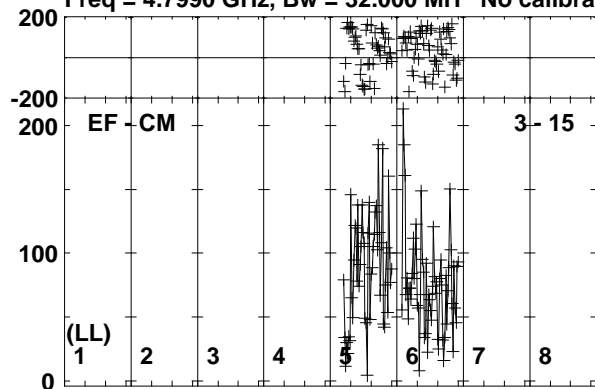

Lower frame: Micro Ampl Jy Top frame: Phas deg
 Vector averaged cross-power spectrum Baseline: EF (03) - CM (15)
 Timerange: 01/03:53:46 to 01/03:57:15

Plot file version 466 created 26-SEP-2019 10:42:52

J0257-1212 RG010A.UVDATA.1

Freq = 4.7990 GHz, Bw = 32.000 MH No calibration applied and no bandpass applied

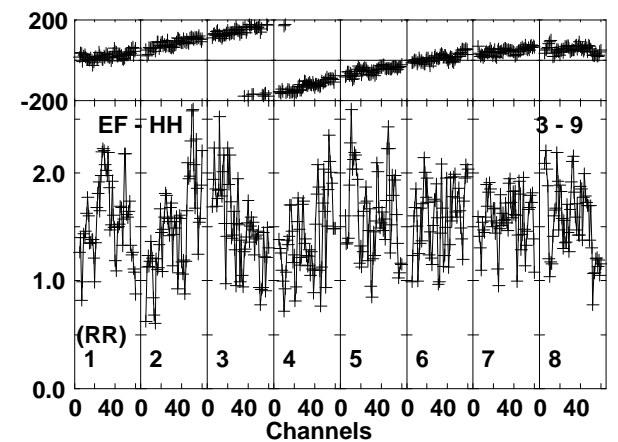
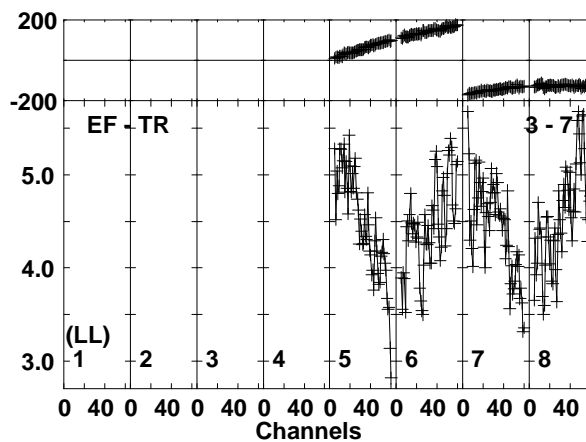
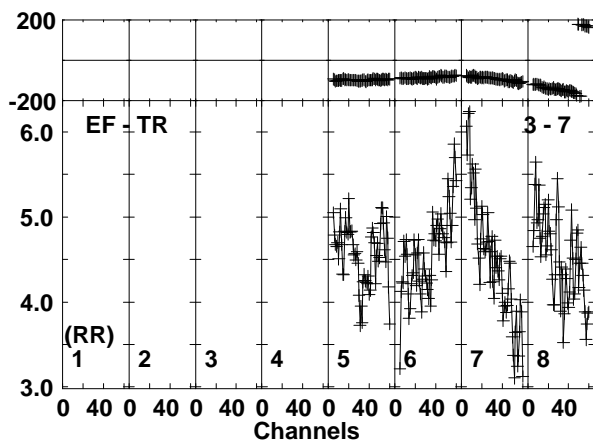
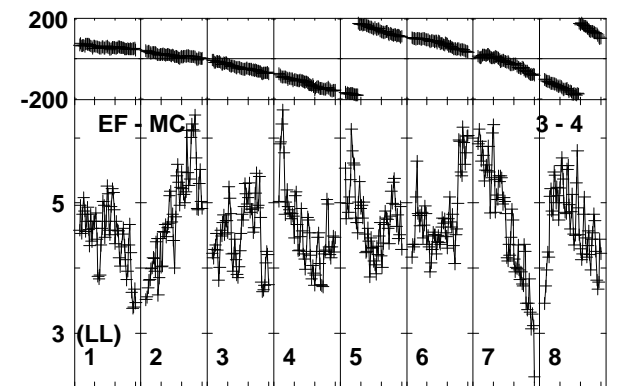
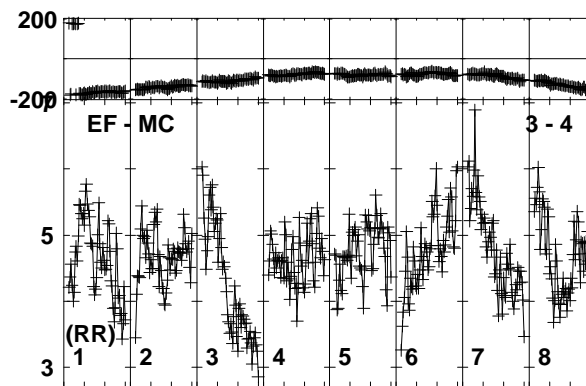
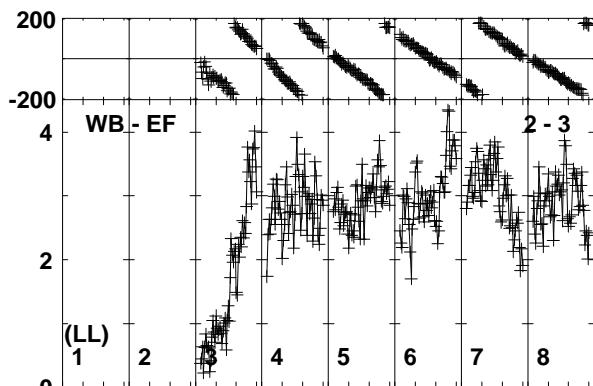
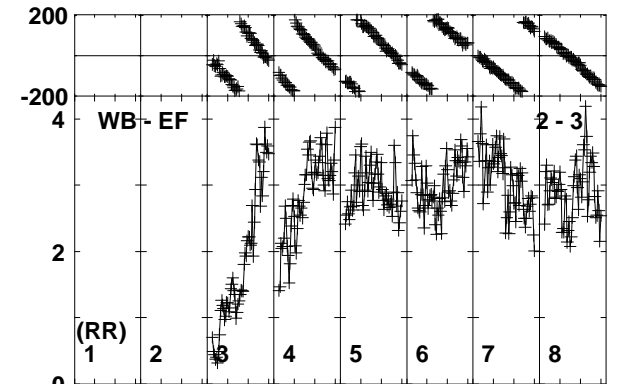
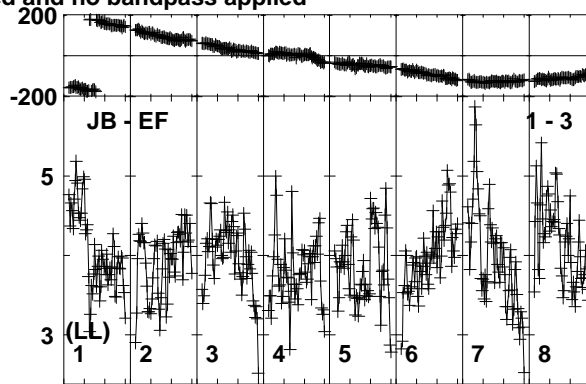
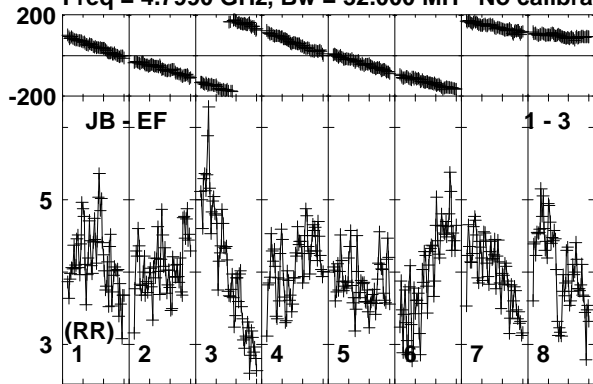

Lower frame: Milli Ampl Jy Top frame: Phas deg
Vector averaged cross-power spectrum Baseline: JB (01) - EF (03)
Timerange: 01/03:57:16 to 01/03:58:14

Plot file version 467 created 26-SEP-2019 10:42:52

J0257-1212 RG010A.UVDATA.1

Freq = 4.7990 GHz, Bw = 32.000 MH No calibration applied and no bandpass applied

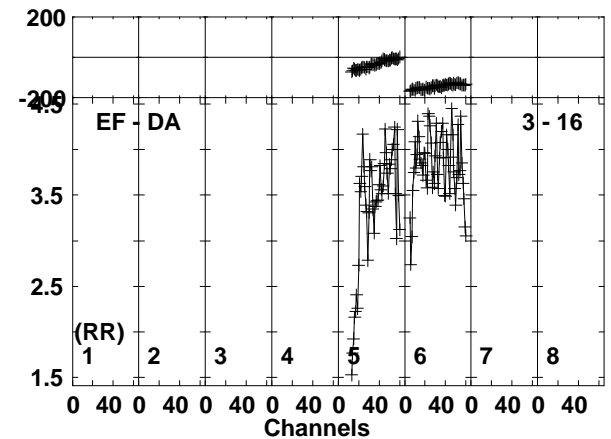
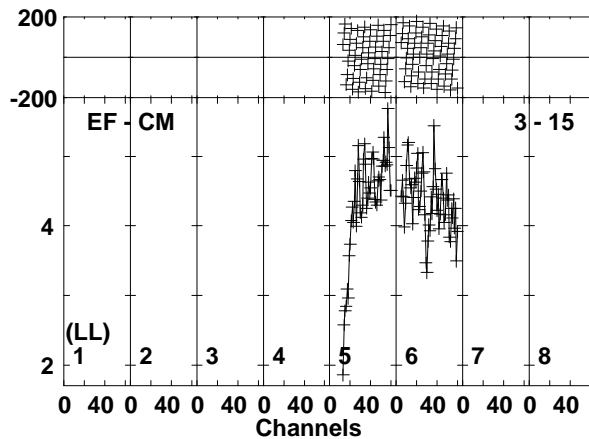
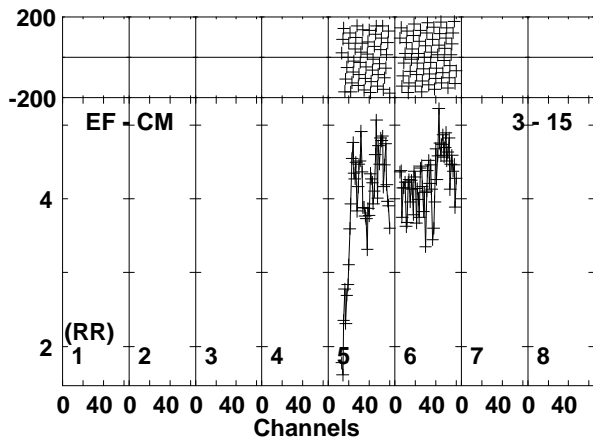
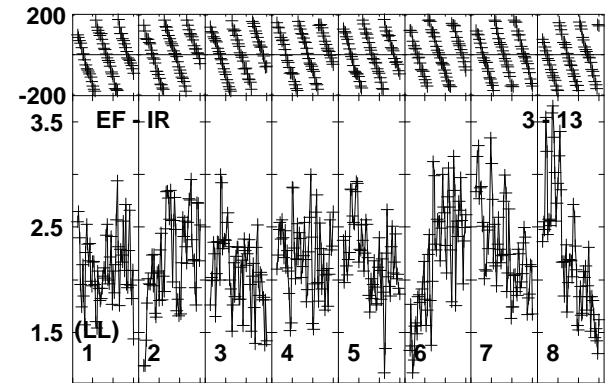
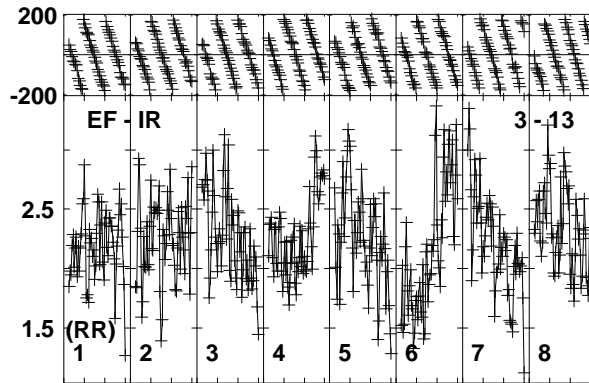
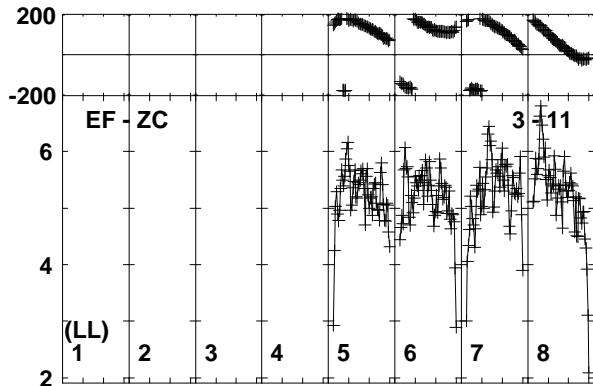
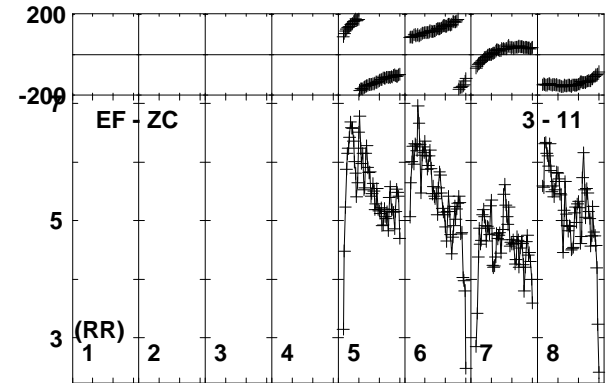
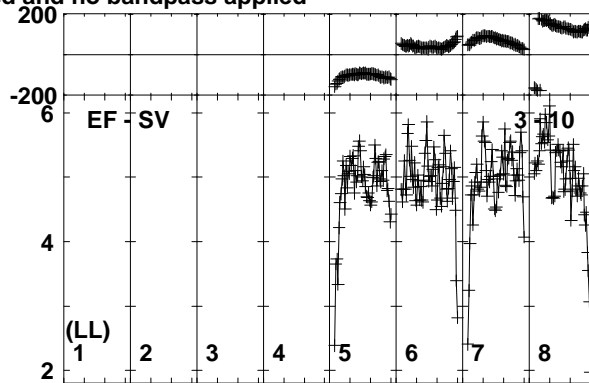
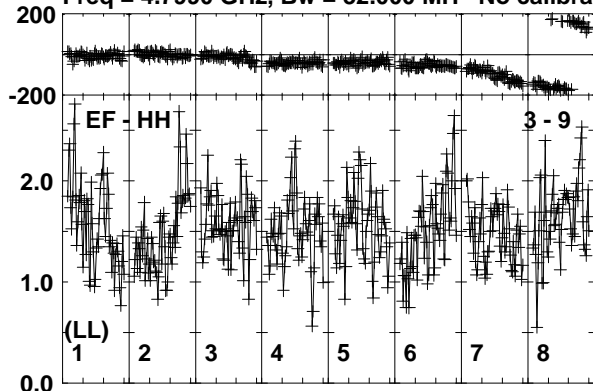

Lower frame: Milli Ampl Jy Top frame: Phas deg
Vector averaged cross-power spectrum Baseline: EF (03) - HH (09)
Timerange: 01/03:57:16 to 01/03:58:14

Plot file version 468 created 26-SEP-2019 10:42:53

J0257-1212 RG010A.UVDATA.1

Freq = 4.7990 GHz, Bw = 32.000 MH No calibration applied and no bandpass applied

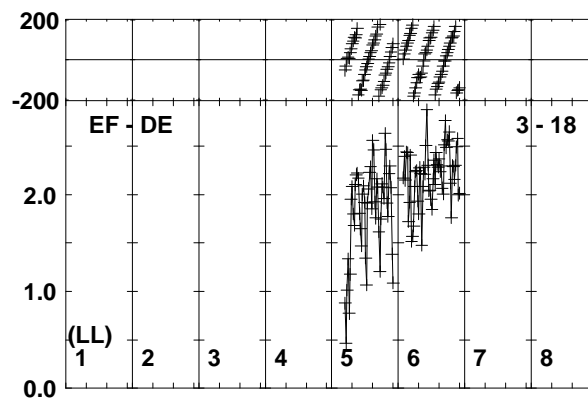
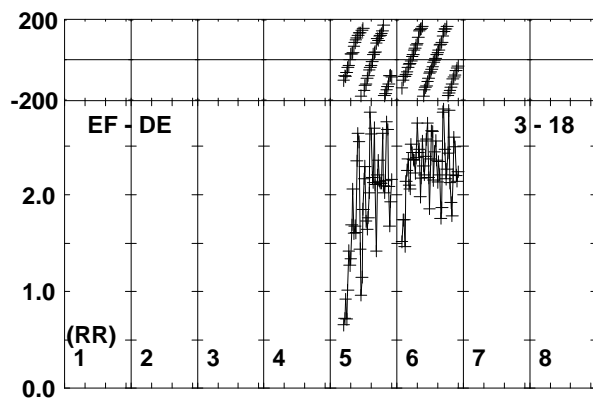
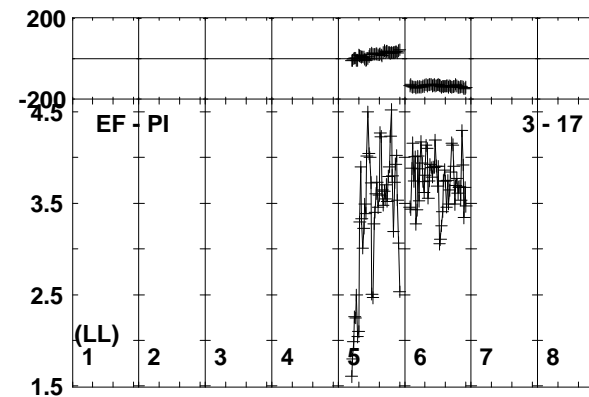
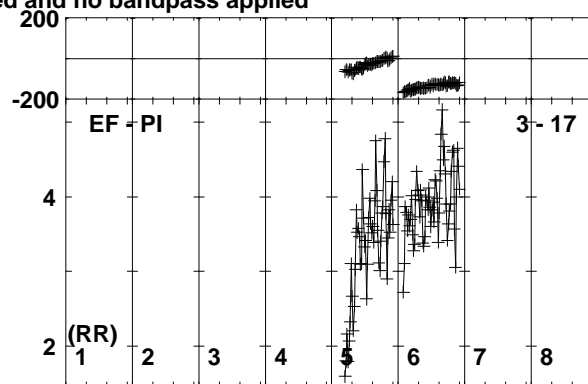
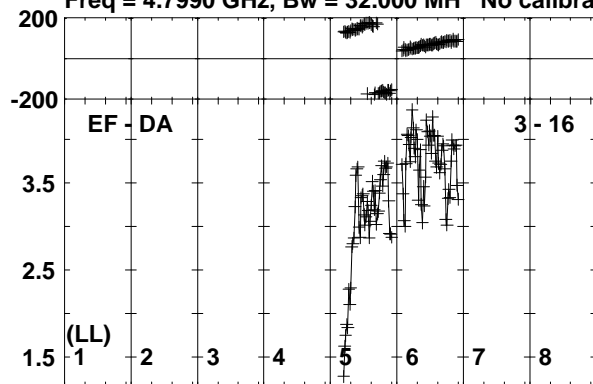

Lower frame: Milli Ampl Jy Top frame: Phas deg
Vector averaged cross-power spectrum Baseline: EF (03) - DA (16)
Timerange: 01/03:57:16 to 01/03:58:14

Plot file version 469 created 26-SEP-2019 10:42:54

190829A RG010A.UVDATA.1

Freq = 4.7990 GHz, Bw = 32.000 MH No calibration applied and no bandpass applied

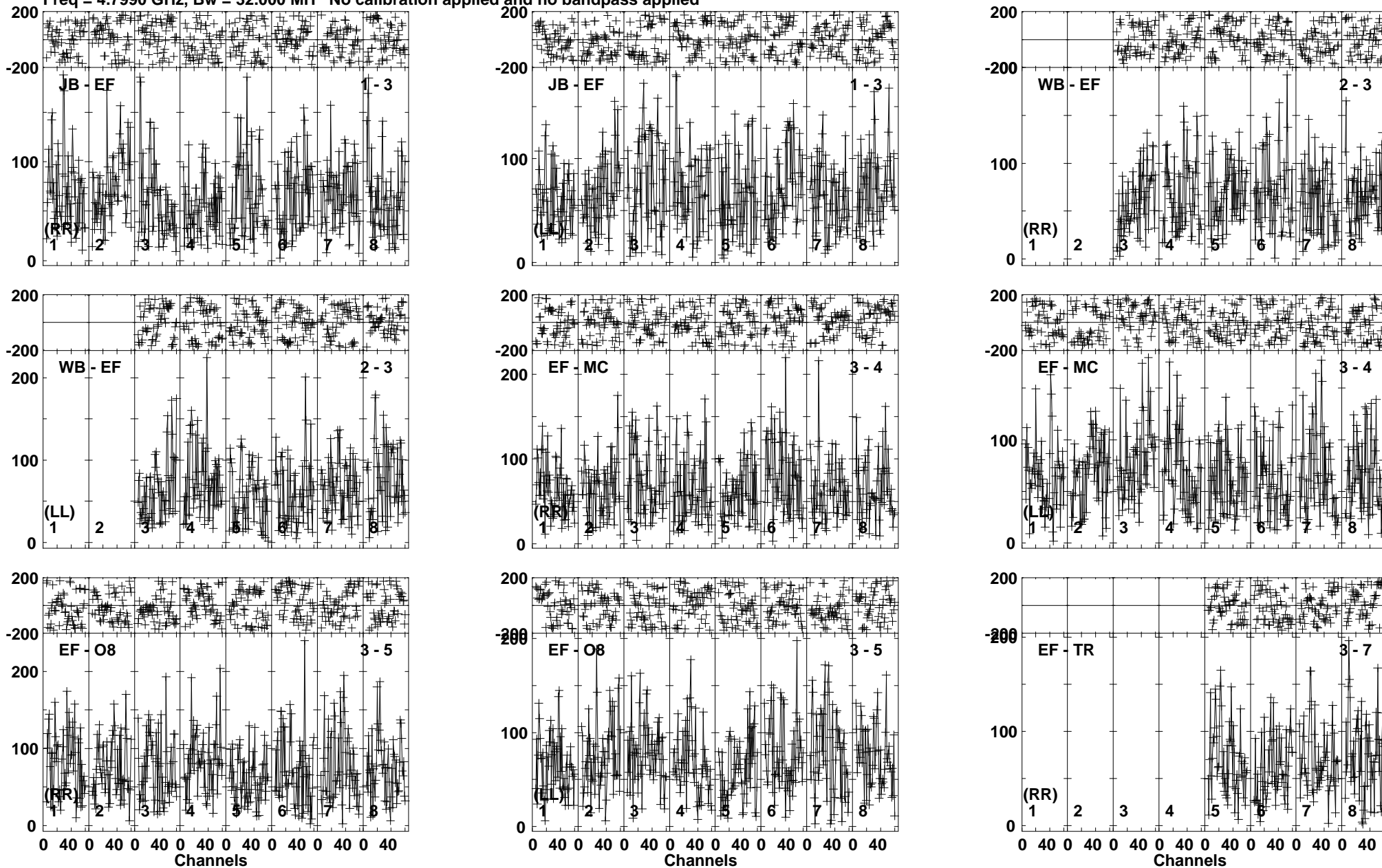

Lower frame: Micro Ampl Jy Top frame: Phas deg
Vector averaged cross-power spectrum Baseline: JB (01) - EF (03)
Timerange: 01/03:58:15 to 01/04:03:14

Plot file version 470 created 26-SEP-2019 10:42:54

190829A RG010A.UVDATA.1

Freq = 4.7990 GHz, Bw = 32.000 MH No calibration applied and no bandpass applied

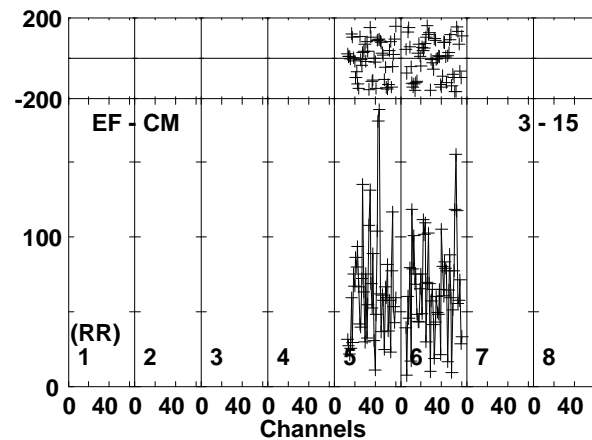
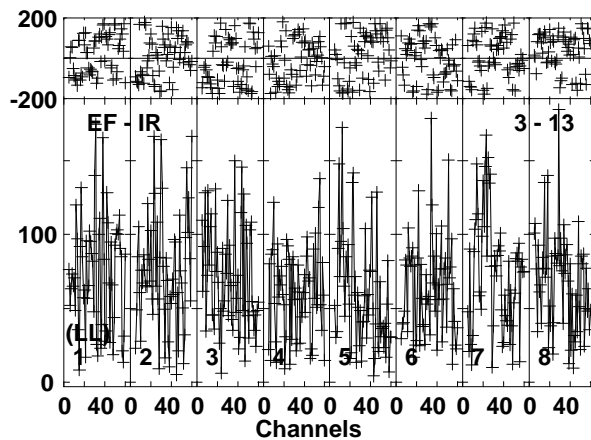
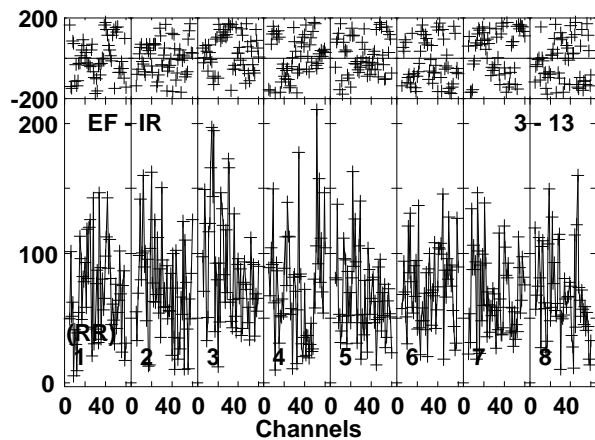
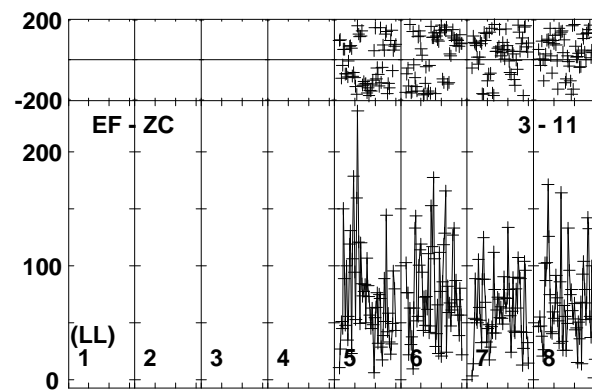
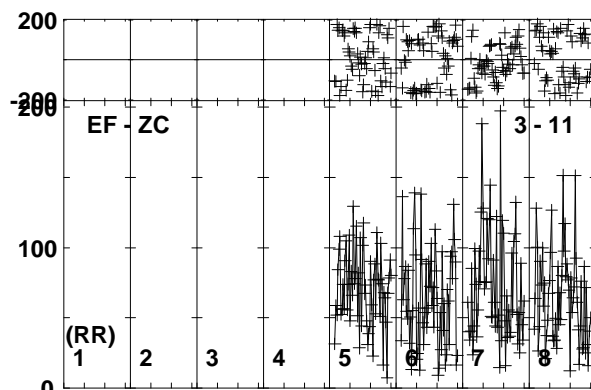
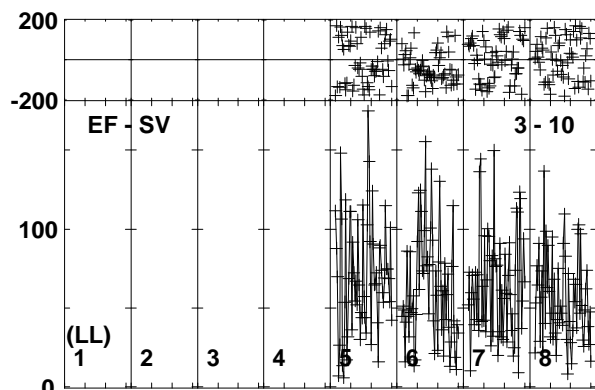
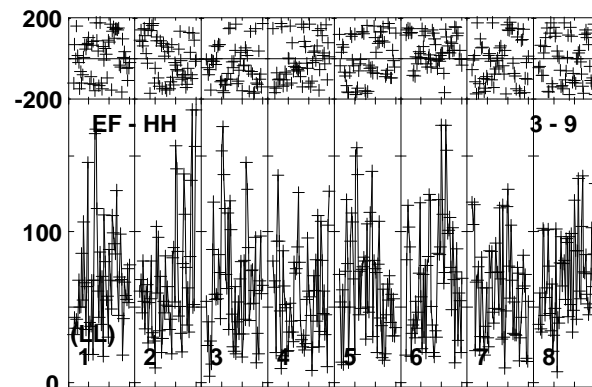
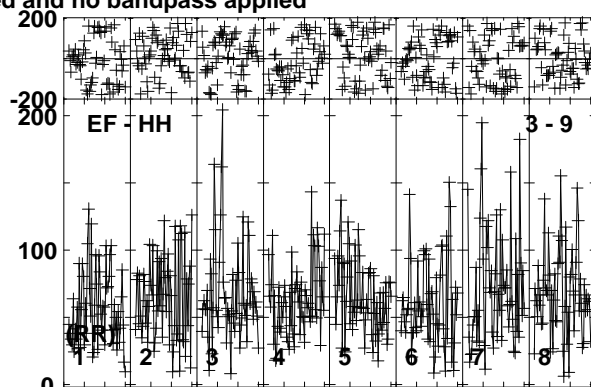
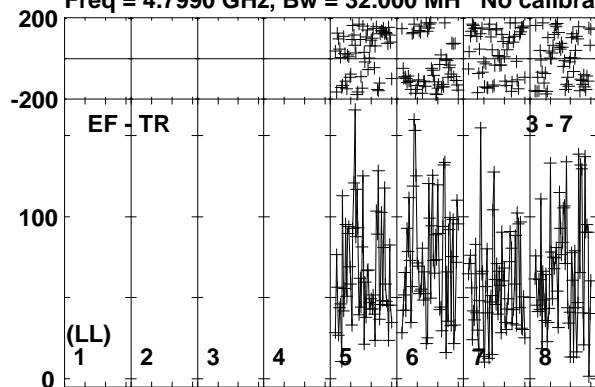

Lower frame: Micro Ampl Jy Top frame: Phas deg
Vector averaged cross-power spectrum Baseline: EF (03) - TR (07)
Timerange: 01/03:58:15 to 01/04:03:14

Plot file version 471 created 26-SEP-2019 10:42:55

190829A RG010A.UVDATA.1

Freq = 4.7990 GHz, Bw = 32.000 MH No calibration applied and no bandpass applied

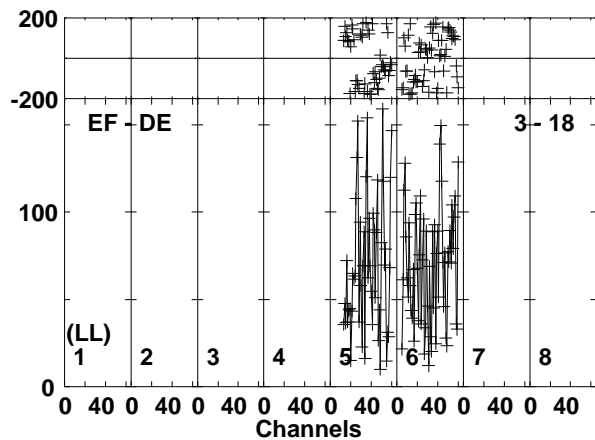
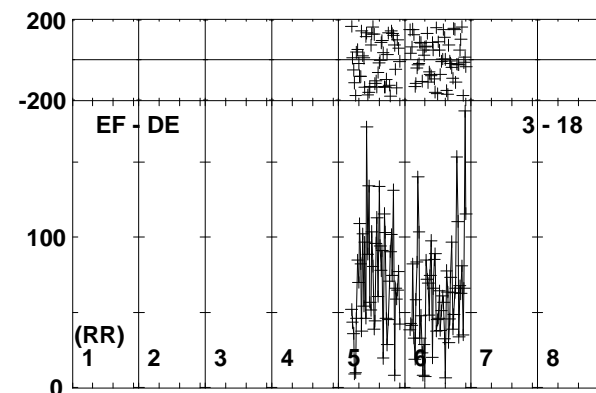
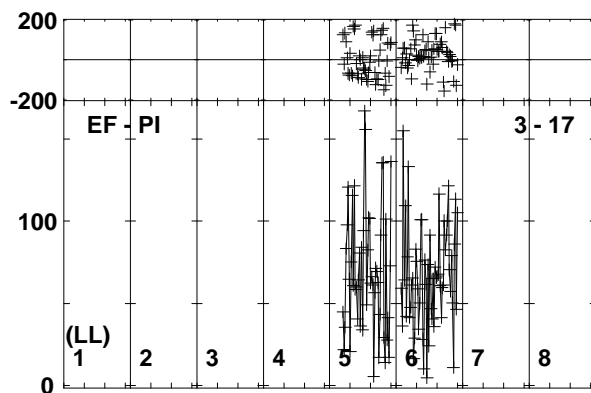
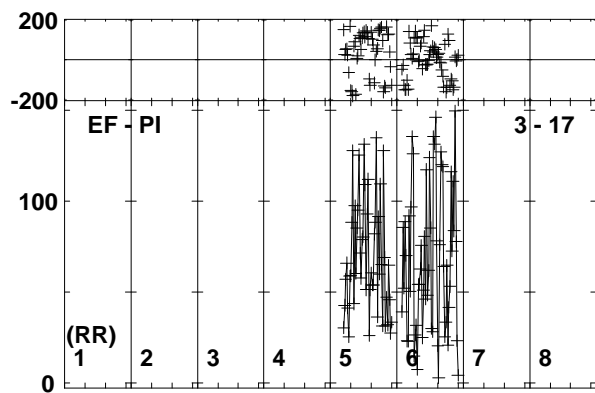
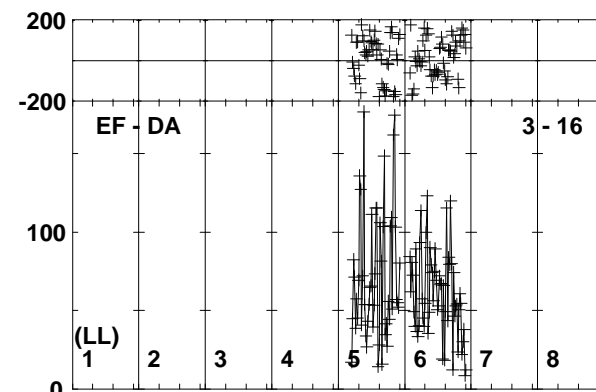
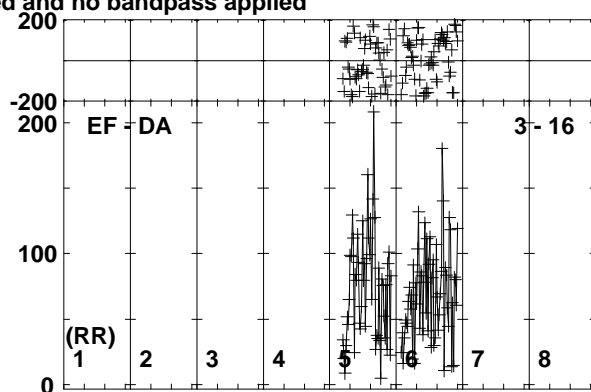
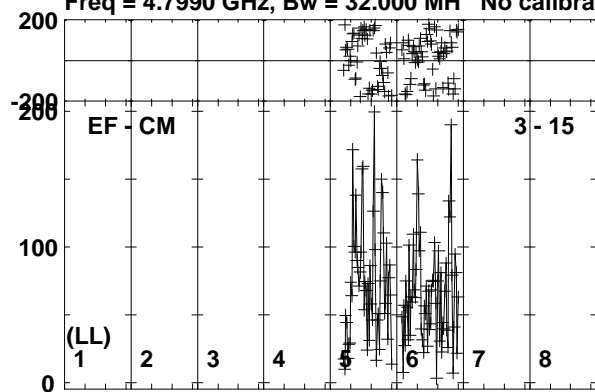

Lower frame: Micro Ampl Jy Top frame: Phas deg
Vector averaged cross-power spectrum Baseline: EF (03) - CM (15)
Timerange: 01/03:58:15 to 01/04:03:14

Plot file version 472 created 26-SEP-2019 10:42:56

J0257-1212 RG010A.UVDATA.1

Freq = 4.7990 GHz, Bw = 32.000 MH No calibration applied and no bandpass applied

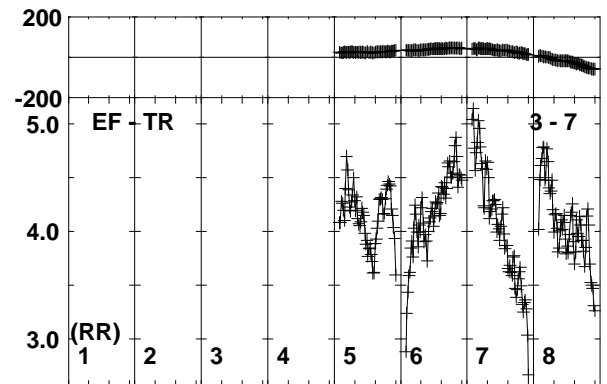
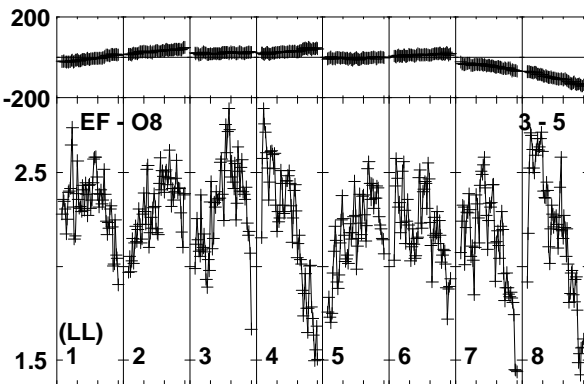
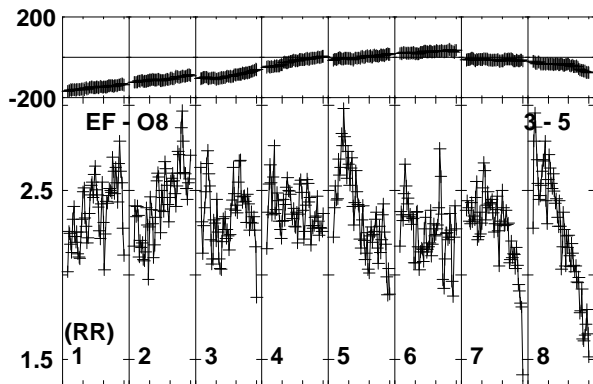
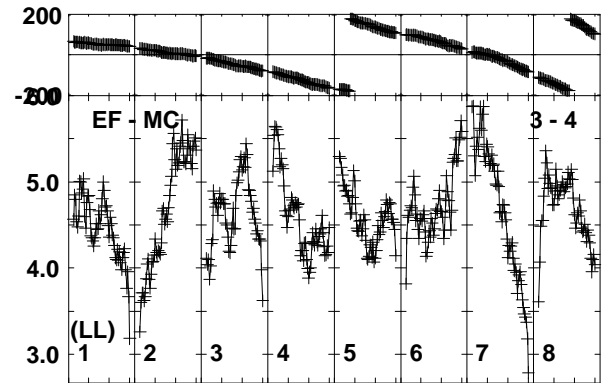
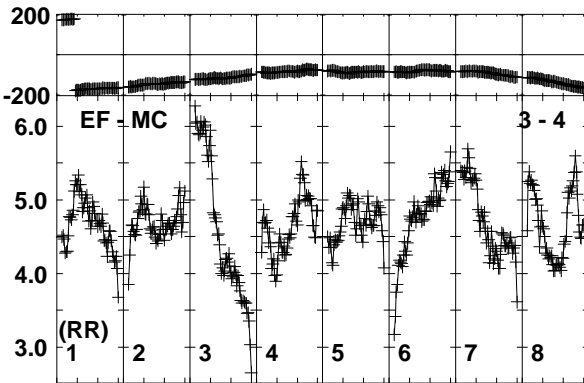
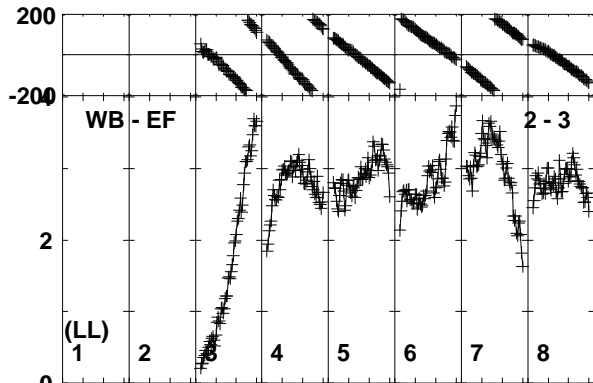
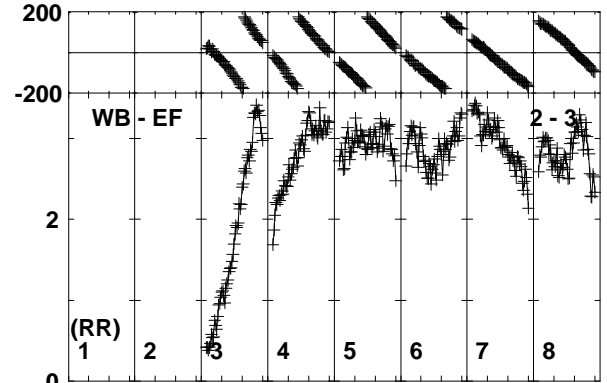
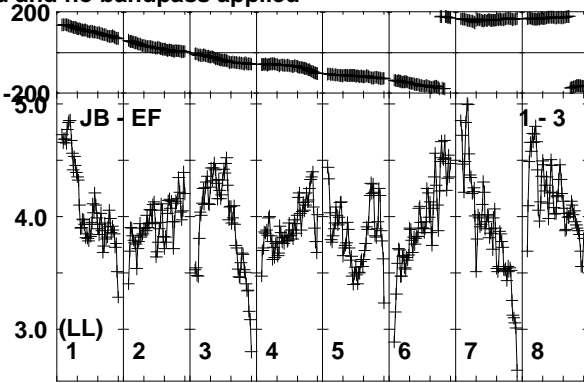
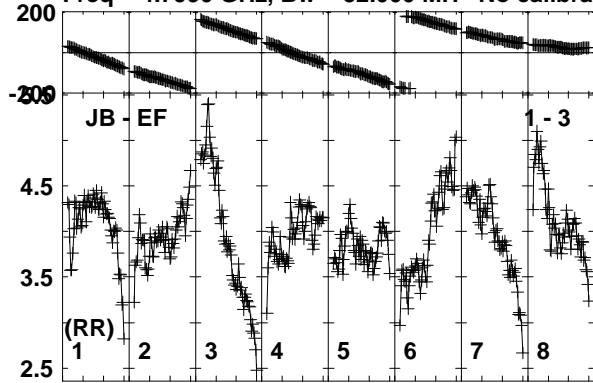

Lower frame: Milli Ampl Jy Top frame: Phas deg

Vector averaged cross-power spectrum Baseline: JB (01) - EF (03)

Timerange: 01/04:03:55 to 01/04:04:54

Plot file version 473 created 26-SEP-2019 10:42:56

J0257-1212 RG010A.UVDATA.1

Freq = 4.7990 GHz, Bw = 32.000 MH No calibration applied and no bandpass applied

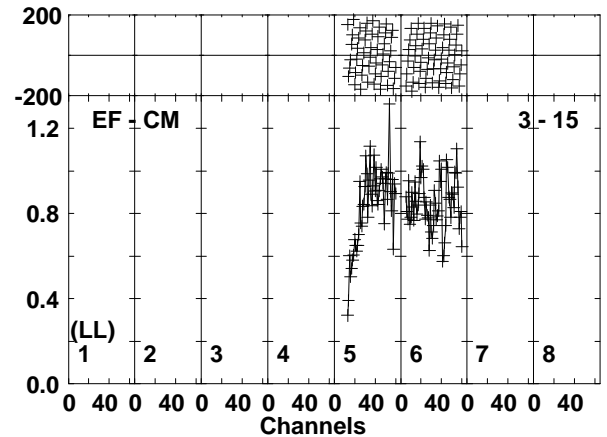
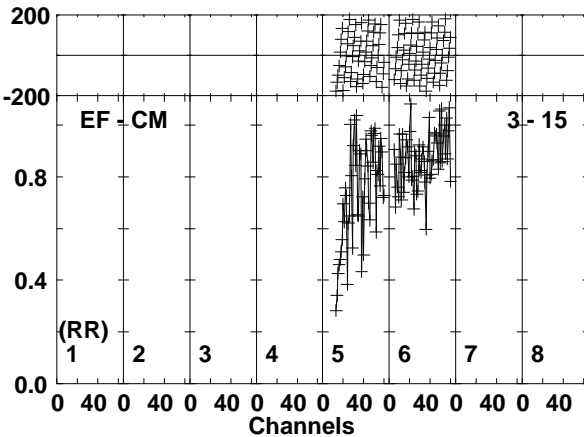
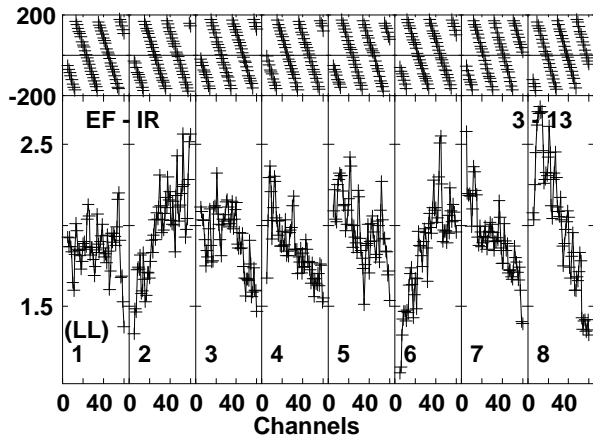
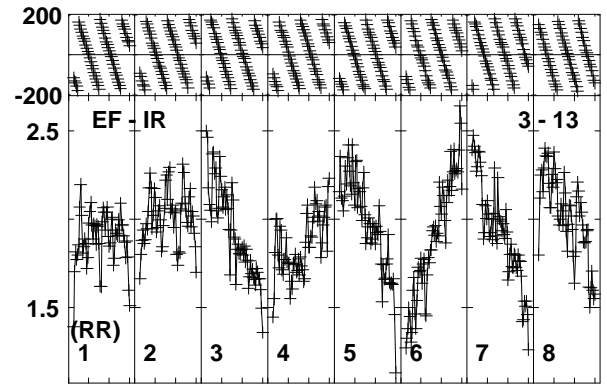
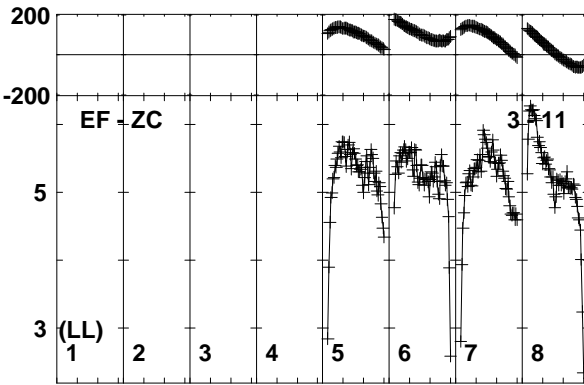
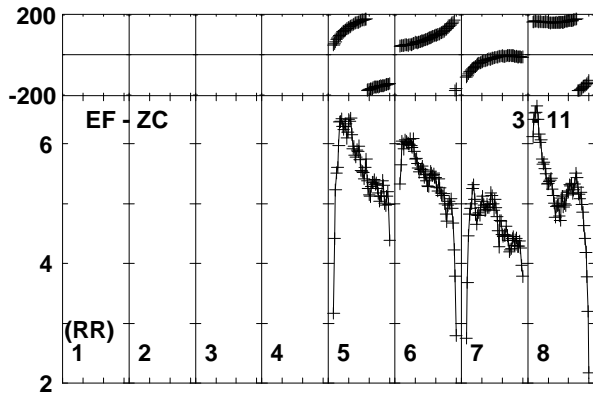
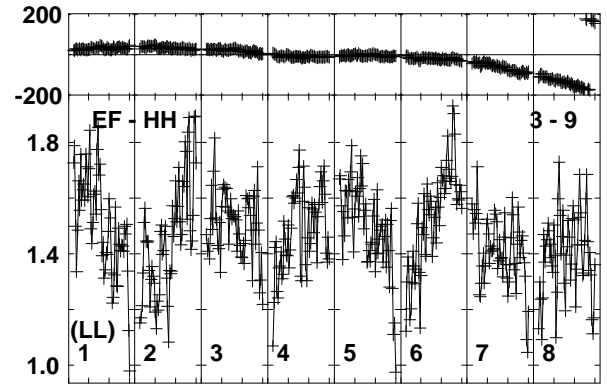
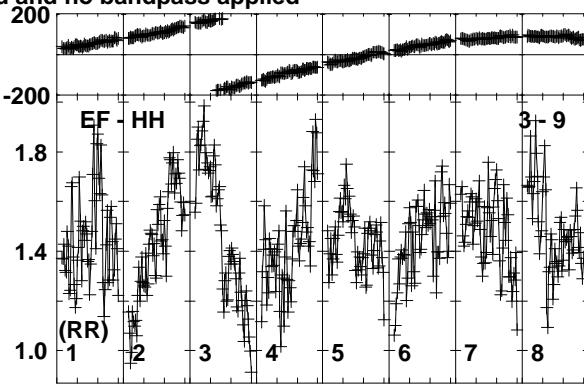
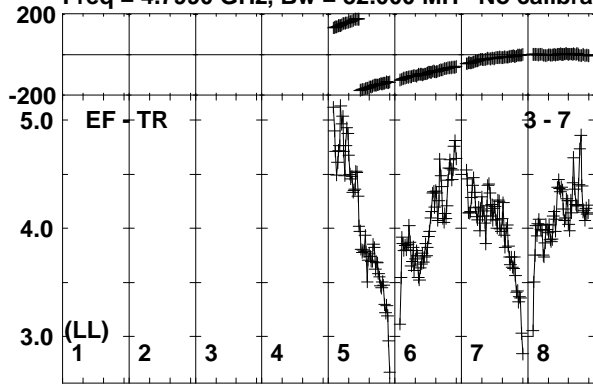

Lower frame: Milli Ampl Jy Top frame: Phas deg
Vector averaged cross-power spectrum Baseline: EF (03) - TR (07)
Timerange: 01/04:03:55 to 01/04:04:54

Plot file version 474 created 26-SEP-2019 10:42:57

J0257-1212 RG010A.UVDATA.1

Freq = 4.7990 GHz, Bw = 32.000 MH No calibration applied and no bandpass applied

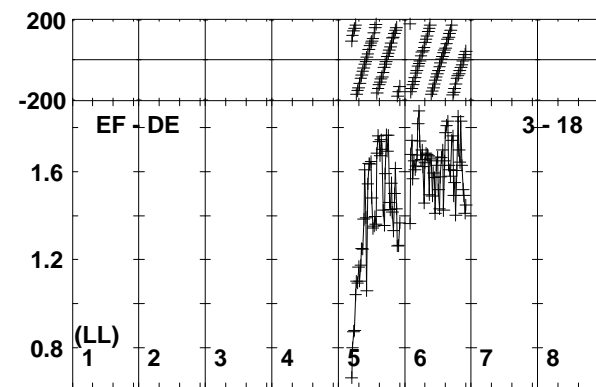
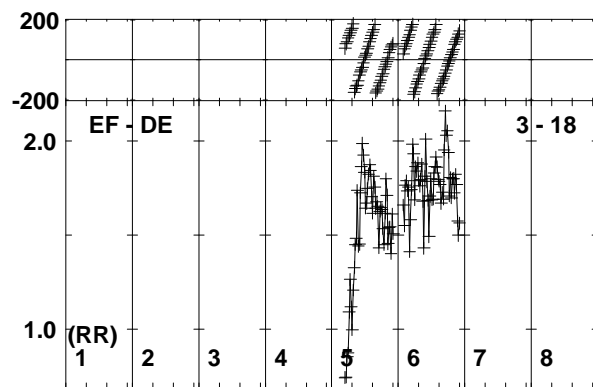
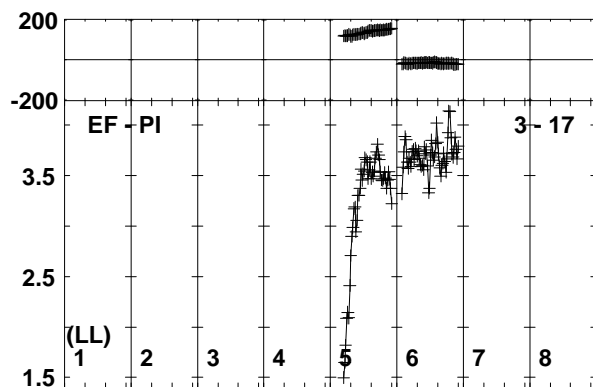
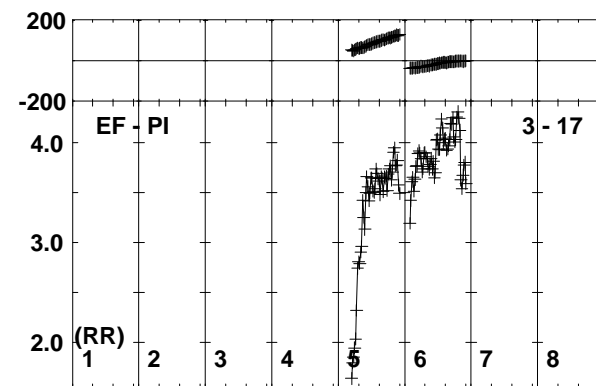
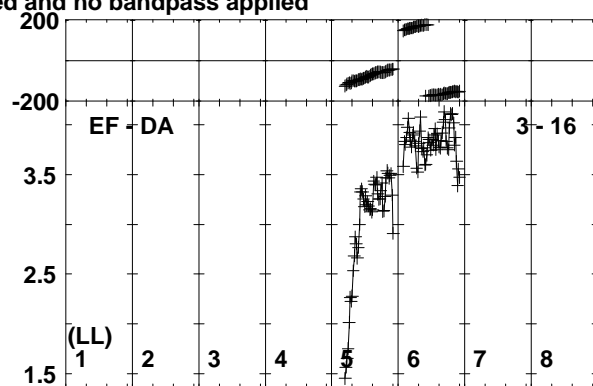
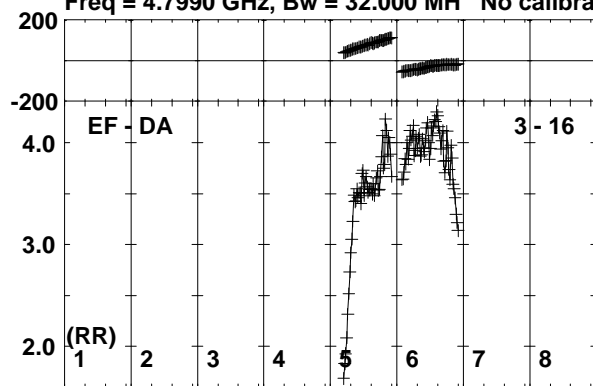

Lower frame: Milli Ampl Jy Top frame: Phas deg
Vector averaged cross-power spectrum Baseline: EF (03) - DA (16)
Timerange: 01/04:03:55 to 01/04:04:54

Plot file version 475 created 26-SEP-2019 10:42:57

190829A RG010A.UVDATA.1

Freq = 4.7990 GHz, Bw = 32.000 MH No calibration applied and no bandpass applied

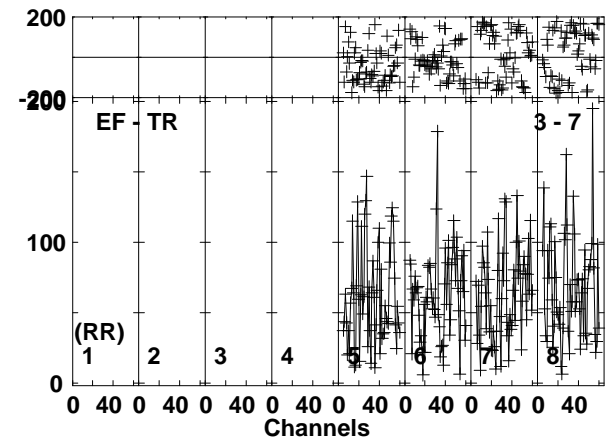
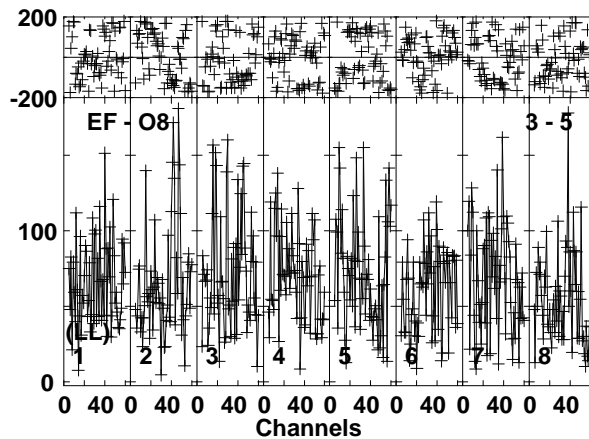
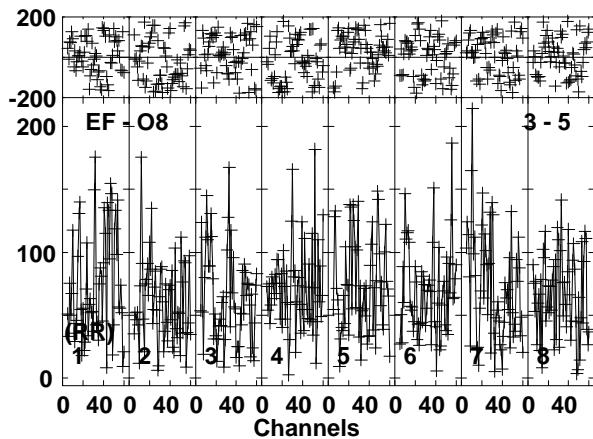
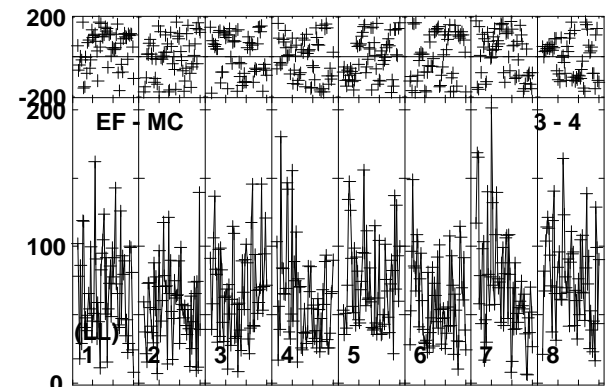
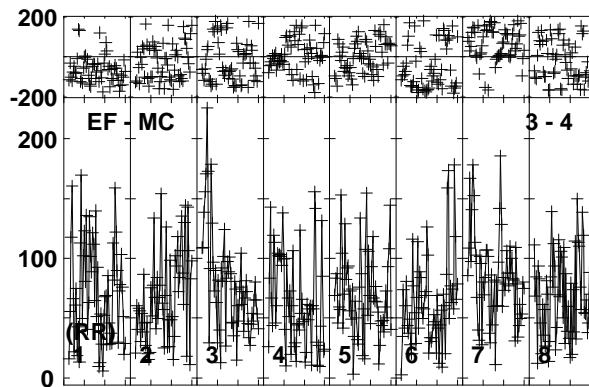
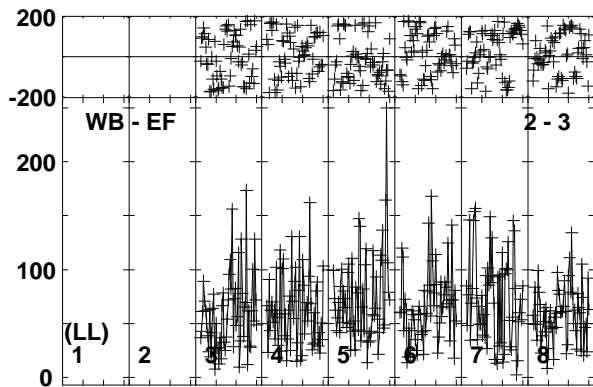
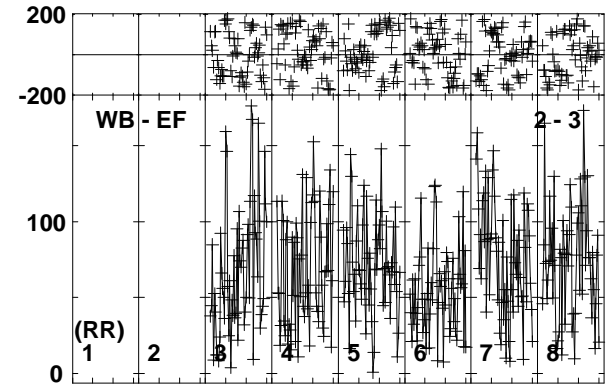
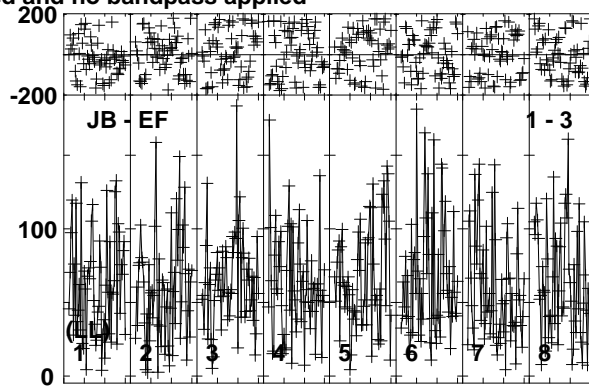
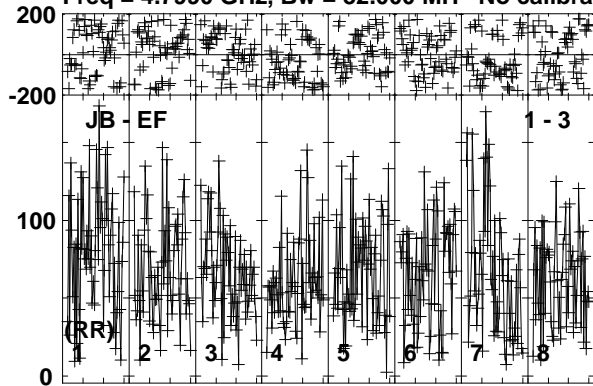

Lower frame: Micro Ampl Jy Top frame: Phas deg
Vector averaged cross-power spectrum Baseline: JB (01) - EF (03)
Timerange: 01/04:04:56 to 01/04:09:55

Plot file version 476 created 26-SEP-2019 10:42:58

190829A RG010A.UVDATA.1

Freq = 4.7990 GHz, Bw = 32.000 MH No calibration applied and no bandpass applied

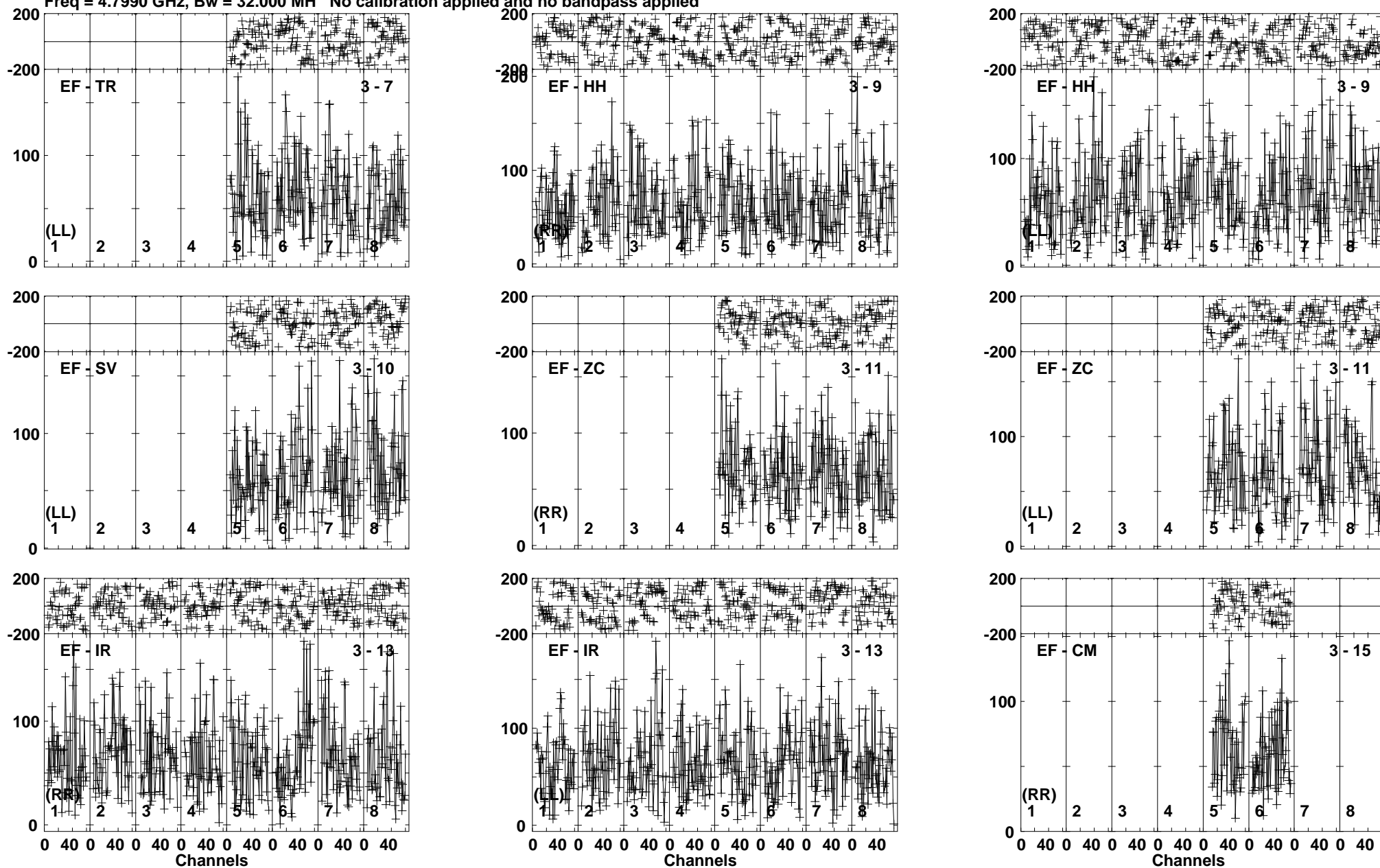

Lower frame: Micro Ampl Jy Top frame: Phas deg
Vector averaged cross-power spectrum Baseline: EF (03) - TR (07)
Timerange: 01/04:04:56 to 01/04:09:55

Plot file version 477 created 26-SEP-2019 10:42:59

190829A RG010A.UVDATA.1

Freq = 4.7990 GHz, Bw = 32.000 MH No calibration applied and no bandpass applied

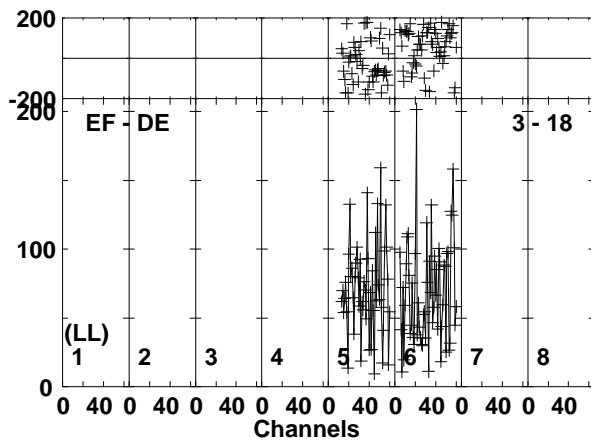
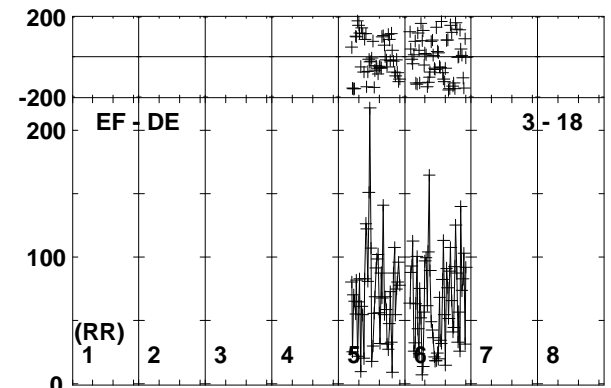
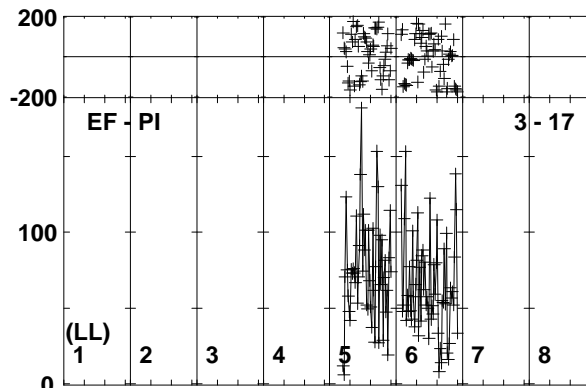
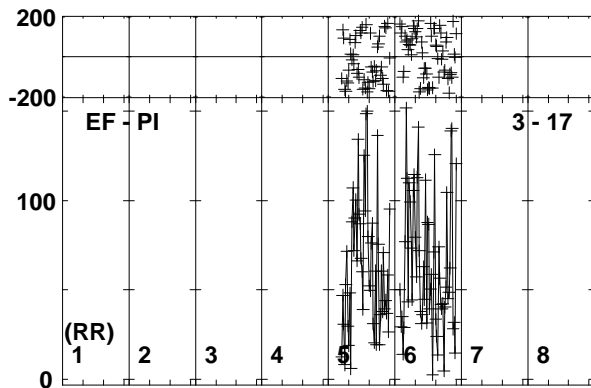
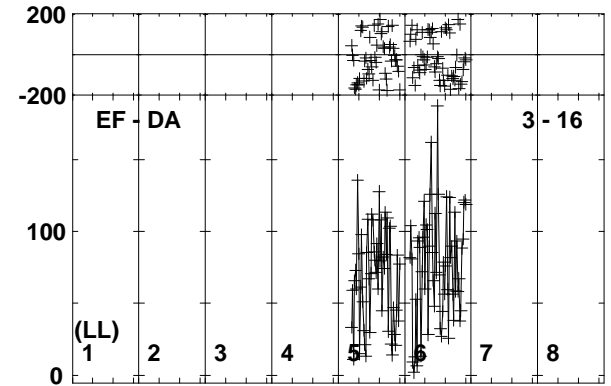
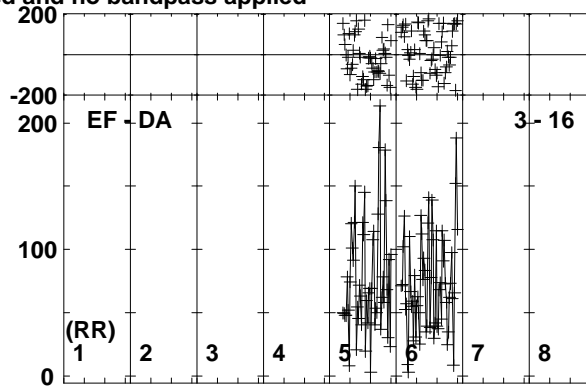
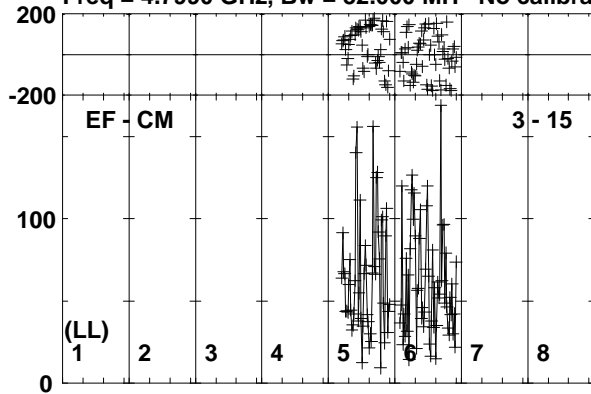

Lower frame: Micro Ampl Jy Top frame: Phas deg
Vector averaged cross-power spectrum Baseline: EF (03) - CM (15)
Timerange: 01/04:04:56 to 01/04:09:55

Plot file version 478 created 26-SEP-2019 10:43:00

J0257-1212 RG010A.UVDATA.1

Freq = 4.7990 GHz, Bw = 32.000 MH No calibration applied and no bandpass applied

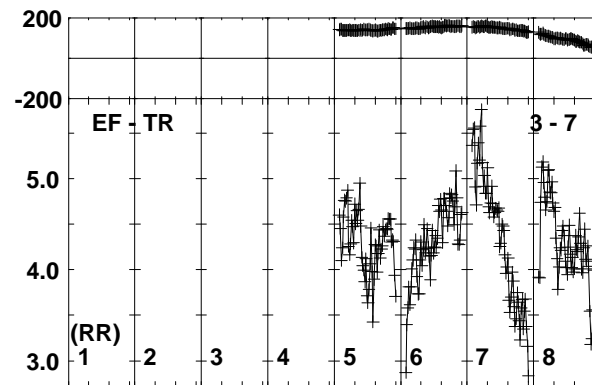
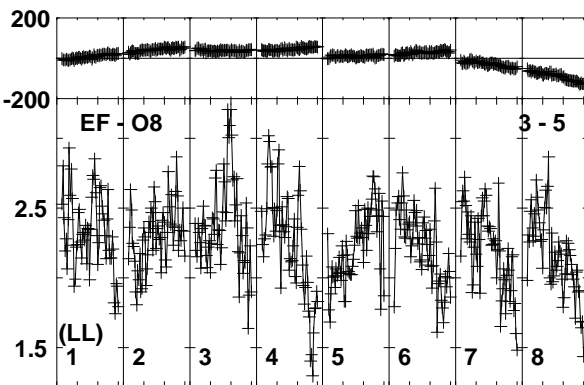
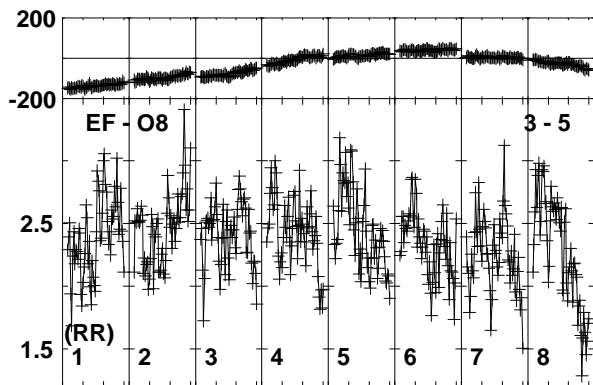
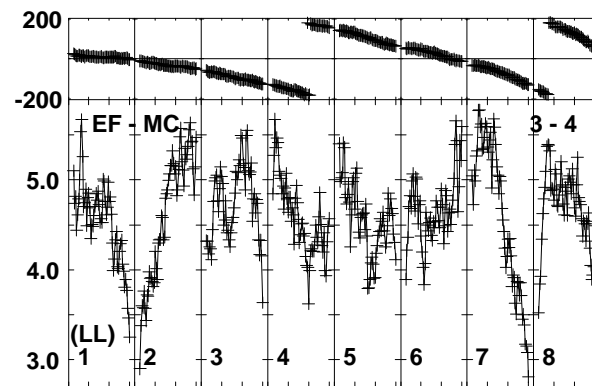
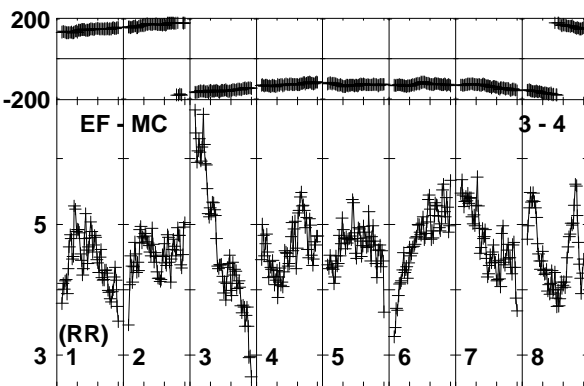
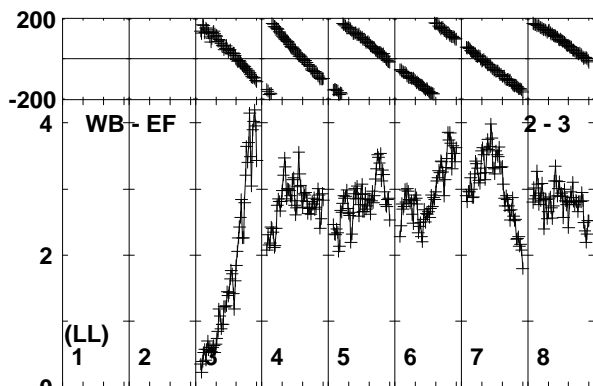
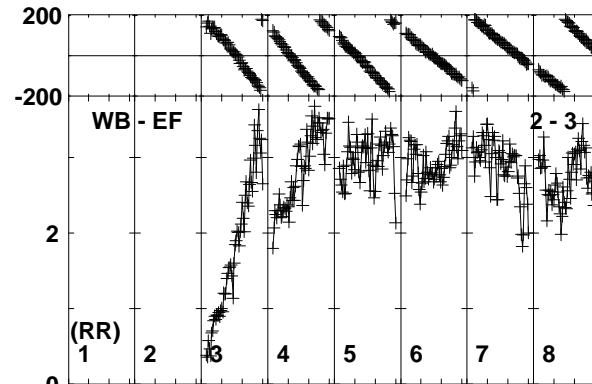
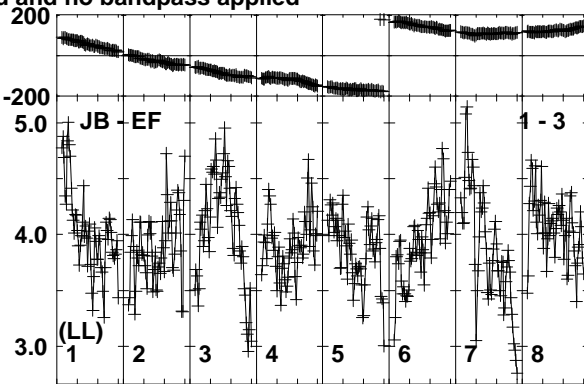
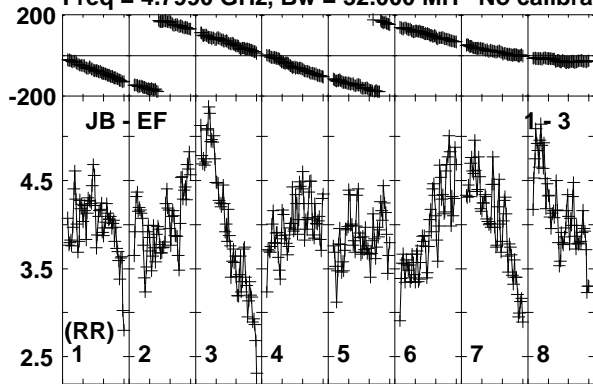

Lower frame: Milli Ampl Jy Top frame: Phas deg

Vector averaged cross-power spectrum Baseline: JB (01) - EF (03)

Timerange: 01/04:10:35 to 01/04:11:05

Plot file version 479 created 26-SEP-2019 10:43:00

J0257-1212 RG010A.UVDATA.1

Freq = 4.7990 GHz, Bw = 32.000 MH No calibration applied and no bandpass applied

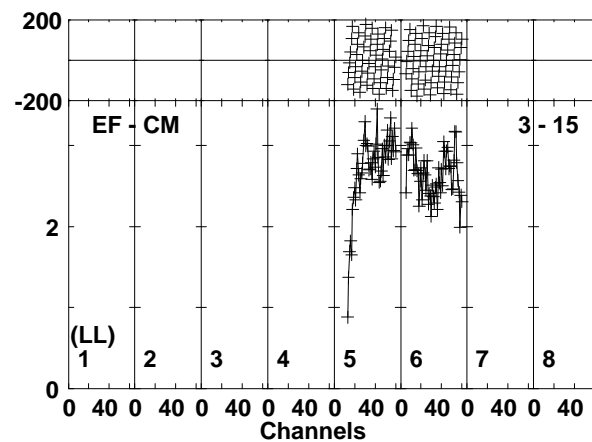
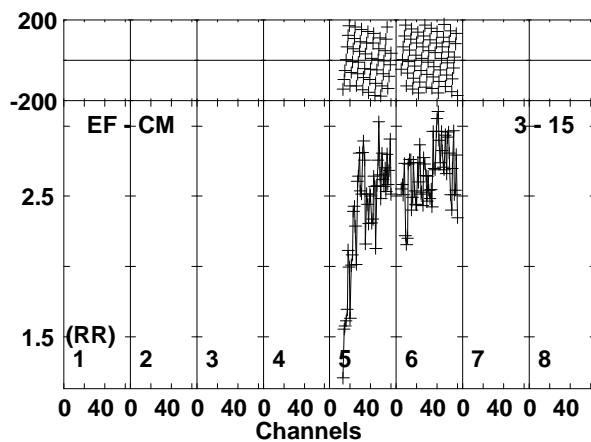
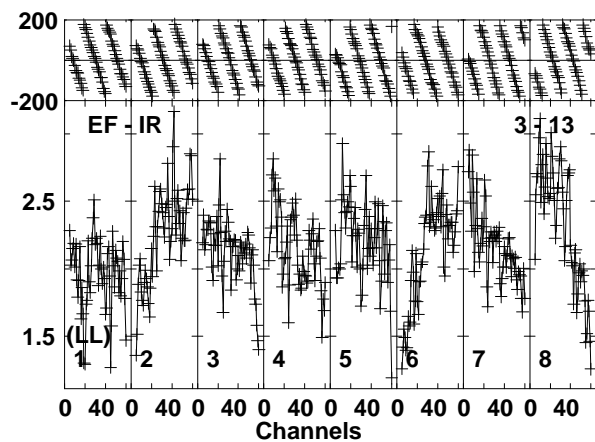
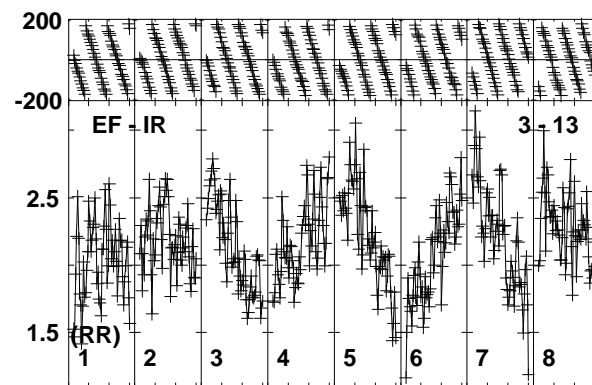
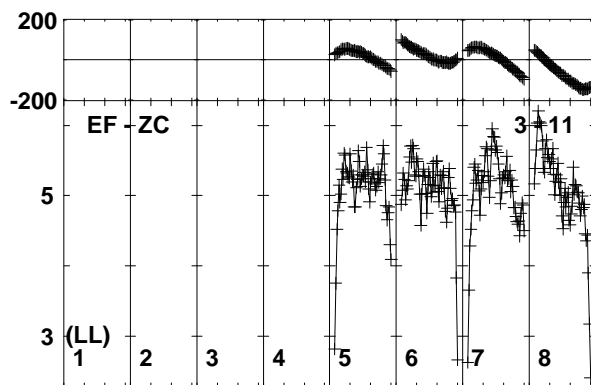
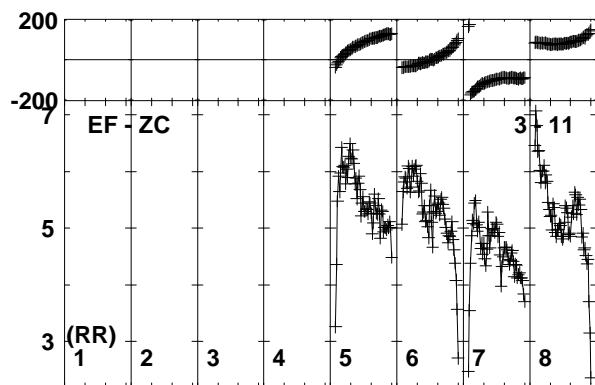
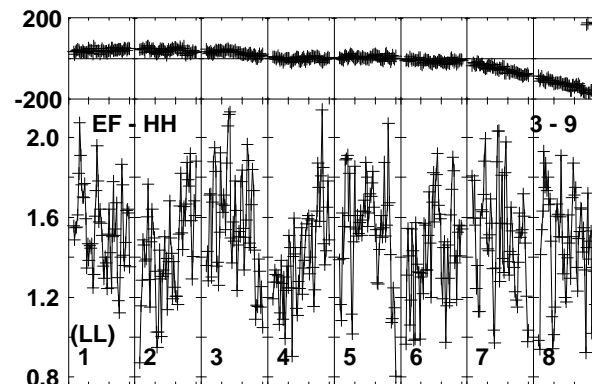
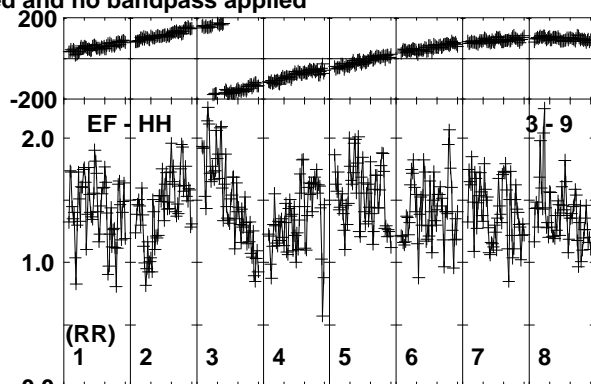
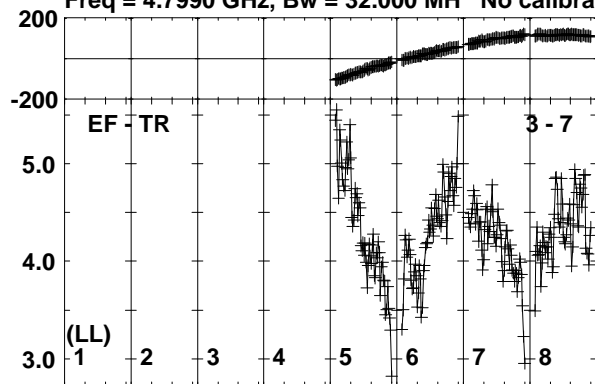

Lower frame: Milli Ampl Jy Top frame: Phas deg
Vector averaged cross-power spectrum Baseline: EF (03) - TR (07)
Timerange: 01/04:10:35 to 01/04:11:05

Plot file version 480 created 26-SEP-2019 10:43:00

J0257-1212 RG010A.UVDATA.1

Freq = 4.7990 GHz, Bw = 32.000 MH No calibration applied and no bandpass applied

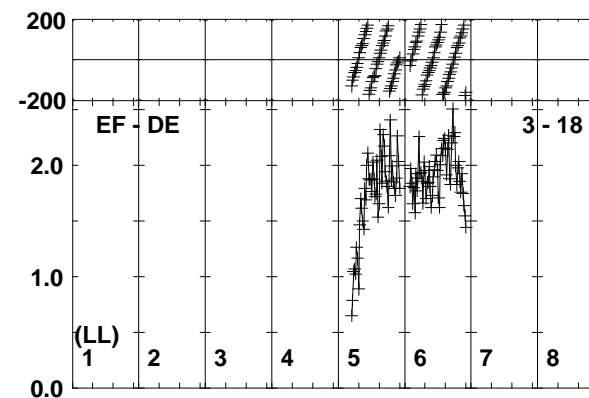
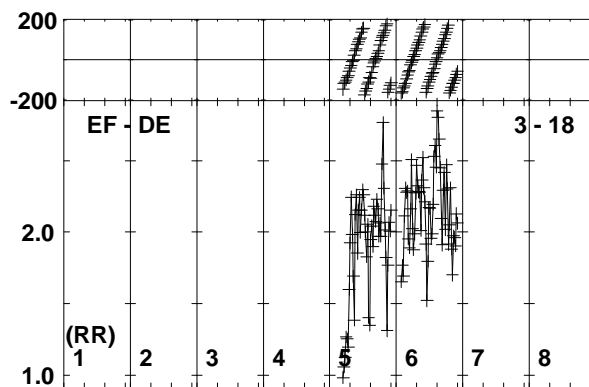
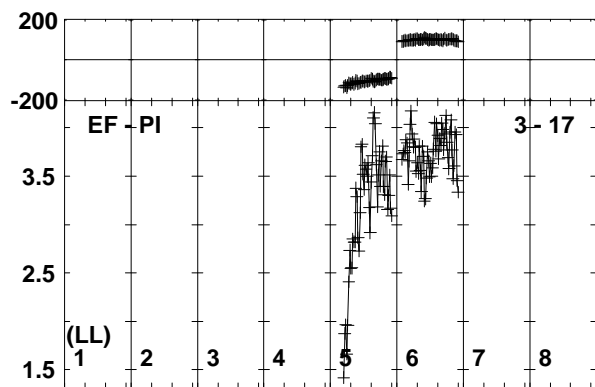
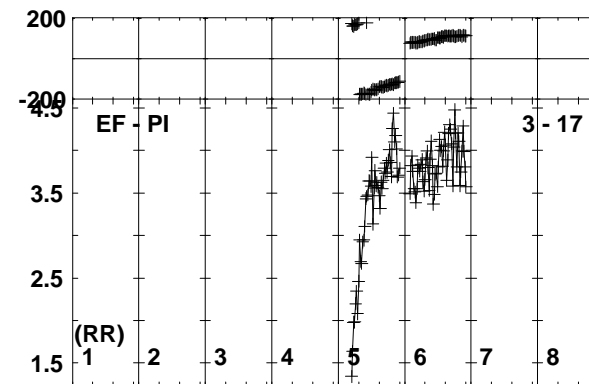
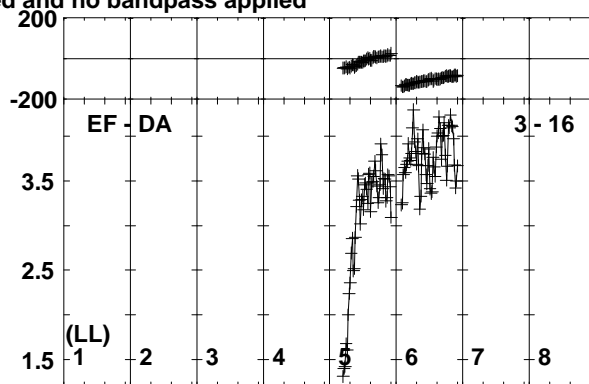
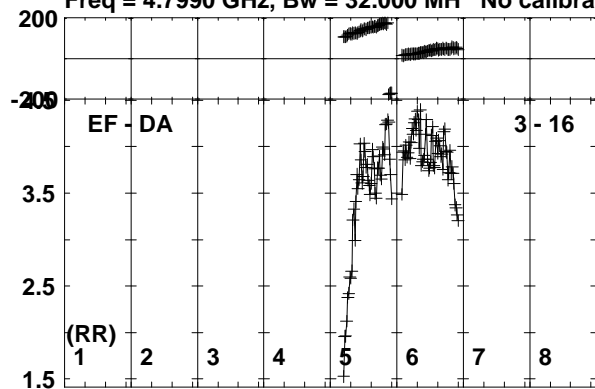

Lower frame: Milli Ampl Jy Top frame: Phas deg
Vector averaged cross-power spectrum Baseline: EF (03) - DA (16)
Timerange: 01/04:10:35 to 01/04:11:05

Plot file version 481 created 26-SEP-2019 10:43:01

J0300-0846 RG010A.UVDATA.1

Freq = 4.7990 GHz, Bw = 32.000 MH No calibration applied and no bandpass applied

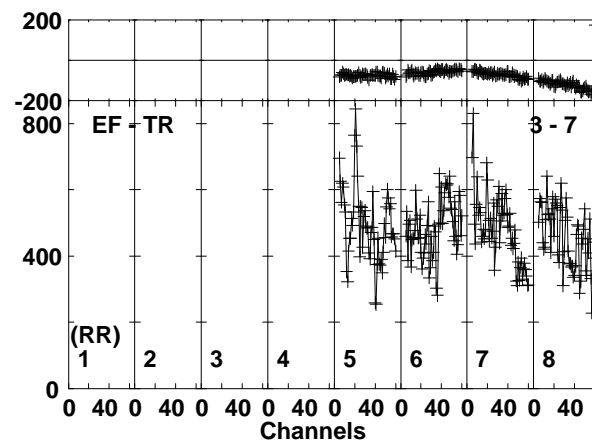
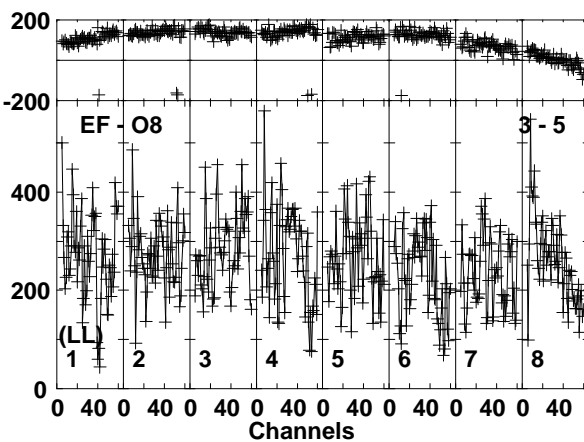
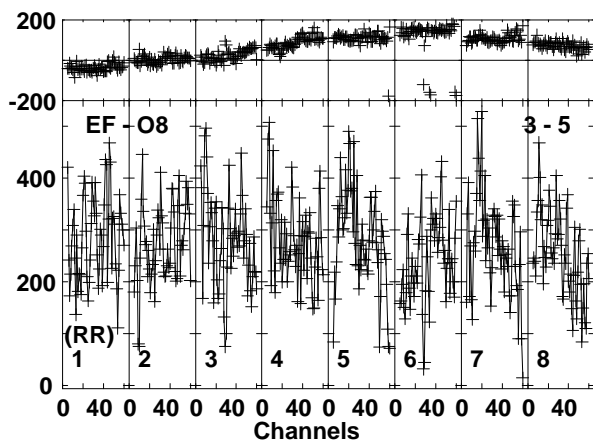
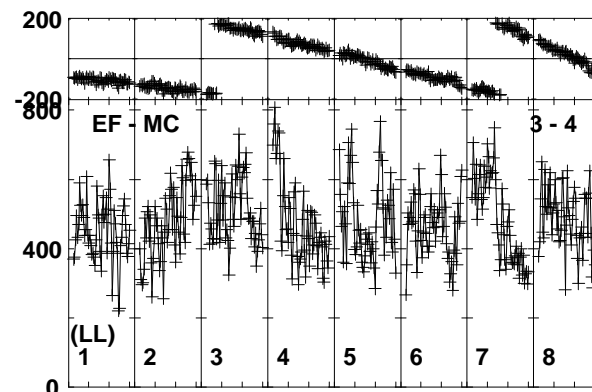
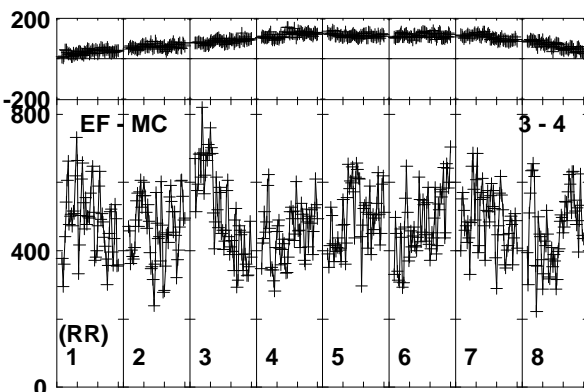
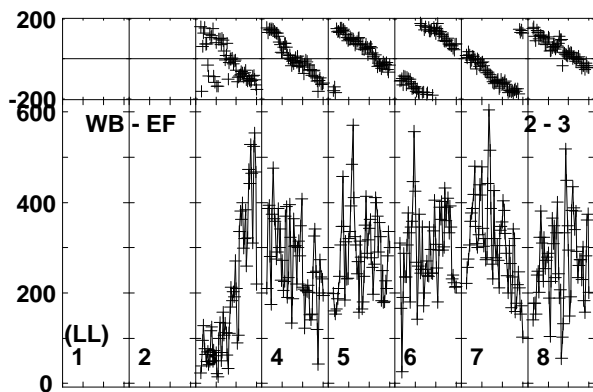
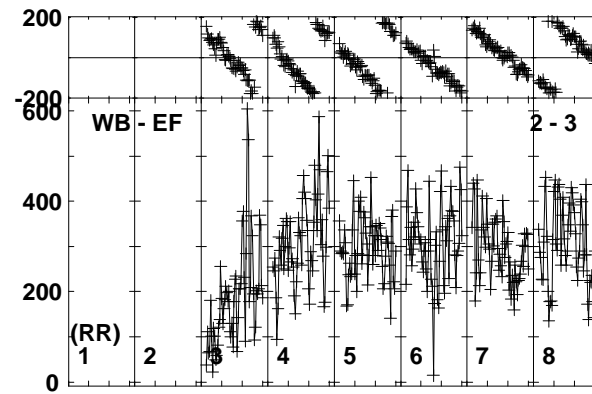
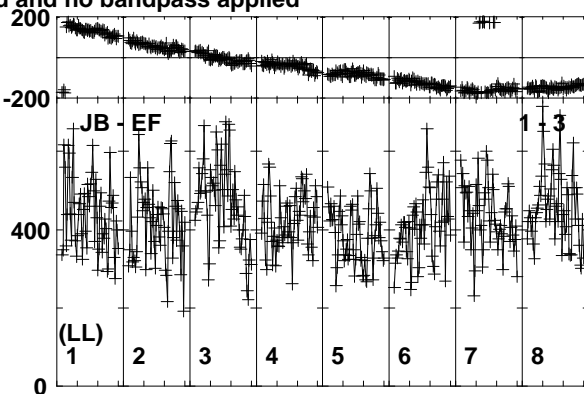
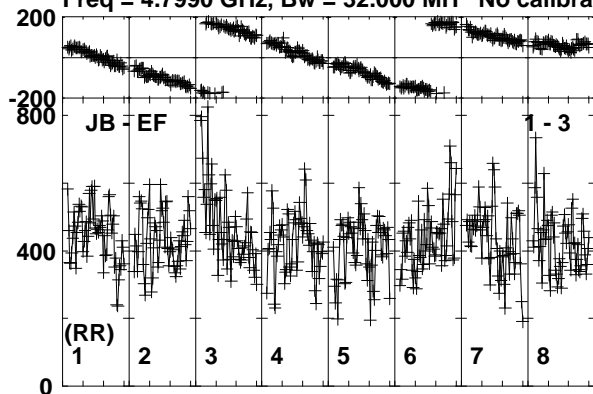

Lower frame: Micro Ampl Jy Top frame: Phas deg
Vector averaged cross-power spectrum Baseline: JB (01) - EF (03)
Timerange: 01/04:11:05 to 01/04:13:35

Plot file version 482 created 26-SEP-2019 10:43:01

J0300-0846 RG010A.UVDATA.1

Freq = 4.7990 GHz, Bw = 32.000 MH No calibration applied and no bandpass applied

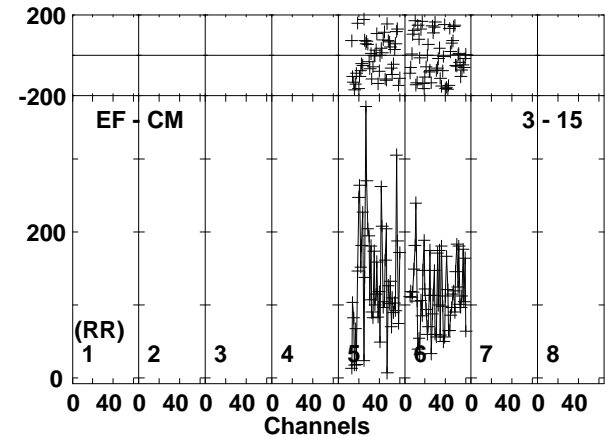
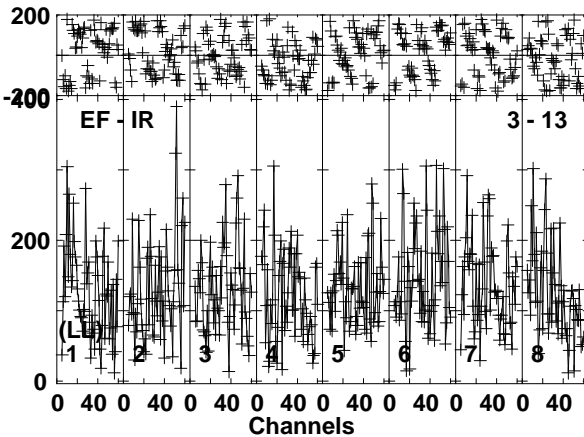
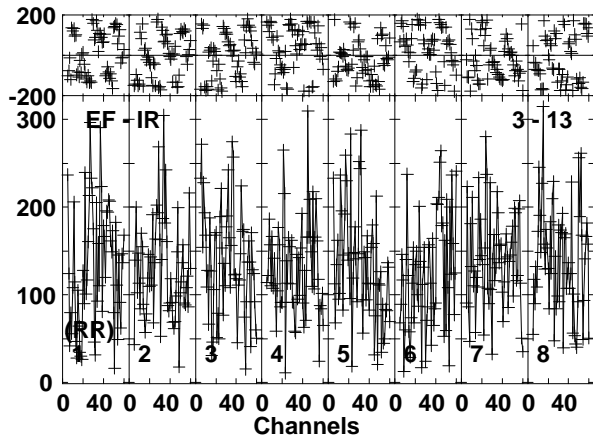
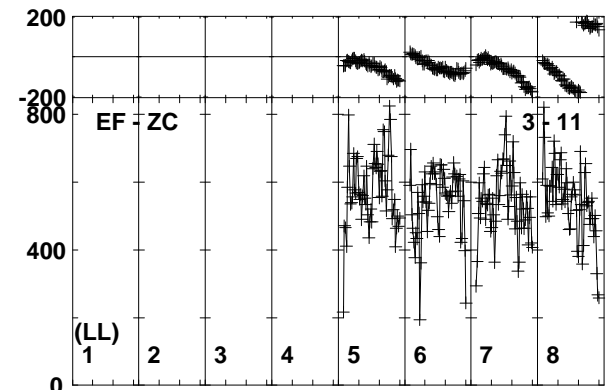
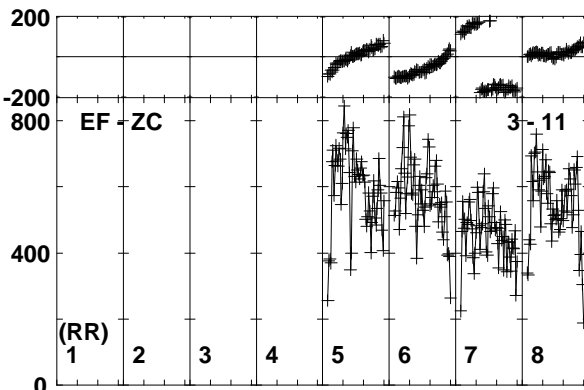
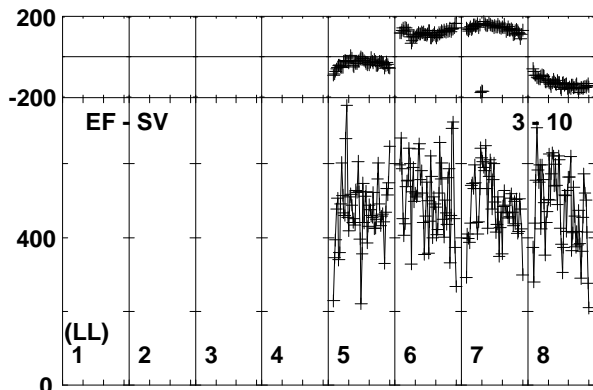
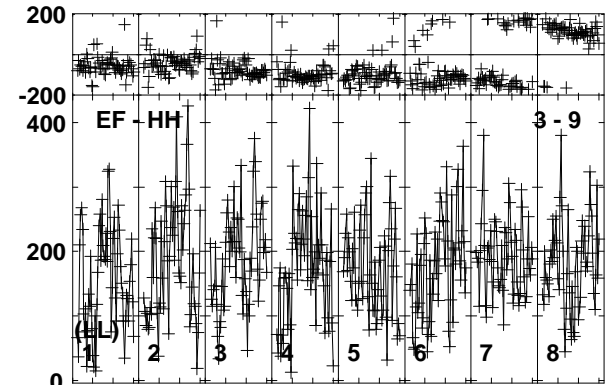
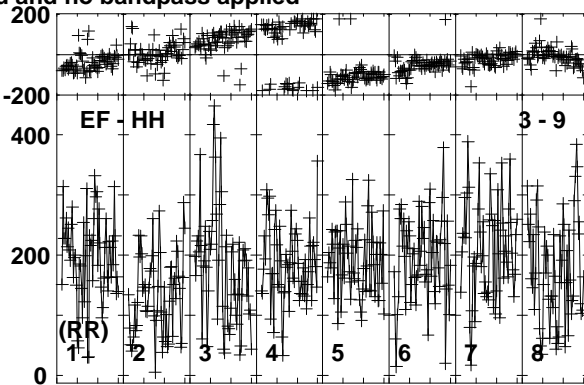
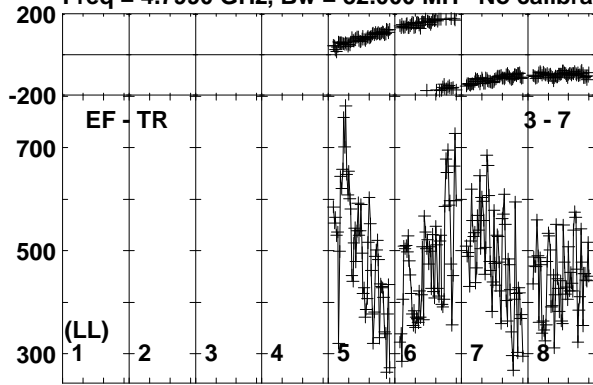

Lower frame: Micro Ampl Jy Top frame: Phas deg
Vector averaged cross-power spectrum Baseline: EF (03) - TR (07)
Timerange: 01/04:11:05 to 01/04:13:35

Plot file version 483 created 26-SEP-2019 10:43:02

J0300-0846 RG010A.UVDATA.1

Freq = 4.7990 GHz, Bw = 32.000 MH No calibration applied and no bandpass applied

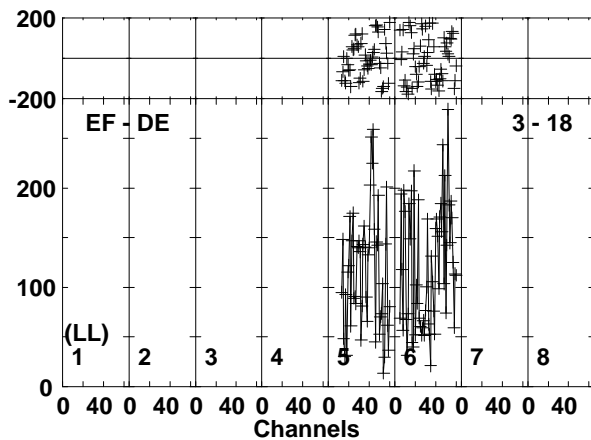
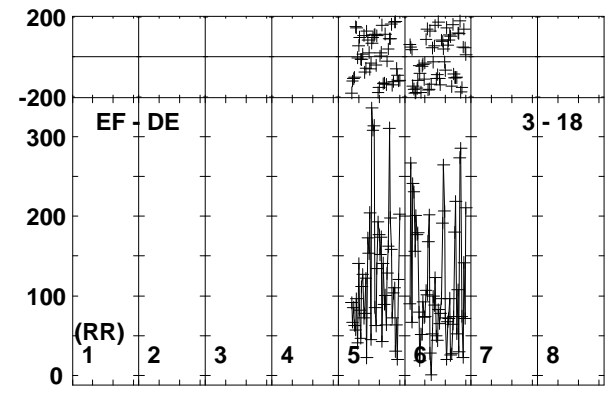
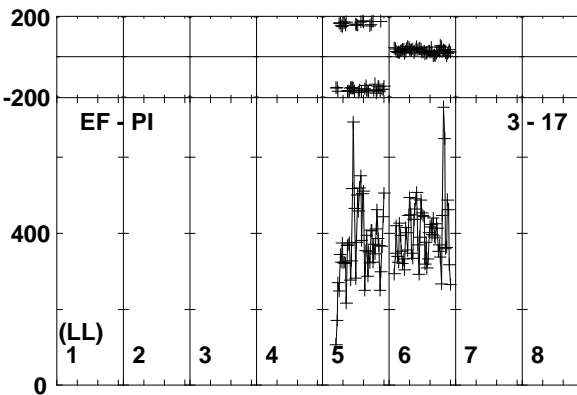
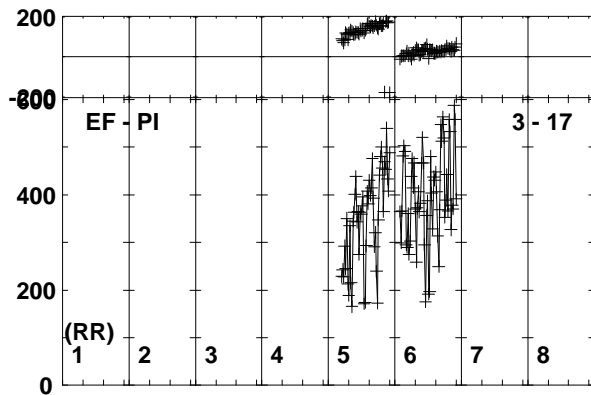
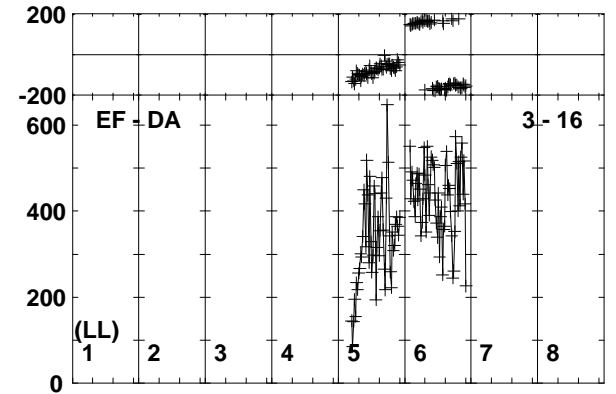
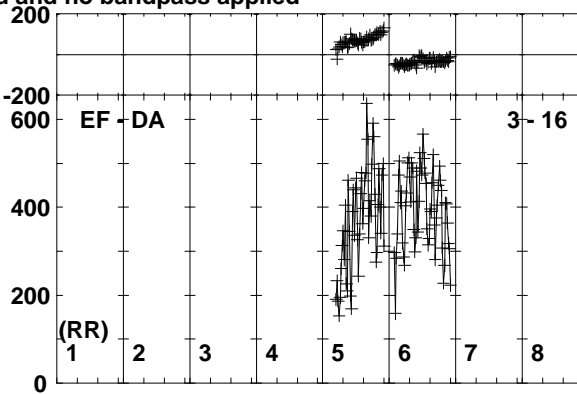
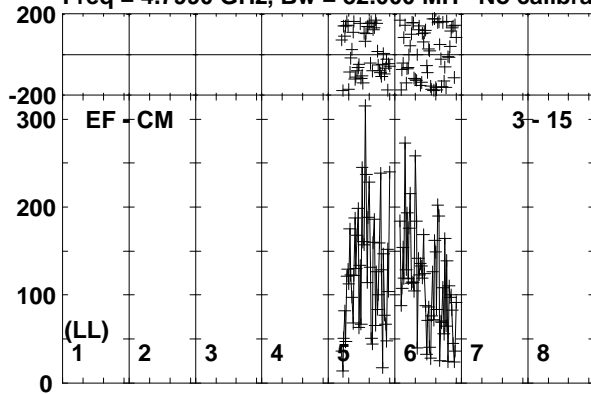

Lower frame: Micro Ampl Jy Top frame: Phas deg
Vector averaged cross-power spectrum Baseline: EF (03) - CM (15)
Timerange: 01/04:11:05 to 01/04:13:35

Plot file version 484 created 26-SEP-2019 10:43:02

190829A RG010A.UVDATA.1

Freq = 4.7990 GHz, Bw = 32.000 MH No calibration applied and no bandpass applied

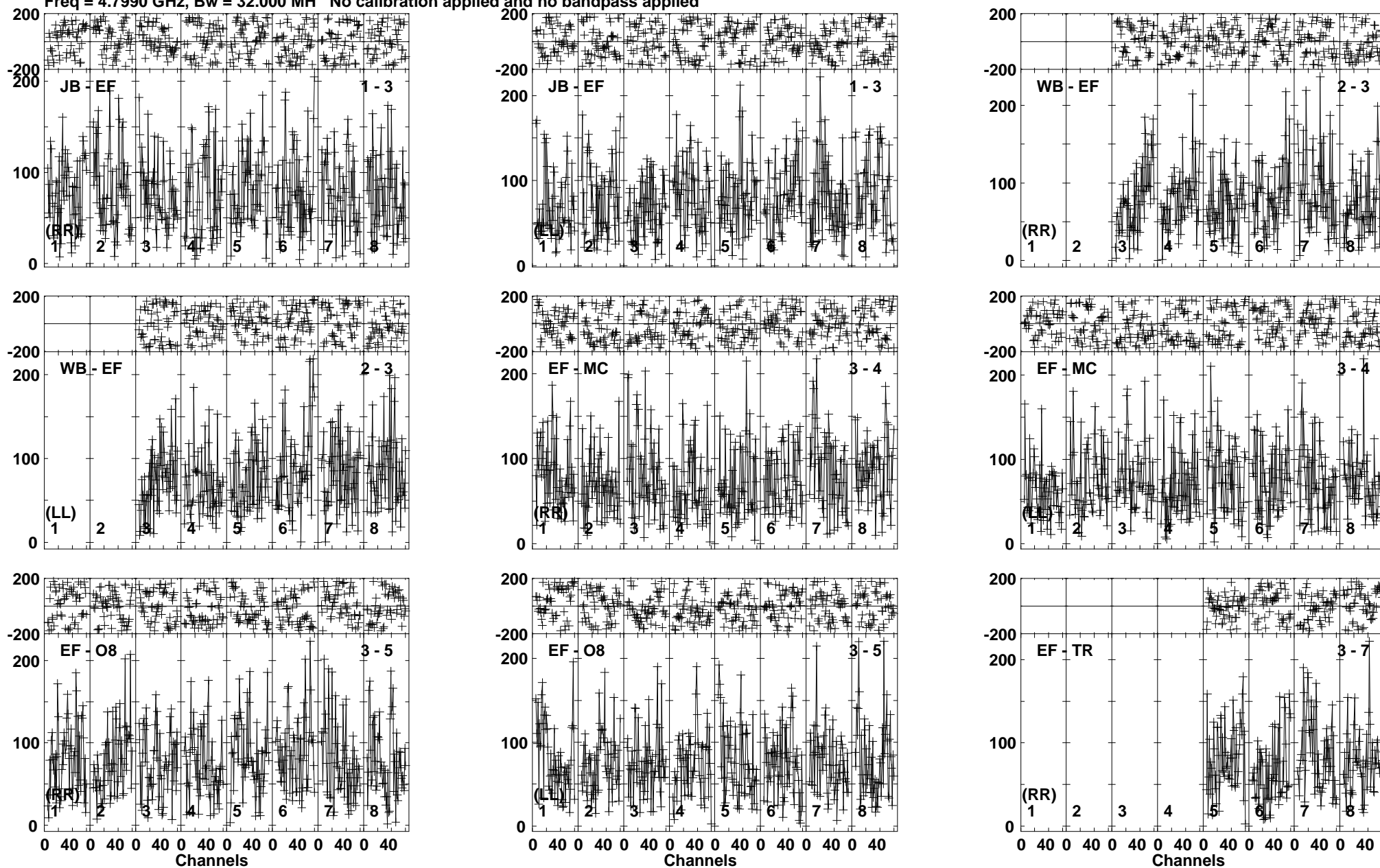

Lower frame: Micro Ampl Jy Top frame: Phas deg
Vector averaged cross-power spectrum Baseline: JB (01) - EF (03)
Timerange: 01/04:13:35 to 01/04:17:04

Plot file version 485 created 26-SEP-2019 10:43:03

190829A RG010A.UVDATA.1

Freq = 4.7990 GHz, Bw = 32.000 MH No calibration applied and no bandpass applied

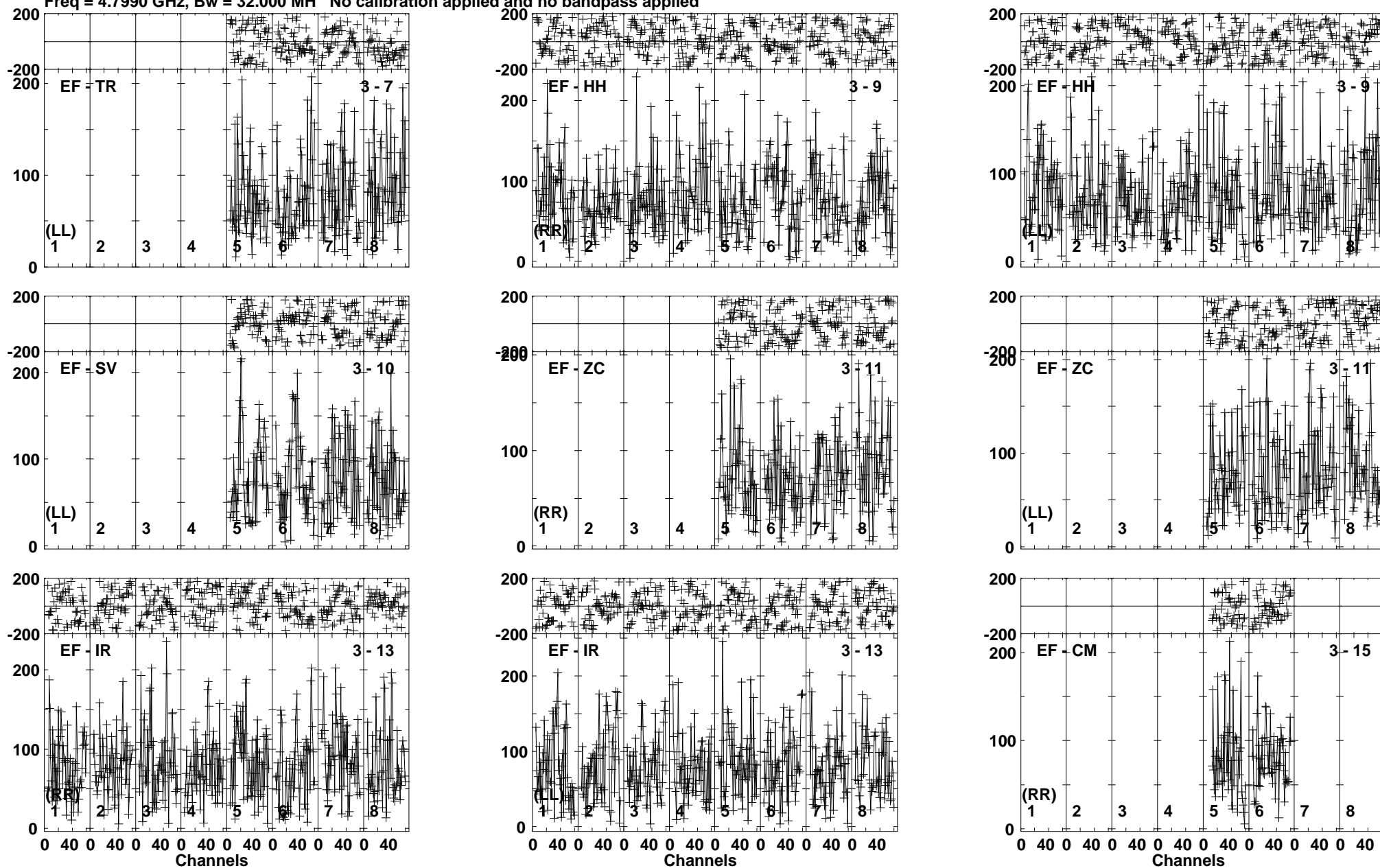

Lower frame: Micro Ampl Jy Top frame: Phas deg
Vector averaged cross-power spectrum Baseline: EF (03) - TR (07)
Timerange: 01/04:13:35 to 01/04:17:04

Plot file version 486 created 26-SEP-2019 10:43:04

190829A RG010A.UVDATA.1

Freq = 4.7990 GHz, Bw = 32.000 MH No calibration applied and no bandpass applied

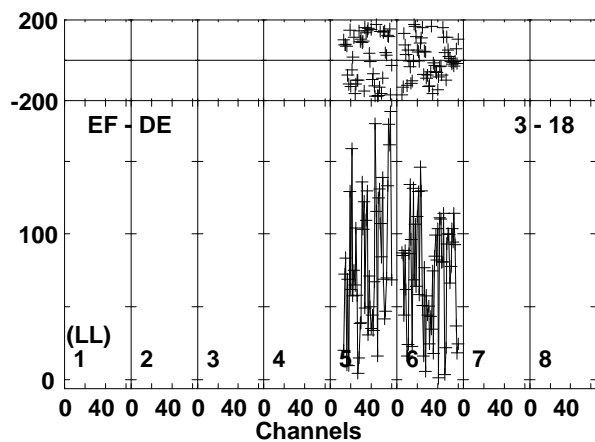
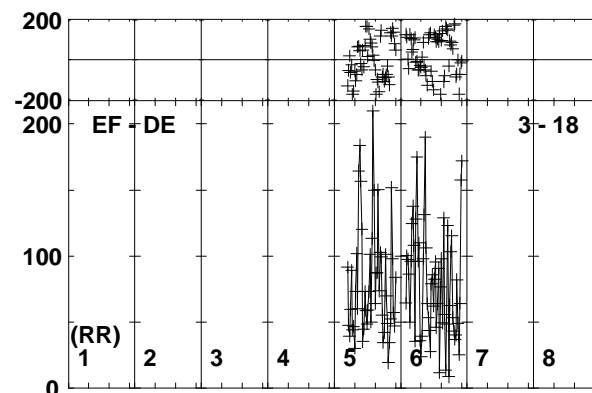
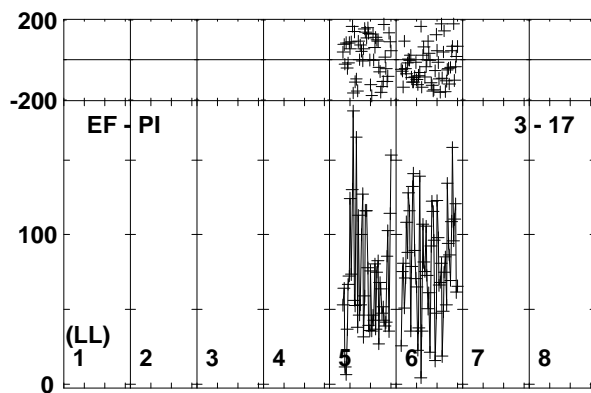
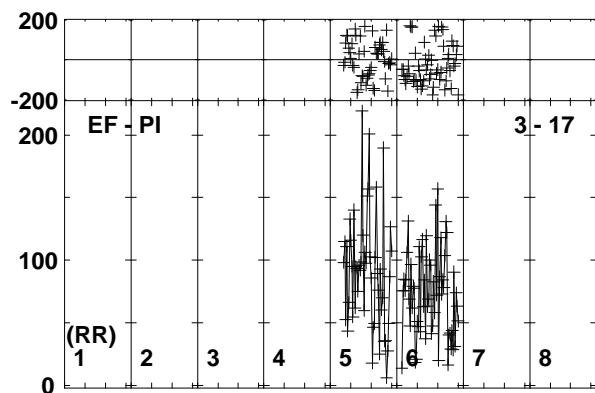
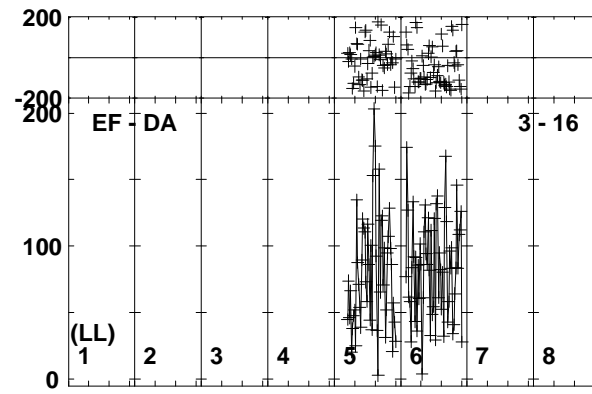
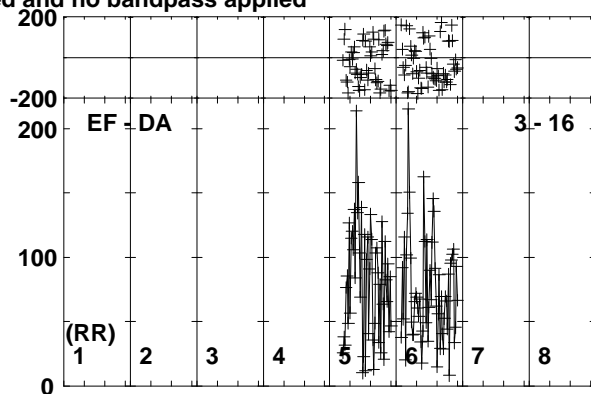
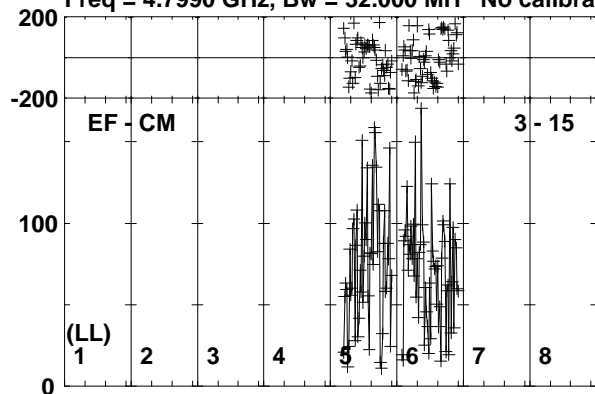

Lower frame: Micro Ampl Jy Top frame: Phas deg
Vector averaged cross-power spectrum Baseline: EF (03) - CM (15)
Timerange: 01/04:13:35 to 01/04:17:04

Plot file version 487 created 26-SEP-2019 10:43:04

J0257-1212 RG010A.UVDATA.1

Freq = 4.7990 GHz, Bw = 32.000 MH No calibration applied and no bandpass applied

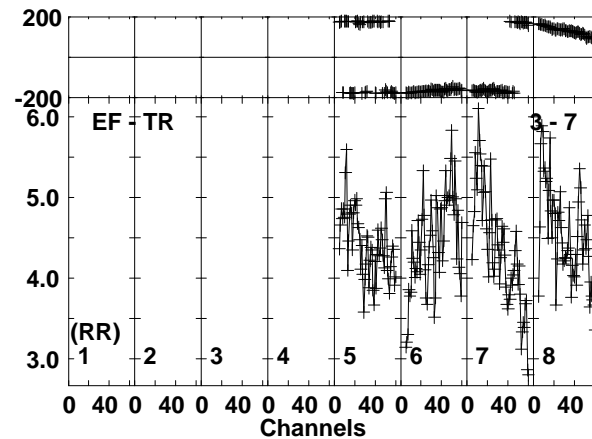
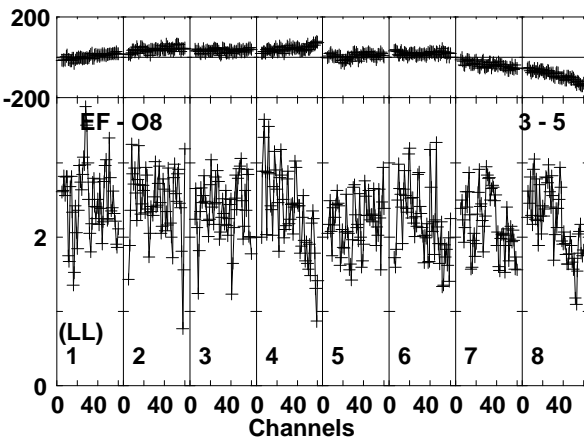
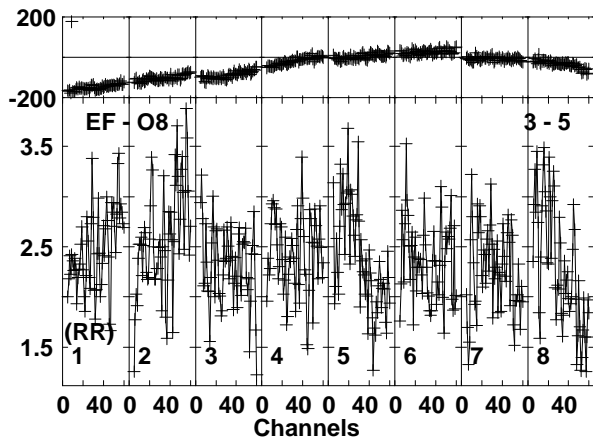
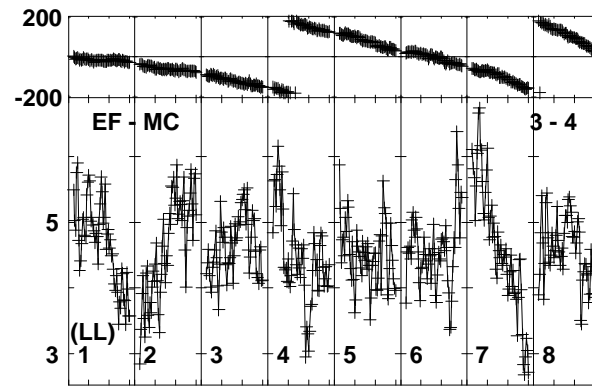
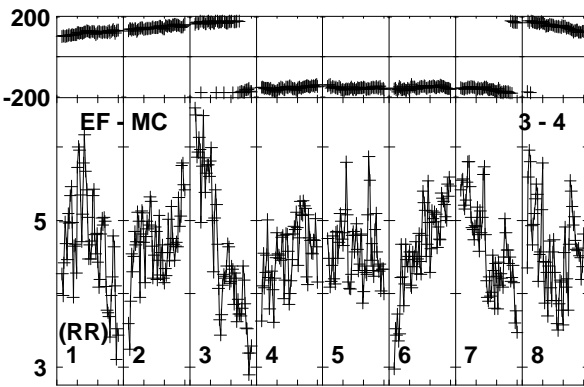
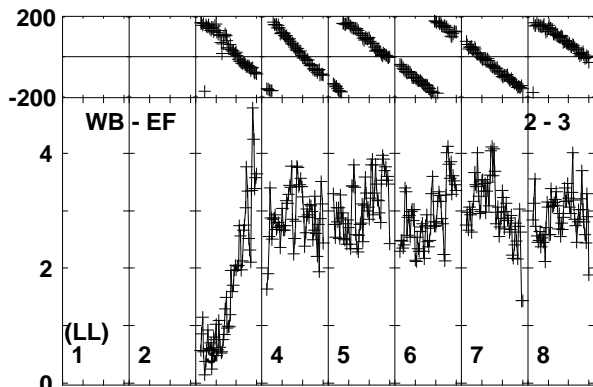
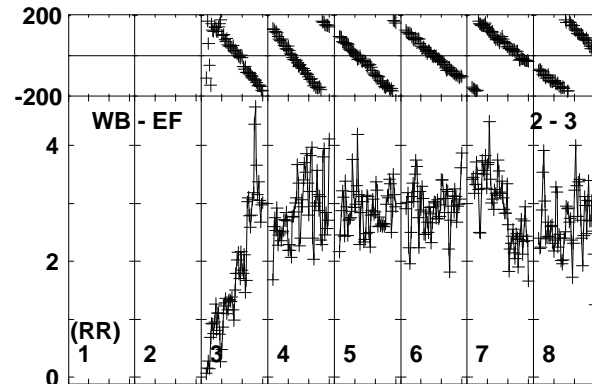
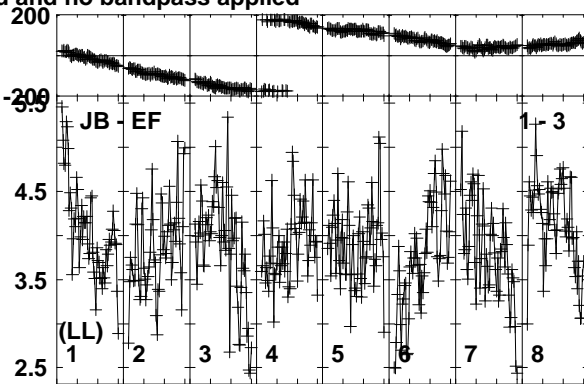
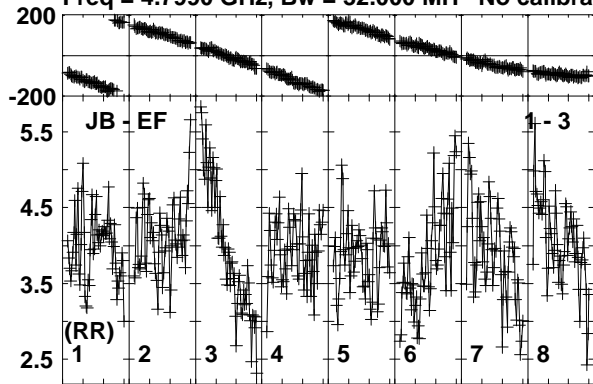

Lower frame: Milli Ampl Jy Top frame: Phas deg
Vector averaged cross-power spectrum Baseline: JB (01) - EF (03)
Timerange: 01/04:17:06 to 01/04:18:05

Plot file version 488 created 26-SEP-2019 10:43:05

J0257-1212 RG010A.UVDATA.1

Freq = 4.7990 GHz, Bw = 32.000 MH No calibration applied and no bandpass applied

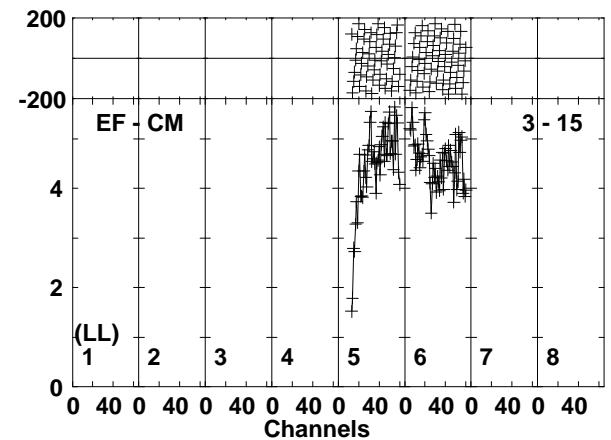
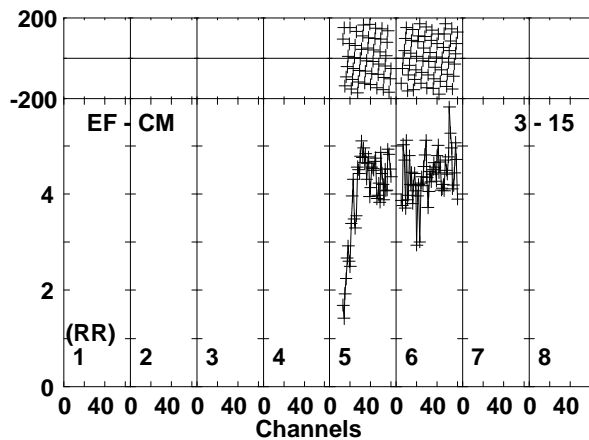
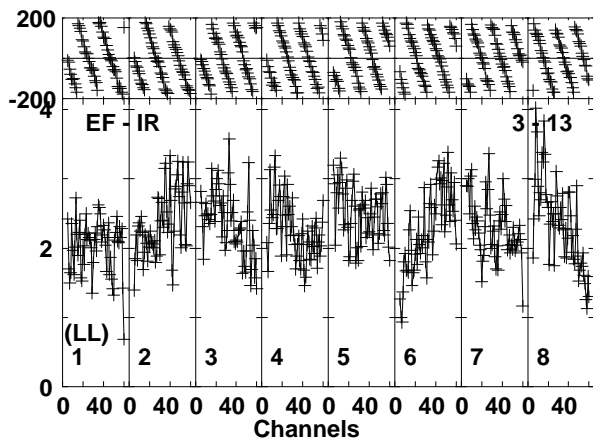
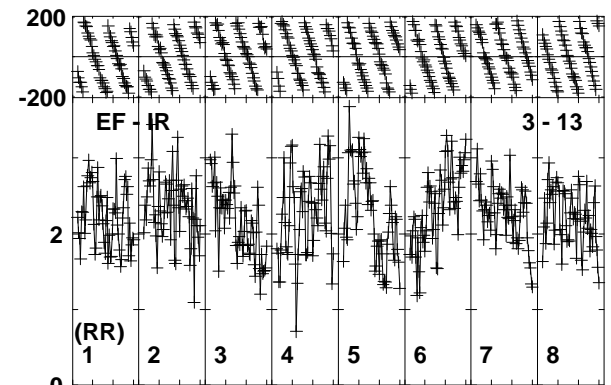
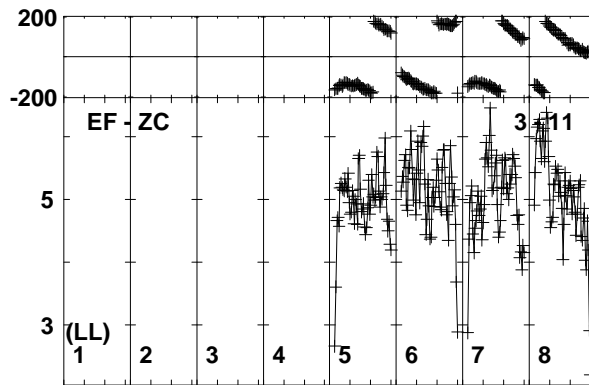
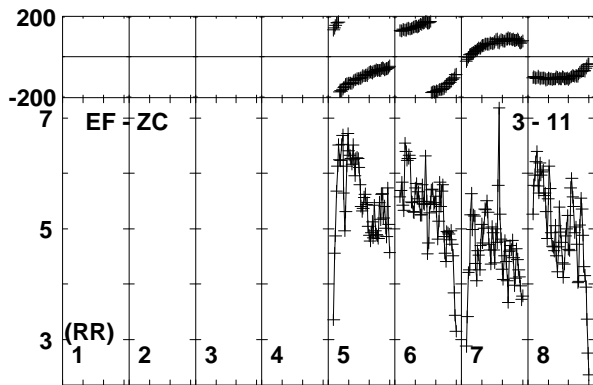
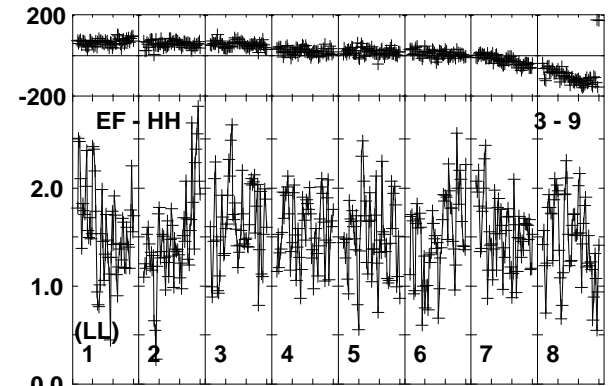
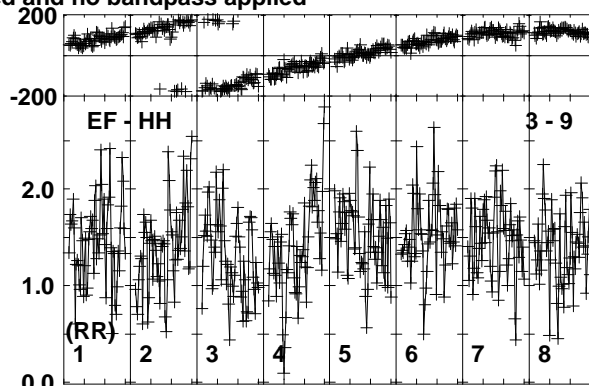
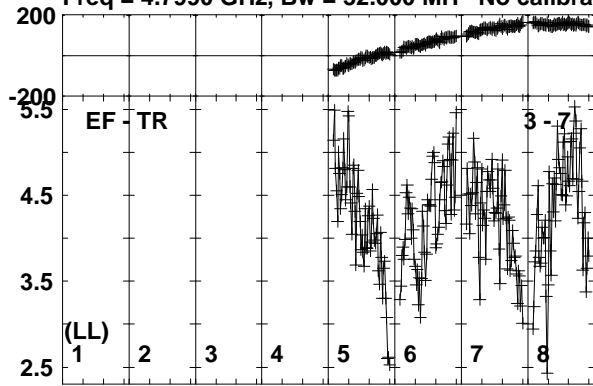

Lower frame: Milli Ampl Jy Top frame: Phas deg
Vector averaged cross-power spectrum Baseline: EF (03) - TR (07)
Timerange: 01/04:17:06 to 01/04:18:05

Plot file version 489 created 26-SEP-2019 10:43:06

J0257-1212 RG010A.UVDATA.1

Freq = 4.7990 GHz, Bw = 32.000 MH No calibration applied and no bandpass applied

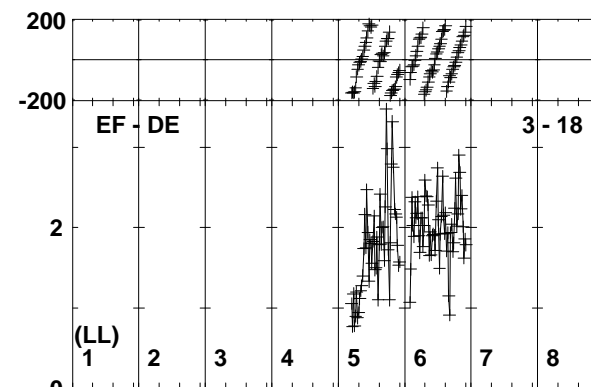
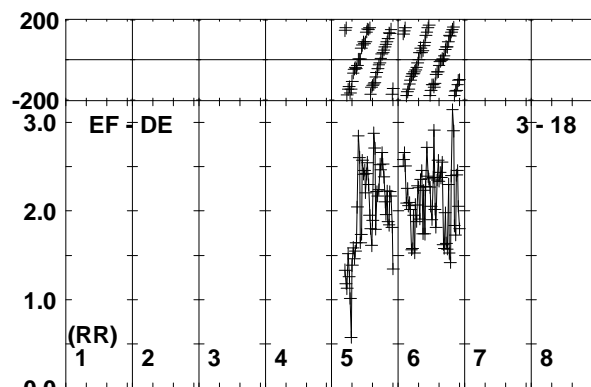
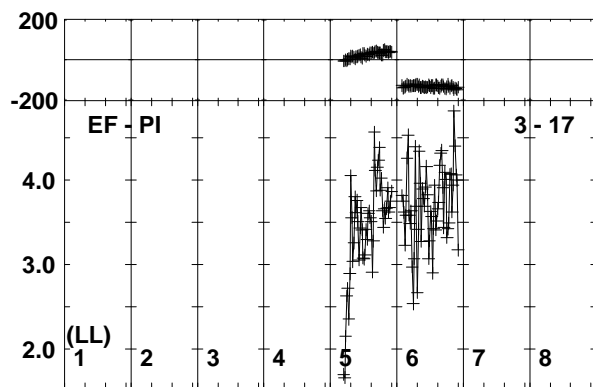
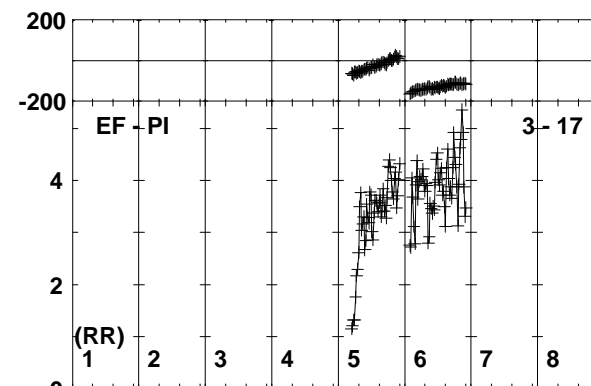
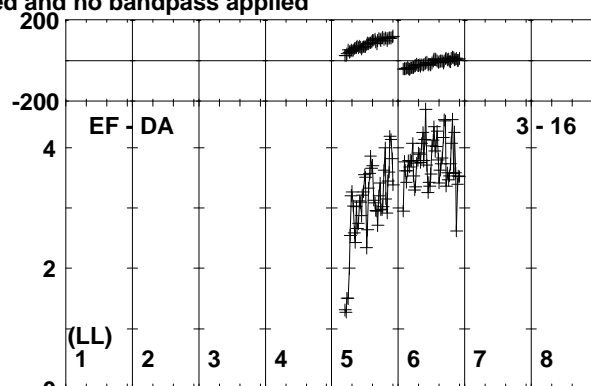
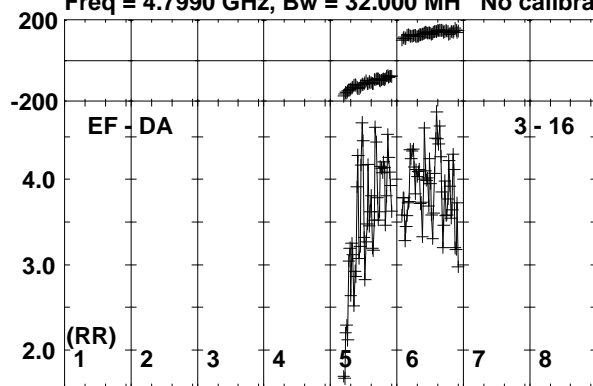

Lower frame: Milli Ampl Jy Top frame: Phas deg
Vector averaged cross-power spectrum Baseline: EF (03) - DA (16)
Timerange: 01/04:17:06 to 01/04:18:05

Plot file version 490 created 26-SEP-2019 10:43:06

190829A RG010A.UVDATA.1

Freq = 4.7990 GHz, Bw = 32.000 MH No calibration applied and no bandpass applied

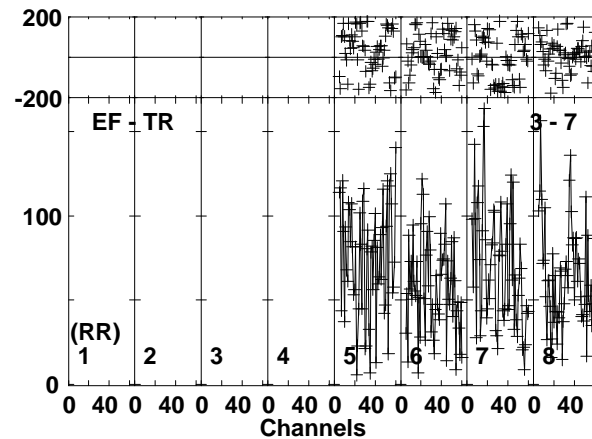
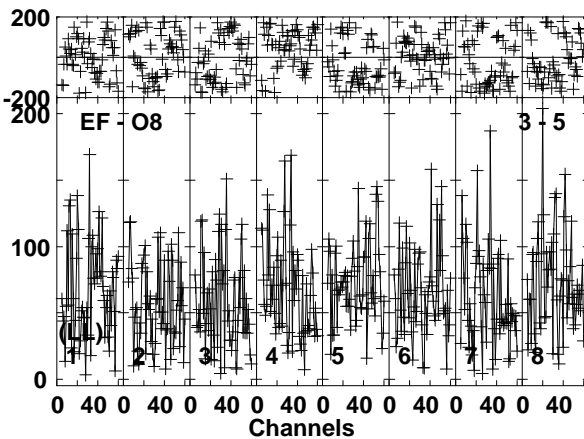
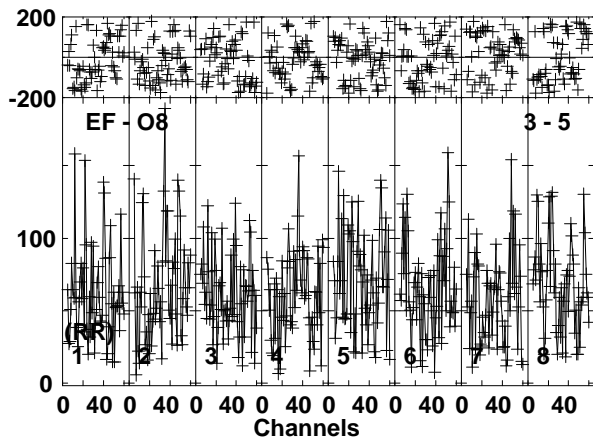
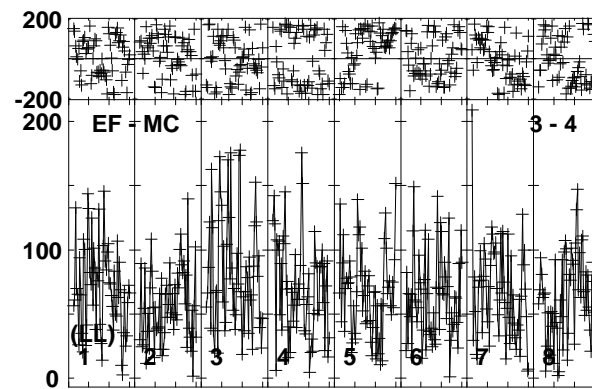
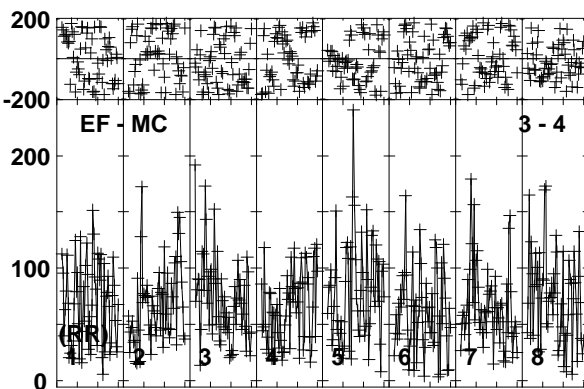
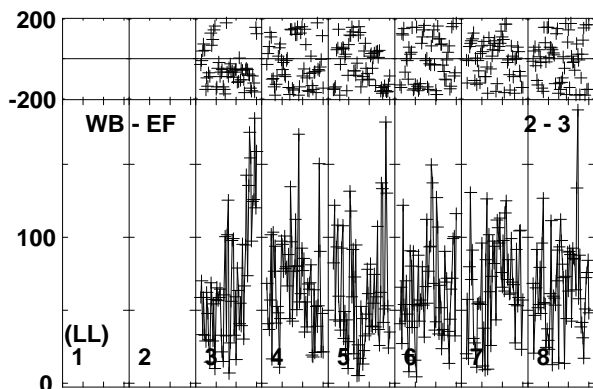
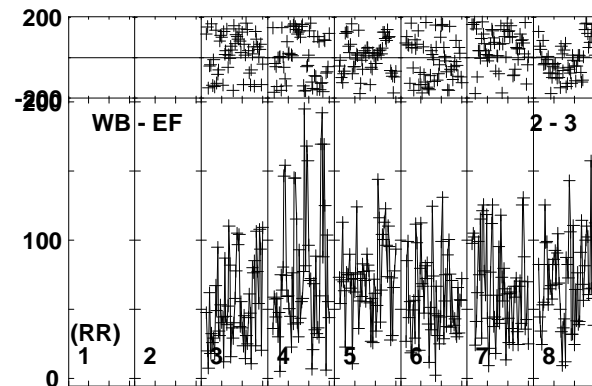
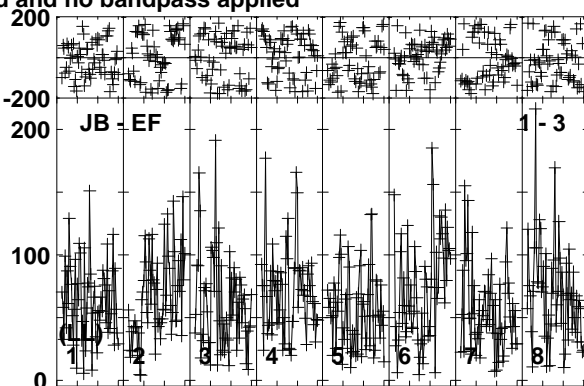
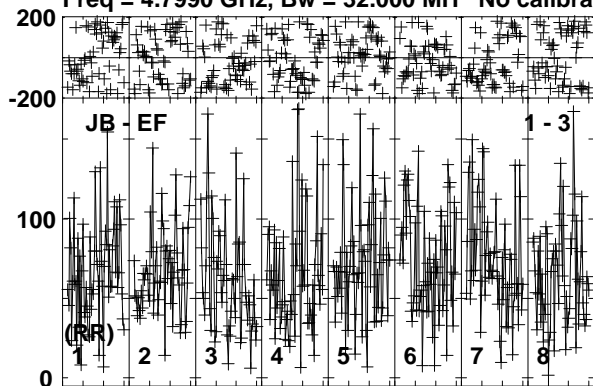

Lower frame: Micro Ampl Jy Top frame: Phas deg
Vector averaged cross-power spectrum Baseline: JB (01) - EF (03)
Timerange: 01/04:18:06 to 01/04:23:05

Plot file version 491 created 26-SEP-2019 10:43:07

190829A RG010A.UVDATA.1

Freq = 4.7990 GHz, Bw = 32.000 MH No calibration applied and no bandpass applied

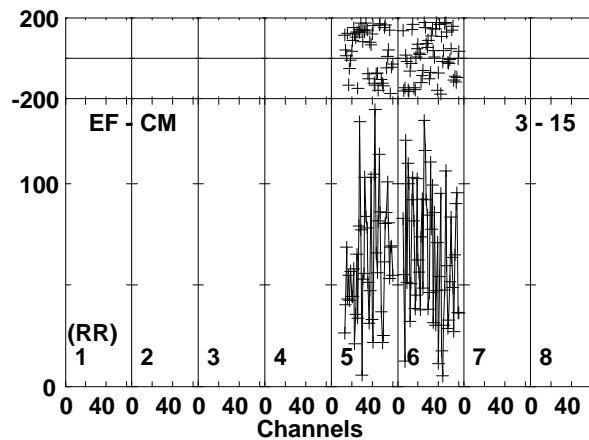
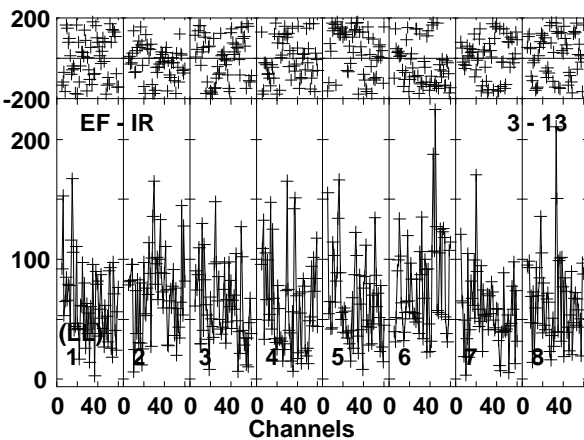
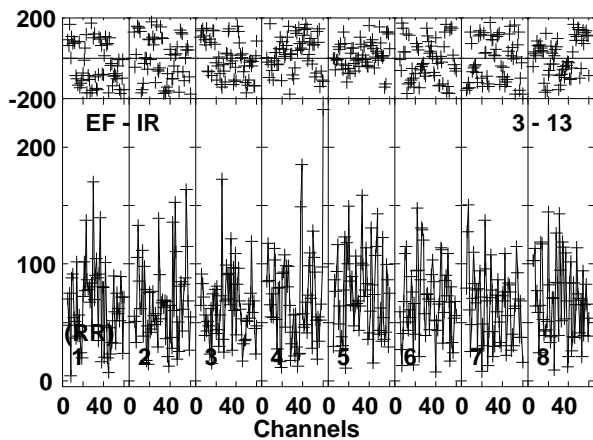
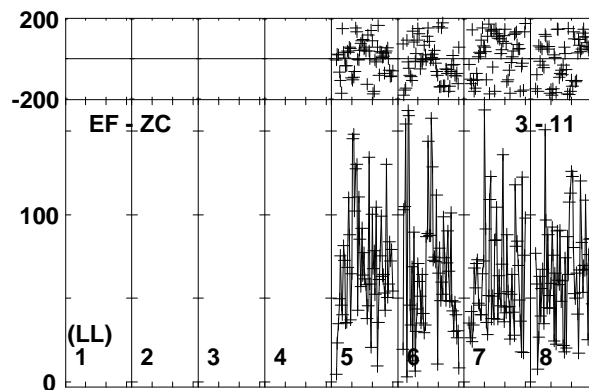
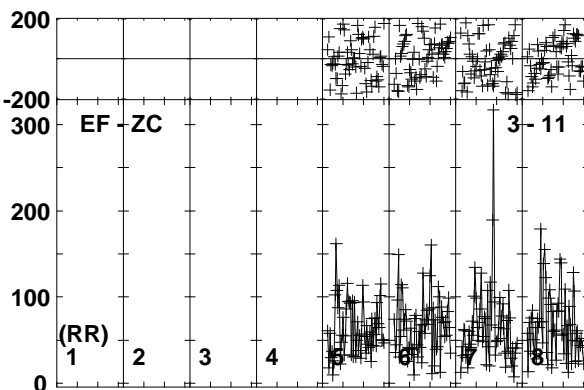
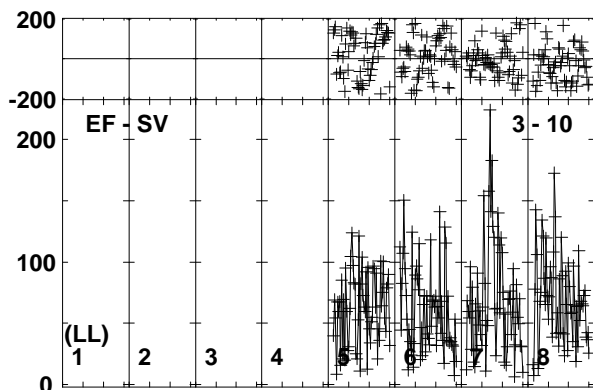
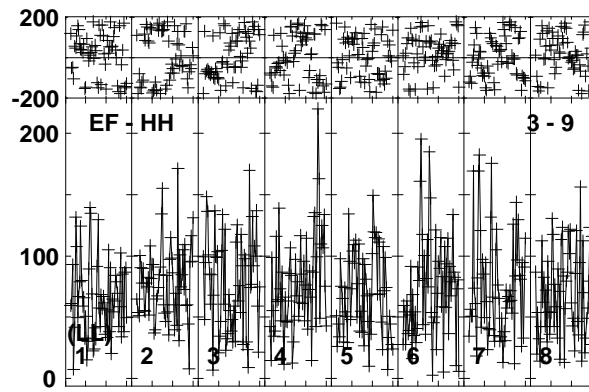
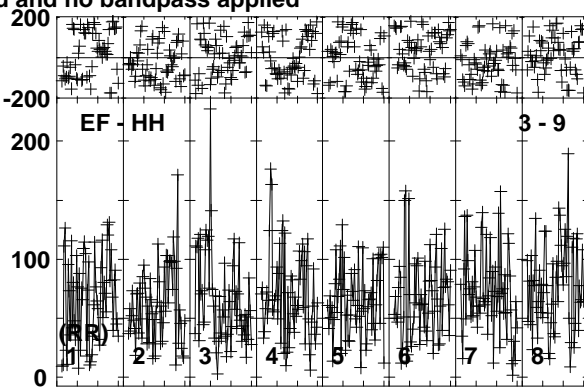
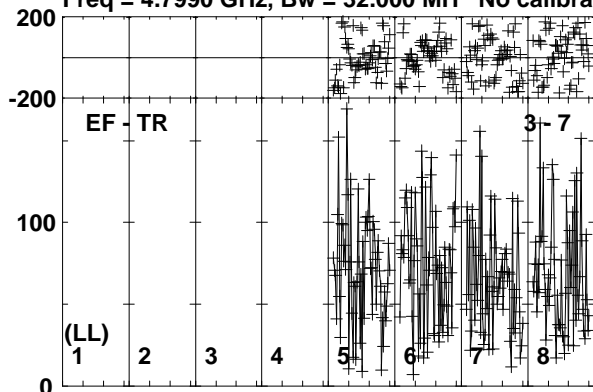

Lower frame: Micro Ampl Jy Top frame: Phas deg
Vector averaged cross-power spectrum Baseline: EF (03) - TR (07)
Timerange: 01/04:18:06 to 01/04:23:05

Plot file version 492 created 26-SEP-2019 10:43:08

190829A RG010A.UVDATA.1

Freq = 4.7990 GHz, Bw = 32.000 MH No calibration applied and no bandpass applied

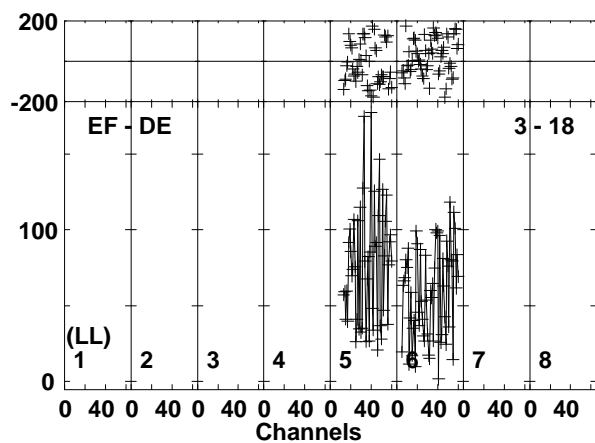
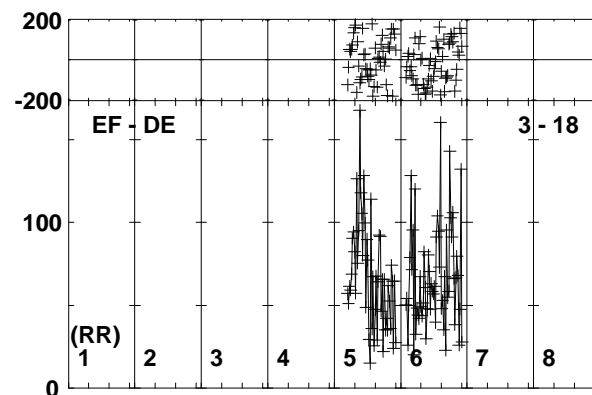
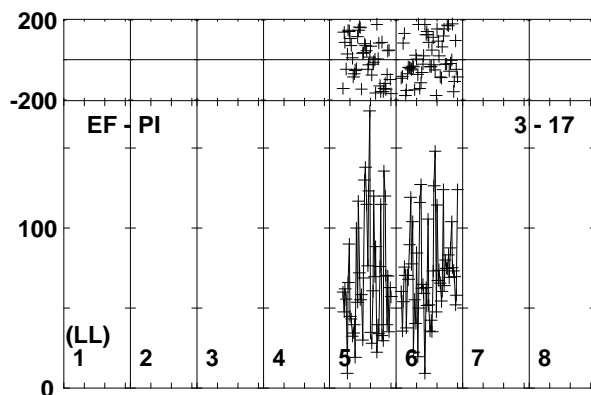
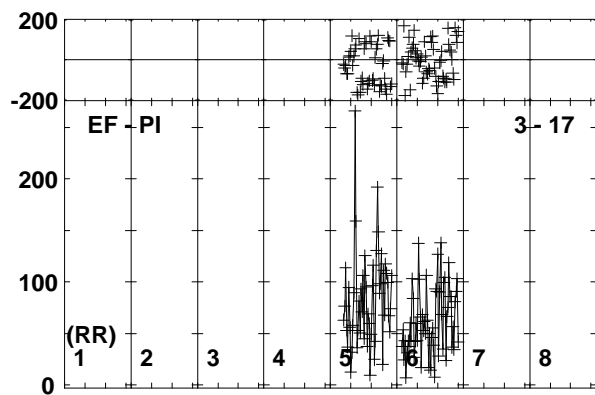
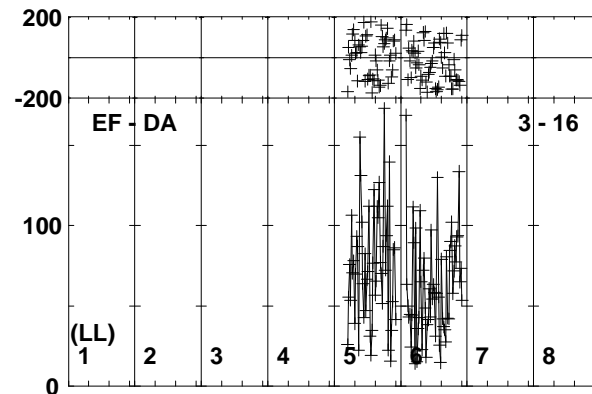
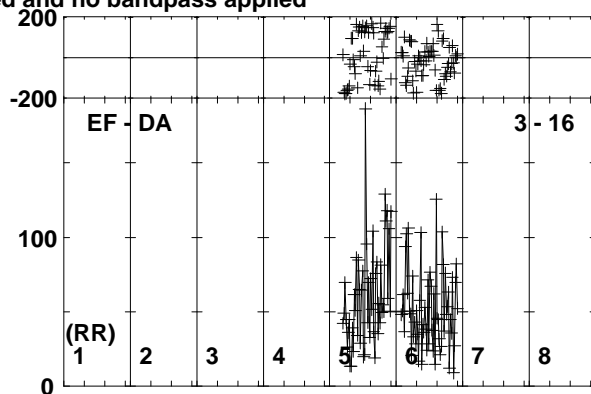
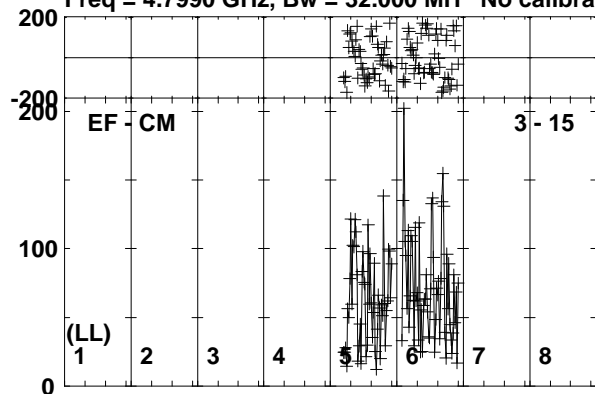

Lower frame: Micro Ampl Jy Top frame: Phas deg
Vector averaged cross-power spectrum Baseline: EF (03) - CM (15)
Timerange: 01/04:18:06 to 01/04:23:05

Plot file version 493 created 26-SEP-2019 10:43:08

J0257-1212 RG010A.UVDATA.1

Freq = 4.7990 GHz, Bw = 32.000 MH No calibration applied and no bandpass applied

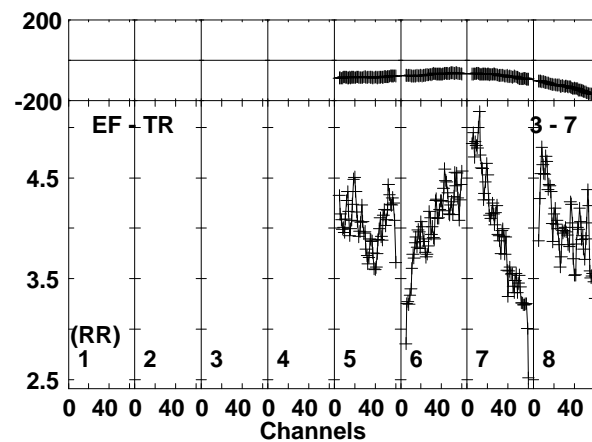
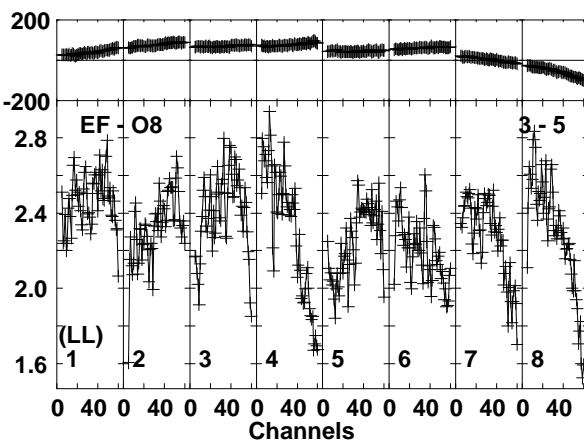
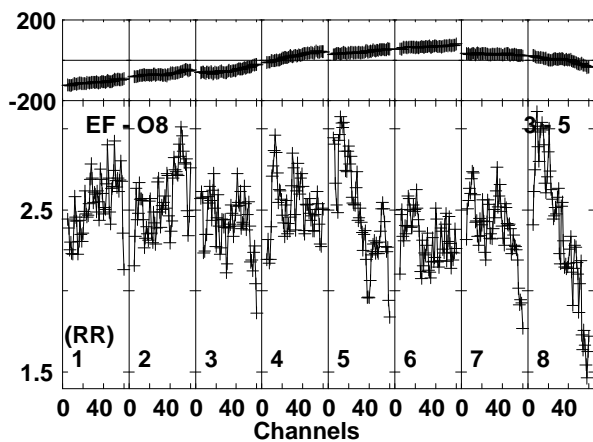
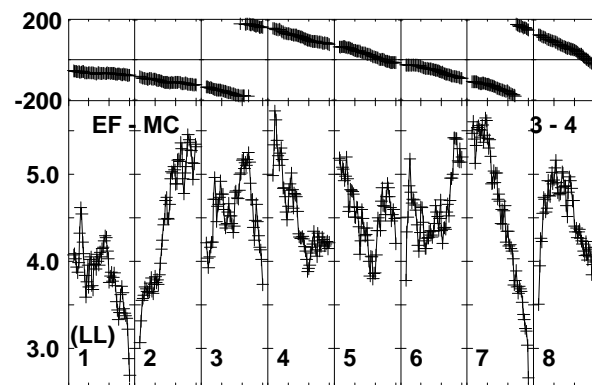
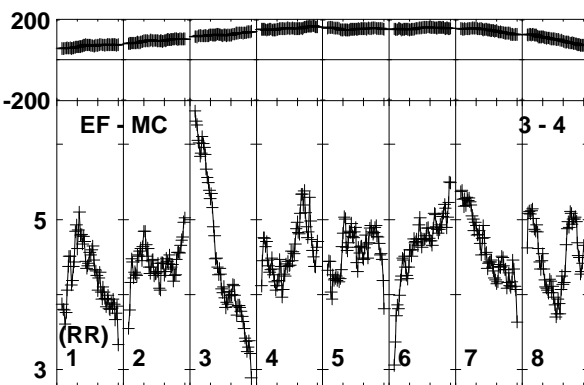
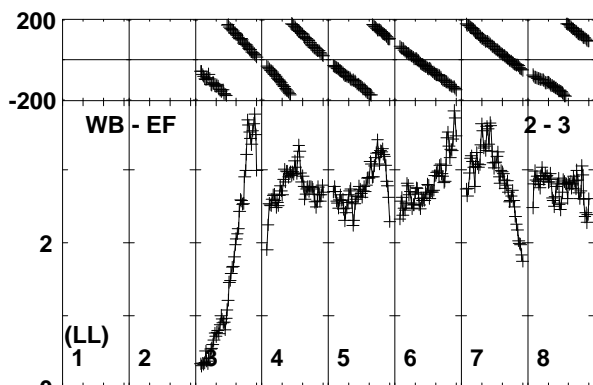
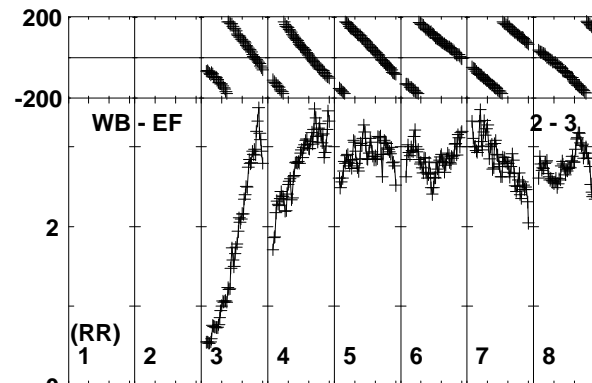
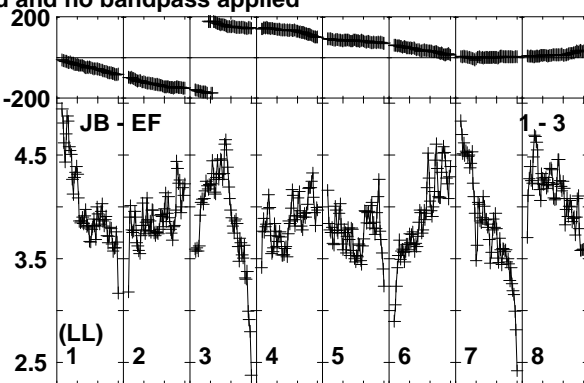
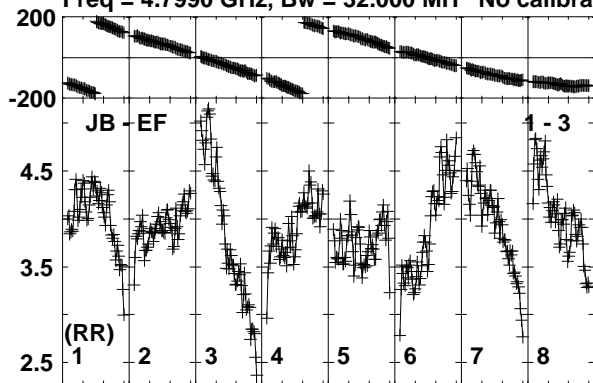

Lower frame: Milli Ampl Jy Top frame: Phas deg
Vector averaged cross-power spectrum Baseline: JB (01) - EF (03)
Timerange: 01/04:23:46 to 01/04:24:45

Plot file version 494 created 26-SEP-2019 10:43:09

J0257-1212 RG010A.UVDATA.1

Freq = 4.7990 GHz, Bw = 32.000 MH No calibration applied and no bandpass applied

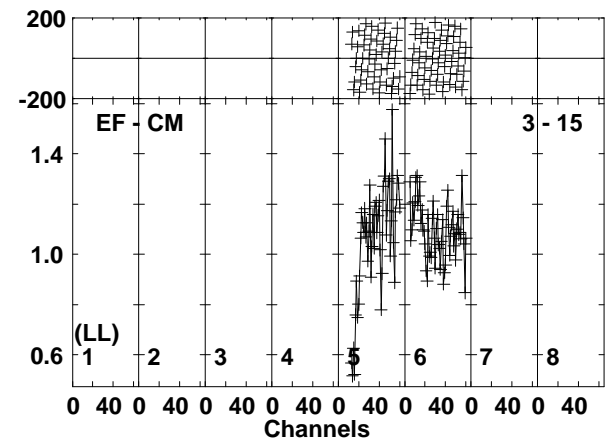
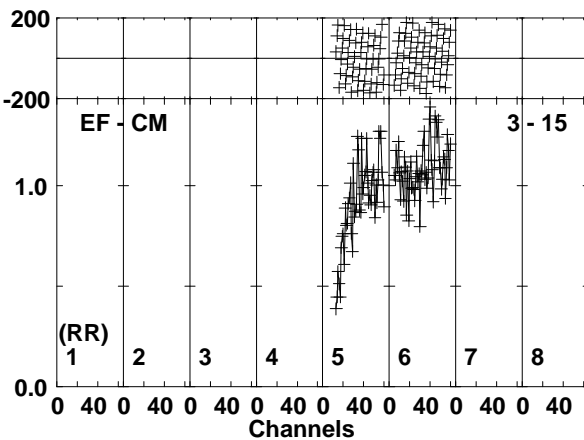
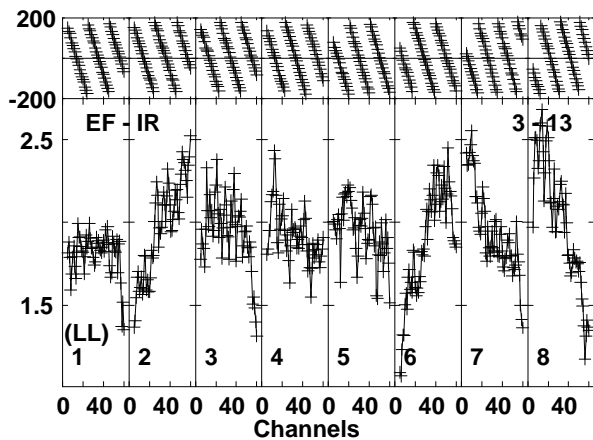
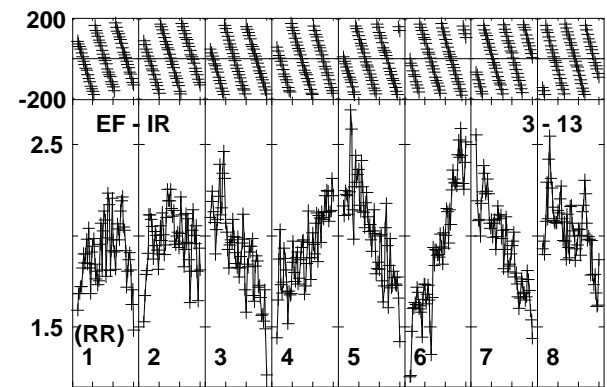
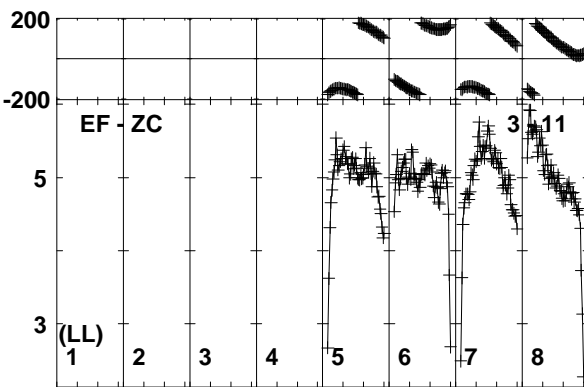
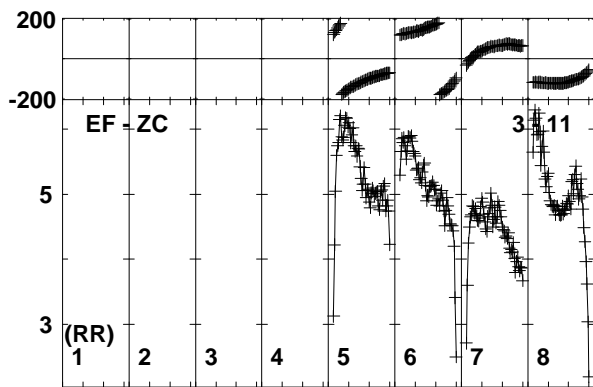
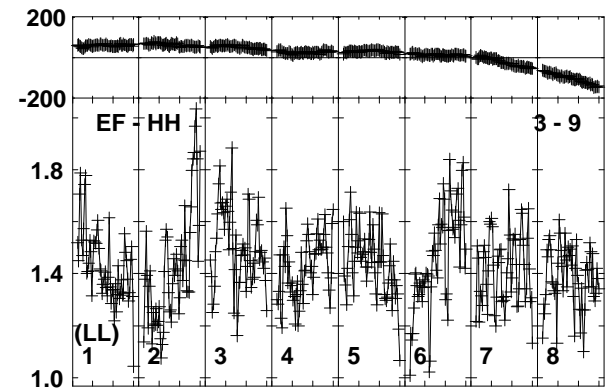
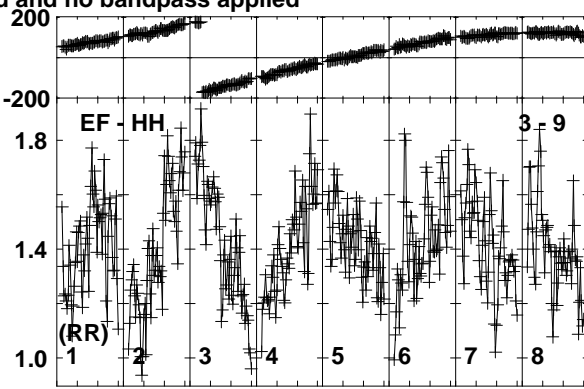
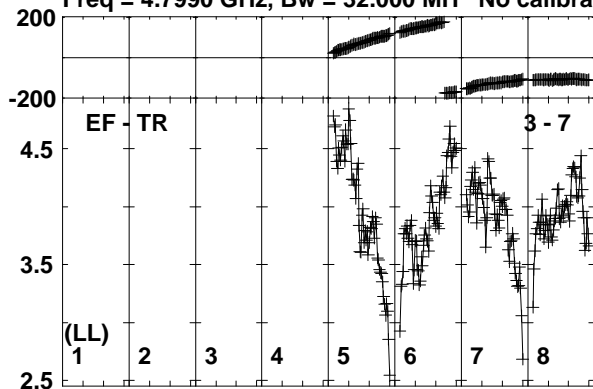

Lower frame: Milli Ampl Jy Top frame: Phas deg
Vector averaged cross-power spectrum Baseline: EF (03) - TR (07)
Timerange: 01/04:23:46 to 01/04:24:45

Plot file version 495 created 26-SEP-2019 10:43:10
 J0257-1212 RG010A.UVDATA.1
 Freq = 4.7990 GHz, Bw = 32.000 MH No calibration applied and no bandpass applied

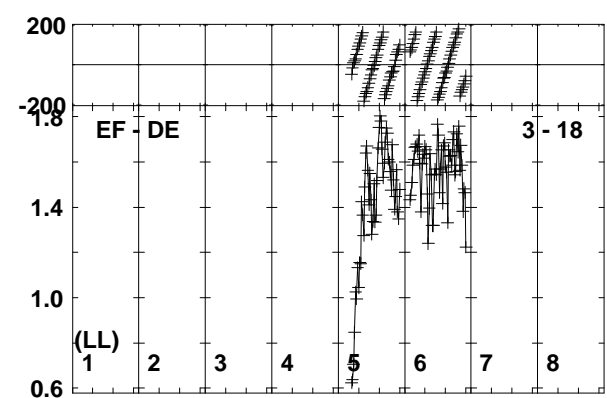
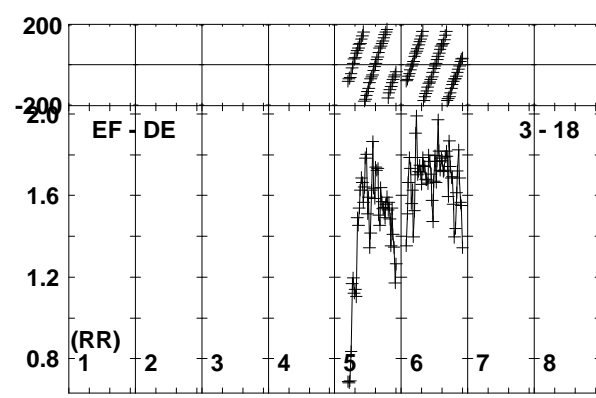
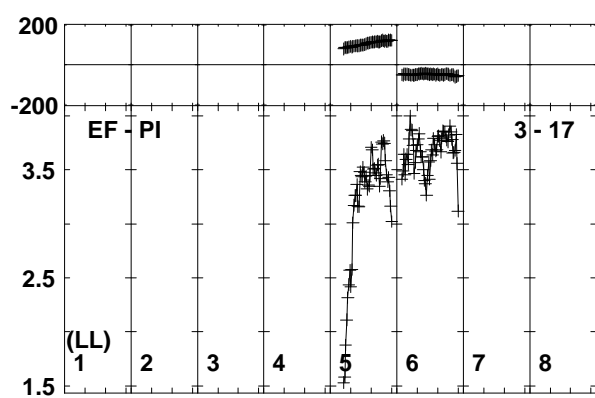
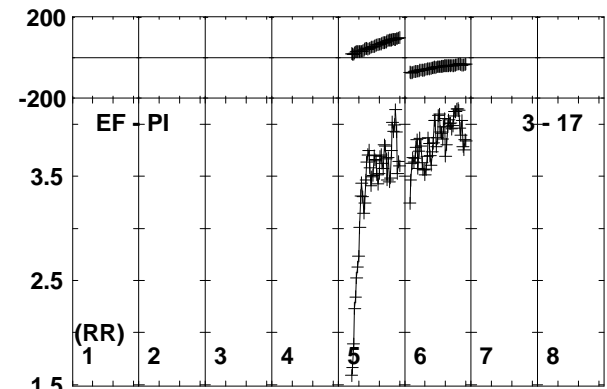
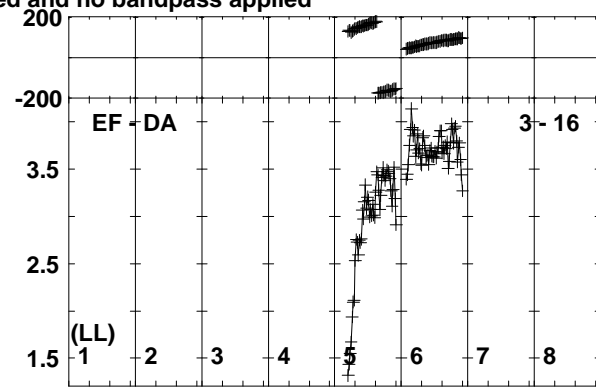
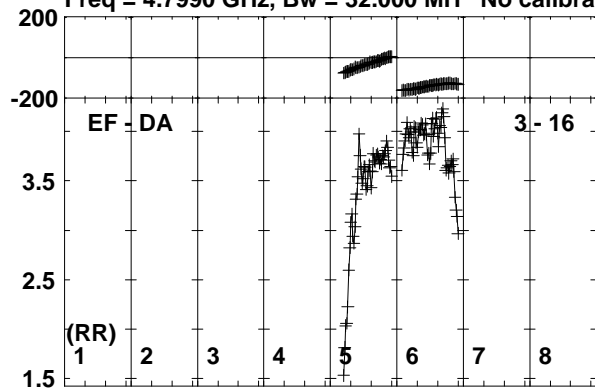

Lower frame: Milli Ampl Jy Top frame: Phas deg
 Vector averaged cross-power spectrum Baseline: EF (03) - DA (16)
 Timerange: 01/04:23:46 to 01/04:24:45

Plot file version 496 created 26-SEP-2019 10:43:10

190829A RG010A.UVDATA.1

Freq = 4.7990 GHz, Bw = 32.000 MH No calibration applied and no bandpass applied

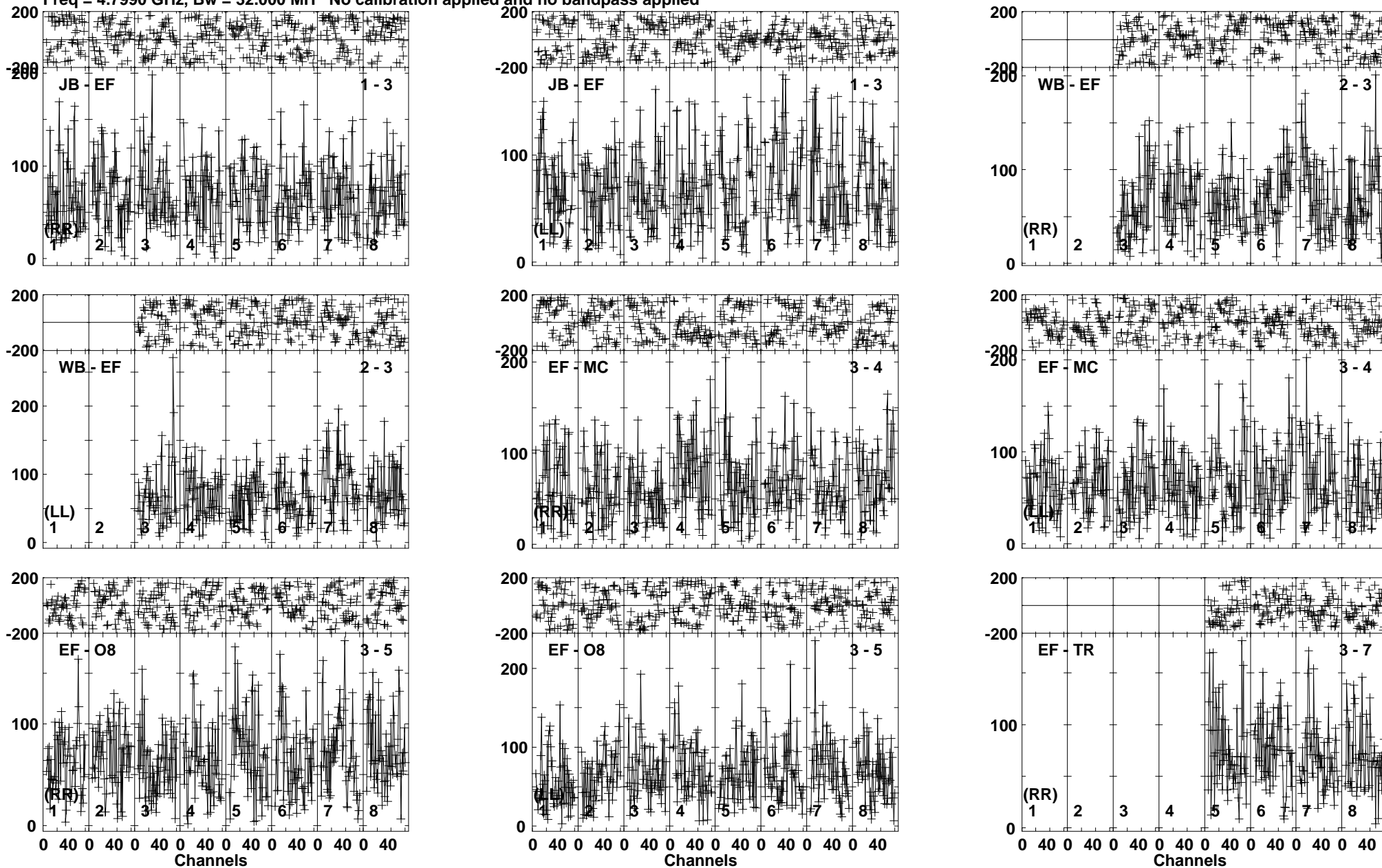

Lower frame: Micro Ampl Jy Top frame: Phas deg
Vector averaged cross-power spectrum Baseline: JB (01) - EF (03)
Timerange: 01/04:24:45 to 01/04:29:44

Plot file version 497 created 26-SEP-2019 10:43:11

190829A RG010A.UVDATA.1

Freq = 4.7990 GHz, Bw = 32.000 MH No calibration applied and no bandpass applied

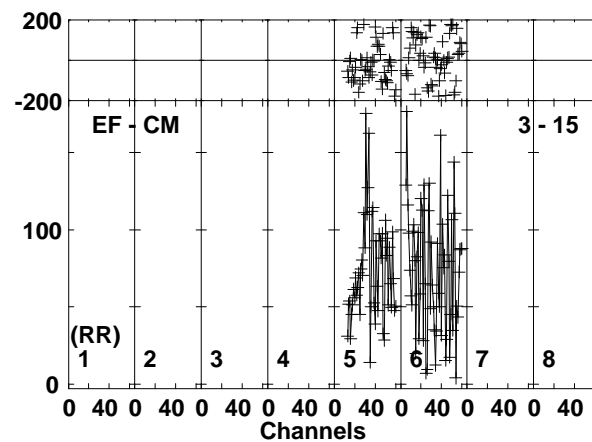
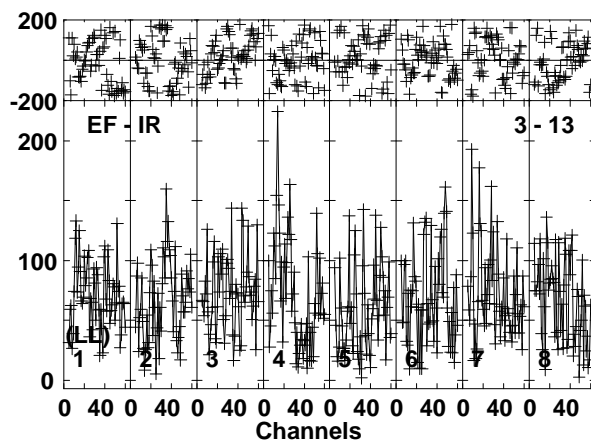
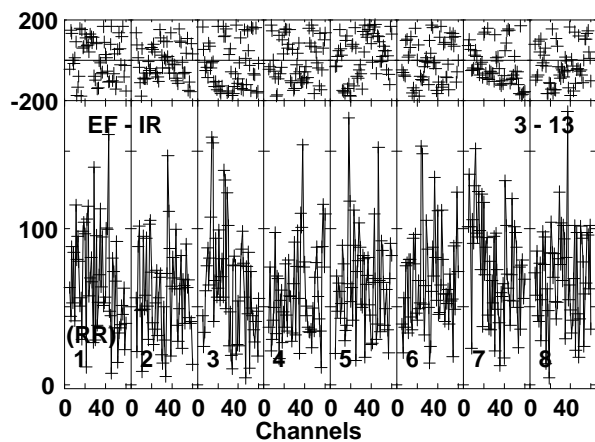
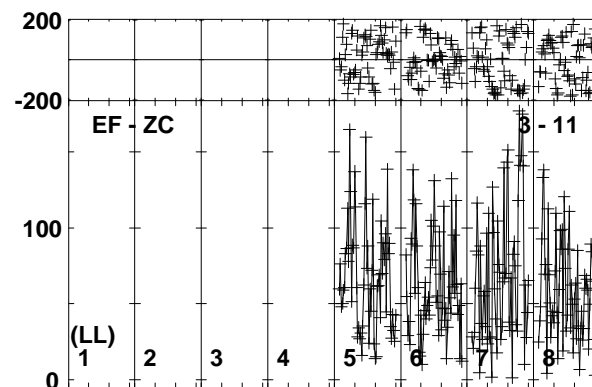
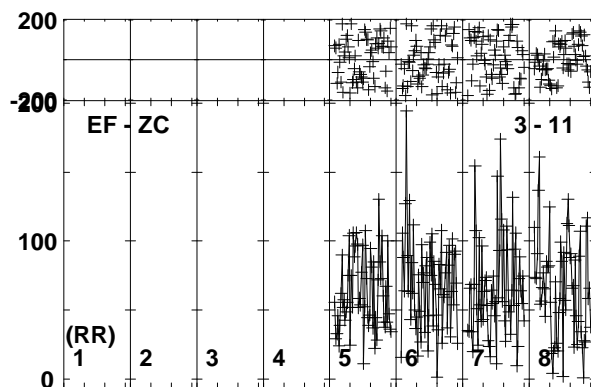
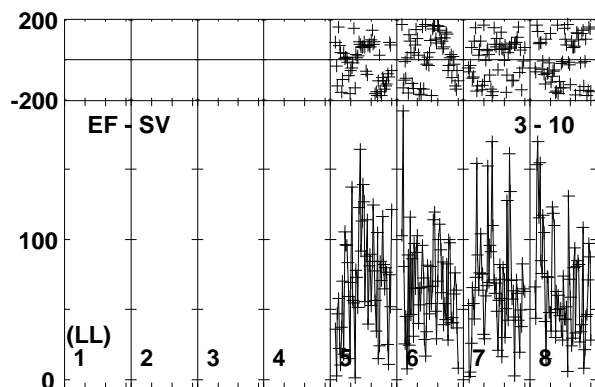
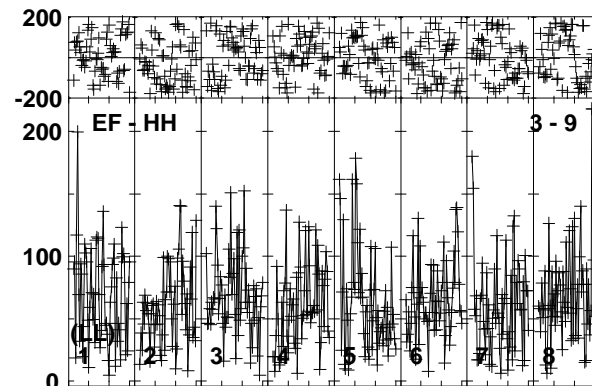
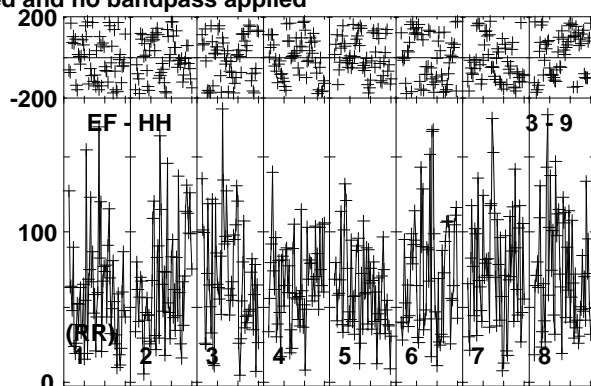
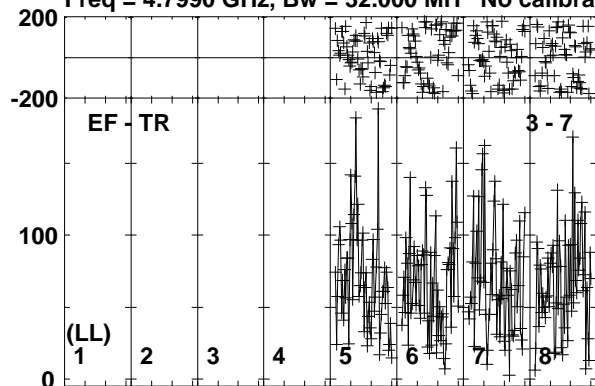

Lower frame: Micro Ampl Jy Top frame: Phas deg
Vector averaged cross-power spectrum Baseline: EF (03) - TR (07)
Timerange: 01/04:24:45 to 01/04:29:44

Plot file version 498 created 26-SEP-2019 10:43:12

190829A RG010A.UVDATA.1

Freq = 4.7990 GHz, Bw = 32.000 MH No calibration applied and no bandpass applied

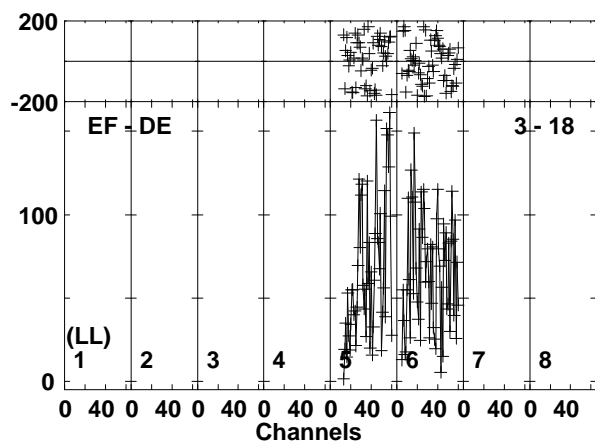
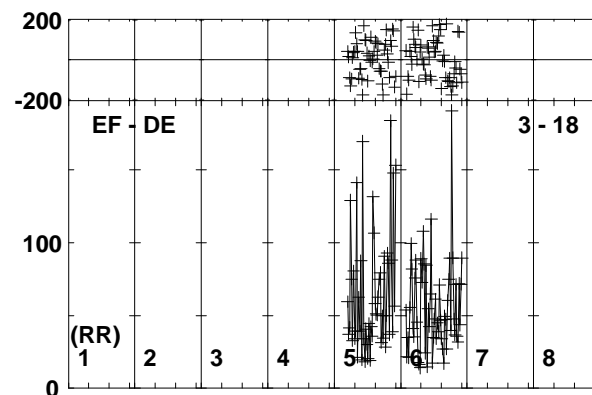
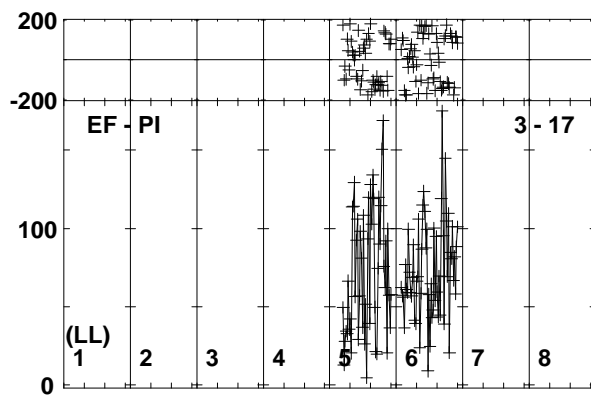
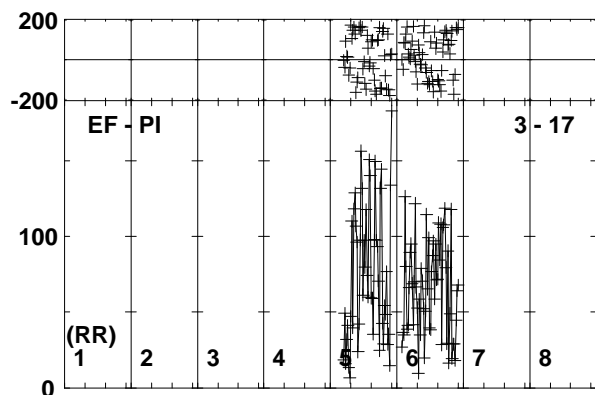
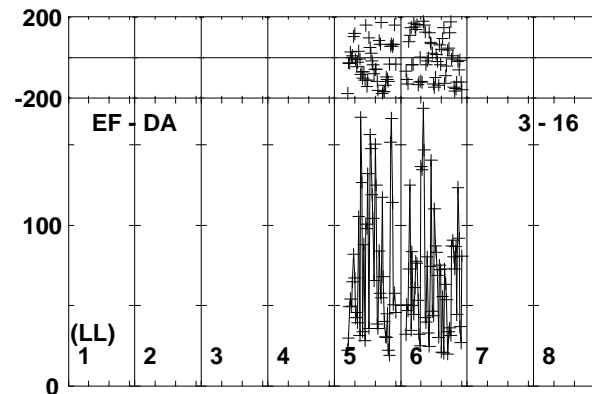
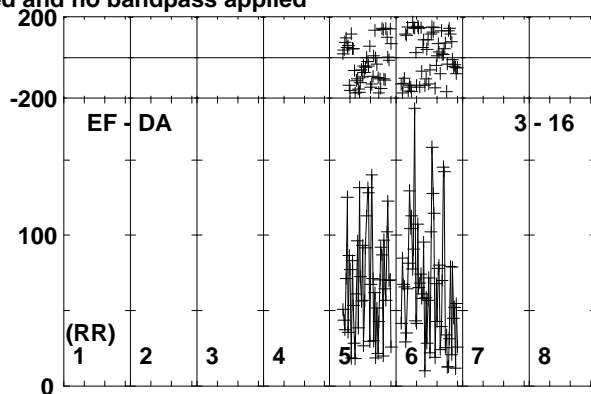
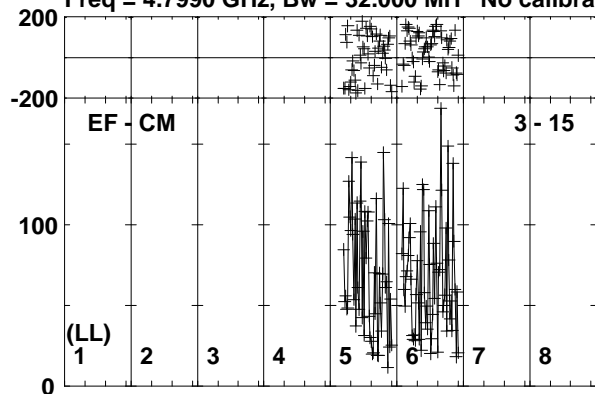

Lower frame: Micro Ampl Jy Top frame: Phas deg
Vector averaged cross-power spectrum Baseline: EF (03) - CM (15)
Timerange: 01/04:24:45 to 01/04:29:44

Plot file version 499 created 26-SEP-2019 10:43:12

J0257-1212 RG010A.UVDATA.1

Freq = 4.7990 GHz, Bw = 32.000 MH No calibration applied and no bandpass applied

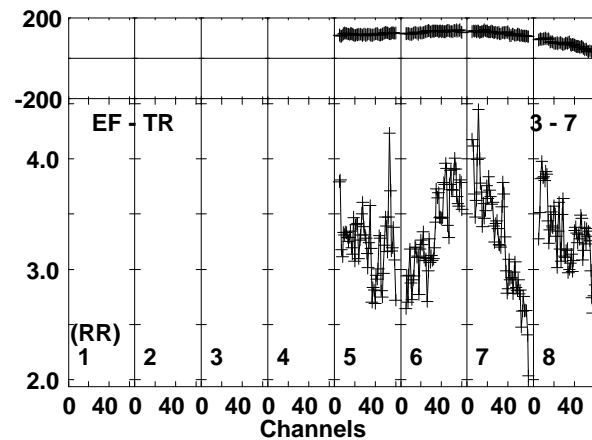
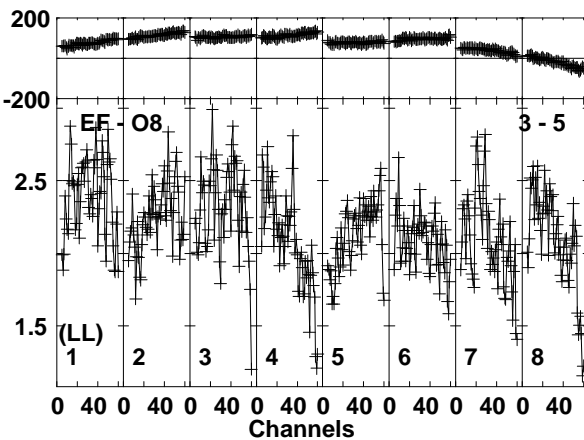
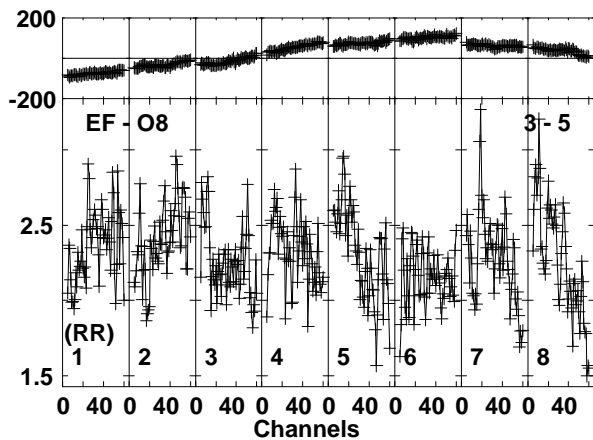
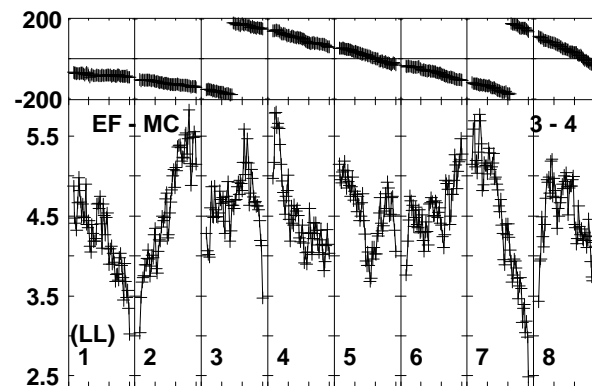
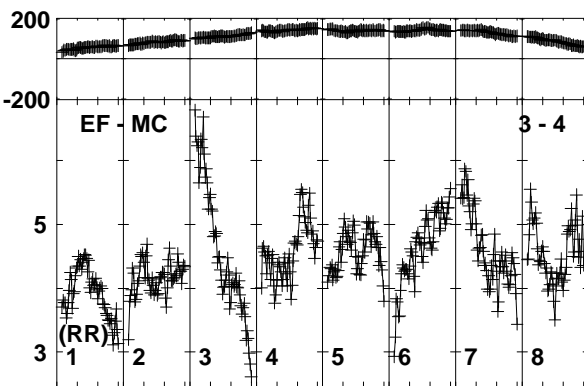
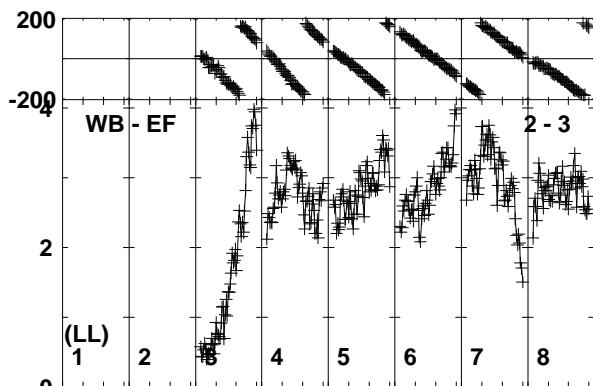
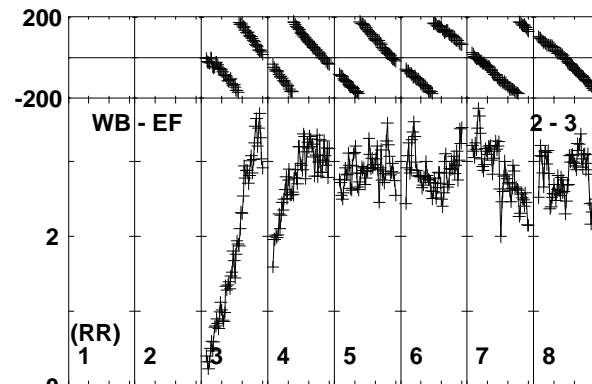
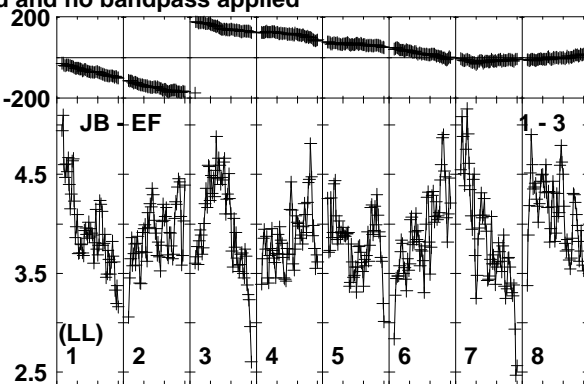
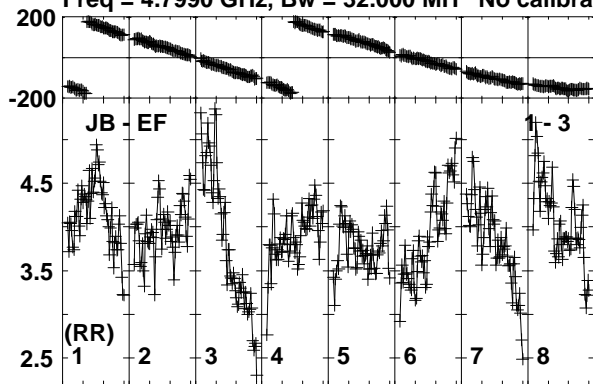

Lower frame: Milli Ampl Jy Top frame: Phas deg
Vector averaged cross-power spectrum Baseline: JB (01) - EF (03)
Timerange: 01/04:30:26 to 01/04:30:55

Plot file version 500 created 26-SEP-2019 10:43:13

J0257-1212 RG010A.UVDATA.1

Freq = 4.7990 GHz, Bw = 32.000 MH No calibration applied and no bandpass applied

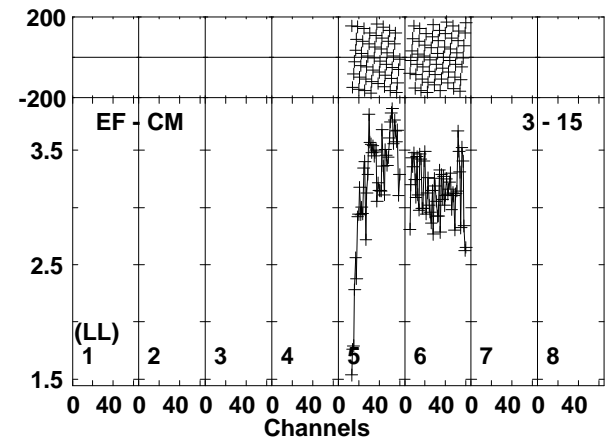
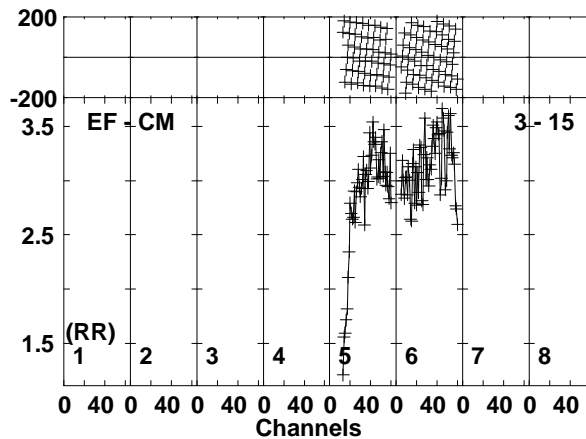
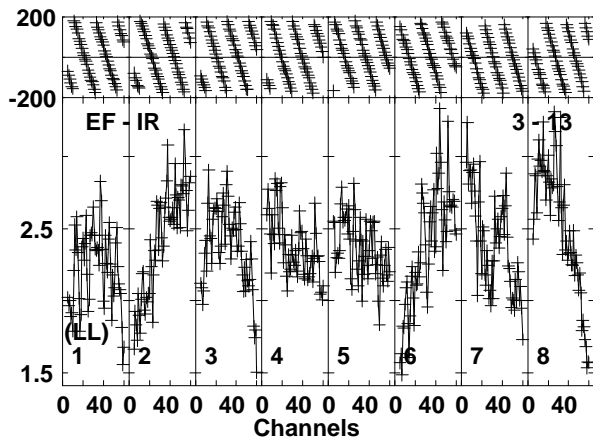
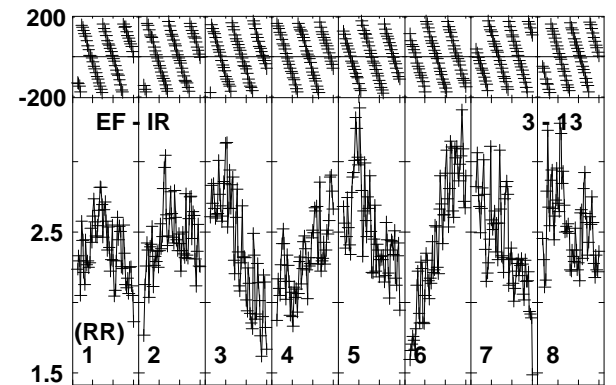
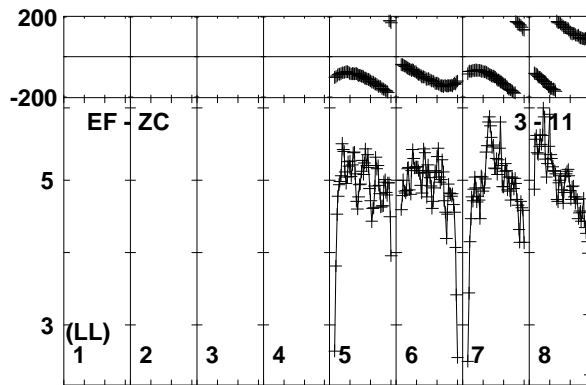
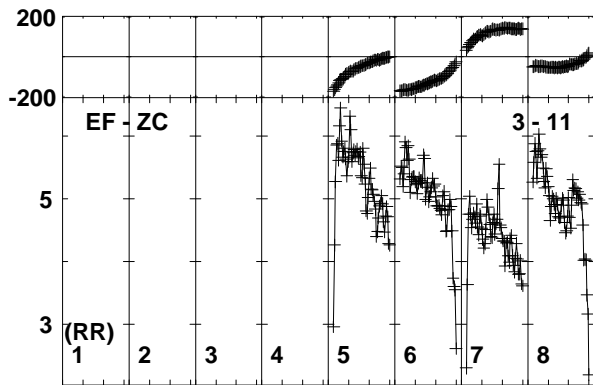
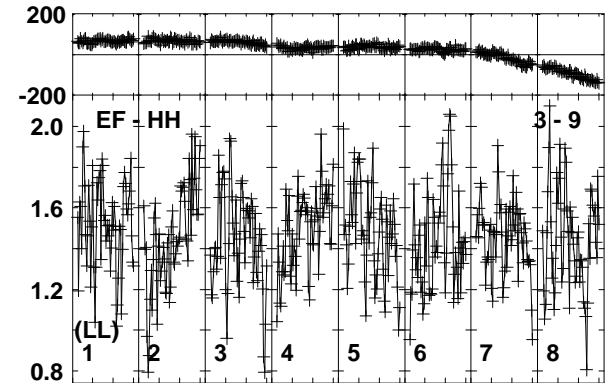
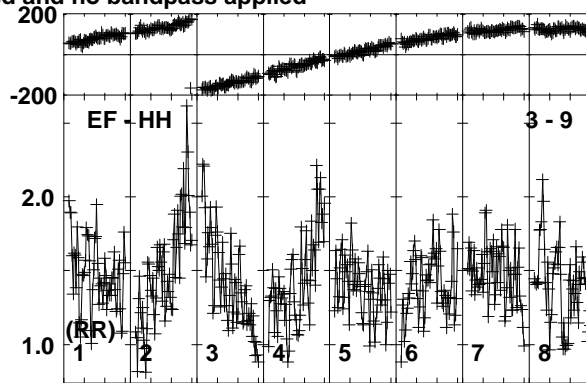
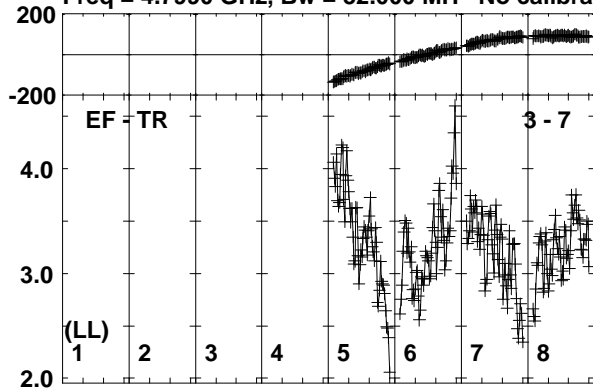

Lower frame: Milli Ampl Jy Top frame: Phas deg
Vector averaged cross-power spectrum Baseline: EF (03) - TR (07)
Timerange: 01/04:30:26 to 01/04:30:55

Plot file version 501 created 26-SEP-2019 10:43:13

J0257-1212 RG010A.UVDATA.1

Freq = 4.7990 GHz, Bw = 32.000 MH No calibration applied and no bandpass applied

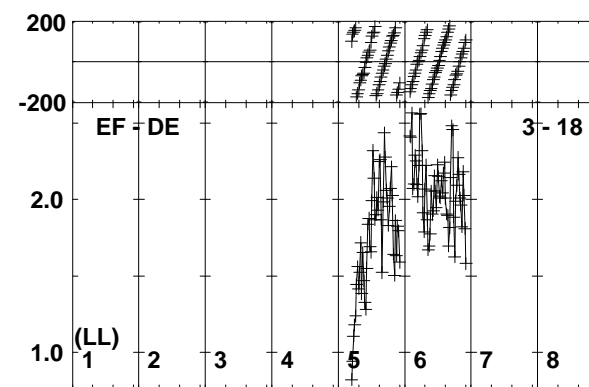
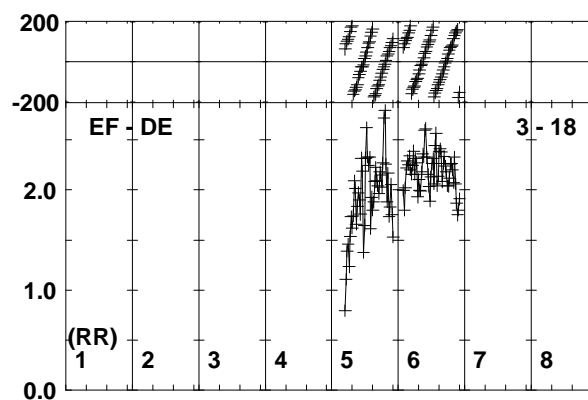
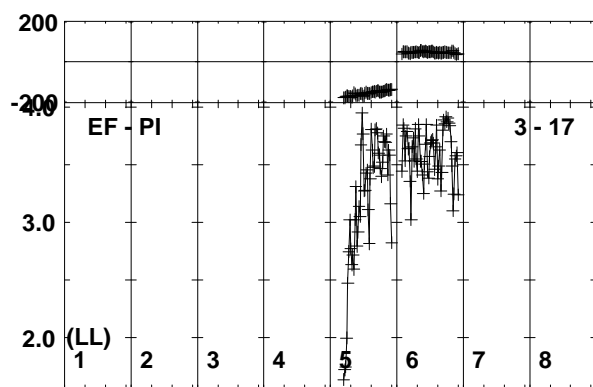
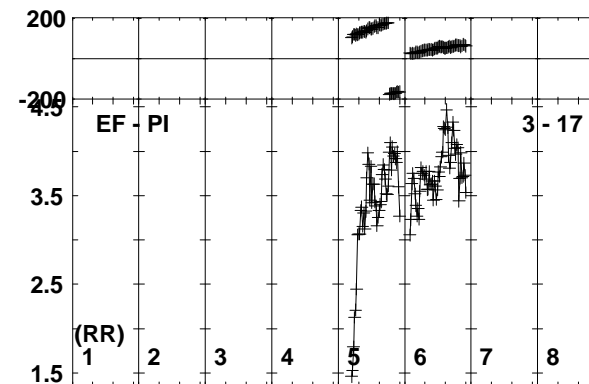
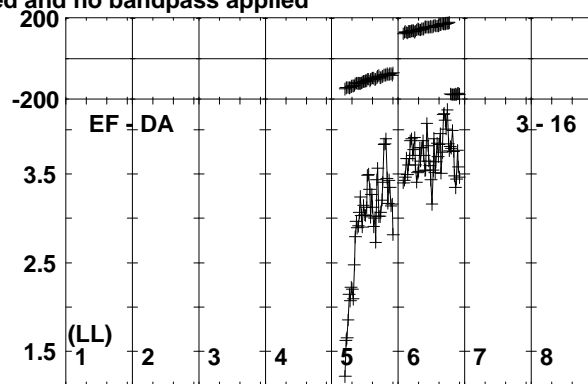
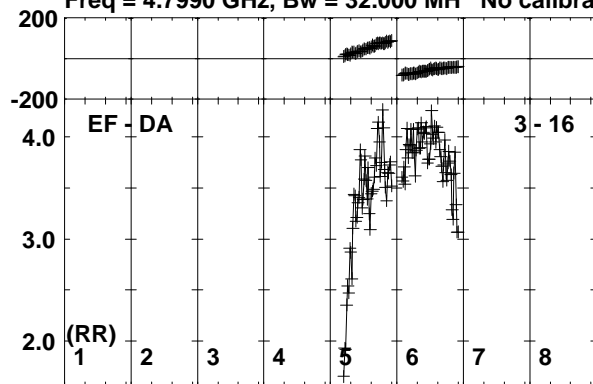

Lower frame: Milli Ampl Jy Top frame: Phas deg
Vector averaged cross-power spectrum Baseline: EF (03) - DA (16)
Timerange: 01/04:30:26 to 01/04:30:55

Plot file version 502 created 26-SEP-2019 10:43:13

J0300-0846 RG010A.UVDATA.1

Freq = 4.7990 GHz, Bw = 32.000 MH No calibration applied and no bandpass applied

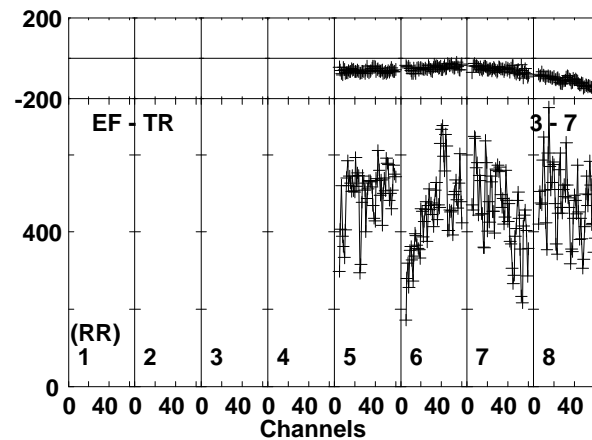
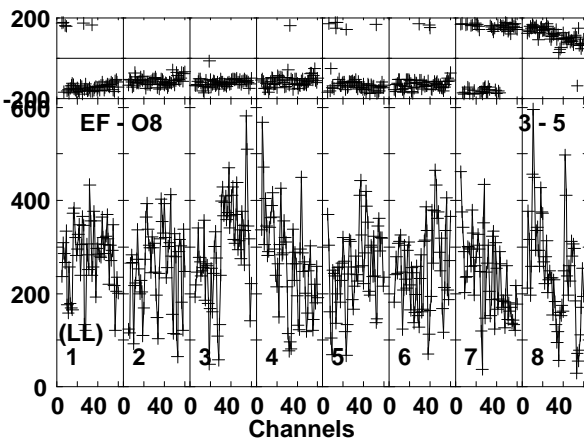
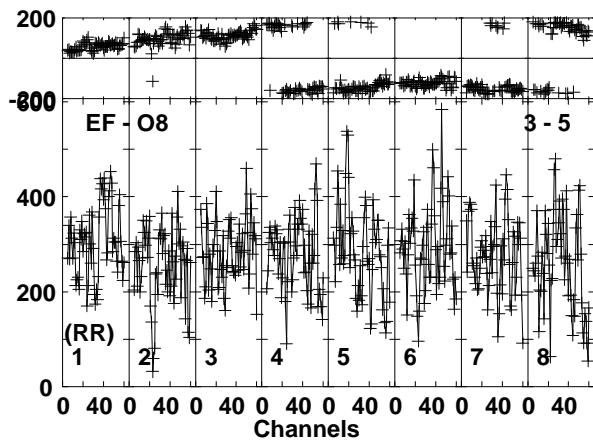
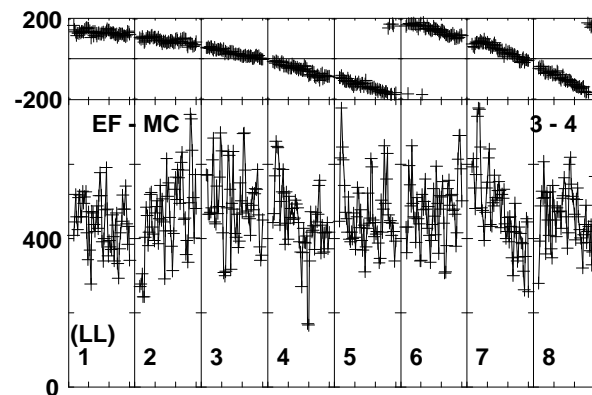
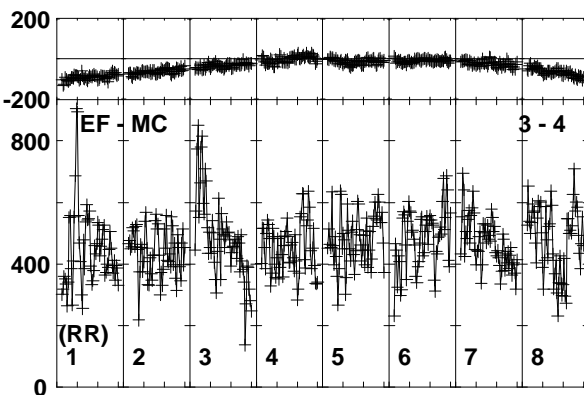
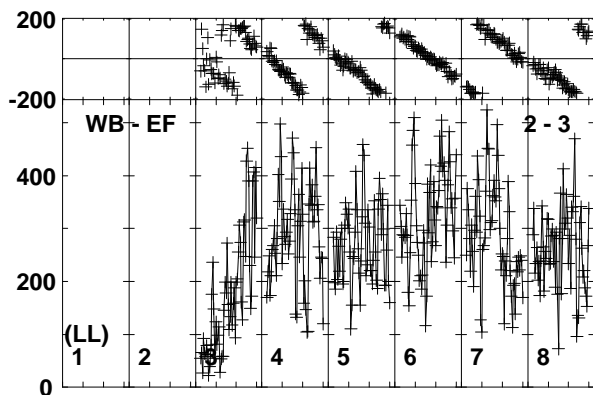
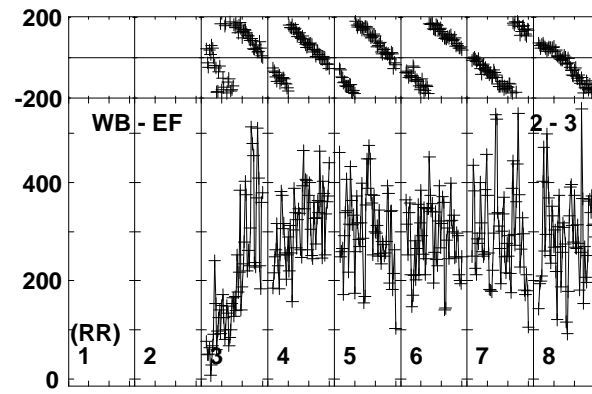
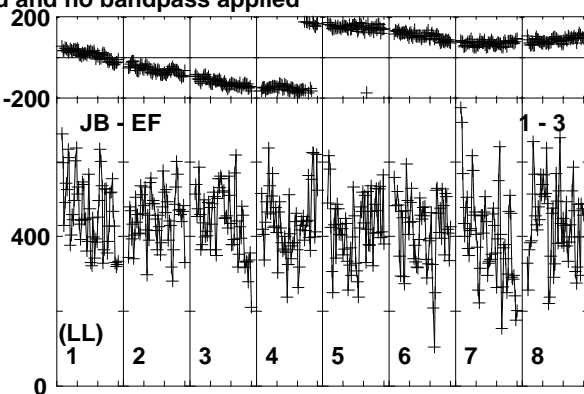
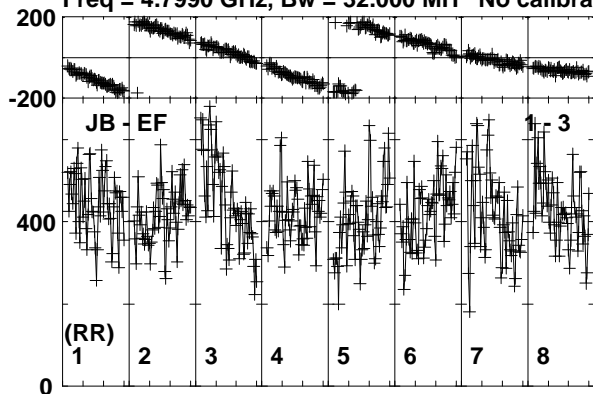

Lower frame: Micro Ampl Jy Top frame: Phas deg
Vector averaged cross-power spectrum Baseline: JB (01) - EF (03)
Timerange: 01/04:30:55 to 01/04:33:25

Plot file version 503 created 26-SEP-2019 10:43:14

J0300-0846 RG010A.UVDATA.1

Freq = 4.7990 GHz, Bw = 32.000 MH No calibration applied and no bandpass applied

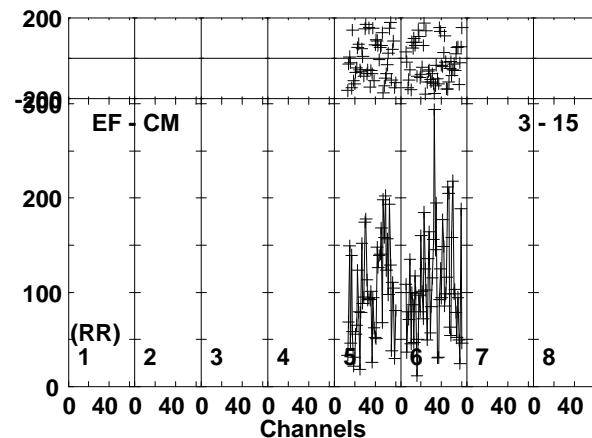
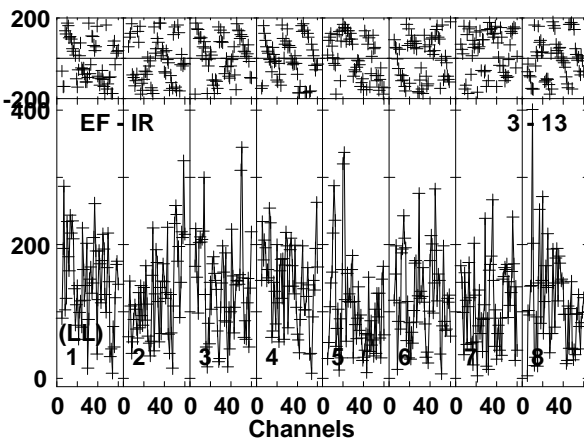
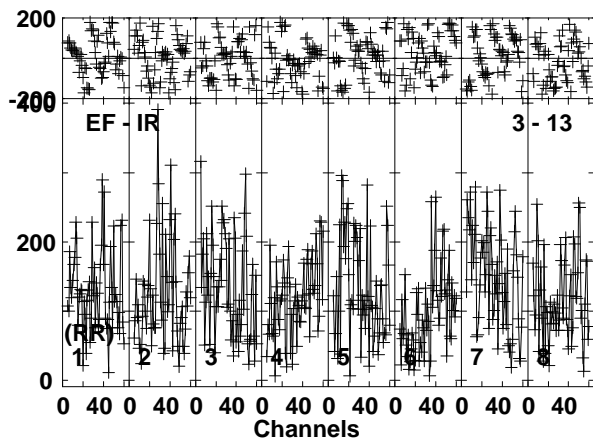
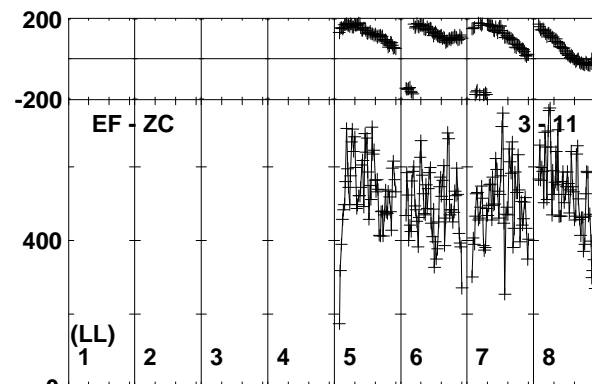
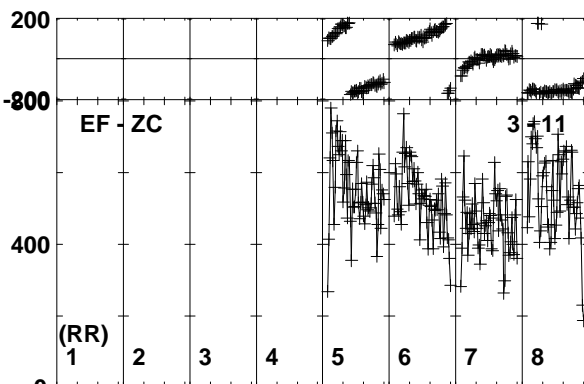
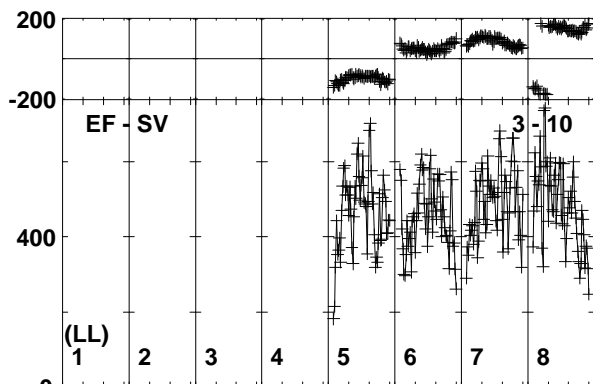
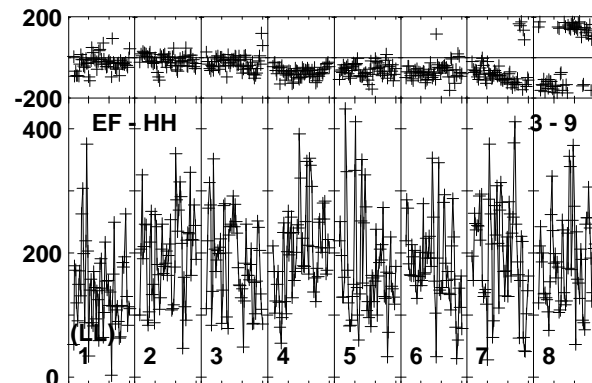
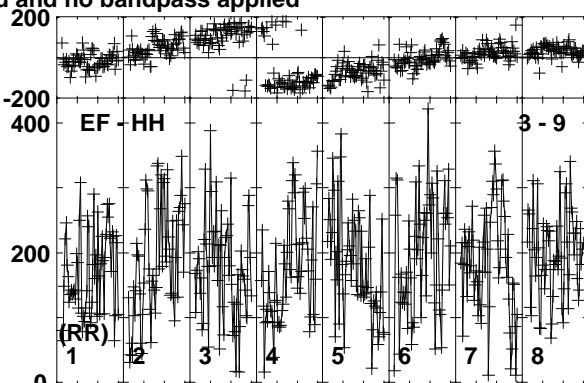
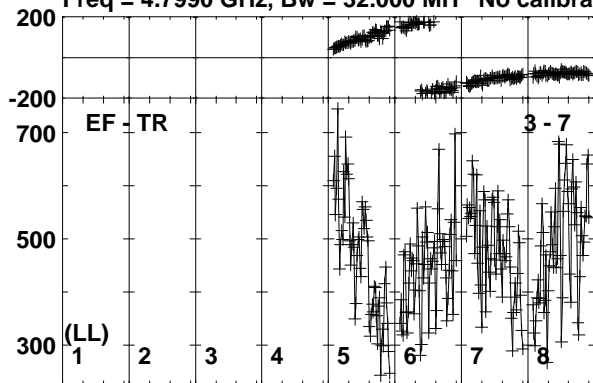

Lower frame: Micro Ampl Jy Top frame: Phas deg
Vector averaged cross-power spectrum Baseline: EF (03) - TR (07)
Timerange: 01/04:30:55 to 01/04:33:25

Plot file version 504 created 26-SEP-2019 10:43:15

J0300-0846 RG010A.UVDATA.1

Freq = 4.7990 GHz, Bw = 32.000 MH No calibration applied and no bandpass applied

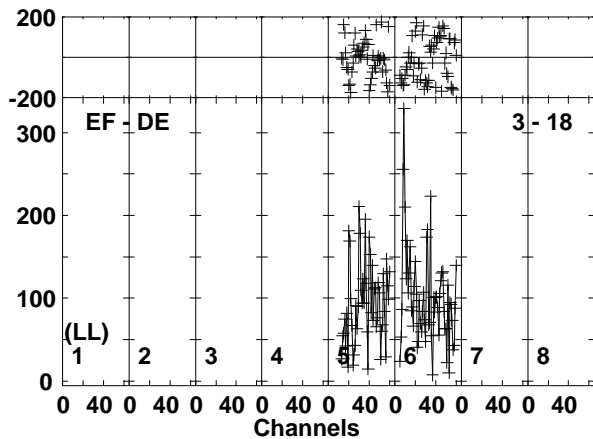
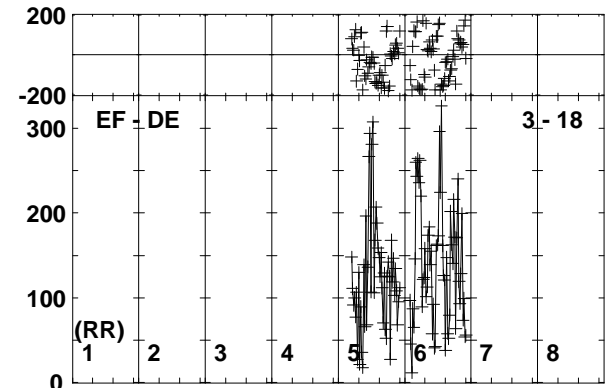
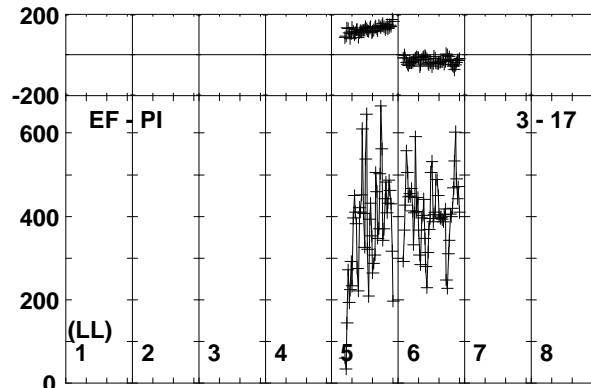
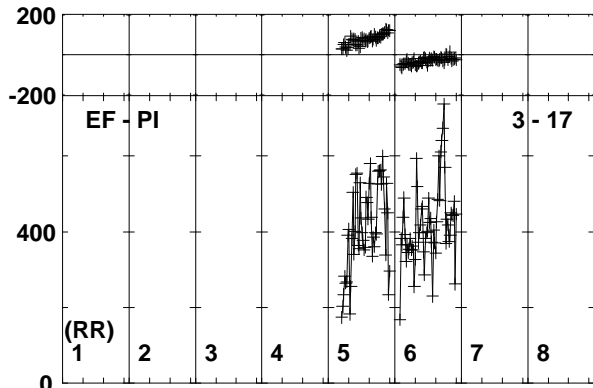
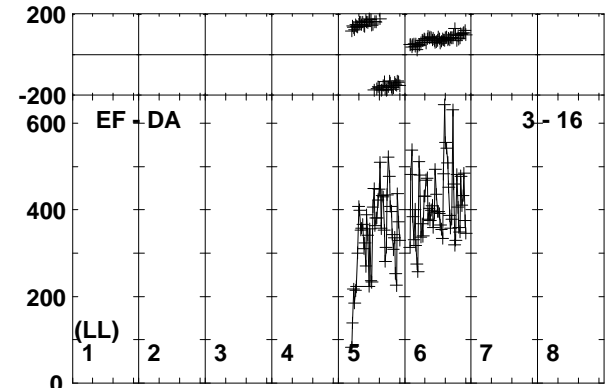
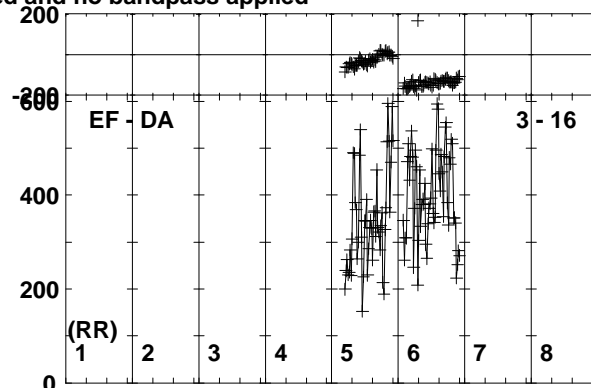
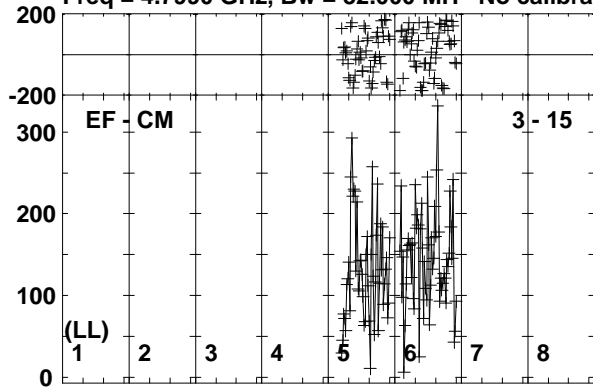

Lower frame: Micro Ampl Jy Top frame: Phas deg
Vector averaged cross-power spectrum Baseline: EF (03) - CM (15)
Timerange: 01/04:30:55 to 01/04:33:25

Plot file version 505 created 26-SEP-2019 10:43:15

190829A RG010A.UVDATA.1

Freq = 4.7990 GHz, Bw = 32.000 MH No calibration applied and no bandpass applied

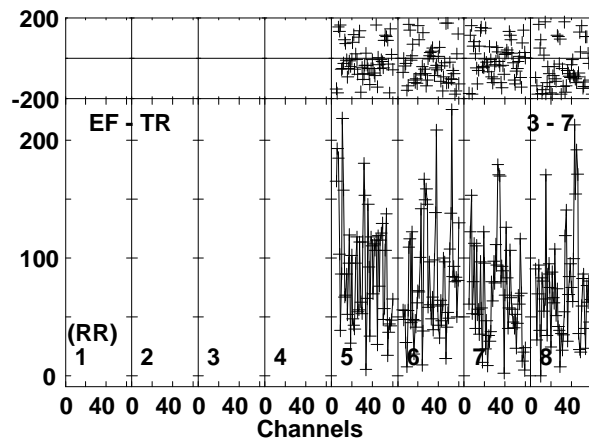
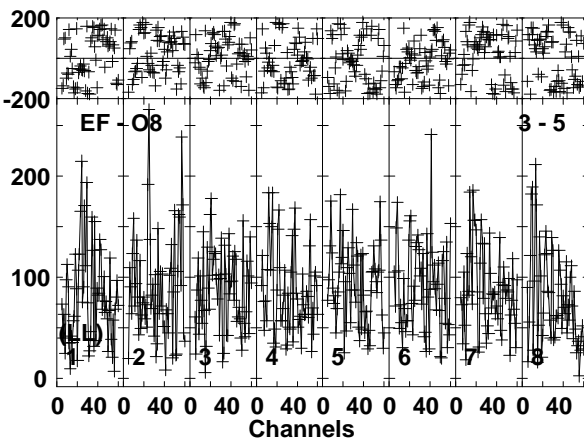
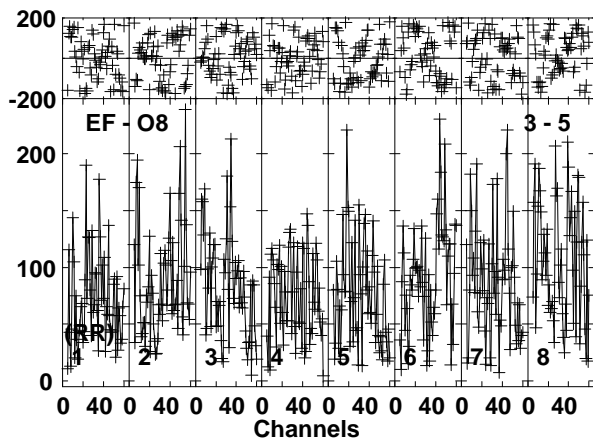
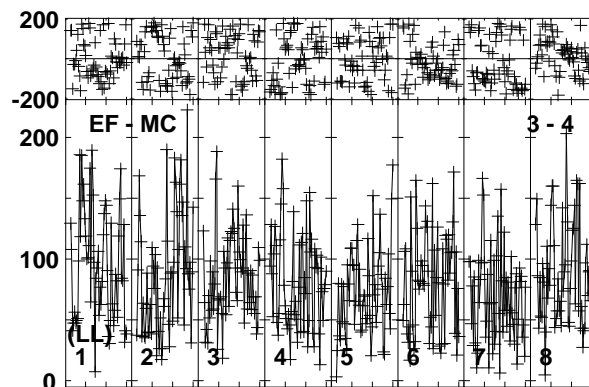
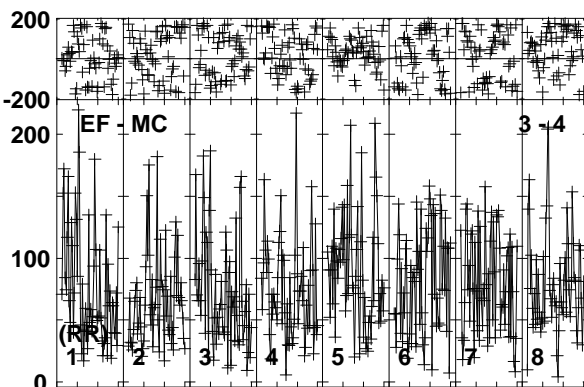
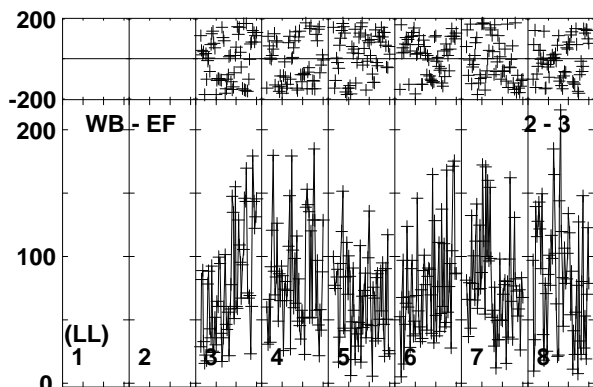
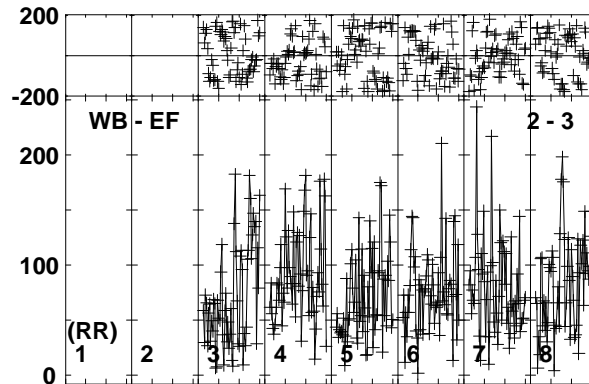
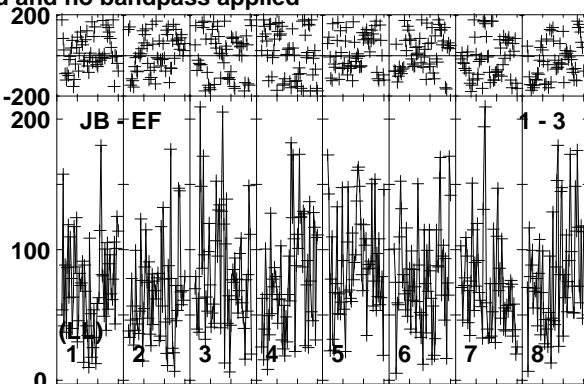
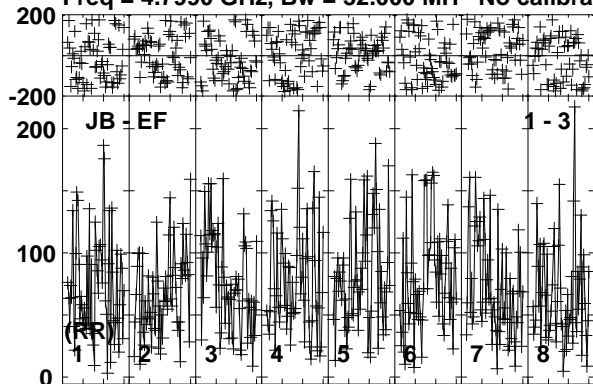

Lower frame: Micro Ampl Jy Top frame: Phas deg
Vector averaged cross-power spectrum Baseline: JB (01) - EF (03)
Timerange: 01/04:33:25 to 01/04:36:55

Plot file version 506 created 26-SEP-2019 10:43:16

190829A RG010A.UVDATA.1

Freq = 4.7990 GHz, Bw = 32.000 MH No calibration applied and no bandpass applied

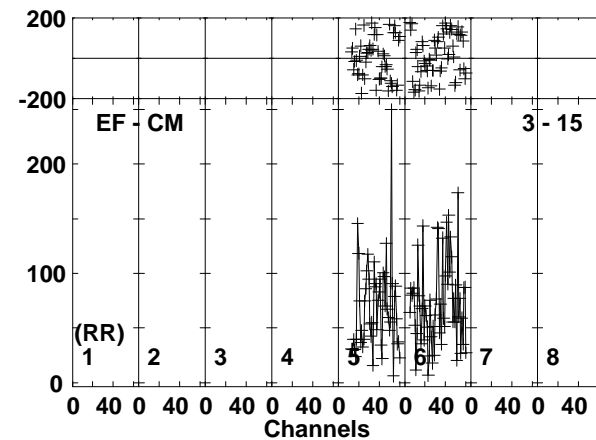
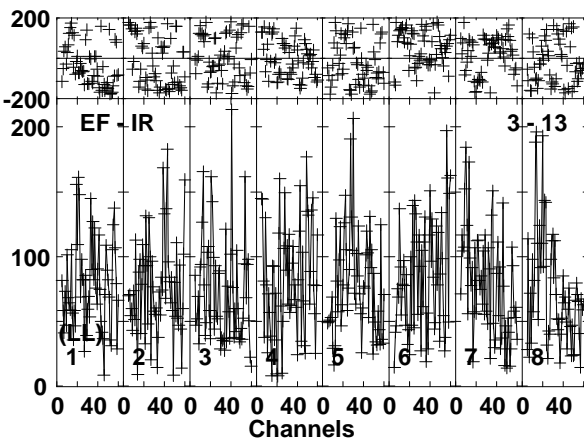
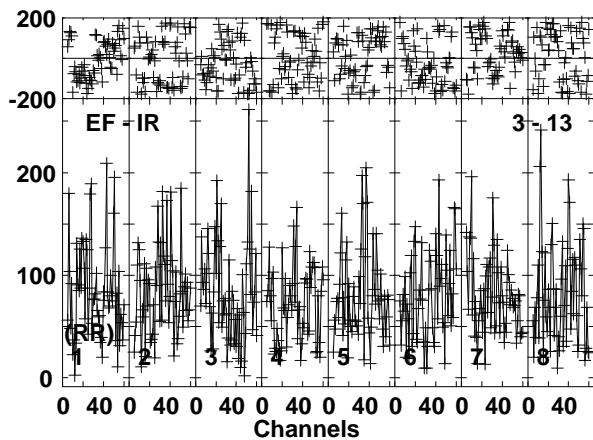
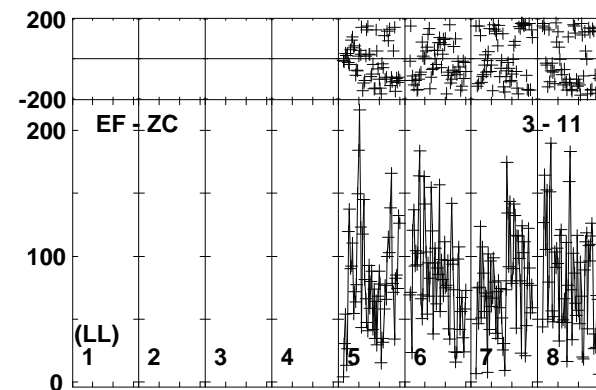
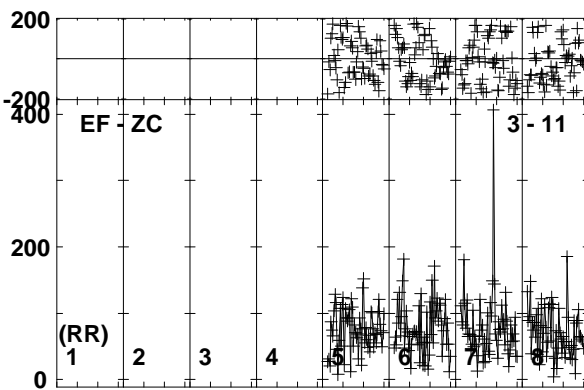
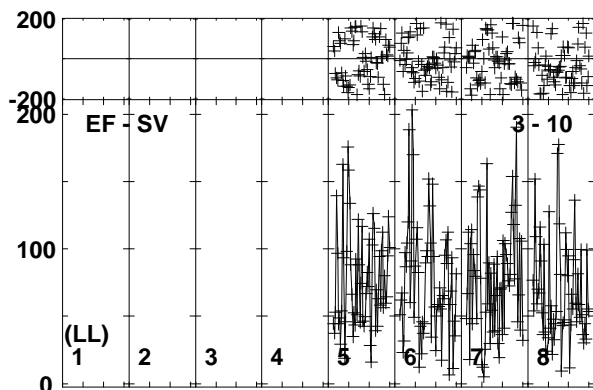
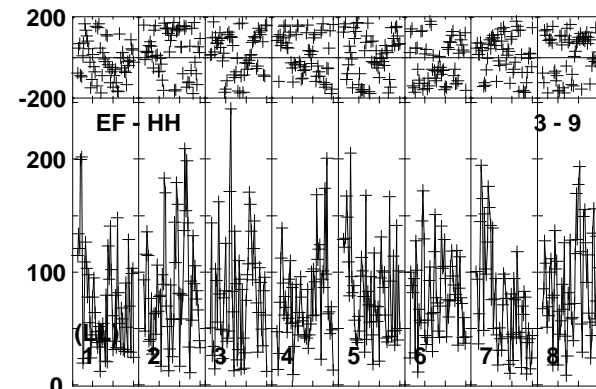
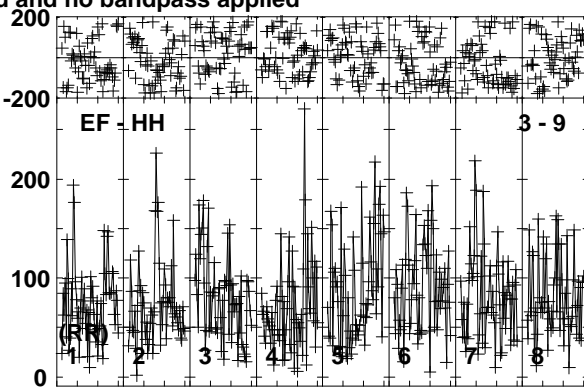
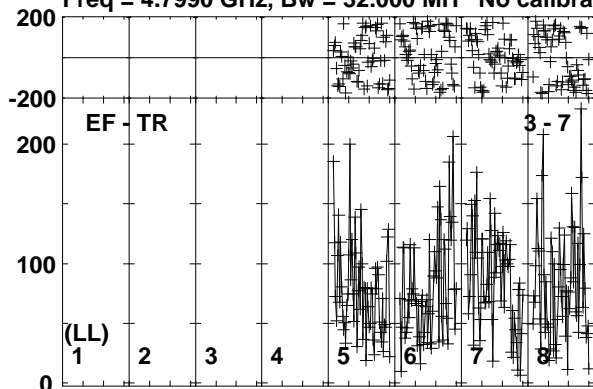

Lower frame: Micro Ampl Jy Top frame: Phas deg
Vector averaged cross-power spectrum Baseline: EF (03) - TR (07)
Timerange: 01/04:33:25 to 01/04:36:55

Plot file version 507 created 26-SEP-2019 10:43:17

190829A RG010A.UVDATA.1

Freq = 4.7990 GHz, Bw = 32.000 MH No calibration applied and no bandpass applied

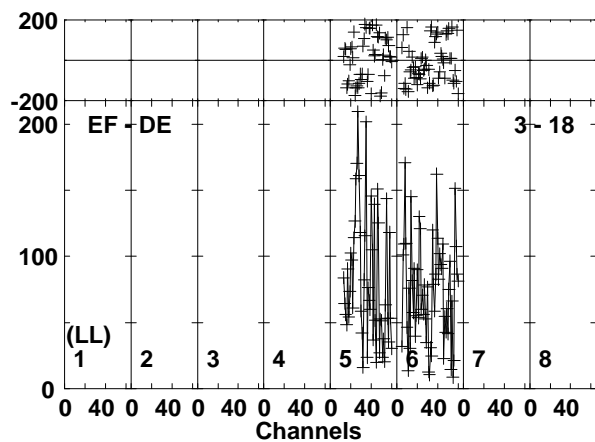
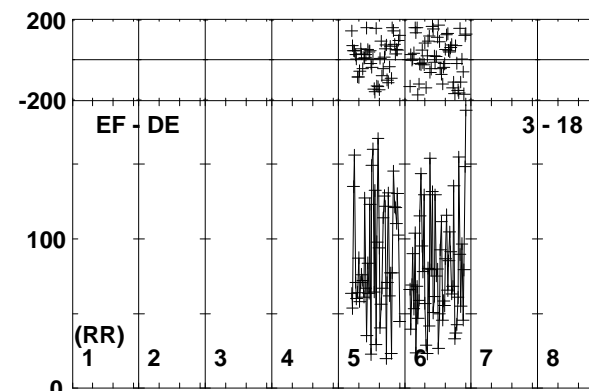
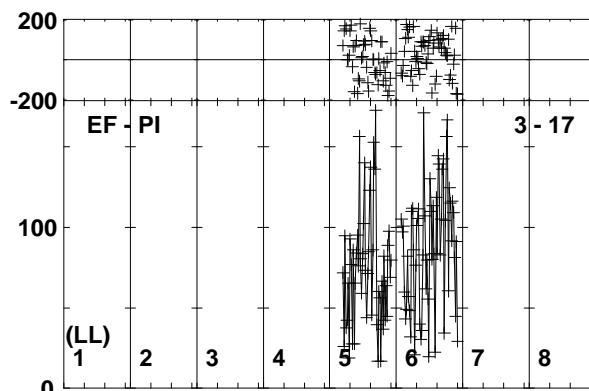
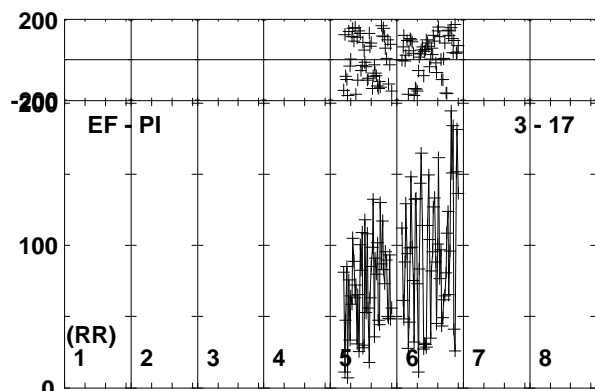
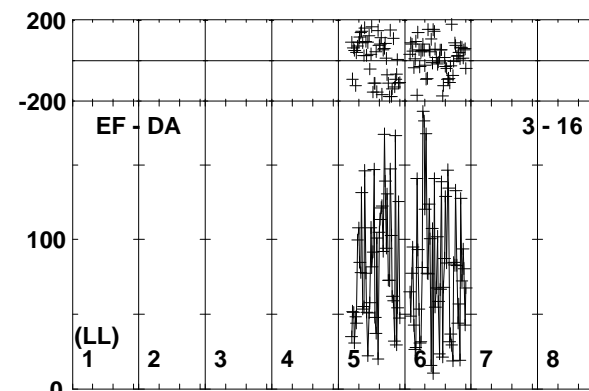
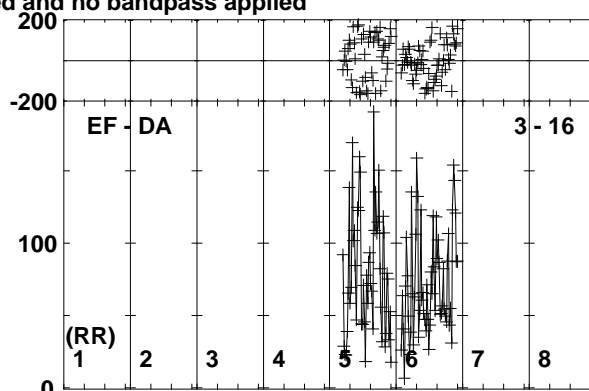
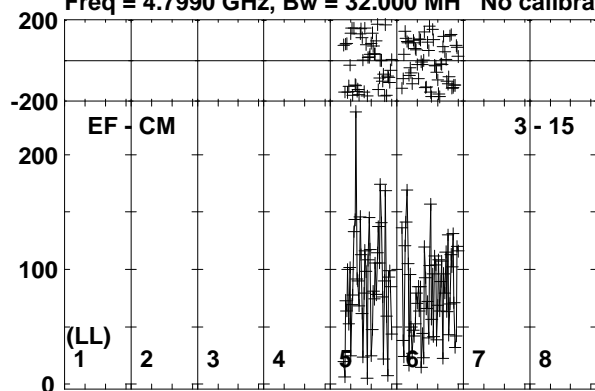

Lower frame: Micro Ampl Jy Top frame: Phas deg
Vector averaged cross-power spectrum Baseline: EF (03) - CM (15)
Timerange: 01/04:33:25 to 01/04:36:55

Plot file version 508 created 26-SEP-2019 10:43:17

J0257-1212 RG010A.UVDATA.1

Freq = 4.7990 GHz, Bw = 32.000 MH No calibration applied and no bandpass applied

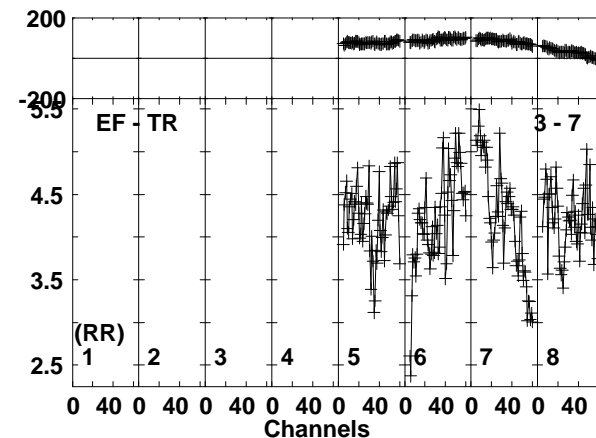
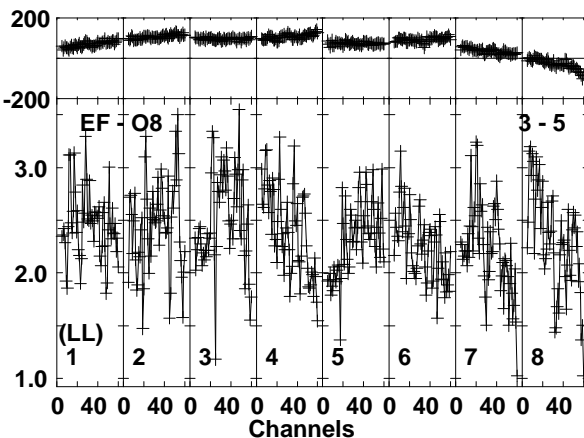
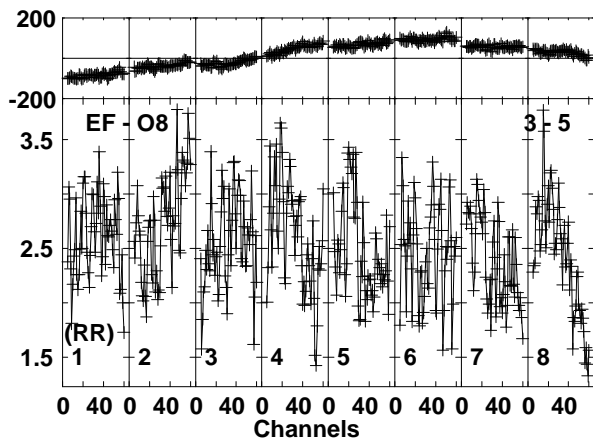
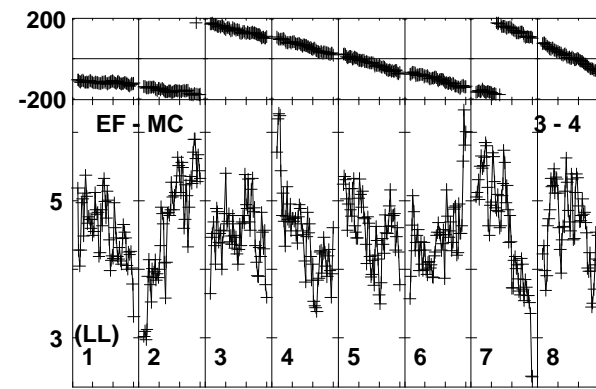
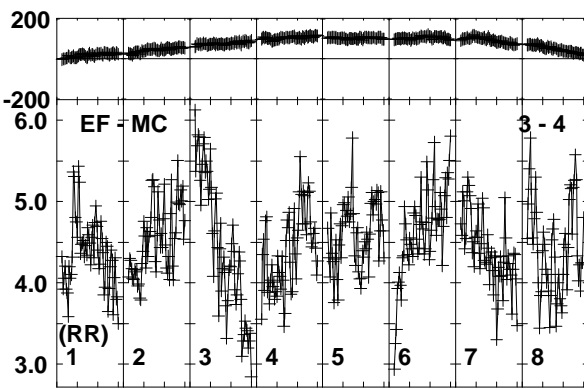
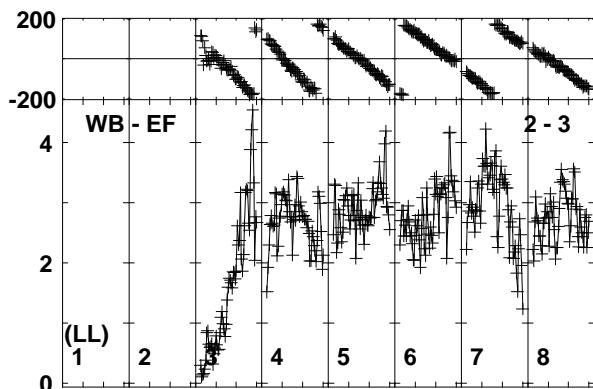
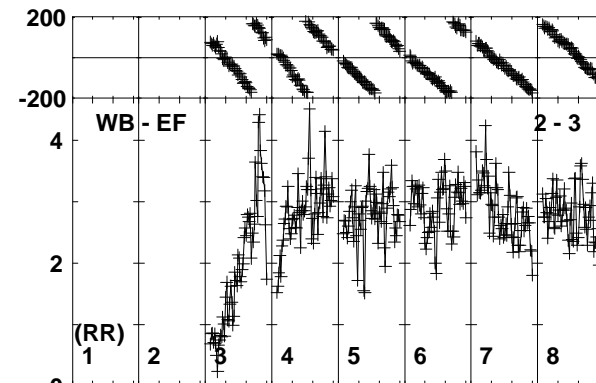
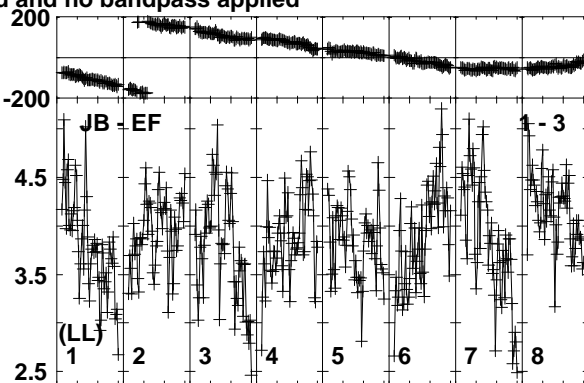
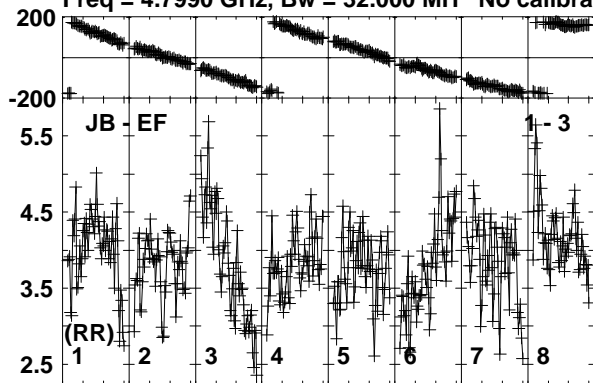

Lower frame: Milli Ampl Jy Top frame: Phas deg
Vector averaged cross-power spectrum Baseline: JB (01) - EF (03)
Timerange: 01/04:36:55 to 01/04:37:54

Plot file version 509 created 26-SEP-2019 10:43:17

J0257-1212 RG010A.UVDATA.1

Freq = 4.7990 GHz, Bw = 32.000 MH No calibration applied and no bandpass applied

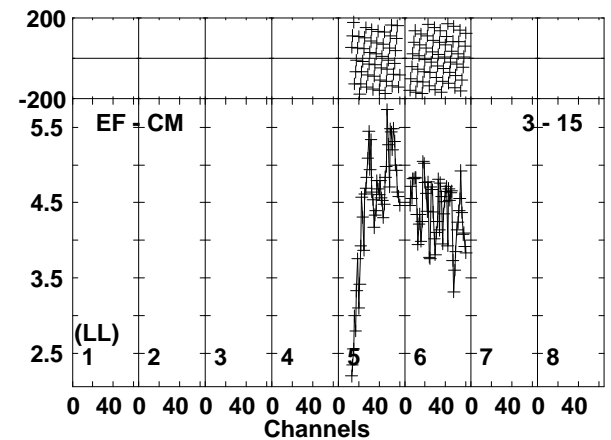
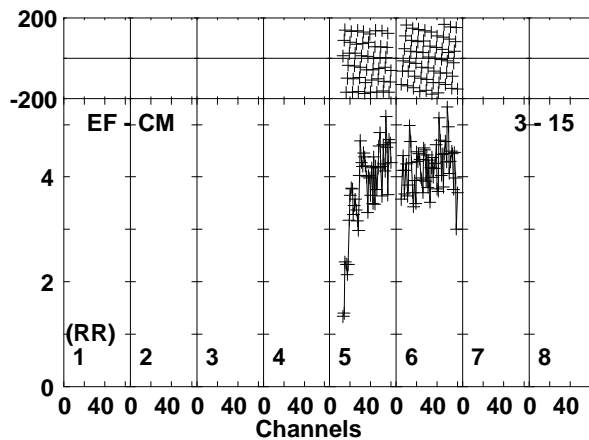
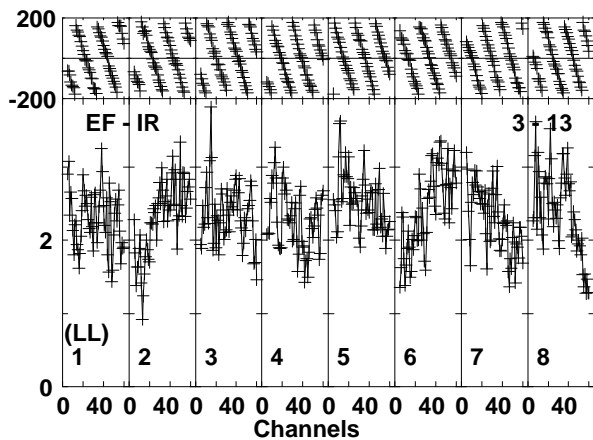
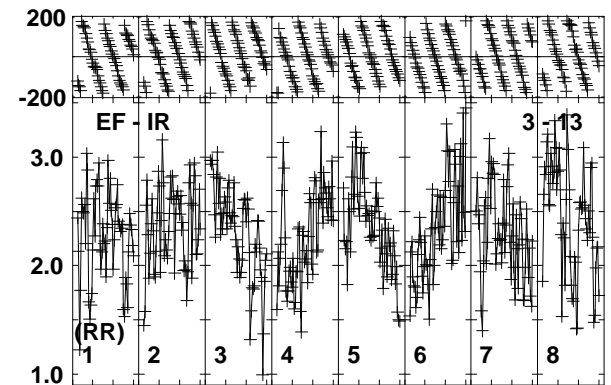
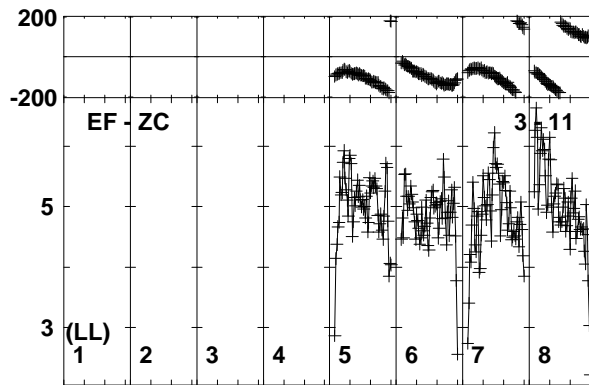
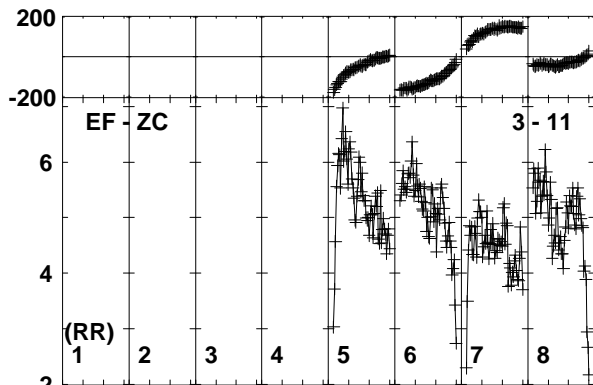
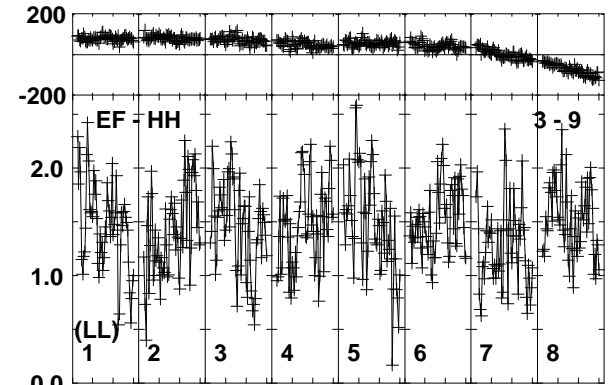
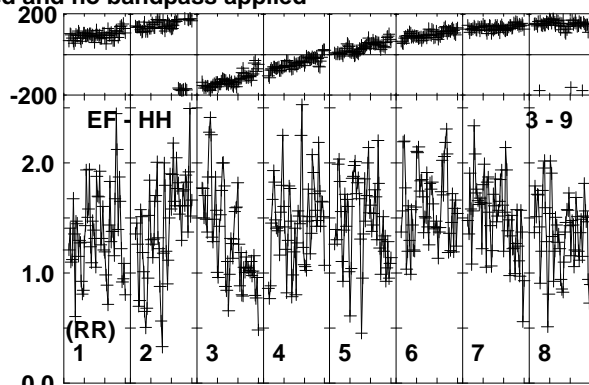
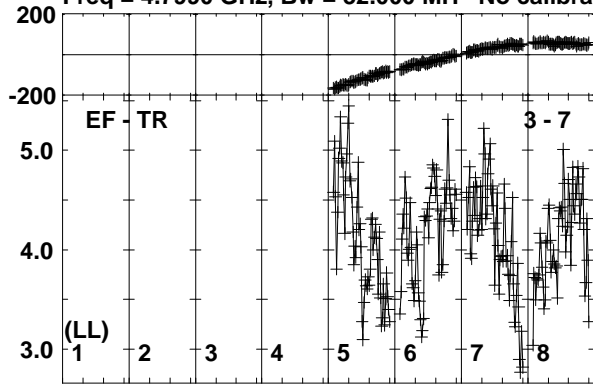

Lower frame: Milli Amply Jy Top frame: Phas deg
Vector averaged cross-power spectrum Baseline: EF (03) - TR (07)
Timerange: 01/04:36:55 to 01/04:37:54

Plot file version 510 created 26-SEP-2019 10:43:18

J0257-1212 RG010A.UVDATA.1

Freq = 4.7990 GHz, Bw = 32.000 MH No calibration applied and no bandpass applied

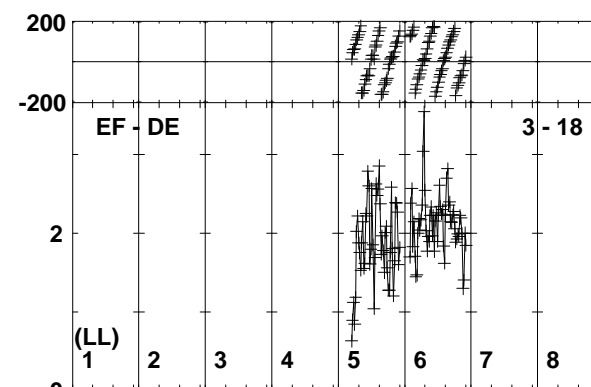
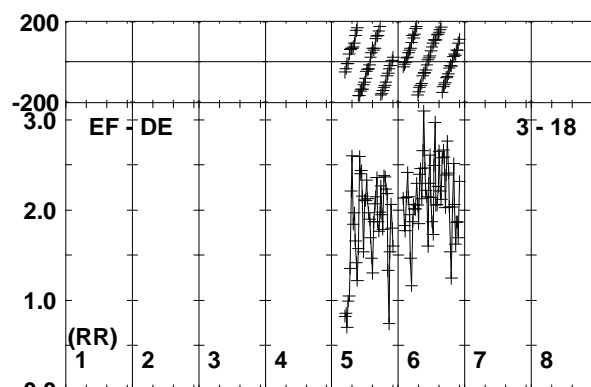
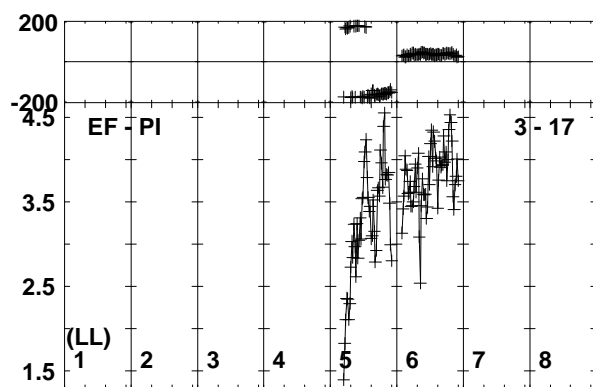
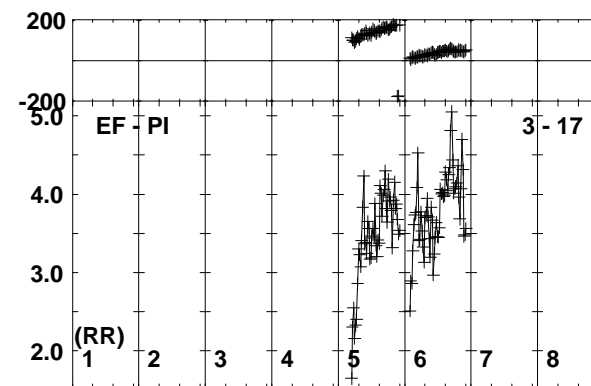
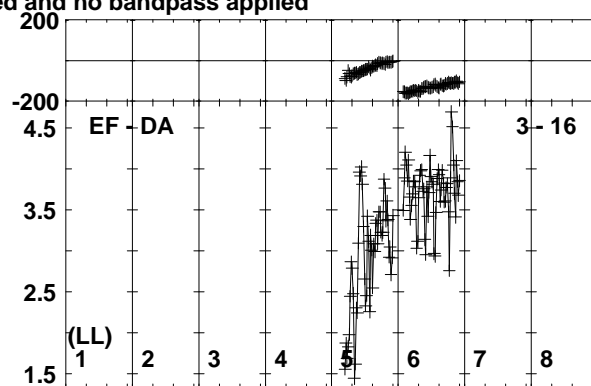
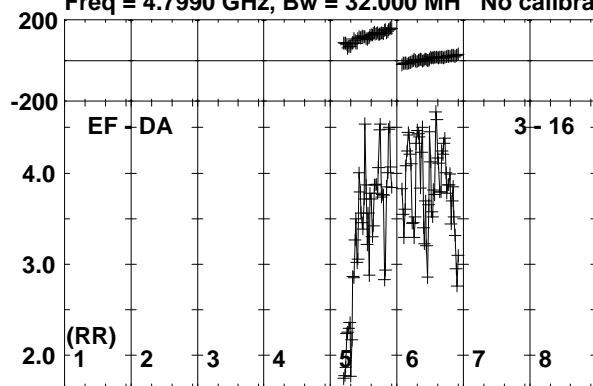

Lower frame: Milli Ampl Jy Top frame: Phas deg
Vector averaged cross-power spectrum Baseline: EF (03) - DA (16)
Timerange: 01/04:36:55 to 01/04:37:54

Plot file version 511 created 26-SEP-2019 10:43:19

190829A RG010A.UVDATA.1

Freq = 4.7990 GHz, Bw = 32.000 MH No calibration applied and no bandpass applied

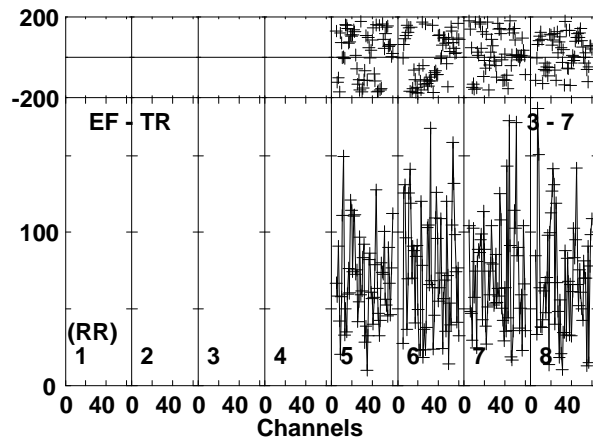
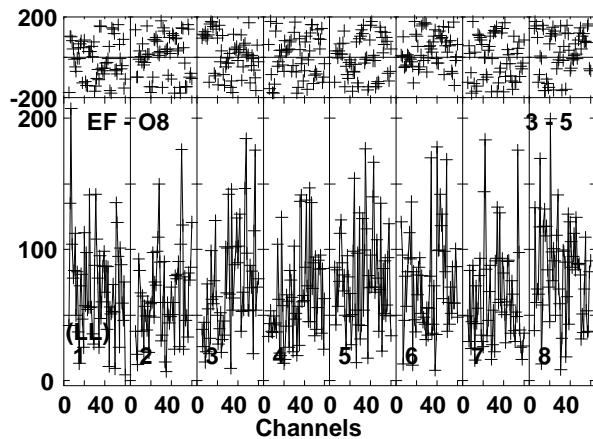
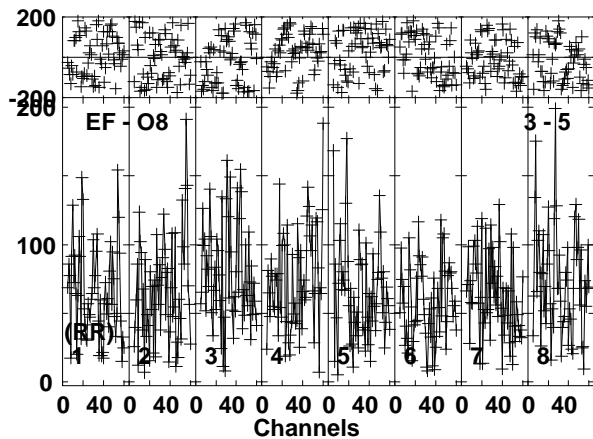
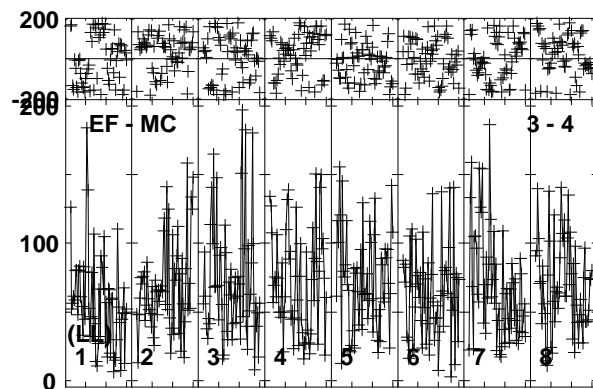
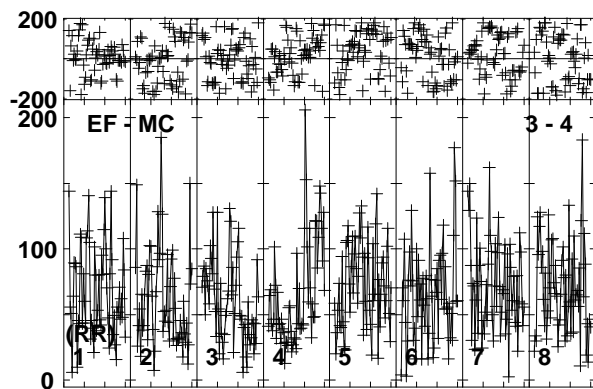
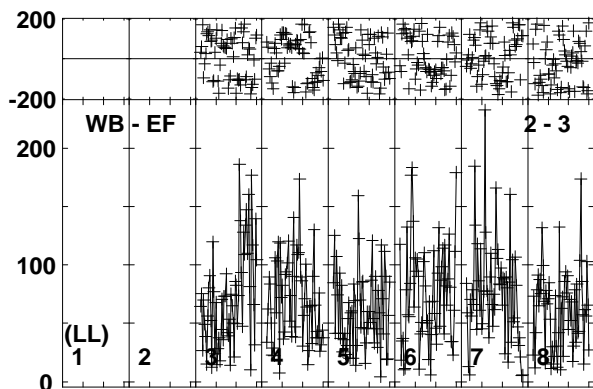
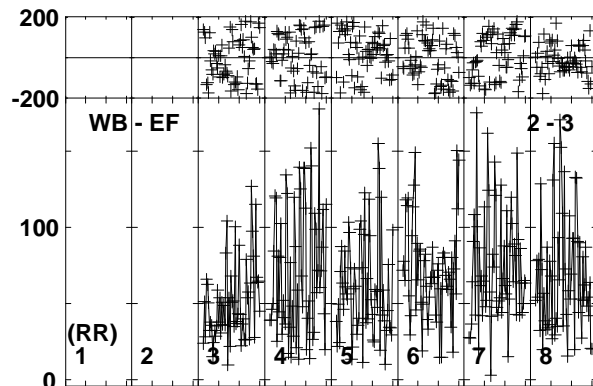
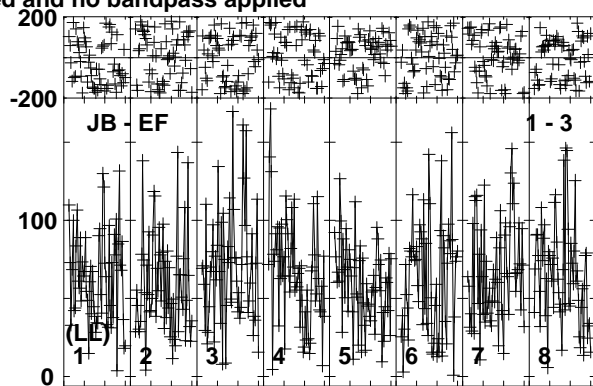
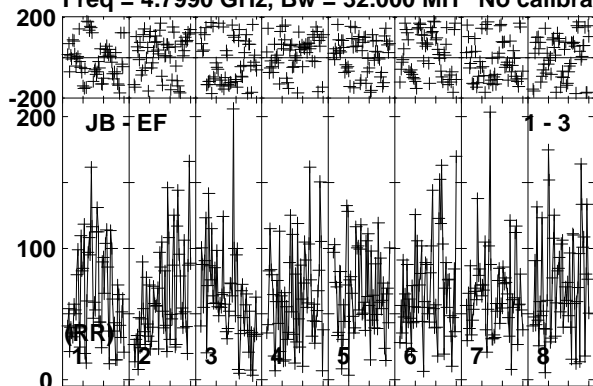

Lower frame: Micro Ampl Jy Top frame: Phas deg
Vector averaged cross-power spectrum Baseline: JB (01) - EF (03)
Timerange: 01/04:37:55 to 01/04:42:54

Plot file version 512 created 26-SEP-2019 10:43:19

190829A RG010A.UVDATA.1

Freq = 4.7990 GHz, Bw = 32.000 MH No calibration applied and no bandpass applied

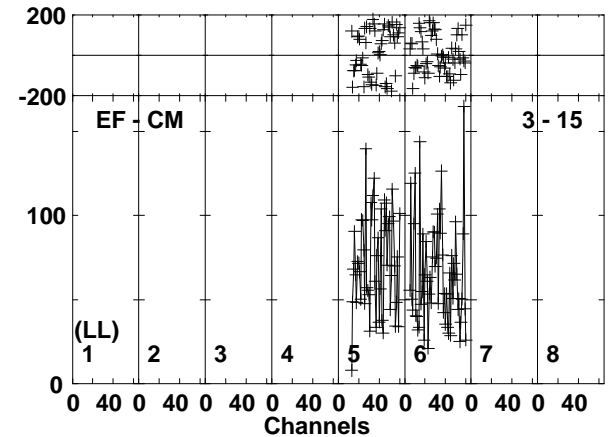
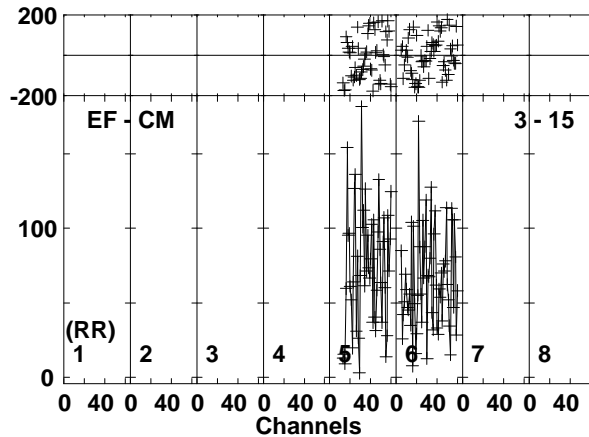
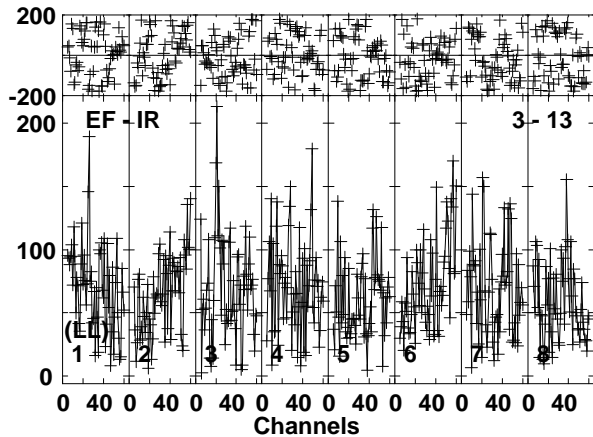
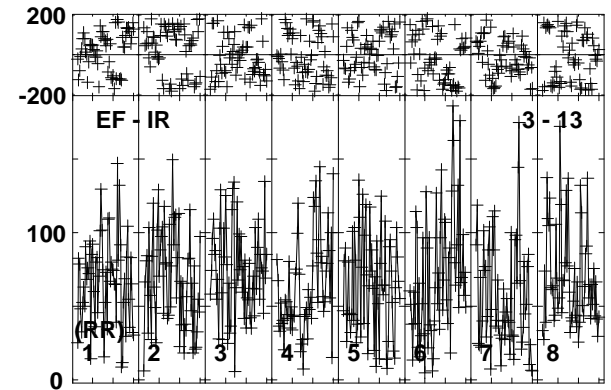
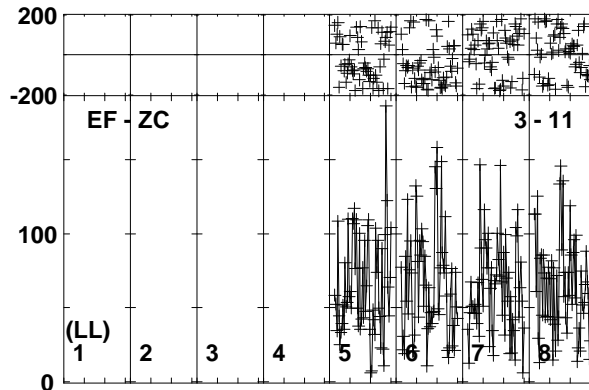
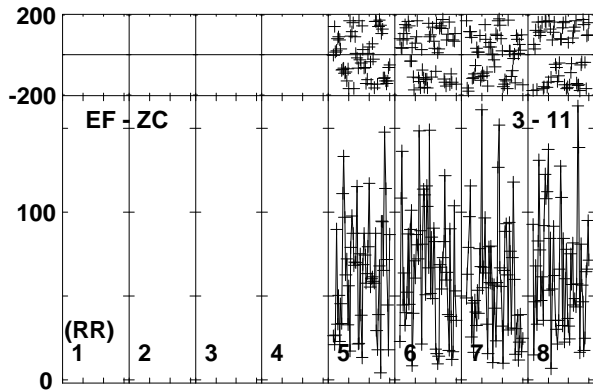
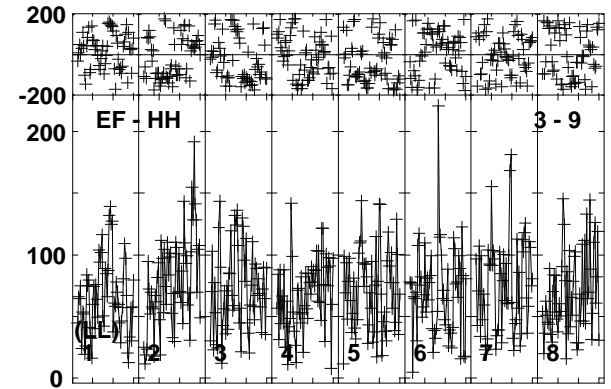
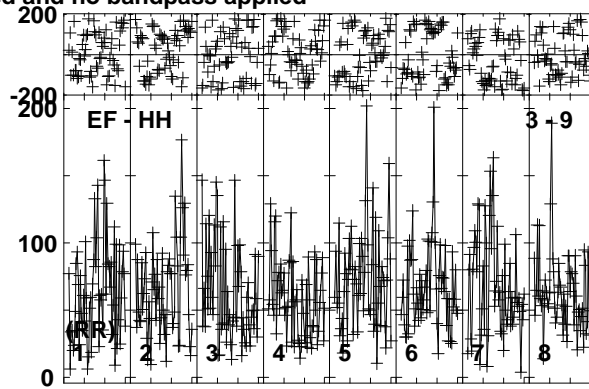
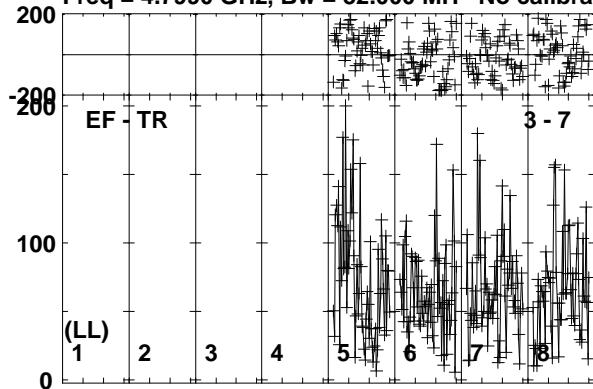

Lower frame: Micro Ampl Jy Top frame: Phas deg
Vector averaged cross-power spectrum Baseline: EF (03) - TR (07)
Timerange: 01/04:37:55 to 01/04:42:54

Plot file version 513 created 26-SEP-2019 10:43:20

190829A RG010A.UVDATA.1

Freq = 4.7990 GHz, Bw = 32.000 MH No calibration applied and no bandpass applied

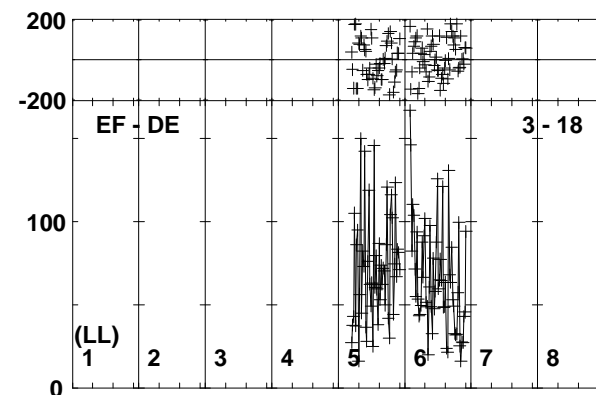
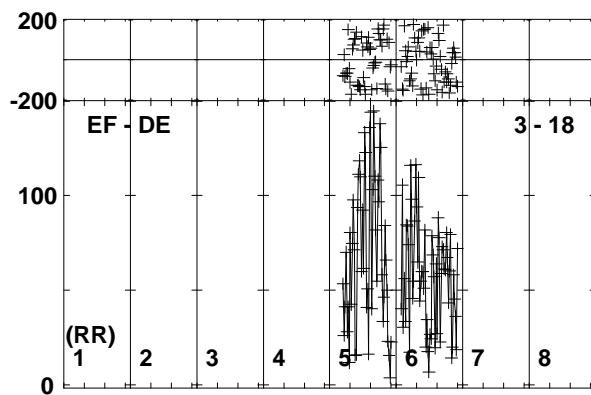
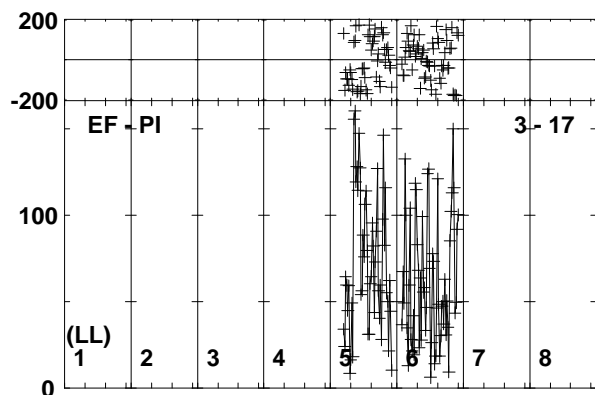
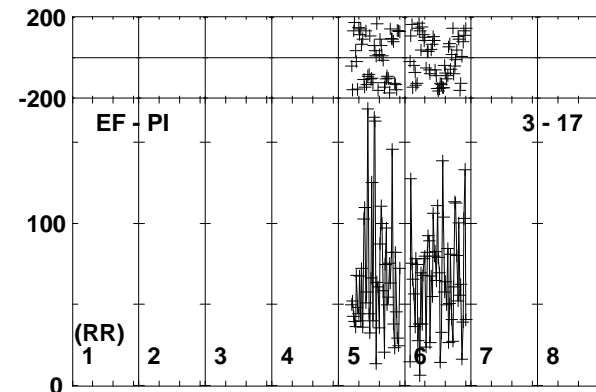
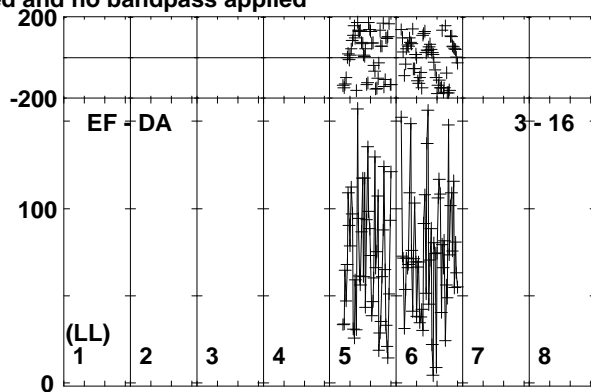
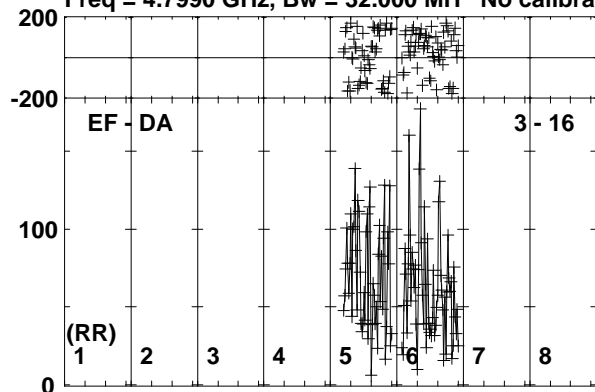

Lower frame: Micro Ampl Jy Top frame: Phas deg
Vector averaged cross-power spectrum Baseline: EF (03) - DA (16)
Timerange: 01/04:37:55 to 01/04:42:54

Plot file version 514 created 26-SEP-2019 10:43:20

J0257-1212 RG010A.UVDATA.1

Freq = 4.7990 GHz, Bw = 32.000 MH No calibration applied and no bandpass applied

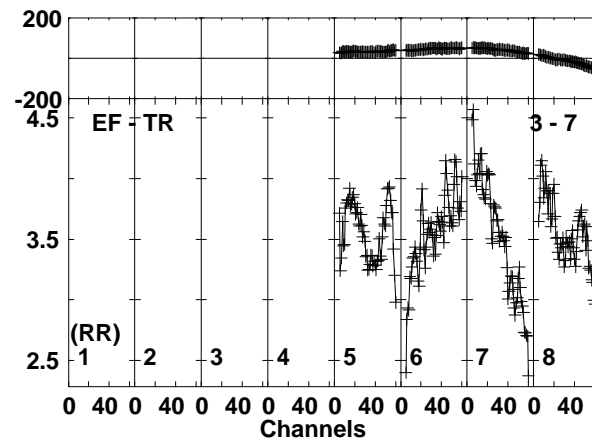
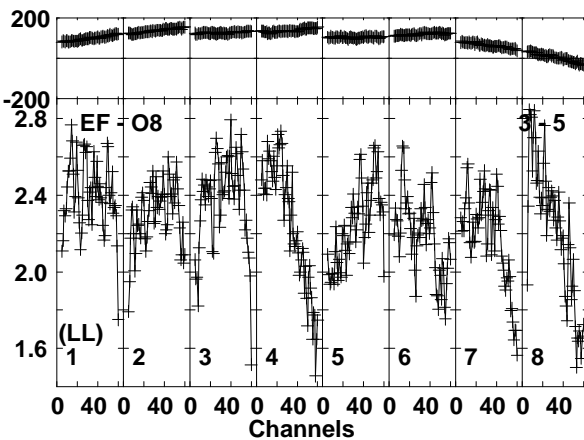
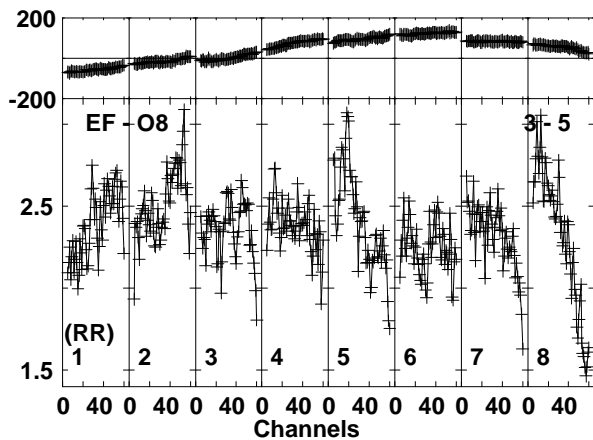
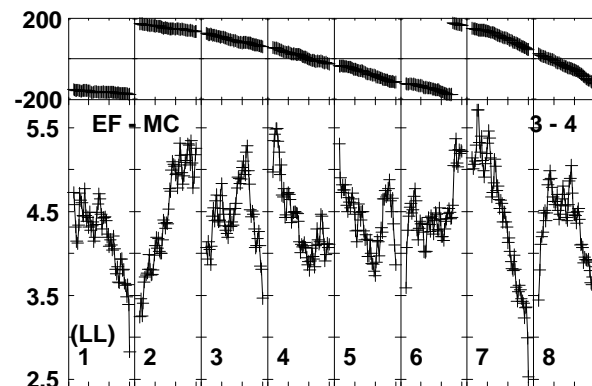
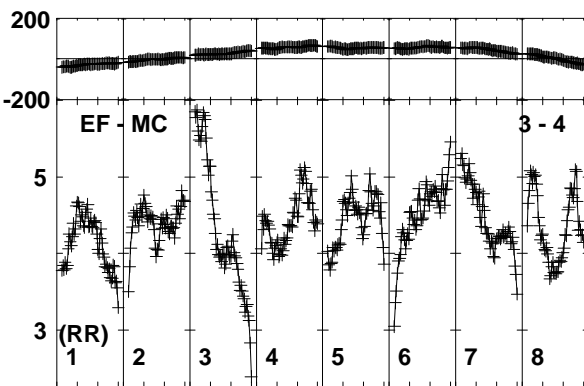
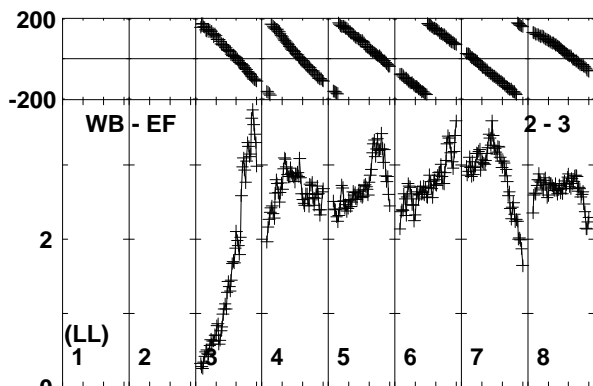
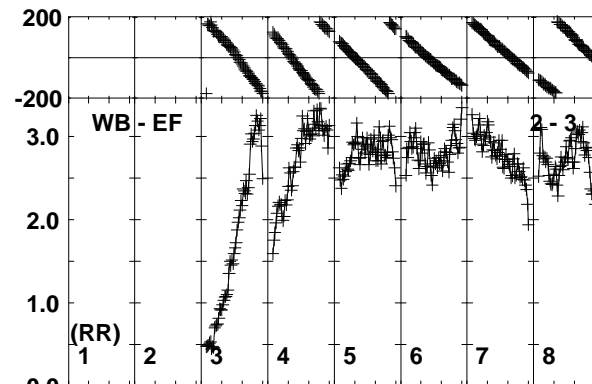
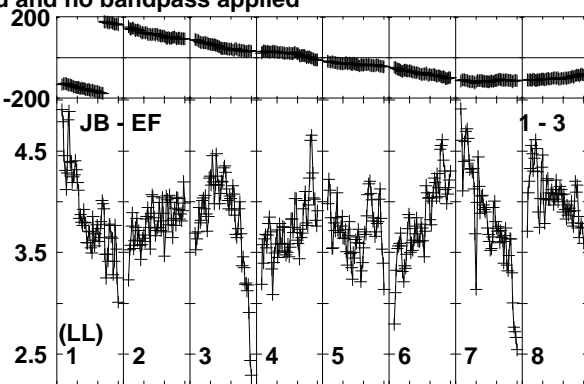
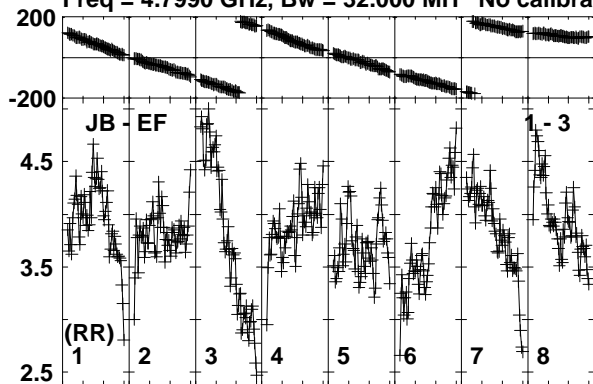

Lower frame: Milli Ampl Jy Top frame: Phas deg
Vector averaged cross-power spectrum Baseline: JB (01) - EF (03)
Timerange: 01/04:43:36 to 01/04:44:35

Plot file version 515 created 26-SEP-2019 10:43:21

J0257-1212 RG010A.UVDATA.1

Freq = 4.7990 GHz, Bw = 32.000 MH No calibration applied and no bandpass applied

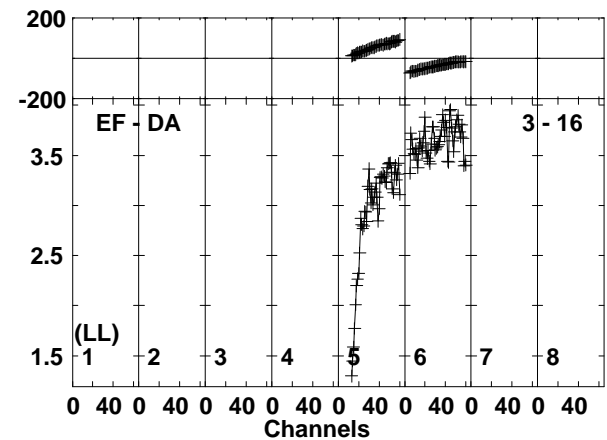
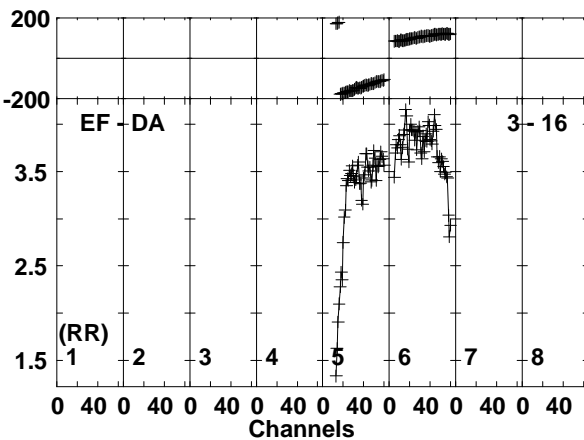
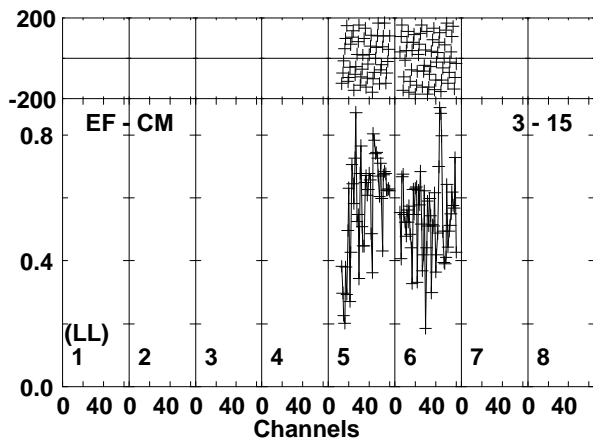
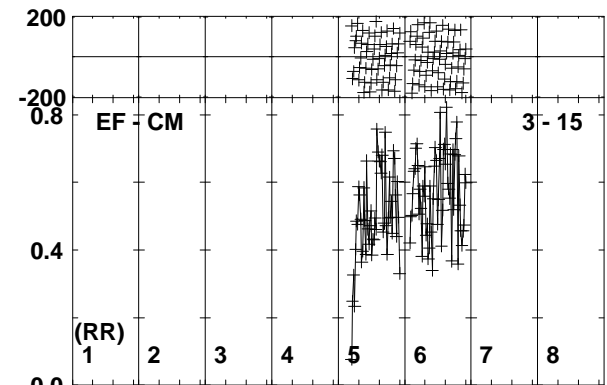
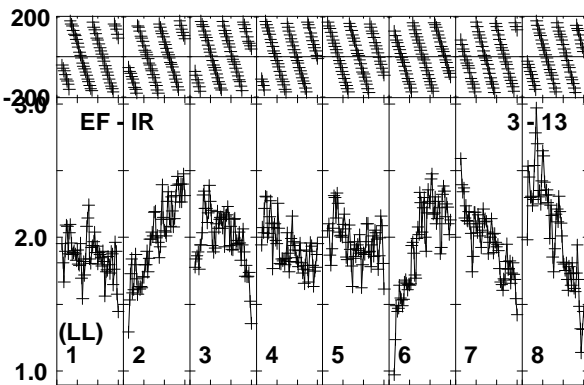
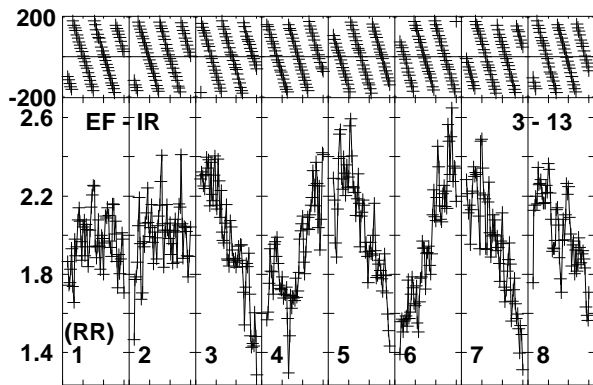
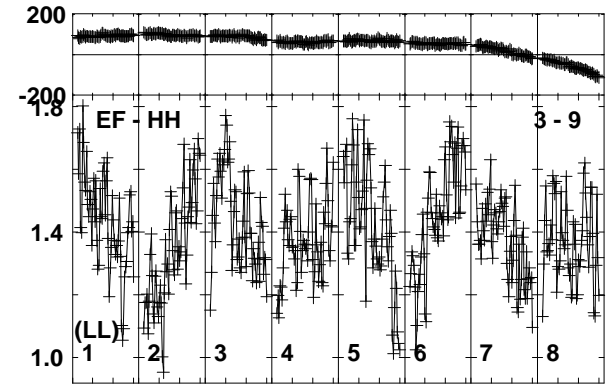
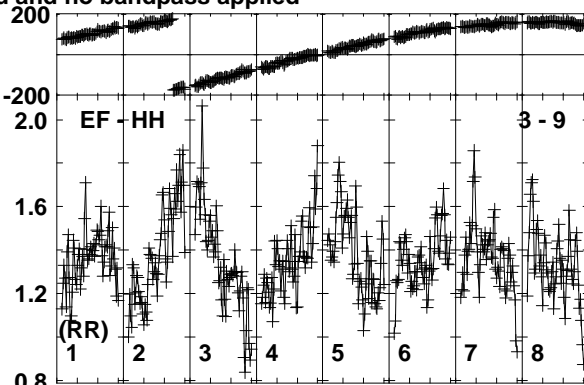
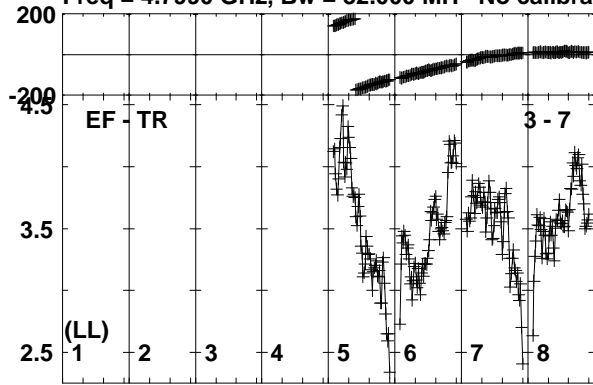

Lower frame: Milli Ampl Jy Top frame: Phas deg
Vector averaged cross-power spectrum Baseline: EF (03) - TR (07)
Timerange: 01/04:43:36 to 01/04:44:35

Plot file version 516 created 26-SEP-2019 10:43:21

J0257-1212 RG010A.UVDATA.1

Freq = 4.7990 GHz, Bw = 32.000 MH No calibration applied and no bandpass applied

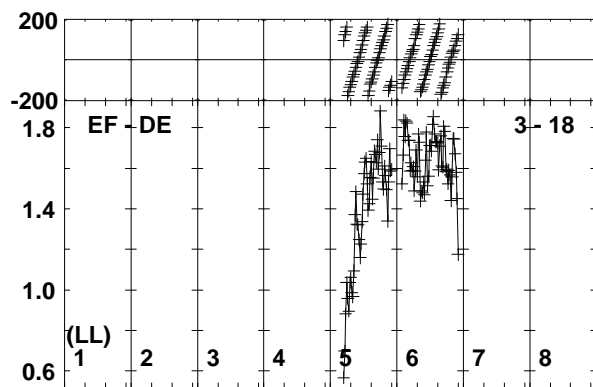
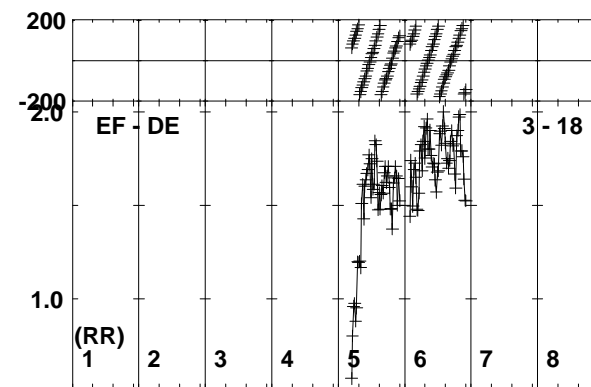
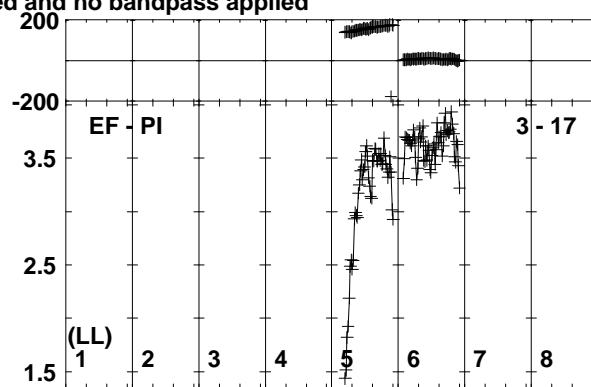
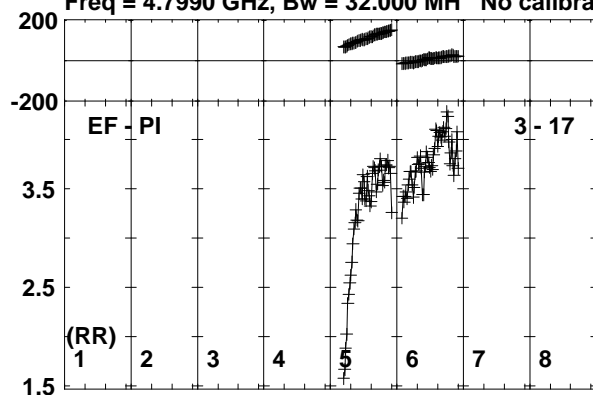

Lower frame: Milli Ampl Jy Top frame: Phas deg
Vector averaged cross-power spectrum Baseline: EF (03) - PI (17)
Timerange: 01/04:43:36 to 01/04:44:35

Plot file version 517 created 26-SEP-2019 10:43:22

190829A RG010A.UVDATA.1

Freq = 4.7990 GHz, Bw = 32.000 MH No calibration applied and no bandpass applied

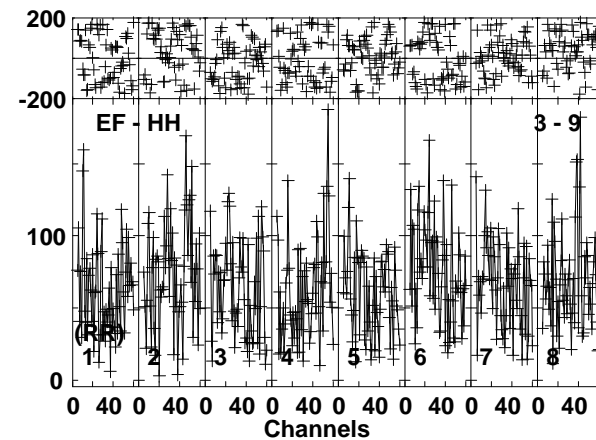
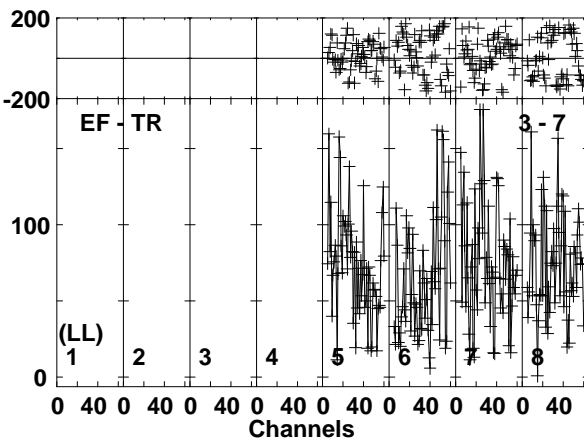
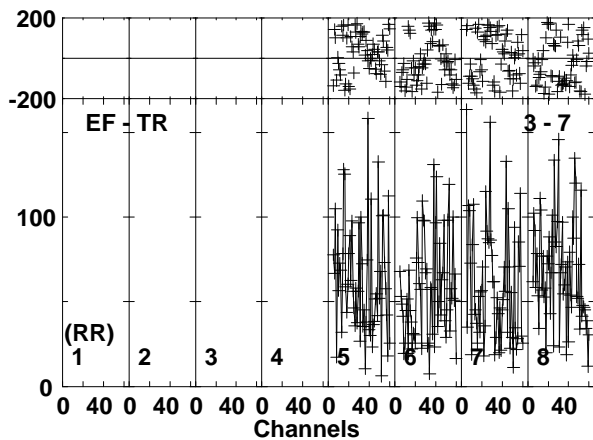
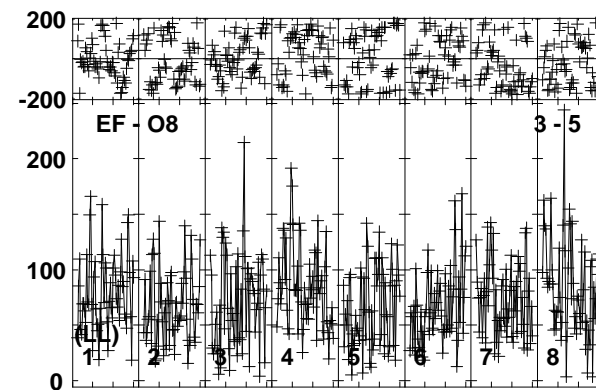
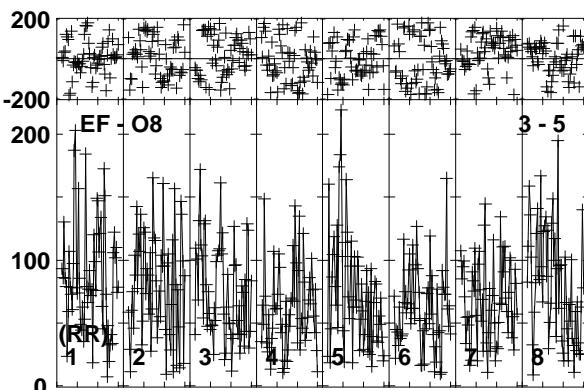
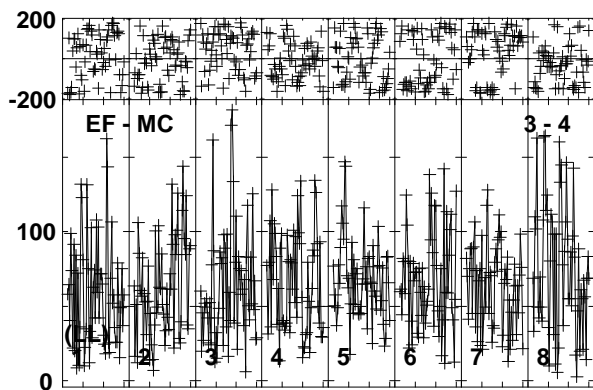
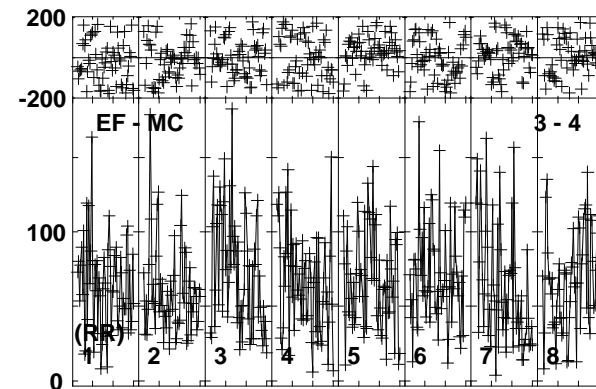
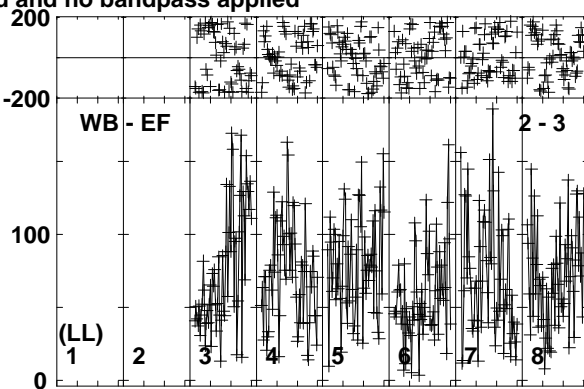
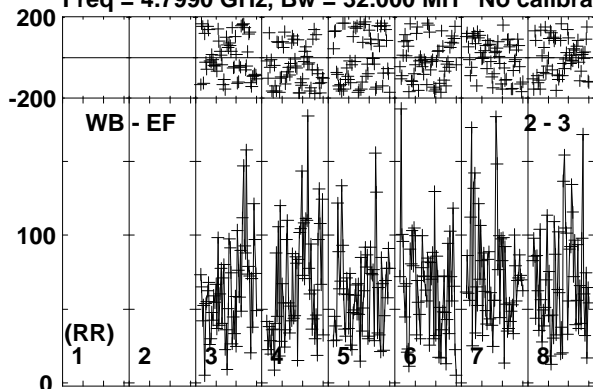

Lower frame: Micro Ampl Jy Top frame: Phas deg
Vector averaged cross-power spectrum Baseline: WB (02) - EF (03)
Timerange: 01/04:44:36 to 01/04:49:35

Plot file version 518 created 26-SEP-2019 10:43:22

190829A RG010A.UVDATA.1

Freq = 4.7990 GHz, Bw = 32.000 MH No calibration applied and no bandpass applied

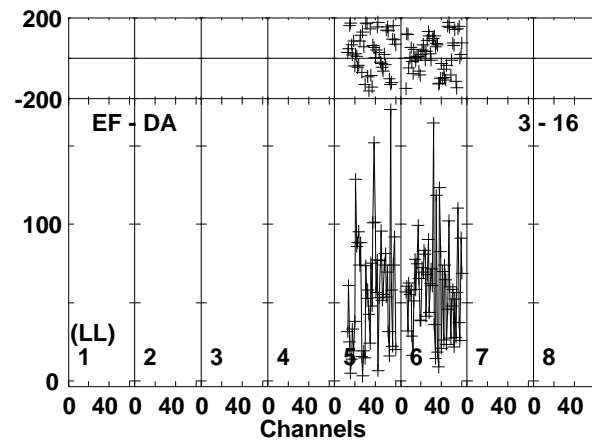
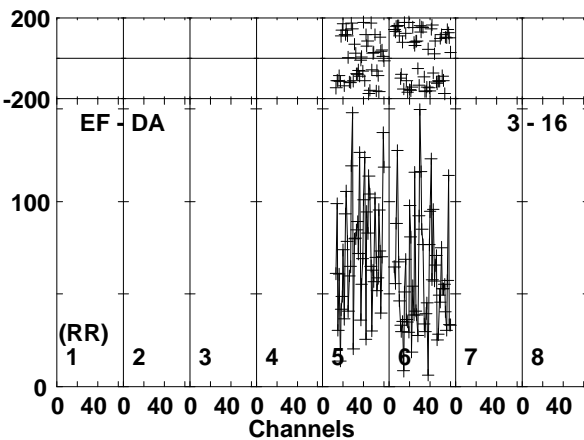
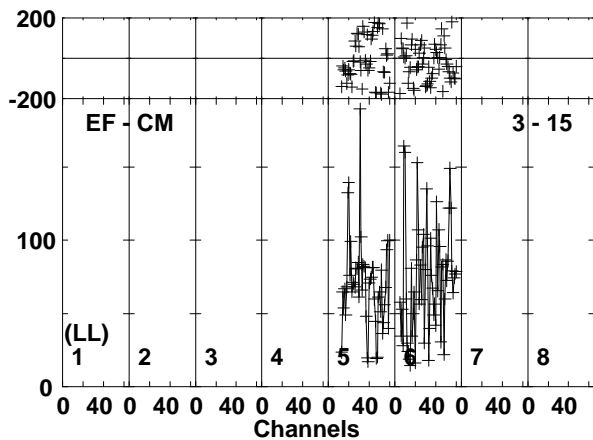
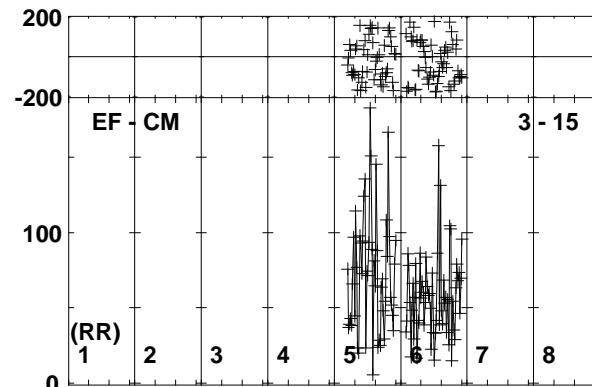
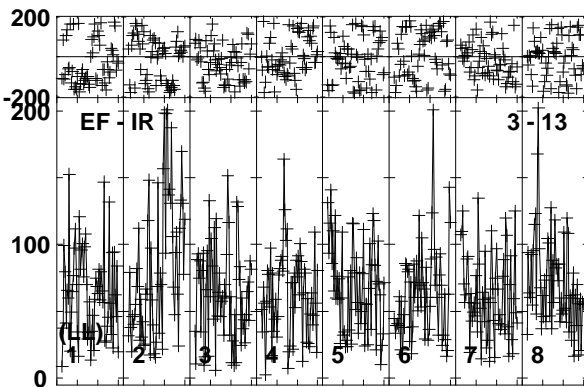
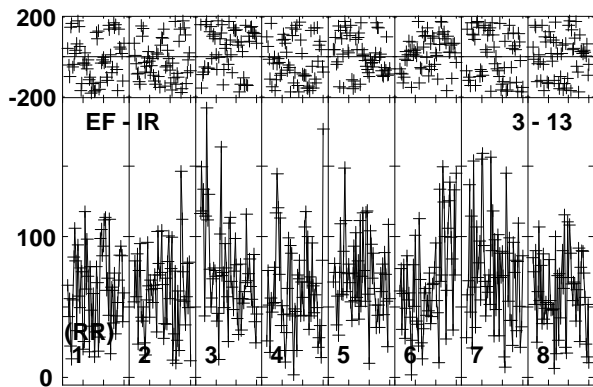
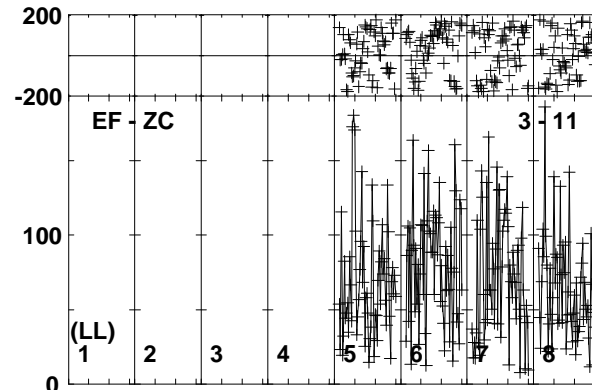
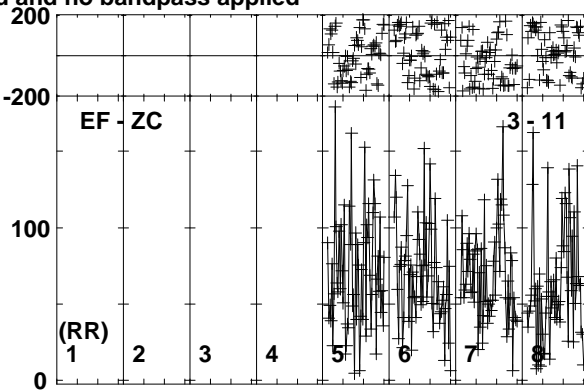
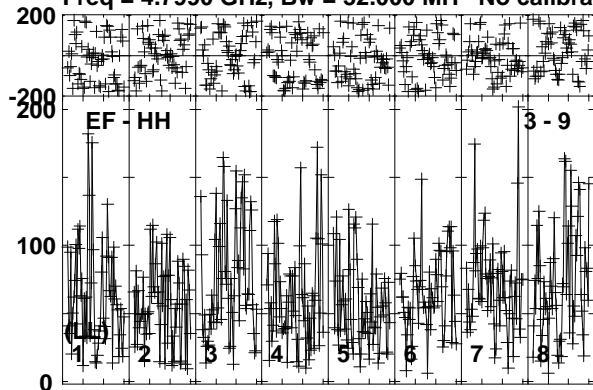

Lower frame: Micro Ampl Jy Top frame: Phas deg
Vector averaged cross-power spectrum Baseline: EF (03) - HH (09)
Timerange: 01/04:44:36 to 01/04:49:35

Plot file version 519 created 26-SEP-2019 10:43:23

190829A RG010A.UVDATA.1

Freq = 4.7990 GHz, Bw = 32.000 MH No calibration applied and no bandpass applied

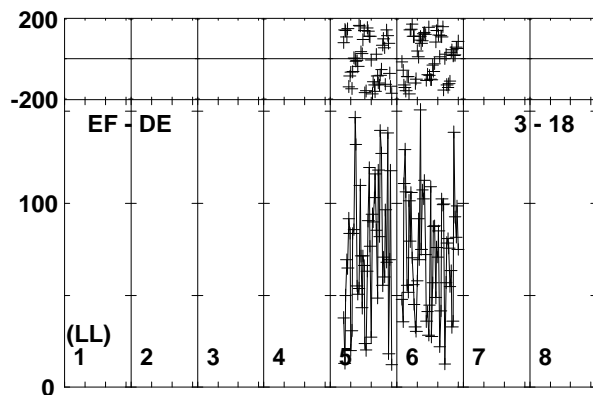
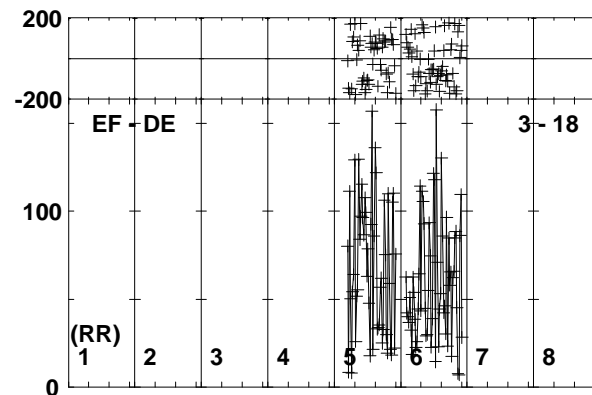
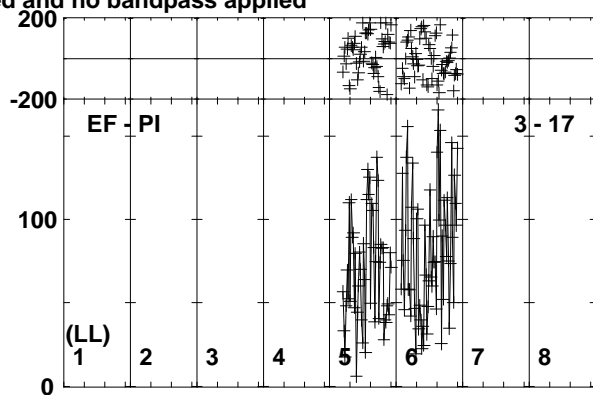
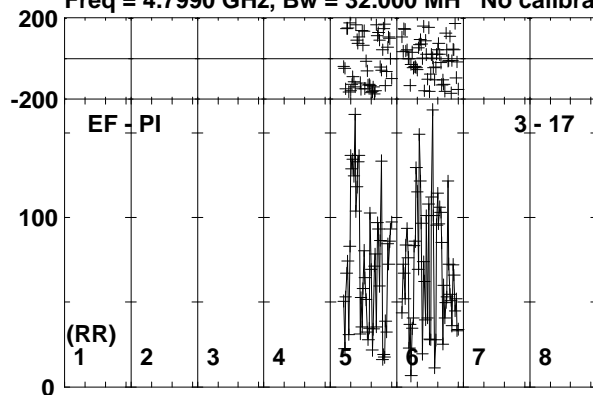

Lower frame: Micro Ampl Jy Top frame: Phas deg
Vector averaged cross-power spectrum Baseline: EF (03) - PI (17)
Timerange: 01/04:44:36 to 01/04:49:35

Plot file version 520 created 26-SEP-2019 10:43:23

J0257-1212 RG010A.UVDATA.1

Freq = 4.7990 GHz, Bw = 32.000 MH No calibration applied and no bandpass applied

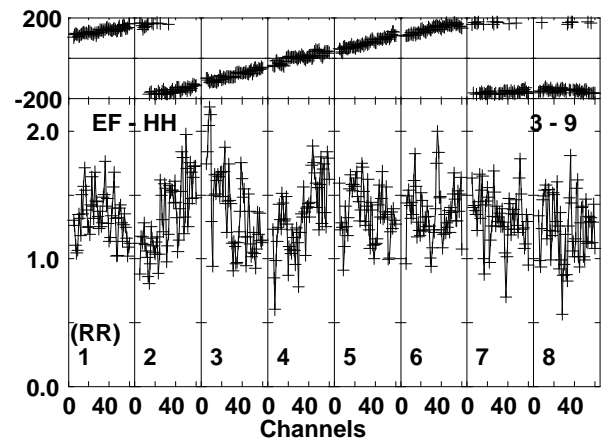
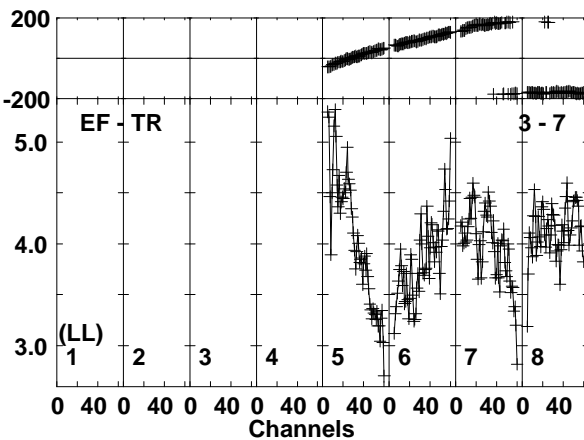
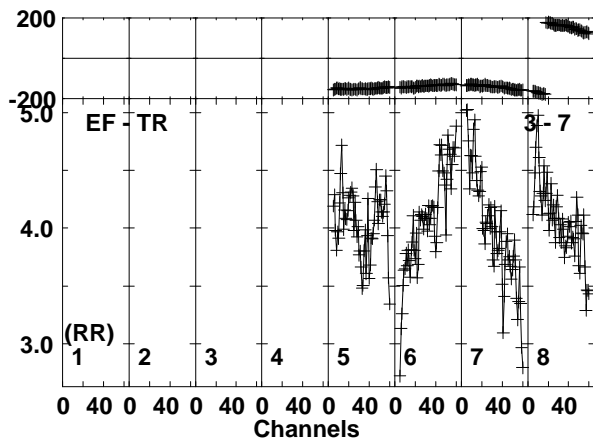
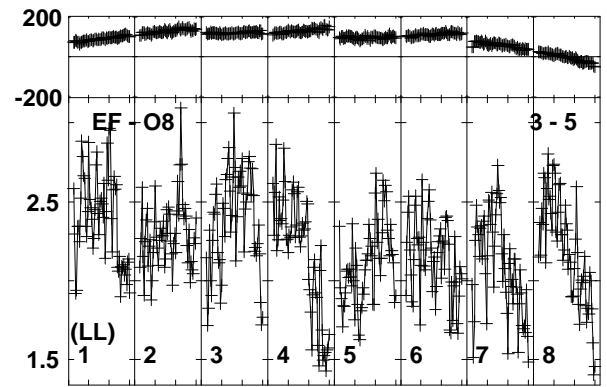
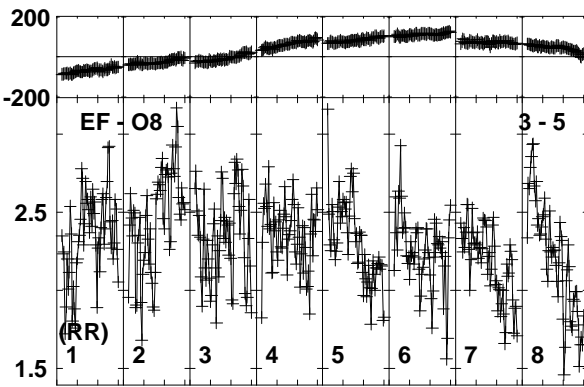
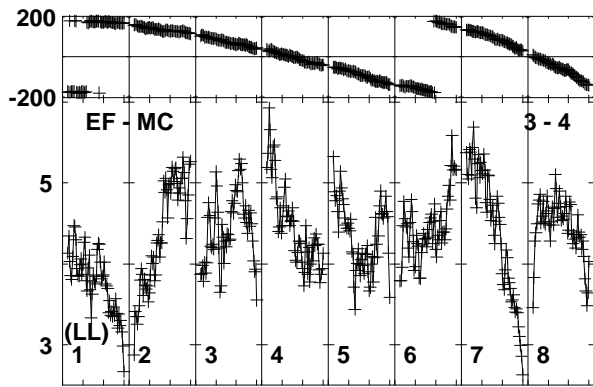
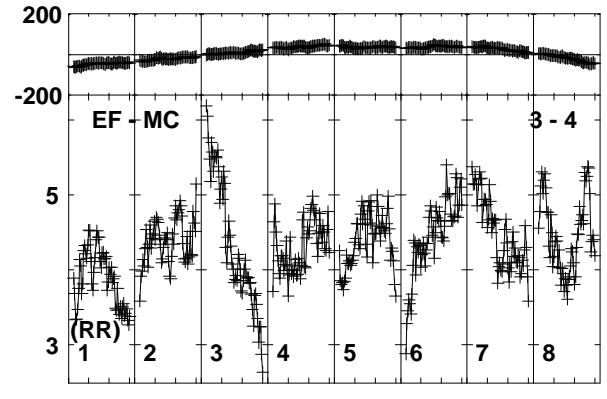
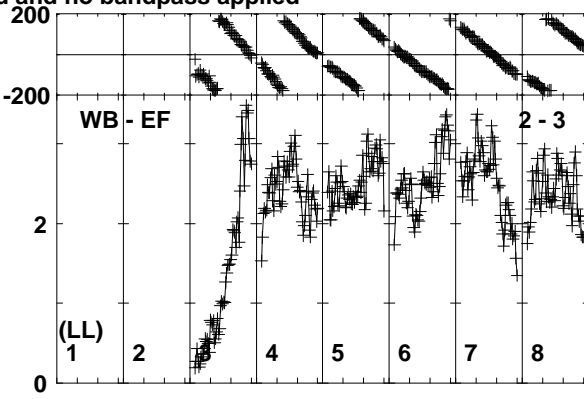
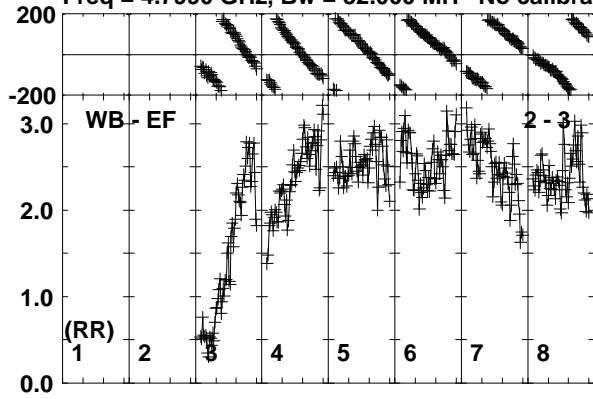

Lower frame: Milli Ampl Jy Top frame: Phas deg
Vector averaged cross-power spectrum Baseline: WB (02) - EF (03)
Timerange: 01/04:50:15 to 01/04:50:45

Plot file version 521 created 26-SEP-2019 10:43:24

J0257-1212 RG010A.UVDATA.1

Freq = 4.7990 GHz, Bw = 32.000 MH No calibration applied and no bandpass applied

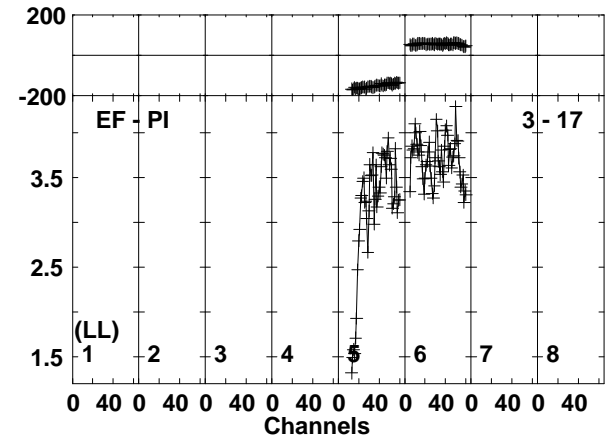
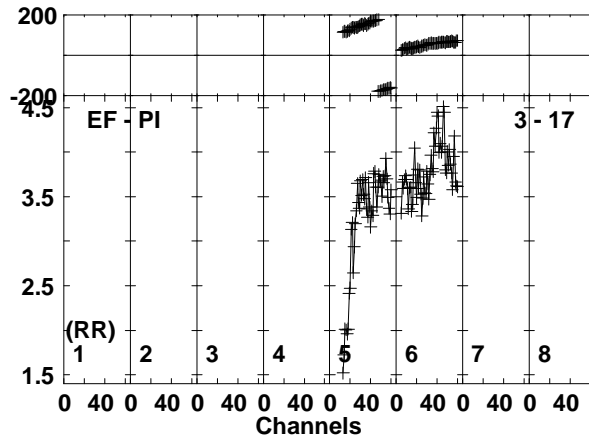
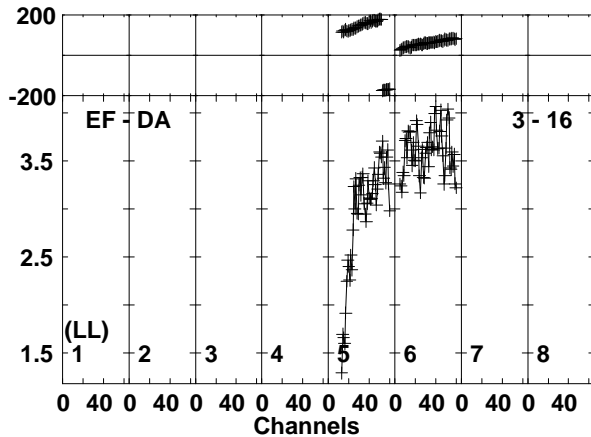
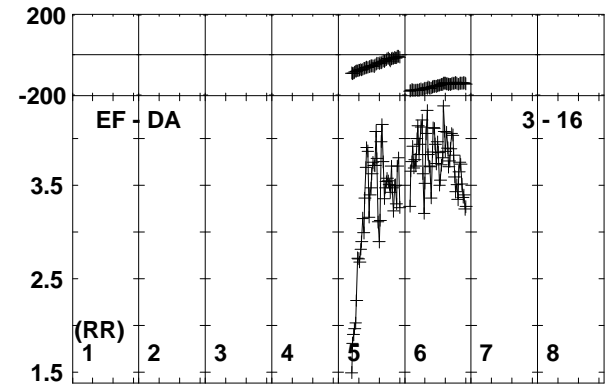
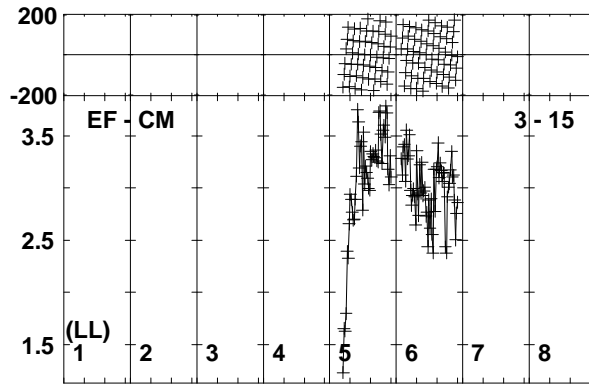
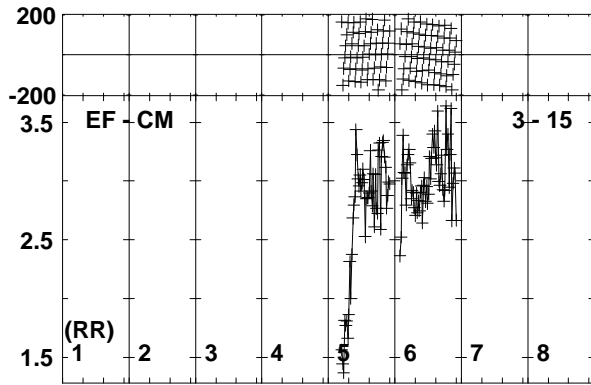
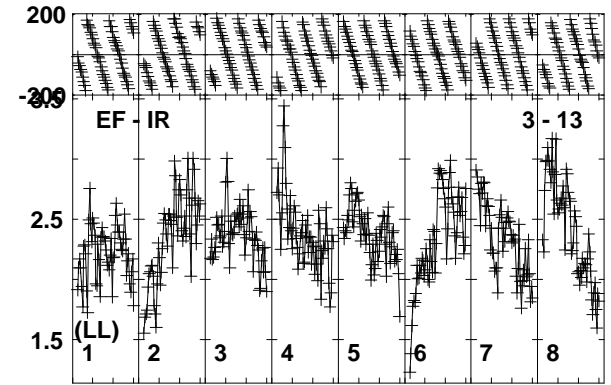
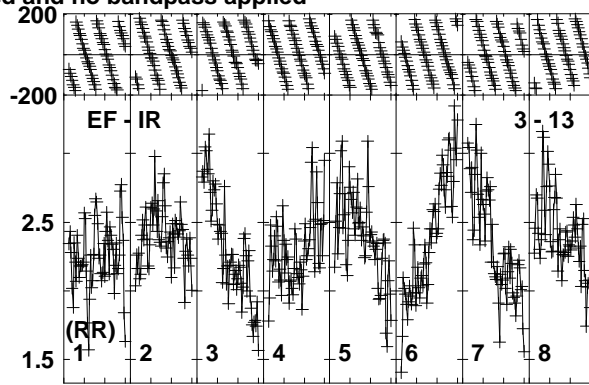
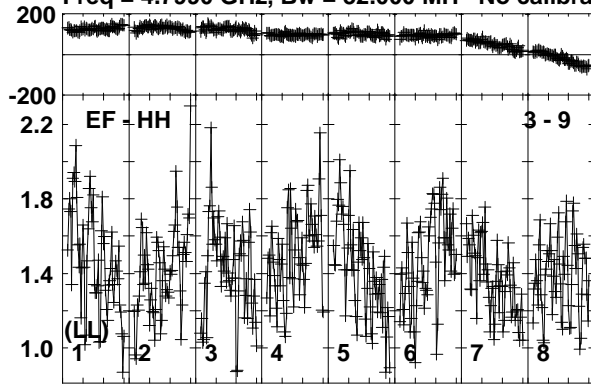

Lower frame: Milli Ampl Jy Top frame: Phas deg
Vector averaged cross-power spectrum Baseline: EF (03) - HH (09)
Timerange: 01/04:50:15 to 01/04:50:45

Plot file version 522 created 26-SEP-2019 10:43:24

J0257-1212 RG010A.UVDATA.1

Freq = 4.7990 GHz, Bw = 32.000 MH No calibration applied and no bandpass applied

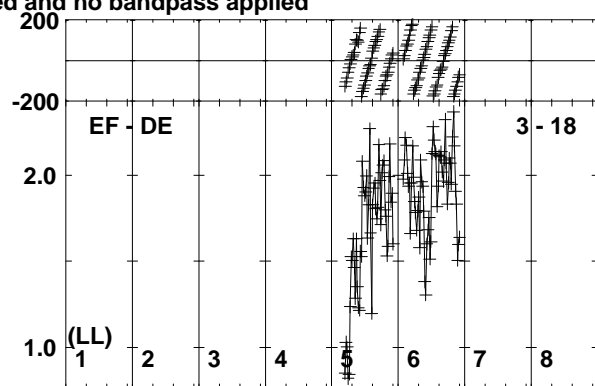
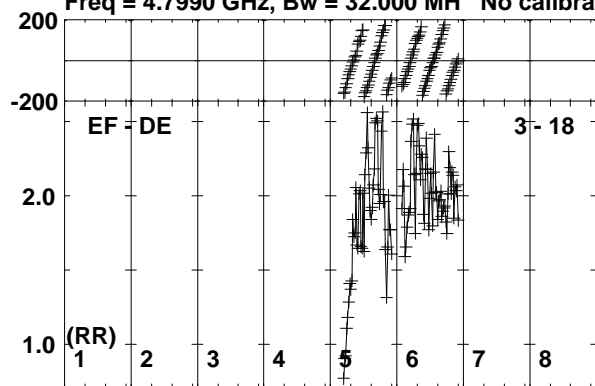

Lower frame: Milli Ampl Jy Top frame: Phas deg
Vector averaged cross-power spectrum Baseline: EF (03) - DE (18)
Timerange: 01/04:50:15 to 01/04:50:45

Plot file version 523 created 26-SEP-2019 10:43:24

J0300-0846 RG010A.UVDATA.1

Freq = 4.7990 GHz, Bw = 32.000 MH No calibration applied and no bandpass applied

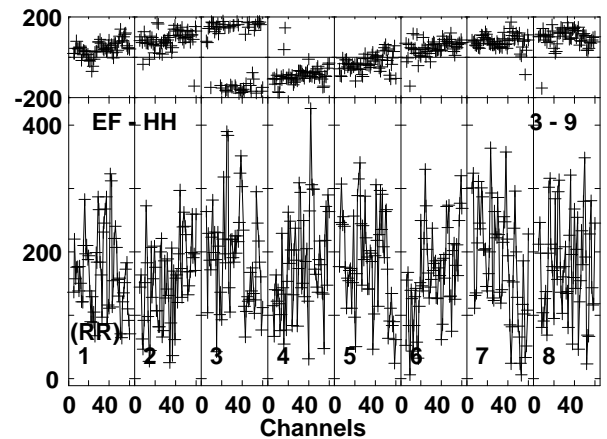
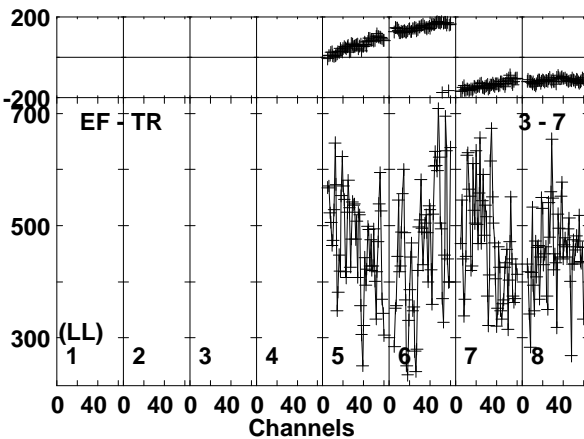
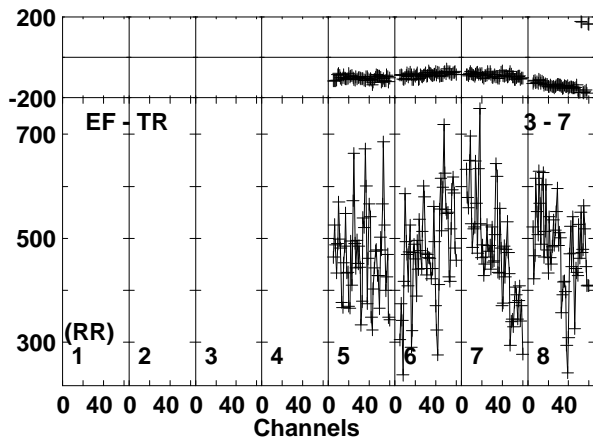
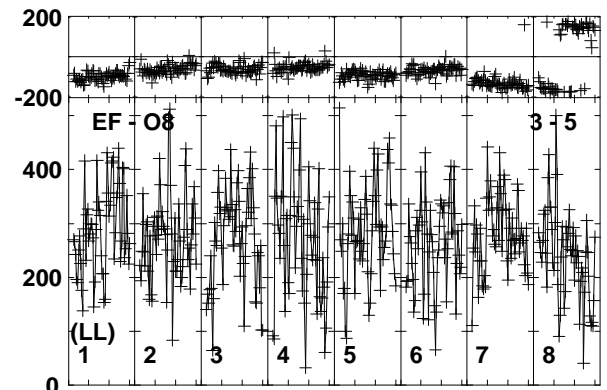
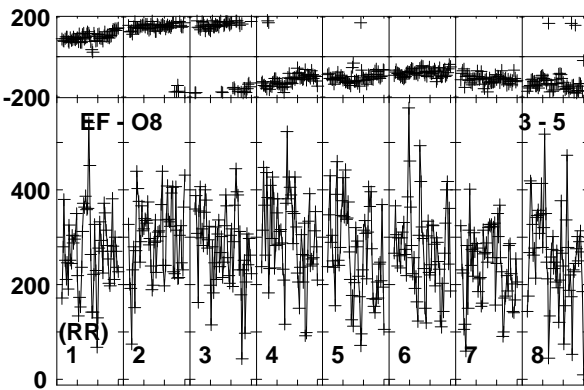
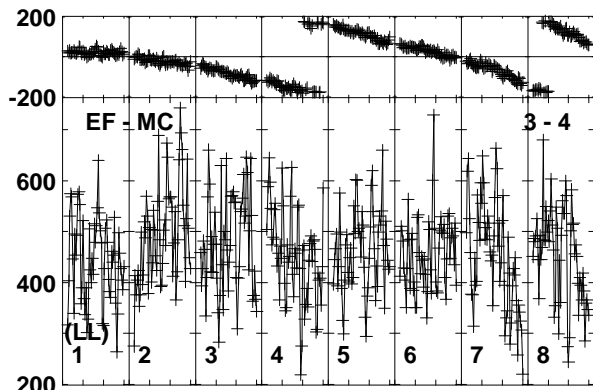
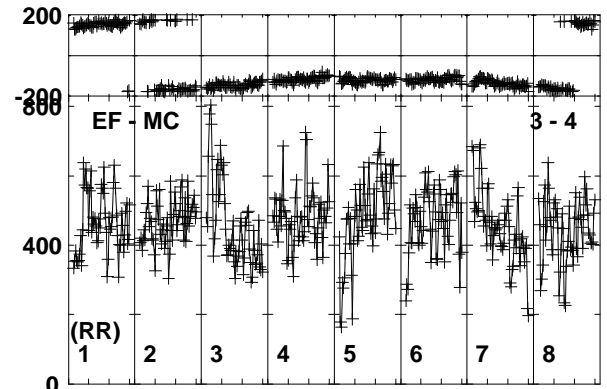
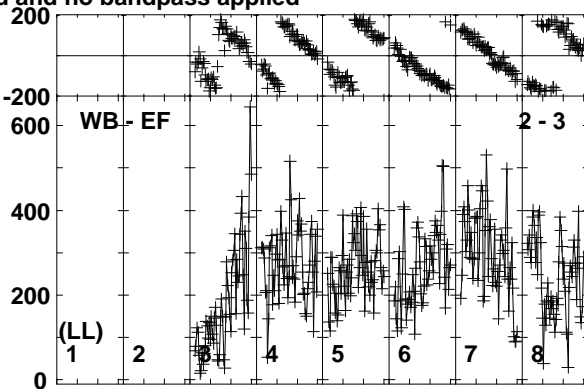
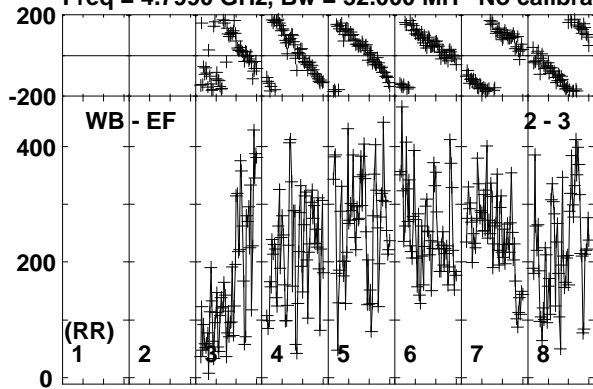

Lower frame: Micro Ampl Jy Top frame: Phas deg
Vector averaged cross-power spectrum Baseline: WB (02) - EF (03)
Timerange: 01/04:50:45 to 01/04:53:14

Plot file version 524 created 26-SEP-2019 10:43:24

J0300-0846 RG010A.UVDATA.1

Freq = 4.7990 GHz, Bw = 32.000 MH No calibration applied and no bandpass applied

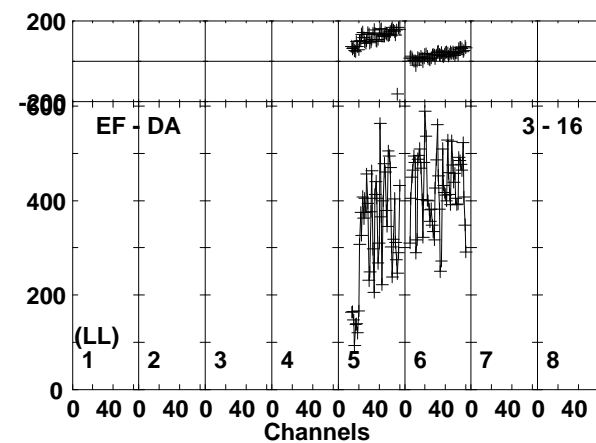
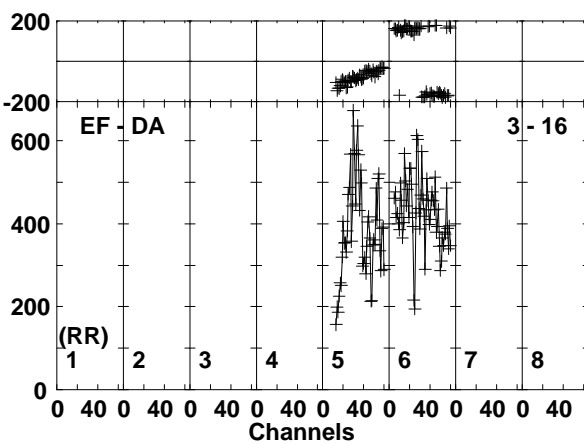
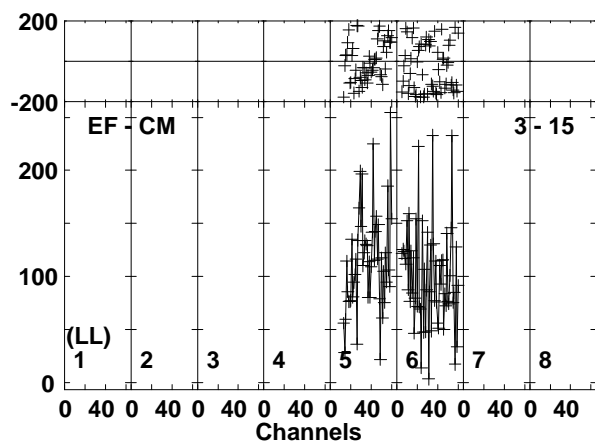
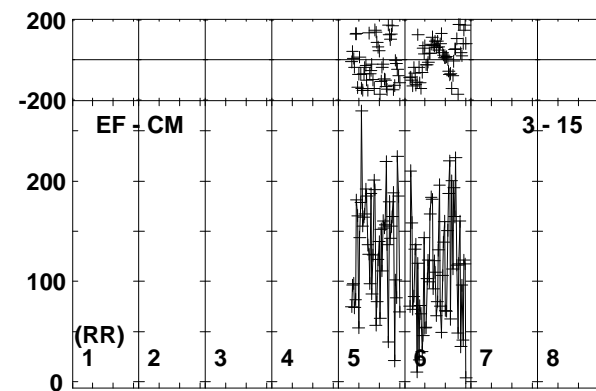
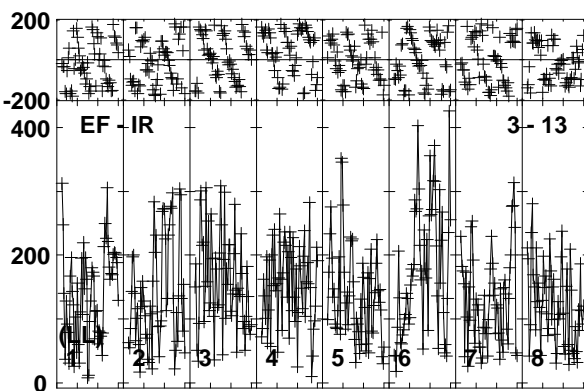
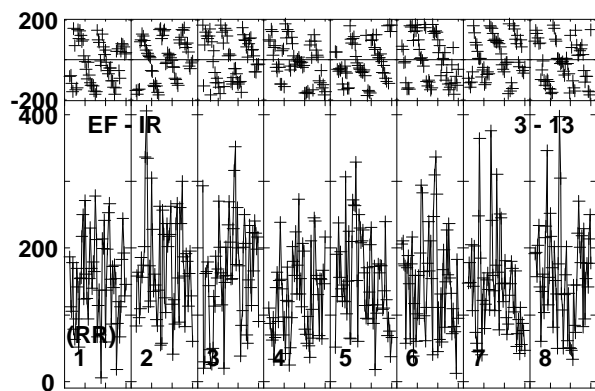
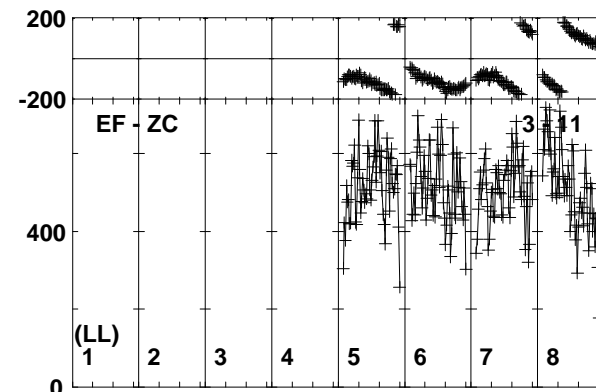
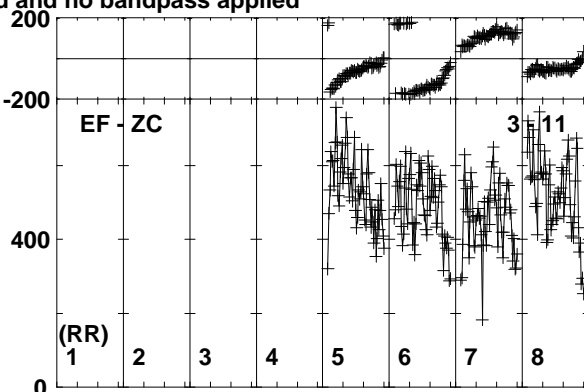
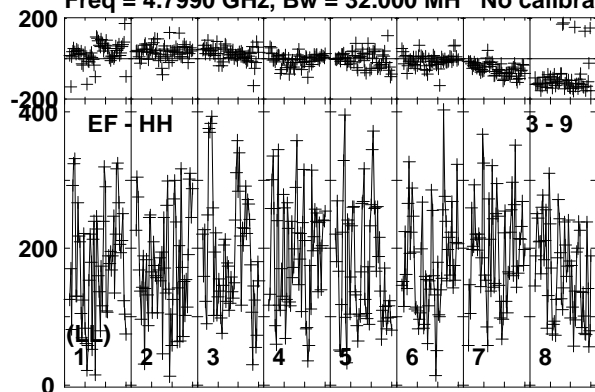

Lower frame: Micro Ampl Jy Top frame: Phas deg
Vector averaged cross-power spectrum Baseline: EF (03) - HH (09)
Timerange: 01/04:50:45 to 01/04:53:14

Plot file version 525 created 26-SEP-2019 10:43:25

J0300-0846 RG010A.UVDATA.1

Freq = 4.7990 GHz, Bw = 32.000 MH No calibration applied and no bandpass applied

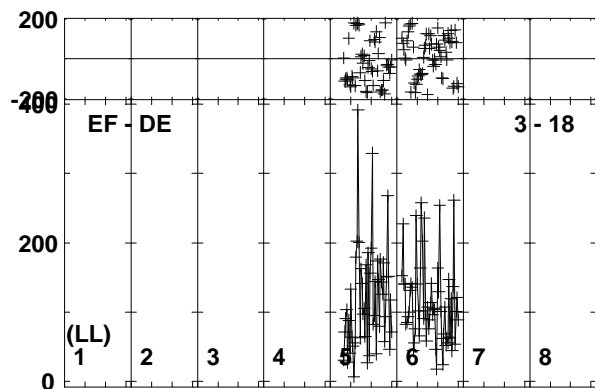
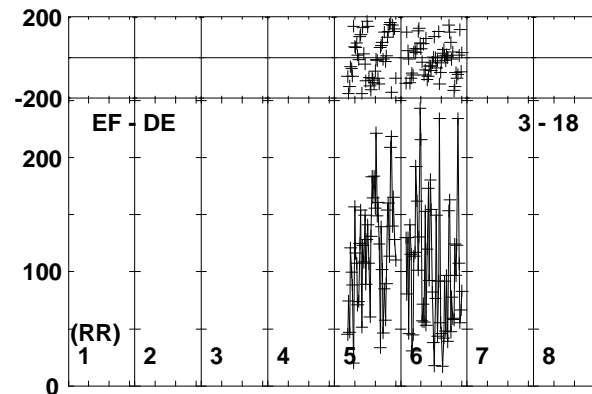
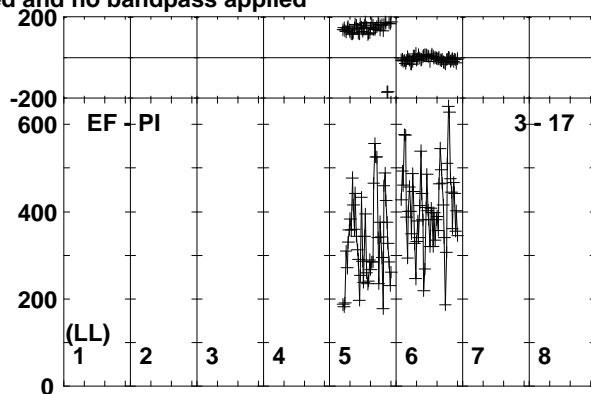
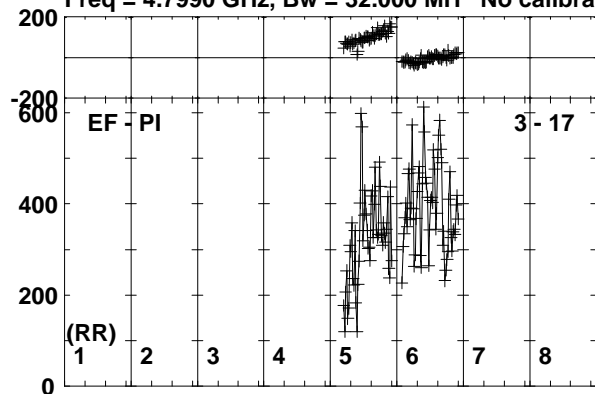

Lower frame: Micro Ampl Jy Top frame: Phas deg
Vector averaged cross-power spectrum Baseline: EF (03) - PI (17)
Timerange: 01/04:50:45 to 01/04:53:14

Plot file version 526 created 26-SEP-2019 10:43:25

190829A RG010A.UVDATA.1

Freq = 4.7990 GHz, Bw = 32.000 MH No calibration applied and no bandpass applied

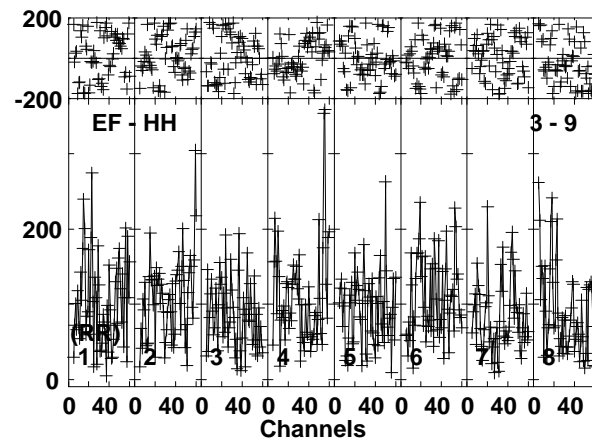
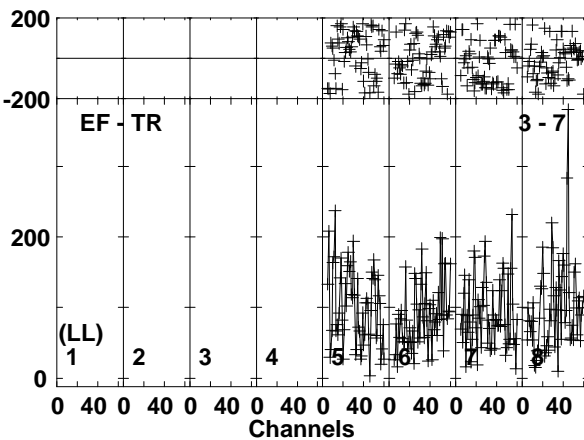
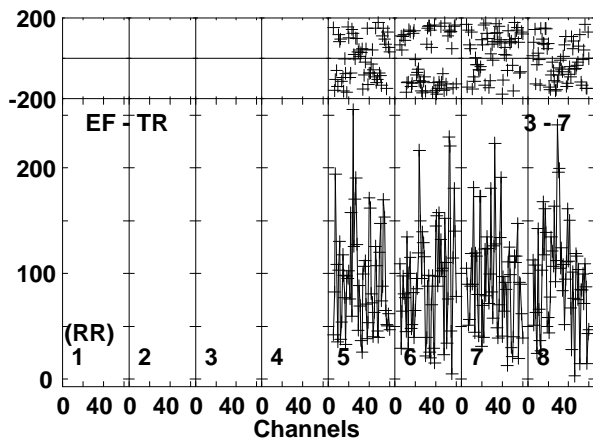
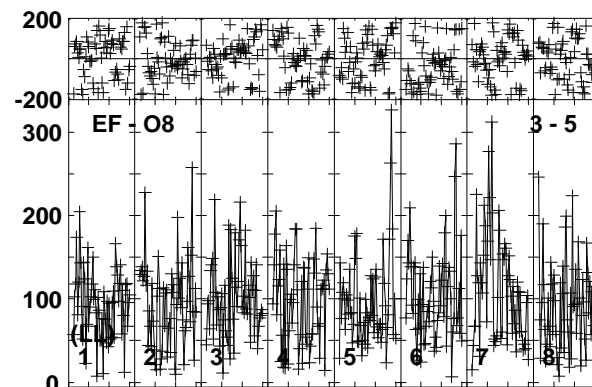
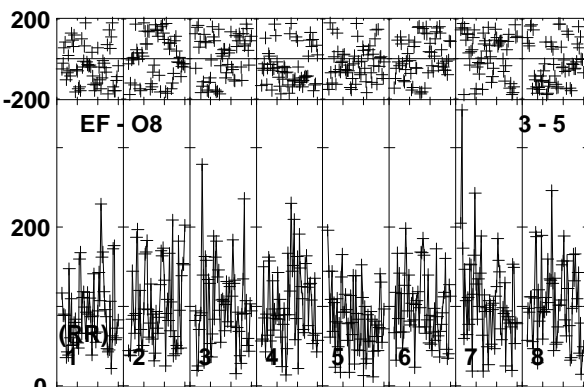
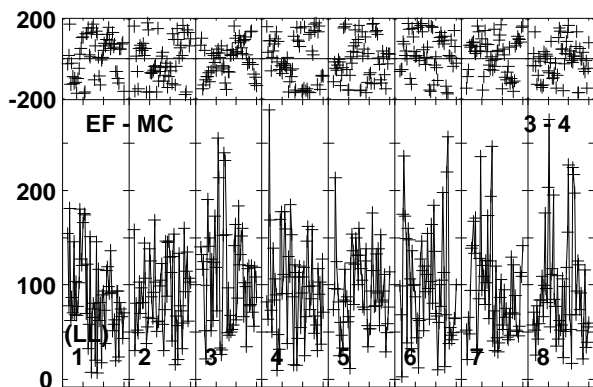
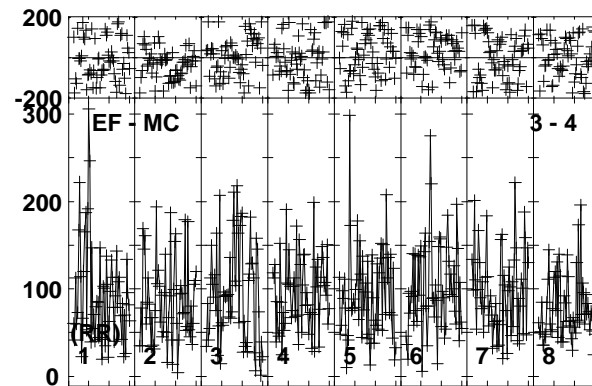
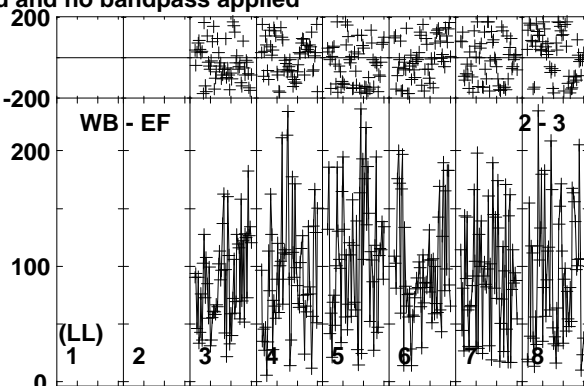
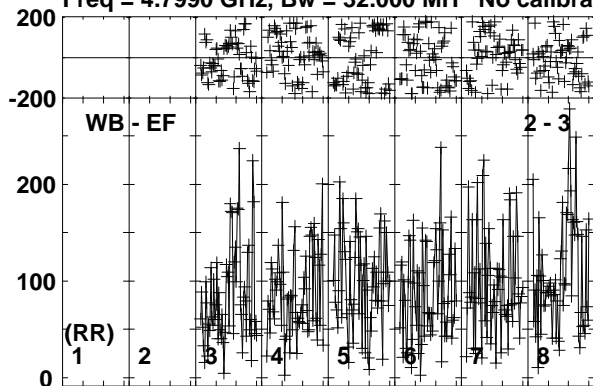

Lower frame: Micro Ampl Jy Top frame: Phas deg
Vector averaged cross-power spectrum Baseline: WB (02) - EF (03)
Timerange: 01/04:53:16 to 01/04:55:44

Plot file version 527 created 26-SEP-2019 10:43:25

190829A RG010A.UVDATA.1

Freq = 4.7990 GHz, Bw = 32.000 MH No calibration applied and no bandpass applied

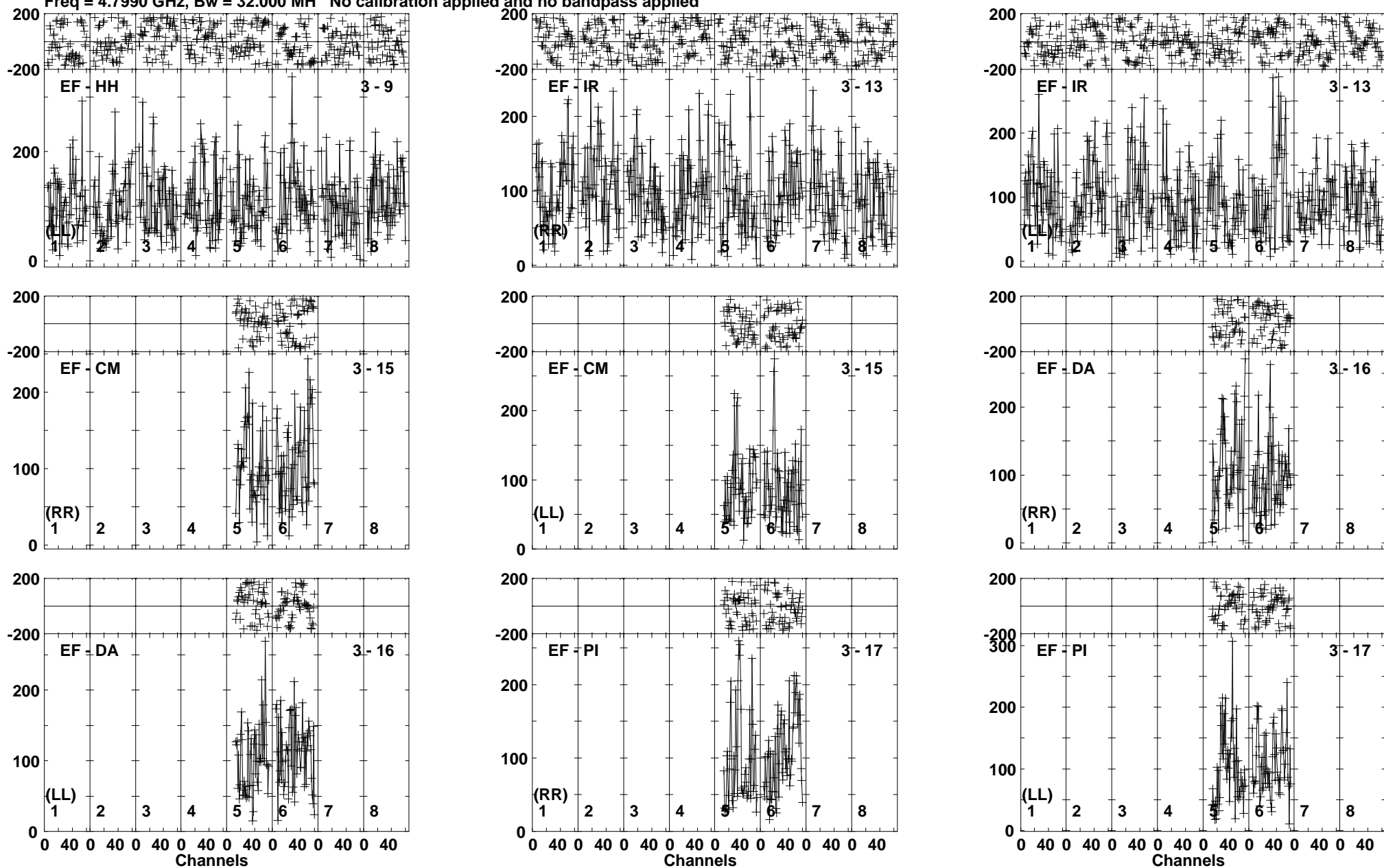

Lower frame: Micro Ampl Jy Top frame: Phas deg
Vector averaged cross-power spectrum Baseline: EF (03) - HH (09)
Timerange: 01/04:53:16 to 01/04:55:44

Plot file version 528 created 26-SEP-2019 10:43:26

190829A RG010A.UVDATA.1

Freq = 4.7990 GHz, Bw = 32.000 MH No calibration applied and no bandpass applied

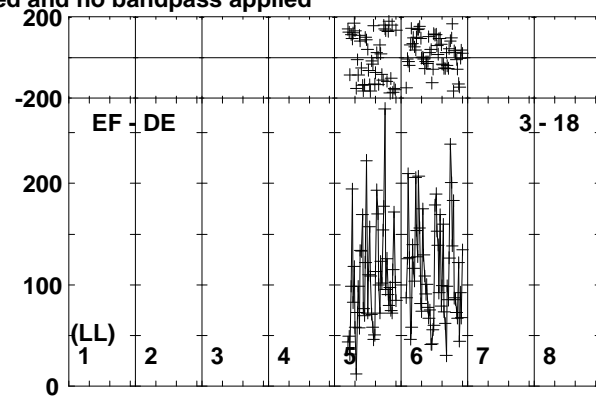
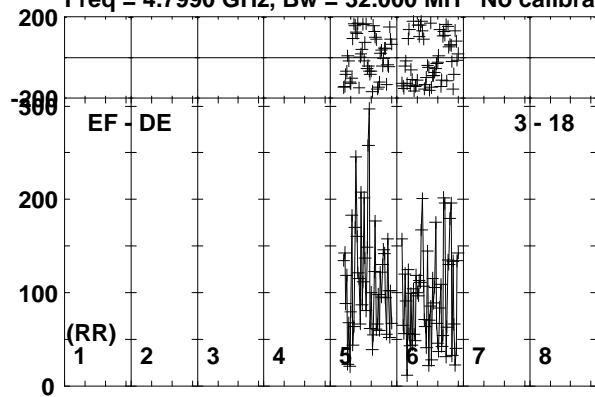

Lower frame: Micro Ampl Jy Top frame: Phas deg
Vector averaged cross-power spectrum Baseline: EF (03) - DE (18)
Timerange: 01/04:53:16 to 01/04:55:44

Plot file version 529 created 26-SEP-2019 10:43:26

J0257-1212 RG010A.UVDATA.1

Freq = 4.7990 GHz, Bw = 32.000 MH No calibration applied and no bandpass applied

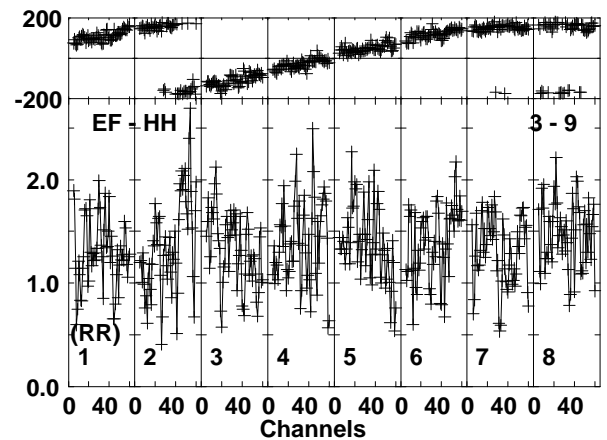
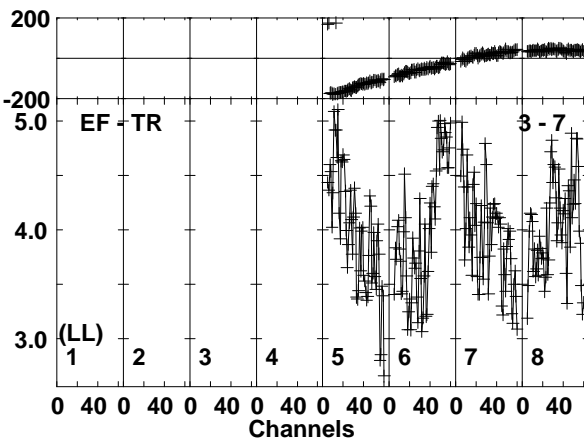
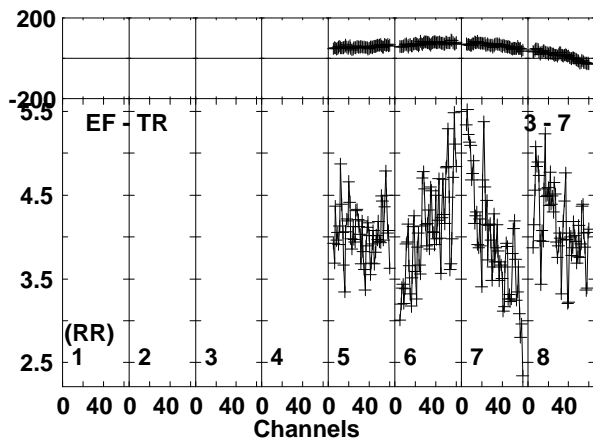
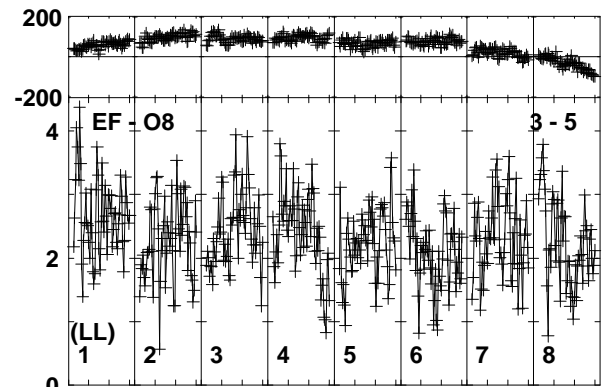
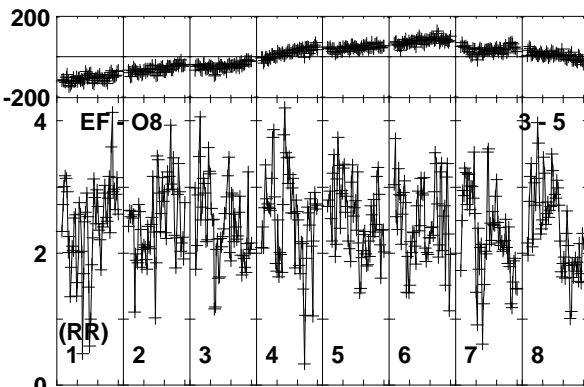
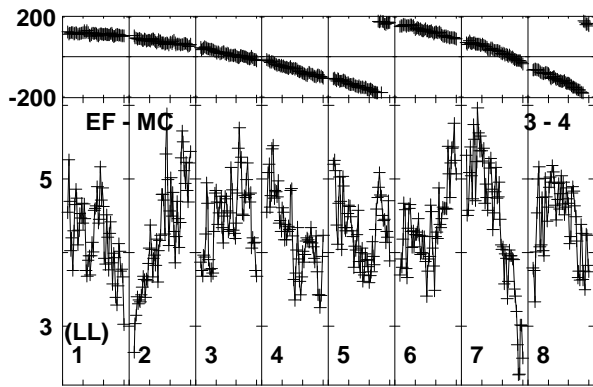
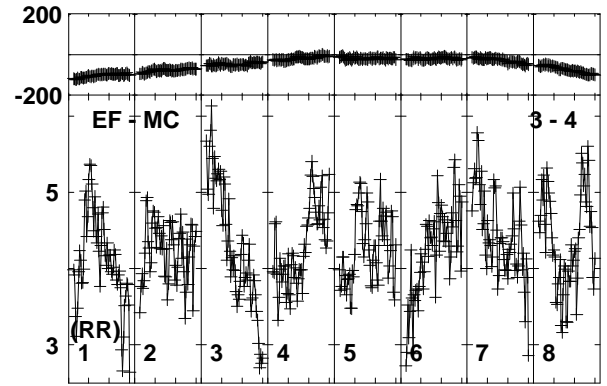
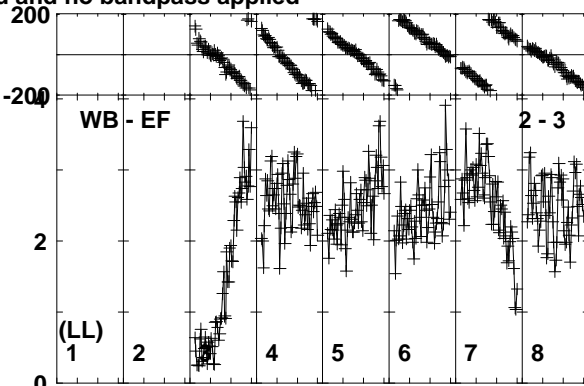
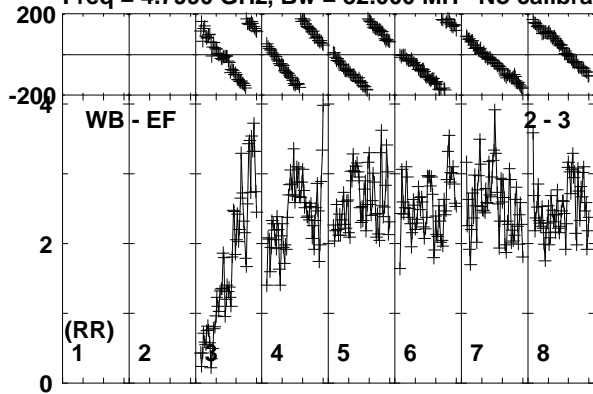

Lower frame: Milli Ampl Jy Top frame: Phas deg
Vector averaged cross-power spectrum Baseline: WB (02) - EF (03)
Timerange: 01/04:55:46 to 01/04:56:45

Plot file version 530 created 26-SEP-2019 10:43:26
J0257-1212 RG010A.UVDATA.1
Freq = 4.7990 GHz, Bw = 32.000 MH No calibration applied and no bandpass applied

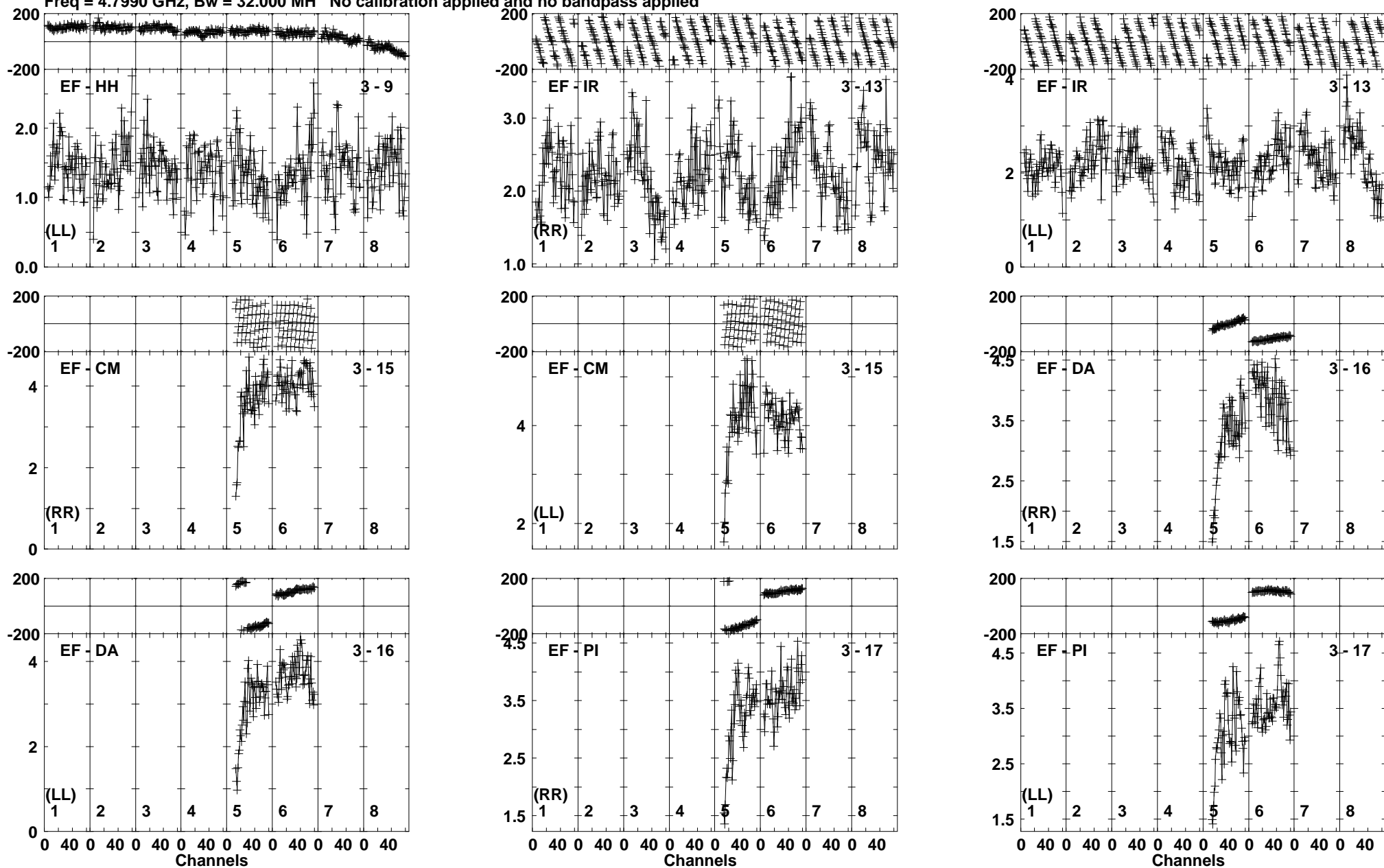

Lower frame: Milli Ampl Jy Top frame: Phas deg
Vector averaged cross-power spectrum Baseline: EF (03) - HH (09)
Timerange: 01/04:55:46 to 01/04:56:45

Plot file version 531 created 26-SEP-2019 10:43:27

J0257-1212 RG010A.UVDATA.1

Freq = 4.7990 GHz, Bw = 32.000 MH No calibration applied and no bandpass applied

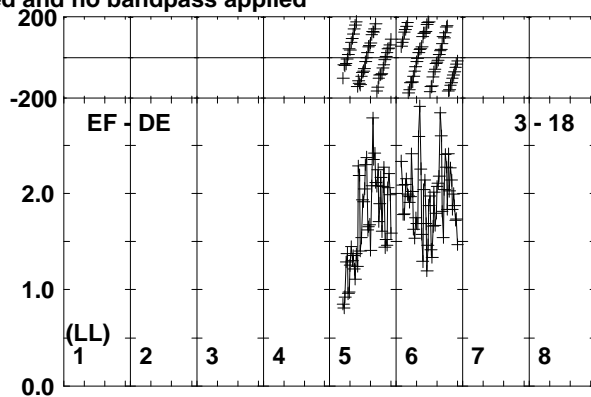
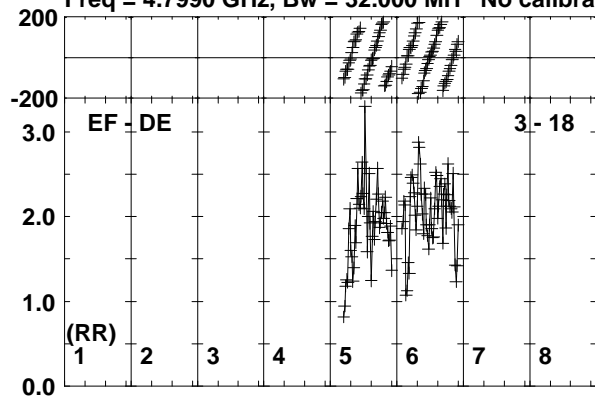

Lower frame: Milli Ampl Jy Top frame: Phas deg
Vector averaged cross-power spectrum Baseline: EF (03) - DE (18)
Timerange: 01/04:55:46 to 01/04:56:45

Plot file version 532 created 26-SEP-2019 10:43:27

NVSS-1 RG010A.UVDATA.1

Freq = 4.7990 GHz, Bw = 32.000 MH No calibration applied and no bandpass applied

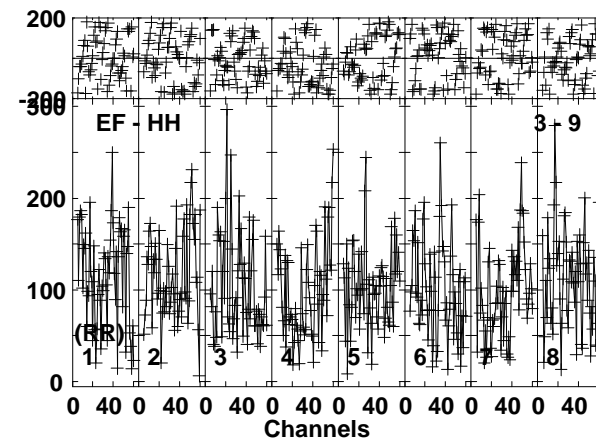
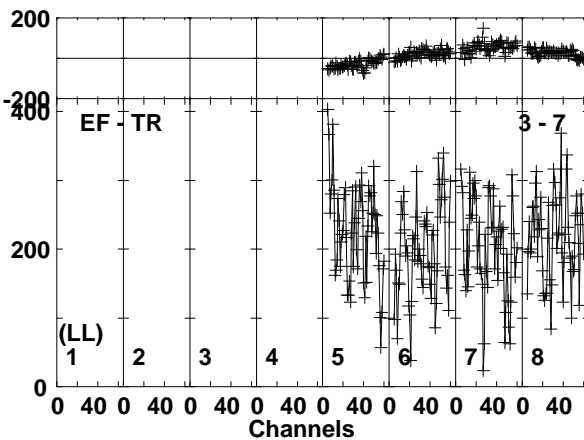
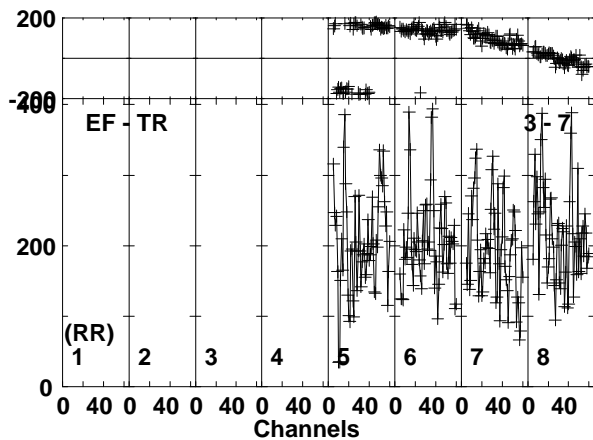
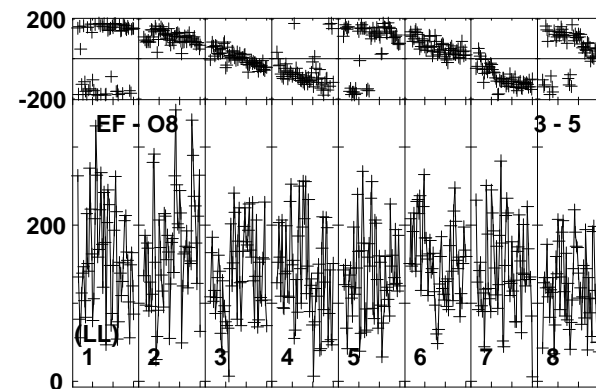
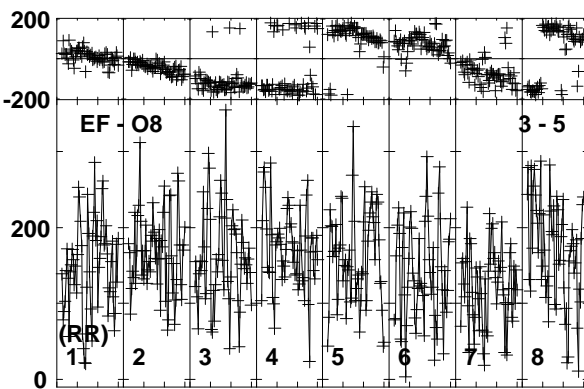
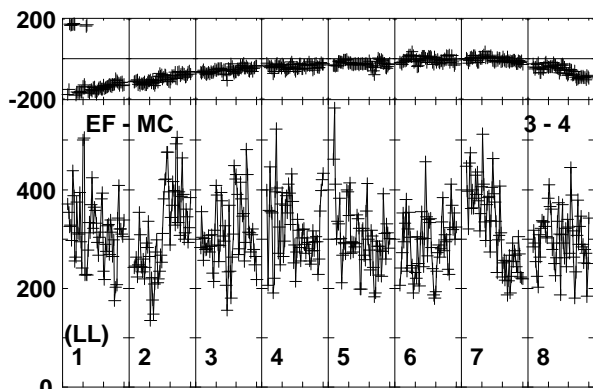
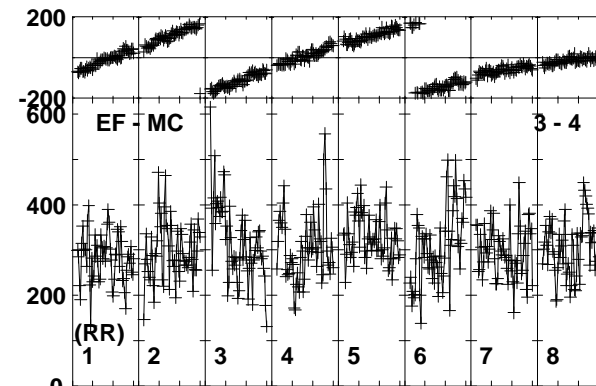
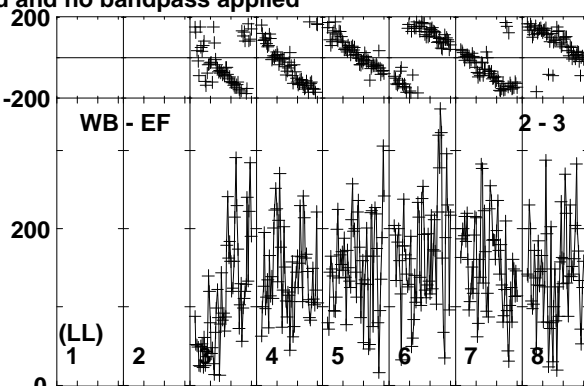
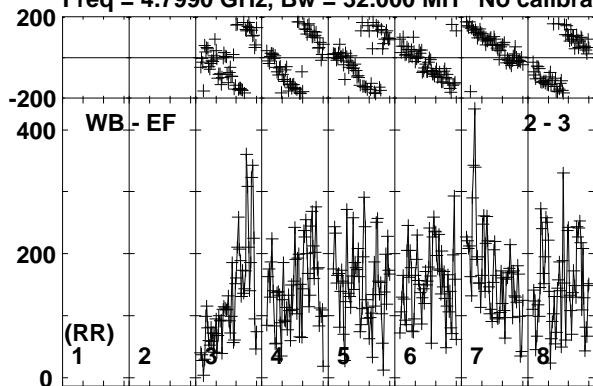

Lower frame: Micro Ampl Jy Top frame: Phas deg
Vector averaged cross-power spectrum Baseline: WB (02) - EF (03)
Timerange: 01/04:56:46 to 01/05:00:24

Plot file version 533 created 26-SEP-2019 10:43:27

NVSS-1 RG010A.UVDATA.1

Freq = 4.7990 GHz, Bw = 32.000 MH No calibration applied and no bandpass applied

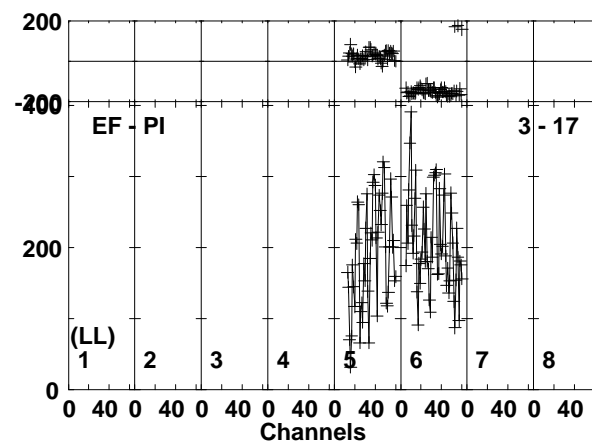
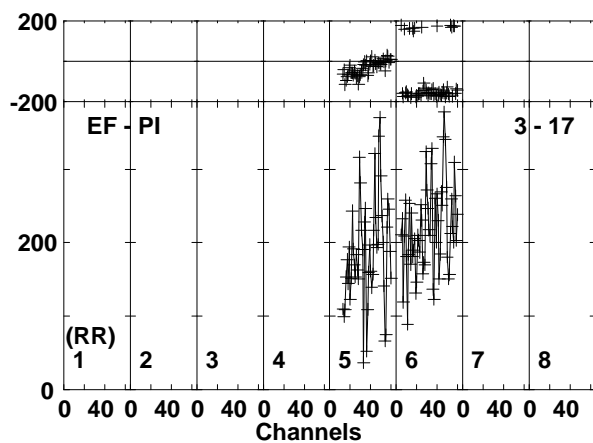
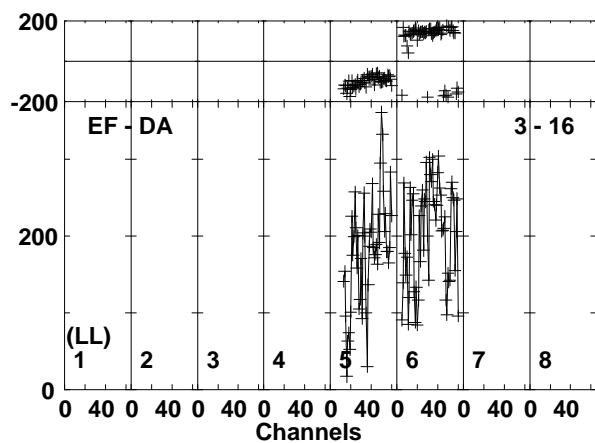
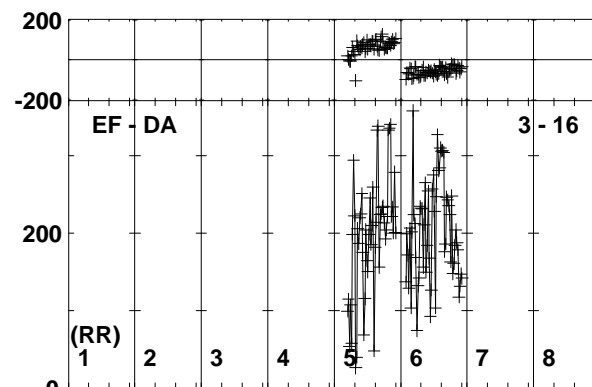
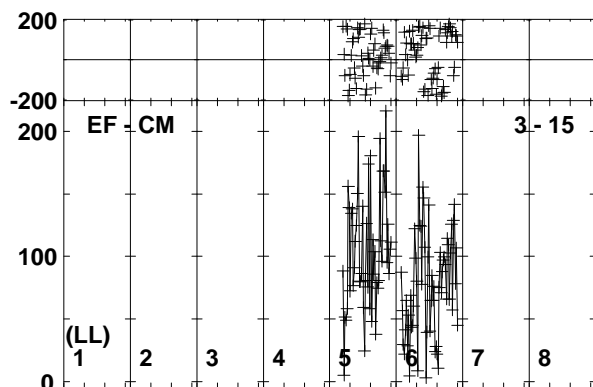
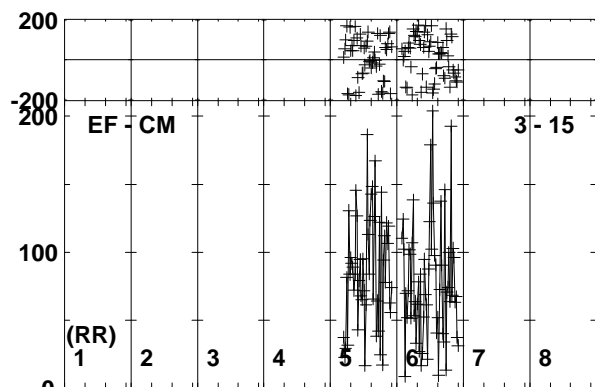
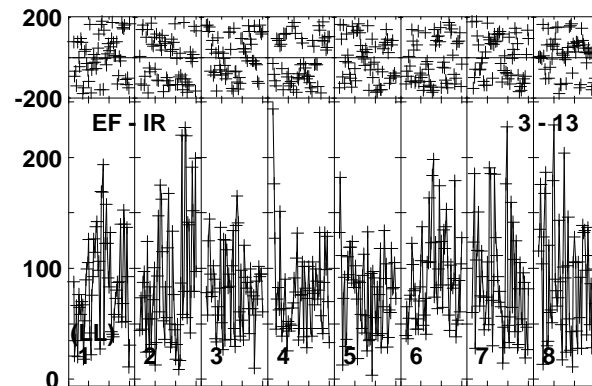
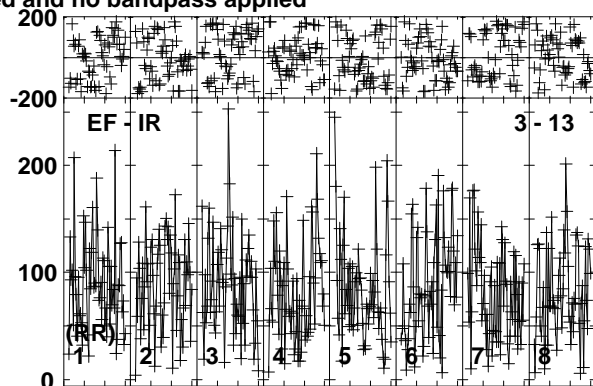
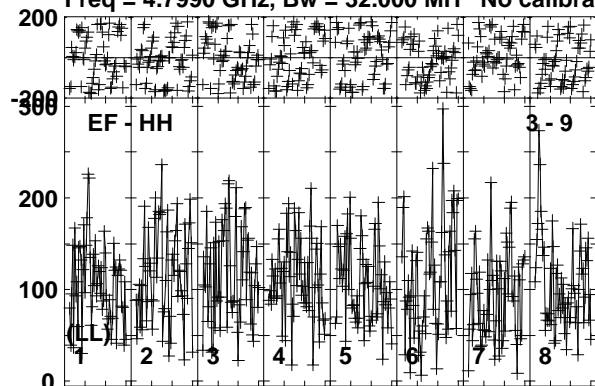

Lower frame: Micro Ampl Jy Top frame: Phas deg
Vector averaged cross-power spectrum Baseline: EF (03) - HH (09)
Timerange: 01/04:56:46 to 01/05:00:24

Plot file version 534 created 26-SEP-2019 10:43:28

NVSS-1 RG010A.UVDATA.1

Freq = 4.7990 GHz, Bw = 32.000 MH No calibration applied and no bandpass applied

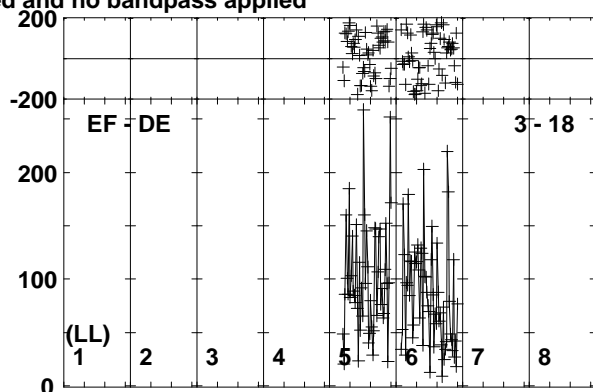
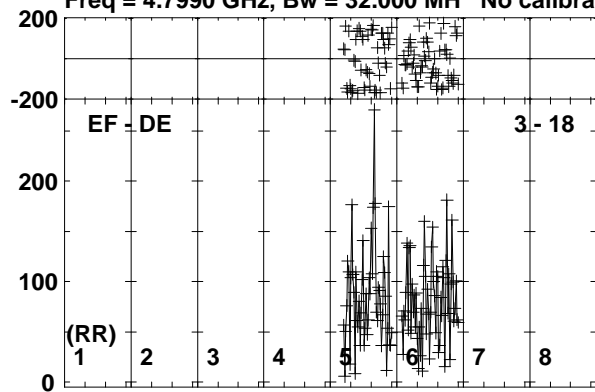

Lower frame: Micro Ampl Jy Top frame: Phas deg
Vector averaged cross-power spectrum Baseline: EF (03) - DE (18)
Timerange: 01/04:56:46 to 01/05:00:24

Plot file version 535 created 26-SEP-2019 10:43:28

J0257-1212 RG010A.UVDATA.1

Freq = 4.7990 GHz, Bw = 32.000 MH No calibration applied and no bandpass applied

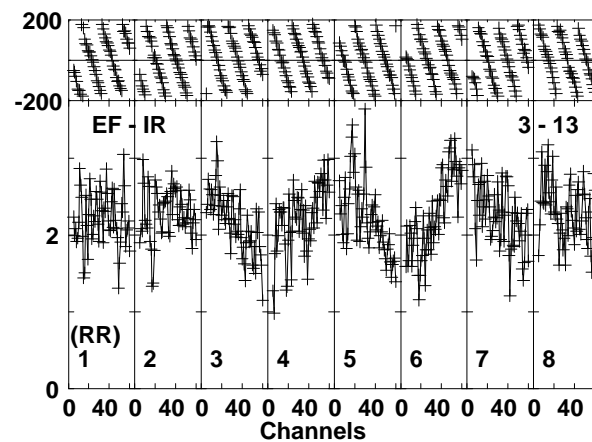
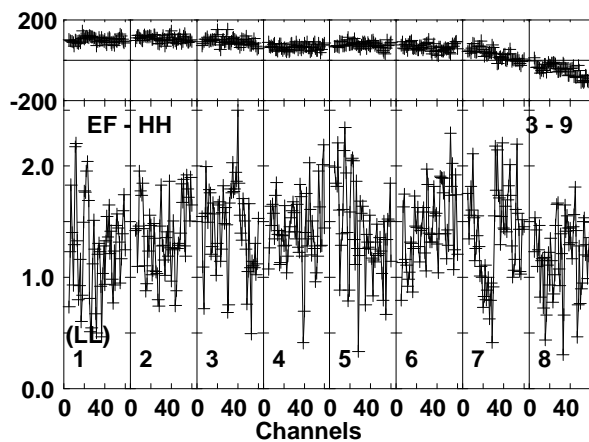
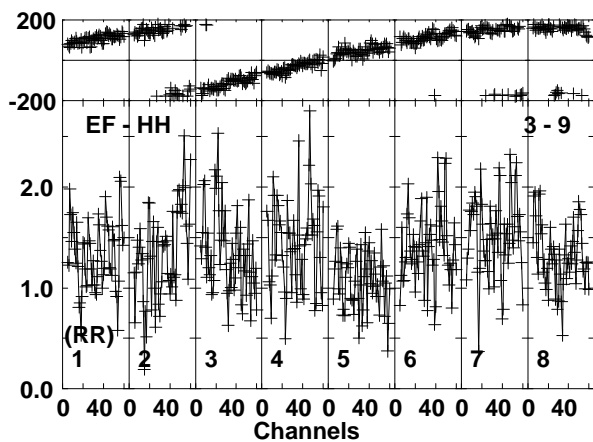
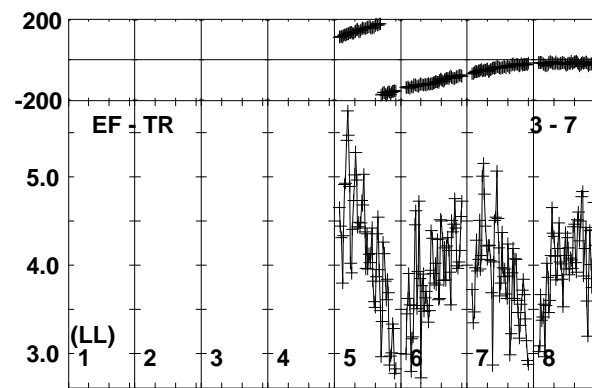
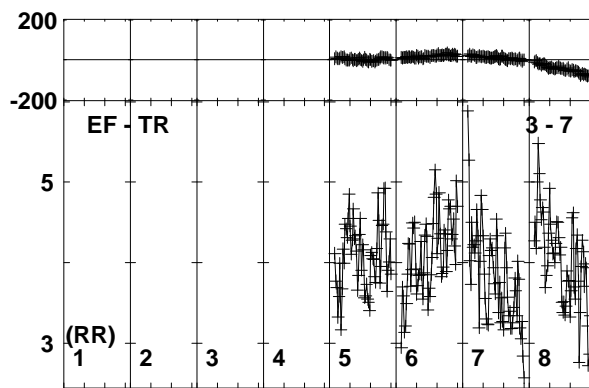
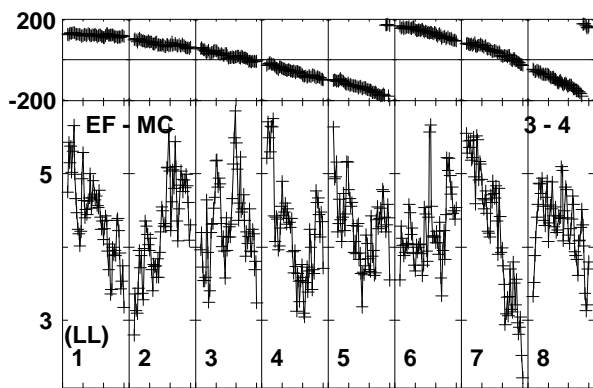
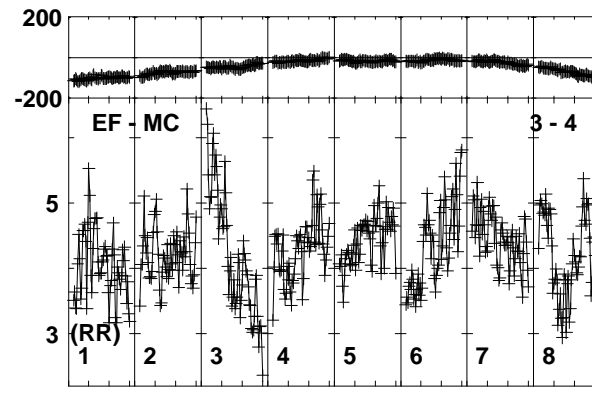
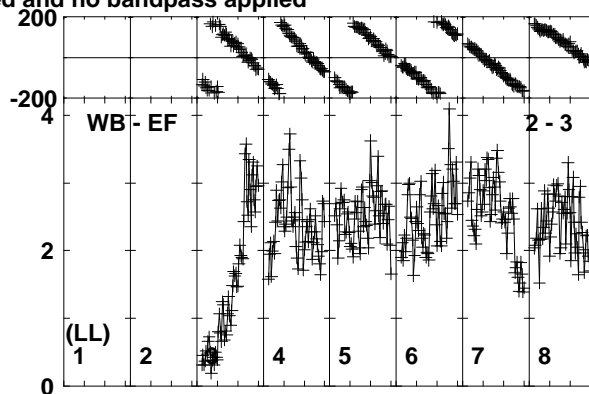
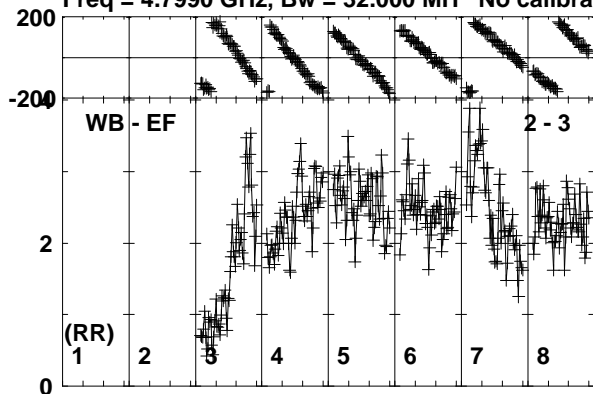

Lower frame: Milli Ampl Jy Top frame: Phas deg
Vector averaged cross-power spectrum Baseline: WB (02) - EF (03)
Timerange: 01/05:00:25 to 01/05:01:24

Plot file version 536 created 26-SEP-2019 10:43:28

J0257-1212 RG010A.UVDATA.1

Freq = 4.7990 GHz, Bw = 32.000 MH No calibration applied and no bandpass applied

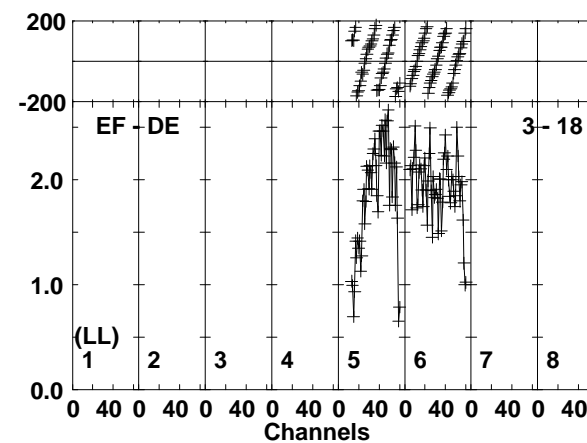
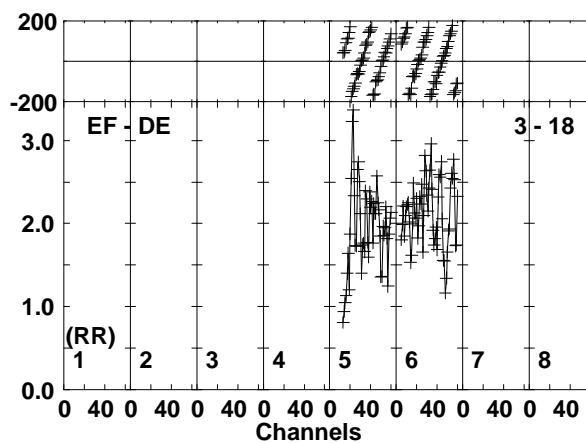
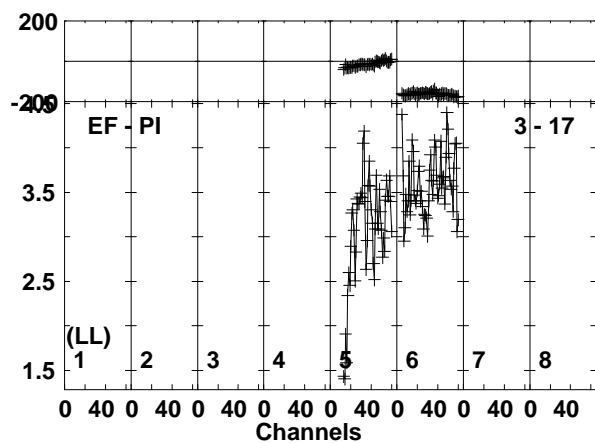
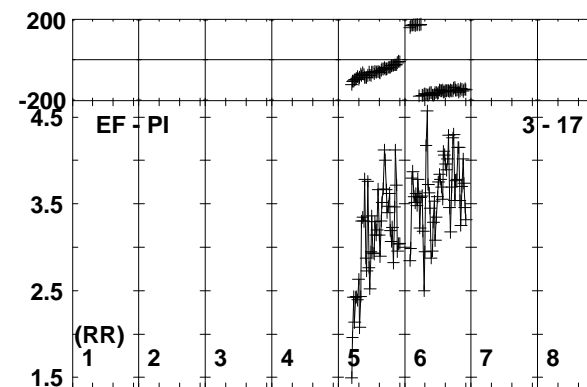
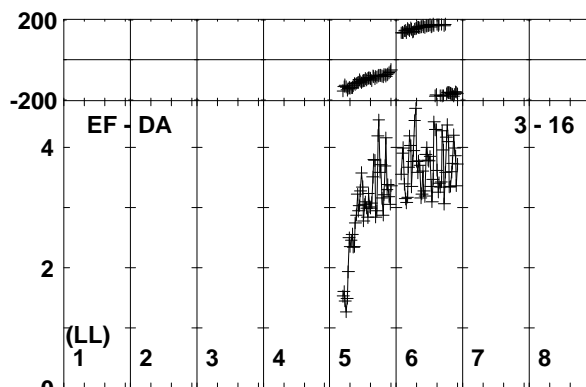
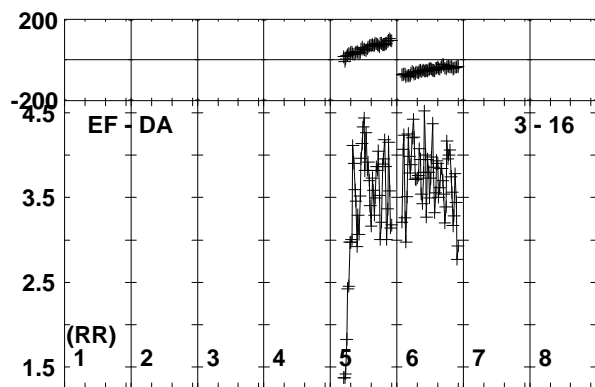
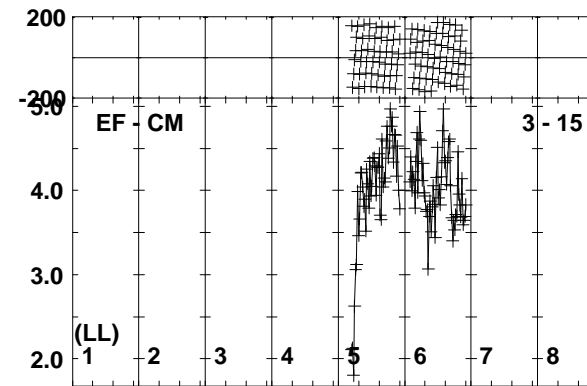
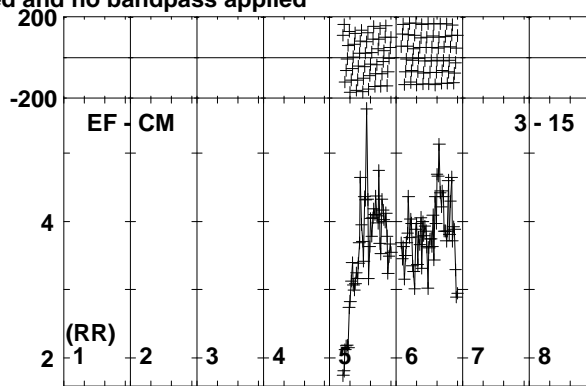
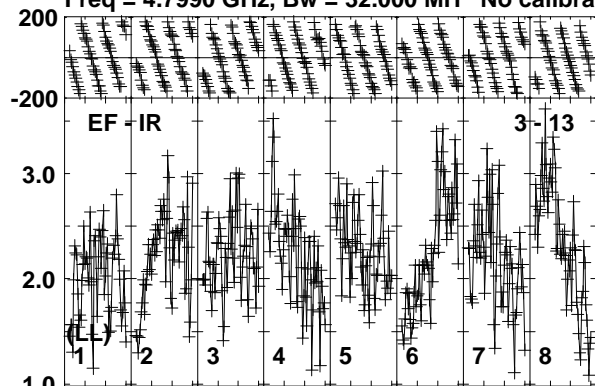

Lower frame: Milli Ampl Jy Top frame: Phas deg
Vector averaged cross-power spectrum Baseline: EF (03) - IR (13)
Timerange: 01/05:00:25 to 01/05:01:24

Plot file version 537 created 26-SEP-2019 10:43:29

0528+134 RG010A.UVDATA.1

Freq = 4.7990 GHz, Bw = 32.000 MH No calibration applied and no bandpass applied

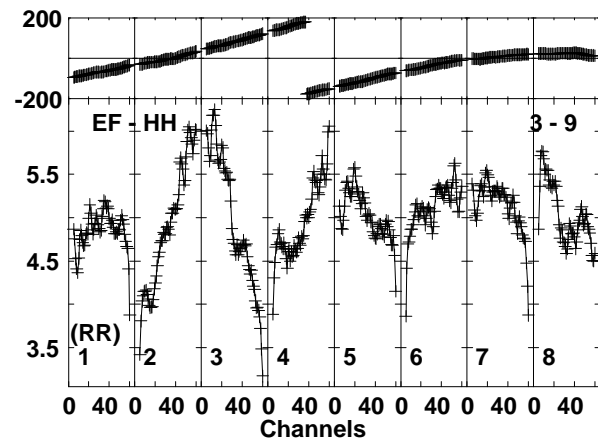
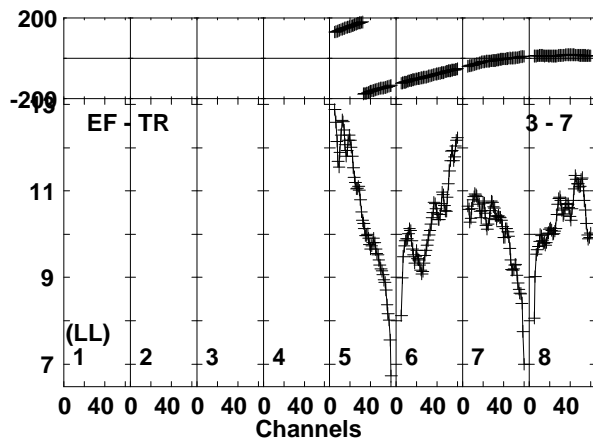
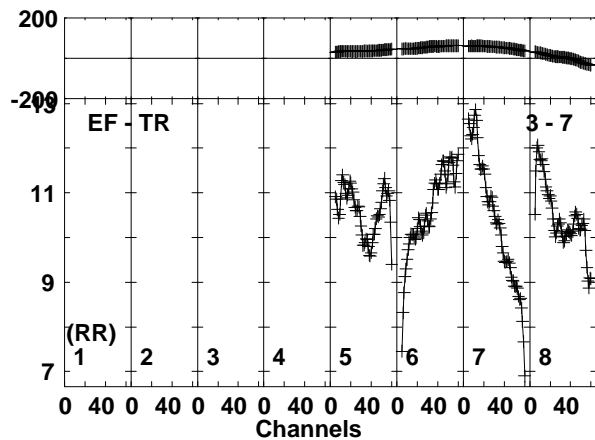
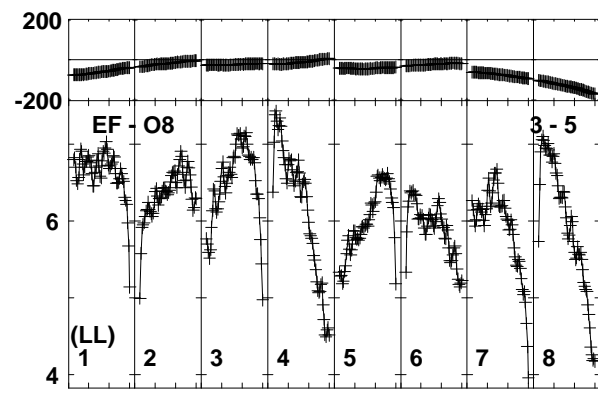
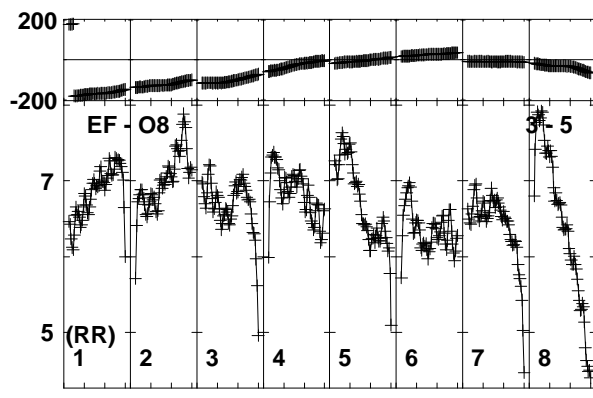
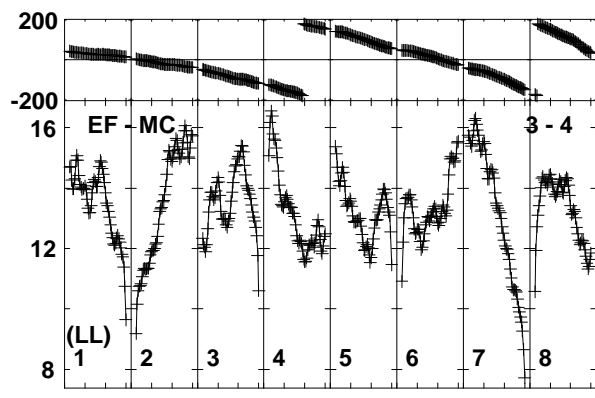
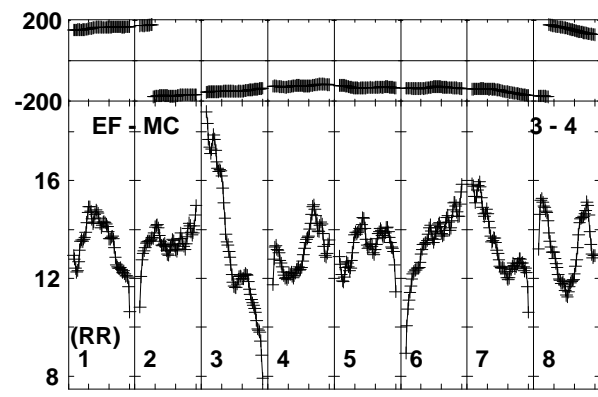
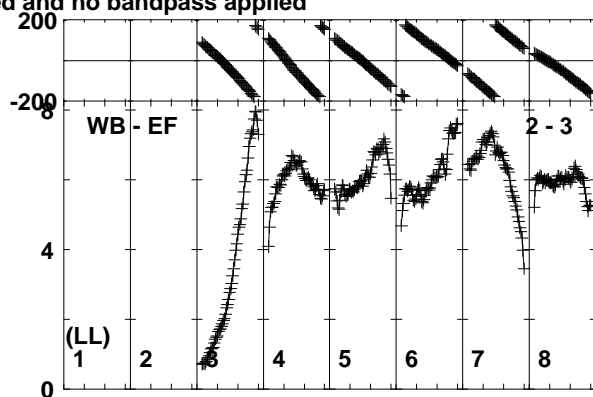
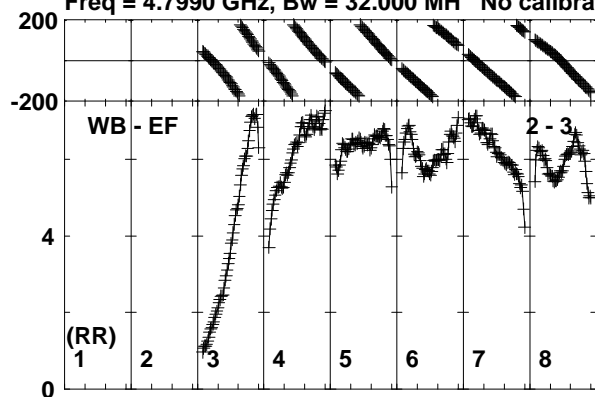

Lower frame: Milli Ampl Jy Top frame: Phas deg
Vector averaged cross-power spectrum Baseline: WB (02) - EF (03)
Timerange: 01/05:04:25 to 01/05:07:25

Plot file version 538 created 26-SEP-2019 10:43:29

0528+134 RG010A.UVDATA.1

Freq = 4.7990 GHz, Bw = 32.000 MH No calibration applied and no bandpass applied

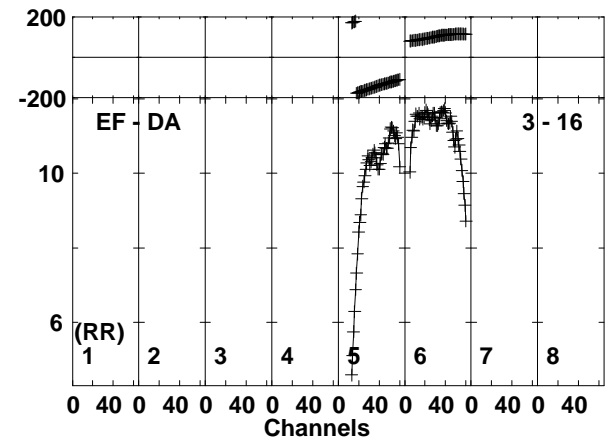
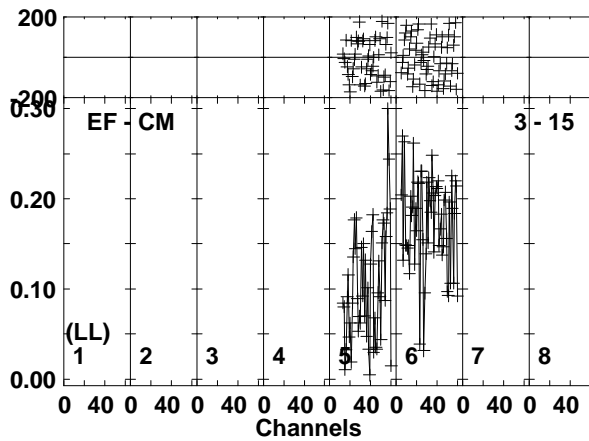
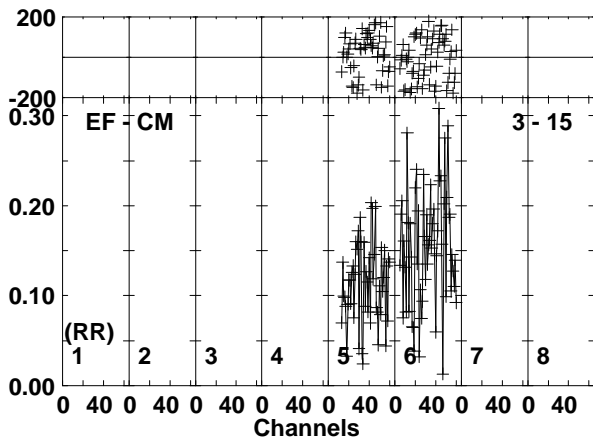
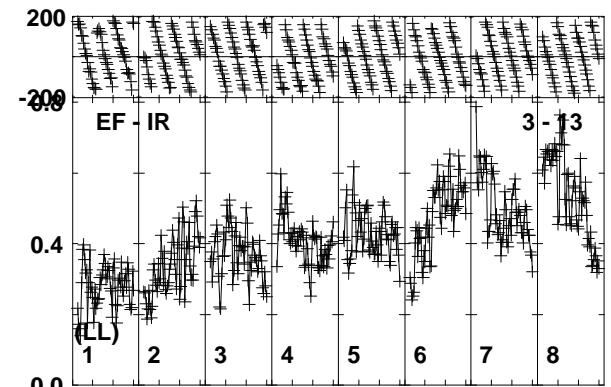
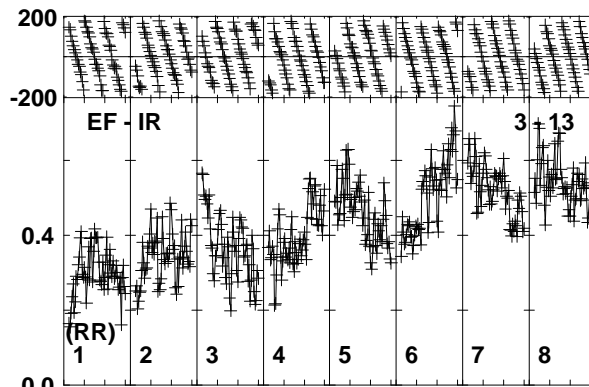
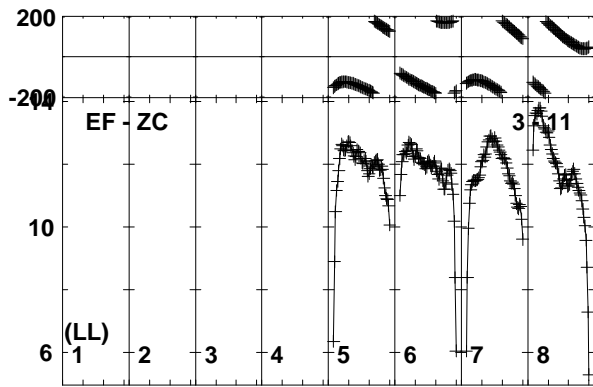
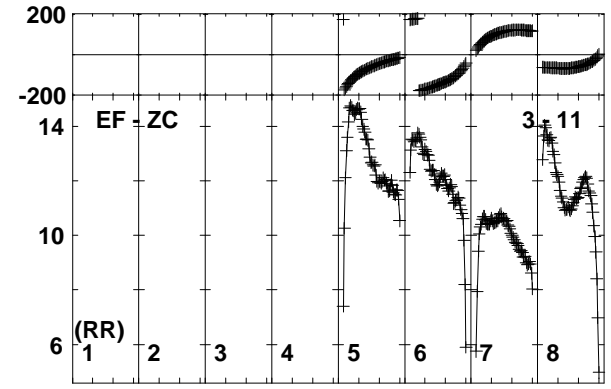
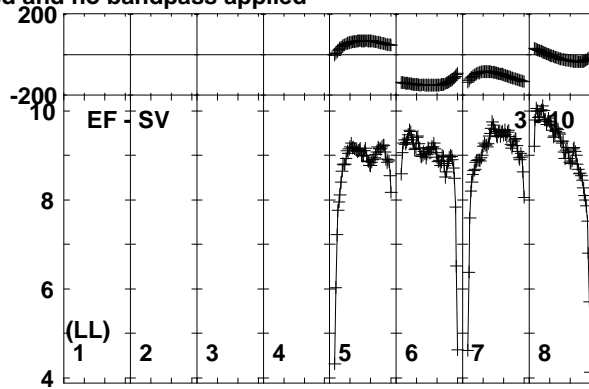
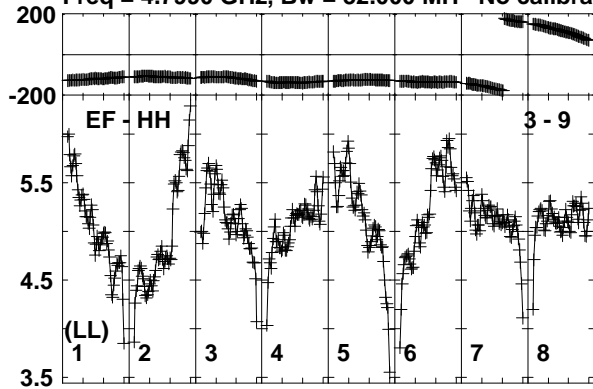

Lower frame: Milli Ampl Jy Top frame: Phas deg
Vector averaged cross-power spectrum Baseline: EF (03) - HH (09)
Timerange: 01/05:04:25 to 01/05:07:25

Plot file version 539 created 26-SEP-2019 10:43:30
 0528+134 RG010A.UVDATA.1
 Freq = 4.7990 GHz, Bw = 32.000 MH No calibration applied and no bandpass applied

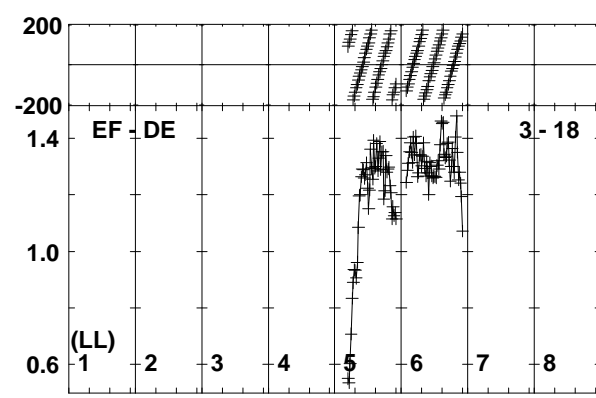
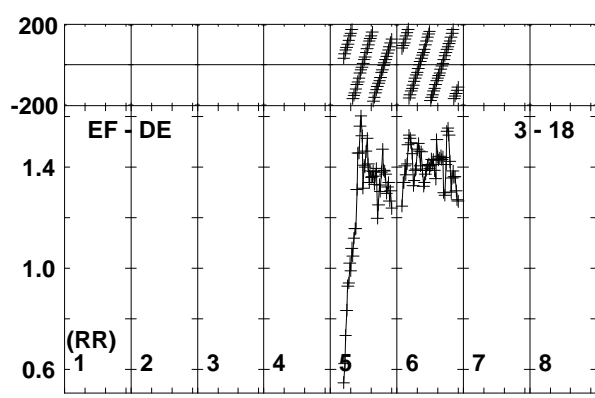
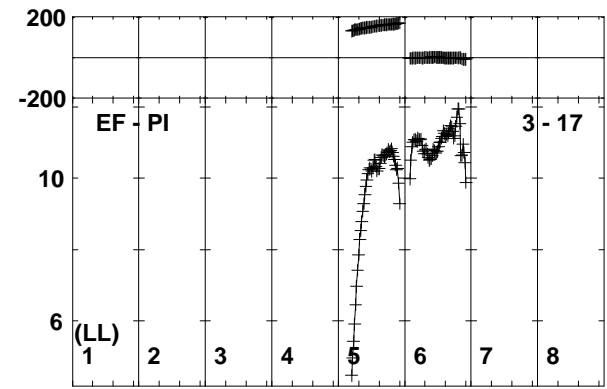
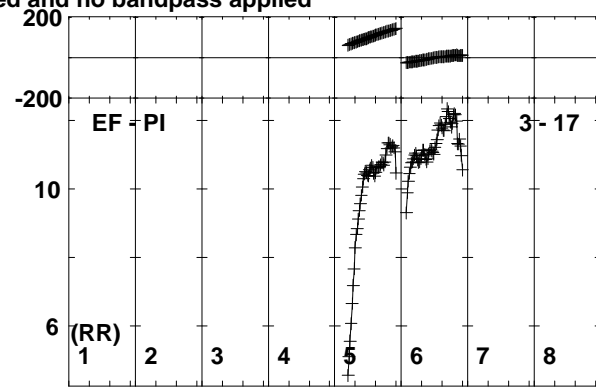
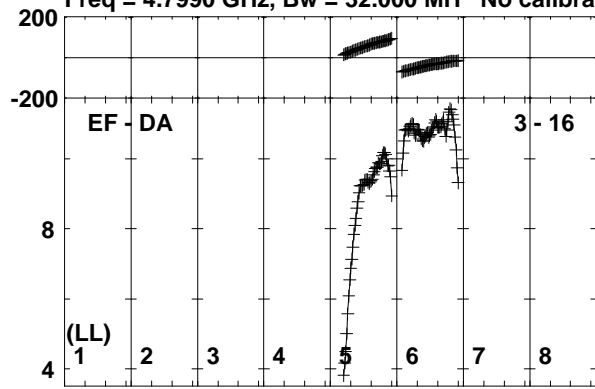

Lower frame: Milli Ampl Jy Top frame: Phas deg
 Vector averaged cross-power spectrum Baseline: EF (03) - DA (16)
 Timerange: 01/05:04:25 to 01/05:07:25

Plot file version 540 created 26-SEP-2019 10:43:30

J0257-1212 RG010A.UVDATA.1

Freq = 4.7990 GHz, Bw = 32.000 MH No calibration applied and no bandpass applied

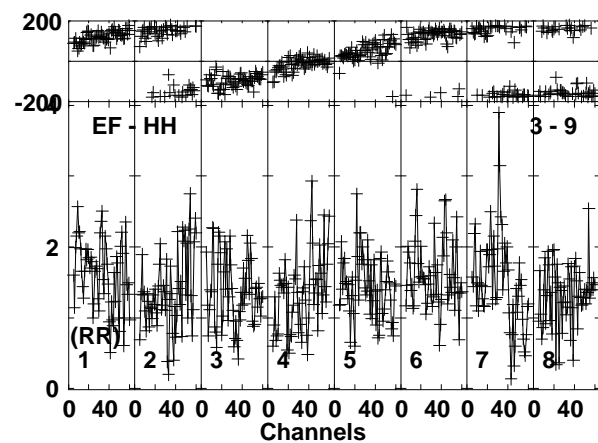
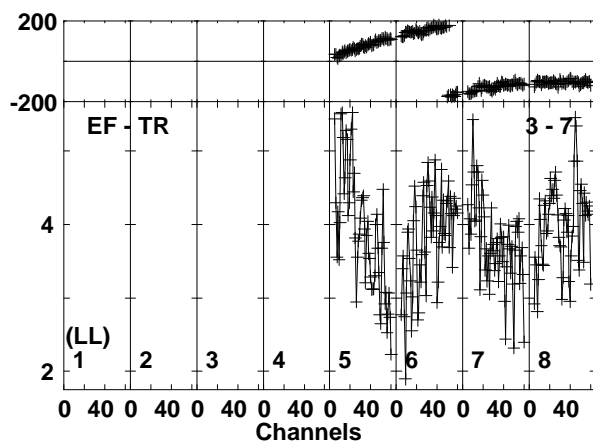
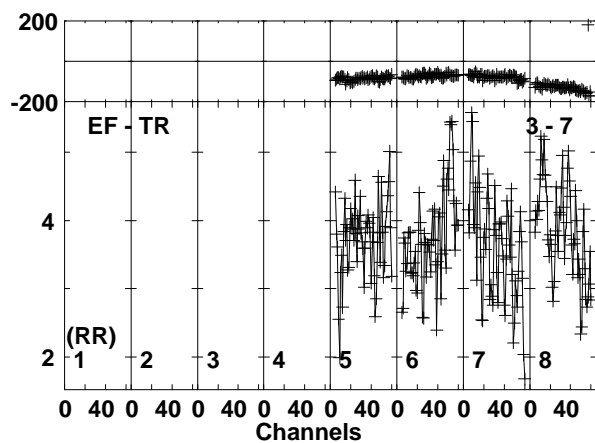
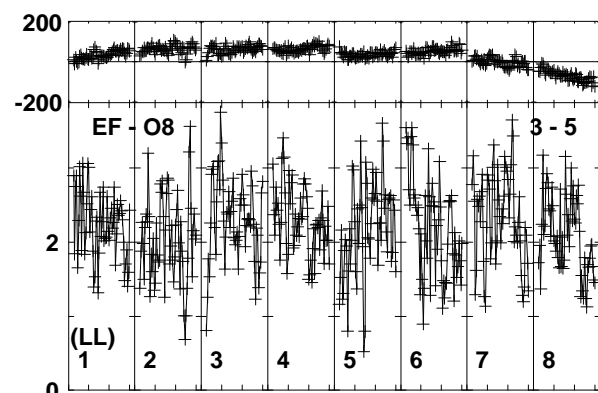
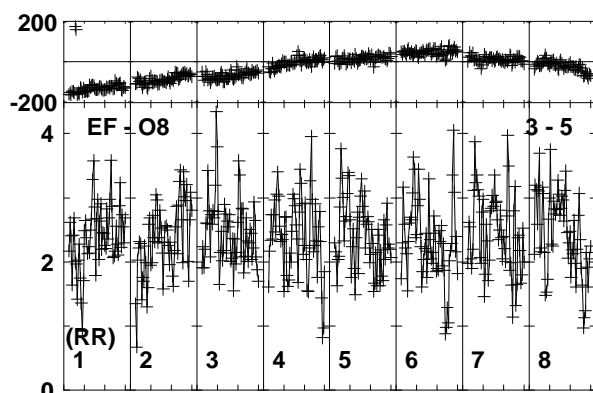
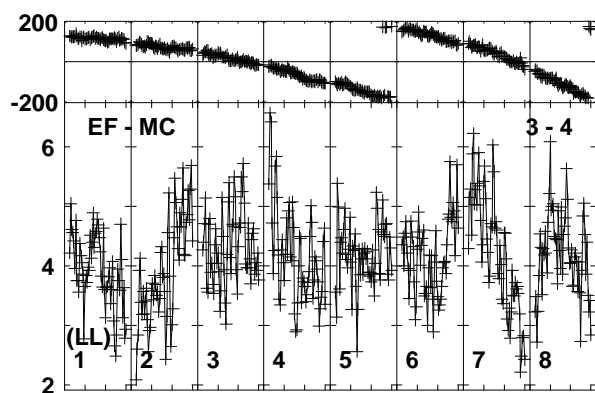
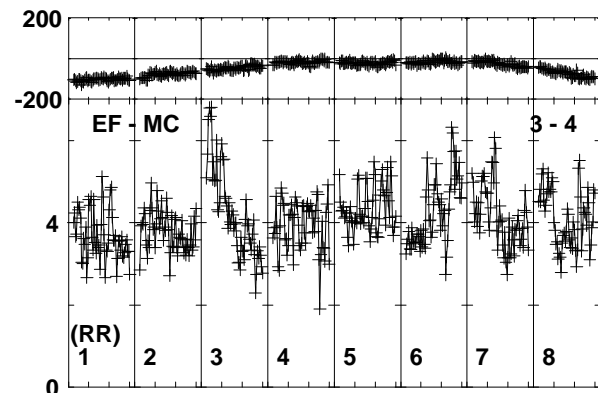
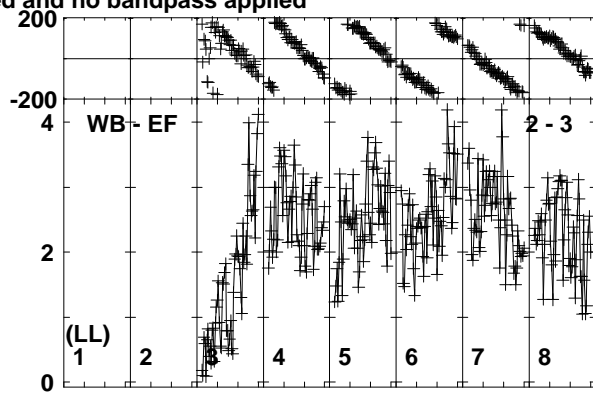
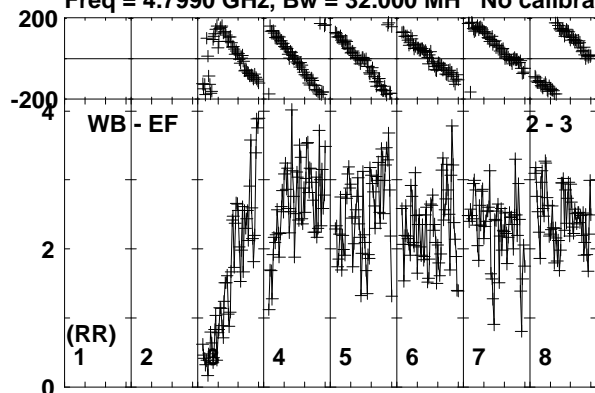

Lower frame: Milli Ampl Jy Top frame: Phas deg
Vector averaged cross-power spectrum Baseline: WB (02) - EF (03)
Timerange: 01/05:09:26 to 01/05:10:25

Plot file version 541 created 26-SEP-2019 10:43:30

J0257-1212 RG010A.UVDATA.1

Freq = 4.7990 GHz, Bw = 32.000 MH No calibration applied and no bandpass applied

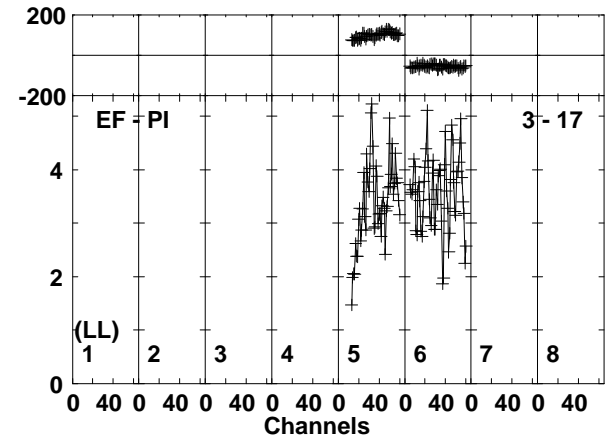
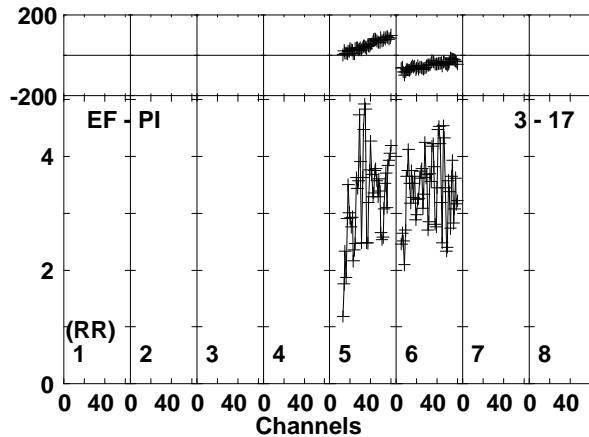
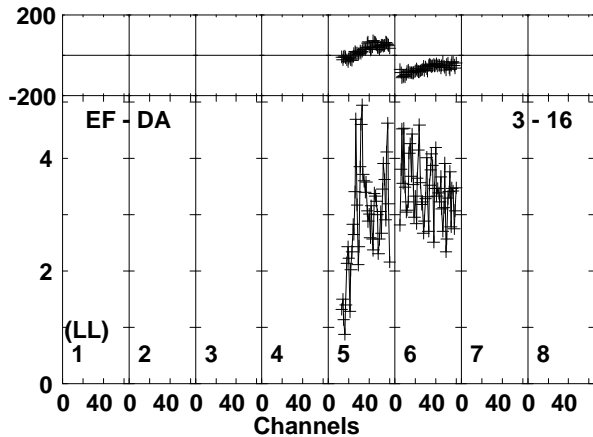
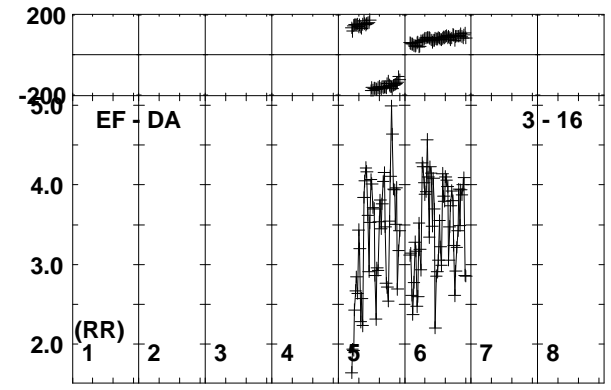
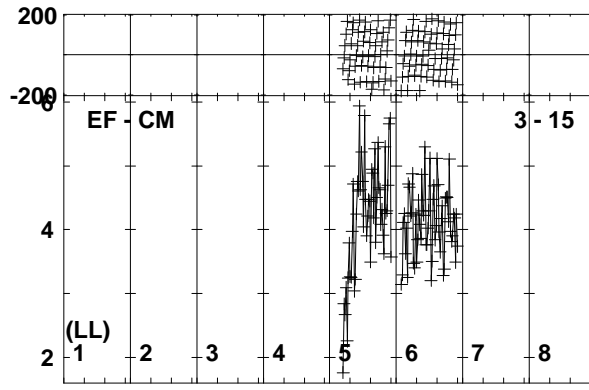
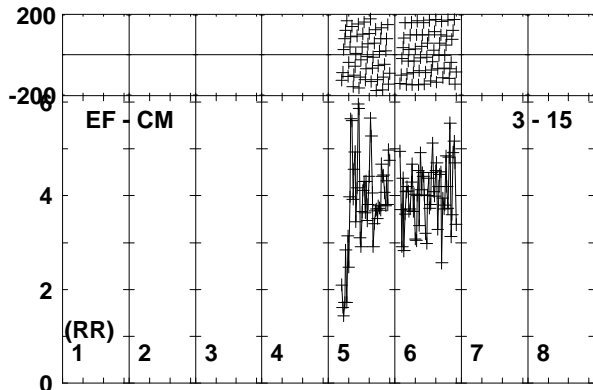
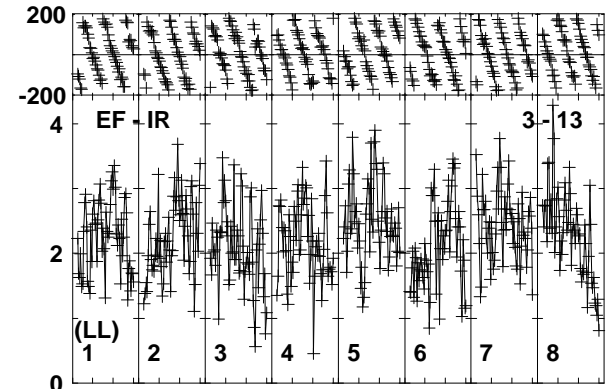
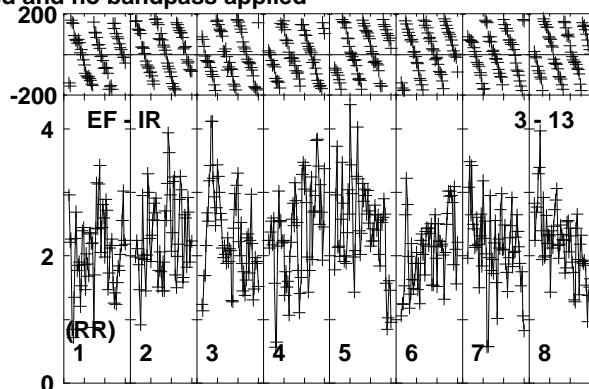
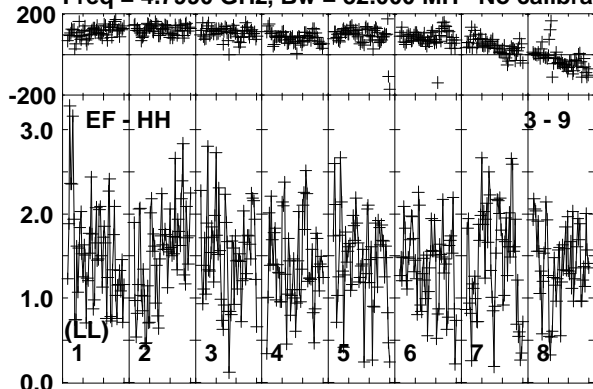

Lower frame: Milli Ampl Jy Top frame: Phas deg
Vector averaged cross-power spectrum Baseline: EF (03) - HH (09)
Timerange: 01/05:09:26 to 01/05:10:25

Plot file version 542 created 26-SEP-2019 10:43:30

J0257-1212 RG010A.UVDATA.1

Freq = 4.7990 GHz, Bw = 32.000 MH No calibration applied and no bandpass applied

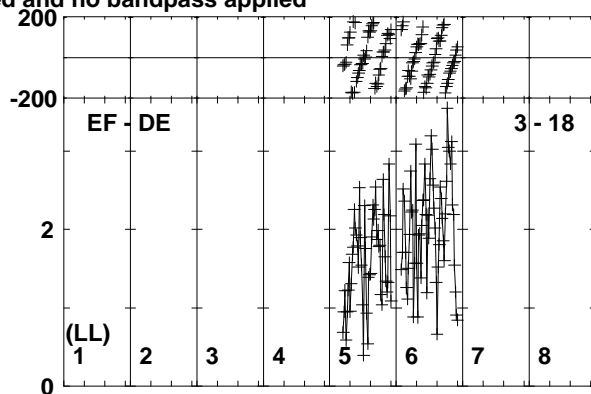
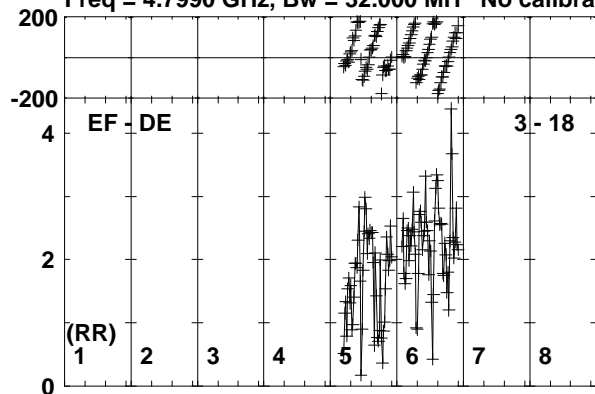

Lower frame: Milli Ampl Jy Top frame: Phas deg
Vector averaged cross-power spectrum Baseline: EF (03) - DE (18)
Timerange: 01/05:09:26 to 01/05:10:25

Plot file version 543 created 26-SEP-2019 10:43:30

J0257-1212 RG010A.UVDATA.1

Freq = 4.7990 GHz, Bw = 32.000 MH No calibration applied and no bandpass applied

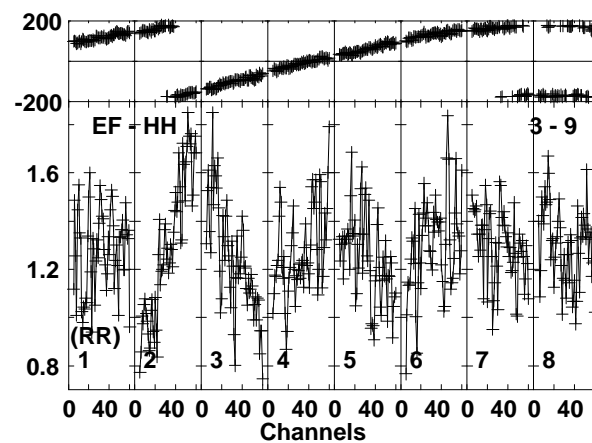
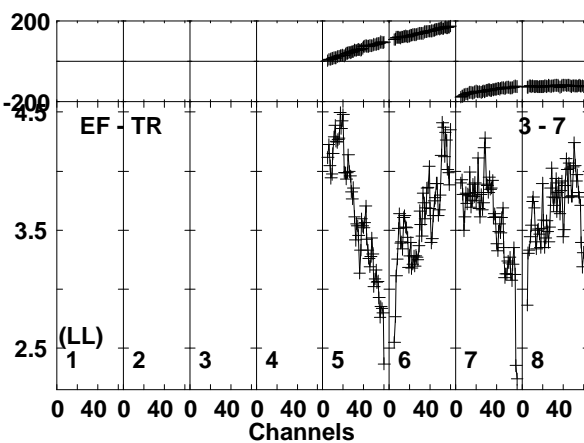
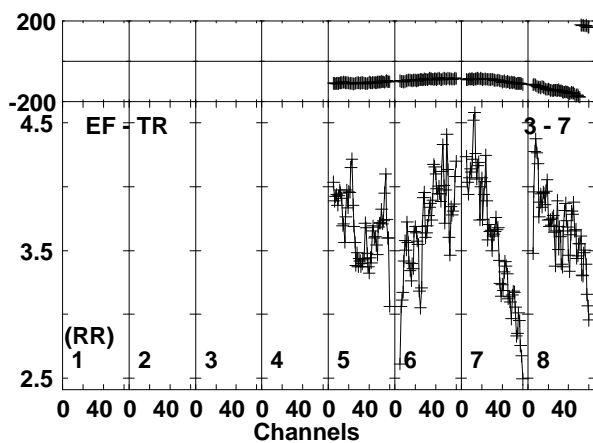
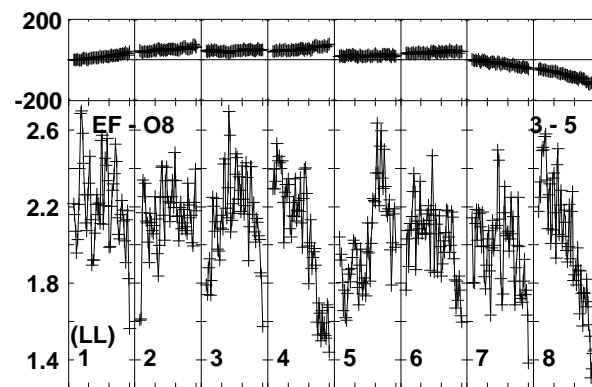
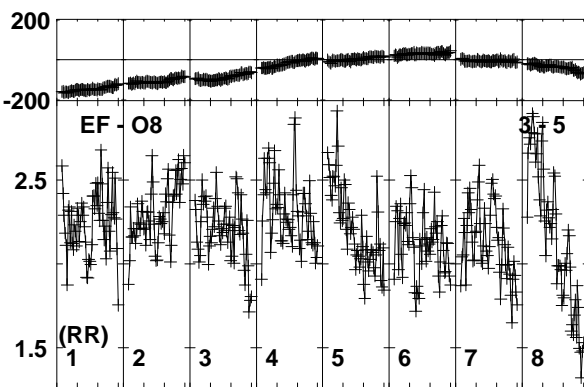
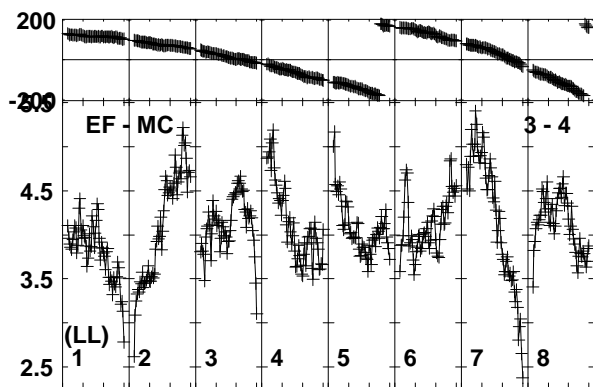
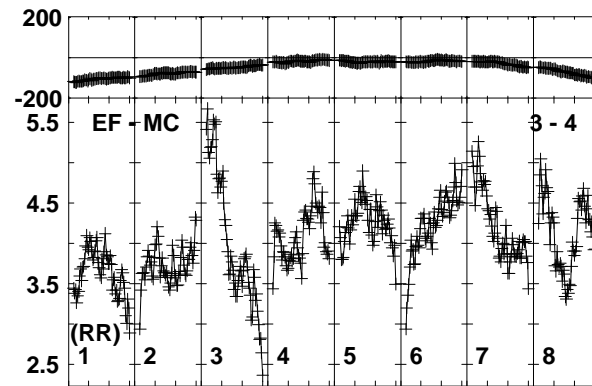
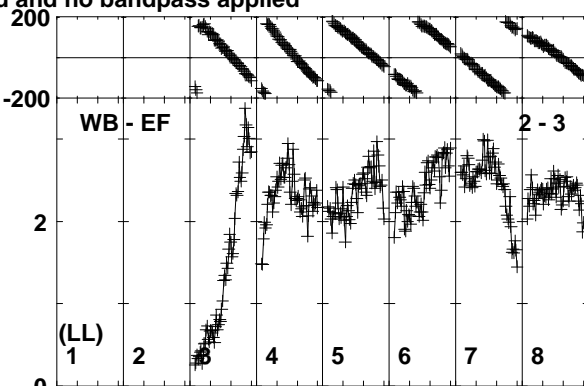
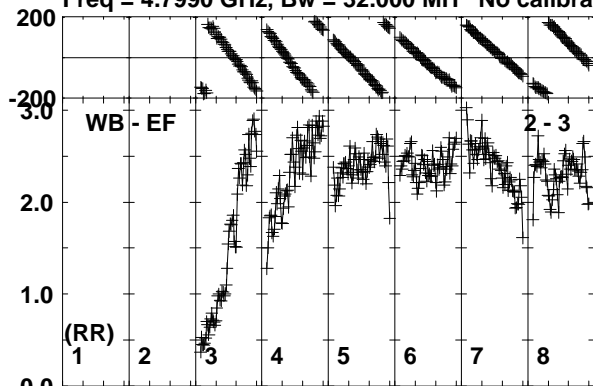

Lower frame: Milli Ampl Jy Top frame: Phas deg
Vector averaged cross-power spectrum Baseline: WB (02) - EF (03)
Timerange: 01/05:11:05 to 01/05:11:35

Plot file version 544 created 26-SEP-2019 10:43:31

J0257-1212 RG010A.UVDATA.1

Freq = 4.7990 GHz, Bw = 32.000 MH No calibration applied and no bandpass applied

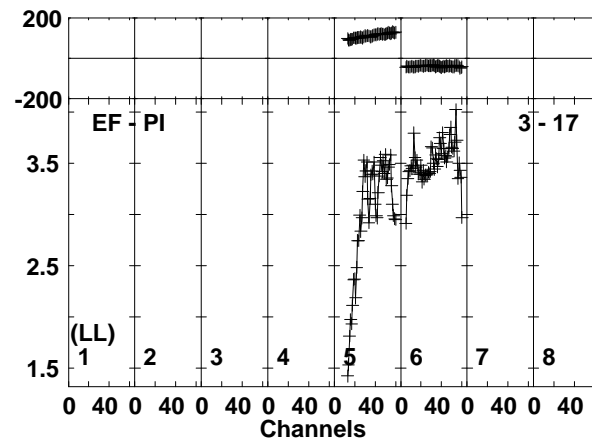
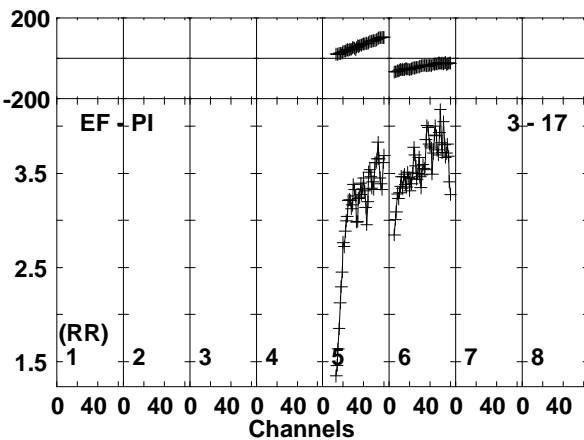
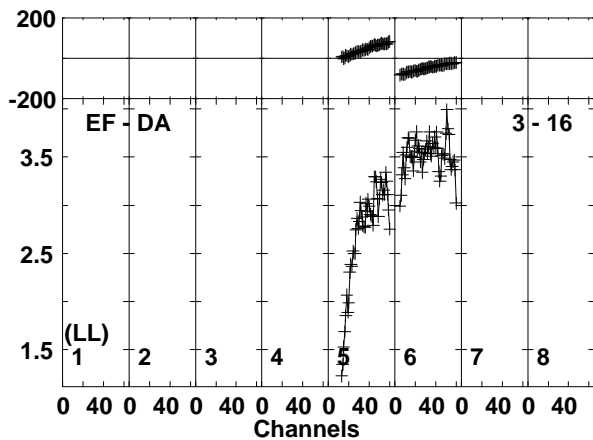
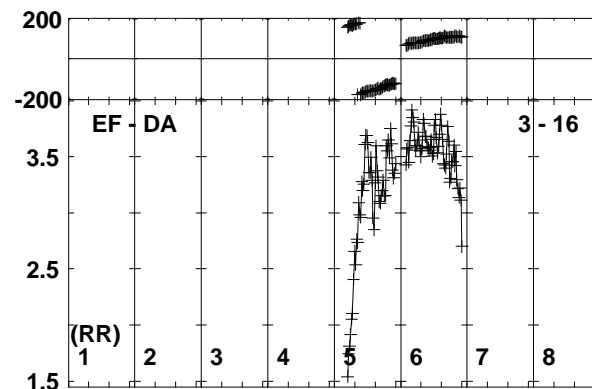
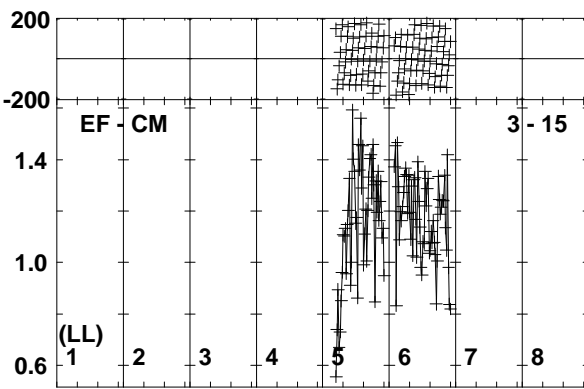
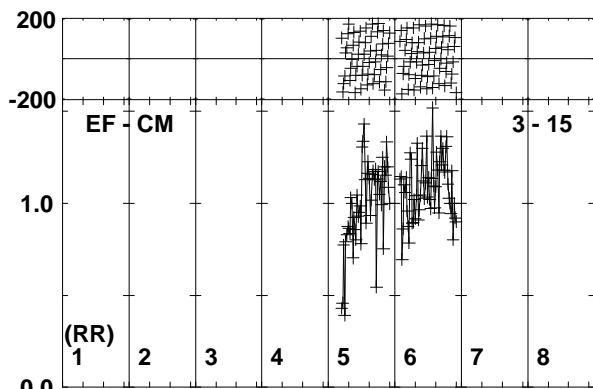
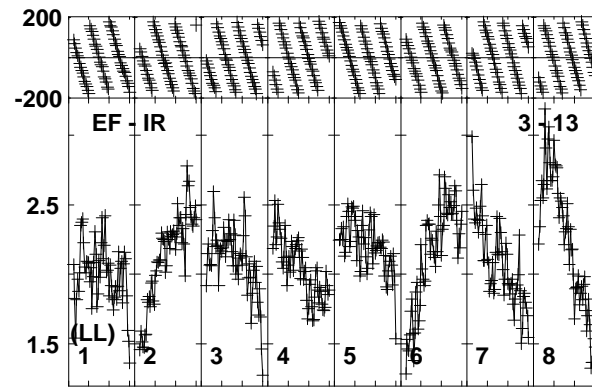
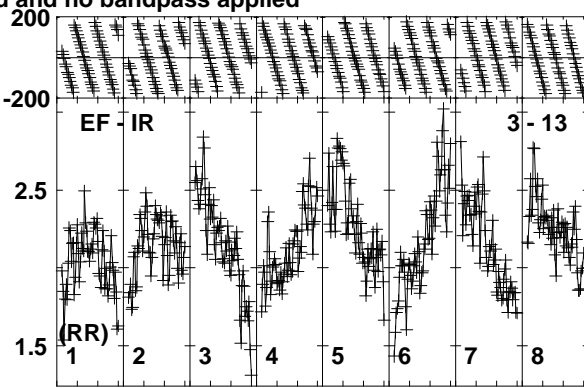
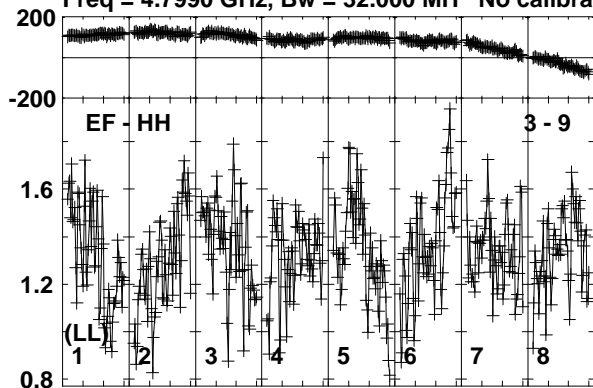

Lower frame: Milli Ampl Jy Top frame: Phas deg
Vector averaged cross-power spectrum Baseline: EF (03) - HH (09)
Timerange: 01/05:11:05 to 01/05:11:35

Plot file version 545 created 26-SEP-2019 10:43:31

J0257-1212 RG010A.UVDATA.1

Freq = 4.7990 GHz, Bw = 32.000 MH No calibration applied and no bandpass applied

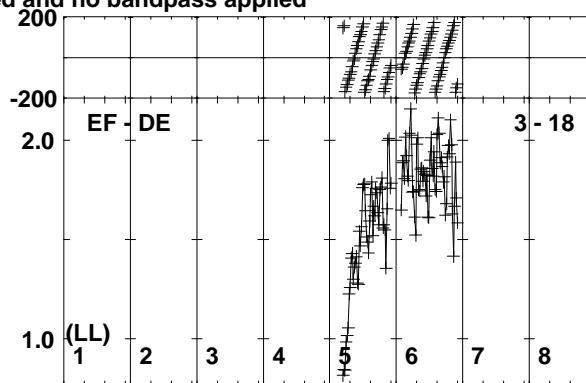
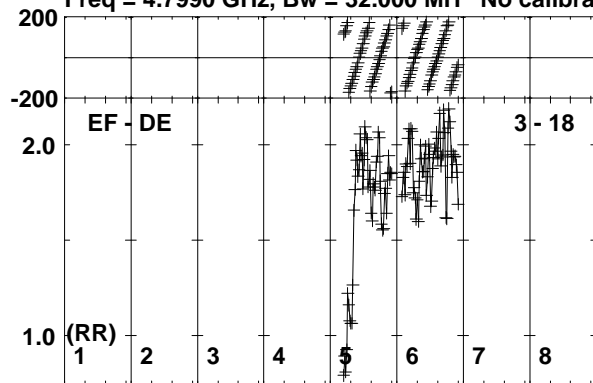

Lower frame: Milli Ampl Jy Top frame: Phas deg
Vector averaged cross-power spectrum Baseline: EF (03) - DE (18)
Timerange: 01/05:11:05 to 01/05:11:35

Plot file version 546 created 26-SEP-2019 10:43:31

J0300-0846 RG010A.UVDATA.1

Freq = 4.7990 GHz, Bw = 32.000 MH No calibration applied and no bandpass applied

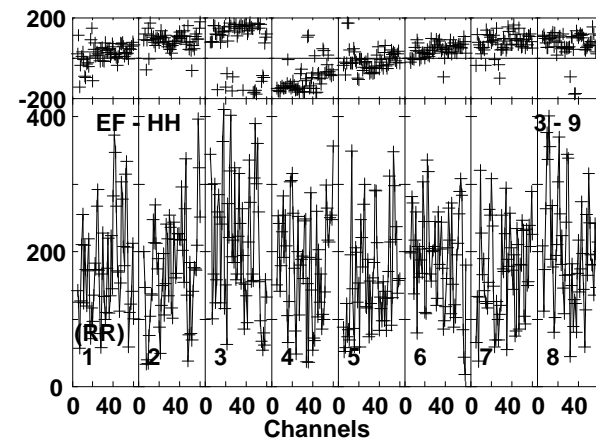
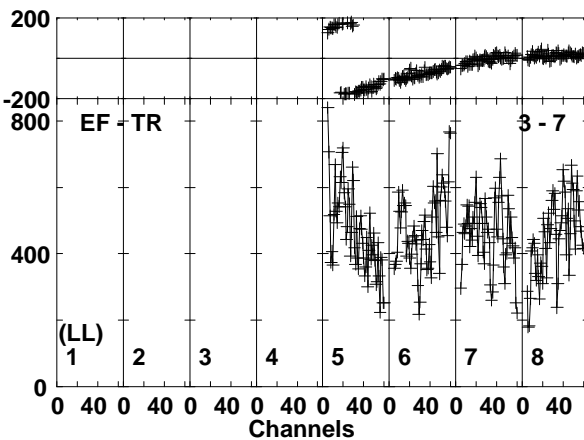
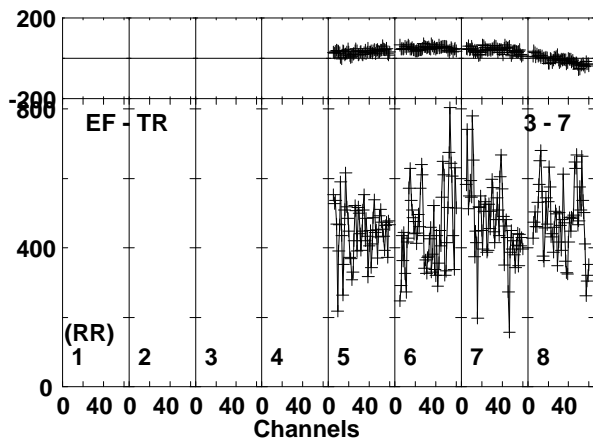
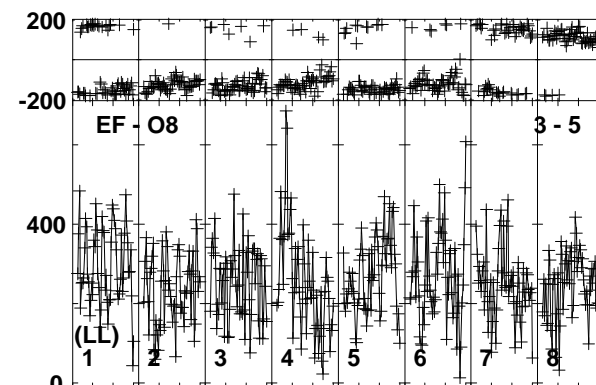
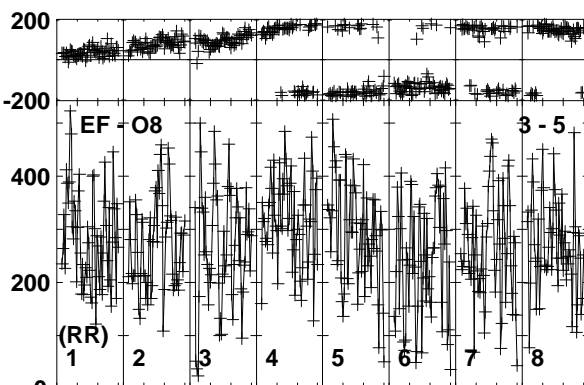
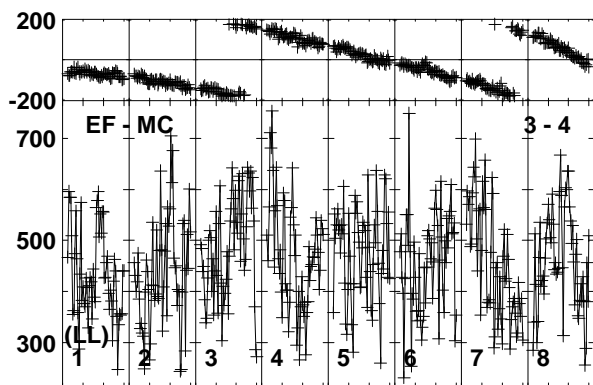
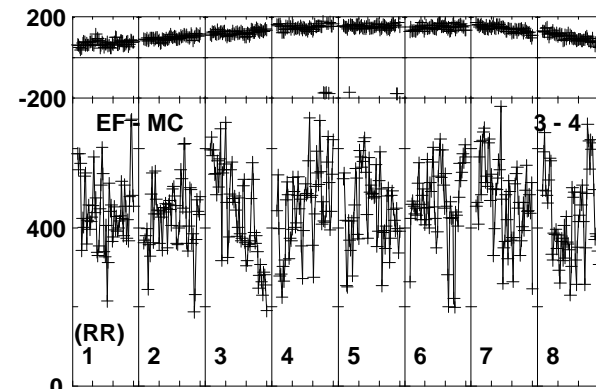
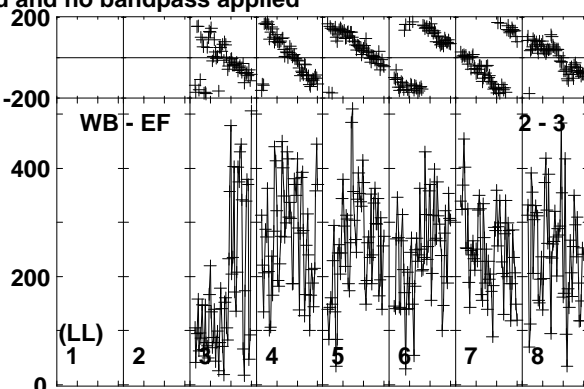
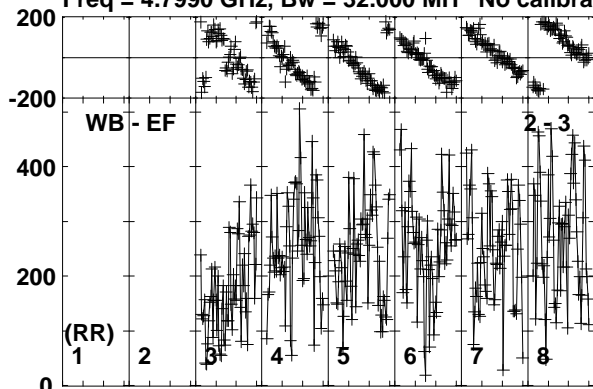

Lower frame: Micro Ampl Jy Top frame: Phas deg
Vector averaged cross-power spectrum Baseline: WB (02) - EF (03)
Timerange: 01/05:11:36 to 01/05:13:45

Plot file version 547 created 26-SEP-2019 10:43:31

J0300-0846 RG010A.UVDATA.1

Freq = 4.7990 GHz, Bw = 32.000 MH No calibration applied and no bandpass applied

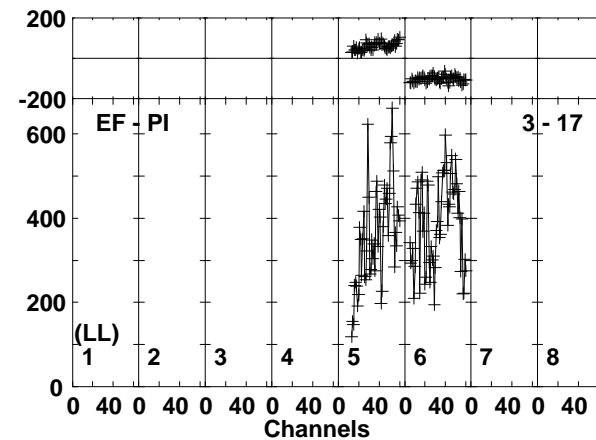
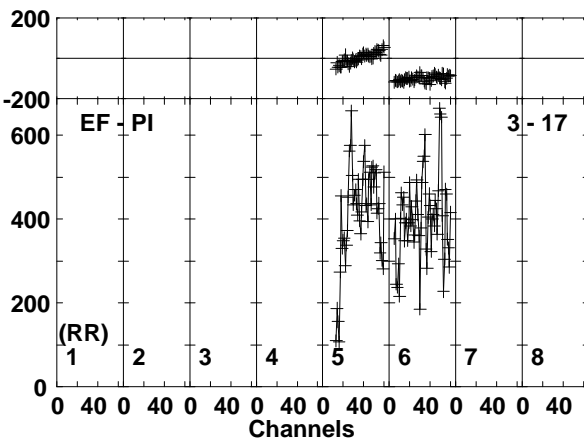
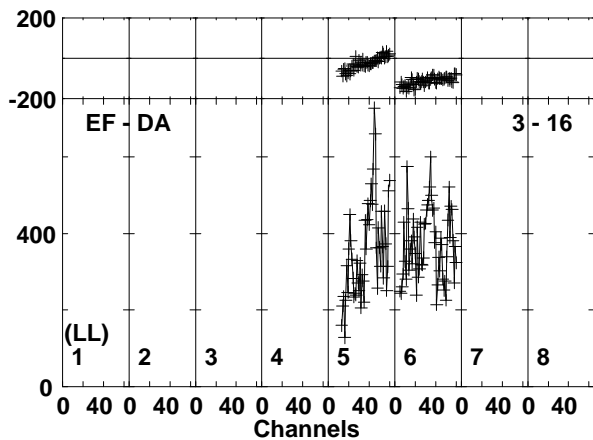
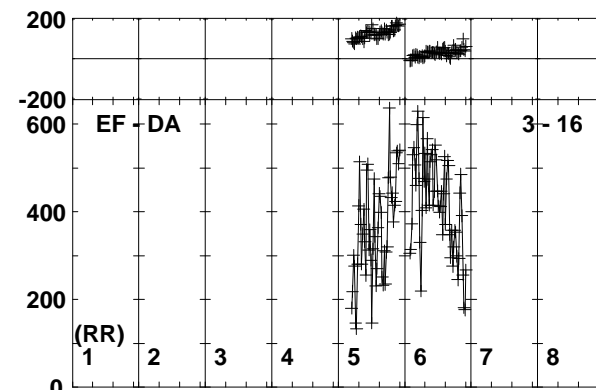
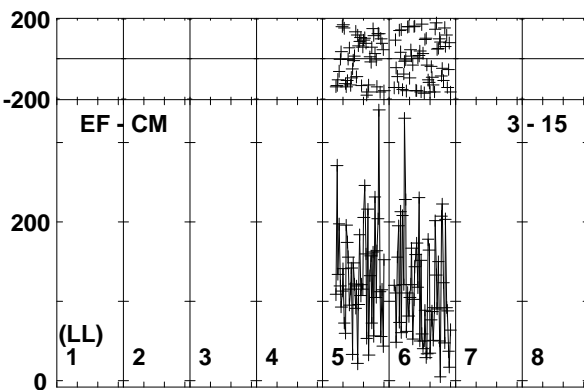
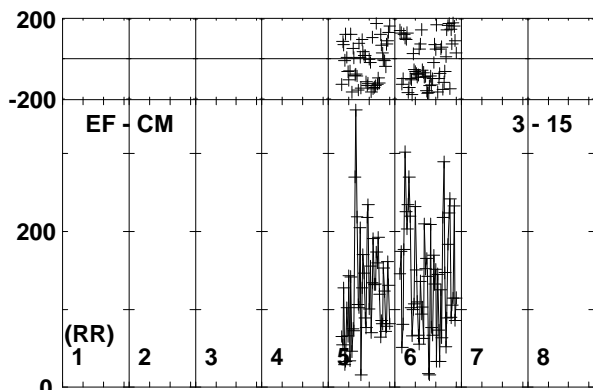
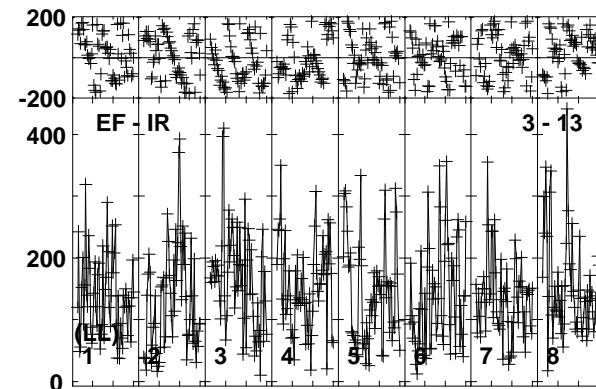
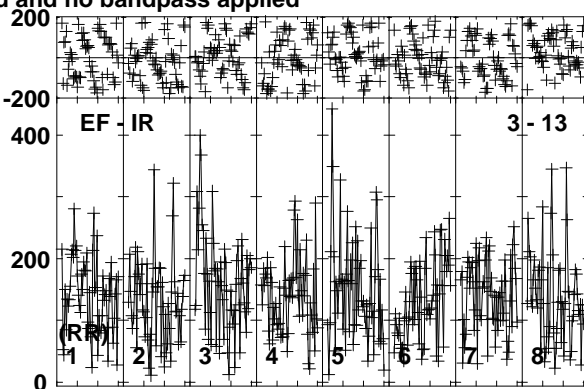
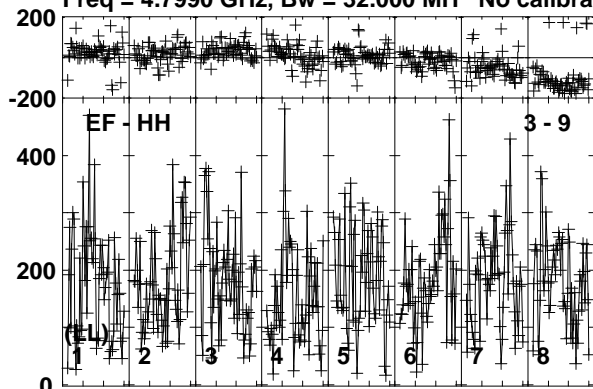

Lower frame: Micro Ampl Jy Top frame: Phas deg
Vector averaged cross-power spectrum Baseline: EF (03) - HH (09)
Timerange: 01/05:11:36 to 01/05:13:45

Plot file version 548 created 26-SEP-2019 10:43:32

J0300-0846 RG010A.UVDATA.1

Freq = 4.7990 GHz, Bw = 32.000 MH No calibration applied and no bandpass applied

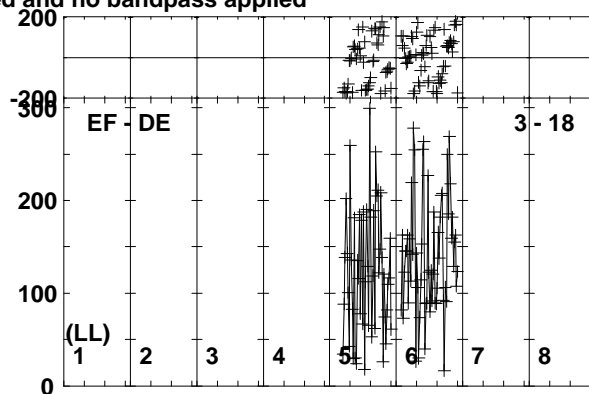
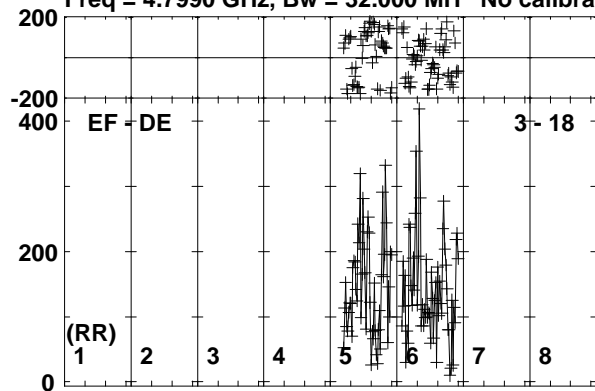

Lower frame: Micro Ampl Jy Top frame: Phas deg
Vector averaged cross-power spectrum Baseline: EF (03) - DE (18)
Timerange: 01/05:11:36 to 01/05:13:45

Plot file version 549 created 26-SEP-2019 10:43:32

J0257-1212 RG010A.UVDATA.1

Freq = 4.7990 GHz, Bw = 32.000 MH No calibration applied and no bandpass applied

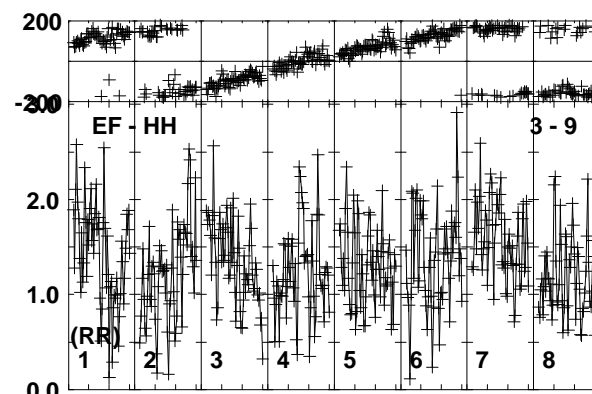
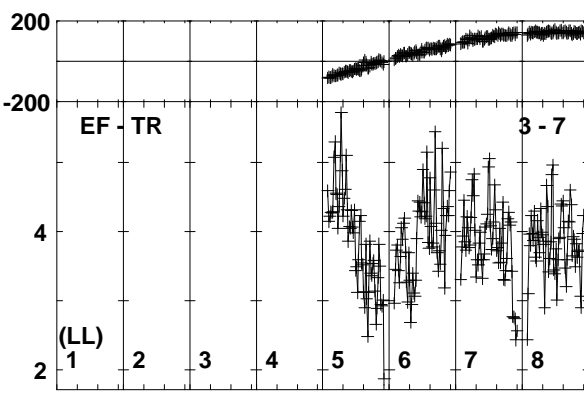
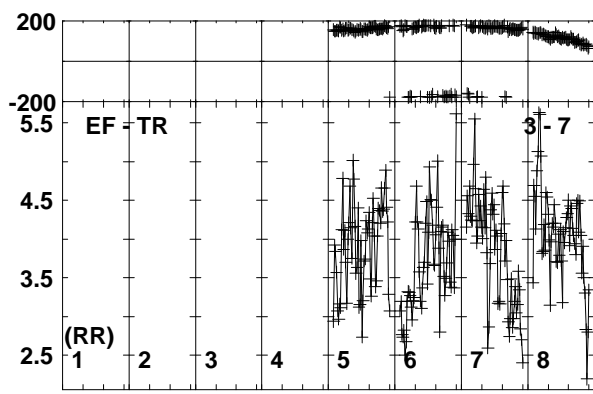
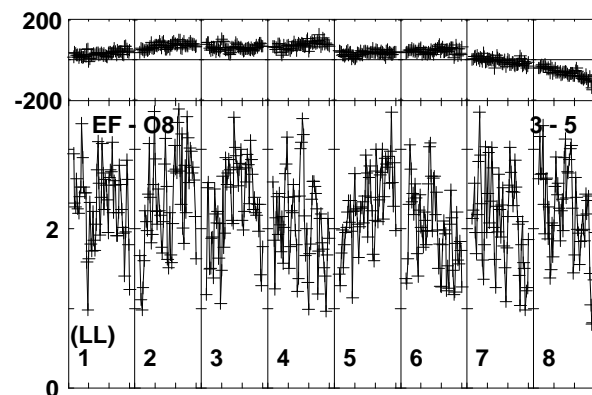
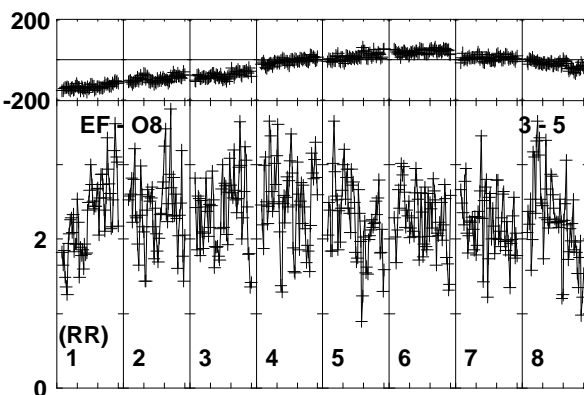
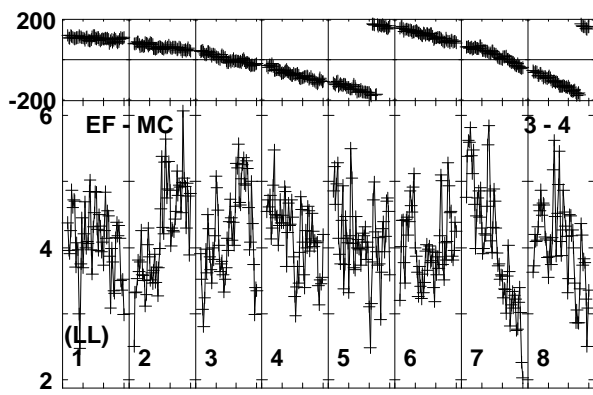
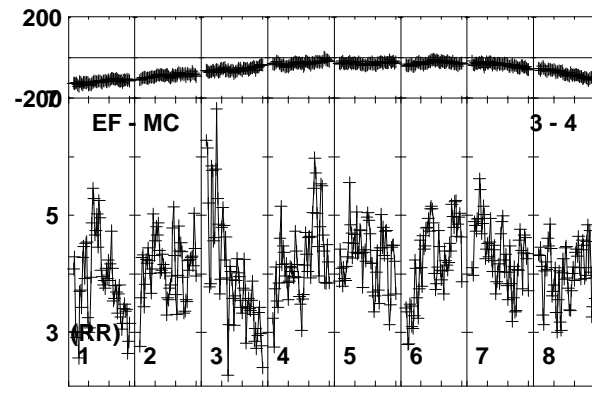
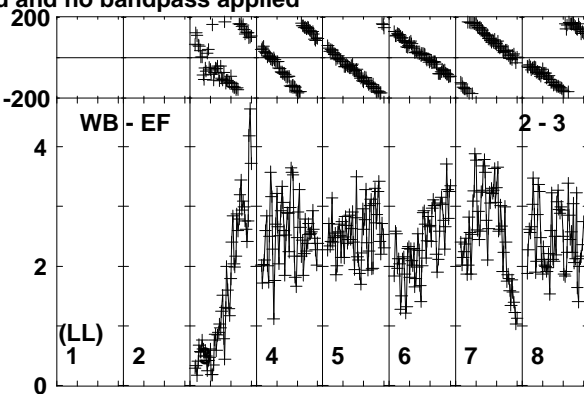
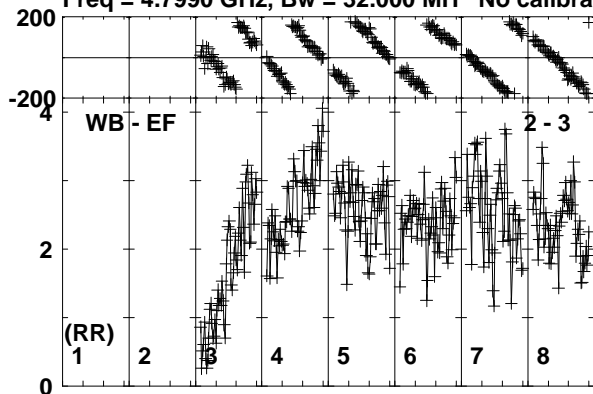

Lower frame: Milli Ampl Jy Top frame: Phas deg
Vector averaged cross-power spectrum Baseline: WB (02) - EF (03)
Timerange: 01/05:13:46 to 01/05:14:44

Plot file version 550 created 26-SEP-2019 10:43:32

J0257-1212 RG010A.UVDATA.1

Freq = 4.7990 GHz, Bw = 32.000 MH No calibration applied and no bandpass applied

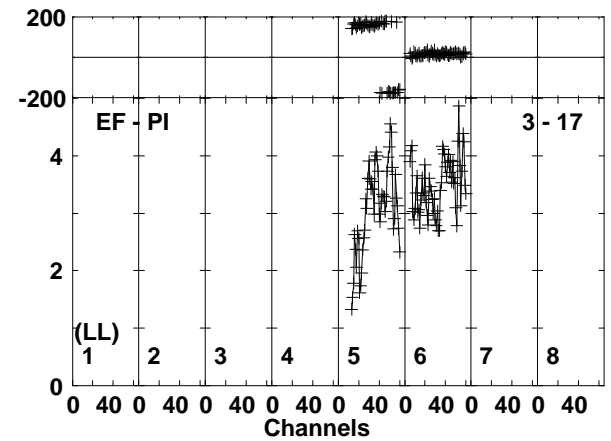
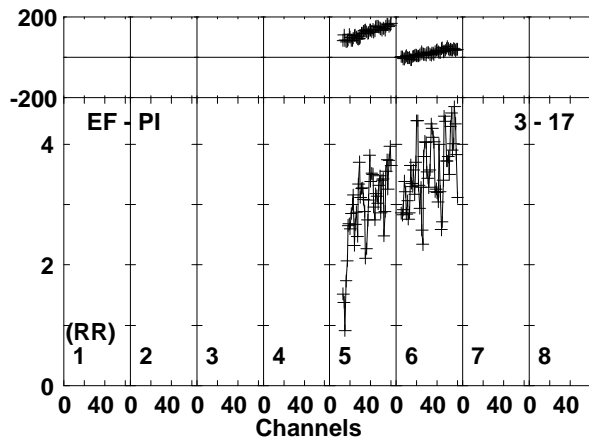
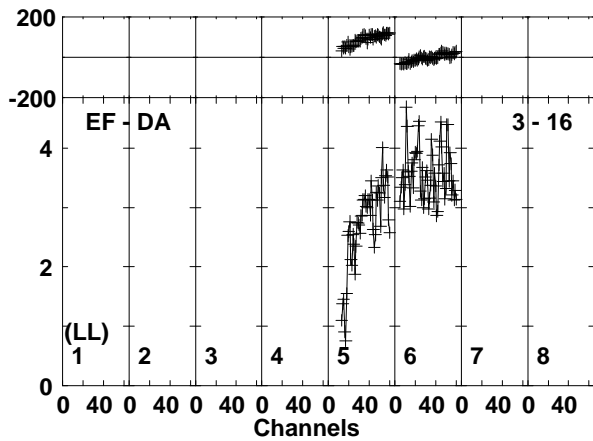
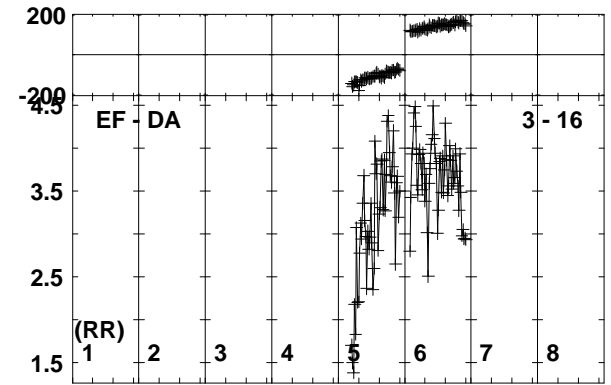
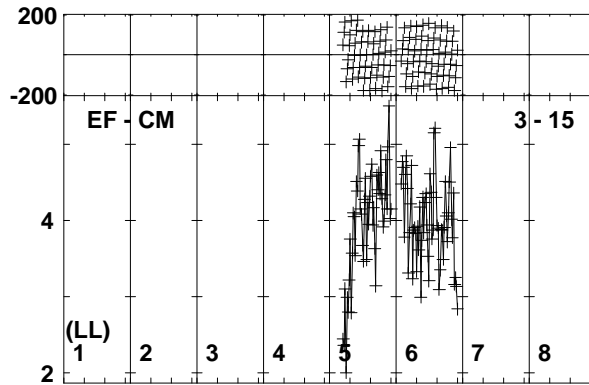
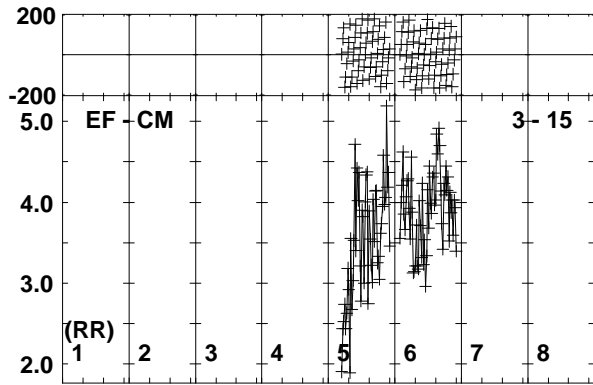
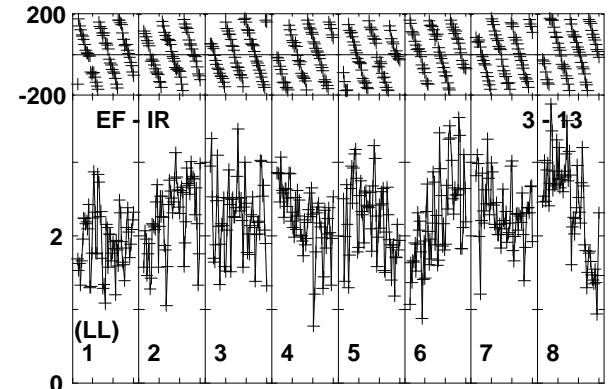
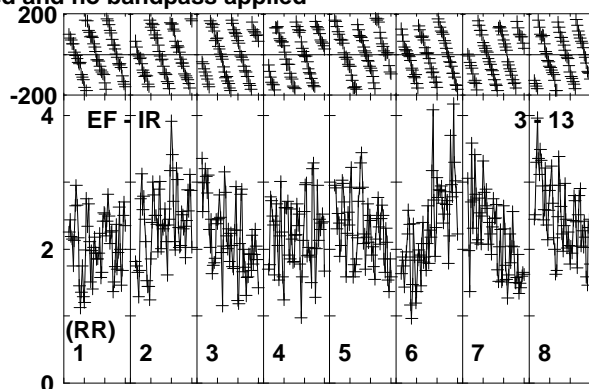
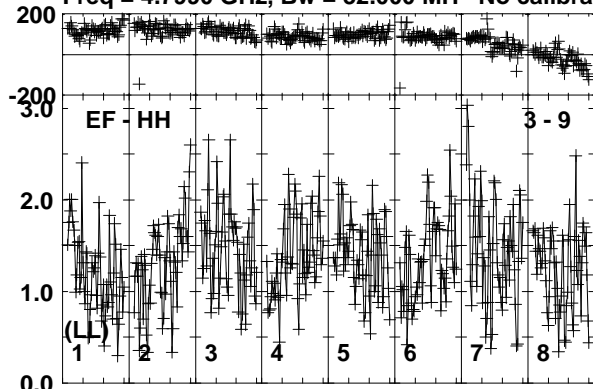

Lower frame: Milli Ampl Jy Top frame: Phas deg
Vector averaged cross-power spectrum Baseline: EF (03) - HH (09)
Timerange: 01/05:13:46 to 01/05:14:44

Plot file version 551 created 26-SEP-2019 10:43:32

J0257-1212 RG010A.UVDATA.1

Freq = 4.7990 GHz, Bw = 32.000 MH No calibration applied and no bandpass applied

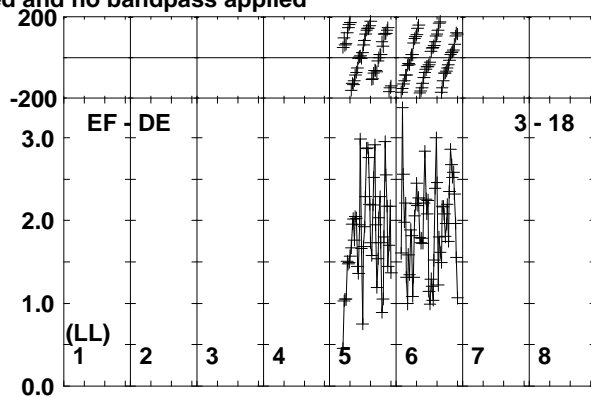
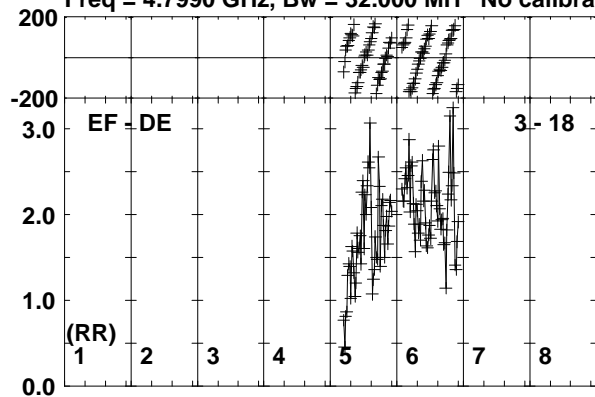

Lower frame: Milli Ampl Jy Top frame: Phas deg
Vector averaged cross-power spectrum Baseline: EF (03) - DE (18)
Timerange: 01/05:13:46 to 01/05:14:44

Plot file version 552 created 26-SEP-2019 10:43:32

190829A RG010A.UVDATA.1

Freq = 4.7990 GHz, Bw = 32.000 MH No calibration applied and no bandpass applied

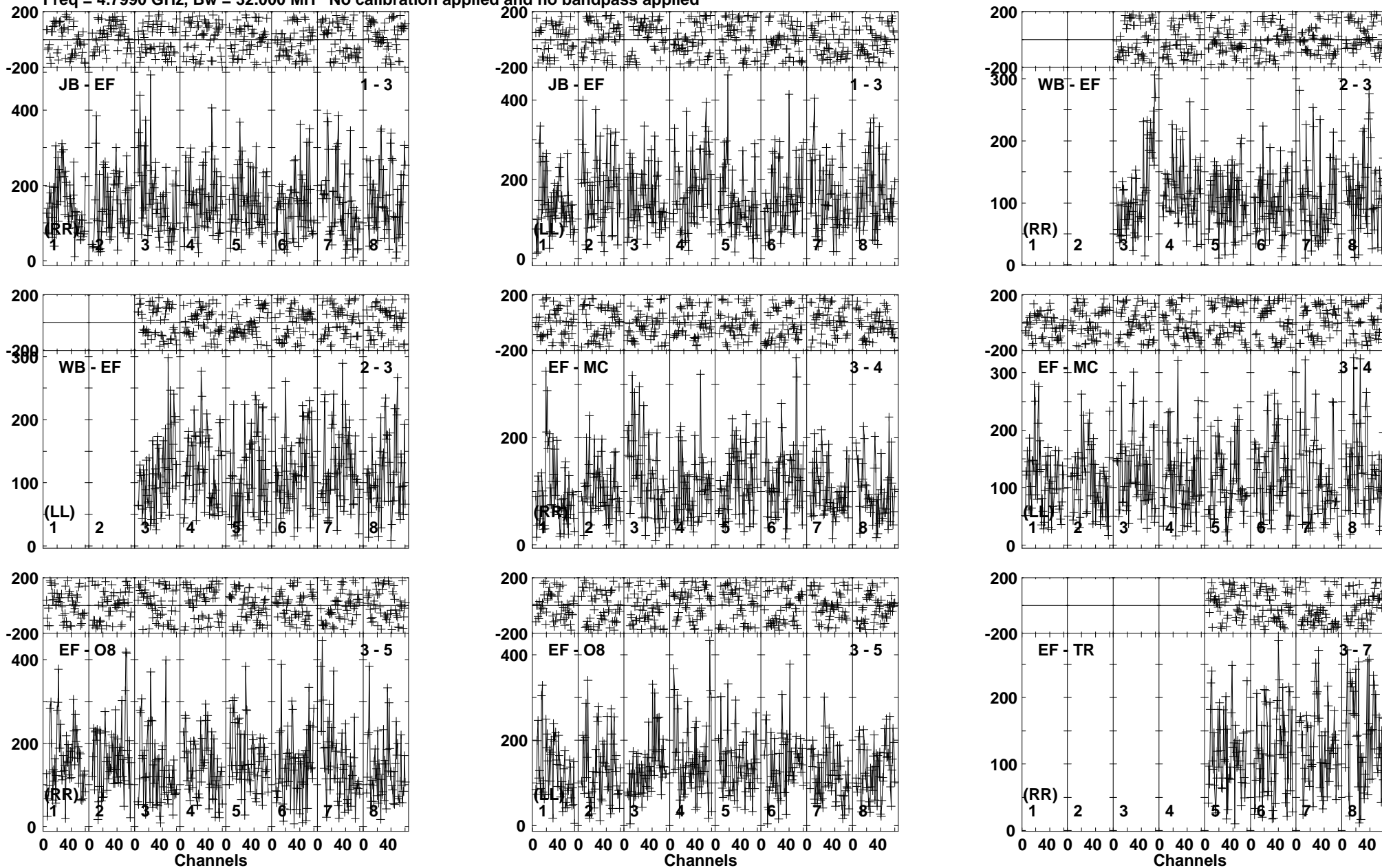

Lower frame: Micro Ampl Jy Top frame: Phas deg
Vector averaged cross-power spectrum Baseline: JB (01) - EF (03)
Timerange: 01/05:14:45 to 01/05:16:54

Plot file version 553 created 26-SEP-2019 10:43:33
 190829A RG010A.UVDATA.1
 Freq = 4.7990 GHz, Bw = 32.000 MH No calibration applied and no bandpass applied

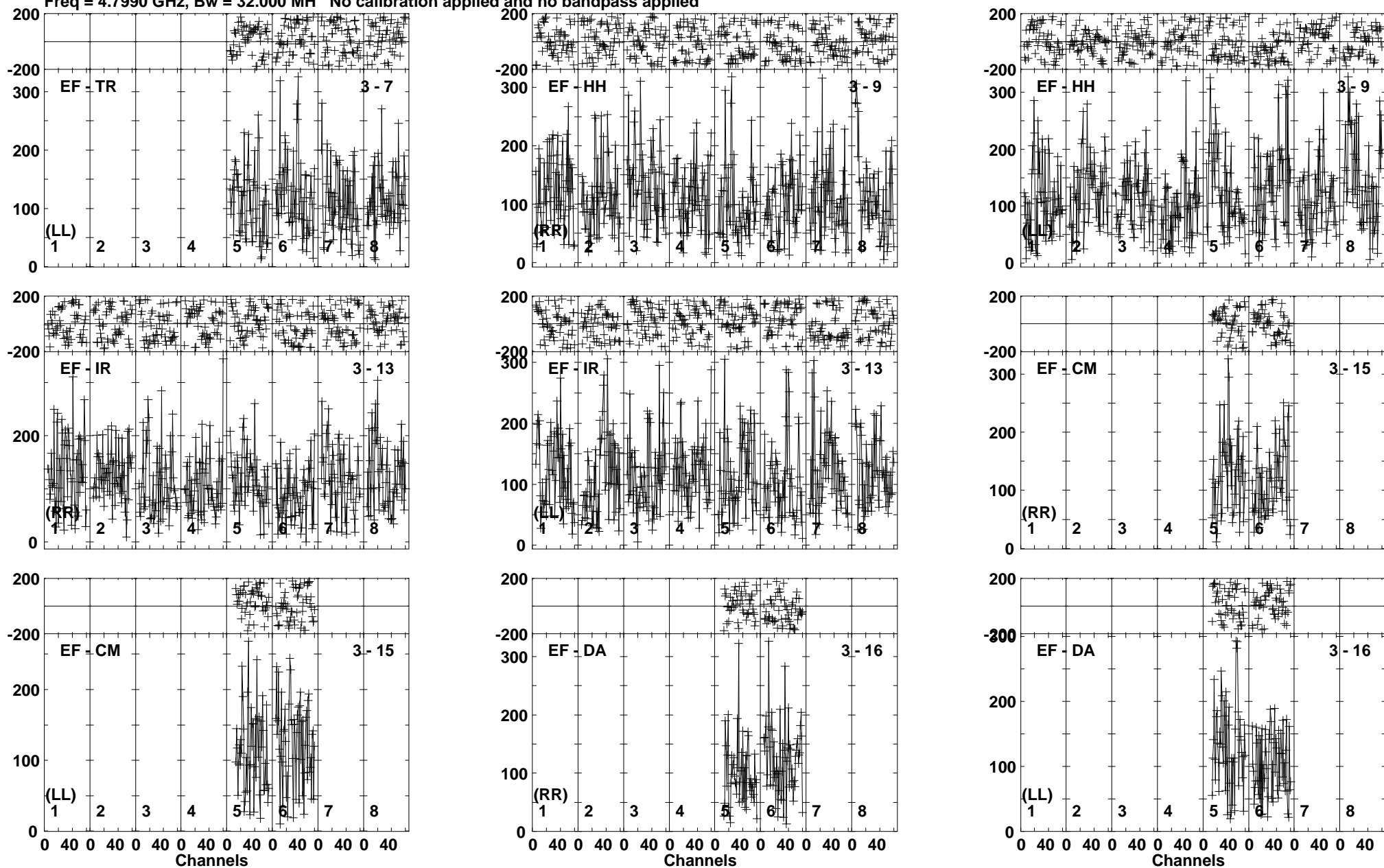

Lower frame: Micro Ampl Jy Top frame: Phas deg
 Vector averaged cross-power spectrum Baseline: EF (03) - TR (07)
 Timerange: 01/05:14:45 to 01/05:16:54

Plot file version 554 created 26-SEP-2019 10:43:33

190829A RG010A.UVDATA.1

Freq = 4.7990 GHz, Bw = 32.000 MH No calibration applied and no bandpass applied

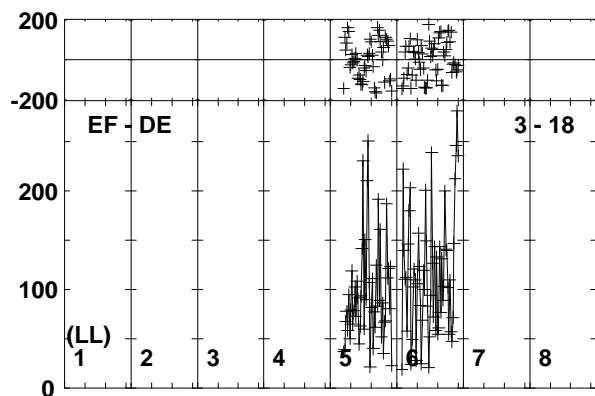
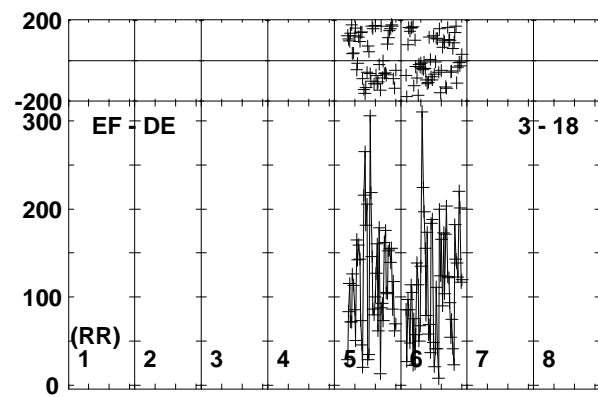
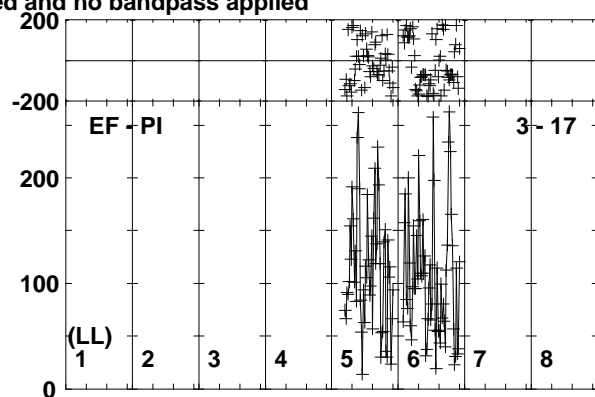
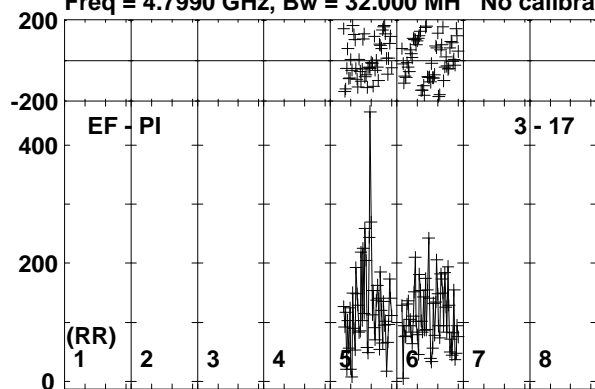

Lower frame: Micro Ampl Jy Top frame: Phas deg
Vector averaged cross-power spectrum Baseline: EF (03) - PI (17)
Timerange: 01/05:14:45 to 01/05:16:54

Plot file version 555 created 26-SEP-2019 10:43:33

J0257-1212 RG010A.UVDATA.1

Freq = 4.7990 GHz, Bw = 32.000 MH No calibration applied and no bandpass applied

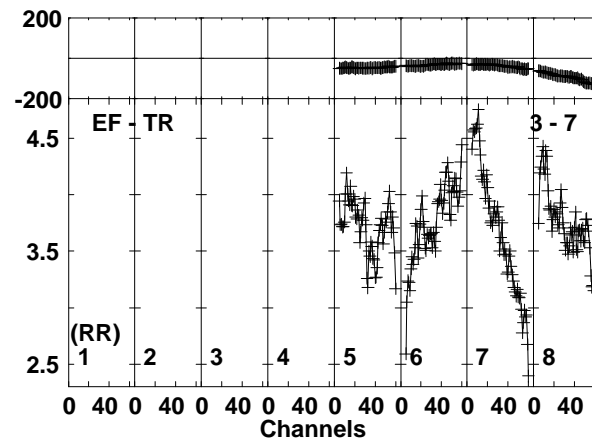
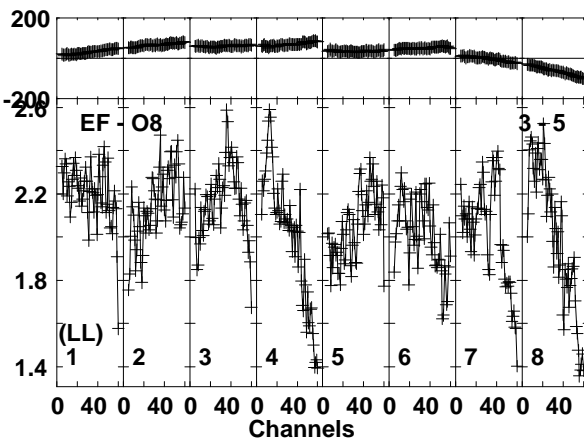
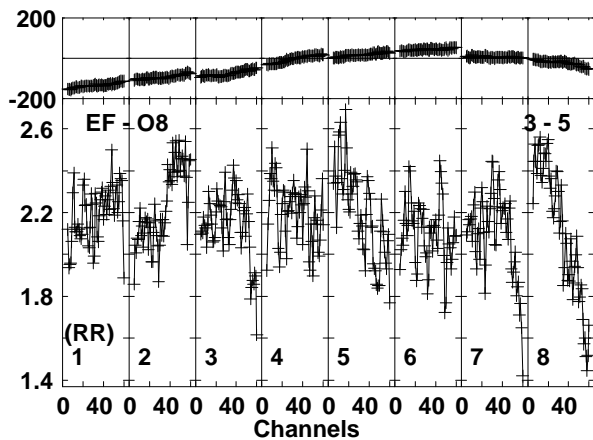
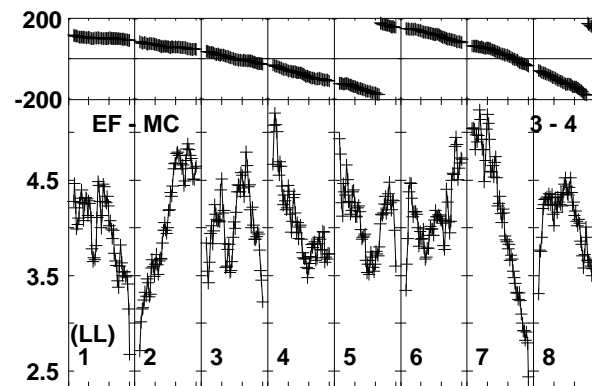
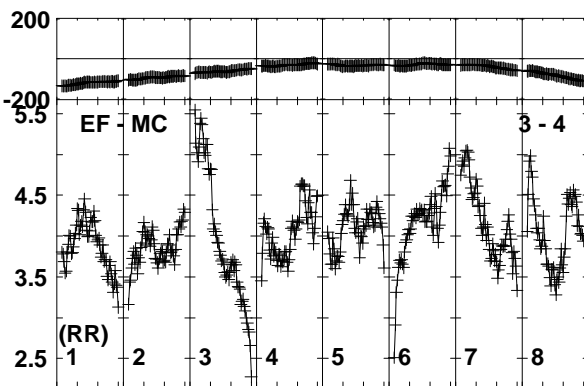
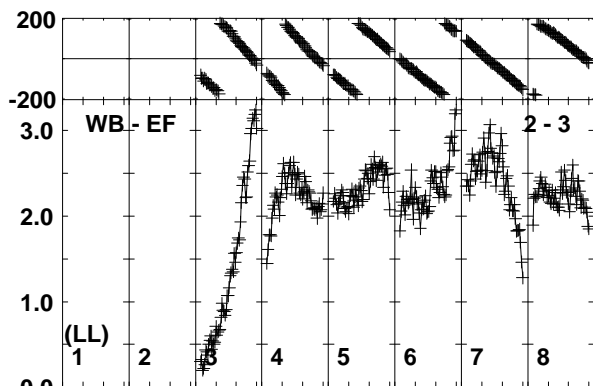
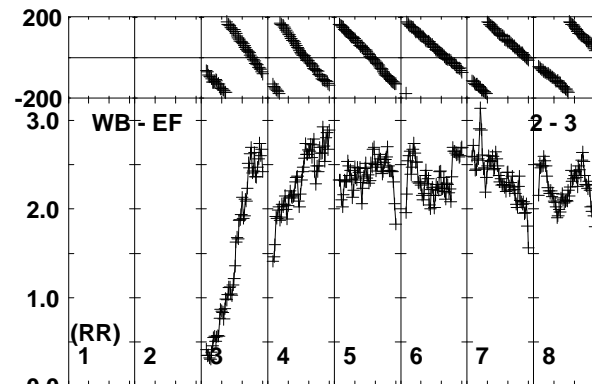
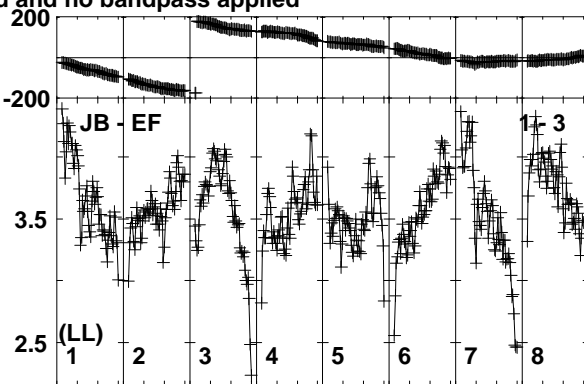
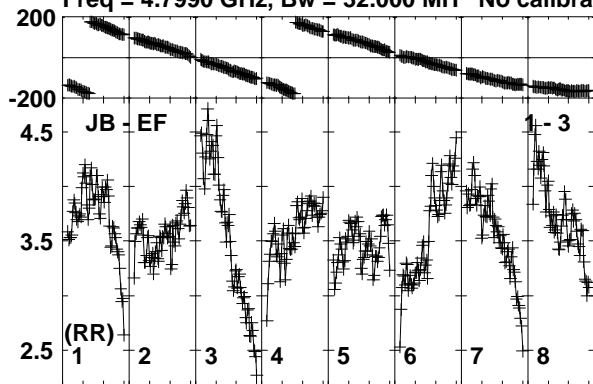

Lower frame: Milli Ampl Jy Top frame: Phas deg
Vector averaged cross-power spectrum Baseline: JB (01) - EF (03)
Timerange: 01/05:17:36 to 01/05:18:35

Plot file version 556 created 26-SEP-2019 10:43:33

J0257-1212 RG010A.UVDATA.1

Freq = 4.7990 GHz, Bw = 32.000 MH No calibration applied and no bandpass applied

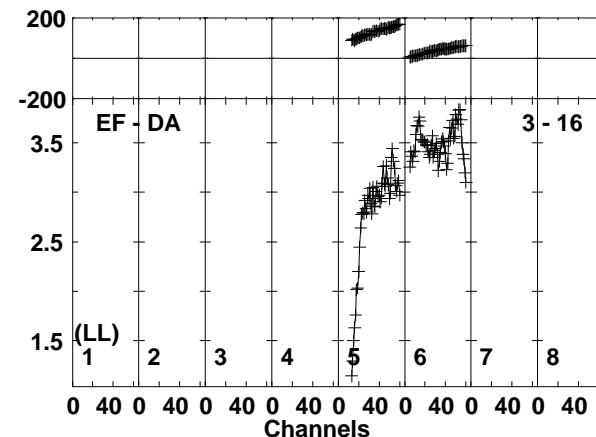
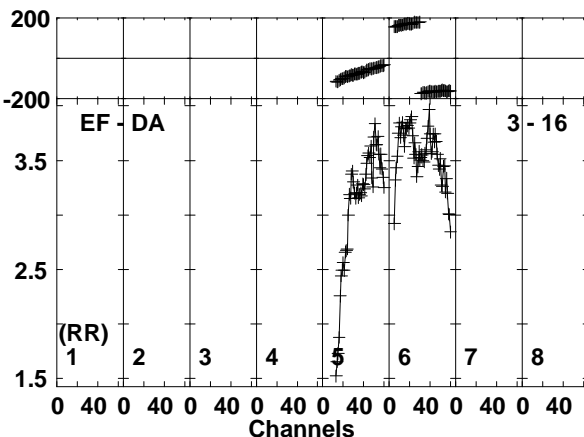
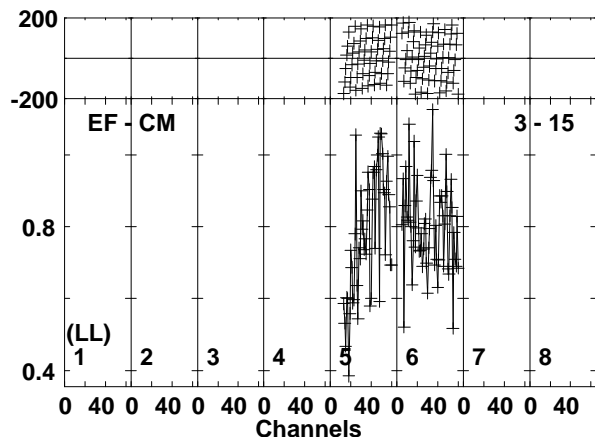
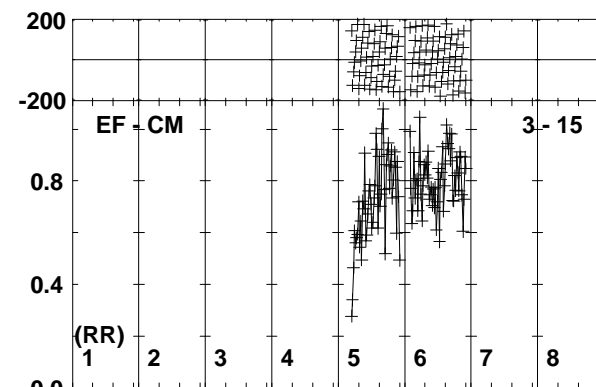
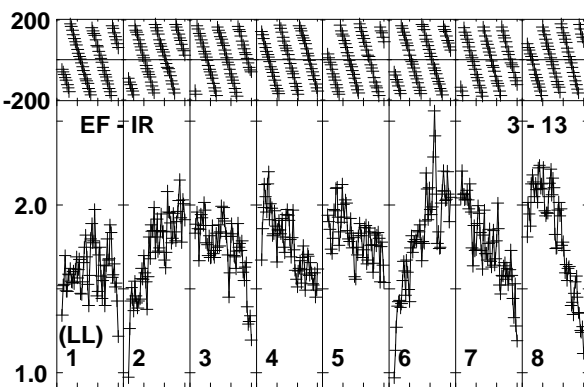
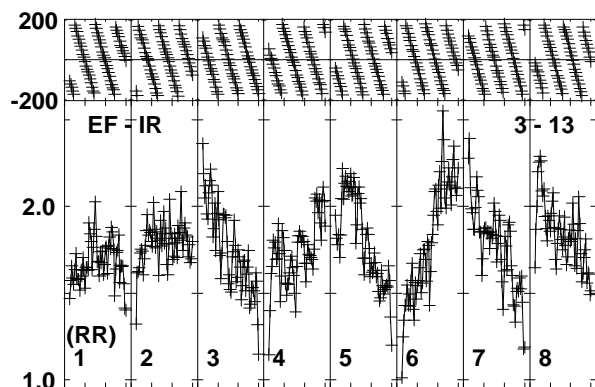
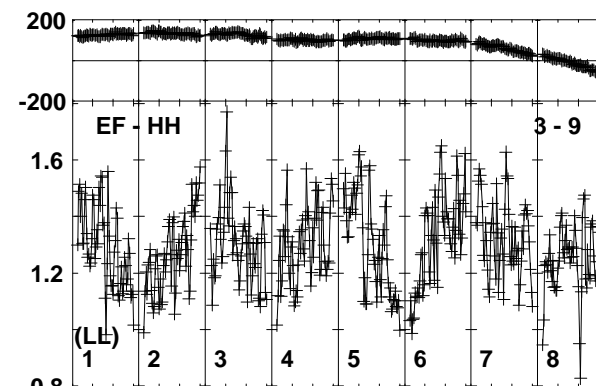
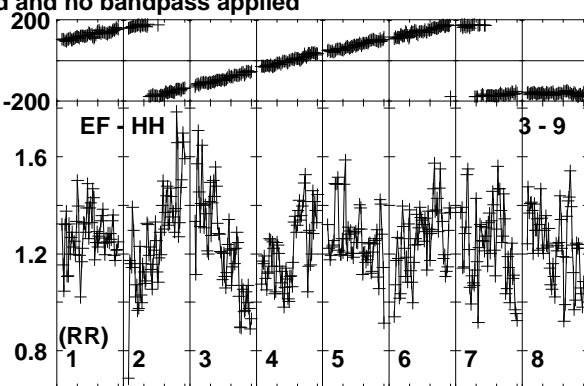
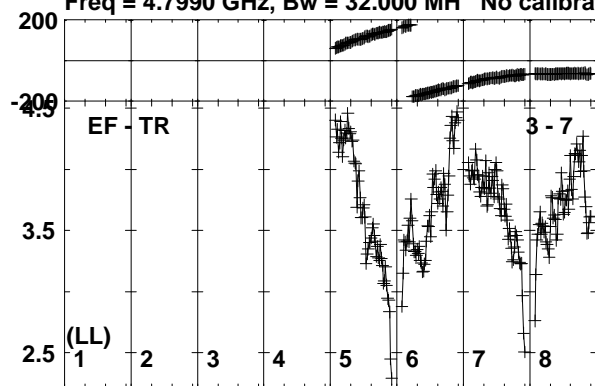

Lower frame: Milli Ampl Jy Top frame: Phas deg
Vector averaged cross-power spectrum Baseline: EF (03) - TR (07)
Timerange: 01/05:17:36 to 01/05:18:35

Plot file version 557 created 26-SEP-2019 10:43:34

J0257-1212 RG010A.UVDATA.1

Freq = 4.7990 GHz, Bw = 32.000 MH No calibration applied and no bandpass applied

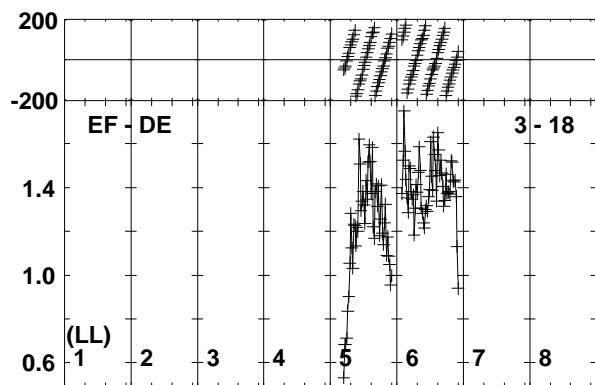
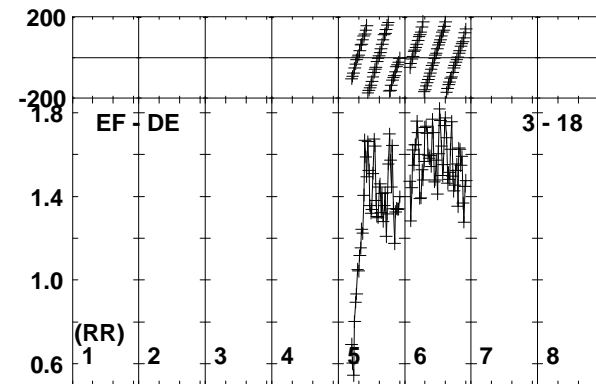
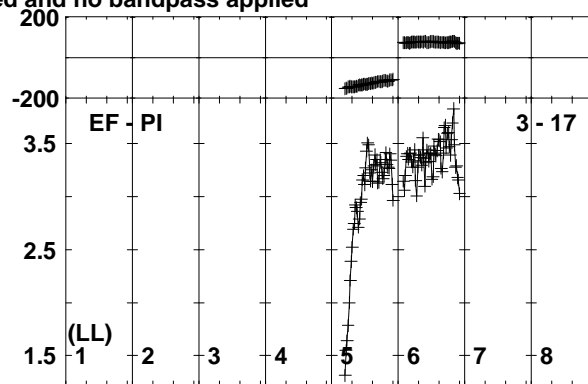
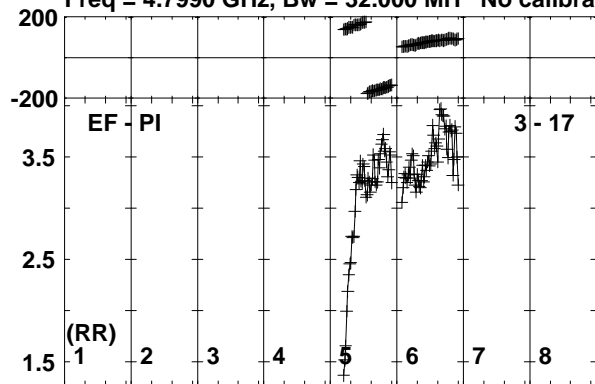

Lower frame: Milli Ampl Jy Top frame: Phas deg
Vector averaged cross-power spectrum Baseline: EF (03) - PI (17)
Timerange: 01/05:17:36 to 01/05:18:35

Plot file version 558 created 26-SEP-2019 10:43:34

190829A RG010A.UVDATA.1

Freq = 4.7990 GHz, Bw = 32.000 MH No calibration applied and no bandpass applied

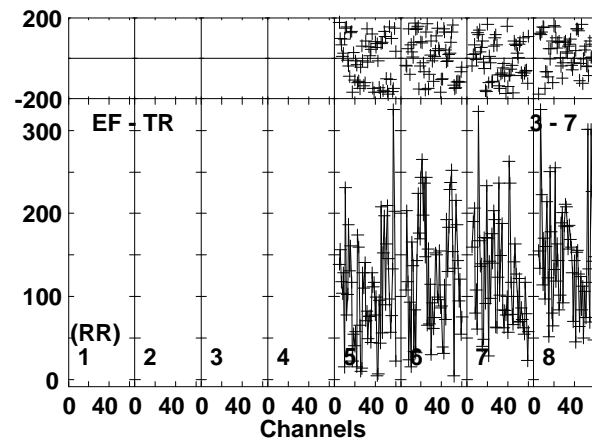
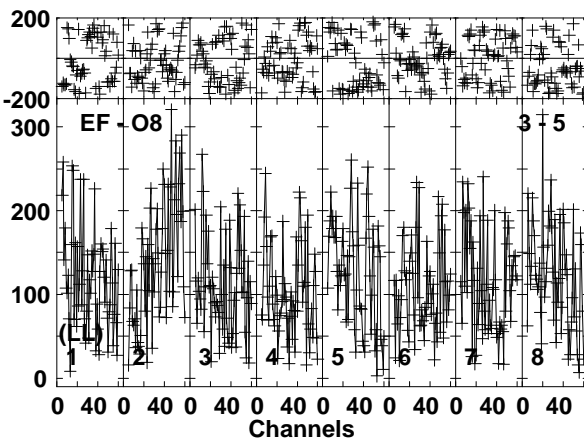
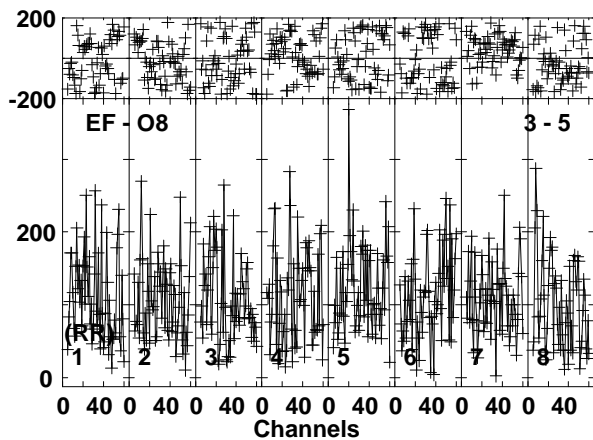
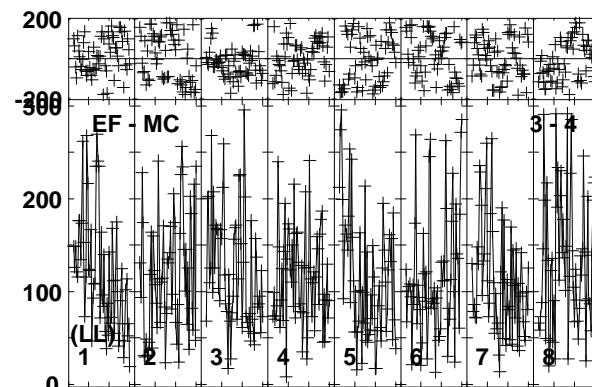
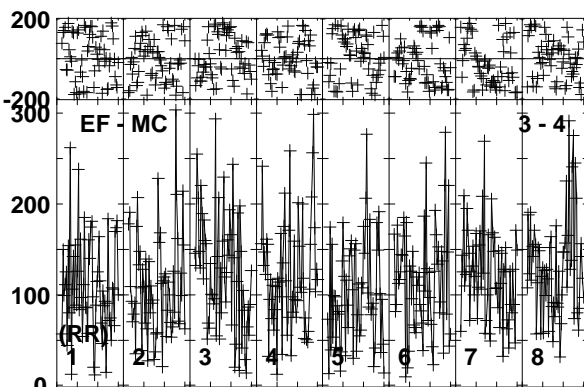
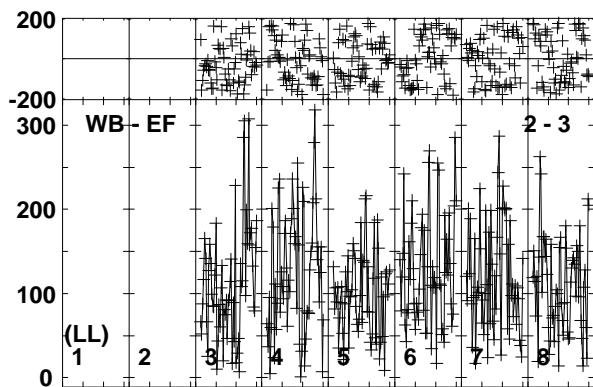
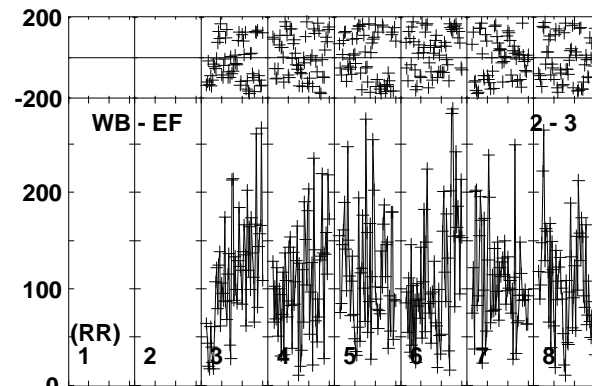
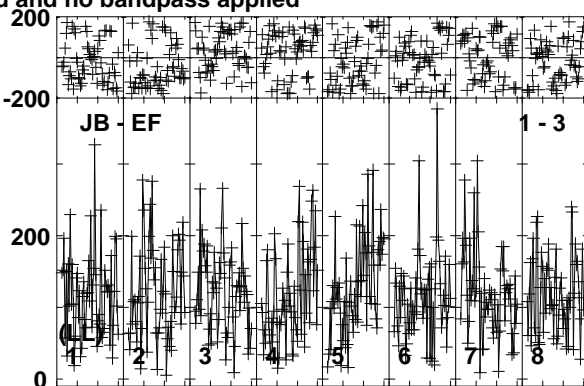
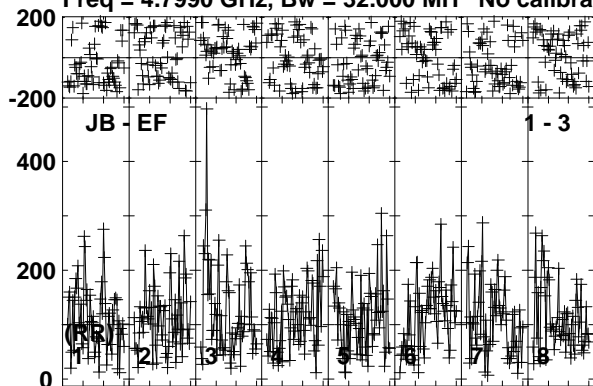

Lower frame: Micro Ampl Jy Top frame: Phas deg
Vector averaged cross-power spectrum Baseline: JB (01) - EF (03)
Timerange: 01/05:18:36 to 01/05:20:45

Plot file version 559 created 26-SEP-2019 10:43:34

190829A RG010A.UVDATA.1

Freq = 4.7990 GHz, Bw = 32.000 MH No calibration applied and no bandpass applied

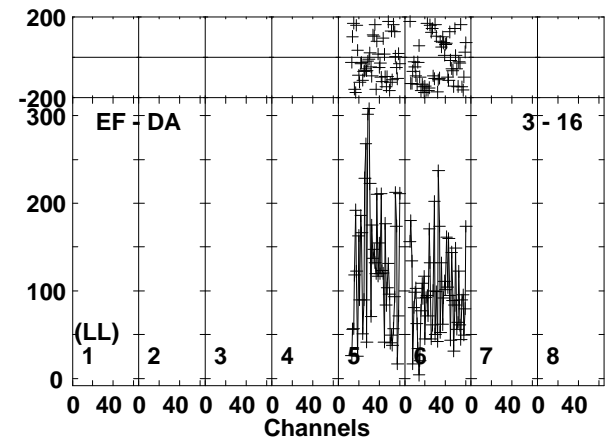
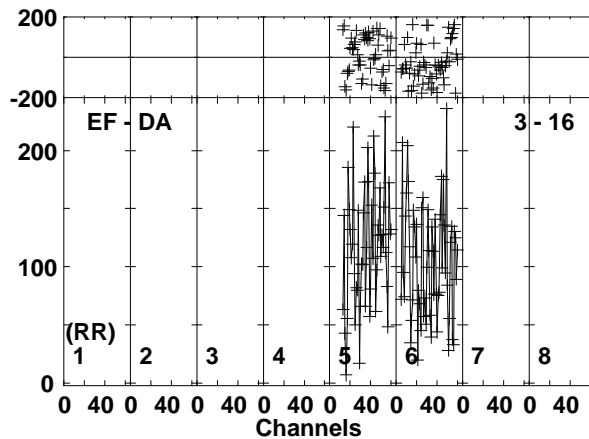
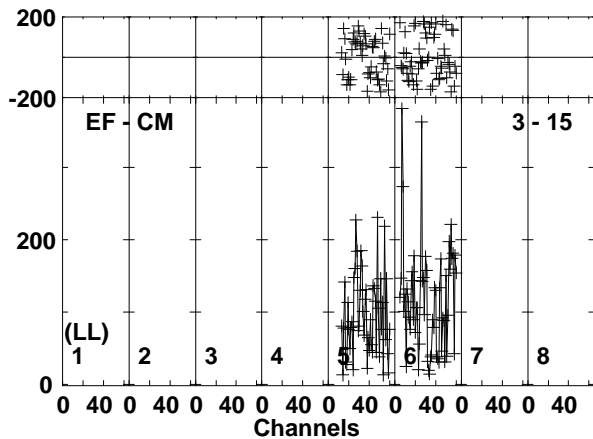
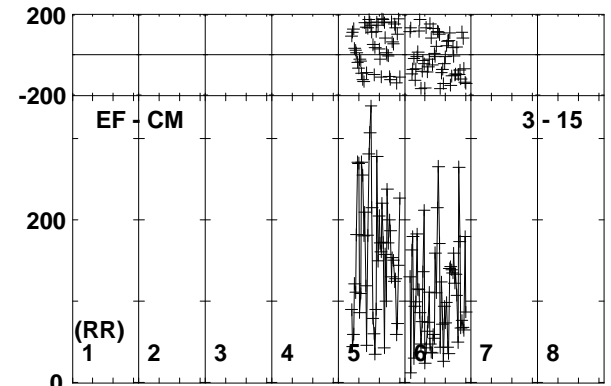
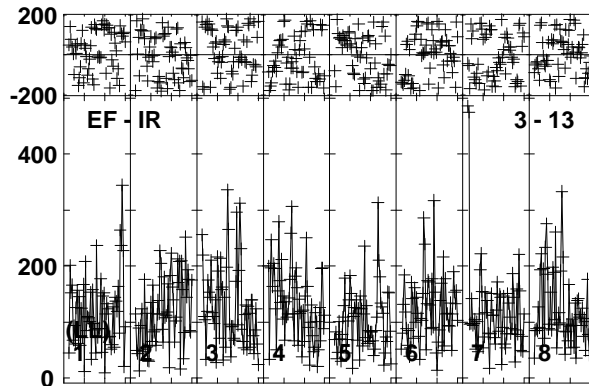
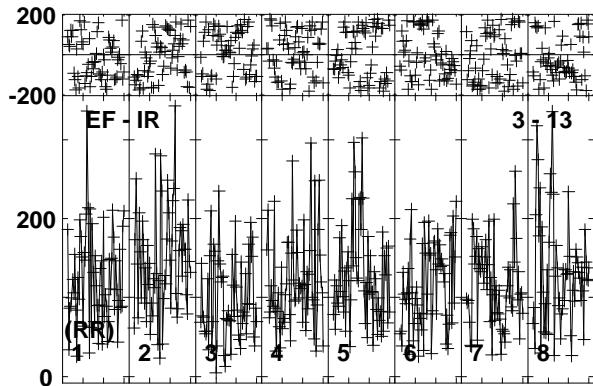
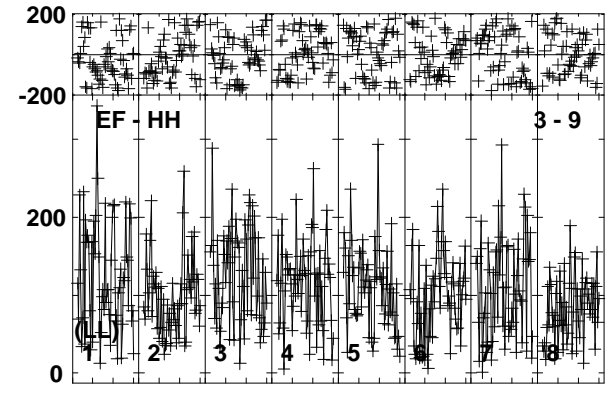
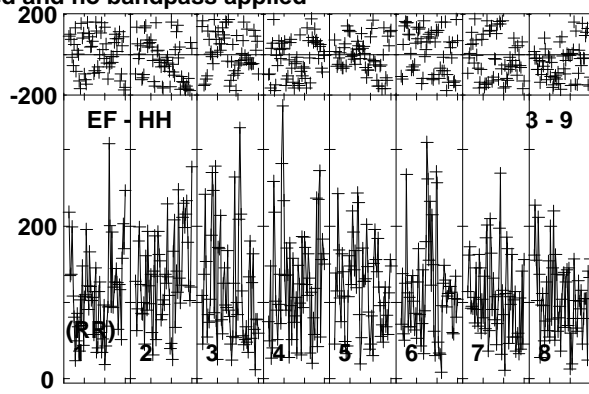
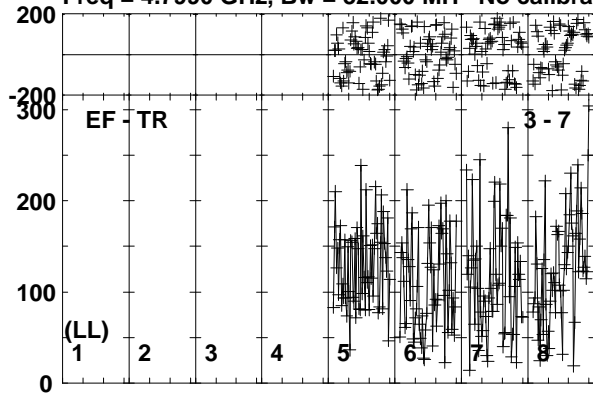

Lower frame: Micro Ampl Jy Top frame: Phas deg
Vector averaged cross-power spectrum Baseline: EF (03) - TR (07)
Timerange: 01/05:18:36 to 01/05:20:45

Plot file version 560 created 26-SEP-2019 10:43:35

190829A RG010A.UVDATA.1

Freq = 4.7990 GHz, Bw = 32.000 MH No calibration applied and no bandpass applied

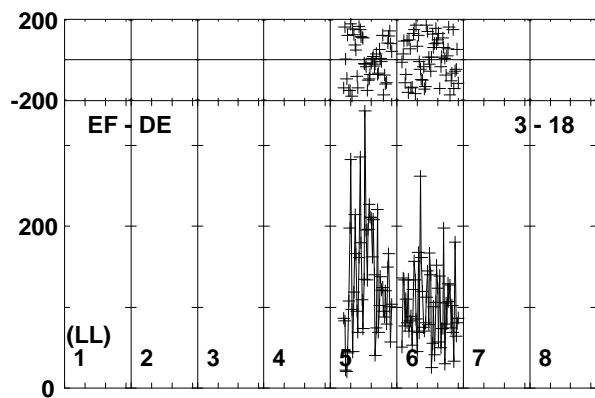
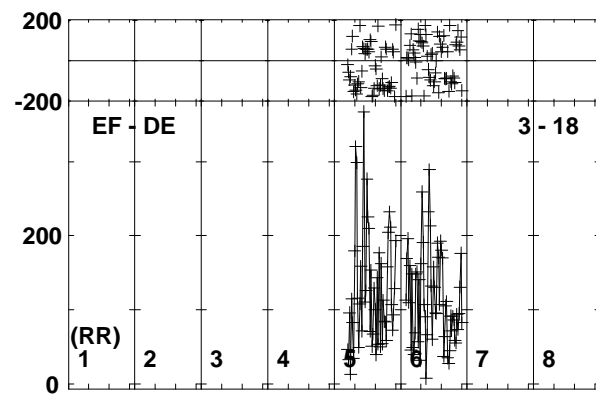
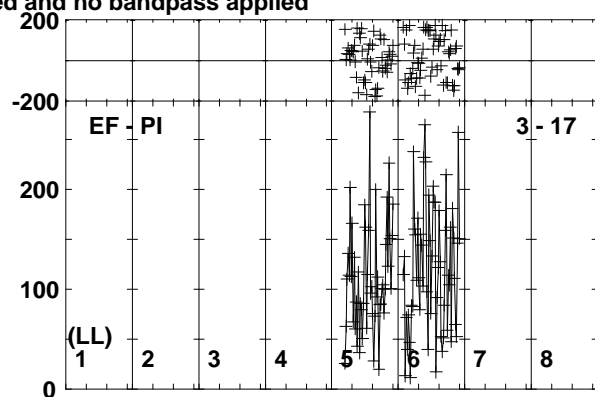
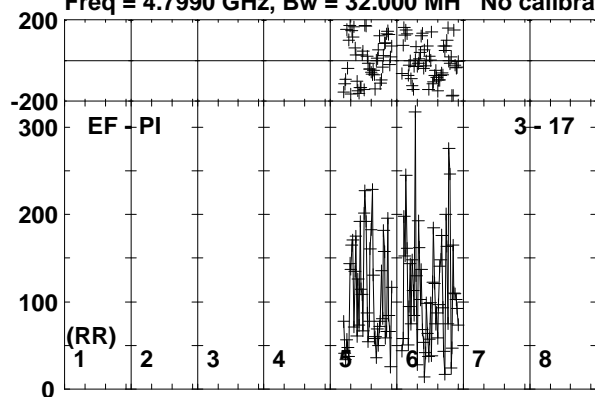

Lower frame: Micro Ampl Jy Top frame: Phas deg
Vector averaged cross-power spectrum Baseline: EF (03) - PI (17)
Timerange: 01/05:18:36 to 01/05:20:45

Plot file version 561 created 26-SEP-2019 10:43:35

J0257-1212 RG010A.UVDATA.1

Freq = 4.7990 GHz, Bw = 32.000 MH No calibration applied and no bandpass applied

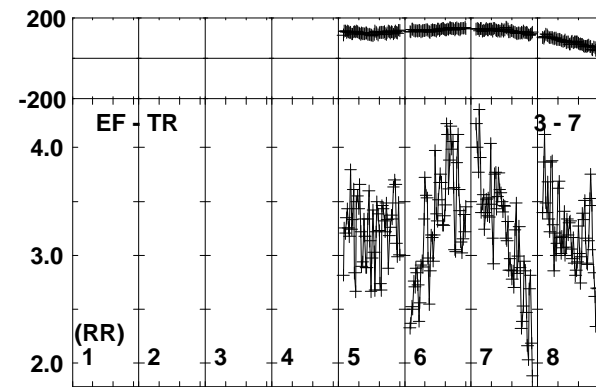
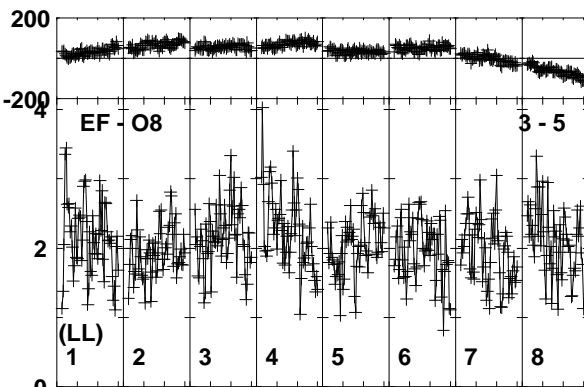
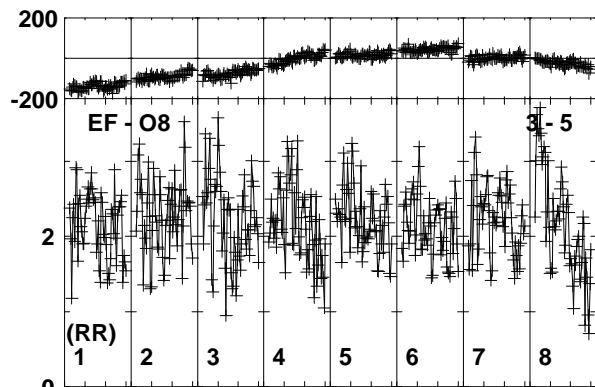
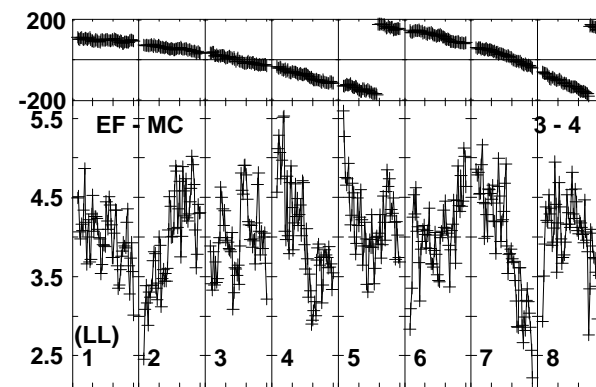
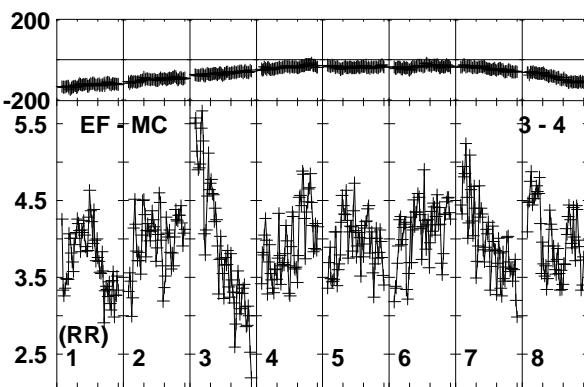
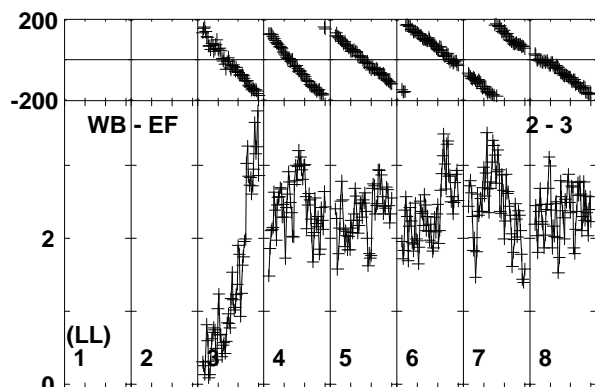
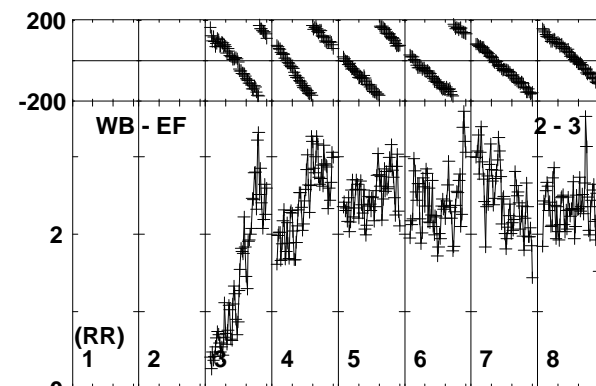
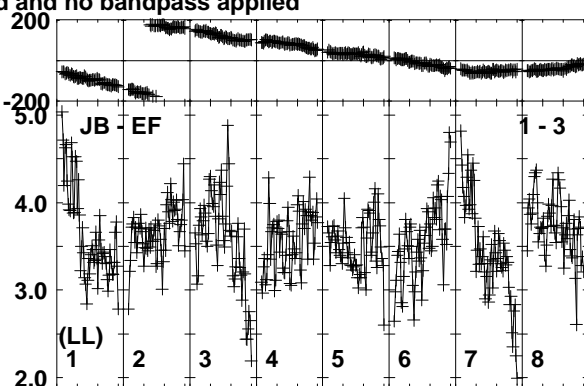
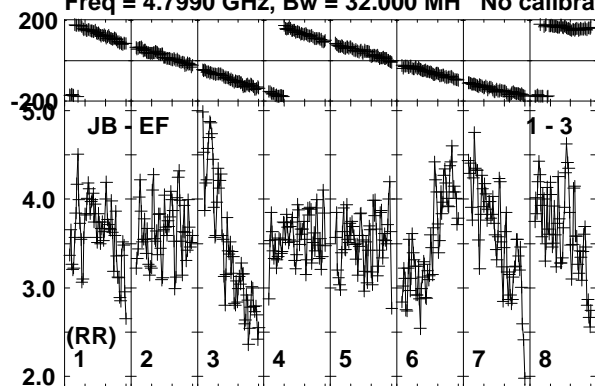

Lower frame: Milli Ampl Jy Top frame: Phas deg
Vector averaged cross-power spectrum Baseline: JB (01) - EF (03)
Timerange: 01/05:20:46 to 01/05:21:44

Plot file version 562 created 26-SEP-2019 10:43:35

J0257-1212 RG010A.UVDATA.1

Freq = 4.7990 GHz, Bw = 32.000 MH No calibration applied and no bandpass applied

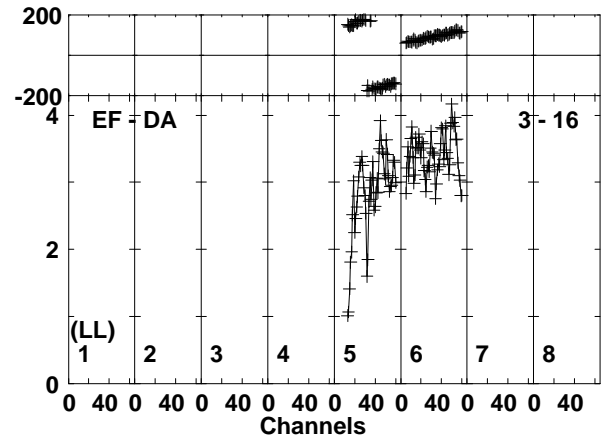
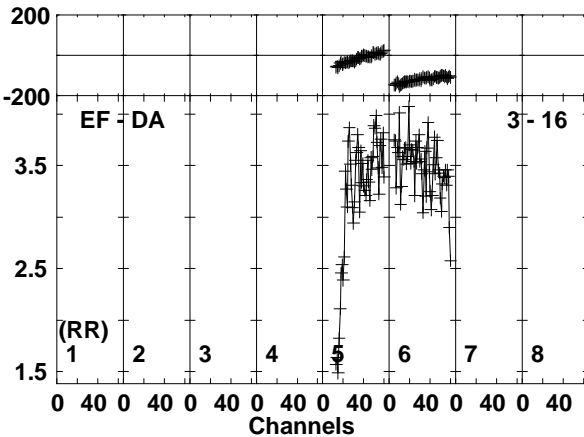
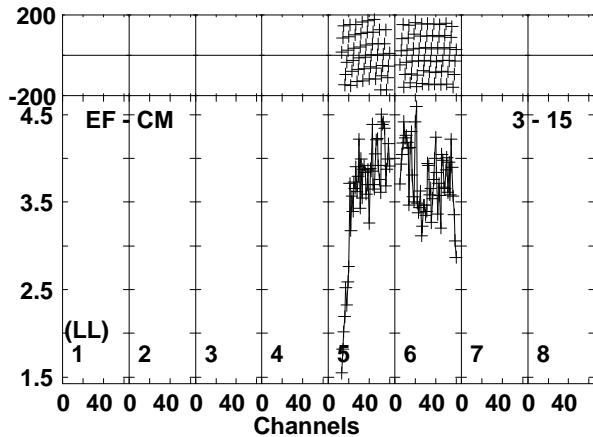
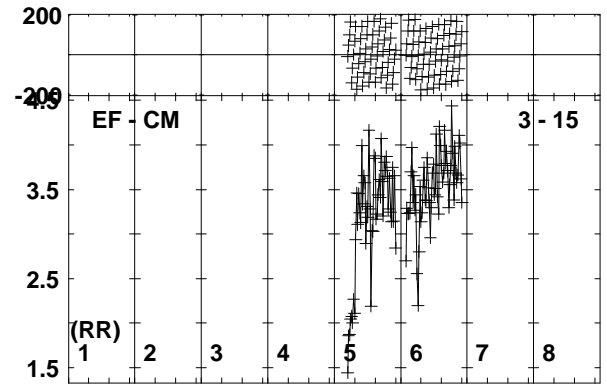
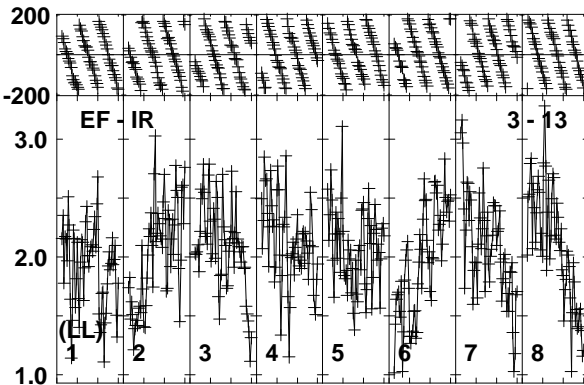
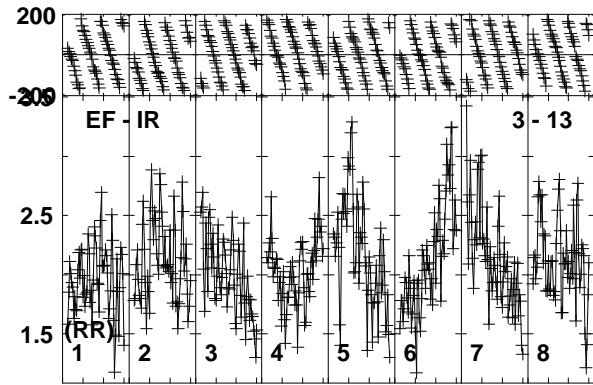
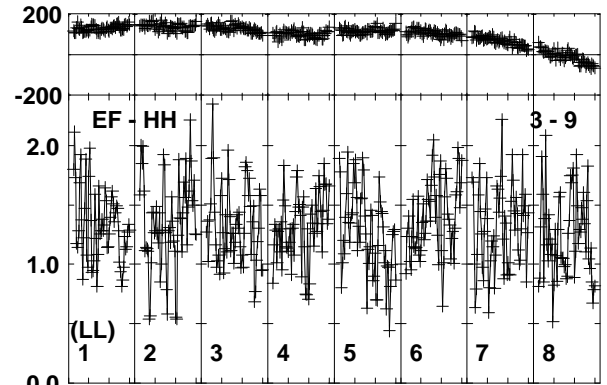
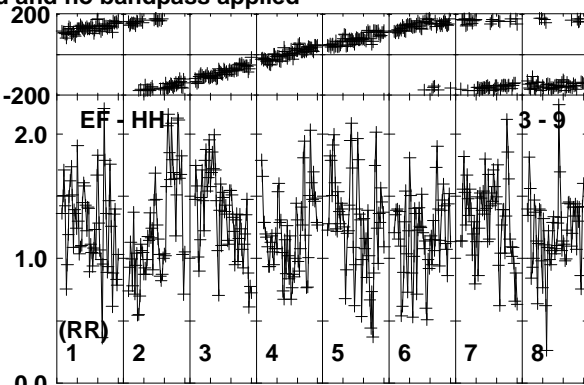
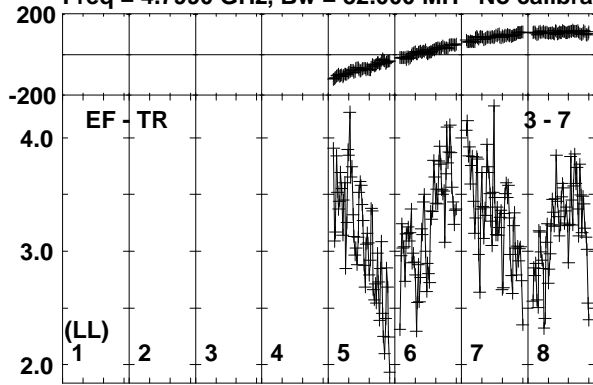

Lower frame: Milli Ampl Jy Top frame: Phas deg
Vector averaged cross-power spectrum Baseline: EF (03) - TR (07)
Timerange: 01/05:20:46 to 01/05:21:44

Plot file version 563 created 26-SEP-2019 10:43:35

J0257-1212 RG010A.UVDATA.1

Freq = 4.7990 GHz, Bw = 32.000 MH No calibration applied and no bandpass applied

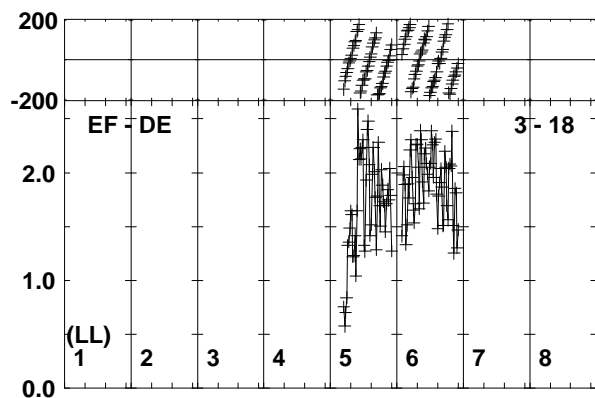
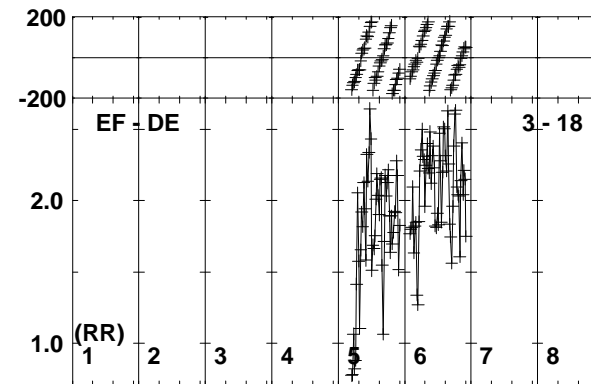
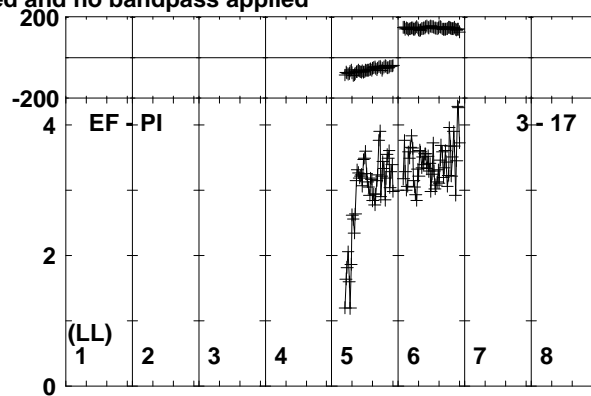
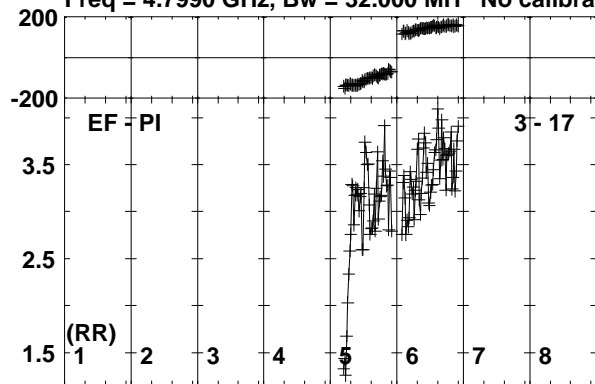

Lower frame: Milli Ampl Jy Top frame: Phas deg
Vector averaged cross-power spectrum Baseline: EF (03) - PI (17)
Timerange: 01/05:20:46 to 01/05:21:44

Plot file version 564 created 26-SEP-2019 10:43:35

190829A RG010A.UVDATA.1

Freq = 4.7990 GHz, Bw = 32.000 MH No calibration applied and no bandpass applied

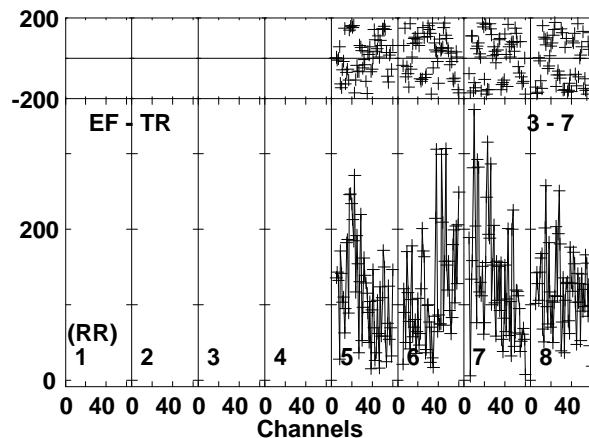
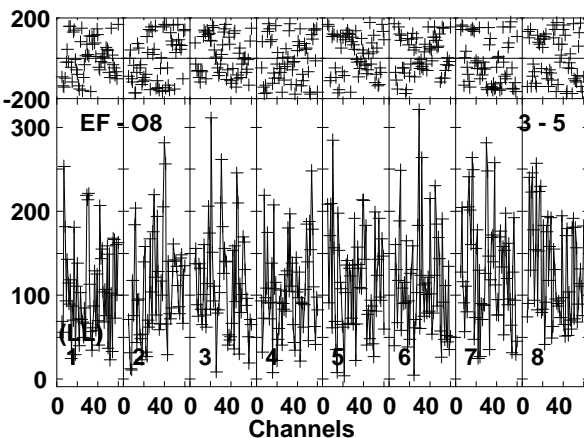
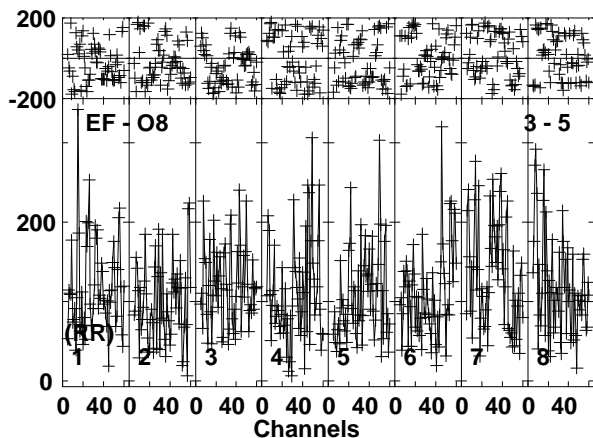
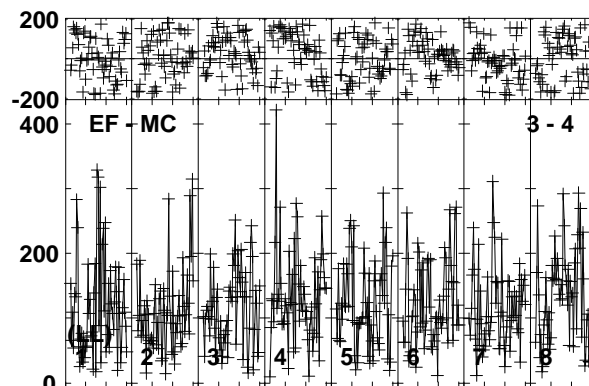
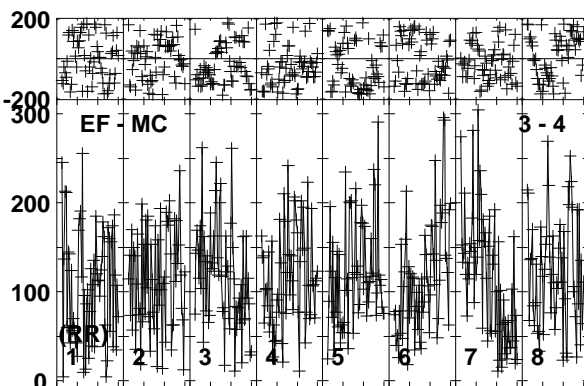
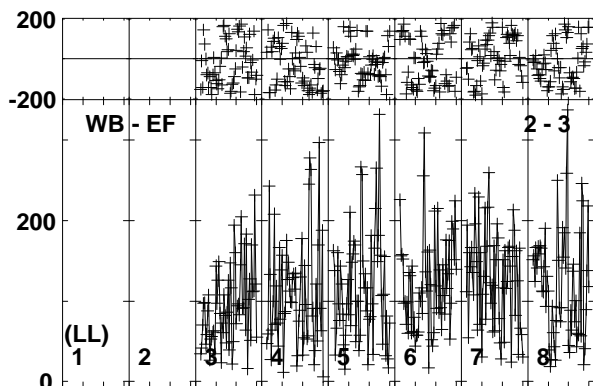
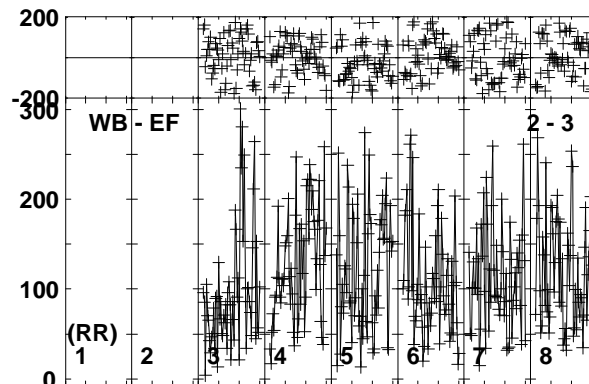
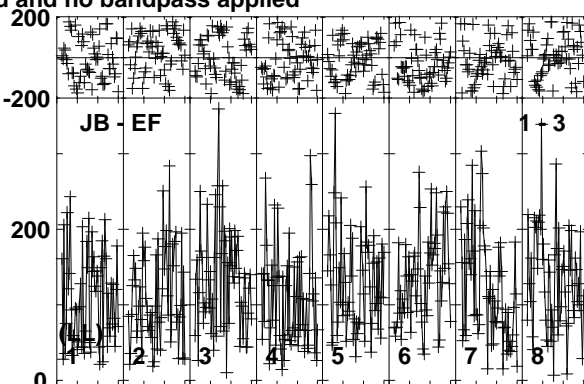
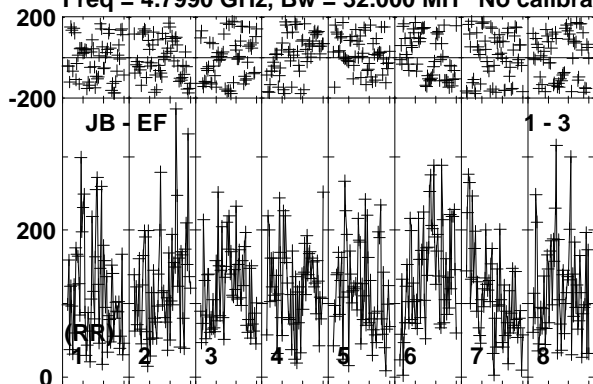

Lower frame: Micro Ampl Jy Top frame: Phas deg
Vector averaged cross-power spectrum Baseline: JB (01) - EF (03)
Timerange: 01/05:21:45 to 01/05:23:54

Plot file version 565 created 26-SEP-2019 10:43:36

190829A RG010A.UVDATA.1

Freq = 4.7990 GHz, Bw = 32.000 MH No calibration applied and no bandpass applied

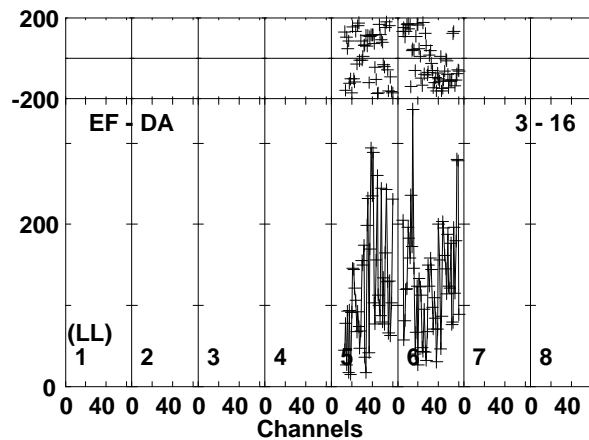
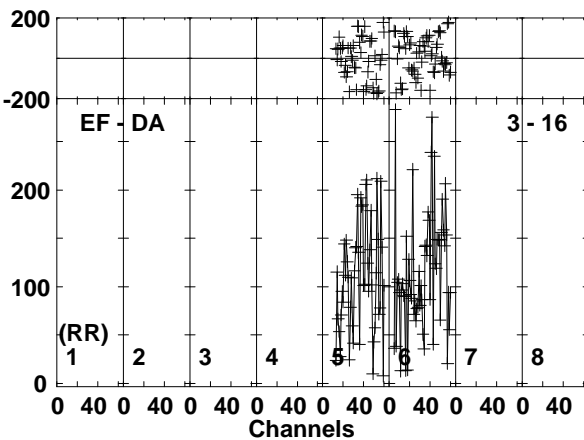
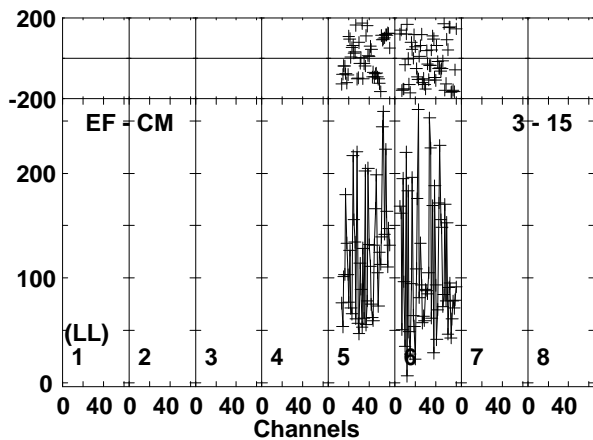
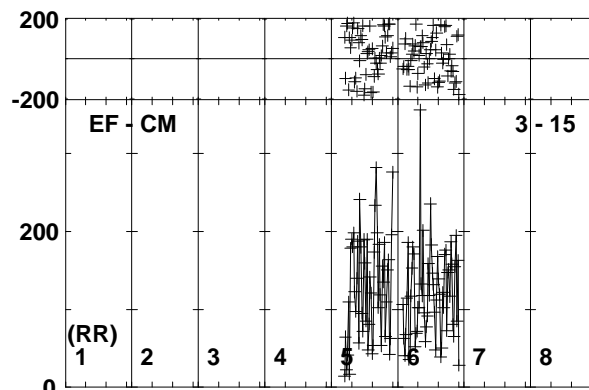
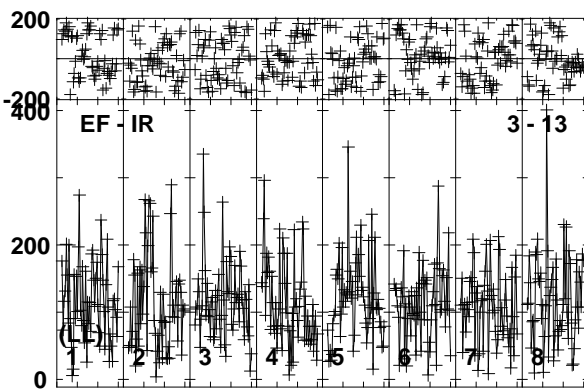
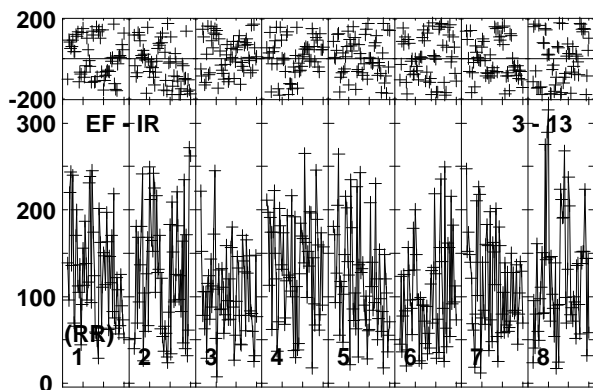
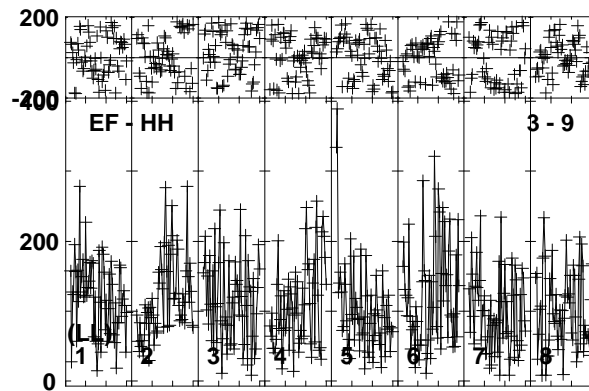
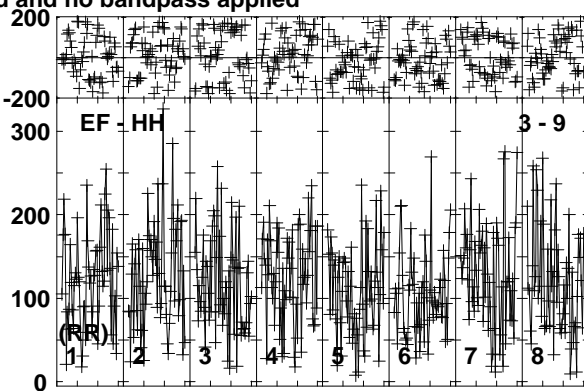
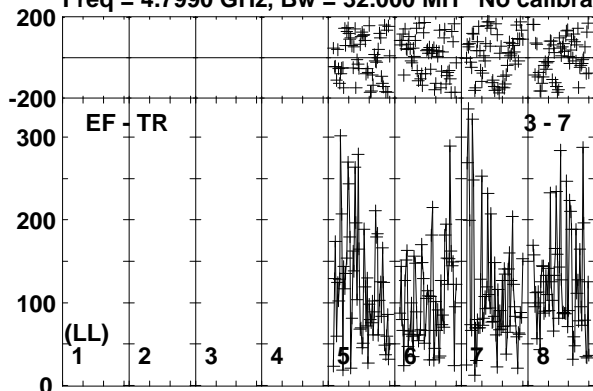

Lower frame: Micro Ampl Jy Top frame: Phas deg
Vector averaged cross-power spectrum Baseline: EF (03) - TR (07)
Timerange: 01/05:21:45 to 01/05:23:54

Plot file version 566 created 26-SEP-2019 10:43:36

190829A RG010A.UVDATA.1

Freq = 4.7990 GHz, Bw = 32.000 MH No calibration applied and no bandpass applied

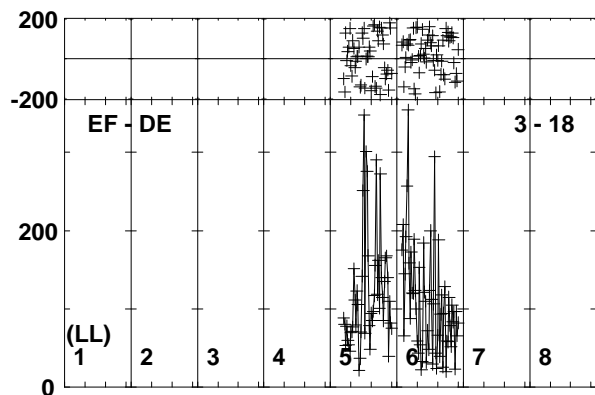
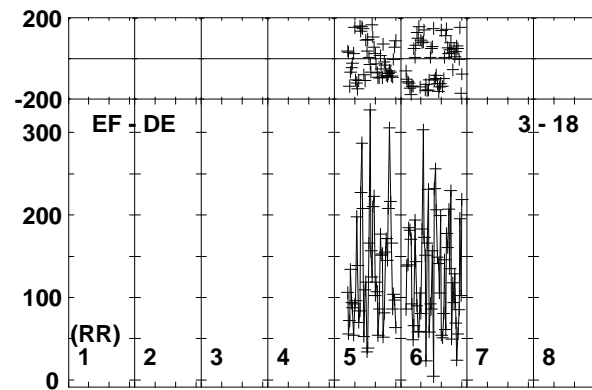
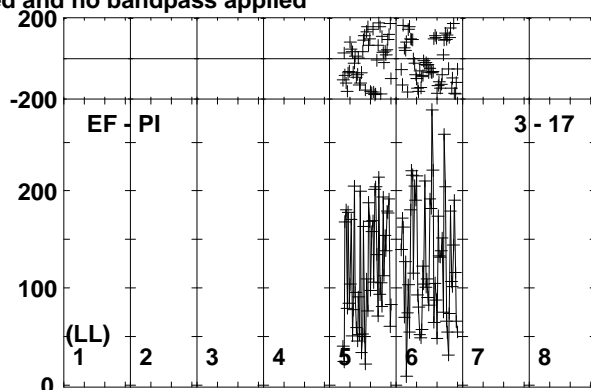
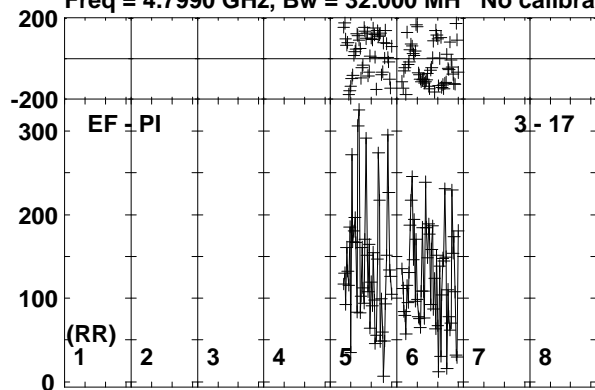

Lower frame: Micro Ampl Jy Top frame: Phas deg
Vector averaged cross-power spectrum Baseline: EF (03) - PI (17)
Timerange: 01/05:21:45 to 01/05:23:54

Plot file version 567 created 26-SEP-2019 10:43:36

J0257-1212 RG010A.UVDATA.1

Freq = 4.7990 GHz, Bw = 32.000 MH No calibration applied and no bandpass applied

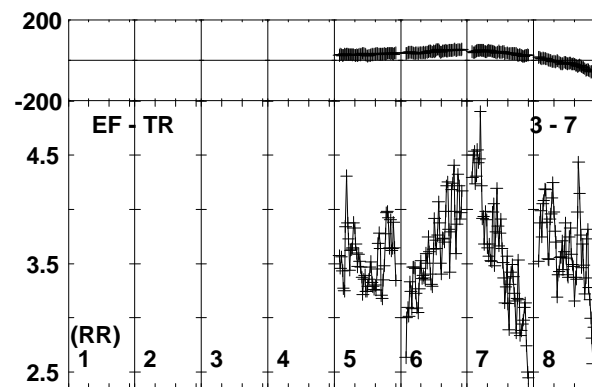
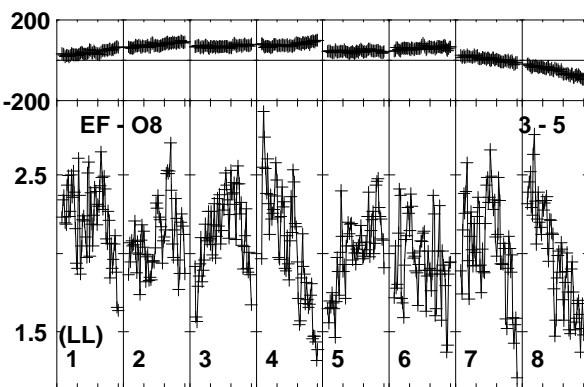
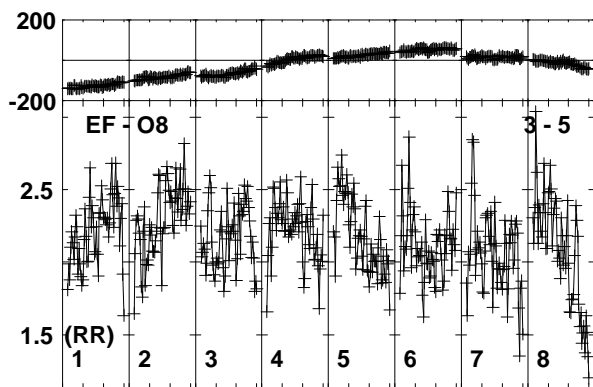
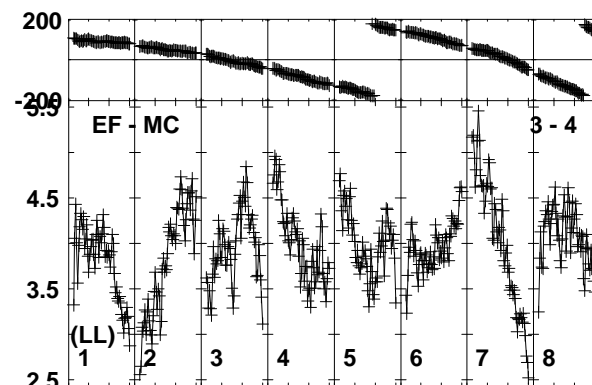
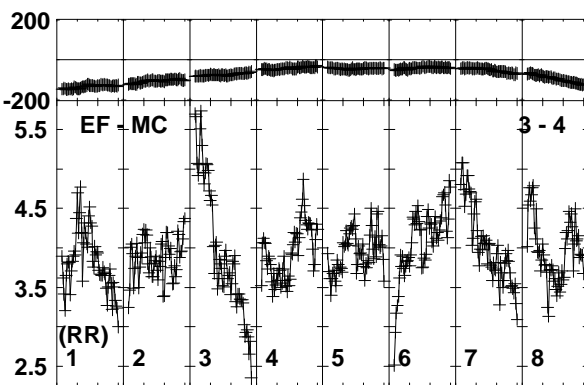
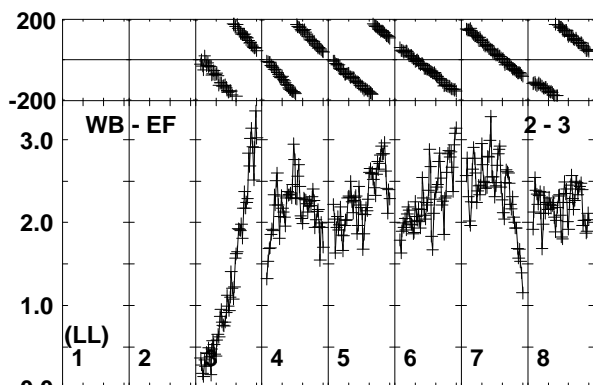
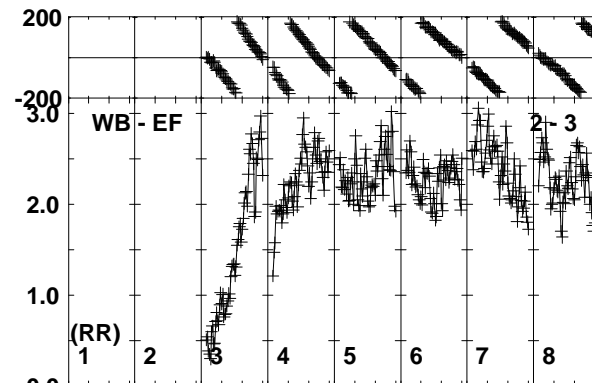
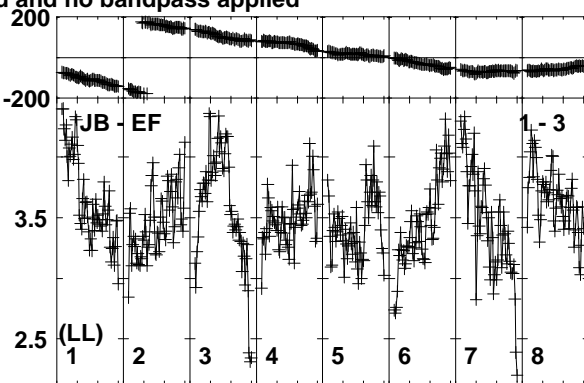
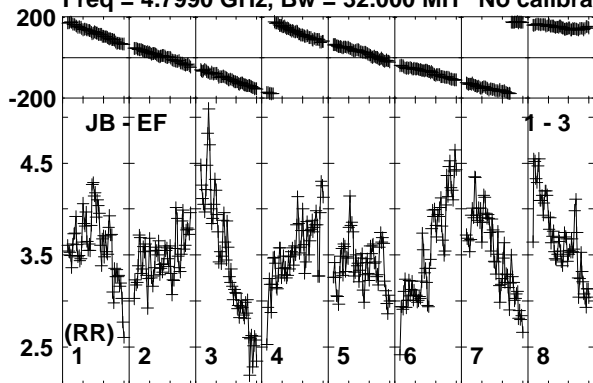

Lower frame: Milli Ampl Jy Top frame: Phas deg

Vector averaged cross-power spectrum Baseline: JB (01) - EF (03)

Timerange: 01/05:24:36 to 01/05:25:05

Plot file version 568 created 26-SEP-2019 10:43:36

J0257-1212 RG010A.UVDATA.1

Freq = 4.7990 GHz, Bw = 32.000 MH No calibration applied and no bandpass applied

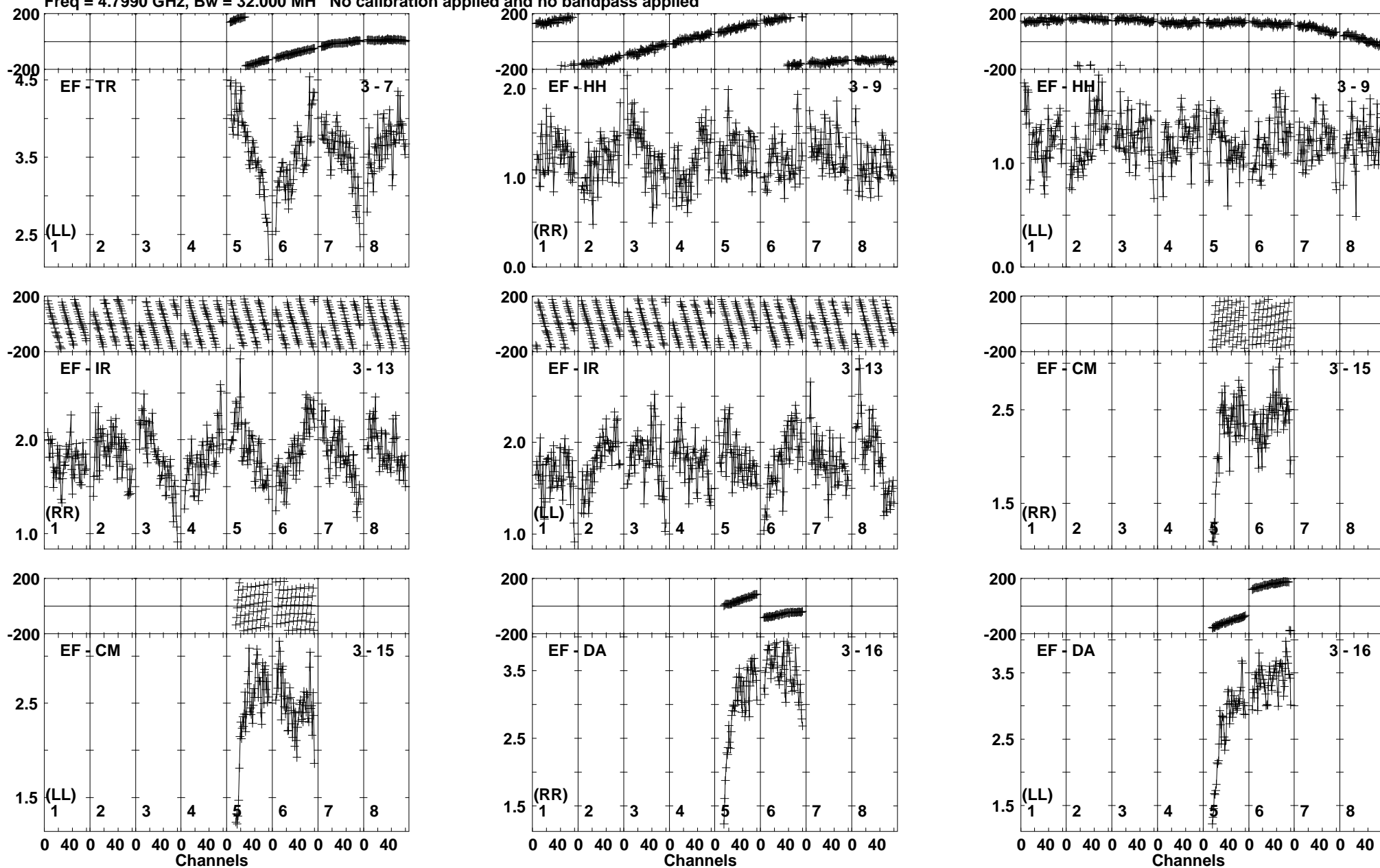

Lower frame: Milli Ampl Jy Top frame: Phas deg
Vector averaged cross-power spectrum Baseline: EF (03) - TR (07)
Timerange: 01/05:24:36 to 01/05:25:05

Plot file version 569 created 26-SEP-2019 10:43:37

J0257-1212 RG010A.UVDATA.1

Freq = 4.7990 GHz, Bw = 32.000 MH No calibration applied and no bandpass applied

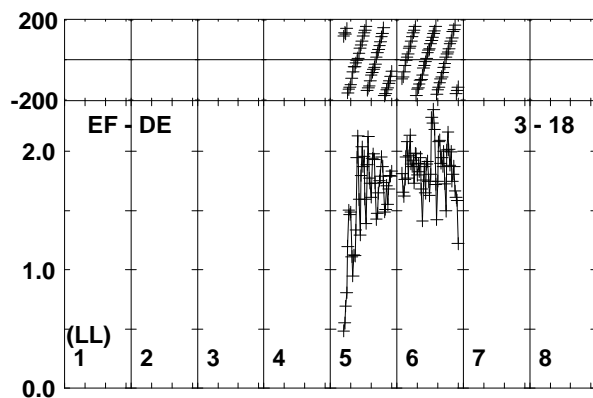
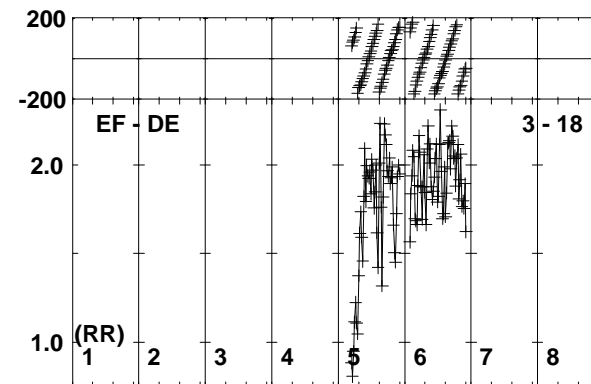
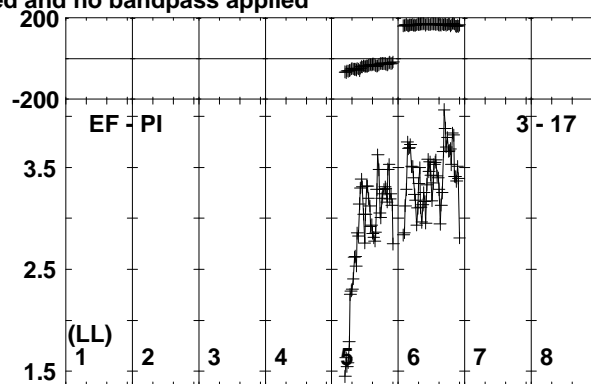
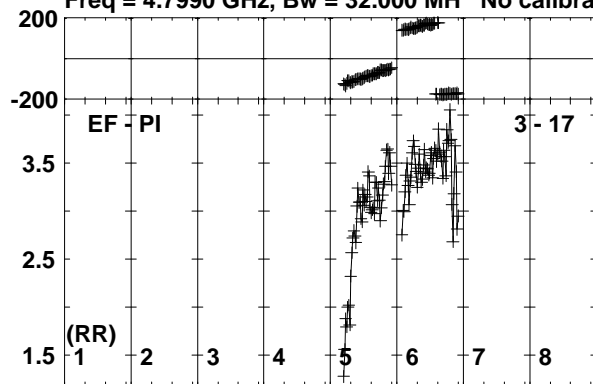

Lower frame: Milli Ampl Jy Top frame: Phas deg
Vector averaged cross-power spectrum Baseline: EF (03) - PI (17)
Timerange: 01/05:24:36 to 01/05:25:05

Plot file version 570 created 26-SEP-2019 10:43:37

J0300-0846 RG010A.UVDATA.1

Freq = 4.7990 GHz, Bw = 32.000 MH No calibration applied and no bandpass applied

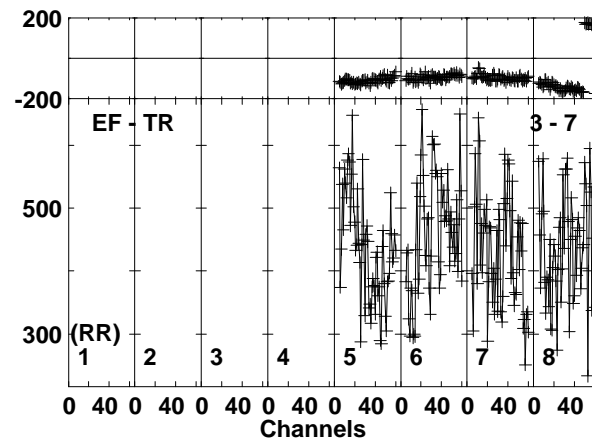
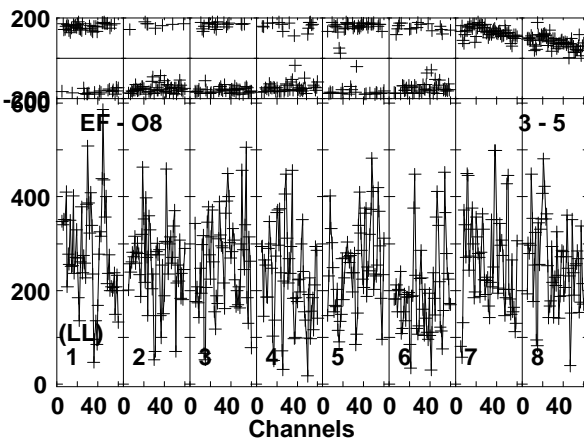
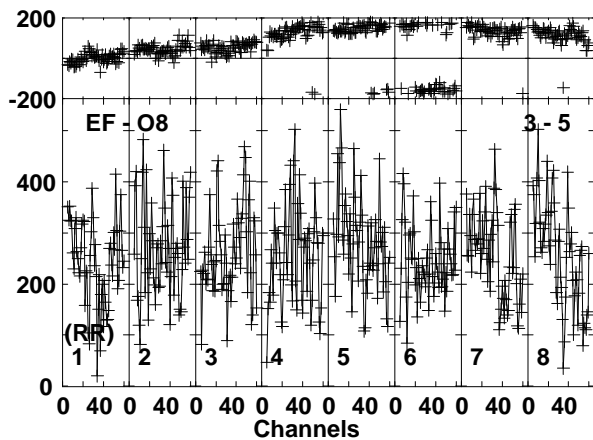
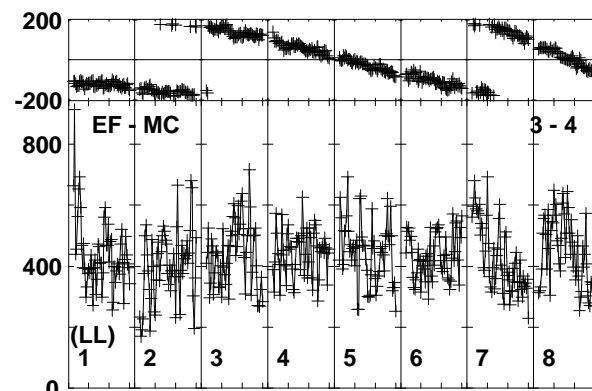
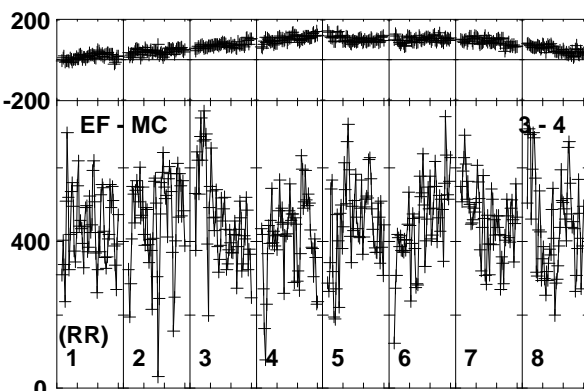
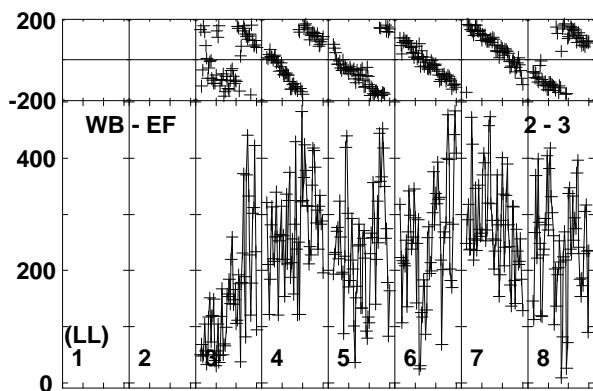
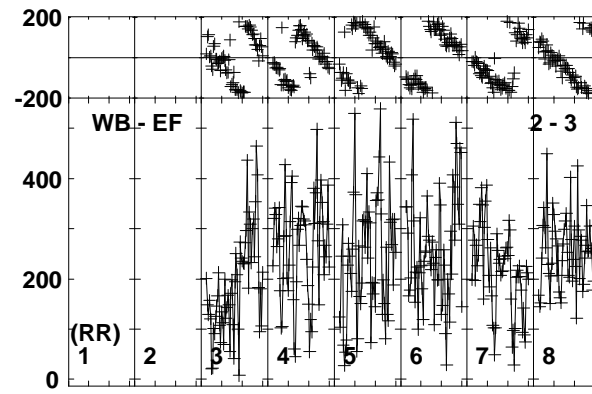
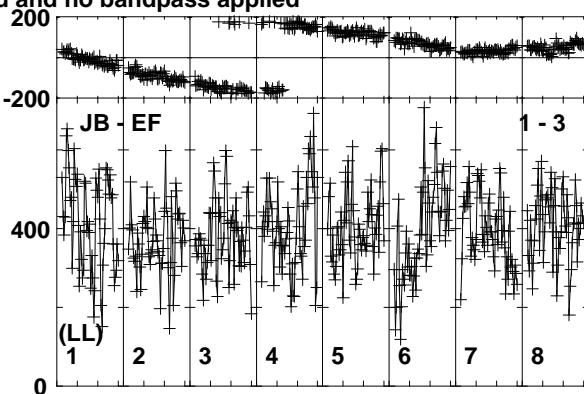
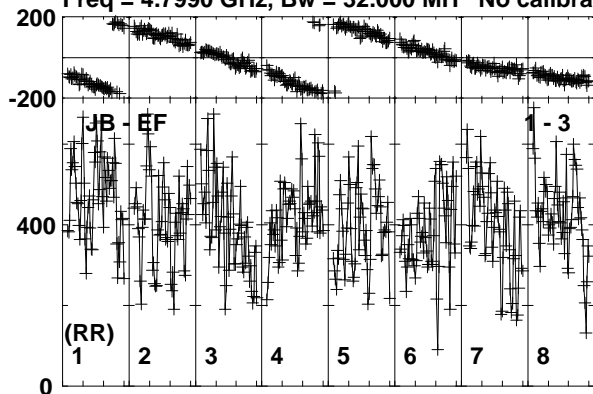

Lower frame: Micro Ampl Jy Top frame: Phas deg
Vector averaged cross-power spectrum Baseline: JB (01) - EF (03)
Timerange: 01/05:25:05 to 01/05:27:14

Plot file version 571 created 26-SEP-2019 10:43:37

J0300-0846 RG010A.UVDATA.1

Freq = 4.7990 GHz, Bw = 32.000 MH No calibration applied and no bandpass applied

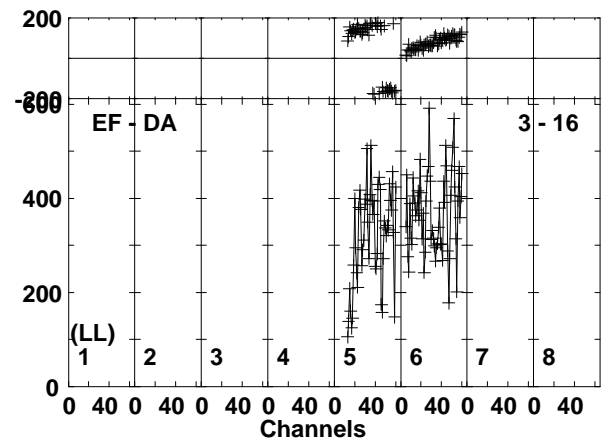
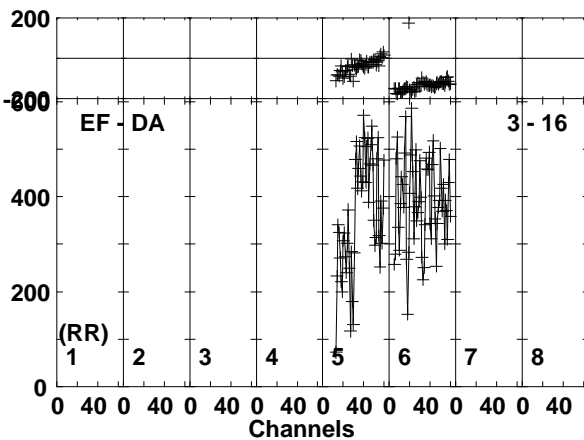
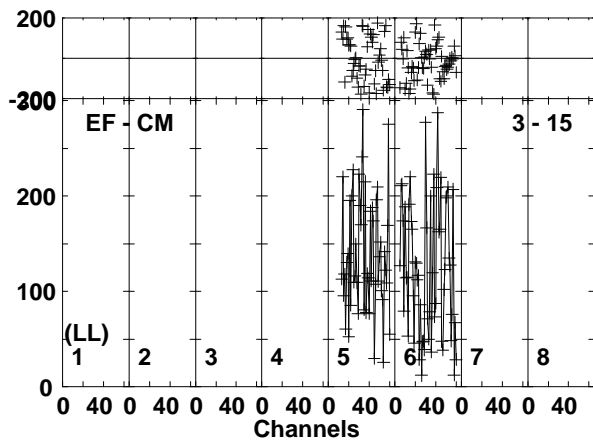
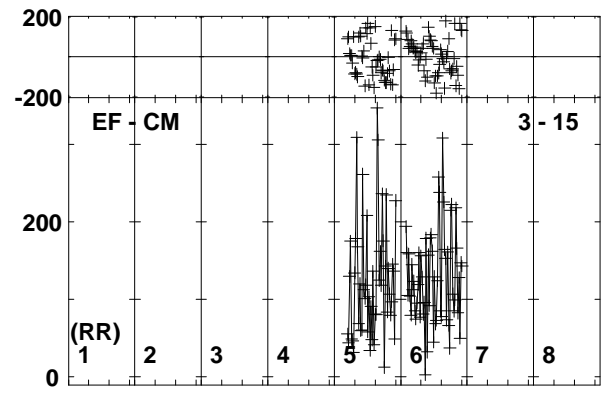
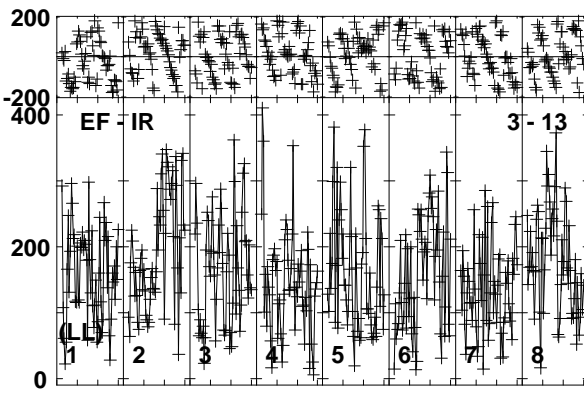
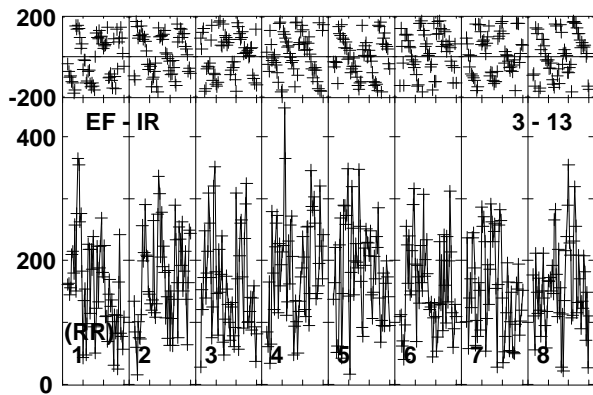
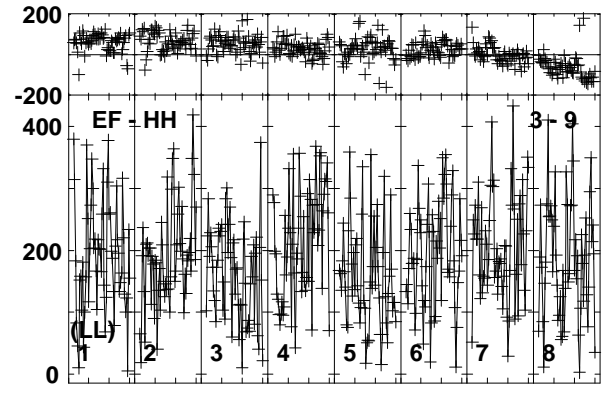
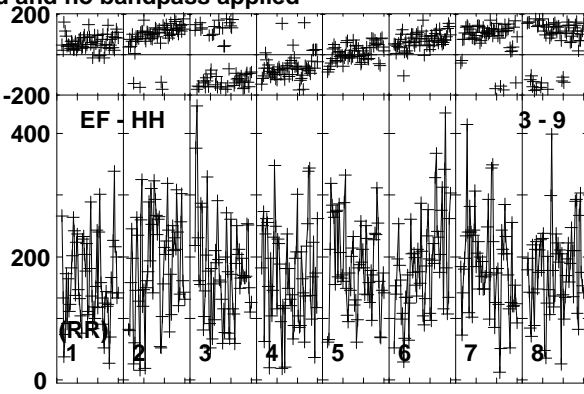
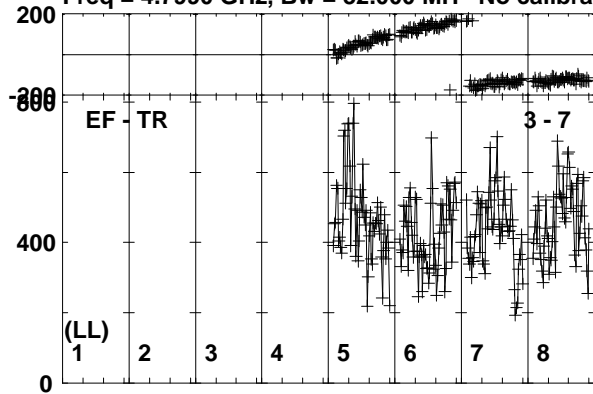

Lower frame: Micro Ampl Jy Top frame: Phas deg
Vector averaged cross-power spectrum Baseline: EF (03) - TR (07)
Timerange: 01/05:25:05 to 01/05:27:14

Plot file version 572 created 26-SEP-2019 10:43:38

J0300-0846 RG010A.UVDATA.1

Freq = 4.7990 GHz, Bw = 32.000 MH No calibration applied and no bandpass applied

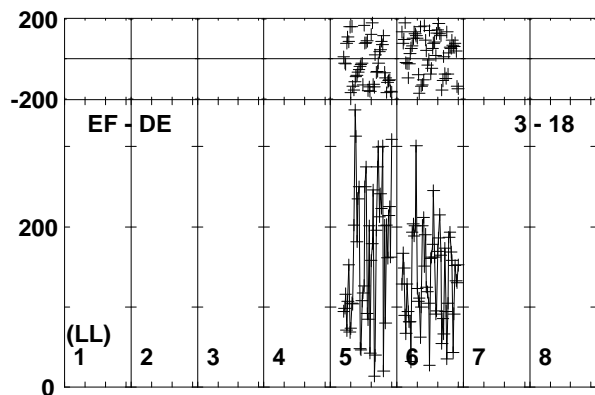
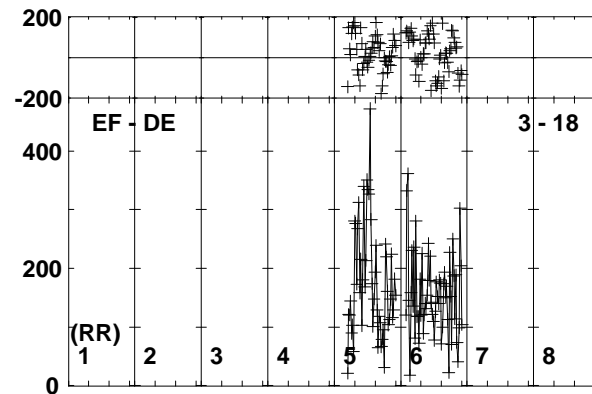
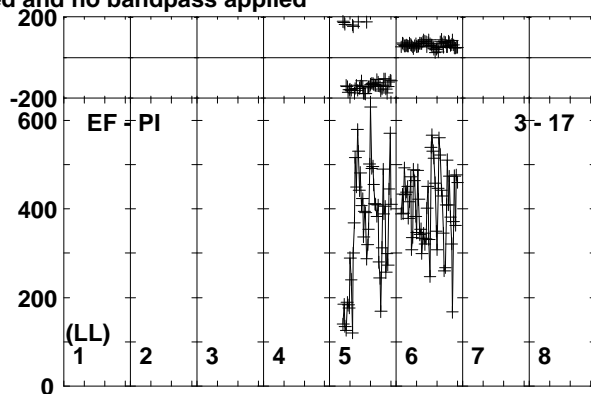
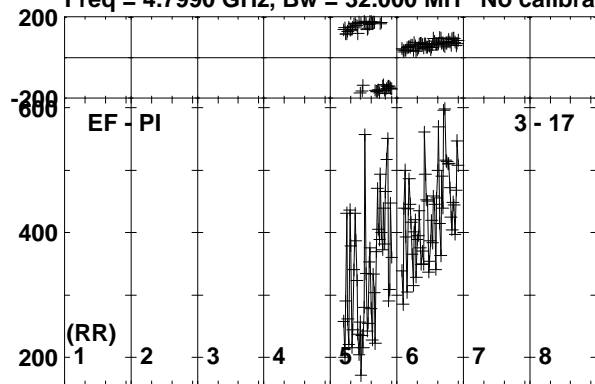

Lower frame: Micro Ampl Jy Top frame: Phas deg
Vector averaged cross-power spectrum Baseline: EF (03) - PI (17)
Timerange: 01/05:25:05 to 01/05:27:14

Plot file version 573 created 26-SEP-2019 10:43:38

J0257-1212 RG010A.UVDATA.1

Freq = 4.7990 GHz, Bw = 32.000 MH No calibration applied and no bandpass applied

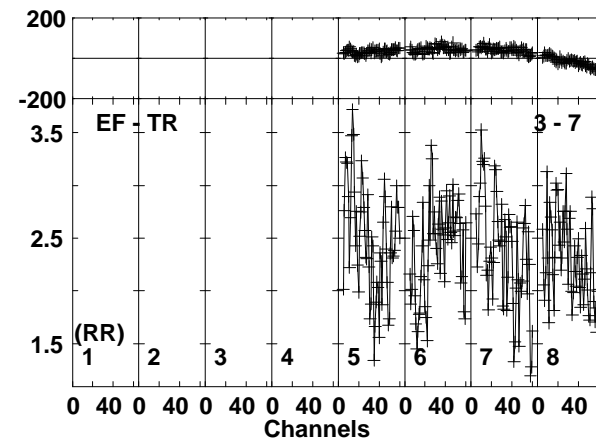
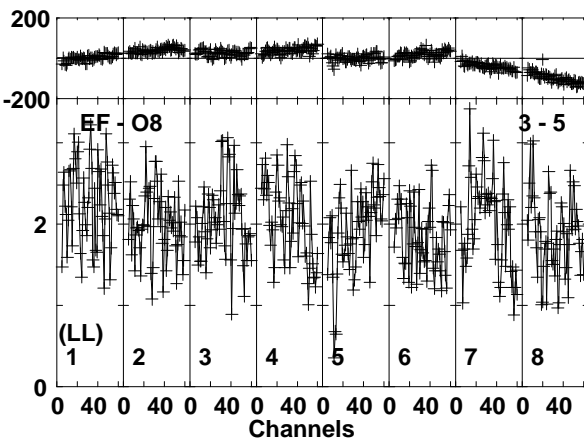
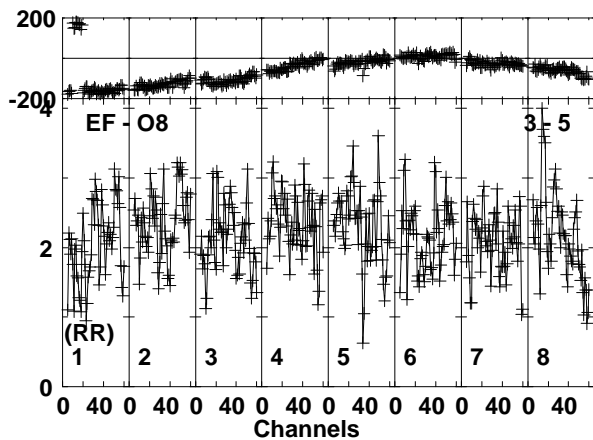
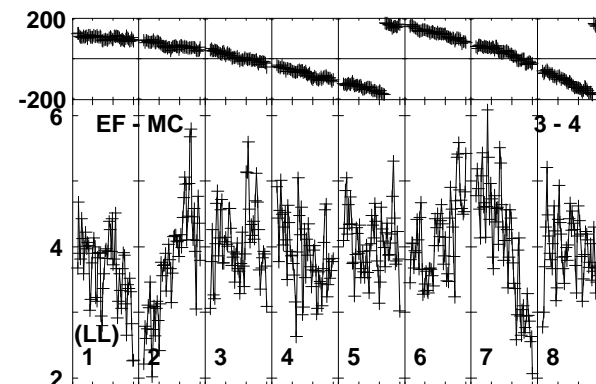
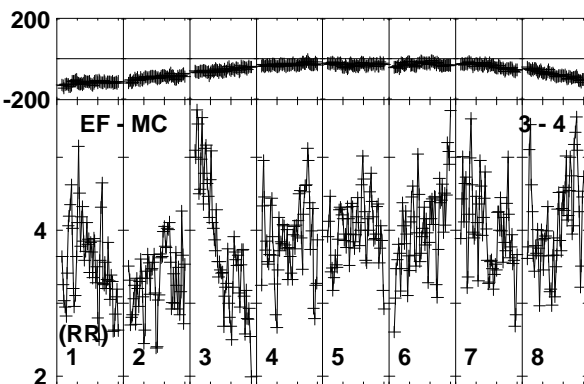
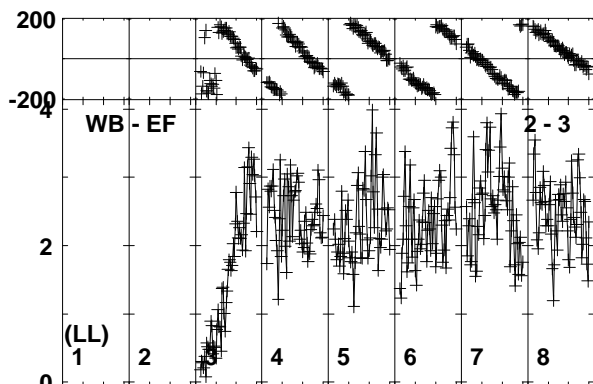
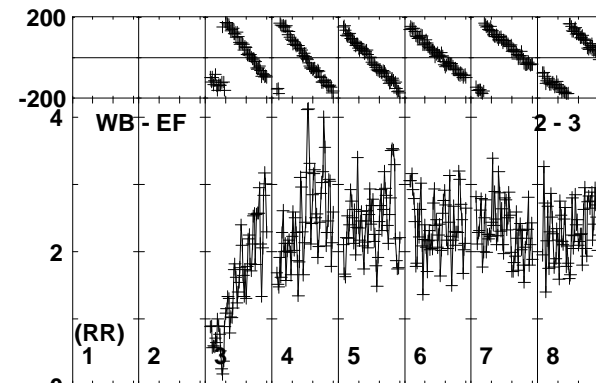
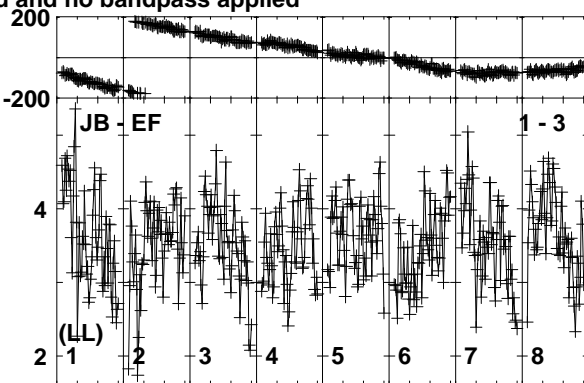
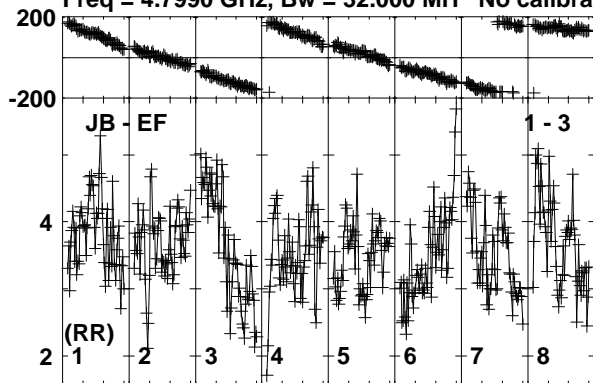

Lower frame: Milli Ampl Jy Top frame: Phas deg
Vector averaged cross-power spectrum Baseline: JB (01) - EF (03)
Timerange: 01/05:27:16 to 01/05:28:14

Plot file version 574 created 26-SEP-2019 10:43:38

J0257-1212 RG010A.UVDATA.1

Freq = 4.7990 GHz, Bw = 32.000 MH No calibration applied and no bandpass applied

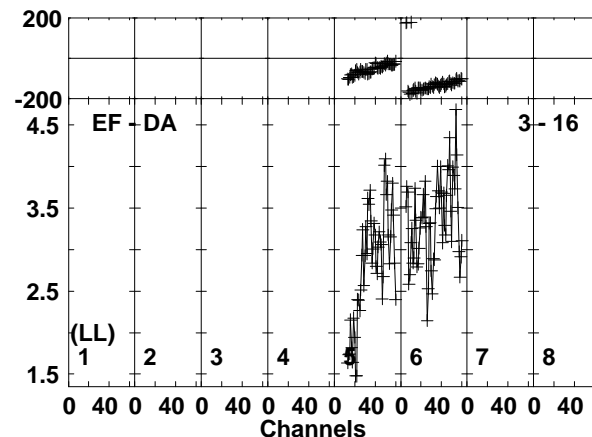
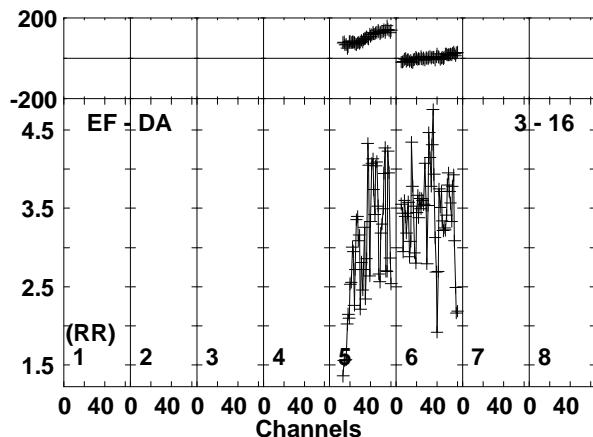
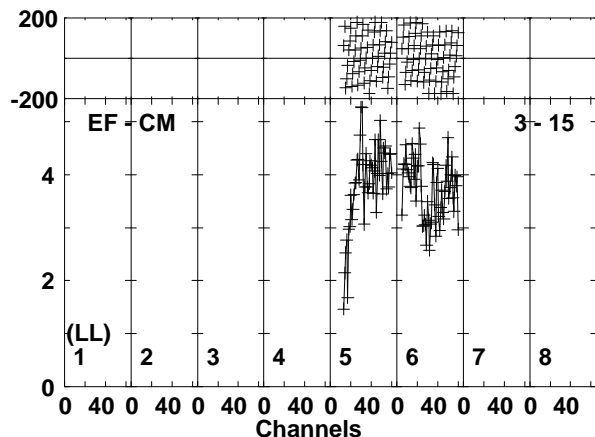
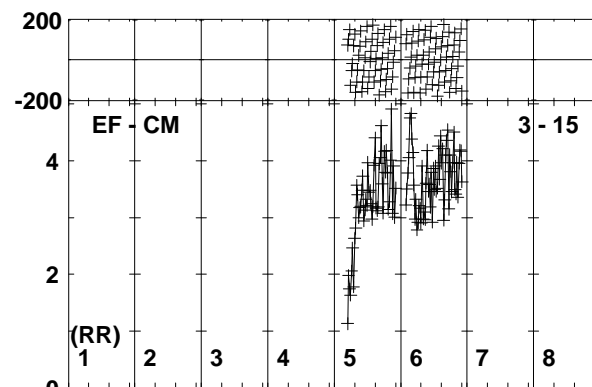
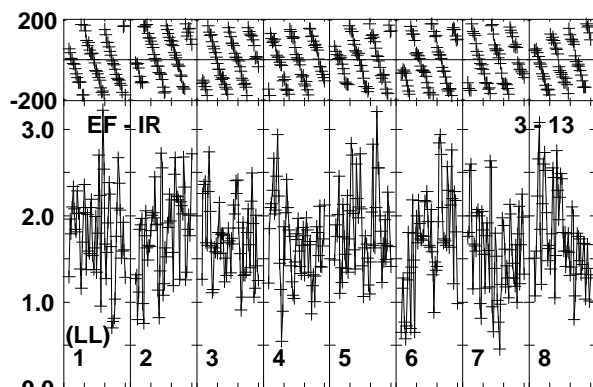
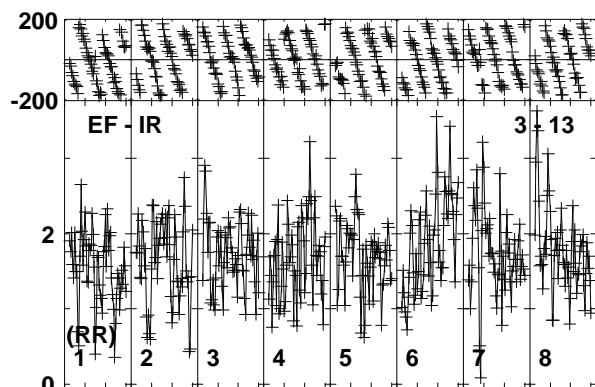
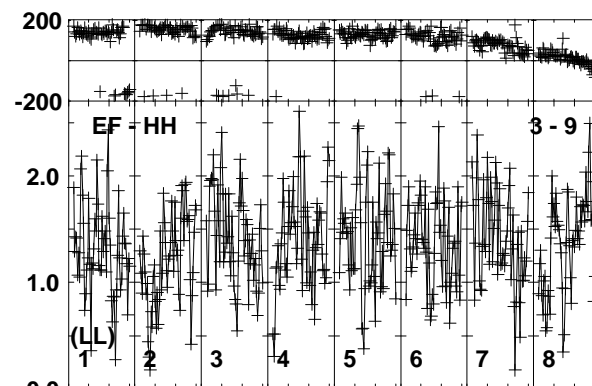
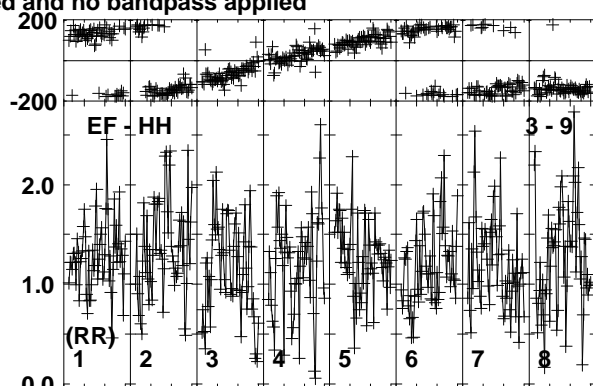
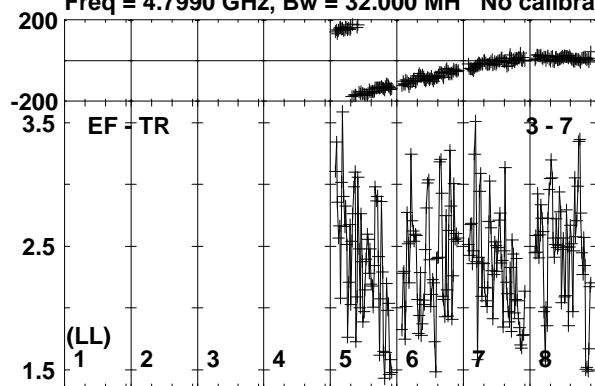

Lower frame: Milli Ampl Jy Top frame: Phas deg
Vector averaged cross-power spectrum Baseline: EF (03) - TR (07)
Timerange: 01/05:27:16 to 01/05:28:14

Plot file version 575 created 26-SEP-2019 10:43:38

J0257-1212 RG010A.UVDATA.1

Freq = 4.7990 GHz, Bw = 32.000 MH No calibration applied and no bandpass applied

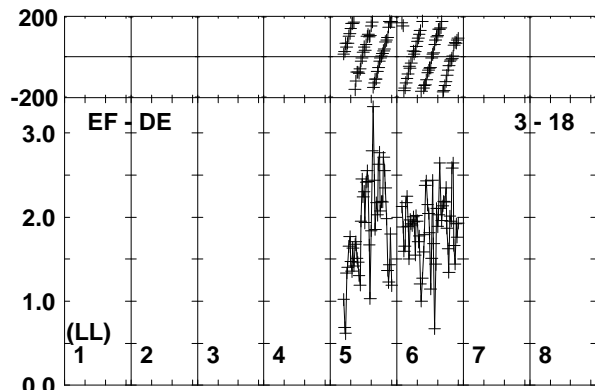
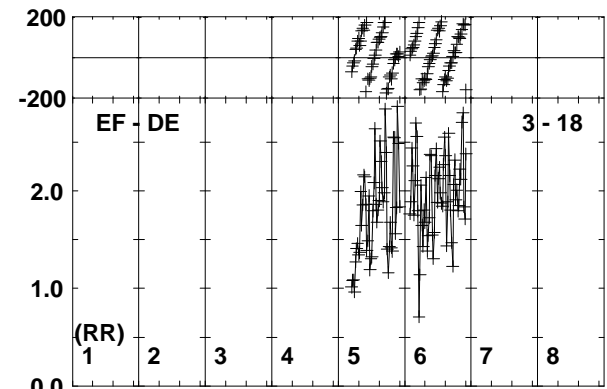
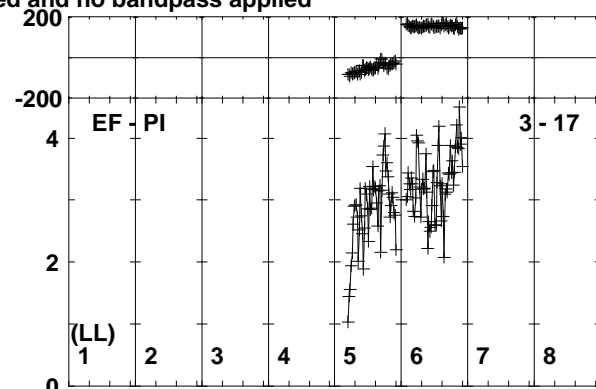
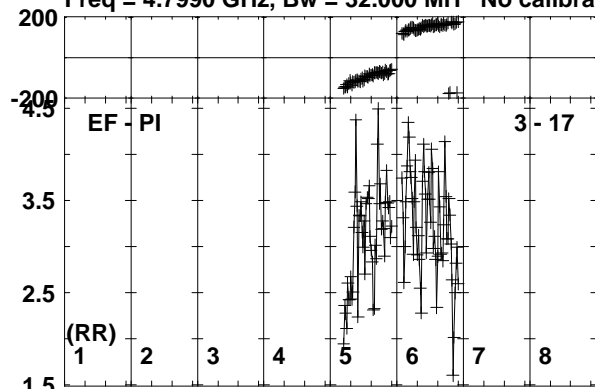

Lower frame: Milli Ampl Jy Top frame: Phas deg
Vector averaged cross-power spectrum Baseline: EF (03) - PI (17)
Timerange: 01/05:27:16 to 01/05:28:14

Plot file version 576 created 26-SEP-2019 10:43:38

190829A RG010A.UVDATA.1

Freq = 4.7990 GHz, Bw = 32.000 MH No calibration applied and no bandpass applied

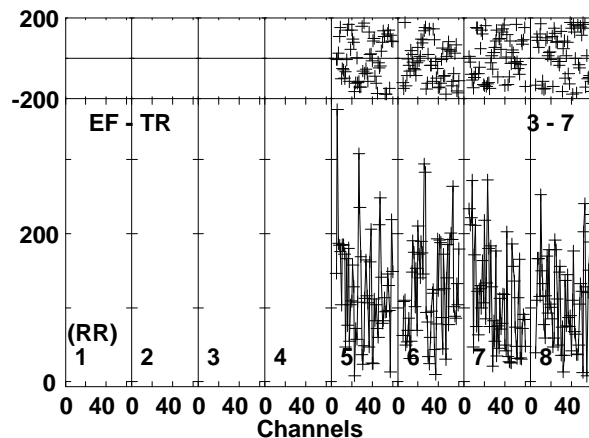
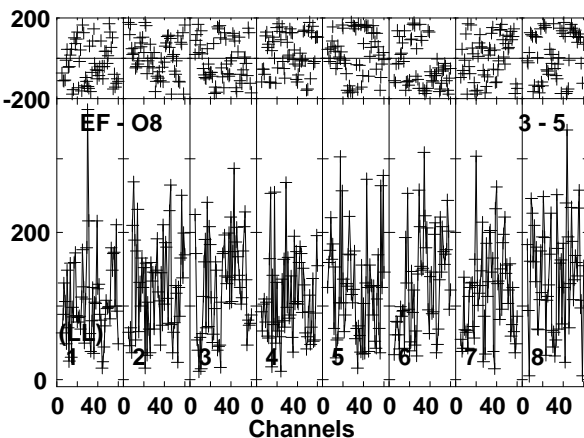
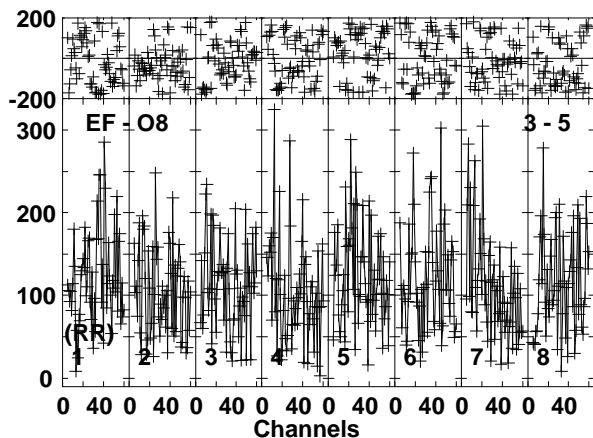
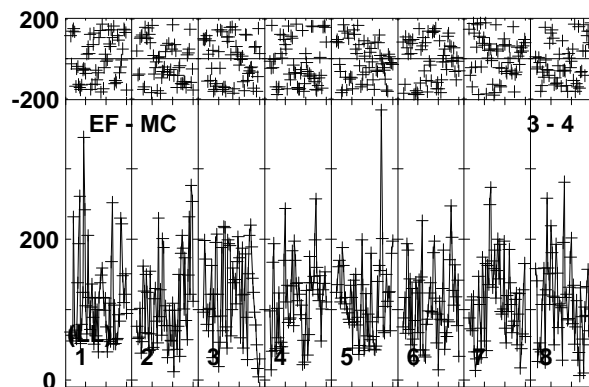
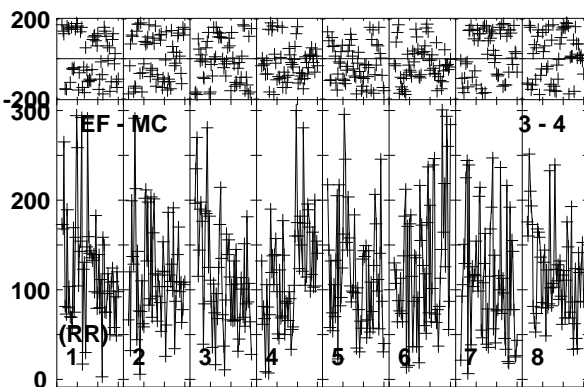
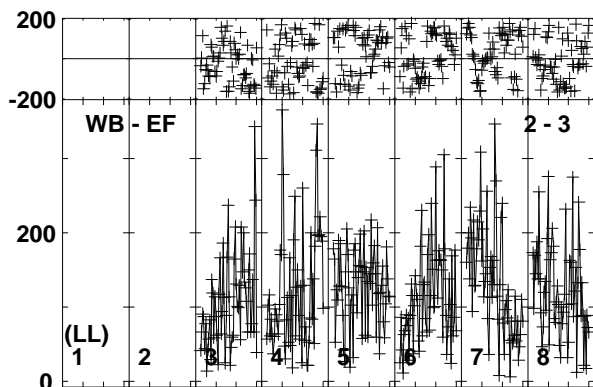
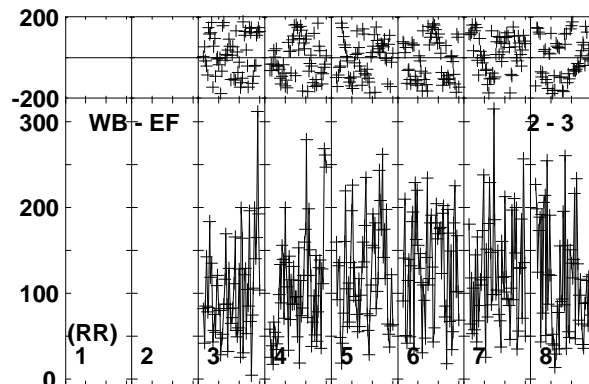
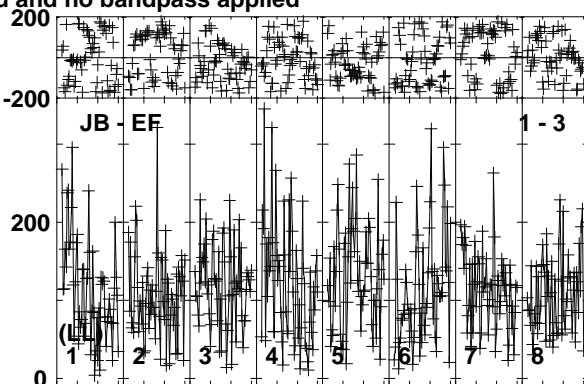
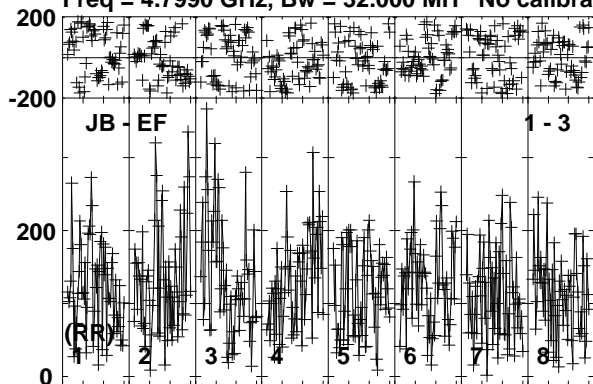

Lower frame: Micro Ampl Jy Top frame: Phas deg
Vector averaged cross-power spectrum Baseline: JB (01) - EF (03)
Timerange: 01/05:28:16 to 01/05:30:24

Plot file version 577 created 26-SEP-2019 10:43:39

190829A RG010A.UVDATA.1

Freq = 4.7990 GHz, Bw = 32.000 MH No calibration applied and no bandpass applied

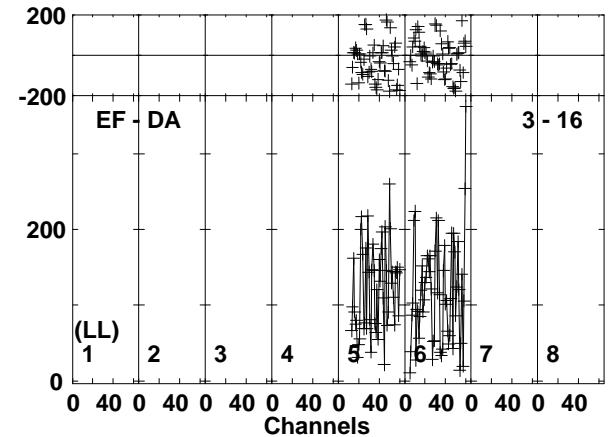
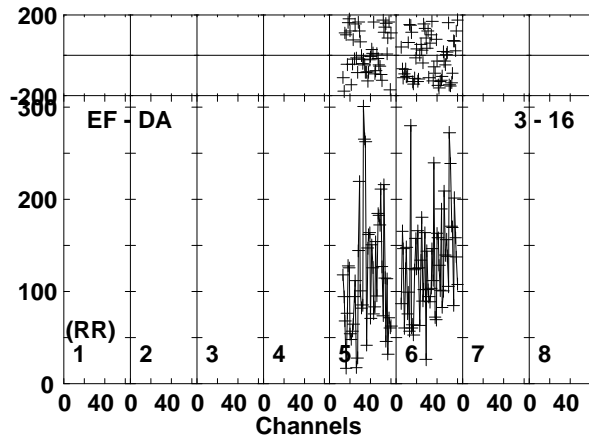
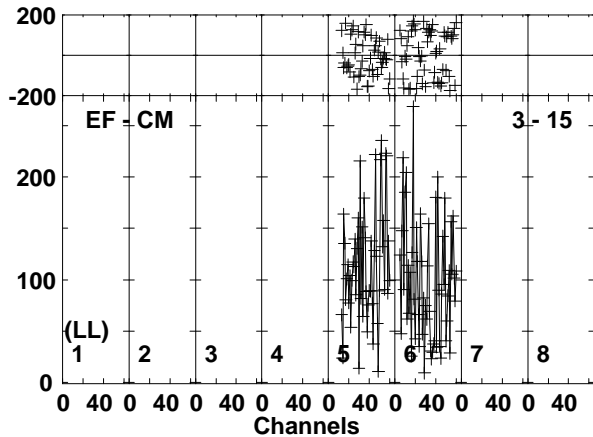
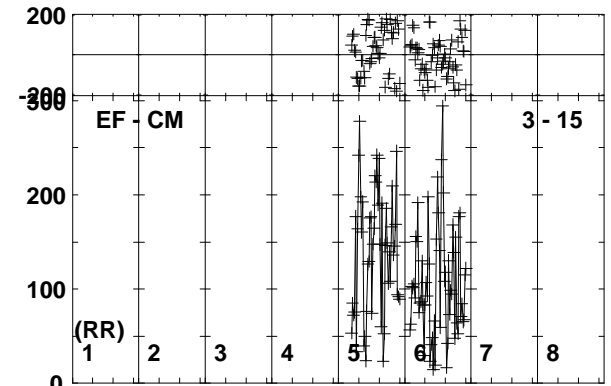
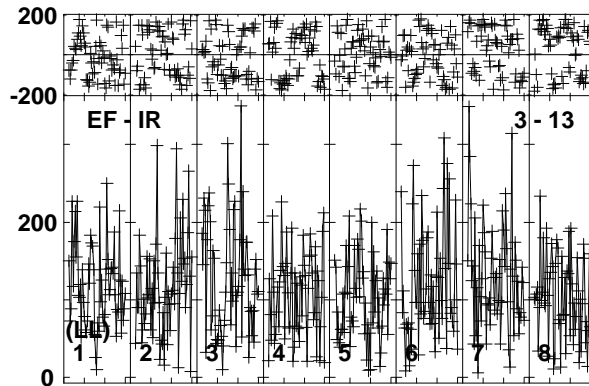
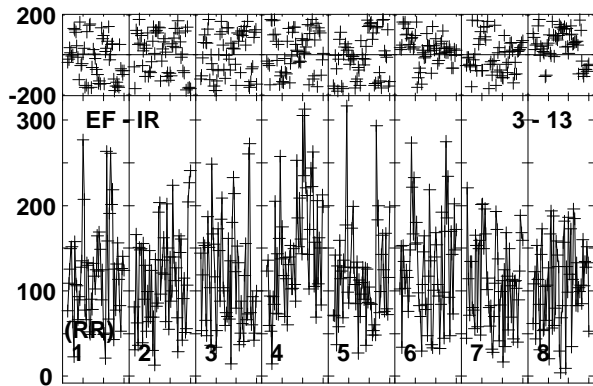
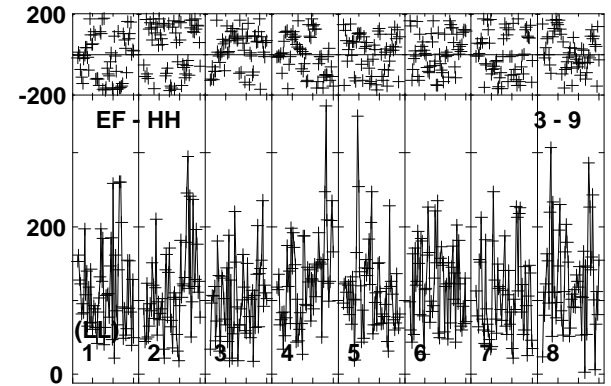
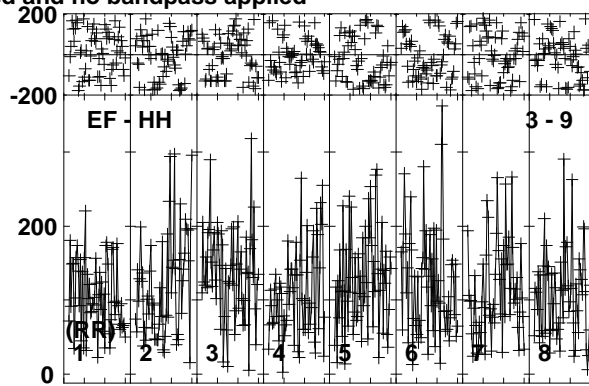
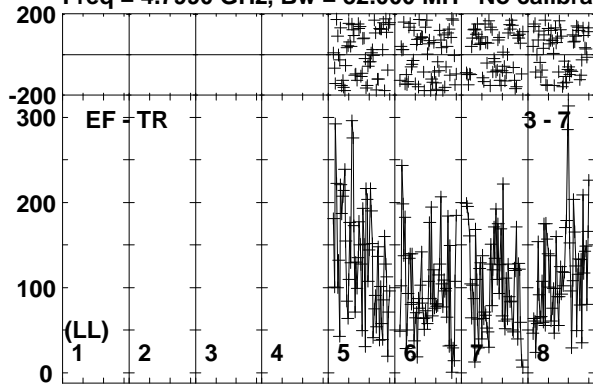

Lower frame: Micro Ampl Jy Top frame: Phas deg
Vector averaged cross-power spectrum Baseline: EF (03) - TR (07)
Timerange: 01/05:28:16 to 01/05:30:24

Plot file version 578 created 26-SEP-2019 10:43:39

190829A RG010A.UVDATA.1

Freq = 4.7990 GHz, Bw = 32.000 MH No calibration applied and no bandpass applied

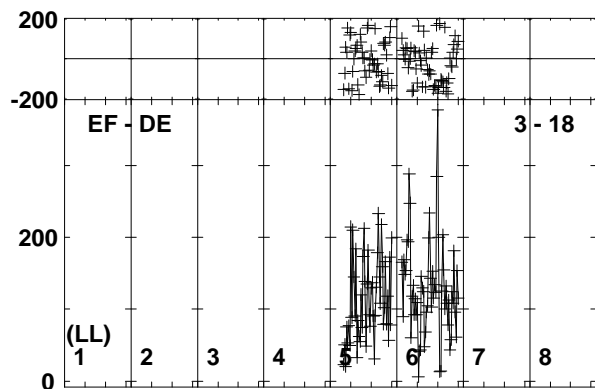
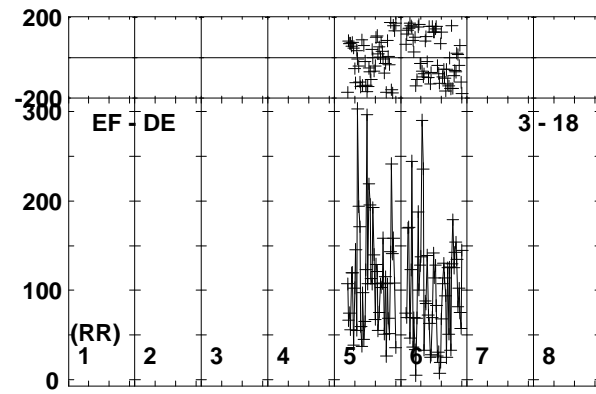
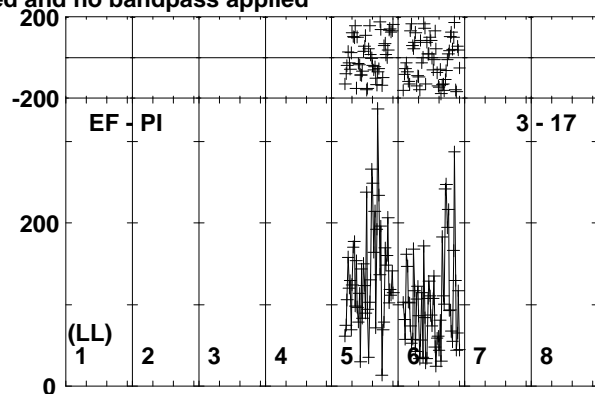
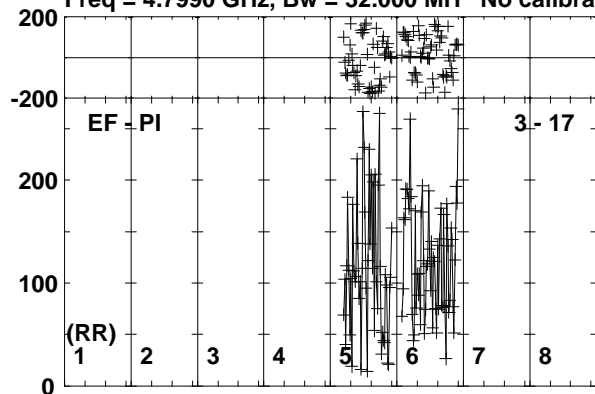

Lower frame: Micro Ampl Jy Top frame: Phas deg
Vector averaged cross-power spectrum Baseline: EF (03) - PI (17)
Timerange: 01/05:28:16 to 01/05:30:24

Plot file version 579 created 26-SEP-2019 10:43:39

J0257-1212 RG010A.UVDATA.1

Freq = 4.7990 GHz, Bw = 32.000 MH No calibration applied and no bandpass applied

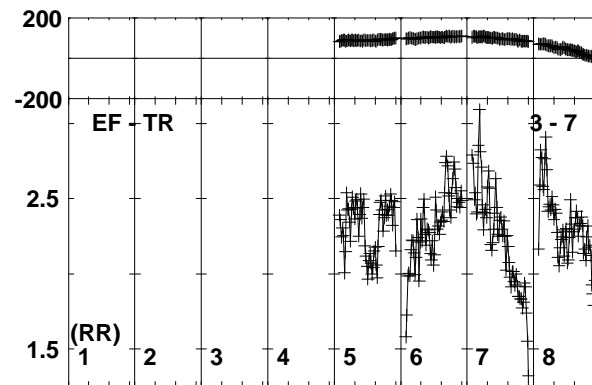
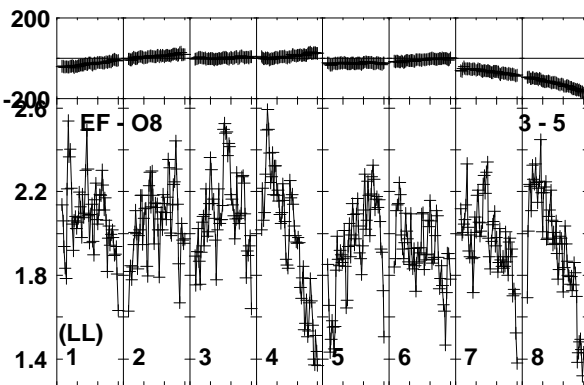
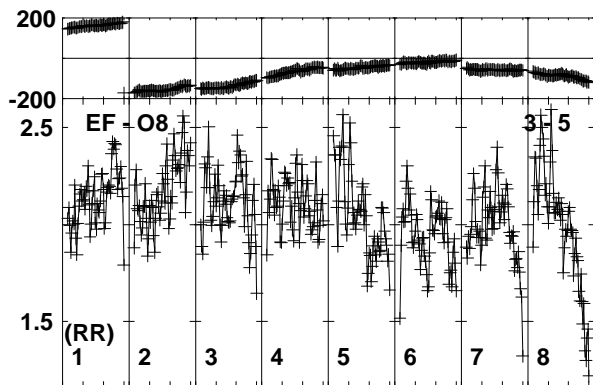
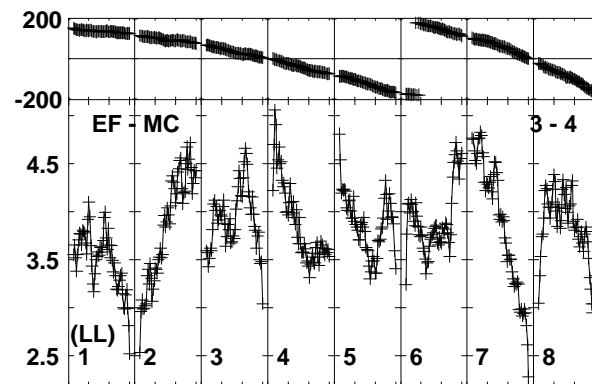
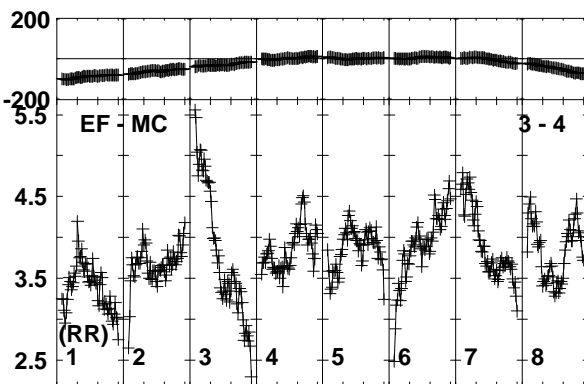
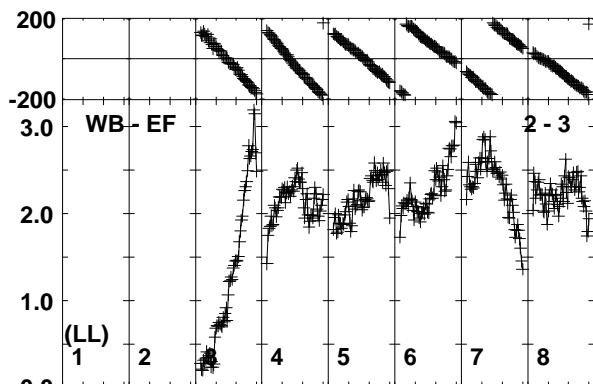
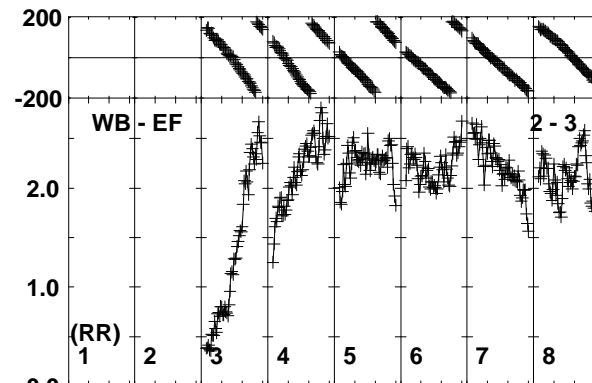
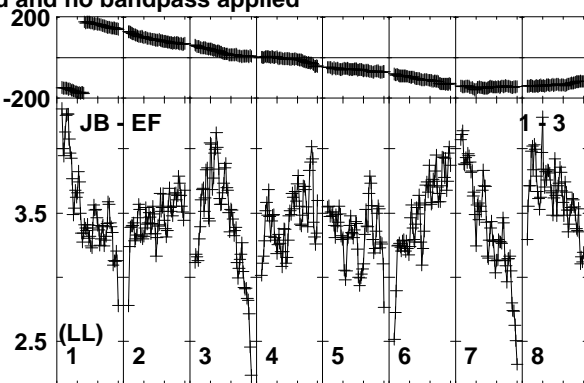
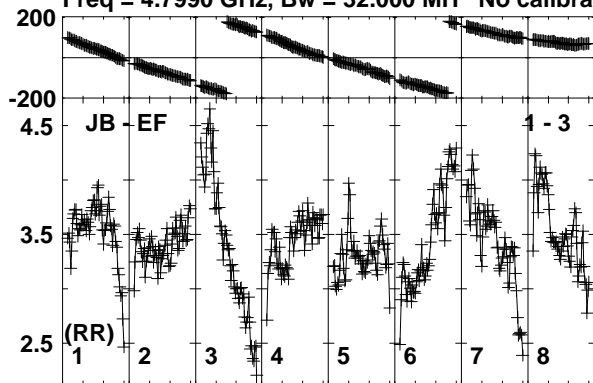

Lower frame: Milli Ampl Jy Top frame: Phas deg

Vector averaged cross-power spectrum Baseline: JB (01) - EF (03)

Timerange: 01/05:31:06 to 01/05:32:04

Plot file version 580 created 26-SEP-2019 10:43:40

J0257-1212 RG010A.UVDATA.1

Freq = 4.7990 GHz, Bw = 32.000 MH No calibration applied and no bandpass applied

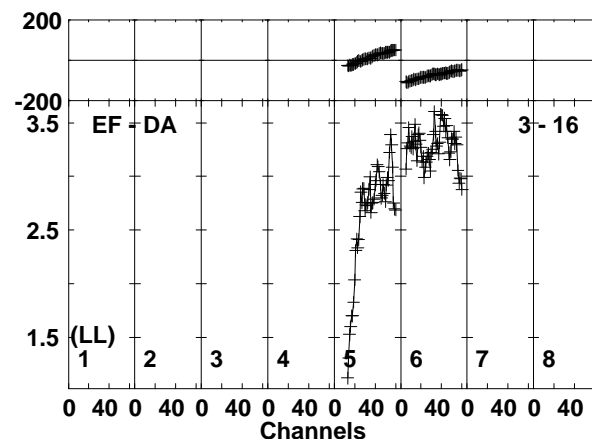
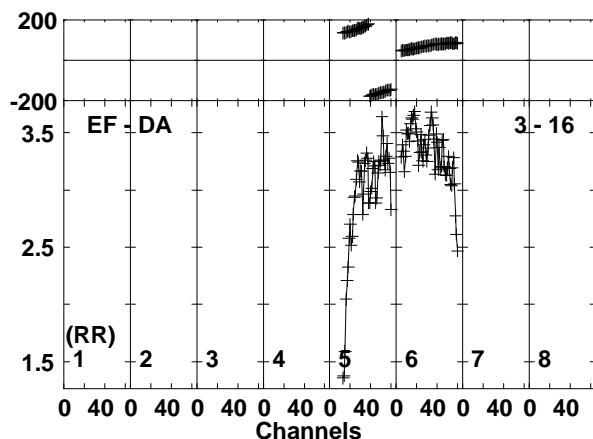
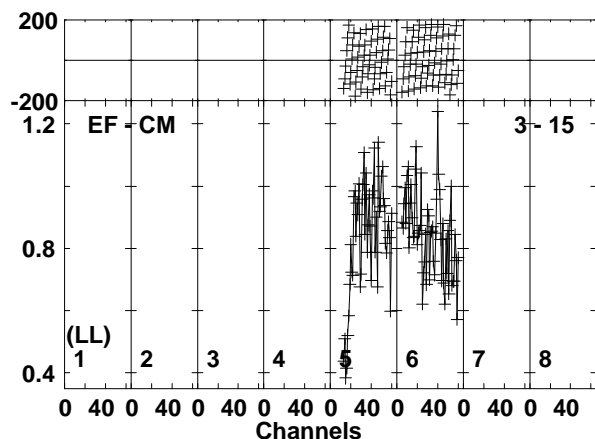
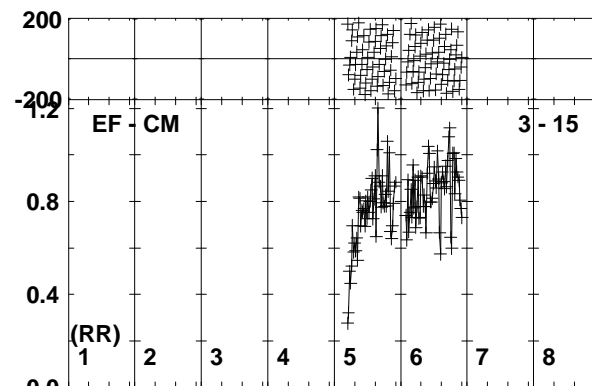
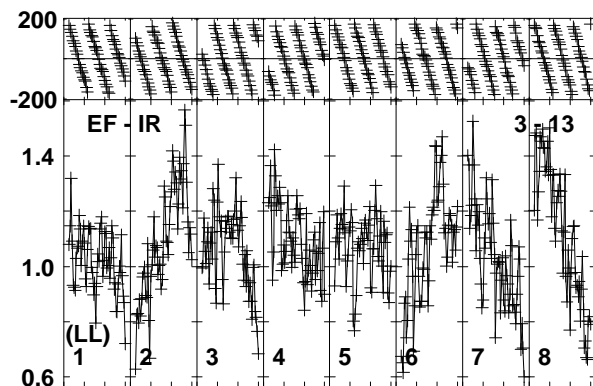
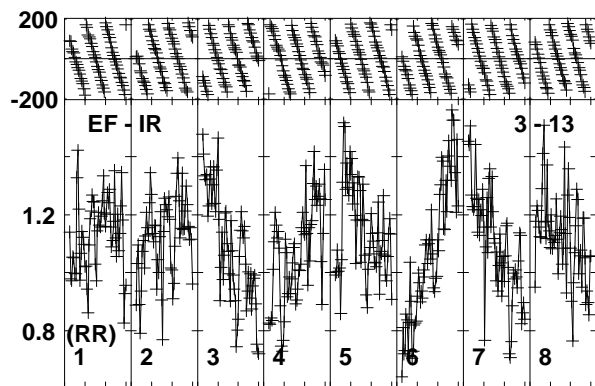
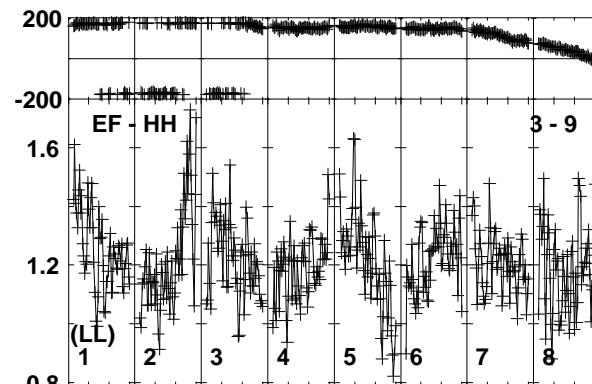
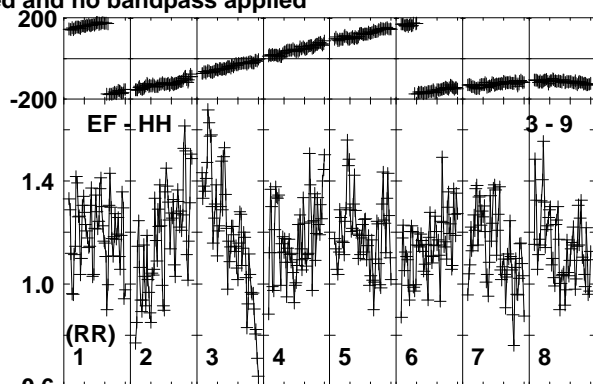
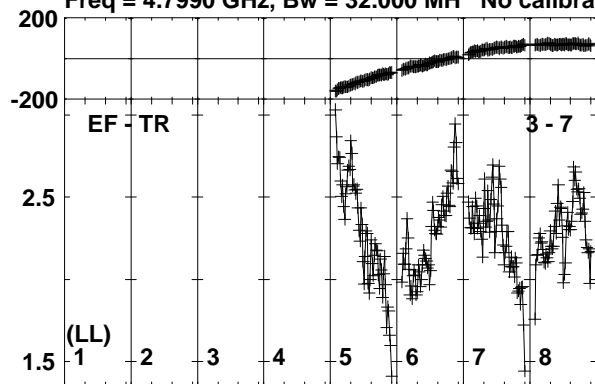

Lower frame: Milli Ampl Jy Top frame: Phas deg
Vector averaged cross-power spectrum Baseline: EF (03) - TR (07)
Timerange: 01/05:31:06 to 01/05:32:04

Plot file version 581 created 26-SEP-2019 10:43:40

J0257-1212 RG010A.UVDATA.1

Freq = 4.7990 GHz, Bw = 32.000 MH No calibration applied and no bandpass applied

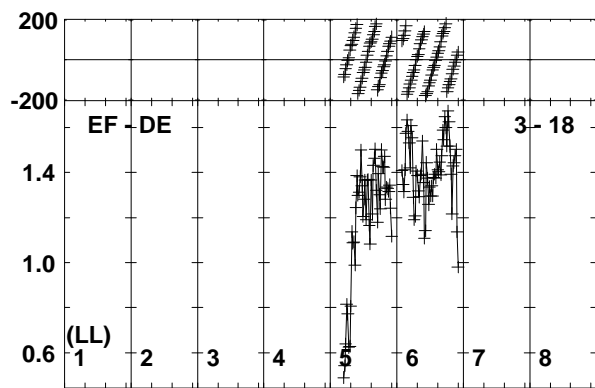
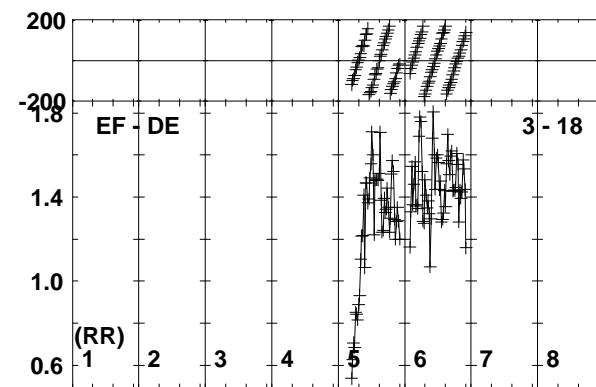
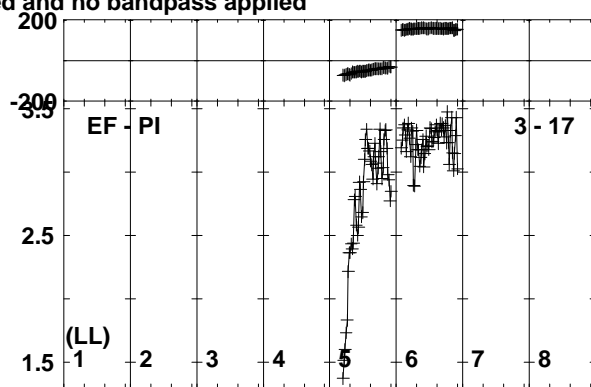
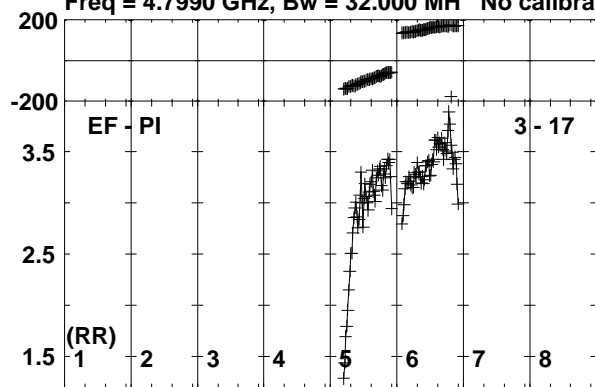

Lower frame: Milli Ampl Jy Top frame: Phas deg
Vector averaged cross-power spectrum Baseline: EF (03) - PI (17)
Timerange: 01/05:31:06 to 01/05:32:04

Plot file version 582 created 26-SEP-2019 10:43:40

190829A RG010A.UVDATA.1

Freq = 4.7990 GHz, Bw = 32.000 MH No calibration applied and no bandpass applied

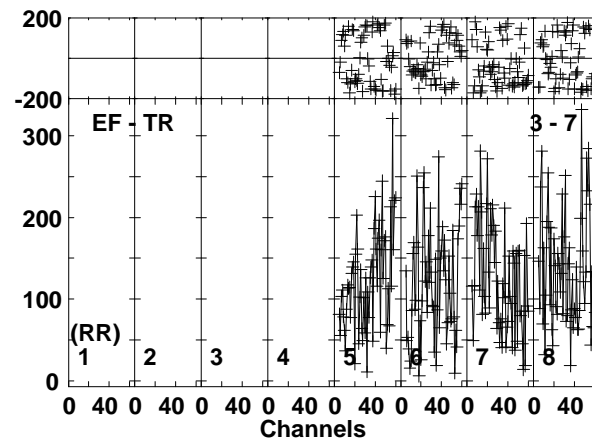
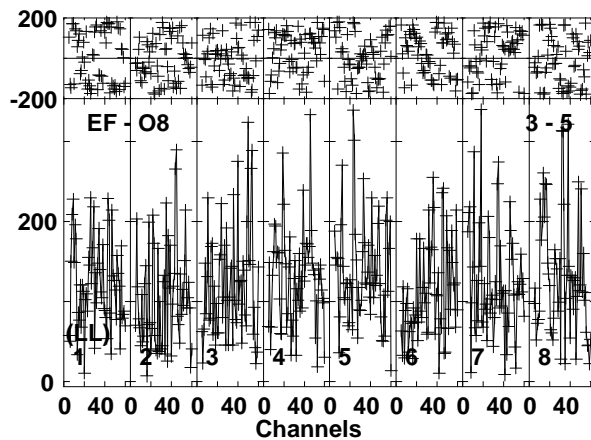
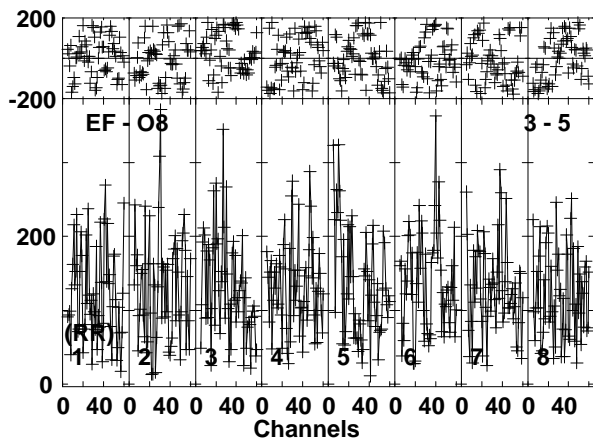
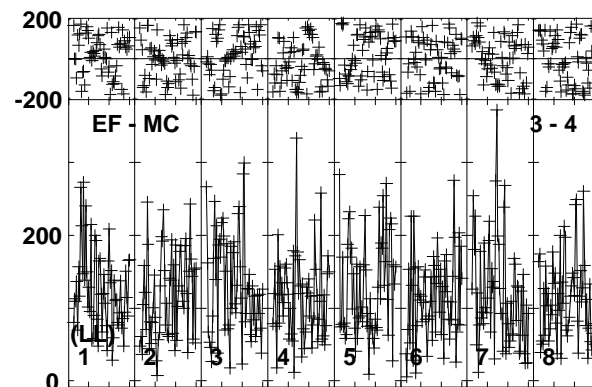
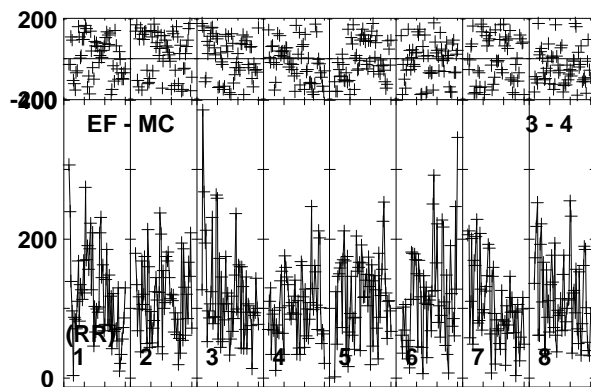
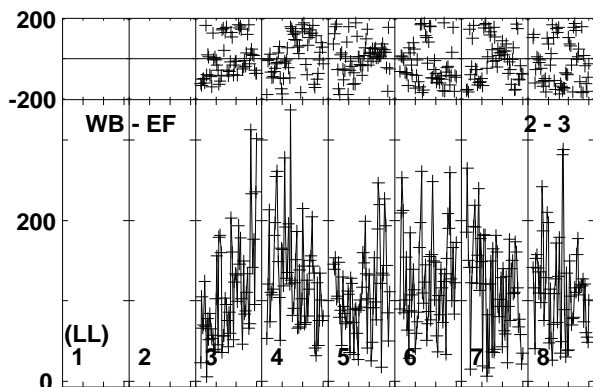
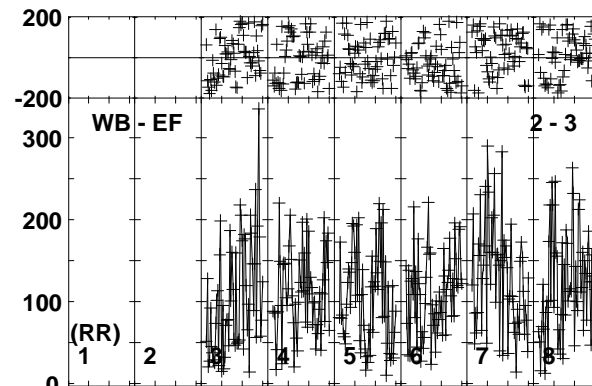
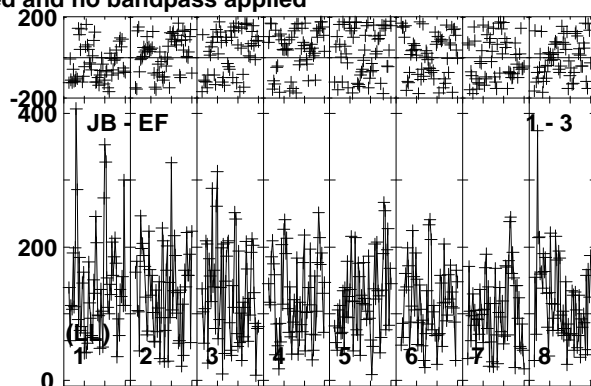
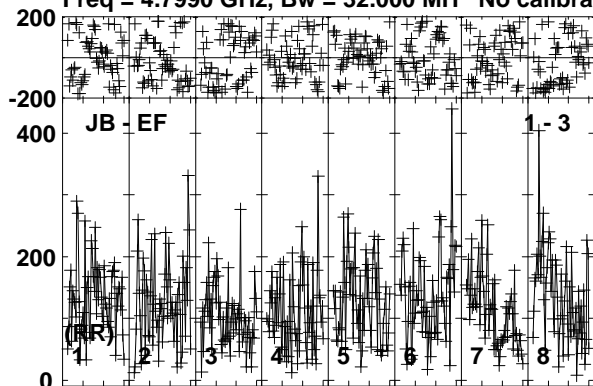

Lower frame: Micro Ampl Jy Top frame: Phas deg
Vector averaged cross-power spectrum Baseline: JB (01) - EF (03)
Timerange: 01/05:32:05 to 01/05:34:14

Plot file version 583 created 26-SEP-2019 10:43:40

190829A RG010A.UVDATA.1

Freq = 4.7990 GHz, Bw = 32.000 MH No calibration applied and no bandpass applied

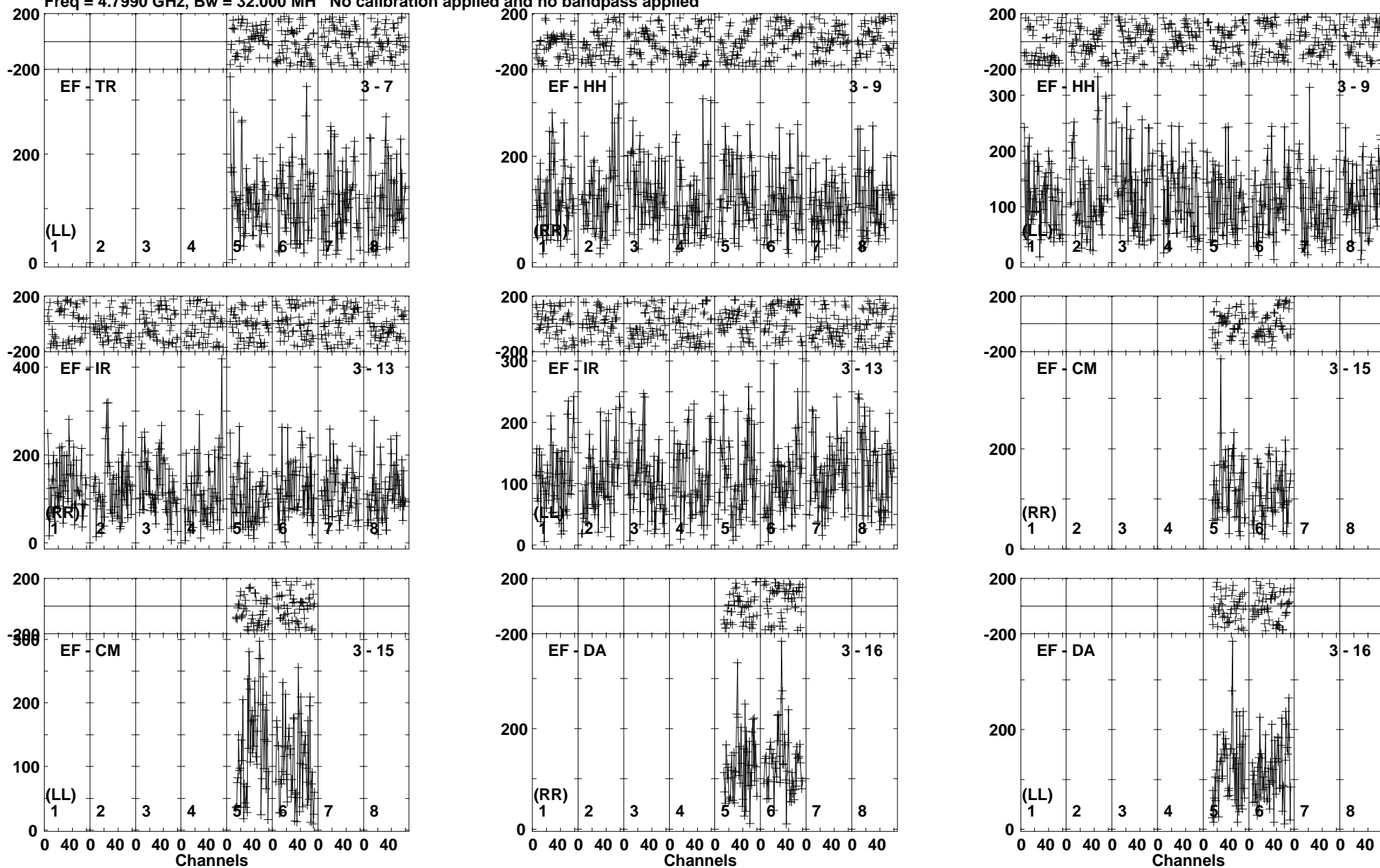

Lower frame: Micro Ampl Jy Top frame: Phas deg
Vector averaged cross-power spectrum Baseline: EF (03) - TR (07)
Timerange: 01/05:32:05 to 01/05:34:14

Plot file version 584 created 26-SEP-2019 10:43:41

190829A RG010A.UVDATA.1

Freq = 4.7990 GHz, Bw = 32.000 MH No calibration applied and no bandpass applied

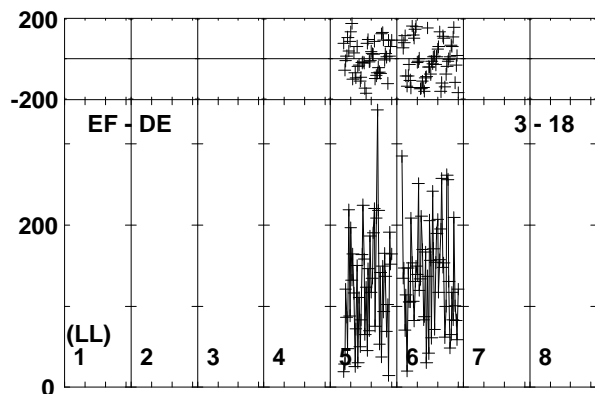
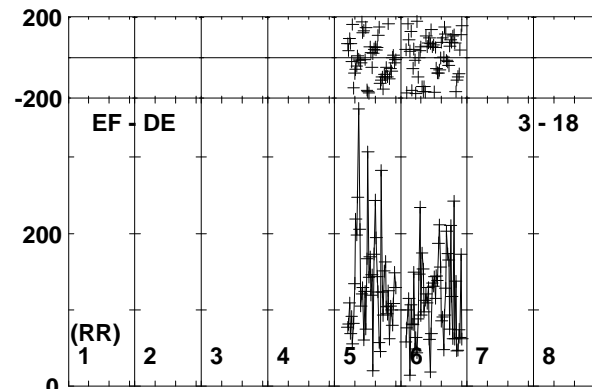
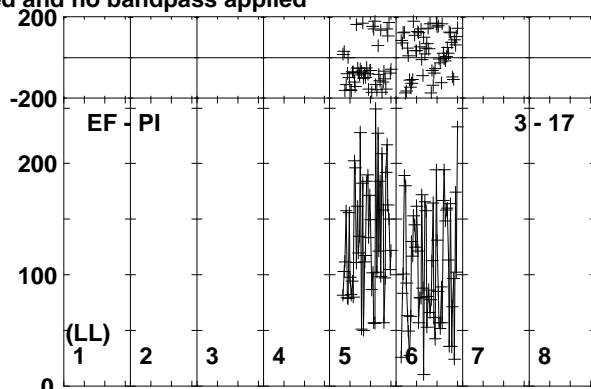
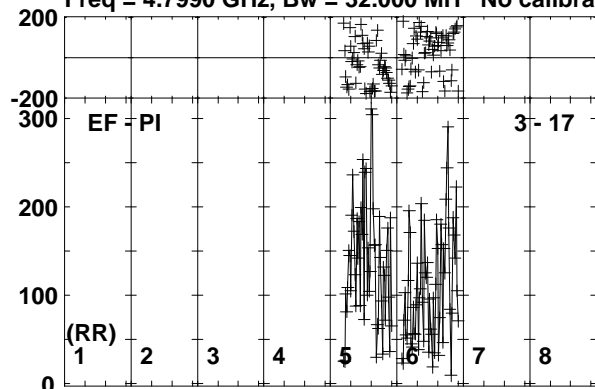

Lower frame: Micro Ampl Jy Top frame: Phas deg
Vector averaged cross-power spectrum Baseline: EF (03) - PI (17)
Timerange: 01/05:32:05 to 01/05:34:14

Plot file version 585 created 26-SEP-2019 10:43:41

J0257-1212 RG010A.UVDATA.1

Freq = 4.7990 GHz, Bw = 32.000 MH No calibration applied and no bandpass applied

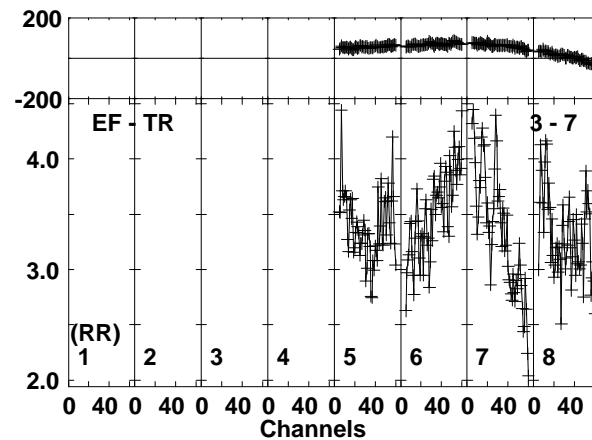
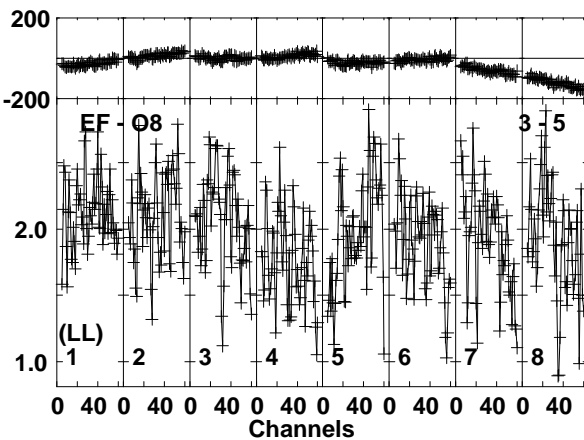
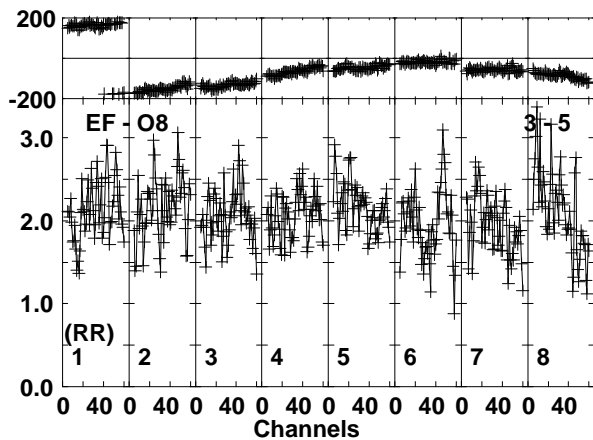
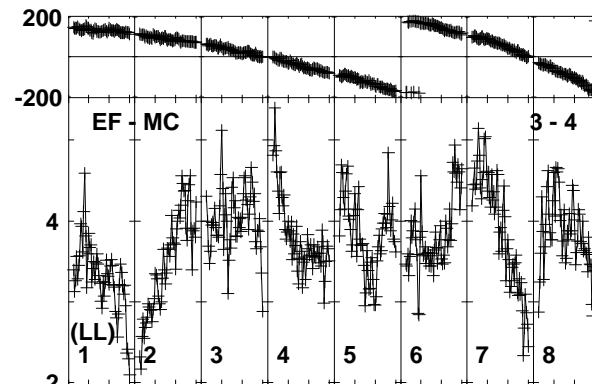
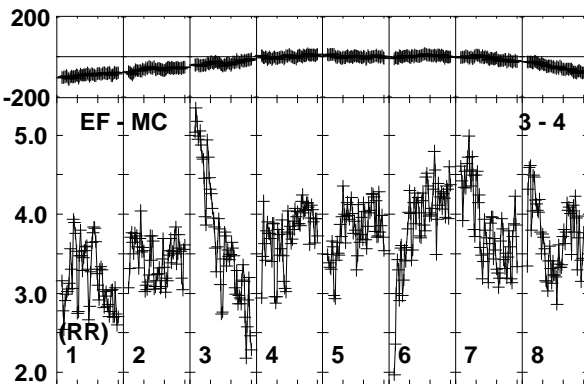
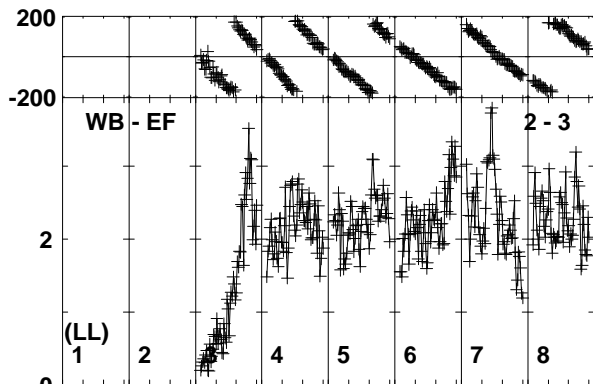
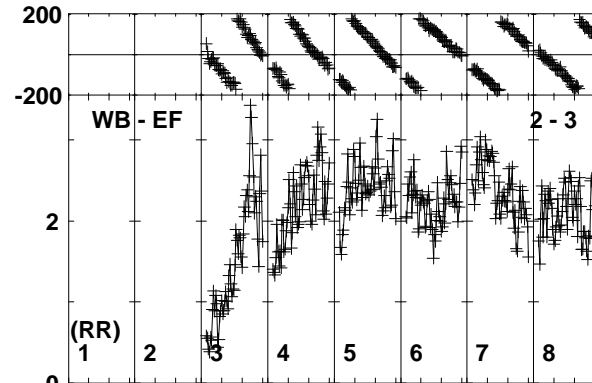
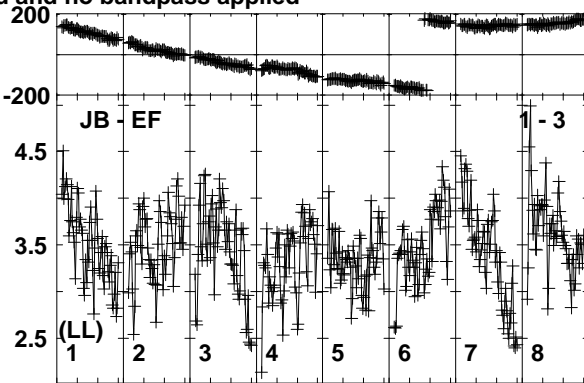
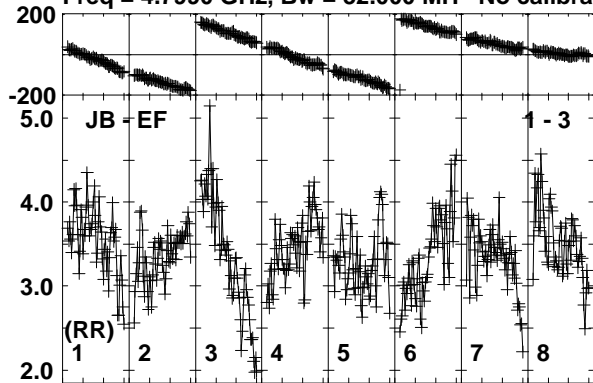

Lower frame: Milli Ampl Jy Top frame: Phas deg
Vector averaged cross-power spectrum Baseline: JB (01) - EF (03)
Timerange: 01/05:34:16 to 01/05:35:14

Plot file version 586 created 26-SEP-2019 10:43:41

J0257-1212 RG010A.UVDATA.1

Freq = 4.7990 GHz, Bw = 32.000 MH No calibration applied and no bandpass applied

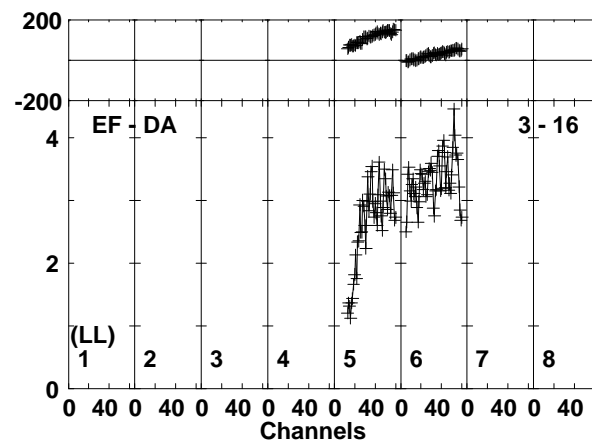
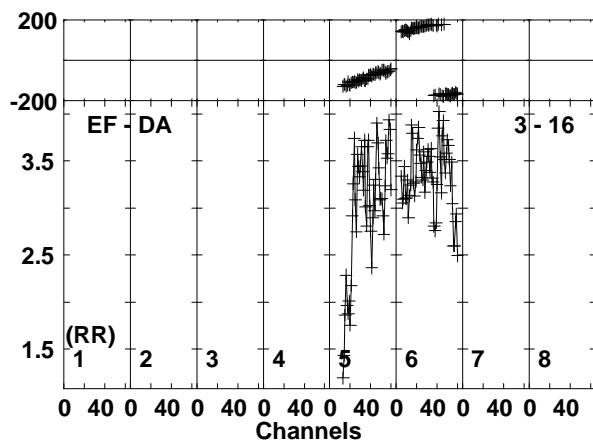
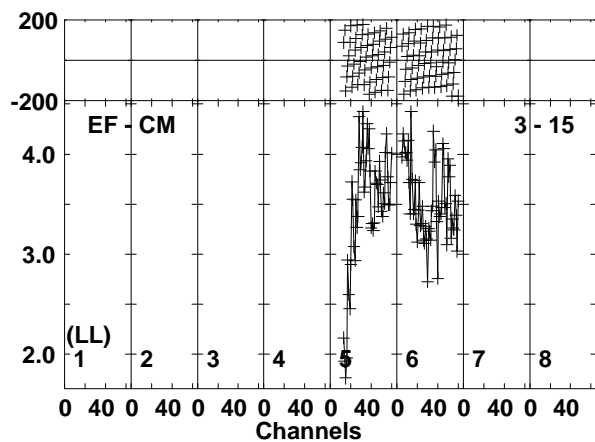
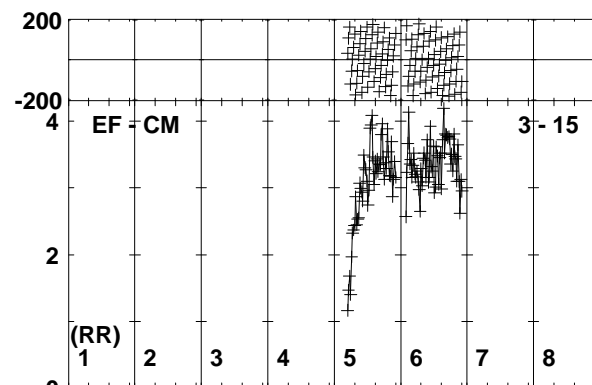
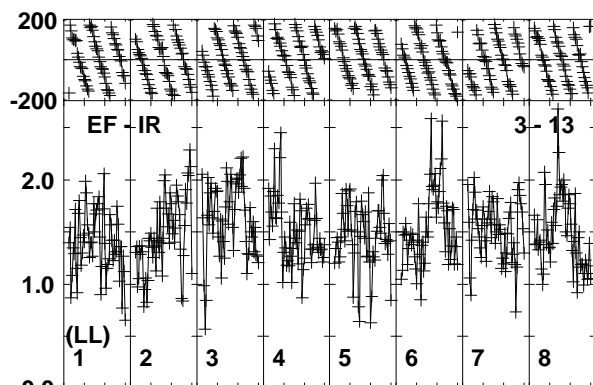
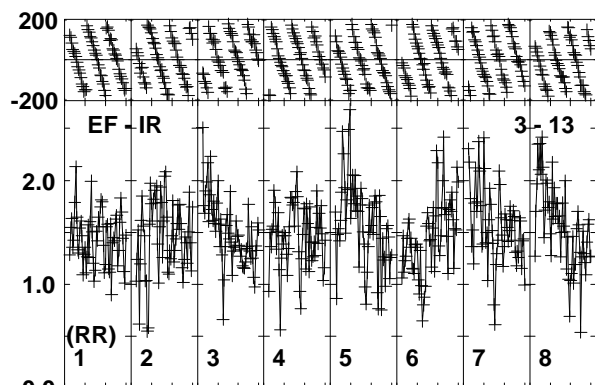
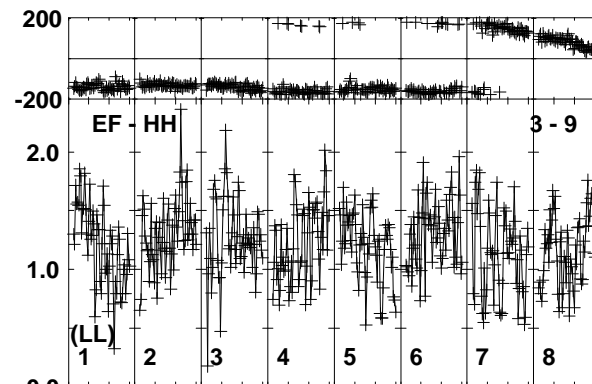
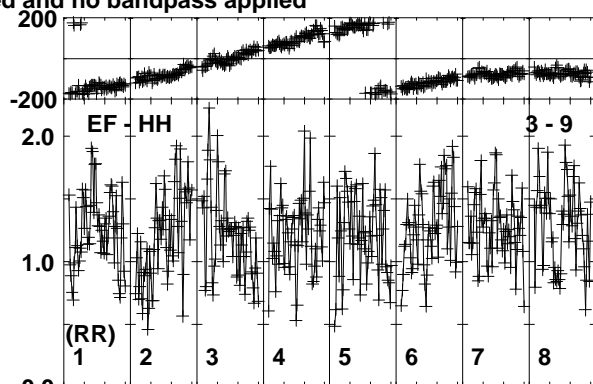
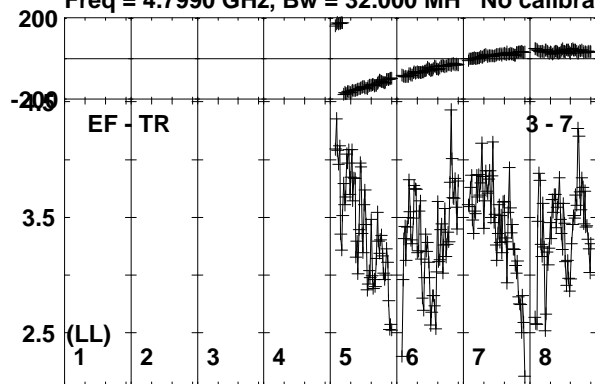

Lower frame: Milli Ampl Jy Top frame: Phas deg
Vector averaged cross-power spectrum Baseline: EF (03) - TR (07)
Timerange: 01/05:34:16 to 01/05:35:14

Plot file version 587 created 26-SEP-2019 10:43:42

J0257-1212 RG010A.UVDATA.1

Freq = 4.7990 GHz, Bw = 32.000 MH No calibration applied and no bandpass applied

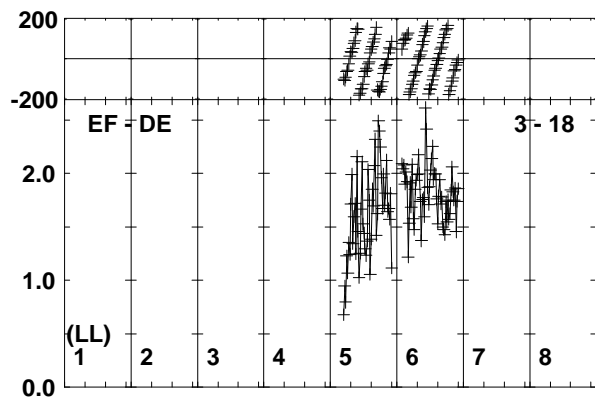
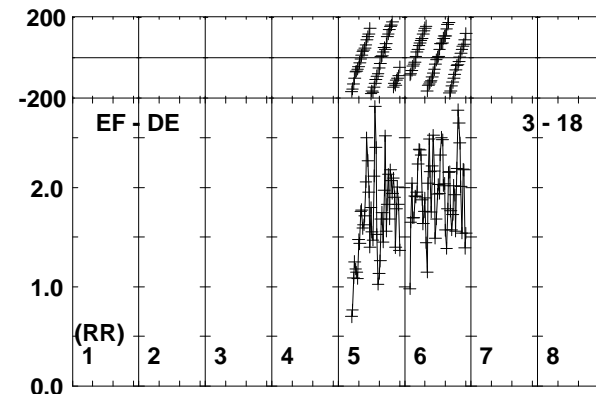
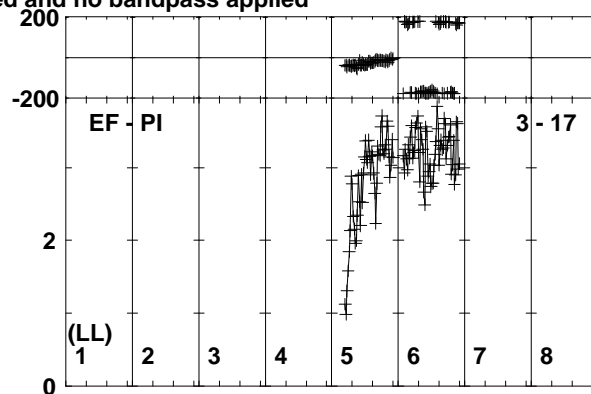
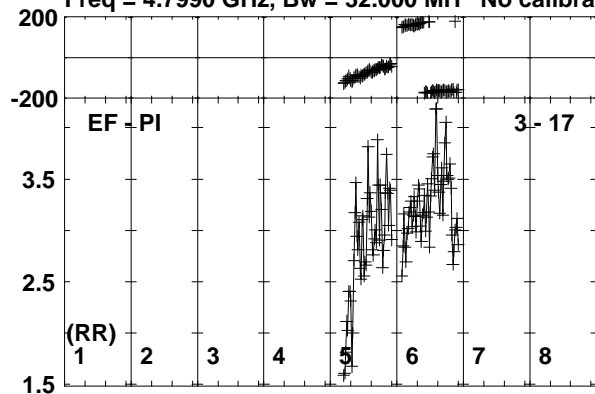

Lower frame: Milli Ampl Jy Top frame: Phas deg
Vector averaged cross-power spectrum Baseline: EF (03) - PI (17)
Timerange: 01/05:34:16 to 01/05:35:14

Plot file version 588 created 26-SEP-2019 10:43:42

190829A RG010A.UVDATA.1

Freq = 4.7990 GHz, Bw = 32.000 MH No calibration applied and no bandpass applied

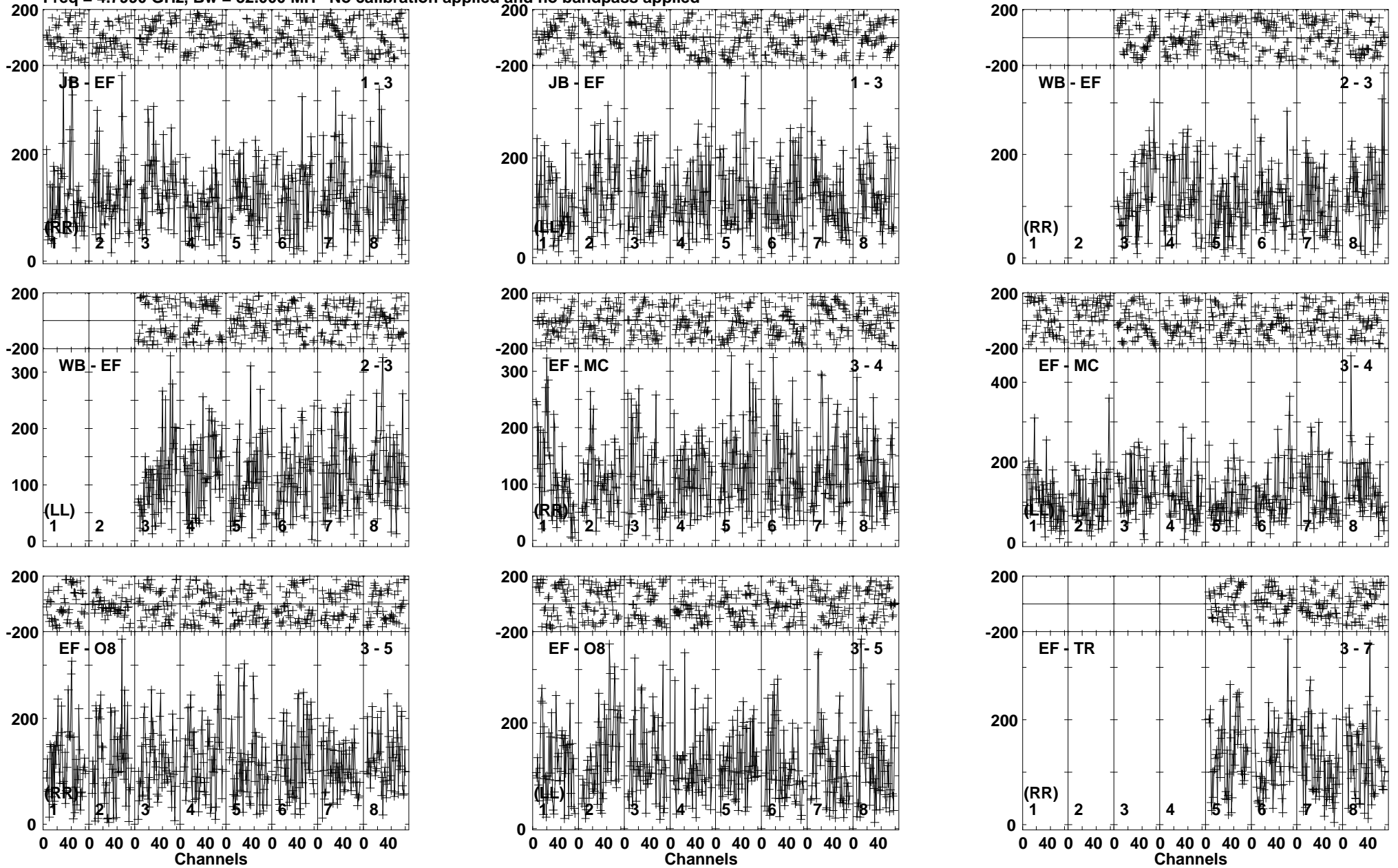

Lower frame: Micro Ampl Jy Top frame: Phas deg
Vector averaged cross-power spectrum Baseline: JB (01) - EF (03)
Timerange: 01/05:35:16 to 01/05:37:24

Plot file version 589 created 26-SEP-2019 10:43:42

190829A RG010A.UVDATA.1

Freq = 4.7990 GHz, Bw = 32.000 MH No calibration applied and no bandpass applied

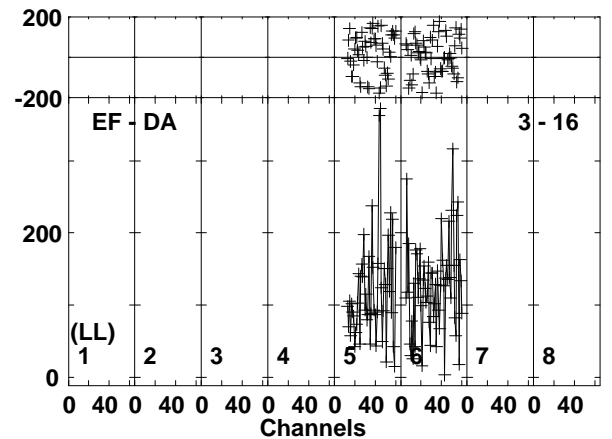
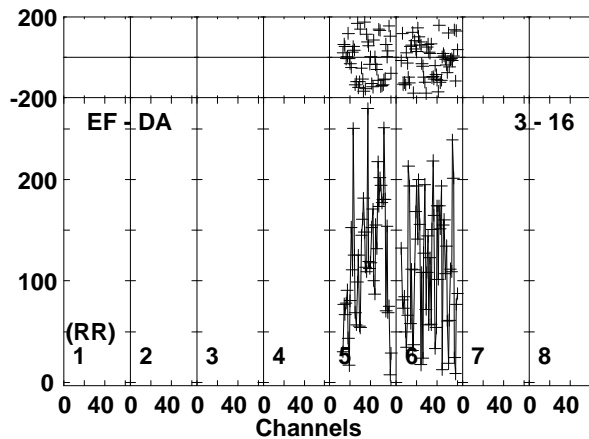
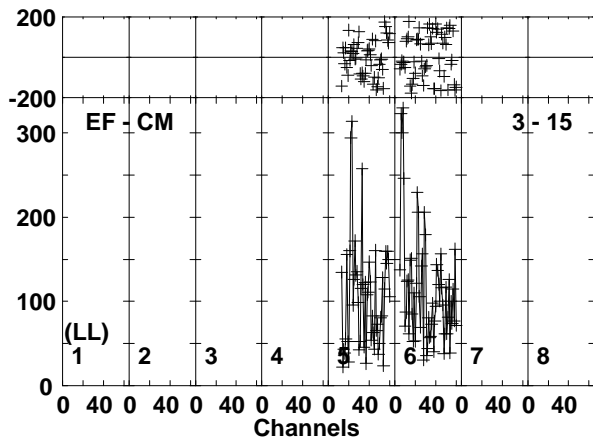
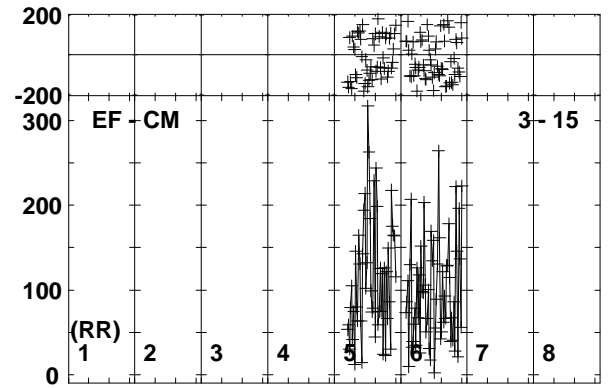
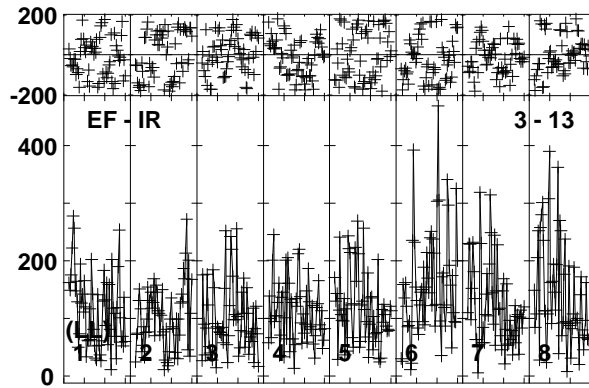
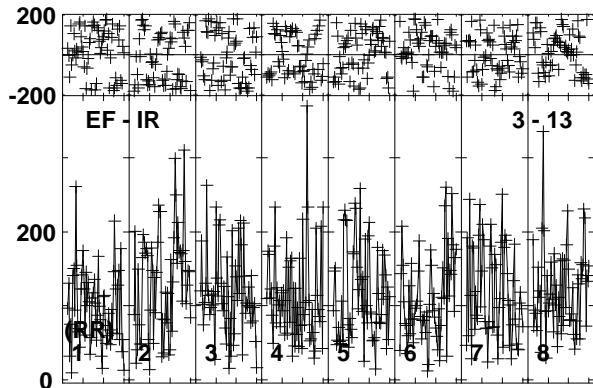
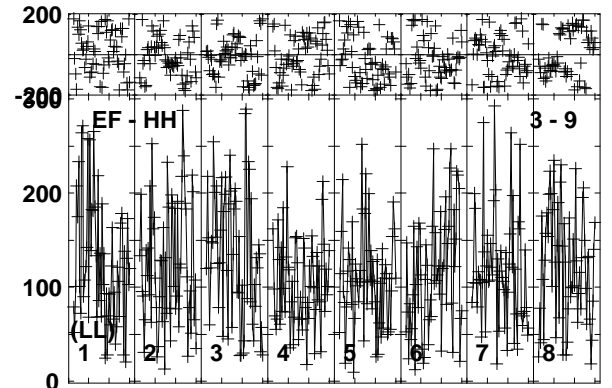
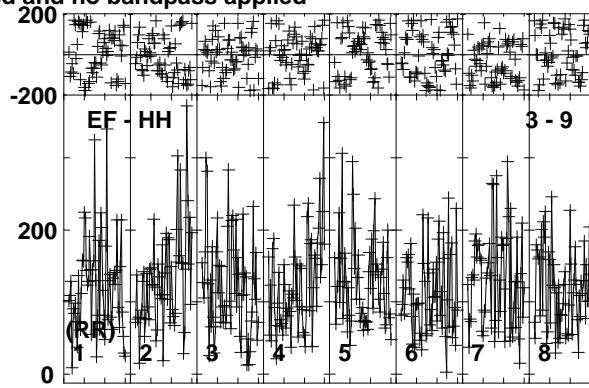
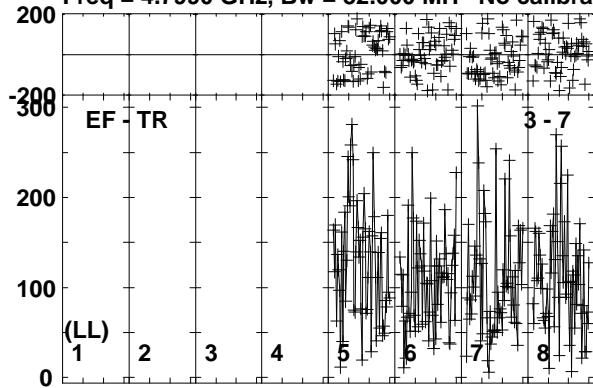

Lower frame: Micro Ampl Jy Top frame: Phas deg
Vector averaged cross-power spectrum Baseline: EF (03) - TR (07)
Timerange: 01/05:35:16 to 01/05:37:24

Plot file version 590 created 26-SEP-2019 10:43:42

190829A RG010A.UVDATA.1

Freq = 4.7990 GHz, Bw = 32.000 MH No calibration applied and no bandpass applied

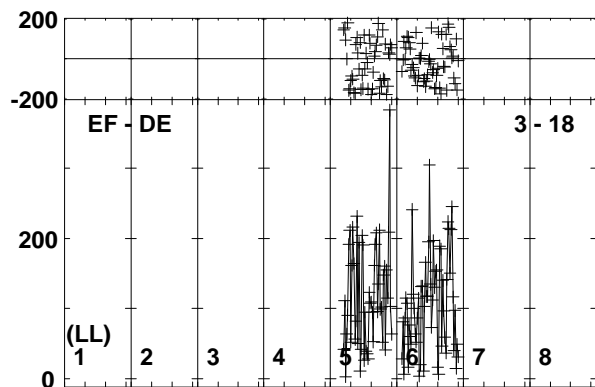
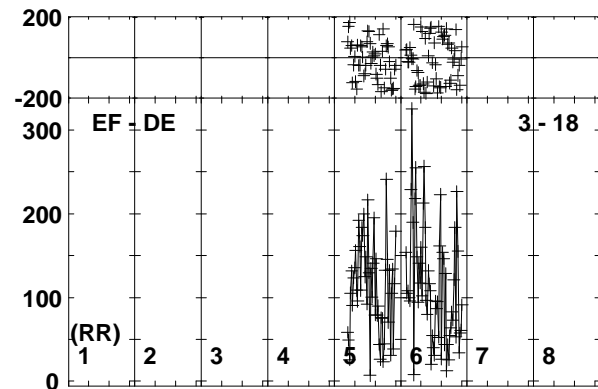
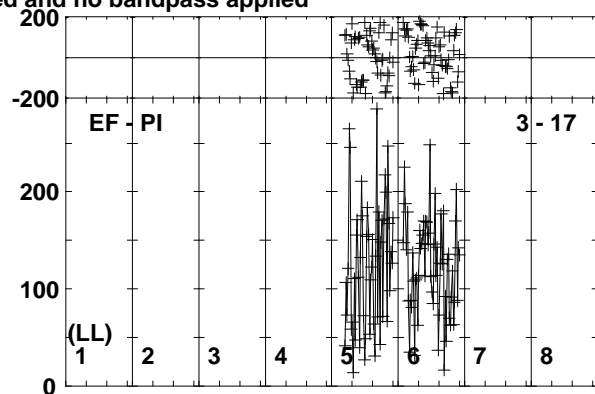
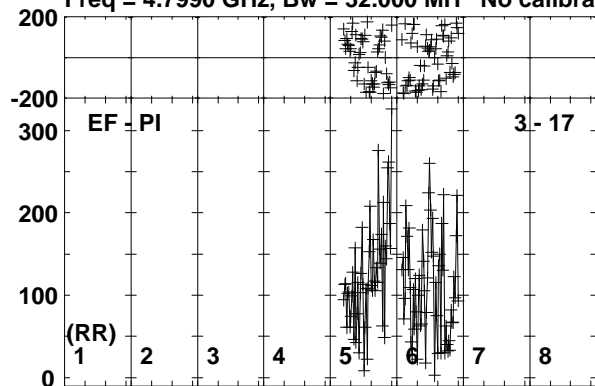

Lower frame: Micro Ampl Jy Top frame: Phas deg
Vector averaged cross-power spectrum Baseline: EF (03) - PI (17)
Timerange: 01/05:35:16 to 01/05:37:24

Plot file version 591 created 26-SEP-2019 10:43:42

J0257-1212 RG010A.UVDATA.1

Freq = 4.7990 GHz, Bw = 32.000 MH No calibration applied and no bandpass applied

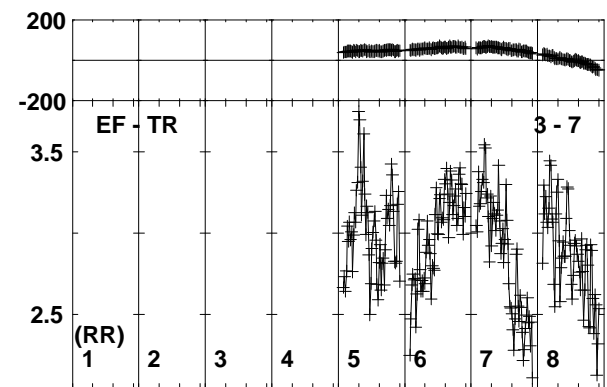
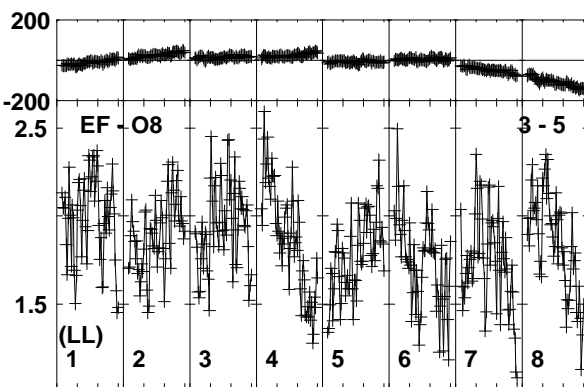
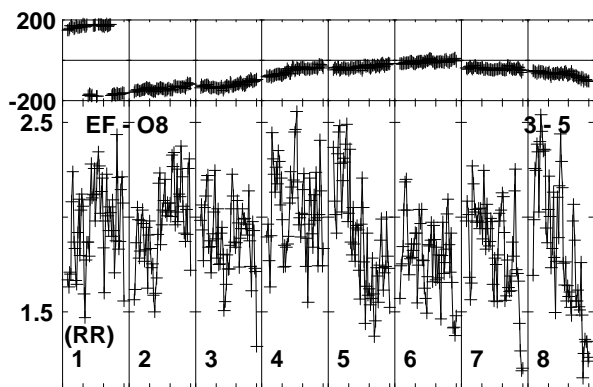
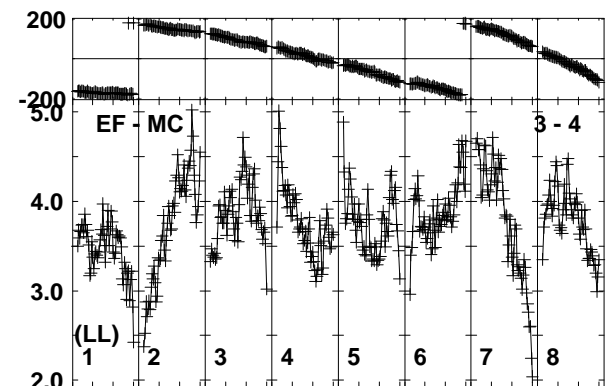
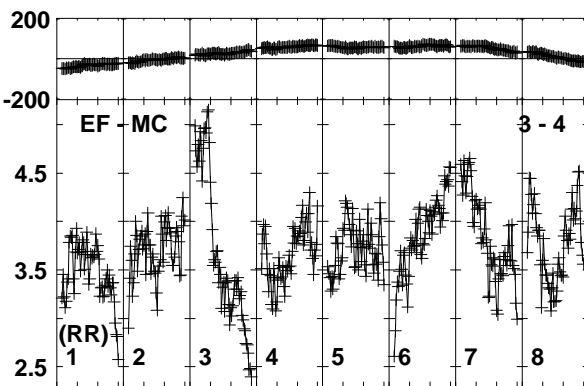
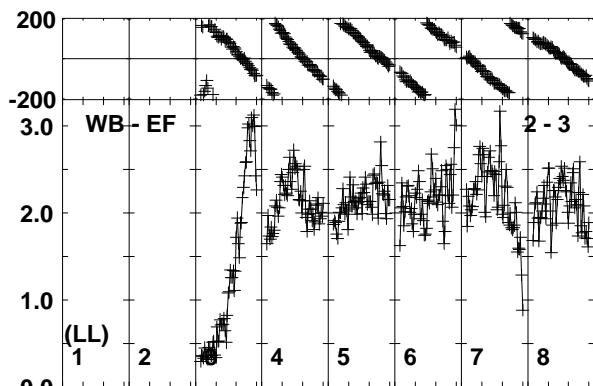
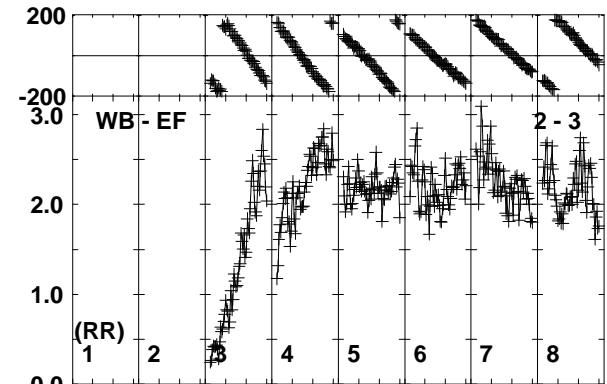
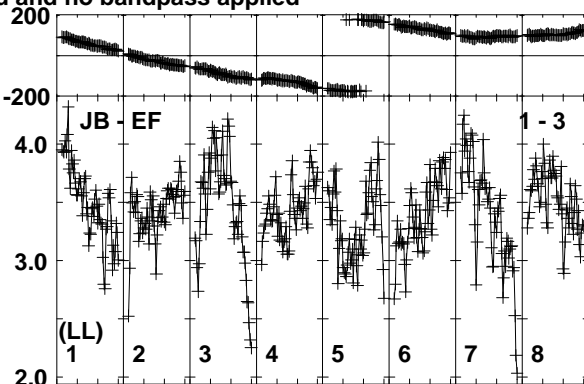
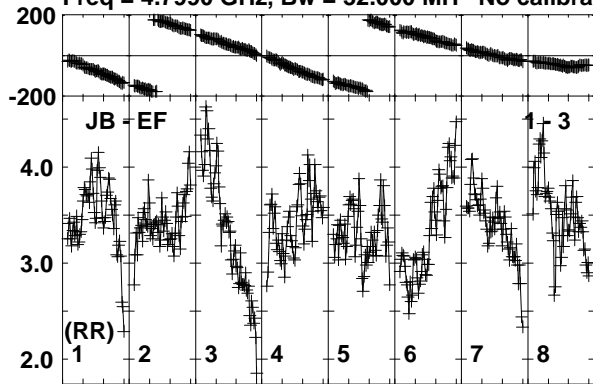

Lower frame: Milli Ampl Jy Top frame: Phas deg
Vector averaged cross-power spectrum Baseline: JB (01) - EF (03)
Timerange: 01/05:38:05 to 01/05:38:34

Plot file version 592 created 26-SEP-2019 10:43:43

J0257-1212 RG010A.UVDATA.1

Freq = 4.7990 GHz, Bw = 32.000 MH No calibration applied and no bandpass applied

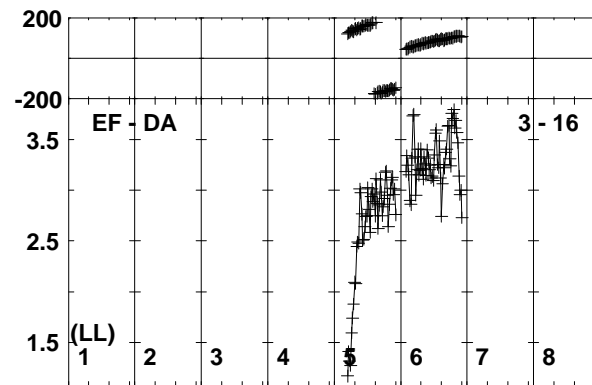
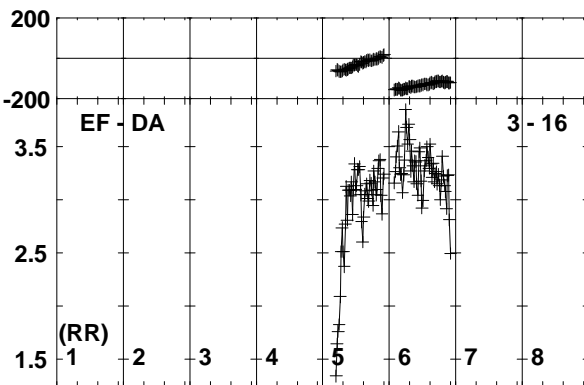
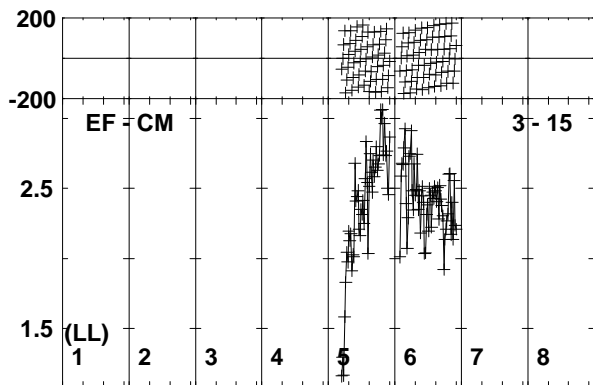
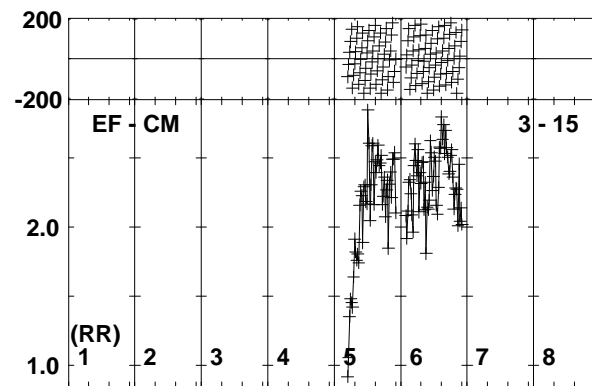
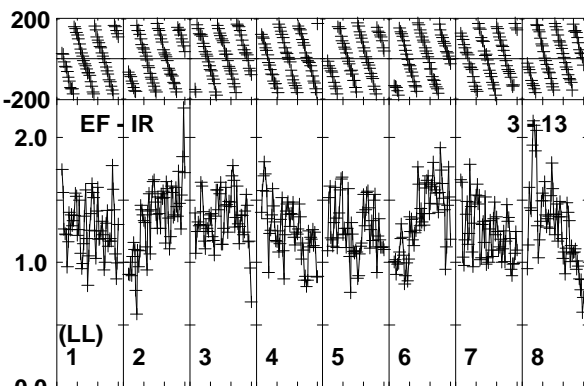
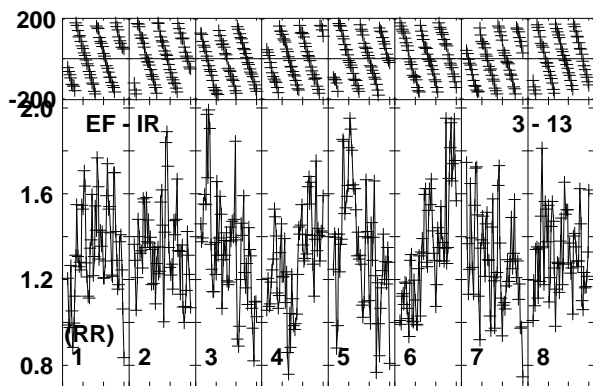
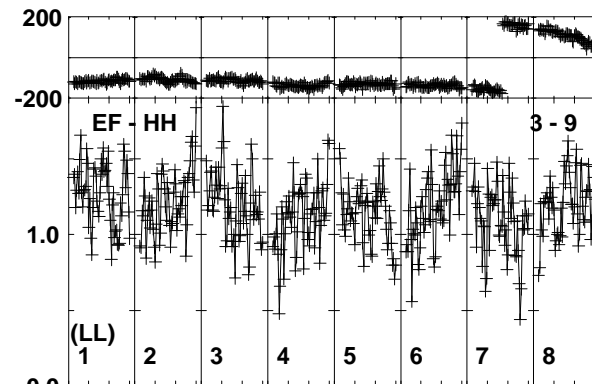
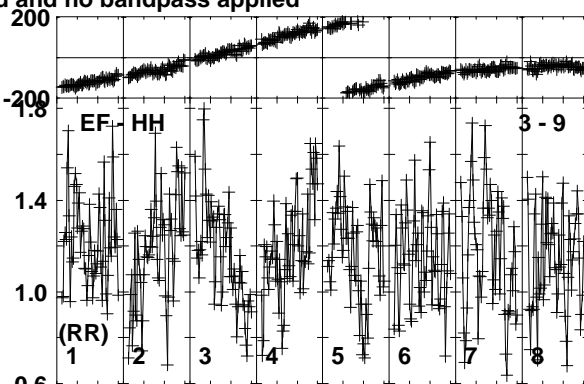
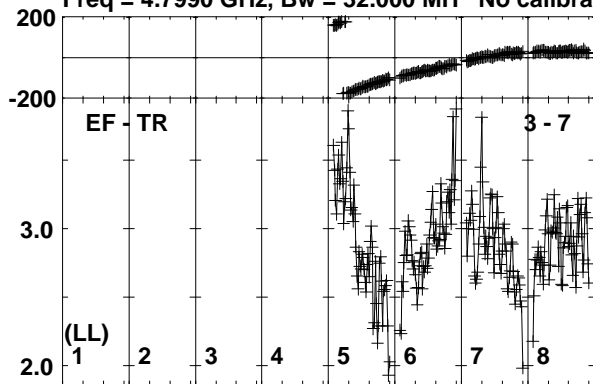

Lower frame: Milli Ampl Jy Top frame: Phas deg
Vector averaged cross-power spectrum Baseline: EF (03) - TR (07)
Timerange: 01/05:38:05 to 01/05:38:34

Plot file version 593 created 26-SEP-2019 10:43:43

J0257-1212 RG010A.UVDATA.1

Freq = 4.7990 GHz, Bw = 32.000 MH No calibration applied and no bandpass applied

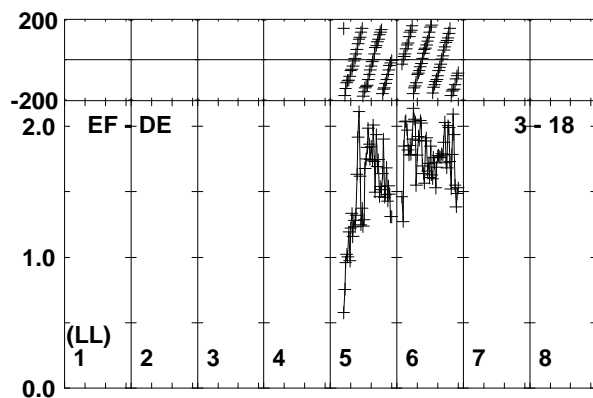
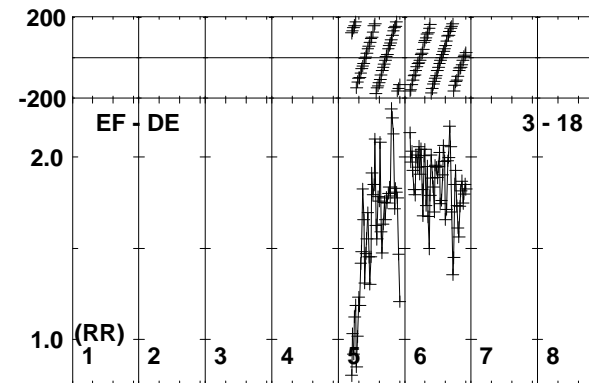
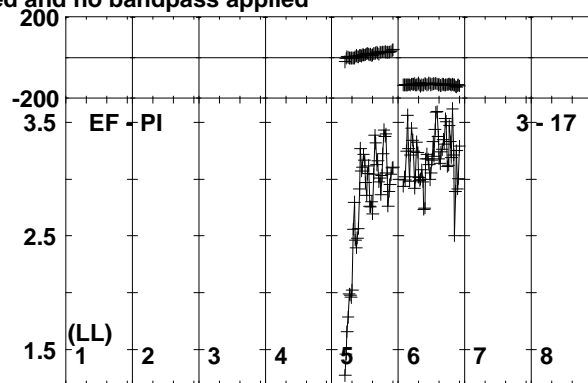
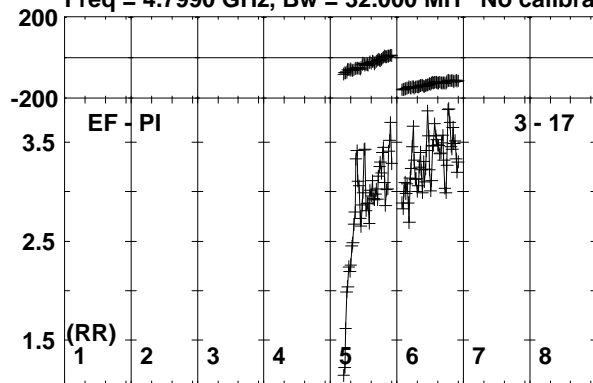

Lower frame: Milli Ampl Jy Top frame: Phas deg
Vector averaged cross-power spectrum Baseline: EF (03) - PI (17)
Timerange: 01/05:38:05 to 01/05:38:34

Plot file version 594 created 26-SEP-2019 10:43:43

J0300-0846 RG010A.UVDATA.1

Freq = 4.7990 GHz, Bw = 32.000 MH No calibration applied and no bandpass applied

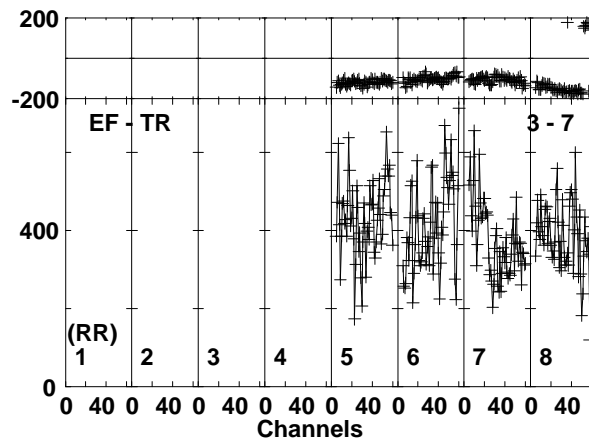
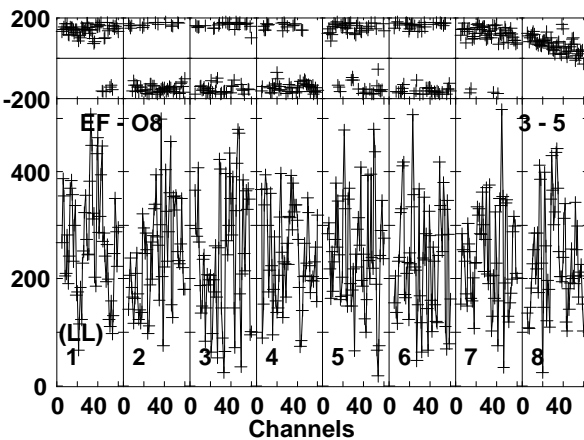
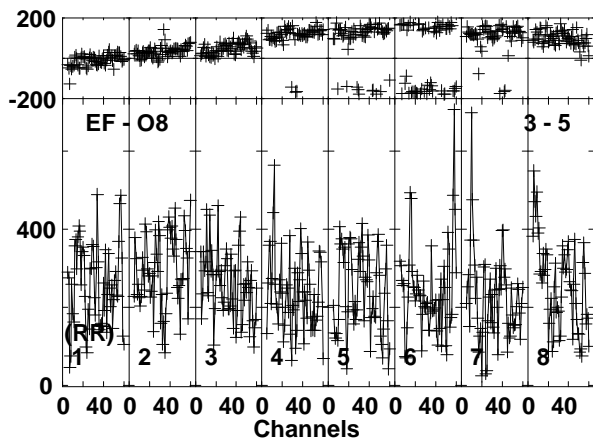
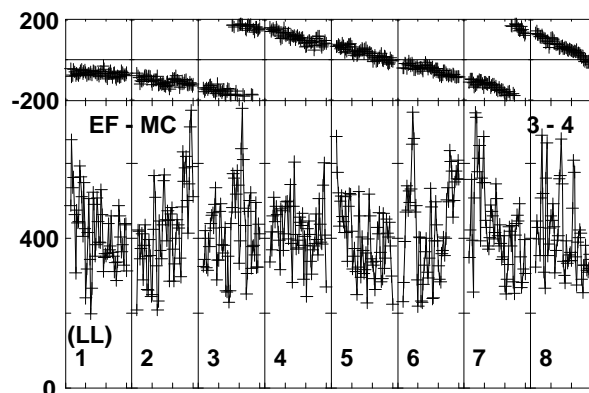
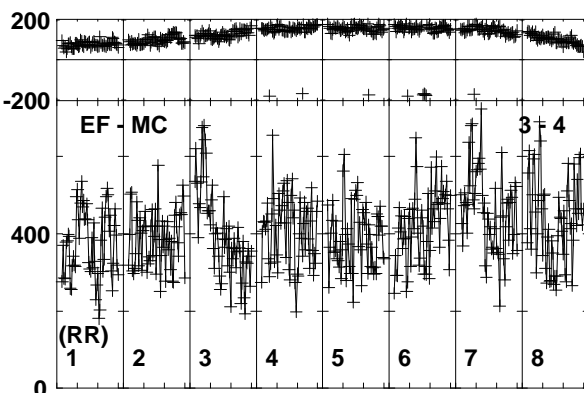
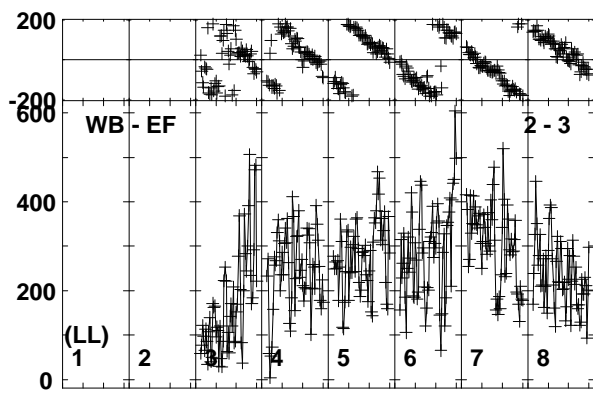
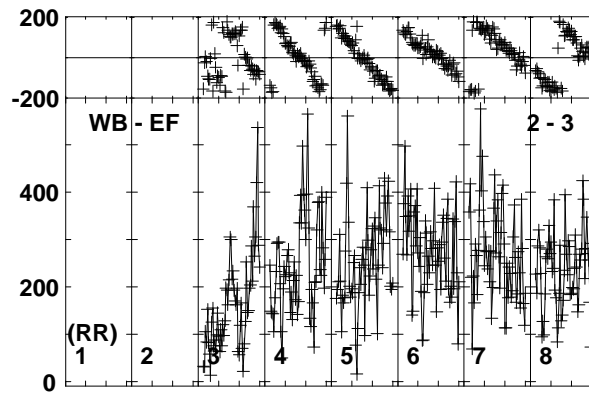
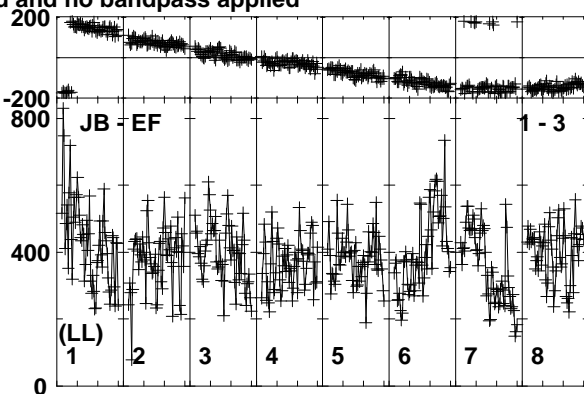
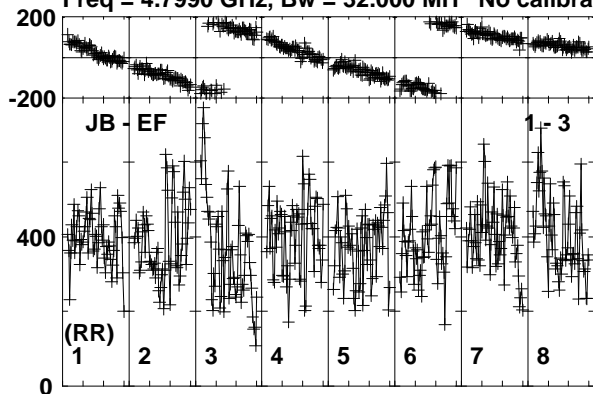

Lower frame: Micro Ampl Jy Top frame: Phas deg
Vector averaged cross-power spectrum Baseline: JB (01) - EF (03)
Timerange: 01/05:38:36 to 01/05:40:44

Plot file version 595 created 26-SEP-2019 10:43:43

J0300-0846 RG010A.UVDATA.1

Freq = 4.7990 GHz, Bw = 32.000 MH No calibration applied and no bandpass applied

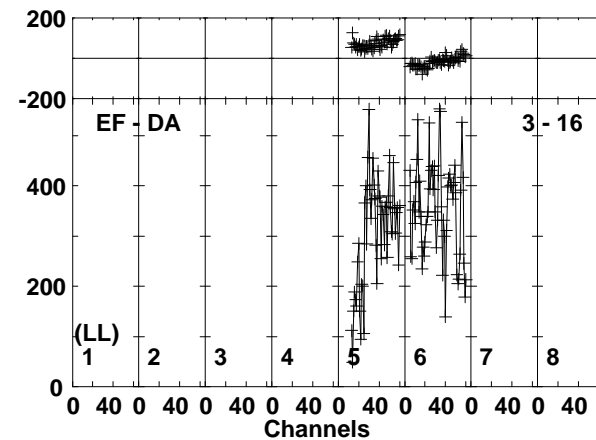
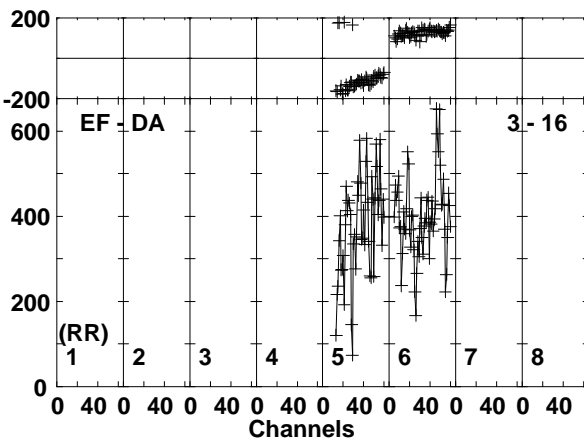
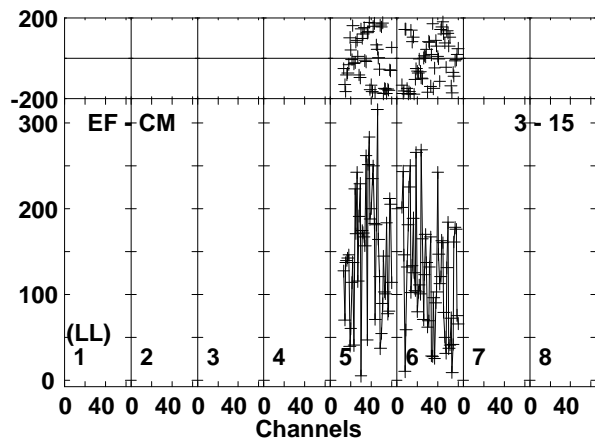
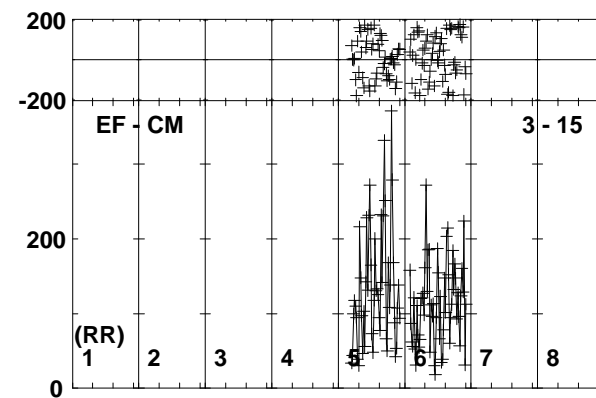
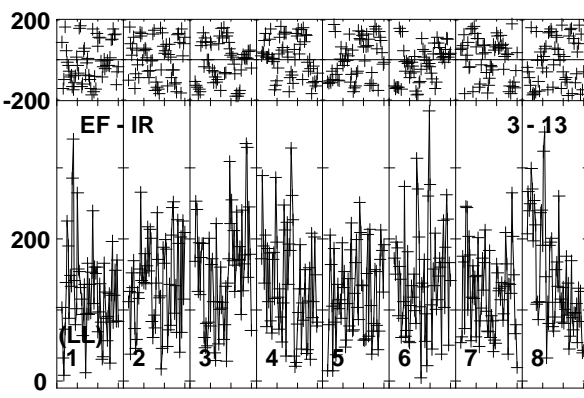
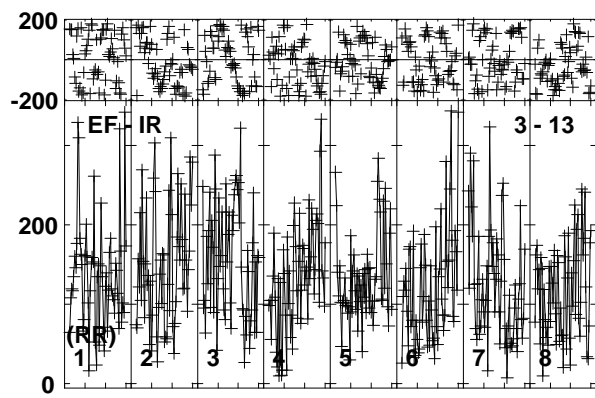
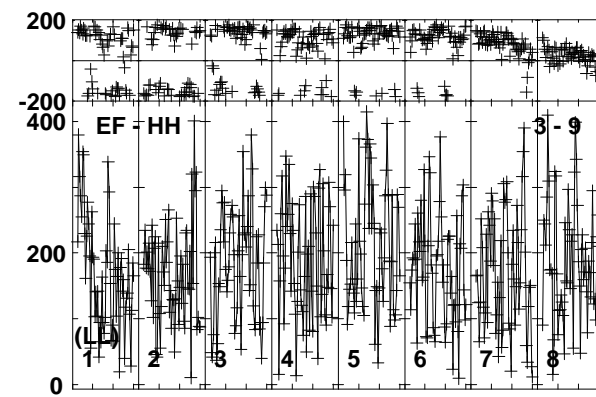
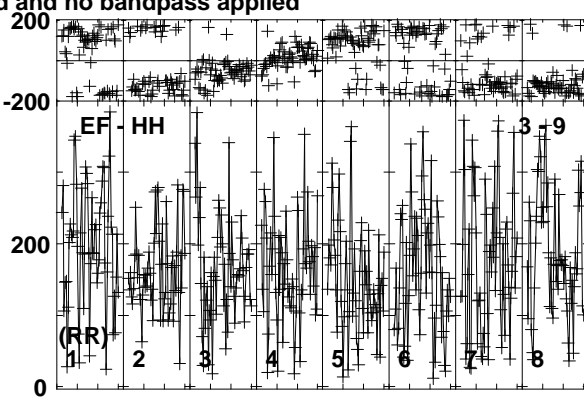
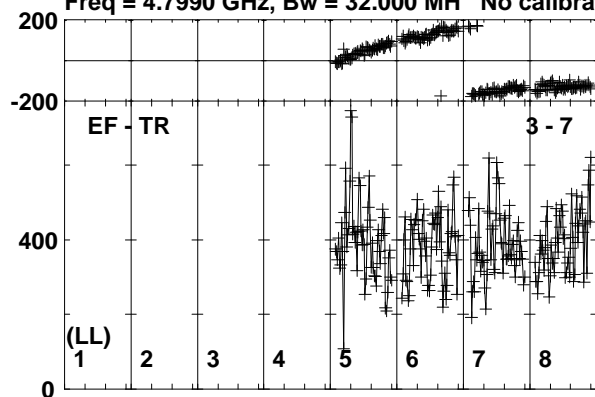

Lower frame: Micro Ampl Jy Top frame: Phas deg
Vector averaged cross-power spectrum Baseline: EF (03) - TR (07)
Timerange: 01/05:38:36 to 01/05:40:44

Plot file version 596 created 26-SEP-2019 10:43:44

J0300-0846 RG010A.UVDATA.1

Freq = 4.7990 GHz, Bw = 32.000 MH No calibration applied and no bandpass applied

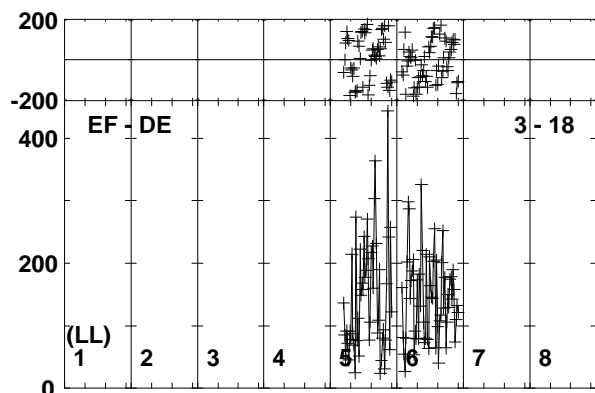
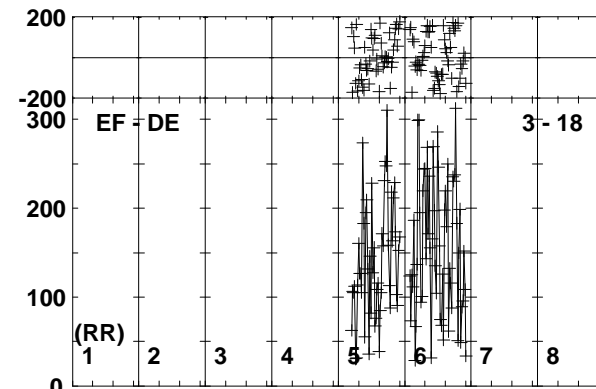
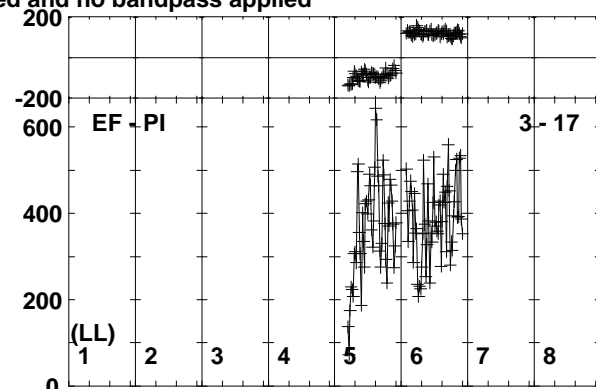
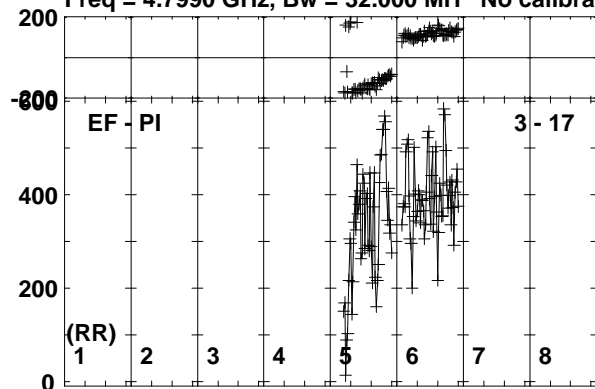

Lower frame: Micro Ampl Jy Top frame: Phas deg
Vector averaged cross-power spectrum Baseline: EF (03) - PI (17)
Timerange: 01/05:38:36 to 01/05:40:44

Plot file version 597 created 26-SEP-2019 10:43:44

J0257-1212 RG010A.UVDATA.1

Freq = 4.7990 GHz, Bw = 32.000 MH No calibration applied and no bandpass applied

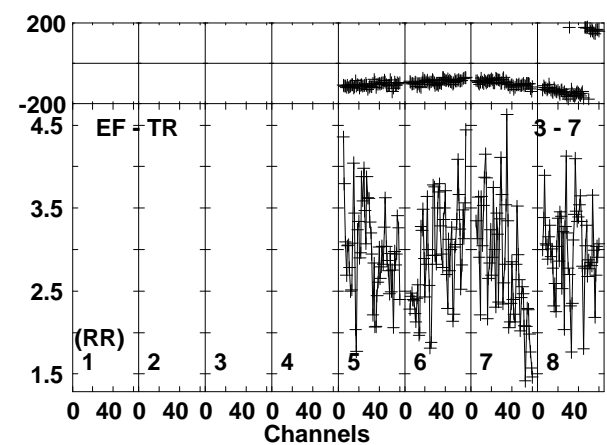
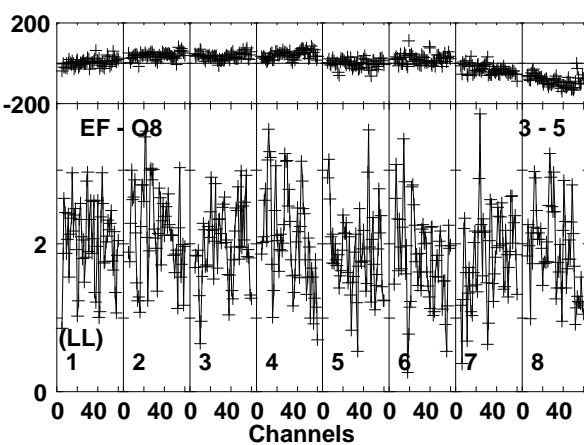
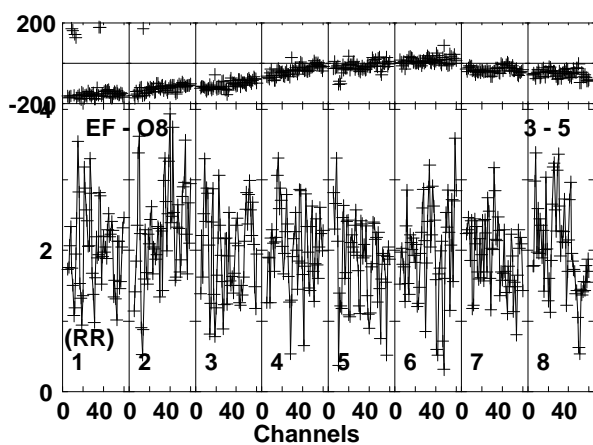
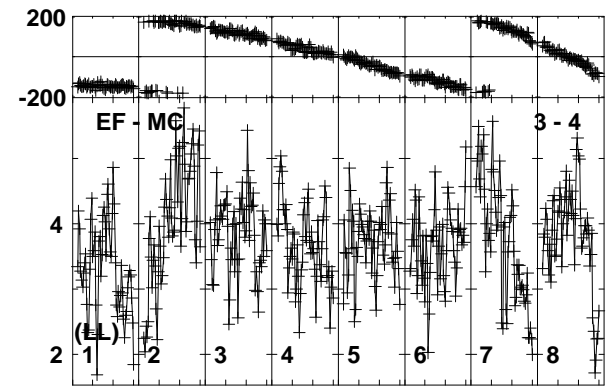
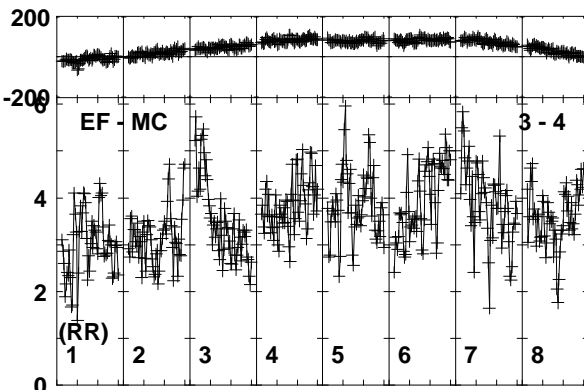
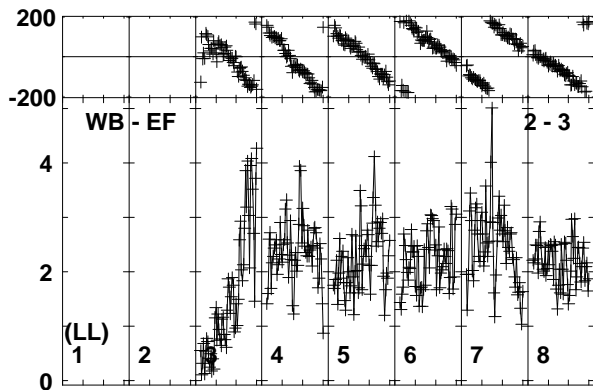
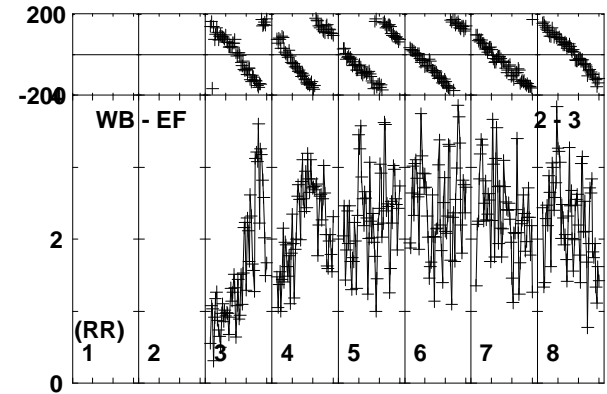
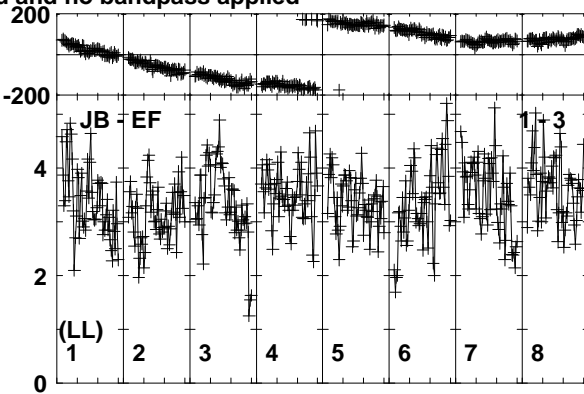
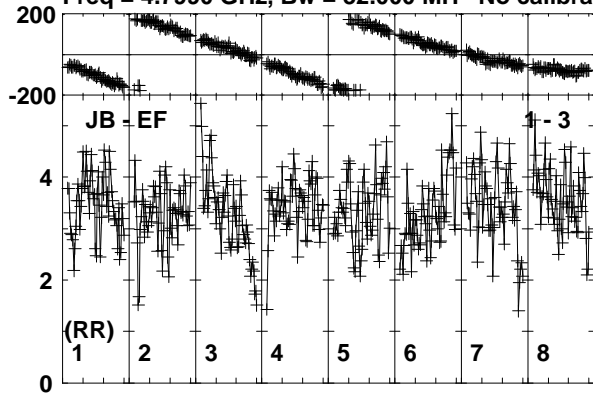

Lower frame: Milli Ampl Jy Top frame: Phas deg
Vector averaged cross-power spectrum Baseline: JB (01) - EF (03)
Timerange: 01/05:40:46 to 01/05:41:45

Plot file version 598 created 26-SEP-2019 10:43:44

J0257-1212 RG010A.UVDATA.1

Freq = 4.7990 GHz, Bw = 32.000 MH No calibration applied and no bandpass applied

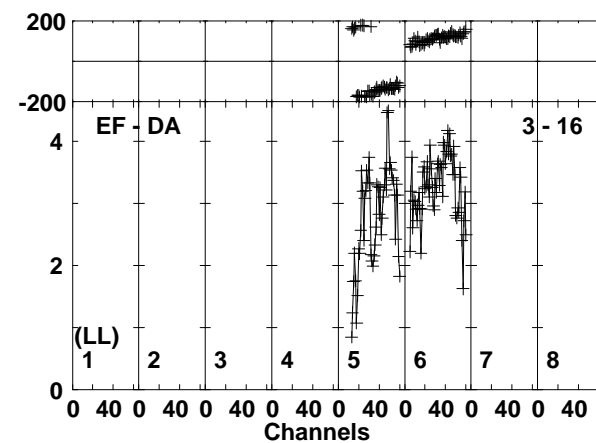
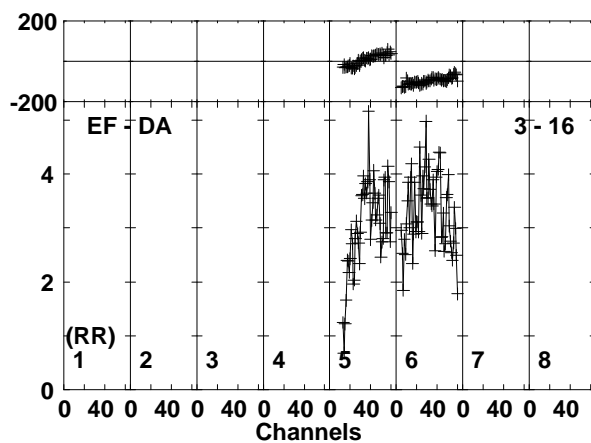
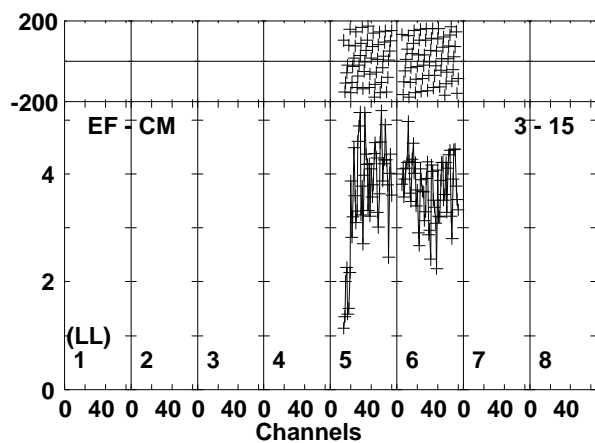
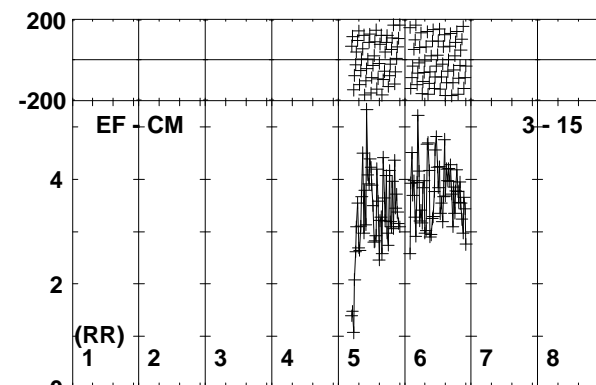
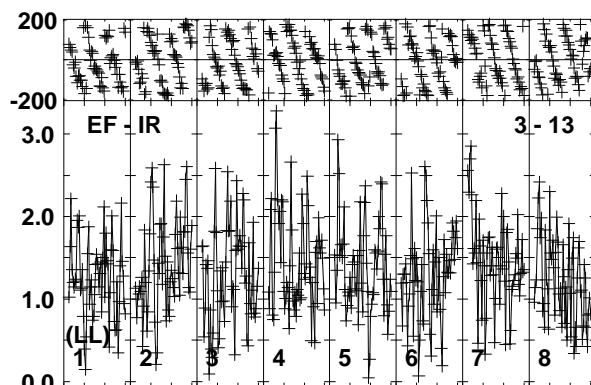
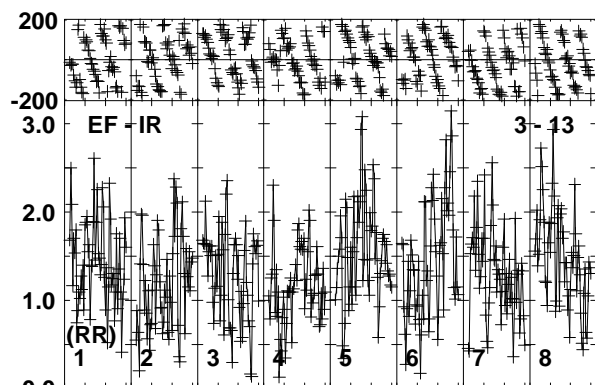
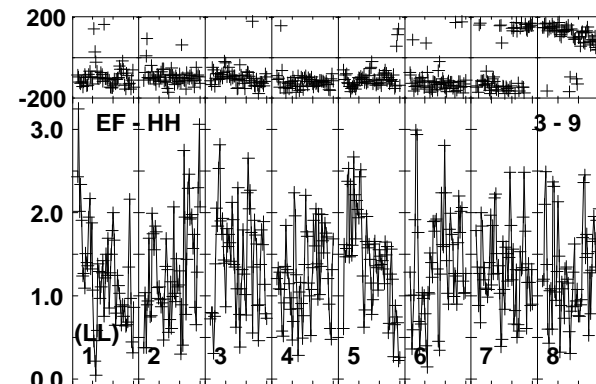
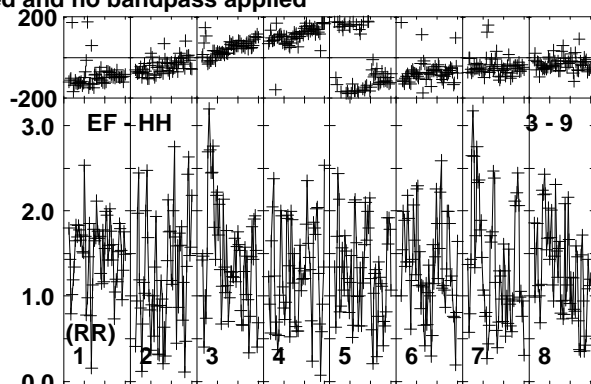
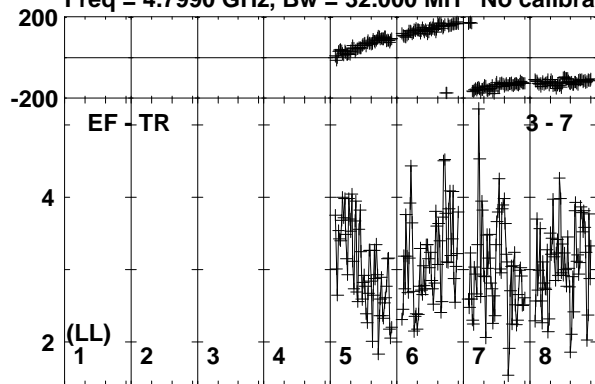

Lower frame: Milli Ampl Jy Top frame: Phas deg
Vector averaged cross-power spectrum Baseline: EF (03) - TR (07)
Timerange: 01/05:40:46 to 01/05:41:45

Plot file version 599 created 26-SEP-2019 10:43:45
J0257-1212 RG010A.UVDATA.1
Freq = 4.7990 GHz, Bw = 32.000 MH No calibration applied and no bandpass applied

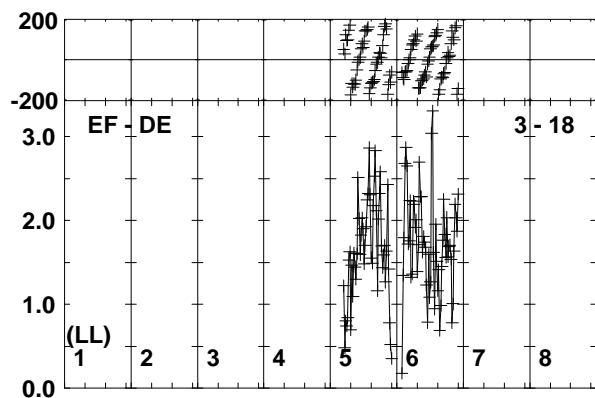
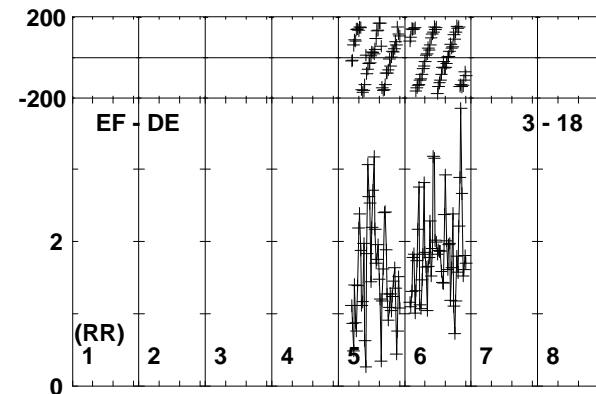
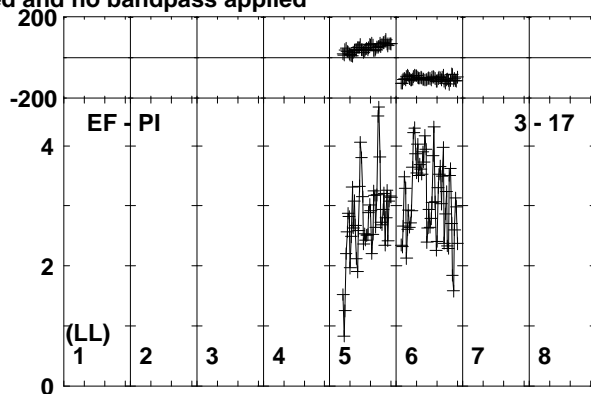
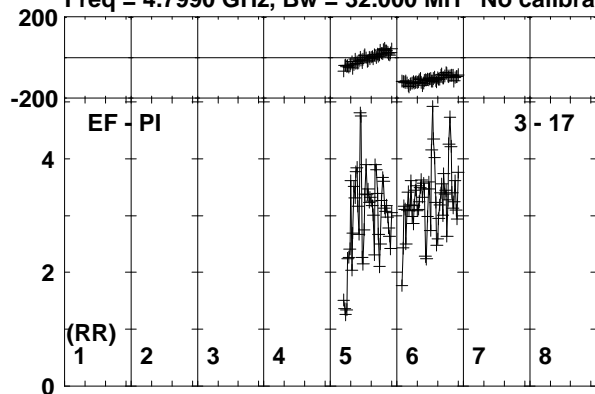

Lower frame: Milli Ampl Jy Top frame: Phas deg
Vector averaged cross-power spectrum Baseline: EF (03) - PI (17)
Timerange: 01/05:40:46 to 01/05:41:45

Plot file version 600 created 26-SEP-2019 10:43:45

190829A RG010A.UVDATA.1

Freq = 4.7990 GHz, Bw = 32.000 MH No calibration applied and no bandpass applied

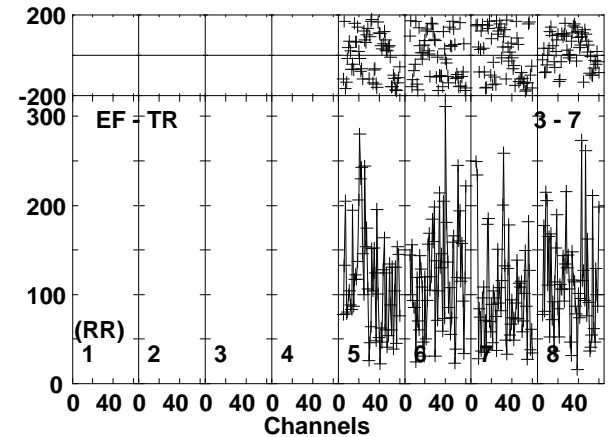
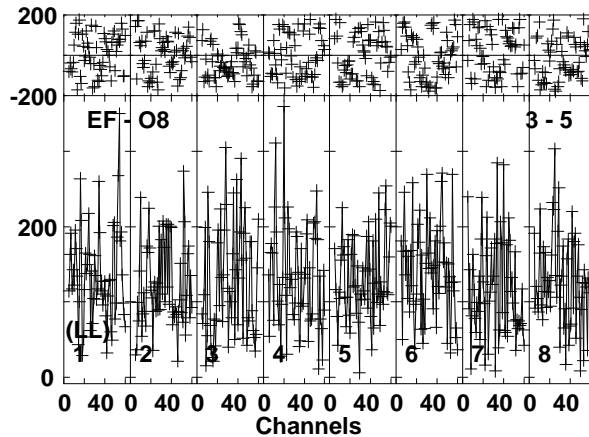
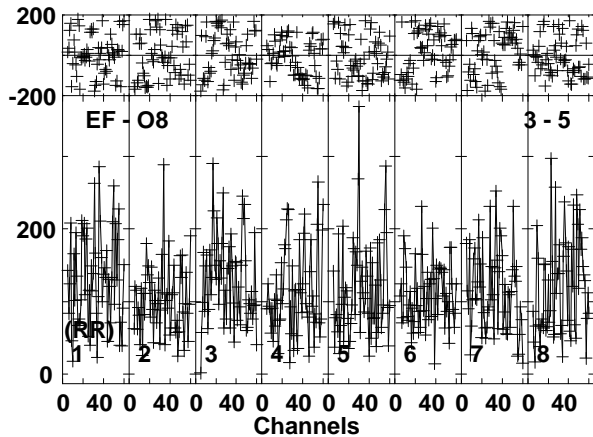
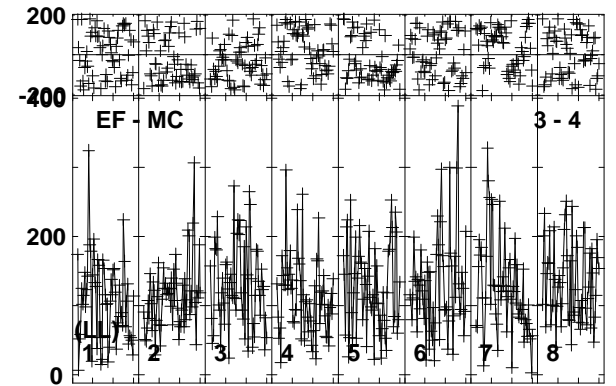
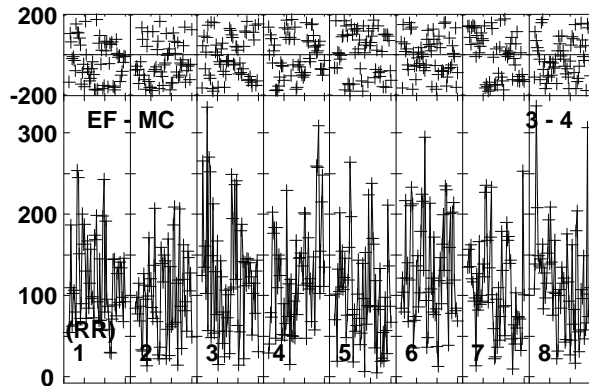
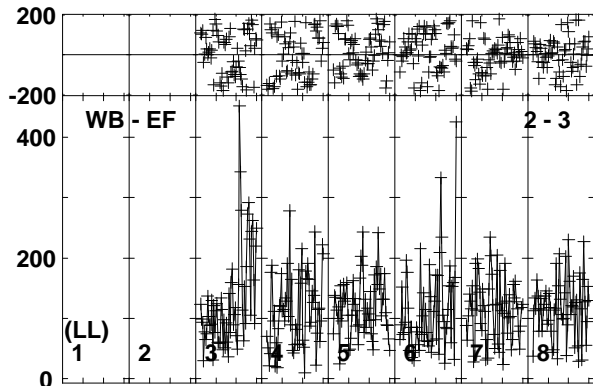
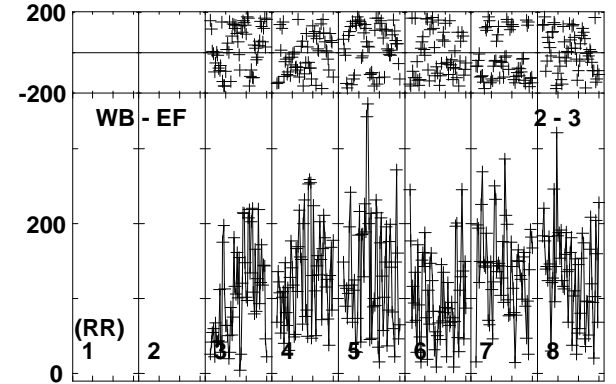
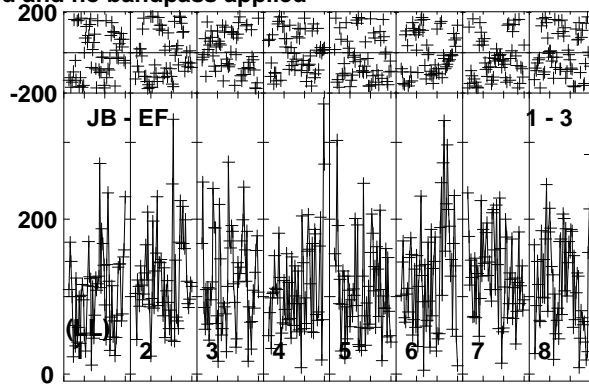
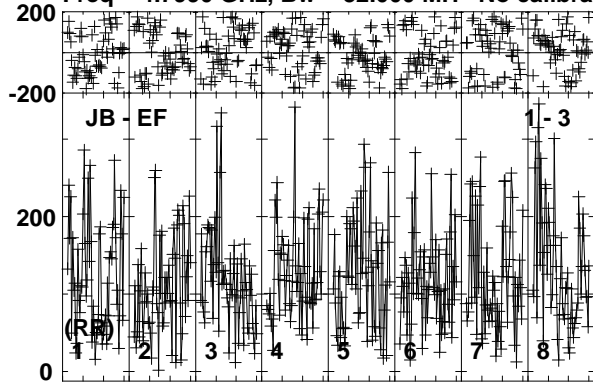

Lower frame: Micro Ampl Jy Top frame: Phas deg
Vector averaged cross-power spectrum Baseline: JB (01) - EF (03)
Timerange: 01/05:41:46 to 01/05:43:54

Plot file version 601 created 26-SEP-2019 10:43:45

190829A RG010A.UVDATA.1

Freq = 4.7990 GHz, Bw = 32.000 MH No calibration applied and no bandpass applied

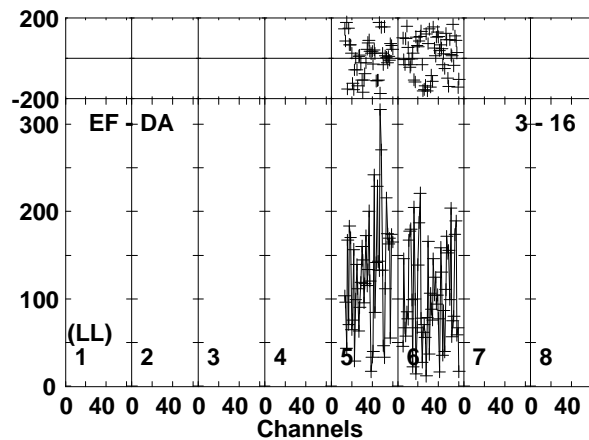
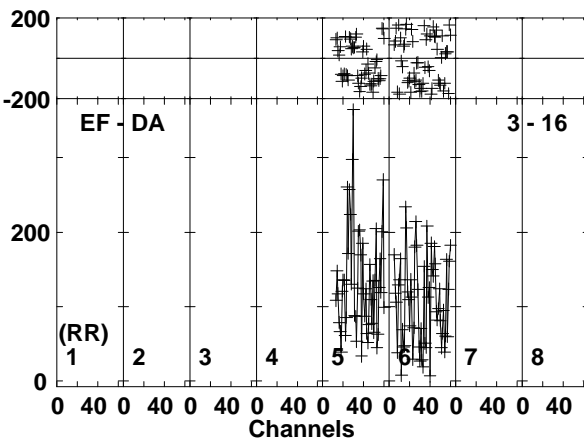
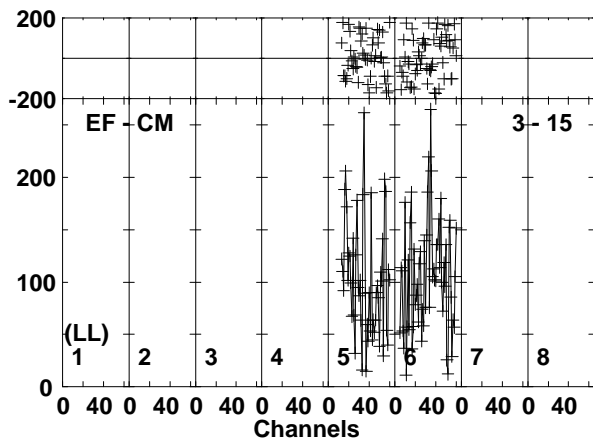
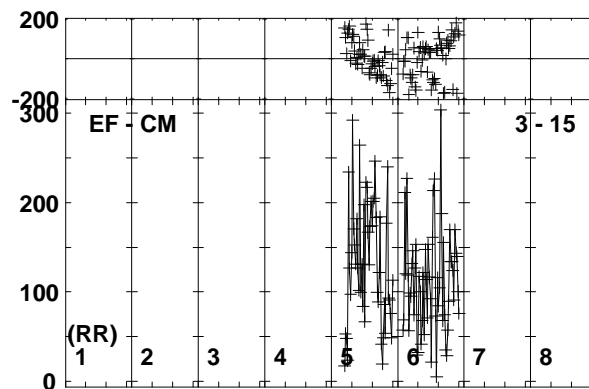
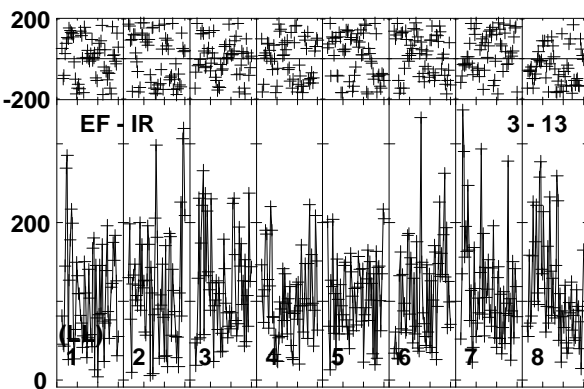
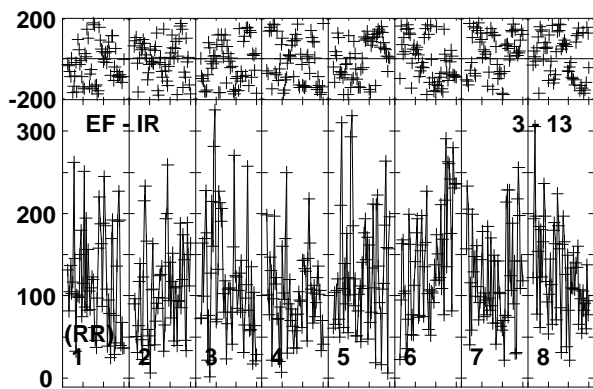
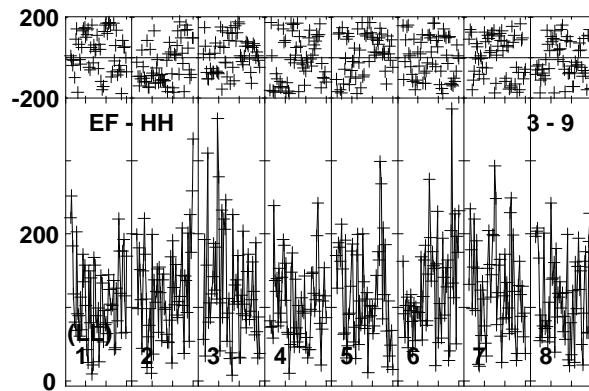
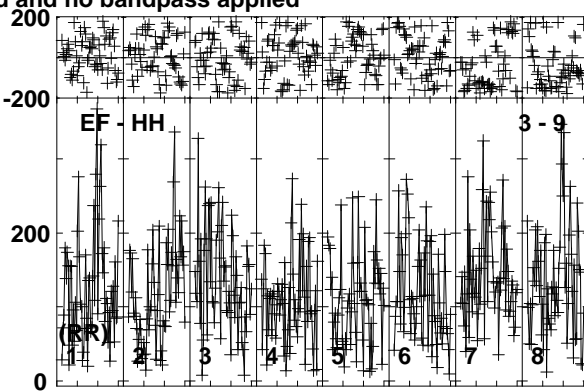
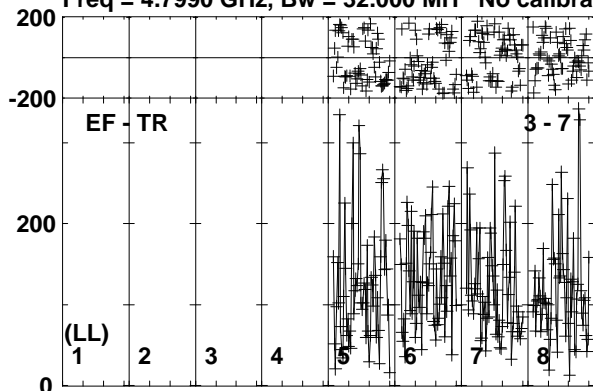

Lower frame: Micro Ampl Jy Top frame: Phas deg
Vector averaged cross-power spectrum Baseline: EF (03) - TR (07)
Timerange: 01/05:41:46 to 01/05:43:54

Plot file version 602 created 26-SEP-2019 10:43:46

190829A RG010A.UVDATA.1

Freq = 4.7990 GHz, Bw = 32.000 MH No calibration applied and no bandpass applied

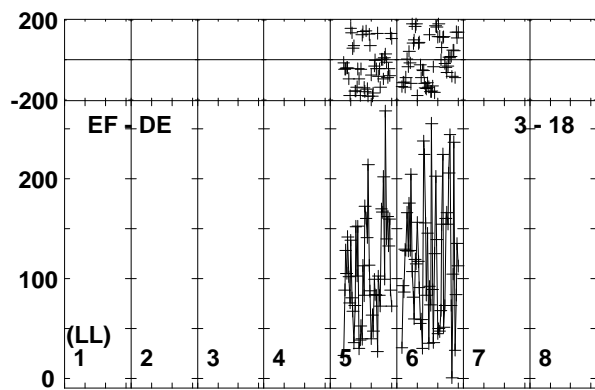
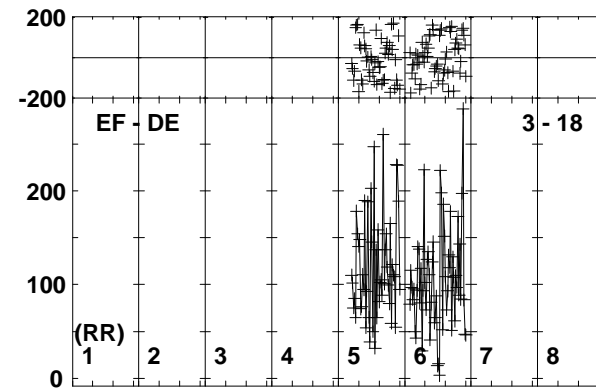
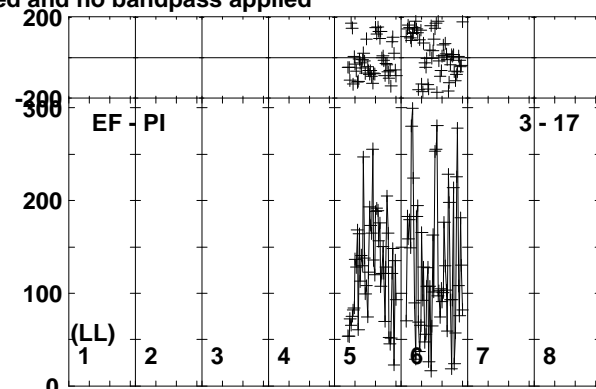
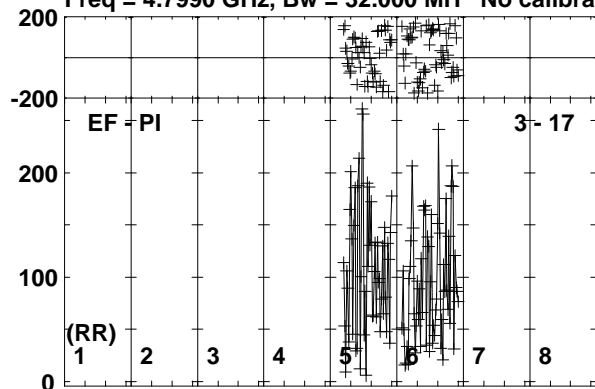

Lower frame: Micro Ampl Jy Top frame: Phas deg
Vector averaged cross-power spectrum Baseline: EF (03) - PI (17)
Timerange: 01/05:41:46 to 01/05:43:54

Plot file version 603 created 26-SEP-2019 10:43:46

J0257-1212 RG010A.UVDATA.1

Freq = 4.7990 GHz, Bw = 32.000 MH No calibration applied and no bandpass applied

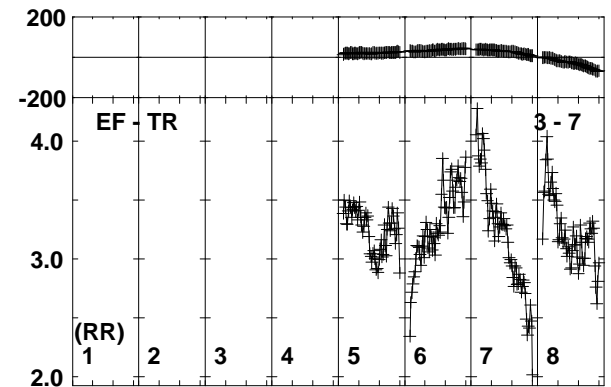
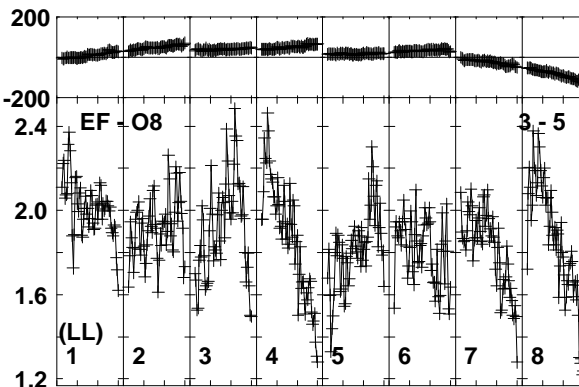
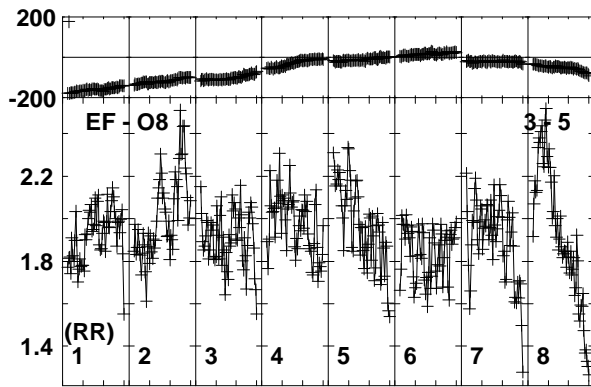
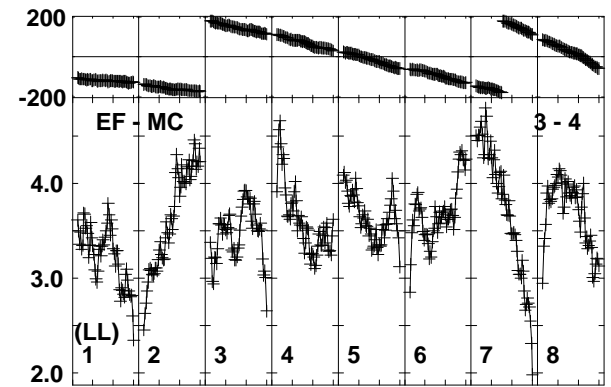
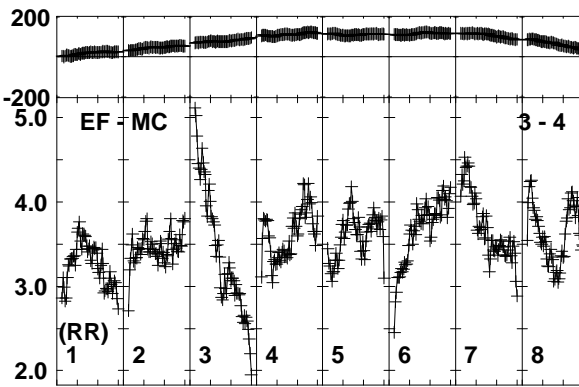
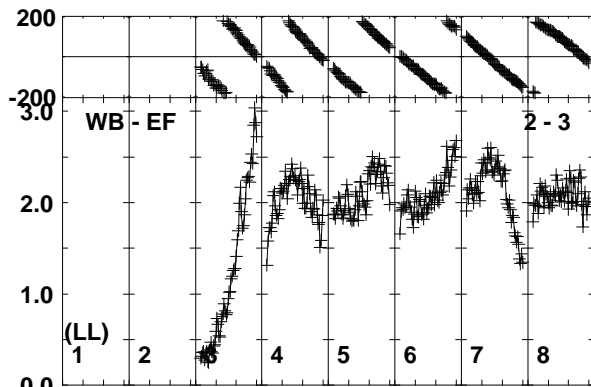
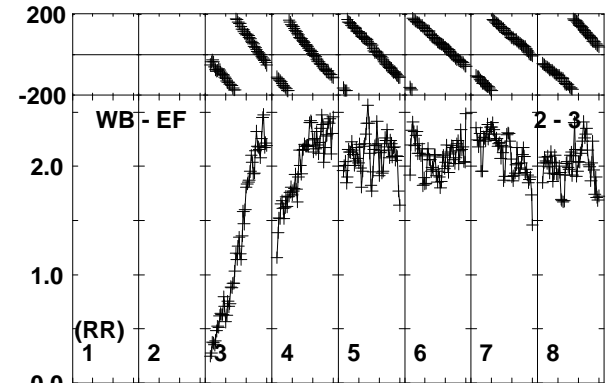
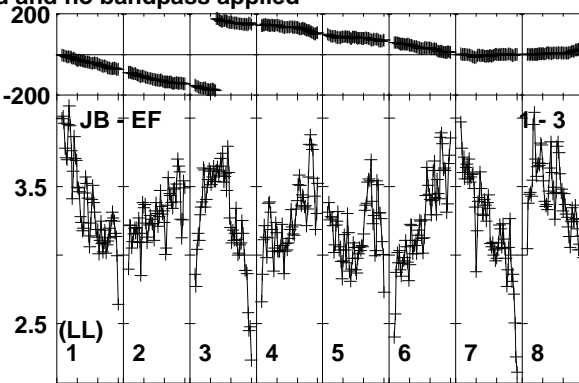
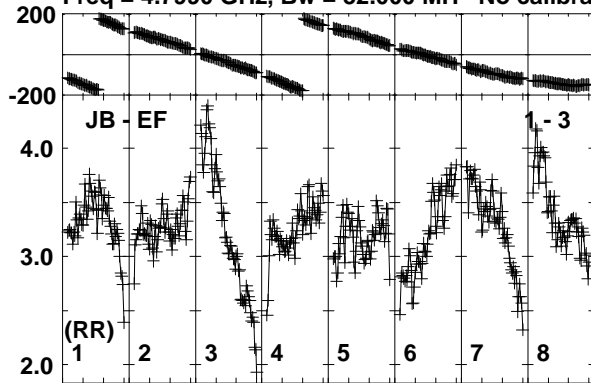

Lower frame: Milli Ampl Jy Top frame: Phas deg

Vector averaged cross-power spectrum Baseline: JB (01) - EF (03)

Timerange: 01/05:44:36 to 01/05:45:34

Plot file version 604 created 26-SEP-2019 10:43:46

J0257-1212 RG010A.UVDATA.1

Freq = 4.7990 GHz, Bw = 32.000 MH No calibration applied and no bandpass applied

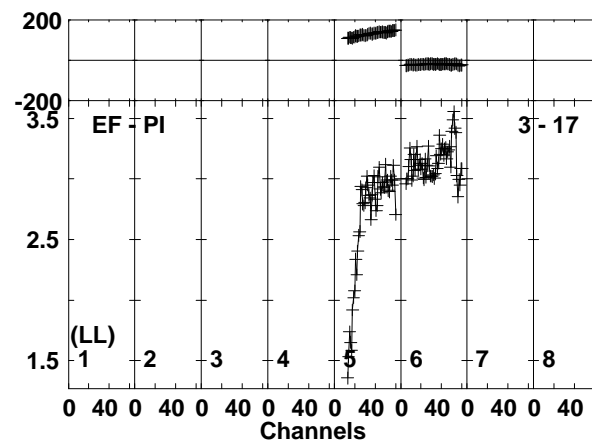
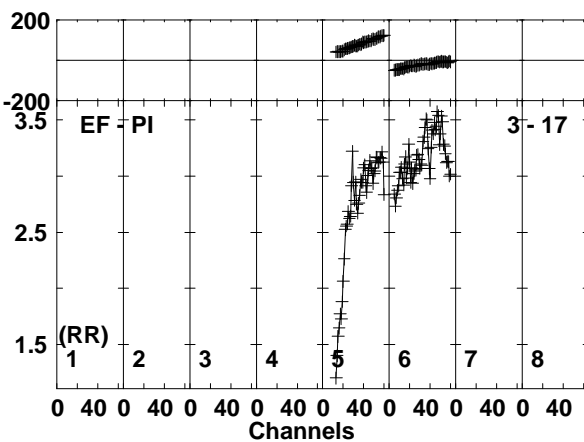
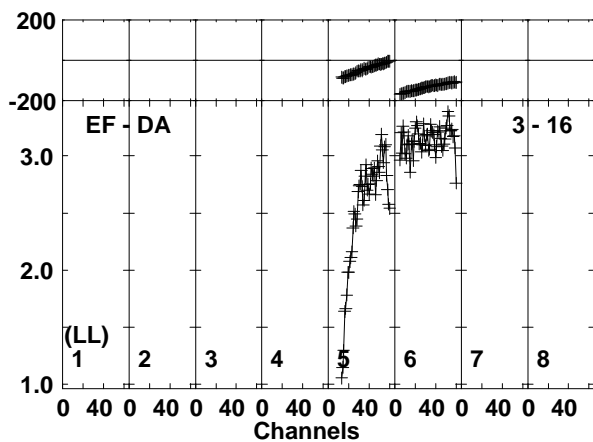
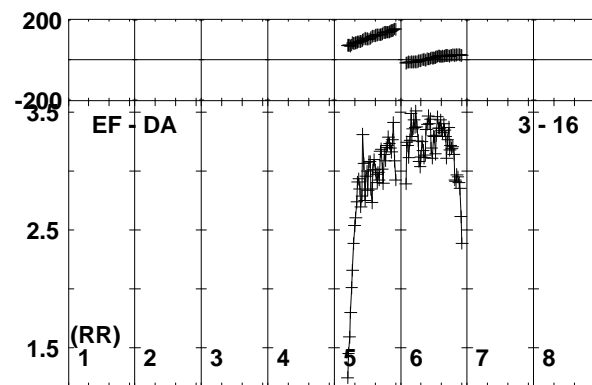
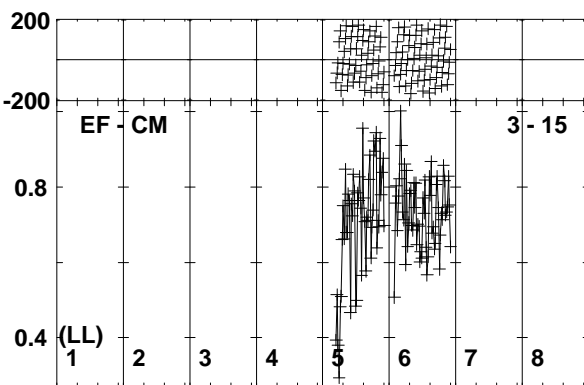
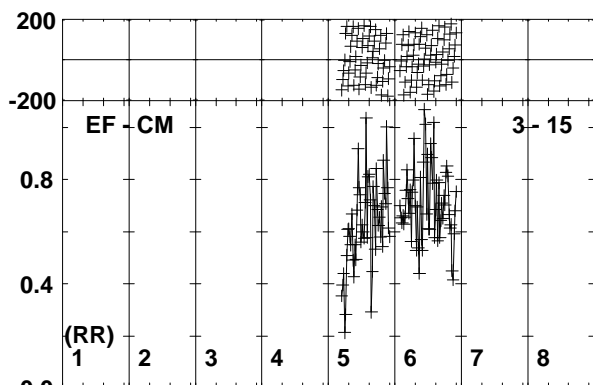
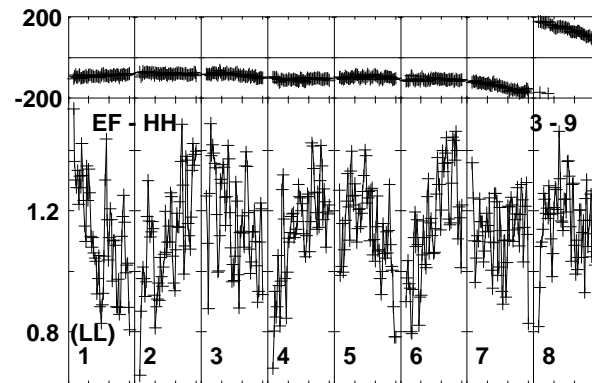
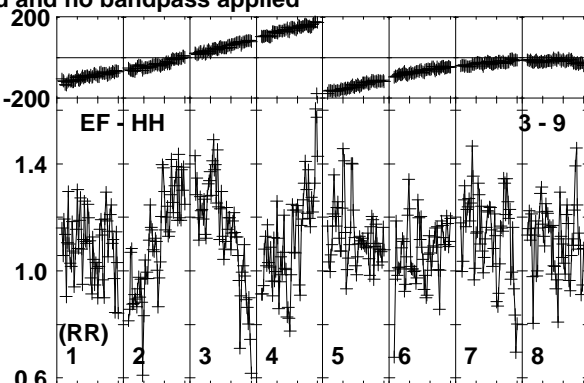
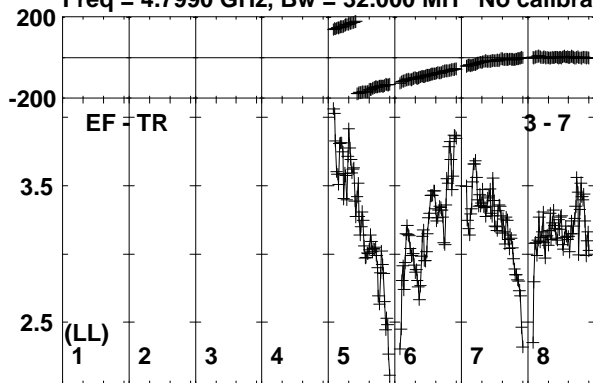

Lower frame: Milli Ampl Jy Top frame: Phas deg
Vector averaged cross-power spectrum Baseline: EF (03) - TR (07)
Timerange: 01/05:44:36 to 01/05:45:34

Plot file version 605 created 26-SEP-2019 10:43:46

J0257-1212 RG010A.UVDATA.1

Freq = 4.7990 GHz, Bw = 32.000 MH No calibration applied and no bandpass applied

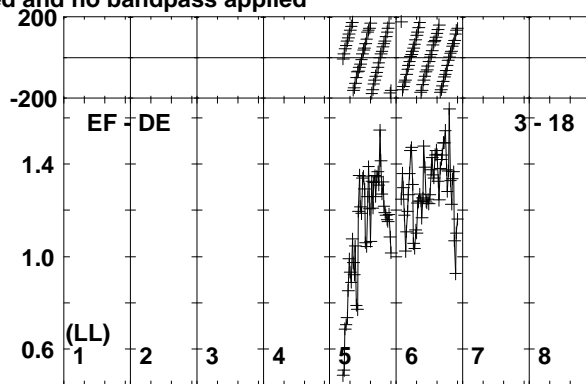
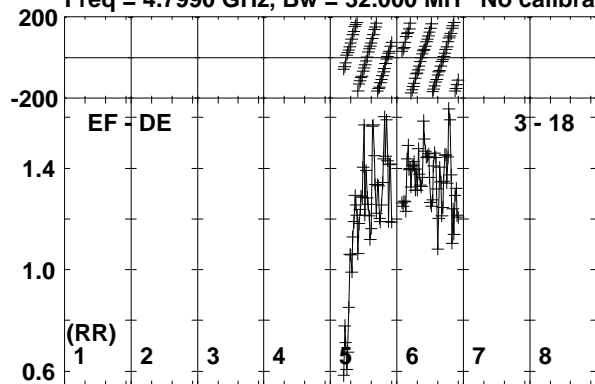

Lower frame: Milli Ampl Jy Top frame: Phas deg
Vector averaged cross-power spectrum Baseline: EF (03) - DE (18)
Timerange: 01/05:44:36 to 01/05:45:34

Plot file version 606 created 26-SEP-2019 10:43:46

190829A RG010A.UVDATA.1

Freq = 4.7990 GHz, Bw = 32.000 MH No calibration applied and no bandpass applied

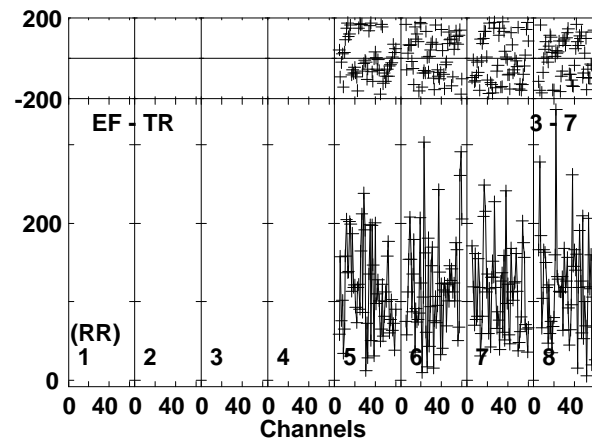
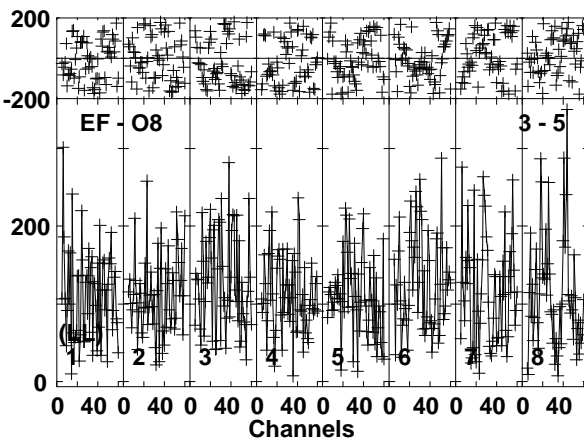
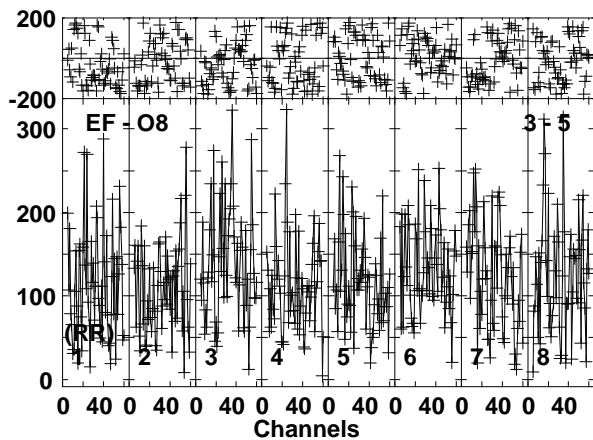
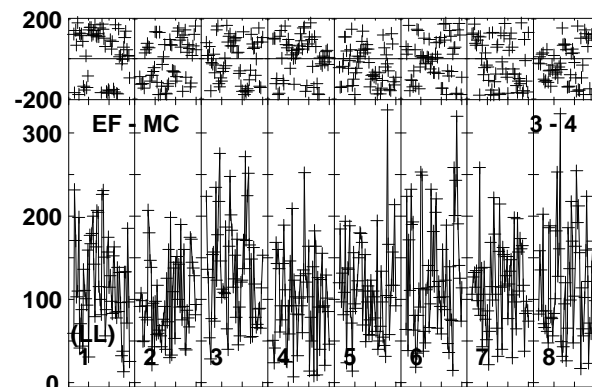
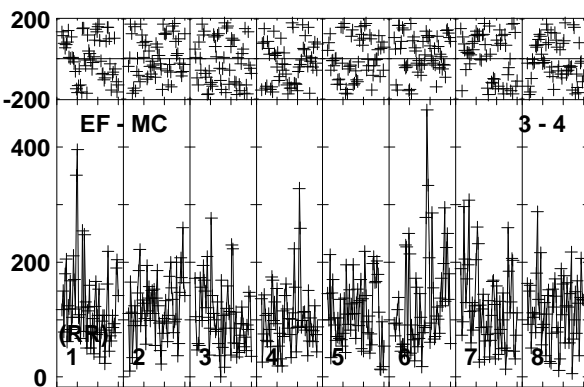
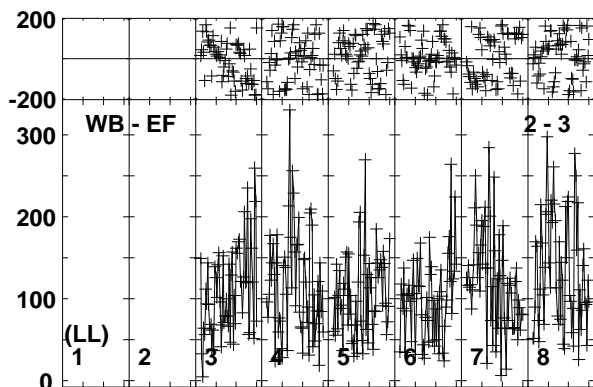
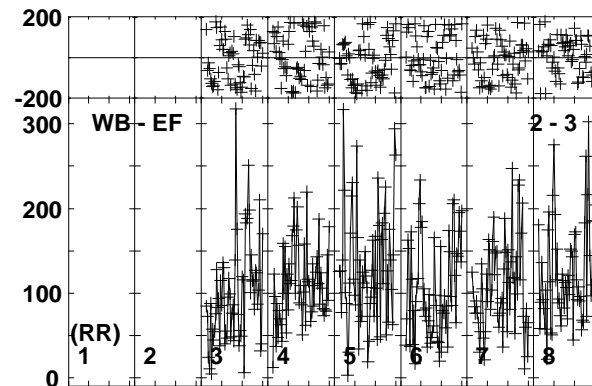
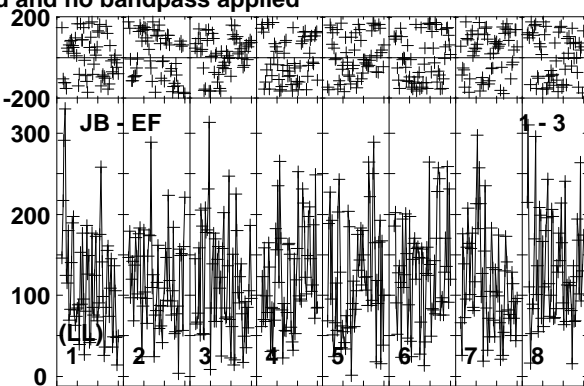
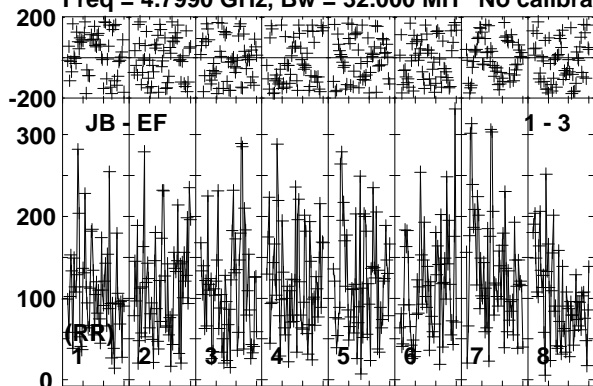

Lower frame: Micro Ampl Jy Top frame: Phas deg
Vector averaged cross-power spectrum Baseline: JB (01) - EF (03)
Timerange: 01/05:45:36 to 01/05:47:44

Plot file version 607 created 26-SEP-2019 10:43:47

190829A RG010A.UVDATA.1

Freq = 4.7990 GHz, Bw = 32.000 MH No calibration applied and no bandpass applied

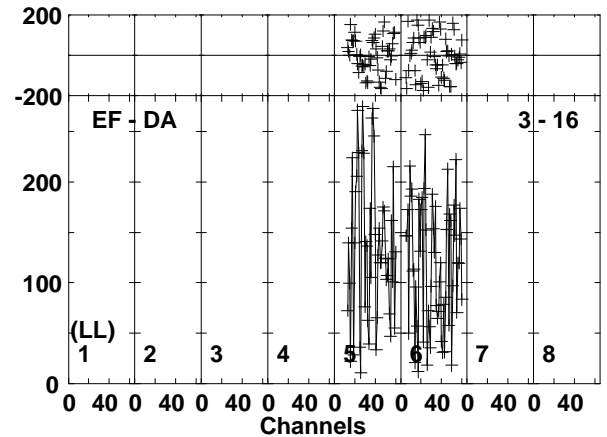
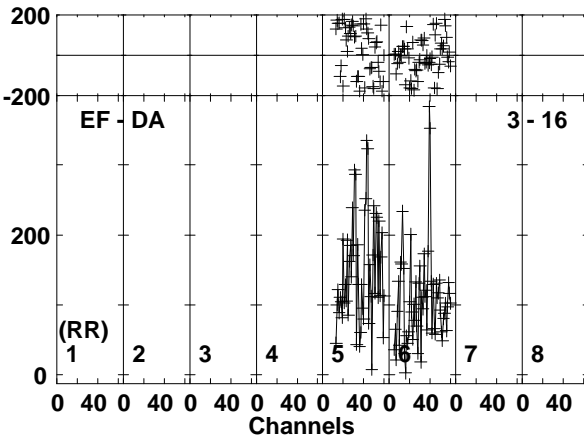
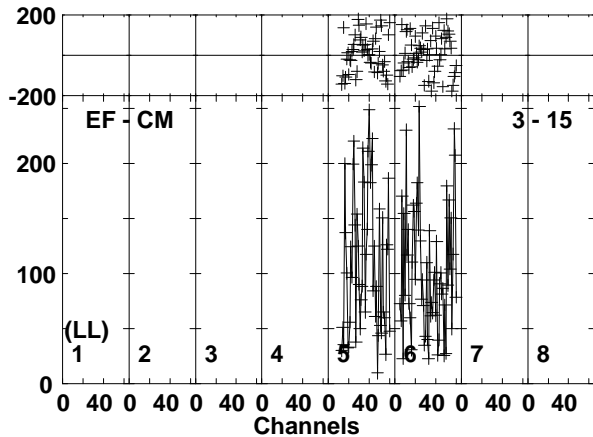
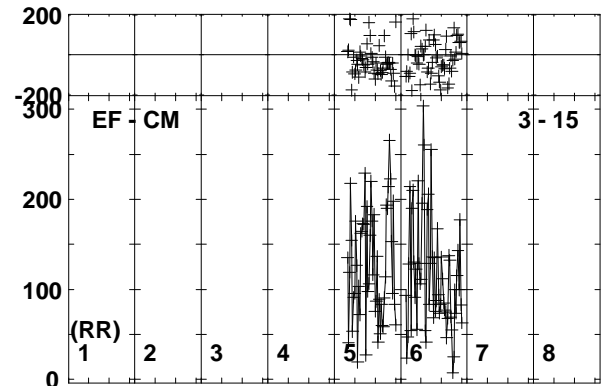
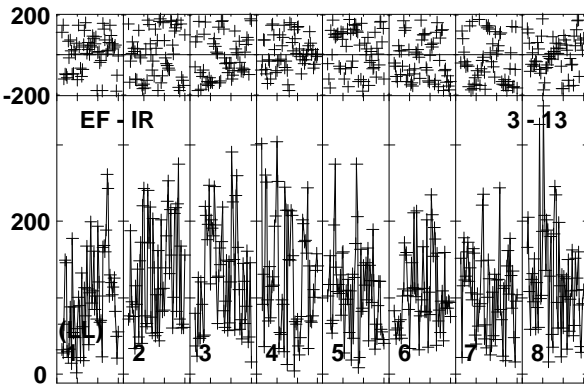
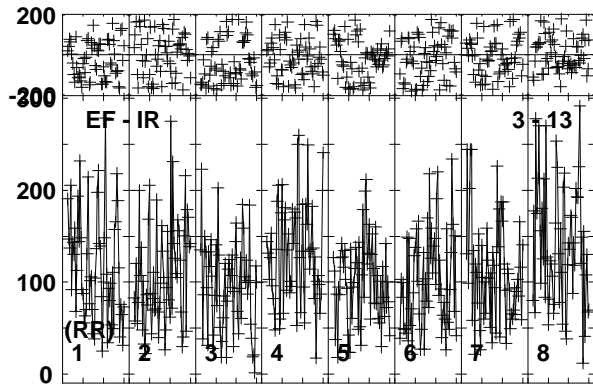
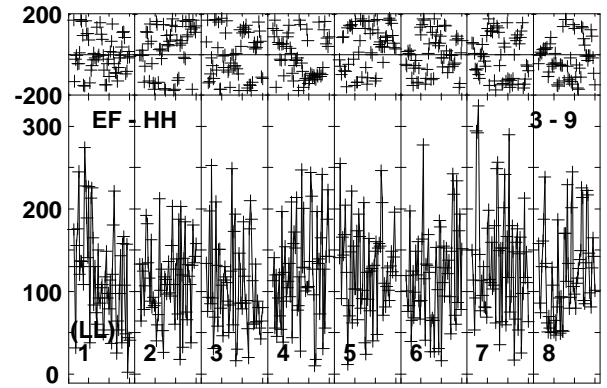
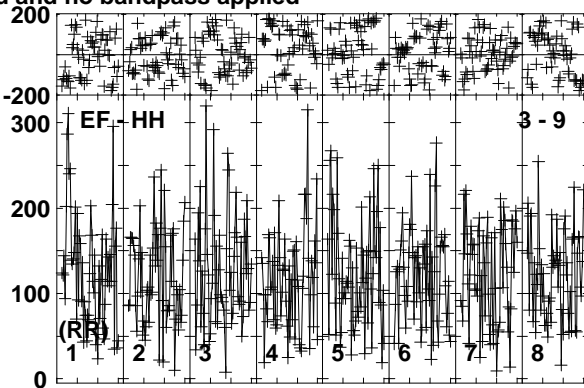
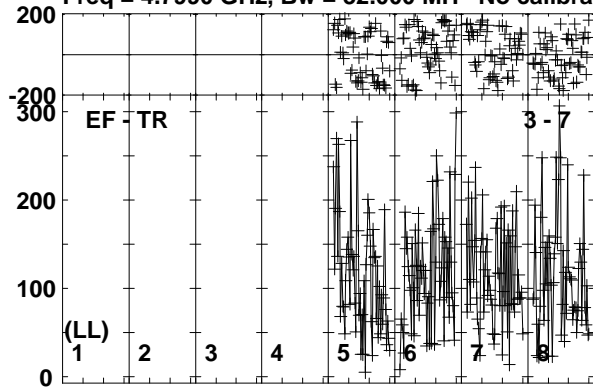

Lower frame: Micro Ampl Jy Top frame: Phas deg
Vector averaged cross-power spectrum Baseline: EF (03) - TR (07)
Timerange: 01/05:45:36 to 01/05:47:44

Plot file version 608 created 26-SEP-2019 10:43:47

190829A RG010A.UVDATA.1

Freq = 4.7990 GHz, Bw = 32.000 MH No calibration applied and no bandpass applied

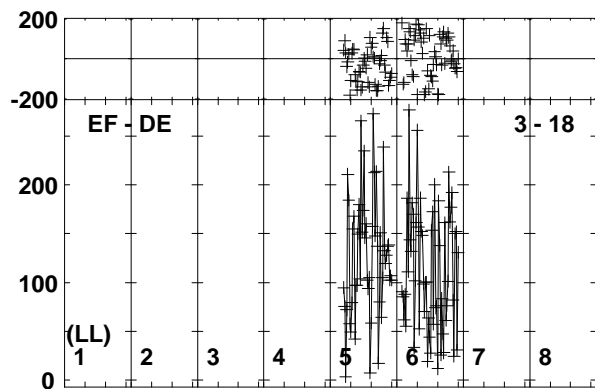
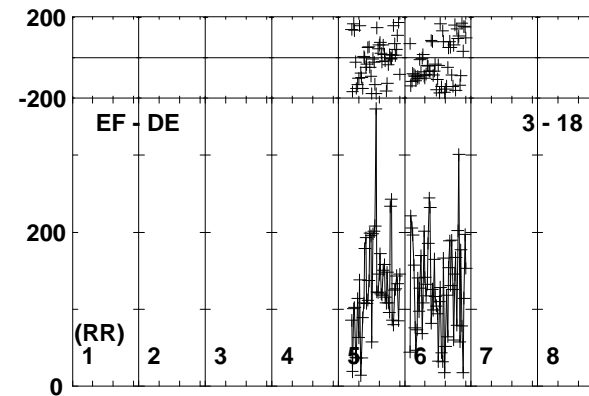
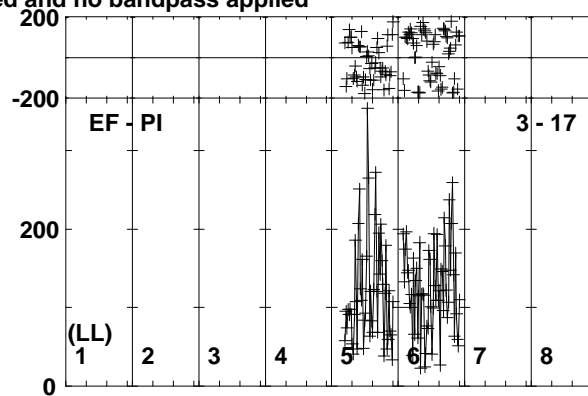
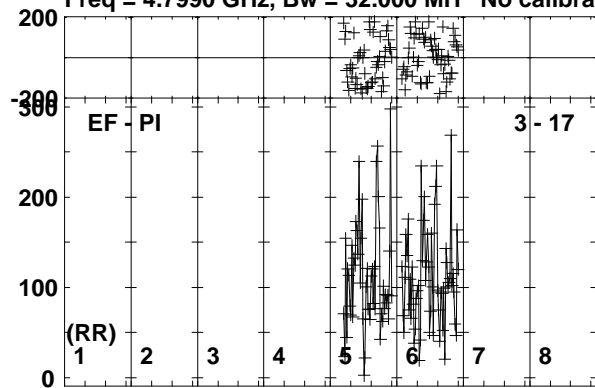

Lower frame: Micro Ampl Jy Top frame: Phas deg
Vector averaged cross-power spectrum Baseline: EF (03) - PI (17)
Timerange: 01/05:45:36 to 01/05:47:44

Plot file version 610 created 26-SEP-2019 10:43:47

J0257-1212 RG010A.UVDATA.1

Freq = 4.7990 GHz, Bw = 32.000 MH No calibration applied and no bandpass applied

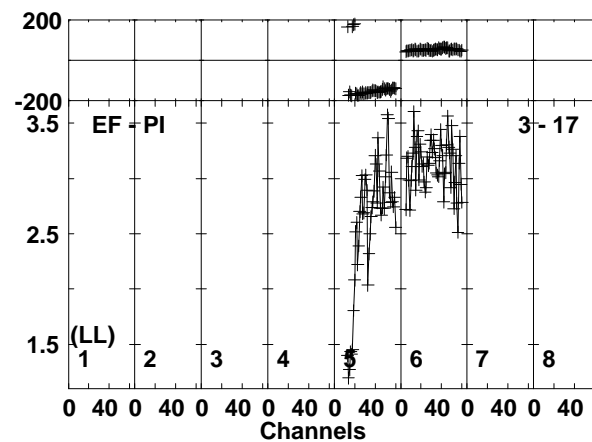
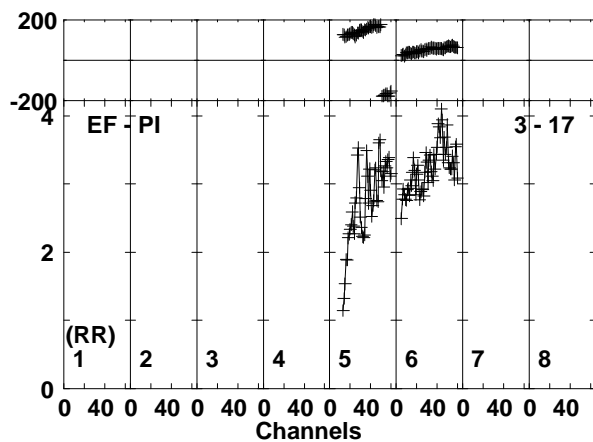
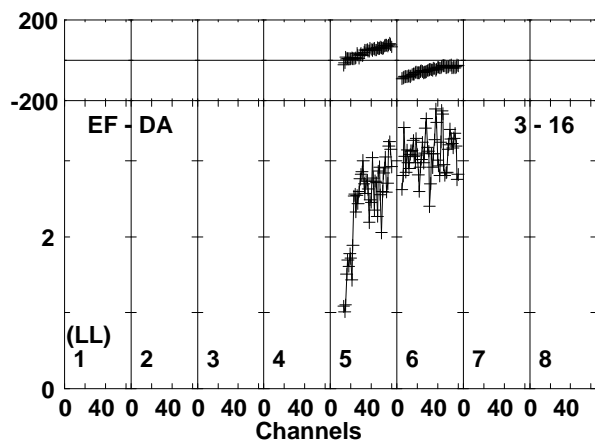
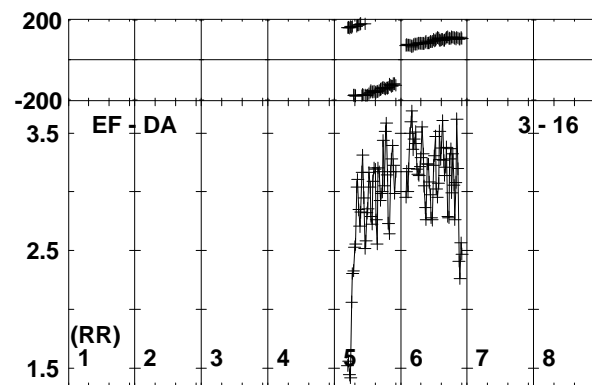
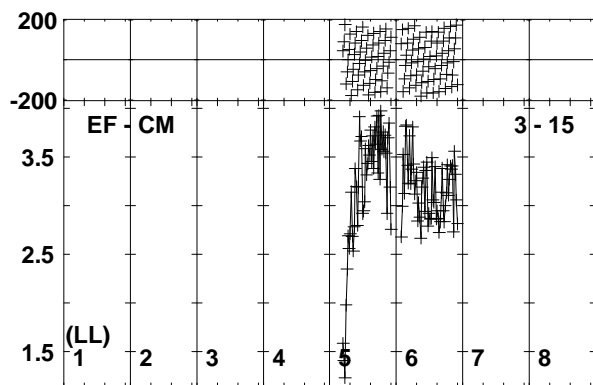
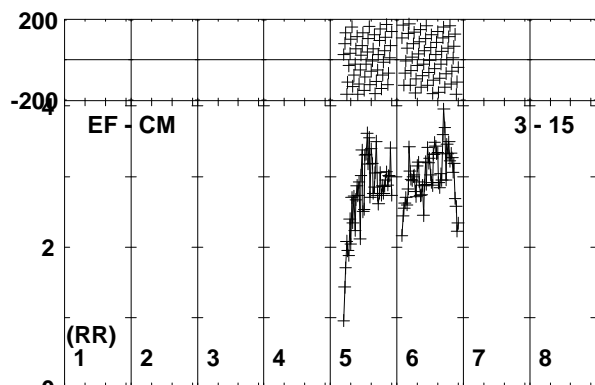
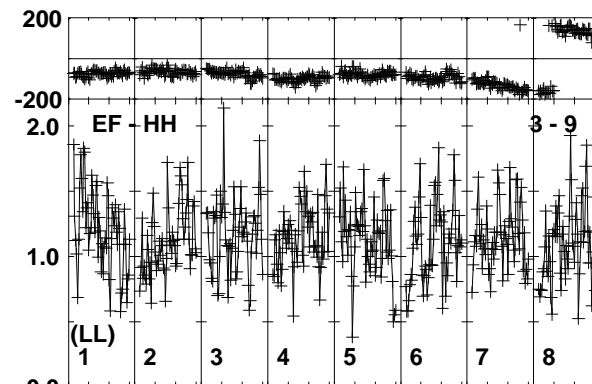
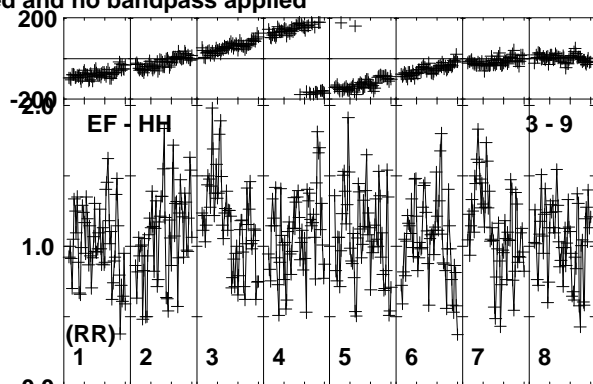
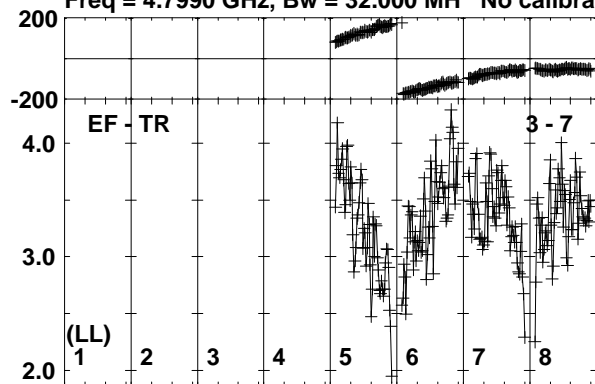

Lower frame: Milli Ampl Jy Top frame: Phas deg
Vector averaged cross-power spectrum Baseline: EF (03) - TR (07)
Timerange: 01/05:47:46 to 01/05:48:45

Plot file version 611 created 26-SEP-2019 10:43:48

J0257-1212 RG010A.UVDATA.1

Freq = 4.7990 GHz, Bw = 32.000 MH No calibration applied and no bandpass applied

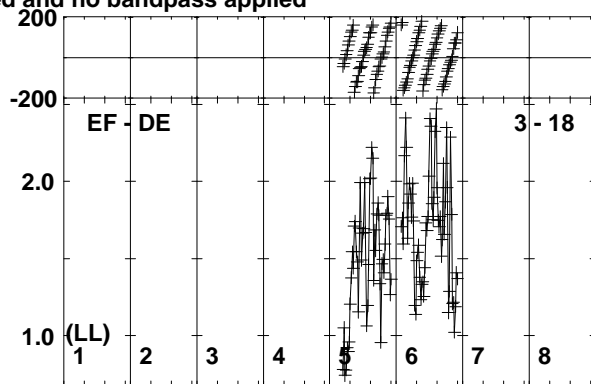
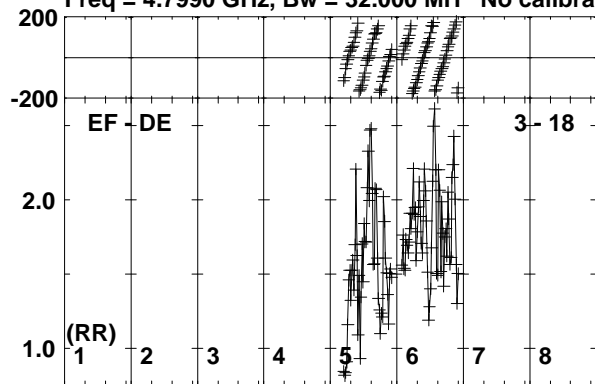

Lower frame: Milli Ampl Jy Top frame: Phas deg
Vector averaged cross-power spectrum Baseline: EF (03) - DE (18)
Timerange: 01/05:47:46 to 01/05:48:45

Plot file version 612 created 26-SEP-2019 10:43:48

190829A RG010A.UVDATA.1

Freq = 4.7990 GHz, Bw = 32.000 MH No calibration applied and no bandpass applied

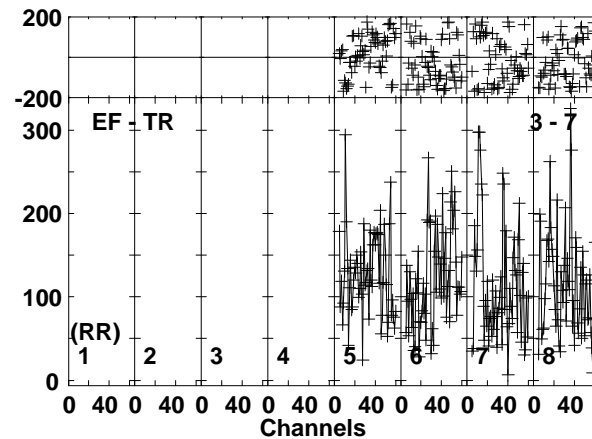
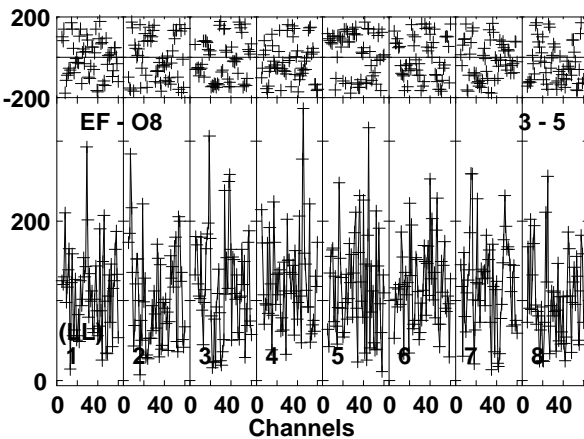
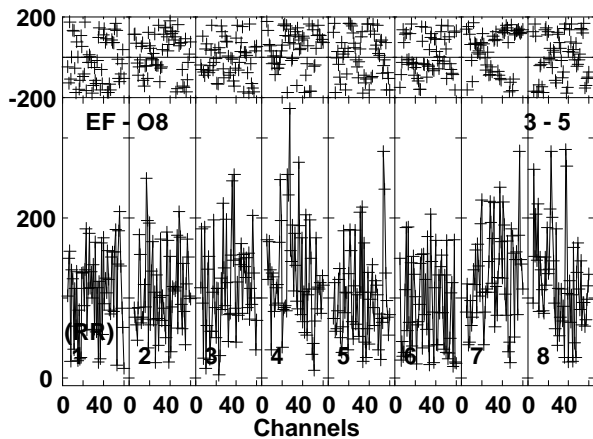
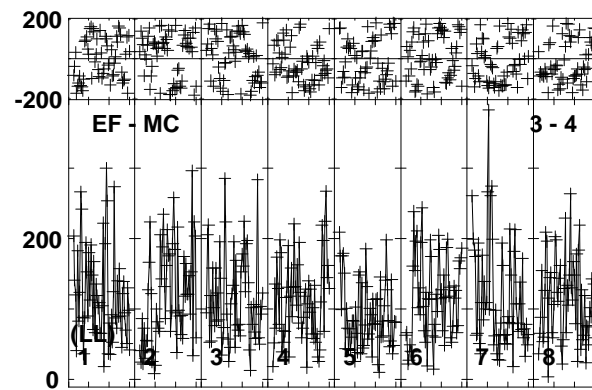
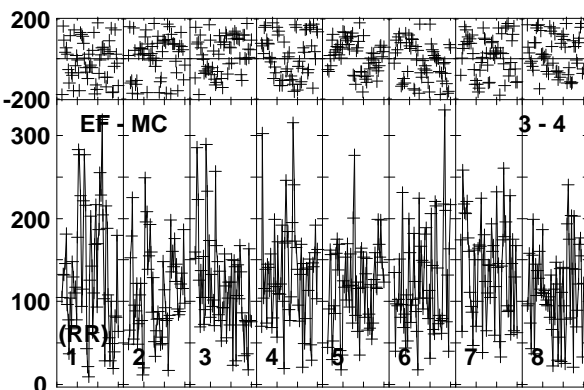
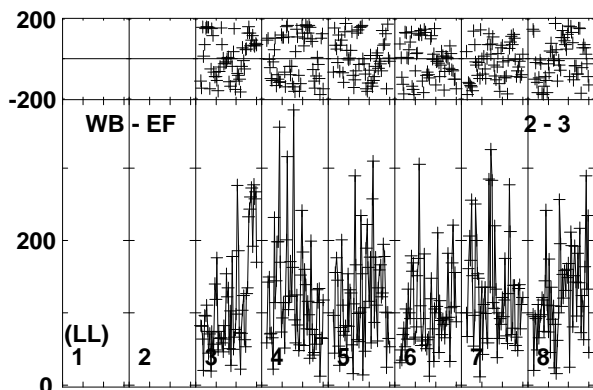
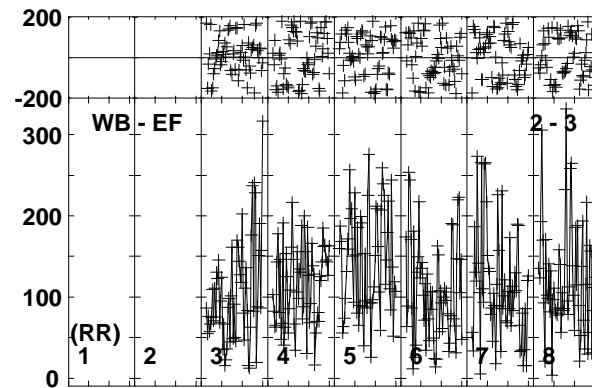
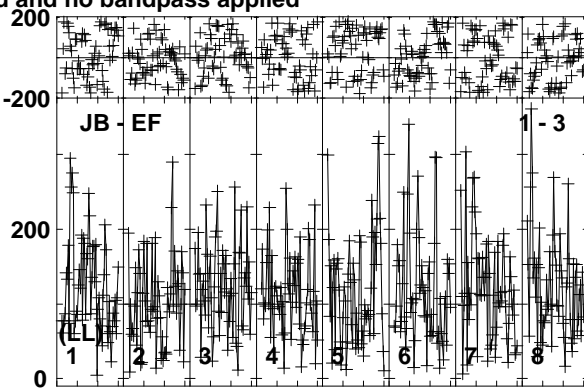
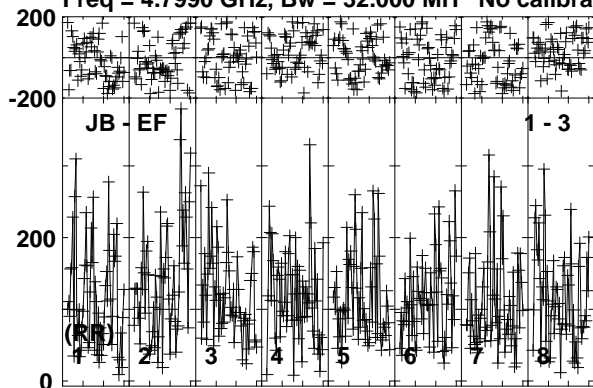

Lower frame: Micro Ampl Jy Top frame: Phas deg
Vector averaged cross-power spectrum Baseline: JB (01) - EF (03)
Timerange: 01/05:48:45 to 01/05:50:54

Plot file version 613 created 26-SEP-2019 10:43:48

190829A RG010A.UVDATA.1

Freq = 4.7990 GHz, Bw = 32.000 MH No calibration applied and no bandpass applied

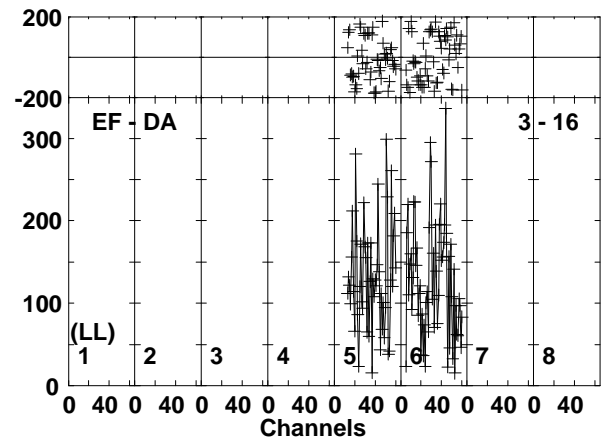
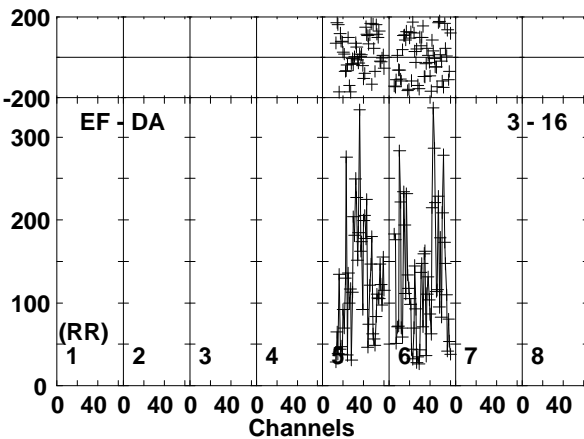
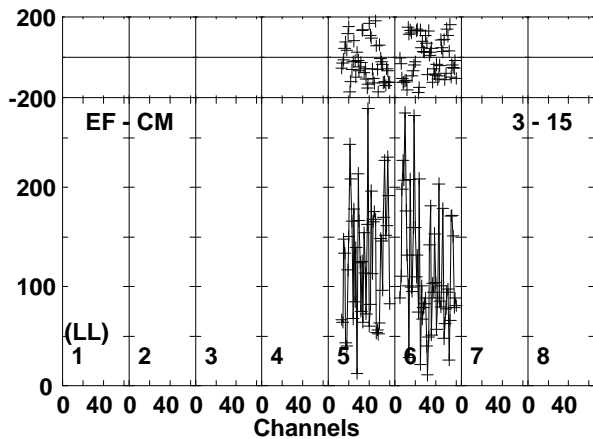
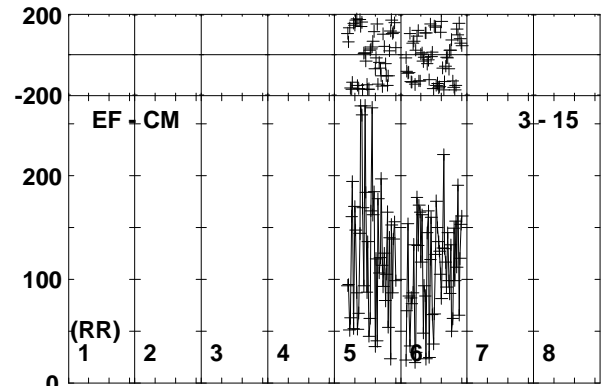
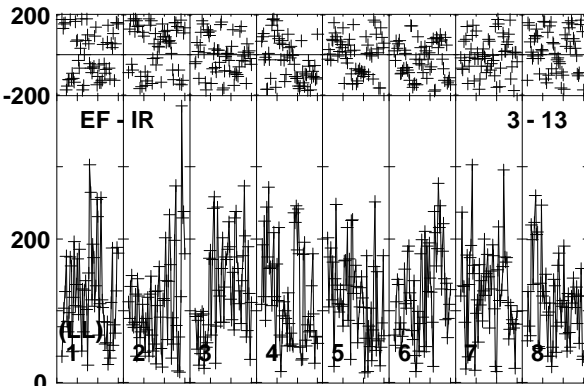
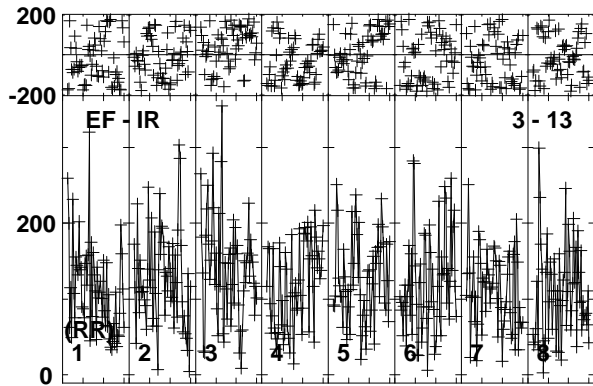
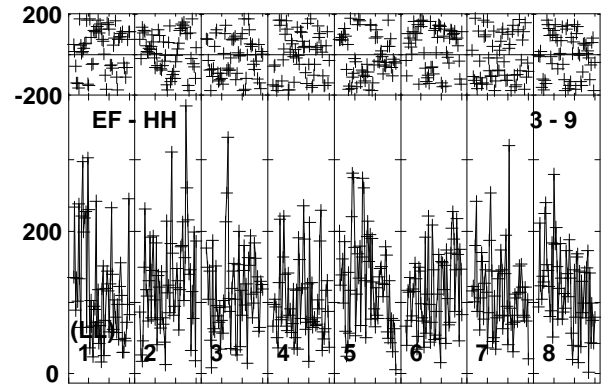
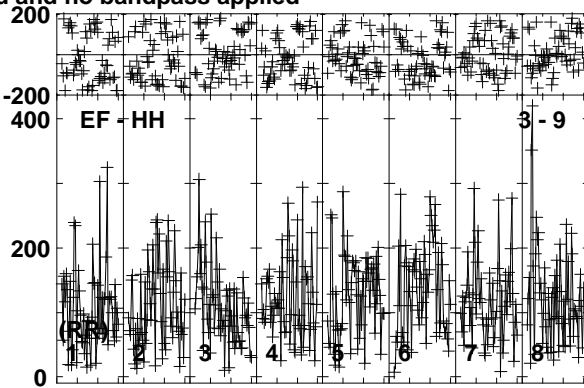
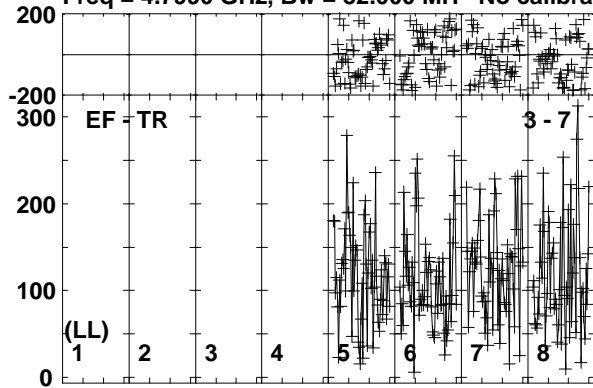

Lower frame: Micro Ampl Jy Top frame: Phas deg
Vector averaged cross-power spectrum Baseline: EF (03) - TR (07)
Timerange: 01/05:48:45 to 01/05:50:54

Plot file version 614 created 26-SEP-2019 10:43:49

190829A RG010A.UVDATA.1

Freq = 4.7990 GHz, Bw = 32.000 MH No calibration applied and no bandpass applied

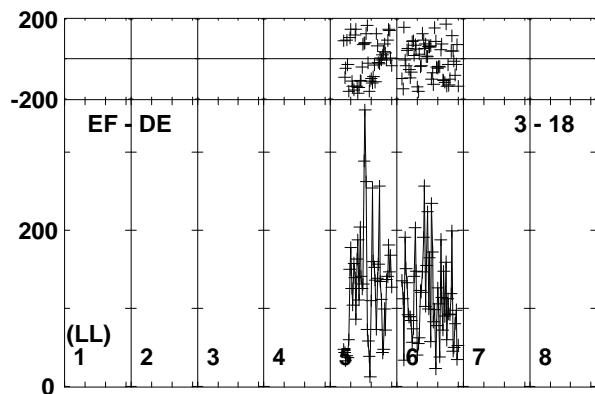
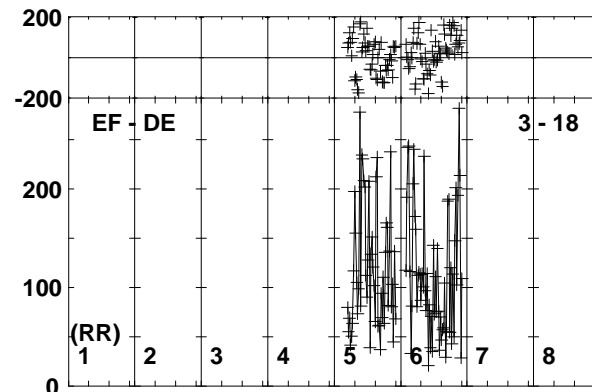
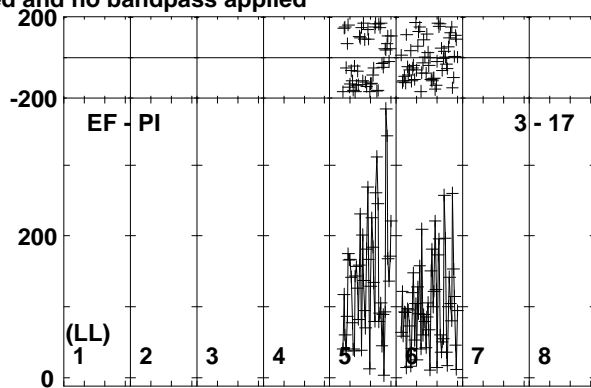
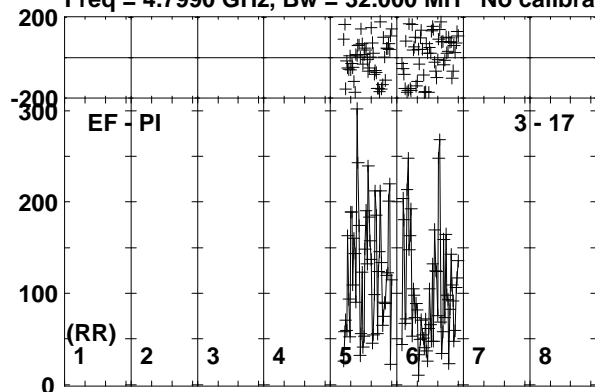

Lower frame: Micro Ampl Jy Top frame: Phas deg
Vector averaged cross-power spectrum Baseline: EF (03) - PI (17)
Timerange: 01/05:48:45 to 01/05:50:54

Plot file version 615 created 26-SEP-2019 10:43:49

J0257-1212 RG010A.UVDATA.1

Freq = 4.7990 GHz, Bw = 32.000 MH No calibration applied and no bandpass applied

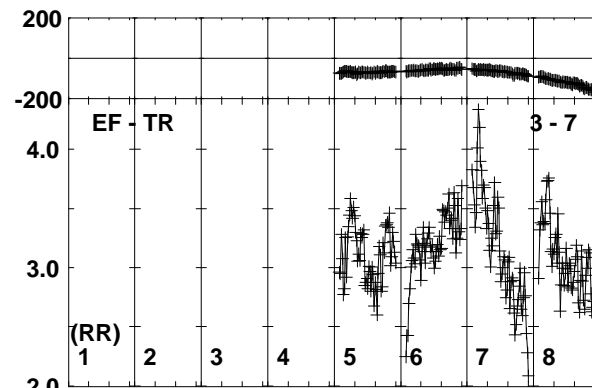
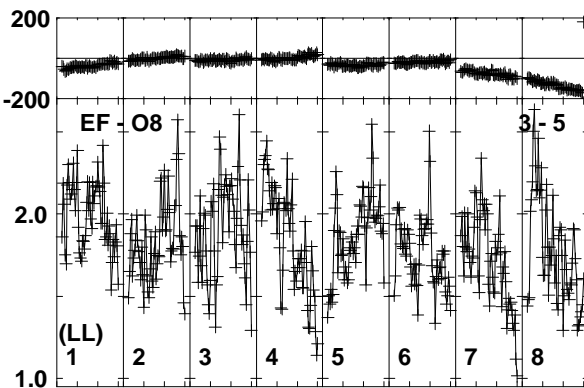
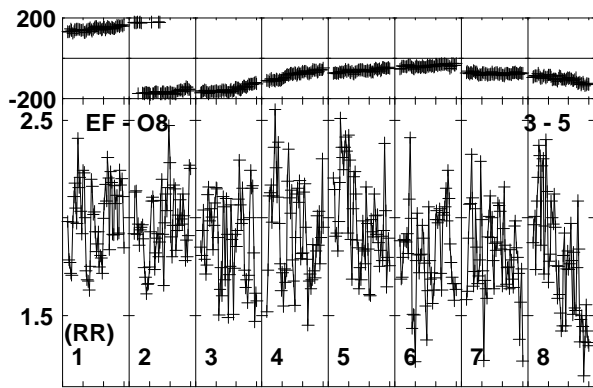
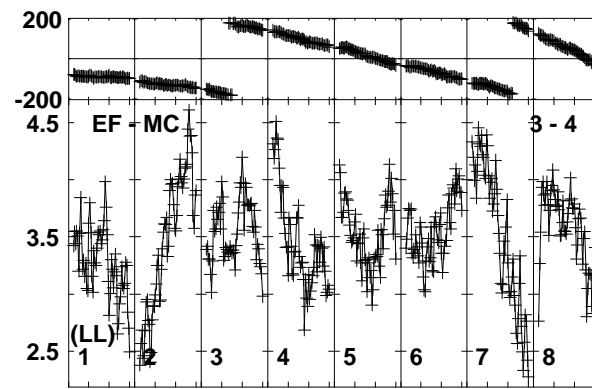
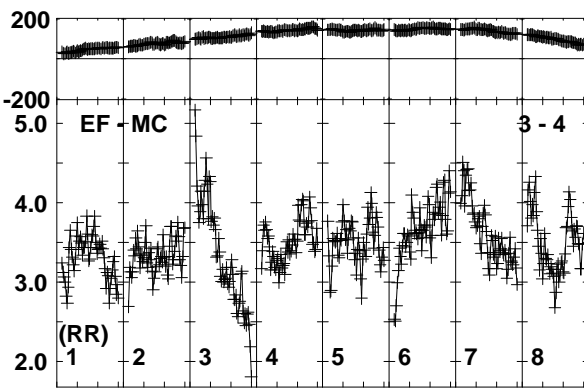
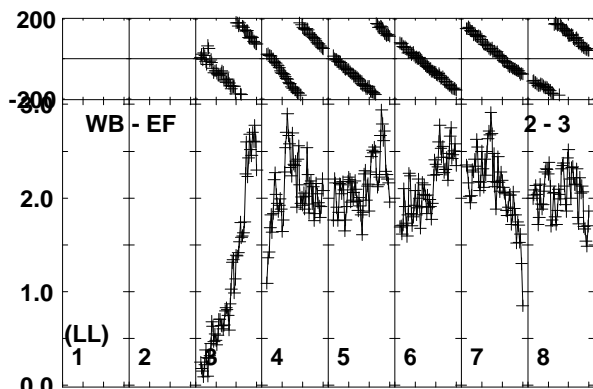
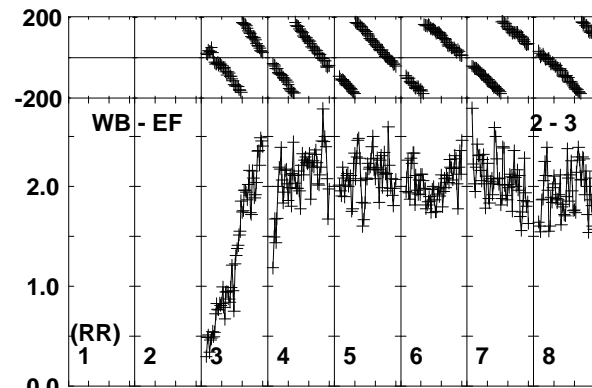
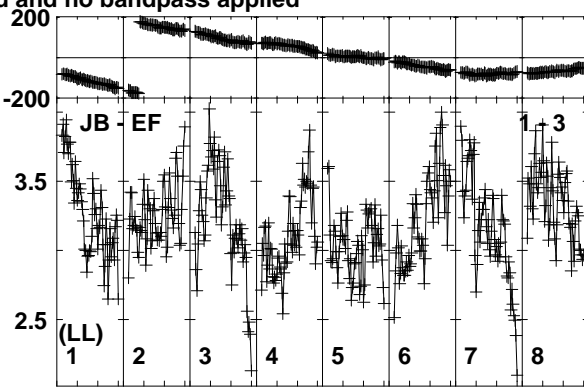
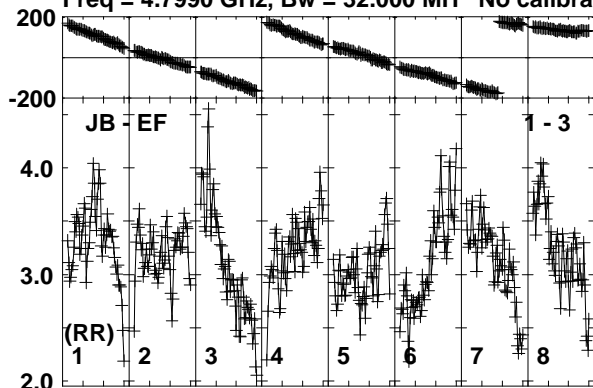

Lower frame: Milli Ampl Jy Top frame: Phas deg
Vector averaged cross-power spectrum Baseline: JB (01) - EF (03)
Timerange: 01/05:51:36 to 01/05:52:05

Plot file version 616 created 26-SEP-2019 10:43:49

J0257-1212 RG010A.UVDATA.1

Freq = 4.7990 GHz, Bw = 32.000 MH No calibration applied and no bandpass applied

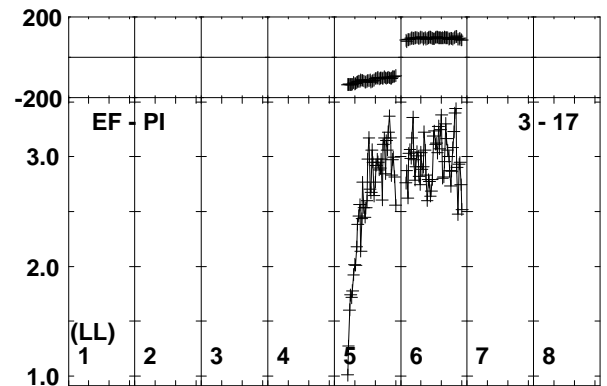
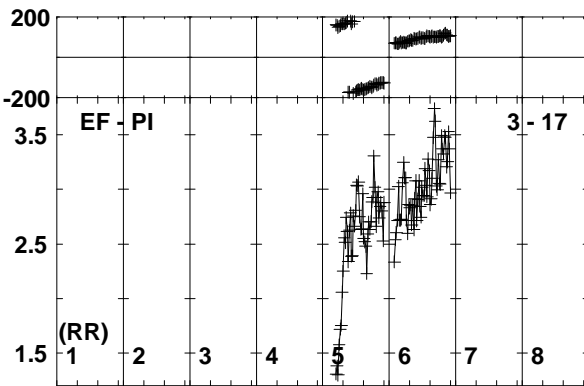
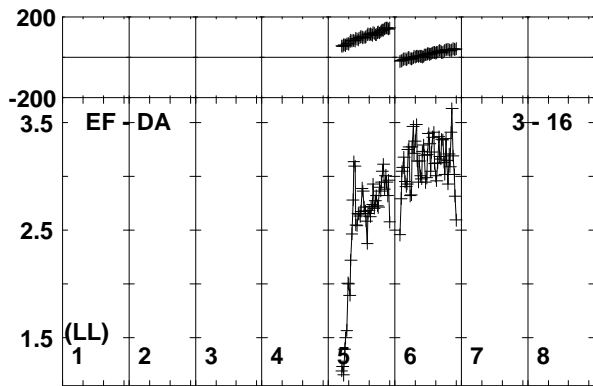
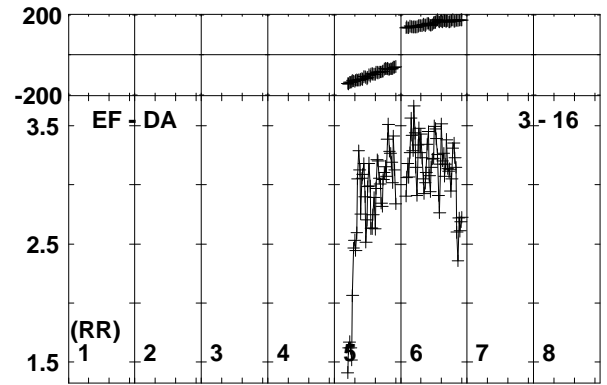
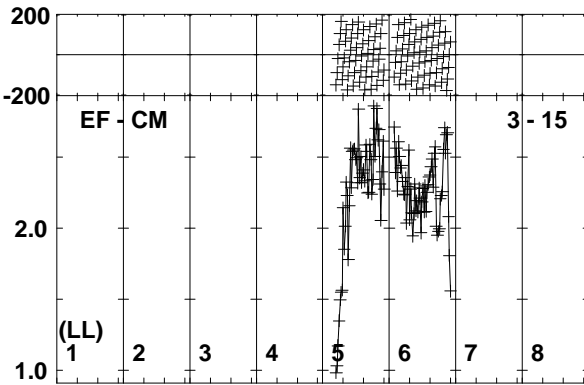
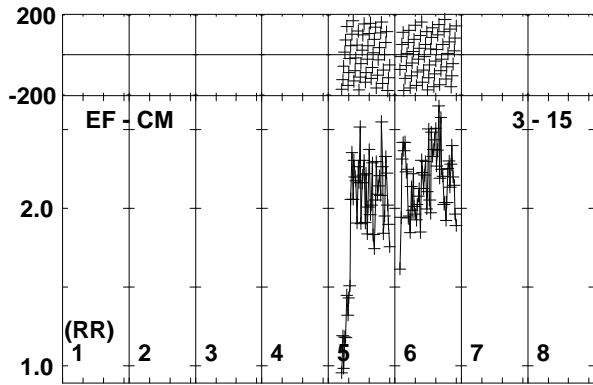
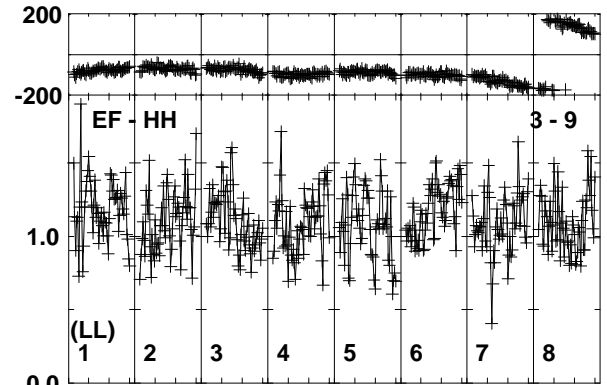
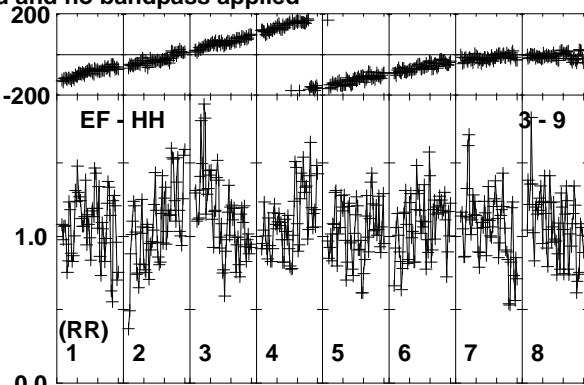
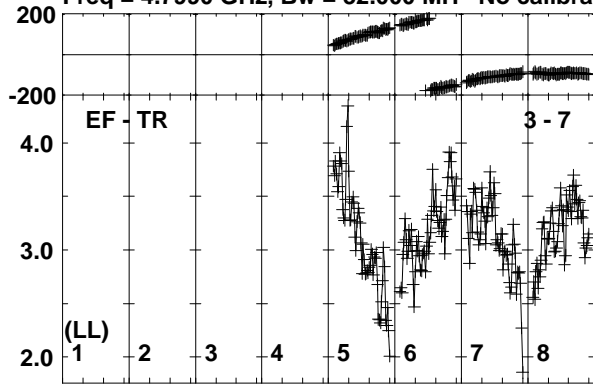

Lower frame: Milli Ampl Jy Top frame: Phas deg
Vector averaged cross-power spectrum Baseline: EF (03) - TR (07)
Timerange: 01/05:51:36 to 01/05:52:05

Plot file version 617 created 26-SEP-2019 10:43:49

J0257-1212 RG010A.UVDATA.1

Freq = 4.7990 GHz, Bw = 32.000 MH No calibration applied and no bandpass applied

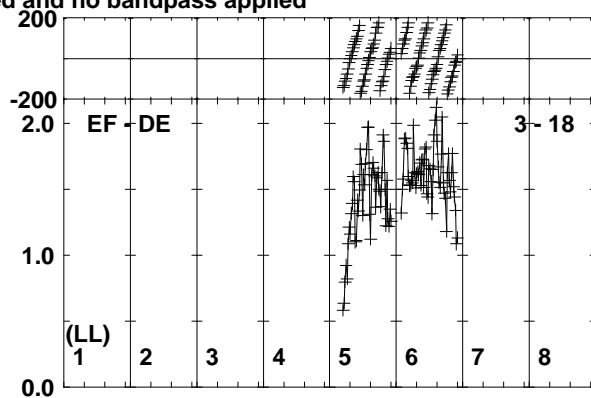
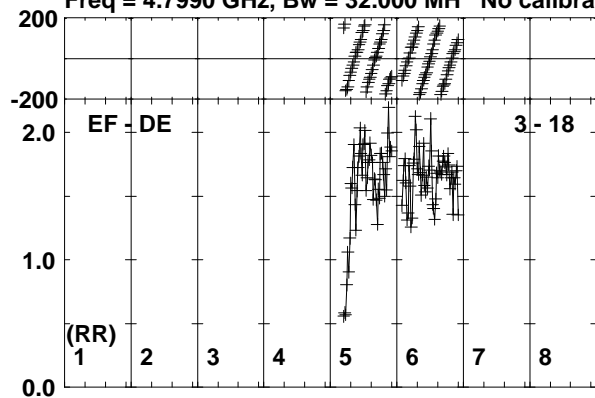

Lower frame: Milli Ampl Jy Top frame: Phas deg
Vector averaged cross-power spectrum Baseline: EF (03) - DE (18)
Timerange: 01/05:51:36 to 01/05:52:05

Plot file version 618 created 26-SEP-2019 10:43:49

J0300-0846 RG010A.UVDATA.1

Freq = 4.7990 GHz, Bw = 32.000 MH No calibration applied and no bandpass applied

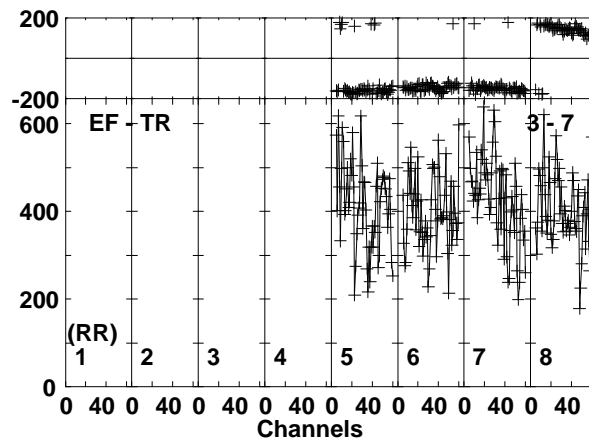
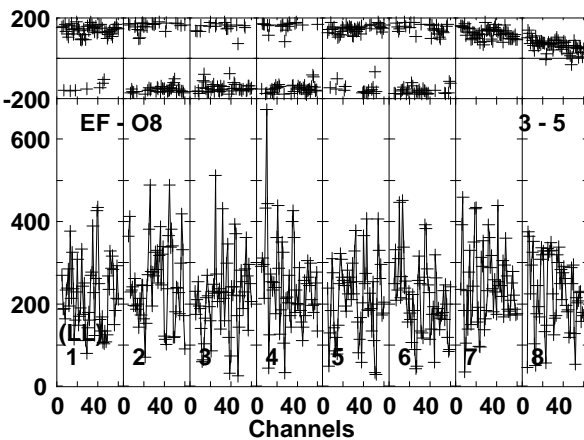
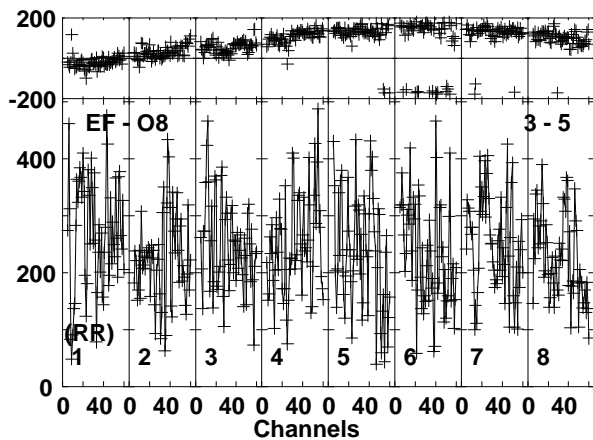
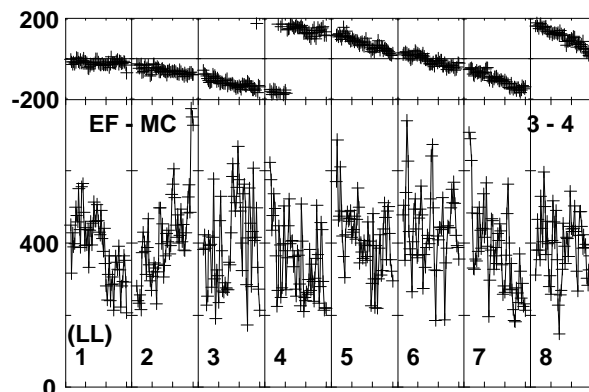
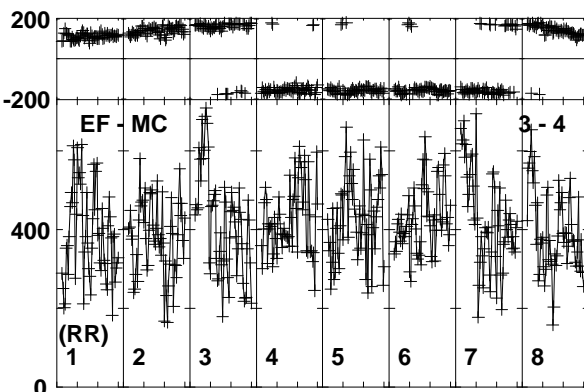
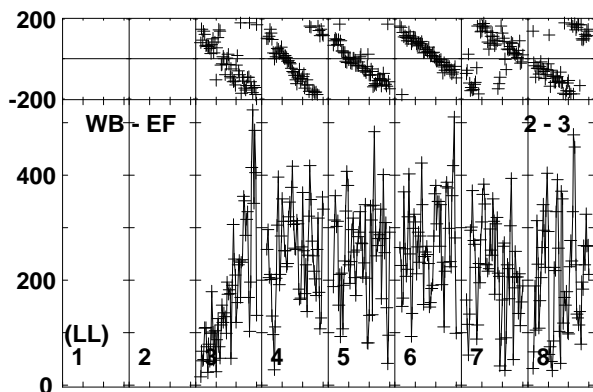
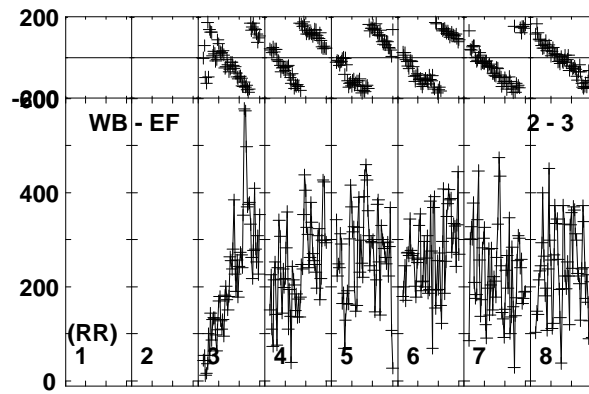
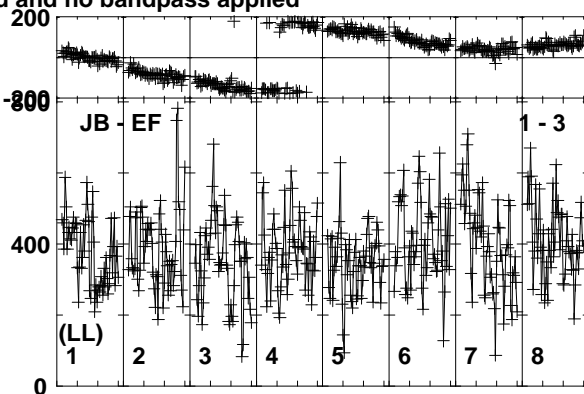
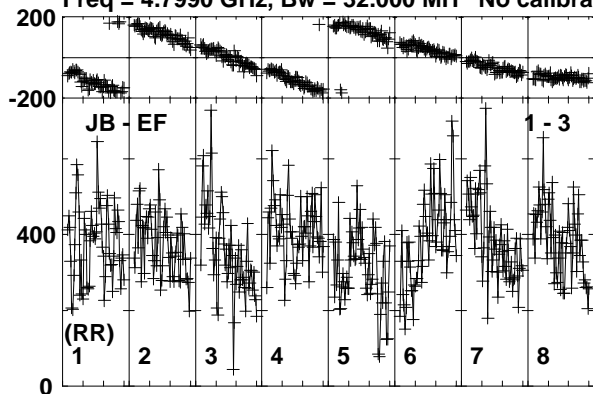

Lower frame: Micro Ampl Jy Top frame: Phas deg
Vector averaged cross-power spectrum Baseline: JB (01) - EF (03)
Timerange: 01/05:52:06 to 01/05:54:14

Plot file version 619 created 26-SEP-2019 10:43:50

J0300-0846 RG010A.UVDATA.1

Freq = 4.7990 GHz, Bw = 32.000 MH No calibration applied and no bandpass applied

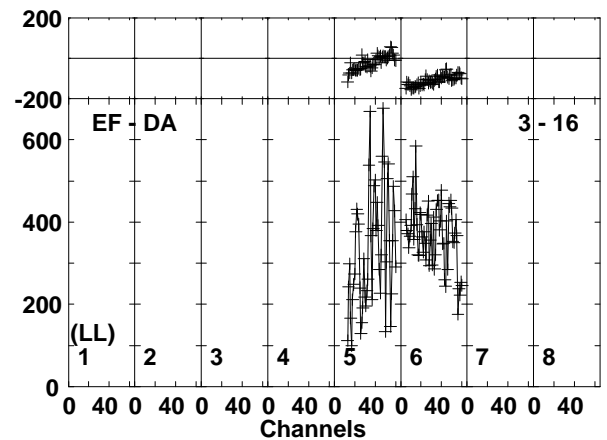
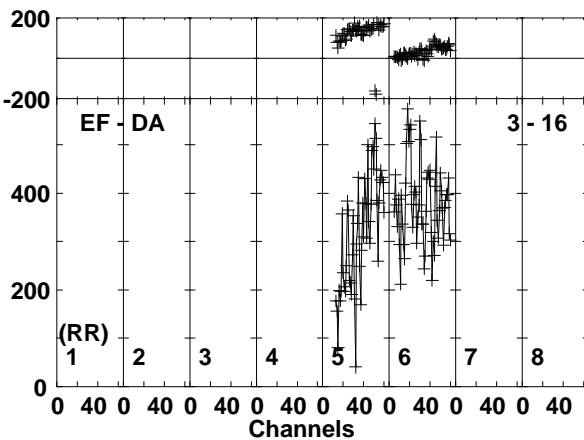
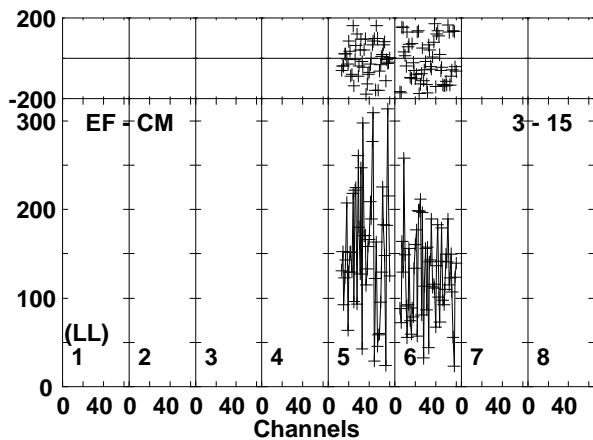
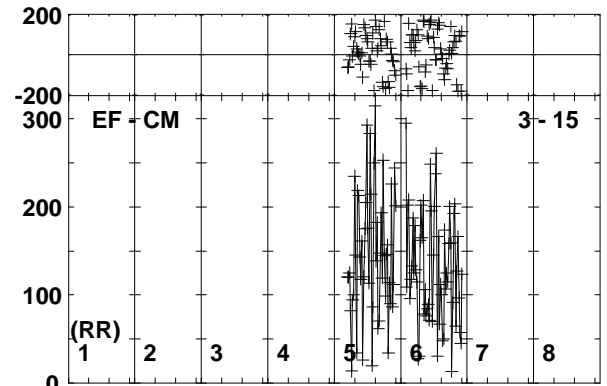
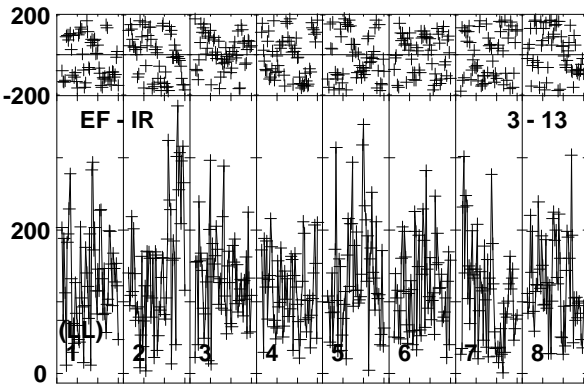
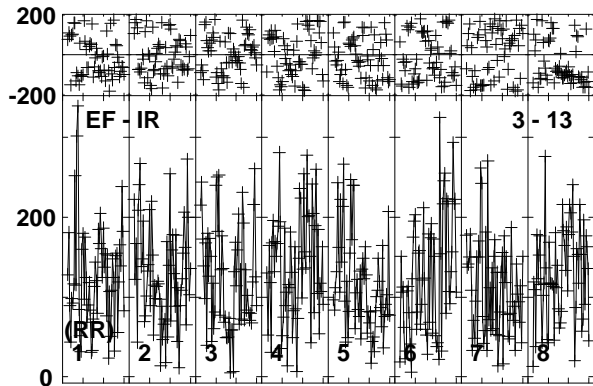
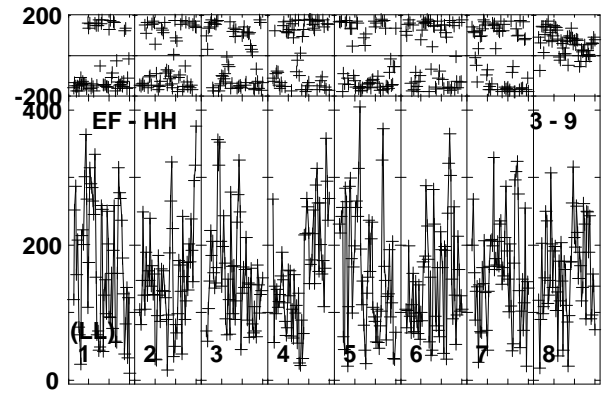
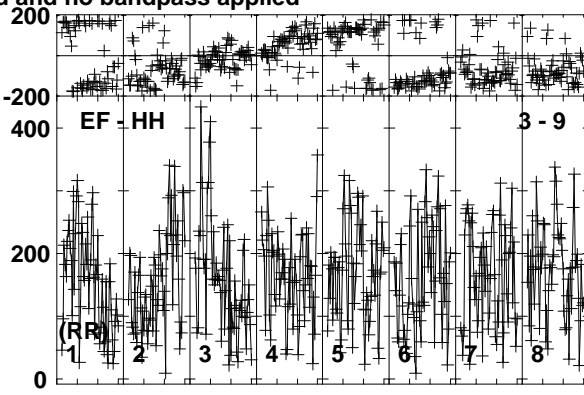
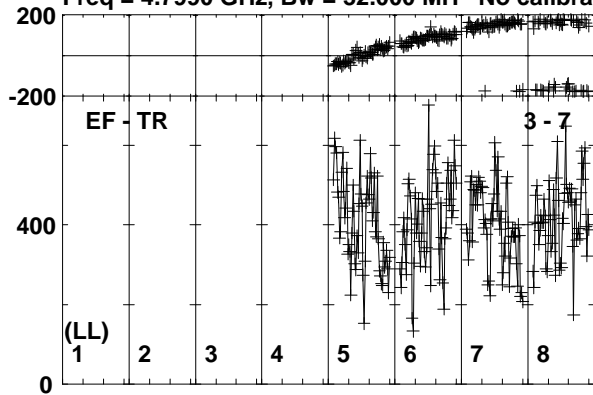

Lower frame: Micro Ampl Jy Top frame: Phas deg
Vector averaged cross-power spectrum Baseline: EF (03) - TR (07)
Timerange: 01/05:52:06 to 01/05:54:14

Plot file version 620 created 26-SEP-2019 10:43:50

J0300-0846 RG010A.UVDATA.1

Freq = 4.7990 GHz, Bw = 32.000 MH No calibration applied and no bandpass applied

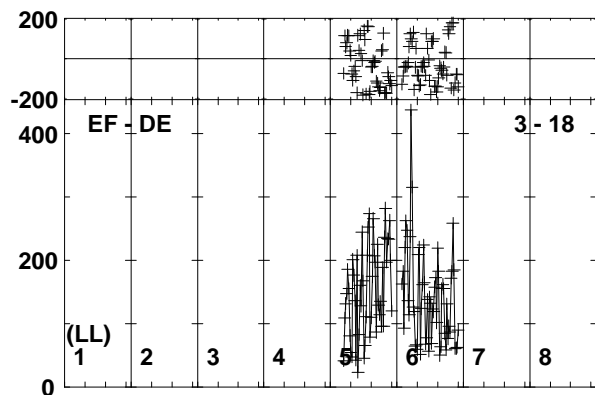
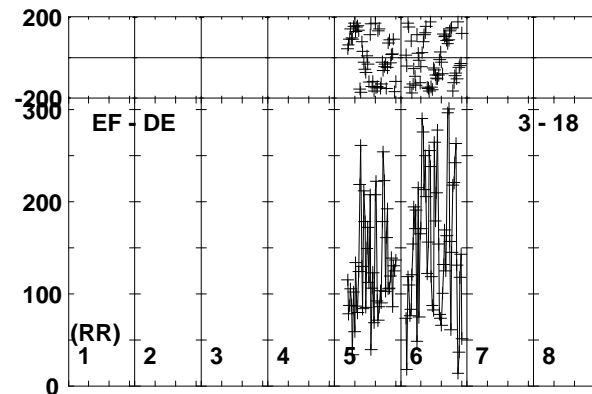
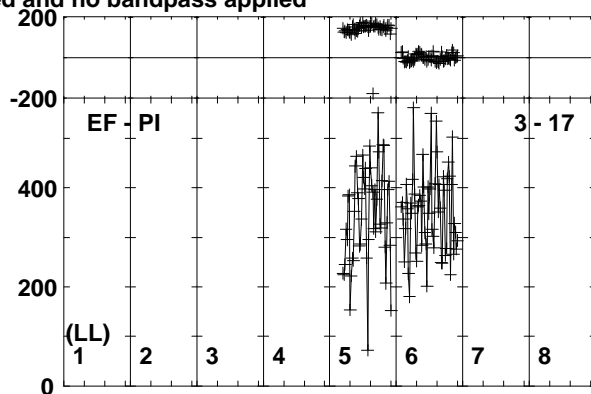
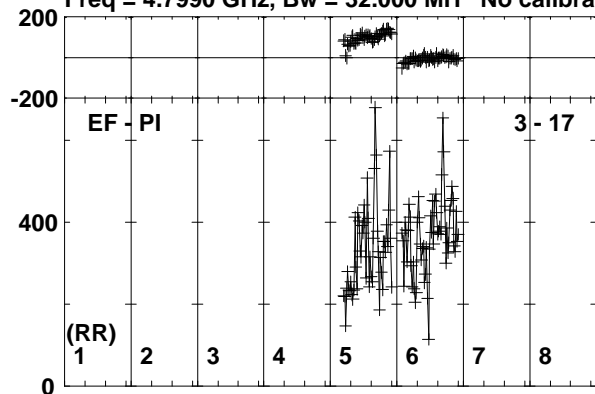

Lower frame: Micro Ampl Jy Top frame: Phas deg
Vector averaged cross-power spectrum Baseline: EF (03) - PI (17)
Timerange: 01/05:52:06 to 01/05:54:14

Plot file version 621 created 26-SEP-2019 10:43:50

J0257-1212 RG010A.UVDATA.1

Freq = 4.7990 GHz, Bw = 32.000 MH No calibration applied and no bandpass applied

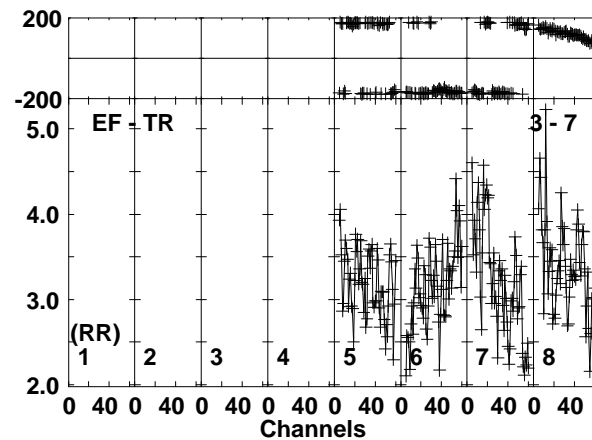
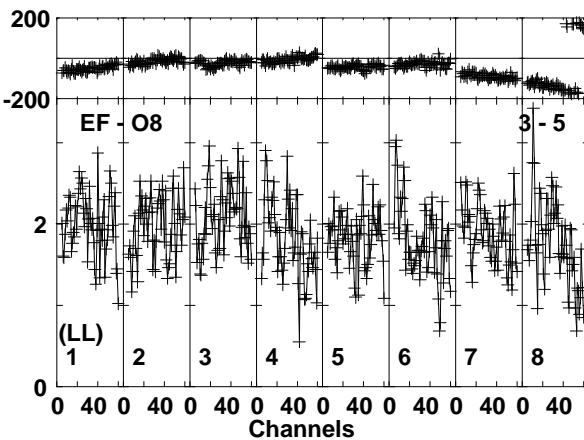
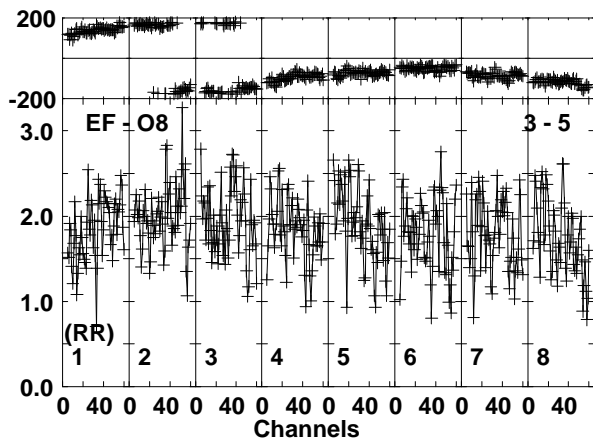
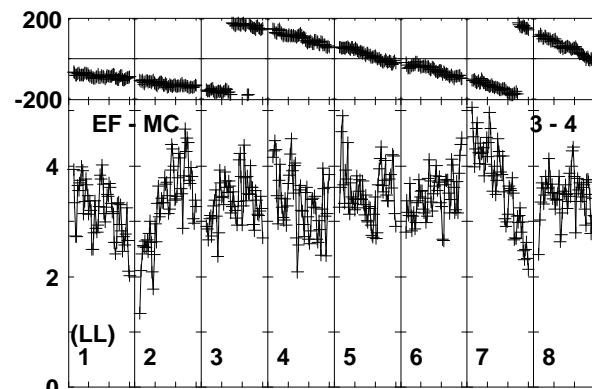
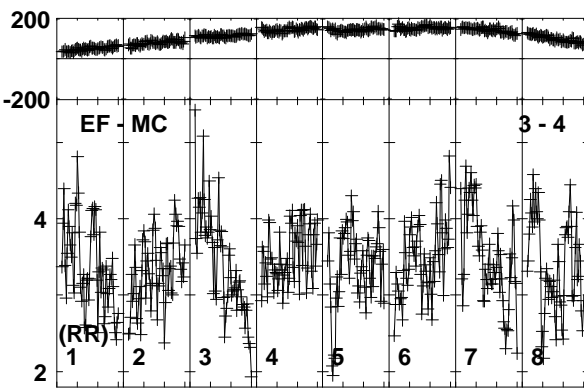
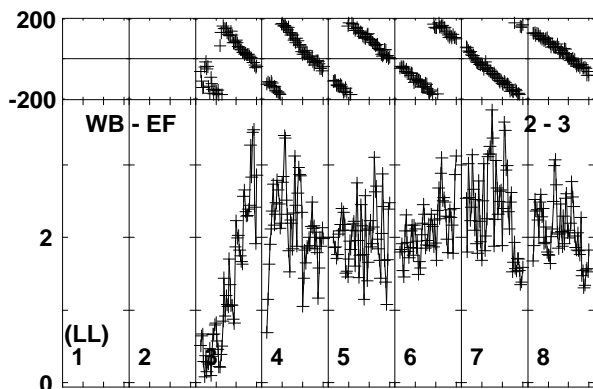
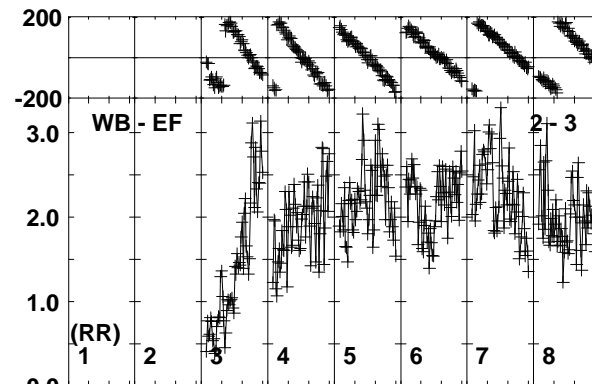
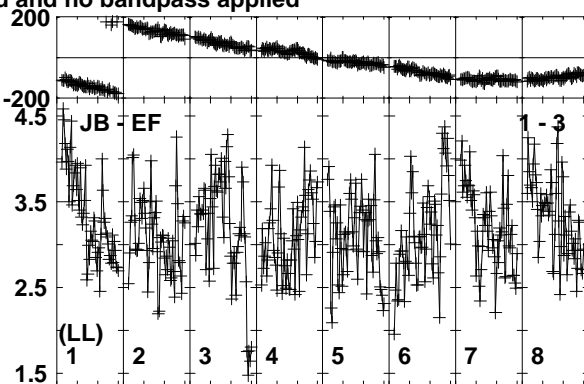
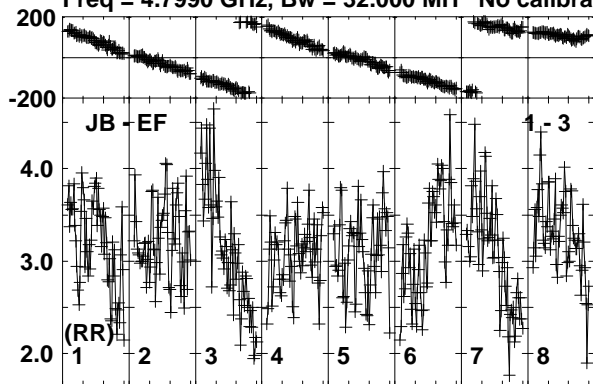

Lower frame: Milli Ampl Jy Top frame: Phas deg
Vector averaged cross-power spectrum Baseline: JB (01) - EF (03)
Timerange: 01/05:54:15 to 01/05:55:14

Plot file version 622 created 26-SEP-2019 10:43:50

J0257-1212 RG010A.UVDATA.1

Freq = 4.7990 GHz, Bw = 32.000 MH No calibration applied and no bandpass applied

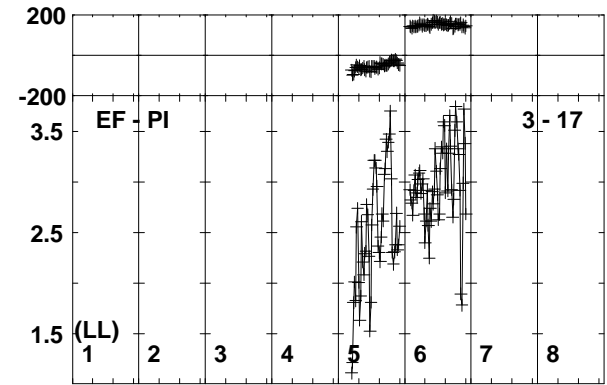
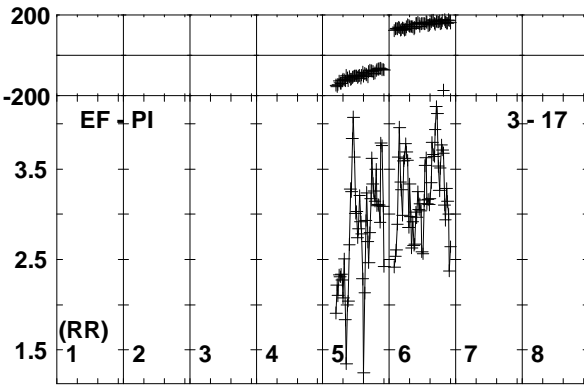
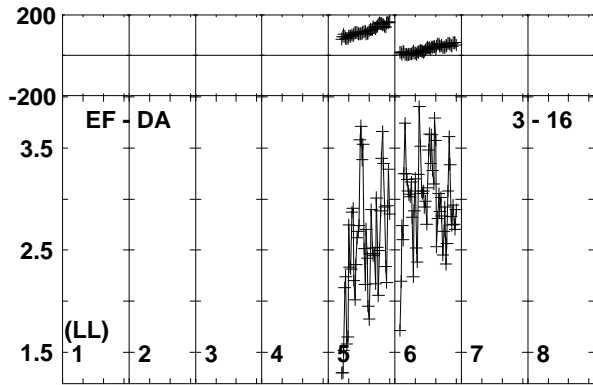
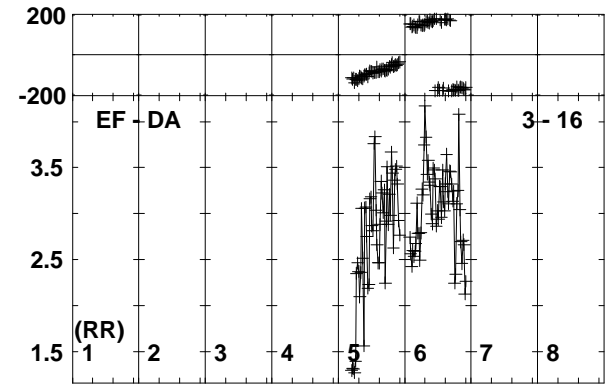
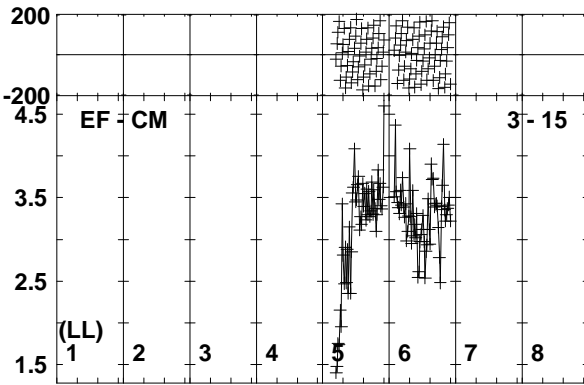
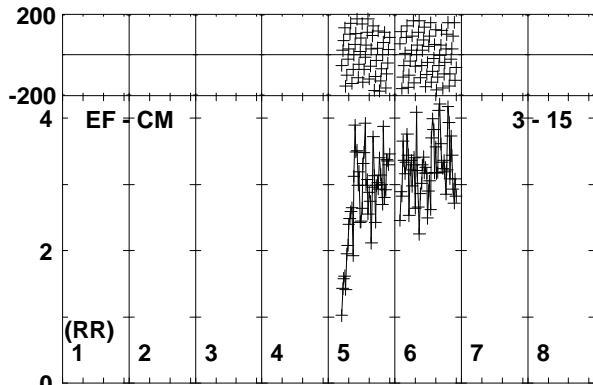
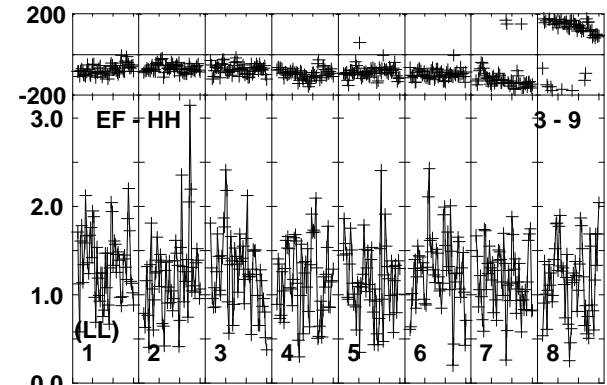
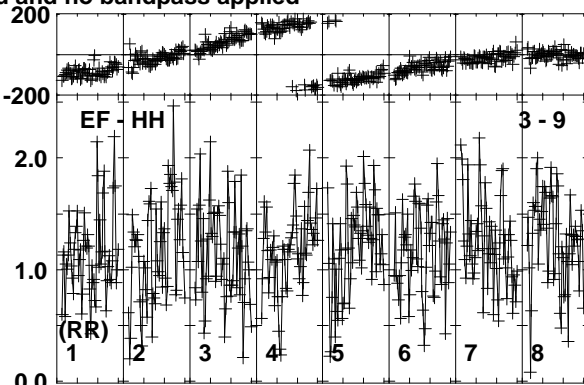
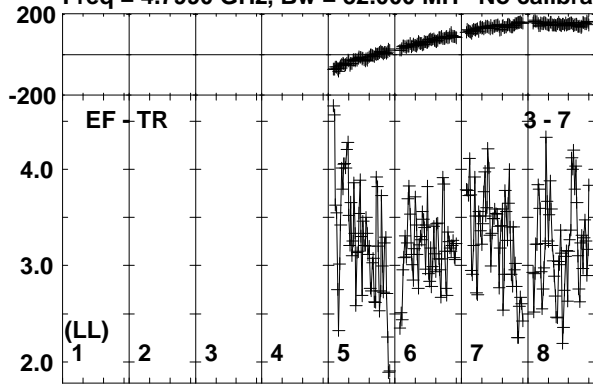

Lower frame: Milli Ampl Jy Top frame: Phas deg
Vector averaged cross-power spectrum Baseline: EF (03) - TR (07)
Timerange: 01/05:54:15 to 01/05:55:14

Plot file version 623 created 26-SEP-2019 10:43:51

J0257-1212 RG010A.UVDATA.1

Freq = 4.7990 GHz, Bw = 32.000 MH No calibration applied and no bandpass applied

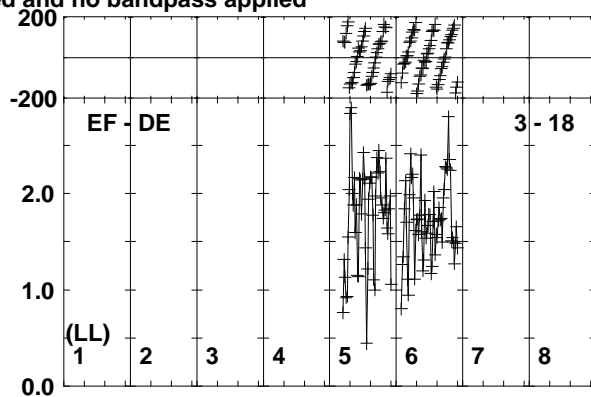
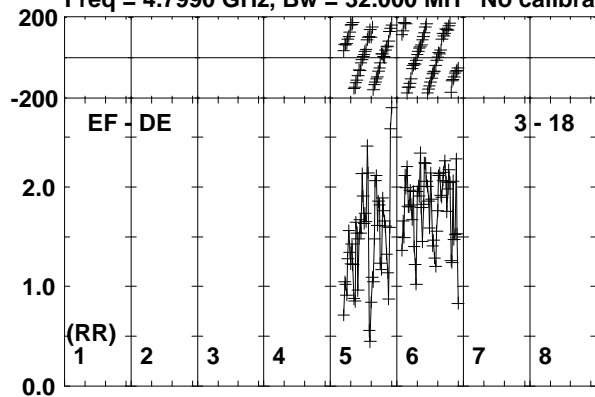

Lower frame: Milli Ampl Jy Top frame: Phas deg
Vector averaged cross-power spectrum Baseline: EF (03) - DE (18)
Timerange: 01/05:54:15 to 01/05:55:14

Plot file version 624 created 26-SEP-2019 10:43:51

190829A RG010A.UVDATA.1

Freq = 4.7990 GHz, Bw = 32.000 MH No calibration applied and no bandpass applied

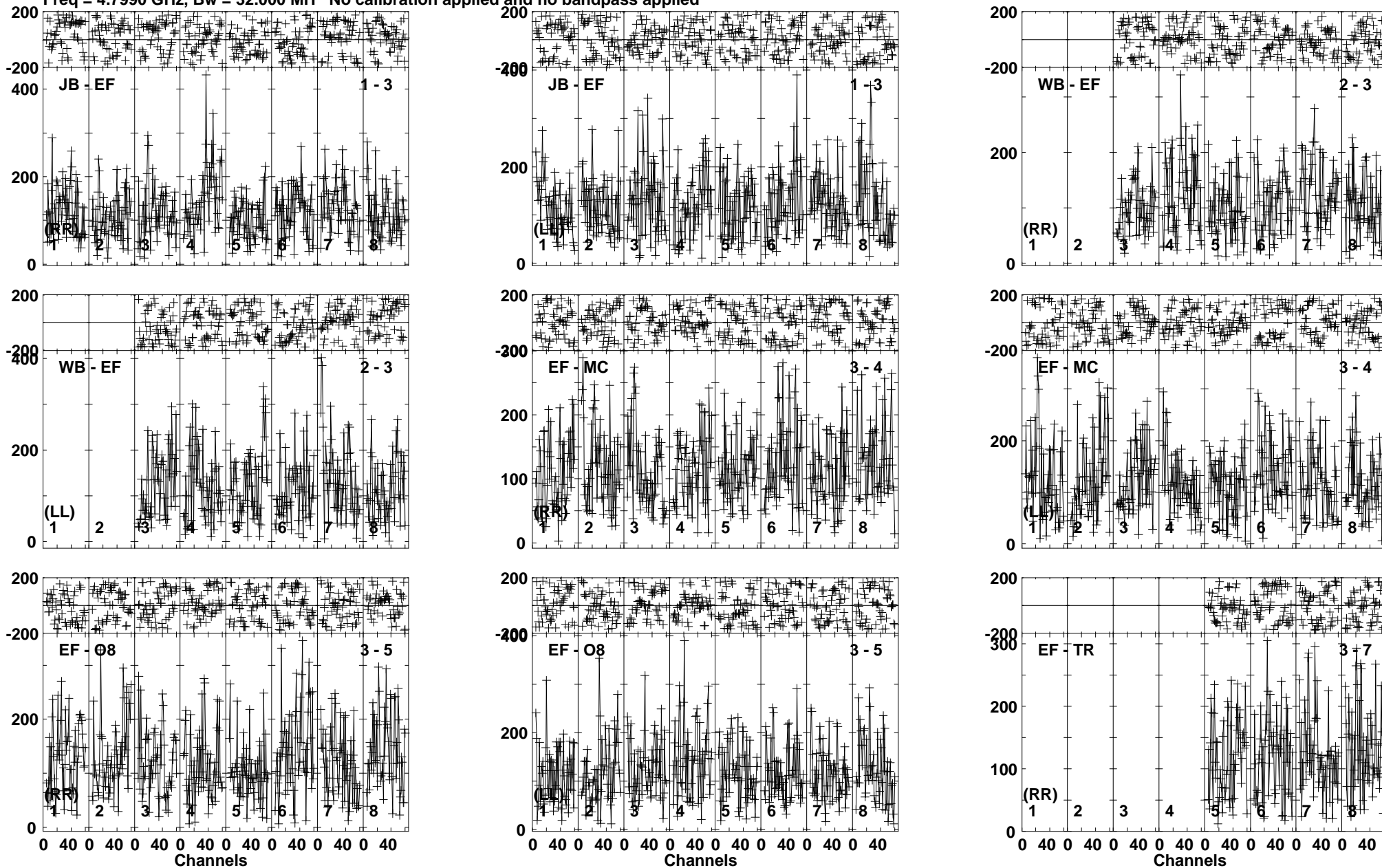

Lower frame: Micro Ampl Jy Top frame: Phas deg
Vector averaged cross-power spectrum Baseline: JB (01) - EF (03)
Timerange: 01/05:55:16 to 01/05:57:24

Plot file version 625 created 26-SEP-2019 10:43:51

190829A RG010A.UVDATA.1

Freq = 4.7990 GHz, Bw = 32.000 MH No calibration applied and no bandpass applied

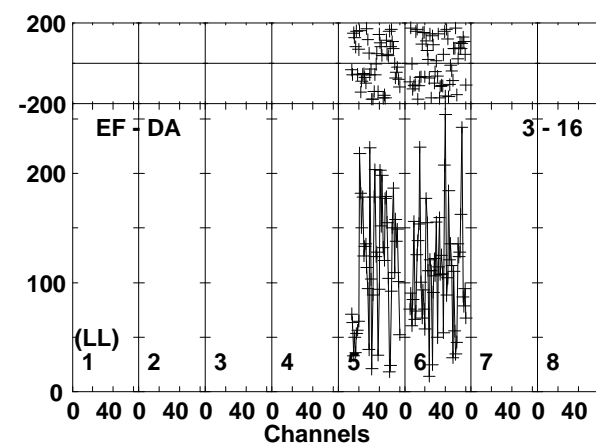
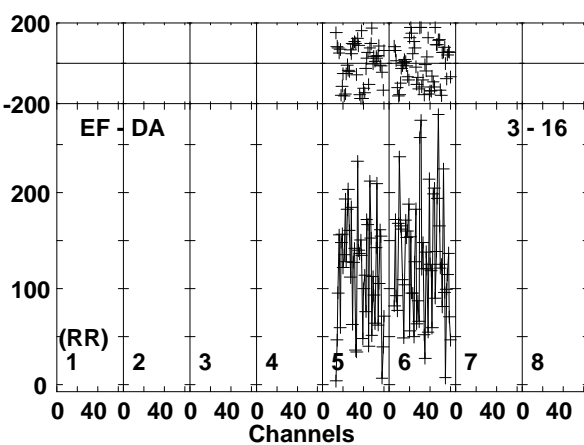
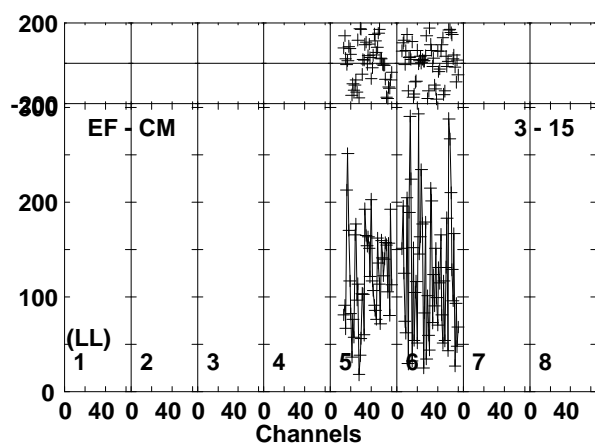
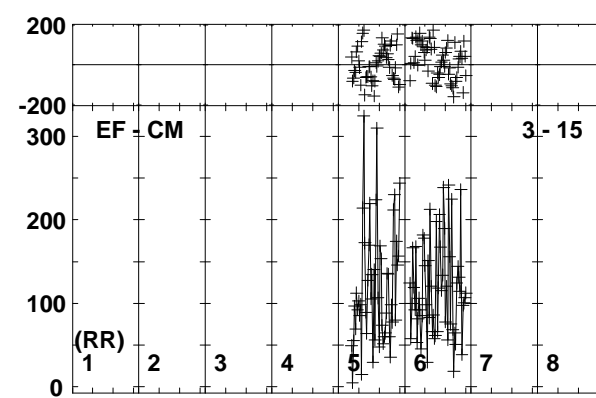
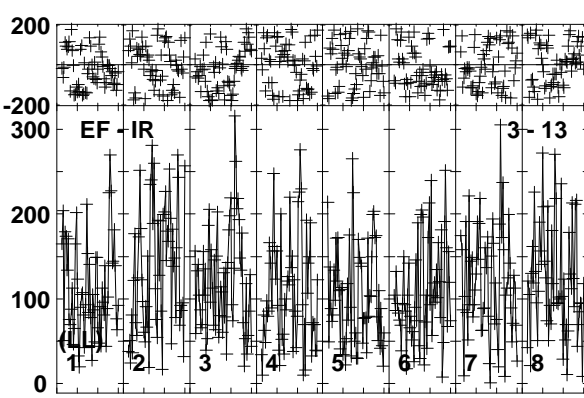
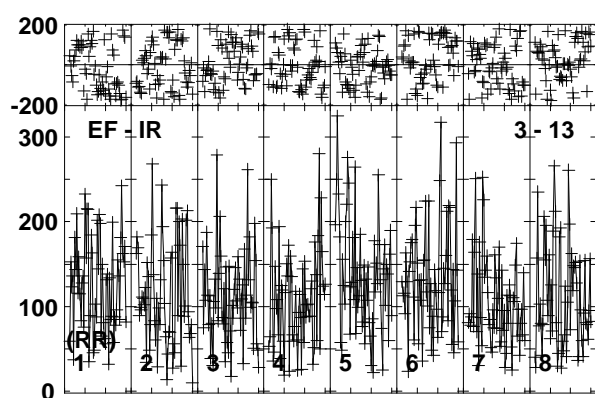
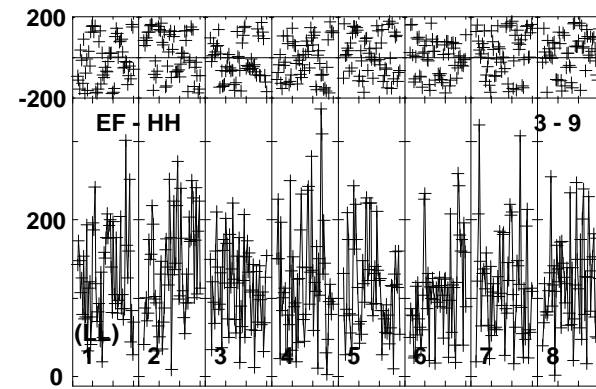
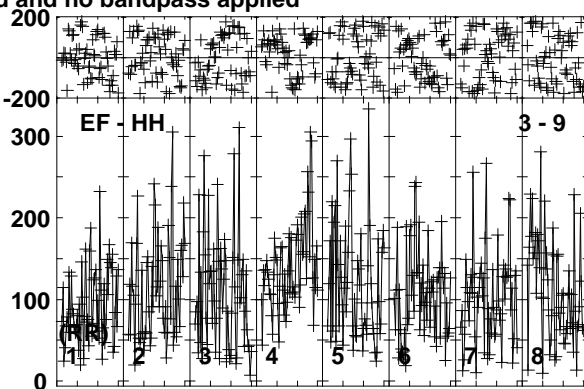
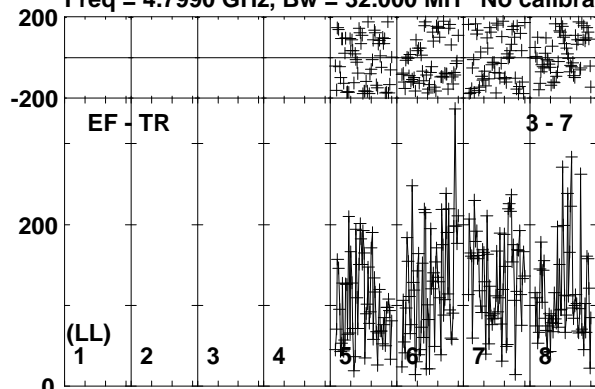

Lower frame: Micro Ampl Jy Top frame: Phas deg
Vector averaged cross-power spectrum Baseline: EF (03) - TR (07)
Timerange: 01/05:55:16 to 01/05:57:24

Plot file version 626 created 26-SEP-2019 10:43:52

190829A RG010A.UVDATA.1

Freq = 4.7990 GHz, Bw = 32.000 MH No calibration applied and no bandpass applied

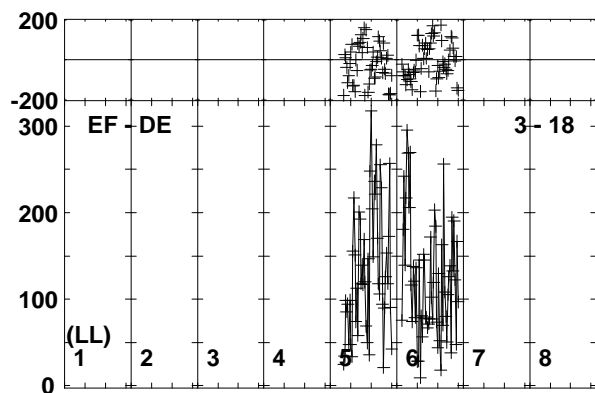
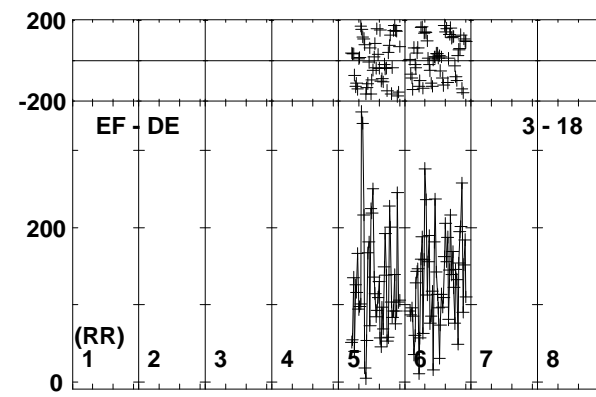
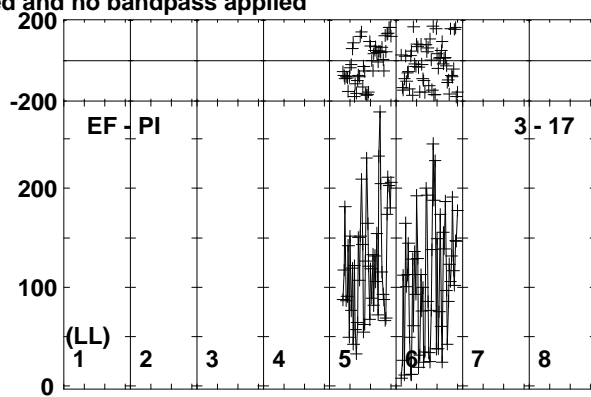
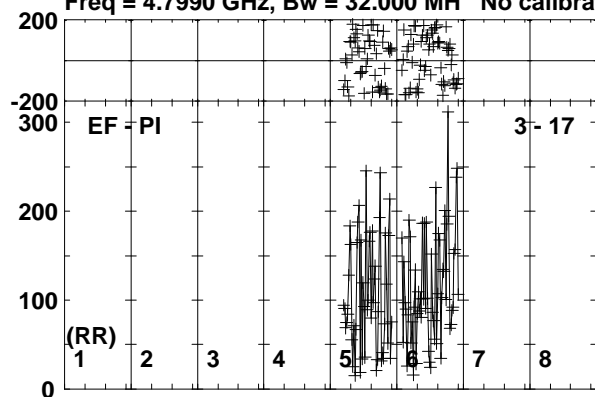

Lower frame: Micro Ampl Jy Top frame: Phas deg
Vector averaged cross-power spectrum Baseline: EF (03) - PI (17)
Timerange: 01/05:55:16 to 01/05:57:24

Plot file version 627 created 26-SEP-2019 10:43:52

J0257-1212 RG010A.UVDATA.1

Freq = 4.7990 GHz, Bw = 32.000 MH No calibration applied and no bandpass applied

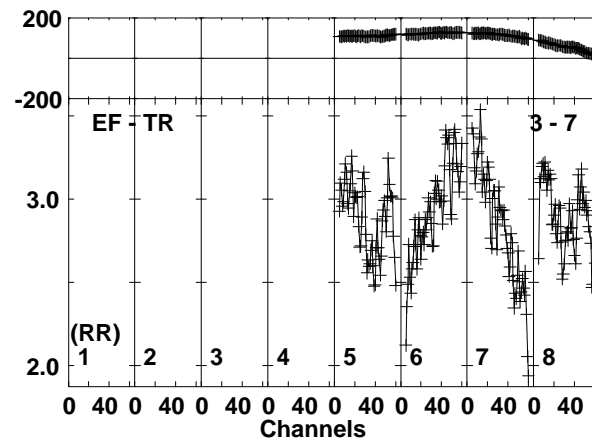
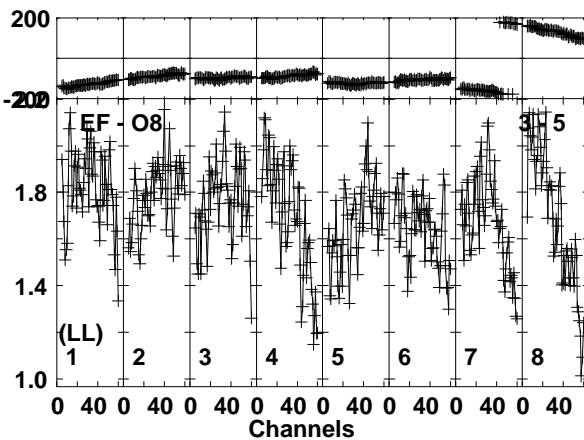
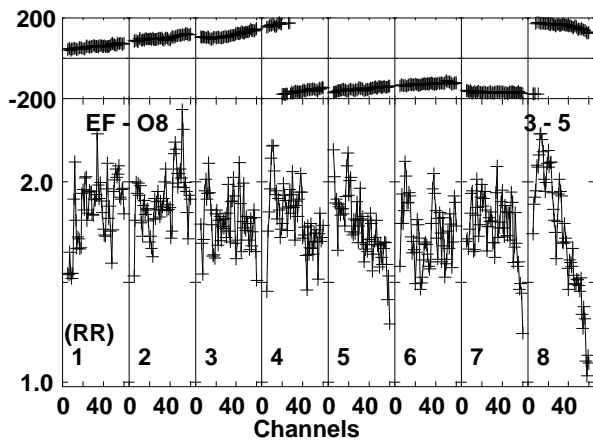
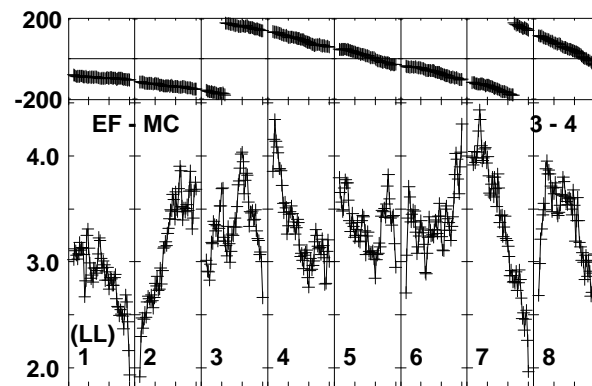
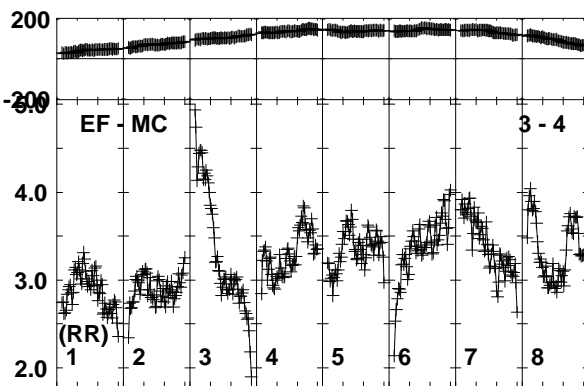
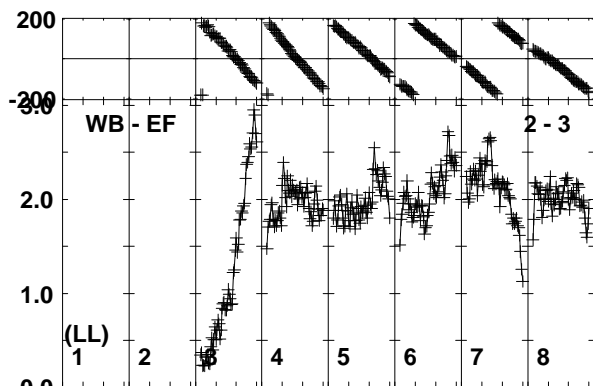
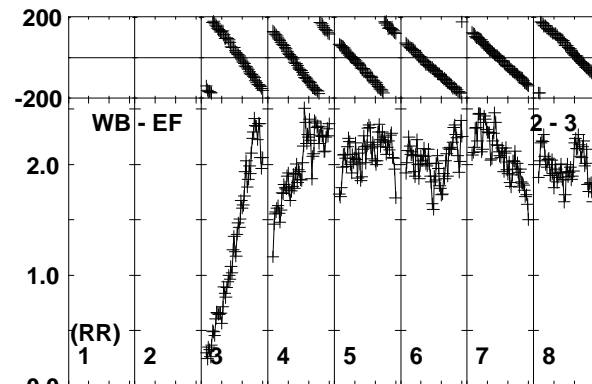
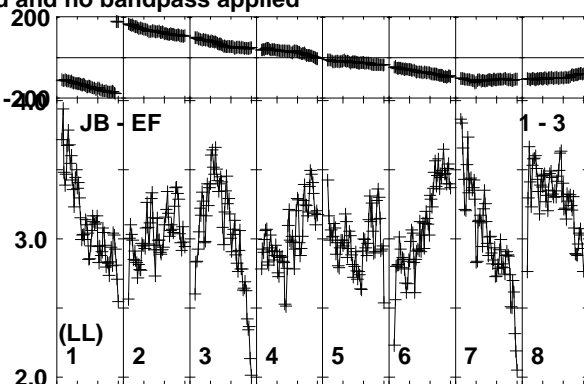
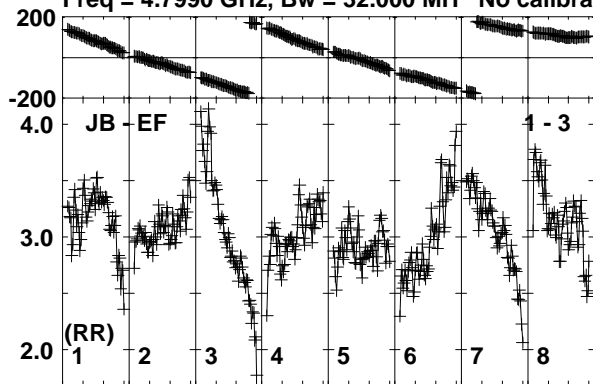

Lower frame: Milli Ampl Jy Top frame: Phas deg
Vector averaged cross-power spectrum Baseline: JB (01) - EF (03)
Timerange: 01/05:58:06 to 01/05:59:05

Plot file version 628 created 26-SEP-2019 10:43:52

J0257-1212 RG010A.UVDATA.1

Freq = 4.7990 GHz, Bw = 32.000 MH No calibration applied and no bandpass applied

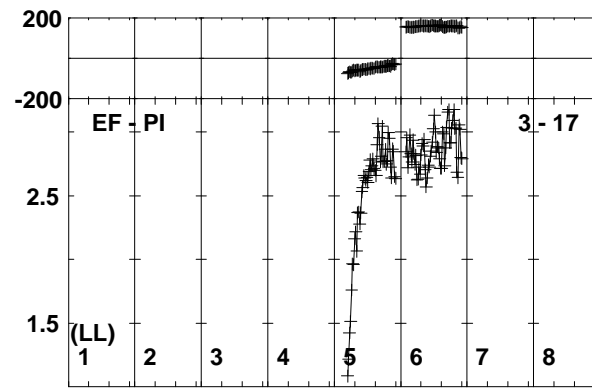
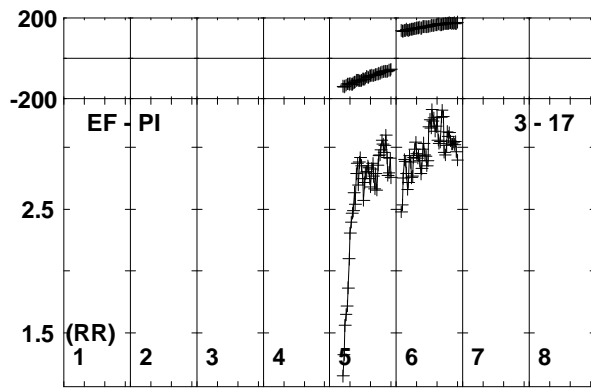
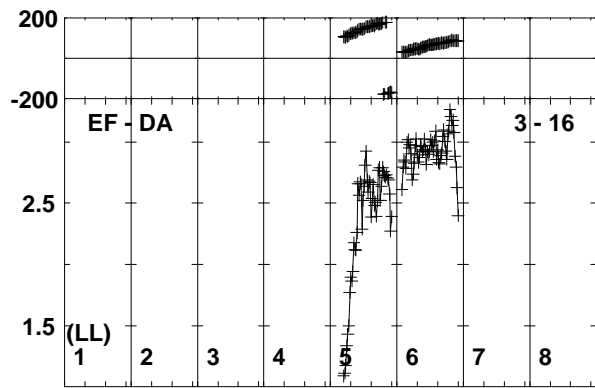
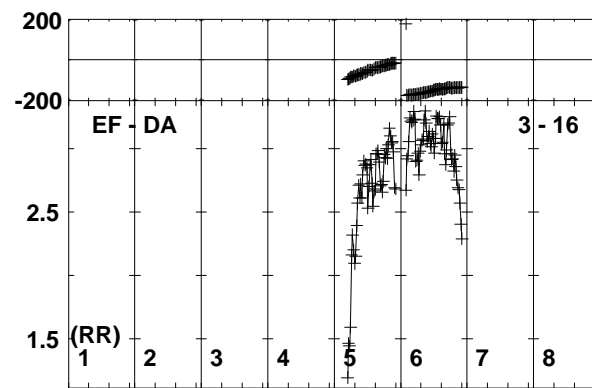
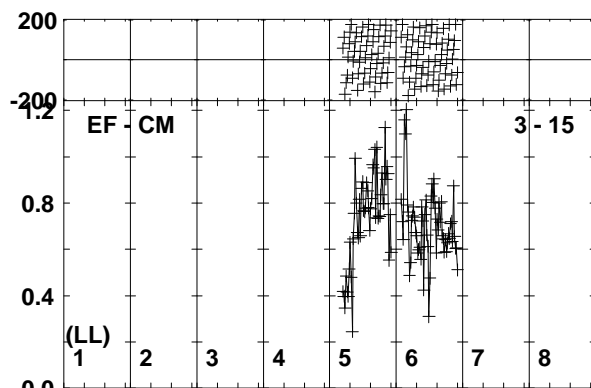
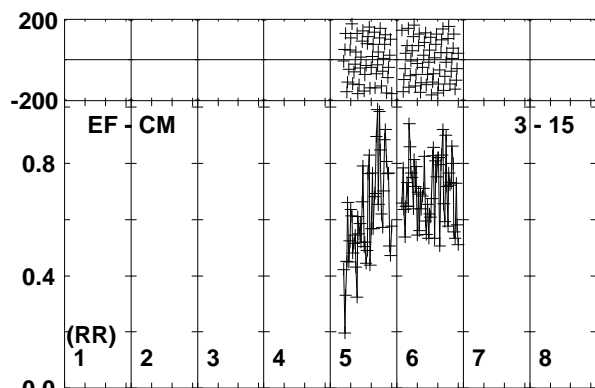
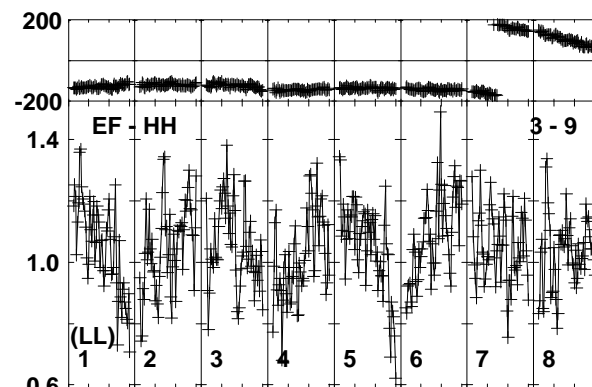
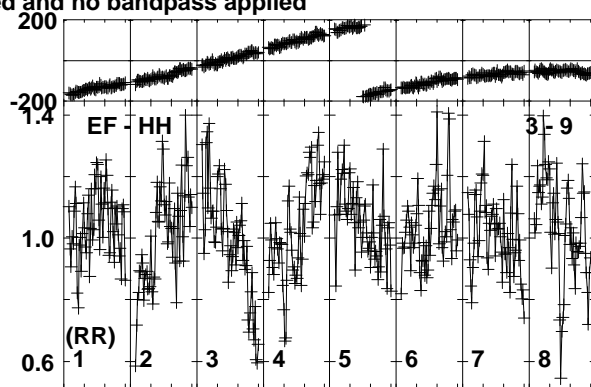
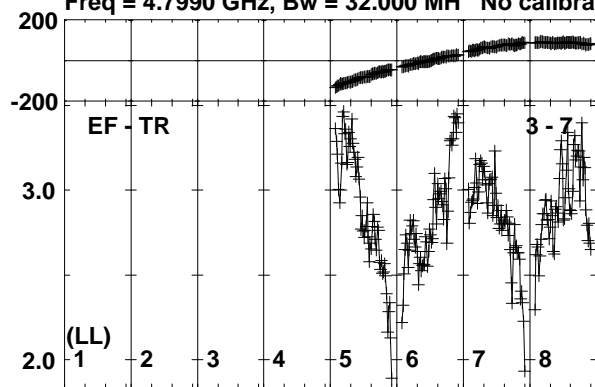

Lower frame: Milli Ampl Jy Top frame: Phas deg
Vector averaged cross-power spectrum Baseline: EF (03) - TR (07)
Timerange: 01/05:58:06 to 01/05:59:05

Plot file version 629 created 26-SEP-2019 10:43:53

J0257-1212 RG010A.UVDATA.1

Freq = 4.7990 GHz, Bw = 32.000 MH No calibration applied and no bandpass applied

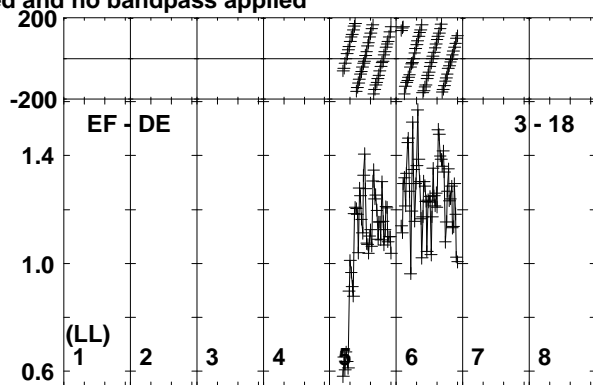
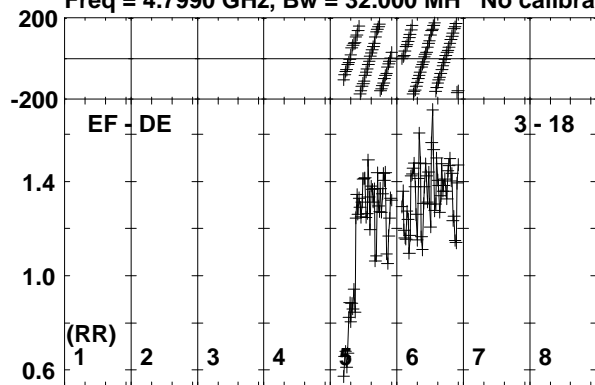

Lower frame: Milli Ampl Jy Top frame: Phas deg
Vector averaged cross-power spectrum Baseline: EF (03) - DE (18)
Timerange: 01/05:58:06 to 01/05:59:05

Plot file version 630 created 26-SEP-2019 10:43:53

190829A RG010A.UVDATA.1

Freq = 4.7990 GHz, Bw = 32.000 MH No calibration applied and no bandpass applied

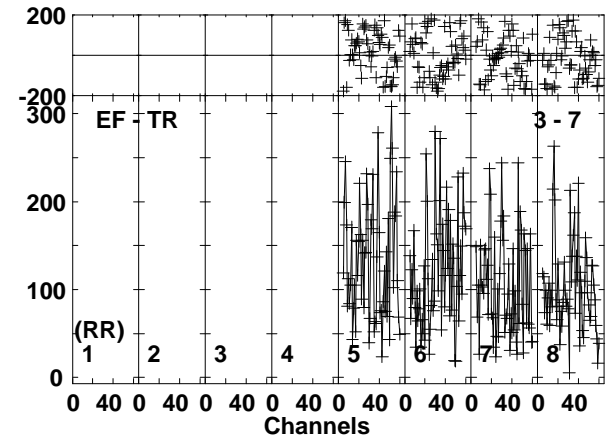
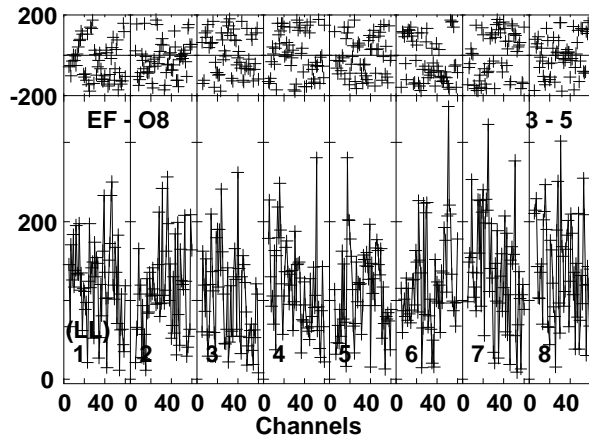
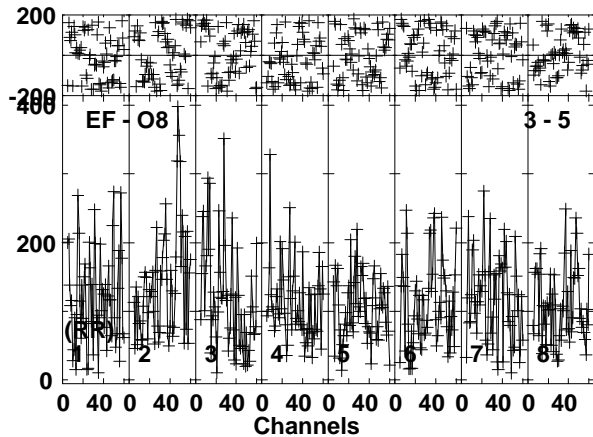
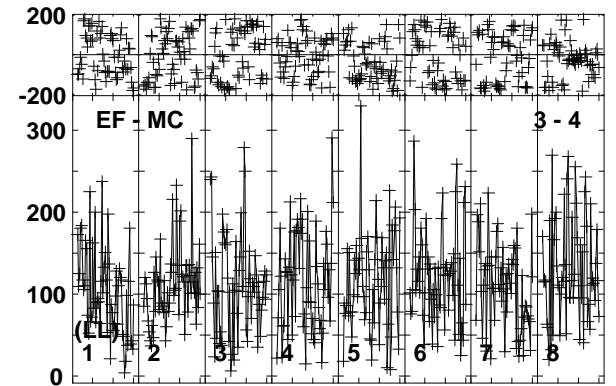
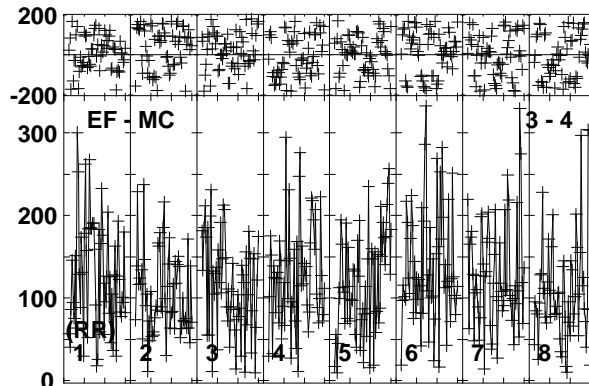
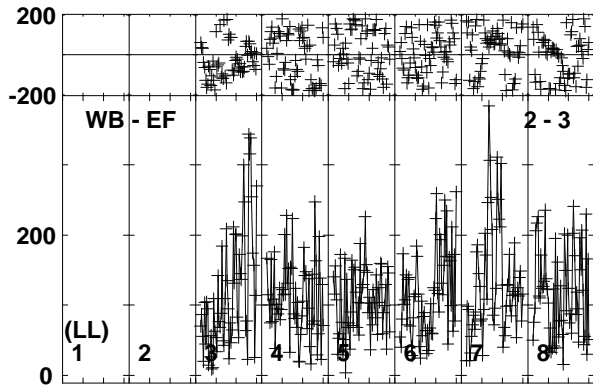
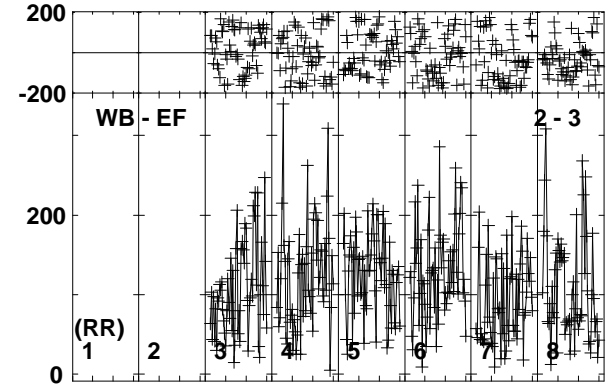
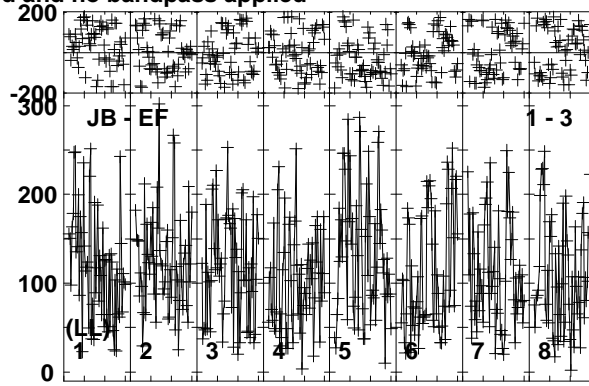
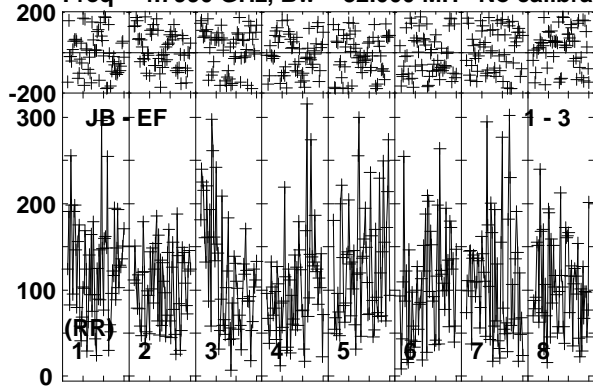

Lower frame: Micro Ampl Jy Top frame: Phas deg
Vector averaged cross-power spectrum Baseline: JB (01) - EF (03)
Timerange: 01/05:59:06 to 01/06:01:14

Plot file version 631 created 26-SEP-2019 10:43:53

190829A RG010A.UVDATA.1

Freq = 4.7990 GHz, Bw = 32.000 MH No calibration applied and no bandpass applied

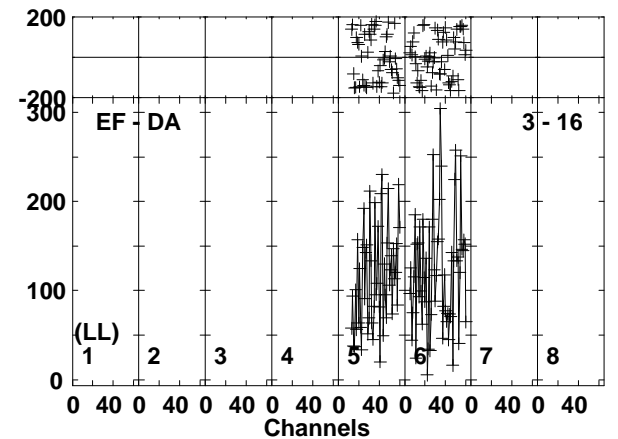
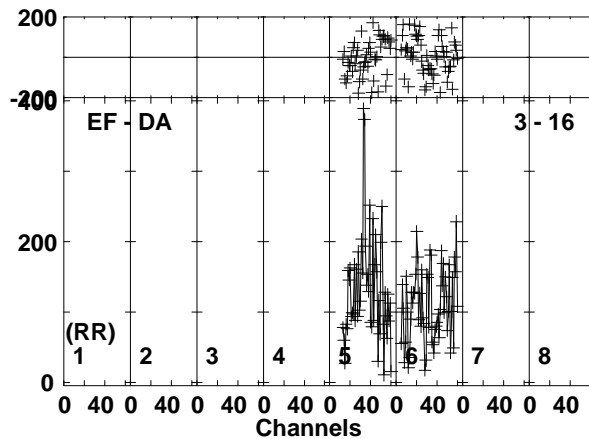
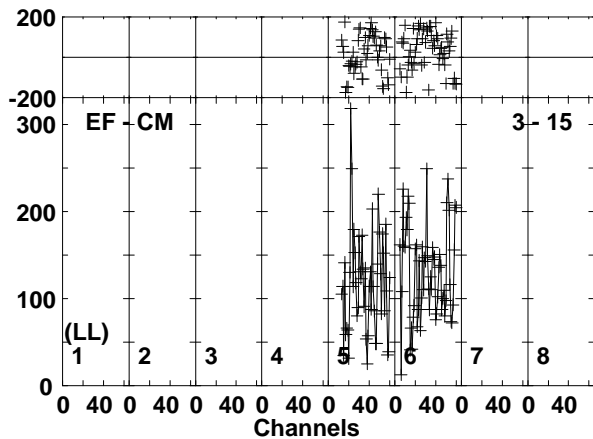
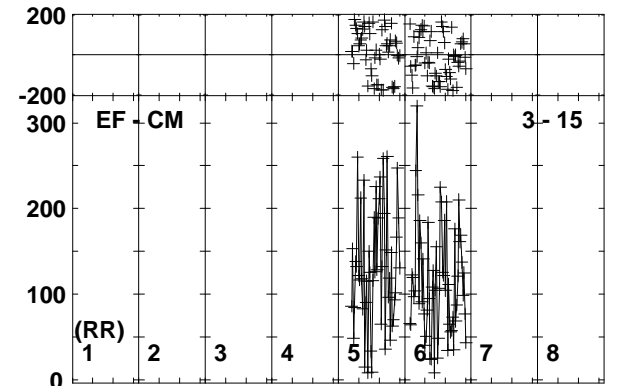
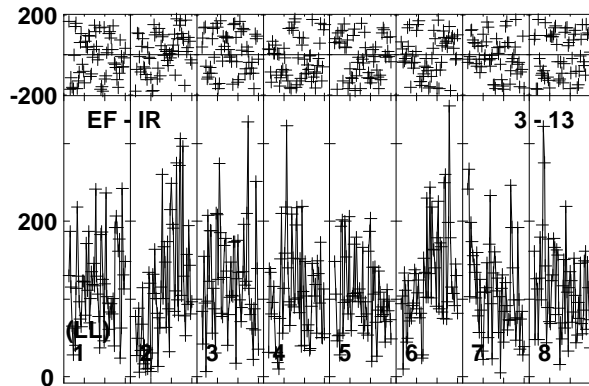
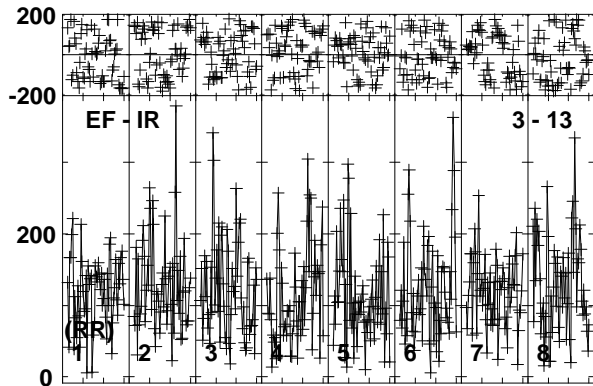
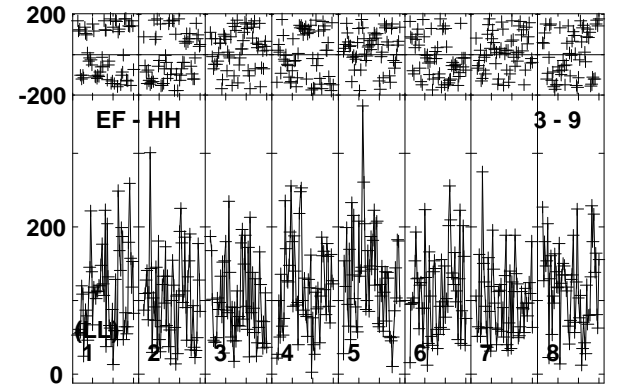
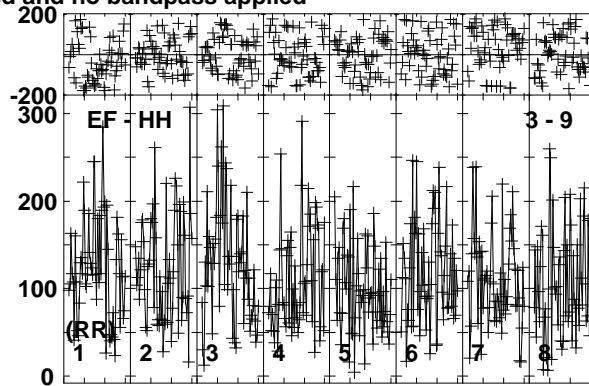
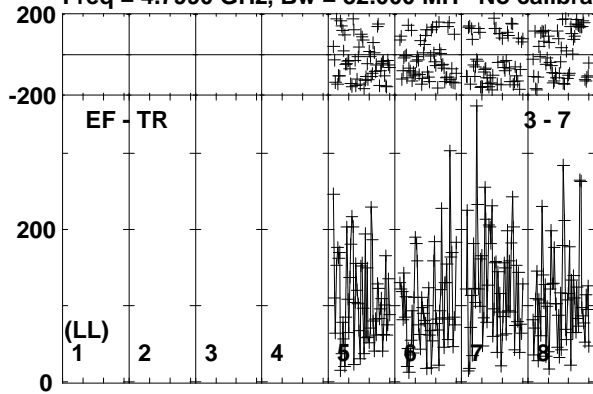

Lower frame: Micro Ampl Jy Top frame: Phas deg
Vector averaged cross-power spectrum Baseline: EF (03) - TR (07)
Timerange: 01/05:59:06 to 01/06:01:14

Plot file version 632 created 26-SEP-2019 10:43:53

190829A RG010A.UVDATA.1

Freq = 4.7990 GHz, Bw = 32.000 MH No calibration applied and no bandpass applied

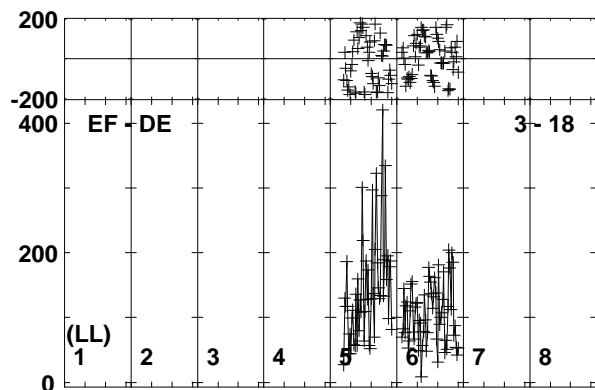
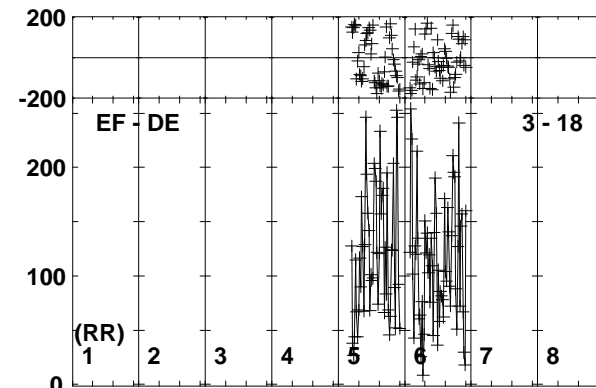
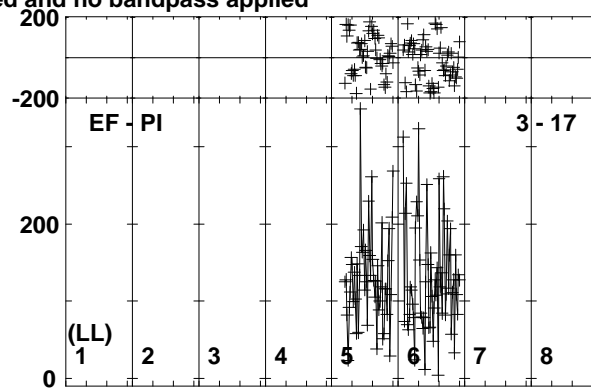
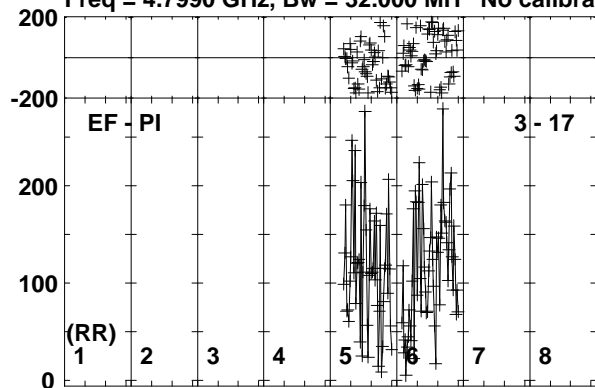

Lower frame: Micro Ampl Jy Top frame: Phas deg
Vector averaged cross-power spectrum Baseline: EF (03) - PI (17)
Timerange: 01/05:59:06 to 01/06:01:14

Plot file version 633 created 26-SEP-2019 10:43:54

J0257-1212 RG010A.UVDATA.1

Freq = 4.7990 GHz, Bw = 32.000 MH No calibration applied and no bandpass applied

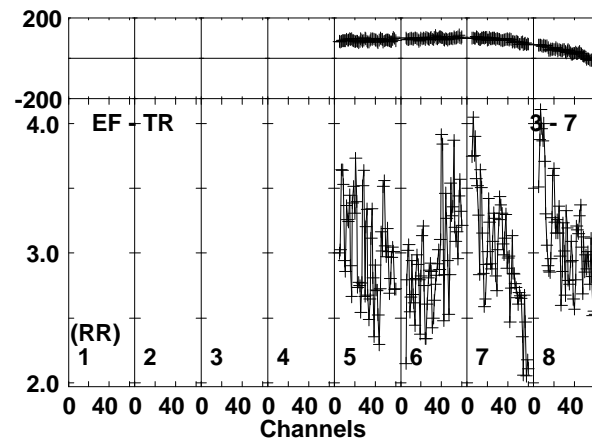
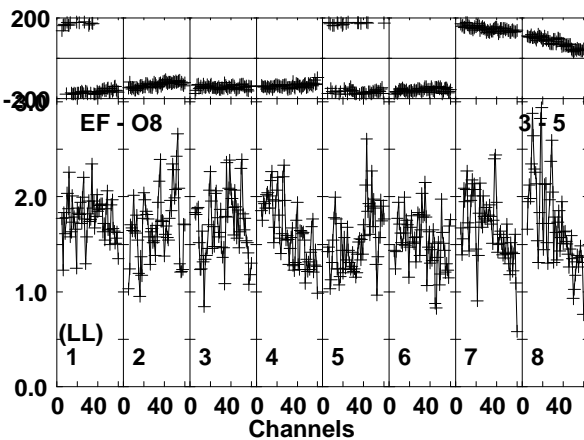
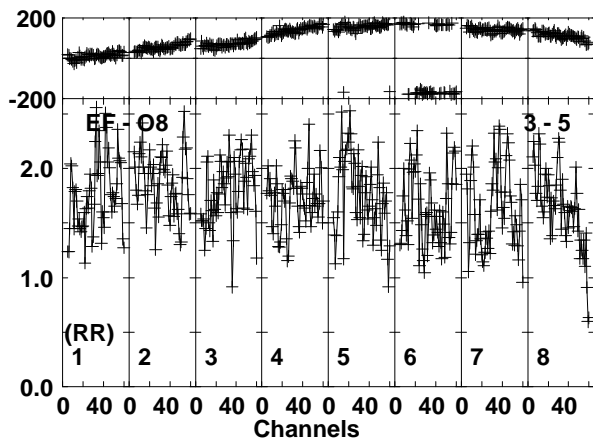
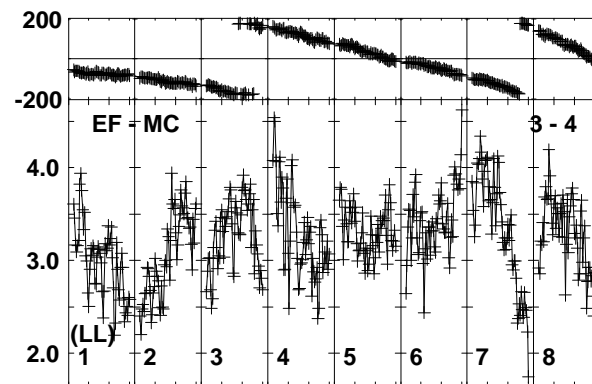
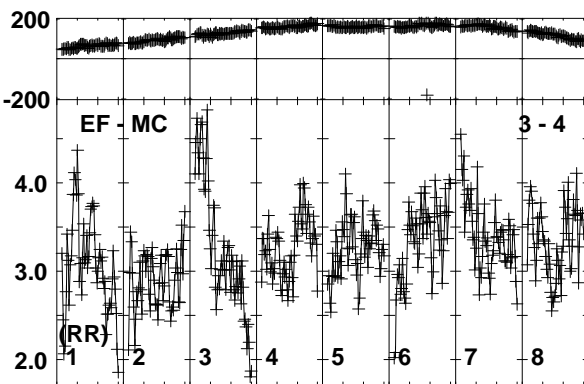
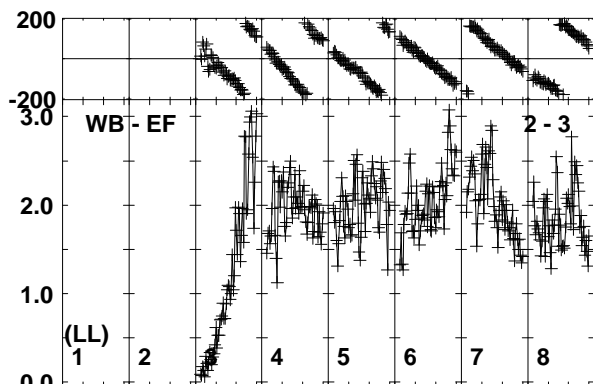
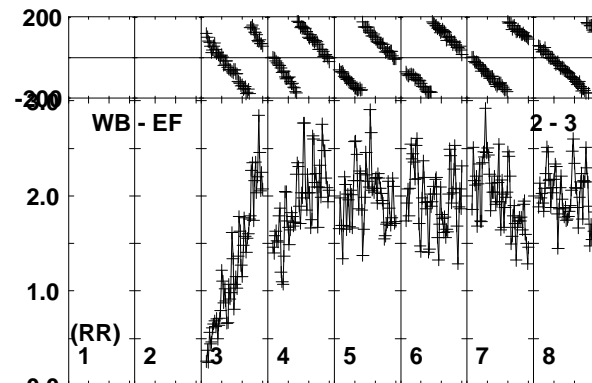
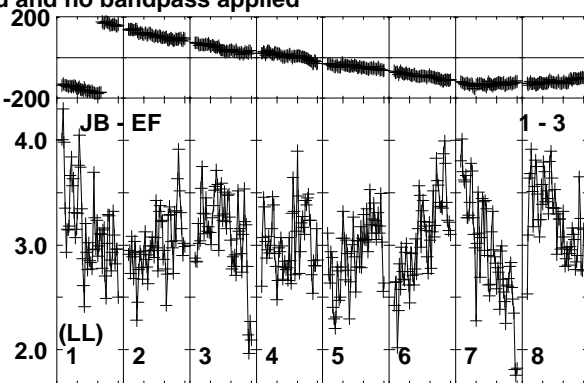
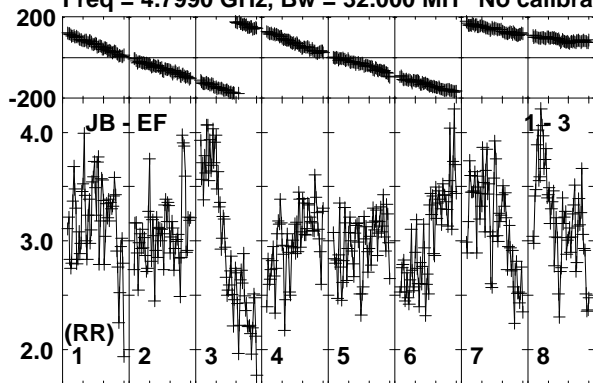

Lower frame: Milli Ampl Jy Top frame: Phas deg
Vector averaged cross-power spectrum Baseline: JB (01) - EF (03)
Timerange: 01/06:01:15 to 01/06:02:14

Plot file version 634 created 26-SEP-2019 10:43:54

J0257-1212 RG010A.UVDATA.1

Freq = 4.7990 GHz, Bw = 32.000 MH No calibration applied and no bandpass applied

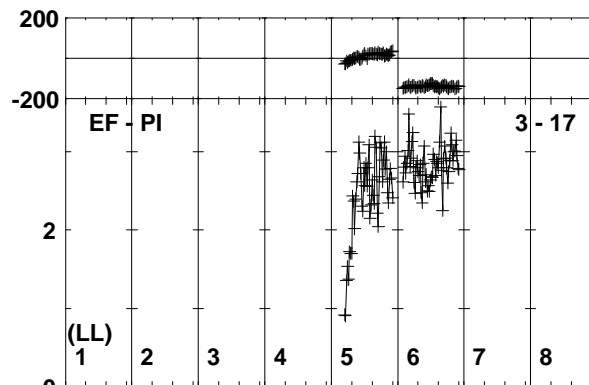
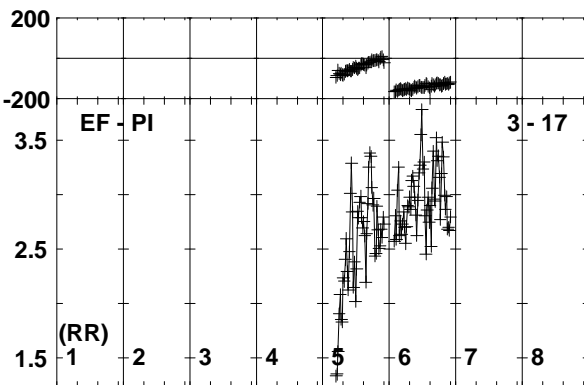
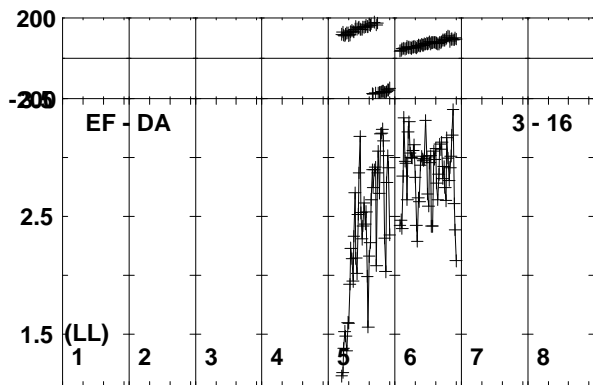
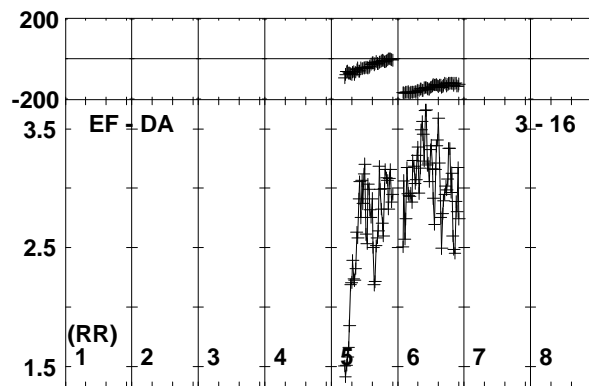
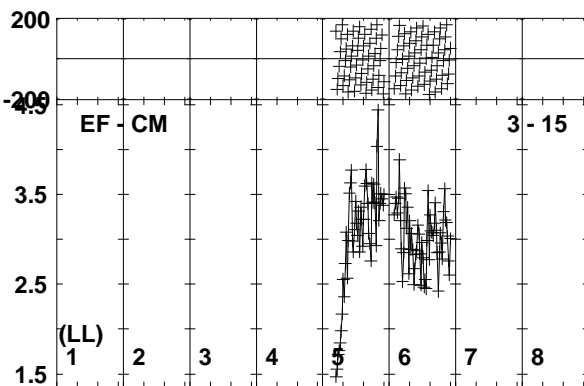
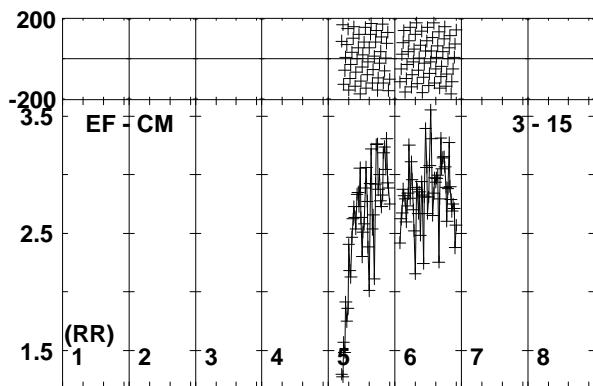
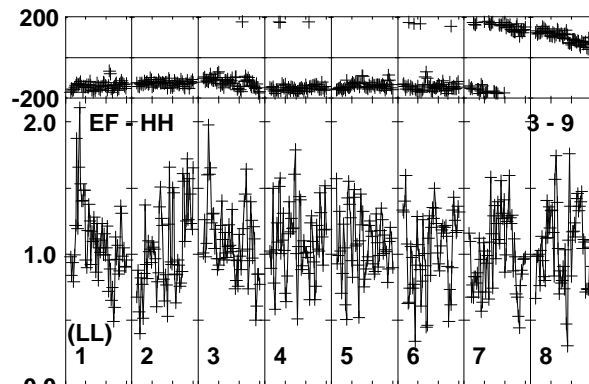
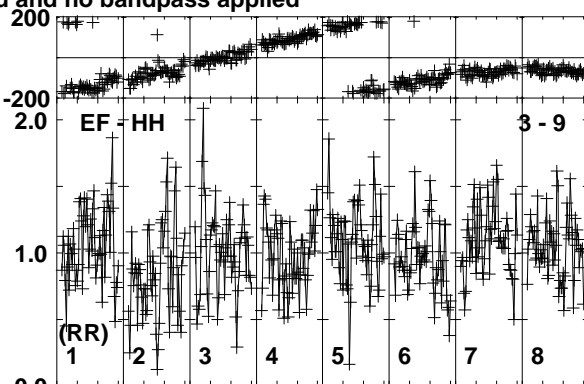
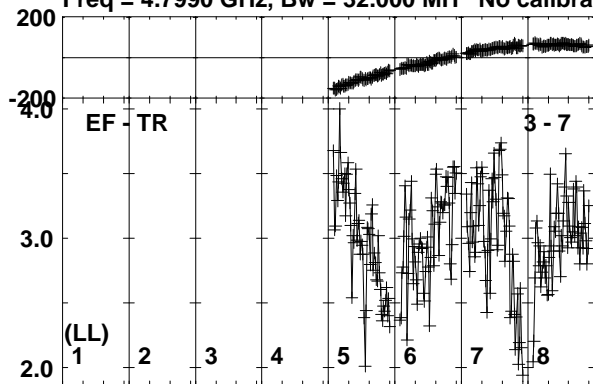

Lower frame: Milli Ampl Jy Top frame: Phas deg
Vector averaged cross-power spectrum Baseline: EF (03) - TR (07)
Timerange: 01/06:01:15 to 01/06:02:14

Plot file version 635 created 26-SEP-2019 10:43:54

J0257-1212 RG010A.UVDATA.1

Freq = 4.7990 GHz, Bw = 32.000 MH No calibration applied and no bandpass applied

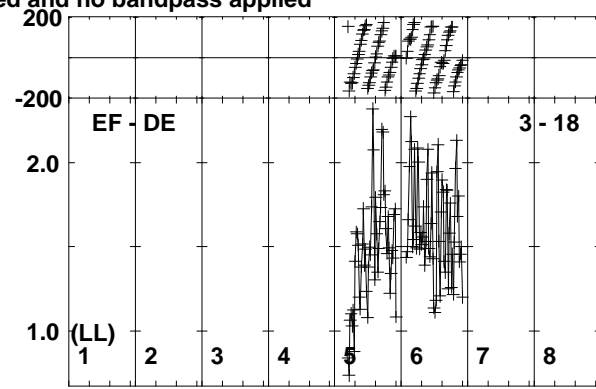
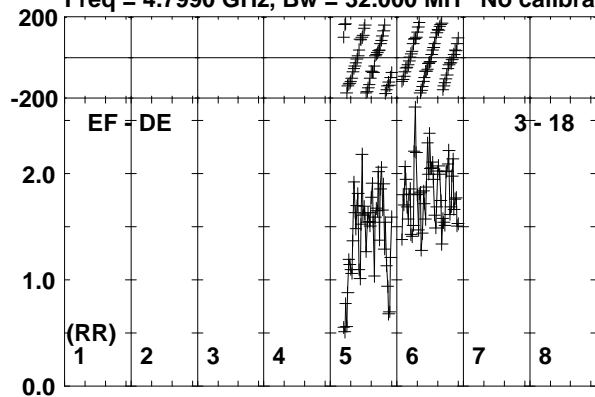

Lower frame: Milli Ampl Jy Top frame: Phas deg
Vector averaged cross-power spectrum Baseline: EF (03) - DE (18)
Timerange: 01/06:01:15 to 01/06:02:14

Plot file version 636 created 26-SEP-2019 10:43:54

190829A RG010A.UVDATA.1

Freq = 4.7990 GHz, Bw = 32.000 MH No calibration applied and no bandpass applied

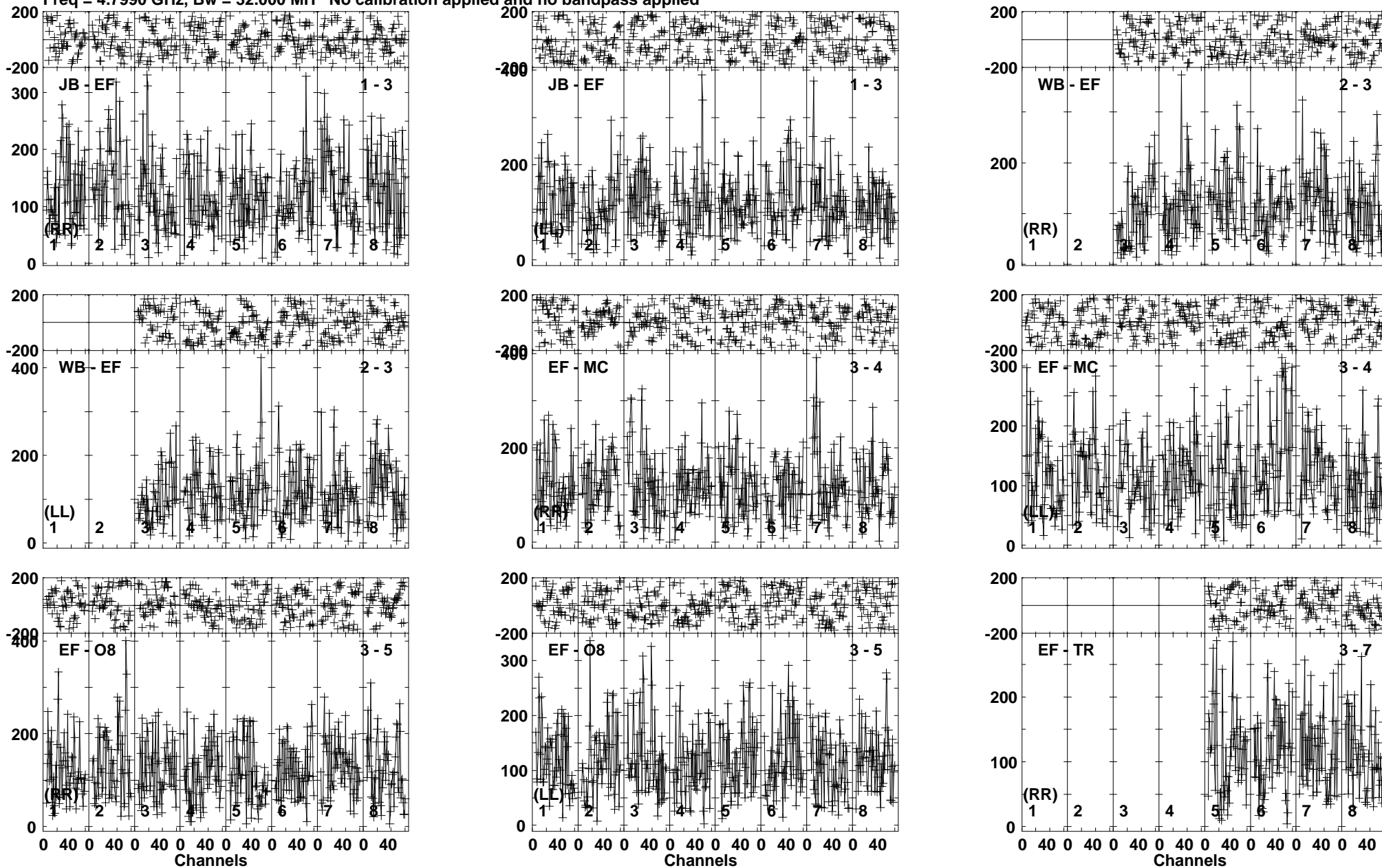

Lower frame: Micro Ampl Jy Top frame: Phas deg
Vector averaged cross-power spectrum Baseline: JB (01) - EF (03)
Timerange: 01/06:02:16 to 01/06:04:24

Plot file version 637 created 26-SEP-2019 10:43:54

190829A RG010A.UVDATA.1

Freq = 4.7990 GHz, Bw = 32.000 MH No calibration applied and no bandpass applied

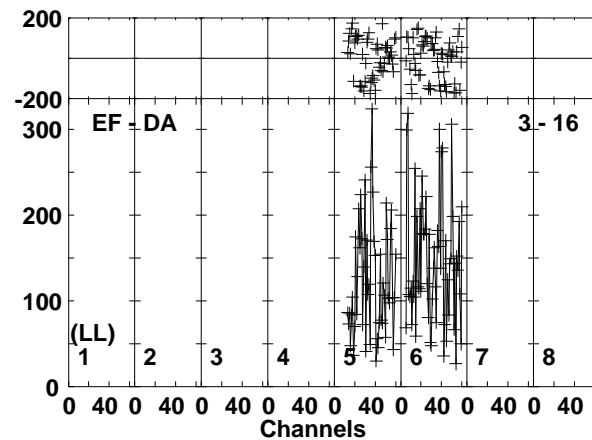
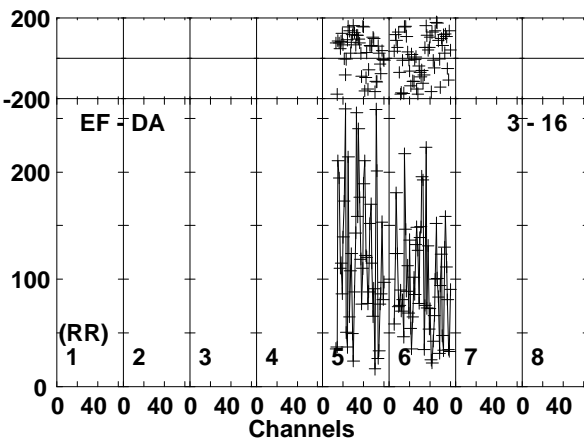
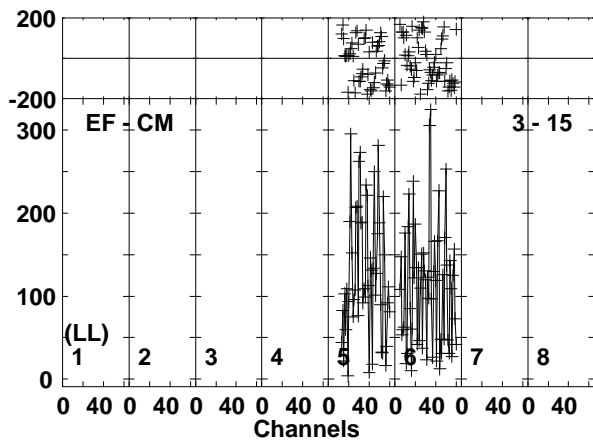
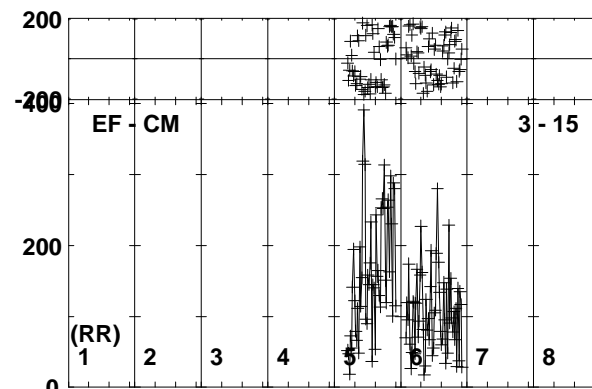
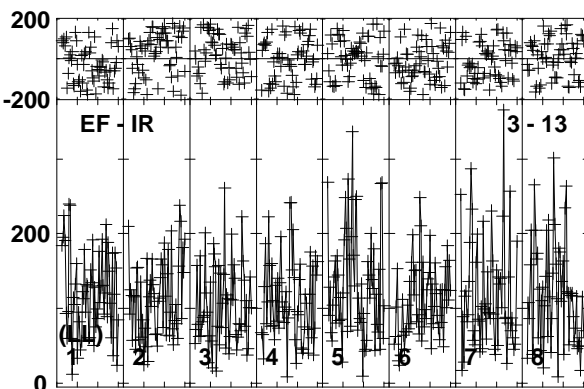
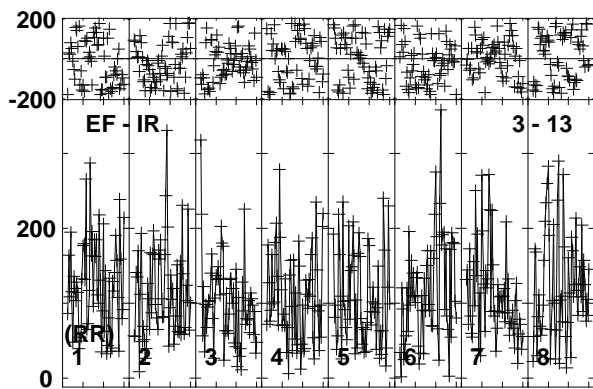
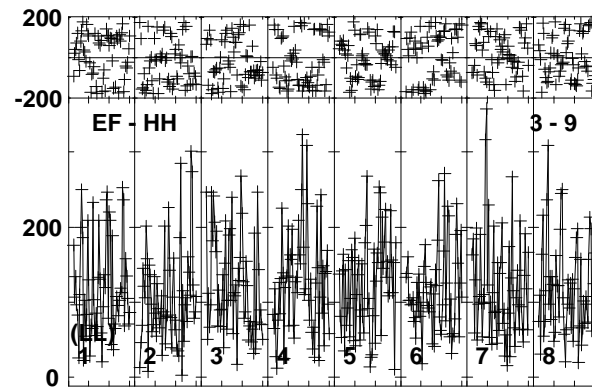
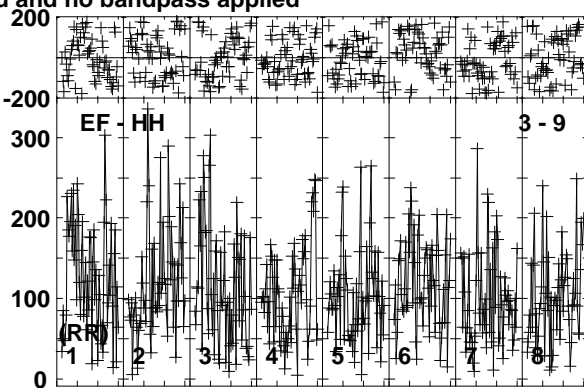
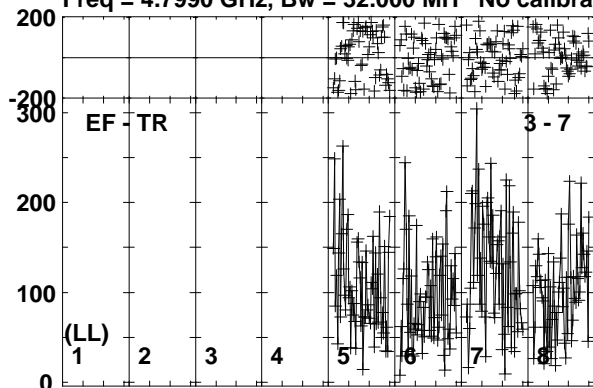

Lower frame: Micro Ampl Jy Top frame: Phas deg
Vector averaged cross-power spectrum Baseline: EF (03) - TR (07)
Timerange: 01/06:02:16 to 01/06:04:24

Plot file version 638 created 26-SEP-2019 10:43:55

190829A RG010A.UVDATA.1

Freq = 4.7990 GHz, Bw = 32.000 MH No calibration applied and no bandpass applied

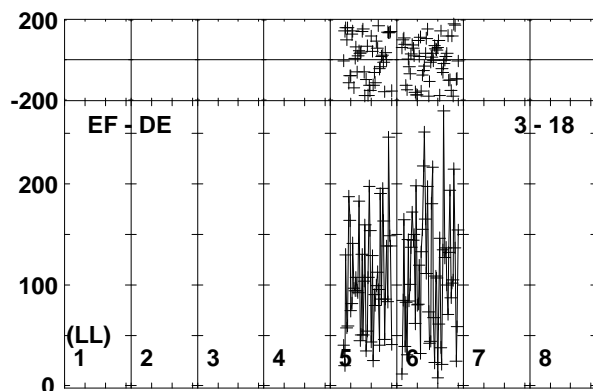
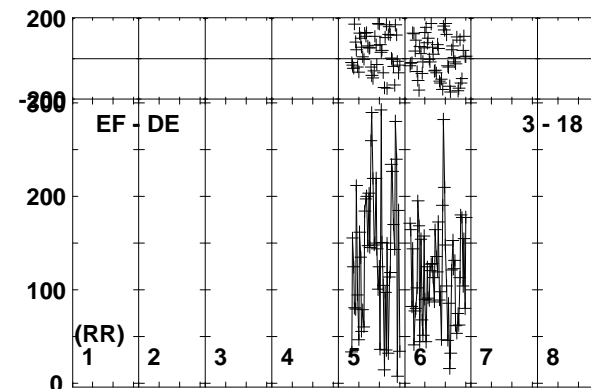
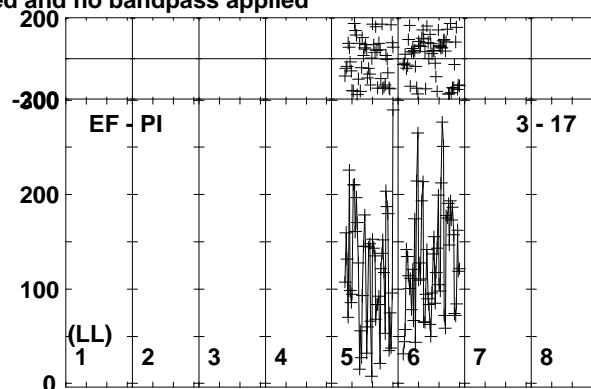
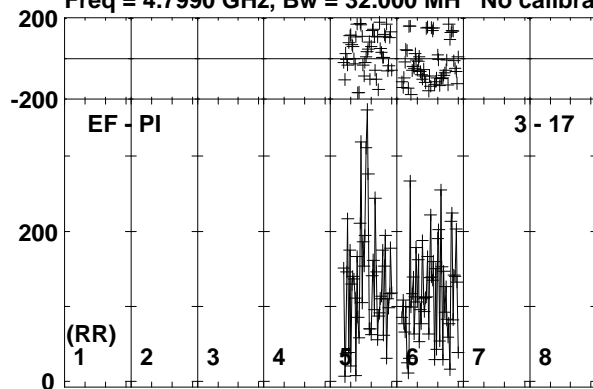

Lower frame: Micro Ampl Jy Top frame: Phas deg
Vector averaged cross-power spectrum Baseline: EF (03) - PI (17)
Timerange: 01/06:02:16 to 01/06:04:24

Plot file version 639 created 26-SEP-2019 10:43:55

J0257-1212 RG010A.UVDATA.1

Freq = 4.7990 GHz, Bw = 32.000 MH No calibration applied and no bandpass applied

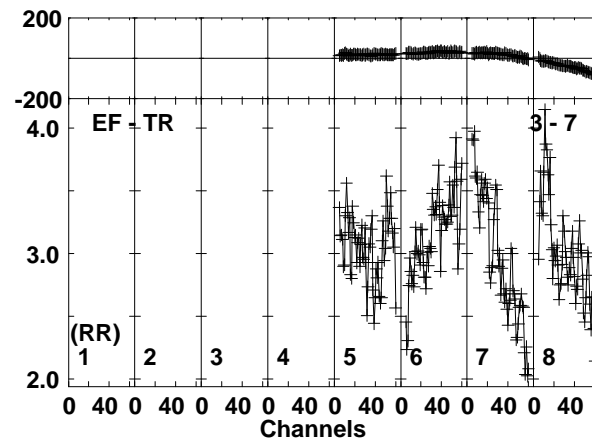
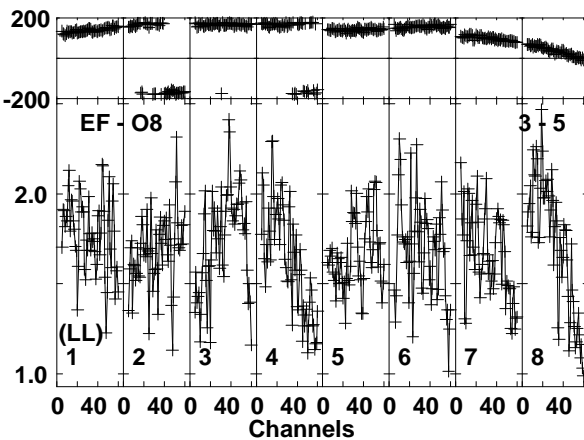
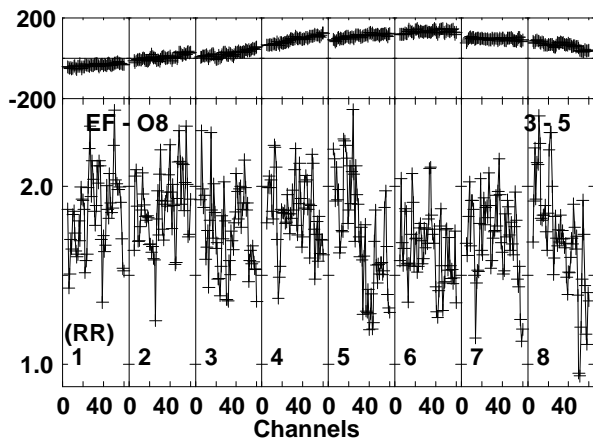
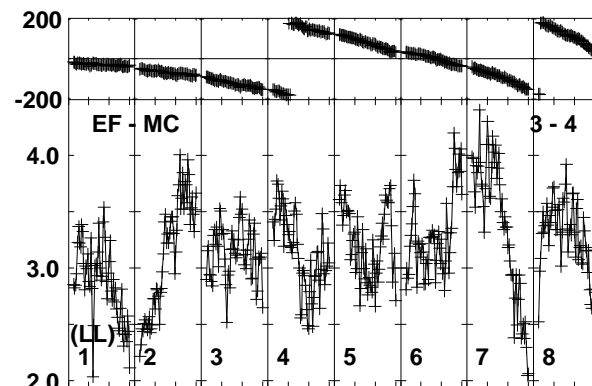
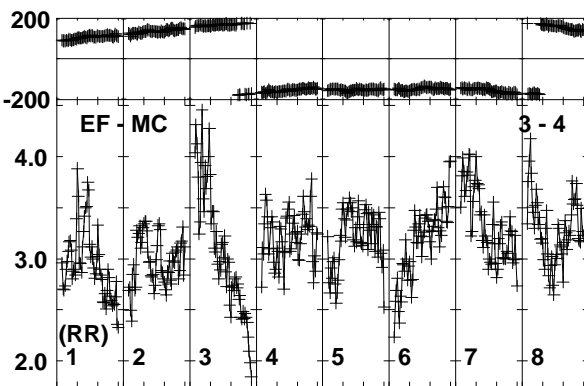
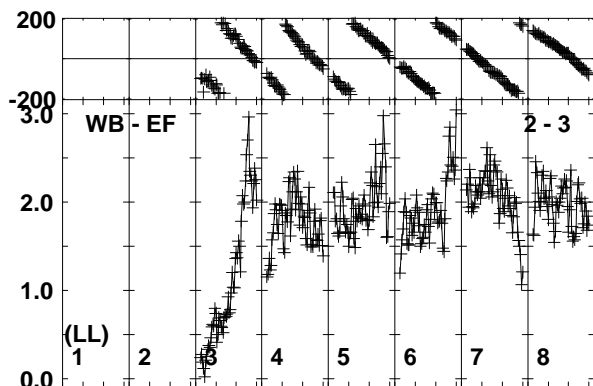
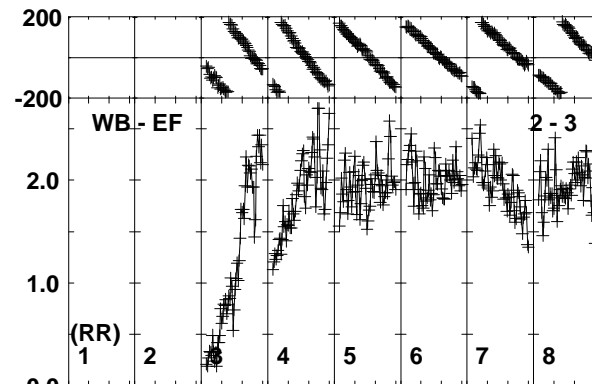
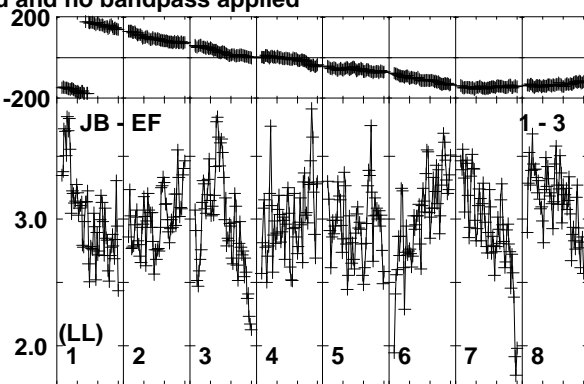
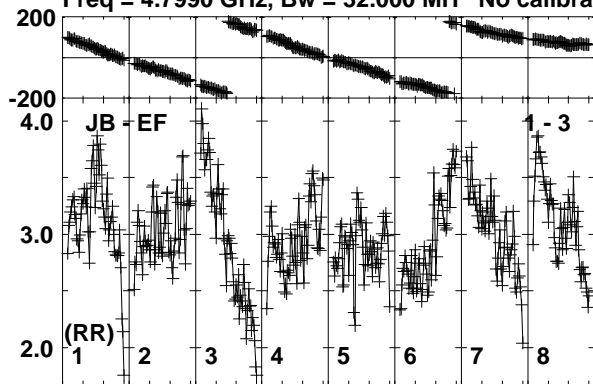

Lower frame: Milli Ampl Jy Top frame: Phas deg
Vector averaged cross-power spectrum Baseline: JB (01) - EF (03)
Timerange: 01/06:05:05 to 01/06:05:35

Plot file version 640 created 26-SEP-2019 10:43:55

J0257-1212 RG010A.UVDATA.1

Freq = 4.7990 GHz, Bw = 32.000 MH No calibration applied and no bandpass applied

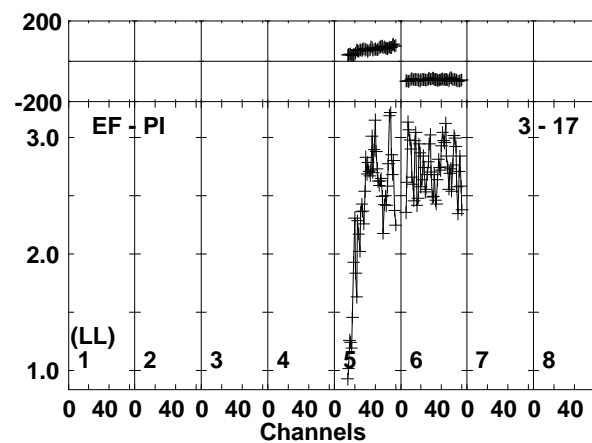
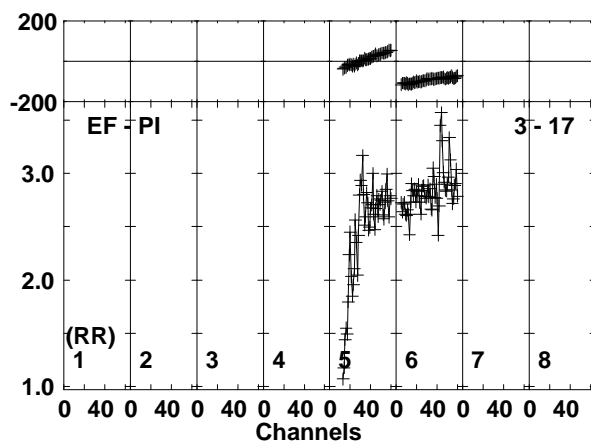
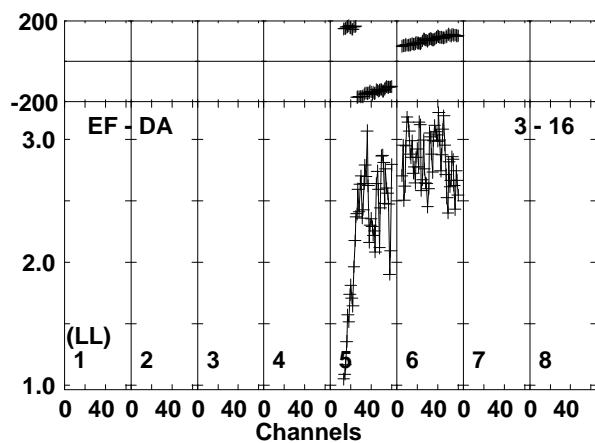
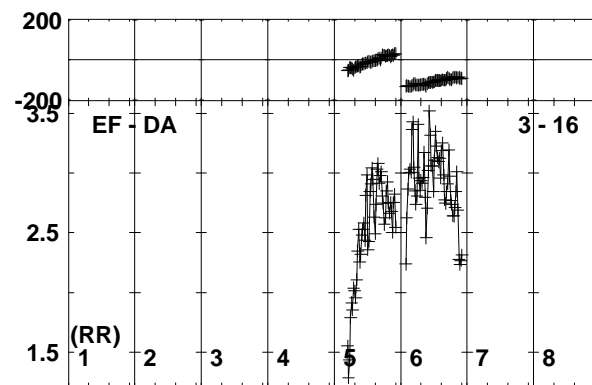
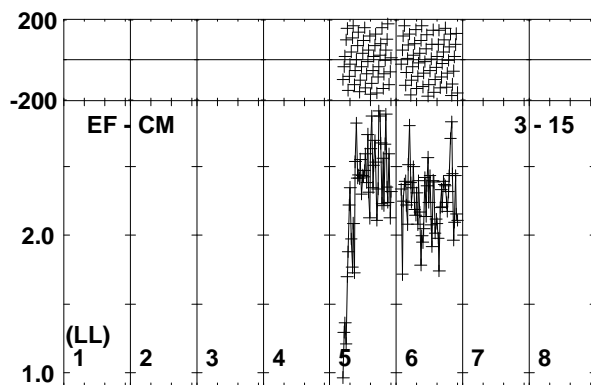
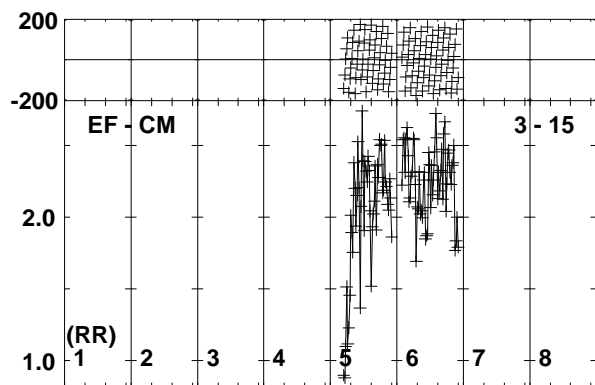
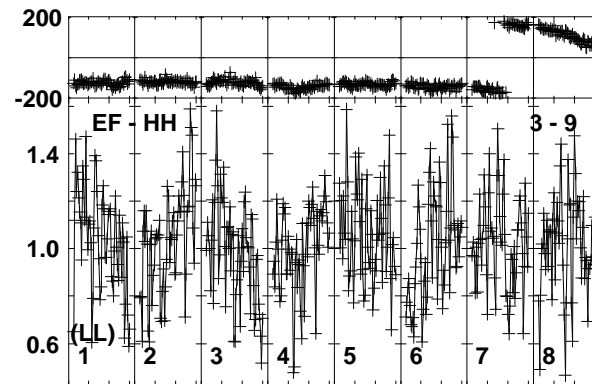
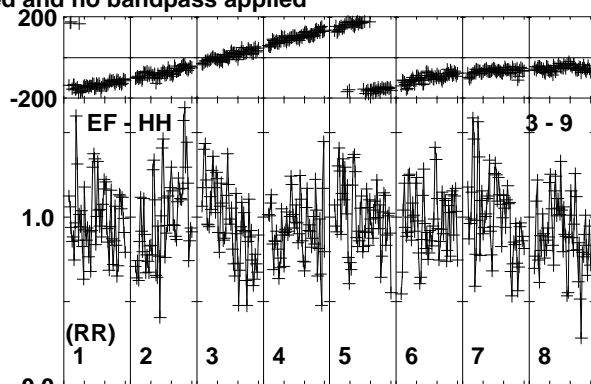
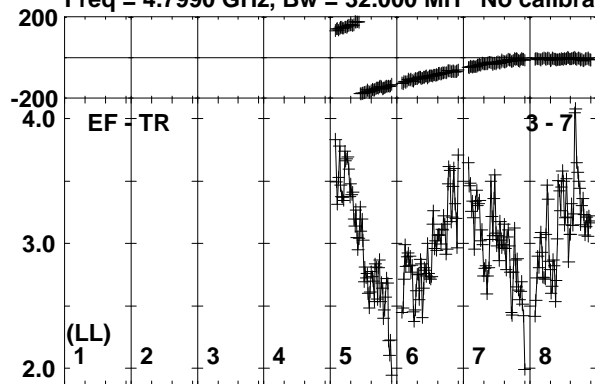

Lower frame: Milli Ampl Jy Top frame: Phas deg
Vector averaged cross-power spectrum Baseline: EF (03) - TR (07)
Timerange: 01/06:05:05 to 01/06:05:35

Plot file version 641 created 26-SEP-2019 10:43:56

J0257-1212 RG010A.UVDATA.1

Freq = 4.7990 GHz, Bw = 32.000 MH No calibration applied and no bandpass applied

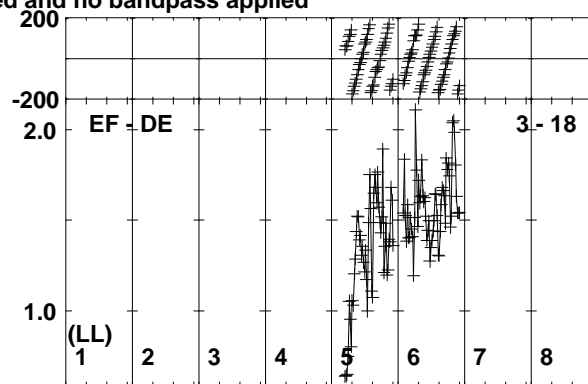
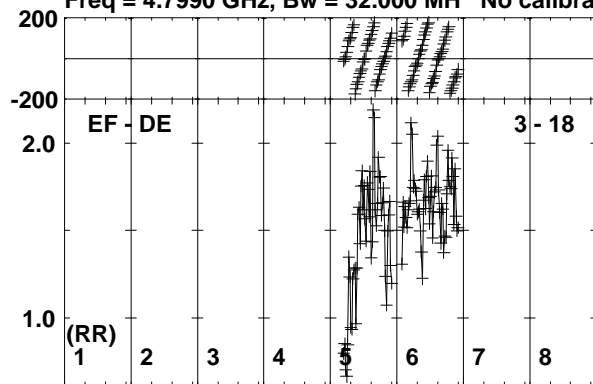

Lower frame: Milli Ampl Jy Top frame: Phas deg
Vector averaged cross-power spectrum Baseline: EF (03) - DE (18)
Timerange: 01/06:05:05 to 01/06:05:35

Plot file version 642 created 26-SEP-2019 10:43:56

J0300-0846 RG010A.UVDATA.1

Freq = 4.7990 GHz, Bw = 32.000 MH No calibration applied and no bandpass applied

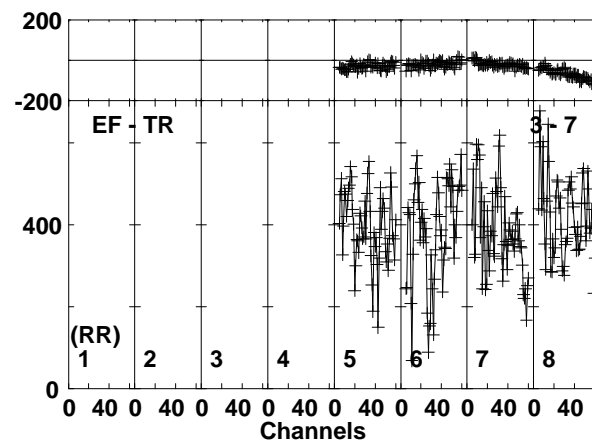
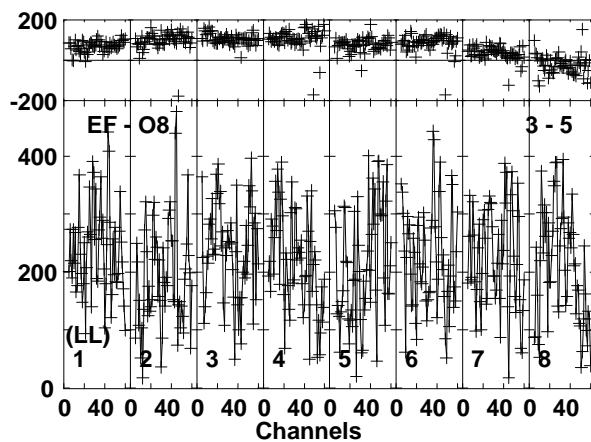
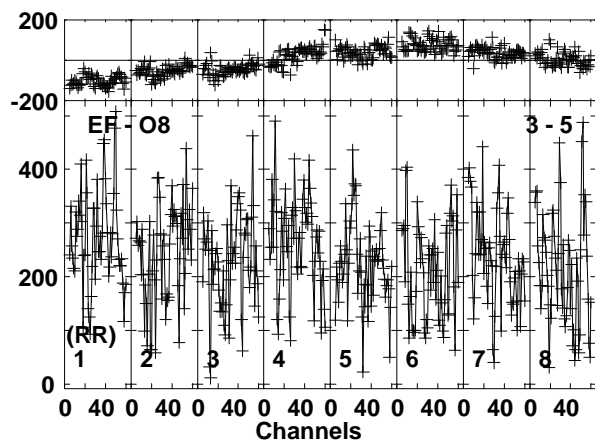
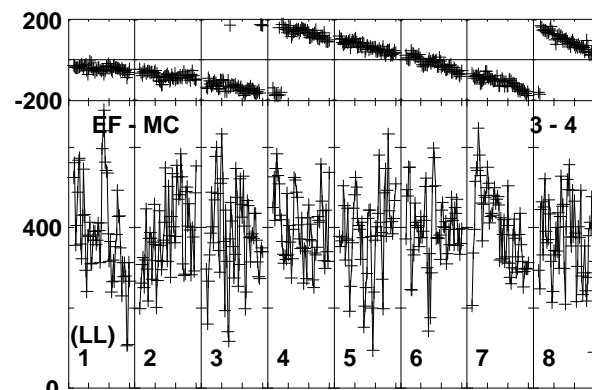
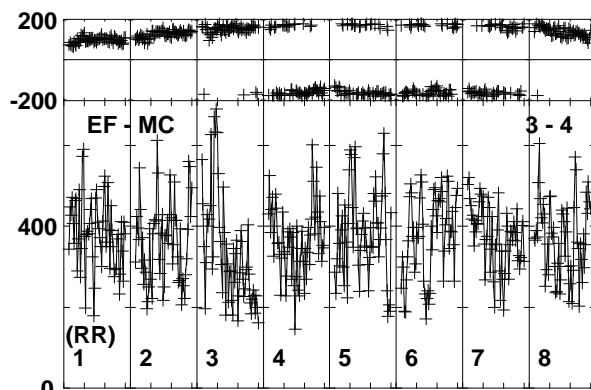
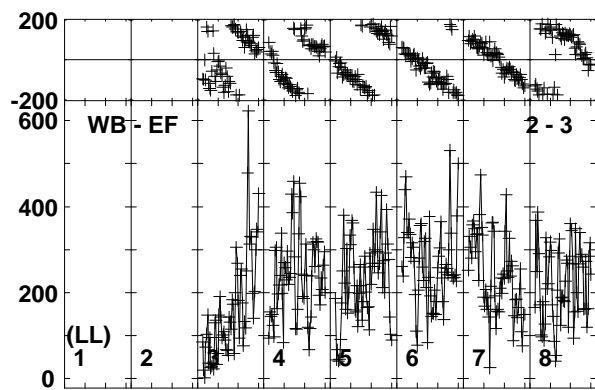
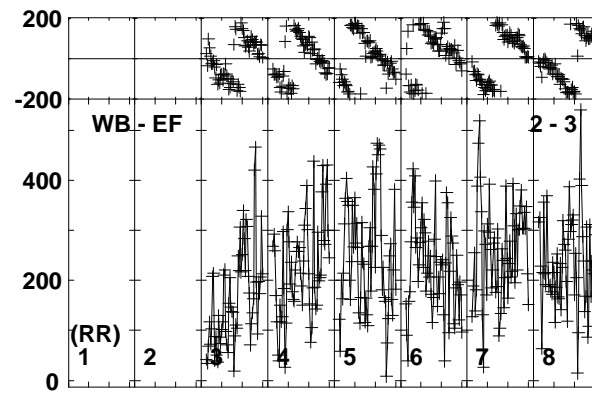
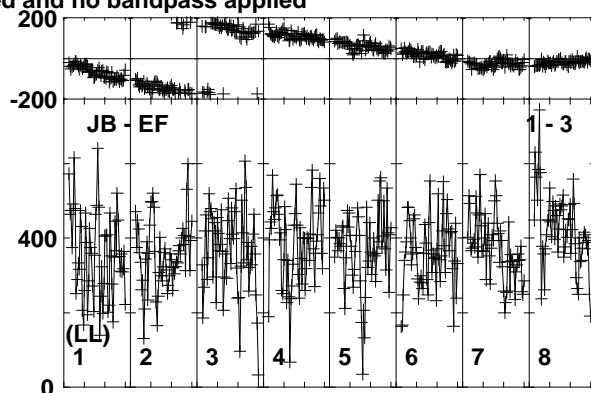
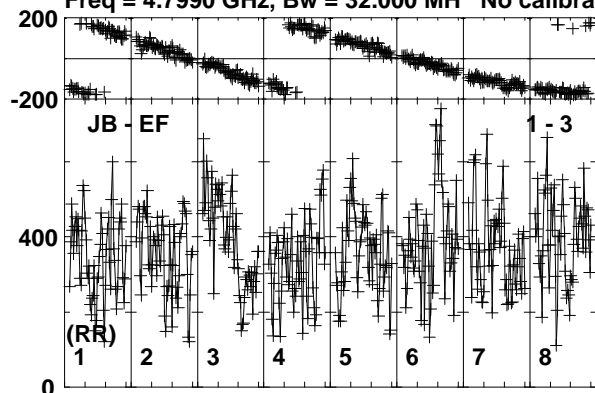

Lower frame: Micro Ampl Jy Top frame: Phas deg
Vector averaged cross-power spectrum Baseline: JB (01) - EF (03)
Timerange: 01/06:05:36 to 01/06:07:44

Plot file version 643 created 26-SEP-2019 10:43:56

J0300-0846 RG010A.UVDATA.1

Freq = 4.7990 GHz, Bw = 32.000 MH No calibration applied and no bandpass applied

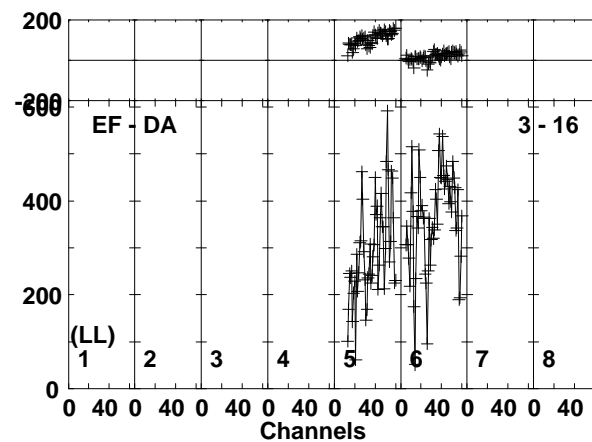
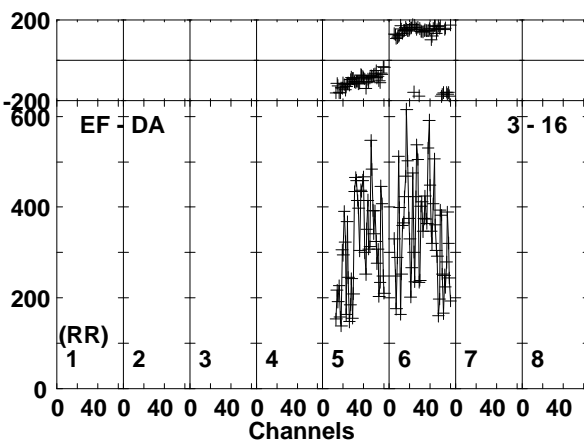
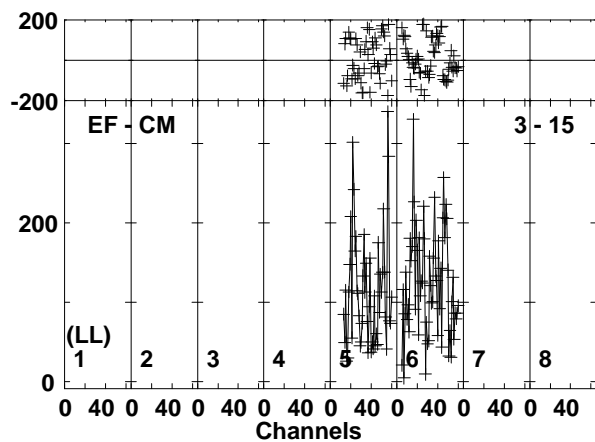
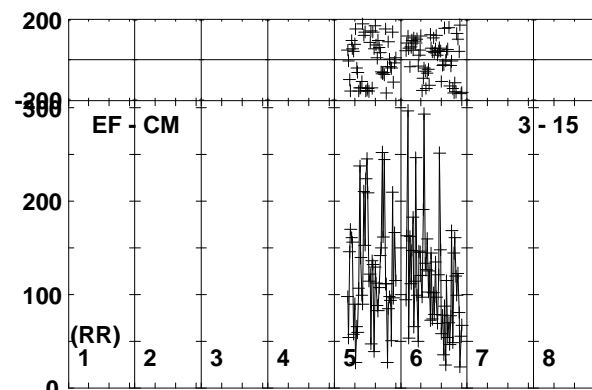
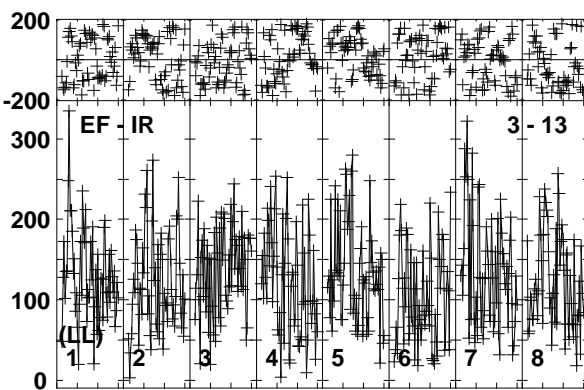
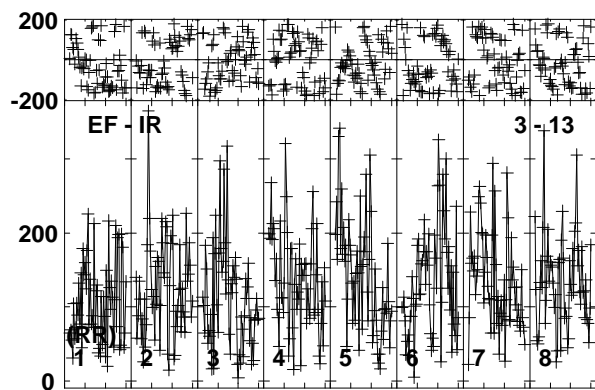
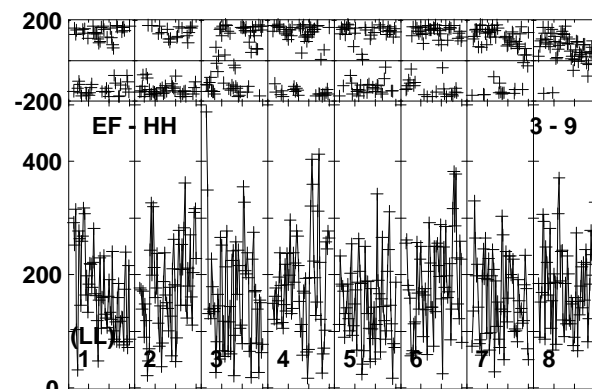
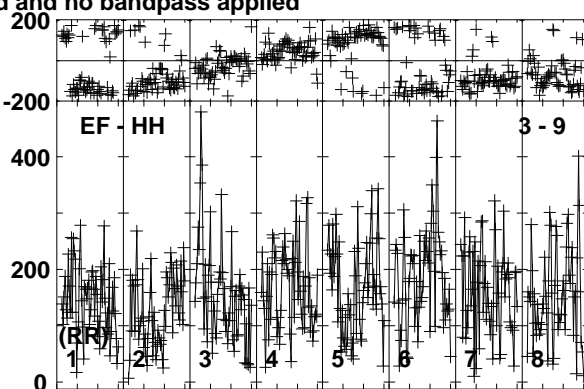
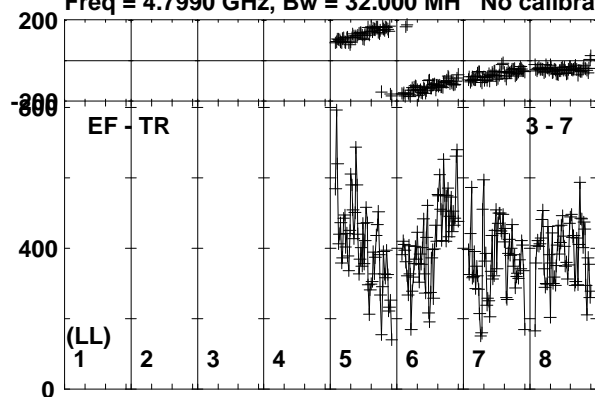

Lower frame: Micro Ampl Jy Top frame: Phas deg
Vector averaged cross-power spectrum Baseline: EF (03) - TR (07)
Timerange: 01/06:05:36 to 01/06:07:44

Plot file version 644 created 26-SEP-2019 10:43:57

J0300-0846 RG010A.UVDATA.1

Freq = 4.7990 GHz, Bw = 32.000 MH No calibration applied and no bandpass applied

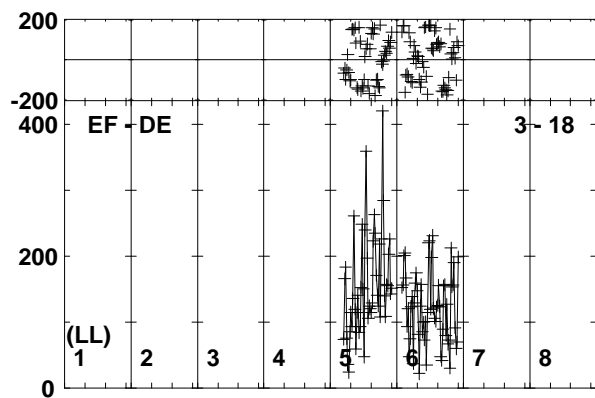
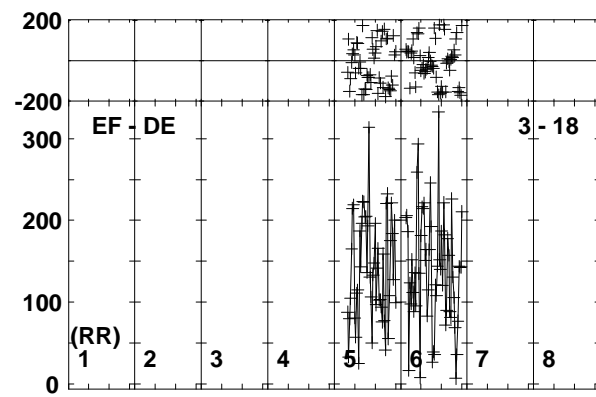
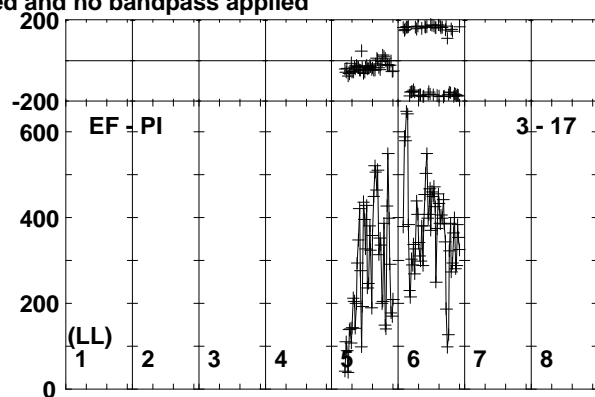
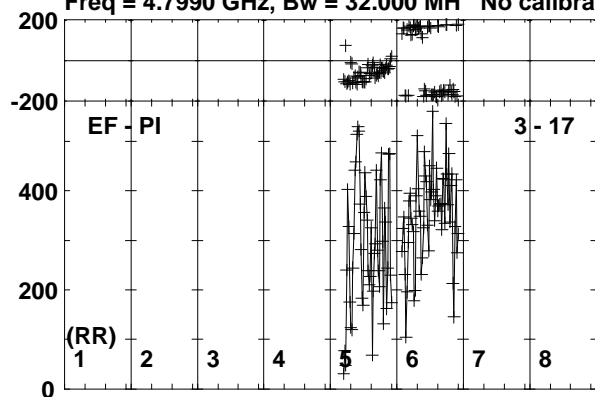

Lower frame: Micro Ampl Jy Top frame: Phas deg
Vector averaged cross-power spectrum Baseline: EF (03) - PI (17)
Timerange: 01/06:05:36 to 01/06:07:44

Plot file version 645 created 26-SEP-2019 10:43:57

J0257-1212 RG010A.UVDATA.1

Freq = 4.7990 GHz, Bw = 32.000 MH No calibration applied and no bandpass applied

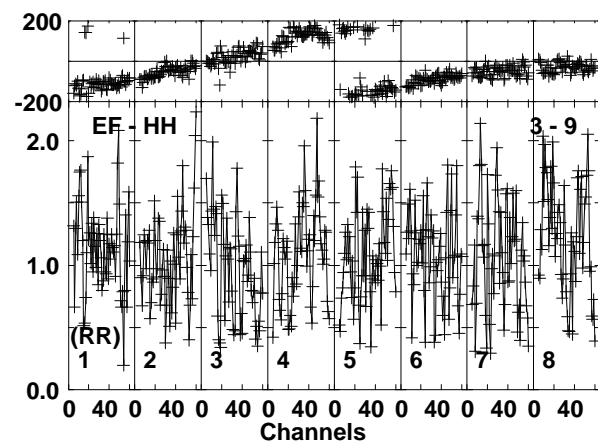
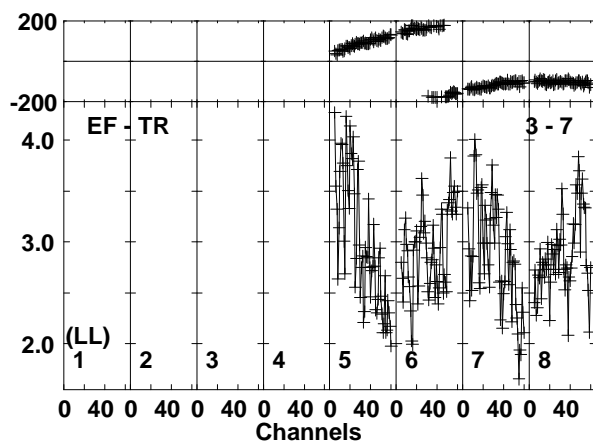
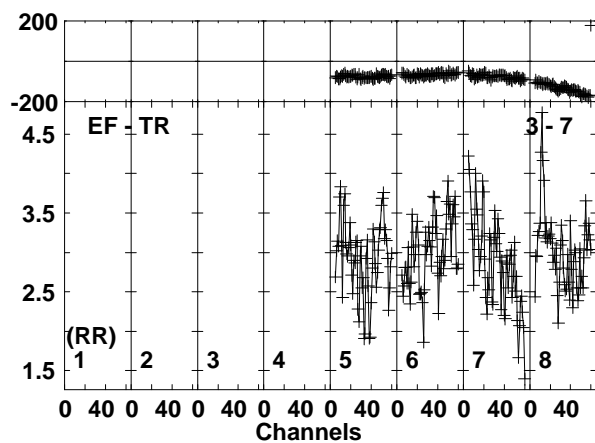
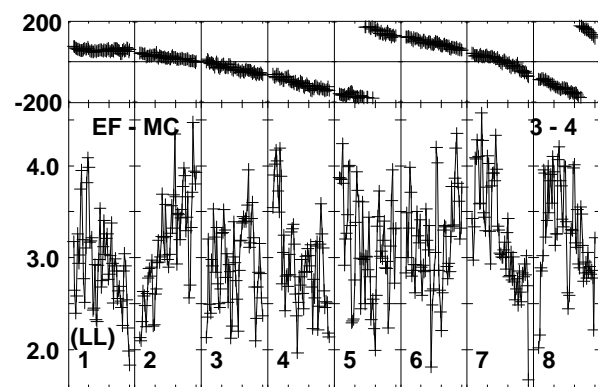
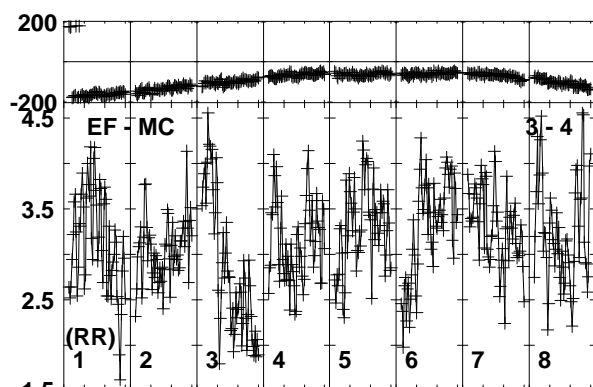
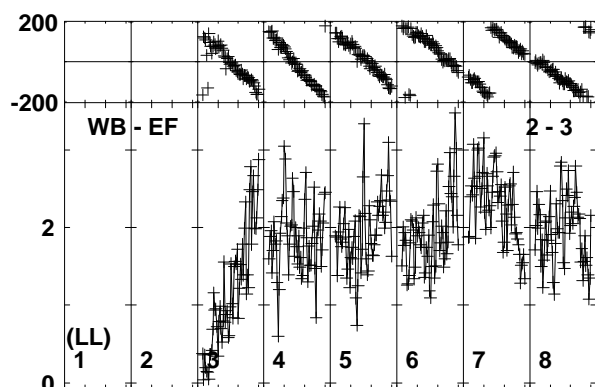
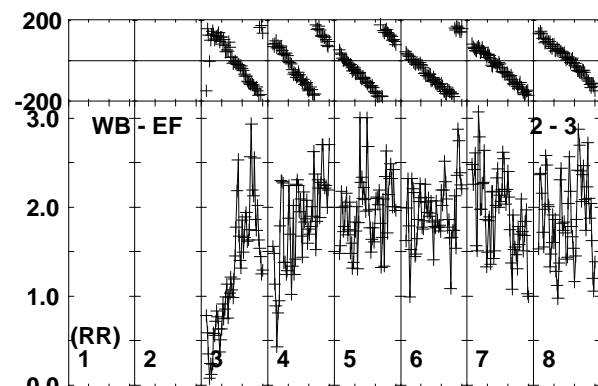
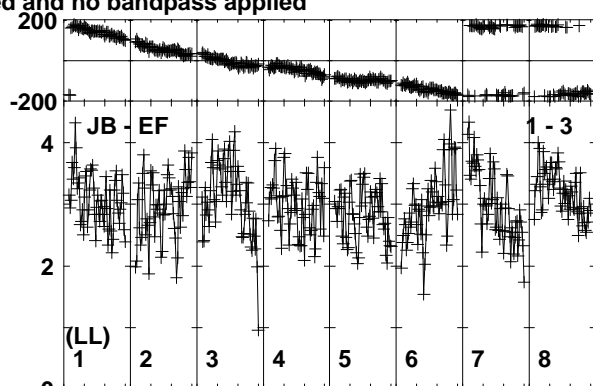
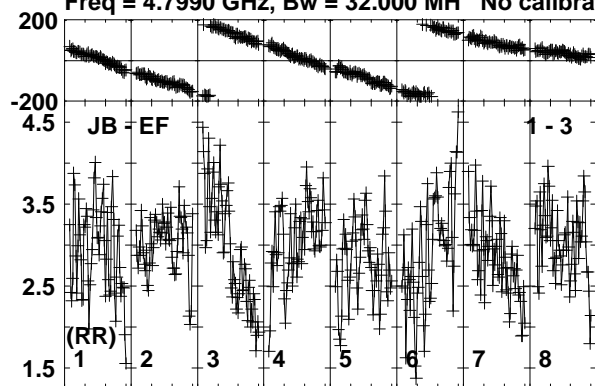

Lower frame: Milli Ampl Jy Top frame: Phas deg
Vector averaged cross-power spectrum Baseline: JB (01) - EF (03)
Timerange: 01/06:07:46 to 01/06:08:45

Plot file version 646 created 26-SEP-2019 10:43:57

J0257-1212 RG010A.UVDATA.1

Freq = 4.7990 GHz, Bw = 32.000 MH No calibration applied and no bandpass applied

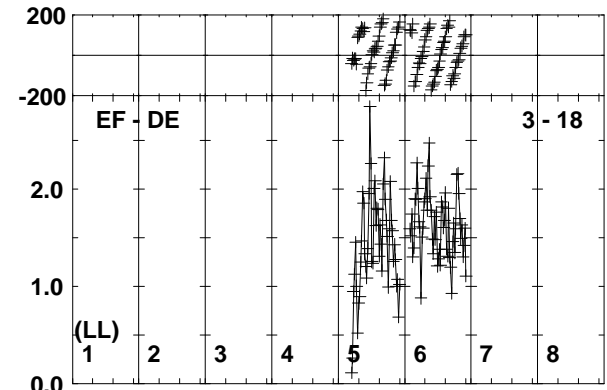
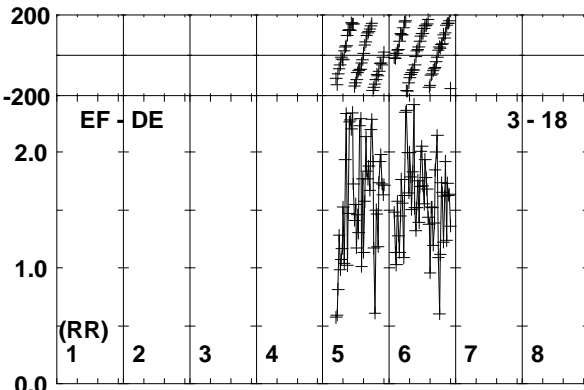
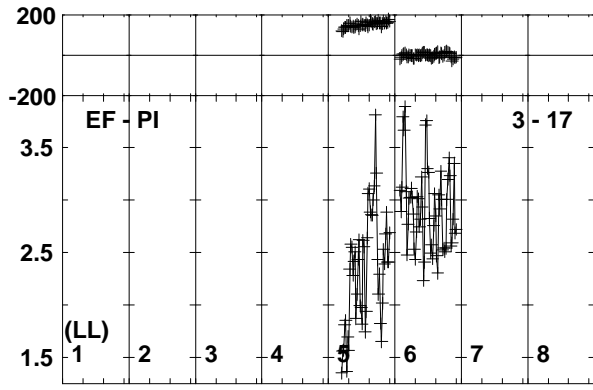
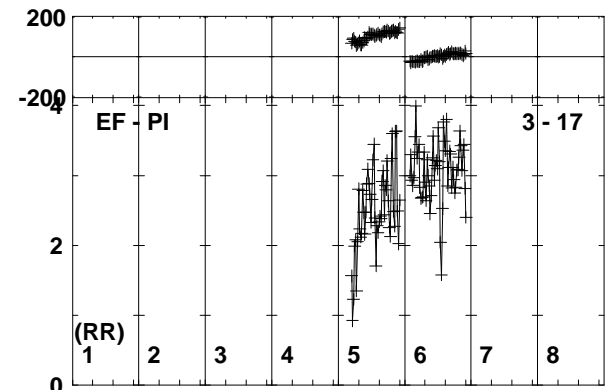
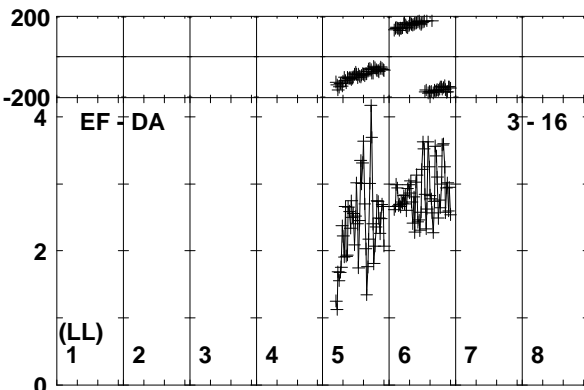
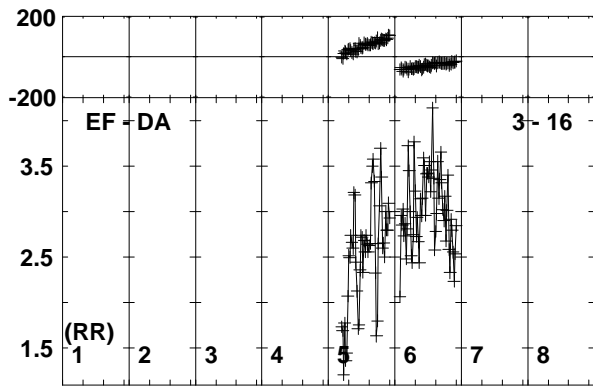
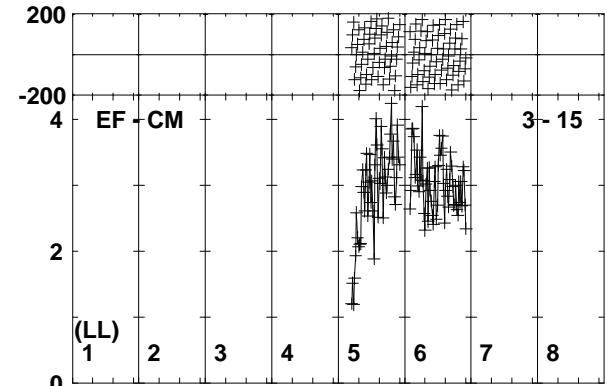
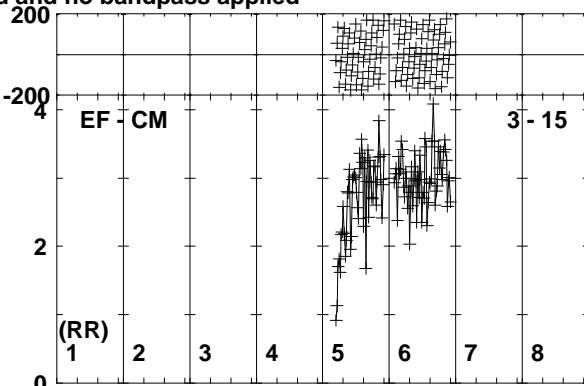
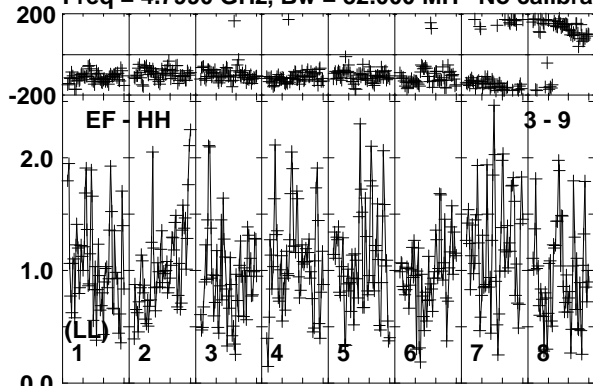

Lower frame: Milli Ampl Jy Top frame: Phas deg
Vector averaged cross-power spectrum Baseline: EF (03) - HH (09)
Timerange: 01/06:07:46 to 01/06:08:45

Plot file version 647 created 26-SEP-2019 10:43:57

190829A RG010A.UVDATA.1

Freq = 4.7990 GHz, Bw = 32.000 MH No calibration applied and no bandpass applied

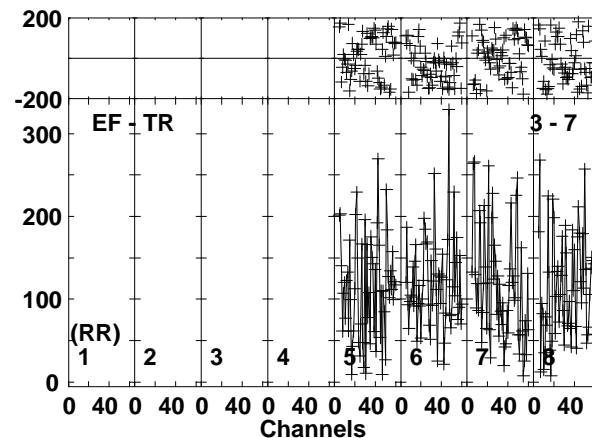
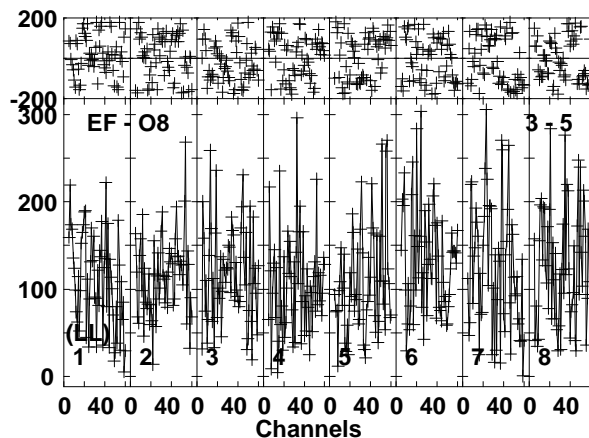
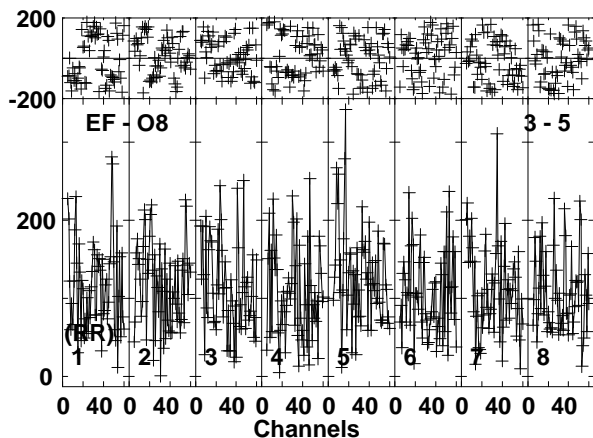
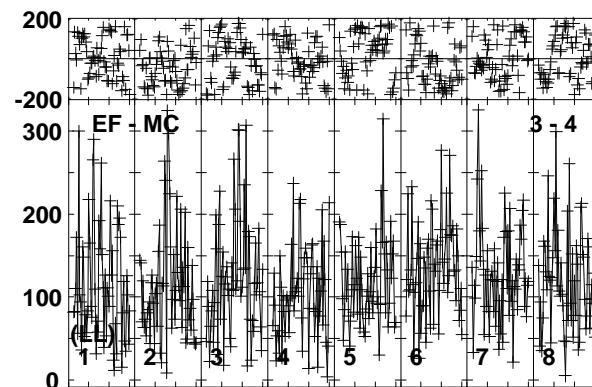
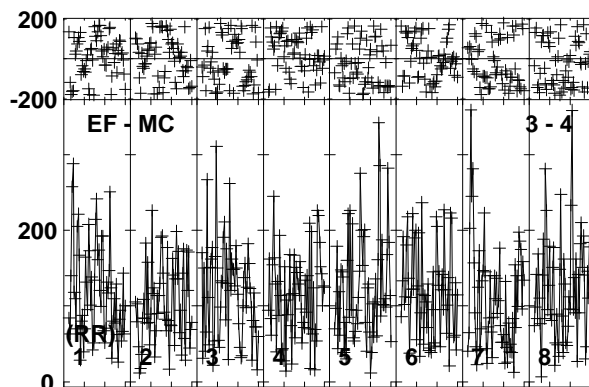
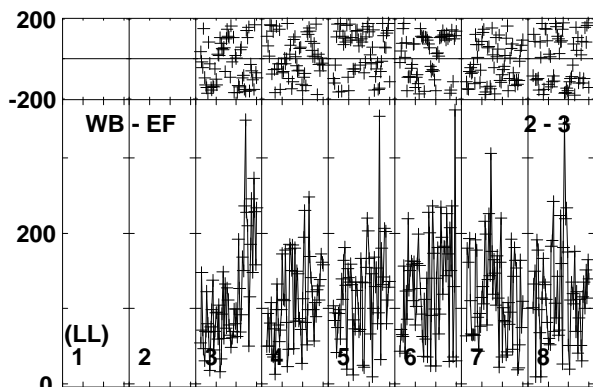
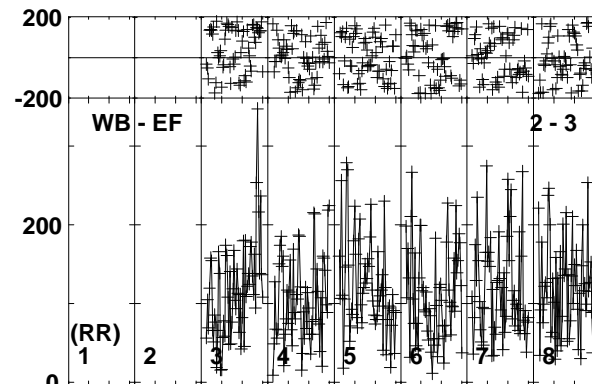
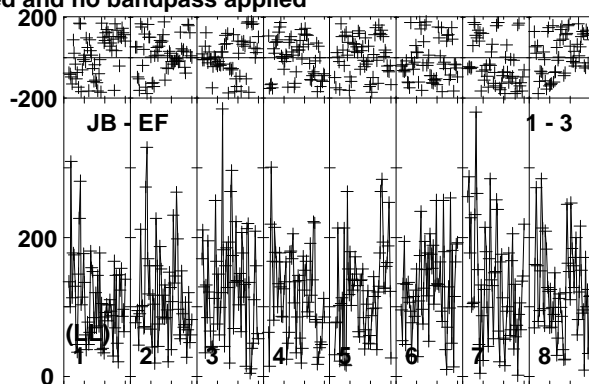
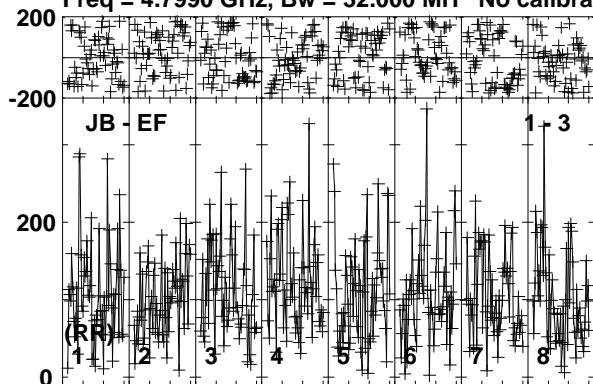

Lower frame: Micro Ampl Jy Top frame: Phas deg
Vector averaged cross-power spectrum Baseline: JB (01) - EF (03)
Timerange: 01/06:08:46 to 01/06:10:55

Plot file version 648 created 26-SEP-2019 10:43:58

190829A RG010A.UVDATA.1

Freq = 4.7990 GHz, Bw = 32.000 MH No calibration applied and no bandpass applied

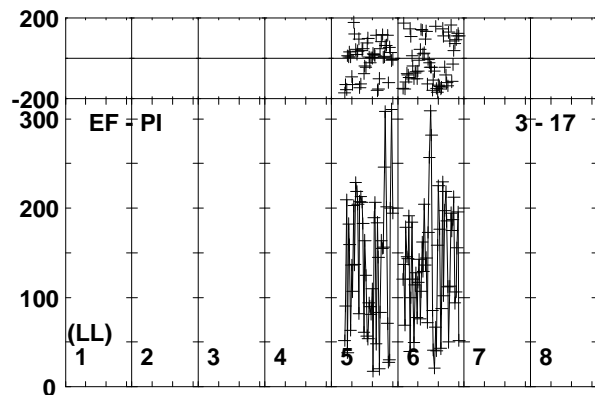
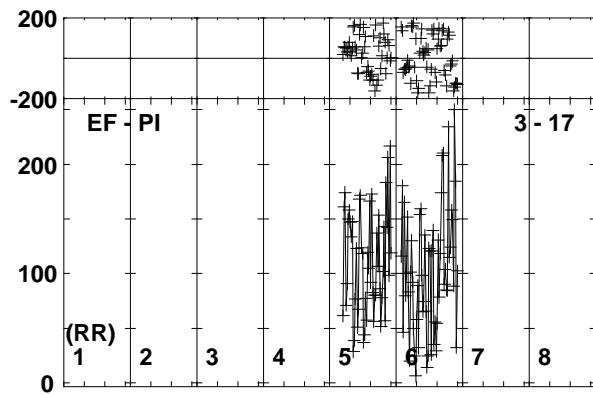
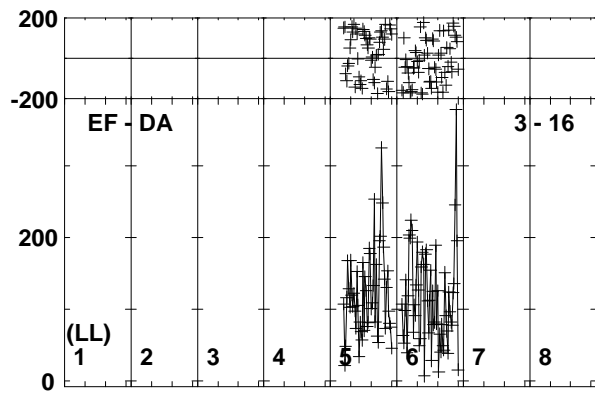
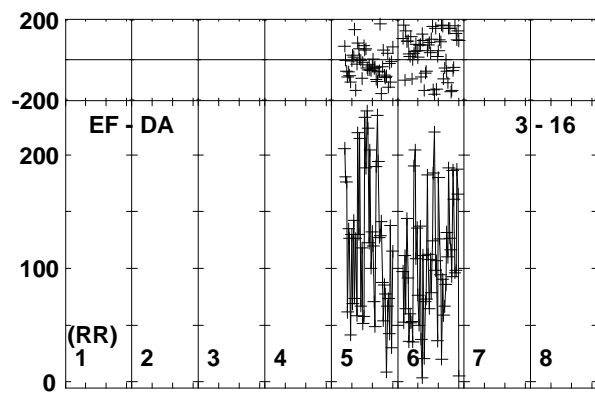
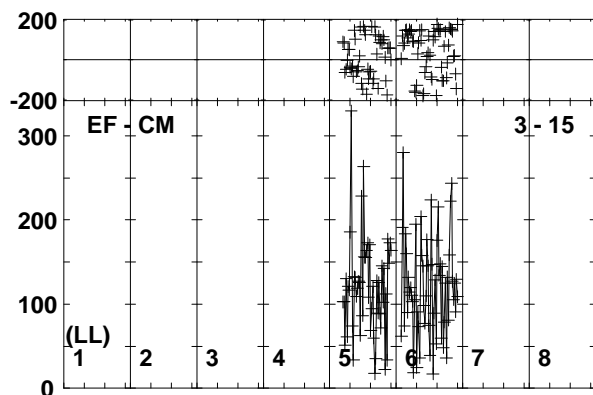
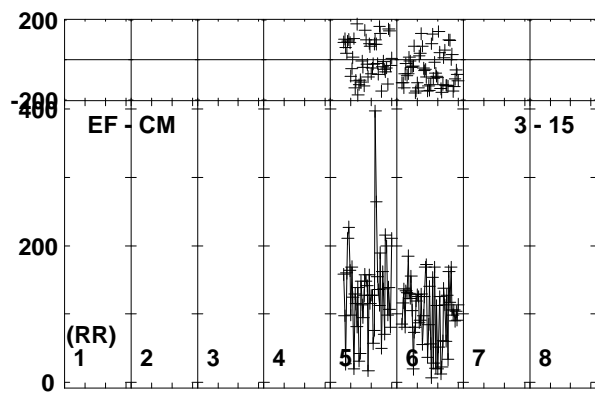
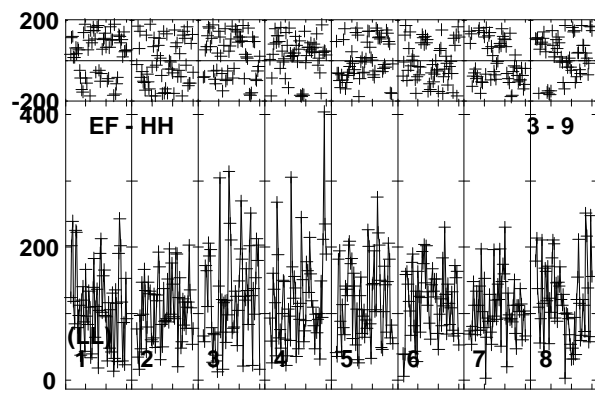
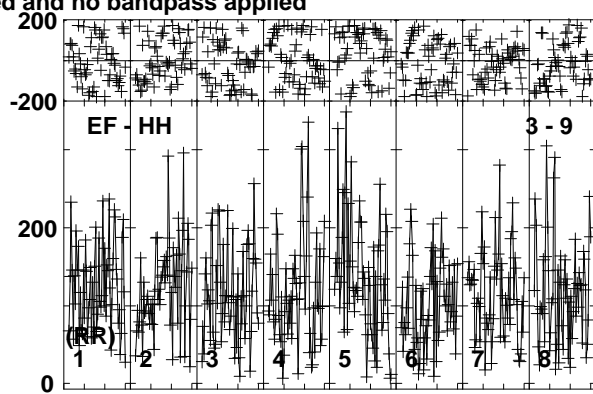
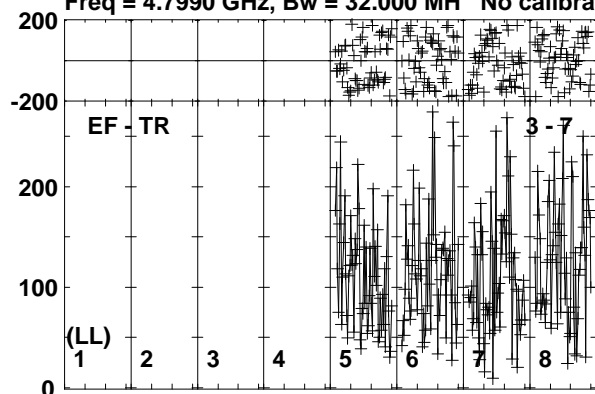

Lower frame: Micro Ampl Jy Top frame: Phas deg
Vector averaged cross-power spectrum Baseline: EF (03) - TR (07)
Timerange: 01/06:08:46 to 01/06:10:55

Plot file version 649 created 26-SEP-2019 10:43:58

190829A RG010A.UVDATA.1

Freq = 4.7990 GHz, Bw = 32.000 MH No calibration applied and no bandpass applied

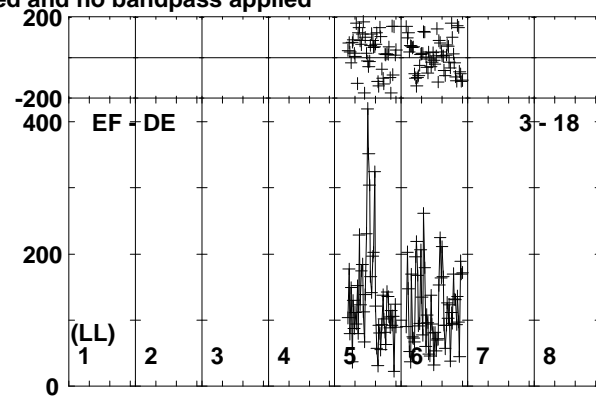
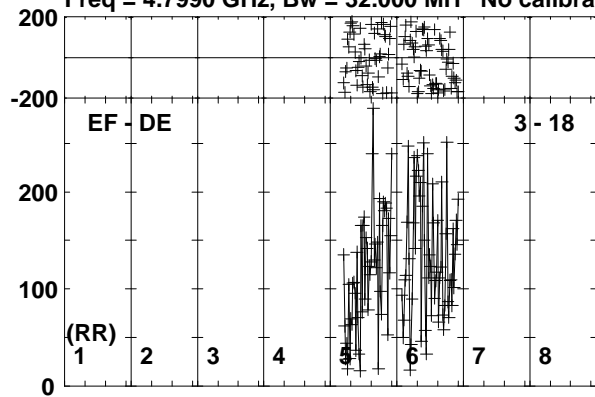

Lower frame: Micro Ampl Jy Top frame: Phas deg
Vector averaged cross-power spectrum Baseline: EF (03) - DE (18)
Timerange: 01/06:08:46 to 01/06:10:55

Plot file version 650 created 26-SEP-2019 10:43:58

J0257-1212 RG010A.UVDATA.1

Freq = 4.7990 GHz, Bw = 32.000 MH No calibration applied and no bandpass applied

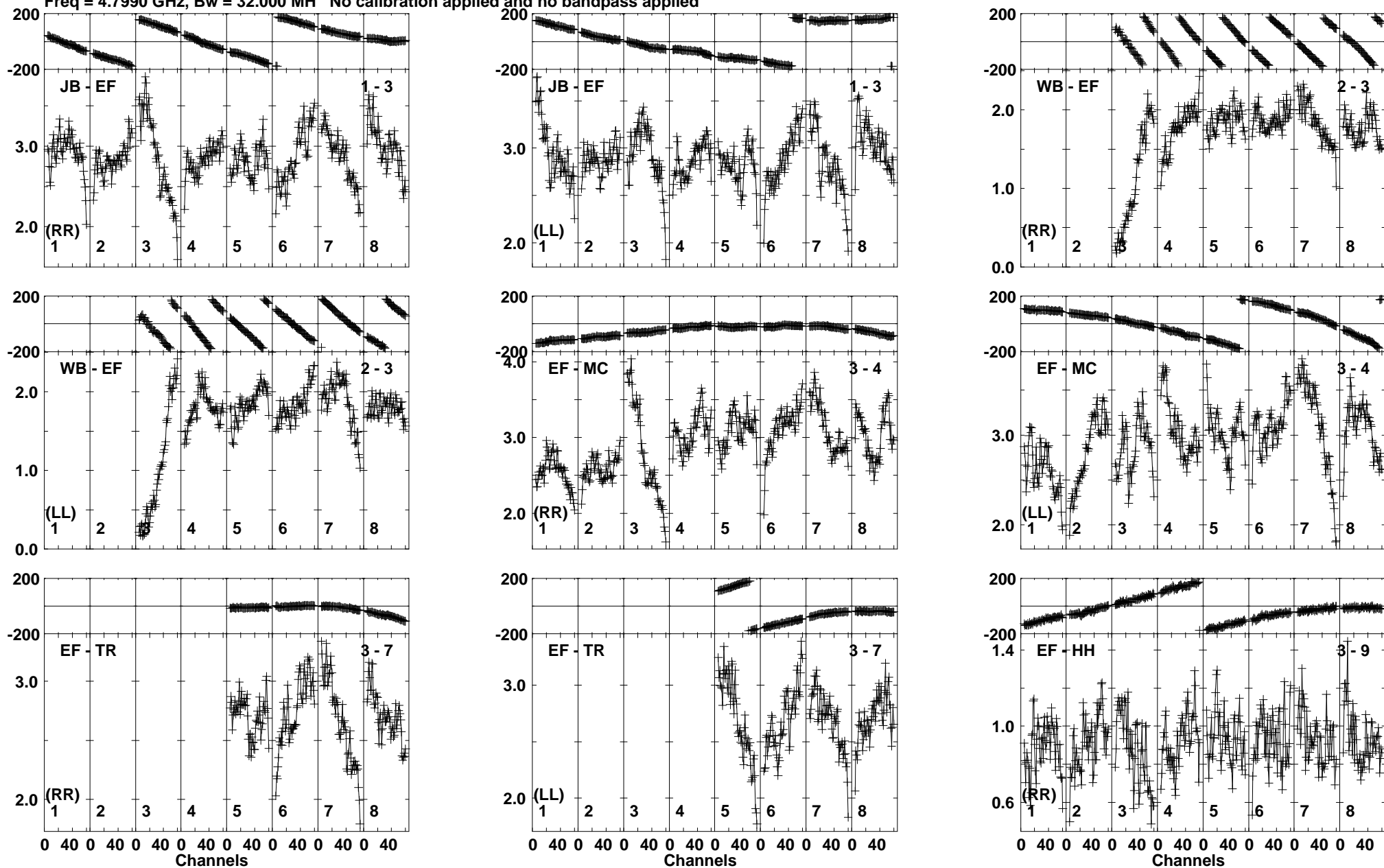

Lower frame: Milli Ampl Jy Top frame: Phas deg
Vector averaged cross-power spectrum Baseline: JB (01) - EF (03)
Timerange: 01/06:11:35 to 01/06:12:34

Plot file version 651 created 26-SEP-2019 10:43:58

J0257-1212 RG010A.UVDATA.1

Freq = 4.7990 GHz, Bw = 32.000 MH No calibration applied and no bandpass applied

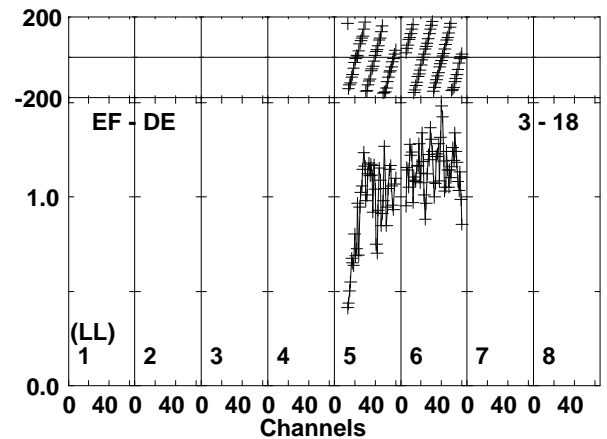
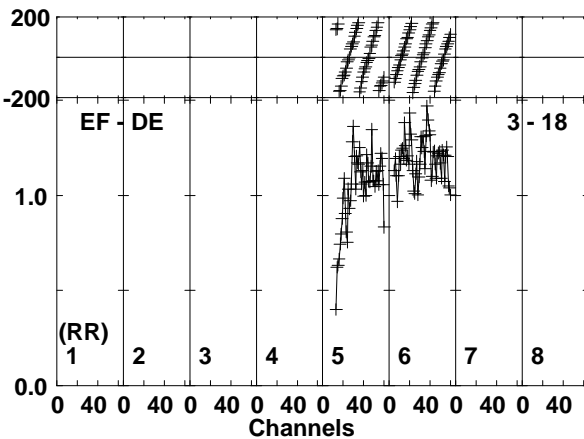
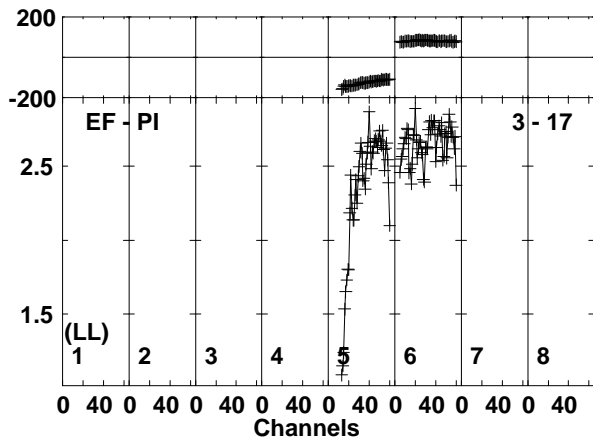
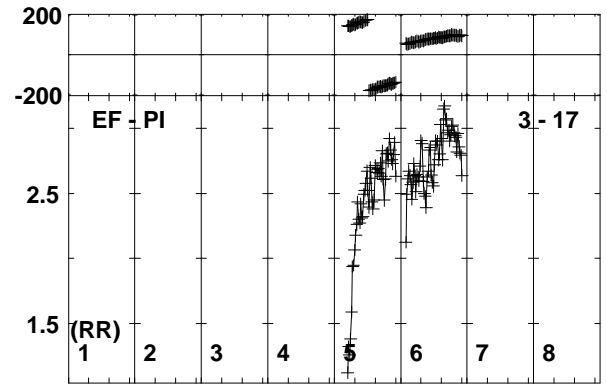
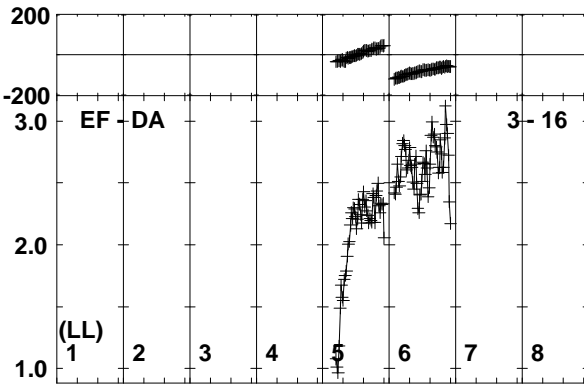
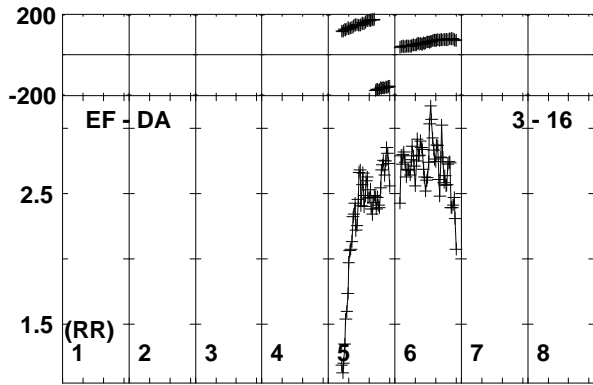
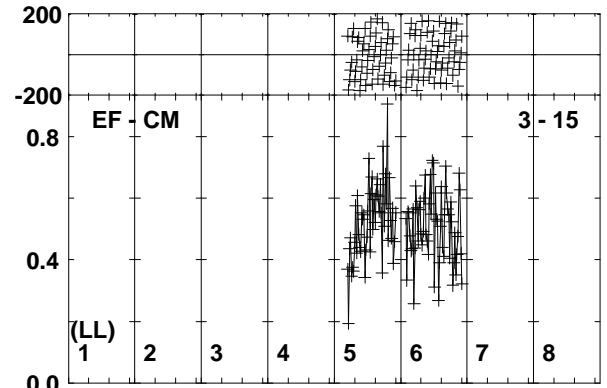
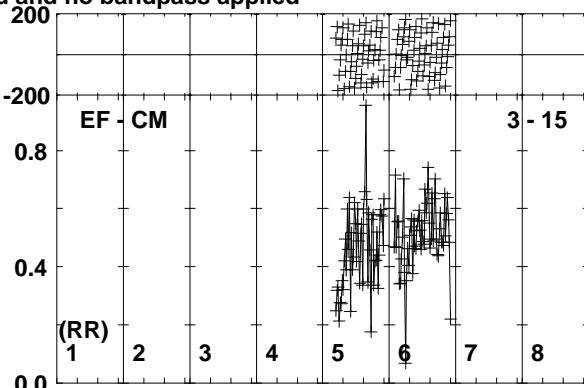
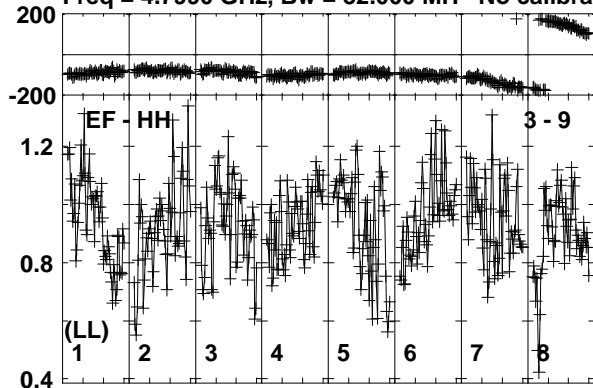

Lower frame: Milli Ampl Jy Top frame: Phas deg
Vector averaged cross-power spectrum Baseline: EF (03) - HH (09)
Timerange: 01/06:11:35 to 01/06:12:34

Plot file version 652 created 26-SEP-2019 10:43:59

190829A RG010A.UVDATA.1

Freq = 4.7990 GHz, Bw = 32.000 MH No calibration applied and no bandpass applied

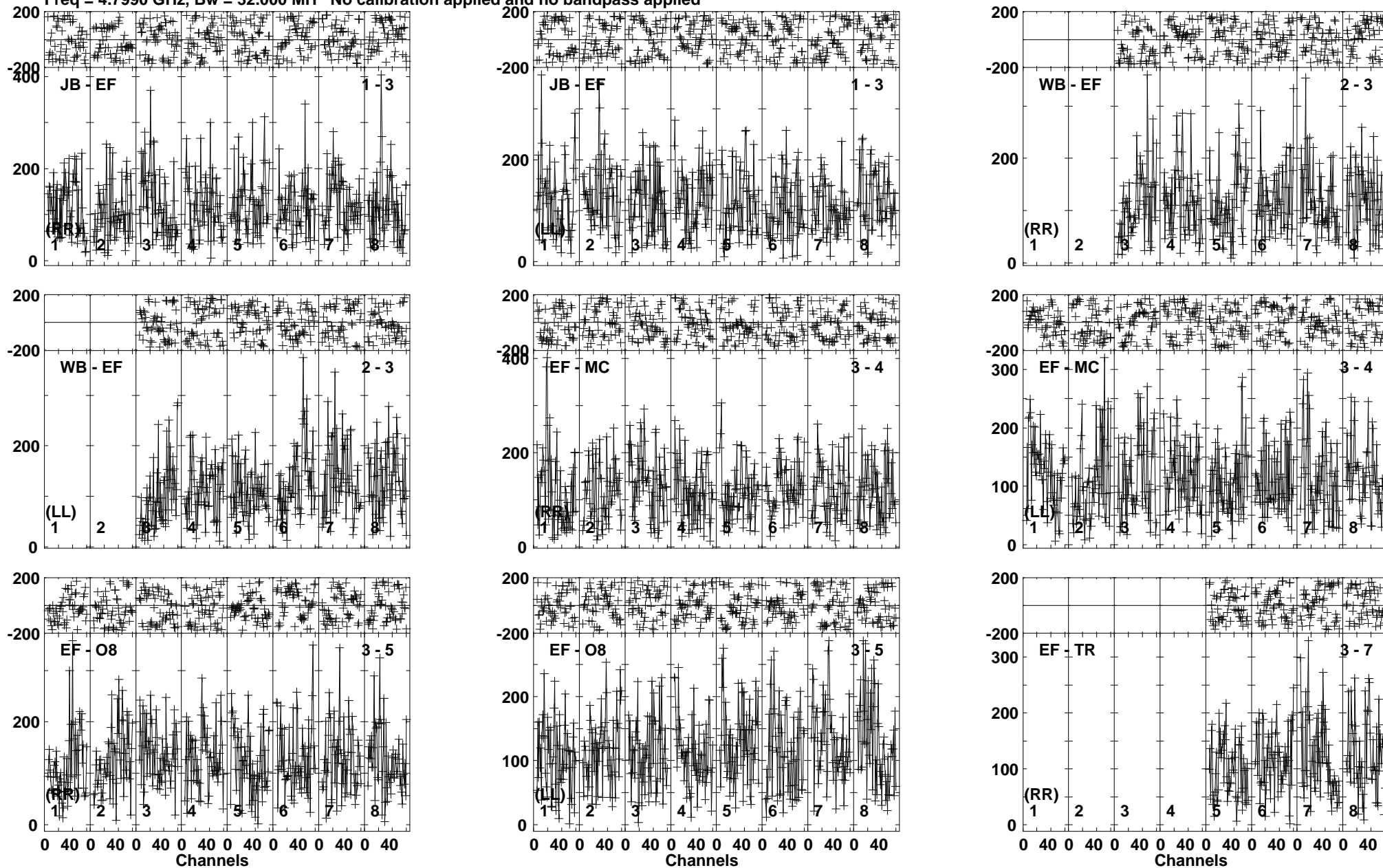

Lower frame: Micro Ampl Jy Top frame: Phas deg
Vector averaged cross-power spectrum Baseline: JB (01) - EF (03)
Timerange: 01/06:12:36 to 01/06:14:44

Plot file version 653 created 26-SEP-2019 10:43:59

190829A RG010A.UVDATA.1

Freq = 4.7990 GHz, Bw = 32.000 MH No calibration applied and no bandpass applied

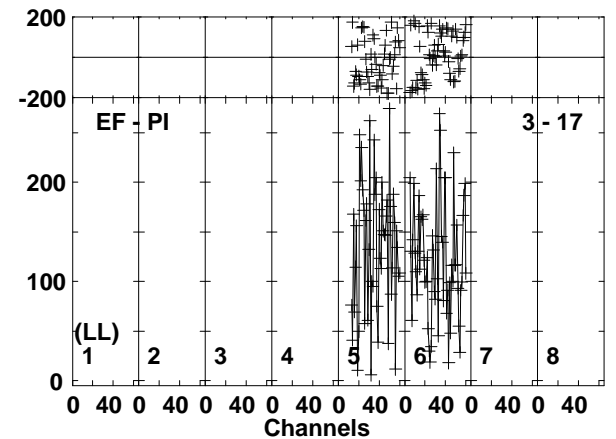
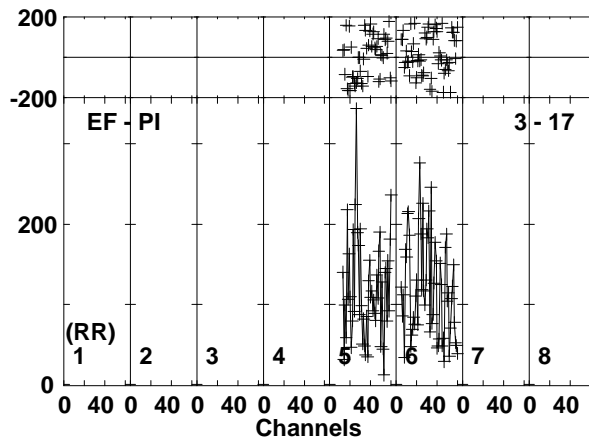
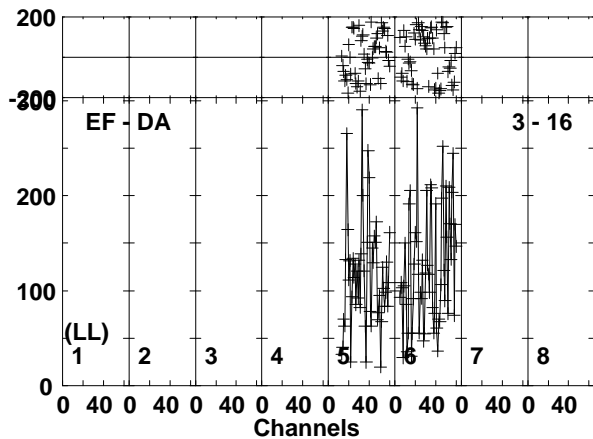
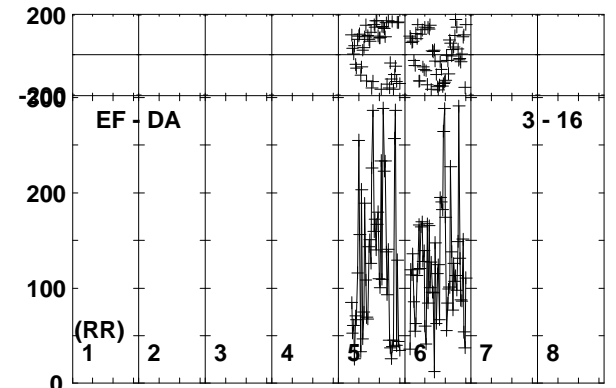
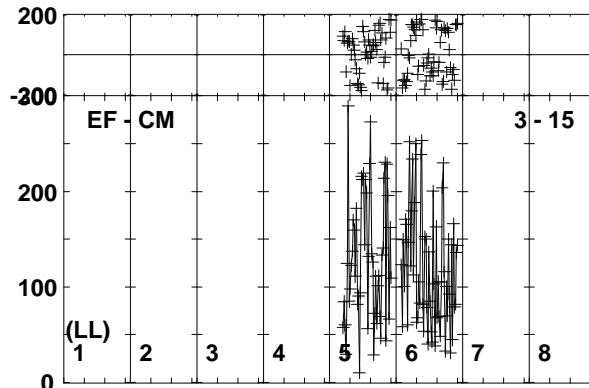
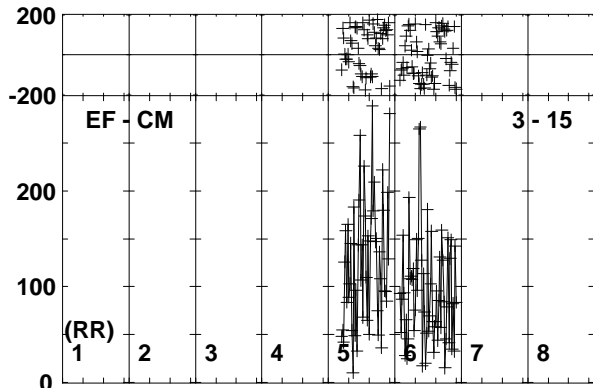
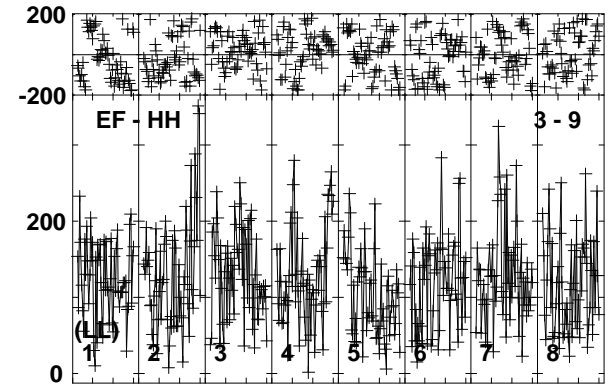
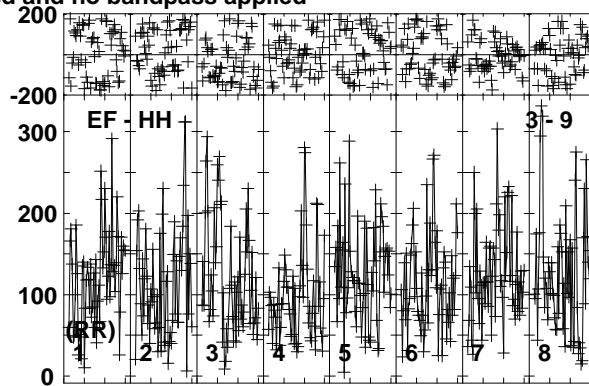
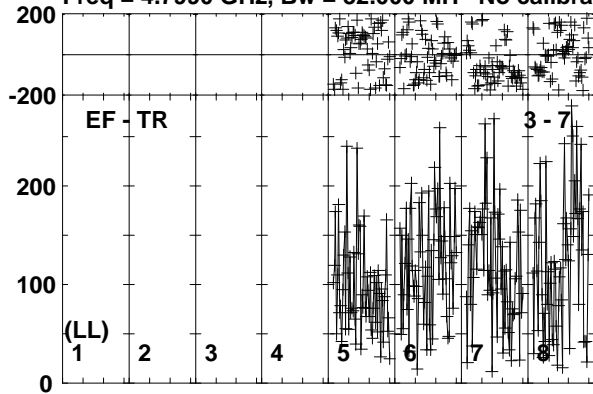

Lower frame: Micro Ampl Jy Top frame: Phas deg
Vector averaged cross-power spectrum Baseline: EF (03) - TR (07)
Timerange: 01/06:12:36 to 01/06:14:44

Plot file version 654 created 26-SEP-2019 10:44:00

190829A RG010A.UVDATA.1

Freq = 4.7990 GHz, Bw = 32.000 MH No calibration applied and no bandpass applied

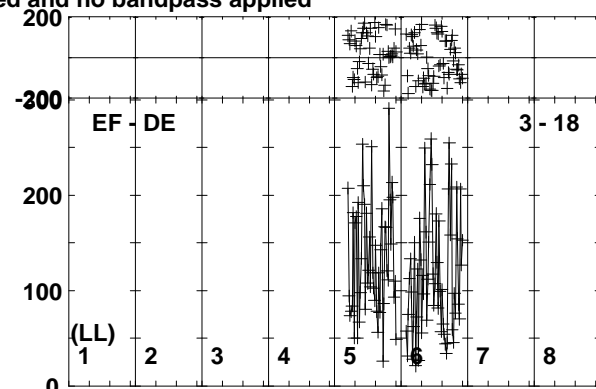
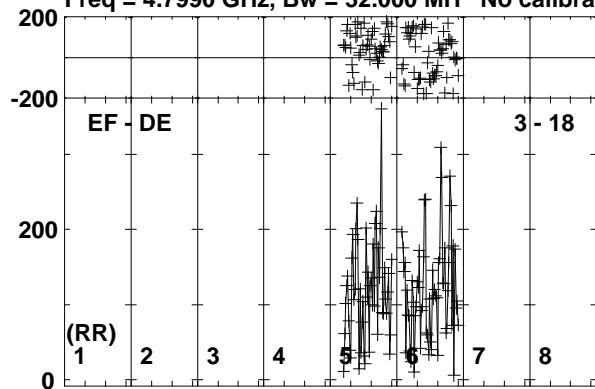

Lower frame: Micro Ampl Jy Top frame: Phas deg
Vector averaged cross-power spectrum Baseline: EF (03) - DE (18)
Timerange: 01/06:12:36 to 01/06:14:44

Plot file version 655 created 26-SEP-2019 10:44:00

J0257-1212 RG010A.UVDATA.1

Freq = 4.7990 GHz, Bw = 32.000 MH No calibration applied and no bandpass applied

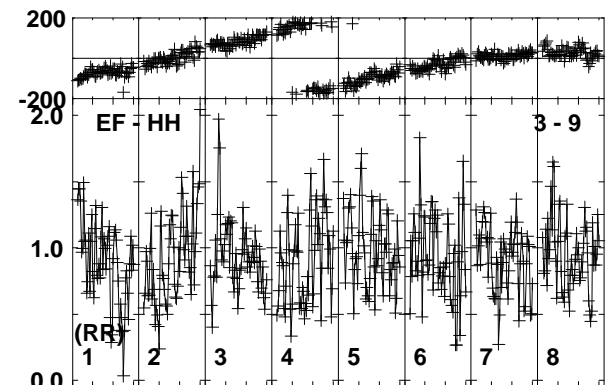
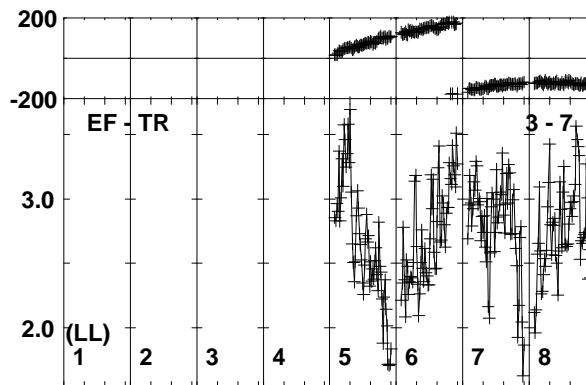
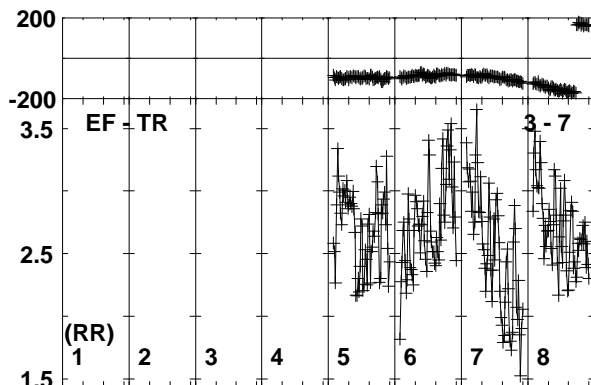
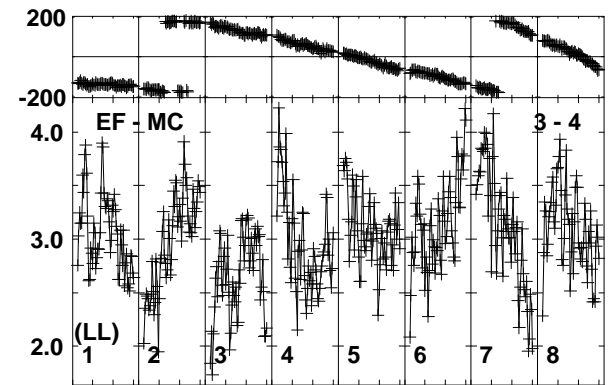
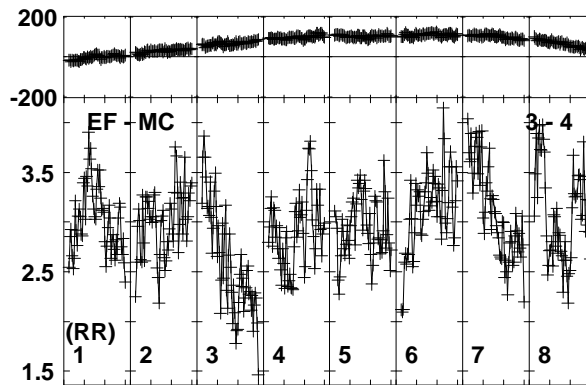
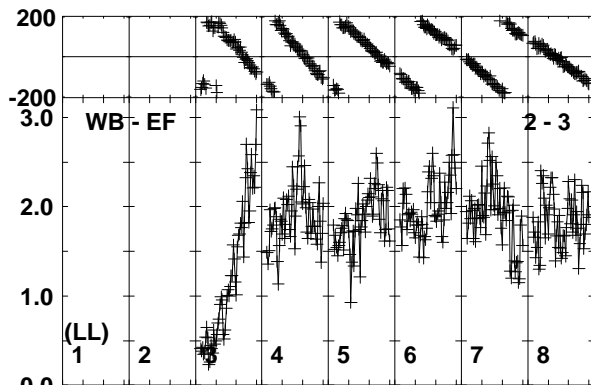
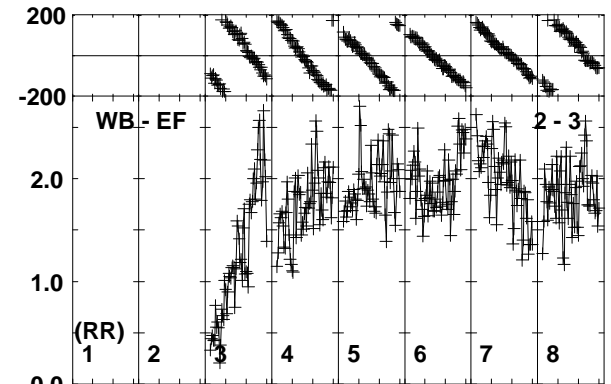
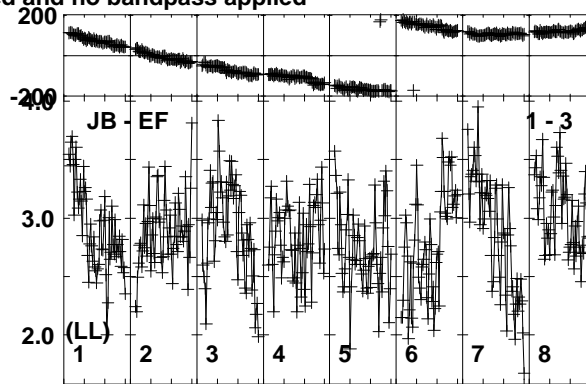
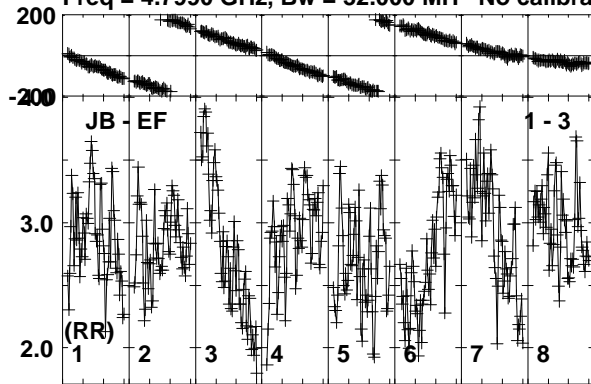

Lower frame: Milli Ampl Jy Top frame: Phas deg

Vector averaged cross-power spectrum Baseline: JB (01) - EF (03)

Timerange: 01/06:14:46 to 01/06:15:45

Plot file version 656 created 26-SEP-2019 10:44:00

J0257-1212 RG010A.UVDATA.1

Freq = 4.7990 GHz, Bw = 32.000 MH No calibration applied and no bandpass applied

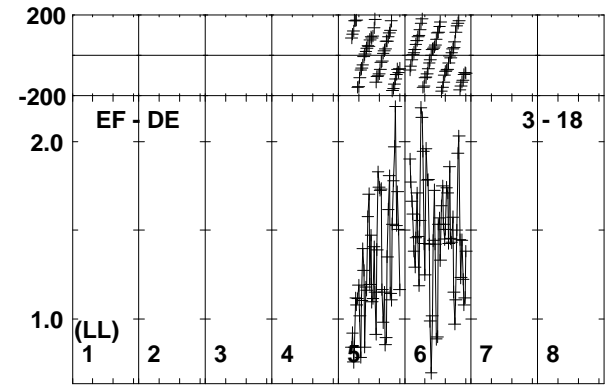
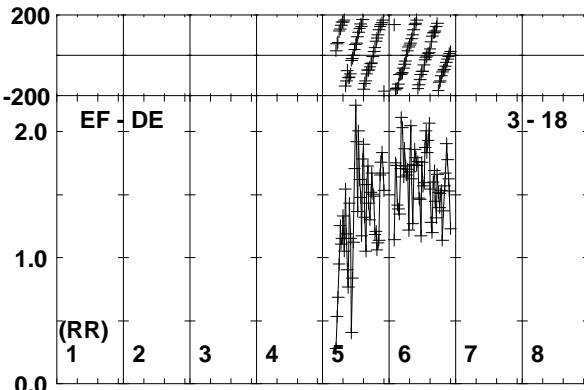
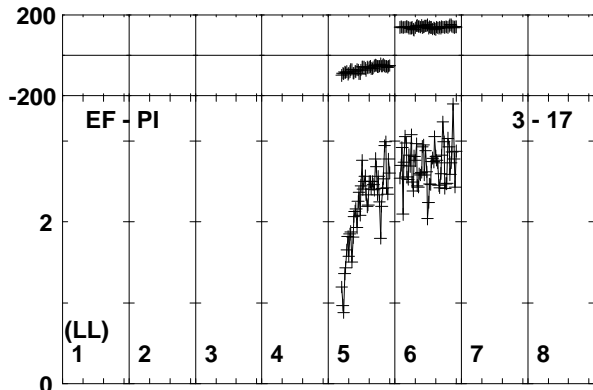
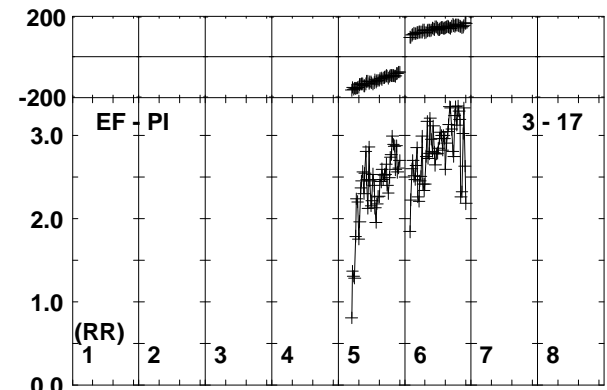
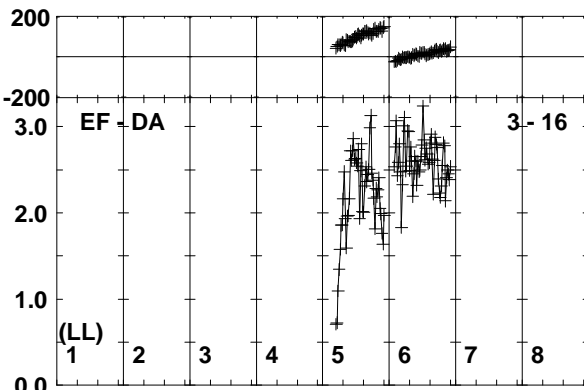
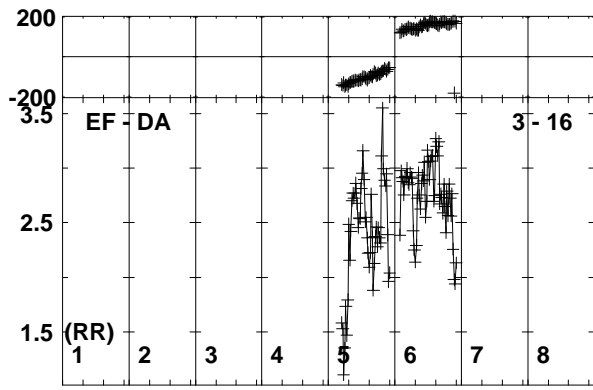
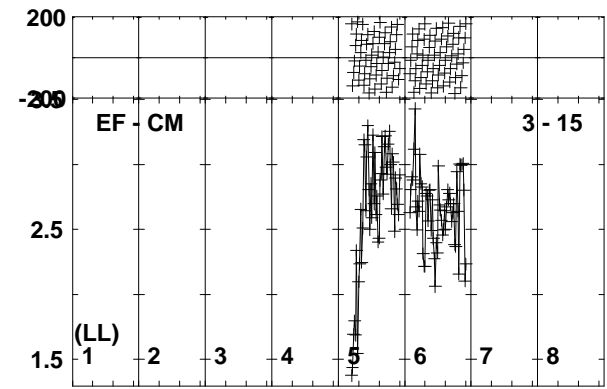
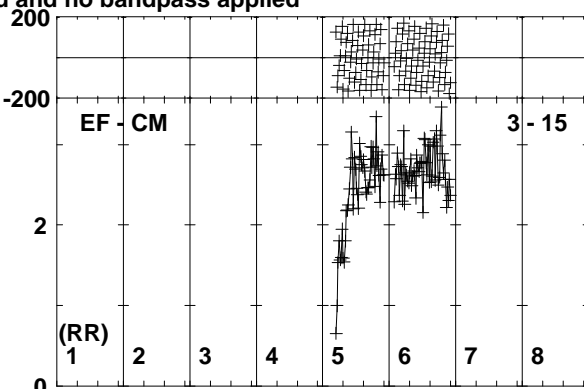
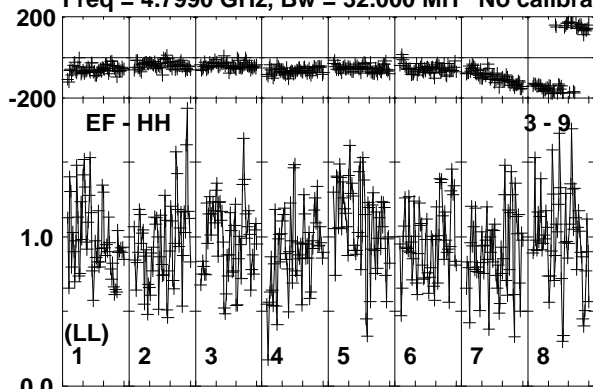

Lower frame: Milli Ampl Jy Top frame: Phas deg
Vector averaged cross-power spectrum Baseline: EF (03) - HH (09)
Timerange: 01/06:14:46 to 01/06:15:45

Plot file version 657 created 26-SEP-2019 10:44:00

190829A RG010A.UVDATA.1

Freq = 4.7990 GHz, Bw = 32.000 MH No calibration applied and no bandpass applied

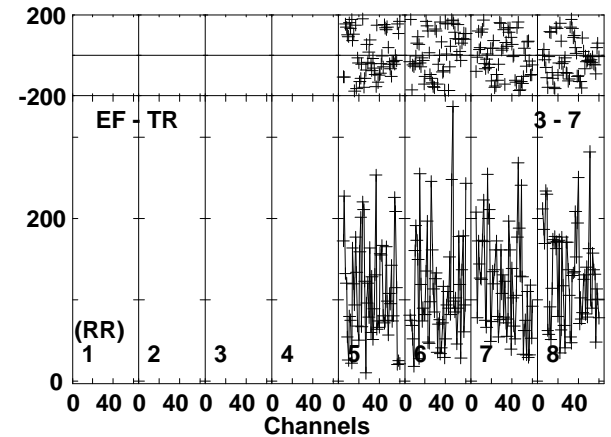
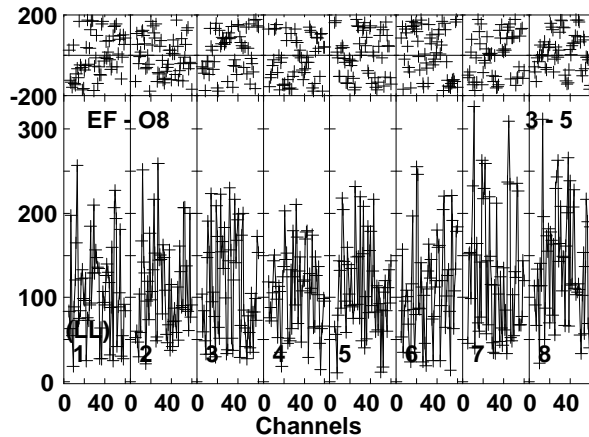
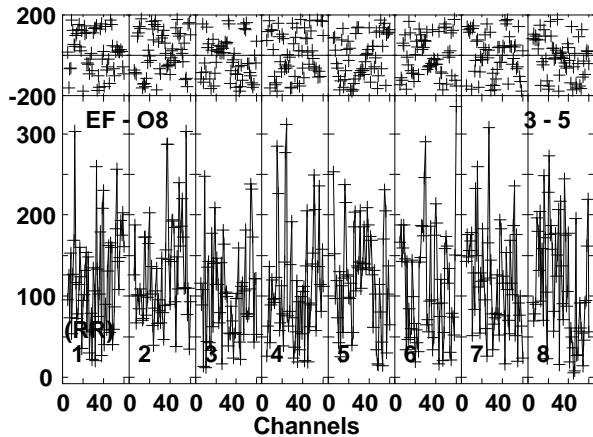
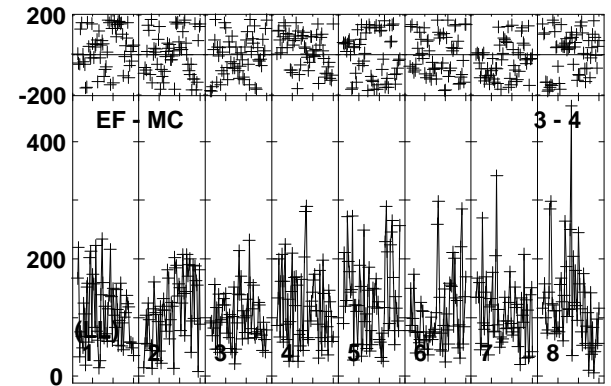
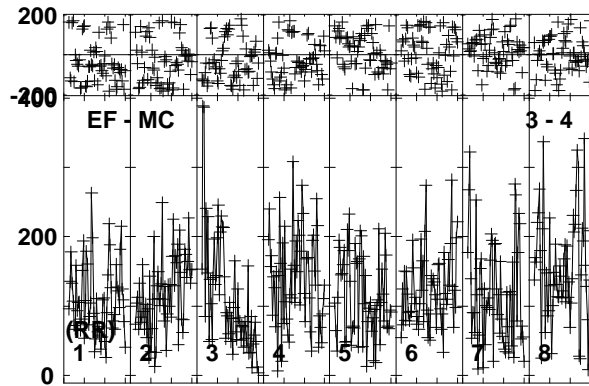
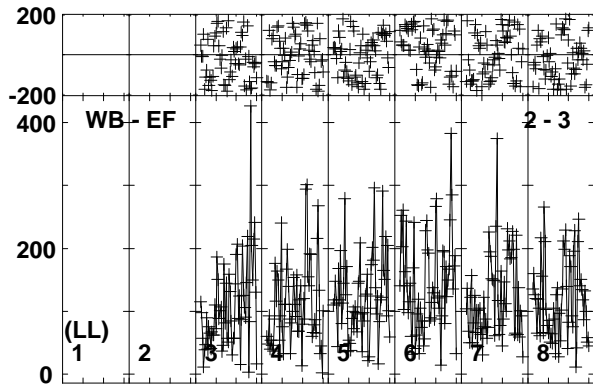
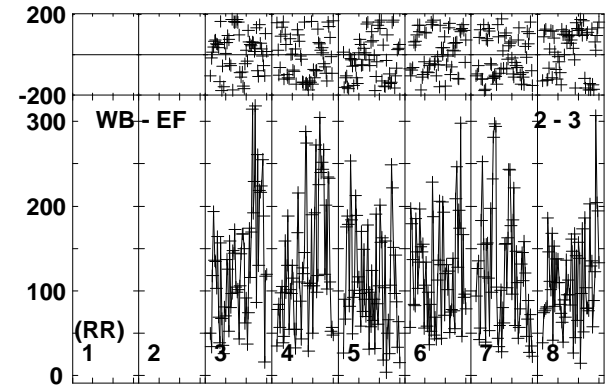
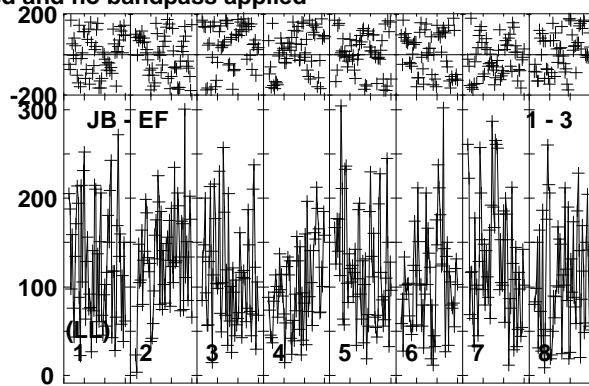
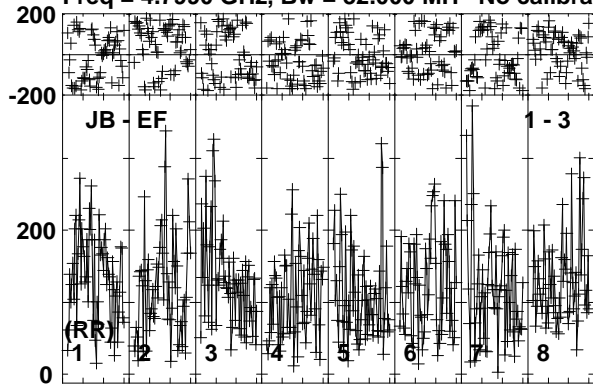

Lower frame: Micro Ampl Jy Top frame: Phas deg
Vector averaged cross-power spectrum Baseline: JB (01) - EF (03)
Timerange: 01/06:15:46 to 01/06:17:55

Plot file version 658 created 26-SEP-2019 10:44:01

190829A RG010A.UVDATA.1

Freq = 4.7990 GHz, Bw = 32.000 MH No calibration applied and no bandpass applied

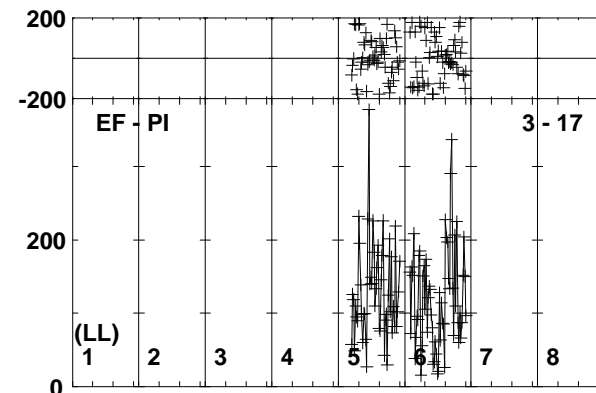
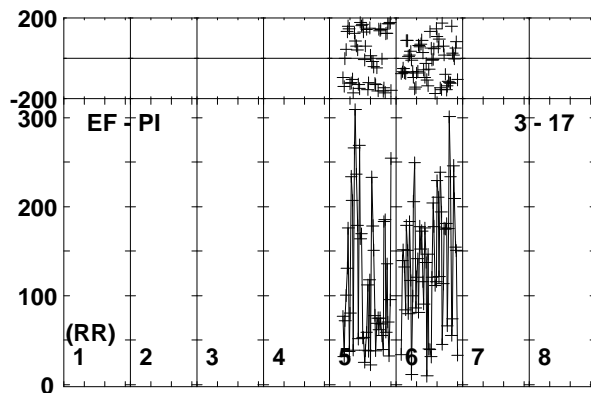
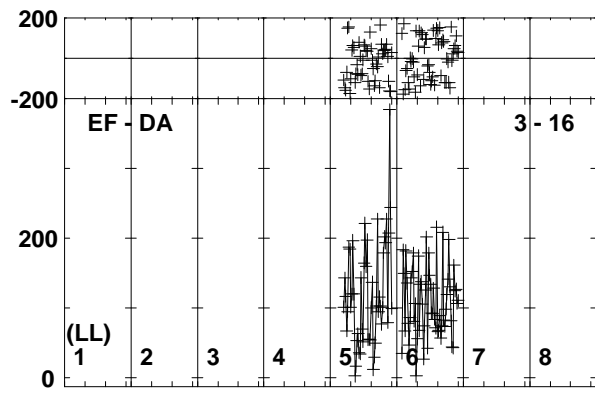
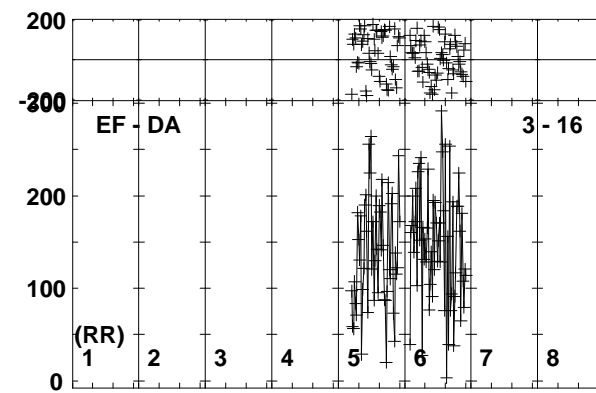
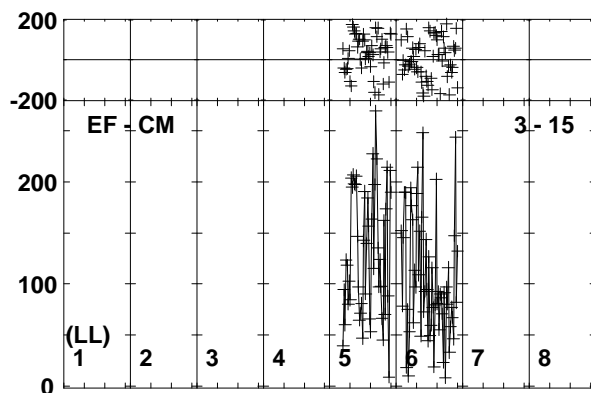
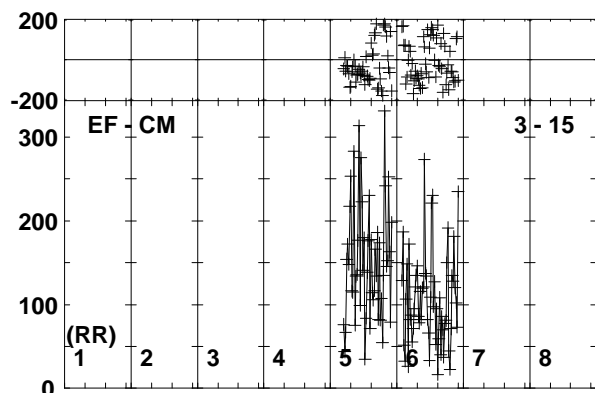
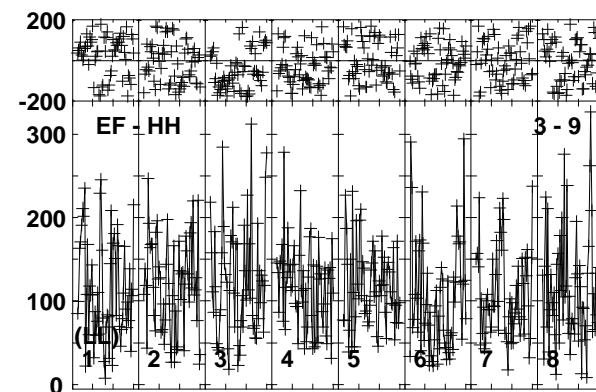
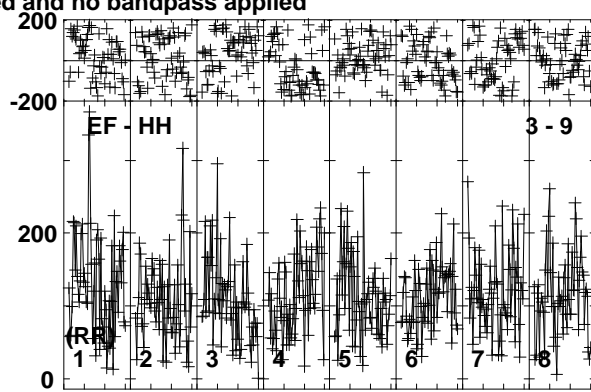
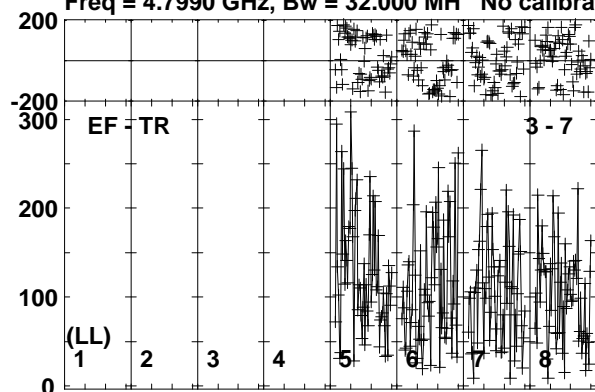

Lower frame: Micro Ampl Jy Top frame: Phas deg
Vector averaged cross-power spectrum Baseline: EF (03) - TR (07)
Timerange: 01/06:15:46 to 01/06:17:55

Plot file version 659 created 26-SEP-2019 10:44:01

190829A RG010A.UVDATA.1

Freq = 4.7990 GHz, Bw = 32.000 MH No calibration applied and no bandpass applied

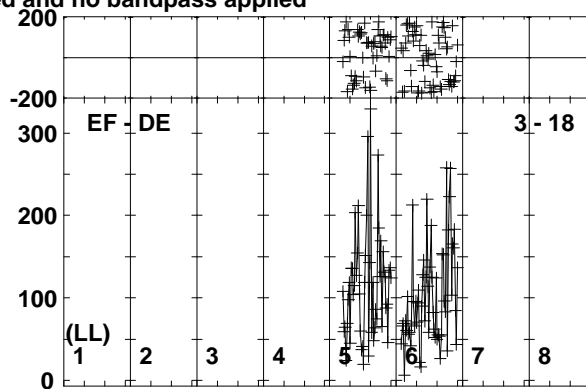
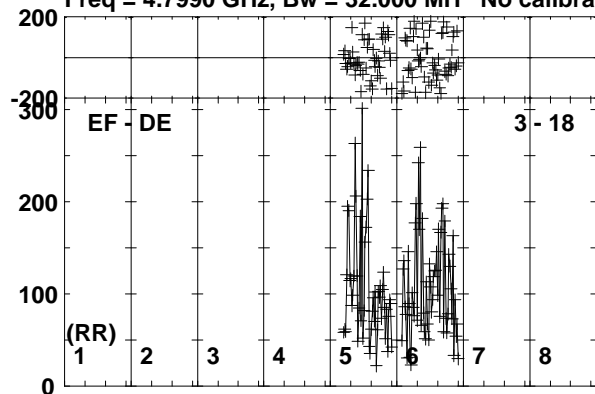

Lower frame: Micro Ampl Jy Top frame: Phas deg
Vector averaged cross-power spectrum Baseline: EF (03) - DE (18)
Timerange: 01/06:15:46 to 01/06:17:55

Plot file version 660 created 26-SEP-2019 10:44:01

J0257-1212 RG010A.UVDATA.1

Freq = 4.7990 GHz, Bw = 32.000 MH No calibration applied and no bandpass applied

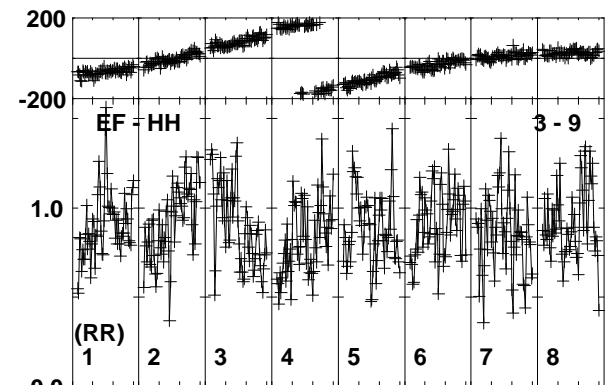
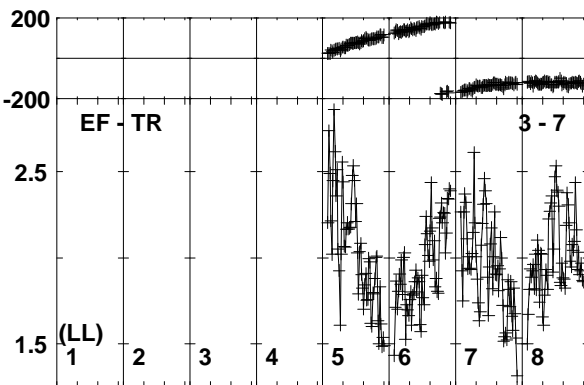
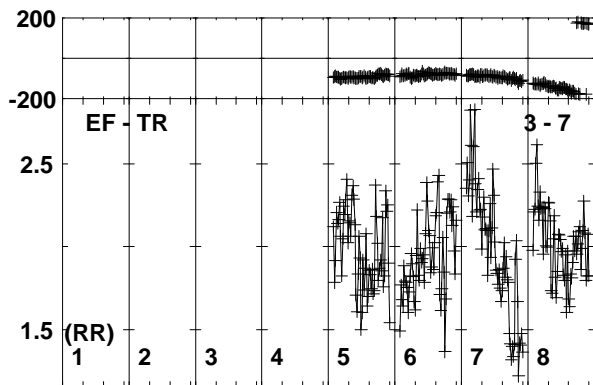
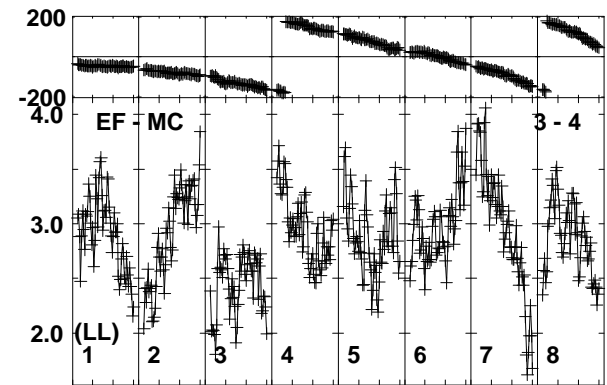
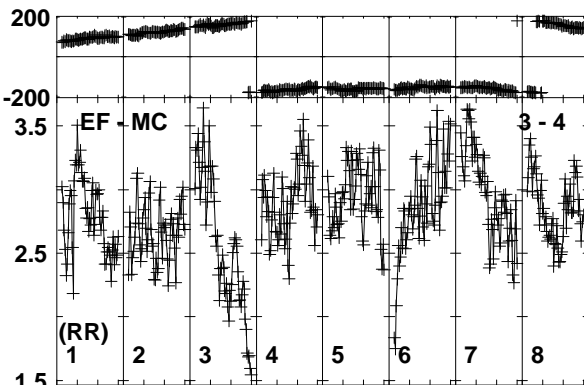
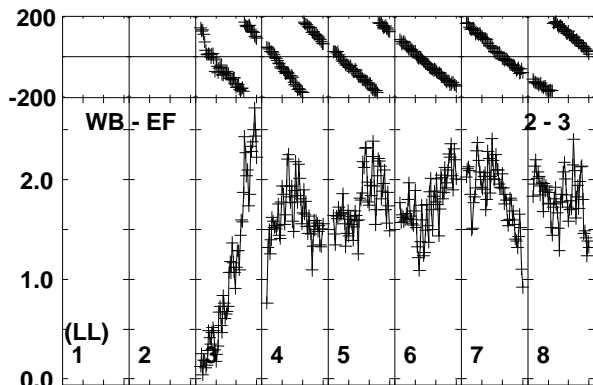
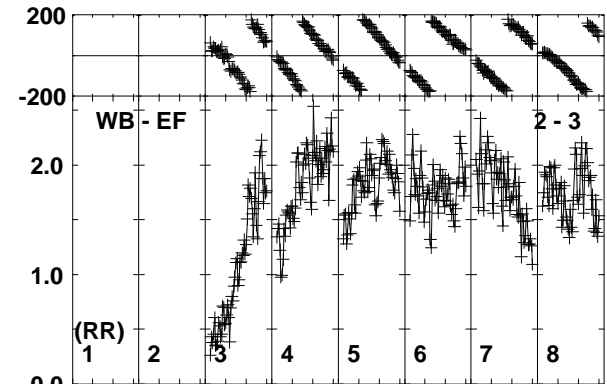
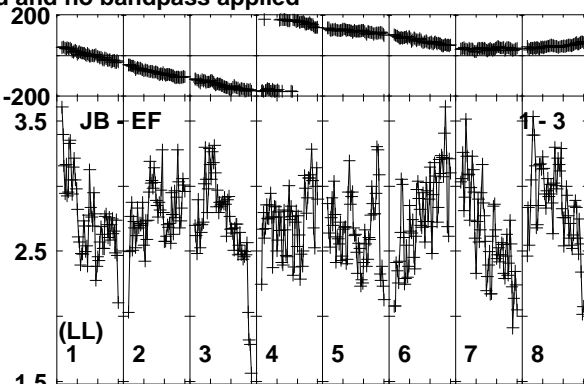
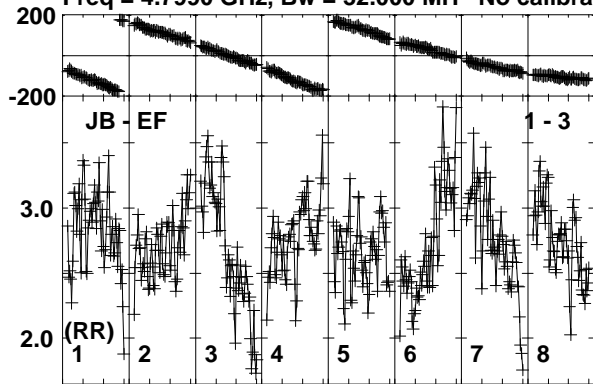

Lower frame: Milli Ampl Jy Top frame: Phas deg
Vector averaged cross-power spectrum Baseline: JB (01) - EF (03)
Timerange: 01/06:18:35 to 01/06:19:05

Plot file version 661 created 26-SEP-2019 10:44:03

J0257-1212 RG010A.UVDATA.1

Freq = 4.7990 GHz, Bw = 32.000 MH No calibration applied and no bandpass applied

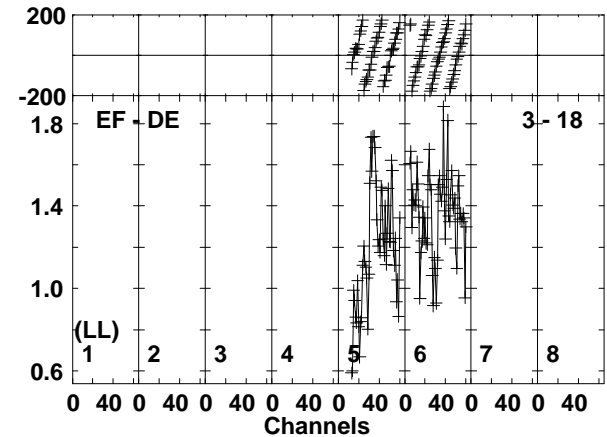
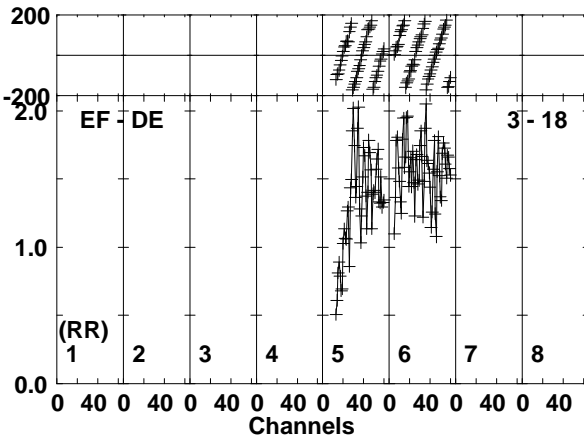
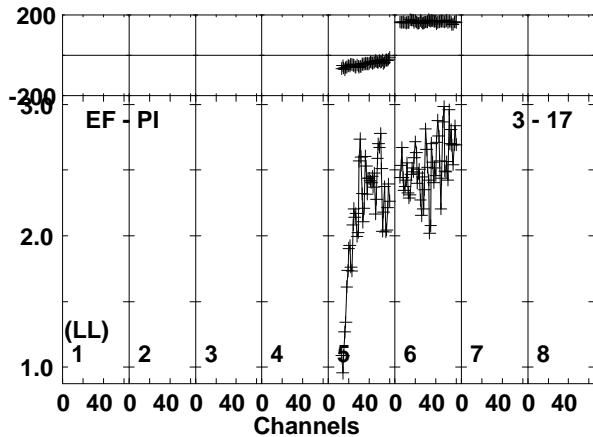
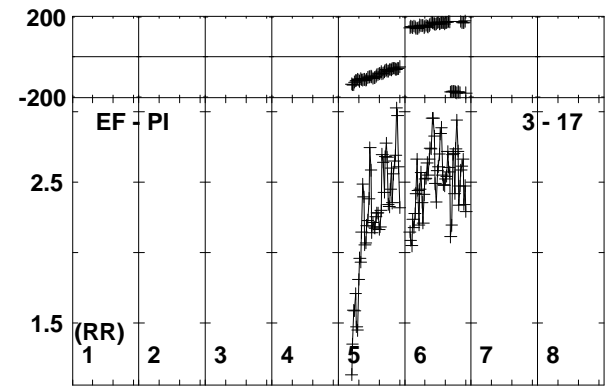
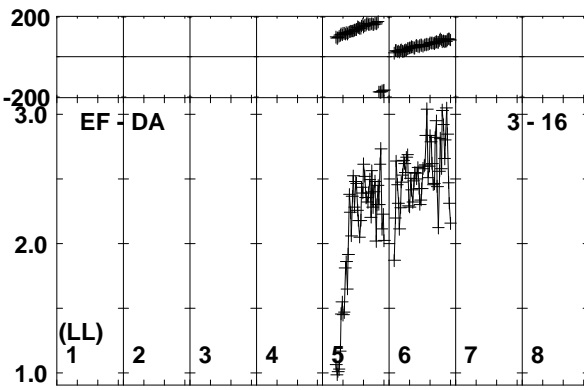
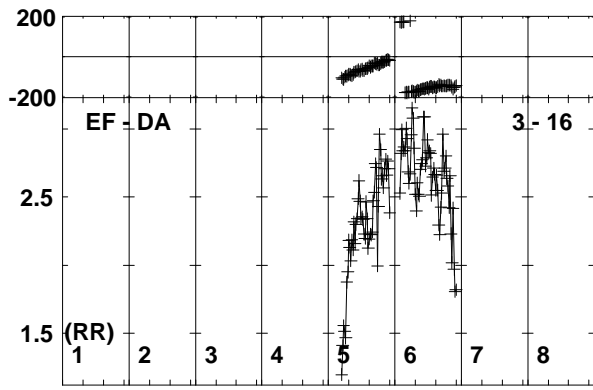
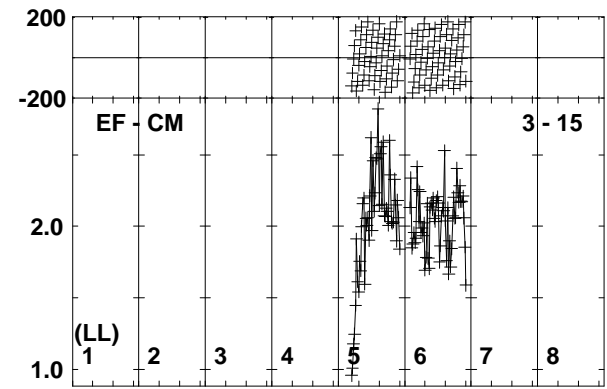
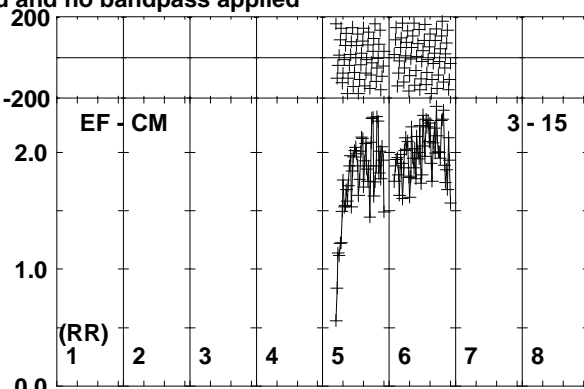
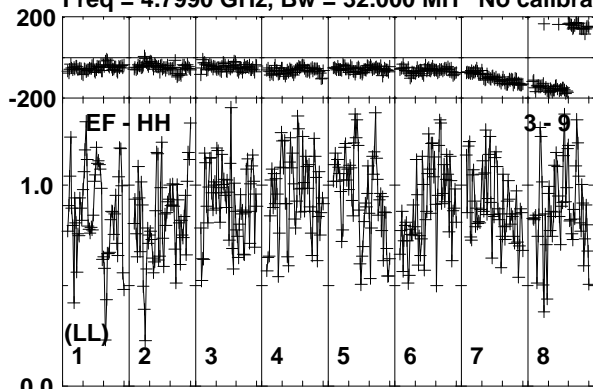

Lower frame: Milli Ampl Jy Top frame: Phas deg
Vector averaged cross-power spectrum Baseline: EF (03) - HH (09)
Timerange: 01/06:18:35 to 01/06:19:05

Plot file version 662 created 26-SEP-2019 10:44:04

J0300-0846 RG010A.UVDATA.1

Freq = 4.7990 GHz, Bw = 32.000 MH No calibration applied and no bandpass applied

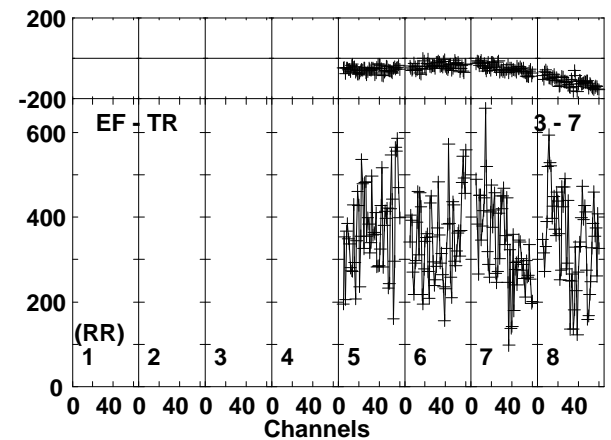
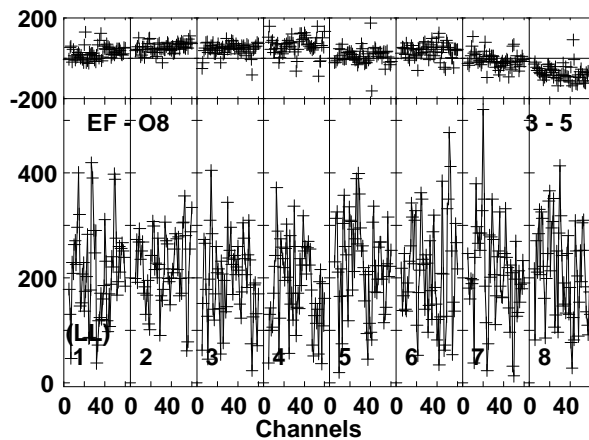
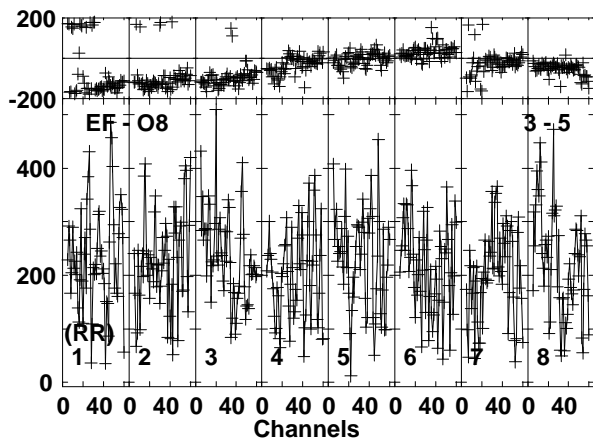
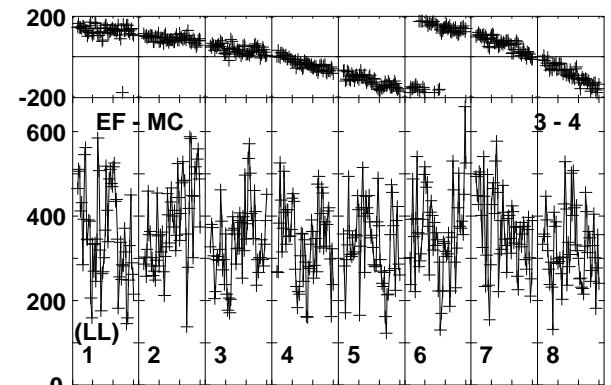
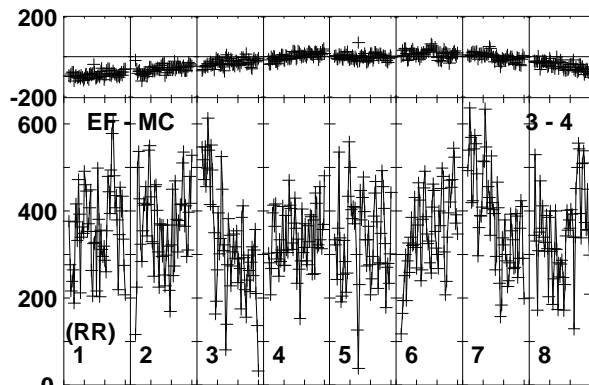
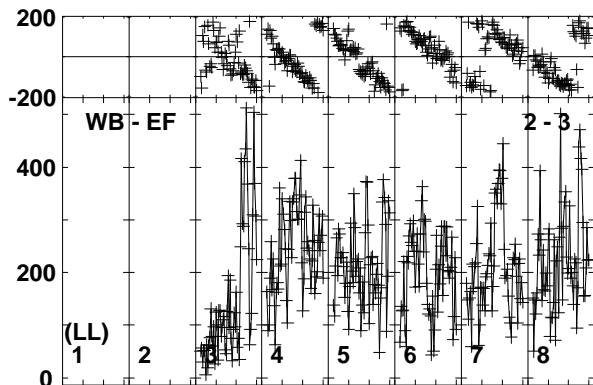
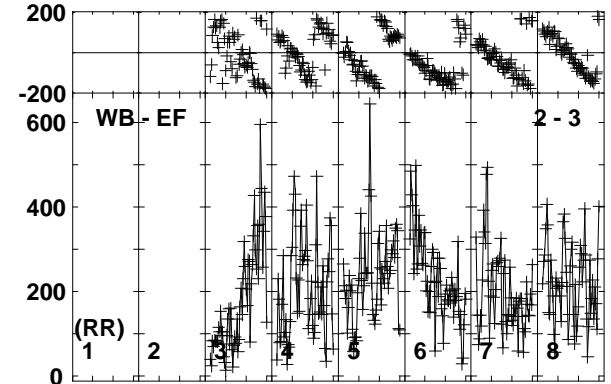
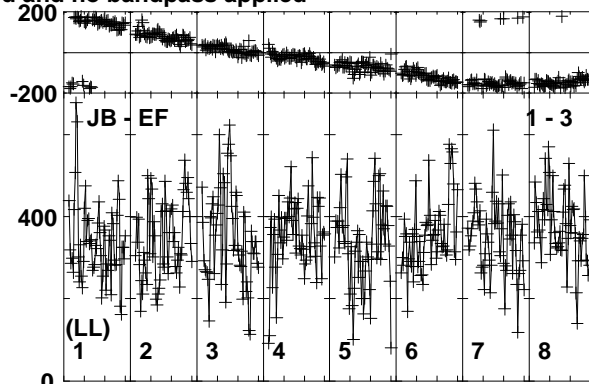
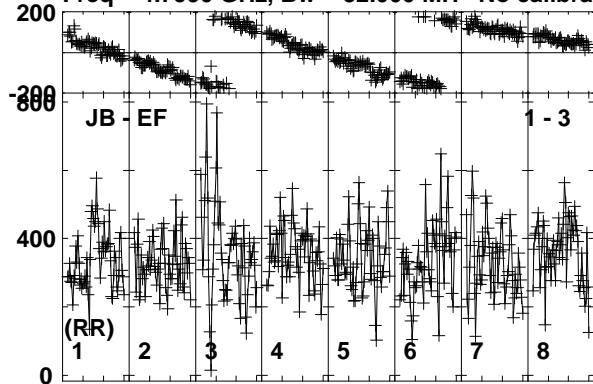

Lower frame: Micro Ampl Jy Top frame: Phas deg
Vector averaged cross-power spectrum Baseline: JB (01) - EF (03)
Timerange: 01/06:19:06 to 01/06:21:15

Plot file version 663 created 26-SEP-2019 10:44:04

J0300-0846 RG010A.UVDATA.1

Freq = 4.7990 GHz, Bw = 32.000 MH No calibration applied and no bandpass applied

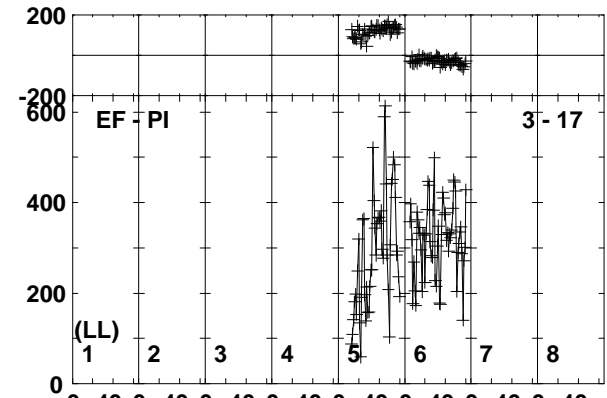
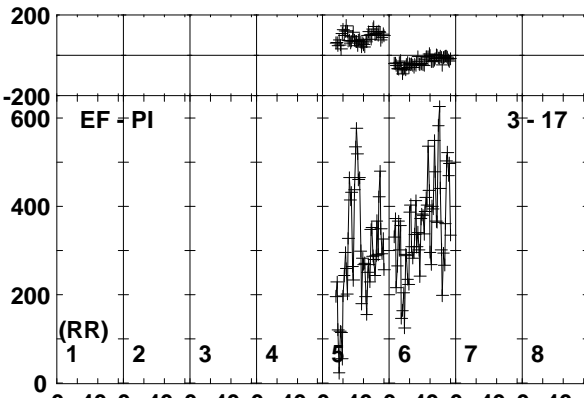
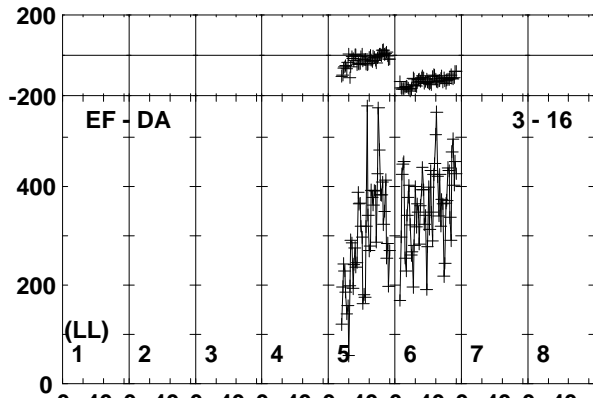
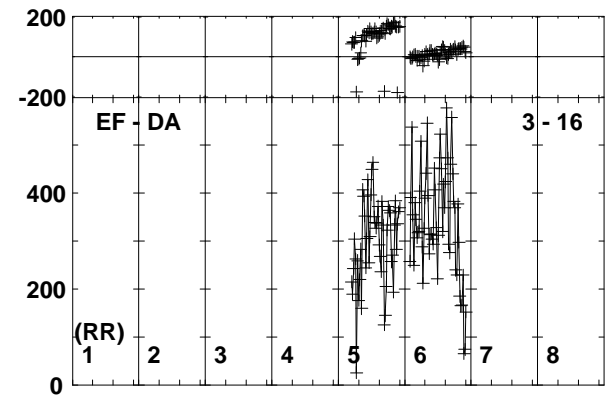
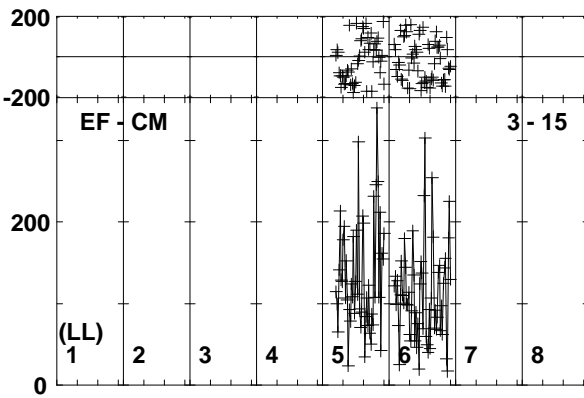
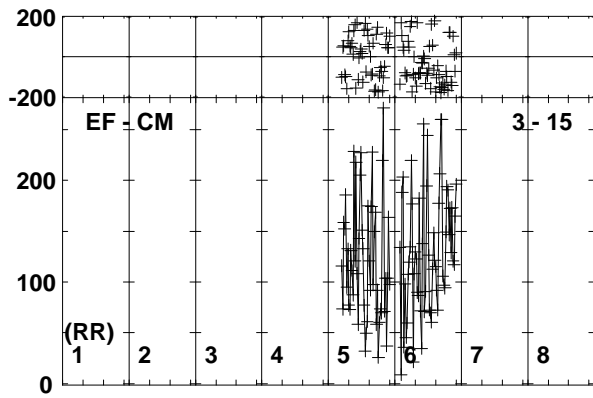
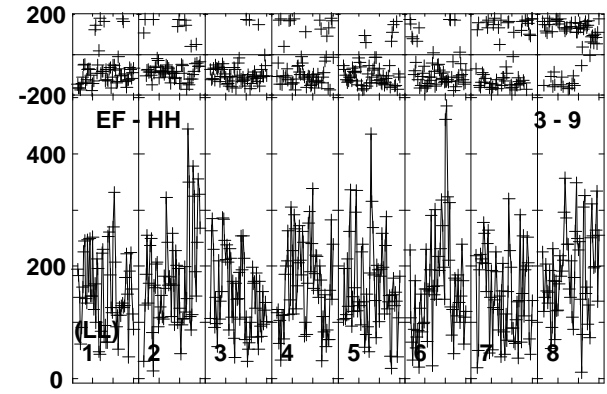
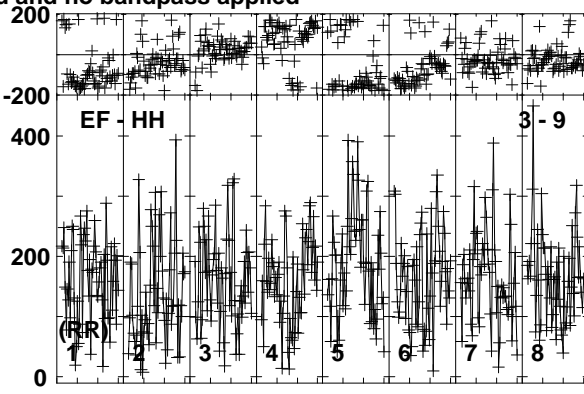
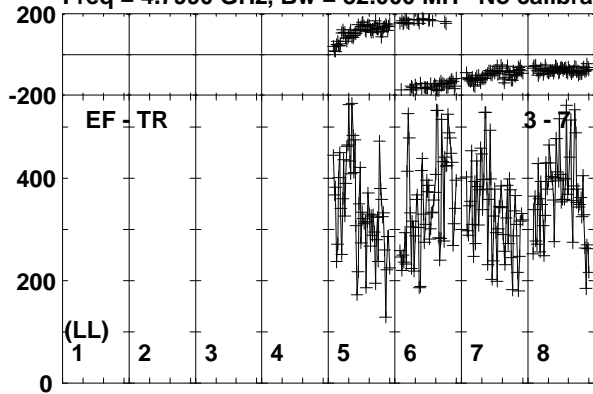

Lower frame: Micro Ampl Jy Top frame: Phas deg
Vector averaged cross-power spectrum Baseline: EF (03) - TR (07)
Timerange: 01/06:19:06 to 01/06:21:15

Plot file version 664 created 26-SEP-2019 10:44:04

J0300-0846 RG010A.UVDATA.1

Freq = 4.7990 GHz, Bw = 32.000 MH No calibration applied and no bandpass applied

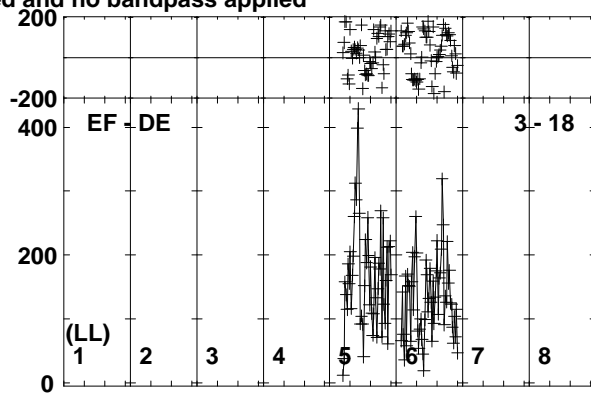
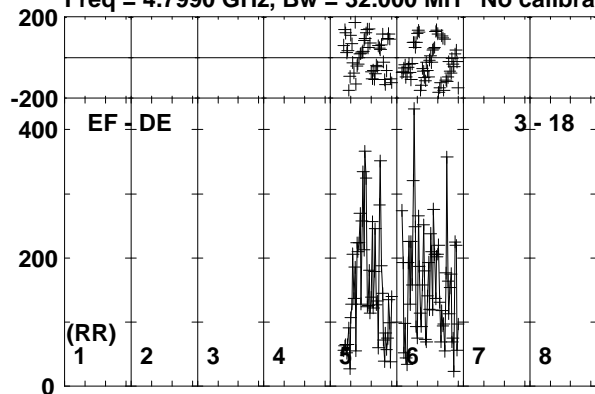

Lower frame: Micro Ampl Jy Top frame: Phas deg
Vector averaged cross-power spectrum Baseline: EF (03) - DE (18)
Timerange: 01/06:19:06 to 01/06:21:15

Plot file version 665 created 26-SEP-2019 10:44:04

J0257-1212 RG010A.UVDATA.1

Freq = 4.7990 GHz, Bw = 32.000 MH No calibration applied and no bandpass applied

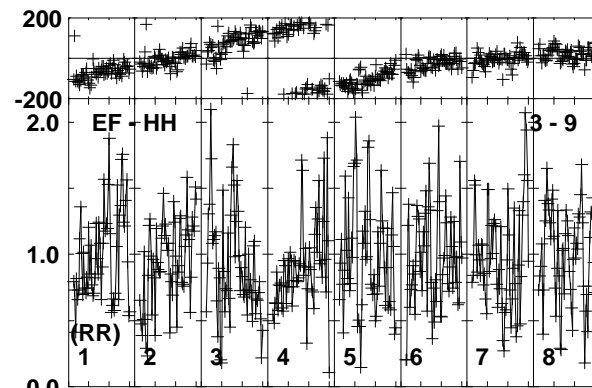
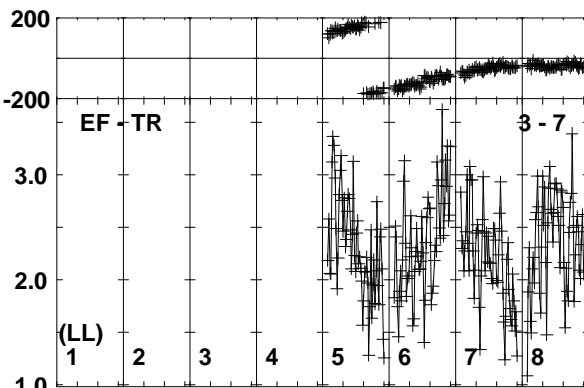
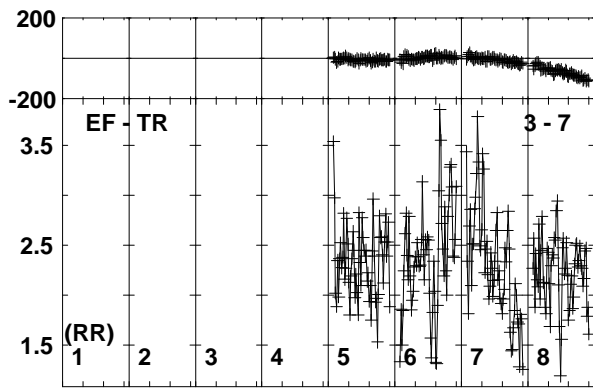
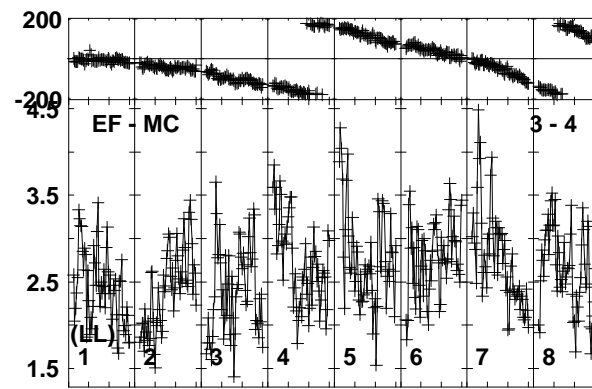
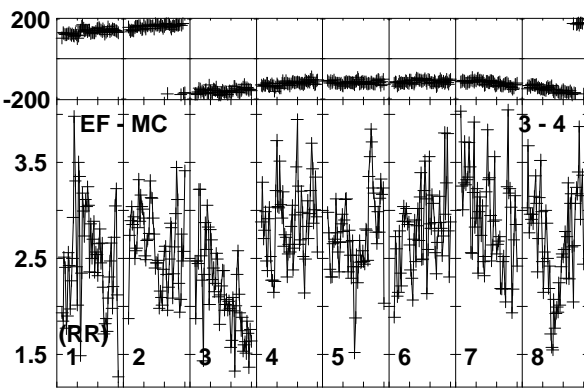
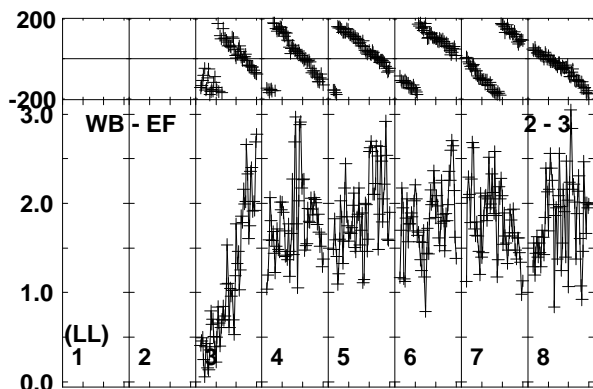
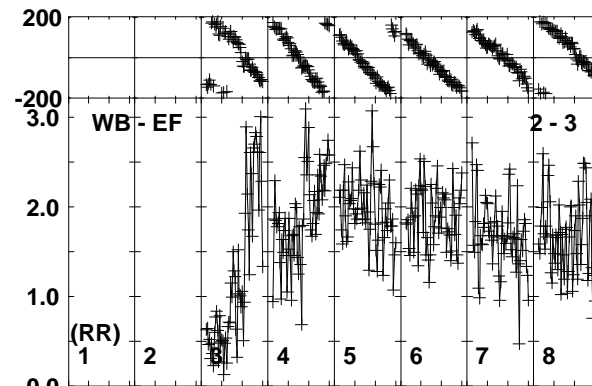
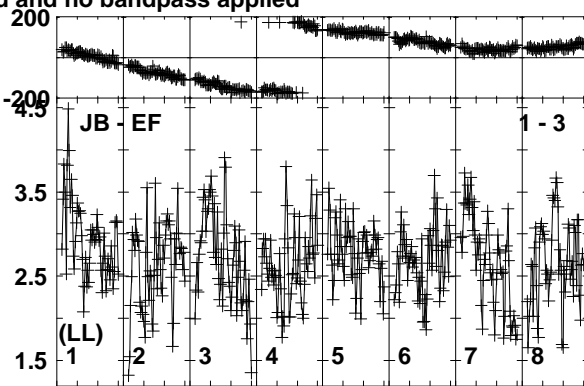
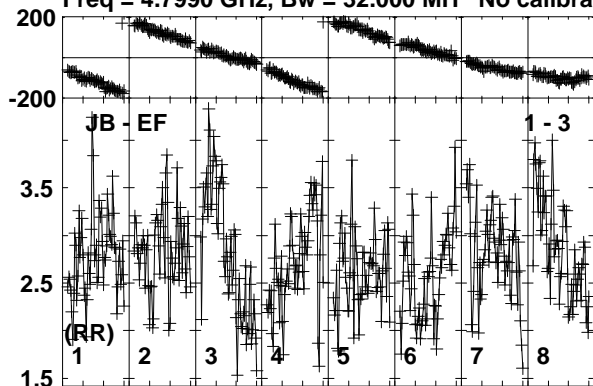

Lower frame: Milli Ampl Jy Top frame: Phas deg
Vector averaged cross-power spectrum Baseline: JB (01) - EF (03)
Timerange: 01/06:21:16 to 01/06:22:14

Plot file version 666 created 26-SEP-2019 10:44:05

J0257-1212 RG010A.UVDATA.1

Freq = 4.7990 GHz, Bw = 32.000 MH No calibration applied and no bandpass applied

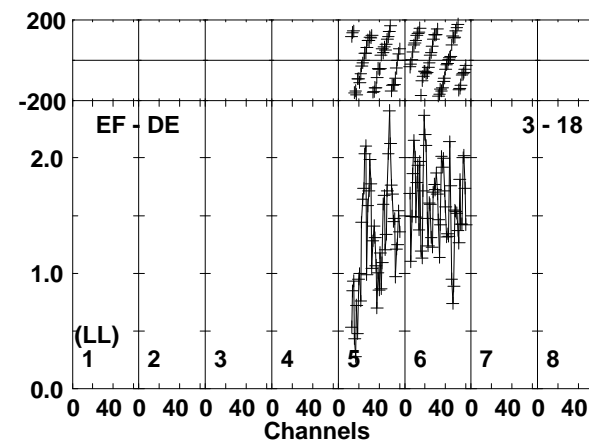
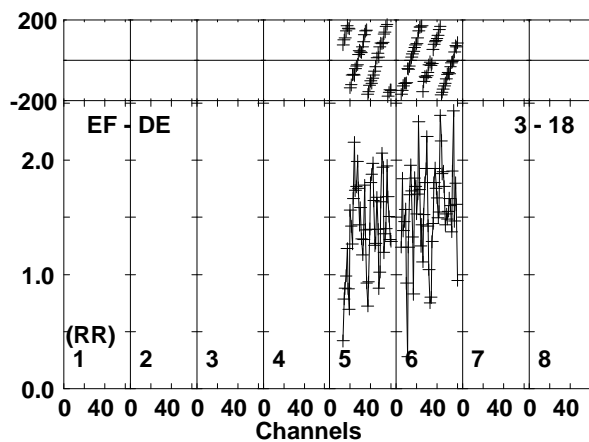
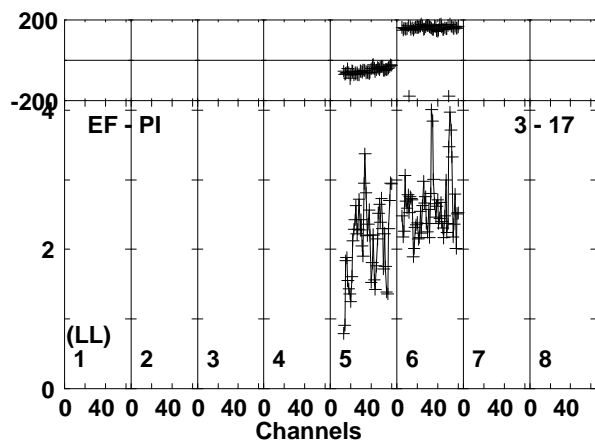
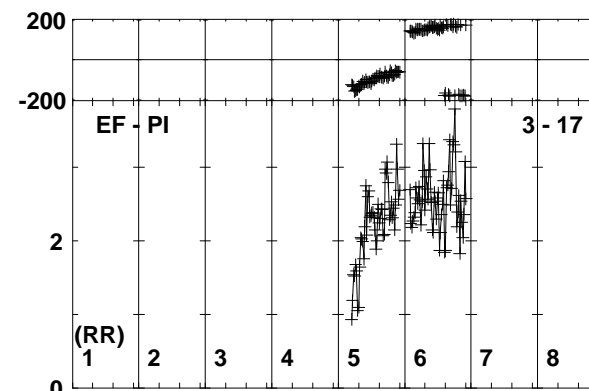
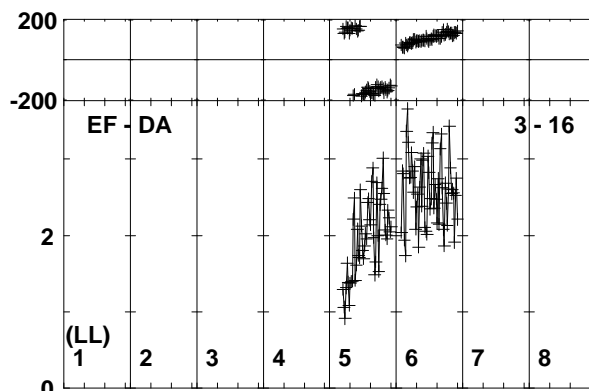
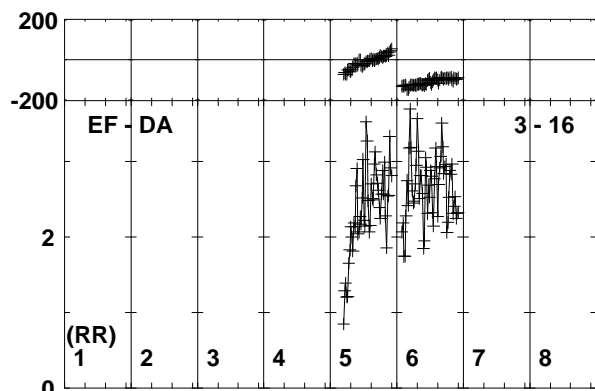
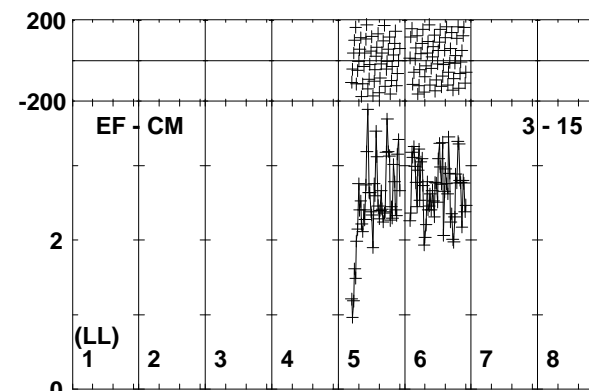
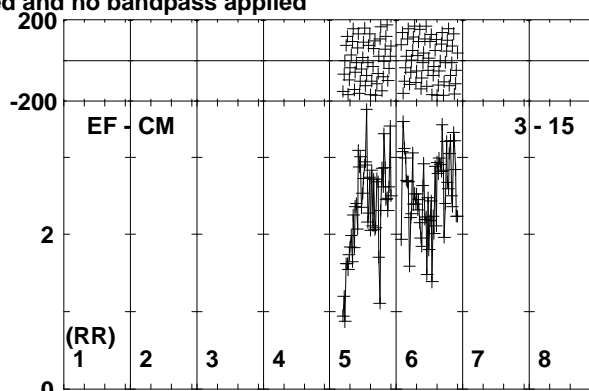
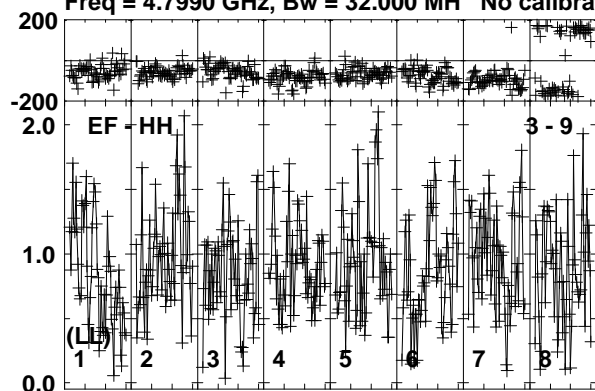

Lower frame: Milli Ampl Jy Top frame: Phas deg
Vector averaged cross-power spectrum Baseline: EF (03) - HH (09)
Timerange: 01/06:21:16 to 01/06:22:14

Plot file version 667 created 26-SEP-2019 10:44:05

190829A RG010A.UVDATA.1

Freq = 4.7990 GHz, Bw = 32.000 MH No calibration applied and no bandpass applied

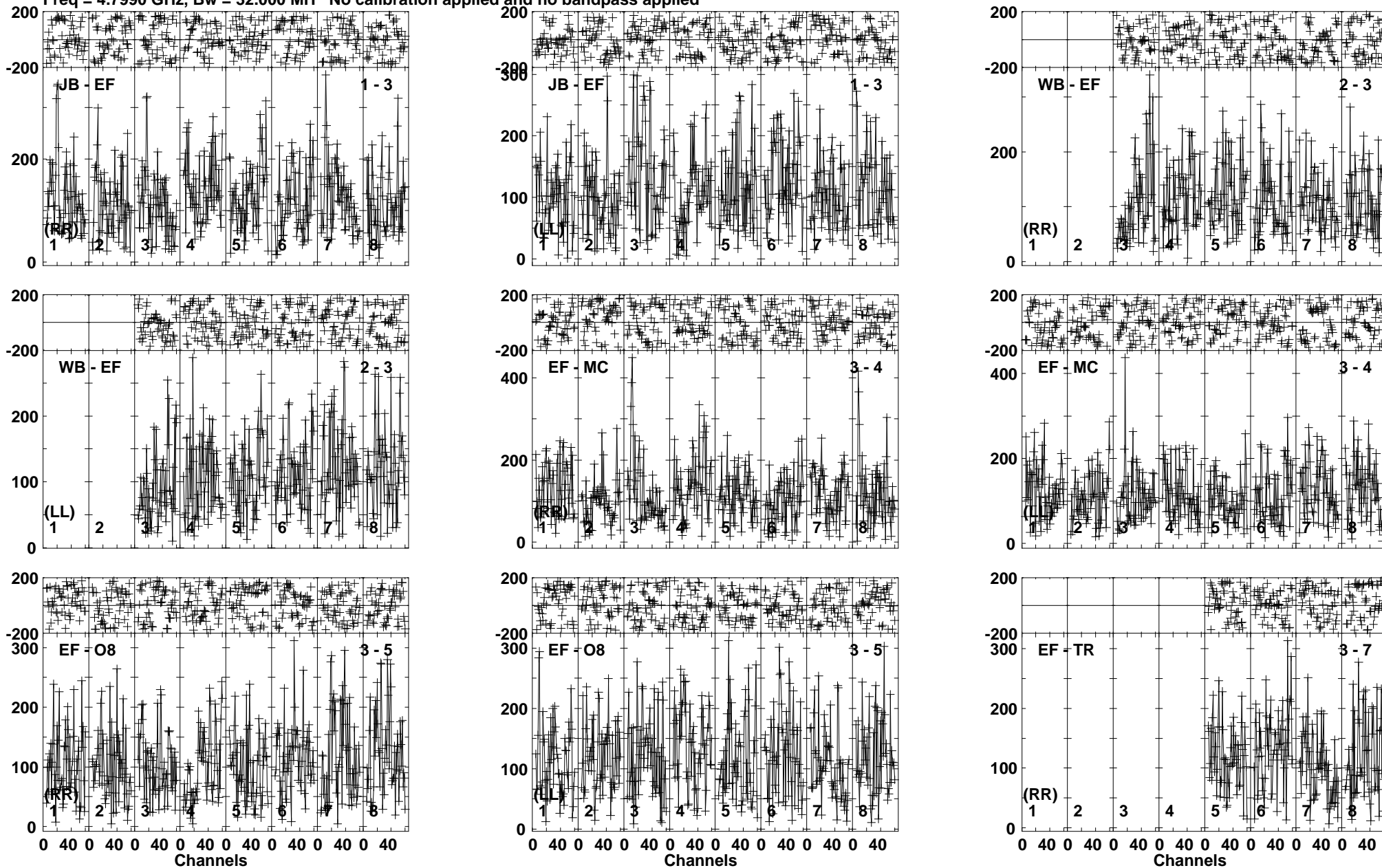

Lower frame: Micro Ampl Jy Top frame: Phas deg
Vector averaged cross-power spectrum Baseline: JB (01) - EF (03)
Timerange: 01/06:22:15 to 01/06:24:24

Plot file version 668 created 26-SEP-2019 10:44:05

190829A RG010A.UVDATA.1

Freq = 4.7990 GHz, Bw = 32.000 MH No calibration applied and no bandpass applied

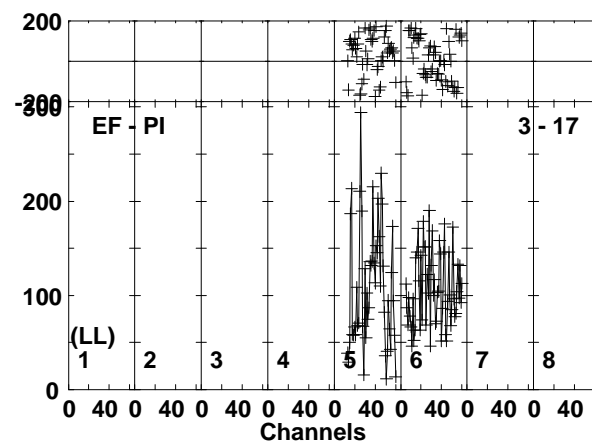
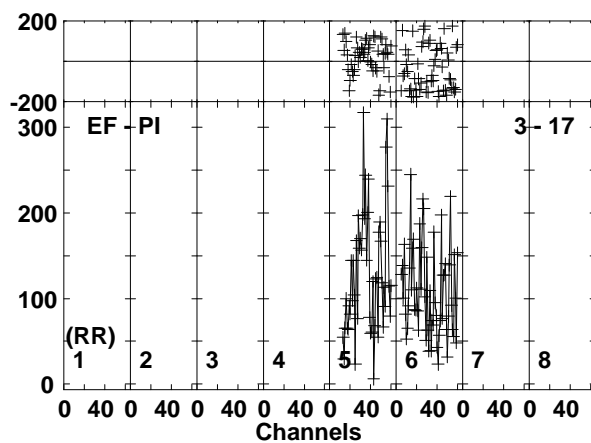
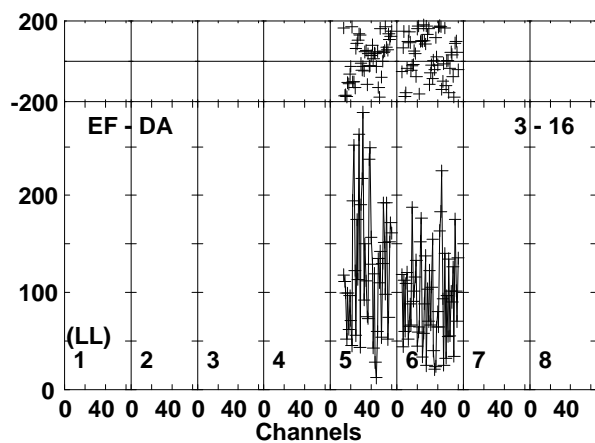
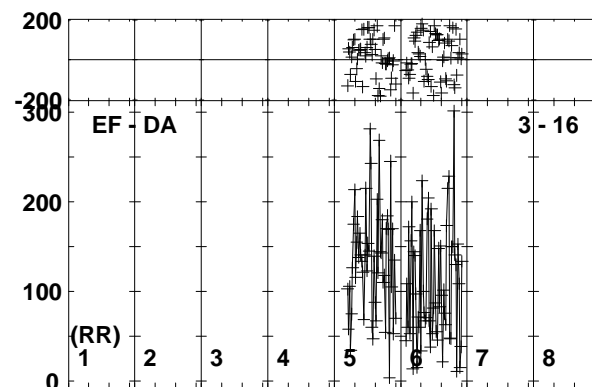
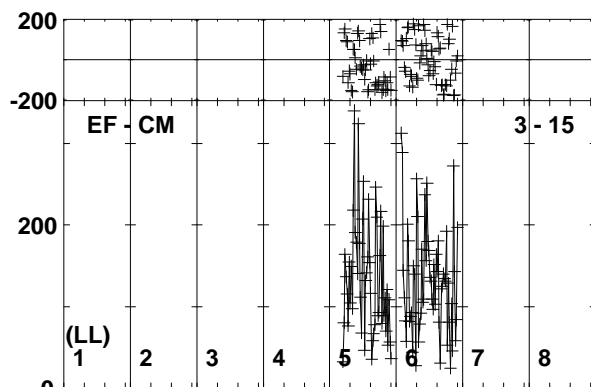
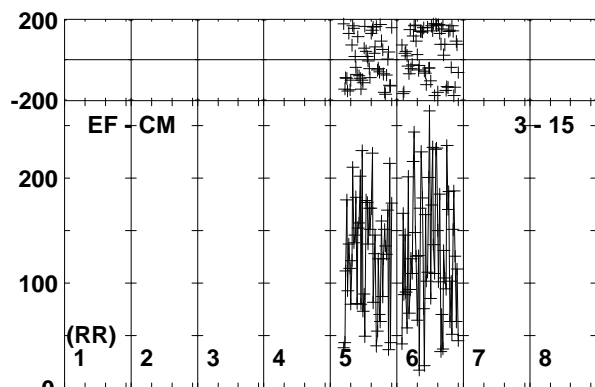
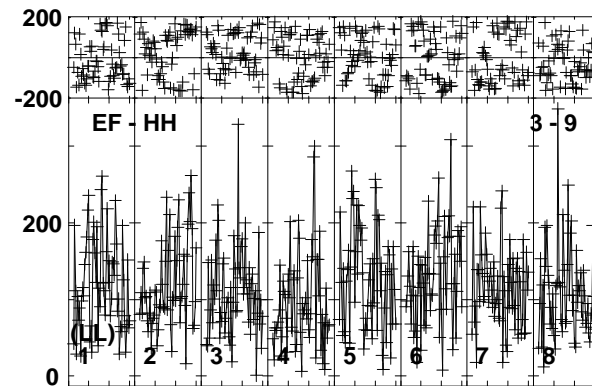
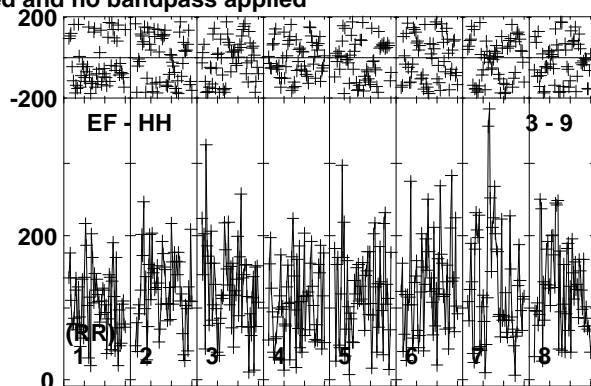
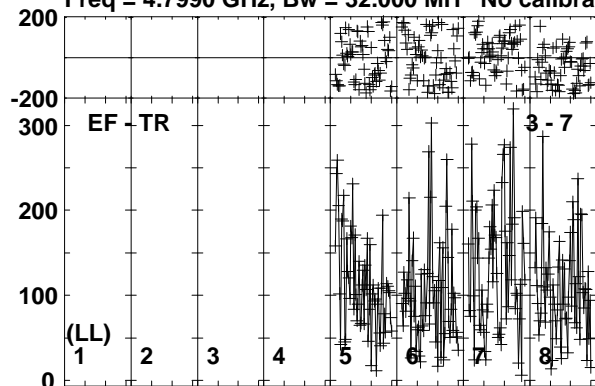

Lower frame: Micro Ampl Jy Top frame: Phas deg
Vector averaged cross-power spectrum Baseline: EF (03) - TR (07)
Timerange: 01/06:22:15 to 01/06:24:24

Plot file version 669 created 26-SEP-2019 10:44:06

190829A RG010A.UVDATA.1

Freq = 4.7990 GHz, Bw = 32.000 MH No calibration applied and no bandpass applied

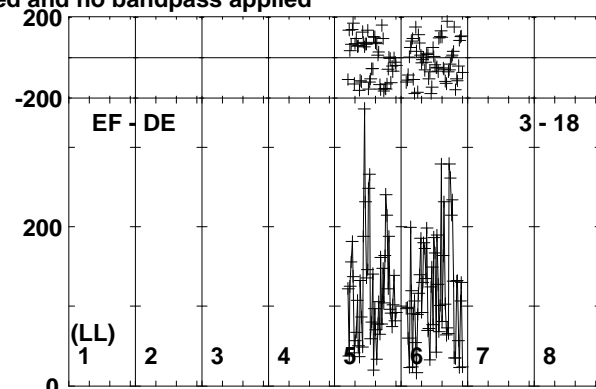
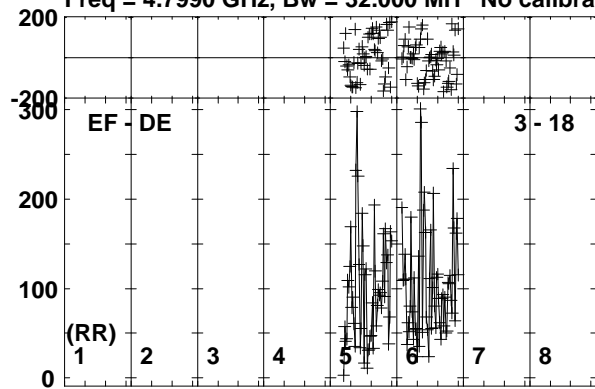

Lower frame: Micro Ampl Jy Top frame: Phas deg
Vector averaged cross-power spectrum Baseline: EF (03) - DE (18)
Timerange: 01/06:22:15 to 01/06:24:24

Plot file version 670 created 26-SEP-2019 10:44:06

J0257-1212 RG010A.UVDATA.1

Freq = 4.7990 GHz, Bw = 32.000 MH No calibration applied and no bandpass applied

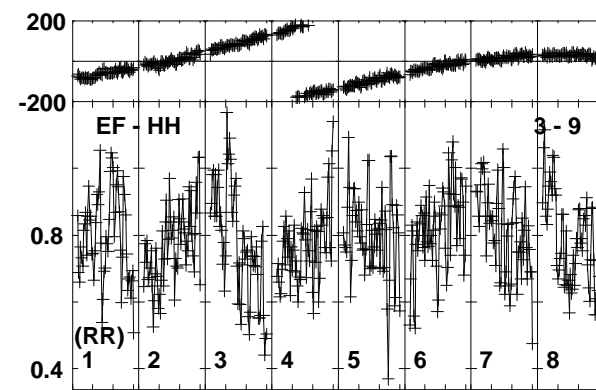
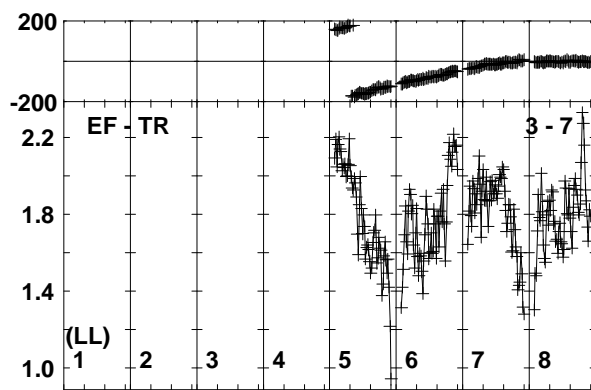
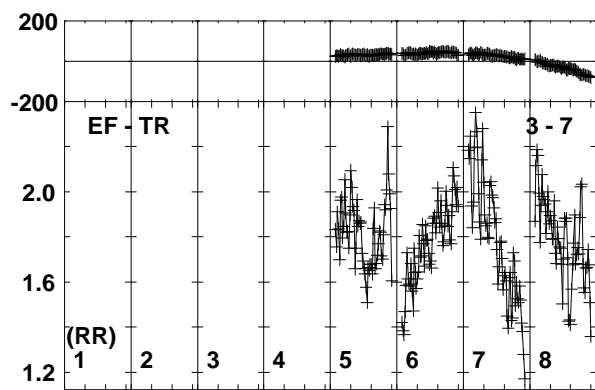
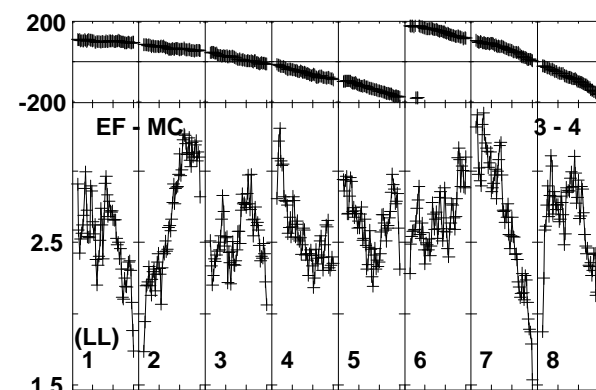
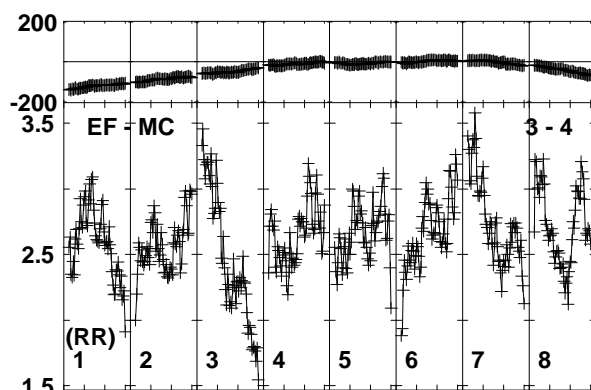
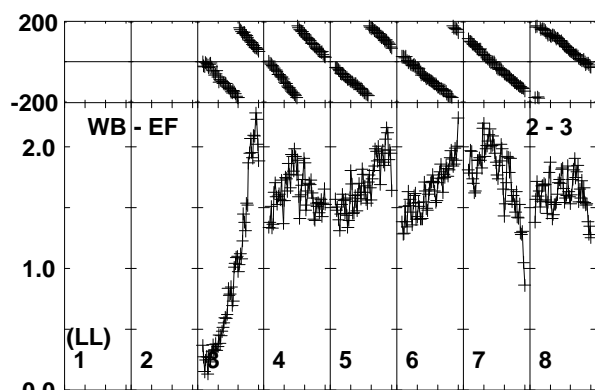
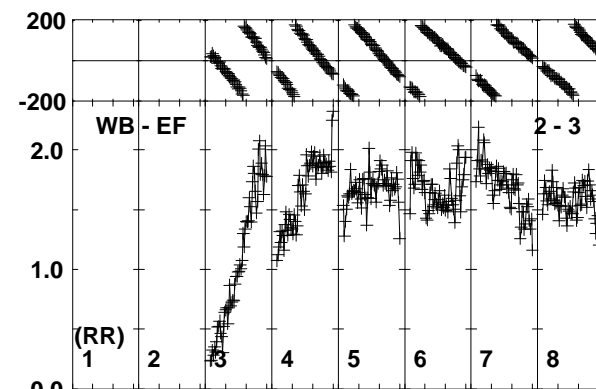
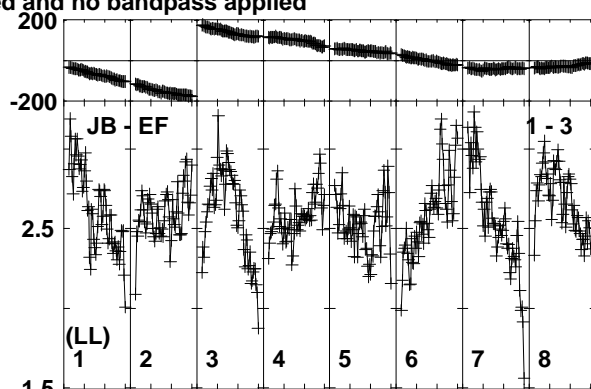
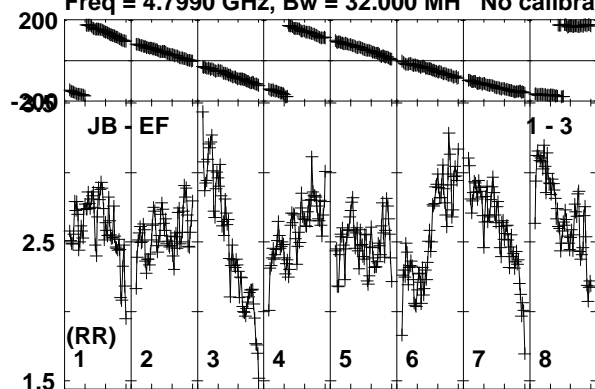

Lower frame: Milli Ampl Jy Top frame: Phas deg
Vector averaged cross-power spectrum Baseline: JB (01) - EF (03)
Timerange: 01/06:25:06 to 01/06:26:05

Plot file version 671 created 26-SEP-2019 10:44:06

J0257-1212 RG010A.UVDATA.1

Freq = 4.7990 GHz, Bw = 32.000 MH No calibration applied and no bandpass applied

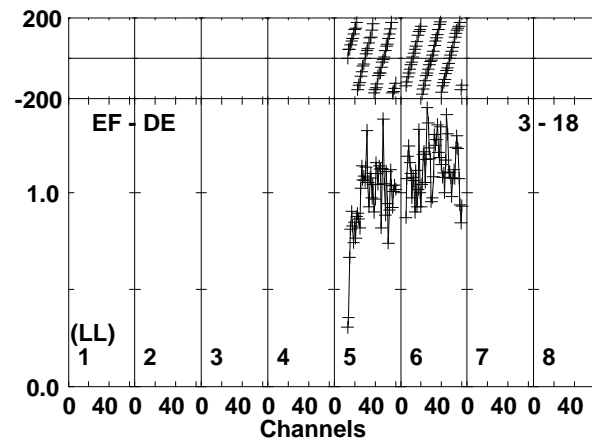
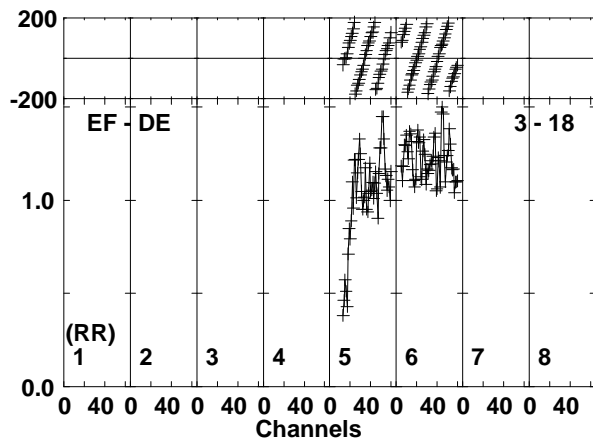
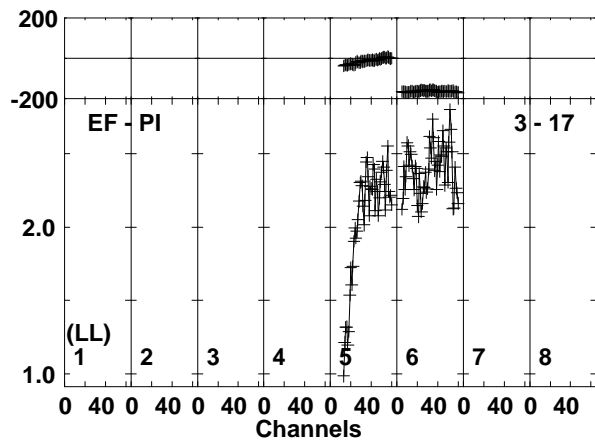
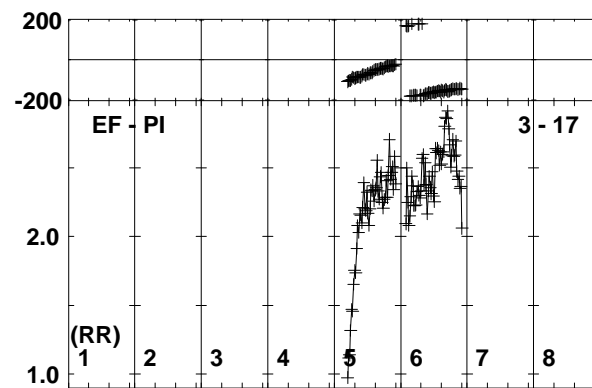
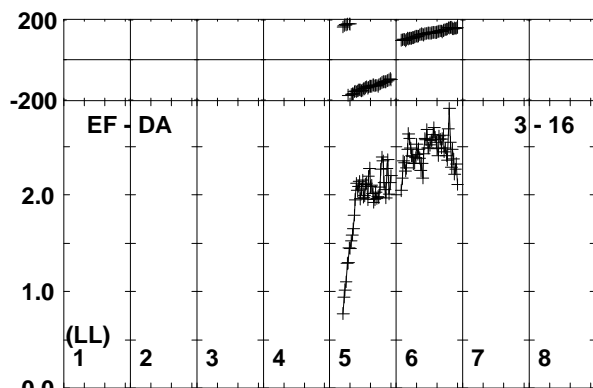
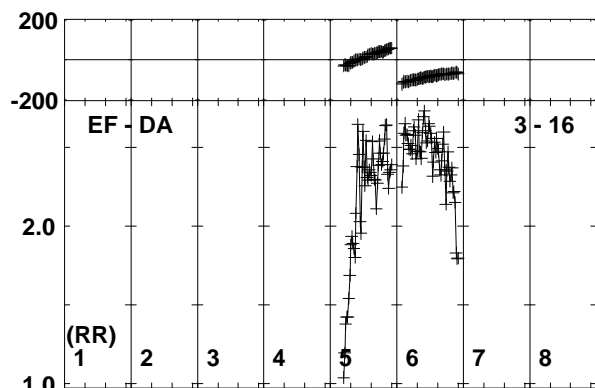
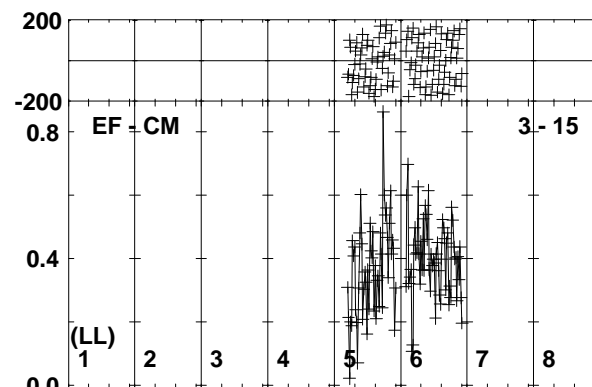
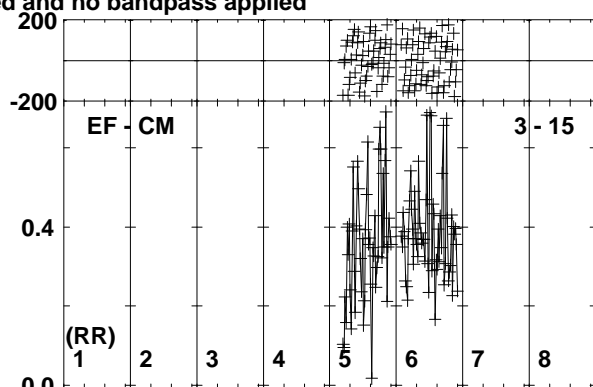
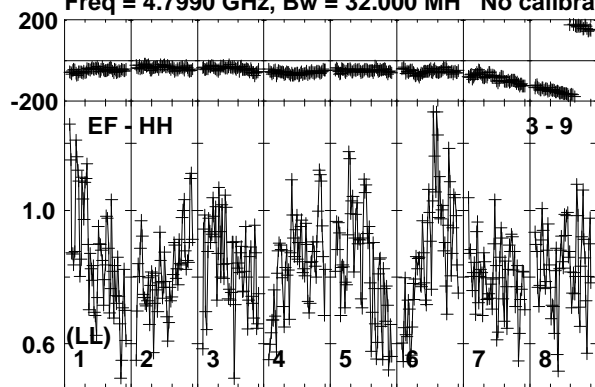

Lower frame: Milli Ampl Jy Top frame: Phas deg
Vector averaged cross-power spectrum Baseline: EF (03) - HH (09)
Timerange: 01/06:25:06 to 01/06:26:05

Plot file version 672 created 26-SEP-2019 10:44:06

190829A RG010A.UVDATA.1

Freq = 4.7990 GHz, Bw = 32.000 MH No calibration applied and no bandpass applied

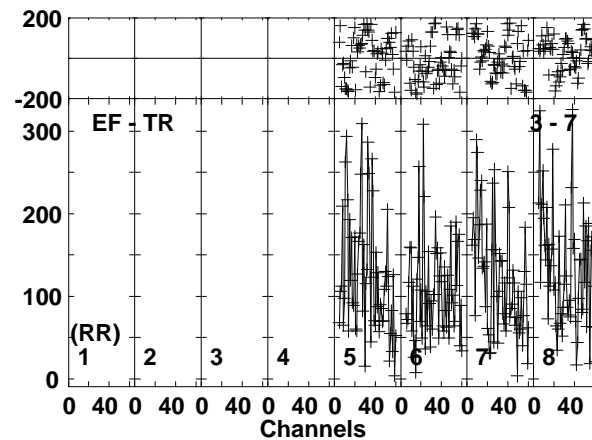
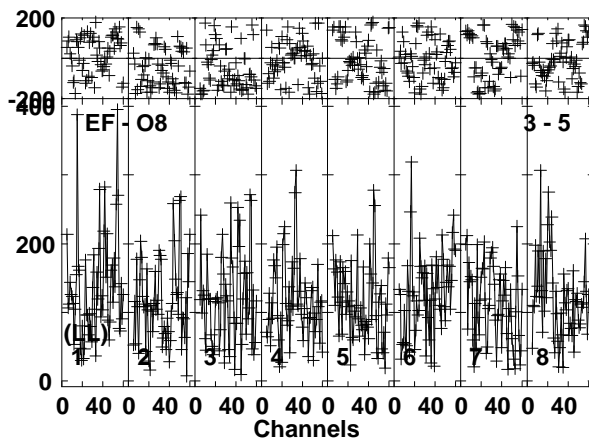
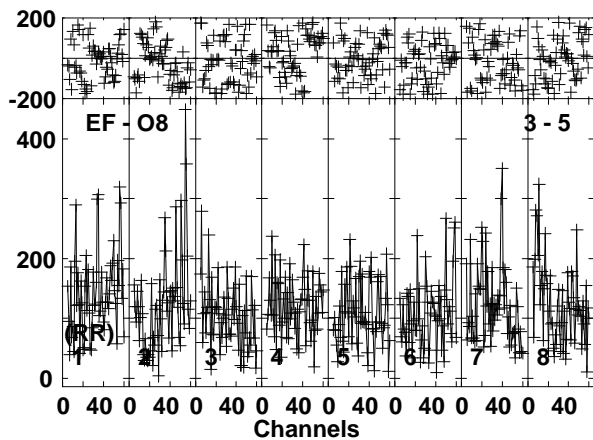
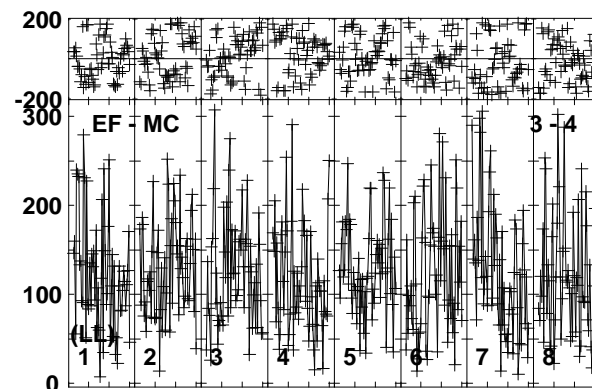
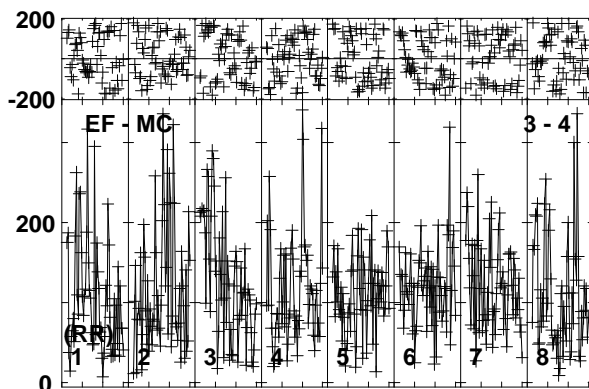
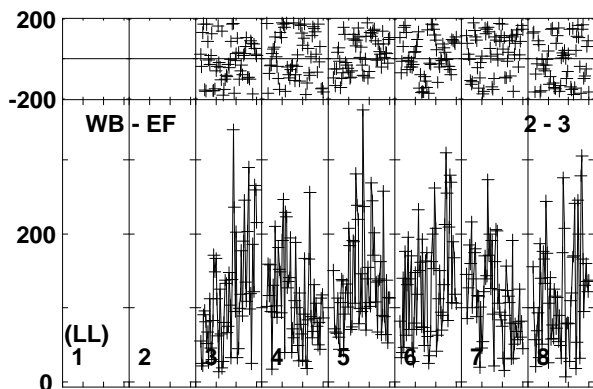
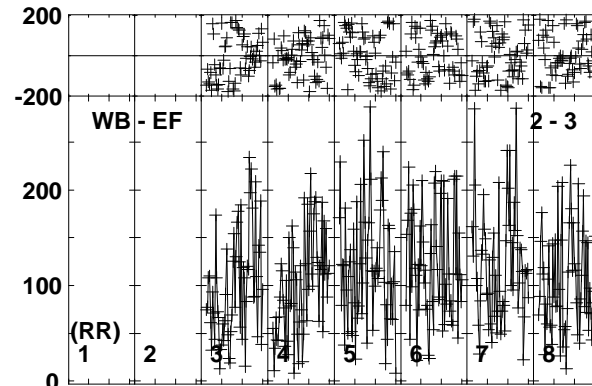
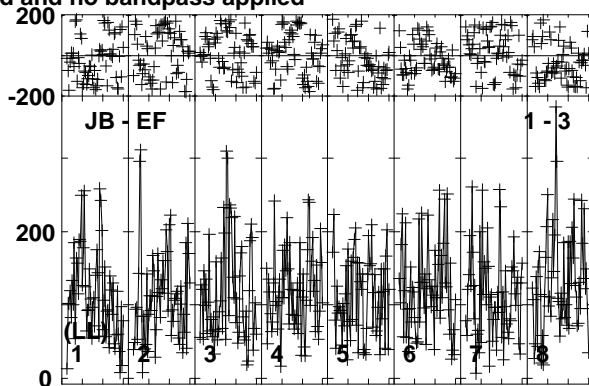
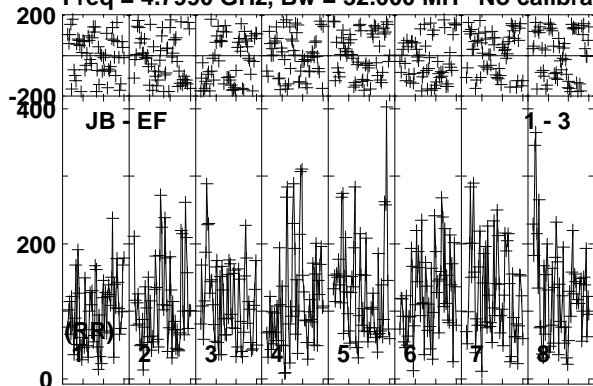

Lower frame: Micro Ampl Jy Top frame: Phas deg
Vector averaged cross-power spectrum Baseline: JB (01) - EF (03)
Timerange: 01/06:26:06 to 01/06:28:15

Plot file version 673 created 26-SEP-2019 10:44:07

190829A RG010A.UVDATA.1

Freq = 4.7990 GHz, Bw = 32.000 MH No calibration applied and no bandpass applied

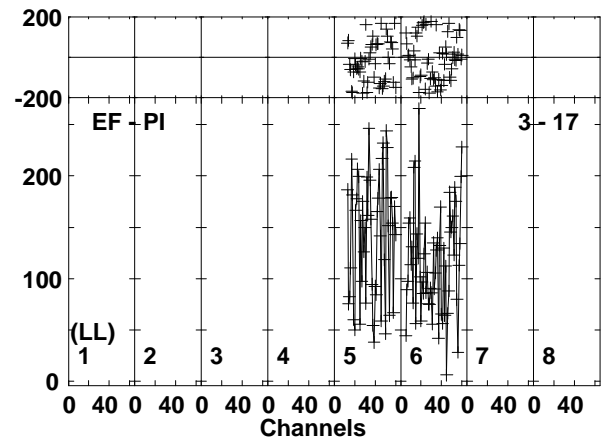
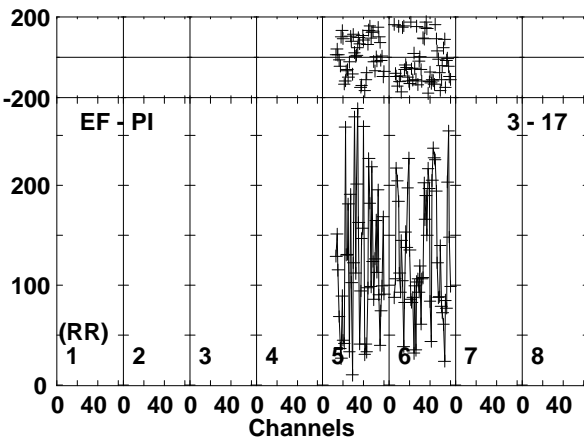
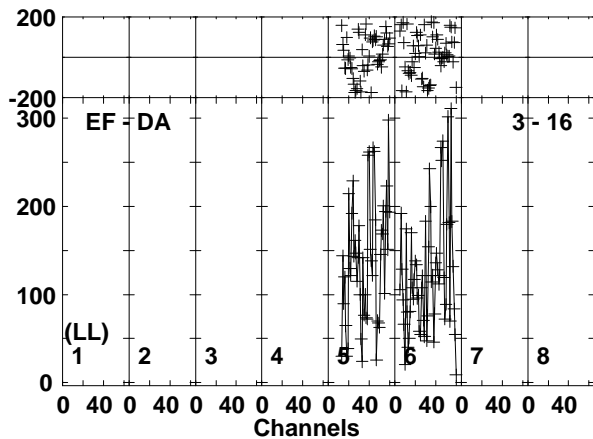
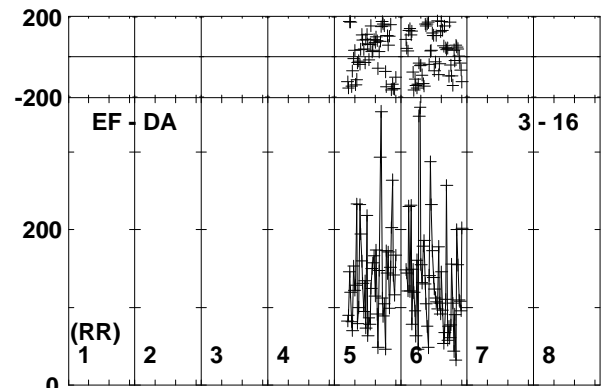
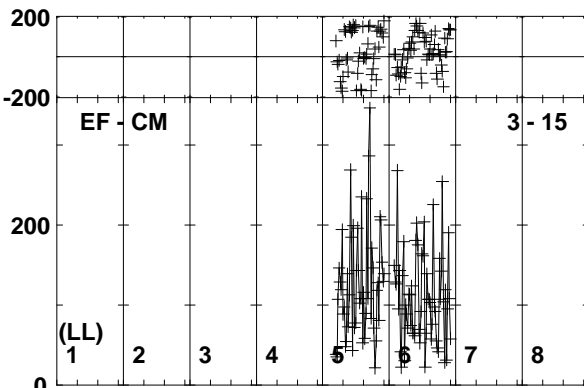
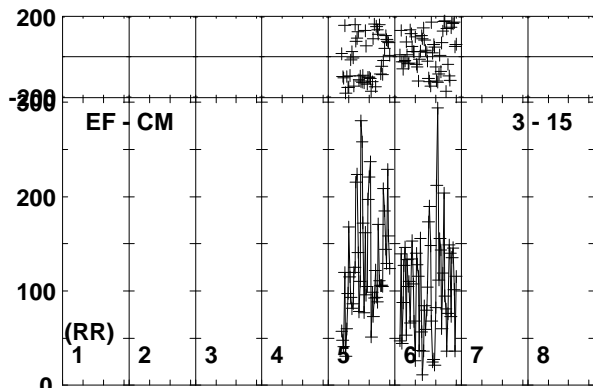
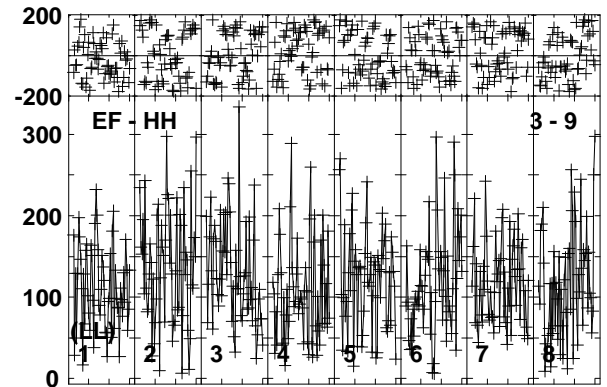
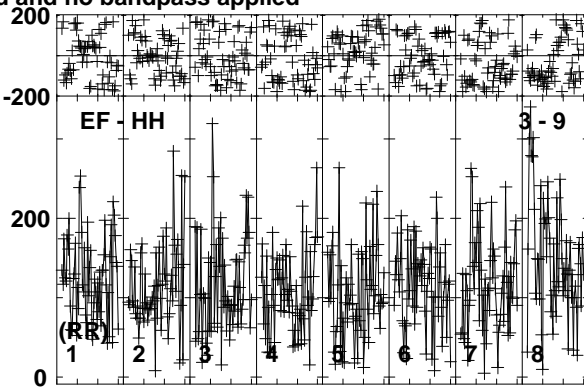
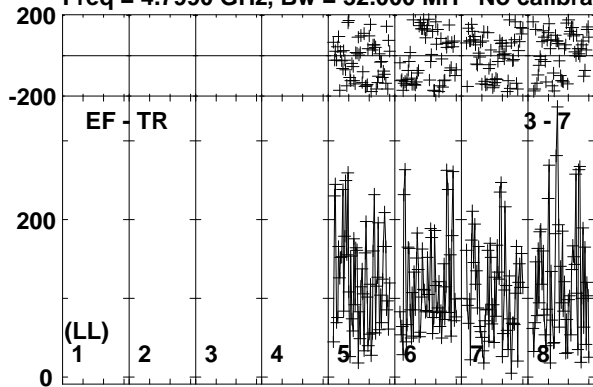

Lower frame: Micro Ampl Jy Top frame: Phas deg
Vector averaged cross-power spectrum Baseline: EF (03) - TR (07)
Timerange: 01/06:26:06 to 01/06:28:15

Plot file version 674 created 26-SEP-2019 10:44:07

190829A RG010A.UVDATA.1

Freq = 4.7990 GHz, Bw = 32.000 MH No calibration applied and no bandpass applied

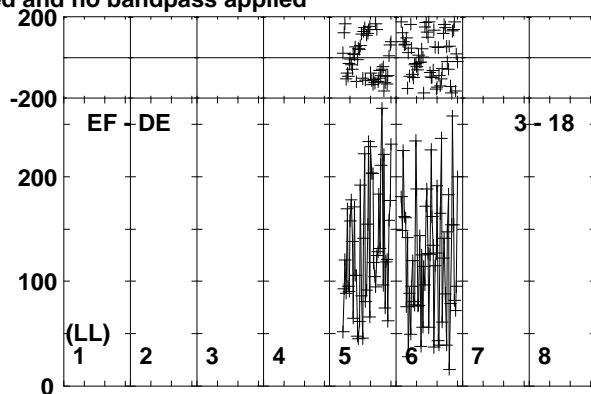
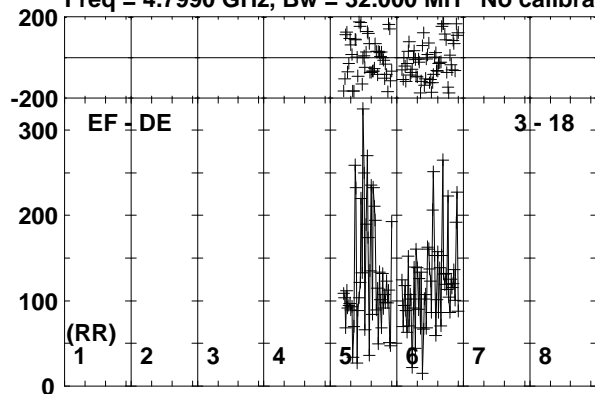

Lower frame: Micro Ampl Jy Top frame: Phas deg
Vector averaged cross-power spectrum Baseline: EF (03) - DE (18)
Timerange: 01/06:26:06 to 01/06:28:15

Plot file version 675 created 26-SEP-2019 10:44:07

J0257-1212 RG010A.UVDATA.1

Freq = 4.7990 GHz, Bw = 32.000 MH No calibration applied and no bandpass applied

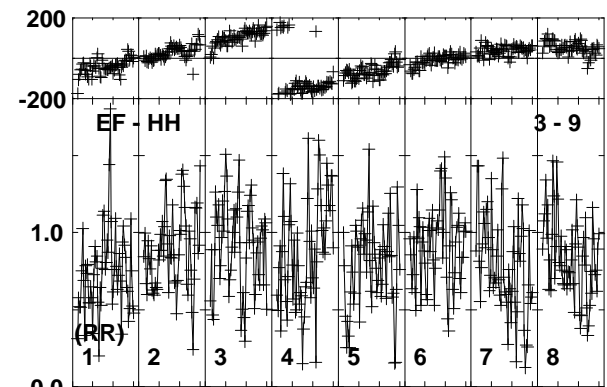
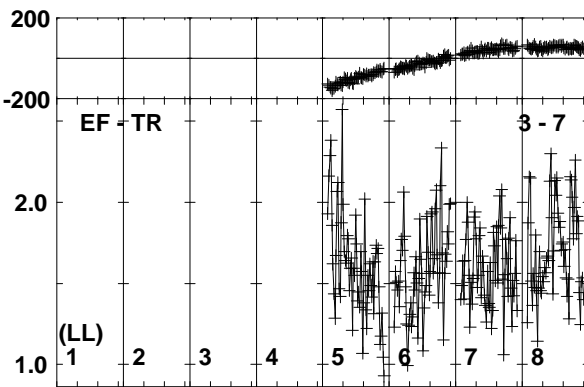
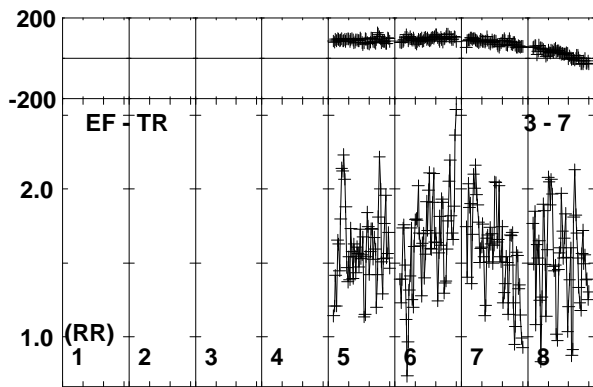
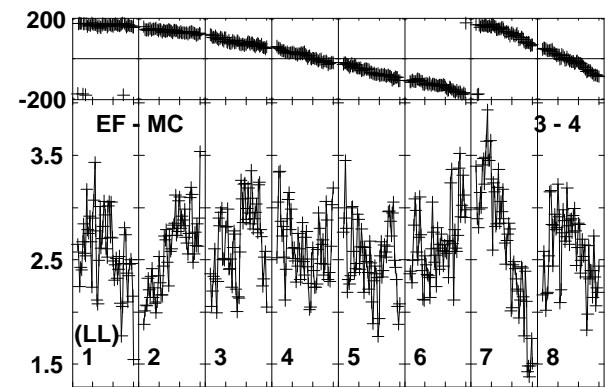
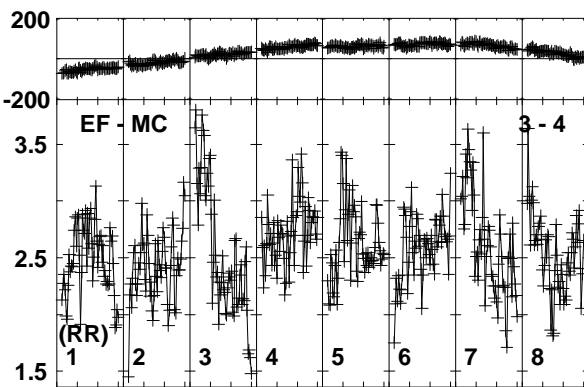
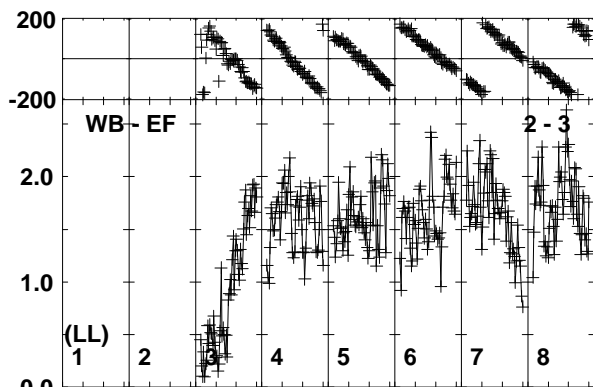
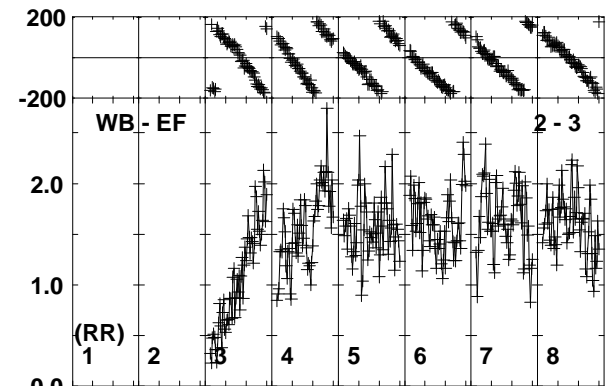
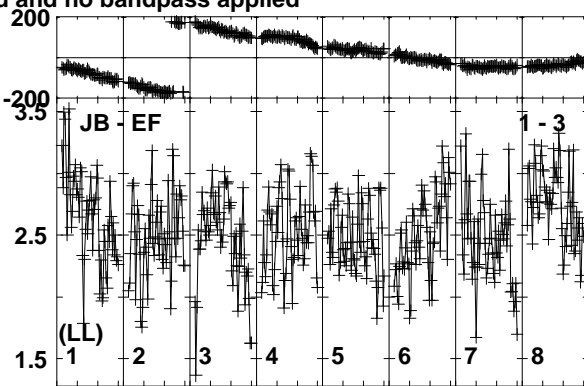
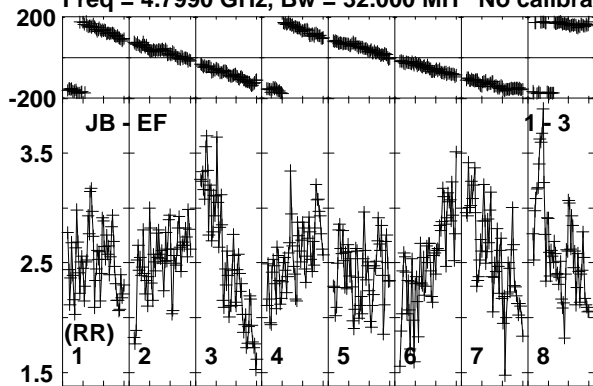

Lower frame: Milli Ampl Jy Top frame: Phas deg
Vector averaged cross-power spectrum Baseline: JB (01) - EF (03)
Timerange: 01/06:28:16 to 01/06:29:14

Plot file version 676 created 26-SEP-2019 10:44:07

J0257-1212 RG010A.UVDATA.1

Freq = 4.7990 GHz, Bw = 32.000 MH No calibration applied and no bandpass applied

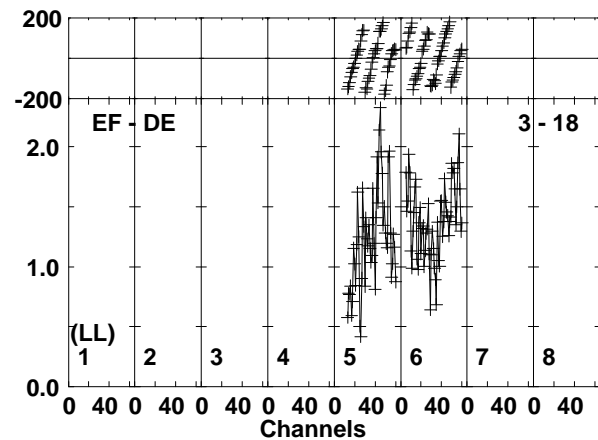
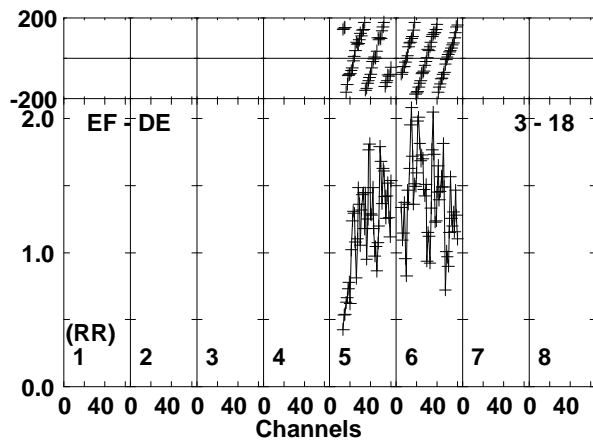
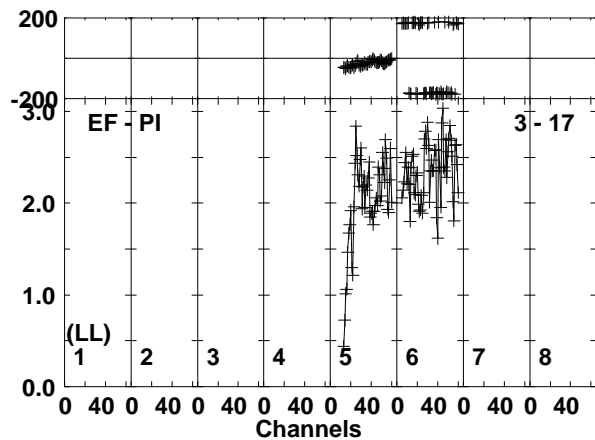
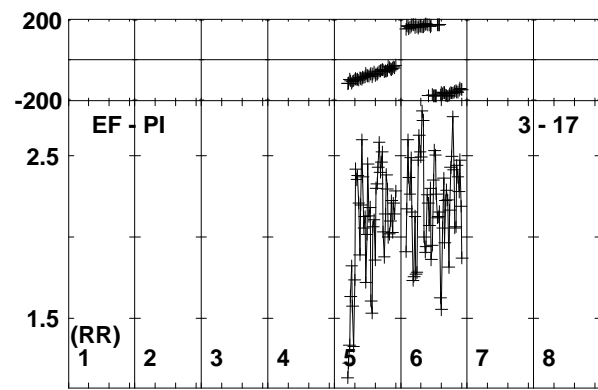
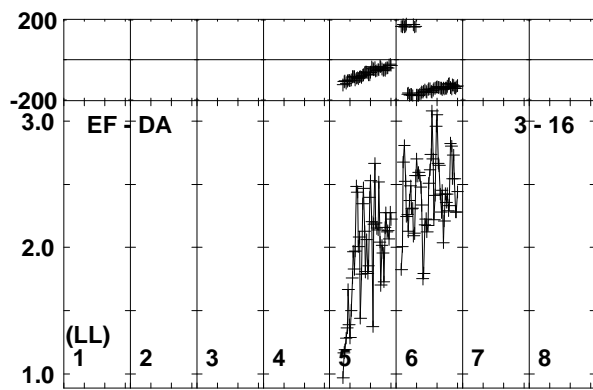
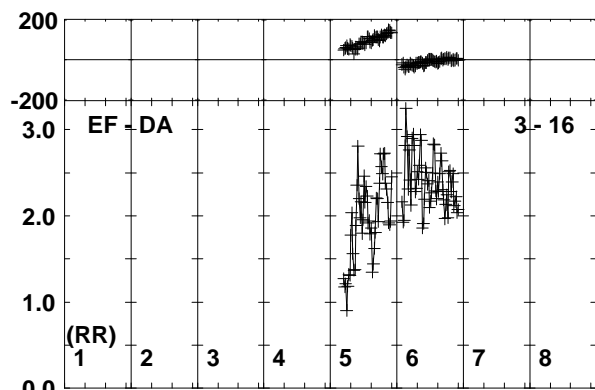
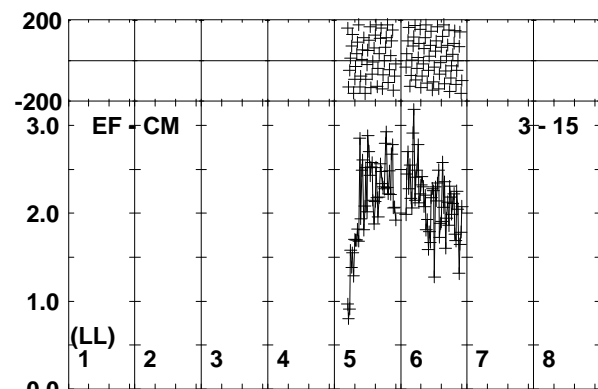
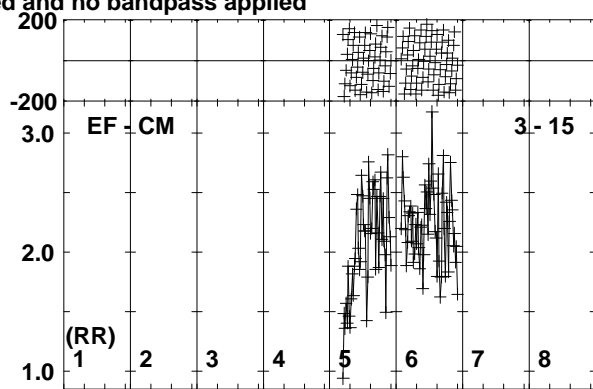
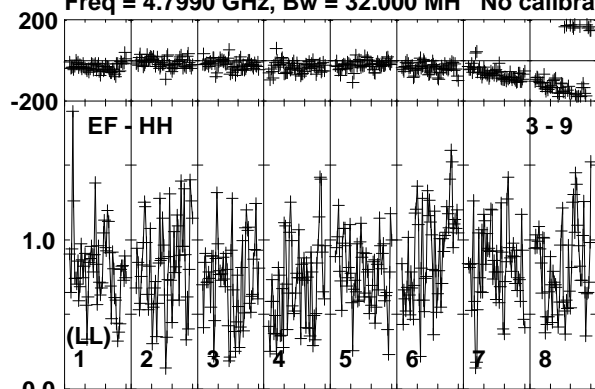

Lower frame: Milli Ampl Jy Top frame: Phas deg
Vector averaged cross-power spectrum Baseline: EF (03) - HH (09)
Timerange: 01/06:28:16 to 01/06:29:14

Plot file version 677 created 26-SEP-2019 10:44:08
 190829A RG010A.UVDATA.1

Freq = 4.7990 GHz, Bw = 32.000 MH No calibration applied and no bandpass applied

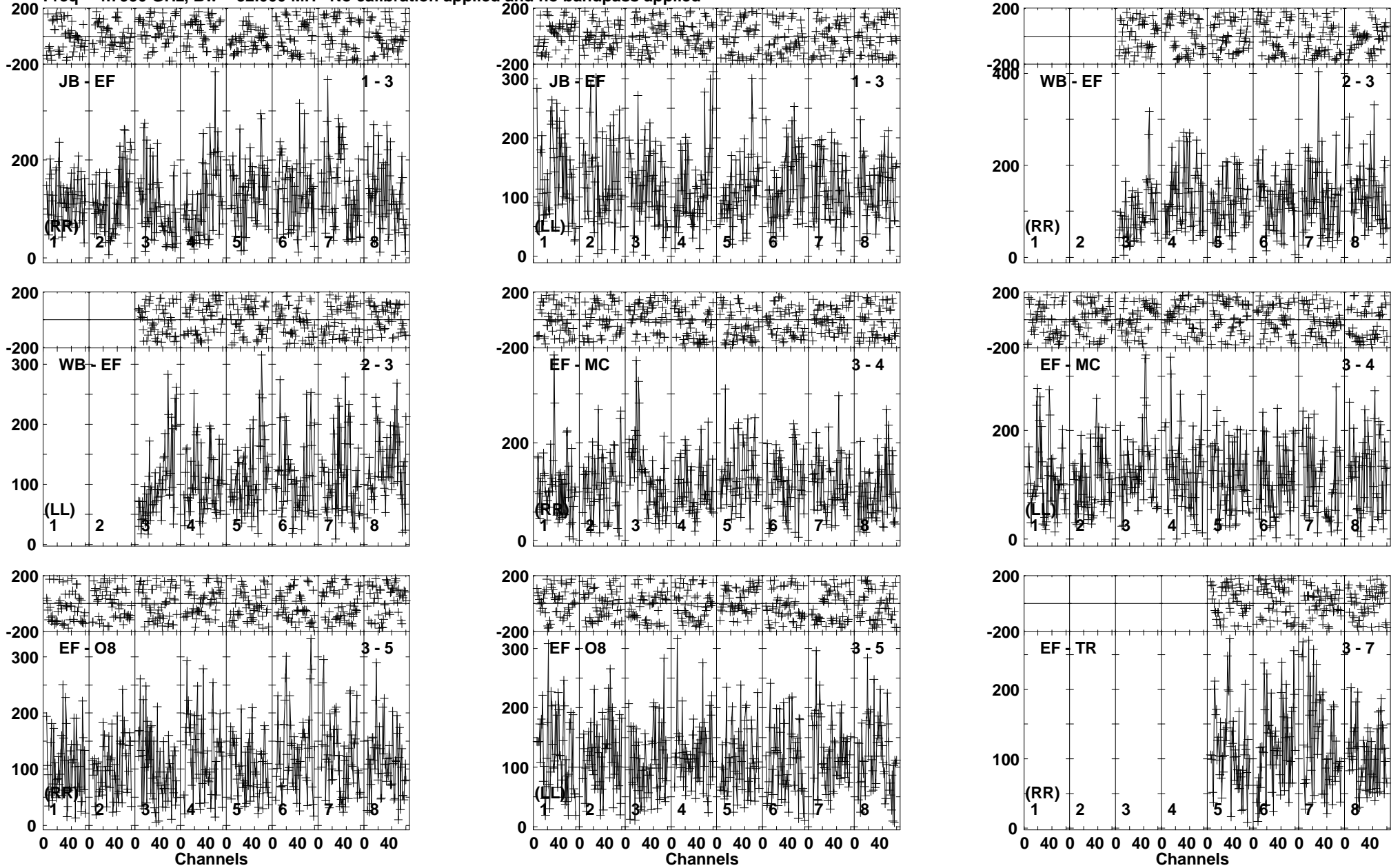

Lower frame: Micro Ampl Jy Top frame: Phas deg
 Vector averaged cross-power spectrum Baseline: JB (01) - EF (03)
 Timerange: 01/06:29:15 to 01/06:31:24

Plot file version 678 created 26-SEP-2019 10:44:08

190829A RG010A.UVDATA.1

Freq = 4.7990 GHz, Bw = 32.000 MH No calibration applied and no bandpass applied

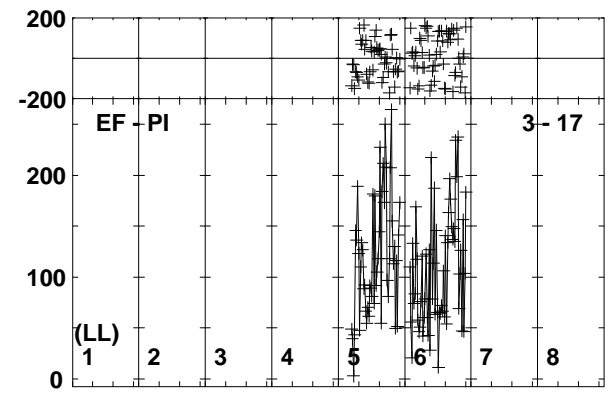
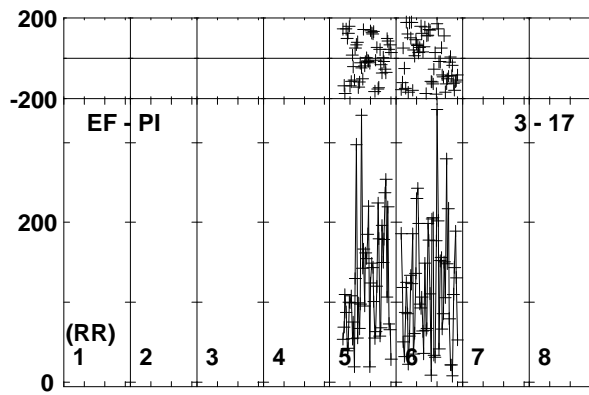
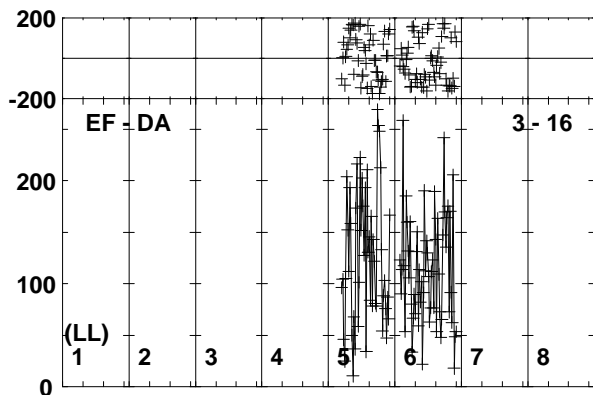
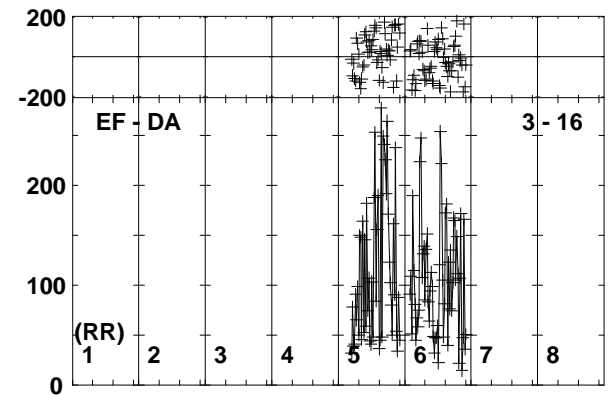
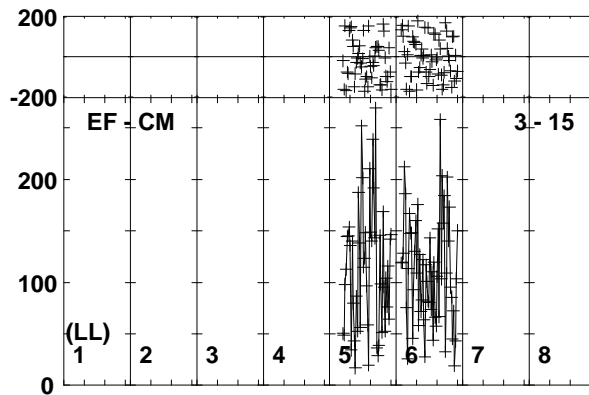
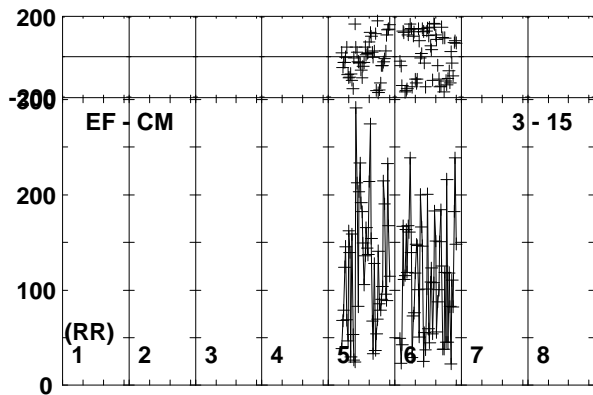
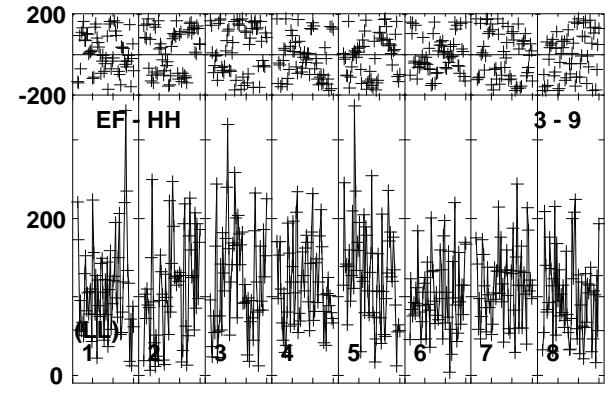
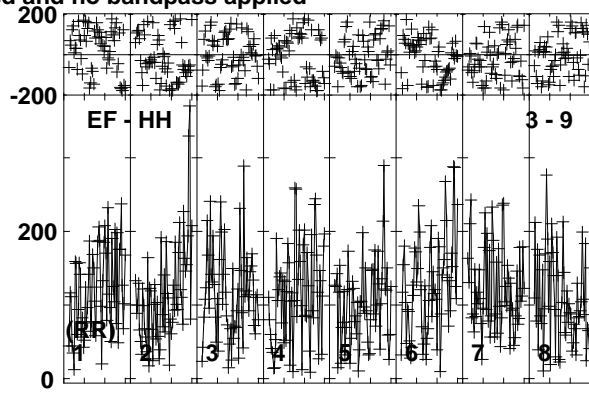
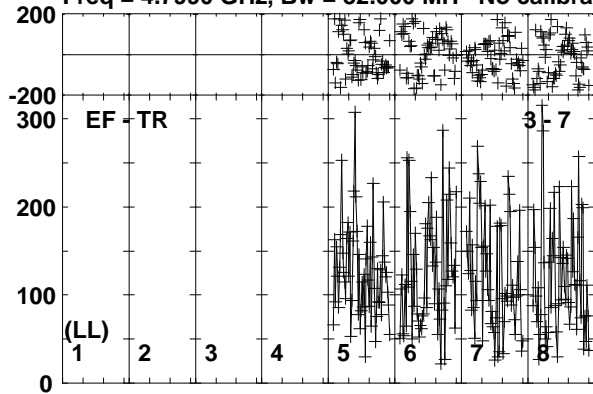

Lower frame: Micro Ampl Jy Top frame: Phas deg
Vector averaged cross-power spectrum Baseline: EF (03) - TR (07)
Timerange: 01/06:29:15 to 01/06:31:24

Plot file version 679 created 26-SEP-2019 10:44:08

190829A RG010A.UVDATA.1

Freq = 4.7990 GHz, Bw = 32.000 MH No calibration applied and no bandpass applied

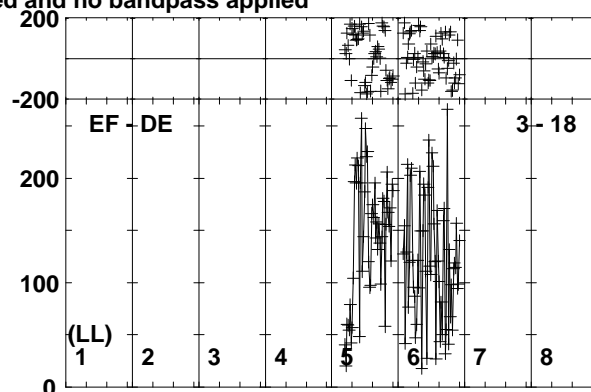
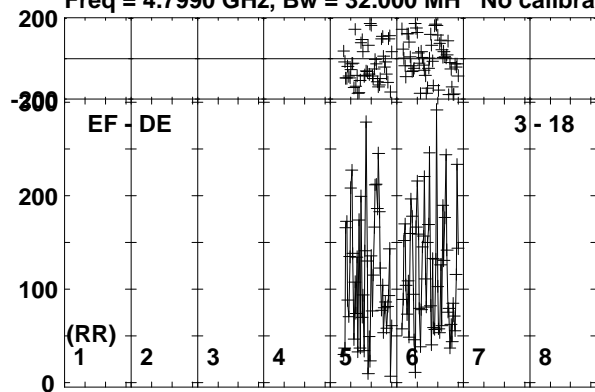

Lower frame: Micro Ampl Jy Top frame: Phas deg
Vector averaged cross-power spectrum Baseline: EF (03) - DE (18)
Timerange: 01/06:29:15 to 01/06:31:24

Plot file version 680 created 26-SEP-2019 10:44:08

J0257-1212 RG010A.UVDATA.1

Freq = 4.7990 GHz, Bw = 32.000 MH No calibration applied and no bandpass applied

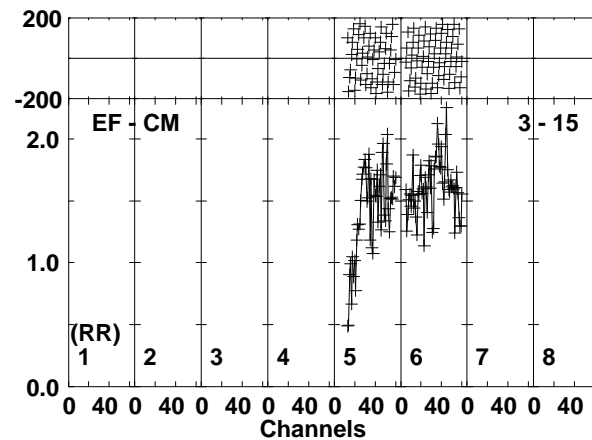
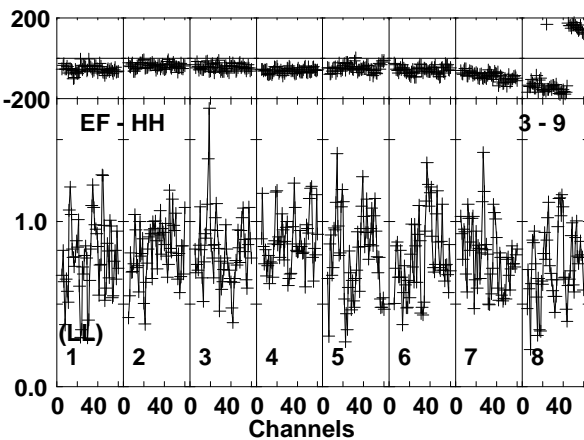
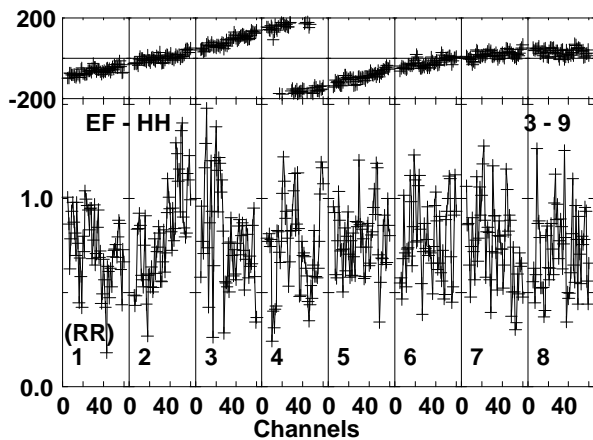
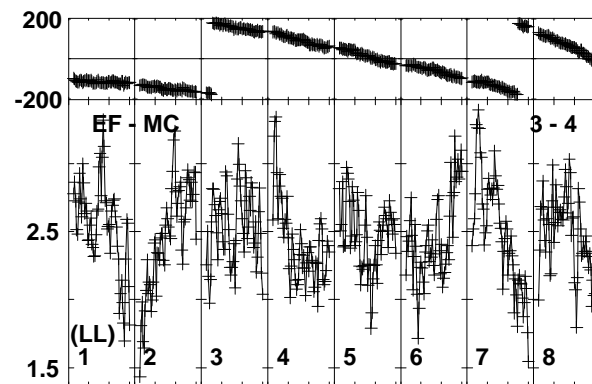
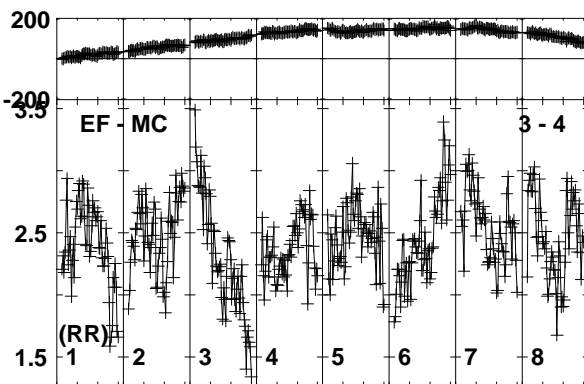
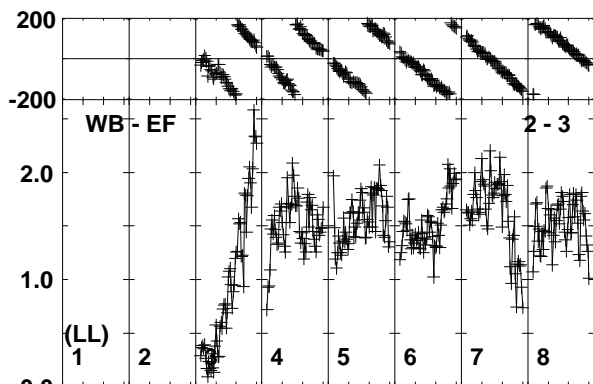
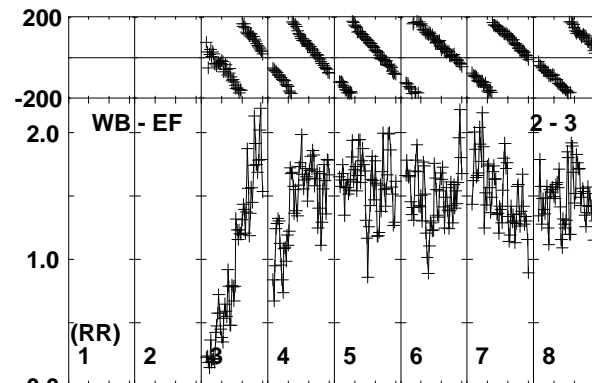
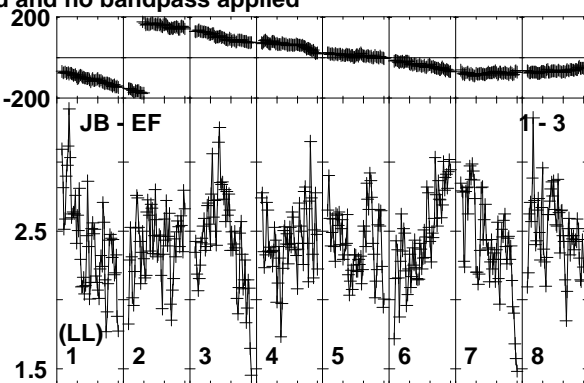
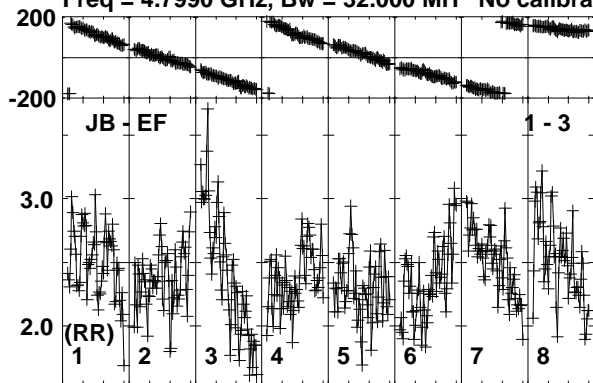

Lower frame: Milli Ampl Jy Top frame: Phas deg
Vector averaged cross-power spectrum Baseline: JB (01) - EF (03)
Timerange: 01/06:32:06 to 01/06:32:35

Plot file version 681 created 26-SEP-2019 10:44:09

J0257-1212 RG010A.UVDATA.1

Freq = 4.7990 GHz, Bw = 32.000 MH No calibration applied and no bandpass applied

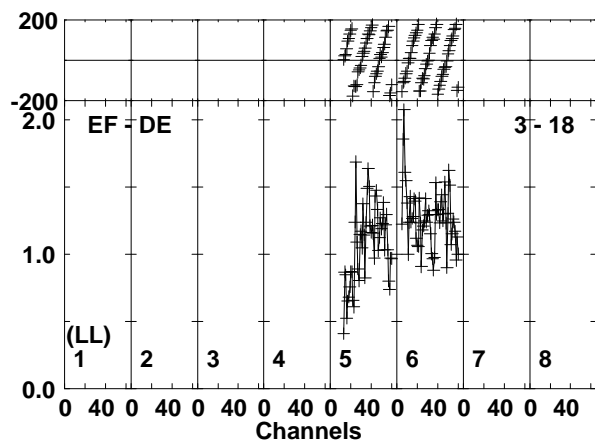
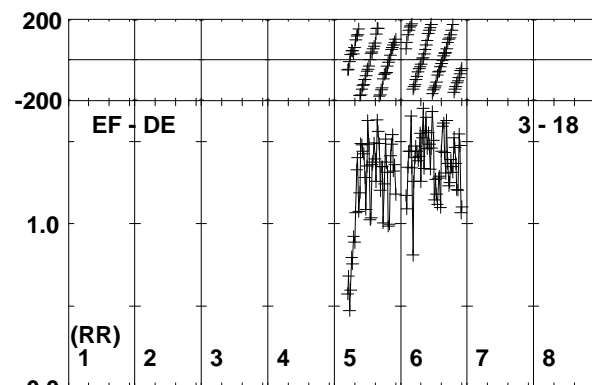
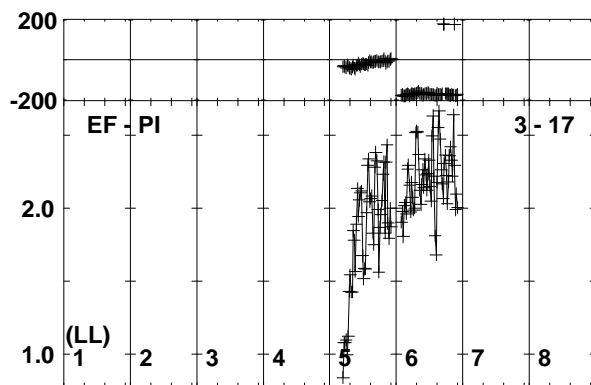
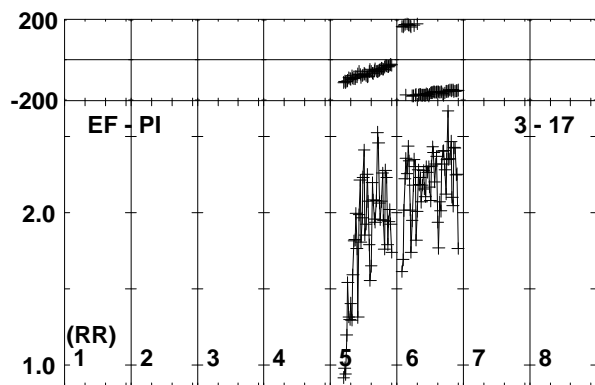
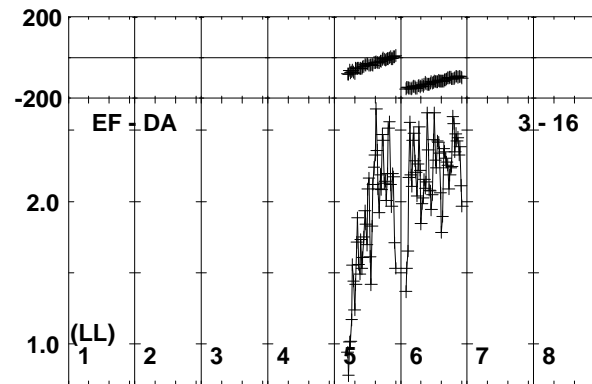
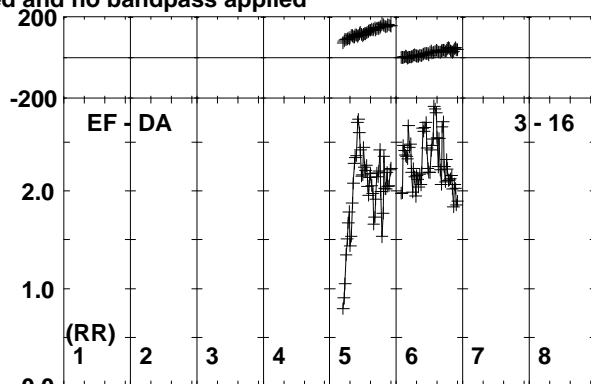
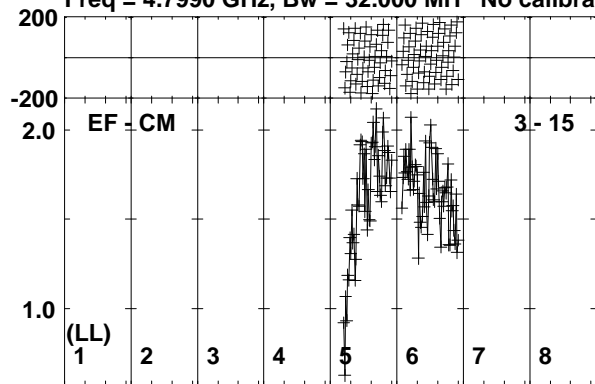

Lower frame: Milli Ampl Jy Top frame: Phas deg
Vector averaged cross-power spectrum Baseline: EF (03) - CM (15)
Timerange: 01/06:32:06 to 01/06:32:35

Plot file version 682 created 26-SEP-2019 10:44:09

J0300-0846 RG010A.UVDATA.1

Freq = 4.7990 GHz, Bw = 32.000 MH No calibration applied and no bandpass applied

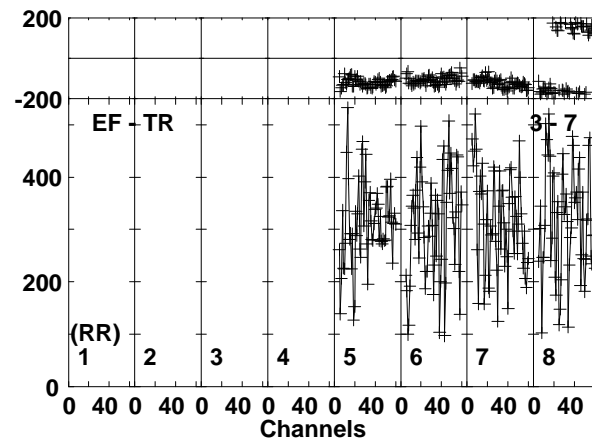
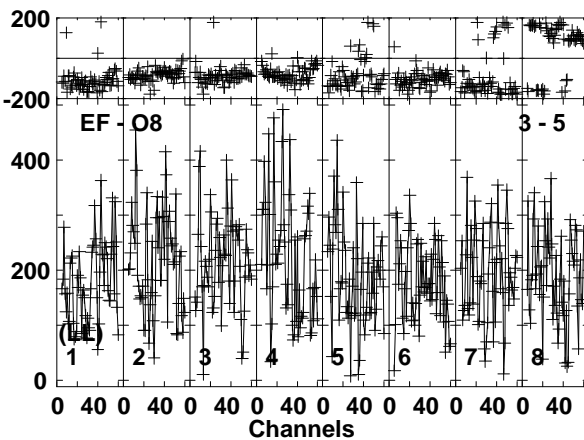
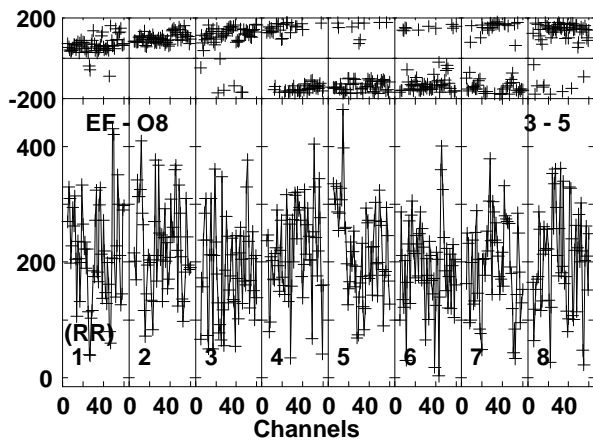
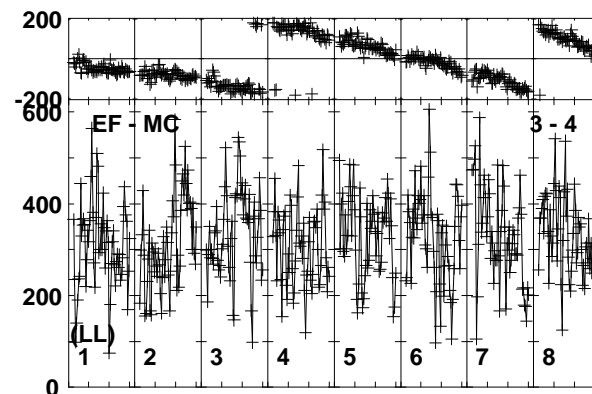
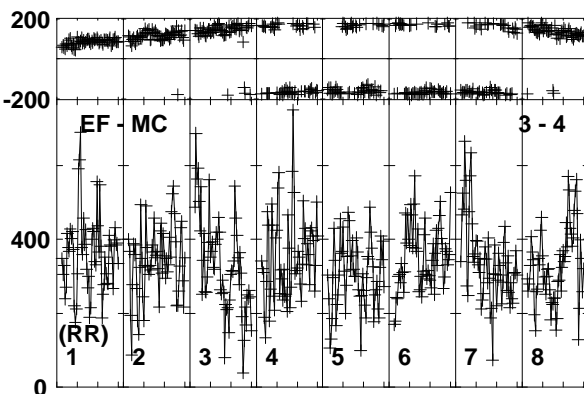
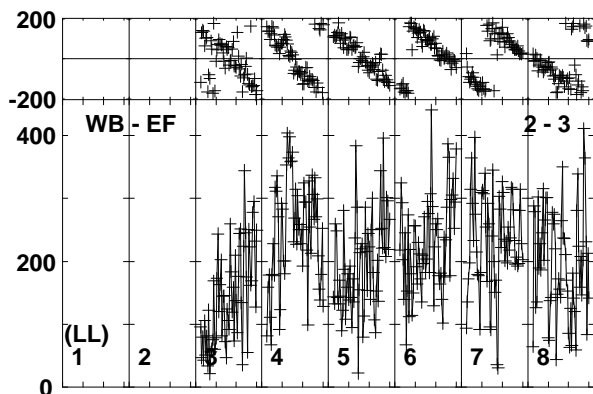
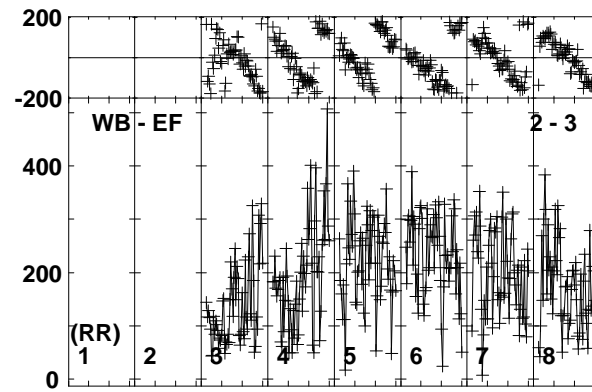
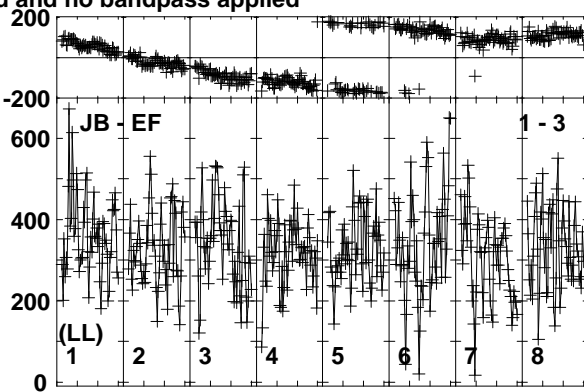
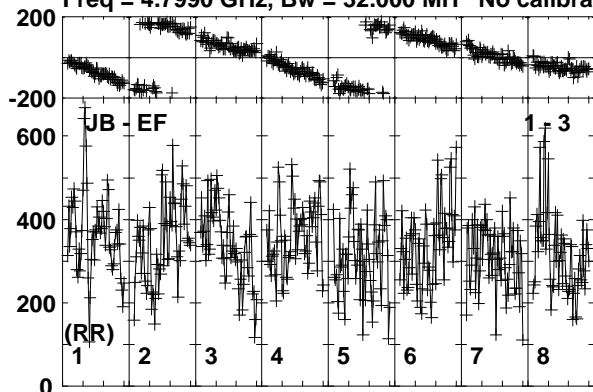

Lower frame: Micro Ampl Jy Top frame: Phas deg
Vector averaged cross-power spectrum Baseline: JB (01) - EF (03)
Timerange: 01/06:32:35 to 01/06:34:44

Plot file version 683 created 26-SEP-2019 10:44:09

J0300-0846 RG010A.UVDATA.1

Freq = 4.7990 GHz, Bw = 32.000 MH No calibration applied and no bandpass applied

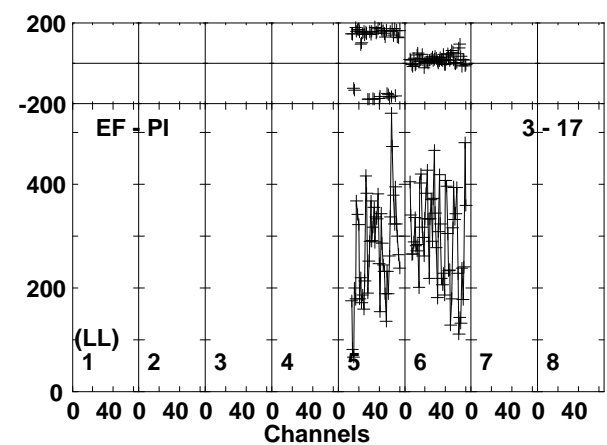
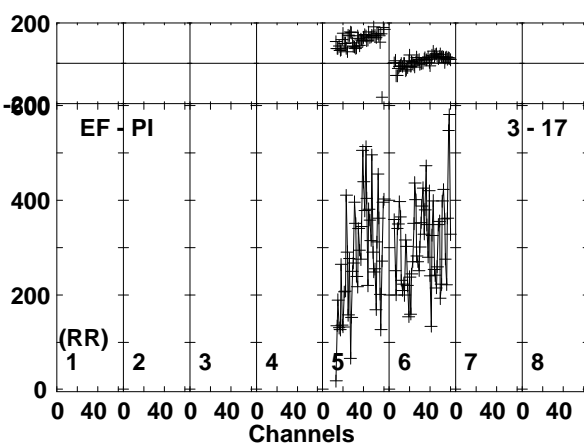
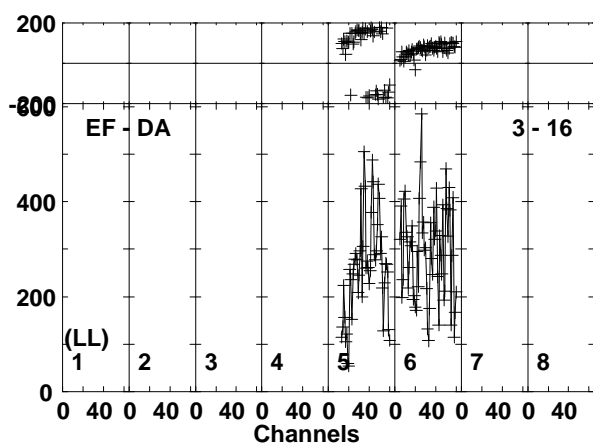
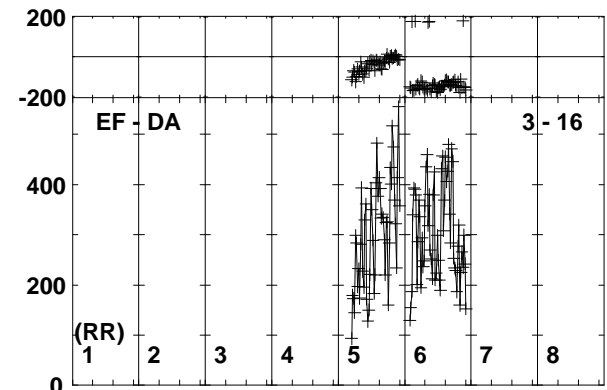
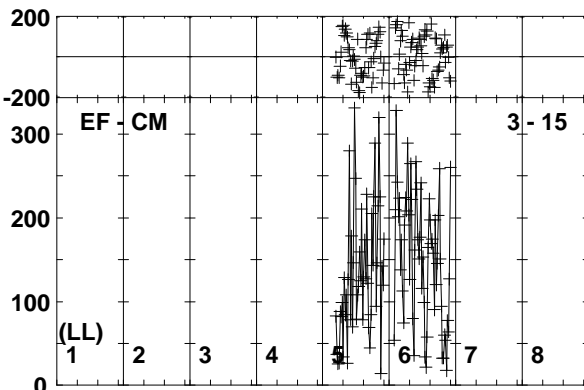
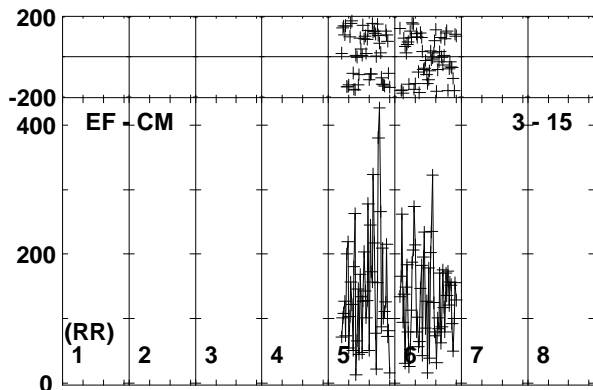
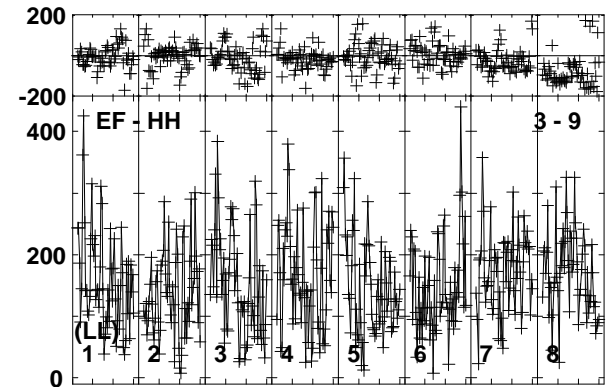
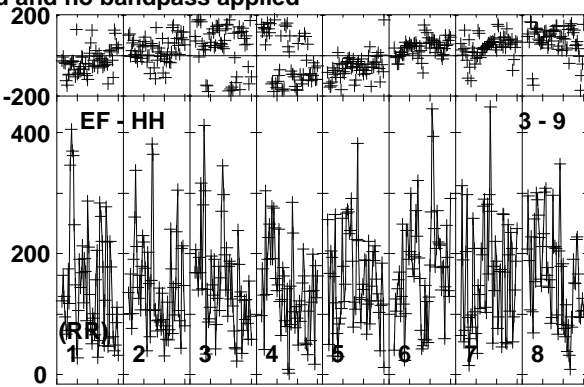
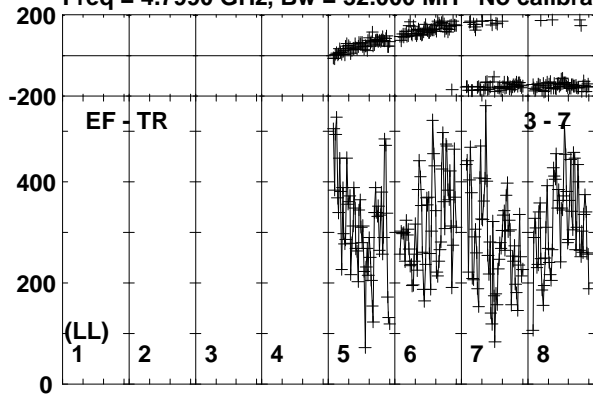

Lower frame: Micro Ampl Jy Top frame: Phas deg
Vector averaged cross-power spectrum Baseline: EF (03) - TR (07)
Timerange: 01/06:32:35 to 01/06:34:44

Plot file version 684 created 26-SEP-2019 10:44:10

J0300-0846 RG010A.UVDATA.1

Freq = 4.7990 GHz, Bw = 32.000 MH No calibration applied and no bandpass applied

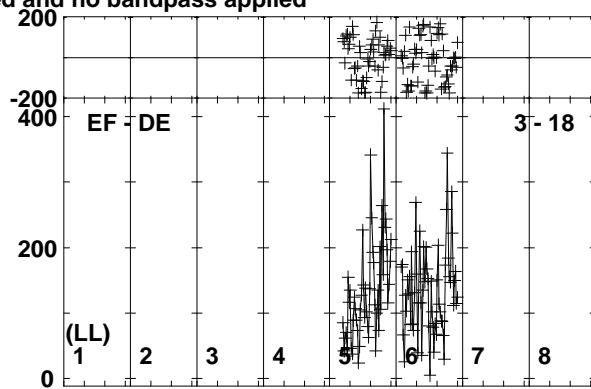
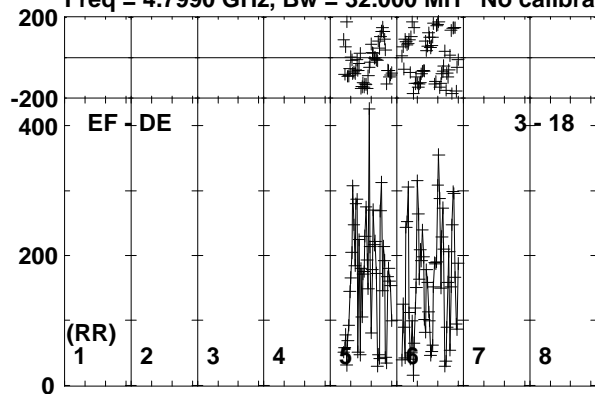

Lower frame: Micro Ampl Jy Top frame: Phas deg
Vector averaged cross-power spectrum Baseline: EF (03) - DE (18)
Timerange: 01/06:32:35 to 01/06:34:44

Plot file version 685 created 26-SEP-2019 10:44:10

J0257-1212 RG010A.UVDATA.1

Freq = 4.7990 GHz, Bw = 32.000 MH No calibration applied and no bandpass applied

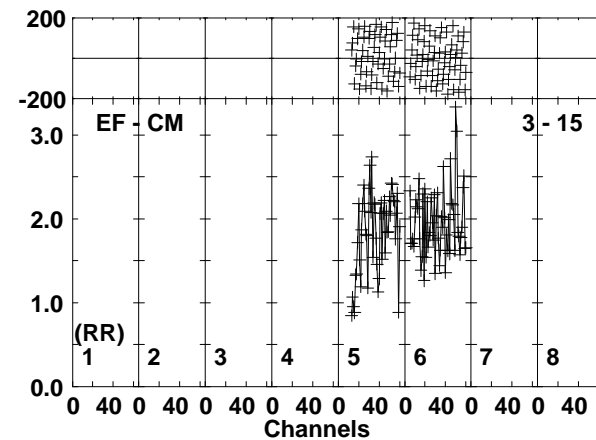
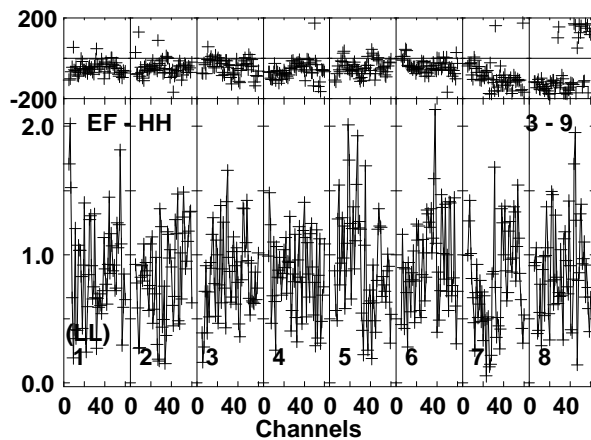
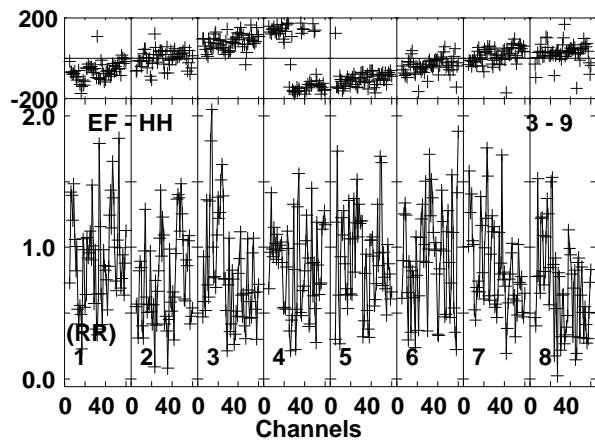
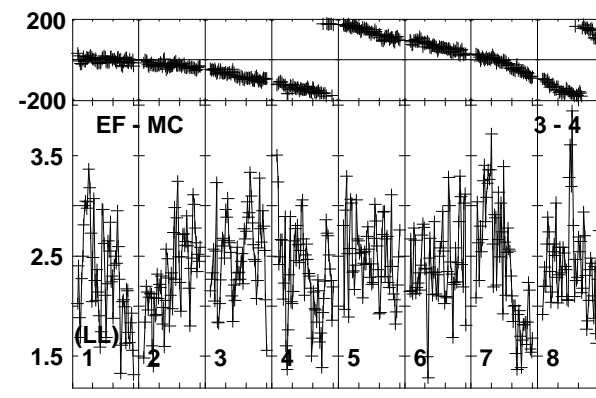
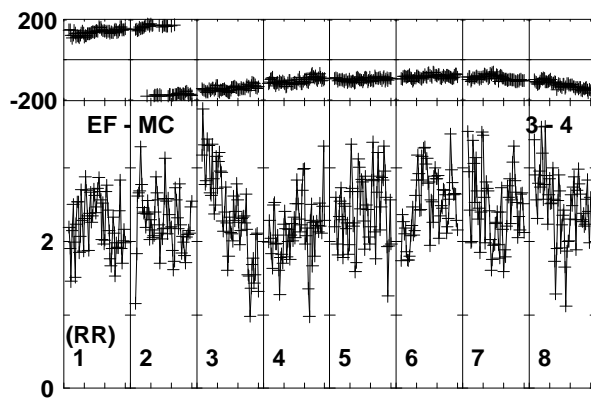
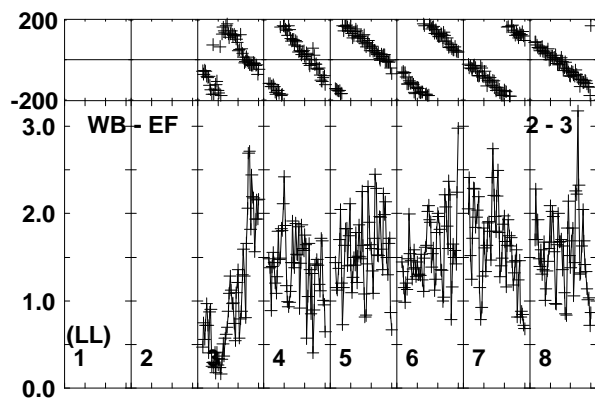
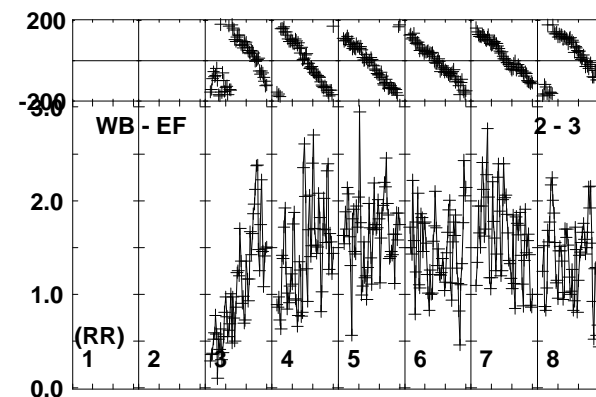
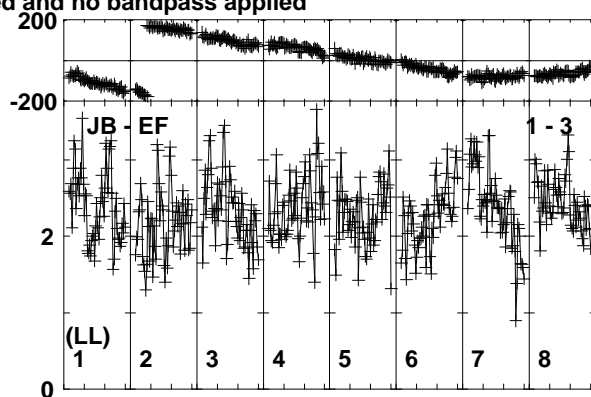
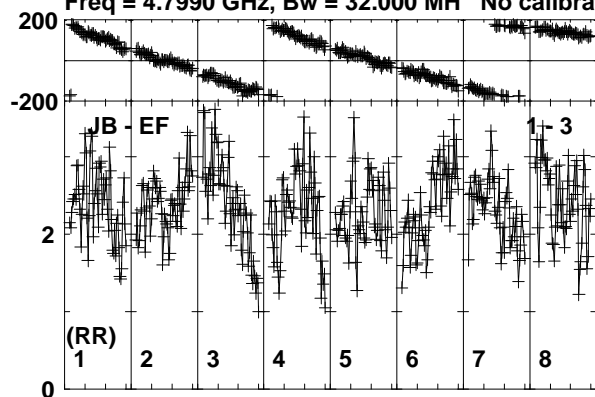

Lower frame: Milli Ampl Jy Top frame: Phas deg
Vector averaged cross-power spectrum Baseline: JB (01) - EF (03)
Timerange: 01/06:34:46 to 01/06:35:44

Plot file version 686 created 26-SEP-2019 10:44:10

J0257-1212 RG010A.UVDATA.1

Freq = 4.7990 GHz, Bw = 32.000 MH No calibration applied and no bandpass applied

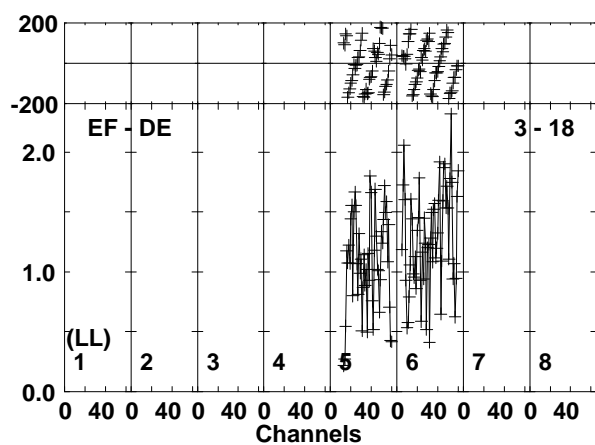
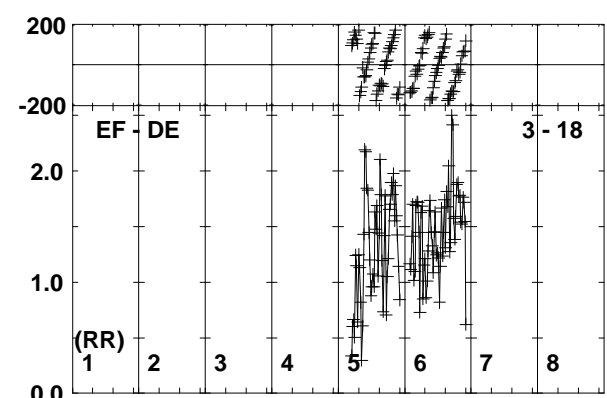
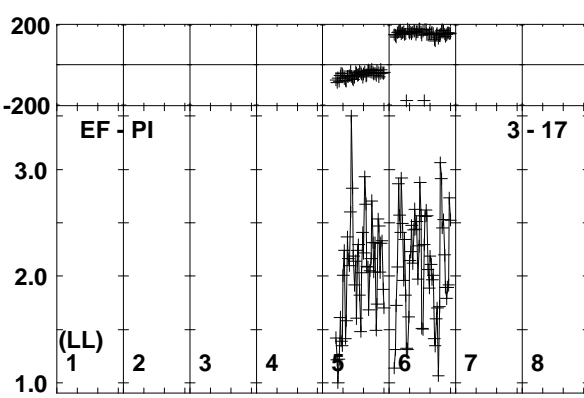
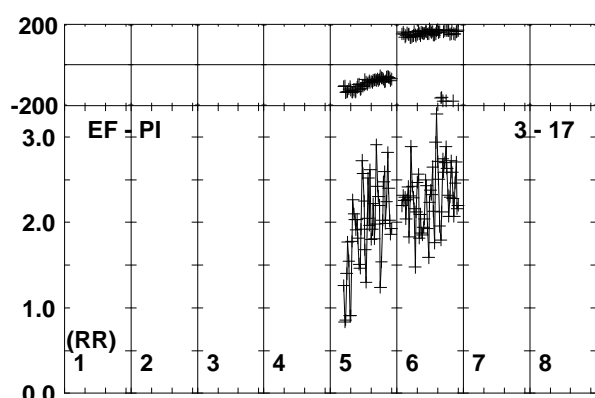
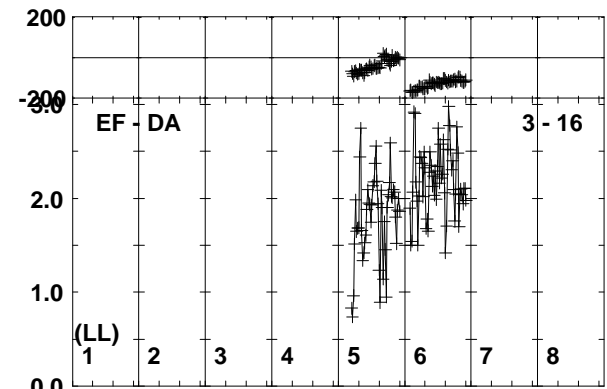
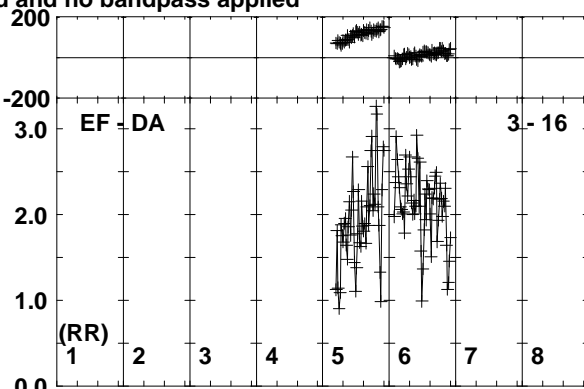
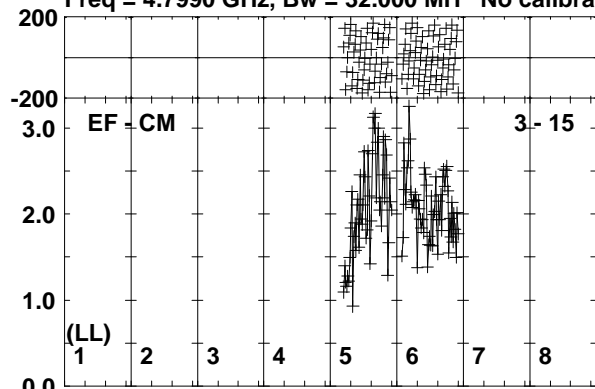

Lower frame: Milli Ampl Jy Top frame: Phas deg
Vector averaged cross-power spectrum Baseline: EF (03) - CM (15)
Timerange: 01/06:34:46 to 01/06:35:44

Plot file version 687 created 26-SEP-2019 10:44:10

190829A RG010A.UVDATA.1

Freq = 4.7990 GHz, Bw = 32.000 MH No calibration applied and no bandpass applied

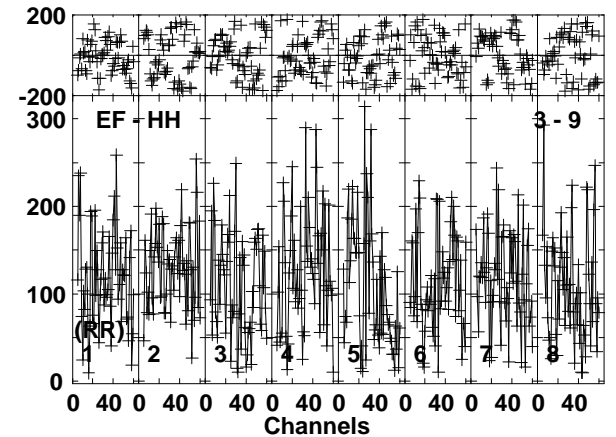
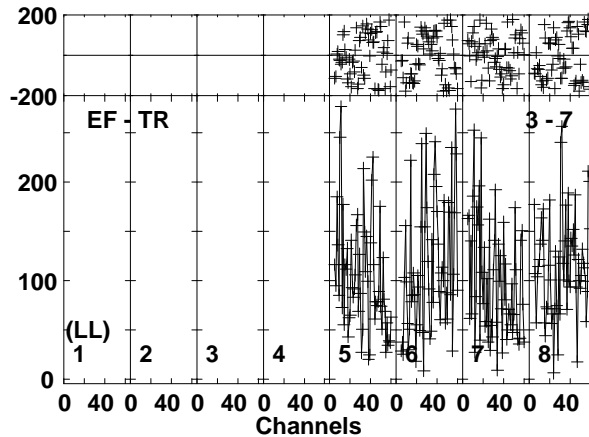
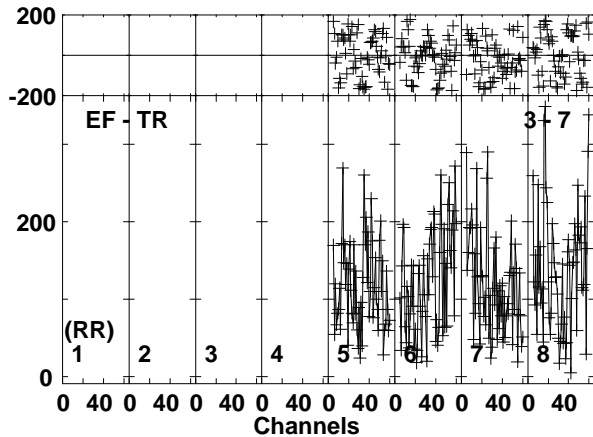
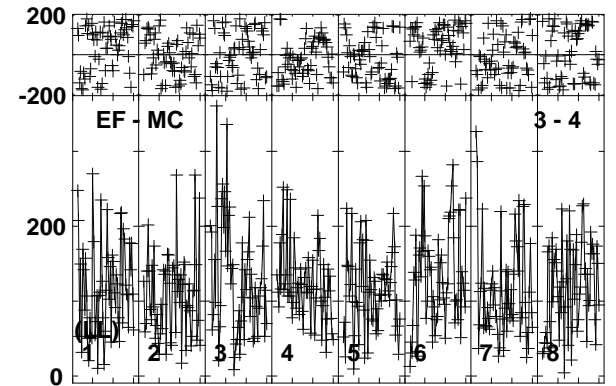
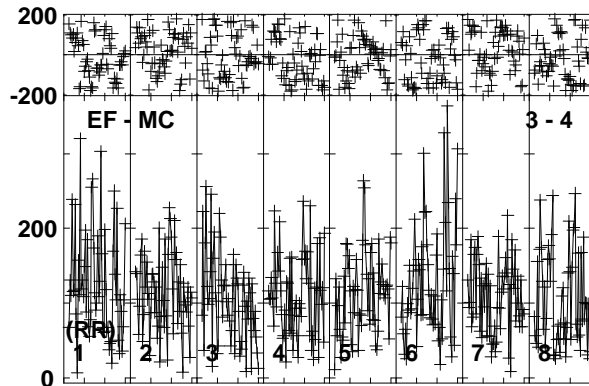
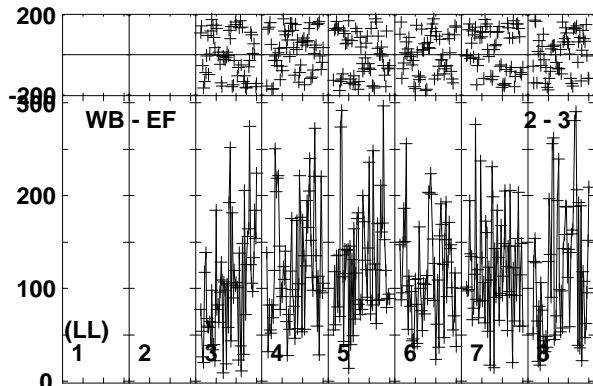
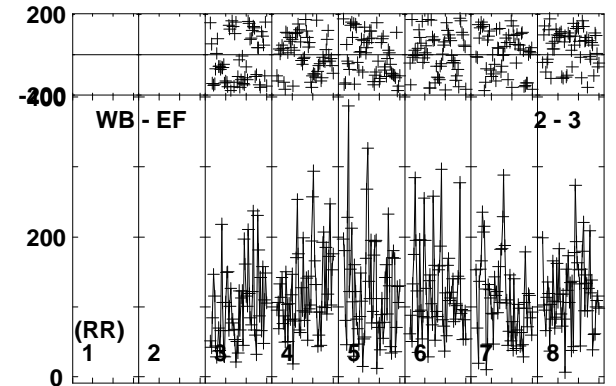
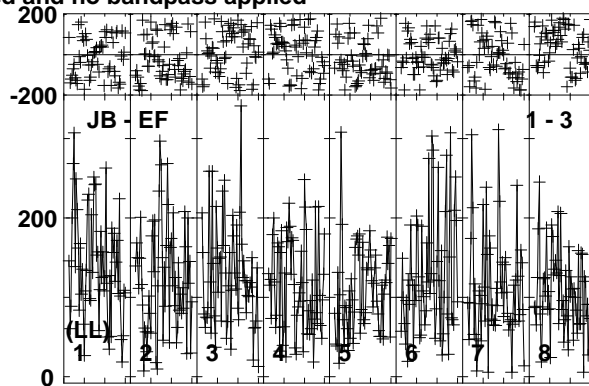
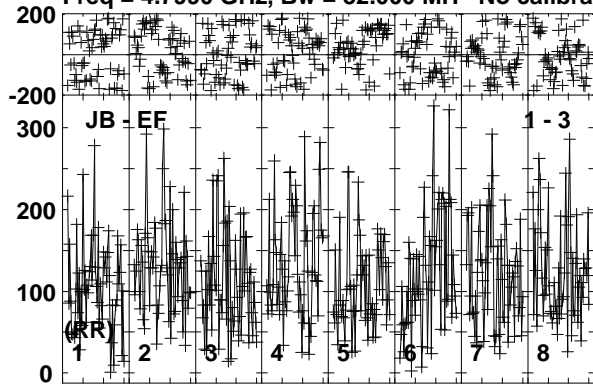

Lower frame: Micro Ampl Jy Top frame: Phas deg
Vector averaged cross-power spectrum Baseline: JB (01) - EF (03)
Timerange: 01/06:35:46 to 01/06:37:54

Plot file version 688 created 26-SEP-2019 10:44:11

190829A RG010A.UVDATA.1

Freq = 4.7990 GHz, Bw = 32.000 MH No calibration applied and no bandpass applied

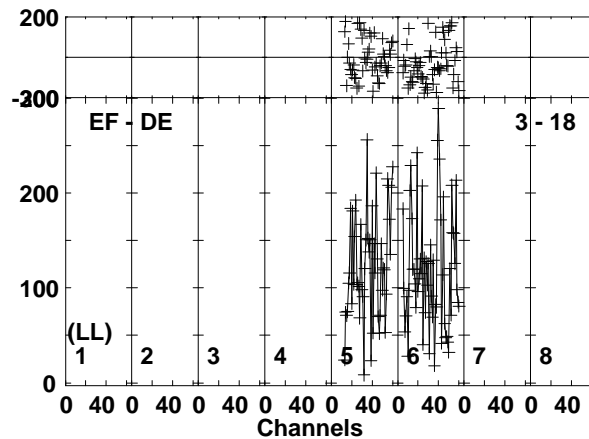
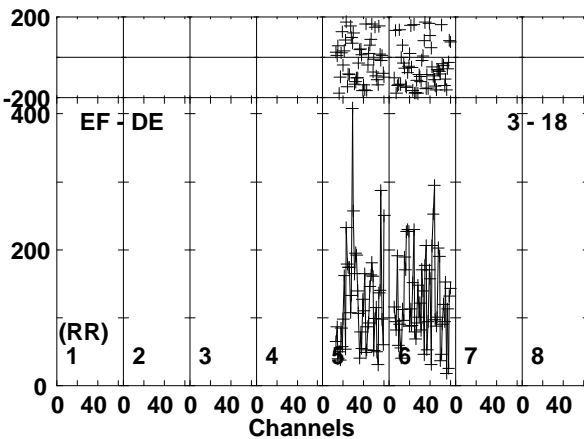
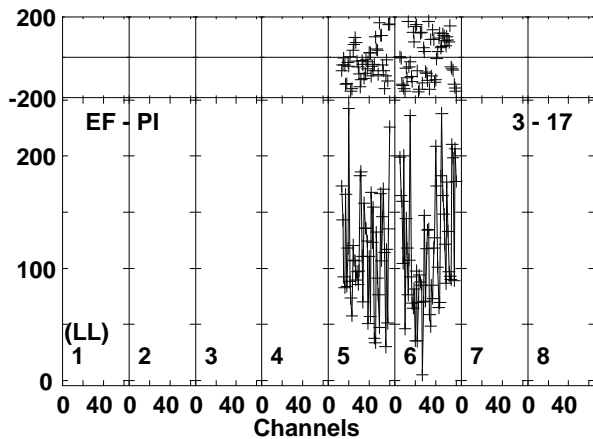
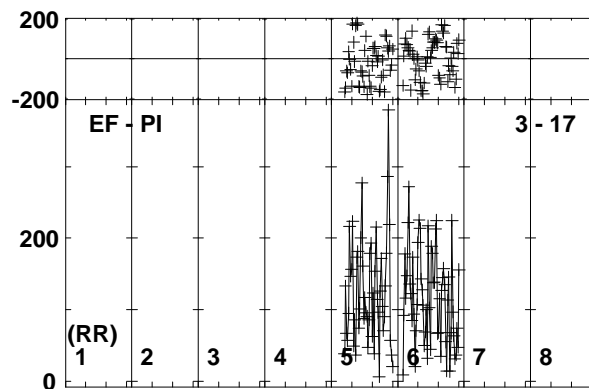
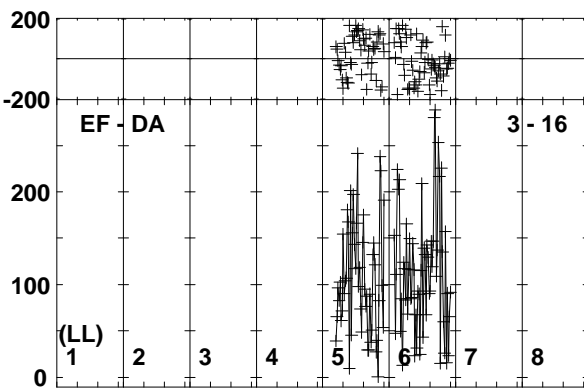
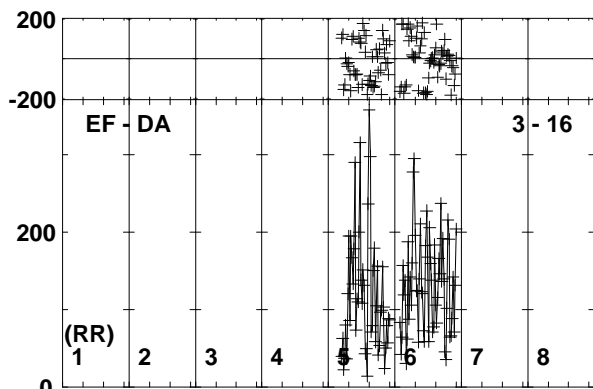
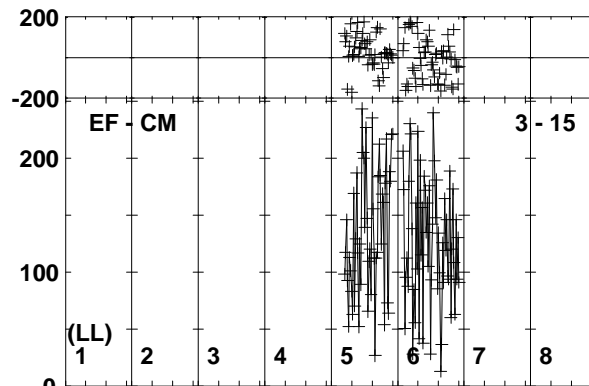
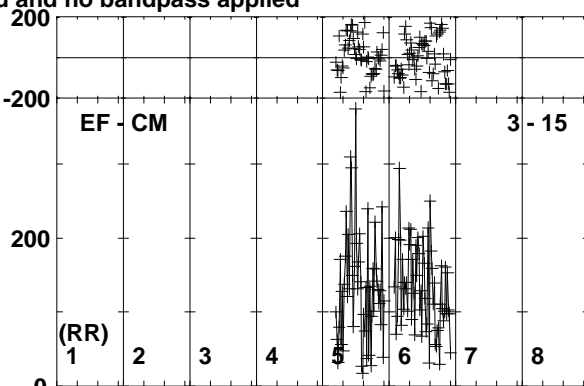
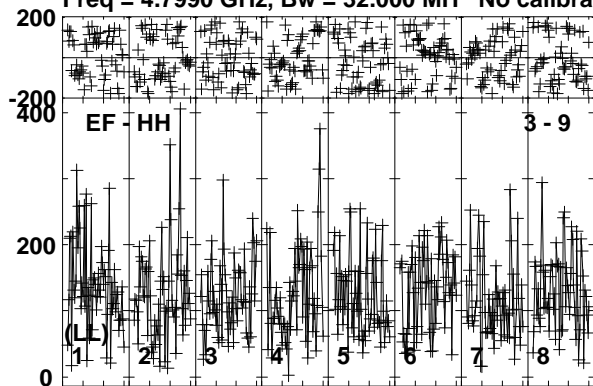

Lower frame: Micro Ampl Jy Top frame: Phas deg
Vector averaged cross-power spectrum Baseline: EF (03) - HH (09)
Timerange: 01/06:35:46 to 01/06:37:54

Plot file version 689 created 26-SEP-2019 10:44:11

J0257-1212 RG010A.UVDATA.1

Freq = 4.7990 GHz, Bw = 32.000 MH No calibration applied and no bandpass applied

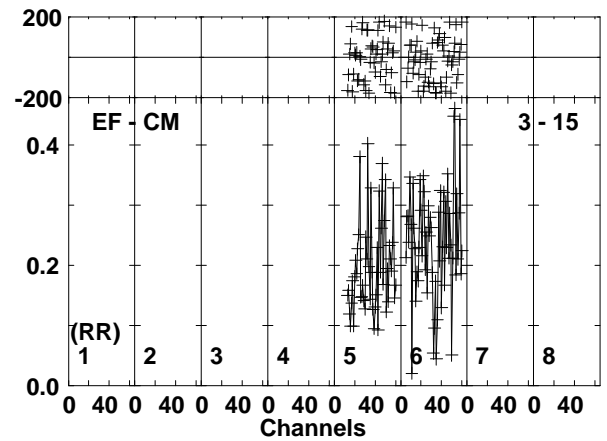
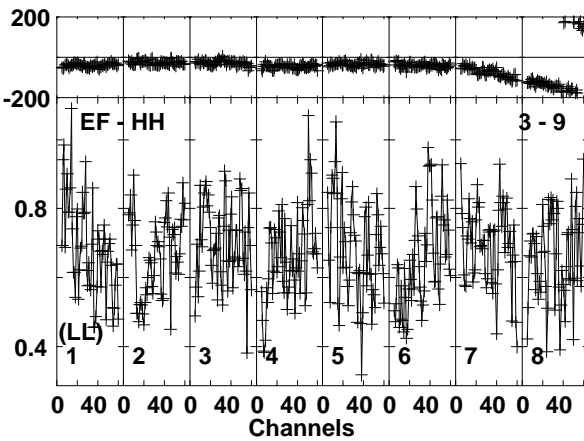
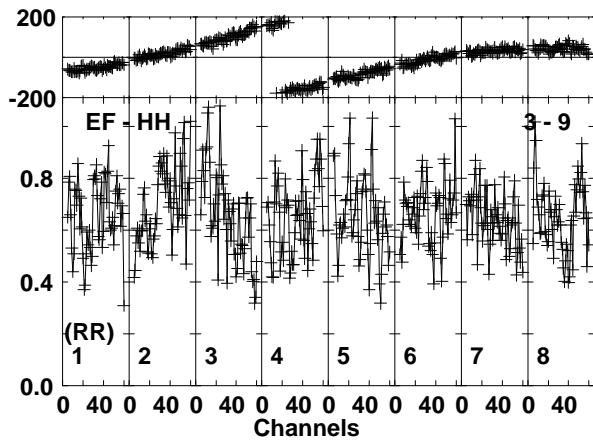
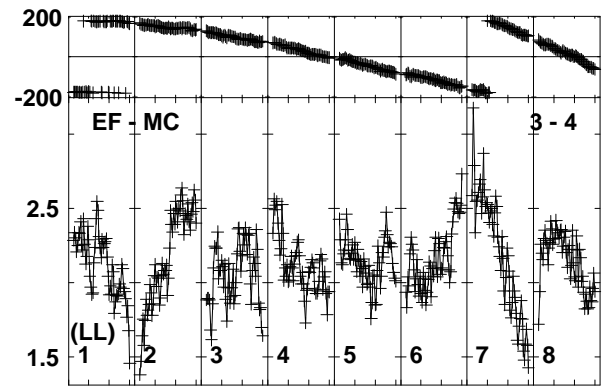
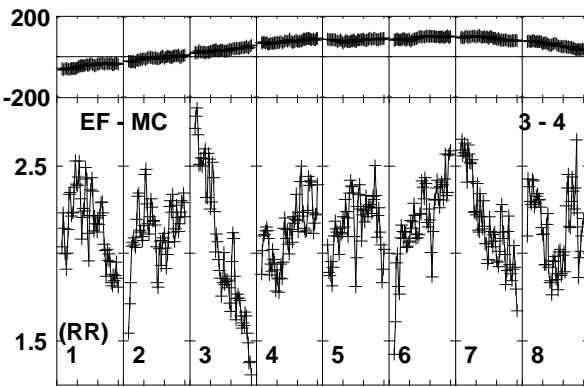
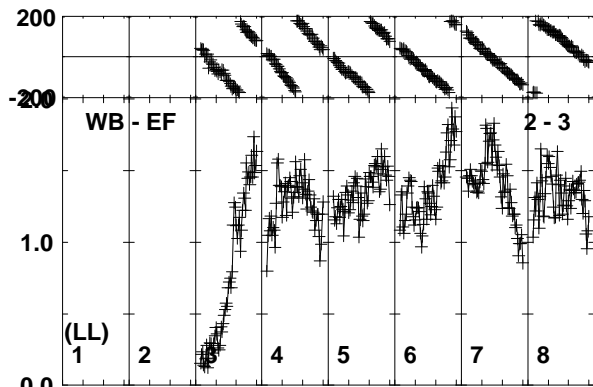
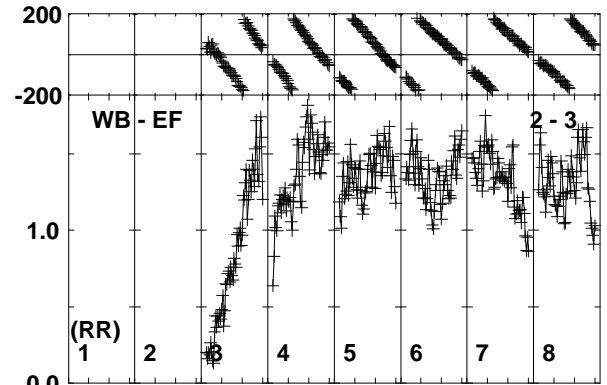
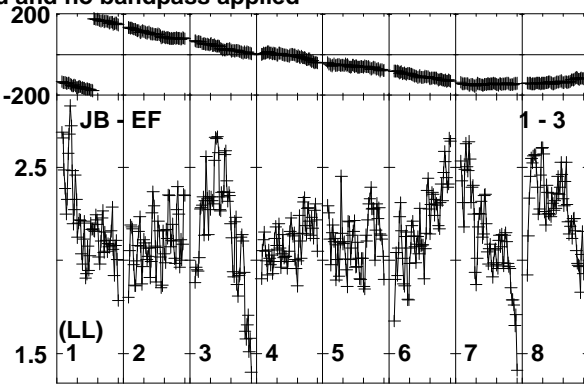
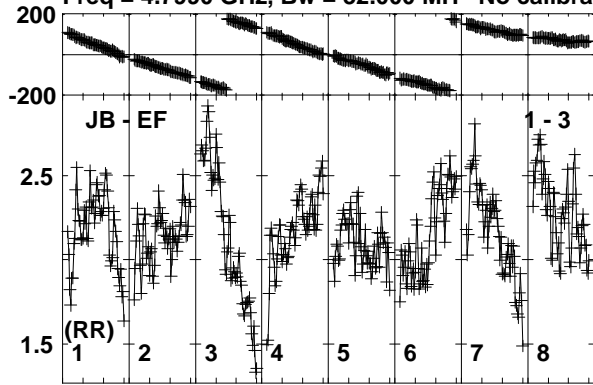

Lower frame: Milli Ampl Jy Top frame: Phas deg
Vector averaged cross-power spectrum Baseline: JB (01) - EF (03)
Timerange: 01/06:38:36 to 01/06:39:34

Plot file version 690 created 26-SEP-2019 10:44:11

J0257-1212 RG010A.UVDATA.1

Freq = 4.7990 GHz, Bw = 32.000 MH No calibration applied and no bandpass applied

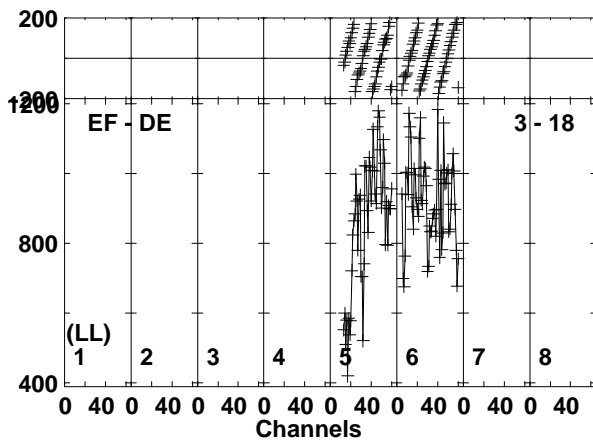
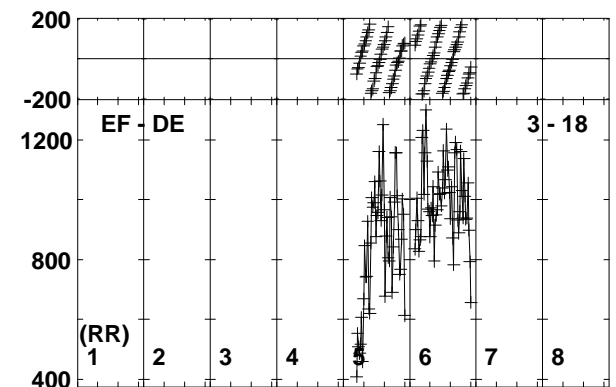
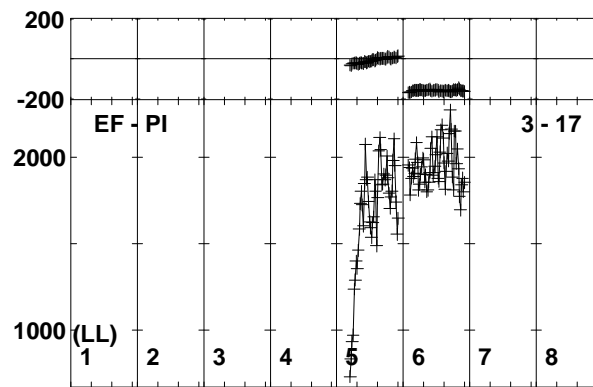
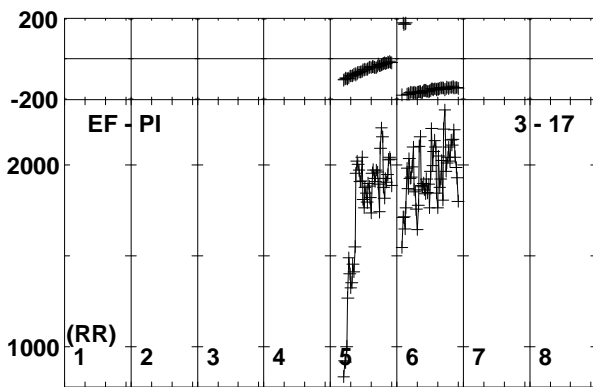
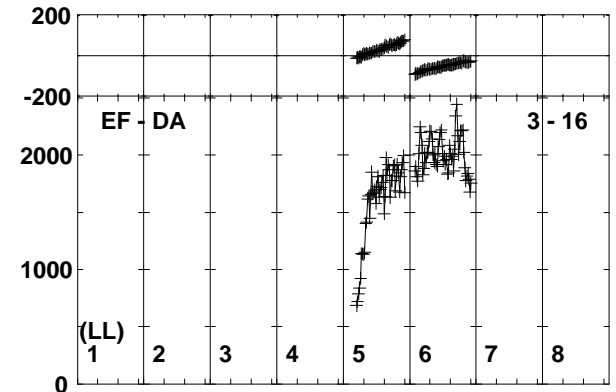
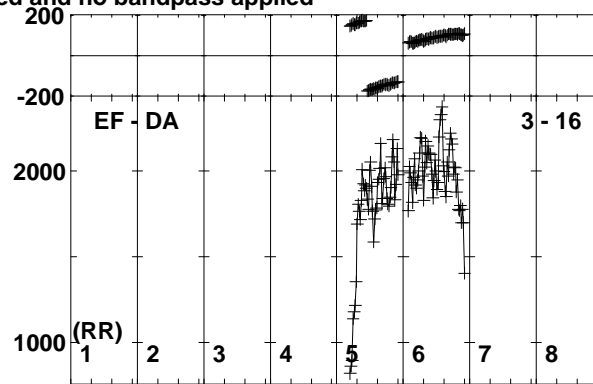
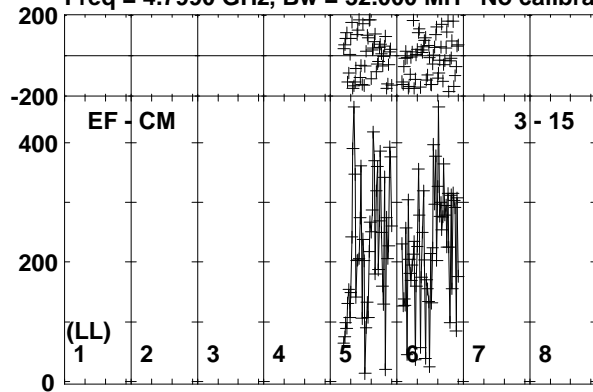

Lower frame: Micro Ampl Jy Top frame: Phas deg
Vector averaged cross-power spectrum Baseline: EF (03) - CM (15)
Timerange: 01/06:38:36 to 01/06:39:34

Plot file version 691 created 26-SEP-2019 10:44:12

190829A RG010A.UVDATA.1

Freq = 4.7990 GHz, Bw = 32.000 MH No calibration applied and no bandpass applied

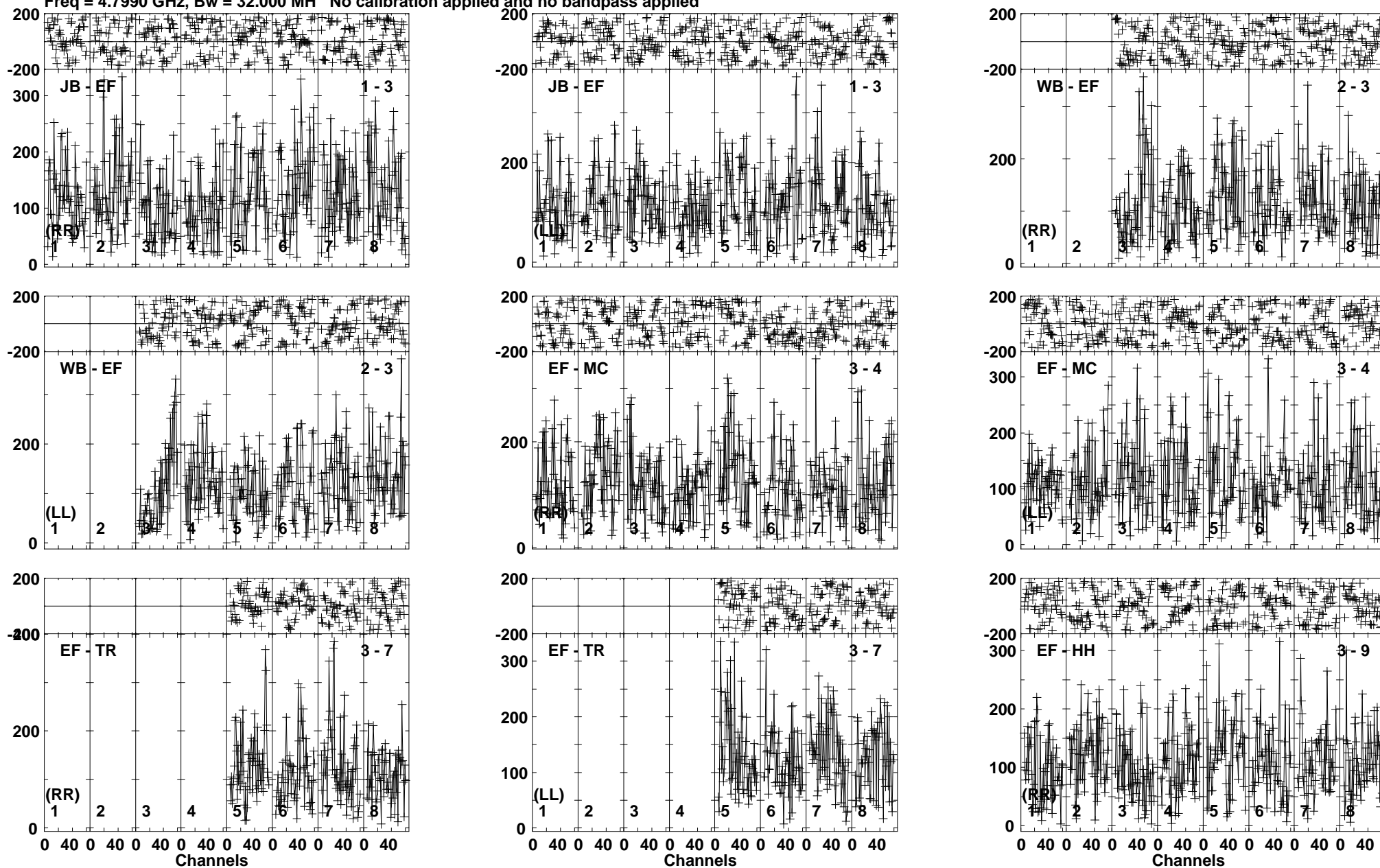

Lower frame: Micro Ampl Jy Top frame: Phas deg
Vector averaged cross-power spectrum Baseline: JB (01) - EF (03)
Timerange: 01/06:39:35 to 01/06:41:44

Plot file version 692 created 26-SEP-2019 10:44:12

190829A RG010A.UVDATA.1

Freq = 4.7990 GHz, Bw = 32.000 MH No calibration applied and no bandpass applied

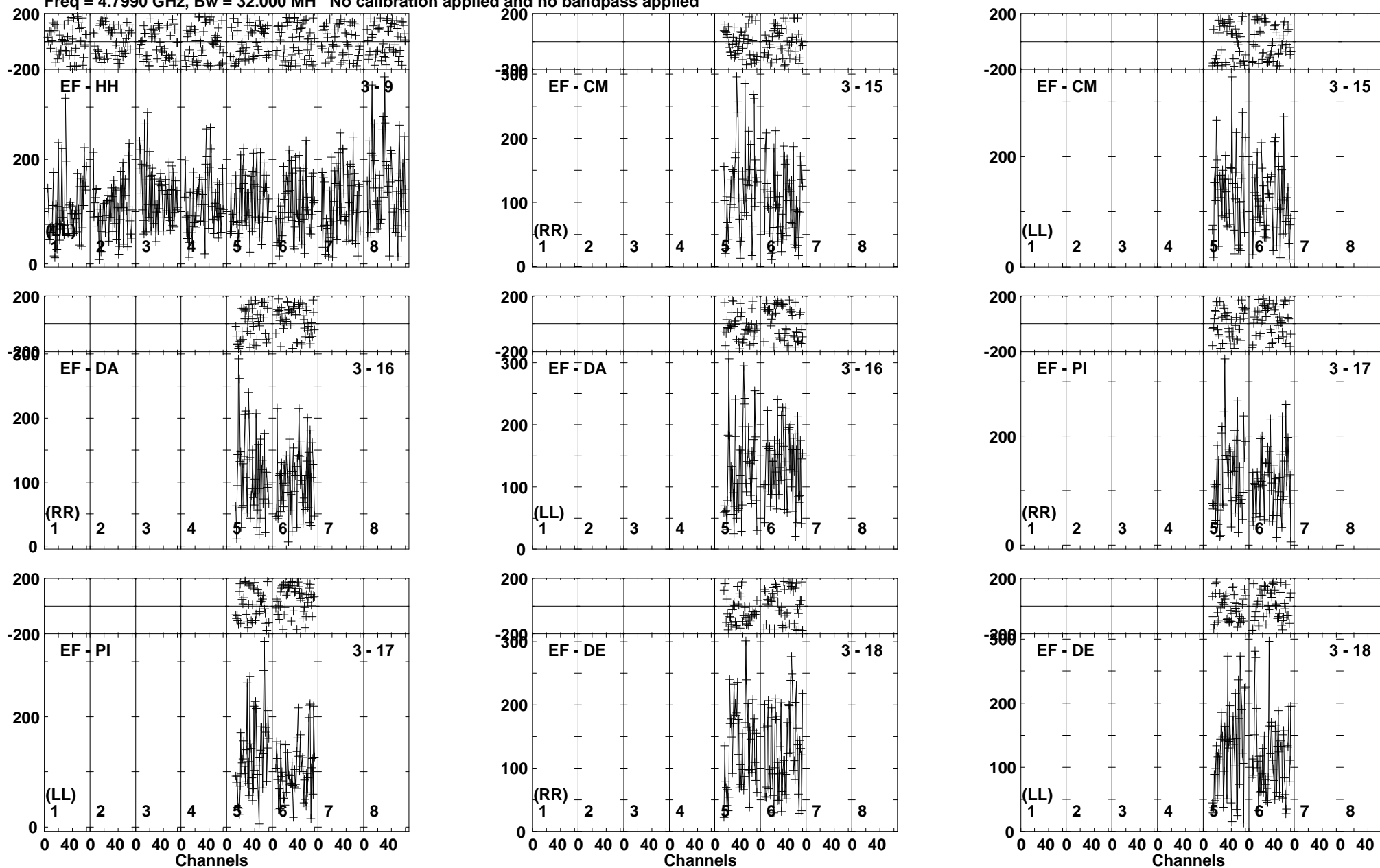

Lower frame: Micro Ampl Jy Top frame: Phas deg
Vector averaged cross-power spectrum Baseline: EF (03) - HH (09)
Timerange: 01/06:39:35 to 01/06:41:44

Plot file version 693 created 26-SEP-2019 10:44:13

190829A RG010A.UVDATA.1

Freq = 4.7990 GHz, Bw = 32.000 MH No calibration applied and no bandpass applied

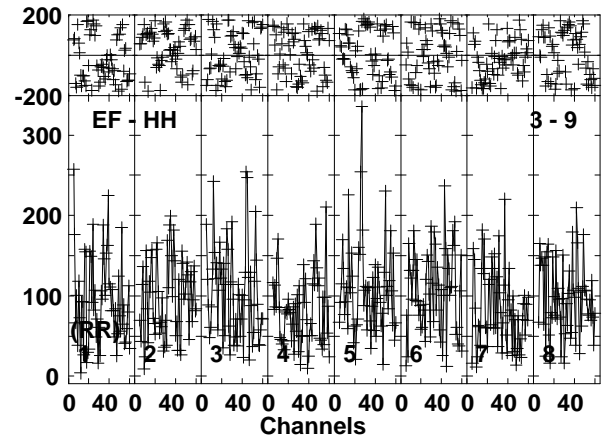
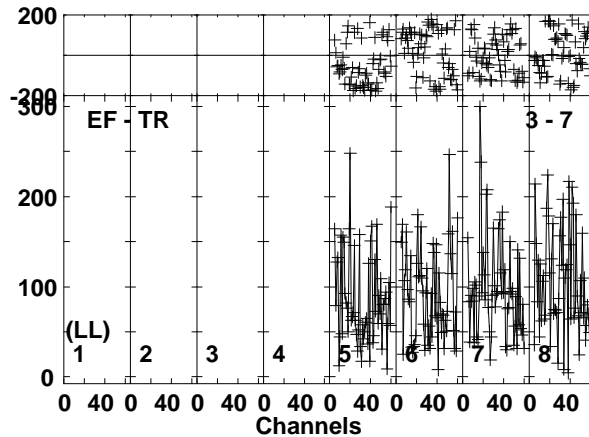
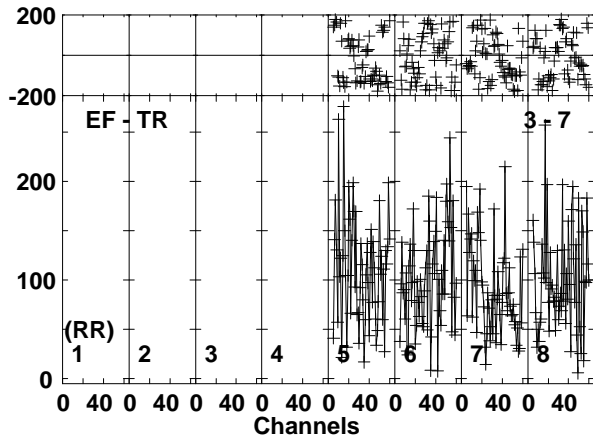
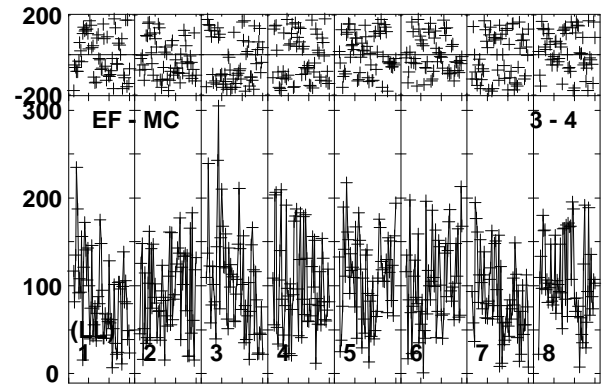
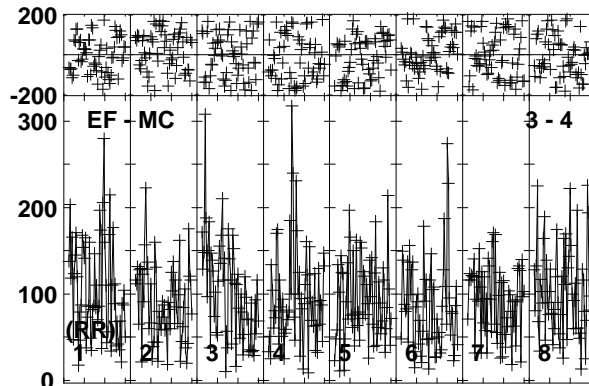
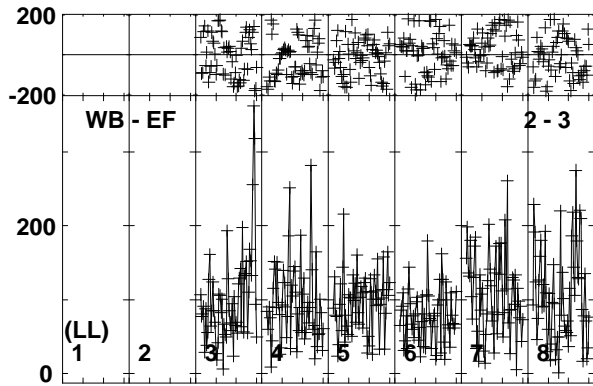
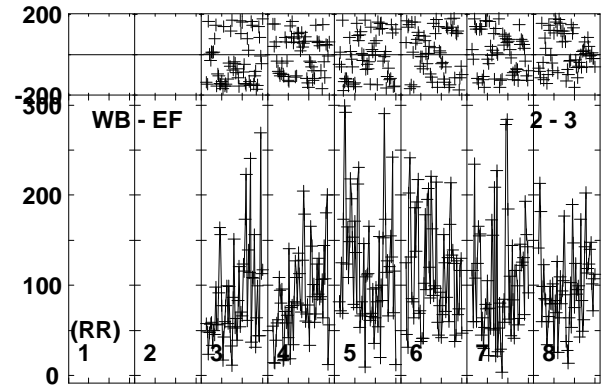
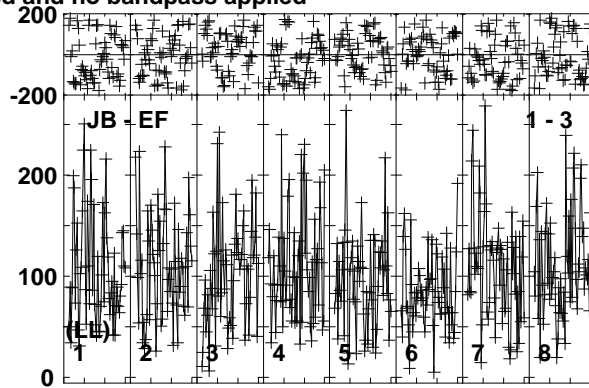
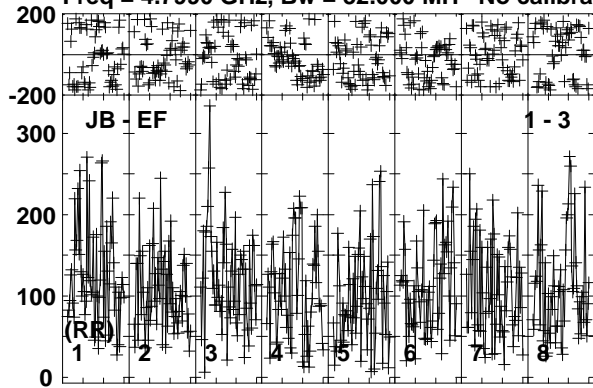

Lower frame: Micro Ampl Jy Top frame: Phas deg
Vector averaged cross-power spectrum Baseline: JB (01) - EF (03)
Timerange: 01/06:42:46 to 01/06:44:54

Plot file version 694 created 26-SEP-2019 10:44:13

190829A RG010A.UVDATA.1

Freq = 4.7990 GHz, Bw = 32.000 MH No calibration applied and no bandpass applied

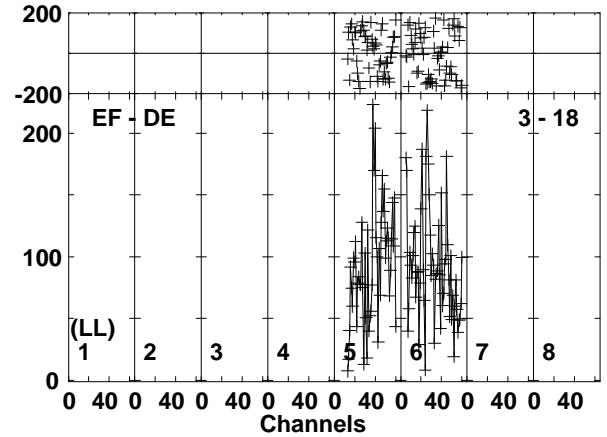
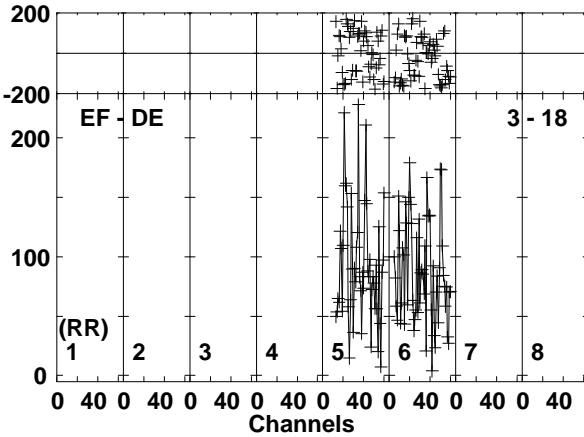
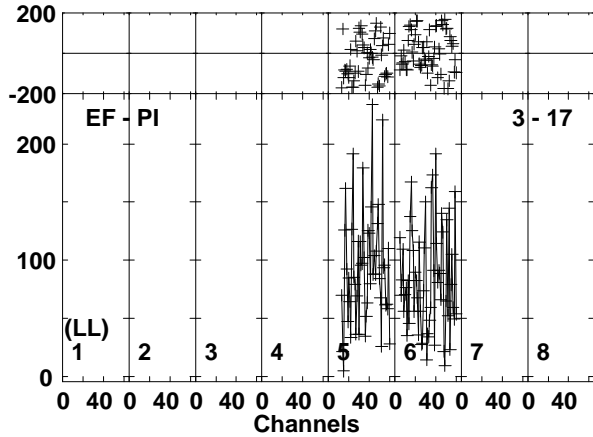
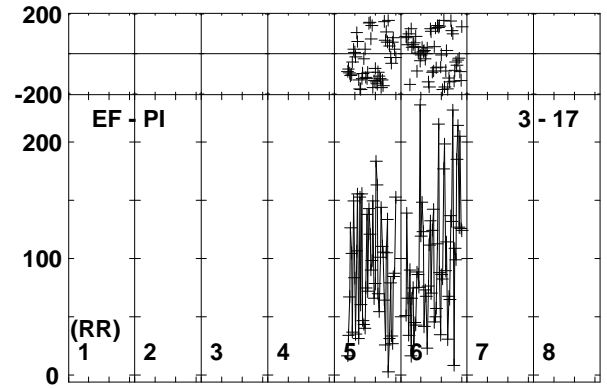
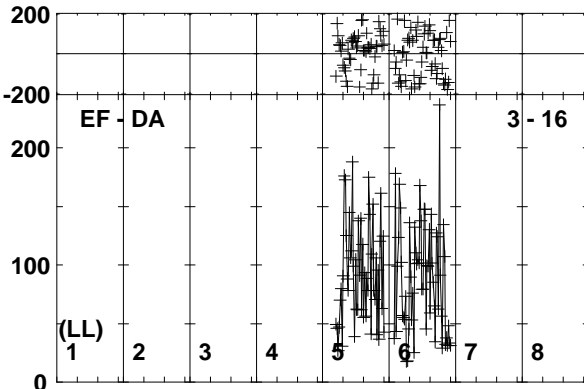
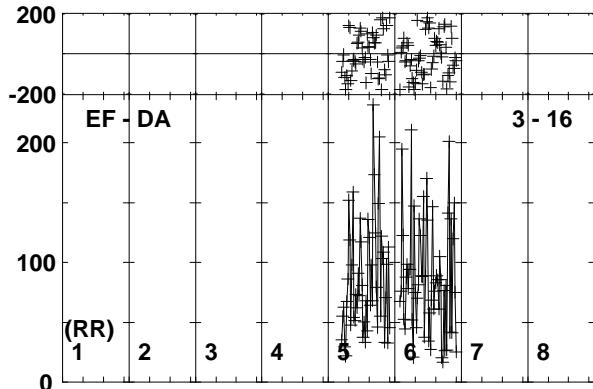
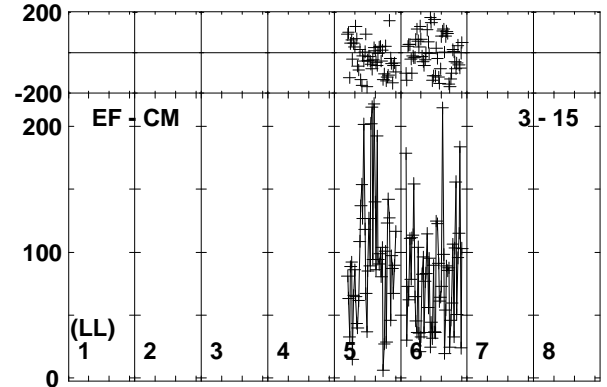
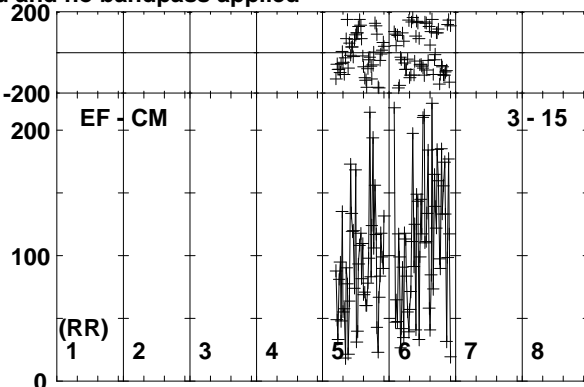
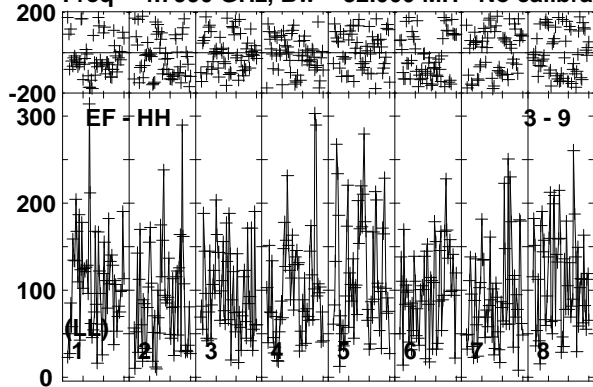

Lower frame: Micro Ampl Jy Top frame: Phas deg
Vector averaged cross-power spectrum Baseline: EF (03) - HH (09)
Timerange: 01/06:42:46 to 01/06:44:54

Plot file version 695 created 26-SEP-2019 10:44:13

J0300-0846 RG010A.UVDATA.1

Freq = 4.7990 GHz, Bw = 32.000 MH No calibration applied and no bandpass applied

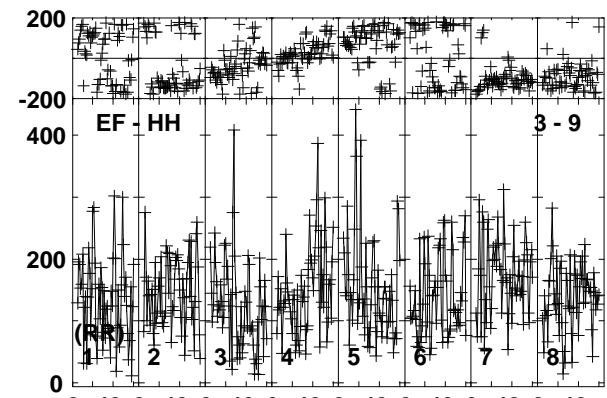
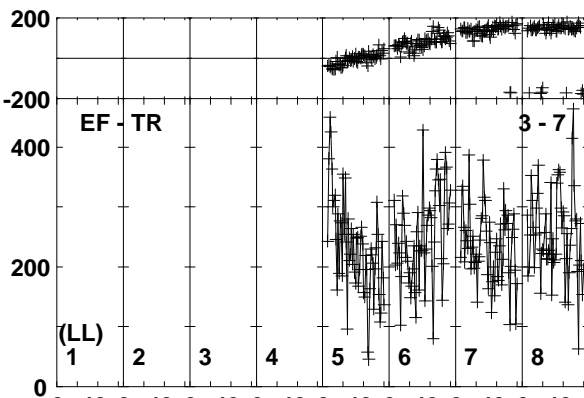
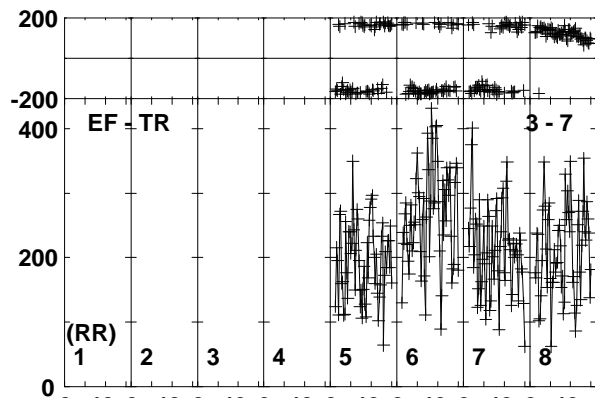
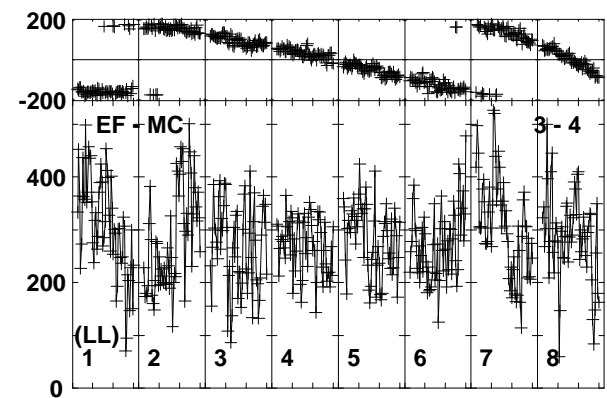
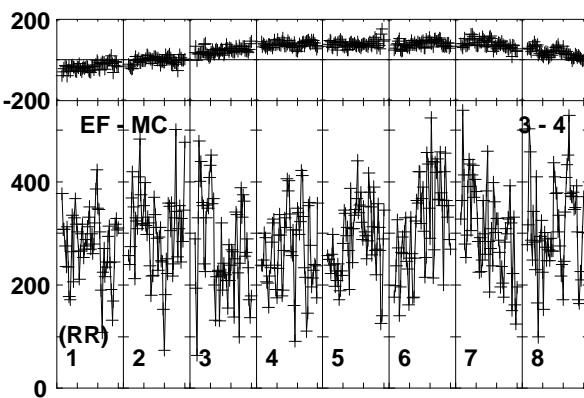
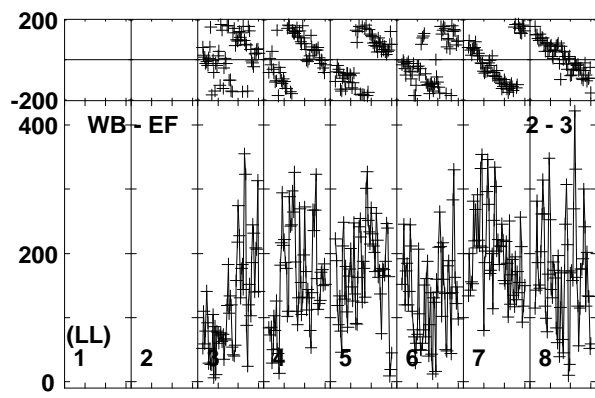
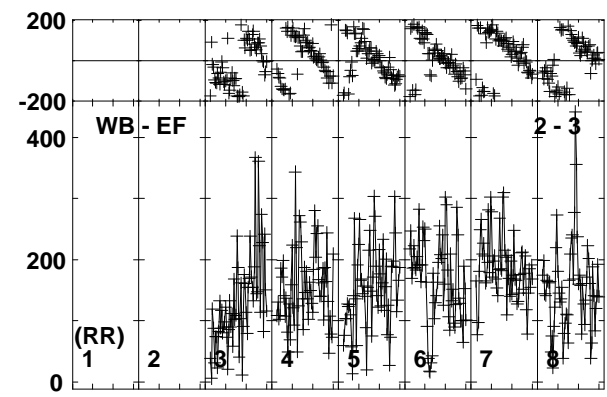
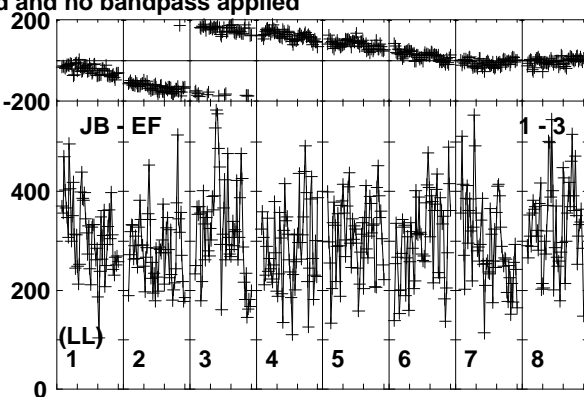
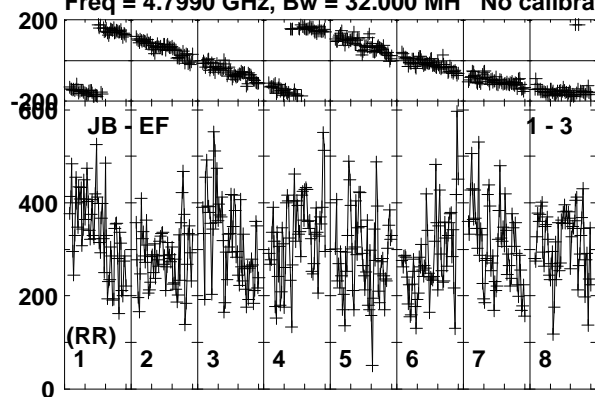

Lower frame: Micro Ampl Jy Top frame: Phas deg
Vector averaged cross-power spectrum Baseline: JB (01) - EF (03)
Timerange: 01/06:46:06 to 01/06:48:14

Plot file version 696 created 26-SEP-2019 10:44:14

J0300-0846 RG010A.UVDATA.1

Freq = 4.7990 GHz, Bw = 32.000 MH No calibration applied and no bandpass applied

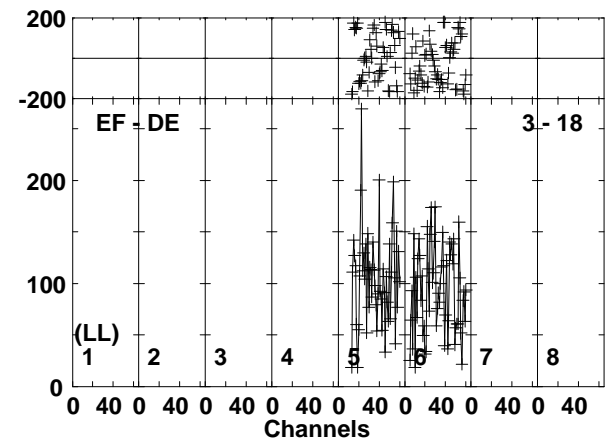
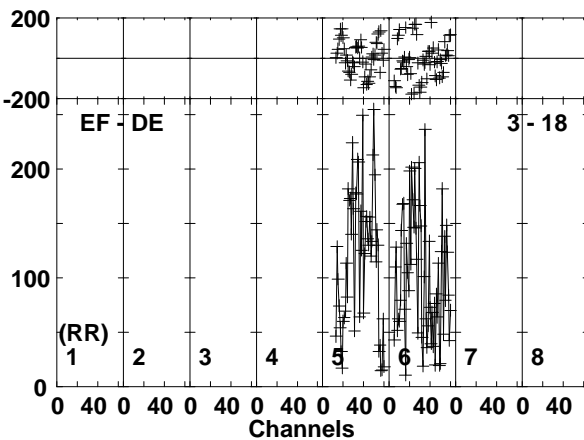
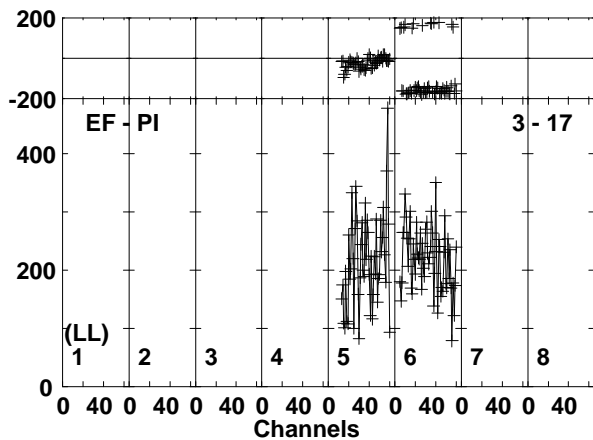
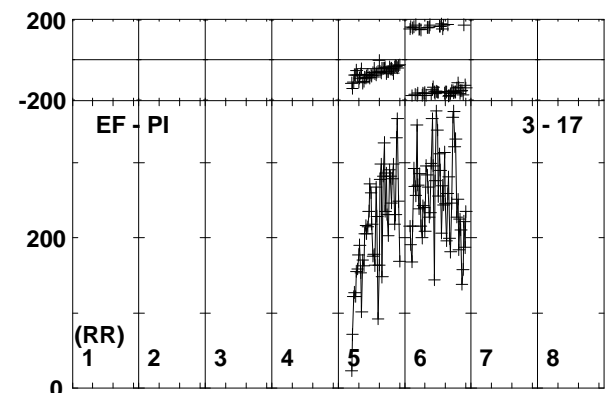
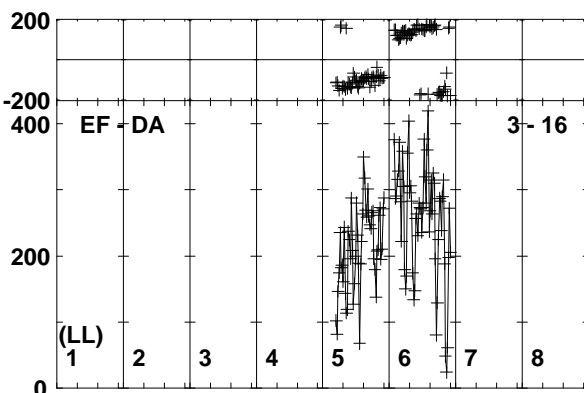
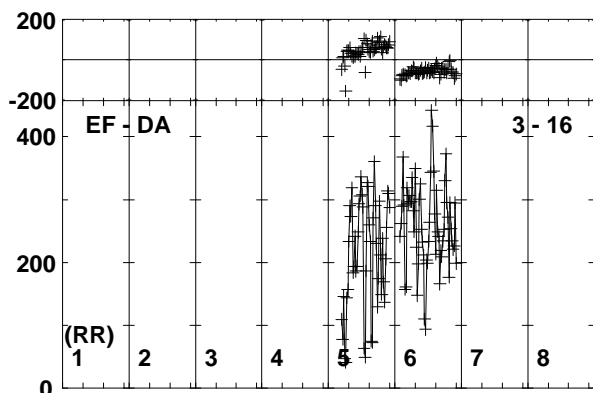
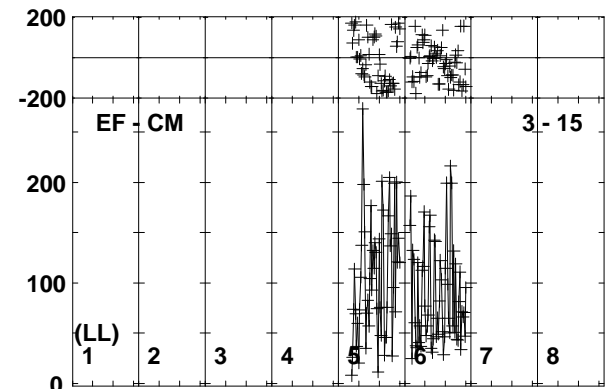
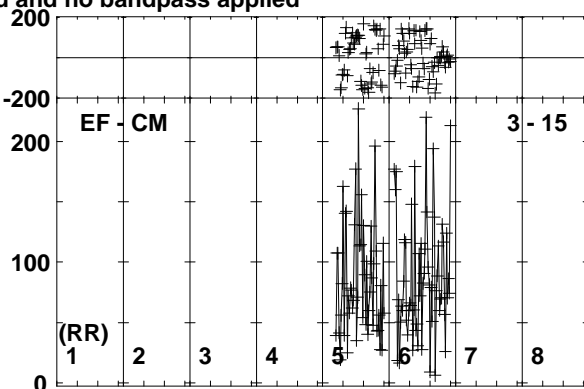
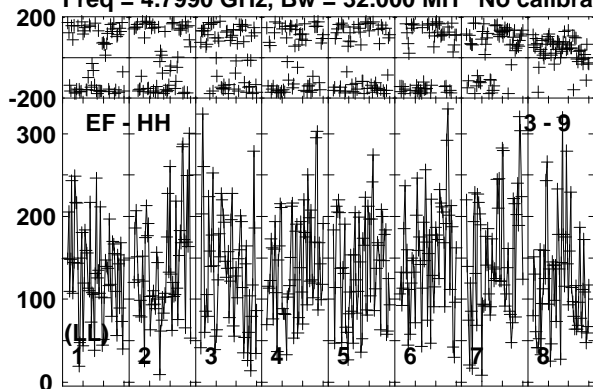

Lower frame: Micro Ampl Jy Top frame: Phas deg
Vector averaged cross-power spectrum Baseline: EF (03) - HH (09)
Timerange: 01/06:46:06 to 01/06:48:14

Plot file version 697 created 26-SEP-2019 10:44:14

NVSS-1 RG010A.UVDATA.1

Freq = 4.7990 GHz, Bw = 32.000 MH No calibration applied and no bandpass applied

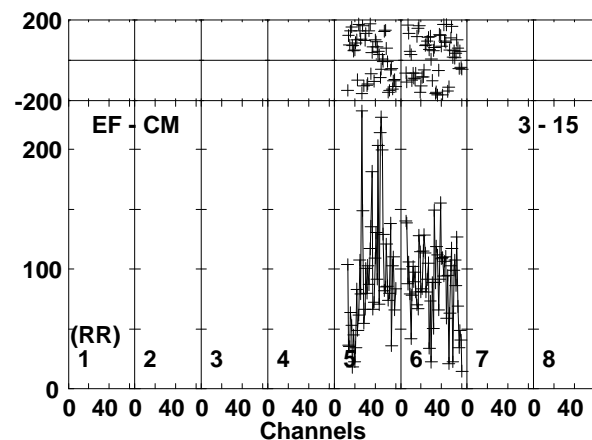
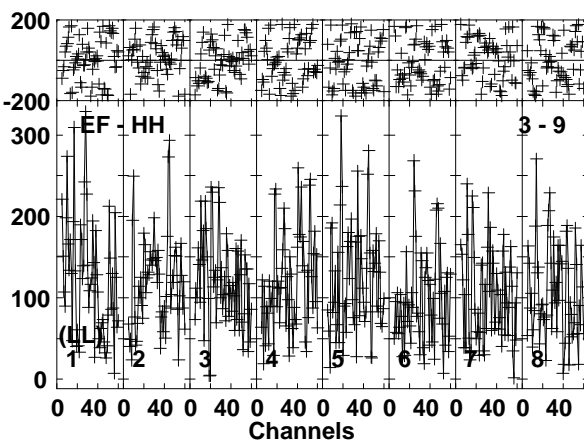
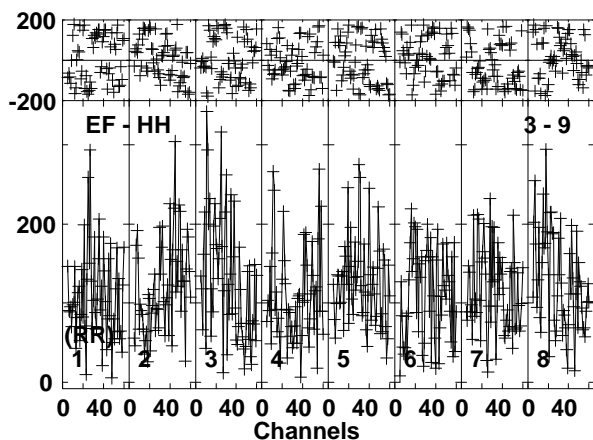
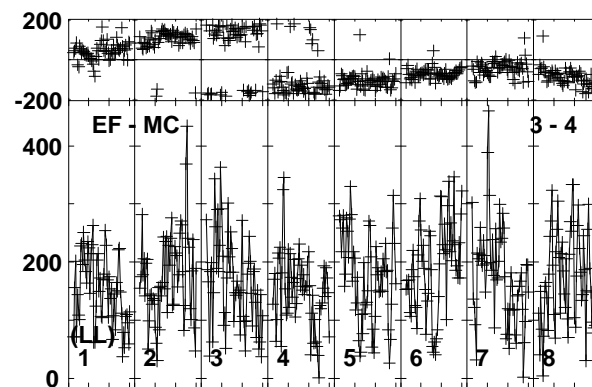
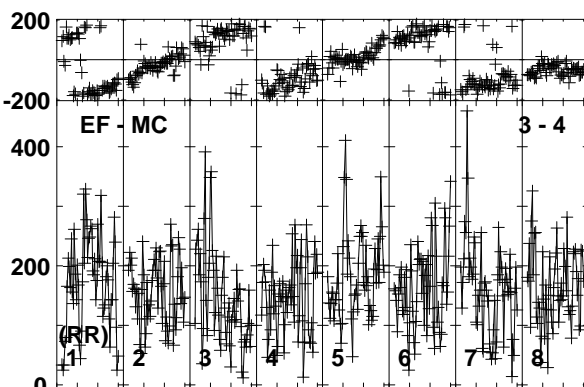
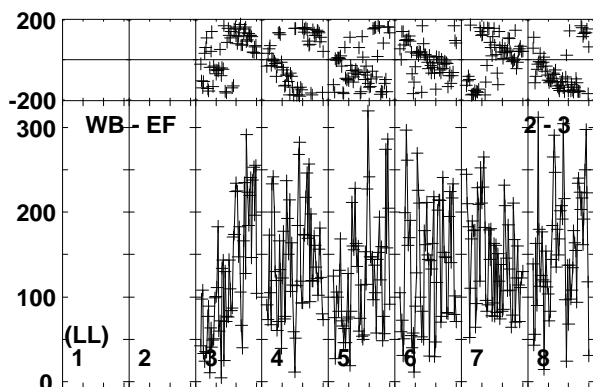
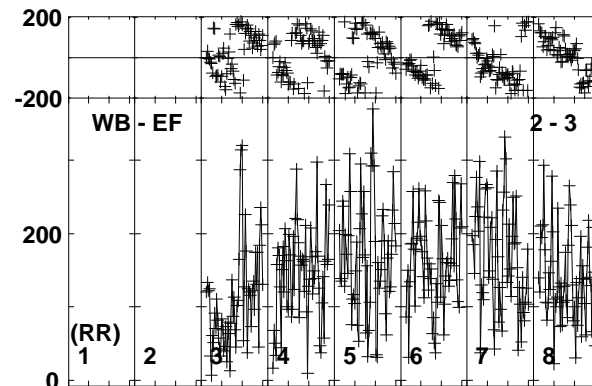
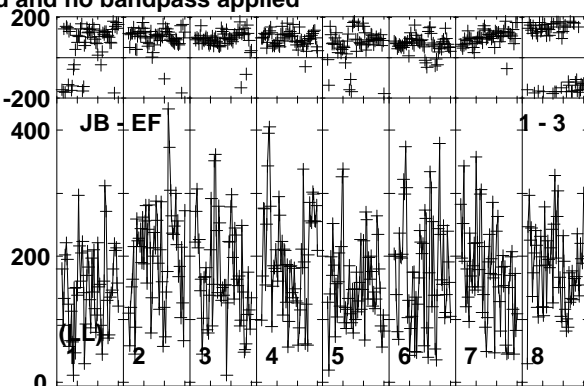
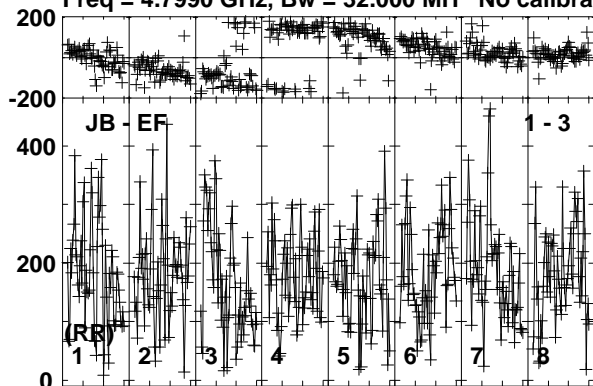

Lower frame: Micro Ampl Jy Top frame: Phas deg
Vector averaged cross-power spectrum Baseline: JB (01) - EF (03)
Timerange: 01/06:49:15 to 01/06:51:24

Plot file version 698 created 26-SEP-2019 10:44:15

NVSS-1 RG010A.UVDATA.1

Freq = 4.7990 GHz, Bw = 32.000 MH No calibration applied and no bandpass applied

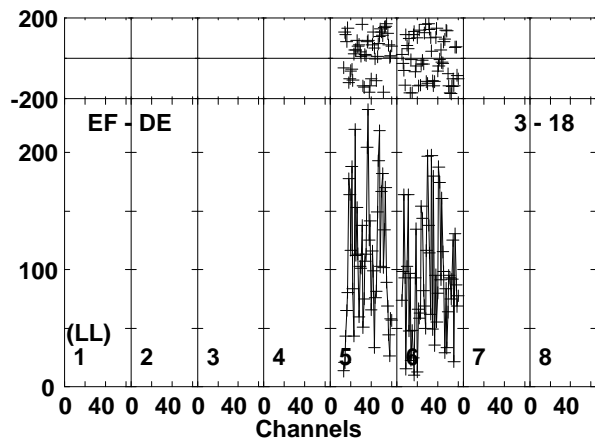
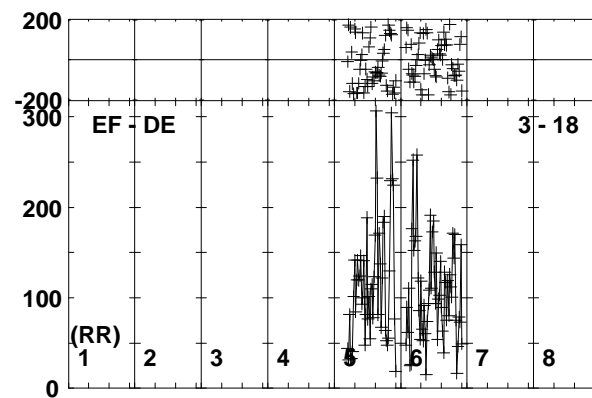
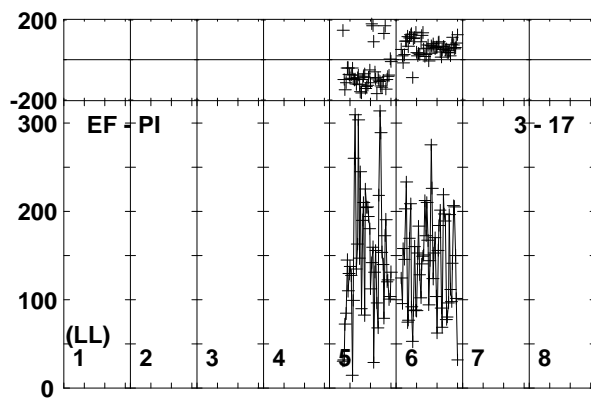
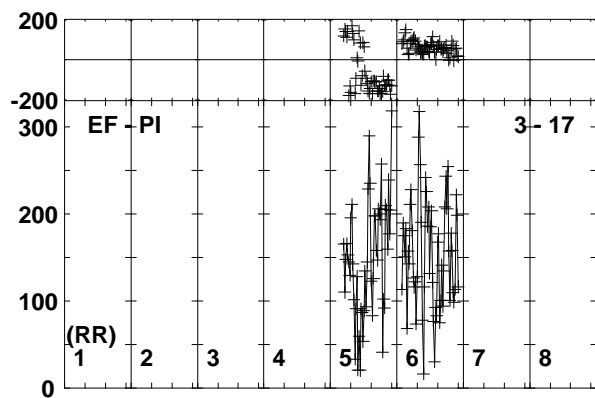
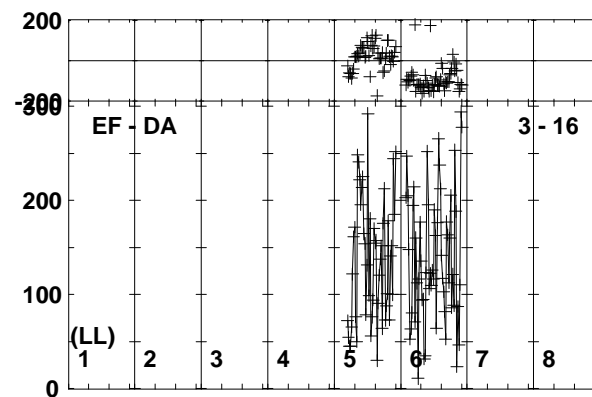
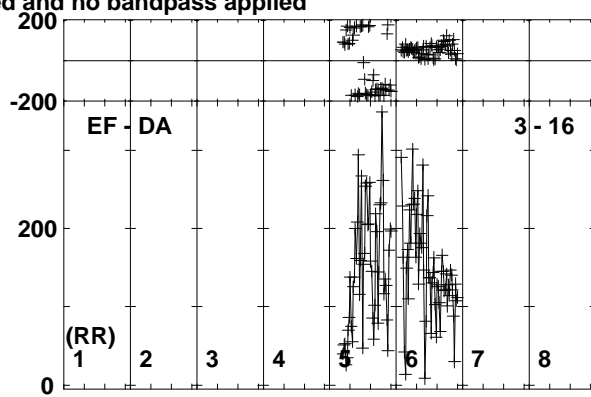
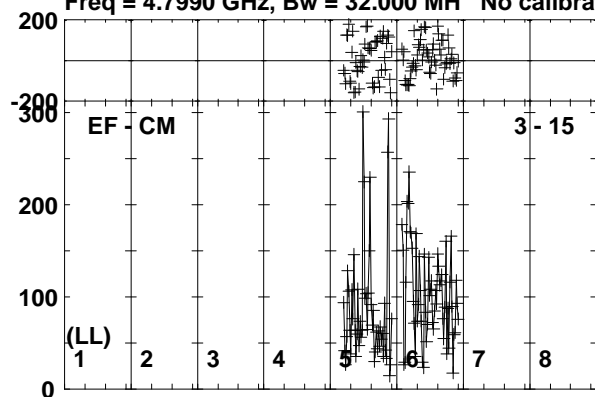

Lower frame: Micro Ampl Jy Top frame: Phas deg
Vector averaged cross-power spectrum Baseline: EF (03) - CM (15)
Timerange: 01/06:49:15 to 01/06:51:24

Plot file version 699 created 26-SEP-2019 10:44:15

190829A RG010A.UVDATA.1

Freq = 4.7990 GHz, Bw = 32.000 MH No calibration applied and no bandpass applied

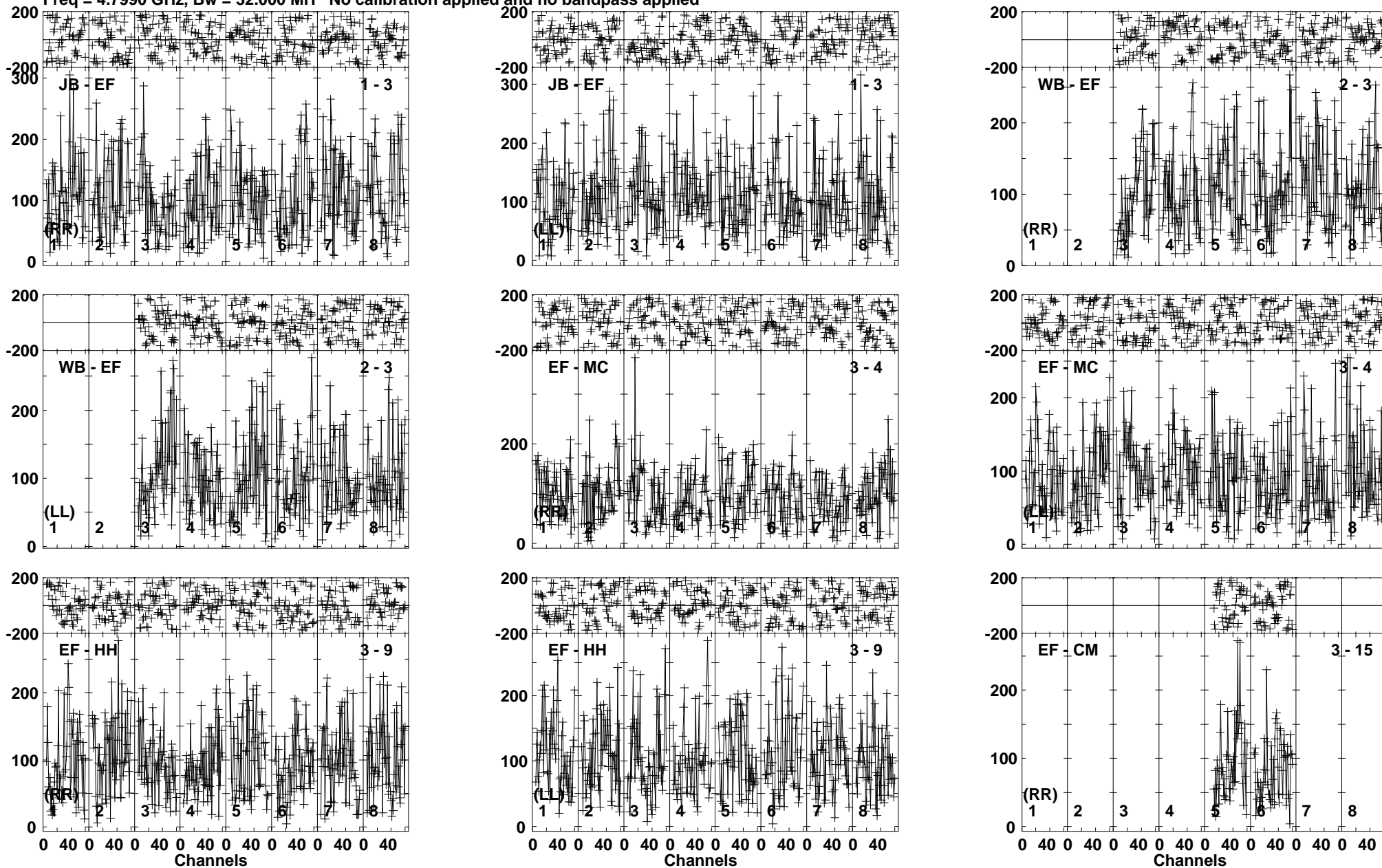

Lower frame: Micro Ampl Jy Top frame: Phas deg
Vector averaged cross-power spectrum Baseline: JB (01) - EF (03)
Timerange: 01/06:52:26 to 01/06:54:34

Plot file version 700 created 26-SEP-2019 10:44:15

190829A RG010A.UVDATA.1

Freq = 4.7990 GHz, Bw = 32.000 MH No calibration applied and no bandpass applied

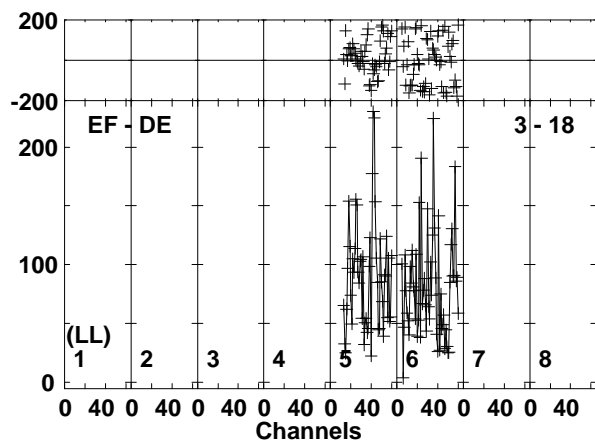
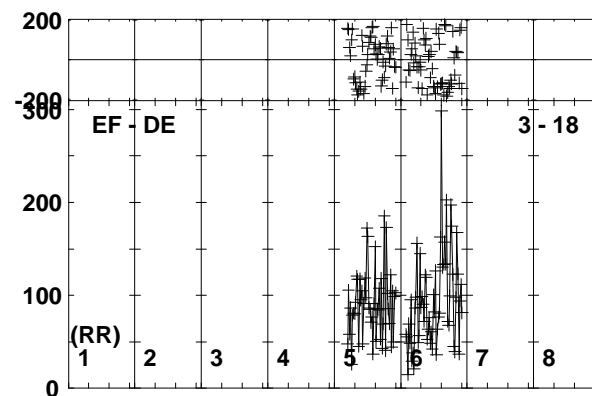
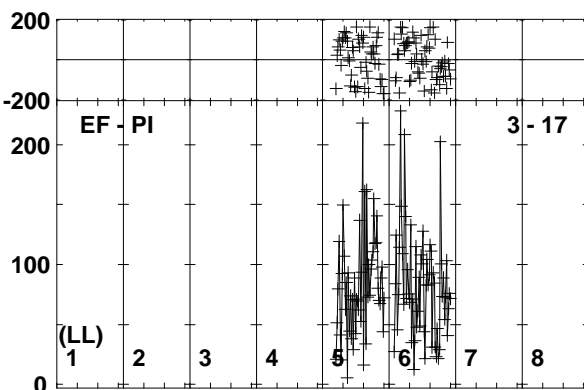
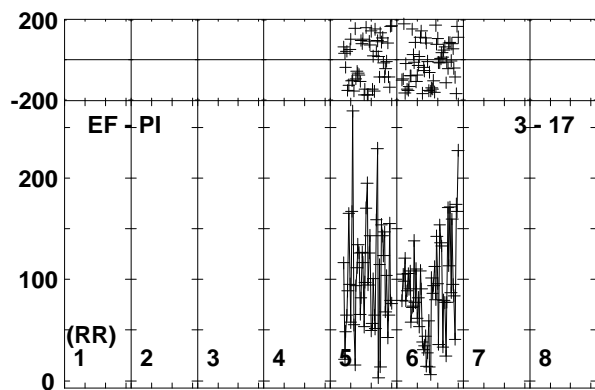
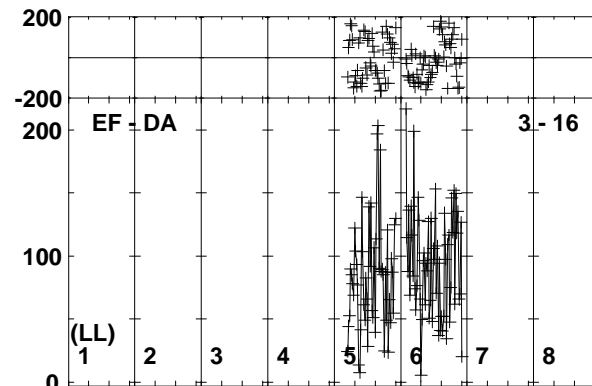
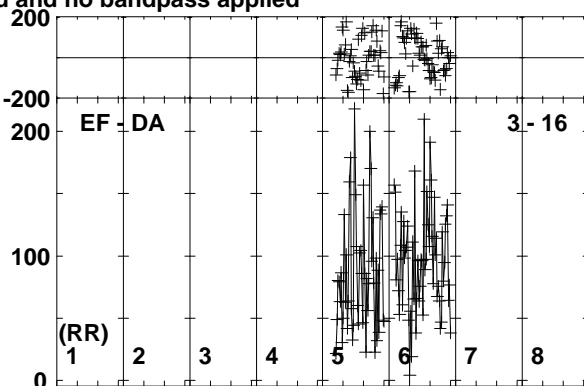
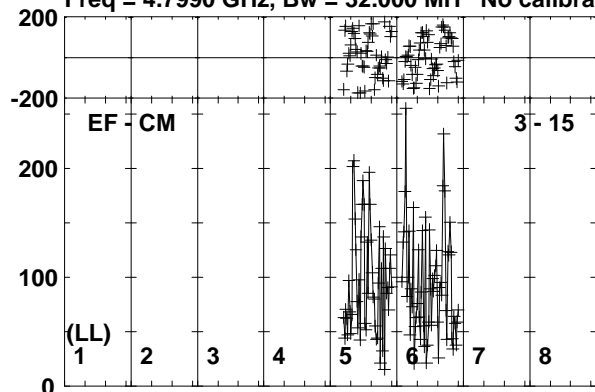

Lower frame: Micro Ampl Jy Top frame: Phas deg
Vector averaged cross-power spectrum Baseline: EF (03) - CM (15)
Timerange: 01/06:52:26 to 01/06:54:34

Plot file version 701 created 26-SEP-2019 10:44:16

0528+134 RG010A.UVDATA.1

Freq = 4.7990 GHz, Bw = 32.000 MH No calibration applied and no bandpass applied

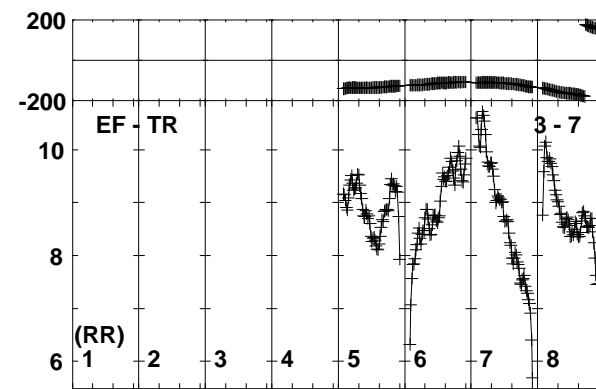
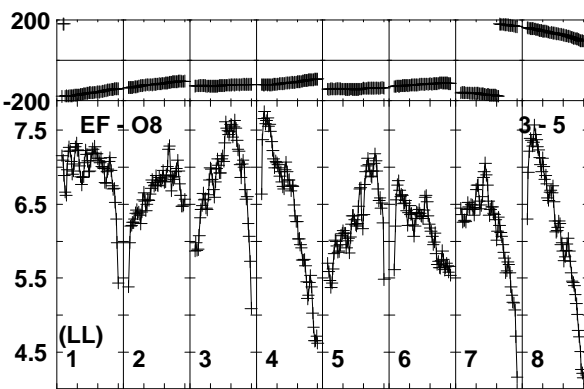
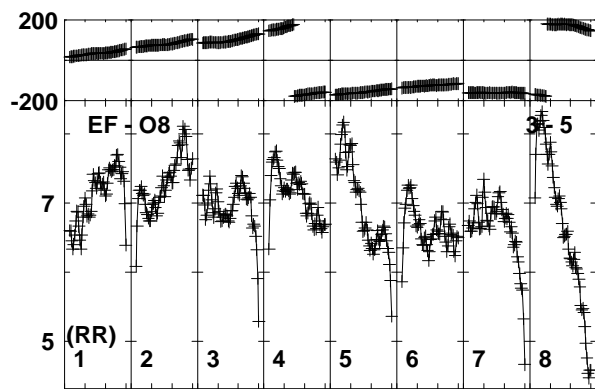
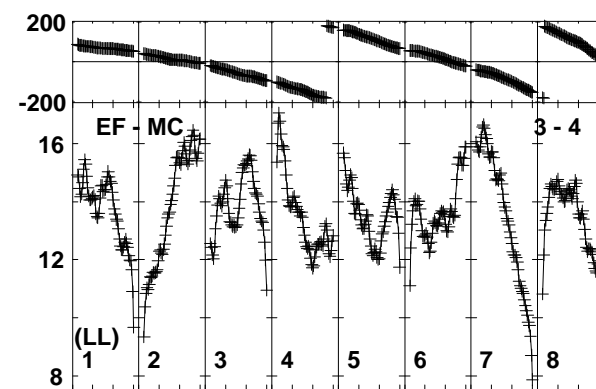
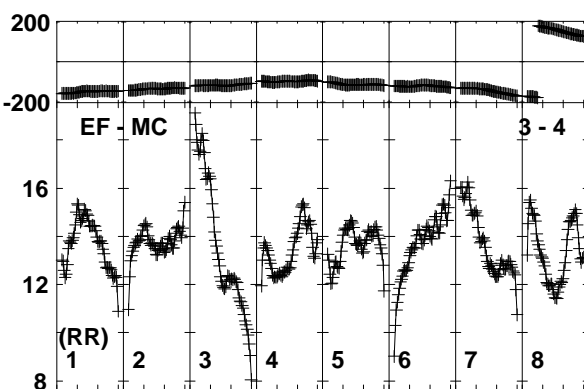
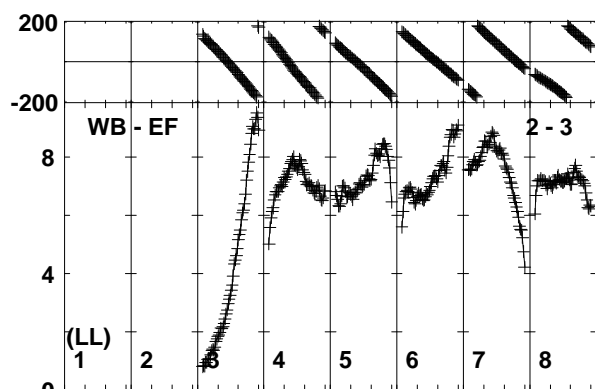
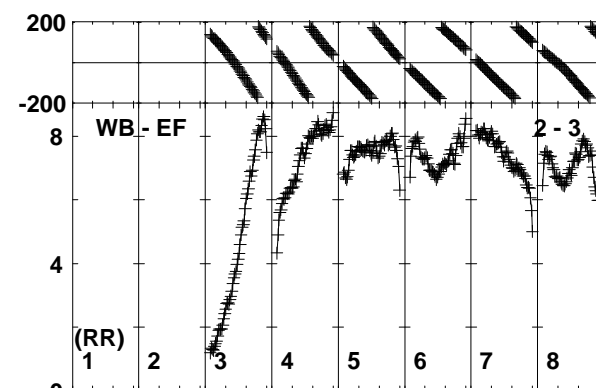
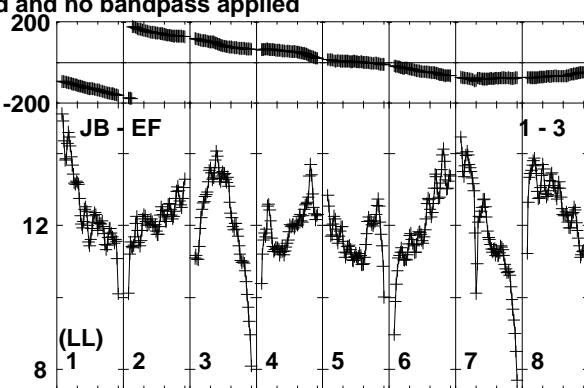
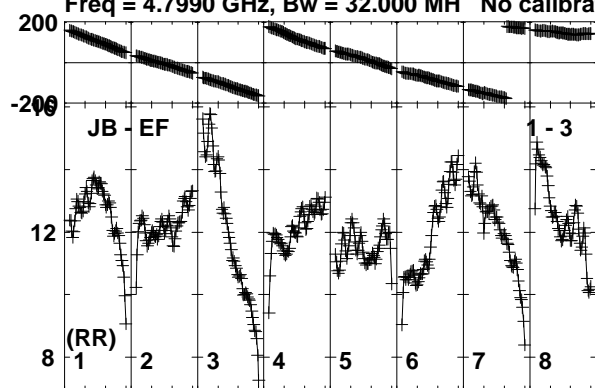

Lower frame: Milli Ampl Jy Top frame: Phas deg
Vector averaged cross-power spectrum Baseline: JB (01) - EF (03)
Timerange: 01/06:58:05 to 01/06:59:59

Plot file version 702 created 26-SEP-2019 10:44:17

0528+134 RG010A.UVDATA.1

Freq = 4.7990 GHz, Bw = 32.000 MH No calibration applied and no bandpass applied

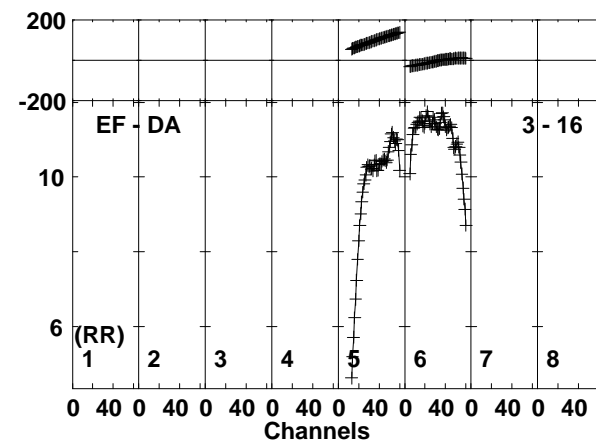
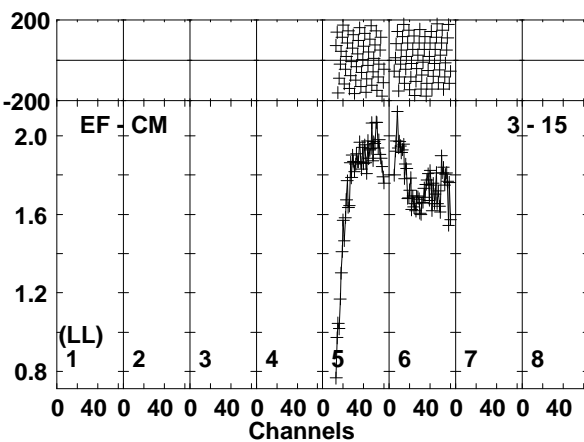
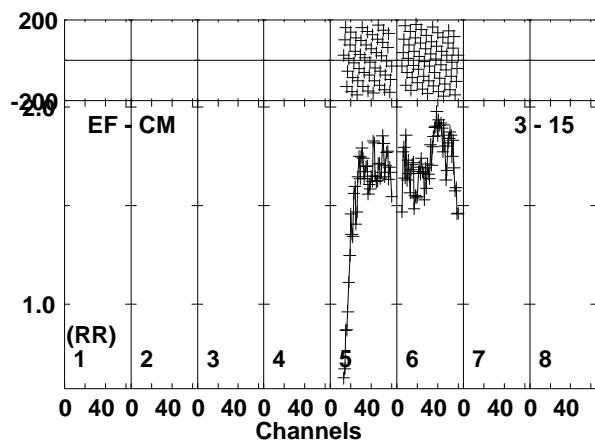
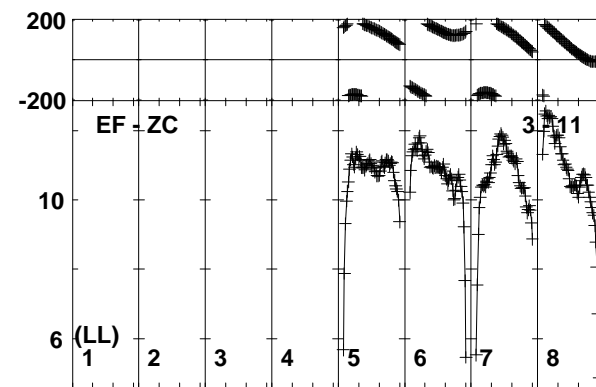
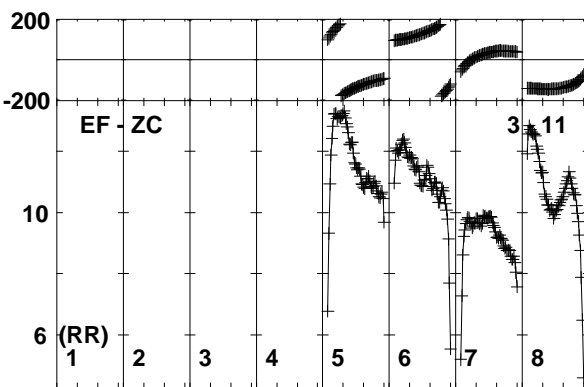
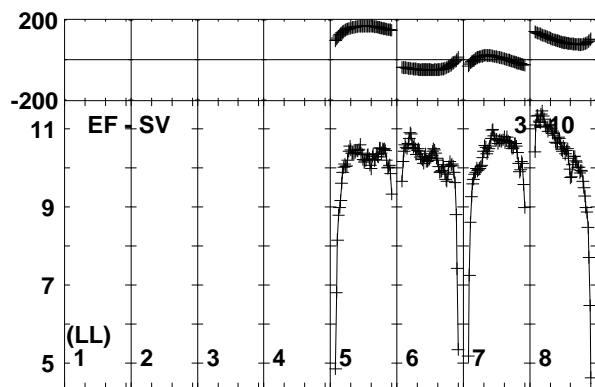
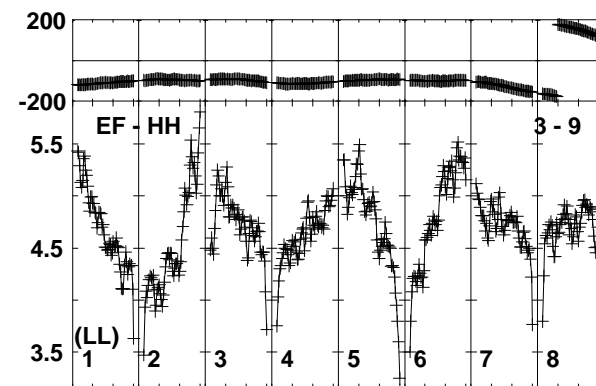
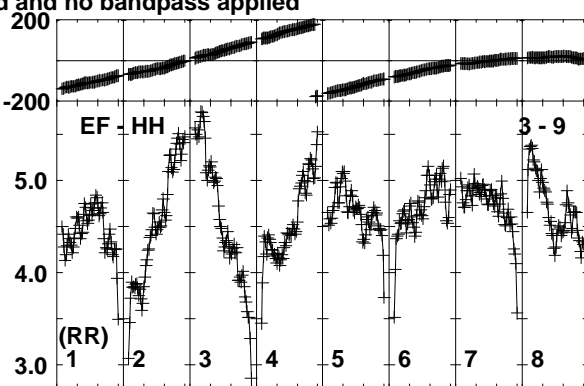
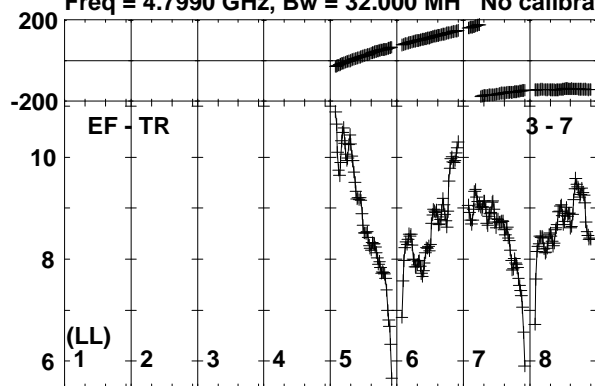

Lower frame: Milli Ampl Jy Top frame: Phas deg
Vector averaged cross-power spectrum Baseline: EF (03) - TR (07)
Timerange: 01/06:58:05 to 01/06:59:59

Plot file version 703 created 26-SEP-2019 10:44:17
 0528+134 RG010A.UVDATA.1
 Freq = 4.7990 GHz, Bw = 32.000 MH No calibration applied and no bandpass applied

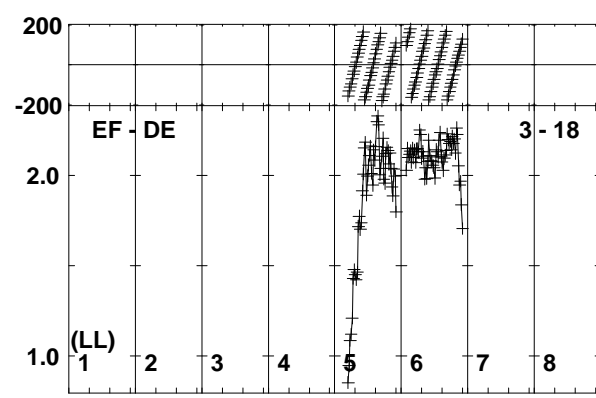
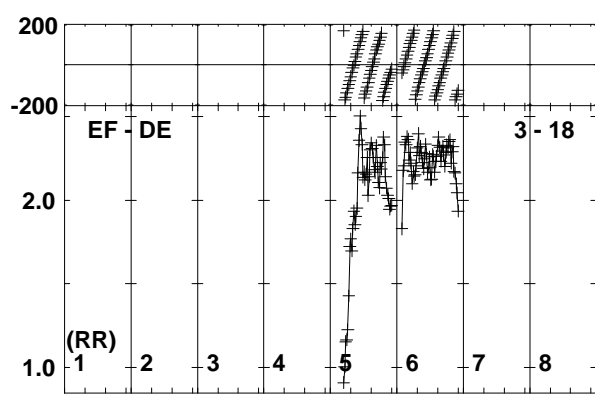
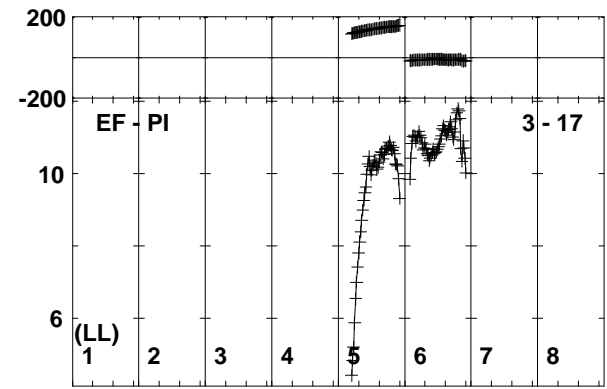
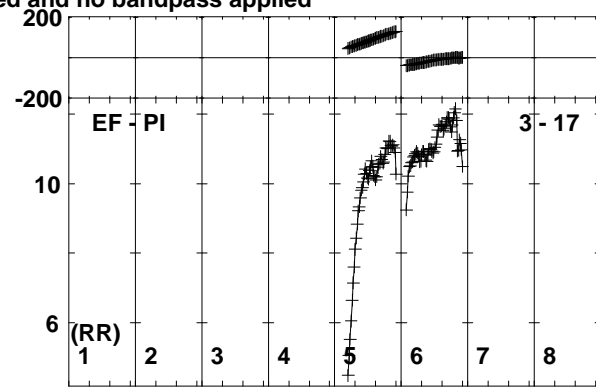
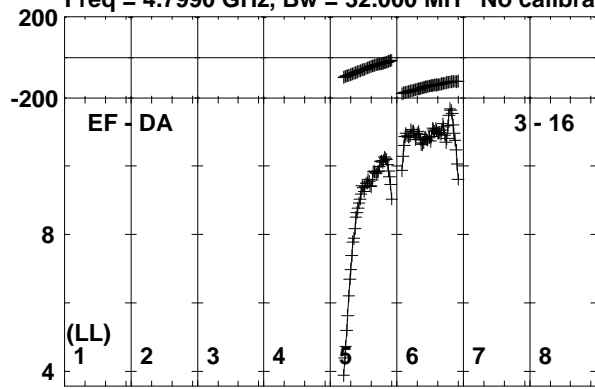

Lower frame: Milli Ampl Jy Top frame: Phas deg
 Vector averaged cross-power spectrum Baseline: EF (03) - DA (16)
 Timerange: 01/06:58:05 to 01/06:59:59